

This version of the Arkansas Nuclear One, Unit 2 Safety Analysis Report (SAR) is the licensee's redacted version, issued in May 2019, with certain additional redactions of sensitive information by the staff of the Nuclear Regulatory Commission (NRC) to allow release to the public. The redactions are made under the provisions of Section 2.390 of Title 10 of the *Code of Federal Regulations*. The material included within is classified as publicly available information. The redactions were made to meet the NRC's criteria on sensitive information, as specified in SECY-04-0191, "Withholding Sensitive Unclassified Information Concerning Nuclear Power Reactors from Public Disclosure," dated October 19, 2004 (ADAMS Accession No. ML042310663), as modified by the NRC Commissioner's Staff Requirements Memorandum on SECY-04-0191, dated November 9, 2004 (ADAMS Accession No. ML043140175).

The following SAR pages were redacted by the NRC staff:

Page 2.4-1

SAR Figure No. 2.2-2

SAR Figure No. 2.4-7

SAR Figure No. 2.5-102

ARKANSAS NUCLEAR ONE - UNIT 2

SAR AMENDMENT 28

FACILITY OPERATING LICENSE NUMBER NPF-6

DOCKET NUMBER 50-368

Changes are indicated by beginning the affected information with a revision bar on the right side of the page which stops at the end of the change. Deletions of entire paragraphs or sections have a revision bar to the right of the page where text was deleted. The amendment number is indicated at the bottom of the affected page near the left margin and indicates the latest revision to the information contained on that page. Absence of a revision bar on a replacement page means the page was reprinted for word processing purposes only. However, general formatting changes may have been made to all pages.

ARKANSAS NUCLEAR ONE
Unit 2

SAFETY ANALYSIS REPORT

TABLE OF CONTENTS

<u>Section</u>	<u>Title</u>	<u>Page</u>
1	<u>INTRODUCTION AND GENERAL DESCRIPTION OF PLANT</u>	1.1-1
1.1	<u>INTRODUCTION</u>	1.1-1
1.2	<u>GENERAL PLANT DESCRIPTION</u>	1.2-1
1.2.1	PRINCIPAL SITE CHARACTERISTICS.....	1.2-1
1.2.2	CONCISE PLANT DESCRIPTION.....	1.2-1
1.3	<u>COMPARISONS</u>	1.3-1
1.3.1	COMPARISON WITH SIMILAR FACILITY DESIGNS.....	1.3-1
1.3.2	COMPARISON OF FINAL AND PRELIMINARY INFORMATION.....	1.3-1
1.3.3	COMPARISON OF PLANT DESIGN WITH REGULATORY GUIDE RECOMMENDATIONS.....	1.3-1
1.4	<u>IDENTIFICATION OF AGENTS AND CONTRACTORS</u>	1.4-1
1.5	<u>REQUIREMENTS FOR FURTHER TECHNICAL INFORMATION</u>	1.5-1
1.5.1	FRETTING AND VIBRATIONS TESTS OF FUEL ASSEMBLIES.....	1.5-1
1.5.2	DEPARTURE FROM NUCLEATE BOILING (DNB) TESTING.....	1.5-1
1.5.3	FUEL ASSEMBLY STRUCTURAL TESTS.....	1.5-1
1.5.4	FUEL ASSEMBLY FLOW MIXING TESTS.....	1.5-2
1.5.5	REACTOR FLOW MODEL TESTING AND EVALUATION.....	1.5-2
1.5.6	FUEL ASSEMBLY FLOW TESTS.....	1.5-3
1.5.7	CONTROL ELEMENT DRIVE MECHANISM (CEDM) TESTS.....	1.5-3
1.5.8	SAFETY INJECTION SYSTEM IMPROVEMENT.....	1.5-3
1.5.9	DNB IMPROVEMENT.....	1.5-3
1.5.10	LOCA REFILL TESTING.....	1.5-4
1.5.11	BLOWDOWN HEAT TRANSFER TESTING.....	1.5-4
1.5.12	STEAM WATER MIXING TEST PROGRAM.....	1.5-5

ARKANSAS NUCLEAR ONE
Unit 2

TABLE OF CONTENTS (continued)

<u>Section</u>	<u>Title</u>	<u>Page</u>
1.6	<u>MATERIAL INCORPORATED BY REFERENCE</u>	1.6-1
1.6.1	CE TOPICAL REPORTS.....	1.6-1
1.6.2	BECHTEL TOPICAL REPORTS	1.6-2
1.7	<u>GLOSSARY OF ITEMS</u>	1.7-1
1.7.1	TEXT ABBREVIATIONS	1.7-1
1.7.2	DRAWING INDEX AND SYMBOLS	1.7-1
1.7.3	PIPING IDENTIFICATION.....	1.7-1
1.7.4	TRADEMARKS	1.7-1
1.8	<u>REFERENCES</u>	1.8-1
1.9	<u>TABLES</u>	1.9-1
2	<u>SITE CHARACTERISTICS</u>	2.1-1
2.1	<u>GEOGRAPHY AND DEMOGRAPHY</u>	2.1-1
2.1.1	SITE LOCATION.....	2.1-1
2.1.2	SITE DESCRIPTION.....	2.1-1
2.1.3	POPULATION AND POPULATION DISTRIBUTION	2.1-3
2.1.4	USES OF ADJACENT LANDS AND WATERS.....	2.1-5
2.2	<u>NEARBY INDUSTRIAL, TRANSPORTATION, AND MILITARY FACILITIES</u>	2.2-1
2.2.1	LOCATIONS, ROUTES, AND DESCRIPTIONS	2.2-1
2.2.2	EVALUATION.....	2.2-2
2.3	<u>METEOROLOGY</u>	2.3-1
2.3.1	REGIONAL CLIMATOLOGY	2.3-1
2.3.2	LOCAL METEROLOGY	2.3-12
2.3.3	ONSITE METEOROLOGICAL PROGRAM.....	2.3-21
2.3.4	SHORT-TERM (ACCIDENT) DIFFUSION ESTIMATES	2.3-29

ARKANSAS NUCLEAR ONE
Unit 2

TABLE OF CONTENTS (continued)

<u>Section</u>	<u>Title</u>	<u>Page</u>
2.3.5	LONG-TERM (ROUTINE) DIFFUSION ESTIMATES.....	2.3-33
2.3.6	ANNUAL RELEASE RATE LIMITS	2.3-33
2.3.7	QUARTERLY RELEASE RATE LIMITS.....	2.3-34
2.3.8	HOURLY RELEASE RATE LIMITS.....	2.3-34
2.4	<u>HYDROLOGIC ENGINEERING</u>	2.4-1
2.4.1	HYDROLOGIC DESCRIPTION.....	2.4-1
2.4.2	FLOODS.....	2.4-2
2.4.3	PROBABLE MAXIMUM FLOOD ON STREAMS AND RIVERS.....	2.4-4
2.4.4	POTENTIAL DAM FAILURES (SEISMICALLY INDUCED).....	2.4-4
2.4.5	PROBABLE MAXIMUM SURGE AND SEICHE FLOODING	2.4-4
2.4.6	PROBABLE MAXIMUM TSUNAMI FLOODING.....	2.4-5
2.4.7	ICE FLOODING.....	2.4-5
2.4.8	COOLING WATER CANALS AND RESERVOIRS	2.4-5
2.4.9	CHANNEL DIVERSIONS	2.4-6
2.4.10	FLOODING PROTECTION REQUIREMENTS	2.4-6
2.4.11	LOW WATER CONSIDERATIONS.....	2.4-7
2.4.12	ENVIRONMENTAL ACCEPTANCE OF EFFLUENTS	2.4-8
2.4.13	GROUNDWATER	2.4-9
2.4.14	TECHNICAL SPECIFICATION AND EMERGENCY OPERATION REQUIREMENTS	2.4-13
2.5	<u>GEOLOGY AND SEISMOLOGY</u>	2.5-1
2.5.1	BASIC GEOLOGIC AND SEISMIC DATA.....	2.5-2
2.5.2	VIBRATORY GROUND MOTION	2.5-10
2.5.3	SURFACE FAULTING	2.5-32
2.5.4	STABILITY OF SUBSURFACE MATERIALS.....	2.5-34

ARKANSAS NUCLEAR ONE
Unit 2

TABLE OF CONTENTS (continued)

<u>Section</u>	<u>Title</u>	<u>Page</u>
2.5.5	SLOPE STABILITY	2.5-39
2.6	<u>REFERENCES</u>	2.6-1
2.7	<u>TABLES</u>	2.7-1
2.8	<u>SITE SPECIFIC INFORMATION</u>	2.8-1
2.8.1	FLOOD RELATED INFORMATION	2.8-1
2.8.2	ADDITIONAL NATURAL GAS PIPELINE INFORMATION	2.8-9
2.8.3	ADDITIONAL NEW FUEL STORAGE INFORMATION.....	2.8-10
2A	<u>APPENDIX 2A</u>	2.A-1
3	<u>DESIGN OF STRUCTURES, COMPONENTS, EQUIPMENT AND SYSTEMS</u>	3.1-1
3.1	<u>CONFORMANCE WITH AEC GENERAL DESIGN CRITERIA</u>	3.1-1
3.1.1	OVERALL REQUIREMENTS.....	3.1-1
3.1.2	PROTECTION BY MULTIPLE FISSION PRODUCT BARRIERS.....	3.1-5
3.1.3	PROTECTION AND REACTIVITY CONTROL SYSTEMS	3.1-12
3.1.4	FLUID SYSTEMS	3.1-16
3.1.5	REACTOR CONTAINMENT.....	3.1-25
3.1.6	FUEL AND RADIOACTIVITY CONTROL.....	3.1-29
3.2	<u>CLASSIFICATION OF STRUCTURES, COMPONENTS AND SYSTEMS</u> ...3.2-1	
3.2.1	SEISMIC CLASSIFICATION	3.2-1
3.2.2	SYSTEM QUALITY GROUP CLASSIFICATION.....	3.2-2
3.3	<u>WIND AND TORNADO LOADINGS</u>	3.3-1
3.3.1	WIND LOADINGS	3.3-1
3.3.2	TORNADO LOADINGS	3.3-1
3.4	<u>WATER LEVEL (FLOOD) DESIGN</u>	3.4-1
3.4.1	FLOOD ELEVATIONS	3.4-1

ARKANSAS NUCLEAR ONE
Unit 2

TABLE OF CONTENTS (continued)

<u>Section</u>	<u>Title</u>	<u>Page</u>
3.4.2	PHENOMENA CONSIDERED IN DESIGN LOAD CALCULATIONS.....	3.4-1
3.4.3	FLOOD FORCE APPLICATION.....	3.4-1
3.4.4	FLOOD PROTECTION.....	3.4-1
3.5	<u>MISSILE PROTECTION</u>	3.5-1
3.5.1	MISSILE BARRIERS AND LOADINGS.....	3.5-4
3.5.2	MISSILE SELECTION.....	3.5-5
3.5.3	SELECTED MISSILES.....	3.5-13
3.5.4	BARRIER DESIGN PROCEDURES.....	3.5-13
3.5.5	MISSILE BARRIER FEATURES.....	3.5-15
3.6	<u>PROTECTION AGAINST DYNAMIC EFFECTS ASSOCIATED WITH THE POSTULATED RUPTURE OF PIPING</u>	3.6-1
3.6.1	SYSTEMS IN WHICH DESIGN BASIS PIPING BREAKS OCCUR.....	3.6-2
3.6.2	DESIGN BASIS PIPING BREAK CRITERIA.....	3.6-3
3.6.3	DESIGN LOADING COMBINATIONS.....	3.6-7
3.6.4	DYNAMIC ANALYSES.....	3.6-8
3.6.5	PROTECTIVE MEASURES.....	3.6-39
3.6.6	LEAK-BEFORE-BREAK EVALUATION.....	3.6-40
3.7	<u>SEISMIC DESIGN</u>	3.7-1
3.7-1	SEISMIC INPUT.....	3.7-1
3.7.2	SEISMIC SYSTEM ANALYSIS.....	3.7-5
3.7.3	SEISMIC SUBSYSTEM ANALYSIS.....	3.7-13
3.7.4	SEISMIC INSTRUMENTATION PROGRAM.....	3.7-31
3.7.5	SEISMIC DESIGN CONTROL MEASURES.....	3.7-32
3.7.6	SEISMIC EVALUATION OF CONCRETE MASONRY WALLS.....	3.7-32

ARKANSAS NUCLEAR ONE
Unit 2

TABLE OF CONTENTS (continued)

<u>Section</u>	<u>Title</u>	<u>Page</u>
3.8	<u>DESIGN OF CATEGORY 1 STRUCTURES</u>	3.8-1
3.8.1	CONCRETE CONTAINMENT	3.8-1
3.8.2	STEEL CONTAINMENT SYSTEM.....	3.8-27
3.8.3	CONCRETE AND STRUCTURAL STEEL INTERNAL STRUCTURES OF CONTAINMENT.....	3.8-28
3.8.4	OTHER CATEGORY 1 STRUCTURES	3.8-36
3.8.5	FOUNDATIONS AND CONCRETE SUPPORTS.....	3.8-50
3.9	<u>MECHANICAL SYSTEMS AND COMPONENTS</u>	3.9-1
3.9.1	DYNAMIC SYSTEM ANALYSIS AND TESTING	3.9-1
3.9.2	ASME CODE CLASS 2 AND 3 COMPONENTS.....	3.9-17
3.9.3	COMPONENTS NOT COVERED BY ASME CODE	3.9-23
3.10	<u>SEISMIC DESIGN OF CATEGORY 1 INSTRUMENTATION AND ELECTRICAL EQUIPMENT</u>	3.10-1
3.10.1	SEISMIC DESIGN CRITERIA	3.10-1
3.10.2	SEISMIC ANALYSES, TESTING PROCEDURES, AND RESTRAINT MEASURES	3.10-2
3.11	<u>ENVIRONMENTAL DESIGN OF MECHANICAL AND ELECTRICAL EQUIPMENT</u>	3.11-1
3.11.1	EQUIPMENT IDENTIFICATION.....	3.11-3
3.11.2	QUALIFICATION TESTS AND ANALYSES.....	3.11-5
3.11.3	QUALIFICATION TEST RESULTS	3.11-6
3.11.4	LOSS OF VENTILATION	3.11-6
3.11.5	CURRENT ENVIRONMENTAL QUALIFICATION PROGRAM.....	3.11-7
3.12	<u>REFERENCES</u>	3.12-1
3.13	<u>TABLES</u>	3.13-1
4	<u>REACTOR</u>	4.1-1

ARKANSAS NUCLEAR ONE
Unit 2

TABLE OF CONTENTS (continued)

<u>Section</u>	<u>Title</u>	<u>Page</u>
4.1	<u>SUMMARY DESCRIPTION</u>	4.1-1
4.2	<u>MECHANICAL DESIGN</u>	4.2-1
4.2.1	FUEL	4.2-1
4.2.2	REACTOR INTERNALS.....	4.2-65
4.2.3	REACTIVITY CONTROL SYSTEMS.....	4.2-72
4.3	<u>NUCLEAR DESIGN</u>	4.3-1
4.3.1	DESIGN BASES.....	4.3-1
4.3.2	DESCRIPTION	4.3-3
4.3.3	ANALYTICAL METHODS.....	4.3-15
4.3.4	CHANGES.....	4.3-23
4.4	<u>THERMAL AND HYDRAULIC DESIGN</u>	4.4-1
4.4.1	DESIGN BASES.....	4.4-1
4.4.2	DESCRIPTION	4.4-2
4.4.3	EVALUATION.....	4.4-15
4.4.4	TESTING AND VERIFICATION	4.4-29
4.4.5	INSTRUMENTATION REQUIREMENTS.....	4.4-36
4.5	<u>STARTUP PROGRAM</u>	4.5-1
4.5.1	PRECRITICAL TEST	4.5-1
4.5.2	LOW POWER PHYSICS TEST	4.5-1
4.5.3	POWER ASCENSION TESTS	4.5-2
4.5.4	PROCEDURE IF ACCEPTANCE CRITERIA ARE NOT MET	4.5-5
4.6	<u>REFERENCES</u>	4.6-1
4.7	<u>TABLES</u>	4.7-1
4A	<u>FUEL RECONSTITUTION</u>	4A.1-1

ARKANSAS NUCLEAR ONE
Unit 2

TABLE OF CONTENTS (continued)

<u>Section</u>	<u>Title</u>	<u>Page</u>
4A.1	<u>INTRODUCTION</u>	4A.1-1
4A.2	<u>CONCLUSION</u>	4A.2-1
4A.3	<u>REFERENCES</u>	4A.3-1
5	<u>REACTOR COOLANT SYSTEM</u>	5.1-1
5.1	<u>SUMMARY DESCRIPTION</u>	5.1-1
5.1.1	SCHEMATIC FLOW DIAGRAM	5.1-2
5.1.2	PIPING AND INSTRUMENT DIAGRAM	5.1-2
5.1.3	ELEVATION DRAWING	5.1-2
5.2	<u>INTEGRITY OF REACTOR COOLANT PRESSURE BOUNDARY</u>	5.2-1
5.2.1	DESIGN OF REACTOR COOLANT PRESSURE BOUNDARY COMPONENTS.....	5.2-1
5.2.2	OVERPRESSURE PROTECTION.....	5.2-19
5.2.3	GENERAL MATERIAL CONSIDERATIONS	5.2-24
5.2.4	FRACTURE TOUGHNESS	5.2-26
5.2.5	AUSTENITIC STAINLESS STEEL	5.2-45
5.2.6	PUMP FLYWHEELS	5.2-50
5.2.7	REACTOR COOLANT PRESSURE BOUNDARY LEAKAGE DETECTION SYSTEMS.....	5.2-53
5.2.8	INSERVICE INSPECTION PROGRAM.....	5.2-59
5.3	<u>THERMAL HYDRAULIC SYSTEM DESIGN</u>	5.3-1
5.3.1	ANALYTICAL METHODS AND DATA	5.3-1
5.3.2	OPERATING RESTRICTIONS ON PUMPS	5.3-2
5.3.3	POWER-FLOW OPERATING MAP (BWR).....	5.3-2
5.3.4	TEMPERATURE-POWER OPERATING MAP (PWR).....	5.3-2
5.3.5	LOAD FOLLOWING CHARACTERISTICS	5.3-3

ARKANSAS NUCLEAR ONE
Unit 2

TABLE OF CONTENTS (continued)

<u>Section</u>	<u>Title</u>	<u>Page</u>
5.3.6	TRANSIENT EFFECTS.....	5.3-3
5.3.7	THERMAL AND HYDRAULIC CHARACTERISTICS TABLE.....	5.3-4
5.4	<u>REACTOR VESSEL AND APPURTENANCES</u>	5.4-1
5.4.1	PROTECTION OF CLOSURE STUDS	5.4-1
5.4.2	SPECIAL PROCESSES FOR FABRICATION AND INSPECTION.....	5.4-1
5.4.3	FEATURES FOR IMPROVED RELIABILITY	5.4-4
5.4.4	QUALITY ASSURANCE SURVEILLANCE	5.4-4
5.4.5	MATERIALS AND INSPECTIONS	5.4-4
5.4.6	REACTOR VESSEL DESIGN DATA.....	5.4-4
5.4.7	REACTOR VESSEL SCHEMATIC (BWR).....	5.4-5
5.5	<u>COMPONENT AND SUBSYSTEM DESIGN</u>	5.5-1
5.5.1	REACTOR COOLANT PUMPS.....	5.5-1
5.5.2	STEAM GENERATOR	5.5-4
5.5.3	REACTOR COOLANT PIPING	5.5-11
5.5.4	MAIN STEAM FLOW RESTRICTIONS.....	5.5-13
5.5.5	MAIN STEAM ISOLATION SYSTEM.....	5.5-13
5.5.6	REACTOR CORE ISOLATION COOLING SYSTEM.....	5.5-14
5.5.7	RESIDUAL HEAT REMOVAL SYSTEM.....	5.5-14
5.5.8	REACTOR COOLANT CLEANUP SYSTEM.....	5.5-14
5.5.9	MAIN STEAM LINE AND FEEDWATER PIPING.....	5.5-14
5.5.10	PRESSURIZER.....	5.5-14
5.5.11	QUENCH TANK (PRESSURIZER RELIEF TANK)	5.5-19
5.5.12	VALVES	5.5-20
5.5.13	SAFETY AND RELIEF VALVES	5.5-21

ARKANSAS NUCLEAR ONE
Unit 2

TABLE OF CONTENTS (continued)

<u>Section</u>	<u>Title</u>	<u>Page</u>
5.5.14	COMPONENT SUPPORTS	5.5-23
5.6	<u>INSTRUMENTATION REQUIREMENTS</u>	5.6-1
5.6.1	TEMPERATURE	5.6-1
5.6.2	PRESSURIZER PRESSURE	5.6-2
5.6.3	LEVEL	5.6-3
5.6.4	REACTOR COOLANT LOOP FLOW	5.6-4
5.6.5	REACTOR COOLANT PUMP INSTRUMENTATION.....	5.6-4
5.7	<u>REFERENCES</u>	5.7-1
5.8	<u>TABLES</u>	5.8-1
6	<u>ENGINEERED SAFETY FEATURES</u>	6.1-1
6.1	<u>GENERAL</u>	6.1-1
6.1.1	CONTAINMENT SYSTEM	6.1-1
6.1.2	SAFETY INJECTION SYSTEM.....	6.1-2
6.1.3	HABITABILITY SYSTEM.....	6.1-2
6.1.4	PENETRATION ROOMS VENTILATION SYSTEM	6.1-2
6.1.5	MAIN STEAM LINE ISOLATION SYSTEM	6.1-2
6.2	<u>CONTAINMENT SYSTEMS</u>	6.2-1
6.2.1	CONTAINMENT FUNCTIONAL DESIGN	6.2-1
6.2.2	CONTAINMENT HEAT REMOVAL SYSTEMS.....	6.2-35
6.2.3	CONTAINMENT AIR PURIFICATION AND CLEANUP SYSTEMS	6.2-49
6.2.4	CONTAINMENT ISOLATION SYSTEMS.....	6.2-54
6.2.5	COMBUSTIBLE GAS CONTROL IN CONTAINMENT.....	6.2-57
6.3	<u>EMERGENCY CORE COOLING SYSTEM</u>	6.3-1
6.3.1	DESIGN BASES.....	6.3-1

ARKANSAS NUCLEAR ONE
Unit 2

TABLE OF CONTENTS (continued)

<u>Section</u>	<u>Title</u>	<u>Page</u>
6.3.2	SYSTEM DESIGN	6.3-4
6.3.3	PERFORMANCE EVALUATION.....	6.3-19
6.3.4	TESTS AND INSPECTIONS	6.3-30
6.3.5	INSTRUMENTATION REQUIREMENTS	6.3-31
6.4	<u>HABITABILITY SYSTEMS</u>	6.4-1
6.4.1	HABITABILITY SYSTEMS FUNCTIONAL DESIGN.....	6.4-1
6.5	<u>PENETRATION ROOMS VENTILATION SYSTEM</u>	6.5-1
6.5.1	DESIGN BASES.....	6.5-1
6.5.2	SYSTEM DESIGN	6.5-1
6.5.3	DESIGN EVALUATION	6.5-5
6.5.4	TESTS AND INSPECTIONS.....	6.5-6
6.5.5	INSTRUMENTATION REQUIREMENTS	6.5-6
6.6	<u>REFERENCES</u>	6.6-1
6.7	<u>TABLES</u>	6.7-1
7	<u>INSTRUMENTATION AND CONTROLS</u>	7.1-1
7.1	<u>INTRODUCTION</u>	7.1-1
7.1.1	IDENTIFICATION OF SAFETY-RELATED SYSTEMS	7.1-1
7.1.2	IDENTIFICATION OF SAFETY CRITERIA	7.1-3
7.2	<u>REACTOR PROTECTIVE SYSTEM (REACTOR TRIP SYSTEM)</u>	7.2-1
7.2.1	DESCRIPTION	7.2-1
7.2.2	ANALYSIS	7.2-114
7.3	<u>ENGINEERED SAFETY FEATURES SYSTEMS</u>	7.3-1
7.3.1	DESCRIPTION	7.3-2
7.3.2	ANALYSIS	7.3-20

ARKANSAS NUCLEAR ONE
Unit 2

TABLE OF CONTENTS (continued)

<u>Section</u>	<u>Title</u>	<u>Page</u>
7.4	<u>SYSTEMS REQUIRED FOR SAFE SHUTDOWN</u>	7.4-1
7.4.1	DESCRIPTION	7.4-1
7.4.2	ANALYSIS	7.4-5
7.5	<u>SAFETY-RELATED DISPLAY INSTRUMENTATION</u>	7.5-1
7.5.1	DESCRIPTION	7.5-1
7.5.2	ANALYSIS	7.5-4
7.6	<u>ALL OTHER SYSTEMS REQUIRED FOR SAFETY</u>	7.6-1
7.6.1	DESCRIPTION	7.6-1
7.6.2	ANALYSIS	7.6-5
7.7	<u>CONTROL SYSTEMS NOT REQUIRED FOR SAFETY</u>	7.7-1
7.7.1	DESCRIPTION	7.7-1
7.7.2	ANALYSIS	7.7-22
7.8	<u>TABLES</u>	7.8-1
8	<u>ELECTRIC POWER</u>	8.1-1
8.1	<u>INTRODUCTION</u>	8.1-1
8.1.1	UTILITY GRID AND ITS INTERCONNECTIONS	8.1-1
8.1.2	ONSITE ELECTRIC SYSTEM	8.1-1
8.1.3	REACTOR PROTECTION AND ENGINEERED SAFETY FEATURE LOADS	8.1-2
8.1.4	DESIGN BASES FOR SAFETY-RELATED ELECTRIC SYSTEMS	8.1-2
8.2	<u>OFF-SITE POWER SYSTEM</u>	8.2-1
8.2.1	DESCRIPTION	8.2-1
8.2.2	ANALYSIS	8.2-8
8.3	<u>ONSITE POWER SYSTEMS</u>	8.3-1
8.3.1	AC POWER SYSTEMS	8.3-1

ARKANSAS NUCLEAR ONE
Unit 2

TABLE OF CONTENTS (continued)

<u>Section</u>	<u>Title</u>	<u>Page</u>
8.3.2	DC POWER SYSTEMS.....	8.3-72
8.3.3	ALTERNATE AC POWER SOURCE	8.3-79
8.4	<u>TABLES</u>	8.4-1
9	<u>AUXILIARY SYSTEMS</u>	9.1-1
9.1	<u>FUEL STORAGE AND HANDLING</u>	9.1-1
9.1.1	NEW FUEL STORAGE	9.1-1
9.1.2	SPENT FUEL STORAGE.....	9.1-3
9.1.3	FUEL POOL SYSTEM (SPENT FUEL POOL COOLING AND CLEANUP SYSTEM)	9.1-16
9.1.4	FUEL HANDLING SYSTEM.....	9.1-24
9.2	<u>WATER SYSTEMS</u>	9.2-1
9.2.1	SERVICE WATER SYSTEM.....	9.2-1
9.2.2	COMPONENT COOLING WATER SYSTEM.....	9.2-12
9.2.3	DEMINERALIZED WATER SYSTEM.....	9.2-16
9.2.4	POTABLE AND SANITARY WATER SYSTEM.....	9.2-17
9.2.5	ULTIMATE HEAT SINK.....	9.2-19
9.2.6	CONDENSATE STORAGE AND TRANSFER SYSTEM	9.2-27
9.3	<u>PROCESS AUXILIARIES</u>	9.3-1
9.3.1	COMPRESSED AIR SYSTEM	9.3-1
9.3.2	PROCESS SAMPLING SYSTEM.....	9.3-3
9.3.3	EQUIPMENT AND FLOOR DRAINAGE SYSTEMS	9.3-9
9.3.4	CHEMICAL AND VOLUME CONTROL SYSTEM.....	9.3-12
9.3.5	FAILED FUEL DETECTION SYSTEM	9.3-29
9.3.6	SHUTDOWN COOLING SYSTEM.....	9.3-29

ARKANSAS NUCLEAR ONE
Unit 2

TABLE OF CONTENTS (continued)

<u>Section</u>	<u>Title</u>	<u>Page</u>
9.4	<u>AIR CONDITIONING, HEATING, COOLING, & VENTILATION SYSTEMS</u>	9.4-1
9.4.1	CONTROL ROOM.....	9.4-1
9.4.2	AUXILIARY BUILDING.....	9.4-9
9.4.3	RADWASTE AREA	9.4-23
9.4.4	TURBINE BUILDING.....	9.4-34
9.4.5	CONTAINMENT BUILDING	9.4-35
9.4.6	INTAKE STRUCTURE	9.4-40
9.4.7	ALTERNATE AC GENERATOR BUILDING.....	9.4-41
9.5	<u>OTHER AUXILIARY SYSTEMS</u>	9.5-1
9.5.1	FIRE PROTECTION SYSTEM - CODES AND STANDARDS	9.5-1
9.5.2	COMMUNICATION SYSTEMS	9.5-23
9.5.3	LIGHTING SYSTEM.....	9.5-25
9.5.4	DIESEL GENERATOR FUEL OIL STORAGE AND TRANSFER SYSTEM..	9.5-26
9.5.5	DIESEL GENERATOR COOLING WATER SYSTEM.....	9.5-31
9.5.6	DIESEL GENERATOR STARTING SYSTEM.....	9.5-33
9.5.7	DIESEL GENERATOR LUBRICATION SYSTEM.....	9.5-36
9.5.8	SEISMIC CATEGORY 1 VALVES.....	9.5-37
9.5.9	DIESEL GENERATOR COMBUSTION AIR INTAKE AND EXHAUST SYSTEM.....	9.5-37
9.6	<u>REFERENCES</u>	9.6-1
9.7	<u>TABLES</u>	9.7-1
9A	<u>FIRE PROTECTION PROGRAM</u>	9A-1
9A.1	<u>PROGRAM DESCRIPTION</u>	9A-1
9A.2	<u>SCOPE AND APPLICABILITY</u>	9A-1
9A.3	<u>ORGANIZATION AND RESPONSIBILITY</u>	9A-1

ARKANSAS NUCLEAR ONE
Unit 2

TABLE OF CONTENTS (continued)

<u>Section</u>	<u>Title</u>	<u>Page</u>
9A.4	<u>ADMINISTRATIVE CONTROLS AND PROCEDURES</u>	9A-1
9A.5	<u>FIRE HAZARDS ANALYSIS</u>	9A-1
9A.6	<u>SAFETY EVALUATION REPORTS</u>	9A-2
9A.7	<u>SAFE SHUTDOWN SYSTEMS</u>	9A-2
9A.8	<u>FIRE PROTECTION SYSTEMS</u>	9A-2
9A.9	<u>QUALITY ASSURANCE</u>	9A-2
9A.10	<u>FIRE BRIGADE</u>	9A-2
9B	<u>FIRE HAZARDS ANALYSIS REPORT</u>	9B-1
9C	<u>SAFE SHUTDOWN CAPABILITY ASSESSMENT</u>	9C-1
9D	<u>FIRE PROTECTION SYSTEM ADMINISTRATIVE REQUIREMENTS</u>	9D-1
9D.1	<u>ADMINISTRATIVE REQUIREMENTS</u>	9D-1
9D.1.1	FIRE BRIGADE	9D-1
9D.1.2	TRAINING	9D-1
10	<u>STEAM AND POWER CONVERSION SYSTEM</u>	10.1-1
10.1	<u>SUMMARY DESCRIPTION</u>	10.1-1
10.2	<u>TURBINE GENERATOR</u>	10.2-1
10.2.1	DESIGN BASES.....	10.2-1
10.2.2	SYSTEM DESCRIPTION	10.2-1
10.2.3	TURBINE MISSILES	10.2-7
10.2.4	EVALUATION.....	10.2-7
10.3	<u>MAIN STEAM SUPPLY SYSTEM</u>	10.3-1
10.3.1	DESIGN BASES.....	10.3-1
10.3.2	SYSTEM DESCRIPTION	10.3-1
10.3.3	SAFETY EVALUATION.....	10.3-3

ARKANSAS NUCLEAR ONE
Unit 2

TABLE OF CONTENTS (continued)

<u>Section</u>	<u>Title</u>	<u>Page</u>
10.3.4	TESTS AND INSPECTIONS	10.3-5
10.3.5	WATER CHEMISTRY	10.3-5
10.4	<u>OTHER FEATURES OF STEAM AND POWER CONVERSION SYSTEM</u> ..	10.4-1
10.4.1	MAIN CONDENSER	10.4-1
10.4.2	MAIN CONDENSER EVACUATION SYSTEM	10.4-4
10.4.3	TURBINE GLAND SEALING SYSTEM	10.4-6
10.4.4	STEAM DUMP AND BYPASS SYSTEM.....	10.4-8
10.4.5	CIRCULATING WATER SYSTEM	10.4-11
10.4.6	CONDENSATE CLEANUP SYSTEM.....	10.4-16
10.4.7	CONDENSATE AND FEEDWATER SYSTEMS	10.4-16
10.4.8	STEAM GENERATOR BLOWDOWN SYSTEM.....	10.4-22
10.4.9	EMERGENCY FEEDWATER SYSTEM.....	10.4-25
10.4.10	STARTUP AND BLOWDOWN DEMINERALIZER SYSTEM	10.4-34
10.4.11	COMMON FEEDWATER SYSTEM	10.4-36
10.5	<u>TABLES</u>	10.5-1
11	<u>RADIOACTIVE WASTE MANAGEMENT</u>	11.1-1
11.1	<u>SOURCE TERMS</u>	11.1-1
11.1.1	FISSION PRODUCTS	11.1-1
11.1.2	CORROSION PRODUCTS	11.1-3
11.1.3	TRITIUM PRODUCTION.....	11.1-5
11.1.4	NITROGEN-16 ACTIVITY	11.1-6
11.1.5	FUEL EXPERIENCE	11.1-7
11.1.6	REACTOR COOLANT LEAKAGE.....	11.1-7
11.1.7	STEAM GENERATOR ACTIVITY	11.1-7

ARKANSAS NUCLEAR ONE
Unit 2

TABLE OF CONTENTS (continued)

<u>Section</u>	<u>Title</u>	<u>Page</u>
11.1.8	DERIVATION OF CORE RESIDENCE TIME (EQUATION 11.1.3)	11.1-8
11.2	<u>LIQUID WASTE SYSTEMS</u>	11.2-1
11.2.1	DESIGN OBJECTIVES	11.2-1
11.2.2	SYSTEM DESCRIPTION	11.2-2
11.2.3	SYSTEM DESIGN	11.2-5
11.2.4	OPERATING PROCEDURES	11.2-7
11.2.5	PERFORMANCE TESTS	11.2-9
11.2.6	ESTIMATED RELEASES	11.2-9
11.2.7	RELEASE POINTS	11.2-13
11.2.8	DILUTION FACTORS.....	11.2-14
11.2.9	ESTIMATED DOSES	11.2-14
11.3	<u>GASEOUS WASTE SYSTEM</u>	11.3-1
11.3.1	DESIGN OBJECTIVES	11.3-1
11.3.2	SYSTEM DESCRIPTION	11.3-1
11.3.3	SYSTEM DESIGN	11.3-2
11.3.4	OPERATING PROCEDURE	11.3-3
11.3.5	PERFORMANCE TESTS	11.3-4
11.3.6	ESTIMATED RELEASES	11.3-4
11.3.7	RELEASE POINTS	11.3-13
11.3.8	DILUTION FACTORS.....	11.3-14
11.3.9	ESTIMATED DOSES	11.3-16
11.4	<u>PROCESS AND EFFLUENT RADIOLOGICAL MONITORING SYSTEMS</u> ..	11.4-1
11.4.1	DESIGN OBJECTIVES	11.4-1
11.4.2	CONTINUOUS MONITORING	11.4-2

ARKANSAS NUCLEAR ONE
Unit 2

TABLE OF CONTENTS (continued)

<u>Section</u>	<u>Title</u>	<u>Page</u>
11.4.3	SAMPLING.....	11.4-11
11.4.4	INSPECTION, CALIBRATION, AND MAINTENANCE.....	11.4-11
11.5	<u>SOLID RADIOACTIVE WASTE PROGRAM</u>	11.5-1
11.5.1	PROGRAM OBJECTIVES.....	11.5-1
11.5.2	RADIOACTIVE WASTE INPUTS	11.5-1
11.5.3	EQUIPMENT DESCRIPTION.....	11.5-2
11.5.4	EXPECTED SOLID WASTE QUANTITIES	11.5-2
11.5.5	PACKAGING AND SHIPPING	11.5-2
11.5.6	STORAGE FACILITIES.....	11.5-2
11.6	<u>OFF-SITE RADIOLOGICAL MONITORING PROGRAM</u>	11.6-1
11.6.1	EXPECTED BACKGROUND	11.6-1
11.6.2	CRITICAL PATHWAYS.....	11.6-1
11.6.3	SAMPLING MEDIA, LOCATIONS AND FREQUENCY.....	11.6-2
11.6.4	ANALYTICAL SENSITIVITY.....	11.6-3
11.6.5	DATA ANALYSIS AND PRESENTATION.....	11.6-3
11.6.6	IN-PLANT EFFLUENT MONITORING	11.6-3
11.7	<u>REFERENCES</u>	11.7-1
11.8	<u>TABLES</u>	11.8-1
12	<u>RADIATION PROTECTION</u>	12.1-1
12.1	<u>SHIELDING</u>	12.1-1
12.1.1	DESIGN OBJECTIVES	12.1-1
12.1.2	DESIGN DESCRIPTION	12.1-2
12.1.3	SOURCE TERMS	12.1-9
12.1.4	AREA RADIATION MONITORING SYSTEM.....	12.1-11

ARKANSAS NUCLEAR ONE
Unit 2

TABLE OF CONTENTS (continued)

<u>Section</u>	<u>Title</u>	<u>Page</u>
12.1.5	OPERATING PROCEDURES	12.1-14
12.1.6	ESTIMATES OF EXPOSURE	12.1-16
12.1.7	EQUIPMENT AND AREA DECONTAMINATION PROVISIONS	12.1-16
12.2	<u>VENTILATION</u>	12.2-1
12.2.1	DESIGN OBJECTIVES	12.2-1
12.2.2	DESIGN DESCRIPTION	12.2-2
12.2.3	SOURCE TERMS	12.2-5
12.2.4	AIRBORNE RADIOACTIVITY MONITORING	12.2-5
12.2.5	OPERATING PROCEDURES	12.2-6
12.2.6	ESTIMATES OF INHALATION DOSES	12.2-6
12.3	<u>HEALTH PHYSICS PROGRAM</u>	12.3-1
12.3.1	PROGRAM OBJECTIVES	12.3-1
12.3.2	FACILITIES AND EQUIPMENT	12.3-2
12.3.3	PERSONNEL DOSIMETRY	12.3-3
12.3.4	PROCEDURES	12.3-4
12.4	<u>RADIOACTIVE MATERIALS SAFETY</u>	12.4-1
12.4.1	RADIOACTIVE MATERIALS SAFETY PROGRAM	12.4-1
12.4.2	RADIOACTIVE MATERIALS CONTROL	12.4-1
12.4.3	RADIOACTIVE MATERIALS	12.4-2
12.5	<u>REFERENCES</u>	12.5-1
12.6	<u>TABLES</u>	12.6-1
13	<u>CONDUCT OF OPERATIONS</u>	13.1-1
13.1	<u>ORGANIZATIONAL STRUCTURES OF APPLICANT</u>	13.1-1
13.1.1	MANAGEMENT AND TECHNICAL SUPPORT ORGANIZATIONS	13.1-1

ARKANSAS NUCLEAR ONE
Unit 2

TABLE OF CONTENTS (continued)

<u>Section</u>	<u>Title</u>	<u>Page</u>
13.1.2	ORGANIZATION INTERFACES AND RESPONSIBILITIES.....	13.1-1
13.1.3	QUALIFICATIONS OF NUCLEAR OPERATIONS PERSONNEL.....	13.1-1
13.1.4	TECHNICAL CONSULTANTS	13.1-1
13.2	<u>TRAINING PROGRAM</u>	13.2-1
13.2.1	PLANT STAFF INITIAL TRAINING PROGRAM.....	13.2-1
13.2.2	REPLACEMENT TRAINING	13.2-1
13.2.3	RETRAINING PROGRAM.....	13.2-2
13.2.4	RECORDS	13.2-2
13.3	<u>EMERGENCY PLANNING</u>	13.3-1
13.4	<u>REVIEW AND AUDIT</u>	13.4-1
13.5	<u>PLANT PROCEDURES</u>	13.5-1
13.5.1	ADMINISTRATIVE PROCEDURES.....	13.5-1
13.5.2	OPERATING AND MAINTENANCE PROCEDURES	13.5-1
13.5.3	PROCEDURE CONTROL	13.5-3
13.6	<u>INDUSTRIAL SECURITY</u>	13.6-1
13.7	<u>FIRE PROTECTION PLAN (See Section 9.5.1.5)</u>	13.7-1
13.8	<u>TECHNICAL REQUIREMENTS MANUAL</u>	13.8-1
13.8.1	REGULATORY STATUS/REQUIREMENTS.....	13.8-1
13.8.2	CHANGES TO THE TRM.....	13.8-1
14	<u>INITIAL TESTS AND OPERATION</u>	14.1-1
14.1	<u>TEST PROGRAM</u>	14.1-1
14.1.1	ADMINISTRATIVE PROCEDURES (TESTING).....	14.1-2
14.1.2	ADMINISTRATIVE PROCEDURES (MODIFICATIONS).....	14.1-6
14.1.3	TEST OBJECTIVES AND PROCEDURES	14.1-6

ARKANSAS NUCLEAR ONE
Unit 2

TABLE OF CONTENTS (continued)

<u>Section</u>	<u>Title</u>	<u>Page</u>
14.1.4	FUEL LOADING AND INITIAL OPERATION	14.1-8
14.1.5	ADMINISTRATIVE PROCEDURES (SYSTEM OPERATION).....	14.1-11
14.1.6	STEAM GENERATOR REPLACEMENT AND POWER UPRATE.....	14.1-12
14.2	<u>AUGMENTATION OF APPLICANT'S STAFF FOR INITIAL TESTS AND OPERATION</u>	14.2-1
14.2.1	ORGANIZATIONAL FUNCTIONS, RESPONSIBILITIES AND AUTHORITIES	14.2-1
14.2.2	INTERRELATIONSHIPS AND INTERFACES.....	14.2-1
14.2.3	PERSONNEL FUNCTIONS, RESPONSIBILITIES AND AUTHORITIES.....	14.2-2
14.2.4	PERSONNEL QUALIFICATIONS	14.2-2
14.3	<u>TABLES</u>	14.3-1
15	<u>ACCIDENT ANALYSIS</u>	15.1-1
15.1	<u>GENERAL</u>	15.1-1
15.1.0	INTRODUCTION	15.1-1
15.1.1	UNCONTROLLED CONTROL ELEMENT ASSEMBLY WITHDRAWAL FROM A SUBCRITICAL CONDITION	15.1-14
15.1.2	UNCONTROLLED CEA WITHDRAWAL FROM CRITICAL CONDITIONS ..	15.1-19
15.1.3	CEA MISOPERATION	15.1-27
15.1.4	UNCONTROLLED BORON DILUTION INCIDENT	15.1-31
15.1.5	TOTAL AND PARTIAL LOSS OF REACTOR COOLANT FORCED FLOW .	15.1-41
15.1.6	IDLE LOOP STARTUP	15.1-57
15.1.7	LOSS OF EXTERNAL LOAD AND/OR TURBINE TRIP	15.1-57
15.1.8	LOSS OF NORMAL FEEDWATER FLOW.....	15.1-61
15.1.9	LOSS OF ALL NORMAL AND PREFERRED AC POWER TO THE STATION AUXILIARIES.....	15.1-64

ARKANSAS NUCLEAR ONE
Unit 2

TABLE OF CONTENTS (continued)

<u>Section</u>	<u>Title</u>	<u>Page</u>
15.1.10	EXCESS HEAT REMOVAL DUE TO SECONDARY SYSTEM MALFUNCTION	15.1-66
15.1.11	FAILURE OF THE REGULATING INSTRUMENTATION	15.1-74
15.1.12	INTERNAL AND EXTERNAL EVENTS INCLUDING MAJOR AND MINOR FIRES, FLOODS, STORMS, AND EARTHQUAKES	15.1-74
15.1.13	MAJOR RUPTURE OF PIPES CONTAINING REACTOR COOLANT UP TO AND INCLUDING DOUBLE-ENDED RUPTURE OF LARGEST PIPE IN THE REACTOR COOLANT SYSTEM (LOSS OF COOLANT ACCIDENT).....	15.1-76
15.1.14	MAJOR SECONDARY SYSTEM PIPE BREAKS WITH OR WITHOUT A CONCURRENT LOSS OF AC POWER.....	15.1-78
15.1.15	INADVERTENT LOADING OF A FUEL ASSEMBLY INTO THE IMPROPER POSITION	15.1-108
15.1.16	WASTE GAS DECAY TANK LEAKAGE OR RUPTURE.....	15.1-111
15.1.17	FAILURE OF AIR EJECTOR LINES (BWR)	15.1-111
15.1.18	STEAM GENERATOR TUBE RUPTURE WITH OR WITHOUT A CONCURRENT LOSS OF AC POWER	15.1-112
15.1.19	FAILURE OF CHARCOAL OF CYROGENIC SYSTEM (BWR).....	15.1-116
15.1.20	CONTROL ELEMENT ASSEMBLY EJECTION.....	15.1-116
15.1.21	THE SPECTRUM OF ROD DROP ACCIDENTS (BWR)	15.1-127
15.1.22	BREAK IN INSTRUMENT LINE OR OTHER LINES FROM REACTOR COOLANT PRESSURE BOUNDARY THAT PENETRATE CONTAINMENT.....	15.1-127
15.1.23	FUEL HANDLING ACCIDENT	15.1-127
15.1.24	SMALL SPILLS OR LEAKS OF RADIOACTIVE MATERIAL OUTSIDE CONTAINMENT	15.1-131
15.1.25	FUEL CLADDING FAILURE COMBINED WITH STEAM GENERATOR LEAK	15.1-132
15.1.26	CONTROL ROOM UNINHABITABILITY	15.1-133
15.1.27	FAILURE OR OVERPRESSURIZATION OF LOW PRESSURE RESIDUAL HEAT REMOVAL SYSTEM.....	15.1-134

ARKANSAS NUCLEAR ONE
Unit 2

TABLE OF CONTENTS (continued)

<u>Section</u>	<u>Title</u>	<u>Page</u>
15.1.28	LOSS OF CONDENSER VACUUM	15.1-134
15.1.29	TURBINE TRIP WITH COINCIDENT FAILURE OF TURBINE BYPASS VALVES TO OPEN	15.1-135
15.1.30	LOSS OF SERVICE WATER SYSTEM	15.1-135
15.1.31	LOSS OF ONE DC SYSTEM	15.1-136
15.1.32	INADVERTENT OPERATION OF ECCS DURING POWER OPERATION ..	15.1-137
15.1.33	TURBINE TRIP WITH FAILURE OF GENERATOR BREAKER TO OPEN ..	15.1-137
15.1.34	LOSS OF INSTRUMENT AIR SYSTEM.....	15.1-138
15.1.35	MALFUNCTION OF TURBINE GLAND SEALING SYSTEM	15.1-138
15.1.36	TRANSIENTS RESULTING FROM THE INSTANTANEOUS CLOSURE OF A SINGLE MSIV	15.1-139
15.2	<u>REFERENCES</u>	15.2-1
15.3	<u>TABLES</u>	15.3-1
16	<u>TECHNICAL SPECIFICATIONS</u>	16.1-1
16.1	<u>MODE 4 TS END STATES</u>	16.1-1
16.1.1	MODE 4 TS END STATE IMPLEMENTATION AND RISK ASSESSMENT	16.1-1
17	<u>QUALITY ASSURANCE</u>	17.1-1
17.1	<u>QUALITY ASSURANCE DURING OPERATIONS</u>	17.1-1
18	<u>AGING MANAGEMENT PROGRAMS AND ACTIVITIES</u>	18.1-1
18.1	<u>PROGRAMS AND ACTIVITIES</u>	18.1-1
18.1.1	ALLOY 600 AGING MANAGEMENT PROGRAM	18.1-1
18.1.2	BOLTING AND TORQUING ACTIVITIES	18.1-1
18.1.3	BORIC ACID CORROSION PREVENTION PROGRAM	18.1-1
18.1.4	BURIED PIPING INSPECTION PROGRAM	18.1-1

ARKANSAS NUCLEAR ONE
Unit 2

TABLE OF CONTENTS (continued)

<u>Section</u>	<u>Title</u>	<u>Page</u>
18.1.5	CAST AUSTENITIC STAINLESS STEEL (CASS) EVALUATION PROGRAM	18.1-2
18.1.6	CONTAINMENT LEAK RATE PROGRAM.....	18.1-2
18.1.7	DIESEL FUEL MONITORING PROGRAM.....	18.1-2
18.1.8	ENVIRONMENTAL QUALIFICATION (EQ) OF ELECTRIC COMPONENTS PROGRAM	18.1-2
18.1.9	FATIGUE MONITORING PROGRAM	18.1-2
18.1.10	FIRE PROTECTION PROGRAM	18.1-3
18.1.11	FIRE WATER SYSTEM PROGRAM	18.1-3
18.1.12	FLOW-ACCELERATED CORROSION PROGRAM.....	18.1-3
18.1.13	HEAT EXCHANGER MONITORING PROGRAM	18.1-3
18.1.14	INSERVICE INSPECTION – CONTAINMENT INSERVICE INSPECTION PROGRAM	18.1-3
18.1.15	INSERVICE INSPECTION – INSERVICE INSPECTION PROGRAM	18.1-4
18.1.16	NON-EQ INACCESSIBLE MEDIUM-VOLTAGE CABLE PROGRAM.....	18.1-4
18.1.17	NON-EQ INSULATED CABLES AND CONNECTIONS PROGRAM	18.1-4
18.1.18	OIL ANALYSIS PROGRAM	18.1-4
18.1.19	PERIODIC SURVEILLANCE AND PREVENTIVE MAINTENANCE PROGRAM.....	18.1-4
18.1.20	PRESSURIZER EXAMINATIONS PROGRAM	18.1-5
18.1.21	REACTOR VESSEL HEAD PENETRATION PROGRAM.....	18.1-5
18.1.22	REACTOR VESSEL INTEGRITY PROGRAM	18.1-5
18.1.23	REACTOR VESSEL INTERNALS CAST AUSTENITIC STAINLESS STEEL (CASS) PROGRAM	18.1-5
18.1.24	REACTOR VESSEL INTERNALS STAINLESS STEEL PLATES, FORGINGS, WELDS, AND BOLTING PROGRAM.....	18.1-5
18.1.25	SERVICE WATER INTEGRITY PROGRAM.....	18.1-5

ARKANSAS NUCLEAR ONE
Unit 2

TABLE OF CONTENTS (continued)

<u>Section</u>	<u>Title</u>	<u>Page</u>
18.1.26	STEAM GENERATOR INTEGRITY PROGRAM.....	18.1-6
18.1.27	STRUCTURES MONITORING – MASONRY WALL PROGRAM.....	18.1-6
18.1.28	STRUCTURES MONITORING – STRUCTURES MONITORING PROGRAM.....	18.1-6
18.1.29	SYSTEM WALKDOWN PROGRAM.....	18.1-6
18.1.30	WALL THINNING MONITORING PROGRAM	18.1-6
18.1.31	WATER CHEMISTRY CONTROL – AUXILIARY SYSTEMS WATER CHEMISTRY CONTROL PROGRAM	18.1-6
18.1.32	WATER CHEMISTRY CONTROL – CLOSED COOLING WATER CHEMISTRY CONTROL PROGRAM	18.1-7
18.1.33	WATER CHEMISTRY CONTROL – PRIMARY AND SECONDARY WATER CHEMISTRY CONTROL PROGRAM	18.1-7
18.1.34	ONE-TIME INSPECTION	18.1-7
18.1.35	SELECTIVE LEACHING	18.1-7
18.2	<u>TIME-LIMITED AGING ANALYSES (TLAAs)</u>	18.2-1
18.2.1	REACTOR VESSEL NEUTRON EMBRITTLEMENT.....	18.2-1
18.2.2	METAL FATIGUE	18.2-2
18.2.3	ENVIRONMENTAL QUALIFICATION OF ELECTRICAL COMPONENTS ...	18.2-4
18.2.4	CONCRETE CONTAINMENT TENDON PRESTRESS	18.2-4
18.2.5	CONTAINMENT LINER PLATE AND PENETRATION FATIGUE ANALYSES	18.2-4
18.2.6	OTHER PLANT-SPECIFIC TIME-LIMITED AGING ANALYSES	18.2-5
18.3	<u>REFERENCES</u>	18.3-1

ARKANSAS NUCLEAR ONE
Unit 2

CHAPTER 1

TABLE OF CONTENTS

<u>Section</u>	<u>Title</u>	<u>Page</u>
1	<u>INTRODUCTION AND GENERAL DESCRIPTION OF PLANT</u>	1.1-1
1.1	<u>INTRODUCTION</u>	1.1-1
1.2	<u>GENERAL PLANT DESCRIPTION</u>	1.2-1
1.2.1	PRINCIPAL SITE CHARACTERISTICS.....	1.2-1
1.2.2	CONCISE PLANT DESCRIPTION.....	1.2-1
1.2.2.1	<u>Reactor and Reactor Coolant System</u>	1.2-1
1.2.2.2	<u>Engineered Safety Features</u>	1.2-2
1.2.2.3	<u>Instrumentation and Control</u>	1.2-3
1.2.2.4	<u>Electrical System</u>	1.2-4
1.2.2.5	<u>Power Conversion</u>	1.2-5
1.2.2.6	<u>Fuel Handling and Storage</u>	1.2-5
1.2.2.7	<u>Cooling Water and Other Auxiliary Systems</u>	1.2-6
1.2.2.8	<u>Radioactive Waste Management Systems</u>	1.2-6
1.2.2.9	<u>General Arrangement of Major Structures and Equipment</u>	1.2-7
1.2.2.10	<u>Interrelationship With Unit 1</u>	1.2-8
1.3	<u>COMPARISONS</u>	1.3-1
1.3.1	COMPARISON WITH SIMILAR FACILITY DESIGNS.....	1.3-1
1.3.2	COMPARISON OF FINAL AND PRELIMINARY INFORMATION.....	1.3-1
1.3.3	COMPARISON OF PLANT DESIGN WITH REGULATORY GUIDE RECOMMENDATIONS.....	1.3-1
1.4	<u>IDENTIFICATION OF AGENTS AND CONTRACTORS</u>	1.4-1
1.5	<u>REQUIREMENTS FOR FURTHER TECHNICAL INFORMATION</u>	1.5-1
1.5.1	FRETTING AND VIBRATIONS TESTS OF FUEL ASSEMBLIES.....	1.5-1

ARKANSAS NUCLEAR ONE
Unit 2

TABLE OF CONTENTS (continued)

<u>Section</u>	<u>Title</u>	<u>Page</u>
1.5.2	DEPARTURE FROM NUCLEATE BOILING (DNB) TESTING	1.5-1
1.5.3	FUEL ASSEMBLY STRUCTURAL TESTS	1.5-1
1.5.4	FUEL ASSEMBLY FLOW MIXING TESTS	1.5-2
1.5.5	REACTOR FLOW MODEL TESTING AND EVALUATION.....	1.5-2
1.5.6	FUEL ASSEMBLY FLOW TESTS	1.5-3
1.5.7	CONTROL ELEMENT DRIVE MECHANISM (CEDM) TESTS	1.5-3
1.5.8	SAFETY INJECTION SYSTEM IMPROVEMENT	1.5-3
1.5.9	DNB IMPROVEMENT	1.5-3
1.5.10	LOCA REFILL TESTING.....	1.5-4
1.5.11	BLOWDOWN HEAT TRANSFER TESTING.....	1.5-4
1.5.12	STEAM WATER MIXING TEST PROGRAM.....	1.5-5
1.6	<u>MATERIAL INCORPORATED BY REFERENCE</u>	1.6-1
1.6.1	CE TOPICAL REPORTS.....	1.6-1
1.6.2	BECHTEL TOPICAL REPORTS	1.6-2
1.7	<u>GLOSSARY OF ITEMS</u>	1.7-1
1.7.1	TEXT ABBREVIATIONS	1.7-1
1.7.2	DRAWING INDEX AND SYMBOLS	1.7-1
1.7.3	PIPING IDENTIFICATION.....	1.7-1
1.7.4	TRADEMARKS	1.7-1
1.8	<u>REFERENCES</u>	1.8-1
1.9	<u>TABLES</u>	1.9-1

ARKANSAS NUCLEAR ONE
Unit 2

LIST OF TABLES

<u>Table No.</u>	<u>Title</u>	<u>Page</u>
1.2-1	EVALUATION OF MISCELLANEOUS SHARED SYSTEMS	1.9-1
1.3-1	PLANT PARAMETER COMPARISON	1.9-3
1.7-1	NONTECHNICAL ABBREVIATIONS	1.9-16
1.7-2	FIGURE - DRAWING CORRELATIONS	1.9-21
1.7-3	PIPING IDENTIFICATION	1.9-30

LIST OF FIGURES

<u>Figure No.</u>	<u>Title</u>
1.2-1 – 1.7-2	Deleted

ARKANSAS NUCLEAR ONE
Unit 2

UPDATE REFERENCE LIST

Sections and references listed below denote documents that contain additional cross reference information used to update the SAR.

<u>Section</u>	<u>Cross References</u>
1.2.2.6	Design Change Package 83-2021, "Spent Fuel Pool Rerack."
1.2.2.10 Table 1.2-1	Design Change Package 82-2086, B, "Q-Condensate Storage Tank."
Figure 1.2-1	Design Change Package 79-2137, "Cooling Tower Water Treatment Facility and Installation."
Figure 1.2-2	Design Change Package 79-2135F, "High Range Gaseous Effluent Radiation Monitors."
Figure 1.2-3	Design Change Package 80-2123J, "Safety Parameter Display System."
Figure 1.2-3	Design Change Package 83-2080, "Remote Shutdown Appendix R."
Figure 1.2-3	Design Change Packages 83-2090, "Controlled Access
Figure 1.2-5	Entry/Exit Modifications," and 86-2090A, "H.P. Renovation Work."
Figure 1.2-4	Design Change Package 79-2195, "Cold Lab (Atomic Absorption Unit Installation)."
Figure 1.7-2	Design Change Package 81-2004A, "Service Water System."
<u>Amendment 8</u>	
1.2	Design Change Package 85-2111, "RCP Vibration Monitoring System."
<u>Amendment 9</u>	
Figure 1.2-2 Figure 1.2-3	Design Change Package 79-2025, "Maintenance Facility and Turbine Deck Expansion."
Figure 1.2-2 Figure 1.2-5 Figure 1.2-7 Figure 1.2-10	Design Change Package 85-2073, "ATWS Diverse Scram System."
Figure 1.2-6	Design Change Package 88-2022, "Opening Between A and C Charging Pump Rooms."

ARKANSAS NUCLEAR ONE
Unit 2

UPDATE REFERENCE LIST (continued)

<u>Section</u>	<u>Cross References</u>
<u>Amendment 10</u>	
1.2.2.10.E Table 1.2-1	Design Change Package 83-2094, "Liquid Nitrogen Storage Tank, NO-1&2."
Table 1.2-1	Design Change Package 84-2083A, "ANO-2 Control Room Emergency A/C Modifications."
Figure 1.2-1	Design Change Package 83-2228, "Radwaste Building."
Figure 1.2-1	Plant Change 90-8019, "Telephone System Upgrade."
Figure 1.2-4	Design Change Package 89-2053, "ATWS Diverse Emergency Feedwater Actuation System."
Figure 1.2-4	Limited Change Package 90-6022, "Boric Acid System Heat Trace Panels Removal."
Figure 1.2-5	Design Change Package 82-2004, "Waste Gas Monitoring Panels."
Figure 1.7-1	Design Change Package 85-2075A, "CPC Room."
<u>Amendment 11</u>	
1.2.2.10 Table 1.2-1	Design Change Package 92-1009, "Feedwater Chemical Addition."
1.2.2.10 Table 1.2-1 Figure 1.2-1	Design Change Package 90-2023, "Sodium Bromide/Sodium Hypochlorite System Addition."
Table 1.7-2 Figure 1.2-3	Plant Change 89-8002, "Modification to H.P. Instrument Room."
Figure 1.2-1	Design Change Package 91-1021, "Controlled Access Number 3."
Figure 1.2-3	Plant Change 91-8079, "Chemistry Department Room Modification."
Figure 1.2-5	Plant Change 91-8036, "Hydrazine Bulk Tank Addition."
Figure 1.2-5	Plant Change 91-8077, "H.P. Room Modification at El. 354'0".
Figure 1.2-6 Figure 1.2-10	Plant Change 92-8026, "Removal of Regenerate Waste Radiation Detector & Monitor."
Figure 1.2-6	Plant Change 91-8076, "H.P. Room Modification at El. 335'0".

ARKANSAS NUCLEAR ONE
Unit 2

UPDATE REFERENCE LIST (continued)

<u>Section</u>	<u>Cross References</u>
<u>Amendment 12</u>	
Table 1.7-2	Electrical Drawing Upgrade Project
<u>Amendment 13</u>	
1.2.2.10 1.2.2.4	Design Change Package 92-2011, "Alternate AC (AAC) Generator System"
Table 1.3-1	Design Change Package 94-2017, "Replacement of the Part Length Control Element Assemblies"
Figure 1.2-1	Design Change Package 91-1021, "Controlled Access Number 3"
Figure 1.2-1	Design Change Package 93-2022, "Operation of the Unit 2 Service Water Corrosion Inhibitor Injection System"
Figure 1.2-1	Plant Change 93-8031, "Central Support Building"
Figure 1.2-2 Figure 1.2-8	Design Change Package 87-2024, "SPING - Boric Acid Mix Room HVAC"
Figure 1.2-2	Limited Change Package 95-6007, "Replacement of Normal Control Room Chillers"
Figure 1.2-3 Figure 1.2-8	Design Change Package 90-2053, "Control Room Expansion Facility Addition"
Figure 1.2-3 Figure 1.2-5	Design Change Package 93-2020, "CA-1/CA-2"
Figure 1.2-4 Figure 1.7-1	Design Change Package 93-2014, "ANO-2 Main Chiller Replacement"
<u>Amendment 14</u>	
1.2.2.3.1 1.2.2.3.2 Figure 1.2-3	Design Change Package 94-2008, "Feedwater Control System Upgrade"
1.2.2.6 1.2.2.10 Table 1.2-1 Figure 1.2-1 Figure 1.2-3	Design Change Package 92-2001, "High Level Waste Storage"

ARKANSAS NUCLEAR ONE
Unit 2

UPDATE REFERENCE LIST (continued)

<u>Section</u>	<u>Cross References</u>
<u>Amendment 15</u>	
1.2.2.9	Design Change Package 946012D201, "Containment Vent Header/Waste Gas
Figure 1.2-5 Figure 1.2-8	System Modification"
1.2.2.10	Condition Report 1-96-0650, "Emergency Cooling Pond Inventory"
1.3.3 Figure 1.2-4	Design Change Package 963242D201, "Vital AC System Upgrade"
Table 1.7-2	Condition Report 2-98-0168, "Removal of Fire Barrier Penetration Seals Details"
Table 1.7-2	Design Change Package 89-2017, "Alternate AC Power Source Project"
Table 1.7-2	Design Change Package 963089D202, "Bus 2A2 & 2H2 Transformer Position Breaker Replacement"
Figure 1.2-1	Design Change Package 963559D301, "Computer/Telephone Room Power & AC Hardening"
Figure 1.2-1	Plant Change 963286P301, "T62B Tank Replacement"
Figure 1.2-2 Figure 1.2-8	Design Change Package 94-2006, "Plant computer Room HVAC Modification"
Figure 1.2-3	Plant Change 963203P201, "Additional Level Gauge to SFP"
Figure 1.2-3	Plant Change 973932P202, "Relocation of OCC to CA2 for Outage"
Figure 1.2-6 Figure 1.2-11	Design Change Package 973950D201, "NaOH Replacement with TSP"
Figure 1.7-1	Design Change Package 93-1009, "Main Chiller Replacement"
<u>Amendment 16</u>	
1.1 1.2.2.1.1 1.2.2.1.2 Table 1.7-2	Design Change Package 980642D210, "Replacement Steam Generator Design/Qualification"
1.2.2.2	Nuclear Change Package 991522N201, "Containment Cooler Upgrade"

ARKANSAS NUCLEAR ONE
Unit 2

UPDATE REFERENCE LIST (continued)

<u>Section</u>	<u>Cross References</u>
1.3.3 Figure 1.2-4	Design Change Package 963242D202, "Vital 120 VAC Upgrade"
Table 1.7-1	Design Change Package 980642D201, "Steam Generator Replacement Facilities"
Table 1.7-2	Design Change Package 963089D201, "Replacement of 4.16 and 6.9 kV Main Supply Breakers on 2H1 and 2A1"
Figure 1.2-4	Nuclear Change Package 963089N201, "Removal of 2X31 and 2A3 Bus Bracing Upgrade"
Figure 1.2-4	Nuclear Change Package 963089N202, "Bus Brace 2A4"
<u>Amendment 17</u>	
1.1 1.2.2.1.1 1.5.2	Engineering Request ANO-2000-2344-026, "Power Uprate Evaluation"
1.2.2.1.2	Unit 2 Technical Specification Amendment 242
1.2.2.10	Unit 2 Technical Specification Amendment 232
1.2.2.10	Engineering Request ANO-2002-0011-000, "Unit 1 and Unit 2 Instrument Air Cross-Connected Configuration"
<u>Amendment 18</u>	
1.2.2.7	SAR Discrepancy 2-97-0235, "Shutdown Cooling Initiation Temperature"
Table 1.7-2	Engineering Request ER-ANO-1998-1050, "Addition of E-2098 Connection Drawings to the ANO-2 SAR"
Figure 1.2-7 Figure 1.2-9	Condition Report ANO-C-1991-0073, "Upgrade of LBD Change Process"
Figure 1.7-1	License Document Change Request 2-1.7-0020, "Addition of Refrigerant Valve and Associated Note to Drawing M-2200, Sheet 3"
Figure 1.7-2	Internal Action, "Conversion of Design Drawings to Electronic Versions"
Figure 1.7-2	Condition Report ANO-1-1994-0322, "Clarification of Thermowells and Temperature Element Symbols"

ARKANSAS NUCLEAR ONE
Unit 2

UPDATE REFERENCE LIST (continued)

<u>Section</u>	<u>Cross References</u>
<u>Amendment 19</u>	
1.7.2	License Document Change Request 2-1.7-0022, "Generic Administrative Controls for SIT O/L Valves"
Figure 1.2-3	Engineering Request ER-ANO-2004-0487-000, "Update Component and Label Designations for Spent Fuel Pool Structures"
1.3.3	License Document Change Request 2-1.3-0009, "Revisions Resulting from Implementation of ANO-2 Technical Specification Amendment 255"
1.2.1 1.2.2.9 1.7.2 Table 1.7-2 All Figures	License Document Change Request 2-1.2-0048, "Deletion/replacement of Excessive Detailed Drawings from SAR"
1.2.2.1.2	License Document Change Request 2-1.2-0049, "License Renewal"
<u>Amendment 20</u>	
Table 1.7-2	License Document Change Request 05-058, "Deletion/simplification of Excessive Detailed Drawings from SAR"
Table 1.7-2	Engineering Request ER-ANO-2003-0399-003, "Modification of Reactor Internals Thimble Tubes"
1.2.2.10	Engineering Request ER-ANO-2006-0389-000, "Use of QCST as Emergency Feedwater Suction Source"
<u>Amendment 21</u>	
1.2.2.6	Engineering Change EC-419, "Use of Metamic Insert Panels in the Spent Fuel Pool"
1.2.2.1.1	Calculation CALC-ANO2-NE-08-00001, "ANO-2 Cycle 20 Reload Analysis Report"
<u>Amendment 22</u>	
Table 1.7-2	Engineering Change EC-443, "Construction of New ECP Spillway"
<u>Amendment 23</u>	
Table 1.3-1	Condition Report CR-ANO-2-2010-1222, "Correct Core Heat Output Units"
1.2.2.2	Engineering Change EC-10746, "Adoption of Alternate Source Terms"

ARKANSAS NUCLEAR ONE
Unit 2

UPDATE REFERENCE LIST (continued)

Section

Cross References

Amendment 24

- 1.2.2.10.E Engineering Change EC-23417, "RCP Vibration Data System Modification"
Table 1.2-1
- 1.3.3 Condition Report CR-ANO-C-2011-2122, "MET Data Exemptions to RG 1.23"
- 1.2.2.10 Engineering Change EC-34309, "Revised ECP Temperature/Inventory Analysis
and EDG Capacity Ratings"
- 1.7.4 Engineering Change EC-32194, "ANO-2 Cycle 23 Reload Report"

Amendment 25

- 1.7.4 Engineering Change EC-42844, "ANO-2 Cycle 24 Reload Report"

Amendment 26

- Table 1.7-2 Engineering Change EC-8011, "Update Drawing References"

Amendment 27

- 1.2.2.10.I Engineering Change EC-58247, "Installation of Common Feedwater System"

ARKANSAS NUCLEAR ONE
Unit 2

RECORD OF REVISIONS

<u>PAGE #</u>	<u>ADMENDMENT #</u>	<u>PAGE #</u>	<u>ADMENDMENT #</u>	<u>PAGE #</u>	<u>ADMENDMENT #</u>
TABLE OF CONTENTS		CHAPTER 1 (continued)		CHAPTER 1 (continued)	
1-i	27	1.6-1	15		
1-ii	27	1.6-2	15		
1-iii	27				
1-iv	27	1.7-1	25		
1-v	27				
1-vi	27	1.8-1	12		
1-vii	27				
1-viii	27	1.9-1	26		
1-ix	27	1.9-2	26		
1-x	27	1.9-3	26		
1-xi	27	1.9-4	26		
		1.9-5	26		
		1.9-6	26		
CHAPTER 1		1.9-7	26		
		1.9-8	26		
1.1-1	17	1.9-9	26		
		1.9-10	26		
1.2-1	27	1.9-11	26		
1.2-2	27	1.9-12	26		
1.2-3	27	1.9-13	26		
1.2-4	27	1.9-14	26		
1.2-5	27	1.9-15	26		
1.2-6	27	1.9-16	26		
1.2-7	27	1.9-17	26		
1.2-8	27	1.9-18	26		
1.2-9	27	1.9-19	26		
1.2-10	27	1.9-20	26		
		1.9-21	26		
1.3-1	24	1.9-22	26		
1.3-2	24	1.9-23	26		
1.3-3	24	1.9-24	26		
1.3-4	24	1.9-25	26		
1.3-5	24	1.9-26	26		
1.3-6	24	1.9-27	26		
		1.9-28	26		
1.4-1	15	1.9-29	26		
		1.9-30	26		
1.5-1	17				
1.5-2	17				
1.5-3	17				
1.5-4	17				
1.5-5	17				

ARKANSAS NUCLEAR ONE
Unit 2

1 INTRODUCTION AND GENERAL DESCRIPTION OF PLANT

1.1 INTRODUCTION

This updated Final Safety Analysis Report (FSAR) is submitted as required by 10 CFR 50.71. Arkansas Nuclear One - Unit 2 is located adjacent to Arkansas Nuclear One - Unit 1 on a peninsula in Dardanelle Reservoir on the Arkansas River in Pope County, Arkansas. The station location is shown on Figure 8.1-2.

Arkansas Nuclear One - Unit 2 began initial operation with core power levels up to 2,815 MWt, which, when contribution from the reactor coolant pumps was included (at 10 MWt), corresponded to an initial net output of approximately 952 MWe. Starting with Cycle 16, all physics and core thermal hydraulics information in this report is based on the rated core power level of 3,026 MWt, which when the maximum contribution from the reactor coolant pumps is added of 18 MWt corresponds to a net electrical output of approximately 1023 MWe. Site parameters, principal structures, engineered safety features, and postulated accidents which could result in a significant release of radioactivity to the environment are evaluated at the expected ultimate core output of 3087 MWt.

The Nuclear Steam Supply System (NSSS) is a Pressurized Water Reactor (PWR) of a type similar to systems now operating or under construction. It uses chemical shim and control rods for reactivity control and produces dry saturated steam in vertical U-tube steam generators. The original NSSS and the design and fabrication of the fuel core have been supplied by Combustion Engineering, Incorporated. The steam generators were replaced in the fall of 2000 prior to Cycle 15 with steam generators supplied by Westinghouse Electric Corporation, LLC.

This unit loaded fuel in August 1978 went critical for the first time in December 1978 and began commercial operation March 1980.

The organization of this report follows closely the "Standard Format and Content of Safety Analysis Reports for Nuclear Power Plants," Revision 1, and the design meets the General Design Criteria as listed in Appendix A to 10CFR50 as described in Section 3.1.

Entergy Operations, Inc., is fully responsible for the safe operation of the plant. The design, construction and aid in the testing and startup of the unit was supplied principally by Bechtel Corporation and Combustion Engineering, Incorporated. Assistance has been and will be rendered by other consultants as required.

On October 23, 1996 (0CNA109617), the NRC issued Amendment No. 177 to the facility operating license to revise the name of the plant's owner from Arkansas Power & Light Company to Entergy Arkansas, Inc. The name "Arkansas Power & Light" or "AP&L" remains in the SAR where the context is historical.

ARKANSAS NUCLEAR ONE
UNIT 2

1.2 GENERAL PLANT DESCRIPTION

1.2.1 PRINCIPAL SITE CHARACTERISTICS

Arkansas Nuclear One - Unit 2 is located adjacent to Arkansas Nuclear One - Unit 1 on a peninsula in Dardanelle Reservoir on the Arkansas River in Pope County, Arkansas. The plant is about six miles west-northwest of Russellville, Arkansas, and about two miles southeast of the village of London, Arkansas.

The 1100-acre site allows a minimum exclusion area radius of 0.65 miles from the center of the reactor. Easements have been obtained from the U.S. Army Corps of Engineers for exclusion rights during periods of emergency to portions of the bed and banks of the Dardanelle Reservoir that are within the 0.65-mile radius.

The site is located in a gently rolling valley south of the Boston Mountains and was previously used mostly for pasture land.

The plant grade elevation (near the center of the site) is 353 feet above Mean Sea Level (MSL) while the Dardanelle Reservoir fluctuates between 336 feet (normal pool) and 338 feet (maximum flood control pool) above MSL.

The site is characterized by remoteness from flooding; sound, hard rock for structure foundations; a reliable network for emergency power; and favorable conditions of hydrology, geology, seismology and meteorology.

1.2.2 CONCISE PLANT DESCRIPTION

1.2.2.1 Reactor and Reactor Coolant System

1.2.2.1.1 Reactor

The Pressurized Water Reactor (PWR) is designed for an initial core thermal output of 2815 MWt and an uprate output of 3026 MWt.

The reactor core is fueled with uranium dioxide pellets enclosed in zircaloy, ZIRLO™ OR Optimized ZIRLO™ tubes pressurized with helium and fitted with welded end plugs. The tubes are fabricated into assemblies in which end fittings prevent axial motion and grids prevent lateral motion of the tubes. The Control Element Assemblies (CEAs) consist of Inconel 625 alloy clad boron carbide absorber rods, guided by tubes in the fuel assembly. The initial core consisted of 177 fuel assemblies with several U-235 enrichments in a 3-batch, mixed central zone arrangement.

Fuel rod clad is designed to maintain cladding integrity throughout fuel life. Fission gas release within the rods and other factors affecting design life are considered for the maximum expected exposures.

The reactor and control systems are designed so that any xenon transients will be adequately damped.

The CEAs are capable of holding the core subcritical at hot zero power conditions with margin following a trip, even with the most reactive CEA stuck in the fully withdrawn position.

ARKANSAS NUCLEAR ONE
UNIT 2

The combined response of the fuel temperature coefficient, the moderator temperature coefficient, the moderator void coefficient and the moderator pressure coefficient to an increase in reactor thermal power is a decrease in reactivity. In addition, the reactor power transient remains bounded and damped in response to any expected changes in any operating variable.

The reactor is designed to accommodate safely and without fuel damage, the anticipated operational occurrences, backed up by automatic and redundant reactor trips.

See Chapter 4 for further information.

1.2.2.1.2 Reactor Coolant System

The Reactor Coolant System (RCS) is arranged as two closed loops connected in parallel to the reactor vessel. Each loop consists of one 42-inch ID outlet (hot) pipe, one steam generator, two 30-inch ID inlet (cold) pipes and two pumps. An electrically heated pressurizer is connected to one of the loops and a safety injection line is connected to each of the four inlet legs. The RCS is designed to operate at 2,200 psia.

The reactor vessel and its closure head are fabricated from SA-533 Grade B steel clad with stainless steel. Fluence and fracture toughness of the reactor vessel are discussed in Section 4.3.3.3 and Section 5.2.4.

The two steam generators are vertical shell and U-tube units. The steam generated in the shell side of the steam generator flows upward through moisture separators which reduce its moisture content to less than 0.1 percent. All RCS surfaces are either stainless steel or NiCrFe alloy in order to maintain reactor coolant purity.

The reactor coolant is circulated by four electric motor-driven, single-suction centrifugal pumps. The pumps shafts are sealed by mechanical seals. The seal performance is monitored by pressure and temperature sensing devices in the seal system.

The RCS is designed and constructed to maintain its integrity throughout the plant life. Appropriate means of test and inspection are provided.

See Chapter 5 for further information.

1.2.2.2 Engineered Safety Features

The plant design incorporates redundant Engineered Safety Features (ESF). These systems, in conjunction with the containment, insure that the off-site radiological consequences following any Loss of Coolant Accident (LOCA), up to and including a double-ended break of the largest reactor coolant pipe, will not exceed the guidelines of 10 CFR 50.67. The systems ensure that the requirements of 10 CFR 50.46 and Appendix K for Emergency Core Cooling Systems for Light Water Power Reactors are satisfied, based upon analytical methods, assumptions and procedures accepted by the Nuclear Regulatory Commission (NRC). The ESF include: (a) independent systems [Containment Cooling System (CCS) and Containment Spray System (CSS)] to remove heat from and reduce the pressure in the containment in order to maintain containment integrity, (b) a Safety Injection System (SIS) to limit fuel and cladding damage to an amount which will not interfere with adequate emergency core cooling and to limit metal-water reactions to negligible amounts, (c) a containment isolation system to minimize post-LOCA

ARKANSAS NUCLEAR ONE
UNIT 2

radiological effects off-site, (d) a hydrogen control system to maintain safe post-LOCA hydrogen concentration within the containment, (e) a habitability system to ensure control room habitability following a LOCA, (f) a penetration room ventilation system to ensure that post-LOCA leakage is collected, filtered, and monitored prior to release to the environment, and (g) a Main Steam Isolation System (MSIS) to protect the reactor and the containment in the event of a main steam line rupture.

See Chapter 6 for further information.

1.2.2.3 Instrumentation and Control

1.2.2.3.1 Control

The Reactor Control System is used for startup and shutdown of the reactor and for adjustment of the reactor power in response to turbine load demand. Normal control is accomplished by manual movement of CEAs or adjustment of boron concentration by the operator in response to a change in reactor coolant temperature. The temperature control program provides a demand temperature which is a function of turbine first stage pressure. This temperature is compared with the existing average reactor coolant temperature. If the temperature is different, operators adjust boron concentration and/or the CEAs until the difference is within the prescribed control band. Regulation of the reactor coolant temperature in accordance with this program maintains the secondary steam pressure within operating limits and matches reactor power to load demand.

Boric acid is used for reactivity changes associated with large but gradual changes in water temperature, xenon concentration and fuel burnup. Additions of boric acid also provide an increased shutdown margin during refueling. The boric acid solution is prepared and stored at a temperature sufficiently high to prevent precipitation.

CEA movement provides changes in reactivity for shutdown or power changes. The CEAs are actuated by control element drive mechanisms mounted on the reactor vessel head. The control element drive mechanisms are designed to permit rapid insertion of the CEAs into the reactor core by gravity.

The Core Operating Limit Supervisory System (COLSS) functions to monitor selected parameters, to provide an on-line calculation of margin to a Limiting Condition for Operation (LCO), and to actuate an alarm when an LCO is reached.

The pressure in the RCS is controlled by regulating the temperature of the coolant in the pressurizer, where steam and water are held in thermal equilibrium. Steam is formed by the pressurizer heaters or condensed by the pressurizer spray to reduce variations caused by expansion and contraction of the reactor coolant due to system temperature changes. Overpressure protection is provided by safety valves connected to the pressurizer and designed in accordance with ASME Code, Section III. The discharge from the pressurizer safety valves is released under water in the quench tank where it is condensed and cooled. When the RCS is below its setpoint (nominally 270 °F), the low temperature overpressure alarm alerts the operator if the low temperature overpressure protection relief isolation valves are not completely open. Overpressure protection for the quench tank is provided by a rupture disc which relieves to the containment.

ARKANSAS NUCLEAR ONE
UNIT 2

1.2.2.3.2 Instrumentation

The nuclear instrumentation includes out-of-core and in-core flux detectors. Six independent channels of out-of-core nuclear instrumentation monitor the fission process. Of these channels, the two startup channels are used to monitor the reactor during startup operations. The four safety channels are used to monitor the reactor from routine startup neutron flux levels up to 200 percent power and are used to initiate a reactor shutdown in the event of high linear or logarithmic power. The in-core monitors provide information on neutron flux distribution.

The reactor parameters are maintained within the acceptable limits by the inherent characteristics of the reactor, by the CEAs, by boric acid dissolved in the moderator, and by the operating procedures. In addition, in order to preclude unsafe conditions for plant equipment or personnel, the Reactor Protective System (RPS) initiates reactor shutdown if selected parameters reach their preset limits. Four independent channels normally monitor each of the selected plant parameters. The RPS logic is designed to initiate protective action whenever the signal of any two of four channels reaches the preset limit. Redundancy is provided in all parts of the RPS to assure that no single failure will prevent protective action when it is required.

The process instrumentation monitoring includes those critical channels which are used for protective action. Additional temperature, pressure, flow and liquid level monitoring is provided, as required, to keep the operating personnel informed of plant conditions, and to provide information from which plant processes can be evaluated and/or regulated.

The plant gaseous and liquid effluents are monitored for radioactivity. Activity levels are displayed and off-normal values are annunciated. Area monitoring stations are provided to measure radioactivity at selected locations in the plant.

See Chapter 7 for further information.

1.2.2.4 Electrical System

Unit 2 generates electrical power at 22 kV and is connected to the 500 kV station switchyard through its unit step-up transformer and a single dead-end span of 500 kV overhead transmission line. A bus-tie autotransformer bank interconnects the 500 kV and 161 kV systems in the station switchyard.

Startup Transformer 3 is energized from the 22 kV tertiary winding of the 500 to 161 kV autotransformer while Startup Transformer 2, which is common to both Units 1 and 2, is supplied from the 161 kV ring bus. Thus, either of these two startup transformers, which are fed from different sources, can provide the necessary startup and emergency load requirement of Unit 2. The normal power supply for the unit is the Unit 2 auxiliary transformer.

In the event of loss of normal and preferred auxiliary power sources, the ESF loads can be supplied from the onsite emergency power sources. The emergency onsite power sources consist of two independent and completely segregated emergency diesel generators, each of which has an adequate capacity to meet the loads required for safe shutdown of the reactor.

In the event of loss of normal and preferred auxiliary power sources and the on site emergency power sources (i.e., station blackout), a bus of ESF loads can be supplied from the Alternate AC power source which has adequate capacity to meet the loads required for safe shutdown of the reactor.

ARKANSAS NUCLEAR ONE
UNIT 2

The ESF redundant systems have been designed and segregated so that failure of one train will not jeopardize proper functioning of the other train in meeting the shutdown and post-shutdown requirements of the reactor.

Stringent quality assurance standards and programs have been followed in the design, selection, and installation of all Class 1E type equipment and systems. These are discussed in detail under appropriate sections of Chapter 8.

1.2.2.5 Power Conversion

The main turbine is an 1,800 rpm, tandem compound, 4-flow, impulse reaction, condensing unit, having one high pressure and two identical low pressure casings. Combination moisture separator reheaters are employed to dry and superheat the steam between the high and low pressure turbines. The auxiliaries include deaerating surface condensers, condenser vacuum pumps, cooling tower, turbine driven main feedwater pumps, motor driven condensate pumps, and seven stages of feedwater heaters.

The power conversion system removes heat energy from the reactor coolant in two U-tube steam generators, and the turbine-generator converts the steam's heat energy into electrical energy.

Steam produced in the steam generators enters the high pressure turbine through stop valves and governing control valves. From the high pressure turbine the steam flows through the moisture separator reheaters before entering the low pressure turbines.

Each steam line is provided with turbine bypass valves, which discharge to the condenser, and safety and dump valves, which discharge to atmosphere. Steam to the emergency feedwater pump turbine can be taken from either steam line.

The condenser transfers the unusable heat in the cycle to the condenser cooling water. The closed regenerative turbine cycle heats the condensate and returns it to the steam generators.

See Chapter 10 for further information.

1.2.2.6 Fuel Handling and Storage

New fuel is stored dry in vertical racks. Room is provided for 63 new fuel assemblies, with fuel assembly spacing and vault construction sufficient to preclude criticality. New fuel assemblies may also be stored in the spent fuel racks.

The stainless steel lined, reinforced concrete spent fuel pool provides storage for 988 fuel assemblies. Spent fuel assemblies are stored in vertical racks. Adequate spacing is provided to preclude criticality with no credit for the borated pool water.

Cooling and purification equipment is provided for the spent fuel pool cooling water.

Spent fuel cooled initially in the spent fuel pool can be stored in dry storage casks in the ANO ISFSI area.

ARKANSAS NUCLEAR ONE
UNIT 2

The fuel handling system provides for the safe handling of fuel assemblies and CEAs and for the required assembly, disassembly and storage of reactor internals. This system includes a refueling machine located inside the containment above the refueling pool, the fuel handling crane, the fuel transfer carriage, the tilting machines, a CEA handling tool and bridge gantry, new fuel elevator, fuel inspection stand, the fuel transfer tube, a fuel handling machine in the spent fuel storage room, and various devices used for handling and storing the reactor vessel head and internals.

See Section 9.1 for further information.

1.2.2.7 Cooling Water and Other Auxiliary Systems

A Service Water System (SWS) provides required cooling water flows to ESF equipment served by the system, as well as to various non safety-related portions of the plant. That portion of the SWS required for safe shutdown of the plant is designed to meet Seismic Category 1 requirements and the single failure criterion as defined in Chapter 3. Non-safety-related portions are isolated from the SWS during events resulting in ESF actuation. A complete description of the system is found in Section 9.2.1.

A Component Cooling Water (CCW) System removes heat from various reactor auxiliary systems which carry radioactive or potentially radioactive fluids. These systems also require higher water quality than that provided by the SWS. Radiation monitors at the inlet of the component cooling water heat exchangers alarm the control room should radioactivity rise above a preset limit. The CCW System is not required for safe plant shutdown. A complete description of the system is found in Section 9.2.2.

A compressed air system is provided to supply dry, oil-free instrument air for pneumatic controls and valve operators. In addition, a service air system is provided to supply air for pneumatic tools and other air operated equipment. This system is not required for safe shutdown since all pneumatically operated devices in the plant which are essential are designed to assume a fail-safe position upon loss of air supply. This system is described in Section 9.3.1.

A Chemical and Volume Control System (CVCS) controls the purity and chemistry of the reactor coolant as described in Section 9.3.4. Part of the reactor coolant is bypassed through the CVCS via regenerative and letdown heat exchangers, a filter, and ion exchangers before being sprayed into the volume control tank. The charging pumps take suction from this tank and pump the coolant back into its system.

The Shutdown Cooling (SDC) System reduces the temperature of the reactor coolant from less than 275 °F to the refueling temperature, removes decay heat during normal shutdown, and removes heat from the recirculating containment sump water via the shutdown cooling heat exchangers following a LOCA. Section 9.3.6 describes this system.

1.2.2.8 Radioactive Waste Management Systems

The Boron Management System (BMS) and Waste Management Systems (WMS) were designed to provide the means for controlled handling, storage and disposal of liquid, gaseous and solid wastes. As the state of the art of waste management improved, it became economically feasible to utilize vendors to treat liquid and solid waste. The BMS was originally designed to reconcentrate and recover dissolved boron from the liquid effluent for reuse in the plant. This capability of the BMS is currently not used.

ARKANSAS NUCLEAR ONE
UNIT 2

Liquid effluent from the RCS first passes through one of the purification filters in the CVCS. When the BMS is used, liquid effluent is processed by successively passing through the vacuum degasifier, filters, and ion exchangers. This operation removes the radioactive material. As the BMS was originally designed, the liquid could then be processed through the boric acid concentrator; however, the concentrator is currently not in use. Other radioactive liquid wastes can be processed in the WMS for release to the environment or (in the original design) solidification and drumming. The solidification feature is currently not used.

All liquid wastes are sampled prior to release. The waste release rates are as low as practicable and within the guidelines and limits for waste release established by 10 CFR 20 and 10 CFR 50.

All solid wastes are stored in suitable containers for ultimate off-site disposal in accordance with applicable regulations.

Waste gases are filtered and released to the atmosphere via the gas collection header. High activity gases collected in the VCT or the BMS vacuum degasifier are compressed into gas decay tanks. The waste gas held in the gas decay tanks is released to the plant vent after sampling. The tank contents are released at rates well within the limits established by 10 CFR 20 and 10 CFR 50.

See Chapter 11 for further information.

1.2.2.9 General Arrangement of Major Structures and Equipment

Unit 2 is on the same site and is adjacent to Unit 1.

Unit 2's major structures include the containment, turbine building, auxiliary building and a single natural draft cooling tower.

The Unit 2 turbine building is directly north of and abutting the Unit 1 turbine building. The containment is west of the turbine building. The auxiliary building is west of the turbine building adjacent to the containment. The cooling tower is west of and slightly north of the containment. The Unit 2 transformer yard is an extension of the Unit 1 yard and is located east of the turbine building.

The containment houses the NSSS consisting of the reactor, two steam generators, four reactor coolant pumps, the pressurizer, and portions of the RCS auxiliaries and ESF.

The turbine building houses the turbine generator, condenser, condensate and feedwater pumps, low pressure feedwater heaters and various turbine auxiliary equipment.

The auxiliary building houses the fuel handling system, waste processing systems, NSSS auxiliary equipment, high pressure feedwater heaters, vital electrical switchgear and power supplies, the control room and portions of the ESF.

ARKANSAS NUCLEAR ONE
UNIT 2

1.2.2.10 Interrelationship With Unit 1

Separate systems and equipment are provided for Unit 2, with few exceptions. Any item or system not specifically identified in the text or on the system diagrams as being shared is used exclusively for Unit 2. The safety of either unit would not be impaired by the failure of the facilities and systems which are shared. A summary of the major shared facilities and equipment follows:

- A. Electrical System - Startup Transformer 2 is common to Units 1 and 2 and is available as a standby transformer for the respective unit auxiliary or startup transformers. Its availability as an additional, independent source of power (Section 8.2) to the two sources normally provided for each unit, allows operational flexibility without loss of the redundancy required for the ESF power supply.
- B. Control Room - The plant is provided with a central control room located in adjacent areas of the respective auxiliary buildings. The control panels and equipment are physically separated in the control room by a partition wall to eliminate interaction between Unit 1 and Unit 2 systems. Vent louvers above the partition are open to allow the ventilation systems to be shared by both units. The intent of the design is to centralize facility control and yet ensure the safe operational status of each plant, even under accident conditions.

There are two normal ventilation systems, one for the Unit 1 half and one for the Unit 2 half of the common control room. The air is monitored for radiation and chlorine. Upon receiving a high radiation signal, the entire control room, both Unit 1 and Unit 2 sections, is sealed except for filtered outside air used for pressurization to minimize unfiltered air inleakage. This arrangement assures redundancy in the monitoring system. Air conditioning for both control rooms under isolated control room conditions is maintained by emergency air handling units and condensing units located in Unit 2. The emergency air conditioners are normally powered from vital buses in Unit 2, but one train can be supplied power from a vital bus in Unit 1. Only one emergency air conditioning train is required to operate during and following a shutdown of both units.

- C. Emergency Cooling Pond - The cooling pond serves as the source of emergency cooling water for simultaneously shutting down both Units 1 and 2 in the unlikely event of a loss of the Dardanelle Reservoir water inventory. It may also be used as the heat sink for normal plant shutdown in lieu of using the Dardanelle Reservoir, if that is desired. Under controlled conditions, with the Dardanelle Reservoir available, the ECP may provide SW/ACW to Unit 1 with Unit 2 and/or Unit 1 providing makeup to preserve ECP inventory. It is sized to contain sufficient water for dissipating the total combined heat transferred to the Unit 1 and 2 SWS during the design basis LOCA in one unit and a normal plant shutdown of the other unit, while limiting the cooling pond temperature to a maximum of 116 °F. It is also sized to provide adequate fire protection water.

Separate suction and discharge water lines are used for supplying pond water to the Unit 1 and Unit 2 SWSs. The end of the lines terminating at the cooling pond are housed in seismic Category 1 structures to prevent blockage of the pipe entrance and outlet. A detailed discussion of the pond is contained in Sections 2.5 and 9.2.

ARKANSAS NUCLEAR ONE
UNIT 2

- D. Waste Disposal System - Certain portions of the waste disposal system are common for Units 1 and 2. These include:
1. Solid Waste Handling and Storage Facilities;
 2. Laundry Waste System;
 3. Liquid Waste Discharge (circulating water discharge), and
 4. Boric Acid Concentrators (currently not in use).
- E. Miscellaneous – The list below contains other common facilities or systems of some significance; it is not intended to list all shared facilities, systems, or components. A functional evaluation of these components is shown in Table 1.2-1. Failure of any of these shared systems will be of no serious consequence since such failure will not prevent the safe shutdown of either unit.
1. Raw Water Storage Tank
 2. Diesel Fuel Oil Bulk Storage Tank
 3. Communications Systems
 4. Clean Chemistry Laboratory and Count Room
 5. Fire Water Main, Fire Pumps
 6. Fuel Handling Crane (Auxiliary Building)
 7. On-Site and Off-Site Environmental Monitoring
 8. Sodium Bromide/Sodium Hypochlorite System
 9. Turbine Building Crane, Elevator
 10. Intake Structure Gantry Crane
 11. Startup Boiler
 12. Office Buildings
 13. Railroad Spur, Access Roads and Parking Facilities
 14. Switchyard, Transmission Lines
 15. Telemetry and Load Dispatching Equipment
 16. Shops (Clean Instrument, Hot Instrument, Hot Machine, Machine, and Welding)
 17. Storeroom, Maintenance Facility, Warehouse, and Gas Bottle Storage
 18. Reservoir Water Canals
 19. Tendon Maintenance Scaffolding (portable)
 20. Instrument Air Systems
 21. Service Air Compressor
 22. Breathing Air System
 23. Control Room Kitchen and Sanitary Facilities
 24. Oily Water Separator

ARKANSAS NUCLEAR ONE
UNIT 2

25. Sewage System
 26. Station Security System
 27. High Purity Hydrogen System
 28. DELETED
 29. Liquid Nitrogen Storage Tank
 30. Bulk Hydrazine Transfer
 31. Post Accident Sampling System (PASS) Building
 32. Independent Spent Fuel Storage Installation (ISFSI)
 33. Low Level Radwaste Storage Building (LLRWSB)
- F. Safety Parameter Display System (SPDS) - The SPDS is a computer-based system designed to monitor and display to the operator a concise set of parameters from which the safety status of the plant can be readily and reliably ascertained. The system functions as the SPDS for both the ANO-1 and ANO-2 Control Rooms and provides plant status information for the Technical Support Center (TSC) and Emergency Operations Facility (EOF).
- See Section 7.6.2.5 for an overall description of the system.
- G. Alternate AC (AAC) Power Source - The AAC power source, which consists of a 4400 kW diesel generator (continuous rating) and supporting auxiliaries, is designed to manually pick up the loads on one 4160V ESF bus in either Unit 1 or Unit 2 in the event of a station blackout in either unit. Additionally, it can be connected to a non-1E bus in either unit for performance testing or peaking.
- H. Condensate Storage Tank T41B - A safety-grade condensate storage tank, T41B, is shared by Unit 1 and Unit 2. This seismically qualified tank is connected to the Unit 2 EFW system as an available source of EFW.
- I. The Common Feed Water (CFW) System is designed to provide a non-safety related backup source of water to either or both steam generators on either Unit 1 or Unit 2 in the event that the EFW system is not available during certain fire scenarios. See Section 10.4.11 for additional information on the CFW system.

ARKANSAS NUCLEAR ONE
Unit 2

1.3 COMPARISONS

1.3.1 COMPARISON WITH SIMILAR FACILITY DESIGNS

Table 1.3-1 presents a summary of the characteristics of the Arkansas Nuclear One - Unit 2 plant for Cycle 1 operation. The table includes similar data for Arkansas Nuclear One - Unit 1 (Docket No. 50-313), San Onofre Units 2 and 3 (Docket Nos. 50-361 and 50-362), and Calvert Cliffs Units 1 and 2 (Docket Nos. 50-317 and 50-318), as published for those units. The parameters listed in the ANO-2 Preliminary Safety Analysis Report (PSAR) are shown in parentheses for ease of comparison.

The San Onofre Units 2 and 3 design was selected for comparison because of the basic similarity of the reactor and Nuclear Steam Supply System (NSSS). The Calvert Cliffs Units 1 and 2 design was selected for comparison because of the similarity of the Reactor Coolant System (RCS) and because it was the most recent Combustion Engineering, Inc., (CE) reactor to complete the operating license review by the Directorate of Licensing (DL) and the Advisory Committee on Reactor Safeguards (ACRS). ANO-1 is representative of another supplier's reactor design and was selected since it shares the site with ANO-2 and since it had recently completed the operating license review by DL and ACRS.

Bechtel Power Corporation has served as the Architect/Engineer on all of these plants and has been responsible for the containment design.

1.3.2 COMPARISON OF FINAL AND PRELIMINARY INFORMATION

In the original Final Safety Analysis Report (FSAR) this section provided a discussion of all significant changes that were made in the plant design between the time the PSAR was submitted and the submittal of the original FSAR. Such a comparison is no longer useful in understanding the FSAR. This section was deleted in the update process. It is still available in the original FSAR.

1.3.3 COMPARISON OF PLANT DESIGN WITH REGULATORY GUIDE RECOMMENDATIONS

This section addresses the extent of conformance of plant design with those regulatory guides (or reference sections where such conformance is noted) in effect at the date of issuance of the construction permit, i.e., the applicable guides. In some cases, later revisions of the original guides are addressed if conformance with the later revision is appropriate for Unit 2. The remaining Division 1 Regulatory Guides are not addressed here as they were not included in the design basis of the unit as determined at issuance of the construction permit. However, elsewhere in this SAR, in the description of specific systems, the extent of conformance to specific guides of later issuance may be addressed even though they were not included in the original design basis.

Regulatory Guide 1.1 (12/1/70)

Net Positive Suction Head For Emergency Core Cooling and Containment Heat Removal System Pumps

See Section 6.2.2.2.1.B.1 for the Containment Heat Removal Systems and Section 6.3.2.14 for the Emergency Core Cooling System (ECCS).

ARKANSAS NUCLEAR ONE
Unit 2

Regulatory Guide 1.2 (11/2/70)

Thermal Shock to Reactor Pressure Vessels

CE has performed detailed analyses dealing with reactor vessel response to thermal shock and a summary of this work, along with the other considerations of this Regulatory Guide, is contained in Section 6.3.3.13.1. This program is in conformance with Regulatory Guide 1.2.

Regulatory Guide 1.3

Assumptions Used for Evaluating the Potential Radiological Consequences of a LOCA for Boiling Water Reactors

Not Applicable.

Regulatory Guide 1.4 (Revision 2, June 1974)

Assumptions Used for Evaluating the Potential Radiological Consequences of a LOCA for Pressurized Water Reactors

Unit 2 conforms to all portions of this guide except C.2.g(3) regarding atmospheric conditions. Site meteorology was used based on a five percentile criterion. Sections 15.1.0.5.2 and 15.1.13.2 provide a more detailed explanation.

Regulatory Guide 1.5

Assumptions Used for Evaluating the Potential Radiological Consequences of a Steam Line Break Accident for Boiling Water Reactors

Not applicable.

Regulatory Guide 1.6 (3/10/71)

Independence Between Redundant Standby (Onsite) Power Sources and Between Their Distribution Systems

See Sections 8.3.1.2 and 8.3.2.2.

Regulatory Guide 1.7 (3/10/71)

Control of Combustible Gas Concentrations in Containment Following a LOCA

See Section 6.2.5.

Regulatory Guide 1.8 (2/10/71)

Personnel Selection and Training

As stated in Section 13.1.2, plant personnel qualification requirements are in compliance with ANSI N18.1 dated March 8, 1971. Personnel training and retraining, described in Section 13.2, are also in compliance with ANSI N18.1 dated March 8, 1971.

ARKANSAS NUCLEAR ONE
Unit 2

Regulatory Guide 1.9 (3/10/71)

Selection of Diesel Generator Set Capacity for Standby Power Supplies

See Section 8.3.1.2.

Regulatory Guide 1.10 (Revision 1, 1/2/73)

Mechanical (Cadmold) Splices in Reinforcing Bars of Concrete Containments

See Sections 3.8.1.2.4 and 3.8.1.6.2.

Regulatory Guide 1.11 (3/10/71)

Instrument Lines Penetrating Primary Reactor Containment

This Regulatory Guide is not applicable to Unit 2 since there are no instrument fluid sensing lines penetrating the containment.

Regulatory Guide 1.12 (3/10/71)

Instrumentation For Earthquakes

See Section 3.7.4.1.

Regulatory Guide 1.13 (3/10/71)

Fuel Storage Facility Design Basis

The Unit 2 design conforms to all aspects of this guide as described in Section 9.1, based on our position that redundant Seismic Category 1 makeup paths provide adequate cooling capability in the event of a DBE.

Regulatory Guide 1.14 (10/27/71)

Reactor Coolant Pump Flywheel Integrity

See Section 5.2.6.1.

Regulatory Guide 1.15 (Revision 1, 12/28/72)

Testing of Reinforcing Bars for Category 1 Concrete Structures

See Sections 3.8.1.2.4 and 3.8.1.6.2.

Regulatory Guide 1.16 (10/27/71)

Reporting of Operating Information

Conformance with this guide is addressed in the Technical Specifications and Technical Requirements Manual since the guide covers only reporting requirements.

ARKANSAS NUCLEAR ONE
Unit 2

Regulatory Guide 1.17 (June 1973)

Protection of Nuclear Power Plants Against Industrial Sabotage

An Industrial Security Plan has been prepared and submitted (Docket 50-313) which provides the information requested by this guide.

Regulatory Guide 1.18 (Revision 1, 12/28/72)

Structural Acceptance Test for Concrete Primary Reactor Containment

See Sections 3.8.1.2.4 and 3.8.1.7.1.

Regulatory Guide 1.19 (Revision 1, 8/11/72)

Nondestructive Examination of Primary Containment Liner Welds

See Sections 3.8.1.2.4 and 3.8.1.6.3.

Regulatory Guide 1.20 (12/29/71)

Comprehensive Vibration Assessment Program for Reactor Internals During Preoperational and Initial Startup Testing

AP&L implemented a PVMP for Unit 2 in accordance with the requirements of Regulatory Guide 1.20 as it relates to other than prototype units. The basis for this approach and supporting data are contained in Section 3.9.1.4 and in references cited in Section 3.9.

Regulatory Guide 1.21 (12/29/71)

Measuring and Reporting of Effluents from Nuclear Power Plants

The reporting and monitoring recommendations of this guide are covered in the Technical Specifications. The waste management equipment described in detail in Chapter 11 is sufficient to provide the capability for monitoring as recommended in the guide.

Regulatory Guide 1.22 (2/17/72)

Periodic testing of Protective System Actuation Functions

See Sections 7.2.1.1.9 and 7.3.1.1.9.

Regulatory Guide 1.23 (2/17/72)

Onsite Meteorological Programs

The meteorological program described in Section 2.3 complies with the guide except as follows:

- A. Temperature difference accuracy is ± 0.3 °C.
- B. Dew point temperature accuracy is ± 2.0 °C.
- C. Wind speed accuracy.

ARKANSAS NUCLEAR ONE
Unit 2

Regulatory Guide 1.25 (3/23/72)

Assumptions Used for Evaluating the Potential Radiological Consequences of a Fuel Handling Accident in Fuel Handling and Storage Facility for Boiling and Pressurized Water Reactors

See Section 15.1.23.2.2.

Regulatory Guide 1.26 (3/23/72)

Quality Group Classifications and Standards

See Section 3.2.2.

Regulatory Guide 1.27 (Revision 1, March 1974)

Ultimate Heat Sink for Nuclear Power Plants

See Section 9.2.5.3.

Regulatory Guide 1.28 (6/7/72)

Quality Assurance Program Requirements

The quality assurance program described in the Quality Assurance Program Manual (QAPM) complies with Regulatory Guide 1.28 and ANSI N45.2, or describes acceptable alternatives and meets the requirements of 10CFR50, Appendix B. The QAPM describes the revision of Regulatory Guide 1.28 and ANSI N45.2 that is satisfied.

Regulatory Guide 1.29 (6/7/72)

Seismic Design Classification

See Section 3.2.1.2.

Regulatory Guide 1.30 (8/11/72)

Quality Assurance Requirements for the Installation, Inspection, and Testing of Instrumentation and Electric Equipment

This guide is fully complied with as detailed in the Quality Assurance Program Manual.

Regulatory Guide 1.31 (Revision 1, June 1973)

Control of Stainless Steel Welding

See Section 5.2.5.7.

Regulatory Guide 1.32 (8/11/72)

Use of IEEE 308-1971, "Criteria for Class 1E Electric Systems for Nuclear Power Generating Stations"

ARKANSAS NUCLEAR ONE
Unit 2

Full compliance with Regulatory Guide 1.32 has been met as shown in Sections 8.3.2.1.2 and 8.3.2.2.

The battery chargers have been sized to restore the station batteries to a fully charged state while simultaneously supplying all connected loads.

Regulatory Guide 1.33 (11/3/72)

Quality Assurance Program Requirements

The program described in the Quality Assurance Program Manual (QAPM) meets the recommendations of this guide. The QAPM describes the revision of Regulatory Guide 1.33 that is satisfied.

ARKANSAS NUCLEAR ONE
Unit 2

1.4 IDENTIFICATION OF AGENTS AND CONTRACTORS

Arkansas Power & Light Company, as owner, arranged for the purchase of equipment and consulting, engineering and construction services for the installation of Unit 2. [Arkansas Power & Light subsequently became Entergy Arkansas, Inc.](#) Entergy Operations, Inc., is responsible for the operation of the unit.

The Bechtel Corporation was retained for engineering, procurement and management of construction services. They also provided assistance in obtaining licenses and permits in pre-operational testing, in quality control, and in initial startup of the project.

Combustion Engineering, Inc., (CE) was contracted to design, manufacture and deliver to the site a complete nuclear steam supply system and fuel. In addition, CE supplied competent technical and professional consultation for erection, initial fuel loading, testing and initial startup of the complete nuclear steam supply system.

The General Electric Company supplied the turbine generator and its auxiliaries.

ARKANSAS NUCLEAR ONE
UNIT 2

1.5 REQUIREMENTS FOR FURTHER TECHNICAL INFORMATION

This section provides a description of safety-related technical information relevant to this application.

The Unit 2 reactor incorporates a 16 x 16 fuel assembly with five guide tubes. This design provides an increase in conservatism for LOCA considerations with a minimum change from previous CE fuel designs. The previous designs have undergone extensive testing and operating experience is now being acquired.

The three test programs described in Sections 1.5.1, 1.5.2 and 1.5.3 are considered necessary to confirm the adequacy of the 16 x 16 fuel design. CENPD-87 (Reference 7) and CENPD-184 (Reference 6) present descriptions of development programs aimed at verifying the NSSS design and the anticipated performance characteristics, and at confirming the design margins. Those programs that apply to this plant are identified in Sections 1.5.4 through 1.5.12.

1.5.1 FRETTING AND VIBRATIONS TESTS OF FUEL ASSEMBLIES

A test has been performed using a full sized 16 x 16 fuel assembly. This assembly is identical to the 16 x 16 five guide tube designs used on the Unit 2 reactor. This assembly was subjected to flow testing under reactor operation conditions of temperature, water chemistry, pressure and flow velocity. The results of this test are presented in the Reference Section of Chapter 4.

1.5.2 DEPARTURE FROM NUCLEATE BOILING (DNB) TESTING

Extensive heat transfer testing has been completed with rod bundles representative of the CE 14 x 14 fuel assembly. Analysis of the data using the CE thermal-hydraulic design methods demonstrated the validity of those methods for computing thermal margin and pressure drop for plants using the 14 x 14 fuel assembly. Additionally, the DNB test program has been extended to include DNB tests to confirm the heat transfer capability of the CE 16 x 16 fuel assembly. DNB data were taken for a range of test conditions using electrically heated rod bundles representative of the 16 x 16 fuel assembly. The COSMO/INTHERMIC design codes and the W3 correlation were then employed to predict DNBR under the test conditions. Measured and predicted DNB heat fluxes were then compared for all data in the pressure range of 1,750 to 2,450 psia and with mass velocities less than 3.2×10^6 lb/hr-ft². The results of this comparison support the use of the COSMO/INTHERMIC codes and the W3 correlation with a minimum DNBR of 1.3 for computing margin to DNB for the CE 16 x 16 fuel assembly. Additional information on the program and results may be found in Section 4.4.4.2. This supports the analytical methods for computing margin to DNB for Cycle 1 operation. Analytical methods used for later cycles are discussed in [Section 4.4.3.4.2](#).

1.5.3 FUEL ASSEMBLY STRUCTURAL TESTS

The fuel assembly structural testing program was designed to verify the structural adequacy of the CE fuel assembly design under normal handling, normal operation, seismic excitation and LOCA loadings. The test program provides the structural characteristics employed in the fuel assembly structural analyses.

A series of tests were conducted on a CE 14x14 fuel assembly to determine the combined axial and lateral load deflection characteristics of the fuel assembly. Axial compression tests and axial drop tests were performed. Measurements were made of axial loads, axial deflections, lateral deflections of all spacer grids, and strains in the guide tubes and fuel rods.

ARKANSAS NUCLEAR ONE UNIT 2

A series of structural tests on the 16x16 fuel assembly design have also been conducted. A prototype fuel assembly has been subjected to both static and dynamic tests which have determined basic structural characteristics. In addition, several 16 x 16 spacer grids have been subjected to impact tests to determine dynamic load deflection characteristics and damage limits. This test program is summarized in Reference 6 and the results of the tests are presented in the Reference Section of Chapter 4.

1.5.4 FUEL ASSEMBLY FLOW MIXING TESTS

The fuel assembly flow mixing program was designed to determine the magnitude of turbulent interchange in the CE fuel assembly designs. Test data were generated from a two-part series of tests conducted in 1966 and 1968. First, in 1966, a series of single phase tests on coolant mixing through turbulent interchange was run on a model fuel assembly which was geometrically similar to the Palisades assembly. The model enabled determination of vertical subchannel flow rates using pressure instrumentation and the average level of turbulent interchange using dye injection and sampling equipment.

A second series of single phase dye injection mixing tests were conducted on a model of a portion of a CEA type fuel assembly which had sufficient instrumentation to enable measurement (via a data reduction computer program) of the lateral flow across the boundaries of 12 subchannels of the model. These tests, further described in Reference 7, established the effect of turbulent interchange and coolant mixing in CE fuel assemblies and have been completed. Additional information is presented in Section 4.4.4.4.

1.5.5 REACTOR FLOW MODEL TESTING AND EVALUATION

The objective of the reactor flow model test programs is to obtain information on: (1) flow and pressure distributions in various regions of the reactor, (2) pressure loss coefficients, (3) hydraulic loads on vessel internal components, and (4) the detailed flow paths within the reactor vessel. This information is used for establishing or verifying design hydraulic parameters.

Flow model testing, which began in 1966, was designed to obtain those reactor hydraulic design data not amenable to direct calculation. Scale model testing possesses the advantages, relative to actual reactor tests, of: (1) providing the information early in the design stage, (2) being more suitable for extensive instrumentation, and (3) being flexible so that proposed design modifications can be investigated.

The reactor flow models used by CE are approximately one-fifth true scale models, with the exception of the core region which to-date has been simulated by closed tubes, one for each fuel bundle.

By the end of 1972, actual "closed-core" flow model tests had been conducted on four configurations. The conclusions from the tests on the first four configurations are summarized in Reference 7. Additional information on the results of these tests and their applicability to Unit 2 is contained in Section 4.4.3.1.1. These tests are the basis for establishing the flow distribution within the reactor vessel, assigning flow maldistribution factors for thermal margin evaluation, and for predicting component and nozzle-to-nozzle pressure drop.

ARKANSAS NUCLEAR ONE
UNIT 2

1.5.6 FUEL ASSEMBLY FLOW TESTS

The purpose of the fuel assembly flow test program was to determine normal fuel assembly distributions and to assess the effect of postulated flow maldistributions on thermal behavior and margin.

The program originated in 1967 with fuel assembly flow distribution testing. Both flow visualization and flow pattern measurements were generated on an overscale model of the lower portion of a Palisades fuel assembly. A second test series was conducted for the CEA type fuel assembly. The second test series was designed to: (1) obtain subchannel flow redistribution data which could be used in developing and validating multi-subchannel thermal and hydraulic analysis methods, (2) determine the effect of various flow obstructions on flow distribution within the fuel assembly, and (3) determine the magnitude of the effect of several of the disturbed flow patterns on the thermal margin within a CEA type reactor.

The information from these tests, described further in Reference 7, has provided subchannel flow redistribution data for confirmation of thermal-hydraulic analysis methods and has established the effect of flow obstructions within the fuel assembly. Additional information on the effects of postulated fuel coolant channel flow blockage is presented in Section 4.4.3.10.

1.5.7 CONTROL ELEMENT DRIVE MECHANISM (CEDM) TESTS

Performance testing of the magnetic jack CEDM is described in Section 4.2.3.4.1 and in Reference 7. The program has confirmed the operability of the drive assembly in normal and misaligned conditions as well as the load-carrying capability and life characteristics.

1.5.8 SAFETY INJECTION SYSTEM IMPROVEMENT

A parametric analysis of Emergency Core Cooling System (ECCS) performance was conducted by calculating the resultant peak clad temperatures for both large and small break Loss of Coolant Accidents (LOCA) for a variety of safety injection tank pressures and water/gas volume fractions. The purpose of this analytical program was to determine if ECCS performance could be improved and accident consequences reduced by optimization of the safety injection tank parameters.

This program, further described in Reference 7, established the effective pressure for safety injection tanks and the required total tank volume and gas/water volume ratio for Unit 2.

1.5.9 DNB IMPROVEMENT

The Departure from Nucleate Boiling (DNB) improvement program was initiated by CE in order to obtain empirical information on the DNB phenomenon and on other thermal and hydraulic characteristics of CE fuel assemblies. Testing has been performed with electrically heated rod bundles which correspond dimensionally to fuel rod configurations under in-reactor temperature pressure and flow conditions to obtain data on DNB, pressure drop, and coolant channel exit temperatures. These data have been employed to verify that the CE thermal hydraulic design methods conservatively predict DNB.

This program is described in References 6 and 7. It is a continuing program providing improvements in the accuracy of CE thermal and hydraulic computer programs for predicting local coolant conditions and pressure drops and confirming the applicability of currently used DNB correlations to the CE fuel design. Additional information on the program and results applicable to Unit 2 are presented in Section 4.4.4.2.

ARKANSAS NUCLEAR ONE
UNIT 2

1.5.10 LOCA REFILL TESTING

The objective of this program was to perform preliminary tests to determine the amount of ECCS water injected during blowdown that is retained in the reactor vessel lower plenum.

As a follow-on to the CE/AEC/EPRI steam-water mixing program, CE conducted additional tests on its own to investigate the ECCS bypass problem. The tests were performed on the one-fifth scale model used for the steam-water mixing tests. The cold leg piping was used to bring the ECC water into the downcomer. Steam up-flow in the annulus was developed by flowing the steam directly into the vessel core region. Varying steam flow rates, ECC injection rates and ECC temperatures were investigated.

The preliminary results showed that the amount of water retained in the lower plenum increased as the steam flow decreased and amount of water injected for annulus condensation increased. The test program is summarized in Reference 6. In the approved CE LOCA large break evaluation mode, Reference 2, no credit is taken for ECC injection prior to the end-of-bypass (EOBYP). Under the New Acceptance Criteria, Reference 1, all of the ECC water injected prior to EOBYP must be discarded.

Task C of the CE/AEC/EPRI steam-water mixing program involved annulus penetration tests to investigate the amount of ECCS water injected during blowdown that is retained in the reactor vessel lower plenum. The reactor vessel was one-fifth scale and the cold leg inlet pipe was one-fifth scale diameter and full scale length. A detailed description of the test facility, including the vessel and nozzle mockup, is presented in Reference 12. The experimental test matrix is given in References 11 and 13 and the test results are presented in References 9 and 10. These scoping tests demonstrated that the approved refill model in Reference 2 was conservative.

As a follow-on to the Task C tests, CE performed additional annulus penetration tests. These tests were performed in the same test facility as the Task C tests. The objective of these tests was to investigate a larger range of steam flow rates, ECC injection rates and ECC temperatures than the Task C tests provided. These preliminary results again demonstrated the conservativeness of the refill model in Reference 2. The scoping plenum refill tests were completed in 1974 at CE. Although the test results appeared promising, it appeared that the development of a more realistic, i.e., less conservative, bypass model would require a significant experimental and analytical effort. In addition, the effect of a new bypass model on 16x16 fuel assembly plants, e.g., Arkansas, which are late reflood limited is negligible. Thus, it was decided to terminate further annulus penetration testing. There are no plans to continue the program or to produce a closeout report.

1.5.11 BLOWDOWN HEAT TRANSFER TESTING

A joint CE/EPRI blowdown heat transfer testing program was conducted. The objectives of the test program were:

- A. To improve the understanding of transient critical heat flux and post-CHF heat transfer phenomena expected to occur in PWR cores during LOCA blowdown conditions.
- B. To experimentally determine the time, location, and distribution of transient CHF and the transient post-CHF heat transfer coefficients in single heated tubes with internal flow and in-rod bundles subjected to conditions representative of large hot and cold leg breaks in PWR's.

ARKANSAS NUCLEAR ONE
UNIT 2

Reactor core transient conditions that are predicted to occur during a hypothetical Loss of Coolant Accident (LOCA) were tested. The test program emphasized hydraulic simulation of large cold leg breaks including the double-ended guillotine break. The test program utilized electrically heated rod bundle and single tube test sections. The Single Tube Test Program was performed in CE test laboratories in Windsor, Connecticut, and the Rod Bundle Test Program was performed at Columbia University Heat Transfer Facilities in New York City. The rod bundles consist of 25 heated rods (5 x 5 square array) and have active heated length of 12.5 feet. The rod bundle had a uniform axial heat flux profile and a non-uniform radial power distribution. The non-uniform radial power profile, which simulates a quadrant of a fuel assembly, had a central 9-rod hot region with a 1.070 peak-to-average power distribution and 16 cooler rods with a 0.961 normalized power factor.

The test facility was modified, instrumentation calibrated, and shakedown tests were performed with power on the test sections prior to conducting the planned testing. Single tube and rod bundle blowdown tests with a uniform axial heat flux profile were completed in 1975. The results of these tests are contained in References 4, 5, and 14. The test program is described in Reference 6.

1.5.12 STEAM WATER MIXING TEST PROGRAM

The purpose of the steam water mixing test has been to generate experimental data relating to:

- A. The hydraulic resistance to steam flow in both the broken and intact cold legs created by the injection of Emergency Core Cooling (ECC) water.
- B. The conditions necessary to establish unrestricted steam passage through the initially water-filled loop seals of the intact cold legs in the presence of ECC injection.
- C. The fraction of ECC injection water which may backflow into the loop seals upon initiation of injection.
- D. The proportion of ECCS water which is injected during blowdown and goes to the lower plenum of the reactor vessel.

These data are applicable to the latter portion of blowdown and post-blowdown periods of a LOCA. The steam-water mixing program was concluded in early 1974. Additional information on the program is provided in Reference 6.

ARKANSAS NUCLEAR ONE
Unit 2

1.6 MATERIAL INCORPORATED BY REFERENCE

The following list is a tabulation of all Topical Reports which were incorporated by reference as part of the original license application. Other Topical Reports for information purposes, not incorporated by reference, were listed in the individual chapter and section references in the FSAR.

Additional Topical Reports incorporated by reference at later dates are not added to this list but are referenced in the appropriate text.

1.6.1 CE TOPICAL REPORTS

<u>NO.</u>	<u>TITLE</u>	<u>DATE ISSUED</u>	<u>FSAR SECTION</u>
CENPD-8	INTHERMIC: A Computer Code for Analysis of Thermal Mixing	1/27/71	4.4
CENPD-9	COSMO IV: Thermal and Hydraulic Analysis Code	1/27/71	4.4
CENPD-26	Description of Loss-of-Coolant Calculation Procedures	8/23/71	15.1
Suppl. #1	Description of Loss-of-Coolant Calculational Procedures	10/14/71	
#2	Steam Venting Experiments	1/10/72	
#3	Moisture Carryover During a PWR post-LOCA Core Refill	1/10/72	
CENPD-42	Dynamic Analysis of Reactor Vessel Internals Under Loss-of-Coolant Accident Conditions with Application of Analysis to CE 800 MWe Class Reactor	8/31/72	4.4 3.9
CENPD-61	Seismic Qualifications of Category 1 Electric Equipment for Nuclear Steam Supply Systems	12/8/72	3.1 3.10
Suppl. #1	Same as above	10/10/72	
#2	Same as above	2/19/73	
#3	Same as above	3/2/73	
#4	Same as above	7/9/73	
#5	Same as above	8/24/73	
CENPD-67	"Iodine Decontamination Factors During PWR Steam Generation and Steam Venting"	10/1/73	10.4
CENPD-80	Moisture Carryover During an NSS Steam Line Break Accident	2/16/73	6.2 15.1
CENPD-98	COAST Code Description	5/10/73	5.3, 15.1
CENPD-168	Design Basis Pipe Breaks for CE Two-Loop RCS	7/75	3.6.2.2
-----	Design Basis Pipe Breaks for ANO Unit 2	6/14/76	3.6.2.2

ARKANSAS NUCLEAR ONE
Unit 2

1.6.2 BECHTEL TOPICAL REPORTS

<u>NO.</u>	<u>TITLE</u>	<u>DATE ISSUED</u>	<u>FSAR SECTION</u>
BC-TOP-1	Containment Building Liner Plate Design	Jan. 1973	3.8
BC-TOP-4	Seismic Analysis of Structures and Equipment for Nuclear Power Plants	April 1972	3.7
BC-TOP-7	Full Scale Buttress Test for Prestressed Nuclear Containment Structures	AEC Approved Aug. 24, 1973	3.8
BC-TOP-8	Tendon End Anchor Reinforcement Test	AEC Approved Aug. 24, 1973	3.8
BC-TOP-9A	Design of Structures for Missile Impact	AEC Approved Nov. 25, 1974	9.1
BN-TOP-1	Testing Criteria for Integrated Leak Rate Testing of Primary Containment Structures for Nuclear Power Plants	AEC Accepted Feb. 1973	6.2
BN-TOP-2 (REV. 2)	Design for Pipe Break Effects	AEC Approved June 1974	3.6
BP-TOP-1	Seismic Analysis of Piping System	May 1973	3.7

1.7 GLOSSARY OF ITEMS

This section presents a glossary of abbreviations, symbols, indices, legends and other aids to facilitate understanding of this Safety Analysis Report (SAR). Information was compiled from applicable specifications, drawings, SAR sections and related publications.

1.7.1 TEXT ABBREVIATIONS

The abbreviations of systems, buildings, components and other non-technical information have been alphabetized in Table 1.7-1. Common phrases such as DNB and EFPY are listed along with drawing component and system abbreviations such as SIS and RWT. Standard technical abbreviations are used throughout this SAR. Powers of 10 are usually presented in standard scientific notation, e.g., 5×10^6 or 5E+6 Powers of 10 may also be represented by parentheses; e.g., 5(+6) or 5(6).

1.7.2 DRAWING INDEX AND SYMBOLS

The drawing index scheme combines letters with numbers such that the letter corresponds to the engineering fields (A - Architectural; C - Civil-Structural; E - Electrical and M - Mechanical) and the numbers give sequential ordering. The Piping and Instrumentation Diagrams (P&IDs) are a part of the Mechanical Engineering (M) drawings referenced in Table 1.7-2. Equipment location drawings are also referenced in Table 1.7-2.

The designated Locked Closed (LC) and Locked Open (LO) refer to the position in which certain valves are normally maintained during power operation. Actual valve positions may vary from those shown on the drawings due to different modes of operation, unavailability of certain equipment, etc. Manual valves are normally locked open (or closed) by means of a mechanical lock on the valve stem or hand wheel. Power operated valves are locked open (or closed), with one exception, by means of key-locked hand switches at the control panel. Section 6.3 has more information regarding these particular valves.

1.7.3 PIPING IDENTIFICATION

Piping identification is given in Table 1.7-3 and corresponds to the codes shown on P&IDs.

1.7.4 TRADEMARKS

Optimized ZIRLO, **ZIRLO**, **Low Tin Zirlo**, and **Guardian** are trademarks or registered trademarks of Westinghouse Electric Company LLC, its affiliates and/or its subsidiaries in the United States of America and may be registered in other countries throughout the world. All rights reserved. Unauthorized use is strictly prohibited. Other names may be trademarks of their respective owners.

ARKANSAS NUCLEAR ONE
Unit 2

1.8 REFERENCES

1. "Acceptance Criteria for Emergency Core Cooling Systems for Lightwater Cooled Nuclear Power Reactors," Federal Register, Vol. 39, No. 3, January 4, 1974.
2. "Calculative Methods for the CE Large Break LOCA Evaluation Model," CENPD-132, August, 1974 (Proprietary).
3. "Moisture Carryover During an NSSS Steamline Break Accident" (Proprietary), CENPD-80, transmitted to DL by letter, Mr. F. M. Stern to Mr. R. C. DeYoung, Jr., February 14, 1973.
4. "Rod Bundle Blowdown Heat Transfer Tests Simulating Pressurized Water Reactor LOCA Conditions," EPRI NP-113, EPRI Research Project Report.
5. "Rod Bundle Test Facility Instrumentation Description, Calibration, and Uncertainty Analysis, DWR Blowdown Heat Transfer Project," EPRI NP-112, EPRI Research Project Report, August 1977.
6. "Safety-Related Research and Development for CE Pressurized Water Reactors, 1974 Program Summaries," CENPD-184, May, 1975.
7. "Safety-Related Research and Development for Combustion Engineering Pressurized Water Reactors, Program Summaries" (Proprietary), CENPD-87, transmitted to DL by letter, Mr. F. M. Stern to Mr. R. C. DeYoung, Jr., March 18, 1973.
8. "Steam Venting Experiments and Their Application to CE Evaluation Model" (Proprietary), CENPD-26, Supplement 2, transmitted to DL by letter, Dr. C .L. Storrs to Dr. P. A. Morris, December 14, 1971.
9. Letter Report for "Steam-Water Interaction Tests, Task C, Annulus Penetration Tests," CENPD-130, March, 1974.
10. Letter Report for "Steam-Water Interaction Tests, Task C, Cold Leg Condensation Tests," CENPD-129, March, 1974.
11. Correspondence from L. E. Anderson to A. Serkiz, QR-73-203, "Steam Water Mixing Test Program Contract AT (11-1) - 2244," October 31, 1973.
12. Lowe, P. A. and C. F. Cynoski, "Steam-Water Mixing Test Program Task D: Informal Report, System Design Description for Task C," AEC-COO-2244-1, CENPD-64, Revision 1 (September, 1973).
13. Lowe, P. A., W. E. Burchill, "Steam-Water Mixing Test Program Task D: Informal Report Test Matrix for Task C," EDNPD-62, October, 1972.
14. Schneider, R. E., S. C. Rose, H. N. Guerrero, F. R. Hubbard, and K. A. Nilsson, "Single Tube and Rod Bundle Blowdown Heat Transfer Experiments Simulating Pressurized Water Reactor LOCA Conditions," 76-HT-11, presented at ASME-AICHE Heat Transfer Conference, St. Louis, August 1976.

ARKANSAS NUCLEAR ONE
Unit 2

Table 1.2-1

**EVALUATION OF MISCELLANEOUS SHARED SYSTEMS
(See Section 1.2.2.10.E and Unit 1 SAR Section 1.7.5, Table 1-3)**

<u>System</u>	<u>Serves Shutdown Function</u>	<u>Serves Emergency Function</u>	<u>Condition Of Maximum Demand</u>	<u>Section of SAR Describing Sufficient Redundancy</u>
1. Raw Water Storage Tank	No	No	NA	NA
2. Diesel Fuel Oil Bulk Storage	No	No	Loss of Off-Site Power	NA
3. Communications Systems	Yes	Yes	Variable	9.5.2
4. Clean Chemistry Laboratory, Count Room	No	No	NA	NA
5. Fire Water Main, Fire Pumps	No	Yes	Fire	9.5.1
6. Fuel Handling Crane (Auxiliary Building)	No	No	NA	NA
7. On-Site and Off-Site Environmental Monitoring	Yes	Yes	DBA	11.4, 11.6
8. Sodium Bromide Sodium Hypochlorite System	No	No	NA	NA
9. Turbine Building Crane, Elevator	No	No	NA	NA
10. Intake Structure Gantry Crane	No	No	NA	NA
11. Startup Boiler	No	No	NA	NA
12. Office Buildings	No	No	NA	NA
13. Railroad Spur, Access Roads, Parking Facilities	No	No	NA	NA
14. Switchyard, Transmission Lines	Yes	Yes	Simultaneous trip of both units	8.2
15. Telemetry and Load Dispatching Equipment	No	No	NA	NA
16. Shops (See 1.2.2.10.E.16)	No	No	NA	NA
17. Storeroom, Maintenance Facility, Warehouse, and Gas Bottle Storage	No	No	NA	NA
18. Reservoir Water Canals	No	No	NA	NA

ARKANSAS NUCLEAR ONE
Unit 2

Table 1.2-1 (continued)

<u>System</u>	<u>Serves Shutdown Function</u>	<u>Serves Emergency Function</u>	<u>Condition Of Maximum Demand</u>	<u>Section of SAR Describing Sufficient Redundancy</u>
19. Tendon Maintenance Scaffolding (portable)	No	No	NA	NA
20. Instrument Air Systems (only when cross-connected)	No	No	NA	NA
21. Service Air Compressor	No	No	NA	NA
22. Breathing Air System	No	No	NA	NA
23. Control Room Kitchen and Sanitary Facilities	No	No	NA	6.4
24. Oily Water Separator	No	No	NA	NA
25. Sewage System	No	No	NA	NA
26. Station Security System	No	No	NA	NA
27. High Purity Hydrogen System	No	No	NA	NA
28. DELETED				
29. Liquid Nitrogen Storage Tank	No	No	Outage	NA
30. Bulk Hydrazine Transfer	No	No	NA	NA
31. Post Accident Sampling System (PASS) Building	No	No	Post DBA	NA
32. Independent Spent Fuel Storage Installation (ISFSI)	No	No	NA	NA
33. Low Level Radwaste Storage Building (LLRWSB)	No	No	NA	NA

ARKANSAS NUCLEAR ONE
Unit 2

Table 1.3-1

PLANT PARAMETER COMPARISON

**Information in this table is applicable to Cycle 1 operation.
For current information, refer to the appropriate section of the SAR.**

<u>HYDRAULIC AND THERMAL DESIGN PARAMETERS</u>	<u>ANO-2</u>	<u>PSAR***</u>	<u>FSAR Reference Section</u>	<u>Calvert Cliffs* Units 1 & 2</u>	<u>ANO-1</u>	<u>San Onofre* Units 2 & 3</u>
Rated Core Heat Output, MWt	2815	(2760)	4.4	2560	2568	3390
Rated Core Heat Output, Btu/hr	9608x10 ⁶	(9420x10 ⁶)	4.4	8740x10 ⁶	8765x10 ⁶	11600x10 ⁶
Heat Generated in Fuel, %	97.4		4.4	97.5	97.3	97.5
System Pressure, Nominal, psia	2250		4.4	2250	2200	2250
System Pressure, Minimum Steady State psia	2200		4.4	2200	2135	2220
Hot Channel Factors, Heat Flux, F _q	2.35	(2.68)	4.4	3.00	3.12	2.60
Enthalpy Rise, F _H	1.57	(1.545)	4.4	1.65	1.78	1.545
DNB Ratio at Nominal Conditions	2.26	(2.12)	4.4	2.18	2.00	2.11
Coolant Flow						
Total Flow Rate, lb/hr	120.4x10 ⁶		4.4	122x10 ⁶	131.3x10 ⁶	147.8x10 ⁶
Effective Flow Rate for Heat Transfer, lb/hr	116.2x10 ⁶		4.4	117.5x10 ⁶	124.2x10 ⁶	142.6x10 ⁶
Effective Flow Area for Heat Transfer, ft ²	44.6	(43.41)	4.4	53.5	49.19	53.2
Avg. Velocity Along Fuel Rods, ft/sec	16.4	(16.8)	4.4	13.6	15.7	16.8
Avg. Mass Velocity, lb/hr-ft ²	2.60x10 ⁶	(2.68x10 ⁶)	4.4	2.20x10 ⁶	2.525x10 ⁶	2.68x10 ⁶

ARKANSAS NUCLEAR ONE
Unit 2

Table 1.3-1 (continued)

<u>HYDRAULIC AND THERMAL DESIGN PARAMETERS (continued)</u>	<u>ANO-2</u>	<u>PSAR***</u>	<u>FSAR Reference Section</u>	<u>Calvert Cliffs* Units 1 & 2</u>	<u>ANO-1</u>	<u>San Onofre* Units 2 & 3</u>
Coolant Temperatures, °F						
Nominal Inlet	553.5	(553)	4.4	543.4	554	553
Design Inlet	556.5	(556)	4.4	548	557	556
Average Rise in Vessel, °F	58.5	(58)	4.4	52	47.8	58
Average Rise in Core, °F	60.5	(60)	4.4	54	49.3	60
Average in Core, °F	583.75	(583)	4.4	570.4	579.7	583
Average in Vessel	582.75	(582)	4.4	569.5	578.9	582
Nominal Outlet of Hot Channel	652.6	(646)	4.4	643	647.1	646
Average Film Coefficient, Btu/hr-ft ² -°F	6200	(6200)	4.4	5240	5000	6200
Average Film Temp. Difference, °F	31	(34)	4.4	33.5	31	34
Heat Transfer at 100% Power						
Active Heat Transfer Surf. Area, ft ²	51,000	(44,900)	4.4	487,400	49,734	55,000
Average Heat Flux, Btu/hr-ft ²	185,000	(204,800)	4.4	176,000	171,470	205,000
Maximum Heat Flux, Btu/hr-ft ²	433,800	(48,740)	4.4	527,900	534,440	533,000
Average Thermal Output, Kw/ft	5.41	(6.9)	4.4	5.94	5.656	6.92
Maximum Thermal Output, Kw/ft	12.7	(18.5)**	4.4	18**	17.63	18
Maximum Clad Surface Temperature at Nominal Pressure, °F	657	(657)	4.4	657	654	657
Fuel Center Temperature, °F Maximum at 100% Power	3420	(4320)	4.4	4170	4220	4010

ARKANSAS NUCLEAR ONE
Unit 2

Table 1.3-1 (continued)

<u>CORE MECHANICAL DESIGN PARAMETERS</u>	<u>ANO-2</u>	<u>PSAR***</u>	<u>FSAR Reference Section</u>	<u>Calvert Cliffs* Units 1 & 2</u>	<u>ANO-1</u>	<u>San Onofre* Units 2 & 3</u>
Fuel Assemblies						
Design	CEA		4.2	CEA	CRA	CEA
Rod Pitch, in	0.506	(0.580)	4.2	0.58	0.568	0.580
Cross-Section Dimensions, in.	7.97x7.97		4.2	7.98 x 7.98	8.536 x 8.536	7.98 x 7.98
Fuel Weight (as UO ₂), pounds	183,834	(192,000)	4.2	207,269	205,250	235,110
Total Weight, pounds	250,208	(247,800)	4.2	282,570	274,350	304,000
Number of Grids Per Assembly	12	(9)	4.2	8	8	9
Fuel Rods						
Number	40,664	(31,152)	4.2	36,896	36,816	38,192
Outside Diameter, in.	0.382	(0.440)	4.2	0.44	0.430	0.440
Diametral Gap, in.	0.007	(0.0085)	4.2	0.0085	.007	0.0085
Clad Thickness, in.	0.025	(0.026)	4.2	0.026	0.0265	0.026
Total Weight, pounds	250,208	(247,800)	4.2	282,570	274,350	304,000
Clad Material	Zircaloy		4.2	Zircaloy	Zircaloy	Zircaloy
Fuel Pellets						
Material	UO ₂ Sintered		4.2	UO ₂ Sintered	UO ₂ Sintered	UO ₂ Sintered
Diameter, in.	0.325	(0.3795)	4.2	0.3795	0.370	0.3795
Length, in.	0.390	0.650)	4.2	0.650	0.700	0.650
Control Assemblies						
Neutron Absorber	B ₄ C/ Ag-In-Cd	(B ₄ C)	4.2	B ₄ C	Cd-In-Ag	B ₄ C
Cladding Material	NiCrFe Alloy		4.2	NiCrFe Alloy	304 SS	NiCrFe Alloy

ARKANSAS NUCLEAR ONE
Unit 2

Table 1.3-1 (continued)

<u>CORE MECHANICAL DESIGN PARAMETERS (continued)</u>	<u>ANO-2</u>	<u>PSAR***</u>	<u>FSAR Reference Section</u>	<u>Calvert Cliffs* Units 1 & 2</u>	<u>ANO-1</u>	<u>San Onofre* Units 2 & 3</u>
Control Assemblies (continued)						
Clad Thickness	0.035	(0.040)	4.2	0.040	0.021	0.035
Number of Assembly, full/part length	73/8	(77)	4.2	77/8	61/8	61/8
Number of Rods per Assembly	5		4.2	5	16	5
 <u>NUCLEAR DESIGN DATA</u>						
Structural Characteristics						
Core Diameter, inches (Equivalent)	123		4.2	136	128.9	136
Core Height, inches (Active Fuel)	150		4.2	136.7	144	150
Reflector Thickness and Composition			4.3			
Top-Water plus steel	10			10	12	10
Bottom--Water plus steel	10			10	12	10
Side-Water plus steel	15			15	18	15
H ₂ O/U, Unit Cell (Cold)		(3.35)	4.3	3.44	2.88	3.35
Number of Fuel Assemblies	177		4.2	217	177	217
UO ₂ Rods per Assembly		(176)		176/164	208	204
Batch A	236		4.3	-	-	176
Batch B	224		4.3	-	-	164
Batch C	224/234/ 233		4.3	-	-	176/164/ 164
Performance Characteristics						
Loading Technique	3 Batch Mixed Central Zone		4.3	3 Batch Mixed Central Zone	3 Region	3 Batch Mixed Central Zone

ARKANSAS NUCLEAR ONE
Unit 2

Table 1.3-1 (continued)

<u>NUCLEAR DESIGN DATA (continued)</u>	<u>ANO-2</u>	<u>PSAR****</u>	<u>FSAR Reference Section</u>	<u>Calvert Cliffs* Units 1 & 2</u>	<u>ANO-1</u>	<u>San Onofre* Units 2 & 3</u>
Fuel Discharge Burnup, MWD/MTU Average First Cycle	12,500		4.3	13,775	14,400	13,138
Feed Enrichment w/o Region 1	1.93	(2.0)	4.3	2.09	2.06	1.9
Region 2	2.27	(2.36)	4.3	2.51	2.72	2.3
Region 3	2.94	(2.97)	4.3	2.99	3.05	2.9
Control Characteristics						
Effective Multiplication (BOC)						
Cold, No Power, Clean	1.195	(1.29)	4.3	1.169	1.237	1.29
Hot, No Power, Clean	1.139	(1.23)	4.3	1.129	1.170	1.23
Hot, Full Power, Xe Equilibrium	1.082	(1.15)	4.3	1.081	1.109	1.15
Control Assemblies Total Rod Worth (Hot), %Δρ	12.3	> 8.0	4.3	11.0	11.1	> 7.2
Boron Concentrations for Criticality: Zero Power no rods inserted, clean, Cold/Hot	1011/1001	(1470/1600)	4.3	985/991	929/463	1400/1600
At Power with no Rods inserted, clean/equilibrium xenon, ppm	881/611	(1400/1100)	4.3	885/650	1441/1091	1400/1100
Kinetic Characteristics, Range Over Life						
Moderator Temperature Coefficient Δρ/°F	-0.3x10 ⁻⁴ to -2.5x10 ⁻⁴	(0 to -2x10 ⁻⁴)	4.3	-0.32x10 ⁻⁴ to -1.96x10 ⁻⁴	+0.28x10 ⁻⁴ to -3.00x10 ⁻⁴	0 to -2x10 ⁻⁴
Moderator Pressure Coefficient Δρ/°F	+0.06x10 ⁻⁶ to +2.6x10 ⁻⁶	(0 to +2x10 ⁻⁶)	4.3	+0.65x10 ⁻⁶ to +2.39x10 ⁻⁶	-3.00x10 ⁻⁷ to +3.00x10 ⁻⁶	0 to +2x10 ⁻⁶
Moderator Void Coefficient Δρ/°F	-0.03x10 ⁻³ to -1.22x10 ⁻³	(0 to -1.6x10 ⁻³)	4.3	-0.41x10 ⁻³ to -1.43x10 ⁻³	-0.03x10 ⁻³ to -.19x10 ⁻³	0 to -1.6x10 ⁻³
Doppler Coefficient†	-1.8x10 ⁻⁵ to - 1.28x10 ⁻⁵	(-1x10 ⁻⁵ to -1.8x10 ⁻⁵)		-1.46x10 ⁻⁵ to -1.02x10 ⁻⁵	-1.10x10 ⁻⁵ to -1.70x10 ⁻⁵	-1.8x10 ⁻⁵ to -1x10 ⁻⁵

ARKANSAS NUCLEAR ONE
Unit 2

Table 1.3-1 (continued)

<u>REACTOR COOLANT CODE REQUIREMENTS</u>	<u>ANO-2</u>	<u>PSAR***</u>	<u>FSAR Reference Section</u>	<u>Calvert Cliffs* Units 1 & 2</u>	<u>ANO-1</u>	<u>San Onofre* Units 2 & 3</u>
Reactor Vessel	ASME III Class A		5.2	ASME III Class A	ASME III Class A	ASME III Class A
Steam Generator Tube Side	ASME III Class A		5.2	ASME III Class A	ASME III Class A	ASME III Class A
Shell Side	ASME III Class A		5.2	ASME III Class A	ASME III Class A	ASME III Class A
Pressurizer	ASME III Class 1		5.2	ASME III Class A	ASME III Class A	ASME III Class A
Pressurizer Relief (or Quench Tank)	ASME III Class C		5.2	ASME III Class C	ASME III Class C	ASME III Class C
Pressurizer Safety Valves	ASME III Class 1		5.2	ASME III Art 9	ASME III Art 9	ASME III
Reactor Coolant Piping	ASME III USAS B 31.1		5.2	USAS B 31.7	USAS B 31.7 ⁽³⁾	USAS B 31.1

PRINCIPAL DESIGN PARAMETERS
REACTOR OF THE COOLANT SYSTEM

Operating Pressure, psig	2235		5.1	2235	2185	2235
Reactor Inlet Temperature, °F	553.5	(553)	5.1	544.5	554	553
Reactor Outlet Temperature, °F	612.5	(611)	5.1	599.4	604	611
Number of Loops	2		5.1	2	2	2
Design Pressure, psig	2485		5.1	2485	2500	2485
Design Temperature, °F	650		5.1	650	650	650
Hydrostatic Test Pressure (cold), psig	3110			3110	3125	3110
Total Coolant Volume, cu. ft.	9376			11,101	11,478	12,376

ARKANSAS NUCLEAR ONE
Unit 2

Table 1.3-1 (continued)

<u>PRINCIPAL DESIGN PARAMETERS OF THE REACTOR VESSEL</u>	<u>ANO-2</u>	<u>PSAR***</u>	<u>FSAR Reference Section</u>	<u>Calvert Cliffs* Units 1 & 2</u>	<u>ANO-1</u>	<u>San Onofre* Units 2 & 3</u>
Material	SA-533, Class 1, low alloy steel, internally clad with Type 304 austenitic SS		5.1	SA-533, Class 1, low alloy steel, internally clad with Type 304 austenitic SS	SA-533, internally clad with Type 304 austenitic SS	SA-533, Class 1 A508 Class 2 clad with Type 304 austenitic SS
Design Pressure, psig	2485		5.4	2485	2500	2485
Design Temperature, °F	650		5.4	650	650	650
Operating Pressure, psig	2235		5.4	2235	2185	2235
Inside Diameter of Shell, in.	157		5.4	172	171	172
Outside Diameter across Nozzles, in.	238			253	249	253
Overall Height of Vessel and Enclosure Head, ft.-in to top of CEDM Nozzle	43-4 1/6		5.4	41-11 3/4	40-8 3/4	43-6 1/2
Minimum Clad Thickness, in.	1/8		5.4	1/8	1/8	5/32
 <u>PRINCIPAL DESIGN PARAMETERS OF THE STEAM GENERATORS</u>						
Number of Units	2		5.5	2	2	3
Type	Vertical U- Tube with integral moisture separator		5.5	Vertical U-Tube with integral moisture separator	Vertical once- through with integral moisture separator	Vertical U-Tube with integral moisture separator

ARKANSAS NUCLEAR ONE
Unit 2

Table 1.3-1 (continued)

<u>PRINCIPAL DESIGN PARAMETERS OF THE STEAM GENERATORS (continued)</u>	<u>ANO-2</u>	<u>PSAR***</u>	<u>FSAR Reference Section</u>	<u>Calvert Cliffs* Units 1 & 2</u>	<u>ANO-1</u>	<u>San Onofre* Units 2 & 3</u>
Tube Material	NiCrFe Alloy		5.5	Inconel	Inconel	Inconel
Shell Material	SA-533 Gr.B Class 1 and SA-516 Gr.70			SA-533 Gr. B Class 1 and SA-1516 Gr. 70	Carbon steel	SA-533 Gr.B Class 1 and SA-516, Gr. 70
Tube Side Design Pressure, psig	2485		5.5	2485	2500	2485
Tube Side Design Temperature, °F	650		5.5	650	650	650
Tube Side Design Flow, lb/hr	60.2 x 10 ⁶		5.5	61 x 10 ⁶	65.66 x 10 ⁶	74 x 10 ⁶
Shell Side Design Pressure, psi	1100		5.5	985	1050	1085
Shell Side Design Temperature, °F	560		5.5	550	600	560
Operating Pressure, Tube Side, Nominal, psig	2235		5.5	2235	2185	2235
Operating Pressure, Shell Side, Maximum, psig	985			885	910	985
Maximum Moisture at Outlet at Full Load, %	0.2		5.5	0.2	(35 °F Superheat)	0.2
Hydrostatic Test Pressure, Tube Side (cold), psig	3110			3110	3125	3110
Steam Pressure, psia at full power	900		5.5	850	910	900
Steam Temperature, °F, at full power	531.95		5.5	525.2	570	532

ARKANSAS NUCLEAR ONE
Unit 2

Table 1.3-1 (continued)

<u>PRINCIPAL DESIGN PARAMETERS OF THE REACTOR COOLANT PUMPS</u>	<u>ANO-2</u>	<u>PSAR***</u>	<u>FSAR Reference Section</u>	<u>Calvert Cliffs* Units 1 & 2</u>	<u>ANO-1</u>	<u>San Onofre* Units 2 & 3</u>
Number of Units	4		5.5	4	4	4
Type	Vertical, single stage centrifugal with bottom suction and horizontal discharge			Vertical, single stage centrifugal with bottom suction and horizontal discharge	Vertical, single stage	Vertical, single stage radial flow with bottom suction and horizontal discharge
Design Pressure, psig	2485		5.5	2485	2500	2485
Design Temperature, °F	650		5.5	650	650	650
Operating Pressure, Nominal, psig	2235		5.5	2235	2185	2235
Suction Temperature, °F	535.5		5.5	543.4	554	535
Design Capacity, gpm	80,000	(80,500)	5.5	81,200	88,000	99,000
Design Head, ft.	275	(248)	5.5	300	396	290
Hydrostatic Test Pressure (cold), psig	3110			3110	3125	3110
Motor Type	AC induction single speed		5.5	AC induction single speed	AC induction single speed	AC induction single speed
Motor Rating, hp	6500			7200	9000	10,000
Material	SA-516 Gr. 70 with nominal 3/16 SS clad		5.5	SA-516 Gr. 70 with nominal 7/32 SS clad	Carbon steel clad with SS	SA-516 Gr. 70 with nominal 7/32 SS clad
Hot Leg - I.D. in.	42		5.5	42	36	42
Cold Leg - I.D. in.	30		5.5	30	28	30

ARKANSAS NUCLEAR ONE
Unit 2

Table 1.3-1 (continued)

<u>CONTAINMENT SYSTEM PARAMETERS</u>	<u>ANO-2</u>	<u>PSAR***</u>	<u>FSAR Reference Section</u>	<u>Calvert Cliffs* Units 1 & 2</u>	<u>ANO-1</u>	<u>San Onofre* Units 2 & 3</u>
Type	Steel-lined prestressed post tensioned concrete cylinder, curve dome roof		6.2	Steel-lined prestressed post tensioned concrete cylinder, curve dome roof	Steel-lined prestressed post tensioned concrete cylinder, curve dome roof	Steel-lined prestressed post tensioned concrete cylinder, shallow dome roof
<u>Design Parameters - Containment</u>						
Inside Diameter, ft.	116		6.2	130	116	150
Height, ft.	208 1/2			181 2/3	208 1/2	151
Design Pressure, psig	59			50	59	60
Concrete Thickness, ft.						
Vertical Wall	3 3/4			3 3/4	3 3/4	4
Dome	3 1/4			3 1/4	3 1/4	3 3/4
<u>Containment Leak Prevention and Mitigation Systems</u>	Leak-tight penetration and continuous steel liner. Automatic isolation where required.		6.2	Leak-tight penetration and continuous steel liner. Automatic isolation where required. The exhaust from penetrations room to vent.	Leak-tight penetration and continuous steel liner. Automatic isolation where required.	Leak-tight penetration and continuous steel liner. Automatic isolation where required.
<u>Gaseous Effluent Purge</u>	Discharge through vent		11.3	Discharge through vent	Discharge through vent	Discharge through vent

ARKANSAS NUCLEAR ONE
Unit 2

Table 1.3-1 (continued)

<u>CONTAINMENT SYSTEM PARAMETERS (continued)</u>	<u>ANO-2</u>	<u>PSAR***</u>	<u>FSAR Reference Section</u>	<u>Calvert Cliffs* Units 1 & 2</u>	<u>ANO-1</u>	<u>San Onofre* Units 2 & 3</u>
<u>Engineered Safety Features</u>						
Safety Injection System			6.3			
No. of High Head Pumps	3			3	3	3
No. of Low Head Pumps	2			2	2	2
Containment Fan Coolers			6.2.2			
No. of Units	4			4	4	4
Air Flow Capacity each, at Emergency Condition, cfm	30,000			55,000	30,000	Not Specified
Containment Spray						
No. of Pumps	2		6.2.2	2	2	2
Emergency Power						
Diesel Generator Units	2		8.2	4 total for both units	2	2
Safety Injection Tanks, Number	4		6.3	4	2	4
<u>RADIOACTIVE WASTE MANAGEMENT SYSTEM</u>						
Liquid Waste Processing Systems						
Reactor Coolant Waste Holdup Tank (BMS)			11.2.2			
Number	4			2	4	2 + 2
Capacity (gal.), each	51,270			90,000	58,000	Not Specified

ARKANSAS NUCLEAR ONE
Unit 2

Table 1.3-1 (continued)

<u>CONTAINMENT SYSTEM PARAMETERS (continued)</u>	<u>ANO-2</u>	<u>PSAR***</u>	<u>FSAR Reference Section</u>	<u>Calvert Cliffs* Units 1 & 2</u>	<u>ANO-1</u>	<u>San Onofre* Units 2 & 3</u>
Liquid Waste Processing Systems (continued)						
Degasifier			11.2.2			
Number	1			2	1	1 (Gas Stripper)
Capacity (gpm)	140			0 – 120	140	Not Specified
Concentrators			11.2.2			
Number	1			3	N/A	
Capacity (gpm)	20			20		Not Specified
Gaseous Waste Processing Systems						
Waste Gas Decay Tanks			11.3.2			
Number	3			3	4	6
Capacity (ft ³), each	300			610	325	500
Pressure (psig)	380			150	132	150
Hold Up Time (days)	30			60	30	30 (minimum)
<u>INSTRUMENTATION SYSTEMS‡</u>						
Reactor Protective System			7.2	7.2	7.1	7.2
Reactor and Reactor Coolant Control System			7.7.1.1 7.7.1.2	7.4	7.3	7.2, 7.3
Steam and Feedwater Control System			7.7.1.3	7.4	7.3	9.11, 10.2.2
Nuclear Instrumentation			7.2.1.1	7.5.2, 7.5.4	7.3.1	7.4, 7.6
Non-Nuclear Process Instrumentation			7.5.1.5	7.5.1	7.3.2	7.5
CEA Position Instrumentation			7.5.1.4	7.5.3	7.2.2	7.3.2

ARKANSAS NUCLEAR ONE
Unit 2

Table 1.3-1 (continued)

<u>ELECTRICAL SYSTEMS</u>	<u>ANO-2</u>	<u>PSAR***</u>	<u>FSAR Reference Section</u>	<u>Calvert Cliffs* Units 1 & 2</u>	<u>ANO-1</u>	<u>San Onofre* Units 2 & 3</u>
Number of Off-site Circuits	3 – 500		8.2.1.1	2 – 500 kV	2–500 kV	8
Number of Incoming Lines to Start up Transformers	2		8.2.1.3	2	2	2
Number of Startup Transformers	1(+1shared)		8.2.1.3	2	1(+1shared)	4 (Aux)
Number of Main Unit Transformers (Single Phase)	3		F / 8.3.1	4	4	1
Number of 4.16 kV Engineered Safety Features System Buses	2		8.3.1.1.3	4	2	3
Number of 480V Engineered Safety Features System Buses	2		8.3.1.1.4	8	2	3
Number of 120V Vital Buses	4		8.3.1.1.5	8	4	4
Number of Standby Diesel Generators	2		8.3.1.1.7	3	2	2 (+1 shared)
Diesel Generator Rating (KW)	2850		8.3.1.1.7	2500	2750	Criteria: PSAR Section 8.2.3.2.2

* The values listed for these plants were taken from public documentation.

** Based on total heat output of the core rather than heat generated in fuel alone.

*** PSAR Data

† Operating Level

‡ This section is not suited for tabular description. SAR section numbers have been included for the location of the detailed description of each system.

(1) Only one is used for engineered safety features systems.

(2) One bus will swing from other two sources; can be connected to only one bus at anytime.

(3) Use of a later ASME Section III code is acceptable, provided the code section(s) used is reconciled.

ARKANSAS NUCLEAR ONE
Unit 2

Table 1.7-1

NONTECHNICAL ABBREVIATIONS

<u>Name</u>	<u>Abbreviation</u>
Alternate AC Generator	AACG
American Institute of Electrical Engineers	AIEE
Air Moving and Conditioning Association	AMCA
American National Standards Institute	ANSI
American Nuclear Society	ANS
American Society of Civil Engineers	ASCE
American Society of Mechanical Engineers	ASME
American Society of Mechanical Engineers Boiler and Pressure Vessel Code	ASME Code
American Society of Heating, Refrigeration and Air Conditioning Engineers	ASHRAE
American Society for Testing Materials	ASTM
American Welding Society	AWS
Arkansas Power and Light Company	AP&L
Atomic Energy Commission	AEC
Automatic Gas Analyzer	AGA
Auxiliary Cooling Water	ACW
Auxiliary Feedwater	AFW
Axial Shape Index	ASI
Bechtel Power Corporation (San Francisco)	Bechtel
Beginning of Core Life	BOL
Boric Acid Makeup	BAM
Boric Acid Makeup Tank	BAMT
Boron Management System	BMS
Chemical and Volume Control System	CVCS

ARKANSAS NUCLEAR ONE
Unit 2

Table 1.7-1 (continued)

<u>Name</u>	<u>Abbreviation</u>
Circulating Water System	CWS
Clean Liquid Radioactive Waste System (Unit 1)	CZ
Combustion Engineering	CE
Component Cooling Water	CCW
Condensate and Feedwater System	CFWS
Condensate Storage Tank	CST
Condensate Storage and Transfer System	CSTS
Containment Air Monitoring System	CAMS
Containment Cooling Actuation Signal	CCAS
Containment Cooling System	CCS
Containment Heat Removal System	CHRS
Containment Isolation System/Signal	CIS
Containment Isolation Actuation System	CIAS or CIS
Containment Spray Actuation Signal	CSAS
Containment Spray System	CSS
Control Element Assembly (ies)	CEA
Control Element Assembly Calculator	CEAC
Control Element Drive Mechanism	CEDM
Control Element Drive Mechanism Control System	CEDMCS
Core Exit Thermocouple	CET
Core Operating Limit Supervisory System	COLSS
Core Operating Limits Report	COLR
Core Protection Calculator	CPC
Decontamination Factor	DF

ARKANSAS NUCLEAR ONE
Unit 2

Table 1.7-1 (continued)

<u>Name</u>	<u>Abbreviation</u>
Design Basis Earthquake	DBE
Design Basis Accident	DBA
Departure from Nucleate Boiling	DNB
Departure from Nucleate Boiling Ratio	DNBR
Diesel Engine Manufacturers Association	DEMA
Diverse Scram System	DSS
Diverse Emergency Feedwater Actuation System	DEFAS
Dirty Liquid Radioactive Waste System (Unit 1)	DZ
Effective Full Power Days	EFPD
Effective Full Power Years	EFPY
Emergency Cooling Pond	ECP
Emergency Core Cooling System	ECCS
Emergency Diesel Generator	EDG
Emergency Feedwater (System)	EFW
Emergency Feedwater Actuation Signal	EFAS
Emergency Operations Center	EOC
End of Cycle	EOC
End of Core Life	EOL
Engineered Safety Features	ESF
Engineered Safety Features Actuation System	ESFAS
Fire Protection System	FPS
Fuel Handling System	FHS
Fuel Transfer System	FTS
Gaseous Waste System	GWS

ARKANSAS NUCLEAR ONE
Unit 2

Table 1.7-1 (continued)

<u>Name</u>	<u>Abbreviation</u>
High Efficiency Particulate Air	HEPA
High Pressure Safety Injection	HPSI
Independent Spent Fuel Storage Installation	ISFSI
Institute of Electrical and Electronic Engineers	IEEE
Loss of Coolant Accident	LOCA
Low Pressure Safety Injection	LPSI
Low Temperature Over Pressure	LTOP
Main Feedwater	MFW
Main Steam System	MS
Main Steam Isolation System/Signal	MSIS
Main Steam Isolation Valve	MSIV
Motor Control Center	MCC
National Electric Code	NEC
National Electrical Manufacturers Association	NEMA
National Fire Protection Association	NFPA
Net Positive Suction Head	NPSH
Nil Ductility Transition Temperature	NDTT
Nuclear Steam Supply System	NSSS
Operating Basis Earthquake	OBE
Original Steam Generator Storage Facility	OSGSF
Piping and Instrumentation Diagram	P&ID
Plant Protection System	PPS
Post Accident Sampling System	PASS
Pressurizer	PZR

ARKANSAS NUCLEAR ONE
Unit 2

Table 1.7-1 (continued)

<u>Name</u>	<u>Abbreviation</u>
Primary Sample System	PSS
Quality Assurance	QA
Quality Control	QC
Reactor Coolant System	RCS
Reactor Drain Tank	RDT
Reactor Makeup Water Tank	RMWT
Reactor Protective (Protection) System	RPS
Recirculation Actuation Signal	RAS
Refueling Water Tank	RWT
Resistance Temperature Detector	RTD
Safety Injection Actuation Signal	SIAS
Safety Injection Tank	SIT
Safety Injection System	SIS
Safety Parameter Display System	SPDS
Safety Review Committee	SRC
Secondary Sampling System	SSS
Service Water	SW
Service Water System	SWS
Shutdown Cooling	SDC
Solid Radioactive Waste System	SRWS
Steam Dump and Bypass Control System	SDBCS
Steam Generator Blowdown System	SGBS
Steam Generator	S/G
Test Working Group	TWG
Vibration and Loose Parts Monitor System	VLPMS
Volume Control Tank	VCT
Waste Management System	WMS

ARKANSAS NUCLEAR ONE
Unit 2

Table 1.7-2

FIGURE – DRAWING CORRELATIONS

<u>Drawing Number</u>	<u>Title</u>	<u>SAR Figure Number</u>
C-2003	Plot Plan	N.A.
C-2104	Containment Prestressing and Reinforcing Details	N.A.
C-2130	Reactor Building Reinforcing Steel Penetration Reinforcing	N.A.
C-2157	Reactor Building Reinforced Concrete Wall Sections and Details	N.A.
C-2158	Reactor Building Reinforced Concrete Wall Sections and Details	N.A.
C-2205	Concrete - Auxiliary Building Plan Elevation 386'-0"	N.A.
C-2214	Concrete - Auxiliary Building - Section A	N.A.
C-2223	Concrete - Auxiliary Building - Section K	N.A.
2CCA-13-1	Large Pipe Isometric - Reactor Coolant System	N.A.
2CCA-14-1	Large Pipe Isometric - Pressurizer Spray System	N.A.
2CCA-15-1	Large Pipe Isometric - Discharge From Spray Valves To Pressurizer Spray System Header	N.A.
2CCA-15-2	Large Pipe Isometric - Pressurizer Spray System	N.A.
2CCA-15-4	Large Pipe Isometric - Pressurizer Spray System	N.A.
2CCA-16-1	Small Pipe Isometric - Chemical & Volume Control System	N.A.
2CCA-16-2	Small Pipe Isometric - Auxiliary Spray From Regenerative Heat Exchanger	N.A.
2DBC-12-1	Large Pipe Isometric - Auxiliary Feedwater Pump (2P75) Check Valve Test Connections	N.A.
2DBC-13-1	Large Pipe Isometric - Auxiliary Feedwater Pump (2P75) Check Valve Test Connections	N.A.
2DBD-34-1	Large Pipe Isometric - Auxiliary Feedwater Discharge Pump 2P75	N.A.
E-2002	Single Line Meter and Relay Diagram Generator System	N.A.
E-2003	Single Line Meter and Relay Diagram 6900 Volt System	N.A.
E-2004	Single Line Meter and Relay Diagram 4160 Volt System Main Supply	N.A.
E-2005	Single Line Meter and Relay Diagram 4160 Volt System ESF	N.A.
E-2008	Single Line Meter and Relay Diagram 480 Volt Load Center ESF and Main Supply	N.A.
E-2014	Single Line Diagram 480 Volt Motor Control Center 2B51, 2B52, 2B53 and 2B54	N.A.
E-2015	Single Line Diagram 480 Volt Motor Control Center 2B61, 2B62, 2B63 and 2B64	N.A.
E-2017	Single Line Meter and Relay Diagram 125 Volt DC	N.A.
E-2018	Single Line Diagram 125 Volt DC Motor Control Center 2D26 and 2D27	N.A.
E-2022	ESF 120 Volt AC and 125 Volt DC Distribution Panels	N.A.
E-2023	120/208 Volt Instrument AC Panels	N.A.
E-2028	125 Volt DC Distribution Panels 480 Volt AC Pressurizer Heater Distribution Panels	N.A.

ARKANSAS NUCLEAR ONE
Unit 2

Table 1.7-2 (continued)

<u>Drawing Number</u>	<u>Title</u>	<u>SAR Figure Number</u>
E-2031	System Phasing and Synchronizing Diagram	N.A.
E-2032	Schematic Meter and Relay Diagram Generator System	N.A.
E-2033	Schematic Meter and Relay Diagram 6900 Volt System	N.A.
E-2034	Schematic Meter and Relay Diagram 4160 Volt System Main Supply	N.A.
E-2035	Schematic Meter and Relay Diagram 4160 Volt System ESF	N.A.
E-2059	Typical Cable Tray Layout	N.A.
E-2073	Electrical Penetration Sealing Details	N.A.
E-2076	Schematic Diagram Typical Circuit Breaker 6900 Volt and 4160 Volt Switchgear	N.A.
E-2077	Schematic Diagram Typical Internal Wiring Diagram 6900 Volt & 4160 Volt Motor Protection	N.A.
E-2079	Schematic Diagram Typical Internal Wiring Diagram Load Center Transformer Feeder Protection	N.A.
E-2081	Schematic Diagram Typical 480 Volt Load Center Breaker	N.A.
E-2083	Typical 480 Volt Motor Control Center FV Starters	N.A.
E-2084	Typical 480 Volt Motor Control Center FV Starters With K.O. Selector	N.A.
E-2085	Typical 125 Volt DC Motor Control Center Full Voltage Reverse Starter	N.A.
E-2090	Schematic Diagram Unit Auxiliary Transformer 4160 Volt ACBs	N.A.
E-2091	Schematic Diagram Startup Transformer No. 3 4160 Volt ACBs	N.A.
E-2092	Schematic Diagram Startup Transformer No. 2 4160 Volt ACBs	N.A.
E-2093	Schematic Diagram Switchgear Bus Lockout and Undervoltage Relays	N.A.
E-2094	Schematic Diagram Startup Transformer No. 2 & 3 Lockout Relay	N.A.
E-2095	Schematic Diagram Transformer Undervoltage Relays Indication and Alarm	N.A.
E-2097	Schematic Diagram 4160 Volt ESF Bus Feeder ACBs	N.A.
E-2098	Schematic Diagram 4160 Volt ESF Bus Tie ACBs	N.A.
E-2099	Schematic Diagram 4160 Volt Bus 2A3 and 2A4 Lockout and Undervolt Relay	N.A.
E-2100	Schematic Diagram Diesel Generator ACBs	N.A.
E-2101	Schematic Diagram Emergency Diesel Generator Lockout Relays	N.A.
E-2102	Schematic Diagram Emergency Diesel Generator	N.A.
E-2103	Schematic Diagram Meter and Relay Diagram 480 Volt System Load Centers	N.A.
E-2104	Schematic Diagram 4160 ACB Transformer Feeder to 480 Volt Load Center	N.A.
E-2107	Schematic Diagram ESF 480 Volt Load Center Main & Tie Feeder ACBs	N.A.
E-2108	Schematic Diagram 480 Volt Motor Control Center Feeder ACBs	N.A.

ARKANSAS NUCLEAR ONE
Unit 2

Table 1.7-2 (continued)

<u>Drawing Number</u>	<u>Title</u>	<u>SAR Figure Number</u>
E-2202	Schematic Diagram Safety Injection Tanks Discharge MOVs	N.A.
E-2456	Schematic Diagram-EDG Generator Control Panels	N.A.
E-2563	Schematic Diagram Safety Signal Actuated MOVs Thermal Overload Bypass	N.A.
E-2801	Plot Plan Grounding and Underground Conduit Layout	N.A.
E-2811	Intake Structure Conduit and Tray Layout	N.A.
E-2856	Conduit and Tray Layout Turbine Auxiliary Building Ar. 23 Elevation 335'-0"	N.A.
E-2857	Conduit and Tray Layout Auxiliary Building Ar. 23 Elevation 354'-0"	N.A.
E-2858	Conduit and Tray Layout Auxiliary Building Ar. 23 Elevation 368'-0" and 372'-0"	N.A.
E-2859	Conduit and Tray Layout Auxiliary Building Ar. 23 Elevation 386'-0"	N.A.
E-2864	Conduit and Tray Layout Auxiliary Building Ar. 24 and 26 Elevation 317'-0"	N.A.
E-2865	Conduit and Tray Layout Auxiliary Building Ar. 24 Elevation 335'-0"	N.A.
E-2866	Conduit and Tray Layout Auxiliary Building Ar. 24 Elevation 354'-0"	N.A.
E-2867	Conduit and Tray Layout Auxiliary Building Ar. 24 Elevation 369'-0" and 372'-0"	N.A.
E-2868	Conduit and Tray Layout Auxiliary Building Ar. 24 Elevation 386'-0"	N.A.
E-2873	Conduit and Tray Layout Cont. Building Ar. 25 Elevation 336'-6"	N.A.
E-2874	Conduit and Tray Layout Cont. Building Ar. 25 Elevation 357'-0"	N.A.
E-2875	Conduit and Tray Layout Cont. Building Ar. 25 Elevations 374'-6" and 376'-6"	N.A.
E-2876	Conduit and Tray Layout Cont. Building Ar. 25 Elevation 386'-0"	N.A.
E-2877	Conduit and Tray Layout Cont. Building Ar. 25 Elevation 405'-6"	N.A.
E-2878	Conduit and Tray Layout Cont. Building Ar. 25 Elevation 426'-6"	N.A.
E-2879	Conduit and Tray Layout Cont. Building Ar. 25 Section & Details	N.A.
E-2880	Conduit and Tray Layout Cont. Building Ar. 25 Sections & Details	N.A.
E-2881	Conduit and Tray Layout Auxiliary Building Ar. 24 & 26 Elevation 326'-0" and 335'-0"	N.A.
E-2882	Conduit and Tray Layout Auxiliary Building Ar. 26 Elevation 354'-0" and 360'-0"	N.A.
E-2884	Control Room Panel Foundations, Blockouts and Embedded Conduits	N.A.
E-2885	Conduit and Tray Layout Cable Spreading Room Elevation 372'-0"	N.A.
E-2890	Conduit and Tray Layout Cont. Penetration Room Ar. 23 Elevation 374'-6" and 386'-0"	N.A.
E-2891	Conduit and Tray Layout Cont. Penetration Room Ar. 22 Elevation 374'-6" and 386'-0"	N.A.
E-2892	Cable Spreading Room Conduit Elevation 372'-0"	N.A.
E-2895	Electrical Layout Emergency Diesel Fuel Storage	N.A.
M-2002	Equipment Location Fuel Handling Floor Plan	N.A.
M-2002	Structures Intended Primarily as Missile Barriers, Plan at Elevation 404'-0"	N.A.

ARKANSAS NUCLEAR ONE
Unit 2

Table 1.7-2 (continued)

<u>Drawing Number</u>	<u>Title</u>	<u>SAR Figure Number</u>
M-2002	Structures Intended Primarily as Missile Barriers, Plan at Elevation 404'-0"	N.A.
M-2002	Temporary Construction Openings, Plan at Elevation 404'-0"	N.A.
M-2003	Equipment Location Operating Floor Plan	N.A.
M-2003	Structures Intended Primarily as Missile Barriers, Plan at Elevation 386'-0"	N.A.
M-2003	Temporary Construction Openings, Plan at Elevation 386'-0"	N.A.
M-2004	Equipment Location Intermediate Floor Plan	N.A.
M-2004	Structures Intended Primarily as Missile Barriers, Plan at Elevation 372'-0"	N.A.
M-2004	Temporary Construction Openings, Plan at Elevation 372'-0"	N.A.
M-2005	Equipment Location Ground Floor Plan	N.A.
M-2005	Structures Intended Primarily as Missile Barriers, Plan at Elevation 354'-0"	N.A.
M-2005	Temporary Construction Openings, Plan at Elevation 354'-0"	N.A.
M-2006	Equipment Location Plan Below Grade	N.A.
M-2006	Temporary Construction Openings, Plan at Elevation 335'-0"	N.A.
M-2007	Equipment Location Section A-A & F-F	N.A.
M-2008	Equipment Location Section B-B	N.A.
M-2009	Equipment Location Section C-C	N.A.
M-2010	Equipment Location Section D-D	N.A.
M-2011	Equipment Location Misc. Plans & Sections	N.A.
M-2031	Plant Design Drawing Area 23 Turbine Auxiliary Building Plan Above 386'-0" and Miscellaneous	N.A.
M-2032	Plant Design Drawing Area 23 Turbine Auxiliary Building Plan at Elev. 368'-0" to 386'-0"	N.A.
M-2033	Plant Design Drawing Area 23 Turbine Auxiliary Building Plan at Elev. 354'-0" to 368'-0"	N.A.
M-2034	Auxiliary Building Section A ₂₃ -A ₂₃	N.A.
M-2037	Plant Design Drawing Area 23 Turbine Auxiliary Building Section D ₂₃ -D ₂₃	N.A.
M-2038	Plant Design Drawing Area 23 Turbine Auxiliary Building Plan Below Elev. 354'-0"	N.A.
M-2039	Plant Design Drawing Area 23 Turbine Auxiliary Building Misc. Sections	N.A.
M-2041	Plant Design Drawing Area 24 Containment Auxiliary Building Plan Above Elev. 404'-0"	N.A.
M-2042	Plant Design Drawing Area 24 Containment Auxiliary Building Plan at Elev. 386'-0" to 404'-0"	N.A.
M-2043	Plant Design Drawing Area 24 Containment Auxiliary Building Plan at Elev. 372'-0" to 386'-0"	N.A.
M-2044	Plant Design Drawing Area 24 Containment Auxiliary Building Plan at Elev. 354'-0" to 372'-0"	N.A.
M-2045	Plant Design Drawing Area 24 Containment Auxiliary Building Plan at Elev. 335'-0" to 354'-0"	N.A.

ARKANSAS NUCLEAR ONE
Unit 2

Table 1.7-2 (continued)

<u>Drawing Number</u>	<u>Title</u>	<u>SAR Figure Number</u>
M-2046	Plant Design Drawing Area 24 & 26 Containment Auxiliary Building Plan at Elev. 335'-0"	N.A.
M-2047	Plant Design Drawing Area 24 Containment Auxiliary Building Section A ₂₄ -A ₂₄	N.A.
M-2048	Plant Design Drawing Area 24 Containment Auxiliary Building Section B ₂₄ -B ₂₄	N.A.
M-2049	Plant Design Drawing Area 24 Containment Auxiliary Building Section C ₂₄ -C ₂₄	N.A.
M-2050	Plant Design Drawing Area 24 Containment Auxiliary Building Section D ₂₄ -D ₂₄ & J ₂₄ -J ₂₄	N.A.
M-2054	Containment Plan 405'-6" to 426'6"	N.A.
M-2055	Containment Plan 376'-6" to 405'6"	N.A.
M-2056	Containment Plan 357'-0" to 376'-6"	N.A.
M-2057	Containment Plan Below 357'-0"	N.A.
M-2058	Containment Section A ₂₅ -A ₂₅	N.A.
M-2059	Containment Section B ₂₅ -B ₂₅	N.A.
M-2060	Containment Section C ₂₅ -C ₂₅	N.A.
M-2063	Plant Design Drawing Area 26 Containment Auxiliary Building Plan Above Grade	N.A.
M-2064	Plant Design Drawing Area 26 Containment Auxiliary Building Plan Below Grade	N.A.
M-2065	Plant Design Drawing Area 26 Containment Auxiliary Building Misc. Plans & Sections	N.A.
M-2066	Plant Design Drawing Area 26 Containment Auxiliary Building Section A ₂₆ -A ₂₆	N.A.
M-2067	Plant Design Drawing Area 26 Containment Auxiliary Building Misc. Sections	N.A.
M-2200	Instrumentation and Component Symbols	N.A.
M-2201	Instrumentation P&ID Symbols	N.A.
M-2250	Service Water Flow Rates	N.A.
M-2260	HVAC Air Flow & Control Diagram Turb. Bldg., Operations Support Facility and Control Room Expansion Facility	N.A.
M-2262	HVAC Air Flow & Control Diagram Aux. Bldg. Radwaste Areas	N.A.
M-2290	Minimum Radiation Shielding Requirements Plan at El. 317'-0"	N.A.
M-2291	Minimum Radiation Shielding Requirements Plan at El. 335'-0"	N.A.
M-2292	Minimum Radiation Shielding Requirements Plan at E1. 354'-0"	N.A.
M-2293	Minimum Radiation Shielding Requirements Plan at El. 372'-0"	N.A.
M-2294	Minimum Radiation Shielding Requirements Plan at El. 386'-0"	N.A.
M-2295	Minimum Radiation Shielding Requirements Plan at El. 404'-0"	N.A.
M-2400	Control Logic Diagram Symbols and Functions	N.A.
M-2401	Functional Description and Logic Diagram Main and Reheat Steam Systems	N.A.
M-2402	Functional Description and Logic Diagram Condensate and Feedwater Systems	N.A.
M-2403	Emergency Feedwater Logic Diagram	N.A.

ARKANSAS NUCLEAR ONE
Unit 2

Table 1.7-2 (continued)

<u>Drawing Number</u>	<u>Title</u>	<u>SAR Figure Number</u>
M-2405	Functional Description and Logic Diagram Circulating Water System	N.A.
M-2406	Service Water System Logic Diagram	N.A.
M-2417	Chemistry and Volume Control System Logic Diagram	N.A.
M-2418	Safety Injection System Logic Diagram	N.A.
M-2420	Containment Isolation System Typical Logic Diagram	N.A.
M-2422	Containment Spray System Logic Diagram	N.A.
M-2432	Penetration Room Ventilation System Logic Diagram	N.A.
M-2508	Level Pressure & Difference Pressure Instrument Piping at Steam Generator and Pressurizer	N.A.
M-2650	Radiation Zoning & Access Control Plan at El. 317'-0"	N.A.
M-2651	Radiation Zoning & Access Control Plan at El. 335'-0"	N.A.
M-2652	Radiation Zoning & Access Control Plan at El. 354'-0"	N.A.
M-2654	Radiation Zoning & Access Control Plan at El. 386'-0"	N.A.
M-2655	Radiation Zoning & Access Control Plan at El. 404'-0"	N.A.
FS-2105	Fire Protection Plan Below Grade	N.A.
FS-2104	Fire Protection Ground Floor Plan	N.A.
FS-2103	Fire Protection Intermediate Floor Plan	N.A.
FS-2102	Fire Protection Operating Floor Plan	N.A.
FS-2101	Fire Protection Fuel Handling Floor Plan	N.A.
FS-2106	Fire Protection Plan at Elevation 317'-0"	N.A.

VENDOR PRINTS

<u>Drawing Number</u>	<u>Title</u>	<u>SAR Figure Number</u>
V6600-M-2001-C9-40-2	RCP Motor Speed Sensor One Line Diagram	N.A.
V6600-M-2001-K2-4	Ex-core Nuclear Instrument Containment Cabling Diagram	N.A.
V6600-M-2001-M1-138	PPS Bypass and Block Schematic	N.A.
V6600-M-2001-M1-139(1)	Reactor Protection System Simplified Functional Diagram	N.A.
V6600-M-2001-M1-139(4)	Plant Protection System Functional Diagram	N.A.
V6600-M-2001-M1-156	Plant Protection System-Remote-Control	N.A.
M6600-M-2001-M1-157	Plant Protection System Bistable Input/Output Signals	N.A.
V6600-M-2001-M1-172	PPS Engineered Safety Features Actuation Logic	N.A.
V6600-M-2001-M1-173	ESFAS Signal Logic	N.A.
V6600-M-2001-M1-187	PPS Testing System Schematic	N.A.
V6600-M-2001-Q2-46	Channel P-102A, P-101A Interconnection Diagram	N.A.
V6600-M-2001-Q7-20	Channels P-1013A & P-1023A Interconnection Diagram	N.A.
V6600-M-2001-Q7-24	Channel L-1113A & L-1123A Interconnection Diagram	N.A.

ARKANSAS NUCLEAR ONE
Unit 2

Table 1.7-2 (continued)

<u>Drawing Number</u>	<u>Title</u>	<u>SAR Figure Number</u>
V6600-M-2001-Q7-25	Channel L-1113B & L-1123B Interconnection Diagram	N.A.
V6600-M-2001-Q7-26	Channel L-1113C & L-1123C Interconnection Diagram	N.A.
V6600-M-2001-Q7-27	Channel L-1113D & L-1123D Interconnection Diagram	N.A.
V6600-M-2012-11	Schematic Diagram - Diesel Engine Generator Skid.	N.A.

The following SAR figures are based on the referenced controlled drawings, but are not necessarily identical to the controlled drawing. Information has been added to or deleted from the controlled drawing to create the SAR figure. These SAR figures may not require revision even though the controlled drawing has changed.

<u>Drawing Number</u>	<u>Title</u>	<u>SAR Figure Number</u>
C-2002	Site Plan	2.5-17
C-2002	Site Plan with Locations for Estimated Exposures	12.1-13
C-2003	CST Yard Area Missile Barriers	
C-2003	Liquid & Gaseous Release Points	11.3-2
C-2008	General Grading & Drainage Plan	2.4-8
C-2012	Plant Excavation Plan	2.5-18
C-2014	Plant Excavation Sections	2.5-19
C-2016	Plant Backfill Plan and Sections	2.5-20
E-0001	500 KV Switchyard Auxiliary Power	8.2-3
E-2001	Station Single Line Diagram	8.3-1
E-2006	Low Voltage Safety Systems Power Supplies	8.3-6
E-2020	Lighting Distribution System	8.3-17 & 18
M-2202	Main Steam System & Auxiliary Steam Systems	10.2-3, 10.4-2
M-2203	Reheat Steam	10.4-3
M-2204	Condensate & Feedwater, Emergency Feedwater & Condenser Vacuum Systems	10.2-4, 10.4-1, 10.4-2, 10.4-3
M-2205	Extraction Steam Heater Vents & Drains – Condenser Connections	10.4-2, 10.4-3
M-2206	Steam Generation & Secondary System	10.2-3
M-2209	Circulating Water System	10.4-1
M-2213	Liquid Radioactive Waste System	11.2-1
M-2214	Boron Management System	11.2-1
M-2215	Gaseous Radioactive Waste	11.3-1
M-2224	Solid Radwaste System	11.3-1
M-2226	Regenerative Waste Processing System	11.2-1

ARKANSAS NUCLEAR ONE
Unit 2

Table 1.7-2 (continued)

<u>Drawing Number</u>	<u>Title</u>	<u>SAR Figure Number</u>
M-2229	Startup & Blowdown Demineralizer System	10.2-4
M-2240	Steam Generator and Feedwater Chemical Feed System	10.2-3
M-2208	Turbine-Generator Auxiliary Systems	3.2-6
M-2210	Service Water System	9.2-1
M-2211	Auxiliary Cooling Water	9.2-1
M-2212	Plant Makeup & Domestic Water System	9.2-7A & B
M-2216	Main Turbine Generator and Main Feedwater Pump Turbine Lube Oil	3.2-1
M-2217	Emergency Diesel Generators Fuel Oil, Starting Air and Aux Systems	9.5-8
M-2218	Instrument, Service and Breathing Air Systems	9.3-1
M-2219	Fire Water, Fire Systems, Deluge Valve Trim Details, Outside Fire Water Loop and Halon Fire Suppression System	9.5-1
M-2220	Plant Heating System	3.2-2
M-2221	Control, Computer, & Electrical Equipment Room Chill Water and Control & Computer Room Emergency HVAC Freon System	3.2-3
M-2222	Containment, Turbine, Auxiliary, Auxiliary Extension Buildings, and Controlled Access Chilled Water Systems	3.2-4
M-2223	Secondary Sampling System	9.3-2
M-2225	Turbine Building Sumps	9.2-7C
M-2230	Reactor Coolant System	5.1-3
M-2231	Chemical Volume and Control System	9.3-4
M-2232	Safety Injection System	6.3-2
M-2234	Component Cooling Water System	9.2-6
M-2235	Fuel Pool System	9.1-1
M-2236	Containment Spray System	6.2-17
M-2237	Sampling Systems	9.3-2
M-2238	Reactor Coolant Pump Connections	5.5-2
M-2239	Nitrogen Addition System and Electrical Penetration Nitrogen Pressurization System	3.2-5
M-2261	HVAC Air Flow & Control Diagram Containment Building and Post Accident Hydrogen Analysis System	9.4-4
M-2263	Aux. Bldg. Control & Computer Room HVAC, Post Accident Sampling Facility HVAC	9.4-1
M-2264	Containment Penetration Rooms Vent. System	6.5-1
M-2502	General Arrangement Plan Main Control Room	12.1-14
M-2589	Local Panel 2C80 Remote Shut Down Monitoring Panel	7.4-3
M-2877	Out of Core Instrument Detector System Containment Building	7.7-4

ARKANSAS NUCLEAR ONE
Unit 2

Table 1.7-2 (continued)

The following SAR drawings are based on vendor prints, but are not necessarily identical to the vendor print. Information has been added to or deleted from the drawing to create the SAR figure. These SAR figures may not require revision even though the vendor print has changed.

<u>Drawing Number</u>	<u>Title</u>	<u>SAR Figure Number</u>
V6600-M-2001-C1-2	Reactor Coolant System Arrangement Plan	5.1-1
V6600-M-2001-C1-3	Reactor Coolant System Arrangement	5.1-2
V6600-M-2001-K3-94(1)	In-core Instrument Assembly	4.2-16
V6600-M-2001-M1-15	Plant Protection System (PPS) 2/4 Logic Matrix System	FMEA Diagram 13
V6600-M-2001-M1-158	Plant Protection System Interface Logic Diagram	FMEA Diagram 1

ARKANSAS NUCLEAR ONE
Unit 2

Table 1.7-3

PIPING IDENTIFICATION

The information in this table is historical in nature and Specification ANO-M-2555 should be referenced for the latest information.

Piping classes are designated by a three-letter code. The first letter indicates the primary valve and flange pressure rating, the second letter the type of material and the third letter the code to which the piping is designated.

The designations are as follows:

First Letter: Pressure Rating⁽¹⁾

B - 2500 #	J - 125#ANSI B16.1
C - 1500 #	K - 75#WOG ⁽²⁾ Underwriter's Laboratories, Inc.
D - 900 #	L - 250#ANSI B16.1
E - 600 #	M - 200#WOG ⁽²⁾
F - 400 #	N - 150# ANSI B16.24 ⁽³⁾
G - 300 #	T - Tubing
H - 150 #	

Second Letter: Material

B - Carbon Steel	H - Cast Iron
C - Stainless Steel	J - Cast Iron – Cement Lined
D - Copper, Brass, or Bronze	L - Carbon Steel – Impact Tested
E - Note 4	S - Carpenter 20 Cb-3 Stainless Steel
F - Note 4	N - Galvanized Carbon Steel
G - Note 4	R - Fiberglass Reinforced

Third Letter: Design Code⁽⁵⁾

A - Nuclear Power Plant Components, ASME B&PV Code, Section III, Class 1
B - Nuclear Power Plant Components, ASME B&PV Code, Section III, Class 2
C - Nuclear Power Plant Components, ASME B&PV Code, Section III, Class 3
D - Power Piping Code, ANSI B31.1.0
F - National Fire Protection Association Codes
J - American Water Works Standards
R - Copper Tubing per ANSI B31.5

Notes

1. All ratings are in accordance with ANSI B16.5 and other ANSI standards as applicable.
2. Water, Oil, or Gas service (not steam service).
3. Not used; listed for historical purposes only.
4. For general use as designated on Piping Class Sheets.
5. Use of a later appropriate ASME Section III code(s) is acceptable provided the section(s) used is reconciled.

ARKANSAS NUCLEAR ONE
Unit 2

CHAPTER 2

TABLE OF CONTENTS

<u>Section</u>	<u>Title</u>	<u>Page</u>
2	<u>SITE CHARACTERISTICS</u>	2.1-1
2.1	<u>GEOGRAPHY AND DEMOGRAPHY</u>	2.1-1
2.1.1	SITE LOCATION	2.1-1
2.1.2	SITE DESCRIPTION	2.1-1
2.1.2.1	<u>Exclusion Area Control</u>	2.1-1
2.1.2.2	<u>Boundaries for Establishing Effluent Release Limits</u>	2.1-2
2.1.3	POPULATION AND POPULATION DISTRIBUTION	2.1-3
2.1.3.1	<u>Population Within 10 Miles</u>	2.1-3
2.1.3.2	<u>Population Between 10 and 50 Miles</u>	2.1-3
2.1.3.3	<u>Low Population Zone</u>	2.1-3
2.1.3.4	<u>Transient Population</u>	2.1-4
2.1.3.5	<u>Population Center</u>	2.1-4
2.1.3.6	<u>Public Facilities and Institutions</u>	2.1-5
2.1.4	USES OF ADJACENT LANDS AND WATERS	2.1-5
2.1.4.1	<u>Recreation</u>	2.1-5
2.1.4.2	<u>Agricultural</u>	2.1-6
2.1.4.3	<u>Fish and Wildlife</u>	2.1-7
2.1.4.4	<u>Forestry</u>	2.1-9
2.2	<u>NEARBY INDUSTRIAL, TRANSPORTATION, AND MILITARY FACILITIES</u>	2.2-1
2.2.1	LOCATIONS, ROUTES, AND DESCRIPTIONS	2.2-1
2.2.2	EVALUATION.....	2.2-2
2.2.2.1	<u>Natural Gas Pipeline</u>	2.2-2

ARKANSAS NUCLEAR ONE
Unit 2

TABLE OF CONTENTS (continued)

<u>Section</u>	<u>Title</u>	<u>Page</u>
2.2.2.2	<u>Cooling Tower</u>	2.2-8
2.2.2.3	<u>Deleted</u>	2.2-8
2.2.2.4	<u>Other</u>	2.2-8
2.3	<u>METEOROLOGY</u>	2.3-1
2.3.1	REGIONAL CLIMATOLOGY	2.3-1
2.3.1.1	<u>Data Sources</u>	2.3-1
2.3.1.2	<u>General Climate</u>	2.3-2
2.3.1.3	<u>Severe Weather</u>	2.3-3
2.3.2	LOCAL METEROLOGY	2.3-12
2.3.2.1	<u>Data Sources</u>	2.3-12
2.3.2.2	<u>Normal and Extreme Values of Meteorological Parameters</u>	2.3-13
2.3.2.3	<u>Potential Influence of the Plant and Its Facilities on Local Meteorology</u>	2.3-19
2.3.2.4	<u>Topographical Description</u>	2.3-20
2.3.3	ONSITE METEOROLOGICAL PROGRAM.....	2.3-21
2.3.3.1	<u>Preoperational Program</u>	2.3-21
2.3.3.2	<u>Wind Roses by Pasquill Stability Categories</u>	2.3-24
2.3.3.3	<u>Wind Persistence</u>	2.3-27
2.3.3.4	<u>Operational Program</u>	2.3-27
2.3.4	SHORT-TERM (ACCIDENT) DIFFUSION ESTIMATES	2.3-29
2.3.4.1	<u>Eight Hours or Less Dilution Factors</u>	2.3-29
2.3.4.2	<u>Longer than Eight Hour Dilution Factors</u>	2.3-30
2.3.4.3	<u>Estimated Values of Hourly Dilution Factors</u>	2.3-30
2.3.4.4	<u>Estimated Values of Dilution Factors for Periods up to 30 Days</u>	2.3-31
2.3.5	LONG-TERM (ROUTINE) DIFFUSION ESTIMATES.....	2.3-33

ARKANSAS NUCLEAR ONE
Unit 2

TABLE OF CONTENTS (continued)

<u>Section</u>	<u>Title</u>	<u>Page</u>
2.3.5.1	<u>General</u>	2.3-33
2.3.5.2	<u>Calculations</u>	2.3-33
2.3.6	ANNUAL RELEASE RATE LIMITS	2.3-33
2.3.7	QUARTERLY RELEASE RATE LIMITS.....	2.3-34
2.3.8	HOURLY RELEASE RATE LIMITS.....	2.3-34
2.4	<u>HYDROLOGIC ENGINEERING</u>	2.4-1
2.4.1	HYDROLOGIC DESCRIPTION.....	2.4-1
2.4.1.1	<u>Site and Facilities</u>	2.4-1
2.4.1.2	<u>Hydrosphere</u>	2.4-1
2.4.2	FLOODS.....	2.4-2
2.4.2.1	<u>Flood History</u>	2.4-2
2.4.2.2	<u>Flood Design Consideration</u>	2.4-2
2.4.2.3	<u>Effects of Local Intense Precipitation</u>	2.4-2
2.4.3	PROBABLE MAXIMUM FLOOD ON STREAMS AND RIVERS.....	2.4-4
2.4.3.1	<u>Probable Maximum Precipitation</u>	2.4-4
2.4.3.2	<u>Precipitation Losses</u>	2.4-4
2.4.3.3	<u>Runoff Model</u>	2.4-4
2.4.3.4	<u>Probable Maximum Flood Flow</u>	2.4-4
2.4.3.5	<u>Water Level Determinations</u>	2.4-4
2.4.3.6	<u>Coincident Wind Wave Activity</u>	2.4-4
2.4.3.7	<u>Site Drainage System</u>	2.4-4
2.4.4	POTENTIAL DAM FAILURES (SEISMICALLY INDUCED).....	2.4-4
2.4.5	PROBABLE MAXIMUM SURGE AND SEICHE FLOODING	2.4-4
2.4.6	PROBABLE MAXIMUM TSUNAMI FLOODING.....	2.4-5

ARKANSAS NUCLEAR ONE
Unit 2

TABLE OF CONTENTS (continued)

<u>Section</u>	<u>Title</u>	<u>Page</u>
2.4.7	ICE FLOODING	2.4-5
2.4.8	COOLING WATER CANALS AND RESERVOIRS	2.4-5
2.4.8.1	<u>Canals</u>	2.4-5
2.4.8.2	<u>Reservoirs</u>	2.4-6
2.4.9	CHANNEL DIVERSIONS	2.4-6
2.4.10	FLOODING PROTECTION REQUIREMENTS	2.4-6
2.4.11	LOW WATER CONSIDERATIONS	2.4-7
2.4.11.1	<u>Low Flow in Rivers and Streams</u>	2.4-7
2.4.11.2	<u>Low Water Resulting from Surges, Seiches, or Tsunamis</u>	2.4-7
2.4.11.3	<u>Historical Low Water</u>	2.4-7
2.4.11.4	<u>Future Control</u>	2.4-7
2.4.11.5	<u>Plant Requirement</u>	2.4-7
2.4.11.6	<u>Heat Sink Dependability Requirements</u>	2.4-8
2.4.12	ENVIRONMENTAL ACCEPTANCE OF EFFLUENTS	2.4-8
2.4.13	GROUNDWATER	2.4-9
2.4.13.1	<u>Description and Onsite Use</u>	2.4-9
2.4.13.2	<u>Sources</u>	2.4-10
2.4.13.3	<u>Accident Effects</u>	2.4-12
2.4.13.4	<u>Monitoring and Safeguard Requirements</u>	2.4-13
2.4.13.5	<u>Design Bases for Subsurface Hydrostatic Loadings</u>	2.4-13
2.4.14	TECHNICAL SPECIFICATION AND EMERGENCY OPERATION REQUIREMENTS	2.4-13
2.5	<u>GEOLOGY AND SEISMOLOGY</u>	2.5-1
2.5.1	BASIC GEOLOGIC AND SEISMIC DATA	2.5-2

ARKANSAS NUCLEAR ONE
Unit 2

TABLE OF CONTENTS (continued)

<u>Section</u>	<u>Title</u>	<u>Page</u>
2.5.1.1	<u>Regional Geology</u>	2.5-2
2.5.1.2	<u>Site Geology</u>	2.5-6
2.5.2	VIBRATORY GROUND MOTION	2.5-10
2.5.2.1	<u>Geologic Conditions of the Site</u>	2.5-11
2.5.2.2	<u>Underlying Tectonic Structures</u>	2.5-11
2.5.2.3	<u>Behavior During Prior Earthquakes</u>	2.5-14
2.5.2.4	<u>Engineering Properties of Materials Underlying the Site</u>	2.5-15
2.5.2.5	<u>Earthquake History</u>	2.5-15
2.5.2.6	<u>Correlation of Epicenters With Geologic Structures</u>	2.5-22
2.5.2.7	<u>Identification and Description of Active Faults</u>	2.5-22
2.5.2.8	<u>Maximum Earthquake</u>	2.5-29
2.5.2.9	<u>Design Basis Earthquake</u>	2.5-31
2.5.2.10	<u>Operating Basis Earthquake</u>	2.5-31
2.5.3	SURFACE FAULTING	2.5-32
2.5.3.1	<u>Geological Conditions of the Site</u>	2.5-32
2.5.3.2	<u>Evidence of Fault Offset</u>	2.5-32
2.5.3.3	<u>Identification of Active Faults</u>	2.5-33
2.5.3.4	<u>Earthquakes Associated with Active Faults</u>	2.5-33
2.5.3.5	<u>Correlation of Epicenters with Active Faults</u>	2.5-33
2.5.3.6	<u>Description of Active Faults</u>	2.5-33
2.5.3.7	<u>Zone Requiring Detailed Fault Investigation</u>	2.5-33
2.5.3.8	<u>Results of Faulting Investigation</u>	2.5-33
2.5.3.9	<u>Design Basis for Surface Faulting</u>	2.5-33
2.5.4	STABILITY OF SUBSURFACE MATERIALS	2.5-34

ARKANSAS NUCLEAR ONE
Unit 2

TABLE OF CONTENTS (continued)

<u>Section</u>	<u>Title</u>	<u>Page</u>
2.5.4.1	<u>Geologic Features</u>	2.5-34
2.5.4.2	<u>Properties of Underlying Materials</u>	2.5-34
2.5.4.3	<u>Plot Plan</u>	2.5-35
2.5.4.4	<u>Excavations and Backfill</u>	2.5-35
2.5.4.5	<u>Groundwater Conditions</u>	2.5-36
2.5.4.6	<u>Response of Soil and Rock to Dynamic Loading</u>	2.5-37
2.5.4.7	<u>Liquefaction Potential</u>	2.5-37
2.5.4.8	<u>Earthquake Design Basis</u>	2.5-37
2.5.4.9	<u>Static Analyses</u>	2.5-37
2.5.4.10	<u>Criteria and Design Methods</u>	2.5-37
2.5.4.11	<u>Techniques to Improve Subsurface Conditions</u>	2.5-39
2.5.5	SLOPE STABILITY	2.5-39
2.5.5.1	<u>Slope Characteristics</u>	2.5-39
2.5.5.2	<u>Design Criteria and Analyses of Slopes</u>	2.5-39
2.5.5.3	<u>Logs of Core Borings</u>	2.5-47
2.5.5.4	<u>Compaction Criteria</u>	2.5-49
2.5.5.5	<u>Lateral Earth Pressure</u>	2.5-49
2.6	<u>REFERENCES</u>	2.6-1
2.7	<u>TABLES</u>	2.7-1
2.8	<u>SITE SPECIFIC INFORMATION</u>	2.8-1
2.8.1	FLOOD RELATED INFORMATION	2.8-1
2.8.1.1	<u>Probable Maximum Flood Combined With Wind Wave Action</u>	2.8-1
2.8.1.2	<u>Probable Maximum Flood Combined With Ozark Dam Failure</u>	2.8-1
2.8.1.3	<u>Probable Maximum Flood on Streams and Rivers</u>	2.8-2

ARKANSAS NUCLEAR ONE
Unit 2

TABLE OF CONTENTS (continued)

<u>Section</u>	<u>Title</u>	<u>Page</u>
2.8.1.4	<u>Potential Dam Failures (Seismically Induced)</u>	2.8-6
2.8.1.5	<u>Design Bases for Subsurface Hydrostatic Loadings</u>	2.8-9
2.8.2	ADDITIONAL NATURAL GAS PIPELINE INFORMATION	2.8-9
2.8.3	ADDITIONAL NEW FUEL STORAGE INFORMATION.....	2.8-10
2A	<u>APPENDIX 2A</u>	2.A-1

ARKANSAS NUCLEAR ONE
Unit 2

LIST OF TABLES

<u>Table No.</u>	<u>Title</u>	<u>Page</u>
2.1-1	DATA ON RESERVOIRS AND LAKES WITHIN A 50-MILE RADIUS.....	2.7-1
2.1-2	GASEOUS RELEASE LOCATION.....	2.7-3
2.1-3	PUBLIC FACILITIES AND INSTITUTIONS WITHIN 10 MILES	2.7-4
2.1-4	FARM STATISTICS FOR COUNTIES WITHIN 50 MILES OF ANO	2.7-5
2.1-5	LIVESTOCK AND POULTRY STATISTICS FOR COUNTIES WITHIN 50 MILES OF ANO.....	2.7-6
2.1-6	CROP STATISTICS FOR COUNTIES WITHIN 50 MILES OF ANO.....	2.7-7
2.1-7	DEER KILL STATISTICS FOR COUNTIES WITHIN 50 MILES OF ANO	2.7-11
2.1-8	1972 FISH POPULATION SAMPLE.....	2.7-12
2.1-9	1971 COMMERCIAL FISHING SURVEY DARDANELLE RESERVOIR.	2.7-15
2.1-10	VOLUME OF FOREST GROWING STOCK ON COMMERCIAL FOREST LAND IN SURVEY REGIONS OF ARKANSAS.....	2.7-16
2.1-11	COMMERCIAL FOREST LAND AROUND ARKANSAS NUCLEAR ONE.....	2.7-17
2.1-12	INCOME AND LOSS TERMS ON THE TIMBER INVENTORY	2.7-18
2.1-13	GROWING STOCK VOLUME ON COMMERCIAL FOREST LAND BY SPECIES GROUP AND COUNTY, 1969	2.7-19
2.1-14	STATE PARKS, NATIONAL FORESTS AND RECREATION AREAS WITHIN 50 MILES OF ARKANSAS PLANT.....	2.7-21
2.1-15	VISITOR ACTIVITIES IN PERCENT USAGE, LAKE DARDANELLE	2.7-23
2.1-16	DARDANELLE RESERVOIR AND DOWNSTREAM ARKANSAS RIVER SURFACE WATER DIVERTERS	2.7-24
2.3-1	ANO ANNUAL 40-FOOT WIND DIRECTION AND SPEED, RELATIVE FREQUENCIES. (FEB. 7, 1972 TO FEB. 7, 1973).....	2.7-25
2.3-2	ANO JANUARY 40-FOOT WIND DIRECTION AND SPEED, RELATIVE FREQUENCIES. (FEB. 7, 1972 TO FEB. 7, 1973).....	2.7-26
2.3-3	ANO FEBRUARY 40-FOOT WIND DIRECTION AND SPEED, RELATIVE FREQUENCIES. (FEB. 7, 1972 TO FEB. 7, 1973).....	2.7-27

ARKANSAS NUCLEAR ONE
Unit 2

LIST OF TABLES (continued)

<u>Table No.</u>	<u>Title</u>	<u>Page</u>
2.3-4	ANO MARCH 40-FOOT WIND DIRECTION AND SPEED, RELATIVE FREQUENCIES. (FEB. 7, 1972 to FEB. 7, 1973).....	2.7-28
2.3-5	ANO APRIL 40-FOOT WIND DIRECTION AND SPEED, RELATIVE FREQUENCIES. (FEB. 7, 1972 TO FEB. 7, 1973).....	2.7-29
2.3-6	ANO MAY 40-FOOT WIND DIRECTION AND SPEED, RELATIVE FREQUENCIES. (FEB. 7, 1972 TO FEB. 7, 1973).....	2.7-30
2.3-7	ANO JUNE 40-FOOT WIND DIRECTION AND SPEED, RELATIVE FREQUENCIES. (FEB. 7, 1972 TO FEB. 7, 1973).....	2.7-31
2.3-8	ANO JULY 40-FOOT WIND DIRECTION AND SPEED, RELATIVE FREQUENCIES. (FEB. 7, 1972 TO FEB. 7, 1973).....	2.7-32
2.3-9	ANO AUGUST 40-FOOT WIND DIRECTION AND SPEED, RELATIVE FREQUENCIES. (FEB. 7, 1972 TO FEB. 7, 1973).....	2.7-33
2.3-10	ANO SEPTEMBER 40-FOOT WIND DIRECTION AND SPEED, RELATIVE FREQUENCIES. (FEB. 7, 1972 TO FEB. 7, 1973).....	2.7-34
2.3-11	ANO OCTOBER 40-FOOT WIND DIRECTION AND SPEED, RELATIVE FREQUENCIES. (FEB. 7, 1972 TO FEB. 7, 1973).....	2.7-35
2.3-12	ANO NOVEMBER 40-FOOT WIND DIRECTION AND SPEED, RELATIVE FREQUENCIES. (FEB. 7, 1972 TO FEB. 7, 1973).....	2.7-36
2.3-13	ANO DECEMBER 40-FOOT WIND DIRECTION AND SPEED, RELATIVE FREQUENCIES. (FEB. 7, 1972 TO FEB. 7, 1973).....	2.7-37
2.3-14	LITTLE ROCK, ARKANSAS WINTER SURFACE WIND DIRECTION AND SPEED, RELATIVE FREQUENCIES FOR 'A' STABILITY	2.7-38
2.3-15	LITTLE ROCK, ARKANSAS WINTER SURFACE WIND DIRECTION AND SPEED, RELATIVE FREQUENCIES FOR 'B' STABILITY	2.7-39
2.3-16	LITTLE ROCK, ARKANSAS WINTER SURFACE WIND DIRECTION AND SPEED, RELATIVE FREQUENCIES FOR 'C' STABILITY	2.7-40
2.3-17	LITTLE ROCK, ARKANSAS WINTER SURFACE WIND DIRECTION AND SPEED, RELATIVE FREQUENCIES FOR 'D' STABILITY	2.7-41
2.3-18	LITTLE ROCK, ARKANSAS WINTER SURFACE WIND DIRECTION AND SPEED, RELATIVE FREQUENCIES FOR 'E' STABILITY	2.7-42
2.3-19	LITTLE ROCK, ARKANSAS SPRING SURFACE WIND DIRECTION AND SPEED, RELATIVE FREQUENCIES FOR 'A' STABILITY	2.7-43

ARKANSAS NUCLEAR ONE
Unit 2

LIST OF TABLES (continued)

<u>Table No.</u>	<u>Title</u>	<u>Page</u>
2.3-20	LITTLE ROCK, ARKANSAS SPRING SURFACE WIND DIRECTION AND SPEED, RELATIVE FREQUENCIES FOR 'B' STABILITY	2.7-44
2.3-21	LITTLE ROCK, ARKANSAS SPRING SURFACE WIND DIRECTION AND SPEED, RELATIVE FREQUENCIES FOR 'C' STABILITY	2.7-45
2.3-22	LITTLE ROCK, ARKANSAS SPRING SURFACE WIND DIRECTION AND SPEED, RELATIVE FREQUENCIES FOR 'D' STABILITY	2.7-46
2.3-23	LITTLE ROCK, ARKANSAS SPRING SURFACE WIND DIRECTION AND SPEED, RELATIVE FREQUENCIES FOR 'E' STABILITY	2.7-47
2.3-24	LITTLE ROCK, ARKANSAS SUMMER SURFACE WIND DIRECTION AND SPEED, RELATIVE FREQUENCIES FOR 'A' STABILITY	2.7-48
2.3-25	LITTLE ROCK, ARKANSAS SUMMER SURFACE WIND DIRECTION AND SPEED, RELATIVE FREQUENCIES FOR 'B' STABILITY	2.7-49
2.3-26	LITTLE ROCK, ARKANSAS SUMMER SURFACE WIND DIRECTION AND SPEED, RELATIVE FREQUENCIES FOR 'C' STABILITY	2.7-50
2.3-27	LITTLE ROCK, ARKANSAS SUMMER SURFACE WIND DIRECTION AND SPEED, RELATIVE FREQUENCIES FOR 'D' STABILITY	2.7-51
2.3-28	LITTLE ROCK, ARKANSAS SUMMER SURFACE WIND DIRECTION AND SPEED, RELATIVE FREQUENCIES FOR 'E' STABILITY	2.7-52
2.3-29	LITTLE ROCK, ARKANSAS AUTUMN SURFACE WIND DIRECTION AND SPEED RELATIVE FREQUENCIES FOR 'A' STABILITY	2.7-53
2.3-30	LITTLE ROCK, ARKANSAS AUTUMN SURFACE WIND DIRECTION AND SPEED, RELATIVE FREQUENCIES FOR 'B' STABILITY	2.7-54
2.3-31	LITTLE ROCK, ARKANSAS AUTUMN SURFACE WIND DIRECTION AND SPEED, RELATIVE FREQUENCIES FOR 'C' STABILITY	2.7-55
2.3-32	LITTLE ROCK, ARKANSAS AUTUMN SURFACE WIND DIRECTION AND SPEED, RELATIVE FREQUENCIES FOR 'D' STABILITY	2.7-56
2.3-33	LITTLE ROCK, ARKANSAS AUTUMN SURFACE WIND DIRECTION AND SPEED, RELATIVE FREQUENCIES FOR 'E' STABILITY	2.7-57
2.3-34	LITTLE ROCK, ARKANSAS ANNUAL SURFACE WIND DIRECTION AND SPEED, RELATIVE FREQUENCIES FOR 'A' STABILITY	2.7-58
2.3-35	LITTLE ROCK, ARKANSAS ANNUAL SURFACE WIND DIRECTION AND SPEED, RELATIVE FREQUENCIES FOR 'B' STABILITY	2.7-59

ARKANSAS NUCLEAR ONE
Unit 2

LIST OF TABLES (continued)

<u>Table No.</u>	<u>Title</u>	<u>Page</u>
2.3-36	LITTLE ROCK, ARKANSAS ANNUAL SURFACE WIND DIRECTION AND SPEED, RELATIVE FREQUENCIES FOR 'C' STABILITY	2.7-60
2.3-37	LITTLE ROCK, ARKANSAS ANNUAL SURFACE WIND DIRECTION AND SPEED, RELATIVE FREQUENCIES FOR 'D' STABILITY	2.7-61
2.3-38	LITTLE ROCK, ARKANSAS ANNUAL SURFACE WIND DIRECTION AND SPEED, RELATIVE FREQUENCIES FOR 'E' STABILITY	2.7-62
2.3-39	SUSTAINED PERIODS OF MISSING OR INVALID DATA.....	2.7-63
2.3-40	WIND FREQUENCY DISTRIBUTION, FEB. 7, 1972 TO FEB. 7, 1973, PASQUILL A THROUGH D.....	2.7-64
2.3-41	WIND FREQUENCY DISTRIBUTION, FEB. 7, 1972 TO FEB. 7, 1973, PASQUILL E THROUGH A-G.....	2.7-68
2.3-42	WIND PERSISTENCE STABILITY INDEPENDENT	2.7-72
2.3-43	WIND PERSISTENCE STABILITY 'A'	2.7-73
2.3-44	WIND PERSISTENCE STABILITY 'B'	2.7-74
2.3-45	WIND PERSISTENCE STABILITY 'C'.....	2.7-75
2.3-46	WIND PERSISTENCE STABILITY 'D'.....	2.7-76
2.3-47	WIND PERSISTENCE STABILITY 'E'	2.7-77
2.3-48	WIND PERSISTENCE STABILITY 'F'	2.7-78
2.3-49	WIND PERSISTENCE STABILITY 'G'	2.7-79
2.3-50	ACTUAL EXCLUSION ZONE BOUNDARIES.....	2.7-80
2.3-51	STANDARD SAR METEOROLOGICAL ANALYSIS OF ONSITE DATA, STEP-BY-STEP DESCRIPTION	2.7-81
2.3-52	AVERAGE RELATIVE CONCENTRATIONS OVER SELECTED AVERAGING INTERVALS (FEB. 7, 1972 TO FEB. 7, 1973).....	2.7-82
2.3-53	AVERAGE RELATIVE CONCENTRATIONS OVER SELECTED AVERAGING INTERVALS, DATA PERIOD FEB. 7, 1972 TO FEB. 7, 1973.....	2.7-83
2.3-54	AVERAGE ANNUAL RELATIVE CONCENTRATION (SEC/CUBIC METER) PER SECTOR PER DISTANCE IN METERS FROM PLANT SITE (100 TO 8,000 METERS).....	2.7-84

ARKANSAS NUCLEAR ONE
Unit 2

LIST OF TABLES (continued)

<u>Table No.</u>	<u>Title</u>	<u>Page</u>
2.3-55	AVERAGE ANNUAL RELATIVE CONCENTRATION (SEC/CUBIC METER) PER SECTOR PER DISTANCE IN METERS FROM PLANT SITE (10 TO 80 METERS)	2.7-85
2.3-56	MONTHLY AND SEASONAL DISTRIBUTION OF TORNADO OCCURRENCE FOR ARKANSAS (1955-1967)	2.7-86
2.3-57	MONTHLY AND SEASONAL LIGHTNING EVENTS FOR ARKANSAS, OCTOBER 1958 THROUGH SEPTEMBER 1968	2.7-87
2.3-58	MONTHLY, SEASONAL AND ANNUAL DIURNAL MEAN AIR TEMPERATURE (°F) VARIATIONS FOR LITTLE ROCK, ARKANSAS (JANUARY 1956 THROUGH DECEMBER 1962)	2.7-88
2.3-59	MONTHLY, SEASONAL AND ANNUAL EXTREMES OF ABSOLUTE HUMIDITY FOR LITTLE ROCK, ARKANSAS (JANUARY 1956 THROUGH DECEMBER 1962)	2.7-89
2.3-60	SEASONAL AND ANNUAL DIURNAL VARIATION OF MEAN ABSOLUTE HUMIDITY (gm/m ³) FOR LITTLE ROCK, ARKANSAS (JANUARY 1956 THROUGH DECEMBER 1962)	2.7-90
2.3-61	MONTHLY, SEASONAL AND ANNUAL DIURNAL VARIATION OF MEAN DEW POINT TEMPERATURE (°F) VARIATIONS FOR LITTLE ROCK, ARKANSAS (JANUARY 1956 THROUGH DECEMBER 1962)	2.7-91
2.3-62	MONTHLY, SEASONAL AND ANNUAL DIURNAL VARIATION OF MEAN RELATIVE HUMIDITY (%) VARIATION FOR LITTLE ROCK, ARKANSAS (JANUARY 1956 THROUGH DECEMBER 1962)	2.7-92
2.3-63	PERCENT FREQUENCY OF OCCURRENCE OF FOG FOR LITTLE ROCK, ARKANSAS (1949-1967)	2.7-93
2.4-1	RAINFALL AND RUNOFF FOR PMF	2.7-94
2.4-2	GROUNDWATER USE IN JOHNSON, LOGAN, POPE, AND YELL COUNTIES - 1970	2.7-95
2.4-3	WELL SURVEY AND	2.7-96
2.4-4	CHEMICAL ANALYSIS OF GROUND AND SURFACE WATER	2.7-98
2.4-5	JUNE 1974 WELL CANVASS	2.7-99
2.5-1	SUMMARY OF DRILL HOLE DATA	2.7-100

ARKANSAS NUCLEAR ONE
Unit 2

LIST OF TABLES (continued)

<u>Table No.</u>	<u>Title</u>	<u>Page</u>
2.5-2	SUMMARY OF LABORATORY ROCK TESTS.....	2.7-102
2.5-3	ENGINEERING PROPERTIES FOR SITE SOILS	2.7-104
2.5-4	STATIC ENGINEERING PROPERTIES FOR DESIGN (EMERGENCY COOLING POND).....	2.7-105
2.5-5a	LONG-TERM STABILITY EMERGENCY COOLINGWATER POND	2.7-105
2.5-5b	FACTORS OF SAFETY OF EMERGENCY COOLING POND SLOPE ..	2.7-105
2.5-5c	FACTORS OF SAFETY OF EMERGENCY COOLING POND SLOPE USING PEAK STRENGTH VALUES	2.7-106
2.5-6	RESULTS OF CLASSIFICATION TESTS - 1970.....	2.7-106
2.5-6a	RESULTS OF LABORATORY TESTS.....	2.7-107
2.5-6b	PRECONSOLIDATION PRESSURE OF SOIL OVERBURDEN	2.7-110
2.5-7	RESULTS OF CLASSIFICATION TESTS - 1972.....	2.7-111
2.5-8	MODIFIED MERCALLI INTENSITY SCALE OF 1931 (ABRIDGED)	2.7-112
2.5-9	CHRONOLOGICAL LIST OF EPICENTER LOCATIONS FOR MAP SHOWING SIGNIFICANT EARTHQUAKE EPICENTERS.....	2.7-113
2.5-10	ANCHOR BAR PULL TESTS	2.7-115
2.5-11	LONG-TERM STABILITY INTAKE AND DISCHARGE CANALS.....	2.7-115
2.5-12	RESULTS OF CLASSIFICATION TESTS	2.7-116

ARKANSAS NUCLEAR ONE
Unit 2

LIST OF FIGURES

<u>Figure No.</u>	<u>Title</u>
2.1-1	COUNTIES WITHIN A 50-MILE RADIUS
2.1-2	DELETED
2.1-3	RESTRICTED AREA
2.1-4	LAND USE (PASTURED/CULTIVATED) WITHIN A 50-MILE RADIUS
2.1-5	1970 POPULATION DISTRIBUTION WITHIN 10 MILES
2.1-6	1980 PROJECTED POPULATION DISTRIBUTION WITHIN 10 MILES
2.1-7	1990 PROJECTED POPULATION DISTRIBUTION WITHIN 10 MILES
2.1-8	2000 PROJECTED POPULATION DISTRIBUTION WITHIN 10 MILES
2.1-9	2010 PROJECTED POPULATION DISTRIBUTION WITHIN 10 MILES
2.1-10	1976 PROJECTED POPULATION DISTRIBUTION WITHIN 10 MILES
2.1-11	2016 PROJECTED POPULATION DISTRIBUTION WITHIN 10 MILES
2.1-12	1970 POPULATION DISTRIBUTION WITHIN 50 MILES
2.1-13	1980 PROJECTED POPULATION DISTRIBUTION WITHIN 50 MILES
2.1-14	1990 PROJECTED POPULATION DISTRIBUTION WITHIN 50 MILES
2.1-15	2000 PROJECTED POPULATION DISTRIBUTION WITHIN 50 MILES
2.1-16	2010 PROJECTED POPULATION DISTRIBUTION WITHIN 50 MILES
2.1-17	1976 PROJECTED POPULATION DISTRIBUTION WITHIN 50 MILES
2.1-18	2016 PROJECTED POPULATION DISTRIBUTION WITHIN 50 MILES
2.1-19	DELETED
2.2-1	AIRLINE ROUTES IN VICINITY OF RUSSELLVILLE
2.2-2	INDUSTRIAL AND TRANSPORTATION FACILITIES 5-MILE RADIUS
2.2-3	GASLINE RELOCATION
2.3-1	CLIMATOLOGICAL STATIONS
2.3-2	TOPOGRAPHIC MAP 5-MILE RADIUS FROM SITE

ARKANSAS NUCLEAR ONE
Unit 2

LIST OF FIGURES (continued)

<u>Figure No.</u>	<u>Title</u>
2.3-3	TOPOGRAPHIC MAP 50-MILE RADIUS FROM SITE
2.3-4	TOPOGRAPHIC PROFILES S-N, SSW-NNE
2.3-5	TOPOGRAPHIC PROFILES SW-NE, WSW-ENE
2.3-6	TOPOGRAPHIC PROFILES WNW-ESE, W-E
2.3-7	TOPOGRAPHIC PROFILES NNW-SSE, NW-SE
2.3-8	RELATIVE CONCENTRATION FREQUENCIES
2.3-9	DILUTION FACTORS - 0 TO 8 HOURS
2.3-10	DILUTION FACTORS - 8 to 24 HOURS
2.3-11	DILUTION FACTORS - 1 to 4 DAYS
2.3-12	DILUTION FACTORS - 4 TO 30 DAYS
2.3-13	DILUTION FACTORS LONG-TERM - 0 TO 5 MILES
2.3-14	DILUTION FACTORS LONG-TERM - 0 TO 50 MILES
2.4-1	LOCATION OF FIELD INVESTIGATIONS
2.4-2	GEOLOGIC SECTION A'- A
2.4-3	LOCATION OF WELL SURVEY
2.4-4	DELETED
2.4-5	DELETED
2.4-6	INTAKE CANAL PLAN, PROFILE & DETAILS
2.4-7	DISCHARGE CANAL PLAN, PROFILE & DETAILS
2.4-8	GENERAL GRADING AND DRAINAGE PLAN
2.5-1	PHYSIOGRAPHIC DIVISIONS
2.5-2	REGIONAL GEOLOGIC MAP
2.5-3	REGIONAL GEOLOGIC SECTIONS
2.5-4	GEOLOGIC MAP SITE AND VICINITY

ARKANSAS NUCLEAR ONE
Unit 2

LIST OF FIGURES (continued)

<u>Figure No.</u>	<u>Title</u>
2.5-5	GENERALIZED GEOLOGIC COLUMN
2.5-6	REGIONAL TECTONIC MAP
2.5-7	SITE INVESTIGATIONS
2.5-8	GRAPHIC LOGS - SHEET 1 OF 5
2.5-9	GRAPHIC LOGS - SHEET 2 OF 5
2.5-10	GRAPHIC LOGS - SHEET 3 OF 5
2.5-11	GRAPHIC LOGS - SHEET 4 OF 5
2.5-12	GRAPHIC LOGS - SHEET 5 OF 5
2.5-13	SITE AREA TOPOGRAPHY
2.5-14	BEDROCK CONTOURS
2.5-15	GEOLOGIC SECTION
2.5-16	SEISMIC PROFILES
2.5-17	SITE PLAN
2.5-18	PLANT EXCAVATION PLAN
2.5-19	PLANT EXCAVATION SECTIONS
2.5-20	PLANT BACKFILL PLAN AND SECTIONS
2.5-21	EMERGENCY COOLING RESERVOIR
2.5-22	RESIDUAL SHEAR STRENGTHS
2.5-23	SIGNIFICANT EARTHQUAKE EPICENTERS AND INTENSITIES AT EPICENTERS 1699 - OCTOBER 1972
2.5-24	NEW MADRID, MISSOURI EARTHQUAKES - 1811-1812
2.5-25	SEISMIC RISK MAP
2.5-26	GENERALIZED ISOSEISMALS - DECEMBER 16, 1811
2.5-27	DESIGN SPECTRA
2.5-28	DESIGN SPECTRA

ARKANSAS NUCLEAR ONE
Unit 2

LIST OF FIGURES (continued)

<u>Figure No.</u>	<u>Title</u>
2.5-29	STABILITY OF EXCAVATED SLOPES-CANAL SIDE SLOPES
2.5-30	STABILITY OF EXCAVATED SLOPE EMERGENCY COOLING POND
2.5-31	TEST PIT LOCATIONS
2.5-32	LOG OF TEST PITS 1 AND 2
2.5-33	LOG OF TEST PITS 3 AND 4
2.5-34	LOG OF TEST PITS 5 AND 6
2.5-35	LOG OF TEST PITS 7 AND 8
2.5-36	LOG OF TEST PIT 9
2.5-37	PLAN OF LOAD TEST AREA
2.5-38	TYPICAL PLATE LOAD TEST ARRANGEMENT
2.5-39	DELETED
2.5-40	MODIFIED COMPACTION CURVES
2.5-41	CLASSIFICATION SOIL DATA SUMMARY
2.5-42	RESULTS OF DIRECT SHEAR TESTS
2.5-43	LOAD - DISPLACEMENT CURVES TESTS 1 AND 2
2.5-44	LOAD - DISPLACEMENT CURVE TEST NO. 3
2.5-45	LOAD - DISPLACEMENT CURVE TEST NO. 4
2.5-46	DELETED
2.5-47	GENERAL CONFIGURATION OF FAILURE SURFACES
2.5-48	DELETED
2.5-49	MODIFIED COMPACTION CURVES
2.5-50	RESIDUAL SHEAR STRENGTH VALUES
2.5-51	CROSS-SECTION ANALYZED - CASE I
2.5-52	CROSS-SECTION ANALYZED - CASE II

ARKANSAS NUCLEAR ONE
Unit 2

LIST OF FIGURES (continued)

<u>Figure No.</u>	<u>Title</u>
2.5-53	CROSS-SECTION ANALYZED - CASE III
2.5-54	CRITICAL SLIP CIRCLES
2.5-55	SHEARING STRESS VERSUS ACCUMULATED STRAIN, BORING NO. 224
2.5-56	NORMAL STRESS VERSUS SHEARING STRESS, BORING NO. 224
2.5-57	SHEARING STRESS VERSUS ACCUMULATED STRAIN, BORING NO. 228
2.5-58	NORMAL STRESS VERSUS SHEARING STRESS, BORING NO. 228
2.5-59	SHEARING STRESS VERSUS ACCUMULATED STRAIN, BORING NO. 232
2.5-60	NORMAL STRESS VERSUS SHEARING STRESS, BORING NO. 232
2.5-61	SHEARING STRESS VERSUS ACCUMULATED STRAIN, BORING NO. 234
2.5-62	NORMAL STRESS VERSUS SHEARING STRESS, BORING NO. 234
2.5-63	LOG OF BORING NO. 201
2.5-64	LOG OF BORING NO. 201
2.5-65	LOG OF BORING NO. 202
2.5-66	LOG OF BORING NO. 203
2.5-67	LOG OF BORING NO. 204
2.5-68	LOG OF BORING NO. 205
2.5-69	LOG OF BORING NO. 206
2.5-70	LOG OF BORING NO. 207
2.5-71	LOG OF BORING NO. 208
2.5-72	LOG OF BORING NO. 209
2.5-73	LOG OF BORING NO. 210
2.5-74	LOG OF BORING NO. 211
2.5-75	LOG OF BORING NO. 212
2.5-76	LOG OF BORING NO. 213

ARKANSAS NUCLEAR ONE
Unit 2

LIST OF FIGURES (continued)

<u>Figure No.</u>	<u>Title</u>
2.5-77	LOG OF BORING NO. 214
2.5-78	LOG OF BORING NO. 215
2.5-79	LOG OF BORING NO. 217
2.5-80	LOG OF BORING NO. 218
2.5-81	LOG OF BORING NO. 219
2.5-82	LOG OF BORING NO. 220
2.5-83	LOG OF BORING NO. 221
2.5-84	LOG OF BORING NO. 222
2.5-85	LOG OF BORING NO. 223
2.5-86	LOG OF BORING NO. 224
2.5-87	LOG OF BORING NO. 225
2.5-88	LOG OF BORING NO. 226
2.5-89	LOG OF BORING NO. 227
2.5-90	LOG OF BORING NO. 228
2.5-91	LOG OF BORING NO. 229
2.5-92	LOG OF BORING NO. 230
2.5-93	LOG OF BORING NO. 231
2.5-94	LOG OF BORING NO. 232
2.5-95	LOG OF BORING NO. 233
2.5-96	LOG OF BORING NO. 234
2.5-97	LOG OF BORING NO. 235
2.5-98	LOG OF BORING NO. 236
2.5-99	AT REST EARTH PRESSURE DIAGRAM
2.5-100	ACTIVE EARTH PRESSURE DIAGRAM
2.5-101	LATERAL EARTH PRESSURE DUE TO SURCHARGE LOADS
2.5-102	LATERAL PRESSURES FOR MAXIMUM FLOOD

ARKANSAS NUCLEAR ONE
Unit 2

UPDATE REFERENCE LIST

Sections and references listed below denote documents that contain additional cross reference information used to update the SAR.

<u>Section</u>	<u>Cross References</u>
2.3.3.1.1 2.3.3.4	Design Change Package 85-2036A, "Meteorological System Upgrade."
2.5.1.2 2.5.2.4 2.5.4.2 2.5.4.7 2.5.4.11	Design Change Package 82-2086, B, "Q-Condensate Storage Tank."
<u>Amendment 9</u>	
2.4.14	Reference to Abnormal Operating Procedure (AOP) 2203.008, "Natural Emergencies."
2.2.2.3	Technical Specification Amendment No. 107, 7/6/90 (0CNA079007)
Figure 2.4-8 Figure 2.5-18	Design Change Package 79-2025, "Maintenance Facility and Turbine Deck Expansion."
<u>Amendment 10</u>	
2.3.3.4	Design Change Package 87-2096, "Dose Assessment System Upgrade."
Figure 2.4-8	Design Change Package 85-2155, "BWST Security System."
Figure 2.4-8	Design Change Package 88-2061, "Security System Perimeter Upgrade."
Figure 2.5-17	Plant Change 90-8019, "Telephone System Upgrade."
<u>Amendment 11</u>	
2.3.2.1.2 2.3.3.4	Condition Report C-92-0023, "Removal of MET Tower Site Printer."
Figure 2.4-8	Plant Engineering Action Request 89-0925, "Site Drainage System."
Figure 2.5-17	Design Change Package 89-1003, "Steam Generator Cleaning Parking Area."
<u>Amendment 13</u>	
Figure 2.4-8 Figure 2.5-17	Design Change Package 93-2022, "CA-1/CA-2."
Figure 2.4-8 Figure 2.5-17	Plant Change 93-8031, "Central Support Building."

ARKANSAS NUCLEAR ONE
Unit 2

UPDATE REFERENCE LIST (continued)

<u>Section</u>	<u>Cross References</u>
<u>Amendment 14</u>	
Figure 2.4-8	Design Change Package 92-2001, "High Level Waste Storage."
<u>Amendment 15</u>	
2.3.6	Procedure 1604.051, "Eberline Radiation Monitoring System."
Figure 2.4-8	Design Change Package 963559D301, "Computer/Telephone Room Power & AC Hardening."
Figure 2.4-8 Figure 2.5-17	Plant Change 963286P301, "T62B Tank Replacement."
<u>Amendment 16</u>	
2.4.14	Engineering Request, "Improvements for ANO Offsite Power Source ST#2"
Figure 2.5-17	Design Change Package 980642D201, "Steam Generator Replacement Facilities"
<u>Amendment 17</u>	
2.4.11.5	Engineering Request ANO-2000-2344-026, "Power Uprate Evaluation"
<u>Amendment 18</u>	
2.1.3.3 2.1.3.5 2.3.4.2 2.3.4.4	SAR Discrepancy 2-97-0764, "Change in Low Population Zone From 4 Miles to 2.6 Miles"
2.3.3.4	ANO-2 TRM Revision 15, "Removal of Redundant MET Tower Requirements"
Figure 2.5-18 Figure 2.5-19 Figure 2.5-20	Condition Report ANO-C-1991-0073, "Upgrade of LBD Change Process"
<u>Amendment 19</u>	
2.2.1.D	License Document Change Request 2-2.2-0004, "Removal of Specified Natural Gas Company Title"
2.5.5.2 2.5.5.2.1.1.2 2.5.5.2.1.3.2 All Figures	License Document Change Request 2-1.2-0048, "Deletion/replacement of Excessive Detailed Drawings from SAR"

ARKANSAS NUCLEAR ONE
Unit 2

UPDATE REFERENCE LIST (continued)

<u>Section</u>	<u>Cross References</u>
<u>Amendment 20</u>	
2.4.11.5	License Document Change Request 05-058, "Deletion/simplification of Excessive Detailed Drawings from SAR"
<u>Amendment 21</u>	
2.4.11.5	Engineering Calculation CALC-89-E-0044-03, "Service Water Pump Suction Requirements"
<u>Amendment 22</u>	
2.4.1.1	Engineering Change EC-443, "Construction of New ECP Spillway"
2.5.4.11	
2.5.5.1	
2.5.5.2	
2.5.5.2.2	
2.6	
Table 2.5-4	
Table 2.5-5a	
Table 2.5-5b	
Table 2.5-5c	
Table 2.5-6	
Figure 2.5-21	
Figure 2.5-51	
Figure 2.5-52	
Figure 2.5-53	
Figure 2.5-17	
Figure 2.5-17	
<u>Amendment 23</u>	
2.3.3.4	License Document Change Request 10-055, "Correction to Met Tower Data Collection System"
<u>Amendment 25</u>	
2.3.6	Condition Report CR-ANO-C-2011-3015, "Provide Consistent Use of X/Q Term with respect to Routine Gas Releases"
2.3.7	
2.3.8	
2.4.13.3	Engineering Change EC-24723, "Addition of Groundwater Wells"
2.1.2.1	Condition Report CR-ANO-2-2013-0904, "Incorporate Consistent References to Maximum Probably Flood Language"
2.4.10	
2.4.13.5	
2.5.5.5	

ARKANSAS NUCLEAR ONE
Unit 2

UPDATE REFERENCE LIST (continued)

<u>Section</u>	<u>Cross References</u>
Figure 2.5-39	Licensing Basis Document Change LBDC 14-031, "Add Detail to OSFSFs and LLRW Building"
<u>Amendment 26</u>	
Figure 2-5-17 Figure 2.5-39	"Condition Report CR-ANO-C-2014-1356, "Add Detail of Outside Radioactive Storage Facilities"
2.3.3.4	Engineering Change EC-54034, "MET Tower Modification"
2.2.2.1 Appendix 2A Figure 2.2-3 Figure 2.4-7	Licensing Basis Document Change LBDC 16-007, "Remove Gas Line Company Name"
2.4.3.3 2.4.13.5 2.4.14	Engineering Change EC-57218, "External Flooding Protection Update"
Figure 2.4-5 Figure 2.4-8 Figure 2.5-17	Licensing Basis Document Change Request 16-021, "SAR Updates based on RIS 2015-17"
<u>Amendment 27</u>	
2.1.2 2.1.2.1 2.3.3.1.1 2.4.1.2 2.4.13.2.2 Table 2.4-5 Figure 2.1-2 Figure 2.1-19 Figure 2.4-4	Licensing Basis Document Change LBDC 17-013, "Removal of Obsolete or Redundant SAR Figures"
<u>Amendment 28</u>	
2.1.2.1 2.2.2.1 2.4.2.1 2.4.2.2.1 2.4.2.2.2 2.4.3 2.4.3.1 2.4.3.2 2.4.3.3 2.4.3.4	Licensing Basis Document Change LBDC 18-032, "Transfer of Redacted Information to New SAR Section"

ARKANSAS NUCLEAR ONE
Unit 2

UPDATE REFERENCE LIST (continued)

Section

Cross References

2.4.3.5
2.4.3.6
2.4.3.7
2.4.4
2.4.13.5
2.4.14
2.5.4.9
2.5.5.5
2.8
2.8.1
2.8.1.1
2.8.1.2
2.8.1.3
2.8.1.3.1
2.8.1.3.2
2.8.1.3.3
2.8.1.3.4
2.8.1.3.5
2.8.1.3.6
2.8.1.3.7
2.8.1.4
2.8.1.5
2.8.2
2.8.3

ARKANSAS NUCLEAR ONE
Unit 2

RECORD OF REVISIONS

<u>PAGE #</u>	<u>AMENDMENT #</u>	<u>PAGE #</u>	<u>AMENDMENT #</u>	<u>PAGE #</u>	<u>AMENDMENT #</u>
TABLE OF CONTENTS		CHAPTER 2 (CONT.)		CHAPTER 2 (CONT.)	
2-i	28	2.2-4	28	2.4-4	28
2-ii	28	2.2-5	28	2.4-5	28
2-iii	28	2.2-6	28	2.4-6	28
2-iv	28	2.2-7	28	2.4-7	28
2-v	28	2.2-8	28	2.4-8	28
2-vi	28	2.2-9	28	2.4-9	28
2-vii	28			2.4-10	28
2-viii	28	2.3-1	27	2.4-11	28
2-ix	28	2.3-2	27	2.4-12	28
2-x	28	2.3-3	27	2.4-13	28
2-xi	28	2.3-4	27		
2-xii	28	2.3-5	27	2.5-1	28
2-xiii	28	2.3-6	27	2.5-2	28
2-xiv	28	2.3-7	27	2.5-3	28
2-xv	28	2.3-8	27	2.5-4	28
2-xvi	28	2.3-9	27	2.5-5	28
2-xvii	28	2.3-10	27	2.5-6	28
2-xviii	28	2.3-11	27	2.5-7	28
2-xix	28	2.3-12	27	2.5-8	28
2-xx	28	2.3-13	27	2.5-9	28
2-xxi	28	2.3-14	27	2.5-10	28
2-xxii	28	2.3-15	27	2.5-11	28
2-xxiii	28	2.3-16	27	2.5-12	28
2-xxiv	28	2.3-17	27	2.5-13	28
2-xxv	28	2.3-18	27	2.5-14	28
2-xxvi	28	2.3-19	27	2.5-15	28
2-xxvii	28	2.3-20	27	2.5-16	28
2-xxviii	28	2.3-21	27	2.5-17	28
		2.3-22	27	2.5-18	28
		2.3-23	27	2.5-19	28
CHAPTER 2		2.3-24	27	2.5-20	28
		2.3-25	27	2.5-21	28
2.1-1	28	2.3-26	27	2.5-22	28
2.1-2	28	2.3-27	27	2.5-23	28
2.1-3	28	2.3-28	27	2.5-24	28
2.1-4	28	2.3-29	27	2.5-25	28
2.1-5	28	2.3-30	27	2.5-26	28
2.1-6	28	2.3-31	27	2.5-27	28
2.1-7	28	2.3-32	27	2.5-28	28
2.1-8	28	2.3-33	27	2.5-29	28
2.1-9	28	2.3-34	27	2.5-30	28
				2.5-31	28
2.2-1	28	2.4-1	28	2.5-32	28
2.2-2	28	2.4-2	28	2.5-33	28
2.2-3	28	2.4-3	28	2.5-34	28

ARKANSAS NUCLEAR ONE
Unit 2

RECORD OF REVISIONS (continued)

<u>PAGE #</u>	<u>AMENDMENT #</u>	<u>PAGE #</u>	<u>AMENDMENT #</u>	<u>PAGE #</u>	<u>AMENDMENT #</u>
CHAPTER 2 (CONT.)		CHAPTER 2 (CONT.)		CHAPTER 2 (CONT.)	
2.5-35	28	2.7-19	27	2.7-62	27
2.5-36	28	2.7-20	27	2.7-63	27
2.5-37	28	2.7-21	27	2.7-64	27
2.5-38	28	2.7-22	27	2.7-65	27
2.5-39	28	2.7-23	27	2.7-66	27
2.5-40	28	2.7-24	27	2.7-67	27
2.5-41	28	2.7-25	27	2.7-68	27
2.5-42	28	2.7-26	27	2.7-69	27
2.5-43	28	2.7-27	27	2.7-70	27
2.5-44	28	2.7-28	27	2.7-71	27
2.5-45	28	2.7-29	27	2.7-72	27
2.5-46	28	2.7-30	27	2.7-73	27
2.5-47	28	2.7-31	27	2.7-74	27
2.5-48	28	2.7-32	27	2.7-75	27
2.5-49	28	2.7-33	27	2.7-76	27
		2.7-34	27	2.7-77	27
2.6-1	22	2.7-35	27	2.7-78	27
2.6-2	22	2.7-36	27	2.7-79	27
2.6-3	22	2.7-37	27	2.7-80	27
2.6-4	22	2.7-38	27	2.7-81	27
2.6-5	22	2.7-39	27	2.7-82	27
2.6-6	22	2.7-40	27	2.7-83	27
2.6-7	22	2.7-41	27	2.7-84	27
		2.7-42	27	2.7-85	27
2.7-1	27	2.7-43	27	2.7-86	27
2.7-2	27	2.7-44	27	2.7-87	27
2.7-3	27	2.7-45	27	2.7-88	27
2.7-4	27	2.7-46	27	2.7-89	27
2.7-5	27	2.7-47	27	2.7-90	27
2.7-6	27	2.7-48	27	2.7-91	27
2.7-7	27	2.7-49	27	2.7-92	27
2.7-8	27	2.7-50	27	2.7-93	27
2.7-9	27	2.7-51	27	2.7-94	27
2.7-10	27	2.7-52	27	2.7-95	27
2.7-11	27	2.7-53	27	2.7-96	27
2.7-12	27	2.7-54	27	2.7-97	27
2.7-13	27	2.7-55	27	2.7-98	27
2.7-14	27	2.7-56	27	2.7-99	27
2.7-15	27	2.7-57	27	2.7-100	27
2.7-16	27	2.7-58	27	2.7-101	27
2.7-17	27	2.7-59	27	2.7-102	27
2.7-18	27	2.7-60	27	2.7-103	27
		2.7-61	27	2.7-104	27

ARKANSAS NUCLEAR ONE
Unit 2

RECORD OF REVISIONS (continued)

<u>PAGE #</u>	<u>AMENDMENT #</u>	<u>PAGE #</u>	<u>AMENDMENT #</u>	<u>PAGE #</u>	<u>AMENDMENT #</u>
CHAPTER 2 (CONT.)		CHAPTER 2 (CONT.)		CHAPTER 2 (CONT.)	
2.7-105	27	F 2.1-14	19	F 2.5-13	19
2.7-106	27	F 2.1-15	19	F 2.5-14	19
2.7-107	27	F 2.1-16	19	F 2.5-15	19
2.7-108	27	F 2.1-17	19	F 2.5-16	19
2.7-109	27	F 2.1-18	19	F 2.5-17	26
2.7-110	27	F 2.1-19	27	F 2.5-18	19
2.7-111	27			F 2.5-19	19
2.7-112	27	F 2.2-1	19	F 2.5-20	19
2.7-113	27	F 2.2-2	19	F 2.5-21	22
2.7-114	27	F 2.2-3	19	F 2.5-22	19
2.7-115	27	F 2.3-1	19	F 2.5-23	19
2.7-116	27	F 2.3-2	19	F 2.5-24	19
		F 2.3-3	26	F 2.5-25	19
2.8-1	28	F 2.3-4	19	F 2.5-26	19
2.8-2	28	F 2.3-5	19	F 2.5-27	19
2.8-3	28	F 2.3-6	19	F 2.5-28	19
2.8-4	28	F 2.3-7	19	F 2.5-29	19
2.8-5	28	F 2.3-8	19	F 2.5-30	19
2.8-6	28	F 2.3-9	19	F 2.5-31	19
2.8-7	28	F 2.3-10	19	F 2.5-32	19
2.8-8	28	F 2.3-11	19	F 2.5-33	19
2.8-9	28	F 2.3-12	19	F 2.5-34	19
2.8-10	28	F 2.3-13	19	F 2.5-35	19
		F 2.3-14	19	F 2.5-36	19
2A-1	26			F 2.5-37	19
2A-2	26	F 2.4-1	19	F 2.5-38	19
2A-3	26	F 2.4-2	19	F 2.5-39	26
2A-4	26	F 2.4-3	19	F 2.5-40	19
2A-5	26	F 2.4-4	27	F 2.5-41	19
2A-6	26	F 2.4-6	19	F 2.5-42	19
2A-7	26	F 2.4-7	26	F 2.5-43	19
		F 2.4-8	26	F 2.5-44	19
F 2.1-1	19			F 2.5-45	19
F 2.1-2	27	F 2.5-1	19	F 2.5-46	19
F 2.1-3	27	F 2.5-2	19	F 2.5-47	19
F 2.1-4	19	F 2.5-3	19	F 2.5-48	19
F 2.1-5	19	F 2.5-4	19	F 2.5-49	19
F 2.1-6	19	F 2.5-5	19	F 2.5-50	19
F 2.1-7	19	F 2.5-6	19	F 2.5-51	22
F 2.1-8	19	F 2.5-7	19	F 2.5-52	22
F 2.1-9	19	F 2.5-8	19	F 2.5-53	22
F 2.1-10	19	F 2.5-9	19	F 2.5-54	19
F 2.1-11	19	F 2.5-10	19	F 2.5-55	19
F 2.1-12	19	F 2.5-11	19	F 2.5-56	19
F 2.1-13	19	F 2.5-12	19	F 2.5-57	19

ARKANSAS NUCLEAR ONE
Unit 2

RECORD OF REVISIONS (continued)

<u>PAGE #</u>	<u>AMENDMENT #</u>	<u>PAGE #</u>	<u>AMENDMENT #</u>	<u>PAGE #</u>	<u>AMENDMENT #</u>
CHAPTER 2 (CONT.)		CHAPTER 2 (CONT.)			
F 2.5-58	19				
F 2.5-59	19				
F 2.5-60	19				
F 2.5-61	19				
F 2.5-62	19				
F 2.5-63	19				
F 2.5-64	19				
F 2.5-65	19				
F 2.5-66	19				
F 2.5-67	19				
F 2.5-68	19				
F 2.5-69	19				
F 2.5-70	19				
F 2.5-71	19				
F 2.5-72	19				
F 2.5-73	19				
F 2.5-74	19				
F 2.5-75	19				
F 2.5-76	19				
F 2.5-77	19				
F 2.5-78	19				
F 2.5-79	19				
F 2.5-80	19				
F 2.5-81	19				
F 2.5-82	19				
F 2.5-83	19				
F 2.5-84	19				
F 2.5-85	19				
F 2.5-86	19				
F 2.5-87	19				
F 2.5-88	19				
F 2.5-89	19				
F 2.5-90	19				
F 2.5-91	19				
F 2.5-92	19				
F 2.5-93	19				
F 2.5-94	19				
F 2.5-95	19				
F 2.5-96	19				
F 2.5-97	19				
F 2.5-98	19				
F 2.5-99	19				
F 2.5-100	19				
F 2.5-101	19				
F 2.5-102	19				

ARKANSAS NUCLEAR ONE
Unit 2

2 SITE CHARACTERISTICS

This chapter provides information on the geological, seismological, hydrological, and meteorological characteristics of the site and vicinity in the context of their influence on plant design and operating criteria showing the adequacy of the site characteristics from a safety viewpoint. These are given in conjunction with population distribution, land use, and site activities and controls.

Sections of this chapter that do not describe the facilities at ANO are not encompassed by the FSAR update rule (10 CFR 50.71(e)) and therefore are not required to be updated. This includes such information as projected population densities, lists of industries or facilities, and groundwater users. This information was developed in support of initial licensing and, even if updated, would be unlikely to affect plant operation, the plant design bases, or the conclusions of safety analyses relative to public health and safety.

2.1 GEOGRAPHY AND DEMOGRAPHY

2.1.1 SITE LOCATION

The Arkansas Nuclear One - Unit 2 site is at latitude 35°-18'-42" N and longitude 93°-13'-15" W (Universal Transverse Mercator Coordinates: E478960m; N3907340m).

The site is located in southwestern Pope County, Arkansas, about 57 miles northwest from Little Rock, Arkansas, and 68 miles east of Fort Smith, Arkansas, on a peninsula formed by the Dardanelle Reservoir. The Reservoir is part of the "Multiple-Purpose Improvement Plan for the Arkansas River" and includes the Arkansas River and the former Illinois Bayou. The area of the Reservoir is 36,000 acres; its normal pool elevation (336-338 feet) is controlled downstream by the Dardanelle Lock and Dam No. 10 on the Arkansas River. The town of Russellville is about six miles east-southeast from the site and the village of London is about two miles northwest from the site. The location of counties within a 50-mile radius is shown in Figure 2.1-1. Figure 2.3-3 shows the general geographical and topographical features within a 50-mile radius of the site and Table 2.1-1 provides data for reservoirs and lakes within a 50-mile radius.

2.1.2 SITE DESCRIPTION

Figure 2.1-3 shows the location of significant plant facilities with respect to the property boundary and delineates the area to be considered as the exclusion area. This exclusion area has a minimum radius of 0.65 miles from the center of the reactor and is controlled to the extent necessary by Entergy Operations, Inc. This area includes certain portions of the bed and banks of Dardanelle Reservoir which are owned by the United States. An easement has been obtained from the U.S. Army Corps of Engineers which entitles the Company to exclude all persons from these areas during periods of emergency. A perimeter fence is erected around the immediate station area. A transcript of the easement is included in Appendix 2A.

2.1.2.1 Exclusion Area Control

The applicant shall have full control of all activities conducted within the exclusion area, as described above. There are no railroads that traverse the exclusion area other than the plant spur. All the property within this exclusion area is owned by the applicant with the exception of that property owned by the United States. The property owned by the United States, including the waterways therein, shall be controlled under provisions of the easement mentioned above.

ARKANSAS NUCLEAR ONE
Unit 2

The only rights to the property within the exclusion area other than those of the U.S. Department of the Army under Condition 6 of the easement are a right-of-way easement to the Arkansas Natural Gas Corporation in 1959, and to the City of London (with regard to the maintenance of water lines).

A number of tracts had oil and gas leases for 10 years which were executed in 1959 and 1960. These oil and gas leases expired by their own terms and no so-called "delay rentals" were paid to keep the leases in effect. No other property rights or contractual obligations relating to property rights which might be inconsistent with or adversely affect the applicant's ability to exercise complete control of the exclusion area at any necessary or required time exists to the knowledge of the applicant.

As shown in Figure 2.1-3, there are two roads within the exclusion area. In the northeast sector just inside the exclusion area boundary is a short stretch of State Highway 333. Near the exclusion area boundary and encircling the plant site on the east, south, and west is a county road. Agreements with both the Arkansas State Police and the Pope County Sheriff have been made for control of traffic on these roads and all roads giving access to the plant site in the event of an emergency. Further details of the emergency plan specifically related to the use of these roads are given in the Arkansas Nuclear One Emergency Plan.

Also shown in Figure 2.1-3 is a small cemetery south of the plant which is within the exclusion area. The applicant owns all rights to this tract, explicitly including the cemetery rights. Ark. Stat. Ann. K41-3712 prohibits anyone from constructing a fence on property so as to enclose any cemetery unless suitable access by automobile to such cemetery is provided by state or otherwise. However, based on the rights to the cemetery which the applicant has acquired, the applicant could exclude persons from the cemetery if it was deemed necessary. Though the applicant has complete control over activities within the cemetery, continued use of the cemetery for burial purposes is allowed. A count made on October 21, 1975, revealed 206 distinguishable graves in the cemetery. The cemetery is frequented often enough that it is well kept and normally fresh flowers appear on two or three graves. Burial space in the cemetery is very limited and new burials are very infrequent.

2.1.2.2 Boundaries for Establishing Effluent Release Limits

The restricted area for the Arkansas Nuclear One site as defined by 10 CFR 20 is shown on Figure 2.1-3. The boundary of this area is approximately 746 meters from the center line of the containment of Unit 2. Land access to this area will be controlled by posting the area. The intake canal and discharge embayment within this restricted area will be continuously monitored.

The immediate plant area, enclosed by the security fence, will be regularly patrolled by the plant guards as required in the Arkansas Nuclear One Industrial Security Plan. The entire restricted area is easily brought under visual inspection during each patrol.

Distances from plant effluent release points to the exclusion area boundary are given in Table 2.1-2.

ARKANSAS NUCLEAR ONE
Unit 2

2.1.3 POPULATION AND POPULATION DISTRIBUTION

Population and population distributions within a 50-mile radius of the site are discussed in this section. Population data presented is based on the 1970 census data, projected to the year 2010 by decades. The influence of transient populations and the locations of population centers, public facilities, and institutions in the vicinity of the site are also discussed.

2.1.3.1 Population Within 10 Miles

The 1970 population distribution within 10 miles of the site is shown on Figure 2.1-5. This distribution is based on the 1970 census and 1971, photo revised Arkansas State Highway Department County Highway Maps. The population in each sector was determined by counting the rural residential dwellings in each sector and adding this population to the town and city population within each respective sector.

The population projections from 1980 through 2010 in increments of a decade, within 10 miles of the site, are shown in Figures 2.1-6 through 2.1-9. The projected populations for initial plant startup (1976) and end of life (2016) are shown in Figures 2.1-10 and 2.1-11. The projections were calculated using the results of the Arkansas River Region Report, Volume I, Section B, which was prepared by the Industrial Research and Extension Center, College of Business Administration, University of Arkansas for the Arkansas Planning Commission. This report quotes a high and a low estimate for the population growth factors through the time span considered, with the projections shown in this section based on the high estimate.

2.1.3.2 Population Between 10 and 50 Miles

The 1970 population distribution between 10 and 50 miles of the site is shown in Figure 2.1-12. This distribution is based on the 1970 census count and the latest maps showing minor civil division (township) boundaries. Estimates of the population distribution were made using 1970 census tabulations for each individual township, and then calculating the areas of townships in each sector.

The population projections between 10 and 50 miles of the site from 1980 through 2010, in increments of a decade, are shown in Figures 2.1-13 through 2.1-16, respectively. The projected populations for initial plant startup and end of life are shown in Figures 2.1-17 and 2.1-18. The projections were made by assuming a continuation to the year 2016 of the percent change in the population experienced in each county between 1960 and 1970, and calculating the percentage of each sector by counties.

2.1.3.3 Low Population Zone

The low population zone consists of the area outside of the exclusion area (0.65-mile radius from the center of the reactor) but within a 4-mile radius of the site. This distance was selected since it meets the requirements of 10 CFR 100 and allows reasonable protective measures to be taken for residents in this area in case of a serious accident (see Section 13.3). As there are no residents within the 0.65-mile radius exclusion area, the population distributions for the low population zone for the years 1970 to 2010 by decades are the same as those shown in Figures 2.1-5 through 2.1-9, respectively, out to the 4-mile radius line. However, Section 2.1 of the ANO-2 SER, Section 2.1 of Supplement 1 to the ANO-2 SER, and Section 2.1 of Supplement 2 to the ANO-2 SER give a summary of discussions which led to redefining the low population zone radius to meet 10 CFR 100 as 2.6 miles based on projections of the growth of the city of Russellville and its surroundings.

ARKANSAS NUCLEAR ONE
Unit 2

2.1.3.4 Transient Population

The major cause of population influx and shifts occurring within 50 miles of the site is recreational activities that peak during the summer months. Table 2.1-14 lists the state parks, national forests, and recreation areas in Arkansas within 50 miles of the site. This table describes the facilities available, distance and direction from site, and the most recent available attendance records. It should be noted that 70 percent of the Ozark National Forest and 30 percent of the Ouachita National Forest are within 50 miles of the site. Information was not available on the number of people entering the area from outside the 50-mile radius (influx) or the number corresponding to shifts within the 50-mile radius. However, a survey conducted by the Parks Department of Arkansas Polytechnic College determined that 36.6 percent of the visitors to all state parks were from Arkansas and 63.4 percent were from out of state. The survey also determined that in-state visitors rank in order from (1) Little Rock, (2) North Little Rock and (3) Fort Smith. Most of the park facilities are nearer the site than these three major population centers and, therefore, the seasonal population shift would tend to be into the 50-mile radius.

The Dardanelle Reservoir is a major contributing factor to part-time population within the low population zone. Recreational use surveys conducted by the Corps of Engineers at Dardanelle Reservoir indicate that approximately 65 percent of the visitors reside within 50 highway miles of Dardanelle Reservoir. Table 2.1-15 lists the activities offered at Lake Dardanelle on a percentage used basis. Based on a 1969 survey by the Corps of Engineers, 38.8 percent of all visits occur between the months of June and August and 0.99 percent of all visits occur on each weekend day in the same time period. From these data, it is estimated that an average of 2,464 visitors per day are present inside the low population zone from June through August. During the summer weekends, the time of highest utilization, an average of approximately 5,777 visitors per day are inside the low population zone.

2.1.3.5 Population Center

The nearest population center is the city of Hot Springs, Arkansas, with a 1970 population of 35,631 and a near-side distance of 55 miles, south-southeast from the reactor.

It appears from Figure 2.1-11 that during the lifetime of the facility, the city of Russellville can become the new population center. The West Central Arkansas Planning and Development District, Inc. publication, "Preliminary Report Regional Growth and Change, 1975-2000, Demographic and Economic Aspects," indicates a 1975 Russellville population of 16,357, a 40 percent increase above that for 1970.

However, a special 1975 Russellville census indicated a tentative count, as of early December 1975, of 14,000, a 19 percent increase above that for 1970. Page 10 of the referenced publication states "the growth in net residential connections is faster than the regional population increases." AP&L records for the Russellville-Dardanelle-Atkins Control Area show a 24 percent increase in residential connections for 1970 through 1975, far below West Central Arkansas' population projection. The actual percentage increase in population for Russellville for the period 1970-1975 is 49 percent of West Central Arkansas' projection. If the subsequent projections are adjusted on a percentage basis, the Russellville population in 2000 is projected to be 22,420.

ARKANSAS NUCLEAR ONE
Unit 2

Russellville is almost totally confined to three sector segments shown in Figure 2.1-11; 4-5 miles east-southeast, 5-10 miles east-southeast, 5-10 miles east. The total population in these three sector segments projected for 2016 in Fig. 2.1-11 is 20,341. If three additional sector segments (4-5 miles east, 3-4 miles east, 3-4 miles east-southeast), which include very small portions of Russellville and into which Russellville could expand, are added to that total, the projected population for 2016, Figure 2.1-11, is 23,277. This number is conservative in two respects. First it includes an area on the order of three times the current area of Russellville. Second, as stated in Section 2.2.1, the projections in Figure 2.1-11 are based on high estimates of the Arkansas River Region Report.

Based on the above, Russellville will not become a population center during the life of the plant. No other municipality could impact the size of the low population zone. Therefore, a low population zone of 4 miles is acceptable. However, Section 2.1 of the ANO-2 SER, Section 2.1 of Supplement 1 to the ANO-2 SER, and Section 2.1 of Supplement 2 to the ANO-2 SER give a summary of discussions which led to redefining the low population zone radius to meet 10 CFR 100 as 2.6 miles based on projections of the growth of the city of Russellville and its surroundings.

2.1.3.6 Public Facilities and Institutions

Table 2.1-3 lists all the known public facilities within 10 miles of the plant site, the direction and distance of each from the reactor, and their recorded attendance.

2.1.4 USES OF ADJACENT LANDS AND WATERS

2.1.4.1 Recreation

The recreation resources in and around Dardanelle Reservoir are a modern example of variety and multiple use. The recreational choices available to the visitor are a combination of public agency, private, and commercial efforts, resulting in 22 developed areas. Four more areas are planned for the future.

Water-based recreation activities are a focal point of interest, with abundant opportunities for boating and fishing. Some portions of the lake and river are not recommended for body contact activities such as water skiing and swimming, although most bays and inlets such as Piney Bay and the Illinois Bayou are free of unacceptable levels of pollution. Efforts are underway to improve the water quality of Lake Dardanelle and the Arkansas River, as evidenced by a 1969 sanitary survey of the area by the Arkansas Department of Pollution Control and Ecology.

At strategic locations around the shoreline, camping, picnicking, sightseeing, photography, and nature study areas satisfy many thousands of visitors annually. The rich history and folklore of the Ozark region intrigue folk enthusiasts.

In addition to providing visitors with facilities for water-oriented recreation, the Corps of Engineers is trying to maintain a natural balance of nature. This is accomplished by the prevention of erosion, by stocking the streams and lakes with fish, and by the control of lands adjacent to the lake through government ownership. Wildlife habitat is preserved by preventing the removal of timber and other vegetative cover. Maintaining a natural balance of nature retains the beauty of the terrain and thereby prevents shoreline spoilage.

ARKANSAS NUCLEAR ONE
Unit 2

Most of the intensively developed tourist accommodations and attractions are located near the northern and eastern end of Dardanelle Reservoir. More primitive facilities are provided near the southwestern and western shoreline.

For the photographer, steep bluffs along the old river channel upstream from the dam and pine-covered 1,800-foot Mount Nebo provide a photogenic combination of scenery and beauty. An overlook on the Russellville side of the lake provides an excellent view of the dam where one may observe barges passing through the Dardanelle Lock. On the Dardanelle side of the river near the historic Dardanelle Rock, visitors may tour the hydroelectric power plant.

Nearby Arkansas Polytechnic College has leased land parcels on the Illinois Bayou portion of the Reservoir from the Corp of Engineers. These resources constitute an outdoor laboratory for a program in recreation education and research supporting the Institute of Leisure Science at the college. Plans are underway to use the area for demonstrating new concepts in outdoor recreation, conducting research projects, and developing a continuing education program in tourism and leisure services.

Dardanelle Reservoir is strategically located between two national forests and mountain ranges - the Ozark National Forest to the north in the Boston Mountains and the Ouachita National Forest in the Ouachita Mountains to the south. In addition to camping, fishing, and other forest recreation opportunities, Big Piney Creek, Illinois Bayou, and the Mulberry River emanating north of the lake are popular for river floating enthusiasts and float fishermen.

Table 2.1-16 lists diverters of surface waters from Dardanelle Reservoir and the Arkansas River downstream. Table 2.1-16 shows that there are no significant water supply intakes in the Dardanelle Reservoir, or any significant level intakes, that may be contaminated by an accidental release that could affect human exposures indirectly through the food chain. There is only one user of river water for industrial processing from the Dardanelle Reservoir to the Mississippi River. This user is the Arkansas Craft Corporation in Morrilton, Arkansas, about 30 miles downstream of the plant site. River water is used as a coolant and processing medium in the manufacture of brown craft paper for corrugated boxes. These boxes are not used for food wrapping or food-related products, and therefore are not capable of causing exposure through the food chain. The average daily water usage by the manufacturer is 4×10^6 gpd.

In Russellville, Arkansas Polytechnic College offers a series of intercollegiate sports and culture programs. The city operates a parks and recreation system, community theater, and community center. Adequate tourist services are available, including motel, restaurants, and supportive services.

To the south, in the city of Dardanelle, similar services are available. Mount Nebo State Park offers a spectacular view of the Arkansas River Valley from an 1,800-foot developed mesa.

2.1.4.2 Agricultural

Figure 2.1-4 shows the area of land in square miles that is pastured and cultivated within a 50-mile radius of the site. The land use is shown in 16 directional sectors centered on the site and within 5-, 10-, 20-, 30-, 40-, and 50-mile radii.

The land data in Figure 2.1-4 were based on the 1964 United States Census of Agriculture Preliminary Report for Arkansas.

ARKANSAS NUCLEAR ONE
Unit 2

The closest dairy herd is maintained by Arkansas Polytechnic College, approximately five miles from the site. Other cattle closer to this site have been observed, and hypothetical dose calculations were made considering the observed pasture nearest the site.

Tables 2.1-4, 2.1-5, and 2.1-6 provide statistics concerning farming for each county that is completely or partially within a 50-mile radius of the plant site. These include numbers of farm animals and acreage and yields of crops. These statistics were taken from the 1969 Census of Agriculture, published by the United States Department of Commerce, the Social and Economic Statistics Administration, and the Bureau of the Census; the 1971 Agriculture Statistics for Arkansas, released in August 1972, by the Statistical Reporting Service of the United States Department of Agriculture in Little Rock, Arkansas; and 1971 Arkansas Poultry Production, published cooperatively by the Cooperative Extension Service of the University of Arkansas, Division of Agriculture, and the United States Department of Agriculture.

2.1.4.3 Fish and Wildlife

About seven air miles from the lake is Holla Bend National Wildlife Refuge, a 6,300-acre haven which is a wintering refuge for ducks and geese. This refuge serves as a concentration point for waterfowl which then spread out through the surrounding areas, providing ideal hunting as well as enjoyment for the public in waterfowl identification.

The major game animals of the area are squirrel, deer, and rabbit. Quail and dove are also hunted to a lesser extent. In an area about 25 miles south of the plant site, near Lake Nimrod, turkey hunting is very popular and productive. In areas bordering the Arkansas River and near certain lakes (notably Harris Brake Lake, about 35 miles southeast of the plant site), a significant amount of duck hunting is also carried on. Statistics concerning annual kills of these animals are kept only for deer. Table 2.1-7 gives the deer kills for each of the 19 counties totally or partially within 50 miles of the plant site for the 1972-1973 deer season. These figures are those kills that were reported and are estimated to be 75 percent of the actual kill. The figures were obtained by personal conversation with the information office of the Arkansas Game and Fish Commission.

Fish population samples have been made in the Dardanelle Reservoir by the Arkansas Game and Fish Commission for several years. In 1971, the fish population sample point was shifted by the Commission from a point near Piney Bay to a cove in the discharge embayment of Arkansas Nuclear One. The results of the fish population sample conducted in late August 1972 are presented in Table 2.1-8.

The sample was made in a 4-acre cove with an average depth of four feet. Rotenone was used as the collection method. The water temperature was 80 °F. Three hundred feet of block-off net was used on this cove sample.

The predator-nonpredator ratio by weight was 1:6.6, which was essentially the same as the previous year's ratio. There was a good sample of adult largemouth bass, channel catfish and crappie in this sample. The condition factor for the large adult fish was very good, but that for the intermediate and young fish was very poor. There was a good population of forage fish, including both species of shad. An overabundance of the shad were non-forageable except for the larger adult fish. There was an obvious absence of small-size forage fish.

ARKANSAS NUCLEAR ONE
Unit 2

There was a total of 777 predator fish in the sample, weighing a total of 237.4 pounds. These accounted for 2.74 percent of the total sample population and 13.16 percent of the weight.

There was a total of 27,574 forage fish in the sample, weighing a total of 1,566.2 pounds. These accounted for 97.26 percent of the total sample population and 86.84 percent of the weight.

Based on a commercial fishing industry survey conducted from May 1966 to June 1971, the following facts were gathered with regard to commercial fishing on the Arkansas River:

The commercial fishing industry exhibited a rapid growth in 1970 over previous years. Compared to 1969, a 42 percent increase in the number of regular commercial fisherman was noted, along with a nine percent increase in the amount of gear. The Arkansas River system was the leader in fish production. Mussel fishermen have, for all practical purposes, dropped out of existence. The Arkansas River system showed rapid gains in catfish and buffalo production, with a decrease in other species. The construction of dams along this stream has seemed to concentrate the fish and reduce the current so that gill and trammel nets are very effective in some areas.

In 1970, the commercial fishing along the Arkansas River exhibited the following species and dollar yield:

<u>SPECIES</u>	<u>WEIGHT</u>	<u>\$ VALUE</u>
Bowfin	1,000	50
Buffalofish	697,105	125,478
Carp	319,377	15,970
Catfish	1,448,528	506,983
Gar	44,700	2,235
Paddlefish	53,074	9,554
Quillback	19,882	1,989
Drum	108,989	19,618
Sturgeon	--	--
Sucker	16,200	810
Food Turtles	10,000	800
Baby Turtles	--	--
TOTALS	2,718,855	\$683,487

In the spring of 1971, the Arkansas Game and Fish Commission made a 30-day survey of the commercial fishing in the Dardanelle Reservoir. A total of 350 gill nets and 140 trammel nets were observed being raised by fisherman during the 30-day observation period. The total catch of all species of fish is listed in Table 2.1-9.

All told, 6,000 pounds of commercial fish were caught, while only 100 pounds of game fish were caught in the same nets. This leads to the conclusion that commercial fishing is not affecting the game fish population, and that removing many pounds of commercial fish from the lake is aiding the sport fishermen by providing more space and food for the game fish and the chance for better growth.

ARKANSAS NUCLEAR ONE
Unit 2

No creel surveys have been made on the Dardanelle Reservoir, and it is therefore impossible to provide any data on the amount of harvest by sport fishermen.

2.1.4.4 Forestry

Tables 2.1-10 through 2.1-13 present information on the growing stock and area of Arkansas forests, with emphasis on the area subject to impact by Arkansas Nuclear One, including the power distribution system.

The Ouachita Province, including all of its higher "mountain" parts, is in the Ouachita Survey district and has been chosen in Table 2.1-10 to give representative tree diameter distributions. The larger size classes not only explain the importance of sawtimber, but also the conservationist's interest in "old growth" stands of particular aesthetic attractiveness.

In brief, Table 2.1-10 numerically documents the generality that shortleaf pine is the softwood of importance in both the Ozark and Ouachita districts, in contrast with loblolly pine, which becomes more important on the Coastal Plain Province (especially the "Southwest" Forest Survey region). Red cedar is less important in volume, but it attracts aesthetic attention in both the Missouri and Arkansas sections of the Ozark Province, more locally in the Ouachitas and rarely in the Coastal Plain. Bald cypress is restricted to bottomlands, minor in the Ozark and Ouachita regions, almost a "rare" species locally but it attains high importance (502 out of a state total of 912 million board-feet) in the Delta Survey region along the Mississippi River and its tributaries. Hardwood species are far more numerous than softwoods, but constitute slightly less than half of the state's board-foot (sawtimber) volume. Yet, within the Ozark and Ouachita regions and most of the individual counties documented separately in Table 2.1-13, hardwoods are several times as important as the softwoods. Geographic differences among counties are of some importance and are included in the table for an indication of the main groups of forests likely to be disturbed by power line clearing along several routings.

ARKANSAS NUCLEAR ONE
Unit 2

2.2 NEARBY INDUSTRIAL, TRANSPORTATION, AND MILITARY FACILITIES

2.2.1 LOCATIONS, ROUTES, AND DESCRIPTIONS

There are no military bases, missile sites, chemical plants and storage facilities, oil pipelines, or airports within a 5-mile radius of the centerline of the containment of Unit 1 and Unit 2.

There is no major airport with a control tower within 50 miles of the plant site. The closest airports are the Russellville Municipal Airport (8 miles) and Clarksville Municipal Airport (15 miles). There are two low altitude airways nearby, as shown in Figure 2.2-1. This airway, V71, whose centerline is about five miles east of the plant site, has one or two scheduled commercial low altitude turbo-prop flights daily.

The centerline of airway V74N is two miles south of the plant site. This is an alternate route of V74, which is the main route between Fort Smith and Little Rock, 20 miles south of the plant. V74N carries very light, unscheduled traffic only.

The closest high altitude (jet) airway is Route J6-14/279, about 30 miles south of the plant site.

The Missouri-Pacific Railroad passes the plant at a distance of approximately 1.1 miles. The railroad spur into the plant site will handle only materials and equipment necessary for construction and operation of the plant itself. This railroad spur has a manually locked derail device located about 50 yards down the spur from the main line switch. This device would prevent any main line trains from passing this point if they were accidentally switched to this spur.

The Arkansas River is navigable from its mouth to Tulsa, Oklahoma. The river channel passes within approximately 1.4 miles of the reactor building. During 1972, approximately 999,000 tons of cargo were transported past the plant site. The major portion of this cargo was coal, fertilizer and miscellaneous construction equipment. It is predicted that in 1971, approximately 20 to 25 million tons of cargo will be transported on the Arkansas River. The cargo will include iron and steel, petroleum, petroleum products and agricultural products, in addition to that mentioned above.

Figure 2.2-2 shows the location of four industrial facilities. The first three are located about five miles from the plant. The fourth (a gas pipeline) passes within about 600 feet of the Unit 1 reactor building. (The Unit 1 containment sits between the pipeline and the Unit 2 containment). The four facilities are described below:

- A. Ward Furniture Manufacturing Company - a manufacturing plant utilizing wood products in the manufacturing process.
- B. Thermo Gas Butane Bulk Plant - several large tanks of butane storage are located at this bulk plant.
- C. Water Craft Boat Manufacturing Plant - this building is now vacant, but has been used for the manufacturing of fiber glass boats. At the present time, there is no known business interested in locating in the building, but it is a new building and will probably be used for some manufacturing process in the near future.
- D. High pressure natural gas line.

ARKANSAS NUCLEAR ONE
Unit 2

The most economically important minerals in the area are stone, such as the Arkansas Cherrystone from quarries in the Hartshorne Sandstone north of Midway, at Altus, and at the Dardanelle Damsite; gravel and sand from Pleistocene deposits such as those 4 miles west of Scranton and from the Arkansas River at Dardanelle; natural methane gas from anticlines in the area; and bituminous coal. The methane gas is tapped by drilling and comes mainly from ocean-deposited sandstones in the lower and middle part of the Atoka formation. Coal is found in the Spadra and Paris shales as a pressurized carbonization of delta-swamp trees and plant debris. Much of it is of coking quality suitable for iron manufacture. Coal strip pits are present north of Russellville, north and west of Clarksville (one seven miles west of Clarksville on U.S. Highway 64 is still working), and near New Spadra. Shaft pits have been abandoned just east of the Dardanelle Dam and are still being worked west and north of Paris. Non-economic minerals of the area include ironstone, manganese minerals, and gypsum.

2.2.2 EVALUATION

2.2.2.1 Natural Gas Pipeline

(also see [Section 2.8.2](#))

The crossing has been constructed beneath the water channel with four feet of earth cover. The pipe is 10-3/4 inch O.D. constructed to Type C specification of ASA Code B31.8. The Type C construction extends approximately 600 feet on each side of the crossing.

The worst possible condition with respect to plant safety would be a brittle fracture of the pipeline when operating at its maximum pressure of 500 psig. There are two separate safety considerations:

- A. The explosive rupture of the pipeline.
- B. Ignition of the gas discharge through the open pipe.

The first consideration when related to TNT equivalent is 0.07 pounds of TNT per foot of pipeline ruptured. During pipeline construction, many times this equivalent is detonated as close as 30 feet to large pipelines in operation without resulting damage. At a distance of several hundred feet from the pipeline, only a few small particles of debris would be expected to fall.

The second consideration is the radiation energy that would be received at the plant resulting from the burning of gas discharged by the pipeline before control valves could be closed.

The computed energy received by one square foot of vertical concrete surface is 21 Btu/ft²-hour with the pipeline discharging a possible maximum of 48 million cubic feet per day.

The radiation energy is under the maximum of 36 Btu/ft²-hour that is expected to be received from solar radiation.

Arkansas Power & Light Company's experience has shown no unusual hazards associated with natural gas pipelines in their fossil fuel plants.

The valves in the 10-inch pipeline which would be used to isolate the section of line near the proposed plant would be closed within two hours after a pipeline rupture.

ARKANSAS NUCLEAR ONE
Unit 2

Included in the crossing of the water channel was replacement of that portion of the line constructed in 1928 that extends approximately 600 feet on each side of the water channel. The crossing and replacement pipe meet requirements of Type C construction of USAS Code B31.8, 1968.

The following is an analysis of the consequences of a rapid gas line leak occurring under inversion conditions for the plant site, prepared by Dr. Joseph B. Knox, a consultant:

The purpose of this report is to present the results of an analysis of the consequences of a rapid leak in the natural gas transmission pipeline located 600 feet from the proposed Arkansas Nuclear One reactor. Two different sets of conditions are considered: (A) gas exiting at sonic velocity from the ruptured gas pipe as a buoyant jet oriented either horizontally or vertically, and (B) a hypothetical case is physically unrealistic and constitutes a worst case for the postulated environmental inversion conditions. The input data for the analysis are summarized below:

Gas Line: Diameter 10 inches.
Shortest diameter to the nuclear reactor is 600 feet.
Operating pressure in line is 500 psig.

Atmospheric Conditions: Pasquill F, 1 mps.
Assume an inversion of 9° C in 60 meters.

Combustion Limits: 5% to 15% gas concentration.

A. The Buoyant Jet Case

It is postulated that an instantaneous rupture of the gas pipeline occurs such that the pipe is fully open and oriented vertically. Gas exits at sonic velocity forming a buoyant jet from both pipe openings. Applying the theory of buoyant jets in stratified flows to one of the jets so formed (Fan, 1967, Turbulent Buoyant Jets into Stratified or Flowing Ambient Fluids, University of Michigan Microfilms), the trajectory of the center of the jet and the buoyant force along the jet is calculable, as well as an estimate of the height at which entrainment produces a negligible buoyant force on the air-methane mixture in the plume.

The results indicate that the time required for the jet to pass the height of 60 meters (about the height of the reactor building) is four to six seconds, during which time there is very little transport of the gas towards the building in the 1 mps ambient wind field. With a reasonable value of the entrainment coefficient of 0, i.e. 0.08, the density deficiency of the plume, and hence the buoyant force, becomes negligible at about 2,000 to 3,000 feet. Under stable atmospheric conditions with a surface inversion, there would be no credible way to transport this neutral buoyancy gas down through the inversion to the plant before it diffused to a non-explosive mixture. It is estimated that about 800 seconds would be required for this to be accomplished in the air-gas cloud above the inversion.

The results of this analysis are not materially changed if the analysis is repeated for a horizontal orientation of the ruptured gas pipeline.

ARKANSAS NUCLEAR ONE
Unit 2

B. The Hypothetical Trapped Gas Case

1. Under the postulated inversion conditions, if gas were to be trapped under the inversion, the gas must somehow be diluted with air immediately upon release such that the gas density is greater than that in the overlying temperature inversion.

For the assumed conditions, the required instantaneous dilution is 13-fold. There is no natural way that such a large instantaneous dilution can be achieved in either stable or unstable atmospheric conditions. At a range of 600 feet (the distance to the plant), about 200 seconds is required for a dilution of a factor of 38 for Pasquill F (1 mps). This dilution rate is more than two orders of magnitude less than that required to keep the gas under the inversion.

2. If one hypothesizes an immediate 13-fold dilution mechanism of some unknown kind necessary to keep the gas under the inversion, and Pasquill F conditions in the environment, then the gas concentration is 0.77 prior to the beginning of its travel downwind. Diffusion under even Pasquill F conditions would be more than sufficient to dilute this gas to a non-explosive mixture prior to traveling 600 feet.
3. If the postulated inversion is less strong than that discussed above, an even larger immediate dilution than 13-fold is required in order to keep the gas under the inversion. Such immediate dilutions are not physically reasonable.

These analyses indicate that the buoyant jet model of the rapid gas leak is physically reasonable, and that explosive gas mixtures will exist only at places removed from the plant. The above analyses have been reviewed by the NRC staff and found acceptable in previous proceedings involving Unit 1 (Docket 50-313) and Unit 2 (Docket 50-368). The conclusions of these reviews are presented in the Safety Evaluation Reports issued at the construction permit and operating license stages of Unit 1 and at the construction permit stage of Unit 2. The following analysis further substantiates the previous conclusions that no adverse consequences from a gas line rupture are foreseen. Since the maximum time between the postulated double-ended rupture of the 10-inch natural gas pipeline and the closing of the isolation valves is two hours, the maximum volume of natural gas which could be released is 13.8 (+6) cubic feet. The volumetric flow rate was calculated to be 5,080 cfs (STP). This was based on the maximum pipe pressure of 500 psig and included the volume between the isolation valves.

As discussed in the buoyant jet analysis above, momentum and buoyancy effects will cause rapid vertical dissipation of the natural gas (96 percent methane) into the atmosphere. Ignition, much less detonation of the gas within the flammable range located on the periphery of the jet, is highly improbable since the turbulence of the jet would inhibit unconfined accumulation of significant quantities of gas in the flammable or detonable range. Normal atmospheric convective and mechanical turbulence efficiently disperses the gas, and only under the most stable atmospheric conditions would it even be feasible to consider this unconfined volume situated on the periphery of the jet potentially detonable. In addition, under surface temperature inversion conditions, potential overpressures resulting from explosions are at a maximum. Thus, the meteorological conditions used for this analysis are based on five percentile meteorology as presented in Section 2.3 and include the same temperature inversion used in the buoyant jet analysis of Dr. Knox.

ARKANSAS NUCLEAR ONE
Unit 2

It should be emphasized that this analysis involves a combination of highly improbable assumptions starting with (1) the double-ended rupture of a Type C section of pipeline (installed in 1969), (2) the existence of an ignition source having a temperature at least as high as 1,200 °F, which is the ignition temperature of the gas, (3) extremely stable atmospheric conditions, (4) a unique, unrealistic detonation of 100 percent of the gas in the detonable range within the jet, (5) the entire volume of gas in the detonable range as a point source at the closest point to the containment, and (6) the detonation rather than deflagration of the unconfined volume of gas. If an ignition event of an unconfined gas-air mixture occurs, deflagration and not detonation will nearly always be the result. Also, the energy requirements for the direct initiation of a detonation in the gas phase appear to be at least four orders of magnitude greater than those for the initiation of a deflagration (Reference 120).

Due to the initial momentum and buoyancy of the release, jet velocity will be much greater than wind speed and the closest point at which the center of a delayed-ignition event could occur will have a vertical coordinate of 200 feet (the height of the containment). Under five percent meteorology, maximum horizontal transport of the centerline would be 10 feet, making 590 feet the distance, d_2 , from the centerline of the jet to the containment. Based on a buoyant jet analysis, the estimated quantity of natural gas released in a volume whose vertical midpoint is 200 feet would be a maximum of 71,000 cubic feet. Since this volume is taken to be acting as a point source at the 200-foot level, this neglects the gas more than 400 feet above the ground.

However, the contribution of this gas to the postulated detonation is small due to its relatively great distance from the effective center of the postulated detonation and probable ignition source.

Although the flammable region of this volume of gas is defined as the portion between the lean (five percent) and rich (15 percent) limits, the detonable range of six percent and 14 percent more accurately represents gas concentrations which are capable of contributing to an explosion (Reference 120). Assuming a Gaussian distribution within the buoyant jet, 2.9 percent will fall within the detonable limits. The following relationship may be used to calculate explosive yield (W_2) in terms of equivalent TNT (Reference 12):

$$W_2 = \frac{(\Delta H)(W_{\text{gas}})}{2000} = \frac{21,500(100\text{lb.})}{2000} = 1075\text{lb. TNT}$$

where

$$\Delta H = 21,500 \text{ BTU/lb.}$$

$$\begin{aligned} W_{\text{gas}} &= \text{Weight of natural gas in the detonable range} \\ &= (.029) (71,000 \text{ ft}^3) (.0485 \text{ lb/ft}^3) = 100 \text{ lbs} \end{aligned}$$

The blast and resulting overpressure from gaseous explosions most closely relate to nuclear explosion effects (Reference 47). The resulting overpressure from an explosive yield of 1075 lb TNT can be estimated using the surface temperature inversion curve (Figure 3.66 of Reference 33) for a 1 kiloton burst and the following cube root scaling law (Reference 33):

ARKANSAS NUCLEAR ONE
Unit 2

$$d_1 = d_2 \sqrt[3]{\frac{W_1}{W_2}} = 590 \text{ft.} \sqrt[3]{\frac{2 \times 10^6 \text{lb}}{1075 \text{lb}}} = 7260 \text{ft.}$$

where

d_1 = equivalent distance from burst of 1 kiloton TNT

d_2 = distance from centerline of gas jet to containment

W_1 = explosive yield from 1 kiloton TNT

W_2 , as defined above (explosive yield of gas in terms of equivalent TNT)

This distance corresponds to a peak overpressure of 1 psi. Peak reflected overpressure can be calculated using the following relationship (Reference 33):

$$P_r = 2P \frac{7P_o + 4P}{7P_o + P} = 2(1) \frac{7(14.73) + 4(1)}{7(14.73) + 1(1)} = 2.06 \text{psi}$$

where

P_r = peak reflected overpressure

P = peak overpressure

P_o = atmospheric pressure

This peak reflected overpressure falls well within the limits of the design basis tornado overpressure of 3 psi, and should be considered a maximum based on the extremely conservative assumptions listed above.

Smaller breaks would release gas at a lower mass flow rate and result in a buoyant jet of smaller cross section, a lower total mass of gas in the 0 - 400 foot column. Based on the assumed Gaussian distribution within the jet, the quantity of gas in the detonable range would also be smaller and thus result in a lower value of peak reflected overpressure.

Increased wind speed would coincide with an increase in atmospheric turbulence, thereby further diminishing the already extremely low probability of a detonation.

The analysis and evaluation given here is a conservative one for Unit 2 since it was made for Unit 1, and Unit 1 is located between the pipeline and Unit 2.

As described above, the results of the buoyant jet model are not materially changed for a horizontal break orientation releasing gas towards the plant. The reason for this is that the gas immediately leaving the pipe is momentum dominated due to its release velocity for only a short time (and distance). Thereafter, density deficiency in the ambient air causes buoyant rise to become the dominant mechanism. From a practical standpoint, the orientation of the postulated pipe rupture would have little consequence on the buoyant gas rise. The catastrophic rupture of the buried pipe would likely blow the dirt away from over the pipe. The exiting methane would quickly become buoyancy dominated and would enter the ambient flow nearly vertically. Hence, the gas concentrations expected at the plant would be essentially zero under the reasoning presented in Dr. Knox's analysis. The closest that an ignitable gas concentration center could extend toward the facility is 590 feet, as cited above.

ARKANSAS NUCLEAR ONE
Unit 2

Isothermal gas expansion was assumed for the double-ended pipe rupture. The causes of such a rupture are usually outside forces such as construction activities. However, large brittle pipe fractures (caused by internal forces) can also be reasonably modeled as an isothermal process after the first moments of the rupture. For the slower leak rates through smaller breaks, adiabatic expansion should be assumed. However, such small releases to the atmosphere would be quickly dispersed below hazardous concentrations. The adiabatic and isothermal processes were compared as to their impact on the model results for the large rupture. The adiabatic case shows a gas temperature decrease of 28 °F during the jet expansion. In terms of the buoyant jet model, the adiabatic assumption is only one percent more conservative than the isothermal assumption.

However, five reported explosion incidents have occurred after apparent gas diffusion through the soil. All of these cases occurred in distribution systems near developed areas. In four cases the leaks were induced by construction activities and in one case by corrosion of plastic pipe. In four cases, the ground between the leak and the buildings where ignition occurred was at least partially covered by concrete or asphalt slabs. For these cases, enough gas was diffused a short distance under these slabs to cause ignitable concentrations in adjacent buildings. In one case, the gas was apparently transported 200 feet along existing underground utility lines. In these five cases, the gas, leaking in small quantities (compared to a transmission line rupture), was transported along a physical path through the soil for relatively short distances. The gasline crosses a sanitary sewer outlet pipe approximately 700 feet from the closest Unit 2 structure. However, the utility line is approximately three feet below the gas line and ends approximately 60 feet from the crossing. In addition, the sewer line leads to a large sand filter bed through which any gas would escape. It is not a direct connection to any plant structure. Hence, it is not considered as a possible transportation path. There are no other utility lines or man-made pathways between the pipeline and plant structures. It is unlikely that escaping gas from the subject transmission pipeline could find such a transport mechanism through the hard ground. Hence, no appreciable gas buildup in the plant structures is expected.

Considering the effects of onsite meteorological data, including effects of calm conditions or light winds, a methane jet escaping from the gas line would rise rapidly under the force of buoyancy and initial momentum to a height above any low level inversion. Any annual or seasonal increase in frequency of light or calm winds at the site would only enhance the vertical escape of gas vented in the manner postulated in the reference analysis.

In addition to the above, probability studies show that the probability of a rupture of this line and subsequent ignition of the gas is less than 10^{-7} per year. Discussions with members of the NRC staff indicate that conditions favorable for engulfing the upper surfaces of the plant in flammable gas concentrations following rupture of the gas line at its closest approach to the plant have a probability of approximately three percent using the staff's assumptions. The staff has indicated that the length of pipeline in which a similar rupture could bring flammable gas concentrations to the plant was approximately 0.5 km. The rate at which flammable gas may be expected to come into contact with plant building surfaces is therefore of the order of 10^{-6} per year, according to the NRC staff. The NRC analysis considers the overall probability of failure of a gas pipeline, the length of line involved and meteorological conditions conducive to transporting the gas to the plant. However, according to Reference 1, of the pipeline ruptures that have occurred only 46 percent were caused by other than outside forces. Since the segment of pipeline under consideration is wholly on Entergy Operations, Inc. controlled property, damage from outside forces is not credible, and the overall probability of a pipeline rupture should be correspondingly less. Finally, the probability of ignition, given a pipeline rupture, is 0.32 (Reference 87) and thus the overall risk probability is of the order of 10^{-7} per year.

ARKANSAS NUCLEAR ONE
Unit 2

2.2.2.2 Cooling Tower

The cooling tower is located a distance away from the service water piping, diesel fuel piping, and critical structures equal to the height of the tower above grade.

If the cooling tower should fail, and in so doing cause the gas pipeline to rupture, either of two consequences could occur; the gas might be ignited or might escape as a buoyant jet conservatively assumed trapped under an inversion. Both of these cases are treated in Section 2.2.2.1, and the analyses show no adverse effect.

2.2.2.3 This section has been deleted.

2.2.2.4 Other

An accident involving the release of noxious or lethal chemicals in the atmosphere could result in an adverse environment at the plant site. Under these conditions, plant personnel not necessary for a reactor shutdown would be evacuated as promptly as possible. The minimum number of personnel for plant operation would continue operation unless equipment failures occur that would necessitate a shutdown. Portable breathing apparatus will be available to allow adequate access and inspection of areas outside the control room. (The control room is an enclosed area that may be isolated from the outside environment.)

The possibility of explosives being detonated in the waterway and on the highway at distances of 1.05 and 1.4 miles from the plant site, respectively, has also been considered. The potential missiles developed during such a phenomenon would be less severe than those established for tornado design. Ground response at the plant site due to the above phenomenon would be much less than the seismic criteria for Class 1 structures.

For the quantities of chemicals dissolved into the Dardanelle Reservoir, the dilution thereof would be such that no adverse effects upon plant equipment would result. Provisions on the design of the intake structure prevent the entry of debris and foreign objects due to shipping accidents. In the unlikely event that the intake structure became inoperative, the plant could be safely shut down using the emergency pond.

Consideration was given to the possibility of a loaded barge entering the plant site area during a maximum flood. Upon notification of a flood warning, Entergy Operations, Inc. can obtain information on barge traffic in the area of the plant site and would check any such barges to ensure that they are either under the control of a tug or securely fastened to a pier. During this flood condition, Entergy Operations, Inc. would maintain communications with the U.S. Corps of Engineers and the U.S. Coast Guard in order to be informed of any such barge traffic on the Dardanelle Reservoir. The U.S. Army Corps of Engineers requires that barge traffic on the Arkansas River be halted if the flow in the river is greater than 350,000 cfs, which is much less than the 900,000 cfs for which the reservoir system is designated. Since adequate notification of a pending flood of this magnitude is available (approximately four to five days advanced warning will be had), it is considered to be a very remote possibility that a barge would become a floating hazard. Further, as one can see by examining Figure 2.1-3, Round Mountain provides a natural barrier to prevent or divert a barge (or other object) from being carried into the plant site area by the current. There is also a substantial tree line separating the plant site from the cove north of Round Mountain. This tree line extends up to an elevation of 383 feet and ranges between 100 to 400 feet in depth, thereby providing a natural barrier against any

ARKANSAS NUCLEAR ONE
Unit 2

barges which might enter this cove, which is highly unlikely. It is therefore concluded that a large floating object could not enter the plant site area, even under the conditions of maximum flood.

Normally, Dardanelle Reservoir will fluctuate between elevations of 336 and 338 feet MSL at the dam, as necessary to re-regulate inflows to the lake for the generation of hydroelectric power. Operational studies indicated that under certain combinations of flow and power loads, the pool may be lowered as low as Elevation 335 at the dam and stay below Elevation 336 for brief periods of less than 1-day duration.

The only conceivable reasons for lowering the pool below an elevation where a source of service water and makeup water supply to the circulating water system would be lost are emergency pool lowering because of indicated damage to a gate, causing loss of the pool and planned temporary lowering of the pool to permit necessary repairs which cannot be performed otherwise. The probability of this severe a drawdown is extremely remote, but if it happened, the plant could be safely shut down by using the emergency pond.

ARKANSAS NUCLEAR ONE
Unit 2

2.3 METEOROLOGY

2.3.1 REGIONAL CLIMATOLOGY

Figure 2.3-1 shows the relative locations of the site and the climatological stations used in the preparation of this section.

2.3.1.1 Data Sources

Sources used in the preparation of the regional climatology include:

- 2.3.1-A Visher, Stephen S., "Climatic Atlas of the United States." Harvard University Press, Cambridge, Mass., 1966.
- 2.3.1-B "Climatic Atlas of the United States." U.S. Department of Commerce, ESSA, Environmental Data Service, June 1968.
- 2.3.1-C "Local Climatological Data," Fort Smith and Little Rock, Arkansas. U.S. Department of Commerce, ESSA, Environmental Data Service, 1969.
- 2.3.1-D "Climatic Summary of the United States - Supplement for 1951 through 1960 - Arkansas." U.S. Department of Commerce, Weather Bureau, Washington, D.C., 1964.
- 2.3.1-E Hershfield, David M., "Rainfall Frequency Atlas of the United States for Durations from 30 Minutes to 24 Hours and Return Periods from 1 to 100 Years." USWB Technical Paper No. 40, U.S. Government Printing Office, Washington, D.C., Revised 1961.
- 2.3.1-F "Maximum Recorded United States Point Rainfall for 5 Minutes to 24 Hours at 296 First Order Stations." USWB Technical Paper No. 2, U.S. Government Printing Office, Washington, D.C., Revised 1963.
- 2.3.1-G "Seasonal Variation of the Probable Maximum Precipitation East of the 105th Meridian for Areas from 10 to 1000 Square Miles and Durations of 6, 12, 24 and 48 Hours." Hydrometeorological Report No. 33, U.S. Government Printing Office, Washington, D.C., April 1956.
- 2.3.1-H "Extremes of Snowfall - States." Weatherwise, Volume 23, No. 6, December 1970.
- 2.3.1-I Thom, H.C.S., "Tornado Probabilities." Monthly Weather Review, October - December 1963.
- 2.3.1-J Cry, George W., "Effects of Tropical Cyclone Rainfall on the Distribution of Precipitation over the Eastern and Southern United States." ESSA Professional Paper 1, U.S. Department of Commerce, Washington, D.C. June 1967.
- 2.3.1-K Thom, H.C.S., "New Distribution of Extreme Winds in the United States." Journal of the Structural Division, Proceedings of the ASCE, July 1968.

ARKANSAS NUCLEAR ONE
Unit 2

- 2.3.1-L Holzworth, George C., "Mixing Heights, Wind Speeds and Potential for Urban Air Pollution Throughout the Contiguous United States." Environmental Protection Agency, Research Triangle Park, North Carolina, January 1972.
- 2.3.1-M Ludlum, David M., "Weather Record Book." Weatherwise, Inc., Princeton, N.J., 1971.
- 2.3.1-N "Severe Local Storm Occurrences, 1955 - 1967." ESSA Technical Memorandum WBTM FCST 12, U.S. Department of Commerce, September 1969.
- 2.3.1-O Briggs, G.A., "Plume Rise." U.S. Atomic Energy Commission, Division of Technical Information, 1969.
- 2.3.2-P Hanna, Steven P., "Rise and Condensation of Large Cooling Tower Plumes," Journal of Applied Meteorology, August 1972, pp. 793-799.
- 2.3.1-Q Csanady, G.T., "Bent Over Plumes," Journal of Applied Meteorology, February 1971, pp. 36-42.
- 2.3.1-R Slade, David E., "Wind Measurement on a Small Tower in Rough and Inhomogeneous Terrain," Journal of Applied Meteorology, April 1969, pp. 293-297.
- 2.3.1-S Pautz, Maurice E., (editor), "Severe Local Storm Occurrences 1955-1967," U.S. Department of Commerce Environmental Science Services Administration, ESSA Technical Memorandum WBTm FCST 12, September 1969.
- 2.3.1-T Reinhold, R.O., "Arkansas Storm Data Study - October 1958 Through September 1968," Weather Bureau Office, Little Rock, Arkansas, November 1968.
- 2.3.1-U Daniels, Glenn E., "Terrestrial Environment (Climatic) Criteria Guidelines for Use in Space Vehicle Development, 1971 Revision," NASA Technical Memorandum TM X-64589, George C. Marshall Space Flight Center, MSFC, Alabama.

2.3.1.2 General Climate

Because it has homogeneous climatic conditions, the boundaries of the state of Arkansas may be used to delineate the general climatic region of the plant site.

Arkansas experiences a continental type climate with large diurnal and seasonal variations in temperature. Yet, because of proximity to the Gulf of Mexico, there are occasional intrusions of maritime tropical air masses during all seasons, but more frequently in the summer. During fall, winter and spring, the weather conditions in Arkansas exhibit frequent wide variations due to synoptic scale events, such as cold frontal passages from the north and northwest, and the development of warm frontal activity or extra tropical cyclones in the Gulf of Mexico and the southern states. In the summer season, most of the weather variations are due to local showers and storms rather than to synoptic scale events. Tropical hurricanes moving north out of the Gulf of Mexico occasionally cause widespread rain in late summer or fall, but hurricane wind conditions are ameliorated before reaching the region.

The Arkansas Nuclear One Station is on a peninsula in Dardanelle Reservoir, an impoundment on that portion of the Arkansas River lying between the Boston Mountains to the north and the Ouachita Mountains to the south, as illustrated in Figure 2.3-3. Although these mountains generally reach to about 2,000 feet--and occasionally 3,000 feet--above sea level, they provide

ARKANSAS NUCLEAR ONE
Unit 2

some shelter from polar and arctic air masses, resulting in less snowfall and fewer extremes of cold weather than are experienced by locations to the east or west of the mountains. These mountain ranges and the river between them also combine their influences to increase the frequency of winds with significant components from the east or west.

Mean annual temperatures show a uniform gradient toward lower values across the state from south to north, whereas summer mean temperatures are quite uniform throughout. In the winter, normal daily minimum temperatures drop to 37 °F in the southeast corner of the state and to 25 °F in the northwest, with normal minimum temperatures at the site averaging near freezing in December and January. Temperatures at 90°F or higher occur more than 90 days per year in central and southern Arkansas, falling off to about 60 days per year in the northern part of the state. (Data sources 2.3.1-A, B)

Annual average rainfall is quite uniform throughout the state, varying from 56 inches per year in some of the mountain regions, to about 52 inches at the plant site, and to 46 inches along the northern borders of the state. The precipitation is also quite uniform throughout the year with monthly average values varying from a little less than three inches per month in some sectors of the region to nearly six inches per month in other sectors. In the winter seasons only, there is a gradient of rainfall intensity from higher values in the south to lower values in the north. Mean annual total snowfall varies from 12 inches in the north to two inches in the south. (Data source 2.3.1-B)

The mean percentage of possible sunshine experienced in the state varies from about 50 percent in the winter to 75 percent in the summer season (Data source 2.3.1-B).

2.3.1.3 Severe Weather

Except for high air pollution and drought, most of the severe weather in the Arkansas region is usually associated with thunderstorms which occur about 60 days per year (Data source 2.3.1-A), with the most frequent activity in May, June, and July (Data source 2.3.1-C.) Hail is observed two to four days per year (Data source 2.3.1-A) in most locations; the average number of tornadoes reported in the state approaches 20 per year.

2.3.1.3.1 Precipitation

Estimated point rainfall maxima (inches) for the region are:

	<u>Return Period (Years)</u>						
<u>Duration</u>	<u>1</u>	<u>2</u>	<u>5</u>	<u>10</u>	<u>25</u>	<u>50</u>	<u>100</u>
30 min	1.25	1.45	1.85	2.10	2.40	2.70	3.00
1 hour	1.55	1.80	2.30	2.65	3.10	3.45	3.75
2 hours	1.90	2.25	2.75	3.25	3.75	4.20	4.65
3 hours	2.10	2.40	3.20	3.60	4.20	4.65	5.15
6 hours	2.50	2.95	3.75	4.45	5.00	5.60	6.20
12 hours	3.00	3.60	4.55	5.25	6.20	6.70	7.40
24 hours	3.50	4.10	5.30	6.10	7.10	7.90	8.70

(Data source 2.3.1-E)

ARKANSAS NUCLEAR ONE
Unit 2

The above values are comparable to the extreme rainfall amounts (inches) which have occurred in a 60-year period at Forth Smith and Little Rock:

<u>Duration</u>	<u>Fort Smith (1901-1961)</u>	<u>Little Rock (1900-1961)</u>
5 min.	0.58	0.63
10 min.	1.15	1.01
15 min.	1.54	1.35
30 min.	2.25	2.07
60 min.	2.47	3.00
2 hr.	4.34	4.60
3 hr.	4.67	6.82
6 hr.	5.13	7.68
12 hr.	6.15	8.19
24 hr.	8.58	9.58

(Data source 2.3.1-F)

The "probable maximum precipitation" estimate of extreme rainfall is used to provide complete safety-design criteria in situations where structural failure might be disastrous. It may be defined as the critical depth-duration-area rainfall relations for a particular area that would result if conditions during an actual storm in the region were increased to represent the most critical meteorological conditions that are considered probable. The probable maximum precipitation values have been estimated for a 10-square-mile area in the vicinity of the site as:

<u>Duration</u>	<u>Inches</u>
6 hr.	30.0
12 hr.	36.0
24 hr.	39.0
48 hr.	42.0

(Data source 2.3.1-G)

Extreme snowfalls (inches) for representative stations in the area are:

<u>Period</u>	<u>Fort Smith (49 yrs, 1921-69)</u>	<u>Little Rock (77 yrs, 1893-1969)</u>
24 hours	17.5	13.0
Calendar Month	18.3	19.4

ARKANSAS NUCLEAR ONE
Unit 2

<u>Period</u>	<u>Fort Smith (29 yrs, 1946-74)</u>	<u>Little Rock (33 yrs, 1942-74)</u>
January	6.3	12.0
February	11.5	9.6
March	5.3	7.0
April	T	T
May	0	0
June	0	0
July	0	0
August	0	0
September	0	0
October	0	0
November	3.9	4.8
December	5.0	9.8
Season	11.5	12.0

(Data source 2.3.1-C)

Extremes of snowfall (inches) for the state of Arkansas are:

24 Hours:	25.0 Corning 1/22/18	(79 years, 1892-1970)
Single Storm:	25.0 Corning 1/22/18	(79 years, 1892-1970)
Calendar Month:	48.0 Calico Rock 1/18	(67 years, 1904-1970)
Season:	61.0 Hardy 1917-18	(74 years, 1897-1970)

(Data source 2.3.1-H)

2.3.1.3.2 Hail

The most commonly reported hailstones are 1/2- to 3/4-inch in diameter and cause little or no property damage. However, much larger stones are associated with the more severe thunderstorms. Hard hail that does not shatter on impact, 1-inch diameter and larger, will cause heavy damage to roofs, pit thin steel surfaces such as automobiles, and may break windows. Larger hail breaks window panes, occasionally shatters automobile windshields, and has been known to puncture automobile roofs.

All of Arkansas is subject to damaging hail. In the 1 degree latitude-longitude square including Russellville, hail 3/4 inches or more in diameter has been reported about once a year. Due to their infrequency, there is no specific hailstorm season, but the peak frequency for the state occurs during April (Data sources 2.3.1-A, N).

ARKANSAS NUCLEAR ONE
Unit 2

2.3.1.3.3 Ice Storms

Glaze and ice storms, attributed to precipitation in the form of freezing rain, although infrequent, are at times severe. It is estimated that one or two short periods of freezing rain will be experienced each year; however, these usually result in such a slight accumulation of glaze ice that little or no damage is done other than slight inconveniences to traffic. Moderate to heavy ice storms are estimated to occur about once every four years and can be very damaging to utility lines and trees, as well as being a serious traffic hazard. The ice coating, resulting from moderate to heavy ice storms in the central United States, seldom endures more than seven days and usually endures less than three days (Data sources 2.3.1-C, M).

2.3.1.3.4 Thunderstorms

In this area, the maximum frequency of thunderstorms occurs in late spring and the summer months, with a wintertime minimum in December and January.

The annual distributions of thunderstorms for Fort Smith and Little Rock are:

Mean Number of Thunderstorm – Days per Month

<u>Month</u>	<u>Fort Smith (24 yrs, 1946-69)</u>	<u>Little Rock (27 yrs, 1943-69)</u>
January	1	2
February	2	2
March	4	5
April	7	7
May	9	7
June	7	7
July	8	9
August	6	6
September	4	4
October	3	2
November	2	3
December	1	1

(Data source 2.3.1-C)

The monthly and seasonal lightning events for Arkansas are given in Table 2.3-57. These lightning data are derived from lightning events in which deaths or serious injuries took place. Therefore, they are not representative of the total lightning occurrences expected. Furthermore, the monthly distribution may not be representative because the number of deaths or injuries would increase as the amount of outside activity increases; and people become more exposed to lightning strokes.

ARKANSAS NUCLEAR ONE
Unit 2

NASA has developed a method of estimating the number of cloud-to-ground lightning strokes from observations of thunderstorms days. This procedure is presented in data source 2.3.1-U.

The factor of 0.23 is multiplied by the number of days per year in which thunder is heard to obtain an estimate of the number of lightning strokes reaching the earth per square mile. This method was developed for the Cape Kennedy area and may be applied to give a rough estimate of the number of lightning strokes.

2.3.1.3.5 Tornadoes

From 1953 through 1962 a total of 19 tornadoes occurred in a 1° square centered near the site. This gives an annual frequency of 1.9 (Data source 2.3.1-I). From 1955 through 1967, a total of 23 tornadoes occurred in the same 1° square. This gives an annual frequency of 1.8 (Data source 2.3.1-N). The probability of a tornado hitting a point is:

$$P = 2.8209 t/A$$

where A is the area in square miles of 1° square centered on the point, and t is the mean annual frequency of tornadoes in the area (Data source 2.3.1-I). For the plant site, t is 1.9 and A is approximately 3,900 square miles.

$$\text{Thus, } P = (2.8209) 1.9/3900 = .00137$$

The return period, the reciprocal of P, is $1/P = 1/.00137 = 730$ years.

Therefore, the probability of a tornado hitting the site in any given year is .00137 with a return frequency of once every 730 years.

Table 2.3-56 provides the monthly and seasonal distribution of tornado occurrence for Arkansas.

ARKANSAS NUCLEAR ONE
Unit 2

2.3.1.3.6 Hurricanes

Tropical cyclones, including hurricanes, lose strength as they move inland, and the greatest concern is possible damage from winds or flooding due to excessive rainfall. The extremes for winds and rainfall presented elsewhere include hurricane effects. The chronology of tropical cyclones that affected Arkansas, 1936-60, follows:

<u>Year</u>	<u>Cyclone's Life</u>	<u>Force</u>
1931	Jul 11-17	T
1932	Aug 26 - Sep 3	T
1932	Sep 18-21	T
1932	Oct 7-18	T
1933	Jul 21-27	T
1934	Jun 4-21	T
1937	Aug 24 - Sep 2	T
1937	Sep 29 - Oct 3	T
1939	Aug 7-2	T
1940	Aug 2-10	T
1940	Sep 19-24	T
1941	Sep 16-25	T
1942	Aug 17-22	T
1943	Sep 15-19	T
1947	Aug 18-27	T
1948	Jul 7-11	T
1948	Sep 1-6	T
1949	Sep 3-5	T
1949	Sep 27 - Oct 6	T
1950	Aug 20 - Sep 1	T
1950	Sep 1-9	T
1953	Sep 14-20	T
1955	Jul 31 - Aug 2	T
1955	Aug 23-29	T
1956	Jun 11-14	T
1957	Jun 25-28	T
1957	Aug 8-11	T
1957	Sep 16-19	T
1959	May 28 - June 2	T
1959	Jul 22-27	T
1960	Jun 22-28	T

* T indicates less than hurricane force winds in Arkansas (Data source 2.3.1-J).

ARKANSAS NUCLEAR ONE
Unit 2

2.3.1.3.7 Extreme Winds

Estimated extreme winds at 30 feet above ground for the general area are:

<u>Return Period (Years)</u>	<u>Faster Mile* (miles per hour)</u>
1000	93
200	79
100	74
50	69
20	63
10	59
5	55
2	49

(Data source 2.3.1-K)

In the one degree latitude-longitude square including Russellville, wind storms with wind speeds 50 knots or greater have been reported about once a year (Data source 2.3.1-N).

* The fastest mile is highest wind speed lasting for any time interval during which a length of air one mile long passes a wind instrument.

2.3.1.3.8 Air Pollution Potential

In January 1972, Holzworth published a study (Data source 2.3.1-L) on mixing heights, wind speeds, and potential for urban air pollution throughout the contiguous United States. Surface and upper air data from the National Weather Service Station at Little Rock, Arkansas were included in the analyses made for this study. The data covered the 5-year period 1960 through 1964.

The mixing height (or depth), as used in the study, is defined as the height above the surface through which relatively vigorous vertical mixing occurs. The morning mixing height was calculated as that existing around the morning commuter rush hours. The afternoon mixing height may be considered to coincide approximately with the usual mid-afternoon minimum concentration of slow-reacting urban pollutants.

Wind speeds for both morning and afternoon were computed as arithmetic averages of speeds observed at the surface and aloft within the mixing layer.

ARKANSAS NUCLEAR ONE
Unit 2

The following table shows mean mixing heights and wind speeds as calculated for Little Rock, Arkansas:

<u>Season</u>	<u>Morning</u>		<u>Afternoon</u>	
	<u>Mixing Height (Meters)</u>	<u>Wind Speed (mps)</u>	<u>Mixing Height (Meters)</u>	<u>Wind Speed (mps)</u>
Winter	541	5.2	1101	6.6
Spring	544	5.7	1612	7.0
Summer	375	3.7	1851	4.9
Autumn	342	3.8	1401	5.2
Annual	450	4.6	1491	5.9

The above data show that, on the average, the greatest air pollution potential (lowest mixing height and lowest wind speed) occurs on summer and autumn mornings.

In his study, Holzworth also used a mathematical model to compute the average normalized concentration (\bar{x}/\bar{q}) (i.e., the concentration (\bar{x}) averaged over a city and normalized for uniform average area emission rate (\bar{q}), as a function of mixing height (H), wind speed (U), and a long-wind distance (S) across the city. The assumptions used in his model are not applicable to point source emissions, but the model can be used to determine concentrations resulting from many widely spaced sources when the average emission rate per unit is known. It should be noted that (\bar{q}) refers to average emission rate per unit area, and that (\bar{x}/\bar{q}) has dimensions of seconds meter⁻¹. This is in contrast to (\bar{x}/\bar{q}) used in Section 2.3.4, which has dimensions of seconds meter⁻³.

Some of Holzworth's results are shown below as a qualitative indication of the diffusion characteristics of the central Arkansas region:

\bar{x}/\bar{q} VALUES FOR 10 KM* CITY AS
CALCULATED FOR LITTLE ROCK, ARKANSAS

<u>Season</u>	<u>Median</u>		<u>Upper Decile</u>	
	<u>Morning (Sec m⁻¹)</u>	<u>Afternoon (Sec m⁻¹)</u>	<u>Morning (Sec m⁻¹)</u>	<u>Afternoon (Sec m⁻¹)</u>
Winter	10	10	48	11
Spring	10	9	47	10
Summer	14	10	53	11
Autumn	19	10	61	11
Annual	12	10	54	11

* Refers to along-wind distance across the city.

ARKANSAS NUCLEAR ONE
Unit 2

East of the Rocky Mountains the annual median concentrations for 10 km cities varies between only 9 and 13 sec m⁻¹ in the morning. Annually, the median afternoon X/Q values for a 10 km city are, for the most part, not much smaller than the values for morning, and they are practically uniform, being either 9 or 10 sec m⁻¹.

The persistence of high meteorological potential for air pollution is indicated by parameters called episodes and episode-days by Holzworth. An episode occurs if a mixing depth of 2,000 meters or less, combined with wind speed six meters per second or less, persists without precipitation for at least two days (five consecutive computations at morning and afternoon). Holzworth determined the frequency of 2-day and 5-day (11 consecutive computations) episodes at several intensities, where intensity is greater at slower winds and shallower mixing depths. Episode-days are the total number of days included in the episodes.

Below are tabulated the numbers of episodes and episode-days in five years at Little Rock. Also shown is the season having the largest number of episode-days.

EPISODES AND EPISODE-DAYS IN 5 YEARS
AT LITTLE ROCK, ARKANSAS FOR EPISODES
LASTING AT LEAST 2 DAYS

Mixing Height (Meters)	(Parameters)	Wind Speed (Meters per second)		
		≤ 2	≤ 4	≤ 6
≤ 500	Episodes	0	1	2
	Episode – days	0	3	5
	Season*	-	W	W
≤ 1000	Episodes	0	9	30
	Episode – days	0	23	83
	Season	-	W&A	W
≤ 1500	Episodes	0	23	68
	Episode – days	0	59	20
	Season	-	A	2 A
≤ 2000	Episodes	0	39	12
	Episode – days	0	105	6
	Season	-	A	38 8 A

*W - Winter
SP - Spring
SU - Summer
A - Autumn

ARKANSAS NUCLEAR ONE
Unit 2

EPISODES AND EPISODE-DAYS IN 5 YEARS
AT LITTLE ROCK, ARKANSAS, FOR EPISODES
LASTING AT LEAST 5 DAYS

Mixing Height (Meters)	(Parameters)	Wind Speed (Meters per second)	
		≤ 4	≤ 6
≤ 500	Episodes	0	0
	Episode – days	0	0
	Season*	-	-
≤ 1000	Episodes	0	2
	Episode – days	0	11
	Season	-	A
≤ 1500	Episodes	0	5
	Episode – days	0	27
	Season	-	A
≤ 2000	Episodes	1	16
	Episode – days	6	91
	Season	SU	A

2.3.2 LOCAL METEOROLOGY

2.3.2.1 Data Sources

Sources used in the preparation of the local meteorology include:

- 2.3.2-A "Wind Distribution by Pasquill Stability Classes (5), Seasonal and Annual, Little Rock, Arkansas." U.S. Department of Commerce, NOAA, Environmental Data Service, National Climatic Center, Asheville, N.C., September 1971.
- 2.3.2-B "Local Climatological Data" for Little Rock and Fort Smith, Arkansas," U.S. Dept. of Commerce, ESSA, Environmental Data Service, Government Printing Office, Washington, D.C., 1969.
- 2.3.2-C "Climatic Summary of the United States - Supplement for 1951 through 1960 - Arkansas." U.S. Department of Commerce, Weather Bureau, Washington, D.C., 1965.
- 2.3.2-D "Climatic Summary of the United States - Supplement for 1951 through 1960 - Arkansas." U.S. Department of Commerce, Weather Bureau, Washington, D.C., 1965.
- 2.3.2-E Personal Communication with Mr. Carl Landers, National Weather Service Office, Little Rock, Arkansas, August 16, 1973.

ARKANSAS NUCLEAR ONE
Unit 2

- 2.3.2-F "Climatic Summary of the United States, Section 59 -Arkansas North of the Arkansas River." U.S. Department of Agriculture, Weather Bureau, Washington, D.C., 1933.
- 2.3.2-G "Climatic Summary of the United States, Section 60 -Arkansas South of the Arkansas River." U.S. Department of Agriculture, Weather Bureau, Washington, D.C., 1933.
- 2.3.2-H American National Standards Institute, "Requirements for Minimum Design Loads in Buildings and Other Structures," ANSI A58.1-1972.
- 2.3.2-I Personal Communication with Mr. Beckerwerth, National Climatic Center, Asheville, North Carolina, May 16, 1974.
- 2.3.2-J Thom, H.C.S., "Distribution of Maximum Annual Water Equivalent of Snow on the Ground." Monthly Weather Review, Volume 94, No. 4, April 1966.
- 2.3.2-K "Snow Load Studies," Housing Research Paper 19. Housing and Home Finance Agency, Division of Housing Research, Washington, D.C., 1952.
- 2.3.2-L "Uniform Summary of Surface Weather Observations Part E - Psychrometric Summary" for January 1956 - December 1962, Jacksonville, Arkansas/Little Rock AFB.
- 2.3.2-M "Uniform Summary of Surface Weather Observations, Parts A-F" for January 1949 to April 1967, Jacksonville, Arkansas/Little Rock AFB.

2.3.2.2 Normal and Extreme Values of Meteorological Parameters

At present, only limited meteorological observational data exist for the plant site and only temperature and precipitation data exist for the Russellville-Dardanelle area. Therefore, data from proximal locations have been used to estimate or indicate normals and extremes that may be expected at the site.

2.3.2.2.1 Winds

Tables 2.3-1 through 2.3-13 show percentage frequencies of the 40-foot above grade wind from each wind sector (22.5°) on an annual and monthly basis at the site. These tables were prepared from data collected from February 7, 1972 through February 7, 1973.

The annual summary, Table 2.3-1, shows the prevailing direction to be from the east, with a secondary maximum, almost as large, from the east-northeast. The annual mean speed is 5.86 mph and the percentage of calms is 1.6 percent.

The "Fastest Miles" on record at Little Rock and Fort Smith are as follows, (mph) (Fastest Mile is defined in Section 2.3.1.3.7):

ARKANSAS NUCLEAR ONE
Unit 2

<u>Month</u>	<u>Little Rock</u> <u>(32 Years, 1942-1974)</u>	<u>Fort Smith</u> <u>(29 Years, 1946-1974)</u>
January	S 44	W 42
February	SW 57	W 56
March	SE 56	SW 41
April	NW 65	W 45
May	NW 61	NW 57
June	NE 60	N 58
July	NW 56	NE 44
August	NW 54	NE 44
September	NW 50	NE 52
October	SSW 58	W 54
November	SW 49	W 56
December	SW 48	SW 45

(Data Source 2.3.2-B)

2.3.2.2.2 Temperatures

The estimated monthly average daily maximum and minimum temperatures and extreme maximum and minimum values are as follows:

<u>Month</u>	<u>DEGREES FAHRENHEIT</u>			
	<u>Average</u> <u>Daily</u> <u>Maximum</u>	<u>Extreme</u> <u>Maximum</u>	<u>Average</u> <u>Daily</u> <u>Minimum</u>	<u>Extreme</u> <u>Minimum</u>
January	51.2	82	29.8	-11
February	53.6	87	31.3	-15
March	64.1	95	40.2	7
April	74.0	96	49.7	25
May	81.7	100	58.1	32
June	89.3	107	66.5	37
July	93.2	113	66.5	49
August	92.7	113	68.5	46
September	86.6	110	61.2	32
October	75.9	98	48.5	23
November	62.7	88	37.7	12
December	52.5	86	31.7	0
ANNUAL	73.1	113	49.4	-15

The above values are based on 48-49 years of record at Dardanelle (1909-1958) and 43-48 years of record at Russellville (1887-1909 and 1936-1950) (Data source 2.3.2-C).

The absolute maximum (113 °F) occurred at Russellville in July and at Dardanelle in August. The absolute minimum (-15 °F) occurred at Russellville in February.

Table 2.3-58 provides monthly, seasonal and annual diurnal mean air temperature variations for Little Rock.

ARKANSAS NUCLEAR ONE
Unit 2

2.3.2.2.3 Humidity

Estimated average relative humidity (%) for four different times of day at the site are:

<u>Month</u>	<u>HOUR (CST)</u>			
	<u>00</u>	<u>06</u>	<u>12</u>	<u>18</u>
January	76	80	60	63
February	74	79	57	57
March	69	76	53	52
April	75	81	56	56
May	82	86	57	58
June	82	87	56	57
July	85	88	58	62
August	83	88	58	62
September	86	90	59	66
October	81	85	49	62
November	78	82	57	64
December	76	80	61	65
Annual	79	84	57	60

The above values are estimated from five years of record at Fort Smith (1965-1969) and nine years of record at Little Rock (1961-1969) (Data source 2.3.2-B).

To estimate the extreme values that occurred, the combination of observed dry and wet bulb temperature that yields the largest and smallest possible value of absolute humidity was determined. The resultant values of extreme, both low and high, absolute humidity for each month, season and annually are presented in Table 2.3-59. Values of relative humidity associated with these extreme absolute humidities give an indication of the expected extremes. Relative humidities of 100 percent can be expected during each month of the year. The extreme low relative humidities of about 10 percent can also be expected throughout all months of the year.

Monthly average dewpoints for the site were estimated based on monthly average temperatures and monthly average relative humidities which were obtained from the above tables. The dewpoint values (°F) are as follows:

January	31.4	July	72.1
February	32.1	August	70.6
March	39.8	September	65.5
April	50.7	October	52.1
May	60.3	November	41.0
June	67.4	December	33.1

Table 2.3-60 presents the seasonal and annual diurnal variations of mean absolute humidity. Table 2.3-61 and 2.3-62 give the expected monthly, seasonal, and annual diurnal variations of dewpoint temperature and relative humidity, respectively.

ARKANSAS NUCLEAR ONE
Unit 2

2.3.2.2.4 Precipitation

Estimated monthly precipitation normals and mean number of days with precipitation equal to or greater than 0.5 inch at the site are presented below:

<u>Month</u>	<u>Normal (Inches) (a)</u>	<u>No. of Days 0.5 In. (b)</u>
January	3.99	2
February	3.86	3
March	4.76	3
April	4.87	4
May	5.70	3
June	4.25	3
July	4.06	3
August	3.55	2
September	3.63	2
October	3.11	2
November	3.98	3
December	3.40	2
Annual	49.16	32

(a) Based on 45 to 50 years of record at Russellville (1887-1909 and 1936-1960).

(b) Based on 9 to 10 years of record at Russellville (1951-1960).

(Data source 2.3.2-C)

Monthly extremes of precipitation on record at Russellville, Little Rock, and Fort Smith are (in inches):

<u>Month</u>	<u>Russellville (24 years, 1937-60)</u>	<u>Little Rock (44 years, 1931-74)</u>	<u>Fort Smith (44 years, 1931-74)</u>
January	12.81	18.04	11.33
February	10.20	11.02	9.21
March	16.05	9.49	13.03
April	12.45	14.20	10.32
May	11.34	12.74	14.71
June	8.97	7.82	15.02
July	9.62	7.76	10.41
August	12.58	14.46	8.71
September	8.01	9.09	10.49
October	11.13	9.68	12.05
November	10.94	9.54	14.01
December	7.52	9.14	10.09

(Data sources 2.3.2-B, C, D)

ARKANSAS NUCLEAR ONE
Unit 2

The snow and sleet season in the area runs from November through March with a trace (T) reported in April. The average monthly totals for Russellville for the period of record (1927 - 1960) are given below (in inches):

January	2.2	July	0
February	2.2	August	0
March	0.3	September	0
April	0	October	0
May	0	November	0.3
June	0	December	0.9
Annual	5.7		

(Data source 2.3.2-C)

Examination of the weather records for Russellville and Dardanelle shows that the maximum snow and ice accumulation occurred during January 10 to January 24, 1918. In this time, 19.7 inches of snow fell and the temperature did not rise above freezing, so the snow fall probably accumulated through the period. A scan of the records back to 1892 indicates no other comparable period occurred. (Data source 2.3.2-E)

The 100-year return period, antecedent snow and ice pack for the area in which the plant is located, in terms of snow load and water equivalent is listed below (Data source 2.3.2-H):

$$\text{Snow load} = 9.0 \text{ lbs/ft}^2$$

$$\text{Water Equivalent} = 1.728 \text{ inches}$$

The water equivalent of new-fallen frozen precipitation is not measured routinely by the National Weather Service (NWS). Since 1952, the NWS has made one daily measurement of the water equivalent of snow on the ground. The water equivalent of new-fallen frozen precipitation would be very difficult to estimate from these data since this parameter is influenced significantly by the promptness and frequency of the observation during or after the storm. Therefore, any statistical study relevant to estimating the probable maximum water equivalent of frozen precipitation from a single winter storm would be hampered by a relatively poor data base.

The record snowfall for the state of Arkansas was 25.0 inches occurring at Corning, which is located in the northeastern corner of the state (Data source 2.3.1-H). Thom (1966) has indicated there is a very poor relationship between snow depth and snow density (Data source 2.3.2-J). Values of water equivalent for several years were obtained from climatological records at Fort Smith and Little Rock (Data source 2.3.2-I). From these data, a conservative value of snow density for new-fallen snow was estimated as 0.20 inch of water per inch of snow.

The maximum probable water equivalent of frozen precipitation from a single winter storm was determined from the record snowfall of 25.0 inches and the conservative value of 0.20 for snow density. The snow load and water equivalent are listed below:

$$\text{Snow load} = 26.04 \text{ lbs/ft}^2$$

$$\text{Water Equivalent} = 5.0 \text{ inches}$$

ARKANSAS NUCLEAR ONE
Unit 2

A study conducted by the U.S. Weather Bureau in 1952 estimated the maximum probable snow load from a single storm in this area to be 20.0 lbs/ft² (Data source 2.3.2-K). Based on this figure, the estimate of 26.04 lbs/ft² is quite conservative.

2.3.2.2.5 Fog

Heavy fog is defined as that fog which reduces visibility to 1/4 mile or less. No fog data are available for the site area. Heavy fog frequencies for Little Rock and Fort Smith area:

<u>Month</u>	<u>Number of Days</u>	
	<u>Little Rock</u>	<u>Fort Smith</u>
January	3	2
February	2	1
March	1	1
April	1	*
May	1	1
June	*	1
July	1	1
August	1	1
September	1	1
October	2	2
November	2	1
December	2	2
Annual	16	16

* Less than 1/2 day. (Based on 32 years (1943-1974) of record at Little Rock and 29 years (1946-1974) of record at Fort Smith) (Data source 2.3.2-B).

The occurrence of fog is greatly influenced by topography and varies significantly over short distances. Therefore, to ascertain the expected and extreme duration of fogs, analysis of hourly or 3-hourly observations from a nearby representative location with a long period record is required. The closest station to the plant site with an adequate fog record is Little Rock. These data may not be representative of the site because of the influences of terrain and the Dardanelle Reservoir. Table 2.3-63 presents the percent frequency of occurrence of fog for Little Rock. The fog frequencies presented in this table are for visibility reductions of six miles or less and, therefore, are not restricted to heavy fogs. Seasonal and annual diurnal variations can be determined from this table.

The frequency of smog has not been estimated. Smog occurrences at the urban locations of Little Rock and Fort Smith, for which adequate climatological records exist, are not representative of the rural environment at Arkansas Nuclear One. No smog or fog records exist at Russellville.

2.3.2.2.6 Atmospheric Stability

In this section, wind direction and speed data are presented in relative frequency distributions by stability classes for each season and annually for Little Rock, Arkansas. Stability classes used are based on Pasquill's class structure (See Journal of Applied Meteorology, February 1964), as follows:

ARKANSAS NUCLEAR ONE
Unit 2

<u>Pasquill Stability Class</u>	<u>Identified In Tables As</u>	<u>Definition</u>
1	A	Extremely Unstable
2	B	Unstable
3	C	Slightly Unstable
4	D	Neutral
5,6,7	E	Slightly Stable to Extremely Stable

Tables 2.3-14 through 2.3-38 contain the wind/stability data. They give the frequency of occurrence of surface winds by direction, speed, and stability class. The data in these tables were developed from observations taken from January 1966 through December 1970. The tables are self-explanatory, except that the calm values have been distributed in the 0-3 speed category, based on the number of observations in speed categories 0-3 and 4-6 (Data source 2.3.2-A).

2.3.2.3 Potential Influence of the Plant and Its Facilities on Local Meteorology

It must be recognized that while data in the previous section are considered representative of local meteorology, the stations from which the data are derived are, in some cases, as much as 75 miles distant from the site. Consequently, departures from the normal and extreme values given above are expected.

Potential modifications of the local meteorology of the plant site resulting from the existence and operations of Unit 2 are recognized, but believed to be minimal. The buildings and ancillary structures, especially the natural draft cooling tower, are expected to have some small influence on the local flow of air; specifically, mechanical turbulence is expected downwind of the plant in the lower layers. Also expected to be of minor influence is a modification of the radiative properties of the site area.

The cooling tower plume is expected to enhance or reinforce naturally occurring low cloud coverage by a small percentage, depending on the position of the observer.

Since temperature and humidity measurements are routinely made near the ground in the levels where man normally lives, it is expected that the cooling tower plume will have little effect on the normals and extremes derived from these measurements. The possibility of the plume surfacing is remote, due to the buoyancy of the plume caused by its sensible heat content.

Drizzle from the natural draft cooling tower plume is largely confined to the site or a few hundred meters beyond. It is expected to occur principally during those times when naturally occurring fog is likely. The maximum rate of precipitation is expected to be less than a thousandth of an inch per hour and will not significantly affect precipitation normals and extremes.

Local fog frequency could be slightly enhanced by the cooling tower plume, first by the surfacing of the plume, and second by the evaporation and condensation of the warm drift during its fall to the ground. As mentioned above, surfacing of the plume is a remote possibility. The second mechanism is effective only during periods of high humidity when natural ground fog is likely to occur, and is expected to be confined within a 0.5-mile radius of the tower.

ARKANSAS NUCLEAR ONE
Unit 2

2.3.2.4 Topographical Description

Figures 2.3-2 and 2.3-3 are maps showing detailed topographic features within radii of five miles and 50 miles of the plant, respectively. Figures 2.3-4 through -7 show topographic cross sections in the 16 compass point sectors radiating from the plant. The topography within five miles of the plant can be described as gently rolling and is not expected to have any adverse effects on either short-term or long-term diffusion conditions, as discussed in the following paragraphs.

These maps and cross sections suggest that two features of the terrain should be examined for possible influences on the dilution qualities of the site and on the mathematical models which are used in the numerical analysis of the hazards due to accidental releases of radionuclides. These features are the Dardanelle Reservoir, plus other adjacent water surfaces, and the ridge-valley configurations within five miles of the reactor building, which might cause channeling of winds under stable conditions.

To assess the influence of the reservoir, the frequency of stable conditions during trajectories from over-water, from limited over-water, and from fully overland directions were examined, as shown in the following table:

Trajectory From	Wind Directions	of Pasquill Classes		
		A-D	E	F&G
Over-Water	E-S-SSW-SW-WSW-W	66.2	20.6	13.2
Limited Over-Water	ENE-ESE-SE-SSE	56.8	27.1	16.1
Overland	WNW-NW-NNW-N-NNW-NE	47.9	28.5	23.6

It is apparent that over-water trajectories tend to have a lower frequency of stable conditions. Further, the trajectories which are overland in approaching the meteorological tower will become over-water trajectories since they must continue across the Dardanelle Reservoir or the Illinois Bayou. Consequently, trajectories from the reactor reaching the far side of these water surfaces should have fewer stable conditions than the meteorological tower data indicate.

The prevailing wind is easterly and this direction preference may be enhanced by the low terrain in the east sector (see Tables 2.3-40 and 2.3-41). Downwind from the plant, this easterly wind, under stable conditions, might be channeled into the west-northwest or into the west-southwest sectors, since topography in these sectors is lower than in the west sector. However, Pasquill F and G conditions prevail only 12 percent of the time during east winds. Further, as already has been shown, these 12 percent Pasquill F and G conditions will be subject to the influence of the Dardanelle Reservoir in reducing the stability of the ground layers. It is concluded that the standard Gaussian dispersion model using Pasquill classes defined by vertical thermal stability will provide an appropriately conservative evaluation of the dilution climate of the plant site.

The top of the natural draft cooling tower will extend above all terrain within three miles of the plant, and the rise of the tower plume should normally carry it above all other terrain in the vicinity.

2.3.3 ONSITE METEOROLOGICAL PROGRAM

2.3.3.1 Preoperational Program

The preoperational meteorological program was designed to measure the parameters needed to evaluate the dispersion characteristics of the site for the evaluation of the consequences of routine operations and of hypothetical accidental releases of radionuclides to the atmosphere.

2.3.3.1.1 Instrumentation and Recording System

The meteorological onsite data acquisition program was begun in September 1967, and data have been collected almost continuously since that date. Initially, wind speed and wind range were observed on a 30-foot pole. In June 1969, a 190-foot tower was erected onsite with wind data observed at approximately 34 feet and at 180 feet and temperature differences observed between approximately 34 and 180 feet. In December 1985, a new 197-foot tower was erected to replace the existing tower with instrument levels at approximately 33 and 187 feet. The tower is at a position 0.51 mile due east of the Unit 1 reactor building, as shown in Figure 2.1-3. It is 800 feet southeast of the early 30-foot pole site, and at a ground elevation of about 360 feet above mean sea level. This location for the tower is far enough from the reactor buildings and other buildings at the site to provide relatively undisturbed weather data; yet its exposure in terms of the terrain of the site is quite similar to that of the reactor buildings. It is a suitable site, therefore, for both preoperational and operational purposes. The recording system is located at the foot of the tower.

It is useful to define the extent to which the data collected at the top of the meteorological tower, 190 feet above grade, is representative of atmospheric conditions which may occur at the cooling tower exit at 475 feet above grade, particularly as these conditions affect the characteristics and behavior of the natural draft cooling tower plumes. These plumes have been extensively investigated to develop mathematical models which predict variations in the plume as the ambient atmospheric conditions vary. It is only necessary, therefore, to evaluate the effects on mathematically predicted plume characteristics of the changes in atmospheric conditions anticipated between 190- and 475-foot elevations. Specifically, model predictions of visible plume height and length and surface fogging and icing conditions depend upon wind speed, temperature and dewpoint of the ambient atmosphere, together with the characteristics of the plume at the tower exit point (Data sources 2.3.1-0 and 2.3.1-P for plume height plus data source 2.3.1-Q for plume length, fogging, and icing).

Data taken on a 900-foot radial tower in Philadelphia, Pennsylvania, were investigated to determine the change of temperature and wind speed with height, as determined by hourly observations at four levels over a 14-month period (Data Source 2.3-1-R). The terrain in the vicinity of Philadelphia tower is fairly rough with a river and a variety of building shapes and sizes nearby. At the site, terrain is hilly, with a river and a few buildings in the vicinity. Temperature decreased with height on the Philadelphia tower at about one-half the adiabatic lapse rate. The average difference between 190 feet and 475 feet was 9.75 °F. Wind speed increased logarithmically with height, with an average difference between speeds at 190 feet (9.2 mph) and at 475 feet (12.0 mph) of 2.8 mph. Data were not taken to measure humidity on this tower, but dewpoint generally decreases with height because moisture sources are near the surface, i.e. surface water evaporation and vegetative evapo-transpiration.

ARKANSAS NUCLEAR ONE
Unit 2

The plume characteristics of rise above tower exit point, visible length, and plume ground level icing and fogging were evaluated by means of the mathematical models referenced above, using a data set at 30 and 190 feet and another data set at 30 and 475 feet above grade. In these two data sets, the atmospheric conditions were assumed to vary between 190 and 475 feet in accordance with the relationship observed on the Philadelphia tower and using the assumption that relative humidity is constant above 190 feet. The following table compares plume characteristics predicted from the 30- to 190-foot data set with those from the 30- to 475-foot data set.

<u>Atmospheric Variable</u>	<u>Plume Rise</u>	<u>Length of Visible Plume</u>	<u>Ground Level Fogging</u>	<u>Ground Level Icing</u>
Temperature difference	-	-	-	-
Wind Speed (Upper)	±	±	±	±
Wind Direction (Upper)	o	-	-	-
Temperature (Upper)	o	o	o	o
Dewpoint (Upper)	o	o	o	o
Moisture Deficit (Upper)	o	-	-	-

Legend of Effects: - Slightly conservative
 o Negligible or no effect
 ± Random and very small

A remaining uncertainty in this evaluation concerns the possibility that orographic effects at the plant site would make 190-foot data less representative of conditions at 475 feet than is the normal case.

The closest terrain at the height of the 190-foot sensors is at one mile to the north-northwest; except in the north-northwest through northeast sectors, such terrain heights are more than two miles away, as shown in Figure 2.3-2. Further, terrain as high as the cooling tower exit is no closer than three miles in any sector, or five miles in sectors other than west and north-northwest. It is unlikely, therefore, that orographic effects on wind flow would influence the representativeness of 190-foot data for characterizing those atmospheric conditions at 475 feet which influence plume characteristics.

It may be concluded that data collected at the 190-foot tower is reasonably representative of atmospheric conditions at the height of the cooling tower exit, particularly as these conditions influence natural draft cooling tower plume characteristics and behavior.

ARKANSAS NUCLEAR ONE
Unit 2

In July of 1971 the elevations of some of the instruments on the meteorological tower were adjusted to conform with changes in accepted meteorological practice. Temperature differences from 30 feet to the higher levels and winds at 40 feet and 190 feet were recorded after that data. Because of malfunction of the lower level wind instrument, a redundant instrument was installed at this level on February 7, 1972 to insure continuity of data.

The important specifications for the tower weather instruments used in the pre-operational program are as follows:

<u>Weather Element</u>	<u>Tower Elevation (ft)</u>	<u>Make & Model</u>	<u>Threshold Mph</u>	<u>Distance Constant (ft)</u>	<u>Damping Ratio</u>	<u>Accuracy</u>
Wind Speed	40 and 90	Litton 511S-4	0.6	5 ⁽¹⁾	NA	± 1% or 0.13 knots, whichever is greater
Wind Direction	40 and 90	Litton 510D-2	0.81	4 ⁽¹⁾	0.4	± 3%
Temp Diff.	30 – 85 30 – 190	Litton				< 0.25 °F
Wind Speed	40 1071	MRI	0.75	18 ⁽¹⁾		± 2%
Wind Dir.	40	MRI 1071	0.75	4 ⁽²⁾	0.5 to 0.6	± 1% full scale

(1) 63% Recovery

(2) 50% Recovery

The data which is incorporated in the following analysis of onsite diffusion conditions at the site were collected between February 7, 1972, and February 7, 1973. This annual meteorological record had a data recovery of nearly 96 percent, thereby providing assurance that a bias did not inadvertently occur because of instrument outages (see Table 2.3-39 for listing of periods of sustained invalid observations). The meteorological record from July 1971 to July 1972, which required power law reduction from 190 feet to determine low level winds for part of the year, was evaluated in the amendments to the PSAR and is fully consistent with the record reported herein. In achieving the 95+ percent data recovery, recourse was made to the redundant wind speed and wind direction sensor for the February 7 to July 29, 1972 period.

2.3.3.1.2 Equipment Maintenance and Calibration

The weather instruments on the tower were checked and calibrated in May and November of 1972. The temperature difference system was found to be within instrument specifications. In May of 1972, the 33- and 190-foot sensors used for assigning Pasquill stability classes were set at the same reference level and the recorders showed zero differential. The wind direction and speed sensors and recorders were also found to be within specifications in November of 1972. In May of 1972 one of the Litton instruments had a bad bearing, and the data presented herein are from the MRI 1071 sensor between February and July 1972.

ARKANSAS NUCLEAR ONE
Unit 2

The MRI instrument was returned to Meteorological Research, Inc. for a calibration check after July 29, 1972, to insure its accuracy during the period February 7 to July 29, 1972, a period when it provided the primary wind record for the site. The calibration check record shows that it was within specified tolerances when received at the MRI factory. There is reasonable assurance, therefore, that the data incorporated in the analyses and summaries in Sections 2.3.3, 2.3.4 and 2.3.5 were from instruments which were within specifications.

2.3.3.1.3 Data Reduction and Analysis

All data were initially recorded on strip charts and were reduced by Dames & Moore, professional meteorologists, or by trained technicians under their direct supervision. Hourly average values of wind speed, direction and temperature differences were read off the charts in the form of sequential values of the concurrently occurring weather elements. These were keypunched and entered into a computer for analysis. The computer programs used for analysis of the data are standard Dames & Moore programs, previously used for Safety Analysis Report preparation at other sites.

The temperature difference values from 33 to 190 feet on the tower were used to define Pasquill class stability conditions at the site in accordance with the following table:

<u>Stability Classification</u>	<u>Pasquill Category</u>	<u>Temperature Change with Height (°C/100m)</u>
Extremely Unstable	A	< -1.9
Moderately Unstable	B	-1.9 to -1.7
Slightly Unstable	C	-1.7 to -1.5
Neutral	D	-1.5 to -0.5
Slightly Stable	E	-0.5 to 1.5
Moderately Stable	F	1.5 to 4.0
Extremely Stable	G	> 4.0

2.3.3.2 Wind Roses by Pasquill Stability Categories

Joint frequency distributions of wind speed and wind direction recorded at 40 feet above grade and of Pasquill stability categories for the period February 7, 1972 through February 7, 1973 are given in Tables 2.3-40 and 2.3-41. Together with the sequential listing of hourly data, these provided the weather data which are necessary and sufficient for the analyses in the following sections which describe the diffusion qualities of the site.

To evaluate the representativeness of the February 7, 1972 to February 7, 1973 period, as compared to long-term conditions in central Arkansas, comparisons of seasonal and annual stability and wind speed distributions (%) for Little Rock, Arkansas are shown here:

ARKANSAS NUCLEAR ONE
Unit 2

<u>Season</u>	<u>Stability</u>	<u>Period</u>	
		<u>1966-70</u>	<u>2/7/72 2/7/73</u>
DJF	A	0	0
	B	1.33	1.10
	C	9.25	8.38
	D	59.31	60.03
	E(F&G)	30.11	14.01
	F(G)	--	16.48
MAM	A	0.90	0.82
	B	6.39	6.79
	C	10.93	11.01
	D	49.52	43.75
	E(F&G)	32.26	15.35
	F(G)	--	22.28
JJA	A	2.15	1.90
	B	12.47	14.27
	C	18.18	16.03
	D	26.71	27.31
	E(F&G)	40.49	10.33
	F(G)	--	30.16
SON	A	0.41	0.14
	B	5.52	5.22
	C	13.35	10.99
	D	36.81	46.57
	E(F&G)	43.90	10.16
	F(G)	--	26.92
ANNUAL	A	0.87	0.72
	B	6.46	6.86
	C	12.95	11.61
	D	43.02	44.36
	E(F&G)	36.71	12.47
	F(G)	--	23.98

ARKANSAS NUCLEAR ONE
Unit 2

<u>Season</u>	<u>Speed (Knots)</u>	<u>Period</u>	
		<u>1966-70</u>	<u>2/7/72 2/7/73</u>
DJF	0 - 3	7.65	9.75
	4 - 6	31.31	25.55
	7 - 10	39.69	39.29
	11 - 16	19.78	22.16
	17 - 21	1.56	3.02
	J 21	0.11	0.27
	Calms	3.63	5.22
MAM	0 - 3	7.72	11.28
	4 - 6	29.08	32.07
	7 - 10	41.26	34.24
	11 - 16	19.71	21.33
	17 - 21	2.15	1.09
	J 21	0.08	0
	Calms	3.78	5.98
JJA	0 - 3	13.67	17.39
	4 - 6	45.62	42.26
	7 - 10	33.53	33.97
	11 - 16	6.87	6.11
	17 - 21	0.27	0.14
	J 21	0.03	0.14
	Calms	6.36	9.10
SON	0 - 3	12.55	17.99
	4 - 6	41.68	37.64
	7 - 10	33.57	32.69
	11 - 16	11.54	11.26
	17 - 21	0.66	0.41
	J 21	0	0
	Calms	6.02	10.44
ANNUAL	0 - 3	10.38	14.11
	4 - 6	36.94	34.39
	7 - 10	37.01	35.04
	11 - 16	14.45	15.20
	17 - 21	1.16	1.16
	J 21	0.05	0.10
	Calms	4.95	7.68

The annual stability distributions are quite similar. The annual distribution of wind speeds shows that the February 7, 1972 to February 7, 1973 period had a greater percentage of calms and winds in the 0 - 3 knot class.

ARKANSAS NUCLEAR ONE
Unit 2

The above data were obtained from STAR program computer runs (Jobs #13029 and #01772) done by the National Climatic Center, Asheville, North Carolina.

2.3.3.3 Wind Persistence

The stability-independent wind persistence over the period of record is summarized in Table 2.3-42. Persistence counts were carried through calms if persistences longer than eight hours were quite rare. The longest persistence was 15 hours, in one case from west-northwest, in the other, from east-northeast; one 14-hour persistence from west-northwest was observed.

The stability-dependent persistences are summarized in Tables 2.3-43 through 2.3-49. In this case, changes in direction or stability class terminated a persistence count. Counts were continued through calms if direction and stability class were maintained by the observation subsequent to the calms. Maximum persistences in the unstable classes (A, B and C) were four hours or less. Persistences longer than six hours under D and E stability were rare, although one 10 and one 11-hour persistence and one 13-hour persistence were observed under D and E stability, respectively. Maximum persistence length for F and G stability was eight and four hours, respectively.

2.3.3.4 Operational Program

During operation of the nuclear station, the meteorological program will be continued for the following purposes:

- A. To provide real-time meteorological information in the control room to be used for decisions concerning routine station operations.
- B. To provide the meteorological summaries from which the concentrations of radionuclides due to atmospheric releases during normal station operations can be estimated.
- C. To provide real-time meteorological data in the control room from which initial estimates of the radiological consequences of an accidental release of radioactive material into the atmosphere can be made.

To satisfy the need by the plant operators for real-time weather information, as described in Regulatory Guide 1.23, all data observed in the tower installation will be recorded on strip chart recorders located in the reactor control room and stored electronically. These data will be summarized and analyzed seasonally to permit assessment of the concentrations of radionuclides in the surrounding region resulting from routine plant operations, in accordance with the requirements of Regulatory Guide 1.21 (12/29/71).

The parameters are recorded at a maximum of 1-minute intervals and averaged over a 1-hour period by the program. The average is made by summing the valid observations within that hour and dividing by the number of valid observations in that hour. When the volume of data unavailable from the magnetic tape is large enough, the data may be reduced from the strip charts.

The quality and reliability of available weather instrumentation has improved since the inception of the preoperational program. The tower, instruments and recording systems have, therefore, been replaced with modern equipment for the operational program.

ARKANSAS NUCLEAR ONE
Unit 2

Historical data on the original tower removed - To review the exact wording please refer to Section 2.3.3.4 of the FSAR.

Instrument inspection and maintenance procedures have been developed for the new tower instruments and recorders to ensure that data recovery will continue to exceed 90 percent. Testing will be performed on frequencies commensurate with the importance of the instrumentation.

In March 1986, the original 190-foot high instrumented meteorological tower, primary sensors, signal conditioners, and control room recorders were replaced by an upgraded meteorological system. This system consists of a 197-foot high meteorological tower with sensors at 10 meters and 57 meters, lightning protection (for the tower, sensor input signal lines, signal conditioning AC power, and the data lines between the tower site and the control room), signal conditioning electronics, a 2.5 KVA liquid propane fueled backup generator with auto start/auto transfer capability, a dedicated line FSK transmitter/receiver pair, new control room recorders and data acquisition system.

The 197-foot high tower is located at approximately the same location as the original 190-foot high tower and is serviced by the same tower site building. Mounted on the tower is an electric winch driven sensor elevator which provides for automatically raising and/or lowering of the sensor carriage assemblies to ground level for servicing of the sensors. Parameters measured at each tower level are: (a) wind direction (0° to 540°), (b) wind speed (0 to 100 mph), (c) ambient temperature (-50°C to $+50^{\circ}\text{C}$), and (d) dew point (-50°C to $+50^{\circ}\text{C}$).

The signal conditioning electronics are comprised of signal conditioners for: (a) each level wind direction, (b) each level wind speed, (c) each level dew point, (d) lower level reference ambient temperature, (e) delta temperature between levels, and (f) standard deviation of upper level wind direction (σ_{θ}). Liquid crystal displays of each of these parameters in engineering units were provided and are located along with the signal conditioners and FSK transmitter at the tower site building. The signals from the signal conditioners are digitized, multiplexed, and transmitted back to the Unit 1 control room where they are de-multiplexed and converted back to analog signals to be sent to the recorders, as well as RDACS via the SPDS.

The sensors, signal converter electronics, FSK transmitter, and data acquisition system, are all on the backup power system. The fuel supply sizing has been selected to provide at least eight (8) hours of continuous use in the event of loss of off-site power. The existing uninterruptible power supply is used in conjunction with the generator to provide for battery backup power during the transition from off-site to generator power. Indication of transfer to backup power is provided on the front panel of the meteorological cabinet located in the Unit 1 control room.

The data acquisition system, provides for transfer of the meteorological data to a remote location for data reduction. Data validation is also provided.

In 2008, meteorological data storage was moved to the Plant Data Server (PDS). Data validation is performed using data from the PDS system.

2.3.4 SHORT-TERM (ACCIDENT) DIFFUSION ESTIMATES

2.3.4.1 Eight Hours or Less Dilution Factors

The atmospheric diffusion evaluations for the Arkansas Nuclear One station are based upon an assumed ground level release, i.e. no advantage is realized from effluent emissions from elevated released points. The effluent plume is assumed to spread, during downwind transports, according to a Gaussian dispersion model. The equation representing this mode (see NRC Regulatory Guide 1.4) is:

$$\frac{X}{Q} = \frac{1}{\bar{u}(\pi\sigma_y(p,D)\sigma_z(p,D) + cA)} \quad 2.3.4-A$$

where

X/Q = dilution factor (seconds/meter³)

p = Pasquill stability class index

$\sigma_y(p,D)$ = horizontal dispersion coefficient of the plume (meters) per Pasquill class, at distance D

$\sigma_z(p,D)$ = vertical dispersion coefficient of the plume (meters) per Pasquill class, at distance D

cA = Building wake term = $0.5(2206)$. The effect on X/Q of the term cA is limited to a factor of 3 or less.

\bar{u} = hourly average wind speed (meters/second)

D = distance from reactor containment structure to exclusion zone, actual site boundary or low-population zone (meters)

Ground reflection is assumed at all points; this doubles the concentrations which are to be expected in the free atmosphere.

The diffusion climatology of a site is defined by the frequency distribution of the dilution factors. This distribution is dependent upon concurrent values of \bar{u} , the diffusion parameters σ_y and σ_z , upon downwind distances and building wake effects. The diffusion parameters depend, in turn, upon values of vertical temperature gradient (Δt) at the site. Wind speed and direction and Δt have been recorded at the site, and hourly values of each have been reduced from strip charts.

Both σ_y and σ_z are functions of downwind distance from the effluent source (the reactor containment structure) and the Pasquill stability class. The minimum distance from the reactor containment structure to the exclusion zone boundary for each of the 16 wind direction sectors is tabulated in Table 2.3-50.

2.3.4.2 Longer than Eight Hour Dilution Factors

After the first eight hours, the dilution factors are best represented by an equation that accounts for changes in wind direction and the resultant meandering of the plume, as shown below:

$$X/Q(i,n) = \frac{2.032}{nD} \sum_{j=1}^n \left[\frac{k}{\bar{u}(j) \left[\sigma_z^2(j) + \frac{cv^2}{\pi} \right]^{1/2}} \right] \quad 2.3.4-B$$

where

$X/Q(i,n)$ = average dilution factor (seconds/meters³) over n hours in section i at the LPZ distance

$\sigma_z(j)$ = vertical dispersion coefficient for hour j (dependent on Pasquill class) at the LPZ distance

$\bar{u}(j)$ = average windspeed (meter/second) for hour j

D = distance of LPZ from site (meters)

v = height of reactor building (meters)

c = building wake shape factor (0.5)

K = wind direction dependent variable:
1 if wind blowing to sector i
0 if wind not blowing to sector i

The effect on X/Q of the term cv^2/π is limited to a factor of $\sqrt{3}$ or less. This equation, which recognizes the influence of building wake effects at shorter radius distances, is derived from Equation 3.142 on Page 112 of Meteorology and Atomic Energy, and it has recently become accepted meteorological practice to use it in place of the sector spread equation given in Regulatory Guide 1.4.

Step by step details of the accident diffusion analysis are given in Table 2.3-51.

2.3.4.3 Estimated Values of Hourly Dilution Factors

The concurrent hourly values of Δt , wind direction and speed have been accumulated and used with a minimum distance of 1,046 meters from the reactor building to the minimum exclusion zone boundary, and a wake factor cA of 1,103 square meters, to develop frequency distributions of 1-hour dilution factors. Dilution factors for the actual exclusion zone boundary have also been computed.

Two cumulative frequency distributions of hourly dilution factors, which describe the diffusion climatology of the site, have been developed using Equation 2.3.4-A with wind speeds and Pasquill classes from the onsite data (see Figure 2.3-8). One distribution shows values for the minimum exclusion zone boundary (minimum EZB); the other shows values for the closest point

ARKANSAS NUCLEAR ONE
Unit 2

in each sector for the actual exclusion zone boundary (actual EZB). The dilution factor which is exceeded five percent of the time, a significant feature of the site diffusion climatology, is 6.5(-4) seconds/meter³ for the minimum EZB. This value is equivalent to dilution qualities associated with Pasquill F and a wind speed of 0.5 meter per second. It should be noted that calm conditions are included in the distribution using the instrument threshold as the upper boundary of the class of wind speeds included in "calm". The 5-percentile and 50-percentile values at both the minimum and actual EZB are given in the following table:

<u>0 – 2 Hours</u>	<u>Percentile</u>	
	<u>5%</u>	<u>50%</u>
Minimum Exclusion Zone Boundary	6.5(-4)	5.0(-5)
Actual Exclusion Zone Boundary	5.5(-4)	4.5(-5)

Hourly Dilution Values, Relative Concentrations, Seconds/meter³.

2.3.4.4 Estimated Values of Dilution Factors for Periods up to 30 Days

The average dilution factors for the outer boundary of the Low Population Zone (LPZ) at 4 miles (6,436 meters) have been calculated for 0-8 hours, 8-24 hours, 1-4 days, and 4-30 days for each sector. Calm conditions were included in the calculations by assigning them a wind speed of 0.3 (1/2 the threshold value; see Section 2.3.3.1.1) and distributing them among the 16 direction sectors in proportion to the directional frequencies of the lowest speed class interval.

The centerline Equation 2.3.4-A was used for the 0-8 hour period, and the sector spread Equation 2.3.4-B was used for longer duration periods. All dilution factor averages at each duration were placed in cumulative frequency distributions for each sector. The worst case, the five and 50 percentile averages, in the worst sector were selected from these frequency distributions for each duration interval, as shown in the following table; the nature of these worst sector frequency distributions is illustrated in Figures 2.3-9 to 2.3-12.

<u>Duration of Averages</u>	<u>Percentile of All Averages</u>	<u>Worst Sector</u>	<u>Sector Affected</u>
		<u>Relative Concentration Seconds/meter³</u>	
8 Hours	Worst	1.29(-4)	W
	5%	2.30(-5)	WSW
	50%	3.00(-7)	W
16 Hours	Worst	7.63(-6)	W
	5%	2.60(-6)	WSW
	50%	2.80(-7)	WSW
3 Days	Worst	2.75(-6)	WSW
	5%	1.50(-6)	WSW
	50%	4.50(-7)	WSW
26 Days	Worst	1.23(-6)	W
	5%	9.40(-7)	WSW, SW
	50%	5.90(-7)	WSW

ARKANSAS NUCLEAR ONE
Unit 2

For most direction sectors, the 50 percentile of the frequency distribution of 8-hour average relative concentrations is zero, i.e. for more than 50 percent of the 8-hour periods the wind did not affect the sector once. This is also true of half of the 16-hour sectors. Except for the 26-day averages, all frequency distribution of all sectors include some averages with a value of zero, because the wind skipped the sector for entire averaging periods. It is useful to know, therefore, the five and 50 percentiles of the frequency distributions from which the zero values have been arbitrarily omitted. The following tables show these distributions:

<u>Duration of Averages</u>	<u>Percentile of the Non-Zero Averages</u>	<u>Worst Sector</u>		<u>Sector Affected</u>
		<u>Frequency of Non-Zero Sector Averages</u>	<u>Relative Concentrates Seconds/meter³</u>	
8 Hours	5%	55.6%	3.3(-5)	WSW
	50%	38.2%	3.5(-6)	SW
16 Hours	5%	76.4%	3.8(-6)	WSW
	50%	58.3%	5.2(-7)	SW
3 Days	5%	99.4%	1.5(-6)	WSW
	50%	99.4%	4.5(-7)	WSW
26 Days	5%	100%	9.4(-7)	WSW, SW
	50%	100%	5.9(-7)	WSW

It may be noted that for the 26-day averages, the values in this and the preceding table are the same.

The details of the diffusion climatology of the site for longer duration accident evaluations are provided in the following tables (Tables 2.3-52 and 2.3-53). This shows for each sector and each averaging period, the highest relative concentration experienced, the five and 50 percentile of all non-zero averages, and the frequency of non-zero averages in the sector.

Relative concentrations falling at the five percentile level in the worst sector of the annual onsite data provided a conservative basis for evaluations of the consequences of an accidental release of radionuclides into the atmosphere. Using this criteria, the dilution factors to be used for accident evaluations are compared with the tentative recommendations provided in Regulatory Guide 1.4, as follows:

<u>Duration of Accidental Release</u>	<u>Recommended for Arkansas Nuclear One</u>	<u>Regulatory Guide 1.4</u>
0 - 8 Hours	2.3(-5)	4.2(-5)
8 - 24 Hours	2.8(-6)	8.3(-6)
1 - 4 Days	1.5(-6)	2.8(-6)
4 - 30 Days	9.4(-7)	6.0(-7)

ARKANSAS NUCLEAR ONE
Unit 2

Section 2.1 of the ANO-2 SER, Section 2.1 of Supplement 1 to the ANO-2 SER, and Section 2.1 of Supplement 2 to the ANO-2 SER give a summary of discussions which led to redefining the low population zone radius to meet 10 CFR 100 as 2.6 miles based on projections of the growth of the city of Russellville and its surroundings. The atmospheric dilution factors used in the analysis of the environmental consequences of accidents at the LPZ given in Table 15.1.0-5 are based on this 2.6 mile (4,184 meters) radius, using the methodology described above.

2.3.5 LONG-TERM (ROUTINE) DIFFUSION ESTIMATES

2.3.5.1 General

The onsite meteorological data has been analyzed to determine the average annual dilution factors which are applicable to routine venting or other routine gaseous effluent releases, using Equation 2.3.4-B.

D = varied in increments out to 80 kilometers
N = numbered of hourly observations in the year.

Calm conditions were included as described in Section 2.3.4.4. Because releases of effluents are assumed to be at the ground, and the terrain is expected to exhibit little or no channeling effects (see Section 2.3.2.4), the choice of the standard finite cloud parameter, with sector widths equal to $\pi/8$ radians is justified. To further insure conservative results, a limitation was placed on the maximum value of the vertical dispersion coefficient. This value was the annual average mixing depth for this region of 925 meters (Data source 2.3.1-L).

2.3.5.2 Calculations

Details of the routine release diffusion analysis are given in Table 2.3.51. Annual average dilution factors at the minimum site boundary and various other distances are given in Table 2.3-54. The maximum value is 8.0(-6) seconds/meter³ at 1,046 meters in the west-southwest sector. The average value at the actual site boundary is 2.8(-6) seconds/meters³. Annual average dilution factors at other distances are shown in Table 2.3-55. Long-term diffusion estimates for distances out to five miles are shown in Figure 2.3-13 and to 50 miles in Figure 2.3-14.

2.3.6 ANNUAL RELEASE RATE LIMITS

The design objective in the ODCM relating to the average annual release rate of noble gases and other radioactive isotopes discharged from the plant (except I-131 and particulate radioisotopes with half-lives greater than eight days) provides that the resulting annual dose at the site boundary should be less than 10 mrem to the whole body or any organ of an individual.

Using the methodology of Regulatory Guide 1.111, the highest annual average X/Q value for a ground level release is 2.0×10^{-5} sec/m³ in the west-southwest sector at a distance of 0.65 miles. This dispersion factor (X/Q) will be used to calculate the annual dose at the site boundary. Dose calculations are based on the dose models in the Standard Radiological Technical Specifications (NUREG-0472).

ARKANSAS NUCLEAR ONE
Unit 2

2.3.7 QUARTERLY RELEASE RATE LIMITS

The maximum allowable quarterly release rate of gross gaseous activity may not exceed eight times the maximum allowable release rate averaged over any 1-hour period.

This method of calculating the maximum allowable quarterly release rate is based on the highest annual average X/Q value of 2.0×10^{-5} sec/m³ and the dose models in NUREG-0472.

2.3.8 HOURLY RELEASE RATE LIMITS

The ODCM limit the release rate of radioactive materials and gaseous wastes (except I-131 and particulate radioisotopes with half-lives greater than eight days) when averaged over any 1-hour period to that rate which would result in an off-site concentration equal to the maximum permissible concentration, as defined in Section 2.5.5.2.1, Table II, Column 1, 10 CFR 20. These calculations will be based on the highest annual average X/Q value of 2.0×10^{-5} sec/m³, consistent with the X/Q value used in calculating annual and quarterly limits.

2.4 HYDROLOGIC ENGINEERING

2.4.1 HYDROLOGIC DESCRIPTION

2.4.1.1 Site and Facilities

The site is located on a peninsula of the Dardanelle Reservoir. Site topography is shown on Figure 2.5-13. The principal features are Round Mountain (elevation 500 feet) to the west, a range of 400 feet-500 feet hills to the north and Bunker Hill (elevation 539 feet) to the south and southeast. Within these confines, the land slopes gently toward two major coves on the west bank and a small cove of the Illinois Bayou on the east bank. The site is characterized by excellent natural drainage. The site grade is at Elevation 353 feet.

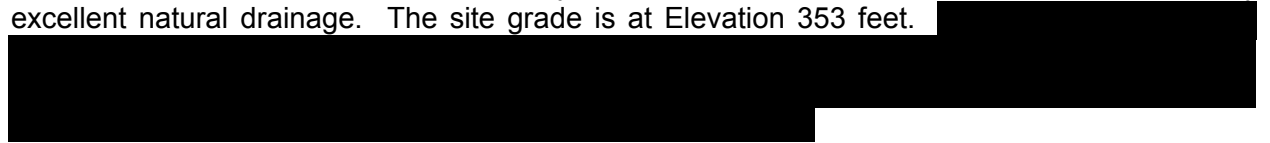

As shown on Figure 2.5-13, the construction of Unit 2 has not significantly altered the natural drainage. The emergency cooling pond collects much of the surface runoff in its vicinity, but it has a spillway which conducts the excess runoff to its natural destination. Likewise, the intake canal alters the path of surface runoff, but not its destination.

2.4.1.2 Hydrosphere

The plant site is located on a peninsula on the left bank of Dardanelle Reservoir on the Arkansas River about seven river-miles upstream from the dam. The downstream side of the peninsula is formed by the flooded valley of Illinois Bayou, a left bank tributary. See Figure 2.1-3.

Dardanelle Reservoir is part of the Arkansas River navigation project. The project provides a minimum 9-foot navigation depth from the mouth of the Arkansas River at the Mississippi River to Catoosa, Oklahoma, near Tulsa, on the Verdigris River, a distance of more than 500 miles. There are 17 locks and dams in the system. Thirteen of these are simple locks and dams, providing navigation lifts of 30 feet or less. Dardanelle, Ozark, Robert S. Kerr, and Webbers Falls Dams (in order from downstream to upstream) are higher, with lifts up to 54 feet, and include some storage for hydropower generation.

Upstream from the head of navigation, there are seven large multi-purpose reservoirs. These reservoirs control the flow from about 140,000 square miles of drainage area with about 12,000,000 acre-feet of storage of which about 6,000,000 acre-feet are reserved for flood control.

Dardanelle Reservoir is 259 miles upstream from the mouth and has a drainage area of 153,703 square miles. A navigation lift of 54 feet raises shipping to the top of the power pool at Elevation 338 feet. The minimum navigation pool elevation is 336 feet, providing a normal two feet of storage in the reservoir for power generation. Power generation is on the basis of mean daily inflow equaling mean daily outflow, within the 336-338 feet limits. Total storage in the reservoir is 486,200 acre-feet at Elevation 336 feet.

ARKANSAS NUCLEAR ONE
Unit 2

2.4.2 FLOODS

2.4.2.1 Flood History

Since the minimum power pool level, 336 feet, was first reached in January 1965, the maximum level of the reservoir was 338.45 feet on June 5, 1974.

The U.S. Geological Survey has operated a gauging station on the Arkansas River at Dardanelle, two miles downstream from the dam, since July 1937. The maximum discharge at this station was 683,000 cfs in May 1943. A flood in April 1927 was somewhat lower than the 1943 flood. Another gauging station at Van Buren, 95 river-miles upstream from Dardanelle Dam, has been in operation since 1927. The drainage area at the Van Buren station is about two percent less than that at the dam. At this station, the 1943 flood, with a discharge of 850,000 cfs, was the greatest flood since at least 1833.

The gauging station at Little Rock, in operation since 1927, is about 90 river-miles downstream from Dardanelle Dam and has a drainage area about three percent larger. The 1833 flood at Little Rock was about 4.5 feet higher than that of 1943. The 1943 peak discharge at Little Rock was 536,000 cfs.

Daily streamflow records for the period January 1923 to September 1957 for the Dardanelle gauging station just below the dam, have been adjusted by the Corp of Engineers to reproduce flows as they would have been regulated by the complete system of dams upstream. The maximum regulated daily discharge during this 34-year period was 480,000 cfs. See Sections 2.4.5, 2.4.6, 2.4.7, and [2.8.1.4](#) for history of dam failures, seiches, tsunami and ice jams, respectively.

2.4.2.2 Flood Design Consideration

All safety-related plant facilities, including structures, systems and equipment, are either designed to withstand or are protected against the PMF level, as discussed in Section 3.4.1. The elevations of two different hypothetical flood conditions were analyzed.

2.4.2.2.1 Probable Maximum Flood Combined With Wind Wave Action

(see [Section 2.8.1.1](#))

2.4.2.2.2 Probable Maximum Flood Combined With Ozark Dam Failure

(see [Section 2.8.1.2](#))

2.4.2.3 Effects of Local Intense Precipitation

The 24-hour Probable Maximum Precipitation (PMP) is tabulated in Section 2.4.3.1 and was determined in accordance with procedures outlined in Reference 117. The ½-hour incremental distribution of the 6-hour PMP was obtained as per current NRC practice. Reference 11 was used to determine the intensities of storms with durations shorter than 30 minutes. They are as follows:

ARKANSAS NUCLEAR ONE
Unit 2

<u>Duration (Min.)</u>	<u>Accumulated PMP (in.)</u>
5	3.1
10	4.8
15	6.0
30	8.3
60	11.7

All safety-related equipment in Seismic Category 1 structures is protected by measures discussed in Section 3.4.4. As these structures are designed to withstand a maximum water level resulting from the PMF, and as this level exceeds that resulting from the PMP (see Section 3.4.1), a failure of yard drainage facilities to carry off the PMP would not affect operation of safety-related equipment. Drainage facilities for Seismic Category 1 structure roofs are designed to handle the effects of the local PMP without causing damage to the roof support structure. Even if drains from the Auxiliary Building roof are fouled, water ponding from a PMP event would not cause the Emergency Diesel Generators (EDGs) to become inoperable due to water ingress via the EDG room air inlet louvers.

The emergency cooling pond is excavated in natural soil; therefore, erosion is limited by the natural topography of the site. The cooling pond will continue to be functional even if this limited amount of erosion occurred during the PMF. The emergency cooling pond spillway is designed to accommodate one-half the PMP. For the PMP, the spillway and adjacent embankment are protected by providing riprap upstream and sod downstream.

Because of the usual light snowfall and the slow rate of snowmelt as compared with the contribution from high-intensity short-duration storms critical to the design of drainage systems, snowmelt contribution is considered not significant for the design of drainage systems in the Unit 2 area.

The all-season PMP has the greatest probability of occurrence in July. However, it is possible to have a seasonal PMP of lesser intensity occurring during the winter or in early spring when there is an appreciable amount of snow or ice accumulation on the roofs of safety-related structures.

The monthly snowfall records for the period of 1951-72 at Russellville, some six miles to the southeast of the ANO-2 site, were examined (References 112 and 113). Daily snowfall records as well as snow-on-ground information at Little Rock and Fort Smith for the period of 1956-72 we also reviewed (References 114 and 115). It was concluded that because of the moderate winter temperature in this area, snow or ice accumulation extending for a period of more than two weeks is a very unlikely event even during January, the coldest month of the year. The records also revealed that about 75 percent of the annual snowfall occurs in the month of January and February with about equal amounts fallen in each of these months. Due to the lack of snow-on-ground information in the site area, the monthly snowfalls recorded at Russellville were assumed to be equivalent to the snow accumulation in the Unit 2 area at the end of the month in question. The snow accumulation frequency analysis was carried out using the maximum of the snowfall recorded in the months of January and February. For safety analysis, a 100-year snow accumulation coincide with a 48-hour PMP was used. It was found that a February PMP (27.0 inches) coincides with a snow accumulation of 1.7 inches (water equivalent) and is the most critical, yielding an equivalent 48-hour water depth of 28.7 inches.

ARKANSAS NUCLEAR ONE
Unit 2

To prevent this amount of water from accumulating on the roofs of safety-related structures, in the event drains are clogged, scuppers have been provided in parapet walls at selected locations.

2.4.3 PROBABLE MAXIMUM FLOOD ON STREAMS AND RIVERS

(see Section 2.8.1.3)

2.4.3.1 Probable Maximum Precipitation

(see Section 2.8.1.3.1)

2.4.3.2 Precipitation Losses

(see Section 2.8.1.3.2)

2.4.3.3 Runoff Model

(see Section 2.8.1.3.3)

2.4.3.4 Probable Maximum Flood Flow

(see Section 2.8.1.3.4)

2.4.3.5 Water Level Determinations

(see Section 2.8.1.3.5)

2.4.3.6 Coincident Wind Wave Activity

(see Section 2.8.1.3.6)

2.4.3.7 Site Drainage System

(see Section 2.8.1.3.7)

2.4.4 POTENTIAL DAM FAILURES (SEISMICALLY INDUCED)

(see Section 2.8.1.4)

2.4.5 PROBABLE MAXIMUM SURGE AND SEICHE FLOODING

Dardanelle Reservoir is not of sufficient size to be affected by surge or seiche flooding.

An analysis of landslide potential has been made for the slopes adjacent to Dardanelle Reservoir between Hartman, Arkansas and Dardanelle Lock and Dam No. 10. Most of the slopes adjacent to the reservoir range from less than 1° up to 12°. These slopes are not sufficiently steep to develop landslides capable of affecting the elevation of the reservoir pool.

ARKANSAS NUCLEAR ONE
Unit 2

An arm of the reservoir connected to the main body of the reservoir by Piney Creek (upstream of the plant site) has adjacent slopes up to 65° on the eastern flanks of Bee Bluff and Perry Bluff. Potential landslides in this area are no hazard to the site, however, because Piney Creek averages only 400 feet wide and is several miles in length between the two bodies. This long, narrow connection would severely dampen any flood or surge before it reached the main body of the reservoir.

Maximum slopes up to 36° occur adjacent to the main body of the reservoir, approximately two miles upstream of Dardanelle Lock and Dam No. 10. These steeper slopes decrease to less than 6° within 500 feet from the reservoir. The velocity of any landslide developing in these slopes would be very low and would create no surge hazard to the site. It is extremely doubtful that a slide in this area could be large enough to affect the flow through the reservoir to the spillway or outlet works. In any case, there would be ample time to remove, if necessary, any slide material, before water levels upstreams would be significantly affected. The U.S. Corps of Engineers is of course obligated to insure that free flow through the reservoir is maintained.

2.4.6 PROBABLE MAXIMUM TSUNAMI FLOODING

Due to its inland location and the presence of several downstream dams, tsunamis cannot reach the site.

2.4.7 ICE FLOODING

Ice formation in this portion of the Arkansas basin is light and infrequent and will not cause flooding problems. The general climate in the area surrounding the Dardanelle Reservoir is not conducive to significant ice formation. Historically, ice formation has been so negligible that the Corps of Engineers does not maintain records of ice formation. In addition, the flow of the river during periods of freezing temperatures is sufficiently large that ice formation is not probable in the main stream. During extended periods of sub-freezing temperatures, minimal icing has been experienced along the banks of sloughs and inlets where the water is slow moving or stagnant. However, no problems with ice flooding are anticipated.

Any surface ice formation in the vicinity of the intake structure will not affect the operation of the intake structure. As shown on Figure 2.4-5, the water entrances and sluice gates from both the intake canal and the emergency cooling pond are well below water level and subsequently will not be affected by surface ice formation.

2.4.8 COOLING WATER CANALS AND RESERVOIRS

2.4.8.1 Canals

The canals which carry the reservoir water to and from Unit 1 for once-through cooling will also be used to supply cooling tower makeup water and service water from Unit 2. The intake canal conveys water from the Illinois Bayou portion of Dardanelle Reservoir to the intake structure. It is approximately 4,000 feet long and, at normal pool level of 338 feet, the width varies from 80 feet at the mouth to 135 feet at the intake structure, with an average depth of 14 feet. As can be seen in Figure 2.4-6, the intake canal deepens and widens before reaching the intake structure. This feature results in debris entrained in the lake water dropping out of suspension and collecting in this area. This prevents excessive amounts of silt from entering the service water system. The discharge canal returns the cooling water to the reservoir. It is approximately 600 feet long and has an average width of 165 feet with an average depth of

ARKANSAS NUCLEAR ONE
Unit 2

11 feet at normal pool elevation of 338 feet. Both canals are completely excavated and contain no sections formed by dikes or in fill. Bank slopes are planted with grass or protected by rip-rap to prevent erosion.

As there is virtually no runoff into the canals nor are there any stream crossings, a PMF could only occur as a result of Arkansas River runoff as discussed in previous sections. The canals would not be destroyed or seriously damaged by floods of any magnitude or by wind effects in Dardanelle Reservoir. For plans, profiles and sections of the intake and discharge canals, see Figures 2.4-6 and 2.4-7. These figures reflect the as-built condition of the canals at the end of plant construction. As a result of normal plant operation they may not reflect the current configuration.

2.4.8.2 Reservoirs

The emergency cooling pond is discussed in Section 9.2.5. The design is discussed in Section 9.2.5.1; hydrology in Section 9.2.5.2.1.1; and hydraulics in Section 9.2.5.2.1.2. For plans and sections of the pond, see Figures 2.5-21 and 9.2-10.

The only other reservoir involved is Dardanelle Reservoir. Dardanelle Dam was designed and built by the Corps of Engineers to withstand the PMF and associated wind effects.

2.4.9 CHANNEL DIVERSIONS

In the unlikely event of upstream diversion or natural damming of the Arkansas River by landslide, ice blockage, or other causes, there would be sufficient storage in Dardanelle Reservoir to permit normal plant shutdown.

2.4.10 FLOODING PROTECTION REQUIREMENTS

All safety-related facilities were designed to withstand the effects of hydrostatic pressures, buoyancy and wave action under the PMF conditions. The design bases required to assure that these structures are adequate for the design flood are discussed in Sections 2.4.2 through 2.4.4 and in Section 3.4.

The specific provisions for flood protection and their implementations are discussed in Section 3.4.4.

A comparison with the Regulatory Guide 1.59 position listed under C.2 shows that the design basis floods considered in the design meet the intent of the Regulatory Guide. A more conservative approach than that presented in Section 2.4.4 was used. A simultaneous occurrence of the PMF and an earthquake capable of failing the upstream Ozark dam was considered in developing the design flood elevation (see Section 2.4.2.2.2). Hence, the wind generated wave action was considered superimposed only on the PMF static water level (see Section 2.4.2.2.1).

Additional conservatism was gained by considering a 45 mph wind velocity in establishing the wind generated wave action in lieu of the 40 mph wind suggested in Regulatory Guide 1.59.

2.4.11 LOW WATER CONSIDERATIONS

2.4.11.1 Low Flow in Rivers and Streams

According to information obtained from the Little Rock District of the U.S. Army Corps of Engineers, it is possible for the inflow to the reservoir to be zero under very exceptional circumstances, but these conditions would exist for only a few hours, during which time there would be more than enough water in storage in the reservoir to supply the consumptive use of the plant.

2.4.11.2 Low Water Resulting from Surges, Seiches, or Tsunamis

Although Dardanelle Reservoir is not subject to surges, seiches, or tsunamis, a study was made of the effect of the probable maximum wind of 93 mph (see Section 2.3.1.3.7) on the minimum navigation pool of 336 feet. With the PMW from the west-southwest, the longest fetch is 3.2 miles. The maximum setback at the intake in the Illinois Bayou estuary under these conditions is 0.7 foot, or a reservoir level of 335.3 feet.

2.4.11.3 Historical Low Water

Since initial filling to an elevation of 336 feet, the bottom of the power pool in January 1965, the minimum level of Dardanelle Reservoir was 335.88 feet in October 1967. The minimum discharge since 1937 at the USGS gauging station two miles downstream from Dardanelle Dam was 416 cfs in October 1956. The USGS gauging station on the Arkansas River at Van Buren measures the flow from about 98 percent of the drainage area above Dardanelle Dam. The minimum flow at this station since 1927 was 300 cfs in October 1956.

The 1923-57 streamflow record for Dardanelle Dam, adjusted by the Corps of Engineers to simulate regulated conditions, had a minimum daily discharge of 400 cfs.

2.4.11.4 Future Control

Since the Dardanelle Reservoir is an essential element in the overall Arkansas River navigation project, any future upstream control can only serve to further firm up the low flows of the river rather than to reduce flows to the extent of endangering the water supply for the plant.

2.4.11.5 Plant Requirement

The descriptive information concerning the Service Water (SW) pump compartment elevation and required and available submergence for the SW pump is given in Section 9.2.1. Based on the minimum allowable water level of 335 feet in the Dardanelle Reservoir, the required submergence of eight feet, zero inches is exceeded, and therefore, the SW pump will deliver the flows shown on drawing M-2250.

Unit 2 shares the intake and discharge canals with Unit 1. The canals are discussed in Section 2.4.8.1. The discharge of the SWS is used as a makeup source for the Circulating Water System (CWS). Site water withdrawal and consumption rates for Lake Dardanelle are specified in a contract with the U.S. Army Corp of Engineers. The CWS is described in Section 10.4.5.

ARKANSAS NUCLEAR ONE
Unit 2

2.4.11.6 Heat Sink Dependability Requirements

The station can obtain the required minimum cooling water from the Dardanelle Reservoir through the canals based on the low water level of 336 feet and the extreme lower water level of 335 feet in the Reservoir. At any water level below 335 feet in the intake canal, the station cannot be assured of obtaining sufficient cooling water for continuous rated power operation. At a water level of 335 feet, the plant will be shut down and the water source shifted to the emergency cooling pond.

Three redundant level indicating switches are located in the intake structure and actuate low water level alarms in the main control room when water level drops below 335 feet in the intake structure.

The emergency cooling pond is the alternate heat sink for the Reservoir. Its design bases are discussed in Section 9.2.5.

The SWS source of water supply will be switched over to the emergency cooling pond by remote manual operation of the control switches of the intake structure sluice gates and the system discharge header valves as described in Section 9.2.1.2.3.7.

Firewater requirements, including source of water supply and the relation to the heat sinks, are described in Section 9.5.1.

2.4.12 ENVIRONMENTAL ACCEPTANCE OF EFFLUENTS

The hydrologic features of the site and site area, together with related plant design features, enable the environment to accept normal, inadvertent or accidental releases of radioactive liquid effluents without undue risk to the general public. The locations and users of surface and groundwater are given in Sections 2.4.1.2 and 2.4.13.2. Section 2.4.13 describes the groundwater conditions in the vicinity of the site and describes the ability of the groundwater to withstand the effects of accidental spills of radiation liquids.

The design bases for those systems which release radioactive nuclides to the environment are described in Chapter 11. The liquid radwaste systems are described in Section 11.2; gaseous radwaste systems in Section 11.3; and solid radwaste systems in Section 11.5. These systems are enclosed in the Seismic Category 1 auxiliary building and the bulk of the liquids are stored below the finish plant grade. The gaseous radwastes are stored below grade in the Category 1 auxiliary building.

In the event an accidental spill of liquids containing radioactive material occurs in the plant, all of the liquids will be contained in the Category 1 auxiliary building. If the spill of liquid is directly to the ground, groundwater contamination is extremely unlikely due to the impervious nature of the soil in the area of the plant.

Section 11.2.9 describes the normal release of plant liquid effluents for potential exposure pathways.

Section 9.2.5 describes the ultimate heat sink and its design bases. During normal shutdown and accident conditions, the Dardanelle Reservoir is the primary heat sink. As described in Section 10.4.5, the bulk of normal plant cooling is supplied by the closed loop CWS. Meteorological effects of the natural draft cooling tower are discussed in Section 2.3. The

ARKANSAS NUCLEAR ONE
Unit 2

Service Water System (SWS) is described in Section 9.2.1. Heat loads are small in relation to Unit 1. Historically, the environmental impact of Unit 1 was analyzed in the Unit 1 Environmental Report (Docket Number 50-313). Thermal and chemical pollution to Dardanelle Reservoir is regulated by the Arkansas Department of Environmental Quality. Authorization to discharge is addressed in the approved site NPDES permit.

2.4.13 GROUNDWATER

Investigation of regional and local conditions indicates that the nuclear plant and appurtenant facilities will have no adverse effects on groundwater resources in the vicinity of the site. If an accidental radioactive spill occurs, it would not affect off-site groundwater supplies.

2.4.13.1 Description and Onsite Use

The principal groundwater resources in the vicinity of the site are in fractured indurated rocks of Paleozoic age and in alluvial sands and gravel along parts of the Arkansas River. The alluvial sands and gravels are not present at the site. The indurated rocks are poor aquifers. Groundwater is not a source of water for plant construction or operation.

2.4.13.1.1 Regional Groundwater Conditions

The site is in the Arkansas Valley section of the South-Central Paleozoic Groundwater Province defined by Meinzer (1923). Conditions in this province are generally unsatisfactory for developing good water wells because of the low permeabilities of the rocks. The principal source of groundwater are sandstones and limestones of Paleozoic age which are widespread in the region. Groundwater in these rocks is meager or of poor quality in much of the province. Good supplies are available from glacial or alluvial deposits, but they are restricted to valleys adjacent to major streams. The principal bedrock aquifer of the Arkansas Valley section is the Atoka Formation of Pennsylvanian age. The most productive wells in the Atoka Formation are in fractured shale rather than the sandstone (McGuinness, 1963). The Atoka Formation crops out two miles north, four miles east, and four miles south of the site and is over 600 feet below land surface at the site. The site is separated from the Atoka Formation by clay as well as by the relatively impermeable shales and sandstones of the McAlester Formation and the Hartshorne sandstone.

The most consistently productive aquifer in the region is the alluvium along the Arkansas River (Bedinger and other, 1963). The alluvial deposits are not present at the site; the nearest exposure of alluvium is about four miles southeast of the site, below Dardanelle Dam.

The quality of groundwater in the region is generally good. However, nearly all of the water is hard and some of it contains excessive iron (McGuinness, 1963).

2.4.13.1.2 Groundwater Conditions at the Site

The site is on a peninsula along the northern shore of Dardanelle Reservoir. The peninsula is about two miles long and about two miles wide at the widest point. The land surface at the site is relatively flat at about an elevation of 353 feet, which is 15 feet higher than normal pool elevation of 338. The tops of several hills on the peninsula range from an elevation of 460 to an elevation of 500 feet.

ARKANSAS NUCLEAR ONE
Unit 2

The site is underlain by unconsolidated clay and silty clay deposits that mantle dense indurated rocks. The thickness of the clay ranges from about eight to 30 feet in the vicinity of the site. The clay is nearly impermeable. The uppermost bedrock unit is the McAlester Formation of Pennsylvanian age. The McAlester Formation at the site includes shale and sandstone, which is exposed on the hills near the site. The porosity of the McAlester Formation is very low. The uppermost few feet of bedrock at the site is slightly more permeable than most of the shale and sandstone sequence, but this zone is relatively impermeable. Limited quantities of groundwater can be pumped from fractures and joints in the McAlester formation.

Groundwater at the site is derived from precipitation on the adjacent hills. The water infiltrates the surface and percolates through fractures in the bedrock toward Dardanelle Reservoir, as shown by water levels in Figures 2.4-1 and 2.4-2. Groundwater in the bedrock at the site is confined by the clay mantle.

The emergency cooling pond, located about 1,200 feet northwest of the plant site, is about 500 feet east of an embayment in Dardanelle Reservoir. Design of the pond is based on the consideration that seepage will build a groundwater mound to the height of water level in the pond at an elevation of 347 feet. However, the impermeable nature of the foundation material at the cooling pond indicates the amount of water lost by seepage will be negligible. Any seepage to the northeast, north or northwest will be intercepted by a drainage pipe underlying the clay blanket before it could infiltrate the shale bedrock. The drainage pipe will divert the seepage into the spillway and consequently westward into Dardanelle Reservoir. To the south and southwest the pond is excavated in impermeable clay. Any seepage not being intercepted by the drainage pipe will migrate southwestward toward Dardanelle Reservoir. This is the shortest path with the steepest gradient. Even with a maximum groundwater level at the pond pool elevation of 347 feet, the potential for groundwater to move southeastward toward the plant is precluded by the longer flow path and the much smaller gradient. A conservatively high value for seepage has been calculated and is included in Section 2.5.5.2.2. This number is so small as to be negligible for ECP thermal performance calculations; however, it is included in the current ECP post-accident inventory analysis (section 9.2.5.3).

2.4.13.1.3 Onsite Use of Groundwater

Groundwater does not supply any of the water required for construction or operation of Arkansas Nuclear One. The soil and rocks at and adjacent to the site are incapable of supplying a significant quantity of groundwater for plant requirements.

2.4.13.2 Sources

Most of the groundwater developed in the vicinity of the site is utilized for rural domestic use. Groundwater discharges into Dardanelle Reservoir about one-half mile southwest of the site. Groundwater is not utilized between the site and the groundwater discharge area.

2.4.13.2.1 Regional Use of Groundwater

Estimated groundwater used during 1970 in the four counties of Arkansas that are within 15 miles of the site was about 9.6 million gallons per day (Halberg, 1972). Groundwater use by county and by use are presented on Table 2.4-2. Wells capable of yielding more than 10 gpm are nearly all extracting water from sands and gravels of the alluvium along the Arkansas River and its larger tributaries. Small wells that provide rural domestic and livestock supplies are distributed throughout the area.

ARKANSAS NUCLEAR ONE
Unit 2

The largest groundwater users within the four counties are the municipalities of Atkins, 16 miles southeast of the site, and Dardanelle, six miles southeast of the site. Other municipal groundwater users along the Arkansas River between Little Rock and Fort Smith are Morrilton, about 30 miles southeast and Ozark, about 30 miles northwest of the site (Bedinger, et al., 1963).

2.4.13.2.2 Use of Groundwater in the Vicinity of the Site

The only use of groundwater in the vicinity of the site is for local domestic purposes. Good groundwater bearing zones are not present in the overburden material at or near the site. Limited supplies are pumped from joint systems in the shale and sandstone bedrock aquifers. Most wells are less than 150 feet in depth. These wells are capable of only relatively low yields and a "good" well may produce up to 50 gpm.

Wells within a 3-mile radius of the site were canvassed in September 1971. Two hundred and eighty-four wells were located in the canvas. Total production from these wells is estimated to be about 100,000 gallons per day. A summary of well data is presented in Table 2.4-3. The area canvassed is shown on Figure 2.4-3. In June 1974 an updated canvass was made of wells in the immediate vicinity of the site west, east, and south between the site and the reservoir as shown in Figure 2.1-3. Data from these wells is given in Table 2.4-5. Location with respect to piezometric gradient relative to the site may be judged from Figures 2.4-1 and 2.4-2.

2.4.13.2.3 Projected Future Use of Groundwater

Future groundwater development in the site vicinity is expected to be small. The low permeability of the aquifer precludes the possibility of developing wells with sufficient production for irrigation or industry. Therefore, future groundwater development in the area will continue to be primarily for rural domestic and livestock use. The location of any future wells drilled near the plant site will be limited because of the property on which the plant is built occupies most of the peninsula. An increase in groundwater use in other areas in the vicinity will be at about the same rate as the increase in rural population. The rural population in the area is not expected to increase significantly during the next several decades.

2.4.13.2.4 Water Levels and Groundwater Movement

The water table generally conforms to the topography in the vicinity of the site. Figure 2.4-1 shows the water levels in wells within one and one-half miles of the site.

At the site, the water table slopes about 24 feet per mile southwestward toward Dardanelle Reservoir as shown on Figure 2.4-2.

2.4.13.2.5 Reversibility of Groundwater Flow

The existing southwestward direction of flow at the site could be reversed only by sustained pumping between the site and the hills approximately one mile to the north and east. The region cannot be significantly affected by future development.

ARKANSAS NUCLEAR ONE
Unit 2

2.4.13.2.6 Water Quality

Samples of group water, of Dardanelle Reservoir water and of Arkansas River water from downstream of the dam (located about nine miles southeast of the site) were chemically analyzed. Table 2.4-4 presents the results of the analyses. Locations of sampling points, except No. 13, are shown on Figure 2.4-1. Sampling point No. 13 is from the Arkansas River below Dardanelle Dam and is beyond the area shown on Figure 2.4-1.

Portions of the above mentioned surface water samples were analyzed by Tracerlab of Richmond, California for gross beta analyses. Values varied from 18.0 to 27.9 picocuries per liter, indicating normal surface water background radioactivity.

Surface water samples had an average pH value of 7.4 and average total dissolved solids of 432 ppm (parts per million). The groundwater from the sampled wells, all from the bedrock confined system, ranges in quality from slightly acidic to alkaline, from a high bicarbonate content of 444 ppm to a low of 5 ppm, and from a high total dissolved solids content of 1,559 ppm to a low of 34 ppm. Total hardness ranges between 830 and 4 ppm.

A preliminary evaluation of the quality of the sampled wells indicates that a zone extending between water wells No. 6 and 3, north and east of the plant site, produces the best quality water. The average total dissolved solids of the samples from this zone is 245 ppm (excluding the low 34 ppm analysis). However, two wells within this zone have some undesirable constituents. Well No. 2 has an iron (Fe) content of 1.3 ppm which is above the U.S. Public Health Service recommended maximum of 0.3 ppm. Wells No. 4 and 5 have manganese (Mn) contents of 0.3 and 4.0 ppm which are above the recommended drinking water maximum of 0.05 ppm. Also it should be noted that wells No. 8 and 9, located about 2,500 feet west of the site area, are undesirable either due to nitrate (NO₃) or due to amount of total dissolved solids.

The two wells sampled in the vicinity of the site (No. 1 and 7) produce alkaline bicarbonate water with total dissolved solids of 773 and 635, respectively, as compared with the recommended maximum of 500 ppm. In all other respects this water is chemically satisfactory for human consumption.

2.4.13.3 Accident Effects

Operating a nuclear plant at this site will not jeopardize the groundwater resources of the site or the region even if radioactive liquids were accidentally spilled at the site. The site area is covered with eight to 30 feet of compact clayey soil which is essentially impermeable to the flow of water downward to the bedrock fracture system.

In the unlikely event that radioactive material percolated through the nearly impermeable clay that underlines the site, the contaminated water would flow slowly southwestward toward Dardanelle Reservoir. The bedrock is characterized by low permeability as indicated by low yields to wells; therefore, groundwater velocity through these rocks is low. Arkansas Power and Light Company property extends nearly to the reservoir shore and the only wells that lie along possible groundwater flow lines are the site groundwater monitoring wells, which have an above grade surface completion that prevents any surface drainage from entering the well. Groundwater development, for reasons presented in Section 2.4.13.2.3, is not expected to change the flow pattern. It is concluded that groundwater resources will not be jeopardized in the future by the plant.

ARKANSAS NUCLEAR ONE
Unit 2

2.4.13.4 Monitoring and Safeguard Requirements

Groundwater monitoring is not needed during plant operation to protect regional or local groundwater systems.

2.4.13.5 Design Bases for Subsurface Hydrostatic Loadings

(see [Section 2.8.1.5](#))

2.4.14 TECHNICAL SPECIFICATION AND EMERGENCY OPERATION REQUIREMENTS

Arkansas Nuclear One - Unit 2 has been designed such that no credible hydrological event can affect its ability to achieve and maintain a safe shutdown condition.

As discussed in Section 9.2.5, the emergency cooling pond is designed to provide sufficient heat dissipation capability to enable simultaneous safe shutdown of both Units 1 and 2 in the event of a loss of Dardanelle Reservoir inventory due to dam failure.

Procedures adopted at Arkansas Nuclear One require initiation of shutdown of both units with the necessary lead time to achieve safe shutdown before the flood level reaches an elevation of 354 feet, the elevation at which turbine building flooding would begin.

As outlined in Section 8.2, it will be necessary to install temporary connections over the 161 kV switchyard to connect Startup Transformer 2 directly to the 161 kV Pleasant Hill transmission line in the event that the flood level exceeds elevation 356 feet, six inches so as to maintain one source of off-site power to the plant. Since the plant will be shut down before the flood reaches an elevation of 354 feet, these temporary connections are not necessary to safely shut down the plant.

As discussed in Chapter 3, flood levels approaching an elevation of 354 feet would be an extremely unusual occurrence and, based upon historical data would take from two days to several weeks to develop. This would allow more than sufficient lead time for the emergency procedures outlined above to be performed.

Since flood levels necessitating plant shutdown are extremely unlikely, this situation will be covered by the abnormal operating procedures for natural emergencies rather than by Technical Specifications.

See [Section 2.8.1.3.4](#) for further information.

ARKANSAS NUCLEAR ONE
Unit 2

2.5 GEOLOGY AND SEISMOLOGY

In accordance with the criteria provided in Appendix A, "Seismic and Geologic Siting Criteria for Nuclear Power Plants," of 10 CFR 100, and the NRC Standard Format, this section describes and evaluates the geologic and seismologic conditions for the region around the Arkansas Nuclear One plant site. Foundation conditions for Unit 2 are evaluated, and the foundation design is described. The seismic history of the region is examined and suitable criteria for seismic design are developed. Field and laboratory test data which provide the basis for the engineering analyses and conclusions presented in this report are summarized on Tables 2.5-1 through 2.5-7.

The purpose of this section is to present the results of the evaluation of regional and site geology. That evaluation was made in sufficient detail to ensure the safe design of the nuclear power facility. Results of the literature study, field studies, foundation exploration, and laboratory test programs are presented. Static and dynamic properties of the foundation materials are described, and design criteria are outlined. Groundwater factors affecting plant construction and operation are discussed. (Groundwater conditions are presented in detail in Section 2.4.13).

The site is located in Pope County, Arkansas, about six miles northwest from Russellville. It is about one and one-quarter miles south of Interstate 40 and two miles from the small town of London. The plant is situated on a peninsula formed by the Corps of Engineers' Dardanelle Reservoir.

The site is underlain by eight to 30 feet of stiff clay which overlies essentially horizontally bedded shale with interbedded sandstone and siltstone of Pennsylvanian age. The rock surface has low relief and slopes gently to the southwest. No evidence of faulting at the site was found during the investigation program. Laboratory testing of numerous rock samples show that the rock has a bearing capacity well above the maximum loads to be imposed by the structures.

A search of published and unpublished literature was made to determine geologic history, stratigraphy and structure of the region around the site. State and federal agencies were contacted to obtain and examine pertinent documents and to discuss geologic and groundwater conditions of the site and region. A list of references is provided at the end of this section.

The scope of investigations was to define site foundation conditions and regional and site geologic, geohydrologic, and seismological conditions. The purpose of the investigation was to determine the characteristics of the foundation materials, especially in regard to their suitability for supporting the structures, to determine the depth and configuration of the groundwater table, to determine the characteristics of the soil and rock materials with respect to their effect on the migration of radioactive solutions should such solutions come in contact with them, and to evaluate the seismicity of the area so that appropriate parameters for seismic design could be selected. Consultants in geology and seismology were retained to evaluate independently the results of the geologic and seismologic investigations.

A geophysical survey was performed by Boyles Bros. Drilling Co., of Auburn, California, to measure P-wave velocities and to calculate the dynamic modulus of elasticity of the foundation rock. Drilling and sampling was done by Grubbs Consulting Engineers, Inc., of Little Rock, Arkansas, under the direction of Bechtel Corporation. Soil tests were designated by Bechtel Corporation and done by Grubbs Engineers, Inc. Selected rock core samples from the drill holes were tested by Bechtel Corporation in their laboratory in San Francisco.

ARKANSAS NUCLEAR ONE
Unit 2

As a result of the investigations performed, it is concluded that geologic, seismologic, and foundation conditions at the Arkansas Nuclear One site are adequate in all respects for a nuclear power plant.

2.5.1 BASIC GEOLOGIC AND SEISMIC DATA

2.5.1.1 Regional Geology

The region around the plant site is underlain by a synclinorium called the Arkansas Valley. The uppermost bedrock unit in the site area is the McAlester formation of Pennsylvanian age. It consists of black, dense, horizontally bedded shale and interbedded sandstone and shale. Some faulting has occurred in the region, but the faults are related to the folding and all are pre-Cretaceous in age.

2.5.1.1.1 Regional Physiography

The site is situated in the center of the Arkansas Valley section of the Ouachita province (see Figure 2.5-1). The Arkansas Valley is a gently undulating east-west trending plain or lowland 25 to 35 miles wide that extends from near Searcy westward beyond Fort Smith. Many long, sharp ridges and several broad-topped hills rise above the general level of the valley. In most parts of the valley the topography is an expression of the east-west trending structure. Broad, open synclines are expressed by high, flat-topped mountains; steeply tilted limbs of anticlines and synclines are generally expressed by sharp ridges, some of which are miles long.

2.5.1.1.2 Regional Geologic History

The Arkansas Valley is essentially a Paleozoic basin which had its most significant development during the Mississippian and Pennsylvanian. The greatest accumulations occurred during the Lower (Morrowan) and Lower Middle (Atokan) Pennsylvanian. Deformation of the Ouachitas occurred during Mid-Pennsylvanian time (Croneis, 1930). During this time, the Ouachitas were strongly folded, with some thrust faulting, especially in Oklahoma. The Arkansas Valley section lies between the essentially flat-lying rocks of the Boston Mountains on the north and complexly folded strata of the Ouachita Mountains on the south. Its structure, therefore, has some of the characteristics of both its bounding regions, but is generally a region of broad, gentle folds which trend east-west and are only moderately faulted. Faulting is related to the folding and is pre-Cretaceous in age (see Section 2.5.1.1.3).

Since Cretaceous (and probably late Paleozoic) time, erosion has been the primary agent in the development of land forms in the region. No sediments younger than Pennsylvanian are found in the region, except for Quaternary terrace and alluvial deposits along the stream valleys (Figure 2.5-2). In a few places, intrusive rocks, mapped by Croneis (1930) as mid-Cretaceous cut the Paleozoic sediments. In the Arkansas Valley, these rocks consist of scattered dikes and sills of varying composition. None occur at the plant site.

2.5.1.1.3 Regional Geologic Structure

The Arkansas Valley section is a trough both structurally and topographically. Near the northern border of the Arkansas Valley the faulting is normal, the folds are gentle, and most of the dips south of the anticlinal crests are steeper than those north of them. Near the southern border of the province thrust faulting is common, the folds are pronounced, and the dips north of the axes of the anticlines are steeper than those south of them. The true intermediate structural

ARKANSAS NUCLEAR ONE Unit 2

character of the central part of the Arkansas Valley is shown by the occurrence of both normal and thrust faults in close proximity, by the increase in the number of symmetrical folds, and by the character of the folding itself which is intermediate between the close folding on the south and the gently open folding on the north. The Arkansas Valley section, unlike the Ouachita section, has been folded down to form a synclinorium (Figure 2.5-3).

The nature of the structural features of the Arkansas Valley and their relation to the structure of the adjacent Ouachita and Boston Mountains show that the dominant force in the production of those features was horizontal pressure exerted from the south. The folding and thrust faulting developed in post-Paleozoic, pre-Cretaceous time due to the subsidence of a land mass to the south (Croneis, 1930). The normal faults were also connected with this episode of deformation and are believed to have formed either contemporaneously with folding, or as a result of tension developed after the period of folding (Croneis, 1930 and Hendricks, 1950). Some normal faults are also believed to have formed during deposition and subsidence of the Pennsylvanian sediments. In the Arkansas Valley the southward-dipping faults terminate against northward dipping normal faults (Haley, 1968). The folds and faults of the Arkansas Valley cannot be precisely dated (Caplan, 1957), but it is known that they are very old geologic structures and probably were formed before Cretaceous time (Croneis, 1930).

East-west trending folds are mapped in the area of the site (Figure 2.5-2). From about three miles north to three miles south of the site there are two anticlines and one syncline (Figure 2.5-4). From north to south these structures are as follows: London anticline, Scranton syncline, and the Prairie View anticline. The plant site is located on the Scranton syncline in which the maximum dip rarely exceeds 10 degrees, except locally where contorted beds may dip as steeply as 20 degrees.

The London anticline extends from about four and one-half miles northwest of the town of London, east to about three miles northwest of the site. This anticline may continue east to connect with the anticline mapped about three miles northeast of the site (Figure 2.5-2). The south limb of the London anticline is steeper than the north limb (Merewether and Haley, 1961).

The Scranton syncline, also known as the Ouita syncline, extends from northeast of Russellville, westward to a point about five miles northwest of Scranton, where it is presumably terminated by the Dublin fault (Haley, 1968). On the western part of the Scranton syncline the south limb is steeper than the north limb. However, on the eastern portion of the syncline the north limb is steeper than the south limb (Merewether and Haley, 1961).

The Prairie View anticline is mapped from a point three miles southwest of the town of Scranton, east to at least as far as Russellville. This nearly symmetrical anticline is broken by northward-dipping normal faults (Haley, 1968).

There are a number of inactive faults mapped in the vicinity of the Arkansas River, particularly to the northwest and west of the site. These are primarily east-west-trending faults. Of these, the London and Prairie View faults are the closest to the site (Figure 2.5-4). The London fault and accompanying unnamed small branch fault trend east-west about four miles north of the site. A small fault which branches from the unnamed fault lies about two and one-half miles northeast of the site. The London fault is a high-angle south-dipping normal fault. It is best exposed about eight miles northwest of the site at Big Piney Creek where the eastern part of the fault ends. At this locality, the fault plane dips 58 degrees south and has an apparent displacement of about 20 feet. The fault is also exposed to the east along Flat Rock Creek and in a drainage ditch along a country road about eight miles from the site. An unnamed east-west-trending fault

ARKANSAS NUCLEAR ONE
Unit 2

lies about one mile south of the London fault. The trend of this unnamed fault changes toward the east to generally southeast. It intersects the London fault in the vicinity of the north fork of Mill Creek (Haley, 1961).

The Prairie View fault is exposed about 12 miles west of the site, and has been projected to within six miles of the site by Merewether and Haley (1961). The Prairie View fault extends to the west as far as three miles northwest of the town of Subiaco. It is an east-west-trending high angle normal fault with the north side downthrown. The maximum displacement along the fault is 350 feet, and occurs about two miles west of the town of Prairie View (Haley, 1968). The fault plane dips 65 degrees northward at the western end and has a displacement of about 170 feet.

Both the London and Prairie View faults, and other similar east-west-trending faults in the Arkansas Valley are associated with the folding which occurred between late Paleozoic and Cretaceous time. These faults have formed either contemporaneously with folding, or as a result of tension developed after the folding (Croneis, 1930 and Hendricks, 1950). Some normal faulting also occurred during deposition and subsidence of the Pennsylvanian sediments.

In summary, the only faults within five miles of the site are the Prairie View fault, and the London fault and its branch faults. The closest fault is only a small branch fault and approaches within about two and one-half miles of the site. The last movement of these faults occurred prior to Cretaceous time, or over 135 million years ago.

2.5.1.1.4 Regional Stratigraphy

The Arkansas Valley lies within the area of outcrop of Paleozoic rocks which occupy essentially the northwestern half of the state. The rocks of the Arkansas Valley are nearly all of sedimentary origin; they include only a few bodies of igneous rock (Figure 2.5-2). The beds in the valley consist chiefly of non-fossiliferous shale and sandstone, and little calcareous material is present.

Mississippian and older rocks occur at depths in excess of 7,000 feet at the site, and are therefore not treated in detail. They consist primarily of sandstone and shale with some thin limestone horizons.

The Pennsylvanian sequence is divided into three main groups in this area. They are the Morrow series of the Lower Pennsylvanian, and the Atoka and Des Moines series of the Middle Pennsylvanian (Figure 2.5-5). The Morrow series consists of the Hale formation and the overlying Boyd shale. The Hale formation is further divided into the Cane Hill and Prairie Grove members. The Gulf Oil Corp., No. 1 W.H. Tackett well (about six miles from the site) terminated in the Cane Hill at a depth of 7,525 feet after penetrating 129 feet of the Cane Hill. That part of the Cane Hill penetrated consisted of shale, very finely sandy siltstone, and well cemented, very silty, very fine-grained sandstone. The Prairie Grove member of the Cane Hill formation and the Boyd shale are very similar, and consist of shale, slightly silty to silty shale, siltstone, very fine to coarse grained sandstone and limy sandstone, and very fine to medium grained sandy fossiliferous limestone (Merewether and Haley, 1961).

The Atoka series is represented in Arkansas by the Atoka formation, which rests unconformably on the rocks of the Morrow series. The Atoka formation consists of dark gray to grayish black shale, dark gray slightly silty to very silty shale, medium to dark gray siltstone, light to dark gray very fine grained sandy siltstone, light to medium gray slightly silty to very silty very fine-grained sandstone, some light to medium gray slightly limy to limy fine to medium grained sandstone,

ARKANSAS NUCLEAR ONE
Unit 2

and, in the upper part, a few coal beds and one zone containing thin beds of very silty limestone (Merewether and Haley, 1961). The Atoka formation is from 6,700 to about 7,800 feet thick in the region around the site.

The Des Moines series is represented in this region by rocks of the Krebs Group; the Hartshorne sandstone, the McAlester formation, and the Savannah formation. The Savannah formation is absent over most of the area, and is not present at the site. The Hartshorne sandstone rests unconformably on the Atoka sequence and was defined by Hendricks and Parks (1950) as the first continuous sandstone underlying the lower Hartshorne coal bed. In general, the Hartshorne is grayish white to light gray, very fine to medium grained, slightly silty sandstone. Its thickness ranges from 80 to about 160 feet in the project area.

The McAlester formation conformably overlies the Hartshorne sandstone, and is the uppermost bedrock unit in the site area. The McAlester is up to 800 feet thick in this area and consists of shale, silty shale, siltstone, silty very fine grained sandstone, and three or more coal beds (Merewether and Haley, 1961). At the site the McAlester formation is about 160 feet thick and contains no coal horizons. The Savannah formation overlies the McAlester formation but does not occur at the site. It consists of 18 feet of siltstone and silty very fine grained sandstone where observed in the area.

Terrace deposits and alluvium of Quaternary age occur along the Arkansas River valley and the valleys of major tributaries. At least two terrace levels exist along the Arkansas River, with the highest about 50 feet above river level. Alluvium along the Arkansas River and most of the major tributaries is largely covered by the waters of the Dardanelle Reservoir. Soil at the site consists of from eight to 30 feet of clay and silty clay.

2.5.1.1.5 Tectonic Structures

The site is located on the axis of the Scranton-Ouita syncline in the Arkansas Valley synclinorium (Figure 2.5-4). The synclinorium lies between the essentially flat-lying rocks of the Boston Mountains on the north and the complexly folded strata of the Ouachita Mountains to the south. Its structure, therefore, has some of the characteristics of both its bounding regions, but is generally a region of broad, gentle folds which trend east-west and are only moderately faulted (Figure 2.5-6). Faulting is related to the folding and is pre-Cretaceous in age.

The folds in the vicinity of the site trend generally east-west. Dips along the flanks are rarely in excess of 15 degrees, and usually less than 10 degrees. A detailed description of the folds and faults in the area around the site is presented in Section 2.5.1.1.3, Geologic Structure. Sections 2.5.2.2 and 2.5.4.1 also discuss regional geologic and tectonic structure.

2.5.1.1.6 Potential Subsidence, Collapse, or Uplift

The rocks in the region around the site are primarily well indurated sandstone and shale with only thin limestone beds, to a depth of at least 7,000 feet. No natural cavernous or karstic terrain exists in the region. The carbonate rocks are buried at great depth and are not subject to solutioning. Thin coal seams occur in the area, but do not occur beneath the site. No mining has occurred in the subsurface within three miles of the site. Oil extraction does not occur in the Arkansas Valley. Natural gas production occurs in the area, but production is from well indurated rocks and subsidence is not a problem. A crustal movement map showing probable vertical movements of the earth's surface was issued by the U.S. Commerce Department in August, 1972. The map does not show any movement within 150 miles of the site; however, it

ARKANSAS NUCLEAR ONE
Unit 2

states that the blank areas simply mean that there is not enough data to determine if they are being uplifted or subsiding. On the same map, the area of indicated movement closest to the site shows only slight regional uplift (1 - 5 mm per year).

The site is located on a gently rolling plain adjacent to the Dardanelle Reservoir. Natural slopes in the vicinity of the site are gentle and no high ridges occur within at least two miles of the site. Potential landslides are not a problem at the plant site. Additional data on stability of subsurface materials is presented in Section 2.5.4.

2.5.1.1.7 Regional Groundwater Conditions

The site is in the Arkansas Valley section of the South-Central Paleozoic Groundwater Province defined by Meinzer (1923). Conditions in this province are generally unsatisfactory for developing good water wells because of the low permeabilities of the rocks. The principal sources of groundwater in the region are sandstones and limestones of Paleozoic age. Although groundwater in these rocks is usually meager or of poor quality, many wells produce small quantities for domestic and farm use. Some large supplies are available from glacial or alluvial deposits, but they are restricted to major stream valleys.

The principal bedrock aquifer of the region is fractured shale of the Atoka Formation. Neither the alluvial deposits, nor the Atoka Formation is available at the site for groundwater. Regional groundwater conditions are more fully described in Section 2.4.13.

2.5.1.2 Site Geology

The site is about six miles northwest from Russellville, and about two miles from the small town of London. The plant is situated on a peninsula formed by the Corps of Engineers' Dardanelle Reservoir. As shown on Figure 2.5-7, a subsurface investigation program, including soil and rock borings, observation wells, and a geophysical survey, was completed at the site to obtain data on geologic, soil, and foundation conditions. Results of the drill holes are summarized in Table 2.5-1, and graphic logs of holes are presented in Figures 2.5-8 through 2.5-12. Samples of soil and rock materials were tested in the laboratory to determine their static and dynamic properties. The results of the testing program are presented in Section 2.5.1.2.5.1.

2.5.1.2.1 Site Physiography

The plant is located on a broad, nearly flat bench adjacent to the floodplain of the Arkansas River. This bench is at about Elevation 353 feet, at the lower of the two Pleistocene terrace levels described by Merewether and Haley (1961). Soil on the terrace consists of clay and silty clay, and is from eight to 30 feet thick at the site. The broad floodplain of the Arkansas River is now covered with the waters of the Dardanelle Reservoir in the vicinity of the site. The low hills adjacent to the site (Figure 2.5-13) are formed by the gently upturned strata along the flanks of the Scranton-Quitita syncline. Relief within the limits of the site area is less than 10 feet.

2.5.1.2.2 Site Stratigraphy

The regional stratigraphy is presented in Section 2.5.1.1.4 and shown on the geologic column, Figure 2.5-5. Rocks of the Hartshorne formation of Des Moinesian age (upper mid-Pennsylvanian) were penetrated by the drill holes, which reached a maximum depth of 165 feet in hole 201. Rock at the site probably represents the lower 70 to 80 percent of the McAlester formation since coal beds occur in the upper part of the formation and none were encountered

ARKANSAS NUCLEAR ONE
Unit 2

at the site. Rock penetrated from depth 159.5 to 165 feet in Hole 201 consisted of gray, dense, fine grained, well cemented, horizontally bedded sandstone. Above this sandstone horizon, a zone of shale with thin sandstone interbeds was penetrated. This zone, approximately 60 feet thick, is primarily light to dark gray, hard shale with minor sandstone interbeds. The uppermost bedrock unit at the site consists of 70 to 90 feet of hard black shale. The upper four to eight feet of bedrock is weathered to a soft gray shale which grades to hard, tan clay at the top.

Soils at the site consist of eight to 30 feet of tan clay and silty clay. Some of this material was deposited by the Arkansas River as alluvium and has since been isolated by further downcutting of the river channel.

2.5.1.2.3 Structural Geology of the Site

The site is located directly over the axis of the gently folded Scranton-Ouita syncline. Rock core recovered during exploration, and site foundation inspection during construction show bedding to be horizontal or dipping gently at the site. The axis of the syncline trends generally east-west, and the rock rises along the flanks of the structure at angles of from four to 15 degrees. The rock is only moderately jointed, with joints inclined from 40 degrees to vertical but predominantly from 50 degrees to 70 degrees. The bedrock surface has low relief and slopes gently to the southwest (Figure 2.5-14). The structural geology of the region around the site is presented in Section 2.5.1.1.3.

2.5.1.2.4 Geologic History of the Site

The geologic history of the region is presented in Section 2.5.1.1.2 and summarized here. The site is in the Arkansas Valley, a Paleozoic basin which had its greatest development in Mississippian and Pennsylvanian time. During late Paleozoic, probably mid-Pennsylvanian, the sediments in the basin were folded and faulted. In the vicinity of the site, both folding and faulting were moderate. Dips of from five to 15 degrees are common on the flanks of the folds. Faulting and significant structural warping occurred in the area before the Cretaceous (Croneis, 1930). Erosion has probably been continuous in the area since the Cretaceous, and no deposits younger than mid-Pennsylvanian are encountered near the site, except for Pleistocene terrace deposits and recent alluvium along the Arkansas River and its major tributaries. The site is located on a terrace of the Arkansas River, adjacent to the Corps of Engineers' Dardanelle Reservoir.

2.5.1.2.5 Site Geologic and Foundation Conditions

The site is underlain by eight to 30 feet of moderate to stiff, plastic, red and tan clay with occasional zones of silty clay, which overlies black, dense, horizontally bedded shale and interbedded shale and sandstone of the McAlester formation. The rock is only moderately jointed with the joints varying in dip from 40 degrees to vertical, but dipping predominantly between 50 degrees and 70 degrees. The joints are tight and essentially impervious. Drill water was lost only at the weathered shale contact, and in all holes the return was nearly 100 percent while coring in shale; indicating few joints and tight, dense rock. Fresh shale cores showed a tendency to part along bedding planes and to expand slightly upon removal and exposure to air. The data from 93 drill holes indicates the bedrock surface has low relief and slopes gently to the southwest (Figure 2.5-14).

ARKANSAS NUCLEAR ONE
Unit 2

The deepest hole, DH-201, penetrated interbedded shale and sandstone at a depth of 97.0 feet and dense fine-grained sandstone at 159.5 feet (Figure 2.5-15). This sandstone was also found in DH-1 at 149.0 feet and crops out near lake level 3,200 feet east of the site. No evidence of faulting or offset of any of the beds was found during these investigations. The nearest mapped fault is two and one-half miles northeast of the site.

Overlying the unweathered shale is four to eight feet of highly weathered shale which grades downward from hard stratified tan clay to very soft, light gray weathered shale. Standard penetration tests in the top of this zone typically required 50 or more blows to penetrate one foot.

During excavation of the foundation for Unit 2 at the Arkansas Nuclear One site, the specifications required that after foundation grade was reached, all rock surfaces would be cleaned and coated with gunite within 24 hours after their exposure. This procedure was followed to prevent slaking of the shale during construction. The rock exposed was dense shale, silty shale and siltstone and no zones with undesirable or unstable mineralogy were encountered. These provisions were successful.

2.5.1.2.5.1 Physical Properties of Site Materials

All Category 1 structures except the Emergency Cooling Pond (ECP) inlet and outlet structures, electrical manholes and the Condensate Storage Tank T41B pipe trenches are founded on competent unweathered bedrock of the McAlester Formation of Pennsylvanian age. The bedrock consists primarily of hard dark gray shale with some thin sandstone and siltstone interbeds. Samples of rock core from the exploratory drilling were tested in the Bechtel Geologic Laboratory in San Francisco. Standard test procedures were followed. The results of these tests are shown in Table 2.5-1. The lowest and highest unconfined compressive strength of the 45 samples tested are 2,420 psi (167 TSF) and 4,690 psi (338 TSF). The average is 3,460 psi or 249 TSF.

Testing showed the specific gravity of the rock to be in the range of 2.51 to 2.67 with about 2.57 the average. Porosity varies from 2.0 percent to 7.81 percent with 5.9 percent about the average. Absorption ranges from 1.13 percent to 3.1 percent with an average of around 2.4 percent. The site seismic survey indicated P-wave velocities in the fresh rock to be from 10,000 to 14,500 fps indicating dense, competent rock. Results of this survey are shown on Figure 2.5-16. S-wave velocities were not measured in situ since the structures are founded on rock, but a value of 5,350 fps was calculated using a P-wave velocity of 10,000 fps and a Poisson's ratio of 0.30. The dynamic modulus of elasticity ranges from 2.8 (+6) psi to over 5 (+6) psi (See Section 1.7 for an explanation of symbols).

Figure 2.5-17 is a site plan showing the arrangement of major plant structures. Plant excavations are shown on Figures 2.5-18 and 2.5-19. Backfill is shown on Figure 2.5-20.

Soil borings were done by Grubbs Consulting Engineers, Inc. and soil tests were performed in their Little Rock laboratory. Engineering properties of site soil materials are listed in Tables 2.5-3, 2.5-4, 2.5-5, and 2.5-6. An additional program of field investigation was initiated in July, 1972 in the ECP area to evaluate the properties of weathered shale and prospective borrow materials. Eight test pits were made in the three proposed borrow areas to evaluate the engineering properties of the soil proposed to be used for the clay blanket and the embankment fill. Two borrow areas south of the intake canal shown on Figure 2.5-31, Section 2.5.5.2.1 were recommended for use. Four plate load tests were made on weathered shale within the pond

ARKANSAS NUCLEAR ONE
Unit 2

area to develop its shear strength parameters for use in the embankment stability analysis. For location of test pits and detailed soil properties, refer to the Soil Report by Grubbs Consulting Engineers, Inc. in Section 2.5.5.2.1.

The clay soil at this site is not a sensitive soil. The consolidated drained direct shear tests on undisturbed samples of overburden soils in boreholes 224, 228, 232 and 234 presented in Section 2.5.5.3.1, Figures 2.5-56, -58, -60 and -62 show that the ratio between the peak and residual shear strength varies between 1.10 to 1.90 which indicates low sensitivity.

Moreover, test results from boreholes 101 through 131 in Table 2.5-6a and that of boreholes 223, 224, 225, 228, 230, 232, 234 and 236 in Section 2.5.5.3.1, Table 2.5-12 show that the in situ moisture content of the soil is close to the plastic limit, therefore the liquidity index is close to zero. The average undrained shear strength, C , of the soil is approximately 1.14 TSF (Table 2.5-6a). From the relation between c/\bar{p} ratio and plasticity index established by Skempton (Reference 95, p. 117) the preconsolidation pressure and the present soil overburden pressures are computed and presented in Table 2.5-6b.

The basis for the assumed properties of weathered shale and filter materials are as below:

Unit weight of weathered shale The insitu density of shale as determined in some boreholes are abstracted below from Table 2.5-6a:

<u>Borehole No.</u>	<u>Depth (ft)</u>	<u>Type of Material</u>	<u>Insitu Density (γ_m), PCF</u>
126	28.0	Weathered Shale	149
127	22.0	Shaley Clay/Shale	141
Average			145

Filter materials properties: For well graded, clean sand used as filter material, the moist density at optimum moisture varies between 128 - 142 pcf and the effective angle of internal friction is of the order of about 38° (Reference 26, Table 9-1, P7-9-2), hence the assumptions of 135 pcf as the unit weight and 35° as the angle of internal friction for saturated sand are quite reasonable.

There are no shears or zones of crushed material in the rock which underlies the plant structures. The bedrock contains some joints and fractures, as does all rock to some degree. Some joints were encountered in the borings, and noted during site foundation inspection, but these were tight and are not significant to the site foundation conditions. Some crenulation of the bedding occurred when the rocks were folded at the end of Paleozoic time. These crenulations occur in localized zones, and do not affect site foundation conditions.

Rock at the site has been exposed at or near the surface since the Cretaceous, over 135 million years ago, and shows no evidence of deformation since that time. Therefore, no significant unrelieved residual stresses should be expected to exist in the foundation rock and no evidence of unrelieved residual stress was observed during the exploration or excavation.

The foundation rocks consist of shale, silty shale and siltstone, and no zone with undesirable or unstable mineralogy were observed during exploration or excavation. Seismic velocities of 11,000 to 14,500 fps (V_p) were recorded, and unconfined compressive strengths ranged from 3,140 psi for the samples tested. A swell test was conducted on a crushed gray shale sample with a nominal surcharge of 200 psf. The recorded maximum swell was 0.30 percent. Obviously, the shale is a competent, well indurated rock, and significant swelling or heave

ARKANSAS NUCLEAR ONE
Unit 2

should not be anticipated. The rock at foundation grade was protected from air slaking and moisture absorption by the application of gunite to exposed surfaces within 24 hours after final excavation. No swelling or heave of the foundation rock was noted prior to placement of concrete.

2.5.1.2.5.2 Behavior of Site Materials During Prior Earthquakes

The behavior of the surficial geologic materials at the site during prior earthquakes was evaluated by studying existing ground conditions, and by comparing the known effects of Intensity VI-VII earthquakes (the maximum the site has experienced historically) on soil and rock similar in strength, density, water content, etc. to those underlying the plant.

There is no evidence at or near the site of any ground failure, such as fissuring, lurching, subsidence or landsliding during recent earthquakes. In view of the intensities which the site has experienced in historic times (discussed in Section 2.5.2.5) and the dense, strong condition of the rock and soil, it is virtually certain that ground failure has not occurred near the site during historic earthquakes.

2.5.1.2.5.3 Properties of Embankment Materials for all Category 1 Structures

The only Category 1 embankment required at this site is in connection with some portions of the emergency cooling pond (Figure 2.5-21). For the soil fill consisting of overconsolidated, highly plastic clay, evaluation of dynamic engineering properties of the embankment material was not required, as such materials will not liquify. The static engineering properties are summarized in Table 2.5-3. Design properties for stability analysis are given in Table 2.5-4 and Figure 2.5-22. A more detailed treatment of the static soil properties is given in Sections 2.5.5.2.1 and 2.5.5.3.1 and for design properties in Section 2.5.5.2.1. The computed factor of safety of the embankment slope was found to be higher than the required factor of safety under all conditions, including earthquake condition as summarized in Tables 2.5-5a and 2.5-5b. For further discussions and details on factor of safety of pond slope stability, refer to Section 2.5.5.

2.5.1.2.5.4 Site Groundwater Conditions

Limited quantities of groundwater can be pumped from fractures and joints in the McAlester and Hartshorne formations. Groundwater in these rocks is confined below the nearly impermeable clay at the site. Groundwater at the site is derived from precipitation on the hills near the site. Water infiltrates the surface and percolates through fractures in the bedrock toward Dardanelle Reservoir as shown by water levels in Figures 2.4-1 and 2.4-2. The water table at the plant site is about 10 feet below ground surface at Elevation 342. Detailed discussion of groundwater conditions at the site are included in Section 2.4.13.

2.5.2 VIBRATORY GROUND MOTION

The pertinent literature regarding the seismology and geology for the general area was studied; the seismic history, geology and foundation conditions at the site were evaluated. Included in this report are summaries of the regional geology and site geology, a description of the earthquake history of the area and a general evaluation of the seismicity of the site and region around it.

ARKANSAS NUCLEAR ONE
Unit 2

The geologic conditions and seismic history are used in determining the Operating Basis Earthquake (OBE) (the greatest earthquake likely to affect the site within the lifetime of the facility) and the Design Basis Earthquake (DBE) (a hypothetical earthquake which exceeds in intensity any earthquake expected to be felt at the site). Taking into account all the seismic information for the site location, conservative values of 0.10 g for the OBE and 0.20 g for the DBE were used.

2.5.2.1 Geologic Conditions of the Site

Detailed descriptions of the geologic conditions at and in the vicinity of the site are presented in Section 2.5.1. However, summaries of the regional and site geology are also presented here.

2.5.2.1.1 Regional Geology

Physiographically, the site is situated in the center of the Arkansas Valley section of the Ouachita province. The Arkansas Valley is a gently undulating east-west-trending plain or lowland, 25 to 35 miles wide, that extends generally from Searcy westward to Fort Smith. Many long, sharp ridges and several broad-topped hills rise above the general level of the valley. In most parts of the valley the topography is an expression of the east-west-trending structure. Broad, open synclines are expressed by high, flat-topped mountains, steeply tilted limbs of anticlines and synclines are generally expressed by sharp ridges, some of which are miles long.

The Arkansas Valley lies within the area of outcrop of Paleozoic rocks which occupy essentially the northwestern half of the state. The rocks of the Arkansas Valley are nearly all of sedimentary origin; they include only a few bodies of igneous rock. The beds in the valley consist chiefly of shale and sandstone, all of Carboniferous age, and most of them belonging to the lower part of the Pennsylvanian series. The rocks are generally highly carbonaceous and in some places are coal bearing. They contain little or no calcareous material.

2.5.2.1.2 Site Geology

The site is located in an area where clay and silty clay overlay bedrock, consisting of Pennsylvanian McAlester formation shale. Thickness of the clayey overburden varies from about eight to 30 feet in the vicinity of the site and may be described as moderate to stiff, plastic, red and tan clay with occasional zones of silty clay. The McAlester formation consists of black, dense, horizontally bedded shale and sandstone. This bedrock sequence forms the trough of the east-west-trending Scranton syncline. Hard, fine-grained sandstone of the Hartshorne formation occurs at a depth of about 150 feet beneath the site.

2.5.2.2 Underlying Tectonic Structures

The Arkansas Valley section, which is a trough both structurally and topographically, lies between the essentially flat-lying rocks of the Boston Mountains on the north and the complexly folded strata of the Ouachita Mountains on the south. Its structure, therefore, has some of the characteristics of both its bounding regions. Near the northern border of the Arkansas Valley the faulting is normal, the folds are gentle, and most of the dips south of the anticlinal crests are steeper than those north of them. Near the southern border of the province, thrust faulting is common, the folds are pronounced, and the dips north of the axes of the anticlines are steeper than those south of them. The true intermediate structural character of the central part of the Arkansas Valley is shown by the occurrence of both normal and thrust faults in close proximity, by the increase in the number of symmetrical folds, and by the character of the folding itself

ARKANSAS NUCLEAR ONE
Unit 2

which is intermediate between the close folding on the south and the gentle open folding on the north. The Arkansas Valley section, unlike the Ouachita section, has been folded down to form a synclorium.

The nature of the structural features of the Arkansas Valley and their relation to the structure of the adjacent Ouachita and Boston Mountains show that the dominant force in the production of those features was horizontal pressure exerted from the south. Croneis (1930) believed that the folding and thrust faulting, which developed in post-Paleozoic but pre-Cretaceous time, may be related to the subsidence of a large land mass to the south; the normal faults were also connected with this episode of deformation. These are believed to have formed either contemporaneously with folding, before folding, or as a result of tension developed after a period of folding (Croneis, 1930 and Hendricks, 1950). Some normal faults are also believed to have formed during deposition and subsidence of the Pennsylvanian sediments. In the Arkansas Valley the southward-dipping faults terminate against northward dipping normal faults (Haley, 1968). The precise dating of the folds and faults of the Arkansas Valley cannot be done with assurance (Caplan, 1954), but it is known that they are very old geologic structures and probably were formed before Cretaceous time (Croneis, 1930).

East-west trending folds are mapped in the area of the site. Within three miles north to three miles south of the site are two anticlines and one syncline. From north to south these structures are as follows: London anticline, Scranton syncline, and Prairie View anticline.

There are a number of old faults mapped in the vicinity of the Arkansas River, particularly to the northwest and west of the site. These are in the main, east-west-trending faults. The only faults within five miles of the site are the Prairie View fault, and the London fault and its branch faults. The closest fault is only a small branch fault and approaches within about two and one-half miles of the site. The last movement of these faults is believed to have occurred prior to the Cretaceous.

A personal interview was conducted with Mr. Boyd R. Haley of the U. S. Geological Survey. During this interview the age of the London and Prairie View faults and their physical characteristics as seen in the field were discussed in detail. The age determination of these faults, as made by Messrs. Haley and Merewether of the U. S. Geological Survey is based on two facts. First, similar, normal faults extend into eastern Arkansas. These faults can be traced under the Cretaceous sediments of the Mississippi embayment and the faults do not cut the Cretaceous materials. Secondly, Mr. Haley has stated (verbal communication) that from well log data, the U.S.G.S. has determined that many of the Arkansas normal faults appear to be "growth faults" - that is faults which developed continuously during deposition. They have determined that displacements along these faults are often greater with depth, and in some cases the faults don't cut the Mesozoic strata. Mr. Haley believes that the London fault is in part this type of fault, and that the Prairie View fault has had a significant growth type displacement. Mr. Haley also stated that neither he nor Mr. Merewether had found any evidence of recent movement on the London or Prairie View faults.

Using the State of Arkansas Information Circulars and the geologic maps of the area (work completed by E. A. Merewether and B. R. Haley), the fault traces and exposures were located and studied.

London Fault. Merewether notes three exposures of the London fault in the Delaware quadrangle. Two of these exposures were located and examined.

ARKANSAS NUCLEAR ONE
Unit 2

In the State of Arkansas Information Circular 20-A, Mr. Merewether states:

The London fault extends into the Delaware quadrangle from the east and probably ends a few hundred yards west of Big Piney Creek. The fault is a high-angle south-dipping normal fault with the downthrown block on the south side. The fault plane is best exposed on the west side of Big Piney Creek in the NW-¼ NW-¼ NW-¼ sec. 15, T. 8 N., R. 22 W. At this locality, the fault plane dips 58° south and the fault has an apparent displacement of about 20 feet.

On the bank at Piney Creek, approximately 6-½ miles northwest of the site, the plane mapped by Mr. Merewether as the fault strikes approximately N 30 E and dips 58° to the southeast. At this location the rock formation consists of the massively bedded, generally fine-grained sandstone of the Hartshorne formation. The sandstone dips gently to the south, but is cross-bedded on a relatively large scale creating apparent local reversals in dip.

At the exposure where Mr. Merewether mapped the fault plane, a sudden steepening of the dip on the south side of the plane could be interpreted as dragging. The dip resumes the gentle southerly trend a few feet south of the plane. No slickensides or crushing were noted along the plane.

At the rock-overburden contact, no offset of the bedrock or soil occurs. This shows that sufficient time has elapsed since the last fault movement for erosion to remove any evidence of a fault-related scarp.

Because of the similarities in the appearance of the bedrock across the fault, correlation of individual units within the sandstone could not be made and actual offset could not be determined.

The other exposure noted by Mr. Merewether that was found, was only described by Mr. Merewether as to its location "...and in a drainage ditch along the county road between secs. 10 and 11, T. 8 N., R. 22 W...." At this location, the fault was difficult to discern. A road cut here exposes very weathered rock. Closely spaced fractures apparently delineate the fault trace as mapped by Mr. Merewether. No slickensides or crushing were noted. The Hartshorne sandstone crops out in the road ditch. The rock's surface is smooth across the fault. The fractures have the appearance of tension cracks along the axis of a small anticline which are vaguely visible in the weathered road cut. No definite fault trace was actually found.

Two other possible exposures were noted a short distance southwest of the Piney Creek exposure. One which is located in an abandoned quarry appears to be fractures along an anticlinal axis. The axis appears to be the line along which relatively undisturbed Hartshorne sandstone beds become folded, jointed and fractured. The axial zone is more disturbed than the surrounding formation. The individual sandstone units appear continuous across the fractured zone although definite correlation is very difficult because of the massive nature of the geologic formation.

The other exposure, which is in an I-40 road cut, strikes roughly N 30 E and dips ± 30° to the southwest. This is about two feet wide and is easily identified by broken and disoriented rock fragments. No slickensides were observed; however, it was noted that a vague correlation of a geologic unit could possibly be made across the trace. If the correlation is correct, the displacement is less than 10 feet.

ARKANSAS NUCLEAR ONE
Unit 2

Only two of the exposures of the fault plane have been mapped by B. R. Haley in the Russellville west quadrangle. One of these exposures was undoubtedly obliterated by recent road work. The other could not be located, although the area was carefully examined.

The main trace of the London fault and its branches often follows rather deep stream valleys, the bottoms of which are usually filled with Quaternary alluvium. The fault does not cut these sediments. Rocks older than the Quaternary and younger than the Pennsylvanian have been eroded making a more accurate relative age determination on the basis of offset units impossible.

The valleys along which the faults are traced, do not appear to be fault produced. When the amount of movement and the length of time since the last movement are considered, the valleys appear to be much too wide and deep to be fault produced. Where the fault is exposed at its western end, no valleys exist.

Mr. Haley stated (verbal communication) that the indicated location of the fault's trace is generally based on the positions and the measured stratigraphic thickness of the geologic units. He agreed that it is very difficult to recognize or locate the faults in the field. At the eastern fault exposure noted by Mr. Haley (not found by field investigation), the geologic units on both sides of the fault appear identical but are mapped as Hartshorne on the south side and Atoka on the north. Mr. Haley stated (verbal communication) that the units are difficult to distinguish but with sufficient field work, they can be shown to be different geologic units. Investigation of the surface indicated by Merewether and Haley disclosed no suggestion of recent fault movement.

Prairie View Fault. In the Information Circular 20-A, Mr. Merewether also states: "The Prairie View fault, the outcrop of which is concealed by alluvium in the Delaware quadrangle, has been extended into the mapped area from the west. Where exposed (west of the Delaware quadrangle), the Prairie View fault is a high-angle north-dipping normal fault with the downthrown block on the north side."

A. J. Collier shows the fault extending westward from the Delaware quadrangle across the New Blain quadrangle and terminating in the Scranton quadrangle. Its nearest approach to the site is 6-½ miles. No exposures of this fault could be found by field investigation. The land surface is undulating because of a series of parallel anticlinal ridges. The limbs of these folds form dip slopes. Along the crest of the Prairie View anticline where this fault is indicated by Collier (1906), the ground surface is irregular and there are no outcrops. A rather broad valley runs along the folds crust. No definite evidence of faulting could be determined in this area.

After the field investigation of the indicated fault traces and the discussion with Mr. Haley, it was concluded that there is no available evidence that these features have experienced recent movement. It is likely that they have not moved since the Cretaceous. They are not considered to present a risk to the site.

2.5.2.3 Behavior During Prior Earthquakes

There is no physical evidence of any fissuring, landsliding, lurching, or caving of banks to indicate that past earthquakes have disturbed either the surficial deposits or the substrata beneath the site. The New Madrid Earthquakes of 1811-1812 (described in detail in Section 2.5.2.5.3) produced areas of earth disturbances in eastern Arkansas; however, these areas were at least 90 miles from the site.

ARKANSAS NUCLEAR ONE
Unit 2

2.5.2.4 Engineering Properties of Materials Underlying the Site

All Category 1 structures except the ECP inlet and outlet structures, electrical manholes, and the Condensate Storage Tank (T41B) pipe trenches are founded on competent unweathered bedrock. The properties of the bedrock materials are summarized in Table 2.5-2.

Seismic velocities of the shale bedrock range from 11,000 to 14,500 fps. The rock has a dynamic modulus of elasticity ranging from a minimum of 2.8 (+6) psi to over 5 (+6) psi, indicating good foundation rock. It has good strength properties and will cause no amplification of ground motion from an earthquake. Additional information on foundation properties of the rock under Category 1 structures is provided in Section 2.5.1.2.5.1.

2.5.2.5 Earthquake History

Historical and instrumental data show that seismic events in the southeastern part of the United States, with the exceptions of those in the New Madrid, Missouri Areas, and the Charleston, South Carolina area, are relatively infrequent and characterized by fairly low intensities and magnitudes.

The site is located in the center of the Arkansas Valley section of the Ouachita province, in an area which appears to be seismically quiet since no significant earthquakes have been reported closer than 48 miles to the site.

The following paragraphs include information on the epicenter map for the area within 200 miles of the site, earthquakes felt in the vicinity of the site, the New Madrid Earthquakes, and the Seismic Risk map of the United States prepared by Dr. S.T. Algermissen of the U.S. Coast and Geodetic Survey.

2.5.2.5.1 Epicenter Map

Figure 2.5-23 shows the locations of the significant historical earthquakes which have occurred within a 200-mile radius of the site--the area bounded by latitudes 32 to 38.5 degrees north, and longitudes 89 to 97 degrees west. The earthquakes plotted within this area are those of Intensity IV-V and greater. All intensities in this report are based on the Modified Mercalli Intensity scale of 1931 unless otherwise stated (see Table 2.5-8 for this scale). Each earthquake is shown on Figure 2.5-23 by a Roman numeral at the epicenter. The Roman numeral indicates the greatest reported intensity for that quake. A list of the epicenters shown on this map is given in Table 2.5-9. Most of the epicenters are listed and located in the references by latitude and longitude. These locations may denote either field epicenters, or instrumentally located epicenters. Many of the older locations are field epicenters; that is, an epicenter was placed at the locality or center of the area receiving the greatest effects from that quake.

References used for this study are shown on Figure 2.5-23 and are also listed in the Reference Section. The first historical quake in the central United States is listed in the references as occurring in 1699, so all quakes on this map have occurred since then. The references for this map have been checked for earthquakes occurring through October 1972.

ARKANSAS NUCLEAR ONE
Unit 2

2.5.2.5.2 Earthquakes Felt in Arkansas

The closest epicenter to the site is 48 miles. This earthquake occurred on October 22, 1882 and had a maximum intensity of VI-VII. The U.S. Coast and Geodetic Survey has approximated the location of this epicenter. They state, however, that it was difficult to accurately locate it because of insufficient reports from the region most affected. Some investigators place this epicenter near El Reno, Oklahoma.

The earthquake of October 22, 1882 is described as follows in the 1973 edition of "Earthquake History of the U.S." (U.S. Dept. of Commerce Publication 41-1, J.L. Coffman and C.A. von Hake, editors).

1882, October 22, Arkansas. This shock was felt in northern Texas, Oklahoma, western Arkansas, and eastern Kansas. It extended from Greenville and Paris, Texas to Wichita and Leavenworth, Kansas, a distance of 450 miles, and to Warrenton, Mo. At Sherman, Texas, heavy machinery vibrated, bricks were thrown from chimneys, and movable objects overturned. Houses were shaken at Fort Smith, Arkansas. It was difficult to obtain the probable epicenter because of insufficient reports from the region most affected.

Authorities listed for the above description are the following three reports:

- A. Rockwood, C.G., "American Earthquakes," Am. Jour. of Sci. and Arts, 3rd Series, Vol. 25. 1883.

Oct. 22 About 4.15 P.M. an earthquake was felt in northern Texas, western Arkansas and eastern Kansas, and presumably in the intervening portions of the Indian Territory. The region affected extended from Greenville and Paris, Tex., and Little Rock, Ark., northwesterly to Wichita and Leavenworth, Kan., a distance of some 300 miles. The shock was reported from numerous places within these boundaries, and also, as a light shock, from Warrenton, MO, which is farther eastward. The most definite report of time was from Wichita, Kan., which gave 4:19, Jefferson City, Mo., time. In many places two or three pulsations were noticed, having a duration of about 30 seconds in all. Reports of direction are too various to be classified. No damage was done other than overturning movable articles and knocking bricks from chimney-tops.

- B. Merriams, D.F., "History of Earthquakes in Kansas," Bull. Seis. Soc. Am., Vol. 46, No. 2, April 1956.

1882, October 22 - (35° N, 94° W; VII-VIII.) (M.M.) The epicenter was in Arkansas but the earthquake was felt over an area of 135,000 square miles, including eastern Kansas, about 4:15 PM. (3 and 6) (The numbers 3 and 6 indicate numbered references in Merriam's publication. Number 3 refers to an early (1947) edition of "Earthquake History of the U.S.", and Number 6 refers to a publication by R.R. Heinrich, in which Heinrich rates the 1882 earthquake as maximum Modified Mercalli Intensity VI).

- C. Monthly Weather Review - October 1882, U. S. Weather Bureau.

The shock of the 22d was felt at various points in the states of Arkansas, Kansas, Missouri and Texas. Concerning this shock, the following reports have been received:

ARKANSAS NUCLEAR ONE
Unit 2

Mount Ida, Arkansas, 22d: At 4:15 p.m., a distinct shock, accompanied by a rumbling sound, was felt at various places in this (Montgomery) county.

Fort Smith, Arkansas, 22d: At 4:15 p.m., three distinct shocks, all occurring within about 30 seconds were felt at this place. The vibrations were east and west. Houses were shaken so that furniture and crockery rattled; bells were rung, and in a few instances bricks were shaken from chimneys.

Little Rock, Arkansas, 22d: Two light shocks of earthquake were felt between 4:00 and 5:00 p.m. The shocks were separated by an interval of two seconds, and the vibration was from southeast to northwest.

Rogers, Arkansas, 22d: A slight earthquake shock, continuing about 30 seconds was felt here at 4:12 p.m. Reports from Seligman, Missouri, state that it was also plainly felt at that place.

Fayetteville, Arkansas, 22d: An earthquake shock was felt here at 4:15 p.m. The vibration was from north to south, and lasted eight seconds. It was sufficiently violent to throw bottles from shelves.

Wichita, Kansas, 22d: An earthquake shock occurred at this place at 4:19 p.m. (Jefferson City, Missouri, mean time.) Its duration was about five seconds. There were three pulsations, the first being the strongest. Windows were rattled, the walls of buildings swayed, and furniture moved in houses.

Wellington, Kansas, 22d: A shock of earthquake was distinctly felt here about 4:00 p.m. The pulsation seemed to be east and west, and continued for several seconds.

Leavenworth, Kansas 22d: A slight earthquake shock was felt here at 3:54 p.m. A tremulous movement of the earth was first noticed, which continued with even intensity from 20 to 40 seconds, when a heavier shock followed, lasting about 15 seconds. The disturbance then became less perceptible for about a minute and 30 seconds, when the most distinct shock occurred, which was sufficient to rattle windows and shake chandeliers.

Warrenton, Missouri 22d: About 4:25 p.m., an earthquake shock was felt at this place. The vibration was north and south. The shock was sufficient to cause windows, etc., to rattle.

Sherman, Texas, 22d: An earthquake shock was felt at this place about 4:00 p.m. At the Eagle mills, which were shut down at the time, the machinery was seen to vibrate, and the belts creaked as if the engine was being started. At Compress, the shock was so violent as to ring the call-bell on the engine, and cotton bales standing on end were seen to sway. McKenny, Greenville, Bonham, and Paris, all in northern Texas, report having experienced the shock. At Paris, a clock was thrown from the side of a wall, and at Bonham, loose bricks were shaken from the top of a wall.

ARKANSAS NUCLEAR ONE
Unit 2

Three other sources contain descriptions of this earthquake.

- A. Heinrich, R.R., "A Contribution to the Seismic History of Missouri," Bull. Seis. Soc. Am., Vol. 31, No. 3, July 1941. Earthquake shock in eastern Kansas and western Missouri at 4:15 p.m. Articles were moved and bricks were shaken from chimneys. Am. Jour. Sci., 3d ser., 25:359. (VI) (M.M.)
- B. Reid, H.F., Reid Earthquake Catalog. Collection of earthquake and volcano data on 3x5 cards, and augmented by newspaper clippings of principal earthquakes. Available on microfilm from N.O.A.A., Boulder, Colorado.

Local Date: 4.15 p.m. 22 Oct. 1882
Locality: Indian Ter., Texas, Arkansas, Kansas
Intensity: VII (R.F.)
Authorities: Am. Jr., Sc., 1883, Vol. 25, p. 359. Felt over an area of 135,000 sq. miles in northern Texas, western Arkansas, eastern Kansas, and presumably in the intervening portions of the Indian Territory.

The region affected extended from Greenville and Paris (Texas), Little Rock (Ark.), and N.W. to Wichita and Leavenworth (Kansas). Also reported from Warrenton, Missouri.

- C. "Earthquake History of Arkansas," U.S. Dept. of Commerce Earthquake Information Bulletin, Vol. 2, No. 4, 1970.

Although the historical record for the central United States can be traced to about 1800, the first shock listed for Arkansas occurred in October 1882. Since few reports were received from the region most affected, the epicenter of this shock is not well known, and several investigators have placed the origin near El Reno, Oklahoma, instead of western Arkansas. The shock threw bricks from chimneys at Sherman, Texas, and shook houses strongly at Fort Smith, Arkansas, Texas, and Missouri, about 135,000 square miles (VII M.M.).

J. Docekal ("Earthquakes of the Stable Interior, with Emphasis on the mid-Continent," 1970, Doctoral thesis - University of Nebraska) has re-evaluated the effects and characteristics of this earthquake. Based on this re-evaluation, he has relocated the epicenter of the 1882 earthquake 175 km. to the south-southwest of coordinates listed in "Earthquake History of the U.S.", in the vicinity of Bonham, Texas, almost 200 miles from the ANO-2 site. He rates this event as epicentral Intensity VII (M.M.).

Docekal's recent investigations probably provide the most complete data available for this earthquake at this time. Therefore, the earthquake is of less significance than thought previously.

In 1969, an earthquake occurred 50 miles from the site. "Seismological Notes" in the Bulletin of the Seismological Society of America rates this shock as epicentral Intensity V. More recent references (U.S. Earthquakes, 1969, and Abstracts of Earthquake Reports for the U.S.) list this shock as having an epicentral intensity of VI. Abstracts of Earthquake Reports for U.S. states that this earthquake was not felt at Russellville.

No other significant earthquakes have occurred within 50 miles of the site during historic times. Other earthquakes probably felt at the site are listed below.

ARKANSAS NUCLEAR ONE
Unit 2

1811-1812 - Described in Section 2.5.2.5.3.

1867, April 24 - 39.5N, 96.7W, Maximum Intensity VII (MM). Shock at Lawrence, Kansas, where objects were thrown from shelves and plaster was cracked. Walls were cracked in Manhattan, Kansas; felt in Arkansas, Illinois, Indiana, Missouri, Nebraska and Kentucky.

1895, October 31 - 37.ON, 89.4W, Maximum Intensity VIII (MM). Heaviest near Charleston, Missouri, where land sunk. At Cairo, Illinois chimneys were demolished. Felt from Canada to Mississippi and from Georgia to Kansas.

1903, November 4 - 38.5N, 90.3W, Maximum Intensity VI-VII (MM). St. Louis. Felt in southern Illinois, Kentucky, Mississippi, Arkansas, Missouri, and Tennessee.

1909, September 27 - 39.ON, 87.7W, Maximum Intensity VII (MM). Indiana. Felt area included southwest half of Indiana, all of Illinois, eastern Iowa and Missouri, west half of Kentucky and Arkansas.

1909, October 23 - 37.ON, 89.5W, Maximum Intensity V (MM). Center in southeastern Missouri. Felt in Missouri, Arkansas, Mississippi, Tennessee, Kentucky, Illinois and Indiana.

1915, December 7 - 36.7N, 89.1W, Maximum Intensity V-VI (MM). A sharp earthquake near mouth of the Ohio River. It was felt in Illinois, Kentucky, Tennessee, Arkansas, Mississippi and Missouri.

1917, April 9 - 38.1N, 90.6W, Maximum Intensity VI (MM). Epicentral region between St. Louis and New Madrid, Missouri, where windows were broken and plaster cracked. Felt in Kansas to Ohio and from Wisconsin to Mississippi.

1927, May 7 - 36.5N, 89.0W, Maximum Intensity VII (MM). Arkansas and adjacent states. Strongest at North Jonesboro, Arkansas where brick chimneys were tumbled down. Although it was felt strongly in Arkansas, the area over which it was felt indicates that the epicenter was further to the east near the position listed.

1940, November 23 - 38.2N, 90.1W, Maximum Intensity VI (MM). Felt throughout Illinois, Kentucky, Tennessee, Missouri, and Arkansas.

1952, April 9 - 35.4N, 97.8W, Maximum Intensity VII (MM). Center near El Reno, Oklahoma, where chimneys fell and walls were cracked. Felt in western Arkansas (I-III) at Clarksville and Dardanelle which are within 20 miles of the site.

1962, July 23 - 36.1N, 89.8W, Maximum Intensity VI (MM). Plaster cracked in Dyersburg, Tennessee. Site area just on edge of felt area according to map but not reported felt by towns near the site area.

1965, October 20 - 37.51'N, 91.05'W, Maximum Intensity VI (MM). Centered in east central Missouri, VI at St. Louis. Not reported felt in towns near site area which lies at the limit of perceptibility.

ARKANSAS NUCLEAR ONE
Unit 2

1968, November 9 - 38.0N, 88.5W, Maximum Intensity VII (MM). Southern Illinois. It was reported not felt at Russellville even though it was felt at Dardanelle. It was reported felt with Intensity V in the extreme northeast part of Arkansas and Intensities I-III as far south as Murfreesboro 90 miles southwest of the site.

1971, October 1 - Jonesboro, Arkansas. According to "Seismological Notes" in the Bulletin of the Seismological Society of America, Vol. 62, No. 3, "Walls shook and teeth rattled at Trumann, Arkansas. Small objects fell from shelves. Many older homes cracked and groaned during the shock. Citizens emerged from their homes to find the cause of the disturbance (Press)."

"Felt in 75 communities. A maximum intensity of V was reported for Sedgwick (135 miles from Russellville) with cracking of concrete floor, Lake City (155 miles from Russellville) which reported cracked buildings, shifting of objects ("Strongest earthquake ever felt; loudest by far"); Bay where many were frightened and earthquake noise was reported as thunderous; Black Oak (160 miles from Russellville), Brookland (140 miles), Delaplane (150 miles) and Trumann (150 miles) (where slight damage occurred to concrete blocks). Scattered felt reports from Missouri (9 communities), Texas (1), Kentucky (6), Mississippi (1), Alabama (2), Indiana (1), Tennessee (10), and Illinois (5), (Questionnaire canvass),"

This shock may have been felt lightly in the vicinity of the site, but probably was not and certainly not with an intensity greater than about II.

Earthquakes have occurred in Arkansas on November 17, 1970, February 1, 1972 and October 2, 1973 but were not felt in the plant site area.

2.5.2.5.3 The New Madrid Earthquakes

The earthquakes which have most significantly affected Arkansas and all adjoining states in the Mississippi Valley region occurred near New Madrid, Missouri in 1811 and 1812. These earthquakes consisted of a succession of shocks of varying intensities, beginning December 16, 1811 and lasting throughout the years 1812 and 1813. The maximum intensity of these shocks was estimated to be XII, with a probable magnitude of 8 (Richter). Nuttli (1973) estimates the surface-wave magnitude of the Dec. 16, 1811 shock as 6.9. Shocks on Jan. 23, 1812 and Feb. 7, 1812 had estimated surface-wave magnitudes of 6.8 and 7.1, respectively.

The nearest points at which systematic attempts were made to record the shocks from the New Madrid earthquake were at Louisville, Kentucky and Cincinnati, Ohio. At Louisville, 250 miles from the epicenter, 1,764 shocks were recorded between Dec. 16, 1811 and May 6, 1812 at which time the recording of shocks ceased. At Cincinnati, 340 miles from the epicenter, 41 periods of shocks were recorded, eight of which occurred between May 5, 1812 and Dec. 12, 1813. The available data indicate that there were at least 1,882 earthquake shocks.

A good description of the area affected is given by Myron L. Fuller in his 1912 paper, "The New Madrid Earthquake."

The area affected by the New Madrid Earthquake may be subdivided into an area of marked earth disturbances, an area of slight earth disturbances, and an area of tremors only. In the first is included the territory characterized by pronounced earthquake phenomena, such as domes and sunk lands, fissures, sinks, sand blows, large landslides, etc. This district included the New Madrid region, originally considered a relatively small

ARKANSAS NUCLEAR ONE
Unit 2

area, including the villages of New Madrid and Little Prairie (Caruthersville). It is now known, however, to be somewhat larger, extending from a point west of Cairo on the north to the latitude of Memphis on the south, a distance of more than 100 miles, and from Crowley Ridge on the west to Chickasaw Bluffs on the east, a distance of over 50 miles. The total area characterized by disturbance of the type mentioned is from 30,000 to 50,000 square miles.

In the area of slight earth disturbances will be included districts in which such minor features as the caving of banks, etc., took place. We have records in the narratives of Latrobe (1836) and others of the occurrence of such phenomena along the Mississippi and Ohio, while Bradbury (1904) records similar disturbances as far down the Mississippi as the mouth of the St. Francis, near Helena. The disappearance of Island 94 near Vicksburg has been described by August Warner. In fact, there is little doubt that such phenomena as caving were prominent northward nearly to Herculaneum, north-eastward to a point beyond the Wabash and southward at least to the mouth of the Arkansas. Although no records from the White River region have been seen, it was probably included in the area of slight disturbance. It is also possible that the lower Arkansas was affected to some extent.

The area of tremors was naturally far more extensive. On the north they are reported to have been felt in "upper Canada", on the northwest they are reported to have been felt by the Indians in the region of the upper portions of the Missouri country, and in the region between the headwaters of the Arkansas and the Missouri, a distance of more than 500 miles from New Madrid. Southwestward the shocks were felt in the Red River settlements and on the Washita River, an equal distance from the center of disturbance. To the south the shock was felt at New Orleans, also 500 miles distant; to the northeast at Detroit, 600 miles away; and to the east at Washington, over 700 miles and at Boston, 1,100 miles distant. A total area of over 1,000,000 square miles, or half that of the entire United States, was so disturbed that the vibrations could be felt without the aid of instruments.

Figure 2.5-24 lists some of the effects of the New Madrid earthquake, as described by Fuller and other investigators. The references are listed on the figure.

2.5.2.5.4 Seismic Risk Map

Figure 2.5-25 is the seismic risk map showing areas of the conterminous United States most vulnerable to earthquakes. The map was made by a group of research geophysicists headed by Dr. S.T. Algermissen of the U.S. Coast and Geodetic Survey and issued in January, 1969.

The map divides the conterminous United States into the following four zones:

- Zone 0: Areas where there is thought to be no reasonable expectancy of earthquake damage.
- Zone 1: Areas of expected minor damage.
- Zone 2: Areas where moderate damage could be expected.
- Zone 3: Areas where major destructive earthquakes may occur.

ARKANSAS NUCLEAR ONE
Unit 2

The zones are based principally on the known distribution of damaging earthquakes, their intensities, and geological considerations.

The site lies well within Zone 1 where minor damage should be expected. According to this map, minor damage corresponds to Intensities V and VI on the Modified Mercalli Intensity Scale.

2.5.2.6 Correlation of Epicenters With Geologic Structures

With the exception of earthquakes associated with the New Madrid area, very few shocks have occurred within a 200-mile radius of the Unit 2 site; and the shocks which have occurred have not been definitely correlated with geologic structures.

Much seismic activity has been associated with the New Madrid and Ste. Genevieve fault zones. The large pattern of earthquake epicenters of the 1811-12 New Madrid earthquake series was elongated northeastward along the New Madrid fault zone into Illinois and Kentucky. A branching lobe of epicenters also extended northwestward up the Ste. Genevieve system nearly to St. Louis (Heyl, et al., 1965).

A second line of seismic activity is the northwestern part of the Ste. Genevieve fault, near St. Louis, Missouri. Earthquake epicenters have been scattered along this fault zone and along the possible southeast extension of this zone into northwestern Tennessee (Heyl, et al., 1965).

Earthquake generation along the fault zones appears to be partly related to domal activity of the ends of the fault zones (Heyl and Brock, 1961).

2.5.2.7 Identification and Description of Active Faults

The New Madrid Fault Zone - In southwest Kentucky, southern Illinois, and Missouri, is the upper part of the Mississippi embayment, a basin in which Paleozoic rocks have been progressively downwarped since mid-Cretaceous time and in which clastic strata of upper Cretaceous, Paleocene, Eocene, Pliocene, Pleistocene, and Holocene ages have been deposited. This gently warped cratonic region is characterized by large gentle domes, basins, and folds. Complex fault systems connect and cross the larger structures at the head of the embayment (Heyl, et al., 1965).

The buried Precambrian surface underlying the region is broad and undulating, a result of warping younger than the Precambrian. This surface is sharply bent and broken along the major fault zones. The larger faults of the area are probably surface expressions of ancient Precambrian lineaments (Heyl, et al., 1965), which have been inferred from geologic and gravity data (McGinnis, et al., 1972).

The larger faults and fault zones include the following (Heyl, et al., 1965).

- A. The Shawneetown-Rough Creek fault zone, traceable from the collapsed Jessamine Dome in central Kentucky to the New Madrid fault zone near Shawneetown, Illinois, where it curves southwestward around the northwest end of the Hicks Dome and joins the northwest side of the New Madrid fault zone.

ARKANSAS NUCLEAR ONE
Unit 2

- B. The Ste. Genevieve fault zone, a high angle thrust fault beginning southwest of St. Louis and extending southeastward into Illinois with an extension into northwestern Tennessee.
- C. The Cottage Grove Fault zone, trending westward across southern Illinois to the Mississippi river, where it may end against the Ste. Genevieve system. Faults of a similar westward nature are traceable further west through southeast Missouri.
- D. The New Madrid fault zone, a broad belt of northeast trending faults extending from near Vincennes, Indiana, southwestward through and beyond New Madrid, Missouri.

As mentioned, earthquake generation along the fault zones appears to be partly related to domal activity at the ends of the fault zones. The development of the Hicks Dome, in southern Illinois, was probably the result of the intrusion of magma deep within the Precambrian basement at the intersection of several basement (Precambrian) fault lineaments (Heyl and Brock, 1961). Tension faults first appeared during uplift in the Permian. Later, the dome was faulted by the New Madrid system along basement lineaments, followed by cooling of the magma and partial collapse of the dome (Heyl, et al., 1965). This action was combined with compressive forces acting along the Rough Creek-Shawneetown fault zone, which compressed and rotated the north end of the anticlinal dome in a counter-clockwise direction, developing the numerous northeast-trending fault blocks. During the late Cretaceous, the Mississippi embayment was formed by downwarping of the block south of the intersection of the New Madrid and Ste. Genevieve fault zones (Heyl and Brock, 1961).

Movement along one fault zone in the region is apparently related to movement along a connected fault zone. The main Rough Creek-Shawneetown system is a zone of sheared and faulted rock considered to be a wrench-fault system. Both strike-slip and reverse faulting has occurred along southward-dipping fault planes. The strike-slip component of movement was left lateral, from the eastern end of the fault zone at its western end. The New Madrid zone apparently acted as a shear-relief feature for the Shawneetown-Rough Creek system (Heyl, et al., 1965).

The New Madrid fault zone is characterized by many narrow fault blocks and wedges that are elongated to the northeast. Vertical displacements between 700 and 800 feet are exhibited along one that follows the course of the Mississippi River (Bond, et al., 1971). The fault follows the trend of faults developed previously in both Paleozoic and Cretaceous strata (Lammlein, et al., 1971). This particular fault has the downthrown side on the west and according to Bond was probably responsible for the New Madrid earthquakes of 1811-12. Another fault, further to the west in Missouri, parallels the Mississippi River fault and is downthrown on the east, so that a graben is formed within the western part of the Mississippi River floodplain (Bond, et al., 1971).

Bond, et al., (1971) state in the section of their article dealing with the northern Mississippi Embayment, under the heading "Faults", as follows (p. 1216):

Because of the sparse subsurface control, only the major displacements can be plotted in the embayment area. A fault that trends northeast is downthrown on the west, has 700 to 800 feet (210 to 240 m) of displacement, and follows the course of the Mississippi River. Movement along this fault probably was responsible for the New Madrid earthquakes in 1811 and 1812, the largest tremor ever recorded in North America.

ARKANSAS NUCLEAR ONE
Unit 2

The article goes on to point out other faults that have been inferred to exist in the Paleozoic rocks beneath the embayment (see Figure 45 of Bond, et al. for locations of these faults), but the only fault shown by Bond, et al. to offset the surface of the Paleozoic-Cretaceous unconformity is the northeast trending fault described in the foregoing quotation. Subsurface contours on the datum defined by the Paleozoic-Cretaceous unconformity and the location of the inferred offset of this surface are shown in Figure 46 of Bond, et al. Deep test control data for the northern Mississippi Embayment are listed in Table 4, p. 51 of Illinois State Geological Survey's 1971 publication, Illinois Petroleum 96. However, Bond, et al. offer no further data or rationale for correlating the particular fault described in the foregoing quotation with the New Madrid earthquakes of 1811-1812.

The northern and southern limits of the New Madrid system have not been definitely established in the literature. According to Heyl, et al., (1965), the zone extends northeastward from the Mississippi River embayment, past New Madrid and across the Wabash River, where it becomes synonymous with the Wabash River fault zone.

The southern end of the New Madrid fault zone was placed in extreme northeastern Arkansas by Heyl and Brock, 1961. King, 1965, extended the zone to about 25 miles south of the northeastern Arkansas-southeastern Missouri border. Based on the location of epicenters of earthquakes having intensities greater than V, McGinnis (1963) placed the southern limit of the zone just north of the Arkansas-Missouri border south of New Madrid. The above limits were determined by the locations of subsurface and surface faults, earthquake epicenters, and basement lineaments.

Recent work by Kisslinger and others (1971) and Followill (1972) indicates that earthquakes occurring in the New Madrid fault zone since 1970 may delineate the southern end of the New Madrid system more accurately. The epicenters of these earthquakes are distributed along a northeast-southwest trend west of New Madrid that is parallel to, but not coincident with previously mapped or inferred faults. The southern end of this trend, as defined by Kisslinger, is marked by a 4.5-magnitude event occurring on Nov. 17, 1970, 10 miles south of the southwest Missouri-northeast Arkansas border, almost 200 miles northeast of the site. This event coincides with the southern limits of the fault zone determined by Heyl and Brock, 1961, based on faulting evidence. Focal depth of this event was about 19 kilometers, indicating a possible basement origin for the earthquake.

One other earthquake, farther south than the 1970 event, may be associated with movement within the New Madrid fault zone. The 1955 event in northeastern Arkansas occurred along the trend established by Kisslinger and others, 1971. This maximum Intensity IV event is the southernmost of any event occurring along the trend of the New Madrid fault zone as established by Kisslinger.

Followill, in 1972, includes both the 1955 Arkansas event and the 1843 Memphis event within the limits of the New Madrid fault zone. This places the fault zone at about 180 miles from the Unit 2 site area. The isolated 1843 Memphis earthquake occurred over 50 miles east of the trend of the New Madrid fault zone as defined by Kisslinger.

Bond, in his 1971 report concerning potential petroleum production in the Northern Mississippi embayment, discusses the regional stratigraphic and structural geology as jointly interpreted by representatives of the Illinois, Indiana, Kentucky, and Tennessee Geological Surveys, Vanderbilt University, and Marathon Oil Company. The data presented in this report are based on numerous petroleum exploration programs. A detailed description of the major regional

ARKANSAS NUCLEAR ONE
Unit 2

faulting provides evidence for the terminus of the New Madrid zone in west-central Tennessee and northeastern Arkansas. Offset along the northeast-southwest trending fault thought by Bond responsible for the 1811-1812 series of earthquakes can be traced in the subsurface to about 90 miles north of Memphis. This fault bisects a much larger (in displacement) east-west-trending fault near its southern end.

There is no reflection of major faulting of the Paleozoic surface found in the Mississippi embayment south of the Pascola arch to and beyond the Ouachita tectonic front. Numerous data points (based on petroleum wells) have been utilized to construct contours on top of Paleozoic strata. In the northern embayment area, the contours reflect the influence of the Mississippi structural trough with its V-shaped contours pointing northeasterly. Continuing south, the gradual trend of the contours changes to an east-west direction. Considering the number of data points, a fault of major proportions similar to the New Madrid zone would be reflected by the structural contours. No major fault is shown to exist.

The basic data from which Bond, et al., (1971) and Schwalb (1971) published subsurface structural interpretations are given in Table 4, p. 51 of Illinois Geological Survey's 1971 publication Illinois Petroleum 96. Additional data points and datum contours are given in Cushing, Boswell and Hosman (1964).

The spacing of the data points, though sparse, is such that major structural displacements on the order of several hundred feet can at least be reasonably postulated. The only fault indicated by the above-referenced sources to involve strata as young as Cretaceous is one which is shown displacing the surface of the unconformity on top of Paleozoic basement, extending for about 100 miles in a north-northeast direction parallel to the axis of the embayment from western Dyer County (Tennessee) to the Illinois-Kentucky border. Displacement along the fault attains a magnitude of 700 to 800 feet, but no displacement of the surface of the Paleozoic-Cretaceous unconformity is shown extending south of the Pascola arch.

Other major faults offsetting Paleozoic strata but not Cretaceous or younger strata are shown by Schwalb (1971, Fig. 1). A very large fault trending slightly south of east for about 90 miles from Dunklin County, Missouri to Henderson County, Tennessee and having an estimated 4,000 feet of displacement, downthrown to the south, appears effectively to define the southern edge of the Pascola arch, as located by Bond, et al., (1971) and by Bristol and Buschbach (1971). However, since this major east-west fault is not shown offsetting the Paleozoic-Cretaceous erosion surface, it must therefore have not experienced movement since prior to Cretaceous time, over 135 million years ago, and so would not be expected to be related to present-day seismic activity in the New Madrid earthquake zone. No major faulting is indicated by any of these above referenced sources for the Paleozoic surface south of the Pascola arch. No significant indications of major faulting can be interpreted from regional Mesozoic structural maps.

No major active faulting has been established in the Cenozoic strata of the Mississippi embayment south of Memphis. The Big Creek fault zone is discussed in Fisk's report and a later report by Krinitsky. Boring data in the latter report are interpreted to indicate minor faulting in the Tertiary strata along the Big Creek escarpment near Helena, Arkansas. However, evidence is inconclusive and does not justify the presence of a major structure. Boring programs initiated by the Corps of Engineers at various river structures (locks and dams) on the Ouachita River encountered no faulting associated with Fisk's topographic lineaments. The Catahoula Lake and Ouachita River fault zones of Fisk were investigated and no faulting associated with these lineaments is evident.

ARKANSAS NUCLEAR ONE
Unit 2

Cushing, 1964, included in his report on the Mississippi embayment, an east-west cross section through the embayment tangential to the northern limit of the Ouachita tectonic front. The borings used to construct the section terminate in either Cretaceous or Paleozoic rock so that a complete record of the Cenozoic history in that part of the embayment is presented. Other than the normal basinal cross-sectional configuration, no major faults or other unusual anomalies are evident.

Caplan in 1954, in describing the subsurface geology of northeastern Arkansas, presented evidence, based on numerous petroleum wells, which suggest the lack of major faulting of Paleozoic and post-Paleozoic strata. The cross-sections are perpendicular to and cross the axis of the Mississippi structural trough north of the Ouachita front.

Geophysical, seismological, physiographic, and structural geologic evidence suggests that the New Madrid seismic zone is restricted to a relatively narrow, elongated belt within the Mississippi embayment paralleling the Mississippi River from Memphis northward to southernmost Illinois.

Physiographic effects of the 1811-1812 New Madrid earthquakes documented by Fuller (1912) were confined to this belt. Its width as delineated by the major surface effects of the 1811-1812 events is about 50 miles and extends from Crowley's Ridge in Arkansas to the Loess Hills in western Tennessee (Fuller, 1912, pl. 1). The closest approach of such a zone to the site would be at least 150 miles. If certain raised areas occurring near and on either side of the Mississippi River, such as the Blytheville and Tiptonville "domes", had been differentially elevated by earthquake action, then they furnish proof that earthquakes occurred there prior to the New Madrid events (Fuller, pp. 12-13, 63-64). Summarizing the evidence indicating likely areas of earthquake disturbance in the embayment, Caplan (1954) states (p. 37):

Faulting, slumping and general evidence of crustal displacement may be expected in those portions of the embayment affected by the New Madrid earthquake of 1811-1812. According to Fuller (1912) the epicenter of this earth movement was in northeastern Arkansas and southeastern Missouri, between Crowley's Ridge and the Mississippi River. Evidence examined by Fuller indicated the existence of a fault or fault system trending northeast-southwest across the general area affected, but actual area placement of the fault or fault system could not be made with the information available. The maximum expression of faulting and related adjustments attributable to the New Madrid earthquake in Arkansas is likely to be found in the region between Crowley's Ridge and the Mississippi River, from the general vicinity west of Memphis, Tennessee, to the Missouri line. The fault system postulated might extend from Memphis to the head of the embayment at Cairo, Illinois.

The area which experiences secondary surface displacement due to violent ground motion should be considerably greater than the area in which occur faults or fault zones capable of causing the ground motion. There is appreciable structural geologic evidence that the area of the embayment within which such a capable fault or fault zone is most likely to occur is located close to the axis of the embayment. Stearns and Marcher (1962), in reconstructing the post-Cretaceous tectonic history of the Mississippi embayment, show (p. 1391, fig. 4) that only the central, axial region has been differentially downflexed. They conclude (p. 1393):

The Mississippi Embayment syncline has not been uniformly bent. Rather, the east and west limbs individually have a uniform slope and bending has occurred within a narrow zone trending along the Mississippi River. This fact may be significant tectonically because

ARKANSAS NUCLEAR ONE
Unit 2

the valley of the Mississippi River in this area has been the locus of many earthquakes, and numerous faults have displaced the Pleistocene valley fill. These structural movements have taken place where the sharp syncline is super-imposed on the crest of the Late Cretaceous dome, i.e. the Pascola arch.

Although many major faults have been postulated by numerous authors to occur in the Paleozoic rocks beneath much of the Mississippi embayment (Bond, et al., 1971; Phelan, 1969; Schwalb, 1971; Tikriti, 1968), it seems highly significant that only one major fault has been demonstrated to offset Cretaceous and younger sediments of the embayment (Bond, et al., 1971; Mateker and others, 1968 (cited in Lammlein and others, 1971); Tikrity, 1968, pl. 14 and p. 91). This fault coincides with the zone of maximum downwarp of the embayment syncline depicted by Stearns and Marcher (1962) and is the one which Bond, et al., (1971) declare was responsible for the 1811-1812 New Madrid earthquakes.

Subsurface stratigraphic evidence of lesser displacements on the order of 100 feet or less is generally lacking in the embayment due to the relatively wide spacing of control points. Boswell, et al., (1965, plate 1) show an offset in Cretaceous rocks of about 100 feet near Cairo in western Carlisle County, Kentucky, and another of about the same magnitude in the Cretaceous in central Crittenden County, Arkansas. A northeast-trending normal fault of about 100 feet of throw is shown by Moore (1965) cutting near-surface strata as young as Pleistocene and Recent in Lake and western Obion Counties, Tennessee, near Reelfoot Lake.

These three faults are in approximate alignment; if they were to be connected, they would form a single fault whose alignment and position would correspond to that of the larger fault displacement shown by Bond, et al., (1971) at the base of the Cretaceous along the axis of the embayment.

The occurrence of major regional fault zones in the embayment was proposed by Fisk (1944) on the basis of his interpretation of aerial photographic lineaments and topographic features. In Arkansas, he shows the "Ozark escarpment fault zone" trending northeast along the Ozark escarpment at the western edge of embayment, the "Big Creek fault zone" extending from Cairo, Illinois to Memphis and southwestward, the "Arkansas River fault zone" extending southeast from Little Rock, Arkansas to Greenville, Mississippi and beyond, and the "White River fault zone", extending from Jackson and Independence Counties, Arkansas, southeast past Helena, Arkansas, and into Mississippi. However, a subsequent publication by Caplan (1954) presents a series of geologic sections across the embayment in Arkansas intersecting Fisk's proposed fault trends, and fails to show any fault offsets in the embayment sediments. Since Caplan's sections were based on rather extensive subsurface data from wells, it appears that the idea of northeast and southwest trending sets of major zones in the embayment as proposed by Fisk (1944) is thus far contradicted by available subsurface data in Arkansas. Tikrity (1968) concludes (p. 93) that a major fault does not occur along the Ozark escarpment north of Batesville, Arkansas. In Tennessee, no faults are shown in the Tertiary by Criner and others (1964) for the Memphis area (Shelby County) in spite of the greater density of control points there. A recent section compiled by Bicker (1974) across the embayment in northern Mississippi shows no fault offsets in the embayment sediments, though many faults are shown in the underlying Paleozoic rocks. If the section by Bicker (1974) and the Section B-B' by Caplan (1954) were combined, they would illustrate the absence of major faulting across the entire Mississippi embayment south of Memphis.

ARKANSAS NUCLEAR ONE
Unit 2

Subsurface structural geologic data therefore indicate that the most likely location for a major fault correlative with the New Madrid events is parallel with, and at or close to, the axis of the Mississippi embayment north of Memphis.

Geophysical investigations show the occurrence of rather localized but prominent Bouguer gravity anomalies of up to 50 milligals near the axis of the northern Mississippi embayment (Phelan, 1969, pl.2). Although there is no direct evidence to relate these anomalies (the Bloomfield, Malden and Covington anomalies) to tectonic or seismic activity, if they are assumed to be related, they would suggest that the origin of tectonic and seismic disturbances in the embayment is confined to a north-south linear zone near the axis of the embayment.

The pattern of earthquake epicenters estimated from intensities reported since 1811 (Figure 2.5-23) reveals a marked concentration centered along the Mississippi River from southern Illinois to Memphis and effectively defines the New Madrid seismic zone. Epicenters of Intensities IV-V and greater belonging to this seismic zone do not appear to be located west of Jonesboro, Arkansas, nor south of Memphis, Tennessee. A microearthquake study conducted in 1968 by Lammlein and others (1971) demonstrates considerable microseismic activity in northwesternmost Tennessee, opposite the "Boot Heel" of Missouri, some stations indicating an average of as many as five microseismic events per day. This area also corresponds to the area of greatest density of macroseismic activity in the New Madrid seismic zone as shown in Figure 2.5-23.

Focal mechanism (nodal plane) solutions determined from the sense of motion of first and second P-wave arrivals and from surface studies (Street and others, in press) indicate high angle normal (tensional) faulting along a north-south structure from Memphis north to about latitude 36.3°N, and high angle thrusting (compression) north of that point to about latitude 38.5°N. Hypocenters occur at depths of 0 to 30 kilometers (0 to 18 miles). Thus along the eastern edge of Arkansas a tensional stress field seems to be operating which would tend to generate north-south normal faulting. The importance of this finding for the Unit 2 site is that it would appear to rule out the existence of seismically active trends that could extend westward toward the site at right angles to the relatively narrow, north-south elongated New Madrid seismic zone.

It is therefore concluded on the basis of all available geophysical, seismological, physiographic and structural geologic evidence that the New Madrid seismic zone is restricted to a relatively narrow, north-south oriented belt centered along the Mississippi River, extending from Memphis north to Illinois and westward as far as Crowley's Ridge in Arkansas. This western limit also corresponds to the approximate western extent of recorded macroseismic activity and of the most severe effects of the 1811-1812 New Madrid earthquakes as documented by Fuller (1912).

The aforementioned evidence leads to the conclusion that future large intensity seismic events are likely to be limited to the region north of Memphis and generally within the northern Mississippi embayment. The cause of major seismic events is attributed to the known major faults in that area such as the New Madrid, Rough Creek, and Ste. Genevieve fault zones. The seismic history of the area, as defined in a recent TVA report and the seismic study for the Unit 2 site, suggests that high intensity earthquakes occur within the limits of the buried Pascola Arch. All available surface and subsurface geologic data indicate that the major faults are not continuous southward beyond central-western Tennessee.

ARKANSAS NUCLEAR ONE
Unit 2

2.5.2.8 Maximum Earthquake

The historical seismicity data indicates that Arkansas is not an area of earthquake centers; however, the effects of distant shocks should be considered, in particular those which occurred over 150 years ago along the Mississippi River north and south of New Madrid, Missouri.

From Myron L. Fuller's publication, "The New Madrid Earthquake" (U.S.G.S. Bull. 494), it may be estimated that St. Louis, Missouri experienced an intensity of VII during the New Madrid shocks. St. Louis is about 60 miles closer to New Madrid than the site and is founded, in part, on thick alluvial deposits overlying shale and limestone, unweathered shale bedrock. Consequently, Fuller's data indicates that the intensities at the Unit 2 site due to the New Madrid shocks were probably less than VII.

Dr. Perry Byerly, in a letter dated August 5, 1970 (see Appendix 2A of the FSAR), has stated:

A study of the earthquake history of the area indicates that the greatest shaking in the area of the site was from the New Madrid earthquakes of 1811 and 1812.

I am impressed by the good foundation at the site, seismic speeds 11,000 to 14,500 ft/sec. I would estimate that the greatest intensity that could be expected at the site would be a high VI or low VII, corresponding to 0.1g (I doubt if that great an intensity has been attained in historic time).

Otto W. Nuttli, in his publication "The Mississippi Valley Earthquakes of 1811 and 1812: Intensities, Ground Motion and Magnitudes." (1973) states "Although the 1811-1812 earthquakes often are called the New Madrid earthquakes or earthquake, there is sufficient evidence to place the epicenter of the first earthquake (Dec. 16, 1811) to the southwest, probably in northeast Arkansas near the southern end of the lake formed by the St. Francis River...". Dr. Nuttli includes in his report a generalized isoseismal map for this particular shock (see Figure 2.5-26), but he does not extend the lines west of the epicenter because "no satisfactory intensity data are available for that area".

According to Nuttli, "It is difficult to assign intensities to the later principal shocks, because many of the published accounts describe the cumulative effects of all the earthquakes... There is insufficient information to construct isoseismal maps, such as that for the earthquake of Dec. 16. In all accounts the Feb, 7, 1812 earthquake was described as being the most severe....The town of New Madrid was completely destroyed. Whereas formerly it was 25 feet above river level, it was only 12 feet above after the earthquake. Near it the river overflowed its banks, and the land was covered with sand blows 12 to 50 feet in diameter (Pennsylvania Gazette, Mar. 18, 1812). From these and other similar accounts, it appears that the epicenter of the Feb. 7 earthquake was close to New Madrid."

Nuttli assumes the Feb. 7 earthquake to have been more severe (magnitude 7.1 as compared to 6.9 for the Dec. 16 shock). He also states that the epicenter was close to New Madrid, in which case it would have been about 220 miles from the Unit 2 site.

As previously mentioned, the limits of the New Madrid fault zone have not been definitely established in the literature. The southern end of the New Madrid fault zone was placed in extreme northeastern Arkansas by Heyl and Brock, 1961, almost 200 miles northeast of the site. King, (1965) extended the zone to about 25 miles south of the northeastern Arkansas/southeastern Missouri border, still over 150 miles east of the site. Based on the

ARKANSAS NUCLEAR ONE
Unit 2

locations of epicenters of earthquakes having intensities greater than V, McGinnis (1963) placed the southern limit of the zone just north of the Arkansas-Missouri border, which is south of New Madrid and over 200 miles from the site.

Recent work by Kisslinger and others (1971) and Followill (1972) indicates that earthquakes occurring in the New Madrid fault zone since 1970 may delineate the southern end of the New Madrid system more accurately. The epicenters of these earthquakes are distributed along a northeast-southwest trend west of New Madrid that is parallel to, but not coincident with previously mapped or inferred faults. The southern end of this trend, as defined by Kisslinger, is marked by a 4.5 magnitude event occurring in November of 1970, 10 miles south of the southwest Missouri-northeast Arkansas border, and almost 200 miles northeast of the site. This event coincides with the southern limit of the fault zone determined by Heyl and Brock, 1961, based on faulting evidence.

One other earthquake, farther south than the 1970 event, may possibly be associated with movement within the New Madrid fault zone. This 1955 event in northeastern Arkansas occurred along the trend established by Kisslinger and others, 1971. This maximum Intensity IV shock is the southernmost of any event occurring along the trend of the New Madrid fault zone as established by Kisslinger. It is over 160 miles from the site. Followill, in 1972, includes both the 1955 Arkansas event and the 1843 Memphis event (which is 180 miles from the site) within the limits of the New Madrid fault zone. All the above studies indicate that the New Madrid fault zone is over 150 miles from the ANO-2 site. It is conservative but reasonable to assume that the Maximum Earthquake for the Unit 2 site is another New Madrid earthquake occurring on the New Madrid fault zone at its closest approach (more than 150 miles) to the site. A study was made to estimate intensities that might be expected to occur at 150 miles from the epicenter.

Nuttli's isoseismal map indicates that 150 miles east of the Dec. 16, 1811 epicenter, intensities were VII-VIII. At Herculaneum, Mo., 150 miles northwest from the epicenter, Nuttli shows an intensity of only VI-VII. At St. Louis, almost 200 miles from the epicenter he indicates an intensity of VII-VIII, but some foundation conditions there are notably poor.

It is likely that intensities experienced to the east of the New Madrid earthquakes are not entirely representative of what might be expected to the west, toward the Unit 2 site. Most of the area to the east is in the Gulf Coastal Province, which contains a thick section of relatively unconsolidated material. To the west the area is part of the Ouachita Province which in general is underlain by more indurated material at a shallower depth than in the Gulf Coast Province. Consequently, it is likely that intensities 150 miles west of the "Maximum Earthquake" would be lower than Dr. Nuttli indicated as occurring 150 miles to the east of the 1811-1812 New Madrid earthquakes. Dr. Byerly supports this. As mentioned earlier, he has stated that he would estimate that the greatest intensity that could be expected at the site could be a high VI or low VII. Also, Dr. Algermissen, on his seismic Risk Map indicates an intensity of only V-VI was associated with the New Madrid earthquakes at 150 miles west of the epicentral area.

Isoseismal and attenuation data from several sources were considered. These included isoseismals by Nuttli, (February 1973) of the December 16, 1811 New Madrid earthquake (maximum Intensity X-XI); isoseismals for the November 8, 1968 south-central Illinois earthquake, maximum Intensity VII, prepared by Gordon, et al. (June, 1970); attenuation curves for eastern Canada prepared by Milne and Davenport (April 1969); and Weston Geophysical Engineer's attenuation curves for the Mississippi Valley area.

ARKANSAS NUCLEAR ONE
Unit 2

The above data indicate that an earthquake with epicentral Intensity X-XI at 150 miles, could be expected to cause an intensity at the site of low VII to a maximum of VII-VIII. The only exception to this are three VII-VIII intensities shown by Nuttli between 150 and 200 miles from the December 16, 1811 New Madrid earthquake. These anomalous intensities occurred at St. Louis, Missouri; Henderson, Kentucky and Nashville, Tennessee, all near major rivers and partially underlain by alluvium. St. Louis has some notably poor foundation conditions, as discussed elsewhere. These higher intensities may have been due to poor foundation conditions. Gordon's isoseismals clearly show lower attenuation at major rivers, presumably due to the alluvium and poorer foundations.

Foundations conditions at the Unit 2 site are certainly better than average conditions in the areas considered in the above described studies. An intensity of VII-VIII at the site, resulting from another New Madrid event 150 miles from the site, is a conservative value for the DBE based on the attenuation data described above.

It is conservative to assume that the "Maximum Earthquake" might result in Intensity VII-VIII at the site. Intensity VII-VIII on Neumann's curve corresponds to a maximum ground acceleration of slightly less than 0.20 g. The maximum earthquake for the site is therefore assumed, for design purposes, to result in a maximum ground acceleration of 0.20 g at the site. It is again stressed, that all Category 1 structures are founded on dense, unweathered bedrock. This acceleration is considered to be ample for design of the structures against postulated future seismic activity.

The site is in a region of gently folded sedimentary rocks of Paleozoic age. These rock units have been only slightly to moderately faulted, and the faults are probably related to the folding, which is pre-Cretaceous in age. In over 160 years of historical record, only three epicenters (all maximum Intensity V) have been located within 100 miles of the site, and none were closer than 50 miles. Recent investigations (Docekal, 1970) indicate that the October 22, 1882 epicenter (maximum Intensity VI-VII) previously shown about 50 miles from the site probably occurred near Bonham, Texas, or about 200 miles from the site.

No active faults are known to exist within 50 miles of the site, and there is no evidence of any seismically active zone near the site. Therefore, the possibility of an earthquake occurring sufficiently close to the site, and of sufficient intensity to cause ground accelerations greater than the DBE is apparently extremely remote.

2.5.2.9 Design Basis Earthquake

The DBE for vibratory ground motion, corresponds to a maximum ground acceleration of 0.20 g at the site. Figure 2.5-27 presents design spectra for the maximum vibratory acceleration of 0.20 g.

2.5.2.10 Operating Basis Earthquake

The OBE for the site is one-half of the DBE, or 0.10 g. Figure 2.5-28 shows the design spectra for the OBE.

2.5.3 SURFACE FAULTING

2.5.3.1 Geological Conditions of the Site

Regional and site geology are presented in Section 2.5.1 and shown on Figures 2.5-1 through 2.5-5. A map of the tectonic structures within 200 miles of the site is shown on Figure 2.5-6.

A literature study was made as part of the geologic evaluation of the Arkansas Nuclear One site to locate faults and other tectonic features that might be significant to the site. The following are descriptions of the faults evaluated as part of this study, with the conclusions drawn regarding their existence and importance to the site.

2.5.3.2 Evidence of Fault Offset

A number of inactive faults are mapped in the vicinity of the Arkansas River, particularly to the northwest and west of the site. These are primarily east-west trending, normal faults related to the broad anticlinal folds of the Arkansas Valley. Of these, the Prairie View and London faults (Figure 2.5-4) are the closest to the site. They are discussed below.

2.5.3.2.1 Prairie View Fault

The surface exposure of the Prairie View Fault closest to the site is approximately 12 miles west of the site, near Prairie View. It extends westward to a point about three miles northwest of Subiaco. Merewether and Haley (1961) projected the trace of this fault to a point about one mile southwest of Piney, six miles northwest from the site. This section of the fault trace is concealed by alluvial deposits along the Arkansas River. The Prairie Creek Fault is shown on the Arkansas state geologic map (1929) as a thrust fault. However, more recent work (Merewether and Haley, 1961) describes the fault as "a high angle north-dipping normal fault with the downthrown block on the north side." The maximum displacement along the fault is 350 feet, two miles west of the town of Prairies View (Haley, 1968). Near the western end of the fault the displacement is about 170 feet. The fault plane dips about 65 degrees north.

About three miles from the western end of the fault there is a small branch fault which is downthrown on the south side and is assumed to be dipping south. The Prairie View Fault follows an anticlinal axis (Prairie View anticline), and is similar to the faulted anticlines in the Fort Smith district discussed by Hendricks and Parks (1950). They state that the relationship between the compressional forces which caused the folding, and the displacement along the fault (downthrown side to the north) indicates contemporaneous folding and faulting. However, they also state that these faults may have formed as tensional faults at the time of the release of the compressional forces to the south. In either case, the last movement of these faults was prior to the Cretaceous, or over 135 million years ago.

2.5.3.2.2 London Fault

The London Fault is a primarily east-west trending zone which extends from Big Piney Creek on the west to about seven miles northeast of the town of London and about seven miles from the site. A number of smaller branch faults are associated with this fault zone. They occur to the northeast of the site (Figure 2.5-2) and extend to within about two and one-half miles of the site. The London Fault is a high angle south-dipping normal fault and is best exposed about eight miles northwest of the site at Big Piney Creek where the western part of the fault ends. At this locality the fault plane dips 58 degrees south and has an apparent displacement of about

ARKANSAS NUCLEAR ONE
Unit 2

20 feet. It is also exposed to the east along Flat Rock Creek and in a drainage ditch along a country road about eight miles from the site. An unnamed east-west trending fault lies about one mile south of the London Fault. The trend of this unnamed fault changes toward the east to generally southeast. It appears to intersect the London Fault in the vicinity of the north fork of Mill Creek (Haley, 1961). This fault is similar to the Prairie View Fault and is pre-Cretaceous in age.

In summary, the only faults within five miles of the site are the Prairie View Fault, and the London Fault and its branch faults. The closest fault is only a small branch fault and approaches within about two and one-half miles of the site. The last movement of these faults occurred prior to the Cretaceous.

2.5.3.3 Identification of Active Faults

As discussed in Section 2.5.3.2 above, the only faults within five miles of the site are the Prairie View and London Faults, neither of these has been active since Cretaceous time, or about 135 million years ago.

2.5.3.4 Earthquakes Associated with Active Faults

There are no earthquakes associated with faults within five miles of the site, and no active faults within five miles of the site.

2.5.3.5 Correlation of Epicenters with Active Faults

There are no active faults within five miles of the site.

2.5.3.6 Description of Active Faults

There are no active faults within five miles of the site.

2.5.3.7 Zone Requiring Detailed Fault Investigation

Recent work by Haley (1967), and Merewether and Haley (1961) for the Arkansas Geological Commission and the U.S. Geological Survey identify the faults in the vicinity of the site as pre-Cretaceous in age. There are no active faults within five miles of the site and no zones requiring detailed faulting investigation.

2.5.3.8 Results of Faulting Investigation

See Section 2.5.3.7. There are no active faults or fault zones requiring detailed investigation within five miles of the site.

2.5.3.9 Design Basis for Surface Faulting

There are no active faults within five miles of the site. Therefore, surface faulting is not a factor in the design of the Arkansas Nuclear One plant.

2.5.4 STABILITY OF SUBSURFACE MATERIALS

2.5.4.1 Geologic Features

Pennsylvanian rocks in the site area are in excess of 8,000 feet thick and consist primarily of shale and sandstone with some thin limestone horizons. There is no karstic or cavernous terrain in the area around the site, and geologic conditions necessary for their development do not exist at the site. No poorly consolidated or mineralogically unstable rocks occur at the plant site. No oil or other mineral extraction, or subsurface mining occurs or has occurred within three miles of the site. Natural gas production occurs in the area, but production is from well indurated rocks and subsidence is not a problem. It is therefore concluded that future subsurface subsidence is not a problem at the plant site.

A crustal movement map showing probable vertical movements of the Earth's surface was issued by the U.S. Commerce Department in August, 1972. The map does not show any movement within 150 miles of the site. However, they state that the blank areas simply mean there is not enough data to determine if they are being uplifted or subsiding. On the same map, the area of indicated movement closest to the site shows only slight regional uplift (1-5mm per year).

There are no shears, faults, or zones of crushed material in the rock which underlies the plant structures. The bedrock contains some joints and fractures, as does all rock to some degree. Some joints were encountered in the borings and noted during site foundation inspection, but these are not significant to site foundation conditions. Some crenulation of the bedding occurred when the rocks at the site were folded at the end of Paleozoic time. These crenulations occur in localized zones, and do not affect the site foundation. Rock at the site has been exposed at or near the surface since Cretaceous, over 135 million years ago, and shows no evidence of deformation since that time. Therefore, no unrelieved residual stresses should be expected to exist in the foundation rock and no evidence of unrelieved residual stress was observed during the exploration or excavation.

There are no rocks or soils at the site that are unstable because of mineralogy, lack of consolidation or water content, nor would any have potentially undesirable response to seismic events. Soils at the the site are hard clays and silty clays. There are no areas subject to liquefaction.

2.5.4.2 Properties of Underlying Materials

All Category 1 structures except the ECP inlet and outlet structures, electrical manholes, and the Condensate Storage Tank (T41B) pipe trenches are founded on competent unweathered bedrock. The properties of the bedrock materials are summarized in Table 2.5-2. Samples of rock core from the exploratory drilling were tested in the Bechtel Geologic Laboratory in San Francisco. Standard test procedures were followed, and the results of these tests are shown in Table 2.5-2. The lowest and highest unconfined compressive strength of the 45 samples tested are 2,420 psi (167 TSF) and 4,690 psi (338 TSF). The average is 3,460 psi or 249 TSF.

Minor slickensides along joint surfaces are not uncommon in shales, especially in a region where the rocks are very old and folding has occurred. No offsets were observed in drill holes, at foundation grade or anywhere in the site area. There are no soft, crushed or clayey materials associated with the slickensides. These slickensides are not considered to be significant to the stability of the foundations of any of the structures.

ARKANSAS NUCLEAR ONE
Unit 2

Where data on water levels observed during drilling are available, they are shown on the logs. The logs are shown on Figures 2.5-8 through 2.5-12.

Testing showed the specific gravity of the rock to be in the range of 2.51 to 2.67 with about 2.57 the average. Porosity varies from 2.0 percent to 7.81 percent with 5.9 percent about the average. Absorption ranges from 1.13 percent to 3.1 percent with an average of around 2.4 percent. The site seismic survey indicated P-wave velocities in the fresh rock to be from 10,000 to 14,500 fps. Results of this survey are shown on Figure 2.5-16. S-wave velocities were not measured in situ since the structures are founded on rock, but a value of 5,350 fps was calculated using a P-wave velocity of 10,000 fps and a Poisson's ratio of 0.30. The dynamic modulus of elasticity ranges from 2.8 (+6) psi to over 5 (+6) psi.

The engineering properties of the site soils are summarized in Table 2.5-3 and the soil properties used for design are summarized in Table 2.5-4. The data used to develop these tables are given in the Grubbs Consulting Engineering, Inc. reports of October 29, 1970 and July 21, 1972.

2.5.4.3 Plot Plan

The plot plan showing site exploration is attached as Figure 2.5-7. A geologic profile through the site showing foundation levels of Category 1 structures is shown as Figure 2.5-15. Site foundation materials are discussed in Section 2.5.1.2.5.

The locations of additional borings A23, and A126 through A132 which were inadvertently not shown earlier are now marked on Figures 2.5-7 and 2.5-14.

There are three borings (AH24, AH25 and A236) on the SW corner of the pond which are not within the pond but are within 200 feet to 300 feet of the edge of the pond. No further borings are considered necessary since the soil profile is uniform throughout the area. Soil samples have not been retained.

2.5.4.4 Excavations and Backfill

Plan and sections showing the extent of excavation and backfill at the plant site are shown in Figures 2.5-18 through 2.5-20. The compaction criteria for different categories of engineered backfill are given below.

- A. Embankment Fill/Select Backfill. Impervious material for embankments and backfill consisted of red silty or sandy clay (CH) from selected borrow areas. These materials were placed in 8-inch loose layers, moisture conditioned and compacted to 95 percent of maximum dry density as determined by ASTM Designation D 1557.
- B. Granular Backfill Material. Material classified as Granular Backfill Material was used for the following conditions.
 1. Beneath structural slabs on grade (95 percent compaction).
 2. Against exterior walls (90 percent compaction).
 3. Beneath footings and other foundations of Non-Category 1 structures which do not extend to firm rock (95 percent compaction).

ARKANSAS NUCLEAR ONE
Unit 2

Granular backfill material was placed in lifts not exceeding eight inches uncompacted thickness, moisture conditioned and compacted to the percent compaction specified above as determined by ASTM Designation D 1557, Method D. The limits of the granular backfill material are shown on Figure 2.5-20.

Granular backfill material did not contain more than 10 percent by weight of particles passing the No. 200 U.S. Standard Sieve. Tests were made on proposed material prior to backfilling to determine gradation, soundness and general suitability of material as granular backfill.

- A. Placing Random Backfill Material. Random backfill material was used only in non-critical areas outside the limits of structural backfill as indicated in Figure 2.5-20. Where used, random backfill was placed in lifts not exceeding eight inches uncompacted thickness, moisture conditioned and compacted to 90 percent of maximum dry density as determined by ASTM Designation D 1557, Method D.

Random backfill consisted of well graded material from plant excavation or trench excavation. The material contained no rocks having a dimension greater than six inches and it contained no organic or frozen material.

- B. Clay Blanket Material. Clay blanket material was impervious material, obtained from the required plant excavation and stockpiled for this purpose.
- C. Pipe Bedding. The bedding material was mechanically tamped, in lifts not exceeding eight inches uncompacted thickness for the depths indicated on the drawings, to 90 percent of maximum dry density determined by ASTM Test Designation D 1557.

After placing and compacting, the bedding material was carefully shaped to fit the bottom quadrant of the pipe so as to provide full even support to the pipe.

Bedding material was clean granular material, free of organic matter and of such gradation that at least 95 percent passed a one-half inch sieve, and no more than 15 percent by weight passed a No. 200 sieve when tested in accordance with ASTM Designation D 422.

2.5.4.5 Groundwater Conditions

Water levels in the site area range from elevation of 341 feet to 343 feet. These levels are about 10 feet below ground surface at the site and are about three feet higher than normal pool elevation in Dardanelle Reservoir. During construction of Unit 2, only small quantities of seepage were encountered. The water was removed as necessary with sump pumps. The natural groundwater regime will not be affected by plant operations.

The ECP, located about 1,200 feet northwest of the plant, is about 500 feet east of an embayment in Dardanelle Reservoir. Design of the pond is based on the consideration that seepage will raise the ground water level adjacent to the pond to the height of water in the pond, Elevation 347 feet. However, the low permeability of the foundation material precludes any large seepage losses, and any seepage that does develop (calculated to be 1.4 gpm) will migrate to the reservoir. Groundwater levels at the plant site will not be significantly affected. ECP level is carefully monitored as detailed in the Technical Specifications (Section 4.12).

ARKANSAS NUCLEAR ONE
Unit 2

A history of groundwater fluctuations at the plant site is not available since it was not required at the time the Unit 2 site study was performed. The design bases for hydrostatic loading on subsurface portions of safety-related structures are discussed in Sections 2.4.13 and 3.4.3.

2.5.4.6 Response of Soil and Rock to Dynamic Loading

The foundation rocks contain joints and fractures, as do essentially all rocks exposed at the earth's surface. However, these features should not be expected to affect the stability of the foundation rock during vibratory motion associated with the Design Basis Earthquake (DBE). The foundation loads are small in comparison to the rock's ultimate bearing capacity. There will not be loss of strength or stability of the foundation rock during vibratory motion. The soil at the site is not subject to liquefaction, and, therefore, response of the soil to dynamic loading was not evaluated.

2.5.4.7 Liquefaction Potential

All Category 1 structures except the ECP inlet and outlet structures, electrical manholes, and the Condensate Storage Tank (T41B) pipe trenches are founded on competent unweathered bedrock. The properties of the bedrock materials are summarized in Table 2.5-2.

2.5.4.8 Earthquake Design Basis

Site structures are designed for a DBE of 0.20g, and an Operating Basis Earthquake (OBE) of 0.10 g. The seismicity of the region and the basis for selection of these values are described in Section 2.5.2. The design spectra are shown on Figures 2.5-27 and 2.5-28. Foundation materials at the site were evaluated and their characteristics were considered with respect to the design spectra.

2.5.4.9 Static Analyses

All Category 1 structures except the ECP inlet and outlet structures, electrical manholes, and the Condensate Storage Tank (T41B) pipe trenches are founded on competent unweathered bedrock. The properties of the bedrock materials are summarized in Table 2.5-2. Tests were made in the laboratory to determine its unconfined compressive strength, static modulus of elasticity and Poisson's ratio. The lowest and highest unconfined compressive strengths of the 45 foundation rock core samples tested are 2,420 psi (167 TSF) and 4,690 psi (338 TSF), respectively. The average is about 3,460 psi or 249 TSF. The static modulus of elasticity measured from core samples ranges from 0.36(+6) psi to 1.0 (+6) psi and averages 0.7 (+6) psi. Poisson's ratio ranged from 0.24 to 0.34, averaging 0.30. Settlement of structures founded on rock will be slight and will occur almost simultaneously with imposition of the loads.

[See Section 2.8.1.2 for more information.](#)

2.5.4.10 Criteria and Design Methods

The results of laboratory tests on samples of the foundation rock are shown on Table 2.5-2. The results of the geophysical survey, made to evaluate the dynamic properties of the foundation rock, are shown in Figure 2.5-16. The unweathered bedrock, which is the foundation rock for the Category 1 structures at the site, has an average unconfined compressive strength of 249 TSF, or over 10 times as great as the loads to be imposed by the structures. The static modulus of elasticity averages 0.7 (+6) psi and the dynamic modulus ranges from 2.8 (+6) psi to over 5 (+6) psi. Design response spectra for the site are shown on Figures 2.5-27 and 2.5-28.

ARKANSAS NUCLEAR ONE
Unit 2

Grouted anchor bars were installed in the Unit 1 holdup tank vault foundation to prevent flotation at the time of probable maximum flood. Pull-out tests on No. 8 deformed reinforcing bars, extending four feet into unweathered rock, were conducted during Unit 1 construction to test the capacity of these anchors. The results of the pull-out tests are shown on Table 2.5-10. The pull-out tests exceeded the yield point of the bars with no evidence of failure.

The same method of slope stability analysis were used for both intake and discharge canal slopes (Figures 2.5-29 through 2.5-30). The stability of excavated slopes and embankment slopes were analyzed by the modified Swedish Slip Circle Method of Analysis, known as the "Method of Slices" (Corps of Engineer Manual EM 110-2-1902) for typical sections, in each case. For the intake and discharge canal slopes, the stability computation was done manually, whereas for the final stability analyses for the ECP slopes, Bechtel Computer Program CE533 (Bechtel, 1966) was used. Experience has shown (Skempton, 1964 and Bjerrum, 1967) that the shear strength of over-consolidated clays in excavations progressively reduces from its peak value to its residual value, hence residual shear strength parameters were used for stability analyses in all the cases. For both natural soil and recompacted soil, design shear strength parameters were selected based on consolidated drained direct shear test data as detailed in Section 2.5.5. In the ECP area, it was not possible to obtain undisturbed samples of the weathered shale and, therefore, shear strength parameters for this material were evaluated from plate load tests made in the field. The evaluation was based on the following equation by Mayerhof (1957):

$$q = c (N_{c_q}) = Y \left(\frac{B}{2} \right) N_{\gamma_q}$$

where:

q is the ultimate bearing capacity in psf.

c is cohesion in psf.

N_{c_q} and N_{γ_q} are bearing capacity factors.

B is the least width of footing in feet.

Y is the density of soil in pcf.

All slopes were evaluated under conditions of normal water level, rapid drawdown, and normal water level combined with earthquake loading. The earthquake ground acceleration used was 0.2g. For further details on evaluation of the design strength parameters, method of analyses and computed factors of safety see Section 2.5.5.

The over-consolidated clay at this site is not susceptible to liquefaction.

2.5.4.11 Techniques to Improve Subsurface Conditions

All Category 1 structures except the ECP inlet and outlet structures, electrical manholes, and the Condensate Storage Tank (T41B) pipe trenches are founded on competent unweathered bedrock. The properties of the bedrock materials are summarized in Table 2.5-2.

In the ECP area, the weathered rock surface, wherever exposed, was covered with a blanket of impervious fill to reduce seepage losses.

2.5.5 SLOPE STABILITY

2.5.5.1 Slope Characteristics

Intake and Discharge Canal Slopes - The overburden soils at this site are mainly stiff highly plastic clays. At the intake canal about 13 to 25 feet of clay overlies the weathered bedrock. Along the discharge canal it is 22 to 25 feet deep. The underlying bedrock is hard and consists of dense shale with about two to five feet of weathered shale. Typical sections of the slopes are shown on Figure 2.5-29.

Emergency Cooling Pond Slopes - The location of the pond, which is a Category 1 facility, is shown on Figure 2.5-17. Typical sections of the slopes are shown on Figure 2.5-21. The pond exploration holes show that the depth to sound bedrock varies from about 10 to 22 feet below the present ground surface. The results of permeability tests made on remolded samples of weathered shale indicated a permeability coefficient of $4.2(-6)$ cm/sec which is rather low. However, the influence of fissures or joints in the original material is not reflected in the remolded samples. Consequently, to ensure against seepage loss, an impervious blanket is provided at the bottom and on the side slopes of the pond. During construction no pervious layers were visible above the weathered rock surface layer. The pond slopes were later grassed to stabilize them against erosion.

The pond involves primarily shallow excavation in overburden. A limited height of embankment was required in certain sections to provide for necessary freeboard as discussed in Section 9.2.5.2.1. The impervious material used for the fill was obtained from required excavation and selected borrow material. The fill properties are discussed in Section 2.5.4.4 and shown in Tables 2.5-6 and 2.5-7 as well as in Figure 2.5-31 of Section 2.5.5.2.1. The material consisted of red silty or sandy clay free of gravel, cobbles, boulders or pockets of silt, sand or other non-plastic material. The side slopes adjacent to the spillway are protected with riprap as discussed in detail in Section 9.2.5.2.1.

2.5.5.2 Design Criteria and Analyses of Slopes

Since the soils at the site consist of overconsolidated clay, the residual shear strength and not the peak strength of the soil was considered in selecting the design shear strength parameters. The reason being that relief of pressure resulting from excavation, results in swelling and a progressive reduction in the shear strength of the soil. Experience has shown (References 8 and 9) that, in time, the soil strength reduces from the peak to its residual value. Based on the results of consolidated drained direct shear tests on undisturbed samples, the following shear strength parameters were adopted for design:

$$S = 200 + P(\tan 23 \text{ degrees})$$

where

S = the residual shear strength of the soil in psf

P = the normal stress on the failure plane, in psf

The results of the tests and the design strength envelope are shown on Figure 2.5-22. Other engineering properties used in the analyses are tabulated in Table 2.5-3.

ARKANSAS NUCLEAR ONE
Unit 2

The stability analyses for the intake and discharge canal slopes and for the original ECP slopes were made in accordance with the modified Swedish Slip Circle method of analysis, known as "The Method of Slices." The earth pressures on the sides of the slices were neglected. The earthquake load used in the analysis was the Design Basis Earthquake (DBE). The effect of this load was introduced into the analysis as a static horizontal load equivalent to the DBE acceleration of 0.2g times the mass of soil and water. The load was applied at the center of gravity of the soil mass under investigation. All slopes were evaluated under conditions of normal water level, rapid drawdown, and normal water level combined with earthquake loading.

For the slopes added with construction of the reinforced concrete spillway for the ECP, the stability analyses were made in accordance with the Simplified Bishop Method, the Simplified Janbu Method, and the Spencer Method. These methods are also part of the family of "The Method of Slices," and provide equivalent or conservative results compared to the Modified Swedish Method (see Army Corps of Engineers, "Slope Stability," EM 1110-2-1902, 2003). For the seismic analysis of these added embankment slopes, the equivalent seismic DBE acceleration of 0.355g was used, which was obtained from an updated soil-structure interaction analysis. The same load conditions as used for the original ECP slopes were used for the analysis of these added embankments. Laboratory test results were used for the shear strength properties for the clay for the new embankments, with all other soil shear strength properties the same as for the original embankments.

The varying depth to bedrock below the bottom of the ECP was considered in the stability analysis of these slopes.

The results of the stability analyses made for the intake and discharge canal slopes are tabulated in Table 2.5-11 and the location of the critical slip surfaces are shown in Figure 2.5-29.

For the ECP slopes, two general slope conditions were analyzed. These were for slopes which are entirely in overburden soil and for slopes which are partly in soil and partly in weathered shale.

The results of long-term stability analysis of the ECP slopes in clay under different loading conditions are summarized in Table 2.5-5a for those slopes that are entirely in overburden. Graphic presentation of the test data and typical sections of the pond are shown in Figures 2.5-30, 2.5-31, 2.5-37, 2.5-47, and 2.5-49 through 2.5-54 and discussed in Section 2.5.5.2.1.

Based on this study, the ECP slopes were safely excavated to two and one-half horizontal to one vertical.

The results of long-term stability analysis of these embankment slopes, which have an impervious blanket to prevent seepage through joints in the weathered shale, are shown in Table 2.5-5b. Three cases were analyzed.

These were full reservoir at Elevation 347 feet with DBE seismic loading; minimum reservoir at Elevation 342.5 feet DBE seismic loading and groundwater table at Elevation 347 feet; and rapid drawdown to Elevation 341 feet from Elevation 347 feet. It should be noted that drawdown to Elevation 341 feet is considered for slope stability only. The soil properties used in the analysis are given in Table 2.5-3. The sections analyzed are discussed in Section 2.5.5.2.1. The results of the analysis are given in Table 2.5-5b.

ARKANSAS NUCLEAR ONE
Unit 2

The strength tests were not done in accordance with Appendix IXA of the U. S. Army Engineer Manual 1110-2-1906, dated November 1970. The use of residual shear strength tests of this type appear to be unduly conservative for cuts in clay having a height of 11 feet and where no previous history of sliding is recorded. The pond is excavated in natural soils with the normal water surface at Elevation 347 feet, which is below the surrounding ground level. Therefore, failure of a clay slope would not result in release of water from the pond.

Conventional stability analyses have been made using peak strength values for the condition of pond water surface at Elevation 347 feet combined with an earthquake acceleration of 0.2g (DBE). This is the most critical condition. Using a pseudostatic analysis and peak strength values, factors of safety were obtained and are presented in Table 2.5-5c.

2.5.5.2.1 Soil Sampling and Testing to Determine Strength Properties of Compacted Clays and in situ Weathered Shale

The following is a report of a soil testing program designed to provide information concerning the strength properties of compacted clay and in situ weathered shale for stability analyses of slopes in an ECP at Arkansas Nuclear One near Russellville, Arkansas. It was understood that the clays investigated in borrow pit studies may be used for blanketing portions of the sides and bottom of the reservoir. The in situ weathered shale stratum was investigated to enable a more complete stability analysis of the reservoir sideslope design. The study was conducted by Grubbs Consulting Engineers, Inc. and submitted to Bechtel Corp. on July 21, 1972.

In order to establish the strength properties requested, a program consisting of the following phases was adopted:

- A. A field investigation wherein disturbed samples of potential borrow area soils were obtained from test pits;
- B. A series of field plate load tests performed on weathered shale in the cooling reservoir area;
- C. A laboratory testing program designed to establish properties and residual strengths of representative remolded clay samples; and,
- D. The preparation of an engineering report with analysis of field and laboratory data and resulting residual strength parameters.

2.5.5.2.1.1 Field Investigations

2.5.5.2.1.1.1 Borrow Areas

Several spoil areas containing soil and rock removed from construction of other structural units at the site were under consideration for use as blanket material. Representative samples were obtained at random in several of these potential borrow areas. A total of nine test pits located as shown on Figure 2.5-31 were utilized to obtain disturbed samples of material for classification and strength studies. The test pits varied in depth from six to 10 feet and were generally terminated when an appreciable thickness of shale material was encountered or the percentage of shale fragments in the cohesive soils increased significantly.

ARKANSAS NUCLEAR ONE
Unit 2

Processes used to dry or wet the clay backfill were as follows:

- A. Material found to contain too high water content was loosened by a roto disc and allowed to dry until material could be compacted to required density.
- B. Material found to be too dry was loosened as required and sprinkled by a water wagon. After absorption the material was transported and/or compacted in place.

Descriptions of the various soils encountered in the test pits and some laboratory test results are presented on the test pit logs, Figures 2.5-32 through 2.5-36. With the exception of Test Pit 5, all test pits were located in existing spoil areas. In general, the spoil materials in the area of Test Pits 1 through 4 consisted of 4 to 8.5 feet of tan and gray with some red, silty clay and varying percentages of shale and weathered shale fragments. The thickness of clay decreased toward the north end of the spoil area. The material encountered in Test Pits 6 and 7 consisted of eight to 10 feet of red and gray with some tan clay with some weathered shale in the upper 1.5 feet. The silty clay soils in Test Pits 8 and 9 contained considerable shaley material overlying weathered shale spoil.

Visual inspection of borrow areas and evaluation of in-place compaction tests were used to ensure the exclusion of shale from backfill.

2.5.5.2.1.1.2 Plate Load Test Areas

At the time of this study, excavation of the cooling water reservoir was in progress and large areas of the weathered shale had been removed prior to selecting load test areas. Due to this fact, only a small unexposed area of the weathered shale in question remained to be removed, and it was necessary to locate the four tests in a relatively small portion of the total reservoir floor, as shown in Figure 2.5-37. Since the testing procedure provided for the use of construction equipment as reaction load for the jacking system in the plate load tests, the maximum reaction load was limited to 50,000 to 60,000 pounds. Consequently, to ensure that a failure could be achieved, test pits were excavated with a prepared slope on one end and load applied to a plate positioned at the top of the slope. Using this system, analysis of the failure could be performed using the Meyerhof Method of Analysis of Footings on Top of Inclined Slopes as discussed in "The Ultimate Bearing Capacity of Foundations on Slopes," Meyerhof, Proceedings Fourth International Conference on Soil Mechanics and Foundation Engineering, Vol. 1, pp. 384-86, London, 1957.

The test pits for the 4-plate load tests were prepared by excavating completely through the weathered shale zone and establishing a known slope on one end of the pit. The thickness of the weathered shale in the load test pit varied from 2.5 to 4.5 feet. A test pit width of at least three times the length of the load plate was utilized to reduce the effects of adjacent continuing pressures on test results. The slopes established varied from 2 to 1 for Tests 1 and 3, 1.75 to 1 for Test 2, and 2.5 to 1 in Test 4. In general, the weathered shale encountered in the plate load areas was fractured and jointed with numerous light gray and tan clay seams, partings and pockets. Occasionally more resistant shale inclusions of irregular dimension were noted, particularly in the excavation for Test Pit 4.

Plate load tests were performed on the weathered shale by applying a compressive load to a steel plate with either a 1 ft² or a 0.5 ft² contact area. In each of the tests, the load was applied through a hydraulic jack and gauge system in increments and deflections recorded from two or three dial indicators (Ames, reading to 0.001 inch) in contact with the load plate. A typical load

ARKANSAS NUCLEAR ONE
Unit 2

test arrangement is shown on Figure 2.5-38. A copy of load test data and load system calibration is included in Section 2.5.5.3.1. All load test were continued until a well-defined shear failure developed in the weathered shale stratum. The general configuration of the failure surfaces for the tests are shown on Figure 2.5-47. Results and analyses of the load tests are presented in subsequent sections of this report.

2.5.5.2.1.2 Laboratory Testing

The laboratory testing program conducted in this study was designed to establish the suitability of possible borrow area soils for use as the compacted clay blanket and to establish residual strength parameters for remolded specimens of two suitable blanket soils. A brief discussion of the procedures and results of shear strength and supplementary tests are presented below.

The classification of soils obtained from the adjacent borrow pits and in the cooling reservoir area were established by performing six Atterberg limit tests and six sieve analyses through the No. 200 sieve. On the basis of classification data, the two most suitable borrow areas were selected and the maximum dry density and optimum moisture content for these soils were determined using the Modified Compaction Procedures (ASTM D 1557). Moisture-density curves are shown on Figure 2.5-40. Soil classification data is summarized on Figure 2.5-41, and portions of the data are tabulated on the test pit logs. Based on the moisture-density criteria established in the compaction tests, one sample was prepared for each of the test pit soils at a minimum of 95 percent of maximum dry density to provide for direct shear test specimens. Three shear test specimens were carved from each of the larger compacted clay samples for residual direct shear testing.

The residual strength parameters requested required the performance of consolidated-drained direct shear tests on the six specimens. The direct shear procedure utilized provided for the placement of the 1-inch high, 2.5-inch O.D. specimen in the split brass shear ring with porous stones on the top and bottom to allow drainage. The split ring was then placed in the direct shear device, inundated, and a normal load applied. The rate of strain used was 0.001-inch per minute. The specimen had achieved essentially 100 percent primary consolidation under the applied normal load when zero movement of the vertical gauge occurred after a minimum period of 24 hours. Horizontal shearing force was applied as required to pass the peak strength and reach sufficient displacement to produce a residual strength condition (approximately 0.25 inch). The shear ring was pushed back to the original position, sheared again, and the process repeated until the strength of the clay obtained a constant residual value. The rate of strain was maintained at sufficiently low magnitude to ensure that no excess pore pressure developed during shear. This procedure was repeated for the three test specimens from each of the selected borrow area soils. Normal pressures of 0.4, 0.8, and 1.2 tons per square foot were used in the 3-specimen test series. Residual shear strength parameters established and other pertinent test data are presented graphically in Figure 2.5-42. No test data are available to check the degree of saturation attained at the end of the test.

2.5.5.2.1.3 Analysis and Conclusions

2.5.5.2.1.3.1 Compacted Clay

Results of the Modified Compaction Tests and residual direct shear tests performed on soils sampled from Test Pits 1 and 7 are summarized below:

ARKANSAS NUCLEAR ONE
Unit 2

<u>Test Pit</u>	<u>Depth</u>	<u>Sample Y Dry</u>	<u>W. C., %</u>	<u>% of Max. Y Dry</u>	<u>Residual Strength</u>	
					<u>Cohesion, tsf</u>	<u>φ, Degrees</u>
1	0-4	113.2	17.8	96	0.08	25.5
7	0-4	107.4	19.6	96	0	29.0

Based on classification data and visual inspection of the test pits, it appears that the clay soils (CH, according to the Unified System) encountered in Test Pits 6 and 7 would be satisfactory for use in the compacted clay blanked required for the cooling water storage reservoir. The lateral extent of the CH soils encountered in the two pits is approximated by the shaded areas shown in Figure 2.5-31. It should be noted that discussions with project personnel indicate that the spoil materials were deposited in the areas investigated in a random pattern and considerable variation in soil properties should be anticipated.

At the time of the investigation, additional spoil was being placed in the area containing Test Pits 1 through 4, and an attempt was being made to separate the clay and weathered shale materials for possible future use. As a result, portions of the area recently deposited should exhibit more uniform soil characteristics. Even so, field density control criteria may require frequent revision during placement.

2.5.5.2.1.3.2 Load Tests in Weathered Shale

Load displacement curves were prepared from plate load test data collected in the four tests and are presented as Figures 2.5-43 through 2.5-45. As shown on the curves for Tests 1 and 2, failure developed in the shale following the instantaneous application of a load increment. The instantaneous load increases resulted from the method of load application, a condition which was alleviated in Tests 3 and 4. However, since the load was maintained in Tests 1 and 2 for a significant period after the load was applied, it is felt that the results are representative of the shear strength inherent to the weathered shale tested. Load Tests 3 and 4 were performed in general accordance with ASTM D 1194-57 criteria, with the exception of the items noted in Section 2.5.5.3.1.

Since the point of failure is clearly established on the load curves, these values were utilized in developing shear strength parameters from Meyerhof's Method of Analysis of Footings on Top of Inclined Slopes as discussed in the previously cited Proceedings of the Fourth International Conference on Soil Mechanics and Foundation Engineering.

Failure loads determined from the tests are as follows:

<u>Load Test No.</u>	<u>Failure Load, ksf</u>
1	21.5
2	14.0
3	24.0
4	20.0

Four plate load tests were made of which only one, Test 4, had a substantial drop in strength after the peak pressure was reached. This residual pressure was 16 KSF. However, the lowest pressure was recorded in Test 2 as 14 KSF and it was selected to develop the design shear strength parameters.

ARKANSAS NUCLEAR ONE
Unit 2

Using the failure loads noted in the formula $q = c(N_{cq}) + Y \left(\frac{B}{2} \right) N_{Yq}$ from the referenced source, analyses of Load Tests 1, 2, and 3 were performed for two conditions: $c = 0$ and $\phi = 0$. These analyses indicate that the $\phi = 0$ condition is most representative of the test results. Cohesion values determined are summarized in the following table. The cohesion value for Load Test 4 was determined using Meyerhof's Formula for the Ultimate Bearing Capacity of a Shallow Rectangular Footing in Cohesive Soil. It should be noted that the failures produced in all load tests resulted from a combination of crushing of the shale directly beneath the plate and a generally horizontal shearing along a clay parting or seam. Cohesion values established are considered to be representative of the average minimum strength of the weathered shale zone.

<u>Load Test</u>	<u>Description of Soil and Failure Surface</u>	<u>Slope Angle, β</u>	<u>Computed c, psf, (From Meyerhof)</u>
1	Gray and tan, weathered shale, horizontal, thin bedding	26.5	4,300
2	Gray and tan, weathered shale, soft, light gray clay seams along base of failure	30	2,690
3	Gray and tan, weathered shale with some light gray, clay partings	26.5	5,100
4	Failure occurred through light gray clay parting	22*	3,570

*Failure did not occur downslope. See Figure 2.5-47 for shape of failure.

2.5.5.2.2 Emergency Cooling Pond Stability Analysis

Stability analyses were carried out on a typical section of the emergency cooling pond slopes using Bechtel Program CE-533, a modification of the Method of Slices. (Stability of Earth and Rockfill Dams, Corps of Engineers, Civil Works Engineering Manual, EM 1110-2-1902.) To evaluate the stability of the slopes under seismic conditions, an equivalent horizontal static force equal to the maximum design ground acceleration times the weight of the soil and water in each slice was added and the same method was again used. These analyses were conducted by Bechtel Inc. and the results presented in August 1972.

The cross section and soil properties used in the analysis were chosen to represent the worst possible conditions. Figures 2.5-51, -52 and -53 show the sections analyzed and the soil properties used.

From the 4-plate load test results, the lowest recorded value, Test 2, was used from computing the shear strength parameters of weathered shale from design. The load deformation curve did not indicate a reduction of strength after the peak load had been reached. The only test in which a significant change in strength was indicated, was Test 4. But the residual strength was higher than in Test 2.

For the cooling pond stability analyses, the residual shear strength parameters were used for fill material. For weathered shale also, the shear strength parameters were computed from the lowest test results obtained from four field plate load tests.

ARKANSAS NUCLEAR ONE
Unit 2

The parameters used in the study are summarized below.

<u>Material</u>	<u>Properties</u>	<u>Source</u>
Clay Blanket	Saturated Unit Weight - 130 pcf Angle of Internal Friction - 25 degrees Cohesion - 100 psf	Results from study by Grubbs
Weathered Shale	Saturated Unit Weight - 145 pcf Angle of Internal Friction - 0 degrees Cohesion - 2,700 psf	Assumed Study by Grubbs
Filter	Saturated Unit Weight - 130 pcf Angle of Internal Friction - 35 degrees Cohesion - 0 psf	Assumed

The minimum acceptable factors of safety under the conditions analyzed were as follows.

<u>Case</u>	<u>Required Condition</u>	<u>Factor of Safety</u>
I	Full Reservoir with Earthquake	1.1
II	Rapid Drawdown with no Earthquake	1.25
III	Minimum Reservoir Level with Earthquake	1.1

RESULTS

Stability analyses as described previously showed all three cases had an adequate factor of safety. The results are summarized below.

<u>Case</u>	<u>Condition</u>	<u>Factor of Safety</u>
I	Full Reservoir with Earthquake	1.4
II	Rapid Drawdown with no Earthquake	2.3
III	Minimum Reservoir Level with Earthquake	1.3

For the highly plastic clay and over-consolidated shale with low confining pressure, long-term stability is ensured by adopting conservative residual shear strength parameters. For these types of soil, no further reduction in strength will occur during transient loading, like the DBE.

In all cases, the critical circles passed through the upper portion of the clay blanket into the filter material and out at the toe.

ARKANSAS NUCLEAR ONE
Unit 2

Groundwater Table

For stability analysis, under full reservoir conditions, the groundwater table has been conservatively assumed to be the same as the full reservoir elevation of 347 feet. However, in reality, this shallow pond in shale, protected with an impervious blanket of two feet of clay, will not cause any significant change in the pre-existing groundwater table conditions. Please refer also to Section 2.4.

The phreatic lines are shown on Figures 2.5-51, -52, -53, and -54. Since the earlier assumptions of phreatic lines resulted in more conservative factors of safety, no reanalysis is required due to the change in the phreatic lines referred above.

Results of the direct shear tests are shown on Figures 2.5-55 through 2.5-62. The results are presented as a plot of accumulated strain in inches versus shearing stress in tons per square foot for each confining pressure and as a plot of normal stress versus shear stress for peak and residual stress.

The containment is founded on competent unweathered bedrock. The sand lens, which was shown at seven to 11 feet in Drill Hole 201, was sand which was stockpiled in that area during Unit 1 construction work and was removed during construction of Unit 2. The ECP is located on weathered, jointed shale, and no sand lenses were encountered, hence the problem of liquefaction during DBE will not arise.

Clay seams (six inches thick) were encountered in only one drill hole (DH-201) in the Unit 2 reactor areas, at depths of 77.4 and 92.5 feet. They were confined within hard, massive shale. They will have no influence on the performance of the structure, hence no tests were conducted.

2.5.5.3 Logs of Core Borings

The locations of exploratory holes within the ECP and its vicinity are shown on Figure 2.5-7 and the log of soil borings are discussed in Sections 2.5.5.2.1 and 2.5.5.3.1. Surface elevation, depth and bedrock elevations for borings within the emergency cooling pond and its vicinity are summarized in Table 2.5-1. Soil properties are shown in Table 2.5-3 and properties to be used for design are given in Table 2.5-4.

2.5.5.3.1 Soil Samples' Laboratory Test Results

The following is a tabulation outlining the samples and test made by Grubbs Consulting Engineers, Inc. for Bechtel Corp. on October 29, 1970.

<u>Hole No.</u>	<u>Sample Depth (ft)</u>	<u>Classification Tests</u>	<u>Strength Tests</u>
223	10.5-11.0	X	
224	11.0-11.5	X	X
225	10.5-11.0	X	
228	9.0-9.5	X	X
230	9.5-10.0	X	
232	15.5-16.0	X	X
234	15.5-16.0	X	X
234	20.5-21.0	X	
236	10.5-11.0	X	

ARKANSAS NUCLEAR ONE
Unit 2

2.5.5.3.2 Test Procedures

The liquid, plastic and shrinkage limits and moisture contents were determined using standard ASTM Laboratory Procedures. The unit weight was determined using water displacement methods in which the sample is weighted and submerged in water. The weight and volume of liquid displaced was used to determine the sample volume. The results of the classification tests are presented in tabular form on Table 2.5-12.

Appropriate ASTM designations for the tests are given below:

- D423 - Liquid Limit of Soils
- D424 - Plastic Limit and Plasticity Index of Soil
- D427 - Shrinkage Factors of Soils
- D2216 - Laboratory Determination of Moisture Content of Soil

The strength tests performed were the consolidated-drained direct shear test carried to a sufficient magnitude of strain to define the residual strengths. Each specimen was tested at 0.5, one and two tons per square feet confining pressure. In performing the test, a 1-inch high, 2.5-inch diameter specimen was placed in a split ring shear apparatus and allowed to saturate and consolidate under the specified confining pressure. The sample was then sheared repeatedly until a stabilized maximum shear resistance was reached. A separate specimen was used for each confining pressure. The sample which was tested from Boring 234 was large enough to obtain only two specimens for the direct shear test. Therefore, results are shown only for two confining pressures: 0.5 tsf and 1.0 tsf.

The direct shear apparatus used was a standard motorized direct shear apparatus manufactured by Soil Test, Inc., U.S.A. The direct shear apparatus has a shear box which is divided horizontally into two halves. A box contained the test specimen which was subjected to a constant normal load through a counter balance load hanger system. Loading for the shearing was accomplished at a predetermined strain rate by means of an electric transmission unit operating through a gear system. The horizontal and vertical displacements were measured by dial indicator gauges reading to 0.001 inch. The test specimens were 1-inch high and 2.5 inches in diameter.

The test specimen was placed in the shear box and the selected normal load was applied. The box was then filled with water and left overnight for a minimum period of 24 hours. The normal load was varied from 0.5 TSF to 2.0 TSF according to the pressure selected for the particular test. The vertical deflection dial was observed to ascertain when consolidation was completed.

The test method used to obtain the shearing stress results shown on Figure 2.5-62 was obtained by following the procedure given in "Soil Testing for Engineers" by T.W. Lambe, pages 138 to 146. Each specimen was sheared slowly using a strain rate 0.001 inch/min. During the tests, vertical and horizontal movements were recorded by dial gauges reading to 0.001 inch. Proving ring readings were taken to obtain the shearing load applied and from the maximum proving ring readings the peak shear strength was calculated.

ARKANSAS NUCLEAR ONE
Unit 2

To obtain residual shear strength, shearing was continued until a consistent shear strength value was obtained. The shear ring was pushed back to the original position, sheared again, and the process repeated until the strength of the clay attained a constant residual value. The same process, as detailed above, was repeated for peak and residual shear strengths at other confining pressures. The shearing strength vs. accumulated strain plot in Figure 2.5-55 provides the peak and residual shear strength and the corresponding strain. From the plot in Figure 2.5-56, the peak and the residual shear strength parameters c' and ϕ' are obtained.

2.5.5.4 Compaction Criteria

Maximum dry density and the optimum water content of soil samples from the prospective borrow pits were determined in the laboratory in accordance with ASTM Designation D1557. Based on the moisture-density criteria established in the compaction tests, samples for consolidated-drained direct shear tests were compacted to 95 percent of the maximum dry density achieved in accordance with ASTM D1557. The design strength parameters for stability analyses were developed from the consolidated-drained direct shear strength tests referred to above. Based on the above laboratory test data, it was specified that embankment material should be placed in 8-inch loose lifts, moisture conditioned and compacted to 95 percent of the maximum dry density as determined in accordance with ASTM Test Designation D1557. The impervious material for embankment and the blanket consisted of red silty or sandy clay from selected borrow areas (Section 2.5.5.2.1).

2.5.5.5 Lateral Earth Pressure

The earth pressure diagrams were constructed following the basic principles outlined in "Soil Mechanics in Engineering Practice" by Terzaghi & Peak, 2nd Ed., Chapter 5, pages 184 to 216, with wall friction considered to be zero.

According to Prof. H.B. Seed, the dynamic increment for structures founded on rock will be about three times the dynamic increment obtained from the Mononobe-Okabe procedure. It therefore will be:

$$\Delta P_{\text{dyn}} = 9/8 Y H^2 K_h$$

where

Y = the unit weight of the soil

H = the depth of soil above bed rock

K_h = the horizontal earthquake acceleration due to gravity

This force is applied as a triangular distribution with the maximum load applied at ground level and tapering to zero at bedrock (or bottom of structure).

The earth pressures developed during the response of structures to DBE are based on the Mononobe-Okabe case described above.

[See Section 2.8.1.2 for more information.](#)

ARKANSAS NUCLEAR ONE
Unit 2

2.6 REFERENCES

1. Analysis and Management of a Pipeline Safety Information System, University of Oklahoma Office of Research Administration (Final Report, October 1974) DOT-OS-30110.
2. Fifth Annual Report of the Secretary of Transportation on the Administration of the Natural Gas Pipeline Safety Act of 1968, Calendar Year 1972.
3. Sixth Annual Report of the Secretary of Transportation on the Administration of the Natural Gas Pipeline Safety Act of 1968, Calendar Year 1973.
4. Arkansas Geological and Conservation Commission, "Mineral Resources of Arkansas," Arkansas Geological and Conservation, Bulletin 6, 1959.
5. Bechtel Computer Program No. CE533, "Slope Stability Analysis," November 18, 1959.
6. Bedinger, MS., et al., 1963, "Groundwater Potential of the Alluvium of the Arkansas River Between Little Rock and Fort Smith, Arkansas," U.S. Geol. Survey Water, Supply Paper 1669-L, 29 pp.
7. Bicker, A.R., Jr., East-West Cross Section Tishomingo County to Tunica County Mississippi, Mississippi Geol. Survey, Jackson, Miss., 1974.
8. Bjerrum, Laurits, "Progressive Failure in Slopes of Overconsolidated Plastic Clay Shales," Journal of the Solid Mechanics Division, Proc. ASCE, September, 1967.
9. Bond, D.C., et al., "Possible Future Petroleum Potential of Region 9 - Illinois Basin, Cincinnati Arch, and Northern Mississippi Embayment in Future Petroleum Provinces of the United States - Their Geology and Potential," Am. Assoc. Petroleum Geologists, Memoir 15, pp. 1165-1218, 1971.
10. Bradbury, John, Early Western Travel, Cleveland, Vol. 5, pp. 204-210, 1904.
11. Branner, G.C., "An Outline of the Physical Features of Arkansas," Arkansas Geological Survey Pub. 1, 1927.
12. Brassie & Simpson, "Guidelines for Estimating Explosion," Loss Prevention, AIChE, Volume 2, 1968, p. 96.
13. Bristol, H.M., and Buschback, T.C., "Structural Features of the Eastern Interior Region of the United States." In Illinois State Geological Survey, "Background Materials for Symposium on Future Petroleum Potential of NPS Region 9 (Illinois Basin, Cincinnati Arch, and Northern Part of Mississippi Embayment) Champaign, Illinois, March 11-2, 1971," Ill. State Geol. Survey, 111. Petrol. 96, pp. 21-28, 1971. ² Boswell, W.H., et al., "Cretaceous Aquifers in the Mississippi Embayment", U.S., Geol. Survey Prof. Paper 448-C, 37 p., 1965.
14. Broadhead, G.C., "The New Madrid Earthquake," American Geologist, Vol. 30, August 1902.

ARKANSAS NUCLEAR ONE
Unit 2

15. Caplan, W.M., "Subsurface Geology of Northwestern Arkansas," Arkansas Geological and Conservation Commission Information Circular No. 19, 1957.
16. Caplan, W.M., "Subsurface Geology of Pre-Everton Rocks in Northern Arkansas," Arkansas Geological and Conservation Commission Information Circular No. 21, 1960.
17. Caplan, W.M., "Subsurface Geology and Related Oil and Gas Possibilities of Northeastern Arkansas," Arkansas Resources and Development Commission, Division of Geology, Bulletin 20, 1954.
18. Clarke, Blake, "America's Greatest Earthquake," Shreveport Magazine, March 1969.
19. Collier, A.J., "The Arkansas Coal Field," USGS Bull. 316, p. 138-141, 1906.
20. Collier, A.M., "The Arkansas Coal Field, with Reports on the Paleontology by David White and G.H. Girty," U.S. Geological Survey Bulletin 326, 1907.
21. Criner, J.H., Sun, P.C., and Nyman, D.J., "Hydrology of Aquifer Systems in the Memphis Area, Tennessee," U.S. Geol. Survey Water- Supply Paper 1779-0, 54 pp., 1964.
22. Croenius, Carey, "Geology of the Arkansas Paleozoic Area," Arkansas Geological Survey Bulletin 3, 1930.
23. Corps of Engineers request dated Dec. 20, 1948, PMP forwarded to Little Rock District with endorsement of office of Chief of Engineers dated 15 March 1949.
24. Corps of Engineers, Stability of Earth and Rock-Fill Dams, Civil Works Engineering Manual EM-1110-2-1902, April 1, 1970.
25. Cushing, E.M., Boswell, E.H., and Hosman, R.L., "General Geology of the Mississippi Embayment," U.S. Geological Survey Prof. Paper 448-B, 1964.
26. Design Manual: NAVFAC DM-7" Soil Mechanics, Foundations and Earth Structures, Dept. Of the Navy Bureau of Yards and Docks, Washington, D.C., 1971.
27. Design Memorandum No. 1, "Hydrological and Hydraulic Analyses," Part 1, Design Discharges for Dardanelle Dam, Corps of Engineers, June 1956.
28. E.S.S.A., Hypocenter Data Cards, January 1968 - December 1969.
29. Fisk, H.N., "Geological Investigations of the Alluvial Valley of the Lower Mississippi River," Mississippi River Commission, Vicksburg, Miss., 1944.
30. Followill, F.F., Personal Communication, 1972.
31. Fuller, M.L., "The New Madrid Earthquake," U.S. Geological Survey Bulletin 494, p. 115, 1912.
32. Geological Survey of Arkansas, Geologic Map of Arkansas, 1929, reprinted 1949.
33. Glasstone, S., Ed., The Effects of Nuclear Weapons, AEC, 1964.

ARKANSAS NUCLEAR ONE
Unit 2

34. Goddard, E.N., compiler, Geologic Map of North America, U.S.G.S. Map, 1965.
35. Halberg, H.N., "Use of Water in Arkansas, 1970" Arkansas Geol. Comm. Water Resources Summary 7, 1972, 17 pp.
36. Haley, B.R., "Coal Resources of Arkansas, 1954," U.S.G.S. Bulletin 1072-P, pp 795-831, 1960.
37. Haley, B.R., "Geologic Map of Russellville West Quadrangle, Pope and Yell Counties, Arkansas," 1963.
38. Haley, B.R., "Geologic Map of Russellville East Quadrangle, Pope County, Arkansas," not yet published.
39. Haley, B.R., "Geology of Paris Quadrangle, Logan County, Arkansas," Arkansas Geological and Conservation Commission Information Circular 20-B, 1961.
40. Haley, B.R., "Geology of the Scranton and New Blain Quadrangles, Logan and Johnson Counties, Arkansas," U.S.G.S. Prof. Paper 536-B, 1968.
41. Haley, B.R., of U.S.G.S. and Arkansas Geological Commission, "Geologic Map of Russellville West Quadrangle," Open File Report, 1967.
42. Heinrich, R.R. "Contribution to the Seismic History of Missouri," B.S.S.A., Vol. 31, No. 3, July 1941.
43. Hendricks, T.A., and Parks, Bryan, "Geology of the Fort Smith District, Arkansas," U.S.G.S. Prof. Paper 221-E, 1950.
44. Heyl, A.V., and Brock, M.R., "Structural Framework of the Illinois- Kentucky Mining District and its Relation to Mineral Deposits," U.S. Geol. Survey, Prof. Paper 424-D, 1961.
45. Heyl, A.V., Brock, M.R., Jolly, J.L., and Wells, C.E., "Regional Structure of the Southeast Missouri and Illinois-Kentucky Mineral Districts," U.S. Geological Survey Bulletin 1202-B, 1965.
46. Illinois State Geological Survey, "Selected Deep Tests in NPC Region 9"; in Illinois State Geological Survey, "Background Materials for Symposium on Future Petroleum Potential of NPC Region 9 (Illinois Basin, Cincinnati Arch, and Northern Mississippi Embayment) Champaign, Illinois, March 11-12, 1971" Ill. State Geol. Survey, Ill. Petrol. 96, pp. 44-56, 1971.
47. Iotti, Krotiu, & Deboisblanc, "Hazards to Nuclear Plants From on (or Near) Site Gaseous Explosions," ANS Topical Meeting on Light Water Reactor Safety, March 1973, p. 652.
48. Keplinger and Wanenmacher, Petroleum Engineers, Tulsa, Oklahoma, Map of Hartshorne Coal Bed.
49. King, P.B., compiler, Tectonic Map of North America, U.S.G.S. Map, 1968.
50. King, P.B., "The Tectonics of North America," U.S.G.S. Prof. Paper 628, 1969.

ARKANSAS NUCLEAR ONE
Unit 2

51. King, P.B., "Tectonics of Quaternary Time in Middle North America," in Wright, H.E., Jr., and Frey, D., eds., The Quaternary of the United States, Princeton U. Press, p. 922, 1965.
52. Kisslinger, C., Agrawal, R., and Rodriguez, R., "Properties of Recent Earthquakes in the New Madrid Seismic Zone," E.O.S. Trans., Ameri. Geophysical Union, Vol. 152, No. 4, p. 278, 1971.
53. Krinitzsky, E.L., "Geological Investigation of Faulting in the Lower Mississippi Valley," Technical Memorandum No. 3-3111, U.S. Waterways Experiment Station, Vicksburg, Mississippi, 1950.
54. Lammlein, D.R., March, S., and Dorman, J., "A Microearthquake Reconnaissance of Southeastern Missouri and Western Tennessee," Bull. Seis. Soc. Am., Vol 61, No. 6, pp. 1705-1716, 1971.
55. Lander, J.F., "Seismological Notes January-February 1969," B.S.S.A., August 1969.
56. Lander, J.F., "Seismological Notes March-April 1969," B.S.S.A., October, 1969.
57. Lander, J.F., "Seismological Notes May-June 1969," B.S.S.A., December, 1969.
58. Lander, J.F., "Seismological Notes September-October 1969," B.S.S.A., April 1970.
59. Lander, J.F., "Seismological Notes January-February 1970," B.S.S.A., August 1970.
60. Lander, J.F., "Seismological Notes March-April 1970," B.S.S.A., October 1970.
61. Lander, J.F., "Seismological Notes May-June 1970," B.S.S.A., December 1970.
62. Lander, J.F., "Seismological Notes September-October 1970," B.S.S.A., April 1971.
63. Lander, J.F., "Seismological Notes November-December 1970," B.S.S.A., August 1971.
64. Lander, J.F., "Seismological Notes January-February 1971," B.S.S.A., October 1971.
65. Lander, J.F., "Seismological Notes March-April 1971," B.S.S.A., December 1971.
66. Lander, J.F., "Seismological Notes May-June 1971," B.S.S.A., February 1972.
67. Lander, J.F., "Seismological Notes July-August 1971," B.S.S.A., April 1972.
68. Lander, J.F., "Seismological Notes September-October 1971," B.S.S.A., June 1972.
69. Lander, J.F., "Seismological Notes November-December 1971," B.S.S.A., August 1972.
70. Lander, J.F., "Seismological Notes January-February 1972," B.S.S.A., October 1972.
71. Lander, J.F., "Seismological Notes March-April 1972," B.S.S.A., December 1972.
72. Lander, J.F., "Seismological Notes May-June 1972," B.S.S.A., February 1973.

ARKANSAS NUCLEAR ONE
Unit 2

73. Lander, J.F., "Seismological Notes July-August 1972," B.S.S.A., April 1973.
74. Latrobe, C.J., The Rambler in North America, 2nd Edition Vol. 1, London 1836.
75. Mateker, E.J., Jr., Tikrity, S.S., and Phelan, J.J., "Earthquake Epicenters and Subsurface Geology in the Mississippi Valley," (abs.) Trans. Ameri. Geophys. Union, Vol. 49, p. 290, 1968.
76. McGinness, C. L., "The Role of Groundwater in the National Situation," U.S. Geol. Survey Water, Supply Paper 1800, 1963, 1121 pp.
77. McGinnis, L.D., "Earthquakes and Crustal Movement as Related to Water Load in the Mississippi Valley Region," Illinois State Geol. Survey, Circ. 344, 1963.
78. Meinzer, O.E., "The Occurrence of Groundwater in the United States," U. S. Geol. Survey Water, Supply Paper 489, 1923, 321 pp.
79. Merewether, E.A., and B.R. Haley, "Geology of Delaware Quadrangel and Vicinity," Arkansas Geological Commission Information Circular 20-A, 1961.
80. Merewether, E.A., "Geology of Knoxville Quadrangel, Johnson and Pope Counties, Arkansas," Arkansas Geological Commission Information Circular 20-E, 1967.
81. Merewether, E.A., and B.R. Haley, "Geology of the Coal Hill, Hartman and Clarksville Quadrangles, Johnson County and Vicinity, Arkansas," U.S.G.S. Prof. Paper 536-C, 1969.
82. Merriam, D.F., "History of Earthquakes in Kansas," B.S.S.A., Vol. 46, No. 2, 1956.
83. "Meteorological Characteristics of the Probable Maximum Hurricane, Atlantic and Gulf Coasts of the United States," HUR 7-97, Hydrometeorological Branch, Office of Hydrology, NOAA, Silver Springs, MD, May 7, 1968.
84. [Slope Stability](#), Engineering Manual, Corps of Engineers, EM 1110-2-1902, [October 31, 2003](#).
85. Moore, G.K., "Geology and Hydrology of the Clairborne Group in Western Tennessee," U.S. Geol. Survey Water-Supply Paper 1809-F, 44 pp., 1965.
86. Meyerhof, G.G., "The Ultimate Bearing Capacity of Foundations on Slopes," Proceedings Fourth International Conference on Soil Mechanics and Foundation Engineering, Vol. 1, pp. 384-86, London, 1957.
87. Nuclear Power Plant Risks from a Natural Gas Pipeline, Mechanics Research, Inc. for Docket 50-518 (August 2, 1974).
88. Osterberg, J.O., "The Earthquake That Rearranged Mid-America," The Testing World, No. 21, Winter 1967-1968.
89. Phelan, M.J., Crustal Structure in the Central Mississippi Valley Earthquake Zone, Unpub. Ph.D. Dissertation, Washington Univ., St. Louis, Missouri, 166 pp., 1969.

ARKANSAS NUCLEAR ONE
Unit 2

90. Sampson, F.A., "The New Madrid and Other Earthquakes of Missouri," B.S.S.A., Vol. 13, No. 2, 1913.
91. Swalb, Howard, "The Northern Mississippi Embayment - a Latent Paleozoic Oil Province"; in Illinois State Geological Survey, "Proceedings of Symposium on Future Petroleum Potential of NPC Region 9 (Illinois Basin Cincinnati Arch, and Northern Part of Mississippi Embayment) Champaign, Illinois, March 11-12, 1971": 111. State Geol. Survey, 111. Petrol. 95, pp. 44-49, 1971.
92. Seed, H.B. and Whitman, Robert V., "Design of Earth Retaining Structures for Dynamic Loads," ASCE 1970 Speciality Conference: Lateral Stresses in the Ground and Design of Earth Retaining Structures, p. 103 to p. 147.
93. Sheldon, M.G., compiler, "Sample Description and Correlations for Selected Wells in Northern Arkansas," Arkansas Resources and Development Commission Information Circular No. 17, 1954.
94. Shepard, E.M., "The New Madrid Earthquake," Journal of Geology, Vol. 13, January-February 1905.
95. Skempton, A.W., "Long-Term Stability of Clay Slopes," Geotechnique, Vol. 14, No. 2, 1964.
96. Soil Report-1970 and Soil Report-1972, prepared for Bechtel Corp. by Grubbs Consulting Engineers, Inc., Little Rock, Arkansas, 1970 and 1972.
97. "Stability of Emergency Cooling Reservoir," Bechtel Inc., San Francisco, CA, August 1972.
98. Stearns, R.G., and Marcher, M.V., "Late Cretaceous and Subsequent Structural Development of the Northern Mississippi Embayment Area," Geol. Soc. Amer. Bull., Vol. 73, No. 11, pp. 1387-1394, 1962.
99. Street, R.L., Herrman, R.B., and Nuttli, O.W., "Earthquake Mechanics in Central United States," pre-publication release Science, in press.
100. Technical Memorandum NWS SR-58, "Atlantic Hurricane Frequencies along the U. S. Coast," Southern Region Headquarters, Scientific Services Div., NOAA, Fort Worth, Texas, June 1971.
101. Terzaghi, Karl and Peck, Ralph B., Soil Mechanics in Engineering Practice, 1967.
102. Tikrity, S.S., Tectonic Genesis of the Ozark Uplift, unpub. Ph.D. Dissertation, Washington Univ., St. Louis, Missouri, 196 pp., 1968.
103. U.S. Army Corps of Engineers, "Geological Investigation of Faulting in the Lower Miss. Valley," Tech. Mem. 3-311, Vicksburg, Mississippi, 1950.
104. U.S.C. & G.S., Earthquake History of the U.S., Part 1.
105. U.S.C. & G.S., United States Earthquakes, 1928-1970.

ARKANSAS NUCLEAR ONE
Unit 2

106. U.S.C. & G.S., "Abstracts of Earthquake Reports for the United States, January 1967 - December 1969."
107. U.S. Geological Survey, "Compilation of Records of Surface Waters of the United States through September 1950," Part 7, Water-Supply Paper 1311, 1955.
108. U.S. Geological Survey, "Compilation of Records of Surface Waters of the United States, October 1950 to September 1960," Part 7, Water Supply Paper 1731, 1964.
109. U.S. Geological Survey, "Surface Water Supply of the United States, 1961-65," Part 7, Volume 2, Water-Supply Paper 1921, 1969.
110. U.S. Geological Survey, "Magnitude and Frequency of Floods in the United States," Part 7, Water-Supply Paper 1681, 1964.
111. U. S. Geological Survey, "Water Resources Data for Arkansas," Part 1, annual publications from 1966.
112. U. S. Weather Bureau, "Climatic Summary of the United States," Supplement for 1951 through 1960, Arkansas, 1965.
113. U. S. Weather Bureau, "Climatological Data," Arkansas, 1961 to 1972.
114. U. S. Weather Bureau, "Local Climatological Data," Fort Smith, Arkansas, 1956 to 1972.
115. U. S. Weather Bureau, "Local Climatological Data," Little Rock, Arkansas, 1956 to 1972.
116. U. S. Weather Bureau, "Rainfall Frequency Atlas of the United States, for Duration from 30 Minutes to 24 Hours and Return Period From one to 100 Years," Technical Report No. 40, May, 1961.
117. U. S. Weather Bureau, "Seasonal Variation of the Probable Maximum Precipitation East of the 105th Meridian," Hydrometeorological Report No. 33, 1956.
118. Walter, E.J., "The Arkansas Earthquake of September 17, 1938," B.S.S.A., Vol. 29, pp. 497-503, 1939.
119. Warner, August, quoted in American Geologist, Vol. 30, p. 83, August 1902.
120. Zabetakis, M. G., "Safety With Cryogenic Fluids," 1967, pp. 57.

ARKANSAS NUCLEAR ONE
Unit 2

Table 2.1-1

**DATA ON RESERVOIRS AND LAKES WITHIN A 50-MILE RADIUS
(MINIMUM SURFACE AREA - 100 ACRES)**

No.	Reservoir-Lake (River)	Owner/ Agency	Distance (miles)	Direction	Purpose ¹	Surface Area (acres)	Total Storage (10 ³ ac-ft)	Dead Storage Surface (acres)	Volume (10 ³ ac-ft)	Discharge Yearly Ave (10 ³ ac-ft/yr)
1.	Dardanelle Reservoir (Arkansas River)	Corps of Engineers	0	S-WNW	N,P	34,300 ²	486.2	31,000 ³	420.8 ⁴	28,000
2.	Lake Atkins (Horsehead Branch)	Game and Fish ⁵	17	ESE	FW	752	15	n.a. ⁶	n.a.	n.a.
3.	Fish Lake (Point Removal Canal)	n.a.	25	ESE	n.a.	120	n.a.	n.a.	n.a.	n.a.
4.	Lake Overcup (Overcup Creek)	Game and Fish	29	ESE	FW	1,025	18.5	n.a.	n.a.	n.a.
5.	Beaver Fork Lake (Beaver Fork River)	City of Conway	47	ESE	W	710	n.a.	n.a.	n.a.	n.a.
6.	Harris Brake Lake (Fourch La Fave Rvr)	Game and Fish	34	SE	FW	1,260	20	n.a.	n.a.	n.a.
7.	Big Maumelle Lake (Maumelle River)	Little Rock Water District	48	SE	W	8,850	196.5	n.a.	n.a.	93 ⁷
8.	Gibson Lake (Mill Creek)	Fish and Wildlife ⁸	13	SSE	FW	480	n.a.	n.a.	n.a.	n.a.
9.	Winona Lake (Alum Fork Creek)	Little Rock Water District	40	SSE	W,P	1,170	41.8	n.a.	n.a.	28.1 ⁷
10.	Nimrod Reservoir (Fourch La Fave Rvr)	Corps of Engineers	24	S	F	18,300	336	3,550	29 ⁹	632
11.	Lake Oauchita (Oauchita River)	Corps of Engineers	50	S	F,P,W	48,300	2,768	20,900	865 ⁹	1,670
12.	Cove Lake (Cover Creek)	U.S. Forest Service	23	WSW	R	166	2	n.a.	n.a.	n.a.

ARKANSAS NUCLEAR ONE
Unit 2

Table 2.1-1 (continued)

No.	Reservoir-Lake (River)	Owner/ Agency	Distance (miles)	Direction	Purpose ¹	Surface Area (acres)	Total Storage (10 ³ ac-ft)	Dead Storage Surface (acres)	Volume (10 ³ ac-ft)	Discharge Yearly Ave (10 ³ ac-ft/yr)
13.	Blue Mountain River (Petit Jean Creek)	Corps of Engineers	30	WSW	F	11,000	258	2,910	24.6 ⁹	413
14.	Harman Lake (Old Arkansas River)	n.a.	24	WNW	n.a.	227	n.a.	n.a.	n.a.	n.a.
15.	Ozark Reservoir ¹⁰ (Arkansas River)	Corps of Engineers	33	WNW	N,P,R	10,600	148.4	8,800	129	25,000
16.	Horsehead Lake (Horsehead Creek)	Game and Fish	29	NW	FW	100	3	n.a.	n.a.	n.a.
17.	Lake Ludwig (Spadra Creek)	City of Clarksville	20	NW	W	240	6	130	1	0.95
18.	Illinois Bayou (Same)	Russellville Water Co.	5 ¹¹	NE	W	n.a.	n.a.	n.a.	n.a.	n.a.

Notes

- 1 F-Flood Control, P-Power, N-Navigation, W-Water Supply, FW-Fish and Wildlife, R-Recreation
- 2 At Elevation 338 Feet
- 3 At Elevation 336 Feet
- 4 At Bottom of Power Pool Level
- 5 State of Arkansas Game and Fish Commission
- 6 n.a. - information not available
- 7 Safe Yield
- 8 U.S. Fish and Wildlife Service
- 9 At the Conservation Pool Level
- 10 Under Construction
- 11 Upstream distance to Water Company Station

ARKANSAS NUCLEAR ONE
Unit 2

Table 2.1-2

GASEOUS RELEASE LOCATION

<u>Release</u>	<u>Note</u>	<u>Distance to Exclusion Area Boundary (Ft)</u>
Waste Gas Decay Tanks	(1)	3372
Gas Collection Header	(1)	3372
Condenser Vacuum Pump	(1)	3372
Radwaste Ventilation	(1)	3372
Fuel Handling Ventilation	(2)	3372
Containment Purge	(3)	3372
Steam Dump Valves	(4)	3350
Steam Relief Valves	(4)	3350
Emergency Feedwater Pump	(4)	3350
Turbine Bldg. Ventilation	(5)	3250
Turbine Gland Seal Exhaust	(6)	3350

NOTES:

- (1) Released from ventilation system ducting via east containment flute at El. 533'.
- (2) Released from ventilation system ducting via southeast containment flute at El. 533'.
- (3) Released from ventilation system ducting via south containment flute at El. 533'.
- (4) Released from Auxiliary Building Roof at El. 455'. Approximate Location: Intersection of Columns H and 4.
- (5) Released from 10 roof exhausters at El. 448'.
- (6) Released between the Auxiliary Building and Turbine Bldg. at El. 461'.

ARKANSAS NUCLEAR ONE
Unit 2

Table 2.1-3

**PUBLIC FACILITIES AND INSTITUTIONS
WITHIN 10 MILES**

<u>Schools</u>	<u>Distance (mi)</u>	<u>Direction</u>	<u>Attendance</u>
O'Brien School	4.8	ESE	90
Westward School (Now Dwight School)	5.2	ESE	337
Russellville High School	6.1	ESE	913
Oakland Heights School	6.5	ESE	477
James School	5.5	ESE	No Longer in Operation
Arkansas Polytechnic College	5.2	ESE	2139
Mountain View School	4.2	SE	12
Crawford School	6.3	ESE	351
Center Valley School	8.3	E	No Longer in Operation
Dover High School	8.9	NE	420
Lamar Elementary (at Knoxville)	9.1	NW	135
London Elementary School	2.0	NNW	77
Dardanelle Elem. School	7.2	SE	638
Dardanelle Jr. High School	7.2	SE	531
Dardanelle Middle School	7.2	SE	531
Dardanelle High School	7.2	SE	412
<u>Hospitals</u>			
St. Mary's Hospital	4.8	ESE	105 beds
Stella Manor Nursing Home	4.6	ESE	144 beds
Russellville Nursing Home	4.8	ESE	88 beds
<u>Other</u>			
Russellville Country Club	5.7	ENE	80
Lake Dardanelle State Park (Russellville Boat Dock Area)	2.0	SE	25
(Dardanelle Boat Dock Area)	3.5	SSE	20
Mt. Nebo State Park	5.3	S/SSW	40
Russellville Municipal Airport	8.3	ESE	10

ARKANSAS NUCLEAR ONE
Unit 2

Table 2.1-4

FARM STATISTICS FOR COUNTIES WITHIN 50 MILES OF ANO

<u>County</u>	<u>Approx. Acres of Land area</u>	<u>No. Farms</u>	<u>Acres in Farms</u>	<u>Average size of Farms</u>	<u>Cropland Harvested</u>	<u>Irrigated Land</u>
Conway	358,912	854	193,832	226.9	49,181	1,642
Crawford	381,440	916	135,787	148.2	37,228	5,353
Faulkner	410,304	1,112	232,735	209.2	32,205	1,325
Franklin	392,448	797	200,984	252.1	28,452	557
Garland	420,800	394	55,771	141.5	4,397	87
Johnson	430,464	695	123,723	178.0	21,734	2,450
Logan	459,200	1,050	210,987	200.9	26,425	79
Madison	532,480	1,057	234,267	221.6	22,413	273
Montgomery	495,936	424	66,709	157.3	6,856	78
Newton	526,080	475	93,882	197.6	6,055	373
Perry	352,576	349	77,352	221.6	17,296	1,054
Pope	519,808	934	180,719	193.4	31,274	2,628
Pulaski	489,408	640	168,005	262.5	71,956	10,985
Saline	463,168	339	61,268	180.7	8,539	184
Scott	574,592	676	119,841	177.2	14,471	112
Searcy	424,960	645	167,409	259.5	8,941	63
Sebastian	337,280	780	263,840	338.2	20,284	21
Van Buren	447,488	590	139,185	235.9	10,097	223
Yell	594,432	1,009	212,570	210.6	38,543	331
Totals	8,611,776	13,736	1,484,071	211.2	456,347	27,818

ARKANSAS NUCLEAR ONE
Unit 2

Table 2.1-5

LIVESTOCK AND POULTRY STATISTICS FOR COUNTIES WITHIN 50 MILES OF ANO

<u>County</u>	<u>Cattle & Calves</u>	<u>Milk Cows</u>	<u>Sheep & Lambs</u>	<u>Hogs & Pigs</u>	<u>Broilers & Turkeys</u>	<u>Hens</u>
Conway	27,700	1,400	40	4,100	6,170,000	55,000
Crawford	31,600	900	547	2,700	12,901,000	133,000
Faulkner	42,800	2,800	181	1,400	100,000	159,000
Franklin	40,800	2,400	455	1,000	4,309,000	55,000
Garland	13,300	900	54	1,600	-----	267,000
Johnson	23,200	800	6	3,200	5,706,000	67,000
Logan	48,300	4,400	75	2,400	7,928,000	93,000
Madison	38,100	3,600	781	10,300	30,745,000	390,000
Montgomery	15,900	400	2	1,300	7,659,000	96,000
Newton	14,800	1,100	304	14,700	-----	-----
Perry	12,500	400	---	1,000	3,105,000	11,000
Pope	38,100	1,200	150	3,300	9,298,000	856,000
Pulaski	22,000	1,100	1	4,300	-----	74,000
Saline	13,700	900	---	1,800	-----	42,000
Scott	28,900	800	---	600	4,293,000	269,000
Searcy	21,000	1,400	88	7,100	-----	-----
Sebastian	27,900	2,000	277	700	4,704,000	35,000
Van Buren	24,200	1,700	235	2,000	4,563,000	-----
Yell	45,200	1,300	---	2,500	23,261,000	706,000
Totals	530,000	29,500	3,196	66,000	124,742,000	3,308,000

ARKANSAS NUCLEAR ONE
Unit 2

Table 2.1-6

CROP STATISTICS FOR COUNTIES WITHIN 50 MILES OF ANO

<u>County</u>	<u>Hay</u>		<u>Alfalfa</u>		<u>Sorghum</u>	
	<u>Acres</u>	<u>Yield</u>	<u>Acres</u>	<u>Yield</u>	<u>Acres</u>	<u>Yield</u>
Conway	15,794	n.a.	450	n.a.	1,834	n.a.
Crawford	10,586	n.a.	2,076	n.a.	173	n.a.
Faulkner	17,876	n.a.	580	n.a.	2,287	n.a.
Franklin	19,705	n.a.	580	n.a.	205	n.a.
Garland	4,072	n.a.	84	n.a.	112	n.a.
Johnson	12,037	n.a.	831	n.a.	153	n.a.
Logan	18,893	n.a.	1,304	n.a.	386	n.a.
Madison	20,347	n.a.	2,645	n.a.	261	n.a.
Montgomery	6,408	n.a.	112	n.a.	188	n.a.
Newton	5,774	n.a.	286	n.a.	143	n.a.
Perry	5,594	n.a.	305	n.a.	770	n.a.
Pope	13,400	n.a.	258	n.a.	1,084	n.a.
Pulaski	7,720	n.a.	982	n.a.	565	n.a.
Saline	7,142	n.a.	---	---	118	n.a.
Scott	13,163	n.a.	146	n.a.	52	n.a.
Searcy	7,813	n.a.	483	n.a.	204	n.a.
Sebastian	14,157	n.a.	1,848	n.a.	56	n.a.
Van Buren	8,210	n.a.	249	n.a.	620	n.a.
Yell	17,722	n.a.	1,026	n.a.	606	n.a.
Totals	226,413	1.6 tons*	14,245	3.35 tons*	9,817	47 bu.*

n.a - Not Available
* 1971 State Average

ARKANSAS NUCLEAR ONE
Unit 2

Table 2.1-6 (continued)

<u>County</u>	<u>Cotton Acres</u>	(Harvested) <u>Yield (lb./acre)</u>	<u>Soybeans Acres</u>	(Harvested) <u>Yield (bu./acre)</u>	<u>Rice Acres</u>	(Planted) <u>Yield (lb./acre)</u>
Conway	3,800	467	27,700	22	470*	4,638*
Crawford	20	240	20,000	24		
Faulkner	1,830	210	7,500	20	470*	4,638*
Franklin	230	501	5,000	22		
Garland			100	20		
Johnson	580	538	5,800	20		
Logan	530	317	9,500	17		
Madison						
Montgomery						
Newton						
Perry	70	343	7,800	22.2	1,010	4,614
Pope	240	400	13,400	19		
Pulaski	13,100	376	48,100	20.5	2,440	4,660
Saline			1,200	20		
Scott			1,200	18		
Searcy			500	18		
Sebastian			3,800	26		
Van Buren	10	240	100	19		
Yell	2,870	577	16,300	20.3		
Totals	23,280	383	168,000	20.5	3,920	4,637

* 1971 State Average

ARKANSAS NUCLEAR ONE
Unit 2

Table 2.1-6 (continued)

<u>County</u>	Potatoes, Orchards		Vegetables Irish & Sweet		Sweet Corn or Melons	
	<u>Acres</u>	<u>Yield</u>	<u>Acres</u>	<u>Yield</u>	<u>Acres</u>	<u>Yield</u>
Conway	26	**	117	n.a.	65	**
Crawford	132	**	193	n.a.	6,611	**
Faulkner	18	**	18	n.a.	86	**
Franklin	745	**	22	n.a.	250	**
Garland	64	**	66	n.a.	18	**
Johnson	985	**	56	n.a.	916	**
Logan	22	**	35	n.a.	3	**
Madison	115	**	52	n.a.	34	**
Montgomery	10	**	37	n.a.	4	**
Newton	9	**	11	n.a.	11	**
Perry	16	**	9	n.a.	9	**
Pope	477	**	47	n.a.	459	**
Pulaski	659	**	16	n.a.	446	**
Saline	4	**	76	n.a.	91	**
Scott	32	**	48	n.a.	8	**
Searcy	25	**	94	n.a.	84	**
Sebastian	45	**	29	n.a.	91	**
Van Buren	13	**	79	n.a.	73	**
Yell	12	**	30	n.a.	18	**
Totals	3,409	**	1,035	73 cwt.*	9,277	**

n.a. - Not Available

* 1971 State Average

** Not applicable due to the diverse types of crops included in this category.

ARKANSAS NUCLEAR ONE
Unit 2

Table 2.1-6 (continued)

County	Corn (Harvested for Grain)		Wheat (Harvested for Grain)	
	<u>Acres</u>	<u>Yield (bu./acre)</u>	<u>Acres</u>	<u>Yield (bu./acre)</u>
Conway	700	32.6	1,600	26.9
Crawford	200	27.0	2,500	28.0
Faulkner	750	28.8	850	26.0
Franklin	150	30.0	400	22.5
Garland	50	24.0	20	30.0
Johnson	400	31.5	600	28.3
Logan	300	26.0	1,100	31.8
Madison	150	38.0	200	29.0
Montgomery	150	24.0		
Newton	100	23.0		
Perry	150	26.0	400	27.5
Pope	400	32.0	1,000	28.0
Pulaski	300	27.0	2,300	28.3
Saline	150	26.0	10	20.0
Scott	250	26.0		
Searcy	300	23.0		
Sebastian	100	30.0	300	26.7
Van Buren	450	28.9		
Yell	550	30.0	800	23.8
Totals	5,600	28.1	6,110	26.9

ARKANSAS NUCLEAR ONE
Unit 2

Table 2.1-7

DEER KILL STATISTICS FOR COUNTIES WITHIN 50 MILES OF ANO

<u>County</u>	<u>1972-1973 Deer Kill</u>
Conway	150
Crawford	146
Faulkner	46
Franklin	236
Garland	98
Johnson	694
Logan	394
Madison	381
Montgomery	146
Newton	341
Perry	93
Pope	284
Pulaski	87
Saline	172
Scott	85
Searcy	69
Sebastian	75
Van Buren	652
Yell	449
Total	4,598

ARKANSAS NUCLEAR ONE
Unit 2

Table 2.1-8

1972 FISH POPULATION SAMPLE

<u>SPECIES</u>	<u>NUMBER IN GROUP</u>	<u>WEIGHT (POUNDS)</u>
Largemouth Bass, Adult	41	92.4
Largemouth Bass, Intermediate	52	6.8
Largemouth Bass, Young	49	1.1
White Bass, Adult	3	3.3
White Bass, Intermediate	1	.2
White Bass, Young	19	.6
White Crappie, Adult	58	28.7
White Crappie, Intermediate	42	2.2
White Crappie, Young	85	.6
Black Crappie, Adult	10	2.8
Black Crappie, Intermediate	44	2.2
Black Crappie, Young	34	.4
Channel Catfish, Adult	28	37.4
Channel Catfish, Intermediate	277	52.1
Channel Catfish, Young	15	.2
Flathead Catfish, Adult	2	3.6
Flathead Catfish, Intermediate	11	1.8
Flathead Catfish, Young	5	.1
Spotted Gar, Intermediate	1	.9
TOTAL PREDATOR POPULATION	777	237.4

ARKANSAS NUCLEAR ONE
Unit 2

Table 2.1-8 (continued)

<u>SPECIES</u>	<u>NUMBER IN GROUP</u>	<u>WEIGHT (POUNDS)</u>
Bluegill, Adult	390	41.5
Bluegill, Intermediate	1059	43.9
Bluegill, Young	2718	7.7
Redear, Adult	6	1.1
Green Sunfish, Intermediate	50	1.8
Green Sunfish, Young	285	.5
Longear, Intermediate	489	19.5
Longear, Young	2580	10.8
Warmouth, Adult	4	.4
Warmouth, Intermediate	73	3.5
Orangespotted Sunfish, Young	1287	2.1
Smallmouth Buffalo, Adult	2	7.6
Smallmouth Buffalo, Intermediate	346	533.9
Largemouth Buffalo, Adult	21	66.8
Largemouth Buffalo, Intermediate	2	3.2
Bowfin, Adult	2	9.6
Yellow Bullheads, Young	3	1.1
Freshwater Drum, Adult	37	30.3
Freshwater Drum, Intermediate	1043	127.7
Freshwater Drum, Young	341	6.6
European Carp, Adult	24	46.0
European Carp, Intermediate	18	20.7
Carp suckers, Adult	49	72.0
Carp suckers, Intermediate	3	.5
Golden Shiners, Adult	11	.3
Bluntnose Minnows, Adult	237	.3
Brook Silversides, Adult	378	.4
TOTAL EDIBLE FORAGE POPULATION	11,487	1059.8

ARKANSAS NUCLEAR ONE
Unit 2

Table 2.1-8 (continued)

<u>SPECIES</u>	<u>NUMBER IN GROUP</u>	<u>WEIGHT (POUNDS)</u>
Gizzard Shad, Adult	1,319	180.8
Gizzard Shad, Intermediate	4,525	269.5
Gizzard Shad, Young	2,142	14.0
Threadfin Shad, Adult	2,076	12.0
Threadfin Shad, Intermediate	6,025	330.1
TOTAL NON-EDIBLE FORAGE POPULATION	16,087	506.4
TOTAL FORAGE POPULATION	27,574	1,566.2
TOTAL POPULATION	28,351	1,803.6
PREDATOR - NONPREDATOR RATIO BY WEIGHT:		1:6.6

ARKANSAS NUCLEAR ONE
Unit 2

Table 2.1-9

1971 COMMERCIAL FISHING SURVEY
DARDANELLE RESERVOIR

<u>SPECIES</u>	<u>NUMBER</u>	<u>WEIGHT POUNDS</u>	<u>PERCENT OF TOTAL BY WT.</u>
Blue Catfish	377	2,301	38.1
Flathead Catfish	72	547	9.1
Channel Catfish	28	57	1.0
TOTAL CATFISH	477	2,905	48.2
Bigmouth Buffalo	470	2,337	38.7
Smallmouth Buffalo	5	30	0.5
Black Buffalo	1	3	0.05
TOTAL BUFFALO	476	2,370	39.2
Carp Sucker	5	10	0.2
Drum	37	37	0.6
Paddle Fish	10	350	5.8
Carp	77	154	2.5
Longnose Gar	13	84	1.4
Shortnose Gar	2	6	0.1
TOTAL	144	641	10.6
Shovelnose Sturgeon	8	16	0.3
River Herring	4	2	0.3
TOTAL ROUGH FISH	1,109	5,934	98.4
Crappie	42	21	0.33
Largemouth Bass	4	26	0.43
Striped Bass	3	30.6	0.5
TOTAL GAME FISH	57	97.6	1.6

ARKANSAS NUCLEAR ONE
Unit 2

Table 2.1-10

VOLUME OF FOREST GROWING STOCK ON COMMERCIAL FOREST LAND IN SURVEY REGIONS OF ARKANSAS

Species	Volume (millions of cubic feet)												
	Ouachita Region by Diameter Classes												
	Entire State	Ozark Region	All classes	Diameter Class (in. at breast height)									
				5.0 - 6.9	7.0 - 8.9	9.0 - 10.9	11.0- 12.9	13.0- 14.9	15.0- 16.9	17.0- 18.9	19.0- 20.9	21.0- 28.9	29.0 & Larger
Softwood:													
Shortleaf pine	3,558.4	492.3	1837.1										
Loblolly pine	2,603.8	8.7	69.6	213.6	346.5	467.8	377.7	240.8	144.7	70.8	28.4	16.4	
Cypress	182.0	0.9	10.2										
Redcedar	48.2	39.3	6.6	2.9	4.2	4.0	1.8	0.8	0.3	0.2	0.7	1.9	
All softwoods	6,422.4	541.2	1,923.5	216.5	350.7	471.8	379.5	241.6	145.0	71.0	29.1	18.3	
Hardwood:													
Select white oaks ^a	1,212.6	575.8	217.9	54.3	43.7	33.2	31.0	21.6	15.2	11.1	4.8	3.0	
Select red oaks ^b	625.4	311.1	67.7	8.3	12.8	13.0	10.1	9.6	7.0	3.6	0.8	2.0	0.5
Other white oaks	1,191.5	400.7	193.7	41.1	38.3	30.4	26.5	26.3	14.7	6.2	7.7	2.5	
Other red oaks	1,961.5	677.7	134.4	21.3	20.4	20.7	20.3	17.1	14.5	10.2	4.8	4.6	0.5
Pecan	193.0	7.3	2.4										
Other hickories	812.0	408.4	107.7	110.1	26.8	28.9	20.0	13.1	10.5	5.7	2.2	2.3	0.6
Sweet gum	1,139.4	143.7	122.8	13.5	18.8	25.9	31.8	19.2	6.0	4.6	1.0	2.0	
Tupelo & black gum	316.3	104.1	43.1	5.1	5.2	4.4	8.7	6.4	7.9	2.0	3.0	0.4	
Hard maple	23.9	20.1	0.8										
Soft maple	58.6	13.5	4.9	2.4	0.7	1.0	0.5	0.8		0.3			
Beech	52.6	10.5											
Ash	221.1	52.8	16.0	3.1	3.9	3.5	3.1	0.9	1.0	0.5			
Cottonwood	84.1	2.1	2.1										
Basswood	14.2	8.0	1.2										
Black walnut	29.5	27.5	0.4										
Black cherry	21.5	10.0	5.2										
Willow	129.0		6.8										
American elm	127.4	26.4	8.8	17.2	13.9	15.0	6.9	4.2	2.5	2.1	1.1	2.6	
Other elms	163.0	41.9	25.6										
Hackberry	188.7	8.1	5.1										
Sycamore	72.1	18.5	2.6										
Other hardwoods	168.8	30.6	7.7										
All hardwoods	8,806.2	2,898.8	976.9	193.1	186.6	167.1	152.0	116.6	74.5	42.8	25.5	17.7	1.0
All Species	15,228.6	3,440.0	2,900.4	409.6	537.7	638.9	531.5	358.2	219.5	113.8	54.6	36.0	1.0

^a Includes white, swamp chestnut, chinkapin, Durand, swamp white, and bur oaks.

^b Includes northern red, cherrybark, and Shumard oaks.

ARKANSAS NUCLEAR ONE
Unit 2

Table 2.1-11

COMMERCIAL FOREST LAND AROUND ARKANSAS NUCLEAR ONE

Area for various forest types (thousands of acres)

<u>County</u>	<u>Pine^a</u>	<u>Oak-pine^a</u>	<u>Oak-hickory</u>	<u>Oak-gum- cypress</u>	<u>Elm & cottonwood</u>	<u>Total commercial forests</u>	<u>Total land</u>
Conway	12.5	25.0	87.5	12.5	0	137.5	359
Faulkner	0.0	0.0	156.8	0.0	0	156.8	347
Franklin	22.2	30.6	158.4	0.0	0	211.2	392
Johnson	36.6	31.8	222.0	7.7	0	298.1	431
Logan	80.6	49.6	111.6	12.4	0	254.2	460
Perry	102.6	119.7	45.6	5.7	0	273.6	353
Pope	54.7	44.6	239.1	0.0	0	338.4	520
Saline	81.0	91.8	167.4	27.0	5.4	372.6	464
Sebastian	6.4	6.4	96.0	19.2	6.4	134.4	362
Yell	145.6	100.8	95.2	61.6	0	403.2	595
Ten counties	542.2	500.3	1379.6	146.1	11.8	2580.0	4283
All Arkansas	3668.0	3039.6	8446.3	2774.7	278.1	18,206.7	33,200

^a Shortleaf pine, loblolly pine, or both.

Based on A. Hedlund and J.M. Earles, FOREST STATISTICS FOR ARKANSAS COUNTIES, USDA Forest Service Resource Bulletin SO-22, Southern Forest Experiment Station, New Orleans, La., 1970, Table 4.

ARKANSAS NUCLEAR ONE
Unit 2

Table 2.1-12

INCOME AND LOSS TERMS ON THE TIMBER INVENTORY

A. For Arkansas Valley counties around Arkansas Nuclear One

<u>County</u>	<u>Annual growth (millions of cubic feet)</u>					<u>Annual Removal (ft³ x 10⁶)</u>		<u>Total Growing Stock (ft³ x 10⁶)</u>	<u>Growth minus removal (ft³ x 10⁶)</u>	
	<u>Softwood (mostly pine)</u>	<u>Oak</u>	<u>Hardwood</u>		<u>Total</u>	<u>Softwood</u>	<u>Hardwood</u>		<u>Percent of growing stock</u>	
Conway	1.9	0.8	0.6	0.6	2.0	1.7	8.1	67.2	- 5.9	-8.8
Franklin	0.9	1.7	0.6	1.9	4.2	1.1	1.8	145.6	+ 2.2	1.5
Johnson	2.8	3.1	0.9	1.1	5.1	1.2	1.8	236.4	+ 4.9	2.1
Logan	4.6	1.6	0.2	1.0	2.8	2.3	1.1	160.5	+ 4.0	2.5
Perry	8.4	3.6	0.7	0.2	4.5	4.1	1.3	260.0	+ 7.5	2.9
Pope	5.0	2.8	1.1	1.2	5.1	3.3	1.9	279.2	+ 4.9	1.8
Yell	11.6	3.9	1.0	1.4	6.3	8.3	2.7	374.4	+ 6.9	1.8
Seven counties	35.2	17.5	5.1	7.4	7.4	22.0	18.7	1523.3	+ 24.5	1.6

B. For all Arkansas

<u>County</u>	<u>Softwood (mostly pine)</u>	<u>Oak</u>	<u>Hardwood Gum</u>	<u>Other</u>	<u>Total</u>	<u>Total Timber</u>
Growing stock, millions of cubic feet	6422.4	4991.0	1455.7	2359.5	8806.2	15,228.6
Annual growth, millions of cubic feet	390.5	212.3	54.9	100.9	368.1	
Percent of growing stock	6.09	4.25	3.77	4.27	4.18	
Annual removal, millions of cubic feet	281.3				289.3	
Percent of growing stock	4.38				3.28	
Growth minus removal, millions of cubic feet						188.0
Percent of growing stock						1.23

Based on A. Hedlund and J. M. Earles, FOREST STATISTICS FOR ARKANSAS COUNTIES, USDA Forest Service Resource Bulletin SO-22, Southern Forest Experiment Station, New Orleans, La., 1970.

ARKANSAS NUCLEAR ONE
Unit 2

Table 2.1-13

**GROWING STOCK VOLUME ON COMMERCIAL FOREST LAND BY
SPECIES GROUP AND COUNTY, 1969**

Growing Stock (million cubic feet)

<u>County</u>	<u>Softwood</u>	<u>Hardwood</u>				<u>All Species</u>	<u>Area (thousands of acres)</u>	<u>Density (ft³/acre)</u>
		<u>Total</u>	<u>Oak</u>	<u>Gum</u>	<u>Other</u>			
Northern Ozark Survey Region								
Baxter	12.7	104.3	83.8	4.2	16.3	117.0	254.8	459
Benton	0.5	135.4	115.1	4.1	16.2	135.9	219.6	619
Boone	0.8	110.8	81.6	0.4	28.8	111.6	195.5	571
Carroll	39.6	110.0	86.7	2.6	20.7	149.6	239.4	625
Fulton	16.7	50.3	42.5	2.8	5.0	67.0	247.0	271
Izard	13.4	64.6	42.9	4.1	17.6	78.0	240.0	325
Madison	7.7	203.5	131.8	12.9	58.8	211.2	356.4	593
Marion	6.2	140.9	113.6	6.1	21.2	147.1	282.0	522
Newton	37.8	274.7	175.1	20.2	79.4	312.5	478.0	654
Randolph	0.9	110.8	83.1	1.2	26.5	111.7	86.2	600
Searcy	21.5	141.2	90.1	4.5	46.6	162.7	310.6	524
Sharp	12.9	73.3	55.8	1.3	16.2	86.2	255.3	338
Stone	37.3	138.3	93.9	11.5	32.9	175.6	322.0	545
Washington	<u>8.2</u>	<u>112.8</u>	<u>78.1</u>	<u>2.4</u>	<u>32.3</u>	<u>121.0</u>	<u>318.8</u>	<u>380</u>
Subtotal	216.2	1770.9	1274.1	78.4	418.5	1,987.1	3,905.6	509
Southern Ozark Survey Region ^a								
Cleburne	45.3	83.4	41.9	15.7	25.8	128.7	240.7	535
Conway	20.8	46.4	16.6	14.1	15.7	67.2	137.5	489
Crawford	21.5	108.8	67.6	20.6	20.6	130.3	208.0	626
Faulkner	1.7	44.0	26.1	6.0	11.9	45.7	156.8	291
Franklin	22.6	123.0	68.4	18.1	36.5	145.6	211.2	332
Independence	14.3	105.4	77.3	2.9	25.2	119.7	244.2	489
Johnson	60.7	175.7	110.3	30.1	35.3	236.4	298.1	793
Pope	88.1	191.1	128.5	30.9	31.7	279.2	338.4	825
Van Buren	44.1	116.6	82.4	8.7	25.5	160.7	303.8	529
White	<u>5.9</u>	<u>133.5</u>	<u>72.1</u>	<u>22.4</u>	<u>39.0</u>	<u>139.4</u>	<u>222.6</u>	<u>626</u>
Subtotal	325.7	1127.9	691.2	169.5	267.2	1452.9	2361.9	615

ARKANSAS NUCLEAR ONE
Unit 2

Table 2.1-13 (continued)

<u>County</u>	<u>Softwood</u>	<u>Hardwood</u>				<u>All Species</u>	Area (thousands of acres)	Density (ft ³ /acre)
		<u>Total</u>	<u>Oak</u>	<u>Gum</u>	<u>Other</u>			
Northern Ouachita Survey Region ^a								
Logan	98.3	62.2	41.9	6.4	13.9	160.5	254.2	631
Perry	201.1	58.9	39.3	11.8	7.8	260.0	273.6	950
Sebastian	8.9	19.4	14.3		5.1	28.3	134.4	211
Scott	311.5	106.6	72.4	14.3	19.9	418.1	448.2	933
Yell	<u>239.3</u>	<u>135.1</u>	<u>68.1</u>	<u>32.9</u>	<u>34.1</u>	<u>374.4</u>	<u>403.2</u>	<u>929</u>
Subtotal	859.1	382.3	236.0	65.4	80.8	1241.3	1513.6	820
Southern Ouachita Survey Region								
Garland	236.6	113.3	78.0	17.4	17.9	349.9	335.5	1043
Montgomery	345.6	124.3	89.6	10.7	24.0	469.9	410.4	1145
Polk	231.0	105.5	69.8	15.6	20.1	336.5	435.0	774
Pulaski	73.4	87.0	51.4	18.4	17.2	160.4	152.0	637
Saline	<u>177.8</u>	<u>164.6</u>	<u>88.9</u>	<u>38.4</u>	<u>37.3</u>	<u>342.4</u>	<u>372.6</u>	<u>919</u>
Subtotal	1064.4	594.7	377.7	100.5	116.5	1659.1	1805.5	919
All counties	6422.0	8806.0	4991.0	1456.0	2359.0	15,299.0		

^a The Forest Survey includes Arkansas Valley counties north of the river in the Southern Ozark Region and those south of the river in the Northern Ouchita Region. Based on A. Hedlund and J. M. Earles, FOREST STATISTICS FOR ARKANSAS COUNTIES, USDA Forest Service Resource Bulletin SO-22, Southern Forest Experiment Station New Orleans, La., 1970.

ARKANSAS NUCLEAR ONE
Unit 2

Table 2.1-14

STATE PARKS, NATIONAL FORESTS AND RECREATION AREAS
WITHIN 50 MILES OF ARKANSAS PLANT

<u>State Parks</u>	<u>Type^(a)</u>	<u>Distance^(b)</u>	<u>Direction</u>	<u>Attendance^(c)</u>		
Lost Valley	2	49.0	N			
Mount Nebo	1	4.6	SSW			
Petit Jean	1	22.0	SE			
Lake Ouachita	1	48.0	S			
Lake Dardanelle ^{(d)(e)}	1	3.2	S			
Ouita ^{(d)(e)}	1	2.8	E			
Russellville ^{(d)(e)}	1	1.3	SE			
<u>National Forests</u>						
				<u>5-1-72 to</u> <u>9-30-72</u>	<u>10-1-72 to</u> <u>11-14-72</u>	<u>11-15-72 to</u> <u>4-30-73</u>
Ozark	1	18.0	S	141,100	26,453	8,801
Ouachita	1	7.3	WSW	NA	NA	NA

ARKANSAS NUCLEAR ONE
Unit 2

Table 2.1-14 (continued)

<u>Other Recreation Areas</u>	<u>Type^(a)</u>	<u>Distance^(b)</u>	<u>Direction</u>	<u>Attendance, Total for 1972</u>
Cabin Creek	1	9.3	WNW	19,100
Cane Creek	1	15.0	WNW	23,300
Dam Site ^(e)	2	3.8	SE	294,000
Delaware ^(e)	1	2.2	WSW	28,400
Dike View ^(e)	-	3.3	E	Leased to Arkansas Polytechnic College
Dublin	1	11.0	W	25,600
Flat Rock	1	4.8	WNW	30,700
Highway 64 Cove	-	6.3	WNW	Future Development
Horsehead	1	18.0	WNW	36,200
Illinois Bayou ^(e)	-	2.3	ENE	Leased to Arkansas Polytechnic College
O'Kane	1	27.0	W	51,400
Piney Bay	1	7.0	NW	40,400
Roseville	-	29.0	W	Future Development
Shoal Bay	1	11.0	W	68,100
Six Mile	1	21.0	W	11,200
Spadra	1	14.0	WNW	122,000
West Creek	1	30.0	WNW	28,800

^(a) Type 1 - Recreation area with overnight facilities
2 - Recreation area with picnic facilities

^(b) Distance in miles to area of park closest to site

^(c) The list figures are for visitor days - A visitor day equals a stay of 12 hours

^(d) The attendance figures for these state parks is a combined total of all three

^(e) Recreation area located in low population zone

ARKANSAS NUCLEAR ONE
Unit 2

Table 2.1-15

VISITOR ACTIVITIES IN PERCENT* USAGE

LAKE DARDANELLE

<u>Activity</u>	<u>Average Summer Weekend Day</u>	<u>June-August</u>	<u>Annual</u>
Boating	1	2	5
Fishing	25	27	44
Water Skiing	12	10	6
Swimming	31	30	12
Camping	13	15	17
Picnicking	11	13	17
Sightseeing	41	38	36

* Column total more than 100% because many people participate in more than one activity.

ARKANSAS NUCLEAR ONE
Unit 2

Table 2.1-16

**DARDANELLE RESERVOIR AND DOWNSTREAM ARKANSAS RIVER
SURFACE WATER DIVERTERS**

<u>Name of Diverter</u>	<u>Location</u>	<u>Use</u>	<u>Annual Volume</u>
John E. Shoemaker	Pope County Section 36**	Irrigation of Lawn and Garden	< 1 Acre-Ft.
Leonard Price	Pope County Section 29**	Irrigation of Small Home Garden, Approximately 1/8 Acre Vegetables	< 1 Acre-Ft.
Herbert Holzhaber	Arkansas County Approx. 185 Miles Downstream on Arkansas River	Irrigation of 133 Acres of Rice & 400 Acres of Soybeans	750 Acre-Ft.
Maumelle Golf Course	Pulaski County Approx. 80 Miles Downstream on Arkansas River	Irrigation of 78 Acres of Grass	1 Acre-Ft.
Walter C. Estes	Pulaski County Approx. 100 Miles Downstream on Arkansas River	Fish Farming 10 Acres	25 Acre-Ft.
Robert M. Carpenter	Pope County Section 29**	Irrigation of 1 Acre	< 1 Acre-Ft.
Dr. Roy H. Kennon	Logan County Paris Address***	Irrigation	1 Acre-Ft.
Laurence P. Schultz	Logan County Section 33**	Irrigation of 1/4 Acre Garden	< 1 Acre-Ft.
Arkansas Kraft Corp.	Morrilton, Arkansas*	Industrial*	18,500 Acre-Ft.
James E. Danaher	Jefferson County Approx. 135 Miles Downstream on Arkansas River	Irrigation of 100 Acres of Cotton and 100 Acres of Soybeans	720 Acre-Ft.

*See Section 2.1.4.1

**See Figure 2.3-2

***See Figure 2.3-3

This information was obtained in May 1974, from the Soil and Water Division of the Arkansas Department of Commerce. Arkansas Power & Light was previously not aware of this source for this type of information.

ARKANSAS NUCLEAR ONE
Unit 2

Table 2.3-1

ARKANSAS NUCLEAR ONE ANNUAL 40-FOOT WIND DIRECTION
AND SPEED, RELATIVE FREQUENCIES. PERIOD OF RECORD
FEBRUARY 7, 1972 TO FEBRUARY 7, 1973

SECTOR	UPPER CLASS INTERVALS OF WIND SPEED (MPH)												TOTAL	MEAN SPEED
	1	2	3	4	5	6	7	8	9	10	11	> 11		
NNE	.6	.8	.7	.6	.4	.6	.4	.2	.1	.0	.0	.0	4.47	4.17
NE	.9	1.9	2.0	1.4	.8	.6	.4	.3	.1	.2	.0	.0	8.60	3.79
ENE	.9	1.7	2.2	2.3	1.9	1.4	.9	.7	.6	.3	.2	.5	13.67	4.92
E	.6	1.3	2.1	2.1	1.9	1.9	1.2	.9	1.0	1.0	.7	1.2	15.88	6.10
ESE	.3	.5	.9	1.3	1.6	1.1	.9	.8	.3	.3	.3	.8	9.08	6.17
SE	.2	.3	.6	1.0	1.3	.9	.7	.5	.3	.2	.1	.0	6.06	5.5
SSE	.1	.2	.3	.6	.8	.7	.5	.4	.3	.1	.0	.0	4.03	5.74
S	.2	.2	.3	.4	.6	.4	.3	.2	.1	.1	.2	.2	3.22	6.10
SSW	.2	.2	.3	.3	.3	.2	.3	.2	.2	.2	.1	.3	2.67	6.64
SW	.1	.2	.3	.3	.3	.3	.2	.2	.1	.1	.1	.3	2.25	6.72
WSW	.3	.5	.5	.4	.4	.5	.4	.4	.2	.2	.2	.9	4.89	7.01
W	.5	.7	.5	.6	.7	.7	.9	.8	.9	.6	.6	1.6	9.03	7.60
WNW	.5	.5	.6	.5	.5	.7	.4	.4	.5	.3	.4	2.1	7.31	8.28
NW	.2	.3	.2	.3	.2	.2	.2	.2	.2	.2	.0	.5	2.69	7.36
NNW	.3	.3	.3	.1	.2	.1	.1	.1	.1	.0	.1	.2	1.92	5.21
N	.3	.4	.4	.4	.3	.3	.1	.1	.1	.1	.0	.0	2.63	4.47
CALM													1.60	
TOTAL	6.2	9.7	11.9	12.7	12.1	10.6	7.9	6.5	5.2	4.0	2.9	8.8	100.00	5.86

NUMBER OF INVALID OBSERVATIONS = 466

ARKANSAS NUCLEAR ONE

Unit 2

Table 2.3-2

**ARKANSAS NUCLEAR ONE JANUARY 40-FOOT WIND DIRECTION
AND SPEED, RELATIVE FREQUENCIES. PERIOD OF RECORD
FEBRUARY 7, 1972 TO FEBRUARY 7, 1973**

<u>SECTOR</u>	UPPER CLASS INTERVALS OF WIND SPEED (MPH)												<u>TOTAL</u>	<u>MEAN SPEED</u>
	<u>1</u>	<u>2</u>	<u>3</u>	<u>4</u>	<u>5</u>	<u>6</u>	<u>7</u>	<u>8</u>	<u>9</u>	<u>10</u>	<u>11</u>	<u>> 11</u>		
NNE	.1	.6	.8	1.5	1.1	1.0	.6	.1	.1	0	0	.1	6.16	4.77
NE	.1	1.3	1.1	1.8	.7	1.1	1.3	.8	.1	0	0	.3	8.68	5.05
ENE	.1	1.8	2.1	2.0	1.8	2.2	1.1	1.0	1.5	.7	.6	2.0	16.95	6.42
E	.3	.7	2.2	1.0	1.1	1.1	.8	.4	.8	.3	.4	1.5	10.78	6.52
ESE	0	.1	1.0	.6	.8	.4	.7	.1	.7	0	0	0	4.48	5.47
SE	0	.3	.4	.3	.4	.6	1.3	.6	.1	.3	.3	.1	4.62	6.70
SSE	0	.1	0.	0	0	.1	0	0	0	.1	0	.1	.56	8.00
S	0	.1	.1	0	0	.1	0	0	0	0	.1	1.0	1.54	10.73
SSW	0	.3	.4	.1	.1	0.	0	0	0	0	.3	.4	1.68	6.83
SW	.1	.6	.6	.3	.3	.3	.1	.1	.1	0	0	.3	2.80	5.10
WSW	.4	1.1	1.3	.4	.7	.6	.6	.3	.4	.7	.1	3.2	9.80	8.10
W	.4	1.0	1.4	1.5	1.4	1.3	1.0	1.1	1.4	1.1	1.1	1.3	14.01	6.86
WNW	.1	.8	1.1	.3	1.1	1.1	1.1	.4	.3	.1	.1	2.4	9.10	8.42
NW	0	.1	.1	.8	.8	.3	0	0	0	0	0	0	2.24	4.44
NNW	0	.1	.1	0	.7	.1	0	.1	0	0	0	0	1.26	4.89
N	.3	.1	0.	.4	1.1	.6	.3	.3	.1	.1	0	0	3.36	5.38
CALM													1.96	
TOTAL	2.1	9.2	12.9	11.1	12.3	10.9	8.8	5.5	5.9	3.5	3.1	12.7	100.00	6.41

ARKANSAS NUCLEAR ONE
Unit 2

Table 2.3-3

ARKANSAS NUCLEAR ONE FEBRUARY 40-FOOT WIND DIRECTION
AND SPEED, RELATIVE FREQUENCIES. PERIOD OF RECORD
FEBRUARY 7, 1972 TO FEBRUARY 7, 1973

<u>SECTOR</u>	UPPER CLASS INTERVALS OF WIND SPEED (MPH)												<u>TOTAL</u>	<u>MEAN SPEED</u>
	<u>1</u>	<u>2</u>	<u>3</u>	<u>4</u>	<u>5</u>	<u>6</u>	<u>7</u>	<u>8</u>	<u>9</u>	<u>10</u>	<u>11</u>	<u>> 11</u>		
NNE	.3	.1	0	.3	.1	.3	0	.4	.1	0	0	0	1.77	5.17
NE	.3	.1	0	.6	0	.1	0	.1	.1	.3	.1	0	1.92	5.69
ENE	.7	1.9	2.2	1.9	2.2	.9	.3	.6	.9	.4	.3	.6	13.00	5.00
E	.7	2.4	3.7	4.0	2.4	4.0	1.5	1.0	2.1	1.9	.3	.9	24.82	5.65
ESE	.3	.4	.3	.9	1.5	1.0	.7	2.1	.4	1.0	.4	1.6	10.78	7.51
SE	.1	.1	.1	.9	.9	1.2	.3	.6	.6	0	0	0	4.87	5.76
SSE	0	0	.3	.7	.3	.4	.3	.3	.1	0	0	.1	2.66	5.83
S	.1	.1	0	.4	.4	.1	0	0	0	.1	.3	.7	2.51	8.06
SSW	.1	0	.4	.4	.9	.1	.3	.3	.4	.4	.3	1.9	5.76	8.90
SW	0	0	.1	.3	.4	.4	.1	.1	0	0	0	1.0	2.66	9.06
WSW	.3	1.0	.7	.1	.1	.4	.3	.3	0	.1	0	1.5	5.02	7.44
W	.4	.6	.3	.1	1.0	.3	.3	.9	.9	.1	.1	2.4	7.53	8.59
WNW	.1	.3	.9	.4	.1	.4	.4	.6	.3	.4	.4	3.4	7.98	9.59
NW	0	.6	.1	.4	0	.1	.4	.3	.9	.1	0	1.6	4.73	10.31
NNW	0	.4	.1	0	0	0	0	0	.1	0	0	.4	1.18	7.88
N	0	.1	.3	.3	0	.1	0	0	0	.1	0	.1	1.18	5.50
CALM													1.62	
TOTAL	3.7	8.4	9.7	12.0	10.5	10.2	5.0	7.7	7.1	5.3	2.4	16.4	100.00	6.89

ARKANSAS NUCLEAR ONE
Unit 2

Table 2.3-4

ARKANSAS NUCLEAR ONE MARCH 40-FOOT WIND DIRECTION
AND SPEED, RELATIVE FREQUENCIES. PERIOD OF RECORD
FEBRUARY 7, 1972 TO FEBRUARY 7, 1973.

SECTOR	UPPER CLASS INTERVALS OF WIND SPEED (MPH)												TOTAL	MEAN SPEED
	1	2	3	4	5	6	7	8	9	10	11	> 11		
NNE	.5	.1	.4	.8	.4	1.1	.4	.4	.4	.1	.1	0	4.85	5.42
NE	0	.7	0	.1	.8	.4	.1	.3	.1	.3	0	0	2.83	5.43
ENE	.7	.9	.7	2.6	1.8	1.6	.8	.4	.1	0	0	0	9.57	4.54
E	.8	1.1	.9	1.8	2.6	2.8	1.5	.7	.4	.4	1.2	2.6	16.71	7.05
ESE	.4	.3	.5	.5	1.6	.4	.9	.7	.1	.5	.5	2.4	9.03	8.12
SE	.1	0	.4	.5	.1	.4	.4	.8	1.1	.4	.4	.1	4.85	7.39
SSE	.1	0	.1	.5	.5	1.2	.9	.9	.4	0	0	0	4.85	6.28
S	0	.5	.1	.1	.3	.8	.7	.3	.1	0	.3	.3	3.50	6.50
SSW	.3	.3	0	.7	.1	.1	.5	.5	.3	.5	.1	.5	4.04	7.23
SW	.1	0	.3	.4	.3	.1	.3	.5	.1	.4	.1	1.1	3.77	8.75
WSW	.7	.4	.1	.1	.1	.5	0	.5	.1	0	.1	1.3	4.18	7.84
W	.4	.8	.7	.4	.5	.7	.7	.7	.3	.3	.5	1.5	7.41	7.73
WNW	.4	.9	.1	.9	.5	.8	.3	.4	.8	.4	.8	5.5	11.98	9.91
NW	.1	.5	.3	0	0	.3	.4	.4	.1	.5	0	2.0	4.72	10.57
NNW	.1	0	.3	0	.1	.3	.1	.3	.4	.3	.5	.8	3.23	8.96
N	.7	0	1.1	.4	.3	.1	.1	.4	.1	0	0	0	3.23	4.04
CALM													1.21	
TOTAL	5.5	6.6	6.1	10.0	10.1	11.7	8.2	8.2	5.1	4.2	4.9	18.2	100.00	7.28

ARKANSAS NUCLEAR ONE
Unit 2

Table 2.3-5

ARKANSAS NUCLEAR ONE APRIL 40-FOOT WIND DIRECTION
AND SPEED, RELATIVE FREQUENCIES. PERIOD OF RECORD
FEBRUARY 7, 1972 TO FEBRUARY 7, 1973

<u>SECTOR</u>	UPPER CLASS INTERVALS OF WIND SPEED (MPH)												<u>TOTAL</u>	<u>MEAN SPEED</u>
	<u>1</u>	<u>2</u>	<u>3</u>	<u>4</u>	<u>5</u>	<u>6</u>	<u>7</u>	<u>8</u>	<u>9</u>	<u>10</u>	<u>11</u>	<u>> 11</u>		
NNE	.3	.3	0	.1	.1	.7	.4	.3	0	0	0	0	2.31	5.13
NE	.1	.4	.7	.4	.6	.3	.4	.3	0	0	0	0	3.32	4.48
ENE	.3	.7	1.7	3.2	2.0	1.2	.7	.3	.1	.1	0	0	10.39	4.50
E	.6	1.7	2.0	2.3	3.0	2.3	1.2	1.7	.7	1.0	.6	2	19.34	6.25
ESE	.1	1.0	.6	2.0	1.7	.9	1.4	1.0	.6	1.0	1.0	3.2	14.57	7.93
SE	.1	.4	.4	.7	2.0	1.0	1.7	1.3	.7	.9	.3	0	9.67	6.43
SSE	.1	.3	.4	.3	1.9	.9	1.4	1.4	1.2	.6	.1	.1	8.80	6.69
S	.3	.1	.1	.1	.1	0	.7	.1	.3	.4	.3	.1	2.89	7.05
SSW	.3	0	0	.1	.1	.4	.3	.4	1.0	1.0	.4	.6	4.76	8.55
SW	0	.1	.3	.3	.1	.3	.4	.6	.4	.4	.3	1.2	4.47	8.84
WSW	.3	0	.3	0	.1	.3	.4	.6	.1	0	0	.3	2.45	6.82
W	.4	0	0	.1	0	.1	.3	.3	.4	.3	.1	2.3	4.47	11.00
WNW	0	0	.3	.7	.1	.4	.3	.3	.1	.3	.4	2.9	5.92	11.46
NW	.1	.3	0	.1	0	.3	.3	0	.1	.3	.3	.6	2.45	8.41
NNW	.1	0	.1	.1	.1	.3	.4	0	.1	.1	.1	.7	2.45	8.94
N	0	0	.1	0	.4	.6	0	.3	.1	.1	0	0	1.73	6.42
CALM													0	
TOTAL	3.3	5.5	7.2	10.8	12.7	10.0	10.5	8.9	6.2	6.0	4.0	14.1	100.00	7.19

ARKANSAS NUCLEAR ONE

Unit 2

Table 2.3-6

**ARKANSAS NUCLEAR ONE MAY 40-FOOT WIND DIRECTION
AND SPEED, RELATIVE FREQUENCIES. PERIOD OF RECORD
FEBRUARY 7, 1972 TO FEBRUARY 7, 1973**

<u>SECTOR</u>	UPPER CLASS INTERVALS OF WIND SPEED (MPH)												<u>TOTAL</u>	<u>MEAN SPEED</u>
	<u>1</u>	<u>2</u>	<u>3</u>	<u>4</u>	<u>5</u>	<u>6</u>	<u>7</u>	<u>8</u>	<u>9</u>	<u>10</u>	<u>11</u>	<u>> 11</u>		
NNE	.9	.3	.5	0	0	.3	0	0	0	0	0	0	2.02	2.38
NE	1.6	.9	.8	.6	.3	.2	0	0	0	0	0	0	4.36	2.46
ENE	1.7	1.9	2.5	2.3	1.2	.3	.3	0	.2	0	0	0	10.44	3.25
E	.9	2.2	1.4	2.2	2.0	1.4	.9	1.6	.3	.8	.3	.9	14.95	5.47
ESE	.6	.6	1.1	1.2	.5	.6	.5	.8	.5	.3	.9	1.2	8.81	6.67
SE	.9	.2	.6	.8	1.2	.3	.2	.3	.2	.2	0	0	4.83	4.32
SSE	.2	0	.2	.9	.8	.3	.5	.2	.5	.5	0	0	3.89	6.04
S	1.1	0	.5	.3	.8	.3	.2	.3	.2	.3	.3	.2	4.36	5.25
SSW	.2	0	.2	0	.3	.2	0	0	.2	0	0	0	.93	4.83
SW	.3	0	.3	.2	0	.2	.3	0	0	0	0	0	1.25	4.00
WSW	.6	.5	.2	1.2	.5	.9	.5	.2	0	0	0	0	4.52	4.31
W	.6	1.1	.5	.5	.6	1.9	1.7	1.9	2.0	1.6	.6	1.7	14.64	7.59
WNW	.9	.9	.8	.9	.3	1.1	.6	.9	1.4	.6	.9	3.7	13.24	8.26
NW	.8	.2	0	.2	.2	.3	.3	.6	.3	.3	0	.6	3.74	6.75
NNW	.5	.5	.2	.5	.5	.2	.6	.2	0	0	0	0	2.96	4.26
N	.5	.5	.2	.5	.2	.2	.2	0	.2	0	0	0	2.18	3.64
CALM													2.80	
TOTAL	12.3	9.7	9.7	12.3	9.3	8.6	6.7	6.9	5.8	4.5	3.1	8.4	100.00	5.53

ARKANSAS NUCLEAR ONE
Unit 2

Table 2.3-7

ARKANSAS NUCLEAR ONE JUNE 40-FOOT WIND DIRECTION AND
SPEED, RELATIVE FREQUENCIES. PERIOD OF RECORD
FEBRUARY 7, 1972 TO FEBRUARY 7, 1973.

SECTOR	UPPER CLASS INTERVALS OF WIND SPEED (MPH)												TOTAL	MEAN SPEED
	1	2	3	4	5	6	7	8	9	10	11	> 11		
NNE	.8	1.4	.8	.3	.3	.6	.3	0	0	.3	.1	0	4.92	3.74
NE	1.5	3.1	.2	2.0	1.8	.1	.7	.1	0	.4	0	.3	13.34	3.66
ENE	1.8	2.4	3.5	2.7	1.8	.7	1.3	.6	.4	.6	0	0	15.73	4.06
E	1.8	.7	1.8	2.5	1.7	1.8	1.1	.4	.8	1.0	1.4	1.1	16.29	5.95
ESE	.6	.1	.6	1.3	1.5	1.3	1.4	.6	.3	0	0	0	7.58	5.24
SE	.3	.1	.8	1.0	.8	1.3	.6	.8	.1	0	0	0	5.90	5.21
SSE	.1	.6	.1	1.0	1.7	2.0	1.1	.7	.4	0	0	0	7.72	5.58
S	.4	.1	0	1.3	.4	.8	.7	.6	.1	.1	.3	0	4.92	5.71
SSW	.4	.1	.4	.7	.4	.3	.6	.1	.3	0	.1	0	3.51	5.04
SW	.1	0	0	.4	.4	.1	.1	.3	0	.1	0	0	1.69	5.58
WSW	.1	.1	.1	.6	.4	.1	0	0	0	0	0	.1	1.69	4.58
W	1.1	.4	.1	.3	.7	.4	.1	.1	.1	.1	.3	.7	4.63	5.61
WNW	1.1	.3	.6	.4	.7	.3	0	.3	.3	.3	.8	0	5.06	5.36
NW	.1	.1	.1	0	.1	0	0	0	0	0	0	0	.56	2.75
NNW	.4	.3	.1	0	0	.1	.1	0	.1	0	0	0	1.26	3.56
N	.7	.6	.3	.6	.4	.6	.4	.1	.1	0	0	0	3.79	4.15
CALM													1.40	
TOTAL	10.7	10.5	12.8	14.9	13.3	10.5	8.6	4.8	3.2	2.9	3.1	2.2	100.00	4.79

ARKANSAS NUCLEAR ONE

Unit 2

Table 2.3-8

**ARKANSAS NUCLEAR ONE JULY 40-FOOT WIND DIRECTION
AND SPEED, RELATIVE FREQUENCIES. PERIOD OF RECORD
FEBRUARY 7, 1972 TO FEBRUARY 7, 1973**

<u>SECTOR</u>	UPPER CLASS INTERVALS OF WIND SPEED (MPH)												<u>TOTAL</u>	<u>MEAN SPEED</u>
	<u>1</u>	<u>2</u>	<u>3</u>	<u>4</u>	<u>5</u>	<u>6</u>	<u>7</u>	<u>8</u>	<u>9</u>	<u>10</u>	<u>11</u>	<u>> 11</u>		
NNE	.7	.8	.5	.7	.7	.7	0	.3	.3	.1	0	0	4.77	4.23
NE	1.4	2.9	2.6	1.6	1.2	.3	.1	0	0	0	0	0	10.08	2.99
ENE	.8	1.5	2.9	3.3	2.9	.8	.1	.1	0	0	0	0	12.40	3.77
E	.5	1.0	2.7	2.7	2.9	1.0	.8	.5	.4	.3	.3	0	13.08	4.67
ESE	.5	.8	1.5	2.9	3.3	2.6	1.0	.7	.1	.3	0	.1	13.76	4.92
SE	0	.5	1.9	3.0	3.3	1.1	.3	.1	.3	0	0	.1	10.63	4.59
SSE	.1	.4	.8	1.4	1.5	.5	.3	.7	0	0	0	0	5.72	4.71
S	0	0	.7	.7	1.2	.7	.7	.1	0	0	.1	0	4.22	5.29
SSW	.3	.3	.5	.5	.7	.1	.8	.5	0	0	0	.1	3.95	5.24
SW	0	.1	.3	.7	.3	.1	.4	.1	0	0	0	0	2.04	4.87
WSW	.3	.5	.3	.5	.7	.3	.4	.3	.4	0	.1	0	3.81	5.14
W	.4	.5	.7	.5	.5	.1	0	.1	.8	.4	.3	0	4.50	5.52
WNW	.3	.4	.7	.4	.5	.4	.1	.3	.3	0	.1	.4	3.95	5.83
NW	.3	.3	.5	.4	.1	.1	0	.1	.1	0	0	0	2.04	3.87
NNW	.3	.4	.1	.4	.5	.1	0	.1	0	0	0	0	2.04	3.80
N	.1	1.0	.4	.3	.3	0	.3	0	.1	.1	0	0	2.59	3.95
CALM													.41	
TOTAL	6.0	11.4	17.2	20.0	20.6	9.0	5.3	4.2	2.9	1.2	1.0	.8	100.00	4.48

ARKANSAS NUCLEAR ONE
Unit 2

TABLE 2.3-9

ARKANSAS NUCLEAR ONE AUGUST 40-FOOT WIND DIRECTION
AND SPEED, RELATIVE FREQUENCIES. PERIOD OF RECORD
FEBRUARY 7, 1972 TO FEBRUARY 7, 1973

SECTOR	UPPER CLASS INTERVALS OF WIND SPEED (MPH)												TOTAL	MEAN SPEED
	1	2	3	4	5	6	7	8	9	10	11	> 11		
NNE	1.4	1.9	.9	.5	.1	.3	0	0	0	0	0	0	5.14	2.42
NE	2.0	3.8	3.5	2.2	1.1	.1	.1	0	0	0	0	0	12.84	2.80
ENE	1.5	1.6	1.9	1.8	1.9	1.1	.4	.4	0	.1	0	0	10.68	3.82
E	.3	.9	1.8	1.8	2.2	.8	.3	.1	.4	.3	.3	.3	9.32	4.96
ESE	.4	.5	1.1	1.6	2.3	1.2	.8	.4	0	.1	0	.1	8.65	4.88
SE	0	.3	.4	2.3	2.2	1.8	.3	.1	.1	.1	0	0	7.57	5.00
SSE	.3	.1	.1	.3	1.8	.9	.3	.7	0	0	0	0	4.46	5.33
S	.3	.3	.5	.7	1.4	.8	.3	.5	.4	.1	0	0	5.27	5.31
SSW	.1	.4	.1	.4	.1	.3	.1	.1	.1	0	0	0	1.89	4.50
SW	0	.1	.3	.5	.9	.4	.4	.1	0	0	0	0	2.84	5.05
WSW	.5	.7	.8	.7	.8	1.4	.7	.4	.7	.4	.4	.1	7.57	5.73
W	.9	.7	.7	.8	.7	.4	2.0	1.4	.9	.7	.7	.7	10.54	6.59
NNW	1.6	.3	1.1	.4	.5	.4	0	.3	.7	.1	.1	.5	6.08	4.98
NW	.4	.3	.1	.3	.3	.3	.1	.1	.1	.1	0	0	2.16	4.63
WNW	.7	0	.1	.1	.3	.1	0	0	0	0	0	0	1.35	2.80
N	.7	.5	.3	0	.1	0	.1	0	0	0	0	0	1.76	2.38
CALM													1.89	
TOTAL	11.1	12.4	13.8	14.3	16.6	10.3	5.9	4.7	3.5	2.2	1.5	1.8	100.00	4.51

ARKANSAS NUCLEAR ONE

Unit 2

Table 2.3-10

**ARKANSAS NUCLEAR ONE SEPTEMBER 40-FOOT WIND DIRECTION
AND SPEED, RELATIVE FREQUENCIES. PERIOD OF RECORD
FEBRUARY 7, 1972 TO FEBRUARY 7, 1973**

<u>SECTOR</u>	UPPER CLASS INTERVALS OF WIND SPEED (MPH)												<u>TOTAL</u>	<u>MEAN SPEED</u>
	<u>1</u>	<u>2</u>	<u>3</u>	<u>4</u>	<u>5</u>	<u>6</u>	<u>7</u>	<u>8</u>	<u>9</u>	<u>10</u>	<u>11</u>	<u>> 11</u>		
NNE	.3	1.0	2.1	1.1	.8	.3	0	.3	0	0	.1	0	6.02	3.77
NE	1.4	2.8	4.2	2.5	1.1	1.4	.4	.1	.1	.3	.1	0	14.57	3.6
ENE	.6	2.5	3.1	2.9	2.2	2.4	.4	.7	.4	0	0	0	15.27	4.22
E	.1	1.5	4.6	3.4	2.4	2.2	.6	.6	.6	.3	.1	0	16.39	4.50
ESE	0	.7	2.4	2.5	2.7	2.1	.6	.1	0	0	.1	0	11.20	4.56
SE	.3	.4	.8	1.4	2.9	2.0	2.1	.8	.3	0	0	0	11.06	5.39
SSE	.1	.4	.3	1.0	.7	1.4	.1	.1	.7	0	0	0	4.90	5.31
S	0	0	.1	.6	1.5	1.1	.6	.7	0	.1	.1	.1	5.04	6.19
SSW	.1	0	0	.4	0	.6	.3	.3	0	0	0	0	1.68	5.58
SW	0	.1	.1	.1	.1	.7	0	0	.1	0	0	0	1.40	5.30
WSW	0	.3	.1	.1	.1	.3	.1	0	0	0	0	0	1.12	4.38
W	.1	.3	.3	.4	.6	.4	.1	.1	.1	.1	0	0	2.66	5.00
WNW	.4	.6	.6	.3	.7	.3	.3	.3	0	0	0	0	3.36	4.08
NW	.3	.3	.3	0	0	0	.1	.3	.3	.1	0	0	1.68	5.25
NNW	.3	.6	0	0	.1	0	0	0	0	0	0	0	.98	2.14
N	.3	.4	.3	.3	.1	0	.1	.1	.1	.1	0	.3	2.24	5.44
CALM													.43	
TOTAL	4.3	11.9	19.3	17.1	16.2	15.1	5.9	4.6	2.8	1.1	.7	.4	100.00	4.54

ARKANSAS NUCLEAR ONE
Unit 2

Table 2.3-11

ARKANSAS NUCLEAR ONE OCTOBER 40-FOOT WIND DIRECTION
AND SPEED, RELATIVE FREQUENCIES. PERIOD OF RECORD
FEBRUARY 7, 1972 TO FEBRUARY 7, 1973

<u>SECTOR</u>	UPPER CLASS INTERVALS OF WIND SPEED (MPH)												<u>TOTAL</u>	<u>MEAN SPEED</u>
	<u>1</u>	<u>2</u>	<u>3</u>	<u>4</u>	<u>5</u>	<u>6</u>	<u>7</u>	<u>8</u>	<u>9</u>	<u>10</u>	<u>11</u>	<u>> 11</u>		
NNE	.6	1.1	.8	1.4	.3	.9	1.2	.3	.5	0	0	.3	7.21	4.96
NE	1.4	3.5	1.7	2.3	1.4	.9	.6	.5	.5	.2	0	0	12.61	3.79
ENE	1.1	2.7	2.3	.3	2.3	1.4	1.8	1.5	1.7	.9	.6	1.5	17.87	6.09
E	.6	1.8	1.8	2.1	.9	2.1	1.7	.9	3.2	2.7	1.8	2.4	21.92	7.32
ESE	.3	.6	.5	1.8	1.2	.5	.8	.9	.6	.3	0	.5	7.81	5.94
SE	0	.2	.3	.9	1.2	.3	.2	.2	0	0	0	.2	3.30	5.23
SSE	0	.5	0	.5	.3	.3	.3	0	0	0	0	0	1.80	4.50
S	.2	0	.3	.2	0	.2	.2	0	0	0	0	0	.90	4.00
SSW	.3	.3	.2	.2	0	.3	.2	0	0	.2	0	0	1.50	4.20
SW	0	.5	0	.2	0	.2	.2	0	0	0	.2	0	1.05	4.86
WSW	0	.2	.3	.2	.3	.9	.8	.3	0	.2	.2	.2	3.30	6.64
W	0	.6	.5	.5	.5	.5	.5	.6	.9	.2	.5	.6	5.56	7.08
WNW	.2	.3	0	.3	.2	1.1	.5	0	.3	.3	.2	.2	3.30	6.45
NW	.3	.2	0	.6	.2	.8	.3	.2	0	0	0	0	2.40	4.81
NNW	.3	.5	.8	.5	.2	0	0	0	0	0	0	0	2.10	2.86
N	.5	.3	.8	.6	.3	.2	.2	.2	.2	.2	0	0	3.15	4.19
CALM													4.20	
TOTAL	5.6	12.9	9.9	12.2	9.0	10.2	9.0	5.4	7.7	5.0	3.3	5.7	100.00	5.53

ARKANSAS NUCLEAR ONE
Unit 2

Table 2.3-12

ARKANSAS NUCLEAR ONE NOVEMBER 40-FOOT WIND DIRECTION
AND SPEED, RELATIVE FREQUENCIES. PERIOD OF RECORD
FEBRUARY 7, 1972 TO FEBRUARY 7, 1973.

SECTOR	UPPER CLASS INTERVALS OF WIND SPEED (MPH)												TOTAL	MEAN SPEED
	1	2	3	4	5	6	7	8	9	10	11	> 11		
NNE	.6	.7	.3	.9	.3	.3	.7	.1	0	0	.1	0	4.00	4.29
NE	.7	1.4	2.4	1.0	.3	.3	.3	.4	0	.4	.1	0	7.43	3.94
ENE	.7	1.1	1.7	2.1	.9	1.9	1.6	1.0	1.4	.6	.4	1.3	14.71	6.20
E	.4	.7	.7	.6	.4	1.9	2.3	1.6	1.9	1.6	.6	1.4	14.00	7.59
ESE	.1	.3	.6	.3	.3	.6	.9	.9	.1	.4	.1	.1	4.71	6.39
SE	.1	.1	.4	0	0	0	.3	0	0	.1	0	0	1.14	4.50
SSE	.3	0	.4	0	0	0	0	0	0	0	0	0	.71	2.20
S	.1	.3	.3	.1	.3	0	0	0	0	0	0	0	1.14	3.13
SSW	0	.1	.7	0	0	0	0	0	0	0	0	0	.86	2.83
SW	0	.3	.1	.1	0	0	0	.1	0	0	.1	.4	1.29	8.22
WSW	.4	.4	.9	.7	.3	.3	.4	.9	.4	.9	.7	3.3	9.57	9.27
W	.9	1.1	.4	1.0	1.3	1.6	2.4	1.7	1.6	1.6	.7	4.0	18.29	8.20
WNW	.4	.4	.4	.3	.7	1.4	.9	.9	.6	.6	.3	3.3	10.14	8.85
NW	0	0	.6	.3	.1	.3	.7	.3	.1	.3	.1	.3	3.14	6.95
NNW	.3	.7	1.3	.1	.1	.1	.1	0	0	0	0	0	2.86	3.05
N	.1	.3	1.1	1.0	.4	.7	0	.1	0	.1	0	.1	4.14	4.62
CALM													1.86	
TOTAL	5.3	8.1	12.4	8.6	5.4	9.3	10.6	8.0	6.1	6.6	3.4	14.3	100.00	6.76

ARKANSAS NUCLEAR ONE
Unit 2

Table 2.3-13

ARKANSAS NUCLEAR ONE DECEMBER 40-FOOT WIND DIRECTION
AND SPEED, RELATIVE FREQUENCIES. PERIOD OF RECORD
FEBRUARY 7, 1972 TO FEBRUARY 7, 1973

SECTOR	UPPER CLASS INTERVALS OF WIND SPEED (MPH)												TOTAL	MEAN SPEED
	1	2	3	4	5	6	7	8	9	10	11	> 11		
NNE	.7	1.4	.9	0	0	.3	.9	0	0	0	0	0	4.11	3.42
NE	.2	1.4	3.3	1.4	.5	1.7	.5	1.5	.5	0	0	0	10.96	4.70
ENE	1.0	1.4	1.9	2.6	2.1	2.6	2.2	2.2	.7	.5	0	.9	17.98	5.62
E	.3	1.2	1.7	1.2	.7	1.2	1.5	1.5	.7	1.4	.9	1.4	13.70	6.85
ESE	.2	.7	.9	.3	.9	1.2	.5	1.9	.3	.2	0	0	7.02	5.76
SE	0	.3	.2	0	.5	.5	.7	.5	.2	.3	0	0	3.25	6.37
SSE	0	0	.2	0	.2	.2	.2	0	.5	.3	0	0	1.54	7.56
S	.2	.3	.2	0	0	0	0	0	.5	.2	.2	.3	1.88	7.36
SSW	0	.2	0	0	.2	0	0	0	0	.3	.3	0	1.03	8.17
SW	0	0	.7	.3	0	.2	.2	0	0	0	0	0	1.37	4.13
WSW	0	.7	.3	.3	.5	.5	1.2	.7	.2	0	.3	.9	5.65	6.94
W	0	1.0	.5	1.2	.9	.5	1.5	.7	1.4	1.5	2.4	4.1	15.75	8.91
WNW	0	.2	.3	.2	.3	.9	1.0	.3	.5	.7	.3	3.3	8.05	9.83
NW	0	.2	0	0	.2	.2	.2	.2	.7	.3	0	.7	2.57	9.07
NNW	0	0	.5	0	0	.2	.3	.3	0	0	0	0	1.37	5.63
N	.2	.7	.2	0	.2	.5	0	0	.3	0	0	0	2.05	4.42
CALM													1.71	
TOTAL	2.7	9.6	11.6	7.5	7.0	10.6	11.0	9.9	6.5	5.8	4.5	11.5	100.00	6.60

ARKANSAS NUCLEAR ONE
Unit 2

Table 2.3-14

LITTLE ROCK, ARKANSAS WINTER SURFACE WIND DIRECTION AND SPEED,
RELATIVE FREQUENCIES FOR "A" STABILITY

<u>SEA-DJF</u>	<u>RELATIVE FREQUENCY DISTRIBUTION SPEED (KTS)</u>					<u>STATION-LITTLE ROCK, AR 66-70</u>	
<u>Direction</u>	<u>0 - 3</u>	<u>4 - 6</u>	<u>7 - 10</u>	<u>11 - 16</u>	<u>17 - 21</u>	<u>Greater Than 21</u>	<u>TOTAL</u>
N	0.000000	0.000000	0.000000	0.000000	0.000000	0.000000	0.000000
NNE	0.000000	0.000000	0.000000	0.000000	0.000000	0.000000	0.000000
NE	0.000000	0.000000	0.000000	0.000000	0.000000	0.000000	0.000000
ENE	0.000000	0.000000	0.000000	0.000000	0.000000	0.000000	0.000000
E	0.000000	0.000000	0.000000	0.000000	0.000000	0.000000	0.000000
ESE	0.000000	0.000000	0.000000	0.000000	0.000000	0.000000	0.000000
SE	0.000000	0.000000	0.000000	0.000000	0.000000	0.000000	0.000000
SSE	0.000000	0.000000	0.000000	0.000000	0.000000	0.000000	0.000000
S	0.000000	0.000000	0.000000	0.000000	0.000000	0.000000	0.000000
SSW	0.000000	0.000000	0.000000	0.000000	0.000000	0.000000	0.000000
SW	0.000000	0.000000	0.000000	0.000000	0.000000	0.000000	0.000000
WSW	0.000000	0.000000	0.000000	0.000000	0.000000	0.000000	0.000000
W	0.000000	0.000000	0.000000	0.000000	0.000000	0.000000	0.000000
WNW	0.000000	0.000000	0.000000	0.000000	0.000000	0.000000	0.000000
NW	0.000000	0.000000	0.000000	0.000000	0.000000	0.000000	0.000000
NNW	0.000000	0.000000	0.000000	0.000000	0.000000	0.000000	0.000000
TOTAL	0.000000	0.000000	0.000000	0.000000	0.000000	0.000000	0.000000

Relative frequency of occurrence of a stability = 0.000000

Relative frequency of calms distributed above with a stability = 0.000000

ARKANSAS NUCLEAR ONE
Unit 2

Table 2.3-15

LITTLE ROCK, AR WINTER SURFACE WIND DIRECTION AND SPEED,
RELATIVE FREQUENCIES FOR "B" STABILITY

<u>SEA-DJF</u>	<u>RELATIVE FREQUENCY DISTRIBUTION SPEED (KTS)</u>					<u>STATION-LITTLE ROCK, AR 66-70</u>	
<u>Direction</u>	<u>0 - 3</u>	<u>4 - 6</u>	<u>7 - 10</u>	<u>11 - 16</u>	<u>17 - 21</u>	<u>Greater Than 21</u>	<u>TOTAL</u>
N	0.000084	0.000556	0.000278	0.000000	0.000000	0.000000	0.000918
NNE	0.000682	0.000278	0.000000	0.000000	0.000000	0.000000	0.000960
NE	0.000446	0.000833	0.000000	0.000000	0.000000	0.000000	0.001279
ENE	0.000084	0.000556	0.000000	0.000000	0.000000	0.000000	0.000640
E	0.000724	0.000556	0.000556	0.000000	0.000000	0.000000	0.001835
ESE	0.000682	0.000273	0.000000	0.000000	0.000000	0.000000	0.000960
SE	0.000320	0.000000	0.000278	0.000000	0.000000	0.000000	0.000598
SSE	0.000362	0.000278	0.000000	0.000000	0.000000	0.000000	0.000640
S	0.000000	0.000000	0.000000	0.000000	0.000000	0.000000	0.000000
SSW	0.000000	0.000000	0.000000	0.000000	0.000000	0.000000	0.000000
SW	0.000000	0.000000	0.000278	0.000000	0.000000	0.000000	0.000278
WSW	0.000724	0.000556	0.000000	0.000000	0.000000	0.000000	0.001279
W	0.000362	0.000278	0.000000	0.000000	0.000000	0.000000	0.000640
WNW	0.000042	0.000278	0.000000	0.000000	0.000000	0.000000	0.000320
NW	0.000682	0.000278	0.000833	0.000000	0.000000	0.000000	0.001793
NNW	0.000362	0.000278	0.000556	0.000000	0.000000	0.000000	0.001195
TOTAL	0.005556	0.005000	0.002778	0.000000	0.000000	0.000000	

Relative frequency of occurrence of "B" stability = 0.013333

Relative frequency of calms distributed above with "B" stability = 0.001389

ARKANSAS NUCLEAR ONE
Unit 2

Table 2.3-16

LITTLE ROCK, AR WINTER SURFACE WIND DIRECTION AND SPEED,
RELATIVE FREQUENCIES FOR "C" STABILITY

<u>SEA-DJF</u>	<u>RELATIVE FREQUENCY DISTRIBUTION SPEED (KTS)</u>					<u>STATION-LITTLE ROCK, AR 66-70</u>	
<u>Direction</u>	<u>0 - 3</u>	<u>4 - 6</u>	<u>7 - 10</u>	<u>11 - 16</u>	<u>17 - 21</u>	<u>Greater Than 21</u>	<u>TOTAL</u>
N	0.000663	0.003333	0.005278	0.000278	0.000000	0.000000	0.009552
NNE	0.000347	0.002222	0.000833	0.000000	0.000000	0.000000	0.003402
NE	0.000061	0.002222	0.003889	0.000000	0.000000	0.000000	0.006172
ENE	0.000670	0.003611	0.003333	0.000000	0.000000	0.000000	0.007615
E	0.000138	0.005000	0.003611	0.000000	0.000000	0.000000	0.008749
ESE	0.000077	0.002778	0.003056	0.000000	0.000000	0.000000	0.005910
SE	0.000046	0.001667	0.002778	0.000000	0.000000	0.000000	0.004490
SSE	0.000046	0.001667	0.002222	0.000000	0.000000	0.000000	0.003935
S	0.000408	0.004444	0.002222	0.000000	0.000000	0.000000	0.007075
SSW	0.000031	0.001111	0.001389	0.000000	0.000000	0.000000	0.002531
SW	0.000308	0.000833	0.002778	0.000278	0.000000	0.000000	0.004197
WSW	0.000100	0.003611	0.005278	0.000000	0.000000	0.000000	0.008988
W	0.000061	0.002222	0.001944	0.000000	0.000000	0.000000	0.004228
WNW	0.000038	0.001389	0.004167	0.000000	0.000000	0.000000	0.005594
NW	0.000038	0.001389	0.003889	0.000278	0.000000	0.000000	0.005594
NNW	0.000023	0.000833	0.003611	0.000000	0.000000	0.000000	0.004467
TOTAL	0.003056	0.038333	0.050278	0.000833	0.000000	0.000000	

Relative frequency of occurrence of "C" Stability = 0.092500

Relative frequency of Calms distributed above with "C" stability = 0.001111

ARKANSAS NUCLEAR ONE
Unit 2

Table 2.3-17

**LITTLE ROCK, ARKANSAS WINTER SURFACE WIND DIRECTION AND SPEED,
RELATIVE FREQUENCIES FOR "D" STABILITY**

<u>SEA-DJF</u>	<u>RELATIVE FREQUENCY DISTRIBUTION SPEED (KTS)</u>					<u>STATION-LITTLE ROCK, AR 66-70</u>	
<u>Direction</u>	<u>0 - 3</u>	<u>4 - 6</u>	<u>7 - 10</u>	<u>11 - 16</u>	<u>17 - 21</u>	<u>Greater Than 21</u>	<u>TOTAL</u>
N	0.000732	0.007500	0.020278	0.026111	0.002222	0.000000	0.056843
NNE	0.000880	0.005000	0.021944	0.014167	0.000556	0.000000	0.042547
NE	0.000846	0.009444	0.022778	0.015556	0.000278	0.000278	0.049179
ENE	0.001336	0.007778	0.020000	0.008611	0.000833	0.000000	0.038559
E	0.003147	0.013611	0.021944	0.005556	0.000000	0.000000	0.044258
ESE	0.002052	0.015000	0.018389	0.003333	0.000000	0.000000	0.039274
SE	0.002348	0.010000	0.016111	0.003889	0.000000	0.000000	0.032348
SSE	0.001549	0.006389	0.015278	0.006944	0.000000	0.000000	0.030160
S	0.001059	0.008056	0.019444	0.014722	0.001111	0.000000	0.044392
SSW	0.000880	0.005000	0.011944	0.012778	0.002222	0.000278	0.033102
SW	0.000456	0.002778	0.008333	0.006944	0.000556	0.000278	0.019345
WSW	0.000880	0.005000	0.010556	0.007778	0.000556	0.000000	0.024769
W	0.000472	0.003056	0.006111	0.010556	0.000833	0.000000	0.021028
WNW	0.001273	0.001667	0.010000	0.022500	0.002222	0.000000	0.037662
NW	0.000505	0.003611	0.014444	0.022778	0.002778	0.000278	0.044394
NNW	0.001028	0.002500	0.015556	0.014722	0.001389	0.000000	0.035195
TOTAL	0.019444	0.106389	0.253611	0.196944	0.015556	0.001111	

Relative frequency of occurrence of "D" stability = 0.593056
 Relative frequency of calms distributed above with "D" stability = 0.006944

ARKANSAS NUCLEAR ONE
Unit 2

Table 2.3-18

LITTLE ROCK, AR WINTER SURFACE WIND DIRECTION AND SPEED,
RELATIVE FREQUENCIES FOR "E" STABILITY

<u>SEA-DJF</u>	<u>RELATIVE FREQUENCY DISTRIBUTION SPEED (KTS)</u>					<u>STATION-LITTLE ROCK, AR 66-70</u>	
<u>Direction</u>	<u>0 - 3</u>	<u>4 - 6</u>	<u>7 - 10</u>	<u>11 - 16</u>	<u>17 - 21</u>	<u>Greater Than 21</u>	<u>TOTAL</u>
N	0.002584	0.011111	0.013611	0.000000	0.000000	0.000000	0.027306
NNE	0.002258	0.008889	0.003889	0.000000	0.000000	0.000000	0.015036
NE	0.002969	0.007222	0.004167	0.000000	0.000000	0.000000	0.014358
ENE	0.003417	0.010278	0.002778	0.000000	0.000000	0.000000	0.016472
E	0.004976	0.012222	0.002500	0.000000	0.000000	0.000000	0.019698
ESE	0.004739	0.012778	0.001389	0.000000	0.000000	0.000000	0.018905
SE	0.003410	0.008056	0.003333	0.000000	0.000000	0.000000	0.014799
SSE	0.002691	0.007500	0.003056	0.000000	0.000000	0.000000	0.013247
S	0.004298	0.011944	0.006389	0.000000	0.000000	0.000000	0.022631
SSW	0.002529	0.006389	0.003056	0.000000	0.000000	0.000000	0.011973
SW	0.003146	0.012778	0.005556	0.000000	0.000000	0.000000	0.021480
WSW	0.004808	0.021944	0.011944	0.000000	0.000000	0.000000	0.038697
W	0.002435	0.014444	0.006667	0.000000	0.000000	0.000000	0.023546
WNW	0.000611	0.004167	0.007500	0.000000	0.000000	0.000000	0.012277
NW	0.000936	0.006389	0.008333	0.000000	0.000000	0.000000	0.015658
NNW	0.001695	0.007222	0.006111	0.000000	0.000000	0.000000	0.015029
TOTAL	0.047500	0.163333	0.090278	0.000000	0.000000	0.000000	

Relative frequency of occurrence of "E" stability = 0.301111

Relative frequency of calms distributed above with "E" stability = 0.026944

ARKANSAS NUCLEAR ONE
Unit 2

Table 2.3-19

LITTLE ROCK, AR SPRING SURFACE WIND DIRECTION AND SPEED,
RELATIVE FREQUENCIES FOR "A" STABILITY

<u>SEA-MAM</u>	<u>RELATIVE FREQUENCY DISTRIBUTION SPEED (KTS)</u>					<u>STATION-LITTLE ROCK, AR 66-70</u>	
<u>Direction</u>	<u>0 - 3</u>	<u>4 - 6</u>	<u>7 - 10</u>	<u>11 - 16</u>	<u>17 - 21</u>	<u>Greater Than 21</u>	<u>TOTAL</u>
N	0.000121	0.000544	0.000000	0.000000	0.000000	0.000000	0.000664
NNE	0.000181	0.000815	0.000000	0.000000	0.000000	0.000000	0.000997
NE	0.000181	0.000815	0.000000	0.000000	0.000000	0.000000	0.000997
ENE	0.000453	0.000544	0.000000	0.000000	0.000000	0.000000	0.000997
E	0.000513	0.000315	0.000000	0.000000	0.000000	0.000000	0.001329
ESE	0.000332	0.000000	0.000000	0.000000	0.000000	0.000000	0.000332
SE	0.000060	0.000272	0.000000	0.000000	0.000000	0.000000	0.000332
SSE	0.000000	0.000000	0.000000	0.000000	0.000000	0.000000	0.000000
S	0.000121	0.000544	0.000000	0.000000	0.000000	0.000000	0.000664
SSW	0.000000	0.000000	0.000000	0.000000	0.000000	0.000000	0.000000
SW	0.000000	0.000000	0.000000	0.000000	0.000000	0.000000	0.000000
WSW	0.000453	0.000544	0.000000	0.000000	0.000000	0.000000	0.000997
W	0.000060	0.000272	0.000000	0.000000	0.000000	0.000000	0.000332
WNW	0.000181	0.000815	0.000000	0.000000	0.000000	0.000000	0.000997
NW	0.000060	0.000272	0.000000	0.000000	0.000000	0.000000	0.000332
NNW	0.000000	0.000000	0.000000	0.000000	0.000000	0.000000	0.000000
TOTAL	0.002718	0.006252	0.000000	0.000000	0.000000	0.000000	

Relative frequency of occurrence of "A" stability = 0.008970
Relative frequency of calms distributed above with "A" stability = 0.001631

ARKANSAS NUCLEAR ONE
Unit 2

Table 2.3-20

LITTLE ROCK, ARKANSAS SPRING SURFACE WIND DIRECTION AND SPEED
RELATIVE FREQUENCIES FOR "B" STABILITY

<u>SEA-MAM</u>	<u>RELATIVE FREQUENCY DISTRIBUTION SPEED (KTS)</u>					<u>STATION-LITTLE ROCK, AR 66-70</u>	
<u>Direction</u>	<u>0 - 3</u>	<u>4 - 6</u>	<u>7 - 10</u>	<u>11 - 16</u>	<u>17 - 21</u>	<u>Greater Than 21</u>	<u>TOTAL</u>
N	0.000014	0.001903	0.000544	0.000000	0.000000	0.000000	0.002460
NNE	0.000016	0.002175	0.001087	0.000000	0.000000	0.000000	0.003278
NE	0.000290	0.002175	0.001359	0.000000	0.000000	0.000000	0.003824
ENE	0.000288	0.001903	0.002446	0.000000	0.000000	0.000000	0.004637
E	0.000860	0.005164	0.002446	0.000000	0.000000	0.000000	0.008470
ESE	0.000590	0.005708	0.002175	0.000000	0.000000	0.000000	0.008473
SE	0.000012	0.001631	0.002175	0.000000	0.000000	0.000000	0.003817
SSE	0.000004	0.000544	0.001631	0.000000	0.000000	0.000000	0.002179
S	0.000016	0.002175	0.002446	0.000000	0.000000	0.000000	0.004637
SSW	0.000012	0.001631	0.000815	0.000000	0.000000	0.000000	0.002458
SW	0.000008	0.001087	0.002990	0.000000	0.000000	0.000000	0.004085
WSW	0.000022	0.002990	0.002175	0.000000	0.000000	0.000000	0.005187
W	0.000562	0.001903	0.000544	0.000000	0.000000	0.000000	0.003008
WNW	0.000284	0.001359	0.000815	0.000000	0.000000	0.000000	0.002458
NW	0.000278	0.000544	0.001631	0.000000	0.000000	0.000000	0.002452
NNW	0.000550	0.000272	0.001631	0.000000	0.000000	0.000000	0.002452
TOTAL	0.003805	0.033161	0.026909	0.000000	0.000000	0.000000	

Relative frequency of occurrence of "B" stability = 0.063876
Relative frequency of calms distributed above with "B" stability = 0.000272

ARKANSAS NUCLEAR ONE
Unit 2

Table 2.3-21

LITTLE ROCK, AR SPRING SURFACE WIND DIRECTION AND SPEED,
RELATIVE FREQUENCIES FOR "C" STABILITY

<u>SEA-MAM</u>	<u>RELATIVE FREQUENCY DISTRIBUTION SPEED (KTS)</u>					<u>STATION-LITTLE ROCK, AR 66-70</u>	
<u>Direction</u>	<u>0 - 3</u>	<u>4 - 6</u>	<u>7 - 10</u>	<u>11 - 16</u>	<u>17 - 21</u>	<u>Greater Than 21</u>	<u>TOTAL</u>
N	0.000065	0.000544	0.002446	0.000544	0.000000	0.000000	0.003599
NNE	0.000098	0.000815	0.002718	0.000815	0.000000	0.000000	0.004447
NE	0.000130	0.001087	0.006795	0.000544	0.000000	0.000000	0.008557
ENE	0.000098	0.000815	0.004893	0.000815	0.000000	0.000000	0.006621
E	0.000163	0.001359	0.008154	0.000272	0.000000	0.000000	0.009948
ESE	0.000979	0.000544	0.005436	0.000815	0.000000	0.000000	0.007774
SE	0.000130	0.001087	0.006252	0.001087	0.000000	0.000000	0.008557
SSE	0.000130	0.001087	0.004621	0.001087	0.000272	0.000000	0.007198
S	0.000402	0.00815	0.007339	0.001903	0.000000	0.000000	0.010459
SSW	0.000065	0.000544	0.005436	0.000544	0.000272	0.000000	0.006861
SW	0.000163	0.001359	0.002718	0.002718	0.000272	0.000000	0.007230
WSW	0.000065	0.000544	0.004621	0.001087	0.000000	0.000000	0.006317
W	0.000065	0.000544	0.003805	0.000544	0.000272	0.000000	0.005230
WNW	0.000033	0.000272	0.004077	0.001631	0.000000	0.000000	0.006012
NW	0.000065	0.000544	0.003805	0.001631	0.000544	0.000000	0.006589
NNW	0.000065	0.000544	0.002446	0.000815	0.000000	0.000000	0.003871
TOTAL	0.002718	0.012503	0.075564	0.016852	0.001631	0.000000	

Relative frequency of occurrence of "C" stability = 0.109269
Relative frequency of calms distributed above with "C" stability = 0.001631

ARKANSAS NUCLEAR ONE
Unit 2

Table 2.3-22

LITTLE ROCK, AR SPRING SURFACE WIND DIRECTION AND SPEED,
RELATIVE FREQUENCIES FOR "D" STABILITY

<u>SEA-MAM</u>	<u>RELATIVE FREQUENCY DISTRIBUTION SPEED (KTS)</u>					<u>STATION-LITTLE ROCK, AR 66-70</u>	
<u>Direction</u>	<u>0 - 3</u>	<u>4 - 6</u>	<u>7 - 10</u>	<u>11 - 16</u>	<u>17 - 21</u>	<u>Greater Than 21</u>	<u>TOTAL</u>
N	0.000143	0.004621	0.015765	0.010873	0.000815	0.000000	0.032217
NNE	0.000917	0.002446	0.013591	0.009785	0.000815	0.000000	0.027554
NE	0.000160	0.005164	0.019842	0.010057	0.001359	0.000000	0.036583
ENE	0.000143	0.004621	0.017396	0.006252	0.000000	0.000000	0.028412
E	0.001060	0.007067	0.017396	0.004893	0.000000	0.000000	0.030416
ESE	0.000483	0.006524	0.010057	0.006795	0.000272	0.000000	0.024130
SE	0.000398	0.003805	0.015493	0.006795	0.000544	0.000000	0.027036
SSE	0.000373	0.002990	0.014950	0.005708	0.000272	0.000000	0.024292
S	0.000345	0.011144	0.037510	0.025279	0.001631	0.000000	0.075909
SSW	0.000110	0.003534	0.012503	0.026909	0.001903	0.000000	0.044959
SW	0.000398	0.003805	0.011960	0.016309	0.002175	0.000000	0.034647
WSW	0.000900	0.001903	0.007611	0.008698	0.001087	0.000000	0.020198
W	0.000042	0.001359	0.004349	0.007339	0.001903	0.000272	0.015264
WNW	0.000586	0.000815	0.006524	0.011144	0.003534	0.000544	0.023146
NW	0.000678	0.003805	0.009242	0.014678	0.003262	0.000000	0.031665
NNW	0.000059	0.001903	0.007883	0.008698	0.000272	0.000000	0.018814
TOTAL	0.006795	0.065507	0.222071	0.180212	0.019842	0.000815	

Relative frequency of occurrence of "D" stability = 0.495243

Relative frequency of calms distributed above with "D" stability = 0.002175

ARKANSAS NUCLEAR ONE
Unit 2

Table 2.3-23

LITTLE ROCK, AR SPRING SURFACE WIND DIRECTION AND SPEED,
RELATIVE FREQUENCIES FOR "E" STABILITY

<u>SEA-MAM</u>	<u>RELATIVE FREQUENCY DISTRIBUTION SPEED (KTS)</u>					<u>STATION-LITTLE ROCK, AR 66-70</u>	
<u>Direction</u>	<u>0 - 3</u>	<u>4 - 6</u>	<u>7 - 10</u>	<u>11 - 16</u>	<u>17 - 21</u>	<u>Greater Than 21</u>	<u>TOTAL</u>
N	0.004112	0.010057	0.007611	0.000000	0.000000	0.000000	0.021780
NNE	0.002594	0.008426	0.001903	0.000000	0.000000	0.000000	0.012923
NE	0.003969	0.011144	0.001359	0.000000	0.000000	0.000000	0.016473
ENE	0.003280	0.006795	0.002718	0.000000	0.000000	0.000000	0.012794
E	0.004370	0.011688	0.003605	0.000000	0.000000	0.000000	0.019864
ESE	0.003455	0.013862	0.002718	0.000000	0.000000	0.000000	0.020036
SE	0.004241	0.010873	0.004593	0.000000	0.000000	0.000000	0.020006
SSE	0.001749	0.007067	0.004893	0.000000	0.000000	0.000000	0.013709
S	0.008008	0.018755	0.012503	0.000000	0.000000	0.000000	0.039267
SSW	0.003854	0.008426	0.005436	0.000000	0.000000	0.000000	0.017716
SW	0.007664	0.016581	0.006524	0.000000	0.000000	0.000000	0.030763
WSW	0.007898	0.027997	0.014406	0.000000	0.000000	0.000000	0.050301
W	0.003296	0.010873	0.005708	0.000000	0.000000	0.000000	0.019877
WNW	0.000788	0.002990	0.003534	0.000000	0.000000	0.000000	0.007312
NW	0.000974	0.002175	0.007883	0.000000	0.000000	0.000000	0.011031
NNW	0.000904	0.005708	0.002175	0.000000	0.000000	0.000000	0.008787
TOTAL	0.061158	0.173416	0.088067	0.000000	0.000000	0.000000	

Relative frequency of occurrence of "E" stability = 0.322642

Relative frequency of calms distributed above with "E" stability = 0.032074

ARKANSAS NUCLEAR ONE
Unit 2

Table 2.3-24

LITTLE ROCK, AR SUMMER SURFACE WIND DIRECTION AND SPEED,
RELATIVE FREQUENCIES FOR "A" STABILITY

<u>SEA-JJA</u>	<u>RELATIVE FREQUENCY DISTRIBUTION SPEED (KTS)</u>					<u>STATION-LITTLE ROCK, AR 66-70</u>	
<u>Direction</u>	<u>0 - 3</u>	<u>4 - 6</u>	<u>7 - 10</u>	<u>11 - 16</u>	<u>17 - 21</u>	<u>Greater Than 21</u>	<u>TOTAL</u>
N	0.000097	0.000543	0.000000	0.000000	0.000000	0.000000	0.000641
NNE	0.000195	0.001087	0.000000	0.000000	0.000000	0.000000	0.001202
NE	0.000097	0.000543	0.000000	0.000000	0.000000	0.000000	0.000641
ENE	0.000049	0.000272	0.000000	0.000000	0.000000	0.000000	0.000320
E	0.000341	0.001902	0.000000	0.000000	0.000000	0.000000	0.002243
ESE	0.000661	0.001902	0.000000	0.000000	0.000000	0.000000	0.002563
SE	0.000146	0.000815	0.000000	0.000000	0.000000	0.000000	0.000961
SSE	0.000243	0.001359	0.000000	0.000000	0.000000	0.000000	0.001602
S	0.001129	0.002717	0.000000	0.000000	0.000000	0.000000	0.003845
SSW	0.000835	0.001087	0.000000	0.000000	0.000000	0.000000	0.001922
SW	0.000243	0.001359	0.000000	0.000000	0.000000	0.000000	0.001602
WSW	0.000689	0.000272	0.000000	0.000000	0.000000	0.000000	0.000961
W	0.000000	0.000000	0.000000	0.000000	0.000000	0.000000	0.000000
WNW	0.000369	0.000272	0.000000	0.000000	0.000000	0.000000	0.000641
NW	0.000515	0.001087	0.000000	0.000000	0.000000	0.000000	0.001602
NNW	0.000097	0.000543	0.000000	0.000000	0.000000	0.000000	0.000641
TOTAL	0.005707	0.015761	0.000000	0.000000	0.000000	0.000000	

Relative frequency of occurrence of "A" stability = 0.021467
Relative frequency of calms distributed above with "A" stability = 0.003261

ARKANSAS NUCLEAR ONE
Unit 2

Table 2.3-25

LITTLE ROCK, AR SUMMER SURFACE WIND DIRECTION AND SPEED,
RELATIVE FREQUENCIES FOR "B" STABILITY

<u>SEA-JJA</u>	<u>RELATIVE FREQUENCY DISTRIBUTION SPEED (KTS)</u>					<u>STATION-LITTLE ROCK, AR 66-70</u>	
<u>Direction</u>	<u>0 - 3</u>	<u>4 - 6</u>	<u>7 - 10</u>	<u>11 - 16</u>	<u>17 - 21</u>	<u>Greater Than 21</u>	<u>TOTAL</u>
N	0.000024	0.001630	0.001087	0.000000	0.000000	0.000000	0.002741
NNE	0.000311	0.002446	0.001359	0.000000	0.000000	0.000000	0.004115
NE	0.001422	0.002989	0.002446	0.000000	0.000000	0.000000	0.006856
ENE	0.000894	0.004620	0.002989	0.000000	0.000000	0.000000	0.008503
E	0.000914	0.005973	0.006250	0.000000	0.000000	0.000000	0.013142
ESE	0.000929	0.007065	0.004891	0.000000	0.000000	0.000000	0.012886
SE	0.001189	0.005978	0.002446	0.000000	0.000000	0.000000	0.009613
SSE	0.000351	0.005163	0.001630	0.000000	0.000000	0.000000	0.007144
S	0.000933	0.007337	0.004891	0.000000	0.000000	0.000000	0.013162
SSW	0.000323	0.003261	0.002989	0.000000	0.000000	0.000000	0.006573
SW	0.000642	0.006250	0.004891	0.000000	0.000000	0.000000	0.011783
WSW	0.000614	0.004348	0.007065	0.000000	0.000000	0.000000	0.012027
W	0.000347	0.004891	0.002717	0.000000	0.000000	0.000000	0.007955
WNW	0.000291	0.001087	0.001087	0.000000	0.000000	0.000000	0.002465
NW	0.000012	0.000815	0.001359	0.000000	0.000000	0.000000	0.002186
NNW	0.000043	0.002989	0.000543	0.000000	0.000000	0.000000	0.003576
TOTAL	0.009239	0.066848	0.048641	0.000000	0.000000	0.000000	

Relative Frequency of occurrence of "B" stability = 0.124728
Relative frequency of calms distributed above with "B" stability = 0.001087

ARKANSAS NUCLEAR ONE
Unit 2

Table 2.3-26

LITTLE ROCK, AR SUMMER SURFACE WIND DIRECTION AND SPEED,
RELATIVE FREQUENCIES FOR "C" STABILITY

<u>SEA-JJA</u>	<u>RELATIVE FREQUENCY DISTRIBUTION SPEED (KTS)</u>					<u>STATION-LITTLE ROCK, AR 66-70</u>	
<u>Direction</u>	<u>0 - 3</u>	<u>4 - 6</u>	<u>7 - 10</u>	<u>11 - 16</u>	<u>17 - 21</u>	<u>Greater Than 21</u>	<u>TOTAL</u>
N	0.000353	0.000272	0.003251	0.000815	0.000000	0.000000	0.004701
NNE	0.000666	0.000272	0.003804	0.001087	0.000000	0.000000	0.005829
NE	0.000910	0.001902	0.007337	0.001087	0.000000	0.000000	0.011236
ENE	0.001101	0.001087	0.007880	0.000543	0.000000	0.000000	0.010611
E	0.001467	0.003533	0.011685	0.000315	0.000000	0.000000	0.017500
ESE	0.001277	0.004348	0.007609	0.000272	0.000000	0.000000	0.013505
SE	0.001223	0.001902	0.005163	0.000000	0.000000	0.000000	0.008288
SSE	0.000910	0.001902	0.005978	0.000000	0.000000	0.000000	0.008791
S	0.001427	0.003261	0.017391	0.001630	0.000000	0.000000	0.023709
SSW	0.001535	0.001902	0.010054	0.001630	0.000000	0.000000	0.015122
SW	0.000285	0.001902	0.013557	0.004891	0.000000	0.000000	0.020666
WSW	0.001658	0.002717	0.014402	0.002717	0.000000	0.000000	0.021495
W	0.000204	0.001359	0.004076	0.001087	0.000000	0.000000	0.006726
WNW	0.000122	0.000815	0.001902	0.001087	0.000000	0.000000	0.003927
NW	0.000557	0.001630	0.001902	0.001902	0.000000	0.000000	0.005992
NNW	0.000163	0.001087	0.002446	0.000000	0.000000	0.000000	0.003696
TOTAL	0.013859	0.029891	0.118478	0.19565	0.000000	0.000000	

Relative frequency of occurrence of "C" stability = 0.181793
Relative frequency of calms distributed above with "C" stability = 0.005707

ARKANSAS NUCLEAR ONE
Unit 2

Table 2.3-27

LITTLE ROCK, AR SUMMER SURFACE WIND DIRECTION AND SPEED,
RELATIVE FREQUENCIES FOR "D" STABILITY

<u>SEA-JJA</u>	<u>RELATIVE FREQUENCY DISTRIBUTION SPEED (KTS)</u>					<u>STATION-LITTLE ROCK, AR 66-70</u>	
<u>Direction</u>	<u>0 - 3</u>	<u>4 - 6</u>	<u>7 - 10</u>	<u>11 - 16</u>	<u>17 - 21</u>	<u>Greater Than 21</u>	<u>TOTAL</u>
N	0.000120	0.004891	0.008967	0.002174	0.000000	0.000000	0.016153
NNE	0.000074	0.002989	0.006793	0.002446	0.000272	0.000000	0.012574
NE	0.000365	0.003533	0.011957	0.005707	0.000000	0.000000	0.021561
ENE	0.000094	0.003804	0.007609	0.002174	0.000272	0.000000	0.013952
E	0.000486	0.008424	0.008424	0.000815	0.000272	0.000000	0.018421
ESE	0.000452	0.007065	0.006522	0.000000	0.000000	0.000000	0.014039
SE	0.001023	0.007609	0.004620	0.000815	0.000000	0.000000	0.014066
SSE	0.000187	0.007609	0.004620	0.000815	0.000000	0.000000	0.013231
S	0.000268	0.010870	0.017120	0.007609	0.000272	0.000000	0.036137
SSW	0.000472	0.007880	0.011413	0.006793	0.000272	0.000000	0.026831
SW	0.000492	0.008696	0.012500	0.008424	0.000272	0.000272	0.030656
WSW	0.000406	0.005163	0.008424	0.005435	0.000272	0.000000	0.019699
W	0.000100	0.004076	0.004076	0.001630	0.000272	0.000000	0.010155
WNW	0.000020	0.000815	0.003804	0.001359	0.000272	0.000000	0.006270
NW	0.000298	0.000815	0.004620	0.001902	0.000272	0.000000	0.007907
NNW	0.000033	0.001359	0.002989	0.001087	0.000000	0.000000	0.005468
TOTAL	0.004891	0.085598	0.124456	0.049185	0.002717	0.000272	

Relative frequency of occurrence of "D" stability = 0.267120

Relative frequency of calms distributed above with "D" stability = 0.002174

ARKANSAS NUCLEAR ONE
Unit 2

Table 2.3-28

LITTLE ROCK, AR SUMMER SURFACE WIND DIRECTION AND SPEED,
RELATIVE FREQUENCIES FOR "E" STABILITY

<u>SEA-JJA</u>	<u>RELATIVE FREQUENCY DISTRIBUTION SPEED (KTS)</u>					<u>STATION-LITTLE ROCK, AR 66-70</u>	
<u>Direction</u>	<u>0 - 3</u>	<u>4 - 6</u>	<u>7 - 10</u>	<u>11 - 16</u>	<u>17 - 21</u>	<u>Greater Than 21</u>	<u>TOTAL</u>
N	0.004201	0.010054	0.004348	0.000000	0.000000	0.000000	0.018603
NNE	0.002255	0.009783	0.002466	0.000000	0.000000	0.000000	0.014484
NE	0.001623	0.007880	0.001902	0.000000	0.000000	0.000000	0.011406
ENE	0.005874	0.012500	0.000815	0.000000	0.000000	0.000000	0.019189
E	0.007276	0.013315	0.001087	0.000000	0.000000	0.000000	0.021678
ESE	0.007727	0.016033	0.000543	0.000000	0.000000	0.000000	0.024303
SE	0.008676	0.017935	0.000272	0.000000	0.000000	0.000000	0.026852
SSE	0.006820	0.018207	0.002174	0.000000	0.000000	0.000000	0.027200
S	0.014952	0.036685	0.007609	0.000000	0.000000	0.000000	0.059246
SSW	0.010031	0.020380	0.004076	0.000000	0.000000	0.000000	0.034488
SW	0.012649	0.030435	0.005978	0.000000	0.000000	0.000000	0.049062
WSW	0.012957	0.041848	0.009239	0.000000	0.000000	0.000000	0.064044
W	0.005150	0.011957	0.002174	0.000000	0.000000	0.000000	0.019281
WNW	0.000451	0.002717	0.000272	0.000000	0.000000	0.000000	0.003440
NW	0.001581	0.003804	0.000272	0.000000	0.000000	0.000000	0.005657
NNW	0.000766	0.004620	0.000543	0.000000	0.000000	0.000000	0.005929
TOTAL	0.102989	0.258152	0.043750	0.000000	0.000000	0.000000	

Relative frequency of occurrence of "E" stability = 0.404091

Relative frequency of calms distributed above with "E" stability = 0.051359

ARKANSAS NUCLEAR ONE
Unit 2

Table 2.3-29

LITTLE ROCK, AR AUTUMN SURFACE WIND DIRECTION AND SPEED,
RELATIVE FREQUENCIES FOR "A" STABILITY

<u>SEA-SON</u>	<u>RELATIVE FREQUENCY DISTRIBUTION SPEED (KTS)</u>					<u>STATION-LITTLE ROCK, AR 66-70</u>	
<u>Direction</u>	<u>0 - 3</u>	<u>4 - 6</u>	<u>7 - 10</u>	<u>11 - 16</u>	<u>17 - 21</u>	<u>Greater Than 21</u>	<u>TOTAL</u>
N	0.000458	0.000000	0.000000	0.000000	0.000000	0.000000	0.000458
NNE	0.000183	0.000275	0.000000	0.000000	0.000000	0.000000	0.000458
NE	0.000000	0.000000	0.000000	0.000000	0.000000	0.000000	0.000000
ENE	0.000000	0.000000	0.000000	0.000000	0.000000	0.000000	0.000000
E	0.000549	0.000824	0.000000	0.000000	0.000000	0.000000	0.001374
ESE	0.000183	0.000275	0.000000	0.000000	0.000000	0.000000	0.000458
SE	0.000000	0.000000	0.000000	0.000000	0.000000	0.000000	0.000000
SSE	0.000000	0.000000	0.000000	0.000000	0.000000	0.000000	0.000000
S	0.000183	0.000275	0.000000	0.000000	0.000000	0.000000	0.000458
SSW	0.000000	0.000000	0.000000	0.000000	0.000000	0.000000	0.000000
SW	0.000000	0.000000	0.000000	0.000000	0.000000	0.000000	0.000000
WSW	0.000641	0.000275	0.000000	0.000000	0.000000	0.000000	0.000916
W	0.000000	0.000000	0.000000	0.000000	0.000000	0.000000	0.000000
WNW	0.000000	0.000000	0.000000	0.000000	0.000000	0.000000	0.000000
NW	0.000000	0.000000	0.000000	0.000000	0.000000	0.000000	0.000000
NNW	0.000000	0.000000	0.000000	0.000000	0.000000	0.000000	0.000000
TOTAL	0.002198	0.001923	0.000000	0.000000	0.000000	0.000000	

Relative frequency of occurrence of "A" stability = 0.004121

Relative frequency of calms distributed above with "A" stability = 0.001648

ARKANSAS NUCLEAR ONE
Unit 2

Table 2.3-30

LITTLE ROCK, AR AUTUMN SURFACE WIND DIRECTION AND SPEED,
RELATIVE FREQUENCIES FOR "B" STABILITY

<u>SEA-SON</u>	<u>RELATIVE FREQUENCY DISTRIBUTION SPEED (KTS)</u>					<u>STATION-LITTLE ROCK, AR 66-70</u>	
<u>Direction</u>	<u>0 - 3</u>	<u>4 - 6</u>	<u>7 - 10</u>	<u>11 - 16</u>	<u>17 - 21</u>	<u>Greater Than 21</u>	<u>TOTAL</u>
N	0.000966	0.000549	0.000824	0.000000	0.000000	0.000000	0.002339
NNE	0.000804	0.001923	0.000549	0.000000	0.000000	0.000000	0.003277
NE	0.000804	0.001923	0.000824	0.000000	0.000000	0.000000	0.003551
ENE	0.000529	0.002198	0.000549	0.000000	0.000000	0.000000	0.003277
E	0.000339	0.003297	0.001923	0.000000	0.000000	0.000000	0.005559
ESE	0.000917	0.003022	0.000824	0.000000	0.000000	0.000000	0.004763
SE	0.000255	0.002473	0.000824	0.000000	0.000000	0.000000	0.003551
SSE	0.000501	0.001923	0.000824	0.000000	0.000000	0.000000	0.003248
S	0.001580	0.003571	0.001099	0.000000	0.000000	0.000000	0.006250
SSW	0.000331	0.000275	0.000275	0.000000	0.000000	0.000000	0.000881
SW	0.001079	0.001648	0.001374	0.000000	0.000000	0.000000	0.004101
WSW	0.000473	0.001648	0.001923	0.000000	0.000000	0.000000	0.004044
W	0.000141	0.001374	0.001648	0.000000	0.000000	0.000000	0.003163
WNW	0.000113	0.001099	0.000000	0.000000	0.000000	0.000000	0.001212
NW	0.000473	0.001648	0.000000	0.000000	0.000000	0.000000	0.002121
NNW	0.000861	0.002473	0.000549	0.000000	0.000000	0.000000	0.003883
TOTAL	0.010165	0.031044	0.014011	0.000000	0.000000	0.000000	

Relative frequency of occurrence of "B" stability = 0.055220

Relative frequency of calms distributed above with "B" stability = 0.003846

ARKANSAS NUCLEAR ONE
Unit 2

Table 2.3-31

LITTLE ROCK, AR AUTUMN SURFACE WIND DIRECTION AND SPEED,
RELATIVE FREQUENCIES FOR "C" STABILITY

<u>SEA-SON</u>	<u>RELATIVE FREQUENCY DISTRIBUTION SPEED (KTS)</u>					<u>STATION-LITTLE ROCK, AR 66-70</u>	
<u>Direction</u>	<u>0 - 3</u>	<u>4 - 6</u>	<u>7 - 10</u>	<u>11 - 16</u>	<u>17 - 21</u>	<u>Greater Than 21</u>	<u>TOTAL</u>
N	0.000018	0.003022	0.005495	0.000275	0.000000	0.000000	0.008810
NNE	0.000010	0.001648	0.005220	0.000275	0.000000	0.000000	0.007153
NE	0.000013	0.002198	0.004945	0.000275	0.000000	0.000000	0.007431
ENE	0.000288	0.001923	0.006044	0.000549	0.000000	0.000000	0.008805
E	0.000583	0.004945	0.005495	0.000275	0.000000	0.000000	0.011297
ESE	0.000018	0.003022	0.002473	0.000275	0.000000	0.000000	0.005788
SE	0.000023	0.003846	0.003297	0.000275	0.000000	0.000000	0.007441
SSE	0.000017	0.002747	0.004121	0.000000	0.000000	0.000000	0.006885
S	0.000034	0.005495	0.008242	0.000275	0.000000	0.000000	0.014044
SSW	0.000008	0.001374	0.004670	0.000275	0.000000	0.000000	0.006327
SW	0.000017	0.002747	0.007692	0.000275	0.000000	0.000000	0.010731
WSW	0.000020	0.003297	0.008242	0.001374	0.000000	0.000000	0.012932
W	0.000290	0.002198	0.003571	0.000824	0.000000	0.000000	0.006883
WNW	0.000005	0.000824	0.003022	0.000275	0.000000	0.000000	0.004126
NW	0.000012	0.001923	0.005495	0.000275	0.000000	0.000000	0.007704
NNW	0.000017	0.002747	0.004121	0.000275	0.000000	0.000000	0.007160
TOTAL	0.001374	0.043956	0.002143	0.006044	0.000000	0.000000	

Relative frequency of occurrence of "C" stability = 0.133516
Relative frequency of calms distributed above with "C" stability = 0.000275

ARKANSAS NUCLEAR ONE
Unit 2

Table 2.3-32

LITTLE ROCK, AR AUTUMN SURFACE WIND DIRECTION AND SPEED,
RELATIVE FREQUENCIES FOR "D" STABILITY

<u>SEA-SON</u>	<u>RELATIVE FREQUENCY DISTRIBUTION SPEED (KTS)</u>					<u>STATION-LITTLE ROCK, AR 66-70</u>	
<u>Direction</u>	<u>0 - 3</u>	<u>4 - 6</u>	<u>7 - 10</u>	<u>11 - 16</u>	<u>17 - 21</u>	<u>Greater Than 21</u>	<u>TOTAL</u>
N	0.000976	0.006593	0.015385	0.014835	0.000824	0.000000	0.038613
NNE	0.000762	0.003022	0.010440	0.004121	0.000275	0.000000	0.018620
NE	0.000553	0.004396	0.019231	0.003297	0.000000	0.000000	0.027476
ENE	0.000377	0.006319	0.010714	0.004670	0.000275	0.000000	0.022355
E	0.000992	0.006868	0.007143	0.002473	0.000000	0.000000	0.017475
ESE	0.000812	0.003846	0.006044	0.001923	0.000000	0.000000	0.012625
SE	0.000619	0.005495	0.009890	0.003022	0.000000	0.000000	0.019025
SSE	0.000488	0.003297	0.011538	0.003571	0.000549	0.000000	0.019444
S	0.001238	0.010989	0.021154	0.015659	0.000275	0.000000	0.049315
SSW	0.001377	0.003571	0.008242	0.007418	0.000549	0.000000	0.021158
SW	0.000795	0.003571	0.009615	0.006044	0.000549	0.000000	0.020575
WSW	0.000812	0.003846	0.009066	0.006319	0.000275	0.000000	0.020317
W	0.000713	0.002198	0.004396	0.003846	0.000000	0.000000	0.011153
WNW	0.000131	0.002198	0.007143	0.011538	0.001648	0.000000	0.022659
NW	0.000246	0.004121	0.012088	0.014011	0.000824	0.000000	0.031290
NNW	0.000098	0.001648	0.007143	0.006593	0.000549	0.000000	0.016032
TOTAL	0.010989	0.071978	0.169230	0.109340	0.006593	0.000000	

Relative frequency of occurrence of "D" stability = 0.368132

Relative frequency of calms distributed above with "D" stability = 0.004670

ARKANSAS NUCLEAR ONE
Unit 2

Table 2.3-33

LITTLE ROCK, AR AUTUMN SURFACE WIND DIRECTION AND SPEED,
RELATIVE FREQUENCIES FOR "E" STABILITY

<u>SEA-SON</u>	<u>RELATIVE FREQUENCY DISTRIBUTION SPEED (KTS)</u>					<u>STATION-LITTLE ROCK, AR 66-70</u>	
<u>Direction</u>	<u>0 - 3</u>	<u>4 - 6</u>	<u>7 - 10</u>	<u>11 - 16</u>	<u>17 - 21</u>	<u>Greater Than 21</u>	<u>TOTAL</u>
N	0.004682	0.013736	0.006319	0.000000	0.000000	0.000000	0.024737
NNE	0.004382	0.011813	0.005769	0.000000	0.000000	0.000000	0.021963
NE	0.005677	0.014011	0.003571	0.000000	0.000000	0.000000	0.023260
ENE	0.006038	0.014286	0.001648	0.000000	0.000000	0.000000	0.021972
E	0.005274	0.013462	0.001374	0.000000	0.000000	0.000000	0.020109
ESE	0.007961	0.012363	0.000824	0.000000	0.000000	0.000000	0.021148
SE	0.007419	0.017033	0.001648	0.000000	0.000000	0.000000	0.026100
SSE	0.006448	0.018956	0.003022	0.000000	0.000000	0.000000	0.028426
S	0.009578	0.028846	0.009890	0.000000	0.000000	0.000000	0.048314
SSW	0.006502	0.013187	0.001923	0.000000	0.000000	0.000000	0.021611
SW	0.007487	0.019505	0.004670	0.000000	0.000000	0.000000	0.031662
WSW	0.013814	0.041758	0.011264	0.000000	0.000000	0.000000	0.066836
W	0.007648	0.026648	0.004670	0.000000	0.000000	0.000000	0.038966
WNW	0.003654	0.007143	0.002747	0.000000	0.000000	0.000000	0.013544
NW	0.001938	0.006319	0.006593	0.000000	0.000000	0.000000	0.014850
NNW	0.002323	0.008791	0.004396	0.000000	0.000000	0.000000	0.015510
TOTAL	0.100824	0.267857	0.070380	0.000000	0.000000	0.000000	

Relative frequency of occurrence of "E" stability = 0.439011
Relative frequency of calms distributed above "E" stability = 0.049725

ARKANSAS NUCLEAR ONE
Unit 2

Table 2.3-34

LITTLE ROCK, AR ANNUAL SURFACE WIND DIRECTION AND SPEED,
RELATIVE FREQUENCIES FOR "A" STABILITY

<u>Direction</u>	<u>RELATIVE FREQUENCY DISTRIBUTION SPEED (KTS)</u>					<u>STATION-LITTLE ROCK, AR 66-70</u>	
	<u>0 - 3</u>	<u>4 - 6</u>	<u>7 - 10</u>	<u>11 - 16</u>	<u>17 - 21</u>	<u>Greater Than 21</u>	<u>TOTAL</u>
N	0.000148	0.000274	0.000000	0.000000	0.000000	0.000000	0.000422
NNE	0.000128	0.000548	0.000000	0.000000	0.000000	0.000000	0.000676
NE	0.000080	0.000342	0.000000	0.000000	0.000000	0.000000	0.000422
ENE	0.000132	0.000205	0.000000	0.000000	0.000000	0.000000	0.000338
E	0.000292	0.000890	0.000000	0.000000	0.000000	0.000000	0.001182
ESE	0.000297	0.000548	0.000000	0.000000	0.000000	0.000000	0.000845
SE	0.000064	0.000274	0.000000	0.000000	0.000000	0.000000	0.000338
SSE	0.000080	0.000842	0.000000	0.000000	0.000000	0.000000	0.000422
S	0.000376	0.000890	0.000000	0.000000	0.000000	0.000000	0.001267
SSW	0.000233	0.000274	0.000000	0.000000	0.000000	0.000000	0.000507
SW	0.000080	0.000342	0.000000	0.000000	0.000000	0.000000	0.000422
WSW	0.000402	0.000274	0.000000	0.000000	0.000000	0.000000	0.000676
W	0.000016	0.000068	0.000000	0.000000	0.000000	0.000000	0.000084
WNW	0.000148	0.000274	0.000000	0.000000	0.000000	0.000000	0.000422
NW	0.000164	0.000342	0.000000	0.000000	0.000000	0.000000	0.000507
NNW	0.000032	0.000137	0.000000	0.000000	0.000000	0.000000	0.000169
TOTAL	0.002671	0.006028	0.000000	0.000000	0.000000	0.000000	

Relative frequency of occurrence of "A" stability = 0.008699

Relative frequency of calms distributed above with "A" stability = 0.001644

ARKANSAS NUCLEAR ONE
Unit 2

Table 2.3-35

LITTLE ROCK, AR ANNUAL SURFACE WIND DIRECTION AND SPEED,
RELATIVE FREQUENCIES FOR "B" STABILITY

<u>Direction</u>	<u>RELATIVE FREQUENCY DISTRIBUTION SPEED (KTS)</u>					<u>STATION-LITTLE ROCK, AR 66-70</u>	
	<u>0 - 3</u>	<u>4 - 6</u>	<u>7 - 10</u>	<u>11 - 16</u>	<u>17 - 21</u>	<u>Greater Than 21</u>	<u>TOTAL</u>
N	0.000262	0.001164	0.000685	0.000000	0.000000	0.000000	0.002112
NNE	0.000428	0.001712	0.000753	0.000000	0.000000	0.000000	0.002893
NE	0.000724	0.001986	0.001164	0.000000	0.000000	0.000000	0.003875
ENE	0.000453	0.002329	0.001507	0.000000	0.000000	0.000000	0.004289
E	0.000727	0.003767	0.002808	0.000000	0.000000	0.000000	0.007302
ESE	0.000809	0.004041	0.001906	0.000000	0.000000	0.000000	0.006837
SE	0.000462	0.002534	0.001438	0.000000	0.000000	0.000000	0.004434
SSE	0.000296	0.001986	0.001027	0.000000	0.000000	0.000000	0.003310
S	0.000635	0.003288	0.002123	0.000000	0.000000	0.000000	0.006047
SSW	0.000197	0.001301	0.001027	0.000000	0.000000	0.000000	0.002525
SW	0.000450	0.002260	0.002397	0.000000	0.000000	0.000000	0.005108
WSW	0.000456	0.002397	0.002808	0.000000	0.000000	0.000000	0.005662
W	0.000878	0.002123	0.001233	0.000000	0.000000	0.000000	0.003730
WNW	0.000182	0.000959	0.000479	0.000000	0.000000	0.000000	0.001621
NW	0.000319	0.000822	0.000959	0.000000	0.000000	0.000000	0.002100
NNW	0.000419	0.001507	0.000322	0.000000	0.000000	0.000000	0.002748
TOTAL	0.007192	0.034180	0.023221	0.000000	0.000000	0.000000	

Relative frequency of occurrence of "B" stability = 0.064593

Relative frequency of calms distributed above with "B" stability = 0.001644

ARKANSAS NUCLEAR ONE
Unit 2

Table 2.3-36

LITTLE ROCK, AR ANNUAL SURFACE WIND DIRECTION AND SPEED,
RELATIVE FREQUENCIES FOR "C" STABILITY

<u>Direction</u>	<u>RELATIVE FREQUENCY DISTRIBUTION SPEED (KTS)</u>					<u>STATION-LITTLE ROCK, AR 66-70</u>	
	<u>0 - 3</u>	<u>4 - 6</u>	<u>7 - 10</u>	<u>11 - 16</u>	<u>17 - 21</u>	<u>Greater Than 21</u>	<u>TOTAL</u>
N	0.000333	0.001781	0.004110	0.000479	0.000000	0.000000	0.006703
NNE	0.000298	0.001233	0.003151	0.000548	0.000000	0.000000	0.005230
NE	0.000264	0.001849	0.005754	0.000479	0.000000	0.000000	0.008347
ENE	0.000556	0.001849	0.005548	0.000479	0.000000	0.000000	0.008433
E	0.000602	0.003699	0.007261	0.000342	0.000000	0.000000	0.011904
ESE	0.000536	0.002671	0.004658	0.000342	0.000000	0.000000	0.008208
SE	0.000355	0.002123	0.004384	0.000342	0.000000	0.000000	0.007205
SSE	0.000264	0.001849	0.004247	0.000274	0.000068	0.000000	0.006703
S	0.000588	0.003593	0.006836	0.000959	0.000000	0.000000	0.013877
SSW	0.000371	0.001233	0.005411	0.000616	0.000068	0.000000	0.007700
SW	0.000183	0.001712	0.006713	0.002055	0.000068	0.000000	0.010731
WSW	0.000454	0.002534	0.008151	0.001301	0.000000	0.000000	0.012441
W	0.000174	0.001575	0.003356	0.000616	0.000068	0.000000	0.005791
WNW	0.000053	0.000822	0.003288	0.000753	0.000000	0.000000	0.004916
NW	0.000161	0.001370	0.003767	0.001027	0.000137	0.000000	0.006463
NNW	0.000083	0.001301	0.003151	0.000274	0.000000	0.000000	0.004810
TOTAL	0.005274	0.031098	0.081786	0.010891	0.000411	0.000000	

Relative frequency of occurrence of "C" stability = 0.129461
Relative frequency of calms distributed above with "C" stability = 0.002192

ARKANSAS NUCLEAR ONE
Unit 2

Table 2.3-37

**LITTLE ROCK, AR ANNUAL SURFACE WIND DIRECTION AND SPEED,
RELATIVE FREQUENCIES FOR "D" STABILITY**

<u>Direction</u>	<u>RELATIVE FREQUENCY DISTRIBUTION SPEED (KTS)</u>					<u>STATION-LITTLE ROCK, AR 66-70</u>	
	<u>0 - 3</u>	<u>4 - 6</u>	<u>7 - 10</u>	<u>11 - 16</u>	<u>17 - 21</u>	<u>Greater Than 21</u>	<u>TOTAL</u>
N	0.000478	0.005891	0.015070	0.013426	0.000959	0.000000	0.035823
NNE	0.000651	0.003356	0.013152	0.007603	0.000479	0.000000	0.025242
NE	0.000466	0.005617	0.018426	0.008631	0.000411	0.000068	0.033619
ENE	0.000466	0.005617	0.013905	0.005411	0.000342	0.000000	0.025742
E	0.001403	0.008973	0.013700	0.003425	0.000068	0.000000	0.027570
ESE	0.000934	0.008083	0.010343	0.003014	0.000068	0.000000	0.022443
SE	0.001088	0.006713	0.011508	0.003630	0.000137	0.000000	0.023075
SSE	0.000656	0.005069	0.011576	0.004247	0.000205	0.000000	0.021754
S	0.000746	0.010275	0.023837	0.015823	0.000822	0.000000	0.051503
SSW	0.000725	0.005000	0.011028	0.013494	0.001233	0.000068	0.031549
SW	0.000569	0.004726	0.010617	0.009453	0.000890	0.000137	0.026393
WSW	0.000750	0.003973	0.005905	0.007055	0.000548	0.000000	0.021231
W	0.000334	0.002671	0.004726	0.005822	0.000753	0.000068	0.014376
WNW	0.000491	0.001370	0.006850	0.011576	0.001918	0.000137	0.022341
NW	0.000424	0.003082	0.010069	0.013289	0.001781	0.000068	0.028714
NNW	0.000297	0.001849	0.008357	0.007740	0.000548	0.000000	0.018792
TOTAL	0.010480	0.082266	0.192068	0.133639	0.011165	0.000548	

Relative frequency of occurrence of "D" stability = 0.430166
Relative frequency of calms distributed above with "D" stability = 0.003973

ARKANSAS NUCLEAR ONE
Unit 2

Table 2.3-38

LITTLE ROCK, AR ANNUAL SURFACE WIND DIRECTION AND SPEED,
RELATIVE FREQUENCIES FOR "E" STABILITY

<u>Direction</u>	<u>RELATIVE FREQUENCY DISTRIBUTION SPEED (KTS)</u>					<u>STATION-LITTLE ROCK, AR 66-70</u>	
	<u>0 - 3</u>	<u>4 - 6</u>	<u>7 - 10</u>	<u>11 - 16</u>	<u>17 - 21</u>	<u>Greater Than 21</u>	<u>TOTAL</u>
N	0.003914	0.011234	0.007946	0.000000	0.000000	0.000000	0.0023093
NNE	0.002883	0.009727	0.003493	0.000000	0.000000	0.000000	0.016103
NE	0.003571	0.010069	0.002740	0.000000	0.000000	0.000000	0.016380
ENE	0.004663	0.010960	0.001986	0.000000	0.000000	0.000000	0.017609
E	0.005489	0.012672	0.002192	0.000000	0.000000	0.000000	0.020353
ESE	0.005979	0.013768	0.001370	0.000000	0.000000	0.000000	0.021117
SE	0.005936	0.013494	0.002534	0.000000	0.000000	0.000000	0.021964
SSE	0.004422	0.012946	0.003288	0.000000	0.000000	0.000000	0.020656
S	0.009197	0.024111	0.009110	0.000000	0.000000	0.000000	0.042418
SSW	0.005719	0.012124	0.003630	0.000000	0.000000	0.000000	0.021474
SW	0.007734	0.019864	0.005685	0.000000	0.000000	0.000000	0.033283
WSW	0.009873	0.033427	0.011713	0.000000	0.000000	0.000000	0.055013
W	0.004659	0.015960	0.004795	0.000000	0.000000	0.000000	0.025414
WNW	0.001384	0.004247	0.008493	0.000000	0.000000	0.000000	0.009124
NW	0.001369	0.004658	0.005784	0.000000	0.000000	0.000000	0.011781
NNW	0.001434	0.006576	0.003288	0.000000	0.000000	0.000000	0.011298
TOTAL	0.078224	0.021536	0.073019	0.000000	0.000000	0.000000	

Relative frequency of occurrence of "E" stability = 0.367080

Relative frequency of calms distributed above with "E" stability = 0.040071

ARKANSAS NUCLEAR ONE
Unit 2

Table 2.3-39

SUSTAINED PERIODS OF MISSING OR INVALID DATA*

<u>Start Time</u>	<u>Start Time</u>	<u>Number of Consecutive Missing Values</u>
02/21/72	1600	10
04/22/72	200	24
05/18/72	1000	98
10/06/72	400	39
10/07/72	2000	3
10/08/72	500	14
10/08/72	2000	9
10/09/72	600	3
12/07/72	2100	137
12/14/72	1600	17
01/05/73	2300	12
01/24/73	400	12

* Periods listed are for 10 or more consecutive invalid observations or for 10 or more invalid observations occurring in a 24-hour period.

ARKANSAS NUCLEAR ONE
Unit 2

Table 2.3-40

WIND FREQUENCY DISTRIBUTION (FREQUENCY IN NUMBER OF OCCURRENCES)

ARKANSAS POWER & LIGHT
DATA PERIOD: FEBRUARY 7, 1972 THROUGH FEBRUARY 7, 1973

PASQUILL A (FROM AEC/DELTA T CRITERIA, 190-30 FEET)

WINDS AT 40 FOOT LEVEL

<u>SECTOR</u>	MID-POINT OF WIND SPEED INTERVAL (MPH)												<u>TOTAL</u>	<u>MEAN SPEED</u>
	<u>1</u>	<u>2</u>	<u>3</u>	<u>4</u>	<u>5</u>	<u>6</u>	<u>7</u>	<u>8</u>	<u>9</u>	<u>10</u>	<u>11</u>	<u>> 11</u>		
NNE	0	0	0	1	1	2	2	0	1	0	0	0	7	6.29
NE	0	0	2	1	0	1	1	1	0	3	0	0	9	6.78
ENE	0	0	0	7	5	1	1	2	3	1	0	3	23	6.91
E	0	0	6	16	9	4	3	1	9	7	3	9	67	7.15
ESE	0	0	2	10	9	6	6	5	1	2	3	6	50	6.98
SE	0	0	4	8	11	2	5	2	2	0	0	0	34	5.29
SSE	0	2	0	2	4	3	7	10	3	1	0	0	32	6.75
S	0	0	3	2	2	7	2	3	0	1	1	1	22	6.41
SSW	0	0	3	4	1	4	2	1	1	0	1	0	17	5.65
SW	0	0	2	5	6	9	4	1	0	0	1	1	29	5.83
WSW	0	0	5	6	7	8	6	5	4	6	7	12	66	8.29
W	0	1	1	3	5	3	12	12	14	13	19	26	109	9.76
WNW	1	2	1	0	0	4	1	4	9	6	6	28	62	11.32
NW	0	0	0	1	1	0	1	1	1	1	0	4	10	12.30
NNW	0	0	0	0	0	2	2	2	0	0	0	0	6	7.00
N	0	0	0	3	1	3	1	1	0	1	0	0	10	6.00
CALM													0	
TOTAL	1	5	29	69	62	59	56	51	48	42	41	90	553	8.01

ARKANSAS NUCLEAR ONE
Unit 2

Table 2.3-40 (continued)

WIND FREQUENCY DISTRIBUTION (FREQUENCY IN NUMBER OF OCCURRENCES)

ARKANSAS POWER & LIGHT
DATA PERIOD: FEBRUARY 7, 1972 THROUGH FEBRUARY 7, 1973

PASQUILL B (FROM AEC/DELTA T CRITERIA, 190-30 FEET)

WINDS AT 40 FOOT LEVEL

SECTOR	MID-POINT OF WIND SPEED INTERVAL (MPH)												TOTAL	MEAN SPEED
	1	2	3	4	5	6	7	8	9	10	11	> 11		
NNE	1	1	0	0	1	0	2	1	1	0	0	0	7	5.57
NE	0	0	3	1	1	0	0	2	0	0	0	1	8	5.75
ENE	0	1	4	6	8	2	3	2	0	2	0	2	30	5.80
E	0	0	15	18	13	9	8	5	7	4	6	10	95	6.69
ESE	0	1	7	15	10	11	5	6	5	4	1	1	66	5.92
SE	0	0	2	9	12	8	10	3	2	2	0	0	48	5.88
SSE	0	0	1	3	7	8	3	1	4	0	0	0	27	6.04
S	0	0	0	5	3	2	5	3	4	1	0	2	25	7.12
SSW	0	1	1	1	1	0	2	1	0	1	1	0	9	6.33
SW	0	1	0	3	2	1	0	2	0	0	0	1	10	6.10
WSW	0	2	4	5	4	4	1	2	1	1	1	7	32	7.34
W	0	0	0	2	0	3	8	6	7	2	6	11	45	9.60
WNW	0	0	1	0	1	4	1	4	4	2	2	25	44	11.95
NW	0	0	0	0	0	1	1	3	0	1	0	7	13	13.08
NNW	0	0	0	0	3	0	0	0	0	0	0	0	3	5.00
N	0	0	1	0	2	0	1	0	0	0	0	0	4	5.00
CALM													1	
TOTAL	1	7	39	68	68	53	50	41	35	20	17	67	467	7.33

ARKANSAS NUCLEAR ONE
Unit 2

Table 2.3-40 (continued)

WIND FREQUENCY DISTRIBUTION (FREQUENCY IN NUMBER OF OCCURRENCES)

ARKANSAS POWER & LIGHT
DATA PERIOD: FEBRUARY 7, 1972 THROUGH FEBRUARY 7, 1973

PASQUILL C (FROM AEC/DELTA T CRITERIA, 190-30 FEET)

WINDS AT 40 FOOT LEVEL

SECTOR	MID-POINT OF WIND SPEED INTERVAL (MPH)												TOTAL	MEAN SPEED
	1	2	3	4	5	6	7	8	9	10	11	> 11		
NNE	1	0	3	0	0	2	2	0	1	0	0	0	9	5.00
NE	1	2	2	1	2	0	1	2	1	0	1	0	13	5.23
ENE	1	2	10	5	7	5	6	6	3	3	1	1	50	5.82
E	1	3	21	19	18	9	7	2	5	3	6	10	104	6.08
ESE	0	2	6	12	14	7	9	5	0	2	0	4	61	5.97
SE	0	1	3	6	15	15	6	5	4	1	0	0	56	5.86
SSE	0	1	3	10	10	6	3	5	3	1	0	2	44	5.89
S	0	0	3	6	5	2	1	2	1	1	3	3	27	6.81
SSW	0	0	6	1	1	2	3	5	0	0	1	3	22	7.00
SW	0	1	3	3	3	2	2	0	0	0	1	6	21	7.57
WSW	0	0	2	2	4	4	6	0	1	0	0	2	21	6.52
W	1	0	2	3	2	4	5	4	8	6	2	11	48	8.92
WNW	1	1	1	0	5	3	2	2	5	1	3	26	50	10.92
NW	0	0	0	1	0	1	2	1	0	3	0	7	15	10.93
NNW	0	0	0	0	4	0	0	0	1	0	0	0	5	5.80
N	1	0	1	0	0	1	2	1	0	0	0	0	6	5.33
CALM													1	
TOTAL	7	13	66	69	90	63	57	40	33	21	18	75	553	6.91

ARKANSAS NUCLEAR ONE
Unit 2

Table 2.3-40 (continued)

WIND FREQUENCY DISTRIBUTION (FREQUENCY IN NUMBER OF OCCURRENCES)

ARKANSAS POWER & LIGHT
DATA PERIOD: FEBRUARY 7, 1972 THROUGH FEBRUARY 7, 1973

PASQUILL D (FROM AEC/DELTA T CRITERIA, 190-30 FEET)

WINDS AT 40 FOOT LEVEL

SECTOR	MID-POINT OF WIND SPEED INTERVAL (MPH)												TOTAL	MEAN SPEED
	1	2	3	4	5	6	7	8	9	10	11	> 11		
NNE	3	9	21	26	17	24	17	10	6	2	4	2	141	5.38
NE	5	20	22	25	23	28	17	12	6	8	2	1	169	5.19
ENE	4	18	32	50	50	46	38	35	34	17	10	27	361	6.49
E	5	27	56	50	62	77	58	48	50	51	36	60	580	7.18
ESE	4	13	19	36	56	47	36	34	14	16	14	50	339	7.21
SE	2	2	25	36	39	35	23	21	13	9	4	3	212	5.90
SSE	0	6	6	17	24	22	14	10	14	5	0	0	118	5.97
S	2	3	5	12	18	15	10	6	3	6	7	11	98	6.97
SSW	1	4	4	6	7	7	8	2	8	10	7	19	83	8.33
SW	1	2	4	7	5	6	8	5	2	2	2	15	59	8.14
WSW	0	7	15	14	11	16	14	14	6	9	5	52	163	8.78
W	3	8	11	26	33	26	37	33	38	26	21	76	338	8.61
WNW	3	4	12	16	19	29	19	18	17	14	16	87	254	9.44
NW	1	5	5	12	12	11	7	10	11	6	3	16	99	7.64
NNW	0	10	16	6	7	4	4	3	2	2	2	8	64	5.94
N	6	9	15	12	10	14	7	4	8	5	0	3	93	5.31
CALM													4	
TOTAL	40	147	268	351	393	407	317	265	232	188	133	430	3175	7.17

ARKANSAS NUCLEAR ONE
Unit 2

Table 2.3-41

WIND FREQUENCY DISTRIBUTION (FREQUENCY IN NUMBER OF OCCURRENCES)

ARKANSAS POWER & LIGHT
DATA PERIOD: FEBRUARY 7, 1972 THROUGH FEBRUARY 7, 1973

PASQUILL E (FROM AEC/DELTA T CRITERIA, 190-30 FEET)

WINDS AT 40 FOOT LEVEL

SECTOR	MID-POINT OF WIND SPEED INTERVAL (MPH)											TOTAL	MEAN SPEED	
	1	2	3	4	5	6	7	8	9	10	11			> 11
NNE	11	23	23	24	10	19	7	5	1	2	0	1	126	4.10
NE	14	49	70	50	28	11	12	9	2	2	0	2	249	3.80
ENE	9	36	66	65	62	49	21	12	10	4	2	9	345	4.80
E	4	25	41	51	36	45	18	16	12	14	5	12	279	5.57
ESE	4	14	34	32	32	17	12	17	5	5	4	4	180	5.18
SE	5	12	13	19	28	13	13	11	5	4	3	1	127	5.31
SSE	2	5	8	11	18	18	11	10	2	2	1	1	89	5.60
S	5	5	9	4	16	8	10	5	3	0	3	2	70	5.43
SSW	4	6	4	8	8	4	7	8	7	5	0	2	63	5.98
SW	0	5	7	3	4	2	4	7	4	5	1	4	46	6.74
WSW	5	12	7	5	7	11	8	8	5	0	1	3	72	5.42
W	9	17	16	11	15	13	11	9	6	6	1	5	119	5.26
WNW	9	8	13	15	14	17	12	5	3	3	5	9	113	5.76
NW	5	7	5	4	1	7	6	0	3	4	0	6	48	6.23
NNW	4	7	8	5	4	4	6	2	3	1	3	6	53	5.94
N	5	7	14	11	14	5	1	5	2	1	0	1	66	4.42
CALM													18	
TOTAL	95	238	338	318	297	243	159	129	73	58	29	68	2063	5.05

ARKANSAS NUCLEAR ONE
Unit 2

Table 2.3-41 (continued)

WIND FREQUENCY DISTRIBUTION (FREQUENCY IN NUMBER OF OCCURRENCES)

ARKANSAS POWER & LIGHT
DATA PERIOD: FEBRUARY 7, 1972 THROUGH FEBRUARY 7, 1973

PASQUILL F (FROM AEC/DELTA T CRITERIA, 190-30 FEET)

WINDS AT 40 FOOT LEVEL

SECTOR	MID-POINT OF WIND SPEED INTERVAL (MPH)												TOTAL	MEAN SPEED
	1	2	3	4	5	6	7	8	9	10	11	> 11		
NNE	28	29	9	3	2	0	0	0	0	0	0	0	71	1.90
NE	40	63	61	34	13	6	1	2	1	0	0	0	221	2.80
ENE	34	52	52	39	23	10	5	1	1	0	0	0	217	3.12
E	19	31	27	15	12	8	3	2	0	1	0	0	118	3.19
ESE	7	10	6	5	7	1	2	1	1	0	0	0	40	3.42
SE	2	5	2	5	4	0	0	1	0	0	0	0	19	3.47
SSE	3	3	1	3	3	2	0	0	0	1	0	0	16	3.81
S	5	1	0	3	2	2	0	0	0	1	0	0	14	3.64
SSW	6	1	2	5	3	0	0	0	0	1	0	1	19	3.79
SW	3	3	4	6	1	1	0	0	0	0	0	1	19	3.74
WSW	10	9	4	2	0	2	1	1	0	0	0	0	29	2.59
W	14	13	6	5	3	6	0	1	0	1	0	0	49	3.00
WNW	7	9	18	7	2	2	1	1	0	0	0	0	47	3.06
NW	6	4	4	3	0	0	3	2	4	0	0	0	26	4.27
NNW	7	4	2	1	1	0	0	0	0	0	0	0	15	2.00
N	8	9	3	4	0	1	0	0	0	0	0	0	25	2.28
CALM													56	
TOTAL	199	246	201	140	76	41	16	12	7	5	0	2	1001	2.83

ARKANSAS NUCLEAR ONE
Unit 2

Table 2.3-41 (continued)

WIND FREQUENCY DISTRIBUTION (FREQUENCY IN NUMBER OF OCCURRENCES)

ARKANSAS POWER & LIGHT
DATA PERIOD: FEBRUARY 7, 1972 THROUGH FEBRUARY 7, 1973

PASQUILL G (FROM AEC/DELTA T CRITERIA, 190-30 FEET)

WINDS AT 40 FOOT LEVEL

SECTOR	MID-POINT OF WIND SPEED INTERVAL (MPH)												TOTAL	MEAN SPEED
	1	2	3	4	5	6	7	8	9	10	11	> 11		
NNE	6	5	0	0	0	0	0	0	0	0	0	0	11	1.45
NE	15	22	3	3	2	1	0	0	0	0	0	0	46	2.09
ENE	28	33	19	20	5	4	1	1	0	0	0	0	111	2.66
E	23	23	11	8	6	5	0	1	1	0	0	0	78	2.71
ESE	10	3	2	2	1	0	1	0	0	0	0	0	19	2.21
SE	5	1	0	1	1	0	0	0	0	0	0	0	8	2.00
SSE	5	0	2	0	2	0	0	0	0	0	0	0	9	2.33
S	6	5	1	0	0	0	0	0	0	0	0	0	12	1.58
SSW	4	2	1	1	0	0	0	0	0	0	1	0	9	2.89
SW	1	1	1	0	0	0	0	0	0	0	0	0	3	2.00
WSW	11	11	1	1	0	0	0	0	0	0	0	0	24	1.67
W	14	17	6	1	2	1	0	1	1	0	0	0	43	2.40
WNW	19	14	2	1	1	0	1	0	0	0	0	0	38	1.82
NW	5	5	2	1	0	0	0	0	0	0	0	0	13	1.92
NNW	10	3	0	0	0	1	0	0	0	0	0	0	14	1.57
N	8	6	1	0	0	0	0	0	0	0	0	0	15	1.53
CALM													53	
TOTAL	170	151	52	39	20	12	3	3	2	0	1	0	506	2.04

ARKANSAS NUCLEAR ONE
Unit 2

Table 2.3-41 (continued)

WIND FREQUENCY DISTRIBUTION (FREQUENCY IN NUMBER OF OCCURRENCES)

ARKANSAS POWER & LIGHT
DATA PERIOD: FEBRUARY 7, 1972 THROUGH FEBRUARY 7, 1973

PASQUILL A-G (FROM AEC/DELTA T CRITERIA, 190-30 FEET)

WINDS AT 40 FOOT LEVEL

SECTOR	MID-POINT OF WIND SPEED INTERVAL (MPH)												TOTAL	MEAN SPEED
	1	2	3	4	5	6	7	8	9	10	11	> 11		
NNE	50	67	56	54	31	47	30	16	10	4	4	3	372	4.17
NE	75	156	163	115	69	47	32	28	10	13	3	4	715	3.79
ENE	76	142	183	192	160	117	75	59	51	27	13	42	1137	4.92
E	52	109	177	177	156	157	97	75	84	80	56	101	1321	6.10
ESE	25	43	76	112	129	89	71	68	26	29	22	65	755	6.17
SE	14	21	49	84	110	73	57	43	26	16	7	4	504	5.55
SSE	10	17	21	46	68	59	38	36	26	10	1	3	335	5.74
S	18	14	21	32	46	36	28	19	11	10	14	19	268	6.10
SSW	15	14	21	26	21	17	22	17	16	17	11	25	222	6.64
SW	5	13	21	27	21	21	18	15	6	7	5	28	187	6.72
WSW	26	41	38	35	33	45	36	30	17	16	14	76	407	7.01
W	41	56	42	51	60	56	73	68	74	54	49	129	751	7.60
WNW	40	38	48	39	42	59	37	34	38	26	32	175	608	8.28
NW	17	21	16	22	14	20	20	17	19	15	3	40	224	7.36
BBW	21	24	26	12	19	11	12	7	6	3	5	14	160	5.21
N	28	31	35	30	27	24	12	11	10	7	0	4	219	4.47
CALM													133	
TOTAL	513	80	993	1054	1006	878	658	541	430	334	239	732	8318	5.86

ARKANSAS NUCLEAR ONE

Unit 2

Table 2.3-42

WIND PERSISTENCE STABILITY INDEPENDENT

<u>Persistence</u>	<u>NNE</u>	<u>NE</u>	<u>ENE</u>	<u>E</u>	<u>ESE</u>	<u>SE</u>	<u>SSE</u>	<u>S</u>	<u>SSW</u>	<u>SW</u>	<u>WSW</u>	<u>W</u>	<u>WNW</u>	<u>NW</u>	<u>NNW</u>	<u>N</u>	<u>CALM</u>	<u>TOTAL</u>
1	159	233	414	428	347	214	169	122	95	89	163	223	206	103	87	111	55	3218
2	50	97	161	188	89	68	40	32	34	23	44	97	56	20	15	31	18	1063
3	16	34	53	70	30	17	13	11	5	10	18	46	18	3	5	8	4	361
4	5	18	29	40	12	11	4	7	2	4	11	19	10	5	5	5	0	187
5	5	9	10	16	12	8	2	3	3	0	4	8	7	1	0	0	0	88
6	1	3	5	2	2	2	2	1	2	1	0	6	9	2	0	0	0	38
7	1	3	2	2	3	1	0	0	0	0	3	3	5	5	0	0	0	28
8	1	3	1	4	0	0	0	0	0	0	1	2	2	0	1	0	1	16
9	0	1	0	1	0	0	1	0	1	0	0	1	1	0	0	0	0	6
10	0	0	1	0	0	0	0	0	0	0	0	0	1	0	0	0	0	2
11	0	0	1	0	0	0	0	0	0	0	1	0	1	0	0	0	0	3
12	0	0	0	0	0	0	0	0	0	0	0	0	0	0	0	0	0	0
13	0	0	0	0	0	0	0	0	0	0	0	0	0	0	0	0	0	0
14	0	0	0	0	0	0	0	0	0	0	0	0	1	0	0	0	0	1
15	0	0	1	0	0	0	0	0	0	0	0	0	1	0	0	0	0	2
16	0	0	0	0	0	0	0	0	0	0	0	0	0	0	0	0	0	0
17	0	0	0	0	0	0	0	0	0	0	0	0	0	0	0	0	0	0
18	0	0	0	0	0	0	0	0	0	0	0	0	0	0	0	0	0	0
19	0	0	0	0	0	0	0	0	0	0	0	0	0	0	0	0	0	0
20	0	0	0	0	0	0	0	0	0	0	0	0	0	0	0	0	0	0
21	0	0	0	0	0	0	0	0	0	0	0	0	0	0	0	0	0	0
22	0	0	0	0	0	0	0	0	0	0	0	0	0	0	0	0	0	0
23	0	0	0	0	0	0	0	0	0	0	0	0	0	0	0	0	0	0
24	0	0	0	0	0	0	0	0	0	0	0	0	0	0	0	0	0	0
25	0	0	0	0	0	0	0	0	0	0	0	0	0	0	0	0	0	0
26	0	0	0	0	0	0	0	0	0	0	0	0	0	0	0	0	0	0
27	0	0	0	0	0	0	0	0	0	0	0	0	0	0	0	0	0	0
28	0	0	0	0	0	0	0	0	0	0	0	0	0	0	0	0	0	0
29	0	0	0	0	0	0	0	0	0	0	0	0	0	0	0	0	0	0
30	0	0	0	0	0	0	0	0	0	0	0	0	0	0	0	0	0	0

ARKANSAS NUCLEAR ONE

Unit 2

Table 2.3-43

WIND PERSISTENCE STABILITY A

<u>Persistence</u>	<u>NNE</u>	<u>NE</u>	<u>ENE</u>	<u>E</u>	<u>ESE</u>	<u>SE</u>	<u>SSE</u>	<u>S</u>	<u>SSW</u>	<u>SW</u>	<u>WSW</u>	<u>W</u>	<u>WNW</u>	<u>NW</u>	<u>NNW</u>	<u>N</u>	<u>CALM</u>	<u>TOTAL</u>
1	3	5	19	41	36	29	15	18	15	14	35	44	28	8	3	8	0	321
2	2	0	2	4	7	1	7	2	1	6	9	17	10	1	0	1	0	70
3	0	0	0	2	0	1	1	0	0	1	3	6	3	0	1	0	0	18
4	0	1	0	3	0	0	0	0	0	0	1	2	0	0	0	0	0	7
5	0	0	0	0	0	0	0	0	0	0	0	1	1	0	0	0	0	2
6	0	0	0	0	0	0	0	0	0	0	0	0	0	0	0	0	0	0
7	0	0	0	0	0	0	0	0	0	0	0	0	0	0	0	0	0	0
8	0	0	0	0	0	0	0	0	0	0	0	0	0	0	0	0	0	0
9	0	0	0	0	0	0	0	0	0	0	0	0	0	0	0	0	0	0
10	0	0	0	0	0	0	0	0	0	0	0	0	0	0	0	0	0	0
11	0	0	0	0	0	0	0	0	0	0	0	0	0	0	0	0	0	0
12	0	0	0	0	0	0	0	0	0	0	0	0	0	0	0	0	0	0
13	0	0	0	0	0	0	0	0	0	0	0	0	0	0	0	0	0	0
14	0	0	0	0	0	0	0	0	0	0	0	0	0	0	0	0	0	0
15	0	0	0	0	0	0	0	0	0	0	0	0	0	0	0	0	0	0
16	0	0	0	0	0	0	0	0	0	0	0	0	0	0	0	0	0	0
17	0	0	0	0	0	0	0	0	0	0	0	0	0	0	0	0	0	0
18	0	0	0	0	0	0	0	0	0	0	0	0	0	0	0	0	0	0
19	0	0	0	0	0	0	0	0	0	0	0	0	0	0	0	0	0	0
20	0	0	0	0	0	0	0	0	0	0	0	0	0	0	0	0	0	0
21	0	0	0	0	0	0	0	0	0	0	0	0	0	0	0	0	0	0
22	0	0	0	0	0	0	0	0	0	0	0	0	0	0	0	0	0	0
23	0	0	0	0	0	0	0	0	0	0	0	0	0	0	0	0	0	0
24	0	0	0	0	0	0	0	0	0	0	0	0	0	0	0	0	0	0
25	0	0	0	0	0	0	0	0	0	0	0	0	0	0	0	0	0	0
26	0	0	0	0	0	0	0	0	0	0	0	0	0	0	0	0	0	0
27	0	0	0	0	0	0	0	0	0	0	0	0	0	0	0	0	0	0
28	0	0	0	0	0	0	0	0	0	0	0	0	0	0	0	0	0	0
29	0	0	0	0	0	0	0	0	0	0	0	0	0	0	0	0	0	0
30	0	0	0	0	0	0	0	0	0	0	0	0	0	0	0	0	0	0

ARKANSAS NUCLEAR ONE
Unit 2

Table 2.3-44

WIND PERSISTENCE STABILITY B

<u>Persistence</u>	<u>NNE</u>	<u>NE</u>	<u>ENE</u>	<u>E</u>	<u>ESE</u>	<u>SE</u>	<u>SSE</u>	<u>S</u>	<u>SSW</u>	<u>SW</u>	<u>WSW</u>	<u>W</u>	<u>WNW</u>	<u>NW</u>	<u>NNW</u>	<u>N</u>	<u>CALM</u>	<u>TOTAL</u>
1	7	8	26	68	44	40	22	11	9	8	24	39	33	9	3	4	1	356
2	0	0	2	10	9	4	1	7	0	1	4	3	4	2	0	0	0	47
3	0	0	0	1	0	0	1	0	0	0	0	0	1	0	0	0	0	3
4	0	0	0	1	1	0	0	0	0	0	0	0	0	0	0	0	0	2
5	0	0	0	0	0	0	0	0	0	0	0	0	0	0	0	0	0	0
6	0	0	0	0	0	0	0	0	0	0	0	0	0	0	0	0	0	0
7	0	0	0	0	0	0	0	0	0	0	0	0	0	0	0	0	0	0
8	0	0	0	0	0	0	0	0	0	0	0	0	0	0	0	0	0	0
9	0	0	0	0	0	0	0	0	0	0	0	0	0	0	0	0	0	0
10	0	0	0	0	0	0	0	0	0	0	0	0	0	0	0	0	0	0
11	0	0	0	0	0	0	0	0	0	0	0	0	0	0	0	0	0	0
12	0	0	0	0	0	0	0	0	0	0	0	0	0	0	0	0	0	0
13	0	0	0	0	0	0	0	0	0	0	0	0	0	0	0	0	0	0
14	0	0	0	0	0	0	0	0	0	0	0	0	0	0	0	0	0	0
15	0	0	0	0	0	0	0	0	0	0	0	0	0	0	0	0	0	0
16	0	0	0	0	0	0	0	0	0	0	0	0	0	0	0	0	0	0
17	0	0	0	0	0	0	0	0	0	0	0	0	0	0	0	0	0	0
18	0	0	0	0	0	0	0	0	0	0	0	0	0	0	0	0	0	0
19	0	0	0	0	0	0	0	0	0	0	0	0	0	0	0	0	0	0
20	0	0	0	0	0	0	0	0	0	0	0	0	0	0	0	0	0	0
21	0	0	0	0	0	0	0	0	0	0	0	0	0	0	0	0	0	0
22	0	0	0	0	0	0	0	0	0	0	0	0	0	0	0	0	0	0
23	0	0	0	0	0	0	0	0	0	0	0	0	0	0	0	0	0	0
24	0	0	0	0	0	0	0	0	0	0	0	0	0	0	0	0	0	0
25	0	0	0	0	0	0	0	0	0	0	0	0	0	0	0	0	0	0
26	0	0	0	0	0	0	0	0	0	0	0	0	0	0	0	0	0	0
27	0	0	0	0	0	0	0	0	0	0	0	0	0	0	0	0	0	0
28	0	0	0	0	0	0	0	0	0	0	0	0	0	0	0	0	0	0
29	0	0	0	0	0	0	0	0	0	0	0	0	0	0	0	0	0	0
30	0	0	0	0	0	0	0	0	0	0	0	0	0	0	0	0	0	0

ARKANSAS NUCLEAR ONE
Unit 2

Table 2.3-45

WIND PERSISTENCE STABILITY C

<u>Persistence</u>	<u>NNE</u>	<u>NE</u>	<u>ENE</u>	<u>E</u>	<u>ESE</u>	<u>SE</u>	<u>SSE</u>	<u>S</u>	<u>SSW</u>	<u>SW</u>	<u>WSW</u>	<u>W</u>	<u>WNW</u>	<u>NW</u>	<u>NNW</u>	<u>N</u>	<u>CALM</u>	<u>TOTAL</u>
1	9	10	48	90	49	43	40	19	20	14	19	41	37	12	5	6	1	463
2	0	0	1	7	6	5	2	4	1	2	1	2	5	0	0	0	0	36
3	0	1	0	0	0	1	0	0	0	1	0	1	1	1	0	0	0	6
4	0	0	0	0	0	0	0	0	0	0	0	0	0	0	0	0	0	0
5	0	0	0	0	0	0	0	0	0	0	0	0	0	0	0	0	0	0
6	0	0	0	0	0	0	0	0	0	0	0	0	0	0	0	0	0	0
7	0	0	0	0	0	0	0	0	0	0	0	0	0	0	0	0	0	0
8	0	0	0	0	0	0	0	0	0	0	0	0	0	0	0	0	0	0
9	0	0	0	0	0	0	0	0	0	0	0	0	0	0	0	0	0	0
10	0	0	0	0	0	0	0	0	0	0	0	0	0	0	0	0	0	0
11	0	0	0	0	0	0	0	0	0	0	0	0	0	0	0	0	0	0
12	0	0	0	0	0	0	0	0	0	0	0	0	0	0	0	0	0	0
13	0	0	0	0	0	0	0	0	0	0	0	0	0	0	0	0	0	0
14	0	0	0	0	0	0	0	0	0	0	0	0	0	0	0	0	0	0
15	0	0	0	0	0	0	0	0	0	0	0	0	0	0	0	0	0	0
16	0	0	0	0	0	0	0	0	0	0	0	0	0	0	0	0	0	0
17	0	0	0	0	0	0	0	0	0	0	0	0	0	0	0	0	0	0
18	0	0	0	0	0	0	0	0	0	0	0	0	0	0	0	0	0	0
19	0	0	0	0	0	0	0	0	0	0	0	0	0	0	0	0	0	0
20	0	0	0	0	0	0	0	0	0	0	0	0	0	0	0	0	0	0
21	0	0	0	0	0	0	0	0	0	0	0	0	0	0	0	0	0	0
22	0	0	0	0	0	0	0	0	0	0	0	0	0	0	0	0	0	0
23	0	0	0	0	0	0	0	0	0	0	0	0	0	0	0	0	0	0
24	0	0	0	0	0	0	0	0	0	0	0	0	0	0	0	0	0	0
25	0	0	0	0	0	0	0	0	0	0	0	0	0	0	0	0	0	0
26	0	0	0	0	0	0	0	0	0	0	0	0	0	0	0	0	0	0
27	0	0	0	0	0	0	0	0	0	0	0	0	0	0	0	0	0	0
28	0	0	0	0	0	0	0	0	0	0	0	0	0	0	0	0	0	0
29	0	0	0	0	0	0	0	0	0	0	0	0	0	0	0	0	0	0
30	0	0	0	0	0	0	0	0	0	0	0	0	0	0	0	0	0	0

ARKANSAS NUCLEAR ONE
Unit 2

Table 2.3-46

WIND PERSISTENCE STABILITY D

<u>Persistence</u>	<u>NNE</u>	<u>NE</u>	<u>ENE</u>	<u>E</u>	<u>ESE</u>	<u>SE</u>	<u>SSE</u>	<u>S</u>	<u>SSW</u>	<u>SW</u>	<u>WSW</u>	<u>W</u>	<u>WNW</u>	<u>NW</u>	<u>NNW</u>	<u>N</u>	<u>CALM</u>	<u>TOTAL</u>
1	57	86	176	240	178	104	79	63	49	40	76	131	103	43	42	41	4	1512
2	14	27	51	86	41	34	12	9	8	5	15	41	32	12	1	14	0	402
3	10	6	12	25	11	8	3	2	2	3	6	17	10	2	2	4	0	123
4	0	1	6	17	2	4	0	0	0	0	4	5	6	3	2	3	0	53
5	4	0	2	2	5	0	0	1	1	0	1	4	2	0	0	0	0	22
6	1	0	1	0	1	0	1	1	0	0	0	2	2	0	1	0	0	10
7	0	1	1	1	1	0	0	0	1	0	0	2	0	2	0	0	0	9
8	0	0	0	1	0	0	0	0	0	0	1	1	0	0	0	0	0	3
9	0	0	0	0	0	0	0	0	0	0	0	0	0	0	0	0	0	0
10	0	0	0	0	0	0	0	0	0	0	1	0	0	0	0	0	0	1
11	0	0	0	0	0	0	0	0	0	0	0	0	1	0	0	0	0	1
12	0	0	0	0	0	0	0	0	0	0	0	0	0	0	0	0	0	0
13	0	0	0	0	0	0	0	0	0	0	0	0	0	0	0	0	0	0
14	0	0	0	0	0	0	0	0	0	0	0	0	0	0	0	0	0	0
15	0	0	0	0	0	0	0	0	0	0	0	0	0	0	0	0	0	0
16	0	0	0	0	0	0	0	0	0	0	0	0	0	0	0	0	0	0
17	0	0	0	0	0	0	0	0	0	0	0	0	0	0	0	0	0	0
18	0	0	0	0	0	0	0	0	0	0	0	0	0	0	0	0	0	0
19	0	0	0	0	0	0	0	0	0	0	0	0	0	0	0	0	0	0
20	0	0	0	0	0	0	0	0	0	0	0	0	0	0	0	0	0	0
21	0	0	0	0	0	0	0	0	0	0	0	0	0	0	0	0	0	0
22	0	0	0	0	0	0	0	0	0	0	0	0	0	0	0	0	0	0
23	0	0	0	0	0	0	0	0	0	0	0	0	0	0	0	0	0	0
24	0	0	0	0	0	0	0	0	0	0	0	0	0	0	0	0	0	0
25	0	0	0	0	0	0	0	0	0	0	0	0	0	0	0	0	0	0
26	0	0	0	0	0	0	0	0	0	0	0	0	0	0	0	0	0	0
27	0	0	0	0	0	0	0	0	0	0	0	0	0	0	0	0	0	0
28	0	0	0	0	0	0	0	0	0	0	0	0	0	0	0	0	0	0
29	0	0	0	0	0	0	0	0	0	0	0	0	0	0	0	0	0	0
30	0	0	0	0	0	0	0	0	0	0	0	0	0	0	0	0	0	0

ARKANSAS NUCLEAR ONE
Unit 2

Table 2.3-47

WIND PERSISTENCE STABILITY E

<u>Persistence</u>	<u>NNE</u>	<u>NE</u>	<u>ENE</u>	<u>E</u>	<u>ESE</u>	<u>SE</u>	<u>SSE</u>	<u>S</u>	<u>SSW</u>	<u>SW</u>	<u>WSW</u>	<u>W</u>	<u>WNW</u>	<u>NW</u>	<u>NNW</u>	<u>N</u>	<u>CALM</u>	<u>TOTAL</u>
1	71	120	174	169	108	88	54	39	32	34	48	75	64	34	26	39	17	1192
2	18	36	64	29	24	12	10	8	7	1	10	16	15	4	8	8	1	271
3	3	8	7	9	3	5	2	2	3	2	0	4	3	0	1	3	0	55
4	1	3	1	5	1	0	1	1	2	1	1	0	1	0	2	0	0	20
5	0	3	1	1	1	0	1	1	0	0	0	0	0	0	0	0	0	8
6	1	1	0	0	0	0	0	0	0	0	0	0	1	1	0	0	0	4
7	0	0	0	0	1	0	0	0	0	0	0	0	0	0	0	0	0	1
8	0	0	0	0	0	0	0	0	0	0	0	0	0	0	0	0	0	0
9	0	0	0	0	0	0	0	0	0	0	0	0	0	0	0	0	0	0
10	0	0	0	0	0	0	0	0	0	0	0	0	0	0	0	0	0	0
11	0	0	0	0	0	0	0	0	0	0	0	0	0	0	0	0	0	0
12	0	0	0	0	0	0	0	0	0	0	0	0	0	0	0	0	0	0
13	0	0	1	0	0	0	0	0	0	0	0	0	0	0	0	0	0	1
14	0	0	0	0	0	0	0	0	0	0	0	0	0	0	0	0	0	0
15	0	0	0	0	0	0	0	0	0	0	0	0	0	0	0	0	0	0
16	0	0	0	0	0	0	0	0	0	0	0	0	0	0	0	0	0	0
17	0	0	0	0	0	0	0	0	0	0	0	0	0	0	0	0	0	0
18	0	0	0	0	0	0	0	0	0	0	0	0	0	0	0	0	0	0
19	0	0	0	0	0	0	0	0	0	0	0	0	0	0	0	0	0	0
20	0	0	0	0	0	0	0	0	0	0	0	0	0	0	0	0	0	0
21	0	0	0	0	0	0	0	0	0	0	0	0	0	0	0	0	0	0
22	0	0	0	0	0	0	0	0	0	0	0	0	0	0	0	0	0	0
23	0	0	0	0	0	0	0	0	0	0	0	0	0	0	0	0	0	0
24	0	0	0	0	0	0	0	0	0	0	0	0	0	0	0	0	0	0
25	0	0	0	0	0	0	0	0	0	0	0	0	0	0	0	0	0	0
26	0	0	0	0	0	0	0	0	0	0	0	0	0	0	0	0	0	0
27	0	0	0	0	0	0	0	0	0	0	0	0	0	0	0	0	0	0
28	0	0	0	0	0	0	0	0	0	0	0	0	0	0	0	0	0	0
29	0	0	0	0	0	0	0	0	0	0	0	0	0	0	0	0	0	0
30	0	0	0	0	0	0	0	0	0	0	0	0	0	0	0	0	0	0

ARKANSAS NUCLEAR ONE
Unit 2

Table 2.3-48

WIND PERSISTENCE STABILITY F

<u>Persistence</u>	<u>NNE</u>	<u>NE</u>	<u>ENE</u>	<u>E</u>	<u>ESE</u>	<u>SE</u>	<u>SSE</u>	<u>S</u>	<u>SSW</u>	<u>SW</u>	<u>WSW</u>	<u>W</u>	<u>WNW</u>	<u>NW</u>	<u>NNW</u>	<u>N</u>	<u>CALM</u>	<u>TOTAL</u>
1	52	106	124	85	38	19	13	8	15	17	29	33	38	18	13	23	31	662
2	5	32	25	12	1	0	0	3	2	1	0	8	3	1	1	1	8	103
3	3	7	7	3	0	0	1	0	0	0	0	0	1	0	0	0	1	23
4	0	3	1	0	0	0	0	0	0	0	0	0	0	0	0	0	1	5
5	0	0	2	0	0	0	0	0	0	0	0	0	0	0	0	0	0	2
6	0	2	0	0	0	0	0	0	0	0	0	0	0	1	0	0	0	3
7	0	0	0	0	0	0	0	0	0	0	0	0	0	0	0	0	0	0
8	0	1	1	0	0	0	0	0	0	0	0	0	0	0	0	0	0	2
9	0	0	0	0	0	0	0	0	0	0	0	0	0	0	0	0	0	0
10	0	0	0	0	0	0	0	0	0	0	0	0	0	0	0	0	0	0
11	0	0	0	0	0	0	0	0	0	0	0	0	0	0	0	0	0	0
12	0	0	0	0	0	0	0	0	0	0	0	0	0	0	0	0	0	0
13	0	0	0	0	0	0	0	0	0	0	0	0	0	0	0	0	0	0
14	0	0	0	0	0	0	0	0	0	0	0	0	0	0	0	0	0	0
15	0	0	0	0	0	0	0	0	0	0	0	0	0	0	0	0	0	0
16	0	0	0	0	0	0	0	0	0	0	0	0	0	0	0	0	0	0
17	0	0	0	0	0	0	0	0	0	0	0	0	0	0	0	0	0	0
18	0	0	0	0	0	0	0	0	0	0	0	0	0	0	0	0	0	0
19	0	0	0	0	0	0	0	0	0	0	0	0	0	0	0	0	0	0
20	0	0	0	0	0	0	0	0	0	0	0	0	0	0	0	0	0	0
21	0	0	0	0	0	0	0	0	0	0	0	0	0	0	0	0	0	0
22	0	0	0	0	0	0	0	0	0	0	0	0	0	0	0	0	0	0
23	0	0	0	0	0	0	0	0	0	0	0	0	0	0	0	0	0	0
24	0	0	0	0	0	0	0	0	0	0	0	0	0	0	0	0	0	0
25	0	0	0	0	0	0	0	0	0	0	0	0	0	0	0	0	0	0
26	0	0	0	0	0	0	0	0	0	0	0	0	0	0	0	0	0	0
27	0	0	0	0	0	0	0	0	0	0	0	0	0	0	0	0	0	0
28	0	0	0	0	0	0	0	0	0	0	0	0	0	0	0	0	0	0
29	0	0	0	0	0	0	0	0	0	0	0	0	0	0	0	0	0	0
30	0	0	0	0	0	0	0	0	0	0	0	0	0	0	0	0	0	0

ARKANSAS NUCLEAR ONE
Unit 2

Table 2.3-49

WIND PERSISTENCE STABILITY G

<u>Persistence</u>	<u>NNE</u>	<u>NE</u>	<u>ENE</u>	<u>E</u>	<u>ESE</u>	<u>SE</u>	<u>SSE</u>	<u>S</u>	<u>SSW</u>	<u>SW</u>	<u>WSW</u>	<u>W</u>	<u>WNW</u>	<u>NW</u>	<u>NNW</u>	<u>N</u>	<u>CALM</u>	<u>TOTAL</u>
1	7	38	63	35	19	6	9	10	9	3	16	24	26	13	10	13	32	333
2	1	4	13	13	0	1	0	1	0	0	0	5	5	0	2	1	6	52
3	1	0	1	4	0	0	0	0	0	0	1	3	0	0	0	0	1	11
4	0	0	3	0	0	0	0	0	0	0	0	0	1	0	0	0	0	4
5	0	0	2	1	0	0	0	0	0	0	1	0	0	0	0	0	0	4
6	0	0	0	0	0	0	0	0	0	0	0	0	0	0	0	0	0	0
7	0	0	0	0	0	0	0	0	0	0	0	0	0	0	0	0	0	0
8	0	0	0	0	0	0	0	0	0	0	0	0	0	0	0	0	0	0
9	0	0	0	0	0	0	0	0	0	0	0	0	0	0	0	0	0	0
10	0	0	0	0	0	0	0	0	0	0	0	0	0	0	0	0	0	0
11	0	0	0	0	0	0	0	0	0	0	0	0	0	0	0	0	0	0
12	0	0	0	0	0	0	0	0	0	0	0	0	0	0	0	0	0	0
13	0	0	0	0	0	0	0	0	0	0	0	0	0	0	0	0	0	0
14	0	0	0	0	0	0	0	0	0	0	0	0	0	0	0	0	0	0
15	0	0	0	0	0	0	0	0	0	0	0	0	0	0	0	0	0	0
16	0	0	0	0	0	0	0	0	0	0	0	0	0	0	0	0	0	0
17	0	0	0	0	0	0	0	0	0	0	0	0	0	0	0	0	0	0
18	0	0	0	0	0	0	0	0	0	0	0	0	0	0	0	0	0	0
19	0	0	0	0	0	0	0	0	0	0	0	0	0	0	0	0	0	0
20	0	0	0	0	0	0	0	0	0	0	0	0	0	0	0	0	0	0
21	0	0	0	0	0	0	0	0	0	0	0	0	0	0	0	0	0	0
22	0	0	0	0	0	0	0	0	0	0	0	0	0	0	0	0	0	0
23	0	0	0	0	0	0	0	0	0	0	0	0	0	0	0	0	0	0
24	0	0	0	0	0	0	0	0	0	0	0	0	0	0	0	0	0	0
25	0	0	0	0	0	0	0	0	0	0	0	0	0	0	0	0	0	0
26	0	0	0	0	0	0	0	0	0	0	0	0	0	0	0	0	0	0
27	0	0	0	0	0	0	0	0	0	0	0	0	0	0	0	0	0	0
28	0	0	0	0	0	0	0	0	0	0	0	0	0	0	0	0	0	0
29	0	0	0	0	0	0	0	0	0	0	0	0	0	0	0	0	0	0
30	0	0	0	0	0	0	0	0	0	0	0	0	0	0	0	0	0	0

ARKANSAS NUCLEAR ONE
Unit 2

Table 2.3-50

ACTUAL EXCLUSION ZONE BOUNDARIES*

<u>Affected Sector</u>	<u>Exclusion Zone Distance (Meters)</u>
N	1250
NNE	1268
NE	1305
ENE	1219
E	1046
ESE	1274
SE	1238
SSE	1219
S	1219
SSW	1046
SW	1046
WSW	1046
W	1128
WNW	1046
NW	1046
NNW	1177

* The origin from which these distances were measured is at the centerline of the Unit 2 Containment.

ARKANSAS NUCLEAR ONE
Unit 2

Table 2.3-51

**STANDARD SAR METEOROLOGICAL ANALYSES OF ONSITE
DATA, STEP-BY-STEP DESCRIPTION**

Hourly (Minimum EZB)	<ul style="list-style-type: none">• Calculate hourly averages values of X/Q using centerline invariant wind with wake effects, at the single, minimum exclusion zone (EZB).• Arrange values in cumulative frequency distribution.• Select 5% and 50% values.
Hourly (Actual EZB)	<ul style="list-style-type: none">• The same as "Hourly" except that the calculation is made at the actual exclusion zone boundary as selected by the wind direction.• Data are arranged in a cumulative frequency distribution.• Select 5% and 50% values.
Eight Hourly	<ul style="list-style-type: none">• The same as "Hourly" except the calculations are made at the minimum outer boundary of the low population zone in each sector as selected by the wind direction.• For each hour, in each sector, average the past 8 hour X/Q values, using X/Q = 0 when wind direction is not in the sector (running 8-hour average).• Determine the probability of each sector being affected.• Arrange all eight-hourly average values for all sectors in a cumulative frequency distribution.• Select the worst, the 5% and 50% values and the respective sectors.
Sixteen Hourly	<ul style="list-style-type: none">• The same as "Eight Hourly" except:<ul style="list-style-type: none">(A) sector spread replaces centerline wind assumption.(B) notation for wake effect,(C) 8-hour running averages replaced with 16-hour running average.
Three Day	<ul style="list-style-type: none">• The same as "Sixteen Hourly" except that the past 16-hour averages are replaced with a 72-hour running average.
Twenty-six	<ul style="list-style-type: none">• The same as "Sixteen Hourly" except that the last 16-hour averages are replaced by a 624-hour running average.
Average Annual Concentrations	<ul style="list-style-type: none">• Calculate average hourly X/Q values using sector spread equations, including wake effect, at the exclusion zone boundary distance in each sector, and out to 50 miles.• Average the X/Q values for the entire year at each radial distance in each sector (X/Q = 0 if wind is in another sector).• Provide analyses for determining the finite cloud parameters for annual average release calculations.

ARKANSAS NUCLEAR ONE
Unit 2

Table 2.3-52

**AVERAGE RELATIVE CONCENTRATIONS OVER SELECTED AVERAGING INTERVALS
DATA PERIOD FEBRUARY 7, 1972 - FEBRUARY 7, 1973**

<u>Sector Affected</u>	<u>Frequency of Non-zero Averages(%)</u>	<u>Percentile of *</u> <u>Non-Zero Averages</u>			<u>Frequency of Non-Zero Averages(%)</u>	<u>Percentile of</u> <u>Non-Zero Averages*</u>		
		<u>Worst</u>	<u>5%</u>	<u>50%</u>		<u>Worst</u>	<u>5%</u>	<u>50%</u>
N	27.6	35.8	10.5	0.61	45.2	2.38	0.92	0.12
NNE	24.5	33.1	9.7	0.69	39.6	2.09	0.91	0.10
NE	23.6	28.0	5.7	0.50	39.2	2.53	0.53	0.09
ENE	30.5	79.6	19.7	0.72	46.5	6.60	1.50	0.15
E	38.1	71.1	25.0	0.94	52.6	5.38	1.70	0.28
ESE	33.4	95.0	24.0	0.80	47.4	5.57	2.00	0.24
SE	23.2	30.4	13.0	1.02	37.1	1.76	1.00	0.14
SSE	20.1	50.5	24.5	0.94	32.8	2.60	1.20	0.13
S	19.9	32.1	19.7	1.24	33.1	1.88	1.10	0.15
SSW	27.7	58.5	18.2	2.00	42.4	4.01	1.60	0.31
SW	38.2	80.9	27.5	3.50	58.3	6.79	2.50	0.52
WSW	55.6	103.7	32.5	2.00	76.4	6.11	2.80	0.46
W	61.8	129.0	27.5	1.10	79.5	7.63	2.30	0.34
WNW	47.7	60.6	14.3	0.78	68.0	4.06	1.20	0.21
NW	38.2	37.6	9.9	0.78	59.2	1.92	0.90	0.17
NNW	31.2	35.8	7.5	0.59	50.2	1.83	0.77	0.12

* 10⁻⁶ Seconds Per Cubic Meter

ARKANSAS NUCLEAR ONE
Unit 2

Table 2.3-53

**AVERAGE RELATIVE CONCENTRATIONS OVER SELECTED AVERAGING INTERVALS
DATA PERIOD FEBRUARY 7, 1972 - FEBRUARY 7, 1973**

<u>Sector Affected</u>	<u>Frequency of Non-zero Averages(%)</u>	<u>1-4 Days</u>			<u>Frequency of Non-Zero Averages(%)</u>	<u>4-30 Days</u>		
		<u>Percentile of *</u>				<u>Percentile of</u>		
		<u>Non-Zero Averages</u>				<u>Non-Zero Averages*</u>		
		<u>Worst</u>	<u>5%</u>	<u>50%</u>		<u>Worst</u>	<u>5%</u>	<u>50%</u>
N	90.3	0.99	0.38	0.06	100	0.29	0.25	0.09
NNE	85.2	0.67	0.33	0.05	100	0.17	0.12	0.08
NE	85.7	0.66	0.25	0.04	100	0.15	0.11	0.06
ENE	89.2	1.82	0.66	0.11	100	0.48	0.26	0.14
E	90.6	1.42	0.89	0.21	100	0.50	0.34	0.25
ESE	87.4	1.74	0.85	0.17	100	0.51	0.35	0.22
SE	79.7	0.53	0.34	0.07	100	0.21	0.14	0.09
SSE	77.9	0.80	0.45	0.07	100	0.24	0.16	0.09
S	78.6	0.74	0.35	0.08	100	0.26	0.21	0.11
SSW	84.5	1.65	0.81	0.18	100	0.54	0.43	0.21
SW	94.2	2.64	1.30	0.38	100	1.09	0.94	0.39
WSW	99.4	2.75	1.50	0.45	100	1.15	0.94	0.59
W	99.9	2.62	1.30	0.38	100	1.23	0.86	0.48
WNW	98.8	1.44	0.70	0.19	100	0.43	0.32	0.24
NW	95.9	1.05	0.50	0.12	100	0.37	0.26	0.14
NNW	92.2	0.74	0.33	0.09	100	0.20	0.14	0.11

*10⁻⁶ Seconds Per Cubic Meter

ARKANSAS NUCLEAR ONE
Unit 2

Table 2.3-54

**ARKANSAS ONE NUCLEAR SITE
ARKANSAS POWER & LIGHT**

AVERAGE ANNUAL RELATIVE CONCENTRATION (SEC./CUBIC METER)
PER SECTOR PER DISTANCE IN METERS FROM PLANT SITE

PERIOD OF RECORD: FEBRUARY 7, 1972 - FEBRUARY 7, 1973

DISTANCE IN METERS

DIRECTION <u>AFFECTED</u>	<u>.06</u> <u>100</u>	<u>.31</u> <u>500</u>	<u>6491</u> <u>1046</u>	<u>1.24</u> <u>2000</u>	<u>1.86</u> <u>3000</u>	<u>3.11</u> <u>5000</u>	<u>4.0</u> <u>6436</u>	<u>4.97</u> <u>8000</u>
NNE	7.2E-05	3.9E-06	1.2E-06	4.4E-07	2.4E-07	1.2E-07	8.7E-08	6.5E-08
NE	5.1E-05	2.8E-06	8.1E-07	3.1E-07	1.7E-07	8.6E-08	6.1E-08	4.5E-08
ENE	1.5E-04	8.0E-06	2.3E-06	8.7E-07	4.8E-07	2.4E-07	1.8E-07	1.3E-07
E	2.4E-04	1.3E-05	3.7E-06	1.4E-06	7.7E-07	3.9E-07	2.8E-07	2.1E-07
ESE	2.0E-04	1.1E-05	3.2E-06	1.2E-06	6.6E-07	3.4E-07	2.4E-07	1.8E-07
SE	8.1E-05	4.4E-06	1.3E-06	4.9E-07	2.7E-07	1.4E-07	9.8E-08	7.3E-08
SSE	8.0E-05	4.4E-06	1.3E-06	4.8E-07	2.6E-07	1.3E-07	9.7E-08	7.2E-08
S	8.4E-05	4.6E-06	1.3E-06	5.0E-07	2.8E-07	1.4E-07	1.0E-07	7.5E-08
SSW	1.8E-04	9.9E-06	2.9E-06	1.1E-06	6.3E-07	3.2E-07	2.3E-07	1.7E-07
SW	3.8E-04	2.1E-05	6.0E-06	2.3E-06	1.3E-06	6.7E-07	4.8E-07	3.6E-07
WSW	5.0E-04	2.7E-05	8.0E-06	3.0E-06	1.7E-06	8.5E-07	6.1E-07	4.6E-07
W	4.4E-04	2.4E-05	7.0E-06	2.6E-06	1.4E-06	7.3E-07	5.2E-07	3.9E-07
WNW	2.1E-04	1.2E-05	3.5E-06	1.3E-06	7.2E-07	3.6E-07	2.6E-07	1.9E-07
NW	1.4E-04	7.4E-06	2.2E-06	8.4E-07	4.6E-07	2.3E-07	1.6E-07	1.2E-07
NNW	9.3E-05	5.1E-06	1.5E-06	5.6E-07	3.1E-07	1.5E-07	1.1E-07	8.1E-08
N	8.8E-05	4.8E-06	1.4E-06	5.3E-07	2.9E-07	1.5E-07	1.0E-07	7.7E-08

TOTAL NUMBER OF VALID OBSERVATION = 8318

NUMBER OF INVALID OBSERVATIONS = 466

ARKANSAS NUCLEAR ONE
Unit 2

Table 2.3-55

**ARKANSAS ONE NUCLEAR SITE
ARKANSAS POWER & LIGHT**

AVERAGE ANNUAL RELATIVE CONCENTRATION (SEC/CUBIC METER)
PER SECTOR PER DISTANCE IN METERS FROM PLANT SITE

PERIOD OF RECORD: February 7, 1972 - FEBRUARY 7, 1973

DISTANCE IN KILOMETERS

DIRECTION <u>AFFECTED</u>	6.21 <u>10</u>	12.4 <u>20</u>	18.6 <u>30</u>	24.8 <u>40</u>	31.1 <u>50</u>	37.3 <u>60</u>	43.5 <u>70</u>	49 <u>80</u>
NNE	4.8E-08	2.0E-08	1.1E-08	8.0E-09	6.0E-09	4.7E-09	3.9E-09	3.3E-09
NE	3.4E-08	1.4E-08	8.0E-09	5.6E-09	4.2E-09	3.3E-09	2.7E-09	2.3E-09
ENE	9.8E-08	4.0E-08	2.4E-08	1.6E-08	1.2E-08	9.7E-09	8.0E-09	6.7E-09
E	1.6E-07	6.4E-08	3.8E-08	2.6E-08	2.0E-08	1.5E-08	1.3E-08	1.1E-08
ESE	1.3E-07	5.5E-08	3.3E-08	2.3E-08	1.7E-08	1.3E-08	1.1E-08	9.3E-09
SE	5.4E-08	2.2E-08	1.3E-08	9.0E-09	6.8E-09	5.3E-09	4.4E-09	3.7E-09
SSE	5.4E-08	2.2E-08	1.3E-08	9.0E-09	6.8E-09	5.3E-09	4.4E-08	3.7E-09
S	5.6E-08	2.3E-08	1.4E-08	9.4E-09	7.1E-09	5.5E-09	4.6E-09	3.8E-09
SSW	1.3E-07	5.1E-08	3.0E-08	2.1E-08	1.5E-08	1.2E-08	1.0E-08	8.4E-09
SW	2.7E-07	1.1E-07	6.4E-08	4.4E-08	3.4E-08	2.6E-08	2.2E-08	1.8E-08
WSW	3.4E-07	1.4E-07	8.3E-08	5.8E-08	4.3E-08	3.4E-08	2.8E-08	2.4E-08
W	2.9E-07	1.2E-07	6.9E-08	4.8E-08	3.6E-08	2.8E-08	2.3E-08	1.9E-08
WNW	1.4E-07	5.6E-08	3.3E-08	2.3E-08	1.7E-08	1.3E-08	1.1E-08	9.3E-09
NW	8.8E-08	3.5E-08	2.1E-08	1.4E-08	1.1E-08	8.3E-09	6.8E-09	5.8E-09
NNW	6.0E-08	2.4E-08	1.4E-08	9.8E-09	7.4E-09	5.8E-09	4.8E-09	4.0E-09
N	5.8E-08	2.3E-08	1.4E-08	9.5E-09	7.2E-09	5.6E-09	4.6E-09	3.9E-09

TOTAL NUMBER OF VALID OBSERVATIONS = 8318

NUMBER OF INVALID OBSERVATIONS = 466

ARKANSAS NUCLEAR ONE
Unit 2

Table 2.3-56

**MONTHLY AND SEASONAL DISTRIBUTION OF TORNADO
OCCURRENCE FOR ARKANSAS (1955 - 1967)**

(Data Source 2.3.1-S)

	<u>Number of Occurrences</u>	<u>Mean Frequency of Occurrence</u>
January	13	1.0
February	34	2.6
March	38	2.9
April	50	3.8
May	67	5.2
June	19	1.5
July	11	0.8
August	7	0.5
September	7	0.5
October	5	0.4
November	21	1.6
December	5	0.4
<u>Season</u>		
Spring (MAM)	155	11.9
Summer (JJA)	37	2.8
Autumn (SON)	33	2.5
Winter (DJF)	52	4.0

ARKANSAS NUCLEAR ONE
Unit 2

Table 2.3-57

**MONTHLY AND SEASONAL LIGHTNING EVENTS FOR ARKANSAS,
OCTOBER 1958 THROUGH SEPTEMBER 1968***

(Data Source 2.3.1-T)

	<u>Number of Occurrences</u>	<u>Mean Frequency of Occurrence</u>
January	0	0
February	0	0
March	8	0.8
April	6	0.6
May	13	1.3
June	18	1.8
July	19	1.9
August	24	2.4
September	7	0.7
October	1	0.1
November	1	0.1
December	0	0
<u>Season</u>		
Spring (MAM)	27	2.7
Summer (JJA)	61	6.1
Autumn (SON)	9	0.9
Winter (DJF)	0	0

* Based on reports of injury or death.

ARKANSAS NUCLEAR ONE
Unit 2

Table 2.3-58

**MONTHLY, SEASONAL AND ANNUAL DIURNAL MEAN AIR TEMPERATURE (°F)
VARIATIONS FOR LITTLE ROCK, ARKANSAS**

(January 1956 through December 1962)
(Data Source 2.3.1-U)

Local Standard Time

<u>Month</u>	<u>00-02</u>	<u>03-05</u>	<u>06-08</u>	<u>09-11</u>	<u>12-14</u>	<u>15-17</u>	<u>18-20</u>	<u>21-23</u>
January	35.8	34.0	32.9	37.5	43.0	44.3	40.5	37.9
February	41.7	39.8	38.9	43.6	48.9	50.6	46.8	43.7
March	45.3	43.2	42.8	49.1	54.6	56.6	52.4	48.6
April	57.0	54.4	55.4	62.8	67.8	69.3	65.1	60.3
May	66.4	63.9	66.5	74.2	79.5	80.5	75.8	70.1
June	71.9	69.9	72.9	80.1	84.0	84.5	80.4	75.1
July	75.5	73.6	76.2	84.1	88.5	88.3	83.7	78.3
August	74.9	72.8	74.8	83.5	88.4	89.0	83.6	77.7
September	68.4	66.5	67.5	76.7	82.1	82.0	75.6	70.9
October	58.3	56.3	56.6	65.7	71.9	72.1	65.4	61.0
November	46.9	44.9	44.5	51.4	57.5	58.2	52.6	48.9
December	39.9	38.4	37.6	42.0	48.5	49.3	45.1	42.1
Annual	56.8	54.8	55.6	62.6	67.9	68.7	63.9	59.6
Spring (MAM)	56.2	53.8	54.9	62.0	67.3	68.8	64.4	59.7
Summer (JJA)	74.1	72.1	74.6	82.6	87.0	87.3	82.6	77.0
Autumn (SON)	57.9	55.9	56.2	64.6	70.5	70.8	64.5	60.3
Winter (DJF)	39.1	37.4	36.5	41.0	46.8	48.1	44.1	41.2

ARKANSAS NUCLEAR ONE
Unit 2

Table 2.3-59

**MONTHLY, SEASONAL AND ANNUAL EXTREMES OF ABSOLUTE HUMIDITY
FOR LITTLE ROCK, ARKANSAS**

(January 1956 Through December 1962)
(Data Source 2.3.2-L)

<u>Season</u>	<u>HIGH EXTREME</u>			<u>LOW EXTREME</u>		
	<u>Ambient T °C</u>	<u>Dew Pt. T °C</u>	<u>Absolute Hum. (g/m³)</u>	<u>Ambient T °C</u>	<u>Dew Pt. T °C</u>	<u>Absolute Hum.(g/m³)</u>
March	20.0	20.0	17.3	6.7	-17.2	1.2
April	26.1	23.3	16.2	8.9	-12.8	1.8
May	25.0	24.4	16.2	12.2	-5.0	3.2
Spring		17.3				1.2
June	32.8	25.6	17.3	24.4	3.9	5.9
July	27.2	26.7	20.7	34.4	9.4	8.3
August	30.6	27.8	22.3	26.7	9.4	8.5
Summer		22.3				5.9
September	28.3	26.7	23.2	21.1	.6	4.7
October	28.3	24.4	25.3	13.3	-9.4	2.2
November	22.2	22.2	26.7	-6.7	-28.3	.5
Autumn		26.7				.5
December	20.0	20.0	25.2	-10.0	-25.0	.7
January	18.9	18.9	22.0	0.0	-28.3	.5
February	18.9	18.9	19.7	-6.7	-23.9	.7
Winter		25.2				.5
Annual	29.4	27.8	26.7	0.0	-28.3	.5

ARKANSAS NUCLEAR ONE
Unit 2

Table 2.3-60

**SEASONAL AND ANNUAL DIURNAL VARIATION OF MEAN ABSOLUTE
HUMIDITY (gm/m³) FOR
LITTLE ROCK, ARKANSAS**

(January 1956 - December 1962)
Local Standard Time

(Data Source 2.3.2-L)

<u>Season/Hour</u>	<u>00-02</u>	<u>03-05</u>	<u>06-08</u>	<u>09-11</u>	<u>12-14</u>	<u>15-17</u>	<u>18-20</u>	<u>21-23</u>
Spring (MAM)	8.5	8.3	8.3	8.3	8.1	8.1	8.4	8.6
Summer (JJA)	17.3	16.8	16.9	16.9	16.5	16.3	17.3	17.5
Autumn (SON)	9.7	9.5	9.5	9.6	9.3	9.3	9.8	9.8
Winter (DJF)	4.7	4.6	4.7	4.8	4.9	4.9	5.0	4.8
Annual	9.1	8.9	8.9	9.0	9.0	8.9	9.2	9.3

ARKANSAS NUCLEAR ONE
Unit 2

Table 2.3-61

**MONTHLY, SEASONAL AND ANNUAL DIURNAL VARIATION OF MEAN DEW POINT
TEMPERATURE (°F) VARIATIONS FOR
LITTLE ROCK, ARKANSAS**

(January 1956 Through December 1962
(Data Source 2.3.2-L)

Local Standard Time

<u>Month</u>	<u>00-02</u>	<u>03-05</u>	<u>06-08</u>	<u>09-11</u>	<u>12-14</u>	<u>15-17</u>	<u>18-20</u>	<u>21-23</u>
January	28.5	27.5	26.9	28.6	29.7	30.5	30.1	29.5
February	33.6	33.2	33.0	34.0	34.8	35.2	35.2	34.7
March	36.3	35.5	35.3	36.1	36.4	36.4	37.2	37.4
April	46.9	46.7	46.7	46.7	46.3	45.9	46.7	47.3
May	59.2	58.5	59.2	59.4	58.8	58.9	59.6	60.1
June	65.9	65.1	65.8	65.9	65.3	56.2	66.4	66.7
July	69.8	69.1	69.3	69.6	69.3	69.2	70.3	70.6
August	69.1	68.3	68.8	69.1	68.3	68.2	69.3	69.6
September	62.8	62.0	62.0	63.0	62.3	62.2	63.5	63.2
October	52.2	51.2	51.2	52.3	51.6	51.7	53.1	52.8
November	39.2	38.6	38.3	38.9	38.7	38.9	39.3	39.0
December	32.4	32.0	31.6	33.2	33.7	33.6	33.6	32.7
Annual	49.7	49.0	49.0	49.7	49.6	49.7	50.4	50.3
Spring (MAM)	47.5	46.9	47.1	47.4	47.2	47.1	47.8	48.3
Summer (JJA)	68.3	76.5	67.6	68.2	67.6	67.5	68.7	69.0
Autumn (SON)	51.4	50.6	50.5	51.4	50.9	50.9	52.0	51.7
Winter (DJF)	31.5	30.9	31.5	31.9	32.7	33.1	33.0	32.3

ARKANSAS NUCLEAR ONE
Unit 2

Table 2.3-62

**MONTHLY, SEASONAL AND ANNUAL DIURNAL VARIATION OF MEAN RELATIVE
HUMIDITY (%) VARIATION FOR LITTLE ROCK, ARKANSAS**

(January 1956 Through December 1962)
(Data Source 2.3.2-L)

Local Standard Time

<u>Month</u>	<u>00-02</u>	<u>03-05</u>	<u>06-08</u>	<u>09-11</u>	<u>12-14</u>	<u>15-17</u>	<u>18-20</u>	<u>21-23</u>
January	75.9	78.0	79.1	71.8	62.2	61.6	68.4	73.3
February	74.	78.3	80.3	70.9	61.4	59.4	66.8	72.3
March	72.2	75.5	76.0	63.5	54.1	51.3	59.4	67.4
April	70.8	76.2	73.8	58.5	49.6	47.8	55.4	64.8
May	78.3	83.0	78.2	61.6	51.3	50.3	59.4	71.6
June	81.9	85.2	79.2	63.4	55.3	54.6	64.1	75.8
July	83.0	86.0	80.1	63.1	54.6	55.2	65.6	78.0
August	82.8	86.1	82.3	63.6	53.4	52.1	63.9	77.0
September	83.1	86.1	83.4	64.6	53.7	53.6	67.9	77.8
October	81.1	83.9	82.9	64.1	51.6	51.7	66.4	75.7
November	75.5	79.0	79.7	64.6	52.9	52.3	62.7	70.1
December	75.6	78.8	80.0	70.8	59.8	58.2	66.2	71.4
Annual	77.9	81.3	79.6	65.0	55.0	54.0	63.9	72.9
Spring (MAM)	73.8	78.2	76.0	61.2	51.7	49.8	58.1	67.9
Summer (JJA)	82.6	85.8	80.5	63.4	54.4	54.0	64.5	76.9
Autumn (SON)	79.9	83.0	82.0	64.4	52.7	52.5	65.7	74.5
Winter (DJF)	75.3	78.4	79.8	71.2	61.1	59.7	67.1	72.3

ARKANSAS NUCLEAR ONE
Unit 2

Table 2.3-63

PERCENT FREQUENCY OF OCCURRENCE OF FOG FOR LITTLE ROCK, ARKANSAS
(1949 Through 1967)

Local Standard Time

(Data Source 2.3.2-M)

<u>Month</u>	<u>00-02</u>	<u>03-05</u>	<u>06-08</u>	<u>09-11</u>	<u>12-14</u>	<u>15-17</u>	<u>18-20</u>	<u>21-23</u>	<u>Average</u>
March	7.5	10.4	13.5	8.9	5.0	5.2	6.5	6.9	8.0
April	5.3	7.5	8.4	3.6	2.3	2.3	3.3	3.7	4.6
May	6.1	9.5	7.5	2.6	1.3	1.3	1.6	3.0	4.1
Spring	6.3	9.1	9.8	5.0	2.9	2.9	3.8	4.5	5.6
June	4.2	9.8	6.5	1.4	0.7	0.2	0.4	1.4	3.1
July	4.2	11.0	10.6	1.0	0.2	0.1	0.2	1.7	3.6
August	3.9	8.7	10.8	2.0	0.7	0.4	0.4	1.3	3.5
Summer	4.1	9.8	9.3	1.5	0.5	0.2	0.3	1.5	3.4
September	7.9	16.2	20.2	3.3	0.9	1.0	1.5	3.2	6.8
October	7.4	11.4	15.2	5.9	2.3	2.2	2.6	4.3	6.4
November	7.6	10.6	12.7	9.0	4.4	3.3	3.3	4.3	6.9
Autumn	7.6	12.7	16.0	6.1	2.5	2.2	2.5	3.9	6.7
December	11.2	12.3	14.9	12.0	8.4	8.5	9.5	10.8	10.9
January	12.4	13.4	16.5	15.0	11.7	10.0	10.1	11.6	12.6
February	10.2	14.4	17.2	11.6	8.0	7.3	9.1	8.8	10.8
Winter	11.3	13.4	16.2	12.9	9.4	8.6	9.6	10.4	11.4
Annual	7.3	11.3	12.8	6.4	3.8	3.5	4.0	5.1	6.8

ARKANSAS NUCLEAR ONE
Unit 2

Table 2.4-1

RAINFALL AND RUNOFF FOR PMF

(furnished by Corps of Engineers)

<u>Area</u>	Effective Drainage Area (sq. mi.)	<u>PMP</u>		Loss (inches)	<u>Runoff</u>	
		(inches)	(inch/miles)		(inches)	(inch/miles)
Arkansas River above Tulsa	6,922	6.10	42,224	3.00	3.10	21,458
Verdigris River above Sageeyah	4,402	6.71	29,537	1.57	5.14	22,626
Grand (Neosho) River above Wagoner	12,307	7.92	97,471	3.12	4.80	59,074
Canadian River above Whitfield	11,178	12.14	135,701	4.00	8.14	90,989
Intervening areas above Fort Smith	11,072	13.17	145,818	1.82	11.35	125,667
Area between Fort Smith and Dardanelle	<u>3,731</u>	11.50	<u>42,906</u>	2.00	9.50	<u>35,444</u>
Total	49,612		493,657			355,258
Weighed average		9.95			7.16	
Runoff percent					72.0	

ARKANSAS NUCLEAR ONE
Unit 2

Table 2.4-2

**GROUNDWATER USE IN JOHNSON
LOGAN, POPE, AND YELL COUNTIES - 1970**

(All numbers are million gallons per day)

<u>COUNTY</u>	<u>PUBLIC SUPPLY</u>	<u>INDUSTRIAL SELF SUPPLIED</u>	<u>DOMESTIC</u>	<u>LIVESTOCK</u>	<u>IRRIGATION</u>	<u>FISH & MINNOW FARMS</u>	<u>WILDLIFE</u>	<u>TOTAL</u>
Johnson	0	0.02	0.48	0.20	0.93	0	0	1.63
Logan	0.11	0.16	0.55	0.38	0.18	0.29	0	1.67
Pope	0.45	0.02	0.94	0.38	0.51	0.30	0.19	2.79
Yell	<u>0.98</u>	<u>0.03</u>	<u>0.56</u>	<u>0.50</u>	<u>0.53</u>	<u>0.91</u>	<u>0</u>	<u>3.51</u>
4-County Total	1.54	0.23	2.53	1.46	2.15	1.50	0.19	9.60

(Data from Halberg, 1972)

ARKANSAS NUCLEAR ONE
Unit 2

Table 2.4-3

WELL SURVEY ARKANSAS NUCLEAR ONE

(3-Mile Radius)

AREA I*

Total Number of Wells	35
Well Usage	
Residential	34
Business	1
Depth Range	60-315 ft.
Location within Area	
East Side	14
South Side	14
West Side	3
North	4

(All wells within this area are located either above plant grade level or out of the path of any drainage from plant)

AREA II*

Total Number of Wells	79
Well Usage	
Residential	71
Business	3
Churches	2
Poultry Farm	1
London Water Works	2
Depth Range (Excluding London Water Works)	40-105 ft.
Depth - London Water Works Wells	285 ft.,450 ft.

* See Figure 2.4-3 for area location.

AREA III*

Total Number of Wells	60
Well Usage	
Residential	58
Business	1
Church	1
Depth Range	60-150 ft.

ARKANSAS NUCLEAR ONE
Unit 2

Table 2.4-3 (continued)

AREA IV*

Total Number of Wells	88
Well Usage	
Residential	80
Businesses	2
Church	1
Poultry Farm	1
Livestock Farm	1
Arkansas State Park	2
Trailer Court (7 trailers)	1
Depth Range	35-300 ft.

AREA V*

Total Number of Wells	22
Well Usage	
Residential	22
Depth Range	28-140 ft.

AREA VI*

Total Number of Wells	0
-----------------------	---

* See Figure 2.4-3 for area location.

ARKANSAS NUCLEAR ONE
Unit 2

Table 2.4-4

CHEMICAL ANALYSES OF GROUND AND SURFACE WATER

(All Values, except pH, given in parts per million)

<u>Sample No. (1)</u>	<u>WATER WELLS</u>										<u>SURFACE WATER</u>		
	<u>1</u>	<u>2</u>	<u>3</u>	<u>4</u>	<u>5</u>	<u>6</u>	<u>7</u>	<u>8</u>	<u>9</u>	<u>10</u>	<u>11⁽²⁾</u>	<u>12⁽²⁾</u>	<u>13⁽³⁾</u>
Silica (SiO ₂)	9	26	13	19	27	29	9	22	24	24	4	3	4
Iron (Fe)	0.1	1.3	0.1	0.1	0.1	0.1	0.1	0.1	0.1	0.1	0.1	0.1	0.25
Manganese (Mn)	0.1	0.1	0.1	0.3	4.0	0.1	0.1	0.1	0.1	0.1	0.1	0.1	0.1
Calcium (Ca)	5	8	28	1.6	33	24	0.8	180	36	46	42	40	43
Magnesium (Mg)	3	10	24	1.5	14	17	0.8	92	41	30	10	9	8
Sodium (Na)	308	30	48	5	27	40	261	150	216	100	103	94	91
Potassium (K)	0.5	2.5	7.3	0.75	0.45	0.75	0.25	2	3.1	1.1	3.9	3.6	3.9
Carbonate (CO ₃)	10	0	2	0	2	0	24	17	0	6	0	0	0
Bicarbonate (HCO ₃)	444	34	134	5	163	183	417	293	107	280	107	100	100
Sulfate (SO ₄)	12	22	41	4	11	6	5	687	178	182	62	56	58
Chloride (Cl)	206	52	90	10	336	41	125	116	196	28	160	144	141
Flouride (F)	1.1	0	0.22	0	0.33	0.22	1.2	0.22	0.22	0.27	0.44	0.33	0.44
Nitrate (NO ₃)	3	13	1.5	2.6	1.5	0.1	2.3	3.8	210	2.5	2.5	2.4	4.5
Total dissolved solids (TDS)	773	197	332	34	218	234	635	1559	1042	535	460	417	419
Hardness, total	24	60	168	10	140	128	4	830	258	240	146	136	142
Alkalinity	388	28	116	4	140	150	402	282	88	245	88	82	82
pH	8.8	6.2	8.4	5.7	8.5	7.6	8.7	8.4	6.8	8.4	7.4	7.4	7.4

(1) Number corresponds to location shown on Figure 2.4-1

(2) Sample from Dardanelle Reservoir.

(3) Sample from Arkansas River downstream of Dardanelle Reservoir, location not shown on Figure 2.4-1.

ARKANSAS NUCLEAR ONE
Unit 2

Table 2.4-5

JUNE 1974 WELL CANVASS

1	50'	Not Used
2	40'	Not Used
3	20'	Not Used
4	40'	Residential
5	30'	Not Used
6	100'	Residential
7	260'	Not Used
8	50'	Not Used
9	N.A.	Not Used
10	112'	Residential (No Drinking Water)
11	50'	Residential
12	80'	Residential
13	70'	Residential
14	152'	Residential
15	300'	Residential
16	150'	Residential
17	30'	Not Used
18	310'	Residential
19	300'	Residential
20	262'	Residential
21	Over 300'	Residential
22	311'	Residential
23	310'	Residential
24	200'	Residential
25	N.A.	N.A.
26	N.A.	N.A.
27	100'	Residential
28	268'	Not Used
29	60'	Not Used
30	59'	AP&L Cabin**

* See Figure 2.1-3 for location

** Within Exclusion Area; cabin was subsequently removed

N.A. = Not Available

ARKANSAS NUCLEAR ONE
Unit 2

Table 2.5-1

SUMMARY OF DRILL HOLE DATA

AUGER HOLES

<u>HOLE NO.</u>	<u>SURFACE ELEVATIONS</u>	<u>DEPTH TO ROCK</u>	<u>ELEVATIONS OF TOP OF ROCK</u>
AH-1	333	18	315
AH-2	340	22	318
AH-3	345	23	322
AH-4	350	24	326
AH-5	352	23	329
AH-6	352	23	329
AH-7	354	12	342
AH-8	353	26	337
AH-9	353	17	336
AH-10	353	15	338
AH-11	354	16	338
AH-12	353	21	332
AH-13	352	21	331
AH-14	352	26	326
AH-15	383	16	367
AH-16	349	17	332
AH-17	348	9	339
AH-18	345	7	338
AH-19	357	13	344
AH-20	354	10	344
AH-21	353	17	336
AH-22	353	21	332
AH-23	349	23	326
AH-24	343	16	327
AH-25	343	13	330
AH-26	339	10	329

SOIL BORINGS

A-101	341.9	17.0	324.9
A-102	352.2	22.5	329.7
A-103	351.5	18.0	333.5
A-104	352.9	17.5	335.4
A-105	352.4	21.0	331.4
A-106	352.5	17.7	334.8
A-107	352.6	12.7	335.9
A-108	352.8	18.5	334.3
A-109	353.5	16.0	337.5
A-110	353.4	13.0	340.4
A-111	347.7	13.5	334.2
A-112	353.9	15.0	338.9
A-113	354.3	24.0	330.3
A-114	353.7	24.0	329.7
A-125	353.0	27.0	326.0

ARKANSAS NUCLEAR ONE
Unit 2

Table 2.5-1 (continued)

<u>HOLE NO.</u>	<u>SURFACE ELEVATIONS</u>	<u>DEPTH TO ROCK</u>	<u>ELEVATIONS OF TOP OF ROCK</u>
A-212	353.3	26.5	326.8
A-213	354.7	27.0	327.7
A-214	354.6	27.0	327.6
A-215	355.4	28.0	327.4
A-216	NOT DRILLED	----	----
A-217	353.5	28.5	326.8
A-218	356.7	16.0	340.9
A-219	355.0	8.0	347.0
A-220	361.5	18.0	343.5
A-221	355.5	19.0	336.5
A-222	351.1	18.0	333.1
A-223	349.8	17.0	332.8
A-224	348.5	18.0	330.5
A-225	347.7	22.5	325.2
A-226	346.7	18.5	328.2
A-227	351.2	19.0	332.0
A-228	352.9	18.5	334.4
A-229	352.5	18.5	334.0
A-230	352.5	17.0	335.5
A-231	348.0	15.0	333.0
A-232	352.0	29.0	321.0
A-233	350.1	26.0	324.1
A-234	348.4	32.0	316.4
A-235	348.3	26.5	321.8
A-236	348.3	22.0	326.3

CORE HOLES

AD-115	352.2	20.0	332.2
AD-116	352.4	21.0	331.4
AD-117	353.1	18.0	335.1
AD-118	353.3	14.5	338.8
AD-119	350.0	17.0	333.0
D-120	352.5	23.5	329.0
D-121	352.6	18.0	334.6
D-122	352.7	18.0	334.7
DH-201	353.5	27.0	326.5
DH-202	354.0	27.0	327.0
DH-203	353.7	26.5	327.2
DH-204	354.5	29.5	325.0
DH-205	353.3	27.0	326.3
DH-206	352.9	27.0	325.9
DH-207	353.4	29.5	323.9
DH-208	348.3	24.0	324.3
DH-209	353.5	16.5	337.0
DH-210	357.4	16.0	341.4
DH-211	353.3	28.0	325.3

ARKANSAS NUCLEAR ONE
Unit 2

Table 2.5-2

SUMMARY OF LABORATORY ROCK TESTS

1967 Investigation-Data from DH-2, 38.5-40.5 feet, and DH-5, 28.9-38.0 feet

<u>TEST</u>	<u>NO. OF TESTS</u>	<u>HIGH</u>	<u>RESULTS</u>	
			<u>LOW</u>	<u>AVERAGE</u>
A. Specific Gravity	10	2.59	2.53	2.57
B. Porosity	10	5.8%	2.0%	5.5%
C. Absorption	10	3.1%	2.1%	2.4%
D. Unconfined Compression	9	3740 psi	3140 psi	3470 psi
E. Modulus of Elasticity	9	1.0x10 ⁶ psi	0.7x10 ⁶ psi	0.8x10 ⁶ psi
F. Poisson's Ratio	4	.26	0.10	0.18

Ten triaxial compression tests resulted in an average $\phi = 37^\circ$ and Cohesion = 890 psi.

1968 Investigations -Data from D-120, 30.0-62.0 feet, D-121, 25.0-51.0 feet

<u>TEST</u>	<u>NO. OF TESTS</u>	<u>HIGH</u>	<u>RESULTS</u>	
			<u>LOW</u>	<u>AVERAGE</u>
A. Unconfined Compression	17	4680 psi	2940 psi	3800 psi
B. Modulus of Elasticity	9	1.08x10 ⁶ psi	.25x10 ⁶ psi	.64x10 ⁶ psi

ARKANSAS NUCLEAR ONE
Unit 2

Table 2.5-2 (continued)

1970 Investigations

<u>DH Hole No.</u>	<u>Depth</u>	<u>Sp. Gr.</u>	<u>% Poro.</u>	<u>% Abs.</u>	<u>Compressive Strength</u>	<u>Ex10⁶</u>	<u>Poisson's Ratio</u>
201	32.0	2.53	6.68	2.64	2730	0.44	0.33
	51.0	2.57	5.26	2.04	3420	0.74	
	66.5	2.50	5.00	1.92	2670	0.76	
	79.6				3450		
	109.0	2.59	4.54	1.75	2760		
	143.0	2.63	2.79	1.13	4690		
202	28.5	2.51	7.14	2.84	2940	0.45	0.34
	37.0	2.60	4.93	1.89	3120	0.87	0.25
	37.5				3150		0.32
	54.0				2790	0.64	
	54.0				3390		
203	33.3				2790		0.50
	39.5	2.55	5.97	2.33	3150		
204	30.7	2.56	6.17	2.40	2540	0.46	0.28
205	40.5	2.5	6.45	2.51	3390	0.83	
206	31.5	2.52	7.81	3.09	2420	0.36	
207	41.5	2.59	5.86	2.25	3760	0.76	0.34
	42.0				4130		
	42.5				4060	0.76	
208	26.0	2.57	6.55	2.54	2670		0.80
	31.0				3540		
	37.5				3060		
	49.5	2.60	5.76	2.22	3670		
209	26.2	2.67	6.48	2.42	2420	0.49	
210	22.0	2.59	6.48	2.50	2970	0.95	0.24
211	30.1	2.54	7.80	3.09	2770		
		<u>7 Samples</u>		<u>28 Samples</u>		<u>15 Samples</u>	<u>7 Samples</u>
HIGH VALUE	2.67	7.81	3.09	4690		0.95	0.34
LOW VALUE	2.51	2.97	1.13	2420		0.36	0.24
AVERAGE	2.57	5.99	2.32	3255		0.65	0.30

ARKANSAS NUCLEAR ONE
Unit 2

Table 2.5-3

ENGINEERING PROPERTIES OF SITE SOILS

(Emergency Cooling Pond)

<u>Static Properties</u>	<u>Foundation Material</u>	<u>Borrow Material (Remoulded)</u>
Soil Type/Classification	CL/CH, Weathered Shale	CL/CH
Total Fines (-No.200 Fraction) (%)	--	94
Natural Moisture Content (%)	21.1	--
In-Situ Wet Density (pcf)	129.3	--
In-Situ Dry Density (pcf)	107.4	--
ASTM D1557, Maximum Dry Density (pcf)	--	114.6
Optimum Moisture Content (%)	--	16.5
Liquid Limit (%)	49	54
Plastic Limit (%)	22	22
Plasticity Index (%)	27	32
Shrinkage Limit (%)	15.1	--
Permeability Coefficient (Cm/Sec)	Negligible	4.2×10^{-6}
<u>Unconsolidated Undrained Shear Strength</u>	For Weathered Shale	
Cohesion, c (tsf)	1.96	
Angle of Internal Friction, ϕ (deg.)	0	
<u>Consolidate Drained Direct Shear Strength</u>		
Peak Cohesion, c (tsf)	0.43	
Angle of Internal Friction, ϕ (deg.)	21.5	
Residual Cohesion, c (tsf)	0.22	.04
Angle of Internal Friction, ϕ (deg.)	19.25	27.25

References

Undisturbed clay test data from Grubbs Consulting Engineers Inc. Report in Appendix"2A"
Borrow Material and weathered shale data from Grubbs Consulting Engineers Inc.
Report in Section 2.5.5.2.1.

ARKANSAS NUCLEAR ONE
Unit 2

Table 2.5-4

STATIC ENGINEERING PROPERTIES FOR DESIGN

(EMERGENCY COOLING POND)

<u>Static Properties</u>	<u>Undisturbed Foundation Clay</u>	<u>Clay Blanket</u>	<u>Weathered Shale</u>	<u>Filter</u>
Saturated Unit Weight (pcf)	124	130	145	130*
Angle of Internal Friction Φ , (Degrees)	23	25	0	35*
Cohesion, c (tsf)	0.10	0.05	1.35	0*

* Design properties are assumed.

Table 2.5-5a

LONG-TERM STABILITY EMERGENCY COOLING WATER POND

<u>Excavation Slope</u>	<u>Loading Condition</u>	<u>Required Factor of Safety</u>	<u>Minimum Computed Factor of Safety</u>
2-1/2 to 1	Normal	1.5	1.67
2-1/2 to 1	Seismic	1.1	1.1
2-1/2 to 1	Rapid Drawdown	1.25	1.77

Table 2.5-5b

**FACTORS OF SAFETY OF
EMERGENCY COOLING POND SLOPE**

<u>Case</u>	<u>Condition</u>	<u>Required Factor of Safety</u>	<u>Computed Factor of Safety</u>
I	Full Reservoir at El. 347 with Earthquake (0.2g)	1.1	1.4
II	Rapid Drawdown to El. 341 with no Earthquake	1.25	2.3
III	Minimum Reservoir Level at El. 342.5 with Earthquake (0.2g)	1.1	1.3

For further discussion and details on factor of safety of pond slope stability, refer to Section 2.5.5.2 and Section 2.5.5.2.2.

ARKANSAS NUCLEAR ONE
Unit 2

Table 2.5-5c

**FACTORS OF SAFETY OF EMERGENCY COOLING POND SLOPE
USING PEAK STRENGTH VALUES**

<u>Case</u>	<u>Type of Strength Used in Analysis</u>	<u>c, tsf</u>	<u>Φ, degrees</u>	<u>Factor of Safety</u>
1	Drained Strength (lowest test value)	0.165	32	2.0
2	Drained Strength (design value)	0.2	22	1.5
3	Undrained Strength (lowest test value)	0.6	0.	2.1

Note: An effective stress analysis was used for Cases 1 and 2 and a total stress analysis for Case

- The criteria for acceptability of slope stability analyses are given in Table 2.5-5a. Since the earthquake analysis indicated a factor of safety of 1.5 or greater, the normal pool and rapid drawdown analyses, being less severe, will yield even higher values; therefore, analyses were not considered necessary and were not carried out.

Table 2.5-6

**RESULTS OF CLASSIFICATION TESTS
1970**

<u>BORING NO.</u>	<u>DEPTH (FEET)</u>	<u>LIQUID LIMIT %</u>	<u>PLASTIC LIMIT %</u>	<u>SHRINKAGE LIMIT %</u>	<u>WATER CONTENT %</u>	<u>WET DENSITY (LB./CU.FT.)</u>	<u>DRY DENSITY (LB./CU.FT.)</u>
223	10.5-11	33	21	15.3	17.1	135.5	115.6
224	11-11.5	33	15	12.5	18.3	134.2	113.5*
225	10.5-11	60	31	14.6	27.6	123.4	96.7
228	9-9.5	24	15	12.7	10.4	129.7	117.5*
230	9.5-10	40	19	15.4	10.6	137.1	123.9
232	15.5-16	65	22	12.9	29.1	123.6	96.0*
234	15.5-16	77	24	17.7	31.3	121.9	92.8*
234	20.5-21	35	26	18.5	19.5	128.2	107.3
236	10.5-11	74	24	16.0	26.4	130.2	103.0

* Refer to Plates 3, 5, 7 and 9 (of Ref. 96) for shear strength parameters based on Consolidated Drained Direct Shear Tests in Section 2.5.5.3.1.

ARKANSAS NUCLEAR ONE
Unit 2

Table 2.5-6a

RESULTS OF LABORATORY TESTS

<u>BORING*</u>	<u>DEPTH FT.</u>	<u>WATER CONTENT PERCENT</u>	<u>UNIT DRY WEIGHT γ_D' PCF</u>	<u>LL</u>	<u>PL</u>	<u>PI</u>	<u>UNCONFINED COMPRESSIVE STRENGTH, TSE</u>
101	4.0	28.6	95.1	68	26	42	x
	10.5	28.6	97.0	74	25	49	x
	11.0	30.2	94.6	x	x	x	1.9
	12.5	24.1	101.3	28	18	10	0.85
102	7.0	25.1	104.6	86	28	58	2.3
	20.0	28.3	98.1	70	18	52	2.4
	24.0	19.5	111.8	32	19	15	0.6
103	3.0	29.2	94.9	73	25	48	0.9
	7.5	20.7	106.0	56	21	35	2.85
	13.5	24.6	105.5	66	23	43	3.75
	17.5	21.9	111.2	45	25	20	x
104	2.0	24.2	106.5	50	21	29	0.9
	7.5	20.4	106.9	50	22	28	2.9
	12.5	25.7	110.2	71	25	46	x
	13.5	23.2	101.5	x	x	x	1.9
	17.5	21.9	100.1	53	24	29	1.9
105	3.0	24.6	102.4	53	21	32	2.2
	6.0	20.1	108.6	67	21	46	4.7
	7.5	21.0	104.5	68	28	40	4.0
	14.0	25.6	100.5	65	25	40	0.95
	17.5	29.5	93.4	74	25	49	1.9
	21.0	31.6	96.4	57	24	33	x
106	3.5	22.4	110.6	59	21	38	2.1
	7.0	16.7	104.8	54	23	31	0.85
	12.5	21.5	104.7	63	24	39	1.1
	18.0	21.0	107.7	40	24	16	0.6
107	4.6	18.5	112.1	63	21	42	3.6
	7.0	21.7	108.1	63	23	40	4.35
	13.0	25.6	99.3	68	26	42	3.1
108	4.5	24.4	100.3	65	27	38	3.2
	10.0	25.6	100.8	71	27	44	2.6
	15.0	26.4	94.7	63	25	38	1.6
109	7.3	15.9	111.4	64	24	40	2.2
	12.5	25.4	103.5	60	23	37	1.7
110	3.0	25.6	99.9	62	24	38	1.2
	7.2	20.2	104.8	65	24	41	4.6
	12.6	21.4	104.8	63	29	38	4.7

ARKANSAS NUCLEAR ONE
Unit 2

Table 2.5-6a (continued)

<u>BORING*</u>	<u>DEPTH FT.</u>	<u>WATER CONTENT PERCENT</u>	<u>UNIT DRY WEIGHT γ_D' PCF</u>	<u>LL</u>	<u>PL</u>	<u>PI</u>	<u>UNCONFINED COMPRESSIVE STRENGTH,TSE</u>
111	5.5	22.2	98.5	x	x	x	2.65
	11.0	29.4	100.7	73	29	44	1.36
112	4.6	28.4	97.7	67	28	39	1.43
	9.7	22.3	111.7	62	28	34	2.63
	13.0	25.4	96.4	56	24	32	1.53
113	5.0	24.6	102.1	51	21	30	x
	8.0	22.2	104.2	59	24	35	2.01
	13.5	24.8	100.7	65	27	38	1.55
	17.0	26.5	100.2	66	27	39	1.83
	22.6	12.7	126.3	30	20	10	1.32
114	5.5	24.8	111.4	56	21	35	1.93
	10.4	25.4	116.9	37	20	17	2.11
	15.3	18.2	117.2	40	20	20	2.40
	20.9	18.2	117.2	27	17	10	1.53
115	3.0	24.0	106.2	54	21	33	x
	8.0	22.3	105.1	63	25	38	0.89
	13.0	30.1	92.5	70	27	43	1.87
	18.0	27.0	100.6	72	25	47	1.09
116	5.5	36.3	87.9	54	20	34	x
	6.5	22.1	108.3	64	25	39	4.38
	13.0	26.6	102.5	61	26	35	2.72
117	4.0	19.0	121.1	52	17	35	6.32
	8.0	23.7	103.4	66	24	42	3.72
	12.5	25.7	106.2	60	18	42	x
	17.2	17.9	117.5	x	x	x	2.97
118	4.0	18.9	107.0	63	25	38	3.92
	7.2	23.3	102.8	59	25	34	3.34
	12.2	14.0	121.0	31	17	14	1.43
119	5.0	22.5	107.5	40	14	26	1.21
	9.5	18.6	117.4	28	17	11	2.09
	15.3	10.9	x	29	19	10	x
125	5.3	19.1	112.0	56	20	36	4.35
	7.0	19.8	114.6	53	21	32	2.82
	12.0	25.2	106.2	62	27	35	x
	16.5	20.2	113.0	26	18	8	0.76
	20.5	21.6	104.9	28	20	8	x

ARKANSAS NUCLEAR ONE
Unit 2

Table 2.5-6a (continued)

<u>BORING* NO.</u>	<u>DEPTH FT</u>	<u>DRY UNIT WT, PCF</u>	<u>WATER CONTENT PERCENT</u>	<u>LIQUID LIMIT</u>	<u>PLASTIC LIMIT</u>	<u>PLASTICITY INDEX</u>	<u>UNCONSOLIDATED- COHESION, TSF</u>	<u>UNDRAINED STRENGTH, 0</u>
126	3.2	104.5	21.5	47	23	24	x	x
	6.8	107.3	20.8	60	24	36	1.76	17.1°
	9.8	99.5	24.9	58	25	33	1.70	0.0
	13.5	108.3	26.6	72	27	45	x	x
	16.5	95.5	28.0	66	27	39	x	x
	18.5	93.5	28.9	72	28	44	x	x
	21.2	108.8	21.0	37	24	13	x	x
	25.2	109.1	19.0	27	16	11	x	x
	28.0	124.7	19.6	35	21	14	x	x
128	3.2	96.1	27.0	58	21	37	x	x
	6.5	103.6	21.3	58	23	35	x	x
	10.0	103.9	25.3	71	26	45	0.60	25.0°
	15.5	92.7	30.1	61	23	38	x	x
130	3.2	118.8	28.8	68	25	43	x	x
	7.0	107.2	25.7	74	28	46	0.70	23.6°
	9.0	101.8	26.1	56	24	32	x	x
	15.0	122.2	15.2	38	22	16	x	x
131	3.2	107.5	21.4	56	18	38	x	x
	4.5	107.4	21.4	x	x	x	0.66	20.9°
	9.0	99.3	26.4	58	22	36	x	x
	13.5	113.0	17.8	31	18	13	x	x
	15.5	117.1	16.5	41	26	15	x	x
127	3.0	103.5	28.1	48	23	25	x	x
	6.0	100.3	30.2	44	21	23	x	x
	9.5	102.5	23.6	60	22	38	1.68	3.5°
	15.0	95.8	27.8	65	24	41	x	x
	22.0	126.8	11.5	35	21	14	x	x
129	3.0	90.4	34.6	57	22	25	x	x
	6.0	93.8	27.6	69	31	38	x	x
	9.0	106.5	20.9	60	25	35	x	x
	15.0	106.8	20.4	35	18	17	x	x
132	3.0	112.6	20.9	49	19	30	x	x
	6.0	103.9	23.8	65	24	41	x	x
	9.0	98.5	27.9	67	26	41	x	x

* See Figure 2.5-7 for boring no. locations.

ARKANSAS NUCLEAR ONE
Unit 2

Table 2.5-6b

**PRECONSOLIDATION PRESSURE OF
SOIL OVERBURDEN**

BOREHOLE NO.	DEPTH (FT)	OVERBURDEN PRESSURE (p_0) TSF	UNCONSOLIDATED UNDRAINED SHEAR STRENGTH (c) TSF	C/\bar{p}^1	PRECONSOLIDATION PRESSURE (\bar{p}), TSF
126	6.5	0.44	1.87	0.24	7.79
	9.8	0.63	1.70	0.23	7.39
127	10.0	0.62	1.70	0.26	6.54
128	10.0	0.63	0.90	0.27	3.3
130	7.0	0.50	0.90	0.28	3.2
131	4.5	0.29	0.79	0.26	3.0

NOTE 1: Terzaghi & Peck Soil Mechanics in Engineering Practice, 1967, Fig. 18.4 (After Skempton 1957), p. 117.

* See Figure 2.5-7 for borehole no. locations.

ARKANSAS NUCLEAR ONE
Unit 2

Table 2.5-7

**RESULTS OF CLASSIFICATION TESTS
1972**

BORING OR TEST PIT #	DEPTH, FT	ATTERBERG LIMITS			ASTM D-1557		GRADUATION PERCENT PASSING					UNIFIED SOIL CLASS		
		L.L. %	P.L. %	P.I. %	MAXIMUM DENSITY, PCF	OPTIMUM MOISTURE %	2"	3/4"	3/8"	#4	#10		#40	#200
1	0-4	9	19	20	117.6	14.6			100	99.9	99.3	98.0	96.7	CL
4	0-4	42	20	22			100	96.2	94.5	90.8	87.6	86.3	77.9	CL
5	0-0.5	46	19	27					100	99.6	99.3	99.0	93.8	CL
6	1-4	54	20	34	50				100	99.6	99.1	98.6	97.3	CH
	5-8		79	29										99.9
7	1.5-4	67	27	40	111.5	18.4		100	99.8	99.4	99.1	99.0	98.8	CH

Refer to Section 2.5.5.2.1 for details.

ARKANSAS NUCLEAR ONE
Unit 2

Table 2.5-8

MODIFIED MERCALLI INTENSITY SCALE OF 1931

(Abridged)

- I. Not felt except by a very few under especially favorable circumstances. (I Rossi-Forel scale).
- II. Felt only by a few persons at rest, especially on upper floors of building. Delicately suspended objects may swing (I to II, Rossi-Forel scale).
- III. Felt quite noticeably indoors, especially on upper floors of buildings, but many people do not recognize it as an earthquake. Standing motor cars may rock slightly. Vibration like passing truck. Duration estimated (III Rossi-Forel scale).
- IV. During the day felt indoors by many, outdoors by few. At night some awakened. Dishes, windows, doors disturbed; walls made creaking sound. Sensation like heavy truck striking building. Standing motor cars rocked noticeably (IV to V Rossi-Forel scale).
- V. Felt by nearly everyone; many awakened. Some dishes, windows, etc., broken; a few instances of cracked plaster; unstable objects overturned. Disturbance of trees, poles, and other tall objects sometimes noticed. Pendulum clocks may stop (V to VI Rossi-Forel scale).
- VI. Felt by all; many frightened and ran outdoors. Some heavy furniture moved; a few instances fallen plaster or damaged chimneys. Damage slight (VI to VII Rossi-Forel Scale).
- VII. Everybody runs outdoors. Damage negligible in buildings of good structures; considerable in poorly built or badly designed structures; some chimneys broken. Noticed by persons driving motor cars (VIII Rossi-Forel scale).
- VIII. Damage slight in specially designed structures; considerable in ordinary substantial buildings with partial collapse; great in poorly built structures. Panel walls thrown out of frame structures. Fall of chimneys, factory stacks, columns, monuments, walls. Heavy furniture overturned. Sand and mud ejected in small amounts. Changes in well water. Disturbed persons driving motor cars (VIII+ to IX Rossi-Forel scale).
- IX. Damage considerable in specially designed structures; well designed frame structures thrown out of plumb; great in substantial buildings, with partial collapse. Buildings shifted off foundations. Ground cracked conspicuously. Underground pipes broken (IX+ Rossi-Forel scale).
- X. Some well-built wooden structures destroyed; most masonry and frame structures destroyed with foundations, ground badly cracked. Rails bent. Landslides considerable from river banks and steep slopes. Shifted sand and mud. Water splashed (slopped) over banks. (X Rossi-Forel scale).
- XI. Few, if any, (masonry) structures remain standing. Bridges destroyed. Broad fissures in ground. Underground pipe lines completely out of service. Earth slumps and land slips in soft ground. Rails bent greatly.
- XII. Damage total. Waves seen on ground surfaces. Lines of sight and level distorted. Objects thrown upward into the air.

ARKANSAS NUCLEAR ONE
Unit 2

Table 2.5-9

**CHRONOLOGICAL LIST OF EPICENTER LOCATIONS
FOR MAP SHOWING SIGNIFICANT EARTHQUAKE EPICENTERS**

<u>DATE</u>	<u>LOCATION</u>		<u>EPICENTRAL INTENSITY MODIFIED MERCALLI SCALE</u>	<u>DISTANCE FROM SITE IN MILES</u>
	<u>°N</u>	<u>°W</u>		
1811, Dec. 16	36.6	89.6	XII	220
1812, Jan.23	36.6	89.6	XII	220
1812, Feb.7	36.6	89.6	XII	220
1838, June 9	38.5	90.3	VI	275
1843, Jan. 4	35.2	90.0	VIII	180
1857, Oct. 8	38.5	90.3	VI	275
1865, Aug. 17	36.5	89.5	VII	228
1878, March 12	36.8	89.2	V	250
1878, Nov. 18	36.7	90.4	VI	180
1882, July 20	38.0	90.0	V	250
1882, Oct. 22	35.0	94.0	VI-VII	48
1883, Jan. 11	37.0	89.2	VI	252
1883, April 12	37.0	89.2	VI-VII	252
1883, Dec. 5	36.3	91.8	V	100
1887, Aug. 2	37.0	89.2	V	252
1889, July 19	35.2	90.0	VI	180
1891, Sept. 26	37.0	89.2	V	252
1895, Oct. 31	37.0	89.4	VIII	245
1903, Feb. 8	38.5	90.3	VI	275
1903, Nov. 4	38.5	90.3	VI-VII	275
1903, Nov. 27	36.5	89.5	V	228
1905, Aug. 21	36.5	90.0	VI	195
1907, July 4	37.7	90.4	IV-V	218
1908, Oct. 27	37.0	89.2	V	252
1909, Oct. 23	37.0	89.5	V	244
1911, March 31	33.8	92.2	V	115
1915, April 28	36.4	89.5	IV-V	222
1915, Dec. 7	36.7	89.1	V-VI	254
1916, Dec. 18	36.6	89.3	VI-VII	244
1917, April 9	38.1	90.6	VI	238
1918, Oct. 4	34.7	92.3	V	67
1918, Oct. 13	Black Rock, Ark.		V	126
1918, Oct. 15	35.2	89.2	V	225
1919, Nov. 3	36.2	90.9	IV-V	140
1920, May 1	38.5	90.5	V	264
1923, Oct. 28	35.5	90.3	VII	162
1923, Dec. 31	35.4	90.3	V	162
1924, March 2	36.9	89.1	V	260
1927, May 7	36.5	89.0	VII	252
1931, Dec. 16	34.0	89.7	VI-VII	224
1933, Dec. 9	35.8	90.2	VI	169
1934, April 11	33.9	95.5	V	160
1934, Aug. 19	37.0	89.2	VII	260
1936, March 14	34.0	95.2	V	145
1937, May 16	35.9	90.4	IV-V	158
1938, Sept.17	35.5	90.3	IV-V	162
1939, June 19	34.1	93.1	V	85

ARKANSAS NUCLEAR ONE
Unit 2

Table 2.5-9 (continued)

DATE	LOCATION		EPICENTRAL INTENSITY MODIFIED MERCALLI SCALE	DISTANCE FROM SITE IN MILES
	°N	°W		
1939, Nov. 23	38.2	90.1	V	264
1940, Nov. 23	38.2	90.1	VI	264
1941, Nov. 16	35.5	89.7	V-VI	200
1947, June 29	38.4	90.2	VI	275
1950, Feb. 8	37.4	92.4	V	150
1952, Feb. 20	36.4	89.5	V	220
1952, July 16	36.2	89.6	VI	218
1954, Feb. 2	36.7	90.3	VI	185
1954, April 26	35.2	90.1	V	175
1955, Jan. 25	35.6	90.3	VI	162
1955, March 29	36.0	89.5	VI	216
1955, April 9	38.1	89.8	VI	274
1955, Sept. 5	36.0	89.5	V	216
1955, Dec. 13	36.0	89.5	V	216
1956, Jan. 28	35.6	89.6	VI	200
1956, April 2	34.2	95.4	V	147
1956, Oct. 29	36.1	89.4	V	225
1956, Oct. 30	Northeast Oklahoma		VII	154
1956, Nov. 25	37.1	90.6	VI	188
1957, March 19	32.0	95.0	V	248
1958, Jan. 26	35.1	90.0	V	180
1958, Jan. 27	37.0	89.0	V	265
1958, April 8	36.2	89.1	V	240
1958, April 26	Lake Co., Tenn.		V	216
1959, Feb. 13	36.2	89.5	V	218
1959, June 15	Seminole, Pontotoc, & Johnston Co., Okla.		V	200
1959, Dec. 21	36.0	89.5	V	214
1960, Jan. 28	36.0	89.5	V	214
1960, April 21	Lake Co., Tenn		V	216
1961, Jan. 10	Southeast Okla.		V	127
1961, April 27	35.0	95.0	V	102
1962, Feb. 2	36.5	89.6	VI	222
1962, July 23	36.1	89.8	VI	200
1963, March 3	36.7	90.1	VI	195
1965, March 6	37°50'	91°10'	5.3	210
1965, Aug. 13	36°19'	89°28'	5.0	234
1965, Aug. 14	37.1	89.2	VII	260
1965, Aug 15	37°22'	89°28'	V	260
1965, Oct. 20	37°51'	91°05'	VI	212
1967, June 4	33.6	90.9	VI	173
1967, June 29	33.6	90.9	V	173
1968, July 21	37.5	90.4	VI	213
1968, Oct. 14	Durant, Okla		VI	196
1969, Jan. 1	34.8	92.6	V	50
1969, May 2	35.2	96.3	V	165
1970, Nov. 16	35.9	89.9	VI	192
1971, Oct. 1	35.8	90.4	VI	164
1972, Feb. 1	36.4	90.8	VI	160
1972, March 29	36.1	89.8	V	200

ARKANSAS NUCLEAR ONE
Unit 2

Table 2.5-10

ANCHOR BAR PULL TESTS

	Elapsed Time (Minutes)	Stress (psi)	Elongation (0.001 inches)
<u>Test No. 1</u>	0	0	0
	2	12730	12
	3	25460	23
	4	38190	38
	6	50920	348
	11	53460	*
<u>Test No. 2</u>	0	0	0
	1	12730	13
	2	25460	24
	3	38190	40
	6	50920	1164
<u>Test No. 3</u>	0	0	0
	1	12730	14
	2	25460	21
	3	38190	61
	6	50920	539
<u>Test No. 4</u>	0	0	0
	1	12730	10
	2	25460	45
	3	38190	70
	6	50920	800

Table 2.5-11

LONG-TERM STABILITY INTAKE AND DISCHARGE CANALS

<u>Structure</u>	<u>Excavation Slope</u>	<u>Loading Condition</u>	<u>Required Factors of Safety</u>	<u>Minimum Computed Factors of Safety*</u>
Intake Canal	2-1/2 to 1	Normal	1.5	2.4
Discharge Canal	2-1/2 to 1	Normal	1.5	1.8
Intake Canal	2-1/2 to 1	Seismic	1.0	1.1
Discharge Canal	2-1/2 to 1	Seismic	1.0	1.0
Intake Canal	2-1/2 to 1	Rapid Drawdown	1.25	1.5
Discharge Canal	2-1/2 to 1	Rapid Drawdown	1.25	1.6

* Above factors of safety are based on residual shear strengths.

ARKANSAS NUCLEAR ONE
Unit 2

Table 2.5-12

RESULTS OF CLASSIFICATION TESTS

<u>BORING NO.</u>	<u>DEPTH (FT)</u>	<u>LIQUID LIMIT (%)</u>	<u>PLASTIC LIMIT (%)</u>	<u>SHRINKAGE LIMIT (%)</u>	<u>WATER CONTENT (%)</u>	<u>WET DENSITY (LB/FT³)</u>	<u>DRY DENSITY LB/FT³</u>
223	10.5 – 11	33	21	15.3	17.1	135.5	115.6
224	11 – 11.5	33	15	12.5	18.3	134.2	115.6
225	10.5 – 11	60	31	14.6	27.6	123.4	96.7
228	9 – 9.5	24	15	12.7	10.4	129.7	117.5
230	9.5 – 10	40	19	15.4	10.6	137.1	123.9
232	15.5 – 16	65	22	12.9	29.1	123.6	96.0
234	15.5 – 16	77	24	17.7	31.3	121.9	92.8
234	20.5 – 21	35	26	18.5	19.5	128.2	107.3
236	10.5 – 11	74	24	16.0	26.4	130.2	103.0

ARKANSAS NUCLEAR ONE
Unit 2

2.8 **SITE SPECIFIC INFORMATION**

2.8.1 **FLOOD RELATED INFORMATION**

**Security-Related Information
Text Withheld Under 10 CFR 2.390**

2.8.1.1 **Probable Maximum Flood Combined With Wind Wave Action**

**Security-Related Information
Text Withheld Under 10 CFR 2.390**

2.8.1.2 **Probable Maximum Flood Combined With Ozark Dam Failure**

**Security-Related Information
Text Withheld Under 10 CFR 2.390**

ARKANSAS NUCLEAR ONE
Unit 2

2.8.1.3 Probable Maximum Flood on Streams and Rivers

**Security-Related Information
Text Withheld Under 10 CFR 2.390**

ARKANSAS NUCLEAR ONE
Unit 2

2.8.1.3.1 **Probable Maximum Precipitation**

**Security-Related Information
Text Withheld Under 10 CFR 2.390**

2.8.1.3.2 Precipitation Losses

Security-Related Information
Text Withheld Under 10 CFR 2.390

2.8.1.3.3 Runoff Model

Security-Related Information
Text Withheld Under 10 CFR 2.390

2.8.1.3.4 Probable Maximum Flood Flow

Security-Related Information
Text Withheld Under 10 CFR 2.390

ARKANSAS NUCLEAR ONE
Unit 2

2.8.1.3.5 Water Level Determinations

Security-Related Information
Text Withheld Under 10 CFR 2.390

2.8.1.3.6 Coincident Wind Wave Activity

Security-Related Information
Text Withheld Under 10 CFR 2.390

ARKANSAS NUCLEAR ONE
Unit 2

2.8.1.3.7 Site Drainage System

Security-Related Information
Text Withheld Under 10 CFR 2.390

2.8.1.4 Potential Dam Failures (Seismically Induced)

Security-Related Information
Text Withheld Under 10 CFR 2.390

ARKANSAS NUCLEAR ONE
Unit 2

Security-Related Information
Text Withheld Under 10 CFR 2.390

ARKANSAS NUCLEAR ONE
Unit 2

Security-Related Information
Text Withheld Under 10 CFR 2.390

ARKANSAS NUCLEAR ONE
Unit 2

2.8.1.5 Design Bases for Subsurface Hydrostatic Loadings

Security-Related Information
Text Withheld Under 10 CFR 2.390

2.8.2 ADDITIONAL NATURAL GAS PIPELINE INFORMATION

Security-Related Information
Text Withheld Under 10 CFR 2.390

ARKANSAS NUCLEAR ONE
Unit 2

2.8.3 ADDITIONAL NEW FUEL STORAGE INFORMATION

**Security-Related Information
Text Withheld Under 10 CFR 2.390**

ARKANSAS NUCLEAR ONE
Unit 2

APPENDIX 2A

This appendix contains transcripts of letters of agreement obtained during initial licensing.
See Section 2.1 of the FSAR for copies of the original documents.

DEPARTMENT OF THE ARMY
LITTLE ROCK DISTRICT, CORPS OF ENGINEERS
Post Office Box 867
Little Rock, Arkansas 72203

SWLRE-A

24 September 1976

Colonel Charles L. Steel
Vice President, Public Affairs
Arkansas Power and Light Company
P. O. Box 551
Little Rock, Arkansas 72203

Dear Colonel Steel:

Please refer to your letter of 20 May 1976 and subsequent correspondence with regard to modifying the conditions of the restrictive easement area granted to the Arkansas Power and Light Company for lands in the Lake Dardanelle project for use of the company's nuclear station in that area.

Inclosed is the easement deed, No. DACW03-2-76-322, which replaces our Easement No. DACW03-2-68-787.

It is hoped that this meets with the approval of all concerned.

Sincerely yours,

CHARLES E. BURCHAM
Chief, Real Estate Division

1 Incl
As stated

ARKANSAS NUCLEAR ONE
Unit 2

DEPARTMENT OF THE ARMY
RESTRICTIVE EASEMENT (EXCLUSION AREA)
DARDANELLE RESERVOIR

No. DACW03-2-76-322

WHEREAS, the Secretary of the Army has determined that it is in the best interests of the government to terminate Easement No. DACW03-2-68-787 for the purpose of revising it to more nearly meet the needs and requirements of the U.S. Nuclear Regulatory Commission, and to hereinafter convey said revised and modified grant to the present grantee, Arkansas Power and Light Company.

NOW, THEREFORE, the Secretary of the Army, under and by virtue of the authority vested in him by the Act of Congress approved October 23, 1962 (76 Stat. 1129), hereby grants to ARKANSAS POWER AND LIGHT COMPANY, a corporation duly organized and existing under and by virtue of the laws of the State of Arkansas, with its principal office at Little Rock, Arkansas, hereinafter designated as the grantee, for a period not exceeding fifty (50) years from March 26, 1968, a Restrictive Easement for the establishment, maintenance, operation, and use of an exclusion area in connection with a nuclear generating unit located in the vicinity of the Dardanelle Reservoir, Pope County, Arkansas. The easement herein granted shall include the rights to prohibit human habitation and to exclude all persons from the said area, before and after the occurrence of any conditions which would present a hazard to the health and safety of the public, which is in, over, across, and upon lands under the control of the Secretary of the Army at the locations shown in red on Exhibit "A" and described in Exhibit "B", both of which are attached hereto and made a part hereof.

THIS EASEMENT is granted subject to the following conditions:

1. Whereas, the grantee has paid to the United States, under prior Contract No. DACW03-2-68-787, compensation in the amount of FOUR THOUSAND FIVE HUNDRED DOLLARS (\$4,500.00) for the term hereof, said sum having been made payable to the Treasurer of the United States and heretofore received by the Finance Officer for the Little Rock District, Corps of Engineers, P.O. Box 867, Little Rock, Arkansas 72203, and also in further consideration the grantee has agreed to the cancellation of prior Easement No. DACW03-2-68-787.
2. That the establishment, maintenance, operation, and use of the exclusion area shall be accomplished without cost or expense to the United States under the general supervision and subject to the approval of the officer having immediate jurisdiction over said lands. It is understood that this does not include the right of said officer to make a rule inconsistent with the grantee's exercise of complete control over the exclusion area.
3. Any property of the United States damaged or destroyed by the grantee incident to the use and occupation of the said premises shall be promptly repaired or replaced by the grantee to the satisfaction of the said officer, or in lieu of such repair or replacement, the grantee shall, if so required by said officer, pay to the United States money in an amount sufficient to compensate for the loss sustained by the United States by reason of damages to or destruction of government property.

ARKANSAS NUCLEAR ONE
Unit 2

4. The use and occupation of said lands of the United States for the purposes authorized by this instrument shall be subject to such rules and regulations as the said officer may prescribe from time to time in order to properly protect the interests of the United States. It is understood that said officer does not have the right to make a rule inconsistent with the grantee's exercise of complete control over the exclusion area.
5. The United States reserves to itself and its assigns the right to construct, use, and maintain across, over, and/or under the easement hereby granted, roads and streets, electric transmission, telephone, telegraph, water, gas, gasoline, oil, and sewer lines, and other facilities, in such manner as not to create any unreasonable interference with the use of the easement right herein granted. It is agreed, however, that any reservation of access herein does not include the right of control over said access since that could be inconsistent with the use of the easement hereby granted.
6. It is to be understood that this instrument is effective only insofar as the rights of the United States in the said property are concerned, and that the grantee shall obtain such permission as may be necessary on account of any other existing rights.
7. The easement rights herein granted may be terminated by the Secretary of the Army for failure to comply with any and all terms or conditions of this grant or for non-use for a two-year period or abandonment of rights granted herein.
8. Upon expiration or termination of this grant, the grantee shall, without expense to the United States and within such time as the Secretary of the Army may indicate, remove any and all property from said land and restore the premises hereby authorized to be used and occupied to conditions satisfactory to said offer. In the event the grantee should fail, neglect, or refuse to remove the said property and so restore the premises, the United States shall have the option either to take over the said property as property of the United States without compensation therefor or to restore the said property and perform the restoration work as aforesaid at the expense of the grantee, and in no event shall the grantee have any claim for damages against the United States or its officers or agents on account of the taking over of said property or on account of its removal.
9. Conditions of this instrument shall extend to and be binding upon and shall inure to the benefit of the representatives, successors, and assigns of the grantee.
10. It is understood that the provisions of Condition No. 2, supra, shall not abrogate or interfere with any agreements or commitments made or entered into between the grantee and any other agency of the United States with regard to financial aid to the grantee in connection with the establishment, maintenance, operation, and use of said exclusion area.
11. The United States shall not be responsible for damages to property or injuries to persons which may arise from or be incident to the use and occupation of the said premises, nor for damages to the property of the grantee, nor for damages to the property or injuries to the person of the grantee's officers, agents, servants, or employees, or others who may be on said premises at their invitation or the invitation of any one of them, arising from or incident to governmental activities, and the grantee shall hold the United States harmless from any and all such claims. The above disclaimer is not intended to be inconsistent with the government insurance coverage under the Price-Anderson Act (Public Law 85-256, 42 U.S.C. 2210).

ARKANSAS NUCLEAR ONE
Unit 2

12. The United States shall not be responsible for damages to property or injuries to persons which may arise from or be incident to the establishment, maintenance, operation, and use of said exclusion area.
13. That the right is hereby reserved to the United States, its officers, agents, and employees, to enter upon the premises at any time for inspection and for any purpose necessary or convenient in connection with government work, to remove therefrom timber or other material, except property of the grantee, required or necessary for such work, to sell and remove merchantable timber therefrom, to flood the premises whenever necessary, to manipulate the level of the reservoir or pool in any manner whatsoever, and to draw down the reservoir or pool to any extent or at any time, and the grantee shall have no claim for damages of any character on account thereof against the United States or any officer, agent, or employee thereof. The grantor agrees to notify the grantee before any of its personnel re-enter the land so that the exact location and number of personnel will be known in the event of a nuclear accident. Also, the grantee is given the right to evacuate the premises of grantor's personnel in the event a danger of impermissible radiation doses is discovered by the grantee.

IN WITNESS WHEREOF, I have hereunto set my hand this 17th day of September, 1976, by authority of the Secretary of the Army.

WOODROW BERGE
Director of Real Estate
Officer, Chief of Engineers
Department of the Army

ARKANSAS NUCLEAR ONE
Unit 2

ACKNOWLEDGMENT

DISTRICT OF COLUMBIA SS

On this 17th day of September, 1976, before me, Theresa A. Thomas, a Notary Public in and for the District of Columbia, duly commissioned and sworn, personally appeared Woodrow Berge, known to me to be Director of Real Estate, and the person who executed the foregoing instrument by the authority of the Secretary of the Army and acknowledged to me that he extended the same as the free and voluntary act and deed of the United States of America, for the uses and purposes therein set forth.

IN WITNESS WHEREOF, I have hereunto set my hand and official seal.

THERESA A. THOMAS
Notary Public
District of Columbia

My Commission Expires January 31, 1981.

PARCEL "A"

A tract of land situated in the County of Pope, State of Arkansas, being a part of the SW¹/₄ and a part of the S¹/₂ of the NW¹/₄ of Section 28, Township 8 North, Range 21 West of the Fifth Principal Meridian, and being more particularly described as follows:

Beginning at the southwest corner of the SE¹/₄ of the NW¹/₄; thence northeasterly to the northeast corner of the SW¹/₂ of the S¹/₂ of the SW¹/₄ of the said SE¹/₄ of the NW¹/₄; thence south to the southeast corner thereof, thence southwest to the center of the NE¹/₄ of the NW¹/₄ of the NE¹/₄ of the SW¹/₄; thence south to the center of the SE¹/₄ of the said NW¹/₄ of the NE¹/₄ of the SW¹/₄, thence southeast to the southeast corner thereof; thence east to the northeast corner of the W¹/₂ of the E¹/₂ of the SE¹/₄ of the said NE¹/₄ of the SW¹/₄; thence southwesterly to the southwest corner thereof; thence south to the southwest corner of the N¹/₂ of the NE¹/₄ of the NE¹/₄ of said SE¹/₄ of the SW¹/₄; thence southeasterly to the southeast corner of the N¹/₂ of the SE¹/₄ of the said NE¹/₄ of the SE¹/₄ of the SW¹/₄; thence south to the southeast corner of the N¹/₂ of said SE¹/₄ of the SW¹/₄; thence west to the southeast corner of the W¹/₂ of the NE¹/₄ of said SE¹/₄ of the SW¹/₄; thence northwesterly to the northwest corner thereof; thence northwest to the center of the SW¹/₄ of the NE¹/₄ of said SW¹/₄; thence west to the center of the SW¹/₄ of the NW¹/₄ of said SW¹/₄; thence northeasterly to the northwest corner of the W¹/₂ of the SW¹/₄ of the SE¹/₄ of the SW¹/₄ of the NW¹/₄; thence southeasterly to the southeast corner thereof; thence east to the point of beginning, and containing 46.00 acres, more or less.

ARKANSAS NUCLEAR ONE
Unit 2

PARCEL "B"

A tract of land situated in the county of Pope, State of Arkansas, being a part of the N $\frac{1}{2}$ and a part of the N $\frac{1}{4}$ of the fractional NE $\frac{1}{4}$ of the fractional SW $\frac{1}{4}$, and a part of the fractional NW $\frac{1}{4}$ of the fractional NW $\frac{1}{4}$ of the fractional SE $\frac{1}{4}$ of Fractional Section 33, Township 8 North, Range 21 West of the Fifth Principal Meridian, and being more particularly described as follows:

Beginning at the northeast corner of the SE $\frac{1}{4}$ of the NE $\frac{1}{4}$ of Section 33; thence southwesterly to a point 660 feet west and 330 feet south of the northeast corner of the S $\frac{1}{2}$ of the fractional NE $\frac{1}{4}$; thence south to the center of the fractional SE $\frac{1}{4}$ of the said fractional NE $\frac{1}{4}$; thence northwesterly to a point 495 feet south of the northwest corner of said fractional SE $\frac{1}{4}$ of the fractional NE $\frac{1}{4}$; thence southwesterly to a point 165 feet west and 495 feet north of the southeast corner of the fractional SW $\frac{1}{4}$ of the said fractional NE $\frac{1}{4}$; thence southwesterly to the southwest corner of the E $\frac{1}{2}$ of the said fractional SW $\frac{1}{4}$ of the fractional NE $\frac{1}{4}$; thence west to a point 165 feet east of the center of Fractional Section 33; thence southwest to the southwest corner of the E $\frac{1}{2}$ of the NE $\frac{1}{4}$ of the NE $\frac{1}{4}$ of the NE $\frac{1}{4}$ of the SW $\frac{1}{4}$; thence northwesterly to a point on the north line of the S $\frac{1}{2}$, said point being 379.5 feet east of the northwest corner of said NE $\frac{1}{4}$ of the SW $\frac{1}{4}$; thence northwesterly to the northwest corner of the S $\frac{1}{2}$ of the SE $\frac{1}{4}$ of the SW $\frac{1}{4}$ of the NW $\frac{1}{4}$ of the NW $\frac{1}{4}$ of Fractional Section 33; thence east to the northeast corner thereof; thence northeasterly to the center of the NW $\frac{1}{4}$ of the SE $\frac{1}{4}$ of the said NW $\frac{1}{4}$ of the NW $\frac{1}{4}$; thence southeasterly to the southwest corner of the SE $\frac{1}{4}$ of the NE $\frac{1}{4}$ of the SE $\frac{1}{4}$ of said NW $\frac{1}{4}$ of the NW $\frac{1}{4}$; thence northeast to the northeast corner thereof; thence northeasterly to the center of the SW $\frac{1}{4}$ of the NW $\frac{1}{4}$ of the NE $\frac{1}{4}$ of the said NW $\frac{1}{4}$; thence southeasterly to the southwest corner of the SE $\frac{1}{4}$ of the NE $\frac{1}{4}$ of the SE $\frac{1}{4}$ of said NW $\frac{1}{4}$ of the NW $\frac{1}{4}$; thence northeast to the northeast corner thereof; thence northeasterly to the center of the SW $\frac{1}{4}$ of the NW $\frac{1}{4}$ of the NE $\frac{1}{4}$ of the said NW $\frac{1}{4}$; thence southeasterly to the northeast corner of the W $\frac{1}{2}$ of the NW $\frac{1}{4}$ of the SE $\frac{1}{4}$ of said NE $\frac{1}{4}$ of the NW $\frac{1}{4}$; thence southwesterly to the southwest corner thereof; thence south to a point which is 125 feet north of the southwest corner of the N $\frac{1}{2}$ of the SW $\frac{1}{4}$ of the said SE $\frac{1}{4}$ of the NE $\frac{1}{4}$ of the NW $\frac{1}{4}$; thence north 72° 28' east 175 feet to a point; thence south 89° 06' east 140 feet to a point; thence south 26° 04' east 151.8 feet to a point; thence south 5° 47' east 211.48 feet to a point on the south line of said NE $\frac{1}{4}$ of the NW $\frac{1}{4}$; thence south 10° 31' west 120 feet to a point; thence north 78° 30' east 130 feet to a point; thence north 57° 00' east 110 feet to a point; thence north 36° 12' 30" east 72.40 feet to a point; thence east 20 feet parallel to the south line of said NE $\frac{1}{4}$ of the NW $\frac{1}{4}$ to a point on the east line of said NE $\frac{1}{4}$; thence north to the northwest corner of the S $\frac{1}{2}$ of the fractional NW $\frac{1}{4}$ of said fractional NE $\frac{1}{4}$; thence northeast to the center of the fractional NW $\frac{1}{4}$ of said fractional NW $\frac{1}{4}$ of the fractional NE $\frac{1}{4}$; thence east to the northwest corner of the E $\frac{1}{2}$ of the fractional SW $\frac{1}{4}$ of the fractional NE $\frac{1}{4}$ of the said fractional NW $\frac{1}{4}$ of the fractional NE $\frac{1}{4}$; thence southeasterly to the southeast corner thereof; thence east to the northeast corner of the S $\frac{1}{2}$ of said fractional NW $\frac{1}{4}$ of the fractional NE $\frac{1}{4}$; thence northeasterly to the northwest corner of the S $\frac{1}{2}$ of the fractional SE $\frac{1}{4}$ of the fractional NW $\frac{1}{4}$ of the fractional NE $\frac{1}{4}$ of the said fractional NE $\frac{1}{4}$; thence southeasterly to the southeast corner thereof; thence southwesterly to the southwest corner of the E $\frac{1}{2}$ of the fractional NE $\frac{1}{4}$ of the fractional SW $\frac{1}{4}$ of the fractional NE $\frac{1}{4}$ of the fractional NE $\frac{1}{4}$; thence east to the northeast corner of the W $\frac{1}{2}$ of the fractional SW $\frac{1}{4}$ of the fractional SE $\frac{1}{4}$ of the said fractional NE $\frac{1}{4}$ of the fractional NE $\frac{1}{4}$; thence northeasterly to a point on the east line of Fractional Section 33, which is 495 feet north of the southeast corner of the N $\frac{1}{2}$ of the said fractional NE $\frac{1}{4}$; thence south along said east line 495 feet to the point of beginning, and containing 160.00 acres, more or less.

ARKANSAS NUCLEAR ONE
Unit 2

PARCEL "C"

A tract of land situated in the county of Pope, State of Arkansas, being a part of the SE $\frac{1}{4}$ of the SW $\frac{1}{4}$ and a part of the SW $\frac{1}{4}$ of the SE $\frac{1}{2}$ of Section 27, and a part of the fractional NE $\frac{1}{4}$ of the fractional NW $\frac{1}{4}$ of Fractional Section 34, Township 8 North, Range 21 West of the Fifth Principal Meridian, and being more particularly described as follows:

Beginning at the northeast corner of the NW $\frac{1}{4}$ of Section 34; thence southwesterly to the center of the fractional NW $\frac{1}{4}$ of the fractional NE $\frac{1}{4}$ of the fractional NE $\frac{1}{4}$ of said fractional NW $\frac{1}{4}$; thence northwest to the northwest corner of the E $\frac{1}{2}$ of the fractional NE $\frac{1}{4}$ of the fractional NW $\frac{1}{4}$; thence northeasterly to the northeast corner of the S $\frac{1}{2}$ of the S $\frac{1}{2}$ of the SE $\frac{1}{4}$ of the SW $\frac{1}{2}$ of Section 27; thence northeasterly to the northeast corner of the W $\frac{1}{2}$ of the NW $\frac{1}{4}$ of the SE $\frac{1}{4}$ of the said SW $\frac{1}{4}$ of the SE $\frac{1}{4}$; thence south to the southeast corner of the W $\frac{1}{2}$ of the SW $\frac{1}{2}$ of said SE $\frac{1}{4}$ of the SW $\frac{1}{4}$ of the SE $\frac{1}{4}$; thence west to the point of beginning, and containing 14.00 acres, more or less.

The above parcels contain, in the aggregate, 220.0 acres, more or less.

COUNTIES WITHIN A 50-MILE RADIUS

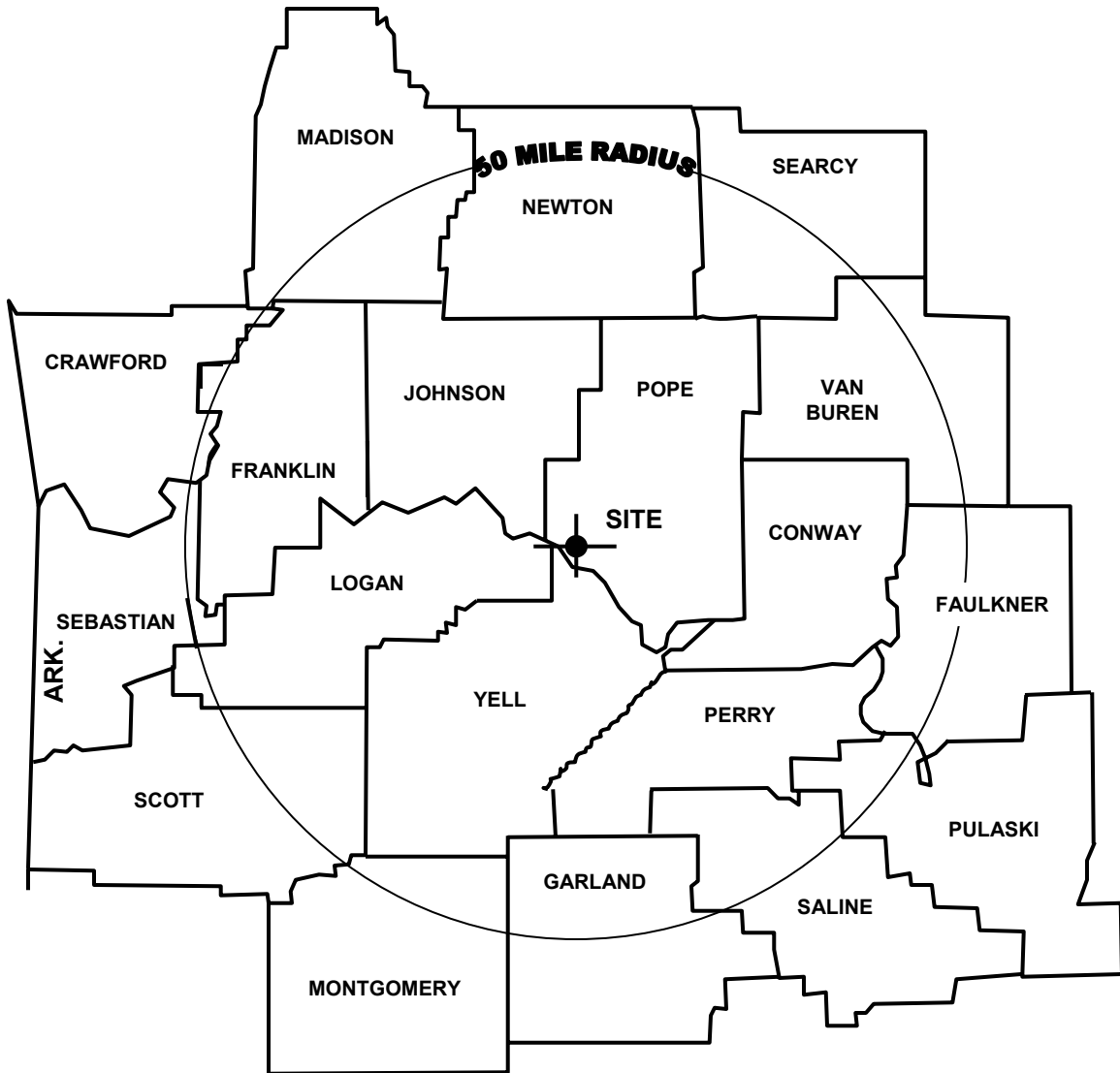

SAR FIGURE NO. 2.1-1

AMENDMENT 19

ARKANSAS NUCLEAR ONE
UNIT 2
RUSSELLVILLE, ARKANSAS



SCALE:	NONE
DRAWN:	
DESIGN:	ENERGY
CAD NO:	

COUNTIES WITHIN A 50 MILE RADIUS

BASED ON DRAWING NO

SHEET

REV.

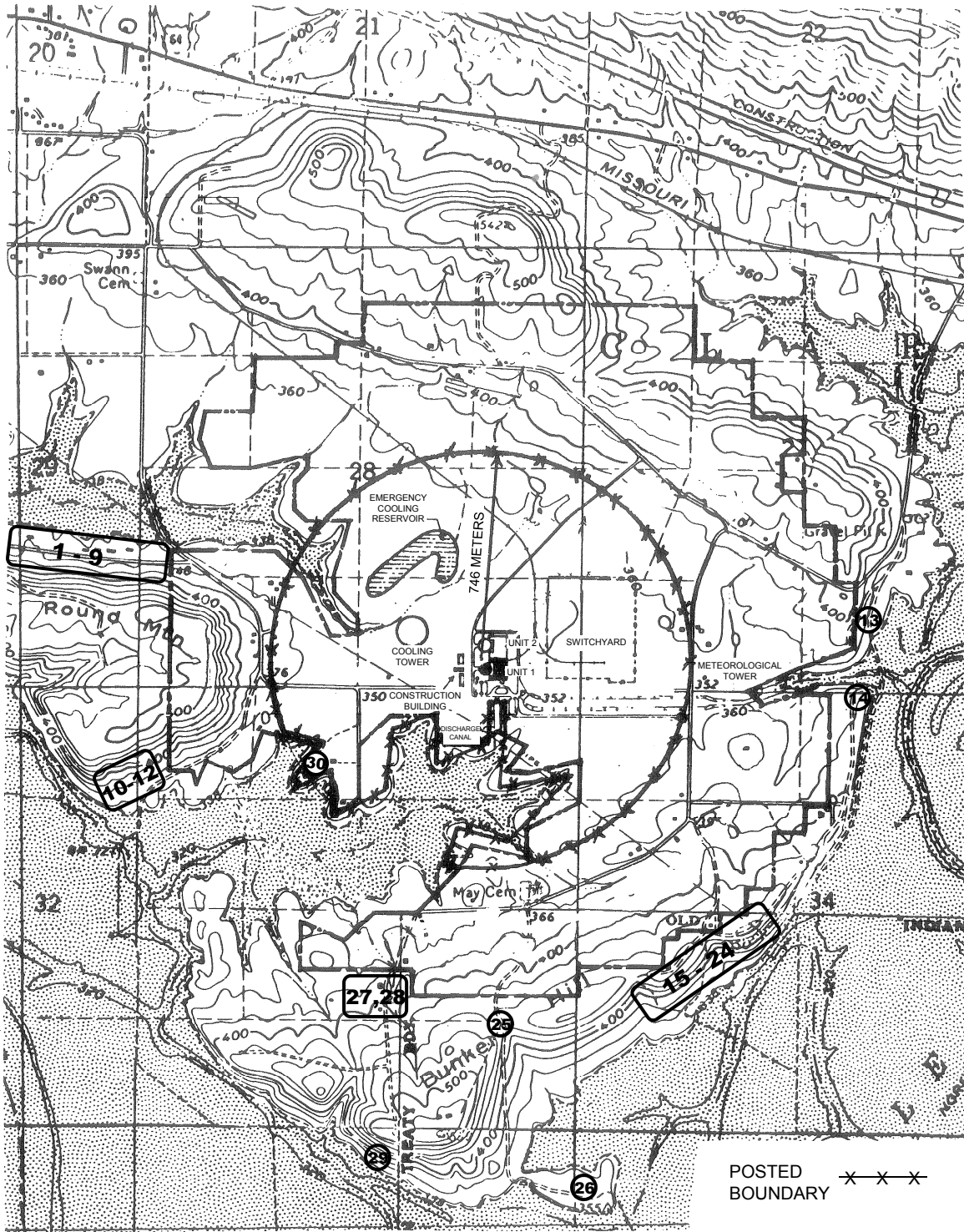

SAR FIGURE NO. 2.1-3

AMENDMENT 27

ARKANSAS NUCLEAR ONE
UNIT 2
RUSSELLVILLE, ARKANSAS



SCALE:	NONE
DRAWN:	
DESIGN:	ENTERGY
CAD NO:	

RESTRICTED AREA

BASED ON DRAWING NO

SHEET

REV.

0 – 5 MILES

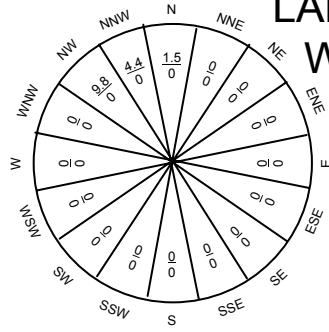

LAND USE IN SQUARE MILES
WITHIN A 50 MILE RADIUS

PASTURED P
CULTIVATED C

5 – 50 MILES

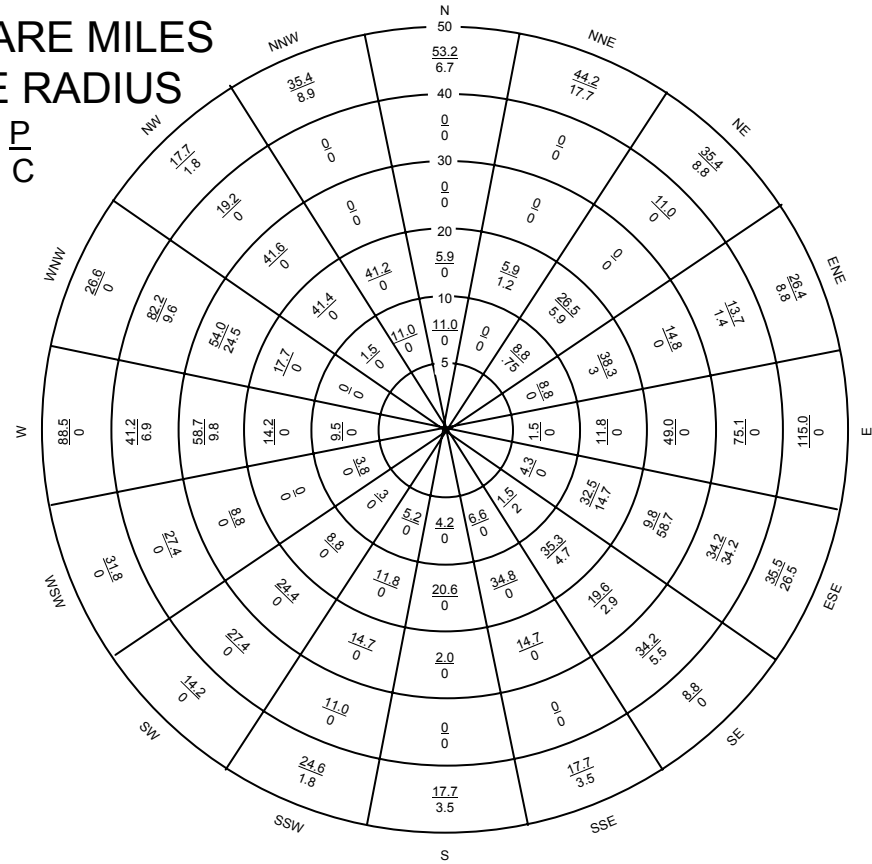

CUMULATIVE TOTALS BY SECTORS

SECTOR	RADIUS IN MILES									
	10		20		30		40		50	
	P	C	P	C	P	C	P	C	P	C
	SQ.MI.		SQ.MI.		SQ.MI.		SQ.MI.		SQ.MI.	
N	12.5	0	18.4	0	18.4	0	18.4	0	71.6	6.7
NNW	15.4	0	56.6	0	55.6	0	56.6	0	92.0	8.9
NW	2.5	0	43.9	0	85.5	0	104.7	0	122.4	1.8
WNW	0	0	17.7	0	71.7	24.5	153.9	34.1	180.5	34.1
W	9.5	0	23.7	0	82.4	9.8	123.6	16.7	212.1	16.7
WSW	3.8	0	3.8	0	12.6	0	40.0	0	71.8	0
SW	0.3	0	9.1	0	33.5	0	60.9	0	75.1	0
SSW	5.2	0	17.0	0	31.7	0	42.7	0	67.3	1.8
S	4.3	0	24.9	0	26.9	0	26.9	0	44.6	3.5
SSE	6.6	0	41.4	0	56.1	0	56.1	0	73.8	3.5
SE	1.5	.2	36.8	4.9	56.4	7.8	90.6	13.3	99.4	13.3
ESE	4.3	0	36.8	14.7	46.6	73.4	80.8	107.6	116.3	142.8
E	1.5	0	13.3	0	62.3	0	137.4	0	252.4	0
ENE	8.8	0	47.1	3	61.9	3	75.6	4.4	102	13.2
NE	8.8	.75	35.3	6.7	35.3	6.7	46.3	6.7	81.7	15.5
NNE	0	0	5.9	1.2	5.9	1.2	5.9	1.2	50.1	18.9

LAND USE (PASTURED/CULTIVATED) WITHIN A 50 MILE RADIUS

SAR FIGURE NO. 2.1-4

ARKANSAS NUCLEAR ONE
UNIT 2
RUSSELLVILLE, ARKANSAS



SCALE: NONE
DRAWN: ENTERGY
DESIGN: ENTERGY
CAD NO:

AMENDMENT 19

BASED ON DRAWING NO

SHEET

REV.

POPULATION IN ANNULAR RINGS

0 - 1	66
1 - 2	497
2 - 3	575
3 - 4	2,187
4 - 5	3,844
5 - 10	15,936

POPULATION WITHIN RADIAL DISTANCE OF SITE

1	66
2	583
3	1,138
4	3,305
5	7,149
10	23,085

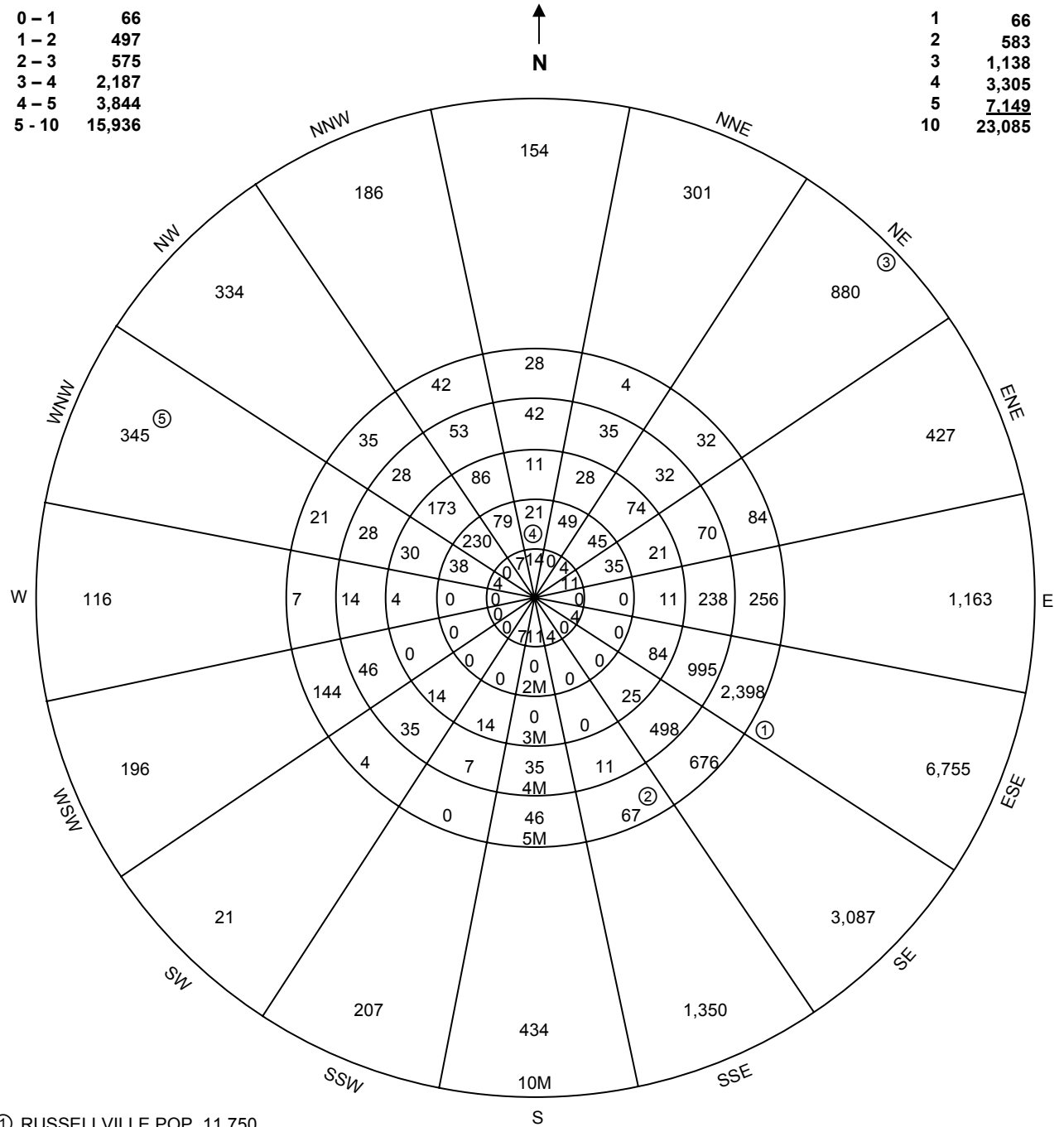

- ① RUSSELLVILLE POP. 11,750
- ② DARDANELLE POP. 3,297
- ③ DOVER POP. 662
- ④ LONDON POP. 539
- ⑤ KNOXVILLE POP. 202

SAR FIGURE NO. 2.1-5

AMENDMENT 19

ARKANSAS NUCLEAR ONE
 UNIT 2
 RUSSELLVILLE, ARKANSAS



SCALE:	NONE
DRAWN:	
DESIGN:	ENTERGY
CAD NO:	

1970 POPULATION DISTRIBUTION
 WITHIN 10 MILES

BASED ON DRAWING NO

SHEET

REV.

POPULATION IN ANNULAR RINGS

0 - 1	78
1 - 2	577
2 - 3	669
3 - 4	2,520
4 - 5	4,471
5 - 10	18,531

POPULATION WITHIN RADIAL DISTANCE OF SITE

1	78
2	655
3	1,324
4	3,844
5	8,315
10	26,846

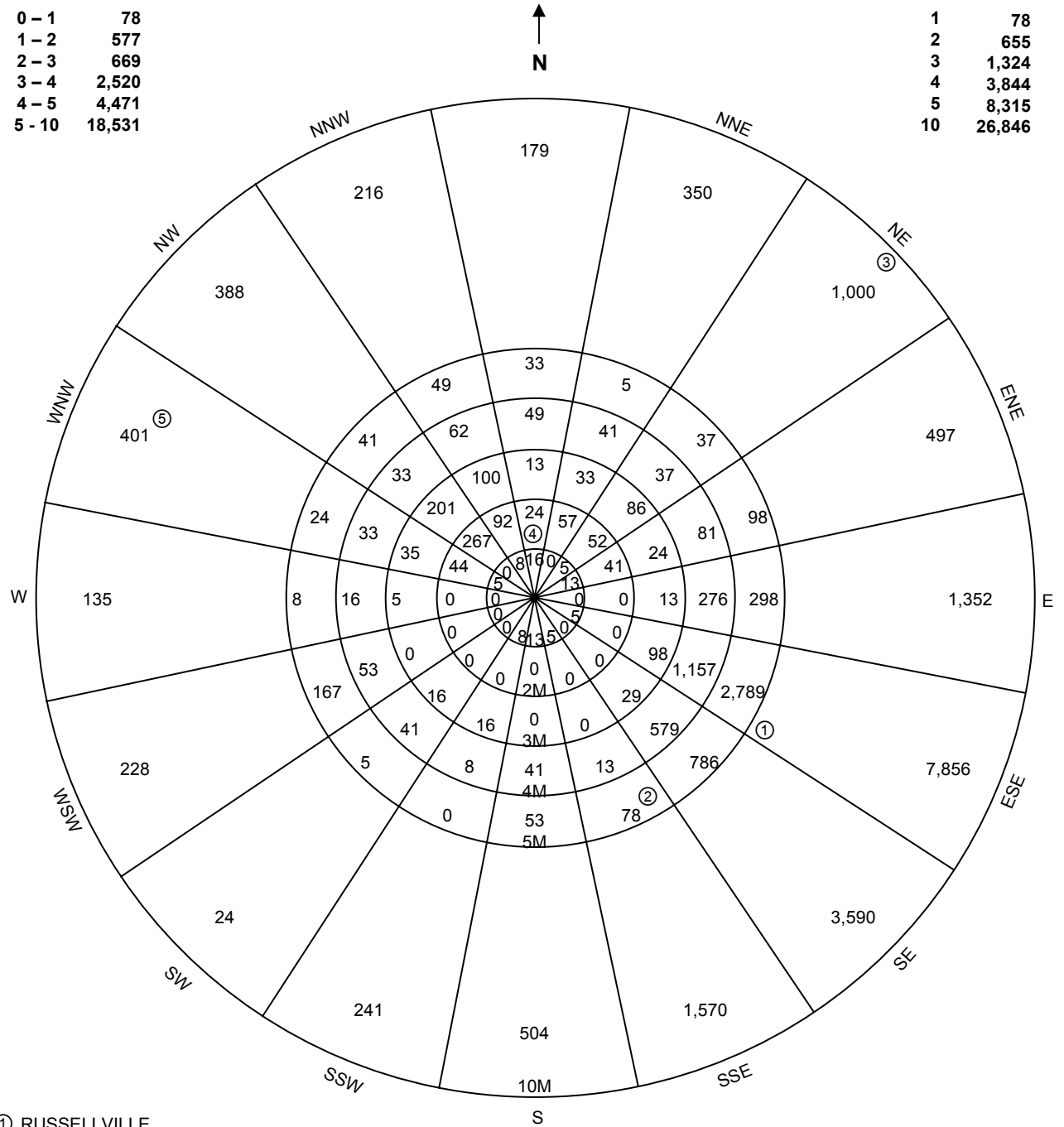

- ① RUSSELLVILLE
- ② DARDANELLE
- ③ DOVER
- ④ LONDON
- ⑤ KNOXVILLE

SAR FIGURE NO. 2.1-6

AMENDMENT 19

ARKANSAS NUCLEAR ONE
 UNIT 2
 RUSSELLVILLE, ARKANSAS



SCALE:	NONE
DRAWN:	
DESIGN:	ENTERGY
CAD NO:	

1980 PROJECTED POPULATION
 DISTRIBUTION WITHIN 10 MILES

BASED ON DRAWING NO

SHEET

REV.

POPULATION IN ANNULAR RINGS

0 - 1	87
1 - 2	670
2 - 3	778
3 - 4	2,930
4 - 5	5,197
5 - 10	21,548

POPULATION WITHIN RADIAL DISTANCE OF SITE

1	87
2	757
3	1,535
4	4,465
5	9,662
10	31,210

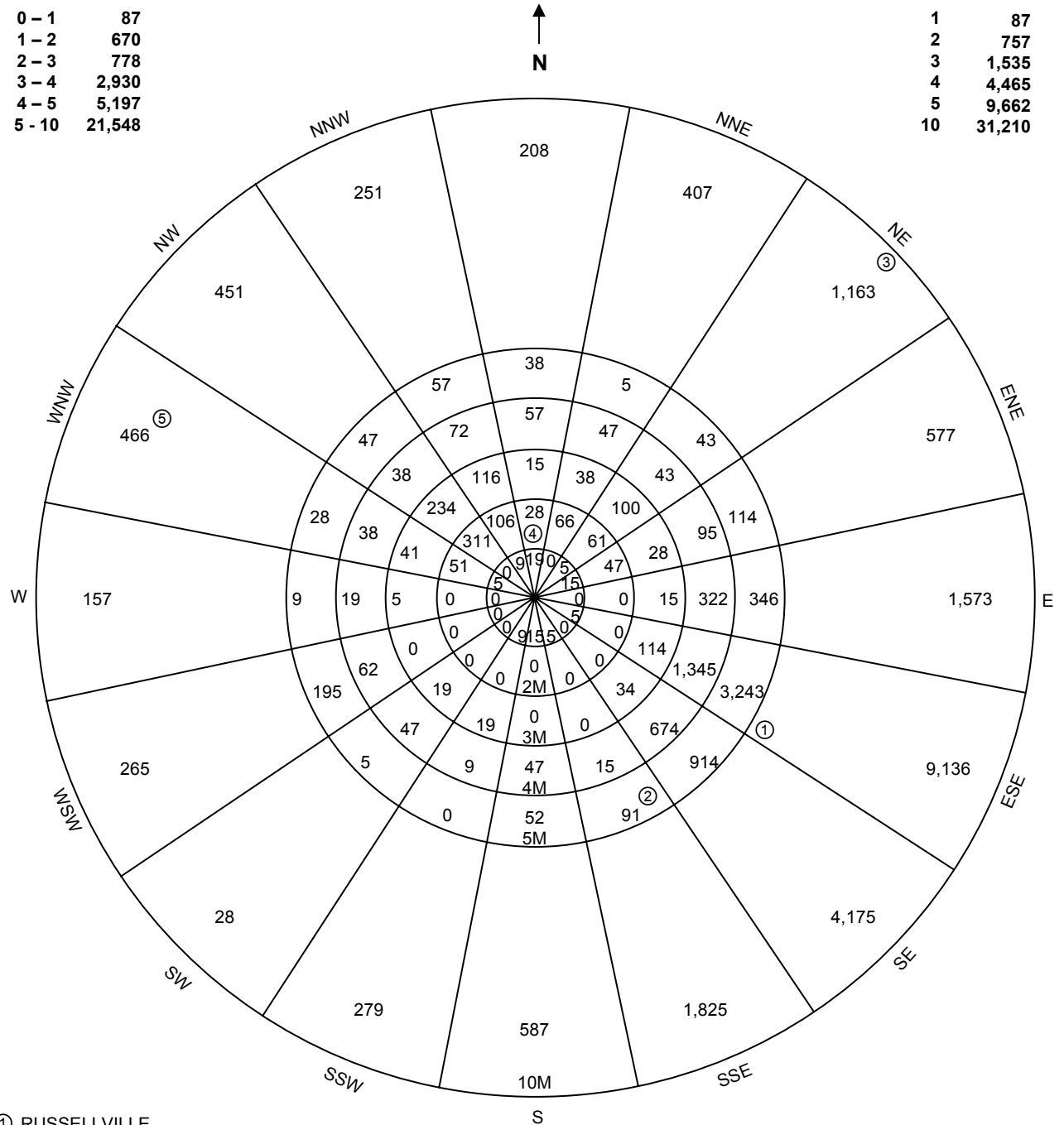

- ① RUSSELLVILLE
- ② DARDANELLE
- ③ DOVER
- ④ LONDON
- ⑤ KNOXVILLE

SAR FIGURE NO. 2.1-7

AMENDMENT 19

ARKANSAS NUCLEAR ONE
 UNIT 2
 RUSSELLVILLE, ARKANSAS



SCALE:	NONE
DRAWN:	
DESIGN:	ENTERGY
CAD NO:	

1990 PROJECTED POPULATION
 DISTRIBUTION WITHIN 10 MILES

BASED ON DRAWING NO

SHEET

REV.

POPULATION IN ANNULAR RINGS

0 - 1	96
1 - 2	782
2 - 3	902
3 - 4	3,406
4 - 5	6,045
5 - 10	25,059

POPULATION WITHIN RADIAL DISTANCE OF SITE

1	96
2	878
3	1,780
4	5,186
5	11,231
10	36,290

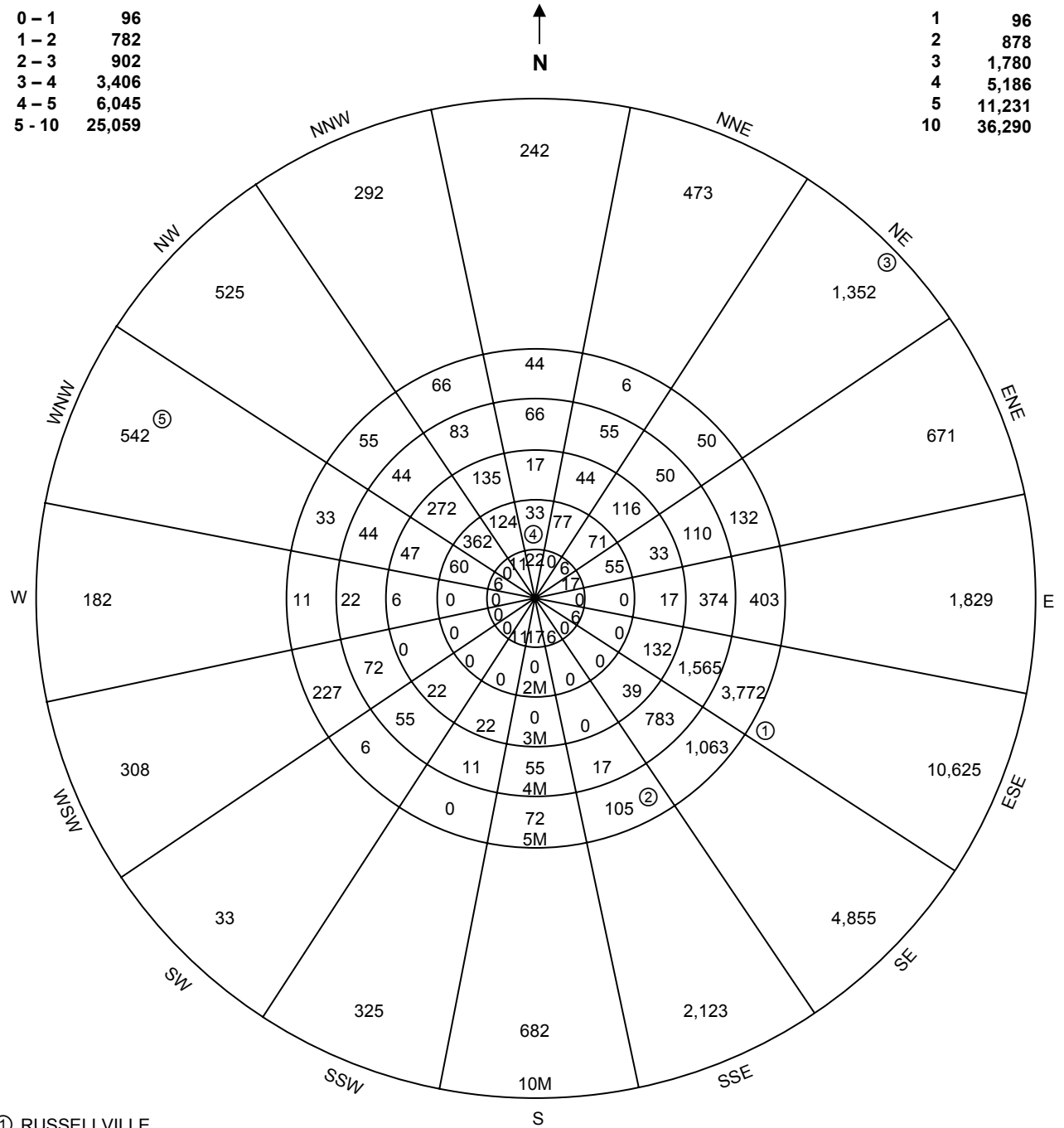

- ① RUSSELLVILLE
- ② DARDANELLE
- ③ DOVER
- ④ LONDON
- ⑤ KNOXVILLE

SAR FIGURE NO. 2.1-8

AMENDMENT 19

ARKANSAS NUCLEAR ONE
 UNIT 2
 RUSSELLVILLE, ARKANSAS



SCALE:	NONE
DRAWN:	
DESIGN:	ENERGY
CAD NO:	

2000 PROJECTED POPULATION
 DISTRIBUTION WITHIN 10 MILES

BASED ON DRAWING NO

SHEET

REV.

POPULATION IN ANNULAR RINGS

0 - 1	120
1 - 2	910
2 - 3	1,051
3 - 4	3,964
4 - 5	7,032
5 - 10	29,149

POPULATION WITHIN RADIAL DISTANCE OF SITE

1	120
2	1,030
3	2,081
4	6,045
5	13,077
10	42,226

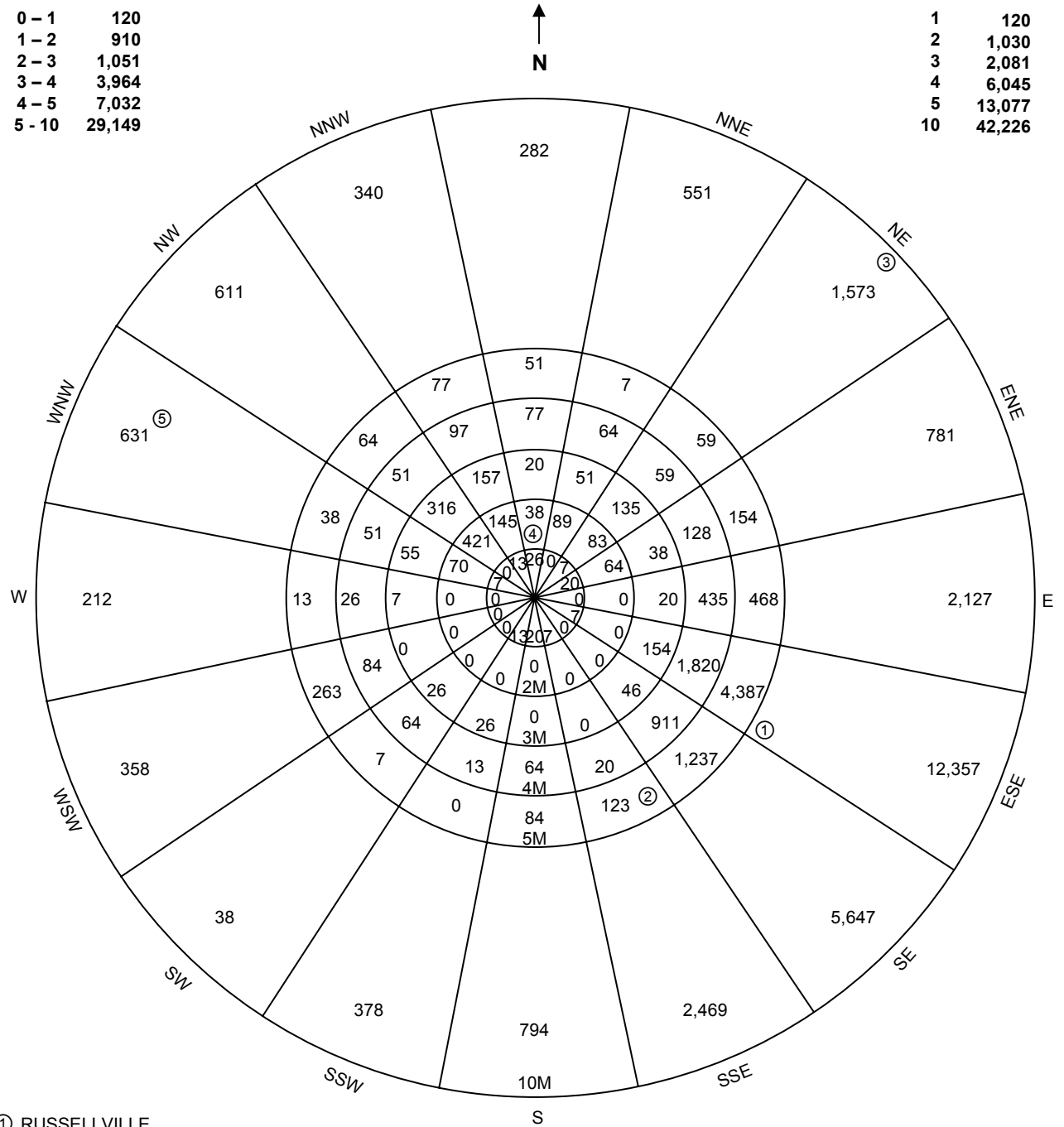

- ① RUSSELLVILLE
- ② DARDANELLE
- ③ DOVER
- ④ LONDON
- ⑤ KNOXVILLE

SAR FIGURE NO. 2.1-9

AMENDMENT 19

ARKANSAS NUCLEAR ONE
 UNIT 2
 RUSSELLVILLE, ARKANSAS



SCALE:	NONE
DRAWN:	
DESIGN:	ENTERGY
CAD NO:	

2010 PROJECTED POPULATION
 DISTRIBUTION WITHIN 10 MILES

BASED ON DRAWING NO

SHEET

REV.

POPULATION IN ANNULAR RINGS

0 - 1	71
1 - 2	542
2 - 3	628
3 - 4	2,361
4 - 5	4,190
5 - 10	17,365

POPULATION WITHIN RADIAL DISTANCE OF SITE

1	71
2	613
3	1,241
4	3,602
5	7,792
10	25,157

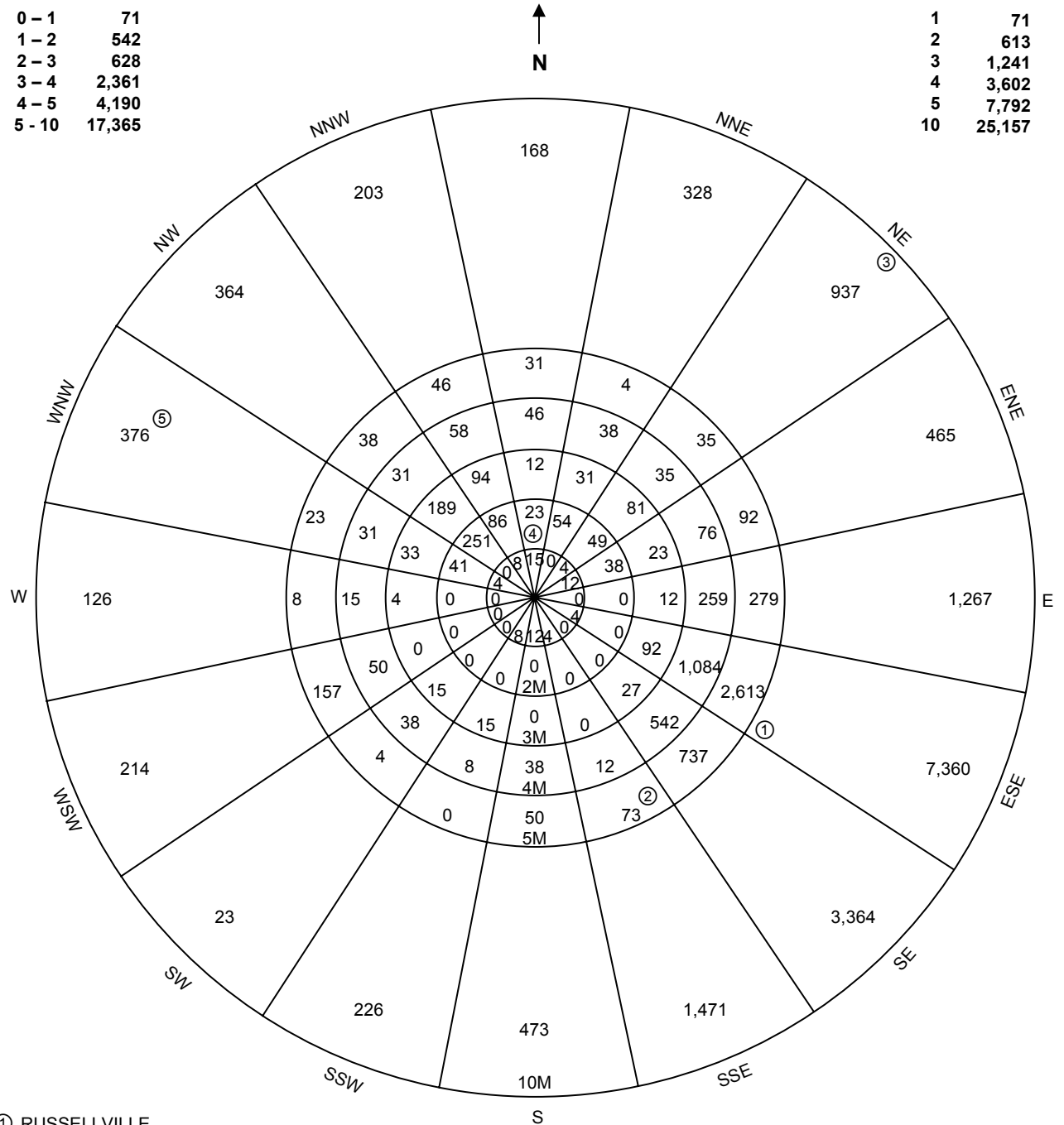

- ① RUSSELLVILLE
- ② DARDANELLE
- ③ DOVER
- ④ LONDON
- ⑤ KNOXVILLE

SAR FIGURE NO. 2.1-10

AMENDMENT 19

ARKANSAS NUCLEAR ONE
UNIT 2
RUSSELLVILLE, ARKANSAS



SCALE:	NONE
DRAWN:	
DESIGN:	ENTERGY
CAD NO:	

1976 PROJECTED POPULATION
DISTRIBUTION WITHIN 10 MILES

BASED ON DRAWING NO

SHEET

REV.

POPULATION IN ANNULAR RINGS

0 - 1	133
1 - 2	980
2 - 3	1,134
3 - 4	4,273
4 - 5	7,577
5 - 10	31,418

POPULATION WITHIN RADIAL DISTANCE OF SITE

1	133
2	1,113
3	2,247
4	6,520
5	14,097
10	45,515

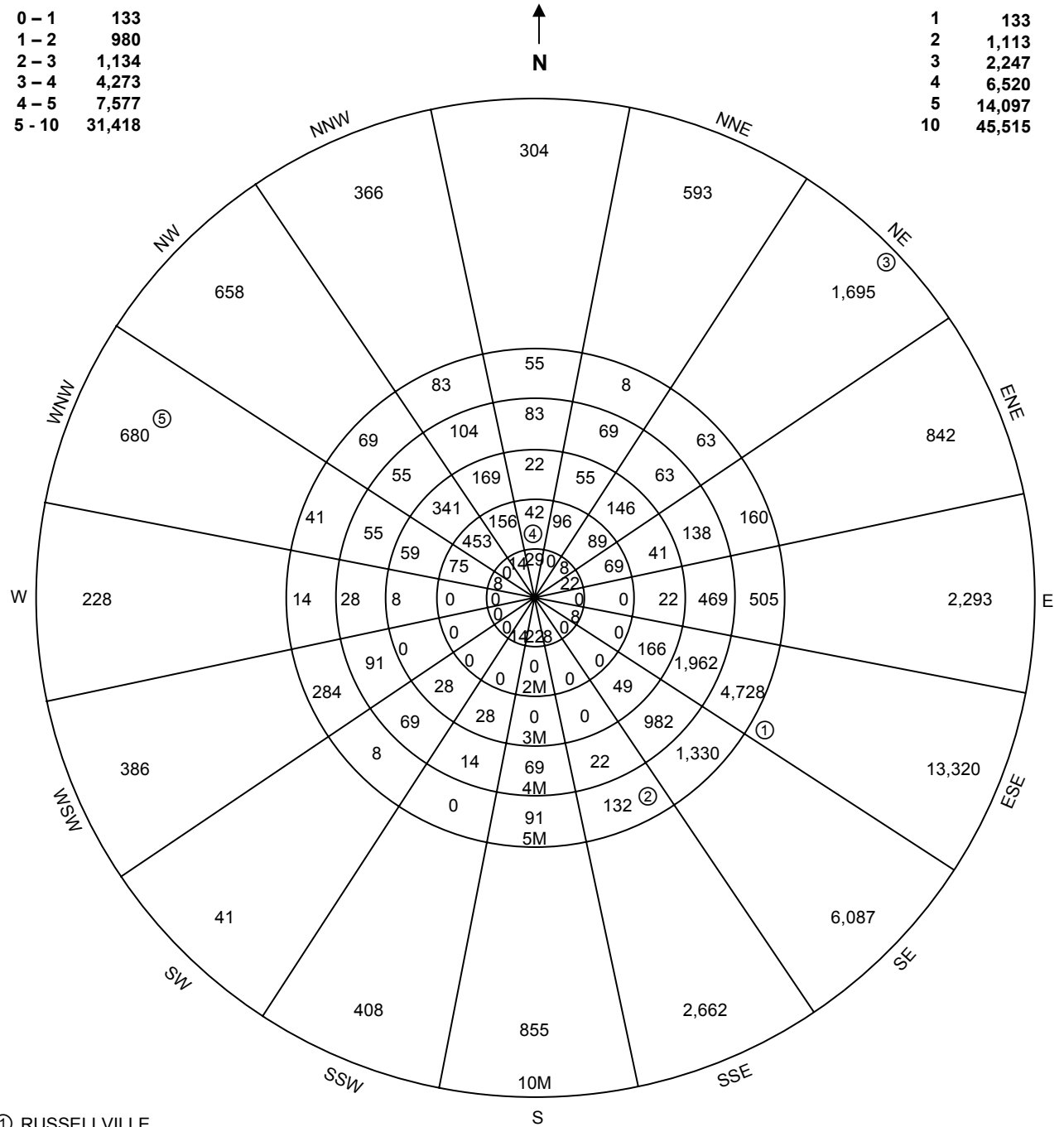

- ① RUSSELLVILLE
- ② DARDANELLE
- ③ DOVER
- ④ LONDON
- ⑤ KNOXVILLE

SAR FIGURE NO. 2.1-11

AMENDMENT 19

ARKANSAS NUCLEAR ONE
 UNIT 2
 RUSSELLVILLE, ARKANSAS



SCALE:	NONE
DRAWN:	
DESIGN:	ENERGY
CAD NO:	

2016 PROJECTED POPULATION
 DISTRIBUTION WITHIN 10 MILES

BASED ON DRAWING NO

SHEET

REV.

POPULATION IN ANNULAR RINGS

10 -20	21,888
20 -30	25,629
30 -40	28,340
40 -50	65,746

POPULATION WITHIN RADIAL DISTANCE OF SITE

10	23,085
20	44,973
30	70,602
40	98,942
50	164,688

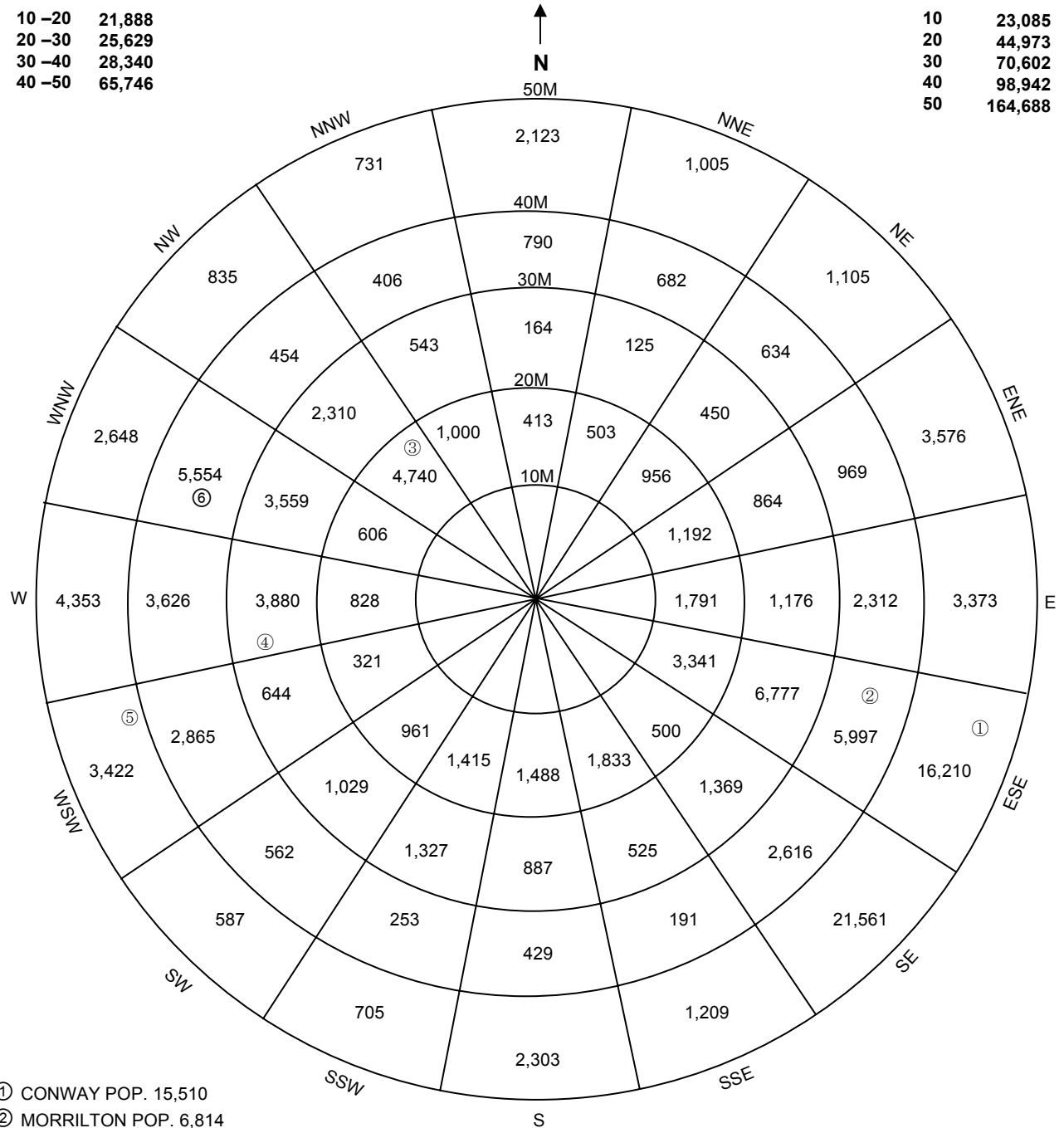

- ① CONWAY POP. 15,510
- ② MORRILTON POP. 6,814
- ③ CLARKSVILLE POP. 4,616
- ④ PARIS POP. 3,646
- ⑤ BOONEVILLE POP. 3,239
- ⑥ OZARK POP. 2,592

SAR FIGURE NO. 2.1-12

AMENDMENT 19

ARKANSAS NUCLEAR ONE
 UNIT 2
 RUSSELLVILLE, ARKANSAS



SCALE:	NONE
DRAWN:	
DESIGN:	ENTERGY
CAD NO:	

1970 PROJECTED POPULATION
 DISTRIBUTION WITHIN 50 MILES

BASED ON DRAWING NO

SHEET

REV.

POPULATION IN ANNULAR RINGS

10 -20	24,880
20 -30	27,046
30 -40	28,582
40 -50	67,819

POPULATION WITHIN RADIAL DISTANCE OF SITE

10	26,846
20	51,726
30	78,772
40	107,354
50	175,173

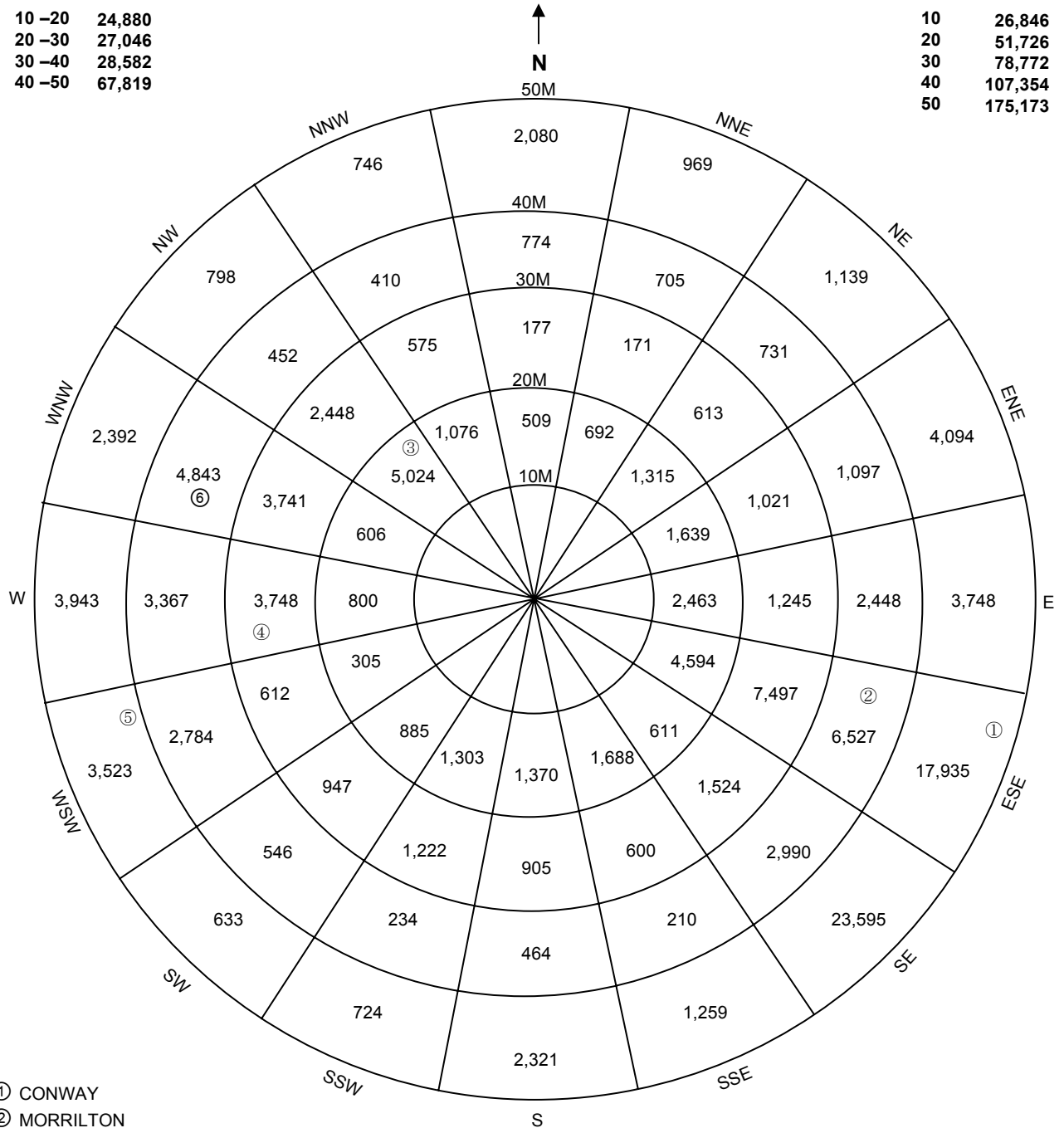

- ① CONWAY
- ② MORRILTON
- ③ CLARKSVILLE
- ④ PARIS
- ⑤ BOONEVILLE
- ⑥ OZARK

SAR FIGURE NO. 2.1-13

AMENDMENT 19

ARKANSAS NUCLEAR ONE
 UNIT 2
 RUSSELLVILLE, ARKANSAS



SCALE:	NONE
DRAWN:	
DESIGN:	ENERGY
CAD NO:	

1980 PROJECTED POPULATION
 DISTRIBUTION WITHIN 50 MILES

BASED ON DRAWING NO

SHEET

REV.

POPULATION IN ANNULAR RINGS

10 -20	29,107
20 -30	28,844
30 -40	29,144
40 -50	74,772

POPULATION WITHIN RADIAL DISTANCE OF SITE

10	31,210
20	60,317
30	89,161
40	118,305
50	193,077

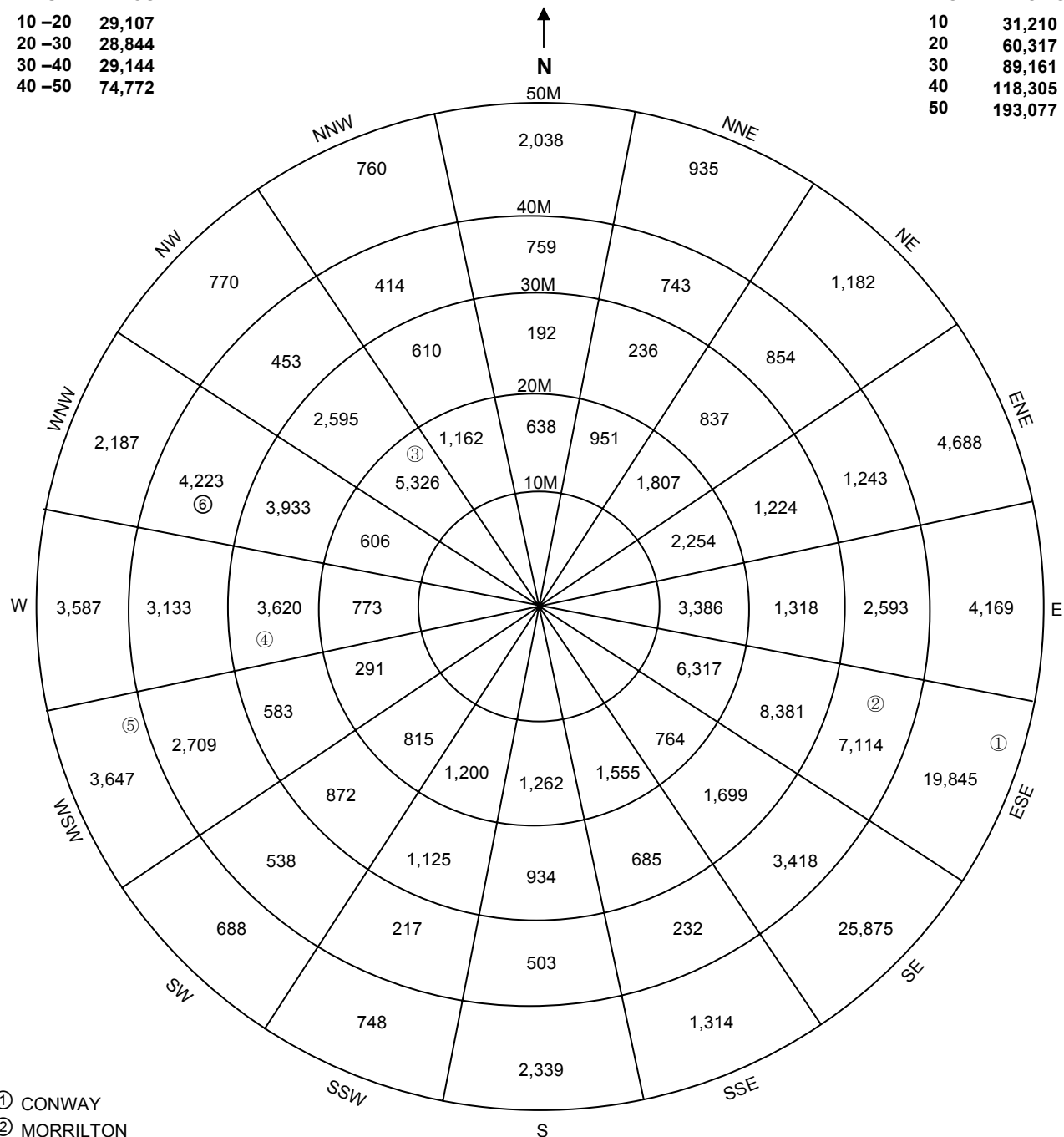

- ① CONWAY
- ② MORRILTON
- ③ CLARKSVILLE
- ④ PARIS
- ⑤ BOONEVILLE
- ⑥ OZARK

SAR FIGURE NO. 2.1-14

AMENDMENT 19

ARKANSAS NUCLEAR ONE
UNIT 2
RUSSELLVILLE, ARKANSAS



SCALE:	NONE
DRAWN:	
DESIGN:	ENERGY
CAD NO:	

1990 PROJECTED POPULATION
DISTRIBUTION WITHIN 50 MILES

BASED ON DRAWING NO

SHEET

REV.

POPULATION IN ANNULAR RINGS

10 -20	35,076
20 -30	31,132
30 -40	30,037
40 -50	80,431

POPULATION WITHIN RADIAL DISTANCE OF SITE

10	36,290
20	71,366
30	102,498
40	132,535
50	212,966

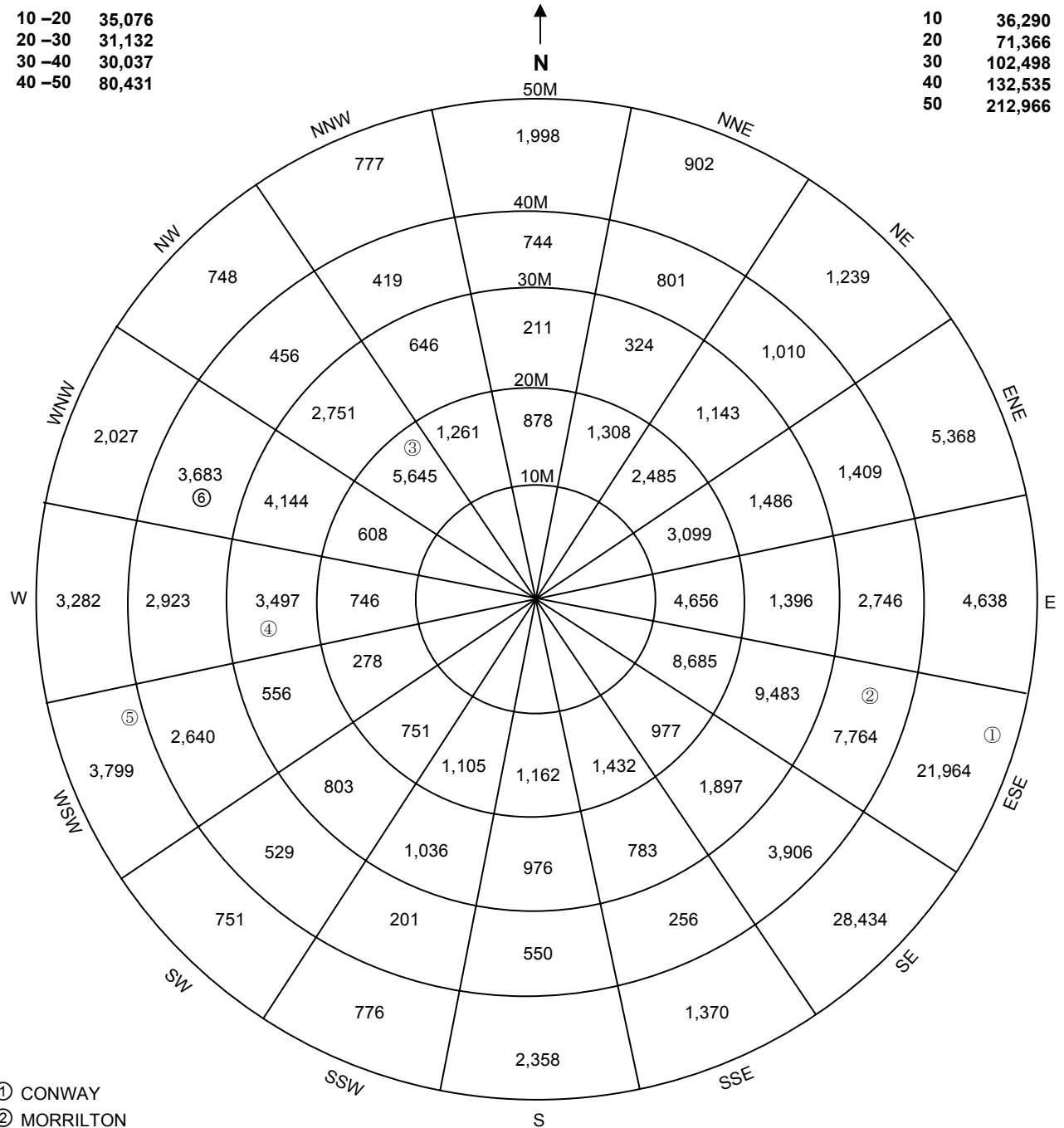

- ① CONWAY
- ② MORRILTON
- ③ CLARKSVILLE
- ④ PARIS
- ⑤ BOONEVILLE
- ⑥ OZARK

SAR FIGURE NO. 2.1-15

AMENDMENT 19

ARKANSAS NUCLEAR ONE
 UNIT 2
 RUSSELLVILLE, ARKANSAS



SCALE:	NONE
DRAWN:	
DESIGN:	ENTERGY
CAD NO:	

2000 PROJECTED POPULATION
 DISTRIBUTION WITHIN 50 MILES

BASED ON DRAWING NO

SHEET

REV.

POPULATION IN ANNULAR RINGS

10 -20	43,355
20 -30	34,051
30 -40	31,296
40 -50	86,939

POPULATION WITHIN RADIAL DISTANCE OF SITE

10	42,226
20	85,581
30	119,632
40	150,928
50	237,867

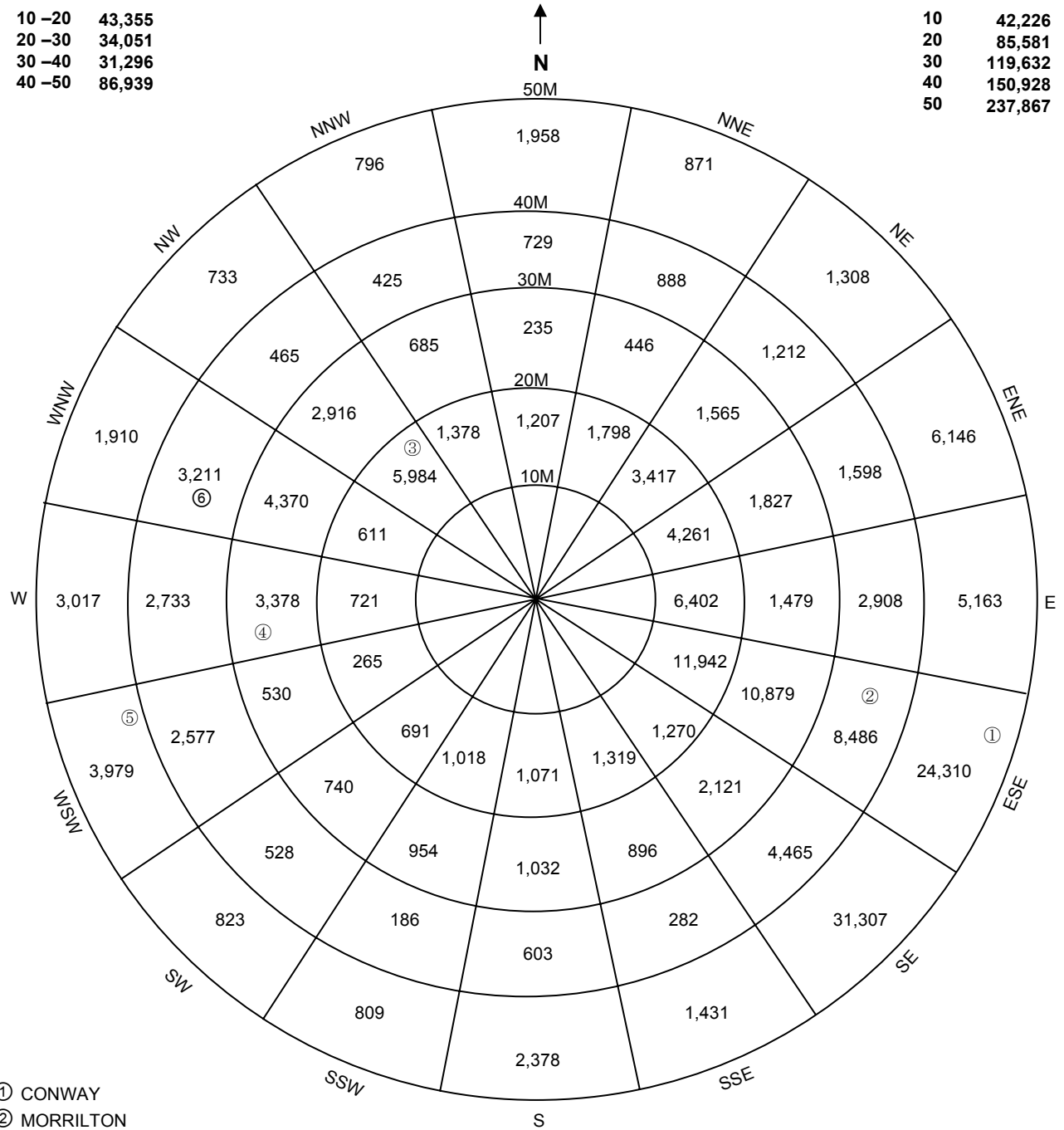

- ① CONWAY
- ② MORRILTON
- ③ CLARKSVILLE
- ④ PARIS
- ⑤ BOONEVILLE
- ⑥ OZARK

SAR FIGURE NO. 2.1-16

AMENDMENT 19

ARKANSAS NUCLEAR ONE
 UNIT 2
 RUSSELLVILLE, ARKANSAS



SCALE:	NONE
DRAWN:	
DESIGN:	ENTERGY
CAD NO:	

2010 PROJECTED POPULATION
 DISTRIBUTION WITHIN 50 MILES

BASED ON DRAWING NO

SHEET

REV.

POPULATION IN ANNULAR RINGS

10 -20	23,682
20 -30	26,479
30 -40	28,483
40 -50	68,236

POPULATION WITHIN RADIAL DISTANCE OF SITE

10	25,157
20	48,839
30	75,318
40	103,801
50	172,037

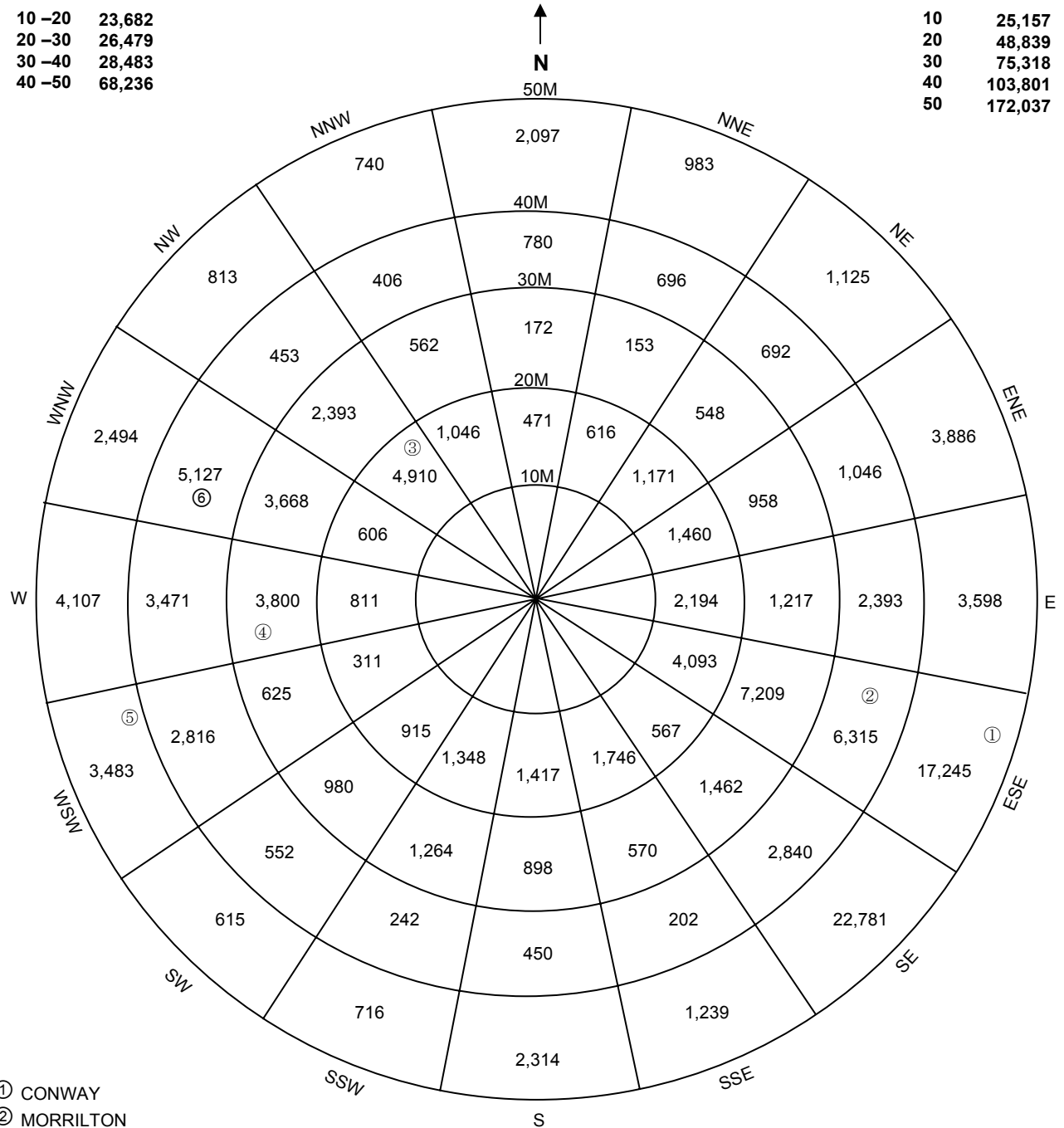

- ① CONWAY
- ② MORRILTON
- ③ CLARKSVILLE
- ④ PARIS
- ⑤ BOONEVILLE
- ⑥ OZARK

SAR FIGURE NO. 2.1-17

AMENDMENT 19

ARKANSAS NUCLEAR ONE
 UNIT 2
 RUSSELLVILLE, ARKANSAS



SCALE:	NONE
DRAWN:	
DESIGN:	ENTERGY
CAD NO:	

1976 PROJECTED POPULATION
 DISTRIBUTION WITHIN 50 MILES

BASED ON DRAWING NO

SHEET

REV.

POPULATION IN ANNULAR RINGS

10 -20	49,816
20 -30	34,989
30 -40	29,699
40 -50	90,841

POPULATION WITHIN RADIAL DISTANCE OF SITE

10	45,515
20	95,331
30	130,320
40	160,019
50	250,860

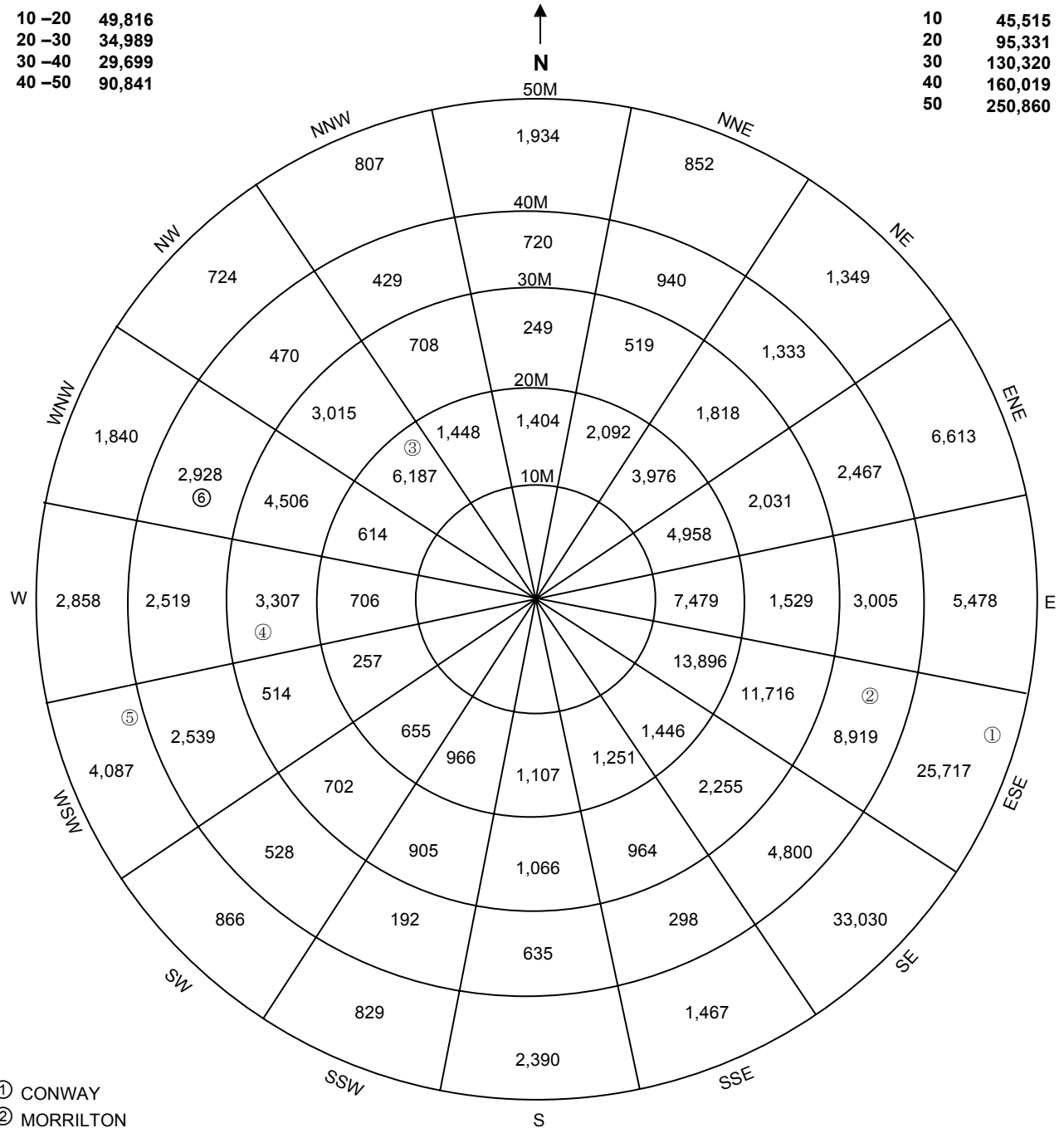

- ① CONWAY
- ② MORRILTON
- ③ CLARKSVILLE
- ④ PARIS
- ⑤ BOONEVILLE
- ⑥ OZARK

SAR FIGURE NO. 2.1-18

AMENDMENT 19

ARKANSAS NUCLEAR ONE
UNIT 2
RUSSELLVILLE, ARKANSAS



SCALE:	NONE
DRAWN:	
DESIGN:	ENERGY
CAD NO:	

2016 PROJECTED POPULATION
DISTRIBUTION WITHIN 50 MILES

BASED ON DRAWING NO

SHEET

REV.

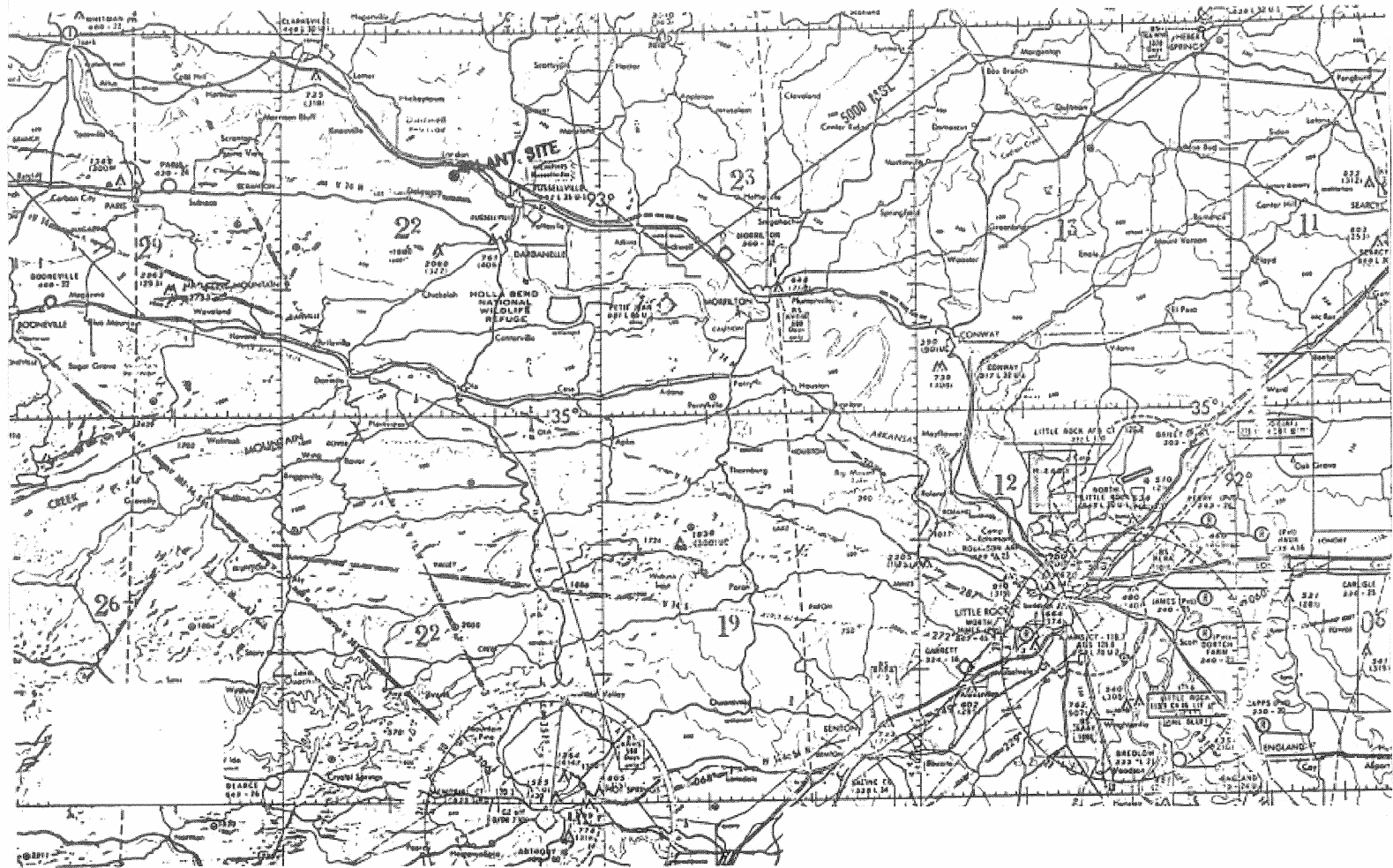

AIRLINE ROUTES IN THE VICINITY OF RUSSELLVILLE

SAR FIGURE NO. 2.2-1

ARKANSAS NUCLEAR ONE
 UNIT 2
 RUSSELLVILLE, ARKANSAS



SCALE:	NONE
DRAWN:	ENERGY
DESIGN:	ENERGY
CAD NO:	

AMENDMENT 19

BASED ON DRAWING NO

SHEET

REV.

Security-Related Information
Text Withheld Under 10 CFR 2.390

SAR FIGURE NO. 2.2-2

AMENDMENT 19

ARKANSAS NUCLEAR ONE
UNIT 2
RUSSELLVILLE, ARKANSAS



SCALE: NONE

DRAWN:

DESIGN: ENTERGY

CAD NO:

INDUSTRIAL AND TRANSPORTATION
FACILITIES 5-MILE RADIUS

BASED ON DRAWING NO

SHEET

REV.

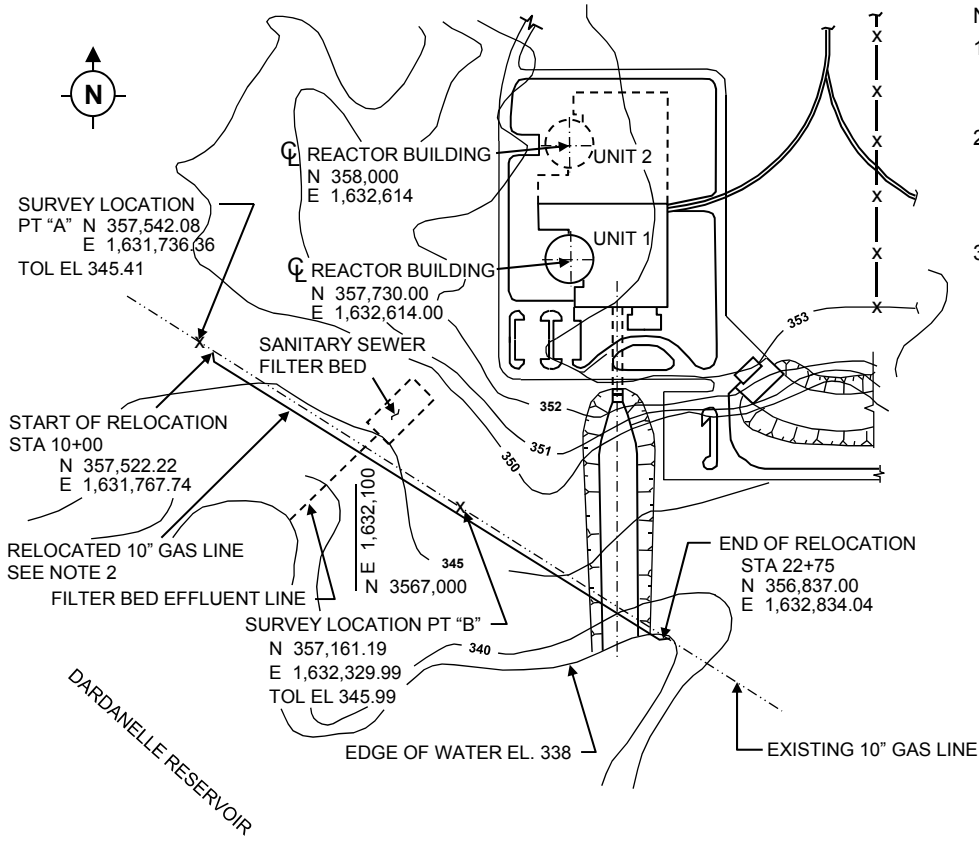

- NOTES:
1. RELOCATION OF EXISTING 10" GAS MAIN SHALL BE DONE BY GAS COMPANY
 2. RELOCATED PIPE SHALL CONFORM TO THE REQUIREMENTS OF ASA-B31.8 TYPE C
 3. CATHODIC PROTECTION SHALL BE IN ACCORDANCE WITH THE STANDARD PRACTICE OF THE GAS COMPANY

PLAN

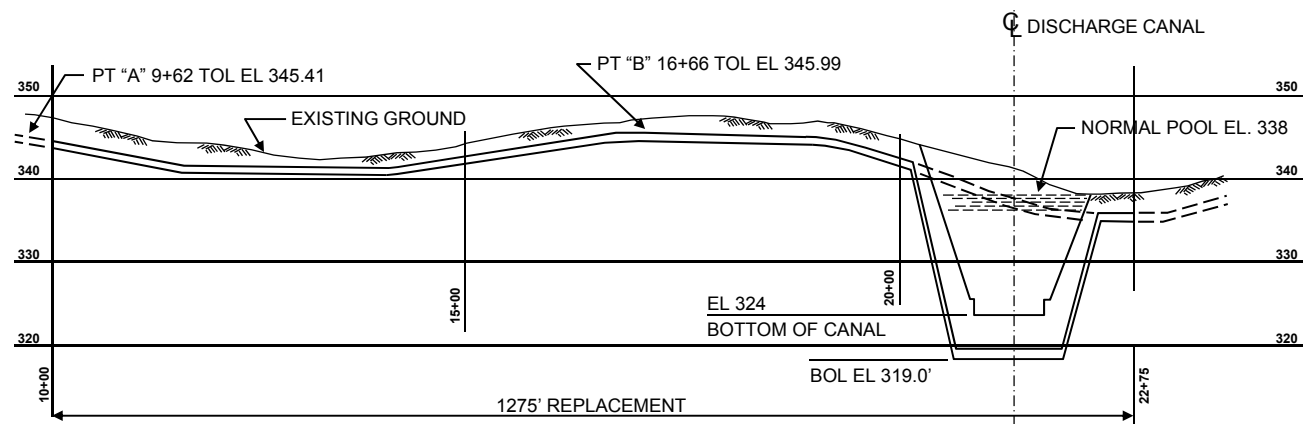

PROFILE

SAR FIGURE NO. 2.2-3

AMENDMENT 26

ARKANSAS NUCLEAR ONE
 UNIT 2
 RUSSELLVILLE, ARKANSAS



SCALE:	NONE
DRAWN:	
DESIGN:	ENTERGY
CAD NO.:	

GASLINE RELOCATION

BASED ON DRAWING NO

SHEET

REV.

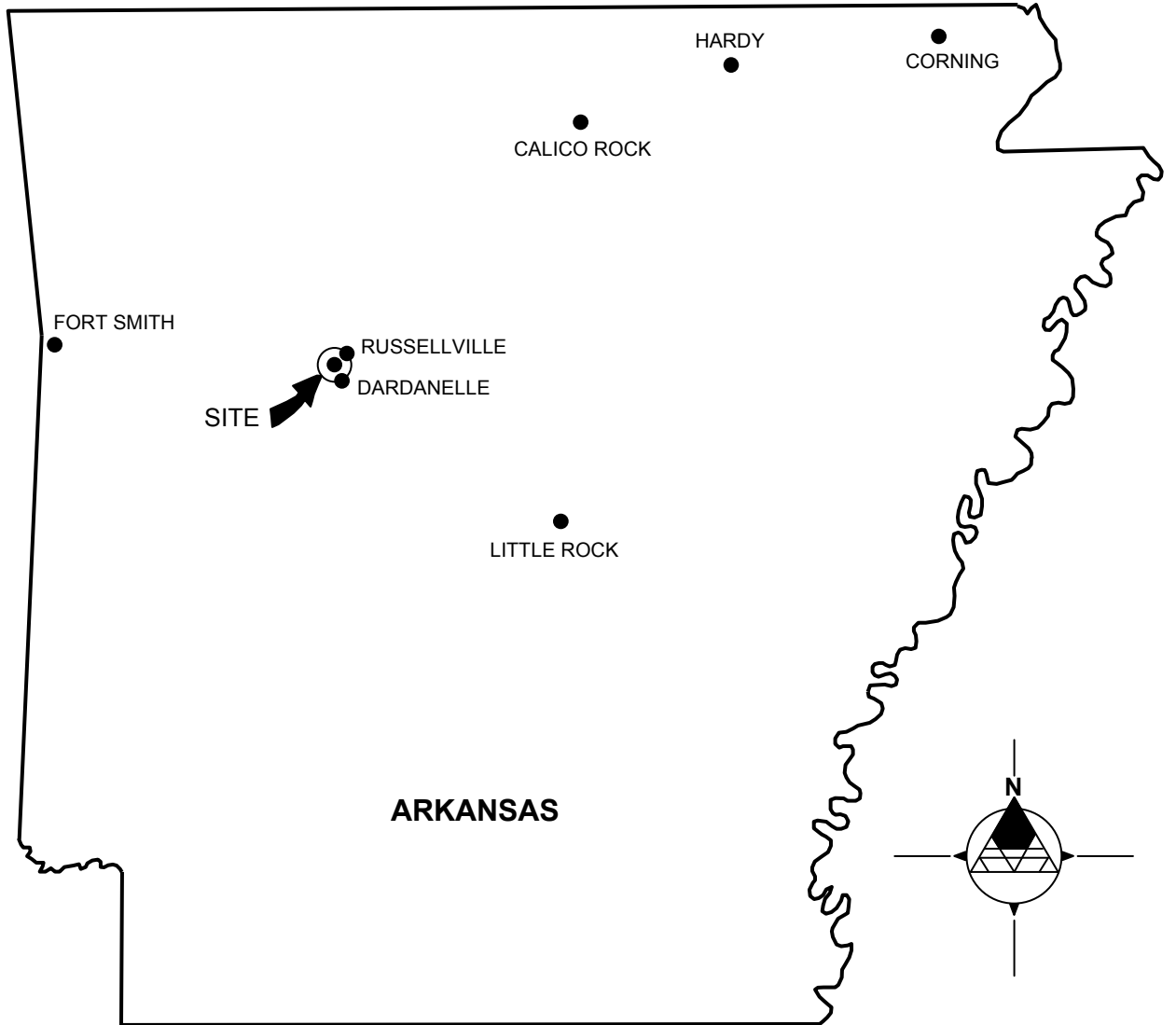

SAR FIGURE NO. 2.3-1

AMENDMENT 19

ARKANSAS NUCLEAR ONE
UNIT 2
RUSSELLVILLE, ARKANSAS



SCALE: NONE

DRAWN:

DESIGN: ENTERGY

CAD NO:

CLIMATOLOGICAL STATIONS

BASED ON DRAWING NO

SHEET

REV.

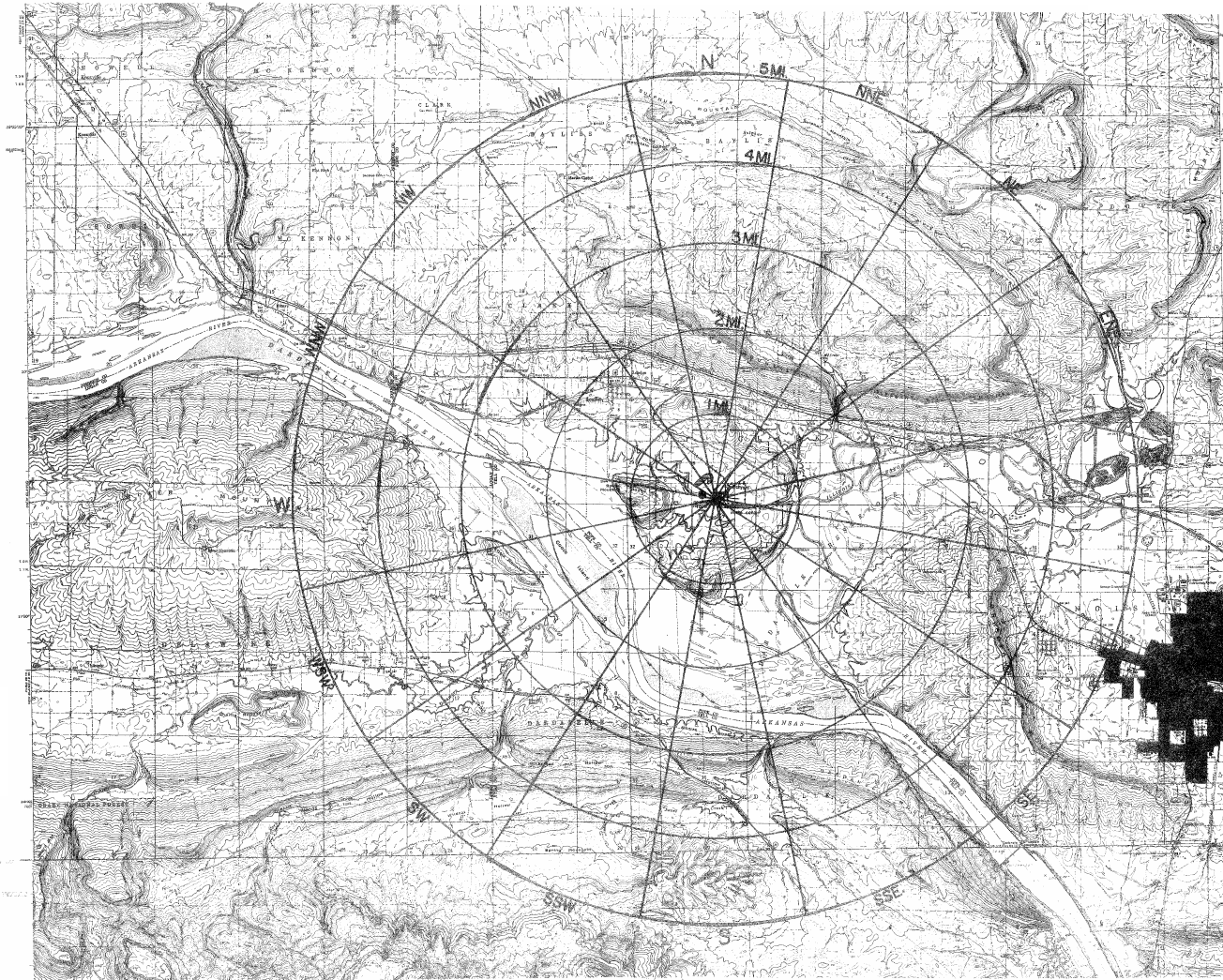

TOPOGRAPHIC MAP 5 MILE RADIUS FROM SITE

SAR FIGURE NO. 2.3-2

ARKANSAS NUCLEAR ONE
 UNIT 2
 RUSSELLVILLE, ARKANSAS



SCALE:	NONE
DRAWN:	ENTERGY
DESIGN:	ENTERGY
CAD NO:	

AMENDMENT 19

BASED ON DRAWING NO

SHEET

REV.

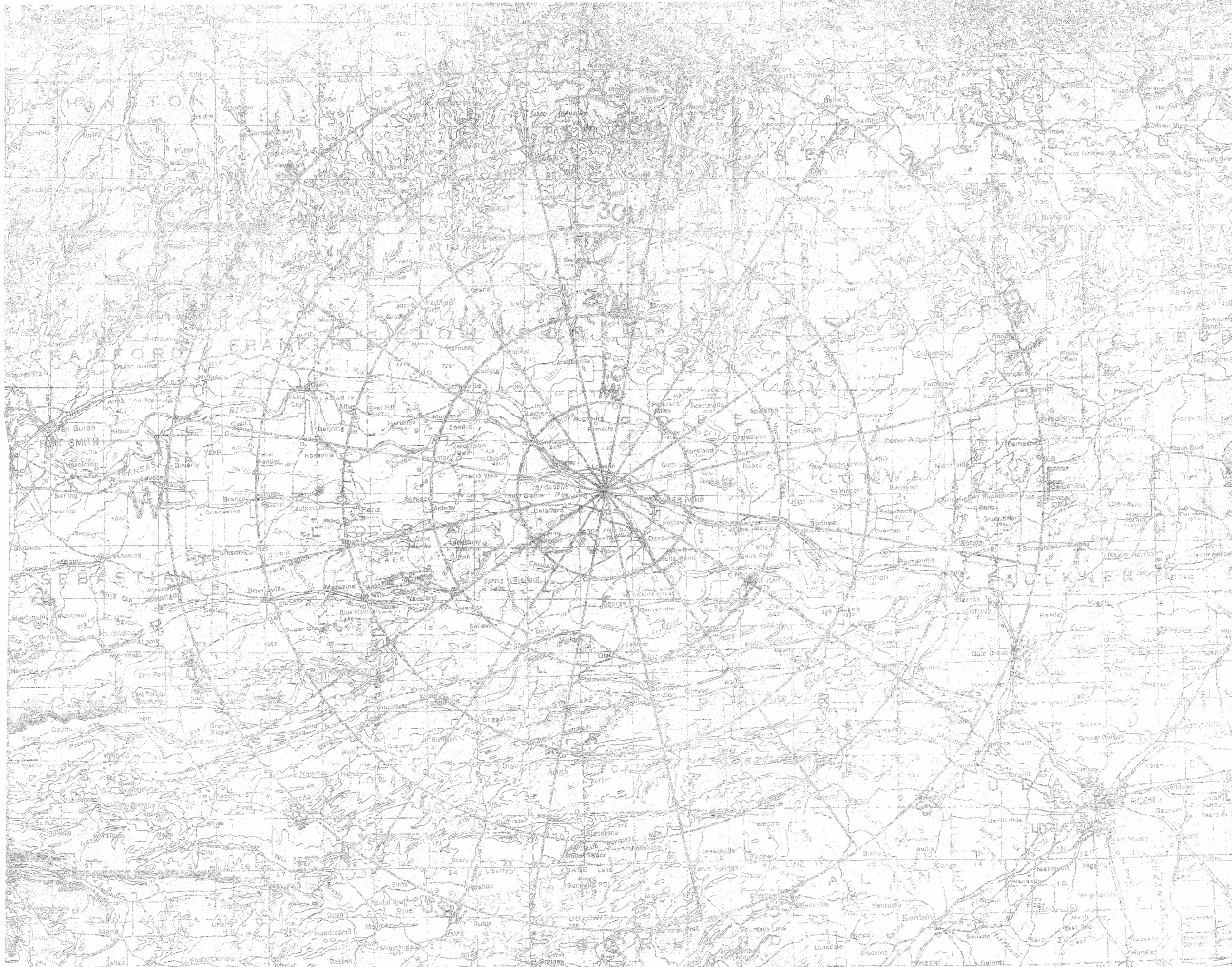

TOPOGRAPHIC MAP 50 MILE RADIUS FROM SITE

SAR FIGURE NO. 2.3-3

ARKANSAS NUCLEAR ONE
 UNIT 2
 RUSSELLVILLE, ARKANSAS



SCALE:	NONE
DRAWN:	ENERGY
DESIGN:	ENERGY
CAD NO:	

AMENDMENT 19

BASED ON DRAWING NO

SHEET

REV.

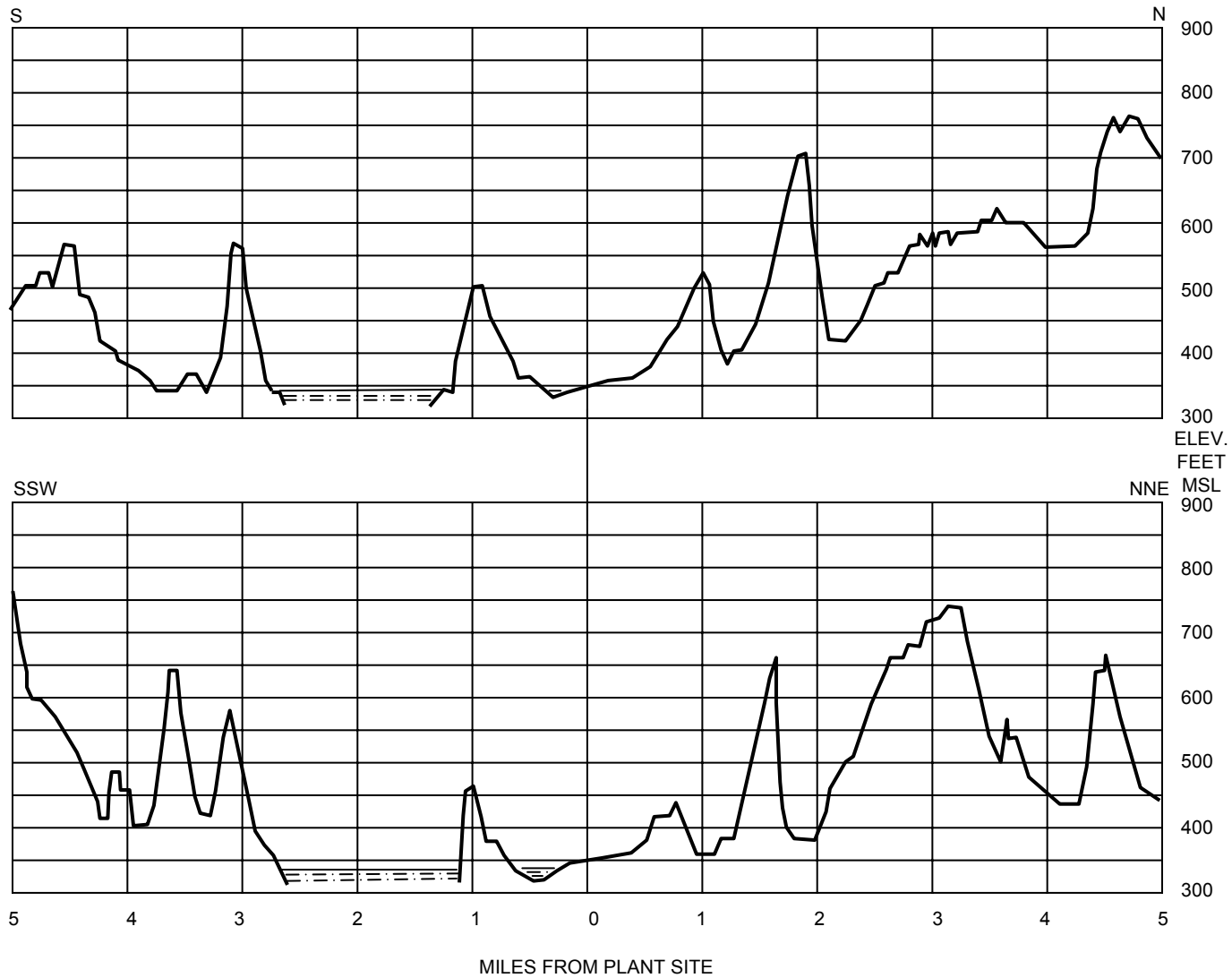

TOPOGRAPHIC PROFILES

SAR FIGURE NO. 2.3-4

ARKANSAS NUCLEAR ONE
 UNIT 2
 RUSSELLVILLE, ARKANSAS



SCALE: NONE
 DRAWN: ENTERGY
 DESIGN: ENTERGY
 CAD NO:

AMENDMENT 19

BASED ON DRAWING NO

SHEET

REV.

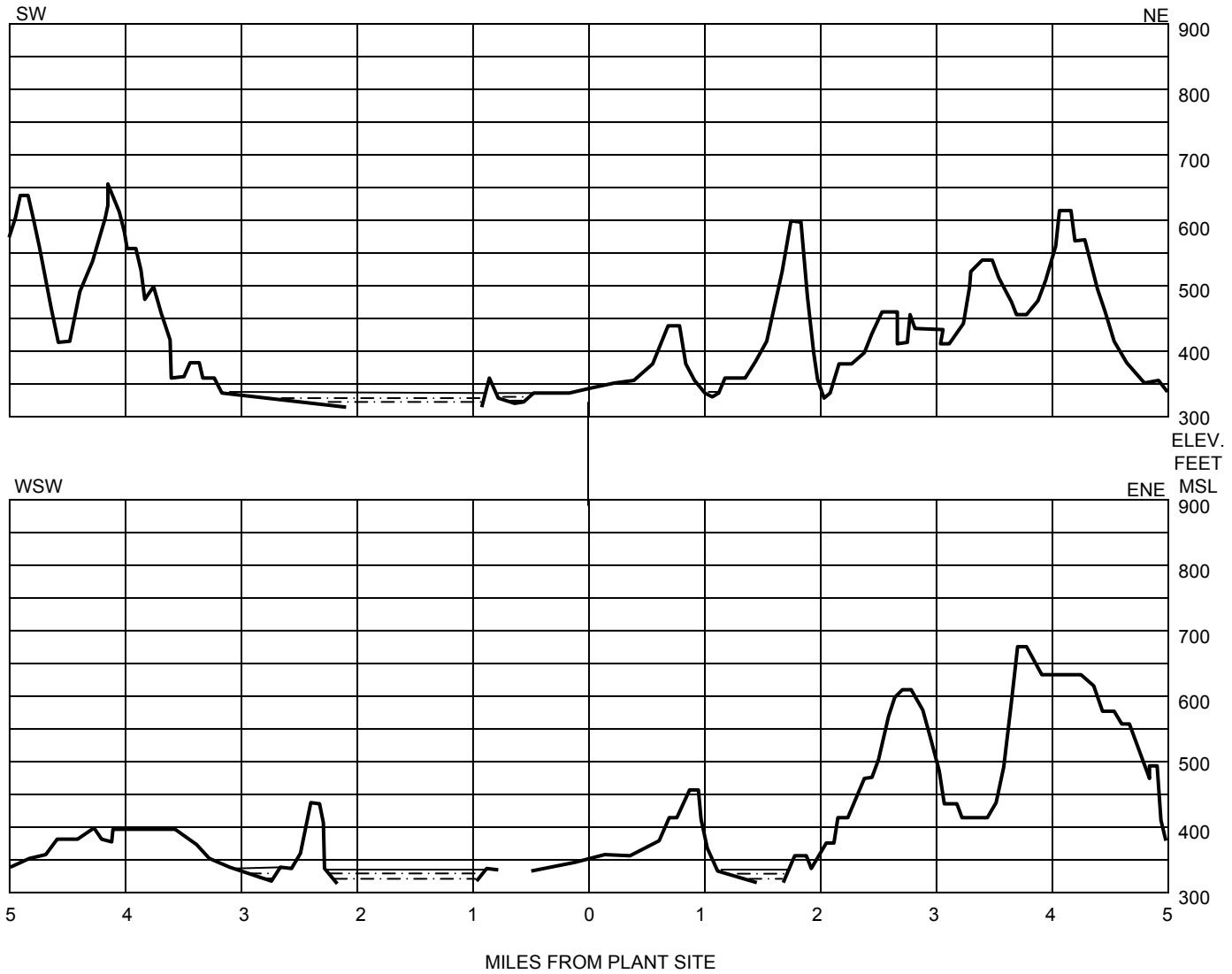

TOPOGRAPHIC PROFILES

SAR FIGURE NO. 2.3-5

ARKANSAS NUCLEAR ONE
 UNIT 2
 RUSSELLVILLE, ARKANSAS



SCALE: NONE
 DRAWN: ENTERGY
 DESIGN: ENTERGY
 CAD NO:

AMENDMENT 19

BASED ON DRAWING NO

SHEET

REV.

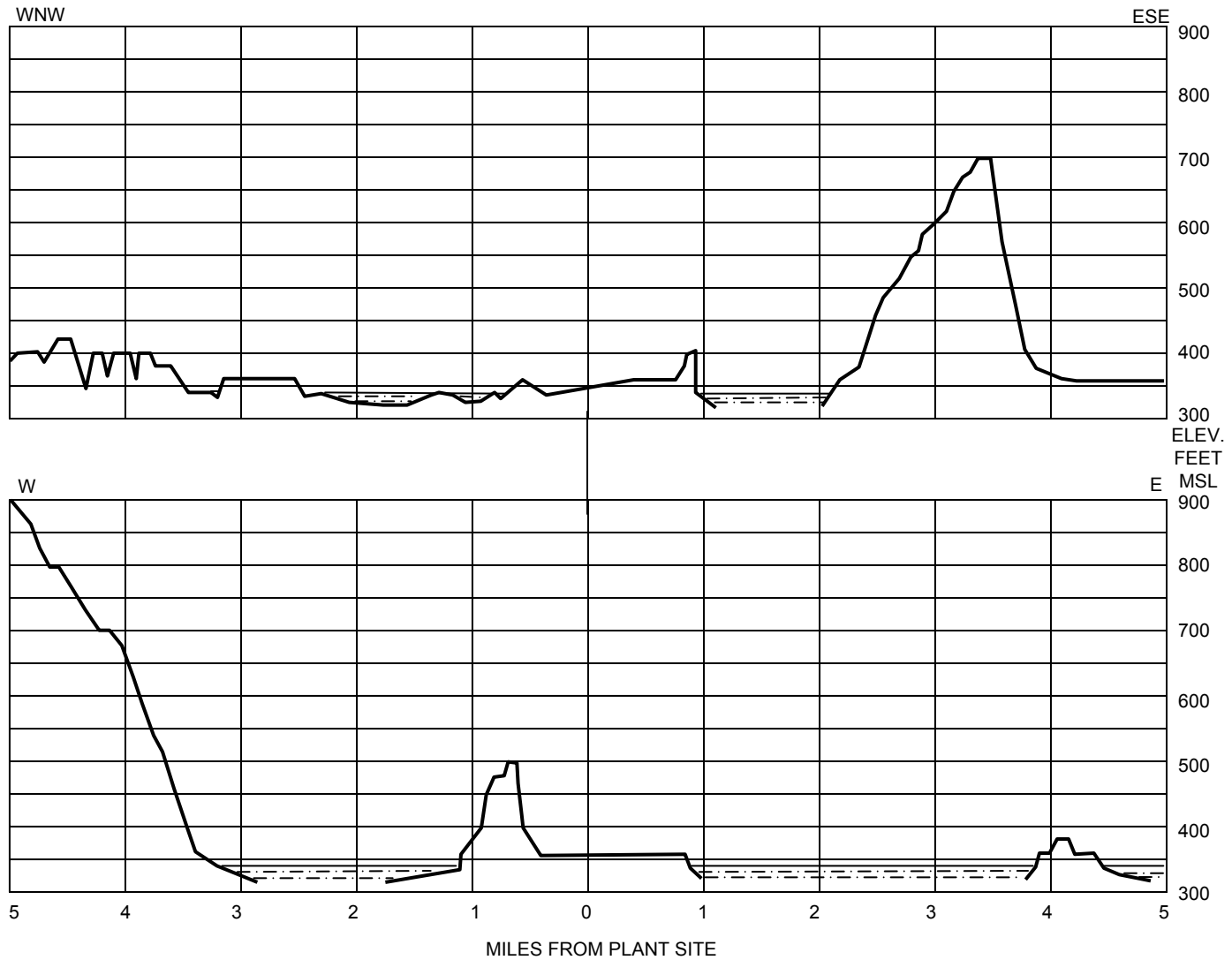

TOPOGRAPHIC PROFILES

SAR FIGURE NO. 2.3-6

ARKANSAS NUCLEAR ONE
 UNIT 2
 RUSSELLVILLE, ARKANSAS



SCALE: NONE
 DRAWN: ENTERGY
 DESIGN: ENTERGY
 CAD NO:

AMENDMENT 19

BASED ON DRAWING NO	SHEET	REV.

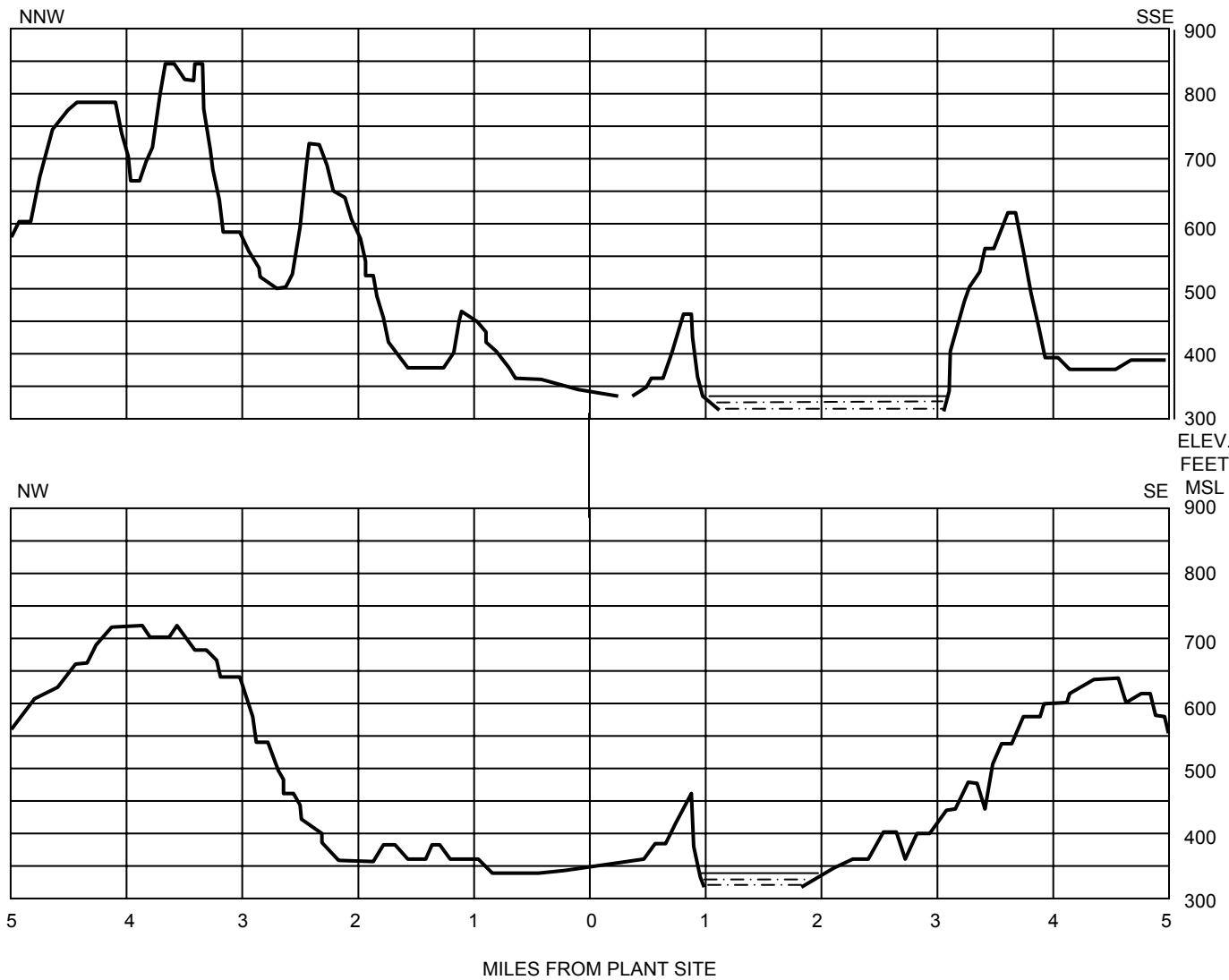

TOPOGRAPHIC PROFILES

SAR FIGURE NO. 2.3-7

ARKANSAS NUCLEAR ONE
 UNIT 2
 RUSSELLVILLE, ARKANSAS



SCALE: NONE
 DRAWN: ENTERGY
 DESIGN: ENTERGY
 CAD NO:

AMENDMENT 19

BASED ON DRAWING NO	SHEET	REV.

RELATIVE CONCENTRATION FREQUENCIES AT THE SITE
BOUNDARY ASSUMING CENTERLINE INVARIANT WIND

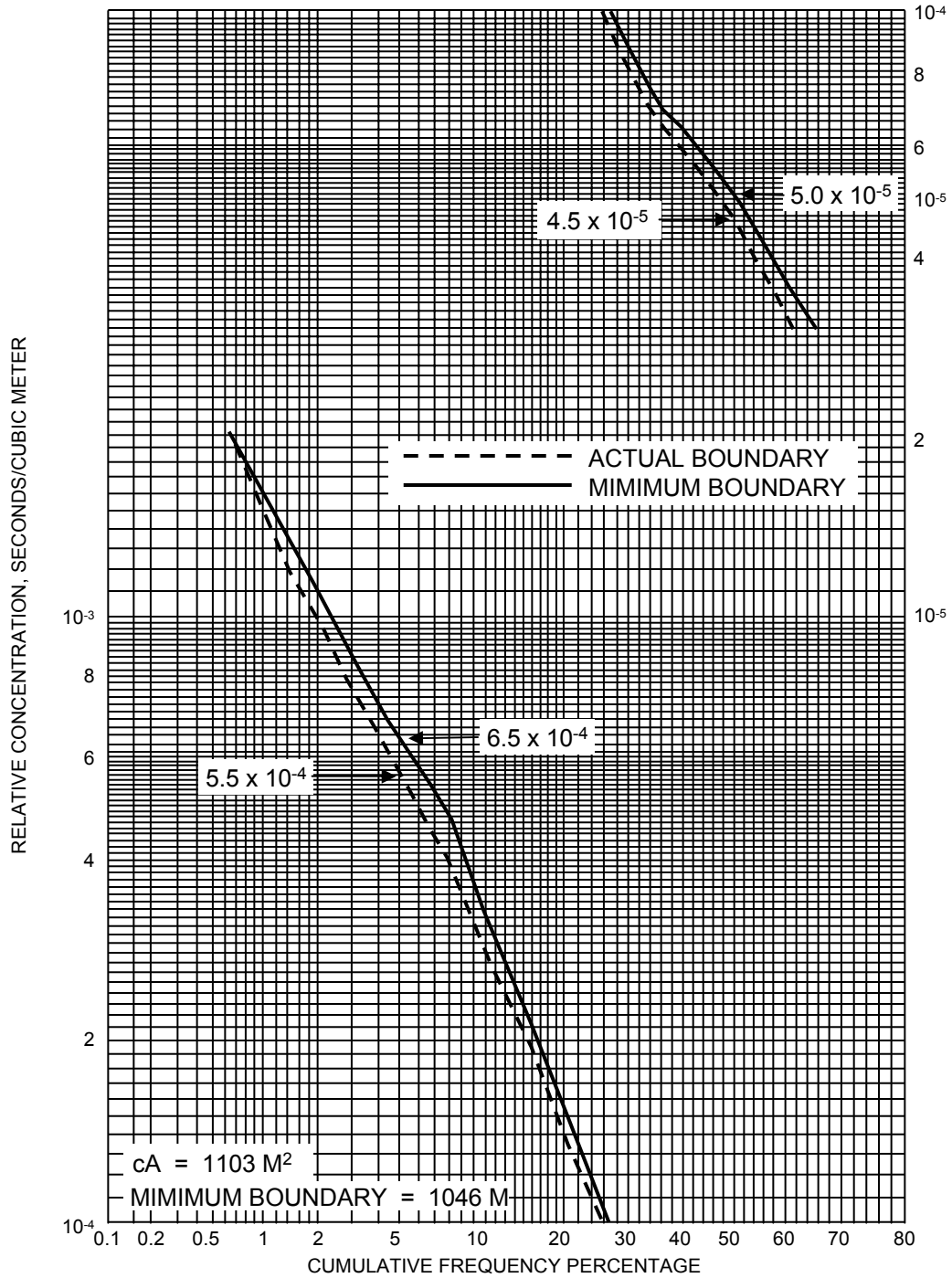

ARKANSAS ONE NUCLEAR SITE
DATA PERIOD FEBRUARY 7, 1972 – FEBRUARY 7, 1973
8401 VALID HOURLY OBSERVATIONS

SAR FIGURE NO. 2.3-8

AMENDMENT 19

ARKANSAS NUCLEAR ONE
UNIT 2
RUSSELLVILLE, ARKANSAS



SCALE: NONE
DRAWN:
DESIGN: ENTERGY
CAD NO:

RELATIVE CONCENTRATION
FREQUENCIES

BASED ON DRAWING NO

SHEET

REV.

0 – 8 HOUR WORST SECTOR PERCENTILE FREQUENCIES OF ALL
 RUNNING AVERAGES AT LOW POPULATION ZONE BOUNDARY (6436 M)

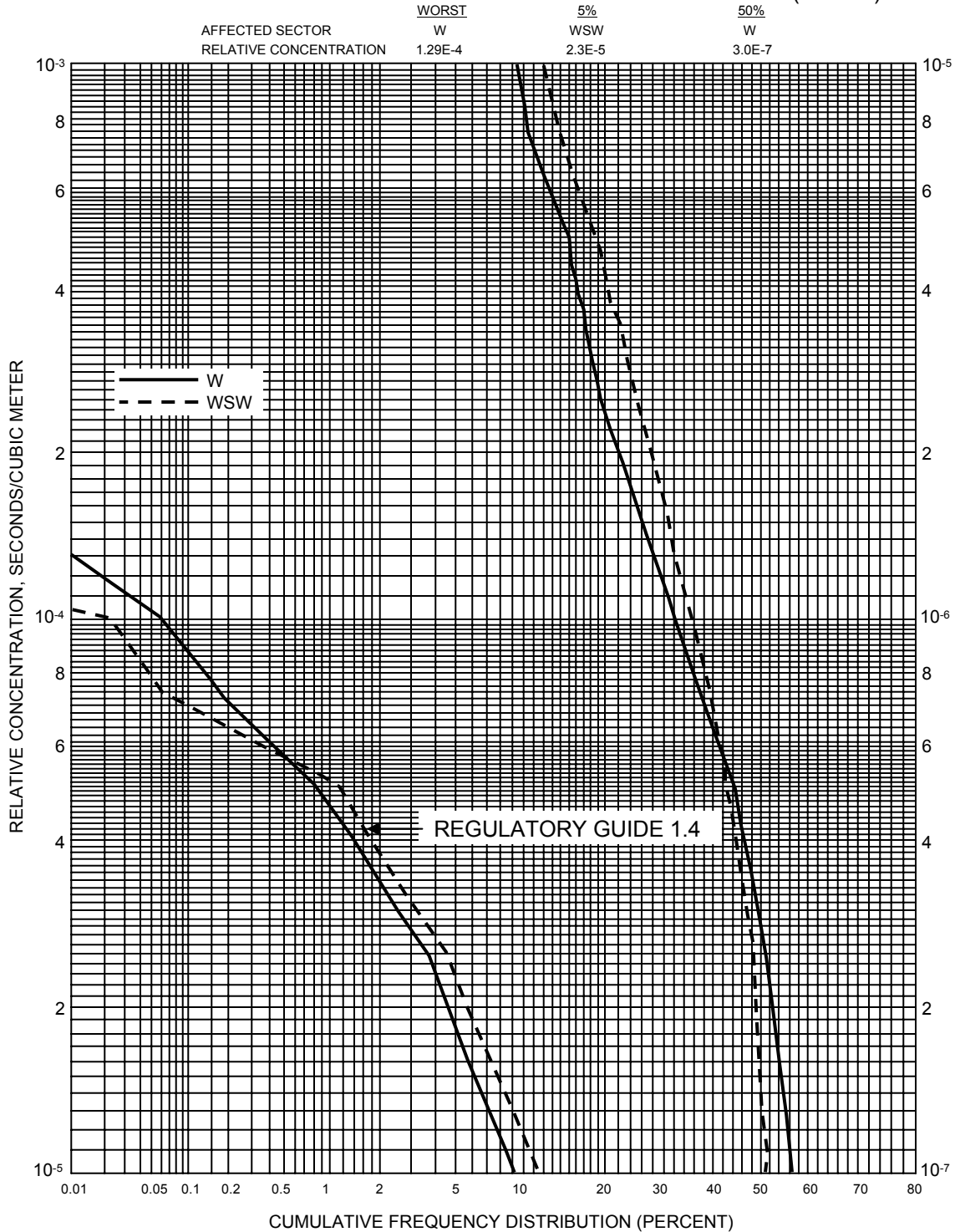

DILUTION FACTORS – SHORT TERM – 0 TO 8 HOURS
 DATA PERIOD FEBRUARY 7, 1972 – FEBRUARY 7, 1973

SAR FIGURE NO. 2.3-9

AMENDMENT 19

ARKANSAS NUCLEAR ONE
 UNIT 2
 RUSSELLVILLE, ARKANSAS



SCALE: NONE
 DRAWN:
 DESIGN: ENTERGY
 CAD NO:

DILUTION FACTORS

BASED ON DRAWING NO

SHEET

REV.

8 – 24 HOUR WORST SECTOR PERCENTILE FREQUENCIES OF ALL
 RUNNING AVERAGES AT LOW POPULATION ZONE BOUNDARY (6436 M)

AFFECTED SECTOR	WORST	5%	50%
	W	WSW	WSW
RELATIVE CONCENTRATION	7.63E-6	2.6E-6	2.8E-7

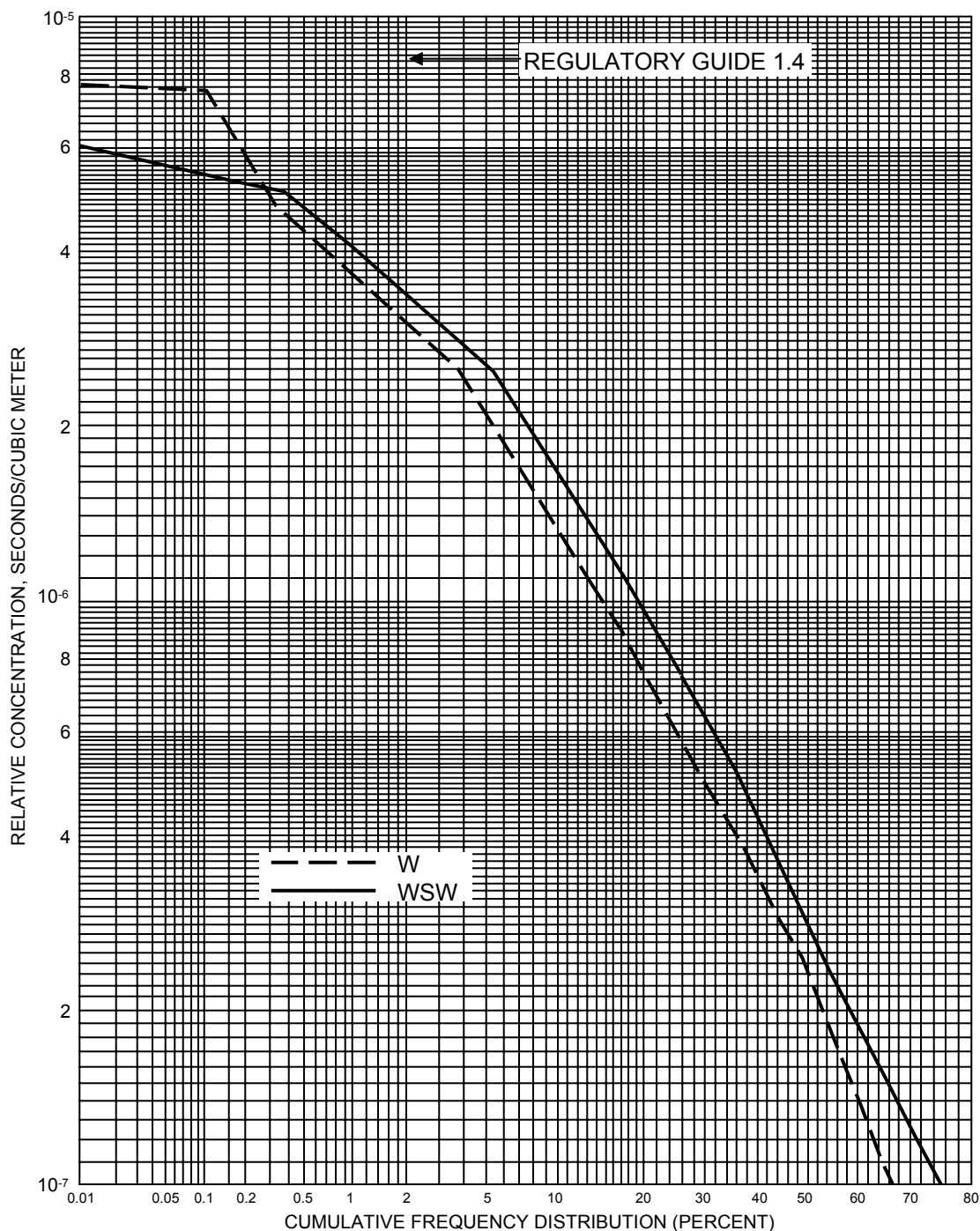

DILUTION FACTORS – SHORT TERM – 8 TO 24 HOURS
 DATA PERIOD FEBRUARY 7, 1972 – FEBRUARY 7, 1973

SAR FIGURE NO. 2.3-10

AMENDMENT 19

ARKANSAS NUCLEAR ONE
 UNIT 2
 RUSSELLVILLE, ARKANSAS



SCALE:	NONE
DRAWN:	
DESIGN:	ENTERGY
CAD NO:	

DILUTION FACTORS

BASED ON DRAWING NO

SHEET

REV.

DATA PERIOD FEBRUARY 7, 1972 – FEBRUARY 7, 1973

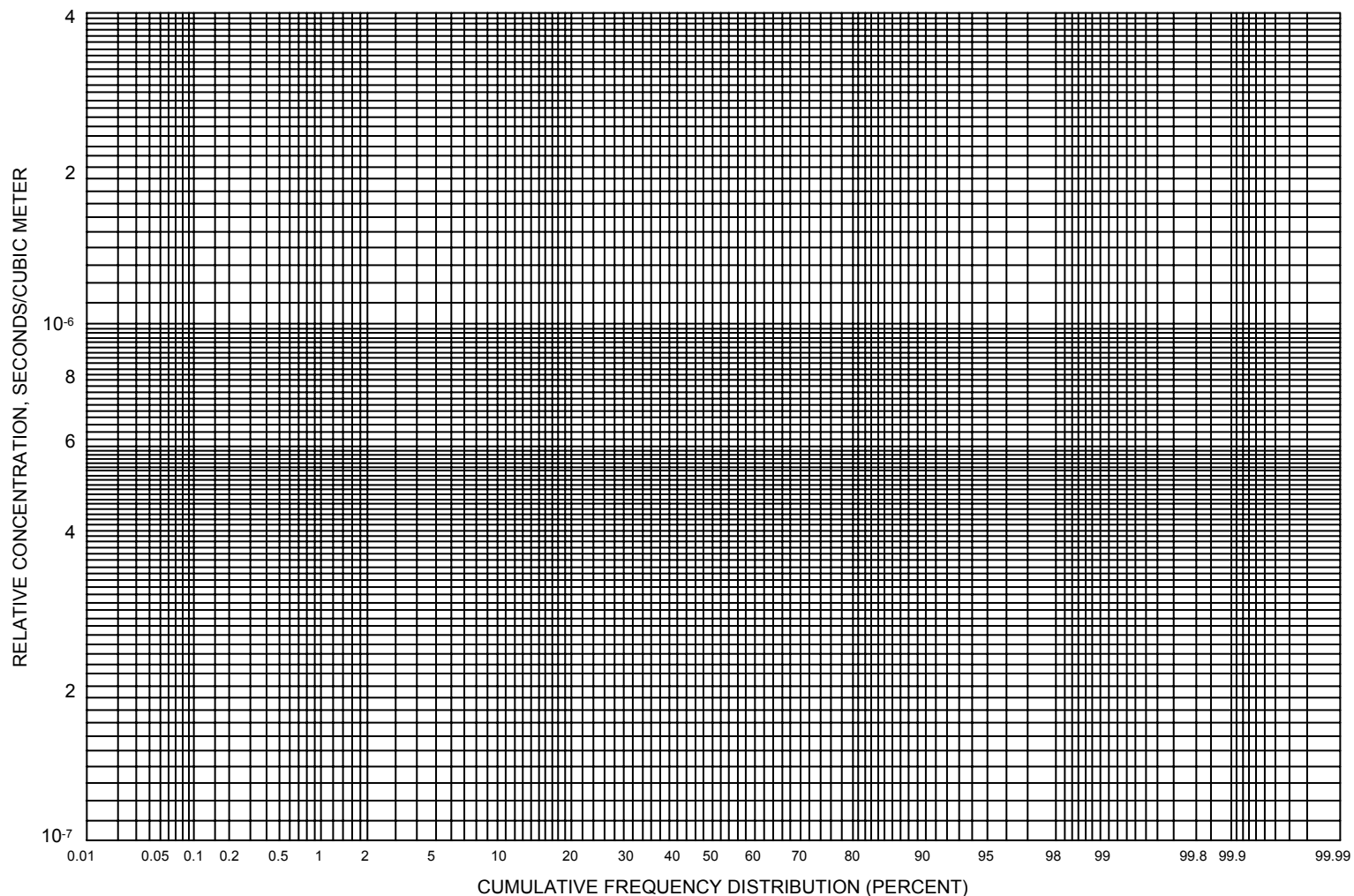

DILUTION FACTORS – SHORT TERM – 1 TO 4 DAYS

DILUTION FACTORS

SAR FIGURE NO. 2.3-11

ARKANSAS NUCLEAR ONE
UNIT 2
RUSSELLVILLE, ARKANSAS



SCALE: NONE
DRAWN: ENTERGY
DESIGN: ENTERGY
CAD NO:

AMENDMENT 19

BASED ON DRAWING NO

SHEET

REV.

DATA PERIOD FEBRUARY 7, 1972 – FEBRUARY 7, 1973

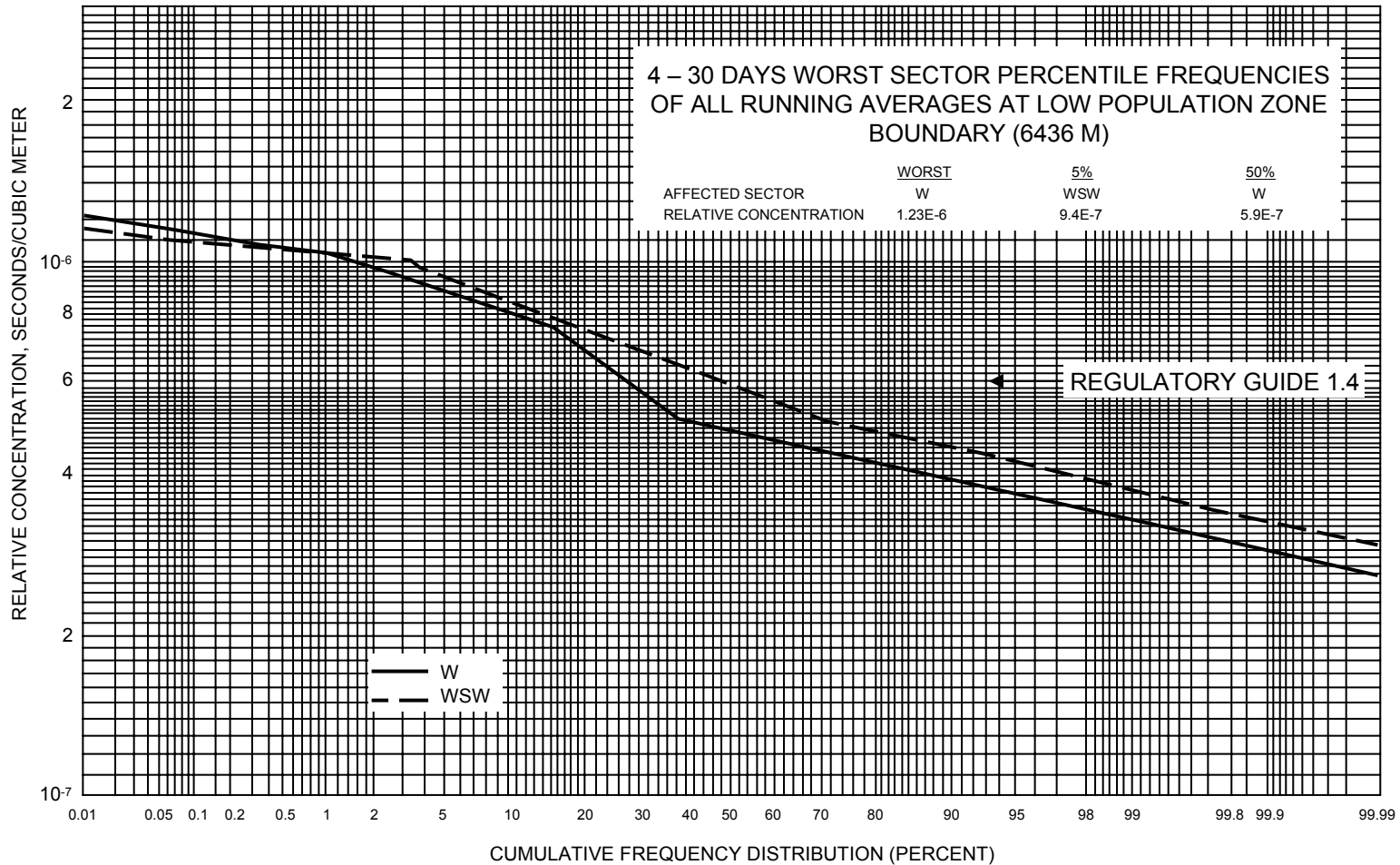

DILUTION FACTORS – SHORT TERM – 4 TO 30 DAYS

DILUTION FACTORS

SAR FIGURE NO. 2.3-12

ARKANSAS NUCLEAR ONE
UNIT 2
RUSSELLVILLE, ARKANSAS



SCALE: NONE
DRAWN: ENTERGY
DESIGN: ENTERGY
CAD NO:

AMENDMENT 19

BASED ON DRAWING NO

SHEET

REV.

DATA PERIOD FEBRUARY 7, 1972 – FEBRUARY 7, 1973

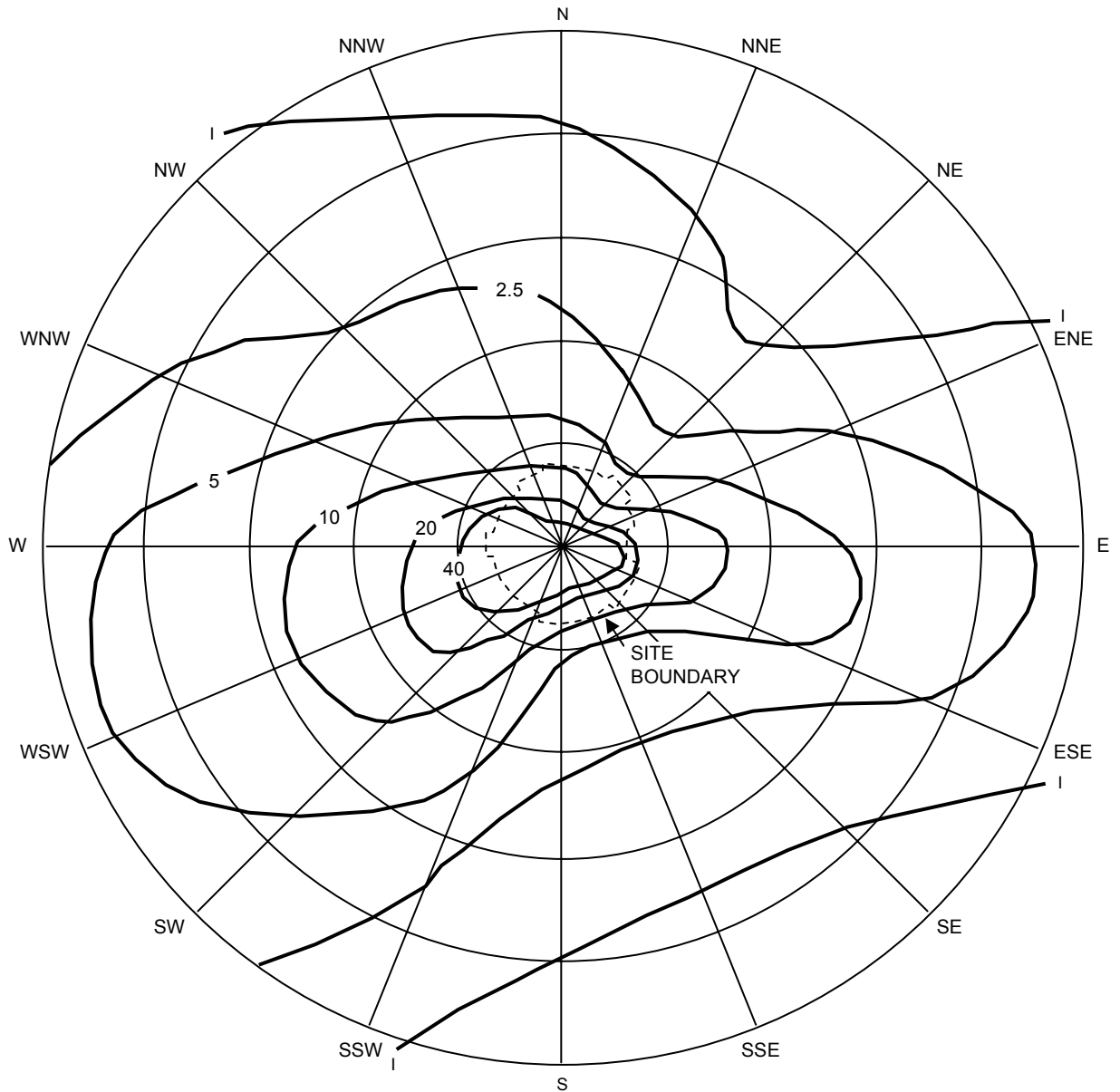

ARKANSAS POWER & LIGHT COMPANY
 ARKANSAS ONE NUCLEAR POWER STATION

DILUTION FACTORS – LONG TERM (X 10⁻⁷ SECONDS/METER³)
 0 TO 5 MILES

SAR FIGURE NO. 2.3-13

AMENDMENT 19

ARKANSAS NUCLEAR ONE
 UNIT 2
 RUSSELLVILLE, ARKANSAS



SCALE:	NONE
DRAWN:	
DESIGN:	ENTERGY
CAD NO:	

DILUTION FACTORS

BASED ON DRAWING NO

SHEET

REV.

DATA PERIOD FEBRUARY 7, 1972 – FEBRUARY 7, 1973

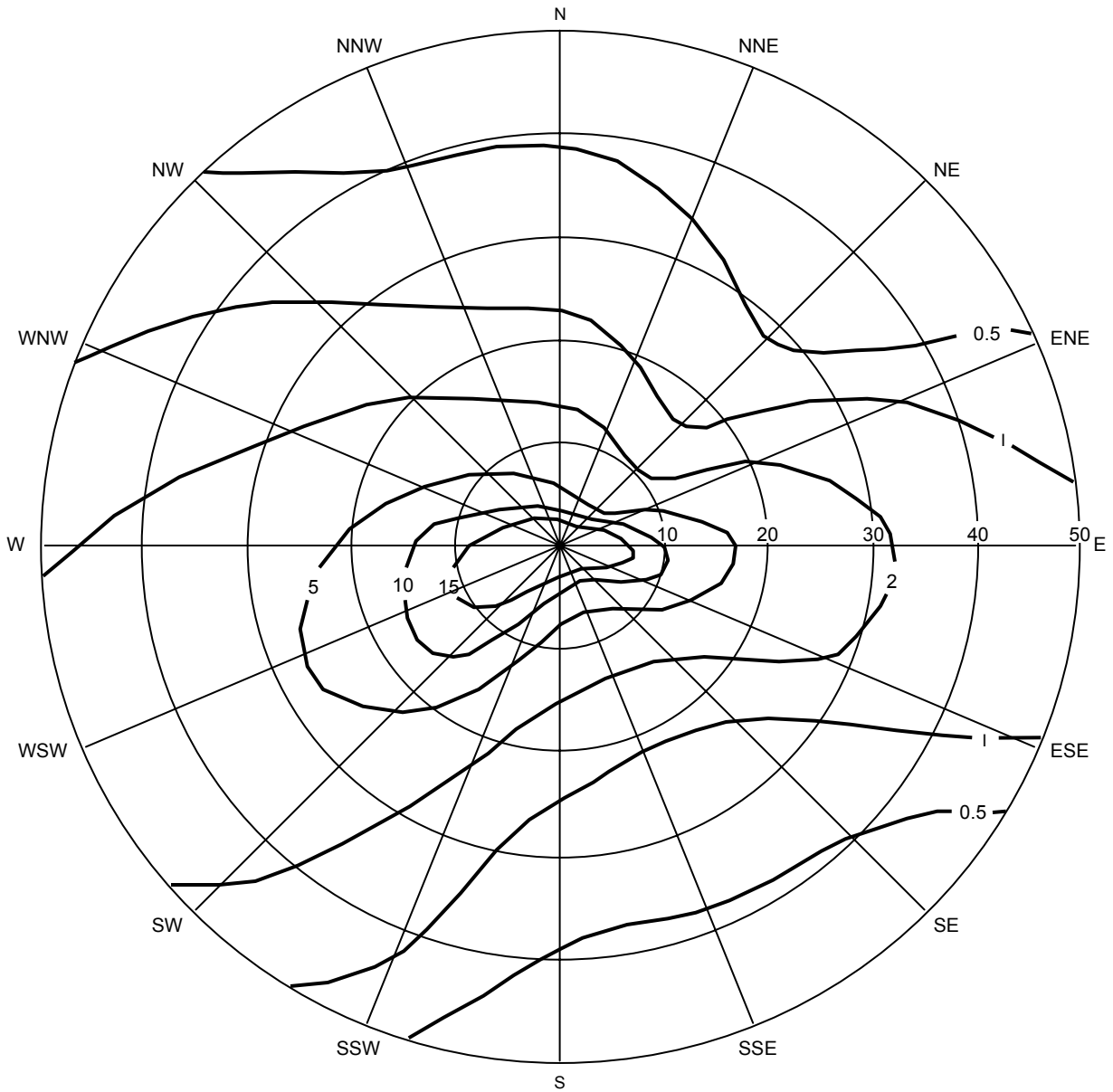

ARKANSAS POWER & LIGHT COMPANY
 ARKANSAS ONE NUCLEAR POWER STATION

DILUTION FACTORS – LONG TERM ($\times 10^{-8}$ SECONDS/METER³)
 0 TO 50 MILES

SAR FIGURE NO. 2.3-14

AMENDMENT 19

ARKANSAS NUCLEAR ONE
 UNIT 2
 RUSSELLVILLE, ARKANSAS



SCALE:	NONE
DRAWN:	
DESIGN:	ENTERGY
CAD NO:	

DILUTION FACTORS

BASED ON DRAWING NO

SHEET

REV.



EXPLANATION

- LINE A' — Seismic Line
- DH Δ — Core Hole
- I ⊕ — Sampled water well and identification (See Table 2.4-1)
- A ⊕ — Measured water well
- P — Piezometer
- O AH — Auger Hole
- O WB — Wash bore hole
- 314 — Bedrock elevation
- 351 — Surface elevation
- 334 — Piezometric surface elevation
- 353 — Surface Elevation
- 333 — Bedrock elevation

NOTES

1. Water sample 13 taken 300' downstream Dardanelle Dam.
2. Wash bore 4 and 5 not shown.

AUGER HOLE DATA					
Hole No.	Surface El.	Bedrock El.	Hole No.	Surface El.	Bedrock El.
1	338'	315'	14	352'	327'
2	340'	318'	15	383'	367'
3	345'	322'	16	349'	332'
4	350'	326'	17	343'	339'
5	352'	329'	18	346'	338'
6	352'	329'	19	357'	344'
7	354'	342'	20	354'	344'
8	353'	337'	21	353'	336'
9	353'	336'	22	353'	332'
10	353'	338'	23	349'	326'
11	354'	338'	24	343'	327'
12	353'	332'	25	343'	330'
13	352'	331'	26	339'	329'

(Topography reproduced from U.S.G.S. 7.5 minute Russellville West, Ark. Map sheet)



Contour interval = 20 feet

LOCATION OF FIELD INVESTIGATIONS

SAR FIGURE NO. 2.4-1

ARKANSAS NUCLEAR ONE
UNIT 2
RUSSELLVILLE, ARKANSAS



SCALE: NONE
DRAWN: ENERGENCY
DESIGN: ENERGENCY
CAD NO:

AMENDMENT 19

BASED ON DRAWING NO

SHEET

REV.

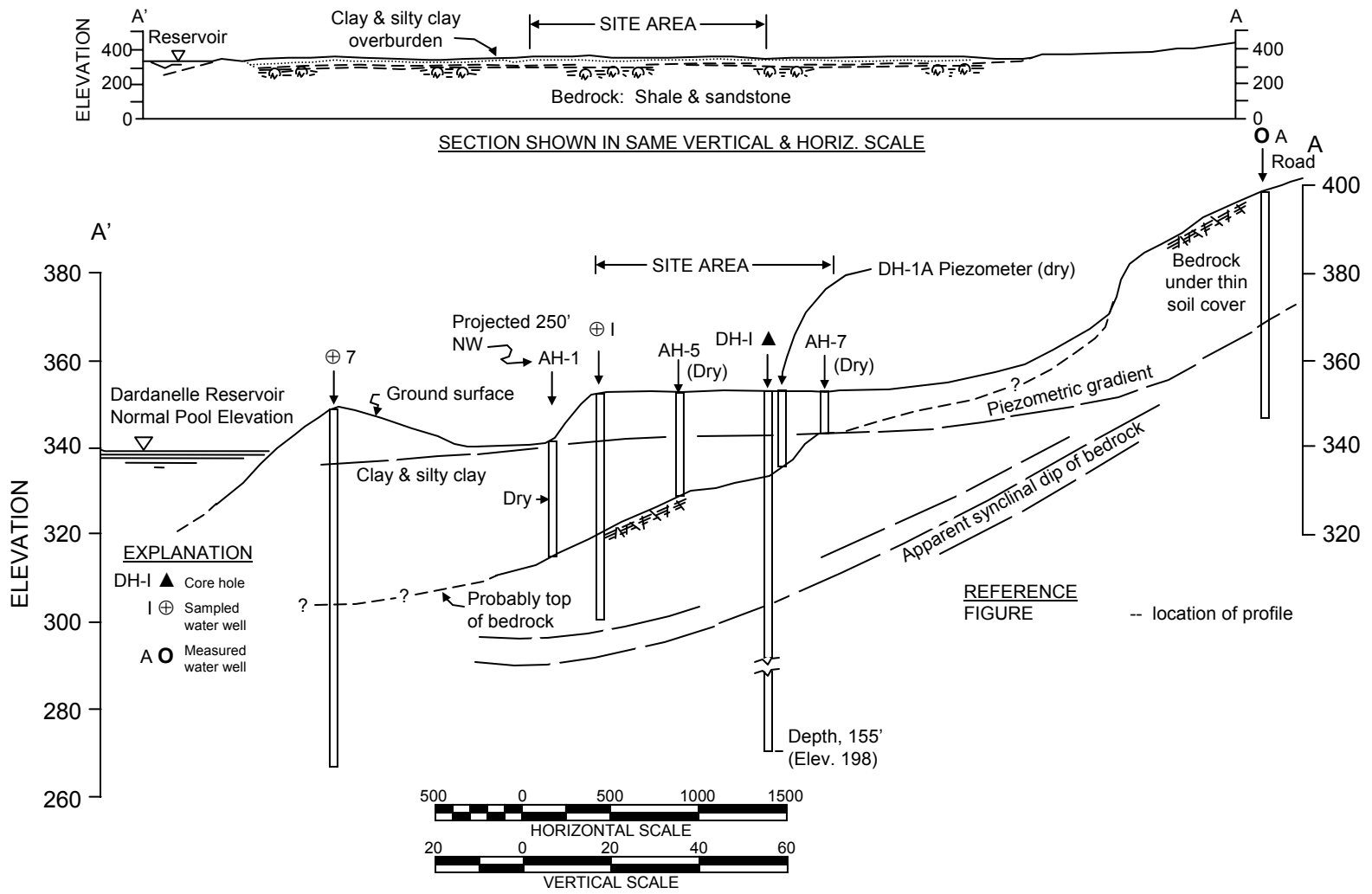

GEOLOGIC SECTION A' - A

SAR FIGURE NO. 2.4-2

ARKANSAS NUCLEAR ONE
UNIT 2
RUSSELLVILLE, ARKANSAS



SCALE: NONE
DRAWN: ENTERGY
DESIGN: ENTERGY
CAD NO:

AMENDMENT 19

BASED ON DRAWING NO	SHEET	REV.
---------------------	-------	------

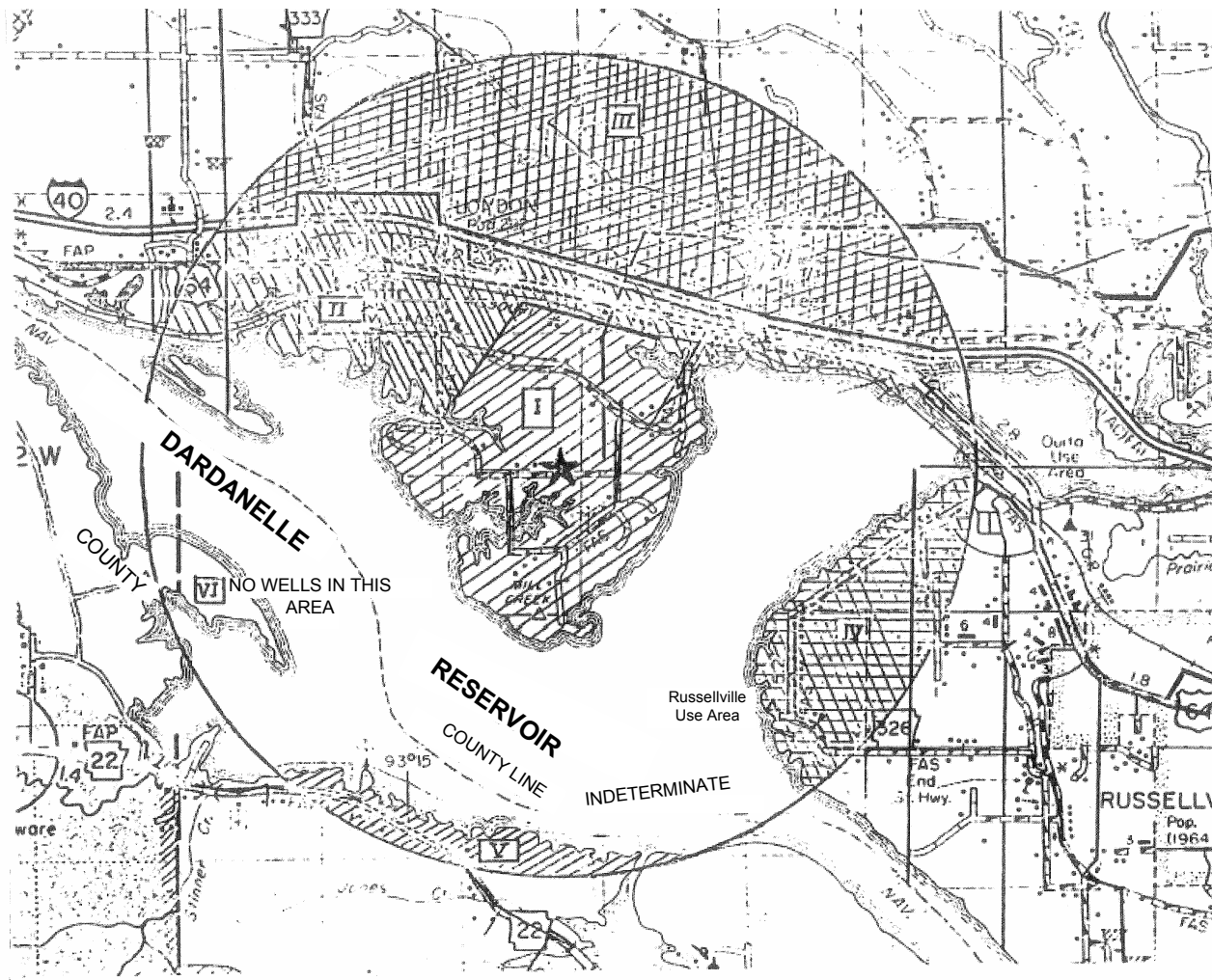

LOCATION OF WELL SURVEY

SAR FIGURE NO. 2.4-3

ARKANSAS NUCLEAR ONE
 UNIT 2
 RUSSELLVILLE, ARKANSAS



SCALE: NONE
 DRAWN: ENTERGY
 DESIGN: ENTERGY
 CAD NO:

AMENDMENT 19

BASED ON DRAWING NO

SHEET

REV.

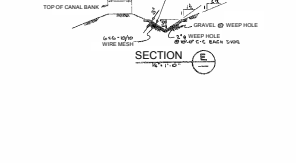
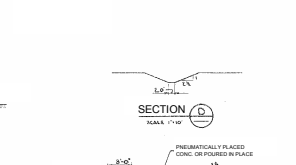
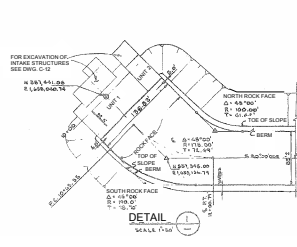
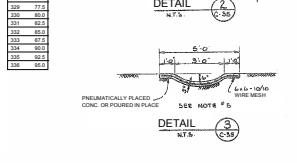
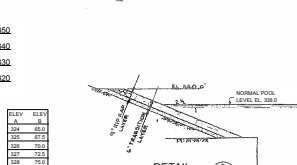
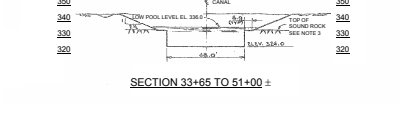
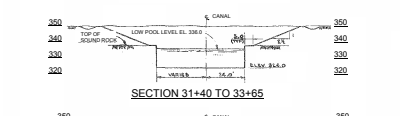
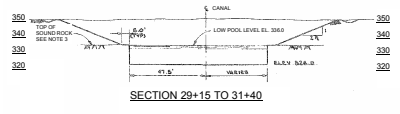
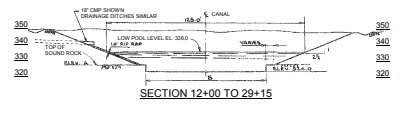
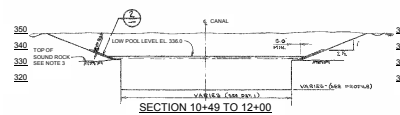
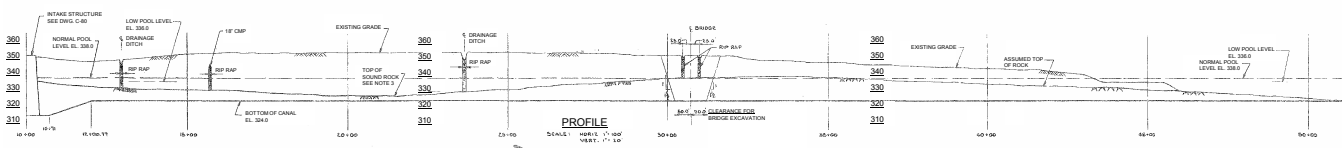
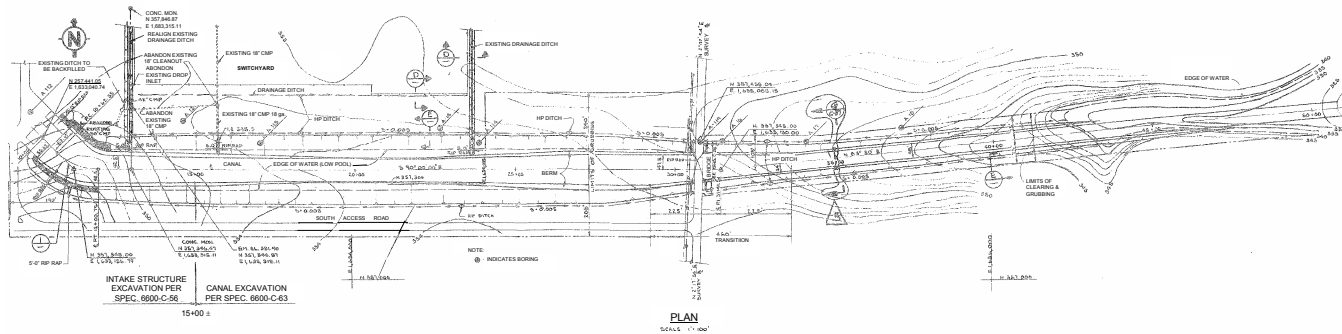

INTAKE CANAL PLAN, PROFILE & DETAILS

SAR FIGURE NO. 2.4-6

ARKANSAS NUCLEAR ONE
UNIT 2
RUSSELLVILLE, ARKANSAS



SCALE:	NONE
DRAWN:	ENERGY
DESIGN:	ENERGY
CAD NO:	

AMENDMENT 19		
BASED ON DRAWING NO	SHEET	REV.

Security-Related Information
Text Withheld Under 10 CFR 2.390

DISCHARGE CANAL PLAN, PROFILE & DETAILS

SAR FIGURE NO. 2.4-7

ARKANSAS NUCLEAR ONE
UNIT 2
RUSSELLVILLE, ARKANSAS



SCALE:	NONE
DRAWN:	ENTERGY
DESIGN:	ENTERGY
CAD NO:	

AMENDMENT 26

BASED ON DRAWING NO

SHEET

REV.

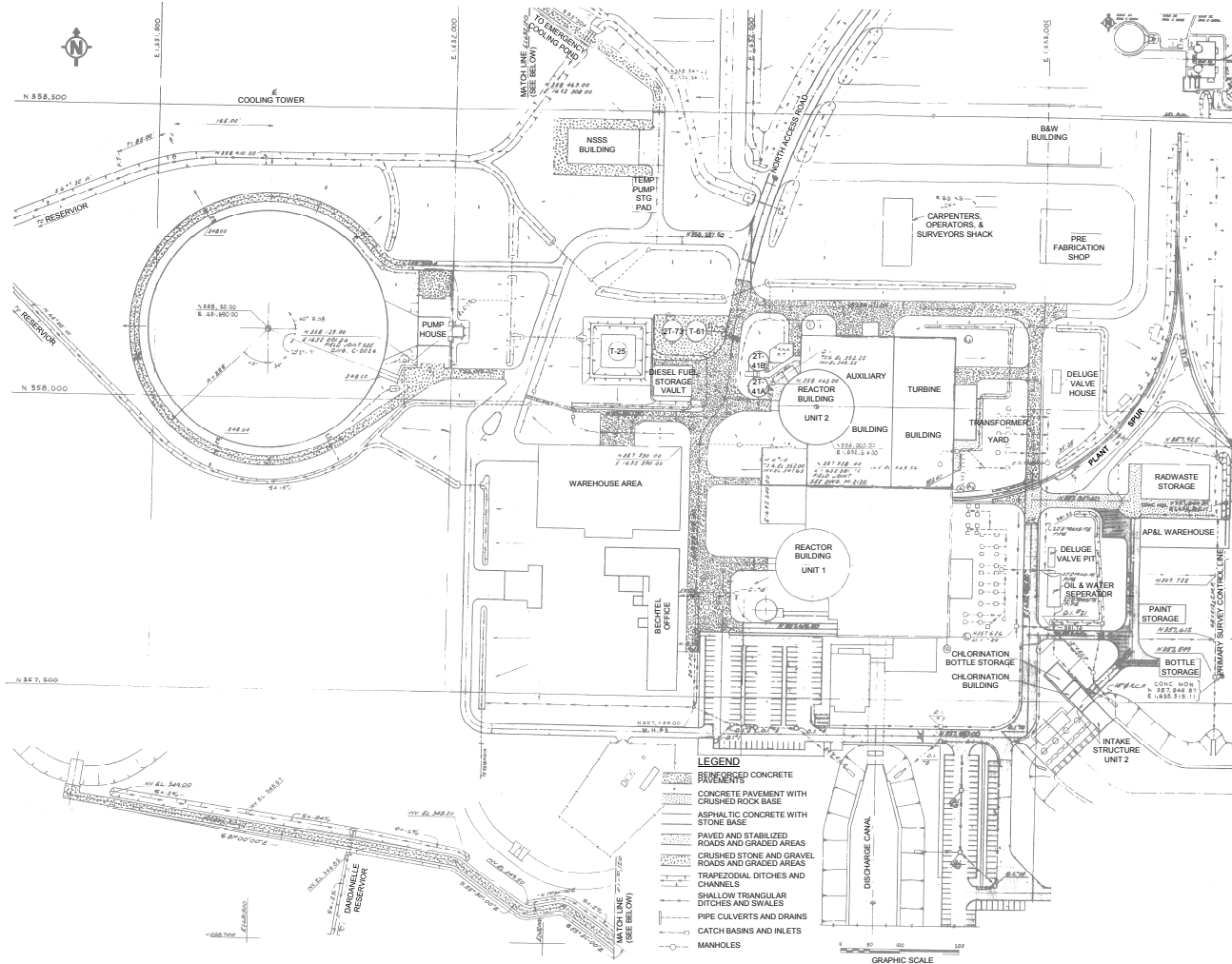

GENERAL GRADING & DRAINAGE PLAN

SAR FIGURE NO. 2.4-8

ARKANSAS NUCLEAR ONE
 UNIT 2
 RUSSELLVILLE, ARKANSAS



SCALE: NONE
 DRAWN: ENTERGY
 DESIGN: ENTERGY
 CAD NO:

AMENDMENT 26

BASED ON DRAWING NO

SHEET

REV.

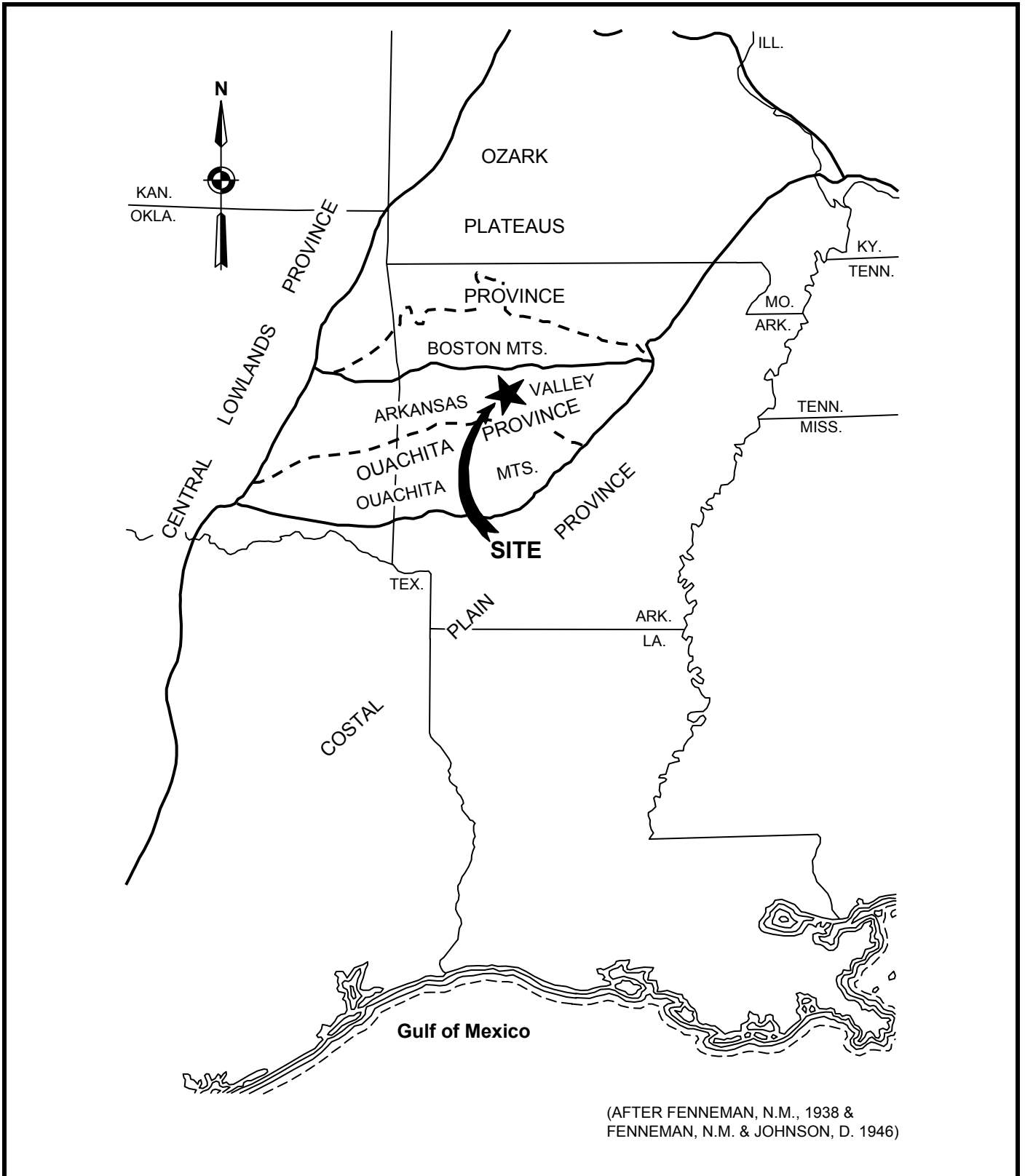

SAR FIGURE NO. 2.5-1

AMENDMENT 19

ARKANSAS NUCLEAR ONE
UNIT 2
RUSSELLVILLE, ARKANSAS



SCALE:	NONE
DRAWN:	
DESIGN:	ENERGY
CAD NO:	

PHYSIOGRAPHIC DIVISIONS

BASED ON DRAWING NO

SHEET

REV.

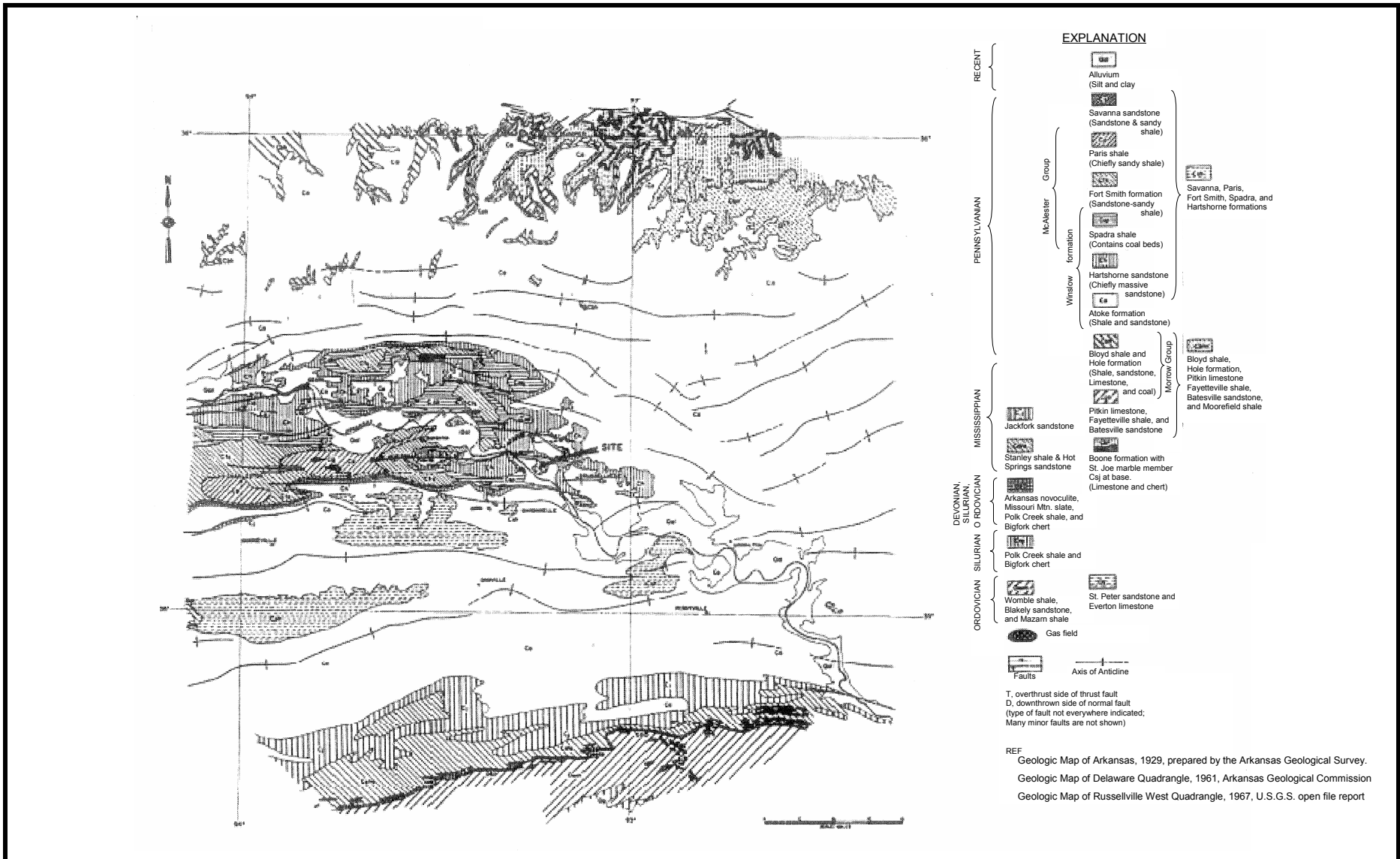

REGIONAL GEOLOGIC MAP

SAR FIGURE NO. 2.5-2

ARKANSAS NUCLEAR ONE
UNIT 2
RUSSELLVILLE, ARKANSAS



SCALE: NONE
DRAWN: ENTERGY
DESIGN: ENTERGY
CAD NO:

AMENDMENT 19

BASED ON DRAWING NO	SHEET	REV.
---------------------	-------	------

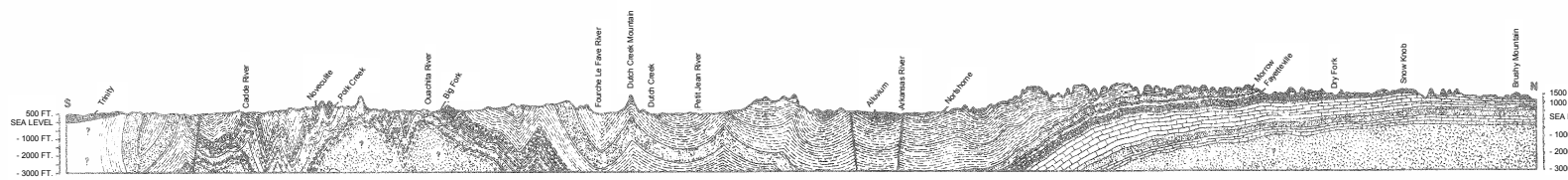
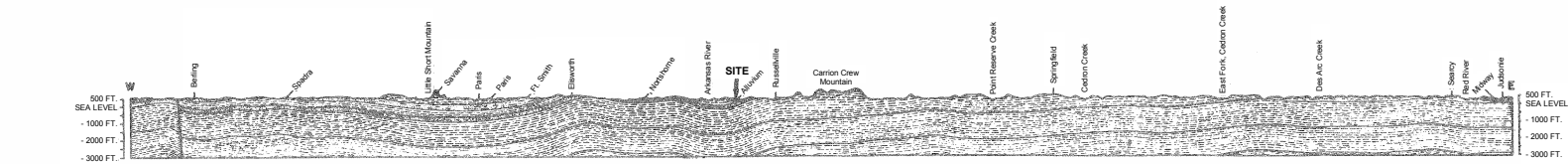

SCALE
 (VERTICAL SCALE EXAGGERATION = 10:4)

1. Sections taken from Cronels, Carey,
 "Geology of the Arkansas Paleozoic
 Area," Arkansas Geological Survey
 Bulletin 3, 1930.

REGIONAL GEOLOGIC SECTIONS

SAR FIGURE NO. 2.5-3

ARKANSAS NUCLEAR ONE
 UNIT 2
 RUSSELLVILLE, ARKANSAS



SCALE:	NONE
DRAWN:	ENERGY
DESIGN:	ENERGY
CAD NO:	

AMENDMENT 19		
BASED ON DRAWING NO	SHEET	REV.

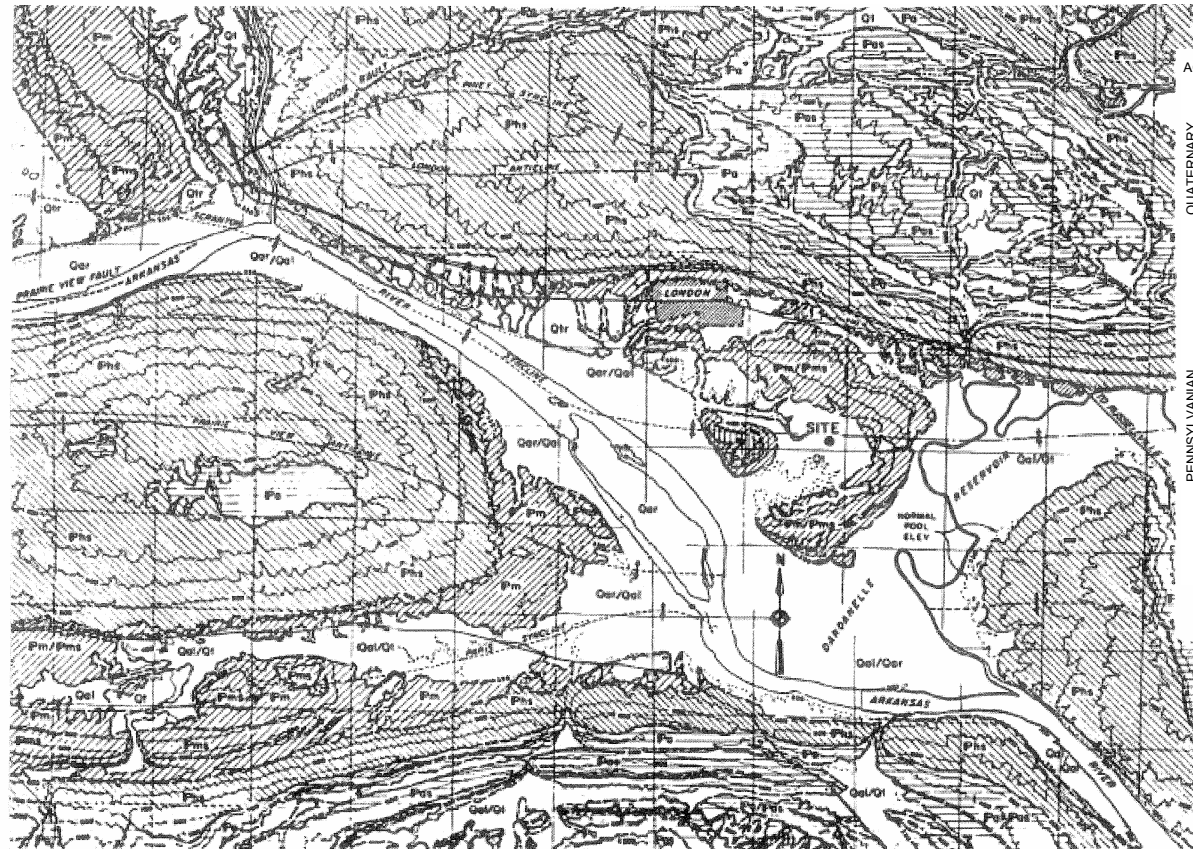

EXPLANATION

AGE:	SYMBOL:	DESCRIPTION:
QUATERNARY		Qal, alluvial deposits along stream channels and, in some places, parts of the lowermost terrace. Qar, alluvial deposits along Arkansas River
		Includes alluvial deposits in two undivided terrace levels: Qt, stream terrace; Qtr, river terrace.
PENNSYLVANIAN	UNCONFORMITY	
		Savanna formation
		Pm, shale, siltstone, and thin beds of sandstone or silty sandstone. Pms, sandstone, silty sandstone, or interbedded sandstone, siltstone and shale.
		Ph, shale, siltstone, and thin beds of sandstone or silty sandstone. Phs, sandstone, silty sandstone, or interbedded sandstone, siltstone and shale.
		Pa, shale, siltstone, and thin beds of sandstone or silty sandstone. Pas, sandstone, silty sandstone, or interbedded sandstone, siltstone and shale.

EXPLANATION OF SYMBOLS

- Geologic contact
- Fault
- Syncline
- Anticline



NOTE: Geology is from the following two sources -

1. Geology of Delaware Quadrangle and Vicinity Info Circular 20-A of Arkansas Geological Commission, 1961, Merewether and Haley
2. Geologic Map of Russellville West Quadrangle, by Boyd R. Haley, U.S. Geological Survey, prepared in cooperation with Arkansas Geological Commission

GEOLOGIC MAP SITE AND VICINITY

SAR FIGURE NO. 2.5-4

ARKANSAS NUCLEAR ONE
UNIT 2
RUSSELLVILLE, ARKANSAS



SCALE:	NONE
DRAWN:	ENERGY
DESIGN:	ENERGY
CAD NO:	

AMENDMENT 19

BASED ON DRAWING NO	SHEET	REV.

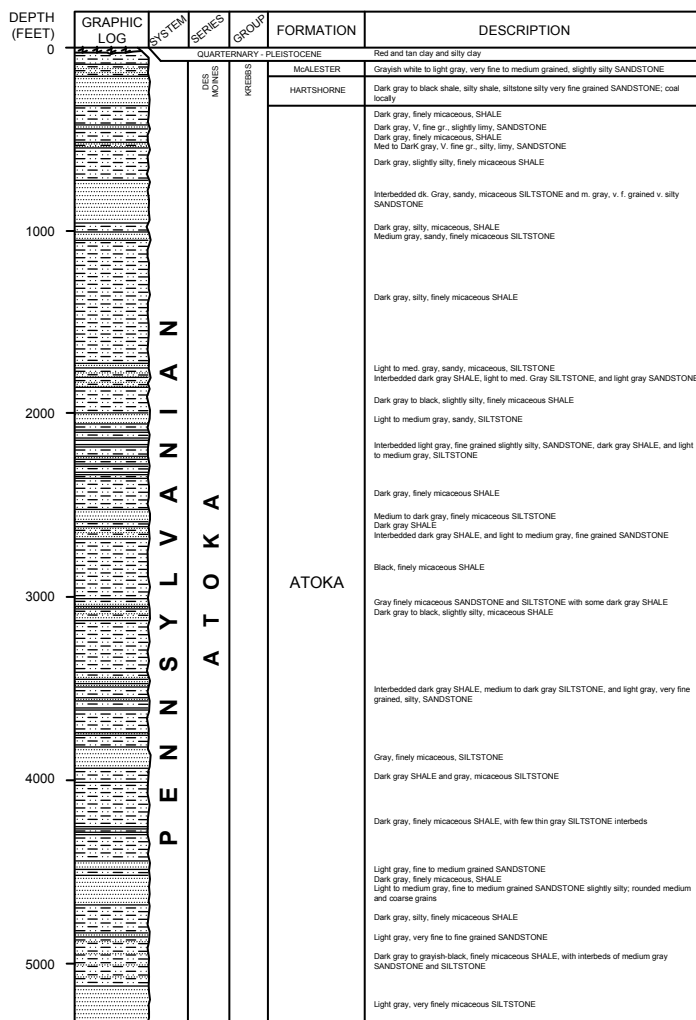

(CONTINUED)

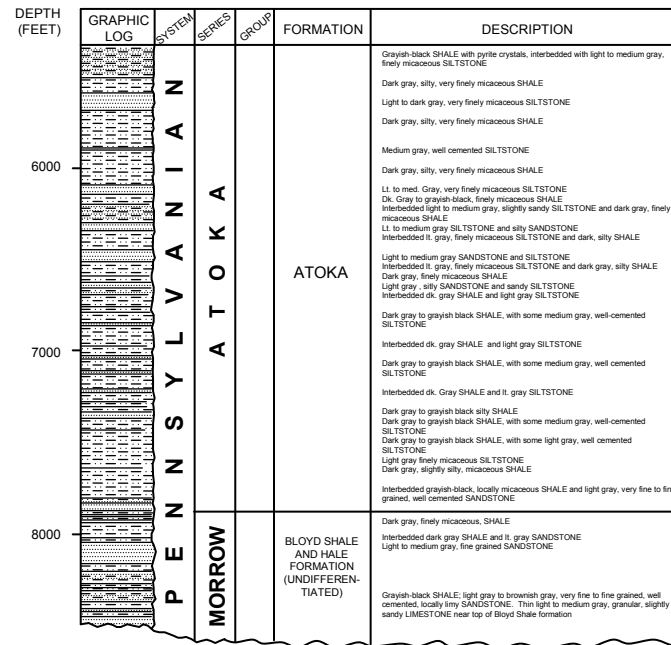

NOTE:

Lithology of formations taken from well logs in the Delaware and Russellville West Quadrangles, and from logs of site exploratory drill holes.

GENERALIZED GEOLOGIC COLUMN

SAR FIGURE NO. 2.5-5

ARKANSAS NUCLEAR ONE
UNIT 2
RUSSELLVILLE, ARKANSAS



SCALE: NONE
DRAWN: ENERGENCY
DESIGN: ENERGENCY
CAD NO:

AMENDMENT 19

BASED ON DRAWING NO

SHEET

REV.

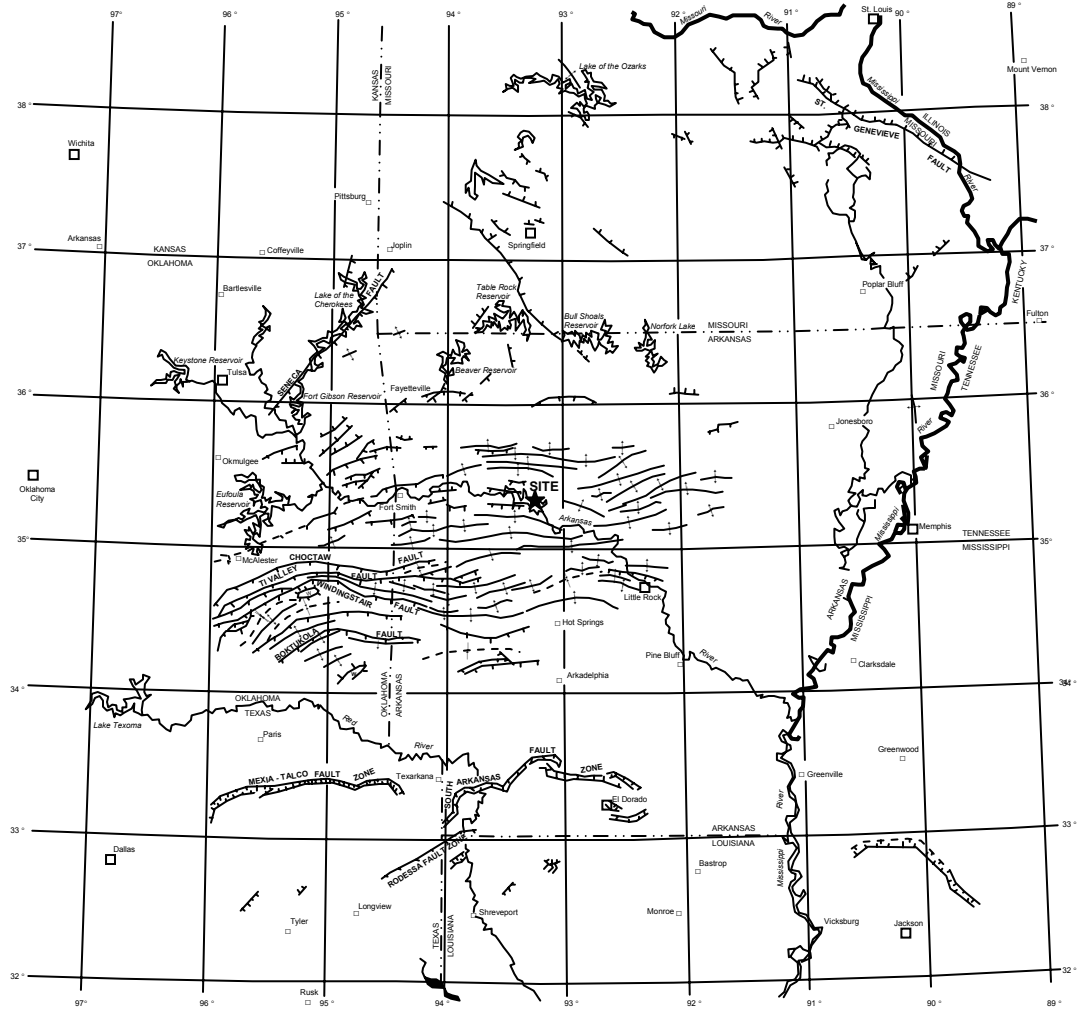

REFERENCE:
 From Tectonic Map of the United States by the
 United States Geological Survey and the American
 Association of Petroleum Geologists, 1962.

REGIONAL TECTONIC MAP

SAR FIGURE NO. 2.5-6

ARKANSAS NUCLEAR ONE
 UNIT 2
 RUSSELLVILLE, ARKANSAS



SCALE: NONE
 DRAWN: ENTERGY
 DESIGN: ENTERGY
 CAD NO:

AMENDMENT 19

BASED ON DRAWING NO	SHEET	REV.
---------------------	-------	------

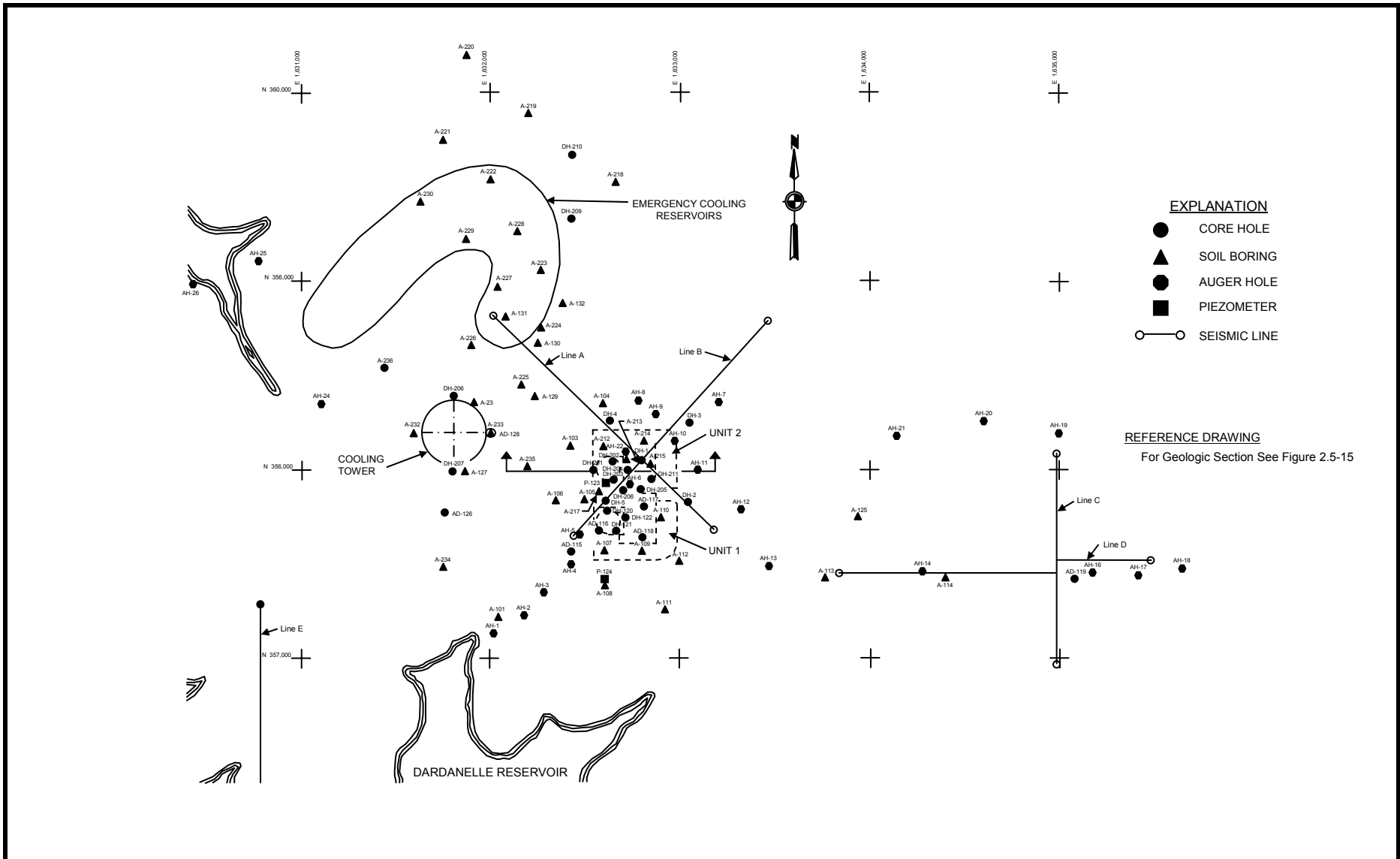

SITE INVESTIGATIONS

SAR FIGURE NO. 2.5-7

ARKANSAS NUCLEAR ONE
UNIT 2
RUSSELLVILLE, ARKANSAS



SCALE:	NONE
DRAWN:	ENERGY
DESIGN:	ENERGY
CAD NO:	

AMENDMENT 19

BASED ON DRAWING NO	SHEET	REV.

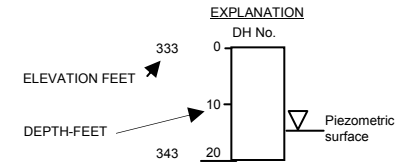
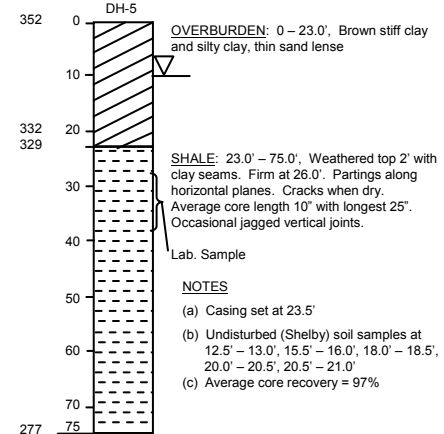
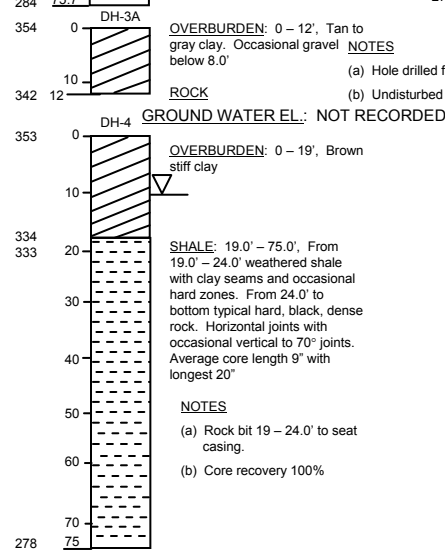
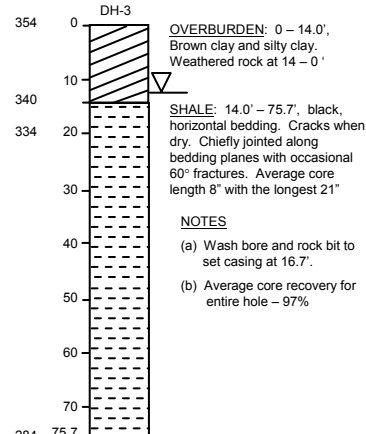
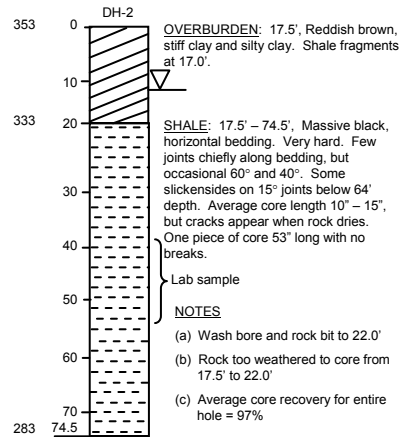
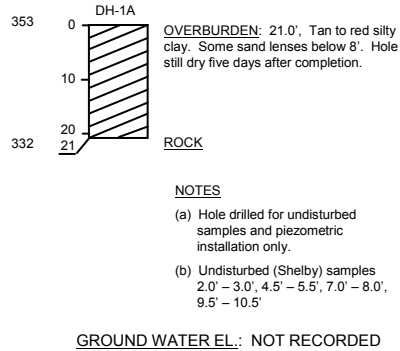
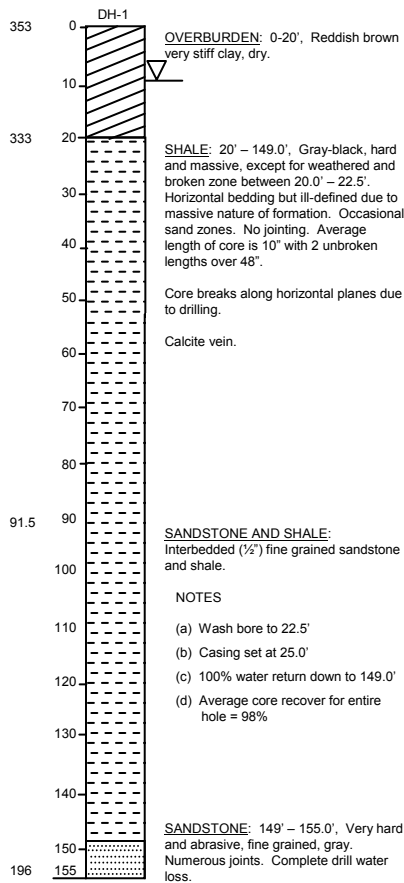

GRAPHIC LOGS OF DRILL HOLES DH-1 THROUGH DH-5

SAR FIGURE NO. 2.5-8

ARKANSAS NUCLEAR ONE
 UNIT 2
 RUSSELLVILLE, ARKANSAS



SCALE: NONE
 DRAWN: ENERGENCY
 DESIGN: ENERGENCY
 CAD NO:

AMENDMENT 19

BASED ON DRAWING NO SHEET REV.

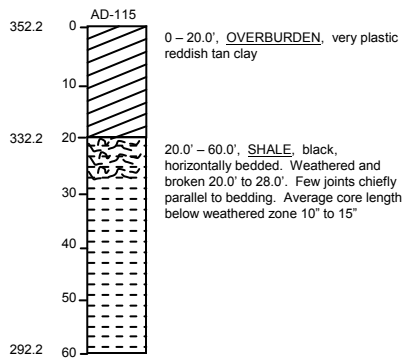

GROUND WATER EL.: NOT RECORDED

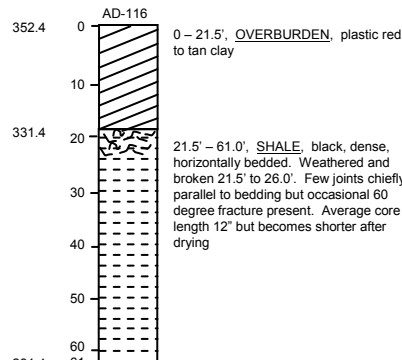

GROUND WATER EL.: NOT RECORDED

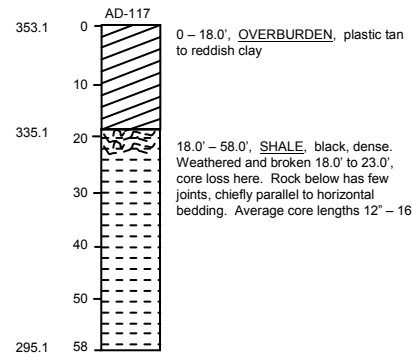

GROUND WATER EL.: NOT RECORDED

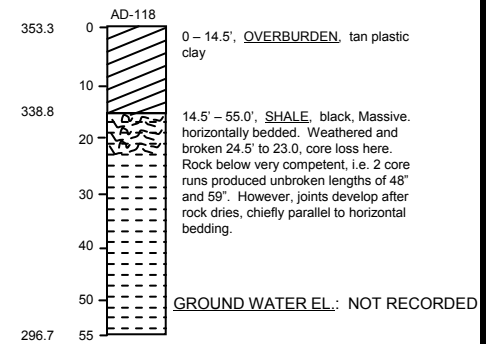

GROUND WATER EL.: NOT RECORDED

EXPLANATION

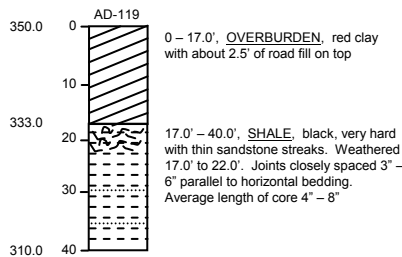
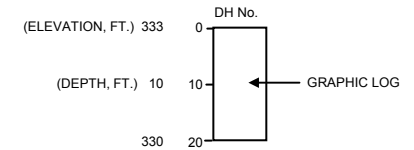

GROUND WATER EL.: NOT RECORDED

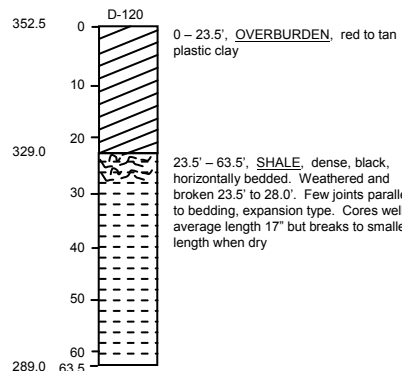

GROUND WATER EL.: NOT RECORDED

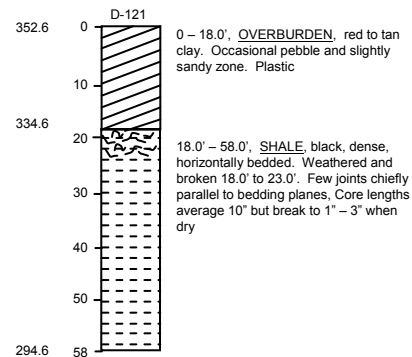

GROUND WATER EL.: NOT RECORDED

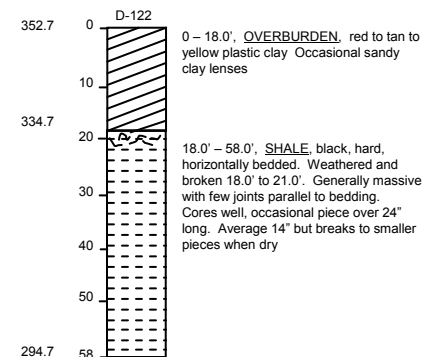

GROUND WATER EL.: NOT RECORDED

GRAPHIC LOGS OF DRILL HOLES AD-115 THROUGH D-122

SAR FIGURE NO. 2.5-9

ARKANSAS NUCLEAR ONE
UNIT 2
RUSSELLVILLE, ARKANSAS



SCALE: NONE
DRAWN: ENTERGY
DESIGN: ENTERGY
CAD NO:

AMENDMENT 19

BASED ON DRAWING NO	SHEET	REV.
---------------------	-------	------

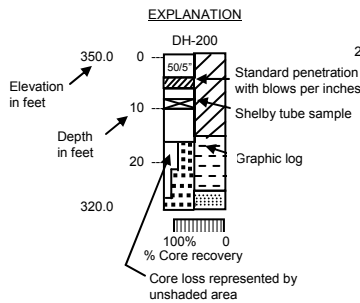
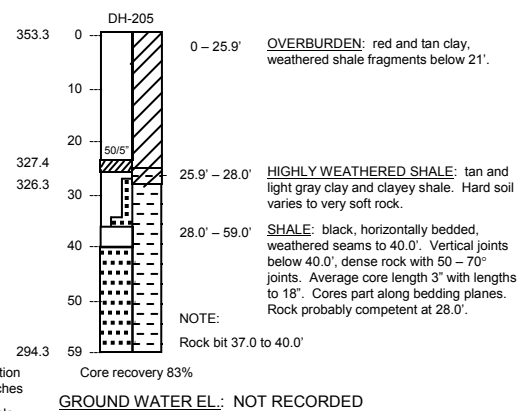
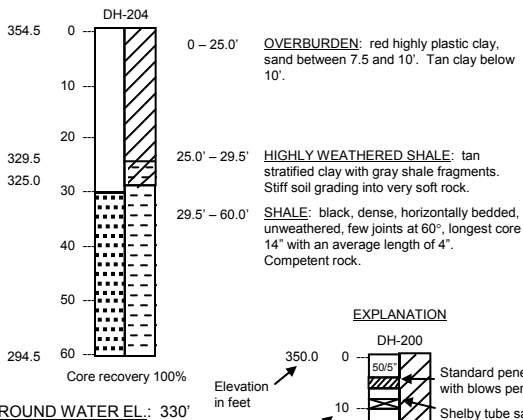
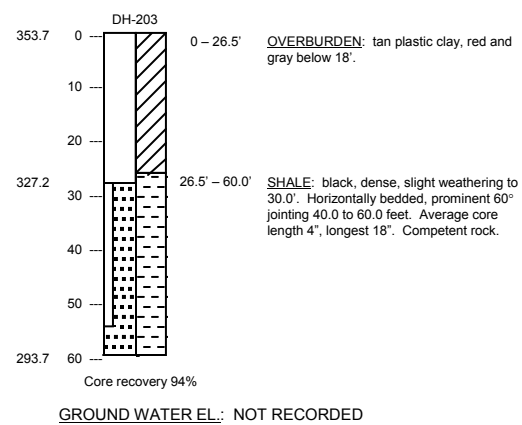
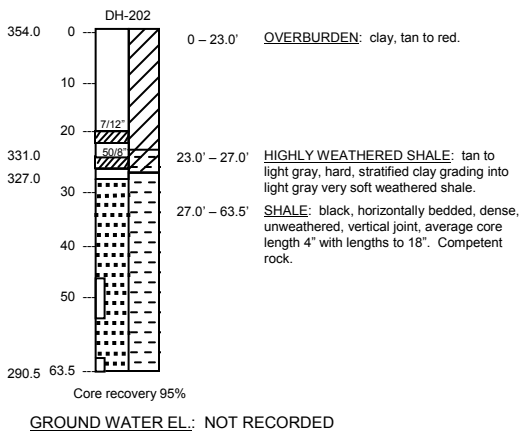
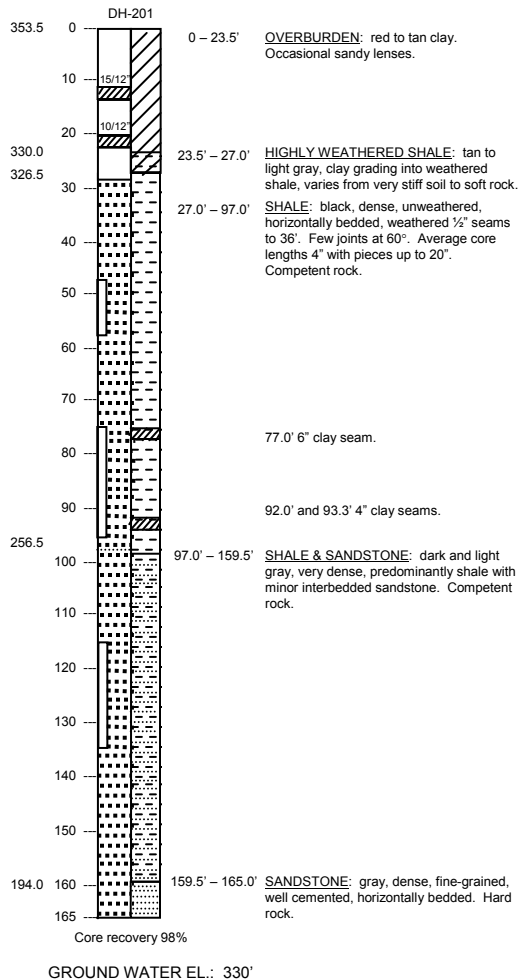

REFERENCE DRAWING
For location of drill holes see Figure 2.5-7

GRAPHIC LOGS OF DRILL HOLES DH-201 THROUGH DH-205

SAR FIGURE NO. 2.5-10

ARKANSAS NUCLEAR ONE
UNIT 2
RUSSELLVILLE, ARKANSAS



SCALE: NONE
DRAWN: ENTERGY
DESIGN: ENTERGY
CAD NO:

AMENDMENT 19

BASED ON DRAWING NO SHEET REV.

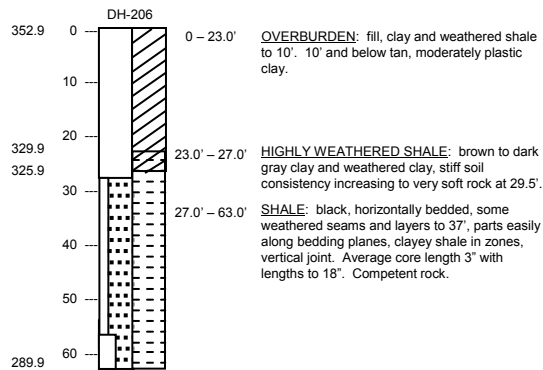

Core recovery 93%

GROUND WATER EL.: NOT RECORDED

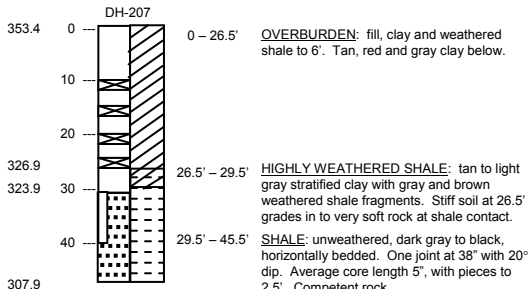

Core recovery 97%

GROUND WATER EL.: NOT RECORDED

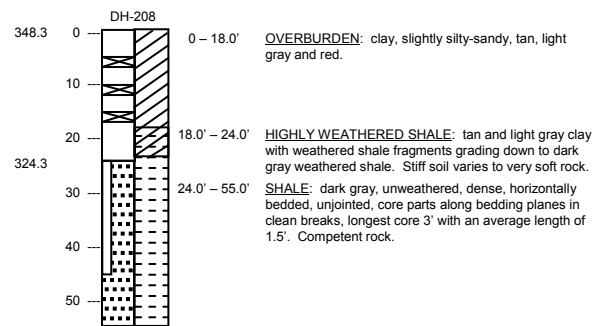

Core recovery 95%

GROUND WATER EL.: NOT RECORDED

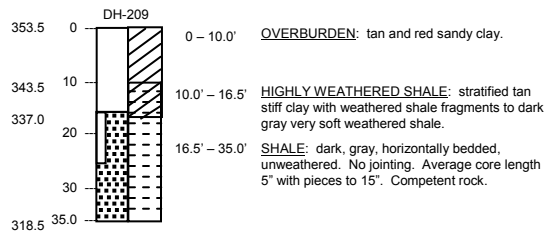

Core recovery 95%

GROUND WATER EL.: NOT RECORDED

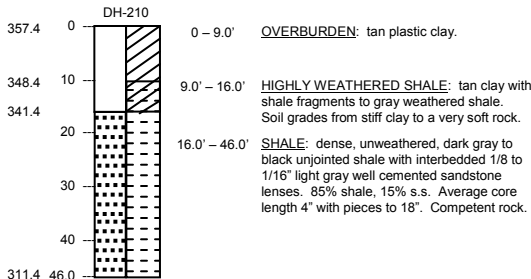

Core recovery 100%

GROUND WATER EL.: NOT RECORDED

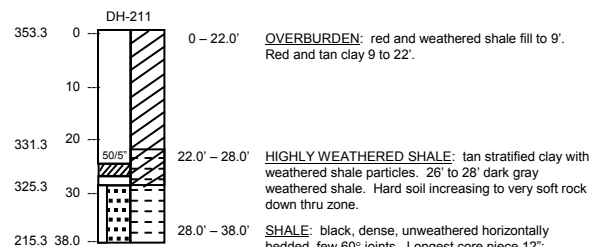

Core recovery 85%

GROUND WATER EL.: NOT RECORDED

REFERENCE DRAWINGS

1. See Figure 2.5-10 for explanation
2. For location of drill holes see Figure 2.5-7

GRAPHIC LOGS OF DRILL HOLES DH-206 THROUGH DH-211

SAR FIGURE NO. 2.5-11

ARKANSAS NUCLEAR ONE
UNIT 2
RUSSELLVILLE, ARKANSAS



SCALE: NONE
DRAWN: ENTERGY
DESIGN: ENTERGY
CAD NO:

AMENDMENT 19

BASED ON DRAWING NO	SHEET	REV.
---------------------	-------	------

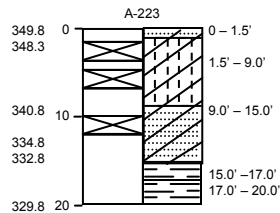

GROUND WATER EL.: DRY HOLE

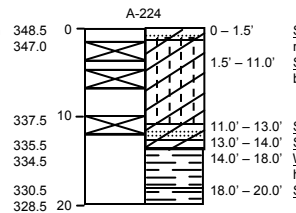

GROUND WATER EL.: 340.5'

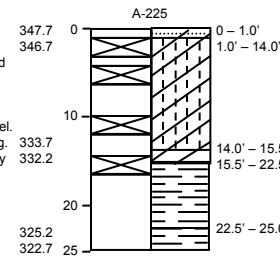

GROUND WATER EL.: DRY HOLE

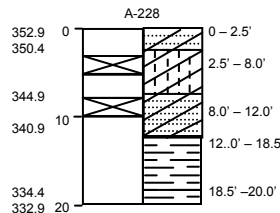

GROUND WATER EL.: 346.9'

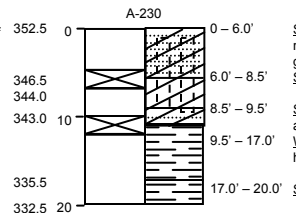

GROUND WATER EL.: 348.5'

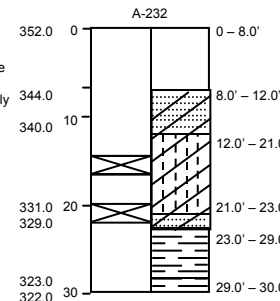

GROUND WATER EL.: NOT RECORDED

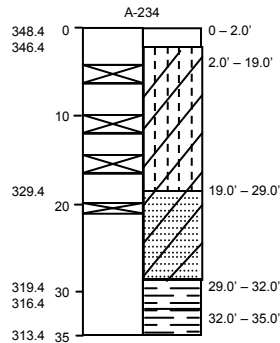

GROUND WATER EL.: NOT RECORDED

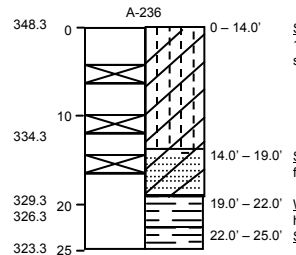

GROUND WATER EL.: NOT RECORDED

NOTES

1. See Figure No. 2.5-10 for Explanation
2. Geologic logs of these holes are based on wash samples, and undisturbed samples taken only where indicated.

GRAPHIC LOGS

SAR FIGURE NO. 2.5-12

ARKANSAS NUCLEAR ONE
UNIT 2
RUSSELLVILLE, ARKANSAS



SCALE: NONE
DRAWN: ENTERGY
DESIGN: ENTERGY
CAD NO:

AMENDMENT 19

BASED ON DRAWING NO

SHEET

REV.



SITE AREA – TOPOGRAPHY

SAR FIGURE NO. 2.5-13

ARKANSAS NUCLEAR ONE
 UNIT 2
 RUSSELLVILLE, ARKANSAS



SCALE: NONE
 DRAWN: ENTERGY
 DESIGN: ENTERGY
 CAD NO:

AMENDMENT 19

BASED ON DRAWING NO

SHEET

REV.

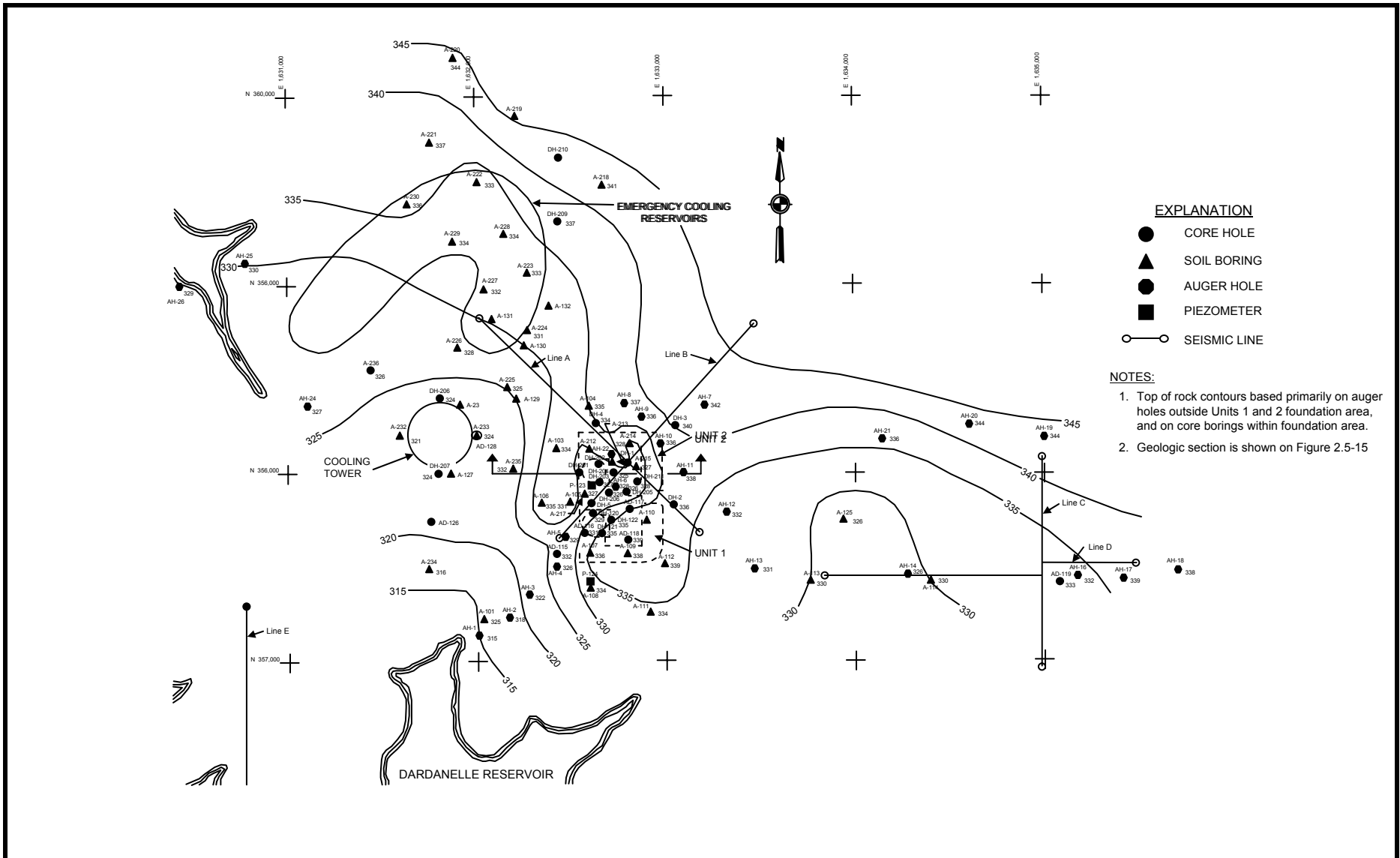

EXPLANATION

- CORE HOLE
- ▲ SOIL BORING
- AUGER HOLE
- PIEZOMETER
- SEISMIC LINE

NOTES:

1. Top of rock contours based primarily on auger holes outside Units 1 and 2 foundation area, and on core borings within foundation area.
2. Geologic section is shown on Figure 2.5-15

BEDROCK CONTOURS

SAR FIGURE NO. 2.5-14

ARKANSAS NUCLEAR ONE
 UNIT 2
 RUSSELLVILLE, ARKANSAS



SCALE: NONE
 DRAWN: ENTERGY
 DESIGN: ENTERGY
 CAD NO:

AMENDMENT 19

BASED ON DRAWING NO	SHEET	REV.
---------------------	-------	------

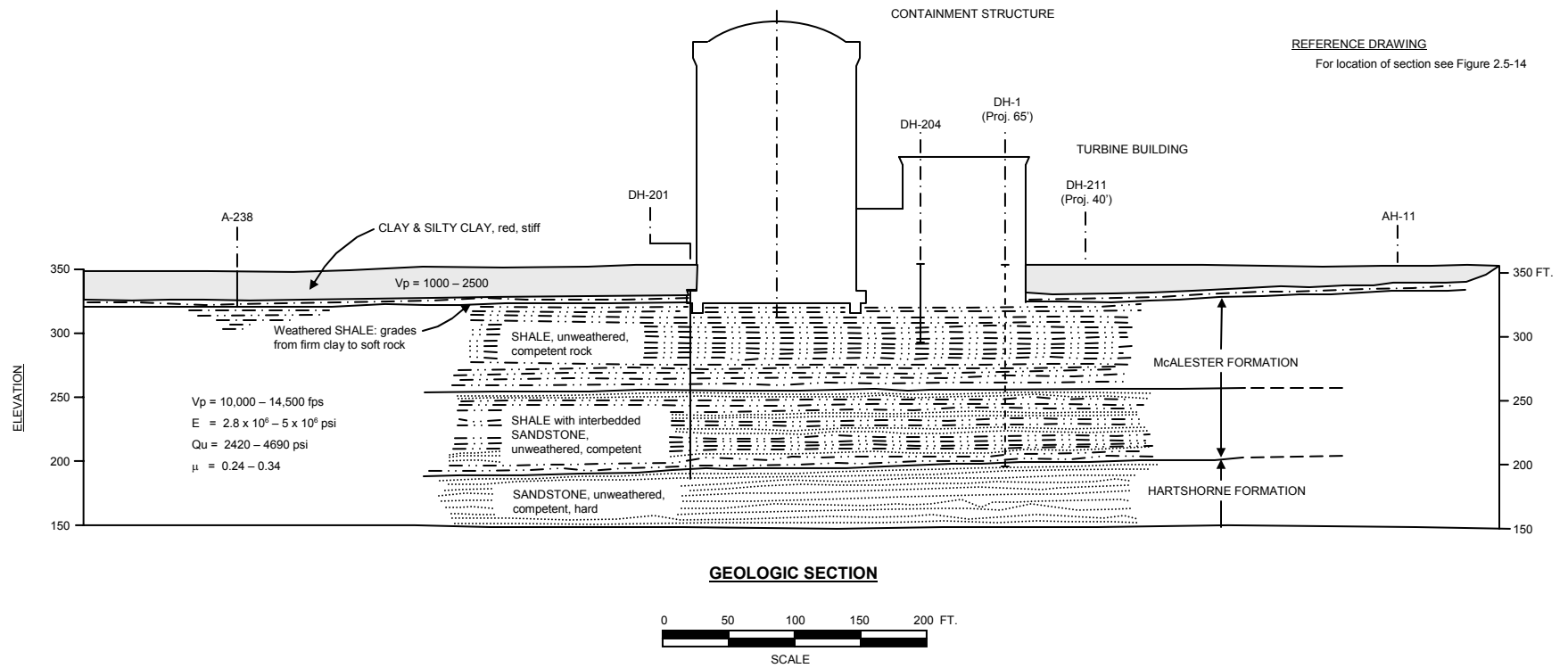

GEOLOGIC SECTION

SAR FIGURE NO. 2.5-15

ARKANSAS NUCLEAR ONE
UNIT 2
RUSSELLVILLE, ARKANSAS



SCALE: NONE
DRAWN: ENTERGY
DESIGN: ENTERGY
CAD NO:

AMENDMENT 19

BASED ON DRAWING NO	SHEET	REV.
---------------------	-------	------

APPROXIMATE ELEVATION

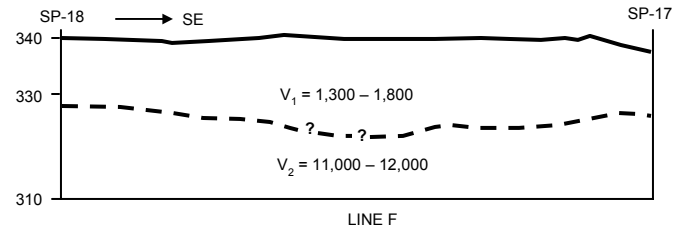
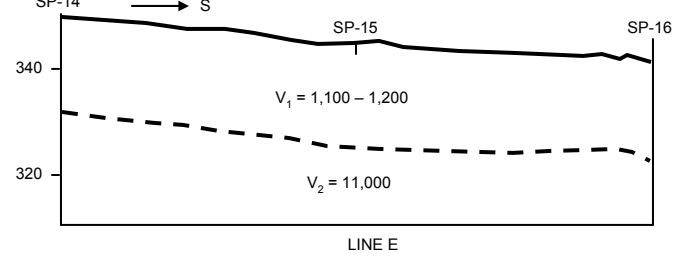
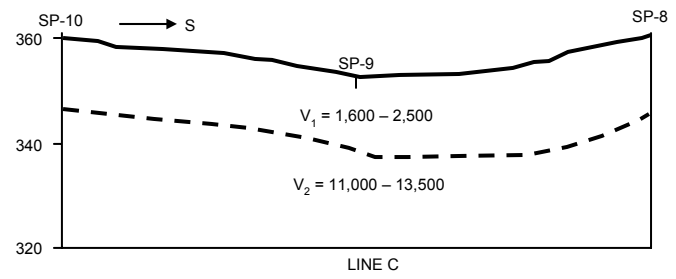
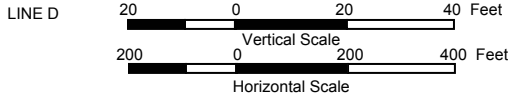
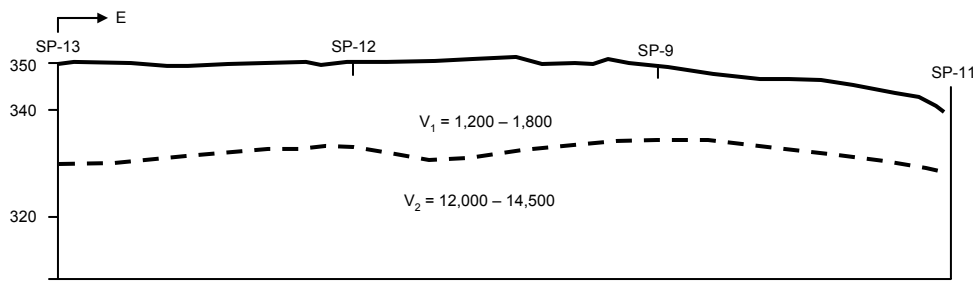
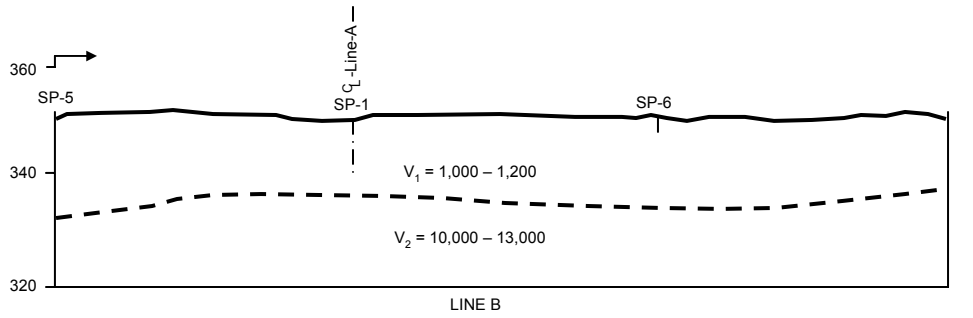
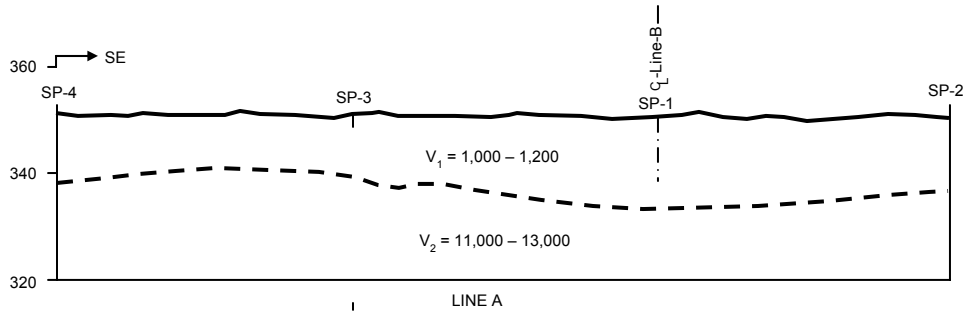

REFERENCE
From Boyles Bros. Drilling Co. Report, PLATE 2

SEISMIC PROFILES

SAR FIGURE NO. 2.5-16

ARKANSAS NUCLEAR ONE
UNIT 2
RUSSELLVILLE, ARKANSAS



SCALE:	NONE
DRAWN:	ENERGY
DESIGN:	ENERGY
CAD NO:	

AMENDMENT 19

BASED ON DRAWING NO	SHEET	REV.

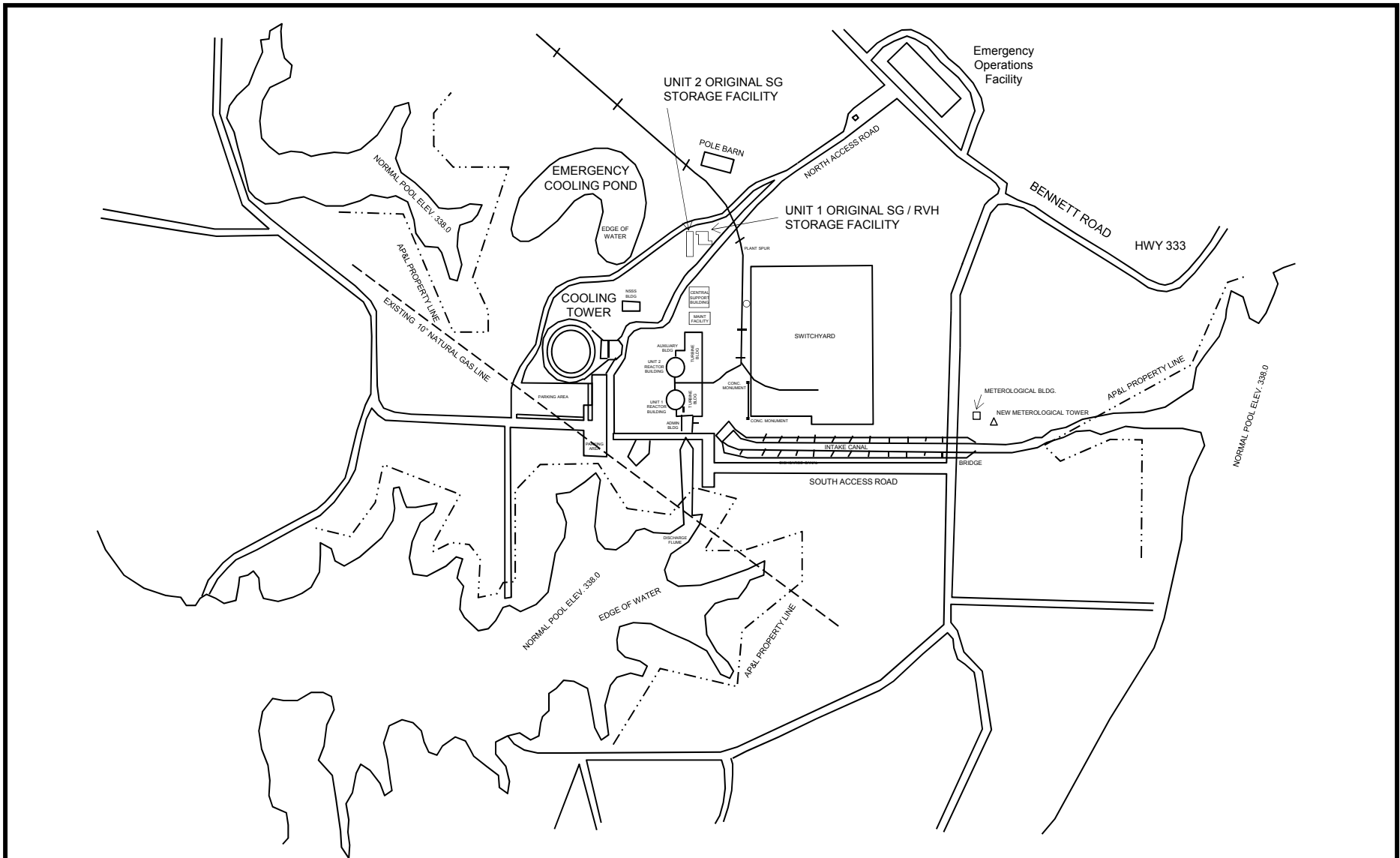

SITE PLAN

SAR FIGURE NO. 2.5-17

ARKANSAS NUCLEAR ONE
 UNIT 2
 RUSSELLVILLE, ARKANSAS



SCALE: NONE
 DRAWN: ENTERGY
 DESIGN: ENTERGY
 CAD NO:

AMENDMENT 26

BASED ON DRAWING NO	SHEET	REV.

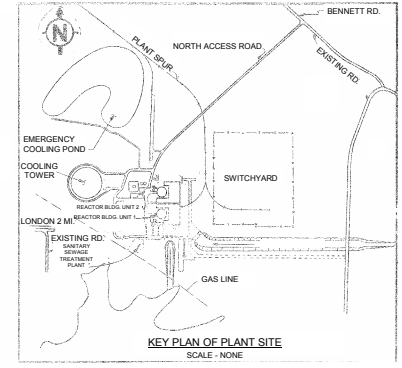
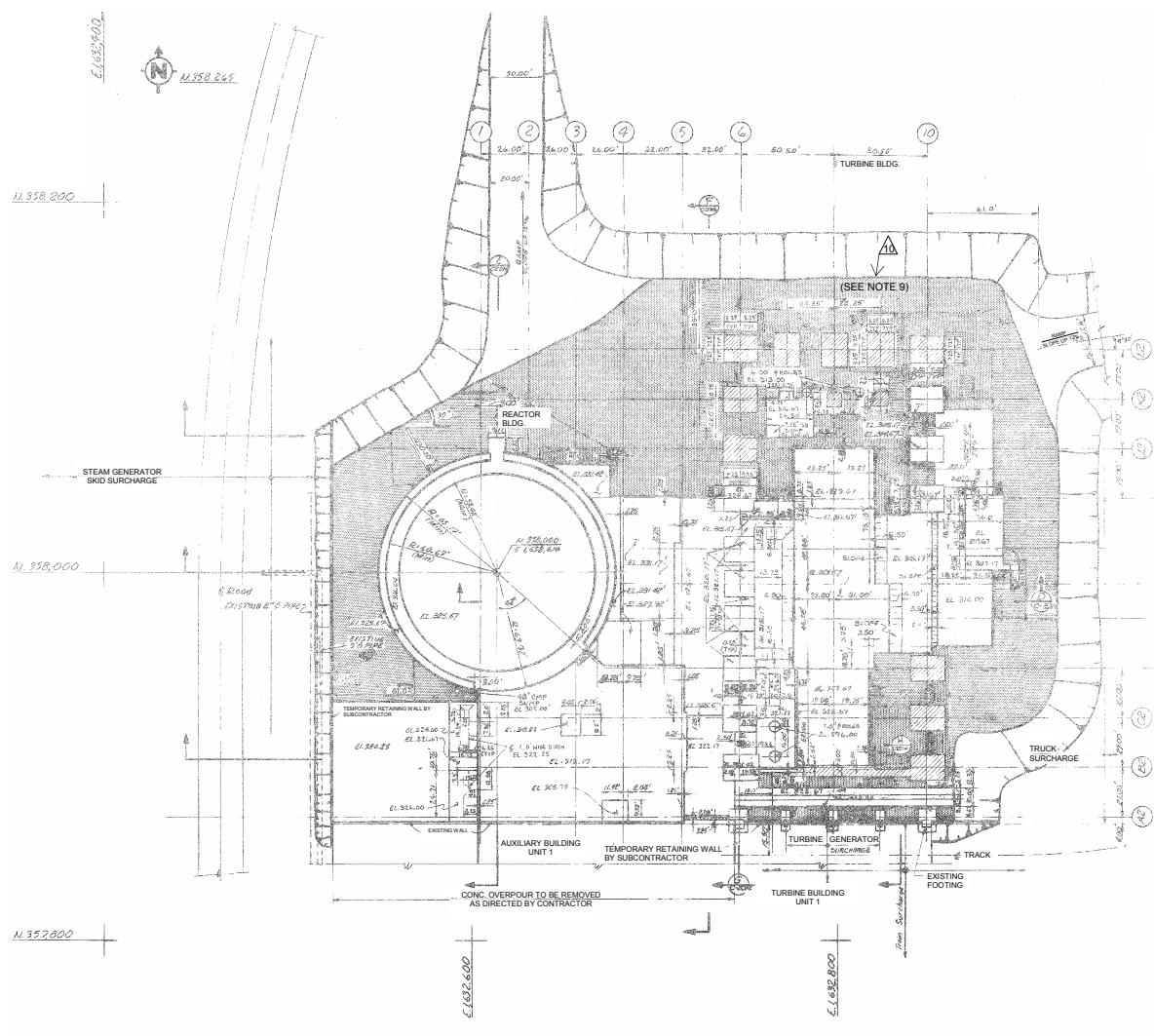

- GENERAL NOTES:**
- EXCAVATION SHALL BE CARRIED TO THE MINIMUM ELEVATION SHOWN ON THE PLAN OR DEEPER UNTIL SOUND ROCK IS ENCOUNTERED. THE CONTRACTOR'S DECISION SHALL BE FINAL WHEN DETERMINING SOUND ROCK.
 - [Symbol] INDICATES TOP OF SOUND ROCK AS DETERMINED BY THE CONTRACTOR.
 - RANDOM BACKFILL AND CLAY BLANKET MATERIAL TO BE STOCKPILED AS DIRECTED BY THE CONTRACTOR.
 - FOR AREAS TO BE COVERED BY CONC. MAT SEE DWG. NO. C-2015.
 - THE ACCESS RAMPS SHOWN ON THIS DWG ARE TENTATIVE ONLY AND ARE SUBJECT TO CHANGE TO SUIT FIELD CONDITIONS AS DIRECTED BY THE CONTRACTOR.
 - EXCAVATION WORK TO BE IN CONFORMANCE WITH REQUIREMENTS OF SPECIFICATION 6600-C-2019.
 - THE SUB-CONTRACTOR SHALL BE RESPONSIBLE FOR THE DESIGN OF RETAINING WALLS WITHIN THE LIMITS SHOWN IN ACCORDANCE WITH SPECIFICATION 6600-C-2019.
 - [Symbol] INDICATES AS-BUILT EXCAVATIONS TO EL. 528.87.
 - THIS AREA OF EXCAVATION PLAN FROM [Symbol] NORTH IS MODIFIED BY THE MAINTENANCE FACILITY. SEE DWG. 78011-C-1R.

PLANT EXCAVATION PLAN

SAR FIGURE NO. 2.5-18

ARKANSAS NUCLEAR ONE
 UNIT 2
 RUSSELLVILLE, ARKANSAS



SCALE:	NONE
DRAWN:	ENERGY
DESIGN:	ENERGY
CAD NO:	

AMENDMENT 19		
BASED ON DRAWING NO	SHEET	REV.

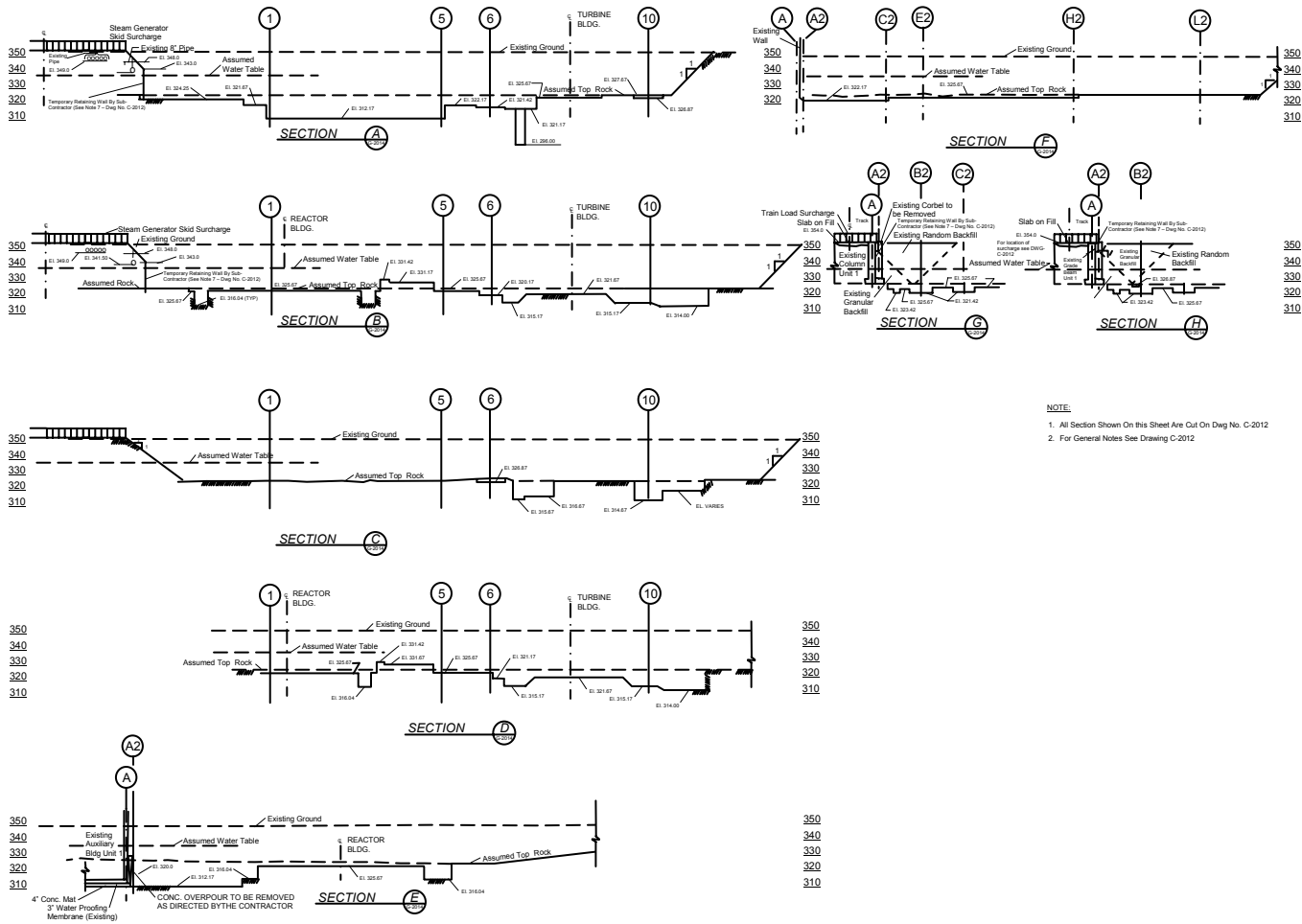

PLANT EXCAVATION SECTIONS

SAR FIGURE NO. 2.5-19

ARKANSAS NUCLEAR ONE
 UNIT 2
 RUSSELLVILLE, ARKANSAS



SCALE: NONE
 DRAWN: ENTERGY
 DESIGN: ENTERGY
 CAD NO:

AMENDMENT 19

BASED ON DRAWING NO SHEET REV.

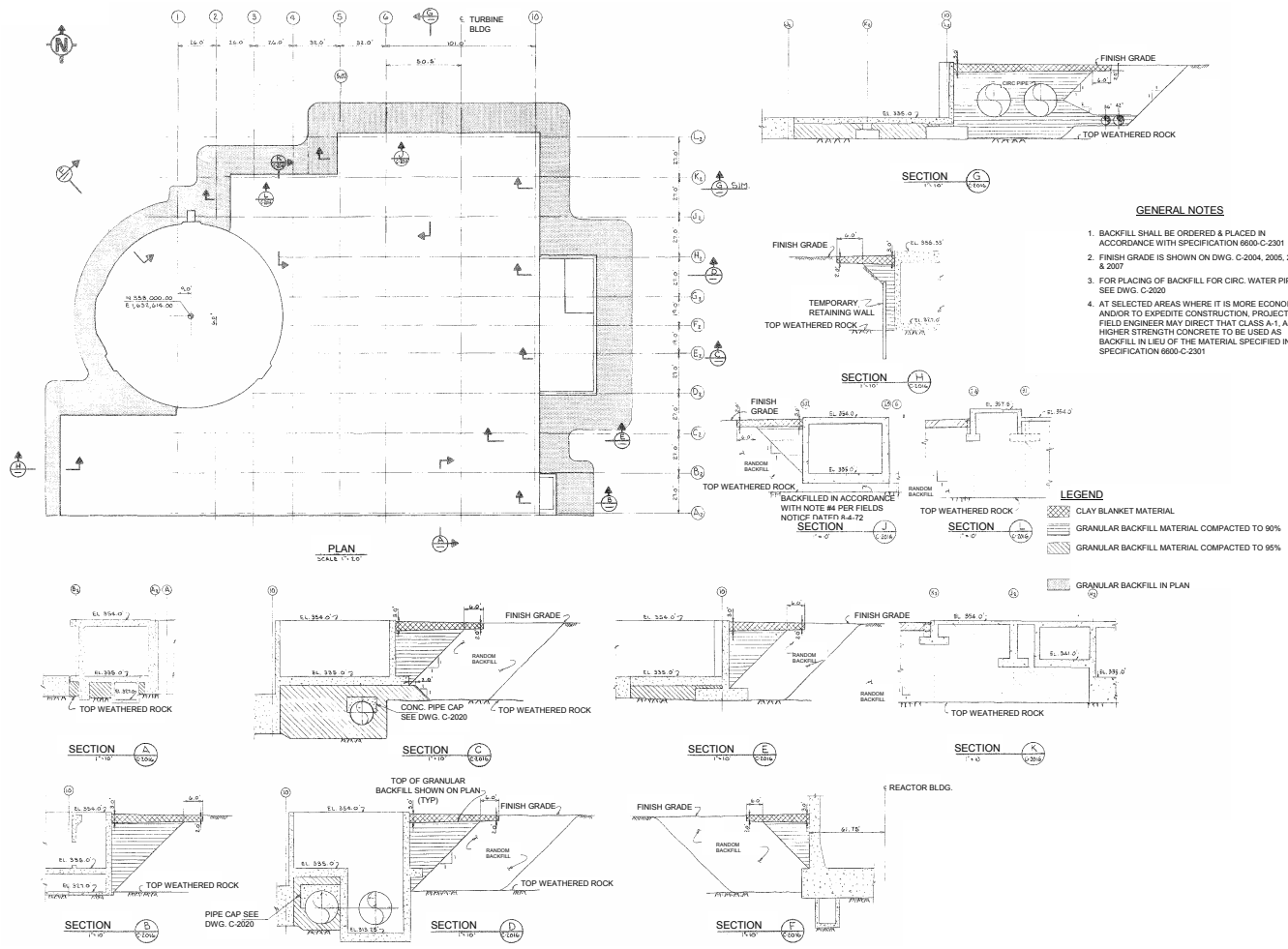

PLANT BACKFILL PLAN AND SECTIONS

SAR FIGURE NO. 2.5-20

ARKANSAS NUCLEAR ONE
UNIT 2
RUSSELLVILLE, ARKANSAS



SCALE: NONE
DRAWN: ENTERGY
DESIGN: ENTERGY
CAD NO:

AMENDMENT 19

BASED ON DRAWING NO

SHEET

REV.

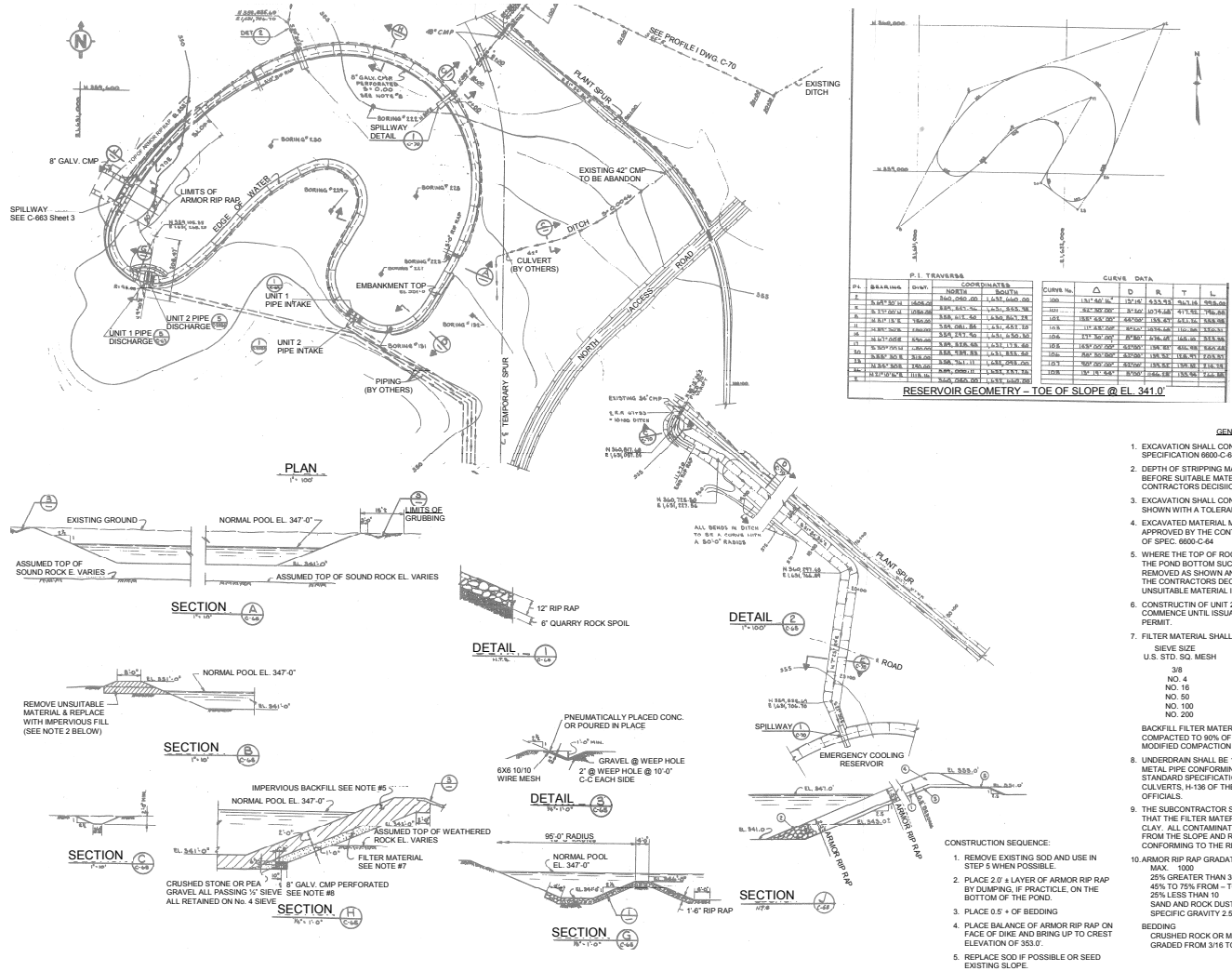

- GENERAL NOTES**
- EXCAVATION SHALL CONFORM TO THE REQUIREMENTS OF SPECIFICATION 6600-C-64.
 - DEPTH OF STRIPPING MAY VARY FROM ONE TO FOUR FEET BEFORE SUITABLE MATERIAL IS ENCOUNTERED. THE CONTRACTOR'S DECISION OF SUITABLE SUBBASE SHALL BE FINAL.
 - EXCAVATION SHALL CONFORM TO THE LIMITS AND GRADES AS SHOWN WITH A TOLERANCE OF PLUS OR MINUS 0.10 FEET.
 - EXCAVATED MATERIAL MAY BE USED FOR EMBANKMENT WHEN APPROVED BY THE CONTRACTOR, IN ACCORDANCE WITH SEC. 3.9 OF SPEC. 6600-C-64.
 - WHERE THE TOP OF ROCK OR WEATHERED SHALE IS AT OR ABOVE THE POND BOTTOM SUCH UNSUITABLE MATERIAL SHALL BE REMOVED AS SHOWN AND REPLACED WITH IMPERVIOUS BACKFILL. THE CONTRACTOR'S DECISION ON THE EXTENT TO WHICH UNSUITABLE MATERIAL IS TO BE REMOVED SHALL BE FINAL.
 - CONSTRUCTION OF UNIT CLASS 1 STRUCTURES SHALL NOT COMMENCE UNTIL ISSUANCE BY A.B.C. OF A CONSTRUCTION PERMIT.
 - FILTER MATERIAL SHALL GRADED AS FOLLOWS:

SIEVE SIZE	U.S. STD. MESH	% PASSED
3/8"		100
NO. 4		95-100
NO. 10		45-90
NO. 50		10-30
NO. 100		2-10
NO. 200		0
 - BACKFILL FILTER MATERIAL SHALL BE PLACED IN LIFTS OF 8 IN. & COMPACTED TO 80% OF MAX. DRY DENSITY DETERMINED BY THE MODIFIED COMPACTION PROCEDURE, A.S.T.M. D. 1587 METHOD D.
 - UNDERDRAIN SHALL BE 18 GA. GALV. CORRUGATED PERFORATED METAL PIPE CONFORMING TO THE REQUIREMENTS OF THE STANDARD SPECIFICATION FOR CORRUGATED METAL PIPE CULVERTS, H-136 OF THE AMERICAN ASS'N OF STATE HIGHWAY OFFICIALS.
 - THE SUBCONTRACTOR SHALL TAKE EXTREME CARE TO ASSURE THAT THE FILTER MATERIAL IS NOT CONTAMINATED BY SILT OR CLAY. ALL CONTAMINATED FILTER MATERIAL SHALL BE REMOVED FROM THE SLOPE AND REPLACED WITH FILTER MATERIAL CONFORMING TO THE REQUIREMENTS OF NOTE #7.
 - ARMOR RIP RAP GRADATION IN POUNDS

MAX.	25% GREATER THAN	45% TO 75% FROM	25% LESS THAN	5% SAND AND ROCK DUST LESS THAN 5% SPECIFIC GRAVITY 2.5 OR GREATER
1000	300	10-300	10	
 - BEDDING: CRUSHED ROCK OR MANURAL GRAVEL GRADED FROM 3/16 TO 3/4 INCHES

- CONSTRUCTION SEQUENCE:**
- REMOVE EXISTING SOD AND USE IN STEP 5 WHEN POSSIBLE.
 - PLACE 2.0' LAYER OF ARMOR RIP RAP BY DUMPING, IF PRACTICAL, ON THE BOTTOM OF THE POND.
 - PLACE 0.5' OF BEDDING.
 - PLACE BALANCE OF ARMOR RIP RAP ON FACE OF DIKE AND BRING UP TO CREST ELEVATION OF 353.0.
 - REPLACE SOD IF POSSIBLE OR SEED EXISTING SLOPE.

EMERGENCY COOLING RESERVOIR

SAR FIGURE NO. 2.5-21

ARKANSAS NUCLEAR ONE
UNIT 2
RUSSELLVILLE, ARKANSAS



SCALE: NONE
DRAWN: ENTERGY
DESIGN: ENTERGY
CAD NO:

AMENDMENT 22

BASED ON DRAWING NO SHEET REV.

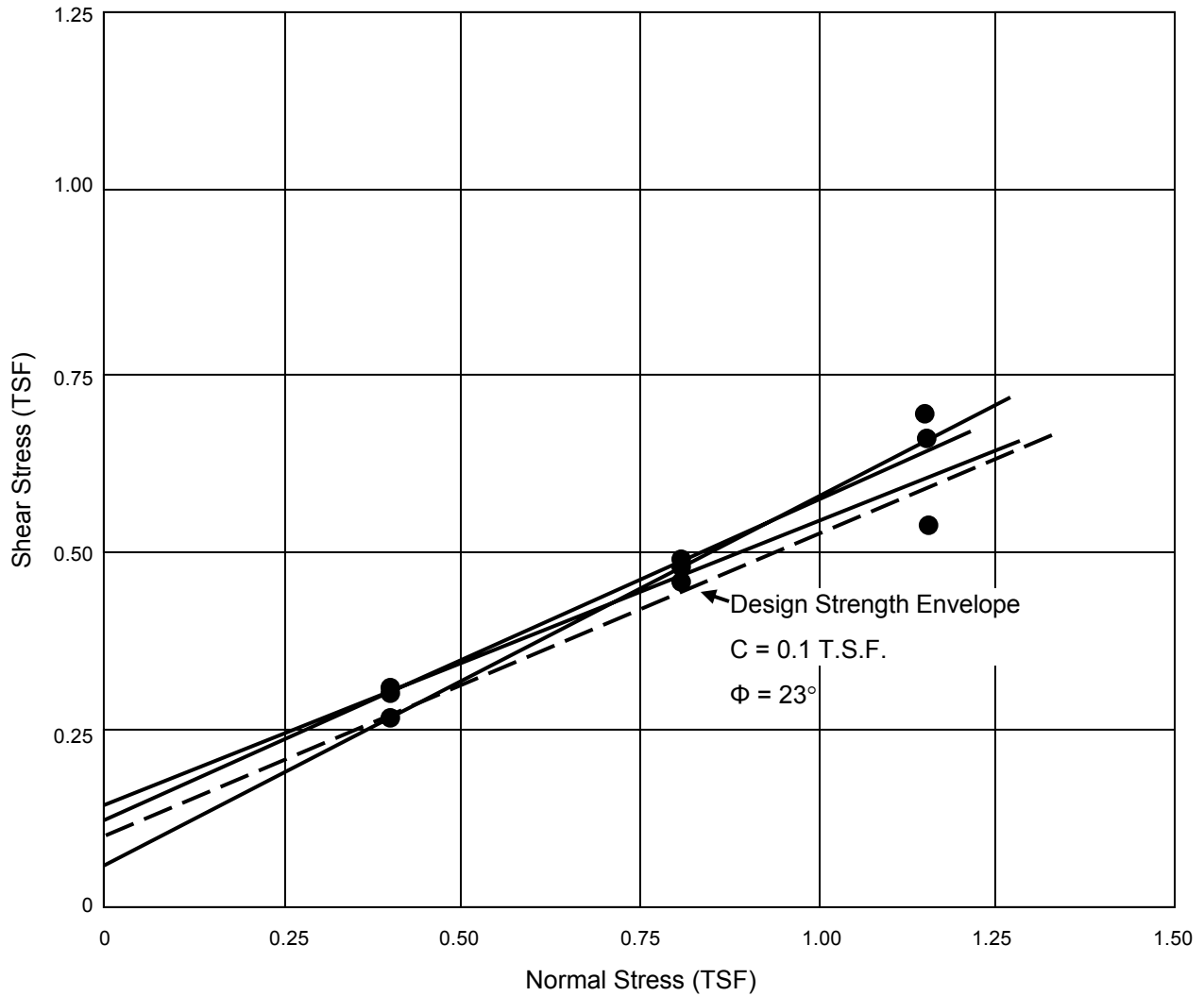

RESIDUAL SHEAR STRENGTH				
BORING NO.	DEPTH (FT)	MATERIAL	SHEAR STRENGTH DATA	
			C, TSF	DEGREES
126	3.8	Tan & Gray Silty Clay	0.13	22.5
131	6.5	Reddish Brown Slickensided Clay	0.06	27.0
131	9.5	Brown Silty Clay	0.12	24.0

**RESULTS OF CONSOLIDATED DRAINED DIRECT SHEAR TESTS
RESIDUAL SHEAR STRENGTHS**

SAR FIGURE NO. 2.5-22

AMENDMENT 19

ARKANSAS NUCLEAR ONE
UNIT 2
RUSSELLVILLE, ARKANSAS



SCALE: NONE
DRAWN:
DESIGN: ENTERGY
CAD NO:

RESIDUAL SHEAR STRENGTHS

BASED ON DRAWING NO

SHEET

REV.

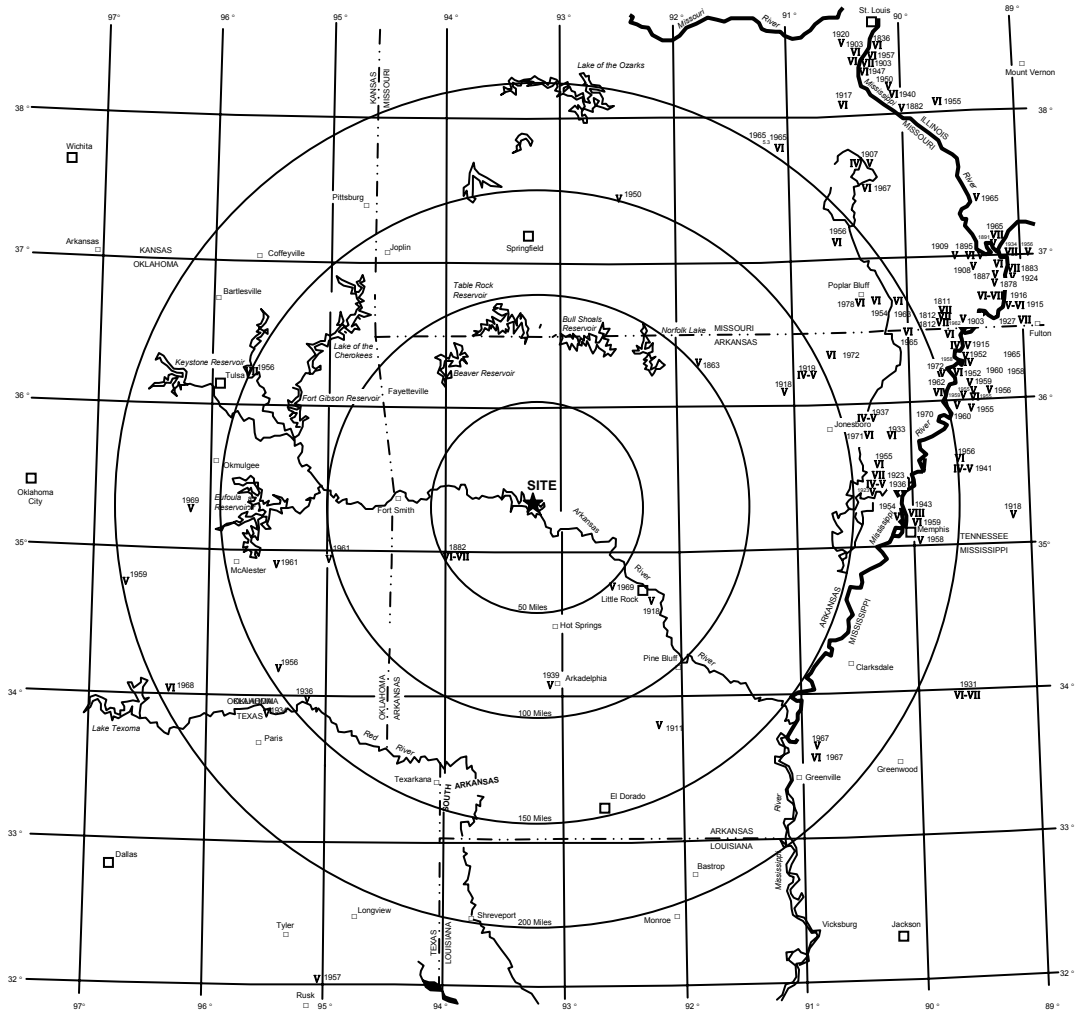

EXPLANATION

Roman Numeral indicates the epicenter of an earthquake, the epicentral intensity of which was given on the Modified Mercalli Scale.

Intensities IV - V and greater are shown.

Dates of earthquakes indicated

REFERENCES:

- U.S.C. & G.S., Earthquake History of the U.S. Part I.
- U.S.C. & G.S., United States Earthquakes 1928-1970
- U.S.C. & G.S., Abstracts of Earthquake Reports for the United States Jan. 1967 - Dec. 1969
- E.S.S.A. Hypocenter Data Cards Jan. 1968 - Oct. 1972
- B.S.S.A. Seismological Notes 1970 - Oct. 1972
- B.S.S.A. Vol. 46, No. 2 History of Earthquakes in Kansas by D.F. Merriam
- B.S.S.A. Vol. 31, No. 3 Contribution to the Seismic History of Missouri by R.R. Heinrich

Base map is taken from U.S.C. & G.S. World Aeronautical Charts CG-20 and CH-24



**SIGNIFICANT EARTHQUAKE EPICENTERS AND INTENSITIES AT EPICENTERS
1699 - OCT. 1972**

SAR FIGURE NO. 2.5-23

ARKANSAS NUCLEAR ONE
UNIT 2
RUSSELLVILLE, ARKANSAS



SCALE:	NONE
DRAWN:	ENERGY
DESIGN:	ENERGY
CAD NO:	

AMENDMENT 19

BASED ON DRAWING NO	SHEET	REV.
---------------------	-------	------

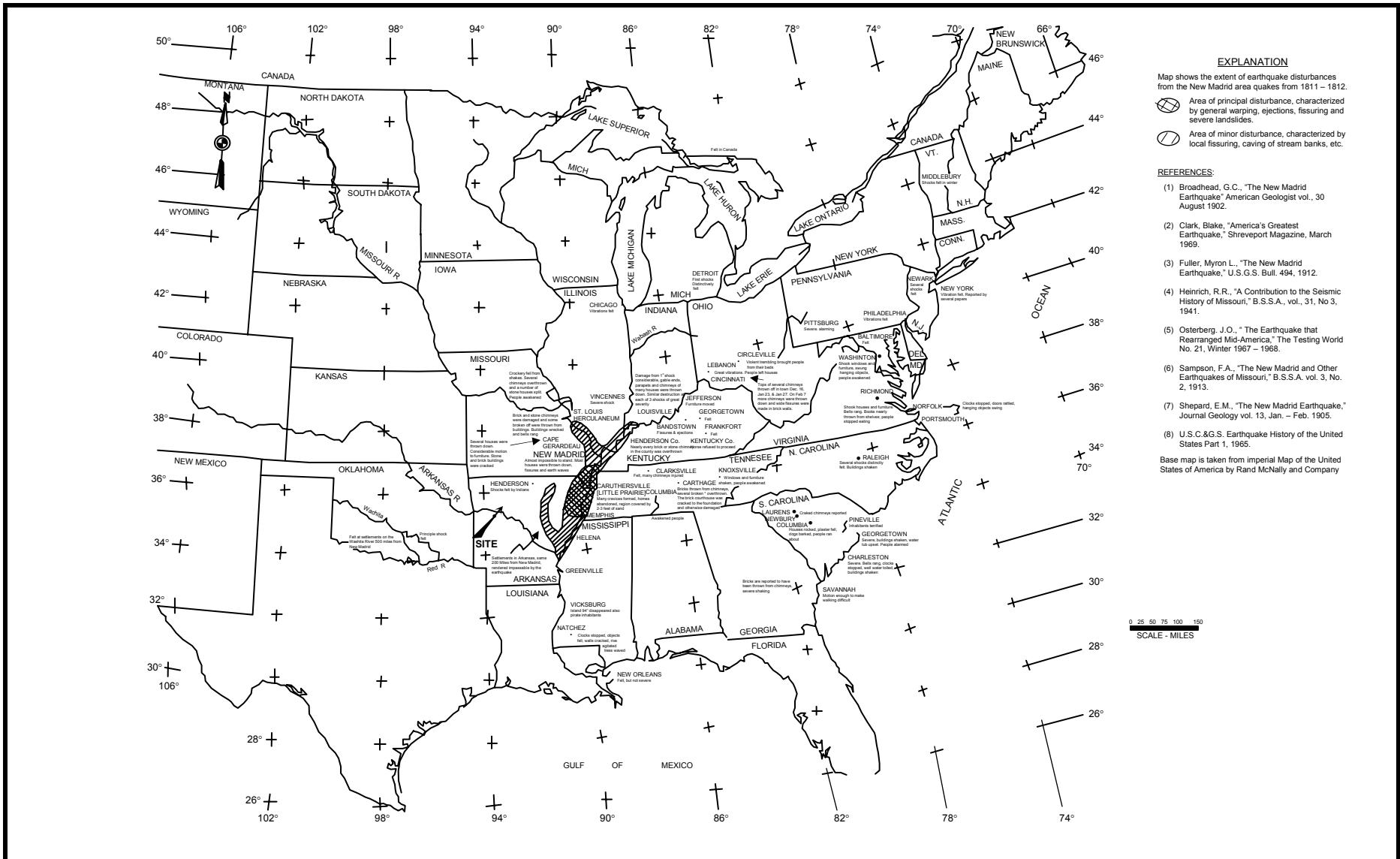

EXPLANATION

Map shows the extent of earthquake disturbances from the New Madrid area quakes from 1811 - 1812.

⊗ Area of principal disturbance, characterized by general warping, ejections, fissuring and severe landslides.

⊕ Area of minor disturbance, characterized by local fissuring, caving of stream banks, etc.

REFERENCES:

- (1) Broadhead, G.C., "The New Madrid Earthquake," American Geologist vol., 30 August 1902.
- (2) Clark, Blake, "America's Greatest Earthquake," Shreveport Magazine, March 1969.
- (3) Fuller, Myron L., "The New Madrid Earthquake," U.S.G.S. Bull. 494, 1912.
- (4) Heinrich, R.R., "A Contribution to the Seismic History of Missouri," B.S.S.A., vol., 31, No. 3, 1941.
- (5) Osterberg, J.O., "The Earthquake that Rearranged Mid-America," The Testing World No. 21, Winter 1967 - 1968.
- (6) Sampson, F.A., "The New Madrid and Other Earthquakes of Missouri," B.S.S.A. vol. 3, No. 2, 1913.
- (7) Shepard, E.M., "The New Madrid Earthquake," Journal Geology vol. 13, Jan. - Feb. 1905.
- (8) U.S.C.&G.S. Earthquake History of the United States Part 1, 1965.

Base map is taken from imperial Map of the United States of America by Rand McNally and Company

THE NEW MADRID, MISSOURI EARTHQUAKES, 1811-1812

SAR FIGURE NO. 2.5-24

ARKANSAS NUCLEAR ONE
 UNIT 2
 RUSSELLVILLE, ARKANSAS



SCALE:	NONE
DRAWN:	ENERGY
DESIGN:	ENERGY
CAD NO:	

AMENDMENT 19		
BASED ON DRAWING NO	SHEET	REV.

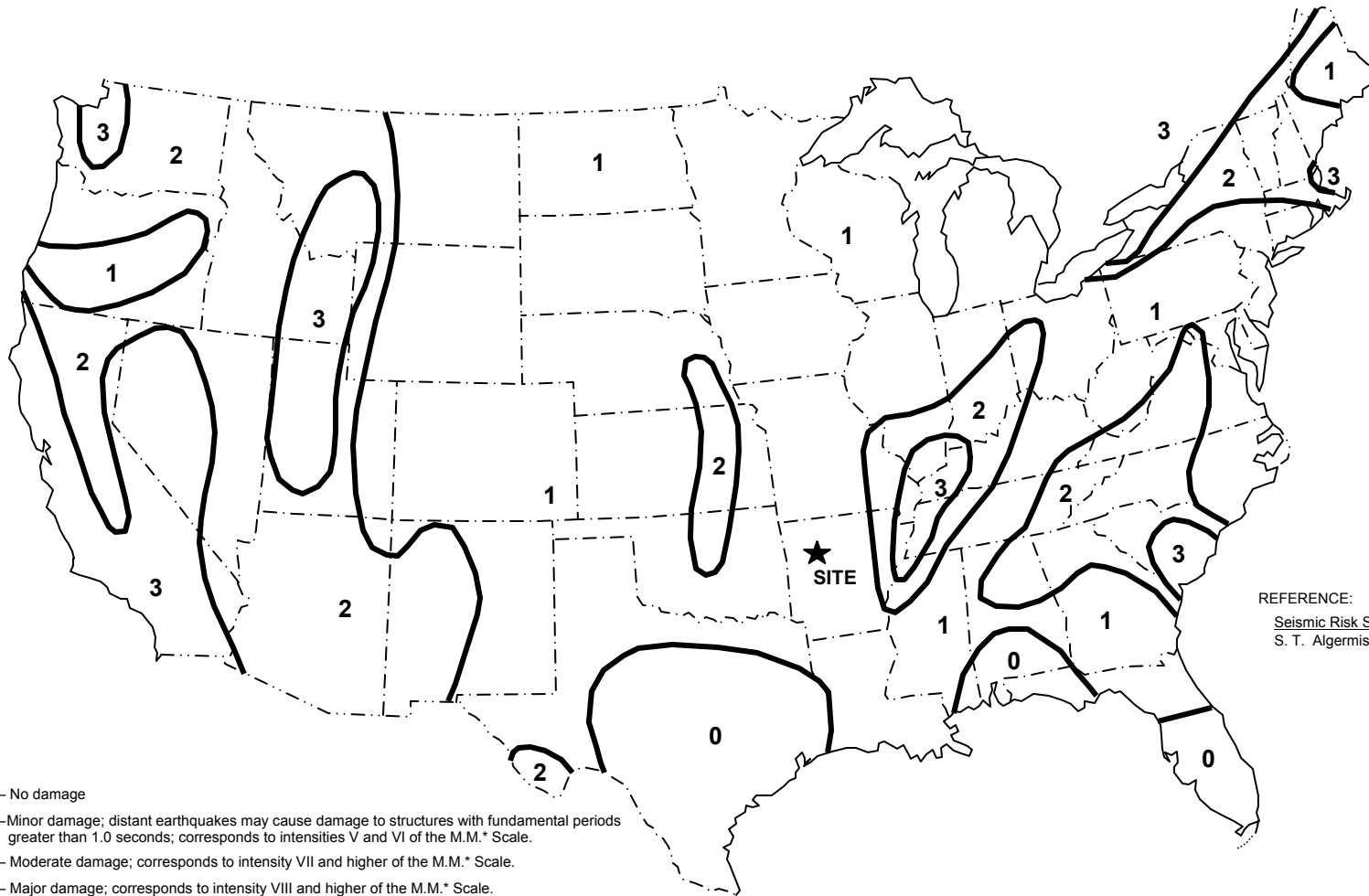

REFERENCE:
Seismic Risk Studies in the U.S.
 S. T. Algermissen, 1969.

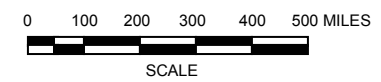

ZONE 0 – No damage
 ZONE 1 – Minor damage; distant earthquakes may cause damage to structures with fundamental periods greater than 1.0 seconds; corresponds to intensities V and VI of the M.M.* Scale.
 ZONE 2 – Moderate damage; corresponds to intensity VII and higher of the M.M.* Scale.
 ZONE 3 – Major damage; corresponds to intensity VIII and higher of the M.M.* Scale.

This map is based on the known distribution of damaging earthquakes and the M.M.* intensities associated with these earthquakes; evidence of strain release; and consideration of major geologic structures and provinces believed to be associated with earthquake activity. The probable frequency of occurrence of damaging earthquakes in each zone was not considered in assigning ratings to the various zones.

*Modified Mercalli Intensity Scale of 1931.

SEISMIC RISK MAP

SAR FIGURE NO. 2.5-25

ARKANSAS NUCLEAR ONE
 UNIT 2
 RUSSELLVILLE, ARKANSAS



SCALE:	NONE
DRAWN:	ENERGY
DESIGN:	ENERGY
CAD NO:	

AMENDMENT 19		
BASED ON DRAWING NO	SHEET	REV.

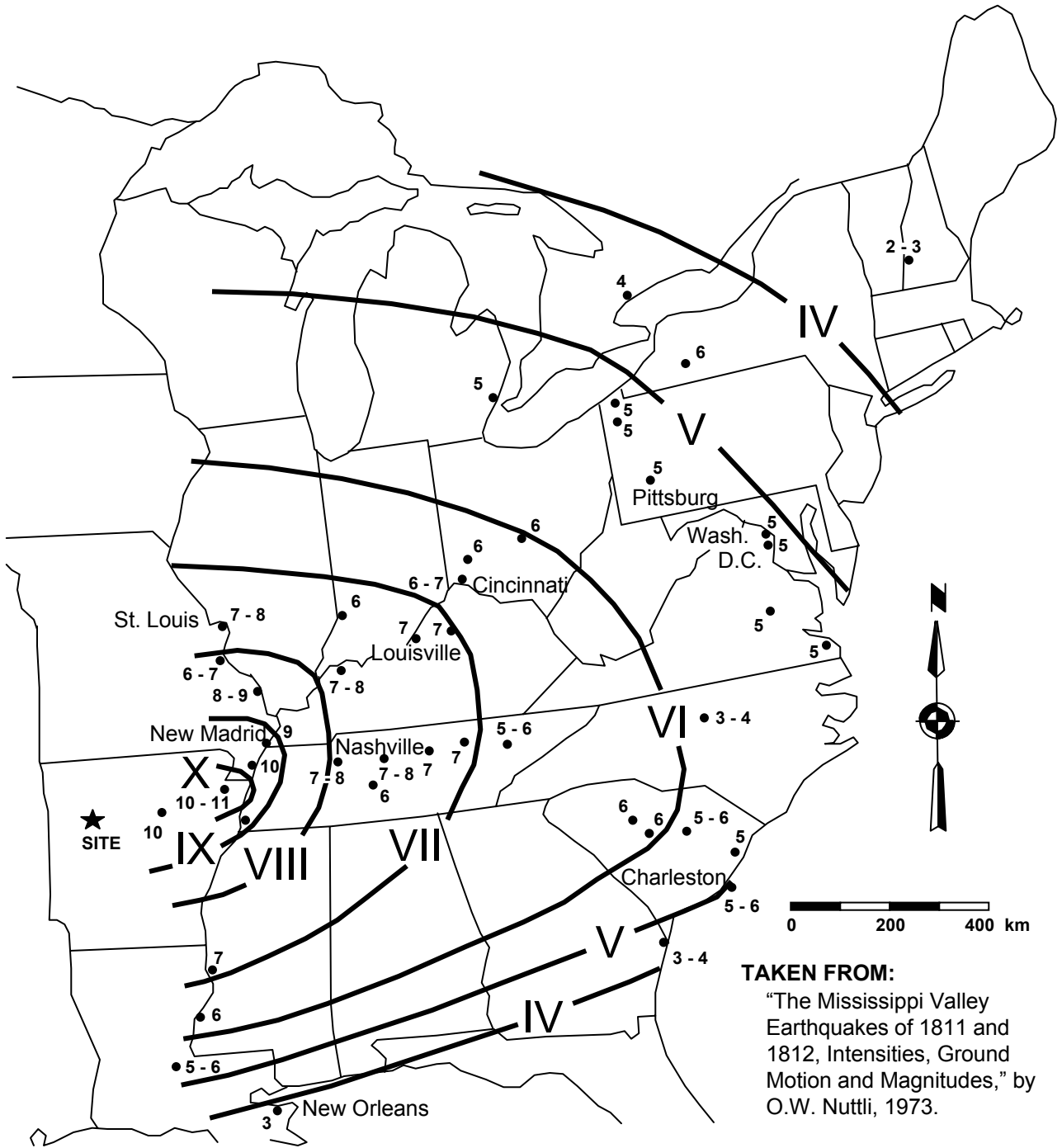

TAKEN FROM:
 "The Mississippi Valley Earthquakes of 1811 and 1812, Intensities, Ground Motion and Magnitudes," by O.W. Nuttli, 1973.

SAR FIGURE NO. 2.5-26

AMENDMENT 19

ARKANSAS NUCLEAR ONE
 UNIT 2
 RUSSELLVILLE, ARKANSAS



SCALE: NONE
 DRAWN:
 DESIGN: ENTERGY
 CAD NO:

GENERALIZED ISOSEISMALS DEC. 16, 1811

BASED ON DRAWING NO

SHEET

REV.

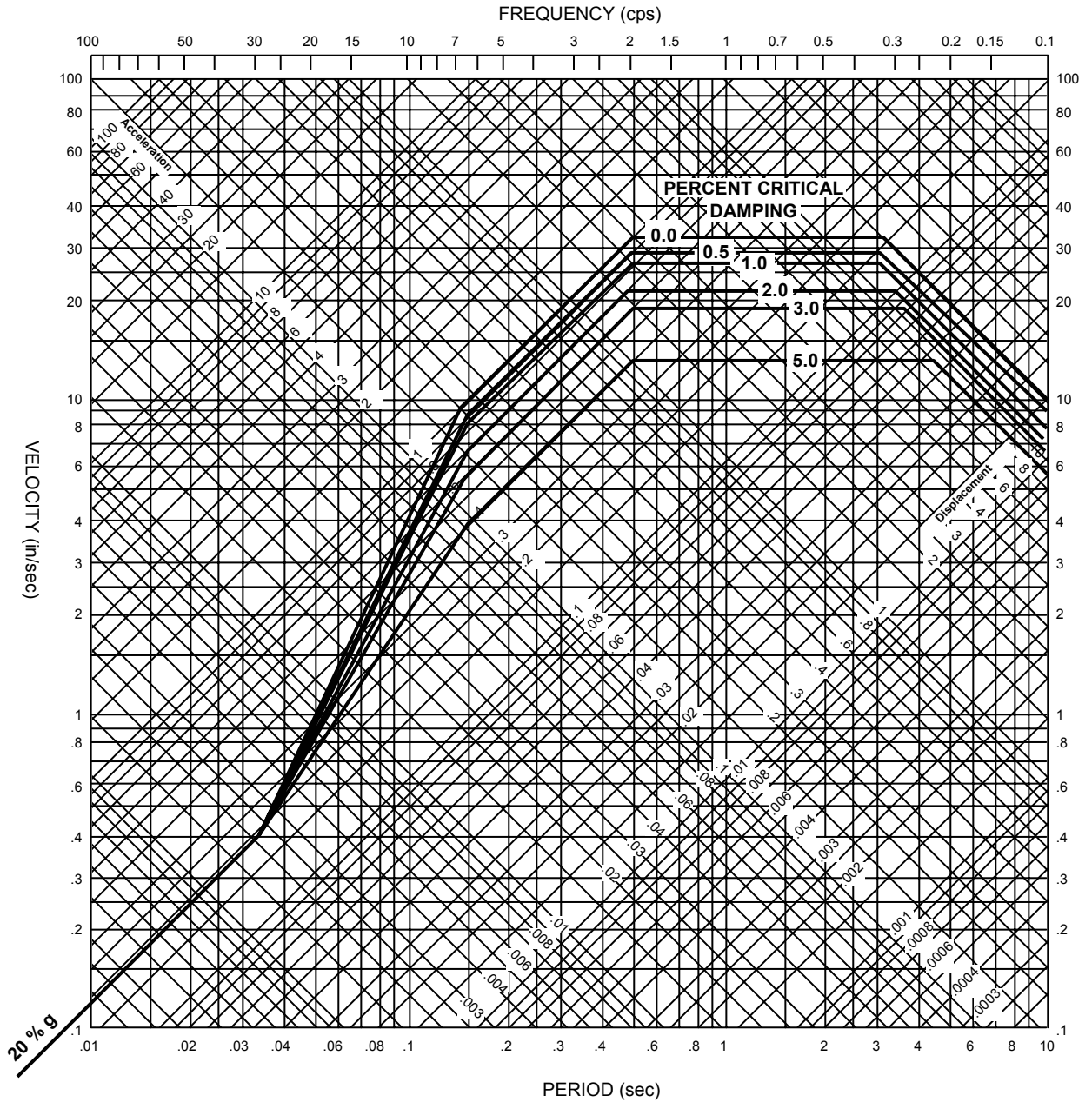

SAR FIGURE NO. 2.5-27

AMENDMENT 19

ARKANSAS NUCLEAR ONE
UNIT 2
RUSSELLVILLE, ARKANSAS



SCALE: NONE
DRAWN:
DESIGN: ENTERGY
CAD NO:

DESIGN SPECTRA

BASED ON DRAWING NO

SHEET

REV.

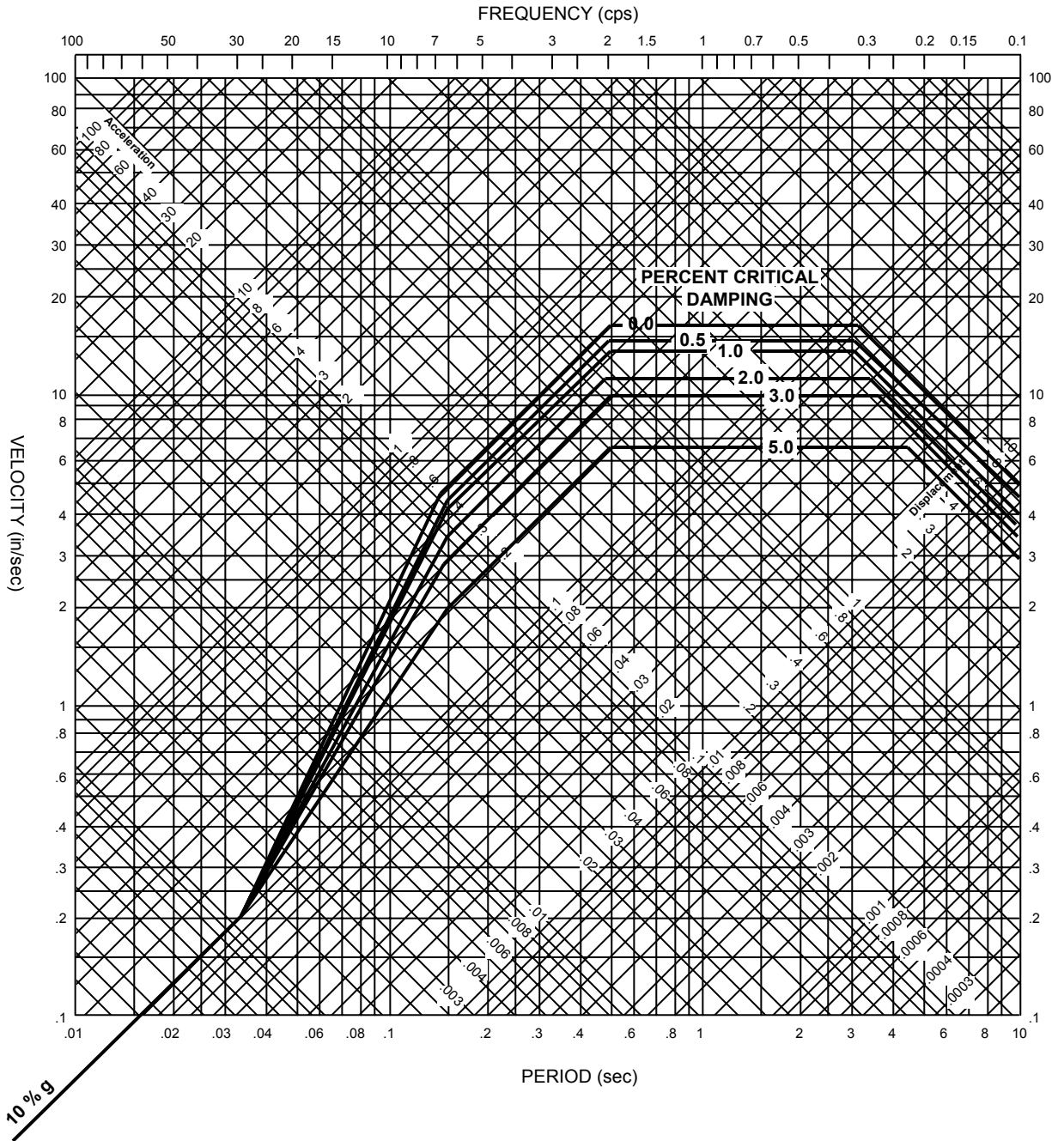

SAR FIGURE NO. 2.5-28

AMENDMENT 19

ARKANSAS NUCLEAR ONE
UNIT 2
RUSSELLVILLE, ARKANSAS



SCALE: NONE
DRAWN:
DESIGN: ENTERGY
CAD NO:

DESIGN SPECTRA

BASED ON DRAWING NO

SHEET

REV.

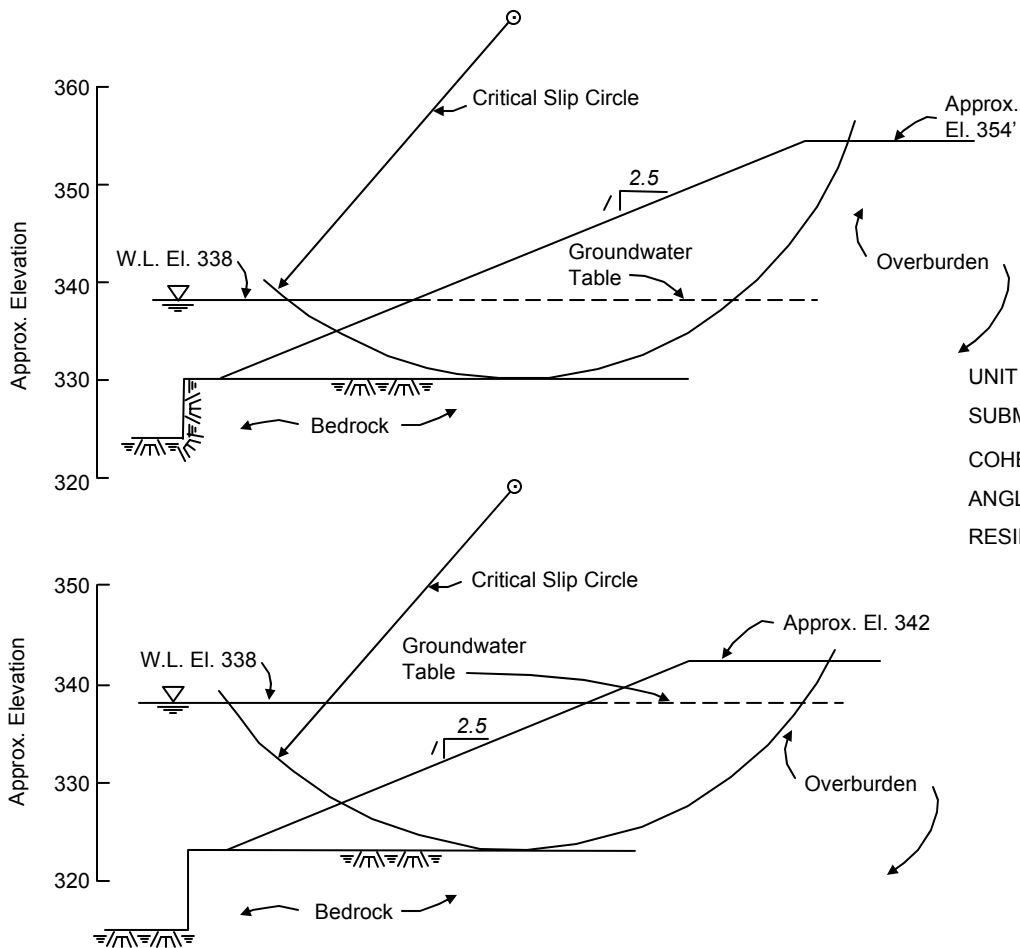

DESIGN SOIL PROPERTIES

UNIT WEIGHT OF SOIL ABOVE GROUND WATER TABLE (γ_m) = 124 PCF.

SUBMERGED UNIT WT. OF SOIL (γ_s) = 62 PCF.

COHESION (C) = 200 LBS/SQUARE FEET

ANGLE OF INTERNAL FRICTION (Φ) = 23°

RESIDUAL SHEAR STRENGTH TEST RESULTS ARE GIVEN ON FIGURE 2.5-22

NOTES:

1. Critical slip circles are for steady state seepage plus seismic loading 0.2 g.
2. The recommended slopes are based on long term stability analyses using residual (ultimate) shear strengths of the soil overburden.

Scale: 1/2" = 10'

STABILITY OF EXCAVATED SLOPES CANAL SIDE SLOPES

SAR FIGURE NO. 2.5-29

ARKANSAS NUCLEAR ONE
UNIT 2
RUSSELLVILLE, ARKANSAS



SCALE: NONE
DRAWN: ENTERGY
DESIGN: ENTERGY
CAD NO:

AMENDMENT 19

BASED ON DRAWING NO

SHEET

REV.

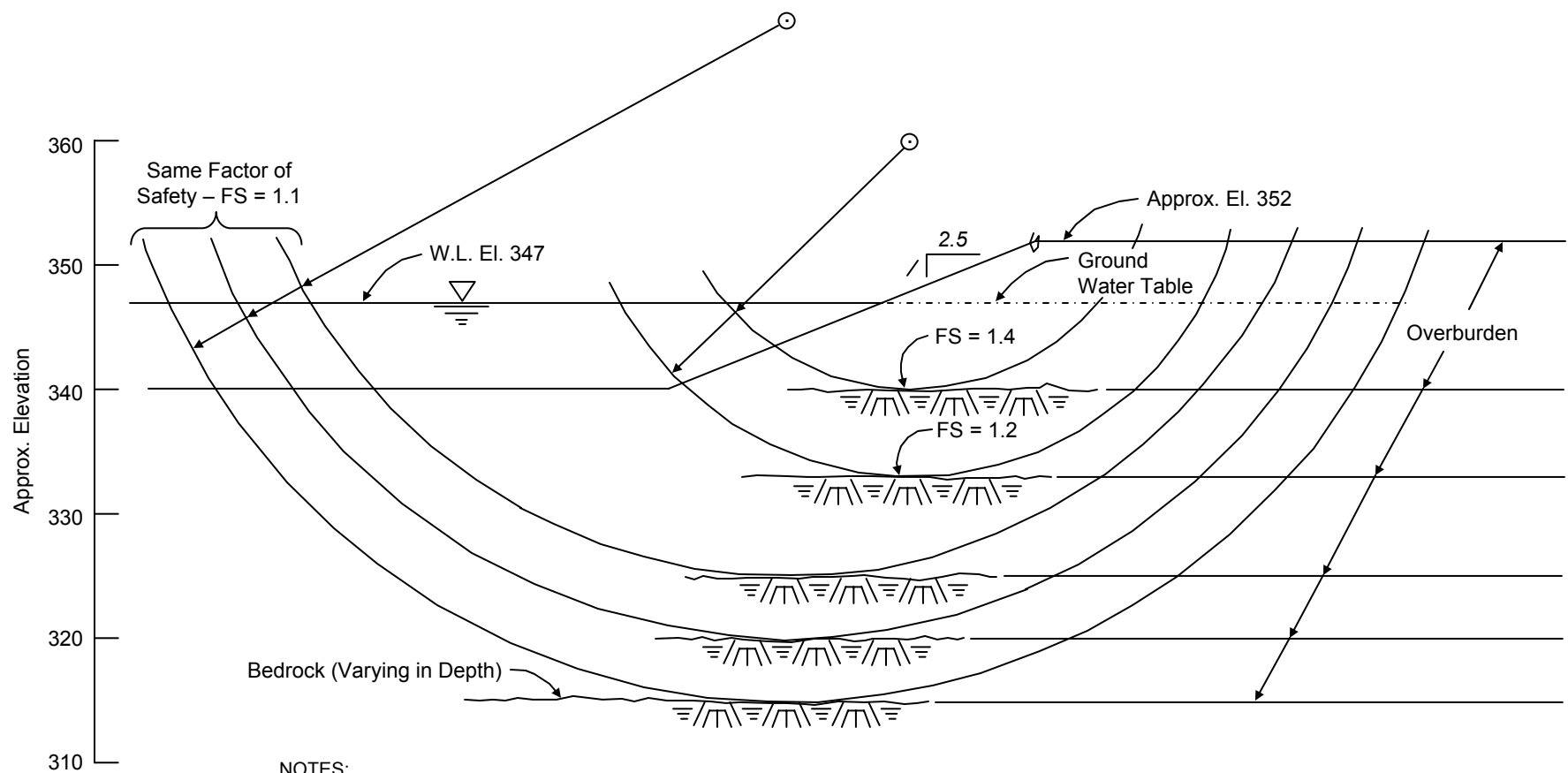

NOTES:

1. Critical slip circles are for steady state seepage plus seismic loading 0.2 g.
2. The recommended slopes are based on long term stability analyses using residual (ultimate) shear strengths of the soil overburden.

Scale: 3/4" = 10'

STABILITY OF EXCAVATED SLOPE EMERGENCY COOLING POND

SAR FIGURE NO. 2.5-30

ARKANSAS NUCLEAR ONE
 UNIT 2
 RUSSELLVILLE, ARKANSAS



SCALE:	NONE
DRAWN:	ENERGY
DESIGN:	ENERGY
CAD NO:	

AMENDMENT 19

BASED ON DRAWING NO	SHEET	REV.

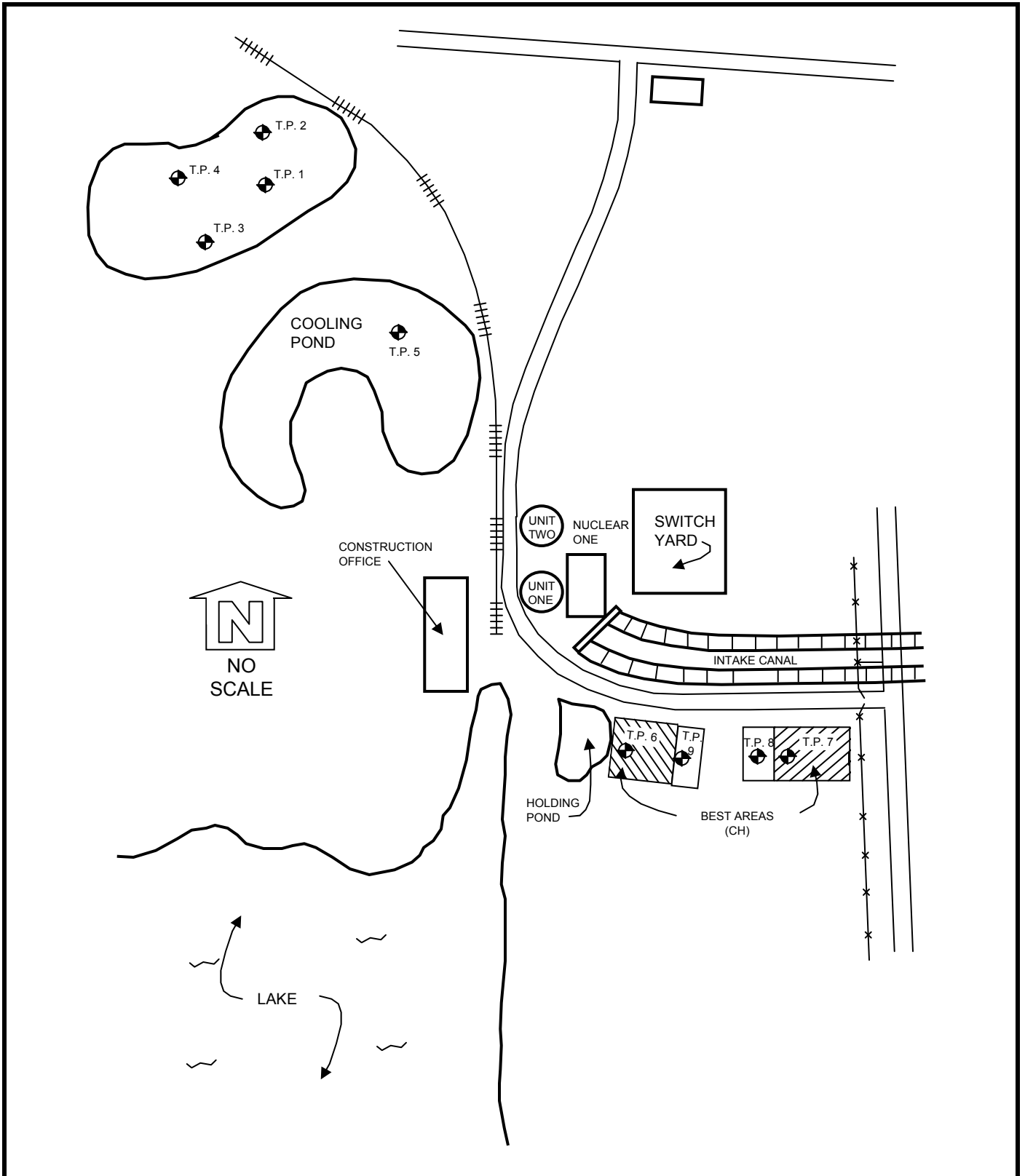

SAR FIGURE NO. 2.5-31

AMENDMENT 19

ARKANSAS NUCLEAR ONE
UNIT 2
RUSSELLVILLE, ARKANSAS



SCALE: NONE
DRAWN:
DESIGN: ENTERGY
CAD NO:

TEST PIT LOCATIONS

BASED ON DRAWING NO

SHEET

REV.

LOG OF TEST PIT NO. 1

DATE:

TYPE: Backhoe

LOCATION: See Plate I

DEPTH, FT.	SYMBOL	SAMPLES	DESCRIPTION OF MATERIAL	CLASSIFICATION DATA
			SURFACE ELEV.	
			Tan and yellowish-tan, silty clay SPOIL CL	Liquid Limit: 39 Plasticity Index: 20 97% passing No. 200 sieve
5			Black Shale SPOIL	

COMPLETION DEPTH: 6 ft

DEPTH TO WATER IN TEST PIT: 4 ft

LOG OF TEST PIT NO. 2

DATE:

TYPE: Backhoe

LOCATION: See Plate I

DEPTH, FT.	SYMBOL	SAMPLES	DESCRIPTION OF MATERIAL	CLASSIFICATION DATA
			SURFACE ELEV.	
			Tan, silty clay with some red and gray, silty clay SPOIL	
5			Black Shale SPOIL	

COMPLETION DEPTH: 6 ft

DEPTH TO WATER IN TEST PIT:

GRUBBS CONSULTING ENGINEERS, INC.

SAR FIGURE NO. 2.5-32

AMENDMENT 19

ARKANSAS NUCLEAR ONE
UNIT 2
RUSSELLVILLE, ARKANSAS



SCALE:	NONE
DRAWN:	
DESIGN:	ENTERGY
CAD NO:	

LOG OF TEST PITS 1 AND 2

BASED ON DRAWING NO

SHEET

REV.

LOG OF TEST PIT NO. 3

DATE:

TYPE: Backhoe

LOCATION: See Plate I

DEPTH, FT.	SYMBOL	SAMPLES	DESCRIPTION OF MATERIAL	CLASSIFICATION DATA
			SURFACE ELEV.	
5			Tan and gray, silty clay SPOIL	
			- red with some gray, silty clay from 3 to 4 ft	
-10				

COMPLETION DEPTH: 7 ft

DEPTH TO WATER IN TEST PIT:

LOG OF TEST PIT NO. 4

DATE:

TYPE: Backhoe

LOCATION: See Plate I

DEPTH, FT.	SYMBOL	SAMPLES	DESCRIPTION OF MATERIAL	CLASSIFICATION DATA
			SURFACE ELEV.	
5			Tan and gray, silty clay with shale fragments SPOIL (CL)	Liquid Limit: 42 Plasticity Index: 22 78% passing No. 200 sieve
			Red, gray and tan, silty clay and clay SPOIL	
			Tan and gray, silty clay SPOIL	
-10				

COMPLETION DEPTH: 8.5 ft

DEPTH TO WATER IN TEST PIT: Dry

GRUBBS CONSULTING ENGINEERS, INC.

SAR FIGURE NO. 2.5-33

AMENDMENT 19

ARKANSAS NUCLEAR ONE
UNIT 2
RUSSELLVILLE, ARKANSAS



SCALE: NONE

DRAWN:

DESIGN: ENTERGY

CAD NO:

LOG OF TEST PITS 3 AND 4

BASED ON DRAWING NO

SHEET

REV.

LOG OF TEST PIT NO. 5

DATE:

TYPE: Backhoe

LOCATION: See Plate I

DEPTH, FT.	SYMBOL	SAMPLES	DESCRIPTION OF MATERIAL	CLASSIFICATION DATA
			SURFACE ELEV.	
			Tan, gray and some red, silty clay	Liquid Limit: 46 Plasticity Index: 27 94% passing No. 200 sieve
			Soil in this area has been excavated since test pit work.	
-5				
-10				

COMPLETION DEPTH: 1.5 ft

DEPTH TO WATER IN TEST PIT: Dry

LOG OF TEST PIT NO. 6

DATE:

TYPE: Backhoe

LOCATION: See Plate I

DEPTH, FT.	SYMBOL	SAMPLES	DESCRIPTION OF MATERIAL	CLASSIFICATION DATA
			SURFACE ELEV.	
			Red and gray clay with some tan, silty clay SPOIL (CH) - dark-gray shale fragments	Liquid Limit: 54 Plasticity Index: 34 97% passing No. 200 sieve
			Red clay with some tan, silty clay SPOIL (CH)	Liquid Limit: 79 Plasticity Index: 50 99% passing No. 200 sieve
-5				
-10				

COMPLETION DEPTH: 8 ft

DEPTH TO WATER IN TEST PIT: Dry

GRUBBS CONSULTING ENGINEERS, INC.

SAR FIGURE NO. 2.5-34

AMENDMENT 19

ARKANSAS NUCLEAR ONE
UNIT 2
RUSSELLVILLE, ARKANSAS



SCALE: NONE
DRAWN:
DESIGN: ENTERGY
CAD NO:

LOG OF TEST PITS 5 AND 6

BASED ON DRAWING NO

SHEET

REV.

LOG OF TEST PIT NO. 7

DATE:

TYPE: Backhoe

LOCATION: See Plate I

DEPTH, FT.	SYMBOL	SAMPLES	DESCRIPTION OF MATERIAL	CLASSIFICATION DATA
			SURFACE ELEV.	
			Weathered shale with red and tan, silty clay SPOIL	Liquid Limit: 67 Plasticity Index: 40 99% passing No. 200 sieve
			Red and gray clay SPOIL (CH)	
-5			Tan and gray, silty clay SPOIL	
			Red and gray clay SPOIL	
-10			-----	

COMPLETION DEPTH: 10 ft

DEPTH TO WATER IN TEST PIT: Dry

LOG OF TEST PIT NO. 8

DATE:

TYPE: Backhoe

LOCATION: See Plate I

DEPTH, FT.	SYMBOL	SAMPLES	DESCRIPTION OF MATERIAL	CLASSIFICATION DATA
			SURFACE ELEV.	
			Tan and gray, silty clay with weathered shale SPOIL	
			Red clay with tan and gray, silty clay SPOIL	
-5			Dark-gray and tan, weathered shale SPOIL	
			- more silty clay below 8 ft	
-10			-----	

COMPLETION DEPTH: 9 ft

DEPTH TO WATER IN TEST PIT: Dry

GRUBBS CONSULTING ENGINEERS, INC.

SAR FIGURE NO. 2.5-35

AMENDMENT 19

ARKANSAS NUCLEAR ONE
UNIT 2
RUSSELLVILLE, ARKANSAS



SCALE:	NONE
DRAWN:	
DESIGN:	ENERGY
CAD NO:	

LOG OF TEST PITS 7 AND 8

BASED ON DRAWING NO

SHEET

REV.

LOG OF TEST PIT NO. 9

DATE:

TYPE: Backhoe

LOCATION: See Plate I

DEPTH, FT.	SYMBOL	SAMPLES	DESCRIPTION OF MATERIAL	CLASSIFICATION DATA
			SURFACE ELEV.	
5			Interbedded red clay, tan, silty clay and weathered shale SPOIL	

COMPLETION DEPTH: 5 ft

DEPTH TO WATER IN TEST PIT: Dry

LOG OF TEST PIT NO.

DATE:

TYPE:

LOCATION:

DEPTH, FT.	SYMBOL	SAMPLES	DESCRIPTION OF MATERIAL	CLASSIFICATION DATA
			SURFACE ELEV.	

COMPLETION DEPTH:

DEPTH TO WATER IN TEST PIT:

GRUBBS CONSULTING ENGINEERS, INC.

SAR FIGURE NO. 2.5-36

AMENDMENT 19

ARKANSAS NUCLEAR ONE
UNIT 2
RUSSELLVILLE, ARKANSAS



SCALE: NONE

DRAWN:

DESIGN: ENTERGY

CAD NO:

LOG OF TEST PIT 9

BASED ON DRAWING NO

SHEET

REV.

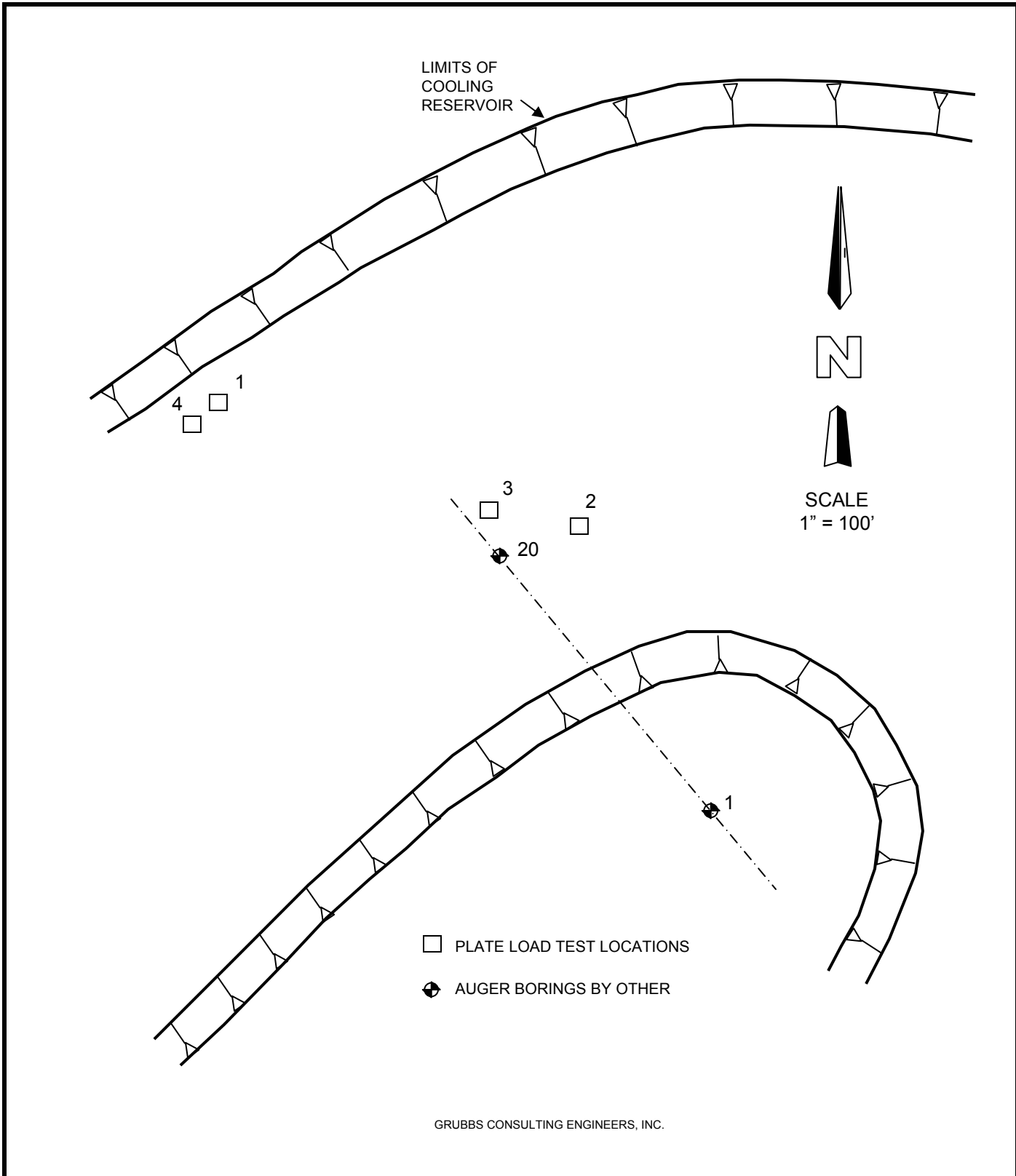

SAR FIGURE NO. 2.5-37

AMENDMENT 19

ARKANSAS NUCLEAR ONE
UNIT 2
RUSSELLVILLE, ARKANSAS



SCALE:	NONE
DRAWN:	
DESIGN:	ENERGY
CAD NO:	

PLAN OF LOAD TEST AREA

BASED ON DRAWING NO

SHEET

REV.

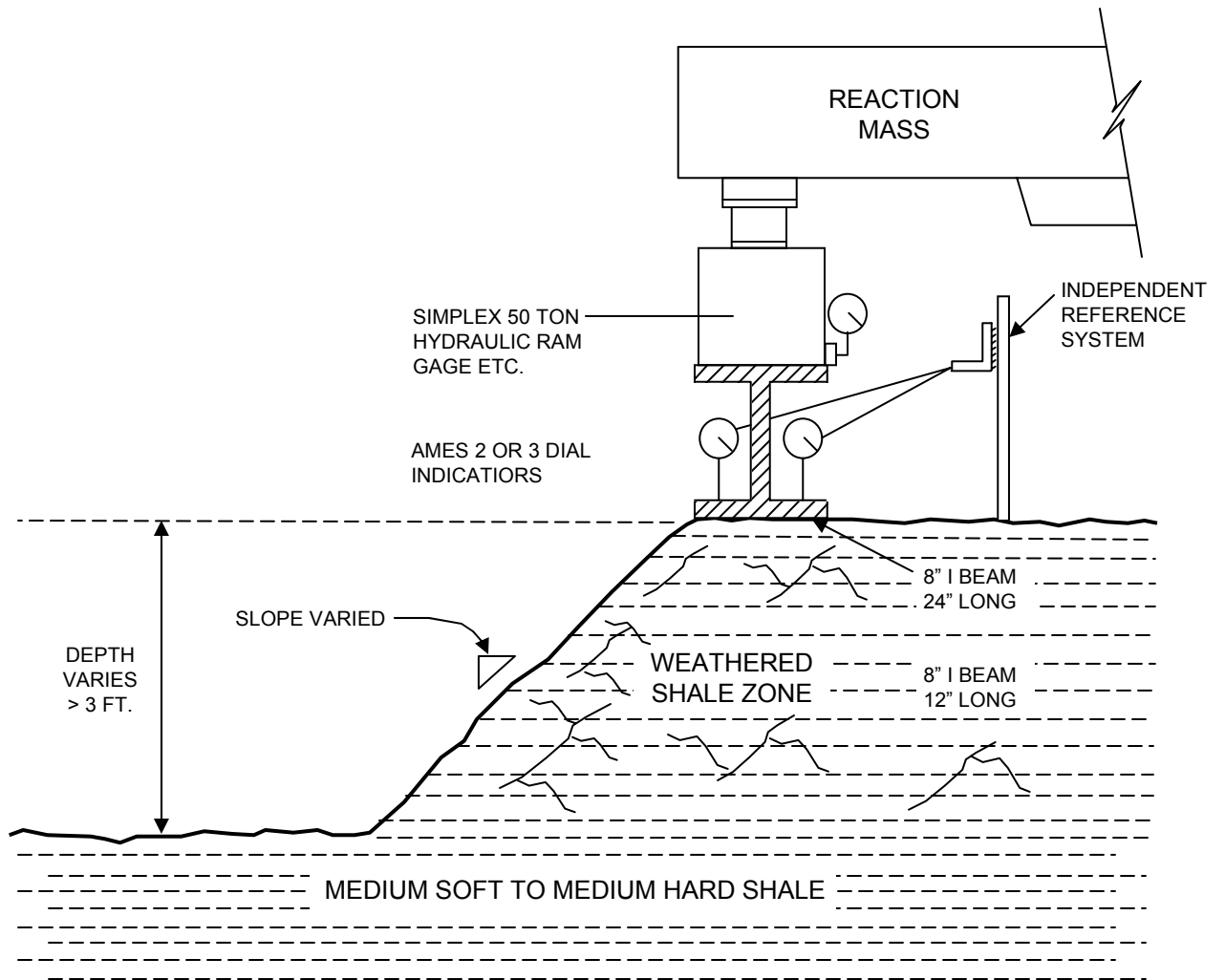

GRUBBS CONSULTING ENGINEERS, INC.

SAR FIGURE NO. 2.5-38

AMENDMENT 19

ARKANSAS NUCLEAR ONE
UNIT 2
RUSSELLVILLE, ARKANSAS



SCALE:	NONE
DRAWN:	
DESIGN:	ENERGY
CAD NO:	

TYPICAL PLATE LOAD TEST
ARRANGEMENT

BASED ON DRAWING NO

SHEET

REV.

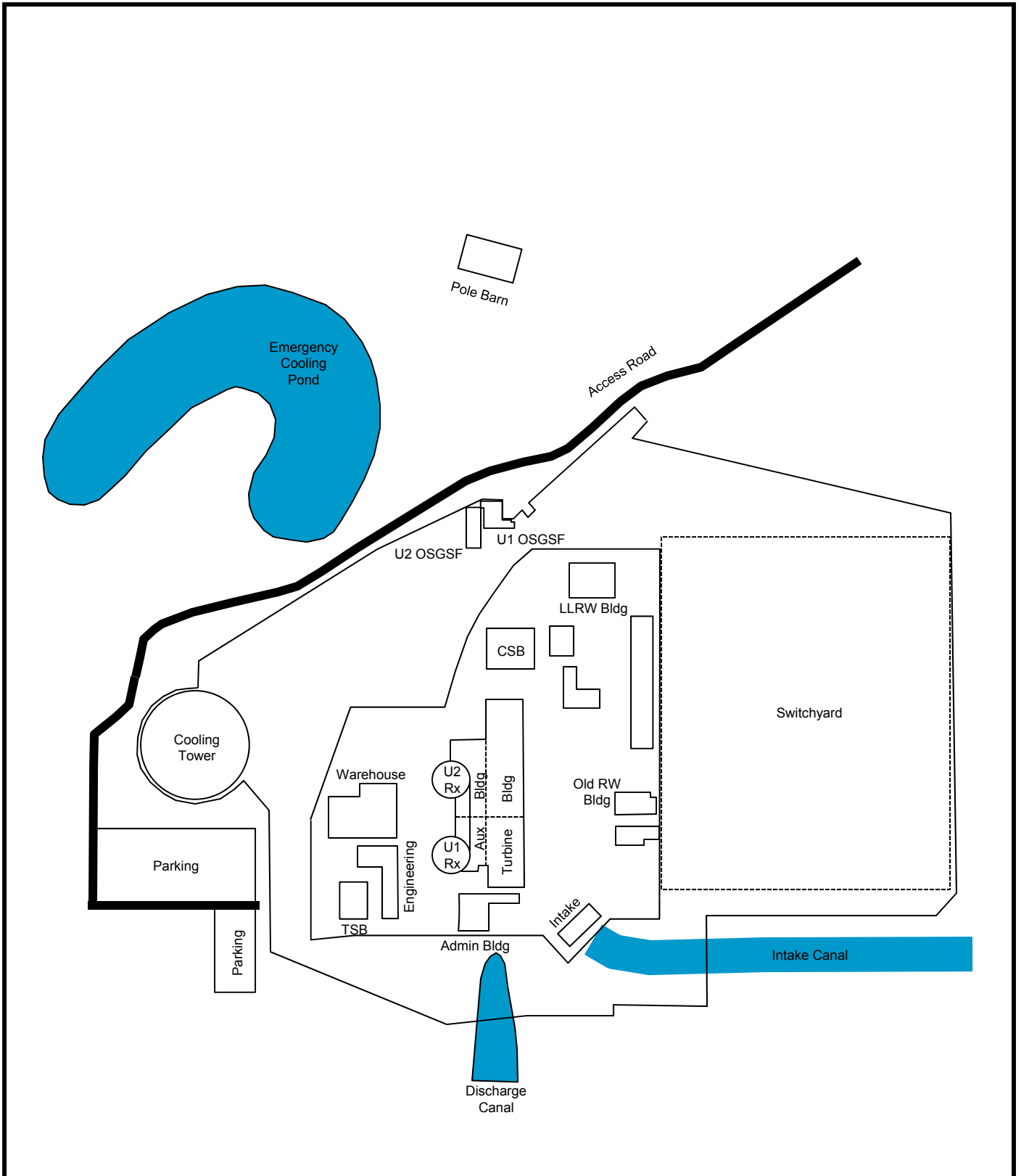

SAR FIGURE NO. 2.5-39

AMENDMENT 26

ARKANSAS NUCLEAR ONE
UNIT 2
RUSSELLVILLE, ARKANSAS



SCALE:	NONE
DRAWN:	ENERGY
DESIGN:	ENERGY
CAD NO:	N/A

GENERAL SITE STRUCTURES

DRAWING NO

SHEET

REV.

SAMPLED FROM: T.P. 1
 DEPTH: 0 -4 FEET
 DESCRIPTION: LIGHT GRAY SILTY CLAY
 MAXIMUM DRY DENSITY: 117.6 LBS/CU FT
 OPTIMUM WATER CONTENT: 14.6%
 PLASTIC LIMIT: 19.1
 LIQUID LIMIT: 38.7

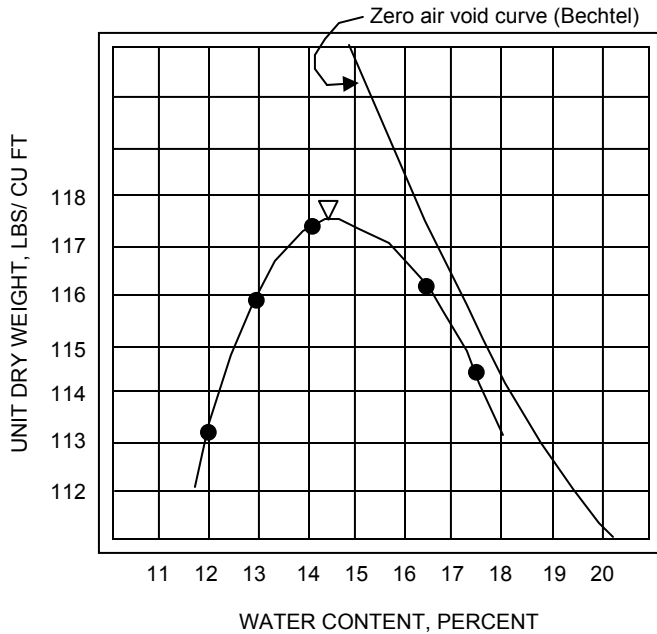

MODIFIED COMPACTION CURVE
 ASTM D 1557

SAMPLED FROM: T.P. 7
 DEPTH: 1.5 -5 FEET
 DESCRIPTION: REDDISH TAN CLAY
 MAXIMUM DRY DENSITY: 111.5 LBS/CU FT
 OPTIMUM WATER CONTENT: 18.4%
 PLASTIC LIMIT: 27.0
 LIQUID LIMIT: 67.0

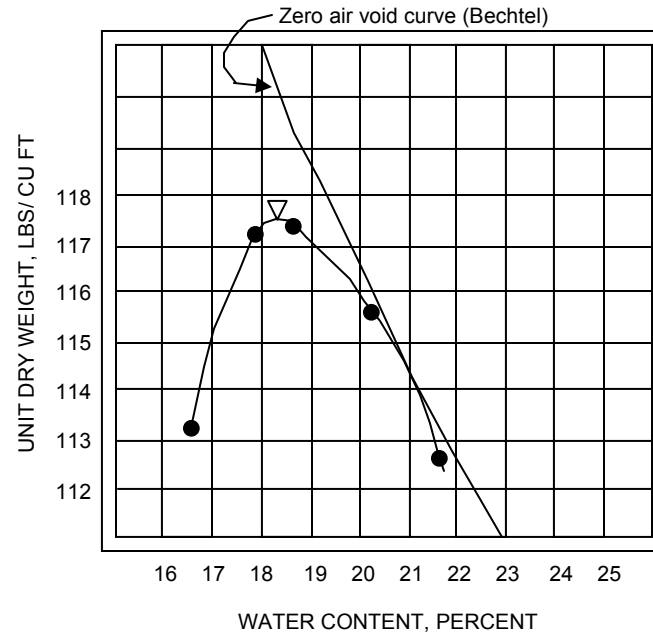

MODIFIED COMPACTION CURVE
 ASTM D 1557

GRUBBS CONSULTING ENGINEERS, INC.

MODIFIED COMPACTION CURVES

SAR FIGURE NO. 2.5-40

ARKANSAS NUCLEAR ONE
 UNIT 2
 RUSSELLVILLE, ARKANSAS



SCALE: NONE
 DRAWN: ENERGY
 DESIGN: ENERGY
 CAD NO:

AMENDMENT 19

BASED ON DRAWING NO	SHEET	REV.

BORING OR TEST PIT NO.	DEPTH FT.	ATTERBERG LIMITS			ASTM D-1557		-----GRADATION-----							UNIFIED SOIL CLASS
		L.L. %	P.L. %	P.I. %	MAXIMUM DENSITY PCF	OPTIMUM MOISTURE %	PERCENT PASSING							
							2 IN.	3/4 IN.	3/8 IN.	NO. 4	NO. 10	NO. 40	NO. 200	
1	0 – 4	9	19	20	117.6	14.6			100	99.9	99.3	98.0	96.7	CL
4	0 – 4	42	20	22			100	96.2	94.5	90.8	87.6	86.3	77.9	CL
5	0 – 0.5	46	19	27					100	99.6	99.3	99.0	93.8	CL
6	1 – 4	54	20	34					100	99.9	99.1	98.6	97.3	CH
	5 – 8	79	29	50						100	99.9	99.9	99.5	CH
7	1.5 – 4	67	27	40	111.5	18.4		100	99.8	99.4	99.1	99.0	98.8	CH

GRUBBS CONSULTING ENINEERS, INC.

CLASSIFICATION SOIL DATA SUMMARY

SAR FIGURE NO. 2.5-41

ARKANSAS NUCLEAR ONE
UNIT 2
RUSSELLVILLE, ARKANSAS



SCALE: NONE
DRAWN: ENERGY
DESIGN: ENERGY
CAD NO:

AMENDMENT 19

BASED ON DRAWING NO	SHEET	REV.
---------------------	-------	------

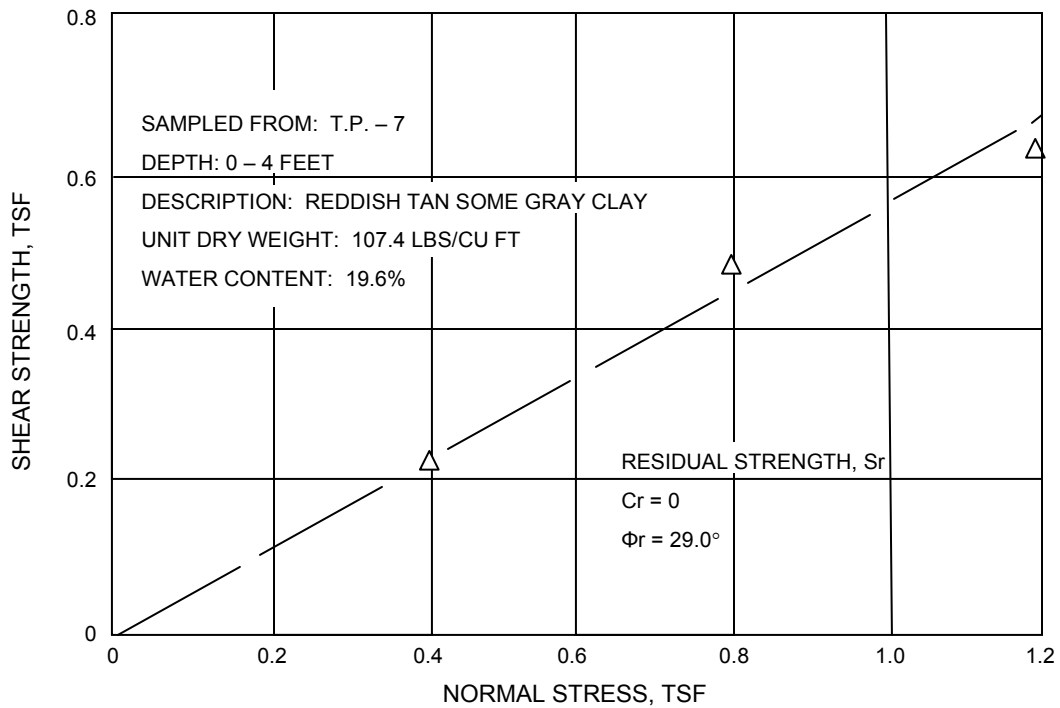
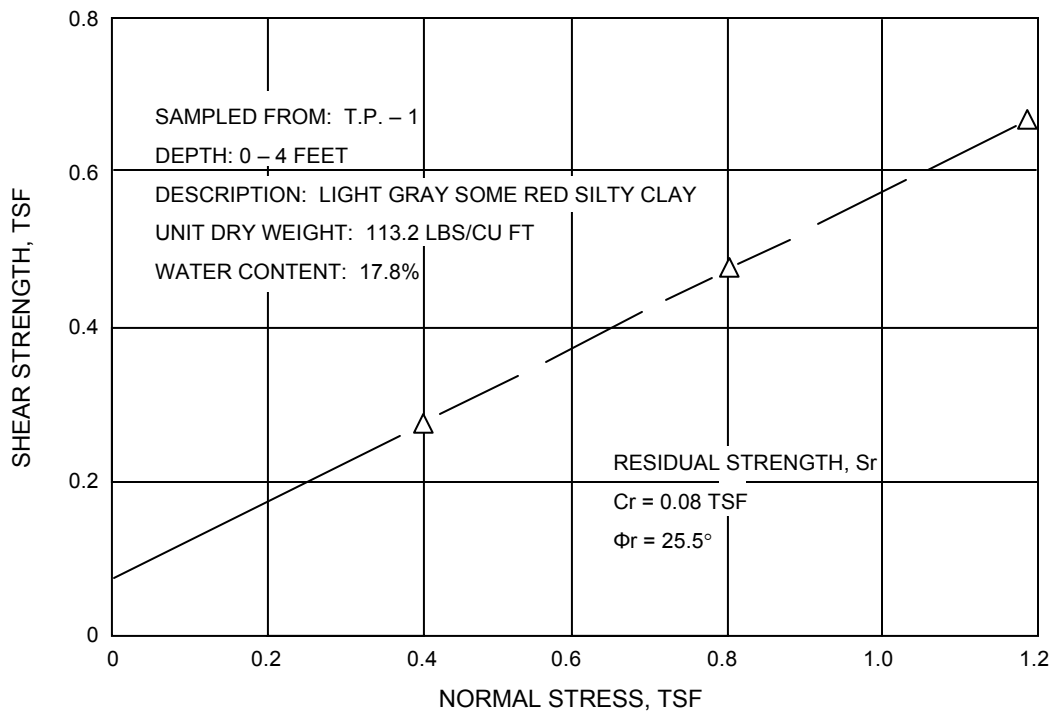

GRUBBS CONSULTING ENGINEERS, INC.

SAR FIGURE NO. 2.5-42

AMENDMENT 19

ARKANSAS NUCLEAR ONE
 UNIT 2
 RUSSELLVILLE, ARKANSAS



SCALE:	NONE
DRAWN:	
DESIGN:	ENTERGY
CAD NO:	

RESULTS OF DIRECT SHEAR TESTS CONSOLIDATED-
 DRAINED RESIDUAL STRENGTH VALUES

BASED ON DRAWING NO

SHEET

REV.

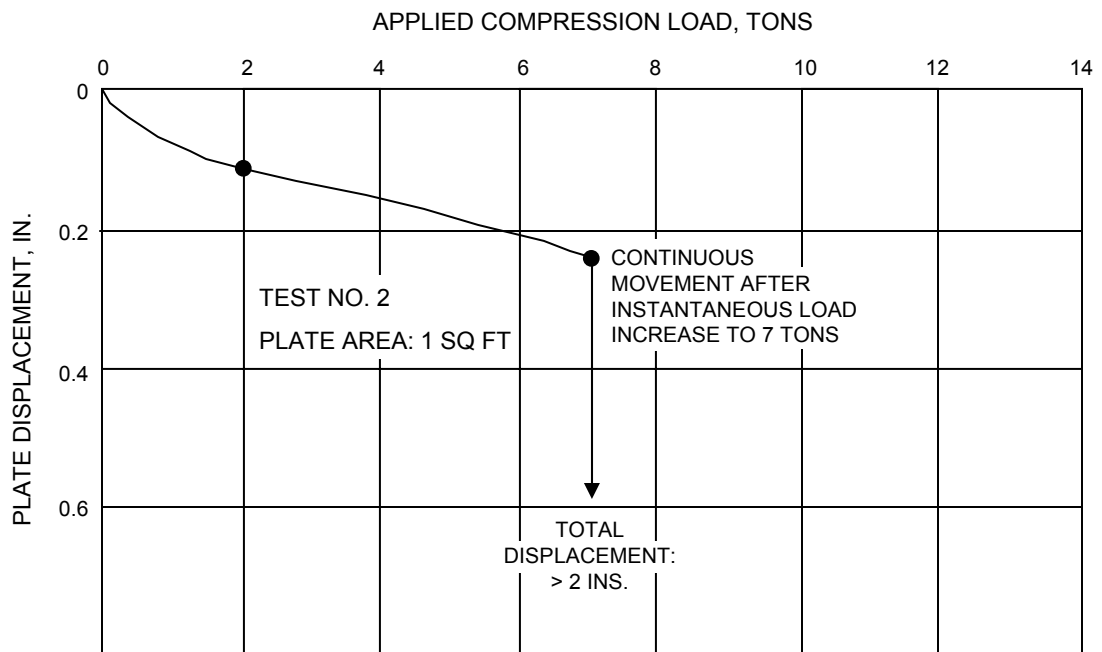
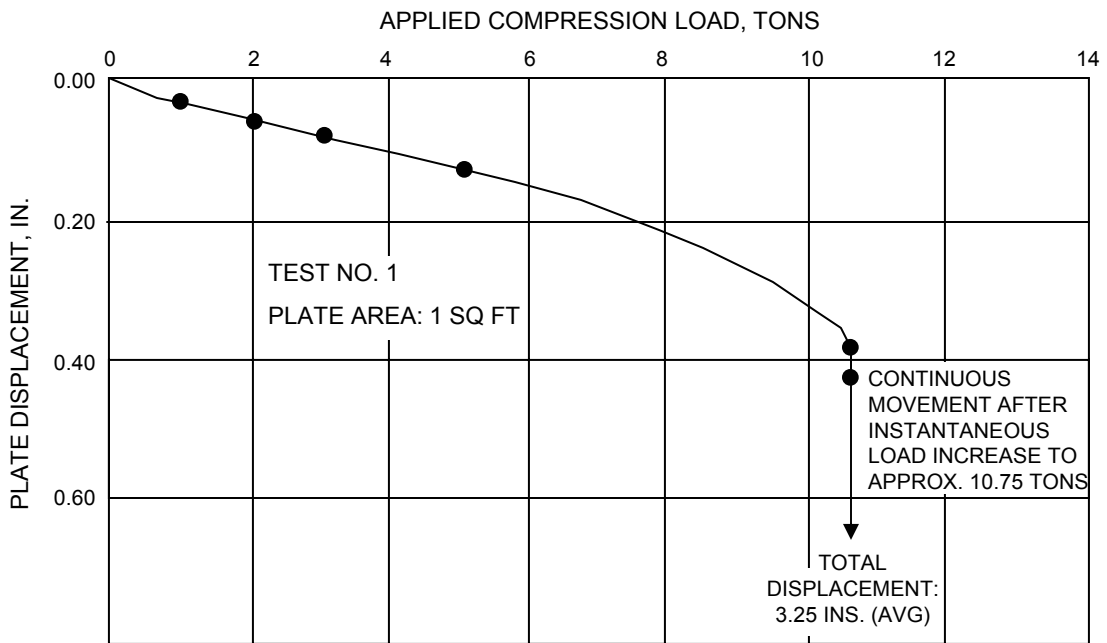

GRUBBS CONSULTING ENGINEERS, INC.

SAR FIGURE NO. 2.5-43

AMENDMENT 19

ARKANSAS NUCLEAR ONE
UNIT 2
RUSSELLVILLE, ARKANSAS



SCALE: NONE
DRAWN:
DESIGN: ENTERGY
CAD NO:

LOAD DISPLACEMENT CURVES

BASED ON DRAWING NO

SHEET

REV.

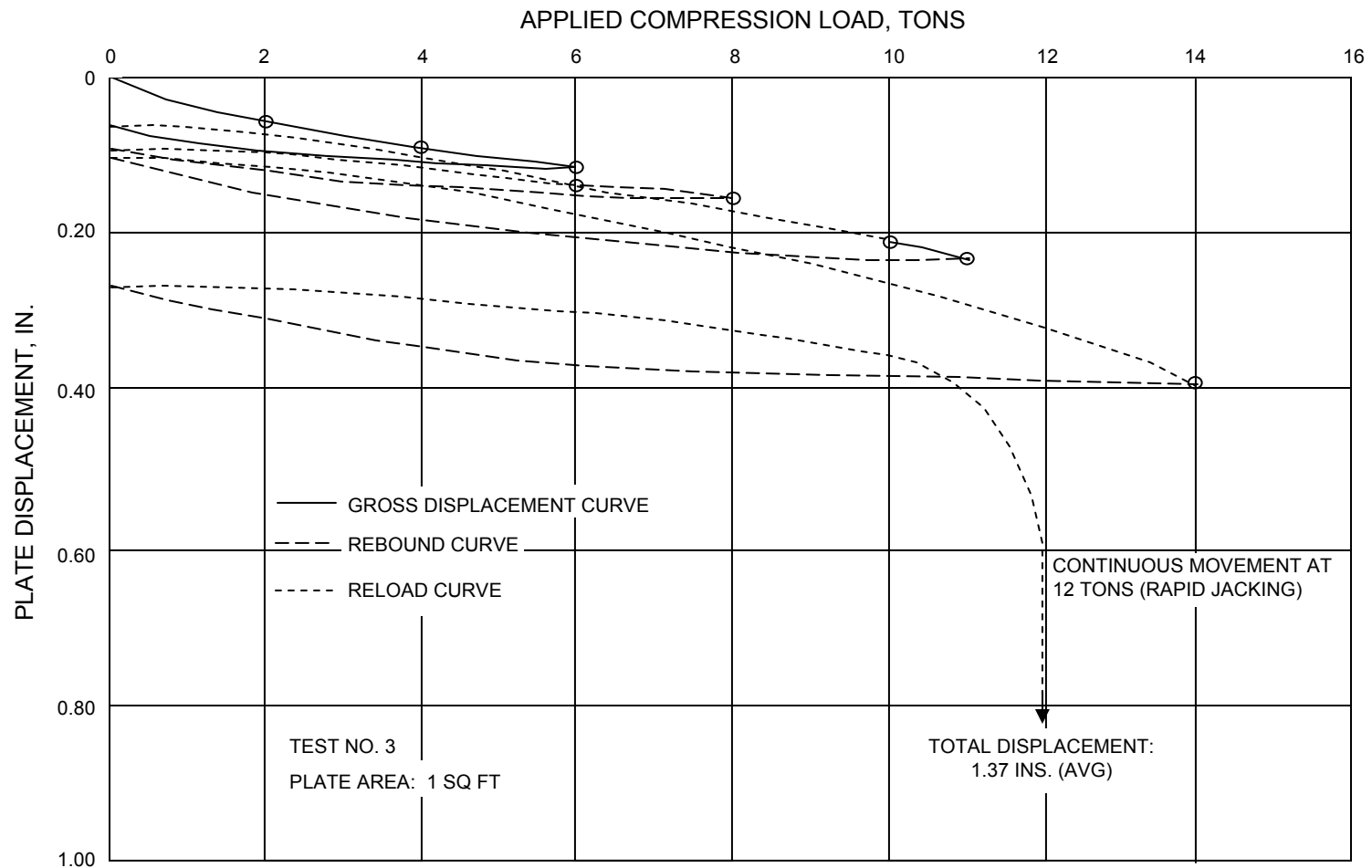

GRUBBS CONSULTING ENGINEERS, INC.

LOAD DISPLACEMENT CURVE

SAR FIGURE NO. 2.5-44

ARKANSAS NUCLEAR ONE
 UNIT 2
 RUSSELLVILLE, ARKANSAS



SCALE: NONE
 DRAWN: ENTERGY
 DESIGN: ENTERGY
 CAD NO:

AMENDMENT 19

BASED ON DRAWING NO

SHEET

REV.

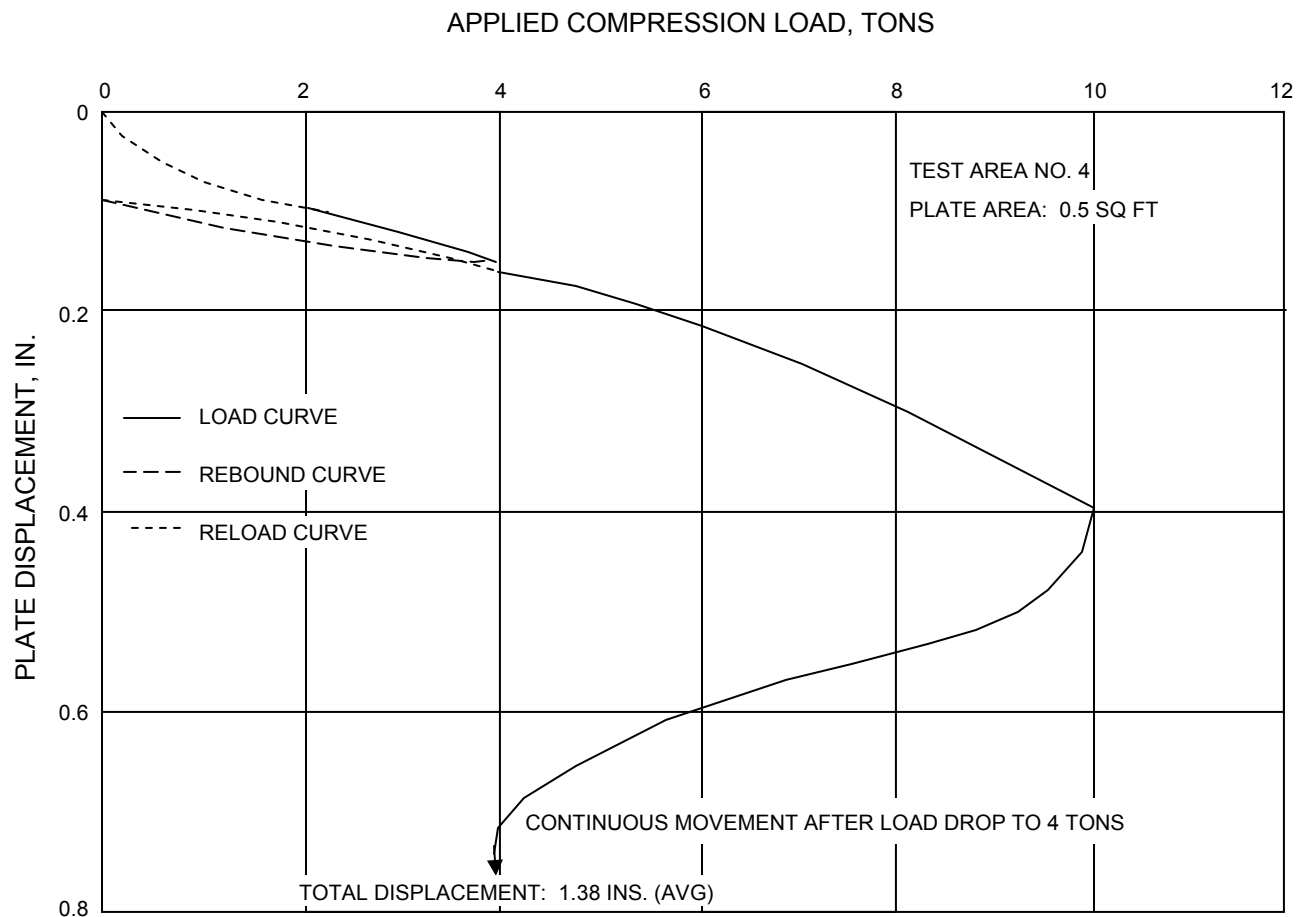

GRUBBS CONSULTING ENGINEERS, INC.

SAR FIGURE NO. 2.5-45

AMENDMENT 19

ARKANSAS NUCLEAR ONE
UNIT 2
RUSSELLVILLE, ARKANSAS



SCALE:	NONE
DRAWN:	
DESIGN:	ENERGY
CAD NO:	

LOAD DISPLACEMENT CURVE

BASED ON DRAWING NO

SHEET

REV.

DELETED

SAR FIGURE NO. 2.5-46

AMENDMENT 19

ARKANSAS NUCLEAR ONE
UNIT 2
RUSSELLVILLE, ARKANSAS



SCALE: NONE

DRAWN:

DESIGN: ENTERGY

CAD NO:

PLAN OF LOAD TEST AREA

BASED ON DRAWING NO

SHEET

REV.

- TEST NO. 1
- - - - TEST NO. 2
- TEST NO. 3
- TEST NO. 4

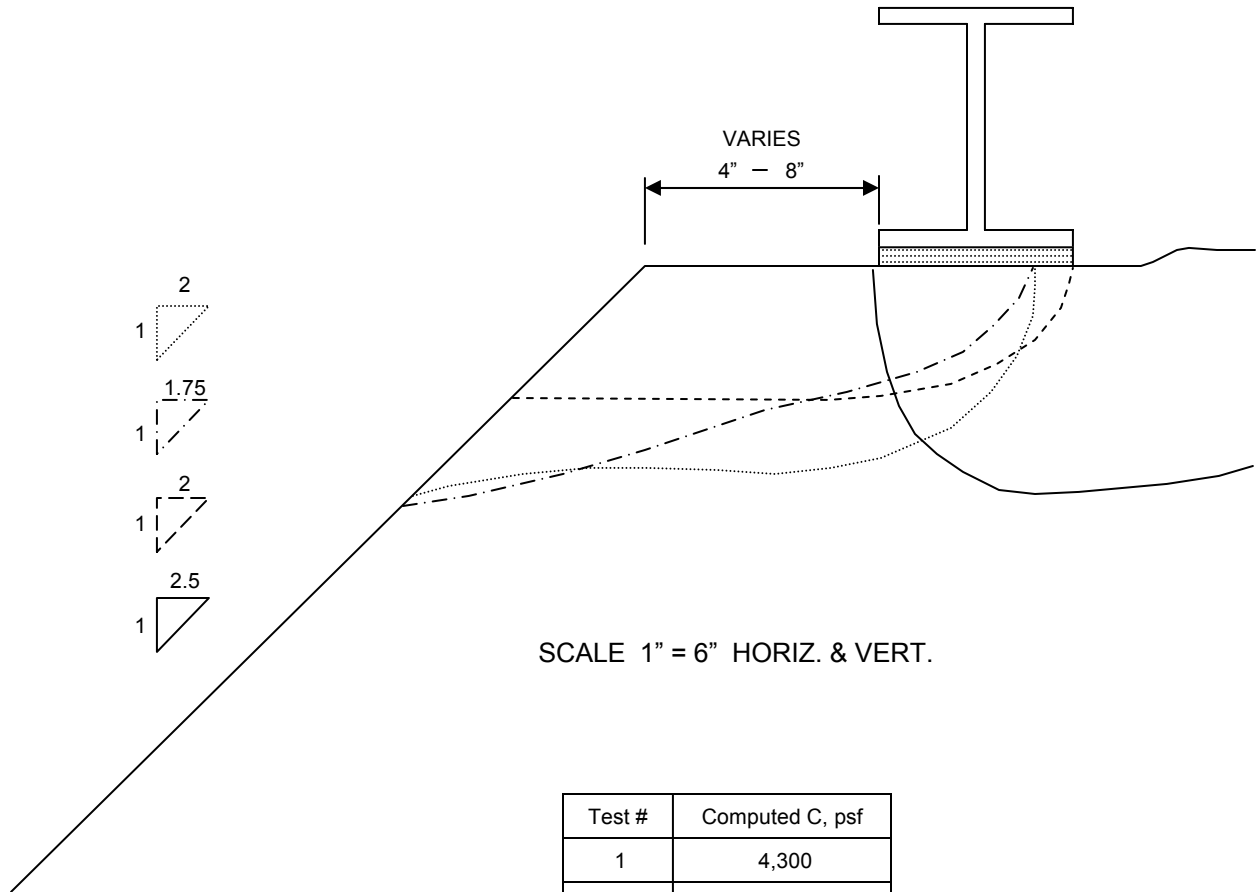

SCALE 1" = 6" HORIZ. & VERT.

Test #	Computed C, psf
1	4,300
2	2,690
3	5,100
4	3,570

SAR FIGURE NO. 2.5-47

AMENDMENT 19

ARKANSAS NUCLEAR ONE
UNIT 2
RUSSELLVILLE, ARKANSAS



SCALE: NONE

DRAWN:

DESIGN: ENTERGY

CAD NO:

GENERAL CONFIGURATION OF FAILURE SURFACES

BASED ON DRAWING NO

SHEET

REV.

DELETED

SAR FIGURE NO. 2.5-48

AMENDMENT 19

ARKANSAS NUCLEAR ONE
UNIT 2
RUSSELLVILLE, ARKANSAS



SCALE: NONE

DRAWN:

DESIGN: ENTERGY

CAD NO:

TEST PIT LOCATIONS

BASED ON DRAWING NO

SHEET

REV.

SAMPLED FROM: T.P. 1
 DEPTH: 0 -4 FEET
 DESCRIPTION: LIGHT GRAY SILTY CLAY
 MAXIMUM DRY DENSITY: 117.6 LBS/CU FT
 OPTIMUM WATER CONTENT: 14.6%
 PLASTIC LIMIT: 19.1
 LIQUID LIMIT: 38.7

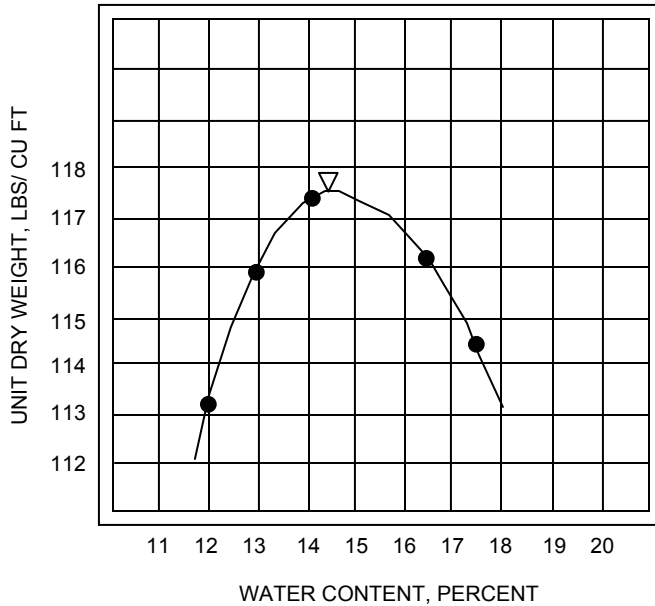

MODIFIED COMPACTION CURVE
 ASTM D 1557

SAMPLED FROM: T.P. 7
 DEPTH: 1.5 -5 FEET
 DESCRIPTION: REDDISH TAN CLAY
 MAXIMUM DRY DENSITY: 111.5 LBS/CU FT
 OPTIMUM WATER CONTENT: 18.4%
 PLASTIC LIMIT: 27.0
 LIQUID LIMIT: 67.0

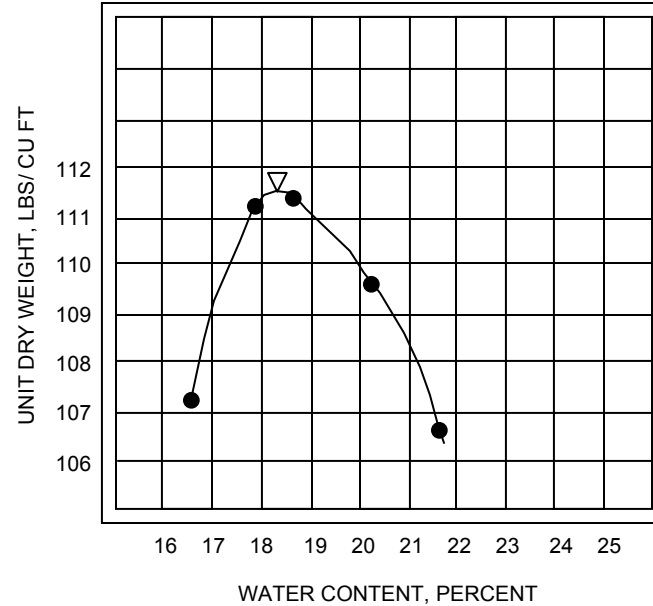

MODIFIED COMPACTION CURVE
 ASTM D 1557

GRUBBS CONSULTING ENGINEERS, INC.

MODIFIED COMPACTION CURVES

SAR FIGURE NO. 2.5-49

ARKANSAS NUCLEAR ONE
 UNIT 2
 RUSSELLVILLE, ARKANSAS



SCALE: NONE
 DRAWN: ENERGY
 DESIGN: ENERGY
 CAD NO:

AMENDMENT 19

BASED ON DRAWING NO	SHEET	REV.
---------------------	-------	------

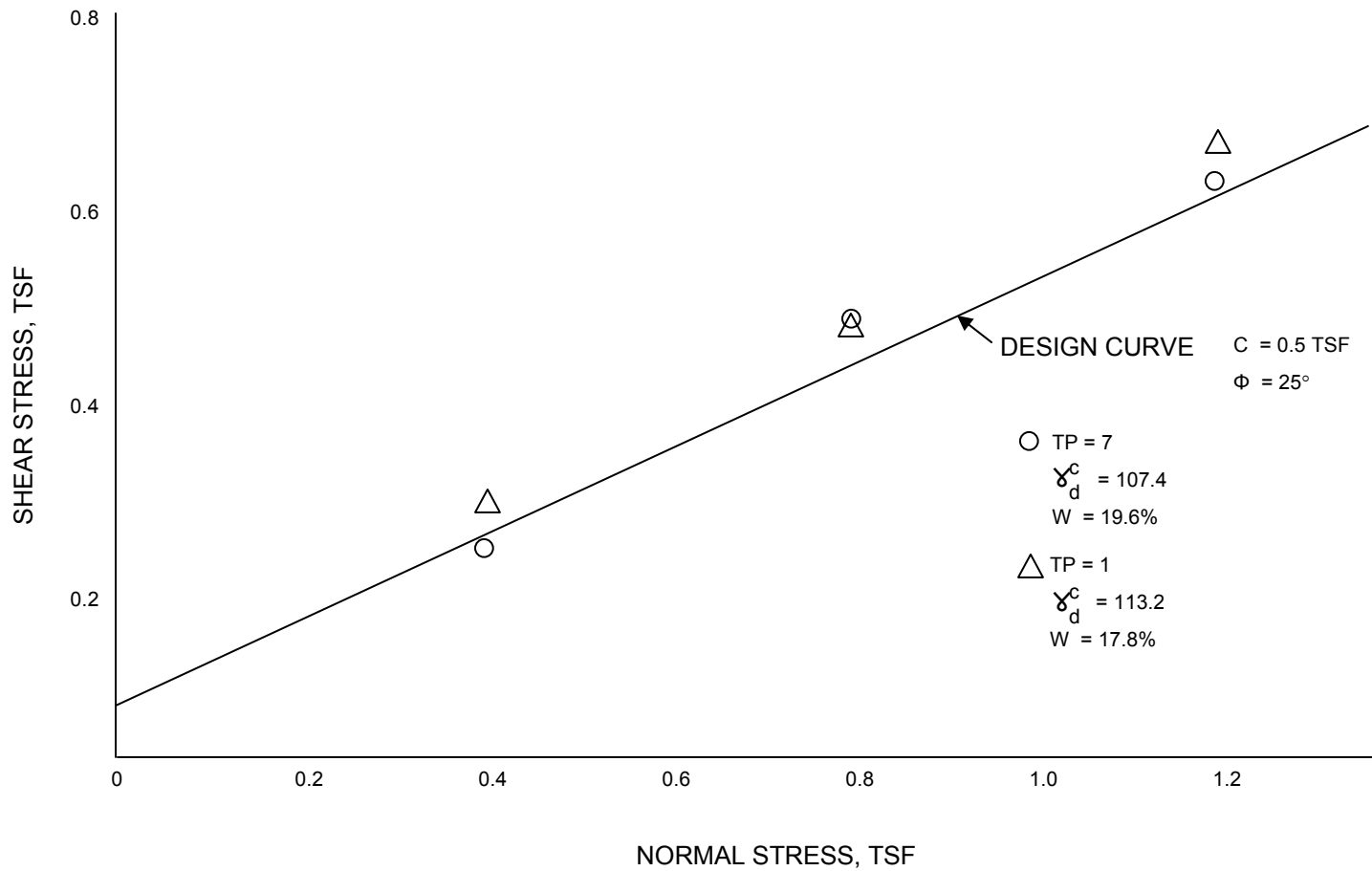

RESIDUAL SHEAR STRENGTH VALUES

SAR FIGURE NO. 2.5-50

ARKANSAS NUCLEAR ONE
 UNIT 2
 RUSSELLVILLE, ARKANSAS



SCALE: NONE
 DRAWN: ENTERGY
 DESIGN: ENTERGY
 CAD NO:

AMENDMENT 19

BASED ON DRAWING NO

SHEET

REV.

355

345

335

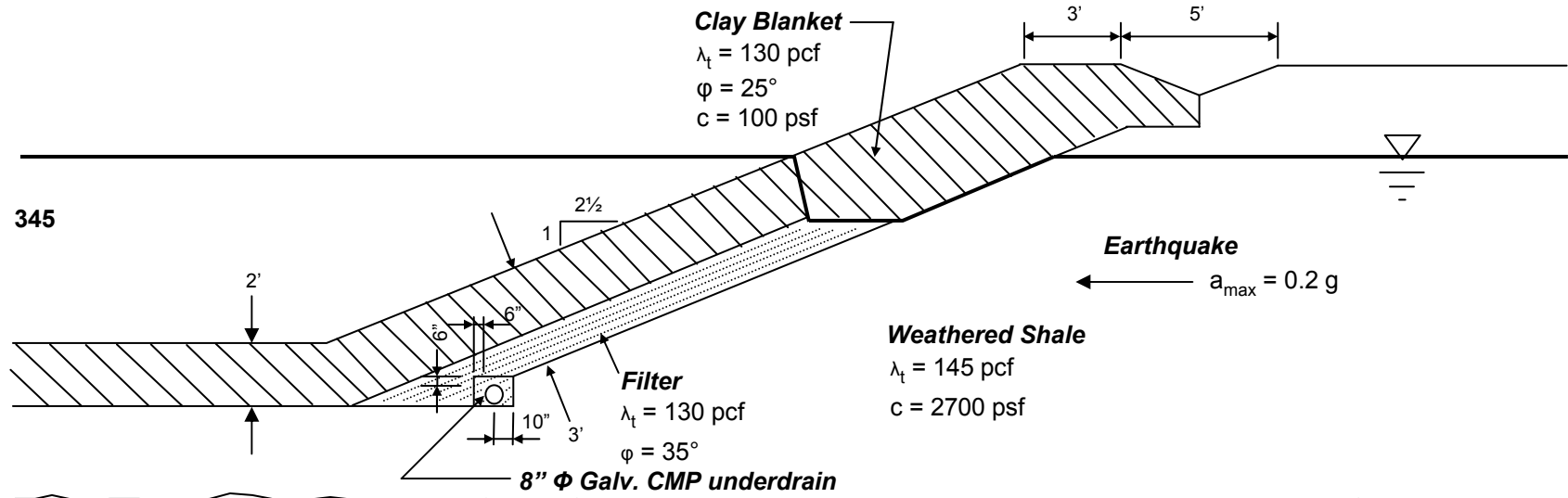

Full Reservoir & Earthquake
 (Required F.S. = 1.1)

CROSS SECTION ANALYZED – CASE I

SAR FIGURE NO. 2.5-51

ARKANSAS NUCLEAR ONE
 UNIT 2
 RUSSELLVILLE, ARKANSAS



SCALE: NONE
 DRAWN: ENTERGY
 DESIGN: ENTERGY
 CAD NO:

AMENDMENT 22

BASED ON DRAWING NO

SHEET

REV.

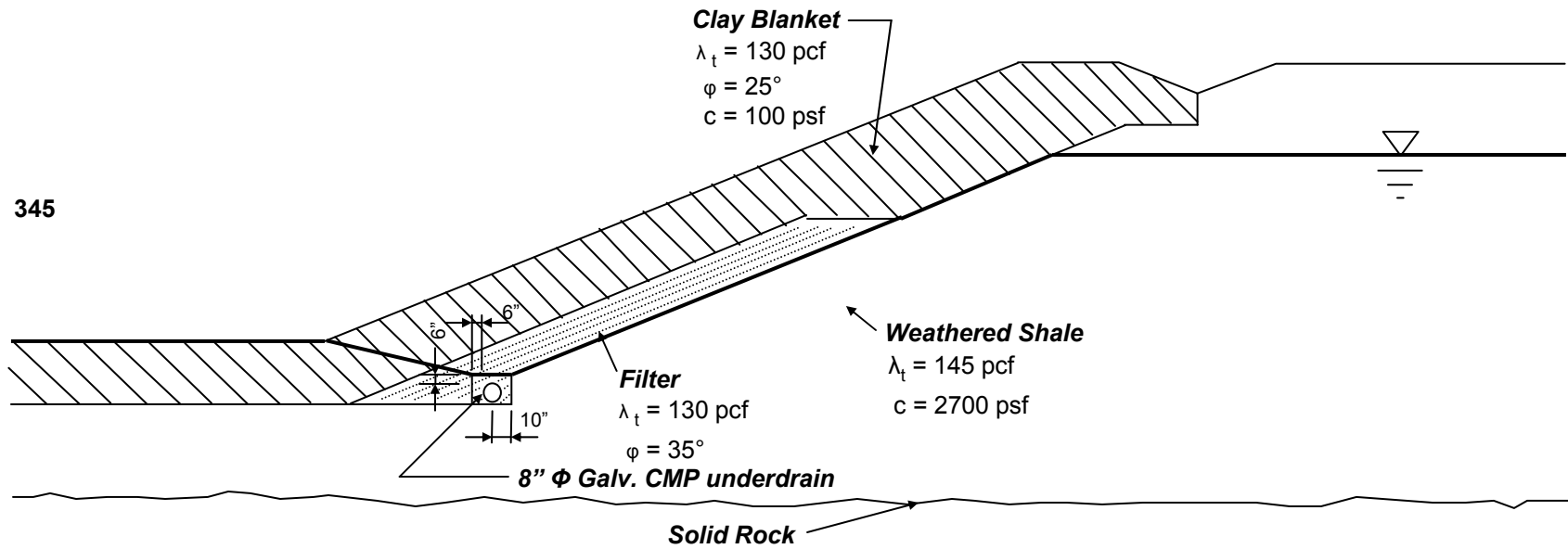

Rapid Draindown & No Earthquake
 (Required F.S. = 1.25)

CROSS SECTION ANALYZED – CASE II

SAR FIGURE NO. 2.5-52

ARKANSAS NUCLEAR ONE
 UNIT 2
 RUSSELLVILLE, ARKANSAS



SCALE: NONE
 DRAWN: ENTERGY
 DESIGN: ENTERGY
 CAD NO:

AMENDMENT 22

BASED ON DRAWING NO

SHEET

REV.

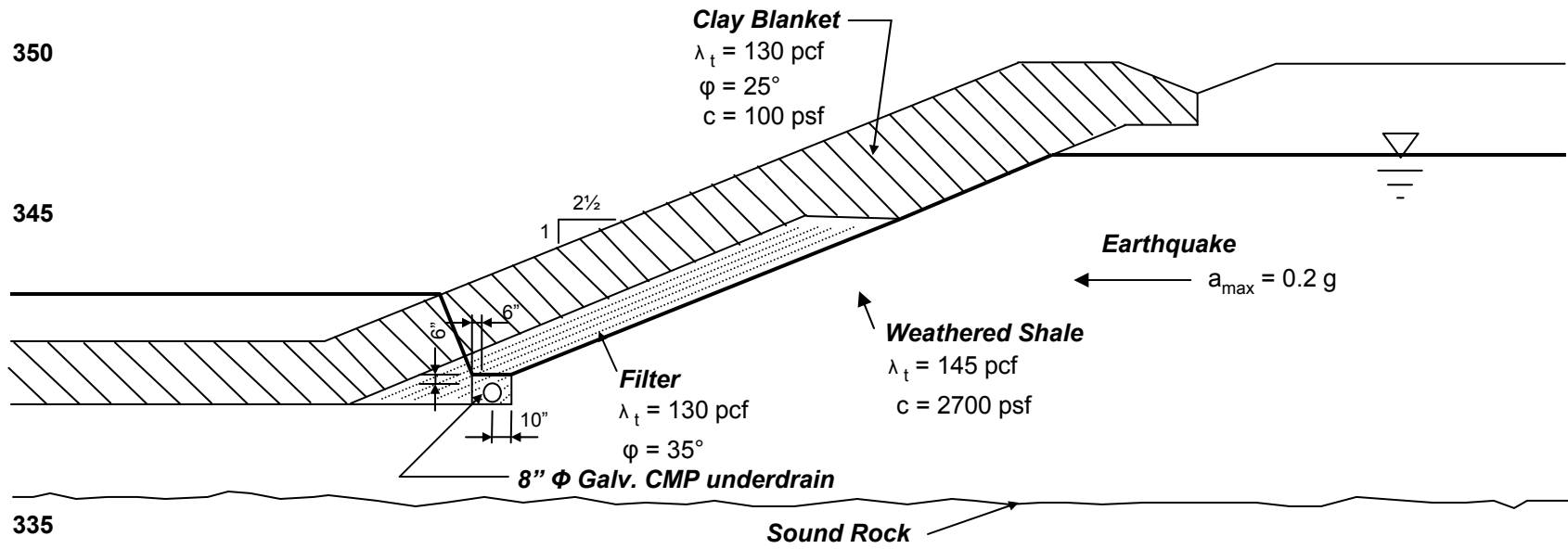

Minimum Reservoir, High Water Table & Earthquake
 (Required F.S. = 1.1)

CROSS SECTION ANALYZED – CASE III

SAR FIGURE NO. 2.5-53

ARKANSAS NUCLEAR ONE
 UNIT 2
 RUSSELLVILLE, ARKANSAS



SCALE: NONE
 DRAWN: ENTERGY
 DESIGN: ENTERGY
 CAD NO:

AMENDMENT 22

BASED ON DRAWING NO	SHEET	REV.
---------------------	-------	------

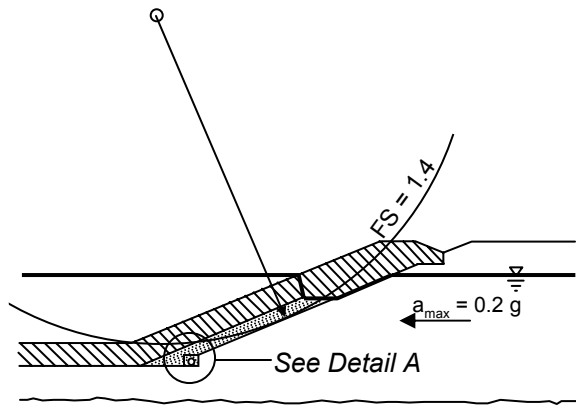

CASE I
Full Reservoir & Earthquake

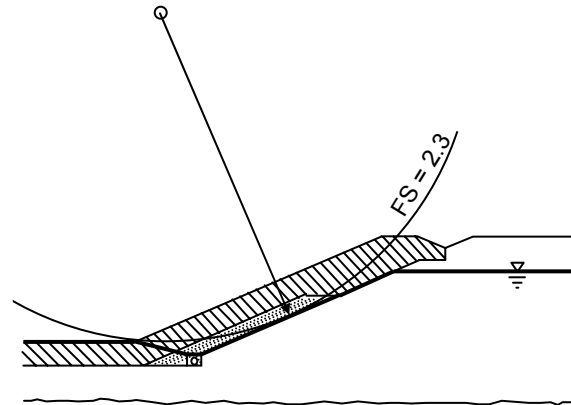

CASE II
Rapid Drawdown

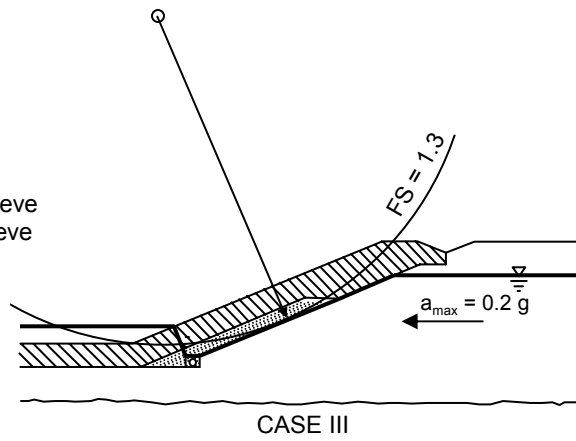
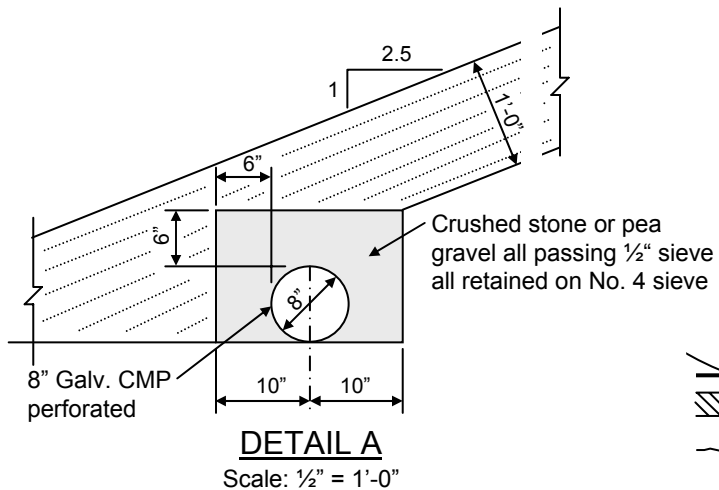

CASE III
Minimum Reservoir, High Water Table & Earthquake

CRITICAL SLIP CIRCLES

SAR FIGURE NO. 2.5-54

ARKANSAS NUCLEAR ONE
UNIT 2
RUSSELLVILLE, ARKANSAS



SCALE:	NONE
DRAWN:	ENERGY
DESIGN:	ENERGY
CAD NO:	

AMENDMENT 19

BASED ON DRAWING NO	SHEET	REV.

BORING NO. 224 WATER CONTENT: 21.6%
 DEPTH: 10.5 – 11 FEET DRY DENSITY: 92.7 LBS/CU FT
 DESCRIPTION: TAN AND GRAY SANDY CLAY

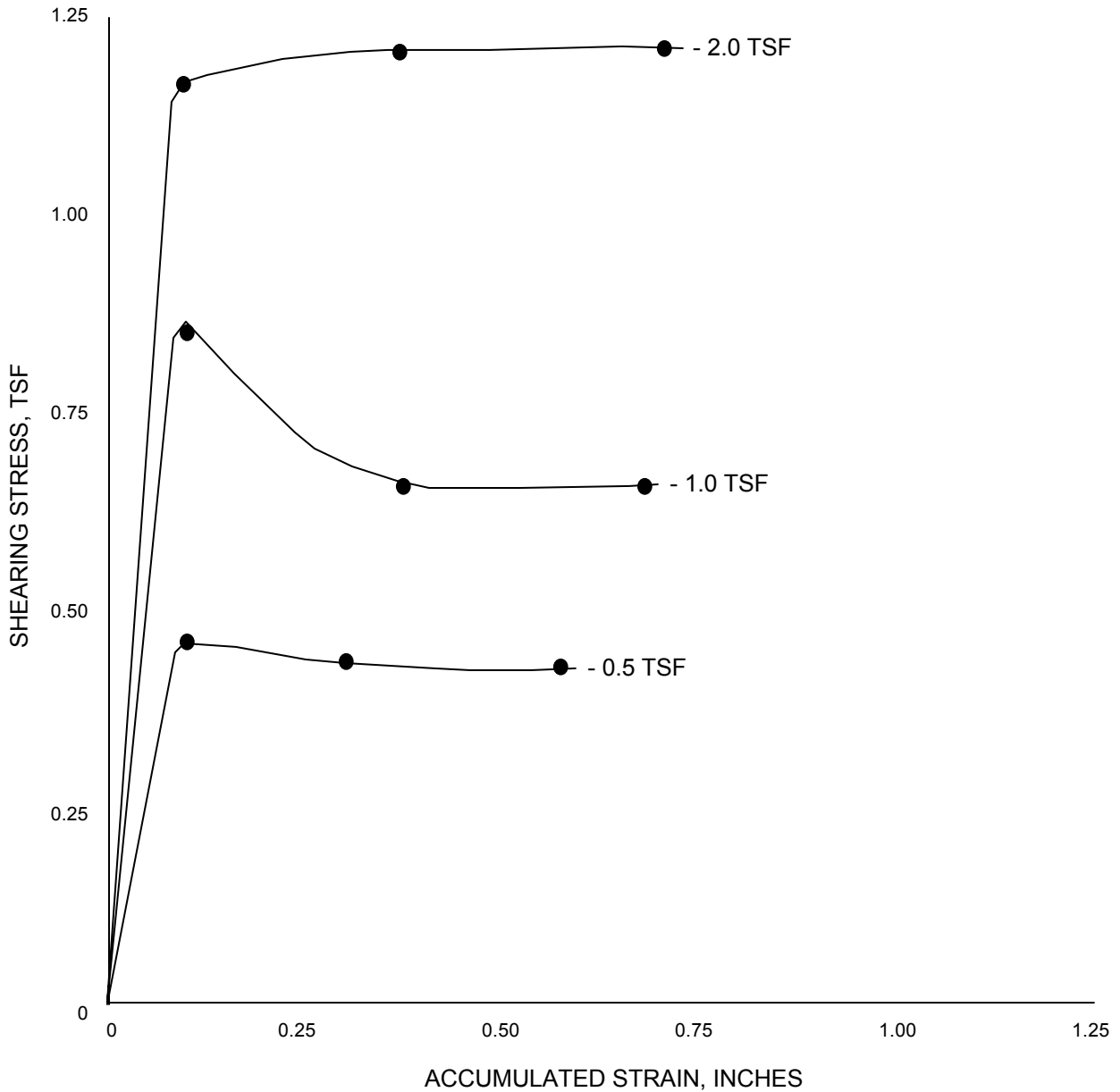

GRUBBS CONSULTING ENGINEERS, INC.

SAR FIGURE NO. 2.5-55

AMENDMENT 19

ARKANSAS NUCLEAR ONE
 UNIT 2
 RUSSELLVILLE, ARKANSAS



SCALE:	NONE
DRAWN:	
DESIGN:	ENTERGY
CAD NO:	

SHEARING STRESS VERSUS
 ACCUMULATED STRAIN

BASED ON DRAWING NO

SHEET

REV.

BORING NO. 224 WATER CONTENT: 21.6%
 DEPTH: 10.5 – 11 FEET DRY DENSITY: 92.7 LBS/CU FT
 DESCRIPTION: TAN AND GRAY SANDY CLAY

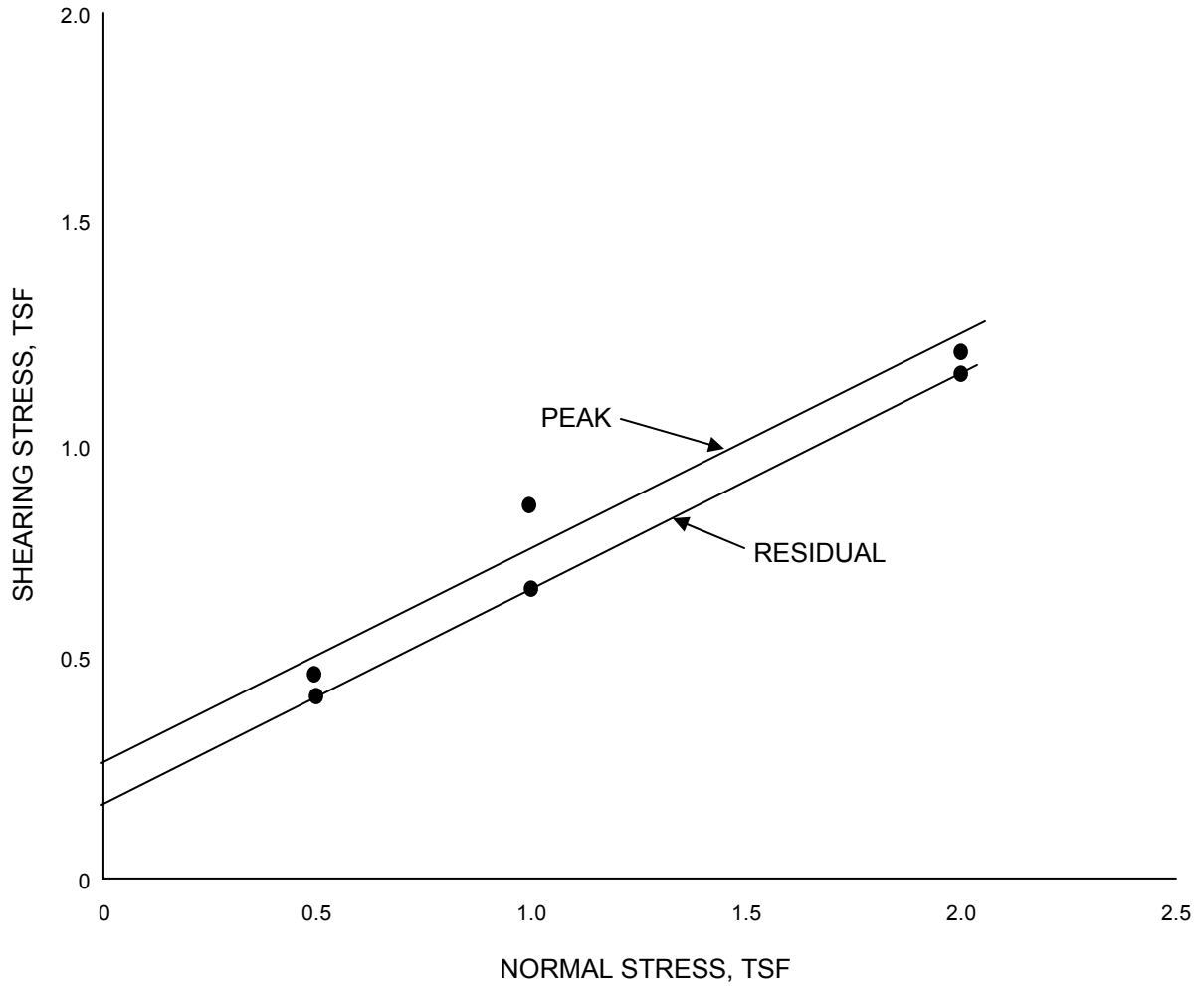

GRUBBS CONSULTING ENGINEERS, INC.

SAR FIGURE NO. 2.5-56

AMENDMENT 19

ARKANSAS NUCLEAR ONE
 UNIT 2
 RUSSELLVILLE, ARKANSAS



SCALE:	NONE
DRAWN:	
DESIGN:	ENTERGY
CAD NO:	

NORMAL STRESS VERSUS SHEARING
 STRESS

BASED ON DRAWING NO

SHEET

REV.

BORING NO. 228 WATER CONTENT: 14.3%
 DEPTH: 9.5 – 10 FEET DRY DENSITY: 116 LBS/CU FT
 DESCRIPTION: TAN FINE SANDY CLAY

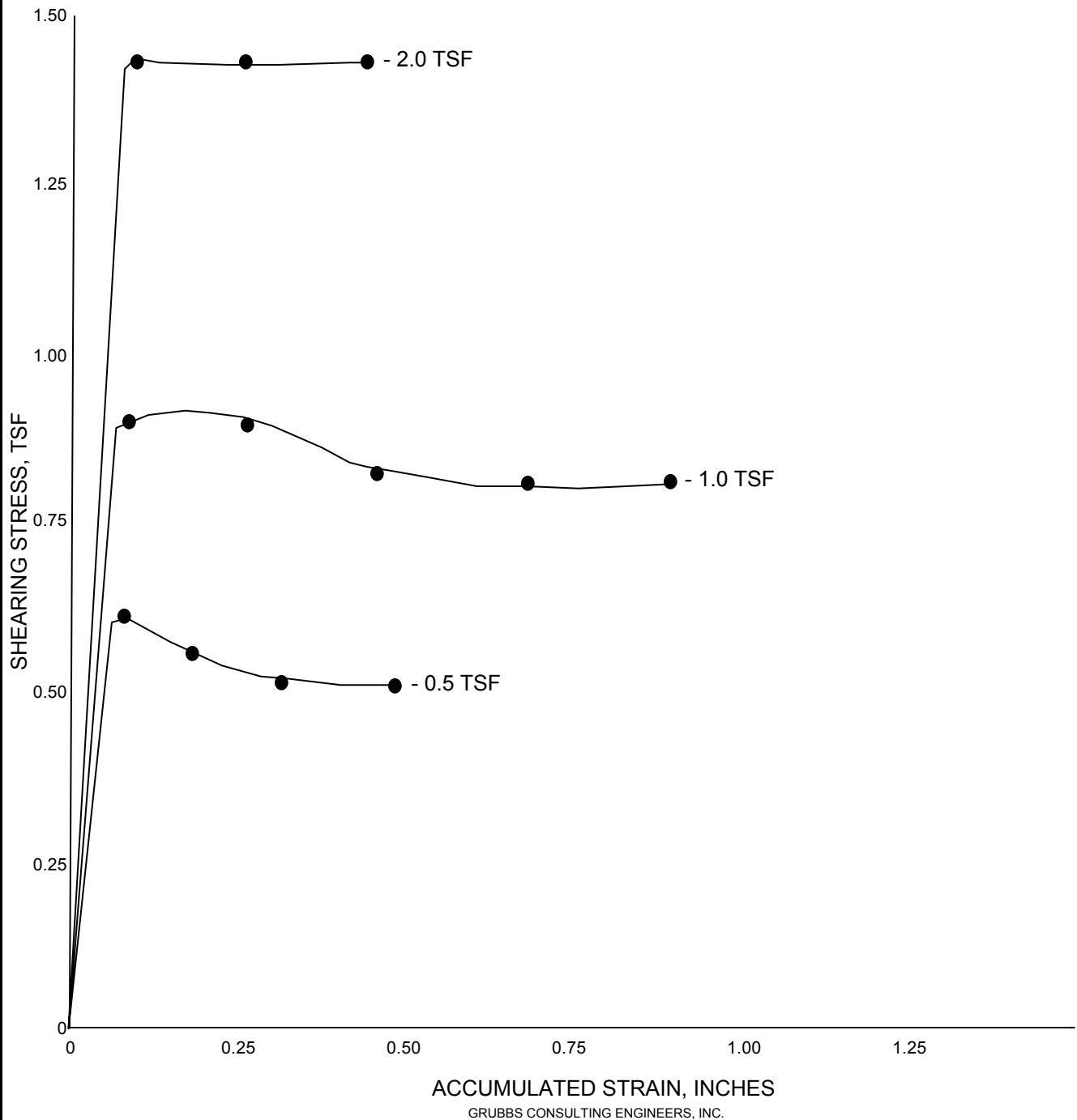

SAR FIGURE NO. 2.5-57

AMENDMENT 19

ARKANSAS NUCLEAR ONE
 UNIT 2
 RUSSELLVILLE, ARKANSAS



SCALE:	NONE
DRAWN:	
DESIGN:	ENERGY
CAD NO:	

SHEARING STRESS VERSUS
 ACCUMULATED STRAIN

BASED ON DRAWING NO

SHEET

REV.

BORING NO. 228

WATER CONTENT: 14.3%

DEPTH: 9.5 – 10 FEET

DRY DENSITY: 116 LBS/CU FT

DESCRIPTION: TAN FINE SANDY CLAY

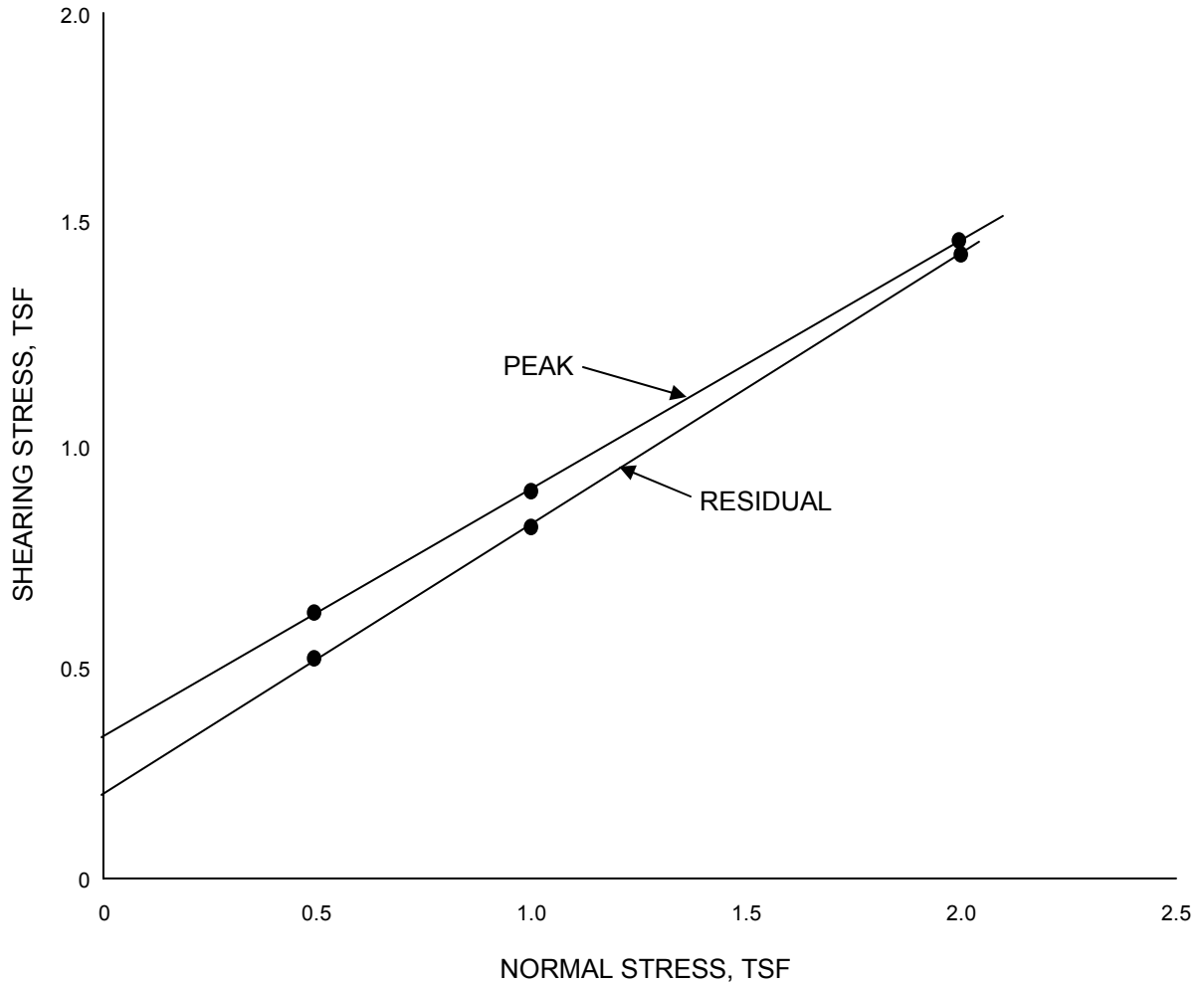

GRUBBS CONSULTING ENGINEERS, INC.

SAR FIGURE NO. 2.5-58

AMENDMENT 19

ARKANSAS NUCLEAR ONE
 UNIT 2
 RUSSELLVILLE, ARKANSAS



SCALE:	NONE
DRAWN:	
DESIGN:	ENTERGY
CAD NO:	

NORMAL STRESS VERSUS SHEARING
 STRESS

BASED ON DRAWING NO

SHEET

REV.

BORING NO. 232 WATER CONTENT: 28.1%
 DEPTH: 16 – 16.5 FEET DRY DENSITY: 92.0 LBS/CU FT
 DESCRIPTION: TAN AND GRAY SILTY CLAY

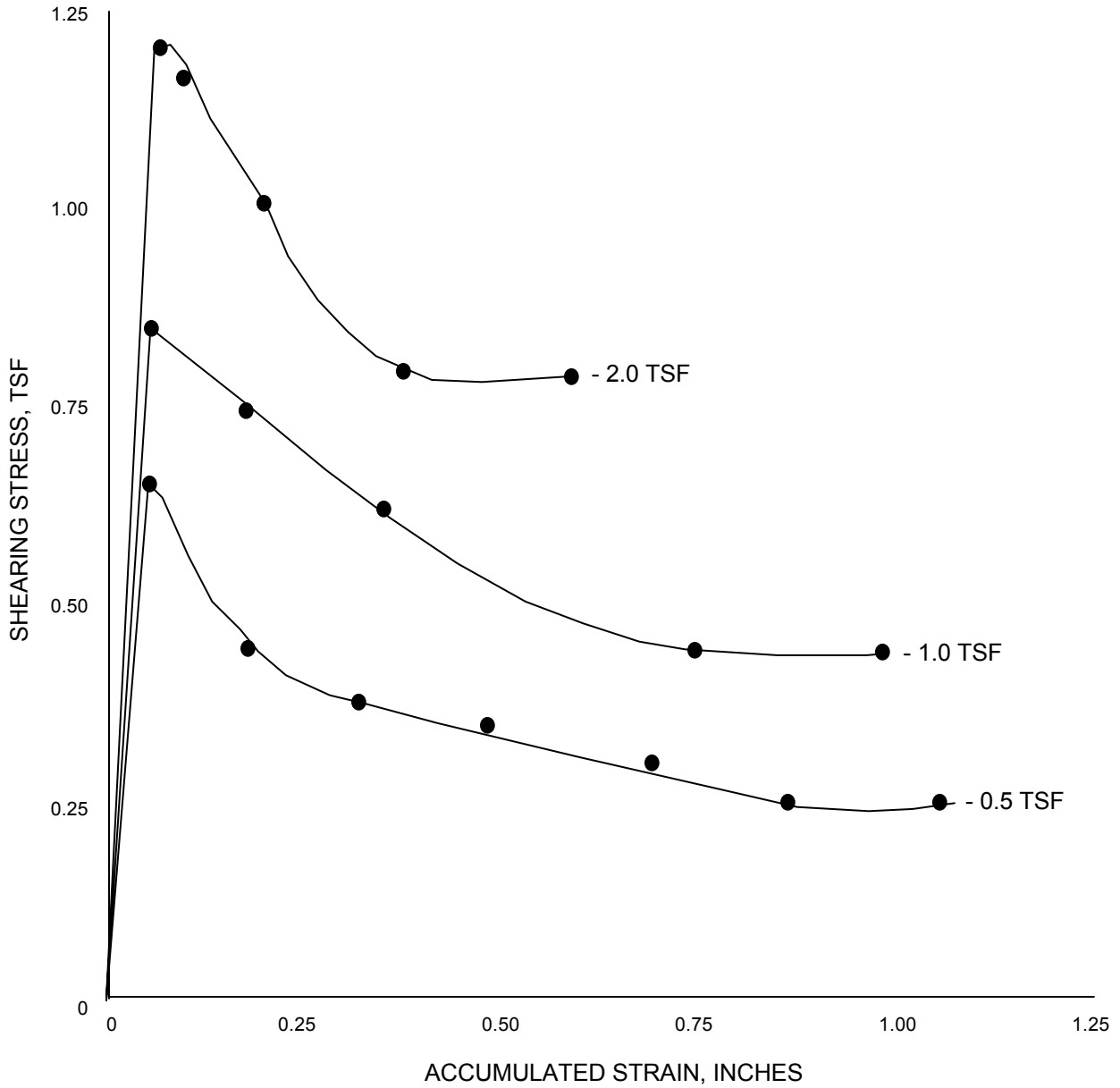

GRUBBS CONSULTING ENGINEERS, INC.

SAR FIGURE NO. 2.5-59

AMENDMENT 19

ARKANSAS NUCLEAR ONE
 UNIT 2
 RUSSELLVILLE, ARKANSAS



SCALE:	NONE
DRAWN:	
DESIGN:	ENTERGY
CAD NO:	

SHEARING STRESS VERSUS
 ACCUMULATED STRAIN

BASED ON DRAWING NO

SHEET

REV.

BORING NO. 232 WATER CONTENT: 28.1%
 DEPTH: 16 – 16.5 FEET DRY DENSITY: 92.0 LBS/CU FT
 DESCRIPTION: TAN AND GRAY SILTY CLAY

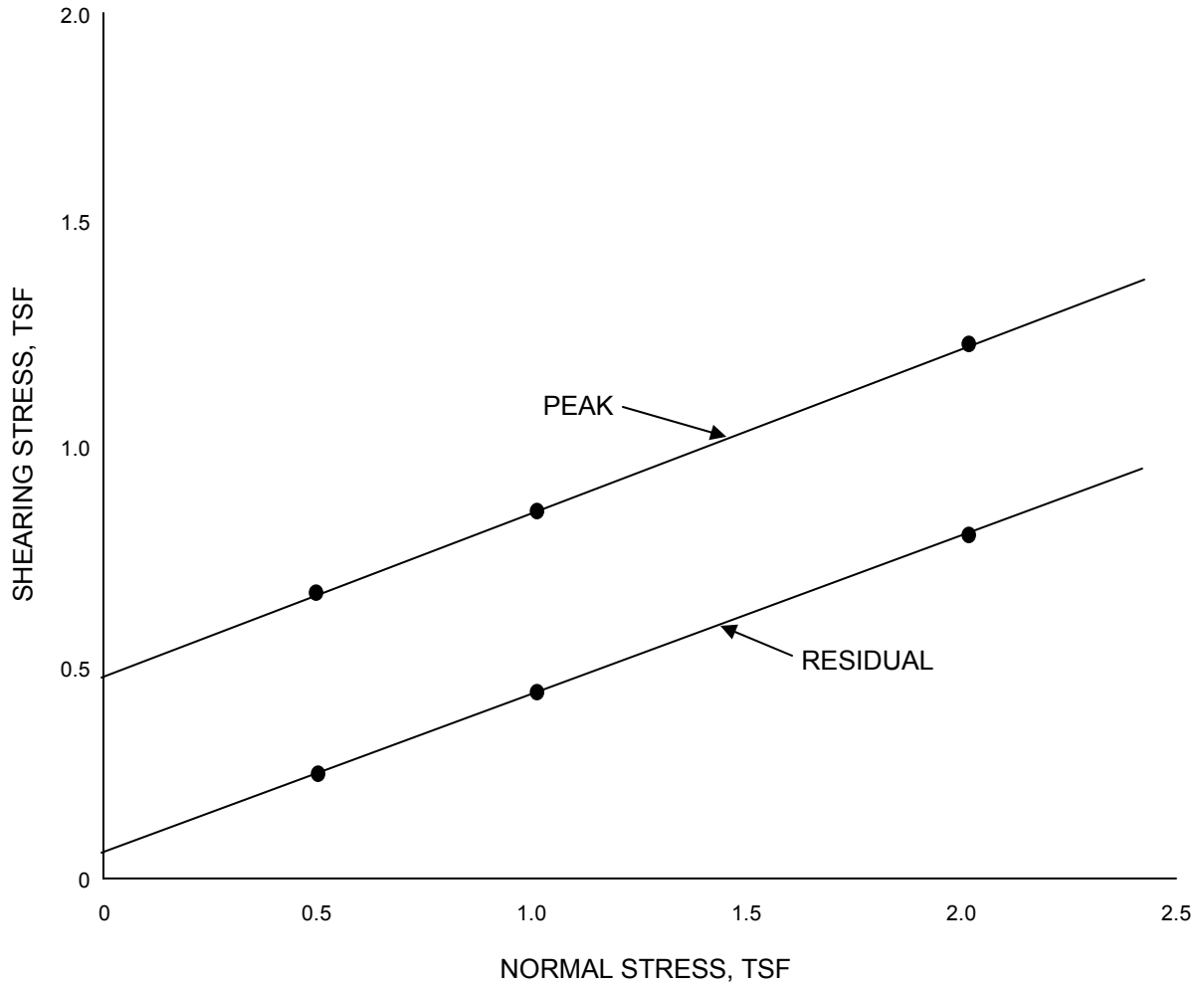

GRUBBS CONSULTING ENGINEERS, INC.

SAR FIGURE NO. 2.5-60

AMENDMENT 19

ARKANSAS NUCLEAR ONE
 UNIT 2
 RUSSELLVILLE, ARKANSAS



SCALE:	NONE
DRAWN:	
DESIGN:	ENTERGY
CAD NO:	

NORMAL STRESS VERSUS SHEARING
 STRESS

BASED ON DRAWING NO

SHEET

REV.

BORING NO. 234

WATER CONTENT: 27.2%

DEPTH: 16 – 16.5 FEET

DRY DENSITY: 98.7 LBS/CU FT

DESCRIPTION: REDDISH TAN AND LIGHT GRAY SILTY CLAY

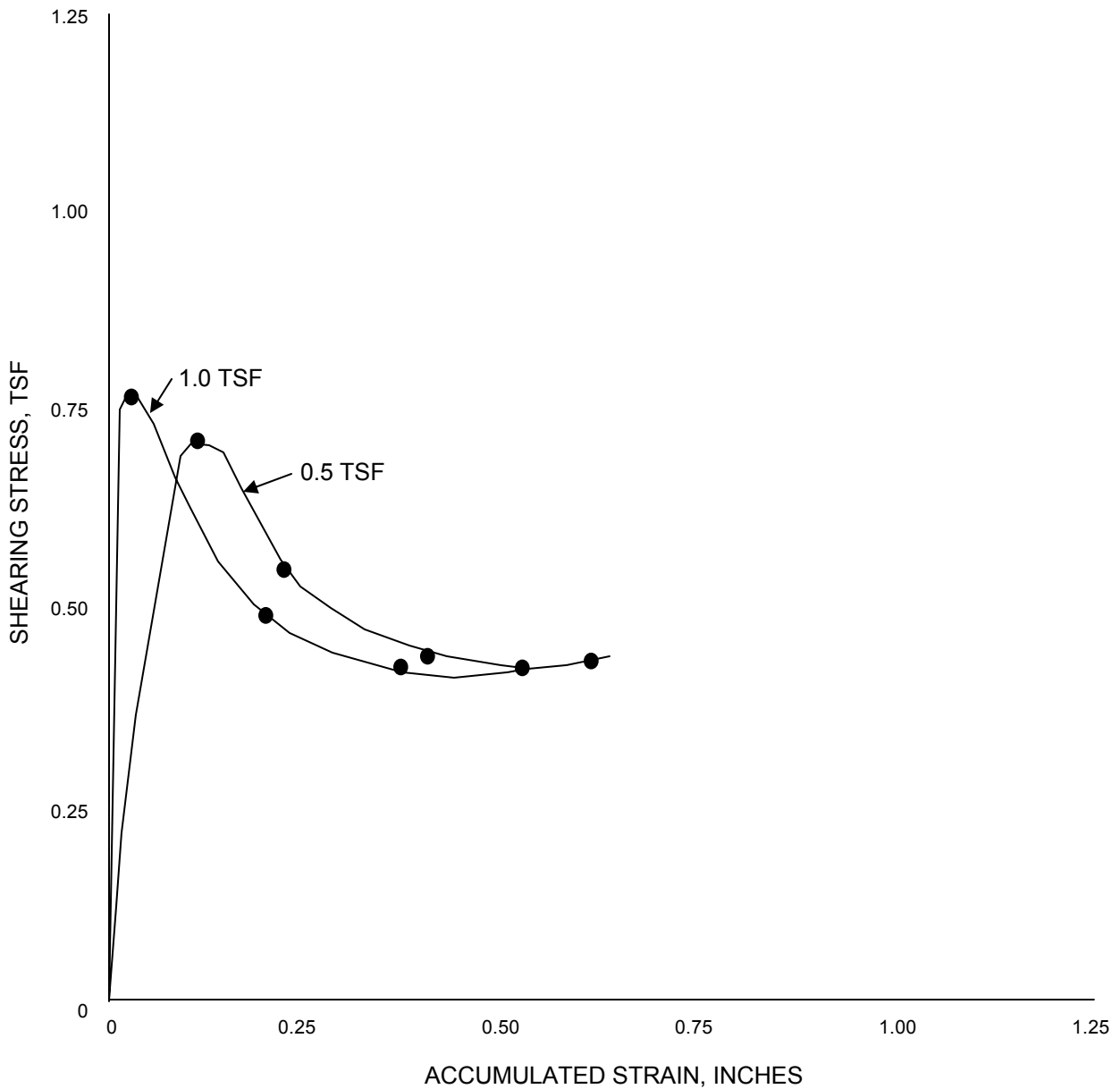

GRUBBS CONSULTING ENGINEERS, INC.

SAR FIGURE NO. 2.5-61

AMENDMENT 19

ARKANSAS NUCLEAR ONE
 UNIT 2
 RUSSELLVILLE, ARKANSAS



SCALE:	NONE
DRAWN:	
DESIGN:	ENTERGY
CAD NO:	

SHEARING STRESS VERSUS
 ACCUMULATED STRAIN

BASED ON DRAWING NO

SHEET

REV.

BORING NO. 234 WATER CONTENT: 27.2%
 DEPTH: 16 – 16.5 FEET DRY DENSITY: 98.7 LBS/CU FT
 DESCRIPTION: TAN AND LIGHT GRAY SILTY CLAY

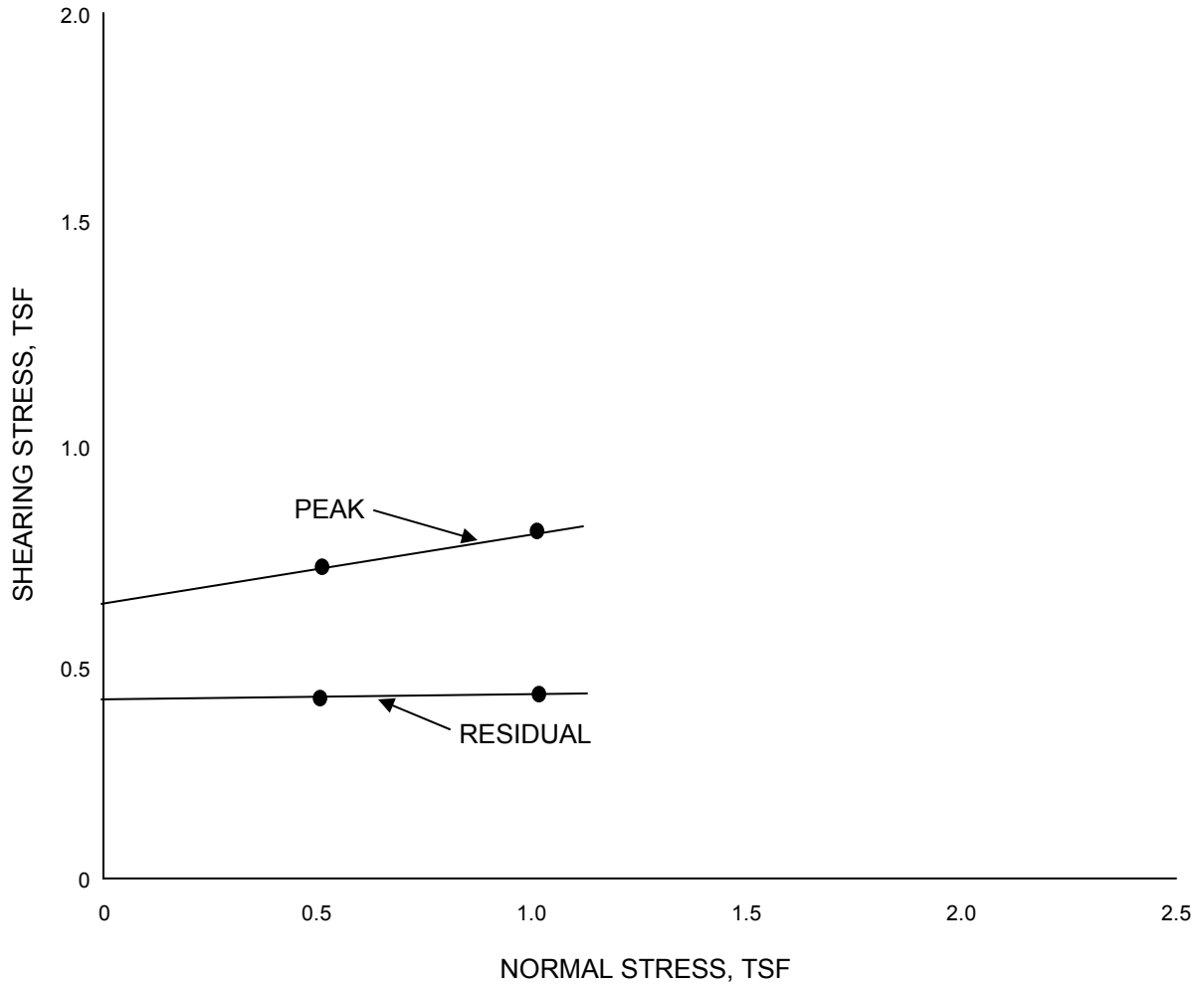

GRUBBS CONSULTING ENGINEERS, INC.

SAR FIGURE NO. 2.5-62

AMENDMENT 19

ARKANSAS NUCLEAR ONE
 UNIT 2
 RUSSELLVILLE, ARKANSAS



SCALE:	NONE
DRAWN:	
DESIGN:	ENTERGY
CAD NO:	

NORMAL STRESS VERSUS SHEARING
 STRESS

BASED ON DRAWING NO

SHEET

REV.

LOG OF BORING NO. 201
ARKANSAS NUCLEAR TWO
RUSSELLVILLE, ARKANSAS

TYPE: Wash and Core

LOCATION: As Directed

DEPTH, FT.	SYMBOL	SAMPLES	DESCRIPTION OF MATERIAL	BLOWS PER FT	RECOVERY, %	COHESION, TON/SQ FT						ELEVATION, FT	
						PLASTIC LIMIT	WATER CONTENT, %		LIQUID LIMIT				
			SURF. EL.			0.2	0.4	0.6	0.8	1.0	1.2	1.4	
						10	20	30	40	50	60	70	
			Crushed rock with brown fine sandy silt, fill										
			Moderately hard dark gray weathered shale fill										
5			Firm red and tan clay fill										
			Medium dense tan very coarse sand										
10													
15			Very stiff red clay	20									⊗
20			Very stiff tan clay with traces of weathered shale fragments	15									
			Moderately hard tan and light gray weathered shale										
30			Hard dark gray shale with horizontal dark gray clay partings		100								
40			- No clay parting below 36 ft		100								
50					100								
60													

NOTE SCALE CHANGE

COMPLETION DEPTH: _____ DEPTH TO WATER IN BORING: _____ DATE: _____

GRUBBS CONSULTING ENGINEERS, INC.

SAR FIGURE NO. 2.5-63

AMENDMENT 19

ARKANSAS NUCLEAR ONE
 UNIT 2
 RUSSELLVILLE, ARKANSAS



SCALE: NONE
 DRAWN: _____
 DESIGN: ENTERGY
 CAD NO: _____

LOG OF BORING NO. 201

BASED ON DRAWING NO

SHEET

REV.

LOG OF BORING NO. 201 (Continued)

ARKANSAS NUCLEAR TWO
RUSSELLVILLE, ARKANSAS

TYPE: Wash and Core

LOCATION: As Directed

DEPTH, FT.	SYMBOL	SAMPLES	DESCRIPTION OF MATERIAL	BLOWS PER FT	RECOVERY, %	COHESION, TON/SQ FT							ELEVATION, FT
						PLASTIC LIMIT		WATER CONTENT, %			LIQUID LIMIT		
						10	20	30	40	50	60	70	
			SURF. EL.										
-70			- 0.5 ft of dark clay seams at 77.5 and 92.5 ft		100								
						100							
-80						92							
-90						98							
-100			Hard dark gray shale with white sandstone partings and seams and dark gray clay partings		100								
-110						99							
-120						96							
-130						97							
-140						100							
-150						98							
-160					100								

COMPLETION DEPTH: 165.0 ft
DATE: 6/23/70

DEPTH TO WATER
IN BORING: 23 ft

DATE: 6/23/70

GRUBBS CONSULTING ENGINEERS, INC.

SAR FIGURE NO. 2.5-64

AMENDMENT 19

ARKANSAS NUCLEAR ONE
UNIT 2
RUSSELLVILLE, ARKANSAS



SCALE: NONE
DRAWN:
DESIGN: ENTERGY
CAD NO:

LOG OF BORING NO. 201

BASED ON DRAWING NO

SHEET

REV.

LOG OF BORING NO. 202
ARKANSAS NUCLEAR TWO
RUSSELLVILLE, ARKANSAS

TYPE: Wash and Core

LOCATION: As Directed

DEPTH, FT.	SYMBOL	SAMPLES	DESCRIPTION OF MATERIAL	BLOWS PER FT	RECOVERY, %	COHESION, TON/SQ FT						ELEVATION, FT	
						0.2	0.4	0.6	0.8	1.0	1.2		1.4
			SURF. EL.			PLASTIC LIMIT WATER CONTENT, % LIQUID LIMIT 10 20 30 40 50 60 70							
			Crushed rock with brown fine sandy silt										
			Firm red and tan clay fill										
-5			- tan and light gray fill below 5 ft										
			- red below 7 ft										
-10			- tan and light gray below 9 ft										
-15													
-20			Stiff tan clay with weathered shale fragments	8									
-25			Moderately hard gray weathered shale with tan clay partings	50-8 in.									
-30			Hard dark gray shale with horizontal dark gray clay partings										
-35					100								
-45			- vertical iron partings from 45 to 48.5 ft		100								
-55					95								
-65					75								

NOTE SCALE CHANGE

COMPLETION DEPTH: 63.5 ft
 DATE: 6/22/70

DEPTH TO WATER
 IN BORING:

DATE:

GRUBBS CONSULTING ENGINEERS, INC.

SAR FIGURE NO. 2.5-65

AMENDMENT 19

ARKANSAS NUCLEAR ONE
 UNIT 2
 RUSSELLVILLE, ARKANSAS



SCALE: NONE
 DRAWN:
 DESIGN: ENTERGY
 CAD NO:

LOG OF BORING NO. 202

BASED ON DRAWING NO

SHEET

REV.

LOG OF BORING NO. 203
ARKANSAS NUCLEAR TWO
RUSSELLVILLE, ARKANSAS

TYPE: Wash and Core

LOCATION: As Directed

DEPTH, FT.	SYMBOL	SAMPLES	DESCRIPTION OF MATERIAL	BLOWS PER FT	RECOVERY, %	COHESION, TON/SQ FT				ELEVATION, FT			
						PLASTIC LIMIT	WATER CONTENT, %	LIQUID LIMIT					
			SURF. EL.			0.2	0.4	0.6	0.8	1.0	1.2	1.4	
			Crushed rock fill			10	20	30	40	50	60	70	
			Moderately hard dark gray weathered shale fill										
- 5			Firm tan and light gray clay fill										
- 10			- red below 10 ft										
- 15			- red and light gray below 18 ft										
- 20			Soft tan clay with traces of dark gray weathered shale fragments	4									
- 25			Moderately hard dark gray weathered shale	50									
- 30			Hard dark gray shale with some weathered seams and layers		93								
- 35					95								
- 45					95								
- 55			- less weathered below 56 ft		99								
- 65													

NOTE SCALE CHANGE

COMPLETION DEPTH: 60 ft
 DATE: 6/26/70

DEPTH TO WATER
 IN BORING:

DATE:

GRUBBS CONSULTING ENGINEERS, INC.

SAR FIGURE NO. 2.5-66

AMENDMENT 19

ARKANSAS NUCLEAR ONE
 UNIT 2
 RUSSELLVILLE, ARKANSAS



SCALE: NONE
 DRAWN:
 DESIGN: ENTERGY
 CAD NO:

LOG OF BORING NO. 203

BASED ON DRAWING NO

SHEET

REV.

LOG OF BORING NO. 204
ARKANSAS NUCLEAR TWO
RUSSELLVILLE, ARKANSAS

TYPE: Wash and Core

LOCATION: As Directed

DEPTH, FT.	SYMBOL	SAMPLES	DESCRIPTION OF MATERIAL	BLOWS PER FT	RECOVERY, %	COHESION, TON/SQ FT				ELEVATION, FT			
						PLASTIC LIMIT	WATER CONTENT, %	LIQUID LIMIT					
			SURF. EL.			0.2	0.4	0.6	0.8	1.0	1.2	1.4	
			Crushed rock, fill			10	20	30	40	50	60	70	
			Medium dense brown fine sandy silt fill										
5			Stiff red clay fill										
			Medium dense brown fine silty sand with gravel fill										
10			Stiff red clay										
15													
20			- tan and light gray below 19 ft										
25			Moderately hard light gray and tan weathered shale	75-9 in.									
			- dark gray below 29.5 ft										
30			Hard dark gray shale with weathered partings above 42 ft		100								
35					100								
45					100								
55			- weathered seams and layers below 52.5 ft		100								
65													

NOTE SCALE CHANGE

COMPLETION DEPTH: 60 ft
 DATE: 6/30/70

DEPTH TO WATER
 IN BORING:

DATE:

GRUBBS CONSULTING ENGINEERS, INC.

SAR FIGURE NO. 2.5-67

AMENDMENT 19

ARKANSAS NUCLEAR ONE
 UNIT 2
 RUSSELLVILLE, ARKANSAS



SCALE: NONE
 DRAWN:
 DESIGN: ENTERGY
 CAD NO:

LOG OF BORING NO. 204

BASED ON DRAWING NO

SHEET

REV.

LOG OF BORING NO. 205
ARKANSAS NUCLEAR TWO
RUSSELLVILLE, ARKANSAS

TYPE: Wash and Core

LOCATION: As Directed

DEPTH, FT.	SYMBOL	SAMPLES	DESCRIPTION OF MATERIAL	BLOWS PER FT	RECOVERY, %	COHESION, TON/SQ FT			ELEVATION, FT				
						PLASTIC LIMIT	WATER CONTENT, %	LIQUID LIMIT					
			SURF. EL.			0.2	0.4	0.6	0.8	1.0	1.2	1.4	
			Crushed rock, fill			10	20	30	40	50	60	70	
			Medium dense fine sandy silt, fill										
5			Moderately hard dark gray weathered shale, fill										
10			Stiff red clay - tan and light gray below 6 ft - red to light gray below 8 ft - red below 10 ft										
15													
20			- tan and light gray below 18 ft										
25			Moderately hard gray and tan weathered shale	76-11 in									
30			Hard dark gray shale with weathered partings, seams and layers										
35					40								
40					85								
45					100								
50													
55					80								
60													
65													

NOTE SCALE CHANGE

COMPLETION DEPTH: 59 ft
 DATE: 6/29/70

DEPTH TO WATER
 IN BORING:

DATE:

GRUBBS CONSULTING ENGINEERS, INC.

SAR FIGURE NO. 2.5-68

AMENDMENT 19

ARKANSAS NUCLEAR ONE
 UNIT 2
 RUSSELLVILLE, ARKANSAS



SCALE: NONE
 DRAWN:
 DESIGN: ENTERGY
 CAD NO:

LOG OF BORING NO. 205

BASED ON DRAWING NO

SHEET

REV.

LOG OF BORING NO. 206
ARKANSAS NUCLEAR TWO
RUSSELLVILLE, ARKANSAS

TYPE: Wash and Core

LOCATION: As Directed

DEPTH, FT.	SYMBOL	SAMPLES	DESCRIPTION OF MATERIAL	BLOWS PER FT	RECOVERY, %	COHESION, TON/SQ FT				ELEVATION, FT
						PLASTIC LIMIT	WATER CONTENT, %	LIQUID LIMIT		
			SURF. EL.							
			Crushed rock, fill							
			Stiff red clay fill							
5										
10										
15			- soft red and tan clay below 12 ft							
20										
25			Moderately hard dark gray and tan weathered shale							
30			Hard dark gray shale with weathered partings		97					
35										
45					99					
55					98					
65					70					

NOTE SCALE CHANGE

COMPLETION DEPTH: 63 ft
 DATE: 6/27/70

DEPTH TO WATER
 IN BORING:

DATE:

GRUBBS CONSULTING ENGINEERS, INC.

SAR FIGURE NO. 2.5-69

AMENDMENT 19

ARKANSAS NUCLEAR ONE
 UNIT 2
 RUSSELLVILLE, ARKANSAS



SCALE: NONE
 DRAWN:
 DESIGN: ENTERGY
 CAD NO:

LOG OF BORING NO. 206

BASED ON DRAWING NO

SHEET

REV.

LOG OF BORING NO. 207
ARKANSAS NUCLEAR TWO
RUSSELLVILLE, ARKANSAS

TYPE: Wash and Core

LOCATION: As Directed

DEPTH, FT.	SYMBOL	SAMPLES	DESCRIPTION OF MATERIAL	BLOWS PER FT	RECOVERY, %	COHESION, TON/SQ FT				ELEVATION, FT			
						PLASTIC LIMIT	WATER CONTENT, %	LIQUID LIMIT					
			SURF. EL.			0.2	0.4	0.6	0.8	1.0	1.2	1.4	
			Moderately hard weathered shale fill with tan fine sandy clay fill										
5			Stiff fine sandy clay										
10			Very stiff tan silty clay - red and light gray with traces of gravel below 8 ft										⊗
15			- no gravel below 17 ft										⊗
20													⊗
25			Very stiff fine sandy clay with shale fragments										⊗
			Moderately hard light gray and tan weathered shale										
30			Hard dark gray shale with some weathered partings and seams		95								
35													
45					100								
55													
65													

NOTE SCALE CHANGE

COMPLETION DEPTH: 45.5 ft
 DATE: 7/8/70

DEPTH TO WATER IN BORING: _____

DATE: _____

GRUBBS CONSULTING ENGINEERS, INC.

SAR FIGURE NO. 2.5-70

AMENDMENT 19

ARKANSAS NUCLEAR ONE
 UNIT 2
 RUSSELLVILLE, ARKANSAS



SCALE: NONE
 DRAWN:
 DESIGN: ENTERGY
 CAD NO:

LOG OF BORING NO. 207

BASED ON DRAWING NO

SHEET

REV.

LOG OF BORING NO. 208
ARKANSAS NUCLEAR TWO
RUSSELLVILLE, ARKANSAS

TYPE: Wash and Core

LOCATION: As Directed

DEPTH, FT.	SYMBOL	SAMPLES	DESCRIPTION OF MATERIAL	BLOWS PER FT	RECOVERY, %	COHESION, TON/SQ FT				ELEVATION, FT
						PLASTIC LIMIT	WATER CONTENT, %	LIQUID LIMIT		
			SURF. EL. Stiff fine sandy clay with traces of gravel and organic							
5			Very stiff tan and light gray silty clay - red and tan below 4.5 ft							
10										
15			- tan and light gray with traces of gravel and weathered shale fragments below 14.5 ft							
20			Moderately hard light gray and tan weathered shale							
25			Hard dark gray shale	80						
30				93						
35										
45				97						
55				100						
65										

NOTE SCALE CHANGE

COMPLETION DEPTH: 55 ft
 DATE: 7/7/70

DEPTH TO WATER
 IN BORING:

DATE:

GRUBBS CONSULTING ENGINEERS, INC.

SAR FIGURE NO. 2.5-71

AMENDMENT 19

ARKANSAS NUCLEAR ONE
 UNIT 2
 RUSSELLVILLE, ARKANSAS



SCALE: NONE
 DRAWN:
 DESIGN: ENTERGY
 CAD NO:

LOG OF BORING NO. 208

BASED ON DRAWING NO

SHEET

REV.

LOG OF BORING NO. 209
ARKANSAS NUCLEAR TWO
RUSSELLVILLE, ARKANSAS

TYPE: Wash and Core

LOCATION: As Directed

DEPTH, FT.	SYMBOL	SAMPLES	DESCRIPTION OF MATERIAL	BLOWS PER FT	RECOVERY, %	COHESION, TON/SQ FT						ELEVATION, FT
						PLASTIC LIMIT		WATER CONTENT, %		LIQUID LIMIT		
						10	20	30	40	50	60	
			SURF. EL.									
5			Stiff tan and light gray fine sandy clay with organic matter above 1 ft - reddish brown below 2 ft					⊗				
10			Moderately hard light gray and tan weathered shale	34							⊗	
15			Hard dark gray shale with some weathered partings		90							
20												
25						100						
30												

COMPLETION DEPTH: 30 ft
 DATE: 6/2/70

DEPTH TO WATER
 IN BORING:

DATE:

GRUBBS CONSULTING ENGINEERS, INC.

SAR FIGURE NO. 2.5-72

AMENDMENT 19

ARKANSAS NUCLEAR ONE
 UNIT 2
 RUSSELLVILLE, ARKANSAS



SCALE: NONE
 DRAWN:
 DESIGN: ENTERGY
 CAD NO:

LOG OF BORING NO. 209

BASED ON DRAWING NO

SHEET

REV.

LOG OF BORING NO. 210
ARKANSAS NUCLEAR TWO
RUSSELLVILLE, ARKANSAS

TYPE: Wash and Core

LOCATION: As Directed

DEPTH, FT.	SYMBOL	SAMPLES	DESCRIPTION OF MATERIAL	BLOWS PER FT	RECOVERY, %	COHESION, TON/SQ FT						ELEVATION, FT	
						0.2	0.4	0.6	0.8	1.0	1.2		1.4
			SURF. EL.			PLASTIC LIMIT WATER CONTENT, % LIQUID LIMIT 10 20 30 40 50 60 70							
5			Firm red and tan clay fill - soft and tan below 1.5 ft - tan and light gray below 4 ft										
10			Firm tan clay with weathered shale fragments										
15			Moderately hard light gray and tan weathered shale - 0.5 ft gray clay layer 12 ft										
20			Hard dark gray shale with white sandstone partings - weathered partings above 25 ft and from 36.5 to 41 ft		100								
25				100									
30													
35					100								
45													
55													

NOTE SCALE CHANGE

COMPLETION DEPTH: 46 ft
DATE: 7/170

DEPTH TO WATER
IN BORING:

DATE:

GRUBBS CONSULTING ENGINEERS, INC.

SAR FIGURE NO. 2.5-73

AMENDMENT 19

ARKANSAS NUCLEAR ONE
 UNIT 2
 RUSSELLVILLE, ARKANSAS



SCALE: NONE
 DRAWN:
 DESIGN: ENTERGY
 CAD NO:

LOG OF BORING NO. 210

BASED ON DRAWING NO

SHEET

REV.

LOG OF BORING NO. 211
ARKANSAS NUCLEAR TWO
RUSSELLVILLE, ARKANSAS

TYPE: Wash and Core

LOCATION: As Directed

DEPTH, FT.	SYMBOL	SAMPLES	DESCRIPTION OF MATERIAL	BLOWS PER FT	RECOVERY, %	COHESION, TON/SQ FT						ELEVATION, FT	
						0.2	0.4	0.6	0.8	1.0	1.2		1.4
			SURF. EL.			PLASTIC LIMIT WATER CONTENT, % LIQUID LIMIT 10 20 30 40 50 60 70							
			Dense brown fine sandy silt with crushed rock fill										
-5			Firm red clay fill - tan with weathered shale fill below 4 ft										
-10			- red below 9 ft										
-15													
-20			- red and light gray below 17 ft - tan below 18 ft										
-25			Moderately hard light gray and tan weathered shale	50-5 in.									
-30			Hard dark gray shale with weathered partings and seams		85								
-35													
-40													
-45													
-50													

COMPLETION DEPTH: 38 ft
 DATE: 7/1/70

DEPTH TO WATER
 IN BORING:

DATE:

GRUBBS CONSULTING ENGINEERS, INC.

SAR FIGURE NO. 2.5-74

AMENDMENT 19

ARKANSAS NUCLEAR ONE
 UNIT 2
 RUSSELLVILLE, ARKANSAS



SCALE: NONE
 DRAWN:
 DESIGN: ENTERGY
 CAD NO:

LOG OF BORING NO. 211

BASED ON DRAWING NO

SHEET

REV.

LOG OF BORING NO. 212
ARKANSAS NUCLEAR TWO
RUSSELLVILLE, ARKANSAS

TYPE: Wash

LOCATION: As Directed

DEPTH, FT.	SYMBOL	SAMPLES	DESCRIPTION OF MATERIAL	BLOWS PER FT	RECOVERY, %	COHESION, TON/SQ FT						ELEVATION, FT
						PLASTIC LIMIT		WATER CONTENT, %		LIQUID LIMIT		
						10	20	30	40	50	60	
			SURF. EL.									
			Crushed rock fill									
			Dense tan clay									
			- tan and light gray below 3 ft									
5												
10												
15												
20			Moderately hard light gray and tan weathered shale									
25												
30			Hard dark gray shale									

NOTE SCALE CHANGE

COMPLETION DEPTH: 30 ft
 DATE: 7/1/70

DEPTH TO WATER
 IN BORING:

DATE:

GRUBBS CONSULTING ENGINEERS, INC.

SAR FIGURE NO. 2.5-75

AMENDMENT 19

ARKANSAS NUCLEAR ONE
 UNIT 2
 RUSSELLVILLE, ARKANSAS



SCALE: NONE
 DRAWN:
 DESIGN: ENTERGY
 CAD NO:

LOG OF BORING NO. 212

BASED ON DRAWING NO

SHEET

REV.

LOG OF BORING NO. 213
ARKANSAS NUCLEAR TWO
RUSSELLVILLE, ARKANSAS

TYPE: Wash

LOCATION: As Directed

DEPTH, FT.	SYMBOL	SAMPLES	DESCRIPTION OF MATERIAL	BLOWS PER FT	RECOVERY, %	COHESION, TON/SQ FT						ELEVATION, FT	
						0.2	0.4	0.6	0.8	1.0	1.2		1.4
			SURF. EL.			PLASTIC LIMIT ——— WATER CONTENT, % ——— LIQUID LIMIT 10 20 30 40 50 60 70							
			Hard crushed rock with fine sandy silt and weathered shale fill										
			Firm tan and light gray clay										
5													
			- red below 8 ft										
10													
			- light gray and red below 19 ft										
15													
			- tan below 21 ft										
20													
			Moderately hard light gray and tan weathered shale										
25													
			Hard dark gray shale										
30													
COMPLETION DEPTH: 29 ft				DEPTH TO WATER IN BORING:				DATE:					
DATE: 7/1/70													

NOTE SCALE CHANGE

GRUBBS CONSULTING ENGINEERS, INC.

SAR FIGURE NO. 2.5-76

AMENDMENT 19

ARKANSAS NUCLEAR ONE
 UNIT 2
 RUSSELLVILLE, ARKANSAS



SCALE: NONE
 DRAWN:
 DESIGN: ENTERGY
 CAD NO:

LOG OF BORING NO. 213

BASED ON DRAWING NO

SHEET

REV.

LOG OF BORING NO. 214
ARKANSAS NUCLEAR TWO
RUSSELLVILLE, ARKANSAS

TYPE: Wash

LOCATION: As Directed

DEPTH, FT.	SYMBOL	SAMPLES	DESCRIPTION OF MATERIAL	BLOWS PER FT	RECOVERY, %	COHESION, TON/SQ FT						ELEVATION, FT	
						0.2	0.4	0.6	0.8	1.0	1.2		1.4
			SURF. EL.			PLASTIC LIMIT ——— WATER CONTENT, % ——— LIQUID LIMIT 10 20 30 40 50 60 70							
			Crushed rock with fine sandy silt and weathered shale fill										
			Stiff tan and light gray clay										
5													
			- red below 9 ft										
10													
			- red and light gray below 17.5 ft										
15													
			Stiff tan clay with weathered shale fragments										
20													
			Moderately hard light gray and tan weathered shale										
25													
			Hard dark gray shale										
30													
COMPLETION DEPTH: 29 ft				DEPTH TO WATER IN BORING:				DATE:					
DATE: 7/1/70													

NOTE SCALE CHANGE

GRUBBS CONSULTING ENGINEERS, INC.

SAR FIGURE NO. 2.5-77

AMENDMENT 19

ARKANSAS NUCLEAR ONE
 UNIT 2
 RUSSELLVILLE, ARKANSAS



SCALE:	NONE
DRAWN:	
DESIGN:	ENTERGY
CAD NO:	

LOG OF BORING NO. 214

BASED ON DRAWING NO

SHEET

REV.

LOG OF BORING NO. 215
ARKANSAS NUCLEAR TWO
RUSSELLVILLE, ARKANSAS

TYPE: Wash

LOCATION: As Directed

DEPTH, FT.	SYMBOL	SAMPLES	DESCRIPTION OF MATERIAL	BLOWS PER FT	RECOVERY, %	COHESION, TON/SQ FT						ELEVATION, FT	
						0.2	0.4	0.6	0.8	1.0	1.2		1.4
			SURF. EL.			PLASTIC LIMIT ——— WATER CONTENT, % ——— LIQUID LIMIT 10 20 30 40 50 60 70							
			Crushed rock with fine sandy silt and weathered shale fill										
			Stiff red clay										
5			- tan and light gray below 5 ft										
10			- red and light gray below 9 ft										
15			- tan and light gray										
20			Firm tan and light gray clay with weathered shale fragments										
25			Moderately hard light gray and tan weathered shale										
30			Hard dark gray shale										

NOTE SCALE CHANGE

COMPLETION DEPTH: 30 ft
 DATE: 7/1/70

DEPTH TO WATER
 IN BORING:

DATE:

GRUBBS CONSULTING ENGINEERS, INC.

SAR FIGURE NO. 2.5-78

AMENDMENT 19

ARKANSAS NUCLEAR ONE
 UNIT 2
 RUSSELLVILLE, ARKANSAS



SCALE: NONE
 DRAWN:
 DESIGN: ENTERGY
 CAD NO:

LOG OF BORING NO. 215

BASED ON DRAWING NO

SHEET

REV.

LOG OF BORING NO. 217
ARKANSAS NUCLEAR TWO
RUSSELLVILLE, ARKANSAS

TYPE: Wash

LOCATION: As Directed

DEPTH, FT.	SYMBOL	SAMPLES	DESCRIPTION OF MATERIAL	BLOWS PER FT	RECOVERY, %	COHESION, TON/SQ FT						ELEVATION, FT	
						0.2	0.4	0.6	0.8	1.0	1.2		1.4
			SURF. EL.			PLASTIC LIMIT ——— WATER CONTENT, % ——— LIQUID LIMIT 10 20 30 40 50 60 70							
			Crushed rock fill										
			Stiff red clay fill above 4.5 ft										
5			- tan below 4.5 ft										
			- red and tan 9 ft										
10													
			-- red and light gray below 17.5 ft										
15													
			Firm tan clay with weathered shale fragments										
20													
			Moderately hard light gray and tan weathered shale										
25													
			Dark gray shale										
30													

NOTE SCALE CHANGE

COMPLETION DEPTH: 30 ft
 DATE: 7/1/70

DEPTH TO WATER
 IN BORING:

DATE:

GRUBBS CONSULTING ENGINEERS, INC.

SAR FIGURE NO. 2.5-79

AMENDMENT 19

ARKANSAS NUCLEAR ONE
 UNIT 2
 RUSSELLVILLE, ARKANSAS



SCALE: NONE
 DRAWN:
 DESIGN: ENTERGY
 CAD NO:

LOG OF BORING NO. 217

BASED ON DRAWING NO

SHEET

REV.

LOG OF BORING NO. 218
ARKANSAS NUCLEAR TWO
RUSSELLVILLE, ARKANSAS

TYPE: Wash

LOCATION: As Directed

DEPTH, FT.	SYMBOL	SAMPLES	DESCRIPTION OF MATERIAL	BLOWS PER FT	RECOVERY, %	COHESION, TON/SQ FT							ELEVATION, FT
						PLASTIC LIMIT		WATER CONTENT, %			LIQUID LIMIT		
						10	20	30	40	50	60	70	
			SURF. EL.										
			Hard dark gray shale with red and tan clay fill										
5			Firm tan and light gray fine sandy clay with metal and wood fill - water from 3.5 to 10 ft										
10			Firm tan clay with weathered shale fragments										
15			Stiff light gray clay Moderately hard light gray and tan weathered shale										
20			Hard dark gray shale										

COMPLETION DEPTH: 18 ft
 DATE: 7/2/70

DEPTH TO WATER
 IN BORING: 3.5 ft

DATE: 7/2/70

GRUBBS CONSULTING ENGINEERS, INC.

SAR FIGURE NO. 2.5-80

AMENDMENT 19

ARKANSAS NUCLEAR ONE
 UNIT 2
 RUSSELLVILLE, ARKANSAS



SCALE: NONE

DRAWN:

DESIGN: ENTERGY

CAD NO:

LOG OF BORING NO. 218

BASED ON DRAWING NO

SHEET

REV.

LOG OF BORING NO. 219
ARKANSAS NUCLEAR TWO
RUSSELLVILLE, ARKANSAS

TYPE: Wash

LOCATION: As Directed

DEPTH, FT.	SYMBOL	SAMPLES	DESCRIPTION OF MATERIAL	BLOWS PER FT	RECOVERY, %	COHESION, TON/SQ FT						ELEVATION, FT	
						PLASTIC LIMIT		WATER CONTENT, %		LIQUID LIMIT			
						10	20	30	40	50	60		70
			SURF. EL. Firm tan and light gray fine sandy clay with sandstone boulder										
5			Moderately hard light gray and tan weathered shale	36-6.5 in									
10			Hard dark gray shale										
COMPLETION DEPTH: 10 ft DATE: 7/3/70				DEPTH TO WATER IN BORING:				DATE:					

GRUBBS CONSULTING ENGINEERS, INC.

SAR FIGURE NO. 2.5-81

AMENDMENT 19

ARKANSAS NUCLEAR ONE
 UNIT 2
 RUSSELLVILLE, ARKANSAS



SCALE:	NONE
DRAWN:	
DESIGN:	ENTERGY
CAD NO:	

LOG OF BORING NO. 219

BASED ON DRAWING NO

SHEET

REV.

LOG OF BORING NO. 220
ARKANSAS NUCLEAR TWO
RUSSELLVILLE, ARKANSAS

TYPE: Wash

LOCATION: As Directed

DEPTH, FT.	SYMBOL	SAMPLES	DESCRIPTION OF MATERIAL	BLOWS PER FT	RECOVERY, %	COHESION, TON/SQ FT						ELEVATION, FT	
						0.2	0.4	0.6	0.8	1.0	1.2		1.4
			SURF. EL.			PLASTIC LIMIT ——— WATER CONTENT, % ——— LIQUID LIMIT 10 20 30 40 50 60 70							
			Very stiff tan fine sandy clay with traces of gravel and organic matter - tan and light gray below 1 ft										⊗
5			Stiff tan and light gray silty clay with traces of gravel										⊗
10			Soft tan and light gray weathered shale with tan clay										⊗
15			Moderately hard tan and light gray weathered shale										
20			Hard dark gray shale										

COMPLETION DEPTH: 20 ft
 DATE: 7/3/70

DEPTH TO WATER
 IN BORING: 7 ft

DATE: 7/3/70

GRUBBS CONSULTING ENGINEERS, INC.

SAR FIGURE NO. 2.5-82

AMENDMENT 19

ARKANSAS NUCLEAR ONE
 UNIT 2
 RUSSELLVILLE, ARKANSAS



SCALE: NONE

DRAWN:

DESIGN: ENTERGY

CAD NO:

LOG OF BORING NO. 220

BASED ON DRAWING NO

SHEET

REV.

LOG OF BORING NO. 221
ARKANSAS NUCLEAR TWO
RUSSELLVILLE, ARKANSAS

TYPE: Wash

LOCATION: As Directed

DEPTH, FT.	SYMBOL	SAMPLES	DESCRIPTION OF MATERIAL	BLOWS PER FT	RECOVERY, %	COHESION, TON/SQ FT						ELEVATION, FT	
						PLASTIC LIMIT	WATER CONTENT, %		LIQUID LIMIT				
			SURF. EL.			0.2	0.4	0.6	0.8	1.0	1.2	1.4	
						10	20	30	40	50	60	70	
			Stiff tan and light gray fine sandy clay fill with sandstone fragments										
5			Stiff tan and light gray silty clay with traces of gravel and organic matter						⊗				
			Soft tan and light gray weathered shale with tan clay							⊗			
-10			Moderately hard light gray and tan weathered shale										⊗ →
-15			Hard dark gray shale										
-20													

COMPLETION DEPTH: 20 ft
 DATE: 7/3/70

DEPTH TO WATER
 IN BORING: 6 ft

DATE: 7/3/70

GRUBBS CONSULTING ENGINEERS, INC.

SAR FIGURE NO. 2.5-83

AMENDMENT 19

ARKANSAS NUCLEAR ONE
 UNIT 2
 RUSSELLVILLE, ARKANSAS



SCALE: NONE
 DRAWN:
 DESIGN: ENTERGY
 CAD NO:

LOG OF BORING NO. 221

BASED ON DRAWING NO

SHEET

REV.

LOG OF BORING NO. 222
ARKANSAS NUCLEAR TWO
RUSSELLVILLE, ARKANSAS

TYPE: Wash

LOCATION: As Directed

DEPTH, FT.	SYMBOL	SAMPLES	DESCRIPTION OF MATERIAL	BLOWS PER FT	RECOVERY, %	COHESION, TON/SQ FT				ELEVATION, FT			
						PLASTIC LIMIT	WATER CONTENT, %	LIQUID LIMIT					
			SURF. EL.			0.2	0.4	0.6	0.8	1.0	1.2	1.4	
			Very stiff tan fine sandy clay with gravel and organic matter										⊗
			Stiff tan and light gray silty clay										⊗
5			Very stiff tan and light gray fine sandy clay with weathered shale and sandstone fragments										⊗
			Moderately hard weathered sandstone with light gray clay seams										
-10													
			Moderately hard light gray and tan weathered shale										
-15													
			Hard dark gray shale										
-20													

COMPLETION DEPTH: 20 ft
 DATE: 7/3/70

DEPTH TO WATER
 IN BORING: 10 ft

DATE: 7/3/70

GRUBBS CONSULTING ENGINEERS, INC.

SAR FIGURE NO. 2.5-84

AMENDMENT 19

ARKANSAS NUCLEAR ONE
 UNIT 2
 RUSSELLVILLE, ARKANSAS



SCALE: NONE

DRAWN:

DESIGN: ENTERGY

CAD NO:

LOG OF BORING NO. 222

BASED ON DRAWING NO

SHEET

REV.

LOG OF BORING NO. 223
ARKANSAS NUCLEAR TWO
RUSSELLVILLE, ARKANSAS

TYPE: Wash

LOCATION: As Directed

DEPTH, FT.	SYMBOL	SAMPLES	DESCRIPTION OF MATERIAL	BLOWS PER FT	RECOVERY, %	COHESION, TON/SQ FT						ELEVATION, FT
						PLASTIC LIMIT		WATER CONTENT, %		LIQUID LIMIT		
						10	20	30	40	50	60	
			SURF. EL. Medium dense tan silty fine sand with organic matter									
			Very stiff tan and light gray silty clay - red below 2 ft									
5												
			Very stiff tan fine sandy clay with weathered shale and sandstone fragments									
10												
			Moderately hard light gray and tan weathered shale									
15												
			Hard dark gray shale									
20												

COMPLETION DEPTH: 20 ft
 DATE: 7/6/70

DEPTH TO WATER
 IN BORING: DRY CAVED TO 10 ft

DATE: 7/6/70

GRUBBS CONSULTING ENGINEERS, INC.

SAR FIGURE NO. 2.5-85

AMENDMENT 19

ARKANSAS NUCLEAR ONE
 UNIT 2
 RUSSELLVILLE, ARKANSAS



SCALE: NONE

DRAWN:

DESIGN: ENTERGY

CAD NO:

LOG OF BORING NO. 223

BASED ON DRAWING NO

SHEET

REV.

LOG OF BORING NO. 224
ARKANSAS NUCLEAR TWO
RUSSELLVILLE, ARKANSAS

TYPE: Wash

LOCATION: As Directed

DEPTH, FT.	SYMBOL	SAMPLES	DESCRIPTION OF MATERIAL	BLOWS PER FT	RECOVERY, %	COHESION, TON/SQ FT						ELEVATION, FT
						PLASTIC LIMIT		WATER CONTENT, %		LIQUID LIMIT		
						10	20	30	40	50	60	
			SURF. EL.									
			Stiff tan fine sandy clay with organic matter									
			Very stiff light gray silty clay with traces of gravel									
5			- red below 4.5 ft									⊗
												⊗
10			- red and light gray below 9.5 ft									
			Firm tan fine sandy clay with traces of gravel			⊗					⊗	
			Very stiff tan fine sandy clay with shale fragments									
15			Moderately hard light gray and tan weathered shale									
			Hard dark gray shale									
20												

COMPLETION DEPTH: 20 ft
 DATE: 7/6/70

DEPTH TO WATER
 IN BORING: 8 ft

DATE: 7/6/70

GRUBBS CONSULTING ENGINEERS, INC.

SAR FIGURE NO. 2.5-86

AMENDMENT 19

ARKANSAS NUCLEAR ONE
 UNIT 2
 RUSSELLVILLE, ARKANSAS



SCALE: NONE

DRAWN:

DESIGN: ENTERGY

CAD NO:

LOG OF BORING NO. 224

BASED ON DRAWING NO

SHEET

REV.

LOG OF BORING NO. 225
ARKANSAS NUCLEAR TWO
RUSSELLVILLE, ARKANSAS

TYPE: Wash

LOCATION: As Directed

DEPTH, FT.	SYMBOL	SAMPLES	DESCRIPTION OF MATERIAL	BLOWS PER FT	RECOVERY, %	COHESION, TON/SQ FT						ELEVATION, FT
						0.2	0.4	0.6	0.8	1.0	1.2	
			SURF. EL.			PLASTIC LIMIT ——— WATER CONTENT, % ——— LIQUID LIMIT 10 20 30 40 50 60 70						
			Very stiff tan fine sandy clay									
			Very stiff red silty clay with organic matter									⊗ →
5												
			- red and light gray below 8 ft									⊗ →
10												
												⊗ →
15			Very stiff tan fine sandy clay with weathered shale fragments									⊗ →
			Moderately hard tan and light gray weathered shale									
			- light gray and tan below 18 ft									
20												
			Hard dark gray shale									
25												

COMPLETION DEPTH: 25 ft
 DATE: 7/6/70

DEPTH TO WATER
 IN BORING: Dry Caved to 5 ft

DATE: 7/6/70

GRUBBS CONSULTING ENGINEERS, INC.

SAR FIGURE NO. 2.5-87

AMENDMENT 19

ARKANSAS NUCLEAR ONE
 UNIT 2
 RUSSELLVILLE, ARKANSAS



SCALE: NONE
 DRAWN:
 DESIGN: ENTERGY
 CAD NO:

LOG OF BORING NO. 225

BASED ON DRAWING NO

SHEET

REV.

LOG OF BORING NO. 226
ARKANSAS NUCLEAR TWO
RUSSELLVILLE, ARKANSAS

TYPE: Wash

LOCATION: As Directed

DEPTH, FT.	SYMBOL	SAMPLES	DESCRIPTION OF MATERIAL	BLOWS PER FT	RECOVERY, %	COHESION, TON/SQ FT					ELEVATION, FT	
						0.2	0.4	0.6	0.8	1.0		1.2
			SURF. EL.			PLASTIC LIMIT ——— WATER CONTENT, % ——— LIQUID LIMIT 10 ——— 20 ——— 30 ——— 40 ——— 50 ——— 60 ——— 70						
			Firm tan fine sandy clay with organic matter									
			Firm red and tan silty clay				⊗					
5			Very stiff red to light gray clay									⊗ →
10			Very stiff tan fine sandy clay with weathered shale and sandstone fragments									⊗ →
15			Moderately hard light gray and tan weathered shale									
20			Hard dark gray shale									
COMPLETION DEPTH: 20.5 ft DATE: 7/6/70			DEPTH TO WATER IN BORING: Dry			DATE: 7/6/70						

GRUBBS CONSULTING ENGINEERS, INC.

SAR FIGURE NO. 2.5-88

AMENDMENT 19

ARKANSAS NUCLEAR ONE
 UNIT 2
 RUSSELLVILLE, ARKANSAS



SCALE: NONE
 DRAWN:
 DESIGN: ENTERGY
 CAD NO:

LOG OF BORING NO. 226

BASED ON DRAWING NO

SHEET

REV.

LOG OF BORING NO. 227
 ARKANSAS NUCLEAR TWO
 RUSSELLVILLE, ARKANSAS

TYPE: Wash

LOCATION: As Directed

DEPTH, FT.	SYMBOL	SAMPLES	DESCRIPTION OF MATERIAL	BLOWS PER FT	RECOVERY, %	COHESION, TON/SQ FT							ELEVATION, FT
						WATER CONTENT, %							
						PLASTIC LIMIT						LIQUID LIMIT	
						10	20	30	40	50	60	70	
			Very stiff tan fine sandy clay with organic matter										
			Very stiff light gray and tan silty clay - red and light gray below 4 ft										
5													
10													
			Stiff tan fine sandy clay with sandstone and shale fragments										
			Moderately hard tan and light gray weathered shale										
15													
			Hard dark gray shale										
20													

COMPLETION DEPTH: 20 ft
 DATE: 7/6/70

DEPTH TO WATER
 IN BORING: Dry

DATE: 7/6/70

GRUBBS CONSULTING ENGINEERS, INC.

SAR FIGURE NO. 2.5-89

AMENDMENT 19

ARKANSAS NUCLEAR ONE
 UNIT 2
 RUSSELLVILLE, ARKANSAS



SCALE: NONE

DRAWN:

DESIGN: ENTERGY

CAD NO:

LOG OF BORING NO. 227

BASED ON DRAWING NO

SHEET

REV.

LOG OF BORING NO. 228
ARKANSAS NUCLEAR TWO
RUSSELLVILLE, ARKANSAS

TYPE: Wash

LOCATION: As Directed

DEPTH, FT.	SYMBOL	SAMPLES	DESCRIPTION OF MATERIAL	BLOWS PER FT	RECOVERY, %	COHESION, TON/SQ FT						ELEVATION, FT	
						PLASTIC LIMIT		WATER CONTENT, %		LIQUID LIMIT			
						10	20	30	40	50	60		70
			SURF. EL. Stiff tan fine sandy clay with traces of gravel and organic matter										
5			Stiff tan and light gray silty clay with traces of gravel - very stiff, red and light gray below 3.5 ft						⊗				⊗ →
10			Very stiff tan fine sandy clay with sandstone and shale fragments										⊗ →
15			Moderately hard tan and light gray weathered shale - light gray and tan below 14 ft										
20			Hard dark gray shale										

COMPLETION DEPTH: 20 ft
 DATE: 7/7/70

DEPTH TO WATER
 IN BORING: 6 ft

DATE: 7/7/70

GRUBBS CONSULTING ENGINEERS, INC.

SAR FIGURE NO. 2.5-90

AMENDMENT 19

ARKANSAS NUCLEAR ONE
 UNIT 2
 RUSSELLVILLE, ARKANSAS



SCALE: NONE

DRAWN:

DESIGN: ENTERGY

CAD NO:

LOG OF BORING NO. 228

BASED ON DRAWING NO

SHEET

REV.

LOG OF BORING NO. 229
ARKANSAS NUCLEAR TWO
RUSSELLVILLE, ARKANSAS

TYPE: Wash

LOCATION: As Directed

DEPTH, FT.	SYMBOL	SAMPLES	DESCRIPTION OF MATERIAL	BLOWS PER FT	RECOVERY, %	COHESION, TON/SQ FT							ELEVATION, FT
						PLASTIC LIMIT		WATER CONTENT, %			LIQUID LIMIT		
						10	20	30	40	50	60	70	
			SURF. EL. Very stiff tan fine sandy clay with traces of gravel and organic matter										
			Very stiff tan and light gray clay with traces of sandstone gravel										
5			Very stiff red silty clay										⊗ →
10			Very stiff tan fine sandy clay with sandstone and shale fragments										⊗ →
15			Moderately hard tan and light gray weathered shale										
20			Hard dark gray shale										

COMPLETION DEPTH: 20 ft
 DATE: 7/7/70

DEPTH TO WATER
 IN BORING: 12 ft

DATE: 7/7/70

GRUBBS CONSULTING ENGINEERS, INC.

SAR FIGURE NO. 2.5-91

AMENDMENT 19

ARKANSAS NUCLEAR ONE
 UNIT 2
 RUSSELLVILLE, ARKANSAS



SCALE: NONE
 DRAWN:
 DESIGN: ENTERGY
 CAD NO:

LOG OF BORING NO. 229

BASED ON DRAWING NO

SHEET

REV.

LOG OF BORING NO. 230
ARKANSAS NUCLEAR TWO
RUSSELLVILLE, ARKANSAS

TYPE: Wash

LOCATION: As Directed

DEPTH, FT.	SYMBOL	SAMPLES	DESCRIPTION OF MATERIAL	BLOWS PER FT	RECOVERY, %	COHESION, TON/SQ FT						ELEVATION, FT	
						PLASTIC LIMIT	WATER CONTENT, %		LIQUID LIMIT				
			SURF. EL.			0.2	0.4	0.6	0.8	1.0	1.2	1.4	
						10	20	30	40	50	60	70	
			Very stiff tan fine sandy clay with organic matter - tan and light gray with traces of gravel below 1 ft										
5			Very stiff red silty clay										⊗ →
10			Very stiff tan fine sandy clay with shale and sandstone fragments										⊗ →
			Moderately hard light gray and tan weathered shale										
15													
			Hard dark gray shale										
20													

COMPLETION DEPTH: 20 ft
 DATE: 7/7/70

DEPTH TO WATER
 IN BORING: 4 ft

DATE: 7/7/70

GRUBBS CONSULTING ENGINEERS, INC.

SAR FIGURE NO. 2.5-92

AMENDMENT 19

ARKANSAS NUCLEAR ONE
 UNIT 2
 RUSSELLVILLE, ARKANSAS



SCALE: NONE

DRAWN:

DESIGN: ENTERGY

CAD NO:

LOG OF BORING NO. 230

BASED ON DRAWING NO

SHEET

REV.

LOG OF BORING NO. 231
ARKANSAS NUCLEAR TWO
RUSSELLVILLE, ARKANSAS

TYPE: Wash

LOCATION: As Directed

DEPTH, FT.	SYMBOL	SAMPLES	DESCRIPTION OF MATERIAL	BLOWS PER FT	RECOVERY, %	COHESION, TON/SQ FT						ELEVATION, FT	
						0.2	0.4	0.6	0.8	1.0	1.2		1.4
			SURF. EL.			PLASTIC LIMIT WATER CONTENT, % LIQUID LIMIT 10 20 30 40 50 60 70							
			Stiff tan fine sandy clay with traces of organic matter and gravel - tan and light gray below 3 ft										
5			Stiff light gray clay Moderately hard light gray and tan weathered shale										
10													
15			Hard dark gray shale										
20													

COMPLETION DEPTH: 17 ft
 DATE: 7/7/70

DEPTH TO WATER
 IN BORING: 6 ft

DATE: 7/7/70

GRUBBS CONSULTING ENGINEERS, INC.

SAR FIGURE NO. 2.5-93

AMENDMENT 19

ARKANSAS NUCLEAR ONE
 UNIT 2
 RUSSELLVILLE, ARKANSAS



SCALE: NONE

DRAWN:

DESIGN: ENTERGY

CAD NO:

LOG OF BORING NO. 231

BASED ON DRAWING NO

SHEET

REV.

LOG OF BORING NO. 232
ARKANSAS NUCLEAR TWO
RUSSELLVILLE, ARKANSAS

TYPE: Wash

LOCATION: As Directed

DEPTH, FT.	SYMBOL	SAMPLES	DESCRIPTION OF MATERIAL	BLOWS PER FT	RECOVERY, %	COHESION, TON/SQ FT						ELEVATION, FT
						0.2	0.4	0.6	0.8	1.0	1.2	
			SURF. EL.			PLASTIC LIMIT ——— WATER CONTENT, % ——— LIQUID LIMIT 10 20 30 40 50 60 70						
0-5	[Symbol]		Moderately hard light gray and tan shale fill with tan fine sandy clay									
5-10	[Symbol]		Stiff tan and light gray fine sandy clay									
10-15	[Symbol]		Very stiff red and light gray silty clay									
15-20	[Symbol]		- red below 17 ft								⊗	
20-25	[Symbol]		Tan fine sandy clay w/ shale & sandstone fragments									⊗ →
25-30	[Symbol]		Moderately hard tan and light gray weathered shale - light gray and tan below 25.5 ft									
30-31	[Symbol]		Hard dark gray shale									

NOTE SCALE CHANGE

COMPLETION DEPTH: 30 ft
 DATE: 7/7/70

DEPTH TO WATER
 IN BORING:

DATE:

GRUBBS CONSULTING ENGINEERS, INC.

SAR FIGURE NO. 2.5-94

AMENDMENT 19

ARKANSAS NUCLEAR ONE
 UNIT 2
 RUSSELLVILLE, ARKANSAS



SCALE:	NONE
DRAWN:	
DESIGN:	ENERGY
CAD NO:	

LOG OF BORING NO. 232

BASED ON DRAWING NO

SHEET

REV.

LOG OF BORING NO. 233
ARKANSAS NUCLEAR TWO
RUSSELLVILLE, ARKANSAS

TYPE: Wash

LOCATION: As Directed

DEPTH, FT.	SYMBOL	SAMPLES	DESCRIPTION OF MATERIAL	BLOWS PER FT	RECOVERY, %	COHESION, TON/SQ FT						ELEVATION, FT	
						PLASTIC LIMIT	WATER CONTENT, %		LIQUID LIMIT				
			SURF. EL.			0.2	0.4	0.6	0.8	1.0	1.2	1.4	
						10	20	30	40	50	60	70	
			Stiff tan fine sandy clay with traces of weathered shale fragments										
			Very stiff tan and light gray silty clay										
5			- red to light gray silty clay										⊗ →
10													⊗ →
15													
			Stiff tan fine sandy clay with sandstone and shale fragments										
20			Moderately hard tan and light gray weathered shale										
25													
			Hard dark gray shale										
30													
COMPLETION DEPTH: 30 ft DATE: 7/7/70				DEPTH TO WATER IN BORING:				DATE:					

NOTE SCALE CHANGE

GRUBBS CONSULTING ENGINEERS, INC.

SAR FIGURE NO. 2.5-95

AMENDMENT 19

ARKANSAS NUCLEAR ONE
 UNIT 2
 RUSSELLVILLE, ARKANSAS



SCALE: NONE
 DRAWN:
 DESIGN: ENTERGY
 CAD NO:

LOG OF BORING NO. 233

BASED ON DRAWING NO

SHEET

REV.

LOG OF BORING NO. 234
ARKANSAS NUCLEAR TWO
RUSSELLVILLE, ARKANSAS

TYPE: Wash

LOCATION: As Directed

DEPTH, FT.	SYMBOL	SAMPLES	DESCRIPTION OF MATERIAL	BLOWS PER FT	RECOVERY, %	COHESION, TON/SQ FT					ELEVATION, FT		
						PLASTIC LIMIT	WATER CONTENT, %			LIQUID LIMIT			
			SURF. EL.			0.2	0.4	0.6	0.8	1.0	1.2	1.4	
						10	20	30	40	50	60	70	
			Stiff tan fine sandy clay fill with crushed rock & shale										
			Very stiff tan and light gray silty clay - red and light gray below 3 ft										
5													⊗ →
			- traces of gravel below 10.5 ft										
10													⊗ →
15													⊗ →
20			Stiff tan fine sandy clay with shale fragments										
25			Tan fine sandy clay w/ shale & sandstone fragments										
30			Moderately hard light gray and tan weathered shale										
35			Hard dark gray shale										

NOTE SCALE CHANGE

COMPLETION DEPTH: 35 ft
 DATE: 7/8/70

DEPTH TO WATER
 IN BORING:

DATE:

GRUBBS CONSULTING ENGINEERS, INC.

SAR FIGURE NO. 2.5-96

AMENDMENT 19

ARKANSAS NUCLEAR ONE
 UNIT 2
 RUSSELLVILLE, ARKANSAS



SCALE: NONE
 DRAWN:
 DESIGN: ENTERGY
 CAD NO:

LOG OF BORING NO. 234

BASED ON DRAWING NO

SHEET

REV.

LOG OF BORING NO. 235
ARKANSAS NUCLEAR TWO
RUSSELLVILLE, ARKANSAS

TYPE: Wash

LOCATION: As Directed

DEPTH, FT.	SYMBOL	SAMPLES	DESCRIPTION OF MATERIAL	BLOWS PER FT	RECOVERY, %	COHESION, TON/SQ FT						ELEVATION, FT	
						0.2	0.4	0.6	0.8	1.0	1.2		1.4
			SURF. EL.			PLASTIC LIMIT ——— WATER CONTENT, % ——— LIQUID LIMIT 10 20 30 40 50 60 70							
			Stiff red and tan silty clay fill above 1.5 ft - tan and light gray										
5			Very stiff red fine sandy clay with sandstone fragments										⊗ →
10			Very stiff red and light gray clay with sandstone fragments										⊗ →
15			- no sandstone fragments below 13 ft									⊗	
20			Stiff tan fine sandy clay with shale fragments										
25			Moderately hard light gray and tan weathered shale										
30			Hard dark gray shale										

NOTE SCALE CHANGE

COMPLETION DEPTH: 30 ft
DATE: 7/8/70

DEPTH TO WATER
IN BORING:

DATE:

GRUBBS CONSULTING ENGINEERS, INC.

SAR FIGURE NO. 2.5-97

AMENDMENT 19

ARKANSAS NUCLEAR ONE
 UNIT 2
 RUSSELLVILLE, ARKANSAS



SCALE: NONE
 DRAWN:
 DESIGN: ENTERGY
 CAD NO:

LOG OF BORING NO. 235

BASED ON DRAWING NO

SHEET

REV.

LOG OF BORING NO. 236
ARKANSAS NUCLEAR TWO
RUSSELLVILLE, ARKANSAS

TYPE: Wash

LOCATION: As Directed

DEPTH, FT.	SYMBOL	SAMPLES	DESCRIPTION OF MATERIAL	BLOWS PER FT	RECOVERY, %	COHESION, TON/SQ FT					ELEVATION, FT		
						PLASTIC LIMIT	WATER CONTENT, %			LIQUID LIMIT			
			SURF. EL.			0.2	0.4	0.6	0.8	1.0	1.2	1.4	
						10	20	30	40	50	60	70	
5			Very stiff tan silty clay with organic matter - tan and light gray below 1.5 ft - red & light gray w/ sandstone fragments below 3 ft										
10													
15			Stiff tan fine sandy clay with shale fragments										
20			Moderately hard light gray and tan weathered shale										
25			Hard dark gray shale										
COMPLETION DEPTH: 25 ft DATE: 7/9/70			DEPTH TO WATER IN BORING:			DATE:							

GRUBBS CONSULTING ENGINEERS, INC.

SAR FIGURE NO. 2.5-98

AMENDMENT 19

ARKANSAS NUCLEAR ONE
 UNIT 2
 RUSSELLVILLE, ARKANSAS



SCALE: NONE
 DRAWN:
 DESIGN: ENTERGY
 CAD NO:

LOG OF BORING NO. 236

BASED ON DRAWING NO

SHEET

REV.

At rest earth pressures without influence of surcharge loads for cohesionless backfill material with $\Phi \geq 30^\circ$, $\gamma \leq 130$ lb/cu. ft.

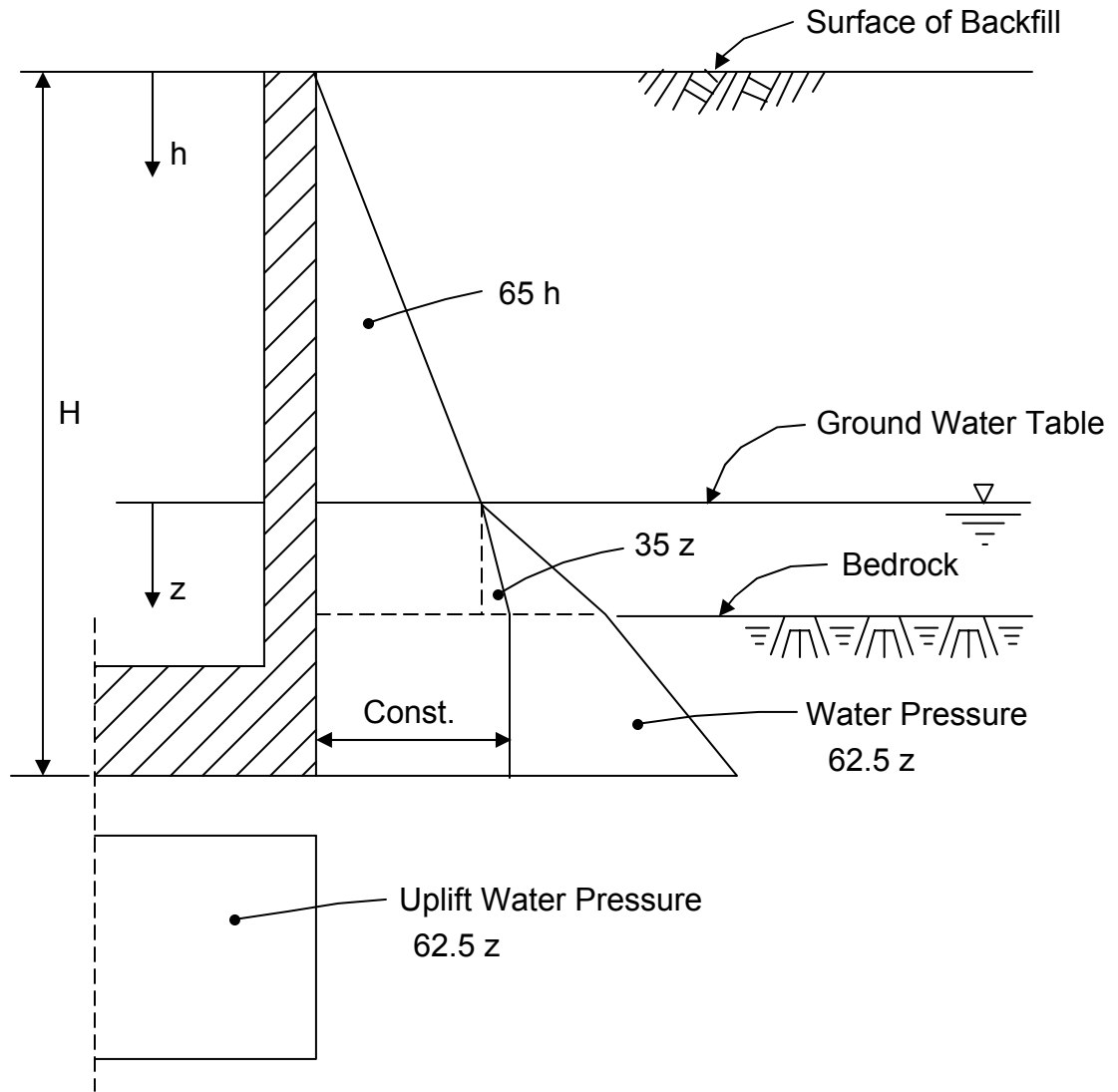

At rest pressures develop, when the wall deflect less than 0.001 H.
(All units in lbs and ft)

SAR FIGURE NO. 2.5-99

AMENDMENT 19

ARKANSAS NUCLEAR ONE
UNIT 2
RUSSELLVILLE, ARKANSAS



SCALE: NONE
DRAWN:
DESIGN: ENTERGY
CAD NO:

AT REST EARTH PRESSURE DIAGRAM

BASED ON DRAWING NO

SHEET

REV.

Active earthpressures without influence of surcharge loads for cohesionless backfill material with $\Phi \geq 30^\circ$, $\gamma \leq 130$ lb/cu. ft.

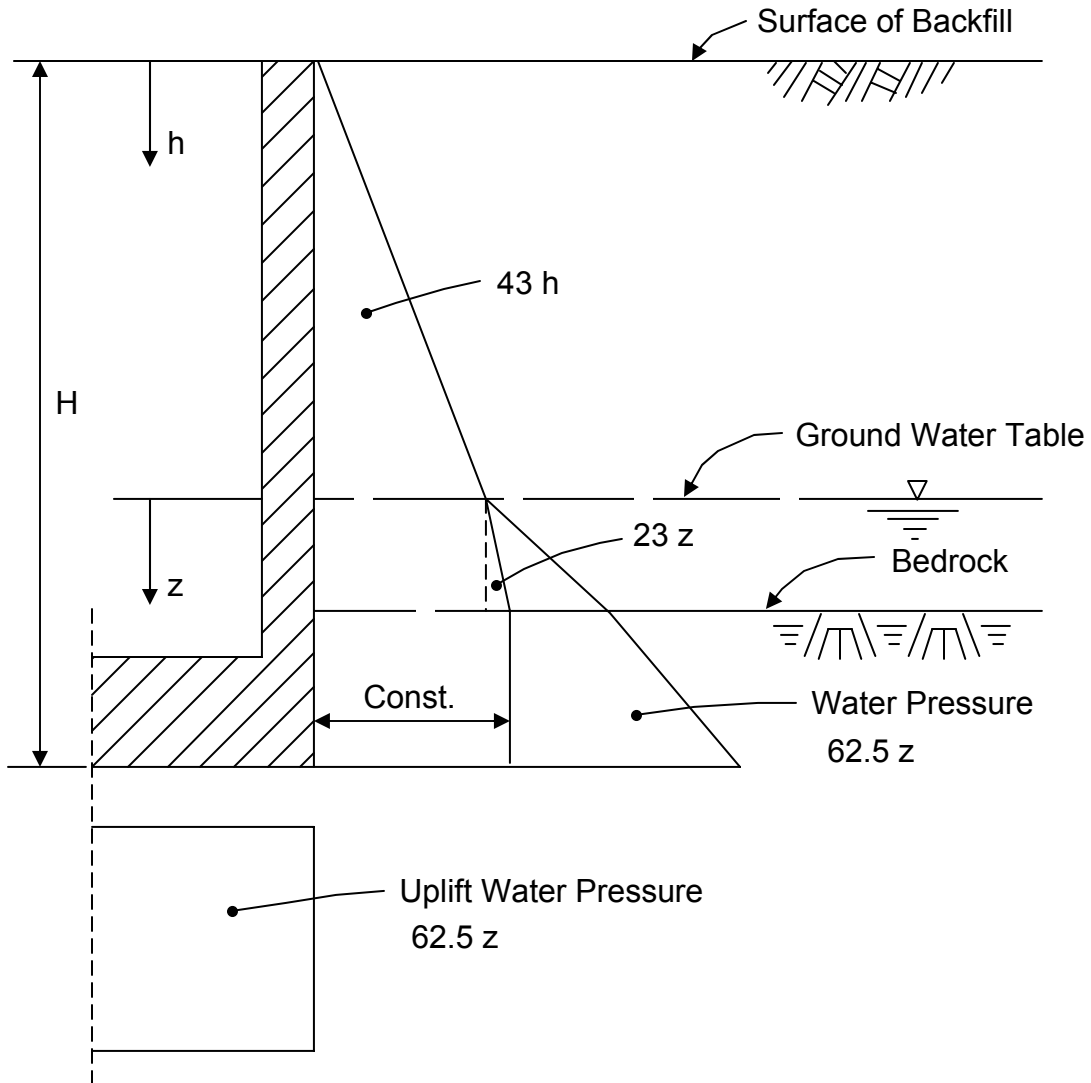

Active pressures develop, when the wall can deflect $\geq 0.001 H$.
(All units in lbs and ft)

SAR FIGURE NO. 2.5-100

AMENDMENT 19

ARKANSAS NUCLEAR ONE
UNIT 2
RUSSELLVILLE, ARKANSAS



SCALE: NONE
DRAWN:
DESIGN: ENTERGY
CAD NO:

ACTIVE EARTH PRESSURE DIAGRAM

BASED ON DRAWING NO

SHEET

REV.

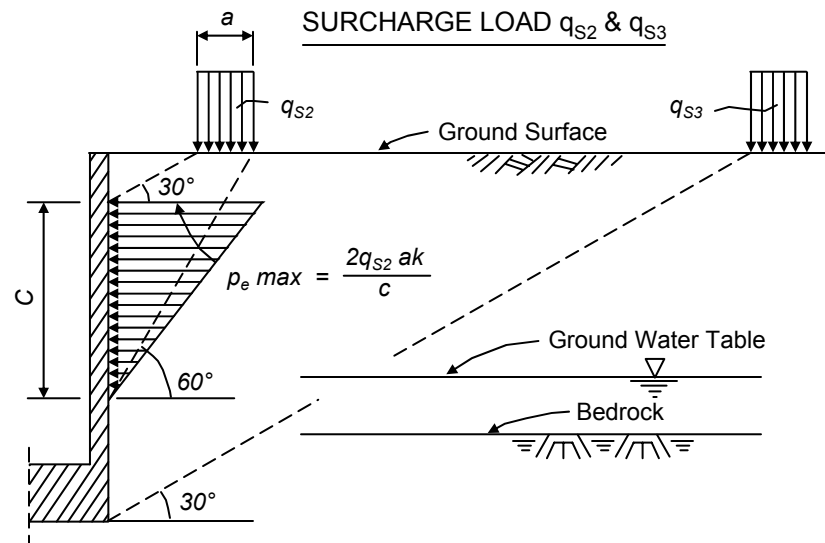
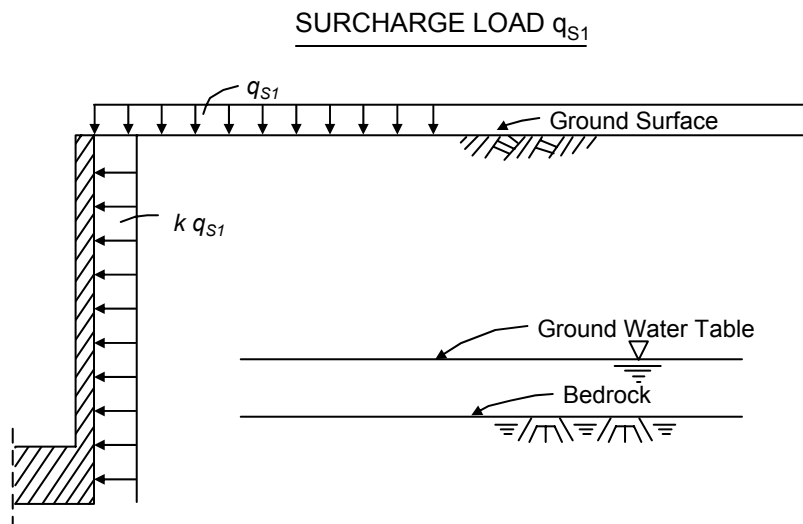

q_{s3} at the surface behind the 30° line has no influence in the lateral earth pressure on the wall.

For Active Pressure Conditions $k = k_A = 0.33$

For At Rest Pressure Conditions $k = k_O = 0.5$ (for normally compacted fill)

$k = k_O = 0.7$ (for highly compacted fill)

This pressure distribution is based on the assumption of cohesionless backfill material with $\Phi \geq 30^\circ$.

LATERAL EARTH PRESSURES DUE TO SURCHARGE LOADS

SAR FIGURE NO. 2.5-101

ARKANSAS NUCLEAR ONE
UNIT 2
RUSSELLVILLE, ARKANSAS



SCALE: NONE
DRAWN: ENTERGY
DESIGN: ENTERGY
CAD NO:

AMENDMENT 19

BASED ON DRAWING NO	SHEET	REV.
---------------------	-------	------

Security- Related Information
Text Withheld Under 10 CFR 2.390

SAR FIGURE NO. 2.5-102

AMENDMENT 19

ARKANSAS NUCLEAR ONE
UNIT 2
RUSSELLVILLE, ARKANSAS



SCALE:	NONE
DRAWN:	
DESIGN:	ENERGY
CAD NO:	

LATERAL PRESSURES FOR MAXIMUM
FLOOD

BASED ON DRAWING NO

SHEET

REV.

ARKANSAS NUCLEAR ONE
Unit 2

CHAPTER 3

TABLE OF CONTENTS

<u>Section</u>	<u>Title</u>	<u>Page</u>
3	<u>DESIGN OF STRUCTURES, COMPONENTS, EQUIPMENT AND SYSTEMS</u>	3.1-1
3.1	<u>CONFORMANCE WITH AEC GENERAL DESIGN CRITERIA</u>	3.1-1
3.1.1	OVERALL REQUIREMENTS.....	3.1-1
3.1.2	PROTECTION BY MULTIPLE FISSION PRODUCT BARRIERS.....	3.1-5
3.1.3	PROTECTION AND REACTIVITY CONTROL SYSTEMS.....	3.1-12
3.1.4	FLUID SYSTEMS.....	3.1-16
3.1.5	REACTOR CONTAINMENT.....	3.1-25
3.1.6	FUEL AND RADIOACTIVITY CONTROL.....	3.1-29
3.2	<u>CLASSIFICATION OF STRUCTURES, COMPONENTS AND SYSTEMS</u> ...	3.2-1
3.2.1	SEISMIC CLASSIFICATION.....	3.2-1
3.2.1.1	<u>Definitions</u>	3.2-1
3.2.1.2	<u>Seismic Classifications</u>	3.2-2
3.2.2	SYSTEM QUALITY GROUP CLASSIFICATION.....	3.2-2
3.2.2.1	<u>Code Requirements</u>	3.2-2
3.2.2.2	<u>Quality Group Classifications</u>	3.2-2
3.3	<u>WIND AND TORNADO LOADINGS</u>	3.3-1
3.3.1	WIND LOADINGS.....	3.3-1
3.3.1.1	<u>Design Wind Velocity</u>	3.3-1
3.3.1.2	<u>Basis for Wind Velocity Selection</u>	3.3-1
3.3.1.3	<u>Vertical Velocity Distribution and Gust Factor</u>	3.3-1
3.3.1.4	<u>Determination of Applied Forces</u>	3.3-1
3.3.2	TORNADO LOADINGS.....	3.3-1

ARKANSAS NUCLEAR ONE
Unit 2

TABLE OF CONTENTS (continued)

<u>Section</u>	<u>Title</u>	<u>Page</u>
3.3.2.1	<u>Applicable Design Parameters</u>	3.3-1
3.3.2.2	<u>Determination of Forces on Structures</u>	3.3-2
3.3.2.3	<u>Ability of Seismic Category 1 Structures to Perform Despite Failure of Structures Not Designed for Tornado Loads</u>	3.3-3
3.4	<u>WATER LEVEL (FLOOD) DESIGN</u>	3.4-1
3.4.1	FLOOD ELEVATIONS	3.4-1
3.4.2	PHENOMENA CONSIDERED IN DESIGN LOAD CALCULATIONS	3.4-1
3.4.3	FLOOD FORCE APPLICATION	3.4-1
3.4.3.1	<u>Consideration of Hydrostatic Pressures</u>	3.4-1
3.4.3.2	<u>Stability of Structures Against Buoyancy</u>	3.4-1
3.4.3.3	<u>Effect of Wave Action</u>	3.4-1
3.4.4	FLOOD PROTECTION	3.4-1
3.4.4.1	<u>Seepage Into Seismic Category 1 Buildings</u>	3.4-3
3.4.4.2	<u>Sumps and Sump Pumps Inside Seismic Category 1 Buildings</u>	3.4-3
3.4.4.3	<u>Local Probable Maximum Precipitation</u>	3.4-5
3.5	<u>MISSILE PROTECTION</u>	3.5-1
3.5.1	MISSILE BARRIERS AND LOADINGS	3.5-4
3.5.1.1	<u>Missile Barriers Within Containment</u>	3.5-4
3.5.1.2	<u>Missile Barriers Within Category 1 Structures Other Than Containment</u>	3.5-4
3.5.1.3	<u>Barriers for Missiles Generated Outside of Category 1 Structures</u>	3.5-5
3.5.1.4	<u>Barriers for Site Proximity Missiles</u>	3.5-5
3.5.2	MISSILE SELECTION	3.5-5
3.5.2.1	<u>General</u>	3.5-5
3.5.2.2	<u>Rotating Component Failure Missiles</u>	3.5-5
3.5.2.3	<u>Pressurized Component Failure Missiles</u>	3.5-11

ARKANSAS NUCLEAR ONE
Unit 2

TABLE OF CONTENTS (continued)

<u>Section</u>	<u>Title</u>	<u>Page</u>
3.5.2.4	<u>Tornado Generated Missiles</u>	3.5-13
3.5.3	SELECTED MISSILES	3.5-13
3.5.3.1	<u>Nuclear Steam Supply System Missiles</u>	3.5-13
3.5.3.2	<u>Missiles From Systems Other Than NSSS</u>	3.5-13
3.5.3.3	<u>Tornado Missiles</u>	3.5-14
3.5.4	BARRIER DESIGN PROCEDURES	3.5-14
3.5.4.1	<u>Reinforced Concrete Targets</u>	3.5-14
3.5.4.2	<u>Steel Targets</u>	3.5-16
3.5.5	MISSILE BARRIER FEATURES	3.5-16
3.6	<u>PROTECTION AGAINST DYNAMIC EFFECTS ASSOCIATED WITH THE POSTULATED RUPTURE OF PIPING</u>	3.6-1
3.6.1	SYSTEMS IN WHICH DESIGN BASIS PIPING BREAKS OCCUR	3.6-2
3.6.2	DESIGN BASIS PIPING BREAK CRITERIA	3.6-3
3.6.2.1	<u>Pipe Break Locations</u>	3.6-3
3.6.2.2	<u>Design Break Geometry</u>	3.6-6
3.6.3	DESIGN LOADING COMBINATIONS	3.6-7
3.6.3.1	<u>Reactor Coolant System</u>	3.6-7
3.6.3.2	<u>Other Systems</u>	3.6-8
3.6.4	DYNAMIC ANALYSES	3.6-8
3.6.4.1	<u>High Energy Pipe Break Outside Containment</u>	3.6-9
3.6.4.2	<u>High Energy Pipe Break Inside Containment</u>	3.6-20
3.6.4.3	<u>Protection From Flooding of Equipment Important to Safety</u>	3.6-30
3.6.4.4	<u>Liquid Storage Tanks</u>	3.6-34
3.6.4.5	<u>Moderate Energy Pipebreak Outside Containment</u>	3.6-36

ARKANSAS NUCLEAR ONE
Unit 2

TABLE OF CONTENTS (continued)

<u>Section</u>	<u>Title</u>	<u>Page</u>
3.6.5	PROTECTIVE MEASURES	3.6-39
3.6.5.1	<u>Separation</u>	3.6-39
3.6.5.2	<u>Pipe Whip Restraints</u>	3.6-39
3.6.5.3	<u>Barrier Protection</u>	3.6-39
3.6.5.4	<u>Electrical Equipment Environmental Qualification</u>	3.6-39
3.6.5.5	<u>Control Room Habitability</u>	3.6-40
3.6.6	LEAK-BEFORE-BREAK EVALUATION	3.6-40
3.6.6.1	<u>Applicability of Leak-Before-Break</u>	3.6-40
3.6.6.2	<u>Leak Detection</u>	3.6-40
3.6.6.3	<u>Material Properties</u>	3.6-41
3.6.6.4	<u>Leakage Crack Length Determination</u>	3.6-41
3.6.6.5	<u>Stability Evaluations</u>	3.6-41
3.6.6.6	<u>Results</u>	3.6-41
3.7	<u>SEISMIC DESIGN</u>	3.7-1
3.7.1	SEISMIC INPUT	3.7-1
3.7.1.1	<u>Design Response Spectra</u>	3.7-1
3.7.1.2	<u>Design Response Spectra Derivation</u>	3.7-1
3.7.1.3	<u>Critical Damping Values</u>	3.7-2
3.7.1.4	<u>Bases for Site Dependent Analysis</u>	3.7-2
3.7.1.5	<u>Soil Supported Category 1 Structures</u>	3.7-2
3.7.1.6	<u>Soil Structure Interaction</u>	3.7-4
3.7.1.7	<u>Pier Supported Category 1 Structures</u>	3.7-4
3.7.2	SEISMIC SYSTEM ANALYSIS	3.7-5
3.7.2.1	<u>Seismic Analysis Methods</u>	3.7-5

ARKANSAS NUCLEAR ONE
Unit 2

TABLE OF CONTENTS (continued)

<u>Section</u>	<u>Title</u>	<u>Page</u>
3.7.2.2	<u>Natural Frequencies and Responses Loads</u>	3.7-7
3.7.2.3	<u>Procedures Used to Lump Masses</u>	3.7-7
3.7.2.4	<u>Rocking and Translational Response Summary</u>	3.7-8
3.7.2.5	<u>Methods Used to Couple Soil With Seismic System Structures</u>	3.7-8
3.7.2.6	<u>Development of Floor Response Spectra</u>	3.7-8
3.7.2.7	<u>Differential Seismic Movement of Interconnected Components</u>	3.7-8
3.7.2.8	<u>Effects of Variations on Floor Response Spectra</u>	3.7-8
3.7.2.9	<u>Use of Constant Vertical Load Factors</u>	3.7-9
3.7.2.10	<u>Method Used to Account for Torsional Effects</u>	3.7-9
3.7.2.11	<u>Comparison of Responses</u>	3.7-9
3.7.2.12	<u>Methods for Seismic Analysis of Dams</u>	3.7-9
3.7.2.13	<u>Methods to Determine Category 1 Structure Overturning Moments</u>	3.7-9
3.7.2.14	<u>Analysis Procedure for Damping</u>	3.7-10
3.7.2.15	<u>Coupled Reactor Building/RCS Seismic Analysis</u>	3.7-10
3.7.3	SEISMIC SUBSYSTEM ANALYSIS	3.7-13
3.7.3.1	<u>Determination of Number of Earthquake Cycles</u>	3.7-13
3.7.3.2	<u>Basis for Selection of Forcing Frequencies</u>	3.7-13
3.7.3.3	<u>Root Mean Square Basis</u>	3.7-13
3.7.3.4	<u>Procedure for Combining Modal Responses</u>	3.7-13
3.7.3.5	<u>Significant Dynamic Response Modes</u>	3.7-29
3.7.3.6	<u>Design Criteria and Analytical Procedures for Piping</u>	3.7-29
3.7.3.7	<u>Basis for Computing Combined Response</u>	3.7-29
3.7.3.8	<u>Amplified Seismic Responses</u>	3.7-30
3.7.3.9	<u>Use of Simplified Dynamic Analysis</u>	3.7-30

ARKANSAS NUCLEAR ONE
Unit 2

TABLE OF CONTENTS (continued)

<u>Section</u>	<u>Title</u>	<u>Page</u>
3.7.3.10	<u>Modal Period Variation</u>	3.7-30
3.7.3.11	<u>Torsional Effects of Eccentric Masses</u>	3.7-30
3.7.3.12	<u>Piping Outside Containment</u>	3.7-30
3.7.3.13	<u>Interaction of Other Piping With Category 1 Piping</u>	3.7-30
3.7.3.14	<u>Field Location of Supports and Restraints</u>	3.7-31
3.7.3.15	<u>Seismic Analysis for Fuel Elements, Control Rod Assemblies and Control Rod Drives</u>	3.7-31
3.7.4	SEISMIC INSTRUMENTATION PROGRAM.....	3.7-31
3.7.4.1	<u>Comparison With Safety Guide 12</u>	3.7-31
3.7.4.2	<u>Location and Description of Instrumentation</u>	3.7-31
3.7.4.3	<u>Control Room Operator Notification</u>	3.7-31
3.7.4.4	<u>Comparison of Measured and Predicted Responses</u>	3.7-32
3.7.5	SEISMIC DESIGN CONTROL MEASURES	3.7-32
3.7.5.1	<u>Category 1 Systems and Components Other Than NSSS</u>	3.7-32
3.7.5.2	<u>Nuclear Steam Supply System</u>	3.7-32
3.7.6	SEISMIC EVALUATION OF CONCRETE MASONRY WALLS	3.7-32
3.7.6.1	<u>Description of Masonry Walls</u>	3.7-33
3.7.6.2	<u>Construction Practices</u>	3.7-34
3.7.6.3	<u>Re-Evaluation Criteria and Commentary</u>	3.7-36
3.7.6.4	<u>Results of the Evaluation</u>	3.7-43
3.8	<u>DESIGN OF CATEGORY 1 STRUCTURES</u>	3.8-1
3.8.1	CONCRETE CONTAINMENT	3.8-1
3.8.1.1	<u>Description of the Containment</u>	3.8-1
3.8.1.2	<u>Applicable Codes, Standards and Specifications</u>	3.8-2
3.8.1.3	<u>Loads and Loading Combinations</u>	3.8-5

ARKANSAS NUCLEAR ONE
Unit 2

TABLE OF CONTENTS (continued)

<u>Section</u>	<u>Title</u>	<u>Page</u>
3.8.1.4	<u>Design and Analysis Procedures</u>	3.8-11
3.8.1.5	<u>Structural Acceptance Criteria</u>	3.8-16
3.8.1.6	<u>Materials, Quality Control, and Special Construction Techniques</u>	3.8-16
3.8.1.7	<u>Testing and Inservice Surveillance Requirements</u>	3.8-25
3.8.2	STEEL CONTAINMENT SYSTEM.....	3.8-27
3.8.3	CONCRETE AND STRUCTURAL STEEL INTERNAL STRUCTURES OF CONTAINMENT.....	3.8-28
3.8.3.1	<u>Description of the Internal Structures</u>	3.8-28
3.8.3.2	<u>Applicable Codes, Standards and Specifications</u>	3.8-29
3.8.3.3	<u>Loads and Loading Combinations</u>	3.8-30
3.8.3.4	<u>Design and Analysis Procedures</u>	3.8-32
3.8.3.5	<u>Structural Acceptance Criteria</u>	3.8-36
3.8.3.6	<u>Materials, Quality Control and Special Construction Techniques</u>	3.8-36
3.8.3.7	<u>Testing and Inservice Surveillance Requirements</u>	3.8-37
3.8.4	OTHER CATEGORY 1 STRUCTURES	3.8-37
3.8.4.1	<u>Description of the Structures</u>	3.8-37
3.8.4.2	<u>Applicable Codes, Standards and Specifications</u>	3.8-40
3.8.4.3	<u>Loads and Loading Combinations</u>	3.8-41
3.8.4.4	<u>Design and Analysis Procedure</u>	3.8-44
3.8.4.5	<u>Structural Acceptance Criteria</u>	3.8-46
3.8.4.6	<u>Materials Quality Control and Special Construction Techniques</u>	3.8-46
3.8.4.7	<u>Testing and Inservice Surveillance Requirements</u>	3.8-49
3.8.5	FOUNDATIONS AND CONCRETE SUPPORTS.....	3.8-50
3.8.5.1	<u>Descriptions of the Foundations and Supports</u>	3.8-50

ARKANSAS NUCLEAR ONE
Unit 2

TABLE OF CONTENTS (continued)

<u>Section</u>	<u>Title</u>	<u>Page</u>
3.8.5.2	<u>Applicable Codes, Standards and Specifications</u>	3.8-51
3.8.5.3	<u>Loads and Loading Combinations</u>	3.8-51
3.8.5.4	<u>Design and Analysis Procedures</u>	3.8-52
3.8.5.5	<u>Structural Acceptance Criteria</u>	3.8-52
3.8.5.6	<u>Materials Quality Control and Special Construction Techniques</u>	3.8-52
3.8.5.7	<u>Testing and Inservice Surveillance Requirements</u>	3.8-52
3.9	<u>MECHANICAL SYSTEMS AND COMPONENTS</u>	3.9-1
3.9.1	DYNAMIC SYSTEM ANALYSIS AND TESTING	3.9-1
3.9.1.1	<u>Vibration Operational Testing</u>	3.9-1
3.9.1.2	DELETED	3.9-2
3.9.1.3	<u>Dynamic Testing Procedures</u>	3.9-2
3.9.1.4	<u>Dynamic System Analysis for Reactor Internals</u>	3.9-8
3.9.1.5	<u>Correlation of Test and Analytical Results</u>	3.9-10
3.9.1.6	<u>Analysis Methods Under LOCA Loadings</u>	3.9-11
3.9.1.7	<u>Analytical Methods for ASME Code Class 1 Components</u>	3.9-15
3.9.2	ASME CODE CLASS 2 AND 3 COMPONENTS	3.9-17
3.9.2.1	<u>Plant Conditions and Design Loading Combinations</u>	3.9-17
3.9.2.2	<u>Design Loading Combination</u>	3.9-18
3.9.2.3	<u>Design Stress Limits</u>	3.9-18
3.9.2.4	<u>Analytical and Empirical Methods for Design of Pumps and Valves</u>	3.9-18
3.9.2.5	<u>Design and Installation Criteria, Pressure Relieving Devices</u>	3.9-22
3.9.2.6	<u>Stress Levels for Category 1 Components</u>	3.9-22
3.9.2.7	<u>Field Run Piping Systems</u>	3.9-23
3.9.3	COMPONENTS NOT COVERED BY ASME CODE	3.9-23

ARKANSAS NUCLEAR ONE
Unit 2

TABLE OF CONTENTS (continued)

<u>Section</u>	<u>Title</u>	<u>Page</u>
3.9.3.1	<u>Reactor Vessel Related Components not Covered by ASME Code</u>	3.9-23
3.9.3.2	<u>Ventilation, Air Conditioning, and the Emergency Diesel Generators</u>	3.9-27
3.9.3.3	<u>Pipe Supports, Base Plates, and Anchors</u>	3.9-27
3.10	<u>SEISMIC DESIGN OF CATEGORY 1 INSTRUMENTATION AND ELECTRICAL EQUIPMENT</u>	3.10-1
3.10.1	SEISMIC DESIGN CRITERIA	3.10-1
3.10.1.1	<u>Equipment Supplied by NSSS Vendor</u>	3.10-1
3.10.1.2	<u>Equipment Supplied by Other Than NSSS Vendor</u>	3.10-1
3.10.2	SEISMIC ANALYSES, TESTING PROCEDURES, AND RESTRAINT MEASURES	3.10-2
3.10.2.1	<u>Equipment Supplied by NSSS Vendor</u>	3.10-2
3.10.2.2	<u>Equipment Supplied by Other Than NSSS Vendor</u>	3.10-4
3.10.2.3	<u>Amplification of Floor Inputs by Supports</u>	3.10-20
3.11	<u>ENVIRONMENTAL DESIGN OF MECHANICAL AND ELECTRICAL EQUIPMENT</u>	3.11-1
3.11.1	EQUIPMENT IDENTIFICATION.....	3.11-3
3.11.2	QUALIFICATION TESTS AND ANALYSES.....	3.11-5
3.11.2.1	<u>Category I-A and I-B Equipment (Original Classification)</u>	3.11-5
3.11.2.2	<u>Category I-C, I-D and I-E Equipment (Original Classification)</u>	3.11-5
3.11.3	QUALIFICATION TEST RESULTS	3.11-6
3.11.3.1	<u>Categories I-A and I-B</u>	3.11-6
3.11.3.2	<u>Category I-C, I-D and I-E</u>	3.11-6
3.11.4	LOSS OF VENTILATION	3.11-6
3.11.5	CURRENT ENVIRONMENTAL QUALIFICATION PROGRAM.....	3.11-7
3.12	<u>REFERENCES</u>	3.12-1
3.13	<u>TABLES</u>	3.13-1

ARKANSAS NUCLEAR ONE
Unit 2

LIST OF TABLES

<u>Table No.</u>	<u>Title</u>	<u>Page</u>
3.2-1	STRUCTURES, SYSTEMS AND COMPONENT CLASSIFICATION	3.13-1
3.2-2	SEISMIC CATEGORIES OF SYSTEMS, COMPONENTS AND STRUCTURES	3.13-2
3.2-3	EQUIPMENT CODE GROUP CLASSIFICATION	3.13-10
3.2-4	SUMMARY OF CODES AND STANDARDS FOR NUCLEAR COMPONENTS	3.13-14
3.2-5	COMPONENTS BUILT TO CODES OTHER THAN THOSE SPECIFIED IN REGULATORY GUIDE 1.26	3.13-17
3.2-6	QUALITY ASSURANCE SUMMARY LEVEL Q-LIST	3.13-20
3.3-1	TORNADO WIND PROTECTED COMPONENTS AND TORNADO RESISTANT ENCLOSURES	3.13-37
3.4-1	FLOOD PROTECTION PROVISIONS	3.13-38
3.4-2	LIST OF SUMPS AND SUMP PUMPS INSIDE SEISMIC CATEGORY 1 BUILDINGS	3.13-38
3.5-1	MISSILE BARRIERS FOR TORNADO AND ACCIDENT MISSILES	3.13-39
3.5-2	EXAMPLE BREAKDOWN OF P2 AND P3 FOR G.E. TURBINE MISSILE FRAGMENTS WITH CONTAINMENT AS TARGET	3.13-40
3.5-3	RESULTS OF TURBINE MISSILE DAMAGE PROBABILITY CALCULATIONS	3.13-41
3.5-4	PRESSURIZED COMPONENT MISSILE CHARACTERISTICS FROM NSSS	3.13-44
3.5-5A	SELECTED PRESSURIZED COMPONENT MISSILE CHARACTERISTICS FROM OTHER THAN NSSS	3.13-46
3.5-5B	SELECTED PRESSURIZED COMPONENT MISSILE CHARACTERISTICS (AUX. BLDG)	3.13-48
3.5-6	TORNADO MISSILE CHARACTERISTICS	3.13-50
3.5-7	RESULTS OF CALCULATIONS ON EFFECTS OF MISSILES ON REINFORCED CONCRETE STRUCTURES	3.13-51
3.5-8	SAFETY-RELATED COMPONENTS LOCATED OUTDOORS	3.13-54

ARKANSAS NUCLEAR ONE
Unit 2

LIST OF TABLES (continued)

<u>Table No.</u>	<u>Title</u>	<u>Page</u>
3.6-1	HIGH ENERGY PIPING SYSTEMS.....	3.13-56
3.6-1A	LIMITING BRANCH LINE PIPE BREAKS FOR THE RCS WITH THE REPLACEMENT STEAM GENERATORS.....	3.13-57
3.6-2	MAIN STEAM STRESS SUMMARY - 2EBD-1.....	3.13-58
3.6-3	MAIN STEAM STRESS SUMMARY - 2EBD-2.....	3.13-59
3.6-4	MAIN FEEDWATER STRESS SUMMARY - 2DBD-1, 2DBD-2	3.13-60
3.6-5	EFW TURBINE STEAM SUPPLY STRESS SUMMARY - 2EBC-1.....	3.13-61
3.6-6	ATMOSPHERIC DUMP STRESS SUMMARY - 2EBB-8, 2EBB-9.....	3.13-62
3.6-7	CHARGING STRESS SUMMARY - 2CCB-8/2CCB-25.....	3.13-63
3.6-8	LETDOWN STRESS SUMMARY - 2CCB-2.....	3.13-64
3.6-9	MAIN STEAM STRESS SUMMARY - 2EBB-1.....	3.13-64
3.6-10	MAIN STEAM STRESS SUMMARY - 2EBB-2.....	3.13-65
3.6-11	MAIN FEEDWATER STRESS SUMMARY - 2DBB-1	3.13-65
3.6-12	MAIN FEEDWATER STRESS SUMMARY - 2DBB-2	3.13-66
3.6-13	SG BLOWDOWN STRESS SUMMARY - 2DBB-7/2DBB-9	3.13-66
3.6-14	SG BLOWDOWN STRESS SUMMARY - 2DBB-8/2DBB-10	3.13-67
3.6-15	EMERGENCY FEEDWATER STRESS SUMMARY - 2DBB-3	3.13-67
3.6-16	EMERGENCY FEEDWATER STRESS SUMMARY - 2DBB-4	3.13-68
3.6-17	PRESSURIZER SURGE STRESS SUMMARY - 2BCA-1.....	3.13-68
3.6-18	SAFETY INJECTION STRESS SUMMARY - 2CCA-21	3.13-69
3.6-19	SAFETY INJECTION STRESS SUMMARY - 2CCA-22.....	3.13-70
3.6-20	SAFETY INJECTION STRESS SUMMARY - 2CCA-23.....	3.13-71
3.6-21	SAFETY INJECTION STRESS SUMMARY - 2CCA-24.....	3.13-72
3.6-22	CHARGING STRESS SUMMARY - 2CCB-25	3.13-72
3.6-23	CHARGING STRESS SUMMARY - 2CCB-9	3.13-73

ARKANSAS NUCLEAR ONE
Unit 2

LIST OF TABLES (continued)

<u>Table No.</u>	<u>Title</u>	<u>Page</u>
3.6-24	LETDOWN STRESS SUMMARY - 2CCB-2.....	3.13-73
3.6-25	LIQUID STORAGE TANKS LOCATED OUTSIDE ANO-2 BUILDINGS.....	3.13-74
3.6-26	LIQUID STORAGE TANKS LOCATED INSIDE CONTAINMENT	3.13-75
3.6-27	LIQUID STORAGE TANKS LOCATED IN THE AUXILIARY BUILDING	3.13-75
3.7-1	SYNTHETIC TIME HISTORY RESPONSE SPECTRA - FREQUENCY RANGES AND INCREMENTS	3.13-77
3.7-2	PERCENTAGE OF CRITICAL DAMPING FACTORS	3.13-77
3.7-3	SUMMARY OF NATURAL FREQUENCIES	3.13-78
3.7-4	COMPARISON OF RESPONSE SPECTRUM AND TIME HISTORY ANALYSIS.....	3.13-79
3.7-5	LOCATIONS OF CE SUPPLIED PANELS WHICH ARE STRUCTURALLY SEISMIC CATEGORY 1	3.13-89
3.7-6	DAMPING VALUES	3.13-89
3.7-7	RCS MODAL DATA WITH REPLACEMENT STEAM GENERATORS.....	3.13-90
3.7-8	MAXIMUM OBE RESULTS FOR HORIZONTAL ± VERTICAL.....	3.13-92
3.7-9	SOLUTION TO TMCALC	3.13-100
3.7-10	MASS AND SUPPORT POINT MOTIONS.....	3.13-100
3.7-11	STRUDL AND FORCE RESULTS	3.13-100
3.7-12	CONCRETE BLOCK WALLS SUPPORTING SEISMIC CATEGORY 1 PIPES.....	3.13-101
3.7-13	CONCRETE BLOCK WALLS WITH SEISMIC CATEGORY 1 ATTACHMENTS OTHER THAN PIPE	3.13-102
3.7-14	CONCRETE BLOCK WALLS IN PROXIMITY TO SAFETY-RELATED SYSTEMS	3.13-104
3.7-15	MODAL PROPERTIES FOR THE COUPLED RB-INTERNAL RCS MODEL	3.13-109
3.7-16	DELETED	

ARKANSAS NUCLEAR ONE
Unit 2

LIST OF TABLES (continued)

<u>Table No.</u>	<u>Title</u>	<u>Page</u>
3.7-17	DELETED	
3.7-18	DELETED	
3.8-1	FLUED HEAD PENETRATIONS.....	3.13-112
3.8-2	WELD REPAIRS	3.13-115
3.8-3	COMPUTER PROGRAMS USED IN THE DESIGN OF CATEGORY 1 STRUCTURES.....	3.13-116
3.8-4	DELETED	3.13-121
3.8-5	DELETED.....	3.13-121
3.8-6	CALCULATED RESULTS - INTERNAL STRUCTURES.....	3.13-121
3.8-7	CALCULATED RESULTS - OTHER CATEGORY 1 STRUCTURES.....	3.13-122
3.8-8	CALCULATED RESULTS - FOUNDATION LOADS AND SETTLEMENTS .	3.13-126
3.8-9	GRADATIONS OF REACTIONS, MOMENTS AND STRESSES FOR STRIP "A" - IN X DIRECTION	3.13-127
3.8-10	GRADATIONS OF REACTIONS, MOMENTS AND STRESSES FOR STRIP "B" - IN Y DIRECTION	3.13-128
3.9-1	SPECIFIED SEISMIC CONSTANTS FOR CLASS 2 AND 3 EQUIPMENT ..	3.13-129
3.9-2	DESIGN LOADING COMBINATIONS AND STRESS LIMITS FOR ASME SECTION III CODE CLASS 2 AND 3 PIPING.....	3.13-130
3.9-3	DESIGN STRESS LIMITS FOR ASME SECTION III CODE CLASS 2 AND 3 VALVES	3.13-131
3.9-4	SAFETY-RELATED EQUIPMENT NOT COVERED BY ASME CODE, SECTION III	3.13-133
3.9-5	COMPARISON OF STRUCTURAL AND HYDRAULIC DESIGN PARAMETERS FOR REACTOR INTERNALS	3.13-134
3.9-6	ACTIVE - CATEGORY 1 - REACTOR COOLANT PRESSURE BOUNDARY VALVES (MOVs).....	3.13-135
3.9-7	LOADING COMBINATIONS AND STRESS LIMITS FOR ASME CODE CLASS 2 AND 3 VESSELS AND ACTIVE AND INACTIVE PUMPS	3.13-137
3.10-1	DELETED	

ARKANSAS NUCLEAR ONE
Unit 2

LIST OF TABLES (continued)

<u>Table No.</u>	<u>Title</u>	<u>Page</u>
3.11-1	POST LOCA ENVIRONMENTAL CONDITIONS SPECIFIED FOR PROCUREMENT OF EQUIPMENT	3.13-139
3.11-2	ENVIRONMENTAL QUALIFICATION REQUIREMENTS SPECIFIED FOR PROCUREMENT OF CE SUPPLIED CLASS 1E PROCESS INSTRUMENTATION	3.13-140
3.11-3	MOTOR OPERATED VALVES SUBMERGED FOLLOWING A LOCA	3.13-141

ARKANSAS NUCLEAR ONE
Unit 2

LIST OF FIGURES

<u>Figure No.</u>	<u>Title</u>
3.2-1	MAIN TURBINE-GENERATOR AND MAIN FEEDWATER PUMP TURBINE LUBE OIL
3.2-2	PLANT HEATING SYSTEM
3.2-3	CONTROL, COMPUTER, & ELECTRICAL EQUIPMENT ROOM CHILL WATER AND CONTROL & COMPUTER ROOM EMERGENCY HVAC FREON SYSTEM
3.2-4	CONTAINMENT, TURBINE, AUXILIARY, AUXILIARY EXTENSION BUILDINGS, AND CONTROLLED ACCESS CHILLED WATER SYSTEMS
3.2-5	NITROGEN ADDITION SYSTEM AND ELECTRICAL PENETRATION NITROGEN PRESSURIZATION SYSTEM
3.2-6	TURBINE-GENERATOR AUXILIARY SYSTEMS
3.4-1	DELETED
3.5-1	RELATIVE POSITION OF CATEGORY 1 STRUCTURES TO TURBINE CENTERLINE
3.5-2	VALUES OF PENETRATIONS COEFFICIENT (K_p) FOR REINFORCED CONCRETE
3.5-3	DELETED
3.5-4	DELETED
3.5-5	DELETED
3.5-6	DELETED
3.5-7	STRUCTURES INTENDED PRIMARILY AS MISSILE BARRIERS
3.5-8	STRUCTURES INTENDED PRIMARILY AS MISSILE BARRIER – PRINCIPAL DESIGN FEATURES
3.5-8A	DELETED
3.5-9 – 3.5-28	DELETED
3.6-1	TYPICAL PIPE WHIP RESTRAINTS
3.6-2 – 3.6-30	DELETED
3.6-31	REACTOR COOLANT PUMP WIRE-ROPE RESTRAINTS
3.6-32	MAIN STEAM LINE RESTRAINTS INSIDE CONTAINMENT

ARKANSAS NUCLEAR ONE
Unit 2

LIST OF FIGURES (continued)

<u>Figure No.</u>	<u>Title</u>
3.6-33–3.6-68	DELETED
3.7-1	SITE DESIGN RESPONSE SPECTRA - DESIGN BASIS EARTHQUAKE (DBE)
3.7-2	SITE DESIGN RESPONSE SPECTRA - OPERATING BASIS EARTHQUAKE (OBE)
3.7-3	SYNTHETIC EARTHQUAKE ACCELERATION TIME HISTORY (OBE)
3.7-4	SITE DESIGN & SYNTHETIC TIME HISTORY RESPONSE SPECTRA (OBE)
3.7-5	MATHEMATICAL MODEL - CONTAINMENT & INTERNAL STRUCTURES
3.7-6	MATHEMATICAL MODELS - CONTAINMENT & INTERNAL STRUCTURES
3.7-7	MODE SHAPES & NATURAL FREQUENCIES - CONTAINMENT & INTERNAL STRUCTURES
3.7-8	RESPONSE SPECTRUM RESULTS - CONTAINMENT
3.7-9	RESPONSE SPECTRUM RESULTS - INTERNAL STRUCTURES N-S DIRECTION
3.7-10	RESPONSE SPECTRUM RESULTS - INTERNAL STRUCTURES E-W DIRECTION
3.7-11	ACCELERATION RESPONSE SPECTRA - CONTAINMENT - OPERATING BASIS EARTHQUAKE
3.7-12	ACCELERATION RESPONSE SPECTRA - CONTAINMENT - OPERATING BASIS EARTHQUAKE
3.7-13	ACCELERATION RESPONSE SPECTRA - CONTAINMENT - OPERATING BASIS EARTHQUAKE
3.7-14	ACCELERATION RESPONSE SPECTRA - CONTAINMENT - OPERATING BASIS EARTHQUAKE
3.7-15	ACCELERATION RESPONSE SPECTRA - CONTAINMENT - DESIGN BASIS EARTHQUAKE
3.7-16	ACCELERATION RESPONSE SPECTRA - CONTAINMENT - DESIGN BASIS EARTHQUAKE
3.7-17	ACCELERATION RESPONSE SPECTRA - CONTAINMENT - DESIGN BASIS EARTHQUAKE
3.7-18	ACCELERATION RESPONSE SPECTRA - CONTAINMENT - DESIGN BASIS EARTHQUAKE

ARKANSAS NUCLEAR ONE
Unit 2

LIST OF FIGURES (continued)

<u>Figure No.</u>	<u>Title</u>
3.7-19	ACCELERATION RESPONSE SPECTRA - AUXILIARY BUILDING - ELEV. 317'-0" AND 335'-0" - OPERATING BASIS EARTHQUAKE
3.7-20	ACCELERATION RESPONSE SPECTRA - AUXILIARY BUILDING - ELEV. 354'-0" - OPERATING BASIS EARTHQUAKE
3.7-21	ACCELERATION RESPONSE SPECTRA - AUXILIARY BUILDING - ELEV. 372'-0" - OPERATING BASIS EARTHQUAKE
3.7-22	ACCELERATION RESPONSE SPECTRA - AUXILIARY BUILDING - ELEV. 386'-0" - OPERATING BASIS EARTHQUAKE
3.7-23	ACCELERATION RESPONSE SPECTRA - AUXILIARY BUILDING - ELEV. 404'-0" - OPERATING BASIS EARTHQUAKE
3.7-24	ACCELERATION RESPONSE SPECTRA - AUXILIARY BUILDING - ELEV. 317'-0" AND 335'-0" - DESIGN BASIS EARTHQUAKE
3.7-25	ACCELERATION RESPONSE SPECTRA - AUXILIARY BUILDING - ELEV. 354'-0" - DESIGN BASIS EARTHQUAKE
3.7-26	ACCELERATION RESPONSE SPECTRA - AUXILIARY BUILDING - ELEV. 372'-0" - DESIGN BASIS EARTHQUAKE
3.7-27	ACCELERATION RESPONSE SPECTRA - AUXILIARY BUILDING - ELEV. 386'-0" - DESIGN BASIS EARTHQUAKE
3.7-28	ACCELERATION RESPONSE SPECTRA - AUXILIARY BUILDING - ELEV. 404'-0" - DESIGN BASIS EARTHQUAKE
3.7-29	ACCELERATION RESPONSE SPECTRA - AUXILIARY BUILDING - ELEV. 317'-0" AND 335'-0" - OPERATING BASIS EARTHQUAKE
3.7-30	GENERALIZED RCS ANSYS MODEL
3.7-31	PRESSURIZER SEISMIC ANALYSIS MODEL
3.7-32	EXAMPLE PROBLEM FOR TMCALC PROGRAM
3.7-33	EXAMPLE PROBLEM FOR FORCE PROGRAM
3.7-34	DELETED
3.7-35	REACTOR INTERNALS LINEAR HORIZONTAL SEISMIC MODEL
3.7-36	REACTOR INTERNALS LINEAR VERTICAL SEISMIC MODEL

ARKANSAS NUCLEAR ONE
Unit 2

LIST OF FIGURES (continued)

<u>Figure No.</u>	<u>Title</u>
3.7-37	COUPLED REACTOR INTERNALS AND CORE HORIZONTAL NONLINEAR SEISMIC MODEL
3.7-38	COUPLED REACTOR INTERNALS AND CORE VERTICAL NONLINEAR SEISMIC MODEL
3.7-39	CORE SUPPORT BARREL UPPER FLANGE FINITE ELEMENT MODEL
3.7-40	HORIZONTAL FREQUENCIES AND MODE SHAPES (MODE 1)
3.7-41	HORIZONTAL FREQUENCIES AND MODE SHAPES (MODE 2)
3.7-42	HORIZONTAL FREQUENCIES AND MODE SHAPES (MODE 3)
3.7-43	HORIZONTAL FREQUENCIES AND MODE SHAPES (MODE 4)
3.7-44	HORIZONTAL FREQUENCIES AND MODE SHAPES (MODE 5)
3.7-45	HORIZONTAL FREQUENCIES AND MODE SHAPES (MODE 6)
3.7-46	DELETED
3.7-47	DELETED
3.7-48	DELETED
3.7-49	HORIZONTAL CORE MODEL
3.7-50	ONE-SIDED AND THROUGH-GRID SPACER GRID IMPACT LOADS
3.7-51	DUAL LOAD PATH SPACER GRID MODEL
3.7-52	ARTIFICIAL ACCELERATION TIME HISTORY COMPATIBLE WITH RG 1.60 HORIZONTAL DIRECTION ZPGA = 0.2G
3.7-53	ARTIFICIAL ACCELERATION TIME HISTORY WITH RG 1.60 RS VERTICAL COMPONENT ZPGA = 0.133G
3.7-54	COMPARISON BETWEEN RG 1.60 TARGET AND GENERATED RS D = 2%
3.7-55	COMPARISON BETWEEN TARGET AND GENERATED RS D = 5%
3.7-56	COMPARISON BETWEEN TARGET RS AND GENERATED RS D = 7%
3.7-57	SKETCH OF CONTAINMENT SHELL STICK MODEL
3.7-58	INTERNAL STRUCTURE 3-D DYNAMIC MODEL

ARKANSAS NUCLEAR ONE
Unit 2

LIST OF FIGURES (continued)

<u>Figure No.</u>	<u>Title</u>
3.8-1	CONTAINMENT GENERAL ARRANGEMENT
3.8-2	CONTAINMENT PRESTRESSING DETAILS
3.8-3	DELETED
3.8-4	CONTAINMENT REINFORCING DETAILS
3.8-5	CONTAINMENT REINFORCING DETAILS
3.8-6	DELETED
3.8-7	CONTAINMENT LINER PLATE DETAILS
3.8-8	CONTAINMENT LINER PLATE BRACKET DETAILS
3.8-9	CONTAINMENT PENETRATION DETAILS
3.8-10	DELETED
3.8-11	DELETED
3.8-12	DELETED
3.8-13	INTERNAL STRUCTURES - PLANS - GENERAL ARRGT.
3.8-13a	INTERNAL STRUCTURES - EQUIPMENT SUPPORTS
3.8-14	DELETED
3.8-14a	DELETED
3.8-15	INTERNAL STRUCTURES - PLAN & SECTION
3.8-19	DELETED
3.8-20	OTHER CATEGORY 1 STRUCTURES - AUXILIARY BLDG. - PLAN & SECTION
3.8-21	DELETED
3.8-22	DELETED
3.8-23	DELETED
3.8-24	DELETED
3.8-25	DELETED

ARKANSAS NUCLEAR ONE
Unit 2

LIST OF FIGURES (continued)

<u>Figure No.</u>	<u>Title</u>
3.8-26	OTHER CATEGORY 1 STRUCTURES - TYPICAL DETAILS
3.8-32	TEMPORARY CONSTRUCTION OPENING IN WALL AT COLUMN LINE 1
3.8-33	DYWIDAG CONNECTOR FOR TEMPORARY CONSTRUCTION OPENING
3.8-34	CONDENSATE STORAGE TANK (T41B) PIPE TRENCHES
3.8-35	CONDENSATE STORAGE TANK (T41B) FOUNDATION
3.9-1A	ANSYS MODEL OF THE REPLACEMENT STEAM GENERATOR
3.9-1B	ANSYS RV-RVI MODEL USED IN THE RCS PRIMARY SIDE BREAK ANALYSIS
3.9-1C	ANSYS MODEL OF THE SURGE LINE
3.9-1D	HLR FINITE ELEMENT MODEL
3.9-1E	PORTION OF ICI MODEL REPRESENTING THE NOZZLE, FLANGE AND SUPPORT POST
3.9-1F	PORTION OF ICI MODEL REPRESENTING THE ICI GUIDE TUBES
3.9-2	SAMMSOR/DYNASOR FINITE ELEMENT MODEL OF CORE SUPPORT BARREL
3.9-3	REACTOR INTERNALS BLPB HORIZONTAL MODEL
3.9-4	REACTOR INTERNALS BLPB VERTICAL MODEL
3.10-1	CATEGORY 1 CABLE TRAY SUPPORT TYPICAL DETAIL
3.10-2	CATEGORY 1 CABLE TRAY SUPPORT TYPICAL DETAIL
3.10-3	CATEGORY 1 CABLE TRAY SUPPORTS TYPICAL DETAIL
3.10-4	CATEGORY 1 CABLE TRAY SUPPORT TYPICAL DETAIL
3.10-5	CATEGORY 1 CABLE TRAY SUPPORT CONNECTIONS, TYPICAL DETAIL
3.10-6	CATEGORY 1 CABLE TRAY SUPPORT CONNECTIONS, TYPICAL DETAIL
3.10-7	INSTRUMENT MOUNTING DETAILS - RACKS, STANDS, BRACKETS AND SUPPORTS
3.10-8	INSTRUMENT RACK - FIELD FABRICATED
3.10-9	TUBING TRAY ARRANGEMENT AND ASSEMBLY DETAILS
3.10-10	TYPICAL INSTRUMENT TRAY SUPPORTS SEISMIC CATEGORY 1

ARKANSAS NUCLEAR ONE
Unit 2

UPDATE REFERENCE LIST

Sections and references listed below denote documents that contain additional cross reference information used to update the SAR.

<u>Section</u>	<u>Cross References</u>
3.1.2	Correspondence from Williams, AP&L to Stolz, NRC, dated January 19, 1979. (0CAN017911)
3.9.1.1	Correspondence from Trimble, AP&L, to Seyfrit, NRC, dated July 6, 1979. (0CAN077901)
3.11, 3.11.3, 3.11.3.2	Correspondence from Trimble, AP&L, to Seyfrit, NRC, dated July 13, 1979. (0CAN077907)
Ch. 3 List of Tables, 3.8.1.4.2 Tables 3.8-1 thru 8	Correspondence from Trimble, AP&L, to Seyfrit, NRC, dated June 27, 1980. (0CAN068023)
Ch. 3 List of Tables, 3.7.6 Tables 3.7-12 thru 18	Correspondence from Trimble, AP&L, to Seyfrit, NRC, dated January 29, 1981. (0CAN018120)
3.4.4.2.1	Design Change Package 82-2100, "Reactor Vessel Cavity Flooding Check Valve"
3.6.4.5.1.3	Design Change Package 83-2196, "Replace Limitorque Motor Operator (2CV-0706) with Manual Operator (2EFW-0706)"
3.11.1.E.20	Design Change Package 82-2170, "Replacement of Limitorque Motor to Comply with IEB 79-01B"
Table 3.2-6	Design Change Package 82-2079, "Modification to Emergency Diesel Fuel Transfer Pump"
Table 3.2-2 Table 3.5-1 3.7.1.5 3.8.4.1 3.8.5.1	Design Change Package 82-2086, "Q-Condensate Storage Tank"
Figure 3.2-6	Design Change Package 82-2103, "EHC Power Unit Modification"
Figure 3.5-11 Figure 3.5.12	Design Change Package 82-2051, Tie-In Line from Neutralizing Tank to Regen. Waste Tank"

ARKANSAS NUCLEAR ONE
Unit 2

UPDATE REFERENCE LIST (continued)

<u>Section</u>	<u>Cross References</u>
Figure 3.5-12	Design Change Package 84-2049, "Service Water Pipe Replacement to 2VUC-6B"
Figure 3.5-15	Design Change Packages 86-2090 "Controlled Access Entry/Exit Modifications," and 86-2090A, "H.P. Renovation Work"
Figure 3.5-19	Design Change Package 81-2004C, "Service Water Piping Change"
Figure 3.5-24 Figure 3.5-28	Design Change Package 82-2004, "Waste Gas Monitoring Panels"
Figure 3.6-38	Design Change Package 82-2028, "Seismic Restraints and Header Beam Mods to Aux. Gantry"
<u>Amendment 6</u>	
Table 3.2-6	Design Change Package 83-2021
<u>Amendment 8</u>	
Figure 3.2-5	Procedure 2104.009 Rev. 13, "N ₂ System"
<u>Amendment 9</u>	
3.4.4	Reference to Abnormal Operating Procedure (AOP) 2203.008, "Natural Emergencies"
Figure 3.2-3	Plant Change 89-0157, "2VCH-2A Evaporator Changeout"
Figure 3.2-4	Plant Change 84-0357, "Main Chiller Flow Switch"
3.5.2.2.2	Design Change Package 88-2077, "'A' Low Pressure Turbine Rotor Replacement"
3.5.5 Figure 3.5-8A	Design Change Package 82-2086, "Q-Condensate Storage Tank"
Figure 3.5-5 Figure 3.8-28	Design Change Package 86-2131, "Operations Support Facility"
Figure 3.5-14	Design Change Package 85-2073, "ATWS Diverse Scram System"
Figure 3.5.18	Design Change Package 88-2105, "Service Water Venturi Completion"
Figure 3.5.18 Figure 3.8-31 Table 3.7-16	Design Change Package 88-2022, "Opening Between "A" and "C" Charging Pump Rooms"

ARKANSAS NUCLEAR ONE
Unit 2

UPDATE REFERENCE LIST (continued)

<u>Section</u>	<u>Cross References</u>
3.6.4.5.1.1.1 Table 3.6-23 Figure 3.6-59 Figure 3.6-60	Design Change Package 86-2110A, "Loop 2 Service Water Valves" Design Change Package 88-2086, "MOVATS 2CV-4824-2"
3.1.4 3.1.6 3.11.1 Table 3.2-2 Table 3.5-8 Table 3.7-12 Table 3.10-1 Figure 3.5-6	ANO Calculation 89-E-0105-01, "Use of Hydrogen Purge System"
<u>Amendment 10</u>	
3.6.4.2.4.2 Figure 3.6-42	Design Change Package 83-2217, "Steam Generator Wide Range Level Indicators - R.G. 1.97"
3.6.4.1.4.1 3.6.4.1.4.2 Figures 3.6-13, 3.6-16, 3.8-31, 3.6-66, 3.6-68	Design Change Package 89-2043, "Auxiliary Feedwater Pump Installation"
3.8.1.1	Procedure 2504.035, Rev. 0, "Install. & Removal of ("Merrimac") Temporary Outage Penetration Cover"
3.10.2.2.1	Correspondence from Fisicaro, ANO, to NRC, dated July 12, 1991. (2CAN079102)
Table 3.9-6	Design Change Package 86-2116D, "MOV Actuator Change on 2CV-4821"
Figure 3.2-1 Figure 3.2-6	Design Change Package 88-2110, "ANO-2 Alarm Upgrade, Phase II"
Figure 3.2-1	Design Change Package 89-2024, "Recorder Upgrade"
Figure 3.2-3	Design Change Package 84-2083, "2VEIA, B Reliability Modifications"
Figure 3.2-3	Design Change Package 84-2083A, "Control Room Emergency A/C Modifications"
Figure 3.2-3	Plant Change 90-8017, "Installation of Loop Seal in Drain Line for VUC-21"
Figure 3.2-4	Plant Change 88-2376, "Replacement of 2ACW-53"

ARKANSAS NUCLEAR ONE
Unit 2

UPDATE REFERENCE LIST (continued)

<u>Section</u>	<u>Cross References</u>
Figure 3.5-9 Figure 3.5-10 Figure 3.6-3	Limited Change Package 90-6011, "Feedwater Heater Condensate Return Pipe Replacement"
<u>Amendment 11</u>	
3.1.1.2	ANO Procedure 2107.001, Rev. 30, "Electrical System Operations"
3.7.4.1	ANO-2 Technical Specifications Amendment 110, dated November 1, 1990. (2CNA119003)
Table 3.2-2	Engineering Action Request 92-594, "Addition of Vortex Eliminators to Q-List"
Table 3.6-6	Design Change Package 91-2010, "Main Steam Motor Operated Valve Modification"
Figure 3.2-1 Figure 3.2-3 Figure 3.2-4	Design Change Package 88-2111, "ANO-2 Annunciator Upgrade Phase III"
Figure 3.2-2	Design Change Package 79-2020, "Modification of Condensate Return Line"
Figure 3.2-5	Design Change Package 92-2007, "Nitrogen Supply System for ANO-2 RB Electrical Penetrations"
Figure 3.2-6 Figure 3.5-15	Design Change Package 90-2036, "Unit 2 Plant Computer Replacement"
Figure 3.5-3	Plant Change 91-8036, "Hydrazine Bulk Tank Addition"
Figure 3.5-3	Plant Change 91-8077, "H.P. Room Modification at El. 354'0"
Figure 3.5-9 Figure 3.6-3	Limited Change Package 90-6003, "Removal of Temporary Supports on Abandoned Feedwater Piping"
Figure 3.5-15	Plant Change 89-8002, "Modification to H.P. Instrument Room"
<u>Amendment 12</u>	
3.1.6 3.2.1.1 Table 3.2-1 Table 3.2-6	"Evaluation of Health Physics Changes Required for Revised 10 CFR 20 Implementation"
Figure 3.2-1 Figure 3.2-6	Limited Change Package 93-6020, "Turbine/Generator Instrumentation Upgrade"
Figure 3.2-4	Plant Change 93-8060, "Installation of Main Chiller Taps"

ARKANSAS NUCLEAR ONE
Unit 2

UPDATE REFERENCE LIST (continued)

<u>Section</u>	<u>Cross References</u>
Figure 3.2-4	Plant Change 90-8074, "Removal of Unused Controller from 2VCC-26"
Figure 3.2-5	Design Change Package 93-2005, "Electrical Penetration Modules"
<u>Amendment 13</u>	
3.1	Design Change Package 94-2017, "Replacement of the Part Length Control Element Assemblies"
3.1.2	Limited Change Package 94-6006, "Replacement of Panel 2CO4 RCS Temperature Indicators and RCP Differential Pressure Indicators"
3.10	
3.11.2	
3.6.4.3.3.1	Limited Change Package 93-6025, "ANO-2 HPSI Pump Room 'C' Floor Drain Modification"
3.6.4.5.2.2.2	
3.7.6.3.1.5.1	Limited Change Package 94-6010, "IEB 80-11 Walls 24B-158/159, 24B-211/212, & 26B-27/28 Modifications"
3.7.6.4.2	
3.7.6.4.3	
3.7.6.4.5	
3.7.6.4.6	
Table 3.7-12	
Table 3.7-13	
Table 3.7-14	
Table 3.7-15	
Table 3.7-16	
Table 3.7-17	
Table 3.7-18	
3.8.1.4.2	Limited Change Package 95-6014, "Penetration 2P-53 Modification"
Table 3.8-1	
Figure 3.5-10	
Figure 3.6-43	
Table 3.2-6	Design Change Package 90-2015, "2R11 LPSI Valve Replacement 2CV-5037-1 and 2CV-5077-2"
Table 3.9-6	
Table 3.9-6	Design Change Package 95-2006, "LPSI Valve Replacement 2CV-5017-1 & 2CV-5057-2"
Figure 3.2.1	Limited Change Package 94-6027, "Main Feedwater Pumps Trip-Hardening"
Figure 3.2-2	Plant Change 87-2968, "Replacement of Plant Heating Boiler Blowdown Valves"
Figure 3.2-2	Limited Change Package 94-6007A, "Piping Code Compliance -Aux Building"

ARKANSAS NUCLEAR ONE
Unit 2

UPDATE REFERENCE LIST (continued)

<u>Section</u>	<u>Cross References</u>
Figure 3.2-3 Figure 3.2-4	Design Change Package 89-2049, "Service Water and Auxiliary Cooling Systems Water Hammer Mitigation"
Figure 3.2-3 Figure 3.2-4 Figure 3.5-9	Design Change Package 93-2014, "ANO-2 Main Chiller Replacement"
Figure 3.2-3	Design Change Package 94-2014, "Unit 2 Emergency Control Room Chiller Controller Replacement"
Figure 3.2-3 Figure 3.5-11	Limited Change Package 95-6007, "Replacement of Normal Control Room Chillers"
Figure 3.2-5	Design Change Package 94-2003, "2R11 Electrical Penetration Modifications"
Figure 3.2-6	Design Change Package 93-2007, "ANO-2 New Points to Plant Monitoring System"
Figure 3.2-6	Plant Change 94-8067, "Stator Leak Monitoring System Installation"
Figure 3.2-6	Plant Change 95-8014, "Addition of Misc. Sample and Vent Valves to SWC Skid"
Figure 3.5-5 Figure 3.8-28	Design Change Package 90-2053, "Control Room Expansion Facility Addition"
Figure 3.5-15	Design Change Package 93-2013, "2C69 Control Room Console Upgrade"
Figure 3.5-6	Design Change Package 87-2024, "SPING - Boric Acid Mix Room HVAC"
Figure 3.6-66 Figure 3.6-67 Figure 3.6-68	Plant Change 95-8022, "Gauge Panel for 2P-7A"
Table 3.2-6 Table 3.9-6	Design Change Package 90-2015, "2R11 LPSI Valve Replacement 2CV-5037-1 and 2CV-5077-2"
Table 3.9-6	Design Change Package 95-2006, "LPSI Valve Replacement 2CV-5017-1 & 2CV-5057-2"
3.6.4.3.3.1 3.6.4.5.2.2.2	Limited Change Package 93-6025, "ANO-2 HPSI Pump Room 'C' Floor Drain Modification"
Table 3.9-6	Design Change Package 95-2006, "LPSI Valve Replacement 2CV-5017-1 & 2CV-5057-2"

ARKANSAS NUCLEAR ONE
Unit 2

UPDATE REFERENCE LIST (continued)

<u>Section</u>	<u>Cross References</u>
<u>Amendment 14</u>	
3.9.2.5 Table 3.6-1	Limited Change Package 96-3355, "High Pressure Turbine First Stage Drain & Bucket Modification"
Table 3.5-4 Table 3.5-7	Limited Change Package 95-6009, "Pressurizer Manway Cover Studs Replacement"
3.6.2.2	Correspondence from Cavanaugh, AP&L, to Stolz, NRC, dated June 14, 1976 (2CAN067607).
Table 3.7-5 Figure 3.5-5 Figure 3.6-3 Figure 3.6-4 Figure 3.8-28	Design Change Package 94-2008, "Feedwater Control System Upgrade"
Figure 3.2-1	Plant Change 963108P201, "Feed Pump Delta T Interlock"
Figure 3.2-1	Plant Change 96-8025, "Lube Oil Sample Point Installation"
Figure 3.2-4	Plant Change 958027P201, "2VET-4 Expansion Tank Replacement"
Figure 3.2-5	Design Change Package 95-2003, "Penetration Module Replacements 2WR-43-1 & 2WR-43-4"
Figure 3.2-5	Design Change Package 96-2001, "Removal of 50GS Relays 2B-7 & 2B-8"
Figure 3.2-6	Plant Change 963042P201, "Stator Cooling Alarm Panel Annunciator Modification"
Figure 3.6-3	Plant Change 91-8079, "Chemistry Lab Modification"
Figure 3.6-3	Plant Change 94-8016, "Chemistry Area HVAC Modification"
<u>Amendment 15</u>	
3.1.4 3.6.4.1.9.2 3.6.4.5.2.1.2 3.9.2.4 3.11 Table 3.2-2 Table 3.2-3 Table 3.2-6 Table 3.5-8 Figure 3.5-18 Figure 3.5-19	Design Change Package 973950D201, "NaOH Replacement with TSP"

ARKANSAS NUCLEAR ONE
Unit 2

UPDATE REFERENCE LIST (continued)

<u>Section</u>	<u>Cross References</u>
Figure 3.5-25 Figure 3.6-35 Figure 3.6-48 Figure 3.8-31	
3.5.2.2.2.1 3.5.2.2.3	Engineering Request 981059E201. "Quarterly Valve Stroke Test Deferral Evaluation"
3.8.4.1.1	Calculation 98E001901, "Removal of External Restraints for L-3 & 2L-35 Cranes"
3.10.2.2.7 3.10.2.2.7.1 3.10.2.2.7.2 3.10.2.2.8.1 Table 3.2-2	Design Change Package 963242D201, "Vital AC System Upgrade"
Figure 3.2-2	Design Change Package 963230D201, "Condenser Tube Bundle Replacement"
Figure 3.2-2	Limited Change Package 962018L201, "Plant Heating Containment Isolation Valves LLRT"
Figure 3.2-2	Plant Change 973636P201, "Chemical Addition Pot for Plant Heating System"
Figure 3.2-4	Plant Change 974904P201, "Main Chill Water Compressor Tank Make Up"
Figure 3.2-5	Design Change Package 946012D201, "Containment Vent Header/Waste Gas System Modification"
Figure 3.2-6	Plant Change 958007P201, "Stator Leak Monitoring System Installation"
Figure 3.2-6	Plant Change 975109P201, "SWC Pressure Spikes"
Figure 3.5-5 Figure 3.8-28	Plant Change 963203P201, "Addition of Level Gauge to SFP"
Figure 3.5-8A	Design Change Package 963559D301, "Computer/Telephone Room Power & AC Hardening"
Figure 3.5-26	Engineering Request 963205L201, "Removal of EDG Exhaust Hoods"
<u>Amendment 16</u>	
3.1.2	Engineering Request 973922A301, "Renaming of ANO-Morrilton East 161 kV Line"

ARKANSAS NUCLEAR ONE
Unit 2

UPDATE REFERENCE LIST (continued)

<u>Section</u>	<u>Cross References</u>	
3.5	Engineering Request 980642E232, "Refueling Reactor Building with Only Liner Plate in Place"	
3.6.2.1	Engineering Request 980529E201, "Steam Generator Subcompartment Pressurization Calculation"	
3.6.4.1.2		
3.6.4.1.3		
3.6.4.1.8		
3.6.4.2.2		
3.6.4.2.3		
3.8.1.3.2		
3.11		
3.6.4.2.3		Nuclear Change Package 975122N201, "High-High Containment Pressure Isolation of Main Feedwater"
3.8.1.2.1		Design Change Package 980642D202, "Containment Construction Opening for Steam Generator Replacement"
3.8.1.6.1		
3.8.1.6.2		
3.8.1.6.3		
3.8.1.6.4		
3.8.1.7		
3.1.1	Design Change Package 980642D210, "Replacement Steam Generator Design/Qualification"	
3.1.2		
3.5.2.3.2		
3.6		
3.6.1		
3.6.2.1		
3.6.2.2		
3.6.4		
3.7.2.6		
3.7.3.4		
3.9.2.5		
Table 3.6-9		
Table 3.6-10		
Table 3.6-11		
Table 3.6-12		
Table 3.6-13		
Table 3.6-14		
Table 3.6-15		
Table 3.6-16		
Table 3.6-17		
Table 3.6-18		
Table 3.6-20		
Table 3.6-21		
Table 3.9-6		

ARKANSAS NUCLEAR ONE
Unit 2

UPDATE REFERENCE LIST (continued)

<u>Section</u>	<u>Cross References</u>
3.1.1	Engineering Request 980642I245, "Design of Structures, Components, Equipment, and Systems Related to Replacement Steam Generator Project"
3.2.2.1	
3.5.2.2.2	
3.5.2.2.3	
3.6	
3.6.1	
3.6.2.1	
3.6.2.2	
3.6.4	
3.6.4.1.8	
3.6.4.2.1	
3.6.4.2.2	
3.6.4.2.3	
3.6.4.2.4	
3.6.4.2.5	
3.6.4.2.6	
3.6.4.2.8	
3.6.4.3.3	
3.6.5.5	
3.6.6	
3.6.6.1	
3.6.6.2	
3.6.6.2.1	
3.6.6.2.2	
3.6.6.3.1	
3.6.6.4	
3.6.6.5	
3.6.6.6	
3.7.1.1	
3.7.1.3.1	
3.7.1.4	
3.7.2.14.1	
3.7.2.15	
3.7.2.15.1	
3.7.2.2	
3.7.3.4.2	
3.7.6.1.3	
3.7.6.2.1	
3.9.1.6.1	
3.9.1.6.2	
3.9.1.7	
3.9.1.7.1	
3.9.1.7.2	
3.9.2.5	
3.9.3.1.1	
3.9.3.1.3	
3.9.3.3	
Table 3.2-3	

ARKANSAS NUCLEAR ONE
Unit 2

UPDATE REFERENCE LIST (continued)

Section

Cross References

Table 3.2-4
Table 3.2-6
Table 3.5-4
Table 3.5-7
Table 3.6-1
Table 3.6-1A
Table 3.6-9
Table 3.6-10
Table 3.6-11
Table 3.6-12
Table 3.6-13
Table 3.6-14
Table 3.6-15
Table 3.6-16
Table 3.6-17
Table 3.6-18
Table 3.6-19
Table 3.6-20
Table 3.6-21
Table 3.7-15
Table 3.7-7
Table 3.7-8
Table 3.9-2
Table 3.11-2
Figure 3.6-33
Figure 3.6-34
Figure 3.6-39
Figure 3.6-40
Figure 3.6-41
Figure 3.6-42
Figure 3.6-44
Figure 3.6-45
Figure 3.6-46
Figure 3.6-50
Figure 3.6-51
Figure 3.6-52
Figure 3.6-53
Figure 3.6-54
Figure 3.6-55
Figure 3.6-56
Figure 3.6-57
Figure 3.7-30
Figure 3.7-37
Figure 3.7-38
Figure 3.7-46
Figure 3.4-47
Figure 3.7-48
Figure 3.7-50

ARKANSAS NUCLEAR ONE
Unit 2

UPDATE REFERENCE LIST (continued)

<u>Section</u>	<u>Cross References</u>
Figure 3.7-51	
Figure 3.7-52	
Figure 3.7-53	
Figure 3.7-54	
Figure 3.7-55	
Figure 3.7-56	
Figure 3.7-57	
Figure 3.7-58	
Figure 3.9-1A through 3.9-1F	
Figure 3.9-3	
Figure 3.9-4	
3.1.2	Engineering Request 991864E238, "Civil Uprate of Containment Structure
3.1.5	from 54 psig to 59 psig
3.7.1.4.1	
3.8.1.2.6	
3.8.1.3.1	
3.8.1.4.1	
3.8.1.4.3	
3.8.1.5	
3.8.1.6.3	
3.8.1.7.1	
Table 3.8-4	
Table 3.8-5	
Figure 3.8-10	
Figure 3.8-11	
3.1.4	Nuclear Change Package 991522N201, "Containment Cooler Chilled Water
Figure 3.2-4	Coil Replacement and Fan Pitch Change
3.6.4.2.4	Design Change Package 980642D209, "Disconnect and Reconnect of Small
Table 3.6-13	Bore Piping and Tubing to Support the Steam Generator Replacement
Table 3.6-14	Project"
Figure 3.6-38	
Figure 3.6-41	
Figure 3.6-42	
3.10.2.2.1	Design Change Package 963089D203, "2A3 Bus Circuit Breaker
Table 3.2-6	Replacement"
3.10.2.2.8	Design Change Package 963242D202, "Inverter Replacement"
3.11.1	
Table 3.2-6	
3.11	Engineering Request 991864E221, "Containment Spray Effects Due to 59
	psig"

ARKANSAS NUCLEAR ONE
Unit 2

UPDATE REFERENCE LIST (continued)

<u>Section</u>	<u>Cross References</u>
Table 3.6-9 Table 3.6-10 Table 3.6-11 Table 3.6-12 Table 3.6-15 Table 3.6-16 Figure 3.6-33 Figure 3.6-34 Figure 3.6-39 Figure 3.6-40 Figure 3.6-44 Figure 3.6-45	Design Change Package 980642D208, "Removal and Reinstallation of Main Steam and Feedwater Piping to Support the Steam Generator Replacement Project"
Table 3.9-6	Engineering Request 002392E201, "CVCS and Boron Management System for Replacement Steam Generators"
Figure 3.2-2	Engineering Request 980711C201, "Plant Heating Boiler Burner and Controls Replacement"
Figure 3.2-4 Figure 3.5-9 Figure 3.5-10 Figure 3.5-12	Nuclear Change Package 980542N201, "Service Water and ACW Modifications for Power Uprate"
Figure 3.2-6	Engineering Request 980397I202, "Mechanical Support for Generator Rewind Project"
Figure 3.5-4	Design Change Package 974814D201, "Installation of Thermal Relief Valves on Containment Penetrations"
Figure 3.5-4 Figure 3.8-29	Nuclear Change Package 963089N201, "Removal of 2X31 and 2A3 Bus Bracing Upgrade"
Figure 3.2-6	Nuclear Change Package 974811N201, "Generator Seal Oil Vacuum Tank Level Switch Replacement"
Figure 3.2-6	Nuclear Change Package 971981N201, "Main Generator Core Monitor Replacement"
<u>Amendment 17</u>	
3.1.1	Unit 2 Technical Specification Amendment 233
3.1.2	Engineering Request ANO-1997-3922-003, "Interlock Scheme for Unit 1 Fast Transfer to Startup #2"
3.1.4	Unit 2 Technical Specification Amendment 242

ARKANSAS NUCLEAR ONE
Unit 2

UPDATE REFERENCE LIST (continued)

<u>Section</u>	<u>Cross References</u>
3.1.4 Table 3.2-2	Unit 2 Technical Specification Amendment 245
3.1.5 3.6.4.1.3.2 3.6.4.2.4.2 3.6.4.2.5.1 3.6.4.2.5.2 3.8.4.1.1 3.9.2.5 Table 3.9-6	Engineering Request ANO-2000-2344-026, "Power Uprate Evaluation"
3.4.4.2.2	Engineering Calculation 90-E-0116-06 Rev 1
3.5.2.2.3	Technical Requirements Manual 4.3.4.1.2
3.6.4.5.1.3.2	Unit 2 Technical Specification Amendment 232
3.7.2.1.3	Engineering Request 002546E201, "Incorporate SQUG/FIP/USI A-46 Seismic Qualification Methods"
Table 3.2-6	Engineering Request 010521E201, "EFW Room Cooler Motor Upgrade"
Figure 3.2-6	Engineering Request 02869N201, "Enhancements to the ANO Unit 2 Electro-Hydraulic (EH) Tank 2T-38"
<u>Amendment 18</u>	
3.6.1	SAR Discrepancy 2-97-0235, "Shutdown Cooling Initiation Temperature"
3.1.4	SAR Discrepancy 2-97-0691, "Clarification of Containment Cooling System Design Basis"
Figure 3.2-2	Condition Report ANO-2-2002-1723, "Valve Labeling Correction"
Figure 3.2-1	Engineering Request ER-ANO-2002-1014-000, "Addition of Lube Oil Temperature Alarm"
Figure 3.2-2	Condition Report ANO-2-2002-1639, "Revision of Plant Heating System Valve Positions"
Figure 3.2-2	Condition Report ANO-2-2002-2035, "Valve Labeling Corrections"
Figure 3.2-4	Engineering Request ER-ANO-2000-3265-001, "Replacement of Condensate and Feedwater Oxygen Analyzers"
Figure 3.2-4	Condition Report ANO-2-2003-0500, "Correction of Drawing Reference"

ARKANSAS NUCLEAR ONE
Unit 2

UPDATE REFERENCE LIST (continued)

<u>Section</u>	<u>Cross References</u>
Figure 3.2-3	Engineering Request ER-ANO-2003-0234-000, "Configuration of Auxiliary Cooling Water to Straight Piping"
3.8.4.1.1 Table 3.2-6	Engineering Request ER-ANO-2000-2688, "Fuel Handling Crane L3 Upgrade"
Figure 3.5-17 Figure 3.8-27	Condition Report ANO-C-1997-0282, "Revision of SAR Figure Titles"
3.8.4.3.2.1 3.8.4.3.2.2	Licensing Document Change 2-3.8-0011, "Typographical Error Corrections"
3.11.5	Licensing Document Change 2-3.11-0006, "Deletion of Specific Title Reference Regarding Plant Component Database"
Figure 3.6-53 Figure 3.6-55	Condition Report ANO-2-2003-0530, "Correction of Valve Lengths"
Figure 3.2-3	Engineering Request ER-ANO-2000-2998-010, "Abandonment of Cable Spreading Room Air Conditioning Unit 2VUC-3A"
Figure 3.5-13 Figure 3.5-20 Figure 3.5-21 Figure 3.5-22 Figure 3.5-23 Figure 3.5-24 Figure 3.5-27 Figure 3.5-28 Figure 3.6-36 Figure 3.6-37 Figure 3.6-49 Figure 3.8-3 Figure 3.8-6 Figure 3.8-14 Figure 3.8-14A Figure 3.8-16 Figure 3.8-17 Figure 3.8-18	Condition Report ANO-C-1991-0073, "Upgrade of LBD Change Process"
Figure 3.2-1	Condition Report ANO-2-2003-1524, "Turbine Lube Oil Valve Corrections"
Figure 3.2-2 Figure 3.2.3	Condition Report ANO-2-2003-1163, "Addition of Sample Valves"
Figure 3.2-5	Condition Report ANO-2-1999-0676, "Valve Labeling Corrections"

ARKANSAS NUCLEAR ONE
Unit 2

UPDATE REFERENCE LIST (continued)

<u>Section</u>	<u>Cross References</u>
Figure 3.5-3	Engineering Request ER-ANO-1994-6012, "Modification of Waste Gas and Containment Vent Headers"
Figure 3.5-4 Figure 3.8-29	Engineering Request ER-ANO-1996-3089, "Replacement of 2A3 and 2A4 Breakers"
Figure 3.5-5 Figure 3.8-28	Engineering Request ER-ANO-1997-3932, "Relocation of the Outage Control Center"
Figure 3.5-14	Engineering Request ER-ANO-1995-6007, "Control Room Chiller Replacement"
Figure 3.6-3 Figure 3.6-4	Engineering Request ER-ANO-1994-2008, "Feedwater Control System Upgrade"
Figure 3.6-60 Figure 3.6-65 Figure 3.6-66 Figure 3.6-67	Condition Report CR-ANO-2-2001-0594, "Addition of ISI Numbers"
Figure 3.6-60	Engineering Request ER-ANO-1999-1699, "ISI Ten Year Update"
Figure 3.6-65	Condition Report CR-ANO-2-1996-0395, "Drawing Revision Associated With As-Built Condition for Pressurizer Spray System"
Figure 3.6-65	Engineering Request ER-ANO-1998-0642, "Deletion of Support 2CCA-14-H5 in Support of the Steam Generator Replacement Project"
Figure 3.6-68	Engineering Request ER-ANO-1998-0489, "Revision of Piping Support Type"
Figure 3.8-31	Engineering Request ER-ANO-1996-2029, "Upgrade of Main Feedwater Recirculation Valves"
<u>Amendment 19</u>	
3.6.4.1.2.1	Engineering Request ER-ANO-2004-0112-000, "Replacement of Carbon Steel Piping in the Main Feedwater System"
Table 3.6-27	Condition Report CR-ANO-2-2004-0192, "Revision of Clean/Dirty Lube Oil Tank 2T-26 Volume"
Figure 3.5-5 Figure 3.8-28	Engineering Request ER-ANO-2004-0487-000, "Update Component and Label Designations for Spent Fuel Pool Structures"
3.1.5 3.8.1.1	Engineering Request ER-ANO-2004-0786-000, "Clarification of Function Regarding the SFP Transfer Gate Valve"

ARKANSAS NUCLEAR ONE
Unit 2

UPDATE REFERENCE LIST (continued)

<u>Section</u>	<u>Cross References</u>
3.3.2.3	License Document Change Request 2-1.2-0048, "Deletion/replacement of Excessive Detailed Drawings from SAR"
3.5.5	
3.6.4.1.1.1	
3.6.4.1.1.2	
3.6.4.1.2.1	
3.6.4.1.2.2	
3.6.4.1.3.1	
3.6.4.1.3.2	
3.6.4.1.4.1	
3.6.4.1.4.2	
3.6.4.1.5.1	
3.6.4.1.5.2	
3.6.4.1.6.2	
3.6.4.1.7.2	
3.6.4.1.8.2	
3.6.4.1.9.2	
3.6.4.2.2.2	
3.6.4.2.3.1	
3.6.4.2.3.2	
3.6.4.2.4.1	
3.6.4.2.4.2	
3.6.4.2.5.1	
3.6.4.2.5.2	
3.6.4.2.6.2	
3.6.4.2.7.1	
3.6.4.2.7.2	
3.6.4.2.8.1	
3.6.4.2.8.2	
3.6.4.2.9.2	
3.6.4.2.10.2	
3.6.4.2.11.1	
3.6.4.2.11.2	
3.6.4.3.3.1	
3.6.4.3.3.2	
3.6.4.3.3.3	
3.6.4.4.3	
3.6.4.5.1.1.2	
3.8.4.1.1	
3.8.4.6.2.1	
3.8.5.1.3.1	
Table 3.5-1	
Tables 3.6-2 through 3.6-27	
Figures 3.5-3 through 3.5-6, 3.5-8A, 3.5-9 through 3.5-28, 3.6-3 through 3.6-30, 3.6-33 through 3.6-68, 3.8-16 through 3.8-18, and 3.8-27 through 3.8-31	

ARKANSAS NUCLEAR ONE
Unit 2

UPDATE REFERENCE LIST (continued)

<u>Section</u>	<u>Cross References</u>
3.6.1	Condition Report CR-ANO-2-2004-1891, "Clarification of Shutdown Cooling Inservice Pressure Limit"
3.6.1	Engineering Request ER-ANO-2002-0875-004, "Removal of the Shutdown Cooling Suction Valve Auto-Closure Function"
3.6.1 3.8.1.6.4	License Document Change Request 2-1.2-0049, "License Renewal"
Figure 3.2-1 Sh2	Condition Report CR-ANO-C-2004-1256, "Addition of Clarification Note to Main Turbine Lube Oil Drawing"
Figure 3.2-1 Sh1	Condition Report ANO-C-2005-0800, "Turbine Lube Oil Drawing Correction"
Figure 3.2-6 Sh1	Engineering Request ER-ANO-2004-0699-000, "Addition of Y-Strainers to Stator Cooling Water System"
<u>Amendment 20</u>	
3.4.4.2 3.6.4.3.3.1 3.6.4.5.1.2.1 3.6.4.5.1.3.1 3.8.1.1 3.8.1.4.1.3 3.8.3.1.2 3.8.3.1.3 3.8.3.4.3 Table 3.4-2 Table 3.5-8 Figures – ALL	License Document Change Request 05-058, "Deletion/simplification of Excessive Detailed Drawings from SAR"
3.11	Condition Report CR-ANO-C-2004-0623, "Incorporate References to Existing Safety Related Qualified Coating Materials"
Figure 3.2-4	Engineering Request ER-ANO-2000-2363-002, "Addition of Temperature Switch to Main Chilled Water System"
3.7.3.4.2.1.3.5.1 3.8.3.4.5 Table 3.2-6 Table 3.5-4 Table 3.7-7	Engineering Request ER-ANO-2002-0836-003, "ANO-2 Pressurizer Replacement"
3.6.1.B 3.6.4.1 Table 3.6-1	Engineering Calculation CALC-06-E-0004-01, "Classification of HPSI Discharge Piping as High Energy Piping"

ARKANSAS NUCLEAR ONE
Unit 2

UPDATE REFERENCE LIST (continued)

<u>Section</u>	<u>Cross References</u>
3.6.4.2.10.1 Table 3.2-2	Engineering Calculation CALC-ANO-ER 06-022, "HELB and Seismic II/I Evaluation for Containment Sump GSI-191 Strainer and Plenum"
<u>Amendment 21</u>	
Table 3.2-6	Engineering Change EC-419, "Use of Metamic Insert Panels in the Spent Fuel Pool"
3.9.3.1.3 3.9.3.1.3.2 3.9.3.1.3.2.1 3.11.B Figure 3.9-1D	Engineering Change EC-592, "Reactor Vessel Closure Head Upgrade"
3.4.4.2.1	Engineering Change EC-3816, "Correction of Reactor Cavity Check Valve Type and Cavity Dimensions"
<u>Amendment 22</u>	
3.3.2.1	Condition Report CR-ANO-C-2008-2284, "Clarification of Tornado Wind Criteria"
3.1.2	Engineering Request EC-14661, "Clarification of Startup Transformer 1 and 2 Operation and Use"
3.6.4.3.3.3 3.6.4.3.3.4	License Document Change Request 09-036, "Match Wording Related to Fire Hydrants to Field Terms"
Table 3.2-6	Engineering Change EC-443, "Construction of New ECP Spillway"
3.1.1	License Document Change Request 09-052, "Revise NDE Methods and Acceptance Criteria IAW 10 CFR 50.55a(b)(2)(xx)"
3.6.4.2.8.1	Engineering Change EC-704, "Installation of new HPSI Pressurization System (HPS)"
<u>Amendment 23</u>	
3.6.4.4.3 Table 3.2-3 Table 3.6-27	Engineering Report ER-ANO-2002-0052-000, "Solid Waste System Abandonment"
Table 3.2-3	Engineering Change EC-25010, "Editorial Change Related to Boric Acid / Waste Concentrators"
3.9.3.3 Table 3.2-6	Engineering Change ECN-27610, "Editorial Specification Change Related to Base Plate Bolt Installations"
Amendment No. 28	3-xxxix

ARKANSAS NUCLEAR ONE
Unit 2

UPDATE REFERENCE LIST (continued)

<u>Section</u>	<u>Cross References</u>
3.1.1	License Document Change Request 11-009, "Implementation of New Welding Program, ASME Section III, 1992 Edition, No Addenda"
Figure 3.6-31	Engineering Change EC-19533, "Permanent Removal of Wire Ropes from 2P-32A"
3.6.4.5	Engineering Change EC-10746, "Adoption of Alternate Source Terms"
<u>Amendment 24</u>	
3.4.4	License Document Change Request 11-043, "Site Access during Floods"
3.1.1	License Document Change Request 12-015, "Correct of Reactor Vessel Internals Program Title"
3.7.4 3.7.4.2	Engineering Change EC-33710, "Seismic Monitoring System Upgrade"
3.1.2	Condition Report CR-ANO-2-2012-3311, "Editorial Correction to Battery Duty Cycle"
Figure 3.2-6	Engineering Change EC-38030, "Editorial Corrections to Drawing Based on P&ID"
<u>Amendment 25</u>	
3.7.4	Licensing Basis Document Change LBDC 13-001, "Clarification of Seismic Monitoring Requirements"
3.1.1 3.8.1.2.1.M	Engineering Change EC-48199, "Alternative to ASME Code, Welding Specifications, and/or Welder Qualifications for Structural Steel Welding"
Table 3.2-2 Table 3.2-3	Engineering Change EC-22075, "Boric Acid Concentrator Abandoned in Place"
3.4.1 3.4.3 3.4.4	Condition Report CR-ANO-2-2013-0904, "Incorporate Consistent References to Maximum Probably Flood Language"
Figure 3.2-6	Engineering Change EC-46295, "Main Generator Core Monitor Replacement"
3.4.4 3.4.4.3	Engineering Change EC-52678, "Tendon Gallery Hatch Replacement"
<u>Amendment 26</u>	
3.1.1	Licensing Basis Document Change Request LBDCR 15-017, "ANO-2 SAR and TRM Updates Support Implementation of NFPA 805"

ARKANSAS NUCLEAR ONE
Unit 2

UPDATE REFERENCE LIST (continued)

<u>Section</u>	<u>Cross References</u>
Table 3.2-3	Condition Report CR-ANO-2-2015-2254, "Clarification of ASME Code Class"
3.4.4	Engineering Change EC-57218, "External Flooding Protection Update"
3.4.4.2	
3.4.4.2.3	
3.4.4.2.4	
3.4.4.2.5	
3.4.4.2.6	
3.4.4.3	
3.8.4.1.1	
Table 3.4-1	
Table 3.4-2	
Figure 3.5-1	Licensing Basis Document Change Request 16-021, "SAR Updates based on
Figure 3.8-19	RIS 2015-17"
Figure 3.8-21	
Figure 3.8-22	
Figure 3.8-23	
Figure 3.8-24	
Figure 3.8-25	
<u>Amendment 27</u>	
3.6.4.4.3	Engineering Change EC-64188, "Boric Acid Makeup System Classification"
Table 3.2-2	
3.5.2.2.3	Licensing Basis Document Change LBDC 16-034, "Credit Turbine Trip in lieu of Turbine Valve Testing"
3.6.4.3.3.1	Engineering Change EC-66091, "Specify ESF Vault Flood Seal Height"
3.6.4.5.1.2.2	
3.6.4.5.2.1.2	
3.6.4.5.2.2.2	
3.4.4	Condition Report CR-ANO-2-2016-4267, "Clarification of Auxiliary Building Boundary and Passive/Non-Passive Flood Seals"
Table 3.4-1	
3.8	Licensing Basis Document Change LBDC 17-012, "Clarifies Concrete Compressive Strength Values and Input from Design Documents"
3.7.3.4.2.2.3	Licensing Basis Document Change LBDC 17-013, "Removal of Obsolete or Redundant SAR Figures"
Figure 3.7-34	
3.5.4	Engineering Change EC-61243, "Clarification of Tornado Protection Licensing Basis"
3.12	
3.6.4.3.3.3	Engineering Change EC-67516, "Upgrade DR-261 to a Fire Door"

ARKANSAS NUCLEAR ONE
Unit 2

UPDATE REFERENCE LIST (continued)

<u>Section</u>	<u>Cross References</u>
3.8.1.4.2	Engineering Change EC-70969, "Evaluation of Containment Building Liner Plate Degradation"
Table 3.2-5	Engineering Change EC-64005, "Shutdown Cooling Heat Exchangers Replacement"
<u>Amendment 28</u>	
Table 3.4-1	Engineering Change EC-75547, "Seal Weld EDG Fuel Oil Storage Vault Roof Opening"
3.10.2.2.7	Condition Report CR-ANO-2-2018-0241, "Editorial Correct of IEEE Reference"
3.10.2.2.8.1	
3.4.2	Licensing Basis Document Change LBDC 18-032, "Transfer of Redacted Information to New SAR Section"
3.4.3	
3.4.4	
Figure 3.2-6	Engineering Change EC-74971, "Addition of Valves to Electro-Hydraulic Fluid System"
3.1.2	Engineering Change EC-69421, "Update SAR in accordance with TS Amendment 311"

ARKANSAS NUCLEAR ONE
Unit 2

RECORD OF REVISIONS

<u>PAGE #</u>	<u>AMENDMENT #</u>	<u>PAGE #</u>	<u>AMENDMENT #</u>	<u>PAGE #</u>	<u>AMENDMENT #</u>
TABLE OF CONTENTS		TABLE OF CONTENTS		CHAPTER 3 (CONT.)	
3-i	28	3-xlvi	28	3.4-1	28
3-ii	28	3-xlvii	28	3.4-2	28
3-iii	28			3.4-3	28
3-iv	28			3.4-4	28
3-v	28	Chapter 3		3.4-5	28
3-vi	28				
3-vii	28	3.1-1	28	3.5-1	27
3-viii	28	3.1-2	28	3.5-2	27
3-ix	28	3.1-3	28	3.5-3	27
3-x	28	3.1-4	28	3.5-4	27
3-xi	28	3.1-5	28	3.5-5	27
3-xii	28	3.1-6	28	3.5-6	27
3-xiii	28	3.1-7	28	3.5-7	27
3-xiv	28	3.1-8	28	3.5-8	27
3-xv	28	3.1-9	28	3.5-9	27
3-xvi	28	3.1-10	28	3.5-10	27
3-xvii	28	3.1-11	28	3.5-11	27
3-xviii	28	3.1-12	28	3.5-12	27
3-xix	28	3.1-13	28	3.5-13	27
3-xx	28	3.1-14	28	3.5-14	27
3-xxi	28	3.1-15	28	3.5-15	27
3-xxii	28	3.1-16	28	3.5-16	27
3-xxiii	28	3.1-17	28		
3-xxiv	28	3.1-18	28	3.6-1	27
3-xxv	28	3.1-19	28	3.6-2	27
3-xxvi	28	3.1-20	28	3.6-3	27
3-xxvii	28	3.1-21	28	3.6-4	27
3-xxviii	28	3.1-22	28	3.6-5	27
3-xxix	28	3.1-23	28	3.6-6	27
3-xxx	28	3.1-24	28	3.6-7	27
3-xxxi	28	3.1-25	28	3.6-8	27
3-xxxii	28	3.1-26	28	3.6-9	27
3-xxxiii	28	3.1-27	28	3.6-10	27
3-xxxiv	28	3.1-28	28	3.6-11	27
3-xxxv	28	3.1-29	28	3.6-12	27
3-xxxvi	28	3.1-30	28	3.6-13	27
3-xxxvii	28	3.1-31	28	3.6-14	27
3-xxxviii	28	3.1-32	28	3.6-15	27
3-xxxix	28			3.6-16	27
3-xl	28	3.2-1	16	3.6-17	27
3-xli	28	3.2-2	16	3.6-18	27
3-xlii	28			3.6-19	27
3-xliii	28	3.3-1	22	3.6-20	27
3-xliv	28	3.3-2	22	3.6-21	27
3-xlv	28	3.3-3	22		

ARKANSAS NUCLEAR ONE
Unit 2

RECORD OF REVISIONS (continued)

<u>PAGE #</u>	<u>AMENDMENT #</u>	<u>PAGE #</u>	<u>AMENDMENT #</u>	<u>PAGE #</u>	<u>AMENDMENT #</u>
CHAPTER 3 (CONT.)		CHAPTER 3 (CONT.)		CHAPTER 3 (CONT.)	
3.6-22	27	3.7-24	27	3.8-21	27
3.6-23	27	3.7-25	27	3.8-22	27
3.6-24	27	3.7-26	27	3.8-23	27
3.6-25	27	3.7-27	27	3.8-24	27
3.6-26	27	3.7-28	27	3.8-25	27
3.6-27	27	3.7-29	27	3.8-26	27
3.6-28	27	3.7-30	27	3.8-27	27
3.6-29	27	3.7-31	27	3.8-28	27
3.6-30	27	3.7-32	27	3.8-29	27
3.6-31	27	3.7-33	27	3.8-30	27
3.6-32	27	3.7-34	27	3.8-31	27
3.6-33	27	3.7-35	27	3.8-32	27
3.6-34	27	3.7-36	27	3.8-33	27
3.6-35	27	3.7-37	27	3.8-34	27
3.6-36	27	3.7-38	27	3.8-35	27
3.6-37	27	3.7-39	27	3.8-36	27
3.6-38	27	3.7-40	27	3.8-37	27
3.6-39	27	3.7-41	27	3.8-38	27
3.6-40	27	3.7-42	27	3.8-39	27
3.6-41	27	3.7-43	27	3.8-40	27
		3.7-44	27	3.8-41	27
3.7-1	27	3.7-45	27	3.8-42	27
3.7-2	27	3.7-46	27	3.8-43	27
3.7-3	27			3.8-44	27
3.7-4	27	3.8-1	27	3.8-45	27
3.7-5	27	3.8-2	27	3.8-46	27
3.7-6	27	3.8-3	27	3.8-47	27
3.7-7	27	3.8-4	27	3.8-48	27
3.7-8	27	3.8-5	27	3.8-49	27
3.7-9	27	3.8-6	27	3.8-50	27
3.7-10	27	3.8-7	27	3.8-51	27
3.7-11	27	3.8-8	27	3.8-52	27
3.7-12	27	3.8-9	27		
3.7-13	27	3.8-10	27	3.9-1	23
3.7-14	27	3.8-11	27	3.9-2	23
3.7-15	27	3.8-12	27	3.9-3	23
3.7-16	27	3.8-13	27	3.9-4	23
3.7-17	27	3.8-14	27	3.9-5	23
3.7-18	27	3.8-15	27	3.9-6	23
3.7-19	27	3.8-16	27	3.9-7	23
3.7-20	27	3.8-17	27	3.9-8	23
3.7-21	27	3.8-18	27	3.9-9	23
3.7-22	27	3.8-19	27	3.9-10	23
3.7-23	27	3.8-20	27	3.9-11	23
				3.9-12	23

ARKANSAS NUCLEAR ONE
Unit 2

RECORD OF REVISIONS (continued)

<u>PAGE #</u>	<u>AMENDMENT #</u>	<u>PAGE #</u>	<u>AMENDMENT #</u>	<u>PAGE #</u>	<u>AMENDMENT #</u>
CHAPTER 3 (CONT.)		CHAPTER 3 (CONT.)		CHAPTER 3 (CONT.)	
3.9-13	23	3.11-7	24	3.13-36	28
3.9-14	23	3.11-8	24	3.13-37	28
3.9-15	23			3.13-38	28
3.9-16	23	3.12-1	27	3.13-39	28
3.9-17	23	3.12-2	27	3.13-40	28
3.9-18	23	3.12-3	27	3.13-41	28
3.9-19	23	3.12-4	27	3.13-42	28
3.9-20	23	3.12-5	27	3.13-43	28
3.9-21	23	3.12-6	27	3.13-44	28
3.9-22	23			3.13-45	28
3.9-23	23	3.13-1	28	3.13-46	28
3.9-24	23	3.13-2	28	3.13-47	28
3.9-25	23	3.13-3	28	3.13-48	28
3.9-26	23	3.13-4	28	3.13-49	28
3.9-27	23	3.13-5	28	3.13-50	28
3.9-28	23	3.13-6	28	3.13-51	28
		3.13-7	28	3.13-52	28
3.10-1	28	3.13-8	28	3.13-53	28
3.10-2	28	3.13-9	28	3.13-54	28
3.10-3	28	3.13-10	28	3.13-55	28
3.10-4	28	3.13-11	28	3.13-56	28
3.10-5	28	3.13-12	28	3.13-57	28
3.10-6	28	3.13-13	28	3.13-58	28
3.10-7	28	3.13-14	28	3.13-59	28
3.10-8	28	3.13-15	28	3.13-60	28
3.10-9	28	3.13-16	28	3.13-61	28
3.10-10	28	3.13-17	28	3.13-62	28
3.10-11	28	3.13-18	28	3.13-63	28
3.10-12	28	3.13-19	28	3.13-64	28
3.10-13	28	3.13-20	28	3.13-65	28
3.10-14	28	3.13-21	28	3.13-66	28
3.10-15	28	3.13-22	28	3.13-67	28
3.10-16	28	3.13-23	28	3.13-68	28
3.10-17	28	3.13-24	28	3.13-69	28
3.10-18	28	3.13-25	28	3.13-70	28
3.10-19	28	3.13-26	28	3.13-71	28
3.10-20	28	3.13-27	28	3.13-72	28
		3.13-28	28	3.13-73	28
3.11-1	24	3.13-29	28	3.13-74	28
3.11-2	24	3.13-30	28	3.13-75	28
3.11-3	24	3.13-31	28	3.13-76	28
3.11-4	24	3.13-32	28	3.13-77	28
3.11-5	24	3.13-33	28	3.13-78	28
3.11-6	24	3.13-34	28	3.13-79	28
		3.13-35	28	3.13-80	28

ARKANSAS NUCLEAR ONE
Unit 2

RECORD OF REVISIONS (continued)

<u>PAGE #</u>	<u>AMENDMENT #</u>	<u>PAGE #</u>	<u>AMENDMENT #</u>	<u>PAGE #</u>	<u>AMENDMENT #</u>
CHAPTER 3 (CONT.)		CHAPTER 3 (CONT.)		CHAPTER 3 (CONT.)	
3.13-81	28	3.13-126	28	F 3.7-12	20
3.13-82	28	3.13-127	28	F 3.7-13	20
3.13-83	28	3.13-128	28	F 3.7-14	20
3.13-84	28	3.13-129	28	F 3.7-15	20
3.13-85	28	3.13-130	28	F 3.7-16	20
3.13-86	28	3.13-131	28	F 3.7-17	20
3.13-87	28	3.13-132	28	F 3.7-18	20
3.13-88	28	3.13-133	28	F 3.7-19	20
3.13-89	28	3.13-134	28	F 3.7-20	20
3.13-90	28	3.13-135	28	F 3.7-21	20
3.13-91	28	3.13-136	28	F 3.7-22	20
3.13-92	28	3.13-137	28	F 3.7-23	20
3.13-93	28	3.13-138	28	F 3.7-24	20
3.13-94	28	3.13-139	28	F 3.7-25	20
3.13-95	28	3.13-140	28	F 3.7-26	20
3.13-96	28	3.13-141	28	F 3.7-27	20
3.13-97	28			F 3.7-28	20
3.13-98	28	F 3.2-1	20	F 3.7-29	20
3.13-99	28	F 3.2-2	20	F 3.7-30	20
3.13-100	28	F 3.2-3	20	F 3.7-31	20
3.13-101	28	F 3.2-4	20	F 3.7-32	20
3.13-102	28	F 3.2-5	20	F 3.7-33	20
3.13-103	28	F 3.2-6	28	F 3.7-34	27
3.13-104	28			F 3.7-35	20
3.13-105	28	F 3.5-1	26	F 3.7-36	20
3.13-106	28	F 3.5-2	20	F 3.7-37	20
3.13-107	28	F 3.5-7	20	F 3.7-38	20
3.13-108	28	F 3.5-8	20	F 3.7-39	20
3.13-109	28			F 3.7-40	20
3.13-110	28	F 3.6-1	20	F 3.7-41	20
3.13-111	28	F 3.6-2	20	F 3.7-42	20
3.13-112	28	F 3.6-31	23	F 3.7-43	20
3.13-113	28	F 3.6-32	20	F 3.7-44	20
3.13-114	28			F 3.7-45	20
3.13-115	28	F 3.7-1	20	F 3.7-46	20
3.13-116	28	F 3.7-2	20	F 3.7-47	20
3.13-117	28	F 3.7-3	20	F 3.7-48	20
3.13-118	28	F 3.7-4	20	F 3.7-49	20
3.13-119	28	F 3.7-5	20	F 3.7-50	20
3.13-120	28	F 3.7-6	20	F 3.7-51	20
3.13-121	28	F 3.7-7	20	F 3.7-52	20
3.13-122	28	F 3.7-8	20	F 3.7-53	20
3.13-123	28	F 3.7-9	20	F 3.7-54	20
3.13-124	28	F 3.7-10	20	F 3.7-55	20
3.13-125	28	F 3.7-11	20	F 3.7-56	20

ARKANSAS NUCLEAR ONE
Unit 2

RECORD OF REVISIONS (continued)

<u>PAGE #</u>	<u>AMENDMENT #</u>	<u>PAGE #</u>	<u>AMENDMENT #</u>	<u>PAGE #</u>	<u>AMENDMENT #</u>
CHAPTER 3 (CONT.)		CHAPTER 3 (CONT.)		CHAPTER 3 (CONT.)	
F 3.7-57	20				
F 3.7-58	20				
F 3.8-1	20				
F 3.8-2	20				
F 3.8-4	20				
F 3.8-5	20				
F 3.8-7	20				
F 3.8-8	20				
F 3.8-9	20				
F 3.8-10	20				
F 3.8-11	20				
F 3.8-12	20				
F 3.8-13	20				
F 3.8-13A	20				
F 3.8-15	20				
F 3.8-20	20				
F 3.8-26	20				
F 3.8-32	20				
F 3.8-33	20				
F 3.8-34	20				
F 3.8-35	20				
F 3.9-1A	20				
F 3.9-1B	20				
F 3.9-1C	20				
F 3.9-1D	21				
F 3.9-1E	20				
F 3.9-1F	20				
F 3.9-2	20				
F 3.9-3	20				
F 3.9-4	20				
F 3.10-1	20				
F 3.10-2	20				
F 3.10-3	20				
F 3.10-4	20				
F 3.10-5	20				
F 3.10-6	20				
F 3.10-7	20				
F 3.10-8	20				
F 3.10-9	20				
F 3.10-10	20				

ARKANSAS NUCLEAR ONE
UNIT 2

3 DESIGN OF STRUCTURES, COMPONENTS, EQUIPMENT, AND SYSTEMS

3.1 CONFORMANCE WITH AEC GENERAL DESIGN CRITERIA

Arkansas Nuclear One - Unit 2 (ANO-2 or Unit 2) was originally designed to comply with the 70 "Proposed General Design Criteria for Nuclear Power Plant Construction Permits," published in July 1967. However, Sections 3.1.1 through 3.1.6 provide a comparison with the AEC General Design Criteria (GDC) published as Appendix A to 10 CFR 50 in 1971. Each criterion is followed by a summary discussion of the design and procedures which are intended to meet the design objectives reflected in the criterion.

Each of the Engineered Safety Features (ESF) is designed to tolerate a single failure during the period of recovery following an incident without loss of its protective function. This period of recovery consists of two segments, the injection phase and the recirculation phase. During the injection phase the single failure is limited to the failure of a single active component to complete its function as required. During the recirculation phase, assuming there were no failures during the injection phase, the ESF are designed to tolerate either a single active failure or a single passive failure without loss of their protective functions.

3.1.1 OVERALL REQUIREMENTS

CRITERION 1 - QUALITY STANDARDS AND RECORDS

Structures, systems, and components important to safety shall be designed, fabricated, erected, and tested to quality standards commensurate with the importance of the safety functions to be performed. Where generally recognized codes and standards are used, they shall be identified and evaluated to determine their applicability, adequacy, and sufficiency and shall be supplemented or modified as necessary to assure a quality product in keeping with the required safety function. A quality assurance program shall be established and implemented in order to provide adequate assurance that these structures, systems and components will satisfactorily perform their safety functions. Appropriate records of the design, fabrication, erection, and testing of structures, systems, and components important to safety shall be maintained by or under the control of the nuclear power unit licensee throughout the life of the unit.

Response

All structures, systems and components of the facility are classified according to their importance in the prevention and mitigation of accidents.

Seismic Category 1 structures, systems and components, listed in Section 3.2.1, may be essential to the protection of the health and safety of the public in the event of hypothetical accidents. Consequently, they are designed, fabricated, inspected and erected, and the materials selected to the applicable provisions of recognized codes, good nuclear practice and to quality standards that reflect their importance. Discussions of applicable codes and standards, code classes and other quality related criteria are given in the sections cited in Section 3.2.1. The quality group classifications as defined in Regulatory Guide 1.26 are discussed in Section 3.2.2. System descriptions contain more specific information on particular components and application of the quality criteria. Quality Assurance programs for Seismic Category 1 structures, systems and components conform with the requirements of 10 CFR 50, Appendix B. Quality related activities ensure compliance with Regulatory Guides 1.10, 1.15, 1.18, and 1.19 on containment construction. Quality Assurance programs meet Regulatory Guides 1.26, 1.28, 1.29, 1.30 and 1.33.

ARKANSAS NUCLEAR ONE
UNIT 2

The following codes and standards are also utilized within the QA program as applicable to those activities to which they are referenced within various sections of this document and the QA Program Manual.

ASME B&PVC Section III, Division 1, 1992 Edition, No Addenda – Nuclear Power Plant Components [In lieu of the original Construction Code, all or portions of later editions/addenda of ASME Section III may be specified for repair or replacement (including system changes) of components or systems, within the rules of ASME B&PVC Section XI and 10 CFR 50.55a. If later editions/addenda are selected, design, fabrication, and examination requirements shall be reconciled with the Owner's specification.] When performing repair/ replacement activities in accordance with ASME Section XI, 2001 Edition / 2003 Addenda, to comply with IWA-4540(a)(2), nondestructive examination method and acceptance criteria of the 1992 Edition (or later) of ASME Section III shall be met for welds when a system leakage test is performed in lieu of a hydrostatic pressure test.

ASME B&PVC Section XI – Rules for Inservice Inspection of Nuclear Power Plant Components. The testing of ASME Class 1, 2, 3, MC and CC components shall be performed in accordance with periodically updated versions of Section XI of the ASME Boiler and Pressure Vessel Code and Addenda as required by 10 CFR 50.55a. Qualification and certification of ultrasonic examination personnel performing inservice inspections shall be performed in accordance with the 1995 edition with addenda through 1996, as required by the NRC.

ASNT SNT-TC-1A, 1984 Edition – Recommended Practice for Nondestructive Testing Personnel Qualification and Certification [This edition shall be used in lieu of earlier editions that might be referenced in other codes or standards to which ANO is committed.]

AWS D1.1, 1992 or later approved Edition – Structural Steel Welding Code. As an alternative to AWS requirements, Welding Procedure Specifications (WPS's), and/or Welder Performance Qualification (WPQ), meeting the ASME Section IX Code requirements may be utilized for structural steel applications provided all other applicable provisions of AWS D1.1 are met unrelated to WPS's and WPQ's.

The sufficiency of the chosen Seismic Category 1 quality standards is shown by the analysis results, which assume maximum defects allowable by the standards and by prior successful applications of these same standards in nuclear power plant design, fabrication, construction, test and operation.

The owner maintains, either in its possession or under its control, the required records of design, fabrication, construction and testing of Category 1 plant components throughout the life of the plants. Construction and test records are developed as outlined throughout the FSAR. Operating records to be maintained throughout the life of the unit are discussed in the Quality Assurance Program Manual (QAPM).

CRITERION 2 - DESIGN BASES FOR PROTECTION AGAINST NATURAL PHENOMENA

Structures, systems, and components important to safety shall be designed to withstand the effects of natural phenomena such as earthquakes, tornadoes, hurricanes, floods, tsunamis, and seiches without loss of capability to perform their safety functions. The design bases for these structures, systems, and components shall reflect: (1) appropriate consideration of the natural phenomena that have been historically reported for the site and surrounding area, with sufficient margin for the limited accuracy, quantity, and period of time in which the historical data have

ARKANSAS NUCLEAR ONE
UNIT 2

been accumulated, (2) appropriate combinations of the effects of normal and accident conditions with the effects of the natural phenomena and (3) the importance of the safety functions to be performed.

Response

All systems and components designated as Seismic Category 1 are designed so that there is no loss of function as a consequence of ground accelerations associated with the Design Basis Earthquake (DBE). The working stresses for Seismic Category 1 items are kept within allowable values for the Operating Basis Earthquake (OBE). Section 2.5, Geology and Seismology, establishes the seismic design bases.

Design bases for other natural phenomena are established in Sections 2.3, Meteorology; 2.4, Hydrologic Engineering; 3.3, Wind and Tornado Loadings; 3.4, Water Level (Flood) Design; and parts of 3.5, Missile Protection. The application and combination of these bases with accident related plant process conditions are discussed in Chapter 15.

Each system description evaluates functional performance under the appropriate natural phenomena conditions. The classification of a structure, system or component as Seismic Category 1 indicates that a safety function exists and must be met under the identified accident and natural phenomena conditions. Design assumptions of natural phenomena and plant process conditions are used which meet Regulatory Guides 1.4, 1.25, and 1.27.

Instrumentation to measure and document natural phenomena meets Regulatory Guides 1.12 and 1.23. The Emergency Plan, which is part of the designed protective action against adverse natural phenomena, complies with the requirements of 10CFR50, Appendix E.

CRITERION 3 - FIRE PROTECTION

Structures, systems, and components important to safety shall be designed and located to minimize, consistent with other safety requirements, the probability and effect of fires and explosions. Noncombustible and heat resistant materials shall be used wherever practical throughout the unit, particularly in locations such as the containment and control room. Fire detection and fighting systems of appropriate capacity and capability shall be provided and designed to minimize the adverse effects of fires on structures, systems, and components important to safety. Fire fighting systems shall be designed to assure that their rupture or inadvertent operation does not significantly impair the safety capability of these structures, systems, and components.

Response

Structures, systems, and components important to safety are designed to comply with the AEC "General Design Criteria for Nuclear Power Plants" and are located to minimize, consistent with other safety requirements, the probability and effect of fires and explosions. Noncombustible and heat resistant materials are used wherever practical throughout the unit, particularly in locations such as the containment and control room. Fire detection and fighting systems of appropriate capacity and capability are provided and designed to minimize the adverse effects of fires on structures, systems, and components important to safety. Fire fighting systems are designed to assure that their rupture or inadvertent operation does not significantly impair the safety capability of these structures, systems, and components.

ARKANSAS NUCLEAR ONE UNIT 2

In addition, the ANO-2 fire protection program has been revised and updated in accordance with NFPA 805, "Performance-Based Standard for Fire Protection for Light Water Reactor Electric Generating Plants," 2001 Edition, as allowed by 10 CFR 50.48. This improved program includes procedures, personnel training, and risk-informed, performance-based analysis of the plant in terms of fire protection. Section 9.5.1 provides a detailed description of the ANO-2 fire protection program.

CRITERION 4 - ENVIRONMENTAL AND MISSILE DESIGN BASES

Structures, systems, and components important to safety shall be designed to accommodate the effects of and be compatible with the environmental conditions associated with normal operation, maintenance, testing, and postulated accidents, including Loss of Coolant Accidents (LOCAs). These structures, systems, and components shall be appropriately protected against dynamic effects, including the effects of missiles, pipe whipping, and discharging fluids, that may result from equipment failures and from events and conditions outside the nuclear power unit.

However, dynamic effects associated with postulated pipe ruptures in nuclear power units may be excluded from the design basis when analyses reviewed and approved by the Commission demonstrate that the probability of fluid system piping rupture is extremely low under conditions consistent with the design basis for the piping. [52FR41288]

Response

The environmental design of safety-related items is discussed in Section 3.8 for the design of structures, Sections 6.2.2 and 6.2.3 for containment heat removal and air purification and Section 9.4 for ventilation systems. Safety-related systems and components use the input from these sections for design as discussed in Section 3.11.

Conservative design methods, segregated routing of piping, missile shield walls and engineered hangers and pipe restraints are all used to accommodate dynamic effects of postulated accidents. These same features as well as the strength of the auxiliary building, containment and intake structure protect the safety-related equipment from missiles which might be generated either within or outside the plant. Sections 3.5 and 3.6 detail the design assumptions, methods and results for missiles and postulated piping ruptures.

In 1987, the Commission modified GDC 4 to allow crediting of a leak-before-break (LBB) technology for an exclusion from the design basis of dynamic effects. Since this time, ANO-2 has credited the LBB technology for various plant modifications. See Section 3.6 of the SAR for additional information.

CRITERION 5 - SHARING OF STRUCTURES, SYSTEMS, AND COMPONENTS

Structures, systems, and components important to safety shall not be shared among nuclear power units unless it can be shown that such sharing will not significantly impair their ability to perform their safety functions, including, in the event of an accident in one unit, an orderly shutdown and cooldown of the remaining units.

ARKANSAS NUCLEAR ONE
UNIT 2

Response

The interrelationship between Unit 1 and Unit 2 is discussed in Section 1.2.2.10. The safety of either unit would not be impaired by the failure of the facilities and systems which are shared. Separate systems and equipment are provided for each unit with few exceptions. The shared systems are specifically listed in Section 1.2.2.10 and the individual system descriptions discuss their adequacy to perform safety-related functions for both units.

3.1.2 PROTECTION BY MULTIPLE FISSION PRODUCT BARRIERS

CRITERION 10 - REACTOR DESIGN

The reactor core and associated coolant, control and protection systems shall be designed with appropriate margins to assure that specified acceptable fuel design limits are not exceeded during any condition of normal operation, including the effects of anticipated operational occurrences.

Response

In ANS N18.2, plant conditions have been categorized in accordance with their anticipated frequency of occurrence and risk to the public, and design requirements are given for each of the four categories. The categories covered by this criterion are Condition I - Normal Operation and Condition II - Faults of Moderate Frequency.

The design requirement for Condition I is that margin shall be provided between any plant parameter and the value of that parameter which would require either automatic or manual protective action; it is met by providing an adequate control system (see Section 7.7). The design requirement for Condition II is that such faults shall be accommodated with, at most, a shutdown of the reactor, with the plant capable of returning to operation after corrective action; it is met by providing an adequate protective system (see Section 7.2 and Chapter 15).

Specified acceptable fuel design limits are stated in Section 4.4. Minimum margins to specified acceptable fuel design limits are prescribed in the Technical Specifications (Limiting Conditions for Operations) which support Chapters 4 and 15. The plant is designed such that operation within Limiting Conditions for Operation, with safety system settings not less conservative than Limiting Safety System Settings prescribed in the Technical Specifications, assures that specified acceptable fuel design limits will not be violated as a result of anticipated operational occurrences. During non-accident conditions, operation of the plant within Limiting Conditions for Operation ensures that specified acceptable fuel design limits are not approached within the minimum margins. Operator action, aided by the control systems and monitored by plant instrumentation, maintains the plant within Limiting Conditions for Operation during non-accident conditions.

CRITERION 11 - REACTOR INHERENT PROTECTION

The reactor core and associated coolant systems shall be designed so that in the power operating range the net effect of the prompt inherent nuclear feedback characteristics tends to compensate for a rapid increase in reactivity.

ARKANSAS NUCLEAR ONE
UNIT 2

Response

In the power operating range, the combined response of the fuel temperature coefficient, the moderator temperature coefficient, the moderator void coefficient, and the moderator pressure coefficient to an increase in reactor power in the power operating range will be a decrease in reactivity; i.e., the inherent nuclear feedback characteristics will not be positive.

The reactivity coefficients for this reactor are listed in Table 4.3-1 and are discussed in detail in Section 4.3.

CRITERION 12 - SUPPRESSION OF REACTOR POWER OSCILLATIONS

The reactor core and associated coolant, control, and protection systems shall be designed to assure that power oscillations which can result in conditions exceeding specified acceptable fuel design limits are not possible or can be reliably and readily detected and suppressed.

Response

Power level oscillations outside of a nominal control band do not occur during normal plant operation. The effect of the negative power coefficient of reactivity (see Criterion 11), together with the coolant temperature program maintained by control of regulating rods and soluble boron, provides fundamental mode stability. Power level is continuously monitored by neutron flux detectors (Chapter 7).

Power distribution oscillations are detected by neutron flux detectors. Axial mode oscillations are suppressed by means of neutron absorber rods. All other modes of oscillation are expected to be convergent. Monitoring and protective requirements imposed by Criteria 10 and 20 are discussed in those responses and in Chapter 4.

CRITERION 13 - INSTRUMENTATION AND CONTROL

Instrumentation shall be provided to monitor variables and systems over their anticipated ranges for normal operation, for anticipated operational occurrences, and for accident conditions as appropriate to assure adequate safety, including those variables and systems that can affect the fission process, the integrity of the reactor core, the reactor coolant pressure boundary, and the containment and its associated systems. Appropriate controls shall be provided to maintain these variables and systems within prescribed operating ranges.

Response

Instrumentation is provided to monitor and maintain significant process variables which can affect the fission process, the integrity of the reactor core, the reactor coolant pressure boundary, and the containment and its associated systems. Controls are provided for the purpose of maintaining these variables within the limits prescribed for safe operation.

The principal process variables to be monitored and controlled are neutron level (reactor power); axial neutron flux shape; CEA position; reactor coolant temperature and pressure; reactor coolant pump speed; pressurizer liquid level; and steam generator level and pressure. In addition, instrumentation is provided for continuous automatic monitoring of activity level in the reactor coolant.

ARKANSAS NUCLEAR ONE
UNIT 2

The Plant Protection System (PPS) consists of the Reactor Protective System (RPS) and the Engineered Safety Features Actuation System (ESFAS). The RPS is designed to monitor the reactor operating conditions and to perform an on-line calculation of the limiting core parameters. Systems are provided to affect reliable and rapid reactor trip if a safety limit may be reached (see Section 7.2). The ESFAS is designed to monitor plant operating conditions and to initiate engineered safety features operation in the event of an accident (see Section 7.3).

The Core Operating Limit Supervisory System (COLSS) provides the operator with an independent indication of the proximity to a Limiting Condition for Operation (LCO) and an alarm when an LCO is reached.

Incore instrumentation is provided to supplement information on core power distribution and to provide a means for calibration of out-of-core flux detectors.

The instrumentation and control systems are described in detail in Chapter 7, and the boronmeter and the process radiation monitor are discussed in Section 9.3.4.

CRITERION 14 - REACTOR COOLANT PRESSURE BOUNDARY

The reactor coolant pressure boundary shall be designed, fabricated, erected and tested so as to have an extremely low probability of abnormal leakage, of rapidly propagating failure and of gross rupture.

Response

Reactor Coolant System (RCS) components are designed in accordance with the ASME Code, Section III. To establish operating pressure and temperature limitations during startup and shutdown of the RCS, the fracture toughness rules defined in Appendix G of the ASME Code, Section XI were followed. Quality control, inspection, and testing as required by this standard and allowable reactor pressure-temperature operations ensure the integrity of the RCS.

The Reactor Coolant Pressure Boundary (RCPB) is designed to accommodate the system pressures and temperatures attained under all expected modes of unit operation including all anticipated transients, and maintain the stresses within applicable stress limits.

Design pressures, temperatures and transients are listed in Chapter 5 and details of the transient analysis are provided in Chapter 15.

Means are provided to detect significant leakage from the RCPB with monitoring readouts and alarms in the control room as discussed in Chapters 5 and 12.

The pressure boundary has provisions for inservice inspection in accordance with ASME Code, Section XI, to ensure continuance of the structural and leak tight integrity of the boundary. For the reactor vessel, a material surveillance program conforming with ASTM-E-185 is provided as discussed in Chapter 5.

CRITERION 15 - REACTOR COOLANT SYSTEM DESIGN

The RCS and associated auxiliary, control, and protection systems shall be designed with sufficient margin to assure that the design conditions of the RCPB are not exceeded during any condition of normal operation including anticipated operational occurrences.

ARKANSAS NUCLEAR ONE
UNIT 2

Response

The design criteria and bases for the RCPB are described in the response to Criterion 14.

The operating conditions established for normal steady state and transient plant operations are discussed in Chapter 5. The normal operating limits are selected so that an adequate margin exists between them and the design limits. The plant control systems are designed to ensure that plant variables are maintained well within the established operating limits. The plant transient response characteristics and pressure and temperature distributions during normal operations are considered in the design as well as the accuracy and response of the instruments and controls. These design techniques ensure that a satisfactory margin is maintained between normal operating conditions, including design transients, and design limits for the RCPB.

The RPS functions to minimize the deviation from normal operating limits in the event of anticipated operational occurrences (ANS N18.2 Condition II occurrences). Analyses for this plant show that the design limits for the RCPB are not exceeded in the event of any ANS N18.2 Condition II occurrence.

CRITERION 16 - CONTAINMENT DESIGN

Reactor containment and associated systems shall be provided to establish an essentially leak tight barrier against the uncontrolled release of radioactivity to the environment and to assure that the containment design conditions important to safety are not exceeded for as long as postulated accident conditions require.

Response

Reactor containment and associated systems are provided and establish an essentially leak tight barrier against the uncontrolled release of radioactivity to the environment. The quality requirements of Regulatory Guides 1.10, 1.15, 1.18, and 1.19 are met. The upper limit for containment leakage is 0.1 percent volume per day at 59 psig internal pressure. The containment is tested prior to initial plant operation, uprated operation, and periodically throughout plant life.

The containment, including access openings and penetrations, has a structural design pressure of 59 psig and a design temperature of at least 300 °F. The electrical penetrations are qualified to design basis accident conditions. The greatest transient peak condition, associated with a postulated rupture of the piping in the RCS and the calculated effects of a metal-water reaction, does not exceed these values.

The containment and engineered safety features have been evaluated for various combinations of credible energy releases. The analysis accounts for system energy and decay heat. The cooling capacity of the containment heat removal systems is adequate to prevent overpressurization of the structure.

Sections 3.8.1, 6.2, and 6.5 describe and evaluate the containment and its associated system.

ARKANSAS NUCLEAR ONE
UNIT 2

CRITERION 17 - ELECTRICAL POWER SYSTEMS

An onsite electric power system and an off-site electric power system shall be provided to permit functioning of structures, systems, and components important to safety. The safety function for each system (assuming the other system is not functioning) shall be to provide sufficient capacity and capability to assure that (1) specified acceptable fuel design limits and design conditions of the RCPB are not exceeded as a result of anticipated operational occurrences and (2) the core is cooled and containment integrity and other vital functions are maintained in the event of postulated accidents.

The onsite electric power supplies, including the batteries, and the onsite electric distribution system, shall have sufficient independence, redundancy, and testability to perform their safety functions assuming a single failure.

Electric power from the transmission network to the onsite electric distribution system shall be supplied by two physically independent circuits (not necessarily on separate rights-of-way) designed and located so as to minimize to the extent practical the likelihood of their simultaneous failure under operating and postulated accident and environmental conditions. A switchyard common to both circuits is acceptable. Each of these circuits shall be designed to be available in sufficient time following a loss of all onsite alternating current power supplies and the other off-site electric power circuit, to assure that specified acceptable fuel design limits and design conditions of the RCPB are not exceeded. One of these circuits shall be designed to be available within a few seconds following a LOCA to assure that core cooling, containment integrity, and other vital safety functions are maintained.

Provisions shall be included to minimize the probability of losing electric power from any of the remaining supplies as a result of, or coincident with, the loss of power generated by the nuclear power unit, the loss of power from the transmission network, or the loss of power from the onsite electric power supplies.

Response

The electric power systems conform to this criterion through the provision of an off-site 500 kV/161 kV transmission system and onsite diesel engine generators and batteries. Each of these systems provides sufficient capacity and capability to assure operation of the necessary safety functions during anticipated operational occurrences and postulated accidents, assuming the other system is not functioning.

The onsite power supplies, including the diesel generators, batteries and distribution system, have sufficient independence, redundancy and testability to perform their safety functions in the event of a single failure.

Electric power is supplied to the station switchyard by five separate transmission lines. Three lines, one from the Mabelvale substation, one from Pleasant Hill and the other from the Ft. Smith substation, feed the 500 kV bus. The remaining two lines, one line from the Russellville East substation and the other from the Pleasant Hill substation, feed the 161 kV ring bus. Startup Transformer 3 is supplied by the autotransformer bank through underground cables, and Startup Transformer 2 is supplied by the 161 kV ring bus.

ARKANSAS NUCLEAR ONE UNIT 2

The onsite electrical distribution system arrangement minimizes the vulnerability of vital circuits to physical damage. Two independent circuits can supply power from the different off-site transmission lines through the corresponding transformer to safety oriented components during operating and postulated accident and environmental conditions. Each of these circuits (Startup Transformer 3 and 2) are designed to be available in sufficient time following a loss of all onsite alternating current power supplies and the other offsite electric power circuit, to assure that specified acceptable fuel design limits and design conditions of the reactor coolant pressure boundary are not exceeded. One of these circuits is designed to be available within a few seconds following a loss-of-coolant accident to assure that core cooling, containment integrity, and other vital safety function are maintained.

Both ANO Unit 1 and Unit 2 are prevented from automatic transfer to Startup Transformer 2 during normal power operations for all buses except buses A1/A3 (Unit 1) and 2A1/2A3 (Unit 2). Procedures administratively control Unit 1 and Unit 2 access to Startup Transformer 2. Procedures may allow other fast transfer capabilities to Startup Transformer 2 for specifically analyzed conditions and restrictions defined in approved Engineering Calculations and Evaluations.

Two emergency diesel generators are provided for use in the event off-site power is lost. Normally, the two 4160-volt ESF buses are fed either from the Unit Auxiliary Transformer (UAT), or from either of the two startup transformers. Upon loss of normal (auxiliary transformer) and preferred (off-site) power sources, the two 4160-volt ESF buses are each energized from their respective diesel generator. The ESF power system is designed to provide continuous power for control instrumentation, reactor protection and engineered safety features systems, safety features actuation control systems and other loads. Two independent and physically separate 125-volt batteries and DC control centers will provide necessary instrumentation through inverters. Each battery is sized to carry the continuous emergency and vital AC loads for a minimum period of eight hours in addition to supplying power for the operation of momentary loads during the 8-hour period.

Provisions are included to minimize the probability of losing electrical power from the remaining sources as a result of, or coincident with, a loss of the nuclear power unit, the transmission network, or the onsite power sources. With a loss of the electrical power generated by the nuclear power unit, auxiliary plant loads will be transferred automatically by bus transfer devices to an off-site power source. With the loss of off-site power to the ESF buses, each ESF bus is cleared of all auxiliaries and ties prior to the application of the associated diesel generator. This prevents loss of the diesel generator as a result of an off-site power fault. Because of the design of the fault protection system, there is a very low probability that loss of onsite diesel generator power sources could cause loss of either the off-site or nuclear unit electrical power sources.

Separation of circuits, switching capability, protective relaying, adequacy of redundancy are all used in system design to assure a higher probability of available electric power for safety-related systems. Chapter 8 discusses in detail each of the electric power systems for Unit 2.

CRITERION 18 - INSPECTION AND TESTING OF ELECTRICAL POWER SYSTEMS

Electrical power systems important to safety shall be designed to permit periodic inspection and testing of important areas and features, such as wiring, insulation, connectors, and switchboards, to assess the continuity of the systems and the condition of their components. The systems shall be designed with a capability to test periodically (1) the operability and

ARKANSAS NUCLEAR ONE
UNIT 2

functional performance of the components of the systems, such as onsite power sources, relays, switches, and buses, and (2) the operability of the systems as a whole and, under conditions as close to design as practical, the full operation sequence that brings the systems into operation, including operation of applicable portions of the protection system, and the transfer of power buses, the off-site power system, and the onsite power system.

Response

All important passive components of the emergency power system such as wiring, insulation, connection, and switchboards are designed to permit appropriate periodic inspection and testing to assess their continuity and condition.

Protective equipment and instrumentation have provisions for inservice testing and calibration. The diesel generators are equipped with means for starting periodically to test for readiness, means for synchronizing the unit onto the bus without interrupting the service, and means for loading.

Surveillance systems, along with periodic tests of power and control circuits for ESF equipment not normally exercised during operation of the station, ensure required performance.

CRITERION 19 - CONTROL ROOM

A control room shall be provided from which actions can be taken to operate the nuclear power unit safely under normal conditions and to maintain it in a safe condition under accident conditions, including LOCAs. Adequate radiation protection shall be provided to permit access and occupancy of the control room under accident conditions without personnel receiving radiation exposure in excess of 5 rem whole body, or its equivalent to any part of the body, for the duration of the accident.

Equipment at appropriate locations outside the control room shall be provided: (1) with a design capability for prompt hot shutdown of the reactor, including necessary instrumentation and controls to maintain the unit in a safe condition during hot shutdown, and (2) with a potential capability for subsequent cold shutdown of the reactor through the use of suitable procedures.

Response

The control room contains the necessary indications and controls for normal operation and post-accident shutdown. The various system descriptions throughout the SAR generally discuss the associated equipment located in the control room.

The post-accident environment and habitability in the control room is described and evaluated in Sections 6.4, 9.4, 12.1, and 12.2.

Instrumentation and controls are provided outside the control room at various locations so that the plant may be safely brought to hot shutdown and potentially to cold shutdown. These provisions are discussed in Section 7.4.1.

ARKANSAS NUCLEAR ONE
UNIT 2

3.1.3 PROTECTION AND REACTIVITY CONTROL SYSTEMS

CRITERION 20 - PROTECTION SYSTEM FUNCTIONS

The protection system shall be designed (1) to initiate automatically the operation of appropriate systems including the reactivity control systems, to assure that specified acceptable fuel design limits are not exceeded as a result of anticipated operational occurrences and (2) to sense accident conditions and to initiate the operation of systems and components important to safety.

Response

A PPS is provided to monitor reactor and plant operating conditions and automatically initiate a reactor trip when the monitored variable or combination of variables exceeds its normal operating range. The trip function setpoints are selected to ensure that anticipated operational occurrences do not cause acceptable fuel design limits (linear heat rate and minimum Departure from Nucleate Boiling Ratio [DNBR]) to be violated. Specific reactor trips are described in Section 7.2.

Reactor trip is accomplished by de-energizing the Control Element Drive Mechanism (CEDM) holding latch coils through the interruption of the CEDM power supply. The Control Element Assemblies (CEAs) are, thus released to drop into the core, reducing reactor power. The CEDMs are described in Section 4.2.

The PPS also functions to monitor potential accident conditions and automatically initiate engineered safety features operation when the monitored variables reach their setpoints. The parameters which automatically actuate engineered safety features are described in Section 7.3. Controls are provided for manual actuation of engineered safety features.

CRITERION 21 - PROTECTION SYSTEM RELIABILITY AND TESTABILITY

The protection system shall be designed for high functional reliability and inservice testability commensurate with the safety functions to be performed. Redundancy and independence designed into the protection system shall be sufficient to assure that (1) no single failure results in loss of the protection function and (2) removal from service of any component or channel does not result in loss of the required minimum redundancy unless the acceptable reliability of operation of the protection system can be otherwise demonstrated. The protection system shall be designed to permit period testing of its functioning when the reactor is in operation, including a capability to test channels independently to determine failures and losses of redundancy that may have occurred.

Response

The PPS is designed to provide high functional reliability and inservice testability. The protection system is designed to comply with the requirements of IEEE 279-1971. No single failure will result in the loss of the protection function. The protection channels are independent, e.g. with respect to piping, wire routing, mounting and supply of power. This independence permits testing and the removal from service of any component or channel without loss of the protection function.

ARKANSAS NUCLEAR ONE
UNIT 2

Each channel of the PPS, including the sensors up to the final actuation device, is capable of being checked during reactor operation. Measurement sensors of each channel used in protection systems are checked by comparison of outputs of similar channels which are presented on indicators and recorders on the control board. Trip units and logic are tested by inserting a signal into the measurement channel ahead of the readout and, upon application of a trip level input, observing that a signal is passed through the trip units and the logic to the logic output relays. The logic output relays are tested individually for initiation of trip action. The parallel trip circuit breakers which supply power to the CEDM holding coils may be tested during reactor operation without affecting a reactor trip.

CRITERION 22 - PROTECTION SYSTEM INDEPENDENCE

The protection system shall be designed to assure that the effects of natural phenomena, and of normal operation, maintenance, testing and postulated accident conditions on redundant channels do not result in loss of the protection function, or shall be demonstrated to be acceptable on some other defined basis. Design techniques, such as functional diversity or diversity in component design and principles of operation, shall be used to the extent practical to prevent loss of the protection function.

Response

The PPS conforms to the provisions of IEEE 279-1971. Four independent measurement channels complete with sensors, sensor power supplies, signal conditioning units and bistable trip units are provided for each protective parameter monitored by the protection systems. The measurement channels are provided with a high degree of independence by separate connection of the channel sensors to the process systems. Power to the channels is provided by independent vital power supply buses. See Chapter 7.

Functional diversity has been incorporated in the system design to the extent that is practical to prevent loss of the protection function.

The PPS is functionally tested to ensure satisfactory operation prior to installation in the plant. Environmental and seismic qualifications are also performed utilizing type tests and specific equipment tests. Seismic qualification of CE supplied instrumentation is described in detail in CENPD-61, "Seismic Qualification of Category 1 Electric Equipment for Nuclear Steam Supply Systems," November 1972, and complies with IEEE 344-1971. Seismic qualification of non-CE supplied instrumentation complies with IEEE 344-1971, 1975, or 1987.

CRITERION 23 - PROTECTION SYSTEM FAILURE MODES

The protection system shall be designed to fail into a safe state or into a state demonstrated to be acceptable on some other defined basis if conditions such as disconnection of the system, loss of energy (e.g., electric power, instrument air) or postulated adverse environments (e.g., extreme heat or cold, fire, pressure, steam, water, and radiation) are experienced.

Response

PPS trip channels have been designed to fail into a safe state or into a state established as acceptable in the event of loss of power supply or disconnection of the system. A loss of power to the CEDM holding coils results in gravity insertion in the core. Redundancy, channel independence, and separation are incorporated in the PPS design to minimize the possibility of the loss of a protection function under adverse environmental conditions. See Chapter 7 and the response to Criterion 22.

ARKANSAS NUCLEAR ONE
UNIT 2

CRITERION 24 - SEPARATION OF PROTECTION AND CONTROL SYSTEMS

The protection system shall be separated from control systems to the extent that failure of any single control system component or channel, or failure or removal from service of any single protection system component or channel which is common to the control and protection systems leaves intact a system satisfying all reliability, redundancy, and independence requirements of the protection system. Interconnection of the protection and control systems shall be limited so as to assure that safety is not significantly impaired.

Response

The protection systems are separated from the control instrumentation systems so that failure or removal from service of any control instrumentation system component or channel does not inhibit the function of the protection system (see Section 7.2).

CRITERION 25 - PROTECTION SYSTEM REQUIREMENTS FOR REACTIVITY CONTROL
MALFUNCTIONS

The protection system shall be designed to assure that specified acceptable fuel design limits are not exceeded for any single malfunction of the reactivity control systems, such as accidental withdrawal (not ejection or dropout) of control rods.

Response

Shutdown of the reactor is accomplished by the opening of the reactor trip breakers which interrupt power to the CEDM holding coils. Actuation of the trip breakers is independent of any existing control signals.

The protection system is designed such that specified acceptable fuel design limits are not exceeded for any single malfunction of the reactivity control systems, including the withdrawal of a single CEA. Analyses of possible control malfunctions are discussed in Chapter 15.

CRITERION 26 - REACTIVITY CONTROL SYSTEM REDUNDANCY AND CAPABILITY

Two independent reactivity control systems of different design principles shall be provided. One of the systems shall use control rods, preferably including a positive means for inserting the rods, and shall be capable of reliably controlling reactivity changes to assure that under conditions of normal operation, including anticipated operation occurrences, and with appropriate margin for malfunctions such as stuck rods, specified acceptable fuel design limits are not exceeded. The second reactivity control system shall be capable of reliably controlling the rate of reactivity changes resulting from planned, normal power changes (including xenon burnout) to assure acceptable fuel design limits are not exceeded. One of the systems shall be capable of holding the reactor core subcritical under cold conditions.

Response

Two independent reactivity control systems of different design principles are provided. The first system, using CEAs, includes a positive means (gravity) for inserting CEAs and is capable of reliably controlling reactivity changes to assure that under conditions of normal operation, including anticipated operational occurrences; specified acceptable fuel design limits are not

ARKANSAS NUCLEAR ONE
UNIT 2

exceeded. The CEAs can be mechanically driven into the core. The appropriate margin for stuck rods is provided by assuming in the analyses of anticipated operational occurrences that the highest worth CEA does not fall into the core.

The second system, the Chemical and Volume Control System (CVCS), using neutron absorbing soluble boron, is capable of reliably compensating for the rate of reactivity changes resulting from planned normal power changes (including xenon burnout) such that acceptable fuel design limits are not exceeded. This system is capable of holding the reactor subcritical under cold conditions.

Either system is capable of making the core subcritical from a hot operating condition and holding it subcritical in the hot standby condition.

Either system is able to insert negative reactivity at a rate sufficient to prevent exceeding acceptable fuel design limits as the result of a power change, i.e., the positive reactivity added by burnup of xenon.

CRITERION 27 - COMBINED REACTIVITY CONTROL SYSTEMS CAPABILITY

The reactivity control systems shall be designed to have a combined capability, in conjunction with poison addition by the Emergency Core Cooling System (ECCS), of reliably controlling reactivity changes to assure that under postulated accident conditions and with appropriate margin for stuck rods the capability to cool the core is maintained.

Response

The reactivity control systems which provide the means for making and holding the core subcritical under postulated accident conditions are discussed in Sections 9.3 and 4.3. Combined use of CEAs and chemical shim control by the CVCS provides the shutdown margin required for plant cooldown and long-term xenon decay, assuming the highest worth CEA is stuck out of the core.

During an accident, the safety injection system functions to inject concentrated boric acid into the RCS for long-term and short-term cooling and for reactivity control. Details of the system are given in Section 6.3.

CRITERION 28 - REACTIVITY LIMITS

The reactivity control systems shall be designed with appropriate limits on the potential amount and rate of reactivity increase to assure that the effects of postulated reactivity accidents can neither (1) result in damage to the RCPB greater than limited local yielding nor (2) sufficiently disturb the core, its support structures or other reactor pressure vessel internals to impair significantly the capability to cool the core. These postulated reactivity accidents shall include consideration of rod ejection (unless prevented by positive means), rod dropout, steam line rupture, changes in reactor coolant temperature and pressure, and cold water addition.

Response

The bases for CEA design include ensuring that the reactivity worth of any one CEA is not greater than a pre-selected maximum value. The CEAs are divided into two sets, a shutdown set and a regulating set, further subdivided into groups as necessary. Administrative

ARKANSAS NUCLEAR ONE
UNIT 2

procedures and interlocks ensure that only one group is withdrawn at a time (except for allowed overlap regions in the regulating groups), and that the regulating groups are withdrawn only after the shutdown groups are fully withdrawn. The regulating groups are programmed to move in sequence and within limits which prevent the rate of reactivity addition and the worth of individual CEAs from exceeding limiting values. See Sections 4.3 and 7.7.

The maximum rate of reactivity addition which may be produced by the CVCS is too low to induce any significant pressure forces which might rupture the RCPB or disturb the reactor vessel internals.

The RCPB (Chapter 5) and the reactor internals (Chapter 4) are designed to appropriate codes (refer for instance, to the response to Criterion 14) and will accommodate the static and dynamic loads associated with an inadvertent, sudden release of energy, such as that resulting from a CEA ejection or a steam line break, without rupture and with limited deformation which will not impair the capability of cooling the core.

CRITERION 29 – PROTECTION AGAINST ANTICIPATED OPERATIONAL OCCURRENCES

The protection and reactivity control systems shall be designed to assure an extremely high probability of accomplishing their safety functions in the event of anticipated operational occurrences.

Response

Plant conditions designated as Condition I and Condition II in ANS N18.2 have been carefully considered in the design of the RPS and the Reactivity Control Systems. Consideration of redundancy, independence and testability in the design, coupled with careful component selection, overall system testing, and adherence to detailed quality assurance, assure an extremely high probability that safety functions are accomplished in the event of anticipated operational occurrences.

3.1.4 FLUID SYSTEMS

CRITERION 30 – QUALITY OF REACTOR COOLANT PRESSURE BOUNDARY

Components which are part of the reactor coolant pressure boundary shall be designed, fabricated, erected, and tested to the highest quality standards practical. Means shall be provided for detecting and, to the extent practical, identifying the location of the source of reactor coolant leakage.

Response

The RCPB components have been designed, fabricated, erected and tested in accordance with the ASME Code Section III, and in conformance with the requirements of 10 CFR 50.55a. The RCPB was specified as "AEC Classification Group A" at the time the construction permit was granted. This classification corresponds to Quality Group A as defined in Regulatory Guide 1.26, issued March, 1972. System classification is discussed in Section 3.2.

Multiple and diverse means are provided for detecting and to the extent practical identifying the location of reactor coolant leakage. These methods include monitoring of the containment atmosphere, sump level and coolant inventory. Section 5.2.7 details these detection and identification methods.

ARKANSAS NUCLEAR ONE
UNIT 2

CRITERION 31 - FRACTURE PREVENTION OF REACTOR COOLANT PRESSURE
BOUNDARY

The RCPB shall be designed with sufficient margin to assure that when stressed under operating, maintenance, testing, and postulated accident conditions (1) the boundary behaves in a nonbrittle manner and (2) the probability of rapidly propagating fracture is minimized.

The design shall reflect consideration of service temperatures and other conditions of the boundary material under operating, maintenance, testing and postulated accident conditions and the uncertainties in determining (1) material properties, (2) the effects of irradiation on material properties, (3) residual, steady state and transient stresses, and (4) size of flaws.

Response

All the RCPB boundary components are designed and constructed in accordance with ASME Code Section III and comply with the test and inspection requirements of these codes. These test and inspection requirements assure that flaw sizes are limited so that the probability of failure by rapid propagation is extremely remote. Particular emphasis is placed on the quality control applied to the reactor vessel, on which tests and inspections exceeding ASME code requirements are performed. The tests and inspections performed on the reactor vessel are summarized in Section 5.4.

Excessive embrittlement of the reactor vessel material due to neutron radiation is prevented by providing an annulus of coolant water between the reactor core and the vessel. In addition, to minimize the effects of irradiation on material toughness properties on core beltline material, restrictions on upper limits for residual elements that directly influence the Nil Ductility Transition Temperature (NDTT) shift were required by the design specification for the deposited welds. Specifically, upper limits were placed on copper, phosphorous, sulfur and vanadium. The actual change in material toughness properties due to irradiation is verified periodically during plant lifetime by a material surveillance program conforming to the requirements of ASTM-E-185. Based on the reference Nil Ductility Temperature (NDT), operating restrictions will be applied as necessary to limit stresses. Fluence and fracture toughness aspects, in regards to the reactor vessel, are discussed in Section 4.3.3.3 and Section 5.2.4.

During normal startup for power operation, the reactor will not be made critical until the RCS temperature is 120 °F greater than the predicted NDTT based on plant records of fast neutron dose to the vessel. The stress criteria in Chapter 5 include the maximum loads associated with the most severe transients during emergency conditions at operating temperature. The operational restrictions that will be invoked will maintain the minimum temperature above NDTT +120 °F for reactor operation. This will assure that a reactivity induced loading which would contribute to elastic or plastic deformation cannot occur below a reactor operating temperature corresponding to NDTT +120 °F in this plant.

Adverse effects that could be caused by exposure of equipment or instrumentation to containment spray water is avoided by designing the equipment or instrumentation to withstand direct spray or by locating it or protecting it to avoid direct spray.

Actuation of the safety injection system will introduce highly borated water into the RCS at pressure significantly below operating pressures and will not cause adverse pressure or reactivity effects.

ARKANSAS NUCLEAR ONE
UNIT 2

The thermal stresses induced by the injection of cold water into the vessel have been examined. The test results and analysis have shown that there is no gross yielding across the vessel wall using the minimum specified yield strength in the ASME Code, Section III. The results of this study are given in the following Combustion Engineering (CE) reports:

- A. A-68-9-1, "Thermal Shock Analysis on Reactor Vessels Due to Emergency Core Cooling System Operation," March 15, 1968, submitted with Amendment 9 to the Maine Yankee PSAR, Docket No. 50-309.
- B. A-68-10-2, "Experimental Determination of Limiting Heat Transfer Coefficients During the Quenching of Thick Steel Plates in Water," Simon, J. J., Davis, M. W. and Tuppeny, W. H., Jr., December 13, 1968, submitted to the AEC in January 1969 and made a part of the public record.
- C. A-70-19-2, "Finite Element Analysis of Structural Integrity of a Reactor Pressure Vessel During Emergency Core Cooling," Ayres, D. J. and Siddal, W. F., January 1970, submitted to the AEC and made a part of the public record.

In addition, CE has completed a detailed analysis of crack arrest under thermal shock conditions. This study was submitted to the AEC as a Topical Report, CENPD-116, "Analysis of the Structural Integrity of CE Reactor Vessel subject to Emergency Core Cooling Conditions," September 1973.

CRITERION 32 - INSPECTION OF REACTOR COOLANT PRESSURE BOUNDARY

Components which are part of the RCPB shall be designed to permit (1) periodic inspection and testing of important areas and features to assess their structural and leak tight integrity, and (2) an appropriate material surveillance program for the reactor pressure vessel.

Response

Provisions have been made in the design for inspection, testing, and surveillance of the RCPB as required by ASME Code Section XI.

The reactor vessel surveillance program conforms with ASTM-E-185 and is compatible with proposed Appendix H to 10CFR50 as published in the Federal Register on July 3, 1971.

The details of the reactor surveillance program are given in Section 5.2.4.4. Sample pieces taken from the same shell plate material used in fabrication of the reactor vessel are installed between the core and the vessel inside wall. These samples will be removed and tested at intervals during vessel life to provide an indication of the extent of the neutron embrittlement of the vessel wall. Charpy tests will be performed on the samples to develop a Charpy transition curve. By comparisons of this curve with the Charpy curve and drop weight tests for specimens taken at the beginning of the vessel life, the change of NDTT will be determined and operating instructions adjusted as required.

ARKANSAS NUCLEAR ONE
UNIT 2

CRITERION 33 - REACTOR COOLANT MAKEUP

A system to supply reactor coolant makeup for protection against small breaks in the RCPB shall be provided. The system safety function shall be to assure that specified acceptable fuel design limits are not exceeded as a result of reactor coolant loss due to leakage from the RCPB and rupture of small piping or other small components which are part of the boundary. The system shall be designed to assure that for onsite electric power system operation (assuming off-site power is not available) and for off-site electric power system operation (assuming onsite power is not available) the system safety function can be accomplished using the piping, pumps and valves used to maintain coolant inventory during normal reactor operation.

Response

Reactor coolant makeup during normal operation is provided by the CVCS which includes three positive displacement charging pumps rated at 44 gpm each. The design incorporates a high degree of functional reliability by provision of redundant components (three pumps), and an alternate path for charging. The charging pumps can be powered from either onsite or off-site power sources, including the emergency diesel generators. The system is described in Section 9.3. It is not the function of the CVCS to provide protection against small breaks; this safety function is provided by the safety injection system. The CVCS does have the capability of replacing the flow loss to the containment for leaks in the reactor coolant piping up to 0.30-inch equivalent diameter with only one charging pump available. However, loss of this CVCS capability in no way compromises the safety of the reactor plant.

CRITERION 34 - RESIDUAL HEAT REMOVAL

A system to remove residual heat shall be provided. The system safety function shall be to transfer fission product decay heat and other residual heat from the reactor core at a rate such that specified acceptable fuel design limits and the design conditions of the RCPB are not exceeded.

Suitable redundancy in components and features, and suitable interconnections, leak detection, and isolation capabilities shall be provided to assure that for onsite electrical power system operation (assuming off-site power is not available) and for off-site electrical power system operation (assuming onsite power is not available) the system safety function can be accomplished, assuming a single failure.

Response

Residual heat removal capability is provided by the shutdown cooling system for reactor coolant temperature less than 275 °F. For temperatures greater than 275 °F, this function is provided by the steam generators. The design incorporates sufficient redundancy, interconnections, leak detection, and isolation, assuming failure of a single active component. Within appropriate design limits, either system will remove fission product decay heat at a rate such that specified acceptable fuel design limits and the design conditions of the RCPB will not be exceeded.

The Shutdown Cooling (SDC) System and the steam generator auxiliaries are designed to operate either from off-site power or from onsite power sources.

Further discussion is included in Chapter 9 for SDC and in Chapter 10 for the steam and power conversion system.

ARKANSAS NUCLEAR ONE
UNIT 2

CRITERION 35 - EMERGENCY CORE COOLING

A system to provide abundant emergency core cooling shall be provided. The system safety function shall be to transfer heat from the reactor core following any loss of reactor coolant at a rate such that (1) fuel and clad damage that could interfere with continued effective core cooling is prevented and (2) clad metal-water reaction is limited to negligible amounts.

Suitable redundancy in components and features, and suitable interconnections, leak detection, isolation, and containment capabilities shall be provided to assure that for onsite electrical power system operation (assuming off-site power is not available) and for off-site electrical power system operation (assuming onsite power is not available) the system safety function can be accomplished, assuming a single failure.

Response

Emergency core cooling is provided by the Safety Injection System (SIS) described in Section 6.3. The system is designed to provide abundant cooling water to remove heat at a rate sufficient to maintain the fuel in a coolable geometry and to assure that zirconium-water reaction is limited to a negligible amount (less than one percent). Detailed analysis has been performed to verify that the system performance is adequate to satisfy the new NRC Acceptance Criteria for ECCS for Light Water Reactors (10 CFR 50, Appendix K, January 4, 1974). Details of this analysis are provided in Section 6.3 and Chapter 15.

The system design includes adequate provisions to assure that the required safety functions are provided with single active failure of any component and with either onsite electrical power system operation or off-site electrical power system.

CRITERION 36 - INSPECTION OF EMERGENCY CORE COOLING SYSTEM

The ECCS shall be designed to permit appropriate periodic inspection of important components, such as spray rings in the reactor pressure vessel, water injection nozzles and piping to assure the integrity and capability of the system.

Response

Design provisions facilitate access to the critical parts of the reactor vessel internals, injection nozzles, pipes and valves for visual or nondestructive inspection.

The components outside the containment which include the pumps and shutdown cooling heat exchangers are accessible for leak tightness inspection during operation of the reactor. All valves, piping and the safety injection components located inside the containment may be inspected during refueling. Details of the inspection program for the reactor vessel internals are included in Section 5.2.8 and inspection of the SIS is discussed in Section 6.3.4.

CRITERION 37 - TESTING OF EMERGENCY CORE COOLING SYSTEM

The ECCS shall be designed to permit appropriate periodic pressure and functional testing to assure: (1) the structural and leak tight integrity of its components, (2) the operability and performance of the active components of the system, and (3) the operability of the system as a whole and, under conditions as close to design as practical, the performance of the full

ARKANSAS NUCLEAR ONE
UNIT 2

operational sequence that brings the system into operation, including operation of applicable portions of the protection system, the transfer between normal and emergency power sources, and the operation of the associated cooling water system.

Response

The ECCS (SIS) is provided with testing capability to demonstrate system and component operability. Testing can be conducted during normal plant operation with the test facilities arranged not to interfere with the performance of the systems or with the initiation of control circuits, as described in Section 6.3.4.

The SIS is designed to permit periodic testing of the delivery capability up to a location as close to the core as practical. Periodic pressure testing of the SIS to assure system integrity is possible using the cross connection to the charging pumps in the CVCS.

With the plant at operating pressure, operation of high pressure and low pressure safety injection pumps may be verified by recirculation back to the refueling water tank. This will permit verification of flow path continuity in the High Pressure Safety Injection (HPSI) lines and suction lines from the refueling water tank.

In addition, the low pressure safety injection pumps are used as shutdown cooling pumps during normal plant cooldown. The pumps discharge into the safety injection header via the shutdown cooling heat exchangers and the Low Pressure Safety Injection (LPSI) lines.

Borated water from the safety injection tanks may be bled through the drain header to verify flow path continuity from each tank to its associated safety injection header.

The operational sequence that brings the SIS into action, including transfer to alternate power sources, can be tested in parts as described in Sections 6.3, 7.3 and 8.3.

CRITERION 38 - CONTAINMENT HEAT REMOVAL

A system to remove heat from the reactor containment shall be provided. The system safety function shall be to reduce rapidly, consistent with the functioning of other associated systems, the containment pressure and temperature following any LOCA and maintain them at acceptably low levels.

Suitable redundancy in components and features, and suitable interconnections, leak detection, isolation, and containment capabilities shall be provided to assure that for onsite electric power system operation (assuming off-site power is not available) and for off-site electric power system operation (assuming onsite power is not available) the system safety function can be accomplished, assuming a single failure.

Response

The Containment Heat Removal System (CHRS), which consists of the Containment Spray System (CSS) and the Containment Cooling System (CCS), will reduce the post-accident containment pressure and temperature to a low level following an accident and maintain this low level thereafter. This is demonstrated by the post-accident containment pressure analysis.

ARKANSAS NUCLEAR ONE
UNIT 2

The two diverse systems are both designed with redundant components so that a single failure of a component of either system will not prevent the function from being fulfilled. Portions of the system may be isolated for leakage control. The containment heat removal systems may be operated from either onsite or off-site power supplies. The containment design capabilities, heat removal systems and isolation system are described in Section 6.2.

CRITERION 39 – INSPECTION OF CONTAINMENT HEAT REMOVAL SYSTEM

The containment heat removal shall be designed to permit appropriate periodic inspection of important components, such as the torus, sumps, spray nozzles, and piping to assure the integrity and capability of the system.

Response

The containment heat removal systems consist of the CSS and the CCS.

Performance testing of all active components of the CSS is accomplished as described in Criterion 40. During these tests, the equipment is visually inspected for leaks. Valves and pumps are operated and inspected after any maintenance to ensure proper operation.

The equipment, piping, valves, and instrumentation of the CCS are arranged so they can be visually inspected. The cooling units and associated piping are outside the concrete secondary shield around the RCS loops. Personnel can enter the containment periodically to inspect and maintain this equipment. Service water piping and valves outside the containment, except buried pipe, are inspectible at all times. Operational tests and inspections are performed prior to initial startup.

CRITERION 40 - TESTING OF CONTAINMENT HEAT REMOVAL SYSTEM

The containment heat removal system shall be designed to permit appropriate periodic pressure and functional testing to assure: (1) the structural and leaktight integrity of its components, (2) the operability and performance of the active components of the system, and (3) the operability of the system as a whole, and, under conditions as close to the design as practical, the performance of the full operational sequence that brings the system into operation, including operation of applicable portions of the protection system, the transfer between normal and emergency power source, and the operation of the associated cooling water system.

Response

The components of the containment heat removal systems are tested on a regular schedule as discussed in Section 6.2.2. The capability is provided to test under conditions as close to design as practical the full operational sequence that would bring the containment pressure reducing system into action just prior to the spray system isolation valves. Test of the transfer to alternate power sources is accomplished by use of a test switch in the control room. Indicating lights will show the source of power being used. The cooling units' service water supply is tested in accordance with Section 9.2.1.4.

Arrangements for testing the CSS components are described in Section 6.2. A test connection is provided for the air test of the spray nozzles and a line is provided for an operational test of the spray pumps by recirculating back to the refueling water tank.

ARKANSAS NUCLEAR ONE
UNIT 2

CRITERION 41 - CONTAINMENT ATMOSPHERE CLEANUP

Systems to control fission products, hydrogen, oxygen, and other substances which may be released into the reactor containment shall be provided as necessary to reduce, consistent with the functioning of other associated systems, the concentration and quality of fission products released to the environment following postulated accidents, and to control the concentration of hydrogen or oxygen and other substances in the containment atmosphere following postulated accidents to assure that containment integrity is maintained.

Each system shall have suitable redundancy in components and features, and suitable interconnections, leak detection, isolation, and containment capabilities to assure that for onsite electrical power system operation (assuming off-site power is not available) and for off-site electrical power system operation (assuming onsite power is not available) its safety function can be accomplished, assuming a single failure.

Response

The CSS serves to scrub most fission products from the containment atmosphere. The system is provided with the necessary redundancy and is designed to operate under post-accident conditions from either off-site or onsite power sources. Sections 6.2.2 and 6.2.3 evaluate the capability of this system to remove fission products. Containment cooling units also provide mixing of the containment atmosphere.

The generation of hydrogen in the containment following a LOCA has been evaluated in accordance with Regulatory Guide 1.7 and is presented in Section 6.2.5.3. Two hydrogen recombiners are provided (see Section 6.2.5). The recombiners are redundant and can be powered from either off-site or onsite electrical power.

Four 5,000 cfm containment recirculation fans were originally designed to ensure an even distribution of hydrogen and prevent local pockets of high hydrogen concentration from forming (see Section 6.2.5); however, these fans are not credited in any design basis accident or transient analysis and are not credited in the probabilistic risk assessment for accomplishing the hydrogen mixing function.

CRITERION 42 - INSPECTION OF CONTAINMENT ATMOSPHERE CLEANUP

The containment atmosphere cleanup systems shall be designed to permit appropriate periodic inspection of important components, such as filter frames, ducts, and piping to assure the integrity and capability of the systems.

Response

All critical parts of the containment atmosphere cleanup systems can be physically inspected. The components external to the containment can be inspected during reactor operation and the components inside the containment can be inspected during shutdown. Specific inspection programs are discussed in Section 6.2.3.4.

ARKANSAS NUCLEAR ONE
UNIT 2

CRITERION 43 - TESTING OF CONTAINMENT ATMOSPHERE CLEANUP SYSTEMS

The containment atmosphere cleanup systems shall be designed to permit appropriate periodic pressure and functional testing to assure (1) the structural and leaktight integrity of its components, (2) the operability and performance of the active components of the systems such as fans, filters, dampers, pumps, and valves and (3) the operability of the systems as a whole and, under conditions as close to design as practical, the performance of the full operational sequence that brings the systems into operation, including operation of applicable portions of the protection system, the transfer between normal and emergency power sources, and the operation of associated systems.

Response

Testing of the CSS and cooling units is as required by Criterion 40. Spray, cooling, purge, and hydrogen recombiner systems can be tested for integrity, operability, and performance under conditions which approximate design conditions as much as is practical. Detailed information concerning containment atmosphere cleanup systems is provided in Sections 6.2.2, 6.2.3, and 6.2.5.

CRITERION 44 - COOLING WATER

A system to transfer heat from structures, systems, and components important to safety, to an ultimate heat sink shall be provided. The system safety function shall be to transfer the combined heat load of these structures, systems and components under normal operating and accident conditions.

Suitable redundancy in components and features, and suitable interconnections, leak detection, and isolation capabilities shall be provided to assure that for onsite electrical power system operation (assuming off-site power is not available) and for off-site electrical power system operation (assuming onsite power is not available) the system safety function can be accomplished, assuming a single failure.

Response

Structures, systems and components important to safety are cooled by the Service Water system (SWS). The SWS is redundant with two 100 percent capacity trains and three 100 percent capacity pumps which can be operated either from off-site power or from onsite emergency power. The SWS consists of Seismic Category 1 and non-Seismic Category 1 portions. Non-Seismic Category 1 portions of the system are automatically isolated from the system upon receipt of a safety injection actuation signal. The ultimate heat sink for the SWS is either the Dardanelle Reservoir or the emergency cooling pond.

Process radiation monitors will indicate any leakage of reactor coolant into the SWS. The SWS is described and evaluated in Section 9.2.1.

CRITERION 45 - INSPECTION OF COOLING WATER SYSTEM

The cooling water system shall be designed to permit appropriate periodic inspection of important components, such as heat exchangers and piping, to assure the integrity and capability of the system.

ARKANSAS NUCLEAR ONE
UNIT 2

Response

The SWS is designed to permit the required periodic inspections of heat exchangers and piping. Three service water pumps are provided which serve the two system loops. The third pump can operate on either loop, allowing inspection and maintenance of a pump while maintaining redundant system capability.

CRITERION 46 - TESTING OF COOLING WATER SYSTEM

The cooling water system shall be designed to permit appropriate periodic pressure and functional testing to assure (1) the structural and leak tight integrity of its components, (2) the operability and the performance of the active components of the system, and (3) the operability of the system as a whole and, under conditions as close to design as practical, the performance of the full operational sequence that brings the system into operation for reactor shutdown and for LOCAs including operation of applicable portions of the protection system and the transfer between normal and emergency power sources.

Response

The SWS is designed to permit the required testing. See Section 9.2.1.4.

3.1.5 REACTOR CONTAINMENT

CRITERION 50 - CONTAINMENT DESIGN BASIS

The reactor containment structure, including access openings, penetrations and the containment heat removal system shall be designed so that the containment structure and its internal compartments can accommodate, without exceeding the design leakage rate and, with sufficient margin, the calculated pressure and temperature conditions resulting from any LOCA. This margin shall reflect consideration of: 1) the effects of potential energy sources which have not been included in the determination of the peak conditions, such as energy in steam generators and energy from metal-water and other chemical reactions that may result from degraded emergency core cooling functioning, 2) the limited experience and experimental data available for defining accident phenomena and containment responses, and 3) the conservatism of the calculational model and input parameters.

Response

The containment, including access openings and penetrations, has a structural design pressure of 59 psig and a design temperature of at least 300 °F. The electrical penetrations are qualified to design basis accident conditions. The greatest transient peak condition, associated with a postulated rupture of the piping in the RCS and the calculated effects of metal-water reaction, does not exceed these values. Additionally, the containment was subjected to an initial Structural Integrity Test (SIT) at 62 psig. Following the containment uprate, the containment was subjected to a second SIT to 68 psig which is 1.15 times the new design pressure, prior to start up following steam generator replacement outage 2R14.

Design pressure and associated conditions specified for the containment consider both blowdown, post-blowdown and long-term mass and energy releases resulting from postulated LOCA's. These design conditions include peak pressure margins and long-term design capability margins which envelop the accident performance predictions using established

ARKANSAS NUCLEAR ONE
UNIT 2

analytical methods and conservative assumptions. The design margins specified reflect an inherent containment capability which is demonstrated to exceed, at all times, the expected conditions during postulated LOCAs. Design margins are related to additional releases of reactor system energy not actually expected. These design margins are considered sufficient to envelop any remaining thermodynamic, geometric or accident phenomena effects currently considered in the containment design.

The cooling capacity of the CCS, CSS, and SIS is adequate to prevent overpressurization of the structure. Electric motors and valves which must function within the containment during accident conditions are designed to operate in a steam-air atmosphere at design basis accident conditions. Sections 6.2.2 and 15.1.13 describe the analyses and margin available.

CRITERION 51 - FRACTURE PREVENTION OF CONTAINMENT PRESSURE BOUNDARY

The reactor containment boundary shall be designed with sufficient margin to assure that under operating, maintenance, testing, and postulated accident conditions (1) its ferritic materials behave in a nonbrittle manner and (2) the probability of rapidly propagating fracture is minimized. The design shall reflect consideration of service temperatures and other conditions of the containment boundary material during operation, maintenance, testing, and postulated accident conditions, and the uncertainties in determining (1) material properties, (2) residual, steady state, and transient stresses, and (3) size of flaws.

Response

The details of provisions for sufficient margins of safety have been described in Section 3.8 and meet the requirements of this criterion.

Basically, two different levels in design basis have been evaluated to predict the performance and the capacity of the containment structure and its components: 1) the lower level is that needed to withstand design basis loads during the normal operating condition, and 2) the higher level is that needed to withstand the most severe design basis loads generated from natural phenomena or from postulated accident conditions.

A further level of conservatism results from the use of capacity reduction factors which derate components, elements or materials below the strength levels found by tests. The margins provided and the manner in which the materials are used provide assurance that the ferritic materials behave in a non-brittle manner and thus minimize the probability of a rapidly propagating brittle fracture. The ferritic penetration materials are selected and fabricated in accordance with the rules of the ASME Code as referenced in section 3.8. Other members and materials are selected and used on the basis of previous history of both testing and actual use for similar environments and load conditions of the containment structure.

The design reflects consideration of temperature extremes as well as service temperature and categories of plant conditions which include but are not limited to those required by this criterion. The method of providing design margins specifically and explicitly considers uncertainties as to material capabilities and predicted stresses.

ARKANSAS NUCLEAR ONE
UNIT 2

CRITERION 52 - CAPABILITY FOR CONTAINMENT LEAKAGE RATE TESTING

The reactor containment and other equipment which may be subjected to containment test conditions shall be designed so that periodic integrated leakage rate testing can be conducted at containment design pressure.

Response

The containment structure and equipment which will be subjected to containment test conditions are designed so that periodic Integrated Leakage Rate Tests (ILRTs) can be conducted at the containment design pressure, as required. Appropriate connection points, temperature, pressure, and humidity instrumentation, spare penetrations, air cooling and moving equipment, etc., are incorporated in the design to facilitate integrated leakage rate testing of the containment. Provisions to facilitate local leakage rate testing are discussed in response to Criterion 53. Additional discussions of the provisions for integrated leakage rate testing of the containment are in Section 6.2 and the Technical Specifications.

CRITERION 53 - PROVISIONS FOR CONTAINMENT TESTING AND INSPECTION

The reactor containment shall be designed to permit (1) appropriate periodic inspection of all important areas, such as penetrations, (2) an appropriate surveillance program, and (3) periodic testing at containment design pressure of the leak tightness of penetrations which have resilient seals and expansion bellows.

Response

The containment design permits Local Leak Rate Test (LLRT) inspection of penetrations and a surveillance program. The ability to test the penetrations is met by conformance to the criteria listed in Appendix J to 10 CFR 50. Electrical penetrations, the refueling transfer tube blind flange, personnel locks and equipment hatches have provisions for pressurizing between the double leak seals to design pressure. There are no piping system penetrations to the containment which require a bellow seal between the pipe and the containment.

The LLRT is described in Section 6.2 and the Technical Specifications.

CRITERION 54 - PIPING SYSTEMS PENETRATING CONTAINMENT

Piping systems penetrating primary reactor containment shall be provided with leak detection, isolation and containment capabilities having redundancy, reliability, and performance capabilities which reflect the importance to safety of isolating these piping systems. Such piping systems shall be designed with a capability to test periodically the operability of the isolation valves and associated apparatus, and to determine if valve leakage is within acceptable limits.

Response

The general design basis governing isolation valve requirements is: leakage through all fluid penetrations not serving accident consequence limiting systems is to be minimized by a double barrier so that no single, credible failure or malfunction of an active component can result in loss of isolation or intolerable leakage. The installed double barriers take the form of closed piping systems, both inside and outside the containment, and various types of isolation valves. See Section 6.2.4 for a detailed discussion of the Containment Isolation System (CIS).

ARKANSAS NUCLEAR ONE
UNIT 2

The Technical Specifications discuss the requirements to test periodically the operability of containment isolation valves and associated apparatus and the requirements for determining if valve leakage is within acceptable limits. Piping systems penetrating containment are designed with the capability to perform the functions required in the Technical Specifications.

CRITERION 55 - REACTOR COOLANT PRESSURE BOUNDARY PENETRATING
CONTAINMENT

Each line that is part of the RCPB and that penetrates primary reactor containment shall be provided with containment isolation valves as follows, unless it can be demonstrated that the containment isolation provisions for a specific class of lines, such as instrument lines, are acceptable on some other defined basis: (1) one locked closed isolation valve inside and one locked closed isolation valve outside containment; or (2) one automatic isolation valve inside and one locked closed isolation valve outside containment; or (3) one locked closed isolation valve inside and one automatic isolation valve outside containment. A simple check valve may not be used as the automatic isolation valve outside containment; or (4) one automatic isolation valve inside and one automatic isolation valve outside containment. A simple check valve may not be used as the automatic isolation valve outside containment.

Isolation valves outside containment shall be located as close to containment as practical and upon loss of actuating power, automatic isolation valves shall be designed to take the position that provides greater safety.

Other appropriate requirements to minimize the probability or consequences of an accidental rupture of these lines or of lines connected to them shall be provided as necessary to assure adequate safety. Determination of the appropriateness of these requirements, such as higher quality in design, fabrication, and testing, additional provisions for inservice inspection, protection against more severe natural phenomena, and additional isolation valves and containment, shall include consideration of the population density, use characteristics, and physical characteristics of the site environs.

Response

Penetration and valving design meets this criterion. Table 6.2-26 lists containment isolation valve information for each penetration. Valves covered by this criterion are defined in Section 6.2.4.

CRITERION 56 - PRIMARY CONTAINMENT ISOLATION

Each line that connects directly to the containment atmosphere and penetrates primary reactor containment shall be provided with containment isolation valves as follows, unless it can be demonstrated that the containment isolation provisions for a specific class of lines, such as instrument lines, are acceptable on some other defined bases: (1) one locked closed isolation valve inside and one locked closed isolation valve outside containment; or (2) one automatic isolation valve inside and one locked closed isolation valve outside containment; or (3) one locked closed isolation valve inside and one automatic isolation valve outside containment. A simple check valve may not be used as the automatic isolation valve outside containment; or (4) one automatic isolation valve inside and one automatic isolation valve outside containment. A simple check valve may not be used as the automatic isolation valve outside containment.

ARKANSAS NUCLEAR ONE
UNIT 2

Isolation valves outside containment shall be located as close to the containment as practical and upon loss of actuating power, automatic isolation valves shall be designed to take the position that provides greater safety.

Response

Valves which are covered by the above criterion are defined in Section 6.2.4. The following components have double resilient leakage seals and meet the requirements of the above criterion on an "other defined basis:" the refueling transfer tube blind flange, personnel locks, and equipment hatches. Penetration and valving information is given in Table 6.2-26. The penetration and valving design meet this criterion.

CRITERION 57 - CLOSED SYSTEM ISOLATION VALVES

Each line that penetrates primary reactor containment and is neither part of the RCPB nor connected directly to the containment atmosphere shall have at least one containment isolation valve which shall be either automatic, or locked closed, or capable of remote manual operation. This valve shall be outside containment and located as close to the containment as practical. A simple check valve may not be used as the automatic isolation valve.

Response

Penetration and valving design meet this criterion. Valves covered by the above criterion are defined in Section 6.2.4. Penetration and valving information is given in Table 6.2-26.

3.1.6 FUEL AND RADIOACTIVITY CONTROL

CRITERION 60 – CONTROL OF RELEASES OF RADIOACTIVITY MATERIALS TO THE ENVIRONMENT

The nuclear power unit design shall include means to control suitably the release of radioactive materials in gaseous and liquid effluents and to handle radioactive solid wastes produced during normal reactor operation, including anticipated operational occurrences. Sufficient holdup capacity shall be provided for retention of gaseous and liquid effluents containing radioactive materials, particularly where unfavorable site environmental conditions can be expected to impose unusual operational limitations upon the release of such effluents to the environment.

Response

The radioactive Waste Management Systems (WMSs), as described in Sections 11.2, 11.3, and 11.5, are designed to provide controlled handling and disposal of liquid, gaseous, and solid wastes. The systems are designed to ensure that the general public and plant personnel are protected against exposure to radioactive material as intended by 10 CFR 20 and 10 CFR 50, Appendix I.

All liquid and gaseous radioactive releases from the WMS are designed to be accomplished on a batch basis. All radioactive materials are sampled prior to release to ensure compliance with 10 CFR 20 and 10 CFR 50, Appendix I and to determine release rates. Radioactive materials which do not meet release requirements will not be discharged to the environment. The systems are designed with sufficient holdup capacity and flexibility for reprocessing of wastes to ensure that release limitations are met.

ARKANSAS NUCLEAR ONE
UNIT 2

The radioactive WMSs are designed to preclude the inadvertent release of radioactive material.

All storage tanks in the liquid waste and gaseous waste systems are administratively controlled to prevent the addition of waste to a tank which is being discharged to the environment. Each discharge path is provided with a radiation monitor which alerts plant personnel and initiates automatic closure of the appropriate isolation valve(s) to halt the release in the event of noncompliance with 10 CFR 20 (see Section 11.4 for details).

The plant design for handling of solid wastes is discussed in Section 11.5.

CRITERION 61 - FUEL STORAGE AND HANDLING AND RADIOACTIVITY CONTROL

The fuel storage and handling, radioactive waste, and other systems which may contain radioactivity shall be designed to assure adequate safety under normal and postulated accident conditions. These systems shall be designed (1) with a capability to permit inspection and testing of components important to safety, (2) with suitable shielding for radiation protection, (3) with appropriate containment, confinement, and filtering systems, (4) with a residual heat removal capability having reliability and testability that reflects the importance to safety of decay heat and other residual heat removal, and (5) to prevent significant reduction in fuel storage coolant inventory under accident conditions.

Response

The fuel storage facility meets Regulatory Guide 1.13 as discussed in Section 9.1. Inspection, testability, purification, and heat removal capability of the fuel storage and handling system is designed to meet Criterion 61 as described in Section 9.1. Adequate shielding is provided as discussed in Section 12.1. Most of the components and systems in this category are in frequent use and no special testing is required. Those systems and components important to safety which are not normally operating will be tested periodically, e.g., the fuel handling equipment (prior to each refueling).

The spent fuel storage racks are located to provide sufficient shielding water over stored fuel assemblies to limit radiation in working areas to no more than 2.5 mrem/hr during the storage period (100 hours after shutdown). The exposure time during refueling will be limited so that the integrated dose to operating personnel does not exceed the limits of 10 CFR 20.

The WMSs are designed to permit controlled handling and disposal of liquid, gaseous, and solid radioactive wastes which will be generated during operation. The principal design criterion is to ensure that plant personnel and the general public are protected against exposure to radiation from wastes as discussed in Chapters 11 and 12.

The spent fuel pool and waste management equipment are located in restricted areas of the auxiliary building. These areas provide confinement capability in the event of an accidental release of radioactive materials. All components important to safety in these functions are designed and located to permit periodic inspection as required and are tested in accordance with accepted codes and standards.

Analysis has indicated that the accidental release of the maximum activity content of a gas decay tank will not result in doses in excess of the guidelines of 10 CFR 100 (see Chapter 15).

ARKANSAS NUCLEAR ONE
UNIT 2

Cooling for the spent fuel pool is designed to prevent damage to the fuel in storage facilities that could result in radioactivity release to the plant operating areas or the public environs.

The spent fuel pool is designed to withstand the postulated missiles and seismic events without loss of the pool water or damage to stored fuel.

CRITERION 62 – PREVENTION OF CRITICALITY IN FUEL STORAGE AND HANDLING

Criticality in the fuel storage and handling system shall be prevented by physical systems or processes, preferably by use of geometrically safe configuration.

Response

The new fuel storage rack, spent fuel storage rack, and associated handling equipment are designed with physical spacing, restraints, and interlocks to maintain a subcritical array during flooding with non-borated water under all design loading conditions including a Design Basis Earthquake (DBE) as discussed in Section 9.1.

CRITERION 63 - MONITORING FUEL AND WASTE STORAGE

Appropriate systems shall be provided in fuel storage and radioactive waste systems and associated handling areas (1) to detect conditions that may result in loss of residual heat removal capability and excessive radiation levels and (2) to initiate appropriate safety actions.

Response

New fuel is stored in a dry pit in which no credible conditions exist which could cause excessive radiation levels.

Failure of the spent fuel pool cooling system or high radiation would cause annunciation of alarms. Through appropriate operator action, backup spent fuel residual heat removal can be provided by flooding with water from the refueling water tank (see Section 9.1.3). Normal radiation control precautions and corrective action will take place following a high radiation alarm.

Heat generated in the waste storage facilities does not require a heat removal system. The gas analyzer and radiation monitors associated with waste system equipment and storage areas are equipped with appropriate indication and alarms to allow automatic and/or operator corrective action in the event of high radiation levels.

CRITERION 64 - MONITORING RADIOACTIVITY RELEASES

Means shall be provided for monitoring the reactor containment atmosphere, spaces containing components for recirculation of LOCA fluids, effluent discharge paths, and the plant environs for radioactivity that may be released from normal operations, including anticipated operational occurrences, and from postulated accidents.

ARKANSAS NUCLEAR ONE
UNIT 2

Response

Means are provided as described in Sections 11.4 and 12.1.4 to monitor the containment environment. This includes an air particulate detector, a gaseous monitor, and high level area monitors. Spaces containing components for recirculation of LOCA fluids are monitored via the penetration rooms ventilation described in Section 6.5.

All effluent discharge paths are monitored. This includes the containment purge system described in Section 11.4, the liquid and gaseous waste process systems described in Sections 11.2 and 11.3, and the plant ventilation system described in Section 12.2.

Monitoring of radioactivity releases is designed such that Criterion 60 and Appendix 1 to 10 CFR 50 are met. Means are provided for monitoring the plant environs as described in Section 11.6.

3.2 CLASSIFICATION OF STRUCTURES, COMPONENTS AND SYSTEMS

This section provides a guide to the method of classification of structures, components and systems of Unit 2. The method used recognizes the need to establish relationships to criteria, philosophy, codes, and regulations which must be met in order to give assurance that a quality product will result. In this regard, it is recognized that during the design and construction of Unit 2, significant industrial and regulatory action has been taken to establish common and agreed upon methods of classification, i.e. Regulatory Guides 1.26 and 1.29. These methods define two groups of classifications: (1) the seismic classification of structures, systems and components; and (2) the system quality group classification for pressure containing components of fluid systems.

The basic approach used in the classification method (Table 3.2-1) is to first categorize structures, systems and components in two categories, Category 1 and Category 2, depending upon whether an item is safety-related or not. Then in the case of fluid systems, components are grouped into four Quality Groups: A, B, C, and D. Generally, A, B, and C are in Category 1 and D is in Category 2. There are, however, numerous examples of Unit 2 Category 2 equipment which are designed to Quality Group B and C standards. Components of the fuel pool system, the quench tank and the tube side of the letdown heat exchanger are some examples. All components grouped in A are Category 1. See Tables 3.2-2 and 3.2-3 for a detailed listing. The slight variance from the correlations made in Table 3.2-1 is a result of compliance with the intent of Regulatory Guides 1.26 and 1.29.

The codes and standards used to define the Unit 2 Quality Groups changed due to new rulemaking and code changes. The codes used for each Quality Group component category are divided as to date of purchase, before or after July, 1971. For components purchased after July, 1971 the codes used are those specified by 10CFR50 and Regulatory Guide 1.26. A guide used for components purchased before July, 1971 was "Summary of Codes and Standards for Components of Water Cooled Nuclear Power Units" which was submitted to Unit 2 by the AEC and is incorporated in Amendment 4 to the Unit 2 PSAR.

Table 3.2-6 maintains the Q-list of safety-related structures, systems, and components required to be within the scope of the Quality Assurance Program Manual (QAPM).

3.2.1 SEISMIC CLASSIFICATION

3.2.1.1 Definitions

Seismic Category 1 structures, components, and systems are defined in accordance with Regulatory Guide 1.29 as those necessary to assure:

- A. the integrity of the Reactor Coolant Pressure Boundary (RCPB);
- B. the capability to shut down the reactor and maintain it in a safe shutdown condition; and
- C. the capability to prevent or mitigate the consequences of accidents that could result in potential off-site doses comparable to the guideline doses of 10 CFR 100.

Category 1 structures, components, and systems are designed to withstand the appropriate seismic loads of the DBE as discussed in Section 3.7, Seismic design, and other applicable loads without loss of function. Category 1 structures are sufficiently isolated or protected from other structures to ensure that their integrity is maintained at all times.

ARKANSAS NUCLEAR ONE
Unit 2

Those structures, systems and components which are not Seismic Category 1 are designated Seismic Category 2. The failure of Seismic Category 2 structures, systems or components may interrupt power generation, but will not reduce the function of Category 1 structures, systems or equipment to an unacceptable safety level. For a more complete discussion, see Section 3.7.2.

3.2.1.2 Seismic Classifications

Table 3.2-2 provides a listing of structures, components, and systems and identifies those which are Seismic Category 1.

Where only portions of systems are identified as Seismic Category 1 in this table, the boundaries of the Seismic Category 1 portions of the system are shown on the piping and instrument diagrams in appropriate sections of this report (see Table 1.7-2). The above seismic classifications meet the intent of Regulatory Guide 1.29. The two dissimilarities with the regulatory position on Category 1 systems are cooling to the spent fuel pool and the reactor coolant pumps. The spent fuel pool cooling system is Category 2, however there is a Seismic Category 1 makeup path and source provided to the pool. Cooling water supplied to the reactor coolant pumps is not Category 1 since operability of the pumps is not relied upon to perform a safety function. Therefore the seismic classifications are in compliance with Regulatory Guide 1.29 except as noted above.

3.2.2 SYSTEM QUALITY GROUP CLASSIFICATION

This section provides the system quality group classification for each fluid system pressure containing component. Components are classified according to safety-related importance as dictated by service and functional requirements and by the consequences of failure. The design, fabrication, inspection, and testing requirements fixed for each classification provide the required degree of conservatism in assuring pressure integrity.

3.2.2.1 Code Requirements

The design bases for those systems that do not meet the strict definitions of Regulatory Guide 1.26 were established prior to issuance of revised codes and standards and Regulatory Guide 1.26. However, the design specifications for systems and components that were designed and built to codes and standards, outside Regulatory Guide 1.26 definitions, specified additional quality assurance and nondestructive testing requirements and have met the intent of these documents considering the date of component design and purchase.

Codes and standards used for components signify and specify design and quality assurance requirements. The codes and standards applicable to each quality group are given in Table 3.2-4.

Table 3.2-5 separately lists equipment from Tables 3.2-2 and 3.2-3 which were not designed and built to the exact codes and standards specified in Regulatory Guide 1.26. Table 3.2-5 also briefly summarizes salient NDT and Quality Assurance requirements imposed by individual equipment design specifications.

3.2.2.2 Quality Group Classifications

Equipment quality group classifications are indicated in Table 3.2-3. System quality group classifications and interfaces between classification in systems with components of different classifications are indicated on the system piping and instrumentation diagrams (see Table 1.7-2). Quality groups are classified according to the intent of Regulatory Guide 1.26 (Quality Groups B, C, and D) and 10 CFR 50.55a (Quality Group A).

3.3 WIND AND TORNADO LOADINGS

Seismic Category 1 structures were designed for the most severe local wind phenomena and tornado effects which can be expected to occur at the site (see Section 2.3). These structures are identified in Table 3.3-1. The refueling water tank is a Seismic Category 1 component not required for safe shutdown after a tornado and was designed for wind loadings as described in Section 3.3.1.1. below. Considerations of tornado loadings on the structural steel framing over the spent fuel pool area are discussed in Section 3.8.4.1.1.

3.3.1 WIND LOADINGS

Wind loadings for all Seismic Category 1 structures have been selected on the basis of ASCE Paper No. 3269, "Wind Forces on Structures." However, these wind loadings acting on the Seismic Category 1 structures produced forces which were less critical than those produced by the tornado loadings. Therefore, tornado loadings governed the design.

3.3.1.1 Design Wind Velocity

The design wind velocity for the refueling water tank was 80 mph at 44 feet, 9 inches above ground for a 100-year recurrence interval. For all other Category 1 structures, tornado loadings governed the design (see Section 3.3.2).

3.3.1.2 Basis for Wind Velocity Selection

The "fastest mile of wind" at the plant site is 67 mph, according to Figure 1(b) of Reference 45. For additional conservatism, the margin of safety was increased by using a ground level wind of 80 mph.

3.3.1.3 Vertical Velocity Distribution and Gust Factor

The design wind velocity of 80 mph included a gust factor of 1.1 for the total 44 feet, 9 inches height of the refueling water tank.

3.3.1.4 Determination of Applied Forces

The method used to translate the wind velocity into applied forces for the refueling water tank was based on wind pressure coefficients shown in Table 4(f) of Reference 45. For Category 1 structures which were designed for tornado loading, the applied forces due to wind were calculated to determine if they were less severe than the applied forces due to tornado loadings. The applied tornado force magnitude and distribution were determined as discussed in Section 3.3.2.2 below. Appropriate stress levels and load factors discussed in Section 3.8 were considered in determination of the governing loads.

3.3.2 TORNADO LOADINGS

3.3.2.1 Applicable Design Parameters

Tornado protected Seismic Category 1 structures were analyzed for tornado loadings not coincident with any unrelated accident condition or earthquake.

ARKANSAS NUCLEAR ONE
Unit 2

For Seismic Category 1 structures, designed to withstand tornadoes and tornado generated missiles, the following three parameters were applied in combinations to produce the most critical conditions.

A. Dynamic Wind Pressure

The dynamic wind pressure is caused by a tornado funnel having a peripheral tangential velocity of 300 mph and a forward progression of 60 mph. The tornado resistant design of the ANO Units was completed prior to the issuance of Regulatory Guide 1.76. As a result, the radius of maximum rotational speed is not significant to the ANO design, and Category I structures were designed considering a uniform pressure resulting from the 300 mph wind velocity (Reference 0CAN059609), except for casks which are governed by Holtec HI-Storm and VSC-24 CFSARs. The applicable portions of wind design methods described in ASCE Paper No. 3269 (Reference 45) were used, particularly for shape factors. The provisions for gust factors and variation of wind velocity with height were not applied.

B. Pressure Differential

The structure interior bursting pressure is taken as rising 1 psi/sec for three seconds, followed by a 2-second calm, then decreasing at 1 psi/sec for three seconds. This cycle accounted for reduced pressure in the eye of a passing tornado. All fully enclosed Seismic Category 1 structures were designed to withstand the full 3 psi pressure differential. A failure mode analysis of safety-related structures for the maximum pressure differential change with time is not normally performed. No such analysis was performed for Unit 2. The degree of conservatism in the design of safety-related structures is assured by the inherent margin of safety provided in the allowable stress values given in the applicable codes and standards listed in Sections 3.8.1.2.1 and 3.8.4.2.1.

C. Missile Impingement

Three types of tornado missiles were considered. Each type was considered to act independently, with only one type occurring at any one time. The three types of missiles are as follows:

1. A wood plank, 4"x12" in cross section, weighing 108 pounds, traveling end on at a speed of 300 mph and striking the structure at any elevation.
2. A steel pipe, schedule 40, 3"x10' long, weighing 75.8 pounds, traveling end on at 100 mph and striking the structure at any elevation.
3. An automobile of 4,000-pound weight, striking the structure at 50 mph on a contact area of 20 square feet, any portion of the impact area being not more than 25 feet above grade.

3.3.2.2 Determination of Forces on Structures

Tornado loads were applied to the Seismic Category 1 structures in the same manner as the wind loads described in Section 3.3.1.4 with the exception that gust factor and variation of wind velocity with height did not apply. The load combinations and involving tornadoes are given in Section 3.8.

ARKANSAS NUCLEAR ONE
Unit 2

The load factor selected for tornado loadings was 1.0, based on the short duration of the loading condition, and the degree of conservatism in the selection of design tornado velocity.

3.3.2.3 Ability of Seismic Category 1 Structures to Perform Despite Failure of Structures Not Designed for Tornado Loads

Failure of Category 2 structures is not expected to affect the ability of Seismic Category 1 structures to perform their functions for the following reasons:

- A. Tornado missiles that may be formed by the failure of Category 2 structures will not exceed the force of those postulated and described in Section 3.3.2.1, against which Seismic Category 1 structures were designed.
- B. An investigation of the structural frame of the Category 2 turbine building in the vicinity of the auxiliary building showed it will not collapse when subjected to tornado loadings, assuming that one-third of the exterior metal siding would be exposed to the full tornado load. The structural steel framing enclosing the auxiliary building spent fuel pool area has also been checked for the same conditions, with the same results. This condition is commonly observed in tornado damage. The fasteners are known to be much weaker in shear and in pull out than the continuous sheet acting as a catenary. Therefore, in the event of a tornado, the fasteners on the two ends of the sheet can be expected to fail and the sheathing assumed to remain balanced and restrained by the central portion of the panel against the girts.

3.4 WATER LEVEL (FLOOD) DESIGN

Seismic Category 1 structures were designed to protect safety-related equipment from external flooding.

3.4.1 FLOOD ELEVATIONS

Flood elevations are discussed in Sections 2.4.2, 2.4.3 and 2.4.4, and expected groundwater elevation in Section 2.4.13. All Seismic Category 1 structures have been designed to resist buoyancy and hydrostatic pressure using the design flood elevation of 361 feet.

3.4.2 PHENOMENA CONSIDERED IN DESIGN LOAD CALCULATIONS

(see Section 2.8.1.1)

3.4.3 FLOOD FORCE APPLICATION

(see Section 2.8.1.2)

3.4.3.1 Consideration of Hydrostatic Pressures

Seismic Category 1 structures and component parts were designed for the hydrostatic forces due to the PMF.

A triangular hydrostatic pressure diagram was used in the wall design and a uniform hydrostatic load application was used in the base and cover slab designs.

The effects on the containment structure were considered in accordance with the load factors and loading combinations stated in Section 3.8.1.3.

3.4.3.2 Stability of Structures Against Buoyancy

Uplift forces during the PMF were accounted for in the design of structures. The calculated minimum factor of safety against buoyancy for structures during the PMF condition was 1.25.

3.4.3.3 Effect of Wave Action

Based on the conditions described in Section 3.4.2, and by the use of the Minikin Method for computing wave forces as detailed in the Corps of Engineers' Technical Report No. 4, "Shore Protection Planning and Design," the maximum wave force at the face of the wall was computed to be less than five kips per foot at the wall support. Seismic Category 1 structures have exterior concrete walls a minimum of two feet thick at this elevation with sufficient strength to resist this wave force.

3.4.4 FLOOD PROTECTION

Seismic Category 1 structures were designed for the PMF (see Section 2.4.3 for a description of the bases for the flood protection criteria). All Category 1 systems and equipment susceptible to the effects of flooding are either located above Elevation 369 feet to protect against splash, or are protected up to flood Elevation 361 feet by the following measures:

ARKANSAS NUCLEAR ONE
Unit 2

- A. Wall thicknesses in Seismic Category 1 structures below flood level were provided a minimum of two feet with certain exceptions, which have been evaluated to ensure their design is adequate to withstand the hydrostatic forces associated with external flooding.
- B. Potential flood paths through construction joints are addressed through the use of waterstops or other seal materials to maintain the required flood protection for Class 1 structures.
- C. The number of openings in walls and slabs below flood level was kept to a minimum.
- D. Watertight doors, watertight equipment hatches, and flood seals were installed as required. Various materials may be employed to seal passive penetrations, including silicone-based, cementitious-based, and urethane-based materials, along with mechanical/compression sealing or boot seals.

Additional specific provisions for flood protection include administrative procedures to assure that all watertight doors will be locked closed in the event of a flood warning. If local seepage occurs through the walls, it will be controlled by sumps and sump pumps.

As discussed in Section 2.4.14, an extremely unusual occurrence of flood levels approaching Elevation 354 feet would take from two days to several weeks to develop. This would allow ample lead time to perform necessary emergency actions for all accesses which need to be protected. These actions will be implemented in accordance with abnormal operating procedures for natural emergencies ([see Section 2.8.1.2](#)).

The watertight doors were assembled complete with coaming and hydrostatically tested prior to shipment. All watertight doors were shop tested to a pressure equivalent to 27 feet of water which corresponds to the highest head of water above the lowest exposed watertight door during the design flood. The doors were then dogged down, crated and shipped as a complete unit. The door coaming was seal welded to the frame and the weld was tested by the liquid penetrant method. Section 2.4.14 discusses shutdown bases.

Note: The above paragraph is considered obsolete. New watertight doors are purchased in accordance with current design documents which require that watertight doors be designed and fabricated to withstand the applicable pressure due to the design flood with a safety factor of 1½ (Table 3.2-6, Item 6.6, lists the purchase specifications for watertight doors which document these requirements).

The high quality concrete used in the containment structure, with compressive membrane stresses, was considered practically waterproof. In addition, the duration of water pressure on the 3-foot, 9-inch thick wall was not expected to be more than a few days. As a secondary precaution, a drainage system was installed behind the liner plate up to flood level and pressure would be released by drainage to the tendon gallery which in turn would drain to the auxiliary building sump.

During the PMF, the distance between the plant and nearest high ground is never more than 2,000 feet. Only a limited number of inspection and maintenance personnel will be required during a flood; heavy equipment will not be required. Access to the plant would be by vehicle, boat, and/or helicopter, depending upon flood level conditions. Passageways from the administration building and/or central support building above flood level provide access to all Seismic Category 1 equipment in the auxiliary building and in the containment.

3.4.4.1 Seepage Into Seismic Category 1 Buildings

Seepage into Seismic Category 1 buildings can be expected to occur via the following:

- A. Through Seismic Category 1 structure walls;
- B. Cracks in the concrete; and
- C. Water stops at construction joints.

The seepage through a two feet thick wall is calculated using Darcy's equation $Q = KA (\Delta h/l)$. The permeability factor (K) used is $10E-12$ feet/second. This value was obtained from Troxell based on a conservative evaluation of the concrete properties. Using the above factor, a conservative seepage rate of $2.2E-10$ cu-feet/second per square foot of wall is calculated. At this low seepage rate, the water would evaporate before it would accumulate.

A significant crack in the concrete or a faulty water stop to a construction joint is not likely to occur. However, assuming either one to the present, the method of analysis is to consider it as a reservoir draining through a pipe. On this basis, Bernoulli's equation may be used in calculating the flow. Using a 1/32-inch wide smooth opening, a flow rate of $0.49E-4$ cubic foot/second per foot of crack length is obtained. This value is extremely conservative since it does not account for the roughness of the concrete, the possible impending effect of the lime leached out of the concrete nor the reduction in crack width as it tapers down to an uncracked section. Since the estimated rate of flow is very low, it can easily be accommodated by the building sump system.

3.4.4.2 Sumps and Sump Pumps Inside Seismic Category 1 Buildings

The sumps and sump pumps located inside Seismic Category 1 buildings include the following:

- A. Containment sump;
- B. Auxiliary building sump and sump pumps;
- C. Regenerative waste holdup tank room sump and sump pumps;
- D. Auxiliary building chiller and pipeway area sumps and sump pumps.
- E. Emergency diesel fuel storage vault sump and sump pump.

3.4.4.2.1 Containment Building Sump

The containment sump is designed to collect all equipment and flow drainage and system leakages within the containment. The liquid collected in the sump is drained by gravity into the auxiliary building sump described in Section 3.4.4.2.2. Redundant isolation valves which close on CIS are provided in the drain line to maintain the containment integrity during the unlikely event of a Design Basis Accident (DBA). The containment sump level is monitored in the control room by an indicator and high level alarm.

ARKANSAS NUCLEAR ONE
Unit 2

Reactor cavity drainage must limit retention of sump inventory in post-accident conditions, but also must prevent flooding of the reactor vessel cavity. A 10 inch diameter drain path with a check valve exists to prevent thermal shocking of the reactor vessel. The drain is integral with the personnel hatch for accessing the reactor vessel cavity. This arrangement will drain excess water in the reactor cavity to the containment building sump and also inhibit water from entering the cavity from the containment building floor area. Such conditions could be the result of an open leak such as a service water or chilled water system pipe break.

3.4.4.2.2 Auxiliary Building Sump and Sump Pumps

The auxiliary building sump is designed to handle the equipment drainage, leakage and possible seepage through the walls into the auxiliary building and the drainage from the containment sump. The auxiliary building sump has a capacity of approximately 1,130 gallons and is equipped with two sump pumps, each with a design capacity of 75 gpm. Sump and sump pump capacity is based on five minutes flow of waste through one 4-inch diameter drain pipe at the rate of 70 gpm. If waste liquid flow volume is greater, the standby pump will start. A sump level indicator and alarm are located in the control room.

3.4.4.2.3 Regenerative Waste Holdup Tank Room Sump and Sump Pump

The regenerative waste holdup tank room sump and sump pump are designed to contain the leakage and accidental release or overflow of the waste liquid inside the tank room.

The waste liquid collected in the sump is pumped back into one of the three holdup tanks in the room at the rate of 25 gpm. The sump pump is designed for submerged operation so that the waste liquid can be removed even if failure of one of the tanks occurred. The pump is controlled by a local level switch.

As shown in Table 3.4-2, the sump and sump pump are Quality Group D and Seismic Category 2. This portion of the Unit 2 Auxiliary Building is not protected from external flooding events. There is no safety-related equipment located in this portion of the auxiliary building and therefore sump level monitoring and level indication in the control room are not required.

3.4.4.2.4 Auxiliary Building Chiller and Pipeway Area Sumps and Sump Pumps

The auxiliary building chiller and pipeway area sumps are designed to collect liquid from local drainage, equipment leakage and periodic washdown. The liquid is uncontaminated. The pumps are designed for 25 gpm and are controlled by level switches mounted on the pumps.

As shown in Table 3.4-2, the sumps and sump pumps are Quality Group D and Seismic Category 2. This portion of the Unit 2 Auxiliary Building is not protected from external flooding events. There is no safety-related equipment located in this portion of the auxiliary building and therefore sump level monitoring and level indication in the Control Room are not required.

3.4.4.2.5 Emergency Diesel Fuel Storage Vault Sump and Sump Pump

Each emergency diesel fuel storage tank vault has a sump which in turn is connected to a main sump equipped with a sump pump. The pump is designed for 15 gpm.

As shown in Table 3.4-2, the sump and sump pump are Seismic Category 2. A level switch in the sump annunciates a high level alarm in the Control Room.

ARKANSAS NUCLEAR ONE
Unit 2

3.4.4.2.6 Safety Evaluation

As indicated in Section 3.4.4.1, the seepage into the Seismic Category 1 buildings is of such minute quantity that the failure of the sump pumps would have no adverse effect on the flood protection of the buildings.

The only sump pumps that are discharging liquid outside of Seismic Category 1 buildings are the auxiliary building chiller and pipeway area sump pumps and the emergency diesel fuel storage vault sump and sump pump. The discharge lines are furnished with backflow valves to prevent backflow of liquid from the outside into the building. The other sump pumps discharge the waste liquid into holdup tanks within the Seismic Category 1 buildings.

3.4.4.3 Local Probable Maximum Precipitation

All Seismic Category 1 structures and safety-related systems and components susceptible to the effects of flooding are protected against flooding due to a sudden local (10 square miles or less) probable maximum storm, which could happen without advance warning. There are a total of five doors and three hatches in the Seismic Category 1 structures located at places and elevations where ponded water could conceivably enter. All of the doors are equipped with intrusion alarms monitored in the control room and are normally closed. Administrative procedures require that these doors must be closed and remain closed during local flood conditions. The containment equipment hatch and the emergency escape hatch are located at Elevation 357 feet. Since it would take several hours for ponded water to reach this elevation, and since the same administrative procedures applicable to the doors also apply to the hatches, ample time is available to secure these hatches. The tendon gallery escape hatch is at Elevation 355 feet and is normally closed. It is spring loaded to assist personnel egress, but is designed to remain closed under the weight of the hatch.

ARKANSAS NUCLEAR ONE
Unit 2

3.5 MISSILE PROTECTION

Missile protection criteria for the facilities conform to 10 CFR 50 General Design Criterion 4, "Environmental and Missile Design Bases." Protection against the missiles identified in Section 3.5.2, Missile Selection, is provided to fulfill the following design criteria.

A. Reactor Coolant Pressure Boundary Missiles

A missile generated from a loop in the Reactor Coolant System (RCS) pressure boundary will not cause:

1. loss of integrity to another loop of the reactor coolant pressure boundary;
2. loss of integrity of the containment liner; or
3. loss of integrity of the main stream or feedwater system.

It will not cause loss of function to systems required to mitigate the consequences of the postulated Loss of Coolant Accident (LOCA) assuming the failure of single active component. These systems are:

1. Containment Spray System (CSS) (Section 6.2.2, 6.2.3);
2. Containment Cooling System (CCS) (Section 6.2.2);
3. Penetration Rooms Ventilation System (Section 6.5);
4. Containment Isolation System (CIS) (Section 6.2.4);
5. Combustible gas control systems (Section 6.2.5);
6. Safety Injection System (SIS) (Section 6.3);
7. Control room habitability systems (Section 6.4);
8. Reactor Protective System (RPS) (Section 7.2) and safety-related display instrumentation for reactor protection trip parameters (Section 7.5);
9. Engineered Safety Features Actuation System (ESFAS) (Section 7.3) and safety-related display instrumentation for Engineered Safety Features (ESF) actuation parameters (Section 7.5) required for operation of other listed systems;
10. The onsite power system including generators, batteries, and distribution systems (Section 8.3) and the diesel fuel oil (Section 9.5.4), cooling water (Section 9.5.5), starting (Section 9.5.6) and lubrication (Section 9.5.7) systems;
11. Portions of the Service Water System (SWS) required for operation of other listed systems (Section 9.2.1); and,
12. Air conditioning cooling and ventilation systems required for operation of other listed systems (Section 9.4).

ARKANSAS NUCLEAR ONE
Unit 2

B. Main Steam and Feedwater Missiles

A missile generated from the main steam or main feedwater pump discharge pressure boundary will not cause:

1. Loss of integrity to the Reactor Coolant Pressure Boundary (RCPB);
2. Loss of integrity to unisolable main steam or feedwater piping in the other loop; or
3. Loss of integrity to the containment liner or CIS (Section 6.2.4), if the missile is generated inside containment.

It will not cause loss of function to systems required to mitigate the consequences of a steam or feedwater line break accident assuming the failure of a single active component. These systems are:

1. CSS (Section 6.2.2) and CCS (Section 6.2.2), if the missile is generated inside containment;
2. SIS (Section 6.3);
3. The RPS (Section 7.2) and safety-related display information for reactor protection trip parameters (Section 7.5);
4. ESFAS (Section 7.3) and safety-related display instrumentation for engineered safety features actuation parameters (Section 7.5) required for operation of other listed systems;
5. The onsite power system including generators, batteries, and distribution systems (Section 8.3) and diesel fuel (Section 9.5.4), cooling water (Section 9.5.5), starting (Section 9.5.6) and lubrication (Section 9.5.7) systems;
6. Portions of the SWS required for operation of other listed systems (Section 9.2.1); and
7. Air conditioning cooling and ventilation systems required for operation of other listed systems (Section 9.4).

It shall not cause loss of function to the systems required to maintain the plant in a hot shutdown condition assuming the failure of a single active component. These systems are:

1. Pressurizer heaters (Section 5.5) and controls (Section 7.7) as required for hot shutdowns;
2. CCS (Section 6.2.2);
3. Actuation systems (Section 7.4) and safety-related display instrumentation for hot shutdown control parameters (Section 7.5) for other listed systems.

ARKANSAS NUCLEAR ONE
Unit 2

4. The onsite power system including generators, batteries and distribution systems (Section 8.3), and the diesel fuel oil (Section 9.5.4), cooling water (Section 9.5.5), starting (Section 9.5.6) and lubrication (Section 9.5.7) systems;
5. Portions of the SWS (Section 9.2.1) required for operation of other listed systems;
6. Air conditioning, cooling and ventilation systems required for operation of other listed systems (Section 9.4);
7. Main steam supply to the turbine driven auxiliary feedwater pump and the power operated dump valves (Section 10.3); and,
8. The Emergency Feedwater (EFW) System (Section 10.4.9) and the service water supply to the pump suction.

A missile generated from the main steam or main feedwater pump discharge pressure boundary will not cause loss of function to the systems required to cool down the plant to at or near ambient conditions. These systems are:

- 1-8. Same as 1 through 8 above for hot shutdown;
9. The Shutdown Cooling (SDC) System (Section 9.3.6); and,
10. The Chemical and Volume Control System (CVCS) components required to increase boron concentration for cold shutdown (Section 9.3.4).

C. Internal Missiles Other Than Reactor Coolant, Main Steam or Feedwater

A missile generated from any plant system, other than the RCS, the main steam system, or main feedwater pump discharge lines shall not penetrate the containment or control room boundary or cause loss of integrity to the spent fuel pool. (Criteria for missiles generated from the reactor coolant and main steam systems and main feedwater pump discharge lines are discussed above). It shall not cause loss of function to any system required to mitigate the consequences of a postulated LOCA or a steam or feedwater line break accident, or to any system required for hot or cold shutdown of the reactor as listed in Criterion B above. Since such missiles do not result in a LOCA or a steam generator steam/water release requiring protective action, a loss of redundancy for such systems is permitted, but a loss of function is not permitted.

D. Tornado Missiles

Missiles generated by a tornado shall not cause loss of containment integrity or penetrate the control room boundary or cause loss of integrity to the spent fuel pool. They shall not cause loss of function to any system required for hot shutdown of the reactor from the control room as listed in Criterion B above even assuming the failure of a single active component. They shall not cause loss of function of any system required for cold shutdown, as listed in Criterion B above.

ARKANSAS NUCLEAR ONE
Unit 2

3.5.1 MISSILE BARRIERS AND LOADINGS

A tabulation of protected components and the structures, shields and barriers that were designed to withstand missile effects is presented in Table 3.5-1.

3.5.1.1 Missile Barriers Within Containment

The secondary shield and the refueling cavity walls act as missile barriers separating each reactor coolant loop from other protected components and missile sources. Structural floor members provide additional missile protection. These barriers, as well as any additional barriers as may be required, prevent a postulated missile from penetrating the RCPB in another loop, the containment structure or liner, containment penetrations, a steam generator shell, steam generator steam side instrumentation connections, the steam, feedwater or blowdown piping or the steam generator drain pipes within the containment structure. They also protect the RCPB in each loop from those identified missiles generated elsewhere in the containment.

Except for short piping runs in the SIS which must supply cooling water to the RCS after a LOCA, the ESF are located outside the secondary shield. The SIS lines which penetrate the secondary shield do so in the vicinity of the primary loop segment to which they are attached.

A missile shield structure is provided over the Control Rod Drive Mechanisms (CRDMs) to block any identified missiles generated in that location. To protect against identified missiles originating in the region of the pressurizer, barriers or suitable restraints are provided as required.

Barriers or retainers are provided as required to prevent missiles generated by the failure of main steam or feedwater components inside containment from causing loss of integrity to the containment liner, isolation system or the steam system associated with the other steam generator, or causing loss of function to other required systems or components inside containment in accordance with the missile protection design criteria above.

3.5.1.2 Missile Barriers Within Category 1 Structures Other Than Containment

Missile barriers or restraints have been provided within Category 1 Structures outside containment in conformance with the missile protection design criteria given previously in Section 3.5.

For the pressurized and rotating component failure missiles identified in Section 3.5.3, which originate outside containment, the following steps are taken to assure that the missile protection design criteria have been met:

- A. Missiles have been categorized as to the system in which they originate.
- B. The components which must be protected from a missile have been identified in accordance with the missile protection design criteria given above.
- C. The following methods have been used as required to prevent a missile from causing loss of function to a protected component:
 1. The missile characteristics have been determined using the procedures given in Section 3.5.3.

ARKANSAS NUCLEAR ONE
Unit 2

2. A determination has been made as to whether the missile characteristics are severe enough to cause loss of function to protected components. Credit has been taken for existing structures or components which are interposed between the missile origin and the protected component.
3. The trajectory has been altered by changing the orientation or position of the missile and/or the position of the protected component if this is feasible.
4. If loss of function of the protected component can occur due to missile damage, either suitable restraints have been provided to prevent the missile from leaving its point of origin, or barriers have been installed to intercept the missile trajectory.

3.5.1.3 Barriers for Missiles Generated Outside of Category 1 Structures

A tabulation of protected components and the structures, shields, and barriers that were designed to provide protection from identified missiles generated outside these structures, shields, and barriers is given in Table 3.5-1. The missile barriers indicated were designed for the tornado and accident missile loadings described in Sections 3.5.2 and 3.5.3 utilizing the procedures given in Section 3.5.4.

3.5.1.4 Barriers for Site Proximity Missiles

Section 2.2 provides the locations, routes and descriptions of nearby industrial, transportation and military facilities. There is no credible basis for anticipating site proximity missiles, and no site proximity missile barriers were considered in the design.

3.5.2 MISSILE SELECTION

3.5.2.1 General

The sources of missiles which, if generated, could affect the safety of the plant were considered as discussed in the following sections. These are rotating component failure missiles, pressurized component failure missiles, and tornado generated missiles.

3.5.2.2 Rotating Component Failure Missiles

3.5.2.2.1 Turbine Missile Generation

Assessment of current turbine failure missile potential has indicated that there is no failure probability of sufficient magnitude to justify installation of turbine failure missile shields.

Analyses of known failures of turbine generator rotating elements have revealed two circumstances when failures have occurred: (1) brittle failure at or near rated operating speed and (2) failure by ductile yielding at overspeed conditions as the result of overspeed trip/speed control malfunctions.

3.5.2.2.1.1 Missiles Generated At or Near Rated Speed

The cause of failures at or near rated speed has been found to be combinations of severe strain concentrations, developed from hydrogen flaking or nonmetallic inclusions, and relatively brittle metals. Progress and development of new alloys and processes, identification and reduction of

ARKANSAS NUCLEAR ONE
Unit 2

Nil Ductility Transition Temperatures (NDTTs), saliently improved techniques of quality control and quality assurance, and application of efficient equipment, instrumentation, and operating procedures have been utilized in the design and manufacture of the turbine components. With all these latest technological developments applied to turbine design, it is highly unlikely that there could be any burst failures of turbine generator rotors operating at or near rated speed.

3.5.2.2.1.2 Missiles Generated by Turbine Overspeed

Significant steps in turbine design have been taken in order to prevent overspeed.

Moreover, exhaustive inspection and testing procedures have been developed to assure proper overspeed protection. To prevent long-term buildups of salts or oxides on valve mechanisms with the eventual result of impairing valve shutting rates, the valves are periodically cycled. As the result of these efforts, the probability of destructive overspeed causing failure of a modern unit has been substantially reduced.

3.5.2.2.2 Hypothetical Rotating Element Failure

General Electric, manufacturer of the turbine generator, determined the most severe turbine missile by assuming instantaneous loss of load from full load operation. In addition, it was postulated that the normal speed governing system and independent overspeed governing systems fail to shut the emergency stop valves. The turbine can then accelerate to approximately 170 percent of rated speed before severe generator damage due to thrown windings and probable retaining ring failure will decelerate the turbine. The last stage, low pressure turbine vanes are postulated to fail when turbine speed reaches 177 percent of rated speed, but wheel burst is unlikely at that point. However, should wheel burst occur, 120 degree segment fragments would be ejected. Such a turbine rotor fragment with a mass of 8,264 pounds and kinetic energy of 2.15E7 foot-pounds upon exit from the turbine casing is determined to be the most dangerous of those which could be formed. High pressure turbine rotors are not expected to fail at destructive overspeed, but, even if failure did occur, the fragments should be retained by the high pressure shells. Generator field and retaining ring parts are expected to be retained by the generator housing, which, by its construction, is an ideal energy absorber.

During the 2R6 Refueling Outage a monoblock type rotor was installed in the "B" section of the low pressure turbine and in LP "A" during 2R7. These rotors differ from the low pressure rotors described in the previous paragraph in that the previous rotors were a "built up" design with shrunk on wheels whereas the monoblock design is a one piece forging. General Electric's position is that the missile generation criteria for the shrunk on wheels does not apply to the monoblock design. A failure for the monoblock assumes the stresses due to centrifugal forces exceed material strength, and calculations performed by G.E. show the required overspeed to develop such centrifugal forces can not be reached even at a loss of full load. The amount of steam entering the turbine from the time of full load loss to stop valve closure is insufficient to drive the turbine to the overspeed required to fail the monoblock. Should the stop valves fail to close, other turbine parts such as the last stage buckets, generator wedges, and bearings (if high vibrations occur) would fail, stopping the turbine, at speeds below that required to burst the forged monoblock rotor.

ARKANSAS NUCLEAR ONE
Unit 2

3.5.2.2.2.1 Probability of Missile Genesis (P1)

The probabilities of missiles generated due to failure of the turbine at or near rated turbine speed (low speed burst) or during destructive overspeed (high speed burst) were provided by the respective vendors, G.E. for Unit 2 and Westinghouse for Unit 1, for a standard 6-flow low pressure turbine.

G.E.: (for 30-year lifetime)

Low speed failure: 2.6×10^{-7}

High speed failure: 1.5×10^{-7}

LP "B" monoblock rotor: 1.0×10^{-8}

Westinghouse: (annual probabilities)

Low speed failure: 1.0×10^{-7}

High speed failure: 1.0×10^{-8}

The numbers for the low and high speed failures were taken from the G.E. memo report, "Hypothetical Turbine Missiles - Probability of Occurrence," by J. E. Downs (Reference 53) and, the N.E.S. Turbine Missiles Report for Byron-Braidwood for the Westinghouse turbine. The probability of generating missiles for the LP "B" monoblock rotor was taken from the August 19, 1987, G.E. letter from G. B. Landes to G. Hayes.

For use in the analysis of turbine missile damage for the Arkansas Nuclear One Units, the P1 values were converted to annual probabilities and multiplied by 2/3 in order to give P1 values for four flow turbines. For the case of a high speed failure in the G.E. turbine, separate analyses were done for missiles generated by the inner wheels and those generated by the end wheels due to differences in the possible missile trajectories. The value of P1 for failure of the inner wheels was taken as 6/7 the value for the entire turbine. For failure of an end wheel the P1 value was 1/7 times the value for the entire turbine. For a low speed failure of the G.E. turbine only the end wheels were postulated to produce missiles external to the turbine case.

For the Westinghouse unit, a separate analysis was done for the failure of each wheel, so that the value of P1 taken for each wheel was 1/6 times the value for the entire turbine (six wheels per Westinghouse turbine flow path). The appropriate P1 values used were accordingly:

G.E.

High Speed Burst, the 24 Inner Wheels	2.86×10^{-9}
High Speed Burst, the 4 End Wheels	4.76×10^{-10}
Low Speed Burst, the 4 End Wheels	5.78×10^{-9}

Westinghouse

Low Speed Burst, per wheel (for any one flow path)	1.1×10^{-8}
High Speed Burst, per wheel (for any one flow path)	1.1×10^{-9}

A meaningful, alternate method of determining missile generation probabilities based on direct statistical observation is not available. The use of past data for a probabilistic estimate is justifiable only where the past data are demonstrated to be reasonably representative of the expected future population. The historical data of failures are based on turbines with integral rotors, and are not representative of the low pressure, shrunk on wheels of modern nuclear

ARKANSAS NUCLEAR ONE
Unit 2

power plant turbines manufactured under the current metallurgical and quality control practices. Further, the total turbine years of operation accumulated by the industry are not long enough to lend a meaningful analysis by such a simplistic approach (Reference 53, page 40). Significant among turbine design advances have been the replacement of the turbine's mechanical-hydraulic speed control system with an electrohydraulic system of increased reliability. The electrohydraulic control system employs three electrical and one mechanical speed input. Logic signals are redundantly processed in both electronic and hydraulic channels. Valve opening actuation is provided by a 1,600 psig hydraulic system which is totally independent of the bearing lubrication system. Valve shutting actuation is provided by springs and aided by steam forces upon the reduction or relief of fluid pressure. The system is designed so that loss of hydraulic fluid pressure for any reason leads to valve shutting and consequent shutdown (fail-safe).

The main steam valves are provided in series arrangements: a group of stop valves actuated by either of two overspeed trip signals followed by a group of controlling valves modulated by the speed governing system, and tripped by either overspeed trip signal.

The intermediate valves are arranged in series pairs, consisting of an intermediate stop valve and an intercept valve in one casing. The closure of either one of the two valves will close the corresponding steam line.

A single failure of any component will not lead to destructive overspeed. A multiple failure, involving combinations of undetected electronic faults and/or mechanically stuck valves and/or hydraulic fluid contamination at the instant of load loss would be required. The probability of such joint occurrences is extremely remote due to the inherently high reliability of components and design.

Note: This analysis applies to the original LP Turbine design. During 2R6 and 2R7, AP&L replaced the "B" and "A", LP turbine rotors, respectively, with a monoblock type rotor. A description of the monoblock type rotor design and its missile generation capability is provided in section 3.5.2.2.2.

3.5.2.2.2.2 Probability of Missile Strike (P2)

From the standpoint of reactor safety it is necessary to consider the probability that, given a turbine failure missile has occurred, the missile will impact the containment, control room, or other structure which houses components or systems required for safe shutdown. The product of the probability of missile genesis (P1) and the probability of missile strike (P2) yields the probability that a turbine missile will impact the structure.

A Fortran program was written to analyze the probability of a turbine missile striking a cylindrical or rectangular target (building containing safety-related equipment). The analysis was based on the following assumptions:

- A. The missile has a uniform probability of ejection at any angle of the 360-degree arc around the turbine axis.
- B. The missile has a uniform probability of ejection at any angle with respect to the vertical radial plane passing through the disc within a range of five degrees for the inner turbine wheels and 25 degrees for the General Electric turbine outer wheels and five to 25 degrees for the Westinghouse wheels. The manufacturer's postulated

ARKANSAS NUCLEAR ONE
Unit 2

missile data provides the basis for the angular limitations given above. Westinghouse postulates that their outer wheel would be ejected only towards the adjacent coupling on the rotor shaft.

- C. The probability of ejection at a given initial velocity is uniform over the range of possible missile ejection velocities.
- D. The trajectory of the missile from source to target is assumed parabolic.
- E. Secondary particles resulting from collisions with obstructions or missiles resulting from the reflection of a missile from an obstruction were not considered.

Figure 3.5-1 shows the orientation of the turbine centerline with respect to the postulated targets.

The missile strike probabilities were divided into high trajectory (lob shot) and low trajectory (elevation angle that could cause a direct strike on a target) components. With the G.E. turbine of Unit 2 as the missile source, the missile damage probabilities (P4) for each target are the sum of the separate products of P1, P2 and P3 (defined in Section 3.5.2.2.3). Three possible modes of turbine missile genesis were considered, each with a different probability (P1): the bursting of an interior turbine wheel during turbine overspeed (high speed burst); the bursting of an end turbine wheel during turbine overspeed; and, the bursting of an end turbine wheel near rated turbine speed (low speed burst). These modes of turbine missile genesis are based on the turbine manufacturer's hypothetical missile data.

For the Westinghouse turbine of Unit 1, the value of P4 is the sum of the product of P1 and P2 for a low speed burst and a high speed burst. However, the P1 and P2 represented in Table 3.5-3 for the Unit 1 turbine are defined differently since each wheel was analyzed separately. P1 represents the probability of missile genesis per wheel and P2 is the sum of the probabilities of missile strike for each wheel. The damage probability (P3) was conservatively assumed to be equal to 1.0 for the Westinghouse turbine missiles; hence, any strike is assumed to cause damage.

Note: This analysis applies to the original LP Turbine design. During 2R6 and 2R7, AP&L replaced the "B" and "A" LP turbine rotors, respectively, with a monoblock type rotor. A description of the monoblock type rotor design and its missile generation capability is provided in section 3.5.2.2.2.

It may be noted that the probabilities of a missile generated by the Unit 1 turbine striking any target other than the containment and auxiliary building of Unit 2 were so small as to be negligible.

3.5.2.2.3 Probability of Penetration of Missile Targets (P3)

In addition to the probability of a missile strike, there is also the probability, given a strike, that the missile will not damage the component which is housed by the structure. We conservatively define the probability of damage (P3) to be the probability of a missile causing spalling within the enclosing structure.

ARKANSAS NUCLEAR ONE
Unit 2

Table 3.5-2 shows an example of the breakdown of P2 and P3 for the spectrum of missile fragments postulated by G.E. The computer program used in the analyses calculates both the strike and damage probabilities for an individual missile in each fragment group postulated. The P2 and P3 column shown in the example represents the probability of each postulated missile fragment causing damage to the target. A binomial distribution is then used, taking into account the number of fragments generated in each postulated fragment group, to determine the probability that any one missile fragment will not damage the target. This probability is then subtracted from unity, which results in the P2 x P3 damaged probability listed in Table 3.5-3. Hence, P2 x P3 is the probability that at least one missile fragment causes damage to the specified target.

The Ballistic Research Laboratory (BRL) formula has been used to calculate the thickness of concrete perforated by a missile. The concrete thickness required to prevent spalling is then determined by doubling the perforation thickness. Of the two formulas commonly used for the calculation of missile damage to concrete structures, the modified Petry and BRL formulas, the BRL formula has been shown to be slightly more conservative for the range of typical turbine missile masses and velocities. The BRL formula determines the concrete thickness corresponding to the initiation of perforation by a cylindrical missile impacting normal to the concrete surface. Because the turbine missile fragments postulated are not cylindrical, the variable (D) in the BRL formula, is calculated as the diameter of a cylinder with cross-sectional area equal to the projected frontal area of the missile. Since the geometry of the enclosing structures and missile trajectories sometimes result in oblique impact angles, the normal missile velocity was determined for input into the BRL formula. In addition, the following assumptions were made in calculating the damage probability:

- A. Intermediate concrete barriers were added to the wall thickness assumed for the structure. Therefore, equipment on lower floors have the added protection of the concrete floors above.
- B. The missile fragments rotate when ejected, therefore, a spectrum of impact areas are equally probable for the 120° and 60° wheel section fragments.

The concrete thickness of the target roof or wall is inserted, along with the appropriate missile data, into the BRL formula to calculate the normal impact velocity sufficient to induce spalling. Then for each initial ejection vector, the ejection velocity sufficient to cause spalling is calculated and a probability of damage determined.

The product of the strike probability increment and the corresponding damage probability determine an increment in the strike and damage probability. The increments are then summed to determine a total strike and damage probability for the particular missile-target combination. An average damage probability for the target is then extracted by dividing the strike and damage probability by the strike probability. This average damage probability is represented by P3 in the example breakout of P2 and P3 shown in Table 3.5-2.

Table 3.5-3 shows the missile ejection probabilities and the resultant total missile damage probabilities for each listed target. For missiles generated from the Unit 2 (GE) turbine, the strike and damage probabilities have been calculated and combined as previously described. For missiles generated from the Unit 1 (Westinghouse) turbine, the damage probability is assumed to be 1.0.

3.5.2.2.2.4 Turbine Missile Damage Probability (P4)

The probability of significant damage to critical components in the plant due to turbine failure (P4) is the product of the probabilities of: (1) turbine failure and ejection of an energetic missile (P1); (2) a missile from the turbine striking a structure enclosing a critical component (P2); and, (3) spalling occurs inside the structure (P3). That is, the overall probability, P4, is the product of $P1 \times P2 \times P3$. Using the values developed above, the annual probability of a turbine failure missile damaging a critical component is determined to be 6.3×10^{-10} . This value is sufficiently low that no specific protective measures are required.

Note: This analysis applies to the original LP turbine design. During 2R6 and 2R7, AP&L replaced the "B" and "A" LP turbine rotors, respectively, with a monoblock type rotor. A description of the monoblock type rotor design and its missile generation capability is provided in Section 3.5.2.2.2.

3.5.2.2.3 Conclusions

Periodic cycling of the steam stop valves will be performed with visual observation of valve motion (except when crediting a turbine trip for full valve travel verification) in accordance with the Technical Requirements Manual. Control valves are periodically exercised to insure that they are free to operate in the event of a turbine trip. Disassembly and inspection of the steam stop valves, the control valves, and the combined stop and intercept valves will be conducted during refueling shutdowns in accordance with the Technical Requirements Manual. Disassembly and inspection of the turbine generator will be conducted on a scheduled basis in accordance with vendor recommendations.

Due to the redundancy and testing features of the turbine overspeed protection, the quality control of manufacturing processes and materials, and the calculated probabilities of the low pressure turbine last stage wheel failure, damage from turbine failure missiles is considered so improbable that specific protective measures are not required.

3.5.2.3 Pressurized Component Failure Missiles

3.5.2.3.1 Nuclear Steam Supply System

Credible missiles resulting from failure of pressurized components in the Nuclear Steam Supply System (NSSS) are listed and described in Table 3.5-4.

3.5.2.3.2 Systems Other Than NSSS

Credible missiles resulting from failures of pressurized components in the balance of plant area given in Table 3.5-5. The bases for selection are discussed below.

Pressurized components in systems whose service temperature exceeds 200 °F or whose design pressure exceeds 275 psig were evaluated as to their potential for becoming a missile.

Temperature or other detectors installed on piping or in wells were evaluated as potential missiles if failure of a single circumferential weld would cause their ejection.

Unrestrained sections of piping such as vents, drains, and test connections were evaluated as potential missiles if the failure of a single circumferential weld could cause their ejection.

ARKANSAS NUCLEAR ONE
Unit 2

Dead end flanges were evaluated as potential missiles.

Valves procured for service at Unit 2 employ one of four valve bonnet attachment methods. The type of valve bonnets used are pressure seal, bolted, breechlock, and welded.

Most ASME Section III valves of ANSI 900 psig rating and above, constructed in accordance with Bechtel specifications are pressure seal bonnet type valves. For pressure seal bonnet valves, valve bonnets are prevented from becoming missiles by the retaining ring, which would have to fail in shear, and by the yoke, which would capture the bonnet or reduce bonnet energy.

Because of the conservative design of the retaining ring of these valves, bonnet ejection is highly improbable and bonnets were not considered credible missiles.

Most valves of ANSI rating 600 psig and below are valves with bolted bonnets. Valve bonnets are prevented from becoming missiles by limiting stresses in the bonnet-to-body bolting material by rules set forth in ASME Code, Section III, and by designing flanges in accordance with applicable code requirements. Even if bolt failure were to occur, the likelihood of all bolts experiencing a simultaneous complete severance failure is very remote. The widespread use of valves with bolted bonnets and the low historical incidence of complete severance valve bonnet failures, Reference 44, confirms that bolted valve bonnets need not be considered as credible missiles.

The remaining valves, those equipped with breechlock or welded bonnets, have two separate bonnet retaining features to preclude their ejection as a potential missile. Both methods of bonnet-to-body attachment use a sealing circumferential weld. In addition, valve bonnets which are welded, also feature a screwed bonnet. Valves with breechlock bonnets, employed for high pressure service, use a key or breech connection. When the bonnet is inserted into the valve body, it is rotated. With the bonnet in this locked position the bonnet is seal welded to the body; hence, valve bonnets are not considered credible missiles.

Valve stems were not considered as potential missiles if at least one feature in addition to the stem threads is included in their design to prevent ejection. Valves with backseats are prevented from becoming missiles by this feature. In addition, air or motor operated valve stems are effectively restrained by the valve operators.

Potential missile sources that are shown to be not credible do not require missile protection features. Among those that have been shown to be not credible are studs, nuts, and bolts. For ANO Unit 2 steam generators, the studs and nuts for the manways, handholes, and inspection ports were designed, manufactured, and analyzed to the requirements of the ASME Code Section III. Preload values or elongation values are specified on the component drawings. These preload or elongation values are used in procedures for installation of the manways, handholes, and inspection ports for closure of the primary and secondary pressure boundaries. The design analyses demonstrate that the bolt stresses are well within the elastic range. Therefore, the generation of missiles by the studs, nuts, or bolts of the SG is not considered to be credible.

Nuts, bolts, nut and bolt combinations, and nuts and stud combinations have only a small amount of stored energy. However, for components other than steam generators, they were considered potential missiles, and an example of their missile characteristics is listed in Table 3.5-5.

3.5.2.4 Tornado Generated Missiles

The tornado generated missiles selected from the design of structures are described in Section 3.3.2.1.

The bases for tornado missile selection were:

- A. Eyewitness accounts from persons making observations during tornadoes.
- B. Results of analyses of photograph taken during tornadoes.
- C. Results of analyses of tornado caused damage or of lack of tornado caused damage.
- D. Results of analyses of the physical aspects of tornado phenomena.
- E. Recommendations of persons familiar with the effects of tornadoes.

3.5.3 SELECTED MISSILES

3.5.3.1 Nuclear System Supply System Missiles

The characteristics of missiles resulting from the failure of pressurized components in the NSSS are given in Table 3.5-4.

3.5.3.2 Missiles From Systems Other Than NSSS

For each selected missile appropriate parameters identifying its characteristics are given in Table 3.5-5. The basis for identifying selected missile parameters is discussed below.

Once an object has been assumed to be a missile, and the mass and shape are known, the initial velocity is determined as follows:

- A. For missiles acted upon by a jet of escaping fluid (gas, liquid/gas, liquid) for a certain distance the calculational techniques given in ORNL-NSIC-5, Reference 44, Section 6.6.1.3, are used to determine missile kinetic energy.

Calculational techniques utilized in obtaining jet velocity at the break are:

1. For a gas/liquid jet with system L/D (pipe length/pipe hydraulic diameter) ratio equal to or greater than 12, Moody, Reference 69, is used.
 2. For a gas/liquid jet with system L/D ratio less than 12, ORNL-NSIC-22, Reference 25, Section 4.1.2, is used.
 3. For a single phase (gas or liquid), ORNL-NSIC-22, Section 4.1.2, is used.
- B. For missiles acted upon by a single phase liquid stream for a certain distance, kinetic energy for these missiles is determined by converting work energy into kinetic energy. The calculational technique utilized in obtaining missile velocity is found in ORNL-NSIC-22, Section 4.1.1.

ARKANSAS NUCLEAR ONE
Unit 2

- C. For missiles which are generated by release of stored strain energy, the strain energy is equated to kinetic energy in determining missile velocity. The ultimate stress of the material is used resulting in a large amount of energy than would be present at fracture. Losses due to heating, friction, and the relaxation of the material are ignored.

3.5.3.3 Tornado Missiles

Appropriate parameters identifying the characteristics of tornado generated missiles are given in Table 3.5-6.

3.5.4 BARRIER DESIGN PROCEDURES

The procedures and calculations employed in design of missile resistant barriers are described in the following sections. [Intervening SSCs including large equipment and structural members may be utilized as missile barriers provided they are qualified for the applicable design loads including tornado winds and differential pressure. For missile barrier design, BC-TOP-9A in conjunction with EPRI NP-440 may be utilized. EPRI NP-440 provides a basis for missile deformation and impact characteristics for designing missile barriers.](#)

3.5.4.1 Reinforced Concrete Targets

Missile resistant concrete barriers and structures were designed to withstand and absorb missile impact loads without being fully penetrated in order to prevent damage to protected components.

The design procedures and calculations used to predict local damage in the impact area included estimating the depth of penetration, minimum thickness required to prevent perforation, and minimum thickness required to preclude spalling. Table 3.5-7 shows results of calculations performed for the selected missiles discussed in Section 3.5.3. The penetration and perforation formulae assumed that the missile strikes the target normal to the surface, and the axis of the missile was assumed parallel to the line of flight. These assumptions resulted in a conservative estimate of local damage to the target.

3.5.4.1.1 Penetration

The depth to which a rigid missile will penetrate a reinforced concrete target of infinite thickness was estimated by the modified Petry formula:

$$X = 12 K_p A_p \text{Log}_{10} \left(1 + \frac{V_s^2}{215,000} \right)$$

where

X = Depth of missile penetration into concrete element of infinite thickness (inches)

Note: Usually this equation expresses the depth of penetration in feet; however, in this text it has been modified to express it in inches.

K_p = Penetration coefficient for reinforced concrete (see Figure 3.5-2)

A_p = Missile weight/projected frontal area of missile (psf)

V_s = Striking velocity of missile (ft/sec). (Limit V_s ≤ 1000 ft/sec)

ARKANSAS NUCLEAR ONE
Unit 2

When the element has a finite thickness the depth of penetration is:

$$X_1 = (1 + \exp(-4 \left\{ \frac{t}{X} - 2 \right\})) X$$

where

- X_1 = Depth of penetration of missile into a concrete element of finite thickness (inches)
- T = Thickness of concrete element (inches) (Limit $t > 2X$).

3.5.4.1.2 Perforation

The thickness of a concrete element that will just be perforated by a missile was estimated by the Ballistic Research Laboratory (BRL) formula:

$$T = \frac{427}{\sqrt{F'_c}} \frac{W}{D^{1.8}} \left(\frac{V_s}{1000} \right)^{1.33}$$

where

- T = Thickness of concrete element to be just perforated (inches)
- W = Weight of missiles (lb)
- D = Diameter of missiles (inches)
- Note: For irregularly shaped missiles, an equivalent diameter was used. The equivalent diameter was taken as the diameter of a circle with an area equal to the circumscribed contact, or projected frontal area, of the noncylindrical missile.
- V_s = Striking velocity of missile (ft/sec)
- F'_c = Compressive strength of concrete (psi)

The thickness, T_p , of a concrete element required to prevent perforation must be greater than T . The design considered an increase of T by 25 percent, but not more than 10 inches, to obtain the T_p , required to prevent perforation:

$$T_p = 1.25T \leq T + 10 \text{ (in inches)}$$

3.5.4.1.3 Spalling

Spalling of concrete from the side opposite the contact surface of the element may occur even if the missile will not perforate the element. For an estimate of the thickness that will just start spalling, the following equation was used:

$$T_s = 2T$$

where

- T_s = Concrete element thickness that will just start spalling (inches)
- T = Concrete thickness to be just perforated (inches). (See Section 3.5.4.1.2)

ARKANSAS NUCLEAR ONE
Unit 2

The thickness, T_s , of a concrete element required to prevent spalling must be greater than T_s . The design considered an increase of T_s by 25 percent, but not more than 10 inches, to prevent spalling.

3.5.4.2 Steel Targets

Missile resistant barriers were designed to withstand and absorb missile impact loads without being fully penetrated in order to prevent damage to protected components.

The design procedures and calculations used to predict local damage in the impact areas are given in BC-TOP-9A, Revision 2.

3.5.5 MISSILE BARRIER FEATURES

The layout and principal design features of structures serving primarily as missile resistant barriers are shown on Figures 3.5-7 and 3.5-8.

ARKANSAS NUCLEAR ONE
UNIT 2

3.6 PROTECTION AGAINST DYNAMIC EFFECTS ASSOCIATED WITH THE POSTULATED RUPTURE OF PIPING

In accordance with 10 CFR 50 General Design Criterion No. 4, "Environmental and Missile Design Bases," special measures have been taken in the design and construction of Unit 2 to protect structures, systems and components required to place the reactor in a safe cold shutdown condition from the dynamic effects associated with the postulated rupture of piping. This section defines the criteria used in the evaluation of postulated breaks, the analyses performed and the protective measures taken to mitigate the consequences of these breaks. Regulatory Guide 1.46 (dated May, 1973), "Protection Against Pipe Whip Inside Containment" was the basic document used in establishing the design criteria for piping systems inside containment. The difference which exists between this regulatory guide and the criteria defined herein concerns design break geometry. In postulating the types of breaks which occur at the break locations established in accordance with Section 3.6.2.1., the criteria presented in the ANS draft standard, ANSI N176, "Design Basis for Protection of Nuclear Plants Against Effects of Postulated Pipe Rupture" (Draft 3 dated June, 1974), was used. These criteria are presented in Section 3.6.2.2.

High energy line break evaluations, performed for changes or additions to systems inside containment, may utilize the criteria of USNRC Standard Review Plan 3.6.2, Revision 1, July 1981, in lieu of the above mentioned criteria.

For the purposes of environmental qualification, many of the high energy line break evaluations were re-performed to obtain more detailed analytical results in the area of compartment pressurization and temperature responses. These analyses are described in greater detail in ANO Environmental Qualification - Environmental Service Conditions, Engineering Standard NES-13.

In establishing the design criteria for piping systems outside containment, the AEC document "General Information Required For Consideration of the Effects of a Piping System Break Outside Containment," and the errata sheet thereto, was used. In establishing intermediate break locations, which this document states shall be "selected on a reasonable basis as necessary to provide protection," the criteria defined in the ANS draft standard ANSI N176 were used.

High energy line break evaluations, performed for changes or additions to systems inside containment, may utilize the criteria of USNRC Standard Review Plan 3.6.2, Revision 1, July 1981, in lieu of the above mentioned criteria.

NRC Generic Letter 87-11 (Ref. 83) relaxed the arbitrary intermediate pipe rupture requirements based on the highest stresses. Accordingly, postulation of the arbitrary intermediate break locations is no longer required. As such, arbitrary intermediate break locations previously postulated may be eliminated. The generic letter also explicitly allows relief from both the dynamic effects (i.e. pipe whip, jet impingement, compartment pressurization, etc.) and all environmental effects (i.e. temperature, pressure, humidity, flooding, etc.) resulting from these postulated arbitrary intermediate breaks. NRC generic letter relief provisions are adopted for the postulation of high-energy line breaks for ANO Unit 2. The consequences of a pipe break were considered to manifest themselves by the following methods:

- A. pipe whip;
- B. jet impingement;

ARKANSAS NUCLEAR ONE
UNIT 2

- C. compartment pressurization;
- D. compartment flooding; and
- E. high temperature/high humidity environment.

In evaluating these consequences, the following assumptions were made:

- A. Concurrent loss of off-site power was assumed for any postulated pipe break which resulted in protective system actuation effecting a plant trip.
- B. The energy level in a whipping pipe was considered as insufficient to rupture an impacted pipe of equal or greater nominal pipe size and equal or heavier wall thickness. An unrestrained whipping pipe is considered capable of rupturing impacted pipes of small nominal pipe sizes and developing through-wall leakage in equal or larger nominal pipe sizes with thinner wall thickness.
- C. In addition to the postulated break, a single active component failure was assumed within the systems required to mitigate the consequences of the break and to place the reactor in a safe cold shutdown condition.
- D. In addition to the postulated break and single active failure, one channel of each RPS and ESFAS function is bypassed.

3.6.1 SYSTEMS IN WHICH DESIGN BASIS PIPING BREAKS OCCUR

Piping systems in which, during normal operating or hot standby conditions, the fluid temperature exceeds 200 °F or the pressure exceeds 275 psig were evaluated for the effects of pipe breaks. The following systems, or portions of systems, were included in this evaluation:

- A. Inside containment
 - 1. Reactor coolant piping, including pressurizer surge line and spray line piping
 - 2. Chemical and Volume Control System (CVCS) letdown and makeup piping
 - 3. Safety Injection System (SIS) piping (only the portions of this system normally subjected to safety injection tank pressure)
 - 4. Main steam piping
 - 5. Steam generator blowdown piping
 - 6. Main feedwater piping
 - 7. Emergency feedwater piping
 - 8. Shutdown Cooling Piping from reactor coolant nozzle to the first isolation valve

ARKANSAS NUCLEAR ONE
UNIT 2

B. Outside containment

1. Main steam piping (including extraction steam piping and steam supply piping to the main feedwater pump turbine drivers and the emergency feedwater pump turbine driver)
2. Main feedwater piping
3. Steam generator blowdown piping
4. CVCS letdown piping (from containment penetration to letdown heat exchanger) and makeup piping (from charging pump discharge to containment penetration)
5. Emergency feedwater piping (from pump discharge to containment penetration)
6. Safety Injection System piping (from pump discharge to containment penetration)

Breaks in the Shutdown Cooling (SDC) line from the reactor coolant pipe nozzle to the first isolation valve have the same consequences as a LOCA, as such breaks have been postulated in this section of the SDC line. Pipe breaks were not postulated in the SDC piping downstream of the isolation valve 2CV-5086-2. The shutdown cooling mode is a manually initiated operation and is initiated only under strict administrative controls when the reactor coolant temperature and pressure are below 275 °F and 300 psia. The system exceeds 200 °F and 275 psig less than two percent of the system operating time. This is based on the following conservative assumptions:

- Refueling occurs once every 18 months and the SDC System is in operation for an average of 21 days (500 hours) each refueling period over the plant life.
- In addition, 20 shutdowns to cold shutdown condition were assumed to occur over the life of the plant, each lasting four days or 96 hours.
- During each shutdown, the system is assumed to operate over 200 °F and 275 psig for six hours. This assumes an average cooldown rate of 25 °F per hour while maximum cooldown rate is 75 °F per hour. The SDC System is not used to heat up the Reactor Coolant System (RCS) after shutdown.

The AEC report entitled "Nuclear Power Plant Operating Experience During 1973" (OOE-ES-004 dated December 1974) shows that the average refueling time is approximately 1,500 hours. This would increase the time during which the system operates below 200 °F and 275 psig without increasing the time above this temperature and pressure. Whenever possible, maintenance and repairs are scheduled during refueling periods to minimize the number of non-refueling shutdowns.

3.6.2 DESIGN BASIS PIPING BREAK CRITERIA

3.6.2.1 Pipe Break Locations

- A. The original design basis for the ANO-2 reactor coolant system (RCS) included postulated breaks for the purposes of evaluating for protection from the dynamic and environmental effects of the main coolant line (MCL) breaks. This basis was consistent with the practices and regulatory requirements in place at the time of the original design and licensing of Unit 2. Due to changes in the regulations, General

ARKANSAS NUCLEAR ONE
UNIT 2

Design Criterion 4 (Reference 82) was revised to allow the application of Leak Before Break (LBB) criteria for the selection of MCL breaks. As discussed in section 6.2.1, this criteria has been implemented in Unit 2 in conjunction with modifications such as the permanent reactor seal plate and replacement of the steam generators. The application of LBB per GDC 4 has eliminated the postulated breaks on the MCL for purposes of the dynamics effects design basis of the RCS. However, in accordance with NUREG-1061 Volume 3, the non-mechanistic MCL piping rupture design basis is maintained for containment design, ECCS performance analysis, and electrical and mechanical environmental qualification.

The original design basis assumed the following locations and types of breaks in the MCL piping (see Figure 3.6-31 for RCS piping arrangement):

1. Reactor vessel outlet pipe: Circumferential breaks were postulated at the terminal ends. Based on the Combustion Engineering report "Design Basis Pipe Breaks for the Arkansas Nuclear One, Unit 2 Reactor Coolant System" (ref. 2CAN067607), longitudinal (slot) breaks do not have to be postulated on the reactor vessel outlet (hot leg) piping. However, it should be noted that as documented in the Unit 2 SAR section 6.2.1, for the purposes of analyzing subcompartment differential pressures, a longitudinal break was postulated for the hot leg based on the Combustion Engineering Report CENPD-168, "Design Basis Pipe Breaks for the Combustion Engineering Two Loop Reactor Coolant System." Although the ANO-2 specific CE report later eliminated the requirement for postulation of longitudinal breaks on the hot leg, the subcompartment differential pressure analysis was conservative since it had considered more than was required, and the analysis did not have to be revised. Therefore, the apparent discrepancy between this section and section 6.2.1 is acceptable and does not violate the pipe break criteria stated herein.
2. Pump suction pipe: Circumferential breaks were postulated at the terminal ends, and longitudinal breaks were postulated at the first elbow closest to the terminal ends. The basis for this criteria is documented in the Combustion Engineering Report "Design Basis Pipe Breaks for the Arkansas Nuclear One, Unit 2 Reactor Coolant System" (ref. 2CAN067607).
3. Pump discharge pipe: Circumferential breaks were postulated at the terminal ends, and no longitudinal breaks were postulated. The basis for this criteria is documented in the Combustion Engineering Report "Design Basis Pipe Breaks for the Arkansas Nuclear One, Unit 2 Reactor Coolant System" (ref. 2CAN067607).

Following the application of LBB, the remaining pipe breaks in the dynamic effects design basis of the RCS are all primary and secondary side branch line pipe breaks (BLPBs) interfacing with the RCS. Of these, the controlling breaks with respect to RCS response are breaks in the largest tributary pipes.

- main steam line (MSL)
- feedwater line (FW)
- surge line (SL)
- safety injection line (SI)
- shutdown cooling line (SDC)

ARKANSAS NUCLEAR ONE
UNIT 2

A review of pipe stresses for the as-built configurations of these piping systems eliminated the intermediate breaks in all but the surge line, and a review of loadings on the RCS for remaining terminal end breaks eliminated the BLPBs at the far terminal ends with respect to their effect on RCS response. Therefore, the final set of BLPBs postulated and analyzed for RCS response for the replacement steam generator configuration with power uprate consisted of fifteen (15) BLPBs listed in Table 3.6-1A (see Section 3.9.1.7 for BLPB analysis of RCS).

- B. In Seismic Category 2 piping which has not been analyzed and designed to withstand the loads associated with the Design Basis Earthquake (DBE), breaks are postulated to occur at any fitting.
- C. In Seismic Category 1 piping (other than the RCS main coolant line) and in the Seismic Category 2 piping which has been analyzed and designed to withstand the loads associated with the DBE, postulated break locations were determined as follows:
 - 1. ASME Code Section III Class 1 piping
 - a. The terminal ends;
 - b. Any intermediate locations between terminal ends where the primary plus secondary stress intensities (circumferential or longitudinal) derived on an elastically calculated basis under the loadings associated with specified seismic events and operational plant conditions exceeded $2.0 S_m$ for ferritic steel and $2.4 S_m$ for austenitic steel, where S_m is the design stress intensity as specified in Section III ASME Code;
 - c. Any intermediate locations between terminal ends where the cumulative usage factor (U) derived from the piping fatigue analysis under the loadings associated with specified seismic events and operational plant conditions exceeded 0.1, where U is the cumulative usage factor as specified in ASME Code, Section III; and,
 - d. As a minimum, when the limits defined in (b) and (c) above are not exceeded, at least two intermediate locations for each piping run or branch run. The intermediate points selected were the ones having the highest combined stress intensities. However, based on the criteria outlined in Section 3.6, postulation of these arbitrary intermediate break locations is no longer required. These break locations may be eliminated if previously postulated.
 - 2. ASME Section III Code Class 2 and 3, and non-nuclear piping
 - a. The terminal ends;
 - b. Any intermediate locations between terminal ends where either the circumferential or longitudinal stresses derived on an elastically calculated basis under the loadings associated with specified seismic events and operational plant conditions exceeded $0.8 (1.2 S_h + S_A)$, where S_h and S_A are stresses calculated by the rules of Articles NC-3600 and ND-3600 in ASME Code, Section III. In lieu of $0.8 (1.2 S_h + S_A)$, a more conservative stress limit of $0.8 (S_h + S_A)$ may be used.

ARKANSAS NUCLEAR ONE
UNIT 2

- c. As a minimum, at least two intermediate locations between each piping run or branch run. The intermediate points selected were those having the highest combined stress intensities. However, based on the criteria outlined in Section 3.6, postulation of these arbitrary intermediate break locations is no longer required. These break locations may be eliminated if previously postulated.

With the exception of the main steam lines, portions of piping which penetrate containment are not exempt from the above criteria. Breaks are not postulated on the main steam lines between the containment penetrations and the isolation valves outside containment. Restraints are provided to ensure valve operability and containment leak tight integrity in the event of a break downstream of the main steam isolation valves. In addition, this section of the main steam piping is designed to meet the following criteria:

- A. The maximum stress ranges as calculated by Equations 9 and 10 in Paragraph NC-3652, ASME Code, Section III, considering normal and upset plant conditions and an Operating Basis Earthquake (OBE) event, will not exceed $0.8 (1.2 S_h + S_A)$.
- B. The maximum stress, as calculated by Equation 9 in Paragraph NC-3652, under the loadings resulting from a postulated piping failure of fluid system piping beyond this portion of piping will not exceed $1.8 S_h$.

In addition to the break locations specified above, cracks were postulated in these piping systems outside containment at the most adverse locations with regard to essential structures and systems. The crack size was taken to be one-half the pipe internal diameter in length and one-half the wall thickness in width.

3.6.2.2 Design Break Geometry

As discussed in Section 3.6.2.1.A, application of LBB criteria has eliminated the postulated breaks on the MCL for purposes of the dynamic effects design basis of the RCS. However, the non-mechanistic MCL piping rupture original design basis is maintained for containment design, ECCS performance analysis, and electrical and mechanical environmental qualification. In evaluating the effects of postulated breaks in the piping systems identified in Section 3.6.1, the following types of breaks were originally assumed:

- A. Circumferential Break - a break perpendicular to the longitudinal axis of the pipe. The break area was assumed to be equivalent to the internal cross-sectional area of the pipe at the break location, except for those cases where restraints have been provided to limit the break area, and/or analyses performed to show that complete separation of the piping at the break point will not occur.

For a circumferential break in the 42-inch I.D. RCS hot leg piping at either the reactor vessel nozzle weld or the steam generator nozzle weld, analyses have shown that the steam generator support system and the reactor vessel support system will limit the separation of the piping such that the resulting maximum break openings will be limited to 100 square inches and 850 square inches, respectively. For the circumferential break in the 30-inch I.D. RCS cold leg piping at the reactor vessel nozzle weld, the reactor vessel support system and cold leg restraint system will limit the separation of the piping such that the resulting maximum break openings will be limited to 200 square inches. These analyses are presented in Combustion Engineering Report

ARKANSAS NUCLEAR ONE
UNIT 2

CENPD-168, "Design Basis Pipe Breaks for C-E Two Loop Plants," and CE Report, "Design Basis Pipe Breaks for the Arkansas Nuclear One, Unit 2 Reactor Coolant System," (2CAN067607).

- B. Longitudinal Break - a break in the pipe wall parallel to the longitudinal axis of the pipe having a length of two pipe inside diameters. With the exception of the RCS piping, the flow area of the break was assumed to be equivalent to the internal cross-sectional area of the ruptured pipe.

For the 42-inch I.D. RCS hot leg piping, analyses were performed which show that the flow area of a break, propagated from a crack in this piping which is twice the pipe inside diameter in length, will not exceed an area equivalent to 0.6 times the pipe cross-sectional area. For the 30-inch I.D. pump suction and discharge piping, these analyses have shown that the maximum break area will not exceed an area equivalent to 0.8 times the pipe cross-sectional area. These analyses are presented in the Combustion Engineering Report CENPD-168, "Design Basis Pipe Breaks for C-E Two Loop Plants"

The following criteria were used to determine the specific type of break assumed in the analysis:

1. No breaks were postulated in piping having a nominal diameter less than or equal to one inch.
2. Circumferential breaks were postulated in piping having a nominal diameter between one and four inches.
3. In piping having a nominal diameter equal to or greater than four inches both circumferential and longitudinal breaks were assumed at each of the postulated break locations unless: (1) the primary plus secondary stress in the axial direction was found to be at least twice that in the circumferential direction for the most severe normal and upset load combination transients in which case only a circumferential break was postulated; or conversely, (2) the primary plus secondary stress in the circumferential direction was found to be at least twice that in the axial direction for the most severe normal and upset transients; in which case only a longitudinal break was postulated. Longitudinal breaks were not postulated at terminal ends, provided the piping at the terminal ends contained no longitudinal welds, or at the arbitrary intermediate locations if considered to satisfy the criterion for a minimum number of break locations (per SAR Section 3.6.2.1).

3.6.3 DESIGN LOADING COMBINATIONS

3.6.3.1 Reactor Coolant System

The design loading combinations applied in the design of RCS major components and supports, as appropriate, include the loads produced by the following conditions:

- A. normal operating conditions;
- B. vibratory motion of the DBE; and,
- C. dynamic effects resulting from postulated pipe rupture conditions.

ARKANSAS NUCLEAR ONE
UNIT 2

Specifically, the following design loading combinations are applied in the design of equipment restraints:

- A. Loading Combination 1 - normal operating loads plus OBE loads;
- B. Loading Combination 2 - normal operating loads plus DBE loads;
- C. Loading Combination 3 - normal operating loads plus DBE loads plus pipe rupture loads.

The design stress limits applied in evaluating Loading Combination 1 are in accordance with the rules of the ASME Code, Section III, Paragraph NB-3223 for Upset Conditions. The design stress limits applied in evaluating Loading Combinations 2 and 3 are dependent upon the type of system or subsystem analysis used to establish design loadings.

Elastic methods are employed in the system or subsystem analysis used to determine the design loadings produced by Loading Combination 2. With the possible exclusion of those local elements of the restraint system which sustain the direct thrust produced by the postulated rupture, elastic methods are also employed in the system or subsystem analysis used to determine the design loadings produced by Loading Combination 3.

When an elastic system or subsystem analysis is used to determine the design loadings produced by Loading Combinations 2 and 3, the associated design stress limits applied in the design of supports and restraints are in accordance with the rules of the ASME Code, Section III, Appendix F, Subparagraph F-1323.3, for component supports.

Inelastic response of supports and restraints is permitted only during postulated pipe rupture conditions and, when permitted, is limited to those local elements of the system which sustain the direct thrust produced by the postulated rupture, and to the piping segment within which the postulated rupture is assumed. When inelastic response is permitted, the system or subsystem analysis used to determine design loadings is modified to consider the inelastic action, including the compatibility of inelastic strains in the supports and the supported equipment. When inelastic response is permitted, the strains produced by Loading Combination 3, above, are limited to 50 percent of the uniform strain (strain at ultimate stress) of the material.

3.6.3.2 Other Systems

Pipe and pipe restraint motion and design of the pipe restraints and supports for postulated pipe breaks (other than the RCS) were analyzed in accordance with the methods described in Section 3 of Bechtel Topical Report BN-TOP-2, Revision 2. Where plastic deformation of the restraint structure was permitted, the deformation was limited to 10 times the yield deformation, i.e., $\mu \leq 10$.

3.6.4 DYNAMIC ANALYSES

The piping systems requiring dynamic analyses to ensure that the safe shutdown capability of the plant is not compromised following a postulated pipe break are listed in Table 3.6-1. Isometric drawings of these piping systems showing location of the postulated break points are referenced in Sections 3.6.4.1 and 3.6.4.2. Additionally, tables showing historical values for the calculated stress levels, usage factors, and jet thrust forces at these points are contained in Tables 3.6-2 through 3.6-24. For actual current calculated stresses or usage factors, refer to the latest qualifying pipe stress analysis calculation(s).

ARKANSAS NUCLEAR ONE
UNIT 2

In determining the dynamic force acting on a pipe following a postulated break, a time independent forcing function was utilized. The forcing function accounts for both the pressure existing in the pipe at the break point and the reaction force exerted on the pipe by the escaping fluid. Pipe friction and restrictions in the flow line were taken into account in the determination of the value of this forcing function. A time independent blowdown model was utilized in the determination of the mass and energy release rates resulting from the postulated break. Isenthalpic flow conditions and constant source pressure were assumed.

In determining the effects of the jet impingement force resulting from a postulated break or crack in a pipe, the total jet force was assumed constant throughout the travel of the escaping fluid and the jet area was assumed to expand uniformly at a half angle of 10°.

A complete description of the mathematical models employed in the dynamic analyses of the piping systems (other than the RCS) is contained in Section 2 of Bechtel Topical Report BN-TOP-2, Revision 2, "Design for Pipe Break Effects." Section 3.9.1.6 addresses the dynamic analysis of the RCS piping performed by CE.

The effects of unrestrained motion of ruptured piping on the containment liner and on structures providing barrier protection for safety-related components were evaluated using the mathematical models described in Bechtel Topical Report BC-TOP-9, Revision 1, "Design of Structures for Missile Impact."

3.6.4.1 High Energy Pipe Break Outside Containment

3.6.4.1.1 Main Steam Lines

3.6.4.1.1.1 General Description

The main steam headers are 38 inches O.D., carbon steel piping. The piping from the steam generators to the main steam isolation valves is Seismic Category 1, designed and fabricated in accordance with the ASME Code, Section III, Class 2 criteria. The remainder of this piping is designed and fabricated in accordance with ANSI B31.1. The wall thickness of the main steam headers is 1.167 inches, however, the portion of the main steam header to which the main steam safety valves are attached has an increased wall thickness of 1.875 inches. The main steam lines pass through the auxiliary building via a pipe tunnel at Elevation 346 feet. Although only the piping upstream of the main steam isolation valves is Seismic Category 1, the entire lengths of both main steam headers have been completely analyzed and designed to withstand the forces associated with the DBE and the OBE.

3.6.4.1.1.2 Safety Evaluation

The historical calculated stress level values at the postulated break points are contained in Tables 3.6-2 and 3.6-3. Section 10.3 describes the main steam lines in detail and discusses the equipment necessary to mitigate the consequences of a break in these lines. A flow restriction is installed in each main steam line inside containment to limit the blowdown rate following a postulated pipe rupture outside containment. In addition, integral flow limiting devices are installed in each steam generator outlet nozzle. This flow restricting nozzle has not been credited in the dynamic analysis but has been credited in the environmental effects analysis.

ARKANSAS NUCLEAR ONE
UNIT 2

Breaks are not postulated on these lines between the containment penetrations and the restraints just beyond the main steam isolation valves. This portion of piping has been designed in accordance with criteria listed in Section 3.6.2.1. Restraints have been provided on both main steam headers which are capable of resisting bending and torsional moments produced by postulated pipe ruptures downstream of the restraints below the isolation valves. Restraints are located above both main steam headers which prevent vertical uplift of the piping in the event of a break on the main steam risers. The restraints provided just below the main steam isolation valves, in conjunction with the restraints above the main steam headers, will ensure the leak tight integrity of containment in the event of any pipe rupture downstream of the valves.

In addition to the break points postulated below the main steam isolation valves, seven additional breaks are postulated on 2EBD-1 and eight additional breaks are postulated on 2EBD-2. All of these additional postulated breaks on 2EBD-1 are located within the turbine building. This structure is not Seismic Category 1 and safety-related equipment is not located in this building. Breaks in this building will not adversely affect the ability to mitigate the consequences of the breaks or reach cold shutdown. The effects of a break postulated at point 30, just outside the auxiliary building will be limited by restraints at the auxiliary building wall (the east end of the main steam tunnel) and at the west end of the main steam tunnel. The bumper at the west end of the tunnel will prevent uncontrolled whip of the main steam risers as well as reduce the impact loading on the wall. The restraints at the east end of the main steam tunnel will act as a guide, and in conjunction with the bumpers prevent pipe whip in the tunnel.

On 2EBD-2, one break is postulated in the main steam tunnel on the elbow at the west end of the tunnel. The remainder of the postulated breaks are located in the turbine building. The main steam tunnel has been modified to withstand the effects of a full area main steam rupture. Grating has been placed over the main steam tunnel which will provide enough vent area to limit the pressure to 14.14 psig with the grating secured. The design pressure of the tunnel walls is 15 psig. The room above the main steam tunnel (to which a postulated main steam break would vent steam) contains component cooling water pumps, heat exchangers, and piping. This equipment is not safety-related and is not Seismic Category 1. This postulated break was reanalyzed for the environmental effects for a power level of 3026 MWt with credit for the flow limiting device located in each steam generator outlet nozzle. The results remain bounded by the above description. Breaks at either point 65 or 73 on 2EBD-2 will not damage any safety-related structure or equipment due to restraint and wall placement.

The main steam headers in the main steam tunnel pass by the emergency feedwater pump rooms. A 2-foot thick Seismic Category 1 wall separates the main steam tunnel from this room. The emergency feedwater pump discharge piping runs parallel to the main steam piping and at its closest point, it is within 10 feet of main steam header #1. The above mentioned wall provides protection for the piping. The location of the postulated break points on the main steam piping, the positioning of restraints, and the design of the main steam tunnel walls will prevent any loss of integrity of the emergency feedwater system due to a break in the main steam headers.

ARKANSAS NUCLEAR ONE
UNIT 2

3.6.4.1.2 Main Feedwater Lines

3.6.4.1.2.1 General Description

The main feedwater piping is 24-inch Schedule 80, carbon steel piping (alternate material may be used provided the material is evaluated and approved for use by Engineering, and satisfies the applicable Codes and Standards). Between the steam generators and the main feedwater isolation valves in the north piping penetration room, the main feedwater piping is designed and fabricated in accordance with the ASME Code, Section III, Class 2 criteria. The remainder of the feedwater piping is designed and fabricated in accordance with ANSI B31.1. The portions of the main feedwater piping from the steam generators to the last stage feedwater heaters (2E1A, 2E1B) have been analyzed and designed to withstand the loads imposed by the DBE and OBE. The piping is routed through non-Seismic 1, non-safety-related areas.

3.6.4.1.2.2 Safety Evaluation

Historical calculated stress level values at the postulated break points are contained in Table 3.6-4. Both main feedwater lines enter containment through the north piping penetration room which is directly below the safety-related electrical penetration room. Main feedwater header #1 (2DBD-2) passes near the electrical equipment room which contains safety-related motor control centers. Check valves are located on each main feedwater line inside the containment. These valves will prevent blowdown of the steam generators following a break at any location in the main feedwater lines outside containment. Even in the event of check valve failure (valve is stuck open) blowdown will be severely restricted by the steam generator feed ring design.

Break points are postulated on each of these lines at the containment penetrations where the line is anchored by the flued head (terminal end). Access to the piping penetration room is available from the chemical storage area, through a locked closed, watertight door, or from the piping room directly below by means of a spiral staircase. The piping room is accessible via a door (3' x 7' x 2") which opens into a large corridor on the 335-foot elevation level. This door is normally closed since the pipe room is directly connected to the piping penetration room and, upon receipt of a containment isolation signal, the penetration room ventilation system functions to maintain a slight vacuum in the penetration rooms.

Design of this door is such that it blows open with a pressure buildup in this compartment of 0.25 psid, which limits peak pressure in the piping and piping penetration rooms. The peak pressure calculated due to a critical crack, using a frictionless subcooled flow model, was determined to be less than 2.2 psig. The room directly above the piping penetration room is the electrical penetration room which contains Channel 4 safety features instrumentation cabling. As the piping penetration room is normally sealed off, the releases of high energy feedwater from a full area break in the feedwater piping in this area would result in overpressurization of the room. The consequences of this failure would be lifting of the ceiling (floor of the electrical penetration room) and damage to safety-related electrical equipment. Therefore, to limit the blowdown from a full area circumferential in the feedwater lines at the containment penetrations, pipe whip restraints are installed in this room to prevent these lines from "backing out" of the flued heads. In conjunction with these restraints, a flow limiting annulus is installed around each of those lines at the penetrations. These annuli are steel plates capable of withstanding full feedwater system pressure and are welded to the penetrations. The clearance between the plates and the feedwater piping is designed such that the blowdown into the piping penetration room, following a line break at the penetration, is limited to that which results from a "critical

ARKANSAS NUCLEAR ONE
UNIT 2

crack" in this piping. The ceiling of the piping penetration room has been strengthened to withstand a pressure of 2.2 psi in the piping penetration room resulting from a critical crack in the main feedwater piping. The remainder of the postulated break points on the main feedwater lines lies outside the piping penetration room. It was determined that the energy release from a main feedwater "Critical Crack" results in higher peak pressures than for other postulated pipe breaks located in the north piping penetration room.

The electrical equipment room is located in the Seismic Category 1 portion of the auxiliary building at floor Elevation 368 feet. Access to the electrical equipment room is available through a locked closed door from the non-Seismic Category 1 portion of the auxiliary building. The feedwater piping is routed within six feet of this door. A missile proof door installed for the electrical equipment room is capable of withstanding the jet impingement forces resulting from a full area break in this piping. Seismic Category 1 walls provide separation and protection of the electrical equipment from the effects of a full feedwater line break in other areas.

Breaks have been postulated at every fitting, valve or welded attachment on the main feedwater piping between the pumps discharge and the last stage feedwater heaters. Although the piping is routed through non-safety-related areas, loadings on required structures due to the effects of pipe break have been analyzed to ensure the integrity of the structures.

One main feedwater line, 2DBD-4-24", is routed over the Seismic Category 1 floor slab at Elevation 354 feet which also acts as a ceiling for the emergency feedwater pump rooms. This slab is two feet thick and can withstand the jet thrust load without failure or spalling of the slab. A concrete pad is provided to limit the gap between the pipe and the concrete and reduce the dynamic load factor.

The emergency feedwater pumps and discharge piping, the steam supply to the turbine driven emergency feedwater pump, electrical equipment required to initiate Main Steam Isolation Signal (MSIS) and Emergency Feedwater Actuation Signal (EFAS), and systems required for the safe shutdown will not be impaired as a result of the consequences of a postulated main feedwater pipe break.

3.6.4.1.3 Steam Generator Blowdown

3.6.4.1.3.1 General Description

The steam generator blowdown lines outside containment are 4-inch Schedule 80, carbon steel piping. The portion of piping from the containment penetrations to the containment isolation valves is Seismic Category 1, designed in accordance with the ASME Code, Section III, Class 2 criteria. The remainder of the piping is designed and fabricated in accordance with ANSI B31.1.0. The blowdown control valves, located at the steam generator blowdown tank, reduce steam generator pressure to condenser pressure. A flow measuring orifice is located outside the containment on both lines which will restrict blowdown in the event of a break downstream of the orifice. The blowdown lines from steam generator 2E24A, 2DBD-9, is routed through the south piping penetration room, through the auxiliary building to the steam generator blowdown tank 2T67 located at floor Elevation 354 feet. The blowdown line from steam generator 2E24B, 2DBD-10, is routed through the north piping penetration room, down a hallway at Elevation 335 feet, through the charging pump rooms and to the steam generator blowdown tank.

ARKANSAS NUCLEAR ONE
UNIT 2

3.6.4.1.3.2 Safety Evaluation

A detailed stress analysis was not performed on these lines to determine break points. Breaks have been postulated at the terminal ends and at each intermediate pipe fitting, welded attachment, and valve. Section 10.4.8 describes system design and operation.

A postulated break in one of the steam generator blowdown lines does not require safety system actuation to mitigate the consequences of the event.

Four postulated break locations on 2DBD-9 are located in the south piping penetration room. The blowdown and energy release associated with blowdown line breaks was determined using a 2-phase, frictionless flow model. The design of this piping penetration room door is such that it blows open when differential pressure reaches 0.25 psid. Analyses showed that a maximum pressure of less than 2.0 psig, resulting from a guillotine break of the steam generator blowdown line, was reached in the room. This break was determined to be the worst case break for pressurization of the south piping penetration room. The walls, floors, and ceiling of the penetration room are designed to withstand a pressure of 2 psig, so pressurization will not cause failure of the structure. Safety-related cable trays and cabling which could be affected by breaks at these locations include power to a number of containment isolation valves and power to train 'A' ESF pumps 235A, 2P60A, and 2P89A. Failure of these components due to a break in the blowdown line from steam generator 2E24A will not impair the ability to shutdown. Isolation of containment is not required as a result of the event, however, valves inside containment will assure containment integrity.

Breaks are also postulated on 2DBD-9 in the piping room below the south penetration room. One safety-related cable tray is located in this room. Shutdown cooling system valves which are powered from this tray include one suction valve from the RCS and one of four Low Pressure Safety Injection (LPSI) valves. These valves can be manually opened when required to safely shutdown the plant. A cable providing power to the train 'A' suction valves from both the refueling water and the NaOH tanks are located near break points postulated on both 2DBD-9 and 2DBD-10 in the room below the steam generator blowdown tank.

Failure of these valves does not impair the ability to reach cold shutdown. One restraint has been provided to prevent impact of the shutdown cooling line, 2GCB-5-14" by 2DBD-9. This restraint provided sufficient protection to ensure the integrity of this line. There is no other safety-related cabling or equipment located in this room.

Two postulated break points on 2DBD-10 are located in charging pump room A and one postulated break point is located in charging pump room B. Due to separation by barriers, a steam generator blowdown line break in any one room cannot cause loss of function to more than one pump and its associated controls. Therefore, two pumps, powered from separate power supplies, are available in the event of these postulated pipe breaks to borate the RCS, if required for shutdown.

Safety-related cables are also located in a hallway outside the charging pump room 5 through which 2DBD-10 is routed. However, the cabling at this location, if damaged by the effects of high energy pipe break, will not impair the ability to reach cold shutdown. With the exception of one safety-related cable tray, safety-related electrical cables, instrumentation and equipment are not located in the piping hallway at Elevation 335. This cable tray contains cables for the motor driven emergency feedwater pump and associated equipment. Loss of this equipment is acceptable since the turbine driven emergency feedwater pump is available for plant cooldown.

ARKANSAS NUCLEAR ONE
UNIT 2

If off-site power is available, the normal condensate system can also bring the plant to a hot shutdown condition. The energy associated with a steam generator blowdown line break is insufficient to impair safety-related piping in the area.

A number of postulated break points on 2DBD-10 are located in the piping room below the north piping penetration room. This room and the penetration room above are connected via a spiral staircase. Pressurization of these rooms due to a steam generator blowdown line break has been determined to result in less severe consequences than a main feedwater critical crack which is also postulated to occur in these rooms. Safety-related cabling which could possibly be affected by these breaks include control cables for the emergency feedwater containment isolation valves, an emergency feedwater flush line valve, and a service water valve on the return header to the reservoir. One isolation valve in each of the emergency feedwater supply lines is designed to fail closed upon loss of electrical power. Since these lines feed the affected steam generator, isolation is required and assured by this design. Safe shutdown may be attained via emergency feedwater to the unaffected steam generator. Breaks on 2DBD-10 are also postulated to occur in the north piping penetration room above the floor at Elevation 356. Containment isolation valves for emergency feedwater supply to 2E24B, the blowdown line from 2E24B, and the service water supply and return to two of four containment cooling coils and their associated power cables are located in this room. The loss of these valves, however, is inconsequential to the safe shutdown capability of the plant.

Steam generator blowdown line pipe breaks outside containment may be isolated when detected by closure of the inner containment isolation valve in the same line. Indication of the break is provided by high auxiliary building sump level, low steam generator level and high feedwater flow, and no flow to the steam generator blowdown tank from the affected steam generator. With the exception of the one restraint provided on 2DBD-9, which ensures the integrity of the shutdown cooling line, restraints are not required on the steam generator blowdown lines outside containment for plant safety. Analysis has shown that the consequences of any one postulated pipe break will not result in loss of function to systems required for safe shutdown.

3.6.4.1.4 Emergency Feedwater

3.6.4.1.4.1 General Description

The discharge piping for the safety related emergency feedwater pumps (2P7A and 2P7B) discharge piping is 4-inch Schedule 80 carbon steel piping designed in accordance with ASME Code, Section III Class 3 criteria up to the containment isolation valves. The remainder of the emergency feedwater discharge piping is designed in accordance with the ASME Code, Section III, Class 2 criteria. The entire piping, from the pump discharges to the connections on the main feedwater lines inside containment, is designed to withstand the DBE and OBE. The discharge piping from both pumps is routed outside the individual pump rooms and to a piping hallway at floor Elevation 335 feet. At this location both discharge lines split into two lines, with one of each being routed to the north piping penetration and one of each to the south piping penetration room. Lines 2DBC-1 and 2DBC-4 are routed to the south piping penetration room where the lines combine into 2DBB-3 before penetrating containment. Lines 2DBC-2 and 2DBC-3 are routed to the north piping penetration room where these lines combine into 2DBB-4 before penetrating containment. System operation is described in Section 10.4.9.

ARKANSAS NUCLEAR ONE
UNIT 2

The discharge piping for the non-safety related Auxiliary Feedwater pump (2P75) is 4-inch Schedule 80 carbon steel, designed in accordance with ASME Code, Section III, Class 3 criteria from the first of the two series check valves to its tie-in with the EFW discharge piping. This portion of the piping is designed to withstand the DBE and OBE.

3.6.4.1.4.2 Safety Evaluation

A detailed stress analysis was not performed on these lines to determine break points. Alternatively, pipe breaks have been postulated at the terminal ends and at each intermediate pipe fitting, welded attachment, and valve. A postulated break of an emergency feedwater pipe would not result in protective system actuation. Therefore the consequences of any one break cannot result in loss of function to required safety systems, but loss of redundancy is permitted.

The emergency feedwater piping is routed through the same rooms as the steam generator blowdown lines. Therefore similar safety-related equipment and piping could be effected by a postulated break of these lines in the two piping penetration rooms and the two piping rooms below. In the south piping penetration, however, pipe whip of 2DBC-4 could cause damage to the integrity of 2GCB-7-6", a shutdown cooling return line. A restraint will be provided to prevent this. Further protection is not required in either piping room or piping penetration room.

Both the emergency feedwater pump discharge piping and suction piping is located in the hallway just outside the emergency feedwater pump rooms. The service water supply to the pump suction is of larger nominal pipe size but thinner wall thickness than the pump discharge piping. Therefore, a through-wall crack was postulated to occur in the one pump suction piping due to a rupture of the other pump discharge piping. The flow rate through this crack is not sufficient however to cause loss of pressure or flow to the pump suction. The required flow rate of the pumps is well below the makeup capability of the service water system.

The routing of the service water supply lines to both the emergency feedwater pumps and their associated room coolers provides sufficient separation to ensure the operation of one pump and cooler in the event of any postulated pipe break in the other pump's discharge line. Therefore, pipe break restraints are not required nor provided in this area. The protection provided on these lines ensures that any postulated emergency feedwater pipe break will not result in loss of function to required safety systems.

3.6.4.1.5 Main Steam Supply to Emergency Feedwater Pump Turbine Driver

3.6.4.1.5.1 General Description

The main steam supply lines to the turbine driven emergency feedwater pump, 2P7A, are 4-inch Schedule 40, carbon steel piping. The main steam supply to the pump driver may be drawn from either or both main steam headers. Connections are provided on both main steam headers upstream of the main steam isolation valves, on the Seismic Category 1 portion of piping. Motor operated gate valves are provided to isolate either or both main steam headers from the emergency feedwater pump driver. The two steam supply connections are run together and one line is routed to the emergency feedwater pump room. Check valves are provided before this junction to prevent loss of steam supply in the event of a break in one main steam header. The entire main steam supply line is Seismic Category 1, designed in accordance with the ASME Code, Section III, Class 3 criteria. The supply line is routed through a vertical shaft near the new fuel storage area and piping drops from Elevation 418 feet, 4 inches to 350 feet, 3 inches. The piping then runs through the fuel pool pump rooms to the

ARKANSAS NUCLEAR ONE
UNIT 2

emergency feedwater pump room. The safety-related piping located in the area includes service water, service water supply to emergency feedwater pump suction, and emergency feedwater pump discharge piping as well as electrical cabling.

3.6.4.1.5.2 Safety Evaluation

Historical calculated stress level values at the postulated break points determined by stress profile are contained in Table 3.6-5. A summary description of the main steam and emergency feedwater systems are provided in Sections 10.3 and 10.4.9, respectively. A break in this 4-inch steam line will not require safety systems actuation since the blowdown in the line is within the makeup of the main feedwater pumps to the steam generators.

Breaks postulated between the main steam header nozzles and the junction of the two lines are located above Elevation 420 feet. The only safety-related electrical equipment or cabling in this area are the control channels to the steam supply isolation valves 2CV-1000-1 and 2CV-1050-2. A break in one line, however, could not result in failure of the other line's isolation valve control channel due to separation by distance and location of the main steam headers. The breaks postulated at points 53 and 55 are located over the new fuel storage area, at least 11 feet above the 404 feet floor elevation. There is no safety-related equipment in the area to be affected by breaks in that portion of piping. The piping then makes a 68-foot vertical drop through an enclosed shaft to Elevation 350 feet.

Breaks postulated at points 76, 80, 82, 100 and 105 are located in a piping hallway and the fuel pool pump room at floor Elevation 335 feet. The safety-related piping in this area is all of equal or larger nominal diameter and equal or larger wall thickness so the integrity of other piping will not be impaired. A cable tray containing channellized safety-related cables also passes in the area. The cables include power supply for the emergency feedwater motor driven pump suction valves and room cooler. A barrier has been provided to protect this cable tray from the dynamic effects of pipe whip and jet impingement. The safety-related cabling is rated for environmental conditions associated with a LOCA. The barrier provided and the low blowdown rate will ensure that the design ratings of the cable are not exceeded.

During normal plant operating conditions, this line is pressurized to valve 2CV-0340-2 which is normally closed. Accordingly, the terminal end of the line is postulated to be at the piping connection to the closed valves. These valves have been located outside the emergency feedwater pump room. The valves are located such that the consequences of a postulated break at the valve would not cause loss of function to systems required for plant shutdown.

3.6.4.1.6 Main Steam Supply to the Atmospheric Dump Valves

3.6.4.1.6.1 General Description

The main steam supply lines to the atmospheric dump valves are 10-inch Schedule 60, carbon steel piping. Both lines are Seismic Category 1 and are designed in accordance with the ASME Code, Section III, Class 2 criteria up to and including the dump valves. The piping connection for the atmospheric dumps is provided upstream of the main steam isolation valves. This ensures the capability of plant cooldown via steam dump in the event of a Main Steam Isolation Signal (MSIS). See Section 10.3 for further discussions of system operation.

ARKANSAS NUCLEAR ONE
UNIT 2

3.6.4.1.6.2 Safety Evaluation

Historical calculated stress level values at the postulated break points are contained in Table 3.6-6. The two atmospheric dump paths, one connected to each of the redundant main steam headers, are located such that a pipe break in either 2EBB-8 or 2EBB-9 will not impact or damage the other pipe. In the event of the failure of one atmospheric dump valve to open, in addition to the break of the other line, the main steam safety valves enable the plant to cooldown.

Power to the main steam isolation valves will not be impaired by a postulated pipe break of either atmospheric dump line. Separation by distance and the location of structures and equipment will ensure that systems required to mitigate the consequences of the pipe break or shutdown the plant are not damaged. Section 10.3 describes equipment required to mitigate the consequences of a break in these lines.

3.6.4.1.7 Charging

3.6.4.1.7.1 General Description

The charging line outside containment is 2- or 3-inch Schedule 160, carbon steel piping designed in accordance with the ASME Code Section III, Class 2 criteria. The charging pump discharge piping is the only portion of the charging line which qualifies as high energy piping. The three charging pumps are located in separate rooms at Elevation 335 feet. The pump discharges are run through the neighboring piping rooms, the south piping penetration room and into containment. In the piping penetration room, the charging line reduces from 3-inch to 2-inch nominal piping. At this point the line number changes from 2CCB-8 to 2CCB-25. The charging pump discharge and suction paths are Seismic Category 1. System operation is discussed in Section 9.3.4.

3.6.4.1.7.2 Safety Evaluation

Historical calculated stress level values at the postulated break points are contained in Table 3.6-7. In accordance with the criteria outlined in Section 3.6.2.2, only guillotine breaks are postulated in the line.

The postulated break points are located in one of three rooms: the charging pump room, the south piping penetration room, and the piping room below. The three charging pumps are each located in a separate room. A second charging path is provided through the High Pressure Safety Injection (HPSI) line. Each pump is capable of being isolated so that a break in any one of the three charging pump rooms will not result in the loss of more than one charging pump or charging path. Power supplies for each of the pumps and associated instrumentation are also separated by the rooms.

Breaks postulated on 2CCB-25 are located in the south piping penetration room. Safety-related electrical trays, piping, and valves located in the vicinity of the line were assumed to fail. However, the ability of the plant to shutdown was not impaired assuming a single active failure in addition to the consequences of the pipe break. Since a break of the charging line will not cause protective system actuation, loss of required safety system redundancy is acceptable.

ARKANSAS NUCLEAR ONE
UNIT 2

One break has been postulated on 2CCB-8 in the piping room below the south piping penetration room. The consequences of this postulated charging line break could cause a through-wall crack in the shutdown cooling line 2GCB-5. To ensure the availability and performance of the shutdown cooling system, one restraint has been placed on 2CCB-8 which will prevent impact of 2GCB-5 by 2CCB-8. The consequences of this postulated break will not impair the ability to shutdown, or cause loss of both redundant trains of a safety system. Therefore, adequate protection has been provided for the charging lines by existing layout, restraints, and structures.

3.6.4.1.8 Letdown

3.6.4.1.8.1 General Description

The letdown line outside containment is 2-inch Schedule 160 and Schedule 40 stainless steel piping designed in accordance with the ASME Code, Section III, Class 2 criteria up to the letdown heat exchanger. The line is designed for the effects of a DBE up to the first pipe anchor downstream of the letdown control valves. The letdown control valves are located in the south piping penetration room. The letdown heat exchanger is located in a room on the floor below. System operation is described in Section 9.3.4.

3.6.4.1.8.2 Safety Evaluation

Historical calculated stress level values at the postulated break points are contained in Table 3.6- 8. Downstream of the letdown control valves breaks are postulated at every fitting. In the event of a letdown line break outside containment, the high break flow will cause a high temperature alarm at the regenerative heat exchanger discharge and generate a signal to close the letdown valve inside containment. A low pressure alarm at the letdown heat exchanger discharge will also alert the operator. A letdown line break results in blowdown of the RCS and subsequent Safety Injection Actuation Signal (SIAS) generation. Redundant SIAS signals are provided to the two letdown valves inside containment which close the valves and terminate the high pressure blowdown and terminate the event. Therefore operator action is not required to mitigate the consequences of the event.

Breaks postulated in the south piping penetration room will not impair plant shutdown capability or cause loss of redundancy to required safety systems.

The mass and energy release rate to the room was determined using a frictionless subcooled flow model and RCS pressure was assumed to remain constant. As a result of this analysis it was determined that steam generator blowdown in the penetration room results in higher room pressure and therefore is more limiting.

Breaks postulated in the piping room below the penetration room and in the letdown heat exchanger room will not result in consequences unacceptable to plant safety. Although the letdown line passes over the shutdown cooling line, whip of a 2-inch Schedule 40S pipe will not damage the 14-inch Schedule 20 shutdown cooling piping. Therefore, restraints are not required on this line to ensure plant safety.

ARKANSAS NUCLEAR ONE
UNIT 2

3.6.4.1.9 Steam Supply to Concentrators

The boric acid concentrator and the waste concentrator are currently not in use and are maintained in long term shutdown condition. The following description and safety evaluation are provided in the event the concentrators are placed in service.

3.6.4.1.9.1 General Description

Steam is supplied to the boric acid concentrator (2M39) and waste concentrator (2M41) from the Unit 1 or Unit 2 main steam lines or from the Unit 1 startup boiler. The concentrators do not perform safety-related functions and therefore the steam supply lines are designed to non-Seismic quality group D requirements. The main steam supply piping to the pressure control valves is 3-inch Schedule 40 carbon steel piping. The pressure reducing station and distribution header is located in the south end of the piping hallway at Elevation 335 feet. Here the steam supplies from all three sources are reduced in pressure to 100 psig and run into a common header. From this header, two 6-inch Schedule 40 carbon steel lines are routed to the concentrators. Within the concentrator rooms the steam is reduced in pressure and desuperheated prior to entering the concentrator package. The piping from the second pressure control valves to the concentrators is 10-inch.

3.6.4.1.9.2 Safety Evaluation

Pipe breaks have been postulated at the terminal ends and at each intermediate pipe fitting, welded attachment, and valve on all high energy piping supplying steam to the boric acid or waste concentrators. A break occurring at any of the postulated locations would not result in protective system actuation. Therefore the consequences of any one postulated break cannot result in loss of function to required safety systems, but loss of safety system redundancy is permitted.

The main steam supply lines from Unit 1 and Unit 2 are routed from the east and north ends of the piping hallway to the pressure reducing station. The main service water headers, emergency feedwater discharge piping and steam supply to the emergency feedwater pump driver are located in the vicinity of postulated breaks. However the size and wall thickness of the steam supply piping is insufficient to damage the safety-related piping listed. Also the consequences of any postulated break will not cause loss of function to any safety-related system due to the separation provided in redundant systems.

For pipe breaks postulated downstream of the first pressure reducing valves the energy of the whipping pipe will be greatly reduced due to the lower steam pressure. With the exception of breaks postulated near the waste concentrator on 2HBD-180-6 inches/10 inches, adequate separation is provided for postulated breaks on the lower pressure steam supply lines. The consequences of postulated breaks located in the concentrator room could result in the development of throughwall leakage cracks in either the refueling water tank or sodium hydroxide tank discharge lines. Since the Refueling Water Tank Discharge line serves both safety trains, loss of integrity is not acceptable. Three restraints have been added to preclude this discharge piping failure as a result of the consequences of postulated pipe breaks in the steam supply piping.

ARKANSAS NUCLEAR ONE
UNIT 2

3.6.4.1.10 Safety Injection System

3.6.4.1.10.1 General Description

The discharge piping from the High Pressure Safety Injection pumps to the isolation valves at the containment penetration is 4" Schedule 80 stainless steel pipe which splits into four 3" Schedule 160 pipes per train and is reduced to 2" Schedule 160 pipe at the isolation valves. This piping is designed to the ASME Code, Section III, Class 2 criteria. The Safety Injection System provides both passive and active means of injection to the RCS in the event of a design basis event. The portion of the piping from the pump discharge to the isolation valve is pressurized to 635 psig during normal operation by the HPSI Pressurization System in order to prevent leakage from the Safety Injection Tanks into the HPSI header, which could result in gas voids. Since this system only provides enough flow to keep the system pressurized, the temperature of the piping and the fluid contained in it will be ambient. This portion of the system will be at higher pressures during a design basis event; however, this will occur less than 2% of the time and, therefore, only the pressurization due to the HPSI Pressurization System and/or leakage is considered for high energy line breaks.

3.6.4.1.10.2 Safety Evaluation

Pipe breaks were considered to be possible at any location. Analysis has shown that a line break will not result in more severe effects than if the piping were moderate energy, since the source of pressurization is extremely low flow. The piping will depressurize very quickly and the jet forces resulting from a break will be negligible. Spray effects and flooding are enveloped by the effects of other line breaks which have already been considered.

3.6.4.2 High Energy Pipe Break Inside Containment

3.6.4.2.1 Reactor Coolant System

3.6.4.2.1.1 General Description

The RCS major piping is stainless steel clad, carbon steel piping; designed and fabricated in accordance with the ASME Code, Section III, Class 1 criteria. The major piping consists of four 30-inch I.D. cold legs (reactor coolant pump suction and discharge) and two 42-inch I.D. hot legs. A plan view showing the location and configuration of the reactor coolant piping with respect to structures, equipment, and restraints is shown in Figure 3.6-31. System operation is described in Section 5.1.

3.6.4.2.1.2 Safety Evaluation

Postulated RCS piping break locations, break orientations, and break areas are described in Section 3.6.2.

As discussed in paragraph 3.6.2.1.A, postulated breaks in the RCS main loop piping were eliminated from the ANO-2 RCS dynamic effects design basis by application of leak-before-break (LBB) methodology. However, in accordance with NUREG-1061 Volume 3, the non-mechanistic RCS main loop pipe rupture design basis is maintained for containment design, ECCS performance analysis, and electrical and mechanical environmental qualification.

ARKANSAS NUCLEAR ONE UNIT 2

The original design effort for the ANO-2 RCS included the placement of restraints and barriers to meet the requirements for the protection of systems and components from the dynamic effects of LOCA. The wire rope restraints on the reactor coolant pumps shown in Figure 3.6-31 were originally installed to limit the horizontal movement of the pumps following postulated guillotine pipe breaks in the pump suction and discharge piping. To limit the vertical motions of the pumps following a postulated guillotine break at the pump suction, built-up beams (not shown in Figure 3.6-31) were located directly above each of the pump motors. The restraints located in the pipe tunnels for each of the pump discharge pipes, shown in Figure 3.6-31, were originally installed to limit the motion of this piping following a postulated guillotine rupture at any of the four reactor vessel cold leg pipe nozzles. In the case of a postulated guillotine break within the vessel subcompartment in either of the two hot leg pipe spools, the steam generator support system and the reactor vessel support system would have limited the separation of the piping at the break and maintain the resulting subcompartment pressure transient within the design limits of the vessel support system. The original design basis for the reactor and steam generator subcompartment differential pressurization did take credit for the LOCA restraints on the MCL when calculating the break size, as discussed in Section 6.2.1.2.3.1.

Steam generator cavity walls and primary shield walls provide barriers which limit jet impingement and other effects of pipe break. The results of containment and subcompartment pressure analyses are provided in Section 6.2.1.

The reactor vessel is mounted on three column supports as shown in Figures 3.8-13A and 5.5-12. These supports, in conjunction with the horizontal supports, also shown in Figure 3.8-13A, serve to limit motion of the reactor vessel under the combined jet thrust and the vessel subcompartment pressure loading conditions resulting from postulated pipe breaks within the vessel subcompartment. The restraints located in the pipe tunnels for each of the pump discharge pipes, shown in Figure 3.6-31, serve to limit the motion of this piping following a postulated guillotine rupture at any of the four reactor vessel cold leg pipe nozzles. In the case of a postulated guillotine break within the vessel subcompartment in either of the two hot leg pipe spools, the steam generator support system and the reactor vessel support system will limit the separation of the piping at the break and maintain the resulting subcompartment pressure transient within the design limits of the vessel support system. As described in Section 6.2.1.2.2, the reactor vessel cavity is no longer required to consider the dynamic effects of a postulated pipe rupture based upon leak-before-break (LBB) considerations. However, the previous analysis remains bounding and is the basis for support design.

3.6.4.2.2 Main Steam

3.6.4.2.2.1 General Description

The main steam piping inside containment is 38-inch O.D. carbon steel with a wall thickness of 1.167 inches. Both headers are Seismic Category 1 up to the main steam isolation valves outside containment. This portion of the main steam headers is designed in accordance with the ASME Code, Section III, Class 2 criteria. The location and configuration of the main steam headers with respect to structures, equipment, restraints and other piping is shown in Figure 3.6-32. The main steam headers connect to a 36-inch diameter (nominal) nozzle at the top of the steam generators. A 38 inches x 36 inches reducer is located at the steam generator nozzle, and the pipe then passes over the steam generator cavity wall at Elevation 436 feet, and along the containment wall to the penetrations. Venturi flow elements are located in each header which limit blowdown in the event of a break downstream of the element. Integral flow limiting devices are also installed in the steam generator nozzles which further reduce the dynamic effects. This reduction has not been credited in the dynamic analysis.

ARKANSAS NUCLEAR ONE
UNIT 2

3.6.4.2.2.2 Safety Evaluation

Historical calculated stress level and jet thrust force values at the postulated break points are contained in Tables 3.6-9 and 3.6-10. The systems and equipment necessary to mitigate the consequences of a main steam break are described in Sections 10.3 and 15.1.14.

The main steam piping inside the containment was reanalyzed due to replacement of the steam generators and power uprate. Based on the criteria outlined in Section 3.6.2.1, the reanalysis eliminated the arbitrary intermediate breaks previously postulated. However, the pipe whip restraints originally installed on these lines to mitigate the effects of these breaks are left in place. Break points were postulated only at the terminal ends of the piping. The steam generator nozzles and the flued heads at the containment penetration are considered terminal ends. A total of eight restraints are provided on 2EBB-1 and seven are provided on 2EBB-2. The 15 restraints provided will prevent impact on the containment liner by the main steam piping. The environmental conditions in containment which result from main steam breaks are discussed in Section 6.2.1. A main steam break inside containment cannot, due to separation and location of structures and restraints, affect the initiation of Main Stream Isolation Signal (MSIS) or Containment Spray Actuation System (CSAS), or prevent isolation of feedwater to the affected steam generator. Also, a break will not affect the integrity of the other steam generator or its association main steam line or cause loss of the emergency feedwater, shutdown cooling, or safety injection systems.

3.6.4.2.3 Main Feedwater

3.6.4.2.3.1 General Description

The main feedwater piping inside containment is Schedule 80, 24-inch O.D. carbon steel piping. Each line is Seismic Category 1 up to the motor operated isolation valve outside containment and the piping is designed in accordance with the ASME Code, Section III, Class 2 criteria. With the exception of the 18-inch steam generator nozzles, the entire main feedwater line lies outside the secondary shield walls. Immediately outside the steam generator cavity walls, the piping drops down with a 90 degree 18 inch by 24 inch reducing elbow. Check valves are provided in both main feedwater lines which prevent blowdown of the steam generators in the event of a main feedwater break on the pump side of the valves.

3.6.4.2.3.2 Safety Evaluation

Historical calculated stress level and jet thrust force values at the postulated break points are contained in Tables 3.6-11 and 3.6-12. The systems and equipment necessary to mitigate the consequences of a main feedwater break are the same as those required for a main steam break. Six pipe break restraints are provided on each main feedwater header. These 12 restraints together with structures and physical separation guarantee the ability to mitigate the consequences of the event and bring the plant to cold shutdown.

The main feedwater piping inside the containment was reanalyzed due to replacement of the steam generators and power uprate. Based on the criteria outlined in Section 3.6.2.1, the reanalysis eliminated the arbitrary intermediate breaks previously postulated. However, the pipe whip restraints originally installed on these lines to mitigate the effects of these breaks are left in place. Break points were postulated only at the terminal ends of the piping. The steam generator nozzles and the flued heads at the containment penetration are considered terminal

ARKANSAS NUCLEAR ONE
UNIT 2

ends. For the breaks postulated at the steam generator nozzles, one restraint is provided on each line which will prevent pipe whip. The steam generator and steam generator cavity wall also act as physical barriers which limits the effects of a break at the nozzles. The effects of breaks which are postulated at the piping penetrations are limited by separation and the steam generator cavity walls. A break on 2DBB-2 at the penetration could also cause loss of emergency feedwater supply to the same steam generator and/or loss of service water supply to two of four containment cooling coils. Loss of both emergency and main feedwater to one steam generator does not affect the ability to mitigate the consequences of the break or to reach cold shutdown. The MSIS will isolate both steam generators and Emergency Feedwater Actuation Signal (EFAS) then will supply emergency feedwater to the intact steam generator only. The energy released to containment atmosphere will be limited by check valves in the feedwater lines which prevent blowdown of the affected steam generator and isolation of main feedwater flow affected by MSIS. There are no safety-related electrical equipment or cables, that are required to mitigate the event or shutdown the plant, which could be adversely affected either by direct jet impingement, pipe whip, or environmental conditions associated with breaks postulated at the piping penetrations.

The environmental conditions caused by a main feedwater break inside containment are less severe than that due to a main steam line rupture. Safety features equipment required to mitigate the consequences of a secondary system pipe rupture have been designed for a main steam break environment. See Section 6.2.1 for the environmental conditions associated with the worst case main steam break.

3.6.4.2.4 Steam Generator Blowdown

3.6.4.2.4.1 General Description

The steam generator blowdown lines are 4-inch nominal diameter Schedule 80, carbon steel piping designed and fabricated in accordance with the ASME Code, Section III, Class 2 criteria. The blowdown lines are Seismic Category 1 up to the air operated isolation valves outside containment. The steam generator blowdown lines are routed from the steam generator nozzles to penetrations in the steam generator cavity wall near Elevation 351 feet, and then continue to the blowdown tanks which are located outside containment. Motor operated isolation valves are located inside containment near the penetrations.

3.6.4.2.4.2 Safety Evaluation

Historical calculated stress level and jet thrust force values at the postulated break points are contained in Tables 3.6-13 and 3.6-14. Section 10.4.8 describes system design and operation.

The steam generator blowdown piping inside the containment was analyzed due to replacement of the steam generators and power uprate. Based on the criteria outlined in Section 3.6.2.1, the analysis eliminated the arbitrary intermediate breaks previously postulated. Breaks were postulated only at the terminal ends of the piping. The steam generator nozzles, the flued heads at the containment penetrations, and the anchor support at elevation 355'-7" on line 2DBB-7 are considered terminal ends.

A full break of a steam generator blowdown line would have the same effect as a main feedwater break of approximately six percent full break area. This small break is not large enough to constitute protective action. The blowdown from this break is within the additional capacity of the main feedwater pumps, and in conjunction with the feedwater control system,

ARKANSAS NUCLEAR ONE
UNIT 2

EFAS will not be initiated. The affected steam generator can be determined by instrumentation in the control room. Indication of low steam generator level, high feedwater flow, high containment temperature and pressure, and high sump level would be obtained.

Steam generator instrument tubing associated with RPS and ESFAS is in the affected area of postulated pipe breaks of the steam generator blowdown lines. Because of separation by distance or barriers such as the steam generator cavity walls and the steam generator, the effect of pipe whip and jet impingement on the instrument tubing is insignificant.

Restraints are not provided on the steam generator 2E24A and 2E24B blowdown lines because of the small energy involved in these lines and the inability of jet impingement or pipe whip to disable required equipment and piping.

One break, outside the steam generator 2E24B cavity wall, which is postulated on 2DBB-8 is located at the containment penetration at Elevation 358 feet. The energy associated with 2DBB-8 is insufficient to damage other safety-related piping in the area such as the containment cooling coil service water supply, 2HBC-104-12", and the emergency feedwater, 2DBB-4-4". A conduit carrying an instrument cable from a speed indicator element on RC Pump 2P32C is in the vicinity of the fluid jet from the circumferential break in the blowdown nozzle of steam generator 2E24B. Due to the distance of the conduit from the jet source, the effect of jet impingement on the conduit is insignificant.

There are two breaks postulated outside the steam generator 2E24A cavity wall on 2DBB-7. One is located at the containment penetration and the other at the in-line anchor located at Elevation 355'-7". The safety-related piping located in this piping penetration area include containment cooling coil service water supply, 2HBC-103-12", containment spray headers, 2HCB-3-10", and 2HCB-4-10", safety injection headers, and emergency feedwater, 2DBB-3-4". The energy associated with a break of 2DBB-7 is insufficient to damage this safety-related piping. The floor over the piping penetration area is 1-foot, 6-inch thick concrete, therefore providing protection for safety-related electrical equipment above. A red channel ground cable is located near the postulated breaks, however loss of this cable will not cause loss of functions to the equipment which it serves.

3.6.4.2.5 Emergency Feedwater

3.6.4.2.5.1 General Description

The emergency feedwater piping inside containment is 4-inch Schedule 80 carbon steel piping. Both emergency feedwater lines are Seismic Category 1 inside containment and are designed in accordance with the ASME Code, Section III, Class 2 criteria. The emergency feedwater lines are connected to the main feedwater lines downstream of the main feedwater check valves. Check valves on the emergency feedwater lines are located close to these connections. This prevents losing both feedwater sources to one steam generator in the event of a pipe rupture in either pipe on the pump side of the check valves. In addition to the check valves inside containment, motor operated gate valves provide isolation outside containment.

3.6.4.2.5.2 Safety Evaluation

Historical calculated stress level and jet thrust force values at the postulated break points are contained in Tables 3.6-15 and 3.6-16. Section 10.4.9 describes system design and operation.

ARKANSAS NUCLEAR ONE
UNIT 2

A break in one of the emergency feedwater lines upstream of the check valves does not require safety system actuation to mitigate the consequences of the event.

The emergency feedwater piping inside the containment was reanalyzed due to replacement of the steam generators and power uprate. Based on the criteria outlined in Section 3.6.2.1, the reanalysis eliminated the arbitrary intermediate breaks previously postulated. Breaks are postulated only at the terminal ends of the emergency feedwater piping. The containment penetrations and the connections to the main feedwater piping are considered terminal ends. Under normal power generation operating conditions the emergency feedwater piping up to the check valve inside containment is not pressurized. This portion of pipe is pressurized during startup, hot standby, hot shutdown, and plant cooldown. The breaks postulated on the pump side of the check valve will be of small consequence. Blowdown from the steam generator is prevented by the check valve. The pump discharge pressure will quickly decrease when the pipe breaks. The energy involved in the emergency feedwater breaks is not sufficient to impair the function of other safety-related piping in the same penetration areas.

Breaks postulated at the connections to the main feedwater lines will be treated as small main feedwater breaks. This piping is on the main feedwater side of the check valves and will be hot and pressurized during normal operation. Postulated breaks at these locations will not prevent isolation of the effected steam generator, or impair emergency feedwater supply to the intact steam generator assuming a single active failure. The energy of an emergency feedwater break is not sufficient to damage other safety-related piping. Electrical equipment and instrumentation located in the areas of postulated breaks on 2DBB-4 is not safety-related.

Below the 2DBB-3 connection to the south steam generator (SG-A) are located Channel 1 cable trays containing steam generator pressure and level signals as well as Channel 3 pressure and level transmitters, none of which are affected by a break of the emergency feedwater line at its connection to the main feedwater line.

3.6.4.2.6 Pressurizer Surge

3.6.4.2.6.1 General Description

The pressurizer surge line is Schedule 160, 12-inch stainless steel pipe designed in accordance with the ASME Code, Section III, Class I criteria. The piping is part of the RCS and is Seismic Category 1. The surge line is located totally within the south steam generator cavity and is routed from the reactor coolant hot leg to the nozzle at the bottom of the pressurizer. Pressurizer operation is discussed in Section 5.5.10.

3.6.4.2.6.2 Safety Evaluation

Historical calculated stress level, usage factor, and jet thrust force values at the postulated break point are contained in Table 3.6-17. The reanalysis performed due to replacement of the steam generators and power uprate did not change these break locations.

One of the four safety injection lines, 2CCA-22-12", is located in the vicinity of the pipe breaks postulated at the 45° elbow. While the safety injection line is the same nominal pipe size as the pressurizer surge line, it is of thinner wall thickness. Therefore, in the event of a postulated pipe break at the 45° elbow, a through-wall crack on the safety injection line has been assumed. This would not cause loss of function of the safety injection line but will result in lower injection

ARKANSAS NUCLEAR ONE
UNIT 2

flow rate to the RCS. This through-wall crack, of course, will result in loss of less injection flow to the reactor vessel than if a complete break of one of the reactor coolant pump discharge pipes is postulated. Also, the surge line break area is smaller than the original non-mechanistic design basis break area. Therefore, the capability of the plant to mitigate the consequences of the break will not be impaired. Furthermore, as noted in paragraph 3.6.2.1.A, the postulated break locations on the surge line were considered in the RCS structural analysis. Surge line response to RCS hot leg motions from Breaks 1 to 5 listed in Table 3.6-1A was determined by analysis. Response of the surge line to pressurizer motions is based on smaller pipe breaks at the top of the pressurizer. These breaks are not affected by LBB, replacement steam generators, or power uprate, and their effects on the surge line are enveloped by the effects of the five major branch line pipe breaks listed in Table 3.6-1A.

As shown on the isometric, pipe break restraints have been provided at five locations which minimize the effects of pipe break. Restraints are suitably located to limit pipe whip as a result of plastic hinge formation at the other postulated break points. A pressurizer surge line break results in a small break LOCA. The consequences of these breaks will be less severe than that of the original non-mechanistic design basis event described in Section 6.2.1. A pipe break at any of the postulated locations will not prevent required safety system actuation or impair the ability to mitigate the consequences of the surge line break.

3.6.4.2.7 Shutdown Cooling

3.6.4.2.7.1 General Description

The shutdown cooling line is Schedule 140, 14-inch stainless steel pipe designed in accordance with the ASME Code, Section III, Class I or 2 criteria. The piping up to valve 2CV-5084-1 is normally exposed to reactor coolant temperature and pressure and therefore is high energy piping. The remainder of the shutdown cooling piping inside containment is moderate energy. Valves 2CV-5084-1 and 2CV-5086-2 are closed when the RCS pressure is above 300 psia. Shutdown cooling may be initiated by opening these valves following cooldown of RCS via steam dump. System operation is described in Section 9.3.6.

3.6.4.2.7.2 Safety Evaluation

Pipe breaks have been postulated to occur at the terminal ends and at each intermediate pipe fitting, welded attachment, and valve. Uncontrolled pipe whip of the shutdown cooling line will not damage the containment liner, result in a LOCA break size larger than the design basis event, or impair the ability to mitigate the consequences of the event and reach cold shutdown. The location of structures and safety-related components will also ensure that jet impingement will not impair safety features actuation. Breaks in the shutdown cooling line up to the first isolation valve will have the same consequences as a LOCA. Breaks have not been postulated in the shutdown cooling system downstream of 2CV5086-2 because the piping is above 275 psig or 200 °F less than two percent of system operating time. See Section 3.6.1.

3.6.4.2.8 Safety Injection

3.6.4.2.8.1 General Description

The Safety Injection System (SIS) provides both passive and active means of injection to the RCS in the event of a design basis event. The piping from the safety injection tanks to the RCS nozzles and to the check valves just inside containment is normally pressurized to 610 psig,

ARKANSAS NUCLEAR ONE
UNIT 2

safety injection tank pressure. Portions of the SIS outside containment will be above 275 psig or 200 °F high energy piping criteria less than two percent of system operating time and, therefore, are considered moderate energy. The portion of SIS from the pump stop check valves to the HPSI Injection MOVs will be pressurized above 275 psig by the HPSI Pressurization System as discussed in Section 3.6.4.1.10.1 and Section 3.6.4.1.10.2. The effects of cracks postulated in this piping are discussed in Section 3.6.4.3. The piping between the safety injection tanks and the RCS nozzles is 12-inch Schedule 140 stainless steel piping. A 3-inch high pressure and 6-inch low pressure injection line combine just inside containment to an 8-inch Schedule 120 pipe. These lines are Seismic Category 1 and have been designed in accordance with the ASME Code, Section III, Class 1 or 2 criteria. The four injection paths tee into their four respective 12-inch injection lines between the safety injection tanks and the RCS nozzles. A description of the SIS design and function is included in Section 6.3.

3.6.4.2.8.2 Safety Evaluation

Historical calculated stress level, usage factor, and jet thrust values at the postulated break points are provided in Tables 3.6-18, 3.6-19, 3.6-20 and 3.6-21.

The consequences of the postulated safety injection line breaks will not require protective system initiation. Each of the four injection paths enter containment through the south piping penetration room. Separation is maintained by both distance and elevation. The high and low pressure lines join together inside containment and are run along the outer steam generator cavity wall. The four safety injection tanks are separately located in the four different quadrants of the containment, also outside the steam generator cavity wall. The 12-inch tank discharge lines are routed through penetrations in the cavity walls, teed with the 8-inch injection paths, and run to their respective reactor coolant pump discharge nozzles. Restraints have been placed on the safety injection lines primarily to ensure the integrity of the containment liner. Uncontrolled whip of the safety injection piping within the steam generator cavity walls will not cause failure of any safety-related instrumentation, piping, or equipment required to mitigate the consequences of the event. Breaks up to the first check valves from the reactor coolant piping nozzle have been considered as small break LOCAs. The containment temperature and pressure response due to the LOCA is discussed in Section 6.2.1.

Safety injection piping was reanalyzed due to replacement of the steam generators and power uprate using ASME code, 1980 edition. This resulted in substantial reduction of the originally postulated intermediate break locations. A few new locations were, however, needed to be postulated due to the reanalysis. These new locations are all in the vicinity of the originally postulated locations. The placement of restraints, the location of structures, and physical separation ensures the integrity of the shutdown cooling line and the ability to shutdown in the event of a postulated safety injection pipe break.

3.6.4.2.9 Charging

3.6.4.2.9.1 General Description

The charging line inside containment is Schedule 160, 2-inch pipe designed in accordance with the ASME Code, Section III, Class 1 or 2 criteria. The two charging lines and the auxiliary spray line are Class 1 from the RCS to the second isolation valve in each line. The remainder of the charging line is Class 2. The charging line penetrates containment at Elevation 362 feet and passes through the south steam generator cavity to the regenerative heat exchanger nozzle. The charging flow is then heated by the letdown flow in the heat exchanger before entering the

ARKANSAS NUCLEAR ONE
UNIT 2

RCS. The charging flow may be directed to pump 2P32C discharge cold leg, pump 2P32B discharge cold leg, or the pressurizer spray line. The charging line inside containment is Seismic Category 1. System operation is described in Section 9.3.4.

3.6.4.2.9.2 Safety Evaluation

For 2CCB-25 and 2CCB-9 intermediate break points were postulated on the basis of highest stress in accordance with the criteria listed in Section 3.6.2.1. Historical stress profiles for these lines are provided in Tables 3.6-22 and 3.6-23, respectively. Break points were postulated at the terminal ends and at each intermediate pipe fitting, welded attachment, and valve for 2CCA-16, 2CCA-26 and 2CCA-27. Breaks postulated on 2CCA-16, 2CCA-26 and 2CCA-27 between the RCS and check valves will have the same consequences as a small LOCA. Systems required to mitigate the consequences of the break will not be impaired by jet impingement or uncontrolled whip of this piping. The shutdown cooling line and valve operators will be protected from the whip of 2CCA-26. Three restraints in addition to existing piping and structures will ensure the availability of the shutdown cooling line if required. The routing of 2CCB-9 and 2CCB-25, the proximity of structures and equipment, and the location of postulated break points will ensure that systems required for safety and shutdown will not be impaired. Breaks located upstream of the check valves, 2CCB-9 and 2CCB-25 will not result in protective system actuation. Blowdown of the RCS is prevented by check valves in the charging lines. If the failure of the check valve is postulated, allowing blowdown of the RCS, safety systems will be available to mitigate the consequences of the break.

3.6.4.2.10 Letdown

3.6.4.2.10.1 General Description

The letdown line inside containment is Schedule 160, 2-inch pipe designed in accordance with the ASME Code, Section III, Class 1 or 2 criteria. The line is Seismic Category 1 from the RCS nozzle to the letdown valves outside containment. The letdown lines runs to the regenerative heat exchanger, where the flow is cooled by charging flow, and then to the containment penetration at Elevation 370 feet. System operation is described in Section 9.3.4.

3.6.4.2.10.2 Safety Evaluation

A detailed stress analysis was performed on 2CCB-2 and intermediate break points were postulated on the basis of highest stress. Table 3.6-24 lists the historical calculated stress level values at the intermediate break points. Breaks were postulated to occur at the terminal ends and at each intermediate pipe fitting, welded attachment, and valve on 2CCA-12. Line 2CCB-1 is composed of 2-inch, 2½-inch and 8-inch diameter sections. For jet impingement evaluations for line 2CCB-1, breaks are postulated to occur at the terminal ends and at each intermediate pipe fitting, welded attachment, and valve for the 2½-inch and 2-inch diameter sections. No breaks are postulated in the 8-inch diameter section of line 2CCB-1 when considering pipe whip evaluations. This is based on the fact that stress analysis of this line has shown that the bending stresses in the 8-inch section are approximately 1/20th of the magnitude of the bending stresses in the 2½ inch-diameter section, due to the large section modulus of the 8-inch pipe. Thus a break would occur at the terminal end of the 2½-inch diameter pipe or in the 2-inch diameter pipe before pipe stresses reach the yield point in the 8-inch diameter pipe. Layout of the letdown lines with respect to required safety systems, structures, and equipment ensures that systems required for safety will not be impaired by the consequences of a letdown line pipe break. A restraint has been placed on 2CCB-2 to protect the containment liner plate. Additional protection is not required to mitigate the consequences of the plant or reach cold shutdown.

ARKANSAS NUCLEAR ONE
UNIT 2

3.6.4.2.11 Pressurizer Spray

3.6.4.2.11.1 General Description

The pressurizer spray line is designed in accordance with the ASME Code, Section III, Class I criteria. A portion of the reactor coolant pump 2P32A and 2P32B discharge is diverted to the pressurizer spray piping. Two 3-inch Schedule 160 lines from the pump discharges are run together into a 4-inch Schedule 140 line which discharges to the pressurizer steam space. The entire pressurizer spray line is Seismic Category 1. Pressurizer operation is discussed in Section 5.5.10.

3.6.4.2.11.2 Safety Evaluation

Pipe breaks have been postulated to occur at the terminal ends and at each intermediate pipe fitting, welded attachment, and valve. The pressurizer spray line is located within the south steam generator cavity and the cavity walls provide protection for the containment liner and required systems outside the cavity. Inside the cavity major equipment; steam generator 2E24A, reactor coolant pumps 2P24A and 2P32B, and the pressurizer 2T1, provide separation and protection from the effects of jet impingement and pipe whip. In addition, six restraints have been located to minimize the effects of pipe whip and protect the pressurizer level and pressure instrumentation lines. Only guillotine breaks were postulated to occur on the 3-inch portion of the line.

Analysis has shown that the consequences of a postulated spray line break will not result in a more severe LOCA than the Design Basis Accident (DBA), will not impact the containment liner, and will not impair systems required to mitigate the event or shutdown the plant.

3.6.4.2.12 Pressurizer Low Temperature Overpressure Protection

3.6.4.2.12.1 General Description

The pressurizer low temperature overpressure protection (LTOP) line is designed in accordance with the ASME Code, Section III, Class 1 and 2 criteria. At the pressurizer nozzle, the LTOP line is a 6-inch Schedule 120 line which tees into two 4-inch Schedule 120 lines. Each side of the tee has two motor-operated isolation valves and a relief valve. The line between the second isolation valve and the relief valve is 4-inch Schedule 40S. The line downstream of the relief valve is 6-inch Schedule 40S and is considered part of the pressurizer safety relief valve discharge line to which it connects. An emergency vent line is also provided which connects to the LTOP line on one side between the two isolation valves and to the discharge line downstream of the relief valve on the same side.

A motor-operated isolation valve is included on the emergency vent line. The LTOP line is Seismic Category I. The discharge piping is Seismic Category II. The LTOP operation is described in Section 5.2.2.4, 7.6.1.3 and 7.6.2.3.

3.6.4.2.12.2 Safety Evaluation

Due to the limited operation of the LTOP system, only the piping between the pressurizer nozzle and the first isolation valve on each side of the tee is classified as high energy. On this portion of this line, pipe breaks have been postulated to occur at the terminal end, at each fitting, and at the valve ends.

ARKANSAS NUCLEAR ONE
UNIT 2

For all breaks, it was shown that either: 1) no adjacent safety-related equipment would be affected by the break; or 2) an alternate path to safe shutdown was identified assuming that potentially affected safety-related equipment would become inoperable. Similar to the pressurizer spray line discussed above, a postulated LTOP line break will not result in a more severe LOCA than the DBA.

Structural steel frames around the upper pressurizer pressure nozzles provide adequate protection against the effects of an LTOP line break.

3.6.4.3 Protection From Flooding of Equipment Important to Safety

3.6.4.3.1 Scope

The following contains the results of an evaluation of systems design and layout of the auxiliary building regarding the effects of flooding resulting from postulated breaks in non Seismic Category 1 piping systems. "Guidelines for Protection from Flooding of Equipment Important to Safety" (presented to Arkansas Power and Light Co. at Unit 2 DRL Meeting held at Bethesda, Maryland on May 17, 1973) provided the basis for the criteria employed in this evaluation. The following outlines the criteria employed in this evaluation, identifies the areas of investigation, and describes the features incorporated into the plant design in order to comply with these criteria.

3.6.4.3.2 Criteria/Protective Guidelines

The criteria employed in this evaluation are as follows:

- A. Separation for redundancy - single failures of non-Class I system components or pipes shall not result in loss of a system important to safety. Redundant safety equipment shall be separated and protected to assure operability in the event a non-Class I system or component fails.
- B. Access doors and alarms - watertight barriers for protection from flooding of equipment important to safety shall have all access doors or hatches fitted with reliable switches and circuits that provide an alarm in the control room when the access is open.
- C. Sealed water passages - passages or piping and other penetrations through walls of a room containing equipment important to safety shall be sealed against water leakage from any postulated failure of non-Class I water systems. The seals shall be designed for the SSE, including seismically induced wave action of water inside the affected compartment during the SSE.
- D. Class I watertight structures - walls, doors, panels, or other compartment closures designed to protect equipment important to safety from damage due to flooding from a non-Class I system rupture shall be designed for the SSE, including seismically induced wave action of water inside the affected compartment during the SSE.
- E. Water level alarms and trips - rooms containing non-Class I system components and pipes whose rupture could result in flood damage to equipment important to safety shall have level alarms and pump trips (where necessary) that alarm in the control room and limit flooding to within the design flood volume. Redundancy of switches is required. Critical pump (i.e, high volume flow, such as condenser circulating water pumps) trip circuits should meet IEEE 279 criteria.

ARKANSAS NUCLEAR ONE
UNIT 2

- F. Class I equipment should be located or protected such that rupture of a non-Class I system connected to a tower containing water or body of water (river, lake, etc.) will not result in failure of the equipment from flooding.
- G. The safety analysis shall consider simultaneous loss of offsite power with the rupture of a non-Class I system component or pipe.

3.6.4.3.3 Evaluation

The areas listed below contain safety-related equipment. The equipment and piping layout in these areas have been evaluated using the above guidelines. Consequences of potential flooding and/or spray from failure of non-Seismic Category 1 components or pipes within these areas and/or in adjacent areas were considered in the evaluation.

3.6.4.3.3.1 Engineered Safety Equipment Pump Rooms

Three separate rooms containing Engineered Safety Features (ESF) equipment are located in the auxiliary building at Elevation 317 feet. The west room contains Train A pumps for the HPSI, LPSI and containment spray systems and the Train A shutdown cooling heat exchanger. The center room contains HPSI pump C. The east room contains Train B pumps for the HPSI, LPSI and containment spray systems and the Train B shutdown cooling heat exchanger. Each of the three rooms is watertight [as necessary for protection from internal and external flooding](#).

The Train A ESF Pump room contains the following non-Seismic Category 1 piping:

- A. Drain piping from the safety injection tanks to the refueling water tank. This pipe is not considered a source of flooding since it is normally isolated from the safety injection tanks and the refueling water tank by locked closed Seismic Category 1 manual isolation valves.
- B. Drain piping from the containment sump to the auxiliary building sump. This piping is provided to gravity drain the containment sump to the auxiliary building. Since it is normally isolated from the containment sump by redundant containment isolation valves, this piping is not considered a potential source of flooding.
- C. Piping from the Reactor Drain Tank (RDT) to the reactor drain pumps. The total capacity of the RDT is 1,600 gallons. This tank is primarily used during plant shutdown periods to collect liquid drained from piping and equipment inside the containment. The tank will contain only a small amount of liquid during normal power operation. This piping is automatically isolated from the RDT by redundant isolation valves upon receipt of the Containment Isolation Signal (CIS). Irrespective of the fact that the automatic valves would isolate this piping in the event of a postulated LOCA (when the equipment located within this room is required to function), the postulated rupture of this piping and the draining of the RDT into this room would represent no hazard to the equipment within this room.

With regard to the Train B ESF pump room, the only non-Seismic Category 1 piping located in this room is a portion of the letdown piping between the letdown heat exchanger and the volume control tank in the CVCS. Although this piping does not require Seismic Category 1 classification per Section C.1 of Regulatory Guide 1.29, Revision 1, that portion of the piping which passes through this room is seismically analyzed and restrained in accordance with Section 2.C of the regulatory guide.

ARKANSAS NUCLEAR ONE
UNIT 2

No non-Seismic Category 1 piping is located in the room containing HPSI Pump C.

Conductance type level detectors have been installed in each of the ESF pump rooms to monitor any significant accumulation of liquid in these rooms. Alarms indicating an increasing water level in these rooms are displayed in the control room. In ESF pump rooms "A" and "B", these level detectors have been installed in the floor drains near each of the HPSI pumps. In HPSI pump room "C", this level detector has been installed on the floor near the floor drain.

3.6.4.3.3.2 Emergency Feedwater Pump Rooms

The Emergency Feedwater (EFW) pumps, one motor driven (2P7B) and one turbine driven (2P7A) are located in the auxiliary building at Elevation 329 feet. Access to the pump room is via an open stairway from the fuel pool pump area at Elevation 335 feet.

Since the area surrounding the pump rooms contains non-Seismic Category 1 piping whose failure could otherwise jeopardize the operation of these pumps, features are incorporated into the design of these rooms in compliance with the guidelines described below.

A watertight door is installed in the passageway to the east EFW pump room and a wall with a watertight door is installed in the west room to provide independent water tight compartments. Each watertight door is fitted with an intrusion alarm displayed in the control room.

Watertight seals on all penetrations into and out of the room are utilized to prevent cross-flooding or flooding from external sources. Backflow preventer valves are installed in the drain lines from each of these rooms to avoid flooding from the drain system. Float type level switches with alarms in the control room have been installed in each EFW pump room near the floor to detect gross leakage accumulation.

3.6.4.3.3.3 Emergency Diesel Generator Rooms

The emergency diesel generators are located in the auxiliary building, at Elevation 369 feet. Surrounding rooms are at Elevation 372 feet and Elevation 374 feet, 6 inches. Access to the diesel generator rooms is via the access corridor near the south stairwell at Elevation 372 feet to the south diesel generator room and a ramp corridor from the electrical equipment area at Elevation 372 feet to the north room. A fireproof/watertight door is provided for access between the rooms. Both rooms are equipped with separate fire protection sprinkler systems, separate drainage systems sized to accommodate the sprinkler system, and diesel exhaust piping.

The non-Seismic Category 1 fire water header supplies the seismically supported deluge water spray systems in each of the diesel generator rooms. This header is located in the ramp access corridor to the north room. The deluge valve supplying each of these rooms is located just outside the room. In case of a rupture of the fire water header, a watertight door is available if needed to protect the north room.

A fire standpipe and hose reel are located in the hallway near the entrance to the south diesel generator room. Although there are sufficient drainage paths which would preclude a significant buildup of water, a 5-inch curb is installed in this doorway to hold back any water that may accumulate in the hallway from a rupture of this standpipe. Also, the watertight door between the rooms may be used if necessary to prevent a cross flooding between the two rooms. Float type level switches have also been provided to detect any gross leakage. Intrusion alarms for the watertight doors and the flood alarms are displayed in the control room.

ARKANSAS NUCLEAR ONE
UNIT 2

To avoid inadvertent spray down of the diesel generator equipment, the pre-action automatic deluge spray has been coupled with wet pipe sprinkler system fusible heads as described in Section 9.5.1.2.3. These fusible heads provide a second pressure boundary should the deluge valves fail or inadvertently open with no existing fire in these rooms.

3.6.4.3.3.4 Electrical Equipment

As described in Section 8.3.1.1.4, ESF Motor Control Centers (MCCs) are located throughout the Seismic Category 1 structure. The MCCs are enclosed in NEMA Type I light splash resistant cabinets and are designed such that up to six inches of standing water may accumulate on the floor before shorting of electrical connections may be expected. Two of the ESF MCCs are located in the upper and lower electrical penetration rooms and are discussed in Section 3.6.4.3.3.5. One ESF MCC is located in the passageway near the spent resin storage tank. Several low energy non-Seismic Category 1 piping systems pass above this MCC. To protect the MCC from possible spray from these pipes, a spray shield has been constructed over the MCC.

ESF 120-volt AC and 125-volt DC distribution panels are located in the hallway connecting the battery rooms to the north diesel generator room at Elevation 372 feet. A fire protection standpipe and hose reel is located at the east end of the hallway near the entrance to the turbine building. An additional hose reel and standpipe are installed at the west end of the hallway near the volume control tank to meet NFPA requirements described in Section 9.5.1.2.2.

3.6.4.3.3.5 Electrical Penetration Rooms

These four rooms are located in the auxiliary building at Elevation 374 feet, 6 inches and 386 feet. The two north electrical penetration rooms contain only electrical cabling to the containment building. The south electrical penetration rooms both contain electrical cabling and an ESF motor control center. Each room is fitted with a seismically supported deluge water spray system.

In addition, the automatic deluge water spray system for each of the electrical penetration rooms has been coupled with fusible heads as described in Section 3.6.4.3.3.3.

3.6.4.3.3.6 Non-Seismic Category 1 Systems

Below are listed the non-Seismic Category 1 systems, components and piping that were considered in this analysis. Some of the systems listed in the NRC guidelines do not appear in this report either because the systems do not pass through areas where safety-related equipment is located or the systems are Seismic Category 1 in those areas.

- A. Auxiliary Cooling Water
- B. Plant Makeup Water
- C. Chemical and Volume Control (non-Seismic Category 1 portion)
- D. Condensate
- E. Fuel Pool
- F. Drains

ARKANSAS NUCLEAR ONE
UNIT 2

- G. Heating and Ventilation
- H. Component Cooling Water
- I. Waste Management
- J. Boron Management
- K. Fire Protection

3.6.4.3.4 Summary/Conclusions

A review of all areas containing safety-related mechanical and electrical equipment was conducted. This focuses only on those areas where potential problems existed and where changes in the plant design and layout were found to be necessary. Consequently, some of the safety-related equipment areas, such as the control room and the battery rooms, are not evaluated.

It has been concluded that the plant layout and design meets the criteria set forth in Section 3.6.4.3.2.

3.6.4.4 Liquid Storage Tanks

3.6.4.4.1 Purpose

The following evaluation was made to determine the effects of flooding resulting from a postulated failure of a liquid storage tank. Tables 3.6-25 through 3.6-27 list all Unit 2 liquid storage tanks and indicate by figures their locations.

3.6.4.4.2 Criterion

The criterion used in this evaluation is that a failure of a tank does not result in the flooding of safety-related equipment that would impair the safe shutdown of the plant.

3.6.4.4.3 Evaluation

Table 3.6-25 lists all Unit 2 liquid storage tanks located outside the confines of the Unit 2 buildings. These tanks are located at ground level and are not considered a flood hazard to safety equipment contained within the Unit 2 buildings.

Table 3.6-26 lists all Unit 2 liquid storage tanks located within the Unit 2 containment. These tanks are not considered a flood hazard to safety equipment since the equipment within the containment has been designed to operate under the post-LOCA spray environment and since any accumulation of liquid from a tank failure will not exceed the design water level in the containment.

Table 3.6-27 lists all liquid storage tanks located within the Unit 2 auxiliary building. Each tank listed in Table 3.6-27 is discussed below.

The boric acid makeup tanks (2T6A, B) are located in the south end of the auxiliary building at Elevation 386 feet. There is no safety-related equipment in the immediate area. Sufficient physical barriers and drainage via floor drains and the adjacent stairwell exist to preclude the fluid from these tanks from impacting safety-related equipment.

ARKANSAS NUCLEAR ONE
UNIT 2

The boron management holdup tanks (2T12A, B, C, and D) are located in the south end of the auxiliary building at Elevation 327 feet. Each tank is contained within a separate vault with access hatches at the 355 feet, 4 inches elevation. Fluid from a failure of any of these tanks would be contained within the vault since the drainage system from each vault is isolated.

The waste tanks (2T20A and B) are located in the south end of the auxiliary building at Elevation 317 feet. All safety-related equipment located at this elevation is protected from internal flooding as described in Section 3.6.4.3.

The waste condensate tanks (2T21A and B) are located in the south end of the auxiliary building at Elevation 335 feet. Although fluid from a failure of one of these tanks would enter the charging pump room, sufficient drainage is available to limit water accumulation so as not to damage the charging pumps which are mounted on elevated pads. Drainage via the floor drains in the tank room, charging pump rooms, and the access corridor are provided. The bulk of the water would drain out of the tank room to the access corridor and down the stairwell across from the center charging pump room, the hatch at the east end of the access corridor, and the stairway at the west end of the access corridor.

The plant heating boiler fuel oil day tank (2T22) is located in the north end of the auxiliary building at Elevation 354 feet. The tank is enclosed in a vault that would contain any fluid from a tank failure.

The clean and dirty lube oil storage tank (2T26) is located in the north end of the auxiliary building at Elevation 335 feet. Fluid from a failure of this tank will drain to the turbine building away from any safety-related equipment.

The emergency diesel generator fuel oil day tanks (2T30A and B) are located inside the emergency diesel generator rooms at Elevation 369 feet. Each tank is enclosed by a fire wall which will limit the amount of fluid flowing to the surrounding diesel generator room. The floor drains in the diesel generator rooms are of adequate capacity to prevent any accumulation of fluid.

The hydrazine tank (2T43) is located in the east side of the auxiliary building. No safety-related equipment is located in the vicinity of this tank and sufficient barriers and floor drains are available which ensure that a failure of this tank would not pose a flood hazard to this equipment.

The domestic water pressure tank (2T44) is located in the north end of the auxiliary building at Elevation 374 feet, 6 inches. It also is located well apart from any safety-related equipment and sufficient barriers and floor drains are available which ensure that a failure of this tank would not pose a flood hazard.

The boric acid condensate tanks (2T69A and B) are located in the southeast corner of the auxiliary building at Elevation 327 feet. The tanks are contained within a room with a normally closed drain system that is designed to contain the contents of one tank in the event of a tank failure. These tanks do not pose a flood hazard to safety-related equipment.

The concentrator bottoms storage tank (2T78) is located in the south end of the auxiliary building at Elevation 354 feet. This tank has been abandoned. It is drained and maintained isolated from any potential source of effluent. However, fluid from a failure of this tank would

ARKANSAS NUCLEAR ONE
UNIT 2

have sufficient drainage paths via floor drains, the opening at the west end of the corridor and the hatch at the southeast corner of the building to limit any water accumulation to less than six inches. The safety-related MCCs located on the same elevation approximately 40 feet east of this tank are designed such that six inches of water may accumulate before shorting of electrical connections is possible.

The waste solidifier storage tank (2T80) and the waste catalyst storage tank (2T81) are located in the north end of the Unit 1 auxiliary building at Elevation 354 feet. This area does not contain any safety-related equipment. Neither Unit 1 nor Unit 2 currently solidify waste for off-site transport and both 2T80 and 2T81 have been abandoned.

The regenerative waste tanks (2T92A, B and C) are located in the north end of the auxiliary building at Elevation 332 feet. The tanks are located in a room designed to contain the liquid in the event of a tank failure. This area of the building does not contain any safety-related equipment.

3.6.4.5 Moderate Energy Pipebreak Outside Containment

This section presents the results of the analysis performed on moderate energy Seismic Category 1 piping systems to ensure that adequate protection is provided in the plant layout and system design to meet the criteria set forth in Branch Technical Position APCSB 3-1, Section B.3. This analysis covers only Seismic Category 1 piping and was performed in conjunction with the analysis contained in Section 3.6.4.3, "Protection From Flooding of Equipment Important to Safety," for non-Seismic Category 1 piping systems. As outlined in Branch Technical Position APCSB 3-1, Section B.3, the following demonstrates that arrangement and design features provide the necessary protection of the systems and components required to shut down the reactor and mitigate the consequences of a postulated moderate energy piping failure. The offsite dose consequences are within the guidelines of 10 CFR Part 50.67 and the environmental conditions resulting from the following postulated pipe failures do not preclude habitability of the control room or access to surrounding areas important to the safe control of reactor operations needed to cope with the consequences of the failure.

3.6.4.5.1 Dual Purpose Moderate Energy Essential Systems

This section discusses the results of the analysis of postulated piping failures assumed to occur in one of two or more redundant trains of a dual purpose moderate energy essential system. Dual purpose moderate energy essential systems are those systems which are required to operate during normal plant conditions as well as during reactor shutdown and post-accident. These systems are designed to Seismic Category 1 standards, are powered from both off-site and onsite sources and are constructed, operated and inspected to quality assurance testing and in-service inspection standards appropriate for nuclear safety systems. Postulated failures within any of these dual purpose moderate energy systems will not cause protective system actuation.

3.6.4.5.1.1 Service Water System

3.6.4.5.1.1.1 General Description

The Service Water System (SWS) (see Figure 9.2-1) consists of two independent Seismic Category 1 flow paths which furnish water to ESF equipment and three Seismic Category 2 flow paths which furnish water to non-safety-related portions of the plant. The Seismic Category 1

ARKANSAS NUCLEAR ONE
UNIT 2

portion of the SWS serves two identical (full capacity) loops of ESF equipment each consisting of one shutdown cooling heat exchanger, one emergency diesel generator, one emergency feedwater pump, one train of room and pump cooler for ESF equipment and two containment cooling coils. System function and component descriptions are in Section 9.2.1.

3.6.4.5.1.1.2 Safety Evaluation

A review of the SWS piping in the north and south electrical switchgear rooms indicated that a potential problem existed in these areas. These switchgear rooms contain safety-related switchgear and are located in the auxiliary building at Elevation 372 feet. The north switchgear room contains the red channel equipment; the south room contains the green channel equipment. Each of these rooms is cooled by a unit cooler which receives cooling water from the associated SWS train. Originally, both trains of SWS piping passed through both of these rooms. Since this arrangement did not meet the criteria set forth in Branch Technical Position APCS B 3-1, the piping was rerouted such that only the SWS piping from the associated SWS train passes through each switchgear room.

Accordingly, the redundant trains of the SWS and the redundant safety-related equipment served by the SWS are designed such that a piping failure in either SWS train will not result in the loss of the unaffected SWS train or the loss of any of the safety-related equipment serviced by the unaffected train.

3.6.4.5.1.2 Shutdown Cooling System

3.6.4.5.1.2.1 General Description

The Shutdown Cooling (SDC) System piping and components are fabricated in accordance with ASME Code, Section III, Class 2 and are Seismic Category 1. The major components of redundant trains outside the containment are the shutdown cooling heat exchangers and the LPSI pumps. The system functional description is in Section 9.3.6.

3.6.4.5.1.2.2 Safety Evaluation

Each train of SDC is contained within an enclosed compartment of the ESF equipment rooms at Elevation 317 feet such that a single postulated piping failure will not affect the other train. Each ESF equipment vault is watertight as necessary for internal and external flood protection. As indicated in Section 3.6.4.3.3.1, conductance type level detectors have been installed in the drains near each of the HPSI pumps to monitor any significant leakage in the associated room.

3.6.4.5.1.3 Emergency Feedwater System

3.6.4.5.1.3.1 General Description

The moderate energy piping and components of the EFW System are designed to meet Seismic Category 1 requirements and ASME Code, Section III requirements. The system functional description is in Section 10.4.9.

3.6.4.5.1.3.2 Safety Evaluation

Each train of the EFW System is contained in a water tight compartment as described in Section 3.6.4.3.3.2 such that the effects of spray or flooding will not affect the other train. The common suction line from the condensate storage tank and the condenser hotwell is isolable by

ARKANSAS NUCLEAR ONE
UNIT 2

closing motor operated valves 2CV-0795-2 for the turbine driven EFW pump (2P7A) and 2CV-0789-1 for the motor driven EFW pump (2P7B) and by closing supply valves 2CV-0707 or 2EFW-0706. Service water can then be supplied to the EFW pumps by opening motor operated valves 2CV-0711-2 for 2P7A or 2CV-0716-1 for 2P7B. However, the service water supply would only be used in emergency cases in the event that the normal condensate storage tank supply or the alternate condenser hotwell supply is unavailable. Automatic operation of these valves on receipt of EFAS signal is described in Section 10.4.9.2.2. Condensate is also available from the Unit 1 Safety grade Condensate Storage Tank, T41B, by manually opening valves 2CS-0816 and 2CS-0817.

3.6.4.5.2 Moderate Energy Safety Systems

This section discusses the results of the analysis of postulated piping failures in Seismic Category 1 safety systems in the auxiliary building which are in a standby status during normal plant operations.

3.6.4.5.2.1 Containment Spray System

3.6.4.5.2.1.1 General Description

The Containment Spray System (CSS) is designed to Seismic Category 1 requirements. System piping and components are designed to meet ASME Code, Section III Class 2 requirements. The system functional description is in Section 6.2.2.2.1.

3.6.4.5.2.1.2 Safety Evaluation

Each loop of the CSS is located in an enclosed compartment located at Elevation 317 feet. Each ESF equipment room is watertight as necessary for internal and external flood protection. The containment spray pump and shutdown cooling heat exchanger of each train are in the same compartment with LPSI pump and HPSI pump that are powered from the same safety system power supply. A single postulated piping failure would only affect one train and would not cause safety system actuation. Any significant leakage can be detected by conductance type level detectors installed in the drain piping of each enclosed compartment. Should one train of CSS become inoperable, plant operation would be administratively controlled and limited by the Technical Specifications.

3.6.4.5.2.2 Emergency Core Cooling System

3.6.4.5.2.2.1 General Description

The Emergency Core Cooling System (ECCS) or Safety Injection System (SIS) is designed to Seismic Category 1 requirements. Components and piping are designed to ASME Code, Section III, Class 2 and ASME Pump & Valve Code Class II requirements. The system functional description is in Section 6.3.

3.6.4.5.2.2.2 Safety Evaluation

The HPSI pump and the associated LPSI pump of each train are contained in ESF equipment rooms with the containment spray and shutdown cooling heat exchanger of the same train. The ESF equipment rooms are water tight as necessary for internal and external flood protection and are arranged such that a postulated piping failure will not affect more than one room. As

ARKANSAS NUCLEAR ONE
UNIT 2

indicated in Section 3.6.4.3.3.1, level detectors are installed to detect any significant leakage in any of the ESF equipment rooms. A single postulated piping failure will not cause automatic safety system actuation, and in the event of a piping break in either train, plant operation would be administratively controlled in accordance with the Technical Specifications.

3.6.5 PROTECTIVE MEASURES

3.6.5.1 Separation

Separation between redundant safety-related components and separation between these components and high energy piping systems has been provided in the design and layout of this plant. This separation provides the primary means of assuring safe plant shutdown capability following a postulated high energy pipe break.

3.6.5.2 Pipe Whip Restraints

Pipe whip restraints were utilized on those piping systems in which adequate protection of components and structures could not be provided either by separation or the presence of suitable structures or barriers. Figure 3.6-1 contains sketches of two typical pipe whip restraints utilized in this plant. Restraint locations are shown on the piping isometrics discussed in Section 3.6.4.

3.6.5.3 Barrier Protection

Floors, walls, and columns within the plant provide barrier protection for safety-related equipment. The containment liner provides barrier protection against the uncontrolled release of radioactivity to the environment in the event of a pipe break within the RCS. Where the unrestrained motion of a high pipe, following a postulated break could result in impact of the pipe with the containment liner or walls and floors providing barrier protection for safety-related equipment, the effects of this impact were evaluated as discussed in Section 3.6.4. If the impact of the whipping pipe could result in loss of integrity of the containment liner or damage to a floor or wall to the extent that the equipment protected by the structure could be rendered inoperative, pipe restraints were provided to prevent this impact.

These structural barriers were designed to withstand the pressure and temperature transients resulting from high energy piping system breaks. The results of the containment pressurization analyses are contained in Section 6.2.1. The results of the pressurization analyses performed on structures outside of the containment building are contained in Section 3.6.4.

3.6.5.4 Electrical Equipment Environmental Qualification

Special design requirements were placed on safety-related electrical equipment, instrumentation and cabling, required to function following a postulated break, to ensure the operability of this equipment under the environmental conditions existing as a result of the break. Section 3.11 lists equipment within the containment required to function following a postulated LOCA or main steam line rupture. The testing and analyses performed to ensure the operability of this equipment under the resulting environmental conditions has been documented in accordance with 10 CFR 50.49. In addition to the environmental conditions specified in Table 3.11-1 for safety-related equipment located in the auxiliary building, the equipment located in those areas described in Section 3.6.5.3 above are qualified to operate under the environmental conditions which would exist in these areas following the postulated pipe break.

ARKANSAS NUCLEAR ONE
UNIT 2

3.6.5.5 Control Room Habitability

The control room is located within the auxiliary building on floor Elevation 386 feet, immediately adjacent to the Unit 1 control room. No high energy pipes are located in or around this area. During normal operation the control room environment is maintained suitable for personnel and equipment with the use of fresh air makeup and chilled water cooling units. Redundant split system air conditioning units, cooled by the Seismic Category 1 portion of the SWS, in conjunction with recirculation fans, powered from the engineered safety features buses, provide a backup means of maintaining a suitable control room environment. See Section 9.4.1 for a detailed description.

3.6.6 LEAK-BEFORE-BREAK EVALUATION

This section describes the Leak-Before-Break (LBB) analysis for the Main Coolant Loop (MCL) piping, hot and cold legs. LBB analysis is used to eliminate from the structural design bases the dynamic effects of double-ended guillotine breaks and equivalent longitudinal breaks for the MCL piping system.

3.6.6.1 Applicability of Leak-Before-Break

MCL piping systems for which LBB is demonstrated are first shown to meet the applicability requirements for NUREG-1061, Volume 3. Specifically, the points considered for applicability for LBB are:

1. Regulatory requirements – level of susceptibility of failure from erosion, erosion/corrosion, corrosion/cavitation, waterhammer, creep fatigue, corrosion resistance, indirect causes, cleavage type failure, and fatigue cracking.
2. Technical requirements – pipe properties, normal operation, and seismic load levels.

Topical Report CEN-367-A, Reference 79 describes the applicability of LBB for the ANO-2 main loop piping.

3.6.6.2 Leak Detection

In order to apply the LBB concept to eliminate consideration of breaks in the MCL piping, leakage detection systems must be capable of detecting RCS leakage before it approaches the leakage rate associated with a critical-sized crack. There are two major aspects to leak rate detection that are based on crack detection in addition to the crack opening size: leak detection capability and flow rate correlation for leakage through a crack.

3.6.6.2.1 Leak Detection System

ANO-2 has an installed leakage detection system, described in Section 5.2.7.1.1, that meets the requirements of Regulatory Guide 1.45. Reference 80 describes the leak detection systems in detail.

ARKANSAS NUCLEAR ONE
UNIT 2

3.6.6.2.2 Flow Rate Correlation

The flow rate correlation for leakage through a given crack size cannot be predicted precisely. Variables such as surface roughness of the side walls of the crack, the nonparallel relationship of the side walls due to the elongated crack shape, and possibly zigzag tearing of the material during crack formation, all introduce uncertainties in defining an exact flow rate correlation. Topical Report CEN-367-A, Reference 79, describes the flow rate correlation in detail.

3.6.6.3 Material Properties

The main loop piping material is SA516Gr70. All hot and cold leg pipe-to-pipe welds and pipe-to-reactor vessel and steam generator safe ends are carbon steel welds. The pump case is 304 stainless steel, causing the pipe to pump safe end weld to be a bimetallic weld.

The detailed analyses of cracks in pipe welds require consideration of the properties of the pipe and weld materials. Section 7.1 of Reference 79 describes the material properties applicable to the LBB evaluation.

The Replacement Steam Generator nozzles to piping weld material properties are discussed in Section 3.6.6.3.1.

3.6.6.3.1 Weld Material Properties

The material properties for the RSG to MCL welds have been reviewed and determined to meet criteria presented in Reference 79.

3.6.6.4 Leakage Crack Length Determination

Hypothetical through-wall cracks must open significantly to allow detection by normal leakage monitoring under normal full power loading. The method for determining the appropriate leakage crack length is described in Reference 79.

3.6.6.5 Stability Evaluations

The stability evaluations, including determination of crack size and detail J-integral calculation, are described in Reference 79.

3.6.6.6 Results

The evaluations performed confirm that the bases for the LBB acceptance criteria according to NUREG 1061, Volume 3, are satisfied by the as-built design and materials of the MCL piping system.

References 79, 80, and 82 identify the acceptability of applications of LBB to the Main Loop piping for ANO-2.

3.7 SEISMIC DESIGN

This section indicates the techniques and discusses the parameters used to develop seismic loadings and criteria for Seismic Category 1 structures, systems, and components. In BC-TOP-4, Revision 1, Reference 35, and BP-TOP-1, Reference 4, the Design Basis Earthquake (DBE) and the Operating Basis Earthquake (OBE) correspond to the Safe Shutdown Earthquake (SSE) and one half magnitude of Safe Shutdown Earthquake ($\frac{1}{2}$ SSE), respectively.

3.7.1 SEISMIC INPUT

The DBE and the OBE were used as the basic seismic input. The DBE was assumed to represent the maximum vibratory ground motion at the site, during which all Category 1 structures, systems and components important to safety were designed to remain functional. The OBE was assumed to represent a vibratory ground motion at the site for which the plant would be permitted to continue to generate power without a thorough check of all safety-related items.

3.7.1.1 Design Response Spectra

The site design response spectra are illustrated in Figures 3.7-1 and 3.7-2 for the DBE and the OBE, respectively.

The shapes of the site design response spectra are in general agreement with the Regulatory Guide 1.60. However, the shapes of the spectra were derived in accord with the method discussed in Section 2.5.1 (b) of BC-TOP-4, Revision 1. These design spectra were based on the existing strong motion earthquake ground records of various durations, and were recorded at sites having different geologic conditions, epicentral distances, and their associated spectral amplification factors.

A discussion of the effects of historical seismic events on the site is given in Section 2.5. Because the modified design spectra were based on the properties of several strong motion records of the earthquakes recorded at sites of various geologic conditions and epicentral distances, the effects of duration, distance, and depth were automatically taken into account.

For the coupled reactor buildings/RCS seismic analysis, the design seismic ground motions are discussed in Section 3.7.2.15.

3.7.1.2 Design Response Spectra Derivation

A synthetic earthquake acceleration time history was generated (Figure 3.7-3), because the response spectra of recorded earthquake motions did not necessarily envelop the site design response spectra. The 24-second duration used was comparable to the strong motion duration of earthquake records. The duration was therefore considered to be adequate for the types of analyses used for the structures and equipment. Figure 3.7-4 shows that the response spectra for two percent, three percent and five percent of critical damping of the synthetic time history envelop the corresponding site design response spectra. The frequency ranges and frequency increments at which the response spectra values of the synthetic time history were calculated are shown in Table 3.7-1. Section 2.5.1(c) of BC-TOP-4, Revision 1, describes the generation of typical synthetic earthquake time histories.

3.7.1.3 Critical Damping Values

3.7.1.3.1 Category 1 Structures Systems and Components Other Than NSSS

The range of damping values in percent of critical damping, and the applicable allowable design stress levels used for Category 1 structures, systems, and components are given in Table 3.7-2.

The damping values used, as listed in Table 3.7-2, are in general agreement and more conservative than the Regulatory Guide 1.61. The only exceptions are for A) welded steel structures during DBE condition where a five percent damping was used and B) vital piping where ASME Code Case N-411 damping values may be used in lieu of those listed in the table with the following conditions:

1. Code Case N-411 damping values will be utilized in response spectrum analyses only, and not in time history analyses.
2. The damping values of Code Case N-411 will not be a mixture of Code Case N-411 and Regulatory Guide 1.61.
3. If pipe supports are removed or relocated as a result of using the Code Case damping values, the displacements of the piping will be reviewed to insure that inline components and adjacent structures are not affected.

All major Seismic Category 1 structures are founded on competent unweathered bedrock and no soil damping was considered in the seismic analysis.

For the coupled reactor building/RCS seismic analysis, the critical damping values are discussed in Section 3.7.2.15.

3.7.1.3.2 Nuclear Steam Supply System

The damping values used in the seismic analysis of the Nuclear Steam Supply System (NSSS) are discussed in Section 3.7.3.4.2.

3.7.1.4 Bases for Site Dependent Analysis

Since the major structures are founded on competent unweathered bedrock, site dependent analysis was not used to develop the design response spectra. Section 2.5.2 of the SAR and Sections 2.4 and 2.5 of BC-TOP-4, Revision 1, describe the bases for specifying the vibratory ground motion for design use.

3.7.1.5 Soil Supported Category 1 Structures

All major Category 1 structures are founded on competent unweathered bedrock. The soil supported Category 1 structures are identified as follows:

<u>Category 1 Structure</u>	<u>Depth of Soil Foundation Over Bedrock</u>
A. Emergency Cooling Pond	
Pipe Inlet	5 feet
Pipe Outlet	10 feet
B. Electrical Manholes	5 - 20 feet
C. Condensate Storage Tank (T41B) Pipe Trenches	~20 feet

ARKANSAS NUCLEAR ONE
Unit 2

Those Seismic Category 1 structures for which a dynamic analysis described in Section 3.7.2.1 was not performed, were checked for their adequacy to withstand loads under the DBE and OBE conditions. These structures are identified as:

- A. Emergency Diesel Fuel Storage Vault
- B. Emergency Cooling Pond Inlet and Pipe Outlet Structures
- C. Electrical Manholes
- D. Condensate Storage Tank (T41B) Pipe Trenches
- E. Condensate Storage Tank (T41B) Foundation

They are described in Sections 3.8.4.1.3, 3.8.4.1.4, 3.8.4.1.5, 3.8.4.1.6 and 3.8.4.1.7 respectively.

The method used to compute the lateral seismic loads was in accordance with the method described in the Seed and Whitman paper, "Design of Earth Retaining Structures for Dynamic Loads," Reference 20.

This method is based on developing a total lateral pressure which is composed of a dynamic lateral earth pressure applied as an equivalent static load at two-thirds the height above the base slab and a static earth pressure applied at one-third the height above the base slab. Representative margins of safety of typical walls are indicated as follows:

<u>STRUCTURE</u>	<u>MAXIMUM REQUIRED CAPACITY*</u>	<u>CAPACITY</u>
Emergency Diesel Fuel Storage Vault	46.4 Ft.-Kips (OBE)	113 Ft.-Kips
	46.1 Ft.-Kips (DBE)	113 Ft.-Kips
Emergency Cooling Pond Pipe Inlet and Outlet Structure	17.2 Ft.-Kips (OBE)	20 Ft.-Kips
	12.8 Ft.-Kips (DBE)	20 Ft.-Kips
Electrical Manholes	7.3 Ft.-Kips (OBE)	9.2 Ft.-Kips
	5.8 Ft.-Kips (DBE)	9.2 Ft.-Kips
Condensate Storage Tank (T41B) Trenches	7.0 Ft.+Kips (OBE)	11.1 Ft.-Kips
	7.2 Ft.+Kips (DBE)	11.1 Ft.-Kips

*Design Equations: OBE: See Section 3.8.4.3.2.1
 DBE: See Section 3.8.4.3.2.2

The analysis procedure for buried piping is described in Section 3.7.3.12. The calculated seismically induced stresses were combined with normal operating stresses and the resultant stresses were considerably less than the design allowable stresses. Since the calculated stresses were within the elastic limit values, no permanent deformations of the pipes are expected to occur.

ARKANSAS NUCLEAR ONE
Unit 2

A similar analysis was performed for the reinforced concrete duct banks which encase the Seismic Category 1 underground conduits and the Condensate Storage Tank (T41B) pipe trenches. The allowable stress values used in the duct bank analysis were in accordance with values described in Section 3.8.4.4. The results of the analysis showed that the calculated stresses are within the elastic limit values and, therefore, no permanent deformations of the duct banks are expected to occur.

The Condensate Storage Tank (T41B) Foundation Analysis is described in Section 3.7.1.7.

3.7.1.6 Soil Structure Interaction

Since the major Seismic Category 1 structures are founded on competent unweathered bedrock, a soil spring approach to characterize soil structure interaction was not used in the dynamic analysis. A simplified lumped mass method using a fixed base model was used.

The selection of a fixed base mathematical model was based on the high quality of foundation rock and was justified by comparing the foundation rocking and sliding motion frequencies with the primary fixed base structural frequencies. The minimum ratios of these frequencies are 3.3 and 2.9, respectively. The foundation vertical motion frequencies are within the rigid range for all structures except the containment. For the containment, the comparison of foundation vertical motion frequency with the primary fixed base structural vertical frequency yields a ratio of 1.7. These minimum values show a sufficient deviation in frequencies to justify the fixed base model assumption.

The average basic foundation rock properties were determined to be as follows:

Modulus of Elasticity (static)	= 6.7E5 psi
Modulus of Elasticity (dynamic)	= 2.8E6 to 5.0E6 psi
Compression Wave Velocity	= 10,000 to 14,500 fps

3.7.1.7 Pier Support Category 1 Structures

3.7.1.7.1 Condensate Storage Tank (T41B) Foundation Analysis

The dynamic analysis of the Condensate Storage Tank (T41B) was performed as follows. A synthetic time history for ground motion was generated from the site response spectra. The peak acceleration computed was .1855 g. To match the required design spectra of .2 g, all points were arbitrarily multiplied by 1.10. The resulting artificial time history spectra envelopes the site design spectra at all points.

This artificial time history was input to the structure model for the computer program FLUSH (see Section 3.7.1.7.2) and the design spectra with soil-structure interaction effects at the top of the foundation was developed. Hand calculations were used to check the FLUSH results and showed good agreement for the calculated fundamental frequencies.

The FLUSH model was a two-dimensional representation of the tank and foundation assuming fixed conditions at the base of the piers.

3.7.1.7.2 FLUSH Computer Program

The Computer Program FLUSH was developed by the University of California, Berkeley. It is a computer program for complex response analysis of soil-structure systems by the finite element method. The analysis is performed iteratively to allow for the strain dependent nature of the non-linear soil-characteristics. In each iteration, the analysis is linear but the soil properties are adjusted from iteration to iteration until the computer strains are compatible with the soil properties used in the analysis. FLUSH allows the adjustment of damping ratios to specified values in each element.

The soil-structure system is represented as a two-dimensional finite element model which provides good evaluations of the response at the base of the structure.

3.7.2 SEISMIC SYSTEM ANALYSIS

Major Seismic Category 1 structures were analyzed for seismic events. These structures include the containment, internal structures, auxiliary building and the intake structure. Seismic Category 2 structures were checked for the design basis loads so that collapse of the structure would not affect the ability of Category 1 structures to perform their intended design functions.

3.7.2.1 Seismic Analysis Methods

3.7.2.1.1 Category 1 Structures

An outline of the procedure used in analyzing structures and equipment for seismic effects is as follows. First an appropriate description of the earthquake was obtained (see Section 3.7.1). Second, the structure was idealized by a mathematical model. Third, the natural frequencies and mode shapes of the model were determined. Fourth, appropriate damping values were selected. Fifth, the spectrum response and time history technique were used in analyzing the structure. (In this phase of the analysis, inertial forces, shear forces, moments, accelerations and displacements were calculated at various elevations in the structure.) Sixth, seismic effects on equipment were determined. The spectrum response method was used to analyze the structure, system or component. Results obtained by the time history technique were compared to the results obtained by the spectrum response method. Time histories, which were produced at floors or nodes, were principally used to determine floor or nodal response spectra.

A separate analysis was made on the model for the two mutually perpendicular horizontal directions and the vertical direction. Since the containment is axisymmetric, only one model was used for both horizontal directions. Design response spectra generated from the acceleration time histories at each floor were used to design or check the adequacy of Category 1 equipment. For the NSSS equipment, acceleration time histories were computed at support points and later used in system design. Stress criteria were determined in accordance with the applicable concrete and steel codes. The material (ϕ) factors for concrete are those specified in ACI 318-63. Load factors are given in Sections 3.8.1, 3.8.3 and 3.8.4. The predicted displacement response was used to check against the allowable clearances between structures or equipment.

In the mathematical model, the locations for lumped masses were chosen at floor levels and other points of interest, such as supports of major systems or equipment. The structural properties between mass points were reduced to uniform segments of cross-sectional area, effective shear area and moments of inertia. The mathematical model of the containment and the internal structures is shown in Figures 3.7-5 and 3.7-6.

ARKANSAS NUCLEAR ONE
Unit 2

3.7.2.1.2 Nuclear Steam Supply System

The methods used in the seismic analysis of the NSSS are described in Sections 3.7.3.4.2.1.2 and 3.7.3.4.2.1.3.

3.7.2.1.3 Equipment Other Than NSSS

The dynamic analysis of systems and equipment was performed using one of the following methods. Each case was evaluated individually to determine the approach to be used.

- A. For structurally simple equipment, the dynamic model could consist of a single mass and a single spring. Using the values of the mass and the spring constant, the natural frequency of the equipment was determined. An acceleration response spectrum yields the equipment acceleration when used in conjunction with the natural frequency and the equipment's damping. The inertia force was obtained by multiplying the mass of the equipment by the acceleration value.

In lieu of a detailed dynamic analysis, for those items of equipment which could be adequately represented by a single degree of freedom system, the peak acceleration of the response spectrum curve was applied. This acceleration value was then used to calculate the inertia force as outlined above.

- B. For structurally complex equipment the following method of analysis was used:
1. The equipment was modeled by using lumped masses and spring constants.
 2. The natural frequencies and mode shapes for the equipment were determined.
 3. The applicable damping value of the equipment was determined.
 4. Using the natural frequencies, damping and the appropriate acceleration response spectrum, the spectral accelerations, per mode, were determined.
 5. The effective forces and weights, per mode, were calculated from the acceleration values obtained in "4" above.
 6. The resulting response values, per mode, of inertia forces, shear forces and moments were determined from these effective forces and weights. The response values, per mode, were combined by using the square root of the sum of the squares.
- C. For rigid equipment having fundamental natural frequencies greater than 30 cps, the response accelerations were equal to the accelerations of the supporting structure at the support point elevation.
- D. For flexible equipment having fundamental natural frequencies smaller than 30 cps, the response accelerations were obtained by same method as discussed in Section 3.7.2.1.3.A.

ARKANSAS NUCLEAR ONE
Unit 2

- E. For equipment, where the structural support system between the ground and Category 1 equipment had a first mode natural frequency below 30 cps, spectrum response curves were generated for vertical and horizontal directions at the equipment support. In generating the vertical curves, the time history utilized at the ground was scaled to two-thirds of the maximum horizontal acceleration value.
- F. An alternative method for the seismic design and verification of new, modified and replacement equipment (e.g., seismic equipment qualification) is to use earthquake and seismic testing experience.

The techniques used in the dynamic analysis of piping are described in BP-TOP-1, Sections 2.0 through 2.4.

3.7.2.2 Natural Frequencies and Responses Loads

Only those natural frequencies near or less than 30 cps were used in the analysis. A summary of these natural frequencies for all major Category 1 structures is given in Table 3.7-3. The mode shapes and natural frequencies of the containment and internal structures are shown in Figure 3.7-7. For the coupled reactor building/RCS seismic analysis, the natural frequencies are summarized in Table 3.7-15.

A sample of a completed analysis for the containment and the internal structures is given in Figures 3.7-8 through 3.7-10. Results for the OBE are shown. Parameters computed in the analyses were inertial force, shear force, moment, acceleration and displacement.

Samples of the floor response spectra are given in Figures 3.7-11 through 3.7-29. These spectra were generated for the containment and auxiliary building and were incorporated into equipment specifications for use by equipment suppliers. Their use is discussed in Section 3.7.2.1.

3.7.2.3 Procedures Used to Lump Masses

3.7.2.3.1 Category 1 Structures, Systems and Components Other Than NSSS

The containment and the internal structures of concrete walls and slabs were represented in the lumped mass model as independent cantilever beams. The validity of modeling a cylindrical containment structure as a cantilever beam is discussed in Appendix E, BC-TOP-4, Revision 1. The lumped masses were computed from tributary structure dead loads and fixed equipment loads. For the containment 15 masses were considered sufficient to conservatively predict the behavior of the structure during seismic conditions. For the internal structures, the masses were lumped at 14 points. Some of the points had mass contributed from supported equipment. A component, system or piece of equipment was usually lumped into the supporting structure mass if its estimated weight was less than one-tenth that of its supporting mass. This equipment, component, or system was later analyzed using the response spectrum generated at the supporting level. The auxiliary building was modeled by lumping masses at the foundation and the concrete floors. The steel framework was lumped into the highest nodal point of the auxiliary building model. The intake structure was modeled similarly by lumping masses at the concrete slab elevations.

ARKANSAS NUCLEAR ONE
Unit 2

The modeling techniques used in dynamic analysis of piping are described in BP-TOP-1, Sections 3.0 through 3.4. An alternative to the Enveloping Response Spectrum Technique delineated in Section 3.3 of BP-TOP-1 is the Independent Support Motion (ISM) Response Spectrum Technique in which individual response spectra are applied to each support.

3.7.2.3.2 Nuclear Steam Supply System

The modeling of the NSSS for the seismic analysis is discussed in Sections 3.7.3.4.2.1.1 and 3.7.3.4.2.1.2.

3.7.2.4 Rocking and Translational Response Summary

Fixed base mathematical models were assumed in the dynamic analysis of the major Category 1 structures, and no rocking and translational response was obtained.

3.7.2.5 Methods Used to Couple Soil With Seismic System Structures

Finite element method was not used and therefore this section is not applicable. See Section 3.7.2.1 for the method used.

3.7.2.6 Development of Floor Response Spectra

The time history method of analysis was used to develop the floor or nodal response spectra for each structural system. A discussion of the technique of finding the nodal time history and then producing the spectrum may be found in Sections 4.2 and 5.2 of BC-TOP-4, Revision 1.

3.7.2.7 Differential Seismic Movement of Interconnected Components

3.7.2.7.1 Category 1 Structures, System and Components Other Than NSSS

BC-TOP-4, Revision 1, Section 5.3, describes the techniques used to compute seismic loadings in interconnected components. BP-TOP-1, Sections 4.2, 6.3.2 and 6.4 describe the techniques used to evaluate differential seismic movements in interconnected piping.

3.7.2.7.2 Nuclear Steam Supply System

Modeling of coupled, multisupported components of the NSSS is described in Sections 3.7.3.4.2.1.1 and 3.7.3.4.2.1.2. The stress and deformation criteria are given in Section 5.2.1.

3.7.2.8 Effects of Variations on Floor Response Spectra

The structural material properties that can affect any variations in seismic response are well known, and they would not cause any significant changes in response. For example, a variation of a few percent in the modulus of elasticity would not cause a significant shift in the natural periods of structural elements because natural frequencies are proportional to the square root of the modulus. For a discussion of spectral peak widening see BC-TOP-4, Revision 1, Section 5.2.

3.7.2.9 Use of Constant Vertical Load Factors

3.7.2.9.1 Category 1 Structures, Systems and Components Other Than NSSS

Vertical seismic analyses determining natural frequencies were made on Category 1 structural systems. For buildings other than the containment, the lowest natural frequency of vertical response for structural modes was above 33 Hz, and the structures were considered rigid in the vertical direction. In accordance with current practice, the horizontal ground response spectra were multiplied by two-thirds to give the vertical ground response spectra. For the containment, a time history analysis in the vertical direction was done. Spectral curves for vertical response at discrete elevations on the shell were determined.

Constant vertical load factors were not used for Category 1 structures, equipment or piping.

3.7.2.9.2 Nuclear Steam Supply System

Constant vertical load factors were not used for the seismic design of the NSSS.

3.7.2.10 Method Used to Account for Torsional Effects

The analysis techniques considered additional shear forces in resisting elements due to the eccentricity between the center of mass and center of rigidity. The torsional effects were obtained by hand calculations and the stresses were combined with the stresses due to horizontal and vertical analyses.

3.7.2.11 Comparison of Responses

A comparison of the results of a modal response spectrum analysis and a modal time history analysis at selected points for the containment, internal structures and auxiliary building is shown in Table 3.7-4. The synthetic ground time history had a spectrum which everywhere enveloped the spectrum used in the modal response spectrum analysis. Its application in the seismic analysis therefore produced conservative results. The ground time history spectrum curve is shown in Figure 3.7-4.

3.7.2.12 Methods for Seismic Analysis of Dams

This section does not apply to this plant since there are no dams used to impound bodies of water serving as heat sinks for the safe shutdown of the plant.

3.7.2.13 Methods to Determine Category 1 Structure Overturning Moments

Overturning moments were computed from the results of the modal response spectrum analysis. The moments of the containment and the internal structures were added. The eccentricity of the shear forces above the bottom of the slab, the effective decrease in weight due to hydrostatic forces, and the effective decrease in weight due to vertical seismic forces were all included in determining the factor of safety against overturning. Calculations showed that this factor of safety was greater than 1.5 for the DBE for the Category 1 structures considered.

Soil pressures were computed on the polygonal area approximating the perimeter of the containment and the neutral axis. The soil pressure was taken as varying linearly from zero at the neutral axis to a maximum at the outer edge. The soil pressures were determined to be within the allowable pressure given in Section 2.5.1.

3.7.2.14 Analysis Procedure for Damping

3.7.2.14.1 Category 1 Structures, Systems and Components Other Than NSSS

None of the Category 1 structural systems, other than the internal structures and containment shell, were modeled as coupled systems. The analysis of the coupled system of steam generators, nuclear reactor, internal structures, and containment shell is discussed in Section 3.7.2.15. For the generation of time histories at the support points of the NSSS, the damping value of the concrete structures was used since the concrete structures contributed most to the response of the model.

3.7.2.14.2 Nuclear Steam Supply System

Modeling and analysis of the coupled components in the NSSS is described in Sections 3.7.3.4.2.1.2.1 and 3.7.3.4.2.1.3.1.

3.7.2.15 Coupled Reactor Building/RCS Seismic Analysis

Seismic response spectra were developed for the reactor building shell, reactor building internal structure, and RCS attachment nozzles and connecting points using a coupled reactor building/RCS model.

Seismic analyses were performed using “state-of-the-art” methodologies and included the following:

1. Seismic ground motion based on R.G. 1.60 recommendations
2. Structural damping based on R.G. 1.61 recommendations
3. 3-dimensional (3-D) representation of the structures and the RCS
4. Soil structure interaction analysis

Because of the axial symmetry of the reactor building containment shell, the existing 2-D model is the same as the 3-D model. Thus, there is no difference between analysis results obtained using the 2-D model versus the 3-D model.

Although the reactor building containment shell is considered symmetrical, the interior structure of the reactor building exhibits some degree of asymmetry, which affects the overall dynamic properties, resulting in added torsional response. A revised 3-D model was generated for the reactor building internals.

Response spectra were generated at 71 locations, including 46 locations for the tributary piping attachment points with the RCS and 25 locations for the reactor building shell and internal structures.

The response spectra were generated for two earthquake levels, OBE and DBE, and for constant damping values of 0.5%, 1%, 2%, 3% and for the variable damping of Code Case N 411.

For the soil structure interaction analysis, the discussion in Section 3.7.1.6 states that the Seismic Category I structures, including the reactor building, are founded on bedrock. Therefore, a fixed base assumption is considered to be appropriate for the ANO-2 reactor building.

ARKANSAS NUCLEAR ONE
Unit 2

3.7.2.15.1 Methodology

Seismic Ground Motion:

The basic seismic input to the building structures was R.G. 1.60 ground motion spectra in two horizontal directions and one vertical direction. The horizontal spectra were normalized to 0.2 g for DBE and 0.1 g for OBE for both horizontal directions, and to 2/3 of the horizontal acceleration in the vertical direction. Uncorrelated acceleration time history functions based on enveloping the 2%, 5%, and 7% shaped R.G. 1.60 spectra were generated for each of the three directions.

Structural Damping:

The structural damping used in generating the original response spectra was 2% OBE and 5% DBE. The response spectra for RCS attached piping was originally generated for 0.5% and 1% damping for OBE and DBE, respectively. By following the requirements of ASME Code Case N-411, a significant reduction in response is achievable due to higher damping. For this coupled reactor building/RCS seismic analysis, the composite modal damping is as follows:

	<u>OBE</u>	<u>DBE</u>
Reactor building – shell	2%	5%
Reactor building – internal structures	4%	7%
RCS	2%	3%

Development of 3-D Model

For this coupled reactor building/RCS seismic analysis, the existing 2-D model of the reactor building was revised to create a 3-D stick model. The stiffness and mass properties of the new 3-D model were developed based on information contained in design bases calculations. The shear center and mass center for each floor elevation were based on design drawings showing the structural details of the walls and floors of the internal structure of the reactor building. This model includes the 3-D representation of the RCS attached at the appropriate elevations.

The new 3-D models are described as follows:

1. Reactor building containment shell stick model – Since the containment shell is axisymmetric, the 3-D reactor building containment shell model is the same as the current 2-D model.
2. Reactor building internal structure stick model – This dynamic model of the internal structures is a multi-branch 3-D stick model. The first stick represents the primary shield walls only. The second stick represents the secondary shield walls only without the steam generator pedestals. This 3-D model is based on the actual wall and floor stiffness and masses, allowing for differences between centers of mass and shear centers at each major floor elevation. This modeling captures the torsional response of the reactor building internal structure.
3. RCS stick model – This is a 3-D stick representation of the RCS incorporating steam generator dynamic properties. A composite 3-D lumped-mass ANSYS model of the reactor vessel, two steam generators, four reactor coolant pumps, and main coolant loop piping is included. In addition, representation of the reactor vessel and steam

ARKANSAS NUCLEAR ONE
Unit 2

generator assemblies used in this model include sufficient detail of the reactor internals and RSG internals to account for possible dynamic interaction between those internal components and the RCS. The RCS stick model is coupled to the reactor building internal structure stick model at appropriate support or restrained elevations. The number of masses and dynamic degrees of freedom are consistent with NRC guidance.

Seismic Analysis:

The seismic analyses consisted of a modal time history analysis, using ANSYS code reduced modal transient analysis option.

The following analyses were performed:

1. A frequency analysis to determine the coupled model natural frequencies and associated mode shapes. The resulting modal properties were used as a basis of comparison with the original models of the reactor building and the RCS.
2. Time-history analysis for both OBE and DBE using the R.G. 1.60 ground spectra as the control motion and R.G. 1.61 damping values for the structures. The 3-D stick model of the reactor building is subjected to simultaneous excitation in the three orthogonal global directions (N-S, E-W, vertical directions).

Upon completion of the dynamic analysis, acceleration and displacement time histories were generated at the main coupling points of the RCS. At each RCS attachment point, and for each earthquake level of OBE and DBE, three time histories of acceleration and displacement response corresponding to three orthogonal global directions were extracted.

Additionally, response spectra were generated for the 71 locations: 46 tributary piping attachment points with the RCS, and 25 locations for the reactor building shell and internal structures. These response spectra were developed using the results of the combined 3-D reactor building model coupled with the RCS model.

3.7.2.15.2 Results

Synthetic time histories were generated based on R.G. 1.60 ground response spectra for 2%, 5%, and 7% damping. Two separate response spectra records were created for the two horizontal directions, and one was created for the vertical direction. The time history was generated from a response spectrum using an iterative procedure. The synthetic time history function is presented in Figures 3.7-52 and 3.7-53 (one horizontal and one vertical component). Figures 3.7-54, 3.7-55, and 3.7-56 show the response spectra generated by the three time history components compared to the target response spectra.

The reactor building shell 3-D dynamic model is shown in Figure 3.7-57. The reactor building internal structure 3-D dynamic model is shown in Figure 3.7-58.

The 3-D model was analyzed with the RCS coupled to the reactor building internal structure and containment shell. A summary of the natural frequencies (modal properties) for the coupled analysis is presented in Table 3.7-15. As a result of this dynamic coupling, the steam generator seismic response shows higher amplification in N/S direction as compared with E/W direction.

3.7.3 SEISMIC SUBSYSTEM ANALYSIS

3.7.3.1 Determination of Number of Earthquake Cycles

3.7.3.1.1 Category 1 Structures, Systems and Components Other Than NSSS

Procedures to determine the number of earthquake cycles for piping during one seismic event are discussed in Section 6.2 of BP-TOP-1. Structures and equipment were designed on the basis of analytical results. In general, the design of structures and majority of the equipment was not fatigue controlled, since most of stress and strain changes would occur only a small number of times and/or would produce only minor stress-strain fluctuations. The occurrence of earthquake and Design Basis Accident (DBA) full design strains is expected to occur too infrequently and with too few cycles to require fatigue design of structures and equipment other than NSSS equipment.

3.7.3.1.2 Nuclear Steam Supply System

The number of maximum amplitude loading cycles specified for the seismic design of the NSSS components is given in Section 5.2.1.5.

3.7.3.2 Basis for Selection of Forcing Frequencies

Structural frequencies ("forcing frequencies") were not selected, but were calculated in accordance with Section 4.2.1 of BC-TOP-4, Revision 1. The seismic qualification of equipment and the design of the equipment supports was accomplished by using the results of one of the methods of seismic analysis outlined in Section 3.7.2.1.3.

3.7.3.3 Root Mean Square Basis

The term "root-mean-square-basis" was not used in the seismic analysis. The term used was "square root of the sum of the squares" and is referred to in Section 3.7.2.1.3 B.

3.7.3.4 Procedure for Combining Modal Responses

3.7.3.4.1 Category 1 Structures, Systems and Components Other Than NSSS

Sections 4.2, 5.3 and Appendix F of BC-TOP-4, Revision 1, describe the techniques used to combine modal responses for structures and equipment. Sections 5.1 and 5.2 of BP-TOP-1 describe the criteria used for piping systems.

3.7.3.4.2 Seismic System Analysis of Nuclear Steam Supply System

3.7.3.4.2.1 Reactor Coolant System

3.7.3.4.2.1.1 Introduction

The adequacy of seismic loadings used for the design of the major components of the Reactor Coolant System (RCS) were confirmed by the methods of dynamic analysis time history and response spectrum techniques. The major components are the reactor, the steam generators, the reactor coolant pumps, the reactor coolant piping and the pressurizer.

ARKANSAS NUCLEAR ONE
Unit 2

In order to account for possible dynamic coupling effects between the components, a composite coupled model was employed in the dynamic analysis of the reactor, the two steam generators, the four reactor coolant pumps and the interconnecting reactor coolant piping. The analysis of these dynamically coupled multisupported components utilized different time dependent input excitations applied simultaneously to each support. In addition, the representation of the reactor vessel assembly used in this coupled model included sufficient detail of the reactor internals to account for possible dynamic coupling from the RCS to the internals. The results of the analysis of the coupled components of the RCS include an appropriate time history forcing function for use in a separate analysis of a more detailed model of the reactor internals.

The analysis of the pressurizer employed a separate mathematical model and utilized response spectrum techniques.

A representation of the coupled components, of sufficient detail to account for possible dynamic coupling effects from the containment internal support structure to the RCS components, was supplied for use in performing the analysis of the containment internal support structure. The results of the analysis of the containment internal support structure included the time history forcing functions for use in the separate analysis of the more detailed model of the coupled components of the RCS. Response spectra were also developed from the containment internal support structure analysis for use in the pressurizer dynamic analysis.

For the time history analyses, dynamic responses to vertical seismic excitation were found for both the case of initial support displacement upward and the case of initial support displacement downward. The responses were combined to determine the most severe combinations produced by the effects of seismic excitations in each of the horizontal directions applied simultaneously with seismic excitation in either vertical direction. The square root of the sum of the squares method was used to combine the modal responses for the response spectrum modal analysis of the pressurizer.

Contributions from all significant modes of response were retained in the analyses.

The damping factors used in the seismic analyses of the major components of the RCS were selected from Table 3.7-6. Modal damping factors of two or three percent of critical and one to two percent of critical for the DBE and OBE, respectively, were used in the seismic analyses of the major components of the RCS.

3.7.3.4.2.1.2 Mathematical Models

In the descriptions of the mathematical models which follow, the spatial orientations are defined by the set of orthogonal axes where Y is in the vertical direction, and X and Z are in the horizontal plane, in the directions indicated on the appropriate figure. The mathematical representation of the section properties of the structural elements employs a 12 x 12 stiffness matrix for the three-dimensional space frame models, and employs a 6 x 6 stiffness matrix for the two-dimensional plane frame model. Elbows in piping runs include the in plane/out of plane bending flexibility factors as specified in the ASME Code, Section III.

3.7.3.4.2.1.2.1 Reactor Coolant System - Coupled Components

A schematic diagram of the composite mathematical model used in the analyses of the dynamically coupled components of the RCS is presented in Figure 3.7-30. This model includes 110 mass points with a total of 555 dynamic degrees of freedom. The mass points and

ARKANSAS NUCLEAR ONE
Unit 2

corresponding dynamic degrees of freedom are distributed to provide appropriate representations of the dynamic characteristics of the components, as follows: the reactor vessel, with internals, is represented by 18 mass points with a total of 75 dynamic degrees of freedom; each of the two steam generators are represented by 37 mass points with a total of 216 dynamic degrees of freedom, each of the four reactor coolant pumps are represented by two mass points with a total of five dynamic degrees of freedom, each pump suction and discharge branch of piping is represented by a mass point with three dynamic degrees of freedom, and each reactor vessel outlet pipe is represented by a mass point with two dynamic degrees of freedom. The representation of the reactor internals if formulated in conjunction with the analysis of the reactor internals discussed in Section 3.7.3.4.2.2, and is designed to simulate the dynamic characteristics of the models used in that analysis.

The mathematical model provides a three-dimensional representation of the dynamic response of the coupled components to seismic excitations in both the horizontal and vertical directions. The mass is distributed at the selected mass points and corresponding translational degrees of freedom are retained to include rotary inertial effects of the components. The total mass of the entire coupled system is dynamically active in each of the three coordinate directions.

3.7.3.4.2.1.2.2 Pressurizer

The mathematical model employed in the analysis of the pressurizer is shown schematically in Figure 3.7-31. This lumped parameter, planar model provides a multi-mass representation of the axially symmetric pressurizer and includes five mass points with a total of six dynamic degrees of freedom.

3.7.3.4.2.1.3 Calculations

3.7.3.4.2.1.3.1 General

As applied in the analysis, the simultaneous equations of motion for linear structural systems with viscous damping can be written, Reference 62:

$$M\ddot{X} + C\dot{X} + KX = M\ddot{Y} - K_{ms}X_s$$

where

- M = diagonal matrix of lumped masses
- C = square symmetric damping matrix
- K = square symmetric stiffness matrix which defines the mass point force to displacement relationship
- \ddot{Y} = column matrix with elements equal to the absolute acceleration of the datum support in the coordinate direction of the related dynamic degree of freedom of the structural system
- K_{ms} = rectangular matrix of stiffness coefficients which defines the mass point force to nondatum support displacement relationship
- X_s = column matrix of displacements relative to the datum at nondatum supports
- X = column matrix of mass point displacements relative to the datum
- \dot{X} = column matrix of mass point velocities relative to the datum
- \ddot{X} = column matrix of mass point acceleration relative to the datum

ARKANSAS NUCLEAR ONE
Unit 2

In this form, the equations define the dynamic response of a multi-mass structural system subjected to time dependent support motion. In the analysis of systems with multiple supports, such as the coupled components of the RCS, the equations provide for different time dependent input motions at each of the supports. In this case, one of the supports of the system is designated the reference, or datum, from which the motions of all other points of the structural system are measured. The reactor vessel support is designated as the datum in the analyses of the coupled components of the RCS.

Normal mode theory, as described in Reference 62, is employed to reduce the equations of motion to a system of independent equations in terms of the normal modes for the time history and spectrum analyses of the RCS components. In the analyses, the dynamic responses of the major components are determined for seismic excitations in each of the three global coordinate directions. The dynamic responses to vertical seismic excitation are found for both the case of initial support displacement upward and the case of initial support displacement downward. These responses are combined to determine the most severe combinations produced by the effects of seismic excitations in each of the horizontal directions applied simultaneously with either seismic excitation in the vertical direction.

3.7.3.4.2.1.3.2 Frequency Analysis – (OSG)

An eigenvalue for the original steam generator analysis was performed utilizing the ICES STRUDL II computer code, Reference 19, to calculate the mode shapes and natural frequencies of the composite mathematical models. Modifications to the standard ICES STRUDL II program have been implemented by CE to include a Jacobi diagonalization procedure in the eigenvalue analysis, and to provide appropriate influence coefficients and stiffness matrices for use in the response and reaction calculations. For analyses with the replacement steam generators (RSGs) see Section 3.7.3.4.2.1.3.5.

A description of the ICES STRUDL II computer code is given in Section 3.7.3.4.2.1.6.

3.7.3.4.2.1.3.3 Mass Point Response Analysis – (OSG)

The time history of mass point responses to seismic excitation are computed using TMCALC, a CE code. This code performs a closed form integration of the equations of motion for singly or multiply supported dynamic systems, utilizing normal mode theory. For the multiply supported systems, the separate time histories of each support are imposed on the system simultaneously. The results are time history responses of the mass points.

A description of the TMCALC code is given in Section 3.7.3.4.2.1.6.

The mass point responses resulting from the spectrum analysis are found utilizing the ICES STRUDL II computer code. This code performs a normal mode response spectrum analysis resulting in modal inertial loads at each mass point. The mass point responses of the pressurizer are found using the response spectrum for the pressurizer support.

3.7.3.4.2.1.3.4 Seismic Reaction Analysis - (OSG)

The dynamically induced loads at all system design points due to the superimposed time history support excitations and mass point responses are calculated utilizing FORCE, a CE computer code. This code performs a complete loads analysis of the deformed structure at each incremental time step by computing internal and external system reactions (forces and moments) by superposition of the reactions due to the mass point displacements and the non-datum support displacements as follows:

ARKANSAS NUCLEAR ONE
Unit 2

$$R(t) = C_m X_m(t) + C_s X_s(t)$$

where

$R(t)$ = the matrix of all components of the reactions at the system design points

C_m = the matrix of mass point displacement influence coefficients

$X_m(t)$ = the column matrix of time history mass point displacements relative to the datum at each time step

C_s = the matrix of support displacement influence coefficients

$X_s(t)$ = the column matrix of time history support displacements relative to the datum at non-datum supports at each time step

The support and mass point displacements due to horizontal and vertical seismic excitations are added algebraically at each time step. The maximum component of each reaction for the entire time domain and its associated time of occurrence are selected.

A description of the FORCE code is given in Section 3.7.3.4.2.1.6.

The maximum reactions for the pressurizer, resulting from the response spectrum analysis, are found by applying the modal inertial loads for each mode, to the structural model using the STRUDL computer code. The design point reactions due to each modal loading are combined by STRUDL by summing the absolute values and by root sum square of the modal reactions.

3.7.3.4.2.1.3.5 Analysis of RCS with Replacement Steam Generator (RSG)

The original analysis was performed using the STRUDL computer code to define the structural properties of the RCS. The current analysis used the ANSYS computer code to define the structural properties of the RCS. The ANSYS model was developed by converting the STRUDL commands that produced the STRUDL structural model to equivalent ANSYS commands. The equivalence of the two models was confirmed by comparison of the predicted frequencies and mode shapes. The RCS model was updated to include the RSGs and detailed RV internals representation shown in Figure 3.7-30.

3.7.3.4.2.1.3.5.1 Frequency Analysis

An eigenvalue analysis was performed using the ANSYS computer code to calculate the mode shapes and natural frequencies of the RCS composite mathematical model. The calculated natural frequencies and dominant degrees of freedom for the RCS and the calculated modal frequencies and corresponding modal participation factors for the Replacement Pressurizer are shown in Table 3.7-7.

3.7.3.4.2.1.3.5.2 Response Analysis

The original OBE time history motions were used as input to the RCS supports. Motions were applied separately in the three orthogonal directions; X parallel to the hot leg, Y vertical, and Z perpendicular to the hot leg. Time history motions were applied at each RCS support location. The motions applied varied depending on the location in the building model to which the RCS support was attached. The response of the RCS for each direction was calculated using the method of modal superposition with a constant damping ratio of 1% for OBE. For DBE, twice the OBE time history input was used with a constant damping ratio of 2%.

ARKANSAS NUCLEAR ONE
Unit 2

3.7.3.4.2.1.4 Results

The reactions (forces and moments) at all design points in the system, obtained from the dynamic seismic analysis, are compared with the seismic loads in each component design specification. The results of this comparison are summarized in tabular form for the points of maximum calculated load in Table 3.7-8.

The maximum seismic loads calculated by the time history techniques are the result of a search and comparison over the entire time domain of each individual component of load due to the simultaneous application of the horizontal and either vertical excitation. The maximum calculated components of load for each design location do not in general occur at the same time, nor for the same combination of horizontal and vertical excitation, and therefore result in a conservative worst case.

The maximum seismic loads calculated by the response spectrum techniques are the result of combining the modal reactions due to the horizontal and the vertical excitation.

3.7.3.4.2.1.5 Conclusion

All seismic loads calculated by the dynamic seismic analyses are less than the corresponding loads in the component design specifications. These analyses were performed for OBE and DBE excitations and the results are compared with OBE and DBE design specification loads. It is concluded the seismic loadings specified for the design of the RCS components and supports are adequate.

3.7.3.4.2.1.6 Description of Computer Codes

3.7.3.4.2.1.6.1 ICES/STRUDL

The ICES/STRUDL-II computer program provides the ability to specify characteristics of problems - framed structures and three-dimensional solid structures, perform analyses - static and dynamic and reduce and combine results.

Analytic procedures in the pertinent portions of ICES/STRUDL-II apply to framed structures. Framed structures are two- or three-dimensional structures composed of slender, linear members which can be represented by properties along a centroidal axis. Such a structure is modeled with joints, including support joints, and members connecting the joints. A variety of force conditions on members or joints can be specified. The member stiffness matrix is computed from beam theory. The total stiffness matrix of the modeled structure is obtained by appropriately combining the individual member stiffnesses.

The stiffness analysis method of solution treats the joint displacements as unknowns. The solution procedure provides results for joints and members. Joint results include displacements and reactions and joint loads are calculated from member end forces. Member results are member end forces and distortions. The assumptions governing the beam element representation of the structure are as follows: linear, elastic, homogeneous, and isotropic behavior, small deformations, plane sections remain plane, and no coupling of axial, torque and bending.

ARKANSAS NUCLEAR ONE
Unit 2

The program is used to define the dynamic characteristics of the structural models used in the dynamic seismic analyses of the RCS components. The natural frequencies and mode shapes of the structural models and the influence coefficients which relate member end forces and moments and support reactions to unit displacements are calculated. The influence coefficients are calculated for each dynamic degree of freedom of each mass point and for each degree of freedom of each support point at which relative motion is imposed. In addition, stiffness coefficients are calculated which relate the forces corresponding to those joint degrees of freedom for which mass is specified to the imposed displacements corresponding to those (support) joint degrees of freedom at which relative motion will be specified during subsequent seismic response calculations. As appropriate, these data are stored for later use in response spectra or time history seismic response calculations.

ICES/STRUDL-II is a program which is in the public domain and has had sufficient use to justify its applicability and validity. The version of the program in use at CE was developed by the McDonnell Automation Company/Engineering Computer International and is run on the IBM-360 computer system.

3.7.3.4.2.1.6.2 TMCALC

The CE program TMCALC solves the differential equations of motion for a singly or multiply excited multi-degree-of-freedom linear structural system. The program accepts separate, independent, time varying inputs at each boundary point in the system at which motions due to a seismic event may be imposed, or where a load forcing function may be imposed. The input excitations are provided in digitized form and are assumed to vary linearly between input time steps. The solution of the equations of motion in normal mode coordinates employs a closed form integration process.

The inputs to TMCALC consist of:

- A. Eigenvalues (natural frequencies) and eigenvectors (mode shapes).
- B. A stiffness matrix which relates mass point degrees of freedom to boundary point degrees of freedom.
- C. Mass and damping matrices.
- D. Digitized time history records which define the excitation in terms of motions at the boundary points of the structural system or forces at mass points.

The output from TMCALC consists of digitized time history records of the absolute accelerations and relative displacements for each mass point and boundary point dynamic degree of freedom of the structural system. The program was developed by CE in 1970 and is used on the CDC 7600 computer at CE.

The program is used to calculate the dynamic response of structural models used in the dynamic seismic analysis of the RCS major components, and in the dynamic analysis of linear structural systems subjected to time varying load forcing functions, such as thrust from postulated pipe ruptures.

To demonstrate the applicability and validity of the TMCALC program, the solutions to test problems were obtained and shown to be substantially identical to the results obtained by hand calculation. One such problem is shown here for purposes of illustration. The satisfactory

ARKANSAS NUCLEAR ONE
Unit 2

agreement between the program results and the theoretical solution indicates the reliability of TMCALC. Figure 3.7-32 is a lumped mass, shear beam representation of a uniform beam with the given properties, subjected to different, arbitrary motions at each of the two supports, as shown. The closed form solution to the equation of motion for this structure can be found using standard integration techniques.

From this closed form solution for the equation of the multiply excited (see References 73 and 76) system shown in Figure 3.7-32, maximum values of relative displacement, velocity and acceleration were derived. These solutions are shown in Table 3.7-9 along with the corresponding results from program TMCALC. Differences can be seen to be less than one percent. The respective times at which these maxima occurred were identical.

3.7.3.4.2.1.6.3 FORCE

The computer program FORCE calculates the internal forces and moments at designated locations in a linear elastic structural system, at each time step, due to the time history of relative displacements of the system and boundary points. The program also selects the maximum value of each component of force or moment at each designated location, and the times at which they occur, over the entire duration of the specified dynamic event. The input to FORCE consists of the following:

- A. A matrix of influence coefficients computed by the ICES/STRUDL-II program, which relate the displacements of the mass point and support point dynamic degrees of freedom to the reaction forces and moments at the designated locations.
- B. The time history of the relative displacements of the mass point and support point dynamic degrees of freedom as calculated by the program TMCALC.

The program forms appropriate linear combinations of the relative displacements at each time step and performs a complete loads analysis of the deformed shape of the structure each time step over the entire duration of the specified dynamic event.

The program was developed by CE in 1970 and is used on the CDC 7600 computer.

The program is used to calculate the time dependent reactions in structural models subjected to dynamic excitation which are analyzed by the TMCALC program.

To demonstrate the validity of the FORCE program, results for test cases were obtained and shown to be substantially identical to those obtained for an equivalent analysis using the public domain program STRUDL. One such test case is shown here for purposes of illustration. Figure 3.7-33 is a lumped mass multiple degree of freedom model of a uniform beam which has been defined to have mass and differential boundary excitation. The arbitrary differential support motion and mass point responses chosen for this example are shown in Table 3.7-10. The matrix of influence coefficients and the arbitrary mass point and differential support point motions are input to the program to calculate the support reactions and internal shear forces and bending moments indicated in Figure 3.7-33. These results and those found by performing a stiffness analysis using the STRUDL program are shown in Table 3.7-11. Results can be seen to be substantially identical.

3.7.3.4.2.1.6.4 ANSYS

The ANSYS computer code, Reference 87, is a large-scale multi-purpose commercial finite element program that may be used for solving several classes of engineering analyses. The analysis capabilities of ANSYS include the ability to solve static and dynamic structural analyses, steady state and transient heat transfer problems, mode-frequency and buckling eigenvalue problems. The program contains many special features that allow nonlinearities or secondary effects to be included in the solution.

3.7.3.4.2.2 Reactor Internals and Core

The procedure for determining the response of the reactor internals and core to a seismic event had three basic steps. First, a response analysis of the reactor coolant system was performed to obtain the motion of the reactor vessel in the two orthogonal directions and the vertical direction. In the second step, the reactor vessel excitation was input to separate horizontal and vertical models of the internals and core. Separate horizontal and vertical models of the internals and core were formulated to more efficiently account for the structural and response differences in these directions. For the horizontal direction, the analysis of the coupled internals and core model provided reactor internals loads and the time history motions of the core plates and core shroud. These motions were then input, in the third step, to detailed models representing various rows of fuel assemblies across the core. The horizontal fuel assembly response and spacer grid impact loads were obtained from the detailed core model analyses.

For the vertical direction, reactor internals and fuel loads were obtained directly from the analysis of the coupled vertical internals and core model.

3.7.3.4.2.2.1 Analysis of the Reactor Internals and Core

3.7.3.4.2.2.1.1 Horizontal Analysis

The reactor coolant system seismic analysis, described in Section 3.7.3.4.2.1, provided horizontal Operating Basis Earthquake (OBE) and Design Basis Earthquake (DBE) acceleration time history motions of the reactor vessel at the vessel ledge and snubbers in the North-South and East-West directions. These time histories were 20 seconds in length.

The analysis of the reactor internals and core under horizontal seismic excitation was performed by nonlinear time history analysis. Coupled internals and core mathematical models were developed that describe the structural behavior of the internals plus core in the horizontal directions. Equations of the motion were formulated in terms of mass, damping and stiffness matrices and associated nodal acceleration, velocity, and displacement vectors.

The earthquake time histories were applied to the reactor vessel nodes. The seismic response of the internals was computed by direct integration of the equations of motion using a numerical step-by-step procedure incorporated in the CESHOCK computer program.

The mathematical models of the internals consist of lumped masses and elastic-beam elements to represent the beam-like behavior of the internals and nonlinear elements to simulate the effect of gaps between components. Typical component gaps represented by nonlinear elements are the core support barrel – reactor vessel snubber gap and the core shroud guide lug – fuel alignment plate gap. At appropriate locations within the internals and core, nodes were chosen to lump the weights of the structure. The criterion for choosing the number and location of mass concentrations was to provide accurate representation of the modes of

ARKANSAS NUCLEAR ONE
Unit 2

vibration of each component. Between the nodes, properties were calculated for moments of inertia, cross-sectional area, effective shear area and length. Stiffnesses for the complex internals structures such as flanges and grid beams were determined by finite element analyses. A sketch of the coupled internal and core model is shown in Figure 3.7-37.

Damping values used for the internals components were 4% of critical for the DBE and 2% of critical for the OBE in accordance with Regulatory Guide 1.61 for welded steel structures. Damping values for the fuel assemblies were based on measured values from full-scale fuel assembly testing.

Fuel assembly modeling in the coupled internals and core model accounted for the total number of assemblies in the core. Thus, the effects of the entire core on the response of the internals were included in the analysis. As shown in Figure 3.7-37, the fuel assemblies were combined into three groupings. The two outer groupings represented the 15 peripheral fuel assemblies on each side of the core. The center grouping represents the remaining 147 fuel assemblies. Individual fuel assemblies were modeled as uniform beams with rotational springs at each end to simulate the end conditions at the top and bottom of the core. The stiffness of each fuel grouping was determined by combining the individual fuel assembly stiffnesses as springs added in parallel. Nonlinear spring couplings between corresponding nodes on the outer rows of fuel assemblies and core shroud were used to permit fuel to core shroud impacting. Incorporated into these nonlinear springs was the spacer grid impact stiffness derived from test results.

3.7.3.4.2.2.1.2 Vertical Analysis

The response of the reactor internals and fuel in the vertical direction was determined by nonlinear analyses of the coupled vertical reactor internals and fuel model. The analyses were performed using the CESHOCK computer program. The input excitations to the model were the vertical OBE and the DBE acceleration time histories of the reactor vessel at the flange elevation.

The mathematical model of the reactor internals and core was developed using methods similar to those used for the horizontal model. A sketch of the vertical reactor internals and fuel model is shown in Figure 3.7-38. Model properties were calculated using cross-sectional structural properties and finite element models. The core was modeled by combining all fuel assemblies into a single grouping that includes the weight of the entire core. The vertical stiffness properties of the fuel grouping were obtained by combining the stiffness of each fuel assembly as springs in parallel. The fuel assembly grouping was subdivided into fuel rods and guide tubes with friction elements representing the interaction between the fuel rods and guide tubes at the spacer grid locations.

In addition to the friction elements, the model includes nonlinear elements that represent the CSB upper flange, the UGS flange, fuel assembly holddown forces provided by the upper end fitting springs and the expansion compensating ring. Damping values used for the internals components and fuel were 4% of critical for the DBE and 2% of critical for the OBE, in accordance with Regulatory Guide 1.61 for welded steel structures.

3.7.3.4.2.2.2 Details of the Reactor Internals Models

The salient details of the internals models described in Section 3.7.3.4.2.2.1 are discussed in the following paragraphs.

3.7.3.4.2.2.2.1 Hydrodynamic Effects

The dynamic analysis of reactor internals presents some special problems due to their immersion in a confined fluid. It has been shown both analytically and experimentally (Reference 57) that immersion of a body in a dense fluid medium lowers its natural frequency and significantly alters its vibratory response as compared to that in air. The effect is more pronounced where the confining boundaries of the fluid are in close proximity to the vibration body as is the case for the reactor internals. The method of accounting for the effects of a surrounding fluid on a vibrating system has been to ascribe to the system additional or "hydrodynamic mass".

This "hydrodynamic mass" decreases the frequencies of the system, but is not directly involved in the inertia force effects. The hydrodynamic mass of an immersed system is a function of the dimensions of the real mass and the space between the real mass and confining boundary.

Hydrodynamic mass effects for moving cylinders in a water annulus are discussed in References 57 and 64. The results of these references were applied to the internals structures to obtain the total (structural plus hydrodynamic) mass matrix which is then used in the evaluation of the natural frequencies and mode shapes for the model.

3.7.3.4.2.2.2.2 Core Support Barrel

The core support barrel was modeled as a beam with shear deformation. It has been shown (References 56 and 71) that the use of beam theory for cylindrical shells gives sufficiently accurate results when shear deformation is included.

3.7.3.4.2.2.2.3 Fuel Assemblies

See Section 3.7.3.4.2.2.6.3 for seismic analysis of fuel assemblies.

3.7.3.4.2.2.2.4 Support Barrel Flanges

To obtain accurate horizontal and vertical stiffnesses of the upper and lower core support barrel flanges and the upper guide structure support barrel upper flange, finite element analyses of these regions were performed. As shown in Figure 3.7-39, these areas were modeled with quadrilateral and triangular ring elements. Asymmetric loads, equivalent to lateral shear loads and bending moments, and symmetric axial loads were applied and the resulting displacements calculated. These results were then used to derive the equivalent member properties for the flanges.

3.7.3.4.2.2.2.5 CEA Shrouds

For the horizontal model, the CEA shrouds were treated as vibrating in unison and were modeled as guided cantilever beams in parallel. To account for the decreased lateral stiffness of the upper guide structure due to local bending of the fuel alignment plate, a short member with properties approximating the local bending stiffness of the fuel alignment was included at the bottom of the CEA shrouds. Since the stiffness of the upper guide structure support plate is large compared to that of the shrouds, the CEA shrouds were assumed to be rigidly connected to the upper guide structure support plate.

3.7.3.4.2.2.6 Upper Guide Structure Support Plate and Lower Support Structure Grid Beams

These grid beam structures were modeled as plane grids. Displacements due to vertical (out of plane) loads applied at the beam junctions were calculated through the use of the STRUDL computer code (Reference 19). Average stiffness values based on these results yielded an equivalent member cross section areas for the vertical model.

3.7.3.4.2.2.3 Linear Models for Reactor Internals

The dynamic characteristics of the reactor internals used to formulate the model for the RCS coupled analysis described in Section 3.7.3.4.2.1.2 were determined from linear models of the reactor internals.

Equivalent multi-mass mathematical models were developed to represent the reactor internals and core. The linear mathematical models of the internals were constructed in terms of lumped masses and elastic beam elements. At appropriate locations within the internals and core, points (nodes) were chosen to lump the weights of the structure. A sketch of the internals and core showing the relative node locations of the horizontal model is presented in Figure 4.1-1. Figures 3.7-35 and 3.7-36 show the idealized linear horizontal and vertical models. The criterion for choosing the number and location of mass concentration was to provide for accurate representation of the dynamically significant modes of vibration of each of the internal components. Between the nodes, properties were calculated for moments of inertia, cross-section areas, effective shear areas and lengths. Natural frequencies and mode shapes were determined using the models.

3.7.3.4.2.2.3.1 Natural Frequencies and Mode Shapes

The mass and beam element properties of the models were utilized in STAR, a computer program from the MRI/STARDYNE Analysis System programs (References 26 and 27) to obtain the natural frequencies and mode shapes. This system utilizes the "stiffness matrix" method of structural analysis. The natural frequencies and mode shapes were extracted from the system of equations:

$$(\underline{K} - W_n^2 \underline{M}) \varnothing_n = 0$$

where

\underline{K} = model stiffness matrix

\underline{M} = Model mass matrix

W_n = Natural circular frequency for the n^{th} mode

\varnothing_n = Normal mode shape matrix for n^{th} mode

The mass matrix, \underline{M} , includes the hydrodynamic and structural masses.

3.7.3.4.2.2.4 Response Calculation Methods

3.7.3.4.2.2.4.1 Response Spectra Method

The response spectrum analysis was performed using the modal extraction data and the following relationships for each mode:

ARKANSAS NUCLEAR ONE
Unit 2

Nodal Accelerations

$$\ddot{\chi}_{in} = \gamma_n A_n \Phi_{in}$$

where

$\ddot{\chi}_{in}$ = Absolute acceleration at node "i" for mode "n"

γ_n = Modal participation factor

A_n = Modal acceleration from response spectrum

Φ_{in} = Mode shape factor at node "i" for mode "n"

Nodal Displacement

$$Y_{in} = \frac{\ddot{\chi}_{in}}{W_n^2}$$

where

Y_{in} = Displacement at node "i" for mode "n" relative to base

W_n = Natural circular frequency for nth mode

Member Forces and Moments

$$F_n = \frac{(\gamma_n A_n)}{W_n^2} \bar{F}_n$$

where

F_n = Actual member force for mode "n"

\bar{F}_n = Modal member force for mode "n"

The effect of the fluid environment was accounted for by defining the modal participation factor as follows:

$$\gamma_n = \frac{\sum_{i=1}^M W_{si} \Phi_{in}}{\sum_{i=1}^M W_{Ti} \Phi_{in}^2}$$

where

W_{si} = Structural weight of node "i"

W_{Ti} = Structural + hydrodynamic weight of node "i"

M = Number of masses

ARKANSAS NUCLEAR ONE
Unit 2

The square root of the sum of the squares method is normally used to combine the modal responses. However, since the modal frequencies were closely spaced, the responses of the closely spaced modes were combined by the sum of their absolute values. The modal damping factors were obtained by the method of "Mass Mode Weighting", which gives:

$$B_n = \frac{\sum M_i |\Phi_{in}| B_i}{\sum M_i |\Phi_{in}|}$$

where

B_n = Modal damping factor

M_i = Structural mass of mass node "i"

$|\Phi_{in}|$ = Absolute value of the mode shape at mass mode "i"

B_i = Damping associated with mass point "i"

3.7.3.4.2.4.2 Nonlinear Analysis

The nonlinear horizontal and vertical seismic loads for the internals were determined using the CESHOCK computer code (Reference 58). This computer code provides the numerical solution to transient dynamic problems by step by step integration of the differential equations of motion. The nonlinear input excitation for the model was lateral time history accelogram of the reactor vessel flange.

Since the CESHOCK code does not directly solve base excited systems, the acceleration time history of the reactor vessel flange was converted into an equivalent fixed base inertia force time history (Reference 77).

Input to the CESHOCK code consisted of initial conditions, nodal lumped masses, linear spring coefficients, mass moments of inertia, nonlinear spring curves and the acceleration time history. The output from the CESHOCK code consisted of displacements, translational and angular accelerations, impact forces, shears, and moments.

A brief description of the general methods used in the CESHOCK code to solve transient dynamic problems is presented below:

All of the dynamic systems capable of being solved by this program can be described by the differential equation:

$$Rx = U\ddot{x} + U^*\dot{x} + F$$

which is the equation of motion for a generalized spring-mass system,

where

R = Mass matrix

U = Stiffness matrix

U^* = Damping matrix

F = Forcing vector

x = Generalized Displacement

\dot{x} = Derivative with respect to time

ARKANSAS NUCLEAR ONE
Unit 2

By programming options, this equation can be used to represent an axial lumped, spring mass system equation:

$$M \ddot{Y} = A_x Y + A_x^* \dot{Y} + L$$

or a system with lateral motion Y and rotational motion θ defined by:

$$M \ddot{Y} = AY + B_\theta + A^* \dot{Y} + B^* \dot{\theta} + L$$

$$J \ddot{\theta} = CY + D\theta + C^* Y + D^* \dot{\theta} + M$$

where

$$A = \begin{bmatrix} \sum_{j=1} A_{j1} & \bullet & \bullet & \bullet \\ -A_{21} & \sum_{j=2} A_{j2} & \bullet & \bullet \\ -A_{31} & -A_{32} & \sum_{j=3} A_{j3} & \bullet \\ \bullet & \bullet & \bullet & \bullet \end{bmatrix} \quad C = \begin{bmatrix} \sum_{j=1} C_{j1} & \bullet & \bullet & \bullet \\ -C_{21} & \sum_{j=2} C_{j2} & \bullet & \bullet \\ -C_{31} & -C_{32} & \sum_{j=3} C_{j3} & \bullet \\ \bullet & \bullet & \bullet & \bullet \end{bmatrix}$$

$$B = \begin{bmatrix} \sum_{j=1} b_{1j} & \bullet & \bullet & \bullet \\ -b_{21} & \sum_{j=2} b_{2j} & \bullet & \bullet \\ -b_{31} & -b_{32} & \sum_{j=3} b_{3j} & \bullet \\ \bullet & \bullet & \bullet & \bullet \end{bmatrix} \quad D = \begin{bmatrix} \sum_{j=1} (d_{j1} - C_{j1} l_{j1}) & \bullet & \bullet & \bullet \\ -d_{21} & \sum_{j=2} (d_{j2} - C_{j2} l_{j2}) & \bullet & \bullet \\ -d_{31} & -d_{32} & \sum_{j=3} (d_{j3} - C_{j3} l_{j3}) & \bullet \\ \bullet & \bullet & \bullet & \bullet \end{bmatrix}$$

Given a coupling between two masses, i and j, the following properties are defined for the specific elements of the above matrices.

A_{ij} = Shear load at mass i caused by a positive unit deflection with no rotation at mass j.

For the axial system, the elements of A_x are defined as the load at mass i caused by a positive unit deflection at mass j. For lateral problems, the basic element used is the beam defined by the following stiffness coefficients.

B_{ij} = Bending moment at mass i caused by a positive unit deflection with no rotation at mass j.

C_{ij} = Shear load at mass i caused by a positive unit rotation with no deflection at mass j.

D_{ij} = Bending moment at mass i caused by a positive unit rotation with no deflection at mass j.

l_{ij} = Distance between the CGs of masses i and j.

m_i = Mass of node i, (lb-sec²/in).

J_i = Polar moment of inertia of node i, (lb-in/sec²)

References 46 and 54 give complete details for the derivation of these elements. The numerical integration is performed using either the Runge Kutta Gill method or Newmark's technique.

3.7.3.4.2.2.5 Results

3.7.3.4.2.2.5.1 Natural Frequencies

The most significant natural frequencies and mode shapes are presented in Figures 3.7-40 through 3.7-45 horizontal direction.

3.7.3.4.2.2.5.2 Response Loads Reactor Internals Nonlinear Analysis

The nonlinear horizontal and vertical seismic analyses determined OBE and DBE seismic loads on the reactor internals components. These loads were used in evaluating the structural integrity of the reactor internals described in Sections 4.2.2 and 4.4.2.

3.7.3.4.2.2.6 Seismic Analysis for Fuel Elements and Control Element Drive Mechanisms

3.7.3.4.2.2.6.1 Introduction

Dynamic analyses of the fuel assemblies were conducted to determine the adequacy of their seismic design under nonlinear conditions that exist when the gaps between fuel assemblies close and when the fuel lifts off the core support plate. These analyses were conducted in conjunction with the nonlinear seismic analysis of the reactor internals as discussed in Sections 3.7.3.4.2.2.1 through 3.7.3.4.2.2.5. The following section describes the mathematical model and analytical procedure used for the nonlinear impacting analyses of the reactor core.

3.7.3.4.2.2.6.2 Horizontal Core Analysis

The horizontal seismic analysis of the reactor internals and core, described in Section 3.7.3.4.2.2.1, provided horizontal OBE and DBE acceleration time history motions of the core boundary (the fuel alignment plate, core support plate, and the core shroud). Nonlinear models of the core were developed to represent the rows of fuel assemblies across the core. The core model representing a row of 15 fuel assemblies, the longest row, is shown in Figure 3.7-49. A core model representing the shortest row with 5 fuel assemblies was also developed and used in the analysis.

In the detailed core models, each fuel assembly is represented as a uniform beam with rotational springs at each end to simulate the end condition at the top and bottom of the core, Lumped masses are located at every spacer grid so that the significant modes of vibration of the fuel are represented to account for possible spacer grid impacting. Nonlinear spring couplings are used to simulate the gaps in the core. Each spacer grid is characterized by the dual load path model, which represents the load paths associated with both one-sided and through-grid impacts. One-sided loads are experienced when only one side of the spacer grid is loaded. This type of impact occurs when the peripheral fuel assembly hits the core shroud, or when two adjacent fuel assemblies strike one another. The second type of impact loading occurs typically when the fuel assemblies pile up on one side of the core causing the spacer grids to be subjected to a through-grid compressive loading. One-sided and through-grid loads on a spacer grid are shown in Figure 3.7-50. A grid model sketch with typical load distribution is shown in Figure 3.7-51.

3.7.3.4.2.2.6.3 Seismic Analysis for Fuel Assembly

The horizontal core analyses determined spacer grid impact loads and fuel assembly deflected shapes at times of peak response. Vertical loads on the fuel assembly components are determined from the vertical reactor internals and core analyses. These results are used in the evaluation of the structural integrity of the fuel assemblies, which is described in Section 4.2.1.

3.7.3.4.2.2.6.4 Reactor Vessel Head Area Components

The response loads of the CEDM components, the Head Lift Rig (HLR), and the ICI Flange Assembly and Support Post due to seismic effects were determined by analysis for the RCS subject to power uprate conditions. ANSYS finite element models (FEMs) of these components were developed, and linear response spectrum analyses were performed to calculate the response of each component to OBE and DBE inputs. These components were evaluated by comparison to the original loads used in the stress analyses.

A detailed discussion of the FEMs and evaluations of these components for seismic and pipe break excitation in combination with normal operation loads is given in Section 3.9.3.1.3.

3.7.3.5 Significant Dynamic Response Modes

3.7.3.5.1 Category 1 Structures, Systems and Components Other Than NSSS

Appendix F of BC-TOP-4, Revision 1, describes the analysis techniques used if the "peak of the spectra" method was used by the equipment suppliers. Such considerations are included in IEEE 344 as referenced in Appendix F of BC-TOP-4, Revision 1. For piping, this is covered in Section 2.3.2 and Appendix D of BP-TOP-1.

3.7.3.5.2 Nuclear Steam Supply System

The "peak of the spectra" method was not used in the NSSS seismic analysis.

3.7.3.6 Design Criteria and Analytical Procedures for Piping

3.7.3.6.1 Piping Other Than NSSS

Procedures and design criteria accounting for relative displacements between piping supports are provided in Sections 4.0, 6.3.2 and 6.4 of BP-TOP-1.

3.7.3.6.2 Nuclear Steam Supply System Piping

The treatment of relative motion of the NSSS supports is described in Sections 3.7.3.4.2.1.1 and 3.7.3.4.2.1.3.1.

3.7.3.7 Basis for Computing Combined Response

Section 5.1 of BP-TOP-1 provides the criteria used to combine the results of horizontal and vertical seismic responses for piping systems.

Sections 4.3, Equation 4-8, and 5.3 of BC-TOP-4, Revision 1, provides the criteria used to combine the results of horizontal and vertical seismic analyses for equipment. Section 3.7.2.1.3 of this report discusses seismic analyses of equipment.

3.7.3.8 Amplified Seismic Responses

A constant load factor was not used for the design of equipment. The natural frequencies of the equipment were computed and the spectrum response method was used to determine inertial forces in the horizontal and vertical directions. Amplification of vertical seismic response by slabs was considered in the seismic design of the equipment when required.

3.7.3.9 Use of Simplified Dynamic Analysis

Section 2.3.2 and Appendix D of BP-TOP-1 describe the basis for the simplified dynamic analysis technique used in lieu of response spectrum analysis technique for piping. Simplified dynamic analysis was not used for Category 1 structures, systems, or components.

3.7.3.10 Modal Period Variation

The procedures used to account for modal natural period variation in models of Category 1 structures are discussed in Section 3.7.2.8.

3.7.3.11 Torsional Effects of Eccentric Masses

The significant torsional effects of valves and other eccentric masses were taken into account in the seismic piping analysis by the techniques discussed in Section 3.2 of BP-TOP-1.

3.7.3.12 Piping Outside Containment

Sections 2.0 and 6.0 of BP-TOP-1 discuss the techniques and criteria used to analyze the Category 1 piping other than the buried type.

Section 6.0 of BC-TOP-4, Revision 1, discusses the techniques used to calculate the stresses from seismic loadings for buried piping. The buried Category 1 piping was designed to remain functional when subjected to seismic loads. This was accomplished by limiting the calculated stresses in the pipe material under all loading combinations, including earthquake, as discussed below.

The sum of the stresses produced by internal and/or external pressures, and those produced by seismic forces, did not exceed $2.4 S_h$ for the DBE or $1.2 S_h$ for OBE.

S_h indicates the allowable stresses prescribed in Tables I-7-1, I-7-2, and I-7-3 of Appendix I of the ASME Code. If ANSI B31.1.0, Power Piping was used, the allowable stresses were considered as indicated in Tables A-1 and A-2 of Appendix A of that code.

The stress allowables of 2.4 for DBE and 1.2 for OBE were based on the discussion given in Section 3.9.2.

3.7.3.13 Interaction of Other Piping With Category 1 Piping

Section 3.4 of BP-TOP-1 describes the techniques used to consider the interaction of Category 1 piping with non-Category 1 piping.

ARKANSAS NUCLEAR ONE
Unit 2

3.7.3.14 Field Location of Supports and Restraints

All Category 1 seismic supports and restraints, including those required for mechanical equipment and electrical components, are located after an appropriate seismic analysis determines the requirements. The required location and type of restraint is then sent to the restraint supplier for design details. These details are carefully reviewed to assure that the location, function and overall design is compatible with the seismic analysis.

Subsequent to installation, field engineers reviewed the installation to ensure compliance with the restraint detail and the assumptions in the analysis.

3.7.3.15 Seismic Analysis for Fuel Elements, Control Rod Assemblies and Control Rod Drives

The seismic analysis of the reactor internals is provided in Section 3.7.3.4.2.2.

3.7.4 SEISMIC INSTRUMENTATION PROGRAM

Three triaxial time-history accelerographs are installed on the Unit 1 reactor building. The location of these instruments coincides with two key elements in the Unit 2 dynamic model for seismic analysis. Therefore, data obtained from these instruments may be analyzed for both Units 1 and 2.

3.7.4.1 Comparison With Safety Guide 12

This seismic instrumentation system conforms to Safety Guide 12, "Instrumentation for Earthquakes," dated March 1971.

3.7.4.2 Location and Description of Instrumentation

The three strong motion triaxial accelerographs are mounted on the outside surface of the Unit 1 reactor building wall. These three instruments are placed at two elevations; one at Elevation 531 feet, 6 inches and the other two at Elevation 335 feet (top of base slab).

The seismic network control center provides two alarms to the control room based on measurements taken by two strong motion triaxial accelerographs located at the base slab provide alarms in the control room for Unit 1. One alarm is triggered when a setpoint of 0.01 g has been exceeded. This alarm will indicate that an earthquake has occurred and the seismic monitoring system is recording seismic data. The other alarm will provide an immediate indication if the predetermined vibratory ground motion acceleration value of 0.1 g for the OBE has been exceeded.

In addition to the above instrumentation, one strong motion peak-recording accelerograph mounted outside the containment on the Unit 2 containment base slab.

3.7.4.3 Control Room Operator Notification

An alarm in the Unit 1 control room will indicate to the operator that a seismic event has activated the seismic instrumentation and that the seismic event is being recorded. The actions to be taken in the event of this alarm are included in the plant operating procedures.

3.7.4.4 Comparison of Measured and Predicted Responses

Following an earthquake, the resulting measurements will be evaluated by qualified seismology and engineering personnel. If the analysis indicates the shock may have caused stresses exceeding design limits specified for OBE to structures, systems, or components, specific action will be taken as recommended by the evaluating personnel.

3.7.5 SEISMIC DESIGN CONTROL MEASURES

3.7.5.1 Category 1 Systems and Components Other Than NSSS

The seismic input data were provided to the suppliers of Category 1 equipment by means of detailed equipment specifications. One part of the specification contained input data in the form of floor response curves (Section 3.7.2.6). The specification designated the particular floor response spectrum curve(s) for the floor(s) on which the equipment or component is located.

The detailed equipment specifications required that the supplier submit test data and/or seismic analyses for review, as a condition of acceptance of the equipment for the intended function. The supplier was permitted to use (1) test reports of the particular component, or (2) reports of tests with applicable data from a previously tested comparable component which, during normal operating conditions has been subjected to equal or greater loadings, or (3) suitable analytical results.

The report from the supplier was reviewed for methods, procedures and results for compliance with the criteria. The submittal and review procedures were repeated, if necessary, when questions as to conformance with the criteria were raised.

3.7.5.2 Nuclear Steam Supply System

Purchase specifications for Seismic Category 1 components specify horizontal and vertical seismic acceleration values based on the floor response spectra at the equipment location. The vendors were required to demonstrate by calculations, operating experience data or testing, the capability of the equipment to withstand the seismic forces, and that the equipment would continue to operate after a DBE. The floor response spectra at the location of the equipment was supplied to the vendors. The vendors were also required to calculate the natural period of vibration of the equipment and see that the natural period did not fall within the critical frequency range of the floor response spectra. The calculations and/or test results received from the vendors were reviewed by cognizant engineering personnel for approval of the seismic qualification method used and verification that the equipment met the design conditions specified. The review and approval of vendor seismic qualification data followed the same procedure as approval of drawings and other design data.

3.7.6 SEISMIC EVALUATION OF CONCRETE MASONRY WALLS

IE Bulletin 80-11 requires that all concrete masonry walls within a Seismic Category 1 building be capable of withstanding loads associated with pipe support reactions during OBE and DBE seismic events. All such walls in Unit 2 are located in the Seismic Category 1 area of the auxiliary building. These walls were re-evaluated for the required loading conditions.

3.7.6.1 Description of Masonry Walls

3.7.6.1.1 Identification and Function of Walls

A field survey of all block walls in Seismic Category 1 buildings was conducted (1) to determine whether or not Seismic Category 1 systems (piping, electrical, HVAC and instrumentation) were attached to, or in the vicinity of, concrete block walls, and (2) to provide the data necessary for evaluation of any attachments found for adequacy of the attachments and ability of the walls to support the attached loads. Depending upon the type of attachment, different means were used to identify an item as Seismic Category 1. For conduits and electrical trays, tag numbers beginning with the letter "E" denote Seismic Category 1. For piping, tubing, and equipment, various drawings were used to identify items that are Seismic Category 1. These include piping area drawings, equipment location drawings, piping and instrument diagrams, and piping summary sheets. For heating and ventilating ducts, the type of support is noted. If the support system is braced, it is conservatively assumed to be Category 1.

A list of the walls, showing wall thickness, height, function, floor elevation, and type of attachments on the wall is given in Tables 3.7-12, 3.7-13 and 3.7-14. While the 60-day report included all walls within the Seismic Category 1 boundary of the auxiliary building, the 180-day report includes only those walls which support Seismic Category 1 pipes, Seismic Category 1 attachments other than pipe, or are in proximity to safety-related systems. Proximity is defined as within distance equal to the height of the wall for cantilevered walls and one-half the height plus the wall thickness for floor to ceiling walls. Consequently, fewer walls are included in the 180-day report than in the previous interim report. A total of 104 walls are classified as follows:

Table 3.7-12 - Walls supporting Seismic Category 1 pipes - 8

Table 3.7-13 - Walls supporting Seismic Category 1 attachments other than pipe - 19

Table 3.7-14 - Walls in the proximity of safety-related system - 77

Wall attachments generally are limited to small piping supports, electrical conduits and boxes, instrument lines, ventilation duct supports, and similar light objects. None of the walls identified are load bearing walls that support the building structure in the vertical direction or act as shear walls in the horizontal direction. In general, the walls fulfill a shielding or fire protection function.

3.7.6.1.2 Wall Configurations and Details

Most of the block walls are shielding walls constructed with heavyweight hollow concrete blocks in which all the cells are filled with grout, and in which continuous reinforcement is embedded in every other cell. The walls which do not have a shielding function are constructed with standard blocks in which only cells containing reinforcing steel, plumbing or other embedded items, are filled with grout.

Walls are constructed of a single wythe or of more than one wythe. Walls constructed of more than one wythe could, alternatively, be made of two wythes with center space filled with grout, or of two or more contiguous wythes with vertical joints packed with mortar.

The concrete block wall details are shown on the design drawings. Vertical reinforcing steel consists of one No. 5 bar at 16 inches spacing in the center of single wythe walls, and one No. 5 bar at 16 inches spacing near each face of multi wythe walls. Horizontal reinforcing steel consists of a bond beam with four No. 4 bars at 48 inches spacing in single wythe walls, and an

ARKANSAS NUCLEAR ONE
Unit 2

identical bond beam at each face of multi wythe walls. Additional reinforcing is provided around doorways and openings. At all block wall intersections with the lower concrete floors, every vertical reinforcing bar is anchored to the concrete with a deformed reinforcing bar dowel threaded into a 3/4-inch diameter concrete anchor. At block wall intersections with the upper concrete floors, a pair of continuous five-inch by three-inch angles with 3/4-inch anchors at 12-inch spacing, attached to floors, are used. At block wall intersections with concrete walls, every pair of horizontal bars is anchored to the concrete with a deformed reinforcing bar dowel threaded into a 5/8-inch diameter concrete anchor.

Concrete anchors are Phillips Red Head self-drilling concrete expansion anchors.

In addition to the above reinforcing steel, joint reinforcing consisting of extra heavy Dur-O-Wall truss steel bars is placed in alternate horizontal joints (16-inch spacing) of shielding walls and in every horizontal joint (8-inch spacing) of other walls. At shielding walls #3 steel tie bars hooked around vertical reinforcing bars are placed at staggered 32-inch spacing horizontally and 16-inch spacing vertically.

3.7.6.1.3 Materials of Construction

Materials specified for the wall construction are as follows:

Concrete blocks: ASTM C90, Grade PI. Heavyweight units cured and oven dried density 135 pounds per cubic foot.

Mortar: ASTM C476, Type PL, 2,000 psi compressive strength at 28 days.

Grout: ASTM C476, 2,000 psi compressive strength at 28 days. For heavyweight units, grout dry density 147 pounds per cubic foot.

Reinforcing bars: ASTM A615 Grade 60.

Horizontal joint reinforcement: ASTM A82 Dur-O-Wall extra heavy truss type.

3.7.6.2 Construction Practices

3.7.6.2.1 General

For Unit 2, Bechtel Power Corporation was the general contractor for all work. The masonry construction work was awarded to a subcontractor who executed the work in accordance with specifications written by Bechtel Power Corporation for the supply and construction of concrete masonry walls.

Quality was assured in the general procedures employed by Bechtel in the selection of the subcontractor. Bechtel field engineering administered the subcontract to assure that the concrete block walls were erected in strict accordance to the drawings and specifications. The subcontractor provided material certificates, samples, testing, testing and inspection reports, and statements of conformance showing that all materials utilized in the installation met the requirements of the Concrete Masonry Specifications.

ARKANSAS NUCLEAR ONE
Unit 2

3.7.6.2.2 Workmanship

Blocks were laid plumb, true to line, with level and accurately spaced courses in locations shown. Blocks were kept plumb and level throughout; corners and reveals were kept plumb and true. Each course was solidly bedded in mortar. Joints were approximately 3/8-inch thick and extended the full depth of the face shells. Anchors, wall plugs, accessories, and other items required with the masonry were built in as the masonry work progressed. Spaces around built in items were solidly filled with mortar.

Masonry work was not performed when the temperature was below 40 °F. The ambient temperature was maintained above 40 °F in interior areas where masonry work was in progress and for 48 hours after erection had stopped.

3.7.6.2.3 Grout

Mortar overhangs and droppings were removed from cells, interior faces and foundations before grout filling the cells was poured. Grout was poured in lifts which did not exceed four feet. Each pour was thoroughly rodded to assure compaction and bond to the preceding pour. When work was required to be stopped for a period of 45 minutes or longer, the pour was stopped approximately 1-½ inches below the top of the last course and the surface of the grout was thoroughly roughened. When work resumed, the laitance was removed and the existing grout was dampened and coated with neat cement before additional grout was poured.

3.7.6.2.4 Inspection

General inspection was performed by the experienced Bechtel field engineering personnel to assure compliance with the requirements of the specification.

Continuous field inspection of all masonry work during laying and grouting was performed by the subcontractor to verify that the installation of reinforcing, placing of mortar and grout and other items were prepared and placed in accordance with the drawings and specifications.

3.7.6.2.5 Tests and Certificates

3.7.6.2.5.1 Tests

The subcontractor provided the following testing:

- A. Sampling by an independent testing laboratory to assure that concrete masonry units conformed to the specifications.
- B. Testing by an independent testing laboratory to assure that mortar and grout mix designs conformed to the specifications.
- C. Testing of concrete anchors in accordance with the specification.

ARKANSAS NUCLEAR ONE
Unit 2

3.7.6.2.5.2 Certificates

The subcontractor submitted the following certificates for the materials utilized in the construction of the concrete masonry walls:

- A. Certificates by an independent testing laboratory verifying that mortar and grout mix designs and concrete masonry units conformed to the specifications.
- B. Mill test reports certifying that reinforcing bars and supports conformed to the specifications.
- C. Statement of conformance certifying that the work met all of the requirements of the subcontract and the applicable specifications.
- D. Field inspection reports of the work in progress.

3.7.6.3 Re-Evaluation Criteria and Commentary

3.7.6.3.1 Scope

The re-evaluation determines whether the concrete masonry walls and/or the safety-related equipment and systems associated with the walls perform their intended function under the loads and load combinations prescribed herein. Verification of wall adequacy includes a review of local transfer of load from block into wall, global response of wall, and transfer of wall reactions into supports. Anchor bolts and embedments for attachments to the walls are not considered to be within the scope of the evaluation.

The concrete masonry walls are evaluated for all applicable loads and load combinations. Calculated wall stresses are first compared against an allowable stress criteria. Wall stresses are maintained within the elastic range of the load carrying components. For the walls with calculated stresses exceeding the allowable limits, an appropriate bracing system is immediately implemented to bring them back to the allowable range.

3.7.6.3.1.1 Stress Criteria

- A. Consideration of cracking for frequency determinations
- B. Recognition of a potential plane of weakness at the collar joint
- C. Stress increase factors for abnormal and extreme environmental loads
- D. Realistic damping values
- E. Interstory drift

3.7.6.3.1.2 Governing Code

The re-evaluation uses the method prescribed by the Uniform Building Code (UBC) and present state of the art techniques. Supplemental allowables, as specified herein, are used for cases not directly covered by the governing code.

ARKANSAS NUCLEAR ONE
Unit 2

3.7.6.3.1.3 Loads and Loads Combinations

The applicable factored load combinations for safety-related concrete structures are used to form the basis for the evaluation.

Load combinations which are used for structural analysis of block walls are as follows:

- A. $1.5D + 1.8L$
- B. $1.25 (D + L + Ro + E)$
- C. $1.0 (D + L + E')$

in which

- D = Dead load of structure and equipment plus any other permanent loads contributing stress.
- L = Live load on structure.
- E = OBE loading.
- E' = DBE loading.
- Ro = Force on structure due to thermal expansion of pipes during operating conditions.

A load factor of 1.0 is used for all load combinations for anchors.

3.7.6.3.1.4 Materials

Material properties used in the re-evaluation are as follows:

Masonry ultimate compressive strength ($f'm$)	1,500 psi
Grout compressive strength ($f'c$)	2,000 psi
Mortar compressive strength	2,000 psi
Reinforcing bar yield strength	60,000 psi

Phillips Red-Head Self-Drilling Concrete anchor ultimate tensile strength

3/4" diameter	16,200 lbs
5/8" diameter	11,700 lbs

3.7.6.3.1.5 Design Allowables

Design allowables are taken from the applicable sections of the ANO-2 FSAR and the UBC.

However, for cases not covered by the code, such as the self-drilling concrete anchors, allowables are based on a safety factor of four for the OBE case, and a safety factor of three for DBE.

ARKANSAS NUCLEAR ONE
Unit 2

In-plane strain allowables for interstory drift effects for non-shear walls were established well below the level of strain required to initiate significant cracking. The allowable strain for a confined wall was based on the equivalent compression strut model discussed in Reference 65 and modified by a factor of safety of three against crushing. Test data (References 51, 60, 61, 65, 66, 67 and 68) were reviewed to determine cracking strains for confined masonry walls subjected to inplane displacements and confirms the predicted strain as given by the equivalent strut model.

Masonry

The allowable tension, compression, and shear stresses are as follows.

Masonry wall flexural compressive stress: $0.33 (f'm) = 500$ psi

Masonry wall shear: $1.1 \sqrt{f'm} = 43$ psi

Modulus of elasticity of the wall: 1,000 f'm

Collar Joint

A collar joint strength of zero has been conservatively assumed in the re-evaluation.

Core Concrete or Cell Grout

The allowable tensile stresses are $1.1 \sqrt{f'm}$

Reinforcing Steel and Ties

The allowable tensile stresses are 20,000 psi as given in the UBC.

Anchorage

The allowable tension force on the self-drilling concrete anchors is as follows:

3/4" diameter 4.0 kips, 5.4 kips (DBE case only)

5/8" diameter 2.9 kips, 3.9 kips (DBE case only)

Since the OBE case is increased by 1.25 and the DBE case uses a factor of 1.0, all allowable loads are factored as stated below.

Code allowable stresses for masonry in compression, tension, shear and bond are increased by a factor of 1.67. In general, this provides a factor of safety against failure of $(3 \div 1.67) = 1.8$.

Reinforcing steel is allowed to approach 0.9 times the yield strength which is typical for reinforcing steel that is required to resist factored loads.

Design allowables for load combinations are as follows:

ARKANSAS NUCLEAR ONE
Unit 2

Masonry

The allowable masonry stresses given in Section 3.7.6.3.1.5.1 are increased as follows:

<u>Stress</u>	<u>Increase Factor</u>
Compression (flexural)	1.67
Shear and Bond:	1.67
Tension	
tension normal to bed joints:	1.67
tension parallel to the bed joints; in running bond:	1.67

Reinforcing Steel and Ties

The allowable steel stresses are 90 percent of minimum ASTM specified yield strength provided lap splice lengths and embedment (anchorage) can develop this stress level. Allowable bond stresses are increased by a factor of 1.67 in determining splice and anchorage lengths.

Anchorage

The allowable tension and shear forces on the self-drilling concrete anchors are not subject to increase.

3.7.6.3.1.5.1 Damping

In general, wall analysis is performed using damping values of three percent for OBE and five percent for DBE. These values are typically recognized as being conservative for reinforced masonry.

An exception is the analysis to determine concrete anchor tensile forces at some of the cantilever walls, where damping values used are four percent for OBE and seven percent for DBE. This is also conservative because the values are equal to or less than those specified for reinforced concrete structures in Regulatory Guide 1.61.

3.7.6.3.1.5.2 Modulus of Rupture

The extreme tensile fiber stress used in determining the lower bound uncracked moment capacity is $1.1 \sqrt{f'_m}$.

3.7.6.3.1.5.3 Non-Category 1 Masonry Walls

Concrete masonry walls not supporting safety systems but whose collapse could result in the loss of required function of safety-related equipment or systems, or the failure of the concerned walls due to the loss of the lateral support are evaluated the same as walls the support safety systems. Alternatively, the walls may be analytically checked to verify that they will not collapse when subjected to DBE loads.

3.7.6.3.1.6 Analysis and Design

3.7.6.3.1.6.1 Structural Response of Masonry Walls

The structural response of the masonry walls subjected to out of plane seismic inertia loads is based on a constant value of gross moment of inertia along the span of the wall for the elastic (uncracked) condition. If the wall is cracked, a better estimate of the moment of inertia is obtained by use of the ACI-318 formula for effective moment of inertia used in calculating immediate deflections. (Reference 50).

The effects of higher modes of vibration and variations in frequencies are considered on a case by case basis. The use of the average acceleration of the floors supporting the wall is considered sufficiently accurate for the purpose of this evaluation.

Equivalent Moment of Inertia (I_e)

To determine the out of plane frequencies of masonry walls, the uncracked behavior and capacities of the walls (Step 1) and, if applicable, the cracked behavior and capacities of the walls (Step 2) are considered.

Step 1 - Uncracked Condition

The equivalent moment of inertia of an uncracked wall (I_g) is obtained from a transformed section consisting of the block, mortar, cell grout and core concrete. Alternatively, the cell grout and core concrete, neglecting block and mortar on the tension side, may be used.

Step 2 - Cracked Condition

If the applied moment (M_a) due to all loads in a load combination exceeds the uncracked moment capacity (M_{cr}), the wall is considered to be cracked. In this event, the equivalent moment of inertia (I_e) is computed as follows:

$$I_e = \left(\frac{M_{cr}}{M_a} \right)^3 I_g + \left[1 - \left(\frac{M_{cr}}{M_a} \right)^3 \right] I_{cr}$$

$$M_{cr} = f_r \frac{(I_g)}{y}$$

where

M_{cr} = Uncracked moment capacity

M_a = Applied maximum moment on the wall

I_g = Moment of inertia of the uncracked gross section

I_{cr} = Moment of inertia of the cracked section

F_r = Modulus of rupture

y = Distance of neutral plane from tension face

ARKANSAS NUCLEAR ONE
Unit 2

In some instances the calculation of I_e is not necessary due to the shape of the curve and the position of either I_{cr} or I_g on the response spectrum curve. For example, if I_{cr} is at or very near the peak, the response at the frequency (f_{cr}) corresponding to I_{cr} may be used because it will result in a response which is higher than the response would be for I_e . Similarly, if I_g is on the left side of the response spectrum peak, the response at the frequency (f_g) corresponding to I_g may be used since it will result in a response which is higher than the response would be for I_e . However, the use of the more conservative peak value of the spectrum curve in lieu of an I_e analysis is optional, or an I_e analysis may be used if it will result in a lower response.

Alternatively, the use of the peak acceleration values from the response spectrum curve is acceptable in lieu of a frequency determination, and is a conservative approach.

In any case where the use of I_e may result in a higher response, an analysis using I_e is performed.

Modes of Vibration

The effect of modes of vibration higher than the fundamental modes is investigated. Modes analyses are performed on several walls to determine the frequencies, mode shapes and participation factors. The resulting forces and bending moments for the walls are computed using the SRSS procedure in response spectrum analyses. These resulting forces and moments are compared with those that are obtained by considering only the fundamental mode for the corresponding walls. The comparisons show that the differences are less than 0.5 percent. Therefore, only the fundamental mode is considered in this re-evaluation.

Frequency Variations

Uncertainties in structural frequencies of the masonry wall resulting from variations in mass, modulus of elasticity, material and section properties shall be taken into account by varying the modulus of elasticity as follows:

$$E = 800 \text{ f'm to } 1200 \text{ f'm}$$

However, the modulus of elasticity varies with time. It is conservative to assume that five years after the date of completion, the modulus of elasticity is 20 percent higher than when the wall was built. Therefore, the nominal value of 1000 f'm is considered as the lower limit and 1200 f'm as the upper limit.

If the wall frequency using the nominal value of E is on the higher frequency side of the peak of the response spectrum, it is conservative to use the lower value of E . If the frequency of the wall using the nominal value of E is on the lower frequency side of the peak, the higher value of E may increase the required response acceleration for the wall analysis. All walls in this category have been checked against this uncertainty and are found to be adequate.

Accelerations

For a wall spanning between two floors, the effective acceleration is the average of the accelerations as given by the floor response spectra corresponding to the wall's natural frequency.

3.7.6.3.1.6.2 Structural Strength of Masonry Walls

Boundary Conditions

Boundary conditions are determined by considering one-way or two-way spans with hinged, fixed or free edges as appropriate. Conservative assumptions are used to simplify the analysis as long as due consideration is given to frequency variations.

The determination of the out of plane structural strength of masonry walls is highly sensitive to boundary conditions assumed for the analysis. Fixed end conditions are justified for walls (a) built into thicker walls or continuous across walls and slabs, (b) that have the strength to resist the fixed end moment, and (c) that have sufficient support rigidity to prevent rotation. Otherwise, the wall edge is simply supported or free depending on the shear carrying capability of the wall and support.

Distribution of Concentrated Out of Plane Loads

Distribution of concentrated loads are affected by the bearing area under the load, horizontal and vertical wall stiffness, boundary conditions and proximity of load to wall supports. Analytical procedures applied to plates based on elastic theory are used to determine the appropriate distribution of concentrated loads.

- Two-Way Action

Where two-way bending is present in the wall, the localized moments per unit width under a concentrated load are determined by using appropriate analytical procedures for plates. Standard solutions and tabular values based on elastic theory contained in textbooks or other published documents are used if applicable for the case under investigation (considering load location and boundary conditions).

- One-Way Action

For dominantly one-way bending, local moments are determined by using beam theory and an effective width equal to:

$$b = 6 t + c$$

in which

b = the effective width

t = the wall thickness

c = the width of the load contact area.

However, the effective width computed by the above equation is limited in the evaluation to the value obtained from $b = 1.4e + c$, in which e is the distance from the concentrated load to the nearest support.

ARKANSAS NUCLEAR ONE
Unit 2

Interstory Drift Effects

Interstory drift values are derived from the original dynamic analysis. Strain allowables depending on the degree of confinement are applied from in plane drift effects on nonshear walls. The allowables are set at sufficiently conservative levels for in-plane effects alone such that a reasonable margin remains for out of plane loads. Out of plane drift effects are considered insignificant.

Stress Calculations

All stress calculations are performed by conventional methods prescribed by the Working Stress Design or other accepted principles of engineering mechanics.

Analytical Techniques

In general, classical methods for analyzing the walls are used in the evaluation. Design curves are developed using these methods and are used to qualify some of the block walls. However, numerical methods utilizing the computer for static or dynamic analyses are used on a case-by-case basis.

The density of the walls used in the analyses ranges from 141 to 146 pounds per cubic foot, depending on the block wall composition. The wall weight is generally increased by 10 percent to represent the weight of all attachments such as piping, piping supports, electrical conduits and boxes, instrumentation, and ventilation ducts. Actual weights of the attachments for some walls are calculated in lieu of the 10 percent increase. Reaction of the Seismic Category 1 pipe supports are considered as concentrated loads applied to the walls.

3.7.6.4 Results of the Evaluation

3.7.6.4.1 General

On the basis of the re-evaluation of the concrete masonry walls, it is concluded that all concerned concrete block walls are capable of withstanding the combined effects of the intended loads, such as wall inertia forces and pipe support reactions during the OBE and DBE without exceeding the allowable stress limits. Walls utilized as lateral support for the concerned walls are evaluated and the stresses are less than the allowable values. Collar joint strength is not used to transmit shear forces between wythes in the analysis.

Thermal effects on concrete block walls due to the ambient temperature in the surrounding areas are negligible and therefore were not taken into account in the re-evaluation.

3.7.6.4.2 Flexural Stresses

Design calculations show maximum masonry compressive stresses and maximum reinforcing steel tensile stresses resulting from the combined effects of wall inertia forces and pipe support loads during the OBE and DBE. All these stresses are less than the allowable values. Generally, the DBE stresses are the only stresses included in the calculations due to the fact that DBE usually governs. In some instances, OBE governs and is shown in the calculations in addition to the DBE case. Also, some walls indicate that the steel stress is negligible for the case in which the tensile stress in the masonry is less than the modulus of rupture. In this situation the masonry does not crack. In two walls, the stresses stay within the allowable limits after the appropriate bracing systems were implemented.

3.7.6.4.3 Wall Anchorage

All walls are anchored to supporting floors by dowels threaded into concrete expansion anchors. For walls extending continuously from floor to floor, the anchors do not have a significant function since lateral support is provided by shear transfer across the mortar joint between block units and the floor. For walls not extending to the floor above, i.e., cantilever walls, stability of the walls is directly related to the capability of the anchors to transmit tensile forces to the supporting concrete floor. Design calculations show anchor tensile forces at those walls which are cantilevered. At some of the cantilever walls the forces indicated are based on four percent damping factor for OBE (shown only if it is the governing case) and seven percent damping factor for DBE. All anchor tensile forces calculated are within the allowable limits.

3.7.6.4.4 Tie Bars

A tie bar investigation is performed to demonstrate that the tie bars have adequate strength to prevent separation of the wythes during vibration. This investigation is necessary since the bond of the collar joint between block and grout or mortar is assumed not to transfer tension or shear forces between the wythes.

All walls thicker than 12 inches are constructed of two or more wythes of concrete blocks, with the center space filled with mortar or grout. Between the wythes are tie bars spaced staggered at 32 inches horizontally and 16 inches vertically. Each end of the tie is hooked around the vertical reinforcement, and serves to prevent the wythes from separating. During seismic excitation the wythes may move together (in-phase) or in opposite directions (out-of-phase). In the case of in-phase motion, the tie bars will be subjected to a shearing force due to the slippage between the wythes. In the case of out-of-phase motion, the ties will be subjected to a tensile force as the wythes attempt to separate.

The analysis shows that the tie bars have adequate strength to resist the forces generated by both the in-phase and out-of-phase motion. The in-phase motion will produce both a shear force and bending moment in the tie due to slippage between the wythes. It is anticipated that some local crushing of the masonry at the rebar may occur. However, the stresses in the tie will stay within the allowable limits.

The out-of-phase motion will produce tensile forces in the tie bars. These tensile forces have been determined to be adequately resisted by the tie bar.

3.7.6.4.5 Effects of Large Openings

In order to determine whether or not calculated stresses using models without openings are representative, two selected walls were analyzed by finite element methods using the computer program STARDYNE. Configuration of the walls and their openings are modeled using plate elements. Supporting cross walls are considered in the analysis. The walls are modeled as being free to rotate at supports in the out-of-plane direction. Modal analysis was performed to determine the frequencies of the walls. The wall acceleration which corresponds to the fundamental frequency is used to determine the inertia force. Wall inertia force and pipe support loads are applied using the static option of STARDYNE to obtain element forces and moments from which masonry and reinforcing steel stresses are calculated.

ARKANSAS NUCLEAR ONE
Unit 2

Calculation 11406-350-4A shows a comparison of calculated maximum flexural stresses obtained by manual analysis using simplified wall models without openings and by finite element calculation using wall models with openings. Calculated frequencies are also compared. The results shown are for both OBE and DBE, and include effects of wall inertia forces and pipe support loads.

Frequencies calculated using the finite element method are generally higher than those calculated using manual analysis with beam models. This is attributed to the 4-side support condition in the computer models as compared to 2-side support condition in the simplified models.

Stresses calculated using the finite element method are generally lower than those calculated by manual analysis with beam models except for the localized stresses. Even though higher frequencies could result in greater accelerations, calculated stresses are reduced due to the two-way action.

The comparison shows that stresses calculated using simplified models without openings can be considered to be conservative.

3.7.6.4.6 Dynamic Analysis

A dynamic analysis is used to verify those walls which cannot be shown to be adequate by a simplified manual analysis or by a static computer analysis. The dynamic analysis is particularly useful for multi-wythe cantilever walls.

Since the shear capability at the collar joint is conservatively assumed to be zero between the grout or mortar and the block, the wall is analyzed as two separate flexural members tied together by tie bars. These ties are modeled as springs connected to the lumped masses of each flexural member. A modal analysis is performed using Bechtel program CE 917 to determine mode shapes, participation factors, and natural frequencies for the wall.

Bechtel program CE 918 is then used with the appropriate floor response spectrum as an input load to determine the resulting forces and moments in the wall.

The walls for which a dynamic analysis is performed are identified in the design calculations.

3.7.6.4.7 Local Stresses at Attachments

Through bolts have been used for all pipe supports. Also, since the loads are not of large magnitude, local stresses at attachments are not a concern.

ARKANSAS NUCLEAR ONE
Unit 2

3.7.6.4.8 Interstory Drift

Effects of building story interstory displacements resulting from seismic loads are calculated for the in-plane direction only, as out-of-plane stresses due to interstory displacements are not significant. For the in-plane direction, shear stress is calculated by

$$f_v = G \frac{\Delta}{h}$$

where

f_v = shear stress

G = modulus of rigidity = 400 f'm

Δ = interstory displacement

h = interstory height

For the in-plane direction, the maximum interstory displacement is predicted not to be more than 0.0006 inch per foot of height, resulting in a maximum shear stress of 30 psi, which is less than the allowable limit of 43 psi.

3.8 DESIGN OF CATEGORY 1 STRUCTURES

This section provides information on the design of Category 1 structures.

Design concrete strengths (f_c) are specified for various structures. Design strength values are less than measured concrete strength values. Documents such as Engineering Standard SES-11 record measured concrete strength values for the containment building, auxiliary building, turbine building, and other structures. Measured concrete strength values are usable input in future design, operability evaluations, and reconciliation. Prior to extrapolating concrete strength values, consideration should be given to Information Notice 2012-17 and requirements in SES-11.

3.8.1 CONCRETE CONTAINMENT

The containment is a structure designed to house the primary nuclear system. It is part of the containment system whose functional requirement is the control of the release of radioactivity from the primary nuclear system. This section describes the structural design considerations, construction, testing, and surveillance for the prestressed concrete containment.

3.8.1.1 Description of the Containment

The general arrangement of the containment is shown in Figure 3.8-1. It consists of three basic parts: (1) a flat circular base slab, (2) a right circular cylinder, and (3) a sphere-torus dome. The containment is constructed of reinforced concrete prestressed by post-tensioned tendons in the cylinder and the dome. Special reinforcing details are provided at discontinuities. The design of the containment is described in Section 3.8.1.4.

The cylinder wall is prestressed by a system of horizontal and vertical tendons. The horizontal tendons are anchored at three buttresses equally spaced around the outside of the containment. The vertical tendons are anchored to the base slab at bottom and the ring girder at top. The dome is prestressed by three systems of dome tendons spaced at 120 degrees apart. The three-way dome tendons are anchored at the side of the ring girder. The tendons are installed in sheaths which are filled with a corrosion inhibitor. An access gallery is provided beneath the base slab for installation of the vertical tendons and inspection of bottom anchorage.

The interior of the containment is lined with steel plates welded together to form a leak tight barrier. The liner plate system is similar to that described in Part I of BC-TOP-1, Revision 1, (Reference 6). Since the base slab liner plate is covered with concrete, leak chase channels are provided at seam welds, to allow for leak testing during normal operation. Liner anchorage and other liner plate details are shown in Figures 3.8-7 and 3.8-8.

Large penetrations for equipment and personnel access, fuel transfer penetrations, piping and electrical penetrations are fabricated of steel, attached to the containment liner plate, and anchored into the concrete structure. Typical details of these penetrations are shown in Figure 3.8-9.

A large diameter equipment hatch is provided for transfer of material and equipment. Two personnel access locks are also provided. Each personnel lock is double door assembly with a quick acting valve system to equalize pressure when personnel are entering or leaving the containment. Hatch and lock doors are supplied with two compression seals with provisions for

ARKANSAS NUCLEAR ONE
Unit 2

leak testing. One transfer tube is provided for fuel movement between the refueling canal in the containment and the spent fuel pool in the auxiliary building. The blind flange for isolating the transfer tube has concentric resilient seals with provisions for leak testing.

During outages, a temporary equipment hatch cover may be used in lieu of the permanent hatch cover. The temporary cover is designed to meet the requirements for reactor building closure during cold shutdown and refueling conditions.

Single barrier piping penetrations are provided for all piping passing through the walls of the containment. The closure for process piping is accomplished with a special head welded into the piping system and to the liner plate penetration nozzle. Piping carrying fluids at elevated temperatures is insulated. All electrical penetrations are of modular design with header plates of stainless steel (high voltage) or carbon steel (low voltage). Modules are bolted to header plates and have "O" ring pressure seals as described in greater detail in Section 8.3.1.1.13.

The details of locks, equipment hatch, transfer tube and penetrations are shown in Figure 3.8-9.

3.8.1.2 Applicable Codes, Standards and Specifications

Codes, specifications, industry standards, design criteria, Regulatory Guides, and Bechtel Topical Reports which constituted the basis for the design and construction of the containment are described in the following sections. Modifications to these codes, standards, etc. were made when necessary, to meet the specific requirements of the structure. These modifications are indicated in the sections where references to the codes, specifications, etc. are made.

3.8.1.2.1 Codes and Specifications

- A. ACI 214-65 "Recommended Practices for Evaluation of Compression Test Results of Field Concrete"
- B. ACI 301-66 "Specifications for Structural Concrete for Buildings"
- C. ACI 306-66 "Recommended Practice for Cold Weather Concreting"
- D. ACI 311-64 "Recommended Practice for Concrete Inspection"
- E. ACI 315-65 Manual of Standard Practice for Detailing Reinforced Concrete Structures
- F. ACI 318-63 "Building Code Requirements for Reinforced Concrete"
- G. ACI 347-68 "Recommended Practice for Concrete Formwork"
- H. ACI 605-59 "Recommended Practice for Hot Weather Concreting"
- I. ACI 613-54 "Recommended Practice for Selecting Proportions for Concrete"
- J. ACI 614-59 "Recommended Practices for Measuring Mixing, and Placing Concrete"
- K. AISC Specification for the Design Fabrication and Erection of Structural Steel for Buildings, 1969, and Supplements No. 1 and 2, November, 1970 and December, 1971

ARKANSAS NUCLEAR ONE
Unit 2

- L. ASME "Boiler and Pressure Vessel Code," Sections III, VIII, and IX-1968 Edition or later ASME code editions provided code used is reconciled.
- Repair/Replacement associated with the containment liner plate shall be in accordance with ASME Section XI, IWA/IWE-4000.
- M. American Welding Society (AWS) D1.1-92 or later approved Edition
AWS D1.4-92 or later approved Edition AWS D1.0 is no longer an active welding code and has been superseded by AWS D1.1. As an alternative to AWS requirements, Welding Procedure Specifications (WPS's), and/or Welder Performance Qualification (WPQ), meeting the ASME Section IX Code requirements may be utilized for structural steel applications provided all other applicable provisions of AWS D1.1 are met unrelated to WPS's and WPQ's
- N. CFR Code of Federal Regulations, Title 10-Atomic Energy, Part 50, "Licensing of Production and Utilization Facilities"
- O. CFR Code of Federal Regulations, Title 29 Labor, Part 1910, "Occupational Safety and Health Standards"

3.8.1.2.2 Industry Standards

Nationally recognized industry standards such as those published by the organizations listed below, were used whenever applicable to describe methods, procedures, and material properties. The specific standards used are identified in the applicable sections.

- A. AASHO American Association of State Highway Officials
- B. ACI American Concrete Institute
- C. AISI American Iron and Steel Institute
- D. ANSI American National Standards Institute
- E. ASTM American Society for Testing and Materials
- F. SNT Society of Nondestructive Testing
- G. SSPC Steel Structures Painting Council

3.8.1.2.3 Design Criteria

- A. ASCE - "Wind Forces on Structures," Paper No. 3269
- B. AEC - "Nuclear Reactors and Earthquake," Publication TID 7024

3.8.1.2.4 Regulatory Guides

The following Regulatory Guides were used:

- Regulatory Guide 1.10 "Mechanical (Cadmold) Splices in Reinforcing Bars of Category 1 Concrete Structures," Revision 1, 1/2/73, except as noted in Section 3.8.1.6.2

ARKANSAS NUCLEAR ONE
Unit 2

Regulatory Guide 1.15	"Testing of Reinforcing Bars for Concrete Structures," Revision 1, 12/28/72, except as noted in Section 3.8.1.6.2
Regulatory Guide 1.18	"Structural Acceptance Test for Concrete Primary Reactor Containment," Revision 1, 12/28/72, except as noted in Section 3.8.1.7.1.
Regulatory Guide 1.19	"Nondestructive Examination of Primary Containment Liner Welds," Revision 1, 8/11/72 of former Safety Guide 19, except as noted in Section 3.8.1.6.3.
Regulatory Guide 1.35	"Inservice Surveillance of Ungrouted Tendons in Prestressed Concrete Containment Structures," 2/5/73.
Regulatory Guide 1.46	"Protection Against Pipe Whip Inside Containment," May, 1973.
Regulatory Guide 1.55	"Concrete Placement in Category 1 Structures," June 1973, except as noted in Section 3.8.1.6.1.6.

Exceptions to and interpretations of Regulatory Guides are given in the references sections.

3.8.1.2.5 Bechtel Topical Reports

BC-TOP-1	"Containment Building, Liner Plate Design Report," Revision 1, December, 1972.
BC-TOP-4	"Seismic Analysis of Structures and Equipment for Nuclear Power Plants," Revision 1, September 1972, and Addendum No. 1, April 1973.
BC-TOP-7	"Full Scale Buttress Test for Prestressed Nuclear Containment Structures," Revision 0, August, 1971.
BC-TOP-8	"Tendon End Anchor Reinforcement Test," Revision 0, November, 1971.
BN-TOP-1	"Testing Criteria for Integrated Leak Rate Testing of Primary Containment Structures for Nuclear Power Plants," Revision 1, November 1972.
BN-TOP-2	"Design for Pipe Break Effects," Revision 2.
BN-TOP-3	"Performance and Sizing of Dry Pressure Containments," Revision 3.

3.8.1.2.6 Deleted

3.8.1.2.7 Structural Specifications

Structural specifications are prepared to cover the areas related to design and construction of the containment. These specifications emphasize important points of the industry standards for this containment and reduce options such as would otherwise be permitted by the industry standards. Unless specifically noted otherwise, these specifications do not deviate from the applicable industry standards. These specifications cover the following areas:

- A. Concrete Material Properties
- B. Placing and Curing of Concrete
- C. Reinforcing Steel and Splices
- D. Structural Steel
- E. Post-Tensioning System
- F. Liner Plate and Penetration Assemblies

3.8.1.3 Loads and Loading Combinations

3.8.1.3.1 Load Definitions

The design loads in the load combinations were identified as dead loads, live loads, prestressing loads, accident pressure loads, pipe rupture loads, thermal loads, seismic loads, wind and tornado loads, external pressure loads and missile loads.

A. Dead Loads

Dead loads considered were those produced by the weight of structures. The following specific weights were used:

1. Reinforced Concrete 150 lb/ft³
2. Structural Steel 490 lb/ft³

Dead loads were also assumed to be those produced by hydrostatic and soil loads.

B. Live Loads

Equipment loads were those specified by the equipment manufacturers. Snow load was considered to be 20 psf.

C. Prestressing Loads

Prestressing loads were considered in all loading combinations.

D. Accident Pressure Loads

The minimum design pressure of the containment is greater than the calculated peak pressure occurring as the result of any rupture of the Reactor Coolant System (RCS). The basis for the containment design pressure of 59 psig is presented in Section 6.2.1.

E. Pipe Rupture Loads

The local forces or pressures on structures or penetrations caused by the rupture of any pipe were considered. Pipe rupture effects are further discussed in Section 3.6.

F. Thermal Loads

The conditions considered in determining thermal stresses in the containment were temperature gradients through the containment wall and the thermal expansion and contraction of liner plate, piping and equipment.

G. Seismic Loads

Seismic loads for the Design Basis Earthquake (DBE) and the Operating Basis Earthquake (OBE) were considered. A more detailed discussion is presented in Section 3.7.1.

ARKANSAS NUCLEAR ONE
Unit 2

H. Wind and Tornado Loads

Wind and tornado loads were considered. A more detailed discussion is presented in Section 3.3.1.

I. External Pressure Loads

An external pressure of 5.0 psi on the containment was considered. A more detailed discussion is presented in Section 6.2.1.

J. Missile Loads

External and internal missile loads were considered. A more detailed discussion is presented in Section 3.5.2.

The following terms are used in the loading combination equations:

- C = Required capacity of the containment to resist factored loads
- D = Dead loads
- E = Operating basis earthquake loads
- E' = Design basis earthquake loads
- F = Prestress loads
- H = Pipe expansion loads
- L = Live loads
- P = LOCA pressure loads
- R = Pipe rupture loads
- T_A = LOCA thermal loads
- T_O = Operating thermal loads
- W' = Tornado wind and tornado missile loads
- ∅ = Capacity reduction factors

3.8.1.3.2 Capacity Reduction Factors

The capacities of all load carrying structural elements are reduced for the factored loading case by capacity reduction factors (∅) as given below. These factors provide for the possibility that small adverse variations in material strengths, workmanship, dimensions, and degree of supervision, while individually within the required tolerances and the limits of good practice, occasionally may combine to result in under-capacity.

- ∅ = 0.90 for concrete in flexure.
- ∅ = 0.85 for shear, bond, and anchorage in concrete.
- ∅ = 0.90 for reinforcing steel in direct tension.
- ∅ = 0.90 for welded or mechanical splices of reinforced steel.
- ∅ = 0.85 for lap splices of reinforcing steel.
- ∅ = 0.95 for prestressed tendons in direct tension

ARKANSAS NUCLEAR ONE
Unit 2

3.8.1.3.3 Loading Combinations

The two loading cases considered in the design of the containment were identified as the design loading case and the factored loading case. Both were used to analyze localized areas of the containment such as penetrations and shell discontinuities, as well as the containment as an entire structure.

A. Design Loading Case:

For the design loading case, the containment design is the basic working stress design. The containment is designed for the following loading combinations:

1. $D + L + F + T_O$
2. $D + L + F + P + T_A$

B. Factored Loading Case:

For the factored loading case, the working stress design method was also used, but with allowable stresses as specified in Section 3.8.1.3.4. The final design of the containment satisfied the following load combinations and factors:

1. $C = 1/\phi [(1.0 + 0.05) D + 1.5P + 1.0T_A + 1.0F]$
2. $C = 1/\phi [(1.0 + 0.05) D + 1.25P + 1.0T_A + 1.25H + 1.25E + 1.0F]$
3. $C = 1/\phi [(1.0 + 0.05) D + 1.25H + 1.0R + 1.0F + 1.25E + 1.0T_O]$
4. $C = 1/\phi [(1.0 + 0.05) D + 1.0F + 1.25H + 1.0W' + 1.0T_O]$
5. $C = 1/\phi [(1.0 + 0.05) D + 1.0P + 1.0T_A + 1.0H + 1.0E' + 1.0F]$
6. $C = 1/\phi [(1.0 + 0.05) D + 1.0H + 1.0R + 1.0E' + 1.0F + 1.0T_O]$

3.8.1.3.4 Design Approach

Safety of the structure under extraordinary circumstances and performance of the containment at various loading stages were the main considerations in establishing the structural design criteria. The two basic criteria are:

- A. The integrity of the liner plate is guaranteed under all loading conditions and,
- B. The structure has a low strain, essentially elastic response such that its behavior is predictable under all design loadings.

The containment was designed to meet the performance and strength requirements under the following conditions:

- A. Prior to prestressing
- B. At transfer of prestress
- C. Under sustained prestress
- D. At design loading case
- E. At factored loading case

ARKANSAS NUCLEAR ONE
Unit 2

3.8.1.3.4.1 Loads Prior to Prestressing

Under these loading conditions, the structure was designed and analyzed as a conventionally reinforced concrete structure. It was designed for dead loads and live loads including construction loads. Allowable stresses are in accordance with the ACI 318-63 Code.

3.8.1.3.4.2 Loads at Transfer of Prestress

The containment was checked for prestress loads and the stresses were compared with those allowed by the ACI 318-63 Code with the following exceptions: ACI 318-63, Section 26 allows a concrete compressive stress of $0.60 f'_{ci}$ at initial transfer. In order to limit creep deformation, the membrane-compression stress was limited to $0.30 f'_{ci}$ whereas in combination with flexural compression the maximum allowable stress was limited to $0.60 f'_{ci}$ per the ACI 318-63 code.

For local stress concentrations with nonlinear stress distributions as predicted by the finite element analysis, a concrete compressive stress of $0.75 f'_{ci}$ was permitted when local reinforcing was included to distribute and control the localized stresses. These high local stresses are present in every structure, but they are seldom identified because of simplifications made in design analysis. These high stresses were allowed because they occur in a very small percentage of the cross section, are confined by material at lower stresses, and would have to be considerably greater than the values allowed before significant local plastic yielding would result.

Membrane tension and flexural tension were permitted provided they did not jeopardize the integrity of the liner plate. Predicted membrane tension was permitted during the post-tensioning sequence, but the average concrete tension stress was limited to $1.0 \sqrt{f'_{ci}}$. When there was flexural tension, but no membrane tension, the section was designed in accordance with Section 2605 (a) of the ACI 318-63 Code. The effects of the prestressing sequence were considered. Shear criteria is in accordance with Chapter 26 of the ACI 318-63 Code, as modified by the equations shown in Section 3.8.1.3.4.5.

3.8.1.3.4.3 Loads Under Sustained Prestress

The allowable stresses for this case were the same as stated in Section 3.8.1.3.4.2. In addition, the allowable tensile stress in non-prestressed reinforcing was limited to $0.5 F_y$ (where F_y is equal to the yield stress of the steel) and no membrane concrete tensile stresses were permitted. The ACI 318-63 Code limits the concrete compression to $0.45 f'_c$ for sustained prestress load. Values of $0.30 f'_c$ and $0.60 f'_c$ are used as described above, which bracket the ACI allowable value. However, with the same limits for concrete stress at transfer of prestress, the predicted stresses under sustained load are reduced due to creep.

3.8.1.3.4.4 At Design Loading Case

Under the design loading case, the same performance limits as in Section 3.8.1.3.4.2 are applied with the following exceptions:

- A. If the net membrane compression is below 100 psi, it is neglected and a cracked section is assumed in the computation of flexural nonprestressed reinforcing steel. Flexural tensile stresses in nonprestressed reinforcing of $0.5 F_y$ is allowed.

ARKANSAS NUCLEAR ONE
Unit 2

- B. When maximum concrete flexural stress does not exceed $6.0 \sqrt{f'_c}$ and the extent of the tension zone is no more than one-third the depth of the section, non-prestressed reinforcing is provided to carry the entire force in the tension block. Otherwise, the non-prestressed reinforcing steel is designed assuming a cracked section. The allowable tensile stress in bonded reinforcing steel is $0.5 F_y$.
- C. The problem of shear and diagonal tension as a prestressed concrete structure is considered in two parts; membrane principal tension and flexural principal tension.

Since sufficient prestressing is used to eliminate membrane tensile stress, membrane principal tension is not critical at design loads. Membrane principal tension due to combined membrane tension and membrane shear is considered in Section 3.8.1.3.4.5.

Flexural principal tension is the tension associated with bending in planes perpendicular to the surface of the shell and shear stress normal to the shell (radial shear stress). The ACI 318-63 code provisions of Chapter 26 for shear are considered adequate for the design purpose with appropriate modifications as discussed in Section 3.8.1.3.4.5 using a load factor of 1.5 for shear loads.

3.8.1.3.4.5 At Factored Loading Case

The containment shell is checked for the factored loading case as described in Section 3.8.1.3.3.

The stress in prestressing steel and bonded reinforcing steel is limited to F_y , where F_y is the guaranteed minimum yield stress given in the appropriate ASTM specifications. The membrane compressive stress in concrete is limited to $0.85 f'_c$. In combination with flexural compression in concrete, the predicted stress is allowed to reach a limit of f'_c , (90-day ultimate compressive stress). The peak predicted strain in concrete due to secondary moments, membrane loads and thermal loads is limited to 0.003 inch/inch.

The strain in the liner is limited to 0.005 inch/inch.

Membrane principal tension in concrete is calculated due to combined membrane tension and membrane shear, excluding flexural tension due to bending moments or thermal gradients. When the value of principal membrane tensile stress exceeds $2\sqrt{f'_c}$, the combination of bonded reinforcing steel and prestressing steel resists the calculated value of principal membrane tension without exceeding the above mentioned stress limitation of F_y .

When the value of principal membrane tension in concrete does not exceed $3\sqrt{f'_c}$ and when the principal concrete tension due to combined membrane tension, membrane shear, and flexural tension caused by bending moments or thermal gradients exceeds $6\sqrt{f'_c}$, bonded reinforcing steel is provided.

The allowable tensile stress in the reinforcing steel is F_y .

The following criteria are used for shear design. A load factor of 1.5 is applied to predicted shear loads.

ARKANSAS NUCLEAR ONE
Unit 2

Shear stress limits and shear reinforcing for radial shear are in accordance with Chapter 26 of the ACI 318-63 Code with the following exceptions:

Formula 26-12 of the Code is replaced by:

$$V_{ci} = Kb'd\sqrt{f'_c} + M_{cr} \frac{V}{M'} + V_i$$

where

$$K = \left[1.75 - \frac{0.036}{np'} + 4.0np' \right]$$

But not less than 0.6 for $p' \geq 0.003$

For $p' < 0.003$, the value of K is zero.

$$M_{cr} = \frac{I}{Y} \left(6\sqrt{f'_c} + f_{pe} + f_n + f_i \right)$$

f_{pe} = Compressive stress in concrete due to prestress applied normal to the cross section after losses (including the stress due to any secondary moment) at the extreme fiber of the section at which tensile stresses are caused by live loads.

F_n = Stress due to applied axial loads (f_n shall be negative for tensile stress and positive for compressive stress).

F_r = Stress due to initial loads, at the extreme fiber of a section at which tensile stresses are caused by applied loads (including the stress due to any secondary moment). f_i shall be negative for tension and positive for compression.

$$n = 505/\sqrt{f'_c}$$

$$P' = \frac{A'_s}{bd}$$

V = Shear at the section under consideration due to applied loads.

M' = Moment at a distance $d/2$ from the section under consideration, measured in the direction of decreasing moment, due to applied loads.

V_i = Shear due to initial loads (positive when initial shear is in the same direction as the shear due to applied loads).

Lower limit placed by ACI 318-63 on V_{ci} as $1.7 b'd\sqrt{f'_c}$ is not applied.

ARKANSAS NUCLEAR ONE
Unit 2

Formula 26-13 of the Code is replaced by:

$$V_{cw} = 3.5 b'd \sqrt{f'_c} \sqrt{\frac{1 + f_{pe} + f_n}{3.5 \sqrt{f'_c}}}$$

The term f_n is as defined above. All other notations are in accordance with Chapter 26, ACI 318-63.

When the above mentioned equations show that the allowable shear in concrete is zero, radial shear ties are provided to resist all the calculated shear.

3.8.1.4 Design and Analysis Procedures

The containment is analyzed for various loading combinations, considering the values of individual loads that generate the most significant stress condition for each component and member of the structure.

The critical areas for analysis are the base slab, the intersection between cylinder wall and base slab, the ring girder, the liner plate, the tendon anchorage zones and the penetration openings.

Classical theory and numerical methods are applied as necessary for the analysis of structural elements. They are described in Section 3.8.1.4.1 and in Section 5.2.1.5 of the Arkansas Nuclear One - Unit 1 SAR.

The design methods of the containment incorporate several phases as described herein. Analysis and design of tendon anchorage zones and reinforcement in buttresses are discussed in BC-TOP-7 (Reference 18), and BC-TOP-8 (Reference 39). The methods used to provide reinforcing steel are discussed in Section 3.8.1.4.1. The methods of analyzing the effects of penetrations, the thickening of walls, reinforcing and embedments, etc., are discussed in Section 3.8.1.4.1.2. The design of the liner and its anchorage system is covered in BC-TOP-1, Revision 1 (Reference 6), and Section 3.8.1.4.2. Information on analyses for computation of seismic loads is provided in Section 3.7.

3.8.1.4.1 Analytical Techniques

The analysis of the containment consisted of five primary analytical models. Four models use non-axisymmetric three-dimensional finite element modeling techniques for the cylindrical shell, dome, basemat, and equipment hatch. The fifth model is an axisymmetric finite element representation of the containment structure to provide an overall analysis and address localized effects in the transition zones of the containment for the ring girder and the haunch area connecting the basemat to the cylindrical shell. The axisymmetric model did not account for the buttresses, penetrations, brackets, and anchors, however, these items were considered in the non-axisymmetric analysis models. The axisymmetric finite element analysis assumed the structure as symmetrical about the axis and included load cases of dead, live, temperature, pressure, and prestress loads. The non-axisymmetric analysis included these loads plus lateral loads such as earthquakes and tornadoes that were allowed to vary depending upon condition and localized containment geometry.

3.8.1.4.1.1 Axisymmetric Analysis

The containment is considered to be an axisymmetric structure for an overall analysis and to specifically address the transition areas of the structure. Although there are deviations from this ideal shape, the deviations are addressed by the combined five analytical models which provide a complete structure analysis evaluation of the pressure uprated condition of 59 psig.

The single axisymmetric model was used to look at the transition areas of the containment at the ring girder between the dome and cylindrical shell, and the haunch between the basemat and the cylindrical shell. The axisymmetric analysis was used in these areas due to the limitations of the plate elements used in the non-axisymmetric models.

The tendons are modeled by a combination of applied pseudo pressure and nodal force loads representing the hoop and vertical tendons in the cylindrical shell and the three overlapping tendon groups in the dome.

The liner plate was simulated by a layer of elements attached to the interior surfaces of the concrete structure.

The finite element mesh of the structure was extended into the foundation to account for the elastic nature of the foundation materials and its effect on the behavior of the base slab.

3.8.1.4.1.2 Nonaxisymmetric Analysis

Non-axisymmetric three dimensional computer models were constructed for the cylindrical shell, dome, basemat, and the equipment hatch to analyze the containment for 59 psig design pressure. Each of the analyses models the liner plate being bonded to the inside face of the element and the temperature is varied to introduce thermal forces into the analyzed element. A temperature gradient is introduced across the shell element to depict the operating and accident temperature effects into the model. The evaluation of all the loading combinations insures the most critical condition is analyzed for design.

The cylindrical shell model is a three-dimensional model that incorporates the basemat, cylindrical shell, buttresses, dome, and internal D ring using shell elements. Also included in the model are brick elements for the reactor and steam generator pedestals along with the rock foundation. The shell tendon and dome prestress loads were modeled using overlapping elements with pseudothermal methods. The cylindrical shell model is used to check the adequacy of the cylindrical shell with the dome, basemat, and the internals included into the model for improved accuracy.

The dome analysis is a three dimensional model that includes the dome, cylindrical shell, and buttresses using shell elements with fixed based boundary conditions along the bottom row of elements around the full circumference of the cylindrical shell. The tendon prestress loads were modeled using the same overlapping pseudo thermal element method used in the cylindrical shell model. The dome tendon prestress shell loads were simulated by applying vectored nodal forces normal to the tendon locations. The dome model is used in determining the adequacy of the dome area only and excludes the basemat and internal structure due to their remote location relative to the dome.

ARKANSAS NUCLEAR ONE
Unit 2

The basemat model is effectively the same three-dimensional analysis model as that used for the cylindrical shell that includes the dome, cylindrical shell, buttresses, internal structure, basemat, and foundation. The difference between the two analyses is that the basemat and foundation elements were modified to better analyze the overturning condition in the basemat. All loading conditions in this model are statically analyzed, including the dynamic seismic conditions which are considered as a pseudo static load using the dynamic results from the cylindrical shell analysis.

The equipment hatch analysis model is a three dimensional model using brick elements combined with plate and truss elements to represent liner plate and tendons in the equipment hatch area, respectively. The remaining cylindrical shell and dome are modeled the same as the cylindrical shell analysis, but have fixed base boundary conditions along the bottom circumference (i.e., no basemat). The tendon prestress loads around the opening were applied using pseudo thermal methods on interlaced truss elements.

3.8.1.4.1.3 Load Combinations and Stress Analysis

After the five finite element analyses were performed, the resulting forces and moments were converted to stress utilizing a post processor computer program that uses ASME Section III, Div. 2 criteria which is different than the ACI 318-63 Code of Record for the containment. The differences in the codes were reconciled and ACI 318-63 remains the code of record.

The calculations for out of plane shear in the base slab uses the equation 17-2 found in ACI 318-63 section 1701 (d). This section states that the limit of M not less than Vd does not apply when using $M' = M - N(4t - d)/8$ in section (e) for members subjected to axial load in addition to shear and flexure. This does not address the extra capacity for shear when the concrete is in compression. The wall and basemat juncture has compression from the tendons in this area. Section (e) of ACI 318-63 would apply, however, the code is not clear about the shear limit. The later 1992 ACI code and ASME Section III, Div. 2 code specifically points this omission out. The limit for M was not used in this analysis and the additional shear capacity from the compression is included.

Radial shear (through thickness shear) is considered using the criteria stated in Section 3.8.1.3.4.5 of the SAR. The criteria for tangential shear was developed by combining ASME Section III, Div. 2 criteria for tangential shear with the Unit 2 shear criteria in Section 3.8.1.3.4.5 of the SAR.

A. Seismic Loadings

The analysis of seismic loadings on the containment was performed using the methods outlined in Section 3.7. The computer models simulate the accelerations and loadings as closely as possible to assure the seismic input is not changed.

B. Wind and Tornado Loadings

Wind and tornado loadings were not considered in this analysis of the containment. The wind loads are negligible and do not appear in the loading combinations in Section 3.8.1.3.3. The factored loading combination #4 in 3.8.1.3.3 containing tornado loads was not included in this analysis because none of the other loads in the formula changed from the original analysis.

ARKANSAS NUCLEAR ONE
Unit 2

C. Buttress and Tendon Anchorage Zones

The containment has three buttresses. At each buttress, two out of any group of three adjacent hoop tendons are anchored on opposite faces of the buttress, with the third tendon continuing past the buttress.

Between the opposite anchorages in the buttress, the compressive forces exerted by the anchored tendons are twice as large as elsewhere on the buttress. This value, combined with the effect of the tendon which continues past the buttress, is 1.5 times the prestressing forces acting in the containment wall. The thickness of the buttress is approximately 1.5 times the thickness of the wall. Hence, the hoop stresses and strains, as well as the radial displacements, may be considered as being nearly constant all around the structure.

The vertical stresses and strains, caused by the vertical post-tensioning, become constant a short distance away from the anchorages because of the stiffness of the cylindrical walls. The effects of the buttresses on the overall behavior of the containment are negligible under dead and prestressing loads. The stresses and strains remain nearly axisymmetric despite the presence of the buttresses.

The design of the tendon anchorage zones was based on two test programs conducted by Bechtel to demonstrate the adequacy of several reinforcing patterns for use in anchorage zone concrete in the base slab, buttresses and ring girder. These tests were undertaken to develop a more efficient design to reduce reinforcement congestion and thereby facilitate the placement of high quality concrete around the tendon anchorages. The test programs were as follows:

1. A full scale model of a simulated containment buttress containing several patterns of reinforcement and types of tendon anchorages was constructed and tested. A detailed description of the test is presented in Bechtel Topical Report BC-TOP-7 (Reference 18).
2. Two large concrete test blocks containing two patterns of reinforcement with different proportions of reinforcing bars were constructed and tested. A detailed description of the test is presented in Bechtel Topical Report BC-TOP-8 (Reference 39).

The test results demonstrated satisfactory performance of the test anchorages. The design of the tendon anchorage zones was based on the results and recommendations of these tests.

D. Large Penetration Openings

Large penetrations were defined as those having an inside diameter equal to or greater than 2.5 times the containment wall thickness. The equipment hatch and personnel airlock fall into this category. The equipment hatch opening was evaluated using a finite element model addressed above. The personnel airlock was analyzed as an opening in a cylindrical shell with forces and moments acting upon it the same as the small penetrations described below. Both penetrations were found to be adequate.

ARKANSAS NUCLEAR ONE
Unit 2

E. Small Penetration Openings

Small penetration openings were defined as those having an inside diameter less than 2.5 times the containment wall thickness.

The stresses at the openings due to applied moments and forces were determined using the methods outlined in References 47 and 48.

The main steam, main feedwater, and the emergency escape lock were analyzed. The results of these analyses showed the stresses to be within the allowable limits. The remaining penetrations were found to be reinforced identically to the Unit 1 penetrations and were not analyzed because these penetrations are typically designed for plastic pipe forces and Unit 1 is designed to 59 psig.

3.8.1.4.2 Steel Liner Plate and Penetrations

The steel liner plate and penetrations were designed to serve as the leakage barrier for the containment. Typical details for the liner plate and penetrations are shown in Figures 3.8-7 through 3.8-9.

The design of the liner plate considered the composite action of the liner and the concrete structure and included the transient effects on the liner due to temperature changes during construction, normal operation, and the Loss of Coolant Accident (LOCA). The changes in strains to be experienced by the liner due to these effects, and those at the pressure testing of the containment, were considered.

The stability of the liner was achieved by anchoring it to the concrete structure. At all penetrations, the liner was thickened to reduce stress concentration. The thickened plate was also anchored to the concrete.

Embedded plates were provided in the liner to transfer concentrated loads to the wall, slab, and dome of the containment. Examples of these concentrated loads are polar crane brackets and floor beam brackets. A typical bracket detail is shown in Figure 3.8-8.

All components of the liner which must resist the full design pressure, such as the equipment hatch, personnel locks, and penetrations, were designed to meet the requirements of the applicable subsection of Section III, Nuclear Vessels, of the ASME Code.

Flued head design was used for all containment penetration connections, except for 2P-53 which has closed flanges on both ends to allow for temporary access to containment. 2P-53 does not require a flued head as process piping does not pass through this penetration.

Penetration connections are butt welds without backing bars. All welds were radiographed. Table 3.8-1 gives pipe sizes and materials for all penetrations. Table 3.8-2 shows results of radiographic examinations and corrective measures for defects.

The Topical Report BC-TOP-1, Revision 1, Reference 6, constitutes the basic approach used in the design of the liner plate.

There are minor differences in the design of the Unit 2 liner plate from that presented in the topical report. The liner plate material is ASTM A-516, Grade 60, with a specified yield stress of 32,000 psi, instead of ASTM A-442, which has a specified yield stress of 30,000 psi.

ARKANSAS NUCLEAR ONE
Unit 2

Additionally, liner plate degradation, such as corrosion and arc strikes, has thinned specific areas below 1/4-inch. These areas may be evaluated for use-as-is if an evaluation documents that the liner plate retains capacity to perform its design function.

3.8.1.4.3 Computer Programs Used in the Analysis

Computer programs used in the original analysis of the containment are presented in Table 3.8-3.

3.8.1.5 Structural Acceptance Criteria

The fundamental acceptance criteria for the completed containment is the successful completion of the initial and uprate structural integrity test, which measured responses within the limits predicted by analyses. The limits are predicted based on test load combinations and code allowable values for stress, strain, or gross deformation for the range of material properties and construction tolerances. In this way the margins of safety associated with the design and construction of the containment are, as a minimum, the accepted margins associated with nationally recognized codes of practice.

The structural integrity test yields information on both the overall response of the containment and the response of localized areas, such as major penetrations or buttresses, which are important to its design functions.

The design and analysis methods, as well as the type of construction and construction materials, were chosen to allow assessment of the structure's capability throughout its service life. Additionally, surveillance testing provided further assurances of the structure's continuing ability to meet its design functions.

During the 2R14 Steam Generator Replacement Outage the containment design pressure was increased from 54 psig to 59 psig. An uprate Structural Integrity Test (SIT) was performed to demonstrate the acceptability of the containment at the 59 psig pressure.

The values of calculated stress and strains for critical sections of the containment and equipment hatch are found in the containment uprate calculations. The test information documented in BC-TOP-8 permits the assessment of the margins of safety for anchorage zones.

3.8.1.6 Materials, Quality Control, and Special Construction Techniques

The containment is constructed of concrete and steel using proven methods common to heavy, industrial construction. The basic categories for steel are reinforcement, prestressing system, and liner plate. The range of properties for design was generally identified by standard industry specifications.

3.8.1.6.1 Concrete

The 90-day compressive strength of the concrete used is 5,750 psi for walls and dome and 4,000 psi for all other portions of the containments. Structural concrete is batched and placed in accordance with "Specifications for Structural Concrete for Buildings" (ACI-301-66) and "Building Code Requirements for Reinforced Concrete" (ACI 318-63) with the additional specific information and exceptions as noted below.

ARKANSAS NUCLEAR ONE
Unit 2

3.8.1.6.1.1 Cement

Cement is Type II conforming to the "Specification for Portland Cement" (ASTM C 150-70). The cement does not contain more than 0.60 percent by weight of alkalis calculated as Na₂O plus 0.658 K₂O. Certified copies of mill test reports showing the chemical composition and physical properties are obtained for each load of cement delivered. The limitation of the alkali content of the cement may be waived provided that the aggregates pass required laboratory tests and have no history of alkali aggregate incompatibility.

Cement used in the repair of the containment construction opening following replacement of the original steam generators is Type II low alkali cement per ASTM C 150-98. Tensile strength tests per the requirements of ASTM C 190 (see below) were not performed since this standard has been withdrawn. Fly ash was provided per ASTM C 618-99, Class C, with loss on ignition not exceeding 6 percent and was tested per ASTM C 311-98.

In addition to the tests required by the cement manufacturers, the following tests are performed:

- ASTM C 114 - Chemical Analysis
- ASTM C 115 - Fineness of Portland Cement (Turbidimeter) or
- ASTM C 204 - Fineness of Portland Cement (Air Permeability)
- ASTM C 151 - Autoclave Expansion
- ASTM C 191 - Time of Set (Vicat Needle) or
- ASTM C 266 - Time of Set (Gillmore Needle)
- ASTM C 109 - Compressive Strength
- ASTM C 190 - Tensile Strength

The purpose of the above tests is to ascertain conformance with ASTM Specification C 150. In addition, tests ASTM C 191 or ASTM C 266 and ASTM C 109 are repeated periodically during construction to check storage environmental effects on cement characteristics. The tests supplement visual inspection of material storage procedures.

3.8.1.6.1.2 Aggregates

All aggregates conform to the "Standard Specifications for Concrete Aggregate" (ASTM C 33-69). In addition to the specified gradation, the fine aggregate (sand) has a fineness modulus of not less than 2.5 or more than 3.0 during normal operations; at least nine of 10 test samples should not vary fineness modulus more than 0.20 from the average. Coarse aggregate may be rejected if the loss when subjected to the Los Angeles abrasion test, ASTM C 131-69 using grading A, exceeds 40 percent by weight at 500 revolutions.

Acceptance of aggregates is based on the following tests:

<u>ASTM Test No</u>	<u>Name of Test</u>	<u>Basis For Test</u>
C 131	Los Angeles Abrasion	ASTM Spec C-33
C 142	Clay Lumps and Friables Particles	ASTM Spec C-33
C 117	Material Finer than No. 200 Sieve	ASTM Spec C-33
C 87	Mortar Making Properties	ASTM Spec C-33

ARKANSAS NUCLEAR ONE
Unit 2

<u>ASTM Test No</u>	<u>Name of Test</u>	<u>Basis For Test</u>
C 40	Organic Impurities	ASTM Spec C-33
C 289	Potential Reactivity (Chemical)	ASTM Spec C-33
C 136	Sieve Analysis	ASTM Spec C-33
C 88	Soundness	ASTM Spec C-33
C 127	Specific Gravity and Absorption	ASTM Spec C-33
C 128	Specific Gravity and Absorption	ASTM Spec C-33
C 295	Petrographic	ASTM Spec C-33

In addition to the foregoing initial tests, a daily inspection control program was carried on during construction to ascertain consistency in potentially variable characteristics such as gradation and organic content.

All aggregates used in the repair of the containment construction opening following replacement of the original steam generators conform to the "Standard Specifications for Concrete Aggregate" (ASTM C 33-99). In addition to the specified gradation, the fine aggregate (sand) has a fineness modulus of not less than 2.5 or more than 3.0. In addition to the foregoing initial tests, a daily inspection control program was carried on during concrete production to ascertain consistency in potentially variable characteristics such as gradation and organic content.

3.8.1.6.1.3 Water

Water used in mixing concrete is free of injurious amounts of oil, acid, alkali, organic matter or other deleterious substances as determined by American Association of State Highway Officials (AASHTO) Methods of Sampling and Testing, Designation T26-51.

Water used in the concrete mix for the repair of the containment construction opening following replacement of the original steam generators complied with American Association of State Highway and Transportation Officials (AASHTO) T-26 for its effect on cement compressive strength per ASTM C 109-99, setting time per ASTM C 191-99, and autoclave expansion per ASTM C 151-98.

3.8.1.6.1.4 Admixtures

The concrete also contains an air entraining admixture, a water-reducing admixture and a pozzolan. The air entraining admixture is in accordance with the "Specification for Air Entraining Admixture for Concrete" (ASTM C 260-69). It is capable of entraining three to six percent air, is completely water soluble, and is completely dissolved when it enters the batch. The water reducing and retarding admixture conforms to the "Standard Specification for Chemical Admixtures for Concrete" (ASTM C 494-68), Types A and D. Type ambient air temperature is 70 °F and above. Pozzolans conform to "Specifications for Fly Ash and Raw or Calcined Natural Pozzolans for Use in Portland Cement Concrete" (ASTM C 618-68).

The air entraining admixture used in the repair of the containment construction opening following replacement of the original steam generators conforms to ASTM C 260-98. The high range water reducing admixture conforms to ASTM C 494-98, Type F.

ARKANSAS NUCLEAR ONE
Unit 2

3.8.1.6.1.5 Concrete Testing

During construction concrete is sampled and tested for slump, air content, temperature, and unit weight prior to casting compressive strength cylinders.

Compressive strength cylinders are cast from representative samples taken in accordance with "Sampling Fresh Concrete" (ASTM C 172-68), Paragraph 3. Cylinders are made, cured and tested in accordance with the "Standard Method for Making and Curing Compression and Flexure Tests in the Field" (ASTM C 31-69) and the "Standard Test for Compressive Strength of Molded Concrete Cylinders" (ASTM C 39-66).

Cylinders improperly made or cured are discarded. Not less than six specimens are made for each test. Three cylinders are tested at 28 days, at least one cylinder is tested at seven days and at least two cylinders are tested at 90 days when 90-day compressive strengths were specified. Three correlation cylinders are taken at the point of deposition in the forms from the same batch sampled at the batching plant to verify the strength results. These cylinders are tested at 28 days.

For structural concrete, six cylinders are made for each 100 yards of concrete placed or fraction thereof for each mix design of concrete places in any one day.

When a correlation of test data is established for each mix, as approved by the contractor, the 90-day test cylinders are discontinued except for prestressed concrete.

Cause for concrete rejection was established in accordance with the "Building Requirements for Reinforced Concrete" (ACI 318-63), Paragraph 504.

During placement of concrete for repair of the containment construction opening following replacement of the original steam generators, samples were taken in accordance with ASTM C 172-97 at the beginning, middle, and at the end of the pour. These samples were used to perform slump tests in accordance with ASTM C 143-98, temperature tests in accordance with ASTM C 1064-86, air content tests in accordance with ASTM C 231-97, and unit weight tests in accordance with ASTM C 31-98 and ASTM C 172-97.

Three sets of 12 cylinders each were made for the compressive strength tests. Two cylinders from each set were tested at 1, 7, and 28 days and 6 cylinders were spared. Note: If the 7-day test showed that the required strength of 5750 psi had been met, the 28 day test was deleted and the spare cylinders discarded. The cylinders were tested in accordance with ASTM C 39-96.

3.8.1.6.1.6 Concrete Placement

Concrete placement in the containment is in accordance with Regulatory Guide 1.55 with the following exception:

Regulatory Positions 2 and 3 of the Regulatory Guide state the presumed functional responsibilities of the "Designer" and the "Constructor". Under the designer's role are listed the responsibilities for checking shop drawings and locations of construction joints. On this job, the former is fully delegated to the Bechtel field, although the design engineering office may check significant portions and may advise the field accordingly. The responsibility for construction joint location is partly delegated to the field in the sense that the field has to follow the

ARKANSAS NUCLEAR ONE
Unit 2

guidelines set out in the design drawings prepared by "Engineering". In interface areas, a delegation of the design engineering office's responsibility to the field office is within the definition of the terms "responsibility" and "delegated responsibility" as discussed in Paragraph 1.3 of the proposed ANSI N45.2.5 - 1972 referenced in the Appendix to the Regulatory Guide. Delegation of the responsibilities for checking the reinforcing drawings to the field engineering group is justified by the following:

- A. The Bechtel field engineering group is segregated from the field supervision group, although both are located at the jobsite and eventually report to the project superintendent.
- B. The field engineering group is staffed for the most part by graduate engineers who have been trained in the use of the ACI code and understand the design implication of the proper location, splicing and embedment of reinforcing steel.
- C. The field inspection of the actual rebar as placed in the forms is conducted using the engineering drawings as the primary source document. This assures a check on any errors which may have passed the critical eye of the field engineer in checking the shop detail or erection drawings.
- D. It is standard practice in the civil engineering profession that engineering requirement drawings for reinforcing are converted to shop detail and erection drawings in accordance with ACI standards applied by steel detailers at the reinforcing steel vendor's shop. Most contractors installing reinforcing steel rely upon their superintendent and foreman for correct interpretation of these detail drawings in erecting the reinforcing steel. While this is also true of Bechtel field operation, we do have the additional help and guidance of the field engineers both during the installation phase and finally at the inspection phase prior to final sign off on the report card.
- E. The field engineers have the added benefit of being able to plan and witness the actual installation and can, therefore, better foresee any difficulties in meeting the intended design requirements. Their assessment of the situation is further assisted by regular telephone communication with the design engineers who also periodically visit the jobsite.

The above procedure of delegation of the design engineering office's responsibility to field personnel and periodic monitoring by the engineering office provides an assurance of correctness and conformance of the shop drawings to the design drawings, and therefore, meets the intent of Regulatory Guide 1.55.

The following codes and specifications are used:

- A. ACI 301-66 - "Specifications for Structural Concrete for Buildings" is used except as noted below:
 - 1. The following requirements apply in place of the requirements specified in Paragraph 405 (a):

Forms for columns, walls, sides of beams, slabs and girders and other parts not supporting the weight of the concrete are removed as soon as practicable in order to avoid delay in curing and repairing surface imperfections. Wood forms or

ARKANSAS NUCLEAR ONE
Unit 2

insulated steel forms for members 2-1/2 feet or greater in thickness are stripped within 24 hours or the forms are kept in place for a minimum of seven days. If forms are stripped within 24 hours, the surface is cured by moist curing or membrane curing as specified in Chapter 12.

2. The following requirements apply in place of Paragraph 1404 (a): Slump is specified for particular locations and degree of congestion rather than holding a 2-inch maximum. A margin for maximum slump above the stated maximum average value is included in job standards.
 3. The following requirement applies in place of Paragraph 1405 (a): The minimum curing period is seven days for heavily reinforced massive sections.
 4. Section 1602, Paragraph (a) 4.a the last sentence concerning the taking of samples at the discharge end of the pump line does not apply.
- B. ACI 306-66 - "Recommended Practice for Cold Weather Concreting" is used without exception.
- C. ACI 318-63 - "Building Code Requirements for Reinforced Concrete" is used without exception.
- D. ACI 347-68 - "Recommended Practice for Concrete Formwork" is used except as modified based on the specific construction procedure used.
- E. ACI 605-59 - "Recommended Practice for Hot-Weather Concreting" is used without exception.
- F. ACI SP. 2-67 - "Manual Of Concrete Inspection" is used without exception.
- G. ASTM C94-69 - "Ready-Mixed Concrete" is used without exception.

Placement of concrete for repair of the containment construction opening following replacement of the original steam generators was done in accordance with ACI 301-96 and ACI 304R-89. Concrete was consolidated by mechanical, internal type vibrators in accordance with ACI 309R-96.

The rate of the concrete pour was limited to no more than three feet per hour. Placement of concrete in hot or cold weather was performed in accordance with ACI 305R-91 or ACI 306R-88, respectively. Concrete placement inspection activities were performed in accordance with Bechtel's Quality Assurance Program and ANSI N45.2.5.

3.8.1.6.2 Reinforcing Steel

Reinforcing bars for concrete are deformed bars meeting the requirements of the "Specification for Deformed and Plain Billet Steel Bars for Concrete Reinforcement" (ASTM A-615-68), Grade 60. Placing and splicing of bars is in accordance with the "Building Code Requirements for Reinforced Concrete" (ACI-318-63). Mill tests reports, in accordance with ASTM A-615, are obtained from the reinforcing steel supplier to substantiate specification requirements.

ARKANSAS NUCLEAR ONE
Unit 2

In addition, user tests are performed on specimens to supplement the standard mill tests. The testing of reinforcing steel including the tonnage of bars of a given size and grade which is represented by a given number of test specimens is in accordance with Regulatory Guide 1.15 with the following exception: ASTM A-615-68 is used in lieu of A-615-72. Hence, for #14 and #18 reinforcing bars, reduced diameter test specimens are used and bend tests are not required.

Bars #11 and smaller are generally lap spliced in accordance with ACI 318-63. Where lap splicing was not used, reinforcing bars were cadweld spliced. Bars #14 and #18 are cadweld spliced exclusively. Splicing of reinforcing bars by welding was not done during containment construction. Splicing of reinforcing bars by use of Dywidag splices was not done in the containment.

Cadweld splicing during construction of the containment was performed in accordance with Regulatory Guide 1.10, Revision 1, 1/2/73, with the following exceptions to the Regulatory Guide:

Section C.1. Crew Qualification. The Regulatory Guide requires requalification of each member of the splicing crew (or each crew if the members work as a unit), if the specific splice position, e.g. horizontal, vertical, diagonal, has not been used for a period of three months or more. The project procedure conforms to the Safety Guide 10, 3/10/71 which does not require the specified member or crew requalification. The project specification was issued for construction prior to the publication of Regulatory Guide 1.10. The specified procedure was based on extensive experience of the crew which had satisfactorily completed similar work on Unit 1.

Section C.5. Procedure for Substandard Tensile Test Results, Paragraph a. The Regulatory Guide requires that if two or more splices from any of the six additional splice samples fail to meet the tensile test specification of Paragraph 3a, the balance of the 100 production splices under investigation should be rejected and replaced.

The intent of the Regulatory Guide is met in the project specification by requiring that if two or more splices from any of the six additional splice samples fail to meet the tensile test specification of Paragraph 3a, the Project Engineer will evaluate and assess the acceptability of the reduced average tensile strength with respect to the required strength at the location from which the samples were taken. There were no substandard tensile test splices for the work done. In the event of any such splices on remaining work, Regulatory Guide 1.10 will form the basis for the Project Engineer's evaluation.

Reinforcing bars (limited to #3 through #11) used in the repair of the containment construction opening following replacement of the original steam generators conform to ASTM A 615-96, Grade 60. Mechanical property tests for yield strength, tensile strength, and percentage elongation as well as bend tests required by ASTM A 615-96 were performed per ASTM A 370-97. Placement of rebar was in accordance with ACI 301-96. Splicing of the new rebar to the existing rebar was accomplished using Cadwelds or welding. Testing of Cadweld splices during the containment opening restoration was performed in the same manner as was done during construction of the containment except that only sister splices were tested.

ARKANSAS NUCLEAR ONE
Unit 2

3.8.1.6.3 Liner Plate and Penetrations

The containment is lined with welded steel plate conforming to the requirements of the ASTM A-516, Grade 60, to ensure low leakage. The A-516, Grade 60 material was chosen on the basis that it has sufficient strength, as well as ductility, to resist the expected strains from design criteria loading and, at the same time, preserve the required leak tightness of the containment. It is readily weldable by all commercially available arc and gas welding processes.

The liner plate is considered as a leak tight membrane. Applicable portions of the ASME Code are referenced in setting the standards for materials, fabrication, inspection, and testing of the liner plate. Mill test results performed according to the requirements of ASTM A-516 are obtained for the liner plate material. In addition, all floor liner plate sections greater than ¼-inch thick used with Cadweld connectors or other anchorages were ultrasonically examined. All welding procedures, welders, and welding operators used in the fabrication and erection of the steel liner plate and penetration sleeves are qualified by tests in accordance with Section IX of the ASME Code.

Nondestructive examination of primary containment liner welds is conducted in accordance with the procedures established for Unit 1 and complies with the procedures described in Regulatory Guide 1.19 except at noted:

- A. Reference: Paragraph C.1.a. For each welder, one spot (not less than 12 inches in length) in the first 10 feet of weld and in each additional 25-foot increment thereafter is radiographed in accordance with the methods and techniques described in UW-51 of the ASME B&PV Code, Section VIII.
- B. Reference: Paragraph C.1.b. Where nonradiographable welds are used, a minimum of 10 percent of all such welding (which includes at least one-third of the locations where there are welded backing strip splices and intersections of joints) is examined by magnetic particle or liquid penetrant examination. Welding which does not satisfy acceptance standards is repaired and retested to the same extent as stipulated for radiography.
- C. Reference: Paragraph C.1.c. The leak detection solution used for vacuum box testing is checked against a standard sample with a known leak path to verify the bubble formation property of the solution.
- D. Reference: Paragraph C.1.d. Leak chase system channels are pressurized to a test pressure of 80 psi which exceeds containment design pressure of 59 psi. All channel to liner welds are soap bubble tested and checked for any pressure decay within 15 minutes.
- E. Reference: Paragraph C.2. All welds are examined in accordance with the methods and techniques noted in Items A through D above.
- F. Reference: Paragraph C.5. Locations for spot radiograph examination are selected at random.

The tolerances for erection of liner plate and the penetration assemblies were determined based upon the structural geometry, liner stability, concrete capability and the construction methods.

ARKANSAS NUCLEAR ONE
Unit 2

During replacement of the original steam generators, a containment construction opening was created. As part of the process for creating this construction opening, a 21'-6" x 27'-9" section of the containment liner was removed. Following completion of the steam generator replacement, this section of liner plate was reinstalled. Welding, magnetic particle, radiographic weld examination, and vacuum box leak testing of the new liner plate welds was performed in accordance with the Bechtel Special Processes Manual (which was based on ANO's commitments to the requirements of ASME Section VIII, Division 1 and Subsection IWE of ASME Section XI) to insure weld acceptability and leak-tightness. Leak testing in accordance with 10 CFR 50, Appendix J was also performed.

3.8.1.6.4 Post-Tensioning System

The prestressed, post-tensioning system selected for the containment is an Prescon BBRV buttonhead system.

A. Tendons

The tendons are composed of stress relieved wires of 1/4-inch diameter with a tensile strength of 240,000 psi in accordance with ASTM A-421, Type BA. The pertinent features of the tendons are as follows:

Number of wires	186
Ultimate tensile capacity (kips)	2192
End anchorage	Buttonheads

Sampling and testing of the tendon material conform to ASTM A-421.

B. Anchorages

The end anchors used are capable of developing 100 percent of the minimum tensile strength of the tendons. Furthermore, the end anchors are capable of maintaining integrity for 500 cycles of loads corresponding to an average axial stress variation between 0.7 and 0.75 F'_c , at a repetition rate of one cycle in 0.1 second. This requirement sets the minimum acceptable limits on fatigue effects on the end anchor and tendon performance in response to earthquake loads.

The anchorage assemblies, including the bearing plates, are capable of transmitting the ultimate loads of the tendons into the structure without brittle fracture at an anticipated lowest service temperature of 0.0 °F.

C. Sheathing

Sheaths for the tendons are classified as concrete forms and are not subjected to any Standard Codes. They provide a void in the concrete in which the tendons are installed, stressed and greased after the concrete is placed.

The sheaths are fabricated from 24-gauge, cold rolled, galvanized carbon steel, and have an internal diameter of five inches. Couplers are provided at all field splices.

ARKANSAS NUCLEAR ONE
Unit 2

Before installation of the tendons, the sheathing is cleaned to remove all water and debris.

Splash caps at the ends of all sheaths, to prevent concrete and laitance from entering into the sheaths during construction, are provided.

D. Corrosion Protection

Suitable atmospheric corrosion protection is maintained for the tendons from the point of manufacture to the installed locations. The atmospheric corrosion protection provides assurance that the tendon integrity is not impaired due to exposure to the environment.

Prior to shipment, a thin film of petroleum oil based rust inhibitor is applied to the tendons in accordance with the manufacturer's instructions. After the tendons are installed and stressed, the interior of the sheathing is pumped full of a modified, thixotropic, refined petroleum oil based product to provide corrosion protection. The tendons and anchors are also encapsulated by gasketed end caps which are filled with the corrosion protection material and sealed against the bearing plates.

E. Prestressing Sequences

The criteria of prestressing sequence are based on the design requirements to limit the membrane tension in concrete and to minimize unbalanced loads of differential stresses in the structure. Prestressing begins after the concrete in the wall and the dome has reached the specified F'_c (5,750 psi).

As part of the creation of the containment construction opening for replacement of the original steam generators, the tendons in the area of the opening, where concrete removal was to take place, were removed to preclude damaging them. Eighteen horizontal tendons (212H20 through 212H28 and 232H21 through 232H29) and six vertical tendons (2V82 through 2V87) were removed. The replacement horizontal tendons were 186 wire (1/4" diameter wires) ASTM A421, Type BA, with relaxation losses not exceeding those for the original tendons. The tendons were re-tensioned to a force level which ensures that the 40 year minimum effective prestress levels exceed 742.2 kip/ft in the hoop direction and 429 kip/ft in the vertical direction. This ensured that the replaced portion of the post-tensioning system was compatible with the existing one.

The evaluation of tendon prestress for the period of extended operation associated with license renewal is discussed in Section 18.2.4.

3.8.1.7 Testing and Inservice Surveillance Requirements

Testing and inservice surveillance requirements for the containment include the following:

- A. Preoperational Structural Integrity Test.
- B. Preoperational Integrated Leak Rate Test.
- C. Inservice Tendon Surveillance.

ARKANSAS NUCLEAR ONE
Unit 2

3.8.1.7.1 Preoperational Structural Integrity Test

Prior to initial fuel loading, the containment was subjected to a pressure of 115 percent of the design pressure. The results of this test demonstrated that the containment is capable of resisting the postulated accident pressure. In addition, by measuring the structural response and comparing the results with analytical predictions, the test also served to verify the anticipated structural behavior.

The structural initial integrity test was conducted in accordance with Regulatory Guide 1.18 with the following exceptions:

- A. Reference: Paragraph C.2 of Regulatory Guide 1.18. The test procedure was in accordance with the regulatory guide subject to the following clarification: It was intended to select the number and distribution of measuring points for monitoring radial deflection so that the as-built condition can be considered in the assessment of roundup, buttress shell interaction, and general shell response. However, to obtain the most significant data, the measuring point locations may have been changed to those where the as-built containment is at the limit of tolerances if such points exist. Accordingly, an arbitrary selection of measurement points was not intended.
- B. Reference: Paragraph C.3 of Regulatory Guide 1.18. Measurement of tangential deflections was not planned. The magnitude of the expected local tangential deformation under the test pressure conditions is so negligibly small that, combined with the difficulty in obtaining fixed reference lines for local measurements, it was impractical to attempt measurement of local tangential deflections.
- C. Reference: Paragraph C.9 of Regulatory Guide 1.18. The structural integrity testing was scheduled when extremely inclement weather was not forecast. If, despite the forecast, snow, heavy rain, or strong wind should have occurred during the test, the test results would have been considered valid unless there had been evidence to indicate otherwise.

Following completion of the repair of the containment construction opening after replacement of the original steam generators, the restored containment was subjected to a post-repair/pre-service "containment pressure test" per Article IWL-5000 of ASME Section XI, a Structural Integrity Test (SIT), and an Integrated Leak Rate Test (ILRT) (per Article IWE-5000 of ASME Section XI). The examinations for the liner plate and post-tensioning system and the pressure test together satisfy all applicable requirements of ASME Section XI for pre-service post-repair/restoration examination/testing.

The uprate structural integrity test for the containment uprate was conducted in accordance with Regulatory Guide 1.18 with the following exceptions:

- A. Reference: Paragraph C.1 or RG 1.18

The uprate test procedure has three monitoring points during pressurization /depressurization of the building during the test. These include initial measurements at atmospheric pressure prior to commencing the test, at 62.1 psig (the initial test pressure), and at 1.15Pd (68 psig). Measurements will be taken again at 62.1 psig during depressurization and at atmospheric pressure if the ILRT is conducted at 68 psig. Should ILRT be conducted at Pa (58 psig) measurements will be taken at 58 psig and at atmospheric pressure during depressurization of the containment building.

ARKANSAS NUCLEAR ONE
Unit 2

B. Reference: Paragraph C.2 RG 1.18

The uprate test procedure was conducted in accordance with the regulatory guide following the same clarifications as given above for the initial test except for the following. The uprate test uses only two meridians of the three meridians that were instrumented during the initial test, meridians 00/1800 and 600/2400. The deflections monitored during the initial test demonstrated that the third meridian deflections were very similar to those of the other two and did not yield additional significant information on the performance of the building.

C. Reference: Paragraph C.3 RG 1.18

The uprate test procedure did not plan for tangential deflections as indicated in the initial test above. The instrumentation locations during the uprate test around the equipment hatch include only two points above and two points to the north of the equipment hatch. The movements of the equipment hatch during the uprate test can adequately be predicted based on the information gathered during the initial test and these monitored points. The points that are monitored are located at the initial test locations.

D. Reference: Paragraph C9 RG 1.18

The same exceptions noted above for the initial test are taken for the uprate test.

E. Reference: Paragraph C12 RG 1.186

The information requested in paragraph C12 to be put into the PSAR will be included in the Final Structural Integrity Test Report and included as permanent plant documentation.

3.8.1.7.2 Preoperational Integrated Leakage Rate Testing

Preoperational integrated leakage rate testing of the containment was conducted in accordance with the procedures described in the Bechtel Power Corporation Topical Report BN-TOP-1, "Testing Criteria for Integrated Leakage Rate Testing of Primary Containment Structures for Nuclear Power Plants", Revision 1, November 1, 1972 (see 2CAN037824).

3.8.1.7.3 Inservice Tendon Surveillance

The objective of the inservice tendon surveillance program during the lifetime of the plant is to provide a systematic means of assessing the continued quality of the post-tensioning system. The program is intended to furnish sufficient inservice historical evidence to provide a measure of confidence in the condition and the functional capability of the system, as well as an opportunity for timely corrective measures should adverse conditions, such as excessive corrosion, be detected.

The inservice tendon surveillance program will be conducted in accordance with the requirements of ASME B&PV Code Section XI Subsection IWL as modified by 10 CFR 50.55a.

3.8.2 STEEL CONTAINMENT SYSTEM

Not applicable to Unit 2, which uses a concrete containment structure.

3.8.3 CONCRETE AND STRUCTURAL STEEL INTERNAL STRUCTURES OF CONTAINMENT

3.8.3.1 Description of the Internal Structures

The internal structures located in the containment consist of the primary shield, secondary shield, refueling canal, removable missile shield above the reactor vessel, floor slabs, gratings and platforms, and steam generator and polar crane supports.

3.8.3.1.1 Primary Shield

The primary shield is a heavily reinforced concrete structure which houses the reactor, provides the primary radiation shielding and pressure barrier and is an integral part of the internal structures.

The massive primary shield walls, which are anchored into the containment base slab, provide a support for the secondary shield walls above the reactor cavity. In plan the primary shield walls are forming a monolithical ring, housing the reactor vessel. Large penetrations in the primary shield walls are provided for the primary loop piping.

The arrangement of the primary shield walls is shown in Figures 3.8-13 through 3.8-15.

3.8.3.1.2 Secondary Shield

The secondary shield is a heavily reinforced concrete structure enclosing the primary shield at the lower levels and the steam generator cavities and the refueling canal walls at the higher levels. The massive secondary shield walls are anchored into the base slab of the containment, in a manner similar to the primary shield walls, in order to allow for load transfer to the foundations. Each of the two enclosed secondary shield cavities houses a steam generator and two reactor coolant pumps. In addition one of the cavities also houses the pressurizer.

Steel embedments in the secondary shield walls transmit loads from various equipment, pipe supports and platforms to the walls.

The arrangement of the secondary shield walls is shown in Figure 3.8-13.

3.8.3.1.3 Refueling Canal

The refueling canal is a reinforced concrete structure which is flooded during the reactor refueling operation. The canal walls are formed by the steam generator cavity walls and by an extension of the primary shield walls. Hydrostatic and other loads from the refueling canal are transferred through these walls to the containment base slab.

The refueling canal is lined with stainless steel plate and is connected with the spent fuel pool in the auxiliary building through the fuel transfer tube.

3.8.3.1.4 Missile Shield

The missile shield is a thick reinforced concrete slab supported by the secondary shield walls and is located above the reactor to provide protection against postulated CRDM missiles. The slab is movable to allow access to the refueling canal and reactor vessel.

3.8.3.1.5 Floor Slabs, Grating and Platform

Concrete floor slabs, structural steel floors, and platforms are provided inside and outside of the secondary shield walls as required. Support for these structures is provided by the secondary shield walls or by concrete or structural steel columns, transmitting loads to the containment base slab. A limited amount of grating supports is attached to the liner plate, which transmits loads to the containment wall concrete through the vertical liner plate stiffeners.

3.8.3.1.6 Steam Generator and Polar Crane Supports

The steam generator is mounted on a thick, heavily reinforced concrete slab. The slab is supported vertically by a massive reinforced concrete pedestal transmitting loads from the steam generator base to the containment base slab, and is supported laterally by the primary and secondary shield walls. The steam generator pedestal is shown in Figure 3.8-13.

The polar crane is supported by crane girders mounted on crane brackets evenly spaced around the inside face of the containment wall. The crane brackets are made of welded steel plates and embedded in the containment wall concrete. Details of this support are presented in Figure 3.8-8.

3.8.3.2 Applicable Codes, Standards and Specifications

The applicable codes, specifications, industry standards, design criteria, Regulatory Guides, and Bechtel Topical Reports used in the structural design of the internal structures are covered in Section 3.8.1.2 with the following exceptions:

- A. Codes and Specifications in addition, considered the use of AWS D12.1-61 Code - "Recommended Practices for Welding Reinforcing Steel, Metal Inserts and Connections in Reinforced Concrete Construction."
- B. Regulatory Guides 1.18, 1.19, and 1.35 listed in Section 3.8.1.2.4 do not apply to the design of the internal structures.
- C. Bechtel Topical Reports BC-TOP-1, Revision 1, BC-TOP-7, BC-TOP-8, and BN-TOP-1 listed in Section 3.8.1.2.5 do not apply to the design of the internal structures.
- D. Discussion on structural specifications in Section 3.8.1.2.7 applies, however, specifications for the internal structures were prepared to cover the following areas:
 1. Concrete Material Properties
 2. Placing and Curing of Concrete
 3. Reinforcing Steel and splices
 4. Structural Steel
 5. Refueling Canal Liner Plate

3.8.3.3 Loads and Loading Combinations

3.8.3.3.1 Load Definitions

The design loads in the loading combinations were identified as dead loads, live loads, pipe rupture loads, thermal loads, seismic loads and missile loads.

A. Dead Loads

For dead loads, the following specific weights were used:

1. Reinforced Concrete 150 pounds/feet³
2. Structural Steel 490 pounds/feet³

B. Live Loads

Floor live loads were considered to be 100 psf for grating floors and 250 psf for reinforced concrete floors.

C. Pipe Rupture Loads

Forces or pressures on structures caused by pipe rupture were considered. Pipe rupture effects are further discussed in Section 3.6.

D. Thermal Loads

The conditions considered in determining stresses due to thermal loads were temperature gradients through the primary and secondary shield walls, and forces on internal structures due to the thermal expansion of piping and equipment.

E. Seismic Loads

Seismic loads for the DBE and the OBE were considered. A more detailed discussion is presented in Section 3.7.1.

F. Missile Loads

Internal missile loads were considered in the design. A more detailed discussion is presented in Section 3.5.2.

G. Accident Pressure Loads

Loads generated inside the steam generator and reactor cavities due to a LOCA.

3.8.3.3.2 Loading Combinations

The two loading cases considered in the design of the internal structures were identified as (1) the normal condition and (2) the accident condition.

The following variables are used in the loading combination equations:

ARKANSAS NUCLEAR ONE
Unit 2

- U = Required ultimate load capacity.
- D = Dead load of structure and equipment plus any other permanent loads contributing stresses, such as hydrostatic loads. An allowance was also made for future permanent loads.
- L = Live load and piping load.
- R = Force or pressure on structure due to rupture of any one pipe.
- T_o = Thermal loads due to temperature gradient through-wall under normal conditions.
- H_o = Force on structure due to thermal expansion of pipes under normal conditions.
- T_A = Thermal loads due to temperature gradient through wall under accident conditions.
- H_A = Force on structure due to thermal expansion of pipes under accident conditions.
- E = Operating Basis Earthquake loads resulting from ground surface acceleration of 0.1 g.
- E' = Design Basis Earthquake loads resulting from ground surface acceleration of 0.2 g.
- P_A = LOCA Pressure Load
- F_s = Allowable working stress in structural steel.
- F_y = Yield stress of structural steel.

3.8.3.3.2.1 Normal Condition

A. Concrete Structures

Design of concrete structures was in accordance with the following loading combinations:

1. $U = 1.5D + 1.8L$
2. $U = 1.25 (D + L + H_o + E) + 1.0 T_o$
3. $U = 0.9 D + 1.25 (H_o + E) + 1.0 T_o$

In addition, for ductile moment resisting concrete space frames and for shear walls the following loading combinations were used:

4. $U = 1.4 (D + L + E) + 1.0 T_o + 1.25 H_o$
5. $U = 0.9 D + 1.25 E + 1.0 T_o + 1.25 H_o$

For structural elements carrying mainly earthquake forces, such as equipment supports, the following loading combinations were used:

6. $U = 1.0 D + 1.0 L + 1.8 E + 1.0 T_o + 1.25 H_o$

ARKANSAS NUCLEAR ONE
Unit 2

B. Structural Steel

Steel structures were designed in accordance with the following loading combinations without exceeding the specified stresses:

1. $D + L$ Stress Limit = F_s
2. $D + L + T_o + H_o + E$ Stress Limit = $1.25F_s$

In addition, for structural elements, carrying mainly earthquake forces, such as struts and bracings, the following loading combination was used.

3. $D + L + T_o + H_o + E$ Stress Limit = F_s

3.8.3.3.2.2 Accident Condition

A. Concrete Structures

Design of concrete structures was in accordance with the following loading combinations:

1. $U = 1.05 D + 1.05 L + 1.25 E + 1.0 T_A + 1.0 H_A + 1.0 R + 1.0 P_A$
2. $U = 0.95 D + 1.25 E + 1.0 T_A + 1.0 H_A + 1.0 R + 1.0 P_A$
3. $U = 1.0 D + 1.0 L + 1.0 E' + 1.0 T_o + 1.25 H_o + 1.0 R$
4. $U = 1.0 D + 1.0 L + 1.0 E' + 1.0 T_A + 1.0 H_A + 1.0 R + 1.0 P_A$

B. Structural Steel

Steel structures were designed in accordance with the following loading combinations without exceeding the specified stress limits:

1. $D + L + R + T_o + H_o + E'$ Stress limit = $1.5F_s$
2. $D + L + R + T_A + H_A + E'$ Stress limit = $1.5F_s$

For the accident condition loading combinations, the maximum allowable stress in bending and tension is limited to $0.9F_y$ and the maximum allowable stress in shear is limited to $0.5F_y$.

3.8.3.4 Design and Analysis Procedures

3.8.3.4.1 General Considerations

The internal structures were designed to provide structural support and radiation shielding for the RCS, auxiliary systems and engineered safety features. The internal structures were designed as an integral unit with all structural components interconnected to allow transmittal of all vertical and horizontal design loads to the containment base slab.

ARKANSAS NUCLEAR ONE
Unit 2

The structural components were designed using both reinforced and structural steel as appropriate. All design aspects were integrated with the design criteria of the Nuclear Steam System (NSS) supplier and included particular attention to the combined thermal and dynamic effects. Design loads and loading combinations for the internal structures are listed and described in Section 3.8.3.3.

The basic techniques of analyzing the internal structures can be classified into two groups: (1) conventional methods involving simplifying assumptions such as those found in beam theory, and (2) plate theories using various degrees of approximation.

Design considerations implemented in the design of the internal structures are presented in the following discussion.

Loads and deformations resulting from a LOCA and the associated effects on any one of the basic systems were restricted so that propagation of the failure to any other system is prevented. In addition, a failure in one loop of the Nuclear Steam Supply System (NSSS) is restricted so that propagation of the failure to the other loop is prevented. All components of engineered safety features are protected by barriers from missiles which might be generated from the primary system.

Full recognition was given to the time increments associated with postulated failure conditions, and yield capacities were appropriately increased when a transient analysis demonstrated that the rapid strain rate justified this approach.

Pressure buildup in locally confined areas such as the reactor cavity or the steam generator cavities are discussed in Sections 3.8.3.4.2 and 3.8.3.4.3, respectively.

The structures were, in general, proportioned to maintain elastic behavior when subject to various combinations of dead loads, thermal loads, seismic and accident loads. The upper limit of elastic behavior was considered to be the yield strength of the effective load carrying structural material. The yield strength, F_y , for steel (including reinforcing steel) was considered to be the guaranteed minimum in appropriate ASTM specifications. The yield strength for reinforced concrete structures was considered to be the ultimate resisting capacity as calculated from the "Ultimate Strength Design" portion of the ACI-318-6 Code.

Reinforced concrete structures were designed for ductile behavior that is with reinforcing steel stresses controlling. The design was in accordance with the "Ultimate Strength Design" portion of the ACI 318-63 Code, except that in localized areas, increased bearing stresses were permitted in accordance with the ACI 318-71 Code.

Under seismic loading, no plastic analysis was considered. Local yielding or erosion of barriers was considered permissible due to pipe rupture loading or missile impact, provided there was no general failure.

Structural steel was designed in accordance with basic working stress design methods. Increased allowable stresses were used for the accident condition.

The final designs of the interior structures and equipment supports were reviewed to assure that they can withstand applicable design pressure loads, jet forces, pipe reactions, and earthquake loads without loss of function. The deflections or deformations of the structures and supports were checked to ensure that the functions of the containment and safety feature systems were not impaired.

3.8.3.4.1.1 Effect of Radiation Generated Heat

The effect of radiation generated heat on the internal structures has been considered in the design of the primary and secondary shield walls. The shield wall thicknesses were determined on the basis of the radiation shielding requirements, much higher than those required for structural purposes. This additional thickness provides reserve strength greater than required to offset minor damages to the structures due to a LOCA. Since high temperatures are damaging to concrete, provisions are made to maintain a constant temperature through ventilation. The ventilation within the containment has been designed to cool the area surrounding the shield walls in order to prevent any appreciable loss of structural strength due to gamma and neutron heating.

The maximum concrete temperatures were considered as follows:

- A. For normal conditions 150 °F, except that in local areas 200 °F was allowed.
- B. For accident conditions 350 °F for the interior surface, except that in local areas 650 °F from steam and/or water jets was allowed.

3.8.3.4.1.2 Range of Design Variables

The range of design variables that influenced the results of the analyses is identified as follows:

- A. Accuracy of design loads
- B. Variations from assumed load distributions
- C. Future changes in type or magnitude of loads
- D. Frequency of loading and impact
- E. Accuracy of analysis
- F. Design accuracy of member sizing and proportioning
- G. Reliability of specified material strengths
- H. Construction dimensional variations
- I. Service of structure

For the working stress design methods, the effects of the design variables, were included in the values of the allowable stresses. For the ultimate strength design method, the effects of these design variables were accounted for in the load factors and capacity reduction factors.

3.8.3.4.1.3 Computer Programs Used in the Analysis

Computer programs used in the original analysis of internal structures are presented in Table 3.8-3.

3.8.3.4.2 Primary Shield

The primary shield was designed for loads and loading combinations in accordance with Section 3.8.3.3.

ARKANSAS NUCLEAR ONE
Unit 2

The reactor cavity was designed to withstand uplift forces and a differential pressure across the cavity wall resulting from an assumed a hypothetical hot leg slot failure. The area of slot was considered equivalent to twice the cross-sectional area of the pipe.

For a discussion of loads generated by postulated pipe ruptures, see Section 6.2.1. Provisions were incorporated in the reactor cavity design to safely withstand the calculated differential pressure so as to maintain the integrity of the reactor cavity. The maximum stress level in the rebar under this loading condition is limited to 0.9 times the yield capacity of the steel reinforcing.

A critical section in the design of the primary shield is shown in Figure 3.8-15 in the lower right hand area of Section A. This area shows the concrete supports and reinforcement for the base of the reactor vessel support columns. Equation A.4 of Section 3.8.3.3.2.2 was the critical design load combination for this section.

The primary shield was analyzed as a cylindrical pressure vessel utilizing "CE 316-FINEL" computer program. The analysis was based on ultimate strength design in accordance with ACI 318-63 Code. No exceptions to the code have been taken in design of the primary shield.

3.8.3.4.3 Steam Generator Cavities

The steam generator cavities are designed for a differential pressure across the cavity walls resulting from a hypothetical hot leg slot failure. The area of the slot was considered equivalent to twice the cross-sectional area of pipe. The cavities are also designed for jet forces on localized areas of the walls resulting from the impingement of escaping fluid.

A critical section in the design of secondary shield is shown in C-2157 referenced in SAR Table 1.7-2 (see area "A"). Equation A.4 of Section 3.8.3.3.2.2 was the critical design load combination for this section. The secondary shield was analyzed as a series of 10'-0" deep ring beams utilizing "CE 309-STRESS" and "CE-901 STRUDL" computer programs. The analysis was based on ultimate strength design in accordance with ACI 318-63 Code. No exceptions to the code have been taken in design of the secondary shield.

3.8.3.4.4 Refueling Canal

For the refueling condition, the walls are designed for the hydrostatic head due to 39.5 feet of water. The pressure loads due to postulated pipe rupture and hydrostatic head were not considered to occur simultaneously.

3.8.3.4.5 Reactor Coolant System Equipment Supports

The steel and concrete supports for the reactor, the reactor coolant pumps, the steam generators, and the pressurizer were designed for loads supplied by Combustion Engineering (CE) and Westinghouse (WEC) (for sketch of supports see Figure 3.8-13a). These loads included the maximum forces on a support due to accident loads, e.g., pipe rupture, with a dynamic load factor of 2, operating loads, and DBE seismic loads. The directions of the seismic forces were chosen to give the largest load at each support.

The loads were combined using the maximum DBE forces and the maximum accident forces simultaneously. This gave the worst possible design condition that could occur for each support.

ARKANSAS NUCLEAR ONE
Unit 2

The pressurizer support and the reactor coolant pump supports were analyzed by conventional design techniques using the loads as described above.

The reactor and steam generator supports were analyzed by a combination of conventional design techniques and computer programs. The reactor vessel support was analyzed by the "CE 316-FINEL" computer program as described in Section 3.8.3.4.2.

The steam generator upper supports were analyzed by the "CE-901 STRUDL" computer program as described in Section 3.8.4.3. The lower steam generator support is described in Section 3.8.3.1.6 and was analyzed by the "CE-309-STRESS" computer program.

A combination of cold gaps, keyways, and snubbers were provided between the above mentioned equipment and their supports so that minimal thermal loads from the expansion of the equipment will be transmitted to the supports.

In all cases the steel and concrete supports were designed in compliance with the AISC-1969 specification and the ACI 318-63 code, except that in localized areas an increased concrete bearing stress was permitted in accordance with the ACI-318-1971 Code.

3.8.3.5 Structural Acceptance Criteria

Internal structures were designed for structural acceptance criteria as outlined in Sections 3.8.3.2 and 3.8.3.3.2.

The limiting values of stress, strain, and gross deformations were established as follows:

- A. to maintain the structural integrity when subjected to the most severe load combinations; and,
- B. to prevent structural deformations from displacing the equipment to the extent that the equipment suffers a loss of function.

The calculated results for representative structural members of the internal structures shown in Table 3.8-6, indicate the margins of safety provided in the design.

3.8.3.6 Materials, Quality Control and Special Construction Techniques

The internal structures are constructed of concrete and steel using proven methods common to heavy industrial construction.

The range of material properties used for the design were generally identified by standard industry specifications.

3.8.3.6.1 Concrete

Concrete generally conforms to the requirements discussed in Section 3.8.1.6.1, except that a 3,000 psi concrete compressive strength at 28 days and 5,500 psi concrete compressive strength at 90 days are used in the design of the internal structures.

ARKANSAS NUCLEAR ONE
Unit 2

3.8.3.6.2 Steel

The two basic categories of steel used in the internal structures are reinforcing steel and structural steel. A discussion for each category follows.

3.8.3.6.2.1 Reinforcing Steel

Reinforcing steel is described in Section 3.8.1.6.2 with one following exception. Because of construction requirements it was necessary to splice nine #18 reinforcing bars with butt welds around the reactor cavity access opening. A special welding procedure conforming to the requirements of AWS D 12.1-61 was used.

3.8.3.6.2.2 Structural and Miscellaneous Steel

Structural and miscellaneous steel generally conform to the following ASTM specifications:

Rolled shaped, Bars and Plates	A36-69 or A441-70a
High Strength Bolts	A325-70a or A490-67
Other Bolts	A307-68
Stainless Steel	A167, Type 304L

Other types of steel were used in small quantities in the internal structures as required.

Mill test reports are obtained for structural steel materials used.

3.8.3.7 Testing and Inservice Surveillance Requirements

A formal program of testing and inservice surveillance is not planned for the internal structures. The internal structures are not directly related to the functioning of the containment concept; hence, no testing or surveillance is required.

3.8.4 OTHER CATEGORY 1 STRUCTURES

3.8.4.1 Description of the Structures

Seismic Category 1 structures, other than the containment and the internal structures, are:

- A. The Auxiliary Building (portions of reinforced concrete)
- B. The Intake Structure
- C. The Emergency Diesel Fuel Storage Vault
- D. The Emergency Cooling Pond Pipe Inlet and Pipe Outlet Structures
- E. The Electrical Manholes (Seismic Category 1)
- F. Condensate Tank Foundation (T41B)
- G. Condensate Storage Tank (T41B) Pipe Trenches
- H. Post Accident Sampling System Building

Relative locations of all Seismic Category 1 structures are shown in Figure 3.5-1.

ARKANSAS NUCLEAR ONE
Unit 2

3.8.4.1.1 Auxiliary Building

The auxiliary building is located between the Unit 2 Category 1 prestressed concrete containment, the Unit 2 Category 2 steel framed turbine building, and the Unit 1 Category 1 auxiliary building. A complete separation has been provided between the Unit 2 auxiliary building and the adjacent concrete Category 1 structures.

The auxiliary building is essentially an opposite hand duplicate of the Unit 1 auxiliary building and consists of a reinforced concrete structure and a structural steel superstructure.

The reinforced concrete portion is a multilevel structure with floors and slabs transmitting loads to the foundation. The structure is founded on rock. The base mat was designed to resist the hydrostatic loads of the Probable Maximum Flood (PMF). Typical plan and sections of the auxiliary building reinforced concrete structure are shown in Figure 3.8-19. Typical details are shown in Figure 3.8-26.

The boron management holdup tank vaults, which is a monolithic Category 1 appendix to the auxiliary building below grade level, is anchored through its base to the foundation rock to counter uplift forces during high water levels. A plan and a section of this reinforced concrete structure is shown in Figure 3.8-20.

The massive reinforced concrete spent fuel pool is monolithically tied to the remaining part of the auxiliary building. The spent fuel pool is designed to withstand 212 °F temperatures inside the pool without failure and the walls are inherently resistant to missiles. Reinforcing steel which is provided in the spent fuel pool walls will also limit concrete cracking during the expected thermal stresses.

The emergency diesel generator rooms are located in the auxiliary building and are well above the PMF elevation. The two generator units are supported by 42-inch thick reinforced concrete slabs. The Auxiliary Building Extension is located at the north end of the Unit 2 Auxiliary Building. The 335 feet and 354 feet elevations of the Auxiliary Building Extension are not protected from external flooding.

The structural steel superstructure has a framing system supporting the roof and metal siding. The fuel loading crane is supported by steel frames straddling the fuel pool bay. This portion of the Auxiliary Building is Category 2, but is designed to withstand the Design Basis Earthquake. During a tornado, portions of siding and roof deck may be blown off, but the steel frame is designed to assure that it will not collapse or distort so as to allow the bridge crane to fall. Steel frames supporting the roof and crane are checked to assure that stresses do not exceed 90 percent of minimum yield stress if one-third of the siding remains in place. The assumption that only one-third siding remains in place is considered reasonable, since the applied forces are 185 psf on the windward side and 110 psf on the leeward side and the normal allowable design pressure is on the order of 25 psf.

In moving the spent fuel cask from the cask washdown area to the railroad spur opening, the loaded fuel handling crane will pass over the relay panel room ceiling. A more detailed description of the spent fuel cask handling is provided in Section 9.1.4.2.10.

ARKANSAS NUCLEAR ONE
Unit 2

3.8.4.1.2 Intake Structure

The intake structure is located in the southeast corner of the plant site. It is a reinforced concrete Category 1 structure and is considered as an extension of the Unit 1 intake structure. There is no separation between the two structures and both are founded on rock. The structure provides a support for a gantry crane to service the equipment. A floor plan arrangement and a section are shown in Figures 3.8-21 and 3.8-22.

3.8.4.1.3 Emergency Diesel Fuel Storage Vault

The Unit 2 emergency diesel fuel storage vault is located to the west of the containment and is an extension of the Unit 1 diesel fuel storage vault to which it is attached monolithically.

The emergency diesel fuel storage vault is an underground, reinforced concrete structure with only the cover slab and an access shaft projecting above grade level. The structure is founded on rock and rock anchors are used to counter the uplift forces during flood. A thick base mat is designed to resist the hydrostatic loads during the PMF. A floor plan arrangement and a section are shown in Figures 3.8-23 and 3.8-24.

3.8.4.1.4 Pipe Inlet and Pipe Outlet Structures at the Emergency Cooling Pond

The pipe inlet and outlet structures are located on the west tips of the kidney shaped emergency cooling pond in a northwest direction from the containment. They are relatively small, reinforced concrete structures and are partially underground, founded on natural soil and surrounded by backfill materials. Plant arrangements and sections are shown in Figure 3.8-25.

3.8.4.1.5 Electrical Manholes

The Seismic Category 1 electrical manholes are placed at various locations within the plant site. They are relatively small, reinforced concrete structures founded either on natural soil or backfill materials. They are surrounded by backfill material and located partially underground. An access opening in the top slab, at grade level, is provided with a missile resistant reinforced concrete cover. A plan arrangement and a section are shown in Figures 3.8-23 and 3.8-24. A detail of the cover is shown in Figure 3.5-8.

3.8.4.1.6 Condensate Storage Tank (T41B) Pipe Trenches

The pipe trenches are reinforced concrete trenches running from the Condensate Storage Tank (T41B) to both Unit-1 and Unit-2 Auxiliary Building walls. Like the electrical manholes, they are surrounded by backfill material and situated on natural soil or backfill material. They project partially out of the ground and are covered by a missile resistant reinforced concrete cover. A section through the trench is shown in Figure 3.8-34.

3.8.4.1.7 Condensate Storage Tank (T41B) Foundation

The Condensate Storage Tank (T41B) Foundation is located west of the Unit-1 Auxiliary Building approximately 150 feet. It is a 2½ foot thick by 52 foot reinforced concrete octagon mat supported on 42" diameter drilled concrete piers. Two 11.5 x 12.5 x 8.5 feet deep valve pits are located partially underneath and on opposite sides of the foundation. A 5 foot high reinforced concrete wall designed for missile protection surrounds the tank. A general layout of the foundation is shown in Figure 3.8-35.

3.8.4.2 Applicable Codes, Standards and Specifications

Codes, specifications, industry standards, design criteria, Regulatory Guides, and Bechtel Topical Reports which constituted the basis for the design and construction of the Other Category 1 Structures, are described in the following sections. Modifications to these codes, standards, etc. were made when necessary, to meet the specific requirements of the structure. These modifications are indicated in the sections where references to the codes, standards, etc. are made.

3.8.4.2.1 Codes and Specifications

The applicable codes and specifications used in the design of the Other Category 1 Structures are covered in Section 3.8.1.2.1, with the following exception: Item L., "ASME Boiler and Pressure Vessel Code," Sections III, VIII and IX - 1968 Edition, does not apply.

3.8.4.2.2 Industry Standards

Nationally recognized industry standards such as those published by the organizations listed below, were used whenever applicable to describe methods, procedures, and material properties. The specific standards used are identified in the applicable sections.

- A. AASHO - American Association of State Highway Officials
- B. ACI - American Concrete Institute
- C. AISI - American Iron and Steel Institute
- D. ANSI - American National Standards Institute
- E. ASTM - American Society for Testing and Materials
- F. SNT - Society of Nondestructive Testing
- G. SSPC - Steel Structures Painting Council

3.8.4.2.3 Design Criteria

- A. ASCE "Wind Forces on Structures," Paper No. 3269.
- B. "Nuclear Reactors and Earthquake," Publication TID 7024.

3.8.4.2.4 Regulatory Guides

The following regulatory guides were used:

Regulatory Guide 1.15 "Testing of Reinforcing Bars for Concrete Structures," December 1972, as noted in Section 3.8.1.6.2.

Regulatory Guide 1.55 "Concrete Placement in Category 1 Structures," June 1973 except as noted in Section 3.8.1.6.1.6.

ARKANSAS NUCLEAR ONE
Unit 2

3.8.4.2.5 Bechtel Topical Reports

The following document was used to the extent referenced in 3.7:

BC-TOP-4 "Seismic Analysis of Structures and Equipment for Nuclear Power Plants,"
Revision 1, September 1972, and Addendum No. 1, April 1973.

3.8.4.2.6 Structural Specifications

Structural specifications are prepared to cover the areas related to design and construction of other Category 1 structures. These specifications emphasize important points of the industry standards for the other Category 1 structures and reduce options such as would otherwise be permitted by the industry standards. Unless specifically noted otherwise, these specifications do not deviate from the applicable industry standards.

These specifications cover the following areas:

- A. Concrete Material Properties
- B. Placing and Curing of Concrete
- C. Reinforcing Steel and Splices
- D. Structural Steel
- E. Spent Fuel Pool Liner Plate

3.8.4.3 Loads and Loading Combinations

3.8.4.3.1 Load Definitions

The design loads in the load combinations were identified as dead loads, live loads, accident pressure loads, pipe rupture loads, thermal loads, seismic loads, wind and tornado loads, hydrostatic loads and missile loads.

A. Dead Loads

For dead loads, the following specific weights were used:

- 1. Reinforced Concrete 150 lb/ft³
- 2. Structural Steel 490 lb/ft³

B. Live Loads

Floor live loads were considered to be 100 psf for grating floors and 250 psf for reinforced concrete floors.

Snow load was considered to be 20 psf.

ARKANSAS NUCLEAR ONE
Unit 2

C. Pipe Rupture Loads

Forces or pressures on structures caused by pipe rupture were considered. Pipe rupture effects are further discussed in Section 3.6.

D. Thermal Loads

Temperature gradient through the spent fuel pool wall considered a maximum temperature of 212 °F on the inside face of the spent fuel pool wall.

E. Seismic Loads

Seismic loads for the DBE and the OBE were considered. A more detailed discussion is presented in Section 3.7.1.

F. Wind and Tornado Loads

Wind and tornado loads were considered. A more detailed discussion is presented in Section 3.3.1.

G. Hydrostatic Loads

Buoyant forces resulting from the displacement of ground or flood water by the structure and lateral hydrostatic forces were considered. A more detailed discussion is presented in Section 3.4.3.

H. Missile Loads

External and internal missile loads were considered. A more detailed discussion is presented in Sections 3.5.2 and 3.5.3.

3.8.4.3.2 Loading Combinations

The loading cases considered in the design of the Other Category 1 Structures were identified as (1) the normal condition and (2) the accident condition.

The following variables are used in the loading combination equations:

- U = Required ultimate load capacity.
- D = Dead load of structure and equipment plus any other permanent loads contributing stresses, such as hydrostatic loads.
- L = Live load and piping load.
- R = Force or pressure on structure due to rupture of any one pipe.
- T_o = Thermal loads due to temperature gradient through-wall under normal conditions.
- H_o = Force on structure due to thermal expansion of pipes under normal conditions.
- T_A = Thermal loads due to temperature gradient through wall under accident conditions.

ARKANSAS NUCLEAR ONE
Unit 2

- H_A = Force on structure due to thermal expansion of pipes under accident conditions.
- E = Operating Basis Earthquake loads resulting from ground surface acceleration of 0.1 g.
- E' = Design Basis Earthquake loads resulting from ground surface acceleration of 0.2 g.
- A = Hydrostatic load due to probable maximum flood.
- W = Wind load.
- W' = Tornado wind load.
- F_s = Allowable working stress in structural steel.
- F_y = Yield stress of structural steel.

3.8.4.3.2.1 Normal Condition

A. Concrete Structures

Design of concrete structures was in accordance with the following loading combinations:

1. $U = 1.5D + 1.8L$
2. $U = 1.25 (D + L + H_o + E) + 1.0 T_o$
3. $U = 1.25 (D + L + H_o + W) + 1.0 T_o$
4. $U = 0.9 D + 1.25 (H_o + E) + 1.0 T_o$
5. $U = 0.9 D + 1.25 (H_o + W) + 1.0 T_o$

In addition, for ductile moment resisting concrete space frames and for shear walls, the following loading combinations were used:

6. $U = 1.4 (D + L + E) + 1.0 T_o + 1.25 H_o$
7. $U = 0.9 D + 1.25 E - 1.0 T_o + 1.25 H_o$

For structural elements carrying mainly earthquake forces, such as equipment supports, the following loading combination was used:

8. $U = 1.0 D + 1.0 L + 1.8 E + 1.0 T_o + 1.25 H_o$

B. Structural Steel

Steel structures were designed in accordance with the following loading combinations without exceeding the specified stresses:

1. $D + L$ - Stress Limit = F_s

ARKANSAS NUCLEAR ONE
Unit 2

2. $D + L + T_o + H_o + E$ - Stress Limit = $1.25F_s$

3. $D + L + T_o + H_o + W$ - Stress Limit = $1.33F_s$

In addition, for structural elements, carrying mainly earthquake forces, such as struts and bracings, the following loading combination was used:

4. $D + L + T_o + H_o + E$ - Stress Limit = F_s

3.8.4.3.2.2 Accident Condition

A. Concrete Structures

Design of concrete structures was in accordance with the following loading combinations:

1. $U = 1.05 D + 1.05 L + 1.25 E + 1.0 T_A + 1.0 H_A + 1.0 R$

2. $U = 0.95 D + 1.25 E + 1.0 T_A + 1.0 H_A + 1.0 R$

3. $U = 1.0 D + 1.0 L + 1.0 E' + 1.0 T_o + 1.25 H_o + 1.0 R$

4. $U = 1.0 D + 1.0 L + 1.0 E' + 1.0 T_A + 1.0 H_A + 1.0 R$

5. $U = 1.0 D + 1.0 L + 1.0 A + 1.0 T_o + 1.25 H_o$

6. $U = 1.0 D + 1.0 L + 1.0 W' + 1.0 T_o + 1.25 H_o$

B. Structural Steel

Steel structures were designed in accordance with the following loading combination without exceeding the specified stress limits:

1. $D + L + R + T_o + H_o + E'$ Stress Limit = $1.5 F_s$

2. $D + L + R + T_A + H_A = E'$ Stress Limit = $1.5 F_s$

3. $D + L + A + T_o + H_o$ Stress Limit = $1.5 F_s$

4. $D + L + T_o + H_o + W'$ Stress Limit = $1.5 F_s$

For the accident loading combinations, the maximum allowable stress in bending and tension is limited to $0.9 F_y$ and the maximum allowable stress in shear is limited to $0.5 F_y$.

3.8.4.4 Design and Analysis Procedure

The analysis procedures including assumptions of load distribution and boundary conditions for the Other Category 1 Structures, listed in Section 3.8.4.1 were based on conventional methods. The basic analytical techniques may be classified in two groups: (1) methods involving simplifying assumptions such as those found in beam theory, and (2) those based on plate

ARKANSAS NUCLEAR ONE
Unit 2

theories of different degree of approximation. The structures were expected to behave under loads as structural units and were provided with connections capable of transmitting axial and lateral loads by diaphragm action to their foundations.

The structures were, in general, proportioned to maintain elastic behavior when subject to various combinations of dead, live, thermal, seismic, tornado and accident loads. The upper limit of elastic behavior was considered to be the yield strength, F_y , for steel (including reinforcing steel) was considered to be the guaranteed minimum in appropriate ASTM specifications. The yield strength for reinforced concrete structures was considered to be the ultimate resisting capacity as calculated from "Ultimate Strength Design" portion of the ACI-318-63 code.

Reinforced concrete structures were designed for ductile behavior, that is, with reinforcing steel stresses controlling. "The Ultimate Strength Design" portion of the ACI 318-63 code was used.

Under seismic loading, no plastic analysis was considered. Local yielding or erosion of barriers was considered permissible due to pipe rupture loading or missile impact, provided there was no general failure.

Structural steel was designed in accordance with basic Working Stress Design Methods. Increased allowable stresses were used for the accident condition.

The range of design variables that influenced the results of the analyses is considered as follows:

- A. Accuracy of design loads
- B. Variations from assumed load distributions
- C. Future changes in type or magnitude of loads
- D. Frequency of loading and impact
- E. Accuracy of analysis
- F. Design accuracy of member sizing and proportioning
- G. Reliability of specified material strengths
- H. Construction dimensional variations
- I. Service of structure

For the working stress design methods, the effects of the design variables were included in the values of the allowable stresses. For the ultimate strength design method, the effects of these design variables were accounted for in the use of load factors and capacity reduction factors.

Seismic Category 2 structures whose collapse could result in loss of required function of Seismic Category 1 structures, equipment or systems were either:

- A. analyzed for the loading combination given in Section 3.8.4.3.2; or,
- B. structurally separated from the Category 1 structures to assure that interaction does not occur.

Computer programs used in the original analysis of the Other Category 1 Structures are presented in Table 3.8-3.

ARKANSAS NUCLEAR ONE
Unit 2

3.8.4.5 Structural Acceptance Criteria

The Other Category 1 Structures were designed for structural acceptance criteria as outlined in Sections 3.8.4.2 and 3.8.4.3.2.

The criteria to limit values of stress, stain and gross deformations for the Other Category 1 Structures were established as follows:

- A. To maintain structural integrity when subjected to the most severe load combinations, and
- B. To prevent structural deformations from displacing the Category 1 equipment to the extent that it suffers a loss of function.

The calculated results for representative structural members of the Other Category 1 Structures, shown in Table 3.8-7, indicate the margins of safety provided in the design.

3.8.4.6 Materials Quality Control and Special Construction Techniques

The Other Category 1 Structures are constructed of concrete and steel using proven methods common to heavy industrial construction. The range of material properties for design was generally identified by standard industry specification.

3.8.4.6.1 Concrete

Concrete generally conformed to the requirements discussed in Section 3.8.1.6.1, except that a 3,000 psi concrete compressive strength at 28 days was used for the Other Category 1 Structures.

3.8.4.6.2 Steel

The two basic categories of steel used in the Other Category 1 Structures are reinforcing and structural steel. A discussion for each category follows.

3.8.4.6.2.1 Reinforcing Steel

Reinforcing steel generally conformed to the requirements discussed in Section 3.8.1.6.2, except that #14 and #18 reinforcing bars were not used.

Reinforcing steel was lap spliced in accordance with ACI 318-63, except at local areas around temporary construction openings where "Dywidag" threaded bars were used as dowels lapped with the normal reinforcing steel. The dowels were spliced with "Dywidag" mechanical connectors at the perimeter of the openings. Splicing of reinforcing steel by welding or by use of cadwelds was not done.

Dywidag mechanical connectors were used for the following reasons:

- A. The Grade 60 reinforcing steel specified is generally difficult to weld properly. Welding procedures are available but are generally more complicated than those used for welding low carbon steels and involve both preheating of the steel as well as post-weld heat treatment.

ARKANSAS NUCLEAR ONE
Unit 2

- B. Both conventional lap splices and welded splices require the reinforcing to project into the construction opening in order for the splice to be completed at the time the temporary construction opening is closed. The protruding rebars therefore require a larger temporary construction opening in the concrete slab or wall to allow for equipment access. In addition to the larger opening size there is the potential danger of damage to the reinforcing in the event the projecting rebars are accidentally bent during construction. Some openings may remain open for a period of a year or more.

Installation of the Dywidag connectors was done in accordance with the manufacturer's instruction except that the joint nuts were tightened and manually torqued using a 24-inch wrench instead of a torque wrench. Drawings were prepared for each opening showing the connector size and spacing. Visual inspection was made for verification and conformance with the placement drawings. Field inspection reports were prepared for each opening.

The method used in making a splice is straightforward and required only normal techniques with which an ironworker is familiar.

Two types of tests were used in connection with the connectors. First a user's test was made on the threaded rebar at a frequency of two tests per order or two tests per mill heat number.

The second test consisted of testing completed test assemblies at the rate of one test per 100 installed splices. The manufacturer's procedures were followed in making the splices except that a 24-inch wrench was used to manually torque the joint nut instead of using a torque wrench. This is the same procedure as for the splices in the structures.

A lower test frequency than that used for cadwelds is justified due to a less complicated installation procedure and the ability to visually inspect splices to determine compliance with the manufacturer's criteria since the splice is completed in stages when employed in temporary construction openings.

The test results show that the minimum ultimate strength of this completed test splice was in excess of 100 ksi which exceeds the minimum specified ultimate strength of 90 ksi for the Grade 60 reinforcing steel furnished for the project.

Dowels for plugs in temporary opening, including the "Dywidag" splice, were at least one size larger than the designed wall or slab reinforcing steel. On this basis the minimum connector called for was a #10 while the maximum main reinforcement was a #9. Therefore an allowance for minor installation variations has been made.

In most cases the tensile capacity of the connector has not been considered in the design of the closure. The wall or slab closure in general has been considered as a point simply supported either for one- or two-way action as the condition required.

For the case where only shear is transferred by the connectors, the maximum shear stress in the rebar is well below the allowable value for this material. Where tensile stresses are transmitted through the connector, the connector has an additional safety factor of 27 percent or more by virtue of the larger size connector assembly used in place of the designed reinforcement.

ARKANSAS NUCLEAR ONE
Unit 2

The wall at column line 1 between column lines A2 and B2 was determined to have the worst case stress conditions for connections.

- A. The height of the temporary construction opening is approximately half the height of the wall and the connectors provide continuity for the vertical and horizontal wall spans.
- B. The wall is an external wall subjected to tornado wind loadings and is a shear wall resisting earthquake loads.

All of the load combinations shown in Section 3.8 were evaluated to determine which combination would give the highest stresses in the connector. The controlling load combination was Equation 6 in Section 3.8.4.3.2.2.A which has the tornado wind as the major load. After the temporary construction opening is closed, the wall will act as a unit. The wall is continuous at its bottom and sides, but is not continuous at the top support. To simulate as close as possible the as-built conditions, a flat plate analysis was used assuming that the wall is simply supported on the top and fixed on the other three sides as shown in Figure 3.8-32.

The location of the maximum stresses and stress gradations in the concrete, the connectors, and the reinforcing steel in the wall are shown on Figure 3.8-32 and Tables 3.8-9 and 3.8-10.

The moment and reaction gradations are obtained from Figures 10 and 17 of "Moments and Reactions for Rectangular Plates" by W.T. Moody, a Water Resources Technical Publication Engineering Monograph, No. 27, dated July 1963.

Floor Slab Temporary Construction Opening

The temporary construction openings in slabs were designed as one-way simply supported slabs, supported on seats in the direction of the span. The mechanical connectors were used around the perimeter of the opening. Because of the design assumptions, there theoretically would be no stress in the connectors. Therefore, the connectors are not required for structural reasons.

In the case of the largest slab temporary construction opening shown on Figure 3.8-30 between column lines 1 and 2, A2 and B2, the 4-foot splice length can resist the developed negative moment if the support is assumed fixed. The stress level in a #10 bar developed by the negative moment is about 25,000 psi.

The method of transferring tensile stresses from the reinforcing steel to the thread bar connector, and back to the reinforcing steel is by the use of a lap splice between reinforcing steel and the thread bar of the connectors as shown in Figure 3.8-33. The bond length used for developing the connector in walls was the tension lap length required by ACI Standard 318-63 for ultimate strength design based on the reinforcing steel bar diameter. In the case of floor openings, where the closure was designed as a simply supported slab, a nominal splice length of four feet was used. The use of the sample bond values for the thread bar as for the reinforcing steel is justified by the comparison of data supplied by the manufacturer and the deformation requirements set forth in ASTM A615-68.

The Columbia University test data on the #11 bar shows a minimum yield point load of 101,000 pounds which is larger than the required yield point load of 93,600 pounds. The 46,800 pounds is a load for a 15-minute hold time during the test and not the ultimate strength

ARKANSAS NUCLEAR ONE
Unit 2

which was 145,000 pounds. In order to show the sensitivity of the connector strengths to different torque values used to tighten the jam nuts, a test program was conducted using complete assemblies (three tests per torque value) torqued to 100, 500, 700 and 1000 foot-pounds. Three assemblies were also torqued manually with a 24-inch wrench in the same manner as the production assemblies. Test results including slippage, yield strength, tensile strength, and location of fracture of the test assembly are shown in the test slippage data which was forwarded to the staff by letter from J.D. Phillips to J. Stolz dated May 5, 1976, (2CAN057601).

Since #10 connectors were not readily available at the time of the tests, only #11 connectors were used in the initial test program. The test data on #10 connectors was submitted August 5, 1976 (2CAN087605).

The tests discussed above are the user's tensile tests on the thread bar. The mill test reports submitted are a part of the documentation for the Columbia University test. The user test reports performed to date were forwarded with the test slippage data noted above.

The test results of the production splice assemblies were included in the user's threaded rebar tensile test reports described above. These reports show the test tensile strength of threaded bars as well as assemblies and the failure location. The minimum required tensile strength was also included in the reports as a splice acceptance criterion.

The reinforcing steel used in the mechanical splices fully conformed to the requirements of ASTM A615-68, Grade 60, as described in Section 3.8.1.6.2. The manufacturer's documentation included certified mill test reports and certified splice test reports. In addition to the manufacturer's documentation, user's tests were also conducted. The testing frequency required was one tensile test of a splice assembly for each 100 splices or at least two splice tests for each shipment or mill rolling heat. The results of the user's tests confirmed that the tensile strengths of these splices equaled or exceeded 125 percent minimum yield strengths specified for the reinforcement.

3.8.4.6.2.2 Structural and Miscellaneous Steel

Structural and miscellaneous steel generally conformed to the following ASTM specifications:

Rolled shaped, bars and plates	A36-69 or A441-70a
High strength bolts	A325-70a or A490-67
Other bolts	A307-68
Stainless steel	A167, Type 304L

Other types of steel are used in small quantities in the Other Category 1 Structures as required.

Mill test reports are obtained for structural steel materials used.

3.8.4.7 Testing and Inservice Surveillance Requirements

Testing and inservice surveillance are not required for Category 1 structures other than the containment and no formal program of testing and inservice surveillance is planned.

3.8.5 FOUNDATIONS AND CONCRETE SUPPORTS

3.8.5.1 Descriptions of the Foundations and Supports

All Category 1 Structures except the emergency cooling pond inlet and outlet structures and Category 1 electrical manholes are founded on competent un-weathered bedrock. The properties of the bedrock materials are discussed in Sections 2.5.4.10 and 2.5.4.11. The emergency cooling pond inlet and outlet structures are founded on natural soil and the Category 1 electrical manholes are founded on natural soils or backfill materials.

3.8.5.1.1 Containment Foundation

The containment foundation is a thick heavily reinforced concrete circular slab bearing directly on rock. At the perimeter the slab provides (1) a fixed support for the containment cylinder wall allowing for a load transfer from the wall to the base slab and (2) an anchorage area for the vertical tendons.

A complete separation has been provided between the containment base slab and the adjacent auxiliary building foundation slab. The general arrangement of the containment, including its base slab, are discussed in Section 3.8.1.1 and shown in Figures 3.8-1, 3.8-2, 3.8-4, 3.8-5 and 3.8-19.

3.8.5.1.2 Internal Structures Foundations and Supports

The foundation for the internal structures is provided by the reinforced concrete containment base slab. The walls and columns of the internal structures are anchored to the base slab and allow for a load transfer from the structure to the base.

The general arrangement of the supports for the internal structures, including the support structure for the equipment are discussed in Sections 3.8.3.1.1, 3.8.3.1.2, 3.8.3.1.6 and shown in Figure 3.8-15. The support structures for the major NSSS equipment are also further discussed in Section 5.5.14.

3.8.5.1.3 Other Category 1 Structures Foundations

3.8.5.1.3.1 Auxiliary Building, Intake Structure and Emergency Diesel Fuel Storage Vaults

The foundations for these structures are provided by thick, reinforced concrete slabs. Fixed connections with the walls and columns of these structures allow for a load transfer into the base. The foundations of these three structures bear directly on rock. Each structure is physically separated from the other. The emergency diesel fuel storage vault structure's foundation and part of the auxiliary building that houses the boron management holdup tanks are provided with rock anchors to transmit uplift forces during flood into the foundation rock. The general arrangement of the structures, including their foundations are discussed in sections and shown in figures as follows:

- A. Auxiliary building in Section 3.8.4.1.1 and Figures 3.8-19 and 3.8-20.
- B. Intake structure in Section 3.8.4.1.2 and Figure 3.8-22.
- C. Emergency diesel storage vault in Section 3.8.4.1.3 and Figure 3.8-24.

3.8.5.1.3.2 Emergency Cooling Pond Inlet and Outlet Structures, Category 1 Electrical Manholes and the Condensate Storage Tank (T41B) Pipe Trenches

The reinforced concrete foundations of these structures provide a fixed support for the walls transmitting loads to them. These structures are relatively small and the relatively light loads are transmitted to the natural soils or backfill materials. Their foundations are completely independent of each other and of foundations for other structures. The general arrangement of the supports for these structures is discussed in sections and shown in figures as follows:

- A. Emergency cooling pond inlet and outlet structures in Section 3.8.4.1.4 and Figure 3.8-25.
- B. Electrical manholes in Section 3.8.4.1.5 and Figure 3.8-24.
- C. Condensate Storage Tank (T41B) Pipe Trenches in Section 3.8.4.1.6 and Figure 3.8-34.

3.8.5.1.3.3 Foundation for the Refueling Water Tank

The foundation for the refueling water tank, which is Seismic Category 1 component, is provided by a thick reinforced concrete cover slab of the boron management holdup tank vaults of the auxiliary building. Loads from the cover slab are transmitted through walls into the vaults' base slab, bearing directly on rock. Anchors extending from the base slab are designed to transmit uplift forces during a flood into the foundation rock.

The general arrangement is shown in Figure 3.8-20.

3.8.5.1.3.4 Condensate Storage Tank (T41B) Foundation

The CST foundation is a thick concrete slab supported by drilled piers which bear directly on rock. The piers were sized for the bearing capacity of 38 ksf of the rock. The general arrangement of this foundation is discussed in Section 3.8.4.1.7 and shown in Figure 3.8-35.

3.8.5.2 Applicable Codes, Standards and Specifications

Applicable codes, standards and specifications which constituted the basis for the design and construction of the foundations and supports were as discussed in Section 3.8.1.2 for the containment, in Section 3.8.3.2 for the internal structures and in Section 3.8.4.2 for the Other Category 1 Structures.

3.8.5.3 Loads and Loading Combinations

Loads and loading combinations which constituted the basis for the design of foundations and concrete supports were as discussed in Section 3.8.1.3 for the containment, in Section 3.8.3.3 for the internal structures and in Section 3.8.4.3 for the Other Category 1 Structures.

Expected settlement of Category 1 Structures founded on rock is discussed in Section 2.5.4.10.

Structures founded on natural soil or backfill materials are completely independent of each other and produce relatively light loading on the foundation soil. They were not expected to produce any significant settlement.

3.8.5.4 Design and Analysis Procedures

Design and analysis procedures used in the design of foundations and supports were as discussed in Section 3.8.1.4 for the containment, in Section 3.8.3.4 for the internal structures, which include the major concrete support structures, and in Section 3.8.4.4 for the Other Category 1 Structures.

Computer programs used in the original design of the Category 1 Structures and their foundations and concrete supports are presented in Table 3.8-3.

3.8.5.5 Structural Acceptance Criteria

The foundations of all Category 1 structures meet the same structural acceptance criteria as discussed in Sections 3.8.1.5, 3.8.3.5, and 3.8.4.5. The limiting conditions for the foundation medium together with a comparison between actual capacity and estimated structure loads are found in Sections 2.5.4.10 and 2.5.4.11. Calculated results of foundation loads are given in Table 3.8-6.

A minimum factor of safety of 1.5 against overturning was maintained for all structures and supports. Overturning moments were determined from the dynamic analysis of the structures or were established using the following simplified method. The mass and center of gravity of the structure were calculated based on dead loads. A horizontal acceleration was applied to the mass. This acceleration was based on the natural frequency of the structure as determined in the dynamic analysis, or was based on the peak of the appropriate response spectrum curve. The resisting moment to overturning was calculated using the dead load of the structure and included the effects of vertical seismic acceleration.

The foundation bearing pressures shown in Table 3.8-8, when compared with the allowable bearing pressures, show that the un-weathered shale foundation medium can safely support the pressures caused by overturning moments.

Category 1 electrical manholes and the emergency cooling pond inlet and outlet structures are surrounded by backfill material. Since the lateral forces for these structures are resisted by passive earth pressures, the effects of overturning moments on the foundation medium were not considered.

The calculated results for representative portions of the containment and other Category 1 structures and foundations, shown in Tables 3.8-4, 3.8-6, and 3.8-8, indicate the margins of safety provided in the design.

3.8.5.6 Materials Quality Control and Special Construction Techniques

The foundations and concrete supports are constructed of reinforced concrete using proven methods common to heavy industrial construction. The same discussion applies as is provided for the structures themselves in Sections 3.8.1.6, 3.8.3.6 and 3.8.4.6.

3.8.5.7 Testing and Inservice Surveillance Requirements

Testing and inservice surveillance are not required and are not planned for foundations of structures or for concrete supports. A discussion of the test program which serves as the basis for the Soils Investigation and Foundation Report may be found in Section 2.5, Geology and Seismology.

3.9 MECHANICAL SYSTEMS AND COMPONENTS

3.9.1 DYNAMIC SYSTEM ANALYSIS AND TESTING

3.9.1.1 Vibration Operational Testing

Safety-related piping systems have been designed in accordance with the ASME Code, Section III.

In order to comply with the Code, each system has been designed to minimize dynamic effects but, due to the complexities of analyzing these effects, an initial test program was also implemented.

[The remainder of the section (Section 3.9.1.1) is historical information; it was written for submittal in the FSAR to describe the testing to be conducted during initial startup.]

The initial test program for the Class 1, 2, and 3 piping systems will simulate actual operating modes to demonstrate that the appurtenances comprising these systems will meet functional design requirements.

Piping systems will be checked in three sequential series of tests and inspections. Construction acceptance, the first step, entails inspection of components for correct installation according to codes, specifications and drawings. During this phase, pipe and equipment supports will be checked for correct assembly and setting based on calculations. The cold locations of Reactor Coolant System (RCS) components such as steam generators and reactor coolant pumps will be recorded.

During the second step of testing, plant heatup, the plant will be heated to normal operating temperatures. During the heatup, expansion data will be recorded and all systems will be observed periodically to verify proper expansion.

During the third step of testing - performance testing - systems will be operated and performance of the pumps, valves, controls, and auxiliary equipment checked. This phase of testing will include transient test, such as reactor coolant pump trips, reactor trip and relief valve testing. During this phase of testing, the piping and piping restraints will be observed for vibration and expansion response. Automatic safety devices, control devices and other major equipment will be observed for indications of overstress, excess vibration, overheating and noise. Also, to verify the piping design for water hammer, each system test will include valve operation during transient system modes.

Vibratory dynamic loadings can be placed in two categories: transient induced vibrations, and steady state vibrations. The first is a dynamic system response to a transient time dependent forcing function, e.g. fast valve closure, while the second is a constant vibration, usually flow induced.

A. Transient Response

Dynamic events falling into this category are anticipated operational occurrences. The systems and the transients to be included in the initial test program are:

1. Main Steam Turbine Stop Valve Trip
2. Main Steam Relief Valve Blowdown

ARKANSAS NUCLEAR ONE
Unit 2

For those types of transients listed above, a time dependent dynamic analysis is performed on the system. The stresses thus obtained are combined with system stresses resulting from other operating conditions in accordance with Table 3.9-2.

Since a comprehensive dynamic analysis has been performed on these systems, movements in excess of those calculated are not anticipated.

B. Steady State Vibration

System vibrations resulting from flow disturbances fall into this category. Positive displacement pumps may cause such flow variations and vibrations and as such are reviewed. Therefore, the charging system will be checked.

Since the exact nature of the flow disturbances is not known prior to pump operation, no analysis is performed. If system vibration is evident during initial operation, the maximum amplitudes will be measured. The acceptance criteria is that the maximum measured amplitudes shall not induce a stress in the piping system greater than one-half the endurance limit as defined in ASME Section III, 1971.

If required, additional restraints will be provided to reduce stresses to acceptable levels.

The testing required to demonstrate satisfactory response to steady state and transient operation is described in the test summaries of Chapter 14. No additional tests are planned to verify pipe break assumptions for high and moderate energy systems outside the containment, inasmuch as such an evaluation would have to include seismic stress levels which cannot be verified by testing.

3.9.1.2 This Text Has Been Deleted

See Section 3.9.3.3.

3.9.1.3 Dynamic Testing Procedures

The methods employed to ensure the design adequacy of the NSSS are described in Section 3.7.

The valves in the plant that are necessary for a safe shutdown and that are subjected to the severest of operating conditions are the active, Category 1, reactor coolant pressure boundary valves, as defined in 10 CFR 50. Unit 2 has 14 motor-operated valves that meet this definition and receive an ES signal. They are required to actuate upon an engineered safety features actuation signal and to either isolate the containment or to open an engineered safety features system flow path. These valves are described in Table 3.9-6. (The list originally included the RCP controlled bleedoff isolation valve, which was subsequently determined not to be part of the RCPB. Although classified as active RCPB valves, check valves in the RCPB and the hot leg injection valves on the HPSI headers are not included in this list because they do not receive an ES signal; see Section 5.2.)

ARKANSAS NUCLEAR ONE
Unit 2

A summary of these valves is as follows:

<u>Valve</u>	<u>Size</u>	<u>Quantity</u>	<u>System</u>
High Pressure Safety Injection	2"	8	Safety Injection System (SIS)
Low Pressure Safety Injection	6"	4	SIS
Letdown Isolation	2"	2	Chemical & Volume Control System (CVCS)

All of these valves received extensive preoperational testing prior to initial fuel loading. (The original HPSI and LPSI valves have been replaced.) The electric motor operators for these valves are all of the Limatorque SMB series and have a history of qualification testing used to verify their reliability and operability. It is to be noted that while they are all designed to RCS pressures and temperatures, their actual operating conditions are lower and, in the case of the Low Pressure Safety Injection (LPSI) valves, an order of magnitude lower. Extensive testing has been carried out by the valve operator manufacturer and by an independent institute. The testing has been done over a number of years and the most recent testing (at the time of license application) in the summer of 1972 bears out the operability confirmed initially.

A. Manufacturer's Electric Motor Operator Qualification Testing

1. Shock and Vibration Testing

In August 1970, a Limatorque SMB Series operator was mounted on a test stand having a threaded valve stem driven by the operator simulating opening and closing a valve. The operator was electrically connected so as to stop at the full open position by means of a geared limit switch. The operator had a 4-train geared limit switch installed and all contacts not being used for motor control were wired to electric indicating lights at a remote panel.

The unit successfully completed a 5.3 G shock level at 32 Hz with no discrepancies noted. An exploratory scan of 5 to 35 Hz was made and no critical resonant frequencies were noted on the operator. The unit was shocked and vibrated in each of three different axes a total of two minutes on, one minute off, three times per axis. The unit was operated electrically to both the full open and full close position and all torque switches and limit switches functioned properly. None of the auxiliary limit switches wired to indicating lights ever flickered or indicated they were opening. All electrical and mechanical devices on the operator worked successfully.

2. Heat Testing

In January 1969, a completely assembled and operational SMB series operator was placed in an oven where the temperature was maintained at approximately 325 °F for a duration of 12 hours. The unit was electrically operated every 30 minutes for a period of approximately two minutes per cycle and the geared limit switches were used to stop the actuator at the full open and full closed position of travel. Indicating light circuits were also wired to the geared limit switches.

ARKANSAS NUCLEAR ONE
Unit 2

The test was successful in every respect. There were no malfunctions of the operator. And, upon inspection of the component parts used, there was no noticeable deterioration or wear.

3. Live Steam Testing

In January 1969, a complete SMB series operator was set up for electrical operation and live steam was piped into the conduit taps on the top of the limit switch compartment. One of the bottom conduit taps was left open to drain any condensate. The operator was set up on a timer basis for operation over a period of approximately nine hours and operating every 30 minutes for two minutes per cycle. During this test, the live steam in the switch compartment seemed to have no effect whatever on the function of the limit switches in their control of the operator at the full open and full closed position of travel. In addition, the limit switches were wired up to indicating lights which operated satisfactorily.

The test was successful and there was no noticeable effect on the function of any of the parts in the limit switch compartment.

4. Life Cycle Testing

In January 1969, the operator was mounted on a stand inside a test chamber and a 150-cycle load test was made on the unit. This test cycle consisted of stroking a 2 3/8-inch diameter valve stem at a speed of six inches per minute for a total of approximately 12 inches in two minutes. The valve stem in the full closed position produced a thrust of 16,500 pounds on a rigid plate securely bolted to the test chamber. The unit was wired for torque seating control in the closing direction and position limiting control in the open direction.

After the life cycle testing was completed, the unit was inspected and found to be in excellent condition. There was no noticeable wear on any of the parts.

5. Simulated Accident Environment Testing

An electric motor operator was tested under conditions which simulated the temperature humidity and chemical environments that could be expected to exist in the containment following some postulated accident such as the rupture of a major reactor coolant pipe.

The operator was placed in an Autoclave type chamber and subjected to 90 psig saturated steam. At specified intervals the operator was cycled to assure proper operation. Forty minutes after the introduction of steam a 1.5 percent boric acid solution was sprayed on the operator assembly. The operator continued to operate satisfactorily. Later, the steam pressure was periodically reduced to simulate post-accident conditions. The boric acid spray was allowed to continue for four hours. The steam pressure was eventually reduced to 15 psig. The test continued for seven days.

During this time the operation of the operator became erratic. The corrosive effects of the steam and boric acid spray caused electrical contact malfunctions which were bypassed by the use of an appropriate jumper. The valve continued to cycle during the 7-day period.

ARKANSAS NUCLEAR ONE
Unit 2

A design change was made to the limit switch in order to correct the erratic operation. It was tested under similar accident conditions and found to operate satisfactorily. This design change has been incorporated into all subsequent applicable models of this operation.

B. Independent Testing - Franklin Institute Tests

More recent tests of the Limatorque SMB series operator were conducted during the summer of 1972 by the Franklin Institute Research Laboratories. In these tests the operator was exposed to gamma radiation (200 megarads), a steam/chemical environment (for 12 days), a steam environment at temperatures going as high as 340 °F during the first day (test consisted of a 30-day exposure) and a seismic test similar to those in August, 1970. During all of these tests, as appropriate, the operator was periodically cycled and found to operate satisfactorily (References 32 and 33).

C. Valve Purchase Specification

In addition to a proven record as verified by the previous testing, the valve vendor must also comply with the purchase specification requirements. The purchase specifications for these valves require that they be hydrostatically tested, leak tested and cycled from the extremes of allowed movement of opened or closed. The hydrostatic test is in accordance with the ASME Boiler and Pressure Vessel Code. The seat leakage test is in accordance with the edition of MSS-SP-61 which was in effect when the valves were purchased as modified by the purchase specifications. Valves will not show a leakage greater than 2 cubic centimeters per hour per inch of diameter of nominal valve size, or permanent deformation when the valves are submitted to two times design pressure, except that the stress developed at test pressure shall not exceed 90 percent of the specified minimum yield strength based on the minimum specified wall thickness.

The valve vendor is also required to submit calculations which show that when the valve assembly is subjected to a 3g horizontal force and a 3g vertical force that stresses incurred are within the code allowable stresses. We have also verified that the first natural frequency is above 20 cps for all 14 original valves.

D. Preoperational Testing

Testing procedures for valves that require operation to meet Engineered Safety Features (ESF) requirements were quite extensive during the preoperational testing program. These tests demonstrate proper installation, strength and functional performance of valves. Subsequent to satisfactory preoperational testing, surveillance testing requirements were established to assure continued satisfactory operation of these valves. Furthermore, if maintenance or repair of these valves is required, appropriate functional testing will be accomplished to assure proper operation subsequent to the maintenance or repair.

[The description of Items 1 through 4 below is historical information; it was written for submittal in the FSAR to describe these preoperational tests.]

ARKANSAS NUCLEAR ONE
Unit 2

1. System Electrical Test

The purpose of these tests is to verify electrical characteristics of valve operators in performing their function. Preliminary checkout of the operator valve assembly requires that the valve be free to move. If the motor operated valve travels in the wrong direction from its mid-travel position, its breaker must be tripped immediately as there would be no torque limit protection. The valve can be operated manually with a handwheel to ascertain its freedom of movement.

The phase rotation of the operator is checked. During valve operation, verification that the valve travel and motor are stopped is done by closing the torque limit switch. Similarly the opening of the valve is terminated by the opening of the limit switch.

In checking the valve for ESF actuation, the valve is placed in the position opposite to its ESF position and then an ESF actuation signal is simulated.

Then the control room switch is turned to the opposite position of ESF operation and the valve is verified as remaining in its ESF position. Similarly, turning the circuit breaker panel switch to the opposite position of ESF operation has no effect on the valve.

Acceptance criteria for these electrical tests are:

- a. Valves must open, close, and travel in the proper direction in response to control and engineered safety features signals.
- b. The valve open and closed indicating lights must indicate correctly.
- c. Valve motor resistance to ground readings must be within specification.
- d. The specified valve travel time is within specification requirements.

2. System Engineered Safety Features

The purpose of these tests is to demonstrate actual valve performance for its intended ESF use. Initially all valves are placed in their non ESF position prior to simulating an ESF signal. Upon initiation of an ESF signal the tests for the subject valve demonstrate containment isolation and also emergency injection flow capacity to the RCS from the Low Pressure Safety Injection (LPSI) system and the High Pressure Safety Injection (HPSI) system.

3. System Functional Testing

The purpose of this testing is to verify that the valves perform as intended for normal operation. Cycling the valves under conditions of specified differential pressure and/or flow that may be encountered during plant operation will verify that the valve motor does not exceed maximum operating current and cycle time.

ARKANSAS NUCLEAR ONE
Unit 2

4. Integrated ESF Actuation Test

The purpose of this test, for which these valves are used to perform is to demonstrate the full operational sequence that would bring the Emergency Core Cooling Systems (ECCSs) and the containment pressure reducing systems into action, including the transfer to alternate power sources.

General acceptance criteria for this test are:

- a. The ESF systems operate as described in the FSAR.
- b. Upon actuation of the ESF signal, HPSI and LPSI to the RCS are supplied in accordance with FSAR requirements.
- c. Upon loss of normal station power, the ESF systems continue to perform their designed functions without interruption.

Following completion of the preoperational test program and issuance of an operating license for the facility these valves are functionally tested as required by the Technical Specifications.

It should be noted that the maximum acceleration for the specific piping systems at the locations of these valves will be less, by design, than the maximum g-force in either the horizontal or vertical direction that the fifteen valves are required to withstand during testing. The entire scope of testing verifies the valves' operability from conditions of extreme duress to normal operation. The results of the earliest environmental, vibratory, and load testing have been verified in later testing by independent research (References 32 and 33).

For other Category 1 mechanical equipment, the manufacturer was required to determine the natural frequency of the equipment, including the supports. The adequacy of the "g" value specified in the component specification was then confirmed.

The static "g" values supplied for principal Category 1 equipment are listed in Table 3.9-1.

In shock and vibration testing of active valve electric motor operators, loads were not applied simultaneously in vertical and horizontal directions because the operators are characterized by Items A, B and C below:

- A. The nature of the equipment is such that the resonance frequencies can be validly identified by sine sweep testing;
- B. Not more than one of the resonance frequencies is below 33 Hz; and,
- C. The absence of significant directional coupling (from the standpoint of response or failure mode) can be determined by inspection or by comparison with tests of similar equipment.

Electrical motor operators and valves were mounted to the test table using the same support points by which they are mounted in the plant. More specifically, valves were mounted from pipe stubs attached to the ends of the valves and motor operators were mounted to the table using the same hardware at the same locations as were used in plant installation.

3.9.1.4 Dynamic System Analysis for Reactor Internals

3.9.1.4.1 Introduction

The flow induced vibration of the core support barrel system, during normal operation, was characterized as a forced response to both deterministic (periodic and transient) and random pressure fluctuations in the coolant. Methods were developed to predict the various components of the hydraulic forcing function and the response of the reactor internals to such excitation. An analytical method based on a theoretical solution of the appropriate governing hydrodynamic differential equations for a mathematically tractable geometry was used to develop the periodic hydraulic forcing function.

The response of the core support barrel system to the normal operating loads was combined with the seismic and LOCA analyses for comparison with the criteria specified in Section 4.2.2.

The effect of cross and parallel flow on the tubular Control Element Assembly (CEA) shrouds and fuel elements has been evaluated analytically by conservative application of techniques and parameters presented in the literature.

3.9.1.4.2 Periodic Forcing Function

An analysis based on an idealized hydrodynamic model was employed to obtain a basic understanding of the relationship between reactor coolant pump pulsations in the inlet ducts and the periodic pressure fluctuations on the core support barrel. The idealized model represented the annulus of coolant between the core support barrel and the reactor vessel. In deriving the governing hydrodynamic differential equation for the above model, the fluid was taken to be compressible and inviscid. Linearized versions of the equations of motion and continuity were used. The excitation of the hydraulic model was assumed harmonic with the frequencies of excitation corresponding to the pump rotational speed, 20 Hz, its first harmonic, 40 Hz, the blade passing frequency, 100 Hz, and its first harmonic, 200 Hz. The result of the hydraulic analysis was a system of equations which defined the force response, natural frequencies and natural modes of the hydrodynamic mode. The forced response equations defined the spatial distribution of pressure on the core support barrel system as a function of time, space and excitation and natural hydraulic frequencies.

3.9.1.4.3 Random Forcing Function

The random hydraulic forcing function was developed by analytical and experimental methods. An analytical expression was developed to define the turbulent pressure fluctuation for fully developed flow. This expression was modified, based upon the result of scale model testing, to account for the fact that flow in the downcomer is not fully developed. In addition, experimentally adjusted analytical expressions were developed to define the peak value of the pressure spectral density associated with the turbulence and the maximum area of coherence, in terms of the boundary layer displacement, across which the random pressure fluctuations are in phase.

3.9.1.4.4 Mathematical Model

A finite element model of the core support barrel system was developed, as shown in Figure 3.9-1. Frequencies and mode shapes of the core support barrel in air were obtained using the ASHSD program (Reference 49). Evaluation of the reduction of these frequencies for the system immersed in coolant was made by means of the "virtual mass" method outlined in Reference 49.

3.9.1.4.5 Response Analysis

3.9.1.4.5.1 Deterministic Response

The normal mode method was used to obtain the structural response of the core support barrel system to deterministic forcing functions. Generalized masses based on mode shapes and the mass matrix from the shell finite element computer program were calculated for each core support barrel mode of vibration. Modal force participation factors, based on the mode shapes and the predicted periodic forcing functions, were calculated for each mode and forcing function. The generalized coordinate response for each mode was then obtained through solution of the corresponding independent second order, single degree of freedom equation. Utilizing displacement and stress mode shapes from the shell finite element computer program, the structural response of the core support barrel for each mode was obtained by means of the appropriate coordinate transformations. Response to the composite forcing function was obtained through summation of the component modes.

The results of these calculations show that the maximum stress is well below the design allowable fatigue stress specified by the ASME Code, Section III.

The effect of crossflow on the tubular CEA shrouds and fuel elements was determined using analytical procedure outlined in Reference 70. This evaluation involved determination of the von Karmen vortex shedding frequencies and the tube natural frequencies, a comparison of the tube and shedding frequencies, and determination of the tube vibration amplitude and stress. The effect of paralleled flow was evaluated using the empirical relation in Reference 74. The stability criterion, presented in Reference 52, for predicting the critical flow velocity above which severe tube vibrations can result, was applied to the CEA shrouds and fuel elements.

The above analysis shows the CEA shroud and fuel elements to be structurally stable in the reactor flow and to have structural responses, due to cross and paralleled flow, which are well within design allowables.

3.9.1.4.5.2 Random Response

The random response analysis considered the response of the core support barrel system to the turbulent downcomer flow during steady state operation. The random forcing function was assumed to be a wideband stationary random process with a pressure spectral density equal to the peak value associated with the turbulence. The rms vibration level of the core support barrel system in terms of a beam mode was obtained based upon a damped, single degree of freedom analysis assuming the rms random pressure fluctuations to be spatially invariant. The maximum rms response calculated was considerably less than the design operating clearances available at the snubbers.

3.9.1.4.6 Precritical Vibration Monitoring Program

The Maine Yankee and Fort Calhoun Precritical Vibration Monitoring Programs (PVMP) together constitute the prototype PVMP for Unit 2. In accordance with Regulatory Guide 1.20, prototype prediction, measurement and inspection programs were developed and performed for the Maine Yankee and Fort Calhoun reactor internals. Theoretical prediction analyses were performed for Maine Yankee (Reference 3) and Fort Calhoun (Reference 2) to estimate the amplitude, time and spatial dependency of the steady state and transient hydraulic and structural responses to be encountered during precritical testing. The precritical vibration

ARKANSAS NUCLEAR ONE Unit 2

monitoring programs for Maine Yankee and Fort Calhoun have been completed successfully (References 24 and 28, respectively). It was concluded from these programs that flow induced vibrations of the Maine Yankee and Fort Calhoun reactor internals are well within design allowables and are acceptable for all normal, steady state and transient flow modes of reactor coolant pump operation.

Comparisons of the measured and predicted responses for Maine Yankee and Fort Calhoun demonstrate that the theoretical prediction methods used provide conservative estimates of the total steady state responses of the core support barrel, thermal shield system.

Presented in Table 3.9-5 is a summary of the significant hydraulic and structural design parameters for each of the three reactor designs.

The effect of these structural and hydraulic parameters on the flow induced vibratory response of the reactor internals is evaluated and summarized in Reference 5. In general, this reference, which is a summary of the flow induced vibration analysis for Unit 2, demonstrates that: 1) the predicted structural response of the Unit 2 reactor internals are well within design allowables and are acceptable for all normal, steady state and transient flow modes of primary coolant pump operation; and, 2) the prototype precritical vibration monitoring programs for Maine Yankee and Fort Calhoun adequately account for the specific design features for Unit 2 which are shared by the two prototype reactor designs.

AP&L implemented a PVMP for Unit 2 in accordance with the requirements of Regulatory Guide 1.20 as it relates to other than prototype units. The reactor vessel internals were subjected during the preoperational and functional testing program to all significant flow modes of normal reactor operation for a sufficient period of time to determine whether the reactor vessel internals exhibited any unexpected vibration problems.

After completion of the preoperational and functional tests, the reactor vessel internals were subjected to visual examination to detect any evidence of unanticipated or excessive vibrations. These examinations were conducted at all major points of contact for load transmission such as the core barrel flange and snubbers.

3.9.1.5 Correlation of Test and Analytical Results

As discussed in Section 3.9.1.4, the Maine Yankee and Fort Calhoun Programs are established as the prototype. The correlations of the results from those precritical vibration monitoring programs with the analytical responses derived from mathematical models are described in References 2, 3, 24, and 28.

Reference 5 presents the results of the Unit 2 reactor internals vibration analyses and provides a comparison of these results to the results of the Maine Yankee and Fort Calhoun analyses and measurements. Reference 1 provides additional information on the analytical methodology, summaries of the prototype PVMPs conducted on Maine Yankee and Fort Calhoun, additional confirmatory data from neutron noise monitoring programs conducted by CE, and additional comparisons of Unit 2 to the prototype plants. The information presented in References 1 and 5 provides a high degree of assurance that the structural responses of the Unit 2 reactor internals is well within design allowable criteria for all normal, steady state and transient flow modes of reactor coolant pump operation.

3.9.1.6 Analysis Methods Under LOCA Loadings

3.9.1.6.1 Introduction

Dynamic analyses were performed to determine the structural response of the reactor vessel internals to the transient LOCA loading and to verify the adequacy of their structural design. The analyses determined the shell, beam and rigid body motions of the internals using established computerized structural response techniques. The time and space dependent pressure loads used in the analyses were obtained from LOCA blowdown analyses performed with the water hammer and CEFLASH computer codes. This method is discussed in Reference 43. The pressure time histories were determined for each node in the hydraulic model for inlet and outlet breaks. The loads resulting from the LOCA analyses of the internals, when combined with normal operating and seismic loads, are subject to the requirements of Sections 4.2.1 and 4.2.2.

The LOCA blowdown analyses have been re-performed to account for the power uprate and the replacement of the steam generators, using the CEFLASH-4B computer code. A detailed description of this code, along with the NRC approval of its use, is provided in Reference 86. The leak before break methodology was adopted for these analyses. Since this methodology limits the scope of the evaluation to breaks in the RCS tributary lines, blowdown analyses were performed for these breaks, rather than the vessel inlet and outlet breaks assumed in the original analysis.

3.9.1.6.2 Method of Analysis

3.9.1.6.2.1 General

The dynamic LOCA analyses of the reactor internals and core consisted basically of three parts. In the first part, the time dependent beam and shell response of the core support barrel to a transient LOCA loading were calculated using the finite element computer code, ASHSD (Reference 49). In performing the dynamic analyses of the core support barrel, the shell and beam responses were considered separately to account for differing boundary conditions. For the load harmonics which give rise to shell responses, the boundary condition at the upper flange of the Core Support Barrel (CSB) was a rigid restraint in all directions. At the lower flange of the CSB, the boundary condition was a simple support in the radial direction, which represented the effects of the lower support structure stiffness on the CSB. For the load harmonic which gives rise to beam response in the barrel, the upper flange boundary condition was identical to the shell response. For the lower end of the CSB two cases were considered. In the first case, the lower end of the CSB was unrestrained. A rigid radial restraint at the snubber elevation was applied in the second case to simulate a closed snubber gap.

In the second part, the CSB potential for buckling when loaded by a net external radial pressure resulting from an outlet line break was evaluated with the finite element computer code, SAMMSOR-DYNASOR (Reference 77). The initial imperfection was applied to the core support barrel by means of a pseudoload, for each circumferential harmonic considered. The actual transient loading in terms of its harmonics was applied to the initially "imperfect" geometry of the CSB and the response obtained for each of the imperfection harmonics.

In the third part, the dynamic structural response of the reactor internals to vertical and horizontal loads resulting from inlet and outlet breaks was determined with the SHOCK code (Reference 58). Separate mathematical models that incorporated structural nonlinearities were developed for the vertical and horizontal directions. The horizontal loads applied to the core

ARKANSAS NUCLEAR ONE
Unit 2

support barrel during an inlet break were obtained by representing the pressure time history as a Fourier expansion and considering the harmonic which excites the beam mode of vibration. Horizontal loads on the CEA shroud tubes were determined directly from the blowdown pressure time history. Vertical loads for the inlet and outlet breaks were also determined directly from the pressure time history.

3.9.1.6.2.2 Mathematical Models

A. Core Support Barrel

For the dynamic response and buckling analyses of the core support barrel, similar finite element models were developed. The core support barrel was modeled as a series of shell elements joined at their nodal point circles as shown in Figures 3.9-1 and 3.9-2 for the ASHSD and SAMMSOR-DYNASOR models, respectively. The length of the elements in each model was selected to be a fraction of the shell attenuation length. Since rapid changes in the stress pattern occur in the regions of structural discontinuity, the nodal point circles were more closely spaced in such regions. The finite element representation of the CSB included the upper and lower flanges and sections of different wall thickness.

B. Internals

The reactor internals model was developed in terms of spring mass systems for both vertical and lateral directions as shown in Figures 3.9-3 and 3.9-4. For both models, the stiffness values were generally evaluated using beam characteristic equations. In complex areas such as the CSB flanges, upper guide structure, support barrel flange and lower support structure grid beams, the beam properties were derived from finite element analyses. The lumped mass weights were generally based upon the mass distribution of the uniform support structures, but included at appropriate nodes were local masses such as snubber blocks and fuel end fittings. To simulate the effect associated with the internals oscillating laterally in the water filled vessel, a virtual or hydrodynamic mass was calculated and added to the structural mass. More details of the spring lumped mass system modeling techniques, component finite element analyses and the hydrodynamic mass effect described above are presented in Section 3.7.3.

In the horizontal model, the CSB reactor vessel snubber clearance was simulated by a nonlinear spring, which accounted for the loads generated when snubbing occurred. In the vertical model, nonlinear springs in the form of compression only springs were used to simulate preload and interface conditions such as those between the fuel and core support plate, the core shroud and fuel alignment plate, and between the upper guide structure flange and core support barrel upper flange. The effect of hydraulic drag in the vertical model is simulated by a force time history applied to the fuel rods nodes.

3.9.1.6.2.3 Response Calculations

A. Dynamic Response of Core Support Barrel

The finite element computer code, ASHSD, was used to calculate the dynamic response of the core support barrel to transient LOCA loading resulting from an inlet break. A damped equation of motion was formulated for each degree of freedom of

ARKANSAS NUCLEAR ONE
Unit 2

the system. Four degrees of freedom, radial displacement, circumferential displacement, vertical displacement and meridional rotation were taken into account in the analysis. The differential equations of motion were solved numerically using a step-by-step integration procedure.

The ASHSD code computed the nodal point displacement, resultant shell forces, and shell stress as function of time. The maximum principal stresses at the internal and external surfaces of the core support barrel were determined from the bending and membrane components during each phase of transient loading. The results were compared to the stress and deformation criteria of Section 4.2.2 and were found to be within the specified limits.

The finite element code SAMMSOR-DYNASOR was used to perform a dynamic buckling analysis of the core support barrel when subjected to radial pressure loads from an outlet break. Stiffness and mass matrices for shells of revolution were generated utilizing the SAMMSOR part of the code. The equation of motion of the shell were solved in DYNASOR using the Houbolt numerical procedure.

The loading history was subdivided into line segments appropriately selected so as to closely approximate the actual time history. Using the DYNASOR program, the radial displacement was calculated at the desired time for each element in the model and for the selected circumferential harmonics.

In order to satisfy the dynamic stability requirement of the ASME Code, Section III, an overload analysis was also performed for the CSB. The maximum applied pressure load was below the permissible value of 75 percent of the dynamic instability load.

B. Dynamic Response of Internals

The reactor vessel internals pipe break analysis was updated to determine the response of the reactor internals and fuel to the excitation caused by a postulated branch line break (BLPB) considering both the replacement steam generators and the power uprate planned for Cycle 16.

During a pipe break the reactor internals are subjected to two forms of excitation:

- Transient pressure forces acting directly on internal components, and
- Vibratory motion of the reactor vessel

The transient pressure forces were calculated by the LOCA blowdown analysis (see Section 3.9.1.6.1) while the reactor vessel motions were obtained from the reactor coolant system pipe break analysis (see Section 3.9.1.7.1).

As was the case for the reactor vessel internals seismic analysis (see Section 3.7.3.4.2.2), separate analyses were performed in the horizontal and vertical directions due to the structural and response differences in these directions.

Horizontal Analysis of the Reactor Internals and Core

The coupled core and internals CESHOCK model used for the pipe break analyses was similar to that used for the seismic analysis. However, additional detail was added to the CEA shroud representation and reactor vessel flange region. A sketch of

ARKANSAS NUCLEAR ONE
Unit 2

the horizontal pipe break reactor internals and core model is shown in Figure 3.9-3. The additional detail for the CEA shroud was added in order to represent the direct transient pressure loading on the CEA shrouds that occur during a hot leg tributary line pipe break. The added detail in the reactor vessel flange region was added to account for possible interaction between the CSB upper flange, UGS flange, and vessel ledge. Nonlinear, hysteresis, and friction elements were used to represent this interface region. A critical damping ratio of 4% was used for the reactor internals components in accordance with Regulatory Guide 1.61 for welded steel structures. The fuel assembly damping values were based on test data from full-scale fuel assembly tests.

The input excitation for a primary side inlet break includes transient pressure loads on CSB and reactor vessel acceleration time histories at the vessel flange and snubber. For a primary side outlet break, the input excitation included transient pressure forces on the CSB and CEA shrouds and the reactor vessel motions. Analyses were performed in two directions, parallel to the outlet nozzles (X direction) and perpendicular to the outlet nozzles (Z direction).

Vertical Analysis of the Reactor Internals and Core

The methodology for the vertical analysis of the reactor internals and core was similar to that used for the vertical seismic analysis. The coupled reactor internals and fuel CESHOCK model is shown in Figure 3.9-4. The input excitation included both pressure forces on the internals and fuel and vessel motions. A critical damping ratio of 4% was used for the reactor internals and the fuel in accordance with the Regulatory Guide 1.61 for welded steel structures.

Nonlinear horizontal and vertical pipe break analyses were performed for the following limiting pipe breaks:

	<u>Vertical Analyses</u>	<u>Horizontal Analyses</u>
Main Steam Line Terminal End Break	0 - 0.4 sec	Not Done
Feedwater Line Terminal End Break	0 - 0.4 sec	Not Done
Safety Injection Line Break	0 - 0.4 sec	0 - 0.4 sec (X & Z direction)
Surge Line Terminal End Break	0 - 0.4 sec	0 - 0.4 sec (X direction)
Surge Line Intermediate Break	0 - 0.4 sec	0 - 0.4 sec (X direction)
Shutdown Cooling Line Break	0 - 0.4 sec	0 - 0.4 sec (X direction)

These analyses determined loads on the reactor internals components that were used in evaluating the structural integrity of the reactor internals (see Sections 3.9.3, 4.2.2, and 4.4.2).

The vertical and horizontal LOCA results were compared to the stress and deformation criteria presented in Sections 4.2.1 and 4.4.2 and found to be within the specified limits.

3.9.1.6.2.4 LOCA Hydraulic Blowdown Analyses for Fuel Assemblies

3.9.1.6.2.4.1 Analytical Methods

The names of the computer codes used by CE to calculate blowdown loads are WATERHAMMER and CEFLASH-4. Detailed descriptions of these codes are given in References 7, 55, and 72. The application of these codes to blowdown loads is described in Reference 43 which has received NRC approval via Reference 59. The LOCA blowdown analyses have been re-performed to account for the power uprate and the replacement of the steam generators, using the CEFLASH-4B computer code.

Thermal hydraulics calculations are used to provide the steady state input description of the system. This input consists of fluid inventories, pressures, temperatures and flow rates throughout the system (reactor vessel, piping, steam generators and pressurizer). A description of the analytical models used to represent the thermal hydraulic characteristics of the various portions of the primary system is given in Reference 43.

3.9.1.6.2.4.2 Horizontal Core Analysis

The methodology for the pipe break analysis of the core is the same as that for the seismic analysis. The detailed core models are the same. The input excitations were the motions of the core boundary from the coupled reactor internals and core analysis.

Only the 15-row model was used for the BLPB analyses because it was found that there was essentially no fuel assembly impacting in the 15-row pipe break analyses.

The horizontal core analysis determined spacer grid impact loads and fuel assembly displacement shapes at times of peak response. Vertical loads on fuel assembly components were obtained from the vertical reactor internals and core analyses. These results were used in the evaluation of the structural integrity of the fuel assemblies, described in Section 4.2.1.

3.9.1.7 Analytical Methods for ASME Code Class 1 Components

The system or subsystem analysis used to establish or confirm loads specified for the design of components and supports was performed on an elastic basis. The analysis on the reactor vessel internals is based on the criteria discussed in Sections 4.2.1 and 4.2.2. Elastic stress analysis methods were also used in the design calculations to evaluate the effects of the loads on the components and supports.

Dynamic analysis, as described in Sections 3.9.1.3 and 3.7.6, is performed to verify that the stresses are within limits specified by the applicable code requirements. Allowable stresses for ASME Code Class 1 components are discussed in Sections 4.2 and 5.2.1.

The dynamic response to postulated pipe breaks of the RCS and surge line with the Replacement Steam Generators (RSGs) was determined by analysis. Since these analyses were performed for system operating parameters consistent with the uprate power level anticipated for Cycle 16, the results are applicable to the power uprate.

The dynamic response of the RCS to pipe breaks was determined, and response loads, motions, and spectra at interface locations were provided as input to specifications and to downstream analyses. Response loads and motions from the RCS analysis were provided as input to the RSG design specifications, NSSS component specifications, and balance of plant piping evaluations.

ARKANSAS NUCLEAR ONE
Unit 2

Hot leg response motions and spectra due to pipe breaks other than surge line breaks were provided as input to the surge line analysis, which is also discussed in this section. The response of the surge line to these excitations was also determined, and response loads at surge line pipe, nozzle, and support locations were provided as input to the surge line stress evaluation.

3.9.1.7.1 Dynamic Analysis of the Reactor Coolant System due to Pipe Break

Nonlinear response time history analyses were performed to calculate the RCS response to the fifteen pipe breaks listed in Table 3.6-1A. Two three-dimensional RCS models were developed for the pipe break analyses from the RCS seismic model, one for secondary side breaks and one for primary side breaks. Figure 3.7-30 shows a generalized picture of the RCS model used in the seismic and BLPB analyses, and Figure 3.9-1A shows the model of the RSG as converted to ANSYS for RCS analysis.

For both pipe break models, gapped and preloaded RCS supports were de-linearized. Directional spring supports, gaps, and preloads at full power were included for all pipe break analyses. The RVI snubbers between the core support barrel (CSB) and the inside of the RV lower head were modeled as gapped springs for all pipe break analyses.

For the secondary side pipe break model, the representation of the RVI is essentially the same as that for the RCS seismic model described in Section 3.7.3, because secondary side breaks do not cause blowdown, just vibratory input to the RV.

A more detailed model of the RVI was included in the primary side pipe break model, because these pipe breaks cause RV blowdown loads. This RVI model included hydro-mass and coupling terms, as well as additional nodes for RV blowdown input loadings. This model, which is shown in Figure 3.9-1B, is a simplified representation of the nonlinear RVI model used in the RVI detailed analysis (Section 3.9.1.4).

Input loadings applied to the RCS included thrust at the break locations, jet impingement loadings at and away from the break locations, RV blowdown loadings for the primary side BLPBs, and asymmetric pressurization loads on the RSG and RCPs for all pipe breaks except the main steam line break (MSLB), which does not cause SG subcompartment pressurization. Jet targets and jet impingement loadings are based on cone jets or fan jets, depending on the break type and break scenario. Jet types for each limiting BLPB are given in Table 3.6-1A. Following the elimination of main coolant loop breaks by application of LBB, none of the limiting BLPBs cause asymmetric pressurization to occur between the RV cavity and RV shell.

The ANSYS computer code was used to perform the dynamic transient time history BLPB analyses, using the modal superposition method and 3% modal damping.

3.9.1.7.1.1 Results – RCS Component and Support Loads

RCS component and support loads were maximized over the response time history for each of the 15 BLPB cases analyzed. Time history response accelerations and displacements were generated at the locations listed below. These results were used in the evaluations of tributary piping, RSG design, and evaluations of the RVI and RV head area components. Maximized RSG shell moments versus RSG shell elevation were also calculated for each break case for use in the detailed RSG design.

ARKANSAS NUCLEAR ONE
Unit 2

- RSG tributary nozzle interfaces
- RCS tributary nozzle interfaces
- RV upper head
- RV closure flange
- RV CSB snubber

3.9.1.7.2 Dynamic Analysis of the Surge Line due to Excitation from Other Pipe Breaks

Linear response time history analysis was used to calculate surge line response to non-surge line BLPBs. A three-dimensional model of the surge line and its supports was developed using ANSYS (Figure 3.9-1C). Time history motions at the RCS hot leg interface due to BLPBs, as discussed above, were applied to the surge line, and the surge line response was determined using the ANSYS computer code. Mass-stiffness damping of not more than 3% at significant modes of vibration was used in the time history analysis of the surge line.

3.9.1.7.2.1 Results of Surge Line Analysis

Responses of the surge line to RCS vibratory motion due to each of five non-surge line BLPBs listed in Table 3.6-1A were calculated. Surge line piping and support response loads were calculated and were maximized over time. These results were used in the surge line evaluation for the Faulted Condition.

3.9.2 ASME CODE CLASS 2 AND 3 COMPONENTS

3.9.2.1 Plant Conditions and Design Loading Combinations

3.9.2.1.1 Plant Conditions

ASME Code Class 2 and 3 components and system are identified in Section 3.2.2, System Quality Group Classification. ASME Code Class 2 and 3 components and systems are constructed for the following plant operating conditions.

- A. All ASME Code Class 2 and 3 components and systems are designed and constructed for anticipated pressure and temperature conditions which may occur during normal plant operations and transients, including startup, power generation, cooldown, relief valve operation, load rejection, and shutdown.
- B. Components required to function during and subsequent to the DBA are designed for the component pressure and temperature conditions which occur during and after this event. Such systems are identified in Chapter 15, Section 3.11, and Section 7.1.1.
- C. All Seismic Category 1 components are also analyzed for a DBE and OBE as described in Section 3.7, Seismic Design.

3.9.2.1.2 Loading Combinations and Stress Limits

Design loading combinations and the corresponding allowable stress limits are given in Tables 3.9-2, 3.9-3 and 3.9-7.

ARKANSAS NUCLEAR ONE
Unit 2

3.9.2.2 Design Loading Combination

The design loading combinations and corresponding design stress limits for ASME Class 2 and 3 piping are provided in Table 3.9-2. The classification of the design loading combination into normal, upset, emergency and faulted conditions is also provided in Table 3.9-2. Design loading combinations and stress limits shown in Table 3.9-2 conform to the requirements of ASME Code, Section III, Winter, 1972 Addenda for the Design, Normal, Upset and Emergency Conditions and to ASME Code Case 1606 for the Faulted condition (or later appropriate ASME Section III code sections provided that they have been reconciled). Design loading conditions for ASME Code Class 2 and 3 vessels and pumps are shown in Table 3.9-7. There are no deformation criteria associated with the above design loading combinations. The design loading combinations listed in Table 3.9-2 do not apply to the plant operating conditions listed in Table 3.9-3, which relate only to design pressure. ASME Code Section III Class 2 and 3 valves used on Unit 2 conform to the requirements of ANSI B16.5 as specified by Subsections NC-3000 and ND-3000.

3.9.2.3 Design Stress Limits

The design stress limits for Class 2 and 3 components as given in Tables 3.9-2 and 3.9-3 are in accordance with the requirements of ASME Code Section III, 1971 (or later appropriate ASME Section III code sections provided that they have been reconciled). Design stress limits for ASME Code Class 2 and 3 vessels and pumps are shown in Table 3.9-7.

If, under pipe failure conditions, the calculated stresses in a portion of a piping system extended into the plastic range, the techniques described in BN-TOP-2 (Reference 8) were used.

3.9.2.4 Analytical and Empirical Methods for Design of Pumps and Valves

Suppliers of ASME Code Class 2 and 3 pumps and valves were required to show, by use of analytical methods, empirical methods and/or tests, that the components will function as designed under the conditions specified. As stated in Section NB-3524 of ASME Code, Section III, the piping, not the valves, is the limiting component.

The design requirements for Seismic Category 1 valves require several conditions be satisfied. The pressure requirements given in Table 3.9-3 ensure that the pressure containing boundary of the valve will not be violated as a result of a system pressure transient. The limits given are consistent with the pressure requirements of NB-3655 and NB-3656 for piping for the plant operating conditions given. Since valves have a greater cross section than the matching piping, their pressure boundary integrity is assured. Design requirements for seismic conditions ensure the top works, i.e. weakest portion of the valve yoke, will remain within the elastic region or be evaluated and qualified for the current loading conditions. Small deflections may result which will not inhibit valve operability during a seismic event.

In addition to the limits of Table 3.9-3, the primary pressure ratings of valves provided by CE are in accordance with the recommendations of Regulatory Guide 1.48.

CE design specifications require that the lowest natural frequency of a valve assembly be greater than 20 cps.

CE specifications require that the seller demonstrate by analysis or test that Class 2 valves be capable of withstanding a 3.0g load applied at the pipe ends in any direction.

ARKANSAS NUCLEAR ONE
Unit 2

- A. Fisher Controls Company provided evidence that their valves would meet these requirements by analysis, with the exception of yoke strength, which was substantiated by actual yoke fracture tests. Control Components, Inc. provided an analysis to substantiate their design.

The following valve features were checked:

1. Yoke Legs
2. Yoke Lock Nuts
3. Combined Bonnet Tensile and Bending Stress
4. Bonnet Bolt Stress
5. Body Line Connection Welded Shear Stress
6. Natural Frequency of Actuator Frame and Yoke

Pressure loaded components such as the valve bonnet and body bolts were analysed by the equivalent pressure method in ANSI B31.7-1969 and ASME Section III. The combination of normal operating loads, dead weight, and seismic loads was considered.

The allowable stress for each component checked was considered to be $1.2 S_m$ or S_y , whichever is greater as provided for in the 1968 edition of Section III of the ASME Code.

- B. Target Rock Corporation provided evidence that their valves would meet seismic requirements by analysis.

The following valve features were checked:

1. Yoke
2. Combined Bonnet Tensile and Bending Stress
3. Bonnet Bolt Stress
4. Natural Frequency of Actuator Frame and Yoke

Pressure loaded components such as the valve bonnet and body bolts were analyzed by the equivalent pressure method in ANSI B31.7-1969. and ASME Section III. The combination of normal operating loads dead weight, and seismic loads was considered.

The allowable stress for each component checked was considered to be S_m .

ARKANSAS NUCLEAR ONE
Unit 2

- C. Wm. Powell Co. provided evidence that their valves would meet seismic requirements by analysis.

The following valve features were checked:

1. Yoke legs
2. Body Neck Maximum Operator thrust
3. Combined Bonnet Tensile and Bending Stress
4. Bonnet to Body Bolt Stress
5. Operator to bonnet bolt face stress
6. Natural Frequency of Valve

Pressure and operator thrust loaded components such as the body neck and bonnet to body bolts were analyzed by the equivalent pressure method in ANSI B31.7-1969 and ASME Section III. The combination of normal operating loads, dead weight, and seismic loads was considered.

The allowable stress for each component checked was considered to be S_m .

CE specifications require that the pressure boundary of all Class 3 valves will remain intact after a seismic acceleration of 3.0g applied at the pipe connections. Calculations or test results were not required to be provided to substantiate this requirements.

All operators for Class 1, 2 and 3 active valves have been tested in accordance with IEEE 382, "IEEE Trail-Use Guide for Type Test of Class 1 Electric Valve Operators for Nuclear Power Generating Stations."

Test criteria are based upon the seismic and accident conditions applicable to this plant design as called out in the design specification for the particular valve. Testing for operability of the mated valve/operator was performed on the following valve types:

- A. Main steam isolation valves
- B. All nuclear class ball valves
- C. All nuclear class solenoid valves

A prototype valve was used in all cases and the testing criteria was taken from the design parameters for seismic and environmental conditions as defined in the design specification for the particular valve. Operability was checked during the environmental tests and the seismic tests. All active Class 1, 2 and 3 valve/operator combinations not tested under simulated conditions have an operator that has undergone the testing outlined above. The combinations used are of standard configurations which have a long history of use under power plant operation and therefore have a high reliability. The periodic functional testing and inspection of these valves together with their history will assure operability to the degree that can be expected from a prototype test program.

ARKANSAS NUCLEAR ONE
Unit 2

Table 3.2-3 lists the design codes for all ASME Code Class 1, 2 and 3 (or ASME Pump and Valve Code) pumps. The reactor coolant pumps are not "active" pumps since they are not required to function following any DBA.

The HPSI and LPSI pumps were ordered to the requirements of the draft ASME Code for Pumps and Valves for Nuclear Power, dated November, 1968, including the March, 1970 Addenda. The orders for both HPSI and LPSI pumps were placed on June 18, 1971. These pumps have been designed and manufactured to Code requirements in force at the time the purchase order was placed and they are presently installed at the Unit 2 site.

The draft ASME Code for Pumps and Valves does not establish pump design criteria but, rather, it places reliance on the cumulative past experience of the pump designer. Ingersoll Rand, the designer of the Unit 2 HPSI and LPSI pumps, has been established as a centrifugal pump designer and manufacturer for more than 50 years and none of the Unit 2 safety injection pumps' features are of a developmental nature.

Operability of the Unit 2 safety injection pumps has been assured both by design and by testing of the pump and motor combination. Loading conditions were evaluated and conservative loading requirements based upon the most adverse combination of loads were included in the pump specifications. The maximum allowable pump nozzle loads were established by the pump manufacturer. Ingersoll Rand was required to demonstrate by analysis or testing that the pumps would not suffer loss of function when seismic loads were imposed in addition to other applicable loads.

During the safety injection pump design process, limitations were placed on stress levels that may be attained in areas where deformation might affect performance. The stresses in the foundation bolting and bearing bracket bolting were examined to ensure that the pump and motor combination could remain functional during all loading conditions, including the DBE. These stresses were found to be extremely low which precludes any significant deformation in the pump and motor assembly.

Prototype test and analytical data were obtained from the safety injection pumps' motor supplier to verify that the motors were designed with conservative margins to drive the pumps under all required operating conditions. Routine NEMA tests were also performed on each motor to verify its electrical integrity per MGI-20.46. In addition, the pump and motor assembly were subjected to a thermal transient test. This test reproduced the maximum temperature change in the pumped fluid that is expected to occur during the plant faulted condition. Pump and motor performance throughout this transient test were satisfactory. The pump and motor assembly was also satisfactorily tested over the entire required performance range, including NPSH limit tests.

Site installation procedures and a preoperational testing program are relied upon to provide assurance of proper installation and onsite performance of the safety injection pumps. The quality assurance program ensures that the safety injection pumps have been designed, manufactured, installed and tested in accordance with applicable component specifications, codes, and regulatory requirements. Periodic testing and inservice inspection during their service life will provide continued assurance that the safety injection pumps will perform as required.

The overall operability assurance program for safety injection pumps described above provides adequate assurance that these pumps will function when called upon to do so. In addition, the component redundancy provided in the safety injection system design accommodates single

ARKANSAS NUCLEAR ONE
Unit 2

active random component failures without a loss of required system performance levels. All other ASME Code pumps were ordered to the requirements of the Code in effect at the time of purchase, which did not require prototype testing. The comments above concerning the HPSI and LPSI pumps are also applicable to the ASME Code Section III Class 2 and 3 pumps.

Industry testing programs conducted in response to Regulatory Guide 1.48 were considered in the design of active components to provide additional assurance of the ability to perform their intended functions.

Section 3.9.1.2 and the above discussion provide adequate assurance that ASME Code Section III Class 1, 2 and 3 valves will remain operable. Associated piping supports are designed in accordance with the ASME Code to remain elastic and deformation of the pipe or support should not directly affect the valves. Supports for active Class 2 and 3 were designed in accordance with the applicable codes listed in Section 3.8 for the location of the pump. No other specific criteria were applied.

3.9.2.5 Design and Installation Criteria, Pressure Relieving Devices

Safety valves are provided on the main steam headers in accordance with ASME Code, Section III for the protection of the steam generator shells and main steam lines against overpressure due to turbine trips or system upsets.

The safety valves are installed on main steam lines of increased wall thickness to reduce bending and compressive stresses. The safety valve discharges are also positioned to minimize the torsional moment of the main steam lines. The safety valves incorporate balanced dual discharges which transmit no moment to the relief valve headers. The dynamic effects of all safety relief valves discharging simultaneously are considered in pipe design.

The total capacity of the safety valves is sufficient to pass 100 percent of the steam flow generated in the steam generators. The nominal setpoint of at least one safety valve on each main steam header is less than or equal to the main steam piping pressure (1,085 psig). Additional valves are set to open at higher pressures; however, the highest setpoint does not permit pressure to exceed 110 percent of design pressure in accordance with the ASME Code, Section III.

Consideration is taken of the back pressure on the safety valve discharge created by the discharge piping. Deflection of the line during the period of jet thrust from the safety relief valves will be maintained within allowable limits based on stress, stability and function. This is accomplished by reinforcement of the header to transfer the loads to points convenient to receive reactive loads and any associated moments.

The forcing function used in the dynamic calculations was conservatively defined as a ramp function based on a valve actuation time of 50 milliseconds. A time history dynamic calculation of the local stress condition was performed in lieu of a dynamic load factor calculation. The stresses thus obtained were combined in accordance with Table 3.9-2.

3.9.2.6 Stress Levels for Category 1 Components

The stress levels and sketches of system configuration for high energy Category 1 system components are given in Section 3.6.4. The stress levels for low energy Category 1 system components at points of significant changes in flexibility are provided under the specified plant condition. Sketches of system configuration are included.

ARKANSAS NUCLEAR ONE
Unit 2

3.9.2.7 Field Run Piping Systems

All original ASME Code, Section III, Class 2 and 3 piping, including lines two inches and smaller, was routed by Bechtel's San Francisco engineering office.

3.9.3 COMPONENTS NOT COVERED BY ASME CODE

Safety-related mechanical components not covered by the ASME Code may be divided into two categories: Reactor Vessel Related and Other. The second category includes ventilation and air conditioning equipment and the emergency diesel generators.

3.9.3.1 Reactor Vessel Related Components Not Covered by ASME Code

Components not presently covered by the ASME Code include (1) reactor vessel internals, (2) fuel, (3) Control Element Drive Mechanisms (CEDMs) and (4) CEAs. Each of these components is designed and fabricated in accordance with specific procedures and criteria to ensure their operability as it relates to plant safety. The fundamental criterion to be met following a postulated faulted condition is to ensure safe and orderly shutdown of the plant and to maintain fuel cladding temperatures within acceptable limits.

3.9.3.1.1 Reactor Vessel Internals

The design loading conditions, stress and deformation limits selected for the reactor internals are discussed in Section 4.2.2. Adherence to these stress limits ensure that the deflections of the reactor internals are essentially elastic during normal and emergency conditions. Description of the analysis methods is presented in Section 3.6. During faulted conditions (see Section 4.2.2.3.3), the deformations of the reactor internals are limited such that the core is maintained in a coolable array and a free path is provided for CEA insertion.

3.9.3.1.2 Fuel

The fuel assembly structural design limits, and the bases for them, are defined in Section 4.2.1. The fuel assembly is designed to maintain its dimensional integrity when subjected to normal handling loads, dead weight, differential clad pressure, flow induced vibration and uplift forces, flow impingement, holddown forces, and shock and seismic loading, thermal stresses and temperature cycling.

3.9.3.1.3 Reactor Vessel Head Area Components

The response loads of the CEDM components and the ICI Flange Assembly and Support Post due to seismic and pipe break effects were determined by analysis for the reactor coolant system with the Replacement Steam Generator (RSG) configuration and power uprate conditions. These head components were evaluated by comparison to the original loads used in the stress analyses. It was necessary to demonstrate that the response loads are bounded by plant operation prior to and after implementation of the RSG installation and power uprate. The effect of power uprate on the CEDMs' normal operating drive impulse load was also evaluated as part of the CEDM evaluation.

The response loads for the Head Lift Rig (HLR) were determined by analysis for the CEDM Cooling shroud upgrade. The HLR components were evaluated by comparison to the original loads and by a new stress analysis.

3.9.3.1.3.1 CEDMs and CEAs Evaluation

The specific design stress and deformation limits for the CEDMs and CEAs are contained in Section 4.2.3. The CEAs are sufficiently flexible to conform to deflections or misalignments of the upper guide structure shrouds during emergency or faulted conditions. Tests on similar equipment have demonstrated CEA operability under conditions of adverse alignment of the upper guide structure and fuel assemblies.

The functional criteria established for the CEDMs ensure that the mechanical reactivity control system is capable for the required CEA insertions during normal operation and following those events classified as emergency or faulted conditions. The loading categories and stress limits for the CEDMs ensure that the mechanical reactivity control system is capable for the required CEA insertions during normal operation and following those events classified as emergency or faulted conditions. The loading categories and stress limits for the CEDMs are defined in Section 4.2.3.

The analyses performed in support of the criteria include the effects of reactor coolant temperature and pressure, dynamic loads induced by driving of the CEAs and by seismic excitation, and loads produced by postulated pipe breaks.

Linear response spectrum analyses were used for both seismic and pipe break excitation to calculate response loads in the CEDM nozzle and CEDM components. A combined axial and horizontal beam finite element model with all spatial degrees of freedom was generated with ANSYS (Reference 87) for these analyses. The numerical model included a sufficient number of nodes to accurately represent the dynamic characteristics of the nozzle components and provide a detailed load response distribution throughout the CEDM structure.

The seismic loads were applied to the CEDM with the longest nozzle length, and the pipe break loads were applied to the CEDM with the shortest nozzle length, because the longest length nozzle produces conservative results for seismic loads, while the shortest nozzle produces conservative results for pipe break loads. Combining the results from these two nozzle lengths produced results that bound the response loads for any one nozzle length. Thus, the results calculated are applicable and conservative for all CEDM locations.

The response distribution of the calculated loads were used as follows:

- Evaluate stresses in the CEDM components for normal operation plus pipe break loads.
- Perform the operability check for normal operating plus seismic loads.

The seismic OBE and DBE input spectra from the RCS seismic analyses described in Section 3.7.3 were generated for 2% and 4% damping respectively for the CEDM analysis. Both sets of spectra (for three orthogonal directions) were broadened by $\pm 15\%$. The pipe break input spectra from the RCS pipe break analyses described in Section 3.9.1.7 was generated for 4% damping for the analysis of the CEDM response to pipe breaks.

The CEDM analyses were performed using ANSYS computer code. The CEDM modal responses were combined by ANSYS using the SRSS rule. The structural responses to each of three orthogonal components of motion (seismic or pipe break) were combined by ANSYS by the SRSS rule with the values of the co-directional responses caused by each of the three components of the considered motions.

ARKANSAS NUCLEAR ONE
Unit 2

The DBE and pipe break results were combined by the SRSS rule to yield the Faulted Condition results, which also included the normal operating loads.

CEDM operability was determined by comparing the critical CEDM deflections due to the DBE plus pipe break motions with those shown to be acceptable by previously documented static test results.

3.9.3.1.3.1.1 Results of CEDM Evaluation

The effect on the CEDM normal operating drive impulse load due to the RSGs and power uprate was evaluated and shown not to be affected by the difference in flow rate because the original loads conservatively envelop the changes in the hydraulic load.

The effect on the CEDM structure due to the RSGs and power uprate for Level A and B service conditions were addressed as follows:

- The RSG and power uprate do not affect CEDM and RV head thermal stresses. Therefore, Level A stresses were not affected.
- The major response load for Level B was the bending moment due to normal operation plus OBE at the head elevation. It was demonstrated that this bending moment is less than the allowable load calculated in the original analysis.
- The shear stresses due to normal operating plus OBE loads were also shown to be negligible and do not affect the total shear stress.

Therefore, the CEDM stresses for both the Level A and B service conditions are within the allowable limits.

CEDM stresses for the Level D service condition for all CEDM components were calculated from calculated response loads. All calculated stresses were shown to be within the allowable limits and no impacting between adjacent CEDMs was predicted when subjected to the combined effects of DBE and pipe break loads. The impact of DBE and pipe break loads on CEA insertability was determined by comparing the predicted horizontal CEDM displacements at the drive shaft upper elevation and at the upper pressure housing mid-point to test data. The tests determined the amount of CEDM deflection permissible for acceptable CEA insertion times. The calculated deflections were significantly less than the deflection established for acceptable CEA insertion time. The deflections of the CEDM were shown to be less than those for which the seismic qualification of the Reed Switch Position Transmitters (RSPTs) had been demonstrated by test.

3.9.3.1.3.2 Head Lift Rig Evaluation

An integrated Finite Element Model (FEM) of the HLR and CEDM Shroud upgraded structure was built using beam and shell elements to accurately represent the dynamic characteristics and response. Figure 3.9-1D illustrates the FEM used in the HLR and CEDM Shroud upgraded structure analysis.

The HLR analyses were performed with the ANSYS computer code and the DBE and pipe break loads were combined by the SRSS rule to generate Faulted Condition results. The faulted loads also included the HLR dead weight load.

3.9.3.1.3.2.1 Results of HLR Evaluation

The HLR structure was analyzed for seismic and pipe break excitations based on the RSG configuration and HLR response loads were generated. The HLR response to loads due to dead weight, seismic (OBE and DBE) and pipe breaks have been evaluated upon the structural capacity of the new and existing components. The structural integrity of the HLR, CEDM Shroud assembly, three vertical ducts from shroud to manifold, and manifold has been evaluated and demonstrated that HLR stresses for all service level conditions are within respective allowable limits, thereby justifying the structural integrity of the HLR. Specific areas of the evaluation include the following:

- The torsion stress in the HLR vertical links, which was not considered in the original stress evaluation, was evaluated and determined to be acceptable.
- Stresses in the lead shield track assembly were calculated and the structural integrity of the lead shield track assembly was determined to be acceptable.
- Stresses in the tie rod assembly for the combined effects of DBE and pipe break loads were calculated and shown to be within allowables, thereby demonstrating its structural integrity.

3.9.3.1.3.3 ICI Flange Assembly and Support Post Evaluation

Linear response spectrum analyses were performed for both seismic and pipe break excitations to calculate response loads in the ICI flange assembly and support post. The seismic OBE and DBE input spectra from the RCS seismic analysis described in Section 3.7.3 were generated at the RV head for 2% and 4% damping, respectively, for the ICI analysis. Both sets of spectra (for three orthogonal directions) were broadened by $\pm 15\%$. The pipe break input spectra from the RCS pipe break analysis described in Section 3.9.1.7 were generated at the RV head for 4% damping for the ICI analysis.

A finite element model (FEM) of the closure head ICI nozzle, ICI nozzle flange adapter, ICI flange (including Grayloc clamp), ICI welded connectors and ICI support post was generated within the ANSYS environment with all necessary spatial degrees of freedom. Figure 3.9-1E shows the portion of the FEM representing the ICI nozzle, reducer, Grayloc and flange components and support post. A separate row of nodes and elements were used to define each of the six guide tubes. The details of this portion of the model are shown in Figure 3.9-1F. The FM was generated with a sufficient number of nodes to accurately represent the dynamic characteristics of the structure and provide detailed response loads.

Response spectrum analyses for specified loading spectra in both horizontal and vertical directions were performed using the modal superposition method in ANSYS for both the seismic and pipe break inputs. Response loads from the seismic and pipe break analyses were combined, and loads at all critical locations of the ICI flange assembly and the base of the support post were compared to response loads previously calculated. For locations where a comparison of loads was not possible, the stresses were calculated and compared to stress allowables.

3.9.3.1.3.3.1 Results of ICI Flange Assembly and Support Post Evaluation

Response loads of the ICI Flange Assembly and Support Post were calculated for OBE, DBE, and pipe break excitations based on the RSG configuration. Evaluation of these results showed the following:

ARKANSAS NUCLEAR ONE
Unit 2

Level A and B Service Conditions

- The significant response loads at the base of the ICI due to OBE are lower than those used in the previous analysis for this component, except for the axial loads which are higher. However, the axial loads comprise a very small portion of the total stress and are considered negligible.
- Similarly, the significant OBE response loads at the base of the Support Post and throughout the Weldable Connector structure are lower than previously calculated, except for the axial loads which are slightly higher. However, the axial loads are a very small fraction of the total stress and are considered secondary.

Since the OBE responses are lower, the stresses of all components of the ICI Nozzle Assembly, including the Support Post and Weldable Connectors, are lower than those in previous analyses, the stresses are acceptable and within the Level A and B allowables.

Level D Service Condition

- The significant response loads at the base of the ICI Nozzle due to DBE are lower than those used in the previous analyses for this component except for the axial loads, which are higher. Since the axial loads contribute insignificantly to the total stress, this increase is considered negligible.
- The significant DBE response loads at the base of the Support Post and throughout the Weldable Connector structure are lower than those used in the previous analysis except for the axial loads, which are slightly higher. Since the axial loads result in a small portion of the total stress, this increase is considered secondary.
- The pipe break response loads at the base of the ICI Nozzle are significantly lower than those used in the previous analysis for this component.
- The pipe break response loads at the base of the Support Post are also significantly lower than those used in the previous analysis for this structure.

Since the DBE and pipe break response loads are lower, the stresses in the ICI Nozzle and Support Post due to dead weight and the combined DBE and pipe break response loads are acceptable and within allowable limits for the Level D service condition.

3.9.3.2 Ventilation, Air Conditioning, and the Emergency Diesel Generators

The ventilation and air conditioning equipment and the emergency diesel generators are not covered by the ASME Code. The applicable codes are identified in Table 3.9-4. The manufacturer's supplying this equipment performed stress and dynamic calculations or performed tests to demonstrate that all design loading combinations will be sustained without impairment of structural integrity or functional capability. Seismic loading calculations are performed in accordance with the criteria presented in Section 3.7.

3.9.3.3 Pipe supports, Base Plates, and Anchors

All flexible pipe anchors and base plates using anchor bolts are analyzed to account for plate flexibility, bolt stiffness, shear tension interaction, minimum edge distance, and proper bolt spacing. Because a flexible base plate can significantly affect the applied forces to an anchor

ARKANSAS NUCLEAR ONE
Unit 2

bolt, a base plate is considered flexible if the unstiffened distance between the member welded to the plate and the edge of the base plate is greater than twice the plate thickness. Depending upon the complexity of the individual base plate configuration, the forces on the bolts are determined using one of the following methods: by hand, utilizing the AISC, ACI-318, or ACI-349 methodologies; the chart method for 2 inch or smaller piping, computer programs such as "Bolts", finite element programs such as "ANSYS", "ME-035", or "Base Plate II", and/or combinations thereof as may be applicable. The resulting force is compared against the bolt allowable; the design bases for which are documented in calculations and engineering reports and the results are summarized for use in a Structural Engineering Standard (SES-18). The bolt installation is controlled in the field by plant procedure and/or specification (ANO-C-2408).

Various types of anchors, including cast-in-place bolts and "J-bolts", grouted "Type 10" bolts, concrete expansion bolts (CEBs), wedge bolts, and undercut anchor bolts are used to attach components to the concrete structures. The initial testing of anchor bolts was either performed on site, at the Fast Flux Test Facility, or by the manufacturer and evaluated for use at the site. Different safety factors may be used depending upon the type of bolt and methodology used to establish the bolt allowables. Certain allowables are referenced in the IE Bulletins 79-02 and 79-14 responses to the NRC. The safety factor, i.e. ratio of bolt ultimate capacity to the design load, has been established as a minimum of four (4) for wedge/CEB type bolts and five (5) for shell type anchors when a service type load is applied. The safety factor for these types of bolts may be reduced to three (3) when extreme environmental loads are included in accordance with Section B.7.2 of the proposed addition to Code Requirements for Nuclear Safety-Related Concrete Structures (ACI-349-76), August 1978. If the specific support has been verified, a safety factor of two (2) is considered to be satisfactory for these bolts if extreme loads are present. Other bolts, i.e. A36 Maxi Bolts undercut anchor bolts, have been extensively evaluated on site and have been demonstrated to be incapable of failing the concrete when designed and installed in accordance with site guidance and the results, including the safety factors, are documented by a series of engineering reports.

The safety factors for Concrete Expansion Bolts (CEBs) were not increased for loads that are cyclic in nature based upon the tests performed at the Fast Flux Test Facility (Drilled-In Expansion Bolts under Static and Alternating Loads, Report No. BR-5853-6-4 by Bechtel Power Corp., January 1975). The test results indicate:

- A. The expansion anchors successfully withstood two million cycles of long-term fatigue loading at a maximum intensity of 0.20 of the static ultimate capacity. When the maximum load intensity was steadily increased beyond the aforementioned value and cycled 2,000 times at each load step, the observed value was about the same as the static ultimate capacity.
- B. The dynamic load capacity of the expansion anchors, under simulated seismic loading, was about the same as their corresponding static ultimate capacities.

3.10 SEISMIC DESIGN OF CATEGORY 1 INSTRUMENTATION AND ELECTRICAL EQUIPMENT

3.10.1 SEISMIC DESIGN CRITERIA

See Table 3.2-2 for a listing of all Category 1 instrumentation and electrical equipment requiring seismic qualification.

3.10.1.1 Equipment Supplied by NSSS Vendor

Category 1 instrumentation and electrical equipment supplied by Combustion Engineering is designed such that it can meet the seismic qualification requirements established in IEEE 344-1971.

A Combustion Engineering Topical Report, CENPD-182, "Seismic Qualification of CE Instrumentation and Electric Equipment" was submitted in December, 1975. This topical report presents a summary of the CE seismic qualification program utilized to demonstrate the seismic design adequacy of the instrumentation and control equipment supplied by CE. Included in the report is a description of the qualification methods and a summary of the qualification effort for each piece of equipment. Appendix A to the report presents a listing of the CE supplied Unit 2 components to be seismically qualified. Appendix B presents the seismic qualification data sheets for the CE supplied equipment which has completed the seismic qualification program. Floor response spectra for Unit 2 are shown in Figures 3.7-11 through 3.7-18 for the OBE and DBE.

3.10.1.2 Equipment Supplied by Other Than NSSS Vendor

The Category 1 instrumentation and electrical equipment was designed to remain functional during and after DBE.

The Reactor Protective System (RPS) and Engineered Safety Features Actuation System (ESFAS) were designed to have the capability to initiate a protective action during the Design Basis Earthquake (DBE).

In addition, the emergency power system and Category 1 instrumentation and electrical equipment necessary for operation of Engineered Safety Features (ESF) were designed to withstand seismic disturbances of the intensity of the DBE and also to perform satisfactorily during and following the DBE.

Qualification and documentation procedures used for Seismic Category 1 equipment and/or systems meet the provisions of IEEE 344-1971 except as noted:

- A. Category 1 Equipment is synonymous with Class 1 as defined in IEEE Standard 344, Paragraph 2.1.
- B. Testing method described in Section 3.2.2.1 of IEEE 344-1971 was met. However, in addition an acceptable test condition was considered to be a uniaxial vibratory motion input at an angle to the horizontal plane of the vibration generator. This resulted in a biaxial test, where the component motions along the horizontal and vertical axes were in phase.
- C. In lieu of IEEE 344-1971, the provisions of IEEE 344-1975 or IEEE 344-1987 are met.

ARKANSAS NUCLEAR ONE
Unit 2

3.10.2 SEISMIC ANALYSES, TESTING PROCEDURES, AND RESTRAINT MEASURES

3.10.2.1 Equipment Supplied by NSSS Vendor

Combustion Engineering Topical Report CENPD-182, provides a description of the seismic qualification program for CE supplied Class 1E instrumentation and electrical equipment.

In addition, the equipment design specifications for systems and components include the appropriate minimum "g" forces in the horizontal and vertical direction for which the equipment must qualify.

The equipment was designed to perform its intended function during and after the DBE, during normal and accident conditions.

The manufacturers are required to substantiate the adequacy of their design by analysis, testing, and/or operating experience, depending on the equipment under consideration and its intended safety function. The choice of the qualification method is made by Combustion Engineering, Inc.

The quality assurance program contains the procedures used in assuring the implementation of the requirements by equipment suppliers.

The plant protection system cabinet frame, reactor trip switchgear and the ESFAS panel were seismically qualified, by test, in accordance with IEEE 344-1971.

Testing of the PPS cabinet was done with the actual electronic subassemblies replaced with weights. The size, distribution and mounting of the weights was such that the dynamic characteristics of the cabinet remain unchanged. Accelerometers were strategically located throughout the cabinet to monitor the response motions, including those present at the subassemblies (simulated) mounting points. This test structurally qualified the cabinet and determined the immediate seismic environment of the subassemblies.

The reactor trip switchgear and the ESFAS panels were tested in their final completely assembled condition.

The results of the above three tests will be included in a Supplement to CENPD-182 which supercedes CENPD-61, and which is applicable to Unit 2.

The following is an item by item comparison of the above three tests, discussing the compliance of Combustion Engineering's instrumentation and electrical equipment seismic qualification program with the "Electrical and Mechanical Equipment Seismic Qualification Program".

Item I.1

In all cases, functional operability is confirmed by vibration testing. Structural integrity is confirmed by test or analysis.

ARKANSAS NUCLEAR ONE
Unit 2

Item I.2

The reference motions for seismic qualification are the in-structure response spectra of the containment and auxiliary building. These response spectra characterize the required input motions of equipment mounted directly to the building structure (floor or wall). For equipment not mounted directly to the building structure, the seismic environment is not the in structure response spectra, but rather the motions of that mechanism which connects the equipment to the building structure. This will be determined by test or analysis.

Item I.3

Equipment operability is verified before, during, and after the seismic test.

Item I.4

The test input motions are characterized by response spectra. The Test Response Spectra (TRS) envelopes the Required Response Spectra (RRS) at all points of equipment resonance. The input amplitude (peak acceleration) is, at a minimum, equal to the zero period of the RRS.

Item I.5

As mentioned in Item I.4, the TRS envelopes the RRS at all points of equipment resonance. Since the in-structure RRS indicates single frequency predominance, a single frequency test input generates all the required modes of the equipment. However, should this not be the case for a specific piece of equipment, a controlled random input is used to create a broader TRS.

Item I.6

Biaxial testing was employed.

Item I.7

The tested equipment is fastened to the excitation system using the intended service mounting. Any test fixture, not intended for service, utilized to facilitate fastening must be rigid with respect to seismic frequencies.

Item I.8

There are at present no plans for the use of in-situ vibratory devices. Should this technique be employed, the results will include an analysis for justification.

Item I.9

Type testing is used wherever possible. Where variations exist within type, each variation is justified.

Item II.1 & II.2.a

See discussion of Item I.2.

ARKANSAS NUCLEAR ONE
Unit 2

Item II.2.b

Where analysis is employed, the calculated stresses are maintained within the required limits.

Item II.3

Enclosure and supports being tested are either the actual devices installed or the devices are simulated with weights in a manner which retains the original dynamic characteristics of the enclosure of support.

Item II.4

Equipment support tests are performed using the same criteria as equipment tests. Testing supports are simpler since there is no need to monitor electrical performance.

The PPS electronics drawers, the excore nuclear instrumentation monitoring system (including detectors), the process protective cabinet and its internal electronics, and the process instrumentation were seismically qualified as described in the PSAR and repeated here for clarity.

Earthquake loads for the design of these systems and equipment were determined consistent with the horizontal ground acceleration specified for the site for the Operating Basis Earthquake (OBE) and for the DBE.

From basic input ground motion data, a series of response curves at various building elevations were developed. This information was included in the purchase specifications for the emergency power system.

Based upon the data contained in these response spectra curves, applicable seismic accelerations were selected for inclusion in the purchase specifications for the RPS and the ESFAS.

Equipment suppliers were required to submit test data, operating experience, or calculations which substantiated that the components will not suffer loss of function before, during or after design loadings due to the DBE accelerations determined by the seismic analysis of the structure to ensure that there will be no loss of function in these systems during or following the DBE.

3.10.2.2 Equipment Supplied by Other Than NSSS Vendor

Category 1 instrumentation and electrical equipment and components were designed to ensure functional integrity of the specific operating requirements in accord with Section 3.7.2.1.3.

IEEE 344-1971, "IEEE Guide for Seismic Qualification for Class 1 Electric Equipment for Nuclear Power Generating Stations," was used as a guide for developing seismic qualification requirements in specifications.

IEEE 344-1975 and IEEE 344-1987 have also been used for the seismic qualification of various Category I instrumentation and electrical equipment.

ARKANSAS NUCLEAR ONE
Unit 2

The procedures described in Section 3.7.2.1.3 were used in the seismic analysis of equipment supports, such as battery racks, instrument racks, control consoles and cable tray supports. Suppliers of equipment were required to submit test data and/or calculations to substantiate that their components and systems would not suffer loss of function before, during, or after seismic loadings due to the DBE.

All cable tray and instrument tubing supports were designed by the response spectrum method. Analysis and seismic restraint measures for tray and tubing supports were based on combined limiting values for static load, span length, and computed seismic response.

The following bases were used in the seismic analysis of cable tray and instrument tubing supports:

- A. All safety-related cable tray and instrument tubing supports were designed for loads determined by dynamic analysis (first mode) using the appropriate seismic response spectrum.
- B. Conservative loading was assumed.
- C. The support system was designed to exclude all natural frequencies in a band covering the peak or peaks of the response spectrum curve.
- D. Maximum stress was limited to 90 percent of minimum yield for the DBE and code allowable stresses for one OBE.

3.10.2.2.1 4.16 kV Metal Clad Switchgear

The seismic qualification for switchgear assemblies 2A3 AND 2A4 is divided into three parts, as follows:

- A. Structural adequacy
- B. Performance of relays
- C. Performance of circuit breaker operating mechanisms

This qualification was performed for the switchgear assemblies in the racked-up configuration only.

3.10.2.2.1.1 Structural Adequacy

- A. Modal Analysis

Four variations of the manufacturer's basic vertical lift metal clad design are analyzed in the Modal Analysis Report. These include:

1. An M26H (350 MVA) 3,000 ampere breaker unit with typical relays, switches and meters. This unit was subjected to seismic tests in accordance with IEEE 344-1971, Section 3.2.3 at the General Electric Valley Forge Space Center in King of Prussia, Pennsylvania, in February, 1972.

ARKANSAS NUCLEAR ONE
Unit 2

2. Qualification of the replacement 1200 amperes, 250MVA to 350MVA upgrade breaker units was performed in accordance with Entergy Specification ANO-C-2506, "Specification for Seismic Qualification of Class 1E Equipment for Arkansas Nuclear One Units 1 & 2" at the Wyle Laboratories, Huntsville, Alabama. These units were subjected to seismic tests, documented in Calculation 88-E-0035-72, which justify that the anticipated frequencies subjected to the model meet or exceed the anticipated seismic response for the site.
3. Three M26 (250 MVA) 1,200 ampere breaker units furnished, as described below:
 - a. Unit 2A310, typical feeder unit
 - b. Unit 2A308, typical unit with superstructure relay cabinet.
 - c. Unit 2A307, typical unit with PT rollout superstructure.

These units represent the three design variations of breaker units used in the Class 1E, 4160-volt switchgear lineups 2A3 and 2A4.

4. The procedure for the modal analysis is as follows:
 - a. Develop a mathematical model for the M26H unit.
 - b. Justify the model selected by comparing the characteristic frequencies determine by modal analysis of the M26H unit with actual frequencies observed during the seismic testing of this unit.
 - c. Perform analyses on the three M26 variations using the same modeling technique.
 - d. Use the results of the analyses and the M26H unit test results to predict the seismic response of the M26 units.

B. Static Analysis

In the static analysis, the inertial forces calculated by modal analysis are superimposed on the normal design loads. The resultant stresses in structural members are calculated and compared to allowable stresses. This proves the structural adequacy of the design.

3.10.2.2.1.2 Relay Performance

The M26H test results and the modal analyses establish the maximum acceleration levels to which any of the critical relays mounted on the units will be subjected to for the specified seismic input. These acceleration values are then determined to be safe by comparing them with the results of separate seismic qualification tests conducted on the various types of relays.

The seismic tests on individual relays were done according to the following procedure:

ARKANSAS NUCLEAR ONE
Unit 2

All devices were mounted in their normal position. A search for resonance was made by sweeping from 5 to 33 Hz at a constant rate of 1 Hz per 15 seconds. If resonance was found in the sweep test, the devices were tested at that frequency. If not, then the devices were tested at 33 Hz for a period of two minutes or malfunction. A failure was defined as a 100 microsecond change of position of either normally open or normally closed contact. The tests included the deenergized and energized states of the relays.

3.10.2.2.1.3 Breaker Operating Mechanisms

The ability of the breaker to function correctly during and after a seismic disturbance was established by the following:

- A. During the tests on the M26H unit, the breakers were tripped and closed successfully during the shaking at a much higher "g" level than specified for this plant.
- B. A calculation by the manufacturer's Design Engineering subsection indicates that very high "g" levels are required, 44 g horizontally and 50 g vertically, before the mechanism would close or trip the breaker falsely.
- C. Field experience (Sylmar, Ca, 1971 earthquake) demonstrated that the M26 units could successfully withstand a severe seismic disturbance.

3.10.2.2.1.4 Switchgear 2A5 Seismic Qualification

Seismic certification for the 2A5 switchgear assembly was furnished by BBC Brown Boveri, Inc. Moreover, functional integrity of the assembly was ascertained by tests before and after seismic simulation.

3.10.2.2.2 480-Volt AC Load Centers

The seismic qualification of the 480-volt load centers consists of seismic certification of the switchgear assembly and seismic certification of the load center transformer, independent of each other.

3.10.2.2.2.1 Switchgear Assembly

A 2-frame low voltage switchgear assembly was subjected to the following tests at the Environmental Test Laboratory under the auspices of Applied Services Corporation.

- A. A frequency sweep establishing points of resonance by mounting the switchgear on a low frequency vibration machine and applying excitation was performed.
- B. An attenuated sinusoidal accelerating force applied at selected frequencies with device monitoring to establish functional integrity. During tests at 4, 6, and 11 Hz the equipment was subjected to the following attenuated sine wave accelerating forces for the total time durations indicated:

ARKANSAS NUCLEAR ONE
Unit 2

CUMULATIVE TEST TIME (SEC)

<u>Frequency (Hz)</u>	<u>Acceleration (g)</u>					<u>Total Time</u>
	<u>0.5</u>	<u>1.0</u>	<u>1.5</u>	<u>2.0</u>	<u>2.5</u>	
4	24.25	11.50	5.50	1.75	-	43.00
6	32.49	20.31	10.83	5.00	1.31	69.94
11	<u>9.36</u>	<u>4.54</u>	<u>2.17</u>	<u>0.81</u>	-	<u>16.88</u>
Total Time	66.10	36.35	18.50	7.56	1.31	129.82

Whereas the above figures are cumulative times for the complete series of test, they are illustrative of the rate of decay of the attenuated sine wave inputs for each test frequency. For instance, at 4 Hz the attenuation is represented by 1.75-second duration at 2.0 g, 5.50 seconds at 1.5 g, 11.50 seconds at 1.0 g, and 24.25 seconds at 0.5 g.

All test input valves exceed the minimum required accelerations and the excitation response was above the required response spectra.

In each test, the method of securing the equipment approximated or equaled the actual mounting in the plant.

3.10.2.2.2 Load Center Transformer

The transformer was installed on a base and mounted on a flatbed trailer where it was anchored at the base. The method of restraint was rigid; chains were attached, but left slack, only being used as a safety precaution.

An Impactograph recording accelerometer was installed, monitoring input accelerations to the transformer. The transformer was transported over selected rough terrain at speeds between 0 and 50 mph.

The recording tape was examined after the test. The highest recorded impacts exceeded 10g in all three directions simultaneously. Moreover, functional integrity of the device was ascertained by tests before and after the road shocks.

3.10.2.2.3 480-Volt AC Motor Control Center

Seismic certification for the Class 1E 480-volt Motor Control Center (MCC) was furnished by ITE Imperial Corporation. This certification is based on simulated seismic testing performed on the Series 5600 MCC by MTS Systems Laboratory.

Two typical MCC stacks were mounted on a vibrating table, capable of applying a continuous amplitude, sinusoidal input waveform. The mounting of units on the shake table simulated the actual restraining conditions used in securing the MCC's to the floor in the plant.

3.10.2.2.3.1 Test Procedure

- A. A low amplitude frequency search was performed to determine the natural frequency, regions of resonance, and the critical damping of the frame and structure.

ARKANSAS NUCLEAR ONE
Unit 2

- B. A continuous, sinusoidal input wave form was applied at the required acceleration level for a period of 30 seconds.
- C. A vibration test at the center band frequency set at the region of resonance, with a bandwidth of ± 3 Hz was conducted for a duration of 60 seconds.
- D. A 5-cycle sine beat input was applied, each beat being delayed by two seconds from the preceding beat to minimize superposition of the equipment effects.

All test input forces exceeded the required minimum OBE, DBE, horizontal, and vertical forces. Output levels enveloped the required response spectra for the MCC plant locations. All components were monitored for malfunction during all phases of testing.

The specific requirements of IEEE 344-1971 have been satisfied by successful implementation of the test procedures described above.

3.10.2.2.4 Distribution Transformers and Panel Board

3.10.2.2.5 125-Volt Station Batteries

The seismic certification for the station batteries consists of qualifying the battery fuse and relay panel and qualifying the batteries and the racks.

3.10.2.2.5.1 Battery Fuse and Relay Panel

Analysis, establishing the structural adequacy, was used for certification. Stress and frequency computations provided allowable stresses and natural frequency figures to be used in verifying the capability of the panel to withstand OBE and DBE conditions.

Component testing on a shake table was performed. Random motion, biaxial input was applied to the devices to ascertain functional integrity. The method of mounting simulated actual panel anchoring while the test was being conducted. The requirements of IEEE 344-1971 are satisfied for this equipment.

3.10.2.2.5.2 Batteries and Racks

Calculations with analysis for stress, frequency, and stiffness were used for qualification for OBE and DBE conditions. Material test data, i.e. yield load, ultimate stress, and nominal stress were used, support the analysis. Stresses were calculated for the support frame, rails and wall bolts for OBE and DBE accelerations.

Prototype battery cells, identical to those used in Unit 2 were subjected to random biaxial seismic excitation. Additional random biaxial seismic excitation was performed on prototype battery cells, identical to those used in Unit 2 except for number of plates, cell length and weight. In the former test, battery performance was demonstrated before and after seismic excitation. In the latter test, battery performance was demonstrated before, during, and after seismic excitation. The above demonstrates the seismic qualification of battery cells.

3.10.2.2.6 125-Volt DC Control Centers

The seismic qualification of the Class 1E DC control centers, 2D01 and 2D02, consists of an analysis to establish the structural adequacy and component tests to provide the functional integrity of critical devices.

3.10.2.2.6.1 Structural Adequacy

Calculations were performed in three orthogonal directions using a conservative model, generally a lumped mass concept. However, where the structure was obviously uniformly loaded, a distributed mass concept was used.

The seismic document justified the modeling technique adopted which includes:

- A. Frequency analyses of panels in the three orthogonal directions. The minimum natural frequency of the panels in any direction was found to be 37.0 Hz.
- B. Stress analyses of structural members to prove the extent of conservative design of the members.
- C. Anchorage calculations for the welding schedule.
- D. Worst case amplification factors and acceleration values at the various component mounting locations. These values were used for the component seismic tests described in Section 3.10.2.2.6.2 below.

3.10.2.2.6.2 Component Tests

- A. Air circuit breakers and auto transfer switches - These components were seismically qualified by simultaneous biaxial tests using random motion excitation. The test procedure used was the same as described in Section 3.10.2.2.8 for the station inverters. In this case, the test spectrum followed the required spectrum up to the frequency of panel resonance. Thereafter the test spectrum acceleration levels were increased in order to account for the amplification effects at the device mounting locations.

The devices were operated during the seismic tests to establish the capability of the devices to function reliably during a seismic disturbance. Also, the devices were monitored continuously during the tests to assure that no malfunction occurred.

- B. Indicating instruments - The indicating instruments used were qualified by seismic tests. The procedure used is outlined below.

An exploratory sweep was made to determine resonant frequencies as follows:

ARKANSAS NUCLEAR ONE
Unit 2

<u>Frequency Range</u>	<u>Acceleration (g)</u>		<u>Long</u>	<u>Time</u>
	<u>Vertical</u>	<u>Horizontal</u>		
1-33-1 Hz	0.37	0.8	0.8	20 minutes
33-100-33 Hz	0.37	0.8	0.8	20 minutes
100-500 Hz, if no resonant frequencies exist 100 Hz & below	0.37	0.8	0.8	33 minutes

An operational endurance test was then conducted as follows:

1. At each resonant frequency found in the sweep test of 100 Hz and below, a 2-minute test was conducted at an acceleration of 1.5g in both the horizontal and longitudinal axes and 0.5g in the vertical axis.
2. A sweep was made over the frequency range of 1-33 Hz at the rate of 15 seconds per cycle and at accelerations of 3.0g in the horizontal and longitudinal axes and 1.5 g in the vertical axis.

A malfunction test was then made at 33 Hz and at every resonant frequency below 33 Hz by increasing the acceleration value until a nondestructive malfunction was observed.

Since the acceleration values at the instrument mounting locations on the panel, determined by the analysis in Part 1 above were considerably lower than the levels at which the qualification tests were conducted, their performance was considered satisfactory.

- C. Undervoltage (alarm) relay - These relays are GE type NGV. They were qualified by seismic tests as described in Section 3.10.2.2.1.2.

3.10.2.2.7 Battery Chargers

The seismic documentation for the battery chargers consists of:

- A. Analysis for structural adequacy,
- B. Seismic test documentation to establish the functional integrity of the components, and
- C. Seismic Qualification(s) documented per applicable ANO/ENTEGRY specification to the requirements of IEEE 344-1971, 1975, and/or 1987 standards.

Functional Integrity of Components

The functional capability of the electromechanical devices was established by seismic tests conducted on a battery charger of the same frame size and bracing as used in the charger furnished.

ARKANSAS NUCLEAR ONE
Unit 2

3.10.2.2.8 Station Inverters

The inverters that furnish the 120-volt vital AC power have been qualified by seismic simulation tests. Each inverter consists of two assemblies, the Uninterruptible Power Supply (UPS) assembly and the static switch assembly. Each of these units was tested separately in accordance with the procedures described below.

3.10.2.2.8.1 Test Procedure

The unit was placed on a multiaxis shake table.

The unit was attached to the test table to simulate the actual mounting conditions when finally installed in the plant.

Testing meets the applicable requirements of IEEE 344-1971, 1975, and 1987.

3.10.2.2.8.2 Functional Integrity

The unit was supplied with 135 VDC power. Additionally, 480 VAC, 1Ø, 60 Hz power was applied to the input of the bypass transformer. The unit was then loaded to approximately 83 amps with a resistive load. Input and output voltages and output current were monitored throughout seismic testing.

The unit was inspected for structural damage and for any change in its functional characteristics before, during and after the simulated excitation.

The test report documents the satisfactory completion of the tests on the units.

3.10.2.2.9 Control Boards

The seismic qualification of the Class 1E control boards, which include consoles and vertical panels, consists of dynamic analysis to establish the control board structural adequacy and device tests to prove the functional integrity of the critical components.

3.10.2.2.9.1 Structural Adequacy

The dynamic analysis to verify the structural adequacy of the control boards follows the procedures presented in Section 3.7.2.1.3.

A stress analysis was performed and the control board structural stresses were checked against the applicable design criteria to verify structural adequacy.

3.10.2.2.9.2 Device Tests

Electrical relays, meters, switches, instruments, and other devices mounted on the consoles and vertical panels, which are required to remain functional during and after a DBE, to ensure functional adequacy of Class 1E systems, were subjected to simulated seismic tests and qualified by the device manufacturer in accordance with the requirements of IEEE 344-1971, 1975, or 1987.

3.10.2.2.10 Instrumentation and Racks

The seismic qualification of the Class 1E instrument racks consists of an analysis to establish the structural adequacy of the racks and device tests to prove the functional integrity of the critical devices.

3.10.2.2.10.1 Structural Adequacy

Instrument racks have been designed and built in accordance with the requirements stated in Section 3.10.1. Typical instrument rack installations are shown in Figure 3.10-7.

The method for qualification consists of a seismic analysis of a standard rack design. This rack was assumed to have the loads shown in Figure 3.10-8. All loads were conservatively chosen such that they would be greater than probable real loads. Neglecting dynamic loads, static loading was assumed. The combination of loads producing the most severe deflections were used. Static loads were combined with the allowable stress of the materials used to construct the rack. The analysis was carried further to show that by adding two additional horizontal supports as shown in Figure 3.10-7, the maximum rack length could be increased from four feet to five feet. The response spectra indicate that no amplification of the seismic input imposed on the rack by the floor would occur since the calculated natural frequency of the rack was found to be greater than 33 Hz.

A static analysis was performed on the design of the base plate anchorage used in the standard rack. The design was analyzed to determine the torsional rigidity and the bending rigidity of the base plate. Both the torsional and bending stresses were found to be within the allowable stress limits for the material used. These base plate loads were then applied to the anchor bolts and found to be within allowable limits of the bolt material.

3.10.2.2.10.2 Device Tests

Rack-mounted devices such as control switches, pressure and differential pressure transmitters and differential pressure indicating switches required for proper functioning of the safety-related systems have been seismically tested and qualified by the device suppliers in accordance with IEEE 344-1971, 1975, or 1987.

3.10.2.2.10.3 Instrument Mounting Details

Standard Seismic Class 1E instrument mounting details are shown in Figure 3.10-7.

3.10.2.2.11 Cable Tray and Instrument Tubing Supporting

The following bases were used in the seismic analysis of cable tray and instrument tubing supports:

- A. All safety-related cable tray and instrument tubing supports were designed for loads determined by dynamic analysis (first mode) using the appropriate seismic response spectrum.
- B. Conservative loading was assumed.

ARKANSAS NUCLEAR ONE
Unit 2

- C. The support system was designed to exclude all natural frequencies in a band covering the peak or peaks of the response spectrum curve.
- D. Maximum stress was limited to 90 percent of minimum yield for the DBE and code allowable stresses for the OBE.

Selected typical details showing the Category 1 cable tray supports and support connections are shown in Figures 3.10-1 and 3.10-6.

Instrument tubing support structures are designed and built in accordance with the requirements of Section 3.10.1. The instrument tubing support structures are shown in Figures 3.10-9 and 3.10-10.

The method for qualification consists of a seismic analysis of each configuration used. The installation is considered to be represented by a free body model subjected to loading in the horizontal plane in two mutually perpendicular directions, N-S and E-W, and in the vertical direction. Seismic loading occurs in all three directions simultaneously and is combined with a dead load in the vertical direction for this analysis. The analysis assumed bending in the horizontal plane and compression or tension in the vertical direction. Using the frequency and "g" level capacity based on 90 percent of yield capacity and using the appropriate damping (two percent for welded structure) and DBE floor response spectra, the "g" level loading for each direction was determined. The method used combines seismic loads for all three directions was determined. The method used combines seismic loads for all three directions plus the vertical dead load based on the square root of the sum of the squares. Conservative loading was assumed. Where the N-S and E-W coordinate axes of the model installation are at an angle with the N-S and E-W orthogonal coordinate axes of the building, then transformation equations were used to transform the loading directions to the same axes for the purpose of analysis.

The analysis showed that maximum stresses for each configuration analyzed did not exceed 90 percent of the minimum yield strengths for materials used.

3.10.2.2.12 Control Valve Assemblies

The valve operators are qualified in accordance with IEEE 344-1971. Test reports were submitted in accordance with IEEE Standards.

3.10.2.2.12.1 Test Outline

The operator was mounted on a shaker table and subjected to vibration testing along each of the three mutually perpendicular axis over the frequency range of 1 to 35 Hz with a maximum acceleration of 1.0 g's in order to determine natural frequencies. At each natural frequency three cycles of vibration at an excitation of 5.3 to 5.8g's were performed. A 1-minute rest period was allowed after each three cycles. If no natural frequencies were apparent, a 10-second dwell was performed at 2, 4, 6, 9, ..., N Hz utilizing maximum available control displacement up to a cutoff level of 3g's and at 5.3 to 5.8g's at 35 Hz.

No apparent natural frequencies were determined as a result of this testing. In all cases for all tests vibration was applied at 3g's for 10 seconds at all even numbered frequencies from 2 Hz to 34 Hz and at a level between 5.3 and 5.8g's at 35 Hz.

ARKANSAS NUCLEAR ONE
Unit 2

3.10.2.2.12.2 Calculations

In addition to the above testing static calculations for the valve operator combination are performed to a natural frequency greater than 33 Hz and acceptability of vibration of 3g's in three mutually perpendicular axes.

3.10.2.2.13 Emergency Diesel Generators

A seismic analysis was done on the engine generating unit skid assembly, including skid mounted and off-skid accessories, to demonstrate ability to perform its required function when subjected to a seismic disturbance. The analysis included evaluation of stresses to meet the requirements of Section 3.7. The following criteria were used for stress analysis:

A. Operating Basis Earthquake Conditions

The load combinations include gravity loads, operating loads, applicable operating temperatures and pressures, combined with the simultaneously applied horizontal and vertical OBE inertial forces. The horizontal and vertical inertial forces are obtained from the appropriate method specified in Section 3.7.

Stresses in the structural portions do not exceed the allowable working stress limits accepted as good practice as set forth in the appropriate design standards that is, the AISC Manual of Steel Construction, the ASME Boiler and Pressure Vessel Code or other industrial codes. If the applicable code permits stress increases for load combinations which include earthquake loads, such stress increase do not apply. The resulting deflections will not prevent normal operation of the equipment.

B. Design Basis Earthquake Conditions

The load combinations include gravity loads, applicable temperatures and pressures combined with the simultaneously applied horizontal and vertical inertial forces and are obtained from the appropriate method specified in Section 3.7.

Note: The vertical DBE acceleration values are 2.0 times the vertical OBE acceleration values.

Allowable stresses in the structural portions of equipment may be increased to a maximum value of $0.90 F_y$ for bending or tension, and $0.50 F_y$ for shear. The resulting deflections will not prevent operation of the equipment nor will the calculated deflections exceed 0.8 times those which could cause loss of function of equipment.

3.10.2.2.13.1 Diesel Engine Generating Unit

The equipment investigated is a Fairbanks Morse 12 cylinder Model 38TD8-1/8 opposed piston diesel engine connected to a Fairbanks Morse 3250 kW generator. The complete unit is mounted on a heavy skid. The generator is of the two bearing design with the connection between the engine crankshaft and generator shaft made with a flexible rubber type coupling. Due to the rigid box type construction of the accessory equipment section of the skid, it was possible to analyze the engine generating unit with its portion of the skid independent of the accessory equipment section. Based on prior experience in Navy shock testing of this engine, the following assumptions were made for the seismic analysis: A) engine block assumed rigid, and B) internal rotating elements such as pistons, connecting rods and crankshafts were not

ARKANSAS NUCLEAR ONE
Unit 2

investigated due to their inherent design nature, e.g., all rotating elements were initially designed to withstand normal firing and inertia loads which are far in excess of any seismic loading.

The seismic analysis was concentrated on areas of either known damage during Navy shock testing or new items not shock tested, and was prepared to test the adequacy of the following:

- A. All main equipment holddown bolts;
- B. Turbocharger bracket mounting on engine block; and,
- C. The last two engine bearing and generator bearings.

The dynamic analysis to determine seismic loads was performed in accordance with Section 3.7.2.1.3. The engine generating unit and skid was modeled separately for horizontal (at 90 percent to engine crankshaft center line) and vertical excitation. Using the lumped masses and spring constant concept, natural frequencies were calculated. Applying a 2-percent damping factor and the applicable acceleration response spectrum, modal forces were determined. The resultant forces for all mode orders, for each of the horizontal and vertical excitation modes, were calculated by adding the absolute maximum mode value plus the square root of the sum of the squares of the others, e.g.,

$$\text{Maximum Resultant} = (\text{max}) + \sqrt{\sum \text{others}^2}$$

The simultaneous effect of horizontal and vertical excitation forces combined with weight and accelerating torque determine the net forces in the equipment hold down bolts, the turbocharger mounting block, and the engine and generator bearings. The following conclusion has been arrived at:

A. Holddown Bolts

The maximum principal stresses are low and are within the stresses allowed in Section 3.7.

B. Mounting Bolts and Bracket of the Engine Mounted Turbo-Charger

The maximum principal stresses for the DBE case are low and are within the allowable stresses of Section 3.7.

C. Engine and Generating Bearings

The vector sum of the horizontal and vertical seismic forces on the generator and on the last two engine bearings combined with operating forces are low. The engine and bearing, which has the highest seismic load, has a total combined seismic and normal peak operating load less than normal operating load on some intermediate bearings. Therefore, a momentary shock will not harm the bearings.

ARKANSAS NUCLEAR ONE
Unit 2

The engine generating unit and skid assembly was also modeled for fore and after horizontal excitation (parallel to engine shaft). The seismic forces for this mode, combined simultaneously with vertical excitation and operating loads were calculated to determine the stresses at the engine thrust bearing support arm and the generator spherical bearing. The engine maximum stresses are low and are within the allowable stresses. The engine thrust bearing support arm will not fail during a seismic disturbance.

SKF No. 22240 spherical bearings are used in the generator. Assuming a seismic disturbance lasting five minutes, the estimated decrease in life expectancy due to maximum seismic and operating loads is 0.05 percent in life per seismic shock which is acceptable.

3.10.2.2.13.2 Analysis of Components

The following components of the emergency diesel generator units have been analyzed for structural integrity. Seismic loads, based on 2-percent damping, including simultaneous horizontal and vertical excitation were combined with gravity loads to determine the effects on the supports. In each case the maximum resultant of different mode orders was calculated using the formula:

$$\text{Maximum Resultant} = (\text{max}) + \sqrt{\sum \text{others}^2}$$

A. Lubricating Oil Filter

The filter is a tall cylinder with its center of gravity near the central height and it is assumed to be rigid with system flexibility at the four mounting feet. The total foot stiffness was calculated to determine the natural frequency.

The results indicate that the lube oil filter will adequately withstand the seismic disturbance.

B. Lubricating Oil Strainer and Starting Air Receiver

The lubricating oil strainer and the starting air receivers are considered tall cylinders with center of gravity near the central height. The same approach and analysis as was used for the lubricating oil filter was applied and the conclusion is that this equipment can adequately withstand the seismic disturbance.

C. Fuel Oil Day Tank

The day tank is a horizontal cylinder of welded steel fabrication. It is supported by an attached saddle at each end which is bolted to the floor. Predominant flexibility is at the saddles so the tank is assumed to act as a rigid body with the center of gravity at the geometric center of the tank. For horizontal excitation two cases were evaluated: one is with excitation parallel to tank axis and the other normal to tank axis. In each case, the horizontal forces on the tank are the same. The effects of horizontal vertical excitation using 2-percent damping and gravity loads due to a full load tank were evaluated for stud stresses, stresses at the tank end and stress in the tank. The maximum calculated stresses are all less than the respective allowable stresses. In this case, there are no critical deflection locations, so no deflections were calculated. Wave effects for both transverse and longitudinal waves due to a partially filled tank were also investigated but it was concluded that the filled tank contributes the worst loading condition.

ARKANSAS NUCLEAR ONE
Unit 2

D. Jacket Water Expansion Tank

The expansion tank is a horizontal cylinder with elliptical ends wall mounted with two saddle shaped supports. Flexibility is assumed in the support saddle and in the tank wall at the saddle connection. The spring constants for each horizontal and vertical excitation were calculated for natural frequencies. Using a 2-percent damping factor seismic forces were established. The simultaneous effects of horizontal and vertical excitation combined with gravity loads determined the net forces. Consequently, the stresses on the parts examined. None of the calculated stresses exceeded the allowed values. Again, deflections were not considered since their effects were not critical. The conclusion is that the tank will adequately withstand the seismic disturbance.

E. Overspeed Governor and Shutdown System

In the event of excessive speed the governor shuts off the fuel injection pumps. The influence of seismic forces have been investigated to determine the safety factor against shutting down of the engine. There are four ways by which linear acceleration of the engine block can put energy into the overspeed system.

1. Due to lateral or vertical accelerations, the overspeed rotating weight assembly can respond at what it would think was an overspeed.
2. The latch and lever system could unhook from vertical acceleration.
3. The manual emergency shutdown linkage could actuate from sufficient lateral acceleration.
4. Plunger inertia causing unhooking of latch.

The lowest linear acceleration determined from the above cases, and the acceleration based on the possibility of an arithmetic summation, were determined to arrive at a safety factor greater than 1.0. Therefore, seismic forces will not result in a failure of the governor system.

F. Skid Piping

For the systems, the largest run of pipe with the longest unsupported section was evaluated. This is the pipe which is expected to have the lowest natural frequency and the highest seismic stresses. Motions from vertical and horizontal excitation were assumed to be uncoupled.

A mass elastic model of the piping was prepared for both horizontal and vertical excitation. Flexible joints were assumed to act as hinges while other joints and points of attachments were assumed to be rigid. This resulted in a system consisting of spans and lumped masses. As anticipated, the resulting stresses are low and a seismic disturbance will not cause any malfunction. Piping stresses at some locations reached as low as 100 to 300 psi and at one support reached 2,300 psi. There are not thought to be any critical deflections which must be considered.

ARKANSAS NUCLEAR ONE
Unit 2

G. Heat Exchanger Stack Assembly

The heat exchangers and the engine inlet air filters make up the heat exchanger stack assembly. The assembly has been analyzed as an independent system assuming no forces on the stack from any external piping. For the analysis, equipment has been modeled separately for vertical and horizontal excitation. For horizontal excitation, two cases were considered: one is parallel to the engine crankshaft, and the other is in the lateral direction. System frequencies were determined and modal forces calculated on the basis of a 2-percent damping factor. Each case of horizontal excitation was simultaneously considered with the vertical excitation and combined gravity and applicable operating forces. The following parts have been examined for stresses: stack bracing, holddown and clamp bolts, welds on attachment plates, brace tubings, spacer blocks, and engine inlet air filter bolts.

The results indicate no overstressing of these parts in either the DBE or OBE design case. The actual deflections at all mass points were considered small and there are no critical points on the heat exchanger stack assembly where momentary deflections due to seismic disturbance would prevent operation of the equipment.

H. Air Compressor Skid Assembly

The air compressor skid is built from a 12-inch channel provided with mounting feet at two places along each side of the channel. The compressor and motor are bolted to the skid.

As in the above cases, a horizontal transverse and a horizontal fore and after excitation were each simultaneously combined with vertical excitation and combined with gravity forces. For horizontal transverse excitation, torsional flexibility of the channel, except for the part under the compressor and motor, was considered. The forces in the holddown bolts and mounting feet are low and the maximum calculated principal stress is far less than the material allowable stress.

I. Local Electric Control Cabinet

The control cabinet is separate from the engine skid. It is made of sheet metal and angle weldment and contains the static exciter and the various meters, switches, and controls for operating the emergency generating set. In the analysis the mass-elastic model is defined, mode shapes and frequencies are calculated, and modal forces are calculated first for horizontal excitation, then for vertical excitation. Finally, resultant forces and stresses are calculated at critical locations, per specification, a 2-percent damping factor was applied.

The following were evaluated:

1. stresses in bolts and studs
2. stresses in reactor feet
3. stresses in current transformer feet
4. stresses in neutral grounding transformer feet
5. acceleration of relays

ARKANSAS NUCLEAR ONE
Unit 2

Results of the analysis indicate that the maximum principal stresses are low and are far less than the allowed stresses for the materials under consideration.

Device Qualification

Diesel generator instrumentation, control, metering, and relay devices required to remain functional during and after a DBE to ensure functional adequacy of Class 1E systems, have been seismically tested and qualified by the device suppliers in accordance with IEEE 344-1971, 1975, or 1987.

3.10.2.3 Amplification of Floor Inputs by Supports

The equipment was analyzed and/or tested as an assembly that simulated the intended service mounting, which accounted for possible amplification of the seismic input by the equipment support.

Seismic documentation for instrumentation and electrical equipment submitted by the vendor, was then reviewed by Bechtel to ensure that the support system had been considered.

Where it was necessary to test individual devices, e.g., relays or instruments, separate from the panel on which they were mounted, the devices were qualified for acceleration levels higher than those they would experience at their mounting locations on the panel.

ARKANSAS NUCLEAR ONE
Unit 2

3.11 ENVIRONMENTAL DESIGN OF MECHANICAL AND ELECTRICAL EQUIPMENT

The current Environmental Qualification (EQ) Program is based on 10 CFR 50.49, "Environmental qualification of electric equipment important to safety for nuclear power plants," and IEB 79-01B, Enclosure 4, "Guidelines for Evaluating Environmental Qualification of Class 1E Electrical Equipment in Operating Reactors" (commonly known as the DOR Guidelines). This program, which encompasses electrical equipment important to safety located in a harsh environment, is described in section 3.11.5. The remainder of this section and sections 3.11.1 through 3.11.4 contain the information required to be in section 3.11 of the SAR by the guidelines to which the SAR was written. This covers environmental conditions and design bases for the electrical and mechanical portions of the Reactor Protective System (RPS) and Engineered Safety Features (ESF) to assure acceptable performance in all environments.

The electrical and mechanical equipment of the Reactor Protective System (RPS) and Engineered Safety Features (ESF) system is designed to assure acceptable performance in all environments (normal and accident). The RPS (including the Core Protection Calculator system and the reactor trip switchgear) and the Engineered Safety Features Actuation System (including the auxiliary relay cabinets) were originally qualified for use using IEEE 323-1971 as a guide, even though IEEE 323-1971 was not a requirement for Unit 2 at the time of issuance of the construction permit.

The design criteria for the RPS and the ESF system are based on equipment location. As far as practical, equipment for these systems is located outside the containment or other areas where high activity levels or adverse environmental conditions could exist.

The RPS and ESF are capable of performing their intended functions under the following environmental service conditions:

- A. All RPS and ESF components are capable of meeting their rated performance specifications under the environmental service conditions expected as a result of normal operating requirements and expected extremes in operating requirements.
- B. All RPS and ESF equipment required to accomplish protective actions in response to a design basis event are capable of completing their function under the environmental service conditions related to the design basis event. The environmental service conditions related to a design basis event are specified to include normal operating conditions before the event, conditions produced by the event, and conditions existing subsequent to the event for such time as is required for the protective actions to be carried to completion.
- C. The RPS and ESF equipment is capable of meeting the specified performance requirements for the most degraded conditions resulting from the long-term environment to which the equipment is normally exposed.

The required qualification envelope for equipment inside containment is defined in Section 3.11.5. Those requirements are the same for all of the equipment although some equipment may not have to operate during all phases of the accident, e.g., hydrogen recombiners and containment isolation valves. The required integrated lifetime radiation dose, including a LOCA, for all of the equipment is 3.3×10^7 rads unless otherwise documented. Because of the conservatism of the calculations which determined the above requirements, additional margin was not always a requirement. The equipment was qualified for the accident radiation level by test.

ARKANSAS NUCLEAR ONE
Unit 2

The valves listed in Table 3.11-3 are EQ motor operated valves within containment which would be submerged following a postulated LOCA. Two of these are part of the Emergency Core Cooling System (ECCS). All of these valves are designed for the environment to which they will be exposed when required to function. Valves 2CV-5647-1 and 2CV-5648-2, the sump isolation valves, are locked open and thus are not required to function in the post-accident environment. The other valves will have completed their isolation function before they are submerged and will not be required to function again.

Ferrous surfaces of equipment exposed to the containment atmosphere had the following protective coating systems installed during construction:

- A. Liner plate dome, walls, structural steel and miscellaneous steel were coated with an inorganic zinc primer. The liner plate is finish painted with a modified phenolic or epoxy to a height of five feet above all grating platforms, to a depth of three feet, six inches below all grating platforms, to a height of five feet above concrete floors, and surrounding penetrations. All remaining liner plate walls from the spring line down, including the brackets for the polar crane rail are finish painted with a modified phenolic or epoxy.
- B. Mechanical and electrical equipment coatings are as follows:
 - 1. Polar Crane: Epoxy primer and epoxy finish
 - 2. H&V Equipment: Modified phenolic or epoxy primer and finish
 - 3. CEDM Cooling Unit Fans: Baked on epoxy primer and baked on epoxy enamel
 - 4. Safety Injection Tanks: Inorganic zinc primer
- C. Carbon steel pipes, valves, and hangers are primed with an inorganic zinc primer.

Repairs of damaged coatings may use reformulated replacement coatings that contain materials different than the previous coatings, may not require a primer, and may not be the same type (e.g., inorganic). Coatings and repairs are governed by Specification ANO-A-2437.

Although not currently used in the EQ program, originally the plant environmental service conditions were classified in the following environmental design categories:

- I-A Short-term containment environment following a LOCA or MSLB accident;
- I-B Long-term containment environment following a LOCA or MSLB accident;
- I-C Containment environment following all other accidents;
- I-D Control room environment following all other accidents; and
- I-E Auxiliary building environment following LOCA.

The environmental conditions specified in procuring components in each category are given in Table 3.11-1. The radiation environment specified for Categories I-A and I-B is based on a LOCA fission product release source consisting of 25 percent of the core halogen inventory, 100 percent of core noble gas inventory and one percent of core solid fission product inventory.

ARKANSAS NUCLEAR ONE
Unit 2

Instrumentation located inside the containment which must function while subject to severe environment caused by either a LOCA or an MSLB was designated as Category I-A or I-B. These safety system instruments are intended to limit the effects of the accident by initiating or monitoring Engineered Safety Features (ESF) and include pressurizer pressure and level and steam generator pressure and level. Containment pressure, also required to initiate and monitor engineered safety features, was categorized as I-B.

Additional instrumentation located inside the containment is not required to initiate or monitor engineered safety features after the LOCA or MSLB accident and was categorized as I-C. Category I-C included such instrumentation as out-of-core neutron detectors, reactor coolant temperature detectors, reactor coolant pump speed sensors, and Control Element Assembly (CEA) position indicators (reed switch assemblies). Since these Category I-C instruments do not provide information required subsequent to the design accident, they do not have the survival requirements that were imposed on Category I-A or I-B instruments.

Equipment in Category I-D is designed to withstand continuous temperatures of 104 °F, which is considered a mild environment.

Following a LOCA, service water may be recycled through the emergency cooling pond. In this event, the maximum expected pond temperature is less than 116 °F, and equipment originally classified as Category 1E may experience the temperatures shown in Table 3.11-1.

3.11.1 EQUIPMENT IDENTIFICATION

The current EQ program (see Section 3.11.5) identifies equipment required to be environmentally qualified in accordance with 10CFR50.49 and IEB 79-01B.

RPS and ESFAS components were originally classified according to the environmental design categories described above dependent upon their location and functional requirements. The components listed in each category were procured to operate in the temperature, pressure, humidity, and radiation environment for the time shown in Table 3.11-1. Components in Categories I-A and I-B are designed to withstand the environmental conditions shown in the table in addition to long-term operation in Category I-C environment.

The following equipment was included in each category:

Category I-A

- Pressurizer pressure sensors
- Steam generator pressure sensors
- Valves and valve controllers for the Safety Injection System (SIS), CIS, and CSS
- Electrical cables and penetration assemblies for the above

Category I-B

Containment sump level sensors	Pressurizer pressure sensors
Containment spray headers	Pressurizer level sensors
Containment cooling units	Steam generator pressure sensors
Containment recirculation fans	Steam generator level sensors
Hydrogen recombiners	Containment pressure sensors
Associated valves and piping for the above	Containment radiation sensors
Electrical cable & penetration assemblies for the above	

ARKANSAS NUCLEAR ONE
Unit 2

Category I-C

Reactor coolant temperature sensors Out of core neutron detectors
Reactor coolant pump speed sensors CEA position indicators (reed switch assemblies)

Category I-D

RPS cabinets RPS trip switchgear
ESFAS measurement and actuation cabinets

Category I-E

High pressure safety injection pumps and motors
Low pressure safety injection pumps and motors
Containment spray pumps and motors
Shutdown cooling heat exchangers
All automatically activated and remotely actuated valves, controllers, and instrumentation associated with the above
Hydrogen analyzers
Associated valves and piping for the above
Cooling unit fans and motors for the purpose of cooling rooms where motors driving safety equipment are located, to include:
 Shutdown cooling heat exchanger room unit coolers
 High pressure safety injection pump room unit coolers
 Charging pump room unit coolers
 ESF switchgear room unit coolers
 Auxiliary building electric equipment room unit cooler
 Auxiliary building emergency diesel generator room exhaust fan
 Penetration rooms ventilation system
 Control room emergency air conditioner units
 Control room emergency supply air unit
Auxiliary electrical equipment for ESF:
 4.16 kV switchgear (Bus 2A3, 2A4 and 2A5)
 4160-480-volt load center transformers (2X25 and 2X26)
 480-volt load centers (Bus 2B5 and 2B6)
 480-volt motor control centers (2B51, 2B52, 2B53, 2B54, 2B61 2B62, 2B63, 2B64)
120-Volt vital AC distribution panels (2RS1, 2RS2, 2RS3, and 2RS4)
DC Equipment for ESF:
 Battery bank #1 (2D11)
 Battery bank #2 (2D12)
 Inverter channels 1-4 (2Y11, 2Y22, 2Y13, 2Y24, 2Y1113, and 2Y2224)
 DC motor control center 2D01 and 2D02
 DC power and distribution panels
Cables and raceways associated with the ESF system
Containment isolation valves and valve controllers
Emergency diesel generators to include:
 Starting air tanks Jacket CW heat exchanger
 Lube oil coolers Air after coolers
 Associated valves and instrumentation
Refueling water tank level sensors
Containment atmosphere monitors (gaseous only)
Emergency Feedwater System Pump MOVs:
 Turbine drive steam admission valves 2P7B suction valve from SW header
 2P7B suction valve from condensate

ARKANSAS NUCLEAR ONE
Unit 2

3.11.2 QUALIFICATION TESTS AND ANALYSES

As specified by the current EQ program (see Section 3.11.5), electrical equipment is qualified by test and/or analysis in accordance with 10CFR50.49 and IEB 79-01B.

Seismic qualification of original plant Class 1 equipment was completed using IEEE 344-1971 as a guide. Seismic qualification of non-original plant Class 1 equipment was completed using the guidance of IEEE 344-1971, 1975, or 1987.

Isolation valve motor operators located within the containment were designed to operate during and/or after an accident in accordance with IEEE 382-1972 and supplementary requirements of Regulatory Guide 1.73, "Qualification Test of Electric Valve Operators Installed Inside the Containment of Nuclear Power Plants." The qualification documentation was in accordance with IEEE 323-1971 (although it is now required to be in conformance with 10 CFR 50.49).

All seismic, normal and accident environmental conditions are specified in the valve design specifications.

The containment cooling units, recirculation fan units and reactor cavity booster fan motors are of the same type and construction as a prototype that has successfully completed the test outlined by IEEE 334-1971 "Guide for Type Tests of Continuous Duty Class 1 Motors Installed Inside the Containment of Nuclear Power Generating Stations."

3.11.2.1 Category I-A and I-B Equipment (Original Classification)

The equipment was qualified for the specified environmental conditions by a combination of type testing and analysis. Type tests are performed wherein the components are subjected to the specified temperature, pressure and humidity conditions. The components were operational during these tests. No zero or span adjustments were allowed during the tests. The acceptance criteria for instrument sensors were:

- A. During the test the calibration must not change more than plus or minus five percent.
- B. The post test calibration must be within plus or minus one percent of the pretest values.

The containment fan cooler motors were qualified in accordance with IEEE 334-1971, "IEEE Trial-Use Guide for Type Tests of Continuous-Duty Class 1 Motors Installed Inside the Containment of Nuclear Power Generating Stations."

3.11.2.2 Category I-C, I-D and I-E Equipment (Original Classification)

This equipment was rated for continuous operation under the specified conditions. Since the extremes of the temperature, pressure and humidity conditions are within the design ratings of standard commercial components, qualification was accomplished by requiring vendor certification of the required capability and supporting documentation of test results or operating experience on similar equipment.

The requirement for meeting the specified performance requirements from the most degraded conditions resulting from long-term environmental effects was met by limiting the amount of degradation allowed. The periodic test and calibration program described in the Technical

ARKANSAS NUCLEAR ONE
Unit 2

Specifications verifies the capability of the equipment to meet the original performance requirements. Periodic testing allows detection of any gradual equipment deterioration and effectively re-qualifies the equipment for the short-term operational period between tests.

3.11.3 QUALIFICATION TEST RESULTS

3.11.3.1 Categories I-A and I-B

Equipment in Categories I-A and I-B is qualified in accordance with the requirements of 10 CFR 50.49 to the conditions specified in Table 3.11-2 as documented by ANO Environmental Qualification - Environmental Conditions, Engineering Standard NES-13. For a historical reference to the original qualification information refer to the ANO-2 Final Safety Analysis Report (FSAR).

3.11.3.2 Category I-C, I-D and I-E

The equipment in this category (except for the electrical trip switchgear) is standard instrument packages for which the vendors specifically certified the individual equipment's capability to meet the operating environments as delineated in the purchase specification. These conclusions were based on a combination of type testing and proven operating capability in similar environments in industrial and previous nuclear power plant applications.

3.11.4 LOSS OF VENTILATION

The control room is normally air conditioned by four 100 percent capacity air conditioning units receiving chilled water from four 100 percent capacity chillers (two for Unit 1 and two for Unit 2). One air conditioning unit from each unit is normally running, with the others in standby status, available for manual actuation in the event of failure of the operating units. In the unlikely event that all four of the normal chilling systems and the emergency air conditions systems fail, the maximum temperature in the control room will be 115 °F Dry Bulb (DB) using forced circulation with outside air. In the event of a failure of all fans and subsequent isolation of the control room from the outside air, either of the emergency air conditioning units located in ANO-2 will cool the control room and instrumentation adequately to permit safe shutdown of both units. The emergency air conditioning units were originally sized such that, if all off-site power was lost and either of the emergency air conditioning units starts, the maximum temperature of the control room would be approximately 84 °F DB. The worse case outside environment assumed for this analysis is 103 °F DB, 83 °F Wet Bulb (WB) and 43 percent relative humidity maximum and is based on records of ambient conditions at the site.

All components of the RPS and ESFAS which are located in the control room are designed to operate in ambient conditions of 104 °F and 90 percent relative humidity. The heat loads within the RPS and ESFAS cabinets are low and the cabinets do not require specific air conditioning ducting. Forced air cooling of each PPS bay is provided by redundant 260 cfm fans.

Individual components and modules of the RPS have been specified to require factory testing at design temperatures and humidity conditions. Similar RPS cabinets, including all portions of the system located in the control room, have been tested as a system at temperatures in excess of the 104 °F design limit. Additional information on environmental testing performed on the PPS has been provided in CE Test Report 00000-ICE-3712.

ARKANSAS NUCLEAR ONE
Unit 2

3.11.5 CURRENT ENVIRONMENTAL QUALIFICATION PROGRAM

The current environmental qualification program is based on 10 CFR 50.49, "Environmental qualification of electric equipment important to safety for nuclear power plants," and IEB 79-01B, Enclosure 4, "Guidelines for Evaluating Environmental Qualification of Class 1E Electrical Equipment in Operating Reactors" (commonly known as the DOR Guidelines).

Promulgated in 1983, 10 CFR 50.49 is applicable to electrical equipment important to safety located in a harsh environment, which includes safety-related equipment, non-safety-related equipment whose failure could adversely affect a safety-related component, and certain post-accident monitoring equipment. Excluded from its scope are requirements for seismic and dynamic qualification, protection against other natural phenomena and external events, and qualification of equipment located in mild environments. A mild environment is defined in 10 CFR 50.49 as an environment that would at no time be significantly more severe than the environment that would occur during normal plant operation, including anticipated operational occurrences.

10 CFR 50.49 requires that licensees perform the following:

1. Establish a program for qualifying electrical equipment important to safety;
2. Prepare and maintain a list of equipment important to safety,
3. Establish and maintain a qualification file which includes details about each item of electrical equipment required to be qualified;
4. Qualify the equipment based on factors such as temperature, pressure, humidity, radiation, etc;
5. Qualify equipment by one of the following methods:
 - testing of an identical component under required conditions,
 - testing a similar equipment item with supporting analysis,
 - use of experience with supporting analysis, or
 - analysis in combination with partial type test data that supports the analytical assumptions and conclusions;
6. Maintain the qualification file in an auditable form during the entire period of storage for future use and installation within the plant; and,
7. Qualify replacement equipment to 10 CFR 50.49 requirements unless there are sound, documented reasons to the contrary.

Licensees were exempted from requalifying equipment to 10 CFR 50.49 requirements if the equipment was previously qualified to prior regulations (such as IEB 79-01B).

ANO established an Environmental Qualification (EQ) Program based primarily on the requirements of the DOR Guidelines. The ANO EQ Program compliance to 10 CFR 50.49 is based in part on the exemption granted for equipment previously qualified to IEB 79-01B. The EQ Program is described in engineering standards and is administratively controlled by plant procedures.

ARKANSAS NUCLEAR ONE
Unit 2

The current list of equipment required to be EQ (the EQ Master List, or EQML) is maintained by the controlling plant database (such as equipment database/component database). Though the specific qualification requirements of 10 CFR 50.49 did not apply to all equipment at ANO (i.e., some items are 79-01B equipment), ANO was required to demonstrate that the scope requirements had been addressed. ANO achieved this through the programmatic development of its EQML.

The environmental conditions at ANO have been determined specifically for the EQ Program. These conditions include normal temperature, pressure, humidity, and radiation, as well as accident (LOCA/HELB) temperature, pressure, humidity, radiation, chemical spray, and submergence. These environmental conditions are incorporated into a single document for ease of use. SAR Section 6.2 and figures in Chapter 6 provide the containment DBA temperature and pressure profiles used in the qualification process to qualify the equipment. Procedural controls identify potential EQ Program impact when plant environmental conditions are revised. The plant environmental conditions are included within the EQ Program evaluation and documentation process. At ANO, a harsh environment exists if the accident temperature exceeds 140 °F or the total normal plus accident radiation dose exceeds 5.0E+4 rads (total integrated dose).

For equipment important to safety located inside containment, the two accident conditions considered were the MSLB and LOCA. These pipe breaks envelop all other potential HELBs for equipment inside containment. With respect to the MSLB, IE Bulletin 79-01B (Section 4.2 of the DOR Guidelines) states that equipment qualified for a LOCA environment is considered qualified for a MSLB environment in plants with automatic spray systems not subject to disabling single component failures. Therefore, the LOCA temperature profiles are used in lieu of the MSLB (inside containment) temperature conditions. This provision is considered applicable to equipment evaluated against 79-01B and for equipment purchased to 10 CFR 50.49.

Outside containment, a harsh environment may be created by HELBs or recirculating fluids from inside containment. Electrical equipment important to safety located in these environments is also environmentally qualified.

The EQ Program has an established process to evaluate and document the qualification of EQ equipment. This process is described and administratively controlled by engineering standards and procedures. The evaluation process identifies and evaluates information including component identification, qualification rules, service conditions, qualified parameters, interfaces, installation details, and comparison of required versus qualified environmental conditions. This process addresses various attributes of qualification including similarity, synergistic effects, margins, sequential tests, use of analysis, test anomalies, and qualification methods. It also includes evaluating, identifying, and documenting requirements necessary to maintain the qualification of EQ equipment. Requirements necessary to maintain qualification are integrated into plant activities to ensure compliance with the EQ Program. Documentation associated with or produced from the evaluation process is maintained within the records management system as an auditable record of qualification.

ARKANSAS NUCLEAR ONE
Unit 2

3.12 REFERENCES

1. "Additional Information, ANO-2, Docket 50-368, Comparison of Arkansas Nuclear One - Unit 2, Maine Yankee and Fort Calhoun Reactor Internals Design Parameters and Flow Induced Structural Response," CEN-8(A)-P, Supplement 1, May, 1975.
2. "Analysis of Flow-Induced Vibrations: Fort Calhoun Precritical Vibration Monitoring Program," CENPD-85, January, 1973.
3. "Analysis of Flow-Induced Vibrations: Maine Yankee Precritical Vibration Monitoring Program Predictions," CENPD-55, May, 1972.
4. "Analysis of Piping System," BP-TOP-1, Bechtel Power Corporation, San Francisco, California, April 1973.
5. "Comparison of Arkansas Nuclear One - Unit 2, Maine Yankee and Fort Calhoun Reactor Internals Design Parameters and Flow Induced Structural Response," CEN-8A, August, 1974.
6. "Containment Building Liner Plate Design Report," BC-TOP-1, Revision 1, Bechtel Corporation, December 1972.
7. "Description of Loss-of-Coolant Calculational Procedures," Report CENPD-26 August, 1971.
8. "Design for Pipe Break Effects," BN-TOP-2, Revision 1, Bechtel Corporation, San Francisco, California, June, 1973.
9. "Design of Structures for Missile Impact," BC-TOP-9A, Revision 2, Bechtel Power Corporation, September 1974.
10. "The Effects of Radiation and Aging on a Coaxial Cable," Raychem Report #518A.
11. "The Effects of Radiation and Aging on Flamtrol Insulated Wire," Raychem Report #517A.
12. "Electric Hydrogen Recombiner for PWR Containments," Westinghouse Proprietary Report WCAP-7709-L, Supplements 1,2,3 and 4.
13. "Environmental Exposure of Liquid Level Sensor," Isomedix Report.
14. "Environmental Qualification Test Report on Foxboro Model E11AH, F & P Model 50EP1041 and 13D2496 and Rosemount Model 1153GA9 Transmitters," Wyle Test Report #26304, Revision 1.
15. Supplement to Wyle Test Report #26304, Revision 1.
16. "Environmental Test Report on TRC Model 72V Type, 1" 'Y' Pattern Solenoid Motor Valve per Provisions of TR Test Procedure #1383," Target Rock Corporation Report 1500.

ARKANSAS NUCLEAR ONE
Unit 2

17. "Environmental Test Report on TRC Model 75G-002, 1" 'Y' Pattern Solenoid Motor Valve Soft Seated, High Pressure Version Per Provisions of TR Test Procedure #1674," Target Rock Corporation Report 1827B.
18. "Full Scale Buttress Test for Prestressed Nuclear Containment Structures," BC-TOP-7, Revision 0, Bechtel Corporation, August, 1971.
19. "ICES STRUDL-II: The Structural Design Language Engineering Users' Manual."
20. "Lateral Stresses in the Ground and Design of Earth-Retaining Structures," State-of-the-Art Papers presented at 1970 Specialty Conference, sponsored by Soil Mechanics and Foundations Division, ASCE Ithaca Section, paper by H. Bolton Seed and Robert V. Whitman under the title; "Design of Earth Retaining Structures for Dynamic Loads."
21. "Long-Term Testing of Electrical Cables Under Simultaneous Exposure to Gamma Radiation, Steam and Chemical Spray," Franklin Institute Report F-C3341.
22. "Loss of Coolant Accident (LOCA) Test on 3 Phase Electric Motor for Bechtel Power Corporation," Wyle Labs Report #58315.
23. "Loss of Coolant Accident Testing of Unitized Header Penetration Assemblies," Amphenol Report #123-1247.
24. "Maine Yankee Precritical Vibration Monitoring Program, Final Report," CENPD-93, G.C. Millman, G.R. McCoy, J.D. Thompson, February, 1973.
25. "Missile Generation and Protection in Light-Water-Cooled Power Reactor Plants," ORNL-NSIC-22, September 1968, Oak Ridge National Laboratory.
26. "MRI/STARDYNE - Static and Dynamic Structural Analysis System: User Information Manual," Control Data Corporation, June 1, 1970.
27. "MRI/STARDYNE User Manual," Computer Methods Department, Mechanics Research, Inc., Los Angeles, California, January 1, 1970.
28. "Omaha Precritical Vibration Monitoring Program, Final Report," CEN-7(0), May, 1974.
29. "Qualification Records for Type NA Valve Actuators (Nuclear Class 1E)," Rotork Technical Report No. TR116.
30. "Qualification Test of a Fan and Motor Designed for Service in Nuclear Containment," Joy Axivane Fan Test.
31. "Qualification Test of Limitorque Operators in a Simulated Reactor Containment Post-Accident Steam Environment," Franklin Institute Report F-C3441.
32. "Qualification Test of Limitorque Valve Operator, Motor Brake, and Other Units in a Simulated Reactor Containment Post-Accident Environment, Final Report," F-C-3327, July, 1972.

ARKANSAS NUCLEAR ONE
Unit 2

33. "Qualification Test of Limtorque Valve Operators in a Simulated Reactor Containment Post-Accident Steam Environment, Final Report," F-C3441, September, 1972.
34. "Qualification Type Test Report Limitorque DC Valve Actuators for Nuclear Power Station Service Conditions," Limitorque Corporation Report No. B-0009.
35. "Seismic Analyses of Structures and Equipment for Nuclear Power Plants," BC-TOP-4, Revision 1, Bechtel Corporation, San Francisco, California, September, 1972, with Addendum 1, April, 1973.
36. "Special Prototype Radiation and Environmental (LOCA) Tests of Medium and Low Voltage Electric Penetration Assembly," Amphenol Report #123-2045, Revision A.
37. "Submersion Test of Type NA Actuator," Rotork Technical Report No. NQR 050-TR178.
38. "Supplementary Test of a Liquid Level Sensor Under Conditions Simulating a Loss-of-Coolant Accident Within the Containment of a Nuclear Power Generating Station," Franklin Institute Report F-C3834.
39. "Tendon End Anchor Reinforcement Test," BC-TOP-8, Revision 0, Bechtel Corporation, November 1971.
40. "Test of a Limitorque Valve Operator Under a Simulated Reactor Containment Post-Accident Steam and Chemical Environment," Franklin Institute Report F-C2232-01.
41. "Testing Criteria for Integrated Leak Rate Testing of Primary Containment Structures for Nuclear Power Plants, Revision 1," Bechtel Corporation, BN-TOP-1, November 1972.
42. "Tests of Electrical Cables Subjected to Thermal Aging, Gamma Radiation, and a Loss of Coolant Accident Simulation," Franklin Institute Report F-C4350-3.
43. "Topical Report on Dynamic Analysis of Reactor Vessel Internals Under Loss-of-Coolant Accident Conditions with Application of Analysis to CE 800 MWe Reactors," CENPD-42.
44. "U.S. Reactor Containment Technology, Volume II," ORNL-NSIC-5, August 1965, Oak Ridge National Laboratory, Subsection 6.6.1.3.
45. "Wind Forces on Structures," ASCE Paper No. 3269, A Final Report by Task Committee on Wind Forces, Committee on Loads and Stresses, Structural Division, published in Transaction, American Society of Civil Engineers.
46. Bakken, L. H. "A Method for Computer, Calculation of Shear and Moment Spring Constants for Lateral Dynamic Axisymmetric Models," SCL-DR-64-64, September, 1964.
47. Bijlaard, P.P., "Stresses from Radial Loads and External Moments in Cylindrical Pressure Vessels," The Welding Journal, 34 (12) Research Supplement 6085-6175, 1955.
48. Bijlaard, P.P., "Stresses from Radial Loads in Cylindrical Pressure Vessels," The Welding Journal 33 (12) Research Supplement 615-5- 623-5, 1954.

ARKANSAS NUCLEAR ONE
Unit 2

49. Bleich, H.H., and M.L. Baron, "Free and Forced Vibrations of an Infinitely Long Cylindrical Shelf in an Infinite Acoustic Medium," Journal of Applied Mechanics, Vol. 76, p. 167-177, June 1954.
50. Branson, D. E., "Instantaneous and Time-Dependent Deflections on Simple and Continuous Reinforced Concrete Beams," HPR Report No. 7, Part 1, Alabama Highway Department, Bureau of Public Roads, August 1965, pp. 1-78.
51. Chen, S. J., Hidalgo, P.A., Mayes, R. L., Clough, R. W., McNiven, H. D., "Cyclic Loading Tests of Masonry Single Piers, Volume 2 - Height to Width Ratio of 1," Report No. EERC 78-28, Earthquake Engineering Research Center, University of California, Berkeley, CA, November, 1978.
52. Connors, H.J. Jr., "Fluidelastic Vibration of Tube Arrays Excited by Crossflow, Flow Induced Vibrations in Heat Exchangers," ASME Annual Winter Meeting, December 1970.
53. Downs, J.E., "Hypothetical Turbine Missiles - Probability of Occurrence," General Electric Company Memo Report, March 14, 1973. Data cited applies to 43-inch last stage blading.
54. Ellis, B. C. and Gabrielson, V. K., "Dynamic Analysis of Lumped-Mass Systems," SCL-TM-64-110, April, 1965.
55. Fabric, S., "Early Blowdown (WATERHAMMER) Analysis for Loss of Fluid Test Facility," Report No. 65-28-RA, Kaiser Engineers, June 1965 revised April, 1967.
56. Forsberg, K., "Axisymmetrical and Beam-Type Vibrations of Thin Cylindrical Shells," AJAA Journal, Volume 7, February 1969.
57. Fritz, R. J., and Kiss, E., "The Vibration Response of a Cantilevered Cylinder Surrounded by an Annular Fluid," KAPL-M-6539, February, 1966.
58. Gabrielson, V. K., "SHOCK - A Computer Code for Solving Lumped Mass Dynamic Systems" SCL-DR-65-34, January 1966.
59. Correspondence from Karl R. Goller (NRC) to F.M. Stern (CE), December 5, 1973.
60. Hidalgo, P.A., Mayes, R. L., McNiven, H. D., Clough, R. W., "Cyclic Loading Tests of Masonry Single Piers, Volume 1 - Height to Width Ratio of 2," Report No. EER 78/27, Earthquake Engineering Research Center, University of California, Berkeley, CA, 1978.
61. Hidalgo, P.A., Mayes, R. L., McNiven, H. D., Clough, R. W., "Cyclic Loading Tests of Masonry Single Piers, Volume 3 - Height to Width Ratio of 0.5," Report No. EERC 79/12, Earthquake Engineering Research Center, University of California, Berkeley, CA, 1979.
62. Hurty, W. C., and Rubinstein, M. F., "Dynamics of Structures", Chapter 8, Prentice Hall, Inc., Englewood Cliffs, New Jersey, 1964.
63. Kilsby, E. R. Jr., "Reactor Primary - Piping - System Rupture Studies," Nuclear Safety, Volume 7 (Winter 1965-1966), p. 185.

ARKANSAS NUCLEAR ONE
Unit 2

64. Kiss, E., "Analysis of the Fundamental Vibration Frequency of a Radial Vane Internal Steam Generator Structure," ANL-7685, Proceedings of Conference on Flow-Induced Vibrations in Reactor System Components, May, 1979, Argonne National Laboratory, Argonne, Ill.
65. Klingner, R. E. and Bertero, V. V., "Infilled Frames in Earthquake Resistant Construction," Report No. EERC 76-32, Earthquake Engineering Research Center, University of California, Berkeley, CA, December, 1976.
66. Mainstone, R. J., "On The Stiffnesses and Strengths of Infilled Frames," Proc. I.C.E., 1971.
67. Meli, R. and Salgado, G., "Comportamiento de muros de mamposteria sujetos a cargas laterales," (Behavior of Masonry Wall Under Lateral Loads, Second Report) Instituto de Ingenieria, UNAM, Informe No. 237, September, 1969.
68. Meli, R., Zeevart, W. and Esteva, L. "Comportamiento de muros de mamposteria hueca ante cargas alternades," (Behavior of Reinforced Masonry Under Alternating Loads), Instituto de Ingenieria, UNAM, Informe No. 156, July, 1968.
69. Moody, F.J., "Two-Phase Vessel Blowdown From Pipes," APEC-4827, General Electric Company, San Jose, California, April 20, 1965.
70. Nelms, H.A., and Segaser, C.L., "Survey of Nuclear Reactor System Primary Circuit Heat Exchanger," USAEC Report ORNL-4399, April 1969.
71. Pahl, P. J., "Modal Response of Containment Structures," Seismic Design for Nuclear Power Plants, M.I.T. Press, Cambridge, Mass.
72. Porching, T.A., et al., "FLASH-4: A Fully Implicit FORTRAN IV Program for the Digital Simulation of Transients in a Reactor Plant," WAPD-TM-840, March, 1969.
73. Przemieniecki, J. S., "Theory of Matrix Structural Analysis," Chapter 13, McGraw-Hill Book Company, New York, New York, 1968.
74. Reavis, J.R., "Vibration Correlation for Maximum Fuel-Element Displacement in Parallel Turbulent Flow," Nuclear Science and Engineering, 38, pp. 63-69 (1969).
75. Semanderes, S. N., "Methods of Determining the Probability of a Turbine Missile Hitting a Particular Plant Region," WCAP-7861, Westinghouse Electric Corporation, Pittsburgh, Pennsylvania, February 1972.
76. Thomson, W. T., "Vibration Theory and Applications," Chapter 3, Prentice Hall, Inc., Englewood Cliffs, New Jersey, 1965.
77. Tillerson, J.R. and Haisler, W.D., "SAMMSOR II - A Finite Element Program to Determine Stiffness and Mass Matrices of Shells-of-Revolution", TEES-RPT-70-1S, Texas A&M University, October, 1970. "DYNASOR II - A Finite Element Program for the Dynamic Non-Linear Analysis of Shells-of-Revolution," TEES-RPT-70-19, Texas A&M University, October 1970.
78. Young, D., "Response of Structural Systems to Ground Shock," Yale University.

ARKANSAS NUCLEAR ONE
Unit 2

79. CEOG Topical Report CEN-367-A, Leak-Before-Break Evaluation of Primary Coolant Loop Piping in Combustion Engineering Designed Nuclear Steam Supply System, February 1, 1991.
80. USNRC Letter 2CNA069601, Subject: Containment Leak Detection Capabilities with Permanent Reactor Vessel Seal Plate at Arkansas Nuclear One, Unit 2 (TAC NO. M90610), June 18, 1996.
81. ANSYS Verification Manual – Release 5.3, 000659, First Addition, SASIP, INC., 201 Johnson Road, Houston, PA.
82. Modification of General Design Criterion 4 Requirements for Protection Against Dynamic Effects of Postulated Pipe Ruptures – Final Rule (Broad Scope), 52 FR 41288, October 27, 1987.
83. NRC Generic Letter 87-11: Relaxation of Arbitrary Intermediate Pipe Rupture Requirements.
84. Entergy Operations Letter NED-90-0262, Subject: Relaxation of Arbitrary Intermediate Break Criteria, August 15, 1990.
85. USNRC Standard Review Plan, NUREG-0800, June 1987.
86. CE Report CENPD-252-P-A: Blowdown Analysis Method, July 1979.
87. ANSYS Verification Manual – Release 5.3, 000659, First Addition, SASIP, INC., 201 Johnson Road, Houston, PA.
88. [EPRI NP-440, “Full-Scale Tornado-Missile Impact Tests,” July 1977](#)

ARKANSAS NUCLEAR ONE
Unit 2

Table 3.2-1

STRUCTURES, SYSTEMS AND COMPONENT CLASSIFICATION

Category 1	Category 2
<p>A. Plant features <u>required</u> to assure (1) the integrity of the reactor coolant pressure boundary, (2) the capability to shut down the reactor and maintain it in a safe shutdown condition, or (3) the capability to prevent or mitigate the consequences of accidents which could result in potential off-site doses comparable to the guideline doses of 10 CFR Part 100.</p> <p>B. Plant features <u>required</u> to meet AEC GDC-1 of Appendix A to 10 CFR Part 50 and Appendix B of 10 CFR Part 50.</p> <p>C. Plant features <u>required</u> to meet AEC GDC-2 of Appendix A to 10 CFR Part 50 and proposed Appendix A to 10 CFR Part 100. Plant features designed to withstand effects of the Design Basis Earthquake.</p>	<p>A. Plant features <u>not required</u> to assure (1) the integrity of the reactor coolant pressure boundary, (2) the capability to shut down the reactor and maintain it in a safe shutdown condition, or (3) the capability to prevent or mitigate the consequences of accidents which could result in exposures comparable to the guideline exposures of 10 CFR Part 100.</p> <p>B. Plant features <u>not required</u> to meet AEC GDC-1 of Appendix A to 10 CFR Part 50 and Appendix B to 10 CFR Part 50.</p> <p>C. Plant features <u>not required</u> to meet AEC GDC-2 of Appendix A to 10 CFR Part 50 and proposed Appendix A to 10 CFR Part 100. Plant features not designed to withstand the effects of the Design Basis Earthquake.</p>

Category 1			Category 2
<u>Quality Group A</u>	<u>Quality Group B</u>	<u>Quality Group C</u>	<u>Quality Group D</u>
<p>Category 1 components of the reactor coolant pressure boundary whose failure during normal operations would prevent orderly shutdown and cooldown assuming makeup is provided by normal makeup systems.</p>	<p>Components of the reactor coolant pressure boundary not included in Quality Group A or components of fluid systems directly required for emergency core cooling, post accident containment heat removal, reactor shutdown, or containment integrity.</p>	<p>Fluid system components not part of the reactor coolant pressure boundary nor included in Quality Group B. These include cooling water or emergency feedwater systems indirectly required for emergency core cooling, post accident containment heat removal, reactor shutdown, or radioactive gas holdup systems.</p>	<p>Category 2 fluid system components which are not essential for safe shut down of the nuclear systems and equipment. Failure of such equipment could cause loss of power generation but would not endanger public safety. This group includes systems which contain radioactive material but whose failure could not release quantities of radioactive material sufficient to endanger public safety.</p>

ARKANSAS NUCLEAR ONE
Unit 2

Table 3.2-2

SEISMIC CATEGORIES OF SYSTEMS, COMPONENTS AND STRUCTURES

<u>REACTOR EQUIPMENT</u>	<u>Q LIST</u> <u>(See Note 7)</u>	<u>SEISMIC</u> <u>CATEGORY</u>
<u>Reactor Vessel and Internals</u>		
Vessel and Head	X	I
Vessel Internals	X	I
Fuel Assemblies and Appurtenances	X	I
<u>Control Element Assemblies</u>		
Control Element Assemblies (CEA)	X	I
Control Element Drive Mechanism	X	I
Control Element Drive Instrumentation and Controls	X	I
<u>Fuel Handling Equipment</u>		
Refueling Machine		II
Fuel Transfer Equipment		II
Spent Fuel Handling Machine	X	I
Fuel Transfer Tube Isolation Valve	X	I
New Fuel Elevator		II
Refueling Seal Plate Assembly		II
<u>Lifting Devices</u>		
Containment Building Crane	X	I
Upper Guide Structure Lifting Rig		II
Core Barrel Lifting Rig		II
Closure Head Lifting Rig		II
Refueling Seal Lifting Rig		II
<u>REACTOR SYSTEMS</u>		
<u>Reactor Coolant System</u>		
Reactor Coolant Pumps	X	I
Reactor Coolant Pump Motor Flywheel	X	II
Pressurizer	X	I
Quench Tank		II
Steam Generators	X	I
Piping		
Reactor Coolant	X	I
Pressurizer Surge and Spray	X	I

ARKANSAS NUCLEAR ONE
Unit 2

Table 3.2-2 (continued)

<u>REACTOR SYSTEMS</u>	<u>Q LIST</u> <u>(See Note 7)</u>	<u>SEISMIC</u> <u>CATEGORY</u>
<u>Chemical and Volume Control System</u>		
Volume Control Tank		II
Boric Acid Makeup Tanks	X	I
Boric Acid Batching Tank		II
Chemical Addition Tank		II
Reactor Makeup Water Tank		II
Demineralizers/Ion Exchanger		II
Charging Pumps and Motors	X	I
Boric Acid Makeup Pumps and Motors	X	I
Reactor Makeup Water Pump		II
Regenerative Heat Exchanger	X	I
Letdown Heat Exchanger		II
<u>Safety Injection/Containment Spray Systems</u>		
Safety Injection Tanks	X	I
Refueling Water Tank	X	I
NaOH Addition Tank	X	I
LPSI Pumps and Motors	X	I
Shutdown Cooling Heat Exchanger	X	I
HPSI Pumps and Motors	X	I
Containment Spray Pumps and Motors	X	I
Containment Spray Nozzles	X	I
Containment Sump Strainers	X	I
Containment Sump Plenum	x	I
Vortex Eliminators	X	I
<u>Component Cooling Water System</u>		
Surge Tank		II
Pumps and Motors		II
Heat Exchangers		II
<u>Boron Management System</u>		
Reactor Drain Tank		II
Boron Management Holdup Tanks		II
Boric Acid Condensate Tanks		II
Holdup Tank Recirculation Pump		II
Degasifier Effluent Pumps		II
Vacuum Degasifier		II
Reactor Drain Pumps		II

ARKANSAS NUCLEAR ONE
Unit 2

Table 3.2-2 (continued)

<u>REACTOR SYSTEMS</u>	<u>Q LIST</u> <u>(See Note 7)</u>	<u>SEISMIC</u> <u>CATEGORY</u>
<u>Boron Management System</u>		
Boric Acid Condensate Pumps		II
Holdup Tank Drain Pumps		II
Preconcentrator Ion Exchangers		II
Boric Acid Condensate Ion Exchangers (currently not in use)		II
Preconcentrator Filters		II
Boric Acid Concentrator Package (Currently not in use)		II
<u>Waste Management System</u>		
Gas Decay Tanks	X	I
Gas Surge Tank		II
Waste Tanks		II
Waste Condensate Tanks		II
Waste Pumps		II
Waste Condensate Pumps		II
Aux. Bldg. Sump Pumps		II
Waste Filter		II
Waste Concentrator Package (Currently not in use)		II
Waste Gas Compressors Packages		II
<u>Waste Management System (cont.)</u>		
Waste Condensate Ion Exchangers (Currently not in use)		II
Spent Resin Tank		II
Concentrator Bottoms Stg. Tank (Currently not in use)		II
<u>Sampling System</u>		
Sample Coolers		II
Sample Containers		II
<u>Hydrogen Recombiner System</u>	X	I
<u>SECONDARY SYSTEMS</u>		
<u>Feedwater System</u>		
Pumps, Motors, and Drivers		
Main Feedwater		II
Emergency Feedwater	X	I
Emergency Feedwater Flow Nozzles	X	I
Condensate Storage Tank (T41B)	X	I
(See Section 1.2.2.10)		

ARKANSAS NUCLEAR ONE
Unit 2

Table 3.2-2 (continued)

<u>SECONDARY SYSTEMS</u>	<u>Q LIST (See Note 7)</u>	<u>SEISMIC CATEGORY</u>
<u>Main Steam System</u>		
Main Steam Isolation Valves	X	I
Main Steam Safety Valves	X	I
Atmospheric Dump Valves Upstream of Main Steam Isolation Valves	X	I
Emergency Feedwater Pump Turbine Line	X	I
Steam Dump and Bypass Valves Downstream of Main Steam Isolation Valves		II
Steam Generator Blowdown Tank		II
<u>Service Water System, (Serving Engineered Safety Features)</u>		
Pumps and Motors	X	I
Strainers	X	I
<u>Auxiliary Service Water System</u>		
		II
<u>Fuel Pool Cooling and Purification System</u>		
Fuel Pool Cooling Pumps		II
Fuel Pool Purification Pump		II
Fuel Pool Heat Exchanger		II
Fuel Pool Ion Exchanger		II
Fuel Pool Ion Exchanger Strainer		II
Fuel Pool Filters		II
<u>Fire Water System</u>		
Containment Penetration Piping	X	I
Containment Isolation Valves (Check and Power Operated)	X	I
<u>Emergency Diesel Generator System</u>		
Emergency Fuel Tanks	X	I
Diesel Oil Transfer Pumps and Motors	X	I
Emergency Diesel Generator Packages		
Emergency Diesel Generators	X	I
Starting Air Tanks	X	I
Lube Oil Coolers	X	I
Jacket Cooling Water Heat Exchangers	X	I
Fuel Oil Day Tanks	X	I
Air After Coolers	X	I

ARKANSAS NUCLEAR ONE
Unit 2

Table 3.2-2 (continued)

<u>SECONDARY SYSTEMS</u>	<u>Q LIST</u> <u>(See Note 7)</u>	<u>SEISMIC</u> <u>CATEGORY</u>
<u>Condenser Circulating Water System</u>		
Circulating Water Pumps		II
Cooling Tower		II
<u>Instrument and Service Air System</u>		
Compressors		II
After Coolers		II
Air Dryers		II
Receivers		II
Filters		II
<u>Hydrogen Addition System</u>		
		II
<u>Nitrogen Addition System</u>		
		II
<u>Vessel Head Decontamination System</u>		
		II
<u>STRUCTURES</u>		
<u>Containment Building</u>		
Containment Liner Plate	X	I
Locks and Hatch	X	I
Structural Steel	X	I
Missile Shield	X	I
<u>Auxiliary Building</u>		
Main Control Room	X	I
Spent Fuel Pool	X	I
Spent Fuel Racks	X	I
Transfer Tube	X	I
New Fuel Racks	X	I
Emergency Generator Room	X	I
Battery Room	X	I
Walls & Floors supporting Category 1 Equipment	X	I
Structural Steel	X	I
<u>Turbine Building</u>		
Foundation and Elevated Slabs		II
Structural Steel		II

ARKANSAS NUCLEAR ONE
Unit 2

Table 3.2-2 (continued)

<u>STRUCTURES</u>	<u>Q LIST (See Note 7)</u>	<u>SEISMIC CATEGORY</u>
<u>Intake Structure</u>		
Portion Housing Service Water Pumps	X	I
<u>Emergency Diesel Fuel Tank Vaults</u>	X	I
<u>Emergency Cooling Pond</u>	X	I
<u>Post Accident Sampling System Building</u>		I
<u>Materials</u> (used in construction of Seismic Category 1 Structures)		
Concrete	X	I
Reinforcing Steel	X	I
Cadwelds	X	I
<u>HEATING VENTILATING & AIR CONDITIONING</u>		
<u>Containment</u>		
<u>Containment Purge System</u>		
Fans		II
Filters, pre- and post-		II
Ductwork		II
Dampers		II
<u>Containment Cooling System</u>		
Fans	X	I
Cooling Coils		
Service water	X	I
Chilled Water		II
Pre-Filters		II
Ductwork		
Return		II
Supply	X	I
CEDM Cooling		II
<u>Auxiliary Building Building Supply and Exhaust System</u>		II
<u>Fuel Handling Area</u>		II
<u>Radwaste Area</u>		II

ARKANSAS NUCLEAR ONE
Unit 2

Table 3.2-2 (continued)

<u>HEATING VENTILATING & AIR CONDITIONING</u>	<u>Q LIST (See Note 7)</u>	<u>SEISMIC CATEGORY</u>
<u>Engineered Safety Features Rooms Cooling Units</u>	X	I
<u>Control Room Area</u>		
Fans, Supply and Recirculation		II
Filters		II
Ductwork		II
Dampers		
Normal system isolation	X	I
Remainder		II
Heaters/coolers (and piping and valves)		II
Control Room Emergency Air Conditioning System	X	I
Computer Equipment Air Conditioning System		II
Cable Spreading and Relay Room Recirculation Units		II
<u>Battery Rooms</u>		
Fans, exhaust	X	I
Ductwork	X	I
Dampers	X	I
<u>Emergency Diesel Generator Rooms</u>		
Fans, exhaust	X	I
Ductwork	X	I
Dampers	X	I
<u>Turbine Building</u>		II
<u>Intake Structure</u>		
Fans		
Exhaust	X	I
Other		II

ARKANSAS NUCLEAR ONE
Unit 2

Table 3.2-2 (continued)

GENERAL NOTES:

1. Seismic 1 classification necessitates Q-listing and the Q-list is defined to include all Category 1 structures, systems, and equipment.
2. For further definition of Seismic Category 1 boundaries, see the specific system P&ID. To locate the P&ID, see Table 1.7-2.
3. All Seismic Category 1 electrical equipment (Electrical Category 1E) that would otherwise be included in this table is listed in Table 8.3-2.
4. All containment penetration piping and containment isolation valves are Seismic Category 1 and Q-listed.
5. All Seismic Category 1 piping is supported by Seismic 1 supports. In addition, at Seismic Category 1/Seismic Category 2 interfaces, the Seismic Category 2 pipe is supported with Seismic Category 1 supports up to the first pipe anchor.
6. Seismic classification of control and instrumentation devices is appropriate to that of the associated piping or equipment.
7. This table is for identification of seismic categories. For quality classification, use the Component Level Q List. See also Table 3.2-6 for the Summary Level Q List.

ARKANSAS NUCLEAR ONE
Unit 2

Table 3.2-3

EQUIPMENT CODE GROUP CLASSIFICATION

Components	Code Group	Code	
		Before 7/1/71	After 7/1/71
<u>Reactor Coolant System</u>			
Reactor Vessel	A	ASME III, Class A	
Steam Generator	A	ASME III, Class A	ASME III, Class 1
Pressurizer	A	ASME III, Class A	
Reactor Coolant Pump	A	ASME III, Class A	
Reactor Coolant Piping	A	ASME III, Class A	
Quench Tank	C	ASME VIII, Div. 1	
Pressurizer Safety Valves	A	ASME P&VC, Class I	
<u>Chemical & Volume Control System</u>			
Regenerative Heat Exchanger	B/B		<u>ASME III, Class 2</u> ASME III, Class 2
Letdown Heat Exchanger	B/C		<u>ASME III, Class 2</u> ASME III, Class 3
Purification Ion Exchanger	B	ASME III, Class C	
Deborating Ion Exchanger	B	ASME III, Class C	
Volume Control Tank	B	ASME III, Class C	
Charging Pumps	B	ASME P&VC, Class II	
Boric Acid Makeup Tank	B	ASME III, Class C	
Boric Acid Makeup Pumps	B		ASME III, Class 2
Purification Filter	B		ASME III, Class 2
Chemical Addition Tank	D		ASME VIII, Div. 1 (Guide Only)
Boric Acid Batching Tank	D		ASME VIII, Div. 1 (Guide Only)
Reactor Makeup Water Pump	D		Hydraulic Institute
Reactor Makeup Water Tank	D		API 650
<u>Safety Injection/Containment Spray Systems</u>			
Safety Injection Tank	B		ASME III, Class 2
Refueling Water Tank	B		ASME III, Class 2
Sodium Hydroxide Tank	B		ASME III, Class 2
HPSI Pumps	B	ASME P&VC, Class II	
LPSI Pumps	B	ASME P&VC, Class II	
Shutdown Cooling Heat Exchanger	B/C	<u>ASME III, Class C</u> ASME VIII, Div. 1	
Containment Spray Pump	B		ASME III, Class 2
Spray Nozzles	B		ASME III, Class 2

ARKANSAS NUCLEAR ONE
Unit 2

Table 3.2-3 (continued)

Components	Code Group	Code	
		Before 7/1/71	After 7/1/71
<u>Boron Management System</u>			
Reactor Drain Tank	C	ASME VIII, Div. 1	
Reactor Drain Pump	C		ASME III, Class 3
Vacuum Degasifier	D		ASME VIII, Div. 1
Degasifier Effluent Pump	D		Hydraulic Institute
Holdup Tanks	C		API 620 and ASME VIII
Holdup Tank Drain Pumps	D		Hydraulic Institute
Holdup Recirculation Pumps	D		Hydraulic Institute
Preconcentrator Ion Exchanger	D	ASME VIII, Div. 1	
Boric Acid Concentrator Package**	D		ASME VIII, Div. 1
Boric Acid Condensate Ion Exch.**	D	ASME VIII, Div. 1	
Boric Acid Condensate Tank	D		API 620
Boric Acid Condensate Pump	D		Hydraulic Institute
Preconcentrator Filters	D		ASME VIII, Div. 1
<u>Waste Management System</u>			
Waste Condensate Ion Exchanger**	D		ASME VIII, Div. 1
Waste Tank	D		ASME VIII, Div. 1 (Guide Only)
Waste Concentrator Package**	D		ASME VIII, Div. 1
Waste Condensate Tank	D		ASME VIII, Div. 1 (Guide Only)
Waste Condensate Pump	D		Hydraulic Institute
Waste Pumps	D		Hydraulic Institute
Auxiliary Building Sump Pump	D		Hydraulic Institute
Waste Filters	D		ASME VIII, Div. 1
Gas Surge Tank	C	ASME VIII, Div. 1	
Waste Gas Compressor Package	C	ASME III, Class 3 (upgraded)	
Gas Decay Tank	C		ASME VIII, Div. 1
Resin Addition Tank	D		ASME VIII, Div. 1 (Guide Only)
<u>Solid Radwaste System</u>			
Bottoms Transfer Pump*	D		Hydraulic Institute
Spent Resin Tank	D	ASME VIII, Div. 1	
Concentrator Bottoms Storage Tank*	D		API 650

* Abandoned in place.

** Currently not in use.

ARKANSAS NUCLEAR ONE
Unit 2

Table 3.2-3 (continued)

Components	Code Group	Code	
		Before 7/1/71	After 7/1/71
<u>Fuel Pool System</u>			
Fuel Pool Heat Exchanger	C/D	<u>ASME VIII, Div. 1</u> ASME VIII, Div. 1	
Fuel Pool Ion Exchanger	C	ASME VIII, Div. 1	
Fuel Pool Pump	C		ASME III, Class 3
Fuel Pool Filters	C		ASME III, Class 3
Fuel Pool Purification Pump	C		ASME III, Class 3
Fuel Pool Ion Exchanger Strainer	C		ASME III, Class 3
<u>Service Water System</u>			
Service Water Pumps	C		ASME III, Class 3
Strainers	C		ASME III, Class 3
<u>Component Cooling Water System</u>			
CCW Surge Tank	D		API 620
CCW Pumps	D		Hydraulic Institute
CCW Heat Exchangers	D		ASME VIII, Div. 1
<u>Sampling System</u>			
Sample Coolers	D		ASME VIII, Div. 1
<u>Emergency Feedwater System</u>			
Emergency Feedwater Pumps	C		ASME III, Class 3
Emergency Feedwater Flow Nozzles	C		ASME III, Class 3
Emergency Feedwater Control Valves	C		ASME III, Class 3
<u>Main Steam System</u>			
Main Steam Isolation Valves	B		ASME III, Class 2
Main Steam Safety Valves	B		ASME III, Class 2
Atmospheric Dump Valves Upstream of Main Steam Isolation Valves	B		ASME III, Class 2
Main Steam Flow Nozzles	B		ASME III, Class 2
Piping and Valves to Turbine Driven Emergency Feedwater Pump	C		ASME III, Class 3

ARKANSAS NUCLEAR ONE
Unit 2

Table 3.2-3 (continued)

Components	Code Group	Code	
		Before 7/1/71	After 7/1/71
<u>Emergency Diesel Generator System</u>			
Emergency Fuel Oil Tanks	C	ASME VIII, Div. 1	
Emergency Diesel Fuel Transfer Pump	C		ASME III, Class 3
Emergency Diesel Generator Package	C		ASME VIII, Div. 1

NOTE:

For this Table, the Code Group applies to the process piping and components, not to the instrument sensing lines. Instrument sensing lines are in accordance with note (f) to Table 3.2-4. ASME VIII Division 1 only applies to pressure vessels.

ARKANSAS NUCLEAR ONE
Unit 2

Table 3.2-4

SUMMARY OF CODES AND STANDARDS FOR NUCLEAR COMPONENTS

<u>Component(f)</u>	<u>Group A</u>	<u>Group B</u>	<u>Group C</u>	<u>Group D</u>	<u>Comments</u>
Pressure Vessels	ASME III, Class A See Note (d)	ASME III, Class C See Note (e)	ASME VIII, Div. 1	ASME VIII, Div. 1	Before 7/1/71 See Note (a)
	ASME III, Class 1	ASME III, Class 2	ASME III, Class 3	ASME VIII, Div. 1	After 7/1/71 See Note (b)
0-15 psig Storage Tanks	N/A	API-620 with Supplementary NDE Req. per ASME III, Class C rules	API-620 with Supplementary NDE Req. per ASME VIII, Div. 1	API-620	Before 7/1/71 See Note (a)
	N/A	ASME III, Class 2	ASME III, Class 3, or ASME VIII, Div. 1	API-620	After 7/1/71 See Note (b)
Atmospheric Storage Tanks	N/A	API-650 or AWWAD100 with Supplementary NDE Req. per ASME III, Class C	API-650 or AWWAD100 with Supplementary NDE Req. per ASME III, Div. 1	API-650 or AWWAD100	Before 7/1/71 See Note (a)
	N/A	ASME III, Class 2	ASME III, Class 3 or ASME VIII, Div. 1	API-650 or AWWAD100	After 7/1/71 See Note (b)

ARKANSAS NUCLEAR ONE
Unit 2

Table 3.2-4 (continued)

<u>Component(f)</u>	<u>Group A</u>	<u>Group B</u>	<u>Group C</u>	<u>Group D</u>	<u>Comments</u>
Piping	ANSI B31.7, Class I	ANSI B31.7, Class II	ANSI B31.7, Class III	ANSI B31.1.0	Before 7/1/71 See Note (a)
	ASME III, Class 1	ASME III, Class 2	ASME III, Class 3	ANSI B31.1.0	After 7/1/71 See Note (b)
Pumps & Valves	ASME P & VC, Class I	ASME P & VC, Class II	ASME P & VC, Class III	Valves – ANSI B31.1.0 Pumps - ASME VIII, Div. 1 See Note (c)	Before 7/1/71
Pumps & Valves	ASME P & VC, Class I	ASME P & VC, Class II	ASME P & VC, Class III	Valves – ANSI B31.1.0 Pumps - ASME VIII, Div. 1 See Note (c)	After 7/1/71

ARKANSAS NUCLEAR ONE
Unit 2

Table 3.2-4 (continued)

General Notes:

- (a) ASME III means ASME Boiler and Pressure Vessel Code, Section III, 1968, Nuclear Vessels plus addenda and Code interpretations to date of purchase award or later appropriate ASME Section III Code sections provided that they have been reconciled.

ASME VIII, Division 1 means ASME Boiler and Pressure Vessel Code, Section VIII, Pressure Vessel Division 1, 1968 Edition, plus addenda and Code interpretations to date of purchase award.

ANSI B31.7 means ANSI B31.7 - 1969, Nuclear Power Piping plus addenda and Code interpretations to date of purchase award or later appropriate ASME Section III Code sections provided that they have been reconciled.

ASME P & VC means the November 1968 Draft ASME Code for Pumps and Valves, plus addenda and Code interpretations to date of purchase award.

ANSI B31.1.0 means ANSI B31.1.0 - 1967 Power Piping Code plus addenda and Code interpretations to date of purchase award.

- (b) For purchase awards on or after July 1, 1971, reference to ASME III, ANSI B31.7 and Draft ASME P & VC should be to ASME Boiler and Pressure Vessel Code, Section III 1971, Nuclear Power Plant Components plus addenda and Code interpretations to date of purchase award or later appropriate ASME Section III Code sections provided that they have been reconciled. Reference to ASME VIII Division 1 should be to ASME Boiler and Pressure Vessel Code, Section VIII, 1971, Pressure Vessels plus addenda and Code interpretations.
- (c) Section VIII, Division 1, of the Boiler and Pressure Vessel code shall be used as a guide in calculating the thickness for pressure rated parts and sizing the cover bolting of pumps operating above 150 psig and 212°F. Below 150 psig and 212°F, use manufacturer's standard for service intended.
- (d) Refer to Chapter 5, "Reactor Coolant System", for reactor pressure vessel requirements.
- (e) The Containment Vessel is ASME III, Class B.
- (f) "Component" refers only to process equipment, Instrument sensing lines up to and including the first process shutoff valve (root valve) are fabricated and installed to the same quality standards as the associated process component. Downstream of the root valve, instrument lines are fabricated and installed in accordance with ASME Section III, Class 3. This exceeds the Unit 2 PSAR commitment to design instrument lines to ANSI B31.1.0 (see Unit 2 PSAR section A.2.1).
- (g) The steam generators are constructed to the requirements of the ASME Code, Section III, 1989 Edition, no Addenda.

ARKANSAS NUCLEAR ONE
Unit 2

Table 3.2-5

**COMPONENTS BUILT TO CODES OTHER THAN
THOSE SPECIFIED IN REGULATORY GUIDE 1.26**

Reactor Coolant System

Quench Tank - Quality Group C; ASME VIII, Division 1.

Specifications required full RT of Category A, B, C butt welds over 3/16-inch thickness, MT or PT under 3/16-inch, MT or PT root and final pass of all nozzle welds, submittal of welding and cleaning procedures and code calculations for CE review, and a Manufacturing and Quality Control Plan in accordance with CE Specification WQC-11.1 (See Chapter 17 of the Unit 2 FSAR).

Chemical and Volume Control System

Purification Ion Exchangers* & Deborating Ion Exchanger*, - Quality Group B; ASME III, Class C. Specification required full RT of shell and nozzle butt welds, PT root and final pass of nozzle welds, submittal of welding, cleaning, hydro, PT, RT procedures and code calculations for CE review, and a Manufacturing and Quality Control Plan in accordance with CE Specification WQC-11.1.

Volume Control Tank* and Boric Acid Makeup Tanks*, - Quality Group B; ASME III, Class C. Specification requirements were same as for Quench Tank.

Charging Pumps - Quality Group B; ASME Pump and Valve Code, Class II. Specification required performance tests in accordance with PTC 7.1 of the ASME Power Test Code followed by disassembly and visual inspection, and a Manufacturing and Quality Control Plan in accordance with CE Specification WQC-11.1.

Chemical Addition Tank and Boric Acid Batching Tank - Quality Group D; ASME VIII, Division 1 used as a guide. Specification required weld design and PT in accordance with ASME VIII, welder qualification and materials in accordance with ASME IX, submittal of welding, cleaning and PT procedures for CE review, and a Manufacturing and Quality Control Plan.

Reactor Makeup Water Pumps - Quality Group D; Hydraulic Institute Standards. Specification required final acceptance inspection by Bechtel.

- * While these components are normally used during plant shutdown, they are not absolutely required for plant shutdown and could be considered quality group D. Associated piping and valves are designed to ASME III, Class 2 requirements.

ARKANSAS NUCLEAR ONE
Unit 2

Table 3.2-5 (continued)

Safety Injection System

Shutdown Cooling Heat Exchangers - Quality Group B and ASME III, Class 3 (reactor coolant side); Quality Group C and ASME VIII, Division 1 (Service Water Side). Specification required or vendor performed PT of tube-to-tubesheet welds, post weld heat treatment in accordance with ASME III and VIII, full RT of Category A,B,C welds, MT or PT root and final pass of nozzle welds, PT of clad surfaces, UT of clad bonding, bubble test of tube-to-tubesheet welds, submittal of welding and cleaning procedures and code calculations, weld procedure qualification in accordance with ASME III, and a Manufacturing and Quality Control Plan.

Boron Management System

Reactor Drain Tank - Quality Group C; ASME VIII, Division 1.

Specification requirements were same as for Quench Tank.

Degasifier Effluent Pumps - Quality Group D; Hydraulic Institute Standards and ASME VIII, Division 1 for pressure-containing parts. Specification required PT of root and final pass and full RT of Category A, B, and C welds, hydrostatic test in accordance with ASME VIII, and submittal of weld procedures, welder qualifications, cleaning and NDE procedures for Bechtel approval.

Holdup Tanks - Quality Group C; API-620 and ASME VIII, Division 1. Specification required PT of all welds, submittal of welding, PT, and cleaning procedures for CE review, and a Manufacturing and Quality Control Plan.

Holdup Tank Drain Pumps, Holdup Recirc. Pump, Boric Acid Condensate Pumps - Quality Group D; Hydraulic Institute Standards. Specification required CE shop inspection.

Waste Management System

Waste Tanks, Waste Condensate tanks, Resin Addition Tank - Quality Group D; ASME VIII, Division 1 used as a guide. Specification requirements were same as for Chemical Addition Tank.

Waste Condensate Pumps, Waste Pumps - Quality Group D; Hydraulic Institute Standards. Specification requirements were same as for Holdup Tank Drain Pumps.

Auxiliary Building Sump Pumps - Quality Group D; Hydraulic Institute Standards. Specification required submittal of weld procedures for Bechtel Approval.

Gas Surge Tank, Gas Decay Tanks - Quality Group C; ASME VIII, Division 1. Specification requirements were same as for Quench Tank.

Solid Radioactive Waste System

Bottoms Transfer Pump-Quality Group D; Hydraulic Institute Standards.

ARKANSAS NUCLEAR ONE
Unit 2

Table 3.2-5 (continued)

Fuel Pool System

Fuel Pool Heat Exchangers - Quality Group C; ASME VIII, Division 1 (fuel pool side), Quality Group D; ASME VIII, Division 1 (Service Water side). Specification required material mill test reports, submittal of inspection and test procedures for CE review, a Manufacturing and Quality Control Plan, and NDT as required for the Shutdown Cooling Heat Exchanger.

Fuel Pool Ion Exchanger - Quality Group C; ASME VIII, Division 1. Specification requirements were same as for the Chemical and Volume Control System Ion Exchangers.

Component Cooling Water System

Component Cooling Water Pumps - Quality Group D; Hydraulic Institute standards. Specification required submittal of weld procedures for Bechtel approval.

Emergency Diesel Generator System

Emergency Fuel Oil Tanks - Quality Group C; ASME VIII, Division 1. Specification required welding in accordance with Bechtel standards and submittal of welding and RT procedures for Bechtel approval.

Emergency Diesel Generators - Quality Group C; ASME VIII, Division 1. Specification required a fully-documented Quality Assurance Program including a description of the vendor's organization, activities, procedures, training, etc., to control quality; submittal of welding procedures for Bechtel approval was also required.

Table 3.2-6

QUALITY ASSURANCE

SUMMARY LEVEL Q-List

GENERAL

The purpose of this "Summary Level" Q-List (SLQL) list is to generally identify those items required to be within the scope of the ANO Quality Assurance Program. Items listed require special consideration during design, manufacture, construction, operation and maintenance as described by Quality Assurance Program Manual (QAPM).

The SLQL is divided into five major sections:

1. CIVIL STRUCTURAL
2. NUCLEAR MECHANICAL
3. CONVENTIONAL MECHANICAL
4. AUXILIARY ELECTRICAL
5. ARCHITECTURAL

NOTES:

1. The designation "Penetration piping" defines the piping connecting to the containment penetration up to the first external and internal isolation valves on either side of the penetration.
2. When structures, systems or equipment as a whole are on this list, portions not associated with a loss of safety function are not meant to be included. The CLQL identifies the specific components that are Q (safety related).
3. Civil-Structural items required to be within the scope of the Nuclear Quality Assurance Program are limited to the following:

Containment
Auxiliary building housing the engineered safety features, emergency diesel generators, control room and radioactive materials.
Emergency diesel fuel tank vaults.
Intake structure housing service water pumps.
Supports for Seismic Category 1 system components.
Emergency Pond and pipelines.
Spent Fuel Pool (Excluding Liner Plate)
4. Safety-related materials and equipment were purchased to one of the corresponding specifications listed (if a specification is referenced). Not all items purchased to these specifications are used in safety-related functions, i.e., classified as "Q".

This SLQL is provided as general reference information only. It preserves the summary level information provided in previous amendments of the SAR "Q-List" with the exception of "Q-numbers", which are no longer used, and "Line or Equip. numbers." A detailed "Component Level Q-List" (CLQL) has been implemented which provides classification of "Q" devices at the component level.

ARKANSAS NUCLEAR ONE
Unit 2

Table 3.2-6 (continued)

A classification of "Q" whether for the CLQL or SLQL is generally intended to be synonymous with the term "Safety-Related" in accordance with criteria of 10 CFR 100, Appendix A. Consequently, the CLQL and SLQL are intended to encompass those structures, systems and components required to assure:

- The integrity of the reactor coolant pressure boundary,
- The capability to shutdown the reactor and maintain it in a safe shutdown condition, or
- The capability to prevent or mitigate the consequences of accidents which could result in potential off site doses comparable to the guideline exposures of 10 CFR 100.

Some non-Safety Related components are included on the list because they are required to be designed to withstand the Design Basis Earthquake.

1.0 CIVIL STRUCTURAL SECTION

<u>Description</u>	<u>Purchase Spec No.</u>	<u>Remarks</u>
1.1 <u>PRESTRESSED & REINFORCED CONCRETE</u>		Note 3
Reinforcing Steel	C-2029 APL-C-2402	
Cadwelds	C-2026 C-2302 C-2060 11406-C-2406	
Shell or Stud Anchors	C-2305 ANO-C-2408	
Anchor Bolts	C-2316	
Masonry Walls	C-2317	
Cold Leg Restraint Block Impact Pads	C-2320	
Prestressing System (Excluding Tendon Sheathing)	C-2034	
Tendon Sheathing Filler	C-2036	
1.2 <u>CONTAINMENT LINER PLATE</u>		Note 3
Containment Structure Liner Plate (excluding leak chase piping system not mating with liner plate and tie nuts)	C-2030 C-2304 C-2058	
Locks and Hatch	C-2031 APL-C-2436	

ARKANSAS NUCLEAR ONE
Unit 2

Table 3.2-6 (continued)

1.0 CIVIL STRUCTURAL SECTION (continued)

1.2 CONTAINMENT LINER PLATE

Note 3

<u>Description</u>	<u>Purchase Spec No.</u>	<u>Remarks</u>
Containment Structure Liner Plate (excluding leak chase piping system not mating with liner plate and tie nuts)	C-2030 C-2304 C-2058	
Locks and Hatch	C-2031 APL-C-2436	

1.3 FUEL RACKS

Note 3

Spent Fuel Racks

Region 1

SPEC-06-00002-A

Holtec

Region 2

Westinghouse

New Fuel Racks

C-2042

CE

1.4 STRUCTURAL STEEL

Note 3

Containment Structural Steel

C-2038

Auxiliary Building Structural Steel

C-2040

Miscellaneous Metals

C-2048

C-2049

1.5 EMERGENCY POND

C-64

Note 3

SPEC-08-00001-A

1.6 QUALITY CONTROL & MATERIAL TESTING

C-2028

Note 3

1.7 SLUICE GATES

C-2022

Note 3

APL-C-2414

1.8 CLASS 1 SYSTEM SUPPORT STRUCTURES

Note 3

Reactor Vessel Supports Foundation

C-2037

Steam Generator Support Foundations and Guides

C-2037

Reactor Coolant Pump Support System

C-2035

Containment Crane Support System

C-2038

RC Pump Hydr. Shock Suppressors

C-2068

RCP Lateral Restraint Blocks

C-2069

ARKANSAS NUCLEAR ONE
Unit 2

Table 3.2-6 (continued)

2.0 NUCLEAR MECHANICAL SECTION

2.1 REACTOR EQUIPMENT

<u>Description</u>	<u>Purchase Spec No.</u>	<u>Remarks</u>
<u>Reactor Vessel Equipment</u>		
Vessel		CE
Vessel Internals		CE
Vessel Column Supports and Bolting		CE
Vessel Closure Equipment		CE
<u>Fuel Handling Equipment</u>		
Fuel Transfer Tube and Isolation Valve	M-2093	
Fuel Transfer Canal Recirc. and Drain Piping	M-2101	
Spent Fuel Handling Machine		CE
<u>Control Element Drive Equipment</u>		
I&C		CE
Control Element Assemblies		CE
Drive Mechanism		CE
<u>Fuel Assemblies and Appurtenances</u>		
2.2 <u>REACTOR PRIMARY SYSTEMS</u>		
<u>Reactor Coolant System</u>		
Reactor Coolant Pumps		CE
Steam Generators	M-2557 Westinghouse	
Reactor Coolant Loop Piping		CE
Branch Piping (out to second valve)	M-2101	
RCP Seal Water Penetration Piping	M-2101	

ARKANSAS NUCLEAR ONE
Unit 2

Table 3.2-6 (continued)

2.0 NUCLEAR MECHANICAL SECTION (continued)

<u>Description</u>	<u>Purchase Spec No.</u>	<u>Remarks</u>
<u>Reactor Coolant System (cont.)</u>		
Valves	M-2114	
Supports	M-2119 APL-M-2410	
I&C		CE
Reactor Coolant Pumps Motor Flywheels		CE
<u>Pressurizer</u>		
Pressurizer Vessel		Westinghouse
Pressurizer/RC Sample Penetration Pipe	M-2101	
Pressurizer Surge Line		CE
Pressurizer Spray Line	M-2101	
Pressurizer Heater Nozzles		Westinghouse
Pressurizer Branch Piping (to 2nd valve)	M-2101	
Quench Tank Penetration Piping	M-2101	
Pressurizer Aux. Spray Line	M-2101	
Valves	M-2114 M-2131	
Pressurizer Safety Valves		CE
Power Operated Valves	M-2232A	
Supports	M-2119 APL-M-2410	
I&C		CE Bechtel

ARKANSAS NUCLEAR ONE
Unit 2

Table 3.2-6 (continued)

2.0 NUCLEAR MECHANICAL SECTION (continued)

<u>Description</u>	<u>Purchase Spec No.</u>	<u>Remarks</u>
<u>Chemical & Volume Control System</u>		
Regenerative Heat Exchanger		CE
Penetration Piping (Letdown and Charging Line	M-2101	
Valves	M-2112 M-2112Z	
Power Operated Valves	M-2257A, B M-2124A	CE
Safety and Relief Valves	M-2235A APL-M-2414	
Supports	M-2119 APL-M-2410	
I&C		CE
<u>Safety Injection and Containment Spray Systems</u>		
Safety Injection Tanks		CE
Refueling Water Tank	M-2291	
High Pressure Safety Injection Pumps & Motors		CE
Low Pressure Safety Injection Pumps & Motors		CE
Containment Spray Pumps & Motors	M-2017	
Shutdown Cooling Heat Exchangers		CE
Piping	M-2101	
Containment Spray Headers	M-2101	
Containment Spray Nozzles	M-2134	
Safety Injection Tank Sample and Drain Penetration Piping	M-2101	

ARKANSAS NUCLEAR ONE
Unit 2

Table 3.2-6 (continued)

2.0 NUCLEAR MECHANICAL SECTION (continued)

<u>Description</u>	<u>Purchase Spec No.</u>	<u>Remarks</u>
<u>Safety Injection and Containment Spray Systems (cont.)</u>		
Valves	M-2112 M-2112Z M-2124A M2114	
Safety and Relief Valves	M-2235A APL-M-2414	
Power Operated Valves	M-2124A M-2257A M-2257B APL-M-2451 ANO-M-2456	
Modulating Control Valve	M-2232A	
Supports	M-2119 APL-M-2410	
I&C		CE

2.3 BORON AND WASTE MANAGEMENT SYSTEMS

Gaseous Radwaste System

Penetration Piping	M-2101	
Valves	M-2114 M-2257A	
Supports	M-2119 APL-M-2410	
I&C		CE

Boron Management System

Reactor Drain Tank Penetration Piping	M-2101	
Valves	M-2112 M-2112Z M-2257A M2257B	

ARKANSAS NUCLEAR ONE
Unit 2

Table 3.2-6 (continued)

2.0 NUCLEAR MECHANICAL SECTION (continued)

<u>Description</u>	<u>Purchase Spec No.</u>	<u>Remarks</u>
<u>Boron Management System (cont.)</u>		
Supports	M-2119 APL-M-2410	
I&C		CE
<u>Liquid Radwaste System</u>		
Containment Sump Drain Penetration Piping	M-2101	
Containment Isolation Valves	M-2257A M-2257B	
Supports	M-2119 APL-M-2410	
I&C		CE
2.4 <u>REACTOR PLANT SERVICE SYSTEMS</u>		
<u>Treated Water Systems</u>		
Demineralized Water Supply Penetration Piping	M-2101	
Containment Isolation Valves	M-2114 M-2257A M-2257B	
Supports	M-2119 APL-M-2410	
<u>Air/Nitrogen System</u>		
Nitrogen Supply Penetrations Piping	M-2101	
Service Air Supply Penetration Piping	M-2101	
Instrument Air Supply Penetration Piping	M-2101	
Containment Test Connection Penetration Piping	M-2101	

ARKANSAS NUCLEAR ONE
Unit 2

Table 3.2-6 (continued)

2.0 NUCLEAR MECHANICAL SECTION (continued)

<u>Description</u>	<u>Purchase Spec No.</u>	<u>Remarks</u>
<u>Air/Nitrogen System (cont.)</u>		
Valves	M-2114 M-2257A	
Supports	M-2119 APL-M-2410	
<u>Component Cooling Water System</u>		
Component Cooling Water Penetration Piping	M-2101	
Containment Isolation Valves	M-2112 M-2112Z	
Valves	M-2114 M-2242A	
Supports	M-2119 APL-M-2410	
I&C		CE
2.5 <u>FUEL POOL SYSTEM</u>		
Make-up Water Piping	M-2101	
Piping	M-2101	Note - this piping is seismically analyzed only and listed for clarification per NRC request.
Containment Penetration Piping	M-2101	
Valves	M-2112 M-2112Z	
Supports	M-2119 APL-M-2410	

ARKANSAS NUCLEAR ONE
Unit 2

Table 3.2-6 (continued)

2.0 NUCLEAR MECHANICAL SECTION (continued)

<u>Description</u>	<u>Purchase Spec No.</u>	<u>Remarks</u>
2.6 <u>SAMPLING SYSTEM</u>		
Reactor Coolant Pressure Boundary Piping	M-2101	
Containment Penetration Piping	M-2101	
Containment Isolation Valves	M-2131 M-2257A	
Reactor Coolant Pressure Boundary Isolation Valves	M-2131	
Supports	M-2119 APL-M-2410	
I&C		CE
2.7 <u>PLANT PROTECTION SYSTEM</u>		
Reactor Protection System		CE
Engineered Safeguard Features Actuation System		CE
3.0 <u>CONVENTIONAL MECHANICAL SECTION</u>		
3.1 <u>REACTOR SECONDARY SYSTEMS</u>		
<u>Main Steam System</u>		
Piping from S/G to Main Steam Isolation Valves	M-2101	
S/G Sample Penetration Piping	M-2101	
Emergency FW Pump Turbine Steam Line	M-2101	
S/G Blowdown Penetration Piping	M-2101	
Emergency FW Pump Turbine Exhaust Line	M-2101	Note – this piping is seismically analyzed only and listed for clarification per NRC request.

ARKANSAS NUCLEAR ONE
Unit 2

Table 3.2-6 (continued)

3.0 CONVENTIONAL MECHANICAL SECTION (continued)

<u>Description</u>	<u>Purchase Spec No.</u>	<u>Remarks</u>
<u>Main Steam System (cont.)</u>		
Main Steam Safety Valves	M-2238	
Other Valves inc. Atmos. Dump Valves	M-2112Z M-2257B M-2114	
Main Steam Isolation Valves	M-2120	
Supports (S/G to first support past Main Steam Isolation Valves)	M-2119	
Steam Generator Upper Support Hydraulic Snubbers		CE
Steam Generator Lower Support Sliding Base Assembly		CE
Main Steam Flow Nozzles		CE
I&C		CE
<u>Feedwater System</u>		
Emergency Feedwater Pumps	M-2018	
FW Piping from S/G to Isolation Valve	M-2101 APL-M-2416	
Emergency Feedwater Piping	M-2101	
Emergency FW Flow Elements	M-2253	
Valves (includes EFW valves and FW Containment Isolation Valves)	M-2112Z M-2124A M-2257B M-2232A M-2257A	
Supports (EFW and FW from S/G to first support past isolation valve)	M-2119 APL-M-2410	
I&C		CE
Emergency FW Pump Turbine Driver	M-2018	

ARKANSAS NUCLEAR ONE
Unit 2

Table 3.2-6 (continued)

3.0 CONVENTIONAL MECHANICAL SECTION (continued)

<u>Description</u>	<u>Purchase Spec No.</u>	<u>Remarks</u>
<u>Feedwater System (cont.)</u>		
Emergency FW Pump Motor	M-2018	
Condensate Storage Tank T41B (See Section 1.2.2.10)	APL-M-2511	
3.2 <u>CONVENTIONAL PLANT SERVICE SYSTEMS</u>		
<u>Service Water System</u>		
Service Water Pumps and Motors	M-2011	
Service Water Strainers	M-2035	
Piping	M-2101 M-2137	
Valves	M-2112 M-2112Z M-2257B M-2242A	
Supports	M-2119 APL-M-2410	
I&C		CE
<u>Heating, Ventilation and Air Conditioning</u>		
Control Room Emergency Air Handling Units	M-2244 APL-M-2516	
Emergency Air Filter Unit Housing, Filters & Fan	M-2267	
Condensing Unit	M-2276	
Fresh Air Inlet Radiation Monitor	M-2217	
Isolation Dampers	M-2056C	
<u>Intake Structure</u>		
Exhaust Fans	M-2100	
Cooling Ducts & Supports	M-2052	
Dampers	M-2056B	

ARKANSAS NUCLEAR ONE
Unit 2

Table 3.2-6 (continued)

3.0 CONVENTIONAL MECHANICAL SECTION (continued)

<u>Description</u>	<u>Purchase Spec No.</u>	<u>Remarks</u>
<u>Containment</u>		
Cooling Units, Fans & Service Water Cooling Coils	M-2061	
Cooling Ducts & Supports	M-2052	
Dampers	M-2056B	
Duct Relief Dampers	M-2216	
Penetration Piping (Plant Heating, Chilled Water, H ₂ Purge)	M-2101	
Chilled Water Containment Isolation Valves	M-2257B	
Air Purge Isolation Valves	M-2239	
Plant H&V Isolation Valves	M-2242A	
H ₂ Recombiners	M-2076	
Hydrogen Monitoring Panel	M-2211	
<u>Auxiliary Building</u>		
Unit Coolers (SDHX Rm., HPSI Rm., Charging Pump Rm., EFW Rm., Swgr. Room, Elec. Equip. Rm.)	M-2244	
Emergency Exhaust Fans (Swgr., Battery & Elect. Equip. Rms.)	APL-M-2516	
Electrical Rm. Air Handling Units	M-2100	
	M-2244 APL-M-2516	
Emergency Diesel Gen. Rm. Exh. Fans	M-2265	
Purge Valves for Aux. & Engineered Safeguard Equipment Rooms	M-2242A	
Cooling Ducts & Supports	M-2052	
Dampers	M-2056B	
Supports	M-2119 APL-M-2410	

ARKANSAS NUCLEAR ONE
Unit 2

Table 3.2-6 (continued)

3.0 CONVENTIONAL MECHANICAL SECTION (continued)

<u>Description</u>	<u>Purchase Spec No.</u>	<u>Remarks</u>
<u>Auxiliary Building (cont.)</u>		
Vibration Isolators	M-2064	
I&C		CE
<u>Emergency Diesel Generators including</u>	M-2012	
Starting Air Tanks		
Lube Oil Coolers		
Filters		
F. O. Day Tanks		
Air Aftercoolers		
Emergency Fuel Tanks	M-2085	
Emergency Diesel Fuel Oil Trans. Pumps and Motors	M-2028	
Emergency Diesel Fuel Oil Strainers Piping	M-2293A M-2101	
Valves	M-2114 M-2257B	
Supports	M-2119 APL-M-2410	
Wall Louvers	M-2215	
I&C		CE
Electrical Control Cabinets	M-2012	
<u>Fire Water Systems</u>		
Fire Water Containment Penetration Piping		
Containment Isolation Check Valves	M-2112 M-2112Z	
Valves - Power Operated	M-2257A M-2257B	

ARKANSAS NUCLEAR ONE
Unit 2

Table 3.2-6 (continued)

3.0 CONVENTIONAL MECHANICAL SECTION (continued)

<u>Description</u>	<u>Purchase Spec No.</u>	<u>Remarks</u>
<u>Fire Water Systems (cont.)</u>		
Supports	M-2119 APL-M-2410	
<u>Miscellaneous Items</u>		
Control Panels	M-2201	J2002
Instrument Valves and Manifolds	M-2297	
Instrument Condensate Chambers for Sensing Lines	M-2206	
Panel Instruments and Transmitters	M-2204	
Flow Switches (Δ P Type)	M-2255	
RTD Thermowells	M-2282	
I&C		CE
Reactor Missile Shield Traveling Platform	M-2203	
4.0 <u>AUXILIARY ELECTRICAL SECTION</u>		
4.1 <u>SWITCHGEAR FOR ENGINEERED SAFETY FEATURES</u>		
<u>4.16kV Switchgear</u>		
4.16kV Switchgear Bus 2A3 and 2A4	E-2008 E-2451	Spec. E-2451 upgraded CBs to 350 MVA IC.
4.16 kV Switchgear Bus 2A5	E-2417	
<u>4160-480V Load Center Transformers</u>		
4160-480V Trans. 2X25 and 2X26	E-2010	
<u>480V Load Centers</u>		
480V Load Center Bus 2B5 and 2B6	E-2010	
<u>480V Motor Control Centers</u>		
Motor Control Center 2B51, 2B52, 2B53 2B54, 2B61, 2B62, 2B63, 2B64	E-2011 E-2400	

ARKANSAS NUCLEAR ONE
Unit 2

Table 3.2-6 (continued)

4.0 AUXILIARY ELECTRICAL SECTION (continued)

<u>Description</u>	<u>Purchase Spec No.</u>	<u>Remarks</u>
4.1 <u>SWITCHGEAR FOR ENGINEERED SAFETY FEATURES (cont.)</u>		
4.2 <u>SWITCHBOARDS & PANELS FOR ENGINEERED SAFETY FEATURES</u>		
<u>120V AC Vital Bus Distribution Panel</u> 120V AC Vital Bus Distribution Panel 2RS1, 2RS2, 2RS3 and 2RS4		
4.3 <u>CONDUIT, CABLE TRAY AND ASSOCIATED SUPPORT SYSTEMS FOR CLASS 1E CABLES</u>		See E-2059 Notes & Details Dwg. for Design
4.4 <u>ELECTRICAL CABLES</u>		
5KV Power Cables	E-2024	
600 V Power & Control Cables	E-2025 E-2412	
Instrument & Special Cables	E-2026 E-2413	
Prefabricated Cable Assemblies	E-2027	CE
4.5 <u>DC EQUIPMENT</u>		
<u>Battery Banks</u>		
Battery Bank 2D11 & 2D12	E-2016	
<u>Fuse & Relay Panels</u>		
Fuse & Relay 2D41, 2D42, 2D43	E-2016	
<u>Battery Chargers Eliminators</u>		
Battery Charger/Eliminator 2D31A, 2D31B, 2D32A, 2D32B, 2D35 & 2D36	E-2015 ANO-E-18	

ARKANSAS NUCLEAR ONE
Unit 2

Table 3.2-6 (continued)

4.0 AUXILIARY ELECTRICAL SECTION (continued)

<u>Description</u>	<u>Purchase Spec No.</u>	<u>Remarks</u>
4.5 <u>DC EQUIPMENT (cont.)</u>		
<u>Uninterruptible Power Systems</u>		
Inverter Channel 2Y11, 2Y1113, 2Y13, 2Y22, 2Y2224 & 2Y24	ANO-E-18	
DC Control Center 2D01 & 2D02	E-2017	
DC Motor Control Center 2D26 & 2D27	E-2037 E-2414	
<u>DC Power & Distribution Panels</u>		
125V DC Distribution Panel 2D23 & 2D24	E-2019	
4.6 <u>MISCELLANEOUS ELECTRICAL EQUIPMENT</u>		
Containment Electrical Penetrations	E-2023	
Miscellaneous Relays	E-2013	
ESF Cable Splice Kits	E-2036	
Electrical Connectors	E-2039	
5.0 <u>ARCHITECTURAL SECTION</u>		
5.1 <u>SPECIAL COATING FOR SURFACING MATERIAL INSIDE CONTAINMENT BUILDING</u>	A-2010	FSC-2210
5.2 <u>SURFACING MATERIAL INSIDE CONTAINMENT BUILDING</u>	A-2032	FSC-2032
5.3 <u>CONCRETE UNIT MASONRY IN CLASS 1 AREAS</u>	A-2011	SFPD-SC
5.4 <u>SURFACE PREPARATION AND COATING OF CONTAINMENT BUILDING LINER PLATE</u>	A-2021 A-2437	FSC-2022
5.5 <u>FIELD PAINTING INSIDE CONTAINMENT BUILDING</u>	A-2022 A-2437	SFPD-SC
5.6 <u>WATERTIGHT DOORS</u>	A-2027 A2407	PO by SFPD
5.7 <u>PENETRATION SEALING</u>	A-2031 A-2431	Field PO

ARKANSAS NUCLEAR ONE
Unit 2

Table 3.3-1

TORNADO WIND PROTECTED COMPONENTS AND TORNADO RESISTANT ENCLOSURES

<u>PROTECTED COMPONENTS</u>	<u>TORNADO RESISTANT ENCLOSURE</u>
Reactor Coolant System	Containment
Reactor Protective System and Engineered Safety Features Inside Containment	Containment
Control Room	Auxiliary Building
Various Electrical, Instrumentation and Control Equipment Required for Safe Shutdown	Containment and Auxiliary Building
Shutdown Cooling System	Auxiliary Building
Reactor Coolant Pressure Control Equipment	Auxiliary Building
Boron Additional Equipment	Auxiliary Building
Spent Fuel Pool	Fuel Pool Wall
Emergency Diesel Generators	Diesel Generator Rooms in Auxiliary Building
Diesel Fuel Oil System	Underground Vault
Service Water Pumps	Intake Structure
Emergency Feedwater Pumps	Auxiliary Building
Safety Injection System	Auxiliary Building

ARKANSAS NUCLEAR ONE
Unit 2

Table 3.4-1

FLOOD PROTECTION PROVISIONS

<u>Structure</u>	<u>Opening or Penetration</u>	<u>Type of Flooding Protection</u>
Containment	Equipment hatch	Double seal in Hatch cover
	Escape lock	Double seal in Lock doors
	Tendon gallery exit	Water Tight Scuttle
Auxiliary Building ²	Door openings	Watertight Doors
	Floor openings	Watertight hatch covers
	Roof openings over underground vaults	Concrete plugs with neoprene seals
	Pipe	Rubber seals or closure plates
Emergency Diesel	Door opening	Watertight Door
Fuel Storage Vaults	Roof opening	Concrete Plug with neoprene seals Seal Weld
	Pipe	Rubber seals or closure plates

¹ The listed provisions are for those penetrations which may be open at the onset of a flood event and could require action to close in accordance with ANO-2 TS 3.7.5.1. Flood protection of passive features is discussed in SAR Section 3.4.4.

² Includes the PASS annex.

Table 3.4-2

LIST OF SUMPS AND SUMP PUMPS INSIDE SEISMIC CATEGORY 1 BUILDINGS

<u>Sump and Sump Pumps</u>	<u>Seismic Category</u>	<u>Quality Group</u>	<u>Description</u>
Auxiliary Building Sump & Pump	2	D	Sect. 3.4.4
Regenerative Waste Holdup Tank Sump & Pumps	2	D	Sect. 3.4.4
Auxiliary Building Chiller and Pipeway Area Sumps & Pumps	2	D	Sect. 3.4.4
Containment Sump	1	D	Sect. 3.4.4
Emergency Diesel Fuel Storage Vault Sump & Pump	2	N/A	Sect. 3.4.4

ARKANSAS NUCLEAR ONE
Unit 2

Table 3.5-1

MISSILE BARRIERS FOR TORNADO AND ACCIDENT MISSILES

<u>Protected Components</u>	<u>Missile Barrier</u>
Reactor Coolant System and other Protected Equipment and systems inside Containment	Prestressed concrete containment, primary and secondary shields, reinforced concrete and refueling cavity wall, internal structures and beams, movable missile shield.
Control Room Components	Enclosure by reinforced concrete auxiliary building walls and slabs.
Safety injection, spray, boron addition, cooling water, ventilation, electrical instrumentation and control and other protected equipment in auxiliary building.	Reinforced concrete auxiliary building. Separation of safety-related trains and enclosure by auxiliary building internal structure, walls and slabs.
Spent Fuel Pool	Fuel pool wall. Heavy structural auxiliary building components are designed such that missile impact will not cause them to fall into the fuel pool.
Emergency Diesel Generators	Separation and enclosure by reinforced concrete auxiliary building walls and slabs.
Diesel Fuel Oil System	Separation and enclosure by reinforced concrete vault partially underground.
Service Water Pumps	Separation and enclosure by reinforced concrete intake structure walls and slabs.
Auxiliary Feedwater Pumps	Separation and enclosure by reinforced concrete Auxiliary Building walls and slabs.
Category 1 Electrical Cables	Reinforced concrete cover
Condensate Storage Tank (T41B) Pipe Trenches and Valve Pits	Reinforced concrete cover
Condensate Storage Tank T41B	Reinforce concrete wall

ARKANSAS NUCLEAR ONE
Unit 2

Table 3.5-2

**EXAMPLE BREAKDOWN OF P2 AND P3 FOR G.E. TURBINE
MISSILE FRAGMENTS WITH CONTAINMENT AS TARGET**

(High Speed Break Inner Wheels)

Fragment Type	Number of Fragments	Missiles Considered	P2	P3	P2 x P3
a	2	HTM+LTM	1.36(-01)	5.00(-03)	6.82(-04)
		HTM	4.73(-02)	9.19(-05)	4.35(-06)
		LTM	-	6.78(-04)	-
b	1	HTM+LTM	1.43(-01)	7.78(-03)	1.11(-03)
		HTM	4.84(-02)	1.81(-04)	8.78(-07)
		LTM	-	-	1.11(-03)
c	3	HTM+LTM	1.48(-01)	6.20(-02)	9.16(-03)
		HTM	4.93(-02)	0	0
		LTM	-	-	9.16(-03)
d	10	HTM+LTM	1.49(-01)	0	0
		HTM	4.94(-02)	0	0
		LTM	-	-	0
a	2	HTM+LTM	1.37(-01)	5.60(-02)	7.67(-03)
		HTM	4.74(-02)	1.61(-04)	7.65(-06)
		LTM	-	-	7.66(-03)
b	1	HTM+LTM	1.43(-01)	6.65(-01)	9.50(-03)
		HTM	4.84(-02)	2.72(-04)	1.32(-05)
		LTM	-	-	9.49(-03)
c	3	HTM+LTM	1.46(-01)	7.49(-02)	1.10(-02)
		HTM	4.90(-02)	1.64(-05)	8.02(-07)
		LTM	-	-	1.10(-02)
d	10	HTM+LTM	1.46(-01)	0	0
		HTM	4.90(-02)	0	0
		LTM	-	-	0

$$\text{TOTAL HTM P2xP3} = 1 - \{ [1-4.35(-06)]^2 [1-8.78(-07)] [1-7.65(-06)]^2 [1-1.32(-05)] [1-8.02(-07)]^3 \} \cong 4.05(-05)$$

$$\text{TOTAL LTM P2xP3} = 1 - \{ [1-6.78(-04)]^2 [1-1.11(-03)] [1-9.16(-03)]^3 [1-7.66(-03)]^2 [1-9.49(-03)] [1-1.10(-02)]^3 \} \cong 8.6(-02)$$

ARKANSAS NUCLEAR ONE
Unit 2

Table 3.5-3

RESULTS OF TURBINE MISSILE DAMAGE PROBABILITY CALCULATIONS

Postulated Unit 2 Target	Source		Probabilities				Target Thickness and Material
	Turbine	Wheels	P ₁	P ₂ x P ₃	P ₄	Total P ₄	
Auxiliary Building	Unit 2	High Speed Break (HSB) Inner Wheels	2.86 (-09)	HTM 1.3(-03) LTM 2.7(-02)	3.7(-12) 7.7(-11)	2.2(-10)	Walls 1'-6" min Slabs 1'-6" min Concrete
		H.S.B. Outer Wheels	4.76(-10)	HTM 4.8(-04) LTM 3.4(-02)	2.3(-13) 1.6(-11)		
		L.S.B. Outer Wheels	5.78(-09)	HTM 6.7(-04) LTM 2.0(-02)	3.9(-12) 1.2(-10)		
Containment	Unit 2	H.S.B. Inner Wheels	2.86(-09)	HTM 4.0(-05) LTM 8.6(-02)	1.1(-13) 2.5(-10)	2.9(-10)	Dome 3'-3" min Walls 3'-9" min Concrete
		H.S.B. Outer Wheels	4.76(-10)	HTM 1.4(-05) LTM 5.7(-02)	6.7(-15) 2.7(-11)		
		L.S.B. Outer Wheels	5.78(-09)	HTM 9.4(-06) LTM 2.5(-03)	5.4(-14) 1.4(-11)		
Diesel Fuel Vault	Unit 2	H.S.B. Inner Wheels	2.86(-09)	HTM* 2.1(-04)	6.0(-13)	8.0(-13)	Walls 2'-0" min Slabs 2'-0" min Concrete
		H.S.B. Outer Wheels	4.76(-10)	HTM* 1.2(-05)	5.7(-15)		
		L.S.B. Outer Wheels	5.78(-09)	HTM* 3.3(-05)	7.5(-14)		
Intake Structure	Unit 2	H.S.B. Inner Wheels	2.86(-09)	HTM* 5.0(-05)	1.4(-13)	2.2(-13)	Walls 1'-6" min Slabs 1'-6" min Concrete
		H.S.B. Outer Wheels	4.76(-10)	HTM* 5.7(-06)	2.7(-15)		
		L.S.B. Outer Wheels	5.78(-09)	HTM* 1.3(-05)	7.5(-14)		

ARKANSAS NUCLEAR ONE
Unit 2

Table 3.5-3 (continued)

Postulated Unit 2 Target	Source		Probabilities				Target Thickness and Material
	Turbine	Wheels	P ₁	P ₂ x P ₃	P ₄	Total P ₄	
Emergency Cooling Pond Pipe Inlet	Unit 2	H.S.B. Inner Wheels	2.86 (-09)	HTM* 3.5(-6)	1.0(-14)	4.7(-14)	Walls 1'-6" Concrete
		H.S.B. Outer Wheels	4.76(-10)	HTM* 4.3(-6)	2.0(-15)		
		L.S.B. Outer Wheels	5.78(-09)	HTM* 6.0(-6)	3.5(-14)		
Emergency Cooling Pond Pipe Outlet	Unit 2	H.S.B. Inner Wheels	2.86(-09)	HTM*7.9(-6)	2.3(-14)	1.3(-13)	Walls 1'-6" Concrete
		H.S.B. Outer Wheels	4.76(-10)	HTM*1.2(-5)	5.7(-15)		
		L.S.B. Outer Wheels	5.78(-09)	HTM*1.7(-5)	9.8(-14)		
Manhole 2MH11	Unit 2	H.S.B. Inner Wheels	2.86(-09)	HTM* 1.9(-5)	5.4(-14)	6.8(-14)	Slabs 1'-6" min Concrete Reinforced concrete cover
		H.S.B. Outer Wheels	4.76(-10)	HTM* 1.3(-6)	6.2(-16)		
		L.S.B. Outer Wheels	5.78(-09)	HTM* 2.2(-6)	1.3(-14)		
Manhole 2MH01	Unit 2	H.S.B. Inner Wheels	2.86(-09)	HTM* 1.4(-5)	4.0(-14)	6.5(-14)	Slabs 1'-6" min Concrete Reinforced concrete cover
		H.S.B. Outer Wheels	4.76(-10)	HTM* 2.4(-6)	1.1(-15)		
		L.S.B. Outer Wheels	5.78(-09)	HTM* 4.1(-6)	2.4(-14)		
Manhole 2MH02	Unit 2	H.S.B. Inner Wheels	2.86(-09)	HTM* 2.6(-5)	7.4(-14)	9.9(-14)	Slabs 1'-6" min Concrete Reinforced concrete cover
		H.S.B. Outer Wheels	4.76(-10)	HTM* 2.5(-6)	1.2(-15)		
		L.S.B. Outer Wheels	5.78(-09)	HTM* 4.1(-6)	2.4(-14)		

ARKANSAS NUCLEAR ONE
Unit 2

Table 3.5-3 (continued)

Postulated Unit 2 Target	Source		Probabilities				Target Thickness and Material
	Turbine	Wheels	P ₁	P ₂ x P ₃	P ₄	Total P ₄	
Manhole 2MH03	Unit 2	H.S.B. Inner Wheels	2.86 (-09)	HTM* 4.1(-5)	1.2(-13)	1.5(-13)	Slabs 1'-6" min Concrete Reinforced concrete cover
		H.S.B. Outer Wheels	4.76(-10)	HTM* 3.0(-6)	1.4(-15) 2.8(-14)		
		L.S.B. Outer Wheels	5.78(-09)	HTM* 4.8(-6)			
Auxiliary Building	Unit 1	Low Speed Burst	1.1(-08)	HTM* .008	8.8(-11)	8.9(-11)	Walls 1'-6" min Slabs 1'-6" min Concrete
		High Speed Burst	1.1(-09)	HTM* .001	1.1(-12)		
Containment	Unit 1	Low Speed Burst	1.1(-08)	HTM* .0028	3.1(-11)	3.1(-11)	Dome 3'-3" min Walls 3'-9" min Concrete
		High Speed Burst	1.1(-09)	HTM* .0005	5.5(-13)		

Notes: All other targets had negligible values of P² with the Unit 1 turbine as the Missile Source.

* The LTM component of turbine missile fragments striking these structures was determined to be insignificant.

Total P₄ = 6.3(-10)

ARKANSAS NUCLEAR ONE
Unit 2

Table 3.5-4

PRESSURIZED COMPONENT MISSILE CHARACTERISTICS FROM NSSS

<u>Item</u>	<u>Kinetic Energy</u>	<u>Impact Velocity (ft/sec)</u>	<u>Weight (lb)</u>	<u>Impact Section</u>
I. Reactor Vessel				
A. Closure Head Nut	1055	28.60	83	Annular Ring, OD = 9 – 11/16” ID = 6-3/8”
B. Closure Head Nut & Stud	3073	21.18	441	Solid Circle 6-1/4” Diameter
C. Instrumentation Assembly	101,615	142.72	321	Solid Disk 6-1/2” Diameter and 3” Thick
D. Instrumentation From Flange Up	114, 000	210.85	165	Solid Disk 6-1/2” Diameter and 3” Thick
II. Deleted				
III. Pressurizer				
A. Safety Valve with Flange	89,200	102.16	550	Solid Circle 2” Diameter
B. Safety Valve Flange Bolt	15	16.15	3.7	Solid Circle 1-1/4” Diameter
C. Lower Temperature Element	290	78.87	3	Edge of Solid disk -3/4” Diameter and 1/2” Thick
D. Manway Stud and Nut	100.16	32.79	6.0	Solid Circle 1-1/4” Diameter
IV. Control Rod Drive Drive Assembly (Mag Jack)	57,600	58.05	1100	Solid Circle 10” Diameter
V. Main Coolant Piping				
Temperature Nozzle with RTD	1095	93.85	8	Edge of Solid Disk 2-3/4” Diameter And 1/2” Thick

ARKANSAS NUCLEAR ONE
Unit 2

Table 3.5-4 (continued)

<u>Item</u>	<u>Kinetic Energy</u>	<u>Impact Velocity (ft/sec)</u>	<u>Weight (lb)</u>	<u>Impact Section</u>
VI. Surge and Spray Piping Thermal Wells with RTD	277	100.92	1.75	Edge of Solid Disk 2-3/4" Diameter And 1/2" Thick
VII. Main Coolant Thermal Well with RTD	1095	93.85	8	Edge of Solid Disk 2-3/4" Diameter And 1/2" Thick

Notes:

- (1) Missile material is assumed to be entirely steel.
- (2) Missile impact orientation is assumed to be the orientation which presents the minimum projected area.
- (3) The selection of potential missiles is based on the application of a single-failure criteria to the normal retention features of plant equipment for which there is a source of energy capable creating a missile in the event of the postulated removal of the normal retention features. Where redundancy is provided by the normal retention features such that sufficient retention capability remains to prevent creation of a missile in the event of a postulated failure of a single retention feature, no potential missile is postulated.
- (4) Replacement pressurizer heater is not considered as a potential missile because the likelihood of a complete circumferential weld (between the heater and heater sleeve) failure leading to the ejection of a heater is not credible. The following is the justification for the same:
 - The weld is designed as a structural weld that meets the ASME Code Case N-405-1 requirements for connecting appurtenances to nozzles of ASME Section III, Division 1, Class 1 vessel.
 - The weld is examined by liquid penetrant (PT) method for multiple passes.
 - The weld is inspected per NB-5350 of the ASME Code, Section III, with indications limited to 1/64 inch rather than 3/16 inch recommended by the Code.
 - The weld is located at the outer extension of the heater sleeve away from the heating element and has a limited exposure to the reactor coolant, and there are no significant additional externally applied thermal or mechanical loadings.

ARKANSAS NUCLEAR ONE
Unit 2

Table 3.5-5A

SELECTED PRESSURIZED COMPONENT MISSILE CHARACTERISTICS FROM OTHER THAN NSSS
(Inside Containment)

<u>Item</u>	<u>Kinetic Energy</u>	<u>Impact Velocity (ft/sec)</u>	<u>Weight (lb)</u>	<u>Impact Section</u>
I. <u>Main Steam</u>				
A. Thermal Well with Element	542.5	66.08	8	Edge of solid disk 2-3/4" diameter and 1/2" thick
B. Pressure Test Connection (Two Valves with 3/4" pipe nipple)	542.5	53.96	12	Annular Ring ID = 1.0" OD = 1.6"
C. Hydrostatic Vents (Two 3/4" Gate Valves with pipe nipple)	542.5	53.96	12	Annular Ring ID = 1.0" OD = 1.6"
D. Hydrostatic Drains (Two 1" Gate Valves with pipe nipple)	542.5	51.84	13	Annular Ring ID = 1.25" OD = 1.8"
II. <u>Feedwater</u>				
A. Thermal Well with Element	780	79.24	8	Edge of solid disk 2-3/4" diameter and 1/2" thick
B. Pressure Test Connection (One 3/4" Root Valve with 3/4" pipe nipple)	780	95.57	5.5	Annular Ring ID = 1.0" OD = 1.7"
C. Drains (Two 1" Gate Valves with pipe and nipple)	780	56.03	16	Annular Ring ID = 1.25" OD = 1.9"

ARKANSAS NUCLEAR ONE
Unit 2

Table 3.5-5A (continued)

<u>Item</u>	<u>Kinetic Energy</u>	<u>Impact Velocity (ft/sec)</u>	<u>Weight (lb)</u>	<u>Impact Section</u>
III. <u>Sample System</u>				
Pressure Test Connections (One 3/4" Root Valve with pipe nipple)	550	80.23	5.5	Annular Ring ID = 1" OD = 1.6"
IV. <u>Miscellaneous</u>				
Valve Bonnet Bolt (Bolt used for example was 3/4" diameter and 7-1/2" long)	77	72.89	1.0	Solid Circle 3/4" in diameter

NOTES:

- (1) Missile material is assumed to be entirely steel.
- (2) Missile impact orientation is assumed to be the orientation which presents the minimum projected area.
- (3) The selection of potential missiles is based on the application of a single-failure criteria to normal retention features of plant equipment for which there is a source of energy capable of creating a missile in the event of the postulated removal of the normal retention features. Where redundancy is provided by the normal retention features such that sufficient retention capability remains to prevent creation of a missile in the event of a postulated failure of a single retention feature, no potential missile is postulated.

ARKANSAS NUCLEAR ONE
Unit 2

Table 3.5-5B

SELECTED PRESSURIZED COMPONENT MISSILE CHARACTERISTICS
(Auxiliary Building)

<u>Item and Line No.</u>	<u>Fig. Ref.</u>	<u>Weight (lb)</u>	<u>Impact Velocity (ft/sec)</u>	<u>Kinetic Energy (ft-lb)</u>	<u>Impact Diameter (in.)</u>
I. <u>Safety Injection</u>					
A. Hydrostatic Vent - 2DCB-1/4" (Two 3/4" Gate Valves with pipe and nipple)	3.5-19	33	21.8	246.1	1.375
B. Welded Cap - 2DCB-2-4"	3.5-19	7.6	636.6	44,882	5.5
C. Hydrostatic Vent - 2CCB-12-3" (Two 3/4" Gate Valves with pipe and nipple)	3.5-17	33	25.9	346.2	1.375
D. Hydrostatic Vent - 2GCB-3-12" (Two 1" Gate Valves with pipe and nipple)	3.5-19	18	14.4	58.7	1.75
E. Thermal Well with Element – 2GCB-3-14"	3.5-19	6	36.1	121.3	0.625
F. Pressure Test Connection – 2GCB-5-14" (Two 3/4" Root Valves with pipe and nipple)	3.5-24	10.6	28	128.4	1.375
II. <u>Containment Spray</u>					
A. Welded Cap – 2GCB-16-12"	3.5-19	7.6	150.1	2659	5.5

ARKANSAS NUCLEAR ONE
Unit 2

Table 3.5-5B (continued)

III.	<u>Chemical & Volume Control</u>					
	A. Hydrostatic Vent – 2CCB-8-3” (Two 1” Gate Valves with pipe and nipple)	3.5-17	34	41.8	920	1.75
IV.	<u>Emergency Feedwater</u>					
	A. Hydrostatic Drain - 2DCB-1-4” (Two 1” Gate Valves with pipe and nipple)	3.5-12	34	29.9	470.1	1.75
	B. 1” Capped Connection – 2DBB-3-4”	3.5-17	0.5	149.6	173.4	1.75
	C. Hydrostatic Vent – 2DBB-3-4” (Two 3/4” Gate Valves with pipe and nipple)	3.5-17	33.2	11.1	63.6	1.375
V.	<u>SG Blowdown</u>					
	A. Pressure Test Connection – 2DBD-10-4” (Two 3/4” Root Valves with pipe and nipple)	3.5-10	19.1	14.0	58.5	1.375
	B. Hydrostatic Vent – 2DBB-8-4” (Two 3/4” Gate Valves with pipe and nipple)	3.5-10	33.2	10.8	60.4	1.375

NOTES:

- (1) Missile material is assumed to be entirely steel.
- (2) Missile impact orientation is assumed to be the orientation which presents the minimum projected area.
- (3) The selection of potential missiles is based on the application of a single-failure criteria to the normal retention features of plant equipment for which there is a source of energy capable of creating a missile in the event of the postulated removal of the normal retention features. Where redundancy is provided by the normal retention features such that sufficient retention capability remains to prevent creation of a missile in the event of a postulated failure of a single retention feature, no potential missile is postulated.

ARKANSAS NUCLEAR ONE
Unit 2

Table 3.5-6

TORNADO MISSILE CHARACTERISTICS

Item	Weight (Lbs)	Impact Area (Sq/Ft)	Maximum Velocity (Ft/Sec)	Kinetic Energy (Ft/Lbs)
1. A wood plank, 4-inches by 12-inches in cross section, weighing 108 lbs., traveling end on at a speed of 300 mph, striking the structure at any elevation.	108	0.333	440	3.25×10^5
2. A steel pipe, Schedule 40, 3-inches in diameter by 10-feet long, weighing 75.8 lbs., traveling end on at 100 mph, striking the structure at any elevation.	75.8	0.063	147	2.54×10^4
3. An automobile of 4000 lbs. weight, striking the structure at 50 mph on a contact area of 20 sq. ft., any portion of the impact being not more than 25 ft. above grade.	4000	20.0	73.5	3.36×10^5

ARKANSAS NUCLEAR ONE
Unit 2

Table 3.5-7

RESULTS OF CALCULATIONS ON EFFECTS OF MISSILES ON REINFORCED CONCRETE STRUCTURES

<u>Missile Description</u>	<u>Penetration X1 In Inches</u>	<u>Perforation T_p In Inches</u>	<u>Spalling t_s In Inches</u>	<u>Available Minimum Concrete Thickness In Inches</u>
1. <u>Missiles from Table 3.5-4</u>				
I. Reactor Vessel				
A. Closure Head Nut	0.015	0.188	0.375	24
B. Closure Head Nut & Stud	0.045	0.688	1.375	24
C. Instrumentation Assembly	1.320	5.960	11.930	24
D. Instrumentation from Flange Up	1.410	5.160	10.310	24
II. Deleted				
III. Pressurizer				
A. Safety Valve Flange Bolt	0.006	0.074	0.148	36
B. Lower Temperature Element	0.022	0.119	0.238	36
C. Manway Stud & Nut	0.037	0.306	0.613	36
IV. Control Rod Drive – Drive Assembly	0.327	2.888	5.775	24
V. Main Coolant Piping – Temperature Nozzle with RTD	0.082	0.400	0.800	36
VI. Surge and Spray – piping thermal wells with RTD Assembly	0.021	0.096	0.193	36
VII. Main Coolant – Thermal well with RTD	0.082	0.400	0.800	36

ARKANSAS NUCLEAR ONE
Unit 2

Table 3.5-7 (continued)

Missile Description	Penetration X1 In Inches	Perforation T _p In Inches	Spalling t _s In Inches	Available Minimum Concrete Thickness In Inches
2. <u>Missiles from Table 3.5-5A</u>				
I. Main Steam				
A. Thermal Well with Element	0.041	0.250	0.500	36
B. Pressure Test Connection	0.120	0.760	1.525	36
C. Hydrostatic Vents	0.120	0.760	1.525	36
D. Hydrostatic Drains	0.094	0.634	1.268	36
II. Feedwater				
A. Thermal Well with Element	0.102	0.434	0.868	18
B. Pressure Test Connection	0.259	0.910	1.820	18
C. Drains	0.210	1.063	2.125	18
III. Sample System Pressure Test Connections	0.210	0.803	1.605	18
IV. Miscellaneous Valve Bonnet Bolt	0.148	0.500	1.000	18
3. <u>Missiles from Table 3.5-5B</u>				
I. Safety Injection				
A. Hydrostatic Vent	0.445	1.130	2.258	18
B. Welded Cap	0.221	1.883	3.768	18
C. Hydrostatic Vent	0.626	1.414	2.828	18
D. Hydrostatic Drain	0.058	0.185	0.370	18
E. Thermal well with element	0.070	1.636	3.272	18
F. Pressure Test connection	0.232	0.499	0.998	18

ARKANSAS NUCLEAR ONE
Unit 2

Table 3.5-7 (continued)

Missile Description	Penetration X1 In Inches	Perforation T _p In Inches	Spalling t _s In Inches	Available Minimum Concrete Thickness In Inches
II. Containment Spray				
A. Welded Cap	0.157	0.277	0.554	18
III. Chemical and Volume Control				
A. Hydrostatic Vent	0.905	1.768	3.535	18
IV. Emergency Feedwater				
A. Hydrostatic Drain	0.464	1.085	2.170	18
B. 1" Capped Connection	0.165	0.481	0.962	18
C. Hydrostatic Vent	0.113	0.461	0.922	18
V. SG Blowdown				
A. Pressure Test Connection	0.104	0.361	0.722	18
B. Hydrostatic Vent	0.107	0.446	0.892	18
4. <u>Missiles from Table 3.5-6</u>				
A. A wood plank 4" x 12" in Cross Section	3.780	8.714	17.428	18
B. A Steel Pipe schedule 40, 3" in Diameter	2.090	7.988	15.975	18
C. An Automobile	0.090	0.750	1.500	18

ARKANSAS NUCLEAR ONE
Unit 2

Table 3.5-8

SAFETY-RELATED COMPONENTS LOCATED OUTDOORS

<u>Component</u>	<u>Location</u>	<u>Seismic Design Category</u>	<u>Protection from Tornado Generated Missiles</u>	<u>Remarks</u>
Intake Structure Exhaust Fans and Air Intake	Fig. 3.5-7	I	Yes	
Emergency Diesel Generator Rooms Air Intake & Exhaust Fans	Figs. 3.5-5 and 3.5-6	I	Yes	See Section 9.4.2.4 for detail
Penetration Room Ventilation System Exhaust	Fig. 3.5-6	I	No, destruction of exhaust pipes will not jeopardize operation of system since they are downstream of the filters and absorber.	See Section 6.5 for detail
Refueling Water Tank	Fig. 3.5-4	I	No – not required for safe shutdown after a tornado	See Sections 6.2 and 6.3 for detail
Main steam lines	Fig. 3.5-6	I	No – a postulated missile cannot destroy integrity of lines	See Table Q310.16-1 for capability to withstand missiles
Emergency Diesel Generator Combustion Air Intake & Exhaust	Fig. 3.5-6 and 3.5-6	I	Intake – Yes Exhaust – No	See Table Q310.16-1 for exhaust capability to withstand missiles

ARKANSAS NUCLEAR ONE
Unit 2

Table 3.5-8 (continued)

<u>Component</u>	<u>Location</u>	<u>Seismic Design Category</u>	<u>Protection from Tornado Generated Missiles</u>	<u>Remarks</u>
Service Water Piping Between ECP and Intake Structure / Auxiliary Building	N.A.	I	Yes – 3' Earth	See Table Q310.16-2 for capability to withstand missiles
ECP Sluice Gate	N.A.	I	Horizontal – Yes Vertical – Yes	
Emergency Diesel Generator Fuel Storage Tanks	Fig. 3.5-1	I	Yes	

Notes:

1. Control Room, Auxiliary Building, and Fuel Handling Area ventilation air inlets and discharges are not safety-related.
2. Protection is for missiles listed in Table 3.5-6 and includes both horizontal and vertical missiles unless otherwise stated.

ARKANSAS NUCLEAR ONE
Unit 2

TABLE 3.6-1
HIGH ENERGY PIPING SYSTEMS

<u>Service</u>	<u>Pipe Size</u>	<u>Operating Conditions upon which the high energy classification is based*</u>
Reactor Coolant System Major Piping	30"/42#	2235 psig/582 °F(T _{avg})
Pressurizer Surge Line	12"	2235 psig/653 °F
Pressurizer Spray Lines	3"/4"	2235 psig/553 °F
Shutdown Cooling Line (2CCA-25 only)	14"	2235 psig/611 °F
Safety Injection Lines (2CCA-21, 2CCA-22, 2CCA-23, 2CCA-24 only)	12"/8"/6"/3"	610 psig/120 °F
Safety Injection Lines (2DCB-1, 2DCB-3, 2CCB-12)	4"/3"/2"	635 PSIG/40 °F
Reactor Coolant Letdown Line	2"	2235 psig/550 °F
Reactor Coolant Charging Line to Regenerative Heat Exchanger	3"/2"	2250 psig/120 °F
Reactor Coolant Charging Line from Regenerative Heat Exchanger	2"	2250 psig/479 °F
Main Steam Lines	38"	985 psig/545 °F
Main Feedwater Lines	24"	1085 psig/455 °F
Main Steam Supply to Atmospheric Dump Valves	10"	985 psig/545 °F
Main Steam Supply to Emergency Feedwater Pump Turbine Driver	4"	985 psig/545 °F
Steam Generator Blowdown Lines	4"	985 psig/545 °F
Emergency Feedwater	4"	1085 psig/85 °F
Steam Supply to Concentrators**	3"	885 psig/529 °F
Steam Supply to Concentrators**	8"	215 psig/400 °F
Steam Supply to Concentrators**	6"/10"	100 psig/400 °F

* The values listed are original design conditions and may not reflect current operating conditions. The latest pressure-temperature analyses shall be utilized for determination of pressure-temperature design inputs.

** Currently not in use.

ARKANSAS NUCLEAR ONE
Unit 2

Table 3.6-1A

**LIMITING BRANCH LINE PIPE BREAKS FOR THE RCS WITH THE
REPLACEMENT STEAM GENERATORS**

	<u>Break Name</u>	<u>Postulated Pipe Break Location</u>	<u>Note</u>	<u>Jet Type</u>
1	ms13t	MS line terminal end guillotine at RSG end		Cone
2	fw10t	FW line terminal end guillotine at RSG end		Cone
3	sia1t10	SI line terminal end guillotine at discharge leg end	RCP Loop A	Cone
4	sib1t4	SI line terminal end guillotine at discharge leg end	RCP Loop B	Cone
5	sdc7t	SDC line terminal end guillotine at hot leg end		Cone
6	srg5t	Surge line terminal end guillotine at hot leg end		Cone
7	srg5t1	Surge line intermediate guillotine		Fan
8	Srgbc	Surge line intermediate guillotine	Thrust directed north	Cone
9	Srgbf	Surge line intermediate guillotine	Thrust directed north	Cone
10	Srgc	Surge line intermediate guillotine	Thrust directed up	Fan
11	Srgc1	Surge line intermediate guillotine	Thrust directed down	Cone
12	Srggc	Surge line intermediate guillotine	Thrust directed east	Cone
13	Srggf	Surge line intermediate guillotine	Thrust directed east	Cone
14	Srgf	Surge line intermediate guillotine	Thrust directed up	Fan
15	Srgf1	Surge line intermediate guillotine	Thrust directed down	Cone

ARKANSAS NUCLEAR ONE
Unit 2

Table 3.6-2

MAIN STEAM STRESS SUMMARY - 2EBD-1

<u>DATA POINT</u>		<u>STRESS (PSI)</u>	<u>JET THRUST FORCE (KIPS)</u>
22	***** TERMINAL END *****		985
30		19892	985
34		17837	985
38		17957	985
39	***** TERMINAL END *****		360
95		15542	360
97		16348	360
98	***** TERMINAL END *****		360
119		16666	360
121		16667	360
122	***** TERMINAL END *****		360

Note: This applies to all tables on this page.

$$0.8 (S_h + S_A) = 35,000 \text{ psi}$$

"The actual resultant pipe stress information (Data Point numbers and values for Stress, Jet Thrust Force or Jet Force, Usage Factor, Sn and 2.4Sm, where applicable) contained in the table above is historical in nature with respect to the latest qualifying pipe stress calculation(s). For current actual pipe stress information, see the latest qualifying pipe stress analysis calculation(s). The postulated break location for the piping system is unchanged."

ARKANSAS NUCLEAR ONE
Unit 2

Table 3.6-3

MAIN STEAM STRESS SUMMARY - 2EBD-2

<u>DATA POINT</u>		<u>STRESS (PSI)</u>	<u>JET THRUST FORCE (KIPS)</u>
62	***** TERMINAL END *****		985
65		18834	985
73		17649	985
74	***** TERMINAL END *****		985
76	***** TERMINAL END *****		360
79		19195	360
81		18150	360
82	***** TERMINAL END *****		360
107		20531	360
109		20712	360
110	***** TERMINAL END *****		360

Note: This applies to all tables on this page.

$$0.8 (S_h + S_A) = 35,000 \text{ psi}$$

"The actual resultant pipe stress information (Data Point numbers and values for Stress, Jet Thrust Force or Jet Force, Usage Factor, Sn and 2.4Sm, where applicable) contained in the table above is historical in nature with respect to the latest qualifying pipe stress calculation(s). For current actual pipe stress information, see the latest qualifying pipe stress analysis calculation(s). The postulated break location for the piping system is unchanged."

ARKANSAS NUCLEAR ONE
Unit 2

Table 3.6-4

MAIN FEEDWATER STRESS SUMMARY - 2DBD-1, 2DBD-2

<u>DATA POINT</u>		<u>STRESS (PSI)</u>	<u>JET THRUST FORCE (KIPS)</u>
5	***** TERMINAL END *****		400
75		22116	400
135		18329	400
160	***** TERMINAL END *****		110
75	***** TERMINAL END *****		400
440		19695	110
435		20499	110
395	***** TERMINAL END *****		110
275	***** TERMINAL END *****		110
343		20539	110
344		14828	110
365	***** TERMINAL END *****		110
215	***** TERMINAL END *****		400
194		21936	400
235		17964	400
340	***** TERMINAL END *****		400
135	***** TERMINAL END *****		400
175		12397	400
187		20937	400
190	***** TERMINAL END *****		400

0.8 (S_h + S_A) = 35,000 psi

"The actual resultant pipe stress information (Data Point numbers and values for Stress, Jet Thrust Force or Jet Force, Usage Factor, S_n and 2.4S_m, where applicable) contained in the table above is historical in nature with respect to the latest qualifying pipe stress calculation(s). For current actual pipe stress information, see the latest qualifying pipe stress analysis calculation(s). The postulated break location for the piping system is unchanged."

ARKANSAS NUCLEAR ONE
Unit 2

Table 3.6-5

EFW TURBINE STEAM SUPPLY STRESS SUMMARY - 2EBC-1

<u>DATA POINT</u>		<u>STRESS (PSI)</u>	<u>JET THRUST FORCE (KIPS)</u>
5	***** TERMINAL END *****		16
35		24645	16
53		28441	16
55		25622	16
70	***** TERMINAL END *****		16
76		18841	16
80		19430	16
82		19431	16
100		10252	16
105	***** TERMINAL END *****		16
140	***** TERMINAL END *****		16
155		22071	16
167		20691	16
185	***** TERMINAL END *****		16

0.8 (S_h + S_A) = 35,000 psi

"The actual resultant pipe stress information (Data Point numbers and values for Stress, Jet Thrust Force or Jet Force, Usage Factor, S_n and 2.4S_m, where applicable) contained in the table above is historical in nature with respect to the latest qualifying pipe stress calculation(s). For current actual pipe stress information, see the latest qualifying pipe stress analysis calculation(s). The postulated break location for the piping system is unchanged."

ARKANSAS NUCLEAR ONE
Unit 2

Table 3.6-6

ATMOSPHERIC DUMP STRESS SUMMARY - 2EBB-8, 2EBB-9

<u>DATA POINT</u>	<u>STRESS (PSI)</u>	<u>JET THRUST FORCE (KIPS)</u>
14 ***** TERMINAL END *****		93
138	30866	93
139	16580	93
145 ***** TERMINAL END *****		93
54 ***** TERMINAL END *****		93
151	12,586	93
161	12,586	93
164 ***** TERMINAL END *****		93

0.8 (S_h + S_A) = 35,000 psi

"The actual resultant pipe stress information (Data Point numbers and values for Stress, Jet Thrust Force or Jet Force, Usage Factor, S_n and 2.4S_m, where applicable) contained in the table above is historical in nature with respect to the latest qualifying pipe stress calculation(s). For current actual pipe stress information, see the latest qualifying pipe stress analysis calculation(s). The postulated break location for the piping system is unchanged."

ARKANSAS NUCLEAR ONE
Unit 2

Table 3.6-7

CHARGING STRESS SUMMARY - 2CCB-8/2CCB-25

<u>DATA POINT</u>		<u>STRESS (PSI)</u>	<u>JET THRUST FORCE (KIPS)</u>
2CCB-8			
5	***** TERMINAL END *****		25
75		16916	25
183		31056	25
80	***** TERMINAL END *****		25
85	***** TERMINAL END *****		7
95		10603	25
115		12487	25
135	***** TERMINAL END *****		25
140	***** TERMINAL END *****		7
142		13014	25
172		11640	25
220	***** TERMINAL END *****		7
2CCB-25			
10	***** TERMINAL END *****		25
40		15232	10
70		14314	10
90	***** TERMINAL END *****		10

0.8 (S_h + S_A) = 36,700 psi

"The actual resultant pipe stress information (Data Point numbers and values for Stress, Jet Thrust Force or Jet Force, Usage Factor, S_n and 2.4S_m, where applicable) contained in the table above is historical in nature with respect to the latest qualifying pipe stress calculation(s). For current actual pipe stress information, see the latest qualifying pipe stress analysis calculation(s). The postulated break location for the piping system is unchanged."

ARKANSAS NUCLEAR ONE
Unit 2

Table 3.6-8

LETDOWN STRESS SUMMARY - 2CCB-2

<u>DATA POINT</u>	<u>STRESS (PSI)</u>	<u>JET THRUST FORCE (KIPS)</u>
5 ***** TERMINAL END *****		10
10	15603	10
117	26889	10
117 ***** TERMINAL END *****		10
136 ***** TERMINAL END *****		10
210	13016	10
215	14867	10
220 ***** TERMINAL END *****		10

0.8 (S_h + S_A) = 33,500 psi

"The actual resultant pipe stress information (Data Point numbers and values for Stress, Jet Thrust Force or Jet Force, Usage Factor, S_n and 2.4S_m, where applicable) contained in the table above is historical in nature with respect to the latest qualifying pipe stress calculation(s). For current actual pipe stress information, see the latest qualifying pipe stress analysis calculation(s). The postulated break location for the piping system is unchanged."

Table 3.6-9

MAIN STEAM STRESS SUMMARY - 2EBB-1

<u>DATA POINT</u>	<u>STRESS >0.8(1.2S_h+S_A)</u>	<u>JET THRUST FORCE (KIPS)</u>
	(None)	
5 ***** TERMINAL END *****		1240
180 ***** TERMINAL END *****		985

Notes:

- 1) The Jet Thrust Force contained in this table is historical in nature with respect to the latest qualifying calculation. For current information, see the latest High Energy Line Break Analysis (HELBA) calculation.
- 2) For current Stress and Stress Allowable values, see the latest qualifying pipe stress calculation.

ARKANSAS NUCLEAR ONE
Unit 2

Table 3.6-10

MAIN STEAM STRESS SUMMARY - 2EBB-2

<u>DATA POINT</u>	<u>STRESS</u> <u>>0.8(1.2Sh+S_A)</u>	<u>JET THRUST FORCE</u> <u>(KIPS)</u>
	(None)	
5 ***** TERMINAL END *****		240
170 ***** TERMINAL END *****		985

Notes:

- 1) The Jet Thrust Force contained in this table is historical in nature with respect to the latest qualifying calculation. For current information, see the latest High Energy Line Break Analysis (HELBA) calculation.
- 2) For current Stress and Stress Allowable values, see the latest qualifying pipe stress calculation.

Table 3.6-11

MAIN FEEDWATER STRESS SUMMARY - 2DBB-1

<u>DATA POINT</u>	<u>STRESS</u> <u>>0.8(1.2Sh+S_A)</u>	<u>JET THRUST FORCE</u> <u>(KIPS)</u>
	(None)	
5 ***** TERMINAL END *****		500
125 ***** TERMINAL END *****		400

Notes:

- 1) The Jet Thrust Force contained in this table is historical in nature with respect to the latest qualifying calculation. For current information, see the latest High Energy Line Break Analysis (HELBA) calculation.
- 2) For current Stress and Stress Allowable values, see the latest qualifying pipe stress calculation.

ARKANSAS NUCLEAR ONE
Unit 2

Table 3.6-12

MAIN FEEDWATER STRESS SUMMARY - 2DBB-2

<u>DATA POINT</u>	<u>STRESS</u> <u>>0.8(1.2Sh+S_A)</u>	<u>JET THRUST FORCE</u> <u>(KIPS)</u>
	(None)	
5 ***** TERMINAL END *****		500
120 ***** TERMINAL END *****		400

Notes:

- 1) The Jet Thrust Force contained in this table is historical in nature with respect to the latest qualifying calculation. For current information, see the latest High Energy Line Break Analysis (HELBA) calculation.
- 2) For current Stress and Stress Allowable values, see the latest qualifying pipe stress calculation.

Table 3.6-13

STEAM GENERATOR BLOWDOWN STRESS SUMMARY - 2DBB-7/2DBB-9

<u>DATA POINT</u>	<u>STRESS</u> <u>>0.8(1.2Sh+S_A)</u>	<u>JET THRUST FORCE</u> <u>(KIPS)</u>
	(None)	
5 ***** TERMINAL END *****		16
95 ***** TERMINAL END *****		16
165 ***** TERMINAL END *****		16

Notes:

- 1) The Jet Thrust Force contained in this table is historical in nature with respect to the latest qualifying calculation. For current information, see the latest High Energy Line Break Analysis (HELBA) calculation.
- 2) For current Stress and Stress Allowable values, see the latest qualifying pipe stress calculation.

ARKANSAS NUCLEAR ONE
Unit 2

Table 3.6-14

STEAM GENERATOR BLOWDOWN STRESS SUMMARY - 2DBB-8/2DBB-10

<u>DATA POINT</u>	<u>STRESS</u> <u>>0.8(1.2Sh+S_A)</u>	<u>JET THRUST FORCE</u> <u>(KIPS)</u>
	(None)	
5 ***** TERMINAL END *****		16
30 ***** TERMINAL END *****		16

Notes:

- 1) The Jet Thrust Force contained in this table is historical in nature with respect to the latest qualifying calculation. For current information, see the latest High Energy Line Break Analysis (HELBA) calculation.
- 2) For current Stress and Stress Allowable values, see the latest qualifying pipe stress calculation.

Table 3.6-15

EMERGENCY FEEDWATER STRESS SUMMARY - 2DBB-3

<u>DATA POINT</u>	<u>STRESS</u> <u>>0.8(1.2Sh+S_A)</u>	<u>JET THRUST FORCE</u> <u>(KIPS)</u>
	(None)	
24 ***** TERMINAL END *****		16
255 ***** TERMINAL END *****		16

Notes:

- 1) The Jet Thrust Force contained in this table is historical in nature with respect to the latest qualifying calculation. For current information, see the latest High Energy Line Break Analysis (HELBA) calculation.
- 2) For current Stress and Stress Allowable values, see the latest qualifying pipe stress calculation.

ARKANSAS NUCLEAR ONE
Unit 2

Table 3.6-16

EMERGENCY FEEDWATER STRESS SUMMARY - 2DBB-4

<u>DATA POINT</u>	<u>STRESS</u> <u>>0.8(1.2Sh+S_A)</u>	<u>JET THRUST FORCE</u> <u>(KIPS)</u>
	(None)	
32 ***** TERMINAL END *****		16
230 ***** TERMINAL END *****		16

Notes:

- 1) The Jet Thrust Force contained in this table is historical in nature with respect to the latest qualifying calculation. For current information, see the latest High Energy Line Break Analysis (HELBA) calculation.
- 2) For current Stress and Stress Allowable values, see the latest qualifying pipe stress calculation.

Table 3.6-17

PRESSURIZER SURGE STRESS SUMMARY - 2BCA-1

<u>DATA POINT</u>	<u>USAGE FACTOR</u> <u>U > 0.1</u>	<u>STRESS INTENSITY</u> <u>S_n > 2.4S_m</u>	<u>JET FORCE</u> <u>(KIPS)</u>
9 ***** TERMINAL END *****			250
14	No	Yes	250
19	No	Yes	250
20	No	Yes	250
34	No	Yes	250
35	No	Yes	250
59	No	Yes	250
60	No	Yes	250
70 ***** TERMINAL END *****			250

Notes:

- 1) The Jet Thrust Force contained in this table is historical in nature with respect to the latest qualifying calculation. For current information, see the latest High Energy Line Break Analysis (HELBA) calculation.
- 2) For current Usage Factor, Stress Intensity, and Stress Allowable values, see the latest qualifying pipe stress calculation.

ARKANSAS NUCLEAR ONE
Unit 2

Table 3.6-18

SAFETY INJECTION STRESS SUMMARY - 2CCA-21

<u>DATA POINT</u>	<u>USAGE FACTOR U > 0.1</u>	<u>STRESS INTENSITY Sn > 2.4Sm</u>	<u>JET FORCE (KIPS)</u>
10 *****	TERMINAL END	*****	315
-30	Yes	No	110
35	Yes	No	110
-55	Yes	No	110
65	Yes	No	110
70	Yes	No	110
114 *****	TERMINAL END	*****	110
116 *****	TERMINAL END	*****	50
154	No	Yes	50
157	No	Yes	50
165	No	Yes	29
170	No	Yes	29
180 *****	TERMINAL END	*****	29
192 *****	TERMINAL END	*****	7
200 *****	TERMINAL END	*****	7

Notes:

- 1) The Jet Thrust Force contained in this table is historical in nature with respect to the latest qualifying calculation. For current information, see the latest High Energy Line Break Analysis (HELBA) calculation.
- 2) For current Usage Factor, Stress Intensity, and Stress Allowable values, see the latest qualifying pipe stress calculation.

ARKANSAS NUCLEAR ONE
Unit 2

Table 3.6-19

SAFETY INJECTION STRESS SUMMARY - 2CCA-22

<u>DATA POINT</u>	<u>USAGE FACTOR U > 0.1</u>	<u>STRESS INTENSITY Sn > 2.4Sm</u>	<u>JET FORCE (KIPS)</u>
10 *****	TERMINAL END	*****	315
175 *****	TERMINAL END	*****	110
180 *****	TERMINAL END	*****	50
230	No	Yes	50
240	No	Yes	50
245 *****	TERMINAL END	*****	29
265 *****	TERMINAL END	*****	7
285 *****	TERMINAL END	*****	7

Notes:

- 1) The Jet Thrust Force contained in this table is historical in nature with respect to the latest qualifying calculation. For current information, see the latest High Energy Line Break Analysis (HELBA) calculation.
- 2) For current Usage Factor, Stress Intensity, and Stress Allowable values, see the latest qualifying pipe stress calculation.

ARKANSAS NUCLEAR ONE
Unit 2

Table 3.6-20

SAFETY INJECTION STRESS SUMMARY - 2CCA-23

<u>DATA POINT</u>	<u>USAGE FACTOR U > 0.1</u>	<u>STRESS INTENSITY Sn > 2.4Sm</u>	<u>JET FORCE (KIPS)</u>
5 *****	TERMINAL END	*****	110
80	Yes	No	110
100	Yes	No	110
105	Yes	No	110
115	Yes	No	110
120	Yes	No	110
125	Yes	Yes	110
160 *****	TERMINAL END	*****	315
165 *****	TERMINAL END	*****	50
210 *****	TERMINAL END	*****	50
211 *****	TERMINAL END	*****	50
255	No	Yes	50
264	No	Yes	50
270	Yes	No	50
275	Yes	No	29
295 *****	TERMINAL END	*****	29
326 *****	TERMINAL END	*****	7
354 *****	TERMINAL END	*****	7
400	Yes	No	29

Notes:

- 1) The Jet Thrust Force contained in this table is historical in nature with respect to the latest qualifying calculation. For current information, see the latest High Energy Line Break Analysis (HELBA) calculation.
- 2) For current Usage Factor, Stress Intensity, and Stress Allowable values, see the latest qualifying pipe stress calculation.

ARKANSAS NUCLEAR ONE
Unit 2

Table 3.6-21

SAFETY INJECTION STRESS SUMMARY - 2CCA-24

DATA POINT	USAGE FACTOR <u>U > 0.1</u>	STRESS INTENSITY <u>Sn > 2.4Sm</u>	JET FORCE <u>(KIPS)</u>
6	***** TERMINAL END *****	*****	315
40	Yes	Yes	110
120	***** TERMINAL END *****	*****	110
140	***** TERMINAL END *****	*****	50
150	No	Yes	50
155	No	Yes	50
170	***** TERMINAL END *****	*****	50
171	***** TERMINAL END *****	*****	50
219	No	Yes	50
255	***** TERMINAL END *****	*****	7
256	***** TERMINAL END *****	*****	7
275	No	Yes	29
290	Yes	No	29
300	***** TERMINAL END *****	*****	29

Notes:

- 1) The Jet Thrust Force contained in this table is historical in nature with respect to the latest qualifying calculation. For current information, see the latest High Energy Line Break Analysis (HELBA) calculation.
- 2) For current Usage Factor, Stress Intensity, and Stress Allowable values, see the latest qualifying pipe stress calculation.

Table 3.6-22

CHARGING STRESS SUMMARY - 2CCB-25

DATA POINT	STRESS <u>(PSI)</u>	JET THRUST FORCE <u>(KIPS)</u>
10	***** TERMINAL END *****	10
110	7853	10
127	10163	10
160	13931	10
170	***** TERMINAL END *****	10

$0.8 (S_h + S_A) = 36,700$

"The actual resultant pipe stress information (Data Point numbers and values for Stress, Jet Thrust Force or Jet Force, Usage Factor, Sn and 2.4Sm, where applicable) contained in the table above is historical in nature with respect to the latest qualifying pipe stress calculation(s). For current actual pipe stress information, see the latest qualifying pipe stress analysis calculation(s). The postulated break location for the piping system is unchanged."

ARKANSAS NUCLEAR ONE
Unit 2

Table 3.6-23

CHARGING STRESS SUMMARY - 2CCB-9

<u>DATA POINT</u>	<u>STRESS (PSI)</u>	<u>JET THRUST FORCE (KIPS)</u>
5 ***** TERMINAL END *****		10
10	9056	10
15	14919	10
20 ***** TERMINAL END *****		10
25	23628	10
35	20704	10
50 ***** TERMINAL END *****		10
55	20990	10
58	28209	10
60 ***** TERMINAL END *****		10
70 ***** TERMINAL END *****		10
75	26547	10
80	32030	10
85 ***** TERMINAL END *****		10
95 ***** TERMINAL END *****		10
100	11287	10
105	12055	10
110 ***** TERMINAL END *****		10
140 ***** TERMINAL END *****		10

0.8 (S_h + S_A) = 36,820 psi

"The actual resultant pipe stress information (Data Point numbers and values for Stress, Jet Thrust Force or Jet Force, Usage Factor, S_n and 2.4S_m, where applicable) contained in the table above is historical in nature with respect to the latest qualifying pipe stress calculation(s). For current actual pipe stress information, see the latest qualifying pipe stress analysis calculation(s). The postulated break location for the piping system is unchanged."

Table 3.6-24

LETDOWN STRESS SUMMARY - 2CCB-2

<u>DATA POINT</u>	<u>STRESS (PSI)</u>	<u>JET THRUST FORCE (KIPS)</u>
5 ***** TERMINAL END *****		10
45	24566	10
80	25107	10
110 ***** TERMINAL END *****		10
165 ***** TERMINAL END *****		10

0.8 (S_h + S_A) = 33,500 psi

"The actual resultant pipe stress information (Data Point numbers and values for Stress, Jet Thrust Force or Jet Force, Usage Factor, S_n and 2.4S_m, where applicable) contained in the table above is historical in nature with respect to the latest qualifying pipe stress calculation(s). For current actual pipe stress information, see the latest qualifying pipe stress analysis calculation(s). The postulated break location for the piping system is unchanged."

ARKANSAS NUCLEAR ONE
Unit 2

Table 3.6-25

LIQUID STORAGE TANKS LOCATED OUTSIDE ANO-2 BUILDINGS

Description	Equipment No.	Seismic Category	Capacity	Figures		Elevation
				P & ID	Area	
Refueling Water Tank	2T3	I	500,500 gal	M2236	1.2-5	354'
Sodium Hydroxide Tank	2T10	I	10,000 gal	M2236	1.2-5	354'
Cooling Tower Acid Storage Tank	2T24	II	15,000 gal	M2209	Not shown	348'
Condensate Storage Tanks	2T41A 2T41B	II	200,000 gal	M2225	1.2-1	354'
Emergency Diesel Fuel Tanks	2T57A 2T57B	I	22,500 gal	M2217	Not shown	328'-2"
Reactor Makeup Water Tank	2T73	II	180,000 gal	M2231	1.2-1	354'
Ammonium Hydroxide Tank	2T103	II	17,000 gal	M2240	1.2-5	354'
Acid Storage Tank	2T104	II	17,000 gal	M2225	1.2-5	354'
Caustic Storage Tank	2T105	II	17,000 gal	M2225	1.2-5	354'

ARKANSAS NUCLEAR ONE
Unit 2

Table 3.6-26

LIQUID STORAGE TANKS LOCATED INSIDE CONTAINMENT

<u>Description</u>	<u>Equipment No.</u>	<u>Seismic Category</u>	<u>Capacity</u>	<u>P & ID</u>	<u>Figures</u>		<u>Elevation</u>
					<u>Area</u>		
Safety Injection Tanks	2T2A 2T2B 2T2C 2T2D	I	1850 cu. ft.	M2232	1.2-4		390'
Quench Tank	2T42	II	254 cu. ft.	M2230	1.2-6		353'
Reactor Drain Tank	2T68	II	1600 gal	M2214	1.2-6		341'-6"

Table 3.6-27

LIQUID STORAGE TANKS LOCATED IN THE AUXILIARY BUILDING

<u>Description</u>	<u>Equipment No.</u>	<u>Seismic Category</u>	<u>Capacity</u>	<u>P & ID</u>	<u>Figures</u>		<u>Elevation</u>
					<u>Area</u>		
Boric Acid Makeup Tanks	2T6A 2T6B	I	11,700 gal	M2231	1.2-3		386'
Boron Management Holdup Tanks	2T12A 2T12B 2T12C 2T12D	II	51,270 gal	M2214	1.2-6		327'

ARKANSAS NUCLEAR ONE
Unit 2

Table 3.6-27 (continued)

Description	Equipment No.	Seismic Category	Capacity	P & ID	Figures	
					Area	Elevation
Waste Tanks	2T20A 2T20B	II	6,000 gal	M2213	1.2-11	317'
Waste Condensate Tanks	2T21A 2T21B	II	15,200 gal	M2213	1.2-6	335'
Plant Heating Boiler Fuel Oil Day Tank	2T22	II	1,540 gal	M2217	1.2-5	354'
Clean & Dirty Lube Oil Storage Tank	2T26	II	31,000 gal	M2216	1.2-6	335'
Emergency Diesel Generator Fuel Oil Day Tanks	2T30A 2T30B	I	550 gal	M2217	1.2-4	369'
Hydrazine Tank	2T43	II	300 gal	M2240	1.2-5	354'-1"
Domestic Water Pressure Tank	2T44	II	1,300 gal	M2225	1.2-4	374'-6"
Boric Acid Condensate Tanks	2T69A 2T69B	II	30,260 gal	M2214	1.2-6	327'
Concentrator Bottoms Tank*	2T78	II	1,600 gal	M2224	1.2-5	354'
Waste Solidifier Storage Tank*	2T80	II	2,985 gal	M2224	1.2-11	354'
Waste Catalyst Storage Tank*	2T81	II	150 gal	M2224	1.2-11	354'
Regenerative Waste Tanks	2T92A 2T92B 2T92C	II	30,000 gal	M2226	1.2-6	332'

* Abandoned in place.

ARKANSAS NUCLEAR ONE
Unit 2

Table 3.7-1

**SYNTHETIC TIME HISTORY RESPONSE SPECTRA-
FREQUENCY RANGES AND INCREMENTS**

<u>Frequency Range (cps)</u>	<u>Frequency Increment (cps)</u>
(1) 0.2 to 7.5	0.05
(2) 7.5 to 10	0.1
(3) 10 to 15	.5
(4) 15 to 25	1.0

Table 3.7-2

PERCENTAGE OF CRITICAL DAMPING FACTORS

<u>Type of Structure</u>	<u>Operating Basis* Earthquake (E) .1g Ground Acceleration</u>	<u>Design Basis** Earthquake (E') .2g Ground Acceleration</u>
Vital Piping	0.50	1.00
Welded Steel Frame Structures	2.00	5.00
Bolted and Riveted Steel	3.00	5.00
Reinforced Concrete Structures and Equipment Supports	3.00	5.00
Prestressed Concrete Structures	2.00	5.00

* The Operating Basis Earthquake condition corresponds to ordinary working stress level in design.

** The Design Basis Earthquake condition corresponds to stress level at or just below yield point in design.

*** In lieu of these values, the damping values of ASME Code Case N-411 may be used provided the analysis is performed as identified in Section 3.7.1.3.1.

ARKANSAS NUCLEAR ONE
Unit 2

Table 3.7-3

SUMMARY OF NATURAL FREQUENCIES

Category 1 Structure		Mode #1 cps.	Mode #2 cps.	Mode #3 cps.
Containment	N-S&E-W	3.8	14.5	28.8
Internal Structures	N-S	12.5	34.6	-
	E-W	12.2	35.4	-
Auxiliary Building	N-S	11.6	32.7	-
	E-W	11.4	31.5	-
Intake Structure	N-S*	19.5	59.1	-
	E-W*	9.7	27.2	-

* Because of the Intake Structure orientation, directions corresponding to N-S and E-W are actually NW-SE and NE-SW respectively.

ARKANSAS NUCLEAR ONE
Unit 2

Table 3.7-4

**CONTAINMENT
COMPARISON OF RESPONSE SPECTRUM AND TIME HISTORY ANALYSIS
DESIGN BASIS EARTHQUAKE**

MASS POINT NO.	INERTIAL FORCE (kips x 10 ³)		SHEAR (kips x 10 ³)		MOMENT (ft-kips x 10 ⁶)		ACCELERATION (Factored g)		DISPLACEMENT (inches)	
	R.S.	T.H.	R.S.	T.H.	R.S.	T.H.	R.S.	T.H.	R.S.	T.H.
3	1.760	1.000	18.40	18.80	1.850	1.950	0.417	0.237	0.067	0.071
5	2.220	1.320	16.20	16.70	1.290	1.260	0.526	0.314	0.144	0.155
8	2.640	1.880	13.10	12.20	.5110	.434	0.624	0.446	0.265	0.293
11	3.180	2.590	6.670	5.200	.0342	.0250	0.683	0.555	0.360	0.395

R.S. - Response Spectrum Analysis Result

T.H. - Time History Analysis Result

Mass Point <u>No.</u>	<u>Elevation</u>
11	531' 0"
8	484' 0"
5	424' 0"
3	384' 0"

ARKANSAS NUCLEAR ONE
Unit 2

Table 3.7-4 (continued)

**CONTAINMENT
COMPARISON OF RESPONSE SPECTRUM AND TIME HISTORY ANALYSIS
OPERATING BASIS EARTHQUAKE**

MASS POINT NO.	INERTIAL FORCE (kips x 10 ³)		SHEAR (kips x 10 ³)		MOMENT (ft-kips x 10 ⁶)		ACCELERATION (Factored g)		DISPLACEMENT (inches)	
	R.S.	T.H.	R.S.	T.H.	R.S.	T.H.	R.S.	T.H.	R.S.	T.H.
3	1.100	.630	14.70	14.50	1.530	1.550	0.260	0.149	0.050	0.055
5	1.500	.920	13.10	13.20	1.060	1.010	0.360	0.218	0.120	0.121
8	1.900	1.490	13.10	9.810	.4000	.0359	0.450	0.354	0.220	0.231
11	2.500	2.160	5.100	4.330	.0300	.0207	0.530	0.462	0.290	0.313

R.S. - Response Spectrum Analysis Result

T.H. - Time History Analysis Result

Mass Point <u>No.</u>	<u>Elevation</u>
11	531' 6"
8	484' 0"
5	424' 0"
3	384' 0"

ARKANSAS NUCLEAR ONE
Unit 2

Table 3.7-4 (continued)

INTERNAL STRUCTURES
COMPARISON OF RESPONSE SPECTRUM AND TIME HISTORY ANALYSIS
DESIGN BASIS EARTHQUAKE
N - S

MASS POINT NO.	INERTIAL FORCE (kips x 10 ³)		SHEAR (kips x 10 ³)		MOMENT (ft-kips x 10 ⁶)		ACCELERATION (Factored g)		DISPLACEMENT (inches)	
	R.S.	T.H.	R.S.	T.H.	R.S.	T.H.	R.S.	T.H.	R.S.	T.H.
3	5020	.3850	6.220	5.950	.1900	.1700	0.296	0.227	.0101	.0099
5	1.290	.8650	5.190	4.820	.1110	.0907	0.411	0.276	.0163	.0164
7	1.120	.9000	3.510	2.720	.0222	.0154	0.494	0.397	.0256	0.258
8	.7340	.5470	1.230	.9170	.0063	.0040	0.562	0.419	.0276	.0274
10&13	.3290	.2020	.3290	.2020	.0	.0	0.776	0.477	.0321	.0311

R.S. - Response Spectrum Analysis Result

T.H. - Time History Analysis Result

Mass Point <u>No.</u>	<u>Elevation</u>
10&13	421' 6"
8	407' 6"
7	403' 6"
5	380' 6"
3	364' 6"

ARKANSAS NUCLEAR ONE
Unit 2

Table 3.7-4 (continued)

INTERNAL STRUCTURES
COMPARISON OF RESPONSE SPECTRUM AND TIME HISTORY ANALYSIS
OPERATING BASIS EARTHQUAKE
N - S

MASS POINT NO.	INERTIAL FORCE (kips x 10 ³)		SHEAR (kips x 10 ³)		MOMENT (ft-kips x 10 ⁶)		ACCELERATION (Factored g)		DISPLACEMENT (inches)	
	R.S.	T.H.	R.S.	T.H.	R.S.	T.H.	R.S.	T.H.	R.S.	T.H.
3	.2900	.2220	4.000	4.010	.1250	.1160	0.174	0.131	.0060	.0067
5	.7800	.5790	3.400	3.280	.0710	.0621	0.249	0.185	.0100	.0111
7	.7200	.6160	2.200	1.870	.0130	.0104	0.318	0.271	.0170	.0175
8	.4600	.3750	.7800	.6260	.0030	.0027	0.356	0.288	.0180	.0187
10&13	.2000	.1360	.2000	.1360	.0	.0	0.474	0.322	.0210	.0212

R.S. - Response Spectrum Analysis Result

T.H. - Time History Analysis Result

Mass Point No.	Elevation
10&13	421' 6"
8	407' 8"
7	403' 6"
5	380' 6"
3	364' 6"

ARKANSAS NUCLEAR ONE
Unit 2

Table 3.7-4 (continued)

**INTERNAL STRUCTURES
COMPARISON OF RESPONSE SPECTRUM AND TIME HISTORY ANALYSIS
DESIGN BASIS EARTHQUAKE
E - W**

MASS POINT NO.	INERTIAL FORCE (kips x 10 ³)		SHEAR (kips x 10 ³)		MOMENT (ft-kips x 10 ⁶)		ACCELERATION (Factored g)		DISPLACEMENT (inches)	
	R.S.	T.H.	R.S.	T.H.	R.S.	T.H.	R.S.	T.H.	R.S.	T.H.
3	.5830	.4710	6.290	6.070	.1970	.1780	0.301	0.243	.0117	.0116
5	1.220	.9230	5.210	4.890	.1160	.0972	0.389	0.294	.0178	.0180
7	1.160	.9190	3.440	2.760	.0285	.0207	0.509	0.405	.0270	.0273
9	.7230	.5370	1.030	.7460	.0022	.0015	0.627	0.465	.0319	.0317
10&13	.3080	.2090	.3080	.2090	.0	.0	0.726	0.494	.0344	.0339

R.S. - Response Spectrum Analysis Result

T.H. - Time History Analysis Result

Mass Point <u>No.</u>	<u>Elevation</u>
10&13	421' 6"
9	414' 6"
7	403' 6"
5	380' 6"
3	364' 6"

ARKANSAS NUCLEAR ONE
Unit 2

Table 3.7-4 (continued)

**INTERNAL STRUCTURES
COMPARISON OF RESPONSE SPECTRUM AND TIME HISTORY ANALYSIS
OPERATING BASIS EARTHQUAKE
E-W**

MASS POINT NO.	INERTIAL FORCE (kips x 10 ³)		SHEAR (kips x 10 ³)		MOMENT (ft-kips x 10 ⁶)		ACCELERATION (Factored g)		DISPLACEMENT (inches)	
	R.S.	T.H.	R.S.	T.H.	R.S.	T.H.	R.S.	T.H.	R.S.	T.H.
3	.3400	.2630	4.100	3.900	.1300	.1150	0.180	0.135	.0700	.0074
5	.7500	.5740	3.400	3.150	.0750	.0628	0.241	0.183	.0120	.0116
7	.7400	.5940	2.200	1.780	.0180	.0134	0.326	0.262	.0180	.0177
9	.4500	.3470	.6400	.4820	.0010	.0009	0.397	0.301	.0210	.0206
10&13	.1900	.1350	.1900	.1350	.0	.0	0.452	0.319	.0230	.0220

R.S. - Response Spectrum Analysis Result

T.H. - Time History Analysis Result

Mass Point <u>No.</u>	<u>Elevation</u>
10&13	421' 6"
9	414' 6"
7	403' 6"
5	380' 6"
3	364' 6"

ARKANSAS NUCLEAR ONE
Unit 2

Table 3.7-4 (continued)

**AUXILIARY BUILDING
COMPARISON OF RESPONSE SPECTRUM AND TIME HISTORY ANALYSIS
DESIGN BASIS EARTHQUAKE
N-S**

MASS POINT NO.	INERTIAL FORCE (kips x 10 ³)		SHEAR (kips x 10 ³)		MOMENT (ft-kips x 10 ⁶)		ACCERATION (Factored g)		DISPLACEMENT (inches)	
	R.S.	T.H.	R.S.	T.H.	R.S.	T.H.	R.S.	T.H.	R.S.	T.H.
1	3.480	3.680	14.00	16.50	.3940	.4220	0.263	0.279	.0131	.0154
2	4.250	4.310	11.40	12.90	.1950	.1900	0.354	0.359	.0211	.0251
3	4.490	4.670	8.410	8.570	.7910	.0703	0.398	0.414	.0263	.0312
4	4.400	3.910	4.440	3.910	.0	.0	0.509	0.452	.0306	.0352

R.S. - Response Spectrum Analysis Result

T.H. - Time History Analysis Result

Mass Point <u>No.</u>	<u>Elevation</u>
4	404' 0"
3	386' 0"
2	372' 0"
1	354' 0"

ARKANSAS NUCLEAR ONE
Unit 2

Table 3.7-4 (continued)

**AUXILIARY BUILDING
COMPARISON OF RESPONSE SPECTRUM AND TIME HISTORY ANALYSIS
OPERATING BASIS EARTHQUAKE
N-S**

MASS POINT NO.	INERTIAL FORCE (kips x 10 ³)		SHEAR (kips x 10 ³)		MOMENT (ft-kips x 10 ⁶)		ACCELERATION (Factored g)		DISPLACEMENT (inches)	
	R.S.	T.H.	R.S.	T.H.	R.S.	T.H.	R.S.	T.H.	R.S.	T.H.
1	2.090	2.040	9.050	9.510	.2540	.2960	0.158	0.154	.0085	.0089
2	2.660	2.470	7.420	7.490	.1240	.1120	0.221	0.205	.0138	.0145
3	2.870	2.720	5.390	2.010	.0495	.0413	0.255	0.241	.0173	.0181
4	2.750	2.300	2.750	2.300	.0	.0	0.318	0.266	.0200	.0205

R.S. - Response Spectrum Analysis Result

T.H. - Time History Analysis Result

Mass Point <u>No.</u>	<u>Elevation</u>
4	404' 0"
3	386' 0"
2	372' 0"
1	354' 0"

ARKANSAS NUCLEAR ONE
Unit 2

Table 3.7-4 (continued)

**AUXILIARY BUILDING
COMPARISON OF RESPONSE SPECTRUM AND TIME HISTORY ANALYSIS
DESIGN BASIS EARTHQUAKE
E-W**

MASS POINT NO.	INERTIAL FORCE (kips x 10 ³)		SHEAR (kips x 10 ³)		MOMENT (ft-kips x 10 ⁶)		ACCERATION (Factored g)		DISPLACEMENT (inches)	
	R.S.	T.H.	R.S.	T.H.	R.S.	T.H.	R.S.	T.H.	R.S.	T.H.
1	3.320	3.435	13.80	15.98	.3950	.4238	0.252	0.260	.0113	.0131
2	4.300	4.184	11.20	12.67	.2000	.1958	0.358	0.348	.0212	.0253
3	4.480	4.534	8.500	8.619	.8500	.7510	0.398	0.402	.0266	.0323
4	4.720	4.172	4.720	4.172	.0	.0	0.547	0.483	.0330	.0379

R.S. - Response Spectrum Analysis Result

T.H. - Time History Analysis Result

Mass Point <u>No.</u>	<u>Elevation</u>
4	404' 0"
3	386' 0"
2	372' 0"
1	354' 0"

ARKANSAS NUCLEAR ONE
Unit 2

Table 3.7-4 (continued)

**AUXILIARY BUILDING
COMPARISON OF RESPONSE SPECTRUM AND TIME HISTORY ANALYSIS
OPERATING BASIS EARTHQUAKE
E-W**

MASS POINT NO.	INERTIAL FORCE (kips x 10 ³)		SHEAR (kips x 10 ³)		MOMENT (ft-kips x 10 ⁶)		ACCELERATION (Factored g)		DISPLACEMENT (inches)	
	R.S.	T.H.	R.S.	T.H.	R.S.	T.H.	R.S.	T.H.	R.S.	T.H.
1	1.944	1.823	8.868	8.971	.2548	.2450	0.147	0.138	.0073	.0074
2	2.662	2.325	7.319	7.283	.1267	.1139	0.221	0.193	.0138	.0144
3	2.856	2.553	5.436	4.993	.0528	.0440	0.253	0.226	.0174	.0185
4	2.932	2.443	2.932	2.443	.0	.0	0.340	0.283	.0215	.0218

R.S. - Response Spectrum Analysis Result

T.H. - Time History Analysis Result

Mass Point <u>No.</u>	<u>Elevation</u>
4	404' 0"
3	386' 0"
2	372' 0"
1	354' 0"

ARKANSAS NUCLEAR ONE
Unit 2

Table 3.7-5

**LOCATIONS OF CE SUPPLIED
PANELS WHICH ARE STRUCTURALLY
SEISMIC CATEGORY 1**

<u>Panel</u>	<u>Class 1E</u>	<u>Location*</u>
2C15	Yes	El. 404'
2C23	Yes	El. 386'
2C29	No	El. 386'
2C39	Yes	El. 386'
2C40	Yes	El. 386'
2C75	Yes	El. 404'

*All are in the Auxiliary Building

Table 3.7-6

DAMPING VALUES

<u>Stress Level</u>	<u>Type of Construction</u>	<u>% Critical Damping</u>
1. Low Stresses	a. Welded piping	0.5
	b. Welded Steel	0.5 to 1.0
2. Ordinary working stress, approximately ½ yield point	a. Welded piping	0.5 to 1.0
	b. Welded Steel	2.0
	c. Bolted or riveted steel	3.0 to 5.0
3. At or just below yield point	a. Welded piping	1.0 to 2.0
	b. Welded Steel	3.5 to 5.0
	c. Bolted or riveted steel	5.0 to 10.0

ARKANSAS NUCLEAR ONE
Unit 2

Table 3.7-7

RCS MODAL DATA WITH REPLACEMENT STEAM GENERATOR

<u>Model Number</u>	<u>Frequency (Hertz)</u>	<u>Participation Factor</u>			<u>Effective Mass⁽¹⁾</u>			<u>Location</u>
		<u>X</u>	<u>Y</u>	<u>Z</u>	<u>X</u>	<u>Y</u>	<u>Z</u>	
1	1.01	19.70	0.00	-8.55	388.2	0.0	73.0	RI
2	1.01	8.57	0.00	19.65	73.4	0.0	386.2	RI
5	4.38	13.06	-0.09	-1.29	170.6	0.0	1.7	RI
6	4.38	1.36	0.00	12.38	1.8	0.0	153.2	RI
7	5.12	-0.94	23.25	-6.10	0.9	540.6	37.2	RCP
9	5.16	14.17	0.03	-0.05	200.8	0.0	0.0	SGI
11	5.17	-0.04	1.57	10.25	0.0	2.5	105.0	SGI
12	5.22	-1.13	18.64	4.53	1.3	347.5	20.5	RCP
13	5.27	0.16	27.67	5.96	0.0	765.3	35.5	RCP
14	5.45	0.36	22.54	-5.24	0.1	508.0	27.4	RCP
17	7.19	4.76	-3.78	38.54	22.6	14.3	1485.4	RCP
18	7.21	-8.04	10.98	24.54	64.6	120.5	602.1	RCP
19	7.21	4.56	-2.79	10.13	20.7	7.8	102.7	RCP
20	7.22	7.19	-7.27	10.09	51.6	52.9	101.8	RCP
21	7.25	22.14	7.05	-3.56	490.4	49.8	12.7	RI
23	8.33	19.77	0.49	-0.39	390.8	0.2	0.2	RI
24	8.34	0.37	-0.02	14.20	0.1	0.0	201.6	RI
29	12.04	56.04	1.81	0.23	3140.4	3.3	0.1	SG/RV
37	12.35	14.56	0.52	0.09	212.0	0.3	0.0	SG
45	13.35	21.62	0.36	0.20	467.5	0.1	0.0	SG
47	13.74	72.81	0.04	0.42	5300.7	0.0	0.2	SG
49	14.49	0.03	0.01	18.40	0.0	0.0	338.4	SG
51	14.75	33.55	0.38	0.60	1125.3	0.1	0.4	SG
53	15.93	6.22	0.27	11.27	38.6	0.1	127.0	CL
55	16.16	-2.45	-0.26	15.36	6.0	0.1	236.1	SG
57	16.19	-4.84	-0.38	50.40	23.4	0.1	2540.4	SG
59	16.26	-2.30	0.30	-22.73	5.3	0.1	516.8	SG
61	16.52	21.13	1.01	7.40	446.6	1.0	54.8	SG
62	17.23	4.92	0.29	26.71	24.2	0.1	713.2	CL/RV
65	18.27	-15.11	-0.51	11.20	228.2	0.3	125.3	SG
66	19.09	1.25	0.46	-21.01	1.6	0.2	441.5	CL/RV
68	19.27	-0.97	0.20	27.24	0.9	0.0	741.8	SG
71	20.59	0.01	-0.13	-13.11	0.0	0.0	172.0	SG

ARKANSAS NUCLEAR ONE
Unit 2

Table 3.7-7 (continued)

<u>Mode Number</u>	<u>Frequency (Hertz)</u>	<u>Participation Factor</u>			<u>Effective Mass⁽¹⁾</u>			<u>Location</u>
		<u>X</u>	<u>Y</u>	<u>Z</u>	<u>X</u>	<u>Y</u>	<u>Z</u>	
74	21.66	-10.12	-5.62	-2.30	102.4	31.6	5.3	SG
78	23.28	0.40	2.94	-16.84	0.2	8.7	282.7	SG
79	23.56	-2.57	61.88	1.00	6.6	3829.3	1.0	RVI
82	24.76	-0.07	0.20	18.39	0.0	0.0	338.2	SG
83	24.77	-0.26	0.46	25.73	0.1	0.2	662.0	SG
87	25.46	-0.19	0.30	20.79	0.0	0.1	432.2	SG
99	29.24	0.76	-39.13	0.81	0.6	1530.9	0.7	SG
100	29.38	-0.10	12.80	-0.42	0.0	163.9	0.2	SG
101	29.42	0.06	72.04	0.78	0.0	5189.4	0.6	SG
020	36.81	16.91	1.47	1.40	285.8	2.2	2.0	RVI
122	37.52	-0.41	-0.16	15.42	0.2	0.0	237.8	SG
123	37.54	1.12	0.31	21.24	1.2	0.1	451.3	SG
124	40.15	-2.06	-0.11	17.17	4.2	0.0	294.8	RVI
131	42.19	0.53	0.00	-11.73	0.3	0.0	137.6	SG
136	48.75	-2.82	0.00	23.08	7.9	0.0	532.5	RV
137	49.16	14.89	0.33	5.30	221.7	0.1	28.1	RV

Note 1 "Mass" is mass active in mode and is an indication of the significance of the mode

MODAL FREQUENCY AND CORRESPONDING MODAL PARTICIPATION FACTORS FOR THE REPLACEMENT PRESSURIZER
Replacement Pressurizer with Bumper Block Restraint

<u>Mode Number</u>	<u>Frequency (Hz)</u>	<u>North – South</u>		<u>East – West</u>	
		<u>Modal Participation Factor</u>	<u>Frequency (Hz)</u>	<u>Modal Participation Factor</u>	<u>Frequency (Hz)</u>
1	20.43	18.4	24.05	18.3	24.05
2	57.62	0.0	57.62	0.0	57.62
3	71.56	-11.3	71.64	-11.5	71.64
4	91.59	0.0	91.59	0.0	91.59
5	159.55	3.6	159.61	3.5	159.61

Note: Mode 1 is always the controlling mode in the horizontal direction, Modes 2 and 4 are vertical modes, and Modes 3 and 5 are horizontal modes of less significance.

ARKANSAS NUCLEAR ONE
Unit 2

Table 3.7-8

MAXIMUM OBE RESULTS FOR HORIZONTAL ± VERTICAL

Support Loads

<u>Direction</u>	<u>Location</u>	<u>Support</u>	<u>Comp/Dir</u>	<u>Load</u>	<u>Specified for Design</u>	
X±Y	SG	UPPER KEY	FZ	6.9	250	
		SNUBBER	FX	520.5	700	
		VERT PAD	FA	72.5	221	
	RV	LOWER KEY	FZ	9.6	155	
			COL BASE	FA	205.9	248
			FB	3.8	6	
			FC	42.2	51	
			MA	968.8	1164	
			MB	346.5	456	
			MC	399.5	648	
		RCP	UPPER KEY	FA	374.9	450
			LOWER KEY	FC	43.9	53
			VERT HANGER	FY	1.3	2
	SG	SNUBBER	FA	51.9	92	
			SKIRT	FA	150.4	200
			FB	12.0	20	
			FC	14.3	280	
			MA	430.8	2040	
			MB	580.4	14760	
			MC	3885.5	4920	
		RV	UPPER KEY	FZ	181.6	250
			SNUBBER	FX	4.0	700
			VERT PAD	FA	176.4	221
			LOWER KEY	FZ	123.8	155
			COL BASE	FA	142.5	248
			FB	5.0	6	
			FC	30.8	51	
			MA	609.3	1164	
			MB	370.5	456	
			MC	537.8	648	
	RCP	UPPER KEY	FA	175.9	450	
		LOWER KEY	FC	30.6	53	
VERT HANGER		FY	1.8	2		
SG	SNUBBER	FA	87.0	92		
		SKIRT	FA	149.9	200	
		FB	.7	20		
		FC	221.2	280		
		MA	1543.8	2040		
		MB	11729.0	14760		
		MC	218.1	4920		

ARKANSAS NUCLEAR ONE
Unit 2

Table 3.7-8 (continued)

Nozzle Loads

<u>Direction</u>	<u>Location</u>	<u>Support</u>	<u>Comp/Dir</u>	<u>Load</u>	<u>Specified for Design</u>
X±Y	RV	INLET	FX	33.0	54
			FY	37.7	67
			FZ	41.2	50
			MX	2408.3	4860
			MY	2071.8	2496
			MZ	2785.6	4716
			FX	169.2	204
			FY	25.3	31
			FZ	0.9	7
	SG	INLET	MX	67.8	504
			MY	106.9	1068
			MZ	1380.8	1668
			FX	150.5	270
			FB	80.1	175
			MX	88.7	2000
			MB	1612.0	4000
			FX	19.7	130
			FB	38.3	315
	B PUMP	OUTLET	MX	2684.2	10000
			MB	2048.8	7200
			FX	14.2	27
			FY	26.2	38
			FZ	11.7	39
			MX	1453.4	2268
MY			1097.8	1764	
MZ			2559.4	3720	
RSSS			3141.4	4700	
A PUMP	OUTLET	FX	49.9	53	
		FY	34.5	54	
		FZ	12.8	25	
		MX	474.5	1860	
		MY	1861.2	3756	
		MZ	5374.0	7980	
		RSSS	5707.0	9014	
		FX	12.5	19	
		FY	31.2	47	
A PUMP	INLET	FZ	10.9	33	
		MX	1711.4	2580	
		MY	713.1	1992	
		MZ	2761.5	4092	
		RSSS	3326.2	5232	

ARKANSAS NUCLEAR ONE
Unit 2

Table 3.7-8 (continued)

Nozzle Loads

<u>Direction</u>	<u>Location</u>	<u>Support</u>	<u>Comp/Dir</u>	<u>Load</u>	<u>Specified for Design</u>
		OUTLET	FX	30.7	33
			FY	31.5	49
			FZ	13.6	15
			MX	503.5	1620
			MY	1469.7	1548
			MZ	5182.7	8016
			RSSS	5410.5	8323
	RV	INLET PIPING	M	4225.1	10320
		OUTLET PIPING	M	1386.6	2400
	SG	INLET PIPING	M	1614.5	2400
		OUTLET PIPING	M	3376.8	10320
	RCP	INLET PIPING	M	3326.2	10320
		OUTLET PIPING	M	5707.0	10320
	COLD LEG	ELBOWS	M	3289.0	10320
Z±Y	RV	INLET	FX	44.4	54
			FY	55.3	67
			FZ	24.3	50
			MX	4042.2	4860
			MY	1725.2	2496
			MZ	3925.9	4716
		OUTLET	FX	20.0	204
			FY	2.3	31
			FZ	5.5	7
			MX	417.4	504
			MY	887.7	1068
			MZ	370.4	1668
	SG	INLET	FX	18.7	270
			FB	14.5	175
			MX	788.3	2000
			MB	545.5	4000
		OUTLET	FX	29.6	130
			FB	67.4	315
			MX	4112.7	10000
			MB	2953.5	7200
	B PUMP	INLET	FX	25.4	27
			FY	36.0	38
			FZ	36.4	39
			MX	2159.7	2268
			MY	1674.5	1764
			MZ	3541.3	3720
			RSSS	4473.2	4700

ARKANSAS NUCLEAR ONE
Unit 2

Table 3.7-8 (continued)

Nozzle Loads

<u>Direction</u>	<u>Location</u>	<u>Support</u>	<u>Comp/Dir</u>	<u>Load</u>	<u>Specified for Design</u>
		OUTLET	FX	43.1	53
			FY	50.6	54
			FZ	23.4	25
			MX	1766.2	1860
			MY	3565.9	3756
			MZ	7589.0	7980
			RSSS	8569.0	9014
	A PUMP	INLET	FX	17.2	19
			FY	44.1	47
			FZ	31.3	33
			MX	2455.0	2580
			MY	1887.5	1992
			MZ	3890.4	4092
			RSSS	4972.4	5232
		OUTLET	FX	29.9	33
			FY	46.3	49
			FZ	6.4	15
			MX	1538.4	1620
			MY	513.9	1548
			MZ	7628.8	8016
			RSSS	7799.3	8323
	RV	INLET PIPING	M	5893.1	10320
		OUTLET PIPING	M	1048.6	2400
	SG	INLET PIPING	M	958.6	2400
		OUTLET PIPING	M	5063.3	10320
	RCP	INLET PIPING	M	4972.4	10320
		OUTLET PIPING	M	8569.0	10320
	COLD LEG	ELBOWS	M	4697.0	10320

MAXIMUM DBE RESULTS FOR HORIZONTAL +/- VERTICAL

Support Loads

<u>Direction</u>	<u>Location</u>	<u>Support</u>	<u>Comp/Dir</u>	<u>Load</u>	<u>Specified for Design</u>
X±Y	SG	UPPER KEY	FZ	6.6	500
		SNUBBER	FX	985.5	1320
		VERT PAD	FA	124.3	431
		LOWER KEY	FZ	11.5	271

ARKANSAS NUCLEAR ONE
Unit 2

Table 3.7-8 (continued)

MAXIMUM DBE RESULTS FOR HORIZONTAL +/- VERTICAL

Support Loads

<u>Direction</u>	<u>Location</u>	<u>Support</u>	<u>Comp/Dir</u>	<u>Load</u>	<u>Specified for Design</u>		
X±Y	SG	UPPER KEY	FZ	6.6	500		
		SNUBBER	FX	985.5	1320		
		VERT PAD	FA	124.3	431		
	RV	LOWER KEY	FZ	11.5	271		
			COL BASE	FA	417.1	10	
			FB	6.4	501		
			FC	85.2	103		
			MA	1954.6	2352		
			MB	697.7	864		
			MC	791.0	1056		
			UPPER KEY	FA	754.5	906	
			LOWER KEY	FC	88.5	107	
			VERT HANGER	FY	2.2	4	
	RCP	SNUBBER	FA	90.7	150		
			SG	FA	255.7	330	
	SG	SKIRT	FB	23.8	50		
			FC	16.2	500		
			MA	557.1	3600		
		RV	UPPER KEY	MB	745.5	26400	
				MC	7408.5	9480	
				FZ	359.5	500	
			SNUBBER	FX	5.4	1320	
				VERT PAD	FA	344.1	431
				LOWER KEY	FZ	216.1	271
			COL BASE	FA	250.7	10	
				FB	8.1	501	
				FC	57.1	103	
				MA	1109.8	2352	
				MB	711.7	864	
				MC	874.5	1056	
	RCP	UPPER KEY	FA	285.8	906		
			LOWER KEY	FC	56.1	107	
		VERT HANGER	FY	3.0	4		
SG	SNUBBER	FA	149.2	150			
		SKIRT	FA	260.3	330		
		FB	1.0	50			
		FC	393.6	500			
		MA	2739.3	3600			
		MB	23117.7	26400			
		MC	385.9	9480			

ARKANSAS NUCLEAR ONE
Unit 2

Table 3.7-8 (continued)

Nozzle Loads

<u>Direction</u>	<u>Location</u>	<u>Support</u>	<u>Comp/Dir</u>	<u>Load</u>	<u>Specified for Design</u>		
X±Y	RV	INLET	FX	60.3	87		
			FY	59.9	109		
			FZ	79.3	96		
			MX	3966.7	7800		
			MY	4239.7	5088		
			MZ	4749.3	7968		
		OUTLET	FX	334.6	402		
			FY	49.6	60		
			FZ	1.9	14		
			MX	104.8	840		
			MY	165.5	1776		
			MZ	2734.5	3288		
	SG	INLET	FX	297.2	540		
			FB	158.8	350		
			MX	159.0	3000		
			MB	3070.4	7000		
			OUTLET	FX	32.2	260	
				FB	60.3	630	
		MX		4317.2	17000		
		MB		3417.1	12200		
		B PUMP		INLET	FX	23.7	45
					FY	45.4	65
			FZ		20.3	66	
			OUTLET	MX	2513.8	3684	
MY	1914.6			3024			
MZ	4374.0			6204			
RSSS	5396.0	7823					
FX	93.7	99					
FY	53.9	88					
A PUMP	INLET	FZ	22.3	42			
		MX	816.6	3312			
		MY	3182.9	6228			
		MZ	8535.5	12972			
		RSSS	9146.2	14766			
		FX	19.7	33			
	FY	50.9	75				
	FZ	17.9	60				
	MX	2802.9	4404				
	MY	1133.7	3456				
	MZ	4482.5	6456				
	RSSS	5406.8	8545				

ARKANSAS NUCLEAR ONE
Unit 2

Table 3.7-8 (continued)

Nozzle Loads

<u>Direction</u>	<u>Location</u>	<u>Support</u>	<u>Comp/Dir</u>	<u>Load</u>	<u>Specified for Design</u>
		OUTLET	FX	60.8	64
			FY	50.7	80
			FZ	27.7	30
			MX	773.6	2868
			MY	2930.3	3084
			MZ	8360.7	13164
			RSSS	8893.0	13821
	RV	INLET PIPING	M	7501.1	17400
		OUTLET PIPING	M	2741.5	4800
	SG	INLET PIPING	M	3074.5	4800
		OUTLET PIPING	M	5505.9	17400
	RCP	INLET PIPING	M	5406.8	17400
		OUTLET PIPING	M	9146.2	17400
	COLD LEG	ELBOWS	M	5379.0	17400
Z±Y	RV	INLET	FX	71.9	87
			FY	90.5	109
			FZ	37.8	96
			MX	6497.4	7800
			MY	2889.1	5088
			MZ	6639.8	7968
		OUTLET	FX	28.0	402
			FY	4.2	60
			FZ	11.0	14
			MX	695.4	840
			MY	1475.5	1776
			MZ	680.9	3288
	SG	INLET	FX	26.3	540
			FB	21.0	350
			MX	1324.0	3000
			MB	923.9	7000
		OUTLET	FX	47.9	260
			FB	112.7	630
			MX	7078.6	17000
			MB	5078.3	12200
	B PUMP	INLET	FX	42.2	45
			FY	61.0	65
			FZ	62.4	66
			MX	3507.5	3684
			MY	2871.9	3024
			MZ	5908.0	6024
			RSSS	7446.8	7823

ARKANSAS NUCLEAR ONE
Unit 2

Table 3.7-8 (continued)

Nozzle Loads

<u>Direction</u>	<u>Location</u>	<u>Support</u>	<u>Comp/Dir</u>	<u>Load</u>	<u>Specified for Design</u>
		OUTLET	FX	68.7	99
			FY	83.2	88
			FZ	39.3	42
			MX	3146.3	3312
			MY	5921.5	6228
			MZ	12352.6	12972
			RSSS	14055.2	14766
	A PUMP	INLET	FX	31.4	33
			FY	70.9	75
			FZ	56.4	60
			MX	4188.7	4404
			MY	3285.3	2456
			MZ	6139.0	6456
			RSSS	8125.7	8545
		OUTLET	FX	52.6	64
			FY	75.5	80
			FZ	10.9	30
			MX	2725.2	2868
			MY	910.9	3084
			MZ	12532.5	13164
			RSSS	12857.7	13821
	RV	INLET PIPING	M	9728.8	17400
		OUTLET PIPING	M	1767.6	4800
	SG	INLET PIPING	M	1614.5	4800
		OUTLET PIPING	M	8711.9	17400
	RCP	INLET PIPING	M	8125.7	17400
		OUTLET PIPING	M	14055.2	17400
	COLD LEG	ELBOWS	M	7673.0	17400

ARKANSAS NUCLEAR ONE
Unit 2

Table 3.7-9

SOLUTION TO TMCALC

<u>Response</u>	<u>Theoretical</u>	<u>TMCLAC</u>
u	4.8000 in	4.8002 in
u	15.2000 in/sec	15.2037 in/sec
u	67.1132 in/sec ²	67.1172 in/sec ²

Table 3.7-10

MASS AND SUPPORT POINT MOTIONS

<u>t</u>	<u>Y15</u>	<u>Y20</u>	<u>Y25</u>	<u>Y30</u>
0.00	-0.10	0.05	0.27	0.31
0.01	-0.16	-0.21	0.47	0.54
0.02	-0.28	0.02	0.36	0.21
0.03	0.19	0.31	-0.17	-0.29

Table 3.7-11

STRUDL AND FORCE RESULTS

<u>LOAD</u>	<u>STRUDL</u>	<u>FORCE</u>
R10	3,105,000	3,105,000
M10	139,600,000	139,600,000
R30	-1,906,000	-1,906,000
M30	75,990,000	75,990,000
V40	890,400	890,400
M40	32,540,000	32,540,000

ARKANSAS NUCLEAR ONE
Unit 2

Table 3.7-12

**CONCRETE BLOCK WALLS SUPPORTING
SEISMIC CATEGORY 1 PIPES
ANO UNIT 2**

WALL NO.	FLOOR EL.	WALL THICK	WALL HEIGHT	(*) WALL TYPE	SYSTEM
23-B-1 2	335'-0"	1'-3"	6'-7"	I	Service Water
23-B-5 6	335'-0"	1'-3"	7'-5"	I	Service Water
23-B-11 12	335'-0"	1'-0"	8'-0"	I	Service Water
24-B-1 26-B-5	317'-0"	2'-0"	15'-6"	I	HPI Recirc.
24-B-32 3	335'-0"	2'-6"	14'-9"	I	Gaseous Rad. Waste
24-B-44 **45	335'-0"	1'-6"	24'-0"	I	Service Water
24-B-233 234	386'-0"	1'-0"	16'-3"	I	CC1 ₂ F ₂ - Freon 12 Room Ventilation
26-B-31 32	354'-0"	1'-6"	11'-6"	I	Hydrogen Analyzers
26-B-45 **46	369'-0"	0'-8"	7'-4"	I	Emergency Diesel Generator

Notes:

1. (*) I = Shield Wall or Firewall
II = Partition Wall
2. (**) Denotes no access for the side of the wall

ARKANSAS NUCLEAR ONE
Unit 2

Table 3.7-13

**CONCRETE BLOCK WALLS WITH
SEISMIC CATEGORY 1 ATTACHMENTS OTHER THAN PIPE
ANO UNIT 2**

WALL NO.	FLOOR EL.	WALL THICK	WALL HEIGHT	(*) WALL TYPE	REMARKS
24-B-24 25	317'-0"	2'-0"	8'-0"	I	
24-B-36 37	335'-0"	2'-0"	16'-3"	I	
24-B-42 43	335'-0"	1'-9"	8'-0"	I	
24-B-64 65	335'-0"	1'-9"	8'-0"	I	
24-B-68 69	335'-0"	2'-9"	16'-3"	I	
24-B-148 149	360'-0"	1'-0"	8'-0"	I	
24-B-166 167	354'-0"	1'-0"	14'-8"	I	
24-B-179 180	369'-0"	1'-6"	14'-4"	I	
24-B-189 190	372'-0"	1'-0"	11'-3"	I	

Notes:

1. (*) I = Shield Wall or Firewall
II = Partition Wall

ARKANSAS NUCLEAR ONE
Unit 2

Table 3.7-13 (continued)

WALL NO.	FLOOR EL.	WALL THICK	WALL HEIGHT	(*) WALL TYPE	REMARKS
24-B-197 198	372'-0"	1'-6"	12'-0"	I	
24-B-207 208	372'-0"	2'-0"	9'-0"	I	
24-B-211 212	372'-0"	1'-0"	12'-0"	I	
24-B-213 214	372'-0"	1'-0"	12'-0"	I	
24-B-217 218	386'-0"	1'-6"	8'-0"	I	
24-B-221 222	386'-0"	1'-6"	16'-3"	I	
24-B-223 224	386'-0"	1'-6"	16'-0"	I	
24-B-235 236	386'-0"	1'-0"	15'-0"	I	
24-B-241 242	386'-0"	1'-0"	14'-0"	I	
26-B-21 22	335'-0"	2'-3"	14'-9"	I	
26-B-29 30	354'-0"	2'-0"	11'-6"	I	

Notes:

1. (*) I = Shield Wall or Firewall
II = Partition Wall

ARKANSAS NUCLEAR ONE
Unit 2

Table 3.7-14

**CONCRETE BLOCK WALLS IN PROXIMITY TO SAFETY-RELATED SYSTEMS
ANO UNIT 2**

WALL NO.	FLOOR EL.	WALL THICK	WALL HEIGHT	(*) WALL TYPE	REMARKS
26-B-33 34	354'-0"	1'-0"	9'-4"	I	
26-B-53 54	386'-0"	1'-6"	8'-0"	I	
23-B-3 4	335'-0"	1'-0"	8'-0"	I	
23-B-7 8	335'-0"	1'-0"	8'-0"	I	
23-B-13 14	335'-0"	1'-0"	8'-0"	I	
23-B-15 16	335'-0"	1'-0"	8'-0"	I	
23-B-17 18	335'-0"	1'-6"	8'-0"	I	No Access For 23-B-18
23-B-19 20	335'-0"	1'-6"	8'-0"	I	No Access For 23-B-20
23-B-25 26	354'-0"	1'-0"	12'-3"	I	No Access For 23-B-25
23-B-27 28	354'-0"	1'-0"	12'-3"	I	No Access For 23-B-27
23-B-29 30	354'-0"	1'-0"	12'-3"	I	No Access For 23-B-20
23-B-31 32	354'-0"	1'-0"	12'-3"	I	No Access For 23-B-31
23-B-33 34	354'-0"	1'-0"	12'-3"	I	No Access For 23-B-33
23-B-35 36	368'-0"	0'-8"	12'-0"	I	No Access For 23-B-35
23-B-37 38	368'-0"	0'-8"	12'-0"	I	No Access For 23-B-37
23-B-39 40	368'-0"	1'-0"	16'-0"	I	No Access For 23-B-40

ARKANSAS NUCLEAR ONE
Unit 2

Table 3.7-14 (continued)

WALL NO.	FLOOR EL.	WALL THICK	WALL HEIGHT	(*) WALL TYPE	REMARKS
23-B-41 42	368'-0"	1'-0"	16'-0"	I	No Access For 23-B-41
23-B-43 44	368'-0"	1'-0"	16'-0"	I	No Access For 23-B-43
24-B- 2 3	317'-0"	2'-0"	10'-0"	I	
24-B-10 11	317'-0"	1'-4"	8'-8"	I	
24-B-30 31	317'-0"	2'-0"	8'-0"	I	
24-B-34 35	335'-0"	1'-6"	8'-0"	I	
24-B-38 39	335'-0"	2'-3"	8'-0"	I	
24-B-40 41	335'-0"	2'-0"	8'-0"	I	
24-B-46 47	335'-0"	1'-6"	23'-11"	I	
24-B-48 49	335'-0"	1'-6"	23'-11"	I	
24-B-50 51	335'-0"	3'-0"	14'-9"	I	
24-B-52 53	335'-0"	2'-0"	8'-0"	I	
24-B-54 55	335'-0"	2'-3"	8'-0"	I	
24-B-56 57	335'-0"	2'-6"	7'-0"	I	
24-B-58 59	335'-0"	3'-6"	16'-3"	I	No Access For 23-B-58
24-B-66 67	335'-0"	1'-0"	6'-8"	I	
24-B-80 81	335'-0"	3'-6" 3'-3" 2'-6"	14'-9"	I	

ARKANSAS NUCLEAR ONE
Unit 2

Table 3.7-14 (continued)

WALL NO.	FLOOR EL.	WALL THICK	WALL HEIGHT	(*) WALL TYPE	REMARKS
24-B-82 83	335'-0"	1'-6"	12'-0"	I	No Access For 23-B-83
24-B-96 97	335'-0"	2'-6"	15'-4"	I	No Access For 23-B-96
24-B-122 123	354'-0"	1'-0"	9'-6"	I	
24-B-128 129	354'-0"	2'-3"	11'-6"	I	
24-B-134 135	354'-0"	1'-0"	11'-6"	I	
24-B-136 137	354'-0"	2'-3"	11'-6"	I	
24-B-138 139	360'-0"	1'-0"	12'-6"	I	
24-B-144 145	354'-0"	2'-9"	11'-6"	I	
24-B-146 147	360'-0"	1'-0"	12'-6"	I	
24-B-150 151	360'-0"	1'-0"	12'-6"	I	
24-B-152 153	354'-0"	2'-9"	15'-0"	I	
24-B-154 155	360'-0"	1'-0"	12'-6"	I	
24-B-156 157	354'-0"	1'-9"	15'-3"	I	
24-B-158 159	354'-0"	2'-0"	15'-3"	I	No Access For 23-B-159
24-B-160 161	354'-0"	3'-0"	14'-6"	I	No Access For 23-B-160
24-B-162 163	354'-0"	1'-4"	9'-0"	I	
24-B-164 165	354'-0"	3'-0"	14'-6"	I	No Access For 23-B-164

ARKANSAS NUCLEAR ONE
Unit 2

Table 3.7-14 (continued)

WALL NO.	FLOOR EL.	WALL THICK	WALL HEIGHT	(*) WALL TYPE	REMARKS
24-B-171 172	369'-0"	1'-6"	14'-3"	I	
24-B-173 174	369'-0"	11'-6"	15'-11"	I	
24-B-175 176	374'-6"	1'-6"	10'-5"	I	
24-B-177 178	372'-0"	2'-9"	11'-3"	I	
24-B-183 184	372'-0"	2'-9"	8'-10"	I	
24-B-185 186	372'-0"	2'-9"	11'-3"	I	
24-B-187 188	372'-0"	3'-0"	11'-3"	I	
24-B-191 192	374'-6"	1'-6"	10'-5"	I	
24-B-193 194	374'-6"	0'-8"	10'-5"	I	No Access For 23-B-194
24-B-195 196	372'-0"	2'-3"	11'-3"	I	
24-B-199 200	372'-0"	3'-3"	12'-0"	I	
24-B-203 204	372'-0"	1'-0"	12'-0"	I	No Access For 23-B-204
24-B-205 206	372'-0"	1'-0"	12'-0"	I	No Access For 23-B-205
24-B-209 210	372'-0"	1'-0"	12'-0"	I	
24-B-215 216	386'-0"	1'-6"	16'-0"	I	
24-B-219 220	386'-0"	1'-0"	16'-0"	II	
24-B-227 228	386'-0"	1'-6"	16'-0"	I	

ARKANSAS NUCLEAR ONE
Unit 2

Table 3.7-14 (continued)

WALL NO.	FLOOR EL.	WALL THICK	WALL HEIGHT	(*) WALL TYPE	REMARKS
24-B-229 230	386'-0"	1'-6"	16'-0"	I	
24-B-231 232	386'-0"	1'-0"	15'-0"	I	
24-B-237 238	386'-0"	1'-0"	9'-4"	I	
24-B-276	404'-0"	1'-0"	8'-0"	I	
24-B-279 280	386'-0"	1'-0"	9'-4"	II	
26-B-7 8	326'-0"	2'-3"	22'-0"	I	
26-B-9 10	326'-0"	1'-3"	16'-4"	I	
26-B-17 18	335'-0"	1'-6"	17'-0"	I	
26-B-25 26	354'-0"	1'-6"	8'-0"	I	
26-B-27 28	354'-0"	2'-0"	8'-4"	I	
26-B-35 36	354'-0"	1'-6"	11'-6"	I	
26-B-37 38	354'-0"	1'-0"	9'-4"	I	
26-B-41 42	369'-0"	0'-8"	7'-4"	I	
26-B-43 44	369'-0"	0'-8"	7'-4"	I	
26-B-47 48	369'-0"	0'-8"	7'-4"	I	
26-B-49 50	369'-0"	0'-8"	7'-4"	II	
26-B-51 52	369'-0"	0'-8"	7'-4"	I	

Notes:

1. (*) I = Shield Wall or Firewall
II = Partition Wall

ARKANSAS NUCLEAR ONE
Unit 2

Table 3.7-15

MODAL PROPERTIES FOR THE COUPLED RB-INTERNALS – RCS MODEL

Mode	Frequency Hz	Modal Damping	Participation factor-X		Participation factor-Y		Participation factor-Z	
			P-X	Ratio	P-Y	Ratio	P-Z	Ratio
1	1.01490	.03000	-.02348	.00011	-.00136	.00001	21.51900	.09559
2	1.01593	.03000	21.49100	.10238	-.00087	.00001	.02275	.00010
3	2.59348	.03000	-.00022	.00000	.00026	.00000	.14739	.00065
4	2.59800	.03000	-.10462	.00050	.00535	.00004	.00000	.00000
5	4.38598	.03000	-.03099	.00015	-.01937	.00014	13.49900	.05997
6	4.40501	.03000	13.29500	.06334	-.05232	.00037	.02504	.00011
7	5.09716	.03000	.03756	.00018	-1.85820	.01327	13.75700	.06111
8	5.11945	.03000	-2.81620	.01342	22.92200	.16372	-7.20430	.03200
9	5.15570	.03001	18.88300	.08995	.56122	.00401	-.44182	.00196
10	5.15912	.03000	.03172	.00015	-.04507	.00032	-.01569	.00007
11	5.16262	.03000	.20235	.00096	1.07470	.00768	12.84600	.05706
12	5.21628	.03000	-2.44770	.01166	19.42600	.13875	6.45250	.02866
13	5.26482	.03000	1.03110	.00491	27.61100	.19721	7.97290	.03542
14	5.44566	.03000	1.38820	.00661	23.17800	.16555	-7.10330	.03155
15	6.33082	.03000	-.00083	.00000	.02876	.00020	-1.21930	.00542
16	6.35046	.03000	.46209	.00220	.03994	.00028	-.00451	.00002
17	7.11244	.03025	1.28000	.00610	-.78668	.00562	70.42300	.31282
18	7.15472	.03001	1.67220	.00797	-.08136	.00058	10.65000	.04731
19	7.20634	.03000	-8.18940	.03901	10.58100	.07557	2.53830	.01127
20	7.22259	.03000	-3.00270	.01430	-11.87600	.08483	1.89000	.00840
21	7.42138	.03002	-.35728	.00170	-.18930	.00135	17.80000	.07907
22	7.49043	.03005	29.01800	.13823	.94298	.00673	-.35854	.00159
23	8.53884	.03013	-.90741	.00432	-.45779	.00327	30.12900	.13383
24	8.58100	.03023	46.42300	.22115	.59993	.00428	.28985	.00129
25	8.83507	.03000	-.00455	.00002	.02807	.00020	-1.99010	.00884
26	8.83997	.03000	-1.20250	.00573	-.00187	.00001	.00623	.00003
27	10.21180	.04693	209.92000	1.00000	.25807	.00184	.78829	.00350
28	10.86370	.05389	-1.08050	.00515	-8.64760	.06177	255.12000	1.00000
29	11.49860	.03149	-.26127	.00125	.01000	.00007	.15659	.00070
30	11.49970	.04283	-.15368	.00073	-.08982	.00064	1.79070	.00796
31	11.85240	.03010	47.45600	.22606	2.02630	.01447	-.75310	.00335
32	12.29860	.03002	-.14538	.00069	-.05147	.00037	-.10824	.00048
33	12.30210	.03000	-.00196	.00001	-.00993	.00007	.00077	.00000
34	12.30230	.03113	.00270	.00001	.32403	.00231	-5.36340	.02382
35	12.30610	.03013	4.99490	.02379	.15235	.00109	-.05815	.00026
36	12.32230	.03010	-.10011	.00048	.08914	.00064	-2.16080	.00960
37	12.32660	.03045	.02412	.00011	.33565	.00240	-4.92120	.02186
38	12.32820	.03000	.02953	.00014	-.02578	.00018	-.01215	.00005
39	12.33990	.03006	-9.01950	.04297	-.34137	.00244	.14377	.00064
40	12.55820	.03000	.29826	.00142	-.11168	.00080	-.11862	.00053
41	12.56400	.03008	-1.03460	.00493	-.07571	.00054	-1.50690	.00669
42	12.60520	.03239	.41747	.00199	1.08920	.00778	-17.74900	.07884
43	12.62530	.03113	18.52700	.08826	.28436	.00203	.16216	.00072
44	12.84830	.03000	-1.60090	.00763	.34478	.00246	.14211	.00063
45	13.26540	.03015	-1.95900	.00933	-.10805	.00077	-2.44290	.01085
46	13.30950	.03027	.31647	.00151	.64267	.00459	-4.29210	.01907
47	13.35340	.03000	-.00663	.00003	.02598	.00019	.02615	.00012
48	13.35820	.03005	-2.84460	.01355	-.34329	.00245	.22859	.00102

ARKANSAS NUCLEAR ONE
Unit 2

Table 3.7-15 (continued)

Mode	Frequency Hz	Modal Damping	Participation factor-X		Participation factor-Y		Participation factor-Z	
			P-X	Ratio	P-Y	Ratio	P-Z	Ratio
49	13.53450	.03029	5.88870	.02805	.72198	.00516	.24441	.00109
50	14.35300	.03620	-.18252	.00087	3.91010	.02793	-39.27700	.17447
51	14.51910	.03591	-39.13500	.18643	-.05881	.00042	-1.05270	.00468
52	14.57920	.03000	-.09314	.00044	-.12325	.00088	-2.68530	.01193
53	14.61400	.03000	-.83163	.00396	.32817	.00234	-.00297	.00001
54	14.72360	.03023	-2.85540	.01360	.00885	.00006	-3.23120	.01435
55	14.92270	.03318	-2.59630	.01237	3.33110	.02379	-21.39900	.09505
56	15.49220	.04207	-77.12600	.36740	.94635	.00676	-.41599	.00185
57	15.93110	.03011	4.95050	.02358	3.46230	.02473	3.29440	.01463
58	16.07600	.03134	-19.83300	.09448	-.54417	.00389	1.03180	.00458
59	16.13470	.03020	-5.16760	.02462	-.51130	.00365	-.20761	.00092
60	16.17720	.03000	.58415	.00278	.50502	.00361	-1.26000	.00560
61	16.21840	.03105	5.78910	.02758	.35758	.00255	-10.25700	.04556
62	16.26530	.03159	8.82380	.04203	2.61470	.01868	-15.50300	.06887
63	16.35860	.03001	-1.05650	.00503	4.27730	.03055	-3.70760	.01647
64	16.73640	.03111	-16.03200	.07637	.04044	.00029	-7.34150	.03261
65	16.81650	.03467	38.77700	.18472	-1.81520	.01296	4.65100	.02066
66	17.09430	.03044	-9.76850	.04653	1.68940	.01207	23.78100	.10564
67	17.24740	.03002	2.14990	.01024	2.11980	.01514	-1.61410	.00717
68	17.67750	.03014	-5.08880	.02424	-5.42380	.03874	1.96520	.00873
69	18.06350	.03077	8.44900	.04025	.84347	.00603	-7.83810	.03482
70	18.13090	.03071	-7.89630	.03762	.85069	.00608	-1.16760	.00519
71	18.33070	.03382	-17.38300	.08281	.33202	.00237	-3.66580	.01628
72	18.70170	.03014	-.33893	.00161	.18992	.00136	.75991	.00338
73	18.79710	.03003	-.72082	.00343	-4.66100	.03329	.26466	.00118
74	19.13990	.03050	-1.36730	.00651	-2.60850	.01863	-11.26900	.05006
75	19.32940	.03001	.63872	.00304	-.64115	.00458	-.12219	.00054
76	20.43370	.03027	-2.96860	.01414	-3.20670	.02290	-.89158	.00396
77	20.46670	.03114	1.82710	.00870	-2.61770	.01870	1.69000	.00751
78	20.66230	.03081	-1.02610	.00489	1.08870	.00778	3.60070	.01599
79	20.75990	.03006	-.98057	.00467	10.04600	.07175	.10036	.00045
80	21.01450	.03009	-2.24030	.01067	58.64300	.41886	-.94592	.00420
81	21.18150	.03068	-2.68280	.01278	-20.40200	.14572	2.33360	.01037
82	21.56600	.03060	-2.85570	.01360	11.48600	.08204	11.71700	.05205
83	21.88580	.03019	4.98540	.02375	-.74842	.00535	8.02970	.03567
84	22.22000	.03126	2.19520	.01046	.32156	.00230	.27352	.00122
85	23.48180	.03173	-.18797	.00090	-2.14170	.01530	21.33200	.09476
86	23.63770	.03000	.07797	.00037	.20195	.00144	.00195	.00001
87	23.65290	.03000	-.61127	.00291	.02615	.00019	-.09182	.00041
88	23.98360	.03046	.47536	.00226	-.52279	.00373	4.94660	.02197
89	25.04000	.03000	.13580	.00065	-.00358	.00003	.20627	.00092
90	25.05190	.03000	-.07485	.00036	-.17496	.00125	.67556	.00300
91	25.10330	.03309	-.05674	.00027	2.77000	.01978	-28.99000	.12878
92	25.47410	.03476	-.06294	.00030	2.52180	.01801	-37.29000	.16565
93	26.29490	.03021	-.16739	.00080	.45779	.00327	-8.97240	.03986
94	26.38890	.03000	.05850	.00028	.03488	.00025	-.03129	.00014
95	26.39050	.03000	-.43661	.00208	-.16387	.00117	-.08961	.00040

ARKANSAS NUCLEAR ONE
Unit 2

Table 3.7-15 (continued)

Mode	Frequency Hz	Modal Damping	Participation factor-X		Participation factor-Y		Participation factor-Z	
			P-X	Ratio	P-Y	Ratio	P-Z	Ratio
96	26.44920	.03000	-.01197	.00006	-.53671	.00383	.10323	.00046
97	27.04800	.03108	-.51452	.00245	6.23520	.04453	-8.34530	.03707
98	27.07850	.03396	-.79143	.00377	140.01000	1.00000	8.17120	.03630
99	27.77630	.03083	29.98500	.14284	2.05980	.01471	.42344	.00188
100	28.13170	.03011	-3.20280	.01526	-11.24800	.08034	-1.21760	.00541
101	28.21440	.03000	-.09265	.00044	.15755	.00112	.45920	.00204
102	28.21730	.03000	-.21725	.00103	.36709	.00262	-.02057	.00009
103	28.23100	.03002	-1.60810	.00766	-4.46420	.03189	-.18079	.00080
104	28.39760	.03000	.58673	.00280	.97921	.00699	-1.50040	.00667
105	29.00440	.03016	-1.56720	.00746	-6.70040	.04786	-1.63960	.00728
106	29.69920	.03024	2.36130	.01125	-2.25760	.01612	1.39460	.00619
107	30.00810	.03000	.17895	.00085	.14287	.00102	.56014	.00249
108	30.00840	.03000	.15223	.00073	.00190	.00001	-.30620	.00136
109	30.00840	.03000	.10905	.00052	-.12928	.00092	-.18000	.00080
110	30.33290	.03001	.15716	.00075	-.09946	.00071	-1.53150	.00680
111	30.65350	.03033	-2.71830	.01295	1.91680	.01369	3.96660	.01762
112	31.61560	.03006	3.79920	.01810	.90285	.00645	.33825	.00150
113	31.61990	.03000	-.37430	.00178	-.10324	.00074	.12286	.00055
114	31.62040	.03000	-.35194	.00168	.33006	.00236	.64450	.00286
115	31.70920	.03085	-8.05800	.03839	-5.22600	.03733	-7.87790	.03499
116	31.90860	.03168	21.19300	.10095	3.59900	.02571	2.63240	.01169
117	32.15090	.03370	28.99700	.13813	.02901	.00021	-2.74900	.01221
118	32.87710	.03001	-1.60000	.00762	.11213	.00080	.42454	.00189
119	32.87720	.03000	-.27393	.00131	-.15601	.00111	-.22291	.00099
120	32.87760	.03000	1.34530	.00641	-.25484	.00182	-.53582	.00238
121	33.11440	.03124	-19.63900	.09355	-1.33420	.00953	-1.81760	.00807
122	33.24450	.06290	-99.76000	.47522	1.46000	.01043	.16354	.00073
123	33.44060	.03157	-1.26300	.00602	15.33900	.10956	16.15200	.07175
124	33.83960	.03000	-.69048	.00329	.50795	.00363	.15745	.00070
125	33.83960	.03000	-.01765	.00008	-.02264	.00016	-.07010	.00031
126	33.84040	.03000	.18718	.00089	-.09567	.00068	-.04768	.00021
127	34.11830	.03011	2.00360	.00954	4.58810	.03277	3.63420	.01614
128	34.84520	.04733	-.76815	.00366	-103.4100	.73860	-36.35900	.16151
129	35.25420	.04462	-.40971	.00195	61.43900	.43883	36.92000	.16400
130	35.77370	.03030	.02634	.00012	-11.66900	.08335	1.25340	.00557

ARKANSAS NUCLEAR ONE
Unit 2

Table 3.8-1

FLUED HEAD PENETRATIONS

<u>PEN #</u>	<u>PIPE MATERIAL</u>	<u>SIZE</u>	<u>APPLICABLE CODE</u>	<u>REPAIR REQUIRED</u>
2P – 1	SA-106, GR. B or SA-155 GR. KCF-70	38"	ASME Section III-1971 THROUGH 1974 SUMMER ADDENDUM	NO
2P – 2	SA-106, GR. B or SA-155 GR. KCF-70	38"	ASME Section III-1971 THROUGH 1974 SUMMER ADDENDUM	NO
2P – 3	SA-106 GRADE C	24"	ASME Section III-1971 THROUGH 1974 SUMMER ADDENDUM	NO
2P – 4	SA-106 GRADE C	24"	ASME Section III-1971 THROUGH 1974 SUMMER ADDENDUM	NO
2P – 5	SA-376 or SA-312 TP-316	3"	ASME Section III-1971 THROUGH 1974 SUMMER ADDENDUM	NO
2P – 6	SA-376 or SA-312 TP-316	2"	ASME Section III-1971 THROUGH 1974 SUMMER ADDENDUM	NO
2P – 7	SA-106 GRADE C	3/4"	ASME Section III-1971 THROUGH 1974 SUMMER ADDENDUM	NO
2P – 8	SA-106, GR. B	3/4"	ASME Section III-1971 THROUGH 1974 SUMMER ADDENDUM	NO
2P – 9	SA-376 or SA-312 TP-316	1"	ASME Section III-1971 THROUGH 1974 SUMMER ADDENDUM	NO
2P – 10	SA-376 or SA-312 TP-316	6"	ASME Section III-1971 THROUGH 1974 SUMMER ADDENDUM	NO
2P – 11	SA-376 or SA-312 TP-316	3"	ASME Section III-1971 THROUGH 1974 SUMMER ADDENDUM	NO
2P – 12	SA-376 or SA-312 TP-316	3"	ASME Section III-1971 THROUGH 1974 SUMMER ADDENDUM	NO
2P – 13	SA-376 or SA-312 TP-316	3"	ASME Section III-1971 THROUGH 1974 SUMMER ADDENDUM	NO
2P – 14	SA-376 or SA-312 TP-316	2"	ASME Section III-1971 THROUGH 1974 SUMMER ADDENDUM	NO
2P – 15	SA-376 or SA-312 TP-316	6"	ASME Section III-1971 THROUGH 1974 SUMMER ADDENDUM	NO
2P – 17	SA-376 or SA-312 TP-304	10"	ASME Section III-1971 THROUGH 1974 SUMMER ADDENDUM	YES
2P – 18	SA-376 or SA-312 TP-316	3/4"	ASME Section III-1971 THROUGH 1974 SUMMER ADDENDUM	NO

ARKANSAS NUCLEAR ONE
Unit 2

Table 3.8-1 (continued)

<u>PEN #</u>	<u>PIPE MATERIAL</u>	<u>SIZE</u>	<u>APPLICABLE CODE</u>	<u>REPAIR REQUIRED</u>
2P – 19	SA-376 or SA-312 TP-3046	3"	ASME Section III-1971 THROUGH 1974 SUMMER ADDENDUM	NO
2P – 20	SA-106 GR. B	12"	ASME Section III-1971 THROUGH 1974 SUMMER ADDENDUM	NO
2P – 21	SA-106 GR. B	12"	ASME Section III-1971 THROUGH 1974 SUMMER ADDENDUM	YES
2P – 23	SA-376 or SA-312 TP-316	10"	ASME Section III-1971 THROUGH 1974 SUMMER ADDENDUM	NO
2P – 24	SA-376 or SA-312 TP-304	6"	ASME Section III-1971 THROUGH 1974 SUMMER ADDENDUM	NO
2P – 25	SA-376 or SA-312 TP-316 TP-304, Cl. 1	3"	ASME Section III-1971 THROUGH 1974 SUMMER ADDENDUM	NO
2P – 29	SA-376 or SA-312 TP-316	6"	ASME Section III-1971 THROUGH 1974 SUMMER ADDENDUM	NO
2P – 30	SA-376 or SA-312 TP-316	3"	ASME Section III-1971 THROUGH 1974 SUMMER ADDENDUM	NO
2P – 31	SA-106 GR. B	2"	ASME Section III-1971 THROUGH 1974 SUMMER ADDENDUM	YES
2P – 32	SA-106 GR. B	4"	ASME Section III-1971 THROUGH 1974 SUMMER ADDENDUM	NO
2P – 33	SA-376 or SA-312 TP-316	2"	ASME Section III-1971 THROUGH 1974 SUMMER ADDENDUM	NO
2P – 345	SA-376 or SA-312 TP-316	2"	ASME Section III-1971 THROUGH 1974 SUMMER ADDENDUM	NO
2P – 37	SA-376 or SA-312 TP-304	3/4"	ASME Section III-1971 THROUGH 1974 SUMMER ADDENDUM	NO
2P – 39	SA-376 or SA-312	2"	ASME Section III-1971 THROUGH 1974 SUMMER ADDENDUM	NO
2P – 40	SA-106 GR. B	3"	ASME Section III-1971 THROUGH 1974 SUMMER ADDENDUM	NO
2P – 41	SA-106 GR. B	1"	ASME Section III-1971 THROUGH 1974 SUMMER ADDENDUM	NO
2P – 42	SA-106 GR. B	3"	ASME Section III-1971 THROUGH 1974 SUMMER ADDENDUM	NO

ARKANSAS NUCLEAR ONE
Unit 2

Table 3.8-1 (continued)

<u>PEN #</u>	<u>PIPE MATERIAL</u>	<u>SIZE</u>	<u>APPLICABLE CODE</u>	<u>REPAIR REQUIRED</u>
2P – 43	SA-106 GR. B	3"	ASME Section III-1971 THROUGH 1974 SUMMER ADDENDUM	NO
2P – 46	SA-106 GR. B	2"	ASME Section III-1971 THROUGH 1974 SUMMER ADDENDUM	NO
2P – 27	SA-358	14"	ASME Section III-1971 THROUGH 1974 SUMMER ADDENDUM	NO
2P – 48	SA-106 GR. B	3"	ASME Section III-1971 THROUGH 1974 SUMMER ADDENDUM	NO
2P – 51	SA-106 GR. B	6"	ASME Section III-1971 THROUGH 1974 SUMMER ADDENDUM	NO
2P – 52	SA-106 GR. B	10"	ASME Section III-1971 THROUGH 1974 SUMMER ADDENDUM	NO
2P – 53	SA-106 GR. B	14"	ASME Section III-1971 THROUGH 1974 SUMMER ADDENDUM	NO
2P – 55	SA-106 GR. B	12"	ASME Section III-1971 THROUGH 1974 SUMMER ADDENDUM	NO
2P – 58	SA-376 or SA-312 TP-304	2"	ASME Section III-1971 THROUGH 1974 SUMMER ADDENDUM	NO
2P – 59	SA-106 GR. B	6"	ASME Section III-1971 THROUGH 1974 SUMMER ADDENDUM	NO
2P – 60	SA-106 or GR. B	10"	ASME Section III-1971 THROUGH 1974 SUMMER ADDENDUM	NO
2P – 61	SA-376 or SA-312	3/4"	ASME Section III-1971 THROUGH 1974 SUMMER ADDENDUM	NO
2P – 62	SA-106 GR. B	6"	ASME Section III-1971 THROUGH 1974 SUMMER ADDENDUM	NO
2P – 63	SA-106 GR. B	12"	ASME Section III-1971 THROUGH 1974 SUMMER ADDENDUM	NO
2P – 64	SA-106 GR. B	4"	ASME Section III-1971 THROUGH 1974 SUMMER ADDENDUM	NO
2P – 65	SA-106 GR. C	4"	ASME Section III-1971 THROUGH 1974 SUMMER ADDENDUM	NO
2P – 66	SA-358 TP-304, Cl. 1	24"	ASME Section III-1971 THROUGH 1974 SUMMER ADDENDUM	NO
2P – 67	SA-358 TP-304, Cl. 1	24"	ASME Section III-1971 THROUGH 1974 SUMMER ADDENDUM	NO
2P – 68	SA-376 or SA-312 TP-304	4"	ASME Section III-1971 THROUGH 1974 SUMMER ADDENDUM	YES

ARKANSAS NUCLEAR ONE
Unit 2

Table 3.8-2

WELD REPAIRS

<u>PENETRATION #</u>	<u>REASON FOR REJECTION</u>	<u>REPAIR* #</u>	<u>REPAIR ACCEPTED/ REJECTED</u>	<u>REASON FOR REJECTION OF REPAIR</u>
2P – 31	Incomplete Fusion	1	Accepted	
2P – 61	Slaglines, Incomplete Fusion	1	Accepted	
2P – 21	Incomplete Fusion	1 2 3	Rejected Rejected Accepted	Incomplete Fusion Slaglines
2P – 17	Incomplete Fusion	1 2 3	Rejected Rejected Accepted	Incomplete Fusion Slaglines
2P – 68	Incomplete Fusion	1	Accepted	

* All repairs consisted of excavating the unacceptable portion of the weld and rewelding.

ARKANSAS NUCLEAR ONE
Unit 2

Table 3.8-3

COMPUTER PROGRAMS USED IN THE DESIGN OF CATEGORY 1 STRUCTURES

PART I - PROGRAM INDEX

<u>STRUCTURE</u>	<u>PROGRAMS USED</u>
Containment	CE 316, CE 611 A & B, CE 639-2, CE 641, CE 650, CE 784, CE 901, CE 917 ASHSD
Internal Structures	CE 309, CE 316, CE 611 A & B, CE 641, CE 650, CE 78
Auxiliary Building	CE 309, CE 611 A & B, CE 641, CE 650, CE 779, CE 784, CE 917
Other Category I Structures	
Intake Structure	CE 611 A & B, CE 641, CE 650, CE 784

PART II - PROGRAM INFORMATION

<u>PROGRAM TITLE</u>	<u>PROGRAM DESCRIPTION</u>	<u>PROGRAM USE</u>	<u>PROGRAM VERIFICATION</u>
<u>CE 309</u> "STRESS"	This program performs a linear analysis of two or three dimensional, elastic, statically loaded, framed structures, whose members and joints may be pinned or rigidly connected. "Stress" can use either a stiffness or displacement method of analysis and can determine joint displacements, reactions, member end forces, and member distortions for each specified loading condition.	This program was used in the design and analysis of the secondary shield walls, structural steel, and pipe restraints in the Containment. The program was also used in the design and analysis of concrete and structural steel in the Auxiliary Building.	See Note 1

ARKANSAS NUCLEAR ONE
Unit 2

Table 3.8-3 (continued)

<u>PROGRAM TITLE</u>	<u>PROGRAM DESCRIPTION</u>	<u>PROGRAM USE</u>	<u>PROGRAM VERIFICATION</u>
<p><u>CE 316</u></p> <p style="text-align: center;">“FINEL”</p>	<p>A description of the features and capabilities of the Bechtel Computer Program "Finel" is given in Section 5.1.1.5.2 of the Arkansas Nuclear One Unit 1 FSAR, Docket No. 50-313.</p>	<p>"Finel" was used in the axisymmetric analysis of the Containment, Equipment Hatch and the Primary Shield.</p>	<p>See Notes 3 & 4</p>
<p><u>CE 611 A & B</u></p> <p style="text-align: center;">“TIME HISTORY RESPONSE ANALYSIS”</p>	<p>This program performs a response time history analysis using modal superposition techniques. The response can be calculated in terms of displacement, velocity, and acceleration time histories. In addition, time histories, inertia forces, moments, and shears can be computed for cantilevered structures. Maximum response values and times of occurrence can be found. The response spectra at selected points can be determined and plotted.</p>	<p>This program was used in the seismic analysis and design of the Containment, Internal Structures, Auxiliary Building and Intake Structure.</p>	<p>See Note 1</p>
<p><u>CE 639-2</u></p> <p style="text-align: center;">“FORCES AND PRESSURES ACTING ON DOME DUE TO PRESTRESSING OR TENDONS”</p>	<p>This program performs an analysis of forces and pressures acting on a dome subjected to prestressed tendons. The shape of the dome can be either sphere-torus, sphere-cone, hemisphere, cone, or ellipsoid, and the tendons may be in one, two, or three directions. The program is capable of analyzing the prestressing losses due to friction and seating of the anchorages. In addition, the program can consider the prestressing sequences.</p>	<p>This program was used in the design and analysis of the Containment.</p>	<p>See Note 1</p>

ARKANSAS NUCLEAR ONE
Unit 2

Table 3.8-3 (continued)

<u>PROGRAM TITLE</u>	<u>PROGRAM DESCRIPTION</u>	<u>PROGRAM USE</u>	<u>PROGRAM VERIFICATION</u>
<p><u>CE 641</u></p> <p>“EARTHQUAKE SPECTRUM RESPONSE ANALYSIS OF STRUCTURES”</p>	<p>This program computes the response of a structure subjected to an earthquake using spectrum response techniques. The input data defines the structure in terms of natural frequencies, mode shapes, lumped masses, and elevations. The earthquake is defined in terms of acceleration values associated with the structure's natural frequencies. The response of the structure is determined at specified locations in terms of inertial forces, shears, moments, accelerations and displacements.</p>	<p>This program was used in the seismic analysis and design of the Containment, Internal Structures, Auxiliary Building and Intake Structure.</p>	<p>See Note 1</p>
<p><u>CE 650</u></p> <p>“BEAM PROPERTIES”</p>	<p>This program computes the cross sectional properties of beams and beam segments. The properties computed are cross sectional area, shear area, moment of inertia, centroidal axes and segment weights.</p>	<p>This program was used in the seismic analysis and design of the Containment, Internal Structures, Auxiliary Building, and Intake Structure.</p>	<p>See Note 1</p>
<p><u>CE 779</u></p> <p>“STRUCTURAL ANALYSES PROGRAM”</p>	<p>This program performs linear elastic analysis of three dimensional structural systems using finite element techniques. The program is capable of analyzing a variety of structural elements, including three dimensional truss, three dimensional beam, plane stress, plane strain, two dimensional axisymmetric solid, three dimensional solid, plate, and shell. Combinations of the above elements may be used.</p>	<p>This program was used in the design and analysis of the spent fuel pool in the Auxiliary Building.</p>	<p>See Notes 3 & 4</p>

ARKANSAS NUCLEAR ONE
Unit 2

Table 3.8-3 (continued)

<u>PROGRAM TITLE</u>	<u>PROGRAM DESCRIPTION</u>	<u>PROGRAM USE</u>	<u>PROGRAM VERIFICATION</u>
<p><u>CE 784</u> “PLANE FRAME RESPONSE”</p>	<p>This program generates natural frequencies and mode shapes for modeled structures. Input data consists of lumped masses, elevations, and cross sectional properties of elements of the structural model.</p>	<p>This program was used in the seismic analysis and design of the Containment, Internal Structures, Auxiliary Building, and Intake Structure.</p>	<p>See Note 1</p>
<p><u>CE 901</u> “STRUDL”</p>	<p>This program performs analysis of a wide range of structural types, both two and three dimensional structures consisting of truss, frame and continuous finite elements. Any combination of these compounds may be used with a variety of analysis and design procedures.</p>	<p>This program was used in the analysis of secondary shield walls.</p>	<p>See Note 6</p>
<p><u>CE 917</u> “MODAL DYNAMIC ANALYSIS”</p>	<p>This program computes the reduced stiffness matrix from the basic geometry input for plane frame or plane truss models, accepts a diagonal or full mass matrix, and computes mode shapes, frequencies, participation factors, and modal damping values.</p>	<p>This program was used in the seismic analysis and design of Class I cable tray supports in all Category I structures.</p>	<p>See Note 3</p>
<p><u>ASHSD</u> “ANALYSIS OF AXISYMMETRIC SHELL AND SOLID SUBJECT TO NON- AXISYMMETRIC STATIC LOADING, DYNAMIC LOADING OR BASE ACCELERATION”</p>	<p>This program analyzes complex axisymmetric structures of arbitrary shape which may be idealized as shell or solid finite elements for dead load, non-axisymmetric static loading as well as for dynamic characteristics and response to any non-axisymmetric dynamic loading or to any given base acceleration history. The shell is discretized as a series of conical frustrums and the solid is idealized as an assemblage of quadrilateral or triangular finite elements.</p>	<p>This program was used to analyze the Equipment Hatch Area of the Containment.</p>	<p>See Note 5</p>

ARKANSAS NUCLEAR ONE
Unit 2

Table 3.8-3 (continued)

NOTES:

1. The descriptions and results of verification tests results on this program are on file at the Bechtel International Corporation, Data Processing Division.
2. Verification tests on this program are currently in process. Results of these tests will be placed on file at the Bechtel International Corporation, Data Processing Division.
3. The descriptions and results of verification tests on this program were submitted in Amendment 6 of the Grand Gulf Nuclear Station, PSAR, AEC Docket No. 50416-23.
4. The description and results of verification tests on this program were submitted in Amendment 3 of the Alvin W. Vogtle Nuclear Plant, PSAR, AEC Docket No. 50424-18.
5. The theoretical background and results of verification tests on this program can be obtained in the following publication: "Dynamic Stress Analysis of Axisymmetric Structures Under Arbitrary Loading", Report No. EERC 69-10, September, 1969, by Sukumar Ghosh and Edward Wilson. A copy of this publication is on file with the National Technical Information Service, National Bureau of Standards, U.S. Department of Commerce, Springfield, Virginia.
6. ICES STRUDL CE 901 is a recognized computer program in the public domain and has had sufficient history of use to justify its applicability and validity without further demonstration.
7. The computer codes listed in this table reflect original construction design and analysis. Other computer codes may have been used for design and analysis activities since the original construction of ANO-2. See the current calculations for details of specific codes used.

ARKANSAS NUCLEAR ONE
Unit 2

Table 3.8-4

DELETED

SEE FSAR FOR HISTORICAL INFORMATION

TABLE 3.8-5

DELETED

SEE FSAR FOR HISTORICAL INFORMATION

Table 3.8-6

CALCULATED RESULTS - INTERNAL STRUCTURES

A. Definitions

M = Required design moment capacity

M_u = Actual design moment capacity

P = Required axial design load capacity (tension positive)

P_u = Actual axial design load capacity (tension positive)

- NOTE:
1. Capacities for walls and slabs are given per foot width
 2. For definition of load combination variables see Section 3.8.3.3.2

B. Materials Design Strengths

a) Concrete design strengths:

Primary and secondary shield walls, refueling canal floor slab, steam generator pedestal and columns: $f'_c = 5500$ psi

Miscellaneous slabs and walls: $f'_c = 3000$ psi

b) Steel reinforcement design strength:

All reinforcement for Internal Structures

$f_y = 60,000$ psi

ARKANSAS NUCLEAR ONE
Unit 2

Table 3.8-7

CALCULATED RESULTS - OTHER CATEGORY 1 STRUCTURES

EMERGENCY DIESEL FUEL STORAGE VAULT

<u>MEMBER DESCRIPTION</u>	<u>MEMBER LOCATION</u>	<u>LOAD COMBINATION</u>	<u>REQUIRED CAPACITY</u>	<u>MAXIMUM CAPACITY</u>
3'-3" Thick Base Slab 18'-0" Span	Top of Slab El. 328'-2"	1.5 D + 1.8 L	122 Ft-K	175 Ft-K
2'-0" Thick Exterior Wall 31'-0" Span	Typical From El. 328'-2" to El. 355'-3"	1.5 D + 1.8 L	Vertical 109 Ft-K	113 Ft-K
			Horizontal 93 Ft-K	109 Ft-K
2'-3" Thick Roof Slab 18'-0" Span	Top of Slab El. 355'-3"	1.5 D + 1.8 L	81 Ft-K	112 Ft-K

INTAKE STRUCTURE

<u>MEMBER DESCRIPTION</u>	<u>MEMBER LOCATION</u>	<u>LOAD COMBINATION</u>	<u>REQUIRED CAPACITY</u>	<u>MAXIMUM CAPACITY</u>
3'-0" Thick Base Slab 14'-6" Span	Intake Bay (Front Section) Top of Slab El. 322'-6"	1.5 D + 1.8 L	167 Ft-K	220 Ft-K
3'-0" Thick Exterior Wall 31'-6" Span	Intake Bay (Front Section) From El. 322'-6" to El. 354'-0"	1.5 D + 1.8 L	135 Ft-K	140 Ft-K
2'-0" Thick Interior Wall 31'-6" Span	Intake Bay (Front Section) From El. 322'-6" to El. 354'-0"	1.5 D + 1.8 L	53 Ft-K	90 Ft-K
2'-0" Thick Slab 28'-0" Span	Back Section Top of Slab El. 366'-0"	1.5 D + 1.8 L	192 Ft-K	312 Ft-K
2'-0" Thick Roof Slab 28'-0" Span	Back Section	1.5 D + 1.8 L	125 Ft-K	173 Ft-K
	Top of Slab El. 378'-0"			
1'-6" Thick Exterior Wall 12'-0" Span	Back Section	1.25 (D + L + H ₀ + W) + 1.0 T ₀	35 Ft-K	68 Ft-K
	From El. 366'-0" to El. 378'-0"			

ARKANSAS NUCLEAR ONE
Unit 2

Table 3.8-7 (continued)

AUXILIARY BUILDING

<u>MEMBER DESCRIPTION</u>	<u>MEMBER LOCATION</u>	<u>LOAD COMBINATION</u>	<u>REQUIRED CAPACITY</u>	<u>MAXIMUM CAPACITY</u>
2'-9" Thick Base Slabs 32'-0" Span	Boron Management Holdup Tank Vaults Top of Slab El. 327'-0"	1.0 D + 1.0 L + 1.0 A + 1.0 T ₀ + 1.0 H ₀	128 Ft-K	202 Ft-K
2'-0" Thick Exterior Wall 27'-0" Vert. Span	Boron Management Holdup Tank Vaults From El. 327'-0" to El. 355'-4"	Vertical: 1.0 D + 1.0 L + 1.0 A + 1.0 T ₀ + 1.0 H ₀	128 Ft-K	138 Ft-K
		Horizontal: 1.5 D + 1.8 L	93 Ft-K	134 Ft-K
2'-0" Thick Interior Wall 27'-0" Vert. Span, 32'-0" Horiz. Span	Boron Management Holdup Tank Vaults From El. 327'-0" to El. 355'-4"	1.5 D + 1.8 L	Vertical: 60 Ft-K	113 Ft-K
			Horizontal: 54 Ft-K	70 Ft-K
3'-9" Thick Roof Slab 32'-0" Span	Boron Management Holdup Tank Vaults Top of Slab El. 355'-4"	1.5 D + 1.8 L	North-South 534 Ft-K	545 Ft-K
			East-West 212 Ft-K	233 Ft-K

CATEGORY I ELECTRICAL MANHOLES

<u>MEMBER DESCRIPTION</u>	<u>MEMBER LOCATION</u>	<u>LOAD COMBINATION</u>	<u>REQUIRED CAPACITY</u>	<u>MAXIMUM CAPACITY</u>
1'-0" Thick Base Slab 8'-0" Span	Base Slab	.5 D + 1.8 L	11.3 Ft-K	12.3 Ft-K
8" Thick Exterior Wall 8'-0" Max. Span	Exterior Wall	.5 D + 1.8 L	9 Ft-K	9.2 Ft-K
8" Thick Interior Walls 8'-0" Max. Span	Interior Wall	.5 D + 1.8 L	5 Ft-K	9.2 Ft-K
1'-7 3/4" Thick Roof Slab 8'-0" Max. Span	Top of Slab at Grade Elevation	.5 D + 1.8 L	29 Ft-K	188 Ft-K

ARKANSAS NUCLEAR ONE
Unit 2

Table 3.8-7 (continued)

EMERGENCY COOLING POND PIPE INLET AND OUTLET

<u>MEMBER DESCRIPTION</u>	<u>MEMBER LOCATION</u>	<u>LOAD COMBINATION</u>	<u>REQUIRED CAPACITY</u>	<u>MAXIMUM CAPACITY</u>
1'-6" Thick Base Slab 5'-6" Span	Pipe Intake, Top of Slab El. 337'-0"	1.5 D + 1.8 L	3.5 Ft-K	20 Ft-K
1'-6" Thick Exterior Wall 11'-6" Span	Pipe Intake, From El. 337'-0" to El. 348'-6"	1.5 D + 1.8 L	17.5 Ft-K	20 Ft-K
1'-6" Thick Exterior Wall 9'-6" Span	Pipe Discharge, From El. 342'-0" to El. 351'-6"	1.5 D + 1.8 L	6.6 Ft-K	20 Ft-K
1'-6" Thick Discharge Tunnel 60" Diameter	Pipe Discharge, Bottom of Tunnel El. 342'-0"	1.5 D + 1.8 L	2.7 Ft-K	35 Ft-K

AUXILIARY BUILDING

<u>MEMBER DESCRIPTION</u>	<u>MEMBER LOCATION</u>	<u>LOAD COMBINATION</u>	<u>REQUIRED CAPACITY</u>	<u>MAXIMUM CAPACITY</u>
2'-0" Thick Slab 23'-6" Span	Top of Slab El. 354'-0" Between Column Lines G ₂ - H ₂ and 4-5	1.5 D + 1.8 L	129 Ft-K	144 Ft-K
2'-0" x 5'-3" Deep Beam 18'-0" Span	Top of Beam El. 354'-0" Between Column Lines B ₂ - D ₂ and 4-5	1.5 D + 1.8 L	1240 Ft-K	1465 Ft-K
1'-6" Thick Wall 18'-0" Span	Typical Interior Wall From El. 386'-0" to El. 404'-0"	1.5 (D + L + H ₀ + E) + 1.0 T ₀	19 Ft-K	42 Ft-K
1'-9" Thick Roof Slab 28'-11" Span	Top of Slab El. 404'-0" Between Column Lines A ₂ - B ₂ and 2-3	1.5 D + 1.8 L <hr/> 1.0 D + 1.0 L + 1.0 W' + 1.0 T ₀ + 1.25 H ₀	75 Ft-K <hr/> -26 Ft-K	93 Ft-K <hr/> -43 Ft-K
4'-3" Thick Base Slab 28'-11" Span	El. 317'-0" Bet. Column Lines A ₂ -B ₂ and 1-5	1.5 D + 1.8 L	375 Ft-K	412 Ft-K

ARKANSAS NUCLEAR ONE
Unit 2

Table 3.8-7 (continued)

<u>MEMBER DESCRIPTION</u>	<u>MEMBER LOCATION</u>	<u>LOAD COMBINATION</u>	<u>REQUIRED CAPACITY</u>	<u>MAXIMUM CAPACITY</u>
2'-0" Thick Exterior Wall 17'-0" Span	Typical From El. 317'-0" to El. 335'-0"	1.0 D + 1.0 L + 1.0 A + 1.0 T ₀ + 1.25 H ₀	56 Ft-K	182 Ft-K
3'-0" x 3'-0" Concrete Column	At Column Lines E ₂ and 5.9 From El. 329'-0" to El. 354'-0"	1.5 D + 1.8 L	P = 1650 K	P _u = 2200 K
6'-0" Thick Spent Fuel Pool Wall	Along Column Line 5 Between D ₂ - G ₂ From El. 362'-0" to El. 404'-0"	1.0 D + 1.0 L + 1.0 E' + 1.0 T ₀ + 1.25 H ₀ + 1.0 R	Vertical: M = 1000 Ft-K	M _u = 1685 Ft-K
			Horizontal: M = 1500 Ft-K	M _u = 1975 Ft-K
1'-6" Thick Exterior Wall 18'-0" Span	Typical From El. 386'-0" to El. 404'-0"	1.0 D + 1.0 L + 1.0 W' + 1.0 T ₀ + 1.25 H ₀	22 Ft-K	54 Ft-K

ARKANSAS NUCLEAR ONE
Unit 2

Table 3.8-8

**CALCULATED RESULTS
FOUNDATION LOADS & SETTLEMENTS**

<u>STRUCTURE</u>	<u>FOUNDATION MEDIUM</u>	<u>FOUNDATION BEARING PRESS (D+L+SEISMIC)</u>	<u>FOUNDATION ALLOWABLE BEARING PRESS</u>	<u>ESTIMATED SHORT TERM SETTLEMENTS OF STRUCTURE</u>	<u>ESTIMATED LONG TERM SETTLEMENTS OF STRUCTURE</u>
CONTAINMENT	ROCK	37.5 KSF	38 KSF	Less than 0.25"	Less than 0.1"
AUXILIARY BUILDING	ROCK	28 KSF	38 KSF	Less than 0.25"	Less than 0.1"
INTAKE STRUCTURE	ROCK	13 KSF	38 KSF	Less than 0.25"	Less than 0.1"
EMERGENCY DIESEL FUEL STORAGE VAULT	ROCK	3.6 KSF	38 KSF	Less than 0.25"	Less than 0.1"
EMERGENCY COOLING POND PIPE INLET & PIPE OUTLET STRUCTURES	SOIL	1.0 KSF	6 KSF	Less than 0.25"	Less than 0.1"
CATEGORY I ELECTRICAL MANHOLES	SOIL	0.5 KSF	6 KSF	Less than 0.25"	Less than 0.1"

ARKANSAS NUCLEAR ONE
Unit 2

Table 3.8-9

**GRADATIONS OF REACTIONS, MOMENTS AND STRESSES
FOR STRIP "A"-IN X DIRECTION, a/b=0.583, y/b=0.6**

<u>x/a</u>	<u>0</u>	<u>0.2</u>	<u>0.4</u>	<u>0.6</u>	<u>0.8</u>	<u>1.0</u>
M_x - Moments $\frac{\text{Ft-Kipps}}{\text{Ft}}$	-19.31	-5.64	1.98	5.99	7.88	8.41
f_c - Concrete Compressive Stresses due to M_x (psi)	913	267	94	283	373	398
f_s - Tension Stresses of #10 DYWIDAG Bars due to M_x (ksi)	--	1.10	1.29	1.17	--	--
f_s - Tension Stresses of #6 Rebars due to M_x (ksi)	36.26	7.41	0	7.88	14.80	15.79
R_x - Reactions $\frac{\text{Kips}}{\text{Ft}}$	-6.55	--	--	--	--	--
v - Concrete Shear Stresses due to R_x (psi)	38	--	--	--	--	--
μ - Bond Stresses for #6 Rebars due to R_x (psi)	188	--	--	--	--	--

Note: To give an indication of worst case stresses a #10 was used in these stress calculations. Review of as-built condition for this opening shows #11 was actually installed.

ARKANSAS NUCLEAR ONE
Unit 2

Table 3.8-10

**GRADATIONS OF REACTIONS, MOMENTS AND STRESSES
FOR STRIP "B" -IN Y DIRECTION, a/b=0.583, x/b=1.0**

<u>y/b</u>	<u>0</u>	<u>0.2</u>	<u>0.4</u>	<u>0.6</u>	<u>0.8</u>	<u>1.0</u>
M _y - Moments $\frac{\text{Ft-Kipps}}{\text{Ft}}$	-20.16	+0.35	+7.72	+9.67	+7.94	0
f _c - Concrete Compressive Stresses due to M _y (psi)	804	14	308	386	317	0
f _s - Tension Stresses of #10 SYWIDAG Bars due to M _y (ksi)	14.31	--	--	6.86	--	--
f _s - Tension Stresses of #8 Rebars due to M _y (ksi)	0	0.40	8.81	0	9.06	0
R _y - Reactions $\frac{\text{Kips}}{\text{Ft}}$	-6.51	--	--	--	--	-4.99
v - Concrete Shear Stresses (psi)	41	--	--	--	--	31
μ - Bond Stresses for #10 DYWIDAG due to R _x (psi)	122	--	--	--	--	--

Note: To give an indication of worst case stresses, a Number 10 DWIDAG was used in these stress calculations. Review of as-built condition for this opening shows Number 11 was actually installed.

ARKANSAS NUCLEAR ONE
Unit 2

Table 3.9-1

**SPECIFIED SEISMIC CONSTANTS FOR
CLASS 2 AND 3 EQUIPMENT**

<u>Equipment</u>	<u>Design Acceleration Horizontal/Vertical</u>	<u>Manufacturer Analysis</u>
<u>Pumps</u>		
Charging	1.5/1.0	Vendor calculations based on specified seismic constants
Other CVCS	1.5/1.0	
Engineered Safety Features	1.0/.66	
Fuel Pool	1.5/1.0	
Waste Management	1.5/1.0	
Waste Gas Compressors	1.5/1.0	
<u>Tanks</u>		
All code tanks	1.0/.66	Vendor calculations based on specified seismic constants
Ion Exchangers	1.0/.66	C-E calculations based on specified seismic constants with vendor concurrence
Filters	1.0/.7	Vendor calculations based on specified seismic constants
<u>Heat Exchangers</u>		
Letdown	1.0/.7	Vendor calculations based on specified seismic constants
Regenerative	1.0/.7	
Shutdown	1.0/.7	
Fuel Pool	1.0/.7	
<u>Valves</u>		
Safety and Relief	3.0/3.0	Vendor calculations based on specified seismic constants
Check and Manual	3.0/3.0	
Motor Operated	3.0/3.0	
Pneumatic Control	3.0/3.0	
Diaphragm	3.0/3.0	

ARKANSAS NUCLEAR ONE
Unit 2

Table 3.9-2

**DESIGN LOADING COMBINATIONS AND STRESS
LIMITS FOR ASME SECTION III CODE CLASS 2 AND 3 PIPING**

LOADS

- PD - Design Pressure
- PO - Operating Pressure
- DW - Piping Dead Weight
- OBE - Operating Basis Earthquake (inertia portion)
- DBE - Design Basis Earthquake (inertia portion)
- RVC - Relief Valve-Closed System (transient)
- RVO - Relief Valve-Open System (sustained)
- FV - Fast Valve Closure
- DU - Other Transient Dynamic Events Defined as an Upset Plant Condition
- S_E - Thermal Expansion Stress (2)
- E_q - Earthquake (anchor point displacement) (2)
- DE - Dynamic Events Defined as an Emergency Condition
- DF - Dynamic Events associated with a Faulted Condition (3)

PLANT OPERATING CONDITION	DESIGN STRESS LIMITS (1)	DESIGN LOADINGS COMBINATIONS
DESIGN	1.0 S _h	PD
NORMAL	1.0 S _h	PO + DW
UPSET	1.2 S _h	PO + DW + OBE PO + DW + RVC PO + DW + FV PO + DW + OBE + RVO PO + DW + DU
EMERGENCY	1.8 S _h	PO + DW + DE
FAULTED	2.40 S _h	PO + DW + DBE + RVO PO + DW + DBE + DF
THERMAL (2)	S _A	S _E + E _q

1. Where S_h (the basic material allowable stress at the operating temperature), S_A (the allowable expansion stress), and S_E are defined in ASME Code, Section III. Either a vectorial combination or absolute sum of stresses will be used.
2. Thermal expansion stress, S_E, is based on Normal and Upset operating conditions per ASME Code, Section III. If stress due to earthquake anchor point displacement is added to OBE stress in Upset load combination it does not need to be added to the thermal expansion stress, S_E.
3. Due to application of leak before break (LBB) technology to ANO-2 RCS, the postulated breaks in the reactor coolant loop are replaced with branch line pipe breaks (BLPBs). The Faulted load case DF for the BLPBs (LOCA) is combined with the DBE by square root sum of the square (SRSS) method.

Table 3.9-3

**DESIGN STRESS LIMITS FOR ASME SECTION III
CODE CLASS 2 AND 3 VALVES**

PRESSURE REQUIREMENTS

<u>PLANT OPERATING CONDITIONS</u>	<u>DESIGN UNIT</u>
NORMAL	P_d
UPSET	P_d
EMERGENCY	$1.5 P_d$
FAULTED	$2.0 P_d$

DYNAMIC QUALIFICATION

1. PROCUREMENT REQUIREMENTS FOR VALVES WITH EXTENDED TOP WORKS

a. FREQUENCY OF TOP WORKS

The design specifications require the valve manufacturer to analyze the valve and demonstrate that the frequency of the top works is in the rigid range of the applicable spectrum response curve.

b. APPLIED ACCELERATION

The design specifications require that valves identified in the Valve Requisition as Seismic Category 1 shall be capable of operation during and after loadings due to seismic forces. Specifically, valves having operators or similar features of extended proportions shall be able to withstand an inertial load of 3.0g in any direction in addition to normal operating loads. The extended parts of the valves shall have a frequency of vibration greater than 33 cps. Fulfillment of this requirement shall be demonstrated either by tests or calculations. In either event, copies of the test data or calculations shall be submitted for approval by the Buyer prior to acceptance of the valves.

The primary bending stress criteria in the weakest section of the valve is as a minimum per the Code of Record for Unit 2:

2. DESIGN REQUIREMENTS FOR INSTALLED VALVES WITH EXTENDED TOP WORKS

a. FREQUENCY OF TOP WORKS

The design requirements for installed valves are that the lowest natural frequency of the top works should be in the rigid range of the applicable spectrum response curve or greater than 33 cps. If the lowest natural frequency of the top works is not in the rigid range, then an appropriate safety factor should be applied to the seismic acceleration for the direction that the frequency is low in the valve seismic qualification calculation. The valve may also be physically changed to raise the lowest natural frequency above 33 cps.

ARKANSAS NUCLEAR ONE
Unit 2

Table 3.9-3 (continued)

b. APPLIED ACCELERATION

Seismic Category 1 valves shall be capable of performing their safety function during and after loading due to seismic forces. Specifically, valves having operators or similar features of extended proportions shall be able to withstand the loading associated with actual seismic accelerations in each direction as calculated in the piping stress calculations in addition to normal or accident operating loads as required by the valve design basis.

c. DESIGN STRESS LIMITS

The design stress limits for pressure retaining components shall be, as a minimum, in accordance with the code of record for Unit 2. The design stress limits for non pressure retaining components shall be designated by the analyst as to ensure that the component stays within the elastic region or be analyzed and qualified using accepted engineering practices.

d. DESIGN VERIFICATION

The piping system analysis, including the valves, is reviewed to assure calculated valve accelerations do not exceed those specified for valve manufacturer analysis or do not exceed those accelerations for which the valve is qualified by analysis or testing.

3. COMPACT VALVES (NO EXTENDED TOP WORKS)

As stated in NB-3524, "...the piping, not the valves, will be limiting."

Therefore, the stresses given in Table 3.9-2 for piping govern the valve stresses.

ACTIVE vs INACTIVE

As stated in 3.9.2, the manufacturer of active valves is required, by analyses or tests, to assure the operability of the valve under imposed loadings.

P_d = DESIGN PRESSURE - the pressure corresponding to the design temperature on the appropriate valve rating table.

P_d = PRIMARY BENDING STRESS

S = DESIGN STRESS

ARKANSAS NUCLEAR ONE
Unit 2

Table 3.9-4

SAFETY-RELATED EQUIPMENT NOT COVERED BY ASME CODE, SECTION III

<u>Equipment</u>	<u>Codes and Standards</u>
Engineered Safety Features Rooms Cooling Units Except the Cooling Coils Which are ASME Code	IEEE, ASTM, ANSI, NEMA, ASHRAE, AMCA, NEC, State of Arkansas Regulations
Containment Cooling Units Except the Service Water Cooling Coils Which are ASME Code	AMCA, ANSI, ASTM, ASHRAE, NEMA, IEEE, State of Arkansas Regulations
Emergency Diesel Units	ASTM, ANSI, DEMA, NFPA, NEMA, IEEE, NEC, State of Arkansas Regulations, ASME
Control Room Emergency Air Conditioning Unit Except the Condensing Coils Which are ASME Code	AMCA, ANSI, ASTM, ASHRAE, NEMA, IEEE, State of Arkansas Regulations

ARKANSAS NUCLEAR ONE
Unit 2

Table 3.9-5

**COMPARISON OF STRUCTURAL AND HYDRAULIC DESIGN
PARAMETERS FOR REACTOR INTERNALS**

Structural Parameters			Fort Calhoun	Maine Yankee	ANO-2
Upper CSB	R _{mean} ,	in.	61-5/16	75-1/4	69
	t,	in.	2	2-1/2	3
	L,	in.	101-3/8	135-5/8	148-3/4
Middle CSB	R _{mean} ,	in.	61-1/16	74-7/8	68-1/4
	t,	in.	1-1/2	1-3/4	2-1/2
	L,	in.	166-1/8	144-3/4	138-3/4
Lower CSB	R _{mean} ,	in.	60-11/16	74-5/8	68-1/4
	t,	in.	2-1/4	2-1/4	2-1/2
	L,	in.	35-5/8	38	65-1/2
Lower Core Support Structure	Cyl. ID,	in.	Integral	141	128
	Cyl. OD,	in.	Integral	145	132
	Cyl. L,	in.	Integral	42	37-5/8
	Supported		Integral	CSB Flange	CSB Flange
Core Shroud Support		Bolted to CSB	Core Support Plate	Core Support Plate	
Cyl.	R _{mean} ,	in.	59-1/6	72-5/8	65-3/4
	T,	in.	1-1/2	2	2-1/2
	L,	in.	24	24	43-3/8
Beams, Plate		in.	24 x 1-1/2	24 x 1-1/2	24 x 2
Thermal Shield	t,	in.	3-1/4	4	3-1/2
			Yes	Yes	No
Hydraulic Parameters			Fort Calhoun	Maine Yankee	ANO-2
No. of Loops			2	3	2
Design Min. Flow, 10 ⁶ lbm/hr			71.7	122	120.4
Inlet Design Temp., °F			547	546	553.2
Inlet Pipe ID, in.			24	33.5	30
Outlet Pipe ID, in.			32	33.5	42
Inlet Pipe Vel., ft/sec.			33.7	39.0	36.5
Structural Parameters			Fort Calhoun	Maine Yankee	ANO-2
Downcomer Vel., ft/sec.			25.2	24.9	23.6
Core Inlet Vel., ft/sec.			12.8	13.3	16.4
Outlet Pipe Vel., ft/sec.			41.5	39.0	41.5
Pump Rotational Speed, rpm			1200	1200	900

CSB = Core Support Barrel

UGS = Upper Guide Structure

Vel. = Design Minimum Velocity

ARKANSAS NUCLEAR ONE
Unit 2

Table 3.9-6

ACTIVE CATEGORY 1 REACTOR COOLANT PRESSURE BOUNDARY VALVES (MOVs)

<u>Valve Number*</u>	<u>System</u>	<u>Service</u>	<u>Size</u>	<u>Purchaser</u>	<u>NUC Class</u>	<u>System Design Rating</u>	<u>Normal Operating Conditions</u>	<u>Motor Operator Type</u>	<u>Valve Manufacturer</u>
2CV-4820-2	CVCS	Letdown Isolation	2"	Bechtel	1	2500 psig 650 °F	2195 psig 551 °F	Limiterque SMB-00-10	Borg Warner
2CV-4821-1	CVCS	Letdown Isolation	2"	Bechtel	1	2500 psig 650 °F	2195 psig 551 °F	Limiterque SMB-00-10	Borg Warner
2CV-5015-1	Safety Injection	High Pressure Injection Isolation	2"	Entergy	2	2500 psig 650 °F	662 psig 60 °F	Limiterque SMB-000-5	Anchor Darling
2CV-5016-2	Safety Injection	High Pressure Injection Isolation	2"	Entergy	2	2500 psig 650 °F	662 psig 60 °F	Limiterque SMB-000-5	Anchor Darling
2CV-5035-1	Safety Injection	High Pressure Injection Isolation	2"	Entergy	2	2500 psig 650 °F	662 psig 60 °F	Limiterque SMB-000-5	Anchor Darling
2CV-5036-2	Safety Injection	High Pressure Injection Isolation	2"	Entergy	2	2500 psig 650 °F	662 psig 60 °F	Limiterque SMB-000-5	Anchor Darling
2CV-5055-1	Safety Injection	High Pressure Injection Isolation	2"	Entergy	2	2500 psig 650 °F	662 psig 60 °F	Limiterque SMB-000-5	Anchor Darling
2CV-5056-2	Safety Injection	High Pressure Injection Isolation	2"	Entergy	2	2500 psig 650 °F	662 psig 60 °F	Limiterque SMB-000-5	Anchor Darling

ARKANSAS NUCLEAR ONE
Unit 2

Table 3.9-6 (continued)

<u>Valve Number*</u>	<u>System</u>	<u>Service</u>	<u>Size</u>	<u>Purchaser</u>	<u>NUC Class</u>	<u>System Design Rating</u>	<u>Normal Operating Conditions</u>	<u>Motor Operator Type</u>	<u>Valve Manufacturer</u>
2CV-5075-1	Safety Injection	High Pressure Injection Isolation	2"	Entergy	2	2500 psig 650 °F	662 psig 60 °F	Limiterque SMB-000-5	Anchor Darling
2CV-5076-2	Safety Injection	High Pressure Injection Isolation	2"	Entergy	2	2500 psig 650 °F	662 psig 60 °F	Limiterque SMB-000-5	Anchor Darling
2CV-5017-1	Safety Injection	Low Pressure Injection Isolation	6"	Entergy	2	2500 psig 300 °F	180 psig 60 °F	Limiterque SMB-2-80	Anchor Darling
2CV-5037-1	Safety Injection	Low Pressure Injection Isolation	6"	Entergy	2	2500 psig 300 °F	180 psig 60 °F	Limiterque SMB-2-80	Anchor Darling
2CV-5057-2	Safety Injection	Low Pressure Injection Isolation	6"	Entergy	2	2500 psig 300 °F	180 psig 60 °F	Limiterque SMB-2-80	Anchor Darling
2CV-5077-2	Safety Injection	Low Pressure Injection Isolation	6"	Entergy	2	2500 psig 300 °F	180 psig 60 °F	Limiterque SMB-2-80	Anchor Darling

* Each valve is a Seismic Category I globe valve which receives an ES signal (HPSI to SDC suction valves are excluded).

ARKANSAS NUCLEAR ONE
Unit 2

Table 3.9-7

**LOADING COMBINATIONS AND STRESS LIMITS FOR ASME CODE
CLASS 2 AND 3 VESSELS AND ACTIVE & INACTIVE PUMPS**

Class 2 or 3 Vessels

<u>Plant Operating Conditions</u>	<u>Loading Combination</u>	<u>STRESS LIMITS</u>	
		<u>Pressure Boundary</u>	<u>Supports</u>
Design	Design	S	-
<u>NSSS Supplied Vessels</u>			
Faulted ⁽⁵⁾	Normal and DBE	$P_m \leq 1.5 S_m$ $P_B + (P_m \text{ or } P_L) \leq 3 S_m$	AISC allowables with no increase permitted for seismic
<u>A/E Supplied Vessels</u>			
Faulted ⁽⁵⁾		(a) NaOH Tank (2T10) -Par. 46-23, ASME, Sect. VIII, Division 1 allowables (b) RWT (2T3)-.90 Yield (Analysis per TID-7024)	- AISC allowables with no increase permitted for seismic

Class 2 & 3 Pumps Designed to Draft Pump & Valve Code

<u>Plant Operating Conditions</u>	<u>Loading Combination</u>	<u>STRESS LIMITS</u>	
		<u>Pressure Boundary</u>	<u>Supports</u>
Design	Design	(1)	-
Faulted ⁽⁵⁾	Normal and DBE	(1)	AISC allowables with no increase permitted for seismic

ARKANSAS NUCLEAR ONE
Unit 2

Table 3.9-7 (continued)

Plant Operating Conditions	Loading Combination	STRESS LIMITS	
		Pressure Boundary	Supports
Design	Design	S	-
Faulted ⁽⁵⁾	Normal and DBE	.90 yield	AISC allowables with no increase permitted for seismic

where

- S = Code allowable stress
- S_m = Code allowable stress intensity
- S_{yield} = Yield strength of material
- P_m = Primary membrane stress
- P_B = Primary bending stress
- P_L = Local membrane stress

NOTES:

1. These pumps meet applicable requirements of the draft ASME Code for Pumps & Valves for Nuclear Power. Design limits were those which the manufacturer demonstrated to be satisfactory for the specific design condition.
2. The same stress limits were considered for normal, upset, emergency and faulted operating conditions. Therefore, since the faulted condition is limiting it was the only condition analyzed.
3. The manufacturer of active pumps was required to demonstrate, by analyses or tests, the operability of the pump under imposed loading.
4. Refer to Table 3.2-3 for listing of equipment with applicable quality group classification and design codes.
5. Faulted conditions apply to those components listed in Seismic Category 1 in Table 3.2-2.

ARKANSAS NUCLEAR ONE
Unit 2

Table 3.11-1

**POST LOCA ENVIRONMENTAL CONDITIONS SPECIFIED FOR
PROCUREMENT OF EQUIPMENT
(HISTORICAL)**

Environmental Design Category	Time	Temp	Pressure	Humidity (Note 1)(Note 2)	Radiation
I-A	0-10 sec	230 °F	25 psig	100%	4.2(+6)R/HR
	10 sec-2 min	289 °F	48 psig	100%	4.0(+6)R/HR
	2-10 min	260 °F	35 psig	100%	3.0(+6)R/HR
	10 min-1 hr	180 °F	10 psig	100%	1.2(+6)R/HR
	1-4 hr	210 °F	16 psig	100%	5.0(+5)R/HR
I-B	4-24 hr	180 °F	10 psig	100%	0.87(+5)R/HR
	1-31 day	100 °F	5 psig	100%	1.0(+4)R/HR
I-C	Continuous	110 °F	Atmos	90%	28.5 R/HR
I-D	Continuous	104 °F	Atmos	50%	Negligible
I-E	Shutdown Heat Exchanger Rms	140 °F			(Note 3)
	Emergency Feed Water Pump Rms	135 °F			(Note 3)
	Switchgear Areas	110 °F			
	High Pressure Safety Injection Pump Room	140 °F			(Note 3)
	Electrical Equipment Rm	120 °F			

- (1) In the event of a reactor coolant pipe rupture inside the containment, the atmosphere will be a mixture of steam and air. Upon initiation of the CSAS the containment spray will consist of a solution of boric acid and sodium hydroxide with a nominal pH of 10.5 (at 77 °F).
- (2) Radiation resistant requirement of 3.3E+7 rads based on the dose calculated for plant operation of 40 years plus a LOCA at the end of 40 years.
- (3) Radiation resistant requirement of 1.0E+7 rads based on footnote (2).

ARKANSAS NUCLEAR ONE
Unit 2

Table 3.11-2

**ENVIRONMENTAL QUALIFICATION REQUIREMENTS SPECIFIED FOR PROCUREMENT
OF CE SUPPLIED CLASS 1E PROCESS INSTRUMENTATION
(HISTORICAL)**

Environmental Design Category I-A and I-B, Containment Following LOCA or MSLB

	<u>Ambient</u>	<u>Worst Case</u>	<u>Duration</u>
Temperature	60-110 °F	300 °F 250 °F 200 °F	10 mins. 1 hour 20 hours
Pressure	Atmospheric	54 psig	3 hours
Humidity	20-70% RH	100% RH	Continuous
Radiation	28.5 RAD/HR	3.3 x 10 ⁷ RADS	40 year Integrated Dose

Chemical Spray: This equipment must be capable of withstanding a chemical spray deluge during the initial two hours of the worst case temperature, pressure, and humidity specified herein. The chemical spray shall consist of the following:

0.1% Sodium Hydroxide by weight
1.0% Sodium Thiosulfate by weight
Boric Acid - 15,000 ppm
pH - 10.5 at 77 °F

Environmental Design Category I-C, Containment

Temperature	60-110 °F	--	--
Pressure	Atmospheric	--	--
Humidity	20-70% RH	90% RH	Continuous
Radiation	28.5 RAD/HR	1.0 x 10 ⁷ RADS	40 year Integrated Dose

Environmental Design Category I-D, Control Room

Temperature	75 ± 10 °F	40 - 104 °F	Continuous
Pressure	Atmospheric	--	--
Humidity	50±10% RH	20-90% RH	Continuous
Radiation	Negligible - 1 mrad/hr.	--	--

ARKANSAS NUCLEAR ONE
Unit 2

Table 3.11-3

**MOTOR OPERATED VALVES
SUBMERGED FOLLOWING A LOCA**

<u>Valve No.</u>	<u>Valve Description</u>	<u>Normal Position</u>
2CV-2060-1	RB Sump to AB Sump Isolation	Closed
2CV-2202-1	Reactor Drain Pumps Suction Isolation	Closed
2CV-5647-1*	Containment Sump Recirc to ESF	Locked Open
2CV-5648-2*	Containment Sump Recirc to ESF	Locked Open
2CV-4821-1	CVCS Letdown	Open
2CV-4820-2	CVCS Letdown	Open

* These valves are part of the Emergency Core Cooling System (ECCS).

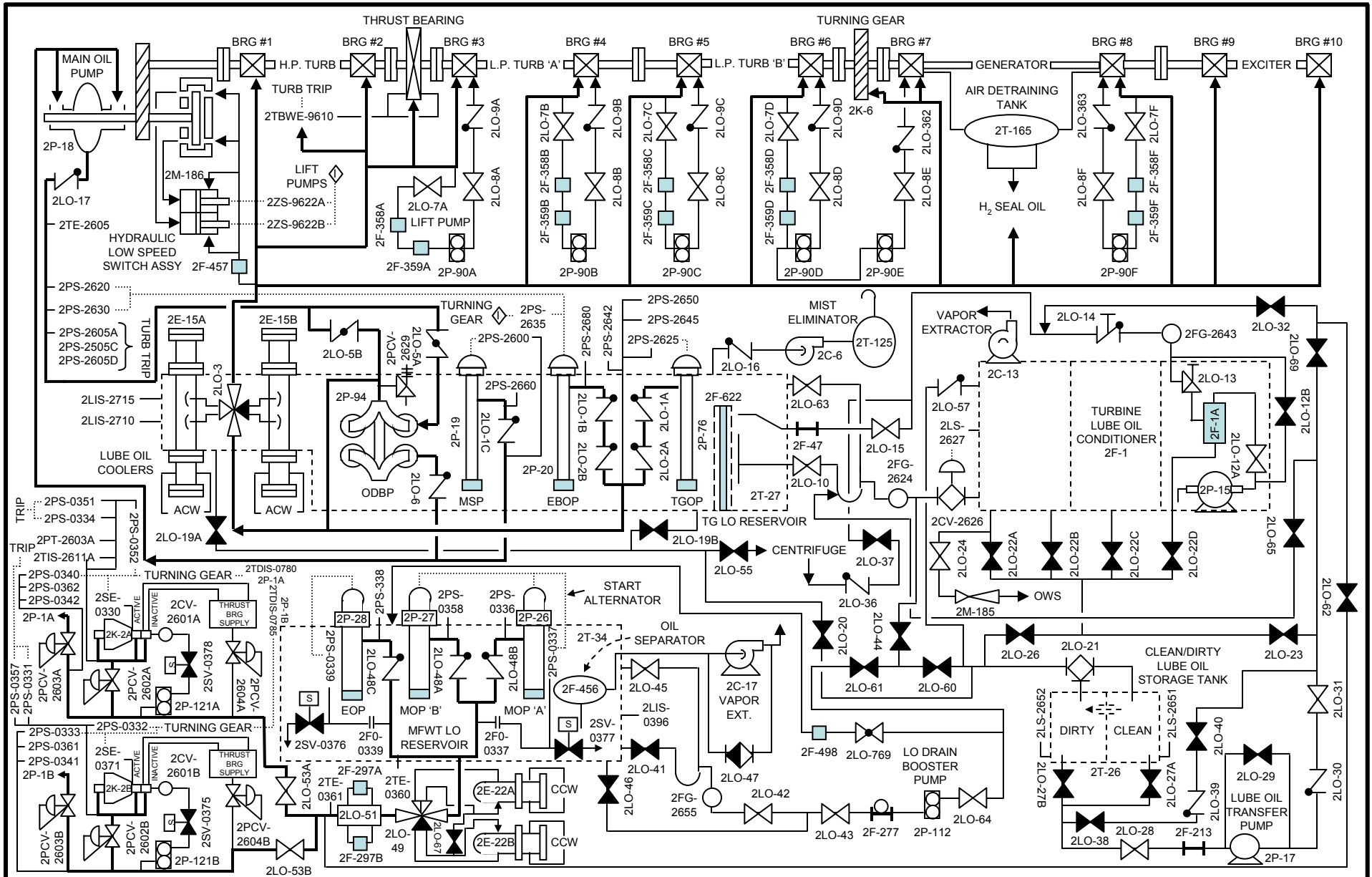

MAIN TURBINE-GENERATOR AND MAIN FEEDWATER PUMP TURBINE LUBE OIL

SAR FIGURE NO. 3.2-1

ARKANSAS NUCLEAR ONE
 UNIT 2
 RUSSELLVILLE, ARKANSAS



SCALE: NONE
 DRAWN: ENERGY
 DESIGN: ENERGY
 CAD NO: NONE

AMENDMENT 20

BASED ON DRAWING NO

SHEET

REV.

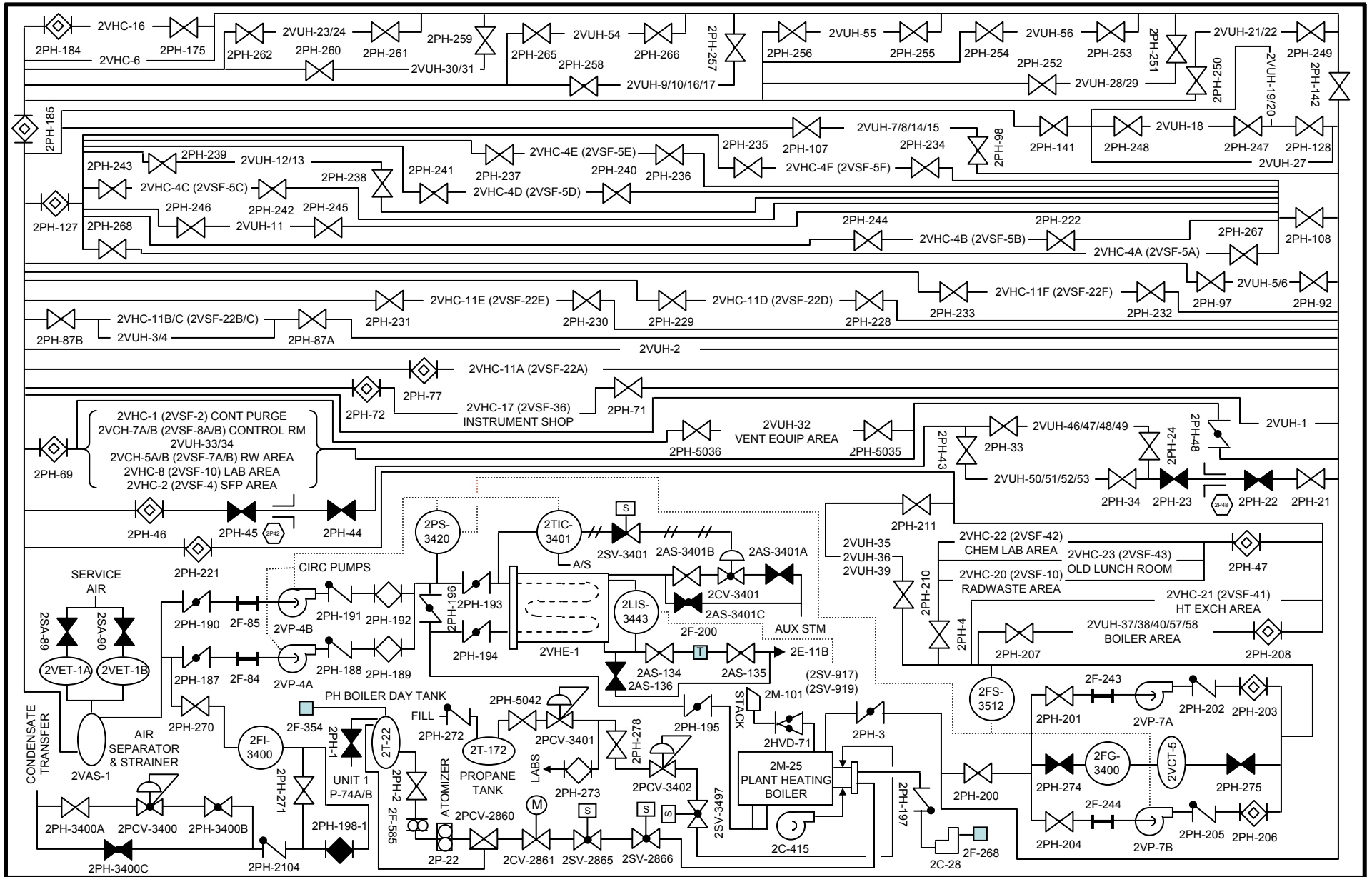

PLANT HEATING SYSTEM

SAR FIGURE NO. 3.2-2

ARKANSAS NUCLEAR ONE
 UNIT 2
 RUSSELLVILLE, ARKANSAS



SCALE:	NONE
DRAWN:	ENERGY
DESIGN:	ENERGY
CAD NO:	NONE

AMENDMENT 20

BASED ON DRAWING NO	SHEET	REV.

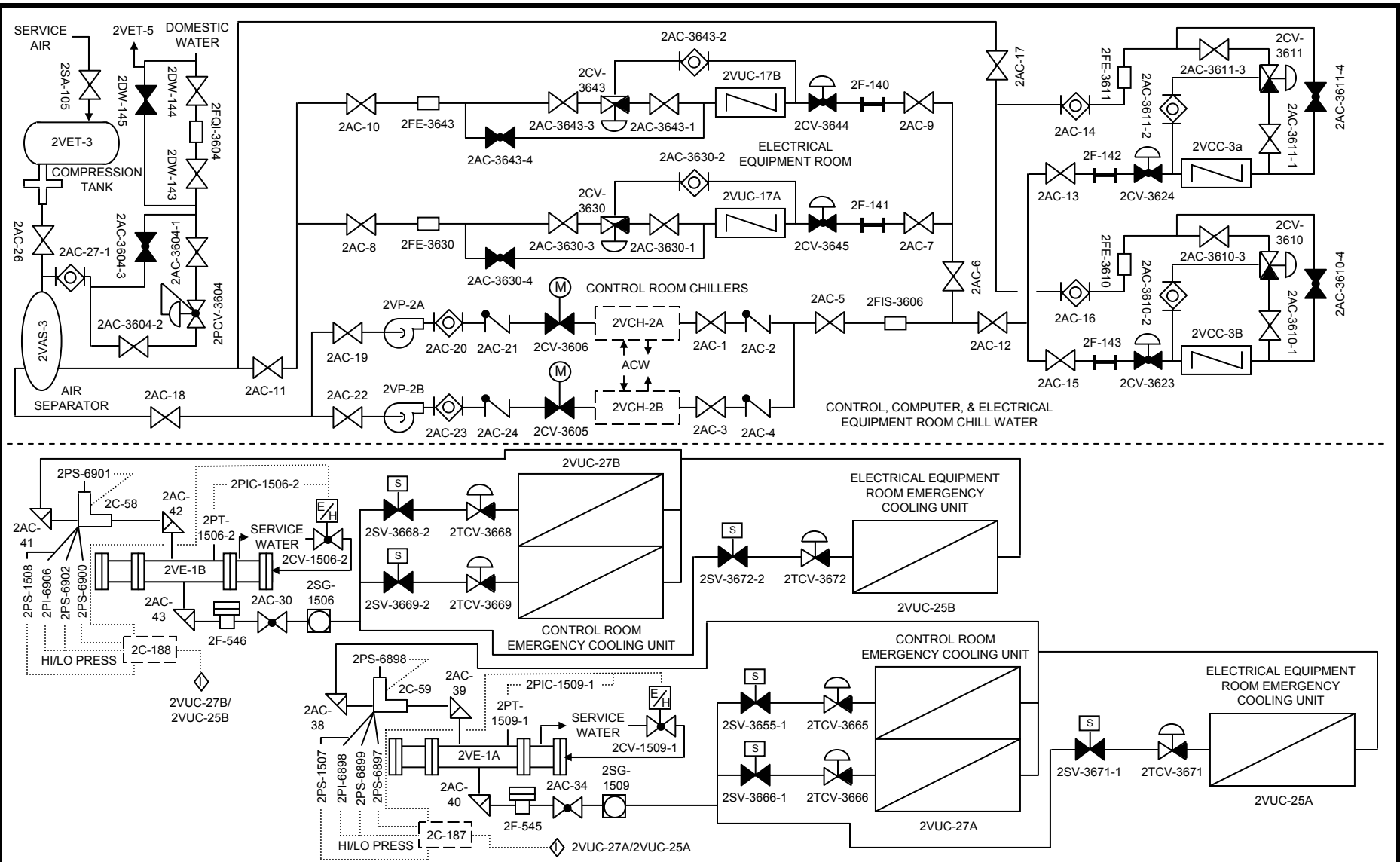

CONTROL, COMPUTER, & ELECTRICAL EQUIPMENT ROOM CHILL WATER AND CONTROL & COMPUTER ROOM EMERGENCY HVAC FREON SYSTEM

SAR FIGURE NO. 3.2-3

ARKANSAS NUCLEAR ONE
UNIT 2
RUSSELLVILLE, ARKANSAS



SCALE: NONE
DRAWN: ENTERGY
DESIGN: ENTERGY
CAD NO:

AMENDMENT 20

BASED ON DRAWING NO

SHEET

REV.

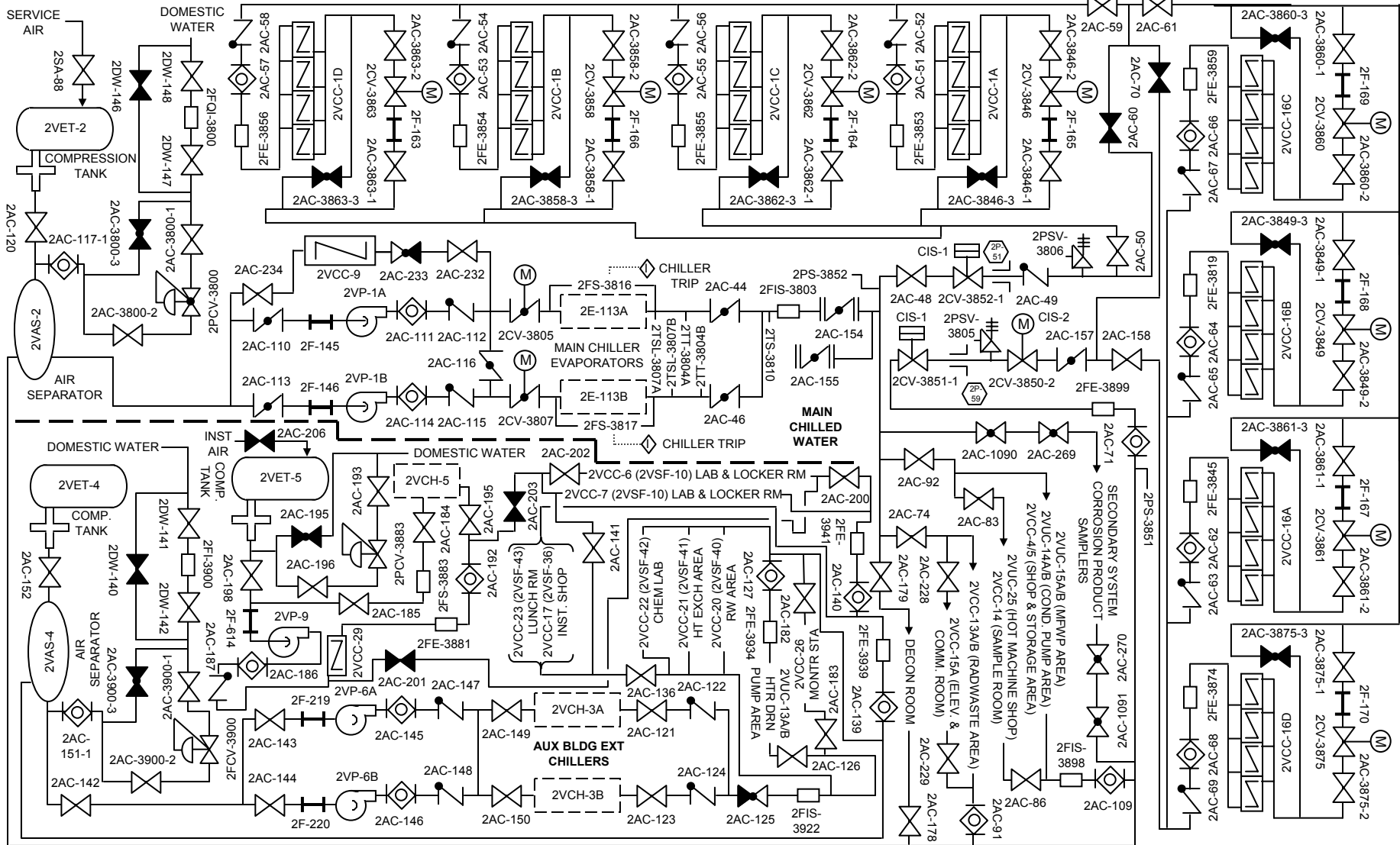

CONTAINMENT, TURBINE, AUXILIARY, AUXILIARY EXTENSION BUILDINGS AND CONTROLLED ACCESS CHILLED WATER SYSTEMS

SAR FIGURE NO. 3.2-4

ARKANSAS NUCLEAR ONE
UNIT 2
RUSSELLVILLE, ARKANSAS



SCALE:	NONE
DRAWN:	ENERGY
DESIGN:	ENERGY
CAD NO:	

AMENDMENT 20

BASED ON DRAWING NO	SHEET	REV.
---------------------	-------	------

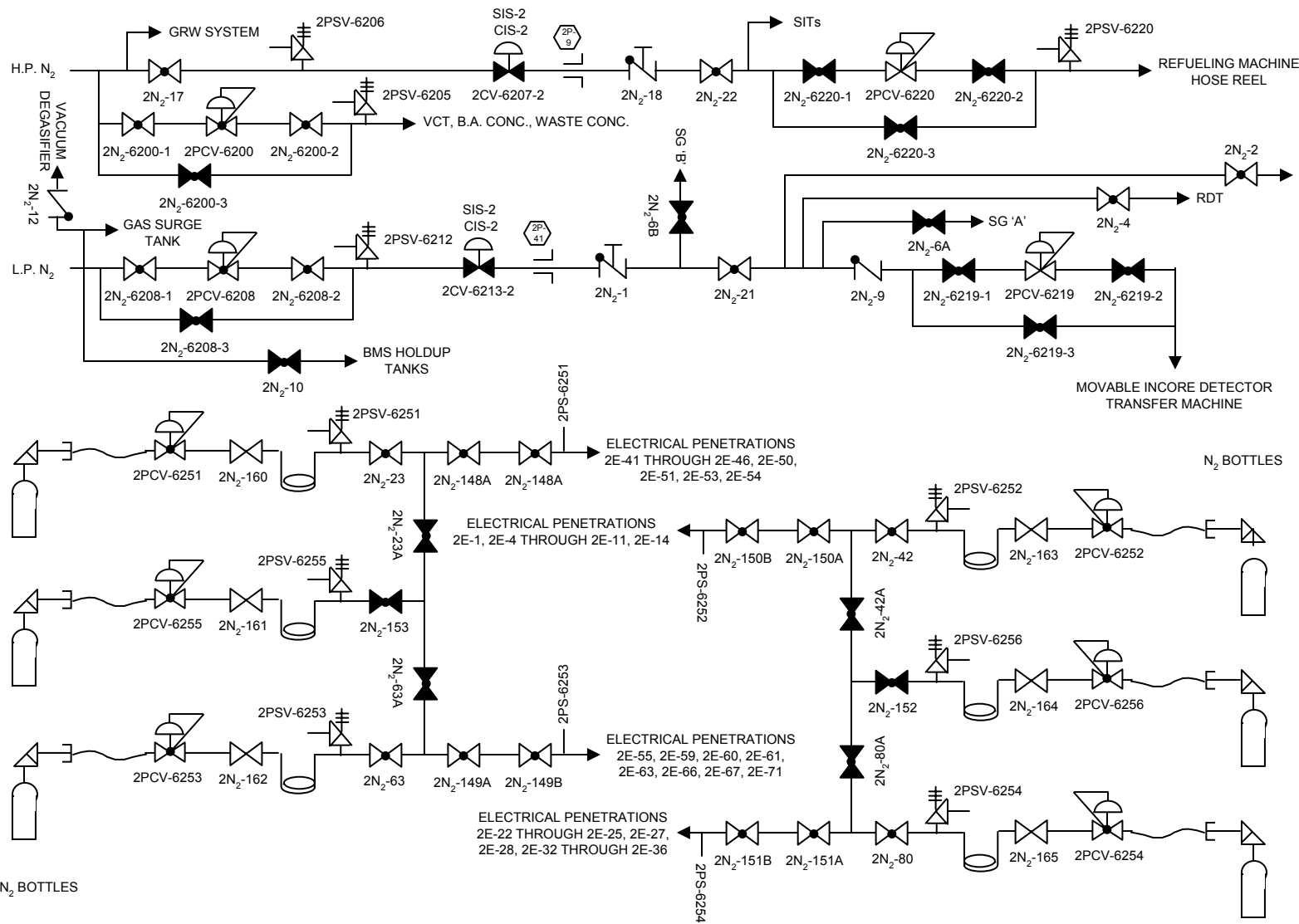

PEN #	WIRE RUN
UPPER SOUTH	
2E-1	2WR-26-1
2E-4	2WR-42-1
2E-5	2WR-43-3
2E-6	2WR-25-1
2E-7	2WR-25-3
2E-8	2WR-25-5
2E-9	2WR-27-1
2E-10	2WR-40-1
2E-11	2WR-41-1
2E-14	2WR-25-7
LOWER SOUTH	
2E-22	2WR-23-1
2E-23	2WR-24-1
2E-24	2WR-23-2
2E-25	2WR-26-3
2E-27	2WR-21-1
2E-28	2WR-28-1
2E-32	2WR-21-3
2E-33	2WR-42-3
2E-34	2WR-43-1
2E-35	2WR-43-5
2E-36	2WR-21-3
UPPER NORTH	
2E-41	2WR-25-2
2E-42	2WR-43-2
2E-43	2WR-42-2
2E-44	2WR-41-2
2E-45	2WR-26-2
2E-50	2WR-25-6
2E-51	2WR-25-4
2E-53	2WR-40-2
2E-54	2WR-27-2
LOWER NORTH	
2E-55	2WR-21-4
2E-59	2WR-22-2
2E-60	2WR-22-1
2E-61	2WR-26-4
2E-63	2WR-21-2
2E-66	2WR-43-4
2E-67	2WR-42-4
2E-71	2WR-27-4

NITROGEN ADDITION SYSTEM AND ELECTRICAL PENETRATION
NITROGEN PRESSURIZATION SYSTEM

SAR FIGURE NO. 3.2-5

ARKANSAS NUCLEAR ONE
UNIT 2
RUSSELLVILLE, ARKANSAS



SCALE: NONE
DRAWN: ENTERGY
DESIGN: ENTERGY
CAD NO:

AMENDMENT 20

BASED ON DRAWING NO	SHEET	REV.
---------------------	-------	------

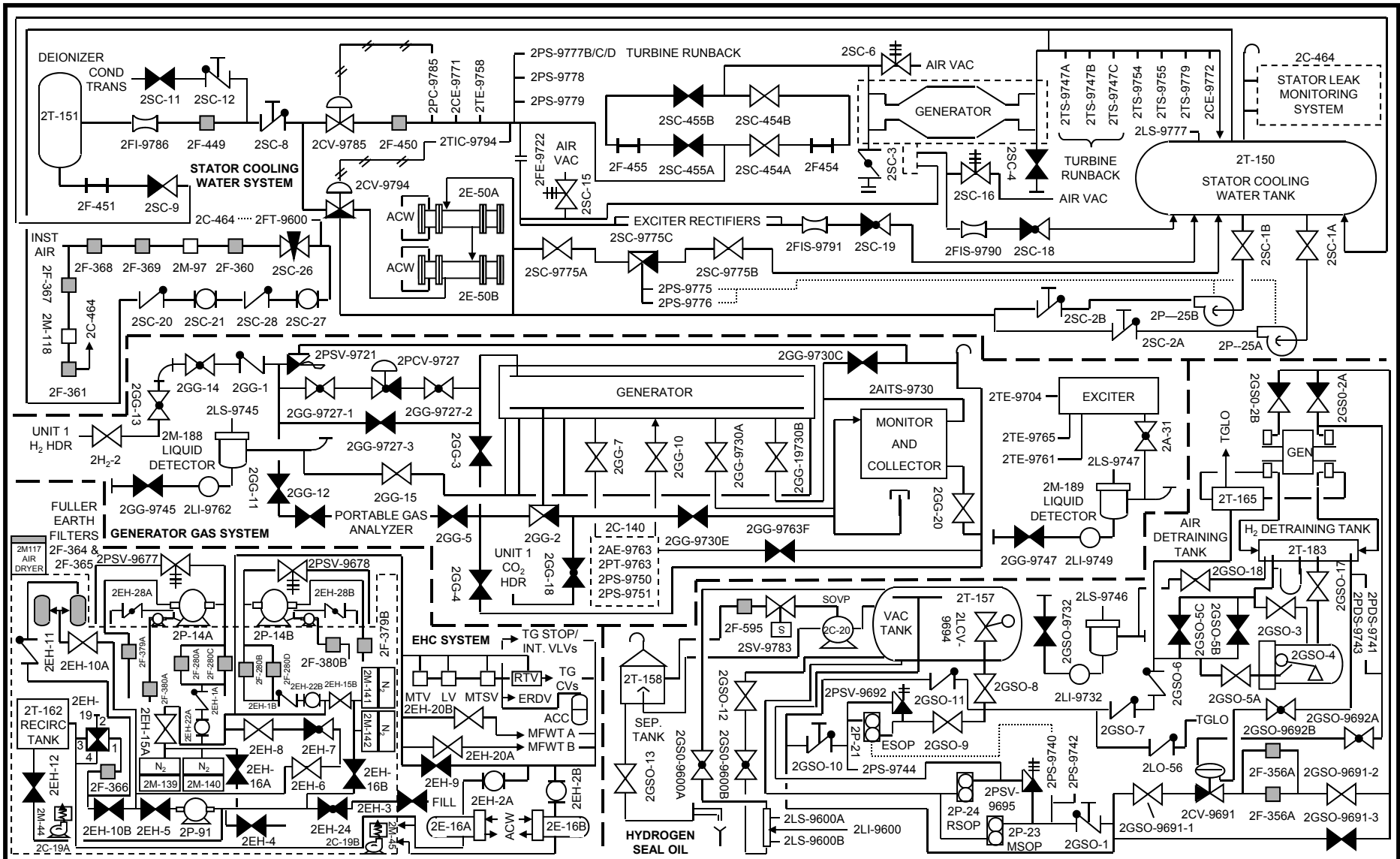

TURBINE - GENERATOR AUXILIARY SYSTEMS

SAR FIGURE NO. 3.2-6

ARKANSAS NUCLEAR ONE
 UNIT 2
 RUSSELLVILLE, ARKANSAS



SCALE: NONE
 DRAWN: ENTERGY
 DESIGN: ENTERGY
 CAD NO:

AMENDMENT 28

BASED ON DRAWING NO

SHEET

REV.

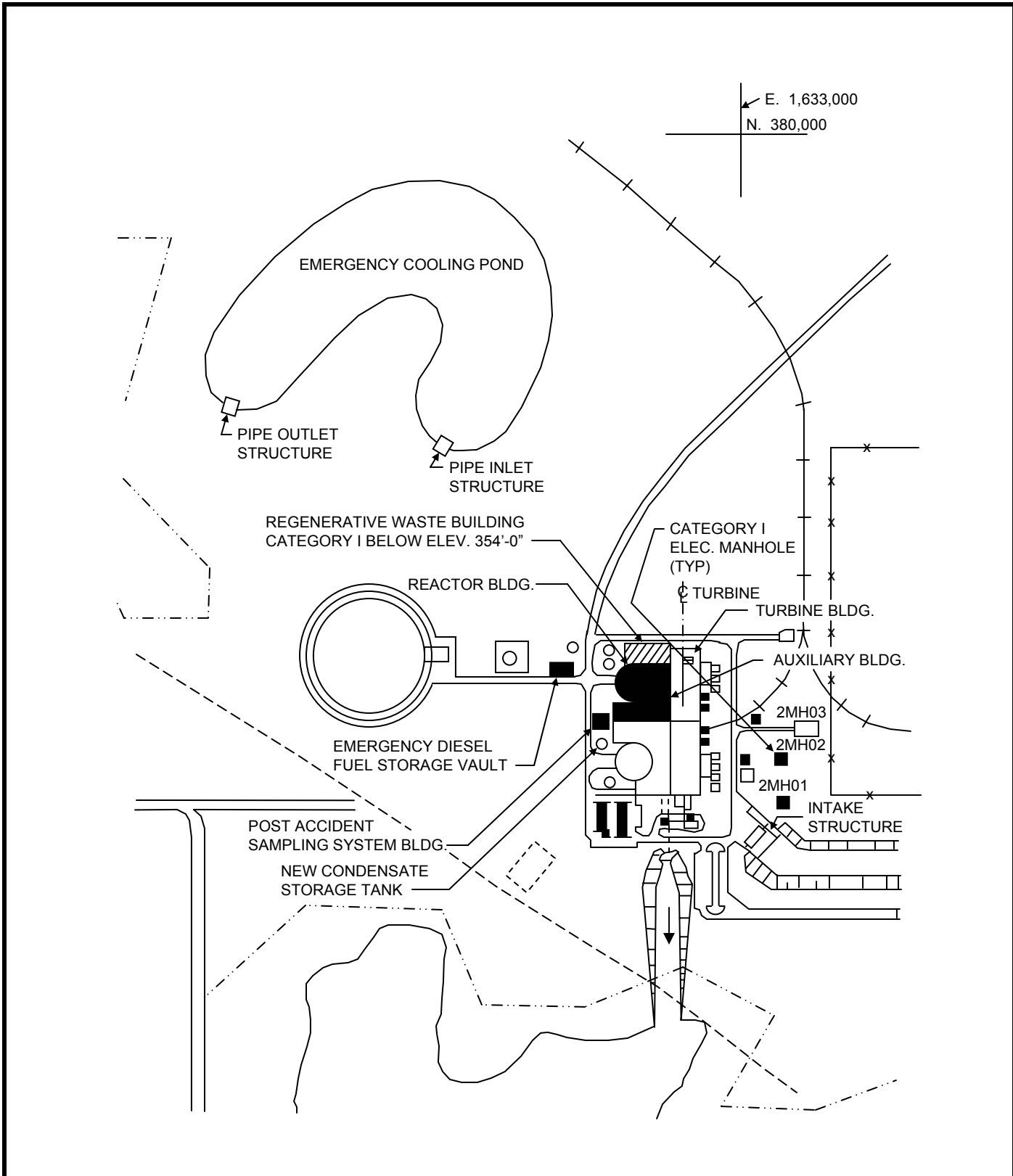

SAR FIGURE NO. 3.5-1

AMENDMENT 20

<p>ARKANSAS NUCLEAR ONE UNIT 2 RUSSELLVILLE, ARKANSAS</p>		<p>SCALE: NONE DRAWN: ENTERGY DESIGN: ENTERGY CAD NO: N/A</p>				
<p>RELATIVE POSITION OF CATEGORY 1 STRUCTURES TO TURBINE CENTERLINE</p>	<p>DRAWING NO</p>	<table border="1"> <tr> <td>SHEET</td> <td>REV.</td> </tr> <tr> <td> </td> <td> </td> </tr> </table>	SHEET	REV.		
SHEET	REV.					

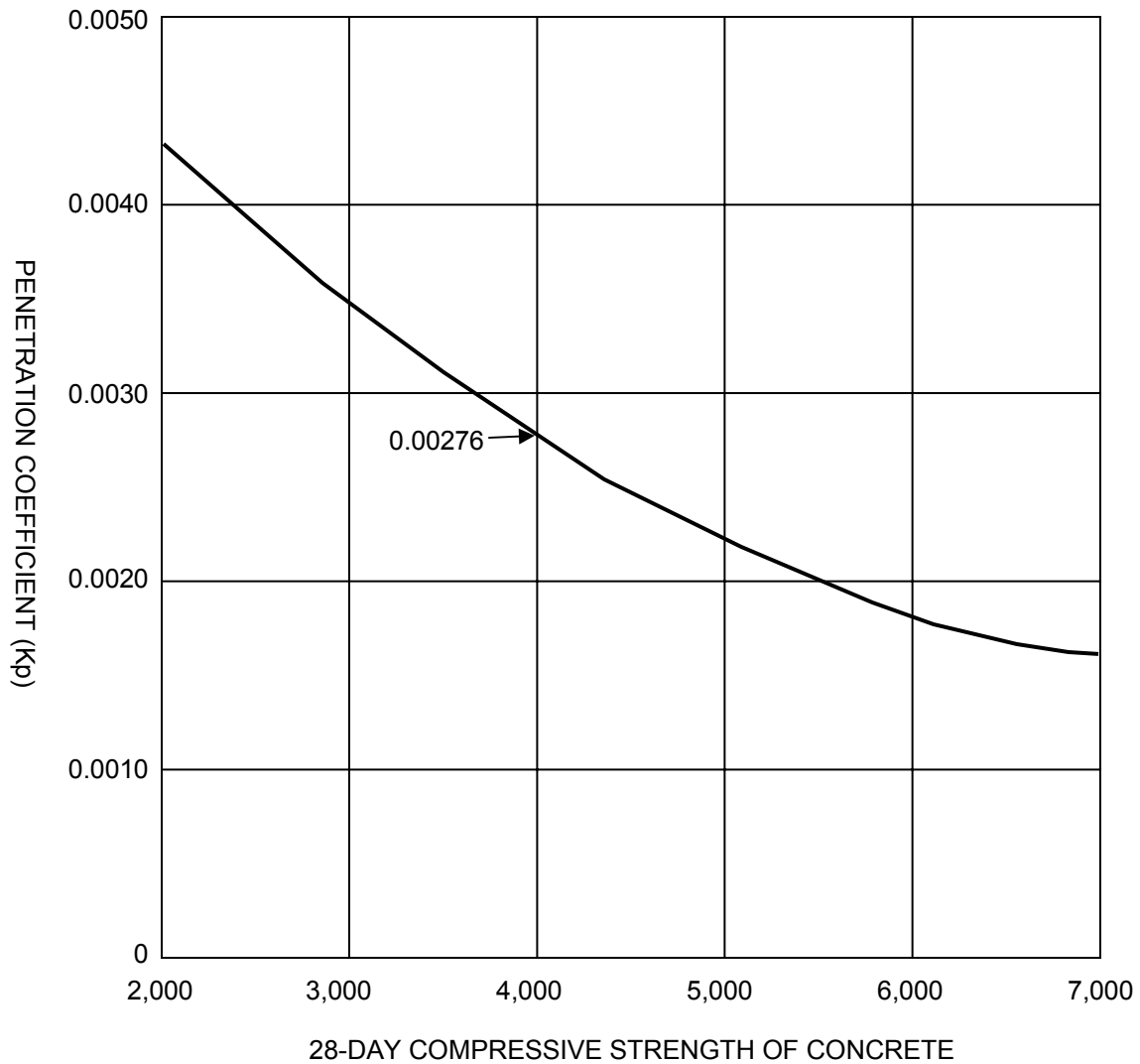

SAR FIGURE NO. 3.5-2

AMENDMENT 20

ARKANSAS NUCLEAR ONE
UNIT 2
RUSSELLVILLE, ARKANSAS



SCALE:	NONE
DRAWN:	ENERGY
DESIGN:	ENERGY
CAD NO:	N/A

VALUES OF PENETRATION COEFFICIENTS
(K_p) FOR REINFORCED CONCRETE

DRAWING NO

SHEET

REV.

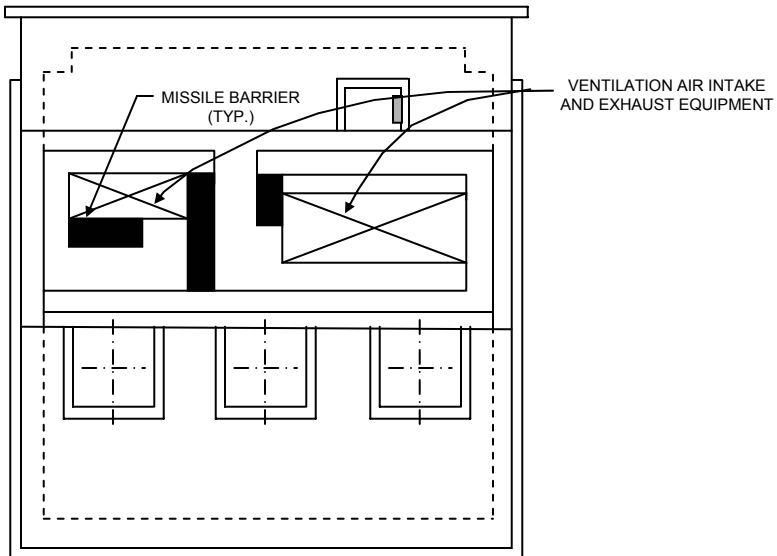

INTAKE STRUCTURE
PLAN AT ELEV. 378'-0"

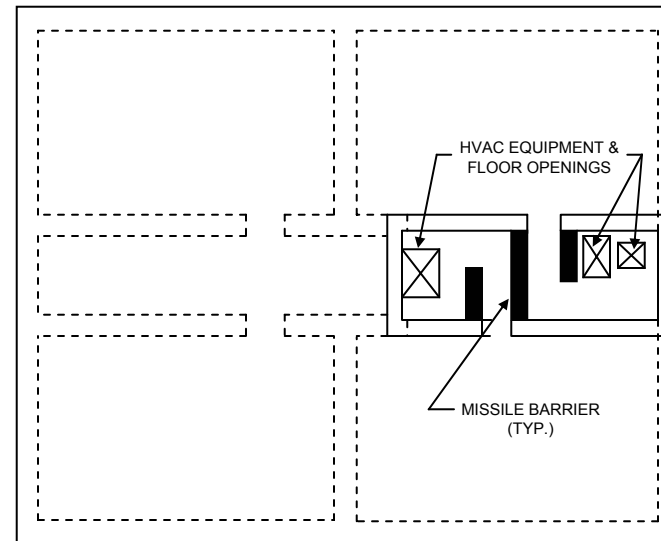

EMERGENCY DIESEL FUEL STORAGE VAULT
PLAN AT ELEV. 370'-2"

STRUCTURES INTENDED PRIMARILY AS MISSILE BARRIERS

SAR FIGURE NO. 3.5-7

ARKANSAS NUCLEAR ONE
UNIT 2
RUSSELLVILLE, ARKANSAS



SCALE: NONE
DRAWN: ENTERGY
DESIGN: ENTERGY
CAD NO:

AMENDMENT 20

BASED ON DRAWING NO

SHEET

REV.

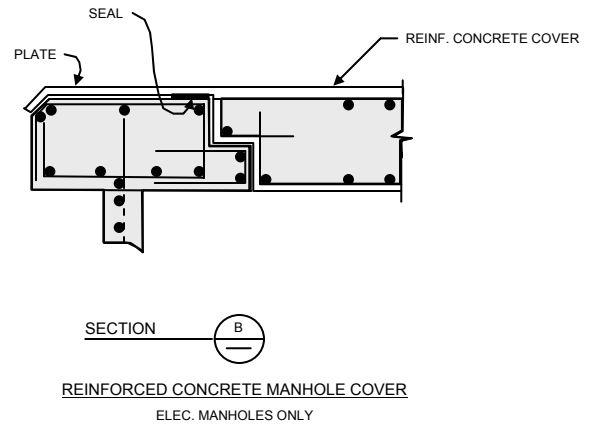
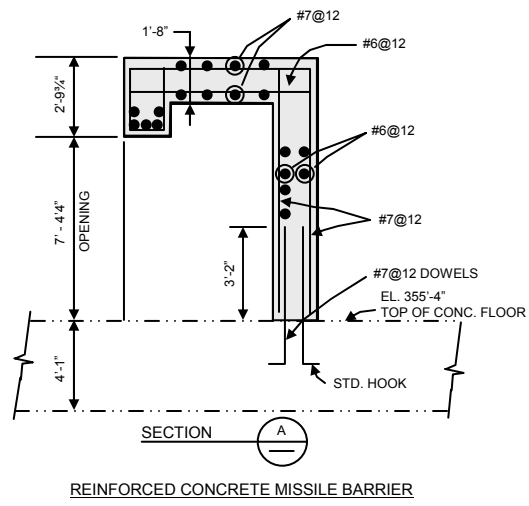
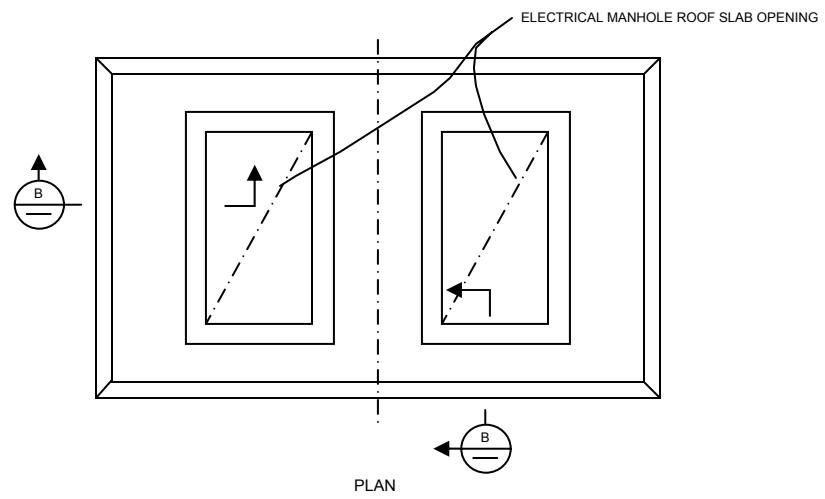
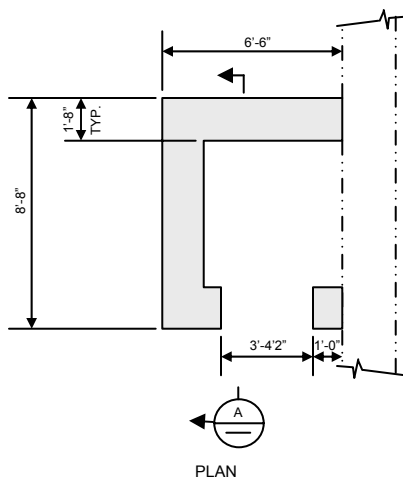

STRUCTURES INTENDED PRIMARILY AS MISSILE BARRIERS –
PRINCIPAL DESIGN FEATURES

SAR FIGURE NO. 3.5-8

ARKANSAS NUCLEAR ONE
UNIT 2
RUSSELLVILLE, ARKANSAS



SCALE:	NONE
DRAWN:	ENERGY
DESIGN:	ENERGY
CAD NO:	

AMENDMENT 20

BASED ON DRAWING NO	SHEET	REV.

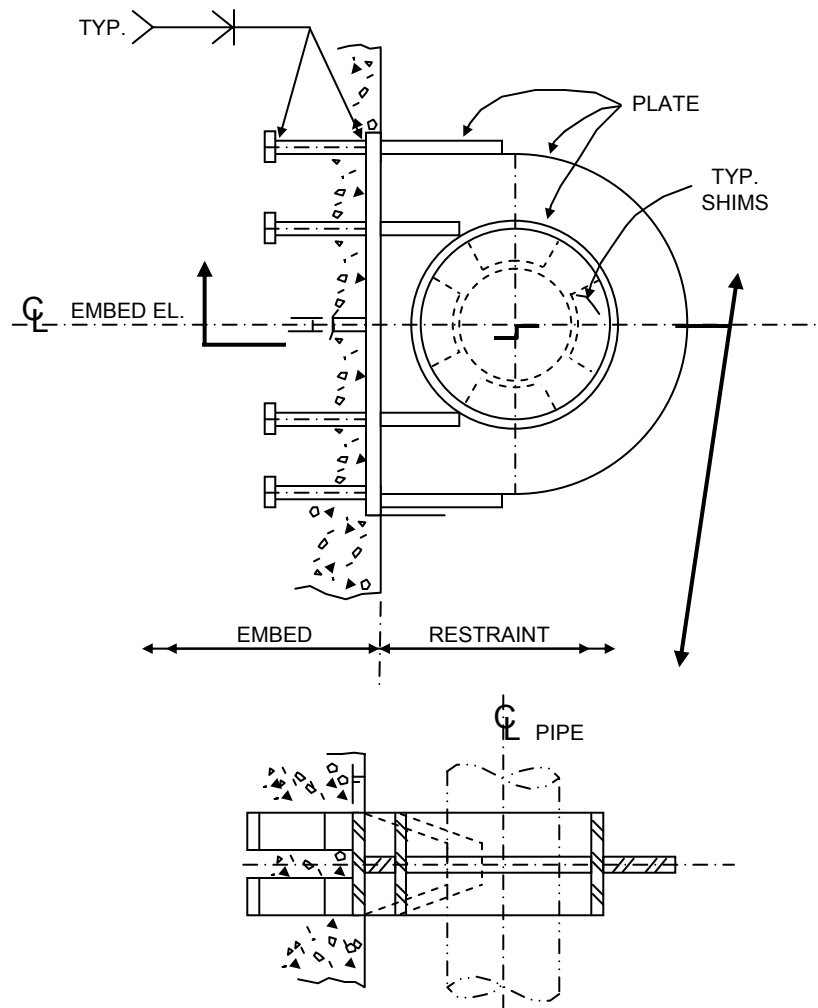
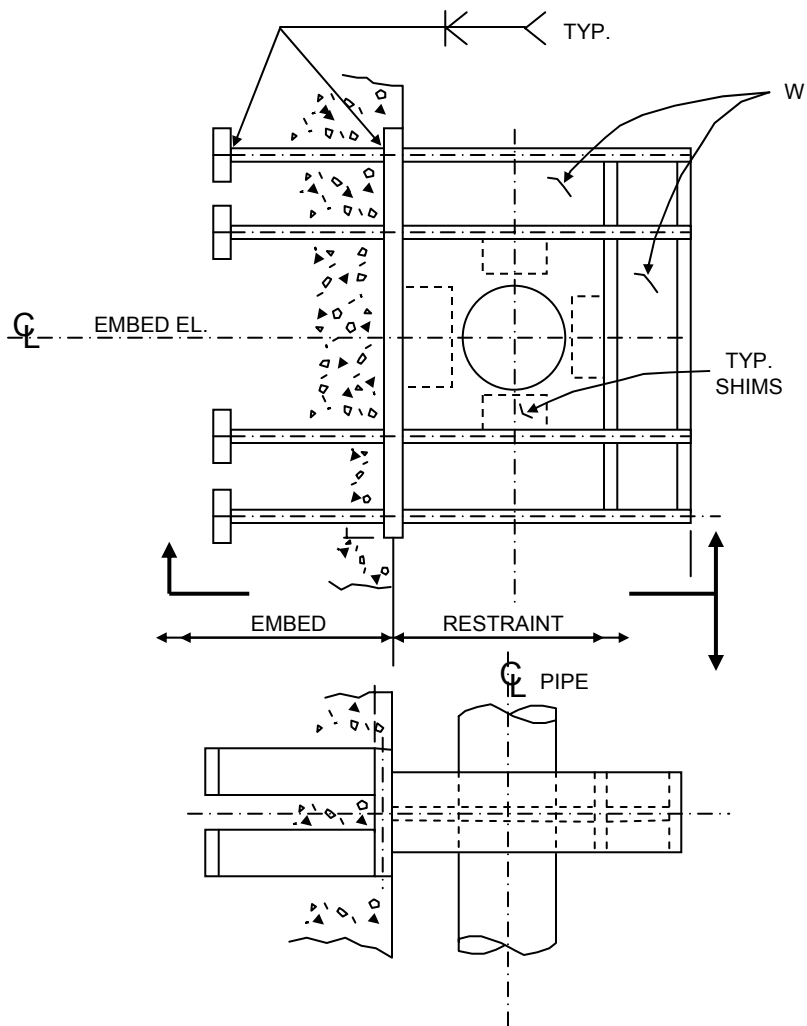

TYPICAL PIPE WHIP RESTRAINTS

SAR FIGURE NO. 3.6-1

ARKANSAS NUCLEAR ONE
UNIT 2
RUSSELLVILLE, ARKANSAS



SCALE: NONE
DRAWN: ENTERGY
DESIGN: ENTERGY
CAD NO:

AMENDMENT 20

BASED ON DRAWING NO

SHEET

REV.

Figure 3.6-2 through Figure 3.6-30 Deleted

SAR FIGURE NO. 3.6-2

AMENDMENT 20

ARKANSAS NUCLEAR ONE
UNIT 2
RUSSELLVILLE, ARKANSAS



SCALE:	NONE
DRAWN:	ENERGY
DESIGN:	ENERGY
CAD NO:	N/A

DRAWING NO

SHEET

REV.

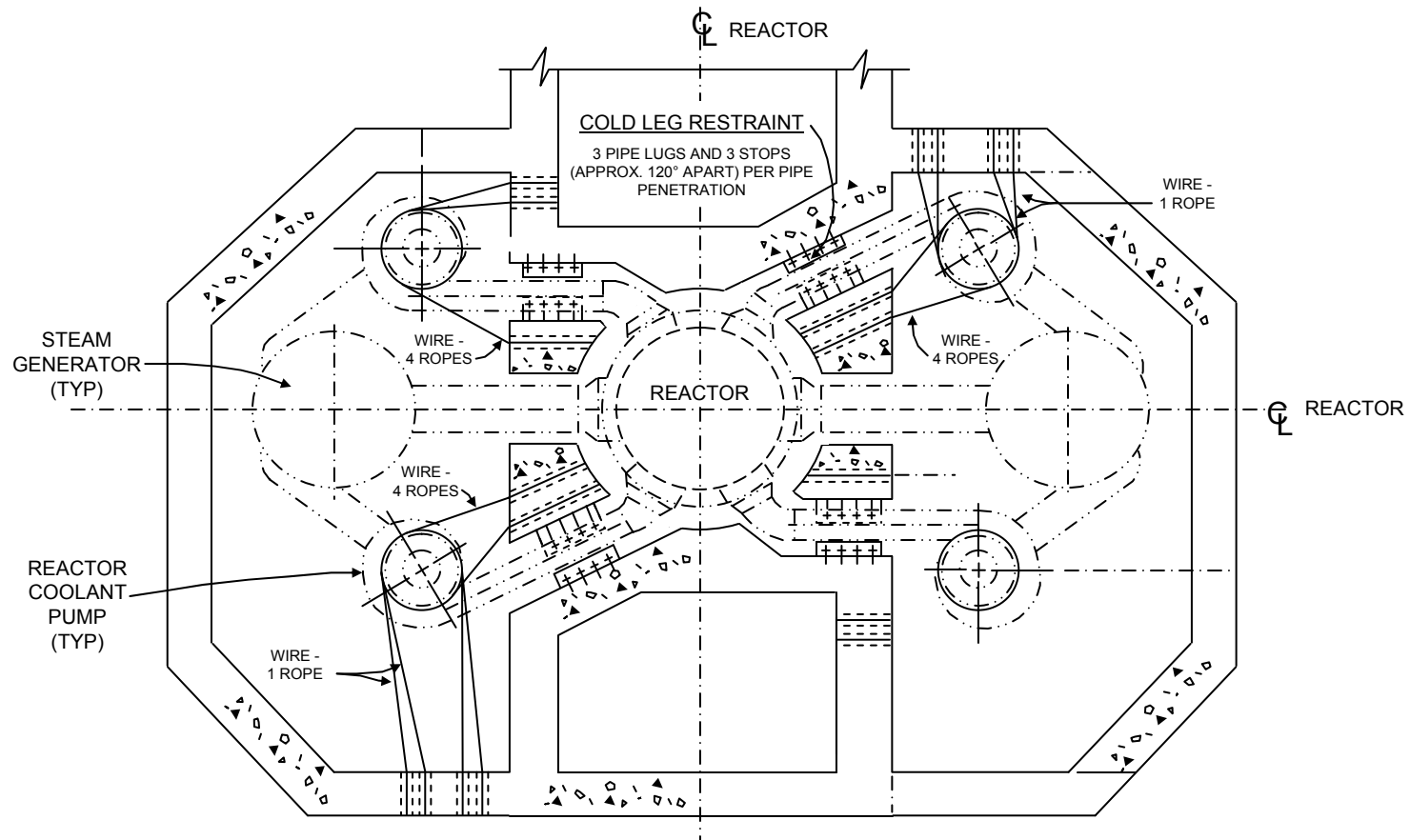

PLAN @ EL. 377' - 6"

REACTOR COOLANT PUMP WIRE-ROPE RESTRAINTS

SAR FIGURE NO. 3.6-31

ARKANSAS NUCLEAR ONE
 UNIT 2
 RUSSELLVILLE, ARKANSAS



SCALE: NONE
 DRAWN: ENTERGY
 DESIGN: ENTERGY
 CAD NO:

AMENDMENT 23

BASED ON DRAWING NO	SHEET	REV.
---------------------	-------	------

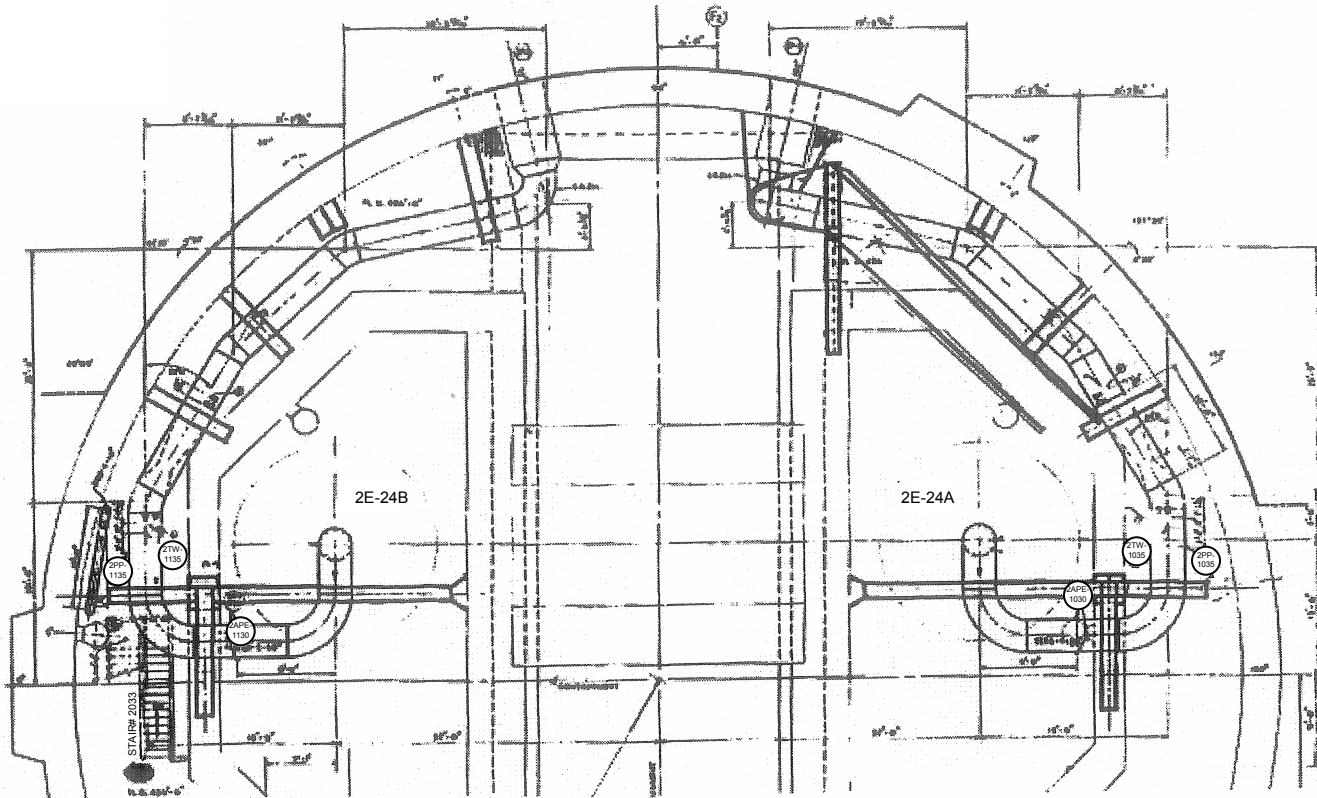

MAIN STEAM LINE RESTRAINTS INSIDE CONTAINMENT

SAR FIGURE NO. 3.6-32

ARKANSAS NUCLEAR ONE
 UNIT 2
 RUSSELLVILLE, ARKANSAS



SCALE: NONE
 DRAWN: ENTERGY
 DESIGN: ENTERGY
 CAD NO:

AMENDMENT 20

BASED ON DRAWING NO

SHEET

REV.

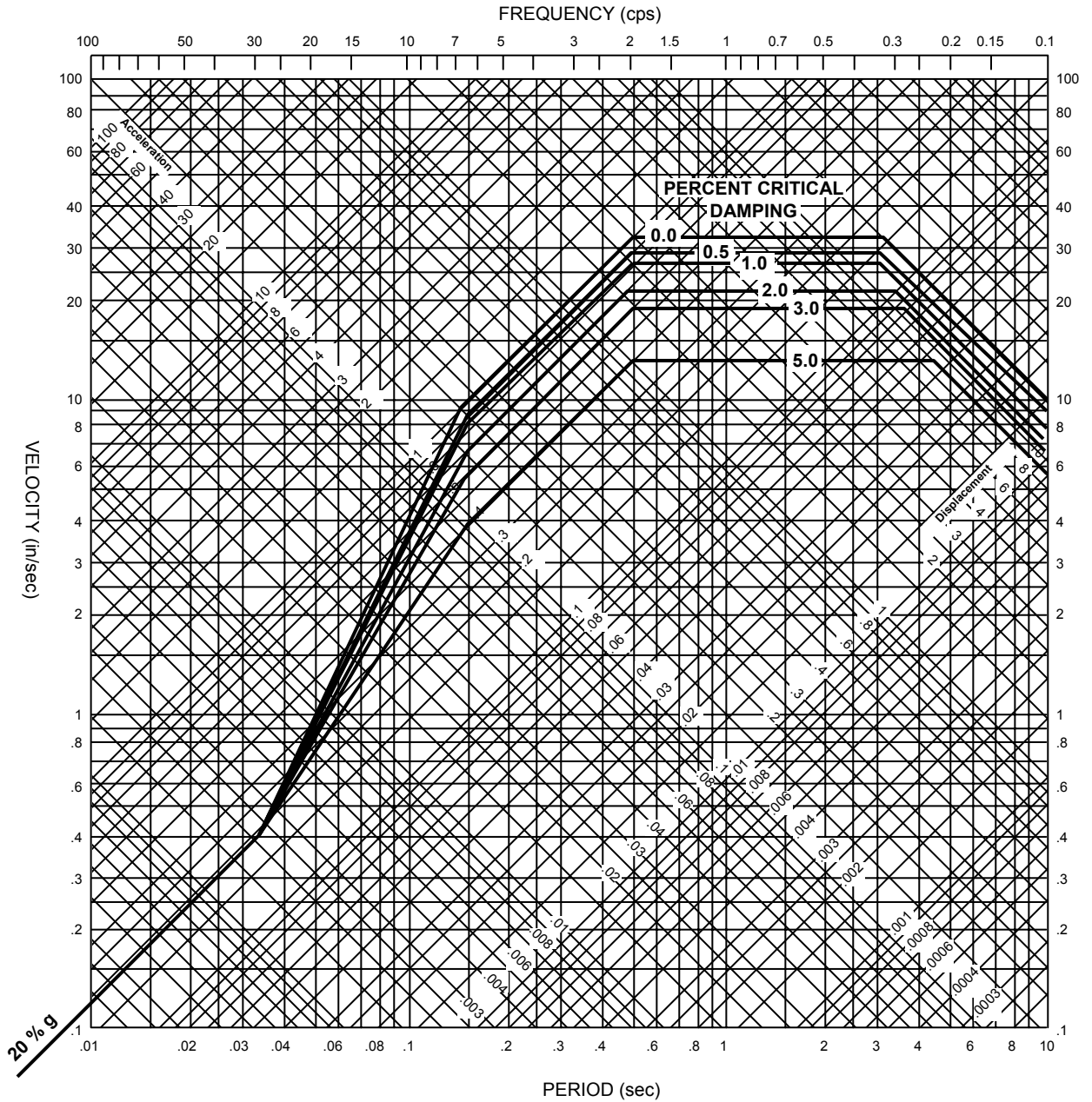

DESIGN SPECTRA

SAR FIGURE NO. 3.7-1

AMENDMENT 20

ARKANSAS NUCLEAR ONE
 UNIT 2
 RUSSELLVILLE, ARKANSAS



SCALE: NONE
 DRAWN:
 DESIGN: ENTERGY
 CAD NO:

SITE DESIGN RESPONSE SPECTRA
 DESIGN BASIS EARTHQUAKE (DBE)

BASED ON DRAWING NO

SHEET

REV.

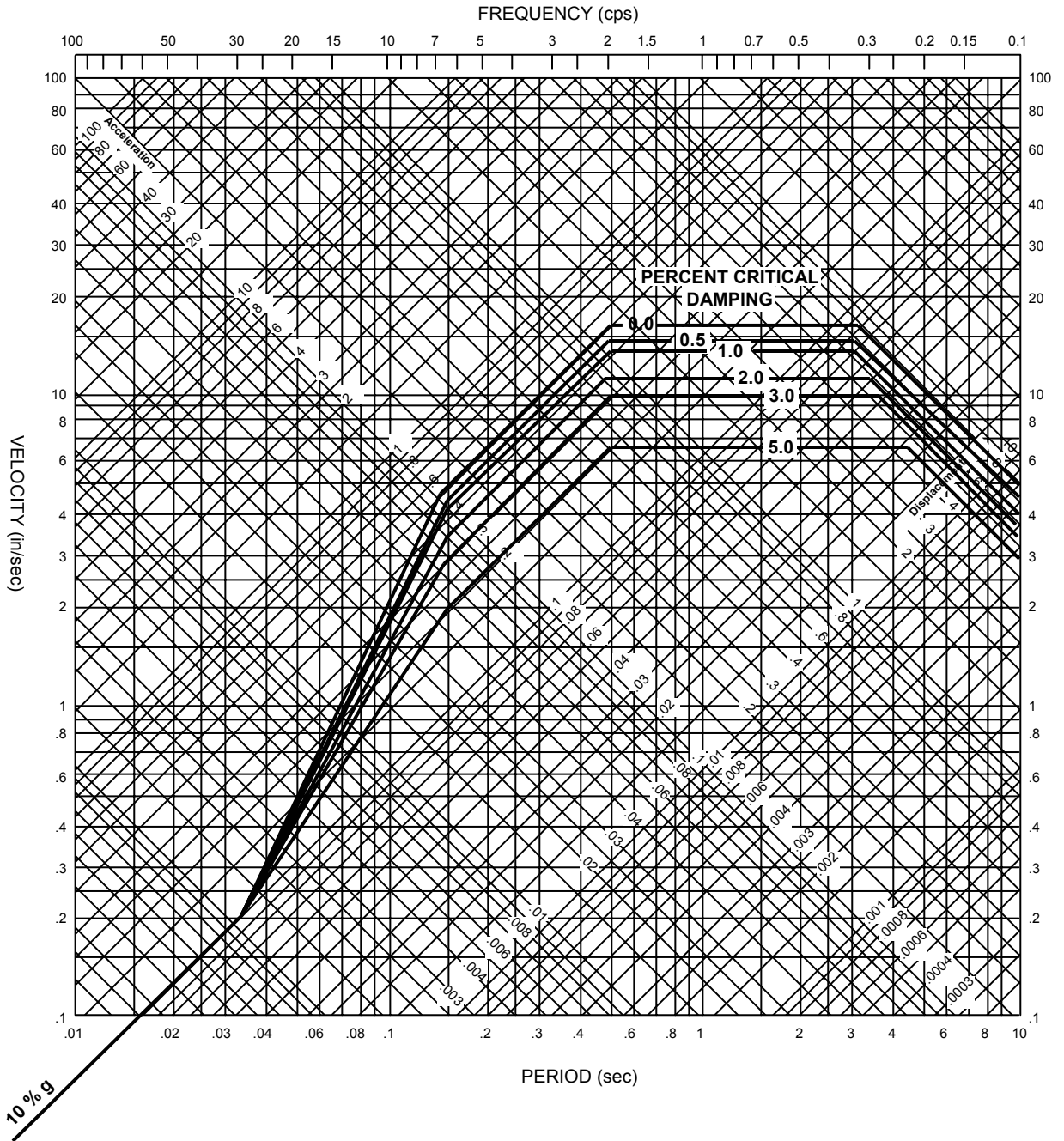

DESIGN SPECTRA

SAR FIGURE NO. 3.7-2

AMENDMENT 20

ARKANSAS NUCLEAR ONE
 UNIT 2
 RUSSELLVILLE, ARKANSAS



SCALE: NONE
 DRAWN:
 DESIGN: ENTERGY
 CAD NO:

SITE DESIGN RESPONSE SPECTRA
 OPERATING BASIS EARTHQUAKE (OBE)

BASED ON DRAWING NO

SHEET

REV.

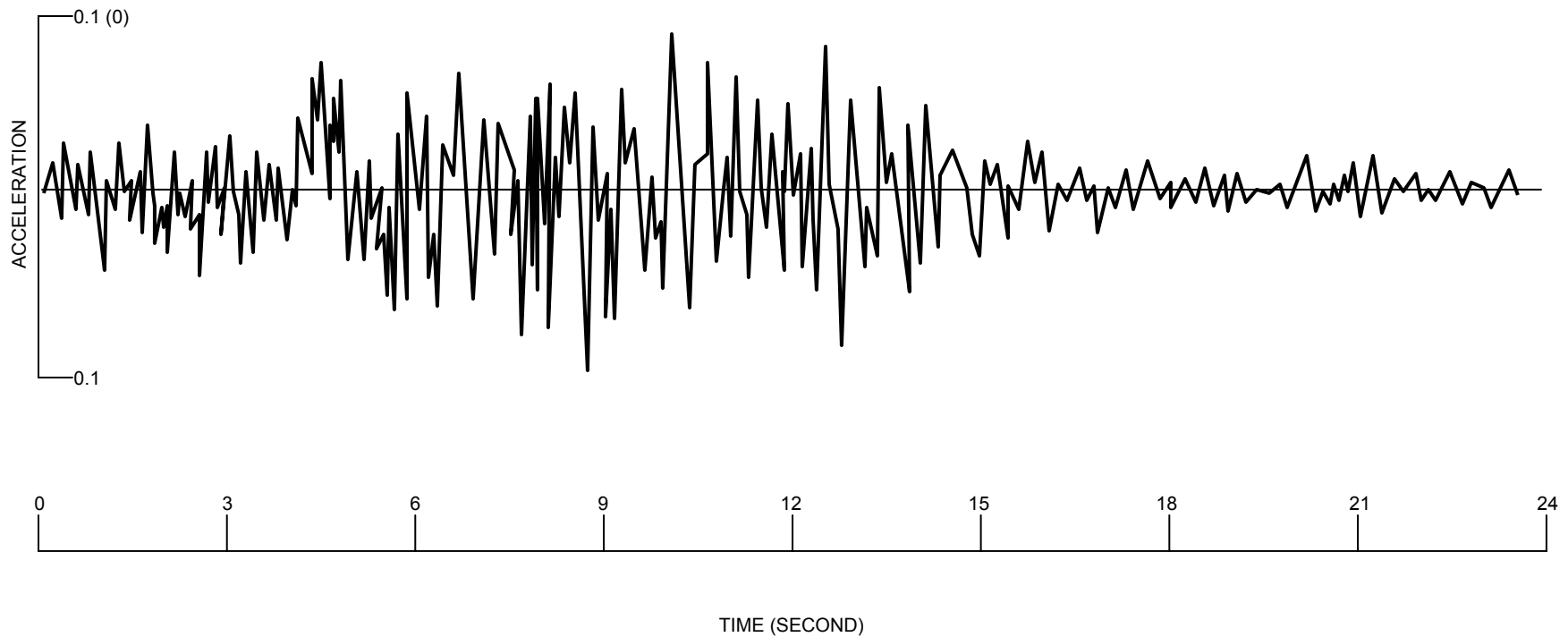

SYNTHETIC EARTHQUAKE ACCELERATION TIME HISTORY (OBE)

SAR FIGURE NO. 3.7-3

ARKANSAS NUCLEAR ONE
 UNIT 2
 RUSSELLVILLE, ARKANSAS



SCALE: NONE
 DRAWN: ENERGY
 DESIGN: ENERGY
 CAD NO:

AMENDMENT 20

BASED ON DRAWING NO

SHEET

REV.

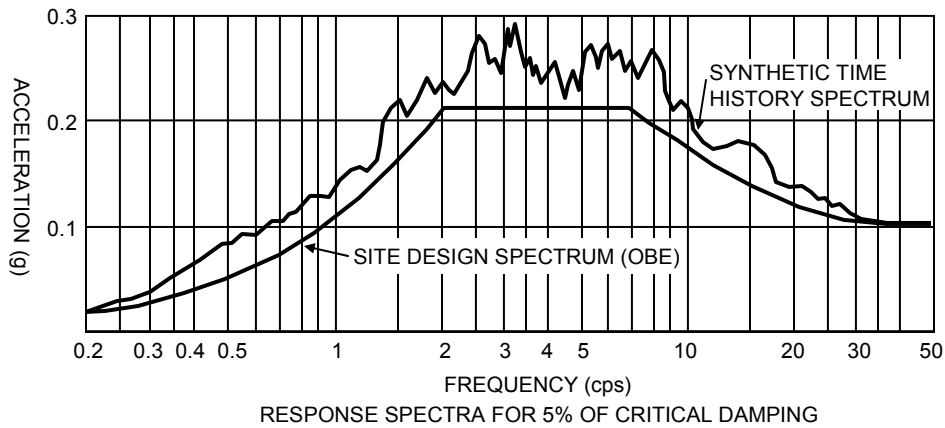
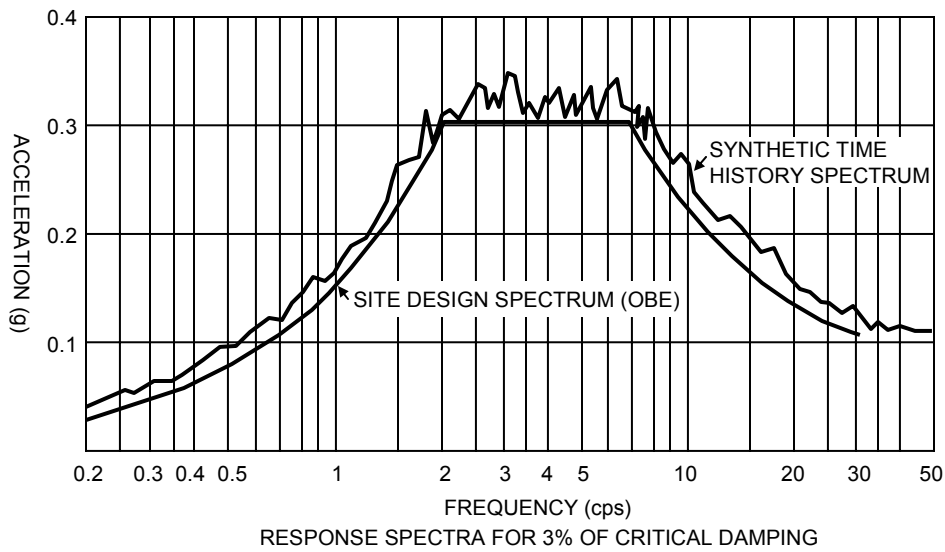
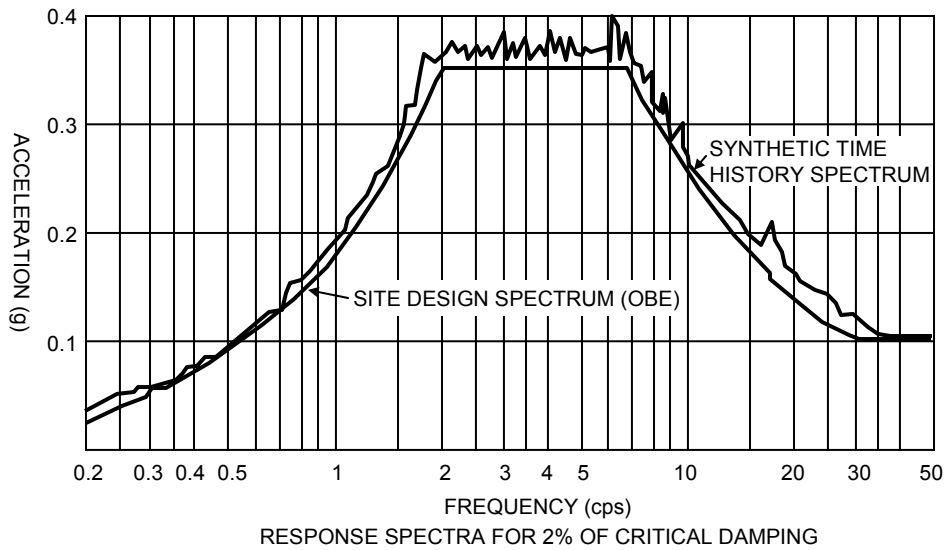

SAR FIGURE NO. 3.7-4

AMENDMENT 20

ARKANSAS NUCLEAR ONE
 UNIT 2
 RUSSELLVILLE, ARKANSAS



SCALE:	NONE
DRAWN:	ENERGY
DESIGN:	ENERGY
CAD NO:	N/A

SITE DESIGN AND SYNTHETIC TIME
 HISTORY RESPONSE SPECTRA (OBE)

DRAWING NO

SHEET

REV.

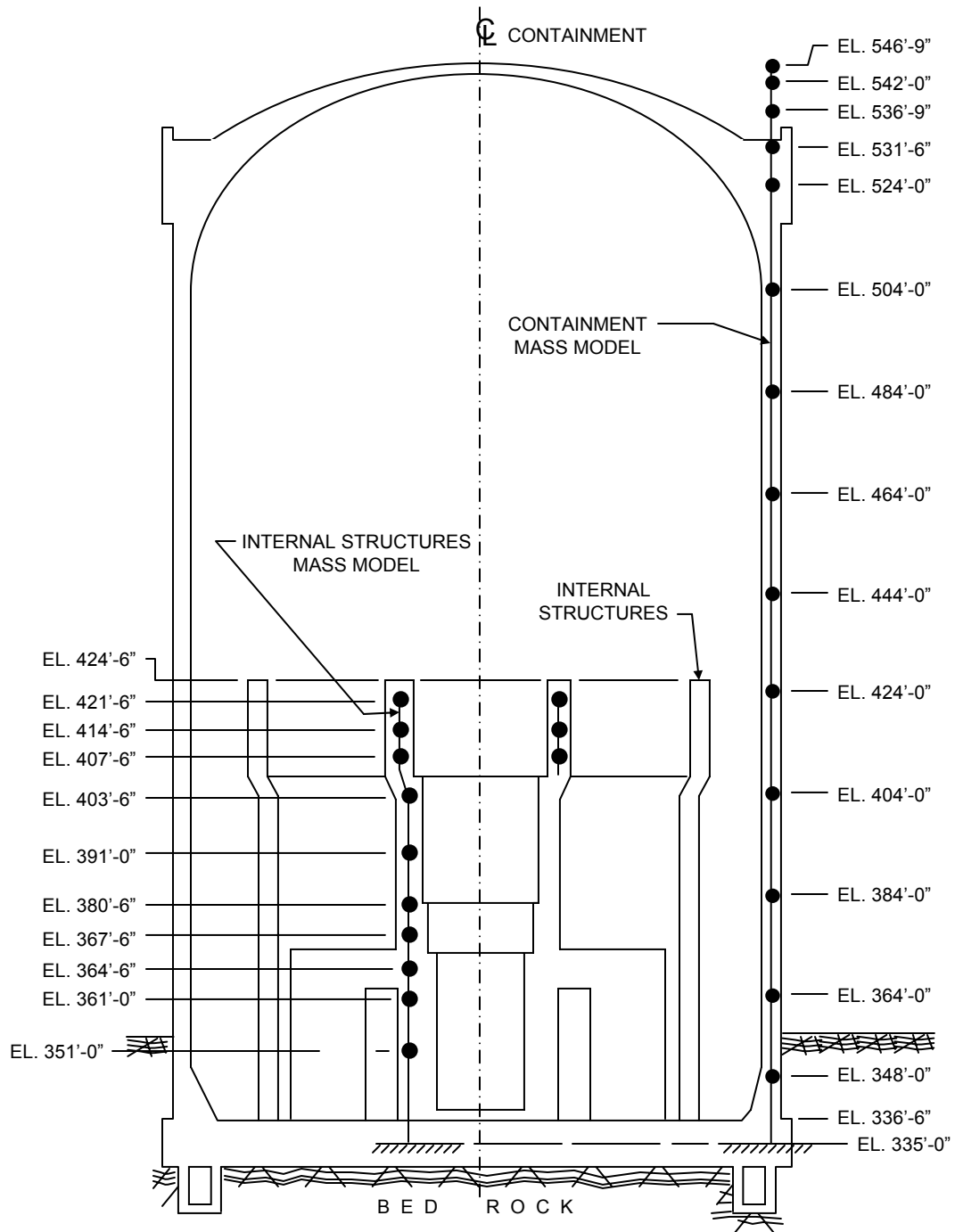

MASS MODEL
NORTH SOUTH AND EAST WEST

SAR FIGURE NO. 3.7-5

AMENDMENT 20

ARKANSAS NUCLEAR ONE
UNIT 2
RUSSELLVILLE, ARKANSAS



SCALE:	NONE
DRAWN:	ENERGY
DESIGN:	ENERGY
CAD NO:	N/A

MATHEMATICAL MODEL
CONTAINMENT & INTERNAL STRUCTURES

DRAWING NO

SHEET

REV.

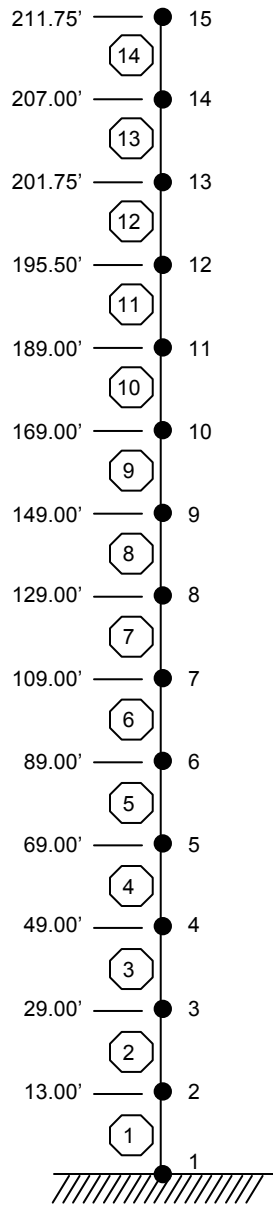

CONTAINMENT

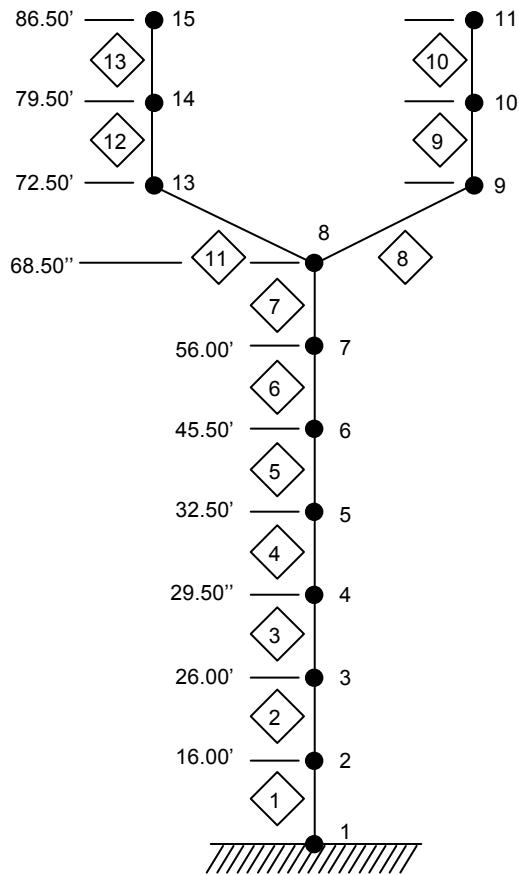

INTERNAL STRUCTURES

SAR FIGURE NO. 3.7-6

AMENDMENT 20

ARKANSAS NUCLEAR ONE
UNIT 2
RUSSELLVILLE, ARKANSAS



SCALE:	NONE
DRAWN:	ENERGY
DESIGN:	ENERGY
CAD NO:	N/A

MATHEMATICAL MODEL
CONTAINMENT & INTERNAL STRUCTURES

DRAWING NO

SHEET

REV.

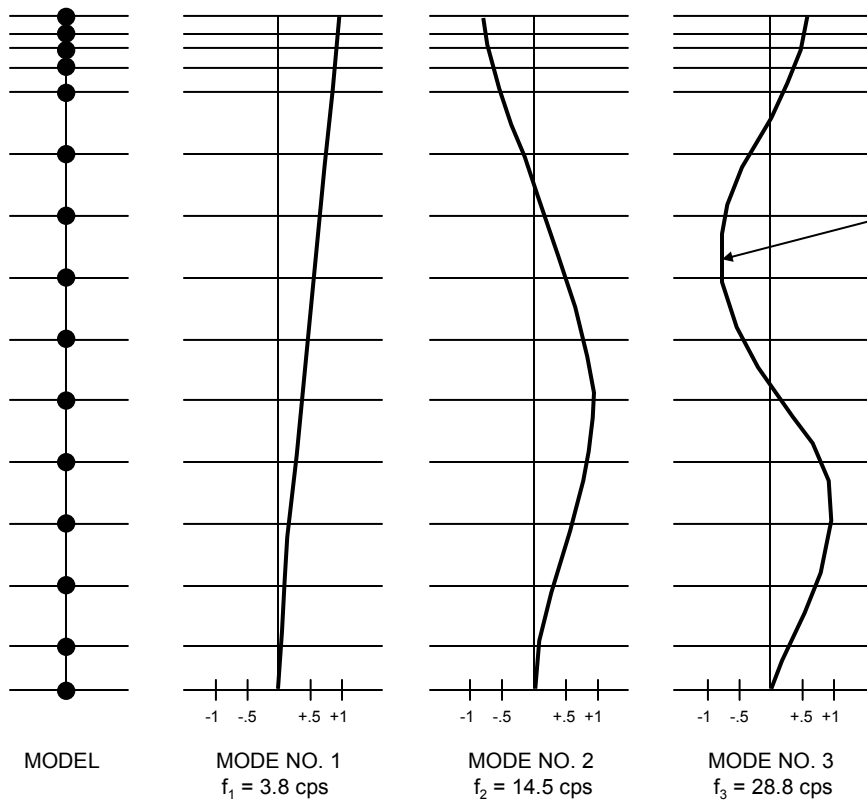

CONTAINMENT

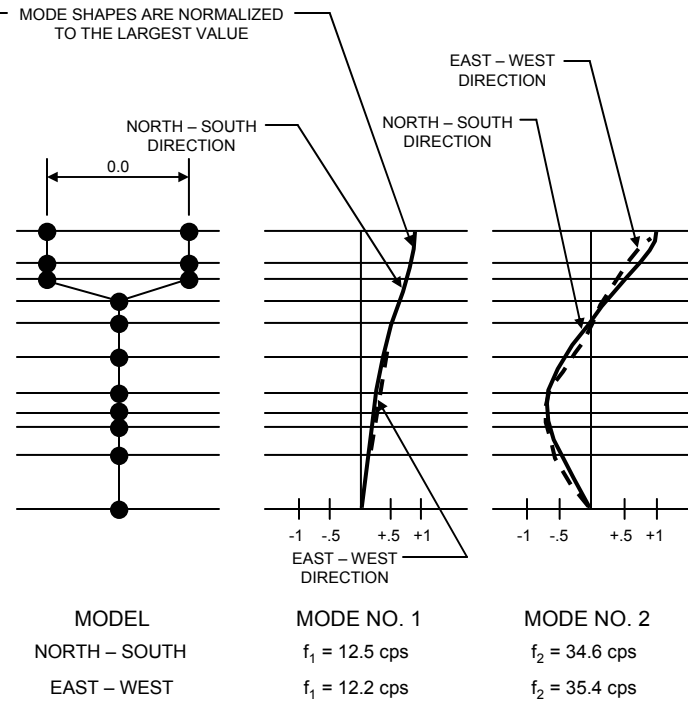

INTERNAL STRUCTURES

MODE SHAPES AND NATURAL FREQUENCIES
CONTAINMENT & INTERNAL STRUCTURES

SAR FIGURE NO. 3.7-7

ARKANSAS NUCLEAR ONE
UNIT 2
RUSSELLVILLE, ARKANSAS



SCALE: NONE
DRAWN: ENTERGY
DESIGN: ENTERGY
CAD NO:

AMENDMENT 20

BASED ON DRAWING NO	SHEET	REV.

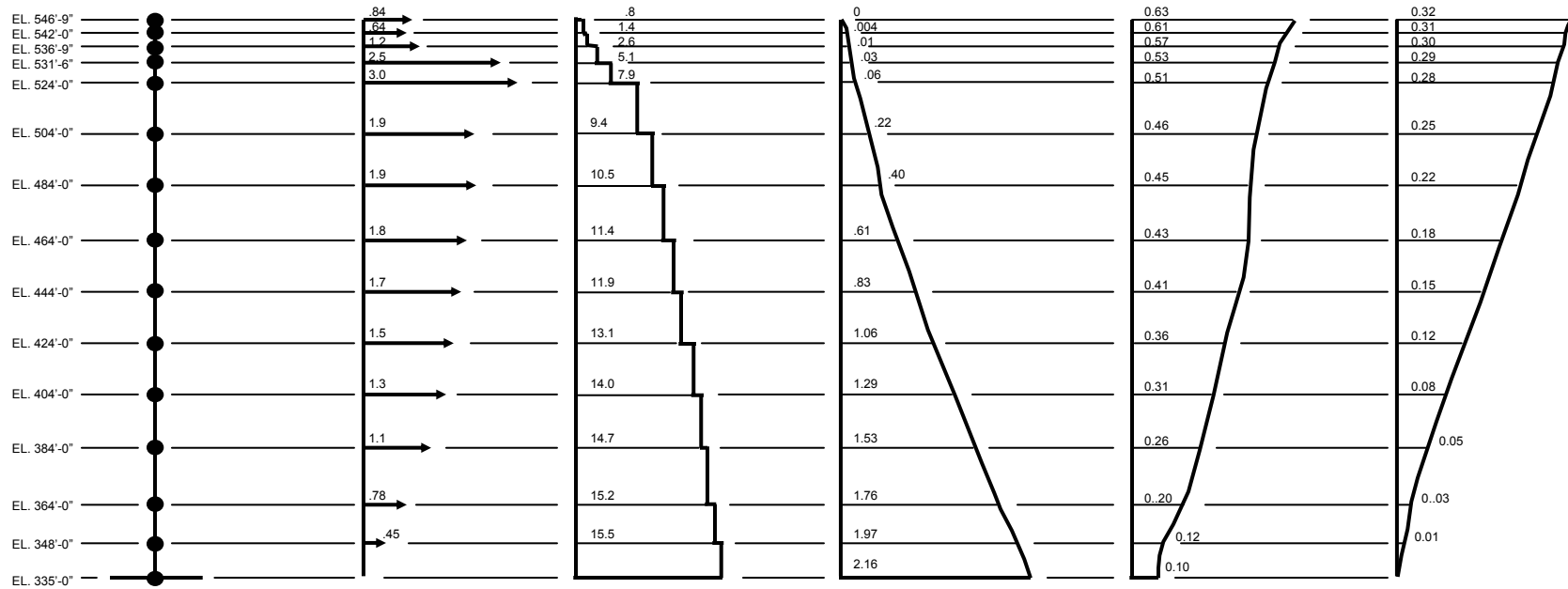

MODEL

INERTIAL FORCE ENVELOPE (KIPS X 10³)

SHEAR ENVELOPE (KIPS X 10³)

MOMENT ENVELOPE (FT-KIPS X 10⁶)

ACCELERATION ENVELOPE (FACTORED g)

DISPLACEMENT ENVELOPE (INCHES)

CONTAINMENT SPECTRUM RESPONSE RESULTS (OBE)

RESPONSE SPECTRUM RESULTS
CONTAINMENT

SAR FIGURE NO. 3.7-8

ARKANSAS NUCLEAR ONE
UNIT 2
RUSSELLVILLE, ARKANSAS



SCALE: NONE
DRAWN: ENTERGY
DESIGN: ENTERGY
CAD NO:

AMENDMENT 20

BASED ON DRAWING NO

SHEET

REV.

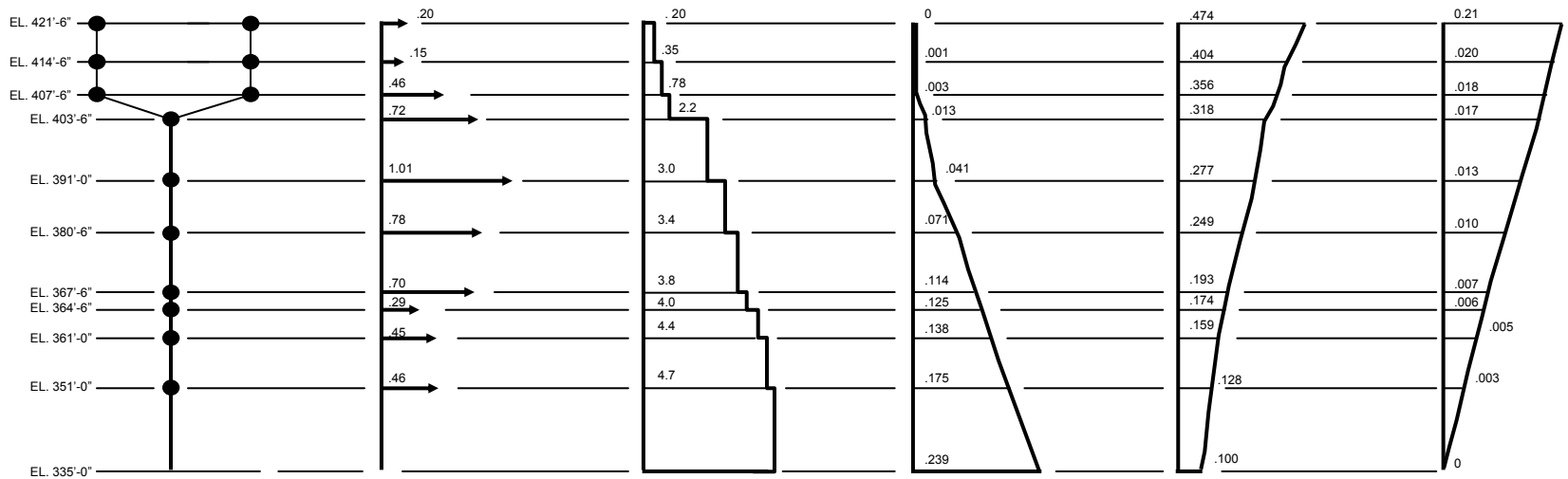

MODEL

INERTIAL FORCE ENVELOPE (KIPS X 10³)

SHEAR ENVELOPE (KIPS X 10³)

MOMENT ENVELOPE (FT-KIPS X 10⁶)

ACCELERATION ENVELOPE (FACTORED g)

DISPLACEMENT ENVELOPE (INCHES)

INTERNAL STRUCTURES SPECTRUM RESPONSE RESULTS (OBE)

RESPONSE SPECTRUM RESULTS INTERNAL STRUCTURES
NORTH – SOUTH DIRECTION

SAR FIGURE NO. 3.7-9

ARKANSAS NUCLEAR ONE
UNIT 2
RUSSELLVILLE, ARKANSAS



SCALE: NONE
DRAWN: ENTERGY
DESIGN: ENTERGY
CAD NO:

AMENDMENT 20

BASED ON DRAWING NO

SHEET

REV.

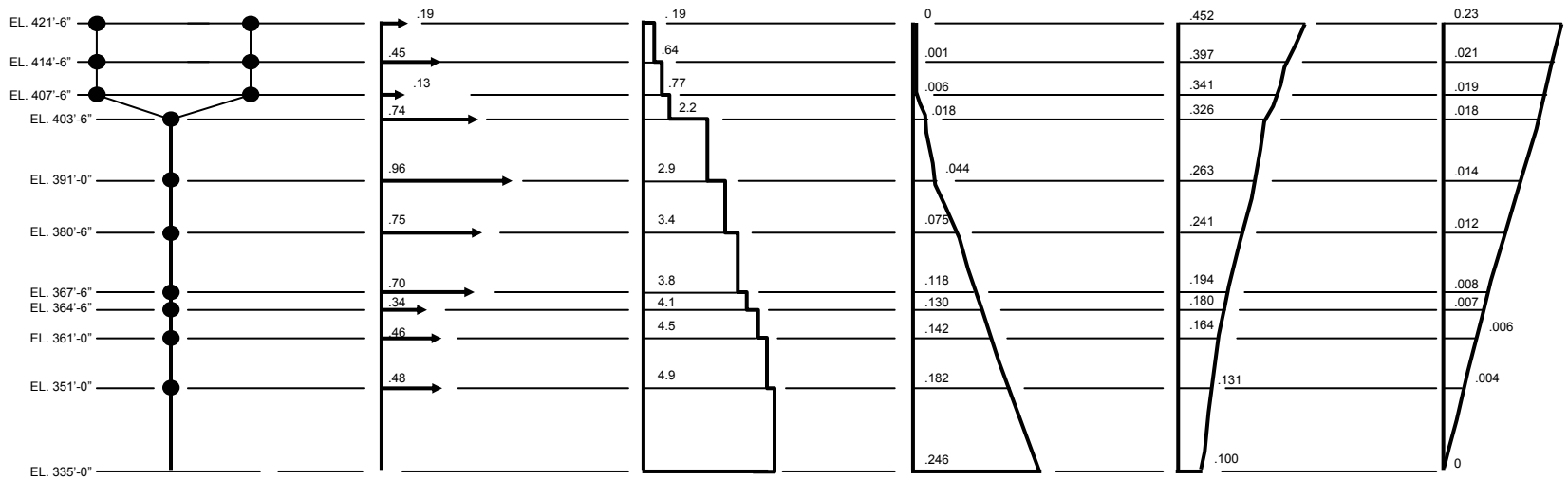

MODEL

INERTIAL FORCE ENVELOPE (KIPS X 10³)

SHEAR ENVELOPE (KIPS X 10³)

MOMENT ENVELOPE (FT-KIPS X 10⁶)

ACCELERATION ENVELOPE (FACTORED g)

DISPLACEMENT ENVELOPE (INCHES)

INTERNAL STRUCTURES SPECTRUM RESPONSE RESULTS (OBE)

RESPONSE SPECTRUM RESULTS INTERNAL STRUCTURES
EAST - WEST DIRECTION

SAR FIGURE NO. 3.7-10

ARKANSAS NUCLEAR ONE
UNIT 2
RUSSELLVILLE, ARKANSAS



SCALE: NONE
DRAWN: ENTERGY
DESIGN: ENTERGY
CAD NO:

AMENDMENT 20

BASED ON DRAWING NO

SHEET

REV.

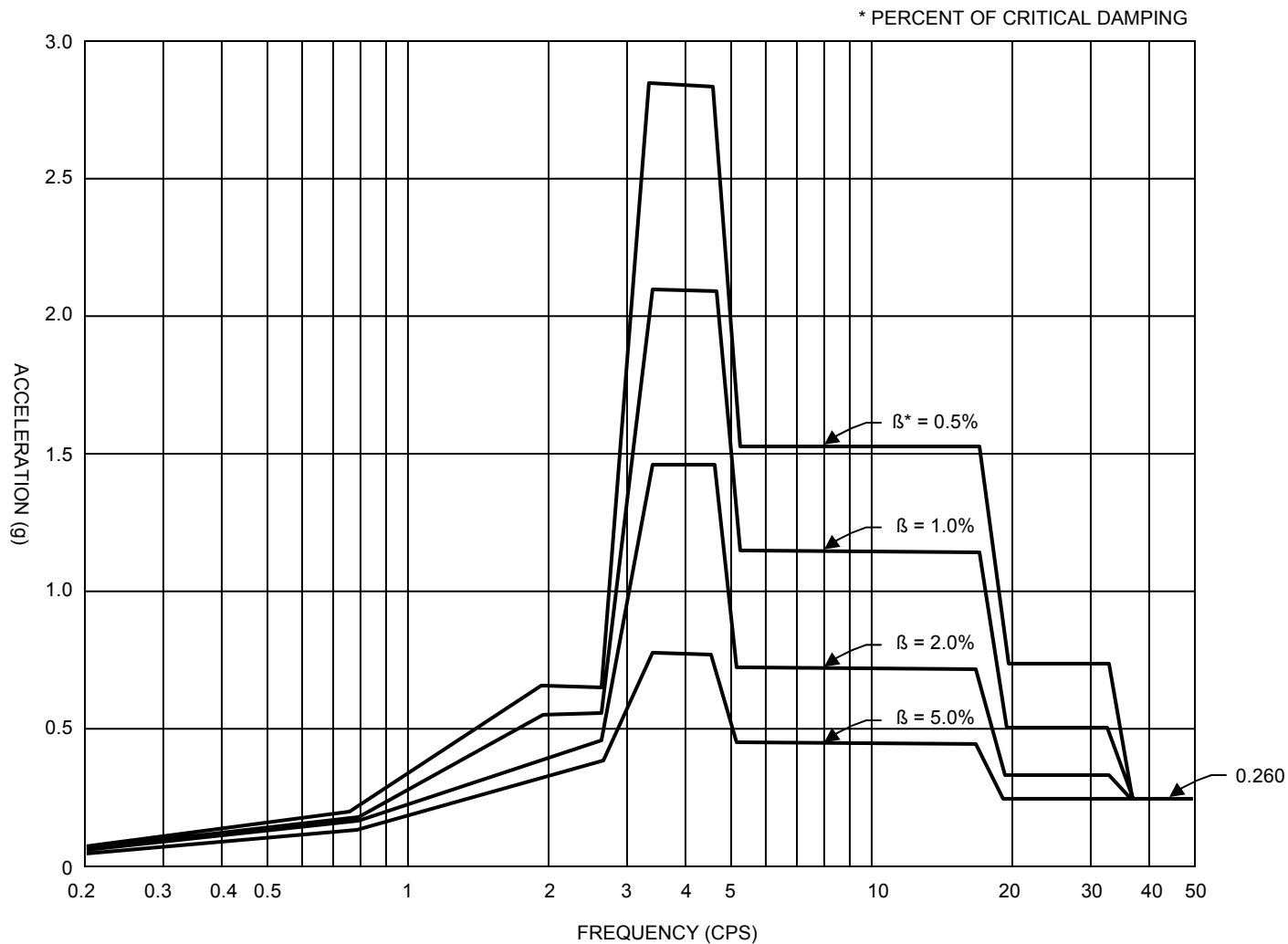

RESPONSE SPECTRA AT ELEVATION 384' - 0"

ACCELERATION RESPONSE SPECTRA
CONTAINMENT OPERATING BASIS EARTHQUAKE

SAR FIGURE NO. 3.7-11

ARKANSAS NUCLEAR ONE
UNIT 2
RUSSELLVILLE, ARKANSAS



SCALE: NONE
DRAWN: ENTERGY
DESIGN: ENTERGY
CAD NO:

AMENDMENT 20

BASED ON DRAWING NO	SHEET	REV.

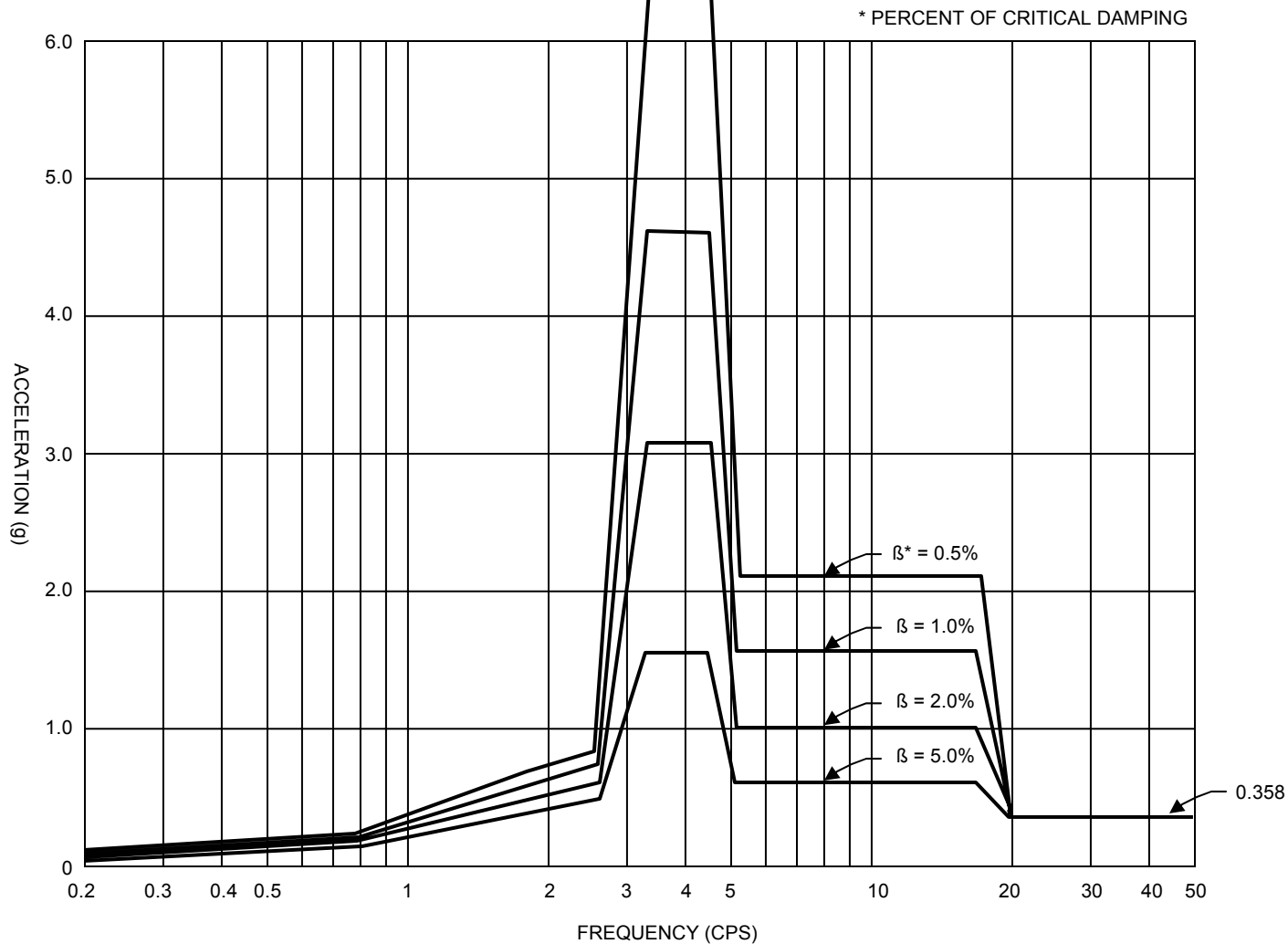

RESPONSE SPECTRA AT ELEVATION 424' - 0"

ACCELERATION RESPONSE SPECTRA
CONTAINMENT OPERATING BASIS EARTHQUAKE

SAR FIGURE NO. 3.7-12

ARKANSAS NUCLEAR ONE
UNIT 2
RUSSELLVILLE, ARKANSAS



SCALE: NONE
DRAWN: ENTERGY
DESIGN: ENTERGY
CAD NO:

AMENDMENT 20

BASED ON DRAWING NO

SHEET

REV.

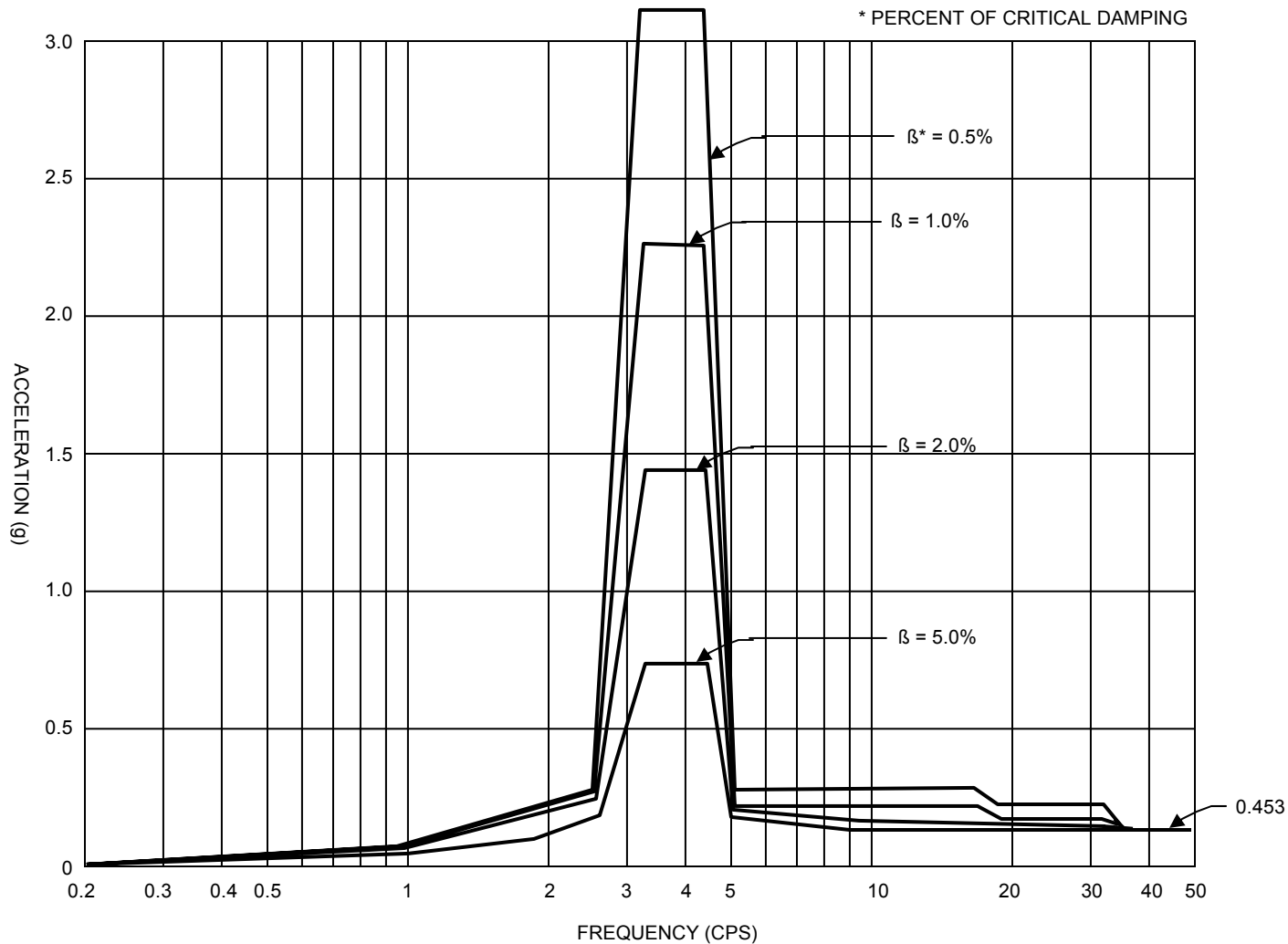

RESPONSE SPECTRA AT ELEVATION 484' - 0"

ACCELERATION RESPONSE SPECTRA
CONTAINMENT OPERATING BASIS EARTHQUAKE

SAR FIGURE NO. 3.7-13

ARKANSAS NUCLEAR ONE
UNIT 2
RUSSELLVILLE, ARKANSAS



SCALE: NONE
DRAWN: ENTERGY
DESIGN: ENTERGY
CAD NO:

AMENDMENT 20

BASED ON DRAWING NO	SHEET	REV.

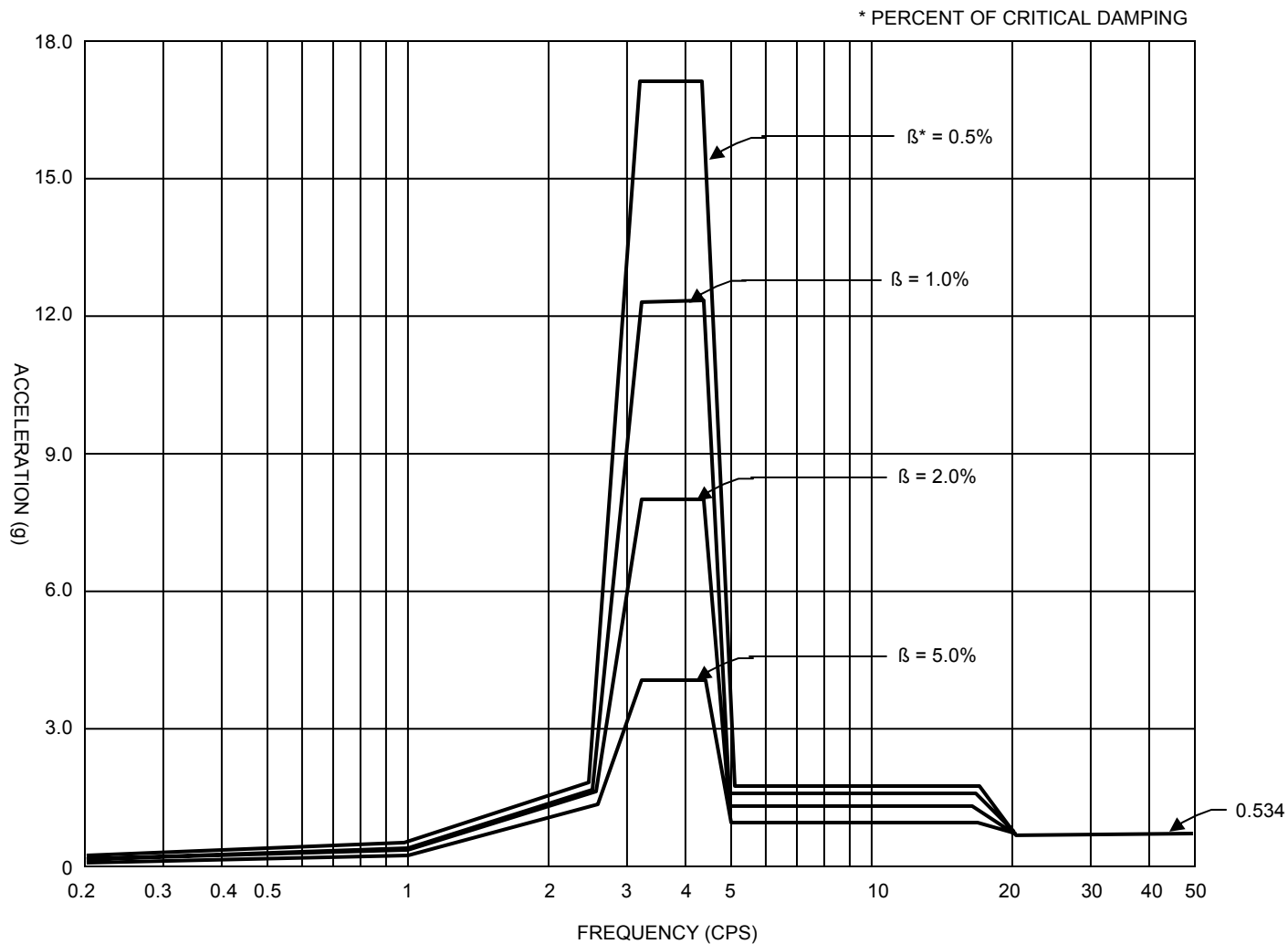

RESPONSE SPECTRA AT ELEVATION 531' - 6"

ACCELERATION RESPONSE SPECTRA
CONTAINMENT OPERATING BASIS EARTHQUAKE

SAR FIGURE NO. 3.7-14

ARKANSAS NUCLEAR ONE
UNIT 2
RUSSELLVILLE, ARKANSAS



SCALE: NONE
DRAWN: ENTERGY
DESIGN: ENTERGY
CAD NO:

AMENDMENT 20

BASED ON DRAWING NO

SHEET

REV.

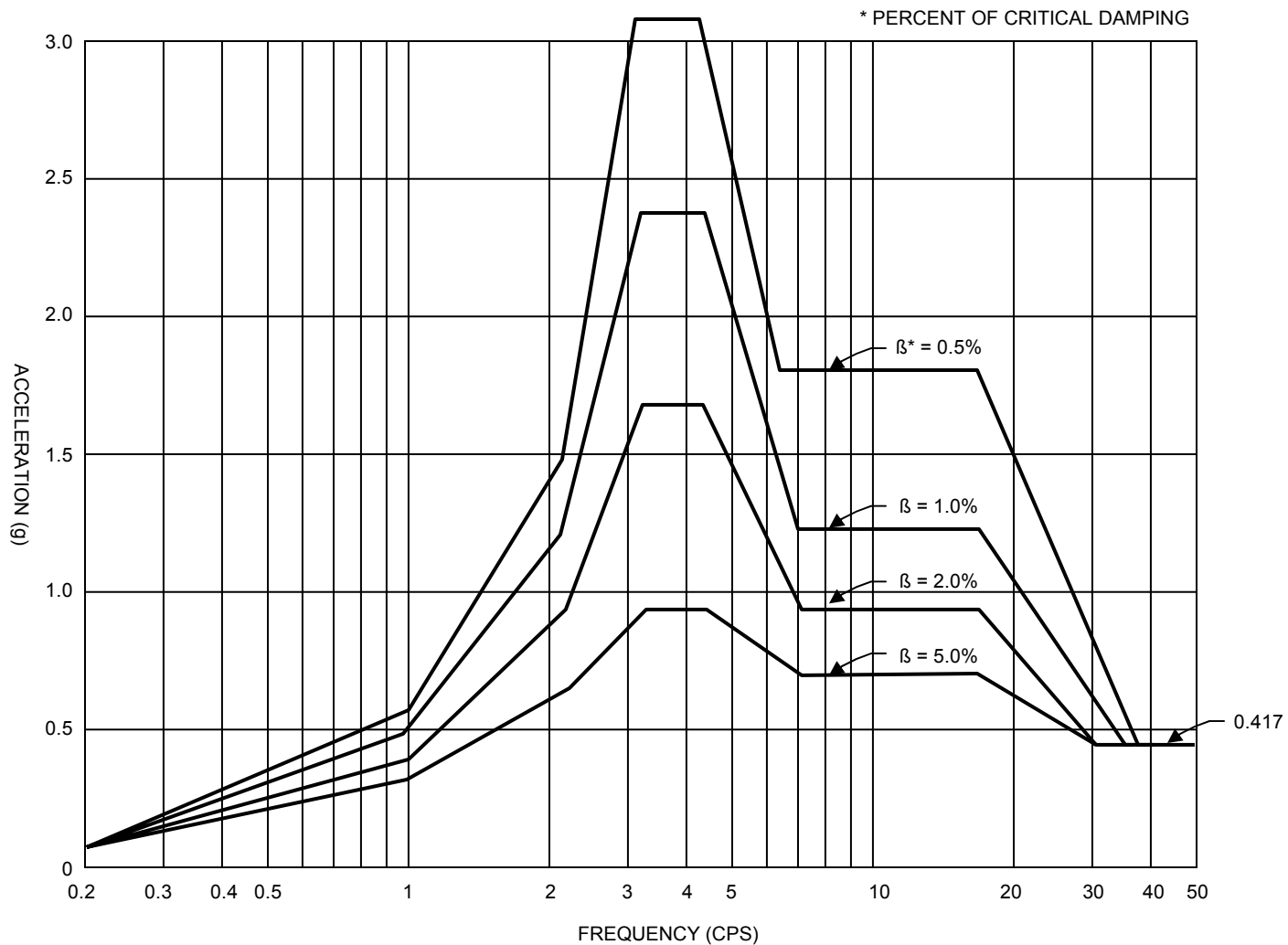

RESPONSE SPECTRA AT ELEVATION 384' - 0"

ACCELERATION RESPONSE SPECTRA
CONTAINMENT DESIGN BASIS EARTHQUAKE

SAR FIGURE NO. 3.7-15

ARKANSAS NUCLEAR ONE
UNIT 2
RUSSELLVILLE, ARKANSAS



SCALE: NONE
DRAWN: ENTERGY
DESIGN: ENTERGY
CAD NO:

AMENDMENT 20

BASED ON DRAWING NO

SHEET

REV.

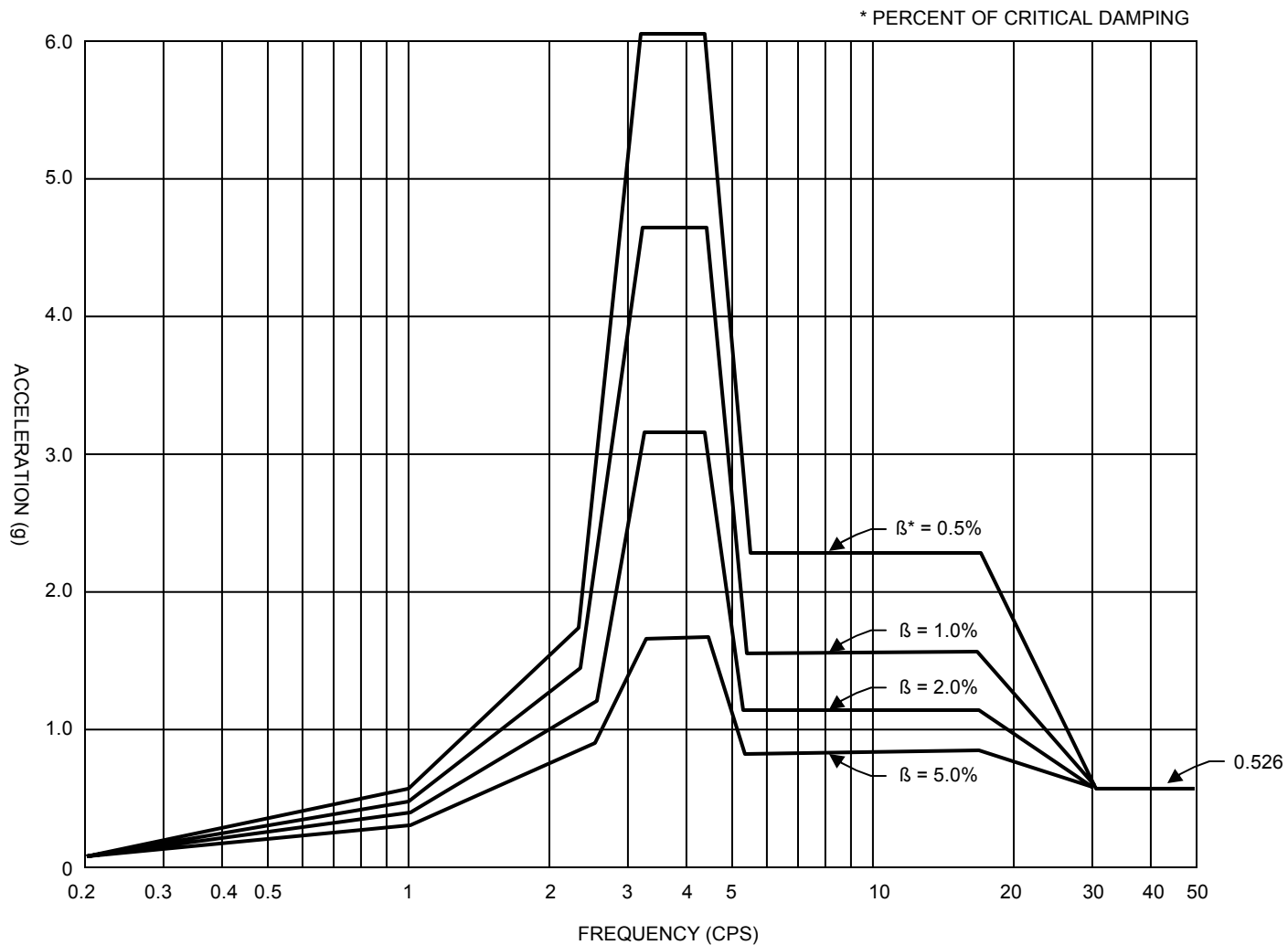

RESPONSE SPECTRA AT ELEVATION 424' - 0"

ACCELERATION RESPONSE SPECTRA
CONTAINMENT DESIGN BASIS EARTHQUAKE

SAR FIGURE NO. 3.7-16

ARKANSAS NUCLEAR ONE
UNIT 2
RUSSELLVILLE, ARKANSAS



SCALE: NONE
DRAWN: ENTERGY
DESIGN: ENTERGY
CAD NO:

AMENDMENT 20

BASED ON DRAWING NO

SHEET

REV.

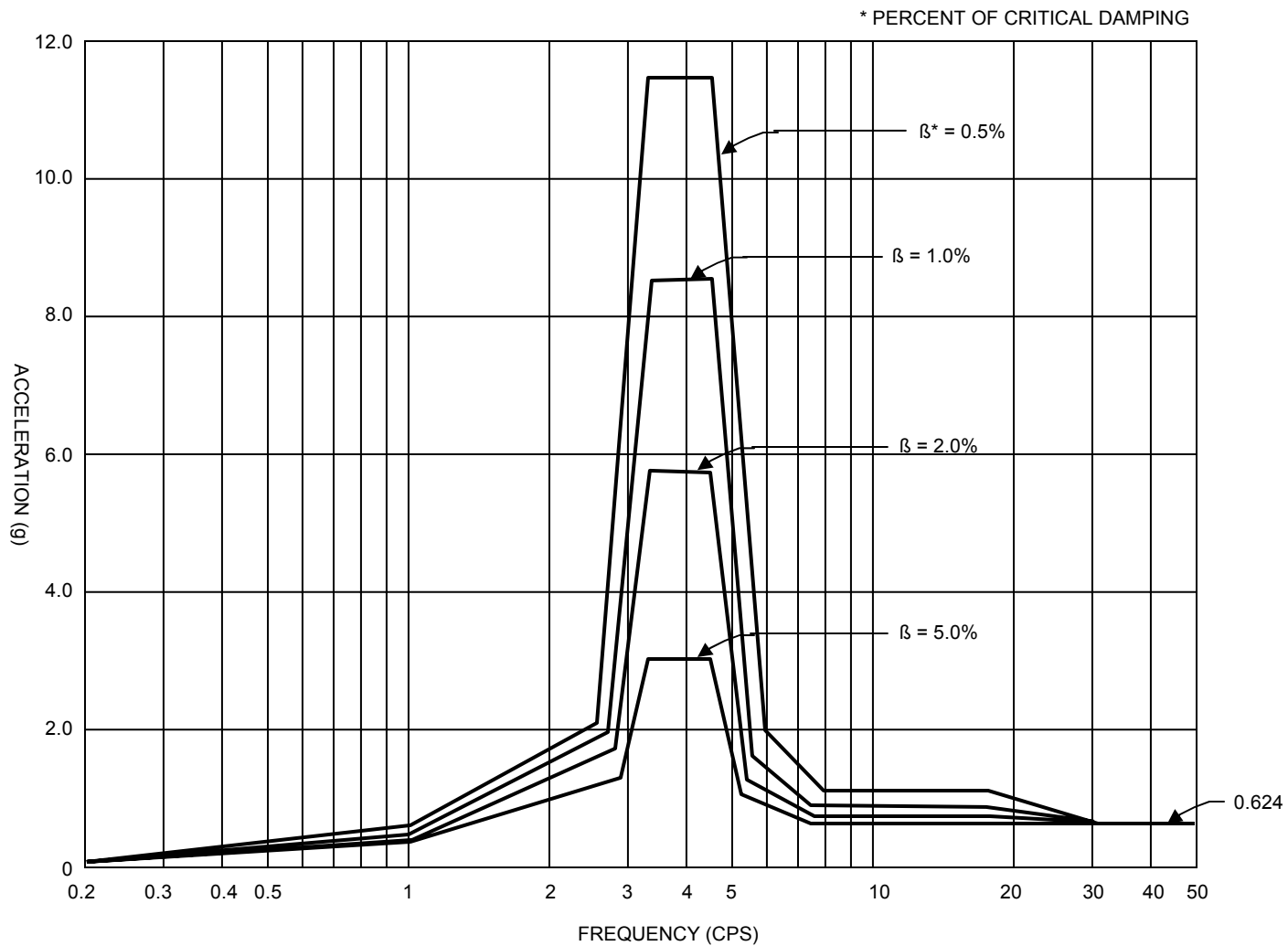

RESPONSE SPECTRA AT ELEVATION 484' - 0"

ACCELERATION RESPONSE SPECTRA
CONTAINMENT DESIGN BASIS EARTHQUAKE

SAR FIGURE NO. 3.7-17

ARKANSAS NUCLEAR ONE
UNIT 2
RUSSELLVILLE, ARKANSAS



SCALE: NONE
DRAWN: ENTERGY
DESIGN: ENTERGY
CAD NO:

AMENDMENT 20

BASED ON DRAWING NO

SHEET

REV.

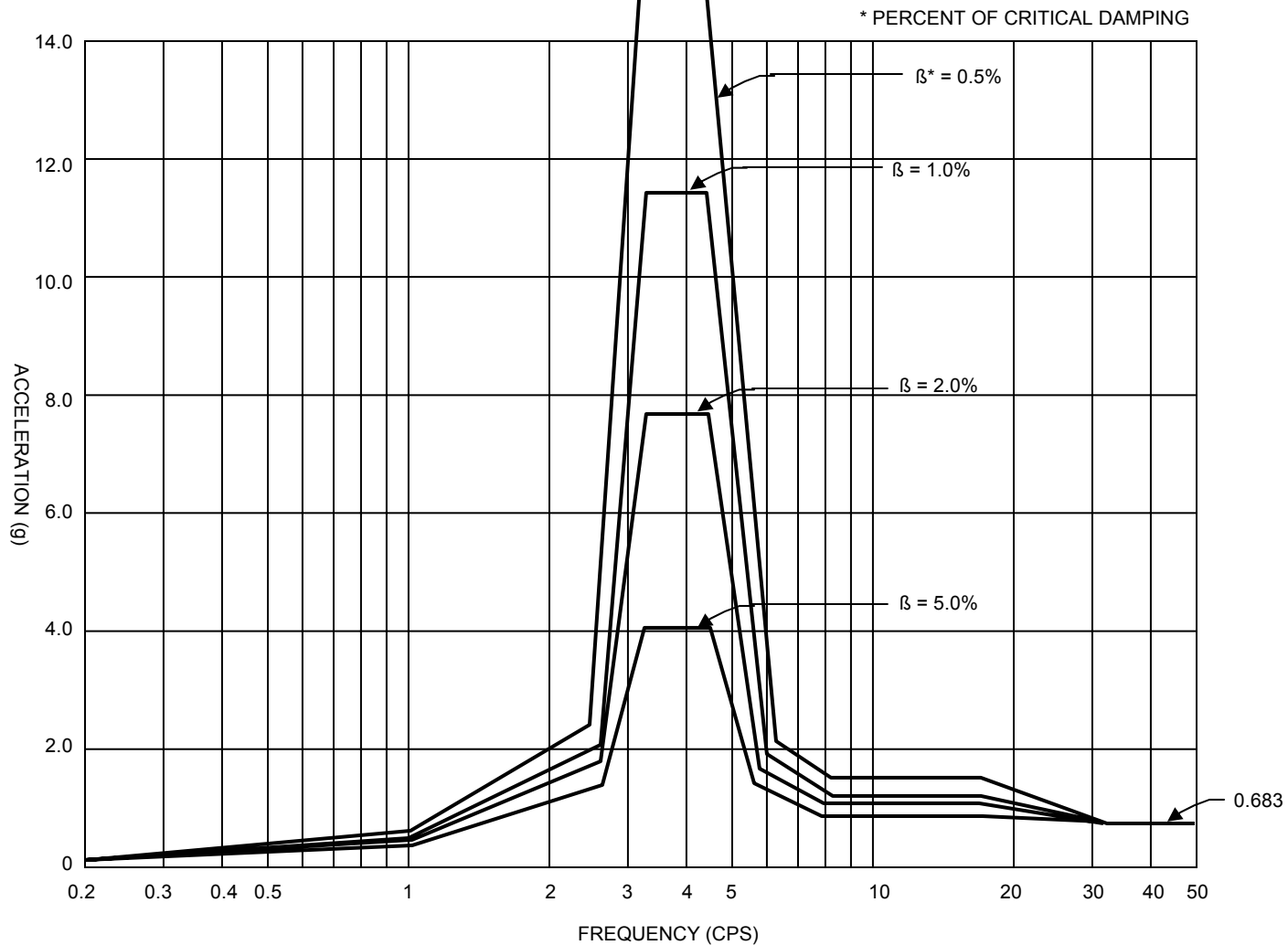

RESPONSE SPECTRA AT ELEVATION 531' - 6"

ACCELERATION RESPONSE SPECTRA
CONTAINMENT DESIGN BASIS EARTHQUAKE

SAR FIGURE NO. 3.7-18

ARKANSAS NUCLEAR ONE
UNIT 2
RUSSELLVILLE, ARKANSAS



SCALE: NONE
DRAWN: ENTERGY
DESIGN: ENTERGY
CAD NO:

AMENDMENT 20

BASED ON DRAWING NO

SHEET

REV.

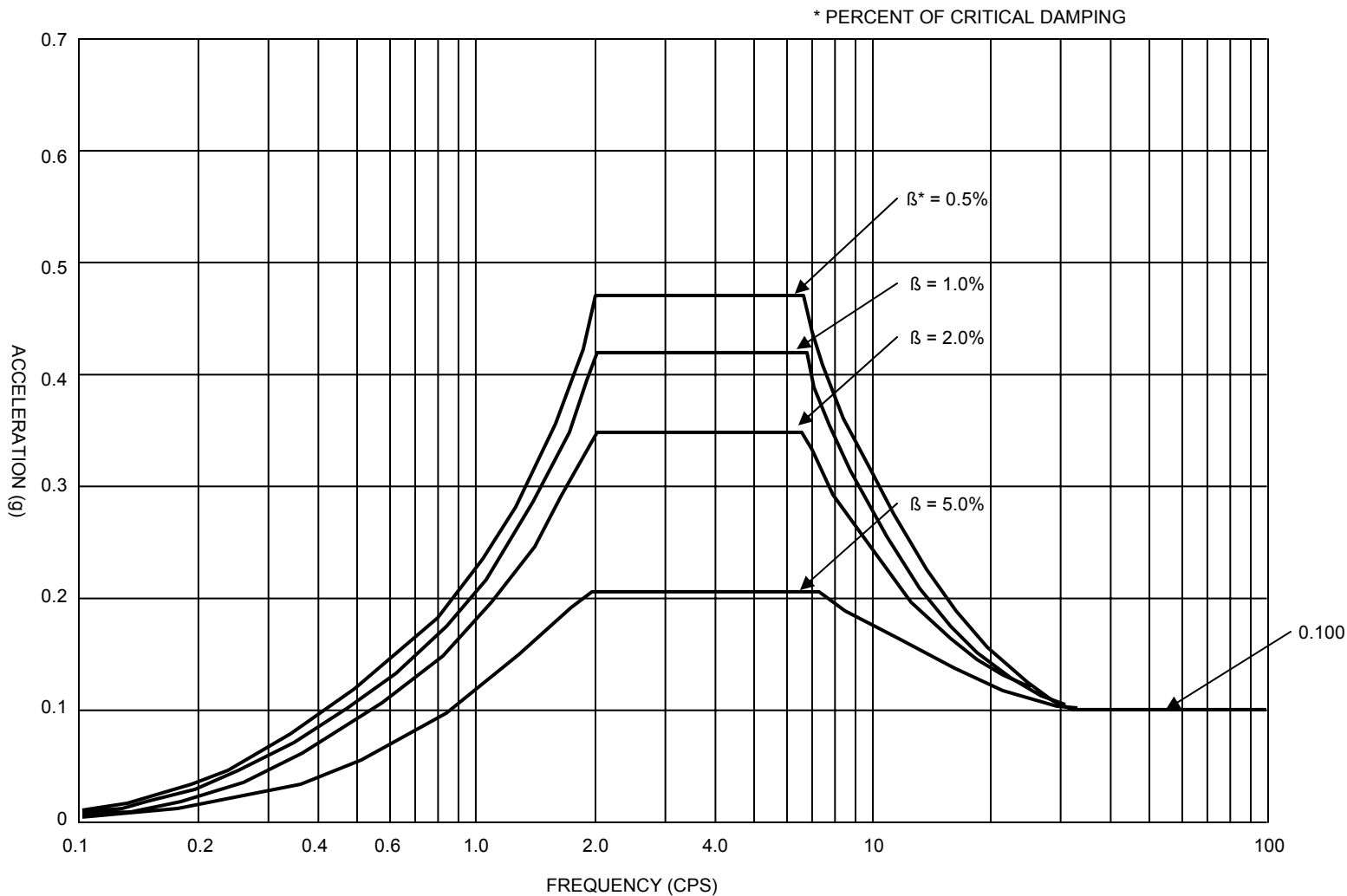

ACCELERATION RESPONSE SPECTRA AUXILIARY BUILDING ELEV. 317'-0" AND 335'-0"
OPERATING BASIS EARTHQUAKE

SAR FIGURE NO. 3.7-19

ARKANSAS NUCLEAR ONE
UNIT 2
RUSSELLVILLE, ARKANSAS



SCALE: NONE
DRAWN: ENTERGY
DESIGN: ENTERGY
CAD NO:

AMENDMENT 20

BASED ON DRAWING NO

SHEET

REV.

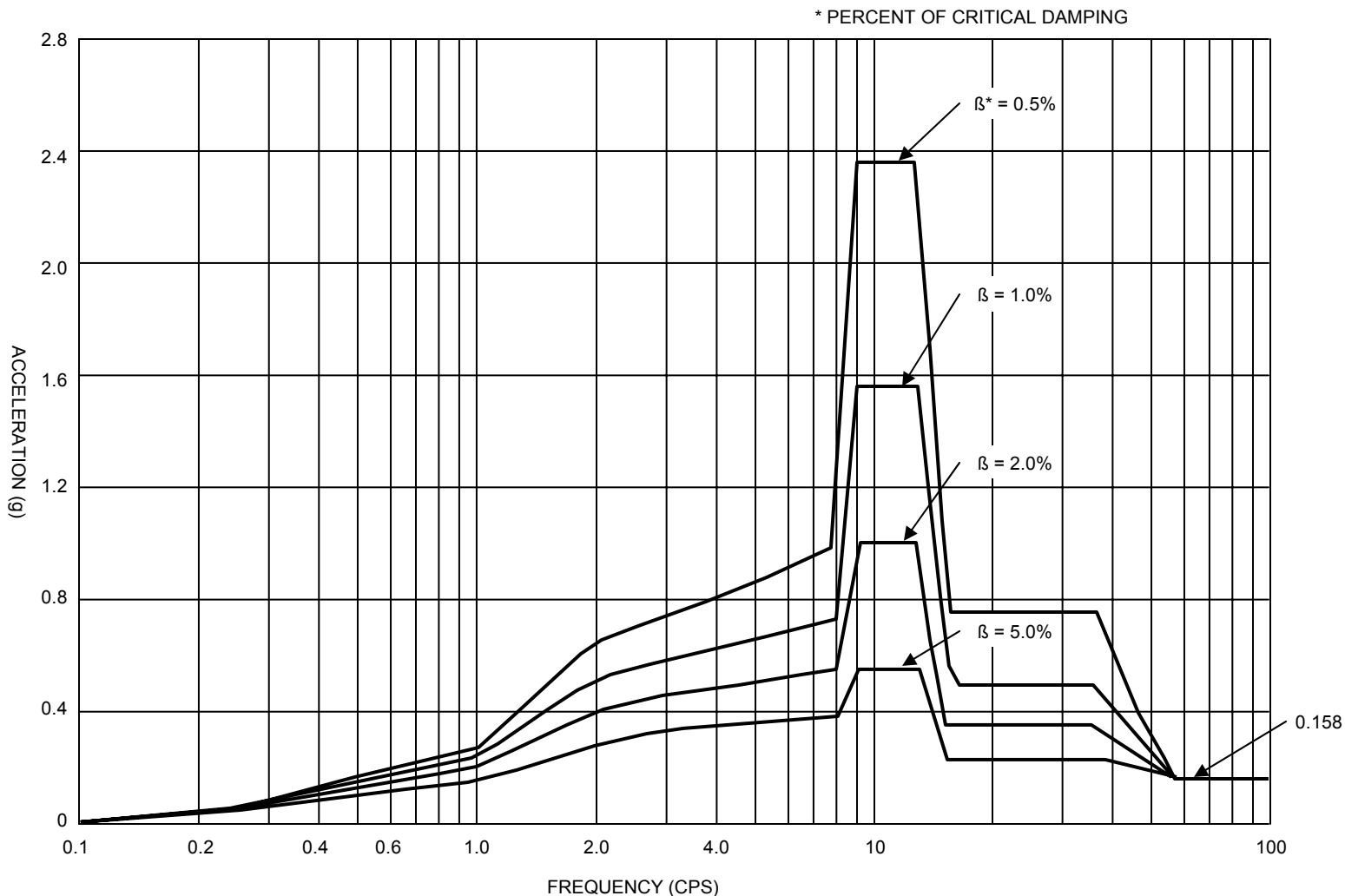

ACCELERATION RESPONSE SPECTRA AUXILIARY BUILDING ELEV. 354' - 0"
OPERATING BASIS EARTHQUAKE

SAR FIGURE NO. 3.7-20

ARKANSAS NUCLEAR ONE
UNIT 2
RUSSELLVILLE, ARKANSAS



SCALE:	NONE
DRAWN:	ENERGY
DESIGN:	ENERGY
CAD NO:	

AMENDMENT 20

BASED ON DRAWING NO

SHEET

REV.

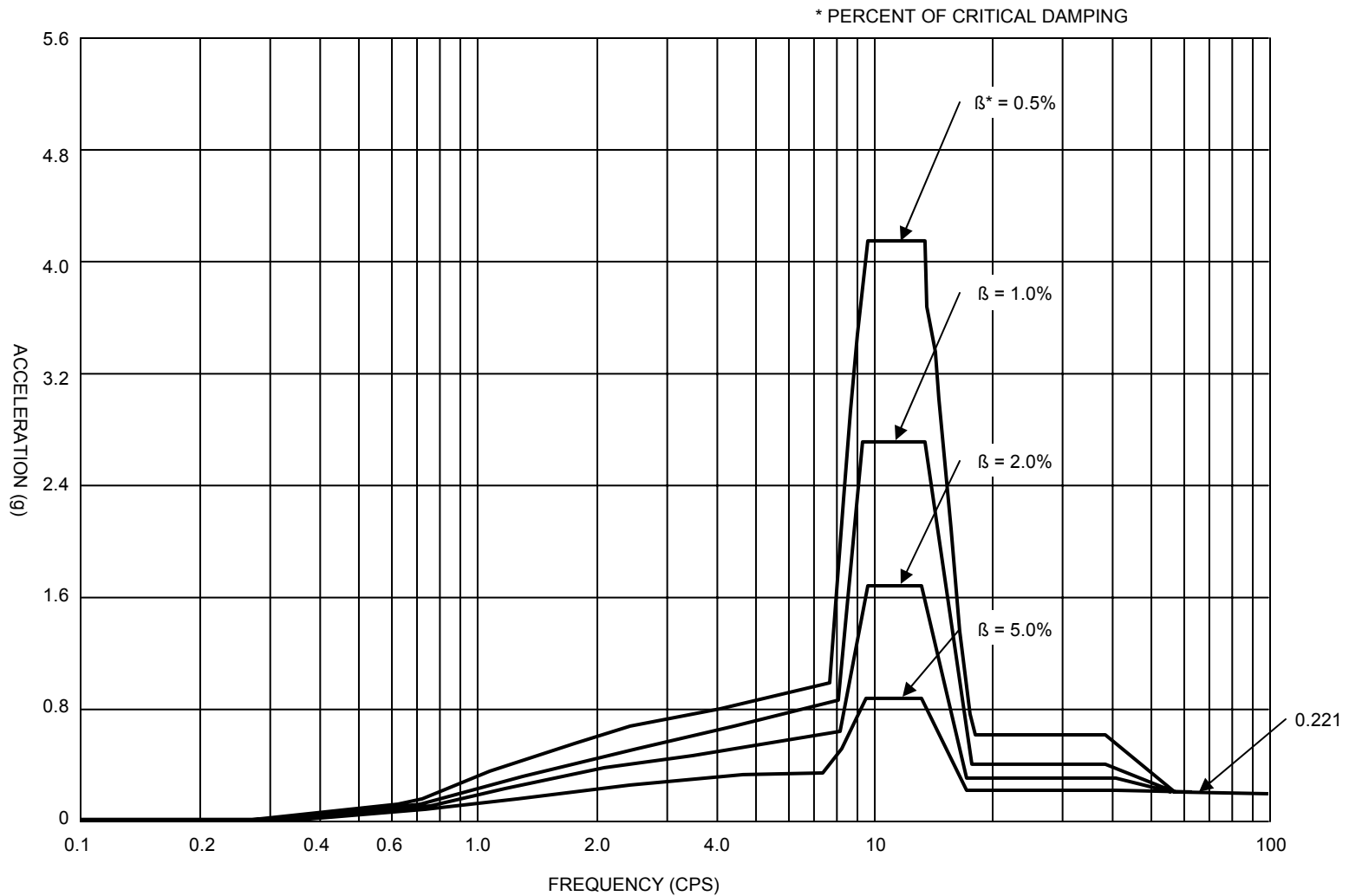

ACCELERATION RESPONSE SPECTRA AUXILIARY BUILDING ELEV. 372' - 0"
OPERATING BASIS EARTHQUAKE

SAR FIGURE NO. 3.7-21

ARKANSAS NUCLEAR ONE
UNIT 2
RUSSELLVILLE, ARKANSAS



SCALE:	NONE
DRAWN:	ENERGY
DESIGN:	ENERGY
CAD NO:	

AMENDMENT 20

BASED ON DRAWING NO

SHEET

REV.

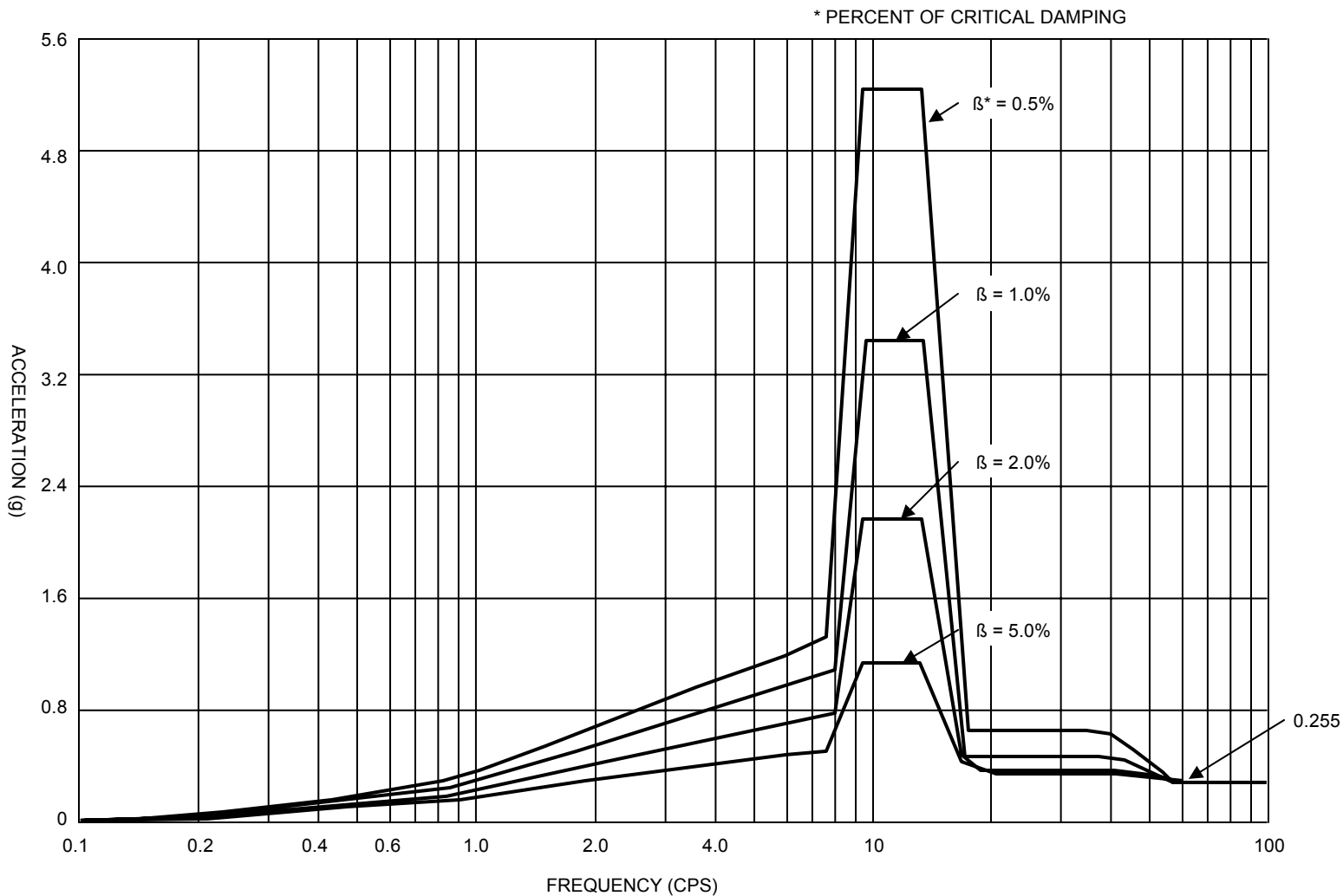

ACCELERATION RESPONSE SPECTRA AUXILIARY BUILDING ELEV. 386' - 0"
OPERATING BASIS EARTHQUAKE

SAR FIGURE NO. 3.7-22

ARKANSAS NUCLEAR ONE
UNIT 2
RUSSELLVILLE, ARKANSAS



SCALE: NONE
DRAWN: ENTERGY
DESIGN: ENTERGY
CAD NO:

AMENDMENT 20

BASED ON DRAWING NO

SHEET

REV.

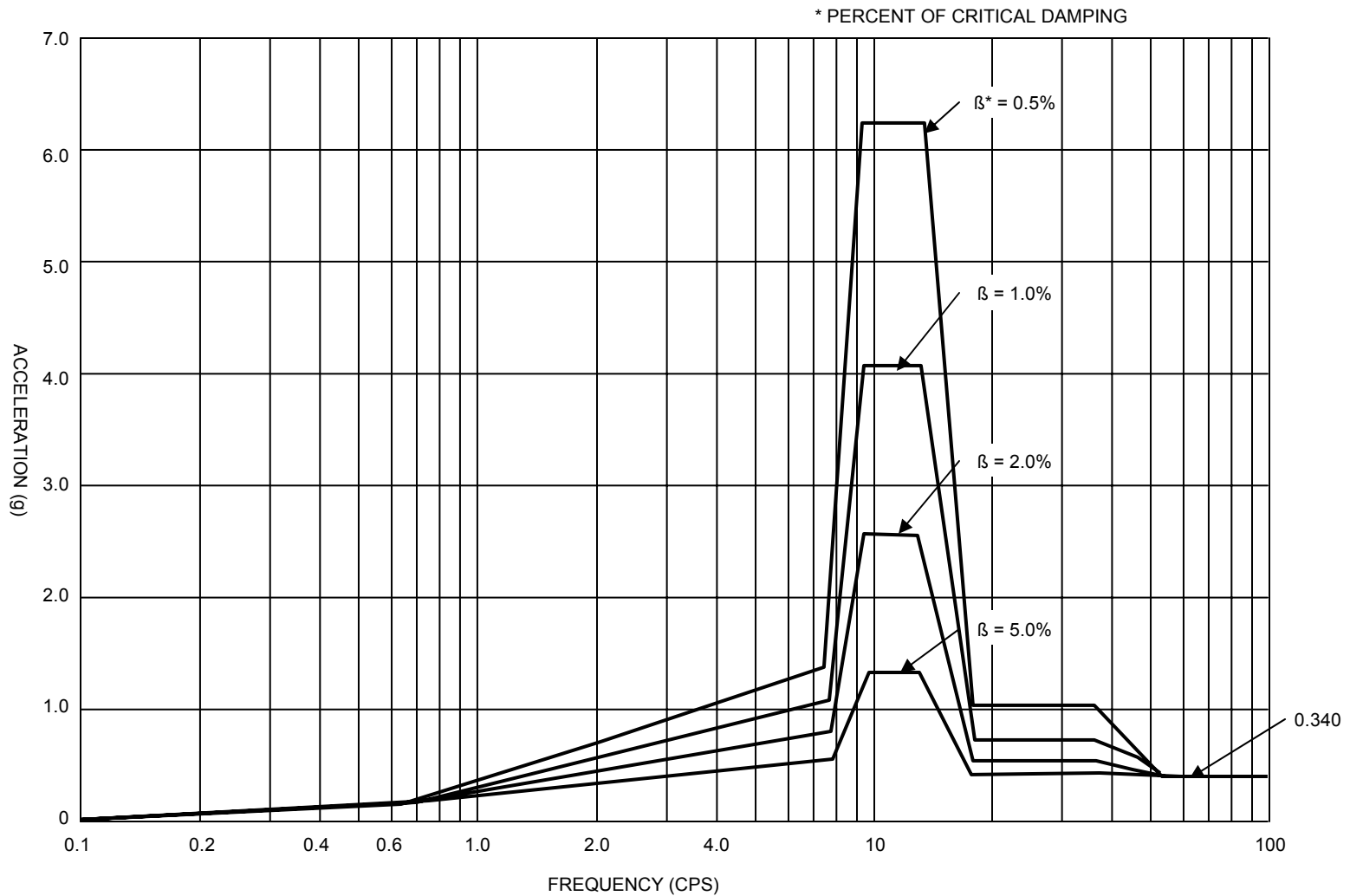

ACCELERATION RESPONSE SPECTRA AUXILIARY BUILDING ELEV. 404' - 0"
OPERATING BASIS EARTHQUAKE

SAR FIGURE NO. 3.7-23

ARKANSAS NUCLEAR ONE
UNIT 2
RUSSELLVILLE, ARKANSAS



SCALE:	NONE
DRAWN:	ENERGY
DESIGN:	ENERGY
CAD NO:	

AMENDMENT 20

BASED ON DRAWING NO

SHEET

REV.

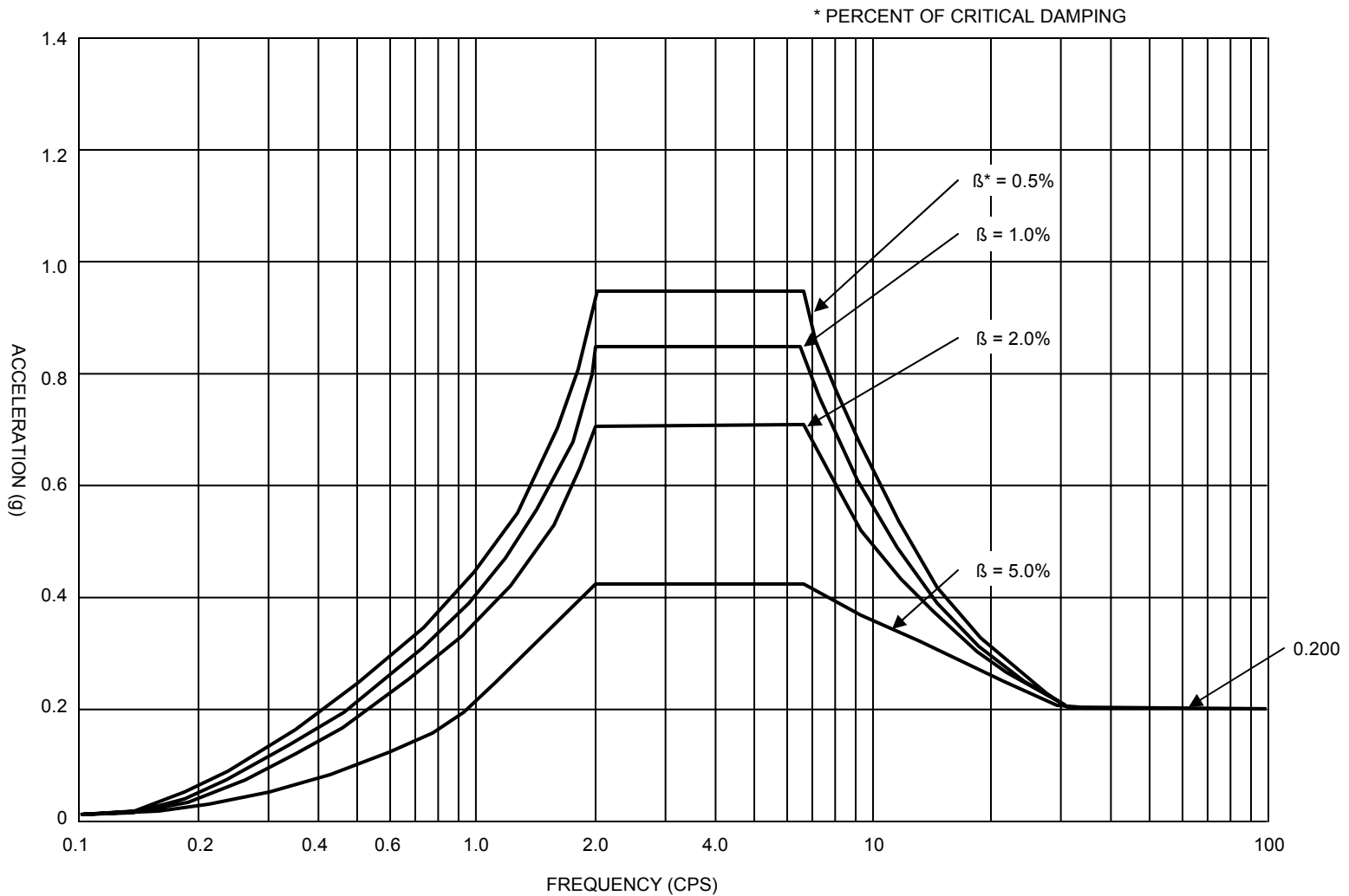

ACCELERATION RESPONSE SPECTRA AUXILIARY BUILDING ELEV. 317'0" AND 335'-0"
DESIGN BASIS EARTHQUAKE

SAR FIGURE NO. 3.7-24

ARKANSAS NUCLEAR ONE
UNIT 2
RUSSELLVILLE, ARKANSAS



SCALE: NONE
DRAWN: ENTERGY
DESIGN: ENTERGY
CAD NO:

AMENDMENT 20

BASED ON DRAWING NO

SHEET

REV.

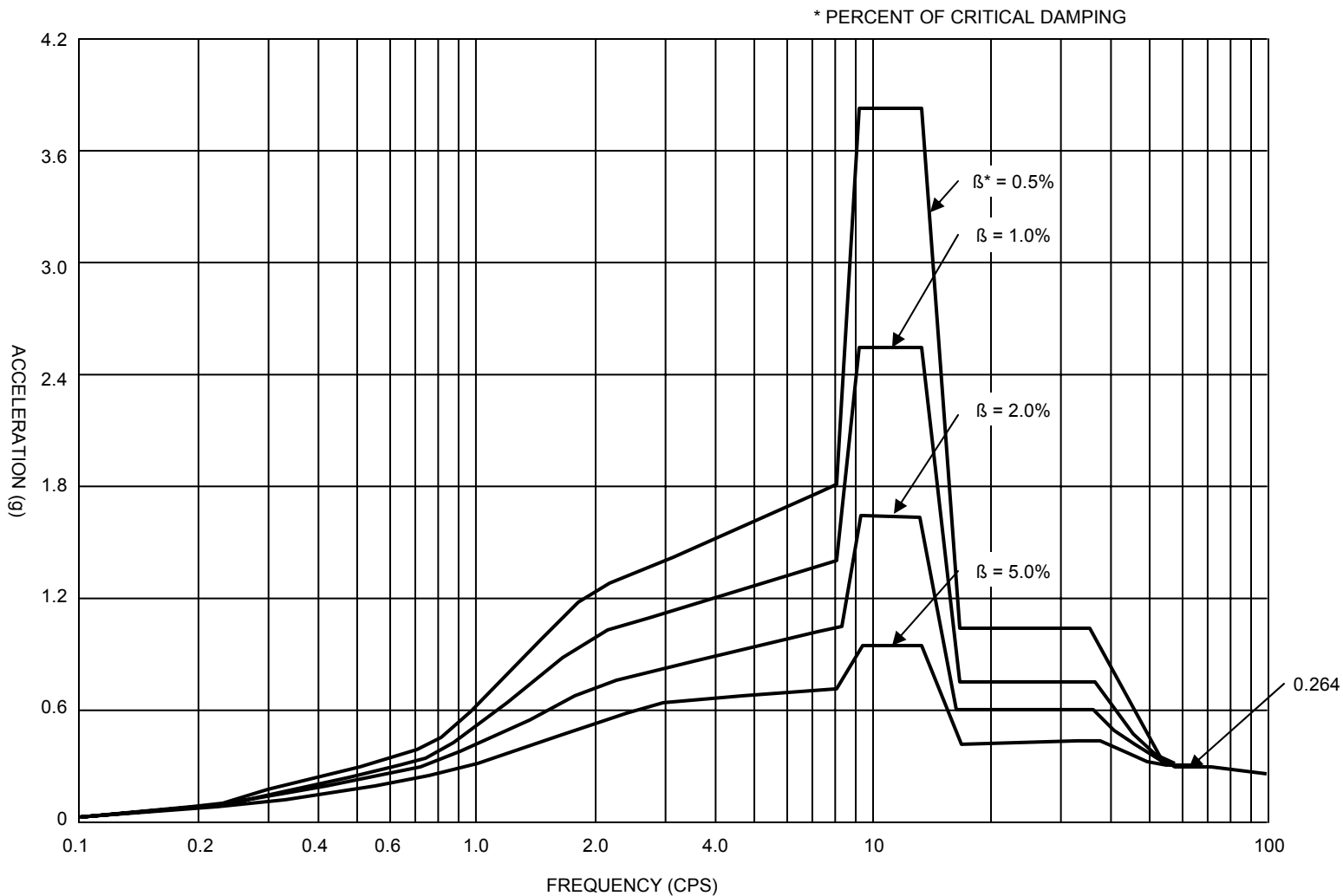

ACCELERATION RESPONSE SPECTRA AUXILIARY BUILDING ELEV. 354' - 0"
 DESIGN BASIS EARTHQUAKE

SAR FIGURE NO. 3.7-25

ARKANSAS NUCLEAR ONE
 UNIT 2
 RUSSELLVILLE, ARKANSAS



SCALE: NONE
 DRAWN: ENTERGY
 DESIGN: ENTERGY
 CAD NO:

AMENDMENT 20

BASED ON DRAWING NO

SHEET

REV.

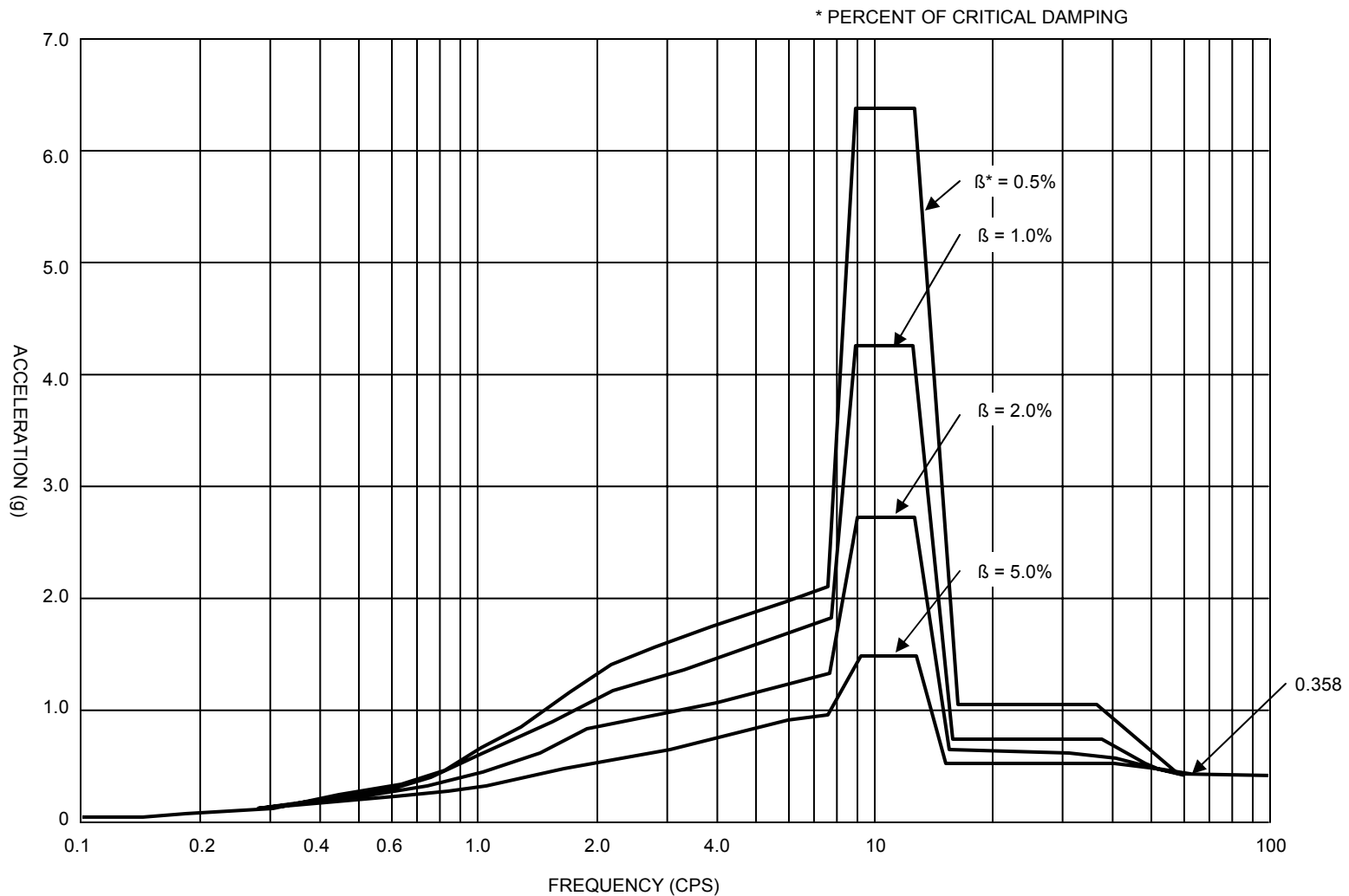

ACCELERATION RESPONSE SPECTRA AUXILIARY BUILDING ELEV. 372' - 0"
 DESIGN BASIS EARTHQUAKE

SAR FIGURE NO. 3.7-26

ARKANSAS NUCLEAR ONE
 UNIT 2
 RUSSELLVILLE, ARKANSAS



SCALE: NONE
 DRAWN: ENTERGY
 DESIGN: ENTERGY
 CAD NO:

AMENDMENT 20

BASED ON DRAWING NO

SHEET

REV.

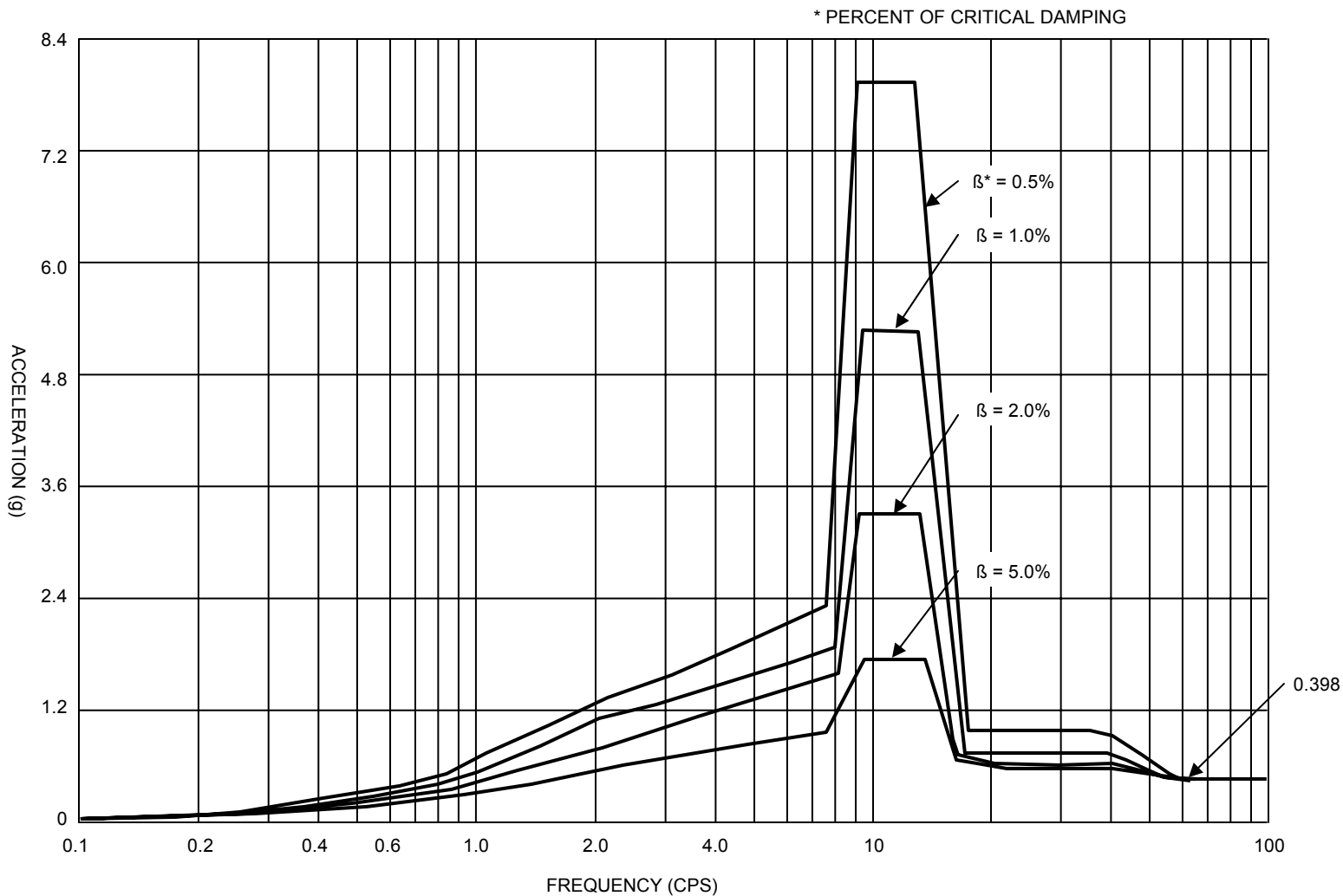

ACCELERATION RESPONSE SPECTRA AUXILIARY BUILDING ELEV. 386' - 0"
DESIGN BASIS EARTHQUAKE

SAR FIGURE NO. 3.7-27

ARKANSAS NUCLEAR ONE
UNIT 2
RUSSELLVILLE, ARKANSAS



SCALE: NONE
DRAWN: ENTERGY
DESIGN: ENTERGY
CAD NO:

AMENDMENT 20

BASED ON DRAWING NO

SHEET

REV.

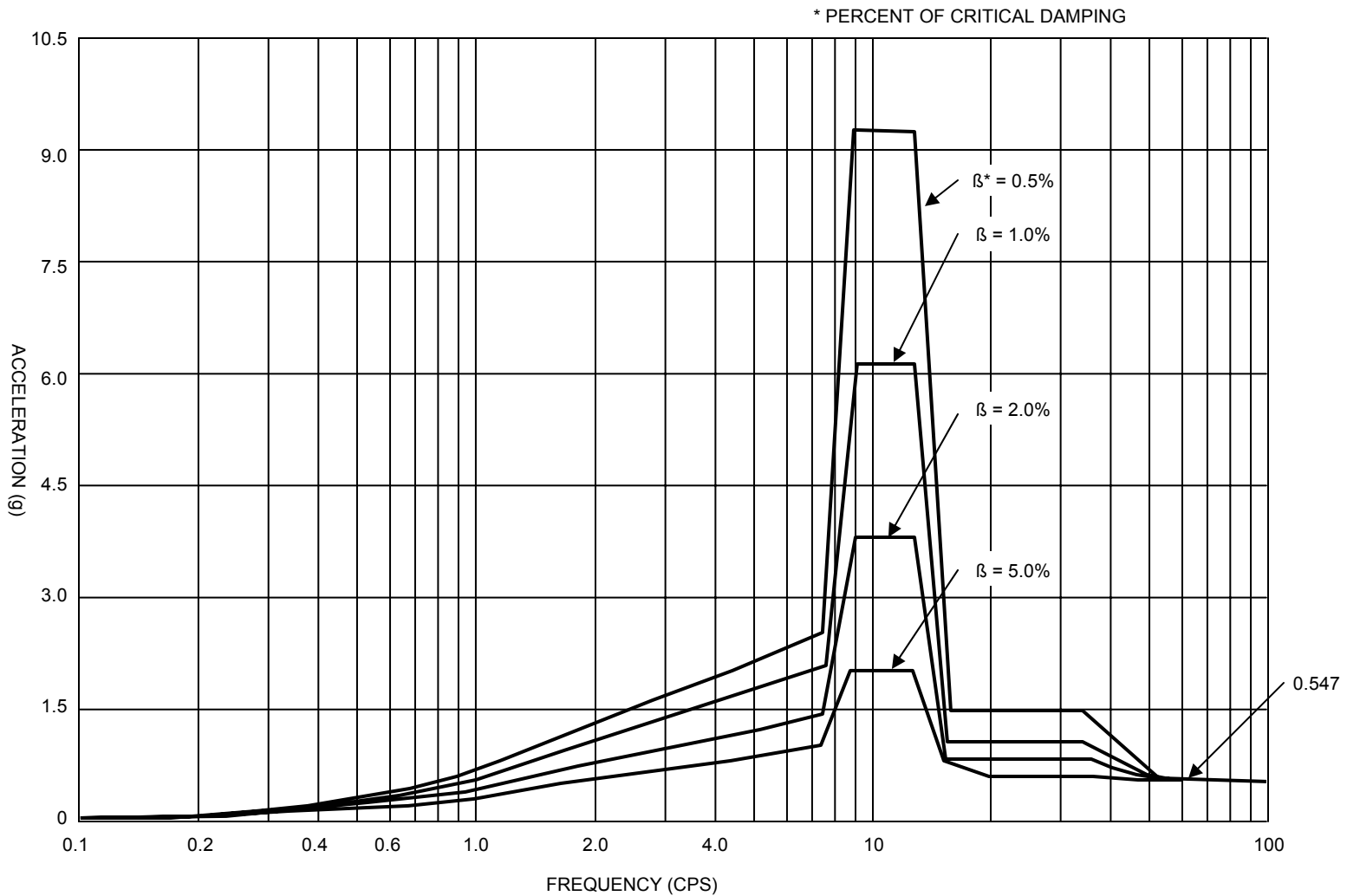

ACCELERATION RESPONSE SPECTRA AUXILIARY BUILDING ELEV. 404' - 0"
DESIGN BASIS EARTHQUAKE

SAR FIGURE NO. 3.7-28

ARKANSAS NUCLEAR ONE
UNIT 2
RUSSELLVILLE, ARKANSAS



SCALE: NONE
DRAWN: ENTERGY
DESIGN: ENTERGY
CAD NO:

AMENDMENT 20

BASED ON DRAWING NO

SHEET

REV.

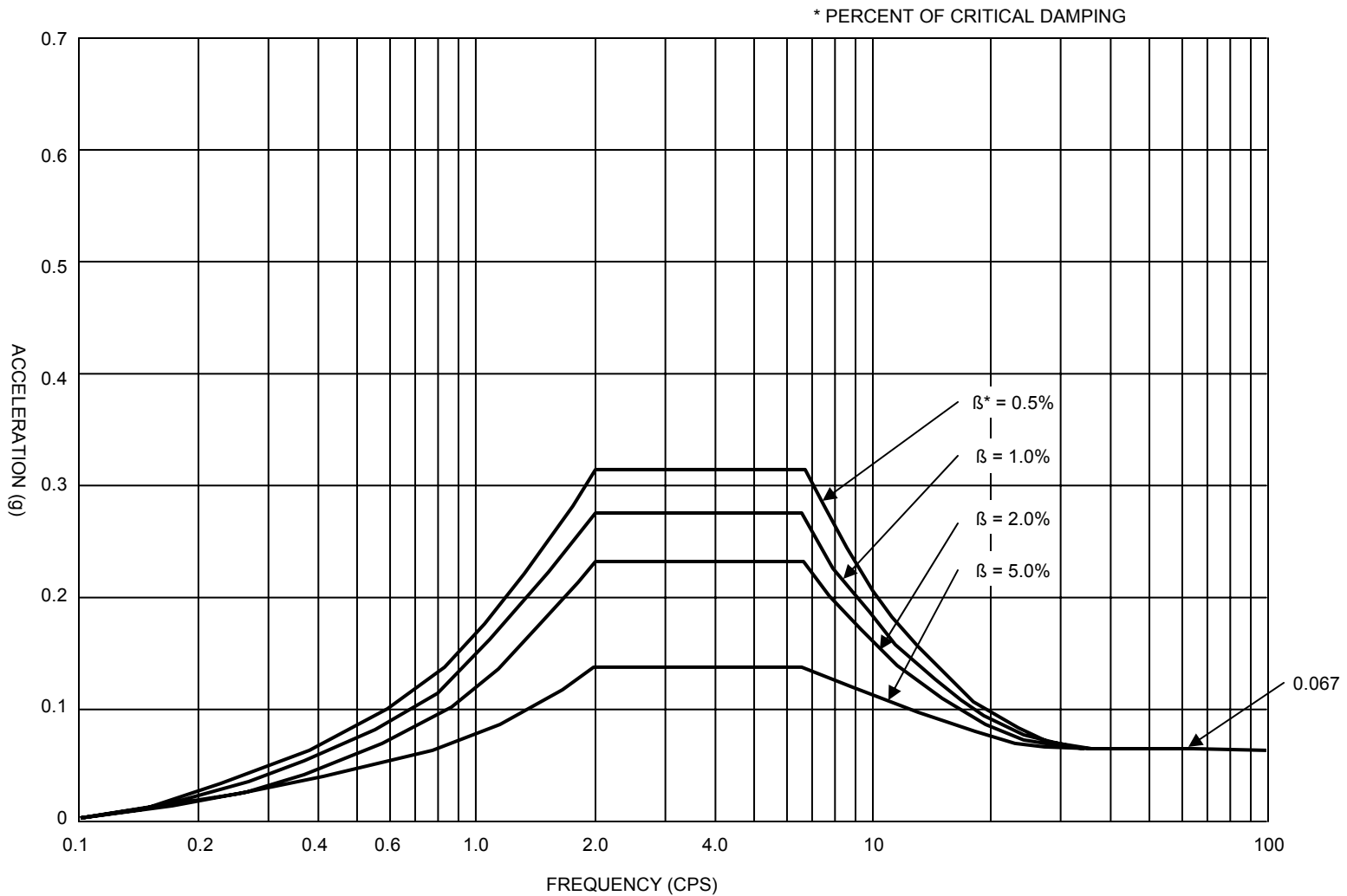

ACCELERATION RESPONSE SPECTRA AUXILIARY BUILDING ELEV. 317'-0" AND 335'-0"
OPERATING BASIS EARTHQUAKE

SAR FIGURE NO. 3.7-29

ARKANSAS NUCLEAR ONE
UNIT 2
RUSSELLVILLE, ARKANSAS



SCALE: NONE
DRAWN: ENTERGY
DESIGN: ENTERGY
CAD NO:

AMENDMENT 20

BASED ON DRAWING NO

SHEET

REV.

● MCL PIPING & RCP MASS POINTS (SEE FIGURES 3.4.4-2 and 3.4.4-3) FOR RSG & RV MASS POINTS)

SUPPORT LOCATIONS

RV	
3	1910
2	2910
1	3910
RSG #1	
S1	205
S2	206
Z1	207
Z2	208
Z11	33
Z12	37
Y1	11
Y3	21
Y4	25
Y2	15
RCP #1A	
S1	1239
S2	1241
HNGR 1	1111
HNGR 2	1115
HNGR 3	1121
HNGR 4	1125

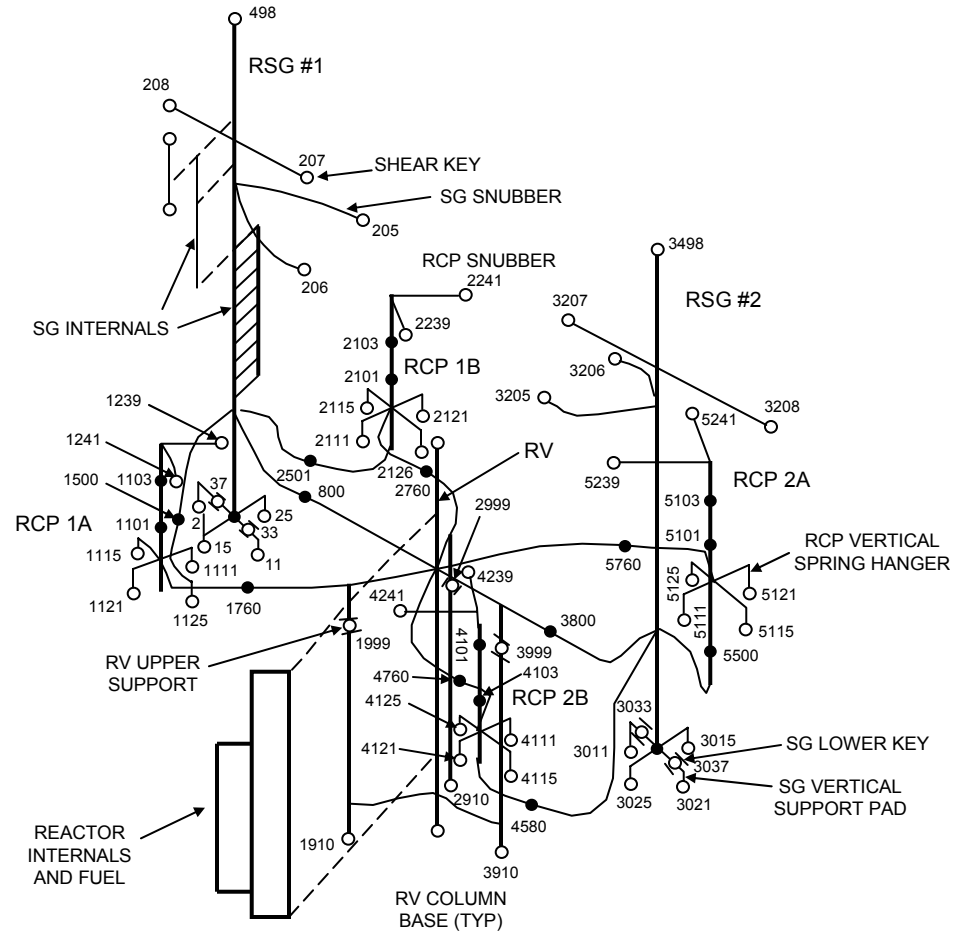
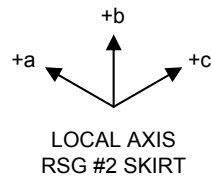
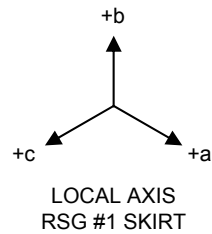
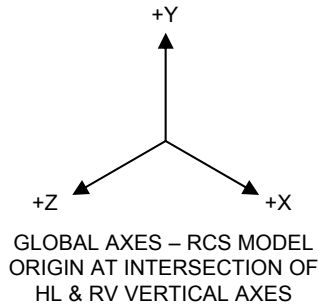

GENERALIZED RCS ANSYS MODEL

SAR FIGURE NO. 3.7-30

ARKANSAS NUCLEAR ONE
UNIT 2
RUSSELLVILLE, ARKANSAS



SCALE:	NONE
DRAWN:	ENERGY
DESIGN:	ENERGY
CAD NO:	

AMENDMENT 20

BASED ON DRAWING NO	SHEET	REV.

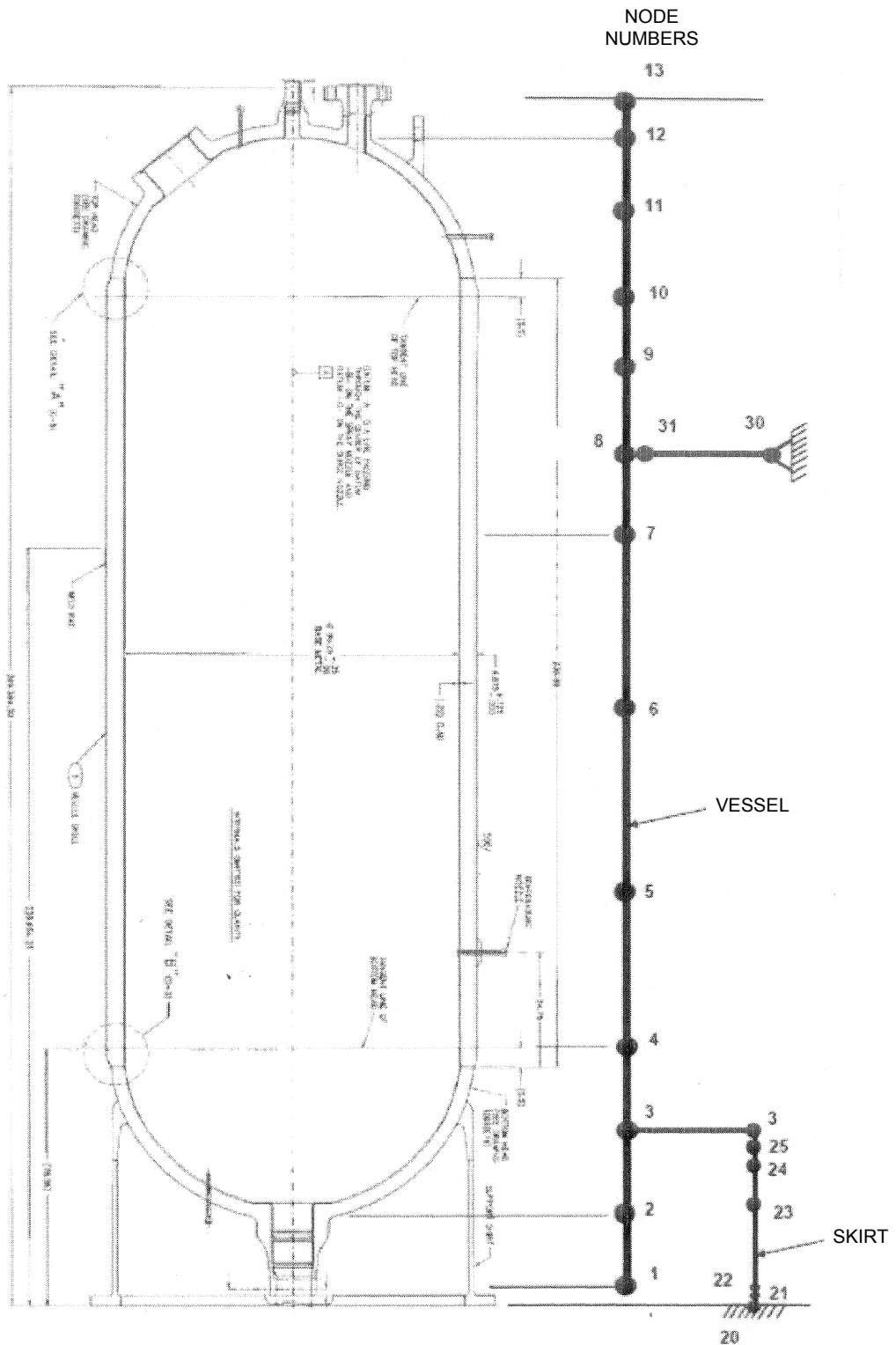

SAR FIGURE NO. 3.7-31

AMENDMENT 20

ARKANSAS NUCLEAR ONE
UNIT 2
RUSSELLVILLE, ARKANSAS



SCALE:	NONE
DRAWN:	ENERGY
DESIGN:	ENERGY
CAD NO:	N/A

PRESSURIZER SEISMIC ANALYSIS MODEL

DRAWING NO

SHEET

REV.

$$Y_2 = 2 (1 - \cos t)$$

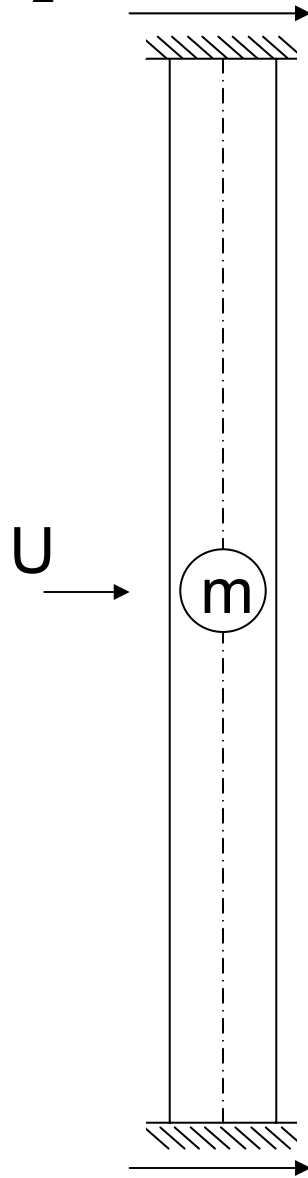

$$E = 30 \times 10^6 \text{ lb/in}^2$$

$$I = 0.469 \text{ in}^4$$

$$A = 19.35 \text{ in}^2$$

$$L = 300 \text{ in}$$

$$P = 0.3 \text{ lb/in}^3$$

$$Y_1 = 4 \Pi^2 \cos \Pi t$$

SAR FIGURE NO. 3.7-32

AMENDMENT 20

ARKANSAS NUCLEAR ONE
UNIT 2
RUSSELLVILLE, ARKANSAS



SCALE:	NONE
DRAWN:	ENERGY
DESIGN:	ENERGY
CAD NO:	N/A

EXAMPLE PROBLEM FOR TMCALC
PROGRAM

DRAWING NO

SHEET

REV.

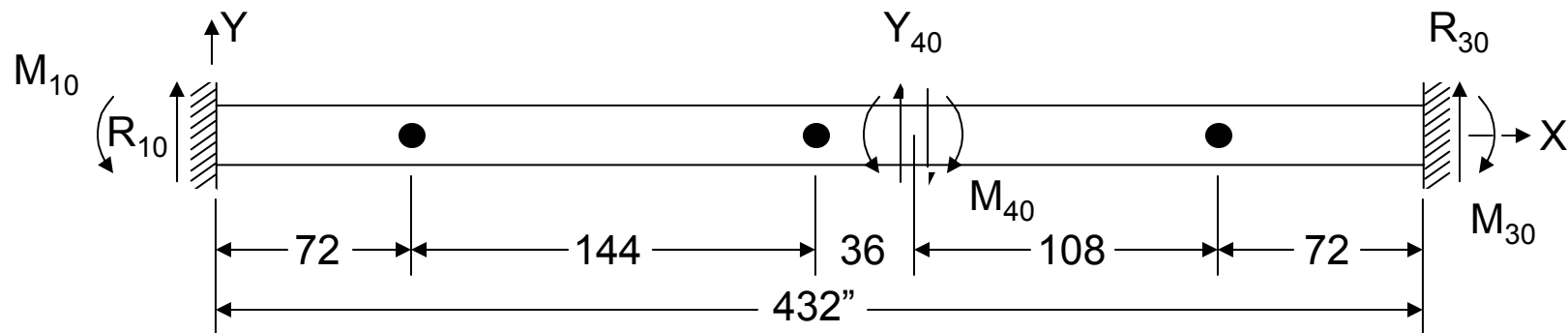

STRUCTURAL PROPERTIES

$AX = 311 \text{ in}^2$

$I_Z = 42,687 \text{ in}^4$

$\rho = 108 \text{ lb/in}$

$AY = 155 \text{ in}^2$

$E = 27 \times 10^6 \text{ lb/in}^2$

EXAMPLE PROBLEM FOR FORCE PROGRAM

SAR FIGURE NO. 3.7-33

ARKANSAS NUCLEAR ONE
UNIT 2
RUSSELLVILLE, ARKANSAS



SCALE: NONE
DRAWN: ENERGY
DESIGN: ENERGY
CAD NO:

AMENDMENT 20

BASED ON DRAWING NO

SHEET

REV.

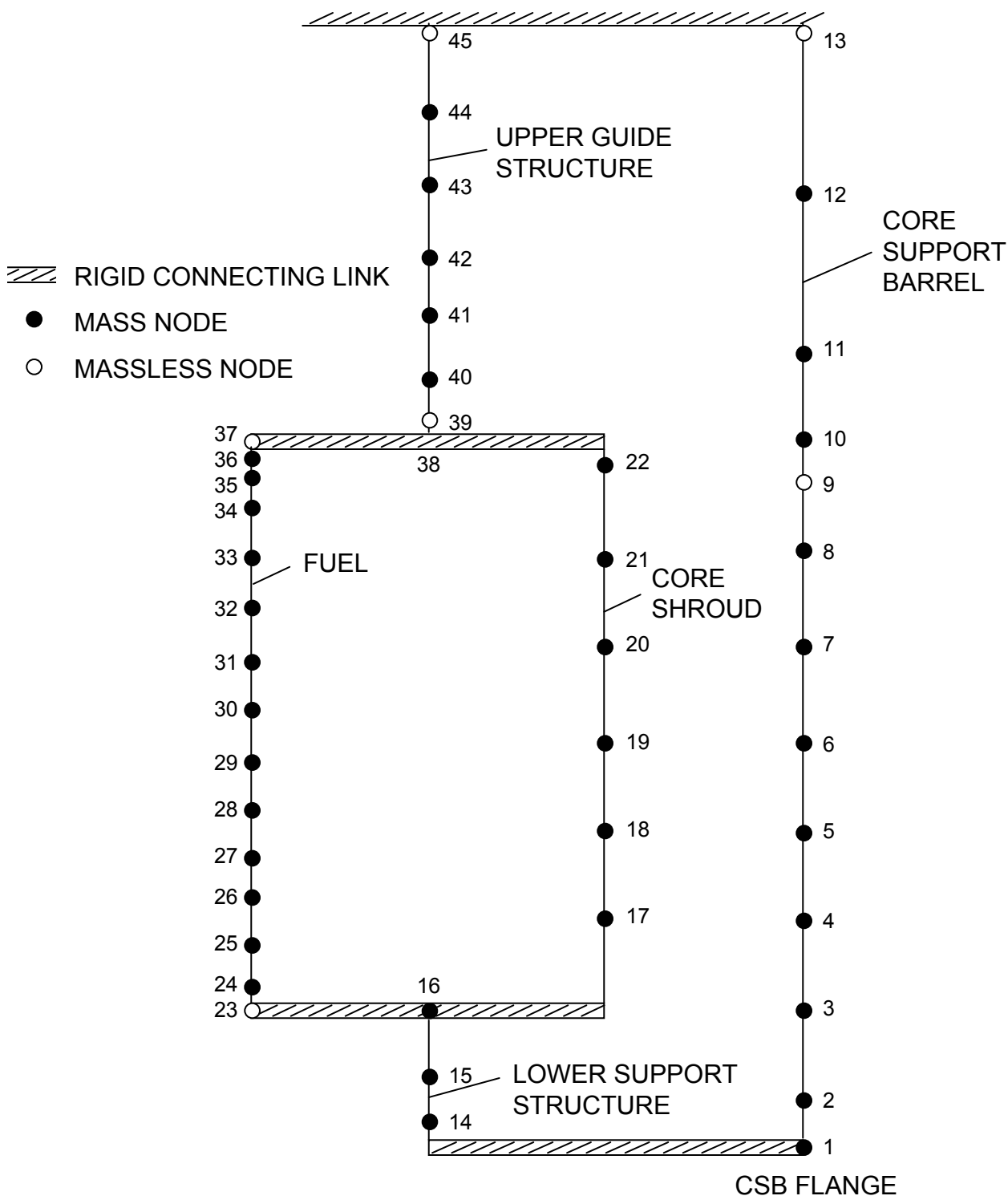

SAR FIGURE NO. 3.7-35

AMENDMENT 20

ARKANSAS NUCLEAR ONE
 UNIT 2
 RUSSELLVILLE, ARKANSAS



SCALE:	NONE
DRAWN:	ENERGY
DESIGN:	ENERGY
CAD NO:	N/A

REACTOR INTERNALS LINEAR HORIZONTAL
 SEISMIC MODEL

DRAWING NO

SHEET

REV.

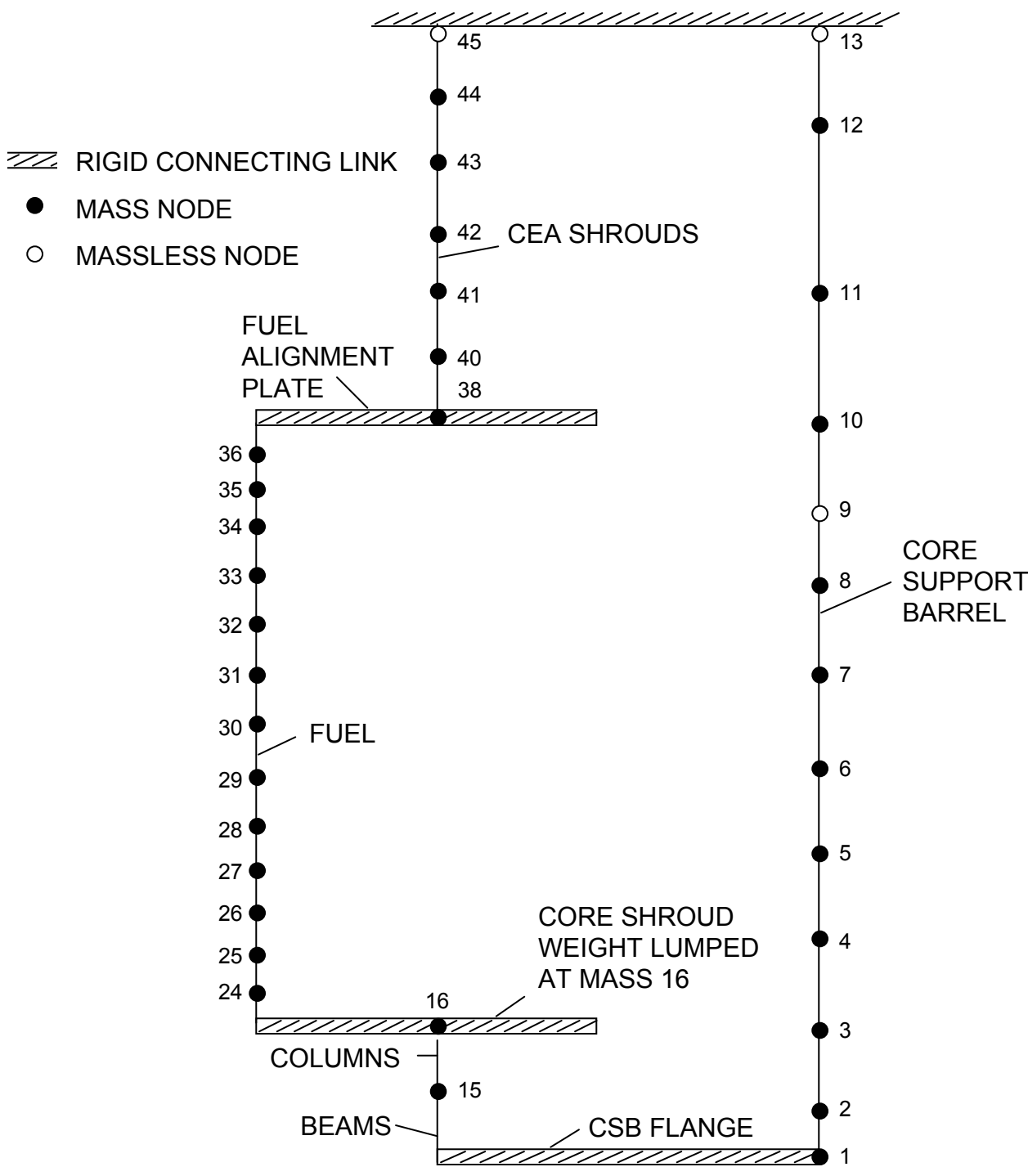

SAR FIGURE NO. 3.7-36

AMENDMENT 20

ARKANSAS NUCLEAR ONE
UNIT 2
RUSSELLVILLE, ARKANSAS



SCALE:	NONE
DRAWN:	ENERGY
DESIGN:	ENERGY
CAD NO:	N/A

REACTOR INTERNALS LINEAR VERTICAL
SEISMIC MODEL

DRAWING NO

SHEET

REV.

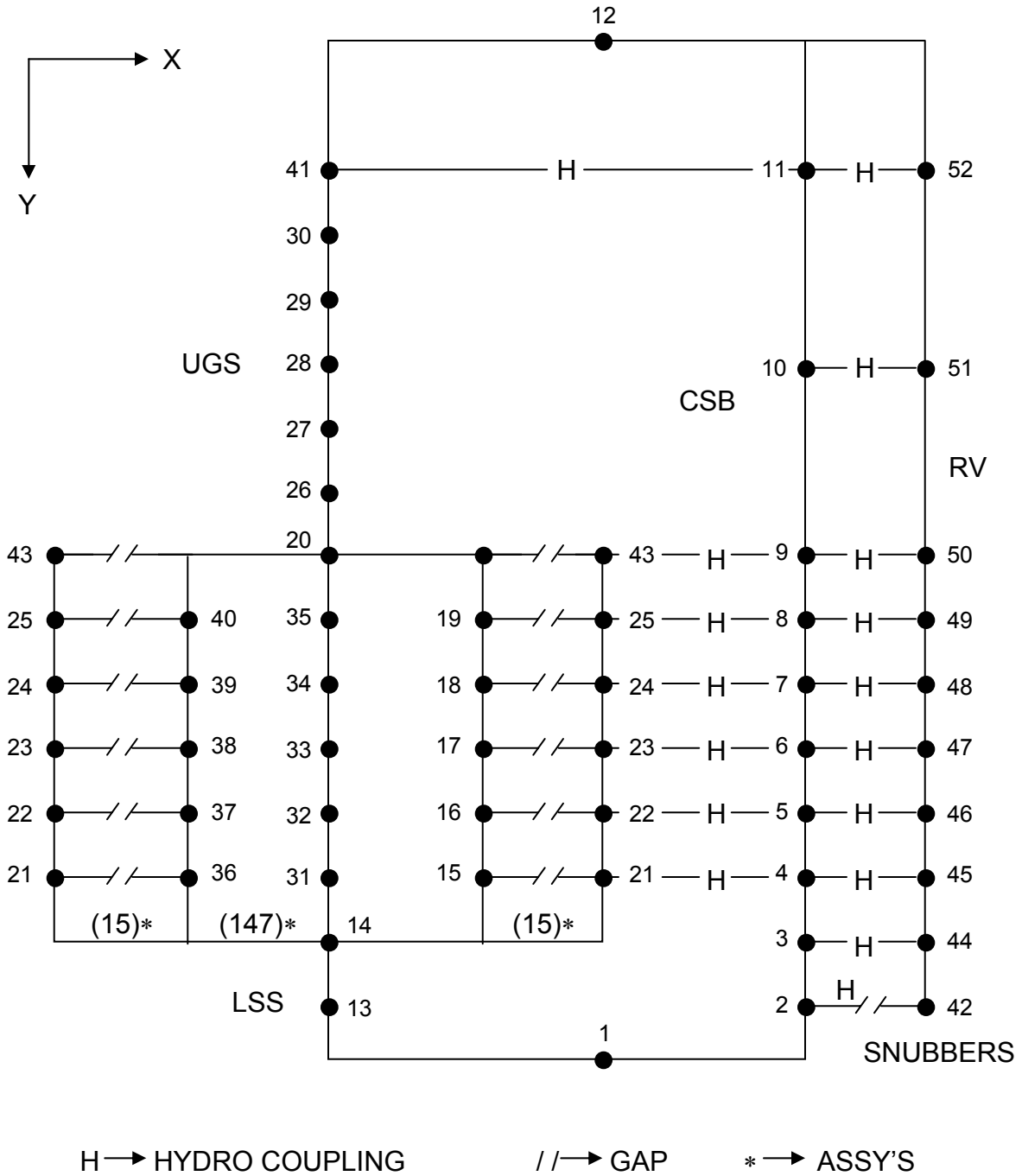

SAR FIGURE NO. 3.7-37

AMENDMENT 20

ARKANSAS NUCLEAR ONE
UNIT 2
RUSSELLVILLE, ARKANSAS



SCALE:	NONE
DRAWN:	ENERGY
DESIGN:	ENERGY
CAD NO:	N/A

REACTOR INTERNALS HORIZONTAL
NONLINEAR SEISMIC MODEL

DRAWING NO

SHEET

REV.

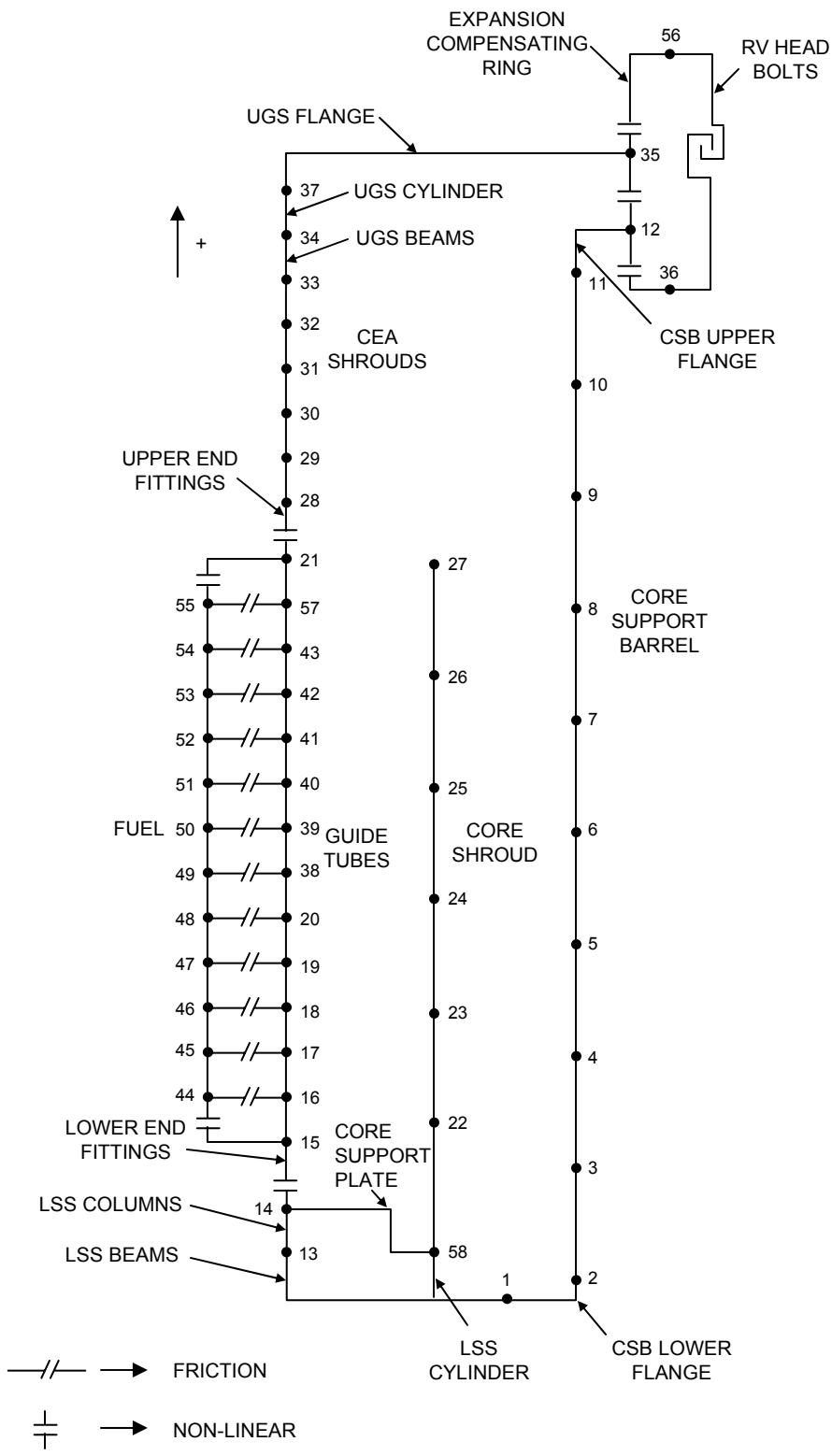

SAR FIGURE NO. 3.7-38

AMENDMENT 20

ARKANSAS NUCLEAR ONE
UNIT 2
RUSSELLVILLE, ARKANSAS



SCALE:	NONE
DRAWN:	ENERGY
DESIGN:	ENERGY
CAD NO:	N/A

COUPLED REACTOR INTERNALS AND CORE
VERTICAL NONLINEAR SEISMIC MODEL

DRAWING NO	SHEET	REV.

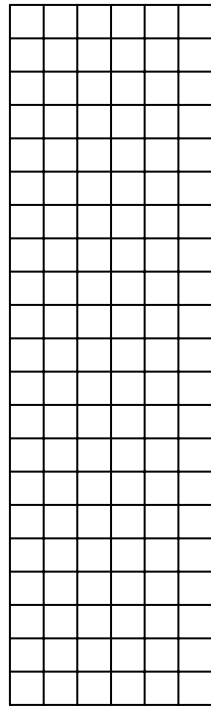

CYLINDER

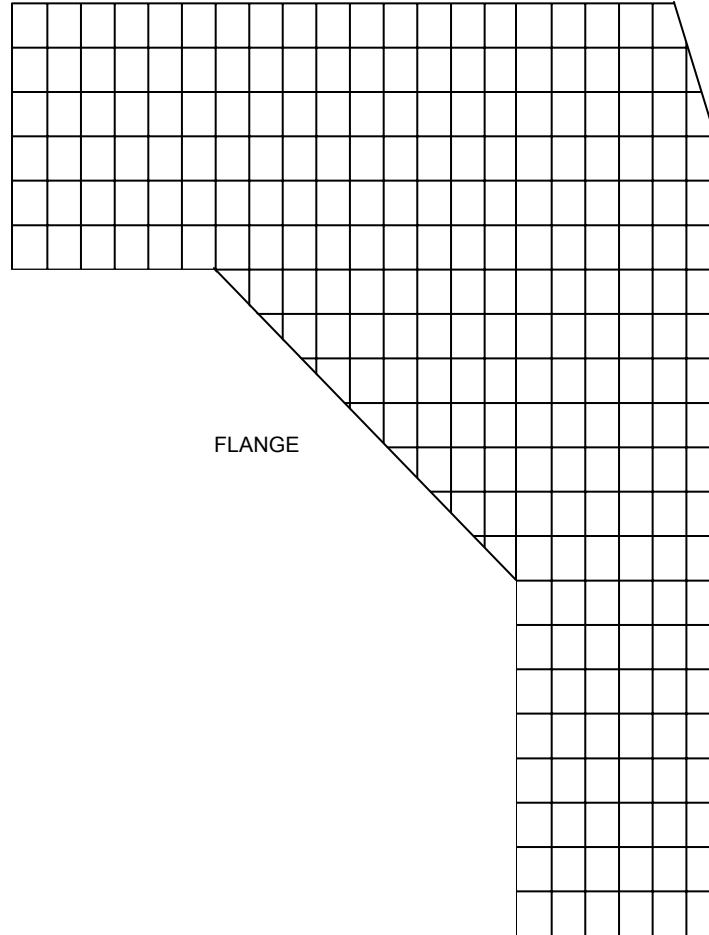

FLANGE

CORE SUPPORT BARREL UPPER FLANGE FINITE ELEMENT MODEL

SAR FIGURE NO. 3.7-39

ARKANSAS NUCLEAR ONE
 UNIT 2
 RUSSELLVILLE, ARKANSAS



SCALE: NONE
 DRAWN: ENTERGY
 DESIGN: ENTERGY
 CAD NO:

AMENDMENT 20

BASED ON DRAWING NO	SHEET	REV.

MODE No. 1
 FREQ. = 2.7 CPS

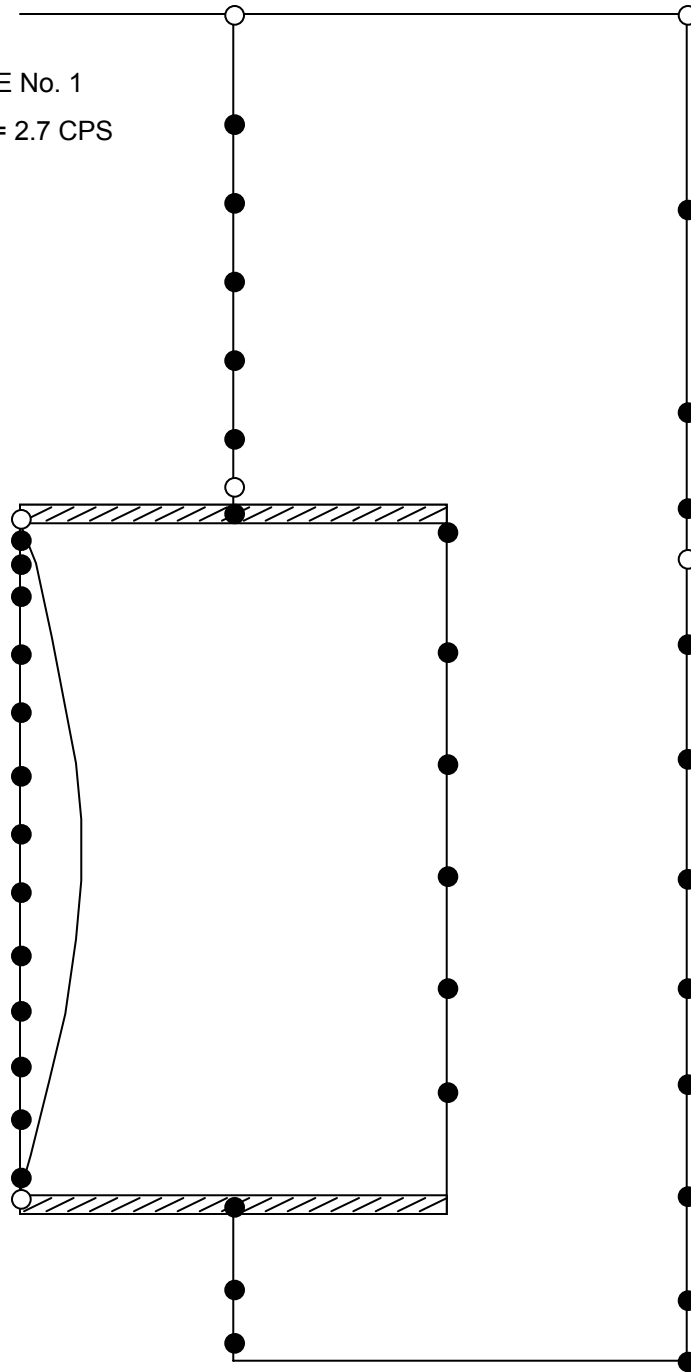

SAR FIGURE NO. 3.7-40

AMENDMENT 20

ARKANSAS NUCLEAR ONE
 UNIT 2
 RUSSELLVILLE, ARKANSAS



SCALE:	NONE
DRAWN:	ENERGY
DESIGN:	ENERGY
CAD NO:	N/A

HORIZONTAL FREQUENCIES AND MODE SHAPES

DRAWING NO

SHEET

REV.

MODE No. 2
 FREQ. = 7.3 CPS

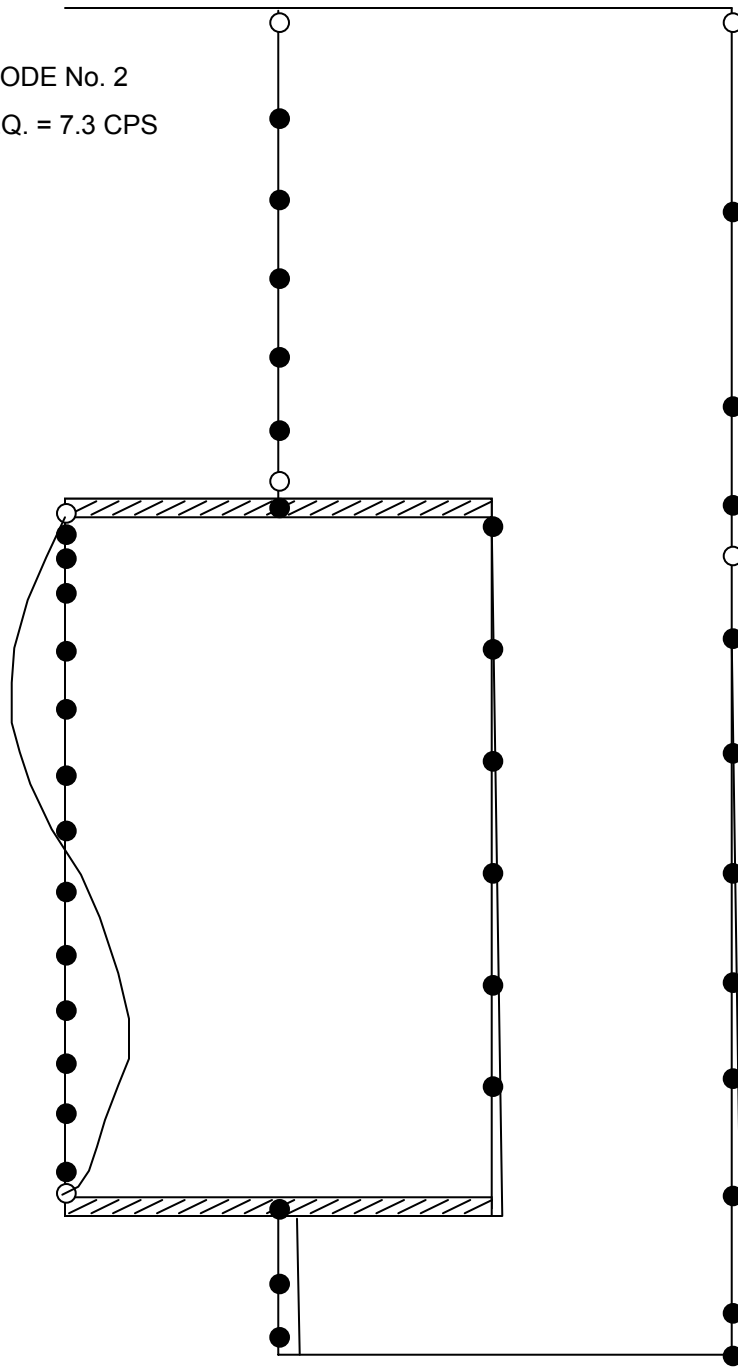

SAR FIGURE NO. 3.7-41

AMENDMENT 20

ARKANSAS NUCLEAR ONE
 UNIT 2
 RUSSELLVILLE, ARKANSAS



SCALE:	NONE
DRAWN:	ENERGY
DESIGN:	ENERGY
CAD NO:	N/A

HORIZONTAL FREQUENCIES AND MODE SHAPES

DRAWING NO

SHEET

REV.

MODE No. 3
 FREQ. = 8.5 CPS

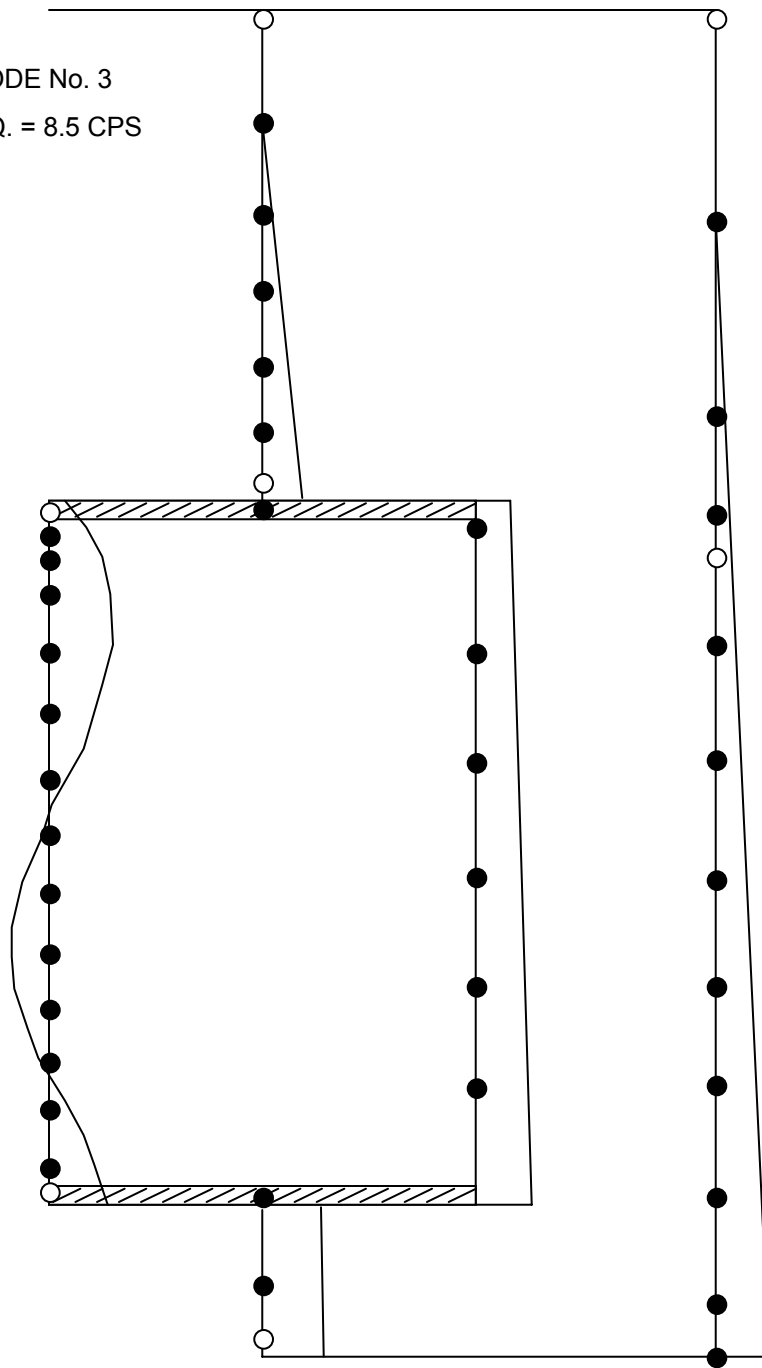

SAR FIGURE NO. 3.7-42

AMENDMENT 20

ARKANSAS NUCLEAR ONE
 UNIT 2
 RUSSELLVILLE, ARKANSAS



SCALE:	NONE
DRAWN:	ENERGY
DESIGN:	ENERGY
CAD NO:	N/A

HORIZONTAL FREQUENCIES AND MODE SHAPES

DRAWING NO

SHEET

REV.

MODE No. 4
 FREQ. = 15.0 CPS

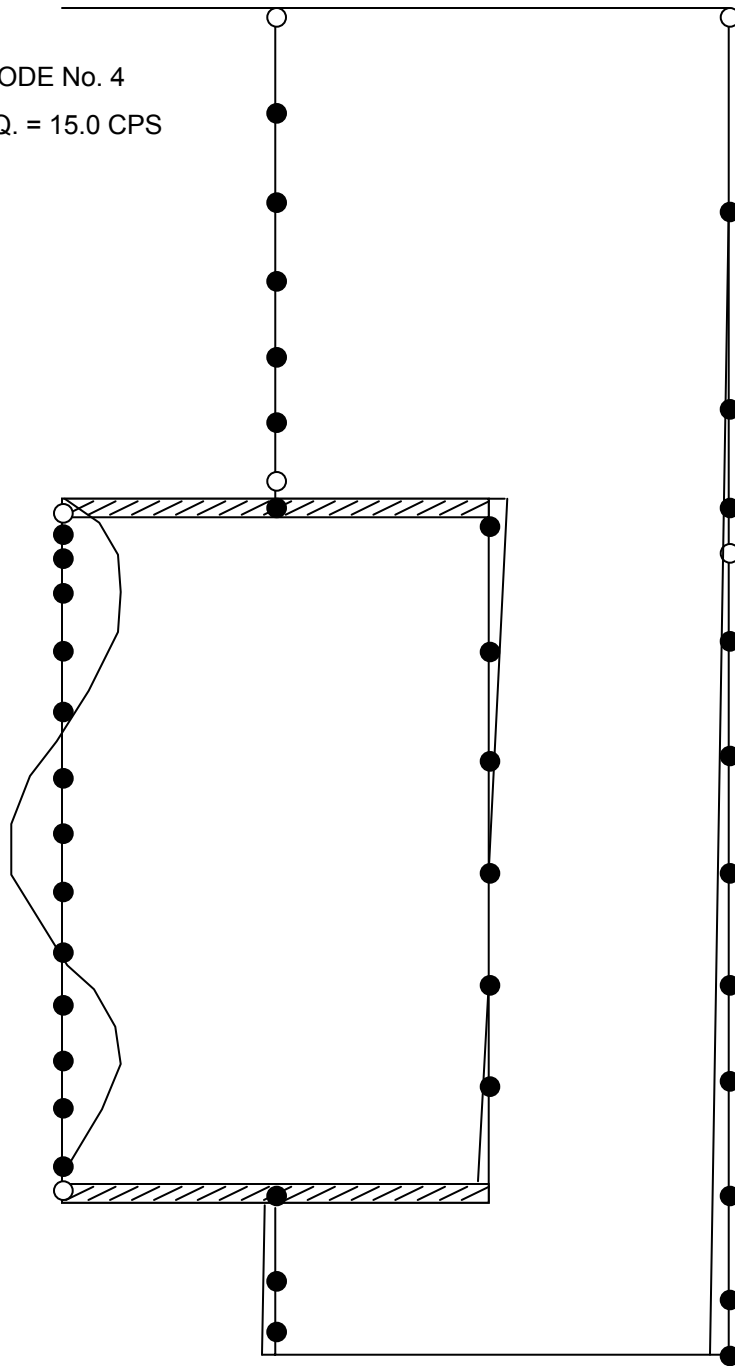

SAR FIGURE NO. 3.7-43

AMENDMENT 20

ARKANSAS NUCLEAR ONE
 UNIT 2
 RUSSELLVILLE, ARKANSAS



SCALE:	NONE
DRAWN:	ENERGY
DESIGN:	ENERGY
CAD NO:	N/A

HORIZONTAL FREQUENCIES AND MODE SHAPES

DRAWING NO

SHEET

REV.

MODE No. 5
 FREQ. = 22.9 CPS

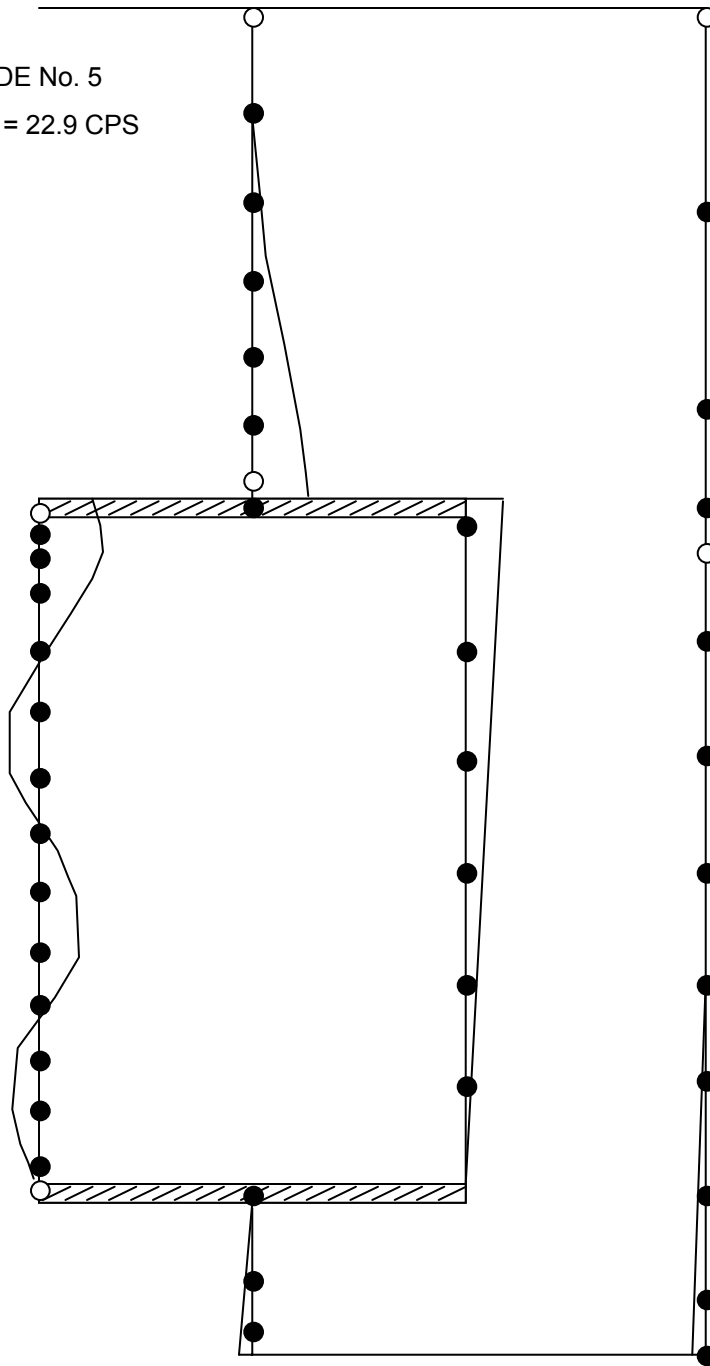

SAR FIGURE NO. 3.7-44

AMENDMENT 20

ARKANSAS NUCLEAR ONE
 UNIT 2
 RUSSELLVILLE, ARKANSAS



SCALE:	NONE
DRAWN:	ENERGY
DESIGN:	ENERGY
CAD NO:	N/A

HORIZONTAL FREQUENCIES AND MODE SHAPES

DRAWING NO

SHEET

REV.

MODE No. 6
 FREQ. = 28.2 CPS

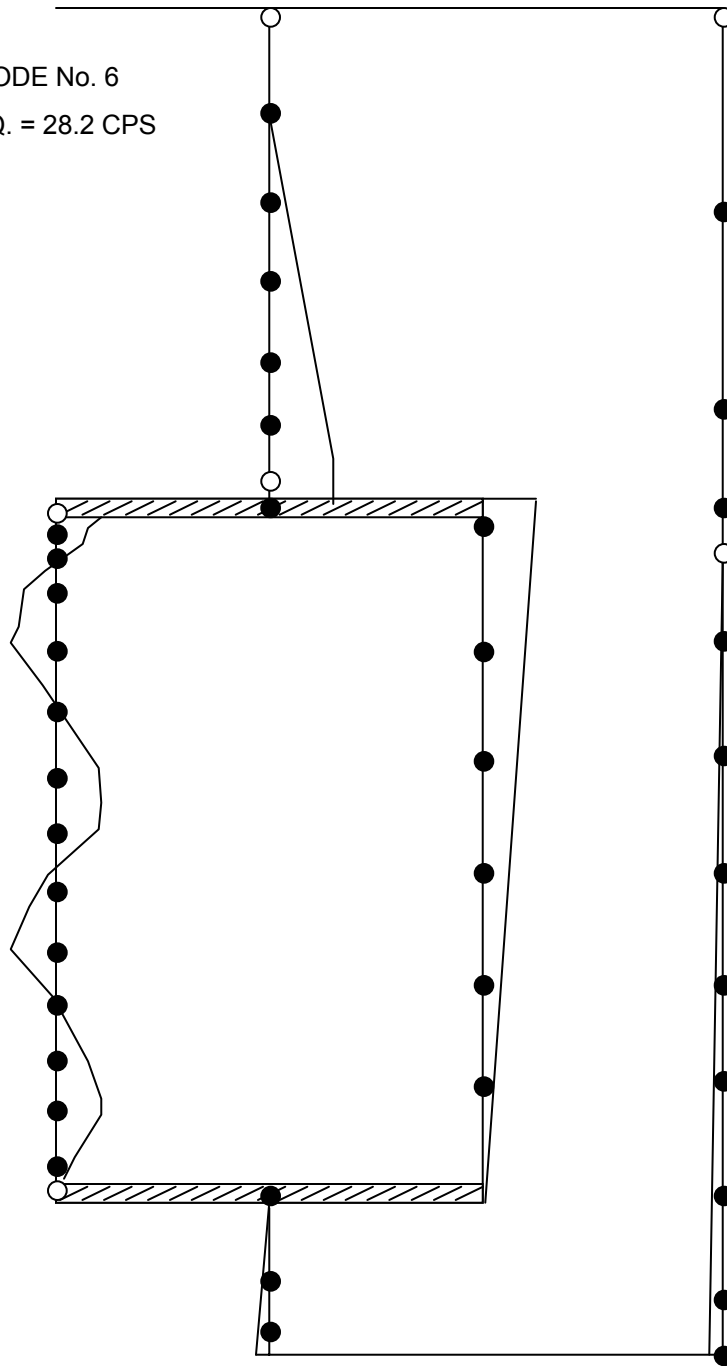

SAR FIGURE NO. 3.7-45

AMENDMENT 20

ARKANSAS NUCLEAR ONE
 UNIT 2
 RUSSELLVILLE, ARKANSAS



SCALE:	NONE
DRAWN:	ENERGY
DESIGN:	ENERGY
CAD NO:	N/A

HORIZONTAL FREQUENCIES AND MODE SHAPES

DRAWING NO

SHEET

REV.

DELETED

SAR FIGURE NO. 3.7-46

AMENDMENT 20

ARKANSAS NUCLEAR ONE
UNIT 2
RUSSELLVILLE, ARKANSAS



SCALE:	NONE
DRAWN:	ENERGY
DESIGN:	ENERGY
CAD NO:	N/A

NORTH – SOUTH OBE RESPONSE SPECTRUM
(5% DAMPING) AT REACTOR VESSEL FLANGE

DRAWING NO

SHEET

REV.

DELETED

SAR FIGURE NO. 3.7-47

AMENDMENT 20

ARKANSAS NUCLEAR ONE
UNIT 2
RUSSELLVILLE, ARKANSAS



SCALE:	NONE
DRAWN:	ENERGY
DESIGN:	ENERGY
CAD NO:	N/A

NORTH – SOUTH OBE RESPONSE SPECTRUM
(2% DAMPING) AT REACTOR VESSEL FLANGE

DRAWING NO

SHEET

REV.

DELETED

SAR FIGURE NO. 3.7-48

AMENDMENT 20

ARKANSAS NUCLEAR ONE
UNIT 2
RUSSELLVILLE, ARKANSAS



SCALE:	NONE
DRAWN:	ENERGY
DESIGN:	ENERGY
CAD NO:	N/A

NORTH – SOUTH OBE RESPONSE SPECTRUM
(1% DAMPING) AT REACTOR VESSEL FLANGE

DRAWING NO

SHEET

REV.

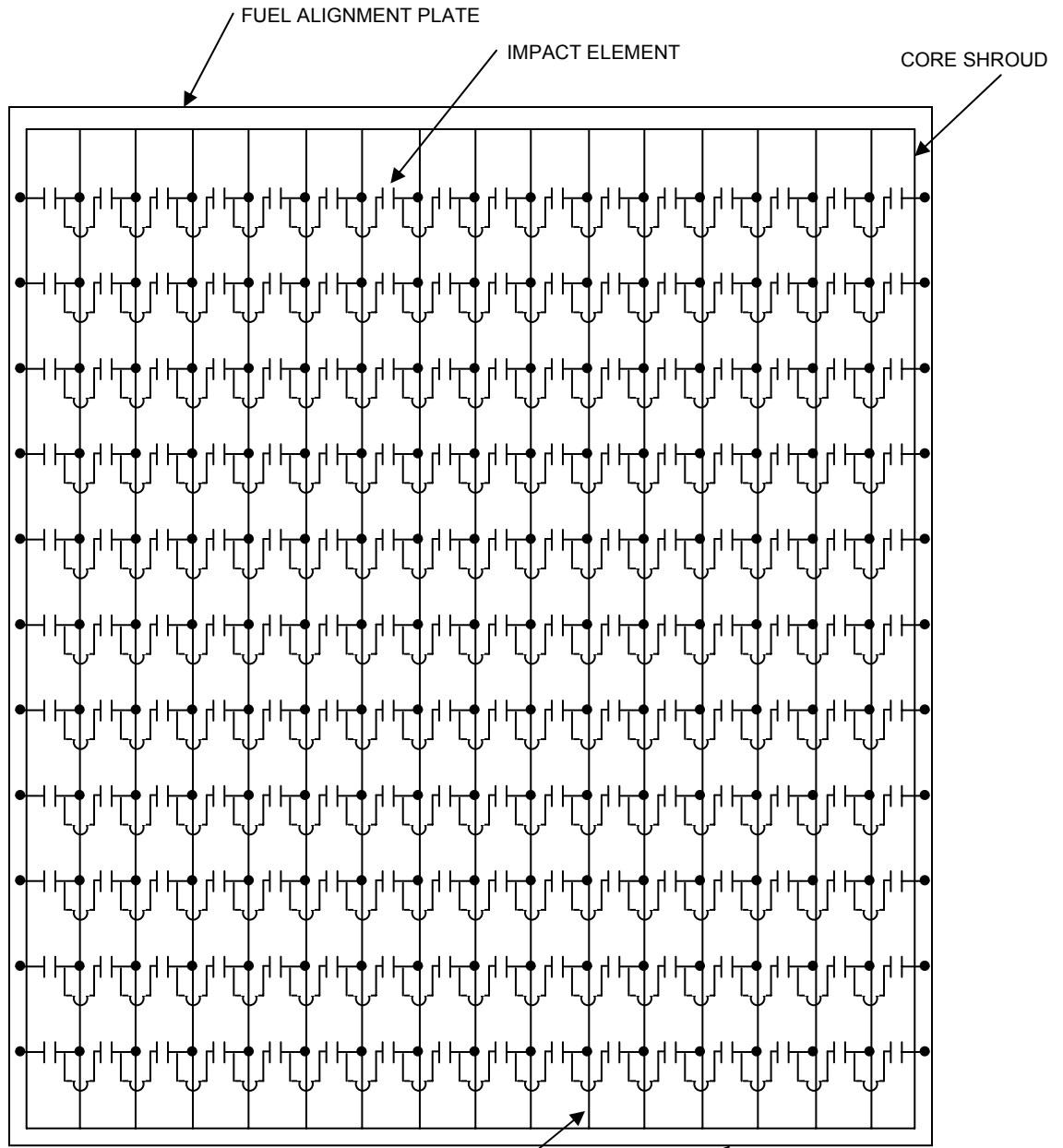

NOTE:
 DETAILED CORE SEISMIC MODEL
 (ONE ROW OF 15 FUEL ASSEMBLIES)

SAR FIGURE NO. 3.7-49

AMENDMENT 20

ARKANSAS NUCLEAR ONE
 UNIT 2
 RUSSELLVILLE, ARKANSAS



SCALE:	NONE
DRAWN:	ENERGY
DESIGN:	ENERGY
CAD NO:	N/A

HORIZONTAL CORE MODEL

DRAWING NO

SHEET

REV.

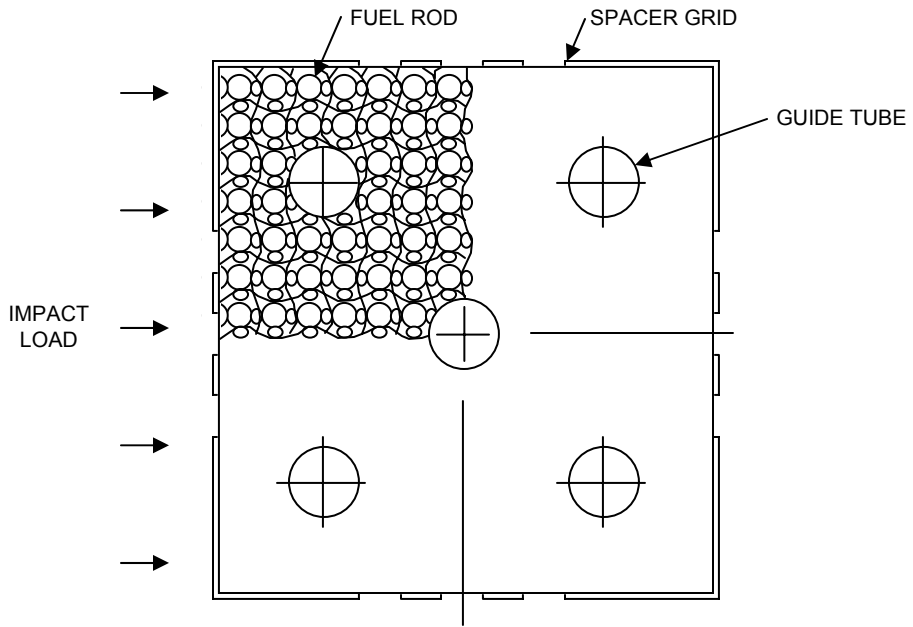

A) ONE-SIDED SPACER GRID IMPACT LOAD

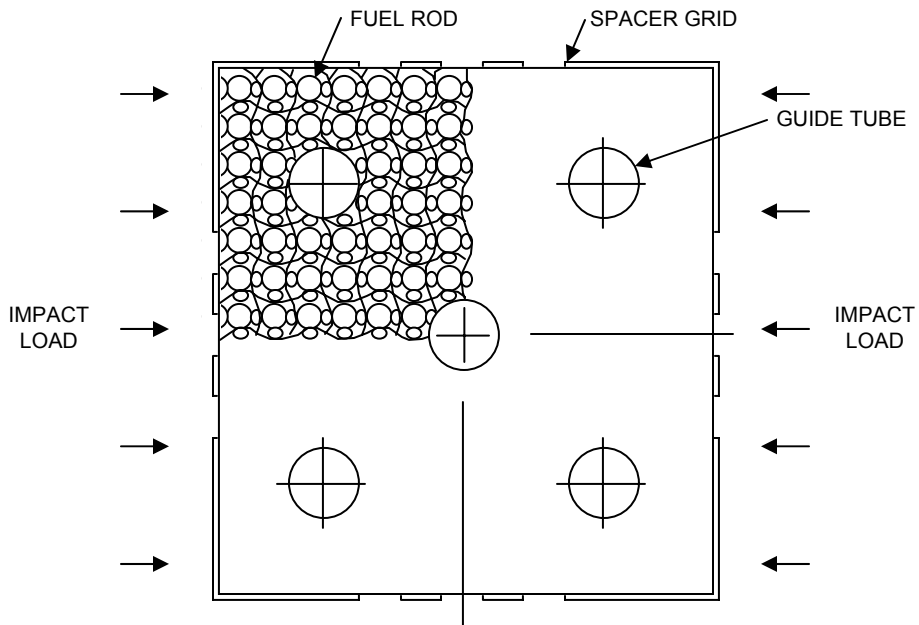

B) THROUGH GRID SPACER GRID IMPACT LOAD

SAR FIGURE NO. 3.7-50

AMENDMENT 20

ARKANSAS NUCLEAR ONE
UNIT 2
RUSSELLVILLE, ARKANSAS



SCALE:	NONE
DRAWN:	ENERGY
DESIGN:	ENERGY
CAD NO:	N/A

ONE-SIDED AND THROUGH-GRID SPACER
GRID IMPACT LOADS

DRAWING NO

SHEET

REV.

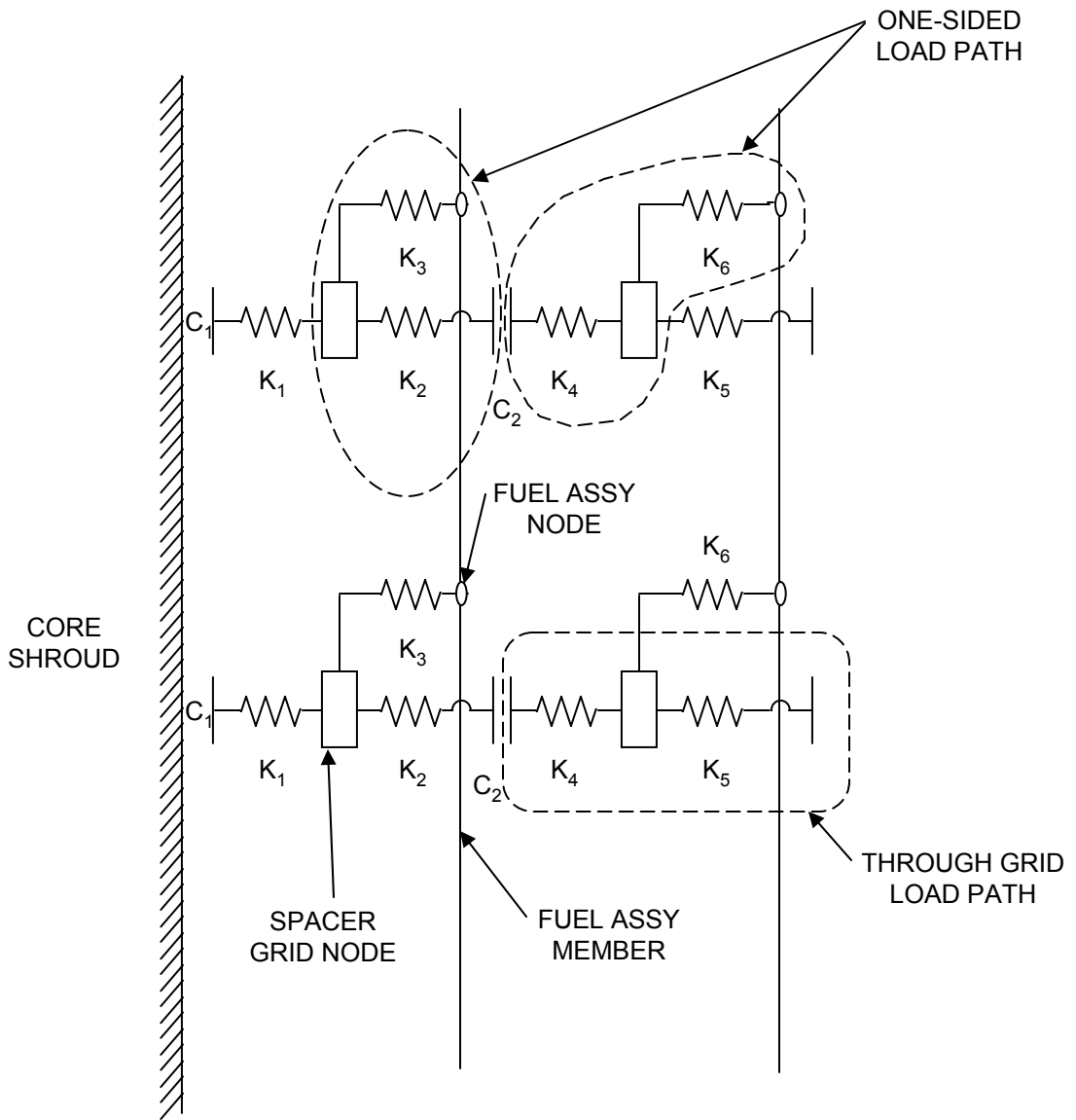

SAR FIGURE NO. 3.7-51

AMENDMENT 20

ARKANSAS NUCLEAR ONE
UNIT 2
RUSSELLVILLE, ARKANSAS



SCALE:	NONE
DRAWN:	ENERGY
DESIGN:	ENERGY
CAD NO:	N/A

DUAL LOAD PATH SPACER GRID MODEL

DRAWING NO

SHEET

REV.

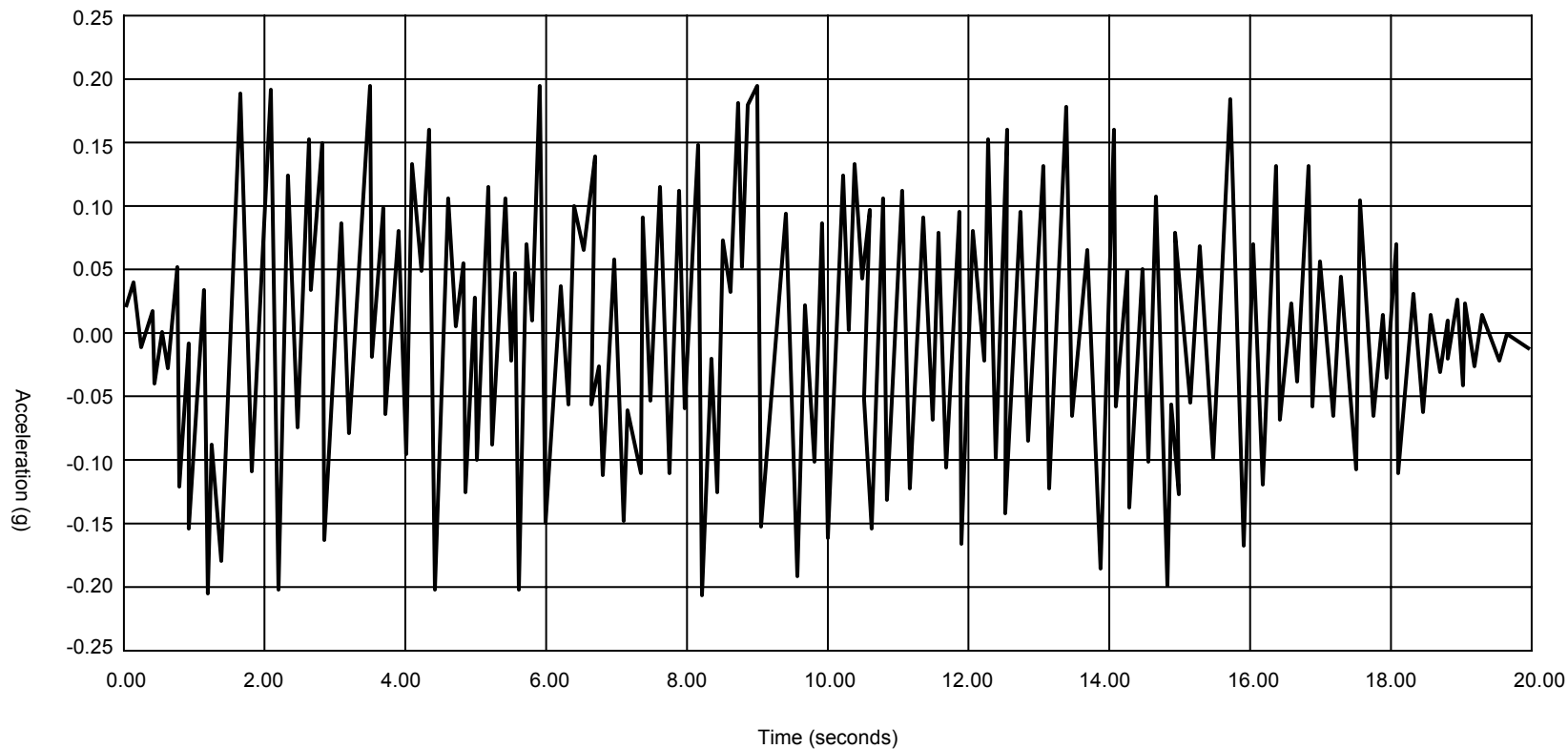

ARTIFICIAL ACCELERATION TIME HISTORY WITH RG 1.60
HORIZONTAL COMPONENT ZPGA = 0.2 G

SAR FIGURE NO. 3.7-52

ARKANSAS NUCLEAR ONE
UNIT 2
RUSSELLVILLE, ARKANSAS



SCALE:	NONE
DRAWN:	ENERGY
DESIGN:	ENERGY
CAD NO:	

AMENDMENT 20

BASED ON DRAWING NO

SHEET

REV.

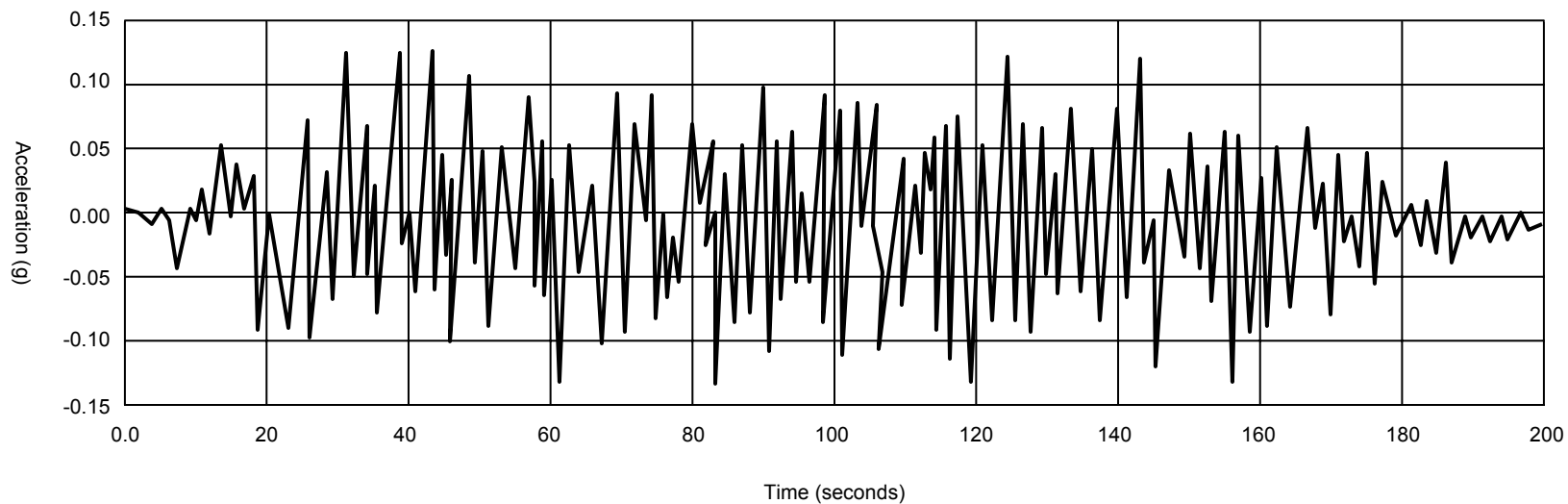

ARTIFICIAL ACCELERATION TIME HISTORY WITH RG 1.60 RS
 VERTICAL COMPONENT ZPGA = 0.133 G

SAR FIGURE NO. 3.7-53

ARKANSAS NUCLEAR ONE
 UNIT 2
 RUSSELLVILLE, ARKANSAS



SCALE:	NONE
DRAWN:	ENERGY
DESIGN:	ENERGY
CAD NO:	

AMENDMENT 20

BASED ON DRAWING NO

SHEET

REV.

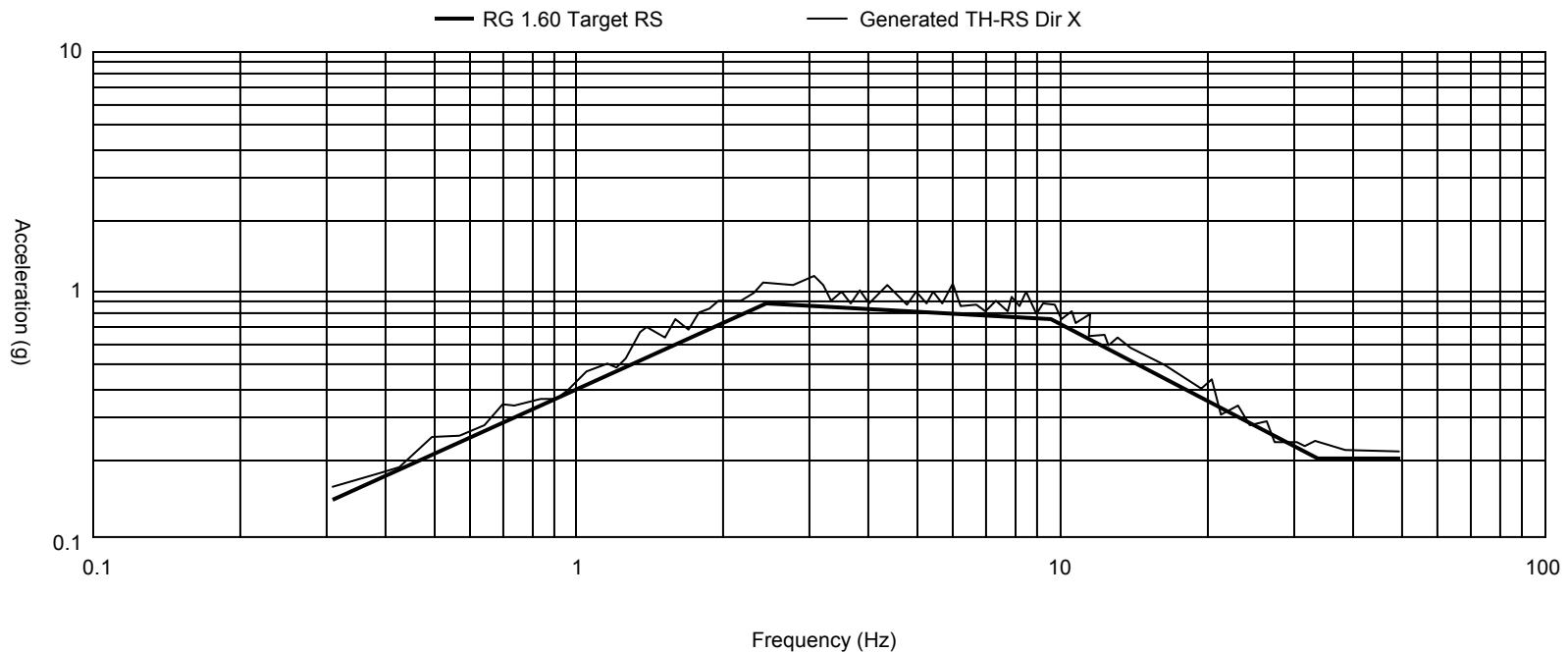

COMPARISON BETWEEN RG 1.60 TARGET AND GENERATED RS D = 2%

SAR FIGURE NO. 3.7-54

ARKANSAS NUCLEAR ONE
 UNIT 2
 RUSSELLVILLE, ARKANSAS



SCALE: NONE
 DRAWN: ENERGY
 DESIGN: ENERGY
 CAD NO:

AMENDMENT 20

BASED ON DRAWING NO

SHEET

REV.

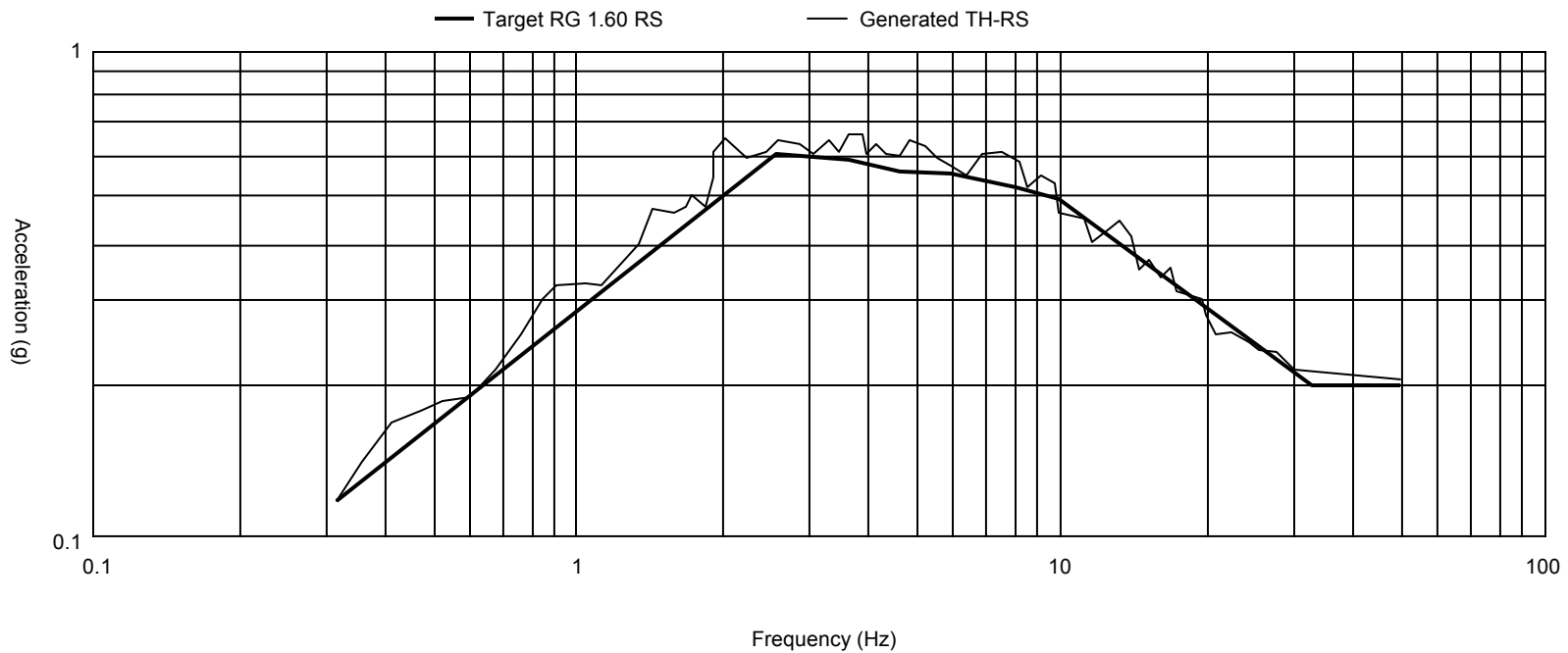

COMPARISON BETWEEN TARGET AND GENERATED RS D = 5%

SAR FIGURE NO. 3.7-55

ARKANSAS NUCLEAR ONE
 UNIT 2
 RUSSELLVILLE, ARKANSAS



SCALE: NONE
 DRAWN: ENTERGY
 DESIGN: ENTERGY
 CAD NO:

AMENDMENT 20

BASED ON DRAWING NO

SHEET

REV.

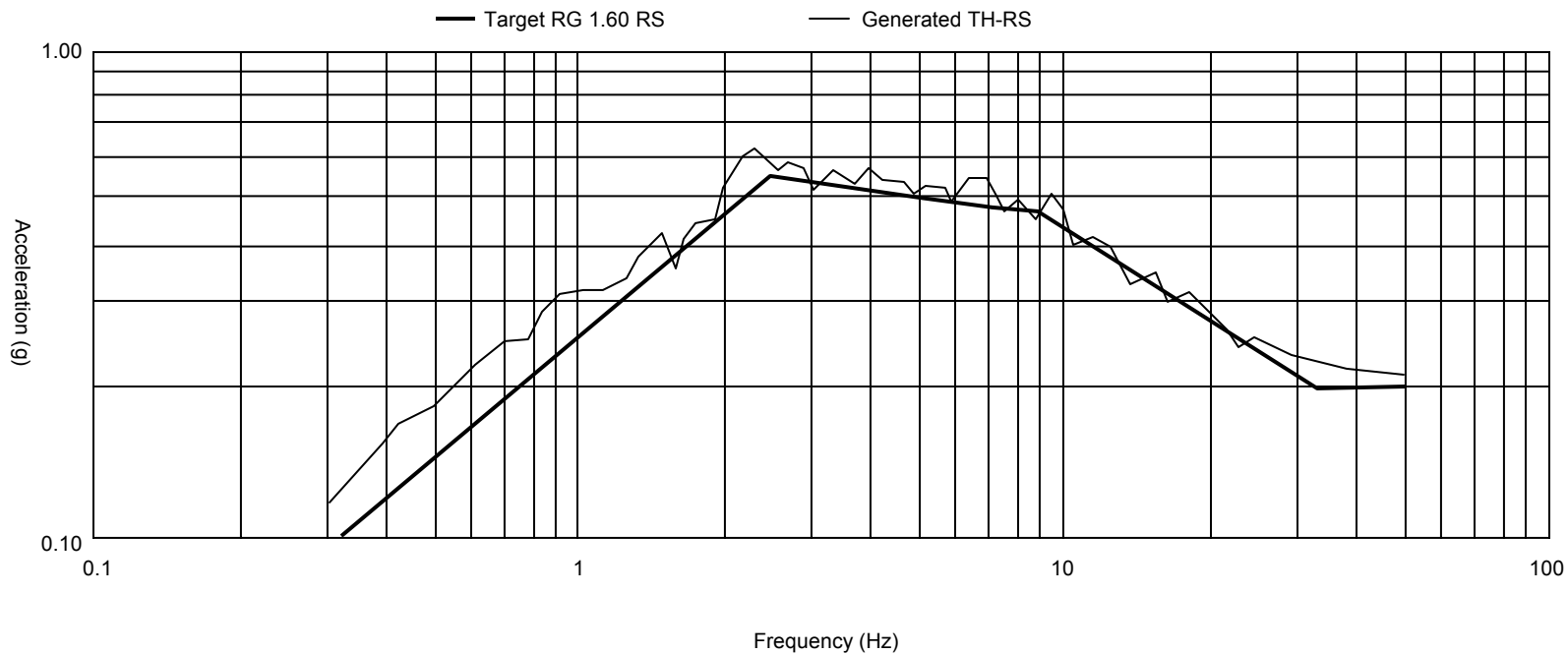

COMPARISON BETWEEN TARGET RS AND GENERATED RS D = 7%

SAR FIGURE NO. 3.7-56

ARKANSAS NUCLEAR ONE
 UNIT 2
 RUSSELLVILLE, ARKANSAS



SCALE: NONE
 DRAWN: ENTERGY
 DESIGN: ENTERGY
 CAD NO:

AMENDMENT 20

BASED ON DRAWING NO

SHEET

REV.

ELEMENTS NODES ELEVATION

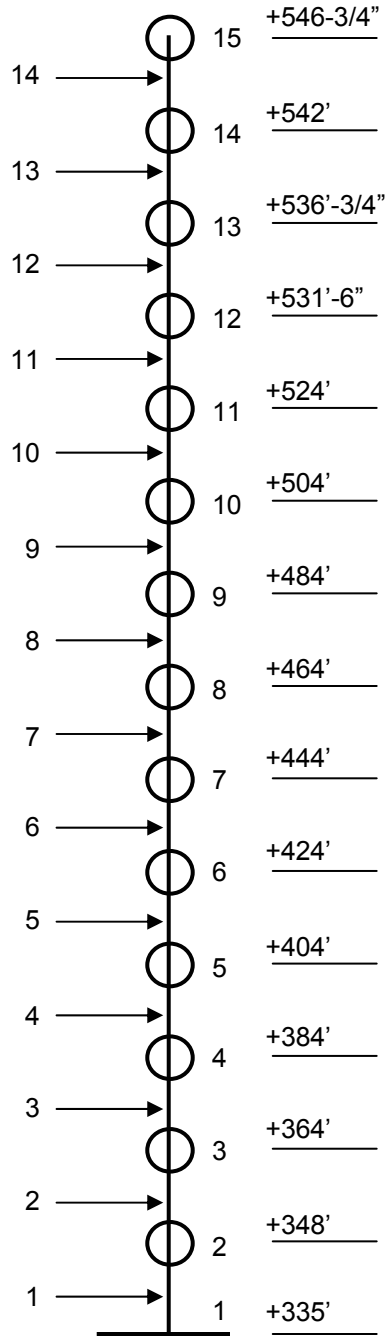

SAR FIGURE NO. 3.7-57

AMENDMENT 20

ARKANSAS NUCLEAR ONE
UNIT 2
RUSSELLVILLE, ARKANSAS



SCALE:	NONE
DRAWN:	ENERGY
DESIGN:	ENERGY
CAD NO:	N/A

SKETCH OF CONTAINMENT SHELL STICK
MODEL

DRAWING NO

SHEET

REV.

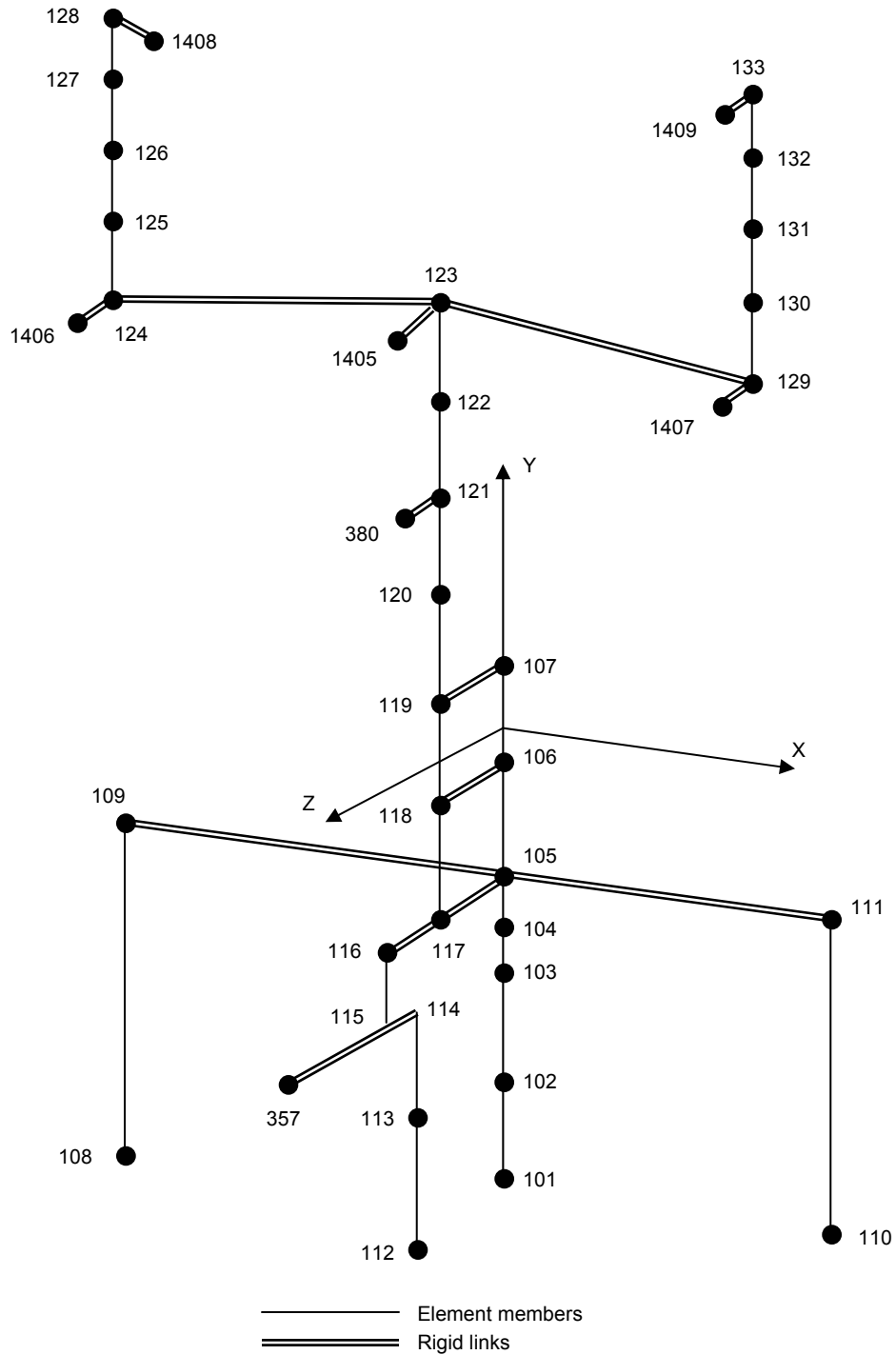

SAR FIGURE NO. 3.7-58

AMENDMENT 20

ARKANSAS NUCLEAR ONE
 UNIT 2
 RUSSELLVILLE, ARKANSAS



SCALE:	NONE
DRAWN:	ENERGY
DESIGN:	ENERGY
CAD NO:	N/A

INTERNAL STRUCTURE 3-D DYNAMIC
 MODEL

DRAWING NO

SHEET

REV.

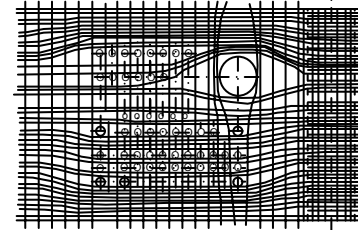
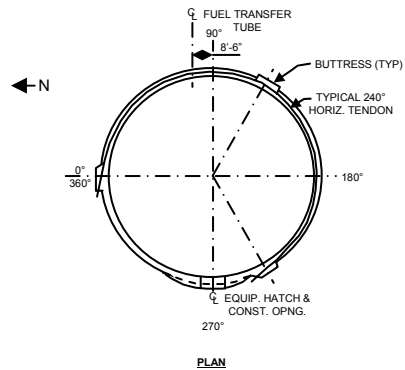
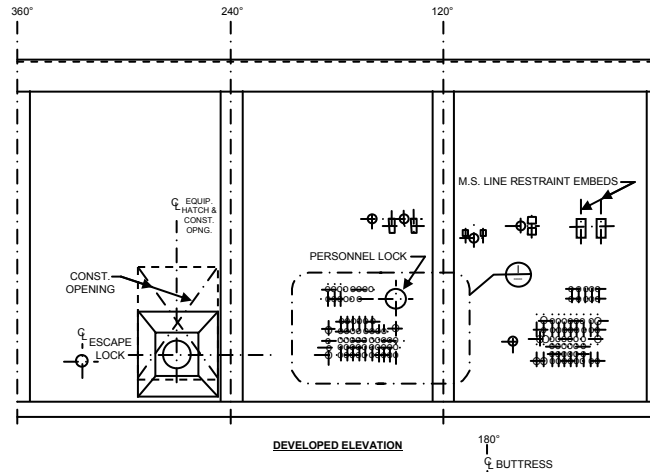
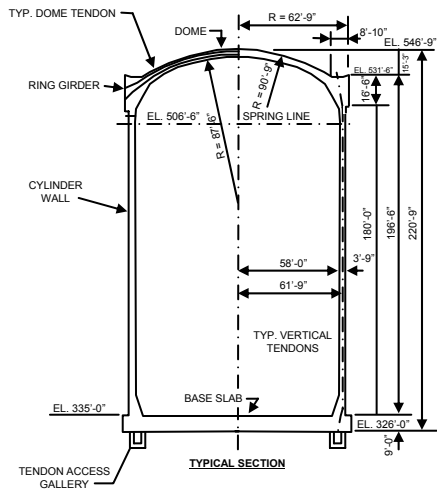

SCHEMATIC TENDON LAYOUT
DETAIL 1

CONTAINMENT GENERAL ARRANGEMENT

SAR FIGURE NO. 3.8-1

ARKANSAS NUCLEAR ONE
UNIT 2
RUSSELLVILLE, ARKANSAS



SCALE: NONE
DRAWN: ENTERGY
DESIGN: ENTERGY
CAD NO:

AMENDMENT 20

BASED ON DRAWING NO	SHEET	REV.
---------------------	-------	------

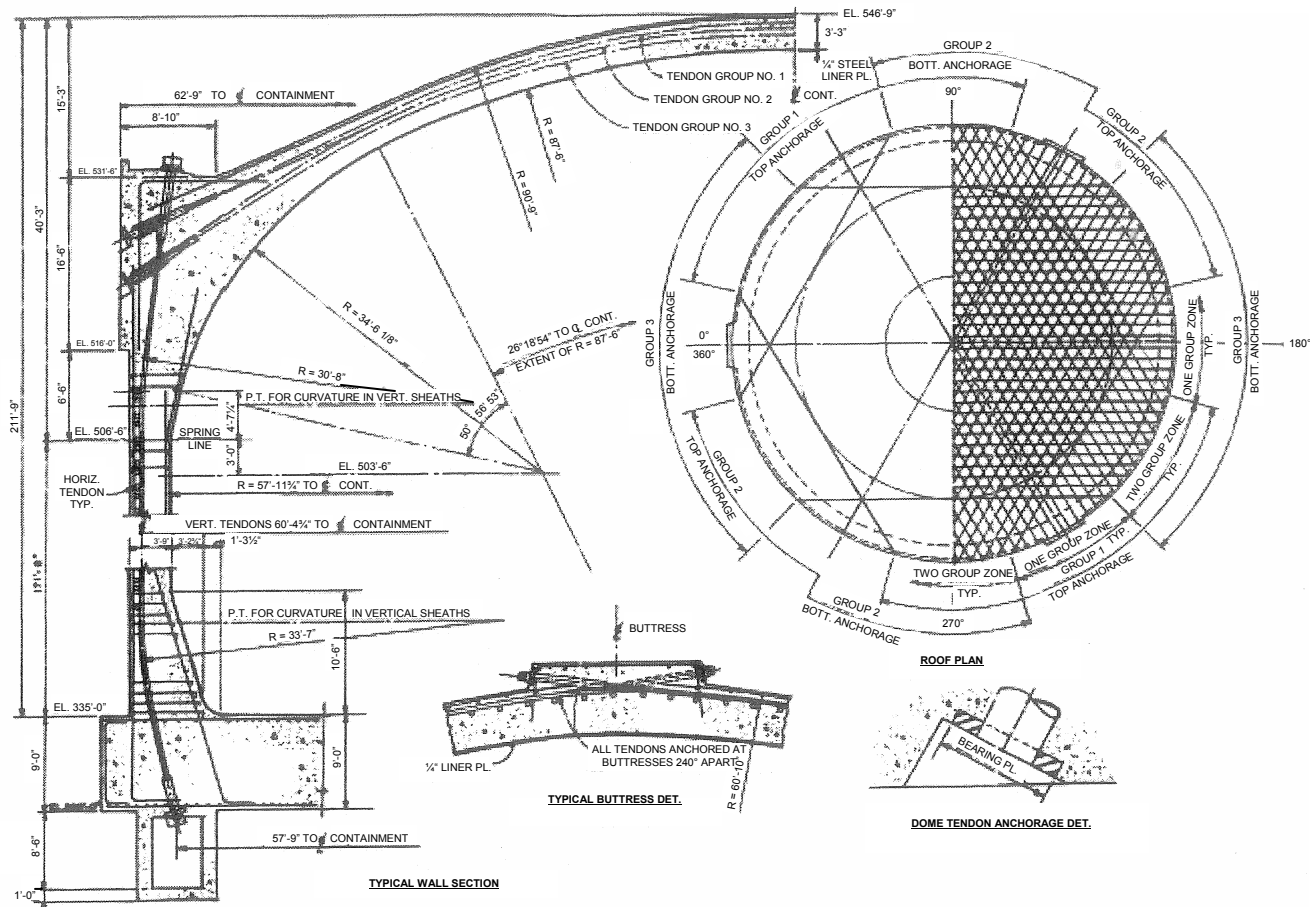

CONTAINMENT PRESTRESSING DETAILS

SAR FIGURE NO. 3.8-2

ARKANSAS NUCLEAR ONE
UNIT 2
RUSSELLVILLE, ARKANSAS



SCALE: NONE
DRAWN: ENTERGY
DESIGN: ENTERGY
CAD NO:

AMENDMENT 20

BASED ON DRAWING NO	SHEET	REV.
---------------------	-------	------

DELETED

SAR FIGURE NO. 3.8-3

AMENDMENT 20

ARKANSAS NUCLEAR ONE
UNIT 2
RUSSELLVILLE, ARKANSAS



SCALE:	NONE
DRAWN:	ENERGY
DESIGN:	ENERGY
CAD NO:	N/A

REACTOR BUILDING PRESTRESSING
REQUIREMENTS EQUIPMENT HATCH DETAILS

DRAWING NO

SHEET

REV.

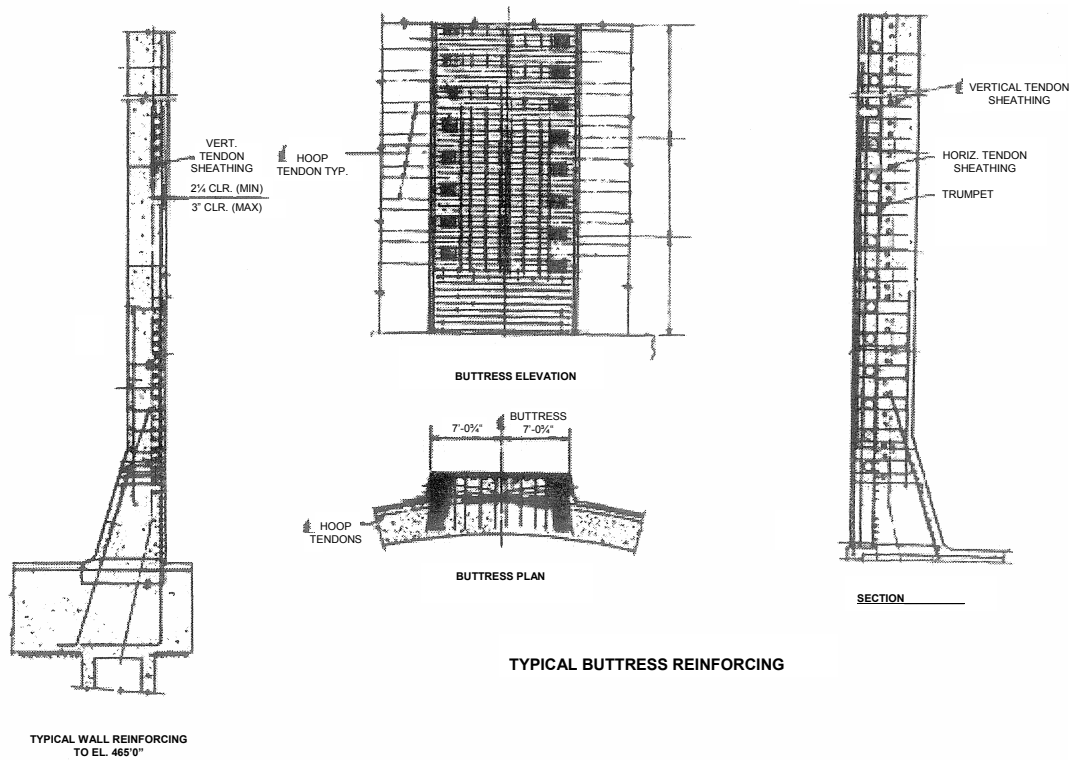

TYPICAL BUTTRESS REINFORCING

CONTAINMENT REINFORCING DETAILS

SAR FIGURE NO. 3.8-4

ARKANSAS NUCLEAR ONE
 UNIT 2
 RUSSELLVILLE, ARKANSAS



SCALE: NONE
 DRAWN: ENERGENCY
 DESIGN: ENERGENCY
 CAD NO:

AMENDMENT 20

BASED ON DRAWING NO	SHEET	REV.
---------------------	-------	------

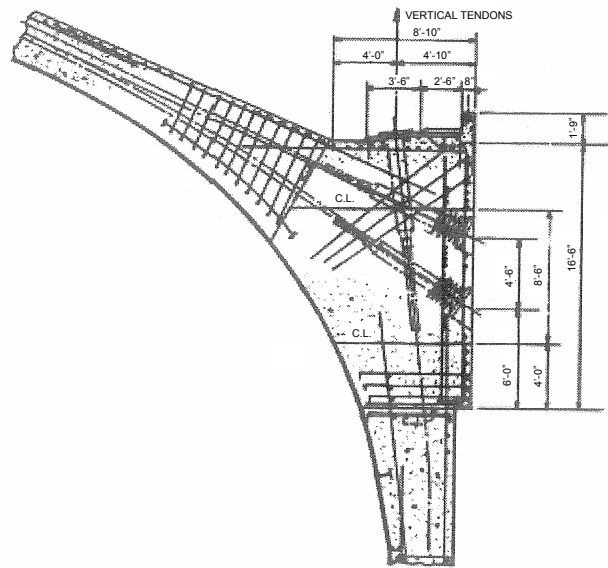

RING GIRDER

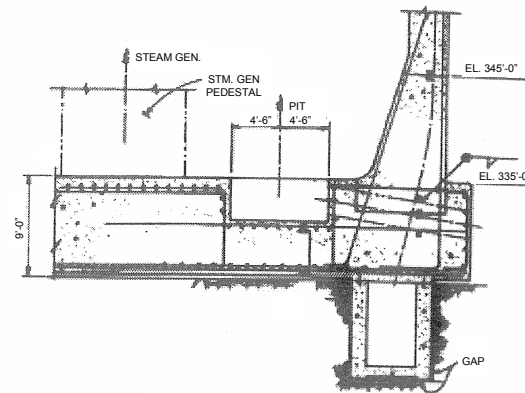

BASE SLAB

CONTAINMENT REINFORCING DETAILS

SAR FIGURE NO. 3.8-5

ARKANSAS NUCLEAR ONE
UNIT 2
RUSSELLVILLE, ARKANSAS



SCALE: NONE
DRAWN: ENTERGY
DESIGN: ENTERGY
CAD NO:

AMENDMENT 20

BASED ON DRAWING NO	SHEET	REV.
---------------------	-------	------

DELETED

SAR FIGURE NO. 3.8-6

AMENDMENT 20

ARKANSAS NUCLEAR ONE
UNIT 2
RUSSELLVILLE, ARKANSAS



SCALE:	NONE
DRAWN:	ENERGY
DESIGN:	ENERGY
CAD NO:	N/A

REACTOR BUILDING REINFORCING STEEL
PENETRATION REINFORCING

DRAWING NO

SHEET

REV.

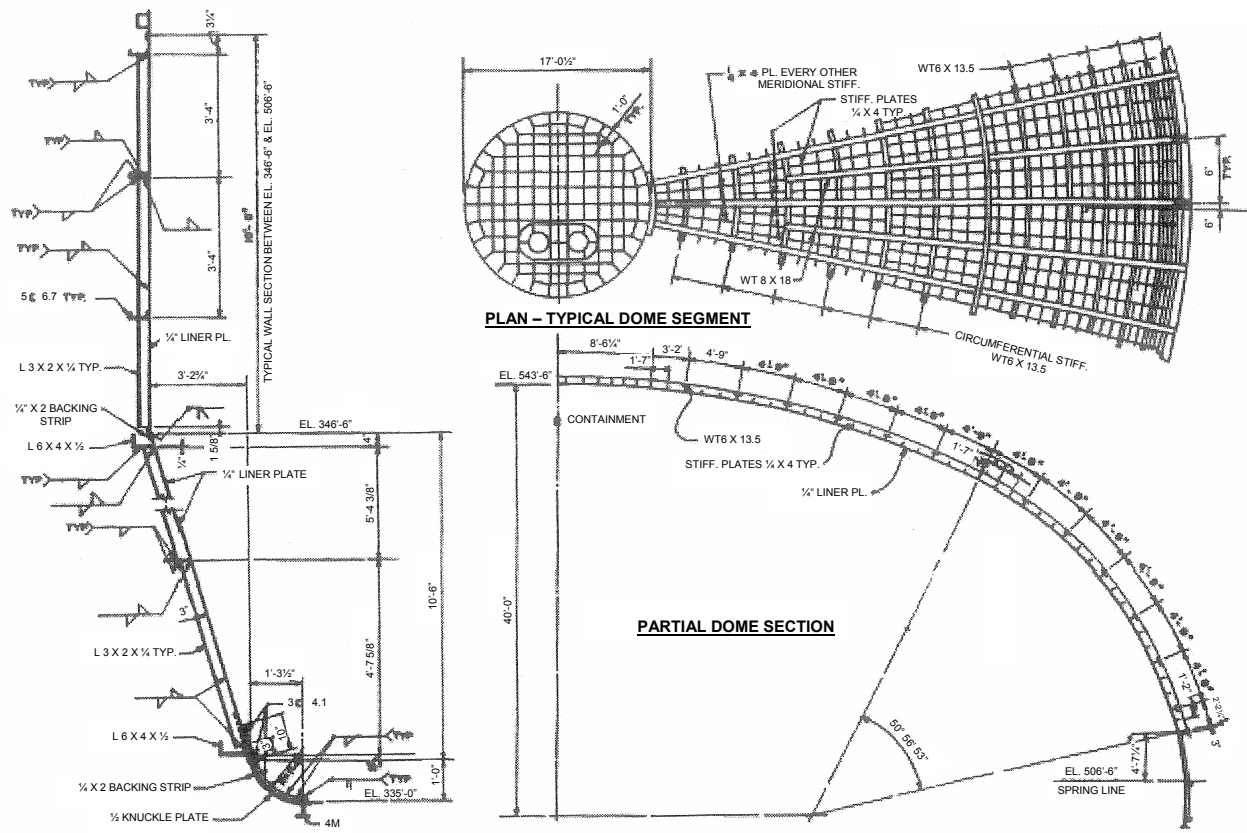

TYPICAL WALL LINER PLATE SECTION

CONTAINMENT LINER PLATE DETAILS

SAR FIGURE NO. 3.8-7

ARKANSAS NUCLEAR ONE
 UNIT 2
 RUSSELLVILLE, ARKANSAS



SCALE: NONE
 DRAWN: ENTERGY
 DESIGN: ENTERGY
 CAD NO:

AMENDMENT 20

BASED ON DRAWING NO	SHEET	REV.

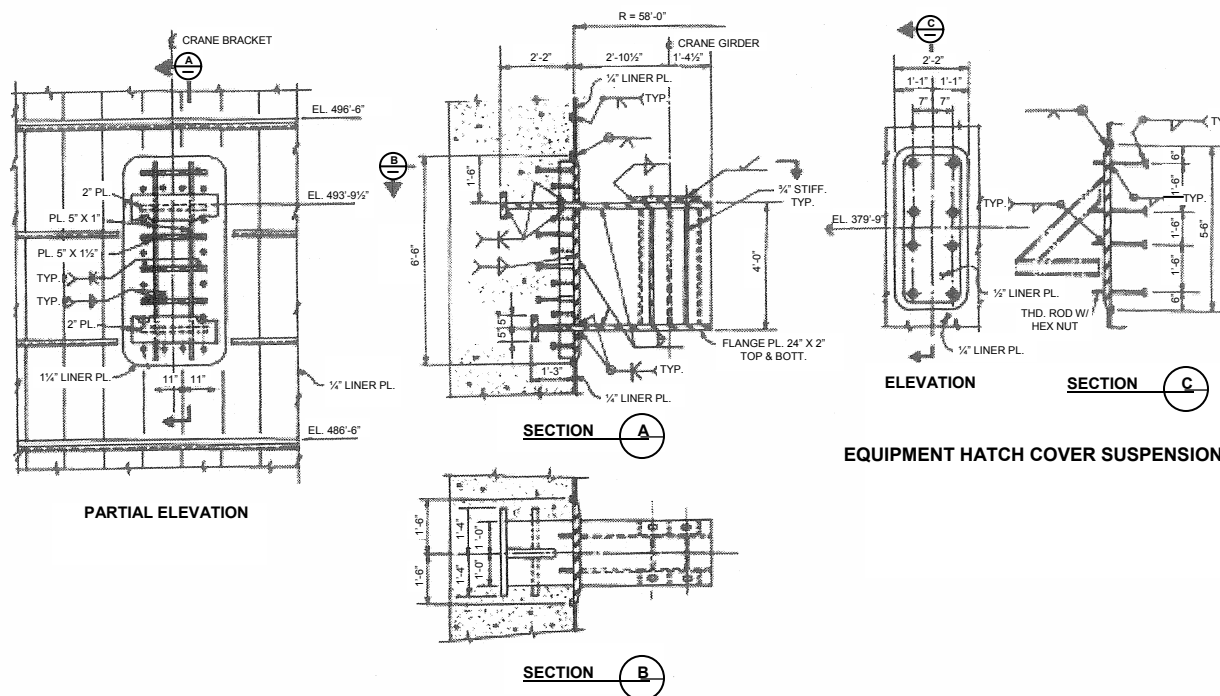

PARTIAL ELEVATION

EQUIPMENT HATCH COVER SUSPENSION BRKT.

POLAR CRANE BRACKET DETAILS

CONTAINMENT LINER PLATE BRACKET DETAILS

SAR FIGURE NO. 3.8-8

ARKANSAS NUCLEAR ONE
UNIT 2
RUSSELLVILLE, ARKANSAS



SCALE: NONE
DRAWN: ENTERGY
DESIGN: ENTERGY
CAD NO:

AMENDMENT 20

BASED ON DRAWING NO	SHEET	REV.
---------------------	-------	------

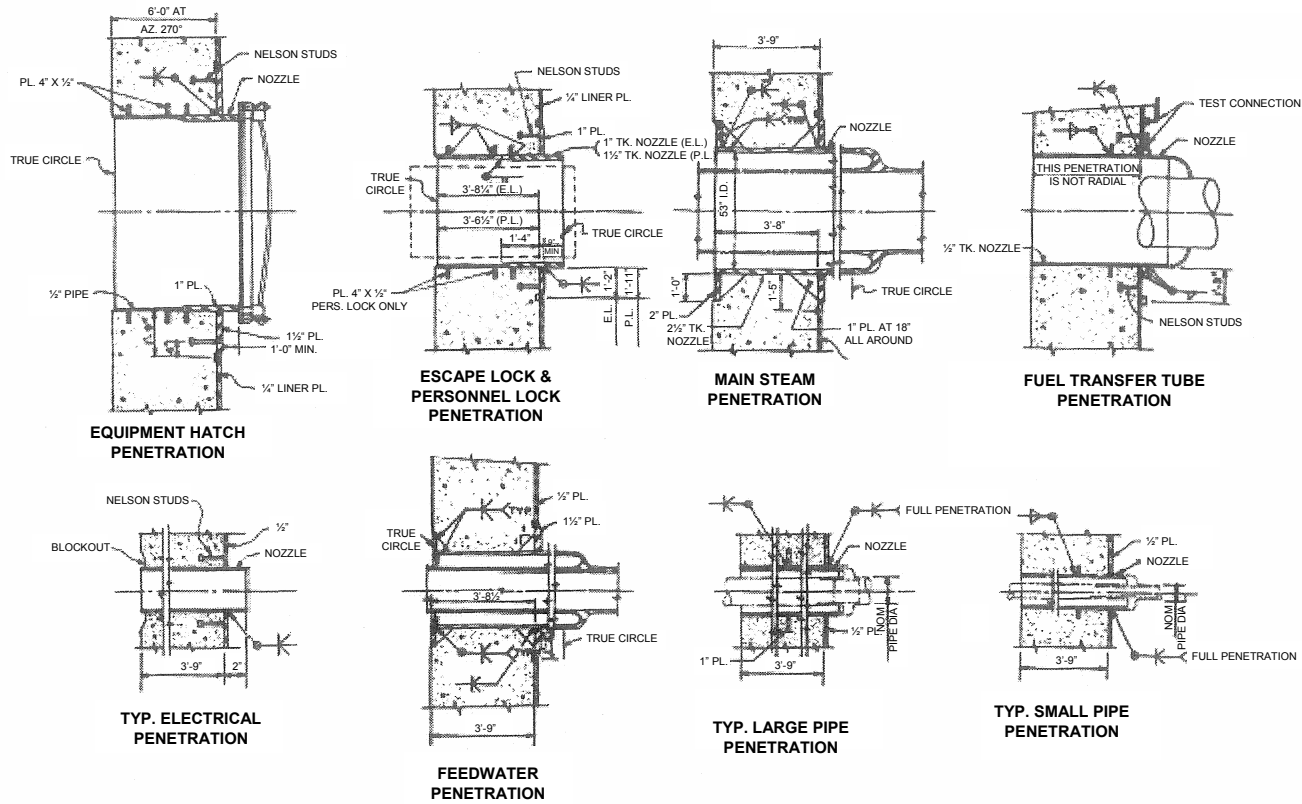

CONTAINMENT PENETRATION DETAILS

SAR FIGURE NO. 3.8-9

ARKANSAS NUCLEAR ONE
UNIT 2
RUSSELLVILLE, ARKANSAS



SCALE: NONE
DRAWN: ENTERGY
DESIGN: ENTERGY
CAD NO:

AMENDMENT 20

BASED ON DRAWING NO	SHEET	REV.
---------------------	-------	------

DELETED

SAR FIGURE NO. 3.8-10

AMENDMENT 20

ARKANSAS NUCLEAR ONE
UNIT 2
RUSSELLVILLE, ARKANSAS



SCALE:	NONE
DRAWN:	ENERGY
DESIGN:	ENERGY
CAD NO:	N/A

CONTAINMENT WALL TEMPERATURE
GRADIENTS

DRAWING NO

SHEET

REV.

DELETED

SAR FIGURE NO. 3.8-11

AMENDMENT 20

ARKANSAS NUCLEAR ONE
UNIT 2
RUSSELLVILLE, ARKANSAS



SCALE:	NONE
DRAWN:	ENERGY
DESIGN:	ENERGY
CAD NO:	N/A

CONTAINMENT FINITE ELEMENT MESH

DRAWING NO

SHEET

REV.

DELETED

SAR FIGURE NO. 3.8-12

AMENDMENT 20

ARKANSAS NUCLEAR ONE
UNIT 2
RUSSELLVILLE, ARKANSAS



SCALE:	NONE
DRAWN:	ENERGY
DESIGN:	ENERGY
CAD NO:	N/A

CONTAINMENT FINITE ELEMENT MESH

DRAWING NO

SHEET

REV.

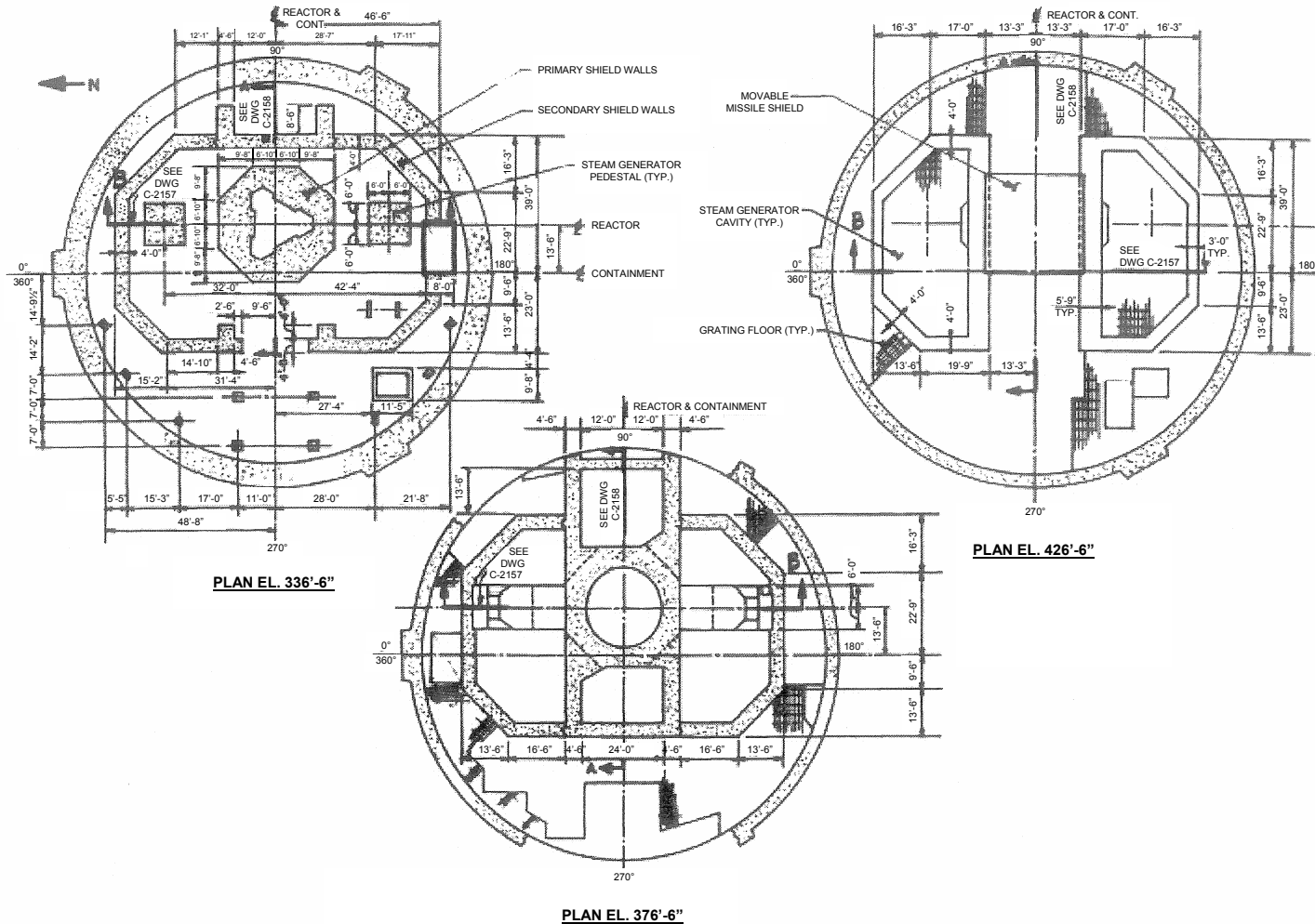

INTERNAL STRUCTURES PLANS – GENERAL ARRANGEMENT

SAR FIGURE NO. 3.8-13

ARKANSAS NUCLEAR ONE
 UNIT 2
 RUSSELLVILLE, ARKANSAS



SCALE: NONE
 DRAWN: ENTERGY
 DESIGN: ENTERGY
 CAD NO:

AMENDMENT 20

BASED ON DRAWING NO

SHEET

REV.

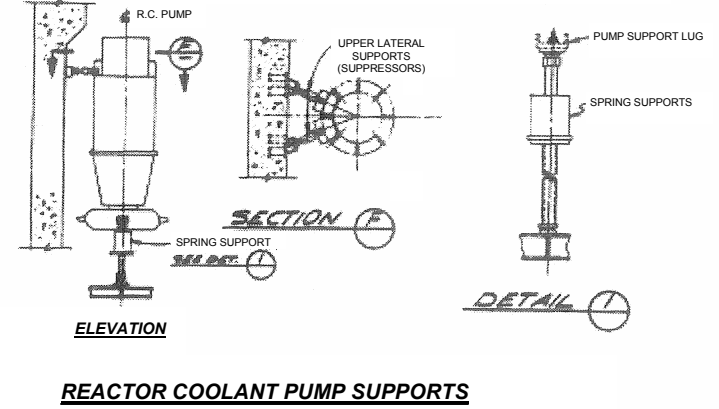
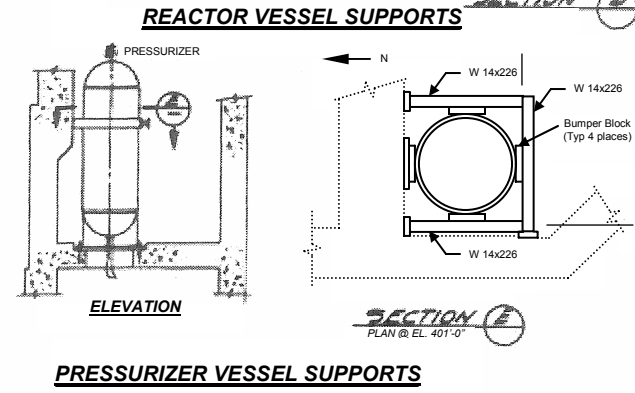
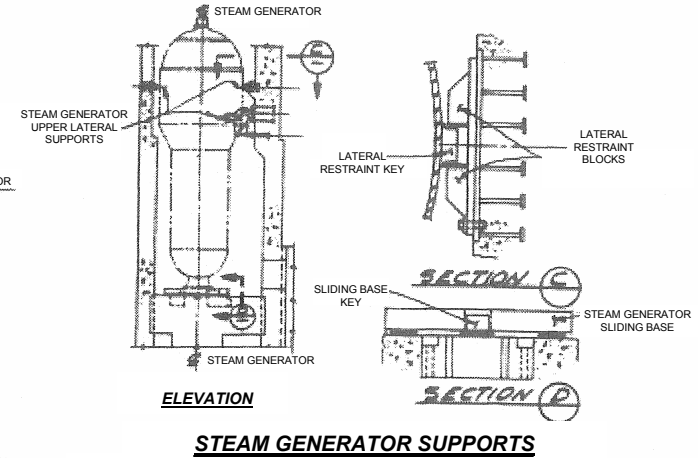
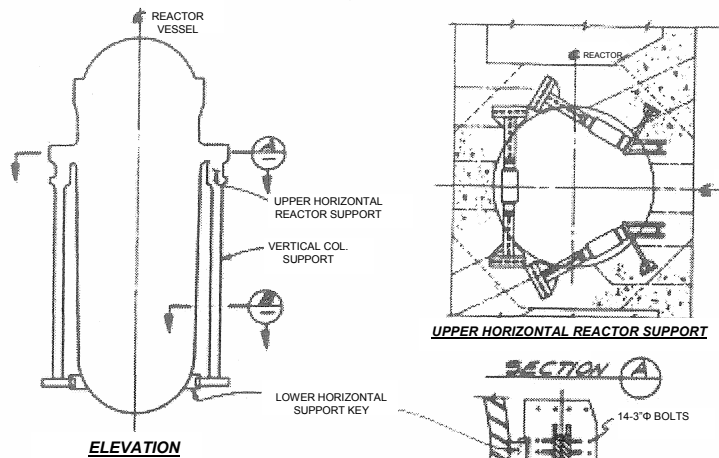

INTERNAL STRUCTURES – EQUIPMENT SUPPORTS

SAR FIGURE NO. 3.8-13A

ARKANSAS NUCLEAR ONE
UNIT 2
RUSSELLVILLE, ARKANSAS



SCALE:	NONE
DRAWN:	ENERGY
DESIGN:	ENERGY
CAD NO:	

AMENDMENT 20

BASED ON DRAWING NO	SHEET	REV.

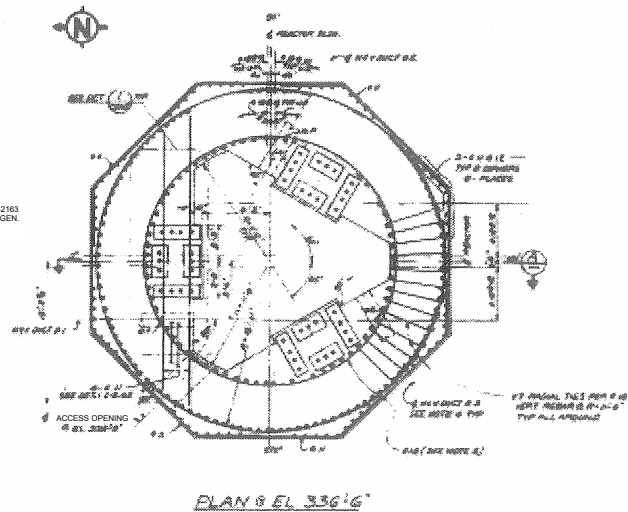
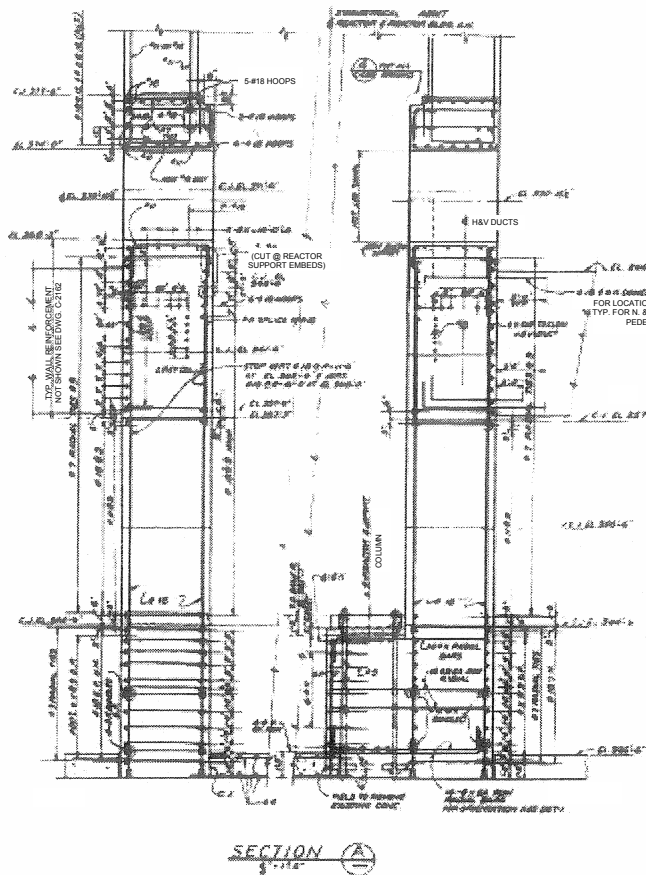

PRIMARY SHIELD WALLS

INTERNAL STRUCTURES PLAN & SECTIONS

SAR FIGURE NO. 3.8-15

ARKANSAS NUCLEAR ONE
 UNIT 2
 RUSSELLVILLE, ARKANSAS



SCALE: NONE
 DRAWN: ENTERGY
 DESIGN: ENTERGY
 CAD NO:

AMENDMENT 20

BASED ON DRAWING NO	SHEET	REV.
---------------------	-------	------

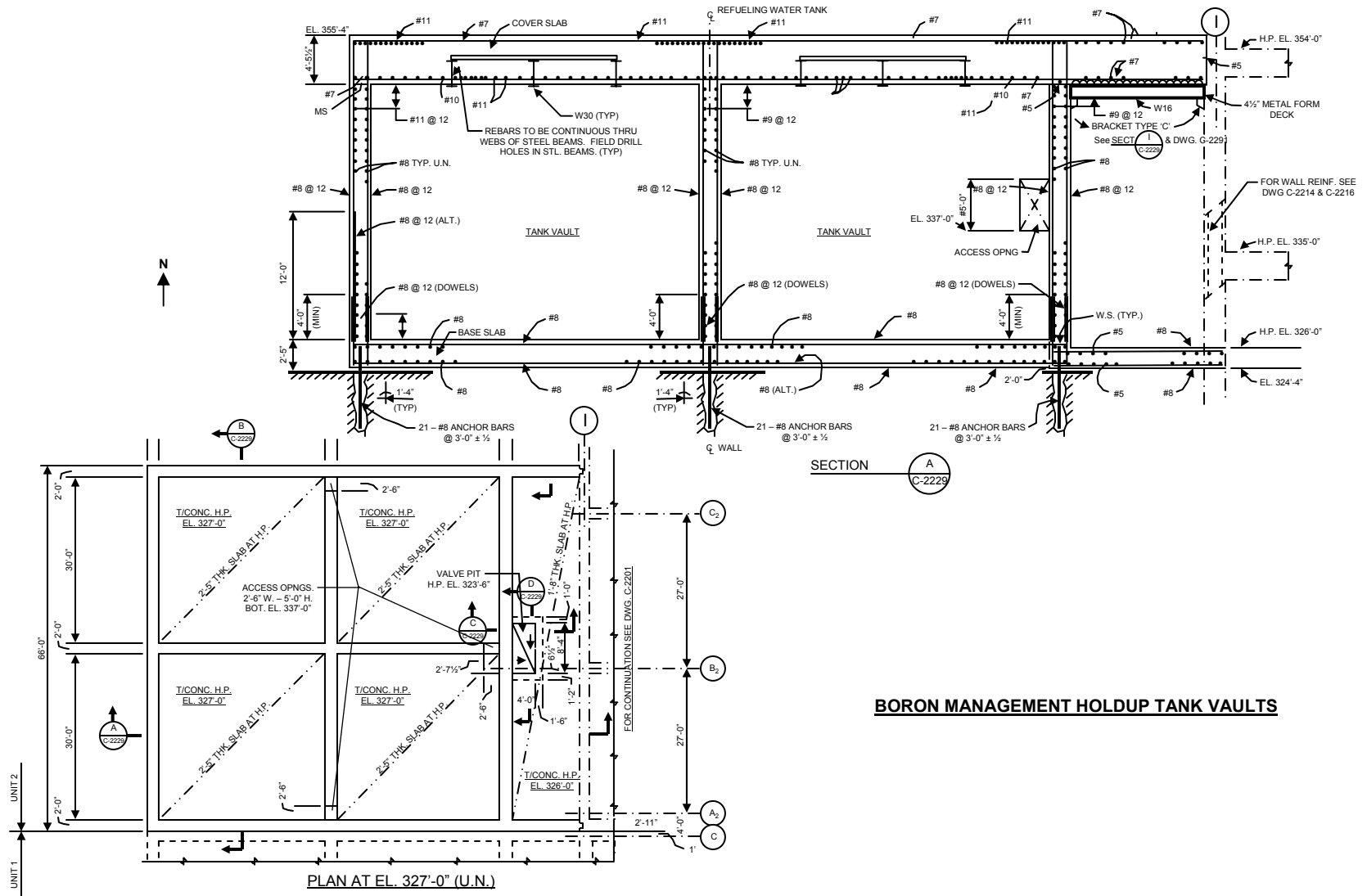

BORON MANAGEMENT HOLDUP TANK VAULTS

OTHER CATEGORY 1 STRUCTURES – AUXILIARY BUILDING PLAN & SECTION

SAR FIGURE NO. 3.8-20

ARKANSAS NUCLEAR ONE
 UNIT 2
 RUSSELLVILLE, ARKANSAS



SCALE:	NONE
DRAWN:	ENERGY
DESIGN:	ENERGY
CAD NO:	

AMENDMENT 20

BASED ON DRAWING NO	SHEET	REV.

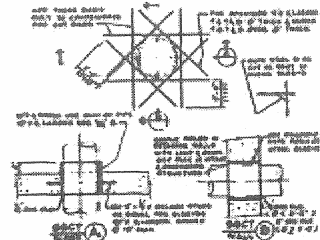

REINFORCEMENT AROUND SLEEVE PENETRATIONS

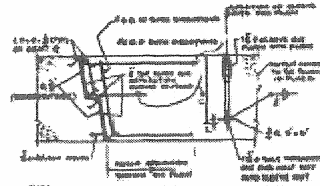

HATCH COVER IN FLOOR SLAB

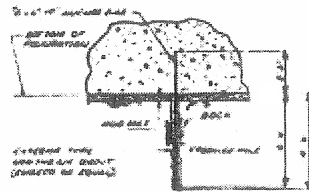

ROCK ANCHOR

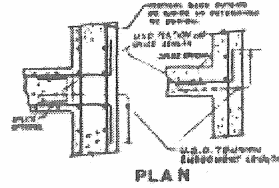

REINFORCING DETAILS AT WALL INTERSECTIONS

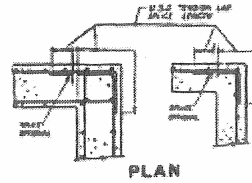

REINFORCING DETAILS AT WALL CORNERS

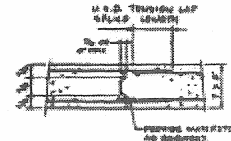

CONSTRUCTION JOINT IN WALLS & SLABS

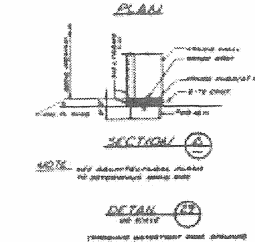
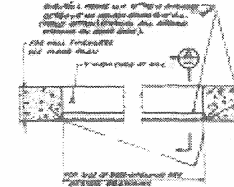

WATERTIGHT DOOR FRAMING

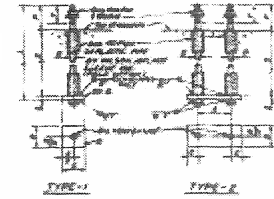

EQUIP. FOUNDATION ANCHOR BOLT

OTHER CATEGORY 1 STRUCTURES TYPICAL DETAILS

SAR FIGURE NO. 3.8-26

ARKANSAS NUCLEAR ONE
UNIT 2
RUSSELLVILLE, ARKANSAS



SCALE:	NONE
DRAWN:	ENERGY
DESIGN:	ENERGY
CAD NO:	

AMENDMENT 20

BASED ON DRAWING NO	SHEET	REV.
---------------------	-------	------

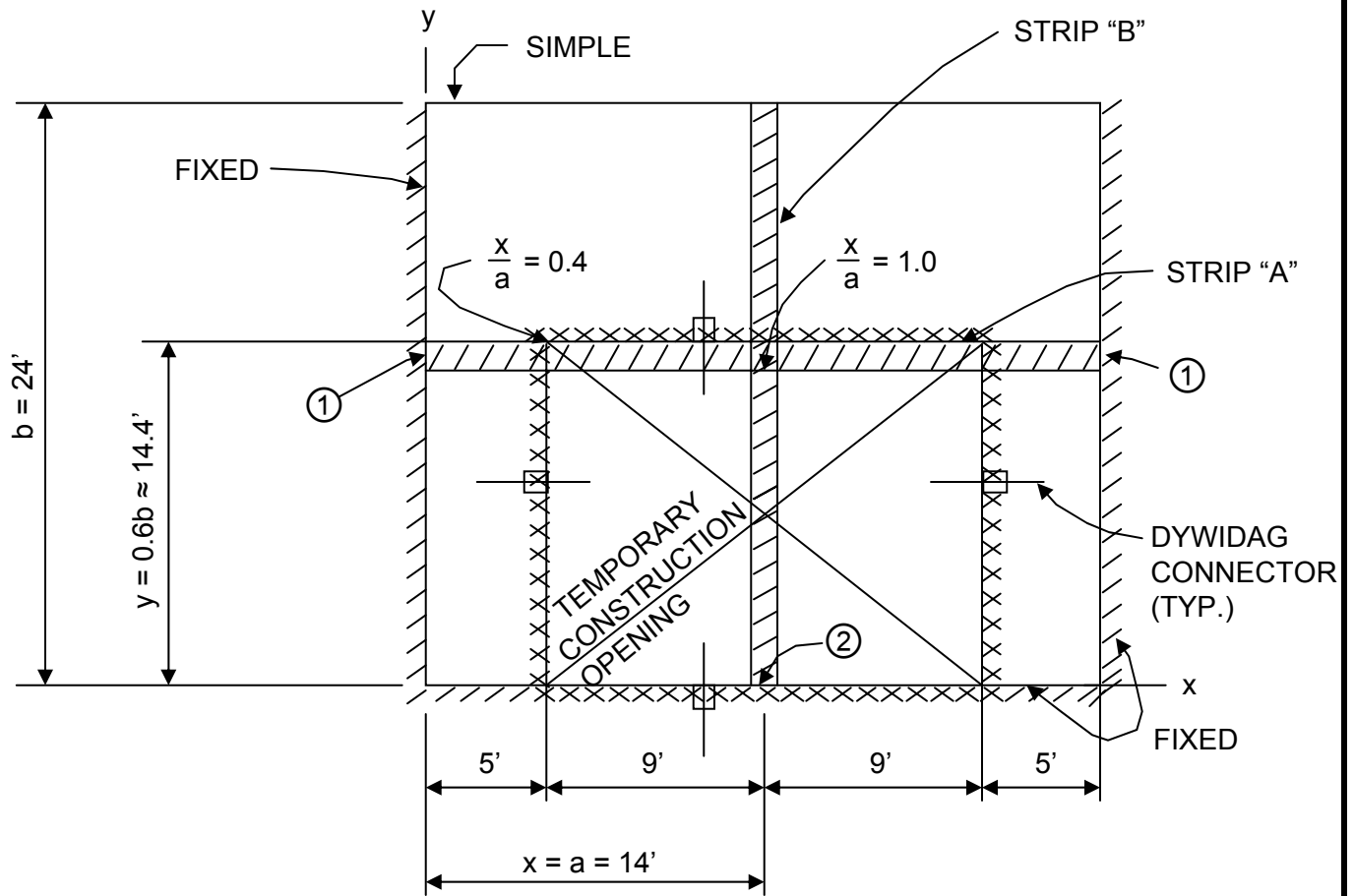

ELEVATION
WALL AT COL LINE ①

MAXIMUM STRESS
FOR STRESS
GRADATION SEE
TABLE Q130.9-1

- ① $f_c = 913$ PSI FOR CONCRETE ($f'_c = 3000$ PSI).
 $f_s = 36.3$ KSI FOR #6 HORIZONTAL REBAR ($F_y = 60$ KSI).
 $\bar{v} = 38$ PSI FOR CONCRETE ($f'_c = 3000$ PSI).
 $\mu = 188$ PSI FOR #6 HORIZONTAL BAR.
- ② $f_c = 804$ PSI FOR CONCRETE
 $f_s = 14.3$ KSI FOR #10 DYWIDAG VERTICAL BAR.
 $\bar{v} = 41$ PSI FOR CONCRETE.
 $\mu = 122$ PSI FOR #10 DYWIDAG VERTICAL BAR.

SAR FIGURE NO. 3.8-32

AMENDMENT 20

ARKANSAS NUCLEAR ONE
UNIT 2
RUSSELLVILLE, ARKANSAS



SCALE: NONE
DRAWN: ENTERGY
DESIGN: ENTERGY
CAD NO: N/A

TEMPORARY CONSTRUCTION OPENING IN
WALL AT COLUMN LINE ①

DRAWING NO

SHEET

REV.

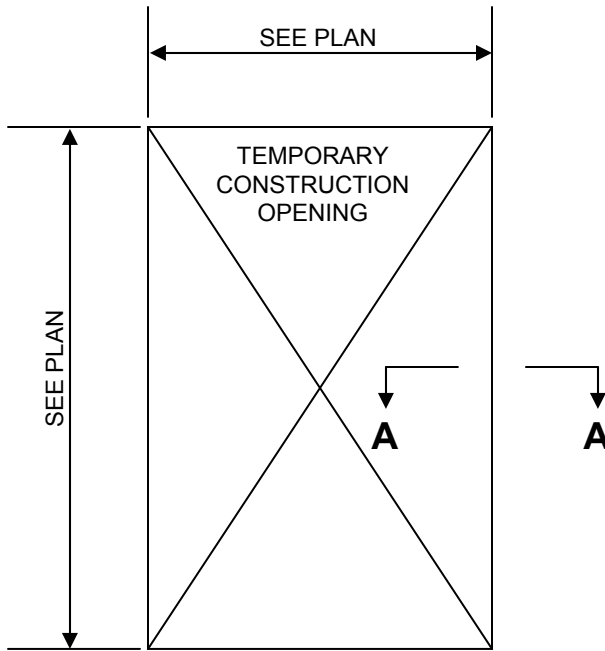

WALL OR FLOOR OPENING

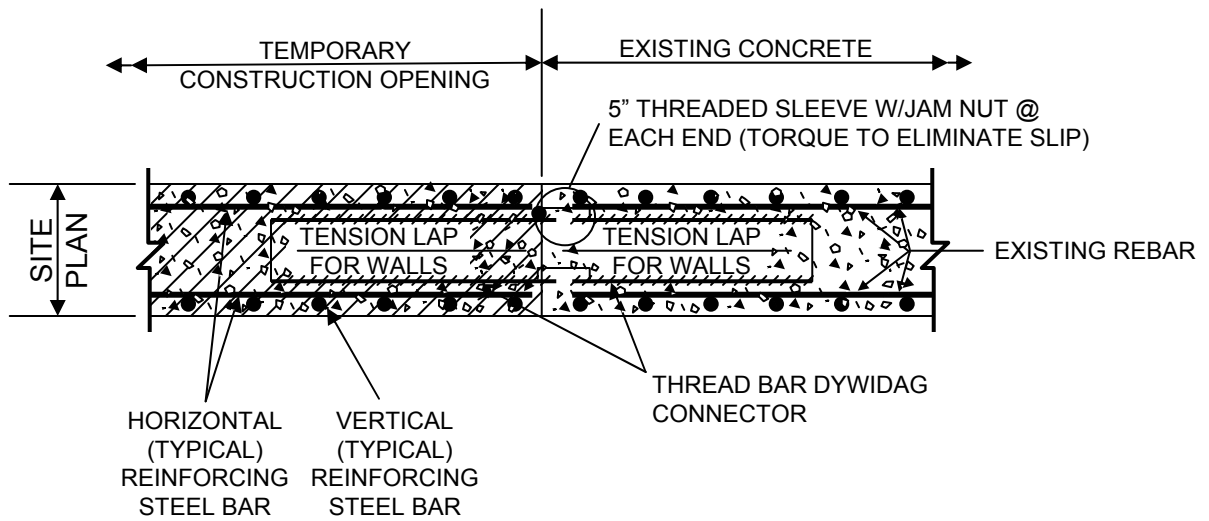

SECTION A - A
SIMILAR - 4 FACES OF OPENING

SAR FIGURE NO. 3.8-33

AMENDMENT 20

ARKANSAS NUCLEAR ONE
UNIT 2
RUSSELLVILLE, ARKANSAS



SCALE:	NONE
DRAWN:	ENERGY
DESIGN:	ENERGY
CAD NO:	N/A

DYWIDAG CONNECTOR FOR TEMPORARY
CONSTRUCTION OPENING

DRAWING NO

SHEET

REV.

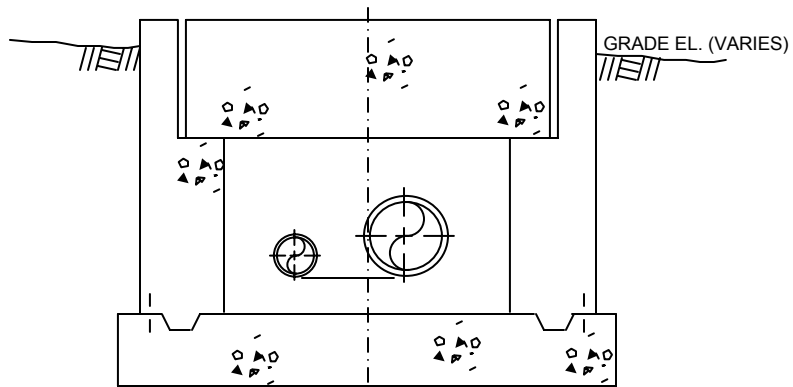

UNIT-2 PIPE CHASE SECTION

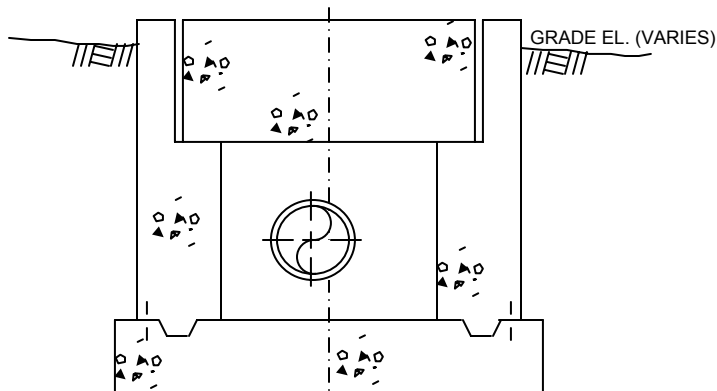

UNIT-1 PIPE CHASE SECTION

SAR FIGURE NO. 3.8-34

AMENDMENT 20

ARKANSAS NUCLEAR ONE
 UNIT 2
 RUSSELLVILLE, ARKANSAS



SCALE:	NONE
DRAWN:	ENERGY
DESIGN:	ENERGY
CAD NO:	N/A

CONDENSATE STORAGE TANK (T41B)
 PIPE TRENCHES

DRAWING NO

SHEET

REV.

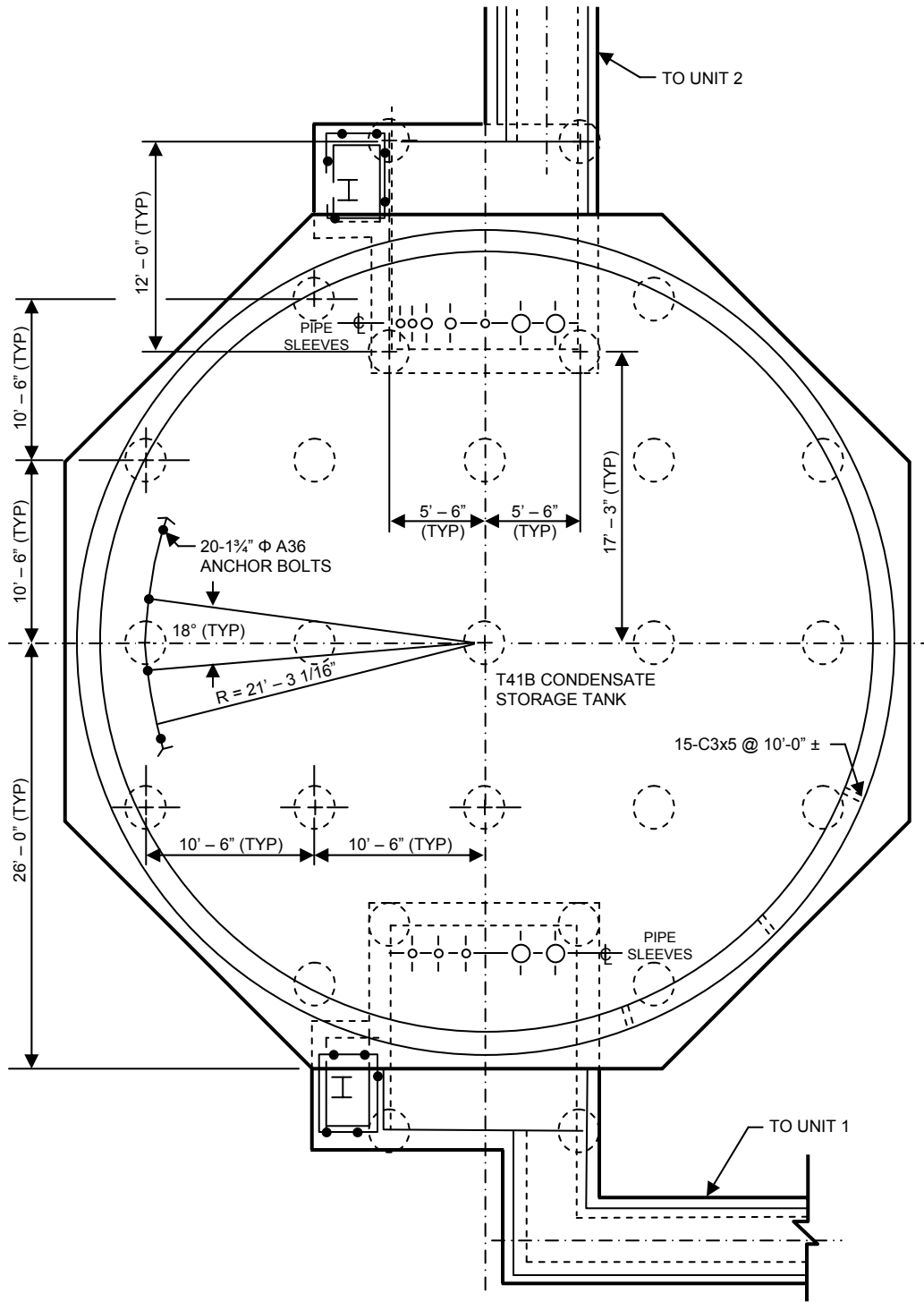

SAR FIGURE NO. 3.8-35

AMENDMENT 20

ARKANSAS NUCLEAR ONE
UNIT 2
RUSSELLVILLE, ARKANSAS



SCALE: NONE
DRAWN: ENTERGY
DESIGN: ENTERGY
CAD NO: N/A

CONDENSATE STORAGE TANK (T41B)
FOUNDATION

DRAWING NO

SHEET

REV.

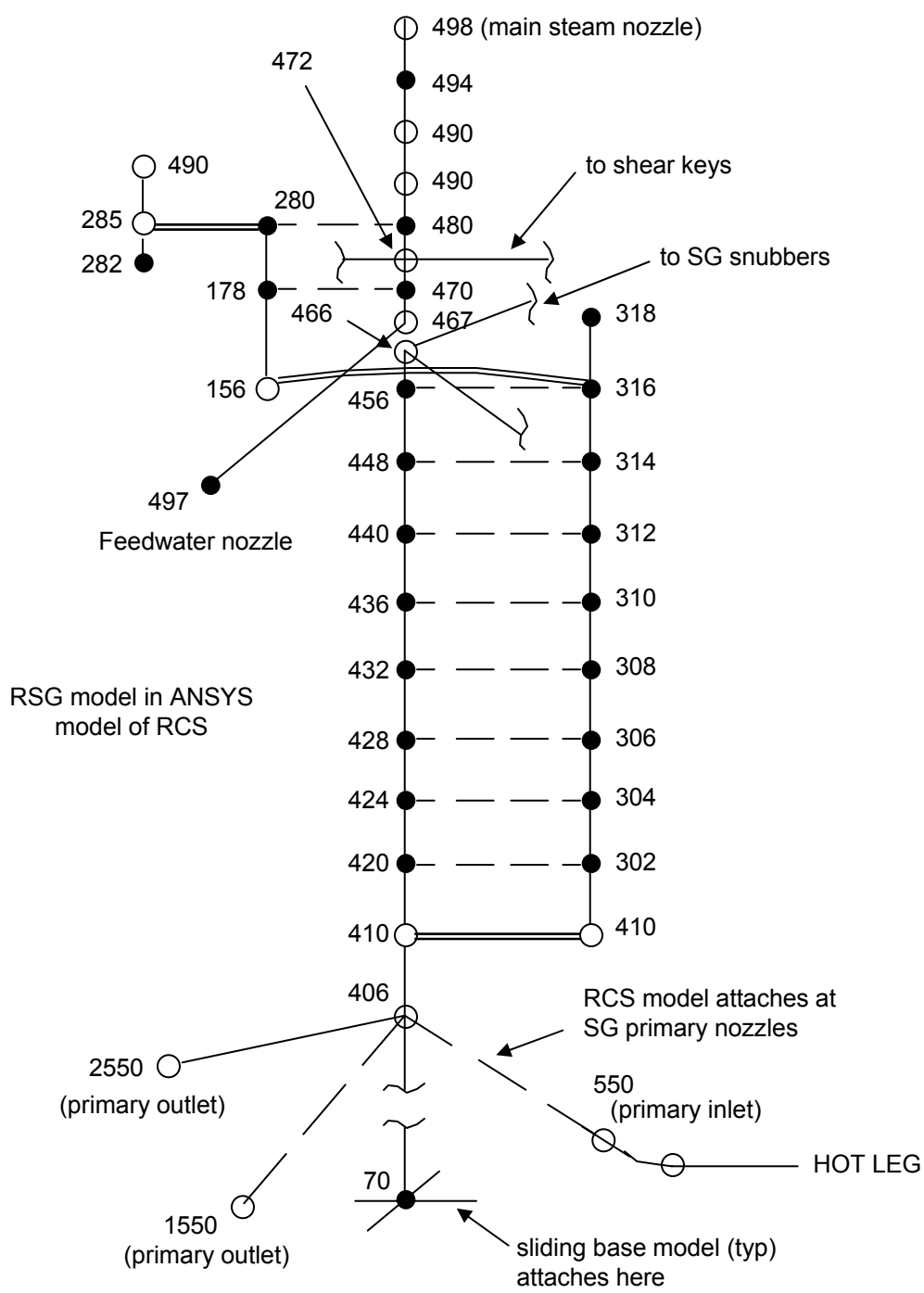

SAR FIGURE NO. 3.9-1A

AMENDMENT 20

ARKANSAS NUCLEAR ONE
 UNIT 2
 RUSSELLVILLE, ARKANSAS



SCALE:	NONE
DRAWN:	ENERGY
DESIGN:	ENERGY
CAD NO:	N/A

ANSYS MODEL OF THE REPLACEMENT
 STEAM GENERATOR

DRAWING NO	SHEET	REV.

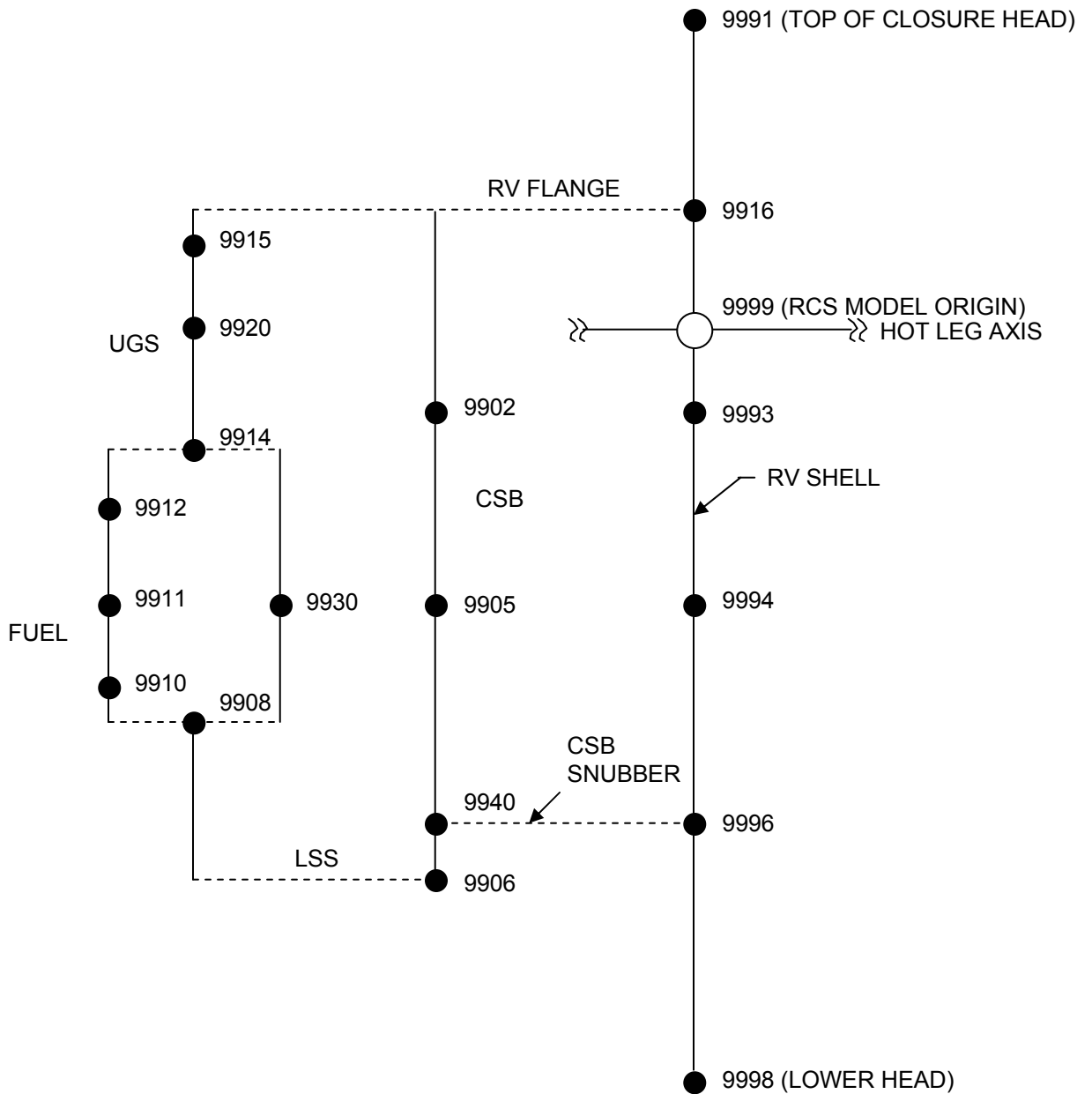

SAR FIGURE NO. 3.9-1B

AMENDMENT 20

ARKANSAS NUCLEAR ONE
UNIT 2
RUSSELLVILLE, ARKANSAS



SCALE:	NONE
DRAWN:	ENERGY
DESIGN:	ENERGY
CAD NO:	N/A

ANSYS RV-RVI MODEL USED IN THE RCS
PRIMARY SIDE BREAK ANALYSIS

DRAWING NO

SHEET

REV.

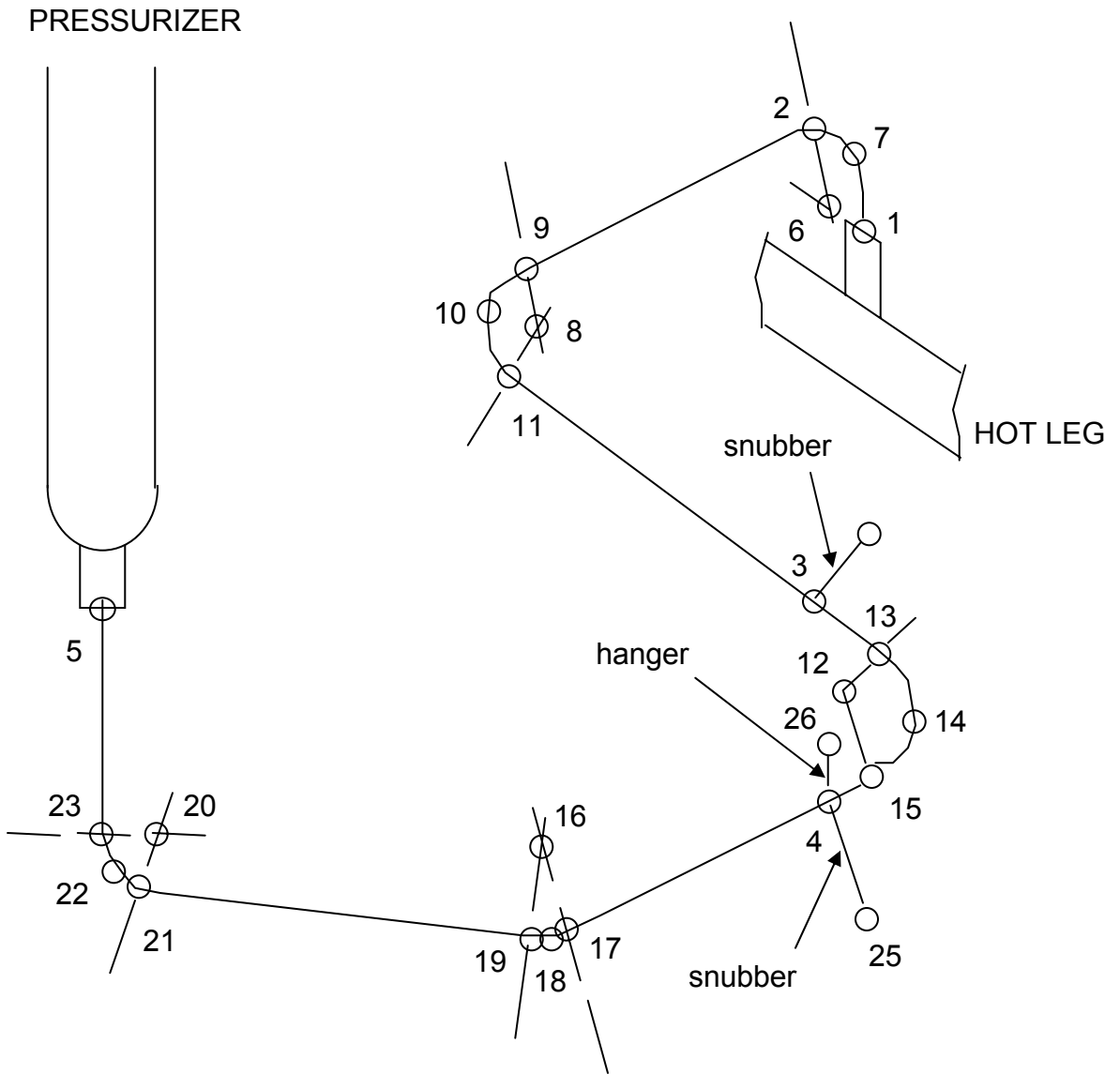

SAR FIGURE NO. 3.9-1C

AMENDMENT 20

ARKANSAS NUCLEAR ONE
UNIT 2
RUSSELLVILLE, ARKANSAS



SCALE:	NONE
DRAWN:	ENERGY
DESIGN:	ENERGY
CAD NO:	N/A

ANSYS MODEL OF THE SURGE LINE

DRAWING NO

SHEET

REV.

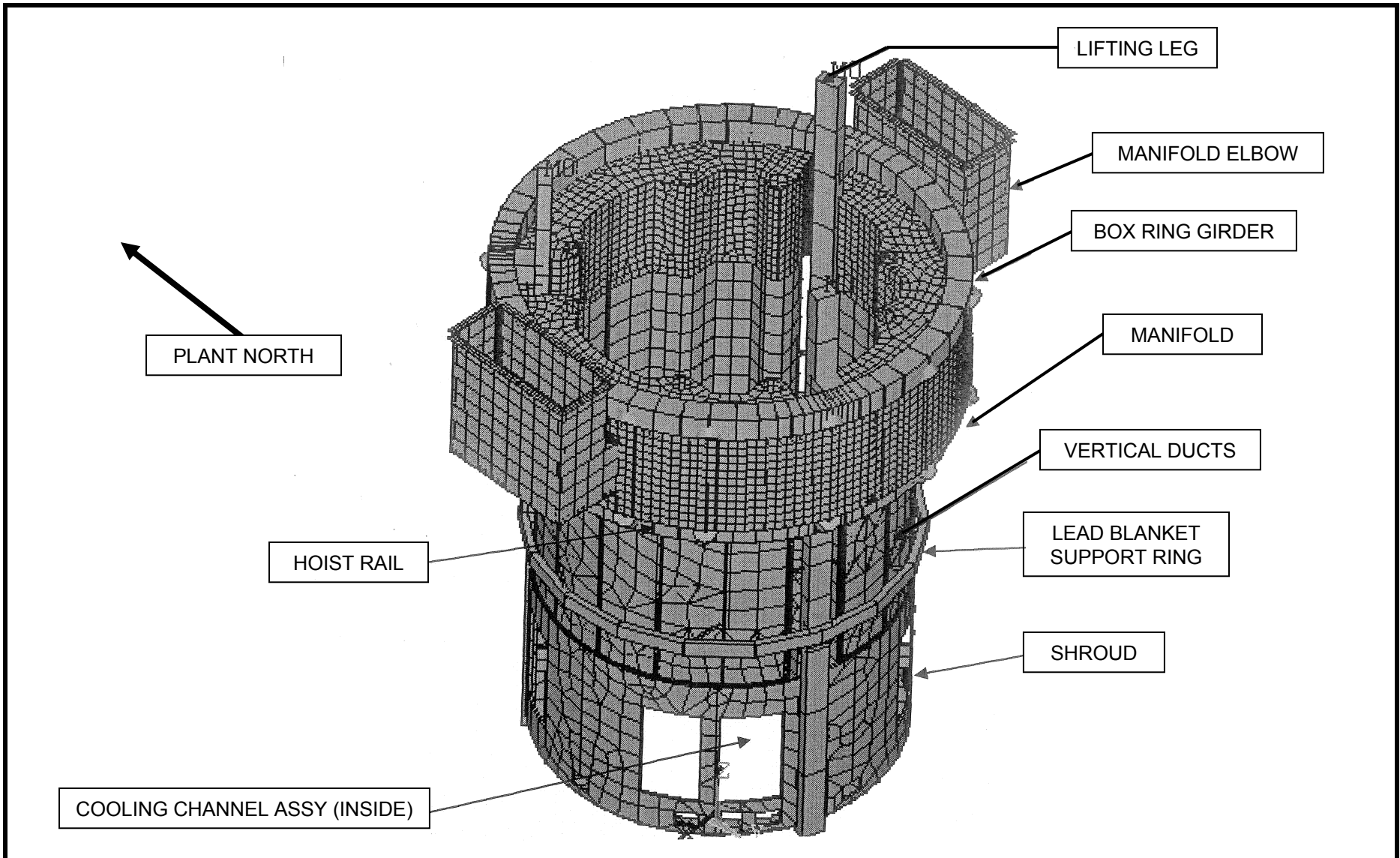

HEAD LIFT RIG FINITE ELEMENT MODEL

SAR FIGURE NO. 3.9-1D

ARKANSAS NUCLEAR ONE
 UNIT 2
 RUSSELLVILLE, ARKANSAS



SCALE: NONE
 DRAWN: ENERGY
 DESIGN: ENERGY
 CAD NO:

AMENDMENT 21

BASED ON DRAWING NO

SHEET

REV.

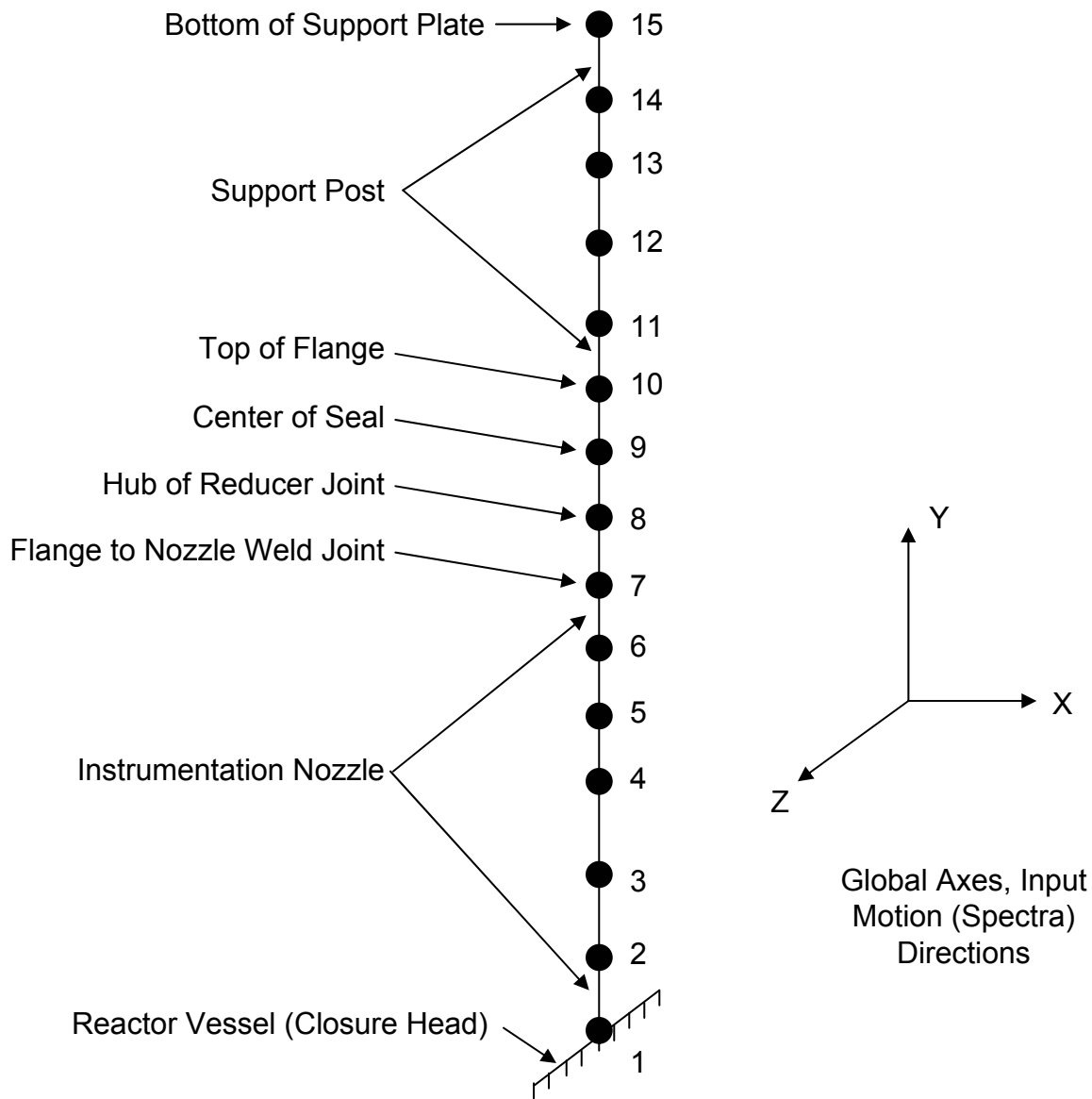

SAR FIGURE NO. 3.9-1E

AMENDMENT 20

ARKANSAS NUCLEAR ONE
 UNIT 2
 RUSSELLVILLE, ARKANSAS



SCALE:	NONE
DRAWN:	ENERGY
DESIGN:	ENERGY
CAD NO:	N/A

PORION OF ICI MODEL REPRESENTING
 THE NOZZLE, FLANGE & SUPPORT POST

DRAWING NO

SHEET

REV.

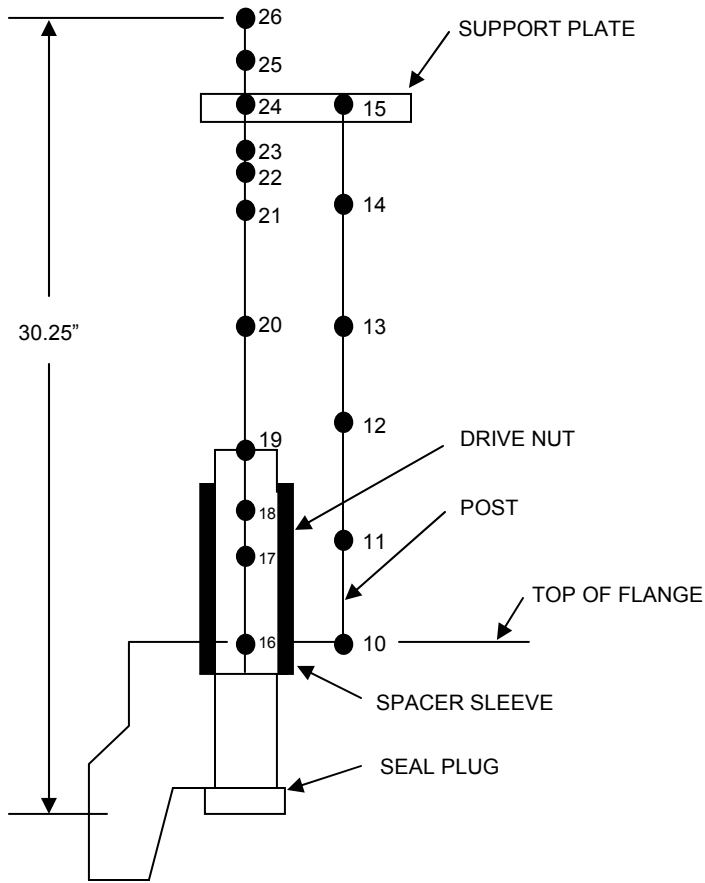

AXIAL VIEW AT ICI FLANGE SECTION

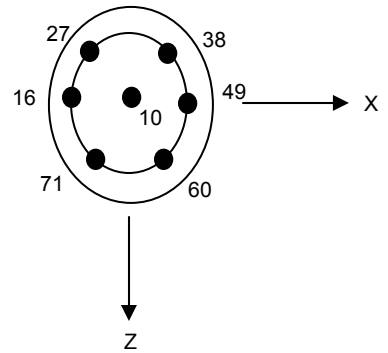

AXIAL VIEW AT ICI POST SUPPORT PLATE

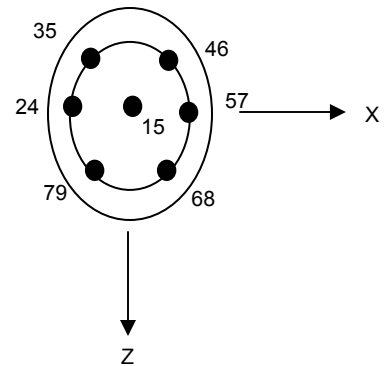

SAR FIGURE NO. 3.9-1F

AMENDMENT 20

ARKANSAS NUCLEAR ONE
UNIT 2
RUSSELLVILLE, ARKANSAS



SCALE:	NONE
DRAWN:	ENERGY
DESIGN:	ENERGY
CAD NO:	N/A

PORTION OF ICI MODEL REPRESENTING
THE ICI GUIDE TUBES

DRAWING NO

SHEET

REV.

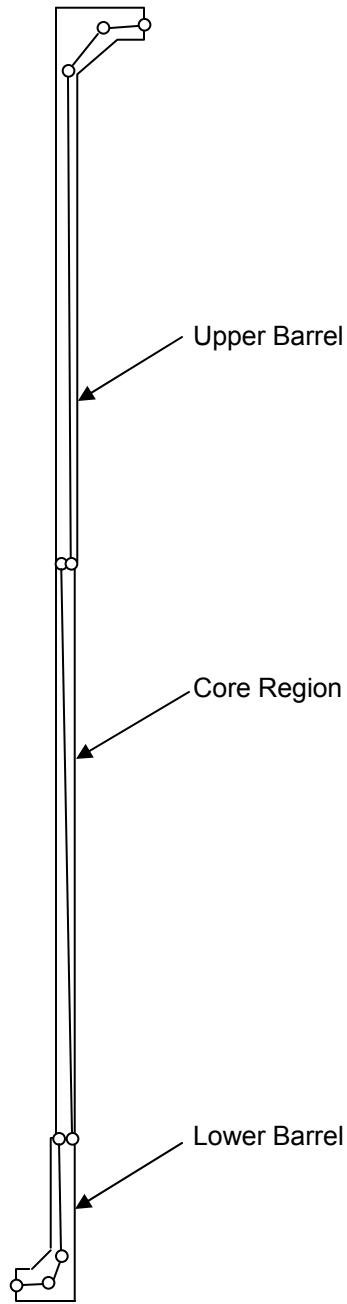

SAR FIGURE NO. 3.9-2

AMENDMENT 20

ARKANSAS NUCLEAR ONE
UNIT 2
RUSSELLVILLE, ARKANSAS



SCALE:	NONE
DRAWN:	ENERGY
DESIGN:	ENERGY
CAD NO:	N/A

SAMMSOR/DYNASOR FINITE ELEMENT
MODEL OF CORE SUPPORT BARREL

DRAWING NO

SHEET

REV.

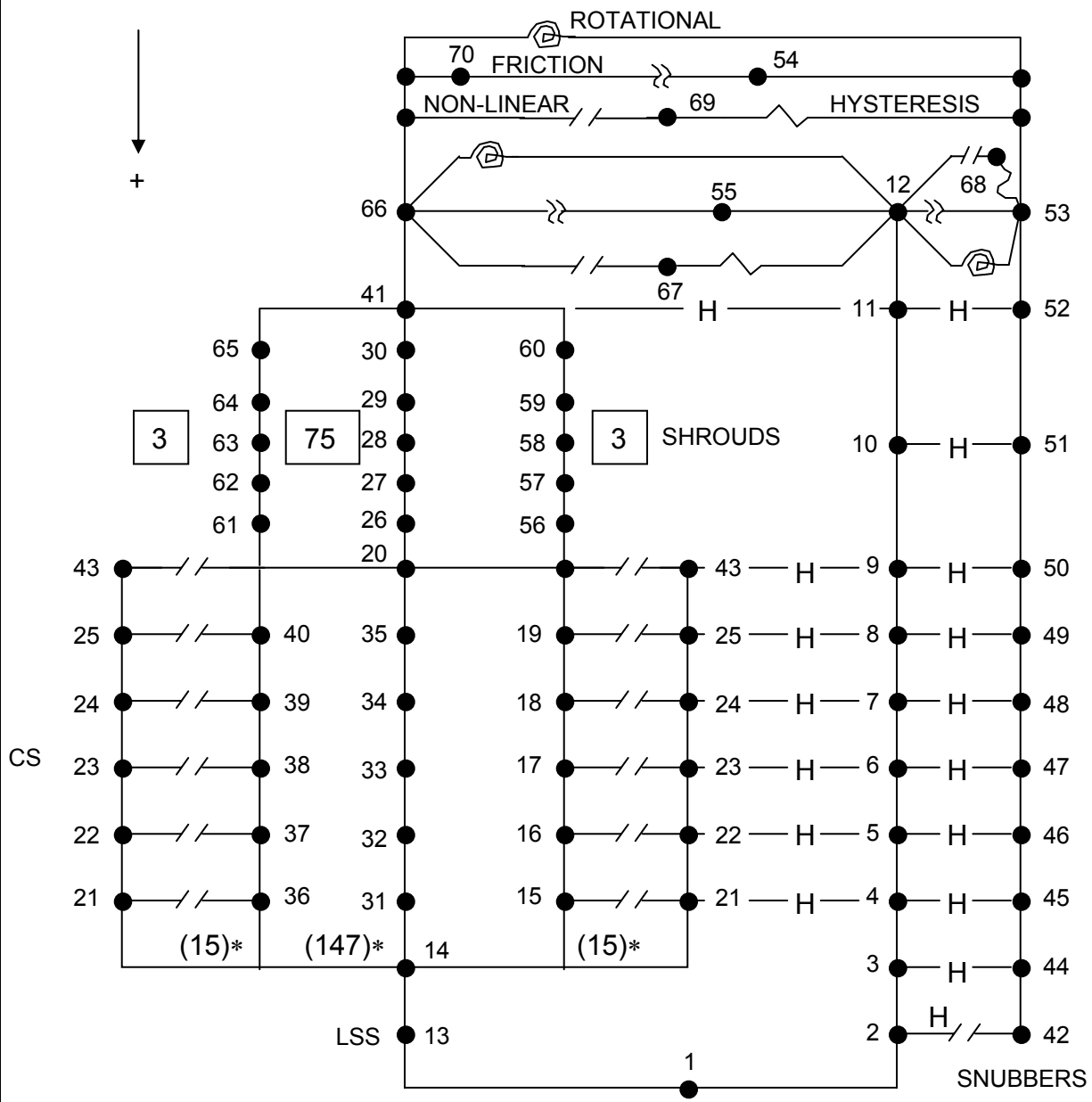

H → HYDRO COUPLING ELEMENT * → NO. OF ASSY'S

SAR FIGURE NO. 3.9-3

AMENDMENT 20

ARKANSAS NUCLEAR ONE
 UNIT 2
 RUSSELLVILLE, ARKANSAS



SCALE:	NONE
DRAWN:	ENERGY
DESIGN:	ENERGY
CAD NO:	N/A

REACTOR INTERNALS BLPB HORIZONTAL MODEL

DRAWING NO	SHEET	REV.

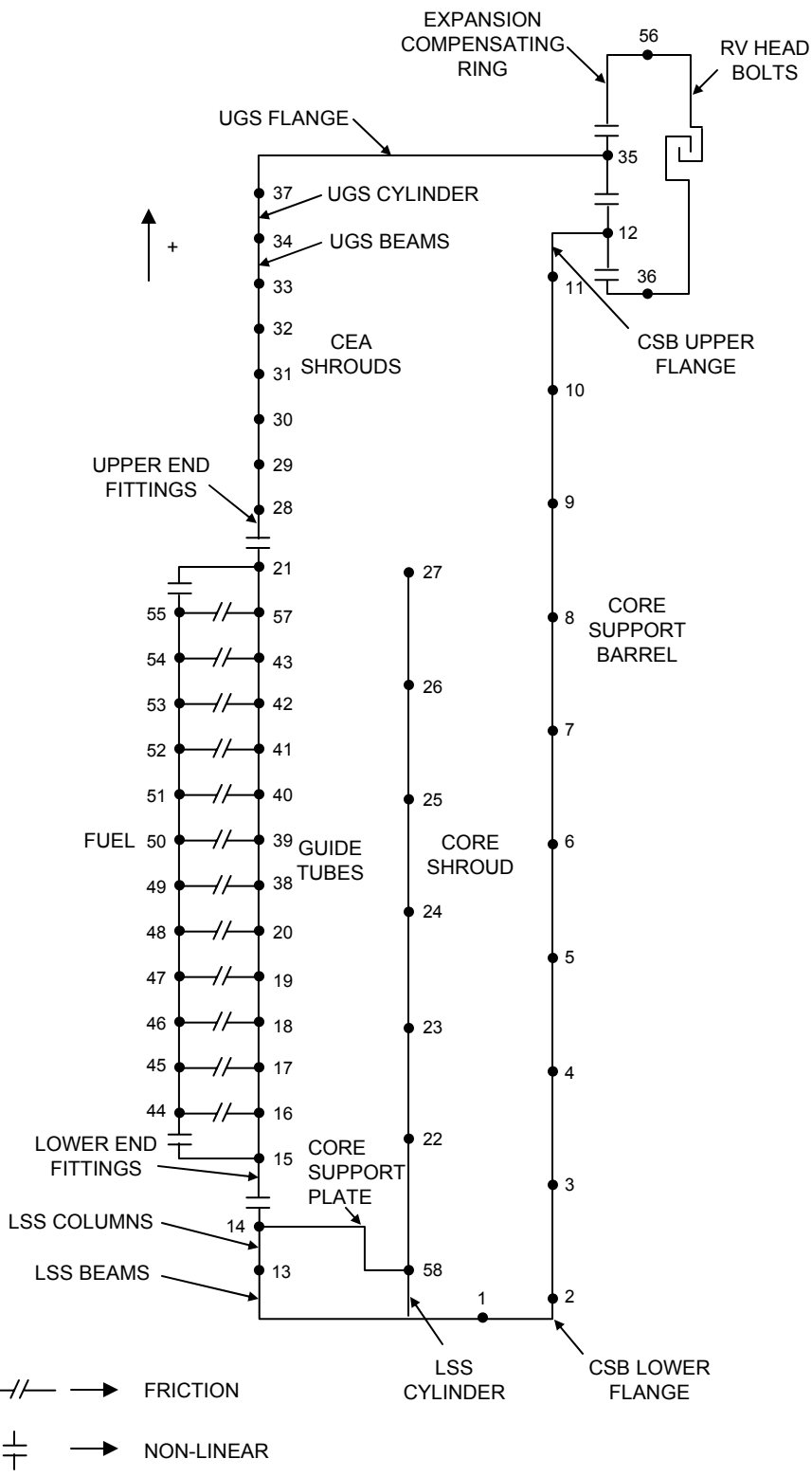

SAR FIGURE NO. 3.9-4

AMENDMENT 20

ARKANSAS NUCLEAR ONE
 UNIT 2
 RUSSELLVILLE, ARKANSAS



SCALE:	NONE
DRAWN:	ENERGY
DESIGN:	ENERGY
CAD NO:	N/A

REACTOR INTERNALS BLPB VERTICAL MODEL	DRAWING NO	SHEET	REV.

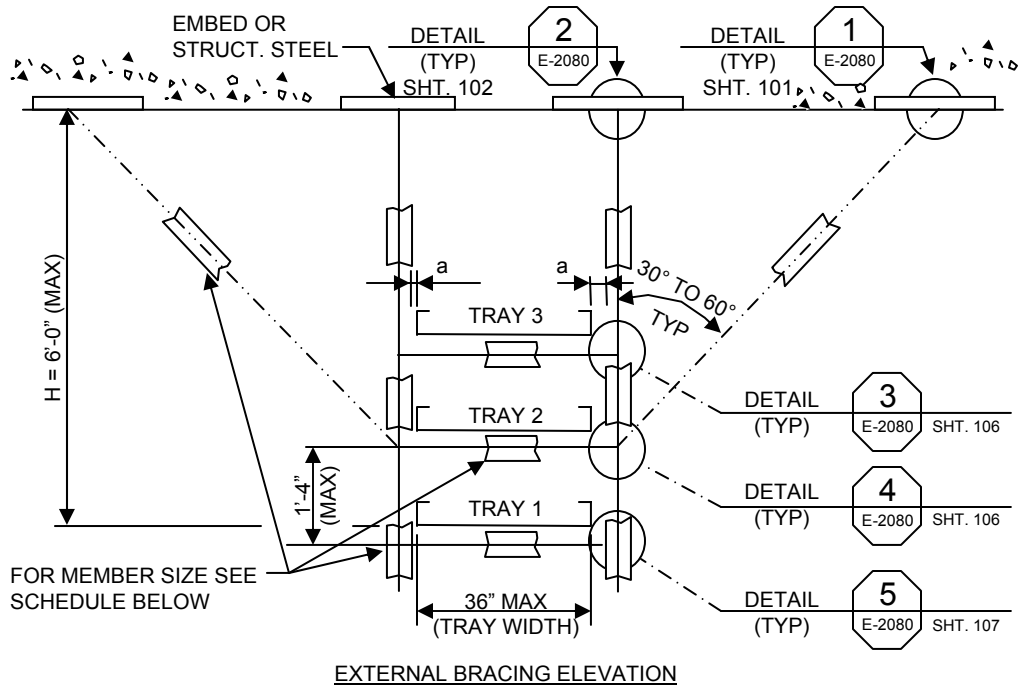

MEMBER SCHEDULE	
MEMBER	3 TRAYS
VERT & HORIZ	P1001
DIAGONALS	P1000 OR P1001

NOTE: IF 'a' EXCEEDS 3½", SEE LIMITATIONS IN DWG. E-2080 SHT. 95 R.

SAR FIGURE NO. 3.10-1

AMENDMENT 20

ARKANSAS NUCLEAR ONE
UNIT 2
RUSSELLVILLE, ARKANSAS



SCALE: NONE
DRAWN: ENTERGY
DESIGN: ENTERGY
CAD NO: N/A

CATEGORY 1 CABLE TRAY SUPPORT
TYPICAL DETAIL

DRAWING NO

SHEET

REV.

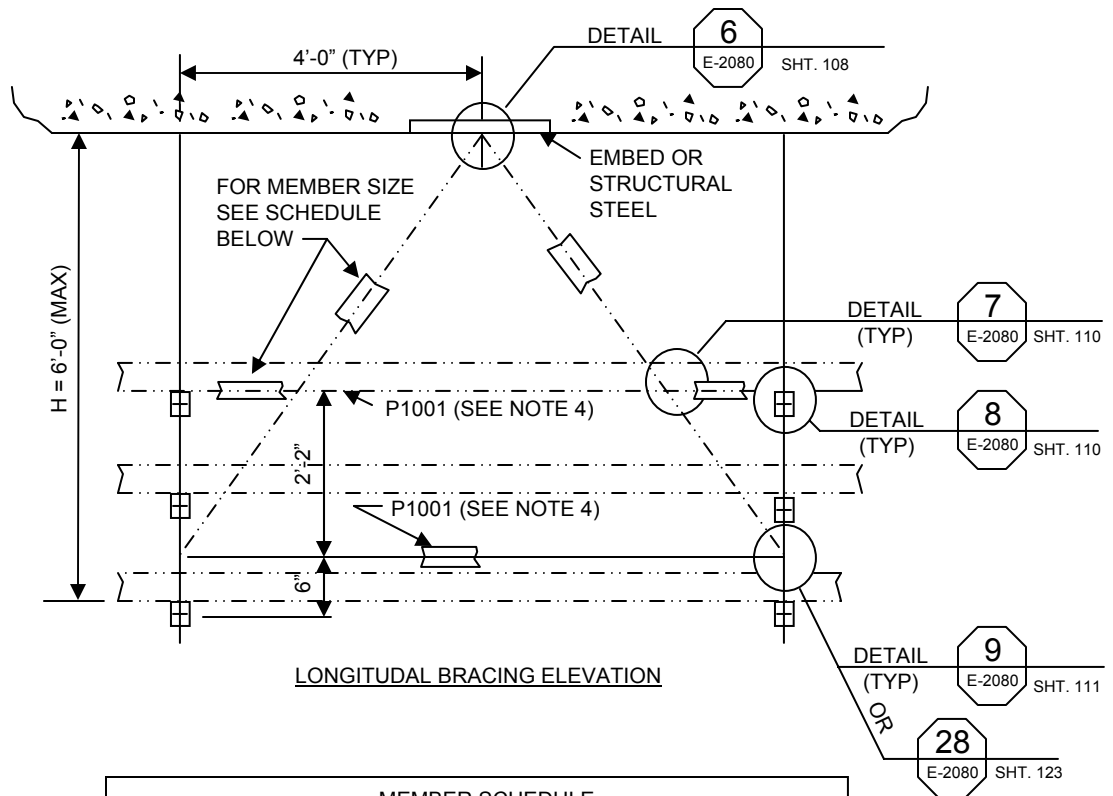

MEMBER SCHEDULE			
MEMBER	1 TRAY	2 TRAYS	3 TRAYS
DIAGONAL	P1000 OR P1001	SEE NOTE (2) P5501	P5501
HORIZONTAL SEE NOTE (1)	NONE	P1000	P1000

- NOTES:
- FOR 2 AND 3 TRAYS ONLY AT H > 3'-0"
 - FOR H ≤ 4'-0" USE A P1001
 - BRACING TO BE IN EVERY OTHER BAY
 - P1001 MEMBERS ARE SHOWN TO REFLECT AS-BUILT SUPPORTS. FOR NEW SUPPORTS, MEMBER SIZE P1001 ARE NOT REQ'D

SAR FIGURE NO. 3.10-2

AMENDMENT 20

ARKANSAS NUCLEAR ONE
UNIT 2
RUSSELLVILLE, ARKANSAS



SCALE: NONE
DRAWN: ENTERGY
DESIGN: ENTERGY
CAD NO: N/A

CATEGORY 1 CABLE TRAY SUPPORT
TYPICAL DETAIL

DRAWING NO

SHEET

REV.

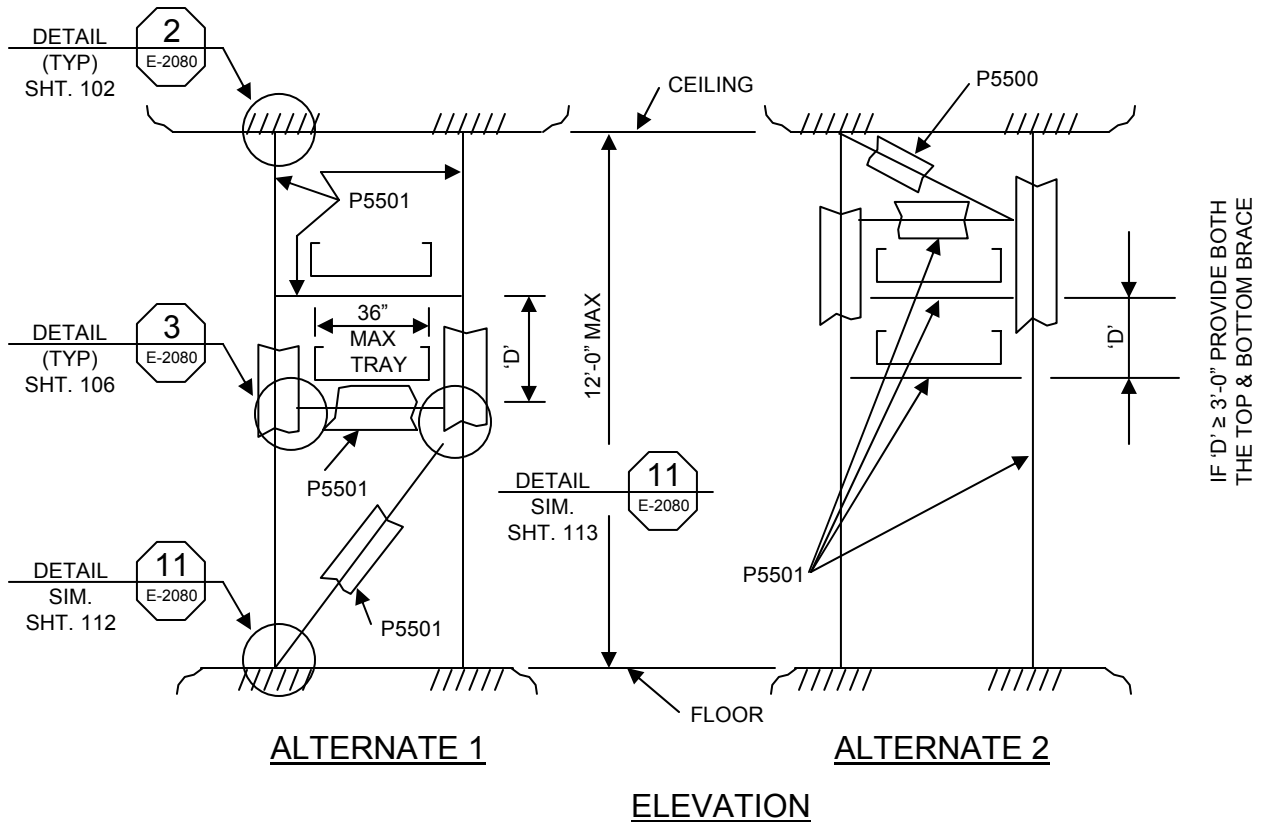

SAR FIGURE NO. 3.10-3

AMENDMENT 20

ARKANSAS NUCLEAR ONE
UNIT 2
RUSSELLVILLE, ARKANSAS



SCALE:	NONE
DRAWN:	ENERGY
DESIGN:	ENERGY
CAD NO:	N/A

CATEGORY 1 CABLE TRAY SUPPORT
TYPICAL DETAIL

DRAWING NO

SHEET

REV.

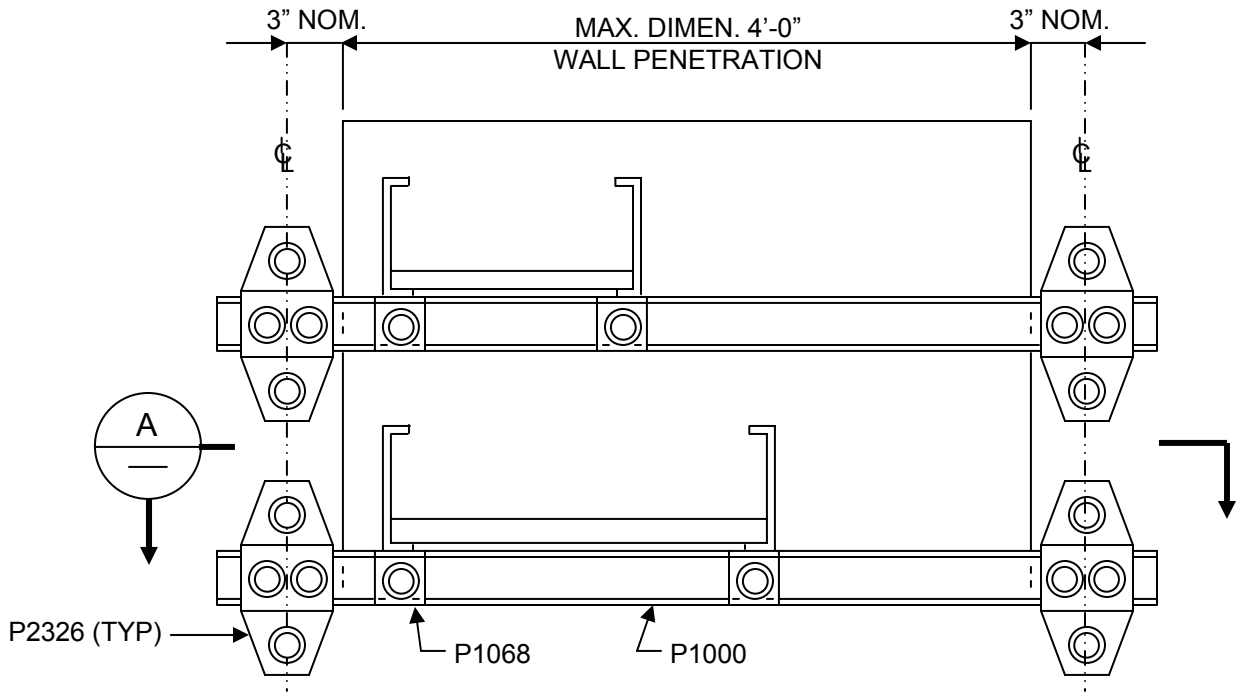

WALL PENETRATION ELEVATION

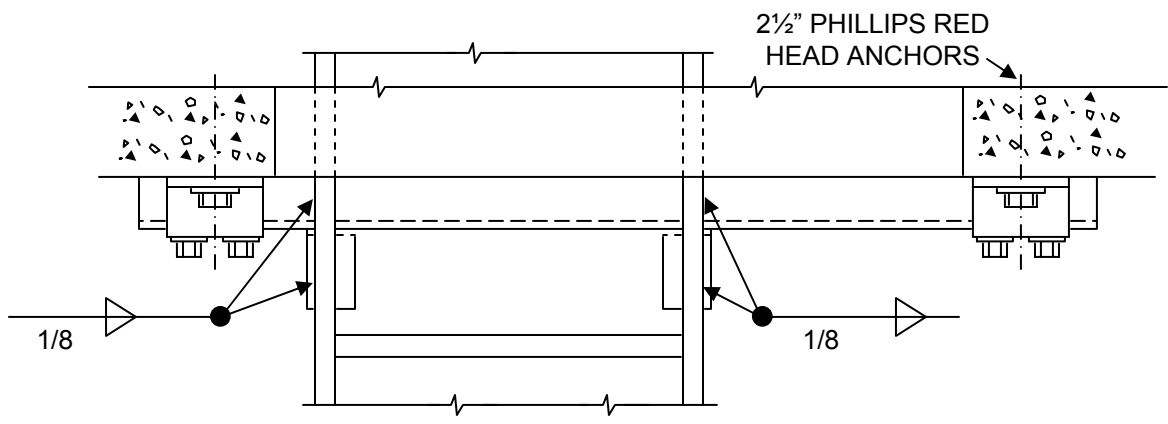

SECTION

SAR FIGURE NO. 3.10-4

AMENDMENT 20

ARKANSAS NUCLEAR ONE
UNIT 2
RUSSELLVILLE, ARKANSAS



SCALE:	NONE
DRAWN:	ENERGY
DESIGN:	ENERGY
CAD NO:	N/A

CATEGORY 1 CABLE TRAY SUPPORT
TYPICAL DETAIL

DRAWING NO	SHEET	REV.

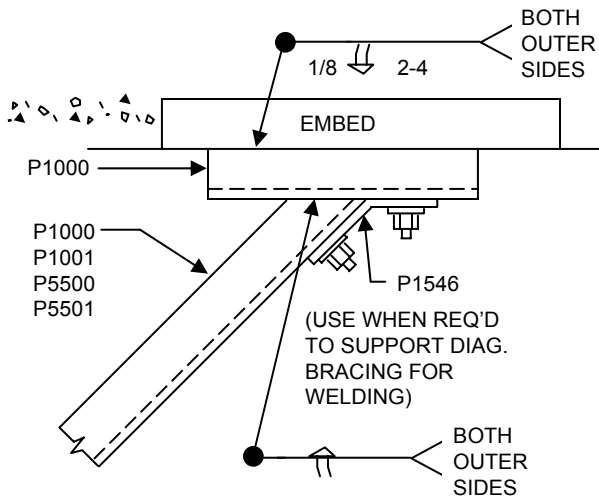

ALTERNATE A

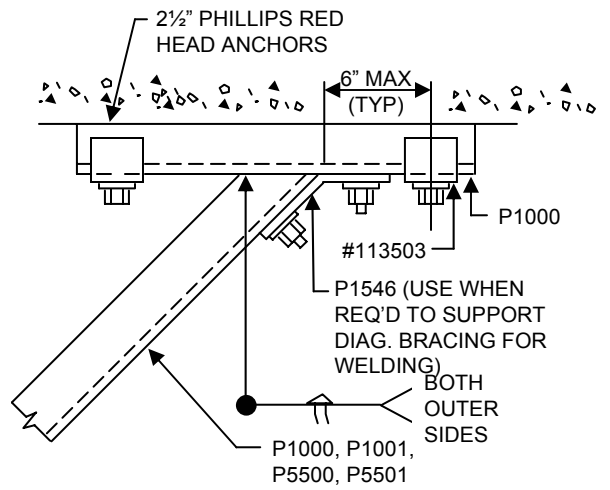

ALTERNATE B

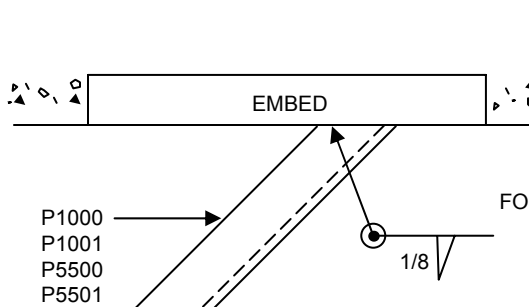

ALTERNATE C

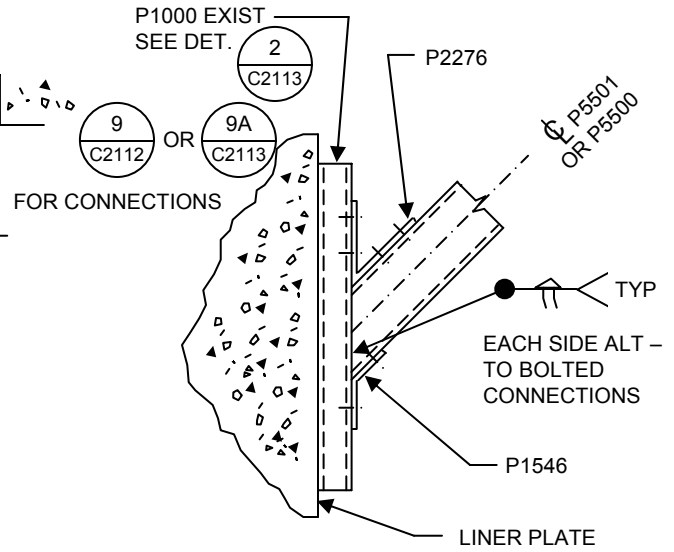

ALTERNATE D

DETAIL I
E-2080

SAR FIGURE NO. 3.10-5

AMENDMENT 20

ARKANSAS NUCLEAR ONE
UNIT 2
RUSSELLVILLE, ARKANSAS



SCALE: NONE
DRAWN: ENTERGY
DESIGN: ENTERGY
CAD NO: N/A

CATEGORY 1 CABLE TRAY SUPPORT
CONNECTIONS, TYPICAL DETAIL

DRAWING NO

SHEET

REV.

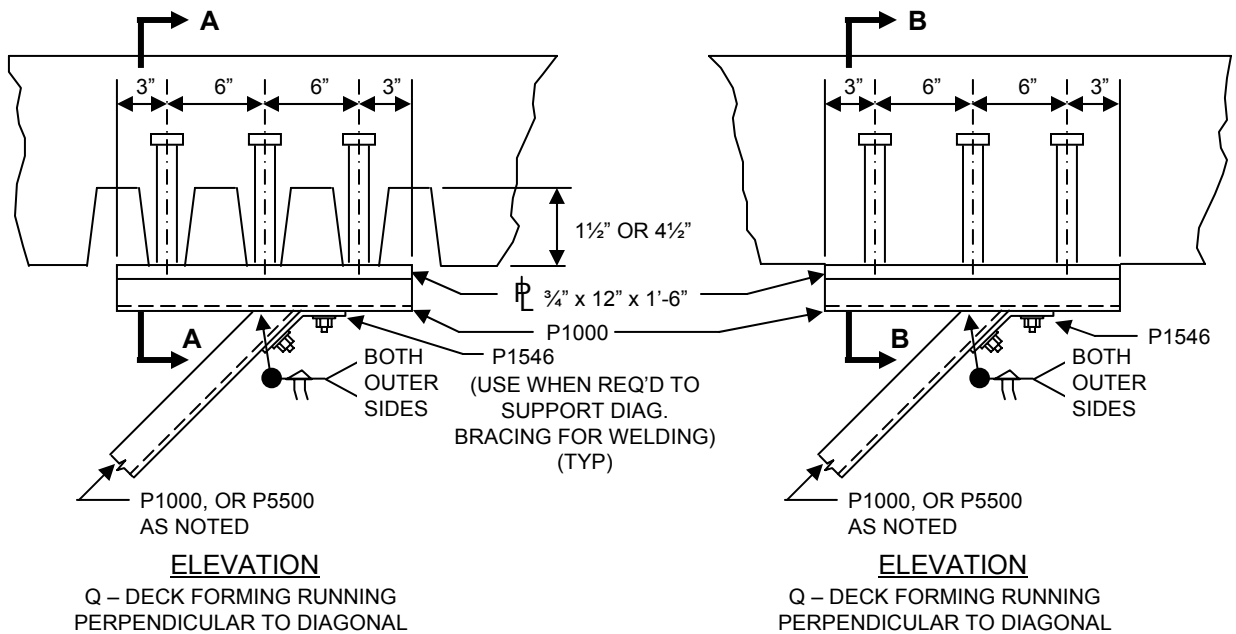
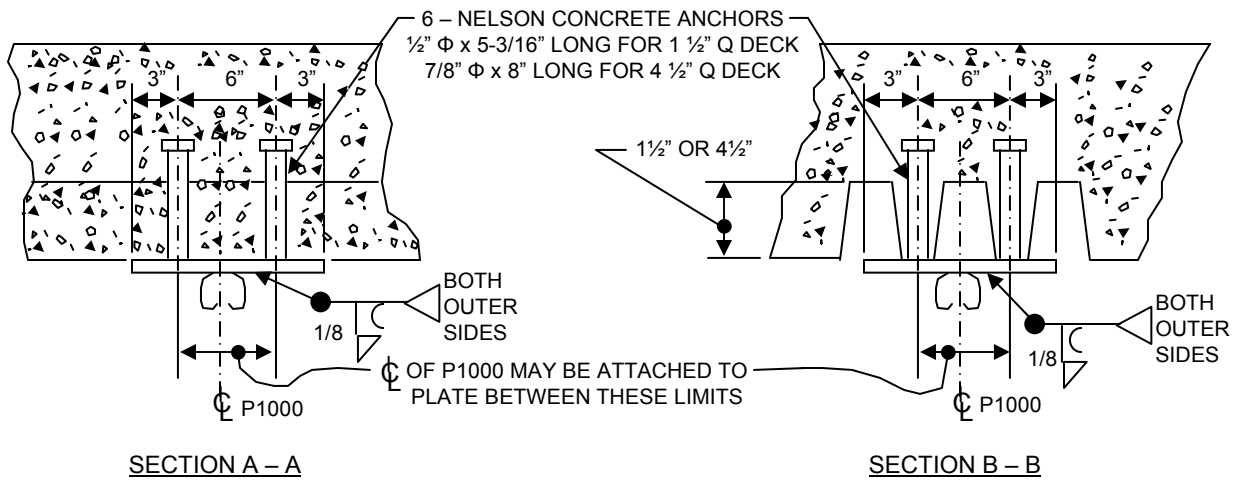

DETAIL 54
E-2080

**ATTACHMENT OF A DIAGONAL TO STRUCTURAL STEEL
ATTACHED TO CONCRETE WITH Q - DECK FORMING**

(ALTERNATE A)

SAR FIGURE NO. 3.10-6

AMENDMENT 20

ARKANSAS NUCLEAR ONE
UNIT 2
RUSSELLVILLE, ARKANSAS



SCALE:	NONE
DRAWN:	ENERGY
DESIGN:	ENERGY
CAD NO:	N/A

**CATEGORY 1 CABLE TRAY SUPPORT
CONNECTIONS, TYPICAL DETAIL**

DRAWING NO	SHEET	REV.

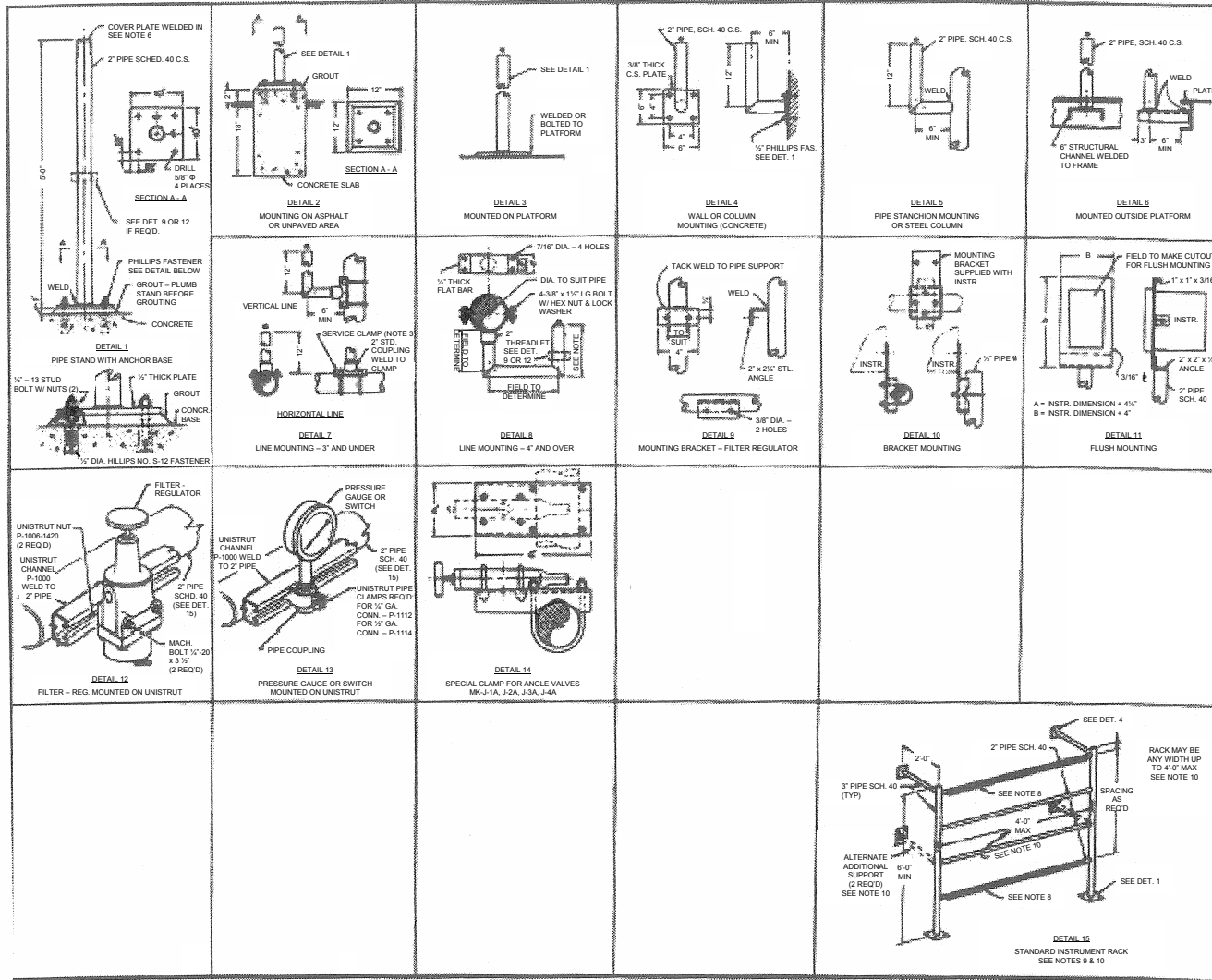

NOTES

1. USE DETAIL #1 FOR INDIVIDUALLY MOUNTED INSTRUMENTS EXCEPT THOSE REQUIRING SEISMICALLY ACCEPTABLE MOUNTING. USE ONLY DETAIL #4 FOR MOUNTING INSTR. COVERED BY SEISMIC REQUIREMENTS
2. USE SAME BASE PLATE FOR DETAILS #1, 3 & 15
3. DO NOT WELD SERVICE CLAMPS OR STANCHIONS TO PROCESS LINES
4. ALL LOCALLY MOUNTED INSTR'S. TO BE 4'-6" ABOVE GRADE IF POSSIBLE
- 5.
6. SEAL OPEN ENDS OF ALL PIPE
7. DO NOT DESIGN RACKS FOR MOUNTING ELECTRICAL JUNCTION BOXES ON RACK. ELECTRICAL JUNCTION BOXES ARE TO BE MOUNTED ON WALL BEHIND RACK AND CONNECTIONS TO INSTRUMENTS ON RACK MADE WITH FLEXIBLE CONDUIT. TERMINATION OF RIGID CONDUIT AT THE RACK WILL REQUIRE SEPARATE SEISMIC ANALYSIS FOR EACH RACK
8. WELD UNISTRUT P-1000 TO LOWER 2" PIPE (DETAIL #15) FOR AIRSETS (DET. #12) WHEN REQUIRED. ADD UNISTRUT IN SAME MANNER TO ANY 2" CROSS MEMBER TO MOUNT GAGES OR SWITCHES (DET. # 13)
9. STANDARD INSTRUMENT RACK SHOWN IN DETAIL 15 WITH MAX AMOUNT OF INSTRUMENTS MOUNTED ON FOUR HORIZONTAL ROWS IS ADEQUATE FOR SEISMIC CATEGORY 1
10. STANDARD INSTRUMENT RACK LENGTH CAN BE INCREASED TO 5'-0" MAX BY ADDING TWO HORIZONTAL SUPPORTING MEMBERS AS SHOWN IN DETAIL 15

INSTRUMENT MOUNTING DETAILS – RACKS, STANDS, BRACKETS, AND SUPPORTS

SAR FIGURE NO. 3.10-7

ARKANSAS NUCLEAR ONE
UNIT 2
RUSSELLVILLE, ARKANSAS



SCALE: NONE
DRAWN: ENTERGY
DESIGN: ENTERGY
CAD NO:

AMENDMENT 20

BASED ON DRAWING NO SHEET REV.

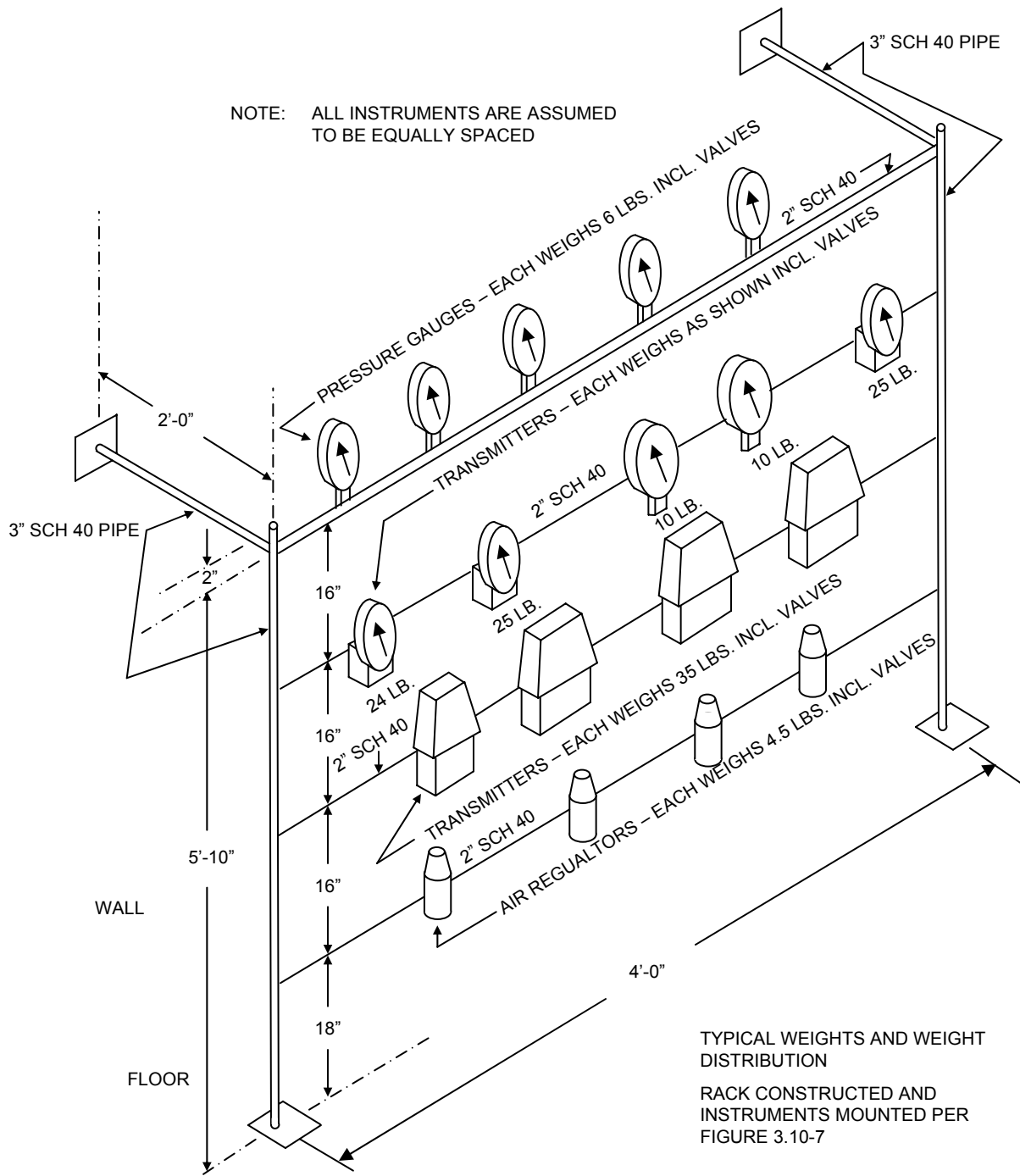

SAR FIGURE NO. 3.10-8

AMENDMENT 20

ARKANSAS NUCLEAR ONE
UNIT 2
RUSSELLVILLE, ARKANSAS



SCALE:	NONE
DRAWN:	ENERGY
DESIGN:	ENERGY
CAD NO:	N/A

INSTRUMENT RACK FIELD FABRICATION

DRAWING NO

SHEET

REV.

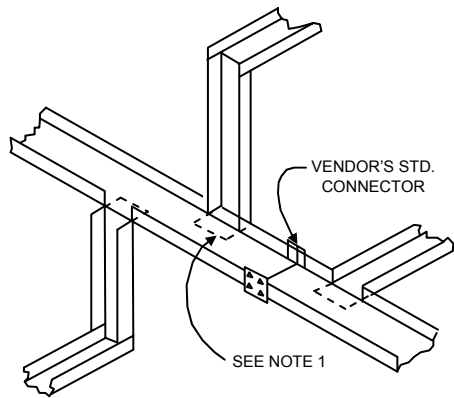

TYPICAL TRAY JOINING METHODS

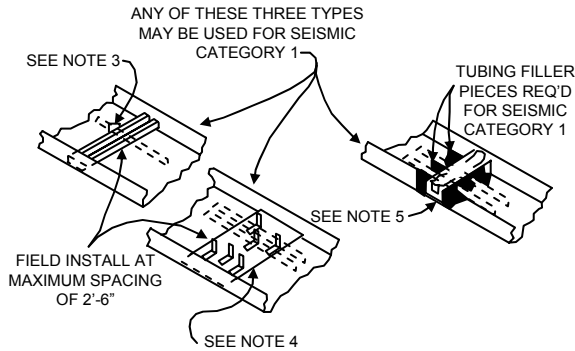

BURNDY TRAY AVAILABLE WITH CLIPS FACTORY INSTALLED ON 2'-6" CENTERS - BURNDY PRT4-6-144 PRT4-12-144

TUBING HOLD-DOWN DETAILS

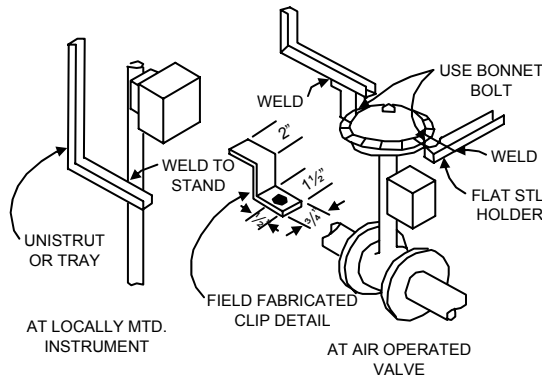
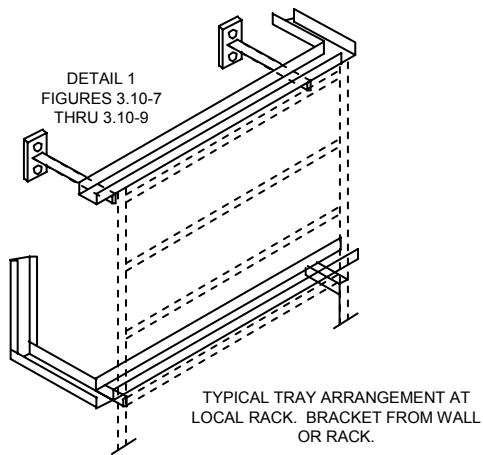

TYPICAL TRAY TERMINATION

1. All joints welded, except straight runs use tray vendors standard connectors. Use portion of bottom for overlap as shown. Paint weld areas. All trays are galvanized steel.

2. Approved Vendors and Trays:

Width	Catalog No.	Capacity
	<u>P&W Industries</u>	
*12"	2817-0012-12	19 tubes
* 6"	2817-0012-06	10 tubes
1½"	2501-0016-15	3 tubes
2½"	2501-0016-25	4 tubes
3-3/8"	2501-0016-33	6 tubes
	<u>Globe (Div. of U.S. Gypsum Co.)</u>	
*12"	SB-SS00-1200-3	19 tubes
* 6"	SB-SS00-0600-3	10 tubes
	<u>Unistrut Corp.</u>	
1-5/8"	P-3000	2 tubes
	<u>Husky-Burndy Co.</u>	
* 6"	SS J6-144	10 tubes
*12"	SS J12-144	19 tubes

3. For Unistrut P-4000 on tray, use Unistrut clip # P-7604

4. Burndy Clip Part # PRT-3, 6, 12-144

5. P&W Clip Part # D S-9004

6. Maximum distance between tube supports in tray - 2'-6" (Seismic Category 1)

7. Refer to Figure 3.7-10 for details on tray supports for Seismic Category 1

8. Do not layer tubing on trays. All seismic analysis based on one layer of 3/8" O.D. tubing tray

*Require flanged covers for Seismic Category 1

TUBING TRAY ARRANGEMENT AND ASSEMBLY DETAILS

SAR FIGURE NO. 3.10-9

ARKANSAS NUCLEAR ONE
UNIT 2
RUSSELLVILLE, ARKANSAS



SCALE: NONE
DRAWN: ENTERGY
DESIGN: ENTERGY
CAD NO:

AMENDMENT 20

BASED ON DRAWING NO SHEET REV.

ARKANSAS NUCLEAR ONE
Unit 2

CHAPTER 4

TABLE OF CONTENTS

<u>Section</u>	<u>Title</u>	<u>Page</u>
4	<u>REACTOR</u>	4.1-1
4.1	<u>SUMMARY DESCRIPTION</u>	4.1-1
4.2	<u>MECHANICAL DESIGN</u>	4.2-1
4.2.1	FUEL	4.2-1
4.2.1.1	<u>Design Basis</u>	4.2-1
4.2.1.2	<u>Fuel Design Description</u>	4.2-17
4.2.1.3	<u>Design Evaluation</u>	4.2-42
4.2.1.4	<u>Testing and Inspection Plan</u>	4.2-59
4.2.2	REACTOR INTERNALS.....	4.2-65
4.2.2.1	<u>Design Basis</u>	4.2-65
4.2.2.2	<u>Description and Drawings</u>	4.2-67
4.2.2.3	<u>Design Loading Conditions</u>	4.2-71
4.2.2.4	<u>Design Loading Categories</u>	4.2-71
4.2.2.5	<u>Design Criteria Bases</u>	4.2-72
4.2.3	REACTIVITY CONTROL SYSTEMS.....	4.2-72
4.2.3.1	<u>Design Bases</u>	4.2-72
4.2.3.2	<u>Reactivity Control System Description and Drawings</u>	4.2-73
4.2.3.3	<u>Reactivity Control System Evaluation</u>	4.2-76
4.2.3.4	<u>Testing and Inspection Plan</u>	4.2-83
4.2.3.5	<u>Instrumentation</u>	4.2-87
4.2.3.6	<u>Neutron Source Assembly</u>	4.2-87
4.3	<u>NUCLEAR DESIGN</u>	4.3-1
4.3.1	DESIGN BASES.....	4.3-1

ARKANSAS NUCLEAR ONE
Unit 2

TABLE OF CONTENTS (continued)

<u>Section</u>	<u>Title</u>	<u>Page</u>
4.3.1.1	<u>Excess Reactivity and Fuel Burnup</u>	4.3-1
4.3.1.2	<u>Core Design Lifetime and Fuel Replacement Program</u>	4.3-1
4.3.1.3	<u>Negative Reactivity Feedback and Reactivity Coefficients</u>	4.3-1
4.3.1.4	<u>Burnable Poison Requirements</u>	4.3-1
4.3.1.5	<u>Stability Criteria</u>	4.3-1
4.3.1.6	<u>Maximum Controlled Reactivity Insertion Rates</u>	4.3-1
4.3.1.7	<u>Power Distribution Control</u>	4.3-2
4.3.1.8	<u>Shutdown Margins and Stuck Rod Criteria</u>	4.3-2
4.3.1.9	<u>Chemical Shim Control</u>	4.3-2
4.3.1.10	<u>Maximum CEA Speeds</u>	4.3-2
4.3.2	DESCRIPTION	4.3-3
4.3.2.1	<u>Nuclear Design Description</u>	4.3-3
4.3.2.2	<u>Power Distribution</u>	4.3-3
4.3.2.3	<u>Reactivity Coefficients</u>	4.3-6
4.3.2.4	<u>CEA Patterns and Reactivity Worths</u>	4.3-9
4.3.2.5	<u>Control Requirements</u>	4.3-10
4.3.2.6	<u>Control and Monitoring of the Power Distribution</u>	4.3-12
4.3.2.7	<u>Criticality of Fuel Assemblies</u>	4.3-13
4.3.2.8	<u>Stability</u>	4.3-12
4.3.2.9	<u>Vessel Irradiation</u>	4.3-15
4.3.3	ANALYTICAL METHODS.....	4.3-15
4.3.3.1	<u>Reactivity and Power Distribution</u>	4.3-15
4.3.3.2	<u>Spatial Stability</u>	4.3-20
4.3.3.3	<u>Reactor Vessel Fluence Calculation Model</u>	4.3-22

ARKANSAS NUCLEAR ONE
Unit 2

TABLE OF CONTENTS (continued)

<u>Section</u>	<u>Title</u>	<u>Page</u>
4.3.3.4	<u>Local Axial Power Peaking Augmentation</u>	4.3-23
4.3.4	CHANGES.....	4.3-23
4.4	<u>THERMAL AND HYDRAULIC DESIGN</u>	4.4-1
4.4.1	DESIGN BASES.....	4.4-1
4.4.1.1	<u>Thermal Design</u>	4.4-1
4.4.1.2	<u>Coolant Flow Rate and Distribution</u>	4.4-1
4.4.1.3	<u>Fuel Design Bases</u>	4.4-1
4.4.2	DESCRIPTION.....	4.4-2
4.4.2.1	<u>Summary Comparison</u>	4.4-2
4.4.2.2	<u>Fuel and Cladding Temperatures</u>	4.4-2
4.4.2.3	<u>Critical Heat Flux Ratio (Departure from Nucleate Boiling)</u>	4.4-4
4.4.2.4	<u>Flux Tilt Consideration</u>	4.4-9
4.4.2.5	<u>Void Fraction Distribution</u>	4.4-9
4.4.2.6	<u>Core Coolant Flow Distribution</u>	4.4-10
4.4.2.7	<u>Core Pressure Drops and Hydraulic Loads</u>	4.4-10
4.4.2.8	<u>Correlations and Physical Data</u>	4.4-11
4.4.2.9	<u>Thermal Effects of Operational Transients</u>	4.4-12
4.4.2.10	<u>Uncertainties in Estimates</u>	4.4-12
4.4.2.11	<u>Plant Configuration Data</u>	4.4-14
4.4.3	EVALUATION.....	4.4-14
4.4.3.1	<u>Core Hydraulics</u>	4.4-14
4.4.3.2	<u>Influence of Power Distributions</u>	4.4-21
4.4.3.3	<u>Core Thermal Response</u>	4.4-21
4.4.3.4	<u>Analytical Techniques</u>	4.4-21

ARKANSAS NUCLEAR ONE
Unit 2

TABLE OF CONTENTS (continued)

<u>Section</u>	<u>Title</u>	<u>Page</u>
4.4.3.5	<u>Hydraulic Instability Analysis</u>	4.4-26
4.4.3.6	<u>Temperature Transient Effects Analysis</u>	4.4-26
4.4.3.7	<u>Potentially Damaging Temperature Effects During Transients</u>	4.4-27
4.4.3.8	<u>Energy Release During Fuel Element Burnout</u>	4.4-28
4.4.3.9	<u>Energy Release on Rupture of Waterlogged Fuel Elements</u>	4.4-28
4.4.3.10	<u>Fuel Rod Behavior Effects from Coolant Flow Blockage</u>	4.4-28
4.4.4	TESTING AND VERIFICATION	4.4-29
4.4.4.1	<u>Introduction</u>	4.4-29
4.4.4.2	<u>DNB Testing</u>	4.4-29
4.4.4.3	<u>Components Testing</u>	4.4-33
4.4.4.4	<u>Turbulent Interchange Testing</u>	4.4-34
4.4.4.5	<u>Reactor Testing</u>	4.4-35
4.4.5	INSTRUMENTATION REQUIREMENTS	4.4-35
4.5	<u>STARTUP PROGRAM</u>	4.5-1
4.5.1	PRECRITICAL TEST	4.5-1
4.5.1.1	<u>Control Element Assembly (CEA) Drop Time Test</u>	4.5-1
4.5.2	LOW POWER PHYSICS TEST	4.5-1
4.5.2.1	<u>Critical Boron Concentration</u>	4.5-1
4.5.2.2	<u>CEA Reactivity Worth</u>	4.5-1
4.5.2.3	<u>Temperature Reactivity Coefficient</u>	4.5-2
4.5.3	POWER ASCENSION TESTS	4.5-2
4.5.3.1	<u>Reactor Coolant Flow</u>	4.5-2
4.5.3.2	<u>Core Power Distribution</u>	4.5-2

ARKANSAS NUCLEAR ONE
Unit 2

TABLE OF CONTENTS (continued)

<u>Section</u>	<u>Title</u>	<u>Page</u>
4.5.3.3	<u>Shape Annealing Matrix (SAM) and Boundary Point Power Correlation Coefficients (BPPCC)</u>	4.5-4
4.5.3.4	<u>Radial Peaking Factor (RPF) and CEA Shadowing Factor (RSF) Verification</u>	4.5-4
4.5.3.5	<u>Temperature Reactivity Coefficient</u>	4.5-4
4.5.3.6	<u>HZP to HFP Reactivity Difference</u>	4.5-5
4.5.4	PROCEDURE IF ACCEPTANCE CRITERIA ARE NOT MET	4.5-5
4.6	<u>REFERENCES</u>	4.6-1
4.7	<u>TABLES</u>	4.7-1

ARKANSAS NUCLEAR ONE
Unit 2

LIST OF TABLES

<u>Table No.</u>	<u>Title</u>	<u>Page</u>
4.1-1	ANALYSIS TECHNIQUES	4.7-1
4.2-1	MECHANICAL DESIGN PARAMETERS	4.7-3
4.2-2	CLADDING BURST TEST RESULTS OF FORT CALHOUN FUEL RODS	4.7-8
4.2-3	CLAD MECHANICAL PROPERTIES	4.7-9
4.2-3A	FUEL ROD CLADDING TEMPERATURE DURING NORMAL AND ANTICIPATED OPERATIONAL OCCURRENCES ORIGINAL DESIGN VALUES	4.7-10
4.2-4	STRESS LIMITS FOR REACTOR VESSEL INTERNAL STRUCTURES	4.7-11
4.2-4A	REACTOR INTERNALS HOLDDOWN RING NET DOWN LOADS	4.7-12
4.2-5	STRESS LIMITS FOR PRESSURE HOUSINGS	4.7-13
4.3-1	NUCLEAR DESIGN CHARACTERISTICS	4.7-14
4.3-2	EFFECTIVE MULTIPLICATION FACTORS AND REACTIVITY DATA	4.7-15
4.3-3	COMPARISON OF CORE REACTIVITY COEFFICIENTS WITH THOSE USED IN VARIOUS SAFETY ANALYSES	4.7-16
4.3-4	REACTIVITY COEFFICIENTS	4.7-17
4.3-5	HFP WORTHS OF CEA GROUPS	4.7-17
4.3-6	CEA REACTIVITY ALLOWANCES	4.7-17
4.3-6A	COMPARISON OF RODDED AND UNRODDED PEAKING HFP FACTORS FOR VARIOUS RODDED CONFIGURATIONS AT BOC AND EOC	4.7-18
4.3-7	COMPARISON OF CALCULATED CEA WORTHS AND REQUIREMENTS	4.7-18
4.3-8	MAXIMUM FAST FLUX GREATER THAN ONE MeV	4.7-19
4.4-1	THERMAL AND HYDRAULIC PARAMETERS	4.7-20
4.4-2	CYCLE 27 THERMAL - HYDRAULIC PARAMETERS AT FULL POWER	4.7-22
4.4-3	REACTOR COOLANT FLOW RATES IN BYPASS CHANNELS	4.7-23

ARKANSAS NUCLEAR ONE
Unit 2

LIST OF TABLES (continued)

<u>Table No.</u>	<u>Title</u>	<u>Page</u>
4.4-4	REACTOR VESSEL ORIGINAL ESTIMATES PRESSURE LOSSES AND COOLANT TEMPERATURES.....	4.7-23
4.4-5	DESIGN STEADY STATE HYDRAULIC LOADS ON VESSEL INTERNALS	4.7-24
4.4-6	REACTOR CONFIGURATION DATA	4.7-25
4.4-6A	STEADY STATE PARAMETERS.....	4.7-26

ARKANSAS NUCLEAR ONE
Unit 2

LIST OF FIGURES

<u>Figure No.</u>	<u>Title</u>
4.1-1	REACTOR VERTICAL ARRANGEMENT
4.1-2	REACTOR CORE CROSS SECTION
4.1-2A	REACTOR CORE CROSS SECTION (CYCLE 20)
4.2-1	CIRCUMFERENTIAL STRAIN vs. TEMPERATURE
4.2-2	DESIGN CURVE FOR CYCLIC STRAIN USAGE OF ZIRCALOY-4 AT 700 °F
4.2-3	FUEL ROD
4.2-3A	FUEL ROD WITH GADOLINIA
4.2-3B	FUEL ROD WITH ERBIA
4.2-3C	FUEL ROD WITH ZrB ₂ IFBA
4.2-3D	NGF FUEL ROD WITH ZrB ₂ IFBA
4.2-4	FUEL ASSEMBLY
4.2-5	DELETED
4.2-6	BURNABLE POISON ROD
4.2-6a	0.2% OFFSET YIELD STRENGTH OF ZIRCALOY-4 TUBING (78% COLD-WORKED AND STRESS RELIEF ANNEALED)
4.2-6b	ULTIMATE TENSILE STRENGTH OF ZIRCALOY-4 TUBING (78% COLD-WORKED AND STRESS RELIEF ANNEALED)
4.2-6c	UNIFORM ELONGATION OF ZIRCALOY-4 TUBING (78% COLD-WORKED AND STRESS RELIEF ANNEALED)
4.2-7	HEAT CONTENT OF ZIRCALOY-4
4.2-8	THERMAL CONDUCTIVITY OF ZIRCALOY-4 TUBING
4.2.8a	COLD WORKED ZIRCALOY GROWTH STRAIN VS FAST NEUTRON FLUENCE
4.2.8b	ANNEALED ZIRCALOY GROWTH STRAIN VS FAST NEUTRON FLUENCE
4.2-9	DELETED
4.2-10	SNUBBER ASSEMBLY

ARKANSAS NUCLEAR ONE
Unit 2

LIST OF FIGURES (continued)

<u>Figure No.</u>	<u>Title</u>
4.2-11	CORE SHROUD ASSEMBLY
4.2-12	UPPER GUIDE ASSEMBLY
4.2-13	MOVABLE DETECTOR SYSTEM LAYOUT
4.2-14	IN-CORE INSTRUMENT NOZZLE
4.2-15	IN-CORE SUPPORT ASSEMBLY
4.2-16	IN-CORE INSTRUMENT ASSEMBLY
4.2-17	CONTROL ELEMENT DRIVE MECHANISM (MAGNETIC JACK)
4.2-18	FULL LENGTH CEA
4.2-18A	DELETED
4.2-19	CONTROL ELEMENT ASSEMBLY LOCATIONS
4.2-20	LATERAL GEOMETRY AND DIRECTION OF ROD BOWING
4.2-21	EFFECT OF BOWED RODS ON CHF IN A 16 X 16 TYPE ROD BUNDLE (2000 PSIA)
4.2-22	EFFECT OF BOWED RODS ON CHF IN A 16 X 16 TYPE ROD BUNDLE (2300 PSIA)
4.3-1	CYCLE 27 FUEL MANAGEMENT SCHEME
4.3-1A	CYCLE 27 INTEGRAL BURNABLE POISON SHIM AND ENRICHMENT ZONING PATTERNS FOR REGION EE, GG, AND HH FUEL ASSEMBLIES
4.3-1B	DELETED
4.3-1C	CYCLE 27 CORE LOADING
4.3-1D	CYCLE 27 CORE MAP
4.3-1E	CYCLE 27 BOC ASSEMBLY AVERAGE BURNUP AND INITIAL ENRICHMENT DISTRIBUTION EOC 26 = SHORT ENDPOINT
4.3-2	CYCLE 27 BOC, HFP, EQUILIBRIUM XENON, ARO, ASSEMBLY RELATIVE POWER DENSITY EOC 26 = SHORT ENDPOINT
4.3-3	CYCLE 27 MOC, HFP, EQUILIBRIUM XENON, ARO, ASSEMBLY RELATIVE POWER DENSITY EOC 26 = SHORT ENDPOINT

ARKANSAS NUCLEAR ONE
Unit 2

LIST OF FIGURES (continued)

<u>Figure No.</u>	<u>Title</u>
4.3-4	CYCLE 27 EOC, HFP, EQUILIBRIUM XENON, ARO, ASSEMBLY RELATIVE POWER DENSITY EOC 26 = LONG ENDPOINT
4.3-5	CYCLE 27 BOC, HFP, BANK P INSERTED, ASSEMBLY RELATIVE POWER DENSITY EOC 26 = SHORT ENDPOINT
4.3-6	CYCLE 27 BOC, HFP, BANK 6 INSERTED, ASSEMBLY RELATIVE POWER DENSITY EOC 26 = SHORT ENDPOINT
4.3-7	CYCLE 27 BOC, HFP, BANKS 6 + P INSERTED, ASSEMBLY RELATIVE POWER DENSITY EOC 26 = SHORT ENDPOINT
4.3-8	CYCLE 27 EOC, HFP, BANK P INSERTED, ASSEMBLY RELATIVE POWER DENSITY EOC 26 = LONG ENDPOINT
4.3-9	CYCLE 27 EOC, HFP, BANK 6 INSERTED, ASSEMBLY RELATIVE POWER DENSITY EOC 26 = LONG ENDPOINT
4.3-10	CYCLE 27 EOC, HFP, BANK 6 + P INSERTED, ASSEMBLY RELATIVE POWER DENSITY EOC 26 = LONG ENDPOINT
4.3-11	DELETED
4.3-12	DELETED
4.3-13	DELETED
4.3-14	AXIAL POWER SHAPE, BEGINNING-OF-CYCLE
4.3-15	AXIAL POWER SHAPE, 3,200 MWD/MTU
4.3-16	AXIAL POWER SHAPE, 6,400 MWD/MTU
4.3-17	AXIAL POWER SHAPE, 9,600 MWD/MTU
4.3-18	AXIAL POWER SHAPE, 12,500 MWD/MTU
4.3-19	DELETED
4.3-20 – 4.3-20C	DELETED
4.3-20D	F_Q & F_R vs TIME FOR A LOAD FOLLOWING TRANSIENT NEAR THE END OF CYCLE
4.3-21	F_Q vs TIME FOR A LOAD FOLLOWING TRANSIENT
4.3-21A	F_Q vs TIME FOR A LOAD FOLLOWING TRANSIENT

ARKANSAS NUCLEAR ONE
Unit 2

LIST OF FIGURES (continued)

<u>Figure No.</u>	<u>Title</u>
4.3-22	F_R vs TIME FOR A LOAD FOLLOWING TRANSIENT
4.3-22A	F_R vs TIME FOR A LOAD FOLLOWING TRANSIENT
4.3-23	NORMALIZED POWER DISTRIBUTION WITHIN TYPICAL UNSHIMMED ASSEMBLY
4.3-24	FUEL TEMPERATURE COEFFICIENT VS EFFECTIVE FUEL TEMPERATURE
4.3-25 – 4.3-27	DELETED
4.3-28	CEA BANK IDENTIFICATION
4.3-29 – 4.3-30	DELETED
4.3-31	FREE OSCILLATION RESPONSE OF DETECTORS AT VARIOUS AZIMUTHAL LOCATIONS
4.3-32	THERMAL NEUTRON FLUX AT THE CENTER OF THE CORE vs TIME
4.3-33	STABILITY INDEX
4.3-34 – 4.3-40	DELETED
4.3-41	A DIVERGENT AXIAL OSCILLATION IN AN EOC CORE WITH REDUCED POWER FEEDBACK
4.3-42	DAMPING COEFFICIENT vs REACTIVITY DIFFERENCE BETWEEN FUNDAMENTAL AND EXCITED STATE
4.3-43 – 4.3-45	DELETED
4.3-46	ROD SHADOWING EFFECT VS. ROD POSITION FOR ROD INSERTION AND WITHDRAWAL TRANSIENTS AT PALISADES
4.3-47	TYPICAL THREE SUB-CHANNEL ANNEALING
4.3-48	GEOMETRY LAYOUT
4.3-49	COMPARISON OF MEASURED AND CALCULATED SHAPE ANNEALING CORRECTION FOR PALISADES
4.3-50	TYPICAL TEMPERATURE DEFECT VS. REACTOR INLET TEMPERATURE
4.4-1	CLAD AVERAGE TEMPERATURE VS. FRACTION OF ACTIVE CORE HEIGHT FROM INLET
4.4-2	AXIAL POWER DISTRIBUTIONS

ARKANSAS NUCLEAR ONE
Unit 2

LIST OF FIGURES (continued)

<u>Figure No.</u>	<u>Title</u>
4.4-3	CUMULATIVE DISTRIBUTION OF NUMBER OF FUEL RODS VERSUS DNBR
4.4-4	CUMULATIVE DISTRIBUTION OF ROD RADIAL FACTOR
4.4-5	AVERAGE VOID FRACTION VERSUS NUCLEAR ENTHALPY RISE FACTOR
4.4-6	HOT CHANNEL VOID FRACTION VS. CORE HEIGHT
4.4-7	REACTOR VERTICAL ARRANGEMENT SHOWING MAIN AND BYPASS FLOW PATHS
4.4-8	PERCENT CHANGE IN CORE POWER VS. PERCENT CHANGE IN ENTHALPY RISE FACTOR FROM DESIGN VALUE
4.4-9	PERCENT CHANGE IN CORE POWER VS. PERCENT CHANGE IN REFERENCE ASSEMBLY PEAK FROM DESIGN VALUE
4.4-10	PRESSURE DROP PREDICTIONS FOR A TWENTY-ONE ROD BUNDLE
4.4-11	TEMPERATURE VS. CORE POWER FOR VARIOUS PRESSURES (FOUR PUMP OPERATION)
4.4-12	DELETED
4.4-13	DNB TEST RESULTS FOR THE C-E 16x16 FUEL ASSEMBLY
4.4-14	DELETED
4.5-1	DELETED

ARKANSAS NUCLEAR ONE
Unit 2

UPDATE REFERENCE LIST

Sections and references listed below denote documents that contain additional cross reference information used to update the SAR.

<u>Section</u>	<u>Cross References</u>
4.4.2.7.1	Correspondence from Rueter, AP&L, to Stolz, NRC, dated April 11, 1977. (2CAN047708).
4.2.1.1.10	Correspondence from Rueter, AP&L, to Stolz, NRC, dated April 25, 1977. (2CAN047713).
4.2.1.3.2	Correspondence from Rueter, AP&L, to Stolz, NRC, dated August 31, 1977. (2CAN087708).
4.2.1.2.2	Correspondence from Williams, AP&L, to Stolz, NRC, dated February 9, 1978. (2CAN027804).
4.2.2.1	Correspondence from Williams, AP&L, to Stolz, NRC, dated June 17, 1978. (2CAN067818).
4.2.1.2.3, 4.2.1.3.2	Correspondence from Williams, AP&L, to Stolz, NRC, dated June 26, 1978. (2CAN067824).
4.2.1.2.3	Correspondence from Trimble, AP&L, to Seyfrit, NRC, dated March 21, 1979. (0CAN037915).
4.2.1.1.1.2	Correspondence from Cavanaugh, AP&L, to Eisenhut, NRC, dated January 7, 1980. (0CAN018005).
4.2.1.1.1.2	Correspondence from Trimble, AP&L, to Eisenhut, NRC, dated January 25, 1980. (2CAN018020).
4.3.3.1.1	Correspondence from Cavanaugh, AP&L, to Reid, NRC, dated August 12, 1980. (2CAN088008).
4.3.2.1, 4.4.1.1	Correspondence from Trimble, AP&L, to Clark, NRC, dated February 20, 1981. (2CAN028107).
4.3.2.1, 4.4.1.1	Correspondence from Trimble, AP&L, to Clark, NRC, dated April 14, 1981. (2CAN048103).
4.3.2.1, 4.4.1.1 4.4.2.10.2	Correspondence from Trimble, AP&L, to Clark, NRC, dated April 21, 1981. (2CAN048107).
4.3.2.1, 4.4.1.1	Correspondence from Trimble, AP&L, to Clark, NRC, dated May 6, 1981. (2CAN058102).

ARKANSAS NUCLEAR ONE
Unit 2

UPDATE REFERENCE LIST (continued)

<u>Section</u>	<u>Cross References</u>
4.3.2.1, 4.4.1.1 4.3.2.3.2, 4.3.2.5.6	Correspondence from Trimble, AP&L, to Clark, NRC, dated May 11, 1981. (2CAN058105).
4.3.2.1 4.4.1.1	Correspondence from Cavanaugh, AP&L, to Clark, NRC, dated May 19, 1981. (2CAN058108).
4.2.1.1.12	Correspondence from Trimble, AP&L, to Eisenhut, NRC, dated May 29, 1981. (0CAN058117).
4.3.2.1, 4.4.1.1	Correspondence from Trimble, AP&L, to Clark, NRC, dated June 8, 1981. (2CAN068105).
4.2.1.1.12	Correspondence from Trimble, AP&L, to Eisenhut, NRC, dated June 22, 1981. (0CAN068108).
4.3.2.1, 4.4.1.1	Correspondence from Trimble, AP&L, to Clark, NRC, dated June 19, 1981. (2CAN068116).
4.2.1.2.3 4.4.2.10.2	Correspondence from Cavanaugh, AP&L, to Clark, NRC, dated June 19, 1981. (2CAN068117).

Amendment 8 and 10

Table 4.2-1	Correspondence from D. R. Earles, CE, to A. G. Mansell, AP&L, dated March 26, 1986 (A-CE-R-132)
-------------	---

Amendment 10

Figure 4.2-16	Limited Change Package 90-6026, "Incore Instrument Assembly Design Upgrade."
---------------	--

Amendment 11

4.1 4.2.3.6	Correspondence from Young, C-E, to Turk, EOI, dated July 19, 1991. (A-91-033)
----------------	---

Amendment 12

4.3.2.8.2	Engineering Action Request 93-0424, "Incore Instrumentation - Design Configuration Documentation Project Concerns"
Figure 4.2-16	Design Change Package 92-2026, "Incore Instrument Assembly Replacement"

ARKANSAS NUCLEAR ONE
Unit 2

UPDATE REFERENCE LIST (continued)

<u>Section</u>	<u>Cross References</u>
<u>Amendment 13</u>	
4.1	Design Change Package 94-2017, "Replacement of the Part Length Control Element Assemblies"
4.2	
4.3	
4.3.2.5.4	
Table 4.2-1	
Table 4.2-3	
Table 4.2-3A	
Table 4.2-5	
Table 4.3-1	
Table 4.3-3	
Table 4.3-6	
Figure 4.2-18	
Figure 4.2-18A	
Figure 4.2-19	
Figure 4.3-8	
Figure 4.3-9	
Figure 4.3-9A	
Figure 4.3-10	
Figure 4.3-11	
Figure 4.3-12	
Figure 4.3-13	
Figure 4.3-19	
Figure 4.3-20	
Figure 4.3-20A	
Figure 4.3-20B	
Figure 4.3-20C	
Figure 4.3-28	
Figure 4.3-29	
<u>Amendment 14</u>	
4.2.1.1.12	Design Change Package 92-2001, "High Level Waste Storage"
4.4.2.7.2	Limited Change Package 96-3355, "High Pressure Turbine First Stage Nozzle and Bucket Modification"

ARKANSAS NUCLEAR ONE
Unit 2

UPDATE REFERENCE LIST (continued)

<u>Section</u>	<u>Cross References</u>
<u>Amendment 15</u>	
4.1	Calculation 97R201802, "Cycle 14 Reload Analysis Report"
1.2.1.1.9	
4.2.1.2.5	
4.3.1.6	
4.3.2.1	
4.3.2.2.3	
4.3.2.3.1	
4.3.2.3.2	
4.3.2.4	
4.3.2.6	
4.3.3.1.1	
4.3.3.2	
4.3.3.2.3	
4.4.2.1	
4.4.2.2.2	
4.4.2.7.1	
4.4.2.7.2	
4.5.2.3	
4.5.3	
4.6.1	
Table 4.2-1	
Table 4.3-1	
Table 4.3-2	
Table 4.3-3	
Table 4.4-2	
Figure 4.1-1	
Figure 4.2-3	
Figure 4.2-4	
Figure 4.3-1A	
Figure 4.3-1B	
Figure 4.3-1C	
Figure 4.3-1D	
Figure 4.3-1E	
Figure 4.3-1F	
Figure 4.3-1G	
Figure 4.3-2	
Figure 4.3-3	
Figure 4.3-4	
Figure 4.3-5	
Figure 4.3-6	
Figure 4.3-7	
Figure 4.3-8	
Figure 4.3-9	
Figure 4.3-10	

ARKANSAS NUCLEAR ONE
Unit 2

UPDATE REFERENCE LIST (continued)

<u>Section</u>	<u>Cross References</u>
4.2.1.2 4.4.2.7.1 4.4.3.8 Table 4.4-2	Engineering Request 975015D201, "Steam Generator Tube Plugging Limits for Reactor Coolant System Flow Variations"
<u>Amendment 16</u>	
4.1	Technical Specification 205, "Relocation of Miscellaneous Design Features from the Technical Specifications to the SAR"
4.2.1.1.1 4.2.1.3.1 4.2.1.3.3 4.2.2.1 4.2.2.3.3 4.2.2.4 4.2.3.3.1 4.2.3.3.2 4.4.1.2 4.4.2.7.1 4.4.2.7.3 4.6 Table 4.1-1 Table 4.2-4 Table 4.2-4A Table 4.4-5	Engineering Request 980642I243, "Mechanical Support for Replacement Steam Generator Project"
4.2.1.3.11 4.2.1.3.2 Table 4.1-1 Table 4.2-4A Table 4.4-4	Design Change Package 980642D210, "Replacement Steam Generator Design/Qualification"
4.3.2.1 4.4.1.2 4.4.2.7.1 Table 4.3-3 Table 4.3-4 Table 4.4-2	ANO Calculation 98R200503, "Cycle 15 Core Design"

ARKANSAS NUCLEAR ONE
Unit 2

UPDATE REFERENCE LIST (continued)

<u>Section</u>	<u>Cross References</u>
<u>Amendment 17</u>	
4.1	ANO Engineering Report 01-R-2008-03, ANO-2 Cycle 16 Reload Analysis Report”
4.2.1.1.1.2	
4.2.1.1.5	
4.2.1.2.1	
4.2.1.2.1.1	
4.2.1.2.3	
4.2.1.2.4	
4.2.1.2.5	
4.2.1.3.13	
4.2.1.4	
4.2.1.4.1	
4.2.1.4.3	
4.2.1.4.6	
4.3.2.3.2	
4.6	
Table 4.2-1	
Table 4.3-1	
Table 4.4-2	
Figure 4.2-3	
Figure 4.2-3A	
Figure 4.2-3B	
Figure 4.2-9	
Figure 4.3-1	
Figure 4.3-1A	
Figure 4.3-1B	
Figure 4.3-1C	
Figure 4.3-1E	
Figure 4.3-1F	
Figure 4.3-1G	
Figure 4.3-2	
Figure 4.3-3	
Figure 4.3-4	
Figure 4.3-5	
Figure 4.3-6	
Figure 4.3-7	
Figure 4.3-8	
Figure 4.3-9	
Figure 4.3-10	

ARKANSAS NUCLEAR ONE
Unit 2

UPDATE REFERENCE LIST (continued)

<u>Section</u>	<u>Cross References</u>
4.2.1.1.1.2	Engineering Request ANO-2000-2344-026, "Power Uprate Evaluation"
4.2.1.1.4	
4.2.1.2.3	
4.2.1.3.12	
4.2.1.3.13	
4.3.2.2.3	
4.4.2.1	
4.4.2.10.2	
4.4.2.3.1	
4.4.2.3.4	
4.4.2.7.3	
4.4.3.1.1	
4.4.3.1.2	
4.4.3.4.1	
4.4.3.4.2	
4.4.3.6	
4.5.2.3	
4.5.3.5	
Table 4.3-3	
Figure 4.3-24A	
4.3.2.9	Unit 2 Technical Specification Amendment 242
4.3.3.3	
4.6	
Table 4.3-7	
4.5.2.3	Unit 2 Technical Specification Amendment 236
4.5.3.5	
4.5.4	
<u>Amendment 18</u>	
4.3.3.2.3	SAR Discrepancy 2-98-0131, "Deletion of Azimuthal Damping Factor Measurement Detail"
4.3.2.2.3	SAR Discrepancy 2-98-0128, "Deletion of COLSS Thermal Margin Uncertainty Value From SAR Section 4.3"
4.3.3.3	Licensing Document Change 2-4.3-0014, "Vessel Fluence Reference Corrections"
4.3.2.4	SAR Discrepancy 2-98-0130, "Revision of CEA Requirements for Reactor Shutdown"
Figure 4.2-16	Engineering Request ER-ANO-1992-2026, "B&W Test Incore Instrument Replacement with CE Incore Assembly"

ARKANSAS NUCLEAR ONE
Unit 2

UPDATE REFERENCE LIST (continued)

<u>Section</u>	<u>Cross References</u>
Table 4.4-2 Figure 4.3-1 Figure 4.3-1A Figure 4.3-1B Figure 4.3-1C Figure 4.3-1D Figure 4.3-1E Figure 4.3-1F Figure 4.3-1G Figure 4.3-2 Figure 4.3-3 Figure 4.3-4 Figure 4.3-5 Figure 4.3-6 Figure 4.3-7 Figure 4.3-8 Figure 4.3-9 Figure 4.3-10	Calculation CALC-A2-NE-2003-001-00, "ANO-2 Cycle 17 Reload Analysis"
<u>Amendment 19</u>	
4.5.2 4.5.3.6 4.5.4 4.6	Topical Report WCAP-16011-P-A, Rev. 0, "Startup Test Activity Reduction"
3.6.1 4.2.2.1.2 4.3.2.9 4.3.3.3	License Document Change Request 2-1.2-0049, "License Renewal"
4.1 4.2.1.1.1.2 4.2.1.1.5 4.2.1.1.6 4.2.1.1.7 4.2.1.1.8 4.2.1.1.10 4.2.1.2.1 4.2.1.2.1.3 4.2.1.2.4 4.2.1.2.4.1 4.2.1.2.4.1.1 4.2.1.2.4.1.2 4.2.1.3.1 4.2.1.3.5.1 4.2.1.3.5.2 4.2.1.3.5.3	Calculation A2-NE-2004-000, "ANO-2 Cycle 18 Reload Analysis Report"

ARKANSAS NUCLEAR ONE
Unit 2

UPDATE REFERENCE LIST (continued)

Section Cross References

4.2.1.3.6
4.2.1.3.6.2
4.2.1.3.9
4.2.1.3.10
4.2.1.3.12
4.2.1.3.13
4.2.1.4.1
4.2.1.4.2
4.2.1.4.6
4.3.2.2.3
4.3.2.3.2
4.3.3.1.1
4.3.3.1.2
4.4.3.7
4.4.3.8
4.6
Table 4.2-1
Table 4.2-2
Table 4.2-3
Table 4.4-2
Figure 4.2-3C
Figure 4.3-1
Figure 4.3-1A
Figure 4.3-1B
Figure 4.3-1C
Figure 4.3-1E
Figure 4.3-1F
Figure 4.3-1G
Figure 4.3-2 through Figure 4.3-10

Amendment 20

4.4.2.3.1 License Document Change Request 05-058, "Deletion/simplification of
Table 4.4-1 Excessive Detailed Drawings from SAR"
Figures – ALL (except Figures 4.3-1 through 4.3-1C and 4.3-1E through 4.3-10)

Figure 4.2-16 Engineering Request ER-ANO-2003-0399-003, "Modification of Reactor
Internals Thimble Tubes"

4.1 Calculation CALC-ANO2-NE-06-00001, "ANO-2 Cycle 19 Reload Report"
4.2.1.1.3
4.2.1.1.4
4.2.1.2.1
4.2.1.2.1.3
4.2.1.4.6
4.3.2.1
4.4.1.1
4.4.2.3.2

ARKANSAS NUCLEAR ONE
Unit 2

UPDATE REFERENCE LIST (continued)

<u>Section</u>	<u>Cross References</u>
4.4.3.4.2	
4.4.4.2	
4.5.3.2	
4.6	
Table 4.3-1	
Table 4.4-2	
Figure 4.2-3C	
Figure 4.3-1	
Figure 4.3-1A	
Figure 4.3-1B	
Figure 4.3-1C	
Figure 4.3-1D	
Figure 4.3-1E	
Figure 4.3-1F	
Figure 4.3-1G	
Figure 4.3-2	
Figure 4.3-3	
Figure 4.3-4	
Figure 4.3-5	
Figure 4.3-6	
Figure 4.3-7	
Figure 4.3-8	
Figure 4.3-9	
Figure 4.3-10	
4.3.2.1	Calculation CALC-ANO2-NE-06-00001, "Revision to the ANO-2 Cycle 19 Reload Report"
Figure 4.3-1	
Figure 4.3-1E	
Figure 4.3-1F	
Figure 4.3-1G	
<u>Amendment 21</u>	
4.1	Calculation CALC-ANO2-NE-08-00001, "ANO-2 Cycle 20 Reload Analysis Report"
4.2.1.1.1.2	
4.2.1.1.1.3	
4.2.1.1.1.5	
4.2.1.1.1.6	
4.2.1.1.1.7	
4.2.1.1.1.8	
4.2.1.1.1.10	
4.2.1.2.1	
4.2.1.2.1.3	
4.2.1.2.3	
4.2.1.2.4.1.2	
4.2.1.2.4.2	
4.2.1.2.4.3	

ARKANSAS NUCLEAR ONE
Unit 2

UPDATE REFERENCE LIST (continued)

Section Cross References

4.2.1.2.4.4
4.2.1.2.4.6
4.2.1.2.4.7
4.2.1.2.4.8
4.2.1.2.4.9
4.2.1.2.4.10
4.2.1.3.1
4.2.1.3.3
4.2.1.3.5.1
4.2.1.3.5.2
4.2.1.3.6.2
4.2.1.3.8.2
4.2.1.3.8.3
4.2.1.3.9
4.2.1.3.11
4.2.1.3.12
4.2.1.3.13
4.2.1.4.4
4.2.1.4.5
4.2.1.4.6
4.3.2.1
4.3.2.3.2
4.3.2.3.3
4.4.1.1
4.4.2.3.2
4.4.2.3.4
4.4.3.1.2
4.4.3.4.2
4.4.3.7
4.4.3.8
4.4.4.2
4.4.4.3
4.4.4.5
4.6
Table 4.2-1
Table 4.2-3
Table 4.3-1
Table 4.3-3
Table 4.3-4
Table 4.4-2
Figure 4.1-2A
Figure 4.2-3D
Figure 4.2-5
Figure 4.3-1
Figures 4.3-1A – G
Figures 4.3-2 – 4.3-10

ARKANSAS NUCLEAR ONE
Unit 2

UPDATE REFERENCE LIST (continued)

<u>Section</u>	<u>Cross References</u>
4.3.3.1.1	License Document Change Request 08-012, "Tie CECOR Libraries to Westinghouse Topical Report"
4.5.2.3 4.5.3.5	TS Amendment 279, "Modification of MTC Surveillances"
4.2.3.1.1 4.2.3.3.2.4 4.2.3.4.2 4.5.1.1	TS Amendment 275, "CEA Drop Time"
<u>Amendment 22</u>	
4.2.1.1.11 4.2.1.4.6	License Document Change Request 09-035, "New Fuel Shipping Cask"
4.1 4.3.2.2.2 4.3.2.2.3 4.3.3.2.4 4.4.4.2	TS Amendment 287, "DNBR Safety Limit"
4.2.1.1.5 4.2.1.2.1 4.2.1.2.1.1 4.2.1.2.1.3 4.2.1.2.3 4.2.1.3.5.1 4.2.1.3.11 4.4.1.1 4.4.2.3.2 4.4.2.3.4 4.4.2.10.2 4.4.3.4.2 Table 4.3-1 Table 4.4-2 Figure 4.3-1 Figure 4.3-1A thru 4.3-1F Figure 4.3-2 thru 4.3-10	Calculation CALC-ANO2-NE-09-00001, "ANO-2 Cycle 21 Reload Report"
4.5.3.1	TS Amendment 286, "Use of RCP Differential Pressure Flow"
<u>Amendment 23</u>	
4.2.1.1.11 4.2.1.2.1.3 4.2.1.4.6 4.4.2.3.2	Calculation CALC-ANO2-NE-10-00002, "ANO-2 Cycle 22 Reload Analysis Report"

ARKANSAS NUCLEAR ONE
Unit 2

UPDATE REFERENCE LIST (continued)

Section Cross References

Table 4.2-1
Table 4.3-1
Table 4.4-2
Figure 4.3-1
Figure 4.3-1A thru 4.3-1F
Figure 4.3-2 thru 4.3-10

Amendment 24

4.2.1.2.1.3 Engineering Change EC-32194, "ANO-2 Cycle 23 Reload Report"
4.3.2.1
4.3.3.3
4.4.2.3.2
4.4.3.4.2
Table 4.2-1
Table 4.3-1
Table 4.4-2
Figure 4.3-1
Figure 4.3-1A
Figure 4.3-1C
Figure 4.3-1D
Figure 4.3-1E
Figure 4.3-2 thru 4.3-10

Amendment 25

4.1 Engineering Change EC-42844, "ANO-2 Cycle 24 Reload Report"
4.2.1.2.1.3
4.3.1.2
4.3.3.3
Table 4.2-1
Figure 4.3-1
Figure 4.3-1A
Figure 4.3-1C
Figure 4.3-1D
Figure 4.3-1E
Figure 4.3-2 thru 4.3-10

Amendment 26

4.1 Engineering Change EC-53837, "ANO-2 Cycle 25 Reload Report"
4.2.1.1.5
4.2.1.2.1.3
4.2.1.3.5.1
4.2.1.3.5.2
4.2.1.3.9.1
4.6
Table 4.2-1

ARKANSAS NUCLEAR ONE
Unit 2

UPDATE REFERENCE LIST (continued)

<u>Section</u>	<u>Cross References</u>	
Table 4.3-1		
Table 4.4-2		
Figure 4.3-1		
Figure 4.3-1A		
Figure 4.3-1C		
Figure 4.3-1D		
Figure 4.3-1E		
Figure 4.3-2 thru 4.3-10		
<u>Amendment 27</u>		
4.2.1.1.1.1	Engineering Change EC-65313, "Material Specification for Fuel Assembly Stainless Steel Cast Components"	
4.2.1.1.1.2		
4.2.1.1.5		
4.2.1.1.6		
4.2.1.1.7		
4.2.1.2.4.6		
4.2.1.4.5		
4.2.1.4.6		
4.2.1.2.1.3	Engineering Change EC-62439, "Cycle 26 Reload Report"	
4.3.2.1		
4.3.2.3.2		
Table 4.2-1		
Table 4.3-1		
Table 4.4-2		
Figure 4.3-1		
Figure 4.3-1A		
Figures 4.3-1C thru 4.3-1E		
Figures 4.3-2 thru 4.3-10		
Figure 4.3-1E		Engineering Change EC-73507, "ANO-2 Cycle 26 Reload Analysis Report, Revision 1"
Figure 4.3-2 thru 4.3-10		
<u>Amendment 28</u>		
4.2.1.2.1.3	Engineering Change EC 75926, "ANO-2 Cycle 27 Reload Report and COLR"	
Table 4.2-1		
Table 4.3-1		
Table 4.4-2		
Figure 4.3-1		
Figure 4.3-1A		
Figures 4.3-1C thru 4.3-1E		
Figures 4.3-2 thru 4.3-10		
4.3.3.3	Engineering Change EC-69421, "Update SAR in accordance with TS Amendment 311"	
4.6		

ARKANSAS NUCLEAR ONE
Unit 2

RECORD OF REVISIONS

<u>PAGE #</u>	<u>AMENDMENT #</u>	<u>PAGE #</u>	<u>AMENDMENT #</u>	<u>PAGE #</u>	<u>AMENDMENT #</u>
TABLE OF CONTENTS		CHAPTER 4 (CONT.)		CHAPTER 4 (CONT.)	
4-i	28	4.2-9	28	4.2-54	28
4-ii	28	4.2-10	28	4.2-55	28
4-iii	28	4.2-11	28	4.2-56	28
4-iv	28	4.2-12	28	4.2-57	28
4-v	28	4.2-13	28	4.2-58	28
4-vi	28	4.2-14	28	4.2-59	28
4-vii	28	4.2-15	28	4.2-60	28
4-viii	28	4.2-16	28	4.2-61	28
4-ix	28	4.2-17	28	4.2-62	28
4-x	28	4.2-18	28	4.2-63	28
4-xi	28	4.2-19	28	4.2-64	28
4-xii	28	4.2-20	28	4.2-65	28
4-xiii	28	4.2-21	28	4.2-66	28
4-xiv	28	4.2-22	28	4.2-67	28
4-xv	28	4.2-23	28	4.2-68	28
4-xvi	28	4.2-24	28	4.2-69	28
4-xvii	28	4.2-25	28	4.2-70	28
4-xviii	28	4.2-26	28	4.2-71	28
4-xix	28	4.2-27	28	4.2-72	28
4-xx	28	4.2-28	28	4.2-73	28
4-xxi	28	4.2-29	28	4.2-74	28
4-xxii	28	4.2-30	28	4.2-75	28
4-xxiii	28	4.2-31	28	4.2-76	28
4-xxiv	28	4.2-32	28	4.2-77	28
4-xxv	28	4.2-33	28	4.2-78	28
4-xxvi	28	4.2-34	28	4.2-79	28
4-xxvii	28	4.2-35	28	4.2-80	28
4-xxviii	28	4.2-36	28	4.2-81	28
4-xxix	28	4.2-37	28	4.2-82	28
		4.2-38	28	4.2-83	28
		4.2-39	28	4.2-84	28
CHAPTER 4		4.2-40	28	4.2-85	28
		4.2-41	28	4.2-86	28
4.1-1	25	4.2-42	28	4.2-87	28
4.1-2	25	4.2-43	28		
4.1-3	25	4.2-44	28	4.3-1	28
		4.2-45	28	4.3-2	28
4.2-1	28	4.2-46	28	4.3-3	28
4.2-2	28	4.2-47	28	4.3-4	28
4.2-3	28	4.2-48	28	4.3-5	28
4.2-4	28	4.2-49	28	4.3-6	28
4.2-5	28	4.2-50	28	4.3-7	28
4.2-6	28	4.2-51	28	4.3-8	28
4.2-7	28	4.2-52	28	4.3-9	28
4.2-8	28	4.2-53	28	4.3-10	28

ARKANSAS NUCLEAR ONE
Unit 2

RECORD OF REVISIONS (continued)

<u>PAGE #</u>	<u>AMENDMENT #</u>	<u>PAGE #</u>	<u>AMENDMENT #</u>	<u>PAGE #</u>	<u>AMENDMENT #</u>
CHAPTER 4 (CONT.)		CHAPTER 4 (CONT.)		CHAPTER 4 (CONT.)	
4.3-11	28	4.4-32	24	4.7-22	28
4.3-12	28	4.4-33	24	4.7-23	28
4.3-13	28	4.4-34	24	4.7-24	28
4.3-14	28	4.4-35	24	4.7-25	28
4.3-15	28			4.7-26	28
4.3-16	28	4.5-1	22		
4.3-17	28	4.5-2	22	F4.1-1	20
4.3-18	28	4.5-3	22	F4.1-2	20
4.3-19	28	4.5-4	22	F 4.1.2A	21
4.3-20	28	4.5-5	22		
4.3-21	28			F 4.2-1	20
4.3-22	28	4.6-1	28	F 4.2-2	20
4.3-23	28	4.6-2	28	F 4.2-3	20
		4.6-3	28	F 4.2-3A	20
4.4-1	24	4.6-4	28	F 4.2-3B	20
4.4-2	24	4.6-5	28	F 4.2-3C	20
4.4-3	24	4.6-6	28	F 4.2-3D	21
4.4-4	24	4.6-7	28	F 4.2-4	20
4.4-5	24	4.6-8	28	F 4.2-5	21
4.4-6	24	4.6-9	28	F 4.2-6	20
4.4-7	24	4.6-10	28	F 4.2-6A	20
4.4-8	24	4.6-11	28	F 4.2-6B	20
4.4-9	24	4.6-12	28	F 4.2-6C	20
4.4-10	24			F 4.2-7	20
4.4-11	24	4.7-1	28	F 4.2-8	20
4.4-12	24	4.7-2	28	F 4.2-8A	20
4.4-13	24	4.7-3	28	F 4.2-8B	20
4.4-14	24	4.7-4	28	F 4.2-9	20
4.4-15	24	4.7-5	28	F 4.2-10	20
4.4-16	24	4.7-6	28	F 4.2-11	20
4.4-17	24	4.7-7	28	F 4.2-12	20
4.4-18	24	4.7-8	28	F 4.2-13	20
4.4-19	24	4.7-9	28	F 4.2-14	20
4.4-20	24	4.7-10	28	F 4.2-15	20
4.4-21	24	4.7-11	28	F 4.2-16	20
4.4-22	24	4.7-12	28	F 4.2-17	20
4.4-23	24	4.7-13	28	F 4.2-18	20
4.4-24	24	4.7-14	28	F 4.2-18A	20
4.4-25	24	4.7-15	28	F 4.2-19	20
4.4-26	24	4.7-16	28	F 4.2-20	20
4.4-27	24	4.7-17	28	F 4.2-21	20
4.4-28	24	4.7-18	28	F 4.2-22	20
4.4-29	24	4.7-19	28	F 4.3-1	28
4.4-30	24	4.7-20	28	F 4.3-1A	28
4.4-31	24	4.7-21	28	F 4.3-1C	28

ARKANSAS NUCLEAR ONE
Unit 2

RECORD OF REVISIONS (continued)

<u>PAGE #</u>	<u>AMENDMENT #</u>	<u>PAGE #</u>	<u>AMENDMENT #</u>	<u>PAGE #</u>	<u>AMENDMENT #</u>
CHAPTER 4 (CONT.)		CHAPTER 4 (CONT.)			
F 4.3-1D	28	F 4.4-1	20		
F 4.3-1E	28	F 4.4-2	20		
F 4.3-2	28	F 4.4-3	20		
F 4.3-3	28	F 4.4-4	20		
F 4.3-4	28	F 4.4-5	20		
F 4.3-5	28	F 4.4-6	20		
F 4.3-6	28	F 4.4-7	20		
F 4.3-7	28	F 4.4-8	20		
F 4.3-8	28	F 4.4-9	20		
F 4.3-9	28	F 4.4-10	20		
F 4.3-10	28	F 4.4-11	20		
F 4.3-11	20	F 4.4-12	20		
F 4.3-12	20	F 4.4-13	20		
F 4.3-13	20				
F 4.3-14	20	F 4.5-1	20		
F 4.3-15	20				
F 4.3-16	20				
F 4.3-17	20				
F 4.3-18	20				
F 4.3-19	20				
F 4.3-20	20				
F 4.3-20D	20				
F 4.3-21	20				
F 4.3-21A	20				
F 4.3-22	20				
F 4.3-22A	20				
F 4.3-23	20				
F 4.3-24	20				
F 4.3-24A	20				
F 4.3-28	20				
F 4.3-29	20				
F 4.3-31	20				
F 4.3-32	20				
F 4.3-33	20				
F 4.3-34	20				
F 4.3-41	20				
F 4.3-42	20				
F 4.3-43	20				
F 4.3-46	20				
F 4.3-47	20				
F 4.3-48	20				
F 4.3-50	20				

ARKANSAS NUCLEAR ONE
UNIT 2

4 REACTOR

4.1 SUMMARY DESCRIPTION

Arkansas Nuclear One - Unit 2 incorporates a Pressurized Water Reactor (PWR) with two reactor coolant loops. A vertical cross section of the reactor is shown in Figure 4.1-1. The reactor core is composed of 177 fuel assemblies and 81 Control Element Assemblies (CEAs). The fuel assemblies are arranged to approximate a right circular cylinder with an equivalent diameter of 123 inches and an active length of 150.0 inches for fuel Batches A through H and 149.610 inches for fuel Batches J through N. The active fuel length for Batch P (Cycle 12 reload batch) and subsequent reload batches is 150 inches. Each fuel rod shall contain a maximum total weight of 2114 grams of uranium. The fuel assembly, which provides for 236 fuel rod positions, consists of five guide tubes welded or bulged to spacer grids and is closed at the top and bottom by end fittings. The welded construction was used for fuel Batches A through Y. A bulged construction was introduced in Batch Z with the implementation of Next Generation Fuel (NGF). The guide tubes each displace four fuel rod positions and provide channels which guide the CEAs over their entire length of travel. In selected fuel assemblies, the central guide tube houses incore instrumentation.

The analyses in Section 4.4 were developed using the W-3 Correlation which yielded a minimum DNBR of 1.30, and the COSMO and INTHERMIC computer codes applicable to Cycle 1 operation. Subsequent cycles through Cycle 20 utilized the CE-1 Correlation, the TORC, and CETOP-D computer codes and a DNBR safety limit of 1.25. Beginning in Cycle 21, both the ABB-NV and WSSV-T Correlations were utilized with the TORC and CETOP-D computer codes along with a DNBR safety limit of 1.23 for NGF assemblies. The DNBR safety limits are described in Section 4.4.2.3.2. TORC and CETOP-D are described in Section 4.4.3.4.2.

The fuel is low enrichment UO_2 in the form of ceramic pellets and is encapsulated in prepressurized Zircaloy, ZIRLO™, or Optimized ZIRLO™ tubes which form a hermetic enclosure.

The reactor coolant enters the inlet nozzles of the reactor vessel, flows downward between the reactor vessel wall and the core barrel, passes through the flow skirt where the flow distribution is equalized, and then into the lower plenum. The coolant then flows upward through the core removing heat from the fuel rods. The heated coolant enters the outlet plenum where it flows around the outside of the CEA shrouds to the reactor vessel outlet nozzles. The CEA shrouds protect the CEAs from the effects of coolant crossflow in the outlet plenum.

Figures 4.1-2 and 4.1-2A contain views of the reactor core cross section and show certain dimensional relations between fuel assemblies, fuel rods and CEA guide tubes.

The reactor internals support and orient the fuel assemblies, CEAs, and incore instrumentation, and guide the reactor coolant through the reactor vessel. They also absorb the static and dynamic loads and transmit the loads to the reactor vessel flange. They will safely perform their functions during normal operating, upset and emergency conditions. The internals are designed to safely withstand the forces due to deadweight, handling, pressure differentials, flow impingement, temperature differentials, vibration and seismic acceleration. All reactor components are considered Seismic Class 1 for seismic design. The reactor internals design limits deflection where required by function. The stress values of all structural members under normal operating and expected transient conditions are not greater than those established by the ASME Code, Section III. The effect of neutron irradiation on the materials concerned is included in the design evaluation. The effect of accident loadings on the internals is included in the design analysis.

ARKANSAS NUCLEAR ONE UNIT 2

Reactivity control is provided by two independent systems: the Control Element Drive System (CEDS) and the Chemical and Volume Control System (CVCS). The CEDS controls short-term reactivity changes and is used for rapid shutdown. The CVCS is used to compensate for long-term reactivity changes and can make the reactor subcritical without the benefit of the CEDS. The design of the core and the Reactor Protective System (RPS) prevents fuel damage limits from being exceeded for any single malfunction in either of the reactor control systems.

Each CEA consists of five neutron absorber rods assembled in a square array, with one rod in the center. The rods are connected to a spider structure which couples to the Control Element Drive Mechanism (CEDM) shafting. There are a total of 81 CEAs. Originally, 8 of the 81 CEAs were part length CEAs (PLCEAs). The PLCEAs were replaced at the end of Cycle 11 with full length CEAs. The original purpose of the PLCEAs was to provide control of axial power distribution, particularly in the event of axial xenon oscillation.

The CEAs are positioned by magnetic jack type CEDMs mounted on the reactor vessel head. The 81 CEAs are divided into control and shutdown groups.

The maximum reactivity worth of the CEAs and the associated reactivity addition rate are limited by system design to prevent sudden large reactivity increases. The design restraints are such that reactivity increases will not result in violation of the fuel damage limits, rupture of the reactor coolant pressure boundary, or disruption of the core or other internals sufficient to impair the effectiveness of emergency cooling.

Boric acid dissolved in the coolant is used as a neutron absorber to provide long-term reactivity control. In order to reduce the boric acid concentration required at beginning of cycle operating conditions, and thus reduce the algebraic magnitude of the moderator temperature coefficient, burnable poison rods (also called shims) or integral burnable absorber rods are provided in certain fuel assemblies. The burnable poison is boron carbide dispersed in alumina pellets; the pellets are clad in Zircaloy to form rods which are similar to the fuel rods and were placed in Batch P (Cycle 12) and all prior reload assemblies. Gadolinia was used as the integral burnable absorber with Batch R (Cycle 13; see Section 4.2.1.2.1.1), Erbium was introduced with Batch U (Cycle 16; see Section 4.2.1.2.1.2), and IFBA (ZrB₂) was introduced with Batch X (Cycle 18; see Section 4.2.1.2.1.3).

A multi-batch fuel management scheme is employed which may use zoned fuel assemblies and poison rods. ANO-2 can operate with an individual rod average fuel burnup (burnup averaged over the length of a fuel rod) not to exceed 60,000 MWD/MTU. Sufficient margin is provided to ensure that peak burnups are within acceptable limits.

The nuclear design of the core ensures that the combined response of all reactivity coefficients in the power operating range to an increase in reactor thermal power yields a net decrease in reactivity.

CEAs are moved in groups to satisfy the requirements of shutdown and power level changes. The control system is designed to produce power distributions that are within the acceptable limits on overall nuclear heat flux factor (F_q) and Departure from Nucleate Boiling Ratio (DNBR). The RPS and administrative controls ensure that these limits are not exceeded.

Axial xenon oscillations, should they occur, will be manually controlled by either utilizing the CEAs or RCS temperature. Axial power information to be used in controlling the xenon oscillation is provided by the nuclear detectors.

ARKANSAS NUCLEAR ONE UNIT 2

The core makes use of a low-leakage fuel management scheme, which places previously burned assemblies on the core periphery and fresh assemblies throughout the interior of the core. This type of fuel management is economically attractive because it reduces uranium requirements for a specific total energy output. It also reduces the total neutron fluence that the reactor vessel is exposed to during the cycle.

Prior to Cycle 10, the core also contained two Plutonium 238-Beryllium neutron sources for initial and subsequent startups. The sources were supported from the fuel assembly upper end fitting and were contained within CEA guide tubes.

A tabulation of the analysis techniques, load conditions and computer codes utilized in the analysis of various reactor internals components is presented in Table 4.1-1. The core mechanical design is discussed in Section 4.2; the nuclear design of the core is discussed in Section 4.3; the thermal and hydraulic design is discussed in Section 4.4. Summary lists of significant core parameters are presented in Tables 4.2-1, 4.3-1, and 4.4-2.

Certain material in this chapter is a nonproprietary version of material submitted in CEN-20(A)-P, Arkansas Nuclear One - Unit 2, Docket 50-368, Final Safety Analysis Report, Combustion Engineering, Inc., Proprietary Information. Specific information classified as proprietary was deleted from this nonproprietary version. The reason for the proprietary classification of the material is that the information consists of test data or other similar data concerning a process, method or component, the application of which results in a substantial competitive advantage to Combustion Engineering, Inc. (now Westinghouse).

4.2 **MECHANICAL DESIGN**

This section summarizes the mechanical design characteristics of the reactor and discusses the design parameters which are of significance to the performance of the reactor. A summary of mechanical design parameters is presented in Table 4.2-1. The data are intended to be descriptive of the design. Limiting values of these and other parameters will be discussed in the appropriate sections.

4.2.1 **FUEL**

4.2.1.1 **Design Bases**

4.2.1.1.1 **Structural Design Bases**

4.2.1.1.1.1 **Fuel Assembly**

The fuel assemblies are required to meet design criteria for the following loading combinations.

A. Normal Operating and Upset Conditions

The fuel rods and fuel assemblies are required to satisfy the design criteria under the following loading combinations:

1. Normal operating conditions of temperature, pressure and steady state and transient power generation up to design burnup and linear heat rate.
2. Flow impingement loads.
3. Weights, reactions and superimposed loads (hydraulic uplift, mechanical holddown).
4. Vibration loads.
5. Seismic loads (OBE).
6. Handling loads (not combined with other loads above).

Under normal and upset conditions, the following criteria for structural integrity apply to components other than fuel rods:

1. $P_m \leq S_m$
 $P_m + P_B \leq F_s S_m$
2. Deflections are limited so that no permanent deformation occurs, the Control Element Assemblies (CEAs) can function and adequate core cooling is preserved.
3. Cumulative fatigue damage fraction to any component shall not exceed 1.0.

ARKANSAS NUCLEAR ONE
UNIT 2

Typical normal and upset conditions that are considered are as follows:

1. Heatup and Cooldowns
2. Power Changes
3. Startup Testing
4. Normal Variations in Operating Temperature and Pressure
5. Reactor Trip
6. Seismic Event (OBE)
7. CEA Withdrawal
8. Loss of Coolant Flow
9. Idle Loop Startup
10. Loss of External Load
11. Loss of Feedwater Flow
12. Excess Feedwater Flow
13. Excess Load

B. Emergency Conditions

The fuel is required to satisfy the emergency conditions design criteria under the conditions of temperature, pressure and flow which occur as results of the emergency conditions. The seismic event up to a DBE combined with normal operating loads is considered an emergency condition.

The following criteria apply:

1. $P_m \leq 1.5 S_m$

$$P_m + P_B \leq 1.5 F_s S_m$$

2. Deflections are limited to a value allowing the CEAs to scram, but not necessarily within the prescribed time.
3. Adequate core cooling is provided although some local yielding may occur. A small number of fuel rods may be damaged.

ARKANSAS NUCLEAR ONE
UNIT 2

C. Faulted Conditions

The fuel assembly is designed to meet the stress and deflection limits specified below during postulated (faulted) incidents. Some permanent deformation of the fuel assemblies may occur under these conditions. Typical faulted conditions that are considered are as follows:

1. Complete loss of secondary pressure (steam line break)
2. Control element assembly ejection
3. Reactor coolant pump shaft seizure
4. Fuel handling accident
5. Reactor coolant branch line pipe break (BLPB)

The primary stresses of the fuel assembly end fittings (excluding holddown springs) are limited by the following:

$$P_m \leq S_m^1$$

$$P_m + P_B \leq F_s S_m^1$$

where:

$$S_m^1 = \text{smaller value of } 2.4 S_m \text{ or } 0.7 S_u$$

For components other than the end fittings, the fuel assembly deformation shall be limited to a value not exceeding the loss of function deformation limit which would preclude satisfactory insertion of the CEAs.

NOMENCLATURE

The symbols used in defining the allowable stress levels are as follows:

P_m = Calculated general primary-membrane stress*

P_B = Calculated primary bending stress*

S_m = Design stress intensity value as defined by Section III, ASME Boiler and Pressure Vessel Code **

S_u = Minimum unirradiated ultimate tensile strength

F_s = Shape factor corresponding to the particular cross section being analyzed***

F_s = 1.5 for a rectangular section

S_m^1 = Design stress intensity value for faulted conditions

ARKANSAS NUCLEAR ONE
UNIT 2

- * P_m and P_B are defined by Article NB-3000, Section III, ASME Boiler and Pressure Vessel Code, 1971.
- ** With the exception of zirconium base alloys, the design stress intensity values, S_m , of materials not specified by the Code are determined in the same manner as the Code, classifying the materials into two groups according to their unirradiated minimum yield strength at temperature. The design stress intensity of zirconium base alloys will not exceed two-thirds of the unirradiated minimum yield strength at temperature. Where material properties are significantly affected by radiation, the effect will be accounted for in the design.
- *** The shape factor F_s is defined as the ratio of the "plastic" moment (all fibers just at the yield stress) to the initial yield amount (extreme fiber at the yield stress and all other fibers stressed in proportion to their distance from the neutral axis). The capability of cross sections loaded in bending to sustain moments considerably in excess of that required to yield the outermost fibers is discussed in Reference 12. The allowable stresses for fuel assembly end fittings under faulted conditions are:

$$P_m \leq S_m^1 \text{ and } P_B \leq F_s S_m^1, \text{ for which } S_m^1 \text{ is defined as the lesser of } 2.4 S_m \text{ and } 0.7 S_u$$

The definition of S_m^1 as the lesser value of $2.4 S_m$ and $0.7 S_u$ is contained in the ASME Boiler Pressure Vessel Code (1974) Section III, Appendix F-1323.1. (Note that these criteria apply only to the grade CF-3 stainless steel end fittings).

4.2.1.1.1.2 Fuel Cladding

The fuel cladding design will prevent fuel element damage under steady state and transient operating conditions. The fuel rod design accounts for external pressure, differential expansion of fuel and clad, fuel swelling, clad creep, fission and other gas releases, initial internal helium pressure, thermal stress, pressure and temperature cycling and flow-induced vibrations. The structural criteria are based on the following for the normal and upset loading combinations identified in Section 4.2.1.1.1.1.

- A. The maximum tensile stress in the Optimized ZIRLO™, ZIRLO®, or Zircaloy clad will not exceed two-thirds of the minimum unirradiated yield strength of the material at the applicable temperature.
- B. Net unrecoverable circumferential strain will not exceed one percent as predicted by computations considering clad creep and fuel-clad interaction effects. In addition, the incremental total strain induced during a transient is also limited to one percent, as described in Reference 176 for Zircaloy-4 cladding, Reference 183 for ZIRLO® cladding, and Reference 195 for the NGF design with Optimized ZIRLO™ cladding.

Data from O'Donnell (Reference 121) and Weber (Reference 155) were used to determine the present one percent strain limit. O'Donnell developed an analytical failure curve for Zircaloy cladding based upon the maximum strain of the material at its point of plastic instability. O'Donnell compared his analytical curve to circumferential strain data obtained on irradiated coextruded Zr-U metal fuel rods tested by Weber. The correlation was good, thus substantiating O'Donnell's instability theory.

ARKANSAS NUCLEAR ONE
UNIT 2

Since O'Donnell performed his analysis, additional data have been derived at Bettis (References 70, 74, and 106) and AECL (Reference 119 and 120). These new data are shown in Figure 4.2-1 along with O'Donnell's curve and Weber's data. This curve was then adjusted because of differences in anisotropy, stress states and strain rates; and the Combustion Engineering design limit was set at one percent.

The conservatism of the clad strain calculations is provided by the selection of adverse initial conditions, e.g. clad and pellet diameters, and material behavior assumptions, e.g. minimum assumed inpile densification, and by the assumed operating history (daily power cycling). The acceptability of the one percent unrecoverable circumferential strain limit is demonstrated by data from irradiated Zircaloy-clad fuel rods which show no cladding failures (due to strain) at or below this level, as illustrated in Figure 4.2-1.

The ductility of ZIRLO™ should be at least equivalent to Zircaloy-4 (Reference 183, Section 5.3.5). Section B.7 of Reference 194 documents that the ductility of Optimized ZIRLO™ and ZIRLO™ are indistinguishable from each other at temperatures above room temperature, so the ductility of Optimized ZIRLO™ is also at least equivalent to that of Zircaloy-4. Ductility is a function of irradiation and hydride formation in the cladding. Since the corrosion rates of Optimized ZIRLO™ and ZIRLO™ are significantly less than Zircaloy-4, fewer hydrides will be formed at high burnups. Therefore, the 1% strain capability limit criterion will continue to be applied and satisfied in Westinghouse fuel mechanical design analysis.

- C. The clad will be initially pressurized with helium (without evacuating air present prior to pressurization) to an amount sufficient to prevent gross clad deformation under the combined effects of external pressure and long-term creep.

The clad collapse calculation method (Reference 12) itself does not include arbitrary safety factors. However, the calculation inputs are deliberately selected to produce a conservative result. For example, the clad dimensional data are chosen to be a worst case combination based either upon drawing tolerances or 95 percent confidence limits on as-built dimensions; the internal pressure history is based on minimum fill pressure with no assistance from released fission gas; and the flux and temperature histories are based on conservative assumptions.

A modification of the above method is described in Reference 171. This modification is applied to the normal CEPAN results to account for the support provided to the cladding by the pellets at the edges of an axial gap. The adjustment varies as a function of the length of the gap or unsupported cladding. As the gap considered becomes longer the modified results approach the result originally calculated by CEPAN.

No large axial gaps have ever been observed in Westinghouse Combustion Engineering's modern design fuel which has prepressurized fuel rods and stable, "nondensifying" fuel pellets. The gaps would be evidenced by large local ovalities of the fuel rod cladding, by a distinct region of atypical crud deposition around the cladding circumference, or by atypical signals during gamma scanning. None of these indications have been observed for major axial gaps during the extensive post-irradiation examination programs conducted on both 14 x 14 and 16 x 16 fuel designs.

ARKANSAS NUCLEAR ONE
UNIT 2

Post irradiation examination of fuel rods has shown that axial gaps in the fuel column are typically a small fraction of the length of a pellet. These gaps are measured in the cold condition. It can be shown that at reactor operation conditions, thermal expansion of the fuel column would close most of the gaps or significantly reduce their length.

The longest axial gap in the cold condition ever observed in any modern Westinghouse C-E fuel rod was measured at 0.90 inches. During operation this gap is calculated to reduce to ≤ 0.2 inches due to thermal expansion of the fuel column. This reduced gap was supported by corrosion patterns observed during visual examination.

The modified method with these conservative assumptions has shown that predicted collapse times far exceed the longest residence time expected. It has therefore been concluded that unless significant design changes or manufacturing methods are introduced, modern Westinghouse C-E fuel and poison rods for both 16 x 16 and 14 x 14 designs are not susceptible to cladding collapse. On this basis, Westinghouse C-E will no longer address cladding collapse specifically for new cores or reload batches unless design or manufacturing changes are introduced which would significantly alter predicted collapse time results.

In the event such changes do occur, the modified method described above will be used to confirm that cladding collapse will not occur during the design lifetime of the fuel.

With the addition of ZrB₂ pellets to the design for Batch X and subsequent batches, the collapse methodology now may also use testing to verify that the holddown spring will prevent clad collapse in the plenum region (Reference 185, Section 4.2.2.4).

- D. Cumulative strain cycling usage, defined as the sum of the ratios of the number of cycles in a given effective strain range ($\Delta\varepsilon$) to the permitted number (N) at that range, as taken from Figure 4.2-2, will not exceed 0.8

The cyclic strain limit design curve shown on Figure 4.2-2, is based upon the "Method of Universal Slopes" developed by S.S. Manson (Reference 102) and has been adjusted to provide a strain cycle margin for the effects of uncertainty and irradiation. The resulting curve has been compared with known data on the cyclic loading of Zircaloy and ZIRLO™ and has been shown to be conservative (Reference 183, Section 5.3.6). Specifically, it encompasses all the data of Reference 122. With respect to Optimized ZIRLO™, Appendix B.10 of Reference 194 documents that there is no distinguishable difference in the fatigue characteristics of ZIRLO™ and Optimized ZIRLO™.

As discussed in Section 4.2.1.3.7, the fatigue calculation method includes the effect of clad creep to reduce the pellet to clad diametral gap during that portion of operation when the pellet and clad are not in contact. The same model is used for predicting clad fatigue as is used for predicting clad strain. Therefore, the effects of creep and fatigue loadings are considered together in determining the End of Cycle (EOC) cumulative fatigue damage factor and the EOC clad strain. Moreover, the current fatigue damage calculation method includes a factor of 2.0 which is applied to the calculated strain before determining the allowable number of cycles associated with that strain. Therefore, the allowable fatigue usage factor of 0.8 ensures a considerable degree of conservatism (See Figure 4.2-2).

ARKANSAS NUCLEAR ONE
UNIT 2

For determining the ability of the fuel rod to satisfy the above criteria, the analyses take into account the most limiting set of temperatures, fluxes and transient rates which would occur in the core for the operating condition being evaluated. It should be noted that the use of most limiting conditions does not necessarily imply the use of "hot spot" values. For example, owing to the effect of local transient rates on the severity of Pellet Clad Interaction (PCI) effects, the "most limiting" situation for PCI during a transient may not coincide with the peak power location in the reactor.

The analytical method presently used to calculate the effects of interaction between the fuel pellets and fuel rod cladding is based on experimentally derived properties and behavioral models. A digital computer model is employed in which the behavior of the fuel pellet and cladding under time varying operating conditions is represented by the response of a set of equations to the effects of a periodic power transient. The cumulative effect of a series of power transients, e.g. daily variation in power level repeated for the design life of the fuel rod, is determined by allowing the transient to be repeated until a preset burnup level has been attained. The net clad circumferential strain and cumulative fatigue damage fraction, based on the circumferential strain range sustained during the series of transients, are calculated at the end of each transient and printed at preselected intervals and after the desired burnup level has been attained.

The transient is divided into 24 intervals called "hours" but having, in fact, not necessarily equal time durations. The transient is input as a set of 24 values of local linear heat rate. The only restrictions on the shape of the transient are that the curve of power level versus time may have not more than one relative maximum during the transient cycle and that power levels selected for time intervals 1 and 24 should be equal.

The sequence of operations followed by the model during a single transient cycle is presented below:

- A. Determine temperature distributions in fuel pellet and cladding based on instantaneous power level.
- B. Determine fuel rod internal pressure based on accumulated burnup and instantaneous power level.
- C. Determine pellet and clad diameters corresponding to the new power level and internal pressure.
- D. Determine changes in clad diameters and pellet diameter which will occur during the time step as the result of cladding creep and pellet swelling.
- E. Based on the information generated in Steps C and D, above, determine the pellet and clad diameters corresponding to the end of the time interval.

This series of steps is repeated for each time interval during which the power level equals or exceeds that which existed during the preceding time interval.

If the time interval being calculated is the first interval in which the power level has decreased, the following additional calculations are made:

ARKANSAS NUCLEAR ONE
UNIT 2

- F. Determine the strain range for the cladding based on the difference in dimensions between the beginning of the transient cycle and the maximum power level point during the transient cycle.
- G. Determine the incremental fatigue damage fraction which occurs as a result of the strain range calculated in Step F. This incremental damage fraction is added to the cumulative fatigue damage fraction.
- H. Determine the amount of clad plastic strain which has occurred due to differential thermal expansion between pellet and clad which occurred during the power increasing portion of the transient cycle.
- I. Adjust the cladding reference dimension to account for the amount of plastic strain calculated in Step H.

Steps F through I are only performed at the end of the last time interval in the power increasing portion of the transient cycle. For all remaining time intervals in the cycle, Steps A through E are repeated.

The 24 time intervals in the transient cycle are recalculated until the desired burnup level is reached.

The calculational steps discussed above take into account the following effects:

- A. Variation of clad temperature (O.D., I.D. and mid-wall) with power level.
- B. Clad diametral thermal expansion based on mid-wall temperature.
- C. Clad elastic deformation due to differential pressure.
- D. Pellet temperature distribution and resulting thermal expansion.
- E. Clad elastic and plastic deformation due to differential thermal expansion between the fuel pellet and the clad.
- F. Variation of internal pressure with power level and burnup (based on linear interpolations of pressures calculated using other analytical models).
- G. Variation of fast flux level with power level.
- H. Clad plastic deformation due to creep strain, including the effects of power dependent temperature, fast flux and differential pressure.
- I. Irreversible pellet swelling due to irradiation, including the dependence of the swelling rate on power level and whether the clad and pellet are in contact.
- J. Fuel pellet in-reactor densification, and the resultant changes in pellet dimensions.
- K. The accumulation of fission products in the dish and porosity volume of the pellet, and the higher apparent pellet swelling rate which is observed when no open volume remains within the pellet for fission product accommodation.

ARKANSAS NUCLEAR ONE UNIT 2

The net cladding circumferential strain and the cumulative fatigue damage fraction are calculated during each transient cycle. The values calculated for the last transient cycle, i.e., for the design burnup, are compared to the allowable design limit values of circumferential strain and cumulative fatigue damage factor.

As a sample of calculation results, the case of a nominal Arkansas Nuclear One - Unit 2 fuel rod was analytically subjected to daily power variation from 15 percent to 100 percent to 15 percent peak linear heat rate (12.5 kW/ft) until the peak local burnup value reached 55,000 MWD/MTU. The daily power cycle consisted of three hours at 15 percent, a 6-hour ramp to 100 percent, six hours at 100 percent, a 6-hour ramp to 15 percent, and three hours at 15 percent. For this case, the predicted EOC clad circumferential strain (referenced to Beginning of Cycle (BOC) dimensions) is .05 percent, and the calculated cumulative fatigue damage fraction is 0.41.

The portion of the cladding strain criterion related to total strain is limited to the incremental strain induced during a transient. The criterion is evaluated by subtracting the existing cladding total strain at the beginning of the transient by the maximum cladding total strain at any time during the transient and comparing that incremental total strain to the one percent criterion.

New NRC models for fuel cladding strain and assembly flow blockage were developed since the evaluation of these factors for the Arkansas Nuclear One - Unit 2 ECCS analysis. Because the NRC models are more conservative in part than those used for the Arkansas Nuclear One – Unit 2 ECCS analysis, the fuel vendor conducted the following additional analysis for plants with Combustion Engineering fuel: "Sensitivity Evaluation of the C-E ECCS Evaluation Model to Cladding Rupture Strain and Fuel Assembly Flow Blockage Models." This analysis confirms that all Combustion Engineering operating plants continue to meet the ECCS acceptance criteria of Appendix K and 10 CFR 50.46. The applicability of the analysis to Unit 2 is provided in Sections 5 and 6 of the Combustion Engineering report.

The average discharge burnup for equilibrium cycle fuel is approximately 45,000 MWD/MTU. The peak rod average burnup will be 60,000 MWD/MTU. This burnup is consistent with the structural criteria described above, and the fuel design as described in Section 4.2.1.2.1. Fuel burnup experience, as described in Section 4.2.1.3.9, demonstrates this to be an acceptable limit.

4.2.1.1.2 Deflections

The design of the fuel assembly and core arrangement will limit the deflection of the assemblies to a value not exceeding the loss of function deflection or deformation limit which would preclude satisfactory insertion of the CEAs or result in refueling difficulties. Tests corresponding to the earlier 14 x 14 design have been conducted which demonstrate that functioning of the CEA is not adversely affected when the guide tubes are bowed one inch. Tests have also shown that the fuel assembly could be deflected one inch at its center without exceeding the yield strength of its structural members. However, some residual deflection will remain due to the interaction of the fuel rods with the spacer grids, but this deflection is small and would not result in refueling difficulties. Based on these tests, the loss-of-function deformation limit was in excess of one inch. The loss-of-function deformation limit for the 16 x 16 fuel assembly design is expected to exceed that value determined by the 14 x 14 tests.

ARKANSAS NUCLEAR ONE
UNIT 2

The maximum possible fuel assembly deflection allowed by the core arrangement would occur in a fuel assembly located on the periphery of the core and would result from an extremely unlikely condition where all fuel assemblies are bowed in the same direction at the same time across the maximum width of the core and no clearance exists between assemblies. The maximum deflection under these conditions will be less than one inch.

There is no specific limit for lateral fuel rod deflection for structural integrity determination except that which is brought about through application of cladding stress criteria. The absence of a specific limit on rod deflection is justified because it is the fuel assembly structure, and not the individual fuel rod, that is the limiting factor for fuel assembly lateral deflection.

4.2.1.1.3 Capacity for Fission Gas Inventory

The greater portion of the gaseous fission products remain either within the lattice or the microporosity of the UO_2 fuel pellets and does not contribute to the fuel rod internal pressure. However, a fraction of the fission gas is released from the pellets by diffusion and pore migration and thereafter contributes to the internal pressure.

The determination of the effect of fission gas generated in and released from the pellet column is discussed in Section 4.2.1.1.4. The rod pressure increase which results from the release of a given quantity of gas from the fuel pellets depends upon the amount of open void volume available within the fuel rod and the temperatures associated with the various void volumes. The annular pellet design has been introduced in Cycle 18 (Batch X) for typical use in the poison rod top and bottom cutback/blanket zones (see Figure 4.2-3C) to increase the rod void volume available and, thus, to enhance the fission gas capacity within the rod (to prevent an excessive gas pressure buildup). In some cycles, annular pellets may also be used in fuel-only rods. In the fuel and poison rod design, the following sources of void volume are considered in computing internal pressure:

- A. Fuel rod upper end plenum;
- B. Fuel clad annulus;
- C. Fuel pellet end dishes;
- D. Fuel pellet open porosity; and,
- E. Hollow center of annular pellets.

The volume available from those sources is not constant during the life of the fuel. The model used for computing the available volume as a function of burnup and power level accounts for the effects of fuel and clad thermal expansion, fuel pellet densification, clad creep, and irradiation induced swelling of the fuel pellets.

4.2.1.1.4 Maximum Internal Gas Pressure

Fuel rod internal pressure increases with increasing burnup, and towards the EOL, the total internal pressure can approach values comparable to the external coolant pressure due to the combined effects of the initial helium fill gas, the released fission gas, and helium gas released from the IFBA coating in the ZrB_2-UO_2 rods. The normal external pressure is equal to the design operating pressure given in Table 4.4-1 plus a small increment equal to the elevation plus flow losses between the reactor core and the pressurizer. The maximum predicted fuel rod internal pressure will be consistent with the following criteria.

ARKANSAS NUCLEAR ONE
UNIT 2

- A. The primary stress in the cladding resulting from differential pressure will not exceed the unirradiated clad yield strength during a plant depressurization transient which does not involve a break in the primary system.
- B. The internal pressure will not cause the clad to creep outward from the fuel pellet surface while operating at the design peak linear heat rate for normal operation. In determining compliance with this criterion, internal pressure is calculated for the peak power rod in the reactor, including accounting for the maximum computed fission and helium gas releases. In addition, the pellet swelling rate (to which the calculated clad creep rate is compared) is based on the observed swelling rate of "restrained" pellets, i.e., pellets in contact with clad, rather than on the greater observed swelling behavior of pellets which are free to expand.

If the maximum fuel rod internal pressure is anticipated to rise above the external coolant pressure, an additional evaluation is performed for application of the No-Clad Lift-Off methodology (Reference 173).

4.2.1.1.5 Material Selection

The fuel material is uranium dioxide in the form of sintered, high density, cylindrical pellets. This material is chemically inert with respect to Optimized ZIRLO™, ZIRLO™, or Zircaloy-4 cladding at reactor operating temperatures and pressures and is also highly resistant to attack by reactor coolant in the event cladding defects should occur. Extensive experimental work and operating experience have shown that the design parameters chosen conservatively account for changes in thermal performance during operation and that coolant activity buildup resulting from cladding rupture is limited by the ability of uranium dioxide to retain solid and gaseous fission products.

The BOC moderator coefficient is reduced by either poison pellets of Al₂O₃-B₄C, Gd₂O₃-UO₂, Er₂O₃-UO₂, or ZrB₂ coated pellets contained within burnable poison rods. Al₂O₃-B₄C has been previously evaluated under irradiated conditions and its behavior (irradiation induced swelling and helium release) is well within acceptable limits. In addition, Al₂O₃-B₄C is chemically compatible with Zircaloy-4 and can encompass all boron loadings required for a given fuel cycle by adjusting the Al₂O₃-B₄C ratio. The material properties that influence the thermal performance of Gd₂O₃-UO₂ relative to UO₂ are discussed in Section 4.2.1.2.1.1. The material properties that influence the thermal performance of Er₂O₃-UO₂ relative to UO₂ are discussed in Section 4.2.1.2.1.2. The material properties that influence the thermal performance of ZrB₂-UO₂ relative to UO₂ are discussed in Section 4.2.1.2.1.3.

Prior to Batch Z, the fuel assembly grid cage structure consisted of 11 Zircaloy-4 spacer grids, one Inconel-625 spacer grid (at the lower end), five Zircaloy-4 CEA guide tubes, and two stainless steel end fittings. With the introduction of the NGF design in Batch Z, the fuel assembly grid cage structure consists of 14 spacer grids (an Inconel-718 top grid, seven vaned Optimized ZIRLO™ mid grids, three unvaned Optimized ZIRLO™ mid grids, two vaned Optimized ZIRLO™ Intermediate Flow Mixing grids (IFMs), and one Inconel-625 bottom grid), five Stress-Relief Annealed (SRA) ZIRLO™ guide tubes, and two stainless steel end fittings. For Batch P and subsequent reload fuel, the lower Inconel-625 spacer grid has been replaced with the GUARDIAN™ lower spacer grid.

ARKANSAS NUCLEAR ONE
UNIT 2

Zirconium alloys, selected for fuel rod cladding, guide tubes and spacer grids, have a low neutron absorption cross section, high corrosion resistance to reactor water environment, and there is little reaction between the cladding and fuel or fission products. As described in Section 4.2.1.3, Zircaloy-4 has demonstrated its ability as a cladding, CEA guide tube and spacer grid material.

Beginning with Batch X Fuel, ZIRLO™ fuel cladding has been used to replace the Zircaloy-4 cladding. ZIRLO™ is a Westinghouse proven zirconium-based alloy that improves fuel assembly corrosion resistance and dimensional stability under irradiation. The topical report (Reference 183) summarizes the ZIRLO™ material properties as they pertain to fuel rod cladding and provides an evaluation of these properties and the correlations for use in design and licensing analysis activities. Reference 197 updates the cladding corrosion model. In addition, since the ZIRLO™ cladding will be implemented in Zircaloy-4 cages with no changes to structural materials, Reference 183 provides a review of Westinghouse experience with ZIRLO™ cladding and Zircaloy-4 structural components to justify full batch implementation in the Westinghouse CENP fuel design.

The chemical composition of the fuel rod cladding fabricated with ZIRLO™ alloy beginning with Batch X fuel assemblies is similar to the Batch W Zircaloy-4 fuel rod cladding except for a slight reduction in the content of tin (Sn), iron (Fe), and the elimination of chromium (Cr). The ZIRLO™ alloy also contains a nominal amount of niobium (Nb). These composition changes, although small, are responsible for the improved corrosion resistance of ZIRLO™ compared to Zircaloy-4. The Batch X ZIRLO™ fuel rod is the same length as the Zircaloy-4 clad fuel rods used in the previous regions. The ZIRLO™ clad fuel rods grow less than their Zircaloy-4 equivalents.

Beginning with Cycle 20 (Batch Z), the NGF design has been in use with the Optimized ZIRLO™ fuel cladding to replace the ZIRLO™ cladding. The topical report, Reference 194, summarizes the material properties as they pertain to fuel rod cladding, design and licensing activities. Reference 197 updates the cladding corrosion model. The difference between Optimized ZIRLO™ fuel cladding and ZIRLO™ cladding is that Optimized ZIRLO™ has a slight reduction in tin content for improved corrosion resistance (0.6% minimum for Optimized ZIRLO™ versus 0.8% minimum for ZIRLO™). The NGF Optimized ZIRLO™ rods are smaller in diameter than those of the preceding designs (outside diameter of 0.374" versus 0.382") to partially offset the pressure drop increase associated with the NGF spacer grids. To minimize the loss in void volume due to the diameter reduction, the overall length of the rod is increased by 0.7" which, in combination with a minor upper end cap change, lengthens the end plenum by 0.875".

The bottom spacer grid is Inconel-625 and is welded to the lower end fitting. In this region of high crossflow, Inconel-625 was selected rather than Zircaloy-4 to provide additional strength and conservatism. Inconel-625 is a very strong material with good ductility, corrosion resistance and stability under irradiation at temperatures below 1,000 °F.

The previous Inconel Spacer Grid Assembly is replaced with a redesigned Inconel spacer grid assembly called the GUARDIAN™ Grid for Batch P and subsequent reload fuel. The design features employed in the GUARDIAN™ Grid improve the spacer grid assembly's ability to entrap debris. To assure that the trapped debris does not breach the cladding, the fuel and poison rods were designed to have long, solid Zircaloy-4 end caps in this region of the core. These end caps will absorb any wear induced by the trapped debris without the rod failing. All rods are secured in place by a detent groove-spring tab feature that prevents a rod from being uplifted. Reconstitution, however, is permitted by overcoming the retaining force provided by the detent groove-spring tab geometry.

ARKANSAS NUCLEAR ONE
UNIT 2

The basic GUARDIAN™ Grid design is preserved with the introduction of the NGF design in Batch Z. Although changes to the grid are made for compatibility with pull-loading of the smaller diameter fuel rods, the GUARDIAN™ Grid maintains the benefits of the strong Inconel material with its debris-trapping features (changes described in detail in Section 4.2.1.2.3).

The NGF design also incorporates an Inconel grid at the top of the assembly to achieve the same benefits as at the bottom; improved strength with good ductility, corrosion resistance, and stability. The grid, discussed in detail in Section 4.2.1.2.3, is an Inconel-718 design with age-hardened straps that are brazed together. The material and basic design have been used in Westinghouse reactors for many years with excellent performance results.

The remaining grids in the NGF design are fabricated using Optimized ZIRLO™ strips. These grids include seven vaned mid grids, three unvaned mid grids, and two vaned IFM grids, and are discussed in detail in Section 4.2.1.2.3. The use of Optimized ZIRLO™ improves the corrosion resistance dimensional stability of the grids, thereby reducing grid growth and improving fretting resistance.

The guide tubes in the NGF design are fabricated from SRA ZIRLO™ instead of SRA Zircaloy-4. As with the NGF mid and IFM spacer grids, this improves the corrosion resistance dimensional stability of the guide tubes. The use of SRA material with the same material strength requirements as the prior guide tubes ensures the NGF guide tubes maintain the same structural capability as the prior guide tubes.

The fuel assembly lower end fitting is of Grade CF-8 or, since 1993, Grade CF-3 cast stainless steel and the upper end fitting assembly consists of two cast grade CF-3 stainless steel plates and five Type 304 stainless steel machined alignment posts. At these locations, neutron economy is not of great importance, but high strength and high corrosion resistance are required. Type 304 stainless steel has been utilized in almost all pressurized water environments. Grade CF-8 or CF-3 castings (the cast counterpart of wrought Type 304), will exhibit equivalent properties.

4.2.1.1.6 Radiation Damage to Fuel Cladding

Optimized ZIRLO™, ZIRLO®, and Zircaloy-4 fuel cladding have been utilized in Pressurized Water Reactors (PWRs) at temperatures and burnup anticipated in current designs with no failures attributable to radiation damage. Mechanical property tests on ZIRLO® and Zircaloy-4 cladding exposed up to neutron irradiation of 9.06×10^{21} n/cm² (estimated) have revealed that the cladding retains a significant amount of ductility from about 1 to over 4 percent total strain. Results are shown in Table 4.2-2 for Zircaloy-4 and in Reference 184 for ZIRLO®. Due to the minimal material compositional differences between Optimized ZIRLO™ and ZIRLO® and the indistinguishable difference in ductility derived from burst testing, the ZIRLO® results of Reference 184 are also concluded to be applicable to Optimized ZIRLO™.

4.2.1.1.7 Mechanical Properties of Cladding

Table 4.2-3 is a list of unirradiated mechanical properties of Zircaloy-4, ZIRLO®, and Optimized ZIRLO™ fuel rod cladding at room temperature and at 675 °F.

ARKANSAS NUCLEAR ONE
UNIT 2

4.2.1.1.8 Effect of Swelling

Fuel swelling due to irradiation (accumulation of solid and gaseous fission products) and thermal expansion results in an increase in the fuel pellet diameter. The design makes provision for accommodating both forms of pellet growth. The fuel-clad diametral gap is more than sufficient to accommodate the thermal expansion of the fuel. To accommodate irradiation-induced swelling, it is conservatively assumed that the fuel-clad gap is used up by the thermal expansion and that only the fuel porosity and the dishes on each end of the pellets are available. Thermal and irradiation induced creep of the restrained fuel results in redistribution of fuel so that the swelling due to irradiation is accommodated by the free volume (8.4 percent of the fuel volume).

For such restrained pellets, and at a total fission-products-induced swelling rate of 0.7 percent $\Delta V/V$ per 10^{20} fiss/cm³, 0.54 percent would be accommodated by the fuel porosity and dishes through fuel creep, and 0.16 percent would increase the fuel diameter. Assuming peak burnup, this would correspond to using up a void volume equal to ~ 7.4 percent of the fuel volume and increasing the fuel rod diameter by a maximum of < 0.0025 inch (< 0.7 percent clad strain). When these numbers were compared to the minimum available volume and the maximum allowable strain, it was concluded that sufficient accommodation volume has been provided even under the most adverse burnup and tolerance conditions.

Demonstration of the margin which exists is seen in the Large Seed Blanket Reactor (LSBR) irradiation. Two rods which operated in the B-4 loop of the MTR offer an interesting simulation for current PWR design (References 47, 70 and 74). Both rods were comprised of 95 percent theoretical density pellets with dished ends and clad in Zircaloy. The first of these, No. 79-21, was operated successfully to a burnup of 12.41×10^{20} fiss/cm³ (> 48,000 MWD/MTU). The second fuel pin, No. 79-25, operated successfully to 15.26×10^{20} fiss/cm³ (>60,000 MWD/MTU). The linear heat rating ranged from 7.1 to 16.0 kW/ft. The wall thickness for the latter pin was 0.028 of an inch as compared with 0.016 of an inch for the former. All other parameters were essentially identical. The two rods were assembled by shrinking the cladding onto the fuel. The maximum diametral increase measured at the ridge heights for rod 79-21 was 0.005 of an inch, while it was less than 0.002 of an inch for rod 79-25. From post-irradiation examination, it was concluded that approximately 84 percent of the total fuel swelling was accommodated by the porosity and dishes, while 16 percent caused diametral expansion of the clad and ridging at pellet interfaces. These results indicate that a comparable irradiation of the fuel elements for the Combustion Engineering design (cold diametral gap 0.007 of an inch, wall thickness of 0.025 of an inch, density 95 percent TD) would allow adequate margin for swelling accommodation.

The successful combined VBWR-Dresden irradiation of Zircaloy-clad oxide pellets provides additional confidence with respect to the design conditions for the fuel rods for this core (References 44 and 111). Ninety-eight rods which had been irradiated in VBWR to an average burnup of about 10,700 MWD/MTU were assembled in fuel bundles and irradiated in Dresden to a peak burnup greater than 48,000 MWD/MTU. The reported maximum heat rating for these rods is 17.3 kW/ft which occurred in VBWR. Post-irradiation examination (Reference 109) revealed that diametral increases in the fuel rods ranged from 0.001 to 0.003 of an inch maximum.

The maximum diametral change corresponds to 1.42 percent $\Delta V/V$ (or .12 percent $\Delta V/V$ per 10^{20} fiss/cm³) for these .424-inch diameter rods. The relevant fuel parameters are listed below for the above test and the Combustion Engineering design.

ARKANSAS NUCLEAR ONE
UNIT 2

	<u>Fuel Density % TD</u>	<u>Cold Diametral Gap (In.)</u>	<u>Peak Burnup (Mwd/MTU)</u>
VBWR-Dresden	95	0.004 to 0.008	> 48,000
LSBR-MTR	95	0.001	50,000; 61,000
C-E Design	95	0.007	55,000
ZIRLO™ Design	95	0.0062	60,000
Optimized ZIRLO™	95	0.0065	60,000

A comparison of the design parameters above, in Reference 183 for ZIRLO™, and in Reference 194 for Optimized ZIRLO™, relative to the test results, provides a demonstration of the clad strains resulting from the swelling of fuel.

4.2.1.1.9 Variation of Melting Point and Fuel Conductivity With Burnup

The variation of melting point and fuel conductivity with burnup is discussed in Section 4.4.3.4.3.

4.2.1.1.10 Combined Effects of Fast Flux and Cladding Temperature

The combined effects of fast flux and cladding temperature are considered in three ways as discussed below:

A. Cladding Creep Rate

The in-pile creep performance of Zircaloy-4, ZIRLO™, and Optimized ZIRLO™ is dependent upon both the local material temperature and the local fast neutron flux. The functional forms of the dependencies are presented in Reference 10 for gap conductance calculations, and in Reference 12 for Zircaloy-4 cladding collapse time predictions. The functional forms of the dependencies are presented in Reference 183 for ZIRLO™, while Reference 194 documents the applicability of the ZIRLO™ functional forms to Optimized ZIRLO™.

B. Cladding Mechanical Properties

The yield strength, ultimate strength and ductility of Zircaloy-4, ZIRLO™, and Optimized ZIRLO™ are dependent upon temperature and accumulated fast neutron fluence. The temperature and fluence dependence is discussed in Section 4.2.1.2.4.1. It is Westinghouse's practice to use unirradiated or irradiated properties depending upon which is more restrictive for the phenomenon being evaluated.

C. Irradiation Induced Dimensional Changes

Zircaloy-4, ZIRLO™, and Optimized ZIRLO™ have been shown to sustain dimensional changes (in the unstressed condition) as a function of the accumulated fast fluence. These changes are considered in the appropriate clearances between the various core components. The irradiation induced growth correlation method is discussed in Section 4.2.1.3.8.

ARKANSAS NUCLEAR ONE
UNIT 2

4.2.1.1.11 New Fuel Handling and Shipping Design Loads

Three specific design bases have been established for shipping and handling loads. These are as follows:

- A. The fuel assembly, when supported in the fuel shipping container, will be capable of sustaining the effects of 5 g axial, lateral or vertical acceleration without sustaining stress levels in excess of those allowed for normal operation.

Impact recorders are included with each shipment which indicate if loadings in excess of 5 g's were sustained by the fuel assembly. A record of shipping loads in excess of 5 g's indicates an unusual shipping occurrence, in which case the fuel assembly is inspected for damage prior to releasing it for use.

The axial shipping load path is through either end fitting to the guide tubes. A 5 g axial load produces a compressive stress level in the guide tubes less than the two-thirds yield stress limit that is allowed for normal operation. The fuel assembly is prevented from buckling by the clamshell. For lateral or vertical shipping loads, the grid spring tabs have an initial preload which exceeds five times the fuel rod weight. Therefore, the spring tabs see no additional deflection as a result of 5 g lateral or vertical acceleration of the shipping container. In addition, the side load on the grid faces produced by a 5 g lateral or vertical acceleration is less than the measured impact strength of the grids.

- B. The fuel assembly will be capable of sustaining a 5,000-pound axial load applied at the upper end fitting by the refueling grapple (and resisted by an equal load at the lower end fitting) without sustaining stress levels in excess of those allowed for normal operation.
- C. The fuel assembly will be capable of withstanding a 0.125 inch deflection in any direction whenever the fuel assembly is raised or lowered from a horizontal position without sustaining a permanent deformation beyond the fuel assembly inspection envelope.

Fuel handling procedures require the fuel assembly deflection be limited to a maximum of 0.125 inch in any direction whenever the fuel assembly is raised from or lowered to a horizontal position. This limits the stress and strain imposed upon the fuel assembly to values well below the limits set for normal operating conditions.

New fuel assemblies arrive at ANO in shipping containers. Each shipping container holds one new fuel assembly and weighs approximately 5100 pounds when loaded. The shipping containers are normally transferred from the ANO train bay to a laydown area in the vicinity of the spent fuel pool by the L3 fuel handling crane. This transfer is conducted in accordance with the procedure for the control of heavy loads. The control of heavy loads procedure implements the requirements of NUREG-0612 and ensures safe load paths and proper heavy load handling practices are observed during the transfer of new fuel. Individual new fuel assemblies weigh less than 2000 pounds and do not meet the definition of a heavy load. New fuel assemblies are removed from the shipping container using the 2L35 crane and are then transferred to the new fuel storage racks or the spent fuel pool storage racks.

The capability of the fuel assembly to withstand the above loading conditions is verified by the structural testing described in Section 1.5.

ARKANSAS NUCLEAR ONE
UNIT 2

4.2.1.2 Fuel Design Description

4.2.1.2.1 Fuel Rod

The fuel rods consist of slightly enriched UO₂ cylindrical ceramic pellets, a round wire Type 302 stainless steel compression spring, and an alumina spacer disc located at each end of the fuel column, all encapsulated within a Zircaloy-4 tube seal welded with Zircaloy-4 end caps for fuel Batches K, M, and N. The upper alumina disc was removed in the Batch P and subsequent reload fuel. The lower alumina disc was removed in the Batch U and subsequent reload fuel (Figure 4.2-3). ZIRLO™ cladding was also used beginning with Batch X. Annular fuel pellets are also used in the cutback/blanket zones in the fuel rods for Batch Y, consistent with the use of such pellets in the poison rods (see Section 4.2.1.2.1.3 and Figure 4.2-3C). The fuel rods are internally pressurized with helium during assembly. A small number of fuel rods of unique design may be included for purposes of testing.

Although the basic configuration of the NGF fuel rod is the same as that prior to Batch Z, there are significant differences in the detailed design of the rods. The nominal active length remains 150", but the fuel rod stack does not include any cutback/blanket pellets. The use of Optimized ZIRLO™ for the NGF rods has been discussed in Section 4.2.1.1.5, as well as the NGF fuel rod having a smaller outside diameter than prior designs (0.374" versus 0.382") to compensate for some of the pressure drop increase associated with the NGF spacer grids. The 0.374" diameter rod is the same as the standard Westinghouse 17 x 17 design, which precipitated the use of the 17 x 17 cladding dimensions and pellet geometry for the NGF design. Therefore, the cladding outside/inside diameters are 0.374" and 0.329", while the fuel pellet has a diameter of 0.3225", a length of 0.387", and a spherical dish at each end instead of a truncated dish. Also as identified in Section 4.2.1.1.5, the overall length of the fuel rod is increased by 0.7" to minimize the loss of void volume associated with the diameter reduction of the rod. To further offset the effect of the diameter reduction, the initial fill gas pressure of the fuel rods has been reduced to approximately 275 psig. The bottom end cap has been modified to include a recess in the bottom end that is necessary for pull-loading the rods into the fuel assemblies. The length of the upper end cap has been reduced and the "acorn" removed to allow as large an increase as possible to the plenum to facilitate the accommodation of fission gas release.

4.2.1.2.1.1 Fuel Rod with Gadolinia (Gd₂O₃) Addition

Some fuel rods in the fuel assembly may contain pellets which incorporate gadolinia (Gd₂O₃) as a burnable absorber into the central portion of the pellet column (Figure 4.2-3a). These fuel rods are analyzed by the same methods and subject to the same design criteria as fuel rods containing only uranium pellets.

The gadolinia-uranium pellets are fabricated by mechanically blending gadolinia powder with uranium powder to produce a homogeneous mixture, followed by pressing and sintering.

The addition of gadolinia fuel pellets may influence the thermal properties of fuel. Of particular importance are the properties that are used in the fuel performance analyses. These properties are: 1) solidus temperature, 2) specific heat, 3) density, 4) thermal expansion, and 5) thermal conductivity. The effect of gadolinia addition on these properties of gadolinia is discussed in Reference 172.

ARKANSAS NUCLEAR ONE
UNIT 2

The performance criterion employed in Reference 172 for the gadolinia-urania ($Gd_2O_3-UO_2$) fuel rod is to assure that these rods are always less limiting in terms of fuel temperature (stored energy), internal rod pressures, and margin-to-melting than the UO_2 rods in a given core.

4.2.1.2.1.2 Fuel Rod with Erbium (Er_2O_3) Addition

Some fuel rods in the Batch U and subsequent fuel assemblies may contain pellets which incorporate erbium (Er_2O_3) as a burnable absorber into the central portion of the pellet column (Figure 4.2-3b). These fuel rods are analyzed by the same methods and subject to the same design criteria as fuel rods containing only urania pellets.

The urania erbium pellets are fabricated by mechanically blending erbium powder with urania powder to produce a homogeneous mixture, followed by pressing and sintering.

The addition of erbium to urania fuel pellets may influence the thermal properties of the fuel. Of particular importance are the properties that are used in fuel performance analyses. These properties are: 1) solidus temperature, 2) specific heat, 3) density, 4) thermal expansion and 5) thermal conductivity. The effect of erbium addition on these properties of urania is discussed in Reference 182.

4.2.1.2.1.3 Fuel Rod with IFBA (ZrB_2) Addition

Beginning with Batch X, the fuel rods include a thin ZrB_2 coating on standard UO_2 pellets as an Integral Fuel Burnable Absorber (IFBA) and include annular pellets in the poison cutback region as new features of the ANO-2 fuel rod design (Figure 4.2-3C). The poison cutback region is the nominal 8 inches of fuel pellets located at each end of the fuel rod pellet stack and may vary with cycles. The fuel pellets in the poison cutback region are annular pellets. The annular pellets have the same pellet outside diameter (.3250 inch) and pellet edge chamfer as the current enriched solid fuel pellets, but have no dish on the pellet ends. The annular pellets are also longer than the solid fuel pellets (.500 inch versus .390 inch prior to Batch Z). The diameter of the annulus is 0.1625 inches which results in about 25% annular volume to accommodate gas release in the IFBA rods. The annular pellets are used to increase the void volume for gas accommodation within the fuel rod, thereby providing margin to meet the rod internal pressure criterion. The annular pellets utilize chamfered pellets, which are slightly different in length from the enriched solid pellets to help prevent accidental mixing during manufacturing.

The NGF IFBA rod design introduced in Batch Z is the same as the NGF fuel rod design discussed in Section 4.2.1.2.1 except for the initial fill gas pressure and the stack configuration. To accommodate the helium release associated with irradiation of the IFBA coating, the initial fill gas pressure of the IFBA rods is approximately 150 psig (consistent with to the prior IFBA rod designs). The stack configuration for Batch HH consists of a 138" central region of IFBA coated enriched pellets and 6" top and bottom cutbacks comprised of enriched annular pellets. The coated pellets are the same configuration as in the fuel rod, while the annular pellets are longer (0.5" versus 0.387" beginning with Batch Z), have a central hole (0.155" diameter), and do not have dishes on the ends.

The IFBA coated fuel pellets are identical to the enriched UO_2 pellets except for the addition of a thin ZrB_2 layer on the pellet cylindrical surface. The ZrB_2 is uniformly coated as a very thin layer (less than half a mil) onto the outer surface of the UO_2 pellets prior to loading into the fuel rod cladding tubes. This is done rather than being mixed with the UO_2 as done with other IFBA

ARKANSAS NUCLEAR ONE
UNIT 2

materials (e.g., erbia or gadolinia). As the B-10 absorber burns out, the fuel rod is left with no residual absorber worth as is the case with other IFBA materials. However, the burnout of the absorber results in production of helium gas, some of which is released into the fuel rod void volume. Coated pellets occupy the central portion of the fuel stack. The number and pattern of IFBA rods within an assembly vary depending on specific application. The ends of the enriched coated pellets are dished to allow for greater axial expansion at the pellet centerline and to increase the void volume for fission gas release. Also, to compensate for the additional helium released from the ZrB_2 coating, the initial fill gas pressure, designed to reduce pressure differences across the cladding, is reduced as compared to non-IFBA rods.

The topical report (Reference 185) describes Westinghouse's 15-year fabrication and operational experience with ZrB_2 IFBA and the implementation and effect of using the coating on the CE fuel assembly design and safety analyses. The neutronics effect, the helium production effect on internal gas pressure, and the mechanical effect of the coating thickness are all taken into account in the design and safety evaluations for CE designed PWRs as described in the reference.

4.2.1.2.2 Burnable Neutron Absorber Rods

Fixed burnable neutron absorber (poison) rods are included in selected fuel assemblies. They replace fuel rods at selected locations. The poison rod cladding and end caps are identical to those in fuel rods. They contain a shorter column of burnable poison pellets instead of fuel pellets. The poison material is alumina with uniformly dispersed boron carbide particles. The balance of the column consists of spacers made of Zircaloy tubing fluted on its end and a stainless steel plenum spring (Figure 4.2-6). A small number of poison rods of unique design may be included for purposes of testing and/or demonstration. The use of test rods has been previously reviewed and accepted by the NRC as described in CEN-50-A(P), Revision 1, which is incorporated by reference.

The design of the poison rods incorporates a number of features aimed at reducing the potential for pellet clad interaction and poison rod failures due to hydriding of the cladding. These include rod pressurization, increased pellet clad diametral gap, reduced plenum spring preload, use of chamfered and tumbled pellets, and spacers made from Zircaloy tubing. In addition, the pellet moisture specification limit was lowered and the manufacturing process eliminates moisture ingress from other components.

The design of the poison rod assembly was changed in Cycle 8 to incorporate a debris-fretting-resistance feature at the lower end of the rod. Similar to the fuel rod assembly (discussed in Section 4.2.1.2.3), a long lower end cap provides this feature. Listed below are the differences between the Cycles 7 and 8 poison rod assemblies:

- a) The overall length of the lower end cap has increased from 0.641 inch to 3.701 inches.
- b) The overall length of the lower spacer tube was decreased from 10.281 inches to 7.250 inches.
- c) The overall length of the upper plenum was increased from 11.008 inches to 11.310 inches.

These changes in the design will enable the use of a debris-fretting-resistance feature at the lower end of the rod while not limiting the mechanical-design-life of the poison rod assembly.

ARKANSAS NUCLEAR ONE
UNIT 2

Unlike Batch N which used burnable poison pellets having a length of one inch, the Cycle 12 Batch P poison rod assemblies used pellets with a length of 0.5". An evaluation shows that replacing one inch pellets with 0.5" pellets will neither positively nor negatively affect the form, fit, or function of the column of pellets.

4.2.1.2.3 Fuel Assembly

The fuel assembly (Figure 4.2-4) consists of 236 fuel rods, five control element guide tubes, 12 fuel rod spacer grids, upper and lower end fittings, and a holddown device. The outer guide tubes, spacer grids and end fittings, form the structural frame of the assembly.

The fuel spacer grids maintain the fuel rod pitch over the full length of the fuel rods providing positive lateral restraint to the fuel rod but only frictional axial restraint to fuel rod motion. The grids are fabricated from preformed Zircaloy or Inconel strips (the bottom spacer grid material is Inconel) interlocked in an egg crate fashion and welded together. Each fuel rod is supported by two leaf springs and two arches which are directly opposite these leaf springs. The leaf springs press the rod against the arches to restrict relative motion between the grids and the fuel rods. The spring and arch positions are reversed from grid to grid to provide additional restriction to relative motion. The perimeter strips also contain springs and arches in addition to special features to prevent hangup of grids during a refueling operation.

In Cycle 11 the HID-1L, laser welded Zircaloy spacer grid assembly, replaced the HID-1, TIG welded Zircaloy spacer grid assembly. The quality of the HID-1L spacer grid assembly is improved because the weld process produces a greater consistency in dimensional control.

A discussion of the HID-1L spacer grid assembly follows:

1. The Cycle 11 fuel bundle HID-1L spacer grids are 0.006 inches larger in width than the Cycle 10 fuel bundle HID-1 spacer grids (8.140 inches vs. 8.134 inches). This initial increase in width is acceptable since this strip is stamped in the transverse direction. Irradiation produces contraction for transversely stamped strips whereas irradiation produces expansion for longitudinally stamped strips (Cycle 10 Fuel). The 0.006 inch increase in width was chosen to preserve the mid-life fuel bundle envelope. The increase in the outside envelope of the spacer grid assembly was accomplished by increasing the perimeter strip spring tab and arch height while making no change in the rod pitch.
2. The four perimeter strips of the HID-1L spacer grid assembly are lap joint welded at the center of each face of the spacer grid assembly, unlike the perimeter strips of the HID-1 spacer grid assembly which are butt joint welded at the corners. This change in the design produces more uniform dimensions since the four corners are preformed.
3. Laser welding produces a smaller and more uniform weld nugget than TIG welding. Strength testing has shown that the laser welded grids will meet all of the design criteria for LOCA and seismic loads.

The GUARDIAN™ Grid was introduced in the Batch P reload fuel assemblies in Cycle 12 and has been retained in subsequent reload fuel assembly designs. The specific changes to the fuel bundle design are as follows:

ARKANSAS NUCLEAR ONE
UNIT 2

1. The top grid surface of the GUARDIAN™ Grid design with respect to the top of the lower end fitting is 2.025" lower than the standard Inconel spacer grid assembly design. The height of the lower end fitting is 3.112" for both Batch N and P fuel.
2. To provide a snug fit up between the GUARDIAN™ Grid and the lower end fitting, the four sides adjacent to the top surface of the lower end fitting were machined to provide a recess midway along each of the four sides. The recess allows the overlap in the four welded joints that connect the GUARDIAN™ Grid perimeter strips to fit properly with the lower end fitting under worst case tolerance conditions. Because this change is not within the normal flowpath of the coolant this modification will not affect the form, fit, or function of the lower end fitting assemblies.
3. The number of welds attaching the GUARDIAN™ Grid to the lower end fitting was increased from five to seven welds per side. This change was necessary to secure the corners of the perimeter strips. The GUARDIAN™ Grid assembly added four cutouts in the perimeter strip corners to allow the bottom edge of the perimeter strip to be tapered inward. The purpose of a taper on the perimeter strips is to assure contact between the grid and lower end fitting. A snug fit-up precludes possible burn through of the strip during welding. The additional two welds located at the corners of the grid assembly and lower end fitting interface assure the perimeter strip will not be bent at these locations during bundle handling. The new weld requirements do not cause any of the design limits in the design criteria to be exceeded.
4. Because the top of the GUARDIAN™ Grid is 2.025" lower than the standard Inconel Spacer Grid Assembly, the length of the standard long 16 x 16 lower end cap for both the fuel and poison rods decreased by 1.140". The length of the Batch N end cap is 3.370" and the length of the Batch P end cap is 2.230". This change in end cap length will keep the clad out of the GUARDIAN™ Grid.
5. To compensate for the decrease in the lower end cap length of 1.140", the length of the fuel rod plenum region was increased by 1.000", the active fuel length was increased to 150.000" and the 0.25" upper alumina spacer disc was removed.
6. The plenum length for the fuel rods was increased from 7.888" for Batch N to 8.888" for Batch P. Because of the change in plenum length, the plenum spring for the fuel rods was redesigned. The new Batch P plenum spring is longer and has a larger material volume than the Batch N design (0.111 in³ vs. 0.096 in³). These changes allow the fuel rods to meet all of their design criteria.
7. The upper alumina spacer disc was removed from the fuel rods to maximize internal rod void volume. As a result of removing the Al₂O₃ spacer disc, the spring to clad and spring to pellet interfaces were evaluated. These evaluations concluded that removing the upper spacer disc will neither have a positive nor a negative impact on fuel rod performance.
8. Using the newly designed long lower end cap causes the active fuel region to be lowered by 1.140". This change in the location of the active fuel region relative to the Batch N design will not impact any of the results for the various accident analyses nor will it negatively impact the reactor vessel and its internals.

ARKANSAS NUCLEAR ONE
UNIT 2

9. The configuration of the lower end cap's tip has been modified to improve the ease of loading the fuel and poison rods into the grid cage assembly. The region where the serial number was engraved in the previous design has been eliminated to provide the end cap with a continuous taper. A continuous taper improves the rod's passage through the spacer grid assembly. The serial number is located within the groove of the lower end cap. These design changes to the end cap design do not impact any of the fuel rod or fuel bundle assembly design criteria.
10. The plenum length for the poison rod design was increased from 11.310" for Batch N to 11.450" for Batch P. Because of the change in plenum length, the plenum spring for the poison rods was redesigned. The new plenum spring is longer and has approximately the same material volume as the Batch N design (0.044 in³ vs. 0.042 in³). These changes allow the poison rods to meet all of their design criteria.
11. To compensate for the decrease in the lower end cap length of 1.140", the length of the poison rod plenum region was increased by 0.140" and the length of the poison column was increased from 135.000" for Batch N to 136.000" for Batch P or 1.000".

Subsequent to implementation of the Guardian grid, the following changes were made (beginning with Batch U assemblies) due to transition of fuel manufacturing to a different facility:

1. To be compatible with the new Tungsten Inert Gas (TIG) welding process, the lower end cap length was changed to 2.125". Additionally, the inclusion of a lower alumina spacer disc was a result of the previous Magnetic Force (MF) welding process. The lower alumina disk has therefore been eliminated.
2. As a result of eliminating the lower alumina disc and changing end cap lengths to support the TIG weld process, the plenum length has increased to 9.138". The basic geometry of the plenum spring was changed in response to the increased plenum length.
3. The result of eliminating the lower alumina spacer disc and the shortening of the lower end cap is a reduction in the active core region bottom elevation. The active fuel elevation is lowered an additional 0.355" relative to the change made for implementation of the Guardian grid.

The 11 Zircaloy-4 spacer grids are fastened to the Zircaloy-4 guide tubes by welding, and each grid is welded to each guide tube at eight locations, four on the upper face of the grid and four on the lower face of the grid, where the spacer strips contact the guide tube surface. The lowest spacer grid (Inconel) is not welded to the guide tubes due to material differences. It is supported by an Inconel-625 skirt which is welded to the spacer grid and to the perimeter of the lower end fitting.

The upper end fitting is an assembly consisting of two cast stainless steel plates, five machined posts, and five helical Inconel X-750 springs, and serves as an attachment for the guide tubes, the fuel assembly lifting fixture, and the alignment device which locates the upper portion of the fuel assembly. The lower cast plate locates the top ends of the guide tubes and is designed to retain the fuel rods in the event of certain postulated accident conditions.

ARKANSAS NUCLEAR ONE
UNIT 2

All fuel assemblies are fitted with stainless steel inserts. These inserts are added to the upper ends of the guide tubes and flared in place to protect against wear from CEA rod vibration. Required fittings inspections performed following Cycle 1 operation indicate that this modification has significantly reduced wear from CEA rod vibration.

The upper cast plate of the assembly which resembles a spider, together with the helical compression springs, comprise the holddown device. The spider is moveable and acts on the underside of the fuel alignment plate. The spider is loaded by the compression springs; one spring is located around each of the posts. Since the springs are located at the upper end of the assembly, the spring load combines with the fuel assembly weight to counteract upward hydraulic forces. The springs are sized and the spring preload selected such that a net downward force will be maintained for all normal and unanticipated transient flow and temperature conditions. The design criteria limit the maximum stress under the most adverse tolerance conditions to below yield strength of the spring material. The maximum stress occurs during cold conditions and decreases as the reactor heats up. The reduction in stress is due to a decrease in spring deflection resulting from differential thermal expansion between the Zircaloy fuel bundles and the stainless steel internals.

During normal operation, a spring will never be compressed to its solid height. However, if the fuel assembly were loaded in an abnormal manner such that a spring was compressed to its solid height, the spring would continue to serve its function when the loading condition returned to normal.

The lower end fitting is a single piece stainless steel casting consisting of a plate with circular flow holes and four support legs which also serve as alignment posts. Precision drilled holes in the support legs mate with four core support plate alignment pins, thereby properly locating the lower end of the fuel assembly. In Cycle 8, the lower end fittings were changed. Listed below are those changes:

- 1) The design of the lower end fittings has been changed to incorporate the following features:
 - a) Two (2) stanchions or panels that face the outer perimeter of the flow plate are placed on each of the four lower end fitting posts. This feature will improve the ease of installing the fuel bundle assemblies in-core.
 - b) The location of the bottom surface of the ribbing that connects the four lower end fitting posts has been changed from being flush to being 0.125" above the bottom seating surface of the posts. Because the lower end fitting was redesigned, this feature was incorporated into the design to improve the fabricability of the lower end fitting.
 - c) Additionally, the height of the ribbing has been increased from 0.613" to 1.000". The change in this feature, in addition to the change discussed above, increases the strength of the lower end fitting under many of the load conditions that a fuel bundle assembly is subjected to.

ARKANSAS NUCLEAR ONE
UNIT 2

- 2) The locking discs that are used in the lower end fitting-to-guide tube connection as an anti-rotation device have been redesigned. The basis for the redesign is to enable one locking disc to be used in all of the various C-E designed fuel bundle assemblies without affecting any of the design interface requirements between the fuel bundle assembly and the four fuel alignment pins located on the core support plate and without affecting the structural integrity of the guide tube connection.

The four outer guide tubes have a widened region at the upper end which contains an internal thread. Connection with the upper end fitting is made by passing the externally threaded end of the guide posts through holes in the flow plate and into the guide tubes. When assembled, the flow plate is tightly secured between flanges on the guide tubes and on the guide posts. The connection with the upper end fitting is locked with a mechanical crimp. Each outer guide tube has, at its lower end, a welded Zircaloy-4 fitting. This fitting has an externally threaded portion which is secured by a Type 304 steel bolt which passes through a hole in the fuel assembly lower end fitting. This joint is secured with a stainless steel locking disc tack welded to the lower end fitting in two places.

The central guide tube inserts into a socket in the upper end fitting and is thus restrained laterally by the relatively small clearance at this location and has an end fitting at the lower end with an internally threaded portion. The central guide tube is secured by a Type 304 stainless steel bolt which passes through a hole in the fuel assembly lower end fitting. This joint is secured with a stainless steel locking disc tack welded to the lower end fitting in two places. The upper end fitting socket is created by the center guide tube post which is threaded into the lower cast flow plate and tack welded in two places.

The guide tubes are fabricated from Zircaloy-4 in the fully-annealed condition for Batches A thru D, except for 10 Batch A fuel assemblies. The guide tubes in those 10 Batch A assemblies, as well as all guide tubes in Batches E thru Y, are fabricated from Zircaloy-4 in the stress-relief annealed (SRA) condition. The guide tubes in Batch Z and beyond are fabricated from SRA ZIRLO™.

The mechanical design of the Cycle 10 and successive cycles reload fuel is essentially the same as the debris-resistant batches of fuel that were used in Cycle 9. The main differences between the Cycle 10 and successive cycles and the Cycle 9 fuel bundle assembly designs are in the designs of the skirt located at the bottom end of the upper end fitting's outer posts and in the flange located at the upper end of the outer guide tube assembly. The outer post, which is screwed into the guide tube flange to fasten the upper end fitting assembly to the grid cage, has its skirt expanded within the flange. The expansion of the skirt into the holes of the flange provides the anti-rotation or locking feature that precludes the post from unfastening. For Cycle 10, the minimum wall thickness of the post's skirt was increased from 0.0115 inch to 0.014 inch and its length was increased by 0.050 inch. The centers of the holes located through the wall of the guide tube flange were placed 0.025 inch lower than the holes in the previous batches and the two 1/4 inch diameter holes were replaced with four 0.188 inch diameter holes. These changes to the designs of the post skirt and guide tube flange, in addition to the changes made to the tooling that is used to expand the post skirt within the guide tube flange, allow the skirt to be expanded without distorting adjacent sections of the post. Distortion in the nonskirt regions of a post could potentially make removal of the post difficult. In addition, these changes will minimize the potential for the skirt material to rupture during the expansion process.

ARKANSAS NUCLEAR ONE
UNIT 2

The NGF design implemented in Batch Z was designed to be mechanically compatible with the standard design of recent batches for reactor operation with mixed fuel cores. The NGF design incorporates many of the same features and geometry as the standard fuel assembly. Both designs have the same overall length at beginning of life. The basic structure consists of 5 large guide thimble tubes connected to spacer grids at intermediate locations and to nozzles at the ends. In both designs the guide thimbles have the same diameters and spacing, the structural spacer grids are at essentially the same elevations, the top and bottom nozzles are very similar, and the guide thimbles are connected to the top and bottom nozzles using the same type of connections. Both designs have 236 fuel rods with the same pitch, and the two designs have a very similar Guardian™ (bottom Inconel debris-filtering/retention) grid. In addition, structural testing has demonstrated that the response to external loads is similar and meets the design criteria for both designs.

Although similar in overall design, the details of the NGF design features a full complement of innovative components to improve fuel reliability, fuel cycle economics, fuel duty, manufacturability, burnup capability, and thermal performance. The major differences between the two designs are the following:

- Two changes in the fabrication of the NGF assembly include the use of bulged joints to build the grid cage versus welded joints and the use of a pull rod loading process versus the current push loading process. These process changes were selected for NGF to improve fabrication of the design while preserving the rigidity of the fuel assembly structure.
- The guide thimbles are made of SRA Zircaloy-4 in the standard design and SRA ZIRLO™ in the NGF design. This change was made because of ZIRLO™'s improved corrosion resistance and dimensional stability under irradiation.
- The NGF guide tube flange is connected to the guide tube by bulging instead of by welding as in the standard design. The bulged flange to guide tube connection retains adequate strength and is necessary with a bulged grid cage design to compensate for the shrinkage of the guide tubes during the forming of the grid-to-guide tube bulges.
- An anti-rotation feature has been incorporated in NGF to prevent the transmittal of torque to the grids during the installation or removal of the upper end fitting outer posts. The guide tube flange design includes four "lugs" or "keys" that engage four slots machined in the upper end fitting flow plate, thereby preventing rotation of the guide tube flange while the outer posts are being installed.
- The welded top grid in the standard design (prior to NGF design) is made of Zircaloy-4, and has cantilever springs. The NGF top grid is made of Inconel-718, has vertical springs, horizontal dimples, and an anti-snap perimeter strap design to minimize adverse assembly interactions during core loading and unloading. Stainless steel sleeves are brazed into the grid at guide tube locations and are bulged with the guide tubes during cage fabrication to secure the grid to the guide tubes. Other than the size and number of guide tube openings, the design is equivalent to that which has an extensive history of successful operation in Westinghouse NSSS nuclear power plants.

ARKANSAS NUCLEAR ONE
UNIT 2

- Mid Spacer Grids
 - The standard design Mid grids (HID-1L) are made using wavy strap Zircaloy-4, while the NGF Mid grids use straight strap Optimized ZIRLO™. The material change was made because of Optimized ZIRLO™'s improved corrosion resistance and dimensional stability under irradiation. The change to straight straps was made to improve fabrication and to facilitate the incorporation of the “I-spring” design and mixing vanes.
 - The standard HID-1L grids have cantilever springs, while the NGF grids have vertical springs with support arches at either end, hence the name “I-springs”, which are designed to reduce grid-to-rod gap formation and to provide a longer contact length to increase grid-to-rod fretting margin.
 - The NGF Mid grids in the upper portion of the fuel assembly have side supported mixing vanes to improve thermal performance and allow reconstitution from the top of the fuel assembly.
 - As with the top grid, the Mid grids have sleeves (in this case, Optimized ZIRLO™ sleeves) welded into the guide tube openings and bulged with the guide tubes both above and below the grid.
- Intermediate Flow Mixing (IFM) Grids
 - The NGF design incorporates two IFM grids to improve thermal performance in two critical grid spans near the top of the active core.
 - The IFMs are short, non-structural grids that are made from straight strap Optimized ZIRLO™ with side-supported mixing vanes and opposing dimples with small grid-to-rod gap in lieu of an active (preloaded spring-dimple) support system.
 - The IFM grids have sleeves that are similar to the Mid grid sleeves, except the protrusion of the sleeve above the IFM grids is less than above the Mid grids because the IFM sleeves are only bulged with the guide tubes below the grid.
- To accommodate the transition from rod push loading to rod pull loading for NGF, changes were made to the Guardian grid design, the lower end fitting, the connection between the two, and the initial axial positioning of the fuel rods:
 - In lieu of direct welding to the lower end fitting, the NGF Guardian grid is retained by inserts that are welded to the four outer guide tube openings and then clamped between the bottom of the guide tube and the lower end fitting.
 - Since the bottom edge of the NGF Guardian grid outer strap is not welded to the lower end fitting, the outer strap was modified to be the same as the upper edge of the outer strap and the NGF lower end fitting has chamfers on both the top and bottom edges of the lower end fitting plate.
 - The head of the NGF bolt has a skirted region that is crimped into recesses in the lower end fitting to secure the bolt, rather than using a separate locking disc that is welded to the lower end fitting to secure the bolt.

ARKANSAS NUCLEAR ONE
UNIT 2

- To facilitate the installation of the lower end fitting after the rods have been pulled into the grid cage, a small gap remains between the bottoms of the NGF fuel rods and the bottom nozzle. This differs from the standard fuel where the rods are seated directly on the upper surface of the lower end fitting.
- As a result of the various design changes associated with the transition from push-loading to pull-loading, the nominal, beginning-of-life location of the start of the active length has been raised to 5.402 inches above the core support plate for NGF (Batch Z and beyond), instead of the 5.237 inches for the recent standard fuel batches prior to Batch Z.
- The NGF bolt design includes a small diameter hole through the center of the bolt to allow water to drain out of the guide tubes after washing the fuel assemblies during fabrication, or prior to the installation of the fuel assemblies in dry casks for spent fuel storage.
- The NGF fuel rod design includes several changes relative to the previous standard fuel rod design, the most significant of which are the reduced diameter/thickness of the cladding, a modified pellet geometry, the use of Optimized ZIRLO™ cladding, and an increase in the overall rod length. These changes, as well as the other design changes associated with the NGF fuel rods, are detailed in Section 4.2.1.2.1 (fuel rod) and Section 4.2.1.2.1.3 (IFBA rod).

The fuel assembly design enables reconstitution, i.e., removal and replacement of fuel and poison rods, of an irradiated fuel assembly. The fuel and poison rod lower end caps are conically shaped to insure proper insertion within the fuel assembly grid cage structure; the upper end caps are designed to enable grappling of the fuel and poison rod for purposes of removal and handling. Threaded joints which mechanically attach the upper end fitting to the control element guide tubes are properly torqued and locked during service, but may be removed to provide access to the fuel and poison rods. Testing has been completed which provides verification of the structural integrity of the upper end fitting to control element guide tube joints. The results of this testing program are presented in References 20 and 21. Although the title of the reports identified the design tested as System 80, the Arkansas Nuclear One - Unit 2 guide tube connection and secondary lock are the same as those tested. In addition, inspection and operational checks have been conducted to determine the behavior of the end fitting to CEA guide tube connection after thermal cycling, crudding, and long-term soaking.

In the Arkansas Nuclear One - Unit 2 fuel assembly design, axial loads (other than hydrostatic) are applied to the fuel rod due to differential thermal expansion and differential irradiation induced growth between fuel rods and guide tubes. All loads are transmitted through the grids, due to the axial clearance in the design which precludes hard contact between the fuel rods and the end fittings, taking into account the combined effects of thermal expansion and fuel rod axial growth. These components are designed to provide the necessary restraint without sustaining excessive stresses. The resultant loading is considered along with other loads encountered in normal operation.

It is a design criterion that the axial restraint offered by the grids and the grid spacing be such that the axial forces on a fuel rod are not sufficient to cause the rod to buckle. The long-term effects of clad creep (reduction in clad O.D.) and partial relaxation of the grid material result in decreased axial restraining force between grids and fuel rods, thereby improving the margin between actual and applied loadings as the fuel is operated.

ARKANSAS NUCLEAR ONE
UNIT 2

As it is currently understood, the observed instances of fuel rod bowing have occurred because the axial restraint of the spacer grids on the fuel rods has been such that relative motion between the fuel rods and the grids, e.g. differential thermal expansion, cannot occur except at axial forces high enough to cause slight bowing of the fuel rods. Fuel assemblies for Arkansas Nuclear One - Unit 2, however, are designed such that the combination of fuel rod rigidity, grid spacing and grid preload will not cause significant fuel rod deformation under axial loads. Moreover, Combustion Engineering's visual inspection of irradiated fuel assemblies from the Maine Yankee (14 x 14), Palisades (15 x 15), and Omaha (14 x 14) reactors has not shown any significant bowing of the fuel rods. In view of these factors, Combustion Engineering does not believe that fuel rod bowing presents a significant problem to the fuel design.

Regarding the effect on thermal margin of fuel rod bowing, Combustion Engineering has obtained experimental information showing that significant rod bowing can occur without significant effect on Departure from Nucleate Boiling (DNB). The information consists of DNB data for two electrically heated 16 x 16 type rod bundles which were virtually identical except that one had a number of heater rods bowed in the vicinity of the DNB location. Comparison of the DNB data obtained with those bundles showed no noticeable effect of the bowed rods.

The bundles used in the tests mentioned above were 21 rod bundles representative of the Combustion Engineering 16 x 16 fuel assembly. The bundles had a heated length of seven feet with uniform axial and non-uniform lateral power distributions. Combustion Engineering standard spacer grids were used. The axial grid spacing was 14.3 inches, and the last grid in the heated length was 14.3 inches from the end of the heated length. Data were obtained first with the bundle having the bowed rods, after which the bowed rods were replaced with straight rods and more data were taken. The bowed rods became bowed in the span just upstream of the end of the heated length due to overheating in an earlier test with special spacer grids. For the test described here with Combustion Engineering standard grids, the bowed rods were reinstalled in the original positions and orientations.

Figure 4.2-20 indicates the rods which were bowed and the direction of bow. That figure also gives, based on detailed measurements at several axial elevations, the magnitude and location of minimum rod-to-rod gaps found to be less than 0.100 of an inch. (nominal rod-to-rod gap is 0.124 of an inch). It can be seen that the rod-to-rod gaps were reduced by as much as 40 percent and that the bowing is most severe just upstream of the DNB elevation (the end of the heated length).

Figures 4.2-21 and 4.2-22 show DNB data obtained from the two tests described above. It can be seen that there is no noticeable effect of the bowed rods on DNB.

However, because rod bowing is fuel burnup dependent, Departure from Nucleate Boiling Ratio (DNBR) penalty factors are applied to the maximum radial power peak for each batch of fuel. These DNBR penalty factors are determined in accordance with Technical Specification 4.2.4.4. In Cycles 2, 3, and 4, a 2% rod bow penalty based on Reference 165 was included in the MDNBR for bundle burnups up to 30,000 MWD/MTU. For Cycles 5 through 15, a 0.5% rod bow penalty based on Reference 169 was used. Starting with Cycle 16, a 0.6% rod bow penalty based on Reference 169 was used for bundle burnups up to 33,000 MWD/MTU. Bundles having burnups in excess of 33,000 MWD/MTU are not limiting with respect to DNB margin. Since the rod bow allowance is specifically included in the DNBR limit, there is no need for additional penalties on the rod radial peak in the Technical Specifications; therefore, Technical Specification 4.2.4.4 was deleted.

ARKANSAS NUCLEAR ONE
UNIT 2

Differential lateral thermal expansion between the stainless steel upper end fitting and the topmost Zircaloy or Inconel spacer grid several inches below it does not cause any stress in the fuel rods because the fuel rods are supported by the spacer grid and receive no lateral support from the upper end fitting. The same situation exists at the lower end fitting.

In the Arkansas Nuclear One - Unit 2 fuel assembly design, the tubular control elements travel through the core in guide tubes. These guide tubes have the effect of ensuring that swelling of the adjacent fuel rods cannot result in obstruction of the control element pathway. This is so because: (1) there is sufficient clearance between the fuel rods and the guide tube surface to allow an adjacent fuel rod to reach rupture strain without contacting the guide tube surface, and (2) the guide tube, having considerably greater diameter and wall thickness (and also, being at a lower temperature) than the fuel rod, is considerably stiffer than the rods and would, therefore, remain straight, rather than be deflected by contact with the surface of a rapidly swelling adjacent fuel rod. Therefore, the swelling of fuel rods during a Loss of Coolant Accident (LOCA) would not result in obstruction of the control element channels such as could hinder CEA movement. This conclusion is equally valid for a case in which the postulated obstruction mechanism is lateral deflection (bowing) of the fuel rod resulting from excessive axial force applied through the grids due to differential thermal expansion between the fuel rods and the guide tubes. Dimension changes in the fuel assembly components occurring as a result of creep during operation are small compared to the clearances involved between the components, and therefore, will not have a significant effect on this particular aspect of LOCA response.

A series of tests were conducted to verify the adequacy of the Arkansas Nuclear One - Unit 2 fuel assembly holddown design. The load deflection characteristics of the holddown device were measured. In addition, tensile testing was conducted to verify the ability of the holddown device to accommodate handling loads. A holddown spring was also subjected to an extensive number of full deflections to verify an acceptable fatigue lifetime for the spring material. The results of these tests indicate that the holddown device will exhibit satisfactory performance characteristics in-reactor. Additional testing of the holddown characteristics was a part of the full scale hot loop testing program described below.

To qualify the complete fuel assembly, full scale hot loop testing has been conducted. The tests are designed to evaluate fretting and wear of components, fuel assembly uplift forces, holddown performance and compatibility of the fuel assembly with interfacing reactor internals, CEAs and Control Element Drive Mechanisms (CEDMs) under conditions of reactor water chemistry, flow velocity, temperature and pressure. The test assembly is identical to the 16x16 guide tube Arkansas Nuclear One - Unit 2 fuel design. The results of this hot flow test program are presented in Reference 1.

Mechanical testing of the fuel assembly and its components has been performed to support analytical means of defining the assembly's structural characteristics. The test program consisted of static and dynamic tests of spacer grids and static and vibratory tests of a full size fuel assembly. The results of tests to determine the axial and lateral deflection characteristics of the 16 x 16 fuel assembly grid cage and the results of mechanical tests on the threaded connection of CEA guide tubes to end fittings are presented in References 3, 20, and 21, respectively. The results of combined axial and lateral deflection tests and pluck tests on the 16 x 16 fuel assembly and the results of 16x16 spacer grid impact testing are presented in References 4 and 9. The results of the forced vibration tests and pluck impact tests are presented in References 2 and 5.

ARKANSAS NUCLEAR ONE
UNIT 2

Extensive testing, both flow testing and mechanical testing, was performed to demonstrate the acceptability of the NGF design introduced in Batch Z. The flow testing program for the NGF design is described in Section 4.2.1.3.6.2 and concludes that the hydraulic performance of the NGF design is acceptable and should be superior to that of the prior designs. The mechanical tests were performed for two reasons: a) to determine fuel assembly mechanical properties that were then modeled in analyses that calculated fuel assembly spacer grid impact loads and component stresses for comparison to the stress limits given in Section 4.2.1.1.1.1; and b) to determine the load carrying capabilities of spacer grids and fuel assembly joints for direct comparison to predicted loads. Reference 195, Section D, identifies the mechanical tests that were performed and states the results of the tests. Application of the mechanical test results through the fuel assembly modeling and through their direct comparison to requirements demonstrates that the NGF design satisfies the design criteria of Section 4.2.1.1.1.

4.2.1.2.4 Fuel Component Properties and Tolerances

The following is a list of chemical, metallurgical, dimensional, thermal and mechanical characteristics of the fuel pellet, cladding and fuel assembly hardware. The material properties that influence the thermal performance of gadolinia-urania ($Gd_2O_3-UO_2$) fuel are discussed in Section 4.2.1.2.1.1. The material properties that influence the thermal performance of erbia-urania ($Er_2O_3-UO_2$) fuel are discussed in Section 4.2.1.2.1.2. The material properties that influence the thermal performance of zirconium diboride (ZrB_2 IFBA) fuel are discussed in Section 4.2.1.2.1.3.

4.2.1.2.4.1 Fuel Rod Cladding

4.2.1.2.4.1.1 Zr-4 Fuel Rod Cladding

Chemical Properties

Chemical analyses are performed for the following alloying elements: Tin, iron, chromium, oxygen and zirconium. Limits are placed on impurity content.

Metallurgical Properties:

Hydride Orientation

A restriction is placed on the hydride orientation factor for any third of the tube cross section (inside, middle or outside). The hydride orientation factor equals the ratio of the radial hydride platelets to the total number of hydride platelets.

Dimensional Requirements:

Tube straightness is limited to 0.010 inch/foot, and inside diameter and wall thickness are tightly controlled.

Ovality is measured as the difference between maximum and minimum inside diameters and is acceptable if within the diameter tolerances.

Eccentricity is measured as the difference between maximum and minimum wall thickness at any one cross section and is acceptable if within the wall tolerances.

ARKANSAS NUCLEAR ONE
UNIT 2

Mechanical Properties:

A. Modulus of Elasticity (Reference 135)

$$\text{Young's Modulus} \times 10^{-6} = [\quad * \quad]$$

(*See CESSAR Proprietary Appendix, Section 4.2.4.1)

where:

$$T = \text{ }^{\circ}\text{F}$$

B. Poisson's Ratio (Reference 117)

$$u = [\quad * \quad]$$

(*See CESSAR Proprietary Appendix, Section 4.2.4.1)

where:

$$T = \text{ }^{\circ}\text{F}$$

C. Thermal Coefficient of Expansion (Reference 19)

$$\text{diametral direction } \alpha = [\quad * \quad]$$

where:

$$T_{av} = \text{average temperature, } ^{\circ}\text{F}$$

(*See CESSAR Proprietary Appendix, Section 4.2.4.1)

D. Yield Strength (References 15, 19, 89, 90, 96, 114, 135, 156 and 158)

- Yield strength in the non-irradiated condition is shown in Figure 4.2-6a as a function of temperature.

- Yield strength in the irradiated condition at 650 °F is:

$$ys = [\quad * \quad] \text{ where: } \phi t = \text{fluence} \times 10^{-21}$$

(*See CESSAR Proprietary Appendix, Section 4.2.4.1)

The cladding stress limits identified in Section 4.2.1.1.1.2 are based on values taken from the minimum yield strength curve at the appropriate temperatures. The limits are applied over the entire fuel lifetime, during conditions of reactor heatup and cooldown, steady state operation, and normal power cycling. Under these conditions, cladding temperatures and fast fluences can range from 70 °F to 750 °F, and from 0 to 1×10^{22} nvt, respectively.

ARKANSAS NUCLEAR ONE
UNIT 2

E. Ultimate Strength (References 15, 19, 89, 90, 96, 114, 135, 156 and 158)

- Ultimate tensile strength in the non-irradiated condition is shown in Figure 4.2-6b as a function of temperature.
- Ultimate tensile strength in the irradiated condition is at 650 °F.

$$UTS = [*]$$

where:

$$\phi t = \text{fluence} \times 10^{-21}$$

(*See CESSAR Proprietary Appendix, Section 4.2.4.1)

F. Uniform Tensile Strain (References 15, 19, 89, 90, 96, 114, 135, 156 and 158)

- Uniform tensile strain in the non-irradiated condition is shown in Figure 4.2-6c as a function of temperature.
- Uniform tensile strain in the irradiated condition approaches one percent at 6×10^{20} nvt and remains relatively constant.

G. Thermal Conductivity

(See Section 4.2.1.2.4.5)

H. Specific Heat

(See Section 4.2.1.2.4.5)

I. Hydrostatic Burst Test

Hydrostatic burst tests are conducted to verify that minimum burst pressure and circumferential elongation exceed prescribed minimum values.

4.2.1.2.4.1.2 ZIRLO™ Fuel Rod Cladding

Chemical Properties

Chemical analyses are performed for the following alloying elements: Tin, iron, niobium, oxygen and zirconium. Limits are placed on impurity content.

Metallurgical Properties:

Hydride Orientation

A restriction is placed on the hydride orientation factor for any third of the tube cross section (inside, middle or outside). The hydride orientation factor equals the ratio of the radial hydride platelets to the total number of hydride platelets.

ARKANSAS NUCLEAR ONE
UNIT 2

Dimensional Requirements:

Tube straightness is limited to 0.010 inch/foot, and inside diameter and wall thickness are tightly controlled.

Ovality is measured as the difference between maximum and minimum inside diameters and is acceptable if within the diameter tolerances.

Wall thickness variation (WTV) shall not exceed 0.002 inch for each tube.

Mechanical Properties:

A. Modulus of Elasticity (Reference 183)

$$\text{Young's Modulus} \times 10^{-6} = [\quad * \quad]$$

(*See "Implementation of ZIRLO™ Cladding," Section 4.3.5.1)

where

$$T = \text{°F}$$

B. Poisson's Ratio (Reference 183)

$$u = [\quad * \quad]$$

(*See "Implementation of ZIRLO™ Cladding," Section 4.3.5.2)

where:

$$T = \text{°F}$$

C. Thermal Coefficient of Expansion (Reference 183)

$$\text{Circumferential and axial direction } \alpha = [\quad * \quad]$$

where:

$$T_{\text{av}} = \text{average temperature, °F}$$

(*See "Implementation of ZIRLO™ Cladding," Section 4.3.4.)

D. Yield Strength

- The best-estimate unirradiated yield strength is given in Reference 183, Section 5.3.7.1, as a function of temperature.
- Yield strength in the irradiated condition is given in Reference 186, Reference 2-17.2, as a function of temperature.

For saturation damage irradiated cladding, these yield strength equations are considered valid for $nvt > 2 \times 10^{21}$ (> 1 MeV), clad mid-wall irradiation temperature below ~ 700 °F, and no significant annealing of irradiation damage in situ.

ARKANSAS NUCLEAR ONE
UNIT 2

E. Ultimate Strength

- The best-estimate unirradiated ultimate strength is given in Reference 183, Section 5.3.7.2, as a function of temperature.
- Ultimate strength in the irradiated condition is given in Reference 186, Section 2.18.2, as a function of temperature.

For saturation damage irradiated cladding, these ultimate strength equations are considered valid for $nvt > 2 \times 10^{21}$ (> 1 MeV), clad mid-wall irradiation temperature below ~ 700 °F, and no significant annealing of irradiation damage in situ.

F. Uniform Tensile Strain

- Ductility is a function of irradiation and hydride formation in the cladding wall. The ductility of ZIRLO™ should be at least equivalent to Zr-4 because the waterside corrosion is significantly lower for ZIRLO™ and will result in less hydrogen uptake and less hydride formation. Total strain capability of ZIRLO™ is projected to be in excess of 1% at burnups of 60 MWd/kgU.

G. Thermal Conductivity

- The correlation for measured thermal conductivity of ZIRLO™ cladding material is given in Reference 183, Section 4.3.3, as a function of temperature.

H. Specific Heat

- The specific heat of ZIRLO™ is given by the values listed in Reference 183, Section 4.3.3, as a function of temperature. The values include the heat of transformation associated with the alpha-to-beta phase change that is slightly different from that of Zr-4 because of the difference in the temperature range over which the phase change occurs for the two alloys.

I. Contractile Strain Ratio (CSR)

The ratio of circumferential strain to radial strain shall be determined by Specification (Reference 187) and shall be acceptable if within 1.20 to 2.25.

4.2.1.2.4.1.3 Optimized ZIRLO™ Fuel Rod Cladding

Reference 195 compares the properties of Optimized ZIRLO™ cladding and ZIRLO™ cladding and documents the equivalency of the material properties, with the following exceptions:

Chemical Properties: The specified range of the tin content in the Optimized ZIRLO™ cladding is allowed to be 0.2% lower than in ZIRLO™ cladding.

Mechanical Properties: The unirradiated yield strength and ultimate strength of the Optimized ZIRLO™ cladding are slightly lower than the corresponding ZIRLO™ cladding due to the lower tin content. These mechanical properties are shown in Table 4.2-3 for both cladding materials.

ARKANSAS NUCLEAR ONE
UNIT 2

4.2.1.2.4.2 Control Element Assembly Guide Tubes

Chemical Properties:

Chemical analyses are performed for the alloying elements. For Zircaloy-4 guide tubes, the analyses check for tin, iron, chromium, oxygen, and zirconium. For ZIRLO™ guide tubes, the analyses check for tin, iron, niobium, oxygen, and zirconium.

Limits are placed on impurity content.

Mechanical Properties:

The guide tubes are fabricated from Zircaloy-4 in the fully-annealed condition for Batches A thru D, except for 10 Batch A fuel assemblies. The guide tubes in those 10 Batch A assemblies, as well as all guide tubes in Batches E thru Y, are fabricated from Zircaloy-4 in the stress-relief annealed (SRA) condition. The guide tubes in Batch Z and beyond are fabricated from SRA ZIRLO™.

Dimensional Requirements:

Dimension Permissible Tolerance (inches)

O.D. ± .003

I.D. ± .005 (thru Batch Y)

I.D. ± .002 (Batch Z and beyond)

4.2.1.2.4.3 Zircaloy-4 Bar Stock

Chemical Properties:

Chemical analyses are performed for the following alloying elements: Tin, lead, chromium, oxygen and zirconium. Limits are placed on impurity content.

Metallurgical Properties:

Grain Size

The maximum average grain size is restricted.

4.2.1.2.4.4 Zirconium-based Strip Stock

Chemical Properties:

Chemical analyses are performed for the alloying elements. For Zircaloy-4 strip stock, the analyses check for tin, iron, chromium, oxygen, and zirconium. For Optimized ZIRLO™ strip stock, the analyses check for tin, iron, niobium, oxygen, and zirconium. Limits are placed on impurity content.

ARKANSAS NUCLEAR ONE
UNIT 2

Metallurgical Properties:

Grain Size

The maximum average grain size is restricted.

4.2.1.2.4.5 Zircaloy-4 Thermal Properties

Heat Content of Zircaloy-4 (Figure 4.2-7)

Thermal Conductivity of Zircaloy-4 (Figure 4.2-8).

4.2.1.2.4.6 Stainless Steel Castings

Stainless steel castings are fabricated in accordance with ASTM A744-84 (Grade CF-8 before 1993 and Grade CF-3 thereafter) with additional requirements.

Starting in 2016, stainless steel end fitting castings are fabricated in accordance with Westinghouse Specification MACASS01. MACASS01 duplicates the requirements of ASTM A744 except for two changes. The heat treatment (i.e., solution anneal) is not necessary for this application and is not required in view of the relatively low carbon content of the CF-3 cast stainless steel. The specification to control delta ferrite level is relaxed. Casting soundness and casting mechanical properties which are affected by the ferrite level are controlled by non-destructive examination and mechanical property measurements of representative samples.

4.2.1.2.4.7 Stainless Steel Tubing

Stainless steel tubing is fabricated in accordance with ASTM A269 (with additional requirements) for wear sleeves and the Guardian grid inserts, and in accordance with either ASTM A213 or A249 (both with additional requirements) for the top Inconel grid sleeve.

4.2.1.2.4.8 Stainless Steel Compression Springs

All stainless steel springs are fabricated in accordance with AMS 5688 thru Batch Y. For Batch Z and beyond, the stainless steel springs are fabricated in accordance with ASTM 313.

4.2.1.2.4.9 Inconel X-750 Compression Springs

All Inconel springs are fabricated in accordance with AMS 5699 with additional requirements.

4.2.1.2.4.10 UO₂ Fuel Pellets

Chemical Properties:

A. Chemical analyses are performed for the following constituents:

Total Uranium	Chlorine and Fluorine	Nickel	Magnesium
Carbon	Iron	Chromium	
Nitrogen	Thorium	Silicon	
Fluorine	Aluminum	Calcium	

ARKANSAS NUCLEAR ONE
UNIT 2

- B. Limits are placed on the oxygen-to-uranium ratio.
- C. The sum of the cross sections of the following impurities will not exceed a specified equivalent thermal-neutron capture cross section of natural boron.
 - 1. Boron
 - 2. Silver
 - 3. Cadmium
 - 4. Gadolinium
 - 5. Europium
 - 6. Samarium
 - 7. Dysprosium
 - 8. Erbium
- D. The total adsorbed and absorbed gas content of finished ground pellets shall not exceed a specified limit as determined by hot extraction techniques on whole pellets.
- E. The total moisture content of finished ground pellets is restricted.
- F. The nominal enrichment of the fuel pellets will be specified and shall be held within $\pm .05$ percent U-235.

Microstructure:

The pellet fabrication process will maximize the pore content of pellets in a specified range. Acceptable porosity distribution will be determined by comparison of approved visual standards with photomicrographs from each pellet lot.

The average grain size shall exceed a specified minimum diameter.

Density:

Until 1989, the density range of the sintered pellet after grinding was 93.5 - 96.0 percent of theoretical density, based on a UO_2 theoretical density of 10.96 g/cm^3 , at the 95/95 confidence level. Thereafter, the density range was increased to 94.0 – 96.5 percent of theoretical density.

Thermal Properties:

A. Thermal Expansion

The thermal expansion of the UO_2 fuel pellets is described by the following temperature dependent equations (References 59 and 62):

% Linear Expansion (from $25 \text{ }^\circ\text{C}$) = $(-1.723 \times 10^{-2}) + (6.797 \times 10^{-2}\text{T}) + (2.896 \times 10^{-7}\text{T}^2)$ up to $2,200 \text{ }^\circ\text{C}$.

% Linear Expansion (from $25 \text{ }^\circ\text{C}$) = $0.204 + (3 \times 10^{-4}\text{T}) + (2 \times 10^{-7}\text{T}^2) + (10^{-10}\text{T}^3)$ above $2,200 \text{ }^\circ\text{C}$.

where

T = degrees centigrade

ARKANSAS NUCLEAR ONE
UNIT 2

B. Thermal Emissivity

A value of 0.85 is used for the thermal emissivity of UO₂ pellets over the temperature range 800 °K to 2600 °K (References 56, 83 and 92).

Mechanical Properties:

A. Young's Modulus of Elasticity

The Young's modulus of elasticity for UO₂ is used in the analytical model for prediction of the effects of pellet clad interaction. It is described by the following porosity and temperature dependent equation: (Reference 157)

$$E = [3.34 \times 10^7 (1 - 3.02 P + 3.57 P^2)] [1.003 - 1.405 \times 10^{-4} (T - 298)]$$

where

E = modulus of elasticity, lb/in²

T = degrees Kelvin

P = volume fraction porosity

B. Poisson's Ratio for UO₂ Pellets

<u>Fuel Density (%TD)</u>	<u>Poisson Ratio</u>
93	0.2970
94	0.3025
95	0.3073
96	0.3110
97	0.3130
98	0.3145
99	0.3155
100	0.3160

C. Yield Stress (not applicable)

D. Ultimate Stress (not applicable)

E. Uniform Ultimate Strain (not applicable)

4.2.1.2.4.11 Al₂O₃-B₄C Burnable Poison Pellets

The Al₂O₃-B₄C burnable poison pellets used in Combustion Engineering designed reactors consist of a continuous matrix of Al₂O₃ with a relatively small volume fraction of fine B₄C particles dispersed in the Al₂O₃ matrix. Typical compositions of B₄C are 0.7 to 4.0 w/o (1 to 6.0 w/o) in the pellets, which have a bulk density of about 90 percent of theoretical. Therefore, many thermal properties of the 2-phase Al₂O₃-B₄C mixture such as swelling, helium release, melting point, and corrosion are dependent on the presence of B₄C. The operating centerline temperature of burnable poison is less than 1100 °F, with maximum surface temperatures close to 750 °F.

ARKANSAS NUCLEAR ONE
UNIT 2

A. Swelling

The swelling of $\text{Al}_2\text{O}_3\text{-B}_4\text{C}$ is dependent on B^{10} burnup and neutron fluence. Early investigations found that generally the irradiation-induced swelling of $\text{Al}_2\text{O}_3\text{-B}_4\text{C}$ increases with B^{10} burnup (see Reference 54). Pellets of $\text{Al}_2\text{O}_3 - 3$ w/o B_4C swelled from one to two percent in diameter (see References 43 and 54). Other data shows that the swelling of the Al_2O_3 matrix increased linearly with neutron fluence to about two percent ΔD after an exposure of 6×10^{21} nvt. Recent measurements performed on material irradiated in a Combustion Engineering PWR (with two w/o B_4C or less) revealed that diametral swelling ranged from [*]. These pellets were irradiated to 100 percent B^{10} burnup at a fluence of 2×10^{21} nvt ($E > .8$ Mev).

The above data lead to a design value for the EOL swelling of $\text{Al}_2\text{O}_3\text{-B}_4\text{C}$ with up to two w/o B_4C of [*] while the EOL swelling of material with > 2 w/o B_4C is [*].

At EOL, $\text{Al}_2\text{O}_3\text{-B}_4\text{C}$ will have exposures up to 9.8×10^{21} nvt ($E > .8$ Mev), with complete burnup of the B^{10} isotopes.

*Proprietary Information

B. Thermal Expansion

The mean thermal expansion coefficients of Al_2O_3 (see Reference 68) and B_4C (see Reference 129) from zero to 1,850 °F are 4.9 and 2.5×10^{-6} in/in-°F, respectively. The thermal expansion of the $\text{Al}_2\text{O}_3\text{-B}_4\text{C}$ 2-phase mixture can be considered to be essentially the same as the value for the continuous Al_2O_3 matrix, as the dispersed B_4C phase has a lower expansion coefficient and occupies only five w/o of the available volume. The low temperature (80 to 250 °F) thermal expansion coefficient of Al_2O_3 irradiated at 480, 900, and 1300 °F does not change as a result of irradiation (see Reference 147). The expansion of a similar material, beryllium oxide, up to 1,900 °F has also been reported to be relatively unchanged by irradiation (see Reference 132). It is therefore appropriate to use the values of thermal expansion measured for Al_2O_3 (see Reference 68) for the burnable poison pellets:

<u>Temp. Range, °F (from 70 °F to)</u>	<u>Linear Expansion, %</u>
400	.12
600	.23
800	.30
1000	.40

C. Melting Point

The melting points of Al_2O_3 (3,710 °F) (see Reference 128) and B_4C (4,440 °F) (see Reference 132) are higher than the melting point of the Zircaloy-4 cladding. No reactions have been reported between the components, which would lower the melting point of the pellets to any significant extent. As the B_4C burns up, the lithium atoms born may form compounds with carbon and boron, although no ternary compounds with B_4C are expected (see Reference 136). The formation of these compounds should not influence the melting point of the $\text{Al}_2\text{O}_3\text{-B}_4\text{C}$ pellets although the small

ARKANSAS NUCLEAR ONE
UNIT 2

quantity of (~.5 w/o) lithium compounds formed during irradiation, may melt below the 3,710 °F value reported for Al₂O₃. The maximum temperature of operation will be below 1,100 °F, however, and irradiation testing has shown no adverse effects due to the ingress of lithium.

D. Thermal Conductivity

The thermal conductivity of Al₂O₃-B₄C was calculated from the measured values for Al₂O₃ and B₄C using the Maxwell-Eucken relationship (see Reference 95) for a continuous matrix phase (Al₂O₃) with a spherical dispersed phase (B₄C) particles. Because of the high Al₂O₃ content of these mixtures and the similarity in thermal conductivity, the resultant values for Al₂O₃-B₄C were essentially the same as the values for Al₂O₃. The measured, unirradiated values of thermal conductivity at 750 °F are 0.06 cal/sec-cm-°K for B₄C and .05 cal/sec-cm-°K for Al₂O₃.

The thermal conductivity of Al₂O₃ after irradiation decreases rapidly as a function of burnup to values of about one-third the unirradiated values (see Reference 147). The irradiated values of Al₂O₃-B₄C calculated from the above relationships, are given below as a function of temperature (see References 147 and 152).

Thermal Conductivity	
<u>Temp. °F</u>	<u>cal/sec-cm-°K</u>
400	.015
600	.013
800	.010
1000	.008

E. Specific Heat

The specific heat of the Al₂O₃-B₄C mixture can be taken to be essentially the same as pure Al₂O₃ since the concentration of B₄C is low (6.0 w/o maximum). In addition, the effect of irradiation on specific heat is expected to be small based on experimental evidence from similar materials, which do not sustain transmutations as a function of neutron exposures.

The values for Al₂O₃ measured on unirradiated (see References 117 and 152) samples are given below:

<u>Temp. °F</u>	<u>cal/gm-°F</u>
250	.12
450	.13
800	.14
000 and above	.15

F. Helium Release

Experimental measurements reveal that less than 5 percent of the helium formed during irradiation will be released (see Reference 54). These measurements were performed on Al₂O₃-B₄C pellets irradiated at temperatures to 500 °F and subsequently

ARKANSAS NUCLEAR ONE
UNIT 2

annealed at 1,000 °F for five days. The helium release in a burnable poison rod, which operated for one cycle in a Combustion Engineering PWR, as calculated from internal pressure measurements to be [*] Combustion Engineering bases the design on a release of [*] of the helium generated. The design of the burnable poison rod is not limited by helium pressure, despite the conservative use of [*] release. The internal pressure produced under operating conditions will be [*] system pressure at EOL. This will not cause clad creep and not limit design life.

*Proprietary Information

G. $\text{Al}_2\text{O}_3\text{-B}_4\text{C}$ Coolant Reactions

Prior to sustaining significant burnup, the corrosion resistance of $\text{Al}_2\text{O}_3\text{-B}_4\text{C}$ pellets is sufficient to retard any appreciable reaction with the coolant in the event of a cladding leak.

Available evidence shows that in the event of a cladding leak in a burnable poison rod, the $\text{Al}_2\text{O}_3\text{-B}_4\text{C}$ pellets will react with the coolant. Those pellets which sustained significant burnup, react fairly fast as they disintegrated after 24 hours at 600 °F in pressurized water (see Reference 54). The disintegration of the pellets is a result of the reaction between irradiated B_4C and water or steam to form B_2O_3 (see Reference 80). There is some evidence that the lithium formed, as B^{10} is burned up along with microcracking, causes the relatively high corrosion rate. The corrosion products formed are soluble in water (B_2O_3 , Li_2O), and therefore cause no detrimental effect on the operation of the plant.

4.2.1.2.5 Fuel Assembly Identification

Exterior means of identification coupled with manufacturing and loading procedures insure proper orientation and placement of each fuel assembly. Additional checks and quality assurance records enable determination of the specifications associated with every component.

Loading and movement of the fuel assemblies is conducted in accordance with strictly monitored administrative procedures, and, at the completion of fuel loading, an independent check as to the location and orientation of each fuel assembly in the core is required.

Markings provided on the fuel assembly upper end fitting enable verification of fuel enrichment and orientation of the fuel assembly.

During the manufacturing process, the lower end cap of each rod is marked to provide a means of identifying the pellet enrichment, pellet lot and fuel stack weight. For some Batch U fuel assemblies, lower end cap markings were not made and individual laser etched bar codes on the top of the fuel rod will be the sole means of identifying the rods. In addition, a quality control program specification requires that measures be established for the identification and control of materials, components, and partially fabricated subassemblies. These means provide a method of relating an item or assembly from initial receipt through fabrication, installation, repair or modification, to an applicable drawing, specification, or other pertinent technical document.

ARKANSAS NUCLEAR ONE
UNIT 2

4.2.1.3 Design Evaluation

4.2.1.3.1 Materials Adequacy Throughout Lifetime

Based on evidence currently available, design bases for Optimized ZIRLO™, ZIRLO™, and Zircaloy-4 fuel cladding have been conservatively established and indicate that cladding and UO₂ fuel performance will be satisfactory.

Evidence of materials adequacy through a period of time far in excess of that contemplated for this design is provided by the combined Vallecitos Boiling Water Reactor (VBWR) - Dresden irradiation of assembly SA-1 (Zircaloy-clad uranium dioxide pellets). This assembly operated about 3.5 years in VBWR (Reference 44) and subsequently in excess of five years in Dresden (Reference 112). The nearly nine years of operation resulted in no time related material failures.

Experience at KWO reactor (Kraftwerk Obrigheim) involved nonpressurized fuel rods operating over three full cycles to burnups over 34,000 MWD/MTU average without evidence of life limit failures. Combustion Engineering fuel has operated well, as indicated by primary system iodine values on the order of 10⁻² and 10⁻⁴ microcuries per cc for Palisades (at peak burnup of 6000 MWD/MTU) and Maine Yankee, respectively. These extremely low iodine values substantiate the argument that conservatism in fuel design coupled with attention to manufacturing detail and quality control leads to low incidence of fuel rod defects.

ZIRLO™ cladding has been in widespread domestic use in at least 38 Westinghouse nuclear plants where it has seen service at burnups of 50,000 MWD/MTU and greater (Reference 183). Optimized ZIRLO™ cladding has been used in a number of LTAs programs (Section D of Reference 195) and, due to the material composition similarities of Optimized ZIRLO™ and ZIRLO™, the performance of the Optimized ZIRLO™ cladding is predicted to be at least as good as that of ZIRLO™ cladding.

4.2.1.3.2 Results of Vibration Analyses

Three sources of periodic excitation are recognized in evaluating the ANO-2 fuel assembly susceptibility to vibration damage. These sources are as follows:

- A. Reactor Coolant Pump Blade Passing Frequency: Precritical vibration monitoring on previous Combustion Engineering reactors indicates that peak pressure pulses are expected at the pump blade passing frequency (75 Hz), and a lesser but still pronounced peak at twice this frequency.
- B. Core Support Plate Motion: Experience with earlier Combustion Engineering reactors indicates that random lateral motion of the core support plate is expected to occur with an amplitude of 0.001 to 0.002 inch and a frequency range of between 2 and 10 Hz.
- C. Flow-induced vibration resulting from coolant flow through the fuel assembly.

These sources of periodic motion are not expected to have an adverse effect on the performance of the Arkansas Nuclear One - Unit 2 fuel assembly. This conclusion is based on the fact that the fuel assembly itself has a predicted lateral natural frequency of 1.55 Hz, and the fuel rod, supported between grids, has a calculated frequency of 109 Hz. Both of these frequencies lie well away from the predicted excitation frequencies.

ARKANSAS NUCLEAR ONE
UNIT 2

The NGF fuel assembly design introduced in Batch Z was designed to have a lateral stiffness comparable to the prior designs that have operated successfully in the Arkansas plant. In addition, bounding NGF configurations were tested to confirm the hydraulic stability of the fuel assembly design and to demonstrate the acceptability of the fretting performance of the fuel assembly design. To address fuel assembly vibration concerns, full scale single bundle tests of the NGF and standard designs were run, as well as a full scale dual bundle test with a NGF fuel assembly and a standard fuel assembly. The single bundle tests demonstrated the hydraulic stability of both designs over the expected range of flow rates. The dual bundle test was an endurance test that provided additional confirmation of the hydraulic stability of the designs and showed a significant improvement in the fretting performance of the NGF design compared to the standard design. Therefore, the similarity of the fuel assembly stiffness between the NGF and prior designs, coupled with the results of the flow testing, indicates that the NGF design should be less susceptible to any vibration effects than the prior designs.

The Unit 2 design includes three specific means for eliminating the consequences of CEA vibration. These are the extension of upper guide structure flow channels, the sleeving of all guide tubes in the fuel assemblies and typically, the programmed insertion of CEAs.

Measurements taken following Cycle 1 operation confirmed the effectiveness of this design change in limiting CEA guide tube wear. These measurements are summarized in the report, CEN-164(A)-P, "A Summary of Fuel Status at ANO-2 End of Cycle 1 Including Preliminary Findings," dated May 18, 1981.

Several vibration analyses have been performed on the similar 14x14 fuel assembly containing fuel rods of slightly larger diameter than those of the 16x16 design. These analyses were conducted to determine the effects of flow-induced vibrations on the fuel assembly under normal operating conditions. Natural frequency and amplitude of vibration of a rod were determined and used as input for autoclave testing. The rods were excited at the computed natural frequency to determine the extent of wear resulting from fuel rod-spacer grid interactions. The test showed that wear between the components is acceptable.

The effect of the vibration of the core support barrel on the entire fuel assembly was also examined. The frequency of core barrel excitation was determined and used as an input in dynamic flow tests discussed in Section 4.2.1.3.6. The tests have shown that under normal operating flow conditions and simulated core barrel vibration, there would be no long-term damage to the fuel bundles.

Vibrations within the Reactor Coolant System (RCS) and reactor core are monitored by the Vibration and Loose Parts (V&LP) Monitoring System. This system has vibration and acoustic channels, and consists of piezoelectric sensors, preamplifiers, a signal processor unit, and other peripheral equipment.

The sensors detect vibration from flow-induced or rotating equipment sources, loose parts in the coolant systems, and other signals. The signals from these channels are compared with preset levels to generate alarms when abnormal conditions are detected. Various diagnostic equipment is available to further identify the source of the problem.

To provide optimum effectiveness of the V&LP, the transducers for the reactor primary system are placed on the lower vessel, upper vessel, and steam generators.

ARKANSAS NUCLEAR ONE
UNIT 2

One accelerometer is located on the lower part of the reactor vessel. An accelerometer is located in the upper vessel region to quantitatively monitor the control rod extensions and vessel internals for vibration. Location of this sensor is on the control rod drive extension tube protection shroud. On the steam generators, accelerometers are located on the channel head.

The loose parts, and core internals channels monitor the major reactor primary system components in which an anomaly could occur. The selection provides a qualitative difference indication of vibration throughout the primary loop. The nuclear channels provide reactivity-related indication of vessel internals motion. The core internals signals are obtained from the ex-core power range ion chamber buffer amplifiers.

4.2.1.3.3 Fuel Assembly Stress Analyses

A fuel assembly stress analysis was conducted to evaluate the fuel assembly stress, circumferential strain and fatigue usage factor resulting from normal and anticipated operational occurrences. The design criteria used in the evaluation, and their bases, are specified in Sections 4.2.1.1.1 and 4.2.1.1.2.

The cladding temperatures used in the analyses are listed in Table 4.2-3a, and are the maximum values calculated during normal operation and anticipated operational occurrences. The temperatures are representative of typical peak power locations.

For fuel assembly components other than fuel rods, the maximum stresses for normal conditions are summarized below:

- A. Guide Tubes - the most limiting stress sustained during normal operation is approximately 6,000 psi. The corresponding allowable stress is 10,500 psi.
- B. End Fitting Springs - the maximum stress sustained during normal operation is approximately 98,000 psi (shear). The corresponding allowable shear stress is 110,000 psi. This minimum margin condition is a conservative estimate of cold EOL shutdown conditions.
- C. Spacer Grids - The acceptability of the spacer grid design is verified by test and through prior operating experience with similar grids. No confirmatory stress analysis is performed for this component.

For the components listed above, the only anticipated operational occurrences which impose significant additional loads are seismic excitations and the postulated branch line pipe breaks. The response of the fuel assembly to combined seismic and branch line pipe break loadings has been analyzed and shown to be within the acceptance criteria. The methods of analysis and results for the Arkansas Nuclear One - Unit 2 fuel assembly design are presented in Reference 36.

Due to the introduction of the NGF design in Batch Z, a fuel assembly stress analysis was performed to address the design and material differences from prior batches. The evaluation used the same design criteria as prior batches, as specified in Sections 4.2.1.1.1 and 4.2.1.1.2. Due to the similarity in the structural design and mechanical properties of the components in the NGF assemblies and the prior assemblies, the results of the evaluation were comparable to those of prior analyses and demonstrated that all applicable criteria continue to be satisfied.

ARKANSAS NUCLEAR ONE
UNIT 2

4.2.1.3.4 Potential for Waterlogging Rupture

The potential for waterlogging rupture is considered remote. Basically, the necessary factors, or combination of factors, include the presence of a small opening in the cladding, time to permit filling of the fuel rod with water, and finally, a rapid power transient. The size of the opening necessary to cause a problem falls within a fairly narrow band. Below a certain defect size, it takes a long time to fill a fuel rod with water. Above a certain defect size, the rod can fill rapidly, but during a power increase it also expels water or steam readily without a large pressure buildup. Holes or defects which could result in an opening in cladding are scrupulously checked for during the fuel rod manufacturing process by both ultrasonic and helium leak testing. Clad defects which could develop during reactor operation due to hydriding are also controlled by limiting those factors, e.g., moisture content of fuel pellets, which contribute to hydriding.

The most likely time for a waterlogging rupture incident would occur after an abnormally long shutdown period. After this time, however, the startup rate is controlled so that even if a fuel rod were filled with coolant, it would "bake out", thus minimizing the possibility of additional cladding rupture. The combination of control and inspection during the manufacturing process and the limits on the rate of power change restrict the potential for waterlogging rupture to a very small number of fuel rods.

4.2.1.3.5 Potential for Chemical Reaction

4.2.1.3.5.1 Corrosion

Corrosion tests of Zircaloy-4 fuel rod tubing which were conducted in excess of 4,000 hours exposure include 600 °F and 650 °F autoclave tests and 600 °F loop tests with borated lithium hydroxide additives to the water chemistry. The test results agree with long-term corrosion tests in lithium hydroxide reported by Bettis (WAPD-MRP-108, Pressurized Water Reactor Project Period January 24, 1964 to April 23, 1964). No deleterious effects have occurred. Experience at both Shippingport and Saxton Core I have shown under PWR conditions (hydrogen overpressure and water additives) in reactor behavior with low heat flux was similar to autoclave behavior.

Experience at Saxton Reactor in Cores II and III, however, have shown that with severe nucleate boiling, some accelerated corrosion was encountered. Similar accelerated corrosion with high crud deposits was also reported at KWO, but was terminated by using hydrogen overpressure and water chemical additives. The potential for chemical reaction will be closely monitored by Westinghouse.

Batch X and Y fuel rods were fabricated with ZIRLO™ cladding to improve the corrosion resistance of the fuel. Section 4.5 of Reference 183 presents corrosion data at high burnup for both Zircaloy-4 cladding and ZIRLO™ cladding and concludes that the ZIRLO™ cladding offers a significant improvement in the corrosion resistance of the cladding. The NGF fuel rods were fabricated with Optimized ZIRLO™ cladding that has a slightly reduced tin content compared to ZIRLO™ specifically to improve its corrosion resistance. Autoclave steam testing demonstrated almost a 20% corrosion resistance improvement of Optimized ZIRLO™ compared to ZIRLO™. Reference 197 presents additional cladding corrosion data and provides updated cladding corrosion models for both ZIRLO® and Optimized ZIRLO™ cladding.

ARKANSAS NUCLEAR ONE
UNIT 2

4.2.1.3.5.2 External Hydriding

During operation of the reactor with exposure to high temperature, high pressure water, Zirconium-based cladding will react to form a protective oxide film in accordance with the following equation.

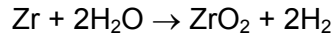

Approximately 20 percent of the hydrogen is absorbed by the Zircaloy. Based on data described in WAPD-MRP-107, the cladding would be expected to contain up to 250 ppm of hydrogen following three years of exposure.

A series of 600 °F burst tests was performed on Zircaloy-4 tubes containing 200 to 250 and 400 ppm of hydrogen precipitated as hydride platelets in various orientations from radial to circumferential. Little difference in burst test ductility was evident. Therefore, hydrogen normally absorbed in Zircaloy-4 tubing will not prove deleterious to the cladding integrity.

The impact of hydrides and hydride reorientation in ZIRLO™ cladding is discussed in Section 4.4.2.5 of Reference 183, where it is concluded that the performance of the ZIRLO™ cladding will be similar to that of the Zircaloy-4 cladding since the hydride reorientation is primarily a function of the tensile stresses and temperatures in the cladding. Due to the similarity of the material composition of Optimized ZIRLO™ and ZIRLO™, the same conclusion applies for Optimized ZIRLO™ cladding. Reference 197 provides updated data and models for ZIRLO® and Optimized ZIRLO™ cladding.

4.2.1.3.5.3 Internal Hydriding

A number of reported fuel rod failures have resulted from excessive moisture available in the fuel. Under operation, this moisture would flash to steam and oxidize the cladding.

The hydrogen, which was not absorbed during normal oxidation, would then be absorbed into the cladding through a scratch in the oxide film. This localized hydrogen absorption by the cladding would shortly result in a localized fuel rod failure. Work performed at the Institute for Atomenergi, Halden, Norway, of which Westinghouse is a member, demonstrated that a threshold value of water moisture is required for hydride sunbursts to occur. Through a series of in-pile experiments, the level of this threshold value was established. Westinghouse's allowable moisture limit in the fuel complies with this requirement, ensuring that hydride sunbursts will not occur.

4.2.1.3.6 Fretting Corrosion

The phenomenon of fretting corrosion particularly in ZIRLO™ or Zircaloy clad fuel rods supported by Zircaloy spacer grids has been extensively investigated. Since irradiation-induced stress relaxation causes a reduction in grid spring load, spacer grids must be designed for EOC conditions as well as BOC conditions to prevent fretting caused by flow-induced tube vibrations. To ensure this, Westinghouse has performed extensive out-of-pile fretting tests, concentrating on the more severe EOC conditions. Two testing approaches have been used, i.e., autoclave vibration tests and dynamic flow tests.

ARKANSAS NUCLEAR ONE
UNIT 2

4.2.1.3.6.1 Autoclave Vibration Tests

The autoclave tests were performed by vibrating a fuel rod sample supported by two rigidly held spacer grid sections. Test conditions matched reactor coolant chemistry, temperature and pressure. Variable parameters provided data to evaluate the effects of:

- A. Time;
- B. Frequency of tube vibration;
- C. Spacer grid spring load (preset); and,
- D. Axial tube movement (simulating reactor load following characteristics).

Data from such tests have indicated wear starts with a brief break-in period and then proceeds at a negligible rate. Changes in frequency, spring preset (including zero preset) and amplitude within representative limits do not significantly alter fretting characteristics. At no time under any conditions was fretting significant.

4.2.1.3.6.2 Dynamic Flow Tests

Dynamic flow tests have been performed on 4x4 rod arrays (16 fuel rods) and on full size fuel assemblies. The 4x4 rod array testing was conducted under the following conditions:

- A. Flow velocities ranged from 14 ft/sec to 25 ft/sec.
- B. Coolant temperature was 590 °F.
- C. Coolant pressure was 2,150 psia.

In addition, the 4 x 4 rod arrays were subjected to cross flow and a mechanically induced forced vibration of the lower end of the rod array at a frequency of 15 Hz and an amplitude of 5 mils (representing vibratory forces imparted by the reactor internals). The 4 x 4 rod array testing also included rod arrays with preset spacer grid springs ranging from approximately 10 mils interference to gaps of up to 5 mils, simulating both tightly held and loose rods. The 4 x 4 rod arrays were tested for intervals from 1,000 hours up to 3,182 hours for a total accumulated test time of 18,000 hours.

The fuel rods in the 4 x 4 assemblies were either of a 0.413-inch diameter on a 0.550-inch pitch or of a 0.440-inch diameter on a 0.580-inch pitch which are representative of a 15 x 15 and 14 x 14 fuel array, respectively. All fuel rods were visually inspected at each spacer grid interface. The depth of wear marks was accurately determined using an optical micrometer. The maximum depth of wear noted for the conditions above was less than 1/2 mil. In a special test where a fuel rod was completely unsupported at its lower end for a distance of 15 inches, a depth of wear of 3 mils was noted after 2,000 hours of flow at 25 ft/sec. This test was not representative of any design condition, but was performed to demonstrate the need for supporting the lower end of the fuel rod. Based on test results of 4 x 4 assemblies which follow the same trend as found in the autoclave vibration test, the maximum expected clad wear at EOL will be less than 3 mils.

ARKANSAS NUCLEAR ONE
UNIT 2

Separate full scale flow tests at or exceeding reactor flow conditions were run with an array of four full size prototypical 15 x 15 fuel assemblies, four full size 14 x 14 fuel assemblies of which two were prototypical and two contained stainless steel fuel rods, and several tests of individual full size 14 x 14 fuel assemblies. The test conditions were as follows:

- A. Flow velocities ranged from 16 ft/sec for 15 x 15 fuel assemblies up to 23.7 ft/sec for some of the 14 x 14 fuel assemblies. In all cases, the flow test velocities exceeded the maximum calculated velocity at operating conditions for fuel assemblies in each particular reactor.
- B. A large number of fuel rods (in some cases all rods within a fuel assembly) were tested with zero preset spacer grid spring loads to conservatively represent EOL spacer grid conditions. A number of fuel rods were also loosely supported at various spacer grid locations, and, in some cases, over the entire length of the rod.
- C. Test time accumulated exceeds 13,500 hours, with the longest single test 4,000 hours in length.

The results of these tests are similar to those of the 4 x 4 fuel assemblies with a few exceptions. On the 14 x 14 fuel assemblies subjected to 4,000 hours of continuous testing at 23.7 ft/sec and 1,000 hours at 19.1 ft/sec., the maximum depth of wear on one assembly was 1.7 mils, while on the other assembly, one wear mark was found to be 2.2 mils deep and a few others ranged from 1.6 to 1.8 mils. The only incidence of significant wear on a full size fuel assembly occurred in special test of the off-design condition where the lower end of the fuel assembly was essentially unrestrained laterally. In this test, the depth of wear of one fuel rod was 10.9 mils after only 1,188 hours of testing at 23.7 ft/sec. Again, this test, as in the case of the cantilevered fuel rod test in a 4 x 4 fuel assembly, showed the need for laterally restraining the lower end of the fuel assembly.

Extrapolation of the test data for design test conditions again indicates that the maximum depth of fuel clad wear at EOL will be less than 3 mils, representing only 12 percent of the cladding wall thickness. Since the 0.440- and 0.413-inch diameter fuel rods did not show any difference in wear characteristics, 0.382-inch diameter fuel rods for 16 x 16 fuel assemblies are also expected to exhibit the same low wear rate.

A hot flow test program has been conducted for the Arkansas Nuclear One - Unit 2 16 x 16 fuel assembly design. A brief description of this test program is presented in Sections 1.5.1 and 4.2.1.2.3. The results of the hot flow testing are presented in Reference 1.

An extensive flow test program was conducted to support the implementation of the NGF design in Batch Z. Bounding NGF configurations were tested to confirm the hydraulic stability of the fuel assembly design and to demonstrate the acceptability of the fretting performance of the fuel assembly design. These tests (discussed in Reference 195, Section 2.3.1.2, Section D, and Enclosure 3 of Section D) included full scale single bundle tests of the NGF and standard designs, a full scale dual bundle test with a NGF fuel assembly and a standard fuel assembly, and a full cross-section/short length bundle test of the NGF design. The single bundle tests were run to evaluate the hydraulic stability of the fuel assemblies. The tests demonstrated the hydraulic stability of both designs over the expected range of flow rates. The dual bundle test was an endurance test to evaluate fretting performance of the two designs. This test provided additional confirmation of the hydraulic stability of the designs and showed a significant improvement in the fretting performance of the NGF design compared to the standard design.

ARKANSAS NUCLEAR ONE
UNIT 2

The short length bundle test was run to confirm the absence of flow-induced strip vibration within the spacer grids, which it did. The successful results of the flow test program demonstrate that the hydraulic performance of the NGF design is acceptable and should be superior to that of the prior designs.

A fatigue analysis of Westinghouse's grid spring has shown that the cyclic stress caused by tube vibration is 30 times lower than the cyclic stress endurance limit based on Goodman diagram calculations. This conservatism is shown in results of all the autoclave fretting tests which act as fatigue tests, where a typical 60-day test induces 2.3×10^8 cycles in the spring.

To further evaluate the fatigue limits in the hydrided condition, a spacer grid section was hydrided, tested at 650 °F for 10^8 cycles, and then tested at room temperature for another 10^8 cycles with no fatigue damage.

The specific criteria for allowable fuel rod stress and strain including cyclic loading are discussed in Sections 4.2.1.1.1 and 4.2.1.1.2. These criteria are applied to analytical predictions, not directly to stress-strain data generated by flow testing.

Fuel assembly stiffness decreases with time due to grid tab relaxation and fretting and is not significantly affected by creep or fatigue. Earlier experiments have shown that about two-thirds of the fuel assembly stiffness is attributed to the fuel assembly frame (no fuel rods). The other one-third of the fuel assembly stiffness is from the fuel rods and fuel rod to spacer grid interaction. Relaxation and wear at the spacer grid locations would result in a reduction in the degree of fuel rod fixity with respect to the assembly, thereby reducing the one-third contribution. However, this contribution would never fall below the case where the fuel rods act completely independently of the fuel assembly structure. In this case, the rods would contribute about one-eighth of the overall stiffness of the assembly. With the exception of two tests, the flow tests described above were performed with fuel assemblies of reduced stiffness to simulate an EOL condition. This was done by presetting the spacer grid spring tabs so as to achieve either zero interference or, in some cases, a clearance between the spring tabs and the fuel rods. There are no stiffness limitations imposed on the spacer grid assembly or on the grid spring.

4.2.1.3.7 Cycling and Fatigue

A fatigue analysis will be performed to determine the cumulative fatigue damage of fuel rods exposed to lifetime power cycling conditions. The fatigue cycle will be determined by considering combinations of normally anticipated events that would produce conservative estimates of strain in the clad. Some of the major conservative assumptions will be as follows:

- A. Hot spot fuel radii will be used in the calculations.
- B. The most adverse tolerance conditions on the fuel and cladding dimensions will be chosen to produce maximum interactions and hence maximum clad strains.
- C. Primary creep rate data for the clad will be used in the calculation of both tensile and compressive strains.

ARKANSAS NUCLEAR ONE
UNIT 2

The chosen fatigue cycle represents daily operation at both full and reduced power. Clad strains will be calculated from the primary creep rate of the clad and used to calculate the effective strain ranges. The cumulative fatigue damage fraction will be determined by summing the ratios of the number of cycles at a given effective strain range to the permitted number at that range as taken from the fatigue curve presented in Figure 4.2-2.

4.2.1.3.8 Dimensional Stability

4.2.1.3.8.1 Dimensional Stability of Zircaloy

Zircaloy components are designed to allow for dimensional changes resulting from irradiation-induced growth. Combustion Engineering has performed extensive analyses of in-pile growth data to formulate a comprehensive model of in-pile growth.

The Zircaloy growth phenomenon has been examined both in the case of fuel cladding and for the case of non-fueled Zircaloy components. Combustion Engineering's Zircaloy irradiation growth model is based on post-irradiation measurements on experimental and production fuel (including Combustion Engineering's Palisades and Maine Yankee reactors, Obrigheim (KWO) and on non-fueled Zircaloy cladding data (References 32, 39, 65, 71, 82, 97, 100, 101, 103 and 113).

The data shown in Figures 4.2-8a and 4.2-8b for cold worked, stress relief annealed and for annealed materials respectively obey the following empirical relationship:

$$\epsilon = (\quad * \quad) (*\text{See Proprietary Reference 25 for growth strain equation})$$

where

ϵ = growth strain (in/in)

ϕt = fast neutron fluence (E > 0.8 Mev)

The upper and lower 95-95 confidence limits are also shown on the figures. Note that the annealed data fall generally between the best estimate and lower 95-95 confidence limit (applicable to annealed guide tubes and spacer grids).

For design calculations of the maximum and minimum irradiation-induced growth of fuel rods, guide tubes and grids, including relative growth, the specific correlations are shown in the following figures from Reference 40.

Fuel Rods:	Figure 3-1
Standard Guide Tubes:	Figure 3-3
High Strength Guide Tubes:	Figure 3-2
Spacer Grids:	Figure 3-3

It will be noted that these figures show both "best fit" and upper and lower 95 percent tolerance limit correlations. It is Combustion Engineering's practice to base design calculations on correlations which are either conservatively above or conservatively below the best fit correlations, depending on which has the more severe effect on the aspect being evaluated.

ARKANSAS NUCLEAR ONE
UNIT 2

4.2.1.3.8.2 Dimensional Stability of ZIRLO™

Fuel rod axial growth is one of the parameters included in the mechanical design methodology to assess irradiation-induced dimensional changes of the fuel. It is well established that fuel rods exhibit axial elongation when irradiated in a neutron flux.

Although fuel rod growth with ZIRLO™ cladding has been observed to be less than that of Zircaloy-4 fuel rod growth. The ZIRLO™ fuel rod growth correlation conservatively ignores this reduced growth for shoulder gap evaluations. The functional form of the fuel rod growth model is given by:

$$\varepsilon = (*) (*\text{See Reference 183, Section 5.3.2, for growth strain equation and constants})$$

where:

ε = growth strain (in/in)

ϕt = fast neutron fluence (E > 1.0 Mev)

Guide tube axial growth is another parameter included in the mechanical design methodology to assess irradiation-induced dimensional changes of the fuel. As with fuel rods, it is well established that guide tubes exhibit axial elongation when irradiated in a neutron flux.

The method for predicting axial growth of the SRA ZIRLO™ guide tubes is specified in Section 2.3.1.1 of Reference 195. This technique involves applying an adjustment factor to predictions made for SRA Zircaloy-4 guide tubes using the SIGREEP code (Reference 176), thereby making the growth predictions dependent on the guide tube stresses during operation.

4.2.1.3.8.3 Dimensional Stability of Optimized ZIRLO™

Section 2.5.8 of Reference 195 identifies the fuel rod growth correlation to be used in irradiation-induced dimensional change evaluations of NGF rods with Optimized ZIRLO™ cladding as the Westinghouse model from Reference 194. The functional form of that growth model is specified in Reference 183 as:

$$\varepsilon = (*) (*\text{See Reference 183, Section 4.3.2, for growth strain equation and constants})$$

where:

ε = growth strain (in/in)

ϕt = fast neutron fluence (E > 1.0 MeV)

4.2.1.3.9 Fuel Burnup Experience

Design bases for the ZIRLO™ and Zircaloy-4 cladding have been established which are conservative with respect to the reported data. Evidence currently available indicates that Optimized ZIRLO™, ZIRLO™, and Zircaloy and UO₂ fuel performance is satisfactory to exposures in excess of 60,000 MWD/MTU.

The effect on fuel mechanical performance when ZIRLO™ cladding is substituted for Zircaloy-4 cladding in fuel rods has been thoroughly evaluated in Reference 183, Section 5.4. Evaluation of the change examined the mechanical performances in areas of creep collapse, stress, strain, fatigue damage, shoulder gap margin, rod bow, cladding wear/fretting, assembly bow, spacer

ARKANSAS NUCLEAR ONE
UNIT 2

grid growth and spring tab relaxation effects, hold down margin, spent fuel handling accident, and seismic and LOCA loads and have shown that the use of ZIRLO™ would result in fuel assembly designs that are fully capable of meeting their current design criteria. Similarly, an evaluation of the effect on fuel mechanical performance when Optimized ZIRLO™ cladding is substituted for ZIRLO™ cladding (Reference 194), along with the effect of the design changes associated with the NGF design (Reference 195), has shown that the NGF design with Optimized ZIRLO™ cladding are fully capable of meeting their design criteria.

A. High Linear Heat Rating Irradiation Experience

The determination of the effect of linear heat rating and fuel cladding gap on the performance of Zircaloy-clad UO₂ fuel rods was the object of two experimental capsule irradiation programs conducted in the Westinghouse Test Reactor (WTR) (Reference 24). In the first program, 18 rods containing 94 percent theoretical density UO₂ pellets were irradiated at 11, 16, 18 and 24 kW/ft with cold diametral gaps of 0.006 inch, 0.012 inch and 0.025 inch. The wall thickness to diameter ratio (t/OD) of the Zircaloy cladding was 0.064 which is comparable to the 0.066 value in this design. Although these irradiations were of short duration (about 40 hours), significant results applicable to this design were obtained. No significant dimensional changes were found in any of the fuel rods. Only one rod, which operated at a linear heat rate of 24 kW/ft with an initial diametral gap of 0.025 inch, experienced center melting. Rods which operated at 24 kW/ft with cold gaps of 0.006 inch and 0.012 inch did not exhibit center melting. On these bases, the initial gap of 0.007 inch and the maximum linear heat ratings for this design provide adequate margin against center melting, even when 112 percent overpower conditions are considered. These results also indicate that an initial diametral gap of 0.007 inch is adequate to accommodate radial thermal expansion without inducing cladding dimensional changes even at a linear heat rate of 24 kW/ft. This margin with respect to thermal expansion will be diminished with increasing burnup at a rate of 0.16 percent $\Delta V/V$ per 10^{20} fissions/cm³. However, the linear heat rating will decrease with burnup and thus limit the sum of the strains to values below the allowable.

Further substantiation of the capability of operation at maximum linear heat ratings in excess of those in this design is obtained from later irradiation tests in WTR (Reference 24). Thirty-eight-inch long and 6-inch long fuel rods were irradiated at linear heat ratings of 19 kW/ft and 22.2 kW/ft to burnups of 3,450 and 6,250 MWD/MTU. The cold diametral gaps in these Zircaloy clad rods containing 94 percent dense UO₂ were 0.002 inch, 0.006 inch and 0.012 inch. The cladding t/OD was 0.064. No measurable diameter changes were noted for the 0.006 inch or 0.012 inch fuel clad gap rods. Only small changes were observed for the rods with a 0.002-inch diametral gap.

B. Shippingport Irradiation Experience

Zircaloy clad fuel rods have operated successfully (three defects have been observed which were a result of fabrication defects) in the Shippingport blanket with burnups of about 37,000 MWD/MTU and maximum linear heat ratings of about 13 kW/ft (Reference 24, 29, 144). Although higher linear heat ratings will be experienced, swelling (primarily burnup dependent) and thermal expansion (linear heat rating dependent) provide the primary forces for fuel cladding strain at the damage limit. Thus, the Shippingport irradiations have demonstrated that Zircaloy clad rods with a

ARKANSAS NUCLEAR ONE
UNIT 2

cladding t/OD less than that for this plant (0.066) can successfully contain the swelling associated with 37,000 MWD/MTU burnup while at the same time containing the radial thermal expansion associated with peak heat ratings. Irradiation test programs in support of Shippingport in in-reactor loops demonstrated successful operation at burnups of 40,000 MWD/MTU and linear heat ratings of about 11 kW/ft with cladding t/OD ratios as low as 0.053 (Reference 42).

C. Saxton Irradiation Experience

Zircaloy-4 clad fuel rods containing UO₂-PuO₂ pellets of 94 percent theoretical density have been successfully irradiated in Saxton to peak burnups of 31,800 MWD/MTU at 16 kW/ft linear heat rate under USAEC Contract AT (30-1)-3385 (Reference 116). The t/OD of the cladding was 0.059 which is less than that of this design. The amount of PuO₂, 6.6 percent, is considered as insignificant with respect to providing any difference in performance when compared with that for UO₂. Subsequent tests on two of the above rods (18,000 MWD/MTU at 10.5 kW/ft) successfully demonstrated the capability of these rods to undergo power transients from 16.8 kW/ft to 18.7 kW/ft.

D. Vallecitos Boiling Water Reactor (VBWR) - Dresden Experience

The combined VBWR - Dresden irradiation of Zircaloy clad oxide pellets provides additional confidence with respect to the design conditions for the fuel rods for this core (References 44, 110, 111). Ninety-eight rods which had been irradiated in VBWR to an average burnup of about 10,700 MWD/MTU were assembled in fuel bundles and irradiated in Dresden to a peak burnup greater than 48,000 MWD/MTU. The reported maximum heat ratings for these rods is 17.3 kW/ft which occurred in VBWR. The t/OD cladding ratio of 0.052, and the external pressure of about 1,000 psi are conditions which are all in the direction of less conservatism with respect to fuel rod integrity when compared with the design values of 0.066 cladding t/OD ratio and an external pressure of 2,250 psi. Ten of these VBWR - Dresden rods representing maximum combinations of burnup, linear heat rating and pellet density have been examined in detail and found to be in satisfactory condition. The remaining 88 rods were returned to Dresden and successfully irradiated to the termination of the program.

E. Large Seed Blanket Reactor (LSBR) Rods Experience

Two rods operated in the B-4 loop at the Materials Testing Reactor (MTR) provide a very interesting simulation for current PWR designs (References 47, 70 and 74). Both rods were comprised of 95 percent theoretical density pellets with dished ends, clad in Zircaloy. The first of these, No. 79-21, was operated successfully to a burnup of 12.41×10^{20} f/cc (~ 48,000 MWD/MTU) through several power cycles which included linear heat rates from 5.6 to 13.6 kW/ft. The second fuel pin, No. 79-25, operated successfully to 15.26×10^{20} f/cc (~ 60,000 MWD/MTU). The basic difference in this rod was the 0.028-inch wall thickness, as compared to 0.016-inch (t/OD = 0.058) in the first rod. All other parameters were essentially identical.

The linear heat rating ranged from 7.1 to 16.0 kW/ft. After the seventh interim examination, the rod operated at a peak linear power of 12.9 kW/ft at a time when the peak burnup was 49,500 MWD/MTU. These high burnups were achieved with fuel elements which were assembled by shrinking the cladding onto the fuel and indicate

ARKANSAS NUCLEAR ONE
UNIT 2

that a comparable irradiation of the fuel elements for this reactor (cold diametral gap of 0.007-inch) would allow a considerable increase in swelling life at a given clad strain.

F. Central Melting in Big Rock Point Experience

As part of a Joint U.S. - Euratom Research and Development Program, Zircaloy-clad UO₂ pellet rods (95 percent theoretical density) were irradiated under conditions designed to induce central melting in the Consumers Power Co. Big Rock Point Reactor (Reference 48). The test includes 0.7-inch diameter fuel rods (cladding t/OD = 0.057; fuel clad gap of about 0.012 inch) at maximum linear heat ratings of about 27 kW/ft and 22 kW/ft with peak burnups up to 30,000 MWD/MTU. Results of these irradiations provide a basis for incorporating linear heat ratings well in excess of those calculated for this reactor, and show that the presence of localized regions of fuel melting is not catastrophic to the fuel rod.

G. KWU Irradiations - KWU Reactor, Obrigheim, Germany

In the area of nuclear fuel performance, the experience at Obrigheim has shown successful operation through three operating cycles. Fuel batches of 95 percent T.D., both pressurized and nonpressurized, have been irradiated. Substantial testing has been performed in the reactor on the load following ability of both pressurized and nonpressurized fuel rods. Selected rods were subjected to power changes from 50 to 100 percent at rates of 20 percent per minute for more than 900 cycles. Peak power densities in the rods were 15 kW/ft with maximum burnups in excess of 30,000 MWD/MTU. No failures have been observed to date. This experiment demonstrates the load-following capability of a design similar to Combustion Engineering's in an operating PWR.

H. High Burnup Combustion Engineering Operational Experience

Reference 176 presents fuel performance data obtained during poolside examinations and hot cell examinations of high burnup fuel utilizing Zircaloy-4 cladding in Combustion Engineering cores. The data demonstrates the acceptability of the fuel's performance to rod average exposures in excess of 60,000 MWD/MTU.

I. Westinghouse Experience Database:

ZIRLO™ cladding material is in widespread use domestically in at least 38 nuclear power plants (Reference 183, Section 3.3). ZIRLO™ has been shown to have improved corrosion resistance compared to Zircaloy-4. Also, no oxide spalling has been observed in current ZIRLO™ fuel rods for normal operation. With over 1 million ZIRLO™ fuel rods in assemblies with Optimized Fuel Assembly type spacer grids, no incidences of leakers due to grid-to-rod fretting has been observed.

Optimized ZIRLO™ cladding has a slightly lower allowed tin level than ZIRLO™ (lower by 0.2%) with the remainder of the material composition requirements being the same. The reduced tin level is to further enhance the corrosion resistance of the cladding. Reference 194 documents that ZIRLO™ material properties currently utilized in various models and methodologies are applicable to analyses for Optimized ZIRLO™ and shows the differences are negligible with no impact on any design or safety analyses. Reference 197 presents additional cladding corrosion data and provides updated

ARKANSAS NUCLEAR ONE
UNIT 2

cladding corrosion models for both ZIRLO® and Optimized ZIRLO™ cladding. Therefore, in addition to the operational experience of Optimized ZIRLO™, the ZIRLO™ operational experience discussed above is applicable to Optimized ZIRLO™.

4.2.1.3.10 Long-Term Irradiation Testing

Combustion Engineering Fuel Development Programs:

Since mid-1972, Combustion Engineering has performed an extensive irradiation test program on fuel densification. When fuel densification became apparent, Combustion Engineering immediately initiated an irradiation test program to determine the causes of densification and to define the specifications and processes required to limit densification of fuel. The first irradiation test program in the sequence confirmed that the phenomenon is real and defined the parameters important in the effect. An immediate response was a change in the Combustion Engineering fuel pellet specification and a modification of the fuel fabrication process to provide densification resistant UO₂ fuel. The irradiation tests were continued to confirm that the changes to the Combustion Engineering fuel pellet specification and fabrication process would result in densification resistant fuel. Results were reported in Reference 17. The summaries of the data and conclusions from Reference 17 were incorporated in Reference 10 which has received NRC approval.

Combustion Engineering is also a participating member of the Halden Reactor Project in Halden, Norway. The Halden project has underway a spectrum of fuel development programs from which Combustion Engineering can further verify present fuel design models and continually evaluate advance fuel design concepts.

Combustion Engineering/Kraftwerk Union Fuel Development Programs:

The primary objectives of the cooperative fuel development program were:

- A. To assess the causes of fuel densification and provide process changes which will preclude densification. Then subsequently to verify through irradiation testing that the process changes have been effective;
- B. To obtain long-term data to further verify fuel performance models;
- C. To evaluate advanced fuel design concepts in reactor.

Combustion Engineering and Kraftwerk Union participated in densification test programs in both U.S. and European test reactors. In addition, Combustion Engineering and Kraftwerk Union participated in the densification test program under the primary sponsorship of the Edison Electric Institute.

Kraftwerk Union Fuel Development Programs:

The design of the Combustion Engineering fuel rods is very similar to the KWU fuel utilized in the Obrigheim Reactor. The Obrigheim core has operated with peak power densities up to 15 kW/ft with maximum burnups in excess of 35,000 MWD/MTU without observed life limiting failures. Several fuel rods, both pressurized and unpressurized, from the Obrigheim Reactor have undergone detailed hot cell examination under the direction of KWU. The results of all nondestructive fuel examinations performed during shutdowns and the complete results of the hot cell program were available to Combustion Engineering under a technical agreement with KWU.

ARKANSAS NUCLEAR ONE
UNIT 2

In addition to the programs to routinely examine high burnup standard fuel, KWU also had comprehensive fuel development programs underway which utilize special test assemblies in the Obrigheim Reactor. Under this program, fuel rod design parameters were varied over significant ranges to experimentally establish the basis for further design optimization. Included in special assemblies were segmented rods or "rodlets" which were connected to form a complete fuel rod.

These rodlets were pre-irradiated in the Obrigheim Reactor and then subsequently separated and irradiated in a test reactor. The test reactor irradiations evaluated fuel rod performance under transient conditions.

In summary, Westinghouse has in process or in the planning stages fuel development programs that will provide additional assurance of fuel design adequacy.

4.2.1.3.11 CEA Guide Tube Evaluation

The CEA guide tubes have been evaluated for structural adequacy using the criteria given in Section 4.2.1.1.1 in the following areas.

- A. Steady axial load due to the combined effects of axial hydraulic forces and upper end fitting hold-down forces - For normal operating conditions, the resultant guide tube stress levels are less than 50 percent of the 2/3 yield stress criterion.
- B. Short-term axial load due to the impact of the spring loaded CEA spider against the top of the fuel assembly at the end of a CEA scram - For scrams occurring during normal power operation, solid impact is not predicted to occur due to the kinetic energy of the CEA being dissipated in the hydraulic buffer and by the CEA springs.
- C. Short-term differential pressure load occurring in the hydraulic buffer regions of the outer guide tubes at the end of each scram stroke - The buffer region slows the CEA during the last few inches of the scram stroke. The resultant differential pressure across the guide tube in this region is predicted to be 300 psi, and this gives rise to circumferential stresses of 3,300 psi, which is less than one-quarter of the yield stress, for a very short-term. The scram is assumed to be repeated daily. However, the resultant stress is too small to have a significant effect on fatigue usage.

For conditions other than normal operation, the additional mechanical loads imposed on the fuel assembly by an Operating Basis Earthquake (OBE), Design Basis Earthquake (DBE) and branch line pipe break (BLPB) and their resultant effect on the control rod guide tubes are discussed in the following paragraphs:

- A. OBE: During the postulated OBE, the fuel assembly is subjected to lateral and axial accelerations which, in turn, cause the fuel assembly to deflect from its normal shape. The magnitude of the lateral deflections is evaluated for acceptability. The fuel assembly is designed to be capable of withstanding the axial loads without buckling and without sustaining excessive stresses.
- B. DBE: The axial and lateral loads and deformation sustained by the fuel assembly during a postulated DBE have the same origin as those discussed above for the OBE, but they arise from initial ground accelerations twice those assumed for OBE.

ARKANSAS NUCLEAR ONE
UNIT 2

- C. BLPB: In the event of a BLPB, there will occur rapid changes in pressure and flow within the reactor vessel. Associated with the transient are relatively large axial and lateral loads on the fuel assemblies. The response of a fuel assembly to the mechanical loads produced by a BLPB is considered acceptable if the fuel rods are maintained in a coolable array, i.e., acceptably low grid crushing.

The methods and results of the combined DBE/BLPB analysis for the Arkansas Nuclear One - Unit 2 16 x 16 fuel assembly design are presented in Reference 36. Implementation of leak-before-break, which resulted in lower LOCA loads, was based on SAR Section 3.12, Reference 79.

CEA guide tube evaluations were performed for the Batch Z NGF design. Due to the similarity in the structural design of the NGF assemblies of Batch Z and beyond versus the prior assemblies, the results were comparable to prior analyses and all applicable criteria continue to be satisfied.

4.2.1.3.12 Fuel Rod Plenum Design

The fuel rod upper end plenum is required to serve the following functions:

- A. Provide space for axial thermal expansion and burnup swelling of the pellet column.
- B. Contain the pellet column holddown spring.
- C. Act as a plenum region to ensure an acceptable range of fuel rod internal pressures.

Of these functions, item "C" is expected to be the most limiting constraint on plenum length selection, since the range of temperatures in the fuel rod, together with the effects of swelling, thermal expansion, and fission gas release, and including the helium release in the ZrB₂ IFBA fuel rods, can produce a wide range of internal pressure during the life of the fuel. The fuel rod plenum pressure will be consistent with the pressurization and clad collapse criteria specified in Sections 4.2.1.1.4 and 4.2.1.1.2, respectively.

The procedure used to size the fuel rod plenum is outlined below:

- A. A parametric study of the effects of plenum length on maximum and minimum rod internal pressure is performed. Because the criteria pertaining to maximum and minimum rod internal pressure differ, the study is divided into two sections:
 - 1. Maximum internal pressure calculation - Maximum rod pressure is limited by the stress criteria. Maximum EOL pressure is determined for each plenum length by including the fission gas released, selecting conservative values for components dimensions and properties, and accounting for burnup effects on component dimensions. The primary cladding stress produced by each maximum pressure is then compared to the stress limits to find the margin available with each plenum length.
 - 2. Minimum internal pressure/collapse calculation - Minimum rod pressure is limited by the criterion that no rod will be subject to collapse during the design lifetime. The minimum pressure history for each plenum length is determined by neglecting

ARKANSAS NUCLEAR ONE
UNIT 2

fission gas release, selecting the worst combination of component dimensions and properties, and accounting for dimension changes during irradiation. Each minimum pressure history is input to the Combustion Engineering cladding collapse model (Reference 12) to establish the acceptability of the associated plenum length. With the introduction of IFBA rods in Batch X, credit may be taken for the radial support provided to the cladding in the end plenum region by the plenum spring.

- B. For each plenum length, there is a resultant range of acceptable initial fill pressures. The optimum plenum length is generally considered to be the shortest which satisfies all criteria related to maximum and minimum rod internal pressure including a range sufficient to accommodate a reasonable manufacturing tolerance on initial fill pressure.

Additional information on those factors which have a bearing on determination of the plenum length are discussed below:

- A. Creep and dimensional stability of the fuel rod assembly influence the fission gas release model and internal pressure calculations, and are accounted for in the procedure of sizing the fuel rod plenum length. Creep in the cladding is accounted for in a change in clad inside diameter, which in turn influences the fuel/clad gap. The gap change varies the gap conductance in the FATES computer code (Reference 10) with resulting change in annulus temperature, internal pressure, and fission gas release. In addition, the change in clad inside diameter causes a change in the internal volume, with its resulting effect on temperature and pressure. Dimensional stability considerations affect the internal volume of the fuel rod, causing changes in internal pressure and temperature. Fuel pellet densification reduces the stack height and pellet diameter. Irradiation-induced radial and axial swelling of the fuel pellets decreases the internal volume within the fuel rod. In-pile growth of the fuel rod cladding contributes to the internal volume. Axial and radial elastic deformation calculations for the cladding are based on the differential pressure the cladding is exposed to, resulting in internal volume changes. Thermal relocation, as well as differential thermal expansion of the fuel rod materials, also affect the internal volume of the fuel rods.
- B. The maximum expected fission gas release in the peak power rod is calculated using the FATES computer code. Rod power history input to the code is consistent with the design limit peak linear heat rate and therefore the gas release used to size the plenum represents an upper limit. Because of time-varying gap conductance, fuel depletion, and expected fuel management, the release rate varies as a function of burnup.

4.2.1.3.13 Fuel Rod Pressurization

Fuel rods are initially pressurized with helium (without evacuating air present prior to pressurization) for two reasons:

- A. To preclude clad collapse during the design life of the fuel. The internal pressurization, by reducing stresses from differential pressure, extends the time required to produce creep collapse beyond the required service life of the fuel.
- B. To improve thermal conductivity of the pellet to clad gap within the fuel rod. Helium has a higher coefficient of conductivity than the gaseous fission products.

ARKANSAS NUCLEAR ONE
UNIT 2

In unpressurized fuel, the initially good helium conductivity is eventually degraded through the addition of the fission product gases released from the pellets. The initial helium pressurization results in a higher helium to fission products ratio over the design life of the fuel with a corresponding increase in the gap conductivity and heat transfer.

The initial helium fill pressure is set at [*], resulting in EOL maximum pressure less than the critical pressure for no clad lift off. The power history used in the determination of the [*] initial fill pressure represents conservative power levels during normal operations. The procedure for calculating the internal pressure of the fuel rods, as well as the initial fill pressure is described in Section 4.2.1.3.12.

Introduction of the ZrB₂ IFBA design has influence fuel rod pressurization as discussed in the topical report, Reference 185. During irradiation, the B-10 isotope absorbs a neutron and fissions into helium and lithium. Much of the helium may be released from the thin coating into the fuel rod void by the time complete burnout is attained. This added helium contributes to the rod internal pressure at end of life. Consequently, the fuel rod is pre-pressurized at a lower helium fill pressure to avoid an unacceptable maximum end of life pressure. The released helium compensates for the reduction in helium fill gas and mitigates the impact of less helium fill gas on the thermal heat transfer from the fuel pellets to the cladding and into the coolant. Thus, the IFBA coating and corresponding helium release has no significant impact on the heat transfer characteristic of the fuel rod after B-10 burnout is complete.

*Proprietary Information

4.2.1.4 Testing and Inspection Plan

Fuel bundle assembly quality assurance is attained by adherence to the ANS Quality Assurance Program Requirements for Nuclear Power Plants, ANSI N45.2-1971. Vendor product certifications, process surveillance, inspections, tests and material check analyses are performed to ensure conformity of all fuel assembly components to the design requirements from material procurement through receiving inspection at the plant site. The following are basic quality assurance measures which are performed in addition to dimensional inspections and material verifications.

4.2.1.4.1 Fuel Pellets

During the conversion of UF₆ to ceramic grade uranium dioxide powder, the UO₂ powder is divided into lots blended to form uniform isotopic, chemical and physical characteristics. Two containers are selected from the total number of containers in each lot for certification sampling. Samples are removed from each of the two selected containers and subdivided to verify specification limits (see Section 4.2.1.2.4.10).

Pellets are divided into lots during fabrication with all pellets within the lot being processed under the same conditions. Representative samples are obtained from each lot for product acceptance tests. Total absorbed and adsorbed gas content and moisture content of finished ground pellets is restricted (Section 4.2.1.2.4.10). The pellets' diameters are 100 percent inspected. Pellets for Batch U and subsequent batches are inspected with a sampling plan that has a 95/99 (95% confidence that at least 99% of the pellets meet diameter) requirement. All other pellet dimensions meet a 90/90 confidence level. Density requirements of the sintered pellet (Section 4.2.1.2.4.10) must meet a 95/95 confidence level. A minimum of 10 pellets from

ARKANSAS NUCLEAR ONE
UNIT 2

each pellet lot is subjected to a duplicate sintering cycle, limiting the resultant average measured increase in density. Longitudinal sections of two sample pellets from each pellet lot are prepared for metallographic examination to ensure conformance to microstructure requirements (See Section 4.2.1.2.4.10). Surface finish of ground pellets is restricted to 63 micro-inches or less arithmetic average when measured in accordance with ASA Specification B46.1-1962; and shall meet a 90/90 confidence limit, with a minimum of one determination per pellet lot. Pellet surfaces are inspected for chips, cracks, and fissures in accordance with approved standards.

Beginning with Batch X, a ZrB₂ IFBA fuel design is introduced. ZrB₂ is applied as a very thin uniform coating on the outer surface of the UO₂ pellet stack prior to loading into the fuel rod cladding tube. The ZrB₂ IFBA coating is applied over the center of the UO₂ pellet stack length and does not extend to either end of the fuel rod. Pellets at the ends of the pellet stack are of an annular design. Helium is released from the thin IFBA coating during burnup which contributes to the rod internal pressure at end of life. The annular pellets provide additional void volume to help control the rod pressure.

4.2.1.4.2 Fuel Cladding

Lots are formed from tubing produced from the same ingot, annealed in the same final vacuum annealing charge, and fabricated using the same procedures. Samples randomly selected from each lot of finished tubing are chemically analyzed to ensure conformance to specified chemical requirements, and to verify mechanical properties, hydride orientation and other tests. Each finished tube is ultrasonically tested over its entire length for defects; visually inspected for cleanliness and the absence of acid stains, surface defects, and deformation; and inspected for dimension and drawing requirements. The following summarizes the test requirements.

Test (Reference Section 4.2.1.2.4.1)

- A. Chemical Analysis - Ingot analysis is required for top, middle and bottom of each ingot.
- B. Tensile Test at Room Temperature (ASTM E8)
- C. Corrosion Resistance Test (ASTM G2)
- D. Hydride Orientation (ASTM B811)
- E. Surface Roughness
- F. Visual Examination
- G. Ultrasonic Test
- H. Dimensions
- I. Contractile Strain Ratio test for ZIRLO™ replaces burst test

4.2.1.4.3 Fuel Rod

The moisture content of fuel pellets prior to loading is limited. Loading and handling of pellets is carefully controlled to minimize chipping of pellets.

ARKANSAS NUCLEAR ONE
UNIT 2

Immediately prior to loading, pellets must be capable of passing approved visual standards. Each fuel pellet stack is weighed to within 0.1 percent accuracy. The loading process is such that cleanliness and dryness of all internal fuel rod components are maintained until after the final end cap weld is completed. Loaded fuel rods are evacuated and back filled with helium to a prescribed level as determined for the fuel batch. Fuel rods for Batch U and subsequent batches are no longer evacuated prior to being backfilled with helium. Impurity content of the fill gas shall not exceed 0.1 percent, including moisture. End cap welds are visually inspected and helium leak tested. Quality of the end cap welds is ensured by evaluating sections cut from weld samples. A quality control plan ensures a minimum weld bond of 85 percent of the measured tube wall thickness and absence of any continuous defect greater than 10 percent of the wall thickness. All finished fuel rods are scanned to ensure a continuous pellet stack, and visually inspected to ensure a proper surface finish (scratches greater than 0.001 inch in depth, cracks, slivers, and other similar defects are not acceptable). The fuel rods must be capable of passing a corrosion test (ASTM G2-67) with no preferential oxidation at the weld in water at 650 °F, 2,200 psi for 3 1/2 days. Each fuel rod is marked to provide a means of identification.

The following procedure is used during fabrication to assure that there are no axial gaps in fuel rods:

A. Plug Gauge

Following loading of the fuel pellets into the fuel rod, a plug gauge is used to verify the stack length is within the required tolerance.

B. Rod Scanner

Finished fuel rods are run through a gamma scanner prior to being loaded into bundles. The gamma scanner is qualified to detect gaps in the pellet stack and to provide an accurate measurement of the plenum length. The fuel rod is assumed to be within tolerances if no gaps are detected and the plenum length is correct.

4.2.1.4.4 Spacer Grids, Guide Tubes

The chemical composition and sampling for testing for all Zircaloy-4 strip conforms to the chemical analysis required by Grade RA-2 under Table I of ASTM B352. Similar sampling is done for all Optimized ZIRLO™ strip. Each lot consists of material of the same size, shape, condition and finish, from the same ingot, and annealed in the same vacuum charge.

The chemical composition and sampling for testing of Inconel-625 strips is specified by ASTM B443.

Welds joining intersections (both Zircaloy grids and Optimized ZIRLO™ grids) and welds joining the Zircaloy grids to the CEA guide tubes are inspected to approved standards. The quality of the grid materials and welds shall be such that they are capable of passing a corrosion test, also in accordance with an approved standard.

Guide tube material is in accordance with ASTM B353 (with additional requirements) and is visually inspected for surface defects and acid stains and ultrasonically inspected for internal defects.

ARKANSAS NUCLEAR ONE
UNIT 2

4.2.1.4.5 Upper and Lower End Fittings

The flow plate, holddown plate and lower end fitting castings are in accordance with ASTM A744 or Westinghouse specification MACASS01 and are examined after machining for casting defects. All castings must be capable of meeting reference radiographic standards of ASTM E192 to specified severity levels.

Holddown spring material is specified by AMS 5699; and any evidence of cracks is cause for rejection.

Upper end fitting posts are in accordance with ASTM A269 or A276 and are ultrasonically inspected to ensure absence of internal defects.

4.2.1.4.6 Fuel Assembly

The welded joints used in the Arkansas Nuclear One - Unit 2 fuel assembly design are listed below in a series of paragraphs which describe the type and function of each weld, and including a brief description of the testing (both destructive and nondestructive) performed to ensure the structural integrity of the joints. The welds are listed from top to bottom in the fuel assembly.

The fuel rod upper end cap to fuel rod cladding tube weld will be a butt weld between the Zircaloy-4 cladding tube and the Zircaloy-4 end cap machined from bar stock. The weld process will be Magnetic Force Welding (MFW). Batch U and subsequent batches will utilize a Tungsten Inert Gas (TIG) weld, accomplished using a friction fit of the cladding on a reduced diameter pedestal section of the end cap. Beginning with Batch X, the ZIRLO[®] cladding tube and the Zircaloy-4 end caps are TIG welded. Similarly, beginning with Batch Z, the Optimized ZIRLO[™] cladding tube and the Zircaloy-4 end caps are TIG welded. Quality assurance on the end cap weld will be as follows:

- A. Destructive examination of a sufficient number of weld samples to establish that the allowable percent of unbonded wall thickness and the maximum allowable continuous unbonded region are satisfied.
- B. Visual examination of all end cap welds to establish freedom from cracks, seams, inclusions, and foreign particles after final machining of the weld region.
- C. Helium leak checking of all end cap welds to establish that no leak rate greater than 10^{-8} cc/sec. is present.
- D. Corrosion testing of a sufficient number of samples to establish that weld zones do not exhibit excessive corrosion compared to a visual standard.

The CEA guide tube joints (between the tube and the threaded upper and lower ends) will be butt welds between the two Zircaloy subcomponents. The welds are required to be full penetration welds and must not cause violation of dimensional or corrosion resistance standards.

ARKANSAS NUCLEAR ONE
UNIT 2

The upper end fitting center guide post to lower cast flow plate joint has a threaded connection which is prevented from unthreading by tack welding the center guide post to the bottom of the lower cast plate using the Gas Tungsten Arc (GTA) process. Each weld is inspected for compliance with a visual standard.

The spacer grid welds at the intersection of perpendicular Zircaloy-4 grid strips are made by the GTA process. Each intersection is welded top and bottom, and each weld is visually inspected by comparison with a visual standard.

For the spacer welds at intersections between inner strips and perimeter strip (both components Zircaloy-4), each inner strip is welded to the perimeter strip using the GTA processor, starting in Cycle 11, the laser welding process. Each weld is inspected by comparison to a visual standard.

For the spacer grid to CEA guide tube weld (both components Zircaloy-4), each grid is welded to each guide tube with eight small welds, evenly divided between the upper and lower faces of the grid. Each weld is required to be free of cracks and burn-through and each weld is inspected by comparison to a visual standard. Also, sufficient testing of sample welds is required to establish acceptable corrosion resistance of the weld region. Each guide tube is inspected after welding to show that welding has not affected clearance for CEA motion.

The lower spacer grid welds at spacer strip intersections and between spacer and perimeter strips (all components Inconel-625) have the same general configuration as for the Zircaloy and are all inspected for compliance with appropriate visual standards.

The lower spacer grid (Inconel) to Inconel skirt weld is made using the GTA process. Each weld is inspected to ensure compliance with a visual standard. With the introduction of the Guardian grid in Batch P, this weld has been eliminated since the Guardian perimeter strips are welded directly to the lower end fitting.

The Inconel skirt (or perimeter strip) to lower end fitting (stainless steel) weld is made using the GTA process and each weld is inspected to ensure compliance with a visual standard.

The lower end fitting is fastened to the Zircaloy guide tubes using 304 stainless steel bolts. The bolts are prevented from unthreading by stainless steel locking rings which are welded to the lower end fitting. Each ring is tack welded to the end fitting using the GTA process, and each weld is inspected for compliance with a visual standard.

The implementation of the NGF design in Batch Z replaces the Zircaloy grid strips with Optimized ZIRLO™ grid strips while maintaining the same inner-to-inner and outer-to-inner laser welded joints within the grid assembly. The NGF implementation also eliminates two weld types within the fuel assembly and introduces two different weld types. As described in Section 4.2.1.2.3, the welds between the flange and the guide tubes and the welds between the Zircaloy-4 spacer grids and the guide tubes are eliminated in the NGF design and replaced by mechanical bulges. The two new weld types involve the welding of ZIRLO® sleeves to the Optimized ZIRLO™ grids (both mid and IFMs) and the welding of stainless steel inserts to the Inconel Guardian grid. For both weld types, each weld is visually inspected to verify that it is free of cracks. To verify the acceptability of any weld penetration on the inside of the sleeve/insert, each sleeve/insert is inspected with a plug gage of the appropriate diameter. In addition, each sleeve-to-grid weld is inspected for compliance with the weld length requirement on the design drawing, and each insert-to-grid weld is inspected for capture by comparison to a standard.

ARKANSAS NUCLEAR ONE
UNIT 2

There is no formal ranking of these welds with respect to categorization of the weld joints by "importance for safety". The inspection requirements and acceptance standards are established on the basis of providing adequate assurance that the connections will perform their required functions.

All guide tubes are internally gauged ensuring free passage within the tubes including the reduced diameter buffer region. An alpha smear test is performed on the exterior surface of the fuel rods, and guide tube to end fitting joints are inspected in accordance with a visual standard. The spacer grid to fuel rod relationship is carefully examined at each grid location.

A comprehensive quality control plan is established to ensure that dimensional requirements of the drawings are met. In those cases where a large number of measurements are required and 100 percent inspection is impractical, these plans shall ensure with 95 percent confidence that 95 percent of these dimensions are within tolerance. Sensitivity and accuracy of all measuring devices are within ± 10 percent of the dimensioned tolerance.

Material traceability is established in accordance with ANSI N45.2-1971 which states:

"Measures shall be established and documented for the identification and control of materials, parts, and components, including partially fabricated subassemblies. These measures shall provide for assuring that only correct and accepted items are used and installed, and relating an item or production 'batch, lot, component, part' at any stage from initial receipt through fabrication, installation, repair or modification, to an applicable drawing, specification, or other pertinent technical document. Physical identification shall be used to the maximum extent possible. Where physical identification is either impractical or insufficient, physical separation, procedural control or other appropriate means shall be employed. Identification may be either on the item or on records traceable to the item, as appropriate."

"Where identification marking is employed, the marking shall be clear, unambiguous and indelible, and it shall be applied in such a manner as not to affect the function of the item. Markings shall be transferred to each part of an item when subdivided, and shall not be obliterated or hidden by surface treatment or coatings, unless other means of identification are substituted."

"When codes, standards or specifications require traceability of materials, parts or components to specific inspection or test records, the program will be designed to provide such traceability."

Each completed fuel assembly is inspected for cleanliness, wrapped to preserve its cleanliness, and loaded within shipping containers.

Protection of the fuel bundle in transit is ensured through proper design of the shipping container. Clamping and support surfaces are provided by the clamshell design. Design of the container will prevent shock loads to the fuel assembly from exceeding 5 g's in any direction when the shipping container assembly is subjected to handling and shipping peak loads typical of the carriers used in accomplishing delivery. Impact recorders are contained within each shipment to determine if shock loads sustained by the fuel assembly in the axial, vertical and lateral directions have exceeded 5 g's. Should the recorders indicate that accelerations have exceeded 5 g's in transit, the fuel assembly will be visually inspected for evidence of damage and repaired, if necessary.

ARKANSAS NUCLEAR ONE
UNIT 2

Visual inspection of the conveyance vehicle, shipping container and fuel assembly are performed at the reactor site. Approved procedures are provided for unloading the fuel assemblies. Following unloading, exterior portions of the fuel assembly components are inspected for shipping damage and cleanliness.

4.2.2 REACTOR INTERNALS

4.2.2.1 Design Bases

The reactor internals are designed to support and position the reactor core fuel assemblies and CEAs, provide holddown for the fuel assemblies, absorb the dynamic loads and transmit these and other loads to the reactor vessel flange, provide flow paths for the reactor coolant and guide in-core instrumentation.

The reactor internals are held in place against the upward hydraulic lift of reactor coolant flow by the reactor internals holddown rings. The Arkansas Nuclear One - Unit 2 holddown ring utilizes a low spring rate design concept which is less sensitive to small changes in deflection than the earlier interference fit design resulting in less holddown load fluctuation. Table 4.2-4a lists the net down load on reactor vessel internals for representative Combustion Engineering installations with this holddown ring design. In all cases, the net down load is sufficient to provide adequate holddown margin.

Earlier holddown ring designs such as the Calvert Cliffs Unit 1 design utilized during the first cycle of operation produced a net down load of approximately one-half the values shown in the table. The newer and heavier design was necessitated by the measurement of much larger than expected irradiation induced Zircaloy growth rate during the first Palisades fuel inspection, and provides additional holddown margin.

4.2.2.1.1 Reactor Internals Structures

The reactor internals are designed to meet the loading conditions listed in Section 4.2.2.3 and the design limits specified in Section 4.2.2.4. The details of the dynamic analysis, input forcing functions and response loadings are described in Section 3.9. The materials used in fabrication of the reactor internal structures are primarily Type 304 stainless steel. The flow skirt is fabricated from Inconel. Welded connections are used where feasible; however, in locations where mechanical connections are required, structural fasteners are used which are designed to remain captured in the event of a single failure. Structural fastener material is typically a high strength austenitic stainless steel; however, in less critical applications, Type 316 stainless steel is employed. Hardfacing, of Stellite material, is used at wear points. The effect of irradiation on the properties of the material is considered in the design of the reactor internal structures.

Reactor internal components are designed to ensure that the stress levels and deflections are within the ASME Code limits. Stress limits for the reactor vessel core support structures are presented in Table 4.2-4. In the design of critical reactor vessel internal components which are subject to fatigue, the stress analysis will be performed utilizing the design fatigue curve of Figure I-9-2 of Section III of the ASME Boiler and Pressure Vessel Code and a cumulative usage factor of less than one as the limiting criteria.

Reactor internal components are subject to pre-critical and periodic surveillance in accordance with the reactor internals inspection and monitoring plan. This plan includes pre-critical and periodic vibration monitoring programs, and surface and visual examinations.

ARKANSAS NUCLEAR ONE UNIT 2

The Pre-critical Vibration Monitoring Program (PVMP) for Unit 2 was established in accordance with the requirements of Regulatory Guide 1.20, Revision 0, as it relates to reactor internals similar to the prototype design, which includes Paragraphs D.2(a) through D.2(e).

With regard to requirements of and definitions within Regulatory Guide 1.20, Revision 0, Unit 2 is considered to be a non-prototype plant for vibration monitoring of the reactor internals. The Unit 2 plant is designated as non-prototypical in Combustion Engineering's report CEN-8(A), "Comparison of Arkansas Nuclear One - Unit 2, Maine Yankee and Fort Calhoun Reactor Internals Design Parameters and Flow Induced Structural Response." The Maine Yankee and Fort Calhoun plants are designated as prototypical plants in this report, and consequently both plants have fully instrumented PVMPs. As a non-prototypical plant, Unit 2 has a non-instrumented PVMP. The CEN-8(A) report, and Supplement 1 to this report, contain the following findings:

- A. The structural response of the Arkansas Nuclear One - Unit 2 reactor internals is well within design allowable criteria for all normal steady state and transient flow modes of reactor coolant pump operation;
- B. The Unit 2 reactor internals' maximum predicted stress, using a conservative estimate of the inlet pressure, is an order of magnitude below the allowable stresses for the structures;
- C. For the two prototype reactors, measured inlet pressures were used to re-compute the maximum predicted stresses, resulting in "best estimate" predicted stresses which were approximately one-third of the former conservative predictions; and,
- D. The measured responses of the two prototype reactor internals confirmed that actual stresses resulting from normal operating flow induced vibrations were seen lower, and were so low as to be negligible (See Figure 6.4 in CEN-8(A), Supplement 1).

The Arkansas Nuclear One - Unit 2 PVMP consists of photographically documented visual inspections and nondestructive weld tests which are repeated periodically. In addition, an installed neutron noise monitoring system is in continuous operation.

Prior to initial hot flow testing with reactor internals installed, a photographically documented visual examination of all major points of contact for load transmission (such as the core barrel flange and snubbers) was conducted. In addition, a baseline liquid penetrant examination of the core barrel flange to cylinder girth weld in the vicinity of the proposed pre-critical instruments was conducted. The results of these examinations have been recorded. The reactor vessel internals have been subjected during the preoperational and functional testing program to all significant flow modes of normal reactor operation for a sufficient period of time to determine whether the reactor vessel internals exhibit any unexpected vibration problems.

After completion of the preoperational and functional tests, the reactor vessel internals were subjected to the same type of photographically documented visual examination to detect any evidence of unanticipated or excessive vibrations. In addition, the liquid penetrant examinations of the flange to cylinder girth weld were repeated. A summary of the inspections is maintained on file at the plant. This program is considered sufficient to address any concerns related to short-term vibration effects on the reactor internals.

ARKANSAS NUCLEAR ONE
UNIT 2

In addition, AP&L has purchased a neutron noise monitoring system which can utilize signals available from the ex-core nuclear instrumentation to permit continuous surveillance of reactor internals motion over extended observation periods. As indicated in CEN-8(A), Supplement 1, neutron noise analysis techniques have been able to consistently characterize both the extent and character of the steady state response of the core support barrel for four different CE plants. Thus, equipment is available which provides a means of long-term monitoring of reactor internals to insure adequate structural performance. This capability goes beyond the requirements of Regulatory Guide 1.20, Revision 0, and provides a significant additional level of assurance that unforeseen vibrational problems of the reactor internals (which typically are not detectable in PVMPs but can develop over extended periods of operation) will be detected, if they occur.

AP&L conducted a visual inspection of all accessible areas of the core support barrel and vessel internals during the first refuel outage of ANO Unit 2. This inspection was conducted in accordance with the 1974 Edition of the ASME Section XI Boiler and Pressure Vessel Code. Additional visual inspections were performed at the end of the first and second 10 year inspection interval in accordance with the latest site approved ASME Section XI Code during that interval. The results of the examinations performed during the first refueling outage and at the end of the first 10 year interval, including documentation required by paragraph D.4 of Regulatory Guide 1.20, Revision 0, will also be maintained on file at the plant. The combination of neutron noise monitoring of reactor internals along with the first refueling inspection and the first 10 year inspection are considered sufficient to address any concerns related to long term vibration effects on the reactor internals.

4.2.2.1.2 In-Core Instrumentation Support and Guidance

The pressure boundary portions of the in-core instrumentation support system are designed to Section III of the ASME Boiler and Pressure Vessel Code. The supports for the pressure tubing are designed to withstand design loadings plus earthquake forces. All components and materials are consistent with a 10-year surveillance cycle and a 5-year mean-time between instrument replacements. The guide tubes are designed to provide smooth and snag-free paths for easy insertion and removal of the instrument assemblies.

The complete system is designed to accommodate the mechanical tolerances and thermal movement of the pressure vessel and reactor internals.

In addition to guiding the instruments, the pressure vessel head nozzles and the instrumentation plate structure guide tubes protect the instruments from crossflow.

4.2.2.2 Description and Drawings

4.2.2.2.1 Reactor Internals Structures

The components of the reactor internals are divided into two major parts consisting of the core support structure and the upper guide structure (including the CEA shrouds). The flow skirt, although functioning as an integral part of the coolant flow path, is separate from the internal and is affixed to the bottom head of the pressure vessel. These components are shown in Figure 4.1-1.

ARKANSAS NUCLEAR ONE
UNIT 2

4.2.2.2.1.1 Core Support Structure

The major structural member of the reactor internals is the core support structure. The core support structure consists of the core support barrel and the lower support structure. The material for the assembly is Type 304 stainless steel.

The core support structure is supported at its upper end by the upper flange of the core support barrel, which rests on a ledge in the reactor vessel. Alignment is accomplished by means of four equally spaced keys in the flange which fit into the keyways in the vessel ledge and closure head.

The lower flange of the core support barrel supports, secures and positions the lower support structure and is attached to the lower support structure by means of a welded flexural type connection. The lower support structure provides support for the core by means of a core support plate supported by columns mounted on support beams which transmit the load to the core support barrel lower flange. The core support plate provides support and orientation for the lower ends of the fuel assemblies. The core shroud, which provides a flow path for the coolant and lateral support for the fuel assemblies, is also supported and positioned by the core support plate. The lower end of the core support barrel is restricted from excessive radial and torsional movement by six snubbers which interface with the pressure vessel wall.

A. Core Support Barrel

The core support barrel is a right circular cylinder including a heavy ring flange at the top end and an internal ring flange at the lower end. The core barrel is supported from a ledge on the pressure vessel. The core support barrel, in turn, supports the lower support structure upon which the fuel assemblies rest. Press-fitted into the flange of the core support barrel are four alignment keys located 90 degrees apart. The reactor vessel, closure head and upper guide structure assembly flange are slotted in locations corresponding to the alignment key locations to provide proper alignment between these components in the vessel flange region.

The upper section of the barrel contains two outlet nozzles which interface with internal projections on the vessel nozzles to minimize leakage of coolant from inlet to outlet.

Since the weight of the core support barrel is supported at its upper end, it is possible that coolant flow could induce vibrations in the structure. Therefore, amplitude limiting devices, or snubbers, are installed on the outside of the core support barrel near the bottom end. The snubbers consist of six equally spaced lugs around the circumference of the barrel and act as a tongue-and-groove assembly with the mating lugs on the pressure vessel. Minimizing the clearance between the two mating pieces limits the amplitude of vibration. During assembly, as the internals are lowered into the pressure vessel, the pressure vessel lugs engage the core support barrel lugs in an axial direction. Radial and axial expansion of the core support barrel are accommodated, but lateral movement of the core support barrel is restricted. The pressure vessel lugs have bolted, captured, Inconel X shims and the core support barrel lug mating surfaces are hardfaced with Stellite to minimize wear. The shims are machined during initial installation to provide minimum clearance. The snubber assembly is shown in Figure 4.2-10.

ARKANSAS NUCLEAR ONE
UNIT 2

B. Core Support Plate and Lower Support Structure

The core support plate is a Type 304 stainless steel plate into which the necessary flow distributor holes for the fuel assemblies have been machined. Fuel assembly locating pins are inserted into this plate.

The fuel assemblies and core shroud are positioned on the core support plate. This plate is welded to the top of a cylindrical structure at the base of which is welded a bottom plate. This structure seats on the lower flange of the core support barrel and transmits the lower support structure loads to the core support barrel. The core support plate is supported by an arrangement of columns welded at the base to support beams. The bottoms of the beams are welded to a bottom plate which contains flow holes for primary coolant flow. The ends of the beams are welded to the lower cylinder. The cylinder guides the main coolant flow and provides core shroud bypass flow by means of holes in the cylinder.

4.2.2.2.1.2 Core Shroud

The core shroud provides an envelope for the core and limits the amounts of coolant bypass flow. The shroud consists of two Type 304 stainless steel ring sections welded to each other and to the core support plate.

A small gap is provided between the core shroud outer perimeter and the core support barrel in order to provide upward coolant flow between the core shroud and the core support barrel, thereby minimizing thermal stresses in the core shroud and eliminating stagnant pockets. The core shroud is shown in Figure 4.2-11. Four equally spaced lugs are furnished on the top of the core shroud to provide alignment of the shroud with the fuel alignment plate.

4.2.2.2.1.3 Flow Skirt

The Inconel flow skirt is a right circular cylinder perforated with flow holes. The flow skirt is used to reduce inequalities in core inlet flow distributions and to prevent formation of large vortices in the lower plenum. The skirt provides a nearly equalized pressure distribution across the bottom of the core support barrel. The skirt is supported by nine equally spaced, machined sections which are welded to the bottom head of the pressure vessel.

4.2.2.2.1.4 Upper Guide Structure Assembly

This assembly consists of the upper guide structure support plate assembly, CEA shrouds and a fuel assembly alignment plate (See Figure 4.2-12). The upper guide structure assembly aligns and laterally supports the upper end of the fuel assemblies, maintains the CEA spacing, holds down the fuel assemblies during operation, prevents fuel assemblies from being lifted out of position during a severe accident condition, protects the CEAs from the effect of coolant crossflow in the upper plenum and supports the in-core instrumentation plate assembly. The upper guide structure assembly is handled as one unit during installation and refueling.

The upper end of the assembly is a structure consisting of a support flange welded to the top of a cylinder. A support plate is welded to the inside of the cylinder approximately in the middle. The support plate is welded to a grid array of deep beams, the ends of which are welded to the cylinder. The support flange contains four accurately machined and located alignment keyways, equally spaced at 90 degree intervals, which engage the core barrel alignment keys. This

ARKANSAS NUCLEAR ONE
UNIT 2

system of keys and slots provides an accurate means of aligning the core with the closure head and thereby with the CEA drive mechanisms. The support plate aligns and supports the upper end of the CEA shrouds. The shrouds extend from the fuel assembly alignment plate to an elevation above the upper guide structure support plate. The CEA shroud consists of a cylindrical upper section welded to a base and a flow channel structure shaped to provide flow passage for the coolant through the alignment plate, while isolating the CEAs from crossflow. The shrouds are bolted and lockwelded to the fuel assembly alignment plate. At the upper guide structure support plate, the shrouds are connected to the plate by spanner nuts. The spanner nuts are tightened to proper torque to assure a rigid connection and lockwelded.

The fuel assembly alignment plate is designed to align the upper ends of the fuel assemblies and to support and align the lower ends of the CEA shrouds. Precision machined and located holes in the fuel assembly alignment plate engage machined posts on fuel assembly upper end fittings to provide accurate alignment. The fuel assembly alignment plate also has four equally spaced slots on its outer edge which engage with Stellite hardfaced pins protruding from the core shroud to limit lateral motion of the upper guide structure assembly during operation. The fuel alignment plate bears the upward force of the fuel assembly holddown devices. This force is transmitted from the alignment plate through the CEA shrouds to the upper guide structure support plate. The flange of the upper guide structure support plate is designed to resist axial upward movement of the upper guide structure assembly and to accommodate axial differential thermal expansion between the core barrel flange, upper guide structure and pressure vessel flange support ledge and head flange recess.

4.2.2.2 In-Core Instrumentation Support System

The complete in-core neutron flux monitoring system includes self-powered in-core detector assemblies, supporting structures and guide paths, and an amplifier system to process detector signals.

The self-powered in-core detector assemblies and the computer system are described in Chapter 7, Instrumentation and Controls. The instrumentation supporting structures and guide paths are described in this section and are shown in Figures 4.2-14 through 4.2-16.

The support system begins outside the pressure vessel, penetrates the vessel boundary and terminates at the lower end of the fuel assembly. Each instrument is guided over its full length by the external guidance conduit, the instrument plate structure guide tubes and the thimbles that extend downward into selected fuel bundles. The in-core instrumentation guide tubes route the instruments so that the detectors are located and spaced throughout the core. The guide tubes and the in-core thimbles are attached to and supported by the instrument plate assembly shown in Figure 4.2-15.

The instrumentation plate assembly fits within the confines of the reactor vessel head and rests in the recessed section of the upper guide structure assembly. Its weight is supported by four bearing pins. The upper guide structure CEA shrouds extend through the instrumentation plate clearance holes. Above the instrumentation plate, the guide tubes bend and are gathered to form stalks which extend into the reactor vessel head instrumentation nozzles. The instrumentation plate assembly is raised and lowered during refueling to insert or withdraw all instruments and their thimbles simultaneously. The pressure boundaries for the individual instruments are at the instrumentation nozzle flange where the external electrical connections to the in-core instruments are also made.

ARKANSAS NUCLEAR ONE
UNIT 2

The supporting structures for the in-core instruments are designed such that the temperature of the coolant surrounding the thermocouples in the in-core instruments is representative of fuel assembly outlet temperatures. The in-core instrument lengths and thimbles are designed to locate individual neutron detectors within a tolerance of ± 2 inches. A typical in-core instrument is shown in Figure 4.2-16.

The assemblies have an integral seal plug which forms a seal at the instrument flange and through which the signal cables pass. Carbon packing rings fitted in a recess in the instrument flange are used to seal against operating pressure. The in-core instrument nozzle sealing arrangement is shown in Figure 4.2-14.

4.2.2.3 Design Loading Conditions

4.2.2.3.1 Normal Operating and Upset Conditions

The reactor internals are designed to perform their functions safely under the following combination of design loading:

- A. Normal operating temperature differences;
- B. Normal operating pressure differences;
- C. Flow impingement loads;
- D. Weights, reactions and superimposed loads;
- E. Vibration loads;
- F. Shock loads (including OBE);
- G. Anticipated transient loadings not requiring forced shutdown; and,
- H. Handling loads (not combined with other loads above).

4.2.2.3.2 Emergency Conditions

The internals are designed to meet the stress limits while experiencing the loadings listed above with the DBE load replacing the OBE load.

4.2.2.3.3 Faulted Conditions

The loadings for these conditions include all the loadings listed for emergency conditions as well as the loadings resulting from postulated branch line pipe breaks. DBE and branch line pipe break loads are combined via SRSS per NUREG-0484, Rev. 1.

4.2.2.4 Design Loading Categories

The loading categories stipulated in Section 4.2.2.3, i.e., normal operating and upset, emergency and faulted, are defined in the March, 1973, draft of Subsection NG of ASME Code, Section III.

ARKANSAS NUCLEAR ONE
UNIT 2

The reactor internals structures are designed to meet the stress and deformation limits of Subsection NG which are summarized in Table 4.2-4. To properly perform their functions, the reactor internals structures will also satisfy the deformation limits listed below:

- A. Under design loadings plus OBE forces or normal operating loadings plus DBE forces, deflections will be limited so that the CEAs can function and adequate core cooling is preserved;
- B. Under normal operating loadings plus SRSS combination of DBE forces and pipe rupture loadings resulting from a break of the largest line connected to the primary system piping, deflections will be limited so that the core will be held in place, adequate core cooling is preserved and all CEAs can be inserted. Those deflections which would influence CEA movement will be limited to less than 80 percent of the deflections required to prevent CEA insertion.

4.2.2.5 Design Criteria Bases

The stress limits summarized in Table 4.2-4 and the deflection limits specified in Section 4.2.2.4 are in accordance with those given in the March, 1973, draft of Subsection NG of the ASME Code, Section III, including Appendix F, "Rules for Evaluation of Faulted Conditions."

4.2.3 REACTIVITY CONTROL SYSTEMS

Reactivity control is accomplished by the adjustment of the boron concentration in the primary coolant, repositioning CEAs and by the presence of fixed burnable neutron absorber rods in the first core. The CVCS is used to adjust the boron concentration. A description of the CVCS is provided in Section 9.3.4. The fixed burnable neutron absorber rods are described in Section 4.2.1. The Control Element Drive Mechanisms (CEDMs) and CEAs are described below. The nuclear characteristics of the reactivity control systems are described in Section 4.3.

4.2.3.1 Design Bases

4.2.3.1.1 Control Element Drive Mechanisms Design Bases

The CEDMs are magnetic jack type drives used to vertically position and indicate the position of the CEAs in the core. Each CEDM is capable of withdrawing, inserting, holding or tripping the CEA from any point within its 150-inch stroke in response to operating signals.

The CEDM is designed to function during and after all normal plant transients. The CEA drop time for 90 percent insertion is 3.2 seconds for the average of all full length CEAs and 3.7 seconds for any individual full length CEA. The drop time is defined as the interval between the time power is removed from the CEDM coils and the time the CEA has reached 90 percent of its fully inserted position. The CEDM has a design life of 40 years. The CEDM is designed to operate without maintenance for a minimum of 1½ years and without replacing components for a minimum of three years. The CEDM is designed to function normally during and after being subjected to the OBE loads. The CEDM will allow scramming and drive-in of the CEA during and after a DBE.

ARKANSAS NUCLEAR ONE
UNIT 2

The design and construction of the CEDM pressure housings fulfill the requirements of the ASME Boiler and Pressure Vessel Code, Section III for Class I vessels. The CEDM pressure housings provide a part of the reactor coolant pressure boundary and they are designed to meet stress requirements consistent with those of the vessel. The pressure housings are capable of withstanding, throughout their design life, all normal operating loads including the steady state and transient operating conditions specified for the reactor vessel. Mechanical excitations are also defined and included as a normal operating load. The CEDM pressure housings are service rated at 2,500 psia and 650 °F. The loading combinations and stress limit categories are presented in Table 4.2-5 and are consistent with definitions employed in the ASME Code.

An extension shaft is coupled to the CEA and joins this system to the CEDM. The extension shaft and CEA coupling system are designed to the allowable stress values of the ASME Code, Section III. These components are also designed to function during and after a DBE condition.

The components are designed such that the resonant frequencies are outside pump and fluid flow excitations.

4.2.3.1.2 Control Element Assembly Design Basis

The mechanical design of the CEAs is based on compliance with the following functional requirements and criteria:

- A. To provide for or initiate short-term reactivity control under all normal and adverse conditions experienced during reactor startup, normal operation, shutdown and accident conditions;
- B. Mechanical clearances of the CEA within the fuel and reactor internals are such that the requirements for CEA positioning and reactor trip are attained under the most adverse accumulation of tolerances; and,
- C. Structural material characteristics and mechanical clearances are selected such that radiation induced changes to the CEA materials will not impair the functions of the reactivity control system.

4.2.3.2 Reactivity Control System Description and Drawings

4.2.3.2.1 Control Element Drive Mechanism Design Description

The CEDMs are mounted on nozzles on top of the reactor vessel closure head. The CEDMs consist of the upper and lower CEDM pressure housings, motor assembly, coil stack assembly, reed switch assembly and extension shaft assembly. The CEDM is shown in Figure 4.2-17. The driver power is supplied by the coil stack assembly, which is positioned around the CEDM housing. Two position indicating reed switch assemblies are supported by the upper pressure housing shroud, which encloses the upper pressure housing assembly.

The lifting operation consists of a series of magnetically operated step movements. Two sets of mechanical latches are utilized engaging a notched extension shaft. To prevent excessive latch wear, a means has been provided to unload the latches during the engaging operations. The magnetic force is obtained from large DC magnet coils mounted on the outside of the motor tube. Power for the electromagnets is obtained from two separate supplies. A control programmer actuates the stepping cycle and obtains the correct CEA position by a forward or

ARKANSAS NUCLEAR ONE
UNIT 2

reverse stepping sequence. CEDM hold is obtained by energizing one coil at a reduced current while all other coils are de-energized. The CEAs are tripped upon interruption of electrical power to all coils. Each CEDM is connected to the CEAs by an extension shaft. The weight of the CEDMs and CEAs is carried by the pressure vessel head. Installation, removal and maintenance of the CEDM is possible with the reactor vessel head in place; however, the CEDM is inaccessible during operation of the plant.

The axial position of a CEA in the core is indicated by three independent readout systems. One counts the CEDM steps electronically, and the other two consist of magnetically actuated reed switches located at regular intervals along the CEDM upper pressure housing. These systems are designed to indicate CEA position to within $\pm 2\frac{1}{2}$ inches of the true location. This accuracy requirement is based on ensuring that the axial alignment between CEAs is maintained within acceptable limits.

4.2.3.2.1.1 CEDM Pressure Housing

The CEDM pressure housing consists of the motor housing assembly and the upper pressure housing assembly. The motor housing assembly is attached to the reactor vessel head nozzle by means of a threaded joint and seal welded. Once the motor housing assembly is seal welded to the head nozzle, it need not be removed since all servicing of the CEDM is performed from the top of the housing. The upper pressure housing is threaded into the top of the motor housing assembly and seal welded. The upper pressure housing encloses the CEDM extension shaft and contains a vent. The top of the upper pressure housing is closed by means of a threaded cap with a welded Omega seal.

4.2.3.2.1.2 Motor Assembly

The motor assembly is an integral unit which fits into the motor housing and provides the linear motion to the CEA. The motor assembly consists of a latch guide tube, driving latches and holding latches.

The driving latches are used to perform the major stepping of the CEA. The holding latches hold the CEA during repositioning of the driving latches and perform a load transfer function to minimize latch and extension shaft wear. Engagement of the extension shaft occurs when the appropriate set of magnetic coils is energized. This moves sliding magnets which cam a 2-bar linkage moving the latches inward. The driving latches move vertically a maximum of 3/4 inch. The holding latches move vertically 1/16 inch to perform the load transfer.

4.2.3.2.1.3 Coil Stack Assembly

The coil stack assembly for the CEDM consists of five large DC magnet coils mounted on the outside of the motor housing assembly. The coils supply magnetic force to actuate mechanical latches for engaging and driving the CEA extension shaft. Power for the magnet coils is supplied from two separate supplies. A magnetic coil power programmer actuates the stepping cycle and obtains the correct CEA position by a forward or reverse stepping sequence. CEDM hold is obtained by energizing one coil at a reduced current while all other coils are de-energized. The CEAs are tripped upon interruption of electrical power to all coils. Electrical pulses from the magnetic coil power programmer provide one of the means for transmitting CEA position indication.

ARKANSAS NUCLEAR ONE
UNIT 2

A conduit assembly containing the lead wires for the coil stack assembly is located at the side of the upper pressure housing.

4.2.3.2.1.4 Reed Switch Assembly

Two reed switch assemblies provide separate means for transmitting CEA position indication. Reed switches and voltage divider networks are used to provide two independent output voltage proportional to the CEA position. The reed switch assemblies are positioned so as to utilize the permanent magnet in the top of the extension shaft. The permanent magnet actuates the reed switches as it passes by them. The reed switch assemblies are provided with accessible electrical connectors at the top of the upper pressure housing. Three additional pairs of reed switches on each CEDM provide upper electrical limit, lower electrical limit and dropped rod indications.

4.2.3.2.1.5 Extension Shaft Assembly

The coupling of the CEDM to the CEA is accomplished by the extension shaft assembly. The inner portion of the assembly consists of a magnet, operating rod and plunger. The outer portion of the assembly consists of an extension sleeve, extension shaft, drive shaft and gripper.

The extension shaft assembly is coupled to the CEA through the action of the plunger and gripper. The plunger is spring loaded to remain in the center of the gripper. In this position, the gripper is expanded sufficiently to maintain engagement with the CEA.

The plunger is in turn fastened to the operating rod which runs the entire length of the extension shaft assembly along its centerline. At the top end of the operating rod is a magnet. The magnet is used to activate reed switches for CEA position indication. The spring loading of the plunger is maintained by the spring bearing against the gripper and a ledge on the gripper assembly.

The gripper assembly is threaded to the extension shaft which in turn is threaded to the notched drive shaft and the extension sleeve. In order to engage or disengage a CEA to or from the extension shaft assembly, a special gripper operating tool is attached to the top of the extension shaft assembly when the reactor vessel closure head has been removed. One part of the tool is attached to the extension sleeve to hold this portion of the extension shaft assembly stable. Another part of the tool is attached to the operating rod at the magnet assembly and is used to lift the plunger which in turn allows separation of the extension shaft assembly from the CEA. Insertion of the operating rod lowers the plunger, thereby spreading the fingers, which in turn allows the gripper to hold the CEA.

4.2.3.2.2 Control Element Assembly Design Description

The CEAs are shown in Figure 4.2.18. All CEAs have four control elements arranged in a 4.050-inch square array plus one element at the center of the array. The diameter of 0.816 inch is common to all control elements.

The control elements of a full length CEA consist of an Inconel-625 tube loaded with a stack of cylindrical poison pellets. The poison material consists of 73 percent TD boron carbide (B_4C) pellets, with the exception of the lower portion of the rods, which contain silver-indium-cadmium (Ag-In-Cd) alloy cylinders.

ARKANSAS NUCLEAR ONE
UNIT 2

Above the poison column is a plenum volume which provides expansion room for gases generated in the poison. The plenum volume also contains a holddown spring which restrains the poison against longitudinal shifting with respect to the clad while allowing for differential expansion between the poison and the clad.

Each full length control element is sealed by welds which join the tube to an Inconel-625 nose cap at the bottom and an Inconel-625 end fitting at the top. The end fittings, in turn, are threaded and pinned to the spider structure which provides rigid lateral and axial support for the control elements. The spider hub bore is specially machined to provide a point of attachment for the CEA extension shaft.

The CEA pattern is shown in Figure 4.2-19. Each CEA is positioned by a magnetic jack CEDM mounted on the reactor vessel closure head. The extension shaft joins with the CEA spider and connects the CEA to the CEDM. CEAs may be connected to any extension shaft depending on control requirements. Mechanical reactivity control is achieved by positioning groups of CEAs by the CEDMs.

In the outlet plenum region, all CEAs are enclosed in CEA shrouds which provide guidance and protect the CEA and drive shaft from coolant cross flow. Within the core, each poison rod travels in a Zircaloy guide tube. The guide tubes are part of the fuel assembly structure and ensure proper orientation of the poison rods with respect to the fuel rods.

Buffering action of the CEA at the end of its stroke during reactor trip is accomplished by means of the dashpot action of the CEA corner elements within their guide tubes.

The lower ends of the four outer CEA guide tubes are tapered gradually to form a region of reduced diameter which, in conjunction with the outer poison rods on the CEA, constitutes an effective hydraulic buffer for reducing the deceleration loads at the end of a trip stroke. This purely hydraulic damping action is augmented by a spring and piston arrangement on the CEA spider. When a CEA is fully inserted, the spider rests on the central post of the fuel assembly upper end fitting.

4.2.3.3 Reactivity Control System Evaluation

4.2.3.3.1 CEDM Design Evaluation

4.2.3.3.1.1 CEDM Stress Limits

The pressure boundary material stress levels comply with the ASME Code, Section III, including Code Cases 1334 and/or 1337. The motor springs are designed to an 80-year fatigue lifetime (double the 40-year expected life) to ensure operation without failure.

The motor assembly hangs from a single ledge which allows for thermal expansion of the motor relative to the lower pressure housing. Tests at reactor operating conditions show that adequate clearances exist and that stress levels will provide a useful life of 40 years.

The CEDM stress analyses consider the following loads:

- A. Reactor coolant pressure and temperature;
- B. Reactor operating transient conditions;

ARKANSAS NUCLEAR ONE
UNIT 2

- C. Dynamic stresses produced by seismic loadings;
- D. Dynamic stresses produced by mechanical excitations;
- E. Loads produced by the operating and scrambling of the mechanism; and,
- F. Loads produced by BLPB.

Computer codes used in analysis of the above loads are listed in Table 4.1-1. The methods used to demonstrate that the CEDMs operate properly under seismic conditions is presented in Section 3.7.3.15.

4.2.3.3.1.2 CEDM Material Selection

The selection of materials used in the CEDMs is based on the following considerations.

- A. Compliance with the ASME Code, Section III including Code Cases 1334 and 1337.
- B. Functional characteristics of the CEDM such as minimizing wear, providing magnetic flux paths, enhancing lifetime, adequate magnetic properties, corrosion resistance and high impact strength.
- C. Compatibility with adjacent CEDM materials and with the reactor environment.
- D. Capability of withstanding radiation for 40 years.

The materials used in the CEDM are listed below.

- A. Motor housing assembly pressure housing - Type 403 stainless steel with end fittings of nickel-chromium-iron alloy to SB 166.
- B. Upper pressure housing - Type 316 stainless steel with vent valve seal utilizing a 440 stainless steel ball on a 316 stainless steel seat.
- C. Motor latches, links and pins - high cobalt alloy.
- D. Motor and extension shaft springs - Inconel-X-750.
- E. Motor magnet - Type 410 stainless steel.
- F. Motor fasteners - Type 304 stainless steel.
- G. Extension shaft - Type 304 stainless steel.
- H. Extension shaft magnets - Alnico No. 5.
- I. Motor and extension shaft wear surfaces - chromium-plated.
- J. Magnet coils - Copper wire insulated with high temperature enamel and vacuum impregnated with a high temperature varnish. After impregnation, coil is wrapped with fiberglass tape and encapsulated with a silicone compound.
- K. Coil housings - Nickel-plated carbon steel.

ARKANSAS NUCLEAR ONE
UNIT 2

4.2.3.3.1.3 CEDM Functional Considerations

Clearances for thermal growth and for dimensional tolerances were investigated and tests have proven that adequate clearances are provided for proper operation of the CEDM.

The latch locations are set by a master gauge and settings are verified by testing at reactor conditions.

A weldable seal closure, per the ASME Code, Section III is provided for the vent valve in case of leakage.

The motor housing fasteners are mechanically positively captured and all threaded connections are preloaded before capturing.

The coil stack assembly can be installed or removed simply by lowering or lifting the stack relative to the CEDM pressure housing for each coil replacement or maintenance.

4.2.3.3.2 Control Element Assembly Design Evaluation

The CEAs are designed for a 10-year lifetime based on conservative estimates of neutron absorber burnup, allowable plastic strain of the Inconel-625 cladding and the resultant dimensional clearances of the elements within the fuel assembly guide tubes.

4.2.3.3.2.1 Control Element Assembly Stress Limits

Stress intensities in the individual structural components do not exceed the allowable limits for the appropriate material established in the ASME Code, Section III. The exceptions to this criteria are that: (a) the Inconel-625 cladding is permitted to sustain plastic strain up to 1.2 percent due to irradiation-induced expansion of the filler materials, (b) where compressive stress occurs, stress limits are revised to take into account critical buckling, and (c) the allowable stresses for the CEA springs are based on values which have been proven in practice. The CEA stress analyses consider the following loads.

- A. Internal pressure buildup due to the effect of irradiation on B₄C (production of helium).
- B. External pressure of reactor coolant.
- C. Dynamic stresses produced by seismic loading.
- D. Dynamic loads produced by stepping motion of the magnetic jack.
- E. Mechanical and hydraulic loads produced during reactor trip.
- F. Loads produced by differential expansion between clad and filler materials.
- G. Loads produced by a BLPB.

The fatigue damage produced by significant cyclic stresses is also determined. The calculated cumulative damage factor for any location must be less than 1.0. The fatigue usage factor calculations are based on the fatigue curves (stress range versus number of cycles) contained in the ASME Code, Section III.

ARKANSAS NUCLEAR ONE
UNIT 2

4.2.3.3.2.2 Control Element Assembly Material Selections

The selection of materials used in the CEAs is based on the following considerations.

- A. Neutron absorption cross section.
- B. Irradiated properties of the material.
- C. Dimensional stability under irradiation.
- D. Compatibility with other CEA materials and with the reactor environment.
- E. Whether the material has been used successfully in similar applications.

The actual materials used in the CEA are listed below:

- A. Spider: The spider is made from Grade CF-8 cast and Type 304 wrought stainless steel. Selection of this material is based on its proven acceptability for use in reactor structural applications.
- B. Cladding tube, end fitting and end cap: These parts are made from Inconel-625. The selection of this material is based on its high strength (including creep resistance), good corrosion resistance and excellent dimensional stability under irradiation at the temperatures and fluences to which it will be subjected. In addition, tests have shown that the Inconel-625 cladding material will sustain less than 0.001 inch of wear during the design life of the CEA.
- C. Holddown spring: The holddown springs are made from Type 302 stainless steel. This selection is based on the proven characteristics of this material for spring applications.
- D. Primary poison material: The poison material used in the CEA is boron carbide (B_4C) in the form of cylindrical pellets. This selection is based on the excellent neutron absorption capabilities of B_4C and the proven acceptability of B_4C for reactor control applications. Under irradiation, the B_4C pellets may swell up to 1.5 percent and some boron is transmuted to lithium and helium. The resulting effects on clad strain and rod worth are accounted for in the CEA design.
- E. Secondary poison material: The selection of Ag-In-Cd alloy in the bottom of the rods is based on its high neutron absorption cross section and its proven acceptability for reactivity control applications. Moreover, this material has good dimensional stability under irradiation (less than 0.5 percent expansion) which contributes to the proper operation of the hydraulic buffer over the lifetime of the CEA by maintaining the proper diametral clearance.
- F. Control Rod Spacer Material: Spacers are fabricated from Type 304 stainless steel. Spacers are located at the top and bottom of poison columns and near tube/end cap welds.
- G. Spider mounted spring: The spring contained within the spider is made from Inconel X-750. Selection of this material is based on its excellent strength, corrosion resistance, and its resistance to relaxation under irradiation.

ARKANSAS NUCLEAR ONE
UNIT 2

All of the materials listed above have been used successfully in similar CEA application in Combustion Engineering reactors.

The effects of neutron irradiation on the integrity and performance of the CEA can be divided into three categories.

- A. Neutron interactions with boron carbide produce helium which causes the poison rod internal pressure to increase. The poison rods contain sufficient plenum volume to prevent the internal pressure from having any adverse effect during the life of the CEA.
- B. Neutron irradiation causes volumetric expansion of the B₄C poison material as the boron burnup proceeds. Expansion on the order of one to two percent in length and diameter of the B₄C pellets is anticipated. The CEA design is based on allowing for the maximum expected expansions. For the temperatures and fluences encountered by the CEA, the dimensional changes in materials other than the B₄C are insignificant.
- C. Long-term neutron irradiation tends to increase the tensile strength and decrease the ductility of reactor structural materials. The only CEA structural material which receives a significant irradiation (from the standpoint of producing changes in the strength and ductility properties) is the Inconel-625 cladding. For the temperatures and fluences seen by the CEA cladding, the maximum strength increase is approximately 10 percent of the unirradiated value, and the ductility is reduced from approximately 30 percent to about six percent. However, the allowable primary stress limit in the cladding assumes no increase in yield strength and the maximum allowable strain for cladding is established at three percent.

4.2.3.3.2.3 CEA Mechanical Clearances

There are two categories into which the mechanical clearances associated with the CEA can be divided: clearances between the CEA and the guide structures and clearances between internal components of the CEA. The clearances between the CEA and its guide structure, both in the fuel assembly and in the Upper Guide Structure (UGS), have been established to meet the following requirements.

- A. Assure adequate coolant flow past the CEA poison rods.
- B. Assure sufficient freedom of CEA axial motion to meet reactor trip time requirements under conditions of worst case bowing of fuel assemblies; most adverse alignment between fuel bundles, upper guide structure and CEDMs; adverse locating and dimensional tolerances of poison rod cladding and CEA guide tube; and radial growth of poison rods due to irradiation effects.
- C. Assure proper hydraulic damping action to prevent damage to the CEA or related components when the CEA is tripped.

The spacing and clearance gaps between the CEA holddown spring, stainless steel spacers, B₄C pellets, and Ag-In-Cd rods assure adequate heat transfer capability between internal components and CEA cladding tubes and prevent excessive filler/clad interaction.

The selection of specific component clearances is based on experience and testing of similar hardware where applicable, as well as tolerance studies performed to demonstrate that the functional requirements of the CEAs are unimpaired under worst tolerance conditions.

ARKANSAS NUCLEAR ONE
UNIT 2

4.2.3.3.2.4 CEA Positioning, Driving and Tripping Requirements

The axial positioning of the CEAs in the core is accomplished by a magnetic jack CEDM which steps the CEA in increments of 0.75 inch maximum.

The selection of the step size is based on a requirement that the positive or negative reactivity insertion produced by a single step not be sufficient to produce effects in the reactor which would cause the original reactor regulating system to signal a step in the opposite direction.

The position of the CEA in the core is known within 2½ inches of its true location by a redundant readout system described in Chapter 7.

The driving requirement for the CEAs is a normal 30 inches/minute.

For all full length CEAs, the CEA drop time at reactor operating conditions for a fully withdrawn position to 90 percent of full insertion does not exceed 3.2 seconds for the average of all full length CEAs and 3.7 seconds for any individual full length CEA, measured from the time power is removed from the CEDM holding coils.

CEA insertion requirements for powered operation have been established on the basis of providing sufficient negative reactivity insertion rates to enable the reactor to follow design power reduction transients without exceeding operational limits

4.2.3.3.2.5 Pressure Forces Tending to Eject CEAs

Under normal operating conditions and during all abnormal and accident conditions, except failures of the reactor coolant pressure boundary, the pressure forces pushing upward on the CEA are much less than the weight (in water) of the CEA and extension shaft. During the period of blowdown following a failure of the reactor coolant pressure boundary (LOCA) the combined weight of the CEA and extension shaft will operate against short-term transient upward forces such that CEA motion is negligible.

A rod ejection incident is possible only in the event of a failure of the CEDM pressure boundary structure in a manner which causes the CEDM to separate from the closure head. The probability for such an event is considered to be very small. The rod ejection accident is analyzed and discussed in Chapter 15.

4.2.3.3.2.6 Potential for and Consequences of CEA/CEDM Functional Failure

The probability for a functional failure of the CEA or CEDM is considered to be very small. This conclusion is based on the conservatism used in the design, the quality control procedures used during manufacturing, and on testing of similar full size CEA/CEDM combinations under simulated reactor conditions for lengths of travel and numbers of scrams greater than that expected to occur during the Arkansas Nuclear One - Unit 2 design life. The consequences of CEA/CEDM functional failure are discussed in Chapter 15.

Another postulated CEA failure mode is cladding failure. In the event that a poison rod is assumed to partially fill with water under low or zero power conditions, the possibility exists that upon returning to power, the path of the water to the outside could be blocked. The expansion of the entrapped water could cause the poison rod to swell. In tests, specimens of CEA

ARKANSAS NUCLEAR ONE
UNIT 2

cladding were filled with a spacer representing the poison material. All but nine percent of the remaining volume was filled with water. The sealed assembly was then subjected to a temperature of 650 °F and an external pressure of 2,250 psi followed by a rapid removal of the external pressure. The resulting diametral increases of the cladding were small and not sufficient to impair axial motion of the CEA. This test result, coupled with the low probability of a poison rod cladding failure leading to a waterlogged rod, demonstrates that the probability for a CEA functional failure from this cause is low.

Other possible consequences of failed poison rod cladding are the release of small quantities of CEA filler materials and helium and lithium (from the neutron boron reactions). However, the amounts which would be released are too small to have significant effects on coolant chemistry or rod worth.

In addition to the failure modes discussed above, a small object carried with the coolant could be swept in the CEA guide tube where it could interfere with normal operation of the CEA. In order to minimize the probability for such an occurrence, the guide tube flow inlet holes are of small diameter and are oriented with their axes perpendicular to the coolant flow direction. However, in the event that an object entered the guide tube and interfered with CEA operation, the most serious consequence would be a stuck rod. The effects of a stuck rod incident are discussed in Chapter 15.

4.2.3.3.2.7 Effect of Violent Fuel Rod Failure on CEA Operation

As discussed in Chapter 15, some postulated accident conditions, e.g., LOCA, rod ejection, may produce rapid failure of the cladding on a small number of fuel rods. Since these fuel rods may be adjacent to the CEA guide tubes, the possible effect of such violent fuel rod failures on CEA operation is considered.

The CEA poison rods travel in individual Zircaloy guide tubes which form a permanent part of the fuel assembly structure. It is not possible for swelled or split fuel elements to interfere with CEA operation unless the swelling or splitting has first caused significant deformation of the guide tubes.

The probability that a rod failure would deform the guide tube sufficiently to prevent normal CEA operation was examined and is considered an unlikely event. This conclusion is based on the following considerations:

- A. The minimum clearance between a fuel rod and a guide tube in the fuel bundle is approximately .124 inch. Thus, the fuel rod diameter would have to swell by approximately 65 percent before it contacted the guide tube.
- B. The guide tube has much greater (~10 times) resistance to lateral deflection than a fuel rod. The fuel rod, therefore, could not exert a lateral force sufficient to cause a significant deflection of the guide tube except at a support grid location. Furthermore, at a support grid, the fuel rod would first have to overcome the additional restraining effects of the support grid before it contacts the guide tube.

In conclusion, even in the event of violent failure of fuel rods adjacent to CEA guide tubes, the probability that such failures would deform the guide tubes enough to affect CEA operation (either driven operation or trip) is small.

ARKANSAS NUCLEAR ONE
UNIT 2

4.2.3.4 Testing and Inspection Plan

4.2.3.4.1 CEDM Testing

4.2.3.4.1.1 Prototype Accelerated Life Tests

This section describes tests performed on a standard Combustion Engineering CEDM magnetic jack design. Arkansas Nuclear One - Unit 2 will use essentially the same basic magnetic jack design with the exception of a longer upper pressure housing on the CEDM to accommodate the 150-inch stroke.

The following describes tests performed on a prototype CEDM of the 138-inch stroke magnetic jack design. The tests described below illustrated the type and magnitude of testing used to demonstrate that the CEDM will meet specified operating requirements for the duration of plant life with normal maintenance. (Since Arkansas Nuclear One - Unit 2 will use essentially the same basic magnetic jack design, testing of the Arkansas Nuclear One - Unit 2 mechanism will consist essentially of verifying the trip characteristics of the mechanism.)

A prototype standard CEDM was subjected to accelerated life tests accumulating approximately 100,000 feet of travel equivalent to a 40-year lifetime. The first phases of the accelerated life test consisted of continuous operation of the mechanism at 40 inches per minute lifting 230 pounds for a total travel of 32,500 feet. This test was performed at simulated reactor operating conditions. Upon completion of the test, the motor bearing surfaces were inspected and measured. A maximum bearing wear of .003 inch was measured. This degree of wear is considered acceptable based on the 40-year design life.

The second phase of the accelerated life test consisted of 200 full height gravity drops and 20,000 reversals at one drive shaft position. This test was also performed at reactor operating temperatures and pressures with 230 pounds lift weight. The additional travel accumulated during this phase of testing was 5,400 feet. The mechanism at this point had accumulated a total travel (hot and cold) of 38,400 feet at 40 inches/minute operation. All drops were completed satisfactorily. Inspection of the drive shaft after this test showed no excessive wear in the area of the reversals.

A third phase of the life test was completed. In this test, the prototype magnetic jack was coupled to a dual CEA and extension shaft assembly (335 pounds dry). The test was conducted under operating conditions of 600 °F and 2,200 psig and the water chemistry adjusted to 1,100 ppm boron. The mechanism was operated lifting the dual CEA and extension shaft assembly at 20 inches per minute for a total of 15,625 feet and 200 full height drops. Post-test inspections again showed that motor bearing wear was negligible. No motor failures were encountered during this test phase. Total accumulated travel at the end of this phase of testing (including operational verification test) was 60,000 feet, or 24 years of design life.

Two inadvertent rod drops occurred during the above test phase. These were encountered during rod drop testing when the mechanism was primarily operated in the withdrawal mode of operation. Driving the mechanism in the insertion mode after each series of 10 drops corrected this condition. It was concluded that crud buildup under the pulldown magnet caused difficulty in resetting the mechanism during withdrawal since the pulldown force on this magnet is less in the withdrawal cycle than in the insertion cycle. It was discovered that by driving in the CEA and extension shaft occasionally, instead of continuously dropping the rods, the crud under the pulldown magnet was displaced and the malfunction eliminated.

ARKANSAS NUCLEAR ONE UNIT 2

A non-tripping control rod drive mechanism (PLCEDM) for the part length CEAs was originally included in the Arkansas Nuclear One - Unit 2 contract. The need for a mechanism of this type no longer exists. However, the following test phase is included in order to present an overall view of the drive mechanism test program.

The prototype CEDM was converted to a PLCEDM by installation of a non-tripping assembly. A sixth coil was added to operate the non-trip device. The remainder of the mechanism was the same as the previous tripping prototype mechanism and was utilized in subsequent testing to accumulate additional travel. The mechanism was installed on a high temperature test facility and coupled to a test CEA having a total weight of 230 pounds dry. Its operating speed was increased to 30 inches/minute. The test loop conditions were set at 600 °F and 2,200 psig, and a fourth accelerated life test was initiated. The object of this accelerated life test was to accumulate an additional 30,000 feet of continuous operation utilizing the prototype mechanism as a part length drive.

After a total of 15,000 feet of operation had been accumulated, the holding latch spring in the motor assembly failed. The total travel accumulated on this particular component to that point was 75,000 feet or an equivalent of 30 years of design life. The holding latch spring was replaced and the life test continued without modification to the other parts.

The spring design was reviewed and an improved spring design was incorporated into the production units with a design life of twice that of the failed spring.

During the latter half of the fourth accelerated life test, the drive shaft was distorted. The cause of this distortion was attributed to the operating rod in the extension shaft assembly having been pinned at its upper end causing a high stress to occur as a result of differential thermal growth between the drive shaft and operating rod. This design was changed for the production units to allow for the differential thermal expansion between the drive shaft and operating rod. Drive shaft bowing has not occurred with the new design. Distortion of the drive shaft caused the mechanism to occasionally fail to complete a step. At no time did the CEA drop due to this distortion. Under these test conditions, an additional 18,000 feet was completed for a total accumulated travel on this prototype mechanism as a part length unit of 33,000 feet. Total travel on the drive shaft and major components of this motor assembly was 93,000 feet. Upon disassembly and inspection, no additional failures were found. Upon completion of the non-tripping accelerated life test, the prototype mechanism was converted back to a tripping CEDM by removal of the non-tripping device.

The reconverted mechanism was again operated in the high temperature test facility at normal reactor temperature and pressure. The driven weight was 230 pounds (dry) including drive shaft and CEA. Limit switches were positioned to give a total stroke of 120 inches over the upper end of the mechanism travel. The remainder of the life test consisted of operating the mechanism for 7,000 feet. Upon completion of this travel, the facility was shut down and the bearing surfaces remeasured. The measurements were recorded and the wear was found to be within acceptable limits.

The fast shutdown capability of the tripping magnetic jack mechanism was verified by dropping the minimum effective weight of 130 pounds (dry) with the prototype mechanism. A curve showing CEA position versus time was generated utilizing the reed switch position transmitter. The facility test conditions were set at 40 psig, ambient temperature and no flow. Six drops were completed. Time deviations between the various drops were less than 0.1 second. A preproduction mechanism was installed on a full flow test facility for drop testing under reactor operating conditions including flow.

ARKANSAS NUCLEAR ONE
UNIT 2

Two hundred and six full height trips and 126 partial height trips were completed under reactor operating conditions including flow. Drop times for 90 percent insertion at full flow reactor operating conditions met the required criteria and displacement curve.

4.2.3.4.1.2 First Production Test

A qualification test program was completed on the first production 138-inch stroke Combustion Engineering magnetic jack design CEDM. During the course of this program over 4,000 feet of travel was accumulated and 30 full height gravity drops were made without mechanism malfunction or measurable wear on operating parts. The program included the following:

- A. Operation of 40 inches per minute lifting 230 pounds (dry) at ambient temperature and 2,000 psig pressure for 800 feet;
- B. Six full height, 230-pound (dry) weight gravity drops at ambient temperature;
- C. Operation at simulated reactor operating conditions at 40 inches per minute lifting 230 pounds for 1,700 feet;
- D. Six full height gravity drops at simulated reactor operating conditions with 230 pounds weight;
- E. An operational test ambient temperature and 2,300 psig pressure lifting 335 pounds at 20 inches per minute for 500 feet;
- F. Six full height gravity drops of the 335-pound weight;
- G. Operation at simulated reactor conditions for 1,700 feet at 20 inches per minute lifting 335 pounds; and,
- H. Operating at ambient temperature and 2,300 psig for 1,100 feet and 20 full height gravity drops with an attached dry weight of 130 pounds.

4.2.3.4.1.3 Production Tests

All CEDM production units will be tested for a minimum of 400 feet of total travel at combinations of pressure and temperature from ambient up to reactor operation conditions. The CEDMs are also tested for six full height gravity drops at simulated reactor operating conditions.

4.2.3.4.1.4 Field Tests

After installation of the CEDMs and prior to power operation, the CEDMs are tested in accordance with procedures developed for the startup test program as outlined in Chapter 14.

4.2.3.4.1.5 Maintenance Tests

Tests to be performed during the design lifetime of the CEDM during normal power operation are described in the Technical Specifications.

ARKANSAS NUCLEAR ONE
UNIT 2

4.2.3.4.2 Verification of CEA Characteristics by Inspection and Test

The CEAs are subjected to numerous inspections and tests during manufacturing and after installation in the reactor. In addition, various CEA hardware tests have been conducted or are in progress.

During manufacturing, the following inspections and tests are performed:

- A. All materials are produced to rigid specifications. A general product specification covers the fabrication, inspection, assembly, cleaning, packaging and shipping of the CEA;
- B. All end caps welds are liquid penetrant examined and helium leak tested. A sampling plan is used to section and examine end cap welds;
- C. The loading of each control element is carefully controlled to obtain the proper amounts and types of filler materials for each type of CEA application,
- D. Each poison rod has unique external features which distinguish it from other types;
- E. Each CEA has unique external characteristics on the spider which distinguish it from others. The CEAs are also serialized. See Figure 4.2-18.
- F. Fully assembled CEAs are checked for proper alignment of the neutron absorber elements using a special fixture. The alignment check ensures that the frictional force that could result from adverse tolerances is below the force which could significantly increase trip time.

In addition to the basic measures discussed above, the manufacturing process includes numerous other quality control steps for ensuring that the individual CEA components satisfy design requirements for material quality, detail dimensions and process control.

After installation in the reactor, but prior to criticality, each CEA is traversed through its full stroke and tripped. A similar procedure will also be conducted at refueling intervals.

Hardware tests to date have been performed using CEA components developed primarily for Combustion Engineering's 800 MWe class reactors which use 14 x 14 fuel assemblies.

CEAs used in the Unit 2 reactor are essentially similar in design and construction to the 800 MWe class CEA, with the exception that the CEA spider arms are shorter and the neutron absorber elements are smaller in diameter for compatibility with the 16x16 fuel assembly guide tube diameters and pitches employed in the Unit 2 plant.

The predicted 90 percent insertion time for the lightest CEA in the Unit 2 reactor is 2.75 seconds under worst case conditions as described in Technical Specification 3.1.3.4. The required time is ≤ 3.2 seconds for the average of all full length CEAs and ≤ 3.7 seconds for any individual full length CEA. The predicted insertion time is determined using the Control Element Assembly Scram Analysis (CEASA) computer program which models the hydraulic forces acting on a CEA during the scram. The CEASA code determines the effects of various parameters, e.g., pressure differential, clearances, weights, friction, etc., on CEA insertion times. After establishing the proper combination of parameters, the CEA design is completed. Verification of

ARKANSAS NUCLEAR ONE
UNIT 2

adequacy will be determined by testing in the Combustion Engineering TF-2 flow test facility, which is scheduled for completion in December 1975. This facility contains prototypical Arkansas-type reactor components consisting of a fuel assembly, a CEA shroud, CEDM, and a simulation of surrounding core internal support components. The test conditions simulate the worst possible core pressure differential at reactor temperature and pressure conditions, in addition to adverse control element assembly alignment.

The buffer mechanism has also been evaluated using the CEASA computer program and was found to be adequate. Verification of the buffer performance will be included in the test program described above.

4.2.3.5 Instrumentation

A detailed discussion of the instrumentation and control systems associated with reactivity control is presented in Chapter 7.

4.2.3.6 Neutron Source Assembly

Prior to Cycle 10, the core contained two neutron source assemblies. The function of the neutron source assembly was to provide a base neutron level such that required monitoring of neutron level could be accomplished during fuel loading, refueling and shutdown conditions. The neutron level provided was sufficient to allow continuous monitoring during fuel loading. The neutron level was sufficient to monitor an approach to criticality when the reactor was in a shutdown condition and during refueling operations.

A primary Pu-238/Be source was utilized to monitor the initial core loading, testing and approach to criticality, while a secondary Sb-Be source fulfilled the function during subsequent operations.

Two source assemblies were used; each source assembly contained a primary and a secondary source. The source assembly was installed in an empty guide tube in the fuel assembly. The neutron source assembly was positively restrained within the guide tube by a spring load applied against a recessed surface in the fuel assembly alignment plate. The two neutron source assemblies were located in fuel assemblies that were adjacent to the out-of-core startup neutron detectors.

The Pu-238/Be primary source material was encapsulated in a 304 stainless steel tube with an outer assembly tube serving as a second encapsulation barrier. Within the outer assembly, Sb-Be pellets were positioned to serve as a secondary source material. All outer parts of the neutron source assembly exposed to reactor coolant conditions were fabricated from an age-hardened nickel base alloy for corrosion resistance and high strength. The spring was housed within the outer encapsulation to ensure that it would remain captured in the event of a failure.

At the end of Cycle 9, the neutron source assemblies were discharged from the core. The function provided by the neutron source assemblies, however, continues to be provided by the irradiated fuel in the core, with neutrons from spontaneous fission and radioactive decay.

4.3 NUCLEAR DESIGN

4.3.1 DESIGN BASES

The bases for the nuclear design of the fuel and reactivity control systems are discussed in the following sections.

4.3.1.1 Excess Reactivity and Fuel Burnup

The excess reactivity provided for each cycle is based on the depletion characteristics of the fuel and burnable poison and on the desired burnup for each cycle. The desired burnup is based on an economic analysis of both the fuel cost and the projected operating load cycle for the plant. The average burnup is chosen so as to ensure that the peak burnup is within limits discussed in Section 4.2.1. This design basis, along with the design basis in Section 4.3.1.7, satisfies General Design Criterion 10.

4.3.1.2 Core Design Lifetime and Fuel Replacement Program

The core design lifetime and fuel replacement program are based on an 18-month (approximately) refueling cycle with about one-half of the fuel assemblies replaced at each refueling. A multi-batch fuel management program is employed which may use zoned fuel assemblies and poison rods.

4.3.1.3 Negative Reactivity Feedback and Reactivity Coefficients

In the power operating range, the inherent combined response of the reactivity feedback characteristics (fuel temperature coefficient, moderator temperature coefficient, and moderator pressure coefficient) to an increase in reactor thermal power will be a decrease in the reactivity. The negative reactivity feedback provided by the design satisfies General Design Criterion 11.

4.3.1.4 Burnable Poison Requirements

The burnable poison reactivity worth provided in the design is sufficient to ensure that moderator coefficients of reactivity have values consistent with the requirements for negative reactivity feedback and acceptable consequences in the event of postulated accidents or anticipated operational occurrences, viewed in conjunction with the characteristics of the Reactor Protective System (RPS).

4.3.1.5 Stability Criteria

The design of the reactor and the instrumentation and control systems is based on meeting the requirements of General Criterion 12, with respect to spatial xenon oscillations and stability. Sufficient Control Element Assembly (CEA) worth is available to suppress xenon-induced spatial oscillations.

4.3.1.6 Maximum Controlled Reactivity Insertion Rates

The maximum reactivity addition rates are limited by core, CEA, and boron charging system design based on preventing increases in reactivity which would result in the violation of specified acceptable fuel design limits, damage to the reactor coolant pressure boundary, or

ARKANSAS NUCLEAR ONE
Unit 2

disruption of the core or other internals sufficient to impair the effectiveness of emergency core cooling. This design basis, along with the design basis in Section 4.3.1.10, satisfies General Design Criteria 25 and 28.

4.3.1.7 Power Distribution Control

The power distribution is controlled such that, in conjunction with other core parameters, limiting conditions for operation are not violated. Limiting conditions for operation are chosen to substantiate the accident analyses in Chapter 15. Limiting conditions for operation and limiting safety system settings are determined such that specified acceptable fuel design limits are not exceeded as a result of anticipated operational occurrences, and such that predicted acceptable consequences are not exceeded for other postulated accidents. This design basis satisfies General Design Criterion 10.

4.3.1.8 Shutdown Margins and Stuck Rod Criteria

The amount of reactivity available from insertion of withdrawn CEAs under all power operating conditions, even when the highest worth CEA fails to insert, will provide for the following:

- A. At least one percent shutdown margin after cooldown to hot zero power; and,
- B. Any additional shutdown reactivity requirements assumed in the safety analyses.

This design basis, along with the design basis in Section 4.3.1.9 satisfies General Design Criterion 26.

4.3.1.9 Chemical Shim Control

The Chemical and Volume Control System (CVCS) (Section 9.3.4) is used to adjust dissolved boron concentration in the moderator. After a reactor shutdown, this system is able to compensate for the reactivity changes associated with xenon decay and reactor coolant temperature decreases to ambient temperature, and it provides adequate shutdown margin during refueling. This system also has the capability of controlling long-term reactivity changes due to fuel burnup, and reactivity changes during xenon transients resulting from changes in reactor load independently of the CEAs. In particular, any xenon burnout transient may be accommodated at any time in the fuel cycle. The maximum reactivity addition rate for which the CVCS will be required to compensate is given in Table 4.3-1. The maximum value occurs at the end-of-cycle when the moderator temperature coefficient is most negative and the soluble boron worth is a minimum. This design basis, along with the design basis in Section 4.3.1.8, satisfies General Design Criterion 26.

4.3.1.10 Maximum CEA Speeds

Maximum CEA speeds are consistent with the accident analyses requirements discussed in Chapter 15 and with Section 4.3.1.6. Maximum CEA speeds are also discussed in Section 4.2.

4.3.2 DESCRIPTION

4.3.2.1 Nuclear Design Description

This section summarizes the nuclear characteristics of the ANO-2 reactor core and discusses the design parameters that are of significance to the performance of the core parameters in steady state and normal transient operation, as presented in Tables 4.3-1 and 4.3-2, and Figures 4.3-1A through 4.3-1E. Figure 4.3-1 shows the fuel management scheme. The core consists of those assembly types and numbers listed in Figure 4.3-1D.

Limiting values for relevant parameters are discussed in the appropriate sections.

Fuel enrichment and burnable poison distributions are shown in Figure 4.3-1A. The other three quadrants of the core have rotational symmetry to the quadrant shown in Figure 4.3-1E. Physical features of the lattice and fuel assemblies are described in Section 4.2.

Typical reload critical soluble boron concentrations and worths, delayed neutron fractions and neutron lifetime are shown in Table 4.3-1. These values vary slightly with core and fuel batch design as noted in Table 4.3-1. Also, typical K_{eff} reactivity and reactivity defect data associated with the cold zero power, hot standby, and hot full power equilibrium xenon and samarium conditions are shown in Table 4.3-2. Soluble boron insertion rates as discussed in Section 9.3.4 are sufficient to compensate for the maximum reactivity addition due to xenon burnout and normal plant cooldown.

4.3.2.2 Power Distribution

4.3.2.2.1 General

The power distribution is one of many items that affect the margin between the actual core conditions at a given instant of time and either the operating limits, or the specified acceptable fuel design limits for the reactor. The acceptability of a given power distribution is therefore, dependent on the power level and coolant conditions.

At all times during operation, it is intended that the power distribution and coolant conditions be controlled so that the peak linear heat rate and the minimum Departure from Nucleate Boiling Ratio (DNBR) are maintained within operating limits supported by the safety analyses (Chapter 15) with due regard for the correlations between measured quantities, the power distribution and uncertainties in the determination of power distribution. Methods of controlling the power distribution include the use of CEAs to alter the axial power distribution; decreasing CEA insertion by boration, thereby improving the radial power distribution; and correcting off-optimum conditions which cause margin degradations, e.g., CEA mis-operation.

The Core Operating Limit Supervisory System (COLSS) has the capability to indicate continuously to the operator how far the core is from the operating limits and give an audible alarm should an operating limit be exceeded. Such a condition signifies reduction of the capability of the plant to withstand an anticipated transient, but does not necessarily imply a substantial reduction of margin to fuel design limits. If the margin to fuel design limits continues to decrease, the Reactor Protection System (RPS) assures that the specified acceptable fuel design conditions are not exceeded, by initiating a trip.

ARKANSAS NUCLEAR ONE
Unit 2

The COLSS monitoring system, described in Section 7.7 and Reference 14, generates continually an assessment of the margin to linear heat rate and DNBR operating limits. The data required for these assessments include measured in-core neutron flux data, CEA positions, and coolant inlet temperature, pressure and flow. In the event of an alarm indicating that a limit has been exceeded, power must be reduced unless the alarm can be cleared by improving the power distribution or another process parameter.

In addition to the monitoring performed by COLSS, the RPS receives primary coolant data, signals from ex-core neutron flux detectors each containing three axially stacked elements, and from redundant reed switch assemblies for CEA position indication. These signals are processed to obtain the core power distribution and thermal margin. In the event the power distributions or other parameters are perturbed as the result of an anticipated operational occurrence, the high local power density or low DNBR trips will initiate a reactor trip if required to prevent the respective fuel design limits from being exceeded.

4.3.2.2.2 Nuclear Design Limits on the Power Distribution

The design limits on the power distribution stated here were employed during the design process as initial conditions for accident analyses described in Chapters 6 and 15. However, the acceptability of the consequences of the accident analyses for the completed design are factored into a final determination of the operating limits. These are not stated separately on the power distributions, but in terms of peak linear heat generation rate and required minimum DNBR overpower, as noted below.

The design limits on power distribution are as follows:

- A. The limiting three-dimensional heat flux peaking factor, F_q^n was established for full power conditions at 2.28. F_q^n is defined in Section 4.4.2.3.4.C, and is termed the nuclear heat flux factor or the total nuclear peaking factor.

An F_q^n of 2.28 in combination with uncertainties and allowances on heat flux which give the peak linear heat rate initially assumed in the safety analyses constituted one limiting combination of parameters for full power operation. Other combinations giving acceptable accident analysis consequences are equally acceptable. Implementation in the Technical Specification is via an operating limit on the monitored peak linear heat generation.

- B. The margin to the Technical Specification DNBR Safety Limit that is available to accommodate anticipated operational occurrences will be as acceptable as the margin calculated with the following combination of:

1. The coolant conditions;
2. The axial power distribution; and,
3. The integrated radial peaking factor, F_r^n , where F_r^n is the rod radial nuclear factor or the rod radial peaking factor and is defined in Section 4.4.2.3.4.A.

An F_r^n of 1.55, the set of axial shapes displayed in Figure 4.4-2, and the coolant conditions assumed in the safety analyses constitute one limiting combination of parameters for full power operation. Other combinations giving acceptable accident

ARKANSAS NUCLEAR ONE
Unit 2

analysis consequences are equally acceptable. Implementation in the Technical Specification is via an operating limit on allowed minimum monitored DNBR overpower versus axial shape index.

It will be shown below that operation within these limits is achievable.

4.3.2.2.3 Comparison Between Expected Core Conditions and Operating Limits

In comparing the expected power distributions and implied Peak Linear Heat Generation Rate (PLHGR) produced by analysis with the anticipated limiting PLHGR operating limit stated in Technical Specification 3/4.2.1, consideration must be given to the uncertainty and allowances associated with monitoring by CECOR, which is discussed in Reference 22.

Figures 4.3-2 through 4.3-10 and 4.3-14 through 4.3-18 show typical planar radial and unrodded core average axial power distributions. They illustrate conditions expected at full power at various times in the fuel cycle as specified on the figures. It is expected that the normal operation of the reactor will be with limited CEA insertion so that those distributions represent the expected power distribution during most of the cycle.

The one-pin planar radial power peaks presented in these figures represent the maximum that could be expected between about 20 and 80 percent of core height. Power peaks outside this axial region were examined and found not to be limiting at any time during the cycle.

The radial power distribution described in this section is calculated data which do not include any uncertainties or allowances. The calculations performed to determine these radial power peaks explicitly account for augmented power peaking which is characteristic of fuel rods adjacent to the water holes.

The three-dimensional peaking factor, F_q^n , expected during steady state operation is then just the product of the unrodded planar radial peak and the axial peak. The maximum value of this product can be seen from the figures to give a maximum F_q^n well below the allowed F_q^n .

This difference between limiting and expected F_q^n represents margin that is available for maneuvering. Reductions in the limiting PLHGR result in reductions in the maximum F_q^n allowed at full power, and are reflected as reductions in the margin available for maneuvering. Reductions below the limits of Technical Specification 3/4.2.1 could lead to restrictions on maneuvering in the form of reduced rates of return to full power or reduced flexibility to initiate maneuvers from non-equilibrium conditions.

For discussion purposes, the typical power distributions occurring during typical load following transients indicate that the power distribution and PLHGR limits can be met. These power distributions consider the effects of the time and spatial variations of xenon and iodine concentration, CEA position, thermal and moderator density feedback mechanisms as well as the effect of the burnup distribution near end-of-cycle.

Figure 4.3-20D shows typical F_q^n , F_r^n , and relative power level for an EOC maneuver. Also, Figures 4.3-21 and 4.3-21A show the calculated F_q^n and relative power level throughout the transient for both early and late in cycle transient calculations. Both step and ramp power changes are illustrated in these figures. The CEA programming used in these calculations is discussed in Section 4.3.2.4. As may be seen from these figures, the limiting value of F_q^n is met with margin.

ARKANSAS NUCLEAR ONE
Unit 2

The values of F_q^n and F_r^n are obtained by synthesis of the three-dimensional power distributions from two-dimensional (planar) MC and one-dimensional (axial) QUIX calculations for Cycles 1 through 3, for Cycles 4 through 17 with the ROCS computer code, and for subsequent cycles, beginning with Cycle 18, with the ANC computer code. Axial-dependent depletion effects are included in the end of cycle synthesized values of F_q^n by using the end of cycle axial nuclide distribution computed from three-dimensional ROCS or ANC depletion calculations.

The ROCS or ANC model calculates values of radial peaking factors for each type of CEA bank insertion (unrodded, Bank 6 inserted, etc.). These radial peaking factors are evaluated for the appropriate core average burnup condition shown in Figures 4.3-20D through 4.3-21A, and are applied over that region of the core having the specified CEA bank configuration, e.g. unrodded, Bank 6 inserted, etc. These radial peaking factors are then used to augment the power distribution in the rodded axial regions to obtain the pseudo-hot channel power for a given rodded core segment. The magnitude of the radial peaking factor is determined primarily by the number and location of the inserted CEAs; it is evaluated at the full power condition and taken to be independent of power level.

Figures 4.3-22 and 4.3-22a show a conservative estimate of the integrated radial peaking factor F_r^n during the load following transients described above. These are shown because they correspond roughly to changes in thermal margin during the maneuvers. As may be seen from the figures, the value of F_r^n remains below a value of 1.55 throughout the full power portion of the maneuvers.

Throughout the calculations of the power distributions during the transient described above, it was assumed that the CEAs were available to be moved to control the axial power distribution. Section 4.3.2.5 discussed the methods of control to be used. However, in the event that the CEAs were not moved properly, the power distribution could have become unacceptable. In this case, the monitoring system would have indicated if insufficient margin were available and would have provided an audible alarm to indicate that action had to be taken to improve the core power distribution, to improve the coolant conditions, or to reduce core power.

The radial peaking factor used in the calculation of required initial margin to DNB for a particular axial shape and set of thermal hydraulic conditions is that peaking factor which produces minimum hot channel DNBR equal to the Technical Specification DNBR Safety Limit during a calculated 4-pump loss of flow transient.

Care is taken in the fuel management design to ensure in effect that no flatter power distribution occurs in assemblies that are limiting or near-limiting with respect to DNB. Section 4.3.3.1.2 discusses the accuracy of the calculation of power distribution within a fuel assembly.

4.3.2.3 Reactivity Coefficients

Reactivity coefficients relate changes in core reactivity to variations in fuel or moderator conditions.

The data identified here illustrate the range of values of the various reactivity coefficients anticipated for a variety of expected conditions. Section 4.3.3 presents a comparison of calculated and measured moderator temperature coefficients and power coefficients for operating reactors. The good agreement provides confidence that the data presented in this section adequately characterize this reactor. The values used in the accident analyses are

ARKANSAS NUCLEAR ONE
Unit 2

chosen in a conservative manner for each analysis, and these values may fall outside the ranges of the data presented in this section whenever appropriate to allow for uncertainties in calculated values. Table 4.3-3 presents a comparison of the reactivity coefficients calculated for this core with those actually used in the safety analysis. As may be seen from this table the safety analyses used suitably conservative values of reactivity coefficients, even allowing for uncertainties as discussed in Section 4.3.3.1.2. A more extensive listing of typical reload core predicted reactivity coefficients is given in Table 4.3-4.

4.3.2.3.1 Fuel Temperature Coefficient

The fuel temperature coefficient is the change in reactivity per unit change in fuel temperature. A change in fuel temperature affects not only the thermal expansion of the fuel pellet but, in addition, the reaction rates in both the thermal and epithermal neutron energy regimes.

Epithermally, the principal contributor to the change in reaction rate with fuel temperature is the Doppler effect arising from the increase in absorption widths of the resonances with an increase in fuel temperature. The ensuing increase in absorption rate with fuel temperature causes a negative fuel temperature coefficient. In the thermal energy regime, a change in reaction rate with fuel temperature arises from the effect of temperature dependent scattering properties of the fuel matrix on the thermal neutron spectrum. In typical PWR fuels containing strong resonance absorbers such as U-238 and Pu-240, the magnitude of the component of the fuel temperature coefficient arising from the Doppler effect is more than a factor of 10 larger than the magnitude of the thermal energy component.

Figure 4.3-24 shows typical dependence of the calculated fuel temperature coefficient on average fuel temperature, both at the beginning and the end of cycle.

4.3.2.3.2 Moderator Temperature Coefficient

The moderator temperature coefficient relates changes in reactivity to uniform changes in moderator temperature, including the effects of moderator density changes with changes in moderator temperature. Typically, an increase in the moderator temperature causes a decrease in the core moderator density and therefore a reduction in the number of neutrons that are slowed to thermal energy and a reduction in the core reactivity.

However, in the presence of soluble boron, a reduction in moderator density causes a reduction in the content of soluble boron in the core, thus producing a positive contribution to the moderator temperature coefficient. One objective of the core design is to limit the moderator temperature coefficient to values that are acceptable from the standpoint of all accident situations treated in Chapter 15. Burnable poison rods (shims) are provided in the form of cylindrical pellets of alumina with uniformly dispersed boron carbide particles, gadolinia dispersed uniformly in UO₂ pellets, erbia dispersed uniformly in UO₂ pellets, or a thin UO₂ pellet coating of zirconium diboride in order to limit the dissolved boron concentration, thereby making the moderator temperature coefficient more negative. The number of poison rods typically used in a reload core design is given in Table 4.3-1, and their distribution in the core is shown for one quadrant in Figure 4.3-1E. As indicated in Table 4.3-1, the specific numbers vary with core and fuel batch design. The distribution is identical for the other three quadrants. The reactivity control provided by the poison rods makes possible a reduction in the dissolved boron concentration relative to the values given in Table 4.3-1.

ARKANSAS NUCLEAR ONE
Unit 2

The calculated moderator temperature coefficient for a typical reload core at various core conditions is given in Table 4.3-4. The CEAs, when inserted into the core, provide a negative contribution to the moderator temperature coefficient. The moderator temperature coefficient becomes more negative with burnup, due mainly to the reduction in the dissolved boron content of the coolant with burnup. The contribution to this negative trend of the neutron spectral effect of plutonium and fission products is small. The net effect of the buildup of equilibrium xenon is a negative contribution to the moderator temperature coefficient due mainly to the contribution of the concomitant reduction in soluble boron content.

The moderator temperature coefficients generated at normal operating temperatures would not be adequate for the conditions that exist during an ATWS. A detailed discussion of the methods used in the ATWS analysis is given in Reference 8.

4.3.2.3.3 Moderator Density Coefficient

The moderator density coefficient is the change in reactivity per unit change in the average core moderator density at constant moderator temperature. The density coefficient is opposite in sign to the moderator temperature coefficient since an increase in moderator temperature means a decrease in moderator density. The density coefficient is always positive in the operating range but the magnitude is reduced in the presence of dissolved boron because an increase in water density (a positive reactivity effect) is accompanied by an increase in the soluble boron content of the core (a negative reactivity effect).

The density coefficients explicitly used in the accident analyses are based upon core conditions with the most limiting temperature coefficients allowed by the Technical Specifications.

Table 4.3-3 shows a comparison of the expected values of core reactivity coefficients with those actually used in the accident analyses.

4.3.2.3.4 Moderator Pressure Coefficient

The moderator pressure coefficient is the change in reactivity per unit change in Reactor Coolant System (RCS) pressure. Since an increase in pressure increases the water density, the pressure coefficient is opposite in sign to the temperature coefficient. The reactivity effect of increasing the pressure is reduced in the presence of dissolved boron because an increase in water density adds boron to the core.

4.3.2.3.5 Moderator Void Coefficient

During full power operation, local subcooled boiling results in a predicted average steam (void) volume fraction in the moderator of substantially less than one percent. Changes in reactivity are associated with the appearance of these voids in the moderator and are reflected in the void coefficient of reactivity. The presence of boron provides a positive contribution to the coefficient since an increase in voids results in a reduction in the boron content of the core.

4.3.2.3.6 Power Coefficient

The power coefficient is the change in reactivity per unit change in core power level. All of the previously mentioned coefficients contribute to the power coefficient, but only the moderator temperature coefficient and the fuel temperature coefficient contributions are significant. The

ARKANSAS NUCLEAR ONE
Unit 2

contributions of the pressure and void coefficients are negligible due to their small magnitude and the small changes in pressure and void fraction per unit change in power level. The effect of moderator density changes is included in the moderator temperature coefficient contribution.

In order to determine the change in reactivity with power, it is necessary to know the changes in the average fuel and moderator temperatures with power. The average moderator (coolant) temperature is controlled to be a linear function of power. The current model used to compute effective fuel temperature employs an empirical function based on power coefficients that have been determined experimentally for operating cores. The following functional relationship is used throughout the burnup cycle.

$$T_{\text{FUEL}} = T_{\text{MOD}} + \left(\sum_0^2 B_i MD^i \right) P + \left(\sum_0^3 C_i MD^i \right) P^2$$

where MD is the nodal burnup - (MWD/TEM)
P is the nodal power density (KWT/FT)
B_i and C_i coefficients are derived from a fuel temperature and fuel rod power correlation.

The total power coefficient at a given core power can be determined by evaluating, for the conditions associated with the given power level, the following expression:

$$\frac{d\rho}{dP} = \frac{\partial\rho}{\partial T_f} \frac{\partial T_f}{\partial P} + \frac{\partial\rho}{\partial T_m} \frac{\partial T_m}{\partial P}$$

Since the factors $\partial\rho/\partial T_f$ and $\partial\rho/\partial T_m$ are functions of one or more independent variables, e.g., burnup, temperature, soluble boron content, xenon worth, and CEA insertion, the total power coefficient, $d\rho/dP$, also depends on these variables.

The power coefficient tends to become more negative with burnup due to the more negative moderator temperature coefficient. The insertion of CEAs into the core at constant power makes the power coefficient more negative due to a reduction in the soluble boron concentration as well as the spectral effects of the control rods.

4.3.2.4 CEA Patterns and Reactivity Worths

CEAs designated as regulating rods and CEAs designated as shutdown rods are divided into groups, where all members of a group are withdrawn or inserted quasi-simultaneously and groups are moved in a specified sequence. Figure 4.3-28 shows the CEA group identification. The order of insertion of the regulating banks, a typical degree of overlap of successive banks of regulating rods, and maximum insertion as a function of power level throughout the cycle are illustrated in the COLR PDIL figure. Shutdown banks are inserted after the regulating banks are inserted and are withdrawn before the regulating banks are withdrawn. The reactivity worths of individual CEA groups at BOC and end of cycle are shown in Table 4.3-5. Compliance with the limiting relationship between power level and CEA insertion limit, a typical example of which is shown in the COLR PDIL figure, ensures that shutdown margin requirements are met and that the core conditions are not more severe than the initial conditions assumed in the accident analyses described in Chapter 15.

ARKANSAS NUCLEAR ONE
Unit 2

The reactor is expected to be operated in an essentially unrodded mode for steady state operation at full power, with only limited insertion of regulating banks (refer to Section 4.3.2.5.4) in order to compensate for minor variations in moderator temperature and boron concentration.

The maximum reactivity worth of any individual CEA and the associated change in power distribution which would result in the event that a CEA was ejected from the core is presented in Section 15.1.20. The reactivity decrease and associated change in power distribution in the event of a dropped CEA is discussed in Section 15.1.3, and the CEA withdrawal accident is discussed in Sections 15.1.1 and 15.1.2. The uncertainties associated with these calculated reactivity worths is eight percent. The reactivity worth uncertainties used in the analyses described in these subsections is 10 percent. The allowable rod misalignment from any bank is specified in the Technical Specifications. Experimental verification of the calculated rod worths used in the accident analyses will be accomplished during startup testing of the reactor. Negative reactivity insertion as a function of time after scram signal is discussed in Chapter 15. Adherence to the rod misalignment limit discussed in the Technical Specifications will ensure that the monitoring and the protective system accurately reflects the power distribution so that no degradation of core margins will occur due to an abnormal power distribution caused by rod misalignment.

4.3.2.5 Control Requirements

Core reactivity data, including reactivity changes associated with core temperature and power changes, the reactivity worth of equilibrium xenon and samarium, and the reactivity available to compensate for burnup and fission product poisoning, are shown in Table 4.3-2. Soluble boron concentrations required for criticality at various core conditions are shown in Table 4.3-1. Burnable poison rods are provided as described in Section 4.3.1.4 to ensure that the moderator temperature coefficient has the required magnitude and algebraic sign. The reactivity controlled by these burnable poison rods is given in Table 4.3-1. At end of cycle, the reactivity worth of the residual burnable poison is small (typically one percent or less), and the soluble boron concentration is near zero.

Soluble boron is used to compensate for slow reactivity changes, for example, reactivity effects due to burnup, changes in xenon worth, etc. Furthermore soluble boron is used as a mechanism to maintain shutdown reactivity at cold conditions. The regulating CEA groups are used to compensate for the changes in reactivity associated with routine power level changes. In addition, the CEAs may be used to compensate for minor variations in moderator temperature and boron concentrations at operating condition. The reactivity worth requirements for the full complement of CEAs (regulating plus shutdown CEAs) are shown in Table 4.3-6 and are discussed below. The total worth of all CEAs, including shutdown CEAs, covers these requirements and provides adequate shutdown capability with the most reactive CEA stuck in the fully withdrawn position as shown in Table 4.3-7, at any time in the cycle.

4.3.2.5.1 Fuel Temperature Variation

The increase in reactivity that occurs when the fuel temperature decreases from a full power value to a zero power value is due primarily to the Doppler effect in U-238.

4.3.2.5.2 Moderator Temperature Variation

An increase in reactivity occurs when the moderator temperature decreases from the full power value to the zero power value. This reactivity increase, which is due to the negative moderator temperature coefficient, is largest at end of cycle when the soluble boron concentration is near zero and the moderator coefficient is strongly negative. At BOC, when the moderator temperature coefficient is less negative, the reactivity increase is smaller. The CEA reactivity allowance for moderator temperature variation given in Table 4.3-6 includes an allowance for this effect plus allowances for the reduction in CEA worth due to increased moderator density in going from full power to zero power and for the effect of the axial flux redistribution that occurs in going from hot full power to hot zero power. The latter effect is included as part of the moderator temperature allowance since it occurs as a result of the change in the axial moderator temperature profile between hot full power and hot zero power in conjunction with the asymmetric burnup distribution resulting from the negative moderator temperature coefficient of reactivity.

4.3.2.5.3 Moderator Voids

In going from full power to zero power, an increase in reactivity results from the collapsing of steam bubbles caused by local boiling at full power. The amount of void reactivity in the core is small and is estimated to be substantially less than one percent at full power. As with the moderator temperature effect, the maximum increase in reactivity from full to zero power occurs at end of cycle, when the least amount of dissolved boron is present. The reactivity effect is small, and the allowance for this effect is shown in Table 4.3-6.

4.3.2.5.4 CEA Bite

The CEA bite is the amount of reactivity worth in CEAs that can be inserted in the core at full power to initiate ramp changes in reactivity associated with load changes, and to compensate for minor variations in moderator temperature, boron concentration, xenon concentration, and power levels. The reactivity allowance for this effect is shown in Table 4.3-6.

4.3.2.5.5 Shutdown Margin and Accident Analysis Allowance

The allowance shown in Table 4.3-6 for shutdown margin is consistent with that assumed under various postulated accident conditions addressed in Chapter 15, which result in predicted acceptable consequences.

4.3.2.5.6 Available Reactivity Worth

Table 4.3-7 shows the reactivity worths of the full complement of CEAs, and the highest reactivity worth of a single CEA in the fully withdrawn position, at beginning and end of cycle. This table also compares the available net shutdown worth (including the effects of the stuck CEA) to the reactivity worth requirements from Table 4.3-6.

The uncertainty in total CEA reactivity worth is nine percent. Even allowing for the maximum calculated errors for CEA worth in the adverse direction, sufficient shutdown margin is available.

4.3.2.6 Control and Monitoring of the Power Distribution

Methods of reactor control include manual regulating CEA motion or dissolved boron concentration changes to change power level or to improve the axial and radial power distribution; and correcting off-optimum conditions which cause margin degradation, e.g., CEA misalignments. In using these methods of control, at any power level and any time in life the following are required.

- A. There is sufficient reactivity worth in withdrawn CEAs to meet shutdown margin requirements.
- B. The amount of CEA insertion and individual CEA worth be such that the core conditions are not more severe than the initial conditions assumed in the accident analyses described in Chapter 15.
- C. Limiting conditions for operation, including required DNBR and kW/ft margins be satisfied.

The first two of these restrictions are met by maintaining the CEAs above the allowable position shown on the Power Dependent Insertion Limit (PDIL) curve typified in the COLR PDIL figure. The zero power PDIL limits the CEA insertion allowed at criticality. The third restriction requires that during normal operation, the combination of power distribution and other variables, e.g., CEA positions, power level, and coolant conditions, be maintained so that the limiting conditions for operation are not violated. The PDIL restricts the maximum amount of inserted CEA reactivity at full power. This allowance is limited to the CEA bite allowance given in Table 4.3-6 and discussed in Section 4.3.2.5.4.

Reactor operation within the limiting conditions for operation is verified by COLSS. COLSS is used to:

- A. Monitor Nuclear Steam Supply System (NSSS) parameters affecting operating limits (such as CEA positions and overlaps, azimuthal tilt, and axial power distributions); and,
- B. Process this information to provide the capability to indicate the margin available to operating limits on linear heat rate, DNBR, and core average power.

From this information provided by COLSS, it is determined whether CEA movement is necessary to improve the power distribution, or whether a reduction in core power is necessary to maintain sufficient core margins. The radial power distribution may be improved by withdrawing full length CEAs, and substituting soluble boron for the concurrent reactivity change. As may be seen in Figures 4.3-2 through 4.3-10, the radial power distribution with no CEAs inserted is more favorable than the radial power distribution with CEAs inserted. Table 4.3-6a summarizes the effects of CEA insertion on the radial power distribution. The CEAs are also used to control the effects of axial xenon oscillations. Partial insertion of the regulating CEA banks during those times when the xenon concentration is increasing in the bottom regions of the core provides an effective means of quickly damping such oscillations.

4.3.2.7 Criticality of Fuel Assemblies

The maximum K_{eff} value of a single fuel assembly, when moderated and completely reflected by unborated water at room temperature, is 0.92 based on an enrichment of 5.0 wt percent U-235 and the fuel parameters shown in Table 9.1-7. Two such assemblies with optimum spacing in water could be supercritical. Note however, that in practical situations ideal reflection is extremely improbable. Under dry conditions, the K_{eff} of a very large array of assemblies is estimated to be less than 0.7. Fuel assembly average U-235 loadings and burnup limits which provide adequate margin to criticality for fuel storage in the spent fuel pool are contained in Technical Specifications.

4.3.2.8 Stability

4.3.2.8.1 General

PWRs with a negative power coefficient are inherently stable to total core power oscillations. Design Basis 4.3.1.3 insures that a negative power coefficient will exist for this core at all times during the cycle. Therefore, the discussion on reactor stability will be limited to a discussion of xenon induced spatial power oscillations. Xenon induced spatial oscillations in large PWRs fall into three classes or modes. These are referred to as axial oscillations, azimuthal oscillations and radial oscillations. An axial oscillation is one in which the axial power distribution periodically shifts upward and downward in the core. An azimuthal oscillation is one in which the X-Y power distribution periodically shifts from one side of the reactor to the other (see Figure 4.3-31). A radial oscillation is one in which the X-Y power distribution shifts inward and outward from the center of the core to the periphery (See Figure 4.3-32).

Stability of a reactor to a particular mode of oscillation is characterized by a damping factor. When the damping factor is positive, the reactor is unstable to that mode of oscillation. This means that when the power distribution is perturbed, i.e. altered in any manner, the magnitude of the oscillation will increase with time in the absence of control intervention. When the damping factor is negative, the reactor is stable and the magnitude of the oscillation decreases with time.

A linear stability criterion, employing only the fundamental and first harmonic modes, has been used to judge the stability of the reactor to xenon induced spatial oscillations. This criterion has been shown to be adequate (Reference 131) when either of the following exist.

- A. The reactor is stable to xenon induced oscillations, since the second harmonic modes contribute little to either the periods or the decay constants of the first harmonic mode oscillations.
- B. The reactor is unstable to xenon induced oscillations, since the first harmonic modes excite the second harmonic modes without affecting the periods of the first harmonic modes.

A discussion of the methods used to calculate the damping factor is given in Section 4.3.3.2.

Xenon oscillation studies lead to the following general conclusions.

- A. The damping factor for an oscillatory mode depends primarily upon the power coefficient and the time in the burnup cycle.

ARKANSAS NUCLEAR ONE
Unit 2

- B. The time scale on which any oscillations occur is long, the period of oscillation being generally between 25 and 30 hours.
- C. As long as the initial power peaking associated with an oscillation inducing perturbation is within limiting conditions for operation, specified acceptable fuel design limits will not be approached for a period of hours if the reactor is unstable to oscillations. If the reactor is stable to xenon oscillations, specified acceptable fuel design limits will not be approached.
- D. The reactor is predicted to be stable to both radial and azimuthal mode xenon oscillations at all times in the burnup cycle. Figure 4.3-33 shows the predicted damping factor for azimuthal xenon oscillations as a function of the core moderator temperature coefficient for a typical eigenvalue separation. The least negative moderator temperature coefficient that is predicted to occur with equilibrium xenon present is $-0.4 \times 10^{-4} \Delta\rho/^\circ\text{F}$. As may be seen from the figure, even with an uncertainty in the moderator coefficient of $\pm 0.3 \times 10^{-4} \Delta\rho/^\circ\text{F}$, the reactor is predicted to be stable to azimuthal xenon oscillations.
- E. The reactor is expected to be naturally unstable to axial mode oscillations before the end of the cycle.
- F. All possible modes of un-damped oscillations can be detected by either out-of-core or in-core instrumentation.

4.3.2.8.2 Detection of Oscillation

The power range (safety channel) out-of-core neutron detectors are used to monitor the symmetry of power distributions by means of parameters derived from the relative responses of detectors located at distinct azimuthal and axial positions.

In addition, the COLSS will be used to detect axial and azimuthal oscillations, as described in Section 7.2.

4.3.2.8.3 Special Features Required by Xenon Instability

The RPS described in Section 7.2.2 is designed to prevent exceeding acceptable fuel design limits and to limit the consequences of postulated accidents. In addition a means is provided to assure that under all allowed operating modes the state of the reactor is confined to conditions not more severe than the initial conditions assumed in the design and analysis of the protective system.

Since the reactor is predicted to be stable with respect to azimuthal xenon oscillations, no special protective system features are needed to accommodate azimuthal mode oscillations. Nevertheless, a maximum quadrant tilt is prescribed in the Technical Specifications along with prescribed operating restrictions in the event that the tilt is exceeded. The quadrant power tilt is determined by COLSS and included in the COLSS determination of core margin. The quadrant power tilt limit is accounted for in the RPS.

ARKANSAS NUCLEAR ONE
Unit 2

In the unlikely event that the core is observed to be unstable to azimuthal xenon oscillations, measures will be taken that will sufficiently increase the natural stability of the core. For instance, CEAs can be inserted to make the power coefficient more negative or to shape the radial power distribution to make the core more stable. Measurements of xenon spatial stability in cores larger than this core have been made. These measurements provide added confidence in the methods that are used to predict the azimuthal stability of this core.

The features provided for azimuthal xenon effects are as follows:

- A. Administrative limits on azimuthal power tilt;
- B. Monitoring and indicating the azimuthal power tilt in COLSS as well as accounting for this tilt in the COLSS determination of core margin; and,
- C. Accounting for azimuthal power tilt limit in the RPS.

The features provided for axial xenon effects and power distribution effect and control are as follows:

- A. CEAs for control of the axial power distribution, if required;
- B. Monitoring and accounting for changes in the axial power distribution in COLSS; and,
- C. Monitoring and accounting for the axial power distribution in the RPS.

4.3.2.9 Vessel Irradiation

The maximum fast neutron fluxes greater than 1 MeV used in the determination of vessel fluence incident on the vessel ID and shroud ID are as shown in Table 4.3-8. Fluence aspects, in regards to the reactor vessel, are discussed in Section 4.3.3.3 and Section 5.2.4. The fluxes are based on a time averaged equilibrium cycle radial power distribution and an axial power distribution with a peak to average of 1.20.

4.3.3 ANALYTICAL METHODS

4.3.3.1 Reactivity and Power Distribution

4.3.3.1.1 Methods of Analysis

The following discussion includes historical information that describes the evolution of the analytical neutronics modeling. Starting with Cycle 18, the Westinghouse neutronics code system consisting of the ANC and PARAGON codes replaces the ROCS/DIT computer codes.

The nuclear design analysis for low enrichment PWR cores is based on the two-dimensional integral transport code DIT, which provide cross sections appropriately averaged over a few broad energy groups for the whole assembly or individual cells, and few group one-, two-, and three-dimensional diffusion theory calculations of integral and differential reactivity effects and power distributions. The ROCS/DIT code system is documented in Reference 159.

ARKANSAS NUCLEAR ONE Unit 2

The reactor physics model derived from the Arkansas Nuclear One - Units 1 and 2 benchmarking effort, together with the methodology used to determine calculational uncertainties, and the resultant reliability factors associated with the model, are presented in the report, MSS-NA1-P, Reference 30, and MSS-NA3-P, Reference 163. Beginning in Cycle 12, the methods, calculational uncertainties, and reliability factors from ENEAD-01-P-A, Reference 174, and ENEAD-02-NP-A, Reference 175, were employed. Beginning in Cycle 20, the methods, calculational uncertainties, and reliability factors from ENEAD-01-P-A (Reference 174) and ENEAD-02-NP-A (Reference 175), or CENPD-153-P Rev. 1 P-A (Reference 22) are employed. Application of this model and calculation techniques commences with Arkansas Nuclear One - Unit 2, Cycle 2, and includes application to reactor operations, safety evaluations, updates to the core monitoring programs (CECOR, COLSS, CPCs, CEACs) and the safety evaluation of reload designs.

Comparisons between calculated and measured data which validate the design procedures are presented in Section 4.3.3.1.2. As improvements in analytical procedures are developed, and improved nuclear data become available, they will be added to the design procedures, but only after validation by comparison with related experimental data.

The function of the DIT lattice code is to prepare few-group averaged cross sections for coarse-mesh and fine-mesh diffusion theory codes. These cross sections are used in ROCS (coarse-mesh) and in the MC module of ROCS (fine-mesh).

Spatial averages of microscopic and macroscopic cross sections are performed for editing purposes and are passed on to ROCS, and MC. Few-group cross sections are prepared in the HARMONY format for ROCS. Cross sections are input directly to MC without intermediate processing.

Static and depletion dependent reactivities and nuclide concentration, flux, and power distributions in two- and three-dimensional representations of the core are determined by diffusion depletion programs, ROCS-MC. The ROCS code is designed to perform two- or three-dimensional coarse-mesh reactor core calculations with full-, half- or quarter-core symmetric geometries.

Cross section information used in the ROCS system is derived from microscopic cross sections supplied by DIT for each nuclide in two energy groups. This information is supplied in table form.

The depletion equations are solved using the flux and microscopic cross section values based on the neutronics and thermal-hydraulic feedback calculations preceding the depletion time step. The initial flux and cross sections are assumed constant over the depletion time step.

Static and time dependent reactivities and power distributions in a one-dimensional (axial) representation of the core are determined by the diffusion theory program QUIX. This program solves the neutron flux and associated eigenvalue for problems containing up to 140 distinct regions or compositions with variable mesh intervals. In addition to the eigenvalue problem, QUIX will perform four types of search calculations to attain a specified eigenvalue, viz., a poison search, buckling search, CEA region boundary search, and a moderator density dependent poison search. The effects of moderator and fuel temperature feedback on the power distribution can be treated.

ARKANSAS NUCLEAR ONE
Unit 2

Analyses have been performed in the same manner and with similar methodologies to those used for previous analyses. However, several method improvements were implemented for Cycle 10. Those improvements include the use of anisotropic scattering within pin cells and anisotropic neutron currents at pin cell interfaces in the DIT code.

Improvements were also made in the ROCS code via the application of the Nodal Expansion Method (NEM), which is based upon a fourth order solution, and by the implementation of assembly discontinuity factors. The improved methodology is discussed in approved topical reports with the exception of the application of assembly discontinuity factors which is, today, a widely accepted and used procedure in the industry.

The new DIT/ROCS methodology was implemented primarily to improve core power distribution predictions. This improvement is obtained via the calculation of more accurate global radial power and local fuel pin power distributions. The global radial power distribution is particularly enhanced through the better modeling of the power sharing between neighboring assemblies. The local pin power distribution is improved via the better modeling of both intra and inter pin phenomena.

In addition to improved power distribution predictions, the new methodology improves upon the calculation of control rod worths. The remaining impact of the improved methodology on the reload analyses performed for Cycle 10 was essentially limited to the application of a revised set of biases and uncertainties determined specifically for use with the improved methodology.

The effect of the new uncertainty values pertaining to scram worth/shutdown margin calculations can be demonstrated as follows. The combined bias and uncertainty used for Cycle 9 was 15.40%. The combined bias and uncertainty that was applied to the Cycle 10 calculated data was 6.28%.

Nuclear design calculations were performed using the coarse mesh code ROCS and the fine mesh code MC. The coarse mesh code ROCS was used in 3-dimensional geometry to calculate all core wide parameters and assembly relative power densities. The fine mesh code MC was used to calculate pin peaking data.

All cross sections for both the coarse (ROCS) and fine mesh calculations (MC) were generated using the DIT assembly spectrum code. The MC calculations intrinsically account for the increased peaking that is characteristic of fuel pins adjacent to water holes in the assembly lattice.

The FLAIR code used for the uncertainty analysis (see Section 7.7), also has the capability of simulating ex-core detector responses expected during operation. The calculated normalized core average power distribution is first corrected by the application of CEA shadowing factors to simulate the peripheral fuel assembly power distribution. Shape annealing factors are then applied to the peripheral axial power distribution to simulate the integrated response of the sub-channels of the three element ex-core detectors.

CEA shadowing is the change in ex-core detector response in going from an unrodded configuration to a core configuration with CEAs inserted while maintaining constant power operation. Although CEA shadowing is a function of azimuthal location, its affect is minimized by placing the ex-core detectors at azimuthal locations where minimum CEA shadowing occurs.

ARKANSAS NUCLEAR ONE
Unit 2

CEA shadowing factors can be determined using FLAIR code with assembly weighing factors and shape annealing functions from SHADRAC and DOT codes. SHADRAC (see Reference 137) calculates fast neutron and gamma ray spectra, heating, and dose rates in a three-dimensional system utilizing a moments method solution of the transport equation. The core, vessel internals, vessel and ex-core detector location are treated explicitly in the calculation.

Normalized CEA shadowing factors are relatively constant with burnup.

Figure 4.3-46 shows the typical behavior of the CEA shadowing factor during a CEA insertion and withdrawal sequence. Simulated factors and experimentally measured CEA shadowing factors during this transient situation are shown to have quite good agreement over a significant range of CEA insertions.

Shadowing factors account for the radial effects and annealing accounts for the axial effects on the ex-core detector responses. Due to neutron scattering in the large air gap between the vessel and the biological shield, the ex-core detector subchannels respond to neutrons from the entire length of the core and not just from the section immediately opposite the subchannel. This effect is independent of the axial power shape and the azimuthal CEA shadowing factors. Typical axial annealing functions, given as fractional response per percent of core height for a three subchannel systems, are shown in Figure 4.3-47.

This annealing is determined utilizing a fixed source DOT calculation. DOT (see Reference 139) is a two-dimensional discrete ordinates transport code. The RZ geometry option is used for the annealing calculation with representation of the core, vessel, vessel internals, air gap, and biological shield. The actual detector walls are not represented in the DOT calculation.

However, the self-shielding effect of the walls on the detector response is small and uniform along the length of the detector and as a result will not change the normalized annealing. The DOT calculation uses an S_{12} angular quadrature and a 13-group neutron cross section set with P_3 scattering as determined by GGC-341 and CEPAC. The fixed source is distributed over 20 uniform axial segments of the active core height. Figure 4.3-48 illustrates the radial regions represented in the DOT calculation as well as one of the axial fixed source segments. The total pointwise subchannel response from that axial fixed source segment is:

$$\sum_{E=1}^{13} \sum_f^{U-235} (E) \theta(E)$$

where

$\sum_f^{U-235} (E)$ is a macroscopic fission cross section taken from GGC-3 and CEPAC results, and

$\theta(E)$ is the neutron flux along the fission chamber centerline

By integrating the total pointwise response along the length of the subchannel, one can determine the subchannel response for each axial fixed source segment. Utilizing this same technique for all 20 axial segments of the core and normalizing to the total ex-core detector response, annealing curves similar to Figure 4.3-47 are determined.

ARKANSAS NUCLEAR ONE
Unit 2

As the annealing is determined using a flat axial shape, the resulting annealing factors (S(z)) must be multiplied by the appropriate peripheral axial shape to obtain total detector response.

$$D_{\text{Lower}} = \sum_z P(z) S(z) \quad \text{Lower}$$

$$D_{\text{Middle}} = \sum_z P(z) S(z) \quad \text{Middle}$$

$$D_{\text{Upper}} = \sum_z P(z) S(z) \quad \text{Upper}$$

The shape annealing factors are purely geometric correction factors applied to the peripheral axial power distribution. As such, the effects of time in fuel cycle, transient xenon redistribution and rod insertion, although affecting the peripheral bundle power shape, do not effect the geometric shape annealing correction factors. Figure 4.3-49 compares the peripheral axial shape index with the external shape index during a rod and PLR motion test for the Palisades reactor. Shown are the results of simulations of the test as well as experimental data taken during the test. From this curve we can conclude that even though the axial power distribution in the core and on the core periphery was changing during this transient, the relationship between the ex-core response and the peripheral response was not. These results justify not only the separability of CEA shadowing and shape annealing as summed in the calculation but also demonstrate that shape annealing is purely a geometric effect, independent of the peripheral axial power distribution.

The ex-core detector temperature decalibration effect is the relative change in detector response as a function of reactor water inlet temperature. The temperature decalibration effect is calculated utilizing SHADRAC with explicit representation of core, vessel internals, vessel and detector location for various reactor inlet temperatures. Typical detector temperature decalibration effect as a function of inlet temperature normalized to an inlet temperature of 525 °F is as shown in Figure 4.3-50.

Beginning with Cycle 18, the Advanced Nodal Code (ANC) (References 188, 189, and 190) was implemented in the reload design analysis. ANC is an advanced nodal analysis theory code capable of two- or three-dimensional calculations. Also beginning with Cycle 18, PARAGON, (Reference 191) computer code was implemented in the reload design analysis. PARAGON is a two-dimensional transport theory based code that calculates lattice physics constants. These are the same methods and models that have been used in other Westinghouse reload cycle designs. These codes are replacements for the ROCS/DIT computer codes.

The primary purpose of PARAGON is to provide input data for use in three dimensional core simulator codes. This includes macroscopic cross sections, microscopic cross sections for feedback adjustments to the macroscopic cross sections, pin factors for pin power reconstruction calculations, and discontinuity factors for a nodal method solution. PARAGON can be used as a standalone or as a direct replacement for all the previously licensed Westinghouse PWR lattice codes, such as PHOENIX-P, as approved by the NRC in Reference 191.

PARAGON is a two-dimensional multi-group neutron (and gamma) transport code. The PARAGON flux solution calculation uses Collision Probability theory within the interface current method to solve the integral transport equation. Throughout the whole calculation, PARAGON uses the exact heterogeneous geometry of the assembly and the same energy groups as in the cross-section library to compute the multi-group fluxes for each micro-region location of the assembly.

ARKANSAS NUCLEAR ONE
Unit 2

In order to generate the multi-group data that will be used by a core simulator code PARAGON goes through four steps of calculations: resonance self-shielding, flux solution, homogenization and burnup calculation.

ANC is the three-dimensional core simulator code in the Westinghouse nuclear design code system. The ANC nodal flux solution is based on a set of two-group diffusion theory nodal balance equations that are solved using a solution method based on the nodal expansion method (NEM). This method and the specific approximations made in the ANC implementation provide an accurate representation of the core nodal neutronics. ANC is used to calculate core reactivity, reactivity coefficients, critical boron, rod worths, and core, assembly, and rod power distributions for normal and off-normal conditions for use in design and safety analyses. The ANC computer code is also used in the uncertainty analysis, as a replacement for the ROCS code, which in turn was a replacement for the FLAIR computer code.

4.3.3.1.2 Comparison with Experiments

The nuclear analytical design methods in use for Arkansas Nuclear One, Unit 2 have been checked against a variety of critical experiments and operating power reactors. Reactivity and reaction rate calculations are performed which lead to information concerning the validity of the basic fuel cell calculations.

The accuracy of the calculational system in its entirety can only be assessed through the analysis of experimental data collected on operating power reactors. The data under investigation consists of critical conditions, reactivity coefficients, and rod worths measured during the startup period, and of critical conditions, power distributions, and reactivity coefficients measured throughout the various cycles. The details of these studies have been previously presented in Reference 159.

The accuracy of the power distribution predictions cannot be disassociated from the accuracy of the instrumentation which is used to measure these power distributions. The instrumentation in C-E reactors consists of fixed self-powered rhodium detectors, whose signals are fed into the computer code system CECOR (Reference 22) which unfolds a full core power distribution with the help of precalculated coupling coefficients. The uncertainties associated with each step of this process, and the differences observed between calculated and measured three-dimensional power distributions, are documented in detail in References 22 and 159.

The benchmarking of the Westinghouse neutronics computer codes, ANC, PHOENIX, and PARAGON, is documented in detail in References 188 through 191.

4.3.3.2 Spatial Stability

4.3.3.2.1 Methods of Analysis

An analysis of xenon induced spatial oscillations may be done by two classes of methods: time dependent spatial calculations and linear mode analysis. The first method is based on computer simulation of the space, energy, and the time dependence of neutron flux and power density distributions. The second method calculates the damping factor based on steady state calculations of flux, importance (adjoint flux), xenon and iodine concentrations, and other relevant variables.

ARKANSAS NUCLEAR ONE
Unit 2

The time dependent calculations are indispensable for studies of the effects of CEA, core margin, out-of-core and in-core detector responses, etc., and are performed in one, two, and three dimensions with few group diffusion theory using tested computer codes and realistic modeling of the reactor core.

The linear modal analysis methods are used to calculate the effect on the damping factors of changes in fuel zoning, enrichment, CEA patterns, operating temperature, and power levels. These methods, using information at a single point in time, are particularly suited to survey type calculations. Methods are based on the work of Randall and St. John (Reference 127) as extended by Stacey (Reference 140). These methods have been verified by comparison with time dependent calculations.

4.3.3.2.2 Radial Xenon Oscillations

To confirm that the radial oscillation mode is extremely stable, a space-time calculation was run for a reflected, zoned core 11 feet in diameter without including the damping effects of the negative power coefficient. The initial perturbation was a poison worth of 0.4 percent in reactivity placed in the central 20 percent of the core for one hour. Following removal of the perturbation, the resulting oscillation was followed in 4-hour time steps for a period of 80 hours. As shown on Figure 4.3-32 the resulting oscillation died out very rapidly with a damping factor of about -0.06 per hour. When this damping factor is corrected for a finite time mesh by the formula in Reference 124, it is more negative and indicates a more strongly convergent oscillation. On this basis, it is concluded that a radial oscillation instability will not occur.

4.3.3.2.3 Azimuthal Xenon Oscillations

Two-dimensional modal analysis techniques have been used to calculate the damping factor for azimuthal oscillations, and have included both the fuel temperature and moderator temperature components of the total power coefficient. These calculational techniques have been used to predict the results of azimuthal oscillation tests at Maine Yankee at 75 percent power. The predicted damping factor of -0.045 hr^{-1} for azimuthal oscillations was found to agree well with the measured value of $-0.47 \pm .005 \text{ hr}^{-1}$.

4.3.3.2.4 Axial Xenon Oscillations

To check and confirm the predictions of the linear modal analysis approach, numerical space-time calculations have been performed for both beginning and end of cycle. The fuel and poison burnup distributions were obtained by depletion with soluble boron control so that the power distribution was strongly flattened. Spatial Doppler feedback was included in these calculations. In Figure 4.3-41, the time variation of the power distribution along the core axis is shown near end of cycle with reduced Doppler feedback. The initial perturbation used to excite the oscillations was a 50 percent insertion into the top of the core of a 1.5 percent reactivity CEA bank for one hour. The damping factor for this case was calculated to be about 0.02 per hour; however, when corrected for finite time mesh intervals by the methods of Reference 124, the damping factor is increased to approximately +0.04. When this damping factor is plotted on Figure 4.3-42 at the appropriate eigenvalue separation for this mode at end of cycle, it is apparent that good agreement is obtained with the modified Randall-St. John prediction. This good agreement is a result of the generally antisymmetric distribution of the moderator coefficient about the core midplane, and its consequent flux and adjoint weighted integrals of approximately zero. Calculations performed with both Doppler and moderator reactivity feedback have resulted in damping factors which are essentially the same as those obtained

ARKANSAS NUCLEAR ONE
Unit 2

with Doppler feedback alone. In addition, one-dimensional linear modal analysis calculations have been performed to predict the results of axial oscillation tests at Maine Yankee at 75 percent power. The measured damping factor of $-0.05 \pm .01 \text{ hr}^{-1}$ was more negative than the calculated value of -0.036 hr^{-1} , illustrating that the calculation is conservative and that the core is somewhat more stable with respect to axial oscillations than predicted by present calculational techniques.

The QUIX code is used to calculate the axial power distributions, shape indices, integrated radial peaking factors, and scram reactivity curves for conditions occurring during a free xenon oscillation which produces large numbers of different iodine and xenon axial distributions. The xenon distributions studied cover a wider range of situations than normal operation including axial xenon redistributions one could observe during maneuvering and transient situations. The calculations are repeated for several different CEA insertions allowed by the power dependent insertion limits. The analyses are repeated for selected times in life.

Thermal margin analyses are performed to determine the sensitivity of the hot channel minimum DNBR to changes of core flow for each of the shapes generated in the above physics calculation which are within a defined range of axial shape indices. The radial peaking factors used in the calculations include values which are greater than the maximum value associated with the power dependent CEA insertion limits given in the COLR PDIL figure. The methods used for these thermal margin calculations are standard CE analysis methods described in Section 4.4. These analyses establish which combinations of conditions produce the nearest approach to the Technical Specification DNBR Safety Limit during a loss of flow transient.

4.3.3.3 Reactor Vessel Fluence Calculation Model

The vessel fluence was calculated based on the methods described in References 198 and 199. These methods use the two dimensional discrete ordinates transport theory code, DORT along with cross-sections, geometry definition and other modeling techniques consistent with the requirements of Regulatory Guide 1.190 (March 2001). DORT is used to calculate the neutron flux distribution, radially and azimuthally along the core mid-plane. A separate axial flux distribution is determined as a function of radial position from the center of the core. These two distributions are combined to produce a synthesized three-dimensional flux distribution for the vessel. The fluence is determined by integrating the actual operating history using the flux distribution applicable to each reload core through the end of Cycle 14. Integration to beyond Cycle 14 is performed based on conservatively extrapolated 18 month core designs. The integration assumes full power operation of 2815 MWt for Cycles 1-15 with a power increase to 3026 MWt occurring at the beginning of Cycle 16. [The third reactor vessel specimen \(refer to Section 5.2.4.3.6\) was withdrawn at the end of Cycle 24.](#) The results of the vessel fluence calculations are discussed in Section 5.2.4.

The calculated fluence uncertainty (95/95) has been established in Reference 198 to be well within the 20% defined by Regulatory Guide 1.190. [Dosimetry Capsule 284](#) was removed from inside the ANO-2 vessel at the end of Cycle 24. Comparisons of the dosimetry measurements to those predicted by the fluence analysis were consistent with the uncertainties reported in Reference 200, confirming method's applicability to ANO-2 (Reference 199).

ARKANSAS NUCLEAR ONE
Unit 2

4.3.3.4 Local Axial Power Peaking Augmentation

An analysis performed by C-E for EPRI, (Reference 160), demonstrated that the increased power peaking associated with the small interpellet gaps found in C-E's modern fuel rods (non-densifying fuel in pre-pressurized tubes) is insignificant compared to the uncertainties in the safety analyses. The report concluded that augmentation factors can be eliminated from the reload analyses of any reactor loaded exclusively with this type of fuel. This discussion of the elimination of the augmentation factors was used by BG&E in Reference 161 and accepted by the NRC in Reference 162. Since the manufacturing process of C-E's modern fuel is the same for both BG&E and AP&L/Entergy Arkansas, Inc., and the fuel differs only in dimensions, it is concluded that the peaking factor penalty due to fuel densification is insignificant compared to the uncertainties incorporated into COLSS and CPC and thus the augmentation factors have been eliminated.

4.3.4 CHANGES

A significant amount of core operating data has been incorporated into the nuclear design methods used for the design of this reactor. Operating reactor power distributions, critical boron concentrations, reactivity coefficients and control rod worths have been measured on the Maine Yankee reactor. The excellent agreement between these measured values and those predicted by the analytic methods used in Combustion Engineering as described in Section 4.3.3 lends confidence to the methods used to design this reactor.

Arkansas Nuclear One - Unit 2 will use continuous, on-line measurement of the core power distribution by in-core detectors in order to monitor the core power distribution. COLSS will continuously evaluate the core margins based on the measured in-core power distribution.

4.4 THERMAL AND HYDRAULIC DESIGN

This section presents a description of the thermal and hydraulic analysis of the reactor core, analytical methods utilized, and experimental work supporting the analytical techniques. The prime objective of the thermal and hydraulic design of the reactor is the assurance that the core can meet normal steady state and transient performance requirements without exceeding the design bases.

4.4.1 DESIGN BASES

4.4.1.1 Thermal Design

Avoidance of thermally induced fuel damage during normal steady state operation and during anticipated operational occurrences is the principal thermal hydraulic design basis. The following design limits are established, but violation of these will not necessarily result in fuel damage. The Reactor Protective System (RPS) will provide for automatic reactor trip or other corrective action before these design limits are reached:

- A. A minimum allowable limit of 1.23 (see Section 4.4.2.3.2) is set on the Departure from Nucleate Boiling Ratio (DNBR) during normal operation and any anticipated operational occurrence.
- B. The peak temperature of the fuel will be less than the melting point (2,805 °C unirradiated and reduced by 32 °C per 10,000 MWD/MTU) during normal operation and any anticipated operational occurrences. A discussion of the maximum fuel and clad temperatures under overpower conditions is presented in Section 4.4.2.2.

The analyses described in Section 4.4 were developed using the W-3 Correlation which yielded a minimum DNBR of 1.30, and the COSMO and INTHERMIC computer codes applicable to Cycle 1 operation. Subsequent cycles utilize either the CE-1, ABB-NV, or WSSV-T Correlation, and the TORC and CETOP-D computer codes. The DNBR safety limit is maintained at a WSSV-T / ABB-NV value of 1.23 as described in Section 4.4.2.3.2. TORC and CETOP-D are described in Section 4.4.3.4.2.

4.4.1.2 Coolant Flow Rate and Distribution

A lower limit on the total primary pump flow rate, called "design" flow, is utilized for all core thermal margin analyses to assure that the core is adequately cooled when uncertainties in system resistance, pump head, and core bypass flow are taken in the adverse direction. (Refer to Chapter 5 for pump design.) The design of the reactor internals ensures that this flow is distributed to the core such that the core is adequately cooled during normal operation and any anticipated operational occurrence. No specific inlet orificing configuration is used.

The hydraulic loads for the design of the internals are based on the upper limit of the flow. The upper limit on flow is obtained when the uncertainties in system resistance, pump head, and core bypass flow are taken in the direction to maximize the flow.

4.4.1.3 Fuel Design Bases

The fuel design bases to assure fuel clad integrity and fuel assembly integrity are given in Section 4.2.1. Thermal and hydraulic parameters which influence the fuel integrity include maximum linear heat rate, core coolant velocity, coolant temperature, clad temperature, fuel-to-

ARKANSAS NUCLEAR ONE
Unit 2

clad gap conductance, fuel burnup, and UO₂ temperature. There are no thermal limits applied directly to these parameters other than those in Section 4.4.1.1, but the values of these parameters given in the following sections are consistent with those used in Section 4.2.1 to show that the fuel design bases are satisfied.

4.4.2 DESCRIPTION

4.4.2.1 Summary Comparison

The thermal and hydraulic parameters for the reactor are listed in Table 4.4-1 for Cycle 1 and Table 4.4-2 for a representative recent cycle. A comparison of these parameters with those of the San Onofre Units 2 and 3 (Unit 2 Docket Number 50-361, Unit 3 Docket Number 50-362) is given in Table 4.4-1. The San Onofre parameters given in the table have been extracted from the San Onofre PSAR up to and including Amendment 17.

The obvious differences include decreases in the power, flow rate, and number of fuel assemblies. Within the reactor vessel, the internals design is basically the same except smaller for those components affected by the fewer fuel assemblies.

The Arkansas Nuclear One - Unit 2 fuel assemblies incorporate a 16 x 16 fuel rod array. Compared to the 14 x 14 fuel rod array described in the San Onofre PSAR (through Amendment 17) and in Table 4.4-1, the 16 x 16 fuel assembly contains a greater number of fuel rods of smaller diameter and pitch. The 16 x 16 fuel assembly has greater heat transfer surface area and fuel rod linear footage, thereby reducing the peak heat flux and linear heat rate. These reductions provide an increased thermal margin relative to a 14 x 14 fuel assembly at a given core power density.

4.4.2.2 Fuel and Cladding Temperatures

This section describes the correlations used and the method of analysis for determining the fuel cladding temperatures and the fuel pellet temperature.

4.4.2.2.1 Fuel Cladding Temperatures

The surface temperature of the cladding is dependent on the axial and radial power distributions, the temperature of the ambient coolant, and the surface heat transfer coefficient. Cladding temperatures are obtained for a typical radial power distribution such as that shown in Figure 4.3-23. The standard thermal-hydraulic codes used to obtain subchannel conditions are utilized with this radial distribution and with typical axial power distributions such as shown in Figure 4.4-2. Use of the resulting temperatures in the calculation of mechanical interactions in the fuel assembly is discussed in Section 4.4.3.7, including effects of differential thermal expansion, transients and growth throughout the fuel lifetime.

The surface heat transfer coefficient for non-boiling forced convection is obtained from the Dittus-Boelter correlation (Reference 69) where fluid properties are evaluated at the bulk condition.

$$h_{db} = \left(\frac{0.023k}{D_e} \right) (N_{Re})^{0.8} (N_{Pr})^{0.4}$$

ARKANSAS NUCLEAR ONE
Unit 2

where:

h_{db} = Heat transfer coefficient, Btu/hr-ft²-°F

K = Thermal conductivity, Btu/hr-ft - °F

De = Equivalent diameter, ft = $\frac{4A}{P_w}$

N_{Re} = Reynolds number, based on the equivalent diameter and coolant properties evaluated at the local bulk coolant temperature.

N_{Pr} = Prandtl number, based on coolant properties evaluated at the local bulk coolant temperature.

A = Cross-sectional area of flow channel, ft²

P_w = Wetted perimeter of flow channel, ft

No specific allowance is made or considered necessary for the uncertainties associated with the Dittus-Boelter correlation. That is because the Dittus-Boelter correlation is not used directly in computing thermal margin, but rather plays a part in determining pressure drop and cladding temperature. The validity of the overall scheme for predicting pressure drop is shown by the excellent agreement between predicted and experimental values obtained during the DNB test program and described in Section 4.4.3.1.2. The uncertainty associated with the cladding temperatures calculated for single-phase heat transfer is not a major concern because the limiting fuel and cladding temperatures occur where the cladding-to-coolant heat transfer is by nucleate boiling.

The temperature drop across the surface film is calculated from:

$$\Delta t_{\text{film}} = q/h_{db}$$

where:

q'' = surface heat flux, Btu/hr-ft²

The maximum heat flux is the product of the core average heat flux and the total heat flux factor. (Refer to Table 4.4-1 and Section 4.4.2.3.4.) At the location of maximum heat flux, nucleate boiling may occur on the clad surface. In the nucleate boiling regime, the surface temperature of the cladding is determined from the Jens and Lottes correlation (Reference 91):

$$T_{\text{wall}} = T_{\text{sat}} + 60 (q'' \times 10^{-6})^{0.25} [\exp (-P/900)]$$

where:

P = Pressure, psia

q'' = Defined above

T_{sat} = Saturation temperature, °F

Nucleate boiling is assumed to exist if T_{wall} is less than the sum of T_{coolant} plus ΔT_{film} .

The cladding surface temperatures are calculated by either summing the temperature of the coolant at the particular location and the temperature drop across the surface film, or directly from the Jens and Lottes correlation, depending on whether nucleate boiling is occurring.

ARKANSAS NUCLEAR ONE
Unit 2

The steady state radial temperature difference through the cladding, assuming uniform internal volumetric heat generation and temperature dependent thermal conductivity, is calculated from the one-dimensional heat conduction equation.

The thermal conductivity of Zircaloy-4 clad material in the range of 100 °F to 1,000 °F is determined from Reference 11.

The axial profile of the average clad temperature over the active fuel length for an average and a hot fuel rod is shown on Figure 4.4-1 for the typical axial power shape used for DNB calculations (Figure 4.4-2). The difference between these rods is that the hot rod experiences design values for the rod radial peak and engineering heat flux factor while the average rod experiences values of unity for these factors. The local coolant temperature surrounding these rods depends on the axial distance along the rod from the channel inlet.

4.4.2.2 Fuel Thermal Performance

Steady state fuel temperatures are determined by the FATES computer program. The calculational procedure considers the effect of linear heat rate, fuel relocation, fuel swelling, densification, thermal expansion, fission gas release, and clad deformations. The model for predicting fuel thermal performance is discussed in detail in Reference 10.

The thermal performance of the various types of fuel assemblies were evaluated using the FATES fuel evaluation model (Reference 10). The analysis was performed using power history data that enveloped the power and burnup levels of the various types of fuel assemblies for rod average burnups up to 60 MWD/kg U (References 176 and 177).

Significant parameters such as cold pellet and clad diameters, gas pressure and composition, burnup and void volumes are calculated and used as initial conditions for subsequent calculations for stored energy during the Emergency Core Cooling System (ECCS) analysis. The coupling mechanism between FATES calculations and the ECCS analysis is described in detail in Reference 35.

4.4.2.3 Critical Heat Flux Ratio (Departure from Nucleate Boiling)

4.4.2.3.1 Departure from Nucleate Boiling (Cycle 1)

The margin to Departure from Nucleate Boiling (DNB) at any point in the core is expressed in terms of the Departure from Nucleate Boiling Ratio (DNBR). The DNBR is defined as the ratio of the heat flux required to produce departure from nucleate boiling at the calculated local coolant conditions to the actual local heat flux. At some point in the core, the DNBR is a minimum and it is at this point that the margin to DNB is evaluated.

The W-3 correlation (Reference 151) was used for determination of DNB in Cycle 1. The design basis value of 1.30 for the minimum DNBR was chosen on the basis of evaluation of the W-3 correlation and its source data. That evaluation indicated that a minimum DNBR of 1.30 provides a 95 percent probability with 95 percent confidence that DNB will not occur in a subchannel having that minimum DNBR during normal operation and any anticipated operational occurrence.

To support this thermal hydraulic design basis, calculations for steady state conditions and for selected limiting transients were performed using the CE-1 CHF correlation. A comparison of the results for the steady state analyses over a wide range of core conditions and for the selected limiting transients shows that the W-3 correlation has conservatively accounted for DNB relative to the CE-1 CHF correlation.

ARKANSAS NUCLEAR ONE
Unit 2

The statistics from the data base were used in CENPD-162-P to establish the minimum DNBR which provides 95 percent probability at the 95 percent confidence level of not having DNB on a rod with that minimum DNBR. For CE-1 that evaluation yielded a minimum DNBR of 1.13.

During the steady state operation, many combinations of power, pressure and coolant inlet temperature may occur. Table 4.4-6a presents a comparison of the DNBR from CE-1 with that from W-3 for a range of these parameters and for constant power distribution. For each combination of pressure and inlet temperature, the reactor power is calculated which gives a W-3 DNBR of 1.30. Then, the CE-1 DNBR is calculated at the same power.

The results in Table 4.4-6a show that the CE-1 DNBR is greater than the W-3 DNBR for normal operating temperatures and pressures. For the low pressure trip limit of 1,750 psi the value of the CE-1 DNBR is less than the W-3 DNBR, but the CE-1 DNBR is greater than the required value of 1.13.

In the development of the CE-1 correlation, the local coolant conditions for the source data were calculated using the TORC computer code. Therefore, the TORC code is used here for the hot bundle subchannel analysis.

The mass velocity into the subchannel array which represents the hot assembly in TORC is set equal to the mass velocity in the hot assembly, which is calculated by COSMO, except that it is first divided by 1.05 to account for inlet plenum flow maldistributions.

The CE-1 DNBR is calculated for all of the subchannels in the array representing the hot assembly. Figure 4.3-23 shows the local normalized radial power distribution for the subchannel array used in TORC. The design hot channel engineering factors given in Table 4.4-1 are applied to the matrix subchannel adjacent to the guide tube as shown on the figure. The location of minimum DNBR is either in this matrix subchannel or in one of the cold wall subchannels adjacent to the guide tube. When a minimum DNBR is quoted for the CE-1 correlation, it is the lowest value in the array of subchannels.

The CE-1 correlation with a DNBR of 1.13 provides the same assurance of not having DNB as previously assumed for a W-3 DNBR of 1.30. Therefore, the CE-1 correlation and its data base provide significantly greater assurance of not having DNB for the same transient conditions. Further discussion of the limiting transients, their effect on DNBR, and their relative magnitudes for W-3 and CE-1 analyses is contained in Chapter 15 and in the CE report, "Application of the CE-1 Correlation for C-E Fuel Assemblies with C-E Standard Spacer Grids and a Nonuniform Axial Power Distribution."

Table 4.4-1 gives the DNBR for 100 percent power.

4.4.2.3.2 Departure from Nucleate Boiling (Cycle 2 and on)

NRC evaluation of the uniform axial power distribution CHF test data for CE's 16 x 16 fuel design results in their concluding that the CE-1 critical heat flux correlation, when coupled with the TORC code, provides an acceptable correlation of uniform axial CHF data and that the minimum acceptable DNBR is 1.19 (Reference 166). Starting with Cycle 2, Statistical Combination of Uncertainties (SCU) methods were used to statistically combine the uncertainties of the thermal hydraulic code input parameters (system parameters) as described in Reference 164. Using this SCU methodology, the following uncertainties were statistically combined with CE-1 CHF correlation statistics at 95/95 confidence/probability level to yield a 1.24 DNBR limit for Cycle 2:

ARKANSAS NUCLEAR ONE
Unit 2

- a) uncertainty in the inlet flow distribution
- b) systematic variation on fuel rod pitch
- c) systematic variation on fuel clad O.D.
- d) engineering enthalpy rise factor
- e) engineering heat flux factor
- f) penalty on minimum DNBR due to fuel rod bowing
- g) statistics associated with the NRC approved 1.19 DNBR limit

Also included in this MDNBR limit is the penalty due to the CHF correlation uncertainty and penalties imposed by NRC to account for CHF correlation "prediction uncertainty" and TORC code uncertainty. Starting with Cycle 3, the MDNBR limit was increased by a 0.01 penalty to 1.25 to conservatively address potential NRC concerns regarding the use of HID-1 spacer grids. The 1.25 DNBR limit is used in safety analysis, CPC trip setpoints and COLSS power operating limit calculations in conjunction with a CETOP model based on a nominal geometry.

The SCU methodology divided the uncertainties into two categories. The uncertainties of the two categories are effectively combined in a deterministic manner due to the separate application in the DNBR limit and the overall uncertainty factors.

In Cycle 12, the SCU methodology was replaced with the Modified Statistical Combination of Uncertainties (MSCU). The MSCU methodology statistically combines the uncertainty components which were previously combined deterministically. Also, the statistical treatment of several uncertainty components is modified so that the overall uncertainty factors can be calculated and applied as a function of burnup, axial shape index, and power in the COLSS and CPCs.

In Cycle 19, the ABB-NV CHF correlation described in Reference 193 was applied to the CPC overall uncertainty analysis. Although improved statistics associated with the ABB-NV correlation provided justification for a smaller DNBR limit, the existing limit of 1.25 (based on CE-1) was maintained to simplify the reload analyses.

In Cycle 20, the WSSV-T correlation described in Reference 196 was applied for NGF assemblies in the mixed core. The DNBR limit for WSSV-T was calculated to be 1.23 using the above uncertainties. However, the existing safety limit of 1.25 (based on CE-1) is maintained for simplicity.

Beginning in Cycle 21, which was comprised of a full core of NGF assemblies, the WSSV-T CHF correlation described in Reference 196 was applied in the mixing vane region of NGF assemblies, and the ABB-NV CHF correlation described in Reference 193 was applied in the non-mixing vane region of NGF assemblies. The SCU DNBR limit of 1.23 derived using the above uncertainties is applicable to both WSSV-T and ABB-NV CHF correlations.

4.4.2.3.3 Distribution of DNB Ratio in the Core

The DNB ratio at a core average rod is much greater than the DNBR at the hottest rod and it would not be meaningful to report this high value to represent the core. However, it is appropriate to present the distribution of the DNBR at a number of high power rods. Figure 4.4-3 shows the number of rods in the reactor at which the DNBR is less than the value indicated on the abscissa when the reactor conditions are such that the W-3 DNBR at the hottest rod in the core is equal to 1.3.

4.4.2.3.4 Application of Hot Channel Factors

The thermal design of the reactor core takes into account the nuclear power distribution, flow distribution, mixing, and manufacturing tolerances. Nuclear power distribution and manufacturing tolerances are expressed as factors which are imposed on the nominal channel in the input to the core analytical model. Flow distribution and mixing are explicitly treated by the core analytical model.

A. Rod Radial Nuclear Factor

The rod radial nuclear or rod radial peaking factor is the ratio of the peak power from a fuel rod relative to the core average fuel rod power. Radial power distributions are dependent upon a variety of parameters (rod insertion, power level, fuel exposure, etc.). A typical cumulative distribution of the fraction of rods above a given rod radial nuclear factor is shown in Figure 4.4-4.

The radial peaking factor used in the calculation of required initial margin to DNB for a particular axial shape and set of thermal hydraulic conditions was that peaking factor which produced a minimum hot channel DNBR equal to the DNB Specified Acceptable Fuel Design Limit (SAFDL) during a calculated 4-pump loss of flow transient. The DNB SAFDL provides at least 95% probability with at least 95% confidence that the hot fuel rod will not experience DNB.

The analyses upon which the Power Dependent Insertion Limits is based employed a limited number of axial shapes and associated scram reactivity curves from Beginning of Cycle (BOC), since BOC conditions were found to be most limiting. The particular axial shapes employed were chosen from the Arkansas Nuclear One - Unit 2 NSSS design data and included the limiting shape used for thermal margin design calculations. These analyses were prepared specifically to illustrate dependence of required initial margin to DNB on axial shape index.

B. Axial Peaking Factor

The axial peaking factor is the ratio of the peak heat flux to the average heat flux in a rod.

The axial power distribution directly affects DNBR. When the axial location of maximum heat flux occurs farther from the core inlet, the DNBR limit may be reached with lower values of peak heat flux. On the other hand, fuel temperature is almost independent of the location of the peak heat flux or linear heat rate. The axial power distribution and the rod radial nuclear factor are continually determined and processed through the Core Operating Limit Supervisory System (COLSS) and the Reactor Protective System (RPS) such that the design basis limits are not exceeded. Section 4.3 describes the power distributions and their control.

C. Nuclear Heat Flux Factor

The nuclear heat flux factor or the total nuclear peaking factor is the ratio of the maximum local heat flux in the core to the core average heat flux. Table 4.4-1 gives the design value for this factor.

ARKANSAS NUCLEAR ONE
Unit 2

D. Engineering Heat Flux Factor

The effect on local heat flux due to deviations from nominal design dimensions and specifications is accounted for by the engineering heat flux factor. Design variables that contribute to this engineering factor are pellet density, fuel enrichment, pellet diameter, and clad outside diameter.

These variables are combined statistically to obtain the engineering heat flux factor. The design value used for the engineering heat flux factor is based on deviations obtained from fuel manufacturing inspection data for the Palisades reactor (Docket No. 50-255) and the Maine Yankee reactor (Docket No. 50-309). Similar tolerances and quality control procedures are used for this reactor, and inspection data is expected to confirm that the factor given in Table 4.4-1 is appropriate. The engineering heat flux factor is applied to the hot rod, and increases the heat flux when calculating DNBR. It does not affect the enthalpy rise in the channel.

Statistical evaluation of the fuel manufacturing inspection data for ANO-2 yields a value of less than 1.025 for the effect on local linear heat rate and heat flux due to variations in fuel density, fuel enrichment, and pellet diameter.

E. Nuclear Enthalpy Rise Factor

The nuclear enthalpy rise factor is the ratio of the average power generated in the four rods that surround the hot channel to the average power generated in all the fuel rods in the core.

F. Engineering Enthalpy Rise Factor

The engineering enthalpy rise factor accounts for the effects of deviation in fuel fabrication from nominal dimensions or specifications on the enthalpy rise in the hot channel. Tolerance deviations (averaged over the length of the fuel rods that enclose the hot channel) for fuel density, enrichment and pellet diameter contribute to this factor. The engineering enthalpy rise factor accounts for the increased heat input resulting from higher than normal U-235 content. The value of the engineering enthalpy rise factor is 1.02.

The engineering enthalpy rise factor is applied by multiplying the rod radial power factor for each of the fuel rods surrounding the limiting subchannel by the factor. This increases the enthalpy rise in the limiting subchannel and, to a lesser extent, also in the surrounding subchannels which are partially bounded by the same fuel rods.

G. Rod Pitch, Bowing and Clad Diameter Factor

The rod pitch, bowing and clad diameter factor accounts for the increased heat input due to the decreased flow rate resulting from a smaller than nominal channel flow area. The rod pitch, bowing and clad diameter factor is 1.05.

The rod pitch, bowing and clad diameter factor is applied by multiplying the incremental heat input in the limiting subchannel by the factor. This increases the heat input in the limiting subchannel in the same manner as does the enthalpy rise factor, but does not directly affect the surrounding subchannel heat input. These increases in subchannel heat input cause higher lateral enthalpy gradients. The net combined

ARKANSAS NUCLEAR ONE
Unit 2

effects of changes in divergent crossflow and in turbulent interchange resulting from the higher heat input and enthalpy rise are computed by the COSMO/INTHERMIC analytic model in Cycle 1 and the TORC model in subsequent cycles (See Reference 37, Appendix D, page D-23 and Appendix E, page E-6), as part of the subchannel analysis for each core condition analyzed.

H. Inlet Flow Distribution (Plenum) Factor

The inlet flow distribution or plenum factor was used with COSMO/INTHERMIC methods in Cycle 1 to account for the effect of nonuniform flow at the core inlet on the hot channel enthalpy rise. Its value is dependent on the number and location of pumps in use. Plenum factors used in Combustion Engineering reactor design are determined from flow model testing as described in Section 4.4.3.1.1.

Taking into consideration the similarities between the Arkansas Nuclear One - Unit 2 reactor and other Combustion Engineering reactors in conjunction with the experimental data from the various flow model programs, the following flow distribution factors for the various pumping configurations were established.

<u>Pump Configuration</u>	<u>Inlet Flow Distribution Factor</u>
Normal Four-Pump Operation	1.05
Three-Pump Operation	1.06

Subsequent to Cycle 1, TORC/CETOP methods have been applied. The core wide inlet and exit hydraulic boundary conditions inferred from the tests discussed above are used in TORC analyses which serve as a benchmark for the CETOP model.

4.4.2.4 Flux Tilt Consideration

An allowance for degradation in the power distribution in the x-y plane (commonly referred to as flux tilt) is provided in the protection limit setpoints even though little, if any, tilt in the x-y plane is expected.

The tilt along with other pertinent core parameters will be continually monitored during operation by the COLSS (described in Section 7.7) and included in the COLSS and CPC on-line thermal margin calculations.

4.4.2.5 Void Fraction Distribution

The core average void fraction and the maximum void fraction are calculated using the Maurer method (Reference 105) which is applicable under subcooled and low quality conditions. The void fractions discussed below are typical values when the reactor conditions are such that the hottest fuel rod experiences a 1.3 W-3 DNBR.

The core average void fraction is 1.1 percent while the local maximum void fraction is 44 percent and occurs at the exit of the hot channel. The channel average void fraction as a function of the nuclear enthalpy rise factor is shown in Figure 4.4-5, and the void fraction axial distribution in the hot channel is shown in Figure 4.4-6. The average void fraction in the hot channel is eight percent.

4.4.2.6 Core Coolant Flow Distribution

The core flow distributions, that form the basis for the plenum factors used in the core thermal margin evaluation, were obtained from reactor flow model tests. See Section 4.4.3.1.1 for a description of the tests and the results and Section 4.4.2.3.4 for a summary of the plenum factors.

Intentional selective orificing is not used in the core design.

4.4.2.7 Core Pressure Drops and Hydraulic Loads

4.4.2.7.1 Reactor Vessel Flow Distribution

The total coolant flow rate entering the four reactor vessel inlet nozzles is given in Table 4.4-1 for Cycle 1 and Table 4.4-2 for a typical recent cycle. The main coolant flow path in the reactor vessel is down the annulus between the reactor vessel and the core support barrel, through the flow skirt and lower support cylinder, up through the core support region and the reactor core, through the fuel alignment plate and out through the two reactor vessel outlet nozzles. A portion of this flow leaves the main flow path as shown schematically in Figure 4.4-7. Part of the bypass flow is used to cool the reactor internals in areas not in the main coolant flow path and to cool the CEAs. Table 4.4-3 lists the bypass flow paths and the percent of the total vessel flow rate that enters these paths for Cycle 1.

The thermal margin calculations conservatively assume a bypass flow rate of 3.5 percent of the total vessel flow rate as compared to the bypass flow rate of 3.2 percent as shown in Table 4.4-3. Cycle specific bypass flow rates are evaluated to ensure that the analytical value remains conservative.

Flow and temperature imbalances which can occur between steam generator loops may be divided into two categories: (1) steady state imbalances such as those which could be introduced by extensive steam generator tube plugging or significant variations in performance characteristics of the individual reactor coolant pumps and (2) transient imbalances which could be introduced by asymmetric secondary system malfunctions such as loss of load or loss of feedwater to a single steam generator.

Steady state flow or temperature imbalances are not anticipated during the initial operating period on the ANO-2 reactor, since very few, if any, steam generator tubes will be plugged and the individual reactor coolant pump characteristics are nearly identical based upon testing performed by the reactor coolant pump vendor prior to delivery to the ANO-2 plant site. Confirmation that no significant steady state asymmetry exists was a part of the startup test program for the ANO-2 reactor.

Steam generator tube plugging limits up to 10% ± 500 tubes with tube plugging asymmetry up to 1000 tubes (1564 tubes plugged for one steam generator, 564 tubes for the other steam generator), have been verified to be acceptable with respect to flow variations.

Asymmetric secondary system transients are not design basis events for the CPC system, because the asymmetric events are terminated by trips other than the thermal margin calculators, and require less initial margin than the loss of flow event. Nevertheless, the CPC core average power, DNBR and local power density algorithms are designed to provide conservative results under conditions of imbalance in the loop temperatures and flow rates. In addition, the effects of loop temperature and flow imbalances are included in the CPC core average power calculation in a manner that ensures that the uncertainty on the core average power used for DNBR and LPD calculations is not increased during these conditions.

4.4.2.7.2 Reactor Vessel and Core Pressure Drops

The irrecoverable pressure losses from the inlet to the outlet nozzles were calculated using standard loss coefficient methods which are verified by flow model tests (Refer to Section 4.4.3.1.1).

The calculated pressure losses at 100 percent power, 100 percent vessel flow rate and an operating pressure of 2,250 psia are listed in Table 4.4-4 together with the coolant temperatures that were used to calculate each pressure loss. The calculated pressure losses included both geometric and Reynolds number dependent effects. A comparison of the calculated nozzle-to-nozzle pressure loss, using the same methods as above, and the as-measured pressure loss on an operating plant indicates good agreement. Representative cycle core and total vessel pressure losses are listed in Table 4.4-2.

4.4.2.7.3 Hydraulic Loads on Internal Components

The significant steady state hydraulic loads which act on the reactor internals during steady state operation are listed in Table 4.4-5. These loads are derived from analyses which make use of reactor flow model and components test results. (Refer to Sections 4.4.3.1.1 and 4.4.4.3, respectively.) For clarity all hydraulic loads in Table 4.4-5 are based on the maximum expected system flow rate and a coolant temperature of 500 °F. Pressure variations axially and laterally within the core are not considered explicitly in fuel rod design. A potential effect of small lateral pressure gradients within assemblies on fuel rod vibration is examined by flow testing as described in Sections 4.2.1.2.3 and 4.2.1.3.6.2. The axial pressure gradient within a fuel assembly is considered in the calculation of fuel assembly uplift forces.

When other coolant conditions and core power levels result in more limiting loading for individual components, the loads in the table are adjusted in the detailed design analysis. The total design hydraulic loads for normal operation consist of the steady state loads given in Table 4.4-5 and the dynamic loads induced by pump pressure pulsations, turbulence, and vortex shedding.

Hydraulic loads for postulated accident conditions are given in Section 3.9.1.6.

4.4.2.8 Correlations and Physical Data

4.4.2.8.1 Heat Transfer Coefficients

The correlations used to determine cladding temperatures for nonboiling forced convection and nucleate boiling are discussed in Section 4.4.2.2.1.

4.4.2.8.2 Core Loss Coefficients

Irrecoverable pressure losses through the core occur as a result of friction and geometric changes. The pressure loss through the lower and upper end fittings is calculated using the standard loss coefficient method and has been verified by test. (Refer to Section 4.4.4.3.) The correlations used to determine frictional and geometric losses in the core are presented in Section 4.4.3.1.2.

4.4.2.8.3 Void Fraction Correlation

There are three separate void regions to be considered in flow boiling. Region 1 is highly subcooled in which a single layer of bubbles develops on the heated surface and remains attached to the surface. Region 2 is a transition region from highly subcooled to bulk boiling where the steam bubbles detach from the heated surface. Region 3 is the bulk boiling regime.

The void fraction in Regions 1 and 2 is predicted using the Maurer method, Reference 105. The calculation of the void fraction in the bulk boiling regime is discussed in Section 4.4.3.1.2.

4.4.2.9 Thermal Effects of Operational Transients

Design basis limits on DNBR and fuel temperature are established to assure that thermally induced fuel damage will not occur during normal steady state operation and during anticipated operational occurrences.

The COLSS provides information to the operator so that he can assure that proper steady state conditions exist. The RPS will prevent the design basis limits from being exceeded.

COLSS provides the reactor operator with a comparison of the actual core operating power to the licensed power and to continually calculated limiting powers based on DNBR and local power density. If the operating power reaches any one of the power limits, an alarm will be sounded. These limits are calculated by COLSS to provide sufficient margin so as not to exceed the design basis limits in the event that the most limiting anticipated operational occurrence occurs simultaneously with the operating power reaching a power limit.

For automatic protection of the core, the RPS is designed to effect a rapid shutdown in the event that the thermal hydraulic design basis limits are approached. The core minimum DNBR and maximum local power density are determined by a CPC which uses core parameters either measured or calculated as input.

For both the RPS and COLSS, an algorithm is developed to provide a rapid on-line calculation of DNBR. The algorithm, like the standard core analytical technique, uses the following core parameters either measured or calculated as input: core inlet temperature, pressure, flow, power, and power distribution. The DNBR calculated by the algorithm will always be less than or equal to that calculated by the standard analytical technique. Additional information concerning the RPS and COLSS is contained in Chapter 7, and additional discussion on the effects of thermal transients is contained in Sections 4.4.3.6 and 4.4.3.7. Analysis of anticipated operational occurrences to demonstrate that the fuel design limits are met is presented in Chapter 15.

4.4.2.10 Uncertainties in Estimates

4.4.2.10.1 Pressure Drop Uncertainties

The reactor vessel pressure losses in Table 4.4-4 are the best estimate values calculated for the design flow and correspond to the best estimate data from the flow model test programs being conducted at Combustion Engineering. Uncertainties due to experimental measurement and dimensional uncertainties on the reactor vessel and internals amount to approximately ± 10 percent in the pressure loss estimates.

ARKANSAS NUCLEAR ONE
Unit 2

4.4.2.10.2 DNBR Calculation

For a given heat flux distribution and local coolant conditions, the uncertainty in the DNBR correlation is accounted for by using the limiting value of 1.3 for the W-3 DNBR, which is higher than the average value of 1.0 at which DNB occurs. The uncertainty associated with the 1.3 W-3 DNBR is discussed in Section 4.4.2.3.1. The uncertainty in the heat flux distribution is accounted for by using limiting values of nuclear peaking factors, which have uncertainty included, and by applying the engineering factors to account for manufacturing tolerances on the fuel rods. In Cycle 1 the uncertainty in the local coolant conditions was accounted for by taking conservative values for flow rate and hot channel factors such that the DNBR is minimized. Manufacturing tolerances are also accounted for in the engineering enthalpy rise factors. Statistical methods were used after Cycle 1 to combine manufacturing tolerance uncertainties and other uncertainties to local coolant conditions with the CHF correlation uncertainty in the DNBR limit as described in Section 4.4.2.3.2.

The COLSS and the RPS utilize the algorithm discussed in Section 4.4.2.9 to assure that the design bases on DNBR are not violated. The DNBR algorithm used in the RPS is biased to give limiting values of DNBR that are equal to or less than those calculated using the analytical method described in Section 4.4.3.4.

CETOP (also referred to as CETOP-D) is the thermal margin design code for Arkansas Nuclear One - Unit 2, starting with Cycle 2, and is the code used for all steady state DNBR analyses.

Steps (A) and (B) describe the sensitivity of DNBR to the enthalpy rise flow factor and the hot assembly radial peak.

A. Sensitivity to the Enthalpy Rise Flow Factor

The enthalpy rise flow factor effectively increases the hot channel enthalpy rise over that due only to the heat input from the surrounding fuel rods. The factors affecting the enthalpy rise are discussed in detail in Section 4.4.2.3.4 on hot channel factors. Figure 4.4-8 shows the percent change in core power to a 1.30 W-3 DNBR as a function of the enthalpy rise flow factor. The percent change in the enthalpy rise factor may be thought of as a change in any of the enthalpy rise factors discussed in Section 4.4.2.3.4. The results are given for two axial power distributions, the design distribution for DNB calculations and a distribution peaked in the lower half of the core, both shown in Figure 4.4-2.

B. Sensitivity to Hot Assembly Radial Peak

The hot assembly power, relative to the hot channel power, influences the openness of the core to divergent crossflow. In the COSMO/INTHERMIC methods applied in Cycle 1 the hot assembly is assumed to be closed and in parallel with other groups of closed assemblies representing the entire core while the hot channel is open to the hot assembly. Hence, when the hot assembly has a radial peak equal to that of the hot channel, the hot channel essentially has no divergent crossflow. As the hot assembly radial peak is reduced from the design value, the hot channel effectively becomes more open to the core. Figure 4.4-9 shows the change in the percent core power from the design value as the hot assembly radial peak is varied about the design value. The change in core power varies from a 1.5 percent increase if the hot assembly is open to the core to about 0.5 percent decrease if the hot assembly is assumed to have the same radial peak as the hot channel. Open core TORC/CETOP analyses have been carried out subsequent to Cycle 1.

ARKANSAS NUCLEAR ONE
Unit 2

To accommodate the effects of rod bowing, which is fuel burnup dependent, DNBR penalty factors were applied to the maximum radial power peak of each fuel batch in Cycle 1. A single net penalty for COLSS and CPC is determined from the penalties associated with each batch, to account for the offsetting margins from the lower radial power peaks in the higher burnup batches. DNBR penalty factors range from zero percent at BOC to 17.4 percent in the burnup range of 30-35 GWD/MTU, and were tabulated in Technical Specification 4.2.4.4. In Cycles 2, 3, and 4, a 2% rod bow penalty based on Reference 165 was included in the MDNBR for bundle burnups up to 30,000 MWD/MTU. Starting with Cycle 5, a 0.5% rod bow penalty based on Reference 169 was used. Starting with Cycle 16, a 0.6% rod bow penalty based on Reference 169 is used to account for bundle burnups up to 33,000 MWD/MTU. Bundles having burnups in excess of 33,000 MWD/MTU are not limiting with respect to DNB margin. Since the rod bow allowance is specifically included in the DNBR limit, there is no need for additional penalties on the rod radial peak in the Technical Specification. Therefore, Technical Specification 4.2.4.4 was deleted. Starting with Cycle 21 (full core of NGF assemblies), a 1% rod bow penalty is used to account for bundle burnups up to 33,000 MWD/MTU. Bundles having burnups in excess of 33,000 MWD/MTU are not limiting with respect to DNBR margin.

4.4.2.10.3 Fuel and Clad Temperature Uncertainty

Uncertainty in the ability to predict the maximum fuel temperature is a function of the uncertainties associated with gap conductance, thermal conductivities, peak linear heat rate and heat generation distribution. Uncertainties in the gap conductance and thermal conductivity are taken into account in the analytical model. Uncertainties in the peak linear heat rate are accounted for by including the uncertainty in estimating the total nuclear peak and by including the uncertainties in fuel pellet density, enrichment, and pellet diameter in the engineering factor (See Section 4.4.2.3.4).

Uncertainty in predicting the cladding temperature at the location of maximum heat flux is due to uncertainty in the film temperature drop, which is minimal at this location where nucleate boiling occurs.

4.4.2.11 Plant Configuration Data

Plant configuration data for the thermal hydraulic and fluid systems external to the reactor are available in Chapters 5, 6, 9 and 15. Reactor configuration data are presented in Table 4.4-6.

4.4.3 EVALUATION

4.4.3.1 Core Hydraulics

4.4.3.1.1 Reactor Flow Model Tests

Design values for the reactor hydraulic parameters are obtained or verified by means of flow model tests. These flow model tests involve the use of scale reactor models and are part of the Combustion Engineering reactor development program. The test programs provide information on flow distribution in various regions of the reactor, on pressure loss coefficients, on hydraulic loads on vessel internal components, and on turbulence induced pressure and velocity fluctuations.

Combustion's PWR designs fall into seven basic geometric configurations as shown below:

ARKANSAS NUCLEAR ONE
Unit 2

<u>Configuration</u>	<u>Reactor(s)</u>	<u>Distinguishing Hydraulic Features</u>
1	Palisades	4 inlets, 2 outlets, cruciform control rods, 204 fuel assemblies
2	Fort Calhoun	4 inlets, 2 outlets, CEAs, 133 fuel assemblies
3	Maine Yankee	3 inlets, 3 outlets, CEAs, 217 fuel assemblies, 137 in. long core
4	Calvert Cliffs 1 & 2 St. Lucie 1 & 2 Millstone (Unit 2)	4 inlets, 2 outlets, CEAs, 217 fuel assemblies, 137 in. long core
5	ANO-2 Blue Hills Station	4 inlets, 2 outlets, CEAs, 177 fuel assemblies, 150 in. long core
6	San Onofre 2&3 Forked River Waterford 3, Pilgrim 2	4 inlets, 2 outlets, CEAs, 217 fuel assemblies, 150 in. long core
7	System 80	4 inlets, 2 outlets, 241 fuel assemblies, modified upper and lower plena design, 150 in. long core

Flow model tests have been conducted on the first four configurations and on System 80. The Palisades and Fort Calhoun flow tests were run under contract with Battelle Memorial Institute using air as the test medium. The Maine Yankee and the Configuration 4 reactor flow model tests were performed in a 15,000 gpm cold water facility in the Combustion Engineering Nuclear Laboratories.

The design hydraulic parameters required for Arkansas Nuclear One - Unit 2, Configuration 5, were obtained by interpolating from the results of the flow model tests on Configurations 1 through 4. Geometric differences between Configuration 5 and the earlier reactor configurations are accounted for by analytical means and by utilizing the experience gained from the earlier tests, during which numerous investigations were made of the effect of various internal components on flow distribution and pressure drop. For example, the Palisades tests were run with and without a flow skirt, with the core barrel concentric and eccentric in the vessel, and with the lower core support plates in place and removed. The Fort Calhoun tests were run with and without the thermal shield, with the lower core support structure removed and in place, and with the upper head guide structure and fuel alignment plate removed and in place. Earlier flow model test programs also investigated the effects of part loop operation and the degree of mixing of the coolant in the vessel upstream and downstream of the core.

The principal design hydraulic parameters include:

- A. Inlet flow distribution enthalpy rise factor (or plenum factor)
- B. Fuel assembly maximum inlet flow factor
- C. Reactor pressure losses
- D. Hydraulic loads on reactor internal components

The approaches for deriving the design hydraulic parameters for Arkansas Nuclear One - Unit 2 from results obtained from earlier reactor flow model tests are described as follows:

ARKANSAS NUCLEAR ONE
Unit 2

A. Inlet Flow Distribution Enthalpy Rise Factor

The inlet flow distribution enthalpy rise factor accounts for the effects of the non-uniform core inlet flow distribution on the hot subchannel enthalpy rise in COSMO/INTHERMIC methods; hydraulic boundary conditions are applied explicitly at the core inlet and exit in TORC/CETOP methods. In utilizing the flow distributions to determine the inlet flow distribution enthalpy rise factor (or plenum factor), it is assumed that the design value of the rod radial peaking factor can occur in any fuel assembly. However, since the assembly power is significantly lower for the peripheral fuel assemblies, the maximum permissible plenum factor is larger for peripheral assemblies, than for those in the interior. This fact is taken into account through a combination of the experimental flow distribution and the most conservative power distribution envelope to yield a single design value for the plenum factor. That value, when used with the designated design values for assembly power and rod peaking factor, results in the most limiting thermal margin. It is equal to or less than the thermal margin that would be calculated for each individual fuel assembly location using the local values of plenum factor and power (Further information on this subject is given in Reference 31).

The core flow distribution data from earlier model tests were used as the basis for establishing the Arkansas Nuclear One - Unit 2 enthalpy rise factor. The geometry in both the lower plenum and the core regions affect the core inlet flow distribution. Consequently, the evaluation of the flow model data took into consideration comparisons of the lower plenum and core geometries for reactor Configurations 1 through 5.

The comparison of lower plenum geometries is shown below:

Reactor <u>Config.</u>	<u>Length Ratios</u>				
	O.D. Core Support <u>Barrel</u>	Height of Lower <u>Plenum</u>	Core Support <u>Structure</u>	Height of <u>Flow Skirt</u>	O.D. Flow <u>Skirt</u>
	I.D. Vessel	I.D. Vessel	I.D. Vessel	I.D. Vessel	I.D. Vessel
1	0.89	0.41	0.23	0.18	0.84
2	0.88	0.48	0.29	0.24	0.83
3	0.88	0.43	0.25	0.18	0.84
4	0.88	0.43	0.25	0.18	0.84
5 ANO-2	0.89	0.48	0.24	0.23	0.83

Reactor <u>Config.</u>	<u>Flow Rate Ratios</u>		
	^A Flow <u>Skirt</u>	^A Bottom Plate in <u>Core Support Structure</u>	^A Core Support Plate
	^A core	^A core	^A core
1	0.61	0.55	0.53
2	1.09	0.59	0.54
3	0.82	0.54	0.53
4	0.82	0.58	0.53
5 ANO-2	0.88	0.57	0.51

ARKANSAS NUCLEAR ONE
Unit 2

Examination of the dimensionless ratios describing the lower plenum geometries shows that the lower plenum designs for the five reactor configurations are very similar, except in one respect. Configurations 2 and 5 (Arkansas Nuclear One - Unit 2) have lower plenums with larger volumes on a relative basis compared to the remaining three configurations. This is evident from the ratios relating to the height of the lower plenum and to the height of the flow skirt. It can be postulated that as the lower plenum volume increases, the core inlet flow distribution will tend to become more uniform. This is supported by the flow model data.

The comparison of core geometries is shown below:

<u>Reactor Config.</u>	<u>Rod Array in Fuel Assembly</u>	<u>Fuel Rod Length (ft)</u>	<u>No. Of Spacer Grids</u>	<u>Hydraulic Config. Diameter (ft)</u>
1	15 x 15	11.7	8 or 9	0.0466
2	14 x 14	11.3	9	0.0449
3	14 x 14	12.2	9	0.0449
4	14 x 14	12.2	9	0.0449
5 ANO-2	16 x 16	13.5	12	0.0403

The configuration five fuel assemblies have design characteristics (longer length, more grids, smaller hydraulic diameter) that produce a larger axial hydraulic resistance relative to the other configurations. The larger core hydraulic resistance tends to produce a more uniform core inlet flow distribution. So for a given lower plenum geometry, the 16x16 core of Configuration 5 will have a flatter flow distribution than the 14 x 14 cores.

Results from the flow model tests on reactor Configurations 1 through 4 are tabulated below, along with the estimated flow distribution parameters for Arkansas Nuclear One - Unit 2.

<u>Reactor Config.</u>	<u>No. of Inlets</u>	<u>No. of Outlets</u>	<u>No. of Assys.</u>	<u>Enthalpy Rise Factor $F_{\Delta H}^{PL}$</u>	<u>Measured Maximum Assy. Flow Rate $(W_i/W)_{Max}$</u>
1	4	2	204	1.05	1.07
2	4	2	133	1.03	1.05
3	3	3	217	1.05	1.05
4	4	2	217	1.05	1.05
5 ANO-2	4	2	177	1.05 (Est)	1.05 (Est)

Generally, the results from the model tests on Configurations 1, 2 and 4, i.e. the 4-loop plants, show that there is quadrantal symmetry in the core inlet flow distribution and that the lowest assembly flow rates appear on the core periphery. More specifically, the Arkansas Nuclear One - Unit 2 reactor is most similar to Configurations 2 and 4. Since the enthalpy rise factor, $F_{\Delta H}^{PL}$, is 1.03 for Configuration 2, is 1.05 for Configuration 4, and is no greater than 1.05 for any of the tested configurations, it was concluded that 1.05 is an appropriate and realistic value for the enthalpy rise factor for Arkansas Nuclear One - Unit 2. Part loop plenum factors were established on the basis of part loop testing on the Configuration 2 model and are itemized in Section 4.4.2.3.4.

ARKANSAS NUCLEAR ONE
Unit 2

B. Fuel Assembly Maximum Inlet Flow Factor

The core inlet flow distribution is also used to define the maximum value of assembly inlet flow rate ratio, $(W_i/\bar{W})_{\text{Max}}$, for calculating the hydraulic uplift loads on the fuel assemblies. (See Section 4.4.2.7.3.) Results from flow model tests on Configurations 1 through 4 for $(W_i/\bar{W})_{\text{Max}}$ values are also listed in the table in Item A, above. The measured value of $(W_i/\bar{W})_{\text{Max}}$ for Configurations 4 and 2 (those most similar to Arkansas Nuclear One - Unit 2) is 1.05; hence, that value was selected for Arkansas Nuclear One - Unit 2.

C. Reactor Pressure Losses

Reactor vessel pressure losses are determined with a standard calculational model. This model was developed partly on the basis of pressure loss results from flow model tests on the earlier reactor Configurations 1 through 4 and partly on analytical methods available in the literature. The calculational model divides the flow path through the reactor into segments. The principal flow path segments are:

1. The inlet region
2. The thermal downcomer region
3. The lower plenum region
4. The core support structure region
5. The core region
6. The upper plenum region

A combination of analytical and/or empirical relationships are used for each flow path segment in the standard pressure loss calculational method. When empirical relationships are used for a new reactor, the loss coefficient(s) from the originating model tests are modified by analytical means to account for geometry variations between the original reactor geometry and that for the new reactor geometry.

Agreement between predictions by the standard calculational method and experimental pressure losses is found to be good. For example, from flow model tests on Configuration 4, the agreement between predicted and measured values for the segmental ΔP losses was within 15 percent while the nozzle-to-nozzle pressure losses agreed within 10 percent. The predicted nozzle-to-nozzle pressure losses were found to be systematically high relative to the measured values. Comparisons have also been made between nozzle-to-nozzle pressure drops measured in two Combustion Engineering reactors (Configurations 1 and 3) and values predicted by the standard calculational method. These latter comparisons show agreement within seven percent, again with the predicted values being higher than the measured values.

The vessel pressure losses for ANO-2 were estimated with the standard calculational method, taking into account the observed systematic differences between predicted and measured pressure losses.

ARKANSAS NUCLEAR ONE
Unit 2

D. Hydraulic Loads on Reactor Internal Components

Hydraulic loads were estimated for ANO-2 based on both experimental data from flow model tests on reactor configurations 1 through 4 and by analytical means. When experimental data are used, they are first reduced to dimensionless form in terms of a pressure difference coefficient,

$$E = \frac{P_{\text{local}} - P_{\text{ref}}}{\frac{\rho V_{\text{ref}}^2}{2g}}$$

a force coefficient,

$$C_F = \frac{F}{\frac{\rho V_{\text{ref}}^2 A_{\text{ref}}}{2g}}$$

or a velocity ratio,

$$\frac{V_{\text{local}}}{V_{\text{ref}}}$$

The quantities with subscript "ref" represent appropriate reference values, for example, the average velocity or pressure at the particular flow path station of interest. These dimensionless quantities are then converted to absolute quantities by multiplying by the appropriate reference quantity, i.e. by

$$\frac{\rho V_{2\text{ref}}}{2g} \text{ or } V_{\text{ref}}$$

Adjustment to the resulting absolute quantities are made by analytical means if there are substantial differences in geometry between the reactor configuration for which the test data were derived and the reactor configuration of interest.

Further discussion of the philosophy of Combustion Engineering flow model testing appears in Reference 6.

4.4.3.1.2 Core Pressure Drop Correlations

The total pressure drop along the active fuel region of the core is computed as the sum of the individual losses resulting from friction, acceleration of the fluid, change in elevation of the fluid and spacer grids. The individual losses are computed using the momentum equation and the consistent set of empirical correlations presented in Reference 126. In the following paragraphs, the correlations used are summarized and the validity of the scheme is demonstrated with a comparison of measured and predicted pressure drop for single-phase and two-phase flow in rod bundles with CEA-type geometry.

For isothermal, single-phase flow, the pressure drop due to friction for flow along the bare rods is based on the equivalent diameter of the bare rod assembly and the Blasius friction factor:

$$f = 0.184 R_e^{-0.2}$$

ARKANSAS NUCLEAR ONE
Unit 2

The pressure drop associated with the HID-IL spacer grids in standard fuel is computed using a grid loss coefficient (K_{SG}) given by:

$$K_{SG} = 0.234 + 6.46Re^{-0.2}$$

For the NGF assemblies, there are three (3) grid designs in the core. Non-mixing grids are in the lower portion of the core, and structural mixing grids are in the mid and upper portions of the core. IFM grids (2) provide improved thermal performance in the upper portion of the core. The pressure drop associated with these grids is computed using the following grid loss coefficient expressions:

$$K_{\text{unvaned grid}} = 0.343 + 6.946Re^{-0.20}$$

$$K_{\text{vaned grid}} = 0.437 + 8.843 Re^{-0.20}$$

$$K_{\text{IFM grid}} = 0.259 + 3.851Re^{-0.20}$$

The coefficients were determined from pressure drop data obtained for a wide range of Reynolds Number for isothermal flow through rod bundles fitted with production grids. The data came from the fuel assemblies and components test program applicable to ANO-2. The standard error of estimate associated with the loss coefficient relation is 2σ or $\sim 10\%$ of the estimate and includes replication and instrument error.

To compute pressure drop either for heating without boiling or for subcooled boiling, the friction factor given above for isothermal flow is modified through the use of the multipliers given in Reference 126. It is important to recognize that the multipliers were developed in such a way as to incorporate the effects of subcooled voids on the acceleration and elevation components of the pressure drop as well as the effect on the friction losses. Consequently, it is not necessary to compute specifically either a void fraction for subcooled boiling or the individual effects of subcooled boiling on the friction, acceleration, or elevation components of the total pressure drop.

The effect of bulk boiling on the friction pressure drop is computed using a curve fit to the Martinelli-Nelson data (Reference 104) above 2000 psia or the Martinelli-Nelson correlation (Reference 104) with the modification given in References 126 and 167 below 2,000 psia. The acceleration component of the pressure drop for bulk boiling conditions is computed in the usual manner for the case of two-phase flow where there may be a nonunity slip ratio (See, for instance, Reference 115). The elevation and spacer grid pressure drops for bulk boiling are computed as for single-phase flow except that the bulk coolant density ($\bar{\rho}$) is used, where:

$$\bar{\rho} = \alpha\rho_v + (1 - \alpha)\rho_\ell$$

and α = Bulk boiling void fraction

$$\rho_v = \text{Density of saturated vapor, lb/ft}^3$$

$$\rho_\ell = \text{Density of saturated liquid, lb/ft}^3$$

ARKANSAS NUCLEAR ONE
Unit 2

The bulk boiling void fraction used in computing the elevation, acceleration, and spacer grid losses is calculated by assuming a slip ratio of unity if the pressure is greater than 1,850 psia or by using the Martinelli-Nelson void fraction correlation (Reference 104) with the modifications presented in Reference 126 if the pressure is below 1,850 psia.

To verify that the scheme described above accurately predicts pressure drop for single-phase and two-phase flow through the Combustion Engineering fuel assembly, comparisons have been made of measured pressure drop and the pressure drop predicted by the Combustion Engineering design code, COSMO, for the rod bundles used in the DNB test program at Columbia University. (Refer to Section 4.4.4.2.) Figure 4.4.-10 shows some typical results for a 21-rod bundle (5x5 array with four rods replaced by a control rod guide tube). The excellent agreement demonstrates the validity of the methods described above. A comparison of TORC predictions with additional measured data in Reference 168 also showed excellent agreement.

4.4.3.2 Influence of Power Distributions

The Core Operating Limit Supervisory System (COLSS) will restrict operation of the plant such that power distributions which are permitted to occur will have adequate margin to satisfy the design bases during anticipated operational occurrences. Expected power distributions and the control of them are discussed in detail in Section 4.3, Nuclear Design. Figure 4.4-2 shows some axial power distributions which are used in design to give limiting values of DNBR and linear heat rate when used in conjunction with other design peaking factors and selected coolant conditions.

4.4.3.3 Core Thermal Response

Core steady state design parameters are summarized in Table 4.4-1 for Cycle 1 and in Table 4.4-2 for later cycles for normal 4-pump operation. Other combinations of temperature, power, and pressure will occur during reactor operation. The limit curves shown in Figure 4.4-11 for normal 4-pump operation show the sensitivity of the various operating conditions to each other at a W-3 DNBR = 1.3, and also show the margins that exist relative to the design conditions. For a given power, pressure, and power distribution, the curves give the maximum permissible temperature to reach the design basis limit on DNBR. The limit curves shown in the figure were calculated for the axial power distributions shown in Figure 4.4-2, a radial nuclear factor of 1.55, and engineering factors as specified in Tables 4.4-1 and 4.4-2. Other power distributions will produce limiting curves different from those shown in the figure. The Reactor Protective System (RPS) will trip the reactor before these limits are reached. The response of the core to transients is given in Chapter 15.

4.4.3.4 Analytical Techniques

4.4.3.4.1 Thermal Margin Analysis (Cycle 1)

In order to evaluate the thermal margin in the Cycle 1 core, an analytical model was established which defines a hypothetical hot channel containing the design radial peak rod and having all factors applied to it which cause it to be the most limiting channel in the core. There are three segmental phases to the calculation of the DNBR for the limiting channel:

- A. Calculation of the core wide flow distribution and pressure drop;
- B. Calculation of the hot channel coolant conditions; and,
- C. Calculation of the DNBR.

ARKANSAS NUCLEAR ONE
Unit 2

These calculations are embodied in the COSMO and INTHERMIC computer codes (Appendices D and E of Reference 37). The following Sections A through D summarize these calculations which represent the design method for core thermal margin evaluations on Arkansas Nuclear One, Unit 2. Another procedure for calculating core thermal margin is embodied in the TORC computer code (Reference 37). This code is a three-dimensional representation of the open lattice core which determines the local coolant conditions at all points within the core. Comparisons between the results from the TORC model and from the COSMO/INTHERMIC model show that the COSMO/INTHERMIC model gives conservative results relative to TORC (See Reference 37). These comparisons are valid for application to the thermal margin results obtained with the COSMO/INTHERMIC model on Unit 2. Hence, the results from the procedure described in the following are a satisfactory representation of the Unit 2 core thermal margin.

A. Core Wide Flow Distribution

In routine design calculations utilizing COSMO, the core wide flow distribution is calculated by considering the core as an array of parallel closed pipe type flow paths with various flow areas and relative powers called zones. The thermal and hydraulic characteristics of each zone are used to calculate the core flow distribution with the provision that the pressure drops across all zones are equal. In this phase of the calculation, each zone is separate from the others and there is no energy or mass interchange between zones. The hot assembly which contains the hot channel, is included as one of the zones in this first phase of the calculations.

The overall core pressure drop is determined using the best estimate assembly peaking distribution which is much flatter than the distribution which accompanies the design peaking condition. The hot assembly peak is assumed at the design value.

B. Hot Channel Coolant Conditions

In the second phase of the calculations, the coolant conditions are determined in the hot channel of the core. A channel is defined as the coolant flow area bounded by four adjacent fuel rods. The limiting channel is assumed to be open to the hot assembly and to have the same axial pressure drop distribution as the hot assembly. The flow rate in the hot channel is calculated using the hot assembly pressure drop distribution determined during the core wide calculations. The resulting flow rate in the hot channel varies along the axial length in order that the hot assembly pressure distributions are matched.

In the calculation of the hot channel enthalpy rise, several factors are applied to the highest powered channel to account for core physics and hydraulics characteristics and for uncertainties due to manufacturing tolerances. These factors are applied simultaneously to the channel to ensure that it is the most limiting channel in the core.

These factors include (refer to Section 4.4.2.3):

1. Nuclear Heat Flux Factor
2. Nuclear Enthalpy Rise Factor
3. Engineering Heat Flux Factor

ARKANSAS NUCLEAR ONE
Unit 2

4. Engineering Enthalpy Rise Factor
5. Rod Pitch, Bowing and Clad Diameter Factor
6. Inlet Flow Distribution (plenum) Factor
7. Turbulent Interchange Thermal Mixing Factor

The Nuclear Factors (1) and (2) arise from the nonuniform heat generation in the core; Engineering Factors (3), (4) and (5) account for uncertainties due to manufacturing tolerances. Factor (6) accounts for the effect of the core inlet flow maldistribution, and Factor (7) relates the effect of turbulent interchange on the hot channel enthalpy rise.

The output of the hot channel analysis is the channel local coolant conditions, in terms of mass velocity, enthalpy, and quality as a function of axial position in the channel. These local conditions are the necessary input to the third phase of the calculations.

C. Determination of DNBR

The final phase of the calculations uses the hot channel coolant conditions and the local heat flux in conjunction with the W-3 correlation in Cycle 1 and the CE-1 correlation in subsequent cycles as discussed in Section 4.4.2.3 to determine the minimum DNBR in the core.

D. Turbulent Interchange

The effect of turbulent interchange or mixing between channels on the hot channel enthalpy rise in Cycle 1 is calculated by the INTHERMIC (Reference 38) computer code. INTHERMIC solves the energy and continuity relations for groups of parallel interconnected channels, taking into account the effect of turbulent interchange as described by an experimental relation described in Section 4.4.4.4.

Results of the INTHERMIC calculations are expressed as the "mixing hot channel factor", defined as the ratio of hot channel mixed to unmixed enthalpy rise. The mixing hot channel factor is not constant, but varies axially along the length of the channel. It has a value of unity at the channel inlet, where no lateral enthalpy gradient exists, and decreases progressively up the channel as the lateral enthalpy gradient builds up.

The geometry and the rod power distribution of the array of channels surrounding the hot channel, the axial and radial power distribution, and the presence of statistical engineering factors all affect the lateral enthalpy distribution and, hence, the mixing hot channel factor. The design value for the mixing hot channel factor is a conservative estimate based on an INTHERMIC case run with the flattest rod power distribution expected for any assembly over core life. This distribution minimizes the beneficial effects of mixing on the enthalpy rise in the hot channel.

4.4.3.4.2 Thermal Margin Analysis (Subsequent Cycles)

Thermal margin analysis of the reactor core is performed using the TORC and the CETOP codes which are based on the open core analytical method of the COBRA-IIIC code (Reference 170). A complete description of the TORC code and application of the code for detailed core thermal margin analyses is contained in CENPD-161 (Reference 37). The CETOP code is used for design thermal margin calculations. CETOP is described in detail in Reference 38. A brief description of the code and its use is given here.

ARKANSAS NUCLEAR ONE
Unit 2

The COBRA-IIIC code solves the conservation equations for mass, axial and lateral momentum, and energy for a collection of parallel flow channels that are hydraulically open to each other. Since the size of a channel in design varies from the size of fuel assembly or more to the size of a subchannel within a fuel assembly, certain modifications were necessary to enable a realistic analysis of thermal-hydraulic conditions in both geometries. The principal revisions to arrive at the TORC code, which leave a basic structure of COBRA-IIIC unaltered, are in the following areas:

- A. Modification of the lateral momentum equation for core wide calculations where the smallest channel size is typically that of a fuel assembly.
- B. Addition of the capability for handling non-zero lateral boundary conditions on the periphery of a collection of parallel flow channels. This capability is particularly important when analyzing the group of subchannels within the hot fuel assembly.
- C. Addition of the capability to handle nonuniform core exit pressure distributions.
- D. Insertion of standard C-E empirical correlations and the ASME fluid property relationships.

Details of the lateral momentum equations and empirical correlations used in the TORC code are given in Reference 37.

The application of the TORC code for detailed core thermal margin calculations typically involves three stages. The first stage consists of calculating coolant conditions throughout the core on the coarse mesh basis. The core is modeled such that the smallest unit represented by a flow channel is a single fuel assembly. The three-dimensional power distribution in the core is superimposed on the core coolant inlet flow and temperature distributions. The core inlet flow and core exit static pressure distribution are obtained from flow model tests discussed in Section 4.4.3.1.1 and the inlet temperature for normal four-loop operation is assumed uniform. The axial distributions of flow and enthalpy in each fuel assembly are then calculated on the basis that the fuel assemblies are hydraulically open to each other. Also determined during this stage are the transport quantities of mass, momentum, and energy which cross the lateral boundaries of each flow channel.

In the second stage, typically the hot assembly and adjoining fuel assemblies are modeled with a coarse mesh. The hot assembly is typically divided into four to five partial assembly regions. One of these regions is centered on the subchannels adjacent to the rod having the minimum DNBR. The three-dimensional power distribution is superimposed on the core coolant inlet flow and temperature distributions. The lateral transport of mass, momentum, and energy from the stage one calculations is imposed on the peripheral boundary enclosing the hot assembly and the neighboring assemblies. The axial distributions of flow and enthalpy in each channel are calculated as well as the transport quantities of mass, momentum, and energy which cross the lateral boundary of each flow channel.

The third stage involves a fine mesh modeling of the partial-assembly region which centers on the subchannels adjacent to the rod having the minimum DNBR. All of the flow channels used in this stage are hydraulically open to their neighbors. The output from the stage two calculations, in terms of the lateral transport of mass, momentum, and energy is imposed on the lateral boundaries of the stage three partial assembly region. Starting with Cycle 14, a more

ARKANSAS NUCLEAR ONE
Unit 2

detailed two-stage TORC model was used replacing the three-stage model. Stage 1 consists of calculating coolant conditions throughout the core on the coarse mesh basis. The core is modeled such that each flow channel is a quarter of a fuel assembly. Stage 2 involves a fine mesh modeling of the fuel assembly that contains the subchannels adjacent to the rod having minimum DNBR. The fuel assembly is modeled such that each flow channel is surrounded by fuel rods or guide tube. The output from the stage 1 calculations, in terms of lateral transport of mass, momentum, and energy is imposed on the lateral boundaries of the limiting fuel assembly in stage 2. Engineering factors are applied to the minimum DNBR rod and subchannel to account for uncertainties on the enthalpy rise and heat flux due to manufacturing tolerances. The local coolant conditions are calculated for each flow channel. These coolant conditions are then input to either the CE-1, ABB-NV, or WSSV-T CHF correlation and the minimum value of DNBR in the core is determined.

A more detailed description of this procedure with example is contained in Reference 37. This procedure is used to analyze in detail any specific three-dimensional power distribution superimposed on explicit core inlet flow and exit pressure distributions. The detailed core thermal margin calculations are used primarily to develop and to support the CETOP design core thermal margin calculational scheme discussed below.

Cycle 20 was a mixed core consisting of standard fuel assemblies and NGF assemblies. Since the mixing vane spacer grids of NGF fuel provide higher flow resistance compared to standard fuel assemblies, the hydraulic characteristics of these two fuel types were explicitly modeled in TORC thermal-hydraulic analyses to calculate coolant pressure drop and cross-flow between assemblies.

Starting with Cycle 21 (full NGF core), WSSV-T and ABB-NV CHF correlations were used to determine the minimum DNBR in the core as discussed in Section 4.4.2.3.2.

The CETOP code, a variant of the TORC code, is used as a design code for thermal margin analyses. The CETOP code uses transport coefficients for improved prediction of diversion cross flow and turbulent mixing between adjoining channels. Furthermore, a prediction-correction method is used to solve the conservation equations, replacing the iterative method used in the TORC code. CETOP is benchmarked against TORC DNBR data to ensure that CETOP DNBR results are accurate or conservative relative to TORC.

The method used for design calculations using CETOP is discussed in detail in Reference 38. In summary, the method is to use one limiting hot assembly radial power distribution for all analyses, to raise or lower the hot assembly power to provide the proper maximum rod radial power factor, and to use the core average mass velocity in all fuel assemblies except the hot assembly. The appropriate reduction for the hot assembly mass velocity was determined after completion of the flow model tests (see Section 4.4.3.1.1). This methodology is used in the thermal margin analyses of the System 80 reactors.

4.4.3.4.3 UO₂ Melting Point

An examination of the published data on the variation of the melting point of UO₂ with burnup shows a decrease at a nearly linear rate of -56 °F per 10,000 MWD/MTU (Reference 60). This rate results in a UO₂ melting point of 4,800 °F after a maximum local burnup of 50,000 MWD/MTU is achieved.

4.4.3.5 Hydraulic Instability Analysis

Flow instabilities leading to flow excursions or flow oscillations have been observed in some boiling flow systems containing one or more closed, heated channels. Flow instabilities are a concern primarily because they may lead to a reduction in the DNB heat flux relative to that observed during a steady flow condition. Flow instabilities of several types have been observed or postulated for closed channel systems. Although the state of the art does not permit detailed theoretical analyses for each type of flow instability, the available information on boiling systems indicates that flow instabilities will not adversely affect thermal margin of Combustion Engineering PWRs during normal operation or anticipated operational occurrences. Flow instabilities which have been observed have occurred almost exclusively in closed channel systems operating at pressures low relative to PWR operating pressures. As shown by the tests discussed in Section 4.4.3.10, the resistance to coolant crossflow among channels of a Combustion Engineering PWR fuel assembly is extremely small. It would be expected that the low resistance to crossflow between adjacent channels would have a stabilizing effect, and that expectation is confirmed by the results of Veziroglu and Lee (Reference 153), who found that flow stability in parallel heated channels was enhanced by having cross connections between the channels. Increasing pressure has been found to have a stabilizing influence in many cases where flow instabilities have been observed (Reference 50) and the high operating pressure characteristic of PWRs tends to minimize the potential for flow instability. Kao, Morgan, and Parker (Reference 93) who conducted flow stability experiments at pressures up to 2,200 psia with closed parallel heated channels, found that no flow oscillations could be induced at pressures above 1,200 psia for flow and power levels encountered in power reactors. Additional evidence that flow instabilities will not adversely affect thermal margin is provided by the data from the rod bundle DNB tests conducted by Combustion Engineering. (Refer to Section 4.4.4.2.) Many rod bundles have been tested over wide ranges of operating conditions with no evidence of premature DNB or of inconsistent data which might be indicative of flow instabilities in the rod bundle.

In summary, it is concluded that flow instabilities will not adversely affect thermal margin of Combustion Engineering PWR cores during normal operation and anticipated operational occurrences.

4.4.3.6 Temperature Transient Effects Analysis

- A. Waterlogged fuel: The potential for a fuel rod to become waterlogged during normal operation is discussed in Section 4.2.1.3.4. In the event that a fuel rod does become waterlogged at low or zero power, it is possible that a subsequent power increase could cause a buildup of hydrostatic pressure to a level sufficient to yield the cladding, possibly causing the cladding to rupture. Such a condition requires that the defect which permitted initial waterlogging be so small that the pressure buildup is not relieved during the transient.

Tests which have been conducted using intentionally waterlogged fuel pins (capsule drive core at SPERT) (References 141, 142) showed that the resulting failures did eject some fuel material from the rod and greatly deformed the test specimens. However, these test rods were completely sealed, and the transient rates used were several orders of magnitude greater than those allowed in normal operation.

In those instances where waterlogged fuel rods have been observed in commercial reactors, it has not been clear that waterlogging was the cause, and not just the result, of associated cladding failures; and Combustion Engineering has not observed and is

ARKANSAS NUCLEAR ONE
Unit 2

not aware of any case in which material was expelled from waterlogged fuel rods or in which the fuel cladding was significantly deformed in a normal power reactor as a result of waterlogged fuel rods. It is therefore concluded that the effect of normal power transients on naturally waterlogged fuel rods will not be to produce the sort of postulated burst failures which could expel fuel material or damage adjacent fuel rods or fuel assembly structural components.

- B. Intact fuel, but with high internal pressure: As noted in Section 4.2.1.3.13, the maximum fuel rod internal pressure in the peak power pin (highest energy output) is predicted to be less than the no-clad-lift-off (NCLO), as required by Reference 173, at all times. This methodology allows fuel rod pressures in excess of system pressures. Therefore, it is concluded that the presence of a substantial internal fuel rod pressure, such as is predicted for the Arkansas Nuclear One - Unit 2 fuel rods at End of Life (EOL), will not have an adverse effect on the fuel rods' performance during transients.

4.4.3.7 Potentially Damaging Temperature Effects During Transients

The thermal effects of anticipated operational occurrences on fuel rod and fuel assembly integrity may be divided into two categories: those which occur within and affect only a single fuel rod, and those which concern the interaction between the fuel rods and the fuel assembly frame (grids, end fittings, etc.) and between the fuel assemblies and the reactor vessel internals. These two categories are discussed in the following paragraphs.

- A. Fuel rod thermal transient effects are basically manifested as the change in internal pressure, the changes in clad thermal gradient and thermal stresses, and the relative differential thermal expansion between pellets and clad.

The first two of these effects are discussed in Section 4.4.3.6, and the third is covered in Section 4.2.1.3.7.

Another possible effect of transients would be to cause an axial expansion of the pellet column against a flattened (collapsed) section of the clad. However, the Arkansas Nuclear One - Unit 2 fuel rod design includes specific provisions to prevent clad flattening, and, therefore, such interactions will not occur.

- B. Thermal transient effects which involve the interaction of fuel rods, fuel assembly structure, and reactor internals include the differential thermal expansion between the fuel rods and the CEA guide tubes (longitudinal structural members in the fuel assembly frame) and the differential thermal expansion between the fuel assembly structure (Zircaloy) and the core barrel (stainless steel).

The temperature of each end fitting is considered to be uniform and equal to the temperature of the coolant flowing through it. Because there is no connection between the end fittings and the fuel rods, the temperature of the end fittings has no direct effect on the interactions of fuel rods and assembly.

The axial interaction between fuel rods and fuel assembly structure does not present a problem because:

1. The fuel rods and fuel assembly are all Zircaloy-4, ZIRLO™, or Optimized ZIRLO™ and have only very small differential expansion;

ARKANSAS NUCLEAR ONE
Unit 2

2. The resistance force imparted by the fuel rod support grids is quite small in relation to the critical buckling load for the fuel tubes, and
3. The fuel assembly design includes sufficient axial clearance to accommodate both the peak differential thermal expansion and the maximum predicted axial fuel rod growth, thus precluding hard contact between the fuel rods and the fuel assembly upper end fittings.

The axial interaction between the fuel assembly structure and the reactor vessel internals is considered because, although the stainless steel internals expand thermally more than the fuel assembly, the fuel assembly is subject to irradiation induced growth. Therefore, if the fuel assembly grows excessively during hot operation, there is a possibility of axial interference between fuel assembly and reactor internals when the reactor is shut down.

In the Unit 2 design, interaction of this type is prevented by allowing sufficient clearance to accommodate the maximum predicted fuel assembly structure axial growth.

4.4.3.8 Energy Release During Fuel Element Burnout

The RPS provides fuel clad protection so that the probability of fuel element burnout during normal operation and anticipated operational occurrences is extremely low. Thus, the potential for fuel element burnout is restricted to low probability of occurrence events. The LOCA is the limiting event since it results in the larger number of fuel rods experiencing burnout. Thus, the LOCA analysis, which is very conservative in predicting fuel element burnout, provides an upper limit for evaluating the consequences of burnout. The LOCA analysis explicitly accounts for the additional heat released due to the chemical reaction between the Zircaloy, ZIRLO™, or Optimized ZIRLO™ clad and the coolant following fuel element burnout in evaluating the consequences of this accident.

4.4.3.9 Energy Release on Rupture of Waterlogged Fuel Elements

A discussion of the potential for waterlogging fuel rods and for subsequent energy release is presented in Sections 4.2.1.3.4 and 4.4.3.6.

4.4.3.10 Fuel Rod Behavior Effects from Coolant Flow Blockage

An experimental and analytical program was conducted to determine the effects of fuel assembly coolant flow maldistribution during normal reactor operation. In the experimental phase, velocity and static pressure measurements were made in cold, flowing water in an oversize model of a Combustion Engineering 14 x 14 fuel assembly in order to determine the three-dimensional flow distributions in the vicinity of several types of flow obstruction. The effects of the distributions on thermal behavior were evaluated, where necessary, with the use of a preliminary version of the TORC thermal and hydraulic code (Reference 37). Subjects investigated included:

- A. The assembly inlet flow maldistribution caused by blockage of a core support plate flow hole. Evaluation of the flow recovery data indicated that even the complete blockage of a core support plate flow hole would not produce a W-3 DNBR of less than 1.0 even though the reactor might be operating at a power sufficient to produce a DNBR of 1.3 without the blockage; and,

ARKANSAS NUCLEAR ONE
Unit 2

- B. The flow maldistribution within the assembly caused by complete blockage of one to nine channels. Flow distributions were measured at positions upstream and downstream of a blockage of one to nine channels. The influence of the blockage diminished very rapidly in the upstream direction. Analysis of the data for a single channel blockage indicated that such a blockage would not produce a W-3 DNBR of less than 1.0 downstream of the blockage even though the reactor might be operating at a power sufficient to produce a DNBR of 1.3 without the blockage.

Although the results quoted above are for the 14 x 14 assembly, those results are considered to represent satisfactorily the effects of similar blockages in the 16 x 16 assembly, particularly since the larger axial flow resistance of the 16 x 16 assembly will lead to a more rapid flow recovery.

4.4.4 TESTING AND VERIFICATION

4.4.4.1 Introduction

This section describes several Combustion Engineering testing and verification programs which yield thermal and hydraulic information germane to Combustion reactors. These are DNB tests, components tests, turbulence interchange measurements, and reactor testing and verification. Two other programs, reactor flow model tests, and fuel assembly flow distribution tests, are discussed in Sections 4.4.3.1 and 4.4.3.10, respectively.

4.4.4.2 DNB Testing

The margin to critical heat flux (CHF) or DNB is expressed in terms of the DNBR. The DNBR is defined as the ratio of the heat flux required to produce DNB at the calculated local coolant conditions to the actual heat flux.

The CE-1 correlation (Reference 16) was used with the TORC and the CETOP computer codes (References 37 and 38) to determine DNBR values for normal operation and anticipated operational occurrences. The CE-1 correlation was used in conjunction with the TORC code specifically for DNB margin predictions for fuel assemblies with standard spacer grids similar to those in Arkansas Nuclear One - Unit 2. Topical Reports CENPD-162 and CENPD-207 (Reference 16) provide detailed information on the CE-1 correlation and source data and also provide comparisons with other data and correlations. In brief, the correlation is based on data from tests conducted for C-E at the Chemical Engineering Research Laboratories of Columbia University. Those tests used electrically-heated 5 x 5 array rod bundles corresponding dimensionally to a portion of a 16 x 16 or 14 x 14 assembly with standard spacer grids. The test programs conducted for the 16 x 16 and 14 x 14 assembly geometries each included tests to determine the effects on DNB of the CEA guide tube, bundle heated length, axial grid spacing, and lateral and axial power distributions.

The uniform axial power CE-1 correlation (Reference 16) was developed from DNB data for six test sections with the following characteristics:

<u>Fuel Assembly Geometry</u>	<u>No. Heated Rods</u>	<u>Lateral Power Distribution</u>	<u>Heated Length (ft)</u>	<u>Axial Grid Spacing (in)</u>
16 x 16	25	Uniform	7	16.0
16 x 16	21	NonUniform	7	18.3
16 x 16	21	NonUniform	12.5	17.4
14 x 14	25	Uniform	7	14.3
14 x 14	21	NonUniform	7	14.3
14 x 14	21	NonUniform	12.5	14.3

ARKANSAS NUCLEAR ONE
Unit 2

Local coolant conditions at the DNB location were determined by using the TORC code in a manner consistent with the use of the code for reactor thermal margin calculations. The uniform axial power CE-1 correlation was developed from 731 DNB data for the following parameter ranges:

Pressure	1785 to 2415 psia
Inlet Temperature	382 to 644 °F
Heat flux	0.213×10^6 to 0.952×10^6 Btu/hr-ft ²
Local coolant quality	-0.16 to 0.20
Local mass velocity	0.87×10^6 to 3.21×10^6 lb/hr-ft ²

The uniform axial power CE-1 correlation predicted the 731 source data with a mean and standard deviation of the ratio of measured and predicted DNB heat fluxes of 1.000 and 0.068, respectively. However, the NRC has approved the use of 1.19 minimum DNBR for the 16 x 16 assembly based on a subset of the 731 source data as reported in CENPD-207 (Reference 16). The validity of the CE-1 correlation for predicting DNB for 16 x 16 fuel assemblies was further verified by the analysis of data obtained by repeating one of the tests for the 16 x 16 assembly geometry at the Winfrith Laboratory of the UKAEA.

For nonuniform axial power distributions, the uniform axial power CE-1 correlation is modified by the F-factor (Reference 151). The conservatism of that method of predicting DNB for 16 x 16 fuel assemblies with nonuniform axial flux shapes is demonstrated in CENPD-207 (Reference 16) which presents measured and predicted DNB heat fluxes for a series of tests using nonuniform axial power rod bundles representative of 16 x 16 or 14 x 14 fuel assemblies with standard spacer grids. Those test sections had the following characteristics:

<u>Fuel Assembly Geometry</u>	<u>No. Heated Rods</u>	<u>Lateral Power Distribution</u>	<u>Axial Power Distribution</u>	<u>Heated Length (ft)</u>	<u>Axial Grid Spacing (in)</u>
16 x 16	21	Nonuniform	1.46 symmetric	12.5	14.2
16 x 16	21	Nonuniform	1.47 top peak	12.5	14.2
14 x 14	21	Uniform	1.68 top peak	12.5	17.4
14 x 14	21	Nonuniform	1.68 bottom peak	12.5	17.4

The DNB data from those tests were evaluated using the CE-1 correlation modified by the F-factor and the TORC code used in a manner consistent with the use of the code for reactor calculations. That evaluation included DNB data within the following parameter ranges:

Pressure	1745 to 2425 psia
Inlet Temperature	333 to 631 °F
Local coolant quality	-0.27 to 0.20
Local mass velocity	0.81×10^6 to 3.07×10^6 lb/hr-ft ²

It was found that the mean and standard deviation of the ratio of measured and predicted DNB heat fluxes were 1.229 and 0.125, respectively, for the 369 DNB data within the parameter ranges mentioned above.

Testing was also conducted with rod bundles representative of the 16 x 16 fuel assembly to determine the effect on DNB of local perturbations in heat flux. Results are presented in CENPD-207 (Reference 16) for two nonuniform axial power rod bundles which were similar

ARKANSAS NUCLEAR ONE
Unit 2

except that one test bundle had a heat flux spike (23% higher heat flux for a 4-inch length) at the location where DNB was anticipated. The results show that there is no significant adverse effect on DNB due to that flux spike. Therefore, it is concluded that no allowance is required for the effect on DNB of local heat flux perturbations less severe than that tested.

One important factor in the prediction of DNB and local coolant conditions is the treatment of coolant mixing or turbulent interchange. The effect of turbulent interchange on enthalpy rise in the subchannels of 16 x 16 fuel assemblies with standard spacer grids is calculated in the TORC code by:

$$\hat{P}_e = \frac{\omega'}{\bar{G} \bar{D}_e}$$

where:

\hat{P}_e = inverse Peclet number

ω' = turbulent interchange between adjacent subchannels, lb/hr-ft

\bar{D}_e = average equivalent diameter of the adjacent subchannels, ft

\bar{G} = average mass velocity of the adjacent subchannels, lb/hr-ft²

The inverse Peclet number of 0.0035 for the 16 x 16 assembly with standard grids was verified with data obtained in the tests conducted at Columbia University (Reference 16) as described in Section 4.4.4.4.

The design basis requires that the minimum DNBR for normal operation and anticipated operational occurrences be chosen to provide a 95% probability at the 95% confidence level that DNB will not occur on a fuel rod having that minimum DNBR. Statistical evaluation of the CE-1 correlation (Reference 16) and relevant data shows that the appropriate minimum DNBR is 1.13. Based on review of CENPD-162 (Reference 16) the NRC requires use of a minimum DNBR of 1.19 with C-E standard grid fuel assemblies.

For the CE-1 correlation, this minimum DNBR has been increased to 1.25 to account for system parameter uncertainties as described in Section 4.4.2.3.2.

The ABB-NV correlation (Reference 193) may also be used with the TORC and CETOP computer codes (References 37 and 38) to determine DNBR values for normal operation and anticipated operational occurrences. Topical Report CENPD-387 (Reference 193) provides detailed information on the ABB-NV correlation, source data and comparisons with other correlations. With respect to non-mixing vane fuel, the ABB-NV correlation was developed as a new correlation form to incorporate the following improvements in the CE-1 correlation:

- A. Special geometry effects for the grid, heated length, and guide tube to improve the fit and probability of the CHF data,
- B. Optimization of the constants for the Tong F_C shape factor to the ABB-CE non-uniform CHF data, and
- C. Use of the primary CHG indication from each test run vs. multiple CHF indications used in development of CE-1.

ARKANSAS NUCLEAR ONE
Unit 2

The CHF test data for ABB-NV were taken from the Columbia University Heat Transfer Research Facility between 1971 and 1977. The majority of CHF tests used in the correlation databases for ABB-NV are the same tests used to develop and support CE-1. Several tests were added to the CE-1 non-mixing vane database to support the special geometry terms for the correlation form and for validation of the correlation. The ABB-NV correlation does not supersede the CE-1 correlation. The CE-1 correlation may still be used if desired.

Statistical evaluation of the ABB-NV correlation (Reference 193) indicates a minimum DNBR limit of 1.13 will provide a 95 probability with 95 percent confidence of not experiencing CHF on a rod showing the limiting value. For the ABB-NV correlation, this minimum DNBR has been increased to 1.23 to account for system parameter uncertainties as described in Section 4.4.2.3.2.

The range of applicability for the ABB-NV correlation is as follows:

Pressure	1750 to 2415	psia
Local mass velocity	0.8×10^6 to 3.16×10^6	lbm/hr-ft ²
Local quality	-0.14 to 0.22	
Heated length, inlet to CHF location	48 to 150	in
Grid spacing	8 to 18.86	in
Heated hydraulic diameter ratio	0.679 to 1.08	D _{hm} /D _h

For NGF assemblies, the WSSV-T critical heat flux correlation (Reference 196) is used with the TORC and CETOP computer codes to predict DNBR. Reference 196 provides detailed information on the WSSV-T correlation along with the source data. The correlation was developed to:

- A. Accurately reflect thermal performance of the NGF design with side supported mixing vane grids in CE PWRs with the 16 x 16 fuel lattice and multiple grid spacing.
- B. Extend the quality range to be applicable to local quality higher than 30% in the hot channels.

The CHF test data for the WSSV-T correlation was taken from the Columbia University Heat Transfer Research Facility between 1993 and 2003. Data was taken on grids with side-supported vanes for 14 x 14 and 16 x 16 fuel geometries. Statistical evaluation of the WSSV-T correlation given in Reference 196 indicates a minimum DNBR limit of 1.12 will provide a 95 percent probability with 95 percent confidence of not experiencing critical heat flux on a rod showing the limiting value. For the WSSV-T correlation, this minimum DNBR has been increased to 1.23 to account for system parameter uncertainties as described in Section 4.4.2.3.2.

ARKANSAS NUCLEAR ONE
Unit 2

The range of applicability for the WSSV-T correlation is as follows:

Pressure	1,495 to 2,450	psia
Local mass velocity	0.90 to 3.46	Mlbm/hr-ft ²
Local coolant quality	< 0.34	
Heated length, HL	48* to 150	inches
Grid spacing	10.28 to 18.86	inches
Heated hydraulic diameter ratio	0.679 to 1.00	Dhm/Dh
Matrix heated hydraulic diameter (Dhm)	0.4635 to 0.5334	inches

* Set as minimum HL value, applied at all elevations below 48 inches.

4.4.4.3 Components Testing

Components test programs have been conducted in support of all Combustion Engineering reactors. The tests subject a full-scale reactor core module comprising one to four fuel assemblies. Some of the tests included a Control Rod Assembly (CRA) and extension shaft, Control Element Drive Mechanism (CEDM), and reactor vessel internals to reactor conditions of water chemistry, flow velocity, temperature, and pressure under the most adverse operating conditions allowed by the design. Two objectives of the programs are to confirm the basic hydraulic characteristics of the components' lifetime. When the reactor design or fuel assembly design is revised, a new program embodying the important aspects of the latest design is conducted. Thus, component tests have been run on the Palisades design, with cruciform control rods, on the Fort Calhoun design with CEAs and rack-and-pinion CEDMs and on the Maine Yankee and later designs, with dual CEAs and magnetic jack CEDMs.

During the course of the tests, information was obtained on fuel rod fretting, on CEA/CEDM trip behavior, and on fuel assembly uplift and pressure drop. For new fuel designs, the tests include fuel rod fretting, rod and assembly vibration data, and pressure drop data. The first two subjects are discussed in Section 4.2. The third is discussed below.

As part of the assessment of fuel assembly margin to uplift in the reactor, measurements are made of fuel assembly net weight, to the point of liftoff for an isothermal temperature range of 150 °F to 600 °F at a system pressure of 350 psi to 2,100 psi. To obtain the desired information, one of the fuel assemblies of the module is mounted on load beams so that the assembly net weight can be measured as a function of flow rate and temperature. Data reduction involves the calculation of an uplift coefficient, describing the hydraulic uplift force acting on the assembly; the coefficient is defined as follows:

$$K_{up} = [W_o]/[\rho V^2 A/2g_c]$$

where

W_o = Wet weight of assembly with no flow, lb

V = Flow velocity in assembly at the point of liftoff, ft/sec

A = Envelope area of assembly, ft²

ρ = Water density, lb/ft³

ARKANSAS NUCLEAR ONE
Unit 2

A plot of the Kup data shows that they can be fitted by the relation:

$$K_{up} = \alpha_a R_c^{-\beta}$$

where α_a and β are peculiar to the particular components tests being run and R_c is the Reynolds Number, and where the standard error of estimate for the latest test is 3.7 percent, including replication and instrument error. An analytical control volume model is used to evaluate new fuel designs where the model has been confirmed to be valid based on test data or previous fuel designs.

The uplift coefficient and its associated uncertainty are employed in the analysis of the uplift forces on the fuel assemblies in the reactor. The force is determined for the most adverse assembly location for startup and normal operating conditions. Additional input to the calculation includes analytical corrections to the coefficient for the absence of the CEA, for crud formation, and for small geometrical differences among the fuel assemblies for the different reactor designs all nominally describable by the same components test.

Pressure drop measurements are also made during components test programs to verify the accuracy of the calculated loss coefficients for various fuel assembly components. Direct reduction of the pressure drop data yields the loss coefficients for the lower and upper end fitting region, while the spacer grid loss coefficient is evaluated by subtracting a calculated fuel rod friction loss from the measured pressure drop across the fuel rod region.

Experience has shown that the experimental end fitting loss coefficients are essentially independent of Reynolds Number and, with their sample standard deviations, are in reasonable agreement with the predicted values used in the calculation of core pressure drop (See Section 4.4.2.7). The experimental spacer grid loss coefficients are based upon experimental results from ANO-2/3410 fuel assembly components test programs.

4.4.4.4 Turbulent Interchange Testing

In 1966, a series of single-phase tests on coolant mixing through turbulent interchange was run on a "prototype" fuel assembly which was geometrically similar to the Palisades assembly. The model enabled determination of vertical channel flow rates using pressure instrumentation and the average level of turbulent interchange using dye injection and sampling equipment.

The tests yielded the value of Inverse Peclet Number characteristic of turbulent interchange in the prototype geometry. The Inverse Peclet Number is a dimensionless parameter defined by the relation:

$$\hat{P}_e = \frac{\hat{\omega}}{\bar{G} \bar{D}_e}$$

where

$\hat{\omega}$ = Turbulent interchange between channels, lb/hr-ft

\bar{D}_e = Average equivalent diameter of two neighbor channels between which turbulent interchange occurs, ft.

\bar{G} = Average mass velocity of two neighbor channels, lb/hr-ft²

ARKANSAS NUCLEAR ONE
Unit 2

In the test geometry, the value of \hat{P}_e was found to be 0.00366, with a sample standard deviation of 16 percent. The value was shown during the course of the tests to be insensitive to coolant temperature and mass velocity. The best estimate value of the Inverse Peclet Number was established at 0.0035 on the basis of the experimental results. The value used in Combustion Engineering thermal and hydraulic calculations is that best estimate value.

As part of a Combustion Engineering sponsored research and development program, a new series of single-phase dye injection mixing tests was conducted in 1968. The tests were performed on a model of a portion of a CEA-type fuel assembly which was sufficiently instrumented to enable measurement (via a data reduction computer program) of the individual lateral flow across the boundaries of 12 channels of the model. The Inverse Peclet Number calculated from the average of 56 individual turbulent interchange flow values (two across each channel boundary) was 0.0034. With respect to general turbulent interchange, therefore, the more recent study on the CEA verifies the constancy of the Inverse Peclet Number for moderately different fuel assembly geometries and confirms the design value of that characteristic.

Verification of the Inverse Peclet Number of 0.0035 for the 16x16 assembly was obtained from data taken as part of the DNB test programs at Columbia University (See Section 4.4.4.2). Figure 4.4-13 shows measured and predicted subchannel coolant temperature rise values for some experiments conducted with an electrically-heated rod bundle representative of the 16x16 assembly. The test section used was a 5x5 array rod bundle with 25 heated rods, a heated length of seven feet, uniform axial and lateral power distributions, and Combustion Engineering standard spacer grids at 14.3-inch axial spacing. (See Reference 16 for additional detail on the test section and test procedure.) The subchannel coolant temperature rise values were determined from coolant temperature measurements made with thermocouples located in the individual subchannels at the downstream end of the heated length. Subchannel coolant temperature measurements made with thermocouples located in the individual subchannels at the downstream end of the heated length. Subchannel coolant temperature rise predictions were made using the TORC subchannel analysis code and an Inverse Peclet Number of 0.0035. For clarity, the results for subchannels similar by symmetry were averaged for each experiment. Figure 4.4-13 shows results for four experiments, two with highly subcooled coolant at the bundle outlet (no subcooled boiling predicted) and two with slightly subcooled coolant at the outlet (substantial subcooled boiling predicted). The good agreement of the measured and predicted subchannel coolant temperature rise values provides confirmation of the Inverse Peclet Number of 0.0035 for the 16x16 assembly with standard spacer grids. Similar tests have shown that the Inverse Peclet Number of 0.0035 is also applicable to the NGF 16 x 16 assembly with the side supported vane.

4.4.4.5 Reactor Testing

During reactor startup, data descriptive of thermal and hydraulic conditions within the reactor vessel were obtained. These included core exit temperature distribution, hot and cold leg temperature, loop flow rates, and core power distributions. The data was evaluated and compared with design calculations and parameters to assure that the reactor thermal and hydraulic behavior was as predicted.

4.4.5 INSTRUMENTATION REQUIREMENTS

The in-core instrumentation system will be used to confirm core power and temperature distributions, perform periodic calibrations of the ex-core flux measurement system, and provide inputs to the Core Operating Limit Supervisory System (COLSS). Further descriptions are contained in Section 7.6.

ARKANSAS NUCLEAR ONE
Unit 2

4.5 STARTUP PROGRAM

The planned startup test program associated with core performance is outlined below. These tests verify that core performance is within the assumptions of the safety analysis and provide information for continued safe operation of the unit. Some of the tests also provide the data needed for adjustment of addressable constants in the CPCS and COLSS.

4.5.1 PRECRITICAL TEST

4.5.1.1 Control Element Assembly (CEA) Drop Time Test

Precritical Control Element Assembly drop times are recorded for all CEAs (81) at hot full flow conditions before low power physics testing begins. Acceptance criteria state that the average CEA drop time from fully withdrawn to 90% inserted shall be less than or equal to 3.2 seconds at the stated conditions and that the individual CEA drop time from fully withdrawn to 90% inserted shall be less than or equal to 3.7 seconds at the stated conditions.

4.5.2 LOW POWER PHYSICS TEST

The following describes a test program conducted using traditional techniques (i.e., utilizing a reactimeter). A reduced scope of physics testing may be performed as described in Topical Report WCAP-16011-P-A, "Startup Test Activity Reduction Program," commonly referred to as the STAR program. Within the limits of Technical Specification surveillance requirements, the STAR program may be used in place of traditional techniques. The intent of testing under the STAR program is to ensure that the core can be operated as designed, while employing normal operating procedures in the startup evolution (i.e., elimination of reactimeter measurements).

4.5.2.1 Critical Boron Concentration

Initial criticality can be achieved by either dilution or by pulling rods. Typically with control rods inserted, the RCS is deborated to an estimated critical boron concentration based on predictions and desired control rod configurations. The control rods are then withdrawn in sequential order to achieve criticality. The critical boron concentration is calculated by correcting the actual boron concentration for any deviation of CEA position from the reference CEA position for the predicted critical boron concentration and by correcting for any deviation of temperature from the reference temperature. Acceptance criteria state that the critical boron concentration shall be within 100 ppm of the predicted value.

4.5.2.2 CEA Reactivity Worth

CEA worths will be measured using the CEA Exchange technique. This technique consists of measuring the worth of a "Reference Group" via standard boration/dilution techniques, then exchanging this group with other groups to measure their worths. The groups to be measured by exchange will be "assigned" to a specific test group, depending on their predicted worths. This measurement technique provides verification that individual group CEA reactivities are within the engineering design safety analysis prediction for all CEA groups. Acceptance criteria state that the measured reference group worth shall be within $\pm 10\%$ of the predicted value, the measured individual group worths shall be within $\pm 15\%$ or $\pm 0.1\% \Delta k/k$ (whichever is larger) of the predicted values, and the total worth of all the groups shall be within $\pm 10\%$ of the predicted value.

ARKANSAS NUCLEAR ONE
Unit 2

4.5.2.3 Temperature Reactivity Coefficient

The isothermal temperature coefficient (ITC) is measured at approximately the all CEA withdrawn configuration. The average coolant temperature is varied by decreasing and increasing temperature. During the change in temperature, reactivity feedback is compensated for by discrete CEA motion; change in reactivity is then calculated by the summation of reactivity associated with the temperature change. Acceptance criteria state that the measured value shall not differ from the predicted value by more than $\pm 0.3 \times 10^{-4} \Delta\rho/^\circ\text{F}$.

The moderator temperature coefficient (MTC) of reactivity is calculated in conjunction with the isothermal temperature coefficient measurement. After the ITC has been measured, a predicted value of fuel temperature coefficient of reactivity is subtracted to obtain the moderator temperature coefficient. The moderator temperature coefficient value must be less positive than the upper COLR MTC curve and less negative than $- 3.8 \times 10^{-4} \Delta\rho/^\circ\text{F}$.

Criteria have been established that allow the near two thirds of expected core burnup MTC surveillance (at power) to be eliminated (see TS surveillance 4.1.1.4.2.c). This surveillance may be eliminated providing the inferred and predicted MTC values at earlier surveillance intervals (see TS surveillance 4.1.1.4.2.a and 4.1.1.4.2.b) are within a tolerance of $0.16 \times 10^{-4} \Delta k/k/^\circ\text{F}$. Inferred and predicted MTC values that are within this tolerance provide assurance that the MTC will be maintained within acceptable values throughout the remainder of the fuel cycle. CE NPSD 911-A, "Analysis of Moderator Temperature Coefficients in Support of a Change in the Technical Specifications End of Cycle Negative MTC Limits", with Amendment 1-A, provide the basis for the above tolerance. The option to eliminate the near two thirds of expected core burnup MTC measurement also requires that the reload analysis and predicted MTC calculation be performed using the CE methodology.

4.5.3 POWER ASCENSION TESTS

Following completion of the Low Power Physics Test sequence, reactor power will be increased in accordance with the power ascension controlling procedure. The power ascension will be monitored by an off-line NSSS performance and data processing computer algorithm. This computer code will be periodically executed in parallel with the power ascension to monitor CPC and COLSS performance relative to the processed plant data against which they are normally calibrated. If necessary, the power ascension will be suspended while necessary data reduction and equipment calibrations are performed. Thus, the monitoring algorithm ensures conservative CPC and COLSS operation while optimizing overall efficiency of the test program.

4.5.3.1 Reactor Coolant Flow

Reactor coolant flow will be measured by either calorimetric calculation or using reactor coolant pump differential pressure instrumentation (COLSS) at steady state conditions in accordance with Technical Specifications. Acceptance criteria will require that the measured flow be within allowable limits and that the CPCS reactor coolant flow rate is within calibration requirements relative to measured flow.

4.5.3.2 Core Power Distribution

Core power distribution data using fixed in-core neutron detectors is used to verify proper core fuel loading and consistency between the as-built and engineering design models. This is accomplished using measurement data from three power plateaus.

ARKANSAS NUCLEAR ONE
Unit 2

The first power distribution measurement is performed after the turbine is synchronized and prior to exceeding 30% of rated power. The objective of this measurement is primarily to identify any fuel misloading that results in power asymmetries or deviations from the reactor physics design. Because of the decreased signal-to-noise ratio at low powers and the absence of xenon stability requirements, radial and azimuthal symmetry criteria are emphasized, whereas pointwise absolute and statistical acceptance criteria are relaxed.

At the intermediate power plateau (40% - 70% power), a core power distribution analysis is performed to again verify proper fuel loading and consistency with design predictions. The intermediate power acceptance criteria ensure that the power distribution is consistent with predictions and that reactor power may be increased to 100% and remain within the design limits.

The final power distribution comparison is performed with equilibrium xenon at approximately 100% power. At this plateau, axial and radial power distributions are compared to design predictions as a final verification that the core is operating in a manner consistent with its design within the associated design uncertainties.

For the first power distribution measurement, the measured results are compared to the predicted values in the following manner:

- 1) The measured and predicted relative power density (RPD) shall agree within $\pm 10\%$ for each assembly with a predicted RPD ≥ 0.9 and within 0.1 RPD units for each assembly with a predicted RPD < 0.9 .
- 2) The power in each operable symmetric detector shall be within $\pm 10\%$ of the average power in its symmetric detector group.
- 3) The vector tilt shall be less than 3%.

The measured results are compared to predicted values in the following manner for the intermediate and full power distribution analyses:

- 1) The measured radial power distribution is compared to the predicted power distribution by calculating the root mean squared deviation from predictions of the relative radial power density distribution for each of the 177 fuel assemblies. This RMS error may not exceed 5%.
- 2) The measured radial power distribution is additionally compared to the predicted power distribution using a box-by-box comparison of the relative radial power density for each of the 177 fuel assemblies. The acceptance criteria state that, for each assembly with a predicted relative power density ≥ 0.9 , the measured and predicted relative power density values must agree within $\pm 10\%$, and for each assembly with a predicted relative power density below 0.9, the measured and predicted relative power density values must agree within $\pm 15\%$.
- 3) The measured axial power distribution is also compared to the predicted power distribution. The acceptance criteria state that the RMS error between the measured axial power distribution and the predicted axial power distribution shall not exceed 5%.

ARKANSAS NUCLEAR ONE
Unit 2

- 4) The measured values of total planar radial peaking factor (F_{xy}), total integrated radial peaking factor (F_r), core average axial peak (F_z), and 3-D power peak (F_q) are compared to predicted values. The acceptance criteria state that the measured values of F_{xy} , F_r , and F_z shall be within $\pm 10\%$ of the predicted values and that COLSS and CPC constants shall be adjusted to appropriately reflect the measured values.

4.5.3.3 Shape Annealing Matrix (SAM) and Boundary Point Power Correlation Coefficients (BPPCC)

The values for SAM and BPPCC constants can either be determined by measurement or by verification of Cycle Independent SAM (CISAM) values. Either approach is used during power ascension testing.

The SAM and BPPCC values are determined from a linear regression analysis of the measured ex-core detector readings and the corresponding core power distribution determined from the in-core detector signals. The spectrum of axial shapes encountered during the power ascension will be used for the calculation of the matrix elements. In-core, ex-core, and related data are recorded, and analysis is performed using the CECOR code. This provides the necessary power distribution ex-core detector data to perform the least squares fitting. The data are processed and compiled by the off-line NSSS performance and data processing algorithm.

Appropriate CPC constants are modified, if needed, based upon the results of the measurements. The CISAM and BPPCC values are verified in a similar manner as the SAM and BPPCC values are determined. The same data are collected and the same computer codes are used. A new SAM is determined if the installed CISAM is determined to be unacceptable as a result of the verification process.

4.5.3.4 Radial Peaking Factor (RPF) and CEA Shadowing Factor (RSF) Verification

The RPF for the "all CEA's out" (or ARO) configuration is calculated using in-core and ex-core detector data measured at steady state ARO conditions. Appropriate CPC and COLSS addressable constants are modified based upon the results of the measurement. Additional modification of the constants is made as needed, based upon the measurement results, to ensure conservatism in the applied peaking factors for CEA configurations not measured during the test.

The RSFs are not measured. The CPC database and addressable constants include allowances for using predicted CEA shadowing factors.

4.5.3.5 Temperature Reactivity Coefficient

During the ITC and the MTC measurement, turbine load is used to increase RCS average temperature, which decreases reactor power, and then to decrease RCS average temperature, which increases reactor power. This manipulation yields a ratio of RCS temperature change to reactor power change. Using a predicted power coefficient with the measured average ratio, an ITC is inferred. Using a predicted fuel temperature coefficient with the inferred ITC yields an MTC. The difference between the predicted and inferred ITC shall be less than $0.3 \times 10^{-4} \Delta\rho/^\circ\text{F}$. The MTC shall be less negative than $-3.8 \times 10^{-4} \Delta\rho/^\circ\text{F}$ but less positive than the upper COLR MTC curve.

ARKANSAS NUCLEAR ONE
Unit 2

Criteria have been established that allow the near two thirds of expected core burnup MTC surveillance (at power) to be eliminated (see TS surveillance 4.1.1.4.2.c). This surveillance may be eliminated providing the inferred and predicted MTC values at earlier surveillance intervals (see TS surveillance 4.1.1.4.2.a and 4.1.1.4.2.b) are within a tolerance of $0.16 \times 10^{-4} \Delta k/k/^\circ F$. Inferred and predicted MTC values that are within this tolerance provide assurance that the MTC will be maintained within acceptable values throughout the remainder of the fuel cycle. CE NPSD 911-A, "Analysis of Moderator Temperature Coefficients in Support of a Change in the Technical Specifications End of Cycle Negative MTC Limits", with Amendment 1-A, provide the basis for the above tolerance. The option to eliminate the near two thirds of expected core burnup MTC measurement also requires that the reload analysis and predicted MTC calculation be performed using the CE methodology.

4.5.3.6 HZP to HFP Reactivity Difference

When STAR program techniques are applied to the startup test program (see Section 4.5.2), the change in critical boron concentration (determined using chemical analysis) between hot zero power and hot full power will be determined. Acceptance criteria state that the difference between measured and predicted boron concentration shall be within 50 ppm.

4.5.4 PROCEDURE IF ACCEPTANCE CRITERIA ARE NOT MET

If the acceptance criteria for any test are not met, an evaluation is performed before the test program is continued. The results of all tests will be reviewed by the plant's reactor engineering group. If acceptance criteria are not met, an evaluation will be performed by the plant's reactor engineering group with assistance from on-site and off-site nuclear engineering personnel and the fuel vendor. The results of this evaluation will be presented to the On-Site Safety Review Committee. Resolution will be required prior to power escalation.

If the BOC MTC measurements are not within the $0.16 \times 10^{-4} \Delta k/k/^\circ F$ tolerance described in Sections 4.5.2.3 and 4.5.3.5 and the discrepancy cannot be resolved, the EOC MTC surveillance must be performed.

In the event that STAR program test results fall outside of test criteria, the safety analysis and STAR program applicability requirements will be shown to remain satisfied or application of the STAR program to the current fuel cycle will be discontinued.

ARKANSAS NUCLEAR ONE
Unit 2

4.6 REFERENCES

1. "16x16 Fuel Assembly Flow Test," PED-76-003-P (Proprietary) and PED-76-003-NP (Nonproprietary), December 1976.
2. "16x16 Fuel Assembly Forced Vibration Test," TR-ESE-110P (Proprietary) and TR-ESE-110-NP (Nonproprietary), July 16, 1976.
3. "16x16 Fuel Assembly Grid Cage Lateral and Axial Deflection Characteristics," TR-ESE-063-P (Proprietary) and TR-ESE-063-NP (Nonproprietary), December 11, 1975.
4. "16x16 Fuel Assembly Lateral and Axial Deflection Characteristics and Pluck Tests," TR-ESE-091-P (Proprietary) and TR-ESE-091-NP (Nonproprietary), June 10, 1976.
5. "16x16 Fuel Assembly Pluck Impact Tests," TR-ESE-128-P (Proprietary) and TR-ESE-128-NP (Nonproprietary), August 25, 1976.
6. "Additional Thermal Hydraulic Information on Combustion Engineering 3,390 MWt Reactor Cores" CENPD-12, (CE Proprietary Report).
7. Amendment 38 to Dockets 50-317 and 50-318, Baltimore Gas and Electric, Calvert Cliffs Nuclear Power Plant Final Safety Analysis Report, Response to Question 14.17, Effect of Fuel Densification on the Calvert Cliffs Safety Analysis, CENPD-106 (Proprietary) and CENPD-106, Revision 1 (Nonproprietary), dated June 1973.
8. "Anticipated Transients Without Scram," CENPD-158, C-E Proprietary Topical Report, September, 1974.
9. "Arkansas Fuel Assembly Spacer Grid Impact Tests," TR-APL-087-P, (Proprietary) and TR-APL-087-NP (Nonproprietary), August 3, 1976.
10. "CE Fuel Evaluation Model Topical Report," CENPD-139 (Proprietary), CENPD-139, Revision 1 (Nonproprietary), CENPD-139, Supplement 1 (Proprietary), CENPD-139, Supplement 1, Revision 1 (Nonproprietary), July, 1974; "Improvements to Fuel Evaluation Model", CEN-161(B)-P-A, August, 1989; and "Improvements to Fuel Evaluation Model", CEN-161(B)-P, Supplement 1-P-A, January, 1992.
11. "CE Materials Manual," Figure 2.
12. "CEPAN, Method of Analyzing Creep Collapse of Oval Cladding," CENPD-187-P-A (Proprietary) and CENPD-187-A (Nonproprietary), March, 1976.
13. "C-E Pellet/Clad Thermal Conductance Model," CENPD-79, January 1973 (C-E Proprietary Report)
14. "COLSS, Assessment of the Accuracy of PWR Operating Limits as Determined by the Core Operating Limit Supervisory System," CENPD-169, C-E Proprietary Topical Report, July, 1975.
15. "Corrosion and Hydriding of Zircaloy, Quarterly Technical Progress Report No. 3, April-June 1967," BAW-3765-3, August 1967.

ARKANSAS NUCLEAR ONE
Unit 2

16. "Critical Heat Flux Correlation for C-E Fuel Assemblies With Standard Spacer Grids," Part 1, Uniform Axial Power Distribution, CENPD-162-P, April, 1975, (C-E Proprietary), and Part 2, Non-Uniform Axial Power Distribution, CENPD-207-P-A, December, 1984, (C-E Proprietary).
17. "Densification of C-E Fuels," CENPD-118 (Proprietary), June, 1974.
18. "EASE, Elastic Analysis for Structural Engineering," Control Data Corporation Publication No. D0001200602, March, 1970.
19. "Eighth Annual Report - AEC Fuels and Materials Development Program," GEMP-1012, Part II, March 31, 1969.
20. "Evaluation of Guide Tube Threaded Connection of System 80 Fuel Assembly," TR-ESE-087-P (Proprietary) and TR-ESE-087-NP (Nonproprietary), August 28, 1975.
21. "Evaluation of System 80 Guide Tube Connection Secondary Lock," TR-ESE-084-P (Proprietary) and TR-ESE-084-NP (Nonproprietary), January 21, 1976.
22. "Evaluation of Uncertainty in the Nuclear Power Peaking Measured by Self-Powered Fixed In-Core Detector Systems," CENPD-153, Rev. 1 C-E Proprietary Topical Report, 1980, which incorporates CENPD-145, "A Method of Analyzing In-Core Detector Data in Power Reactors."
23. "ICES STRUDL-II, The Structural Design Language: Engineering Users' Manual," Volume I, Structures Division and Civil Engineering Systems Laboratory, Department of Civil Engineering, MIT, Second Edition, June, 1970.
24. Indian Point Nuclear Generating Unit No. 2, Preliminary Safety Analysis Report – Appendix A, (Docket No. 50-247).
25. "In-Reactor Dimensional Changes to Zircaloy-4 Fuel Assemblies," TR-FMDT-003, May 1975, C-E Proprietary.
26. "KWU Information Exchange, KWO Fuel Rod Creep and Growth Data," April 1973.
27. "MRI/STARDYNE - Static and Dynamic Structural Analysis Systems; User Information Manual," Control Data Corporation, June 1, 1970.
28. "MRI/STARDYNE Users' Manual," Computer Methods Department, Mechanics Research, Inc., Los Angeles, California, January 1, 1970.
29. Prairie Island Nuclear Generating Plant, Preliminary Safety Analysis Report, Question V.B.2, (Docket No. 50-306).
30. "Qualification of Reactor Physics Method for Application to Pressurized Water Reactors of the Middle South Utilities System," MSS-NA1-P.
31. "Response to AEC Questions Related to San Onofre No. 2 and 3 Cores," CENPD-7, (CE Proprietary Report).

ARKANSAS NUCLEAR ONE
Unit 2

32. "Saxton Plutonium Project Quarterly Progress Report," WCAP-3385-30, December 1971.
33. "Sensitivity Evaluation of the C-E ECCS Evaluation Model to Cladding Rupture Strain and Fuel Assembly Flow Blockage Models," Combustion Engineering report.
34. "SHELL ***; Analysis of Thin Shells of Revolution," General Electric Mark II Time-Sharing Service User's Guide No. 910369.
35. "STRIKIN-II - A Cylindrical Geometry Fuel Rod Heat Transfer Program," CENPD-135P (Proprietary), CENPD-135 (Nonproprietary), August, 1974; "STRIKIN-II, A Cylindrical Geometry Fuel Rod Heat Transfer Program (Modifications)", CENPD-135-P, Supplement 2-P, February, 1975; "STRIKIN-II, A Cylindrical Geometry Fuel Rod Heat Transfer Program", CENPD-135-P, Supplement 4-P, August, 1976; "STRIKIN-II, A Cylindrical Geometry Fuel Rod Heat Transfer Program", CENPD-135-P, Supplement 5-P, April, 1977.
36. "Structural Analysis of the 16x16 Fuel Assembly for Combined Seismic and Loss of Coolant Accident Loadings," CENPD-178-P (Proprietary) and CENPD-178-NP (Nonproprietary), August, 1976.
37. "TORC Code: A Computer Code for Determining the Thermal Margin of a Reactor Core," CENPD-161-P-A, April, 1986. (CE - Proprietary).
38. "CETOP-D Code Structure and Modeling Method for Arkansas Nuclear One - Unit 2," CEN-214(A)-P, July 1986.
39. "Yankee Core Evaluation Program, Final Report," WCAP-3017-6094, January 1971.
40. "Zircaloy Growth In-Reactor Dimensional Changes in Zircaloy-4 Fuel Assemblies, CENPD-198-P (Proprietary) and CENPD-198 (Nonproprietary), December 1975.
41. Adir, H., et al., "Users' and Programmers' Manual for the GGC-3 Multigroup Cross Section Code," GA-7137, July 1967.
42. Anderson, T. D., "Effects of High Burnup on Bulk UO₂ Fuel Elements," Nuclear Safety, Vol. 6, No. 2, Winter 1964-65, pp. 164-169.
43. Barney, W. K., Sehmel, G. A., Seymour, W. E., "The Use of Boron Carbide for Reactor Control," Nuclear Science and Engineering, Volume 4, No. 3, Pages 439-449, 1958.
44. Baroch, S. J., et. al., "Comparative Performance of Zircaloy and Stainless Steel Clad Fuel Rods Operated to 10,000 Mwd/MTU in the VBWR," GEAP-4849, April, 1966.
45. Barrett, L.E., "Spectral Shift Control Reactor," Basic Physics Program B&W-1233, March 1962.
46. Bates, J. L., "High Temperature Thermal Conductivity of 'Round Robin' to Uranium Dioxide," BNWI-1431, 7/70.

ARKANSAS NUCLEAR ONE
Unit 2

47. Berman, R. M., Meieran, H. B. and Patterson, P., "Irradiation Behavior of Zircaloy-Clad Fuel Rods Containing Dished End UO₂ Pellets, (LWBR-LSBR Development Program)," WAPD-TM-629, July, 1967.
48. Blakely, J. P., "Action on Reactor and Other Projects Undergoing Regulatory Review of Consideration," Nuclear Safety, Vol. 9, No. 4, p. 326, July-August 1968.
49. Borrensen, S. and Goldstein, R., "An Equivalence Formulation for Absorption in Plutonium," Trans. Am. Nucl. Soc., 15, 296, 1972.
50. Boure, J. A., Bergles, A. E., and Tong, L. S., "Review of Two-Phase Flow Instability," ASME Paper 71-HT-42, August 1971.
51. Breen, R. J., et al., "HARMONY - System for Nuclear Reactor Depletion Computation," WAPD-TM-478, January 1965.
52. Bronner, G., et al., "Neutronenphysikalische Untersuchungen Bei Inbetriebnahme des KWO," Atomwirtschaft, p. 618, December 1968.
53. Brown, J. R. et al., "Kinetic and Buckling Measurements on Lattices of Slightly Enriched Uranium and UO₂ Rods in Light Water," WAPD-176, 1958.
54. Burian, R. J., Fromm, E. O., Gates, J. E., "Effect of High Boron Burnups on B₄C and ZrB₂ Dispersions in Al₂O₃ and Zircaloy-2," BMI-1627, April 24, 1963.
55. Byrne, S. T., "Palisades Zircaloy-4 Growth Data," NLC-73-M-249, November 19, 1973 and NLC-74-M-070, February 14, 1974, C-E Proprietary.
56. Cabannes, F., and Stora, J. P., "Reflection and Emission Factors of UO₂ at High Temperatures," C. R. Acad. Sci., Paris, Ser. B.264 (1) 45-48, 1967.
57. Cadwell, W. R., "PDQ-7 Reference Manual," WAPD-TM-678, January 1968.
58. Chajson, L. et al., "Yankee Core Evaluation Program - Quarterly Report for the Period Ending September 30, 1963," WCAP-6056, October 1963.
59. Christensen, J. A., "Thermal Expansion of UO₂," HW-75148, 1962.
60. Christensen, J. A., et al., "Melting Point of Irradiated Uranium Dioxide," WCAP-6065, February, 1965.
61. Clark, R. H., et al., "Physics Verification Program," Final Report B&W - 3647-3, March 1967.
62. Conway, J. B., "The Thermal Expansion and Heat Capacity of UO₂ to 2200°C," GE-NMPD-TM-63-6-6.
63. Conway, J. B., and Faith, A. D., "Interim Report on a 'Round Robin' to Measure the Thermal Conductivity of Stoichiometric Uranium Dioxide," GEMP-715, Addendum (1/70).

ARKANSAS NUCLEAR ONE
Unit 2

64. Corcoran, W. R., et al., "Damping of Xenon Oscillations in the Maine Yankee Reactor," Presented at the American Nuclear Society Sixth Biennial Conference on Reactor Operating Experience, August 5-8, 1973.
65. Daniel, R. C., "In-Pile Dimensional Changes of Zr-4 Tubing Having Low Stresses," Nuclear Technology, Vol. 14, May 1972, pp. 171-186.
66. Davidson, P. W. et al., "Yankee Critical Experiments," YAEC-94, April 1959.
67. Dawson, F. D., "Plutonium Utilization Program Annual Report," BNWL-624, December 1964.
68. Deverall, J. E. LA-2269 USAEC, Vol. 62, 1954.
69. Ditus, F. W., and Boelter, L. M. K., University of California Pubs Eng., 2, 443, 1930.
70. Duncombe, E., Meyer, J. E. and Coffman, W. A., "Comparisons with Experiment of Calculated Dimensional Changes and Failure Analysis of Irradiated Bulk Oxide Fuel Test Rods Using the CYGRO-1 Computer Program," WAPD-TM-583, September, 1966.
71. Duncombe, D., F. A. Nichols, S. H. Leiden, W. F. Bourgeois, "Predictions of In-Reactor Deformation of Zircaloy Cladding for Oxide Fuel Rods (LWBR Development Program)," WAPD-TM-808(L), December 1969, pp. 33-37.
72. Dunham, R. S., Nickell, R. E., et al., "NAOS - Finite Element Analysis of Axisymmetric Solids with Arbitrary Loadings," Structural Engineering Laboratory, University of California, Berkeley, California, June 1967.
73. Eich, W. J. and Rocacik, W. P., "Reactivity and Neutron Flux Studies in Multi-Region Loaded Cores," WCAP-1443, 1961.
74. Engel, J. T. and Meieran, H. B., "Performance of Fuel Rods Having 97 Percent Theoretical Density UO₂ Pellets Sheathed in Zircaloy-4 and Irradiated at Low Thermal Ratings," WAPD-TM-631, July, 1968.
75. Engelder, T. C., et al., "Spectral Shift Control Reactor, Basic Physics Program," B&W-1273, November 1963.
76. England, T. R., "CINDER-A One Point Depletion and Fission Product Program," WAPD-TM-334, Revised June 1964.
77. Engle Wald W. Jr., "A User's Manual for ANISN, A One-Dimensional Discrete Ordinates Transport Code with Anisotropic Scattering," K-1693, March 30, 1967.
78. Fayers, F. J. et al., "An Evaluation of Some Uncertainties in the Comparison Between Theory and Experiments for Regular Light Water Lattices," Brit. Nuc. En. Soc. J., 6, April 1967.
79. Gabrielson, V. K., "SHOCK - A Computer Code for Solving Lumped-Mass Dynamic Systems," SCL-DR-65-34, January 1966.
80. Gray, R. G., and Lynam, L. R., "Irradiation Behavior of Bulk B₄C and B₄C and SiC Burnable Poison Plates," WAPD-261, pp. 43-51.

ARKANSAS NUCLEAR ONE
Unit 2

81. Ghosh S. and Wilson E., "Dynamic Stress Analysis of Axisymmetric Structures under Arbitrary Loading," Dept. No. EERC 69-10, University of California, Berkeley, September 1969.
82. Harbottle, J. E., "The Temperature and Neutron Dose Dependence of Irrad. Growth in Zircaloy-2, Irrad Effect on Structural Alloys for Nuclear Reactor Applications," ASTM-STP-484, 1970, pp. 287-298.
83. Held, P. C. and Wilder, D. R., "High Temperature Hemispherical Spectral Emittance of Uranium Dioxide at 0.65 and 0.70 μ ," J. Am. Cer. Soc., Vol. 52, No. 4, 1969.
84. Hellstrand, E., "Measurement of Resonance Integral," Proceedings of National Topical Meeting of the ANS, San Diego, The M.I.T. Press, February 7-9, 1966.
85. Henry, A. F., "A Theoretical Method for Determining the Worth of Control Rods," WAPD-218, August 1959.
86. Himmelwright, J.R., "The Start-Up Test Program of the Conn. Yankee Reactor," September 1967.
87. Honeck, H., "Description of the Code GAKER," BNL Memorandum, January 6, 1964.
88. Honeck, H., "THERMOS-A Thermalization Transport Theory Code for Reactor Lattice Calculations," BNL-5816, July 1961.
89. Howe, L. M. and W. R. Thomas, "The Effect of Neutron Irradiation on Tensile Properties of Zircaloy-2," AECL-809, March 1959.
90. Irvin, J. E. "Effects of Irradiation and Environment on the Mechanical Properties and Hydrogen Pickup of Zircaloy," Zirconium and Its Alloys, Electrochem. Society, New York, New York, pp. 240-249.
91. Jens, W. H., and Lottes, P. A., "Analysis of Heat Transfer, Burnout, Pressure Drop, and Density Data for High Pressure Water," ANL-4627, May 1, 1951.
92. Jones, J. M. et al., "Optical Properties of Uranium Oxides," Nature, 205, 663-665, 1965.
93. Kao, H. S., Morgan, C. D., and Parker, M. B., "Prediction of Flow Oscillation in Reactor Core Channel," ANS Transactions, Vol. 16, 1973, p. 212.
94. Kear, G. N. and Ruderman, M. J., "An Analysis of Methods in Control Rod Theory and Comparison with Experiment," GEAP-3937, May 1962.
95. Kingery, W. D., Introduction to Ceramics, John Wiley & Sons, pp. 486-504.
96. Knecht, R. L. and P. J. Pankaskie, "Zircaloy-2 Pressure Tubing," BNWL-746, December 1968.
97. Kreyms, P. H., WAPD-TM-583, Westinghouse Atomic Power Division, 1966.

ARKANSAS NUCLEAR ONE
Unit 2

98. Lathrop, L. D., "DTF-IV, A Fortran IV Program for Solving the Multigroup Transport Equation with Anisotropic Scattering," LA-3373, July 15, 1965.
99. Leamer, R. D., "PuO₂-H₂O Fueled Critical Experiments," WCAP-3726-1, July, 1967.
100. List, F., P. Knudsen, "Pellet Stack Shortening and Cladding Elongation of Irradiated UO₂-Zr Fuel Pins," Halden Information Exchange, Program 1972.
101. Lustman, B., "Fuel Clad Design Basis for Thermal Reactors," WAPD-T-1939, May 1966.
102. Manson, S. S., "Fatigue: A Complex Subject - Some Simple Approximations," Experimental Mechanics, Vol. 22, No. 2 pp. 193-226, July, 1965.
103. Manzel, R., Siemens A. G., "Langenwachstum von Brennstaben mit Zry-4-Hullrohren," Atom Wertschaft, 17, No. 11 563-4, November 1972.
104. Martinelli, R. C., and Nelson, D. B., "Prediction of Pressure Drop During Forced Circulation Boiling of Water," ASME Trans., August 1948.
105. Maurer, G. W., "A Method of Predicting Steady State Boiling Vapor Fractions in Reactor Coolant Channels," Bettis Technical Review, WAPD-BT-19, Reactor Technology, June 1960.
106. McCauley, J. E., Daniel, R. C., Meieran, H. B. and Engel, J. T., "Evaluation of the Irradiation Performance of Zircaloy-4 Clad Test Rod Containing Annular UO₂ Fuel Pellets (Rod 79-19)," WAPD-TM-595, December, 1966.
107. McCormack, T. R., "WIN 12100, Heat Transfer by Relaxation," Combustion Engineering, Windsor, Connecticut, 1968.
108. McGoff, D. J., "FORM-A Fourier Transform Fast Spectrum Code for the IBM-7090," NAA-SR-Memo, September 1960.
109. Megerth, F. H., "Zircaloy-Clad UO₂ Fuel Rod Evaluation Program, Quarterly Progress Report No. 1, November 1967-January 1968," GEAP-5598, March, 1968.
110. Megerth, F. H., "Zircaloy-Clad UO₂ Fuel Rod Evaluation Program, Quarterly Progress Report No. 2, February 1968-April 1968," GEAP-5624, May, 1968.
111. Megerth, F. H., "Zircaloy-Clad UO₂ Fuel Rod Evaluation Program, Quarterly Progress Report No. 8, August 1969-October 1969," GEAP-10121, November, 1969.
112. Megerth, F. H., "Zircaloy-Clad UO₂ Fuel Rod Evaluation Program, Quarterly Progress Report No. 9," GEAP-10160, January, 1970.
113. Megerth, F. H., "Zircaloy-Clad UO₂ Fuel Rod Evaluation Program," General Electric (Dresden data), GEAP-10371, June 1971.
114. Melahan, J. B. "Yankee Core Evaluation Program, Final Report," WCAP-3017-6094, January 1971.

ARKANSAS NUCLEAR ONE
Unit 2

115. Mendler, O. J., et.al., "Natural-Circulation Tests with Water at 800 to 200 psia Under Non-Boiling, Local Boiling, and Bulk Boiling Conditions," Journal of Heat Transfer, August 1961.
116. Miller, R. S. et al., "Operating Experience with the Saxton Reactor Partial Plutonium Core - II," paper presented at AEC Plutonium Meeting in Phoenix August, 1967.
117. Moore, G. E., Kelley, K. K., J. Am. Chem. Soc., Vol. 69, 1947, pp. 309-16.
118. Nieh, L. C., "SAAS - Finite Element Stress Analysis of Axisymmetric Solids with Orthotropic Temperature Dependent Material Properties, AVCO Digital Computer Program 2663 User's Manual," AVCO Missiles, Space and Electronics Group, Missile Systems Division, April 1968.
119. Notley, M. J. F., Bain, A. S. and Robertson, J. A. L., "The Longitudinal and Diametral Expansion of UO₂ Fuel Elements," AECL-2143, November, 1964.
120. Notley, M. J. F., "The Thermal Conductivity of Columnar Grains in Irradiated UO₂ Fuel Elements," AECL-1822, July, 1962.
121. O'Donnell, W. J., "Fracture of Cylindrical Fuel Rod Cladding due to Plastic Instability," WAPD-TM-651, April, 1967.
122. O'Donnell, W. J. and Langer, B. F., "Fatigue Design Basis for Zircaloy Components," Nuc. Sci. Eng., Vol. 20, pp. 1-12, 1964.
123. Peck, C. C., "AEC-NFA Measurement Data Comparison - Yankee Reactor Fuel," January 1968.
124. Ponselet, C. G., "The Effect of a Finite Time Step Length on Calculated Spatial Xenon Stability Characteristics in Large PWR's," Trans. ANS, 10, 2. p. 571, 1967.
125. Price, G. A., "Uranium-Water Lattice Compilation, Part i," BNL 50035 (T-449), December 1966.
126. Pyle, R. S., "A Program for the Thermal Analysis of a Pressurized Water Nuclear Reactor During Steady State Operation," STDY-3, WAPD-TM-213, June 1960.
127. Randall, D. and St. John, D. S., "Xenon Spatial Oscillations," Nucleonics, 16, 3, p. 82-86, 1958.
128. Rason, N. S., Smith, A. W., NAA-SR-862, Vol. 37 (AD85006), 1954.
129. Rudkin, R. L., Parker, J. W., Jenkins, R. J., ASD-TDR-62-24, Vol. 1, p. 20, 1963.
130. Rutherford, C. N., "MO-807 - A Diffusion Theory Fitting Program Using Fortran-IV," WAPD-TM-671, September 1967.
131. Rydin, R. A., "Higher Flux Made Effects in Xenon Spatial Oscillations," Nuclear Science and Engineering, 50, 147, 1973.
132. Saba, W. G., Sterret, K. F., J. Am. Chem. Soc., Vol. 79, pp. 3637-38.
133. Schiff, D. and Stein, S., "Escape Probability and Capture Fraction for Grey Slabs," WAPD-149, June 1956.

ARKANSAS NUCLEAR ONE
Unit 2

134. Schmid, L. C., et al., "Critical Masses and Buckling of P_uO_2 - UO_2 - H_2O System," ANS Trans, 1, 216, 1964.
135. Scott, D. B. "Physical and Mechanical Properties of Zircaloy-2 and -4," WCAP-3269-41, May 1965.
136. Secrist, D. R., Childs, W. J., "Lithium-Boron Carbide Reaction Studies," TID-17149, Sept. 1962.
137. SHADRAC, "Shield Heating and Dose Rate Attenuation Calculation," G30-1365, March 25, 1966.
138. Simnad, M. T. and Meyer, R. A., "BeO Review of Properties for Nuclear Reactor Applications," Proceedings of The Conference on Nuclear Applications of Nonfissionable Ceramics, May 9-11, 1966, pp. 209-210.
139. Soltész, R. G. and Disney, R. K., "Users' Manual for the DOT-IIW Discrete Ordinates Transport Computer Code," WANL-TME-1982, December 1969.
140. Stacey, W. M. Jr., "Linear Analysis of Xenon Spatial Oscillations," Nuc. Sci. Eng. 30, p. 453-455, 1967.
141. Stephan, L. A., "The Effects of Cladding Material and Heat Treatment on the Response of Waterlogged UO_2 Fuel Rods to Power Bursts," IM-ITR-111, January 1970.
142. Stephan, L. A., "The Response of Waterlogged UO_2 Fuel Rods to Power Bursts," IDO-ITR-105, April 1969.
143. Stephen, D. W., "Fast Neutron Attenuation by the P3MG C-17 Shielding Method," CENPD-302, July 1967.
144. Stiefel, J. T., Feinroth, H. and Oldham, G. M., "Shippingport Atomic Power Station Operating Experience, Developments and Future Plans," WAPD-TM-390, April, 1963.
145. Stuart, G. W. and Woodruff, R. W., "Method of Successive Generations," Nuclear Science and Engineering, Vol. 3, p. 339, 1958.
146. Suich, J. E. and Honeck, H. C., "The HAMMER System," DP-1064, January 1967.
147. Thorne, R. P., Howard, V. C., "Changes in Polycrystalline Alumina by Fast Neutron Irradiation," Proceedings of the British Ceramic Society, No. 7, February 1967, p. 415.
148. Tillerson, J. R. and Haisler W. E., "SAMMSOR II - A Finite Element Program to Determine Stiffness and Mass Matrices of Shells-of-Revolution," Texas A&M University, TEES-RPT-70-18, October, 1970. "DYNASOR II - A Finite Element Program for the Dynamic Non-Linear Analysis of Shells-of-Revolution," Texas A&M University, TEES-RPT-70-19, October 1970.
149. Timoshenko, S., "Strength of Materials, Part II Chapter IX," D. VanNostrand Co., Inc., New York, 1956.

ARKANSAS NUCLEAR ONE
Unit 2

150. Tomlinson, L., "Delayed Neutrons for Fission," UKAEA Report AERE-R-6993, Harwell, Berkshire, 1972.
151. Tong, L. S., "Prediction of Departure from Nucleate Boiling for an Axially Nonuniform Heat Flux Distribution," Journal of Nuclear Energy, Vol. 21, 1967 pp. 241 to 248.
152. Toulookan, Y. S., Thermophysical Properties of High Temperature Solid Materials, Macmillan, Vols. 4 and 5.
153. Veziroglu, T. N., and Lee, S. S., "Boiling-Flow Instabilities in a Cross-Connected Parallel-Channel or Flow System," ASME Paper 71-HT-12.
154. Wachspress, E. L., "Thin Regions in Diffusion Theory Calculations," Nuclear Science and Engineering, Vol. 3, p. 186, 1958.
155. Weber, J. M., "Plastic Stability of Zr-2 Fuel Cladding, Effects of Radiation on Structural Metals," ASTM STP 426, Am. Soc. Testing Mats., 1967, pp. 653-669.
156. White, J. F. "Interim Summary of Work Applicable to ECC on Physics-Chemical Studies of Clad UO₂ under Reactor Accident Conditions," GEMP-619, July 1968.
157. Wolfe, P. A., "Mechanical Properties of Oxide Fuels," WAPD-TM-587, October 1967.
158. Woods, C. R., Editor, "Properties of Zircaloy-4 Tubing," WAPD-TM-585, December 1966.
159. "The ROCS and DIT Computer Codes for Nuclear Design." CENPD-266-P-A, CE Proprietary Topical Report, April, 1983.
160. "CEPAN Method of Analyzing Creep Collapse of Oval Cladding, Volume 5: Evaluation of Interpellet Gap Formation and Clad Collapse in Modern PWR Fuel Rods," EPRI NP-3966-CCM, Volume 5, Project 2061-6, Computer Code Manual, April, 1985.
161. A. E. Lundvall (BG&E) to J. R. Miller (NRC), "Calvert Cliffs Nuclear Power Plant Unit 1; Docket No. 50-317 Eighth Cycle License Application," February 22, 1985.
162. "Safety Evaluation of the Office of Nuclear Reactor Regulation Related to Amendment No. 104 to Facility Operating License No. DPR-53 Baltimore Gas and Electric Company Calvert Cliffs Nuclear Power Plant Unit No. 1, Docket No. 50-317."
163. MSS-NA3-P, "Verification of CECOR Coefficient Methodology for Application to Pressurized Water Reactors of the Middle South Utilities System," August 1, 1984.
164. "Statistical Combination of Uncertainties; Combination of System Parameter Uncertainties in Thermal Margin Analyses for Arkansas Nuclear One - Unit 2," CEN-139(A)-P, November, 1980.
165. CENPD-225-P-A, "Fuel and Poison Rod Bowing," June, 1979.
166. Letter from Olan O. Parr (NRC) to A. E. Scherer (C-E) concerning NRC review of CENPD-162, May 5, 1976.

ARKANSAS NUCLEAR ONE
Unit 2

167. Sher, N. C. and Green, S. J., "Boiling Pressure Drop in Thin Rectangular Channels," Chem. Eng. Prog. Symposium Series, No. 23, Vol. 55, pp. 61-73.
168. "TORC Code Verification and Simplified Modeling Methods," CENPD-206-P-A, June, 1981.
169. "Revised Rod Bow Penalties for Arkansas Nuclear One Unit 2," CEN-289(A)-P, December, 1984.
170. Rowe, D. S., "COBRA-IIIC: A Digital Computer Program for Steady State and Transient Thermal-Hydraulic Analysis of Rod Bundle Nuclear Fuel Elements," BNWL-1695, March, 1973.
171. "CEPAN Method of Analyzing Creep Collapse of Oval Cladding," EPRI NP-3966-CCM Volume 5, April, 1985.
172. "C-E Methodology for Core Designs Containing Gadolinia-Urania Burnable Absorbers", CENPD-275-P, Revision 1-P-A, May, 1988.
173. "Fuel Rod Maximum Allowable Gas Pressure", CEN-372-P-A, May, 1990.
174. "Qualification of Reactor Physics Methods for the Pressurized Water Reactors of the Entergy System", ENEAD-01-P-A, September, 1995.
175. "Verification of CECOR Coefficient Methodology for Application to Pressurized Water Reactors of the Entergy System", ENEAD-02-NP-A, September, 1995.
176. "Verification of the Acceptability of a 1-pin Burnup Limit of 60 MWD/kgU for Combustion Engineering 16 x 16 PWR Fuel," CEN-386-P-A, August 1992.
177. "Report on the Continued Applicability of 60 MWD/kgU for ABB Combustion Engineering PWR Fuel," CENPD-384-P, September 1995.
178. Software Verification and Validation Report No. MISC-ME-C-234, Rev. 00, "Verification of the FSLIB, MELIB (including CESHOCK) and RELIB Computer Codes on the HP 9000/800 Series Workstations with a HP-UX 10.20 Operating System", March 1997.
179. Software Verification and Validation Report No. MISC-ME-C-230, Rev. 02, "Verification of the ANSYS Version 5.3 on HP 9000/800 Series Workstations with a HP-UX 10.20 Operating System", December 1998.
180. "Fluence and Uncertainty Methodologies," BAW-2241P-A, Revision 1, Framatome-ANP, April 1999.
181. "ANO Unit 2 104 Capsule Fluence Analysis Report," 86-5012082-00 and 86-5012082-01.
182. "Methodology for Core Designs Containing Erbium Burnable Absorbers", CENPD-382-P-A, August, 1993.
183. CENPD-404-P-A, "Implementation of ZIRLO™ Material Cladding in CE Nuclear Power Fuel Assembly Designs," November 2001.
184. "ZIRLO™ Burst Test Results," PP-92-006, January 10, 1992.

ARKANSAS NUCLEAR ONE
Unit 2

185. WCAP-16072-P-A, "Implementation of Zirconium Diboride Burnable Absorber Coatings in CE Nuclear Power Fuel Assembly Designs," August 2004.
186. "Product Engineering Department Materials Property Manual," September 1996.
187. "Seamless ZIRLO™ Tubing," NFD 31088/MATBZLOO, September 12, 2003.
188. WCAP-11596-P-A, "Qualification of the PHOENIX-P/ANC Nuclear Design System for Pressurized Water Reactor Cores," June 1988.
189. WCAP-10965-P-A, "ANC: A Westinghouse Advanced Nodal Computer Code," September 1986.
190. WCAP-10965-P-A Addendum 1, "ANC: A Westinghouse Advanced Nodal Computer Code: Enhancements to ANC Rod Power Recovery," April 1989.
191. WCAP-16045-P-A, "Qualification of the Two-Dimensional Transport Code PARAGON," August 2004.
192. "Startup Test Activity Reduction Program," WCAP-16011-P-A, Revision 0, February 2005.
193. CENPD-387-P-A, "ABB Critical Heat Flux Correlations for PWR Fuel," May 2000.
194. WCAP-12610-P-A and CENPD-404-P-A Addendum 1, "Addendum 1 to WCAP-12610-P-A and CENPD-404-P-A Optimized ZIRLO™," February 2003.
195. WCAP-16500-P-A, "CE 16 x 16 Next Generation Fuel Core Reference Report," August 2007.
196. WCAP-16523-P-A, "Westinghouse Correlations WSSV and WSSV-T for Predicting Critical Heat Flux in Rod Bundles with Side-Supported Mixing Vanes," March 2006.
197. WCAP-12610-P-A and CENPD-404-P-A Addendum 2-A, "Westinghouse Clad Corrosion Model for ZIRLO and Optimized ZIRLO," October 2013.
198. WCAP-18169-NP, "Arkansas Nuclear One Unit 2 Heatup and Cooldown Limit Curves for Normal Operation," December 2016.
199. WCAP-18166-NP, "Analysis of Capsule 284° from the Entergy Operations, Inc. Arkansas Nuclear One Unit 2 Reactor Vessel Radiation Surveillance Program," September 2016.
200. WCAP-14040-A, "Methodology Use to Develop Cold Overpressure Mitigating System Setpoints and RCS Heatup and Cooldown Limit Curves," May 2004.

ARKANSAS NUCLEAR ONE
Unit 2

Table 4.1-1

ANALYSIS TECHNIQUES

<u>Internals Components</u>	<u>Load Conditions</u>	<u>Analysis Technique</u>	<u>Computer Code & Ref. No.</u>
Core Support Barrel	Axial and Lateral Loads	Shell Analysis Beam Analysis	ASHSD SHOCK (79) STARDYNE (27,28)
	Dynamic Buckling	Shell Analysis	SAMMSOR (148) – DYNASOR
Upper and Lower Core Support Barrel Flanges	Lateral Loads Axial Loads Bending Moments	Finite Element Analysis	SAAS (118) NAOS (72)
Lower Support Structure – Beams – Columns	Lateral Loads	Plane Grid Structure Analysis Simply Supported Beams	STRUDL II (23)
	Axial Loads Bending Loads	Column Analysis	CESHOCK (178) STARDYNE (27,28)
Upper Guide Structure – CEAs – Beam Structure – Support Plate Flange	Lateral Loads	Beam Analysis	CESHOCK (178)
	Axial Loads	Column Analysis	STARDYNE (27,28)
	Uniform Lateral Loading	Plane Grid Structure	STRUDL II (23)
	Axial Loads Bending Moments	Finite Element Analysis	SAAS (118) NAOS (72)
Core Shroud CEDM	Thermal and Pressure Loading	Finite Element Analysis	EASE (18)
	Pressure, Fatigue & Thermal Loads	Finite Element Analysis	SAAS (118)
	Seismic Loading	Framed Structure Analysis	ANSYS (179)
CEDM and R.V. Nozzles	Thermal Loading	Relaxation Analysis	WIN 12100 (107)
CEDM Omega Seals	Pressure, Thermal Rotational and Displacement Loadings	Shell Analysis	SHELL *** (34)

ARKANSAS NUCLEAR ONE
Unit 2

Table 4.1-1 (continued)

<u>Internals Components</u>	<u>Load Conditions</u>	<u>Analysis Technique</u>	<u>Computer Code & Ref. No.</u>
Fuel Assembly	Seismic Lateral Vertical	Lumped Mass-Spring-Damper (Direct Numerical Integration, Non linear/ Linear Capability)	CESHOCK (178)
	Loss of Coolant Accident Lateral Vertical	(Springs From Beam Stiffness Coefficients)	
Fuel Rod	Thermal-Mechanical	Generalized Plane Strain Analysis including Thermal, Mechanical and Creep Effects Solved by Finite Difference Techniques	FATES

ARKANSAS NUCLEAR ONE
Unit 2

Table 4.2-1

MECHANICAL DESIGN PARAMETERS

<u>Core Arrangement</u>		<u>NGF Design</u>
Number of Fuel Assemblies in Core, Total	177	
Number of CEAs	81	
Number of Fuel Rods	41,772*	
Spacing Between Fuel Assemblies, Fuel Rod Surface to Surface, inches	.208	.216
Spacing, Outer Fuel Rod Surface to Core Shroud, inches	.214	.218
Hydraulic Diameter, Nominal Channel, feet	.0394	.0415
Total Flow Area (Excluding Guide Tubes), sq.ft.	44.7	46.1
Total Core Area, sq.ft.	82.25	
Core Equivalent Diameter, inches	123	
Core Circumscribed Diameter, inches	130	
Total Fuel Loading, Kg U	72,319*	
Total Fuel Weight, pounds UO ₂	180,903*	
Total Weight of Zircaloy, pounds	52,280*	
Fuel Volume (Including Dishes), cu.ft.	288.3*	
<u>Fuel Assemblies</u>		<u>NGF Design</u>
Fuel Rod Array, square	16x16	
Fuel Rod Pitch, inches	0.506	
Bottom Spacer Grid		
Type	Leaf Spring (Fuel Batches N and prior) GUARDIAN™ (Batch P and subsequent reload batches)	
Material	Inconel 625	
Number per Assembly	1	
Weight, each, lb	2.6*	
Remaining Spacer Grids		
Type – HID-1L	Leaf Spring	
Material	Zircaloy-4	
Number per Assembly	11	
Weight, each, lb	1.7*	
Type – Inconel Top Grid		Vertical Spring
Material		Inconel-718
Number per Assembly		1
Weight, each, lb		1.5

ARKANSAS NUCLEAR ONE
Unit 2

Table 4.2-1 (continued)

Fuel Assemblies (continued)

NGF Design

Remaining Spacer Grids (continued)

Type – Vaned Mid Grid		I-Spring
Material		Optimized ZIRLO™
Number per Assembly		7
Weight, each, lb		2.8
Type – Unvaned Mid Grid		I-Spring
Material		Optimized ZIRLO™
Number per Assembly		3
Weight, each, lb		2.7
Type – IFM Grid		Co-planar Dimples
Material		Optimized ZIRLO™
Number per Assembly		2
Weight, each, lb		1.1
Approximate Dry Weight of Fuel Assembly, lb	1451*	1419
Outside Dimensions Fuel Rod to Fuel Rod, inches	7.972 x 7.972	7.964 x 7.964

* Batch R (Cycle 13) values are shown; values vary with cycle.

Fuel Rod

NGF Design

Fuel Rod Material (sintered pellets)	UO ₂	
Pellet Diameter, inches	0.325	0.3225
Pellet Length, inches	0.390	0.387
Approximate Pellet Initial Density, g/cc	10.4*	
Pellet Theoretical Density, g/cc	10.96	
Pellet Density (% Theoretical) mean	94.75*	
Approximate Stack Height Density, g/cc	10.11*	10.31
Clad Material	ZIRLO™*** or Zircaloy-4	Optimized ZIRLO™
Clad I.D., inches	0.332	0.329
Clad O.D., (nominal), inches	0.382	0.374
Clad Thickness, (nominal), inches	0.025	0.0225
Diametral Gap, (cold, nominal), inches	0.007	0.0065
Active Length, inches	149.610	
	(Batches J through N)	
	150.0	
	(Batches A through H, P, and subsequent batches)	

ARKANSAS NUCLEAR ONE
Unit 2

Table 4.2-1 (continued)

Fuel Rod (continued)

NGF Design

Plenum Length, inches	9.527 (Batches A through H) 7.888 (Batches J through N) 8.888 (Batch P through T) 9.138 (Batch U through Y) 10.013 (Batch Z and subsequent reload batches)
-----------------------	--

Fuel Rod with Gadolinia (Gd₂O₃) Additions

NGF Design

Integral Burnable Poison Pellet Material (sintered)	Gd ₂ O ₃ - UO ₂
Pellet Diameter, inches	0.325
Pellet Length, inches	0.390
Approximate Pellet Initial Density, g/cc	10.25*
Approximate Stack Height Density, g/cc	9.93*
Clad Material	Zircaloy-4
Clad I.D., inches	0.332
Clad O.D., (nominal), inches	0.382
Clad Thickness, (nominal), inches	0.025
Diametral Gap, (cold, nominal), inches	0.007
Active Fuel Length, inches	150.0
UO ₂ - Only Sections (at top and bottom ends), inches	7.0*
Gd ₂ O ₃ - UO ₂ Center Section, inches	136.0*
Plenum Length, inches	8.888*

* Batch R (Cycle 13) values are shown; values vary with cycle.

*** Batch X (Cycle 18) values shown; values vary with cycle.

ARKANSAS NUCLEAR ONE
Unit 2

Table 4.2-1 (continued)

<u>Fuel Rod with Erbia (Er₂O₃) Additions</u>	<u>NGF Design</u>	
Integral Burnable Poison Pellet Material (sintered)	Er ₂ O ₃ - UO ₂	
Pellet Diameter, inches	0.325	
Pellet Length, inches	0.390	
Approximate Pellet Initial Density, g/cc	10.41**	
Approximate Stack Height Density, g/cc	10.09**	
Clad Material	Zircaloy-4	
Clad I.D., inches	0.332	
Clad O.D., (nominal), inches	0.382	
Clad Thickness, (nominal), inches	0.025	
Diametral Gap, (cold, nominal), inches	0.007	
Active Fuel Length, inches	150.0	
UO ₂ - Only Sections (at top and bottom ends), inches	7.0**	
Er ₂ O ₃ - UO ₂ Center Section, inches	136.0**	
Plenum Length, inches	9.138**	
<u>Fuel Rod with IFBA (ZrB₂) Coating***</u>	<u>NGF Design</u>	
Integral Fuel Burnable Absorber	ZrB ₂ - UO ₂	
Pellet Diameter, inches	0.325	0.3225
Pellet Length, inches	0.390	0.387
Approximate Solid Pellet Initial Density, g/cc	10.4	
Approximate Solid Pellet Stack Height Density, g/cc	10.1	10.31
Clad Material	ZIRLO™	Optimized ZIRLO™
Clad I.D., (nominal), inches	0.332	0.329
Clad O.D., (nominal), inches	0.382	0.374
Clad Thickness, (nominal), inches	0.025	0.0225
Diametral Gap, (cold, nominal), inches	0.0062	0.0057
Active Fuel Length, inches	150.0	
UO ₂ - Annular Sections (at top and bottom ends), inches	8.0	6****
ZrB ₂ - UO ₂ Center Section, inches	134.0	138****
Plenum Length, inches	9.138	10.013
<u>Control Element Drive Mechanisms (CEDM)</u>	<u>CEDM</u>	
Number of Drive Mechanisms	81	
Stroke, inches	150	
Speed, inches per minute	30 (CEA)	
Trip time, seconds (90% of stroke)	≤ 3.2	

** Batch U (Cycle 16) values shown; values vary with cycle.

*** Batch X (Cycle 18) values shown; values vary with cycle.

**** Batch HH (Cycle 27) values shown; values vary with cycle.

ARKANSAS NUCLEAR ONE
Unit 2

Table 4.2-1 (continued)

<u>Control Element (CEA)</u>	<u>Full Length</u>
Number	81
No. of Absorber Elements per Assembly	5
Type	Cylindrical Rods
Clad Material	Inconel 625
Clad Thickness, inches	0.035
Clad O.D., inches	0.816
Diametral Gap, (B ₄ C), inches	0.009
Poison Material	B ₄ C/Ag-In-Cd
Poison length, inches	136/12.5
B ₄ C Pellet	
Diameter, inches	0.737
Density, % of theoretical Density of 2.52 g/cc	73
Weight % boron, minimum	78

Neutron Absorber Rod

Poison Material	Al ₂ O ₃ -B ₄ C
Pellet Diameter, inches	0.310
Pellet Length, inches	0.500 Min.
Pellet Density (% Theoretical)	85 Min.
Theoretical Density, Al ₂ O ₃ , g/cc	3.90
Theoretical Density, B ₄ C, g/cc	2.52
Clad Material	Zircaloy-4
Clad I.D., inches	0.332
Clad O.D., inches	0.382
Clad Thickness, (nominal), inches	0.025
Diametral Gap, (cold, nominal), in	0.022
Active Length, inches	136.0
Plenum Length, inches	11.2

ARKANSAS NUCLEAR ONE
Unit 2

Table 4.2-2

**ZIRCALOY-4 CLADDING BURST TEST RESULTS
OF FORT CALHOUN FUEL RODS**

Fuel Rod Serial No.	Burst Specimen ⁽¹⁾	Local Burnup (GWd/mtU)	Rod Avg. Fluence ⁽²⁾ x 10 ⁻²¹ n/cm ² , E > .821 MeV	0.2% Yield	Hoop Stress (ksi)		Circumferential Strain (%)	
					Ultimate	Failure	Uniform	Total ⁽³⁾
KKMO98	75 - 83	41.6	6.94	121	126.6	126.2	3.5	6.9
KKMO98	94 1/2 - 102 1/2	41.6	6.94	117	124.8	124.1	3.7	5.6
KJE076	75 - 83	53.2	9.06	108	129.0	128.1	3.8	4.5
KJE076	92 11/16 - 100 11/16	52.3	9.06	121	128.2	128.2	3.4	4.7

TEST PARAMETERS: 600 °F, STRAIN RATE - 0.004/min.

- (1) Inches from bottom of rod.
- (2) Fluence normalized for total rod length.
- (3) Max. strain measured by metallography.
- (4) Uniform strain calculated as per Reference 12.

G. P. Smith, "The Evaluation and Demonstration of Methods for Improved Fuel Utilization," DOE/ET/34010-10, October, 1983.

ARKANSAS NUCLEAR ONE
Unit 2

Table 4.2-3

CLAD MECHANICAL PROPERTIES

	<u>Zircaloy-4</u>		<u>ZIRLO™</u>		<u>Optimized ZIRLO™</u>	
	<u>Room Temperature</u>	<u>675 °F</u>	<u>Room Temperature</u>	<u>675 °F</u>	<u>Room Temperature</u>	<u>675 °F</u>
Modulus of Elasticity (psi)	15.0 x 10 ⁶ psi	10.0 x 10 ⁶ psi	15.0 x 10 ⁶	10.0 x 10 ⁶	15.0 x 10 ⁶	10.0 x 10 ⁶
Poisson's Ratio	0.296	0.252	0.296	0.252	0.296	0.252
Ultimate Tensile Strength (Tension, psi)						
Minimum	79,000 psi	45,000 psi	103,000	53,441	90,000 psi	51,000 psi
Average	94,000 psi	62,000 psi	118,423	68,864	100,500 psi	56,950 psi
Yield Strength (Tension, psi)						
Minimum	52,000 psi	32,000 psi	77,000	44,426	68,000 psi	39,000 psi
Average	70,000 psi	48,000 psi	90,199	57,625	75,050 psi	43,045 psi
Total Elongation						
Minimum	18.0%	10.0%	12%	N/A	12%	N/A
Average	22.0%	19.0%	17.8%	N/A	N/A	N/A
Uniform Elongation						
Minimum	7.0%	3.0%	N/A	N/A	N/A	N/A
Average	8.0%	5.0%	N/A	N/A	N/A	N/A
Reduction in Area						
Minimum	38%	42%	N/A	N/A	N/A	N/A
Average	50%	54%	N/A	N/A	N/A	N/A

ARKANSAS NUCLEAR ONE
Unit 2

Table 4.2-3A

**FUEL ROD CLADDING TEMPERATURE
DURING NORMAL AND ANTICIPATED OPERATIONAL OCCURRENCES
ORIGINAL DESIGN VALUES**

<u>Occurrence</u>	<u>Maximum Cladding Midwall Temperature</u>
Normal Operation	[]†
Uncontrolled CEA Withdrawal	
a. Subcritical conditions	[]†
b. 1% power	≤ normal operation temp.*
c. Full power	[]†
CEA Drop	≤ normal operation
Four Pump Loss of Flow	≤ normal operation
Idle Loop Startup	≤ normal operation
Loss of External Load	[]†
Loss of Feedwater	≤ normal operation
Loss of Offsite Power	≤ normal operation
Excess Heat Removal	
a. Feedwater malfunction	[]†
b. Steam bypass malfunction	[]†

* Maximum calculated temperature was less than the maximum predicted for normal operation.

† See ANO-2 Proprietary Information letter submittal for actual values.

ARKANSAS NUCLEAR ONE
Unit 2

Table 4.2-4

**STRESS LIMITS FOR REACTOR VESSEL
INTERNAL STRUCTURES**

<u>Operating Conditions</u>	<u>Stress Categories & Limits of Stress Intensities</u>
1. Normal plus Upset	Figure NG 3221.1 including notes.
2. Emergency	Figure NG 3224.1 including notes.
3. Faulted	Appendix F, "Rules for Evaluating Faulted Conditions," Section F-1380 and Table F-1322 including notes.

The above listed stress categories and limits for Normal plus Upset, and the Emergency operating conditions are defined in the March, 1973, draft of Subsection NG of the ASME Code, Section III.

ARKANSAS NUCLEAR ONE
Unit 2

Table 4.2-4A

**REACTOR INTERNALS HOLDDOWN RING NET DOWN LOADS
(Historical Information)**

	<u>Design Best Flow (10³ gpm)</u>	<u>Estimate Flow</u>	<u>Active Fuel Length (in.)</u>	<u>No. Fuel Ass.</u>	<u>Holdown Ring Load (10³ lbs.)</u>	<u>Total* Down Load (10³ lbs.)</u>	<u>Max. Assumed Flow</u>	<u>Hydraulic Lift (10³ lbs)</u>	<u>Net Down** Load (10³ lbs.)</u>
Omaha	190	108%	128.0	133	453	799	115%	284	515
Maine Yankee	325	120%	136.7	217	508	1085	126%	555	530
Calvert Cliffs	324	124%	136.7	217	547	1049	125%	525	524
ANO-2	322	113%	150.0	177	828	1329	120%	805	524

* Comprises the weight of the reactor vessel internals plus fuel.

**Net Down Load = Total Down Load - Hydraulic Lift

ARKANSAS NUCLEAR ONE
Unit 2

Table 4.2-5

STRESS LIMITS FOR PRESSURE HOUSINGS

<u>Loading Conditions and Categories</u>	<u>Stress Categories & Limits of Stress Intensities(*)</u>
1. <u>Normal & Upset:</u> Normal Operating Loading plus Operating Basis Earthquake Forces	Figures NB-322-1 and 3222-1 including notes.
2. <u>Emergency:</u> Normal Operating Loadings plus Design Basis Earthquake Forces	Figure NB-3224-1 including notes.
3. <u>Faulted:</u> Operating Loadings plus Design Basis Earthquake Forces plus Pipe Rupture Loadings	Table F-1322.1-1, Appendix F, "Rules for Evaluating Faulted Conditions".

For the above listed conditions and categories, the following limits regarding function apply:

1. Normal and Upset: The CEDMs are designed to function normally during and after exposure to these conditions.
2. Emergency: The CEDMs are designed to permit tripping of the CEAs during and after exposure to these conditions.
3. Faulted: The deflections of the CEDM are limited so that the CEAs can be inserted after exposure to these conditions. Those deflections which could influence the ability to move CEAs are limited to less than 80 percent of the deflections required to prevent CEA movement.

(*) References listed are taken from the ASME Code, Section III.

ARKANSAS NUCLEAR ONE
Unit 2

Table 4.3-1

NUCLEAR DESIGN CHARACTERISTICS

General Characteristics

Fuel Management	3-batch
Maximum Fuel Rod Burnup	52693* MWD/T (includes a +750 MWD/T uncertainty)
Number of Control Element Assemblies Full Length	81

Burnable Poison Rods

Number/Material	7712 / Zr ₂ B ₂ – UO ₂
-----------------	---

Dissolved Boron

Dissolved Boron Concentration for Criticality, ppm, (CEAs withdrawn, BOC) Hot Full Power, Equilibrium Xe	1446*
Dissolved Boron Content (ppm) for: Refueling	2,500
Inverse Boron Worth, ppm/%Δρ	
HFP, BOC	127*
HFP, EOC	93*

Neutron Parameters*

Neutron Lifetime (minimum), Microseconds	
BOC	13.0*
EOC	36.0*
Delayed Neutron Fraction	
BOC	0.0064*
EOC	0.0052*

* These values vary slightly with core and fuel batch designs.

ARKANSAS NUCLEAR ONE
Unit 2

Table 4.3-2

EFFECTIVE MULTIPLICATION FACTORS AND REACTIVITY DATA

(All data are Cycle 1 values; values vary with cycle)

(No Control Element Assemblies or Dissolved Boron¹)

	k_{eff}	ρ
Cold (68 °F)	1.227	0.185
Cold (68 °F) at Minimum Refueling Boron Concentration (2500 ppm)	0.906	-0.104
Hot, 545 °F, Zero Power	1.175	0.149
Hot, Full Power, Equilibrium Xe (For Depletion)	1.112	0.101
Reactivity Decrease, HFP Xe Zero to Full Power, BOC	—	0.011
Full Temperature	—	0.010
Moderator Temperature	—	0.001
Reactivity Decrease, HFP Xe Zero to Full Power, EOC	—	0.023
Fuel Temperature	—	0.014
Moderator Temperature	—	0.009

¹ Except as noted

ARKANSAS NUCLEAR ONE
Unit 2

Table 4.3-3

**COMPARISON OF CORE REACTIVITY COEFFICIENTS
WITH THOSE USED IN VARIOUS SAFETY ANALYSES**

	MTC ($\Delta\rho/^\circ\text{F}\times 10^{-4}$)	Doppler ⁽¹⁾ Coefficient	Density Coefficient ($\Delta\rho/\text{gm/cc}$)
Full Power, ARO			
BOC	-0.437	Fig. 4.3-24	N/A ⁽³⁾
EOC	-3.732	Fig. 4.3-24	N/A ⁽³⁾
<u>Coefficients Used in Accident Analyses</u>			
CEA Withdrawal ⁽⁵⁾ Full Zero Power	0.5 / +0.5	0.85	N/A
CEA Misoperation (Full length) ⁽⁵⁾			
Misaligned CEA	-3.5	1.15	N/A
Dropped CEA	-3.5	1.15	N/A
Loss of Flow ⁽⁵⁾	0.5	0.85	N/A
CEA Ejection ⁽⁵⁾			
Full/Zero Power	0.5 / +0.5	.85 W_R / .85 W_R ⁽²⁾	N/A
Loss of Coolant Accident	N/A ⁽⁴⁾	1.15	-0.077

(1) Nominal values of the Doppler coefficient ($\Delta\rho/^\circ\text{F}$) as a function of the fuel temperature are shown in Figure 4.3-24. The numbers entered in the Doppler column of this table are the multipliers applied to the nominal value for analysis of designated accident (See Note 5). The SBLOCA and LBLOCA analyses used the EOC data in Figure 15.1.0-4, which includes a 1.4 multiplier.

(2) W_R is a reactivity dependent factor, the origin of which is explained in Section 15.1.20.2.1.

(3) Not applicable.

(4) A Curve of Reactivity vs Moderator Density is used for the LOCA evaluation. The value of density coefficient shown here is the initial slope of this curve for the LBLOCA evaluation. SBLOCA used an initial slope of $-0.007 \Delta\rho/\text{gm/cc}$.

(5) Values may have varied for cycle specific analyses. See Chapter 15 accident analysis descriptions for more current information.

ARKANSAS NUCLEAR ONE
Unit 2

Table 4.3-4

REACTIVITY COEFFICIENTS

<u>Moderator Temperature Coefficients</u>	MTC <u>$\Delta\rho/^\circ\text{F}\times 10^{-4}$</u>
Hot Full Power, Equilibrium Xenon:	
Beginning of Cycle	-0.66
End of Cycle	-3.1
Hot Zero Power, No Xenon:	
Beginning of Cycle	+0.12

Cycle 13 values are shown; values vary with cycle

Table 4.3-5

HFP WORTHS OF CEA GROUPS, % $\Delta\rho$

	<u>BOC 12</u>	<u>EOC 12</u>
Regulating CEAs		
Group 6	0.5	.5
Group P	1.0	1.1

Cycle 12 values are shown; values vary with cycle.

Table 4.3-6

CEA REACTIVITY ALLOWANCES, % $\Delta\rho$

(Hot Full Power to Hot Zero Power)

Fuel Temperature Variation	1.4
Moderator Temperature Variation	2.0
Moderator Voids	0.1
CEA Bite	0.2
Shutdown Margin and Accident Analysis Allowance	<u>2.4</u>
Total Reactivity Allowance	6.1

Cycle 1 values are shown.

ARKANSAS NUCLEAR ONE
Unit 2

Table 4.3-6A

**COMPARISON OF RODDED AND UNRODDED PEAKING HFP FACTORS FOR
VARIOUS RODDED CONFIGURATIONS AT BOC AND EOC**

	Maximum Rod Radial Peaking Factor F_{xy}^n	
	<u>BOC</u>	<u>EOC</u>
Unrodded	1.54	1.42
Bank 6	1.59	1.57
Bank P + 6	1.73	1.68

Cycle 13 values are shown; values vary with reload cycle.

Table 4.3-7

**COMPARISON OF CALCULATED CEA WORTHS AND
REQUIREMENTS, $\% \Delta \rho$**

	<u>BOC</u>	<u>EOC</u>
All Full Length CEAs Inserted, Hot (583 °F),	10.6	12.5
Total Reactivity Requirements, Full Power	6.8	8.1
Stuck Rod Worth	1.3	2.1
Excess Over Nominal Design Requirement	2.5	2.3
Excess Over Nominal, Assuming Most Adverse Stack-up of CEA Worth Uncertainties	1.7	1.4

Cycle 12 values are shown; values vary with cycle.

ARKANSAS NUCLEAR ONE
Unit 2

Table 4.3-8

**MAXIMUM FAST FLUX GREATER THAN ONE MeV
(n/cm²-sec)**

<u>Neutron Group</u>	<u>Lower Energy (MeV)</u>	<u>Flux, Shroud ID</u>
1	7.41	2.69 (+11) ^(a)
2	4.97	1.39 (+12)
3	3.33	3.09 (+12)
4	2.23	6.49 (+12)
5	1.50	6.74 (+12)
6	1.22	3.86 (+12)
7	1.00	3.28 (+12)
Total	—	2.51 (+13)

^(a)Denotes power of ten (10)

ARKANSAS NUCLEAR ONE
Unit 2

Table 4.4-1

**THERMAL AND HYDRAULIC PARAMETERS
(Cycle 1)**

<u>General Characteristics</u>	<u>ANO-2</u>	<u>San Onofre Units 2 & 3 Docket #50-361 & 362</u>
Total Core Heat Input, Mwt	2815	3390
Million Btu/Hr	9608	11,600
Heat Generated in Fuel Rod, Fraction Core Avg.	0.975	0.975
Hot Rod	0.975	0.975
Pressure, psia	2250	2250
Coolant Inlet Temperature, °F	553.5	553
Vessel Outlet Temperature, °F	612	611
Core Bulk Outlet Temperature, °F	614	613
Total Primary Coolant Flow, Million lb/hr	120.4	147.8
External Leakage, %	3.5	3.7
Coolant Flow Through Core, Million lb/hr	116.2	142.6
Hydraulic Diameter Nominal Channel, ft.	.03928	0.04445
Core Flow Area, ft ²	44.7	53.2
Average Mass Velocity, Million lb/hr-ft ²	2.60	2.68
Average Coolant Velocity in Core, ft/sec	16.4	16.8
Core Average Heat Flux, Btu/hr-ft ²	185,000	205,000
Total Heat Transfer Area, ft ²	51,000	55,000
Film Coefficient at Average Conditions, Btu/hr-ft ² -°F	6200	6200
Average Film Temperature Difference, °F	31	34
Average Linear Heat Rate of Rod, kw/ft (For Fraction Generated Avg. Rod)	5.41	6.92
Specific Power, kw/kg	38.3	35.7
Power Density, kw/liter	96.6	94.7
Average Core Enthalpy Rise, Btu/lb	82.7	81.1
 <u>Heat Flux Factors</u>		
Rod Radial Nuclear Factor	1.55	1.55
Nuclear Heat Flux Factor	1.03	1.03
Total Heat Flux Factor	2.35	2.60
 <u>Enthalpy Rise Factors</u>		
Factors Affecting Heat Input:	1.53	1.5
Engineering Factor on Enthalpy Rise	1.03	1.03
Total Heat Input Enthalpy Rise Factor	1.57	1.545
Factors Affecting Flow:		
Plenum Factor	1.05	1.03
Rod Pitch, Bowing, and Clad Diameter	1.05	1.05

ARKANSAS NUCLEAR ONE
Unit 2

Table 4.4-1 (continued)

<u>General Characteristics</u>	<u>ANO-2</u>	<u>San Onofre Units 2 & 3 Docket #50-361 & 362</u>
Total Enthalpy Rise Flow Factor	1.10	1.08
Total Enthalpy Rise Factor (ΔH Hot Channel/ ΔH Core)	1.84 1.84	1.68 1.68
<u>Enthalpy Rise Factors</u>		
Factors Affecting Heat Input:	1.53	1.5
Engineering Factor on Enthalpy Rise	1.03	1.03
Total Heat Input Enthalpy Rise Factor	1.57	1.545
Factors Affecting Flow:		
Plenum Factor	1.05	1.03
Rod Pitch, Bowing, and Clad Diameter	1.05	1.05
Total Enthalpy Rise Flow Factor	1.10	1.08
Total Enthalpy Rise Factor (ΔH Hot Channel/ ΔH Core)	1.84 1.84	1.68 1.68
<u>Hot Channel and Hot Spot Parameters</u>		
Maximum Heat Flux, Btu/hr-ft ²	433,800	533,000*
Maximum Linear Heat Rate of Rod, kw/ft (For fraction generated in Hot Rod)	12.7**	18.0
UO ₂ Temperature, Steady State, Maximum during Fuel Life, °F	3420	4010*
Maximum Clad Surface Temperature, °F	657.6	657*
Hot Channel Outlet Temperature, °F	652.6	646*
Hot Channel Outlet Enthalpy, Btu/lb	703.7	687*
DNB Ratio (W-3 Correlation), Steady State	2.14	2.11

* These parameters are revised as indicated in Supplement 1 to CENPD-46, "Analysis of Combustion Engineering 3410 Mwt Plant Emergency Core Cooling System Performance in Accordance with AEC Interim Acceptance Criteria," July 7, 1972

**To get the maximum linear heat rate of a rod apply the appropriate Augmentation factor for the particular axial power distribution.

ARKANSAS NUCLEAR ONE
Unit 2

Table 4.4-2

**Arkansas Nuclear One Unit 2 Cycle 27
Thermal-Hydraulic Parameters at Full Power**

<u>General Characteristics</u>	<u>Units</u>	<u>Cycle 25</u> (NGF)	<u>Cycle 27</u> (NGF)
Total Heat Output (Core Only)	Mw _{th} 10 ⁶ Btu/hr	3026 10328	3026 10328
Fraction of Heat Generated in Fuel Rod	---	0.9755	0.9755
Primary System Pressure (Nominal)	psia	2200	2200
Primary System Pressure (Minimum in Steady State)	psia	2000	2000
Primary System Pressure (Maximum in Steady State)	psia	2300	2300
Inlet Temperature (Maximum Indicated)	°F	554.7	554.7
Total Reactor Coolant Flow (Minimum Steady State)	gpm 10 ⁶ lbm/hr	315,560 117.7	315,560 117.7
Coolant Flow Through Core (Minimum)	10 ⁶ lbm/hr	113.6	113.6
Hydraulic Diameter (Nominal Channel)	ft	0.041	0.041
Core Average Mass Velocity	10 ⁶ lbm/hr-ft ²	2.46	2.46
Pressure Drop Across Core (at Minimum Steady State Core Flow Rate)	psi	21.0	21.0
Total Pressure Drop Across Vessel (Based on Nominal Dimensions and Minimum Steady State Flow)	psi	40.5	40.5
Core Average Heat Flux (Accounts for Fraction of Heat Generated in Fuel Rod and Axial Densification Factor)	Btu/hr-ft ²	197,405 ⁽¹⁾	197,405 ⁽¹⁾
Total Heat Transfer Area (Accounts for Axial Densification Factor)	ft ²	51023 ⁽¹⁾	51023 ⁽¹⁾
Film Coefficient at Average Conditions	Btu/hr-ft ² -°F	5997	5997
Average Film Temperature Difference	°F	32.92 ⁽¹⁾	32.92 ⁽¹⁾
Average Linear Heat Rate of Undensified Fuel Rod (Accounts for Fraction of Heat Generated in Fuel Rod)	kw/ft	5.65 ⁽¹⁾	5.65 ⁽¹⁾
Average Core Enthalpy Rise	Btu/lb	90.9	90.9
Maximum Clad Surface Temperature	°F	653.8 ⁽¹⁾	653.8 ⁽¹⁾
Engineering Heat Flux Factor	---	1.025 ^{(2),(3)}	1.025 ^{(2),(3)}
Engineering Factor on Hot Channel Heat Input	---	1.020 ^{(2),(3)}	1.020 ^{(2),(3)}
Rod Pitch, Bowing and Clad Diameter Factor	---	1.05 ^{(2),(3)}	1.05 ^{(2),(3)}
Fuel Densification Factor (Axial)	---	1.002	1.002

Notes:

- (1) Based on 0 shims in the core.
- (2) These factors have been combined statistically with other uncertainty factors at 95/95 confidence/probability level and included in the design limit on WSSV-T and ABB-NV minimum DNBR.
- (3) These values are generic based on fuel design drawing tolerances and are also applicable to NGF.

ARKANSAS NUCLEAR ONE
Unit 2

Table 4.4-3

REACTOR COOLANT FLOW RATES IN BYPASS CHANNELS

<u>Bypass</u>	<u>Percent of Total Vessel Flow Rate</u>
Outlet Nozzle Clearances	0.4
Alignment Keyways	0.4
Support Cylinder Holes	0.3
Core Shroud Clearances	0.4
Guide Tubes	<u>1.7</u>
 TOTAL BYPASS	 3.2

Table 4.4-4

**REACTOR VESSEL ORIGINAL ESTIMATES
PRESSURE LOSSES AND COOLANT TEMPERATURES**

	<u>Pressure Loss, psi</u>	<u>Temperature, °F</u>
Inlet Nozzle and 90° Turn	4.3	553
Downcomer, Lower Plenum and Support Structure	8.9	553
Fuel Assembly	13.7	584
Fuel Assembly Outlet to Outlet Nozzle	<u>7.1</u>	614
	34.0	

ARKANSAS NUCLEAR ONE
Unit 2

Table 4.4-5

**DESIGN STEADY STATE HYDRAULIC LOADS
ON VESSEL INTERNALS***

<u>Component</u>	<u>Load Description</u>	<u>Load Value</u>
1. Core Support Barrel	Steady-state radial pressure differential directed inward opposite inlet duct	73 psi
2. Core Support Barrel and Upper Guide Structure	Steady-state uplift load	1,036,000 lb
3. Flow Skirt	Steady-state radial drag load, directed inward	3400 lb/ft of circumference, average; 7100 lb/ft maximum
4. Bottom Plate	Steady-state drag load directed upward	44,000 lb
5. Core Support Plate	Steady-state drag load directed upward	59,000 lb
6. Fuel Assembly	Steady-state uplift load	2500 lb
7. Core Shroud	Steady-state radial pressure differential directed outward	34 psi at bottom, zero psi at top
8. Upper Guide Structure	Steady-state load directed upward	401,000 lb
9. Fuel Alignment Plate	Steady-state drag load directed upward	109,000 lb
10. Upper Guide Plate	Steady-state load directed downward	47,500 lb
11. CEA Shrouds	Steady-state lateral drag load	4100 lb
12. CEA Shrouds	Steady-state radial pressure differential directed inward	12 psi

* Loads listed are at 500 °F, 120 percent design flow, core in place.

ARKANSAS NUCLEAR ONE
Unit 2

Table 4.4-6

REACTOR CONFIGURATION DATA

<u>Region</u>	<u>Flow Path Length (ft)</u>	<u>Height & Liquid Level (ft)</u>	<u>Bottom Elevation⁽¹⁾ (ft)</u>	<u>Minimum Flow Area (ft²)</u>	<u>Volume (ft³)</u>
Inlet Nozzle (each)	3.2	2.5	- 1.25	4.9	17.5
Downcomer	24.6	32.3	- 29.2	26.7	856.0
Lower Plenum	6.6	9.4	- 26.1	22.7	670.9
Below Active Core	.4	.4	- 19.8	35.9	25.0
Active Core	12.5	12.5	- 19.4	44.8	555.0
Above Active Core	1.9	1.9	- 6.9	19.8	116.6
Outlet Plenum	8.0	9.2	- 5.0	25.3	599.9
CEA Shrouds	13.1	14.3	- 5.0	5.2	375.1
Upper Head	4.0	7.9	4.6	.5	493.2
Outlet Nozzle (each)	3.8	3.5	- 1.75	9.6	39.4

(1) Relative to reactor vessel nozzle centerline.

(2) Flow rates, temperatures and pressures in the above regions may be obtained from Table 4.4-4.

ARKANSAS NUCLEAR ONE
Unit 2

Table 4.4-6A

STEADY STATE PARAMETERS

Comparison of W-3 and CE-1 DNBR**

<u>Inlet Temp. (°F)</u>	<u>Pressure (psia)</u>	<u>Power (% 2815 Mwt)</u>	<u>W-3 DNBR</u>	<u>CE-1 DNBR</u>
580	2400	105	1.30	1.50
	2250	99	1.30	1.49
	2000	91	1.30	1.39
	1750	*	1.30	*
556.5	2400	124	1.30	1.40
	2250	117	1.30	1.43
	2000	108	1.30	1.36
	1750	100	1.30	1.15
525	2400	149	1.30	1.30
	2250	142	1.30	1.32
	2000	131	1.30	1.33
	1750	120	1.30	1.19

* core saturation limit occurs before W-3 DNBR reaches 1.30

**based on axial power distribution with 1.26 peak at 85 percent point (ASI = 0.07)

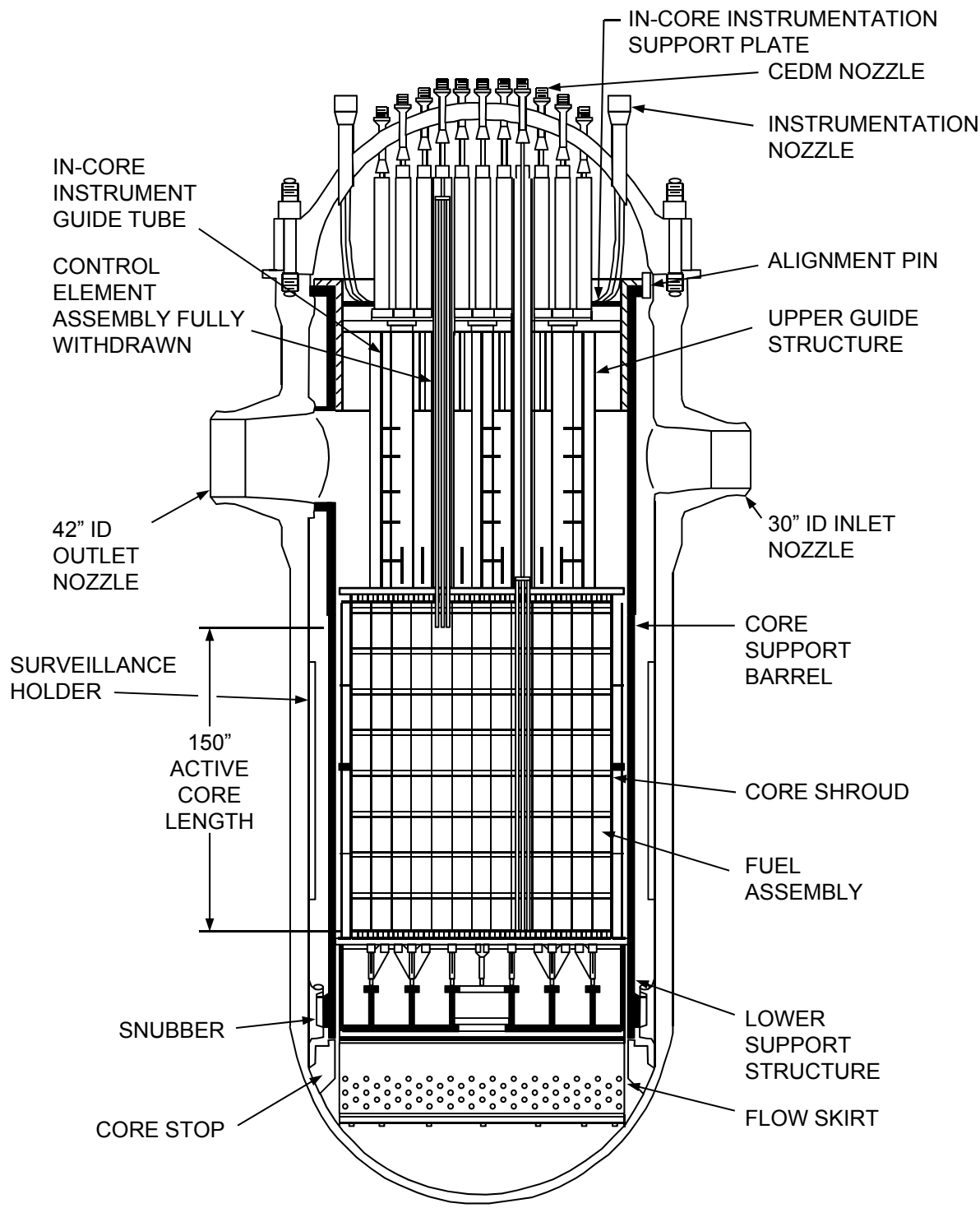

SAR FIGURE NO. 4.1-1

AMENDMENT 20

ARKANSAS NUCLEAR ONE
UNIT 2
RUSSELLVILLE, ARKANSAS



SCALE:	NONE
DRAWN:	ENERGY
DESIGN:	ENERGY
CAD NO:	N/A

REACTOR VERTICAL ARRANGEMENT

DRAWING NO

SHEET

REV.

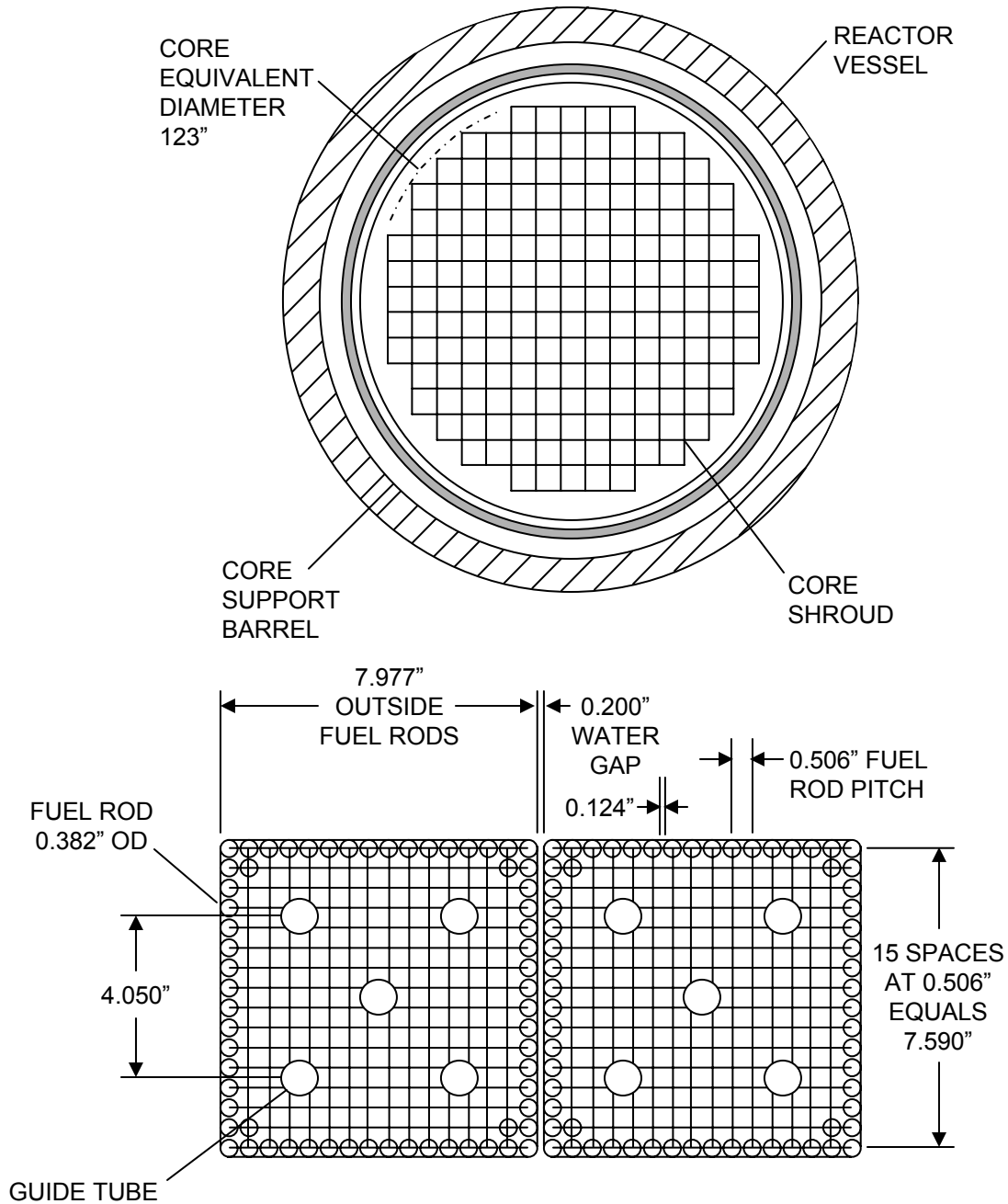

SAR FIGURE NO. 4.1-2

AMENDMENT 20

ARKANSAS NUCLEAR ONE
 UNIT 2
 RUSSELLVILLE, ARKANSAS



SCALE:	NONE
DRAWN:	ENERGY
DESIGN:	ENERGY
CAD NO:	N/A

REACTOR CORE CROSS SECTION

DRAWING NO

SHEET

REV.

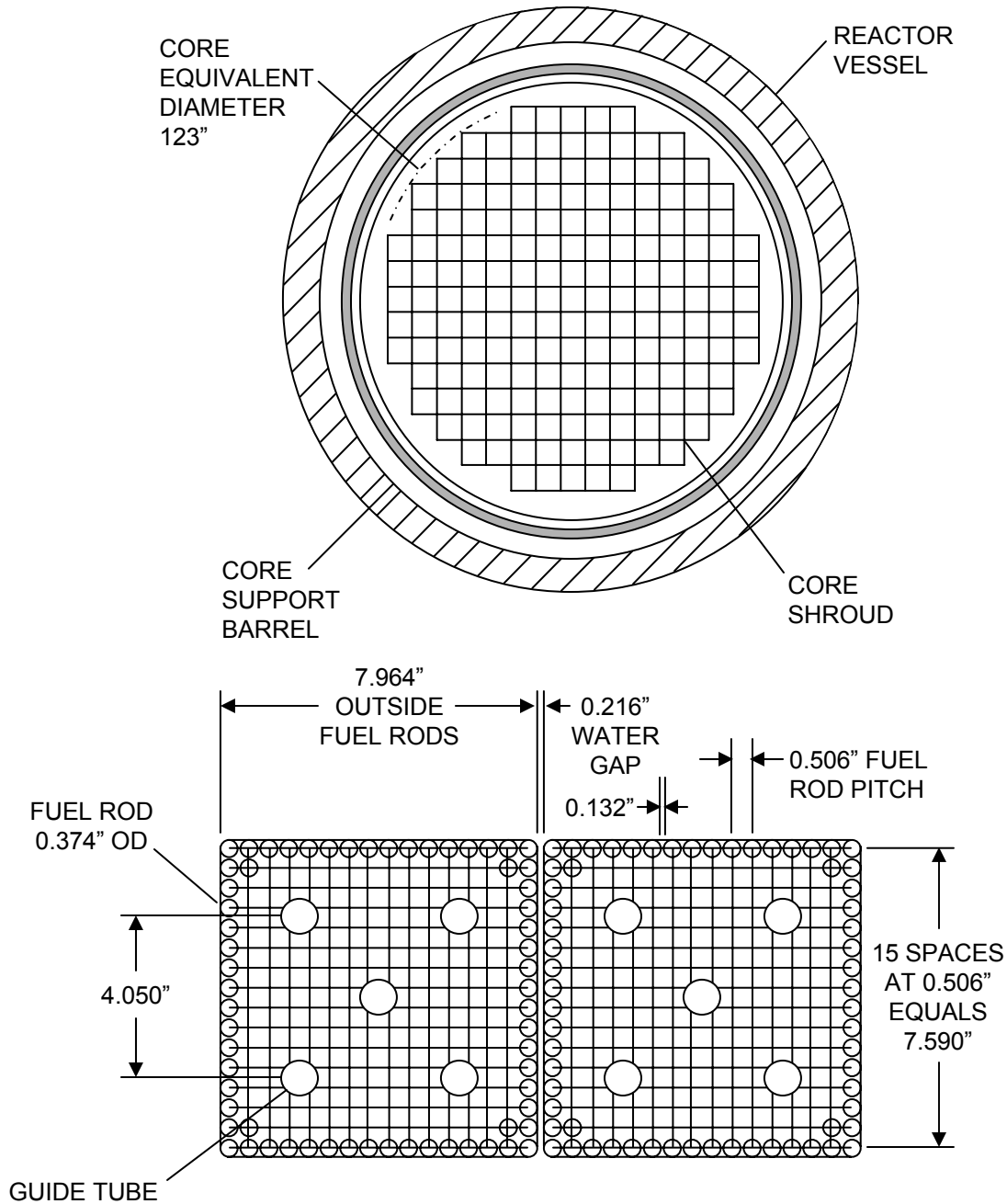

Cycle 20 Configuration Shown (NGF Design)

SAR FIGURE NO. 4.1-2A

AMENDMENT 21

ARKANSAS NUCLEAR ONE
UNIT 2
RUSSELLVILLE, ARKANSAS



SCALE:	NONE
DRAWN:	ENERGY
DESIGN:	ENERGY
CAD NO:	N/A

REACTOR CORE CROSS SECTION

DRAWING NO

SHEET

REV.

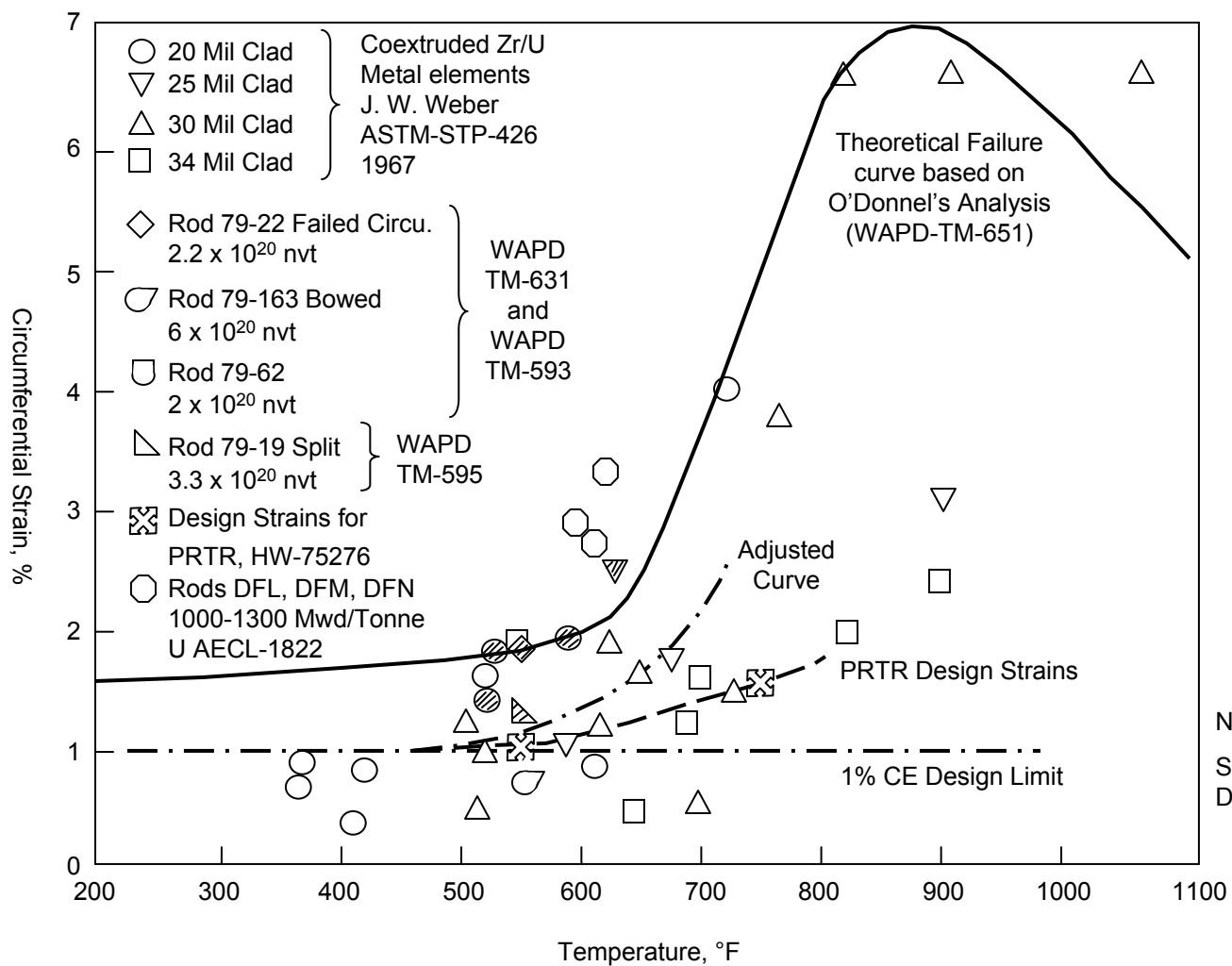

CIRCUMFERENTIAL STRAIN VS TEMPERATURE

SAR FIGURE NO. 4.2-1

ARKANSAS NUCLEAR ONE
UNIT 2
RUSSELLVILLE, ARKANSAS



SCALE: NONE
DRAWN: ENTERGY
DESIGN: ENTERGY
CAD NO:

AMENDMENT 20

BASED ON DRAWING NO

SHEET

REV.

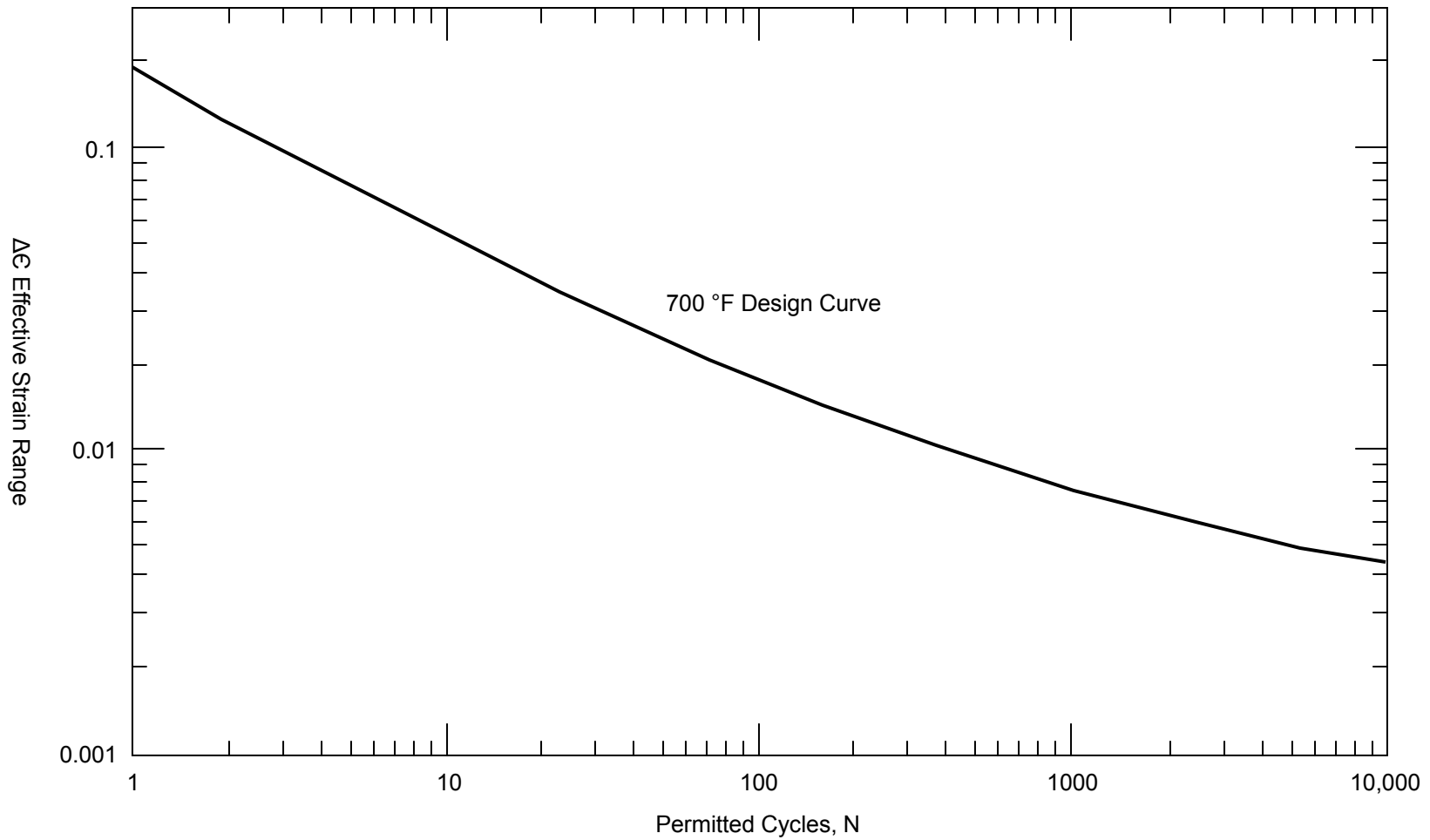

DESIGN CURVE FOR CYCLIC STRAIN USAGE OF ZIRCALOY-4 AT 700 °F

SAR FIGURE NO. 4.2-2

ARKANSAS NUCLEAR ONE
 UNIT 2
 RUSSELLVILLE, ARKANSAS



SCALE: NONE
 DRAWN: ENTERGY
 DESIGN: ENTERGY
 CAD NO:

AMENDMENT 20

BASED ON DRAWING NO

SHEET

REV.

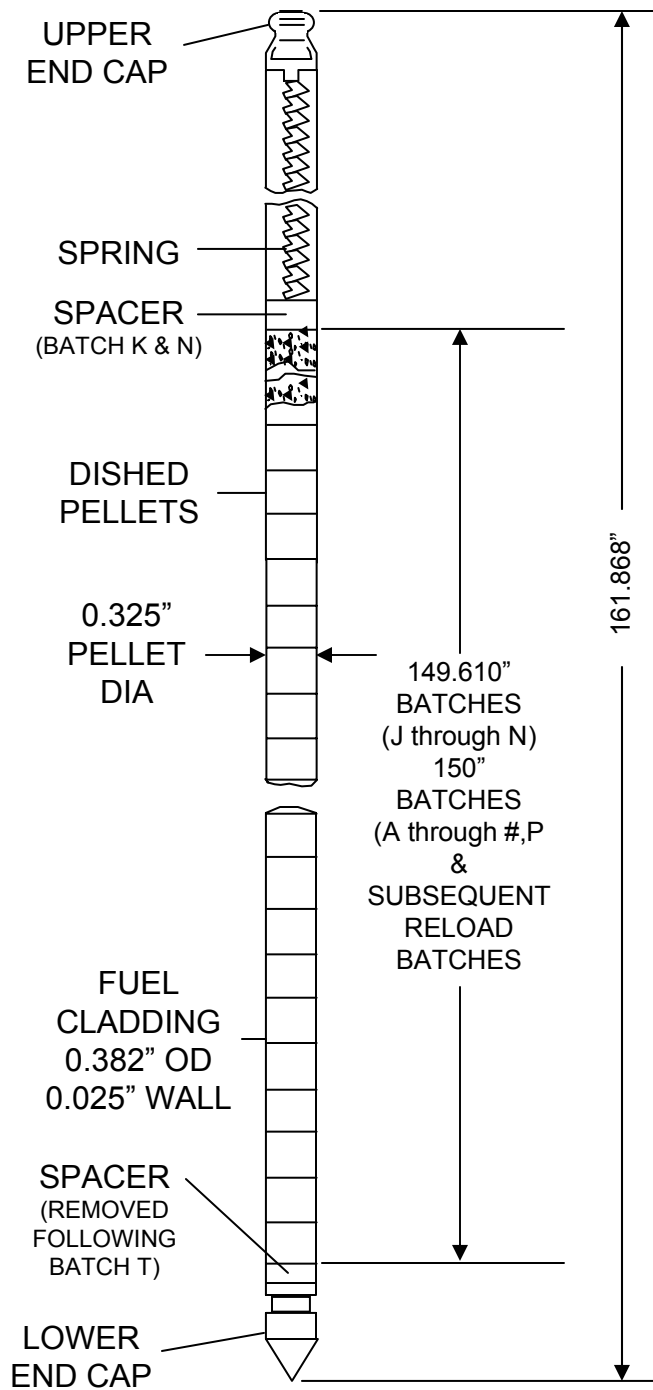

SAR FIGURE NO. 4.2-3

AMENDMENT 20

ARKANSAS NUCLEAR ONE
UNIT 2
RUSSELLVILLE, ARKANSAS



SCALE:	NONE
DRAWN:	ENERGY
DESIGN:	ENERGY
CAD NO:	N/A

FUEL ROD

DRAWING NO

SHEET

REV.

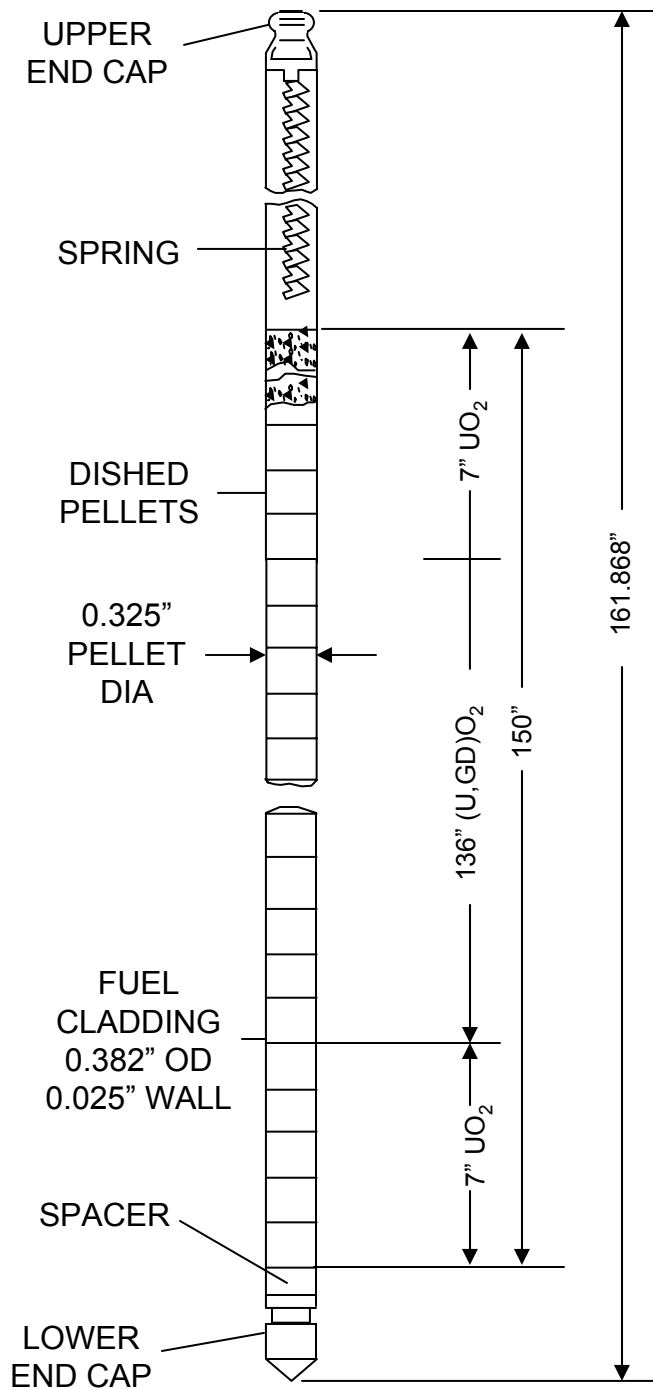

SAR FIGURE NO. 4.2-3A

AMENDMENT 20

ARKANSAS NUCLEAR ONE
UNIT 2
RUSSELLVILLE, ARKANSAS



SCALE:	NONE
DRAWN:	ENERGY
DESIGN:	ENERGY
CAD NO:	N/A

FUEL ROD WITH GADOLINIA

DRAWING NO

SHEET

REV.

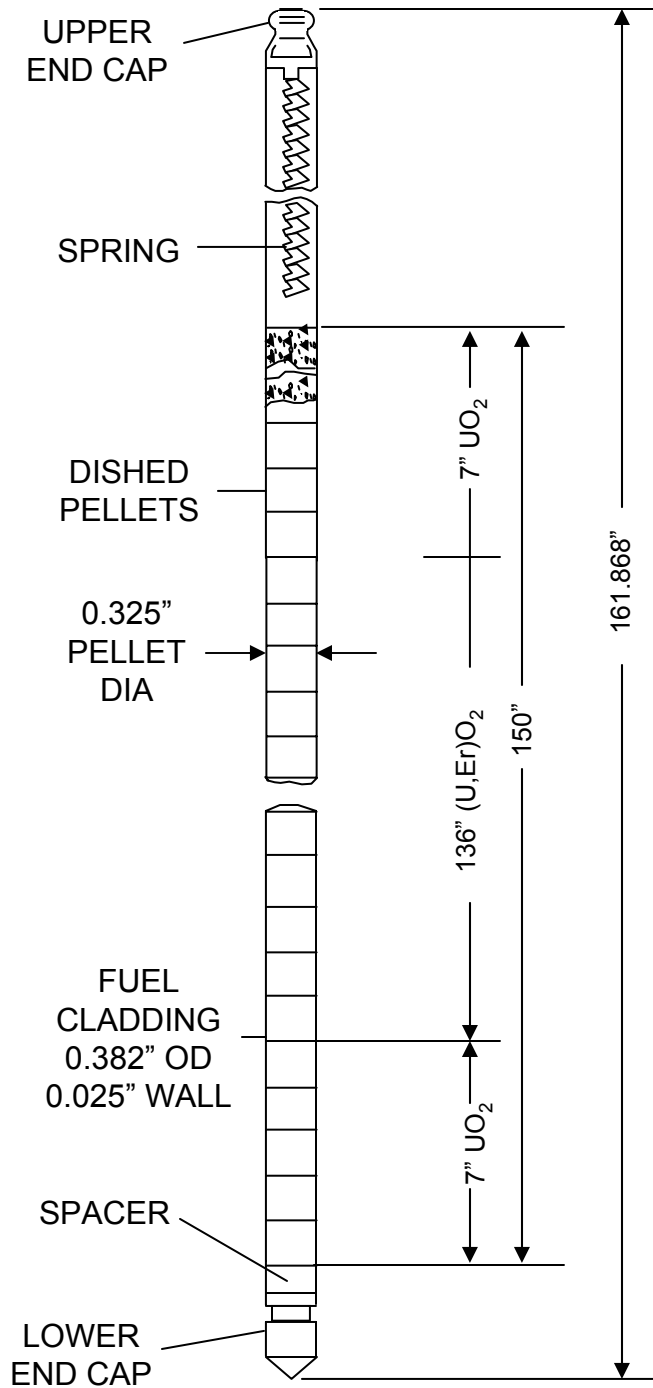

SAR FIGURE NO. 4.2-3B

AMENDMENT 20

ARKANSAS NUCLEAR ONE
UNIT 2
RUSSELLVILLE, ARKANSAS



SCALE:	NONE
DRAWN:	ENERGY
DESIGN:	ENERGY
CAD NO:	N/A

FUEL ROD WITH ERBIA

DRAWING NO

SHEET

REV.

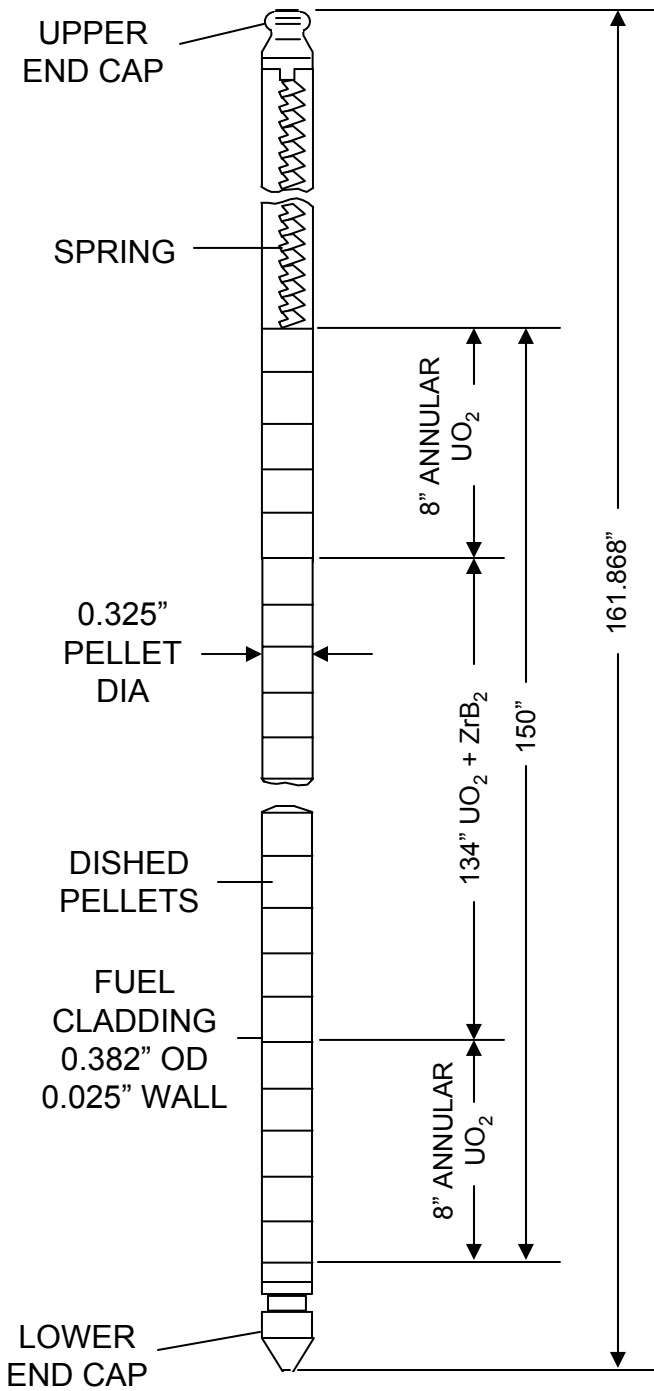

NOTE: BATCH X (CYCLE 18) VALUES SHOWN; VALUES MAY VARY WITH CYCLE.

SAR FIGURE NO. 4.2-3C

AMENDMENT 20

ARKANSAS NUCLEAR ONE
UNIT 2
RUSSELLVILLE, ARKANSAS



SCALE: NONE
DRAWN:
DESIGN: ENTERGY
CAD NO:

FUEL ROD WITH ZrB₂ IFBA

BASED ON DRAWING NO

SHEET

REV.

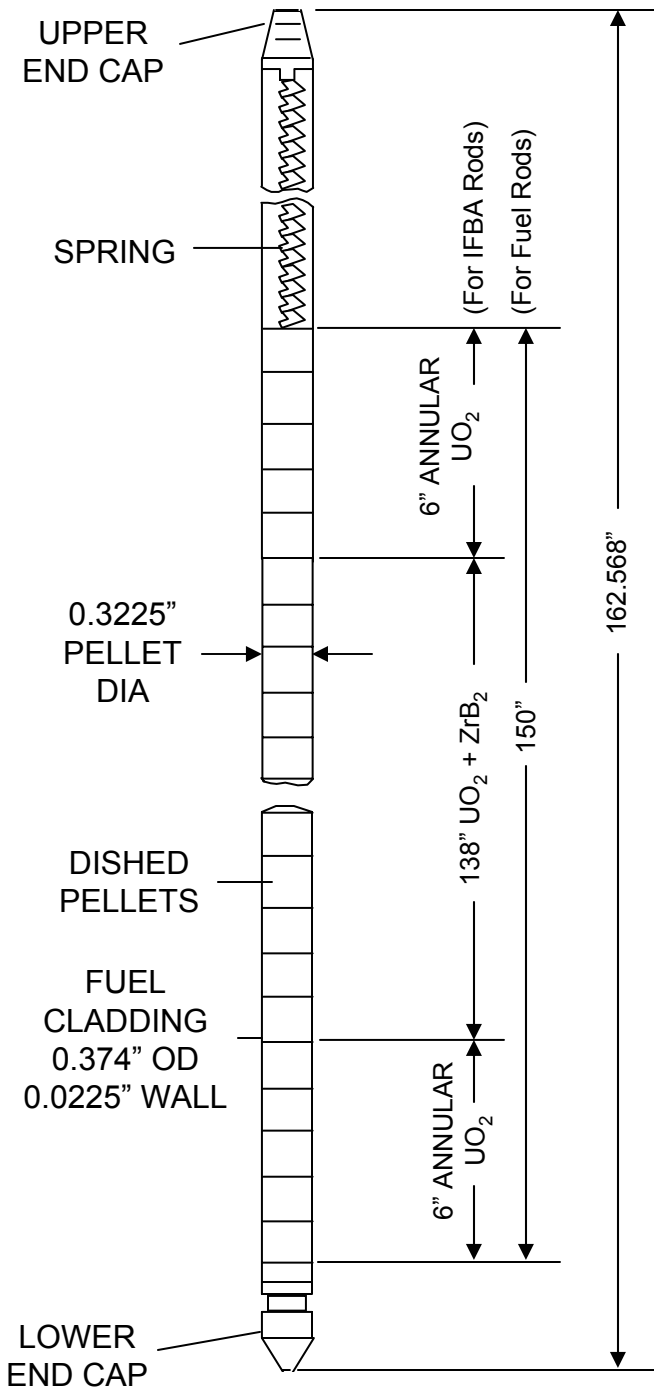

NGF DESIGN

NOTE: BATCH Z (CYCLE 20) VALUES SHOWN; VALUES MAY VARY WITH CYCLE.

SAR FIGURE NO. 4.2-3D

AMENDMENT 21

ARKANSAS NUCLEAR ONE
UNIT 2
RUSSELLVILLE, ARKANSAS



SCALE: NONE
DRAWN:
DESIGN: ENTERGY
CAD NO:

NGF FUEL ROD WITH ZrB₂ IFBA

BASED ON DRAWING NO

SHEET

REV.

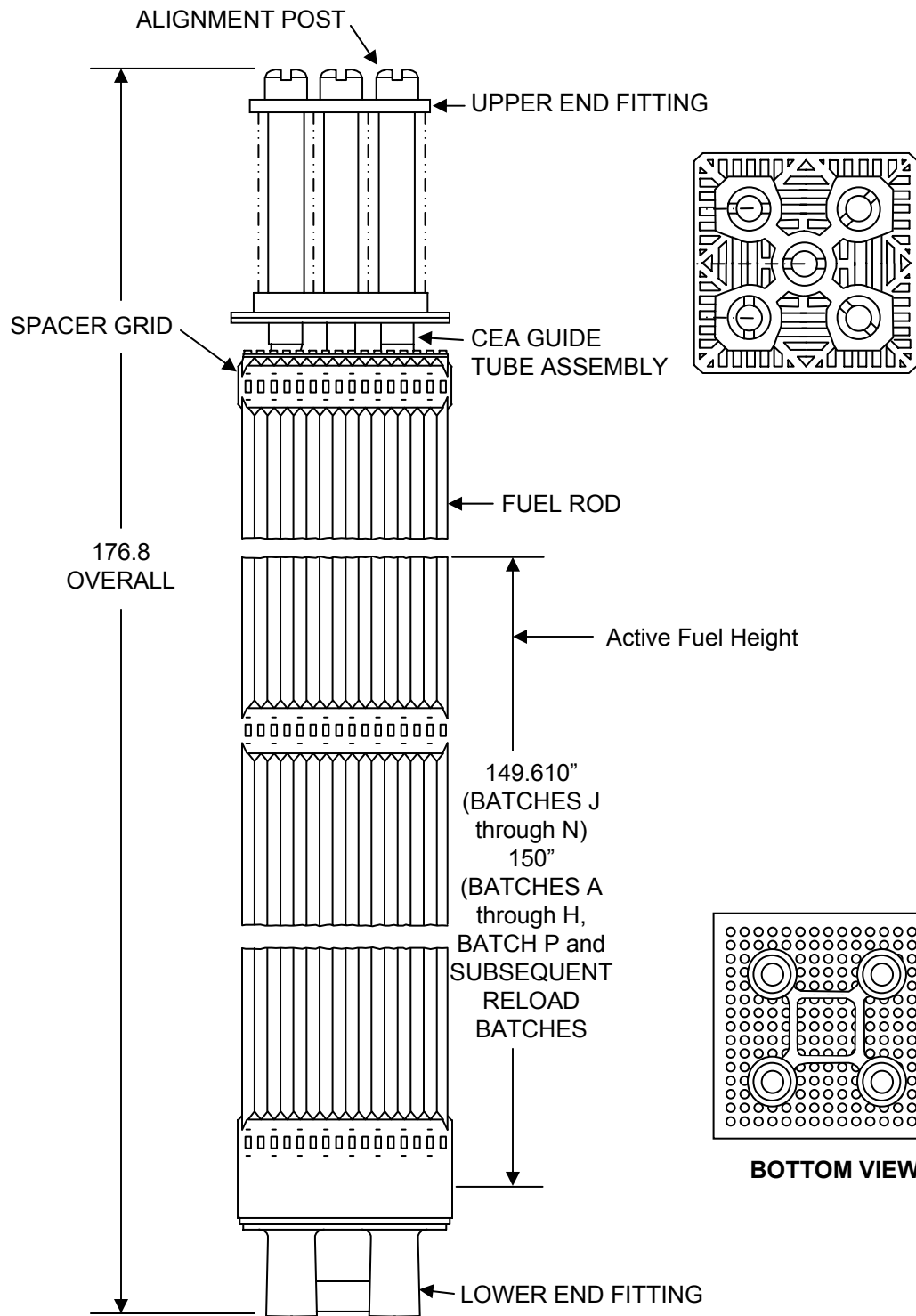

SAR FIGURE NO. 4.2-4

AMENDMENT 20

ARKANSAS NUCLEAR ONE
 UNIT 2
 RUSSELLVILLE, ARKANSAS



SCALE: NONE
 DRAWN: ENTERGY
 DESIGN: ENTERGY
 CAD NO: N/A

FUEL ASSEMBLY

DRAWING NO

SHEET

REV.

DELETED

SAR FIGURE NO. 4.2-5

AMENDMENT 21

ARKANSAS NUCLEAR ONE
UNIT 2
RUSSELLVILLE, ARKANSAS



SCALE:	NONE
DRAWN:	ENERGY
DESIGN:	ENERGY
CAD NO:	N/A

DRAWING NO

SHEET

REV.

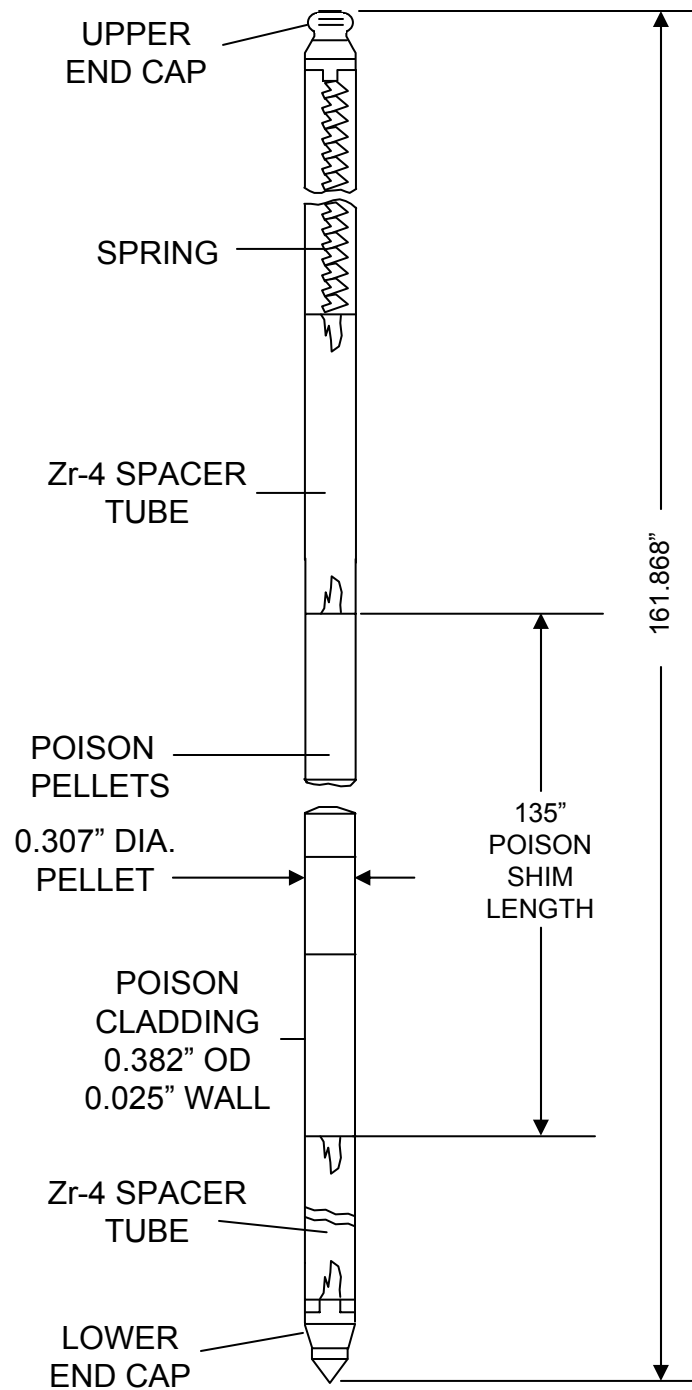

SAR FIGURE NO. 4.2-6

AMENDMENT 20

ARKANSAS NUCLEAR ONE
UNIT 2
RUSSELLVILLE, ARKANSAS



SCALE: NONE
DRAWN: ENTERGY
DESIGN: ENTERGY
CAD NO: N/A

BURNABLE POISON ROD

DRAWING NO

SHEET

REV.

SEE CESSAR PROPRIETARY
FIGURE 4.2-20 SUBMITTED ON
DOCKET 50-470

SAR FIGURE NO. 4.2-6A

AMENDMENT 20

ARKANSAS NUCLEAR ONE
UNIT 2
RUSSELLVILLE, ARKANSAS



SCALE:	NONE
DRAWN:	ENERGY
DESIGN:	ENERGY
CAD NO:	N/A

0.2% OFFSET YIELD STRENGTH OF ZIRCALOY-4 TUBING
(78% COLD-WORKED & STRESS RELIEF ANNEALED)

DRAWING NO

SHEET

REV.

SEE CESSAR PROPRIETARY
FIGURE 4.2-21 SUBMITTED ON
DOCKET 50-470

SAR FIGURE NO. 4.2-6B

AMENDMENT 20

ARKANSAS NUCLEAR ONE
UNIT 2
RUSSELLVILLE, ARKANSAS



SCALE:	NONE
DRAWN:	ENERGY
DESIGN:	ENERGY
CAD NO:	N/A

ULTIMATE TENSILE STRENGTH OF ZIRCALOY-4 TUBING
(78% COLD-WORKED & STRESS RELIEF ANNEALED)

DRAWING NO

SHEET

REV.

SEE CESSAR PROPRIETARY
FIGURE 4.2-22 SUBMITTED ON
DOCKET 50-470

SAR FIGURE NO. 4.2-6C

AMENDMENT 20

ARKANSAS NUCLEAR ONE
UNIT 2
RUSSELLVILLE, ARKANSAS



SCALE:	NONE
DRAWN:	ENERGY
DESIGN:	ENERGY
CAD NO:	N/A

UNIFORM ELOGATION OF ZIRCALOY-4 TUBING
(78% COLD-WORKED & STRESS RELIEF ANNEALED)

DRAWING NO

SHEET

REV.

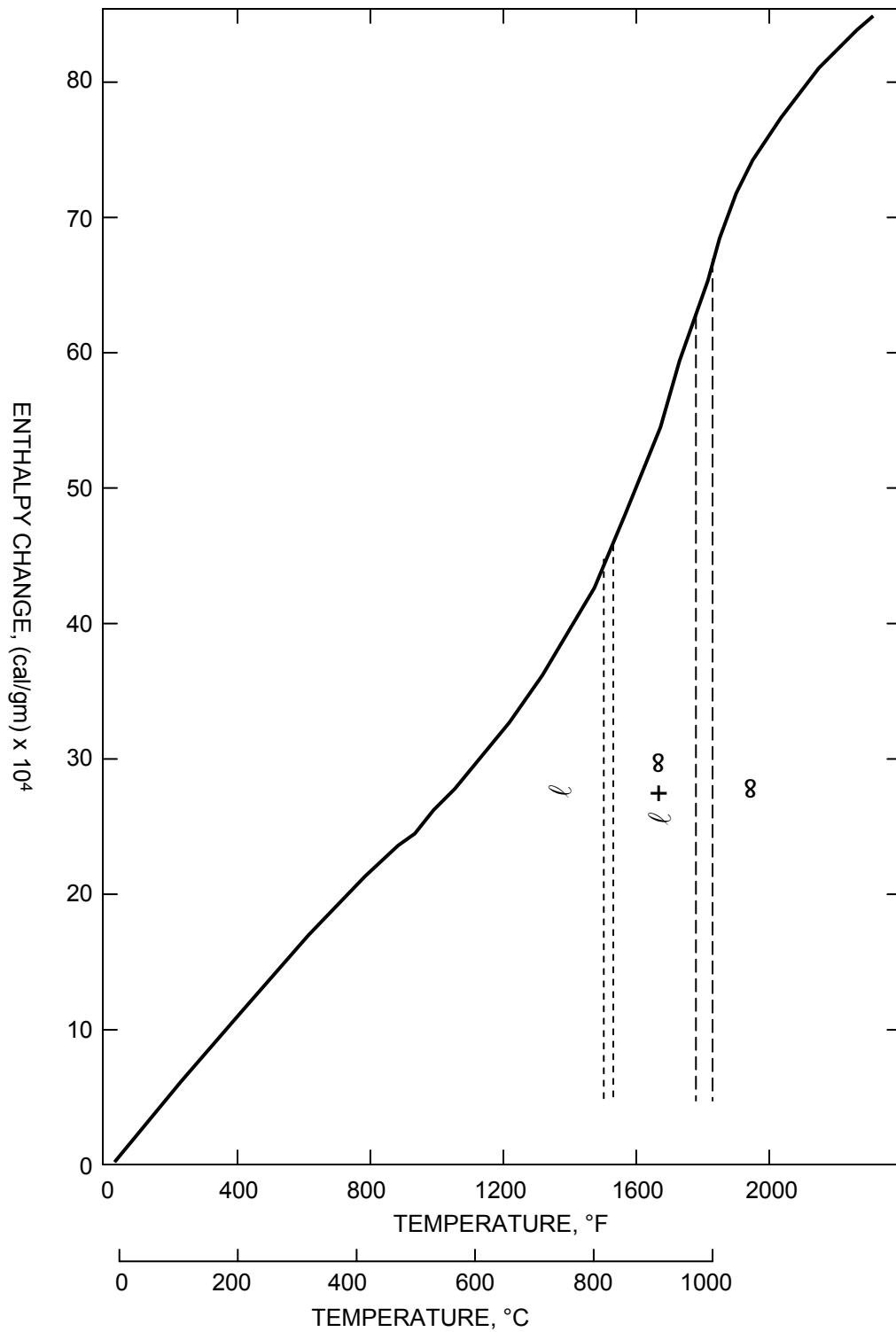

SAR FIGURE NO. 4.2-7

AMENDMENT 20

ARKANSAS NUCLEAR ONE
 UNIT 2
 RUSSELLVILLE, ARKANSAS



SCALE:	NONE
DRAWN:	ENERGY
DESIGN:	ENERGY
CAD NO:	N/A

HEAT CONTENT OF ZIRCALOY-4

DRAWING NO

SHEET

REV.

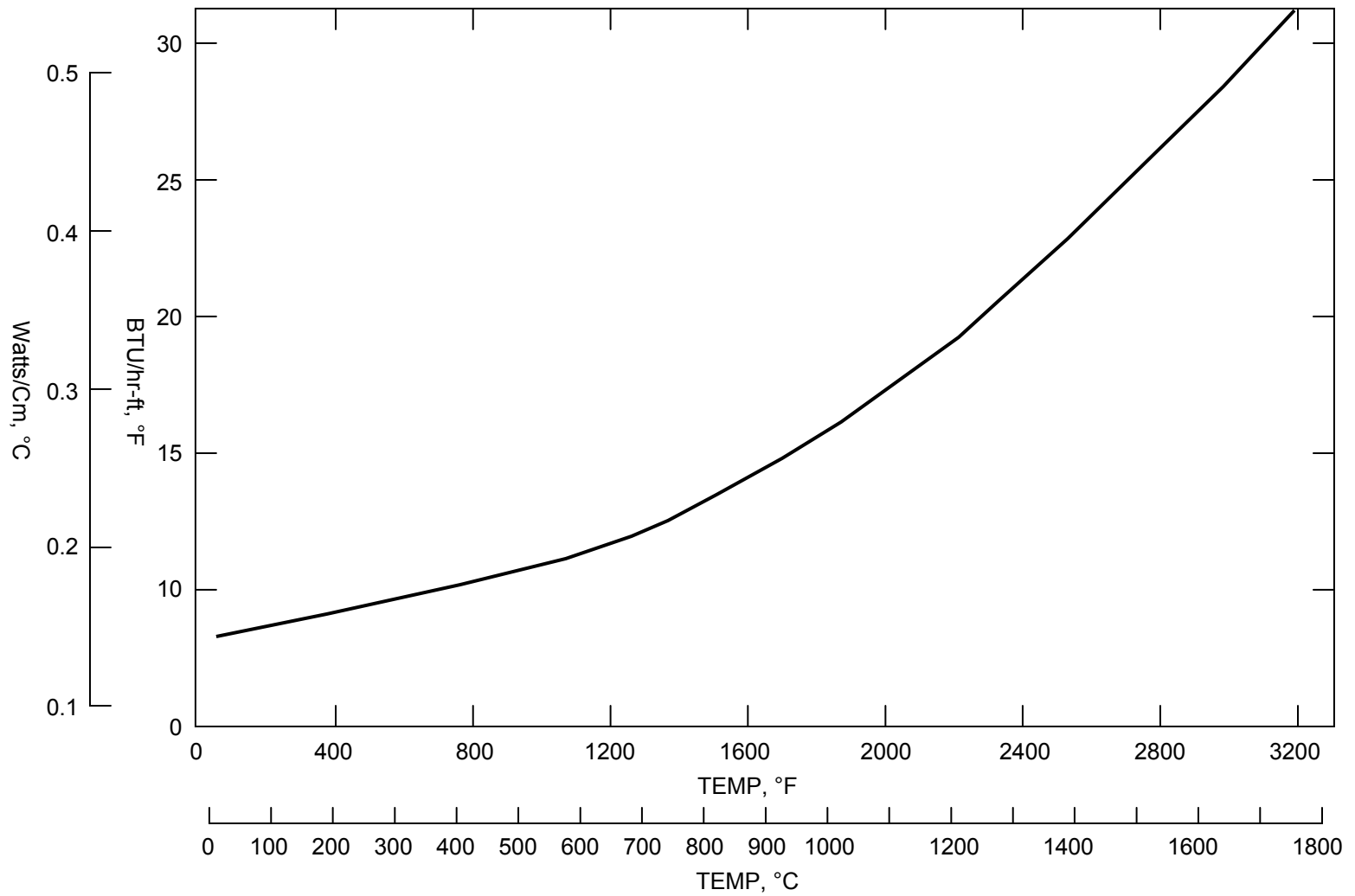

THERMAL CONDUCTIVITY OF ZIRCALOY-4 TUBING

SAR FIGURE NO. 4.2-8

ARKANSAS NUCLEAR ONE
 UNIT 2
 RUSSELLVILLE, ARKANSAS



SCALE: NONE
 DRAWN: ENTERGY
 DESIGN: ENTERGY
 CAD NO:

AMENDMENT 20

BASED ON DRAWING NO	SHEET	REV.

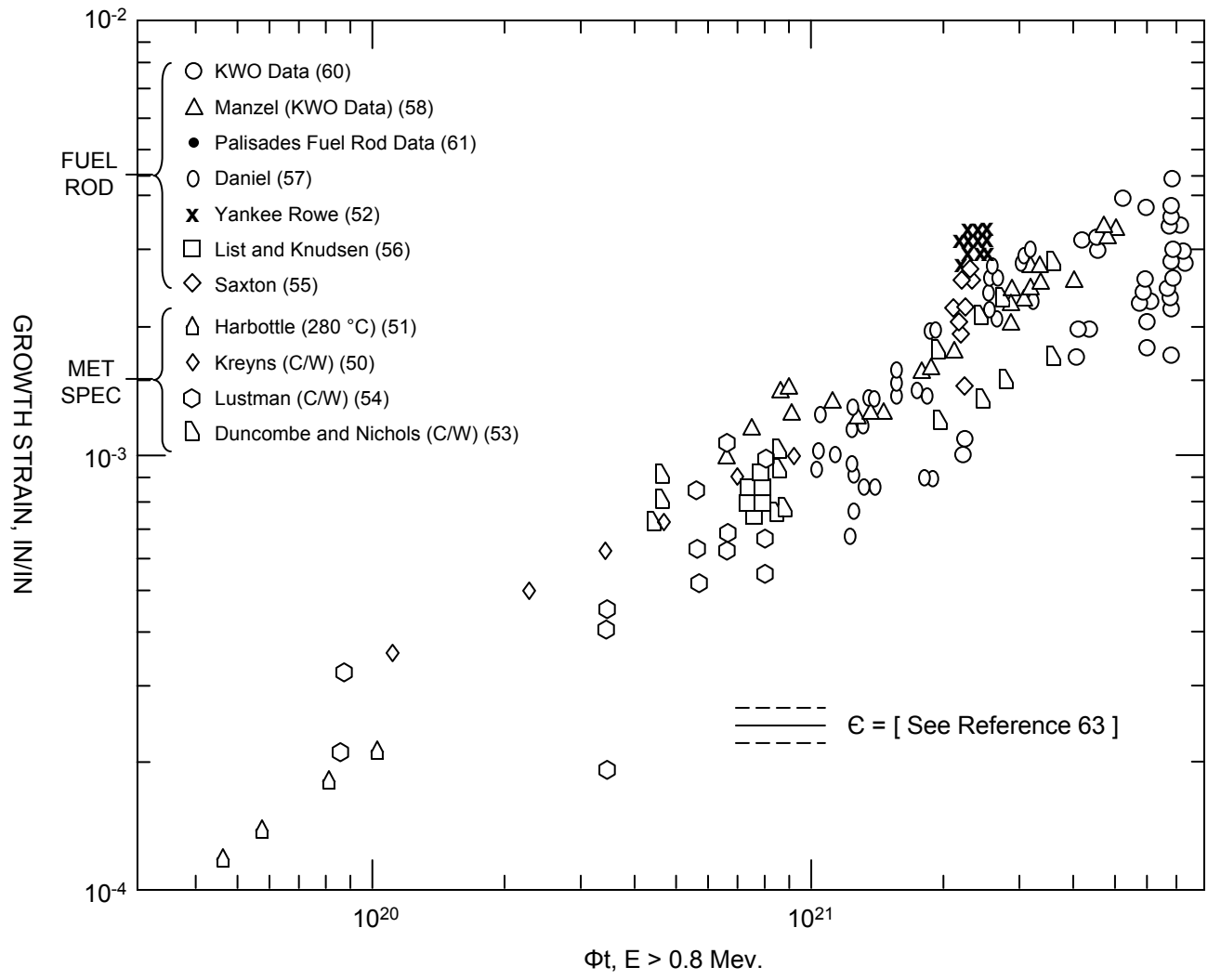

COLD WORKED ZIRCALOY GROWTH STRAIN VS FAST NEUTRON FLUENCE

SAR FIGURE NO. 4.2-8A

ARKANSAS NUCLEAR ONE
 UNIT 2
 RUSSELLVILLE, ARKANSAS



SCALE: NONE
 DRAWN: ENTERGY
 DESIGN: ENTERGY
 CAD NO:

AMENDMENT 20

BASED ON DRAWING NO

SHEET

REV.

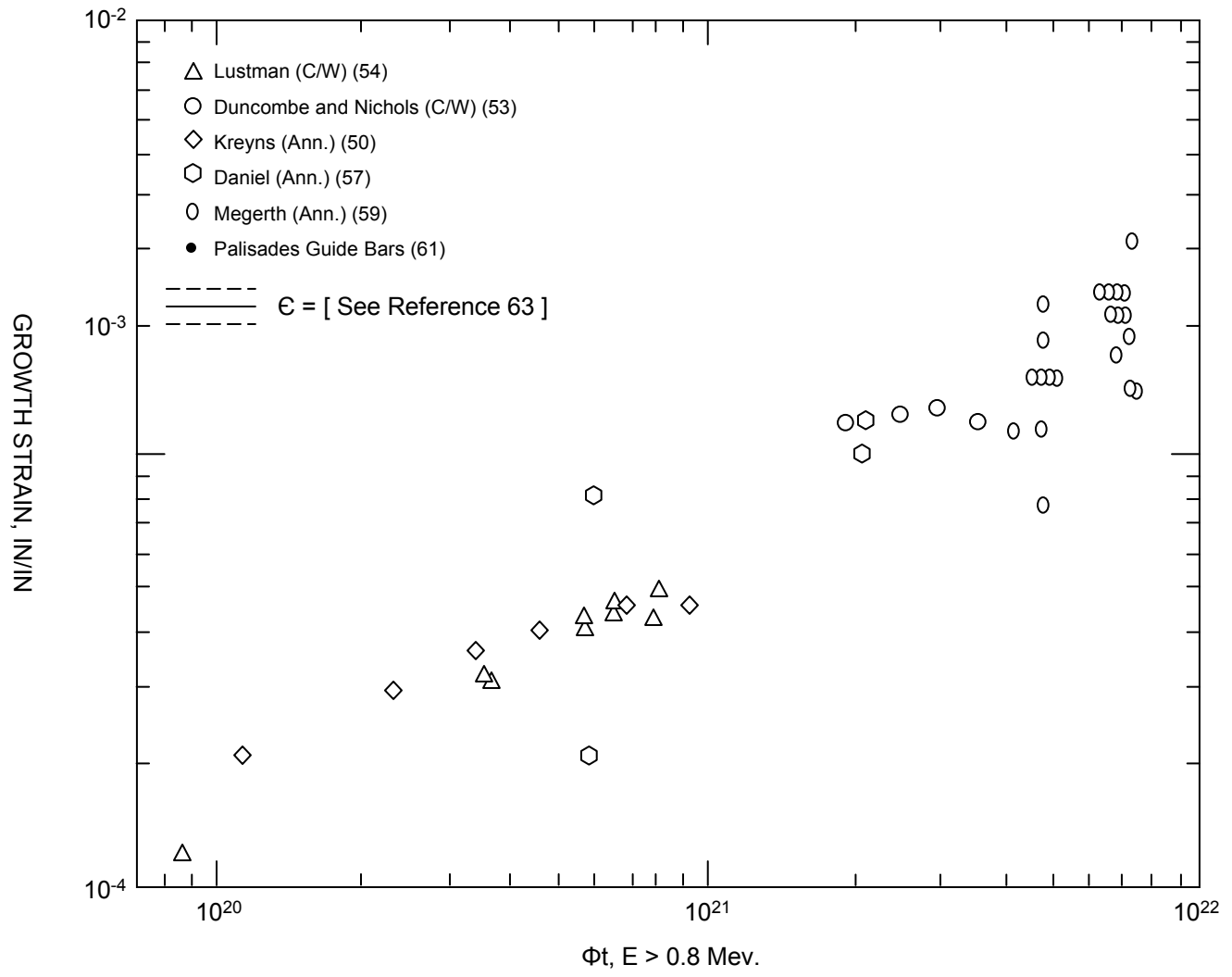

ANNEALED ZIRCALOY GROWTH STRAIN VS FAST NEUTRON FLUENCE

SAR FIGURE NO. 4.2-8B

ARKANSAS NUCLEAR ONE
 UNIT 2
 RUSSELLVILLE, ARKANSAS



SCALE: NONE
 DRAWN: ENERGENCY
 DESIGN: ENERGENCY
 CAD NO:

AMENDMENT 20

BASED ON DRAWING NO

SHEET

REV.

FIGURE 4.2-9
DELETED

SAR FIGURE NO. 4.2-9

AMENDMENT 20

ARKANSAS NUCLEAR ONE
UNIT 2
RUSSELLVILLE, ARKANSAS



SCALE:	NONE
DRAWN:	ENERGY
DESIGN:	ENERGY
CAD NO:	N/A

Quality Assurance Flow Chart

DRAWING NO

SHEET

REV.

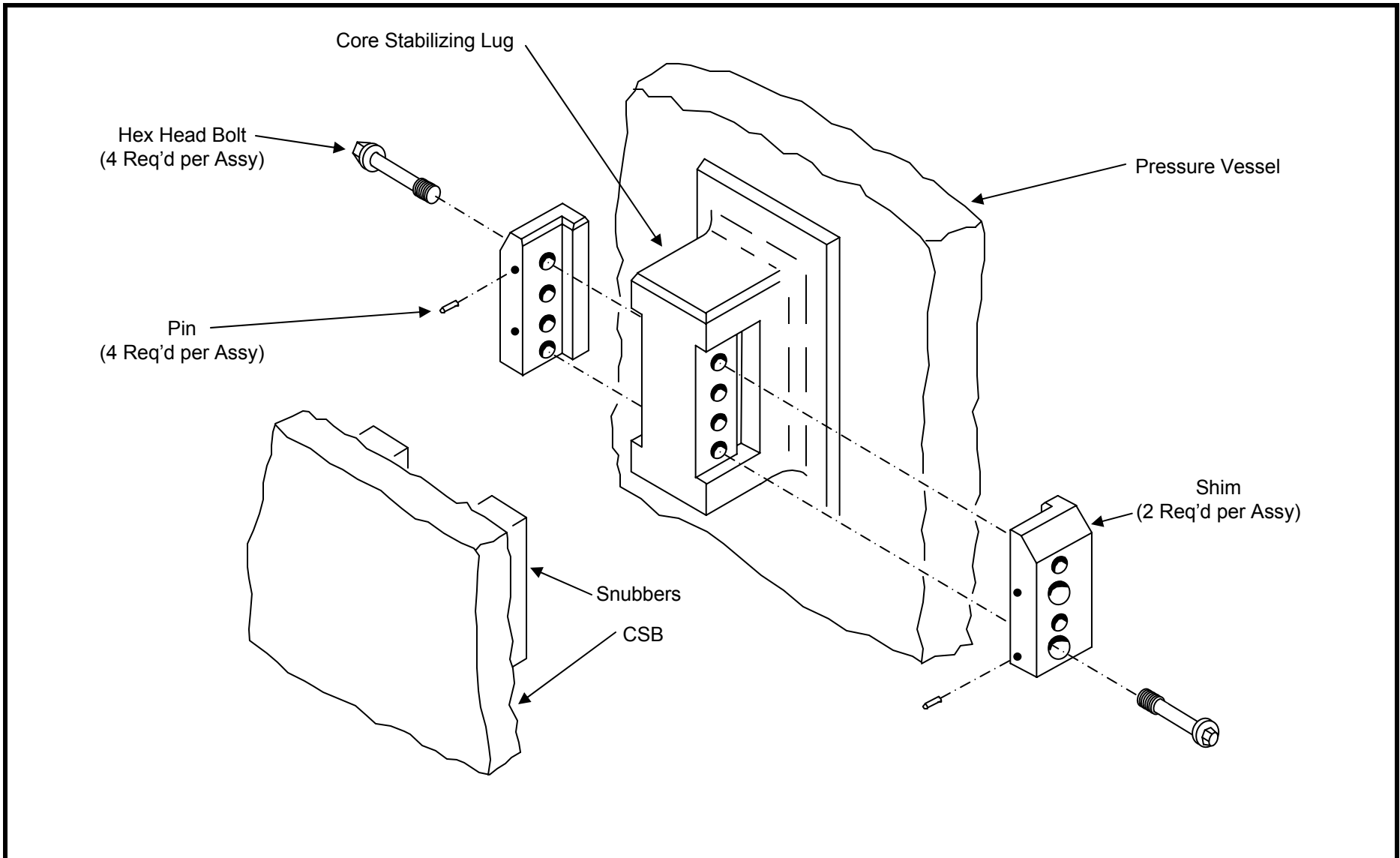

SNUBBER ASSEMBLY

SAR FIGURE NO. 4.2-10

ARKANSAS NUCLEAR ONE
 UNIT 2
 RUSSELLVILLE, ARKANSAS



SCALE:	NONE
DRAWN:	ENERGY
DESIGN:	ENERGY
CAD NO:	

AMENDMENT 20

BASED ON DRAWING NO	SHEET	REV.

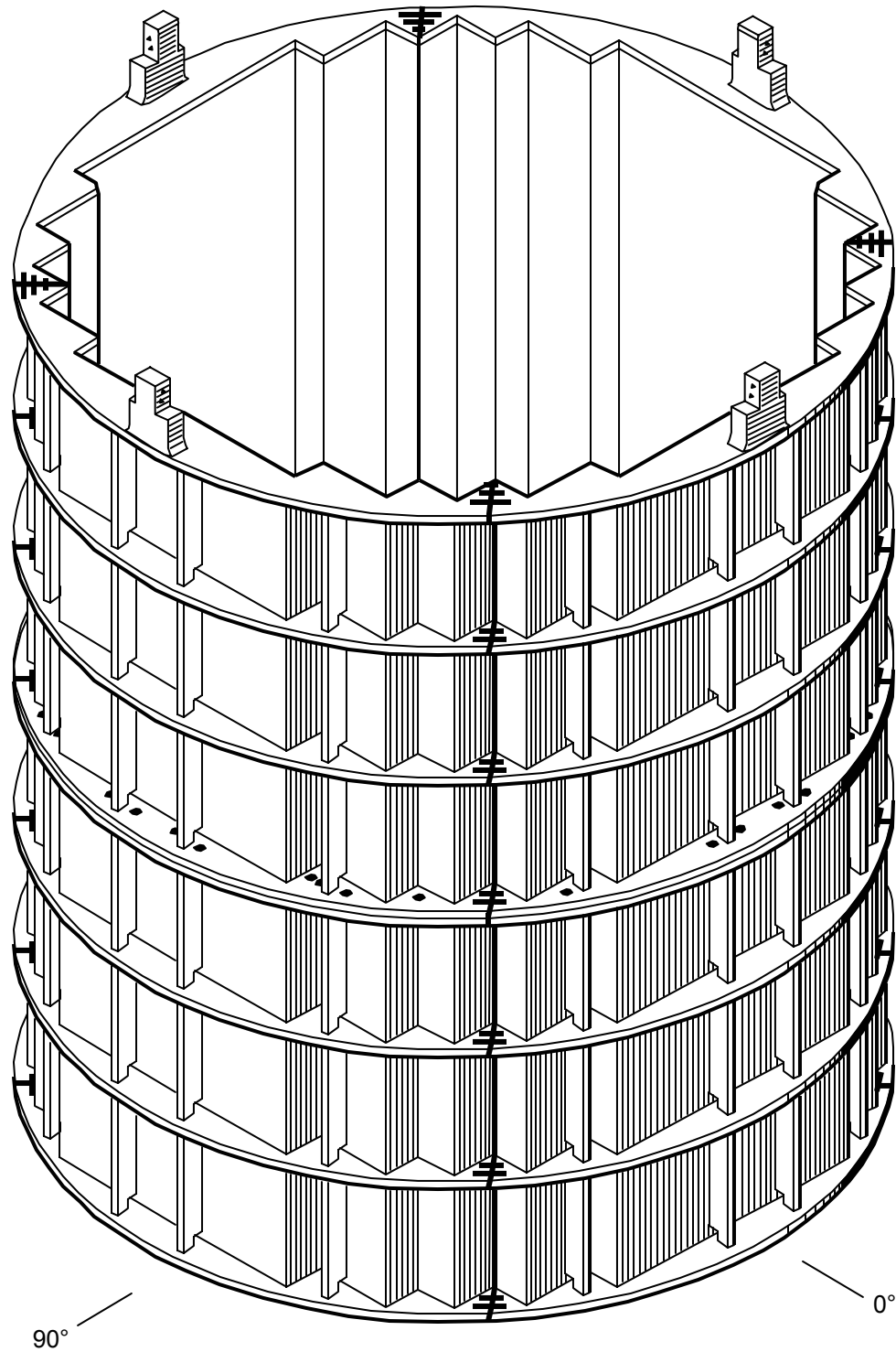

SAR FIGURE NO. 4.2-11

AMENDMENT 20

ARKANSAS NUCLEAR ONE
 UNIT 2
 RUSSELLVILLE, ARKANSAS



SCALE:	NONE
DRAWN:	ENERGY
DESIGN:	ENERGY
CAD NO:	N/A

CORE SHROUD ASSEMBLY

DRAWING NO

SHEET

REV.

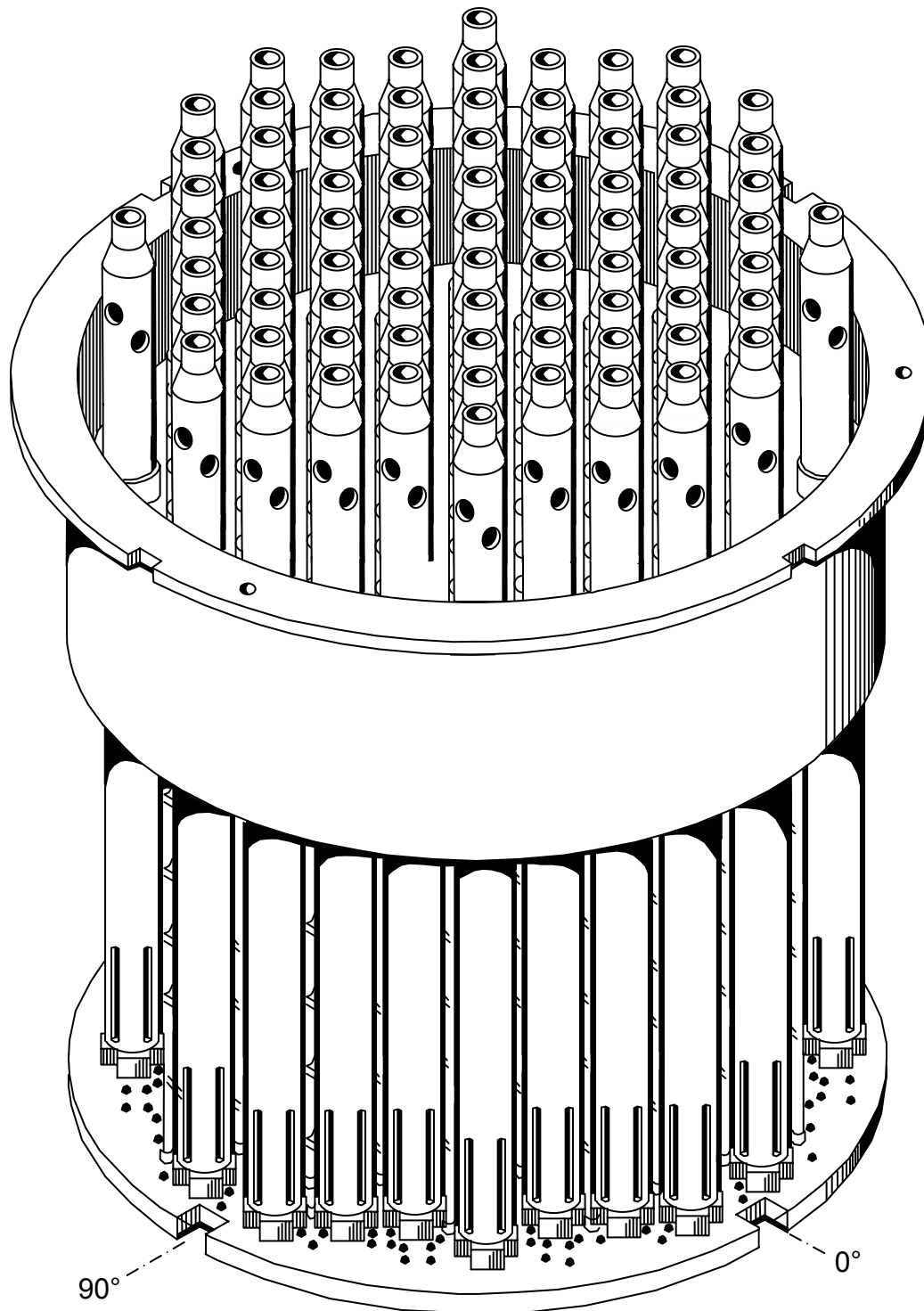

SAR FIGURE NO. 4.2-12

AMENDMENT 20

ARKANSAS NUCLEAR ONE
 UNIT 2
 RUSSELLVILLE, ARKANSAS



SCALE:	NONE
DRAWN:	ENERGY
DESIGN:	ENERGY
CAD NO:	N/A

UPPER GUIDE ASSEMBLY

DRAWING NO

SHEET

REV.

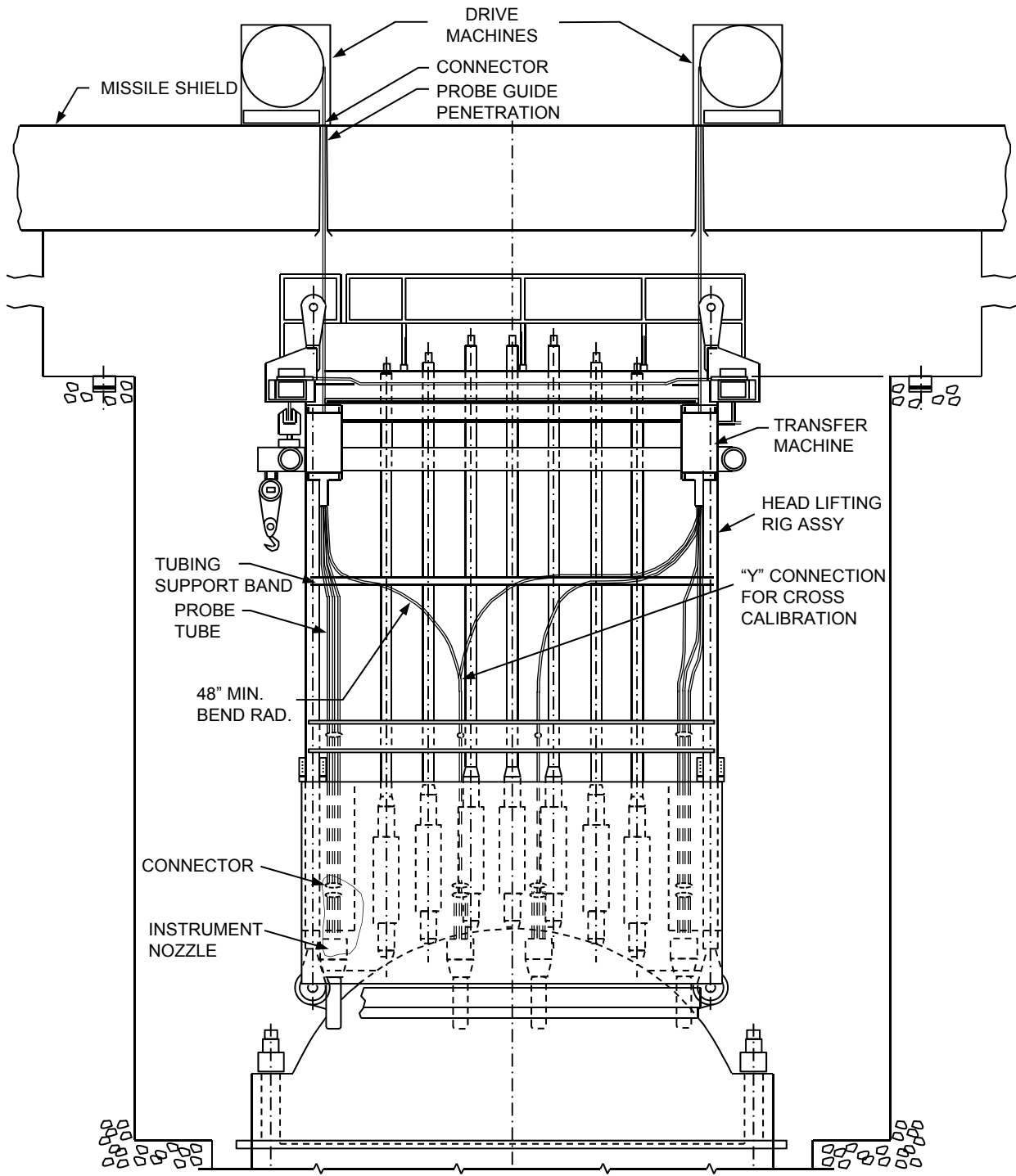

SAR FIGURE NO. 4.2-13

AMENDMENT 20

ARKANSAS NUCLEAR ONE
 UNIT 2
 RUSSELLVILLE, ARKANSAS



SCALE:	NONE
DRAWN:	ENERGY
DESIGN:	ENERGY
CAD NO:	N/A

MOVABLE DETECTOR SYSTEM LAYOUT

DRAWING NO

SHEET

REV.

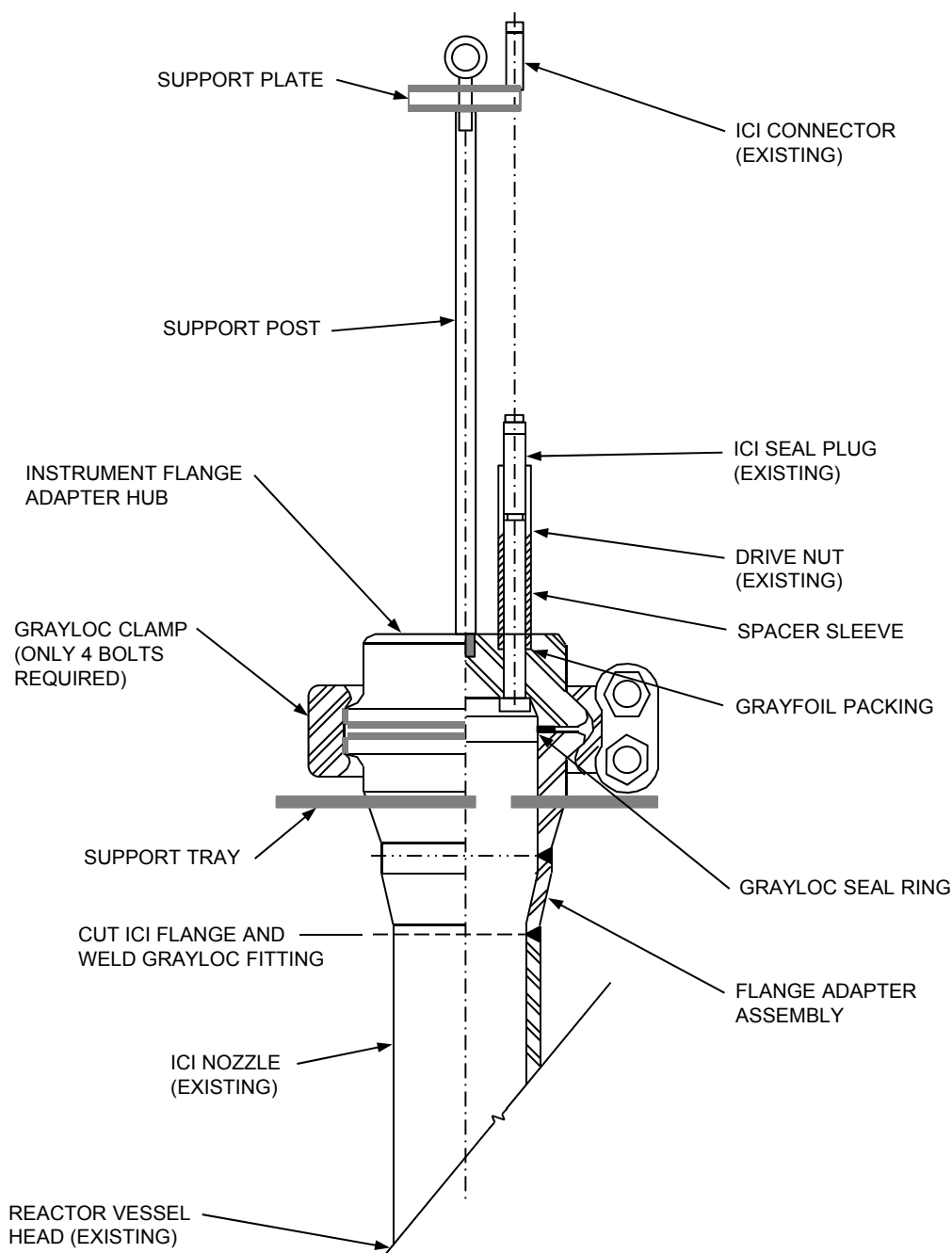

SAR FIGURE NO. 4.2-14

AMENDMENT 20

ARKANSAS NUCLEAR ONE
UNIT 2
RUSSELLVILLE, ARKANSAS



SCALE:	NONE
DRAWN:	ENERGY
DESIGN:	ENERGY
CAD NO:	N/A

IN-CORE INSTRUMENT NOZZLE

DRAWING NO

SHEET

REV.

GUIDE TUBE CLUSTER ASSEMBLY

GUIDE TUBE

SUPPORT PLATE ASSEMBLY

THIMBLE ASSEMBLY

0°

SAR FIGURE NO. 4.2-15

AMENDMENT 20

ARKANSAS NUCLEAR ONE
UNIT 2
RUSSELLVILLE, ARKANSAS



SCALE:	NONE
DRAWN:	ENERGY
DESIGN:	ENERGY
CAD NO:	N/A

IN-CORE SUPPORT ASSEMBLY

DRAWING NO

SHEET

REV.

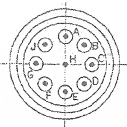

SECTION A-A
(NOT TO SCALE)

HOOKUP	
PIN	CONNECT TO
A	RHODIUM 1
B	RHODIUM 2
C	RHODIUM 3
D	RHODIUM 4
E	RHODIUM 5
F	THERMOCOUPLE (CHROMEL)
G	THERMOCOUPLE (ALUMEL)
H	SHELL COMMON
J	BACKGROUND

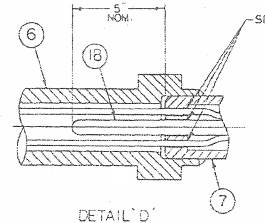
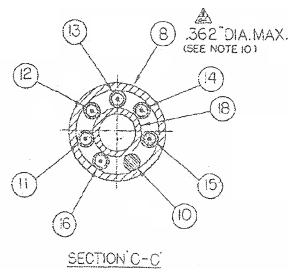
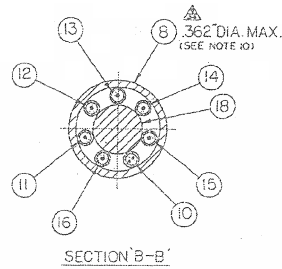

BILL OF MATERIAL			
ITEM NO.	DESCRIPTION	QTY	REFERENCE
1	DUST CAP ASSEMBLY	1	ERD #128391
2	RECEPTACLE	1	ERD #128317
3	BACKSHELL ASSEMBLY	1	SERIES 300S.S
4	SWAGELOK NUT & FERRULS	1	SERIES 300S.S
5	FLEX HOSE ASSEMBLY	1	313-1705
6	SEAL PLUG	1	316-0816
7	HEADER	1	347 OR 341 S.S
8	OUTER SHEATH TUBE	1	INCONEL 600
9	ADAPTER	1	SERIES 300S.S
10	THERMOCOUPLE	1	313-9500
11	RHODIUM DETECTOR 1	1	313-0000
12	RHODIUM DETECTOR 2	1	313-0001
13	RHODIUM DETECTOR 3	1	313-0001
14	RHODIUM DETECTOR 4	1	313-0001
15	RHODIUM DETECTOR 5	1	313-0001
16	BACKGROUND DETECTOR	1	313-0400
17	BULLET NOSE	1	INCONEL 600
18	CENTRAL MEMBER ASS'Y	1	313-2004
19	SWAGELOK NUT & FERRULS	1	SERIES 300S.S

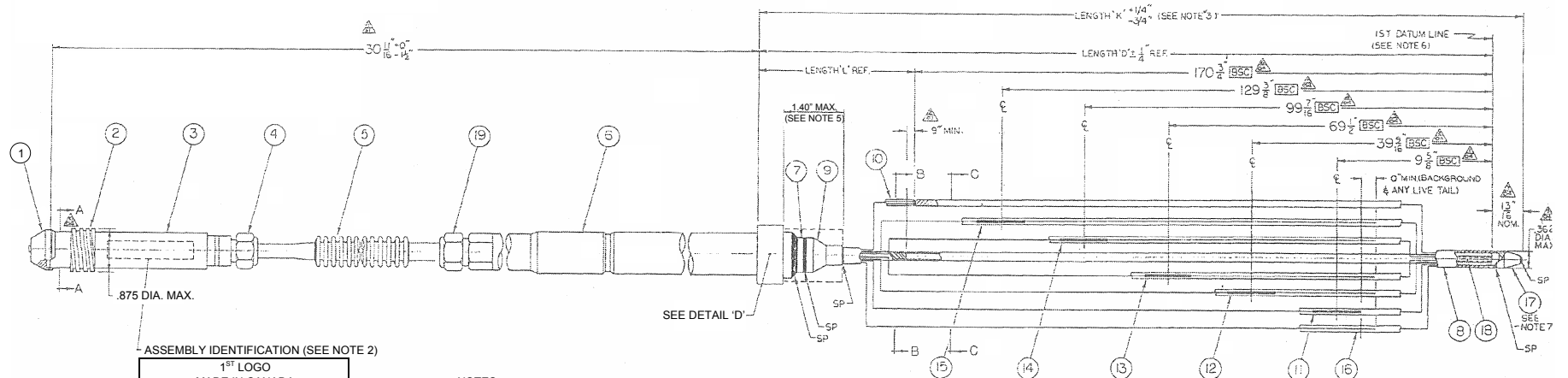

ASSEMBLY IDENTIFICATION (SEE NOTE 2)

1ST LOGO
MADE IN CANADA
DATE OF MFR. 'LLL'-19'MM'
IN-CORE INSTRUMENT ASSEMBLY
DWG. E-6370-165-020 REV. 'XX'
ABB-CE P.O. _____
CUST. P.O. _____
INST. I.D. _____-'KK'
FLANGE 'Y'
CORE CO-ORDINATE 'C-C'

LEGEND:
'LLL' - MONTH OF MANUFACTURE
'MM' - YEAR OF MANUFACTURER
'XX' - DRAWING REVISION NO.
'KK' - FLANGE NO.
'C-C' - CORE CO-ORDINATE

- NOTES**
- 1) PRODUCT SHALL BE IN ACCORDANCE WITH CENPD SPEC. NO. 00000-FEA-6106 & CENPD DWG. NO. E-6370-165-020.
 - 2) ELECTRO-ETCH ASSEMBLY IDENTIFICATION PER FORMAT SHOWN IN BOX. UNDERLINED HOLDERS (EG. 'XX') TO BE ASSIGNED PER LEGEND. LETTERING TO BE 1/8" HIGH NOMINAL, EXCEPT FOR TWO (2) DIGITS, 'C-C' WHICH ARE TO BE 1/4" HIGH NOMINAL, IN TWO PLACES 180° APART.
 - 3) FOR SCOPE OF SUPPLY & AS BUILT INFORMATION, SEE M-2001-K3-090, SHEET 2.
 - 4) PROCESSED TO IMQP CHART NO. 310-9546 (WHERE SP'S & QP'S ARE REFERENCED).
 - 5) ADAPTOR CONFIGURATION SHALL NOT EXCEED .937" DIA. OVER SPECIFIED LENGTH.
 - 6) ALL BSC DIMENSIONS TO BE ± 1/8".
 - 7) BULLET NOSE SURFACES & JOINTS TO BE SMOOTH & FREE FROM SHARP EDGES. POLISH TO 32 OR BETTER.
 - 8) ITEMS 10 THRU 16 MUST BE ASSEMBLED SO THAT EACH IS EVENLY HELIXED AROUND ITEM 18 MAKING AT LEAST 1 REVOLUTION, BUT NO MORE THAN 1 1/2 REVOLUTIONS EVERY 40 CM.
 - 9) O.S.T SHALL BE PURGED FREE OF AIR & BACKFILLED WITH HELIUM @ 1 ATMOSPHERE PRESSURE MINIMUM.
 - 10) AFTER PROCESSING O.S.T., THE DIAMETRICAL CLEARANCE OF THE DETECTORS & THERMOCOUPLE TO THE CENTRAL MEMBER ASS'Y & OUTER SHEATH TUBE TO BE +.004 / -.000

IN-CORE INSTRUMENT ASSEMBLY

SAR FIGURE NO. 4.2-16

ARKANSAS NUCLEAR ONE
UNIT 2
RUSSELLVILLE, ARKANSAS



SCALE:	NONE
DRAWN:	ENERGY
DESIGN:	ENERGY
CAD NO:	

AMENDMENT 20		
BASED ON DRAWING NO	SHEET	REV.

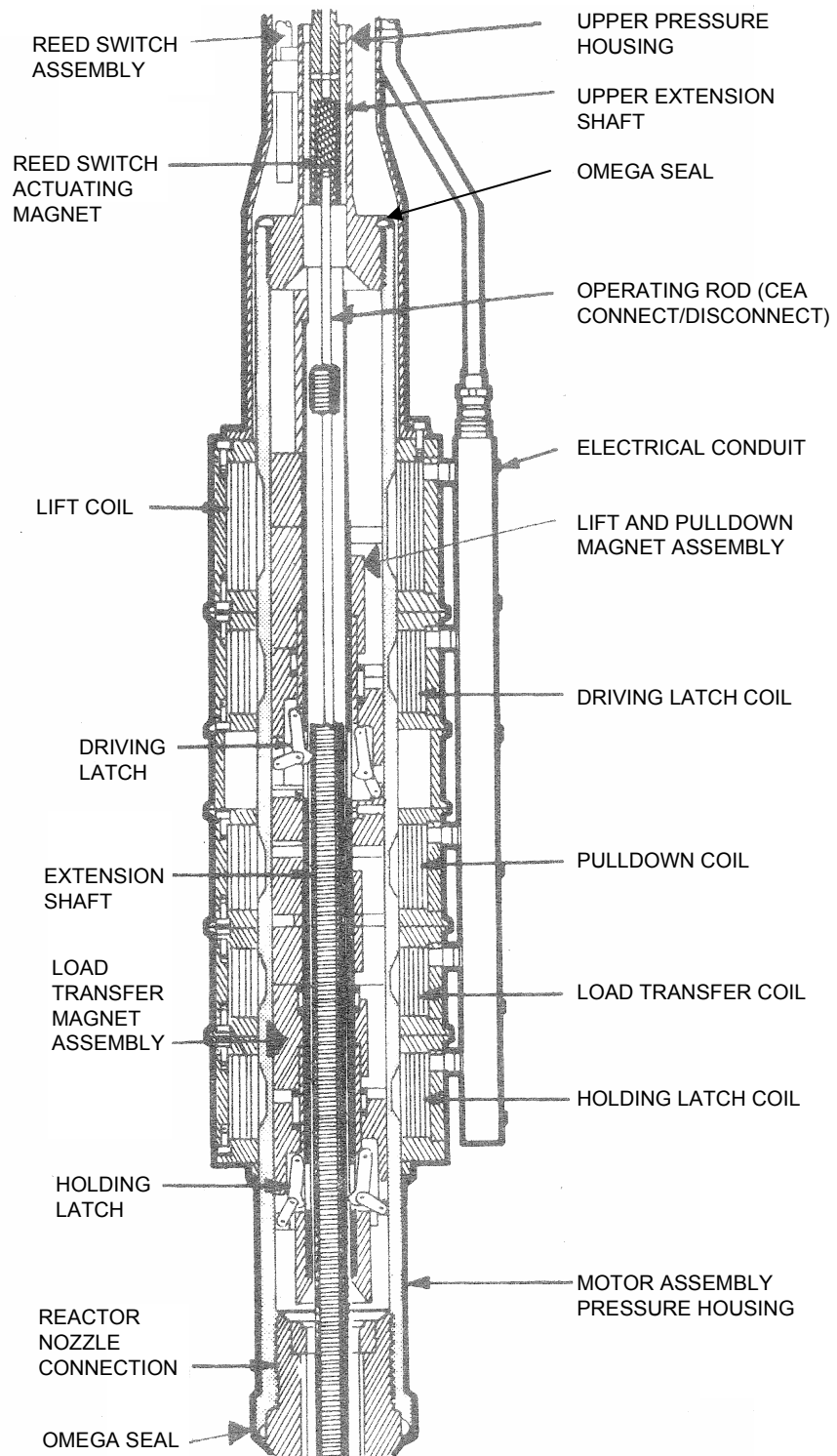

SAR FIGURE NO. 4.2-17

AMENDMENT 20

ARKANSAS NUCLEAR ONE
UNIT 2
RUSSELLVILLE, ARKANSAS



SCALE:	NONE
DRAWN:	ENERGY
DESIGN:	ENERGY
CAD NO:	N/A

CONTROL ELEMENT DRIVE MECHANISM
(MAGNETIC JACK)

DRAWING NO

SHEET

REV.

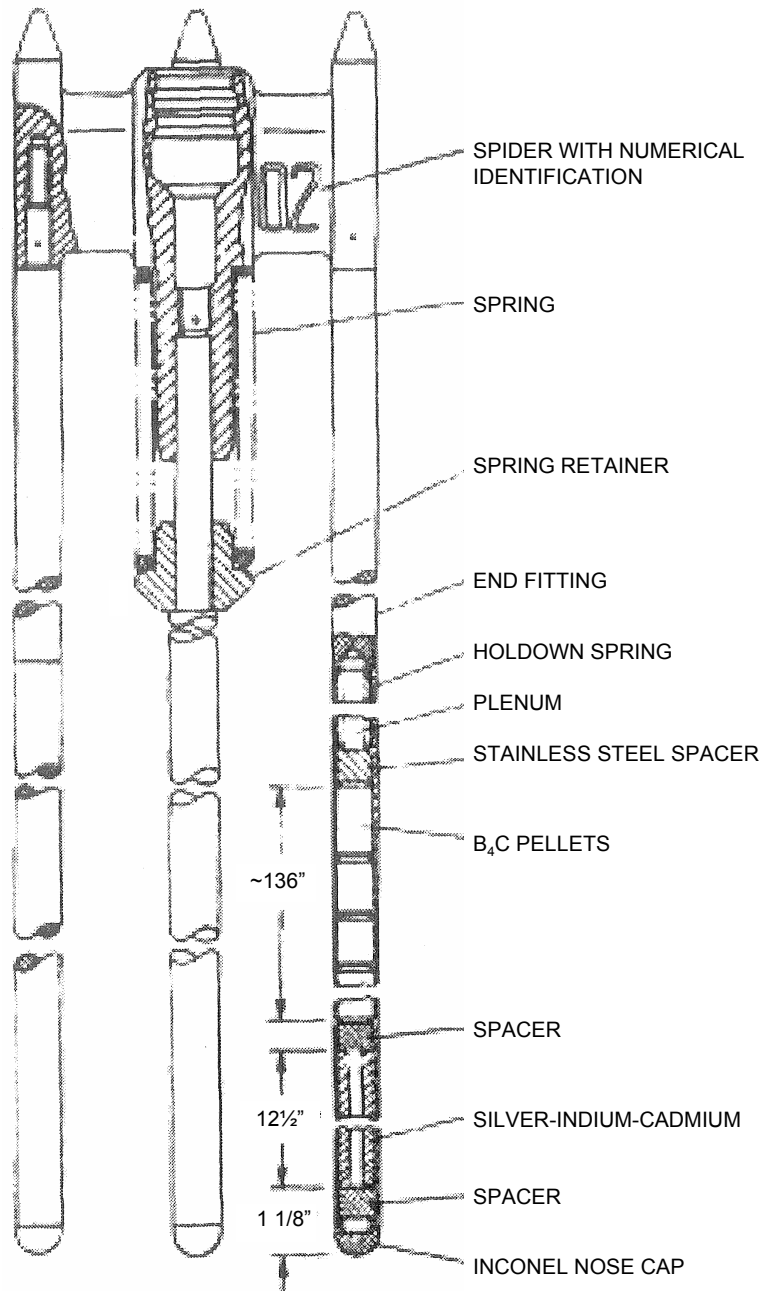

SAR FIGURE NO. 4.2-18

AMENDMENT 20

ARKANSAS NUCLEAR ONE
UNIT 2
RUSSELLVILLE, ARKANSAS



SCALE:	NONE
DRAWN:	ENERGY
DESIGN:	ENERGY
CAD NO:	N/A

FULL LENGTH CEA

DRAWING NO

SHEET

REV.

DELETED

SAR FIGURE NO. 4.2-18A

AMENDMENT 20

ARKANSAS NUCLEAR ONE
UNIT 2
RUSSELLVILLE, ARKANSAS



SCALE:	NONE
DRAWN:	ENERGY
DESIGN:	ENERGY
CAD NO:	N/A

PART LENGTH CEA

DRAWING NO

SHEET

REV.

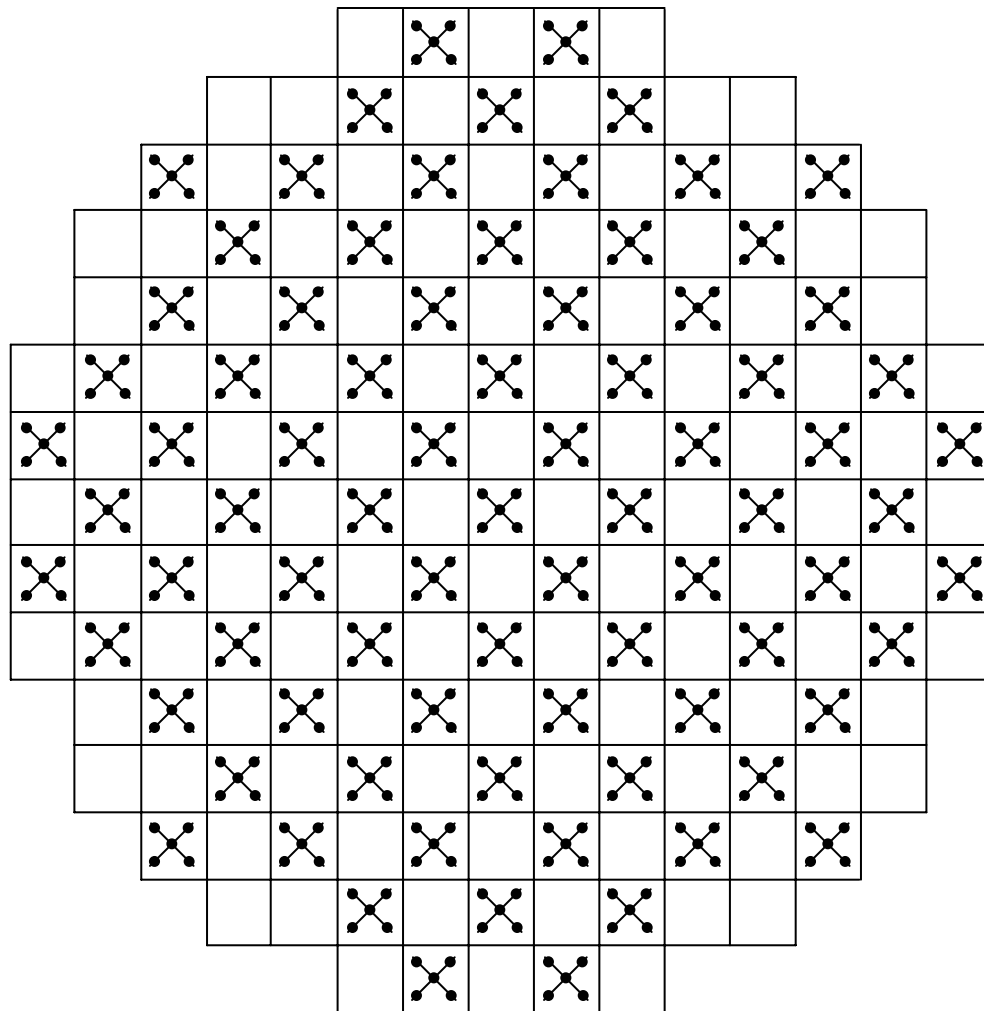

- FULL LENGTH CEA'S 81

SAR FIGURE NO. 4.2-19

AMENDMENT 20

ARKANSAS NUCLEAR ONE
 UNIT 2
 RUSSELLVILLE, ARKANSAS



SCALE:	NONE
DRAWN:	ENERGY
DESIGN:	ENERGY
CAD NO:	N/A

CONTROL ELEMENT ASSEMBLY
 LOCATIONS

DRAWING NO

SHEET

REV.

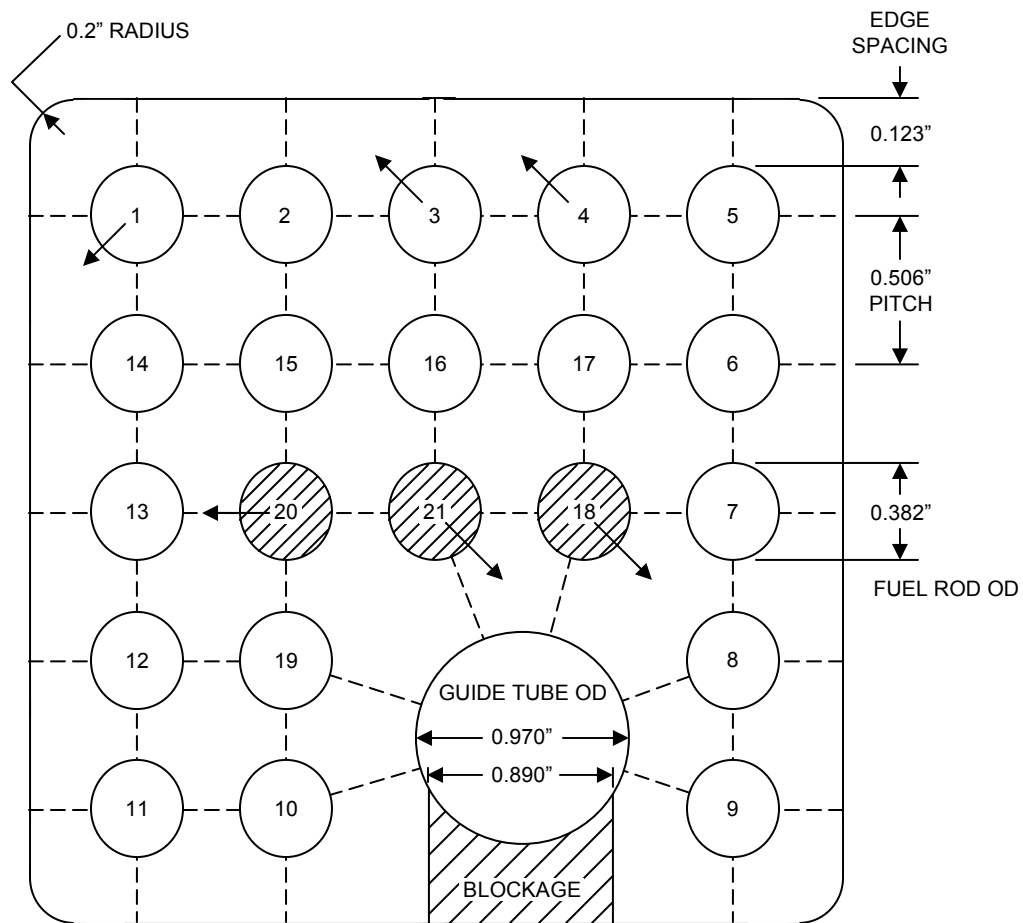

CROSS-HATCH RODS HAVE APPROXIMATELY 20% HIGHER POWER THAN OTHER RODS
AXIAL LOCATION AND MAGNITUDE OF ROD TO ROD GAPS LESS THAN 0.100 IN.

<u>RODS</u>	<u>MINIMUM GAP, IN.</u>	<u>DISTANCE UPSTREAM OF END OF HEATED LENGTH, IN.</u>
PROPRIETARY INFORMATION		

NOTE:
AS-BUILT GUIDE TUBE DIMENSIONS ARE:
OD 0.98"
ID 0.90"

SAR FIGURE NO. 4.2-20

AMENDMENT 20

ARKANSAS NUCLEAR ONE
UNIT 2
RUSSELLVILLE, ARKANSAS



SCALE:	NONE
DRAWN:	ENERGY
DESIGN:	ENERGY
CAD NO:	N/A

LATERAL GEOMETRY AND DIRECTION OF
ROD BOWING

DRAWING NO

SHEET

REV.

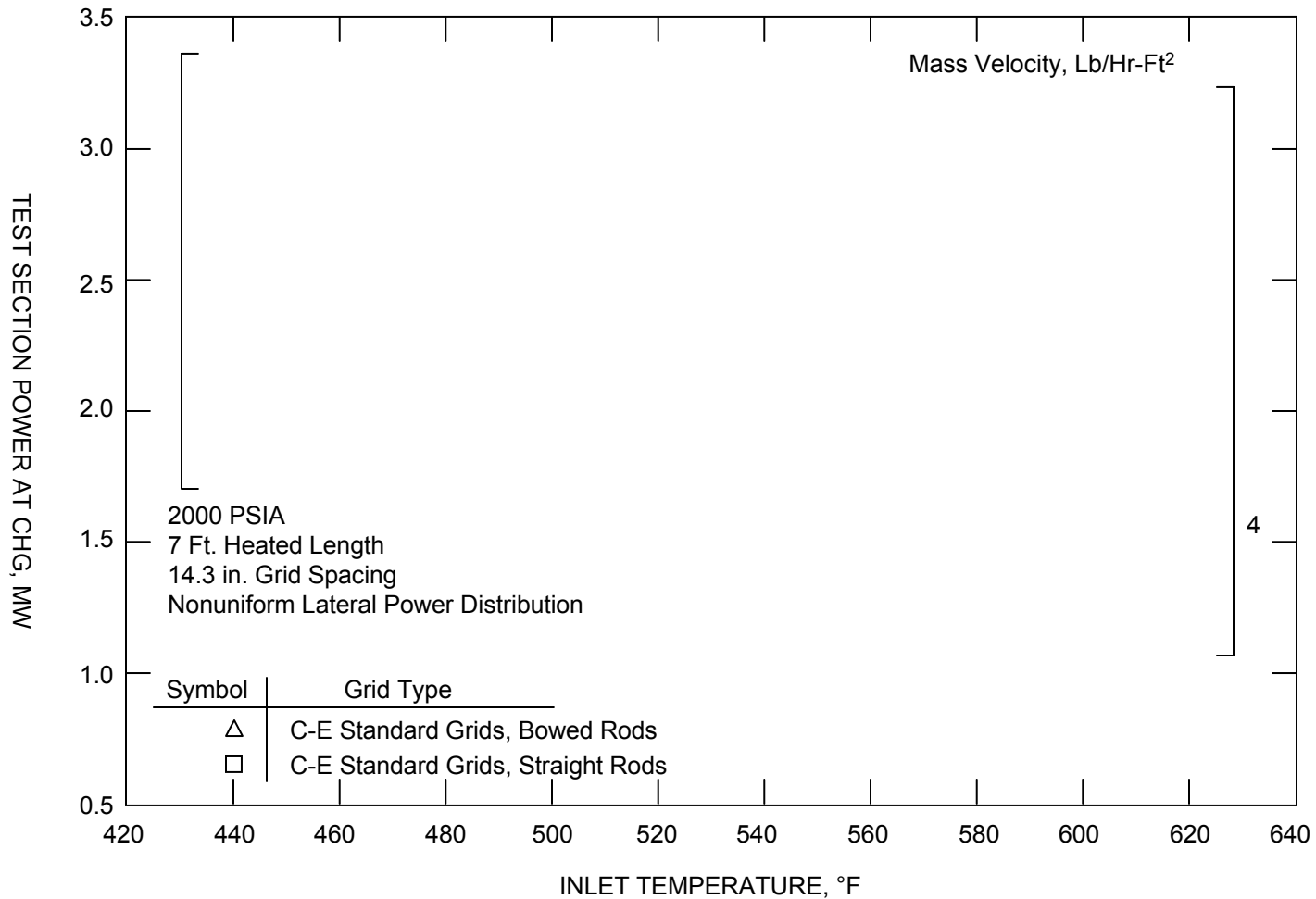

EFFECT OF BOWED RODS ON CHF IN A 16 X 16 TYPE ROD BUNDLE

SAR FIGURE NO. 4.2-21

ARKANSAS NUCLEAR ONE
UNIT 2
RUSSELLVILLE, ARKANSAS



SCALE: NONE
DRAWN: ENTERGY
DESIGN: ENTERGY
CAD NO:

AMENDMENT 20

BASED ON DRAWING NO

SHEET

REV.

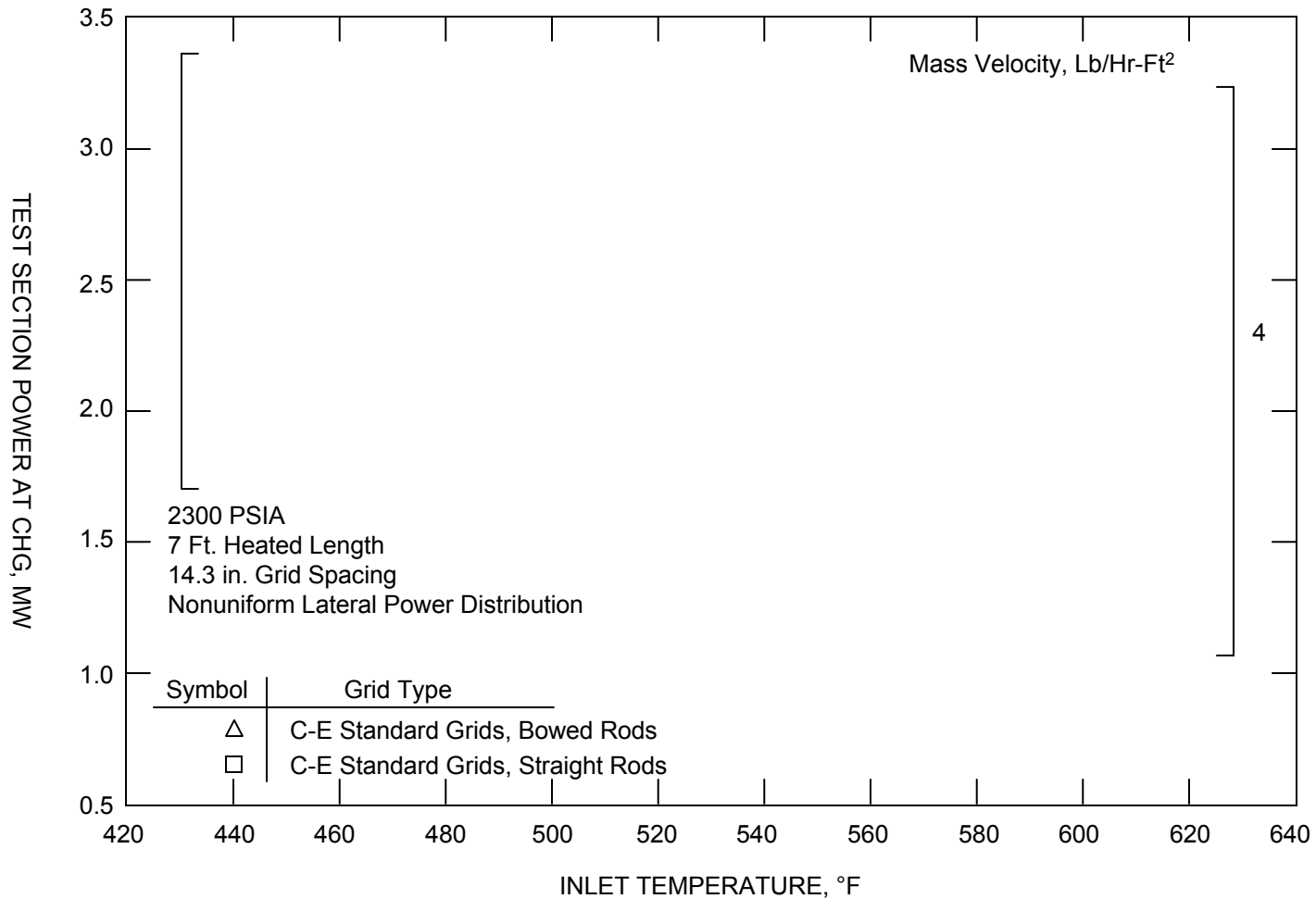

EFFECT OF BOWED RODS ON CHF IN A 16 X 16 TYPE BUNDLE

SAR FIGURE NO. 4.2-22

ARKANSAS NUCLEAR ONE
UNIT 2
RUSSELLVILLE, ARKANSAS



SCALE: NONE
DRAWN: ENTERGY
DESIGN: ENTERGY
CAD NO:

AMENDMENT 20

BASED ON DRAWING NO

SHEET

REV.

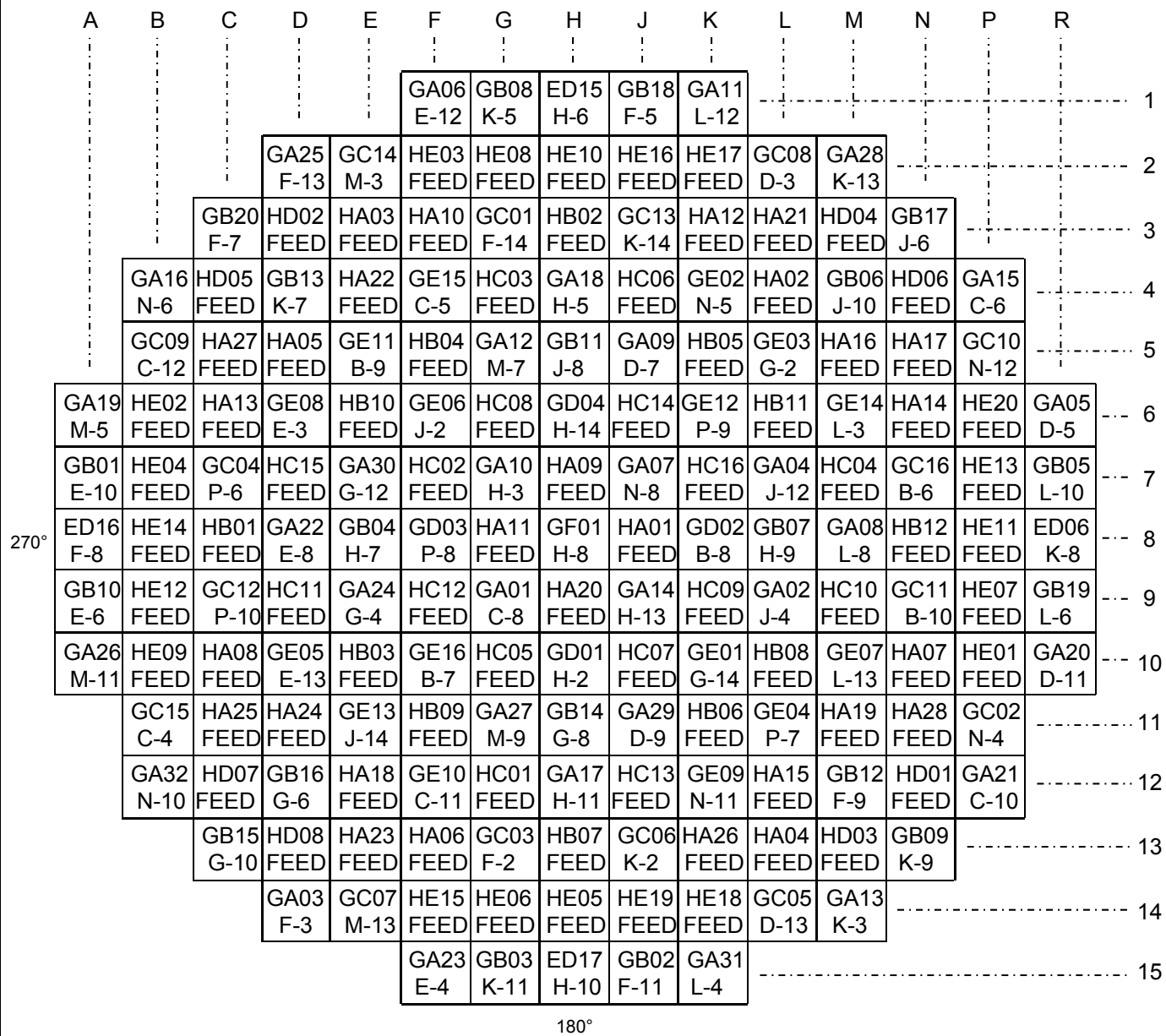
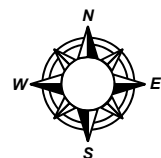

Y YY Assembly Identifier
 Z-ZZ Previous Cycle Location

SAR FIGURE NO. 4.3-1

AMENDMENT 28

ARKANSAS NUCLEAR ONE
 UNIT 2
 RUSSELLVILLE, ARKANSAS



SDALE:	NONE
DRAWN:	WESTINGHOUSE
EBSIGN:	ENERGY
DAD NO:	

CYCLE 27 FUEL MANAGEMENT SCHEME

BASED ON DRAWING NO

SHEET

REV.

1

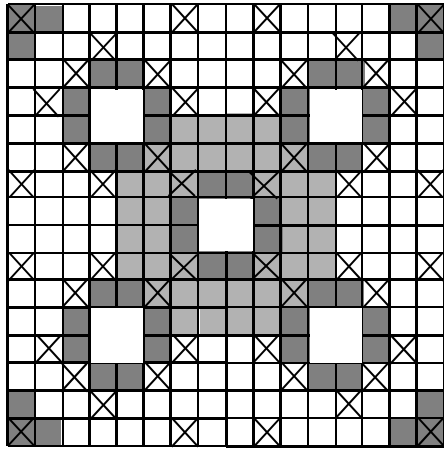

HD (48 ZrB₂ Pins)

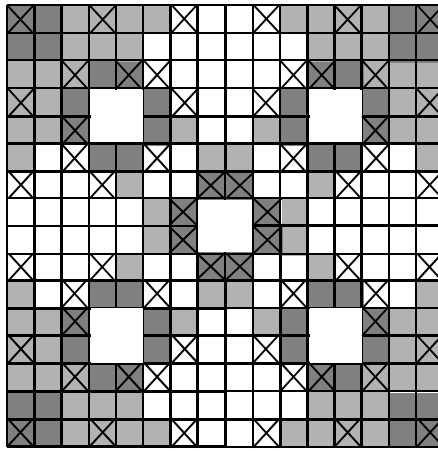

HE and GC (60 ZrB₂ Pins)

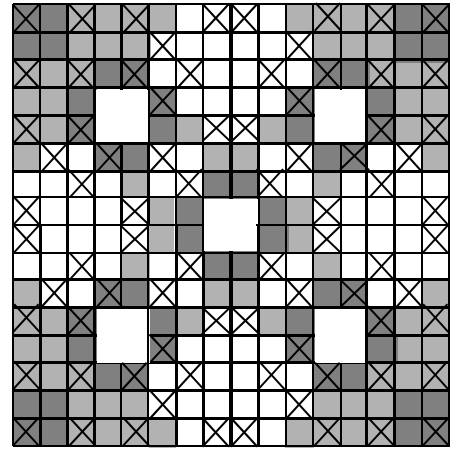

GD (80 ZrB₂ Pins)

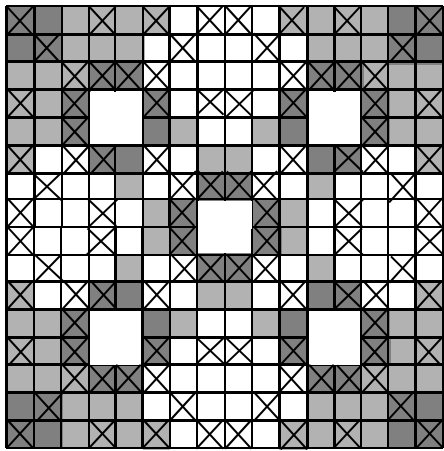

HA and GE (100 ZrB₂ Pins)

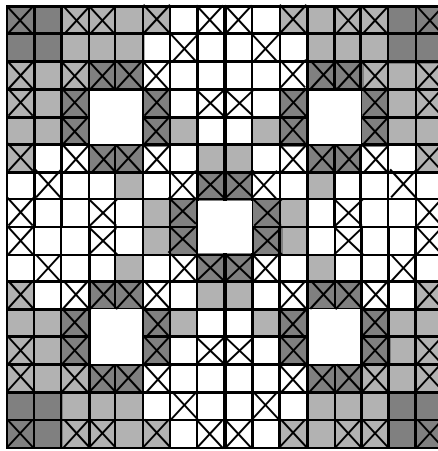

HB, ED and GA (112 ZrB₂ Pins)

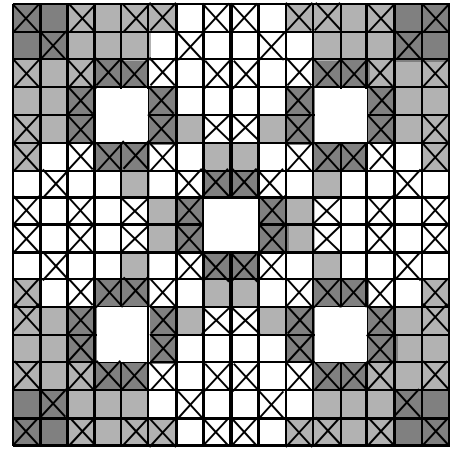

HC and GB (124 ZrB₂ Pins)

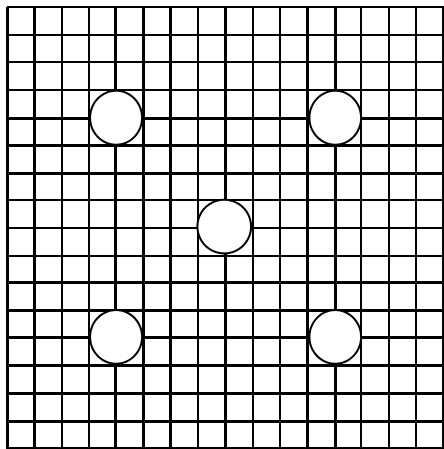

GF (0 ZrB₂ Pins)

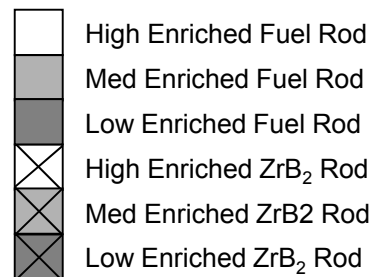

Note: Region GF contains only low, low enriched non-ZrB₂ pins.

SAR FIGURE NO. 4.3-1A

AMENDMENT 28

ARKANSAS NUCLEAR ONE
 UNIT 2
 RUSSELLVILLE, ARKANSAS



SCALE: NONE
 DRAWN: WESTINGHOUSE
 DESIGN: ENTERGY
 CAD NO:

CYCLE 27 INTEGRAL BURNABLE POISON SHIM AND ENRICHMENT ZONING PATTERNS FOR REGION EE, GG AND HH FUEL ASSEMBLIES

BASED ON DRAWING NO

SHEET

REV.

1

Sub-Batch ID	Number of Assemblies	Fuel Rods per Assembly (Excluding ZrB ₂ Rods)	Nominal Enrichment (wt. %)	ZrB ₂ Rods per Assembly	Shim Loading (ZrB ₂)	Number of Fuel Rods (Including ZrB ₂ rods)	Number of ZrB ₂ Rods
HA	28	64	3.75	40	2.0 x	2912	1120
		56	3.50	20	2.0 x	2128	560
		16	3.25	40	2.0 x	1568	1120
HB	12	64	3.75	40	2.0 x	1248	480
		48	3.50	28	2.0 x	912	336
		12	3.25	44	2.0 x	672	528
HC	16	56	3.75	48	2.0 x	1664	768
		48	3.50	28	2.0 x	1216	448
		8	3.25	48	2.0 x	896	768
HD	8	108	3.95	36	2.0 x	1152	288
		32	3.70	8	2.0 x	320	64
		48	3.45	4	2.0 x	416	32
HE	20	76	3.95	28	2.0 x	2080	560
		64	3.70	12	2.0 x	1520	240
		36	3.45	20	2.0 x	1120	400
Total	84					19824	7712

Sub-Batch ID	Number of Assemblies	Fuel Rods per Assembly (Excluding ZrB ₂ Rods)	Nominal Enrichment (wt. %)	ZrB ₂ Rods per Assembly	Shim Loading (ZrB ₂)	Number of Fuel Rods (Including ZrB ₂ rods)	Number of ZrB ₂ Rods
GA	32	64	4.12	40	2.0 x	3328	1280
		48	3.87	28	2.0 x	2432	896
		12	3.62	44	2.0 x	1792	1408
GB	20	56	4.12	48	2.0 x	2080	960
		48	3.87	28	2.0 x	1520	560
		8	3.62	48	2.0 x	1120	960
GC	16	76	4.37	28	2.0 x	1664	448
		64	4.12	12	2.0 x	1216	192
		36	3.87	20	2.0 x	896	320
GD	4	64	4.37	40	2.0 x	416	160
		56	4.12	20	2.0 x	304	80
		36	3.87	20	2.0 x	224	80
GE	16	64	4.37	40	2.0 x	1664	640
		56	4.12	20	2.0 x	1216	320
		16	3.87	40	2.0 x	896	640
GF	1	236	1.80	0	N/A	236	0
Total	89					21004	8944

Sub-Batch ID	Number of Assemblies	Fuel Rods per Assembly (Excluding ZrB ₂ Rods)	Nominal Enrichment (wt. %)	ZrB ₂ Rods per Assembly	Shim Loading (ZrB ₂)	Number of Fuel Rods (Including ZrB ₂ rods)	Number of ZrB ₂ Rods
ED	4	64	3.50	40	2.0 x	416	160
		48	3.25	28	2.0 x	304	112
		12	3.00	44	2.0 x	224	176
Total	4					944	448

GRAND TOTAL	177					41772	17104
--------------------	------------	--	--	--	--	--------------	--------------

SAR FIGURE NO. 4.3-1C

AMENDMENT 28

ARKANSAS NUCLEAR ONE
UNIT 2
RUSSELLVILLE, ARKANSAS



SCALE: NONE
DRAWN: WESTINGHOUSE
DESIGN: ENTERGY
CAD NO:

CYCLE 27 CORE LOADING

BASED ON DRAWING NO

SHEET

REV.

1

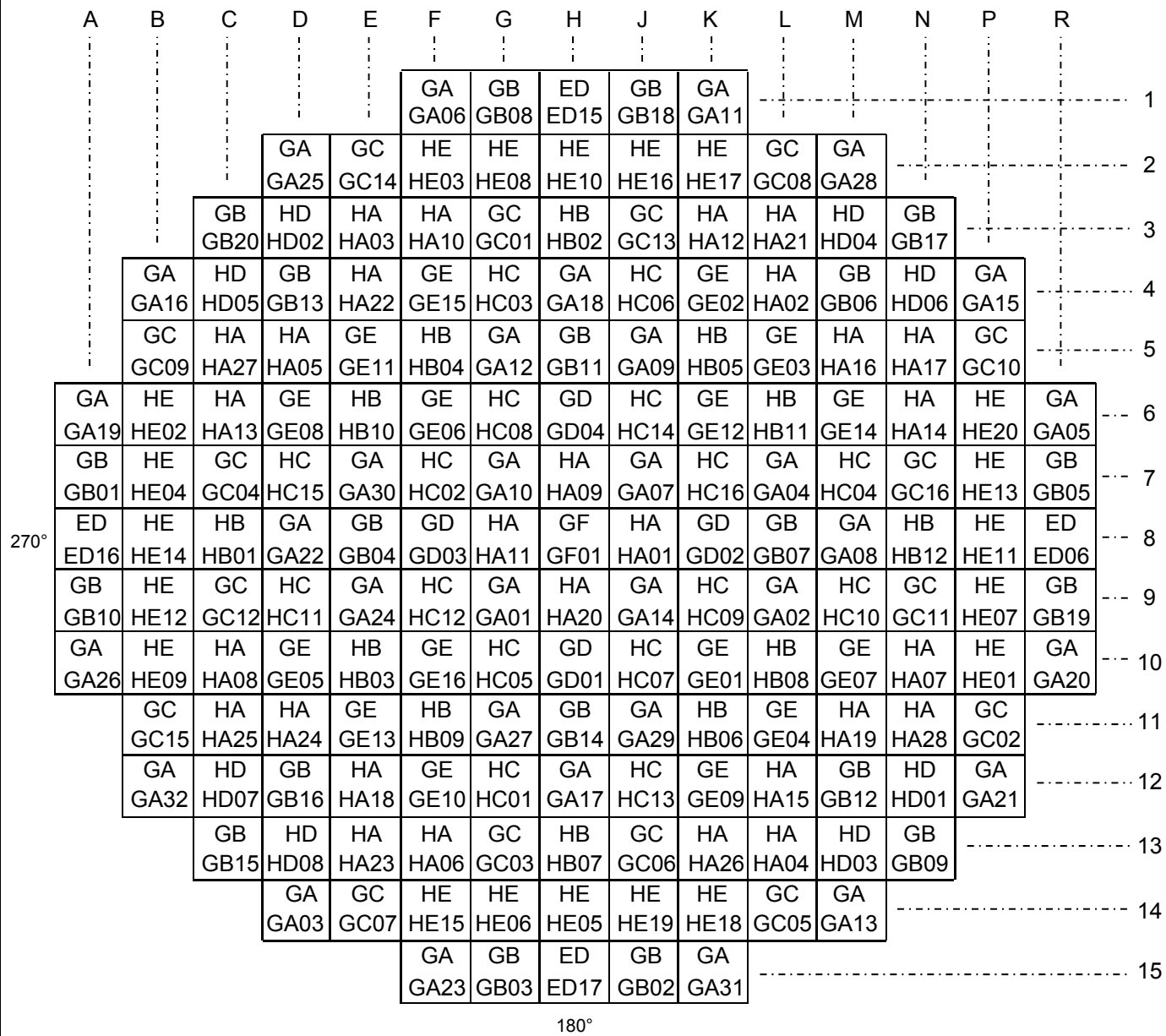
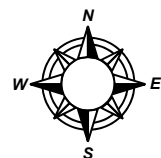

SAR FIGURE NO. 4.3-1D

AMENDMENT 28

ARKANSAS NUCLEAR ONE
UNIT 2
RUSSELLVILLE, ARKANSAS



SCALE:	NONE
DRAWN:	WESTINGHOUSE
DESIGN:	ENERGY
CAD NO:	

CYCLE 27 CORE MAP

BASED ON DRAWING NO

SHEET

REV.

1

nn	DD
XXXXX	
Y.YY/Y.YY/Y.YY	

DD = Batch Identifier for Assembly nn

Assembly Average Burnup (MWD/T)

Enrichment Zoning

1	GF	2	HA	3	GD	4	GB	5	GA	6	HB	7	HE	8	ED
15753		0		18780		20045		21241		0		0		37845	
		3.75/3.50/3.25								3.75/3.50/3.25		3.95/3.70/3.45			
9	HA	10	GA	11	HC	12	GA	13	HC	14	GC	15	HE	16	GB
0		21206		0		21481		0		16225		0		21671	
3.75/3.50/3.25				3.75/3.50/3.25				3.75/3.50/3.25				3.95/3.70/3.45			
17	GD	18	HC	19	GE	20	HB	21	GE	22	HA	23	HE	24	GA
18780		0		17969		0		19025		0		0		21058	
		3.75/3.50/3.25				3.75/3.50/3.25				3.75/3.50/3.25		3.95/3.70/3.45			
25	GB	26	GA	27	HB	28	GE	29	HA	30	HA	31	GC		
20045		21493		0		17977		0		0		15479			
				3.75/3.50/3.25				3.75/3.50/3.25		3.75/3.50/3.25					
32	GA	33	HC	34	GE	35	HA	36	GB	37	HD	38	GA		
21241		0		19014		0		20901		0		20308			
		3.75/3.50/3.25				3.75/3.50/3.25				3.95/3.70/3.45					
39	HB	40	GC	41	HA	42	HA	43	HD	44	GB				
0		16214		0		0		0		20901					
3.75/3.50/3.25				3.75/3.50/3.25		3.75/3.50/3.25		3.95/3.70/3.45							
45	HE	46	HE	47	HE	48	GC	49	GA						
0		0		0		15480		20291							
3.95/3.70/3.45		3.95/3.70/3.45		3.95/3.70/3.45											
50	ED	51	GB	52	GA										
37845		21640		21025											

Regions EE, GG and HH rods have annular pellets in top & bottom 6" of rod at the rod's nominal enrichment

SAR FIGURE NO. 4.3-1E

AMENDMENT 28

ARKANSAS NUCLEAR ONE
UNIT 2
RUSSELLVILLE, ARKANSAS



SCALE:	NONE
DRAWN:	
DESIGN:	
CAD NO:	

CYCLE 27 BOC ASSEMBLY AVERAGE BURNUP AND
INITIAL ENRICHMENT DISTRIBUTION EOC 26 = SHORT
ENDPOINT

BASED ON DRAWING NO

SHEET

REV.

1

GF 0.85	HA 1.13	GD 1.29	GB 1.30	GA 1.24	HB 1.16	HE 1.14	ED 0.44
HA 1.13	GA 1.16	HC 1.12	GA 1.23	HC 1.13	GC 1.30	HE 1.13	GB 0.55
GD 1.29	HC 1.12	GE 1.27	HB 1.16	GE 1.24	HA 1.09	HE 0.98	GA 0.44
GB 1.30	GA 1.23	HB 1.16	GE 1.27	HA 1.11	HA 0.96	GC 0.72	
GA 1.24	HC 1.13	GE 1.23	HA 1.10	GB 1.07	HD 0.94	GA 0.43	
HB 1.16	GC 1.30	HA 1.09	HA 0.95	HD 0.94	GB 0.52		
HE 1.14	HE 1.13	HE 0.98	GC 0.72	GA 0.43			
ED 0.44	GB 0.56	GA 0.44					

1A	Region
AP	Assembly Power

Maximum 1-Pin Peak (Fxy) = 1.436 in quarter-core assembly (1, 4)

SAR FIGURE NO. 4.3-2

AMENDMENT 28

ARKANSAS NUCLEAR ONE
UNIT 2
RUSSELLVILLE, ARKANSAS



SCALE:	NONE
DRAWN:	
DESIGN:	
CAD NO:	

CYCLE 27 BOC, HFP, EQUILIBRIUM XENON, ARO,
ASSEMBLY RELATIVE POWER DENSITY
EOC 26 = SHORT ENDPOINT

BASED ON DRAWING NO

SHEET

REV.

1

GF 0.82	HA 1.20	GD 1.10	GB 1.02	GA 1.07	HB 1.26	HE 1.11	ED 0.39
HA 1.20	GA 1.07	HC 1.23	GA 1.07	HC 1.25	GC 1.18	HE 1.09	GB 0.49
GD 1.10	HC 1.23	GE 1.18	HB 1.29	GE 1.19	HA 1.26	HE 1.01	GA 0.40
GB 1.02	GA 1.07	HB 1.29	GE 1.21	HA 1.28	HA 1.16	GC 0.71	
GA 1.07	HC 1.25	GE 1.19	HA 1.28	GB 1.02	HD 0.94	GA 0.41	
HB 1.26	GC 1.18	HA 1.26	HA 1.16	HD 0.94	GB 0.47		
HE 1.11	HE 1.09	HE 1.01	GC 0.71	GA 0.41			
ED 0.39	GB 0.49	GA 0.40					

1A	Region
AP	Assembly Power

Maximum 1-Pin Peak (Fxy) = 1.405 in quarter-core assembly (4, 5)

SAR FIGURE NO. 4.3-3

AMENDMENT 28

ARKANSAS NUCLEAR ONE
UNIT 2
RUSSELLVILLE, ARKANSAS



SCALE:	NONE
DRAWN:	
DESIGN:	
CAD NO:	

CYCLE 27 MOC, HFP, EQUILIBRIUM XENON, ARO,
ASSEMBLY RELATIVE POWER DENSITY
EOC 26 = SHORT ENDPOINT

BASED ON DRAWING NO

SHEET

REV.

1

GF 0.87	HA 1.22	GD 1.07	GB 0.98	GA 1.02	HB 1.24	HE 1.13	ED 0.44
HA 1.22	GA 1.05	HC 1.22	GA 1.02	HC 1.22	GC 1.13	HE 1.13	GB 0.54
GD 1.07	HC 1.22	GE 1.12	HB 1.24	GE 1.12	HA 1.25	HE 1.06	GA 0.45
GB 0.98	GA 1.02	HB 1.24	GE 1.13	HA 1.25	HA 1.19	GC 0.75	
GA 1.02	HC 1.22	GE 1.12	HA 1.25	GB 1.01	HD 1.01	GA 0.46	
HB 1.24	GC 1.13	HA 1.25	HA 1.19	HD 1.01	GB 0.52		
HE 1.13	HE 1.13	HE 1.06	GC 0.75	GA 0.46			
ED 0.44	GB 0.54	GA 0.45					

1A	Region
AP	Assembly Power

Maximum 1-Pin Peak (Fxy) = 1.338 in quarter-core assembly (6, 3)

SAR FIGURE NO. 4.3-4

AMENDMENT 28

ARKANSAS NUCLEAR ONE
UNIT 2
RUSSELLVILLE, ARKANSAS



SCALE: NONE
DRAWN:
DESIGN:
CAD NO:

CYCLE 27 EOC, HFP, EQUILIBRIUM XENON, ARO,
ASSEMBLY RELATIVE POWER DENSITY
EOC 26 = LONG ENDPOINT

BASED ON DRAWING NO

SHEET

REV.

1

GF 0.95	HA 1.24	GD 1.35	GB 1.21	GA 0.80	HB 1.12	HE 1.23	ED 0.50
HA 1.24	GA 1.26	HC 1.16	GA 1.18	HC 1.04	GC 1.31	HE 1.24	GB 0.63
GD 1.35	HC 1.16	GE 1.23	HB 1.05	GE 1.19	HA 1.14	HE 1.09	GA 0.50
GB 1.21	GA 1.18	HB 1.05	GE 0.80	HA 1.02	HA 1.01	GC 0.80	
GA 0.80	HC 1.04	GE 1.18	HA 1.02	GB 1.06	HD 1.01	GA 0.48	
HB 1.12	GC 1.31	HA 1.14	HA 1.00	HD 1.01	GB 0.56		
HE 1.23	HE 1.24	HE 1.09	GC 0.80	GA 0.48			
ED 0.50	GB 0.63	GA 0.51					

1A	Region
AP	Assembly Power

Maximum 1-Pin Peak (Fxy) = 1.500 in quarter-core assembly (1, 3)

SAR FIGURE NO. 4.3-5

AMENDMENT 28

ARKANSAS NUCLEAR ONE
UNIT 2
RUSSELLVILLE, ARKANSAS



SCALE: NONE
DRAWN:
DESIGN:
CAD NO:

CYCLE 27 BOC, HFP, BANK P INSERTED, ASSEMBLY
RELATIVE POWER DENSITY EOC 26 = SHORT ENDPOINT

BASED ON DRAWING NO

SHEET

REV.

1

GF 0.55	HA 1.07	GD 1.34	GB 1.38	GA 1.33	HB 1.26	HE 1.25	ED 0.49
HA 1.07	GA 1.16	HC 1.17	GA 1.30	HC 1.20	GC 1.39	HE 1.23	GB 0.61
GD 1.34	HC 1.17	GE 1.32	HB 1.19	GE 1.25	HA 1.12	HE 1.03	GA 0.47
GB 1.38	GA 1.30	HB 1.19	GE 1.22	HA 0.99	HA 0.88	GC 0.70	
GA 1.33	HC 1.20	GE 1.25	HA 0.98	GB 0.61	HD 0.74	GA 0.38	
HB 1.26	GC 1.39	HA 1.12	HA 0.88	HD 0.74	GB 0.40		
HE 1.25	HE 1.23	HE 1.03	GC 0.70	GA 0.38			
ED 0.49	GB 0.61	GA 0.48					

1A	Region
AP	Assembly Power

Maximum 1-Pin Peak (Fxy) = 1.539 in quarter-core assembly (1, 4)

SAR FIGURE NO. 4.3-6

AMENDMENT 28

ARKANSAS NUCLEAR ONE
UNIT 2
RUSSELLVILLE, ARKANSAS



SCALE: NONE
DRAWN:
DESIGN:
CAD NO:

CYCLE 27 BOC, HFP, BANK 6 INSERTED, ASSEMBLY
RELATIVE POWER DENSITY EOC 26 = SHORT ENDPOINT

BASED ON DRAWING NO

SHEET

REV.

1

GF 0.61	HA 1.17	GD 1.39	GB 1.28	GA 0.86	HB 1.22	HE 1.35	ED 0.55
HA 1.17	GA 1.25	HC 1.20	GA 1.24	HC 1.11	GC 1.41	HE 1.34	GB 0.69
GD 1.39	HC 1.20	GE 1.28	HB 1.08	GE 1.21	HA 1.17	HE 1.14	GA 0.54
GB 1.28	GA 1.24	HB 1.08	GE 0.76	HA 0.90	HA 0.93	GC 0.78	
GA 0.86	HC 1.11	GE 1.21	HA 0.90	GB 0.60	HD 0.80	GA 0.43	
HB 1.22	GC 1.41	HA 1.17	HA 0.93	HD 0.80	GB 0.44		
HE 1.35	HE 1.34	HE 1.14	GC 0.78	GA 0.42			
ED 0.55	GB 0.69	GA 0.54					

1A	Region
AP	Assembly Power

Maximum 1-Pin Peak (Fxy) = 1.605 in quarter-core assembly (2, 7)

SAR FIGURE NO. 4.3-7

AMENDMENT 28

ARKANSAS NUCLEAR ONE
UNIT 2
RUSSELLVILLE, ARKANSAS



SCALE: NONE
DRAWN:
DESIGN:
CAD NO:

CYCLE 27 BOC, HFP, BANK 6+P INSERTED, ASSEMBLY
RELATIVE POWER DENSITY EOC 26 = SHORT ENDPOINT

BASED ON DRAWING NO

SHEET

REV.

1

GF 0.96	HA 1.33	GD 1.12	GB 0.92	GA 0.65	HB 1.19	HE 1.21	ED 0.49
HA 1.33	GA 1.13	HC 1.26	GA 0.98	HC 1.13	GC 1.14	HE 1.21	GB 0.60
GD 1.12	HC 1.26	GE 1.09	HB 1.13	GE 1.08	HA 1.30	HE 1.16	GA 0.50
GB 0.92	GA 0.98	HB 1.13	GE 0.71	HA 1.17	HA 1.25	GC 0.82	
GA 0.65	HC 1.13	GE 1.08	HA 1.17	GB 1.01	HD 1.07	GA 0.50	
HB 1.19	GC 1.14	HA 1.30	HA 1.25	HD 1.07	GB 0.56		
HE 1.21	HE 1.21	HE 1.16	GC 0.82	GA 0.50			
ED 0.49	GB 0.60	GA 0.50					

1A	Region
AP	Assembly Power

Maximum 1-Pin Peak (Fxy) = 1.447 in quarter-core assembly (1, 2)

SAR FIGURE NO. 4.3-8

AMENDMENT 28

ARKANSAS NUCLEAR ONE
UNIT 2
RUSSELLVILLE, ARKANSAS



SCALE: NONE
DRAWN:
DESIGN:
CAD NO:

CYCLE 27 EOC, HFP, BANK P INSERTED, ASSEMBLY
RELATIVE POWER DENSITY EOC 26 = LONG ENDPOINT

BASED ON DRAWING NO

SHEET

REV.

1

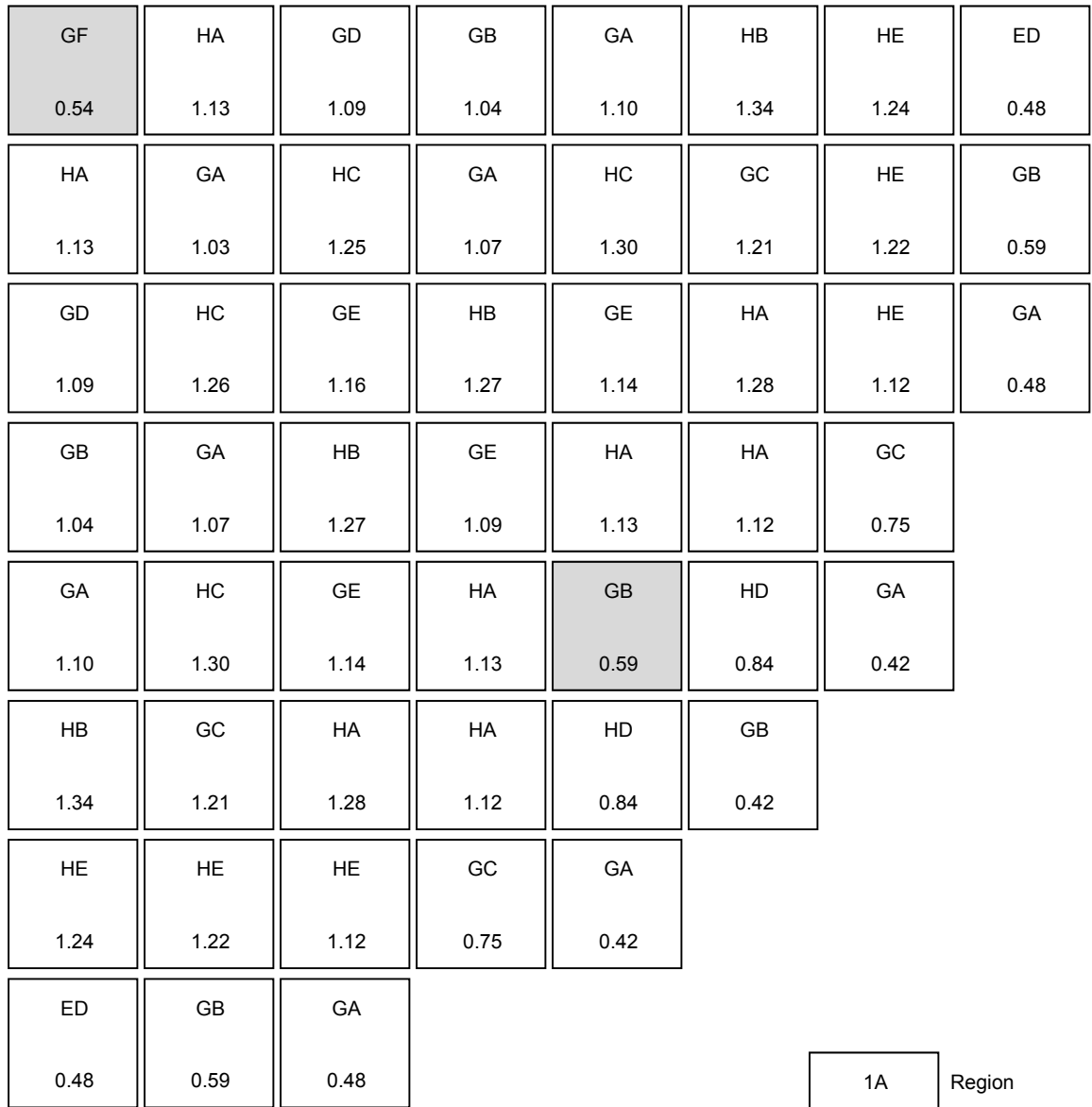

1A	Region
AP	Assembly Power

Maximum 1-Pin Peak (Fxy) = 1.448 in quarter-core assembly (1, 6)

SAR FIGURE NO. 4.3-9

AMENDMENT 28

ARKANSAS NUCLEAR ONE
UNIT 2
RUSSELLVILLE, ARKANSAS



SCALE:	NONE
DRAWN:	
DESIGN:	
CAD NO:	

CYCLE 27 EOC, HFP, BANK 6 INSERTED, ASSEMBLY
RELATIVE POWER DENSITY EOC 26 = LONG ENDPOINT

BASED ON DRAWING NO

SHEET

REV.

1

GF 0.59	HA 1.23	GD 1.14	GB 0.97	GA 0.70	HB 1.29	HE 1.32	ED 0.54
HA 1.23	GA 1.10	HC 1.29	GA 1.03	HC 1.20	GC 1.22	HE 1.31	GB 0.66
GD 1.14	HC 1.29	GE 1.13	HB 1.16	GE 1.10	HA 1.34	HE 1.22	GA 0.54
GB 0.97	GA 1.03	HB 1.16	GE 0.68	HA 1.06	HA 1.18	GC 0.82	
GA 0.70	HC 1.20	GE 1.10	HA 1.06	GB 0.58	HD 0.89	GA 0.46	
HB 1.29	GC 1.22	HA 1.34	HA 1.18	HD 0.89	GB 0.46		
HE 1.32	HE 1.31	HE 1.22	GC 0.82	GA 0.46			
ED 0.54	GB 0.66	GA 0.54					

1A	Region
AP	Assembly Power

Maximum 1-Pin Peak (Fxy) = 1.490 in quarter-core assembly (1, 7)

SAR FIGURE NO. 4.3-10

AMENDMENT 28

ARKANSAS NUCLEAR ONE
UNIT 2
RUSSELLVILLE, ARKANSAS



SCALE: NONE
DRAWN:
DESIGN:
CAD NO:

CYCLE 27 EOC, HFP, BANK 6+P INSERTED, ASSEMBLY
RELATIVE POWER DENSITY EOC 26 = LONG ENDPOINT

BASED ON DRAWING NO

SHEET

REV.

1

DELETED

SAR FIGURE NO. 4.3-11

AMENDMENT 20

ARKANSAS NUCLEAR ONE
UNIT 2
RUSSELLVILLE, ARKANSAS



SCALE:	NONE
DRAWN:	ENERGY
DESIGN:	ENERGY
CAD NO:	N/A

PLANAR AVERAGE POWER DISTRIBUTION BOL, PART
LENGTH ROD AS IF FULL LENGTH, BANK 6 FULL IN,
FULL POWER, NO XENON

BASED ON DRAWING NO

SHEET

REV.

DELETED

SAR FIGURE NO. 4.3-12

AMENDMENT 20

ARKANSAS NUCLEAR ONE
UNIT 2
RUSSELLVILLE, ARKANSAS



SCALE:	NONE
DRAWN:	ENERGY
DESIGN:	ENERGY
CAD NO:	N/A

PLANAR AVERAGE POWER DISTRIBUTION EOL, PART
LENGTH ROD AS IF FULL LENGTH, BANK 6 FULL IN,
FULL POWER, EQUILIBRIUM XENON

BASED ON DRAWING NO

SHEET

REV.

DELETED

SAR FIGURE NO. 4.3-13

AMENDMENT 20

ARKANSAS NUCLEAR ONE
UNIT 2
RUSSELLVILLE, ARKANSAS



SCALE:	NONE
DRAWN:	ENERGY
DESIGN:	ENERGY
CAD NO:	N/A

PLANAR AVERAGE POWER DISTRIBUTION BOL, PART
LENGTH ROD AS IF FULL LENGTH, BANK 6 FULL IN,
FULL POWER, EQUILIBRIUM XENON

BASED ON DRAWING NO

SHEET

REV.

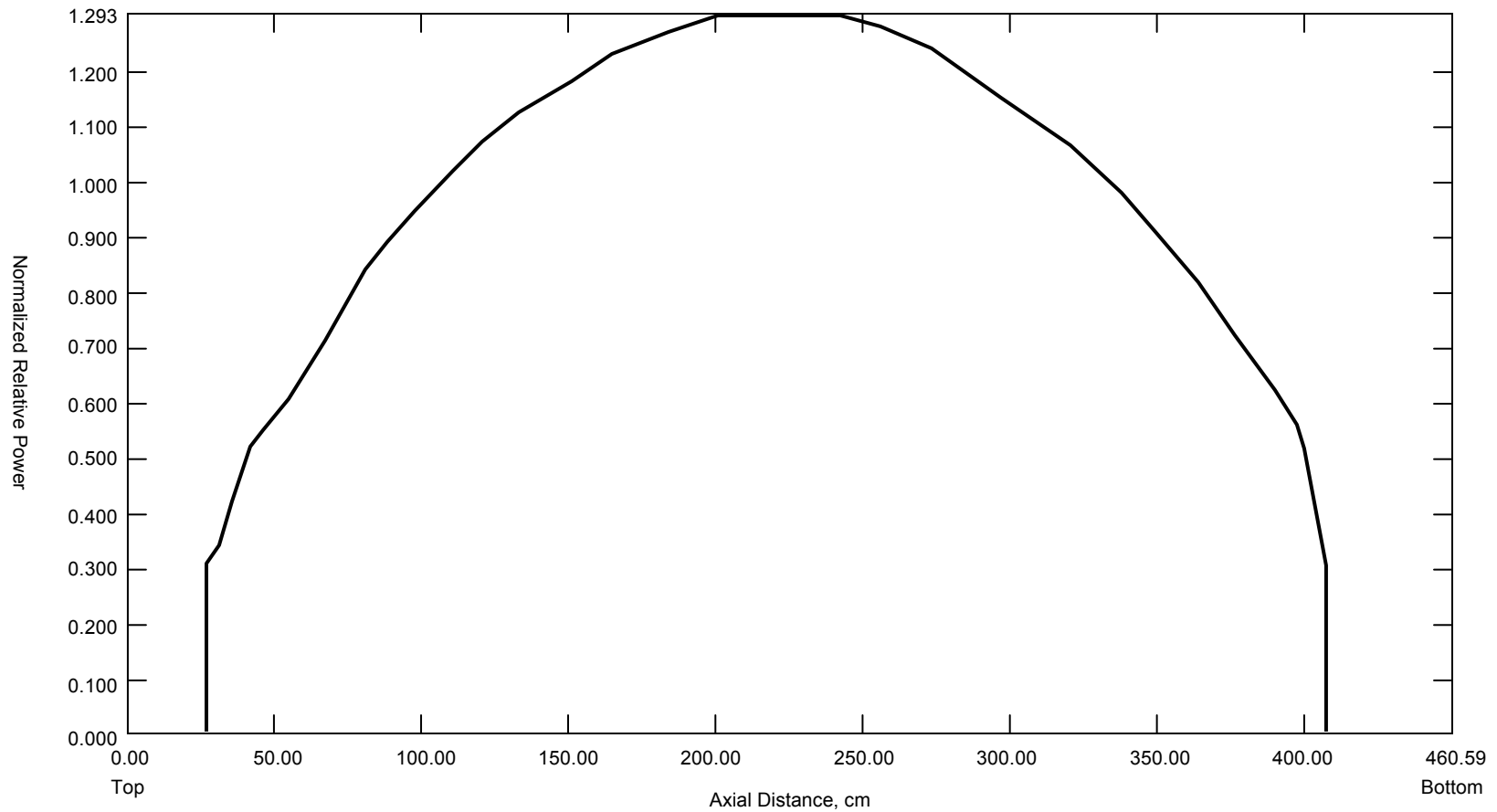

AXIAL POWER SHAPE BEGINNING OF CYCLE

SAR FIGURE NO. 4.3-14

ARKANSAS NUCLEAR ONE
 UNIT 2
 RUSSELLVILLE, ARKANSAS



SCALE: NONE
 DRAWN: ENTERGY
 DESIGN: ENTERGY
 CAD NO:

AMENDMENT 20

BASED ON DRAWING NO	SHEET	REV.

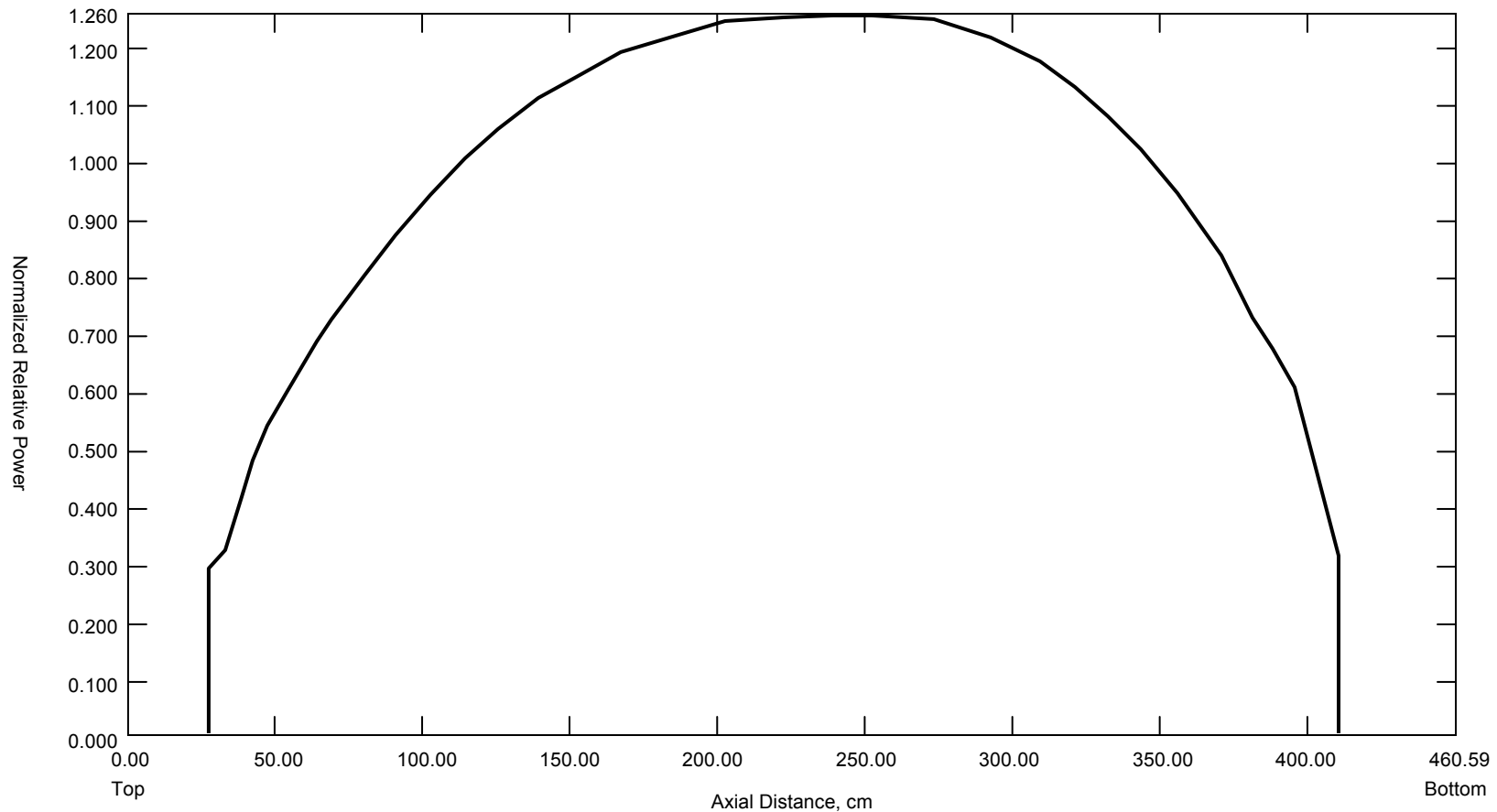

AXIAL POWER SHAPE 3,200 MWD/MTU

SAR FIGURE NO. 4.3-15

ARKANSAS NUCLEAR ONE
 UNIT 2
 RUSSELLVILLE, ARKANSAS



SCALE: NONE
 DRAWN: ENTERGY
 DESIGN: ENTERGY
 CAD NO:

AMENDMENT 20

BASED ON DRAWING NO

SHEET

REV.

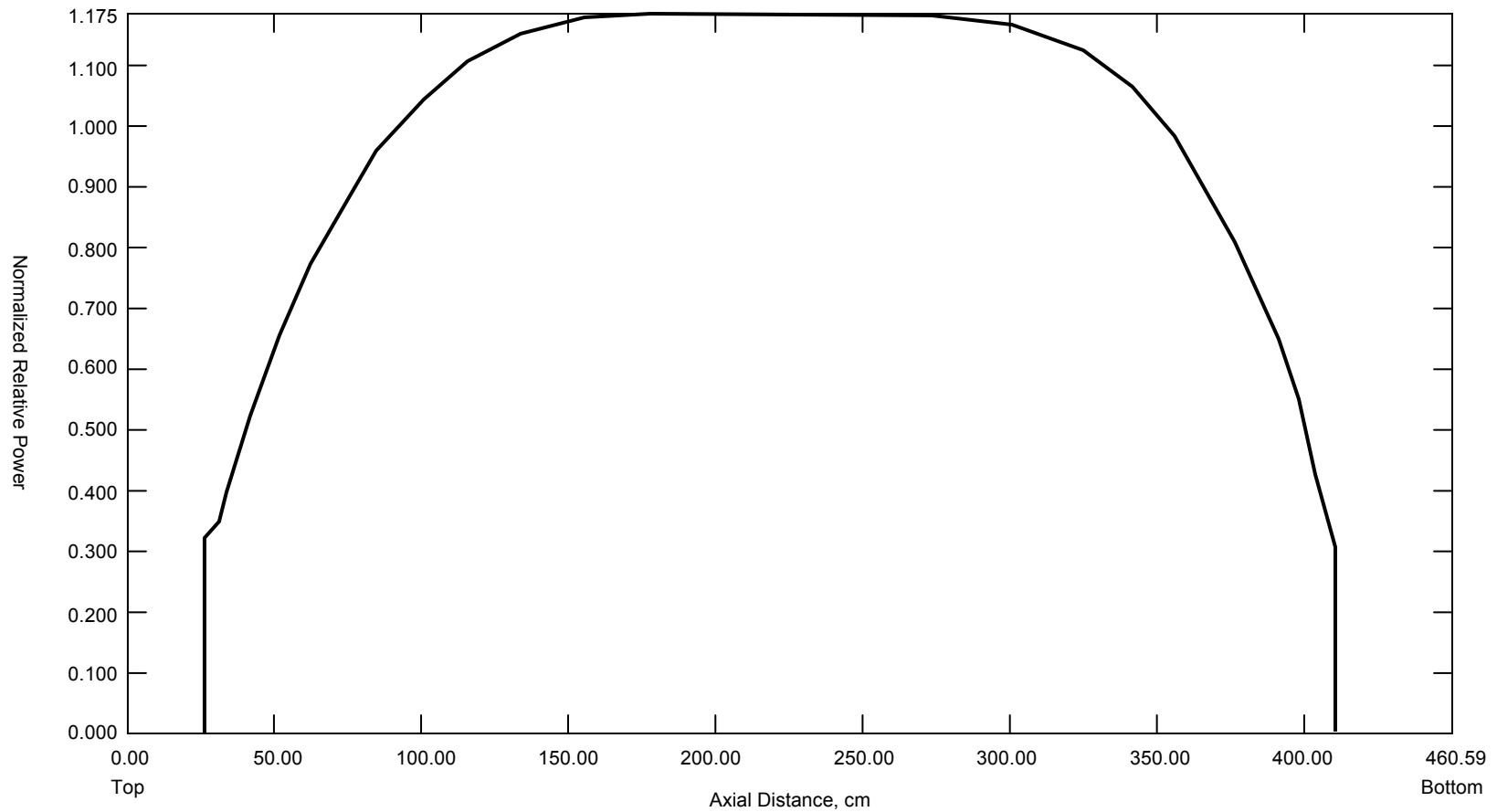

AXIAL POWER SHAPE 6,400 MWD/MTU

SAR FIGURE NO. 4.3-16

ARKANSAS NUCLEAR ONE
 UNIT 2
 RUSSELLVILLE, ARKANSAS



SCALE: NONE
 DRAWN: ENTERGY
 DESIGN: ENTERGY
 CAD NO:

AMENDMENT 20

BASED ON DRAWING NO

SHEET

REV.

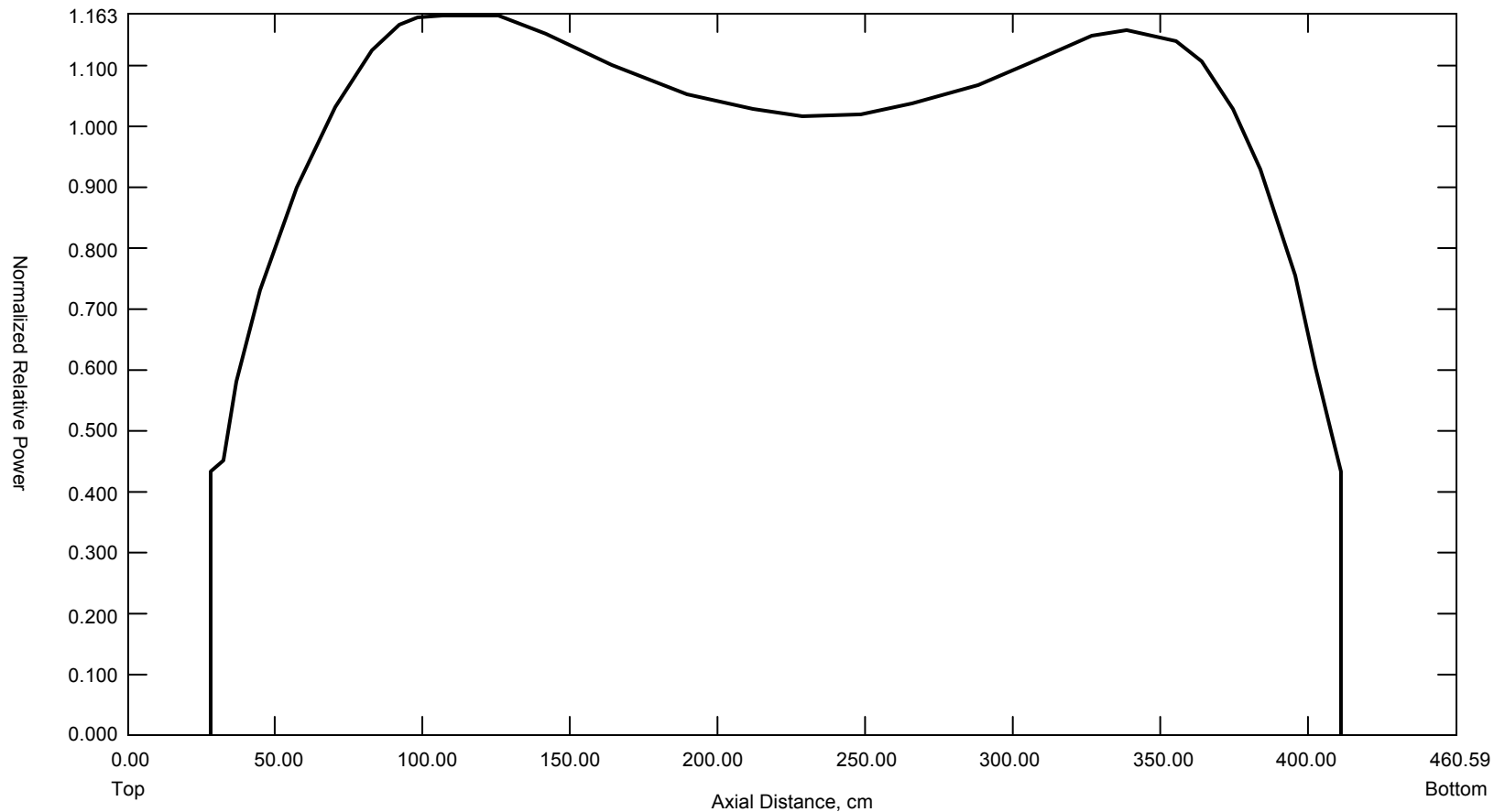

AXIAL POWER SHAPE 9,600 MWD/MTU

SAR FIGURE NO. 4.3-17

ARKANSAS NUCLEAR ONE
 UNIT 2
 RUSSELLVILLE, ARKANSAS



SCALE: NONE
 DRAWN: ENERGY
 DESIGN: ENERGY
 CAD NO:

AMENDMENT 20

BASED ON DRAWING NO

SHEET

REV.

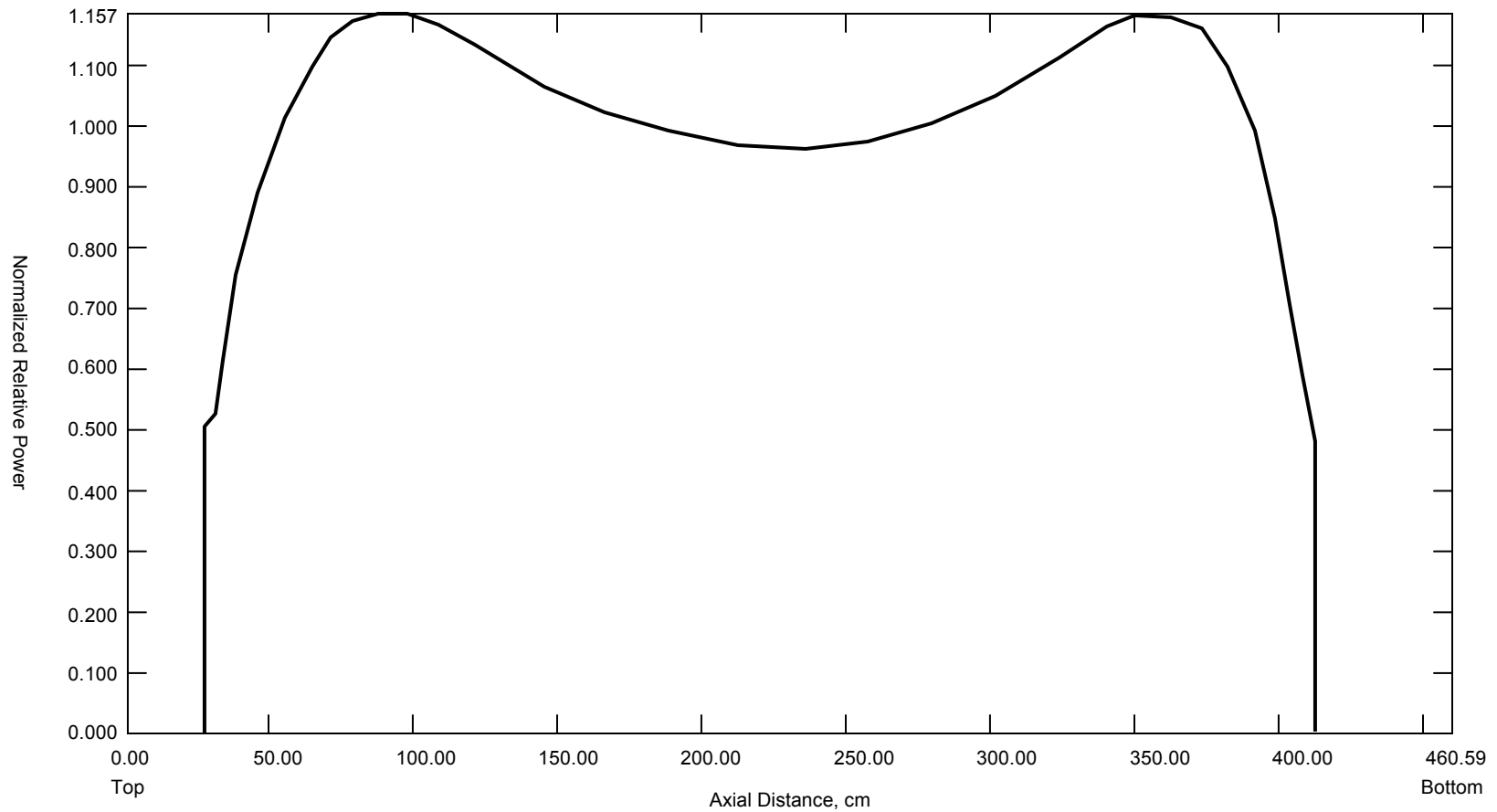

AXIAL POWER SHAPE 12,500 MWD/MTU

SAR FIGURE NO. 4.3-18

ARKANSAS NUCLEAR ONE
 UNIT 2
 RUSSELLVILLE, ARKANSAS



SCALE: NONE
 DRAWN: ENERGY
 DESIGN: ENERGY
 CAD NO:

AMENDMENT 20

BASED ON DRAWING NO	SHEET	REV.

DELETED

SAR FIGURE NO. 4.3-19

AMENDMENT 20

ARKANSAS NUCLEAR ONE
UNIT 2
RUSSELLVILLE, ARKANSAS



SCALE:	NONE
DRAWN:	ENERGY
DESIGN:	ENERGY
CAD NO:	N/A

DAILY REACTOR POWER MANEUVERING
NEAR THE BEGINNING OF LIFE

BASED ON DRAWING NO

SHEET

REV.

**FIGURES 4.3-20
 THROUGH 4.3-20C
 DELETED**

SAR FIGURE NO. 4.3-20

AMENDMENT 20

ARKANSAS NUCLEAR ONE
 UNIT 2
 RUSSELLVILLE, ARKANSAS



SCALE:	NONE
DRAWN:	ENERGY
DESIGN:	ENERGY
CAD NO:	N/A

DAILY REACTOR POWER MANEUVERING

BASED ON DRAWING NO

SHEET

REV.

DELETED

SAR FIGURE NO. 4.3-20A

AMENDMENT 20

ARKANSAS NUCLEAR ONE
UNIT 2
RUSSELLVILLE, ARKANSAS



SCALE:	NONE
DRAWN:	ENERGY
DESIGN:	ENERGY
CAD NO:	N/A

DAILY REACTOR POWER MANEUVERING
NEAR THE BEGINNING OF LIFE

BASED ON DRAWING NO

SHEET

REV.

DELETED

SAR FIGURE NO. 4.3-20B

AMENDMENT 20

ARKANSAS NUCLEAR ONE
UNIT 2
RUSSELLVILLE, ARKANSAS



SCALE:	NONE
DRAWN:	ENERGY
DESIGN:	ENERGY
CAD NO:	N/A

DAILY REACTOR POWER MANEUVERING
NEAR THE END OF LIFE

BASED ON DRAWING NO

SHEET

REV.

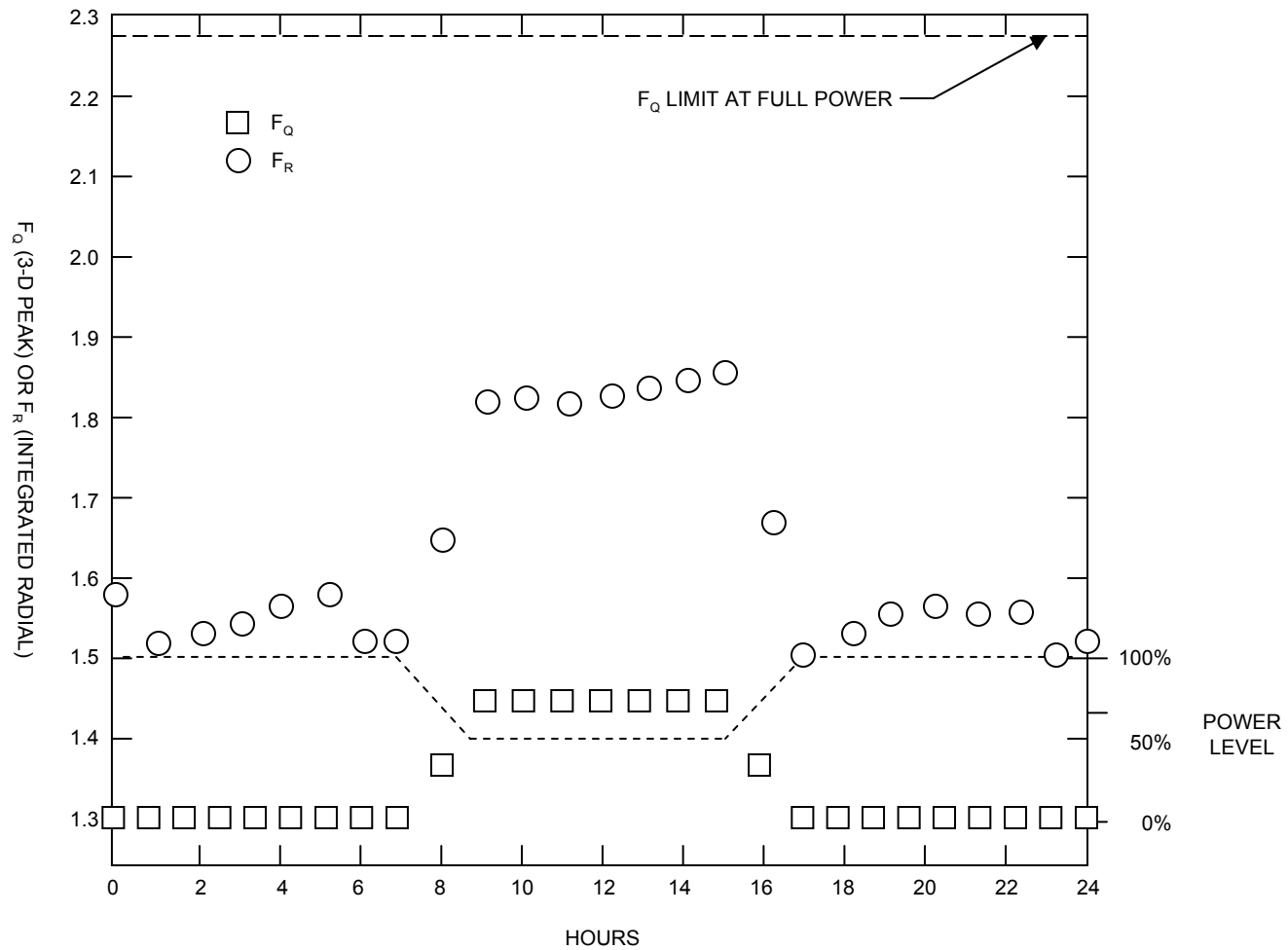

F_Q & F_R VS TIME FOR A LOAD FOLLOWING TRANSIENT NEAR THE END-OF-CYCLE

SAR FIGURE NO. 4.3-20D

ARKANSAS NUCLEAR ONE
 UNIT 2
 RUSSELLVILLE, ARKANSAS



SCALE: NONE
 DRAWN: ENTERGY
 DESIGN: ENTERGY
 CAD NO:

AMENDMENT 20

BASED ON DRAWING NO

SHEET

REV.

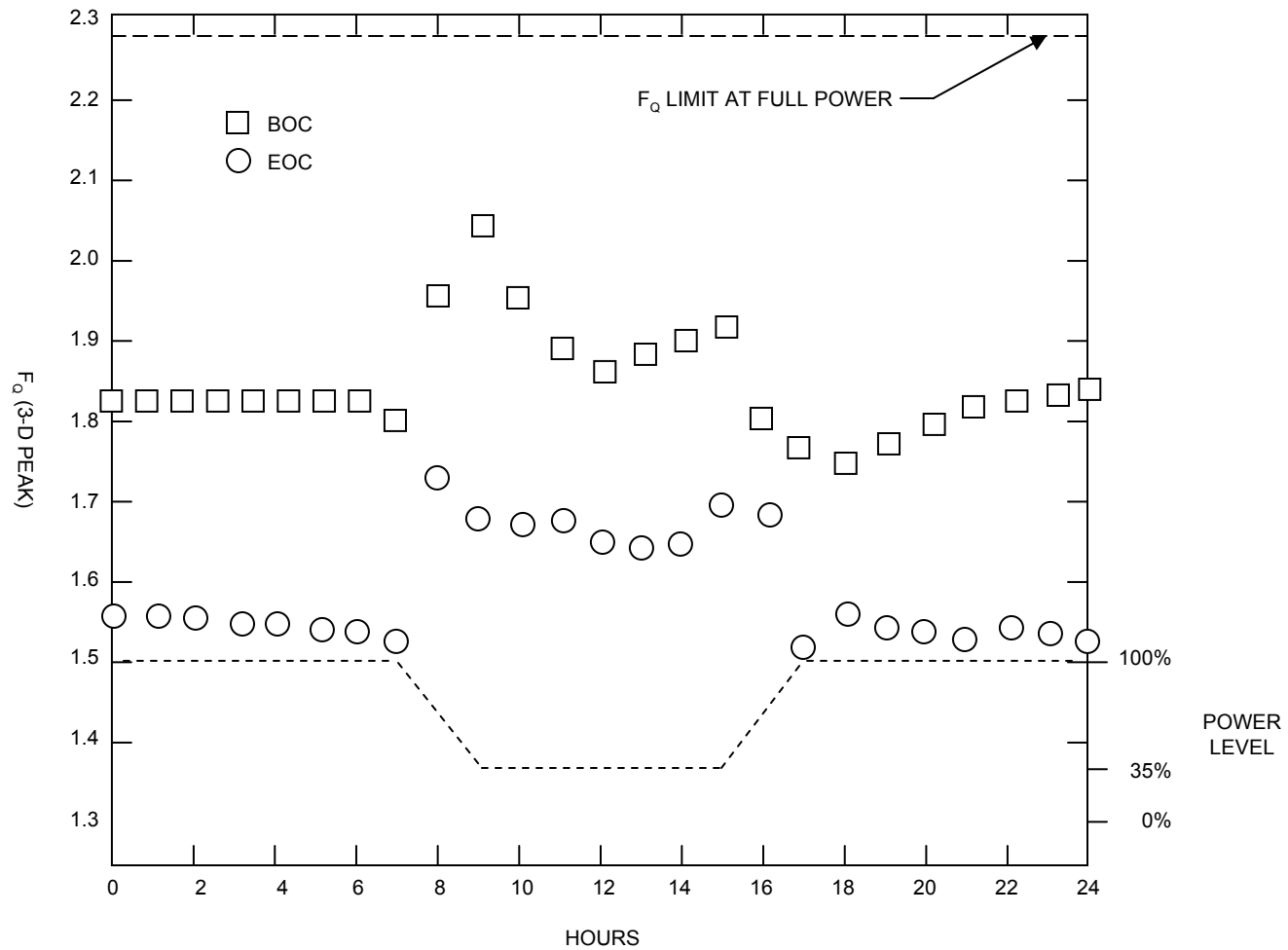

F_Q VS TIME FOR A LOAD FOLLOWING TRANSIENT

SAR FIGURE NO. 4.3-21

ARKANSAS NUCLEAR ONE
UNIT 2
RUSSELLVILLE, ARKANSAS



SCALE: NONE
DRAWN: ENTERGY
DESIGN: ENTERGY
CAD NO:

AMENDMENT 20

BASED ON DRAWING NO

SHEET

REV.

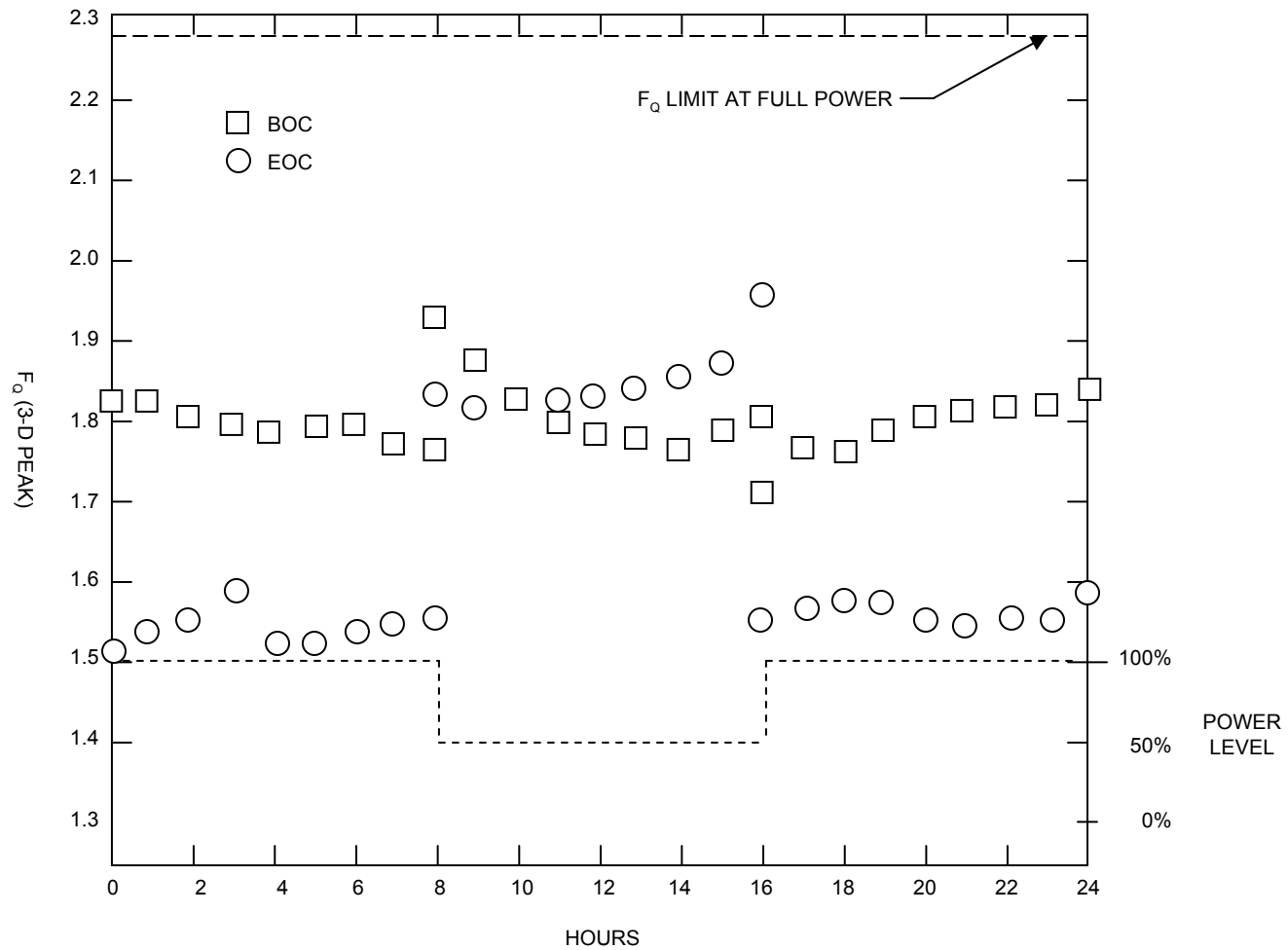

F_Q VS TIME FOR A LOAD FOLLOWING TRANSIENT

SAR FIGURE NO. 4.3-21A

ARKANSAS NUCLEAR ONE
UNIT 2
RUSSELLVILLE, ARKANSAS



SCALE: NONE
DRAWN: ENTERGY
DESIGN: ENTERGY
CAD NO:

AMENDMENT 20

BASED ON DRAWING NO	SHEET	REV.

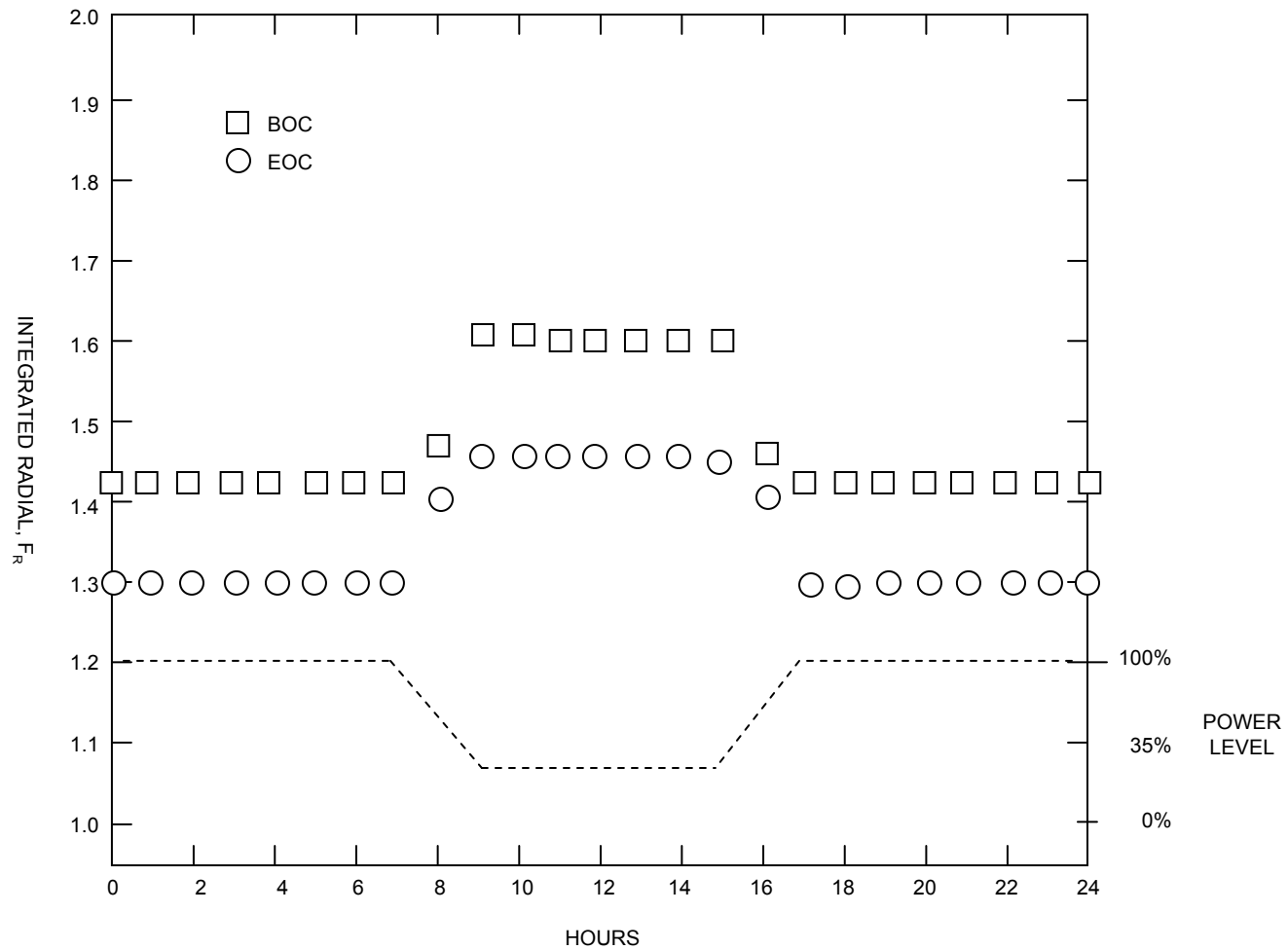

F_R VS TIME FOR A LOAD FOLLOWING TRANSIENT

SAR FIGURE NO. 4.3-22

ARKANSAS NUCLEAR ONE
UNIT 2
RUSSELLVILLE, ARKANSAS



SCALE: NONE
DRAWN: ENTERGY
DESIGN: ENTERGY
CAD NO:

AMENDMENT 20

BASED ON DRAWING NO

SHEET

REV.

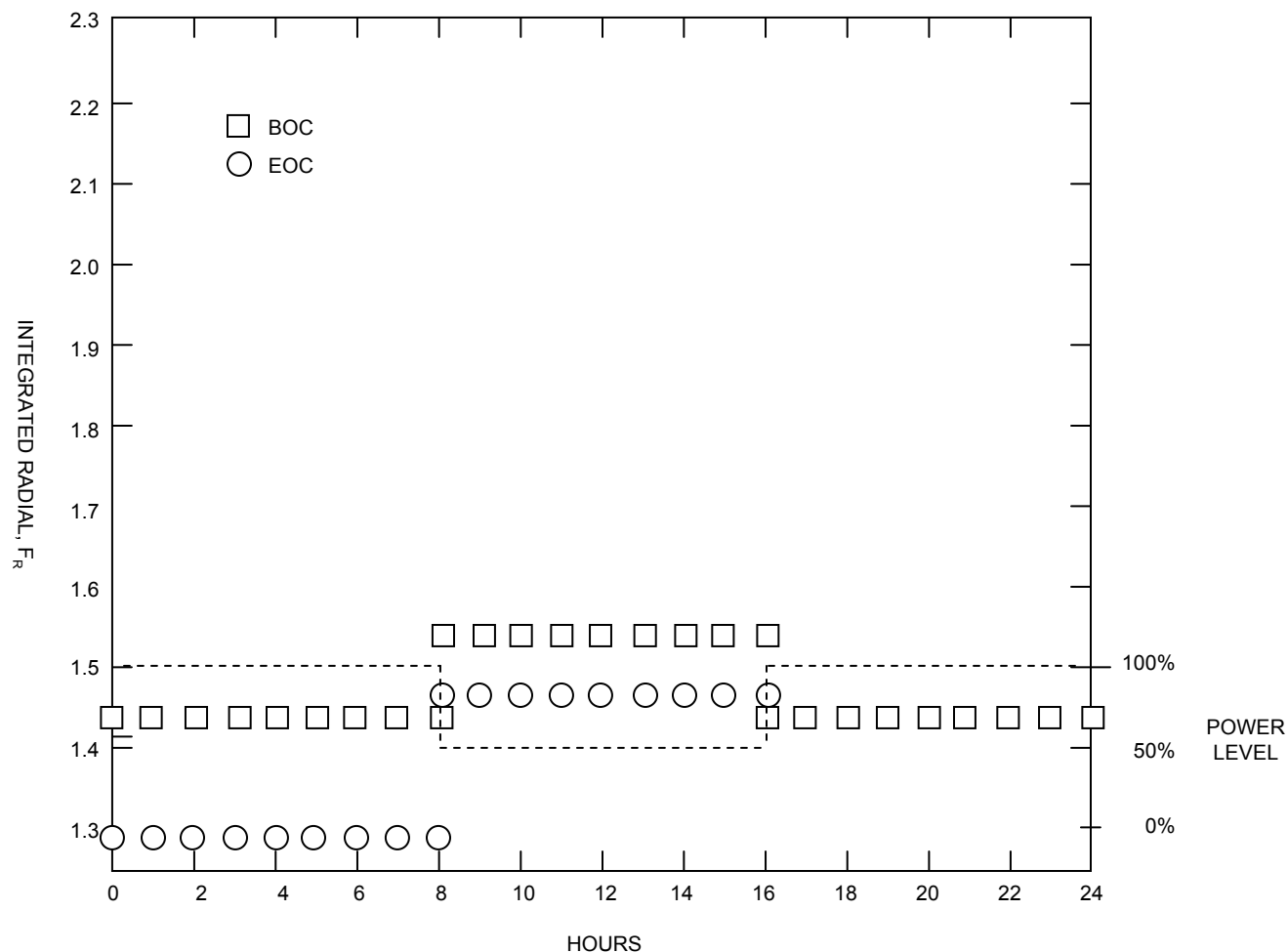

F_R VS TIME FOR A LOAD FOLLOWING TRANSIENT

SAR FIGURE NO. 4.3-22A

ARKANSAS NUCLEAR ONE
 UNIT 2
 RUSSELLVILLE, ARKANSAS



SCALE: NONE
 DRAWN: ENTERGY
 DESIGN: ENTERGY
 CAD NO:

AMENDMENT 20

BASED ON DRAWING NO

SHEET

REV.

⊕

1.00	0.99	1.00	1.00	0.98	0.95	0.94	0.93
	0.99	1.00	1.03	1.00	0.97	0.94	0.95
		1.05	1.07	1.06	1.03	0.99	0.96
					1.05	1.00	0.97
					1.05	1.01	0.98
					1.03	0.98	1.01
						1.03	1.04

⊕

SAR FIGURE NO. 4.3-23

AMENDMENT 20

ARKANSAS NUCLEAR ONE
 UNIT 2
 RUSSELLVILLE, ARKANSAS



SCALE:	NONE
DRAWN:	ENERGY
DESIGN:	ENERGY
CAD NO:	N/A

NORMALIZED POWER DISTRIBUTION
 WITHIN TYPICAL UNSHIMMED ASSEMBLY

BASED ON DRAWING NO

SHEET

REV.

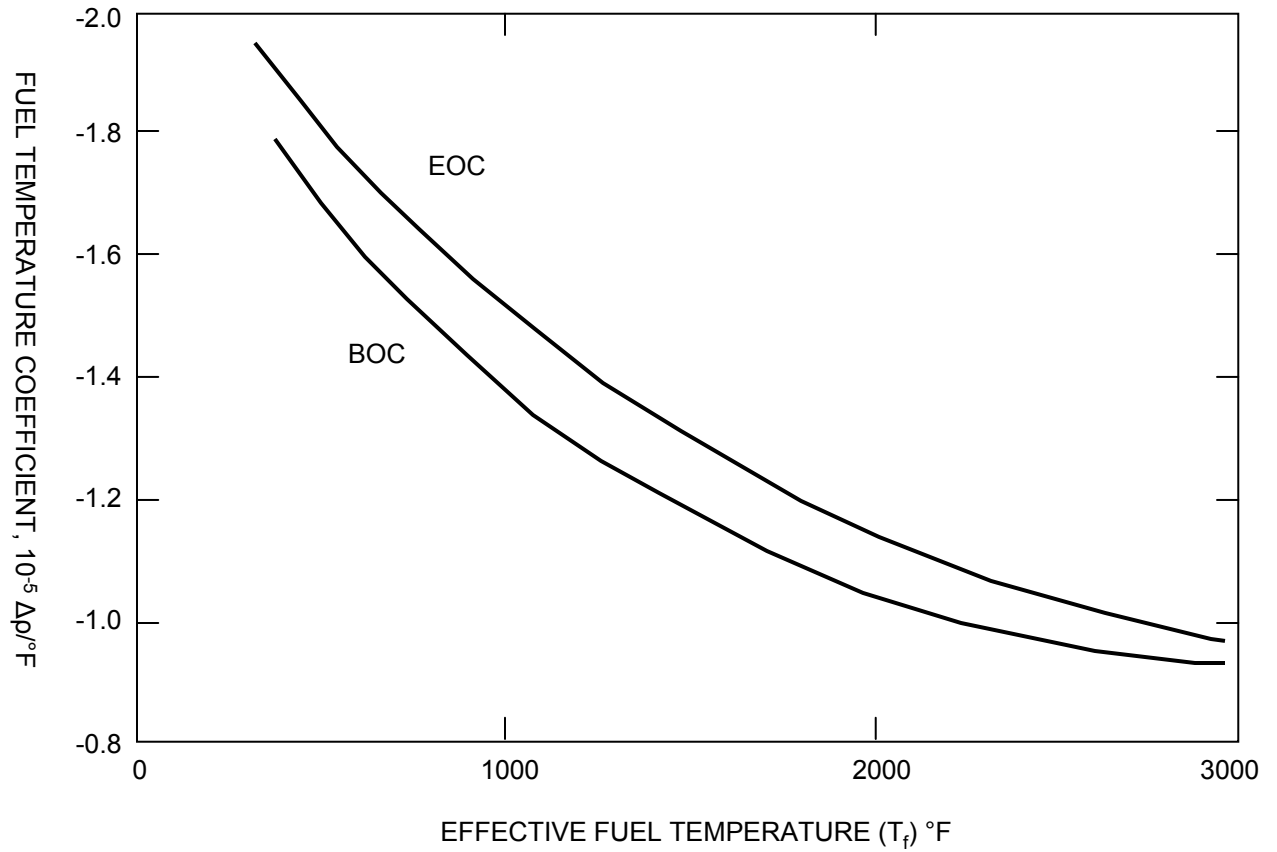

SAR FIGURE NO. 4.3-24

AMENDMENT 20

ARKANSAS NUCLEAR ONE
 UNIT 2
 RUSSELLVILLE, ARKANSAS



SCALE:	NONE
DRAWN:	ENERGY
DESIGN:	ENERGY
CAD NO:	N/A

FUEL TEMPERATURE COEFFICIENT VS
 EFFECTIVE FUEL TEMPERATURE

BASED ON DRAWING NO

SHEET

REV.

Figures 4.3-25 through 4.3-27
DELETED

SAR FIGURE NO. 4.3-25

AMENDMENT 20

ARKANSAS NUCLEAR ONE
UNIT 2
RUSSELLVILLE, ARKANSAS



SCALE:	NONE
DRAWN:	ENERGY
DESIGN:	ENERGY
CAD NO:	N/A

DRAWING NO

SHEET

REV.

					1	2 SHUT DOWN	3
			4	5	6 3	7	8 5
		9 2	10	11 SHUT DOWN	12	13 1	14
	15	16	17 6	18	19 SHUT DOWN	20	21 P
	22	23 SHUT DOWN	24	25 P	26	27 SHUT DOWN	28
29	30 3	31	32 SHUT DOWN	33	34 4	35	36 2
37 SHUT DOWN	38	39 1	40	41 SHUT DOWN	42	43 SHUT DOWN	44
45	46 5	47	48 P	49	50 2	51	52 6

SAR FIGURE NO. 4.3-28

AMENDMENT 20

ARKANSAS NUCLEAR ONE
UNIT 2
RUSSELLVILLE, ARKANSAS



SCALE:	NONE
DRAWN:	ENERGY
DESIGN:	ENERGY
CAD NO:	N/A

CEA BANK IDENTIFICATION

BASED ON DRAWING NO

SHEET

REV.

FIGURES 4.3-29
THROUGH 4.3-30
DELETED

SAR FIGURE NO. 4.3-29

AMENDMENT 20

ARKANSAS NUCLEAR ONE
UNIT 2
RUSSELLVILLE, ARKANSAS



SCALE:	NONE
DRAWN:	ENERGY
DESIGN:	ENERGY
CAD NO:	N/A

BASED ON DRAWING NO

SHEET

REV.

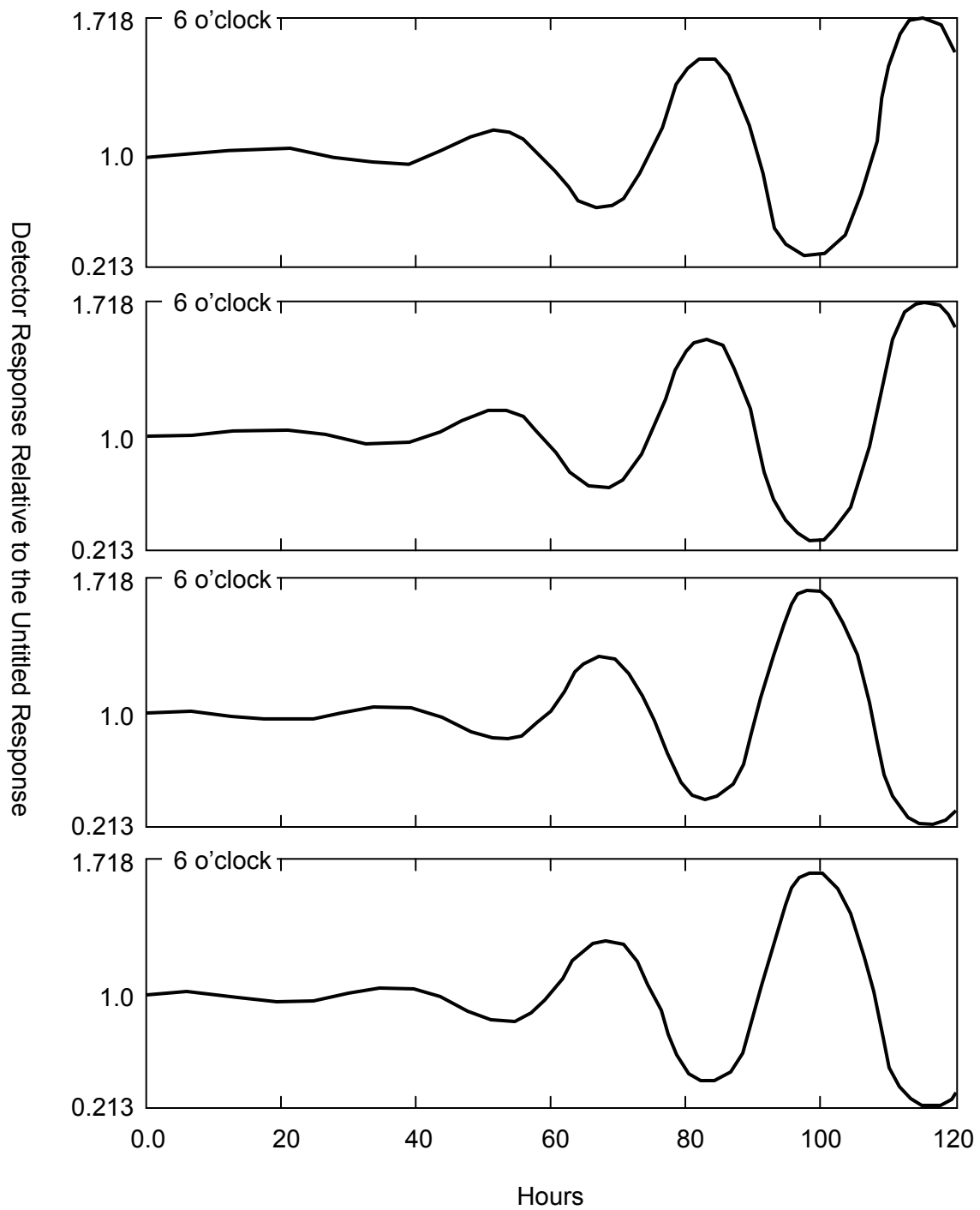

SAR FIGURE NO. 4.3-31

AMENDMENT 20

ARKANSAS NUCLEAR ONE
UNIT 2
RUSSELLVILLE, ARKANSAS



SCALE:	NONE
DRAWN:	ENERGY
DESIGN:	ENERGY
CAD NO:	N/A

FREE OSCILLATION RESPONSE OF DETECTORS AT
VARIOUS AZIMUTHAL LOCATIONS

BASED ON DRAWING NO

SHEET

REV.

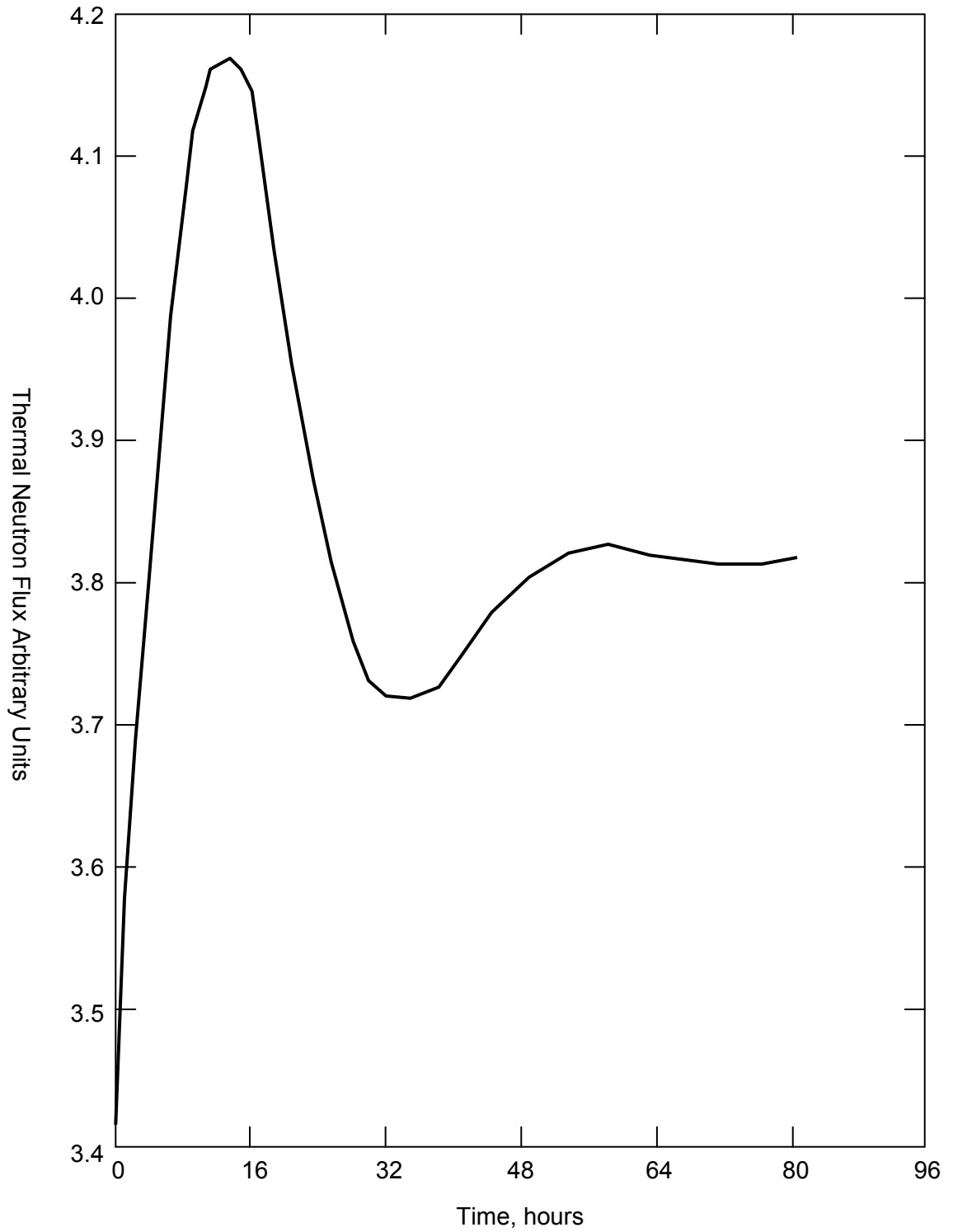

SAR FIGURE NO. 4.3-32

AMENDMENT 20

ARKANSAS NUCLEAR ONE
UNIT 2
RUSSELLVILLE, ARKANSAS



SCALE:	NONE
DRAWN:	ENERGY
DESIGN:	ENERGY
CAD NO:	N/A

THERMAL NEUTRON FLUX AT THE CENTER
OF THE CORE VS TIME

BASED ON DRAWING NO

SHEET

REV.

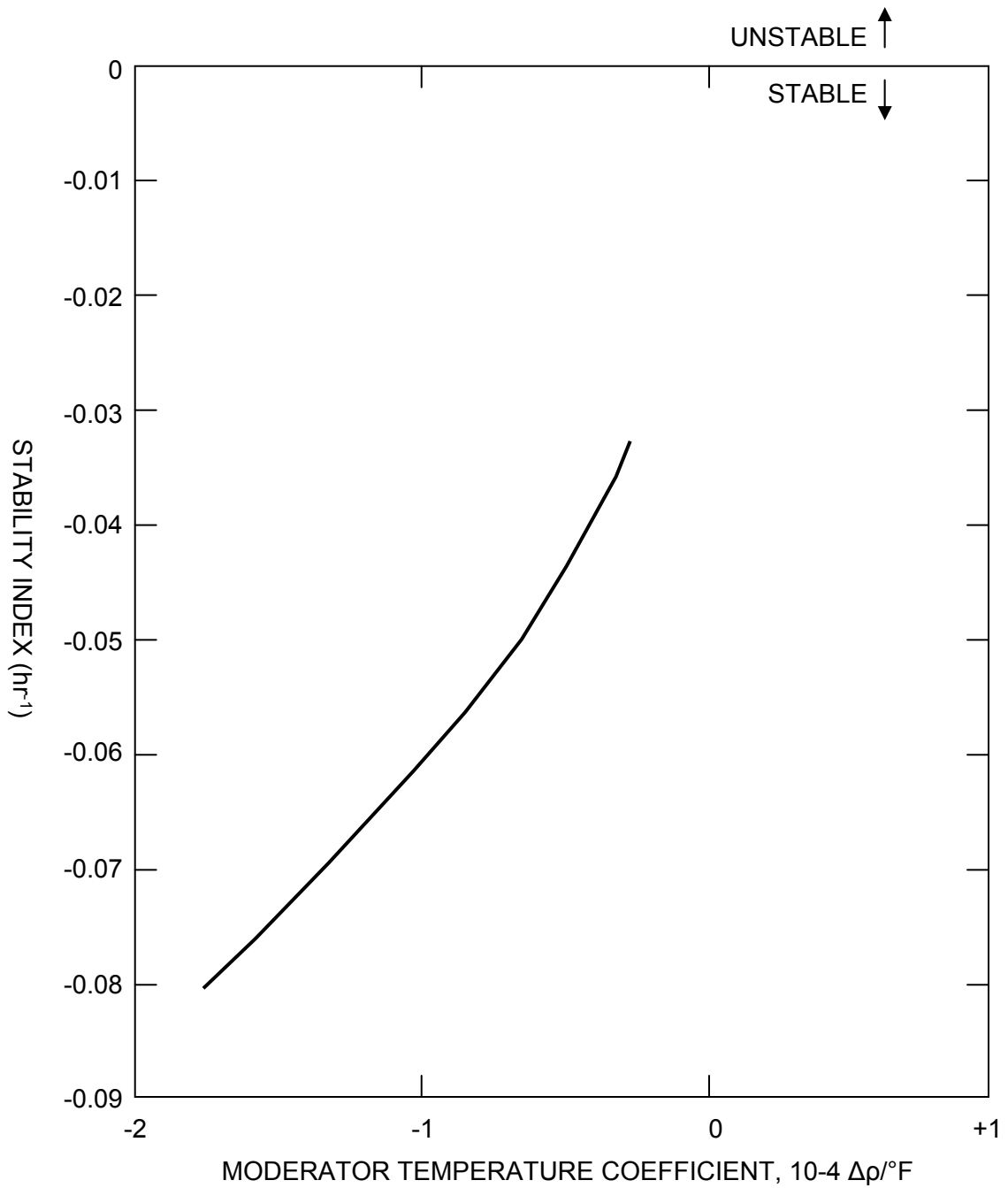

SAR FIGURE NO. 4.3-33

AMENDMENT 20

ARKANSAS NUCLEAR ONE
UNIT 2
RUSSELLVILLE, ARKANSAS



SCALE:	NONE
DRAWN:	ENERGY
DESIGN:	ENERGY
CAD NO:	N/A

STABILITY INDEX

BASED ON DRAWING NO

SHEET

REV.

FIGURES 4.3-34
THROUGH 4.3-40
DELETED

SAR FIGURE NO. 4.3-34

AMENDMENT 20

ARKANSAS NUCLEAR ONE
UNIT 2
RUSSELLVILLE, ARKANSAS



SCALE:	NONE
DRAWN:	ENERGY
DESIGN:	ENERGY
CAD NO:	N/A

BASED ON DRAWING NO

SHEET

REV.

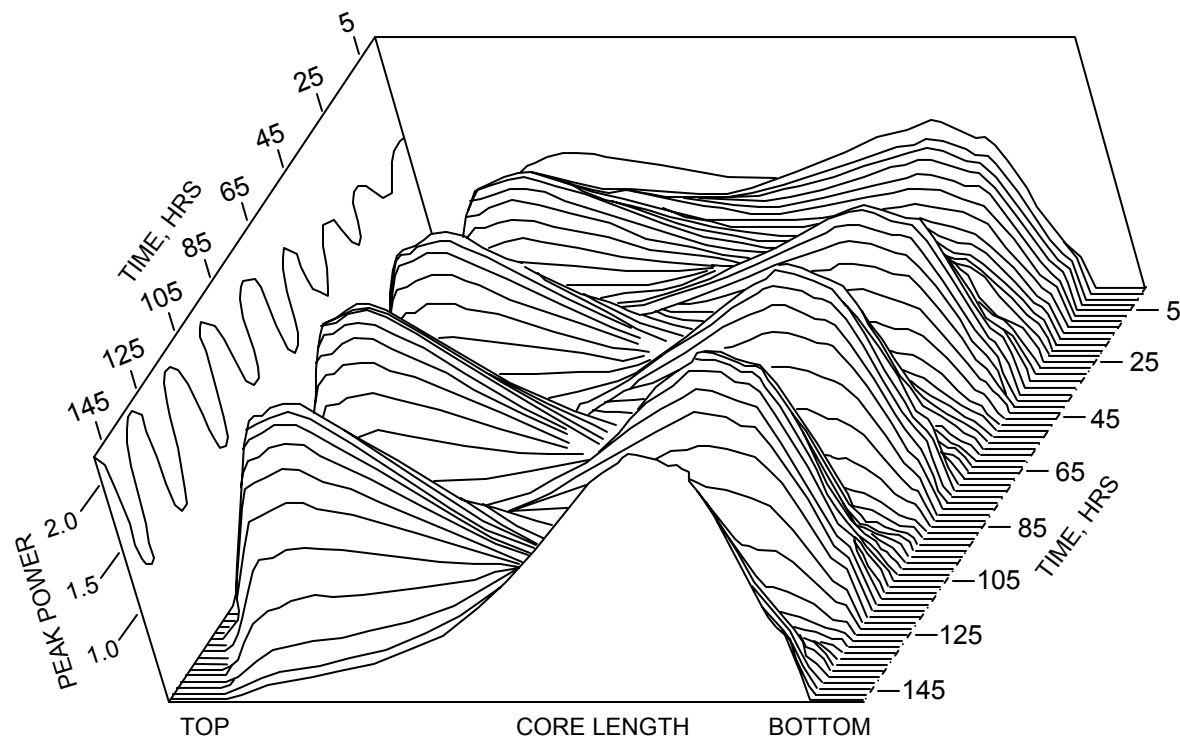

A DIVERGENT AXIAL OSCILLATION IN AN EOC CORE WITH REDUCED POWER
 FEEDBACK ($\alpha = 0.96 \times 10^{-4} \Delta\rho/(KW/FT)$)

SAR FIGURE NO. 4.3-41

ARKANSAS NUCLEAR ONE
 UNIT 2
 RUSSELLVILLE, ARKANSAS



SCALE: NONE
 DRAWN: ENTERGY
 DESIGN: ENTERGY
 CAD NO:

AMENDMENT 20

BASED ON DRAWING NO

SHEET

REV.

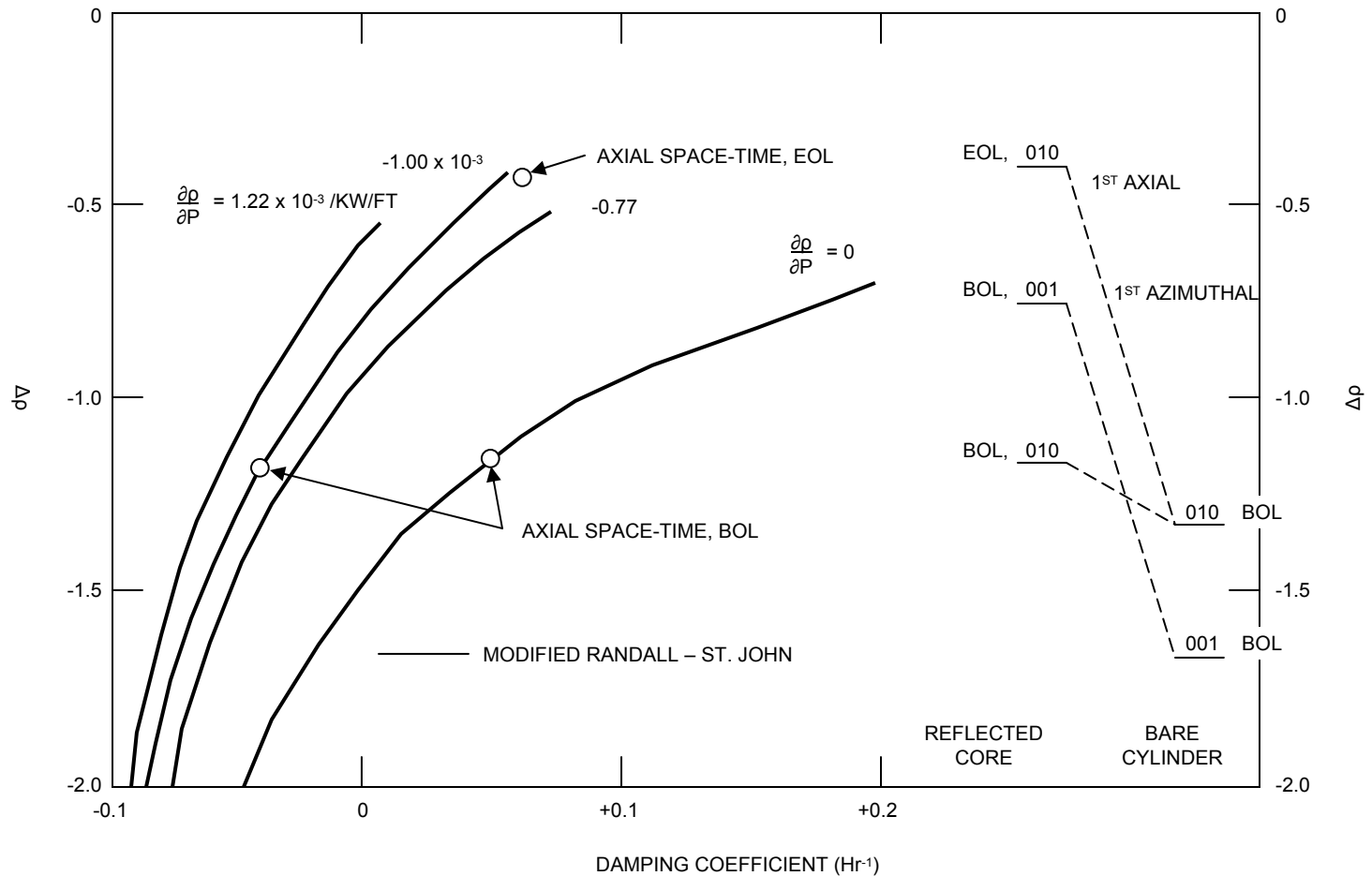

DAMPING COEFFICIENT VS REACTIVITY DIFFERENCE BETWEEN FUNDAMENTAL AND EXCITED STATE

SAR FIGURE NO. 4.3-42

ARKANSAS NUCLEAR ONE
UNIT 2
RUSSELLVILLE, ARKANSAS



SCALE: NONE
DRAWN: ENERGENCY
DESIGN: ENERGENCY
CAD NO:

AMENDMENT 20

BASED ON DRAWING NO

SHEET

REV.

FIGURES 4.3-43
THROUGH 4.3-45
DELETED

SAR FIGURE NO. 4.3-43

AMENDMENT 20

ARKANSAS NUCLEAR ONE
UNIT 2
RUSSELLVILLE, ARKANSAS



SCALE:	NONE
DRAWN:	ENERGY
DESIGN:	ENERGY
CAD NO:	N/A

BASED ON DRAWING NO

SHEET

REV.

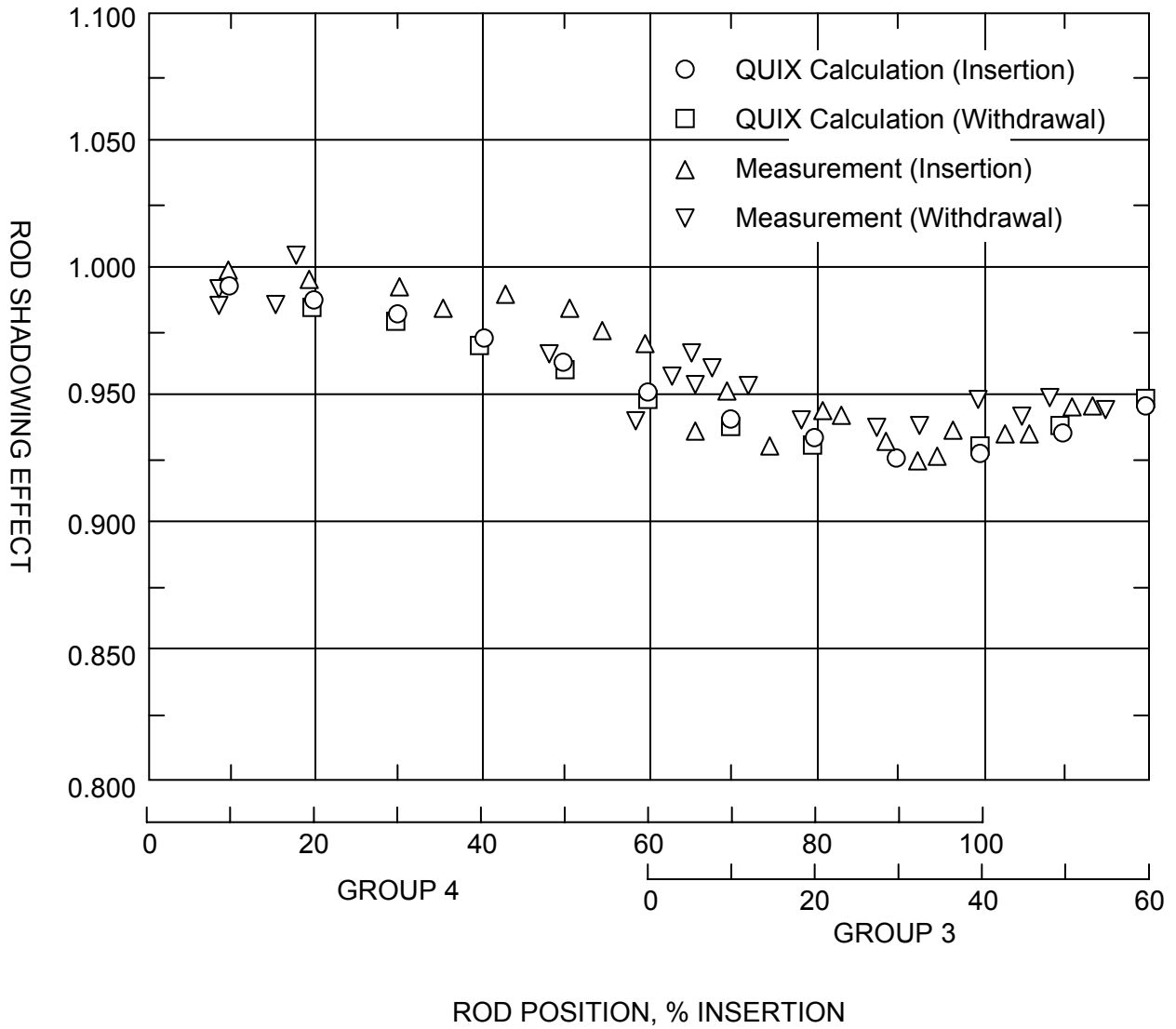

SAR FIGURE NO. 4.3-46

AMENDMENT 20

ARKANSAS NUCLEAR ONE
 UNIT 2
 RUSSELLVILLE, ARKANSAS



SCALE:	NONE
DRAWN:	ENERGY
DESIGN:	ENERGY
CAD NO:	N/A

ROD SHADOWING EFFECT VS ROD POSITION FOR
 ROD INSERTION & WITHDRAWAL TRANSIENTS AT
 PALISADES

BASED ON DRAWING NO

SHEET

REV.

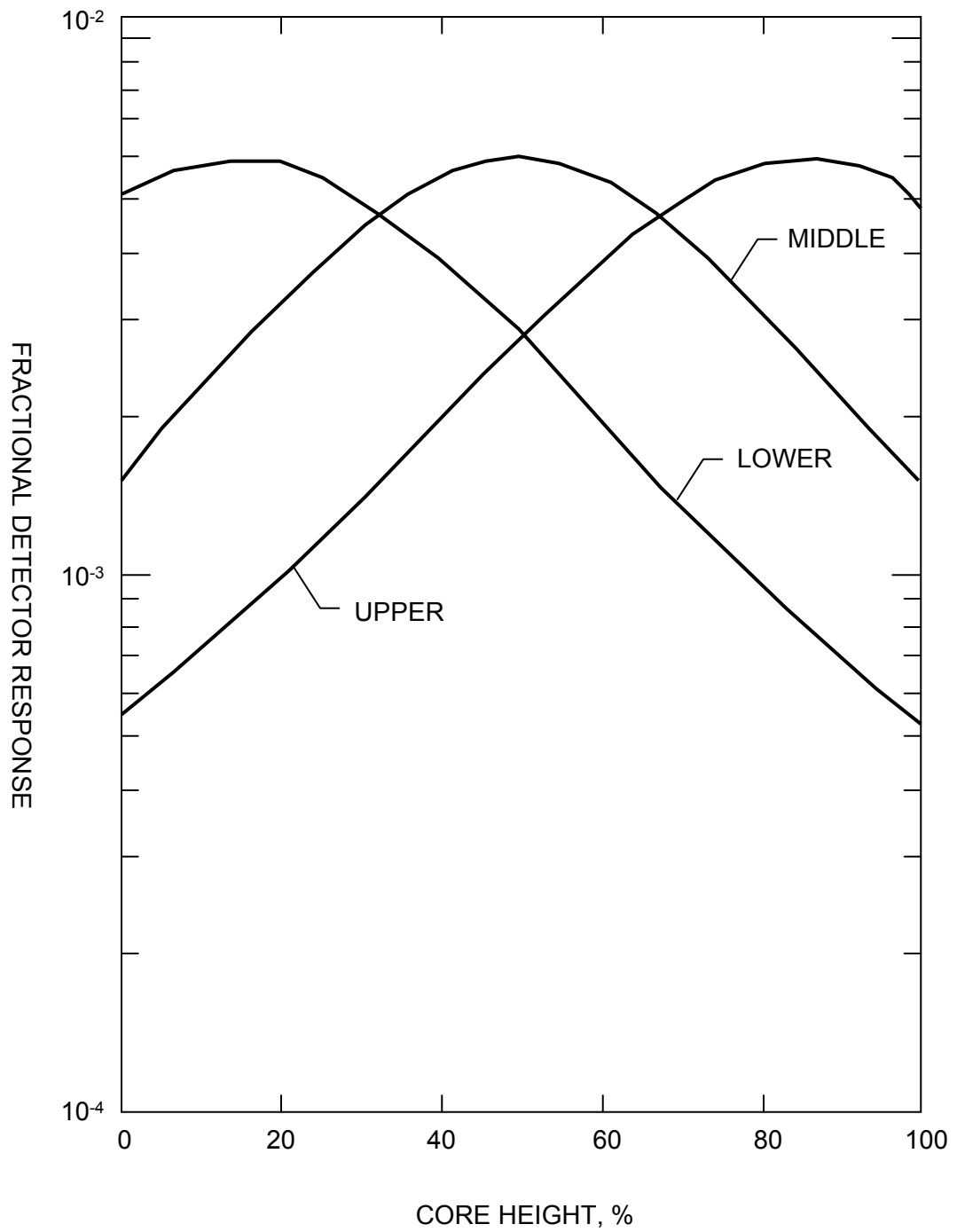

SAR FIGURE NO. 4.3-47

AMENDMENT 20

ARKANSAS NUCLEAR ONE
UNIT 2
RUSSELLVILLE, ARKANSAS



SCALE:	NONE
DRAWN:	ENERGY
DESIGN:	ENERGY
CAD NO:	N/A

TYPICAL THREE SUB-CHANNEL
ANNEALING

BASED ON DRAWING NO

SHEET

REV.

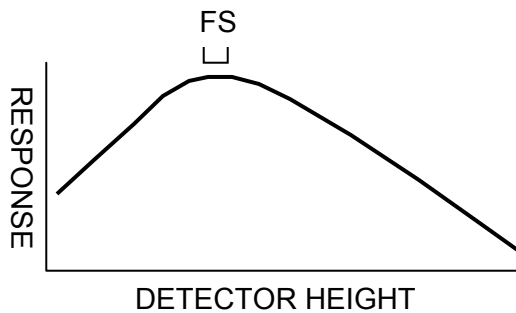
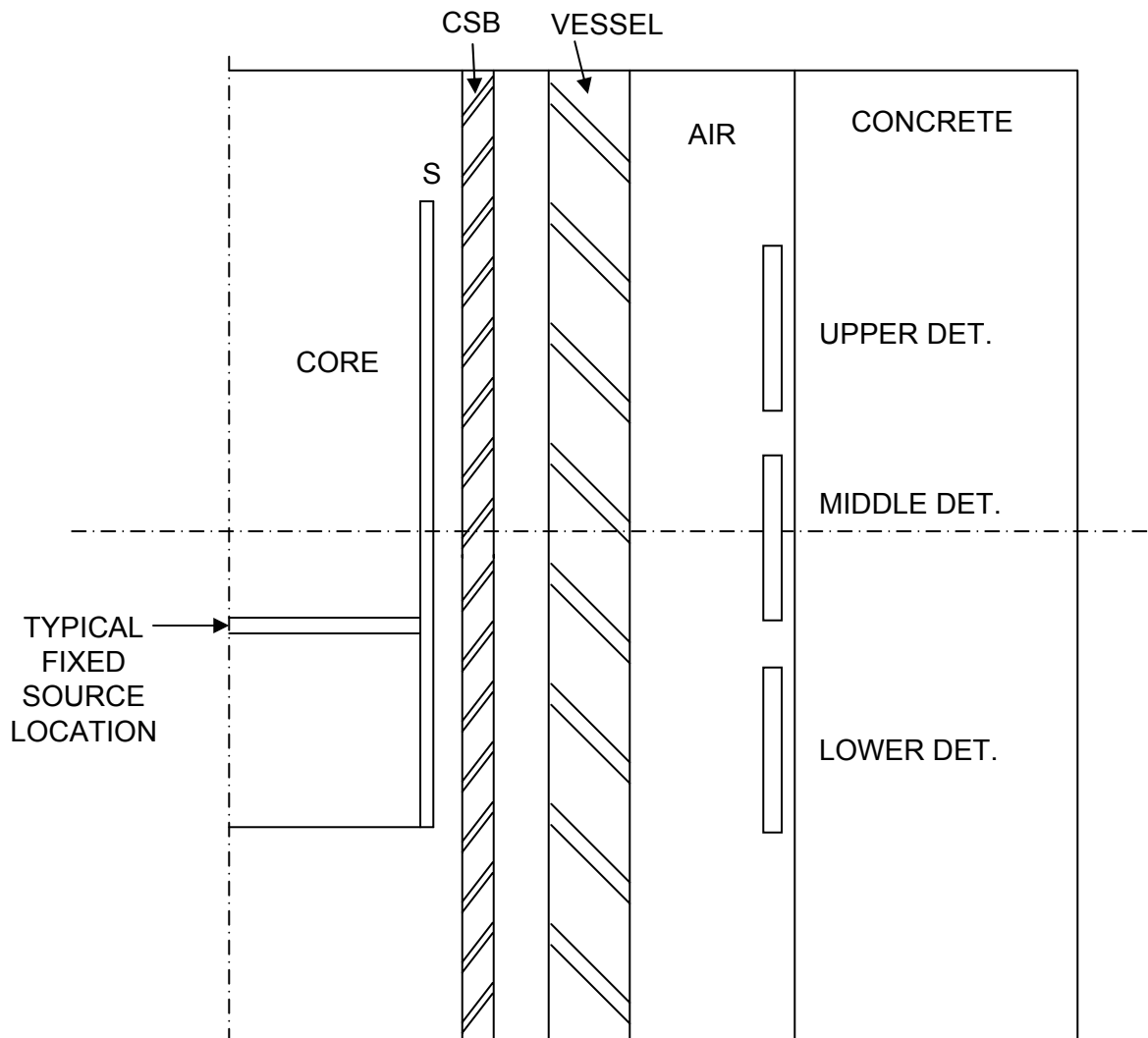

SAR FIGURE NO. 4.3-48

AMENDMENT 20

ARKANSAS NUCLEAR ONE
UNIT 2
RUSSELLVILLE, ARKANSAS



SCALE:	NONE
DRAWN:	ENERGY
DESIGN:	ENERGY
CAD NO:	N/A

GEOMETRY LAYOUT

BASED ON DRAWING NO

SHEET

REV.

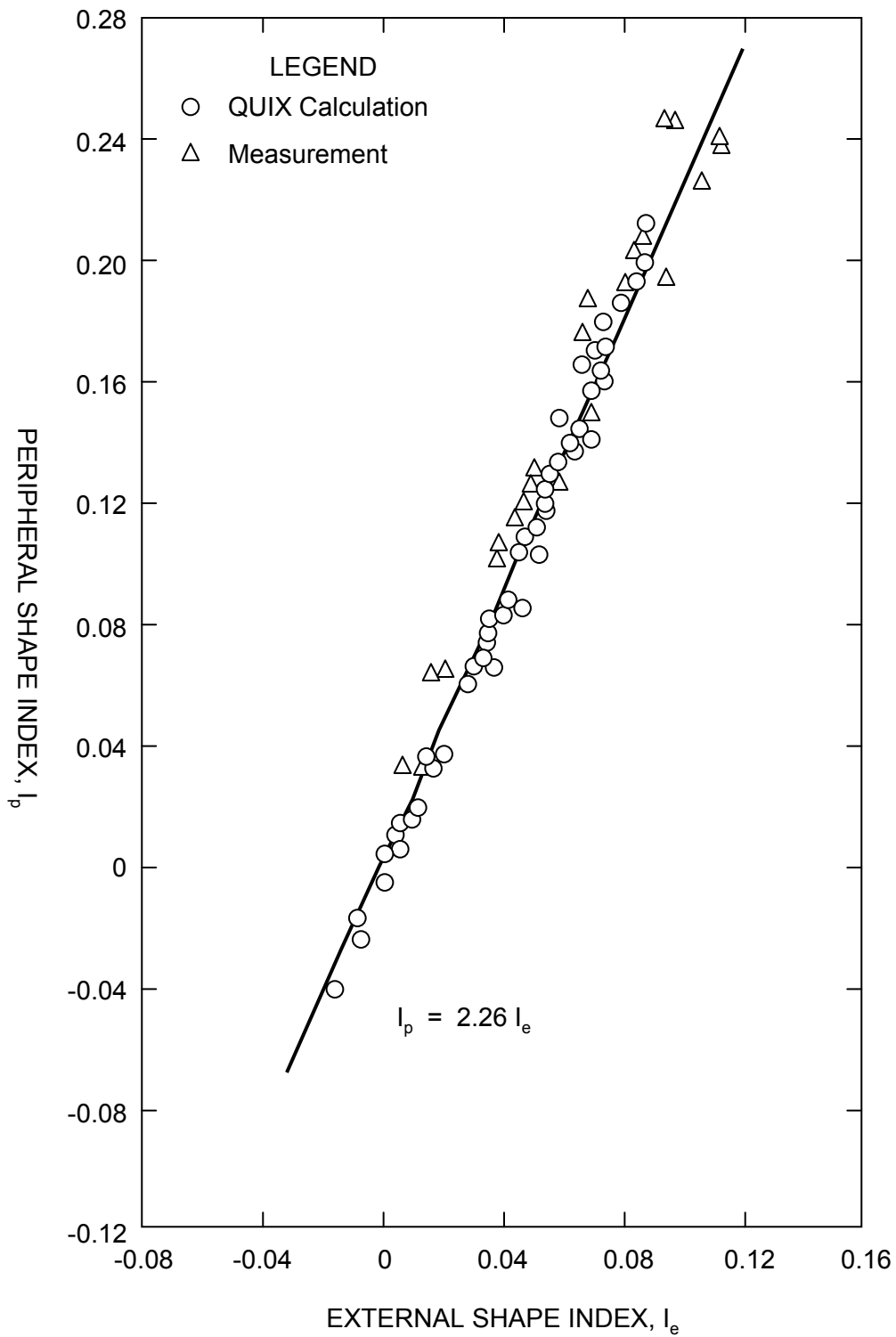

SAR FIGURE NO. 4.3-49

AMENDMENT 20

ARKANSAS NUCLEAR ONE
UNIT 2
RUSSELLVILLE, ARKANSAS



SCALE:	NONE
DRAWN:	ENERGY
DESIGN:	ENERGY
CAD NO:	N/A

COMPARISON OF MEASURED AND CALCULATED
SHAPE ANNEALING CORRECTION FOR PALISADES

BASED ON DRAWING NO

SHEET

REV.

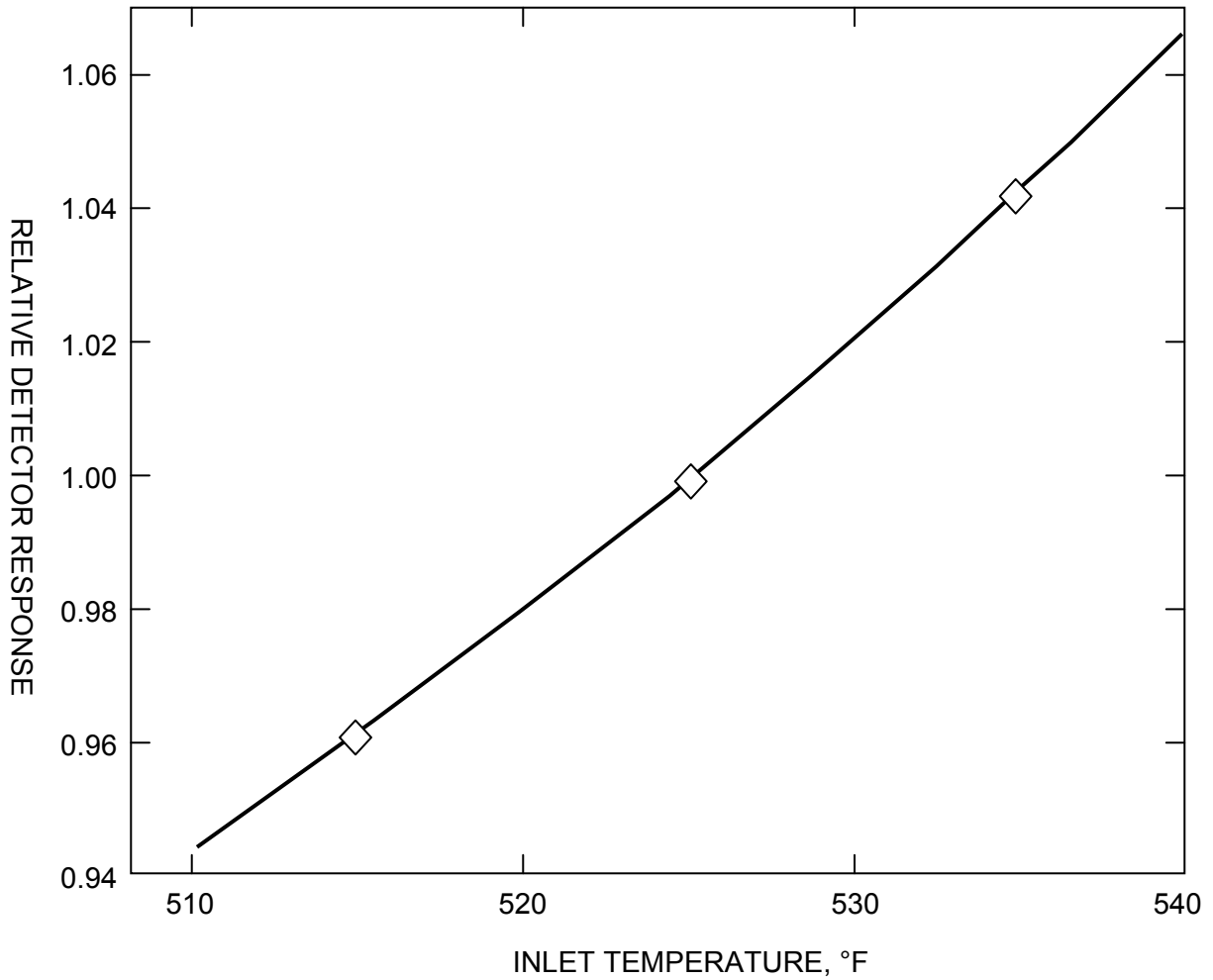

SAR FIGURE NO. 4.3-50

AMENDMENT 20

ARKANSAS NUCLEAR ONE
UNIT 2
RUSSELLVILLE, ARKANSAS



SCALE:	NONE
DRAWN:	ENERGY
DESIGN:	ENERGY
CAD NO:	N/A

TYPICAL TEMPERATURE DEFECT VS
REACTOR INLET TEMPERATURE

BASED ON DRAWING NO

SHEET

REV.

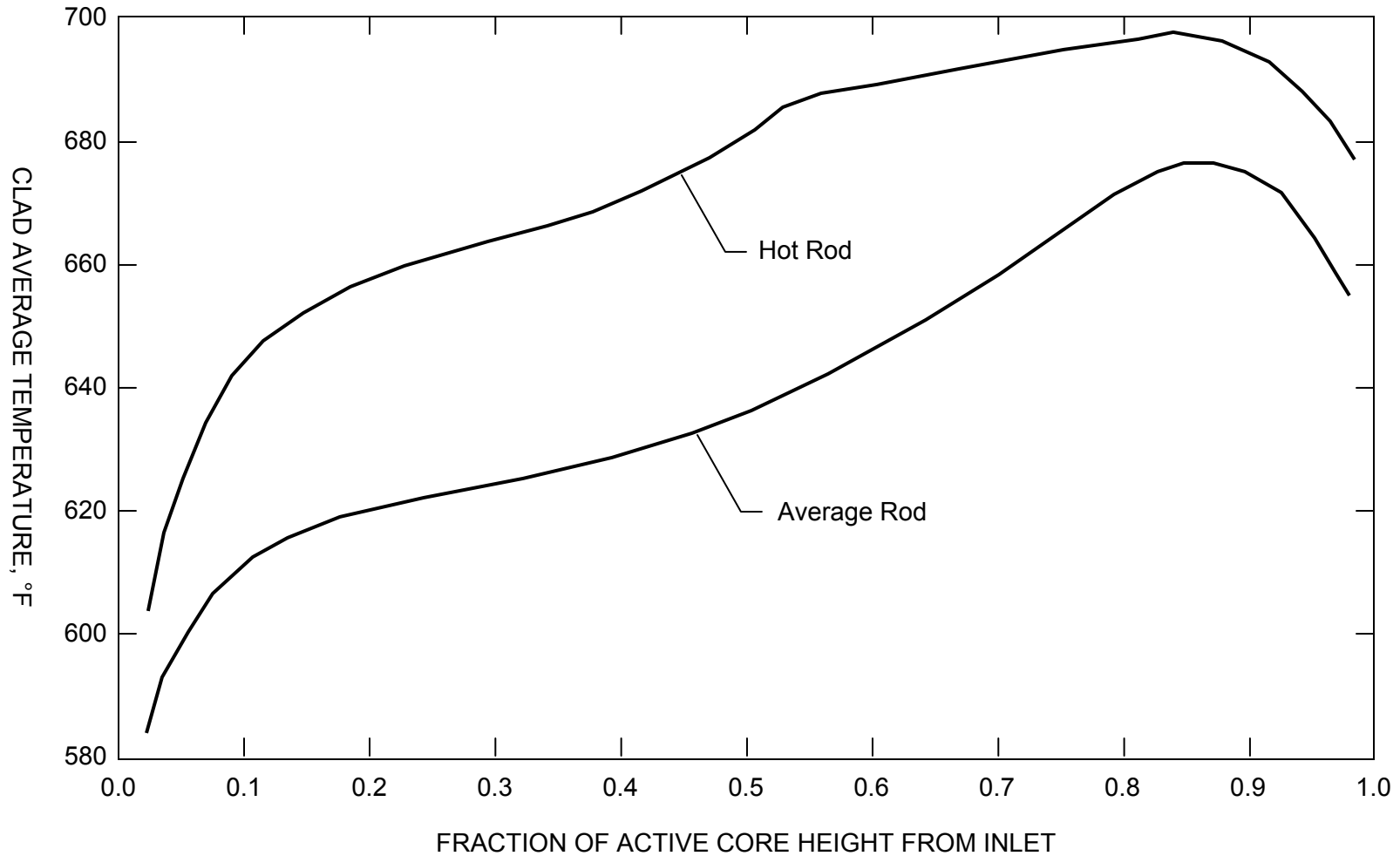

CLAD AVERAGE TEMPERATURE VS FRACTION OF ACTIVE CORE HEIGHT FROM INLET

SAR FIGURE NO. 4.4-1

ARKANSAS NUCLEAR ONE
 UNIT 2
 RUSSELLVILLE, ARKANSAS



SCALE: NONE
 DRAWN: ENERGY
 DESIGN: ENERGY
 CAD NO:

AMENDMENT 20

BASED ON DRAWING NO	SHEET	REV.

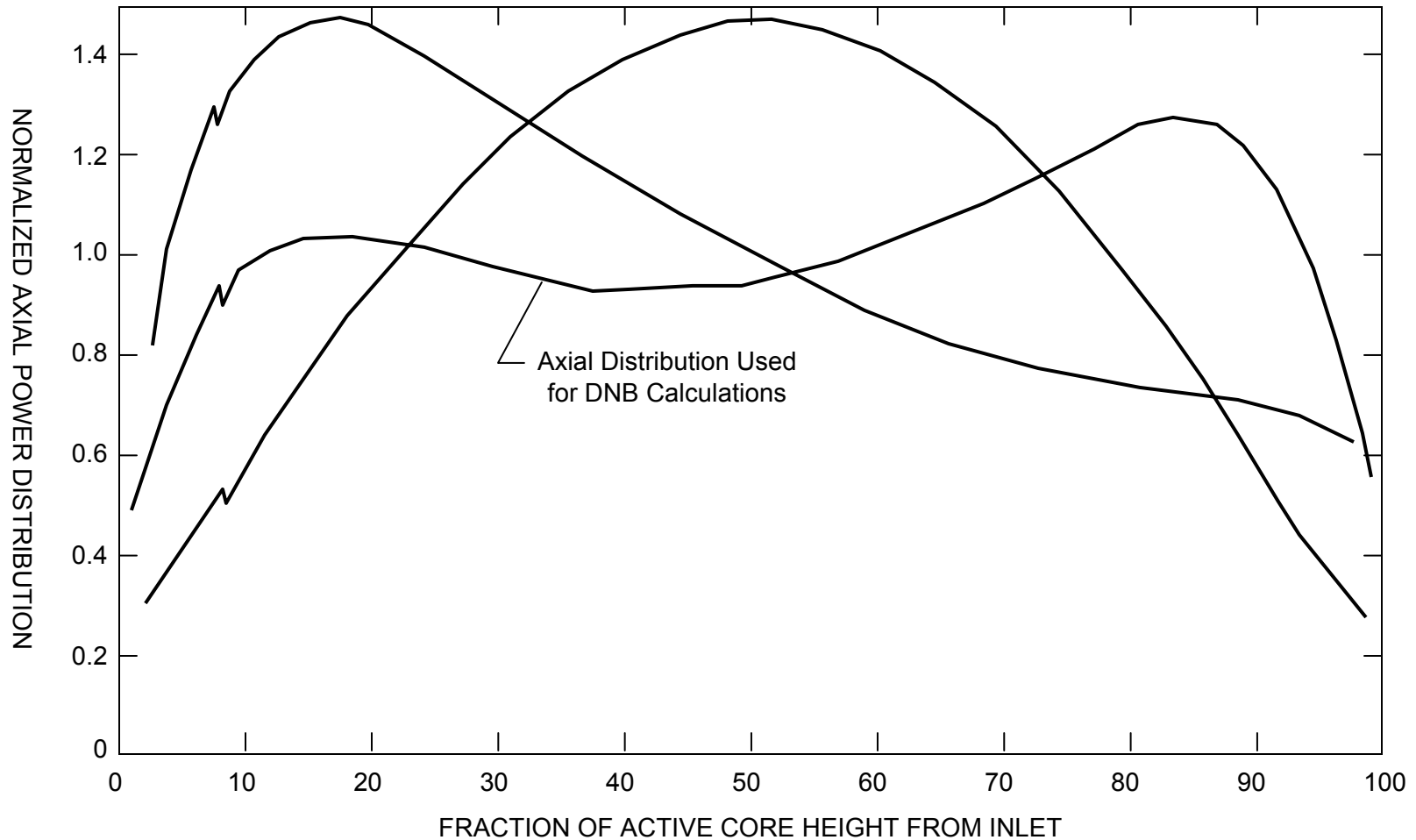

AXIAL POWER DISTRIBUTIONS

SAR FIGURE NO. 4.4-2

ARKANSAS NUCLEAR ONE
 UNIT 2
 RUSSELLVILLE, ARKANSAS



SCALE: NONE
 DRAWN: ENTERGY
 DESIGN: ENTERGY
 CAD NO:

AMENDMENT 20

BASED ON DRAWING NO	SHEET	REV.

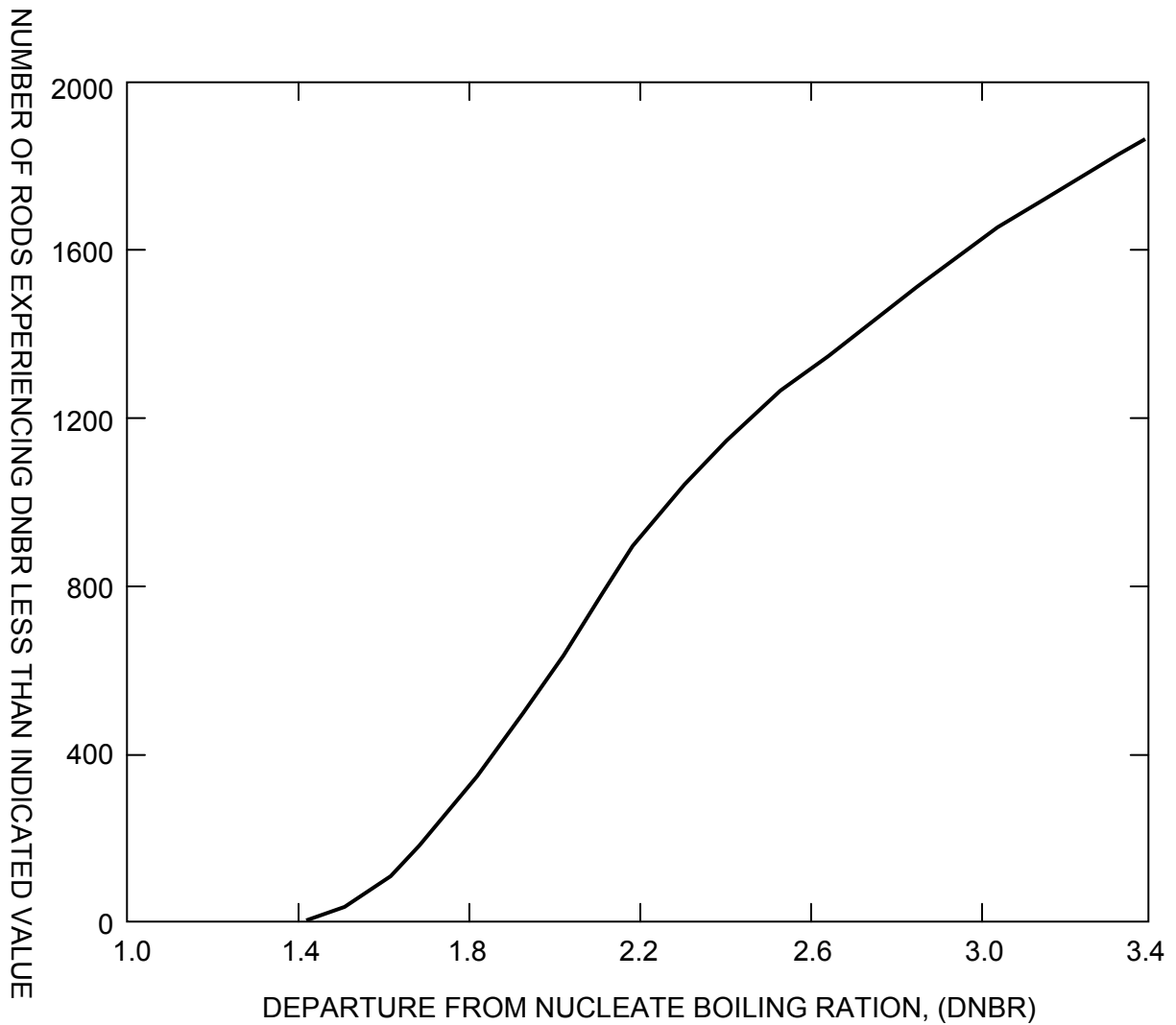

SAR FIGURE NO. 4.4-3

AMENDMENT 20

ARKANSAS NUCLEAR ONE
UNIT 2
RUSSELLVILLE, ARKANSAS



SCALE:	NONE
DRAWN:	ENERGY
DESIGN:	ENERGY
CAD NO:	N/A

CUMULATIVE DISTRIBUTION OF NUMBER
OF FUEL RODS VS DNBR

BASED ON DRAWING NO

SHEET

REV.

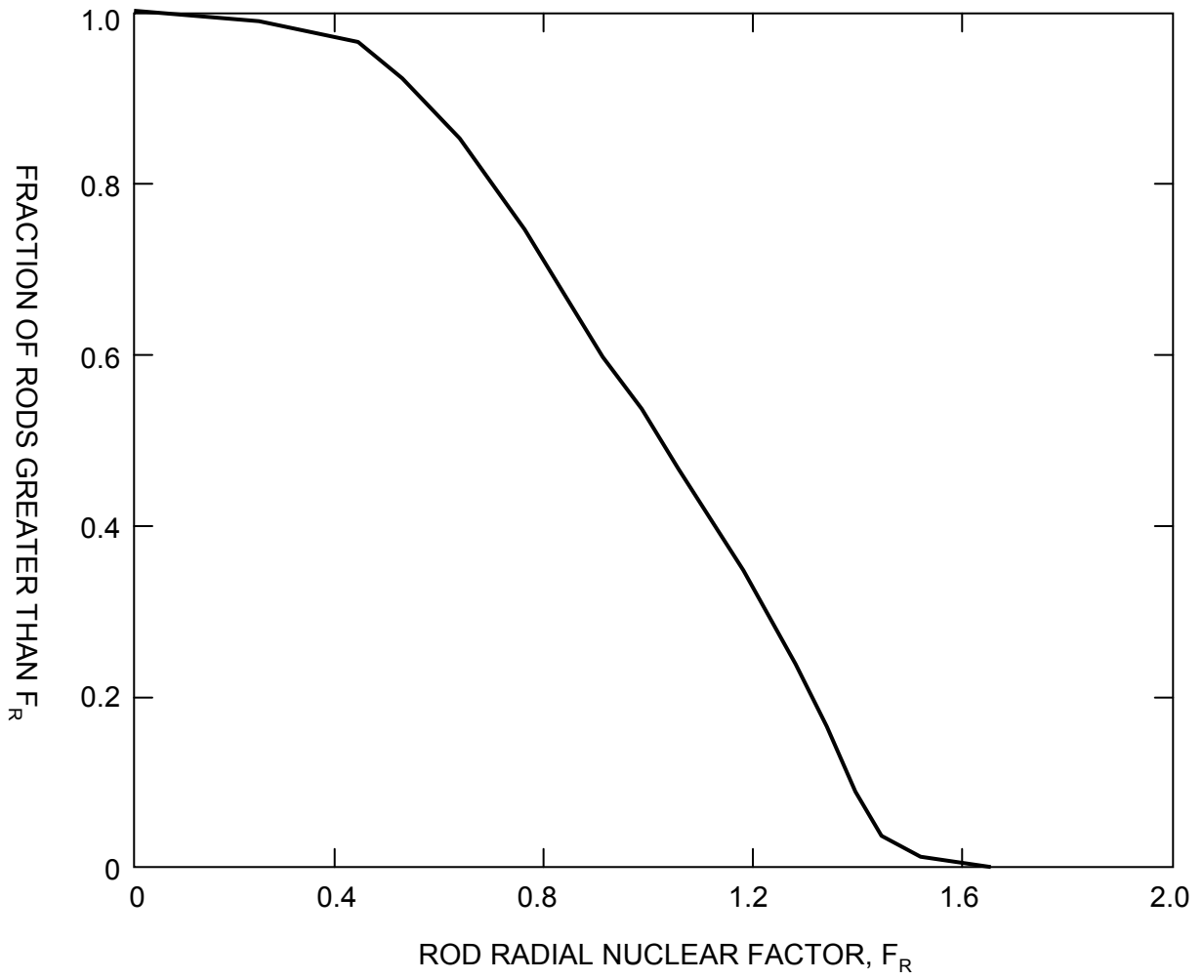

SAR FIGURE NO. 4.4-4

AMENDMENT 20

ARKANSAS NUCLEAR ONE
UNIT 2
RUSSELLVILLE, ARKANSAS



SCALE:	NONE
DRAWN:	ENERGY
DESIGN:	ENERGY
CAD NO:	N/A

CUMULATIVE DISTRIBUTION OF ROD
RADIAL FACTOR

BASED ON DRAWING NO

SHEET

REV.

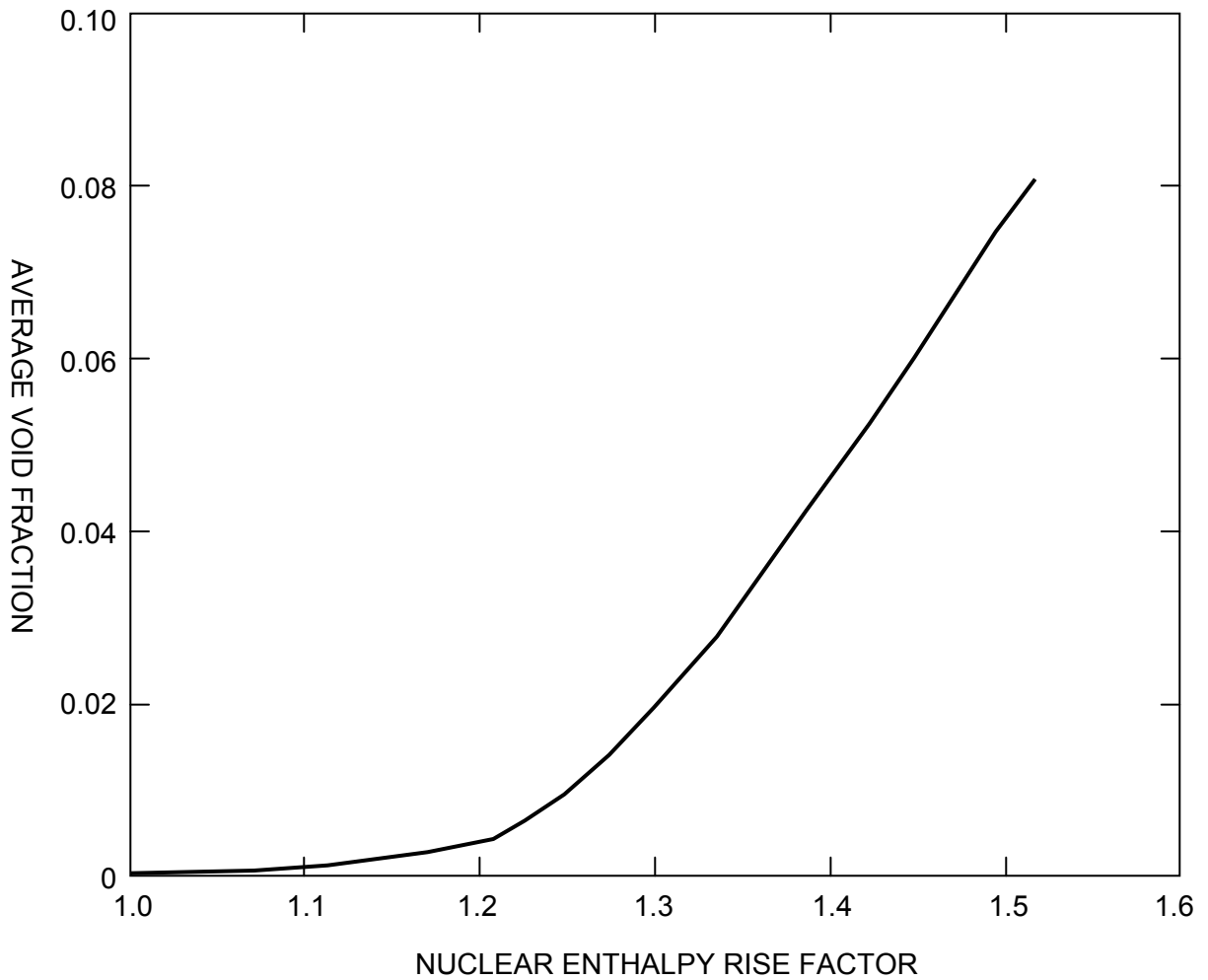

SAR FIGURE NO. 4.4-5

AMENDMENT 20

ARKANSAS NUCLEAR ONE
 UNIT 2
 RUSSELLVILLE, ARKANSAS



SCALE:	NONE
DRAWN:	ENERGY
DESIGN:	ENERGY
CAD NO:	N/A

AVERAGE VOID FRACTION VS NUCLEAR
 ENTHALPY RISE FACTOR

BASED ON DRAWING NO

SHEET

REV.

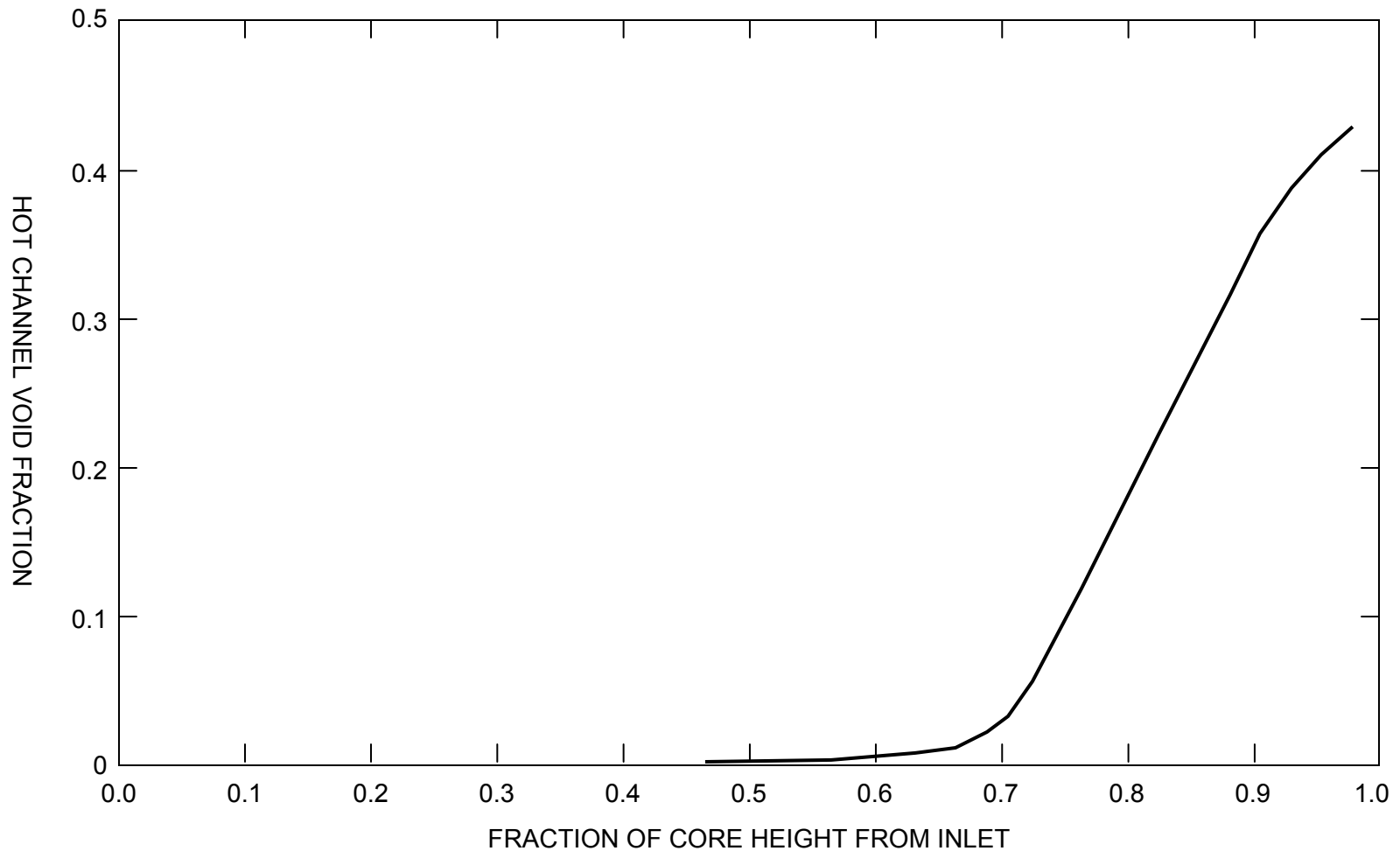

HOT CHANNEL VOID FRACTION VS CORE HEIGHT

SAR FIGURE NO. 4.4-6

ARKANSAS NUCLEAR ONE
 UNIT 2
 RUSSELLVILLE, ARKANSAS



SCALE: NONE
 DRAWN: ENERGY
 DESIGN: ENERGY
 CAD NO:

AMENDMENT 20

BASED ON DRAWING NO	SHEET	REV.

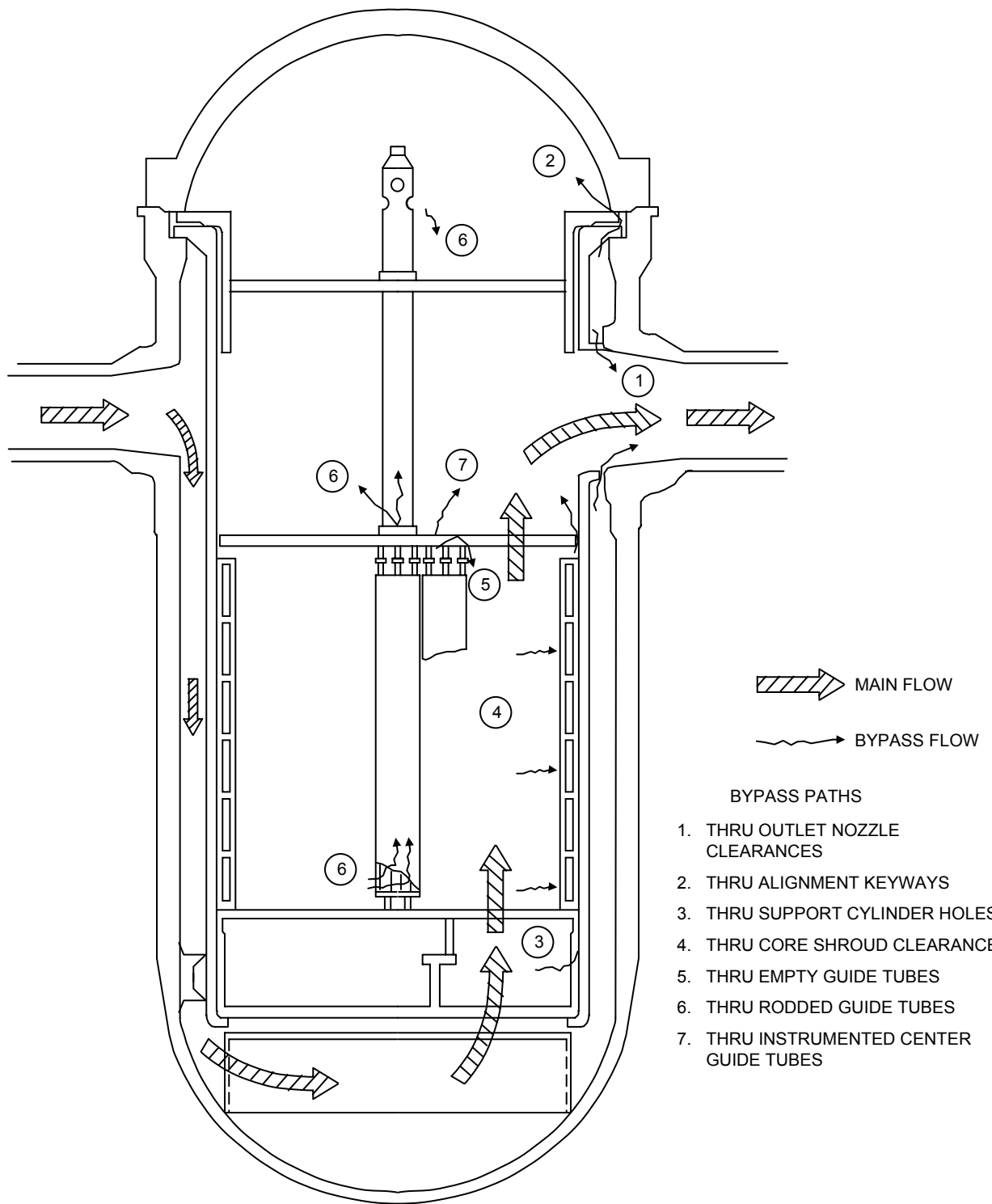

SAR FIGURE NO. 4.4-7

AMENDMENT 20

ARKANSAS NUCLEAR ONE
UNIT 2
RUSSELLVILLE, ARKANSAS



SCALE:	NONE
DRAWN:	ENERGY
DESIGN:	ENERGY
CAD NO:	N/A

REACTOR VERTICAL ARRANGEMENT
SHOWING MAIN & BYPASS FLOW PATHS

DRAWING NO

SHEET

REV.

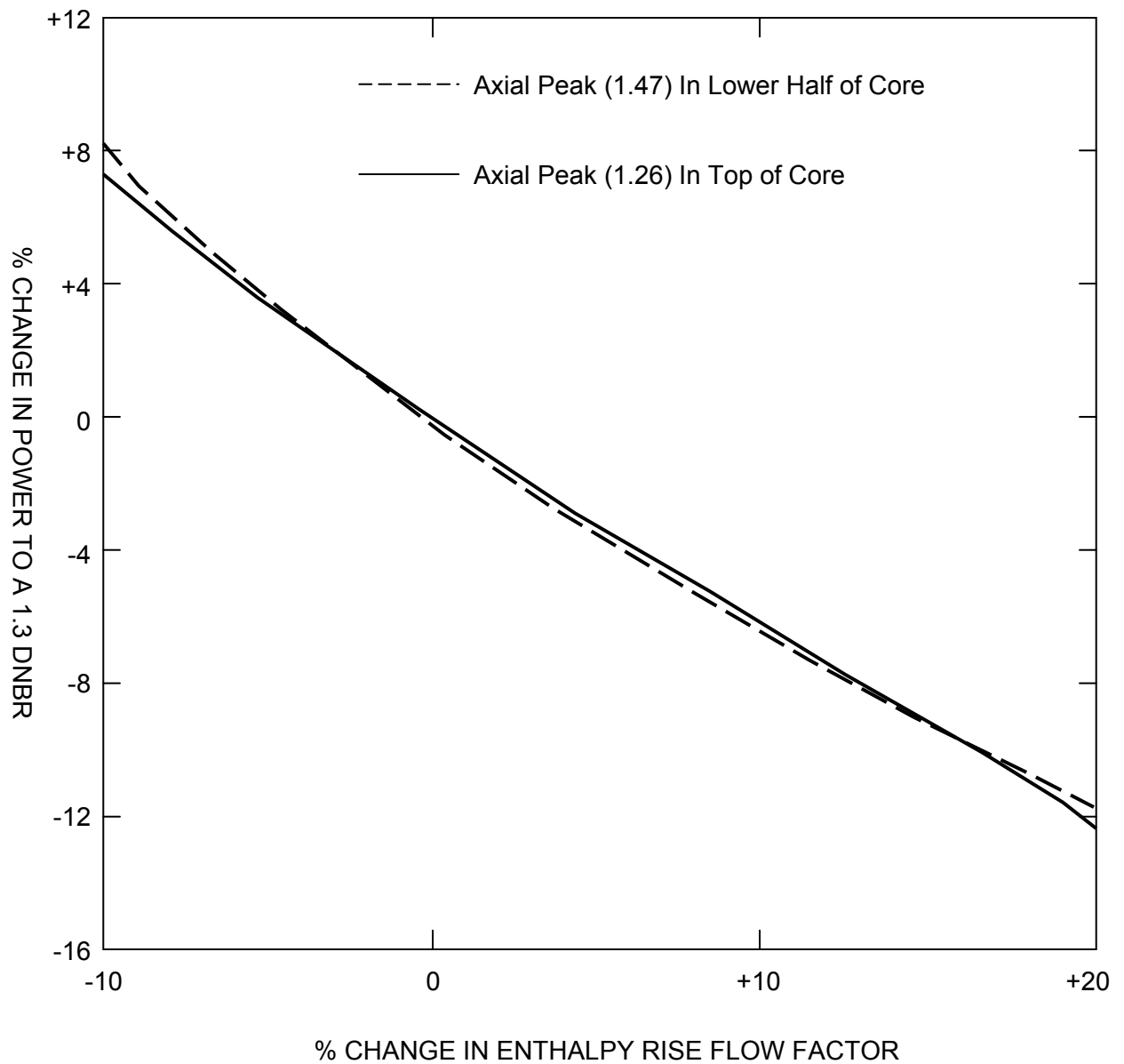

SAR FIGURE NO. 4.4-8

AMENDMENT 20

ARKANSAS NUCLEAR ONE
UNIT 2
RUSSELLVILLE, ARKANSAS



SCALE:	NONE
DRAWN:	ENERGY
DESIGN:	ENERGY
CAD NO:	N/A

PERCENT CHANGE IN CORE POWER VS PERCENT
CHANGE IN ENTHALPY RISE FACTOR FROM DESIGN
VALUE

BASED ON DRAWING NO

SHEET

REV.

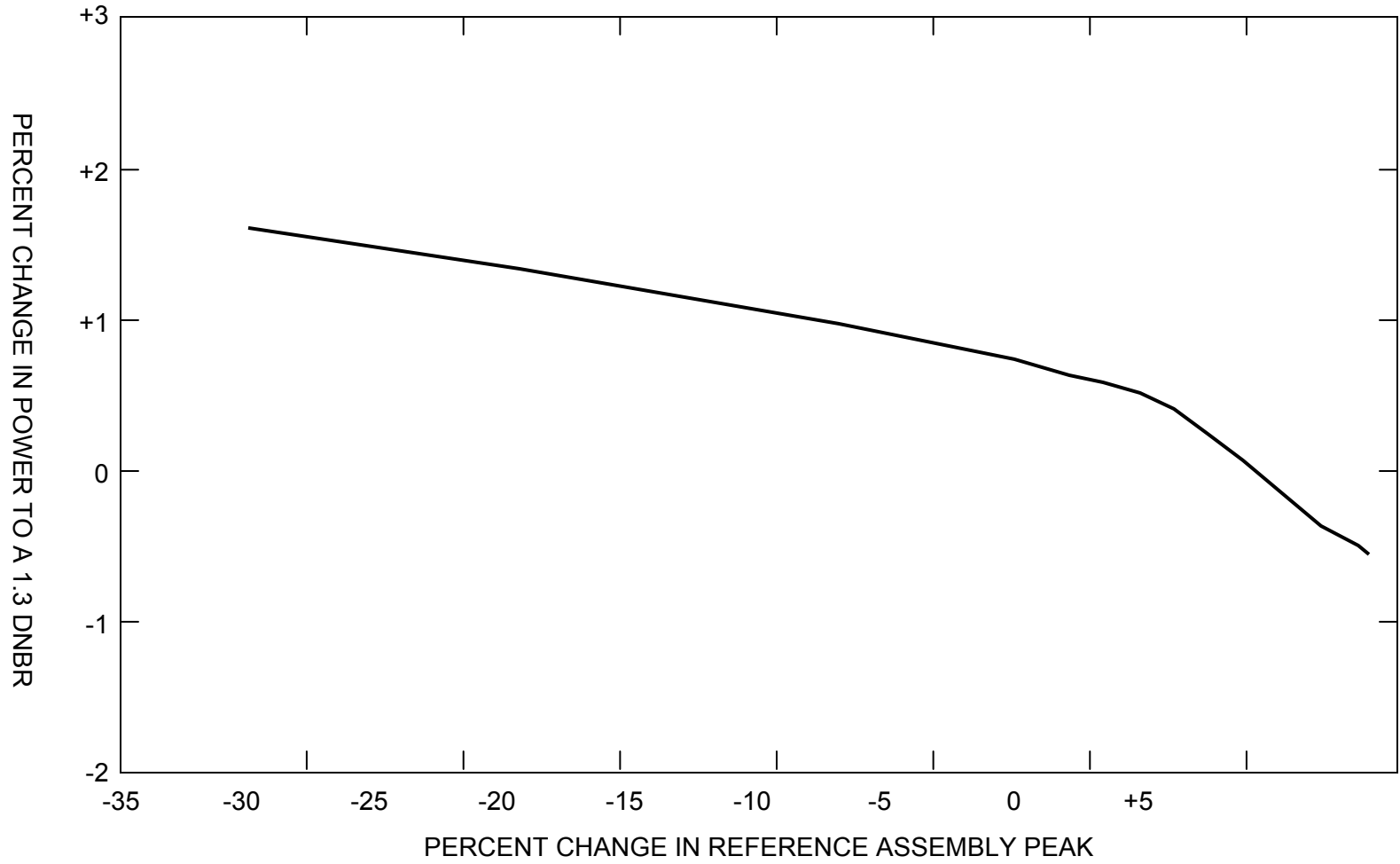

PERCENT CHANGE IN CORE POWER VS PERCENT CHANGE IN REFERENCE ASSEMBLY PEAK FROM DESIGN

SAR FIGURE NO. 4.4-9

ARKANSAS NUCLEAR ONE
 UNIT 2
 RUSSELLVILLE, ARKANSAS



SCALE:	NONE
DRAWN:	ENERGY
DESIGN:	ENERGY
CAD NO:	

AMENDMENT 20

BASED ON DRAWING NO	SHEET	REV.

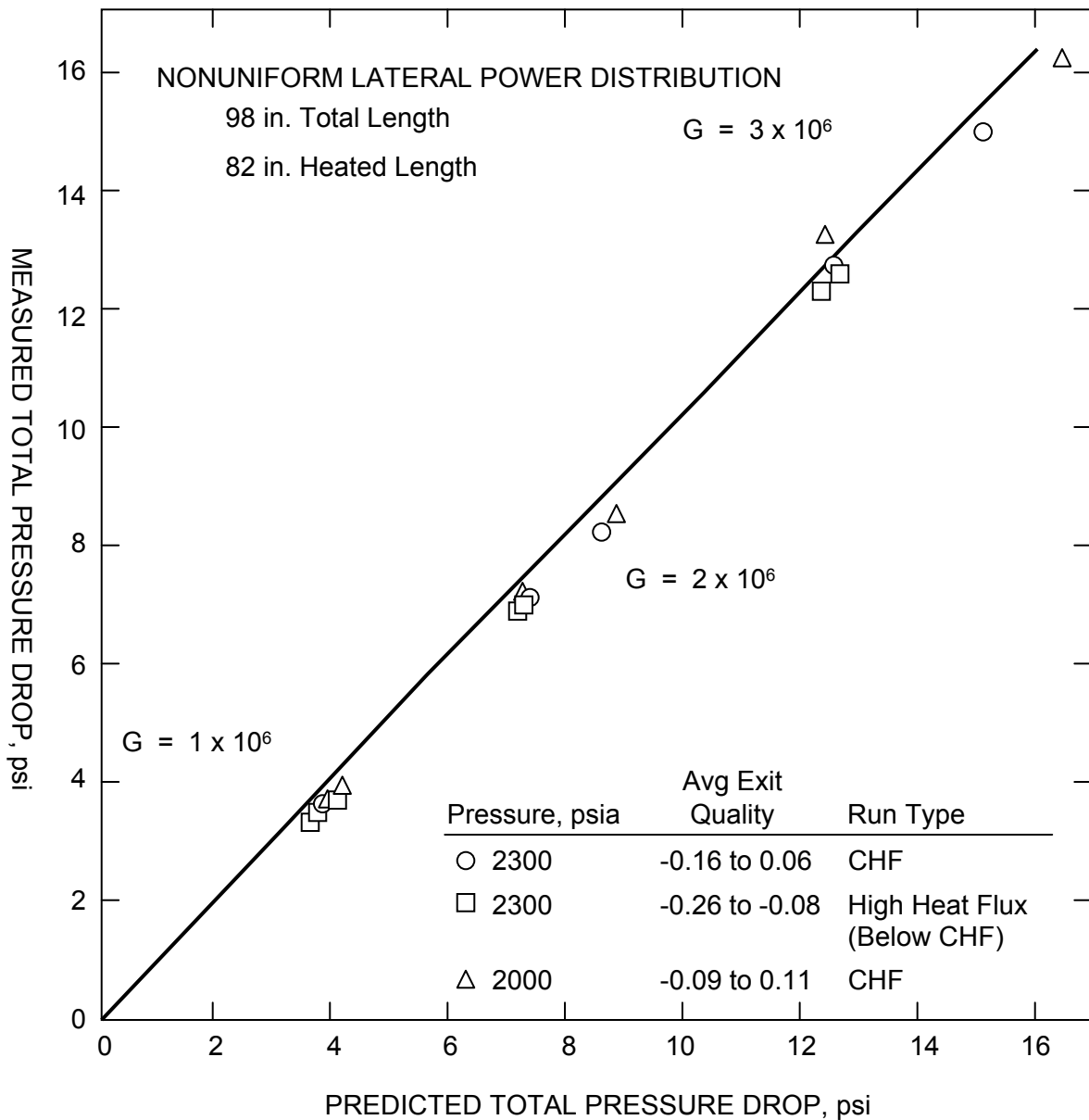

SAR FIGURE NO. 4.4-10

AMENDMENT 20

ARKANSAS NUCLEAR ONE
 UNIT 2
 RUSSELLVILLE, ARKANSAS



SCALE:	NONE
DRAWN:	ENERGY
DESIGN:	ENERGY
CAD NO:	N/A

PRESSURE DROP PREDICTIONS FOR A
 TWENTY-ONE ROD BUNDLE

BASED ON DRAWING NO

SHEET

REV.

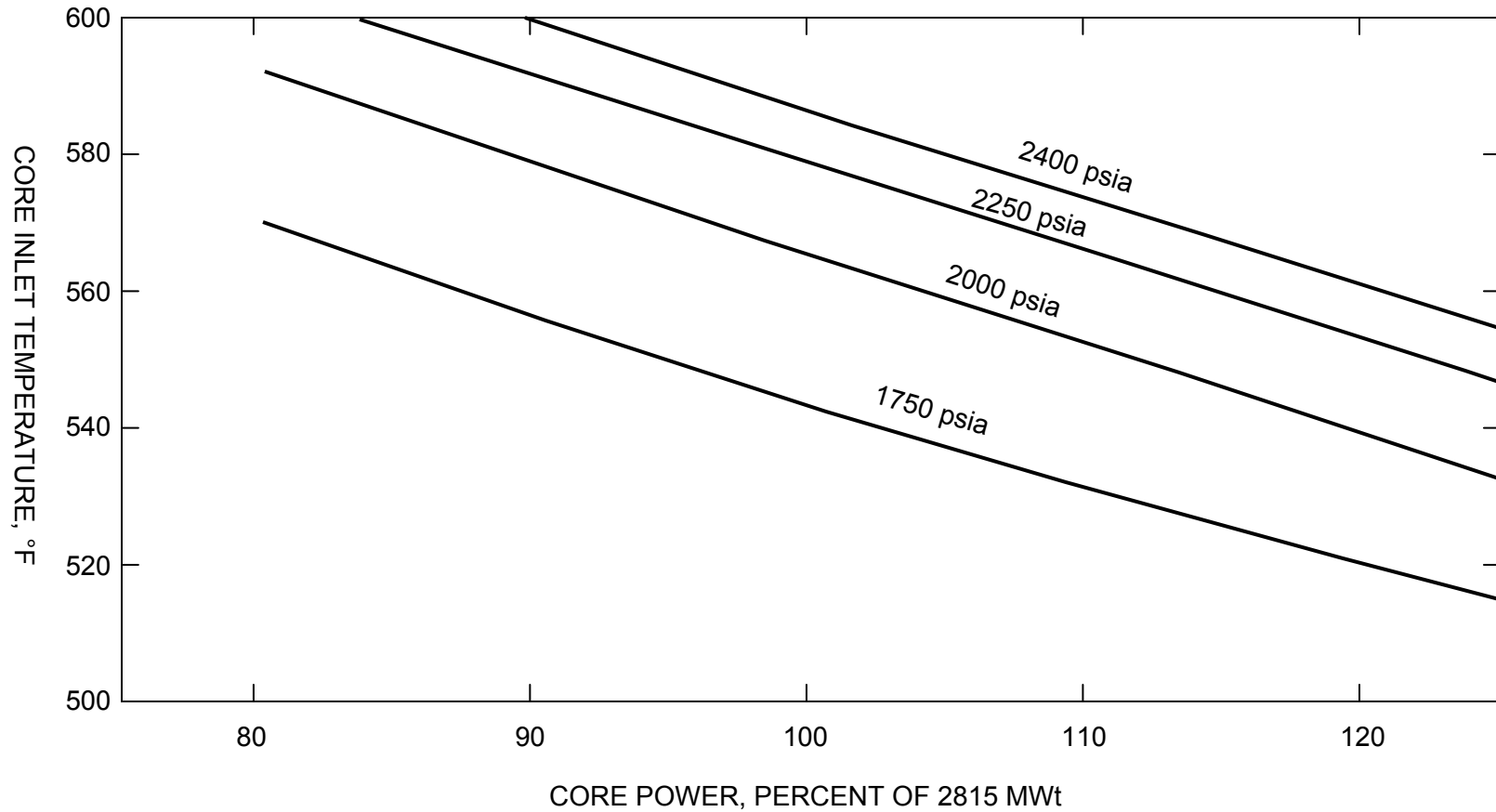

TEMPERATURE VS CORE POWER FOR VARIOUS PRESSURES (4-PUMP OPERATION)

SAR FIGURE NO. 4.4-11

ARKANSAS NUCLEAR ONE
 UNIT 2
 RUSSELLVILLE, ARKANSAS



SCALE: NONE
 DRAWN: ENTERGY
 DESIGN: ENTERGY
 CAD NO:

AMENDMENT 20

BASED ON DRAWING NO

SHEET

REV.

DELETED

SAR FIGURE NO. 4.4-12

AMENDMENT 20

ARKANSAS NUCLEAR ONE
UNIT 2
RUSSELLVILLE, ARKANSAS



SCALE:	NONE
DRAWN:	ENERGY
DESIGN:	ENERGY
CAD NO:	N/A

COMPARISON OF MEASURED AND
COSMO/INTHERMIC/W3 PREDICTED DNB HEAT
FLUXES FOR THE C-E 16 X 16 FUEL ASSEMBLY

BASED ON DRAWING NO

SHEET

REV.

MEASURED AND PREDICTED SUBCHANNEL COOLANT TEMPERATURE RISE FOR
A HEATED ROD BUNDLE REPRESENTATIVE OF THE C-E 16 X 16 ASSEMBLY

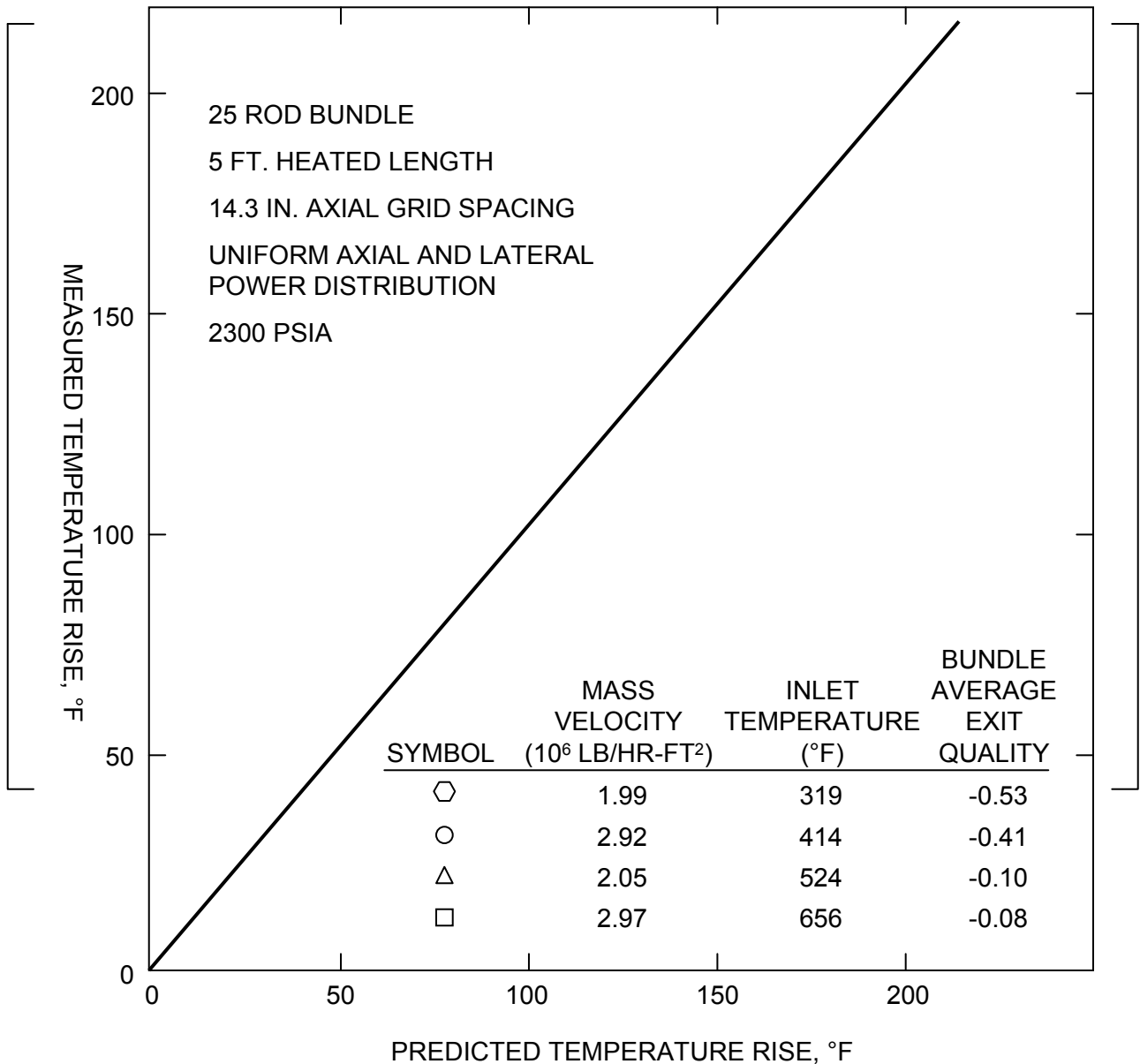

4

SAR FIGURE NO. 4.4-13

AMENDMENT 20

ARKANSAS NUCLEAR ONE
UNIT 2
RUSSELLVILLE, ARKANSAS



SCALE:	NONE
DRAWN:	ENERGY
DESIGN:	ENERGY
CAD NO:	N/A

DNB TEST RESULTS FOR THE CE 16 X 16
FUEL ASSEMBLY

BASED ON DRAWING NO

SHEET

REV.

FIGURE 4.4-14 AND
FIGURE 4.5-1
DELETED

SAR FIGURE NO. 4.5-1

AMENDMENT 20

ARKANSAS NUCLEAR ONE
UNIT 2
RUSSELLVILLE, ARKANSAS



SCALE:	NONE
DRAWN:	ENERGY
DESIGN:	ENERGY
CAD NO:	N/A

MOST POSITIVE MODERATOR
TEMPERATURE COEFFICIENT

BASED ON DRAWING NO

SHEET

REV.

ARKANSAS NUCLEAR ONE
Unit 2

CHAPTER 4A

TABLE OF CONTENTS

<u>Section</u>	<u>Title</u>	<u>Page</u>
4A	FUEL RECONSTITUTION	4A.1-1
4A.1	<u>INTRODUCTION</u>	4A.1-1
4A.2	<u>CONCLUSION</u>	4A.2-1
4A.3	<u>REFERENCES</u>	4A.3-1

ARKANSAS NUCLEAR ONE
Unit 2

CHAPTER 4A

RECORD OF REVISIONS

PAGE # AMENDMENT #

TABLE OF CONTENTS

4A-i	17
4A-ii	17

CHAPTER 4A

4A.1-1	17
--------	----

4A.2-1	17
--------	----

4A.3-1	17
--------	----

ARKANSAS NUCLEAR ONE
Unit 2

4A FUEL RECONSTITUTION

4A.1 INTRODUCTION

Reference 1 discusses the replacement of failed fuel rods or fuel reconstitution. Fuel assemblies containing failed fuel rods have been repaired by replacing the failed rods with either discharged fuel rods or with inert replacement rods. The latter method is preferred since fuel rod handling is minimized. Stainless steel rods of essentially identical geometry to the fuel rods that they replace are employed to preserve the flow geometries and minimize changes in local neutronics properties.

When reconstitution is needed, guidance has been provided for the repairs using inert replacement rods. The guidance has typically limited fuel rod replacement to the use of stainless steel replacement rods and has defined the number and allowed location for such replacements. Limitations regarding the number and locations of replacement rods were formulated from calculations performed to evaluate the effects of replacement rods on core peaking and incore power distribution monitoring system response.

ARKANSAS NUCLEAR ONE
Unit 2

4A.2 CONCLUSION

Reference 1 provides guidance for replacement of failed fuel rods and has concluded:

- (a) Rod replacements denoted as Class A replacements which satisfy the following guidelines may be made without further justification or cycle specific analyses:

[Proprietary Information - See Reference 1]

- (b) Inert rod replacements which fall outside of the Class A criteria given in Reference 1 may be implemented only after evaluation of the explicit replacement geometry. These evaluations will address the effects of the replacement to assure that:
 - i. The applicable safety analysis and thermal margin calculation remain conservative with respect to previously approved limits.
 - ii. The cycle specific CECOR library constants are updated, if necessary, to assure that the online thermal margin and peak power surveillance remain conservative with respect to previously defined limits.

If the number of inert rod replacements exceed the approved/allowable number of inert rods [Proprietary Information - See Reference 1] per fuel assembly, then explicit fuel mechanical design performance analyses may be necessary.

ARKANSAS NUCLEAR ONE
Unit 2

4A.3 REFERENCES

1. CENPD-289-P-A, "Use of Inert Replacement Rods in ABB CENF Fuel Assemblies," [July, 1999.](#) |

ARKANSAS NUCLEAR ONE
Unit 2

CHAPTER 5

TABLE OF CONTENTS

<u>Section</u>	<u>Title</u>	<u>Page</u>
5	<u>REACTOR COOLANT SYSTEM</u>	5.1-1
5.1	<u>SUMMARY DESCRIPTION</u>	5.1-1
5.1.1	<u>SCHEMATIC FLOW DIAGRAM</u>	5.1-2
5.1.2	<u>PIPING AND INSTRUMENT DIAGRAM</u>	5.1-2
5.1.3	<u>ELEVATION DRAWING</u>	5.1-2
5.2	<u>INTEGRITY OF REACTOR COOLANT PRESSURE BOUNDARY</u>	5.2-1
5.2.1	<u>DESIGN OF REACTOR COOLANT PRESSURE BOUNDARY COMPONENTS</u>	5.2-1
5.2.1.1	<u>Performance Objective</u>	5.2-1
5.2.1.2	<u>Design Parameters</u>	5.2-2
5.2.1.3	<u>Compliance With 10 CFR 50.55a</u>	5.2-2
5.2.1.4	<u>Applicable Code Cases</u>	5.2-2
5.2.1.5	<u>Design Transients</u>	5.2-3
5.2.1.6	<u>Identification of Active Pumps and Valves</u>	5.2-7
5.2.1.7	<u>Design of Active Pumps and Valves</u>	5.2-7
5.2.1.8	<u>Inadvertent Operation of Valves</u>	5.2-8
5.2.1.9	<u>Stress and Pressure Limits</u>	5.2-9
5.2.1.10	<u>Stress Analysis For Structural Adequacy</u>	5.2-10
5.2.1.11	<u>Analysis Method for Faulted Condition</u>	5.2-15
5.2.1.12	<u>Protection Against Environmental Factors</u>	5.2-15
5.2.1.13	<u>Compliance With Code Requirements</u>	5.2-15
5.2.1.14	<u>Stress Analysis for Emergency and Faulted Condition Loadings</u>	5.2-15
5.2.1.15	<u>Stress Levels in Seismic Category 1 Systems</u>	5.2-15

ARKANSAS NUCLEAR ONE
Unit 2

TABLE OF CONTENTS (continued)

<u>Section</u>	<u>Title</u>	<u>Page</u>
5.2.1.16	<u>Analytical Methods Used to Evaluate Pump Speed and Bearing Integrity</u>	5.2-16
5.2.1.17	<u>Operation of Active Valves Under Transient Loading</u>	5.2-18
5.2.1.18	<u>Field Run Piping</u>	5.2-19
5.2.1.19	<u>Design of Reactor Coolant System and Lower Pressure System Interfaces</u>	5.2-19
5.2.2	OVERPRESSURE PROTECTION	5.2-19
5.2.2.1	<u>Location of Pressure-Relieving Devices</u>	5.2-20
5.2.2.2	<u>Mounting of Pressure-Relieving Devices</u>	5.2-20
5.2.2.3	<u>Report on Overpressure Protection</u>	5.2-20
5.2.2.4	<u>Low Temperature Overpressure Protection</u>	5.2-23
5.2.2.5	<u>Diverse Scram System (DSS) Overpressure Protection</u>	5.2-24
5.2.3	GENERAL MATERIAL CONSIDERATIONS	5.2-24
5.2.3.1	<u>Material Specifications</u>	5.2-24
5.2.3.2	<u>Compatibility With Reactor Coolant</u>	5.2-25
5.2.3.3	<u>Compatibility With External Insulation and Environmental Atmosphere</u>	5.2-25
5.2.3.4	<u>Chemistry of Reactor Coolant</u>	5.2-25
5.2.3.5	<u>Compliance With Regulatory Guide 1.66</u>	5.2-25
5.2.3.6	<u>Compliance with Regulatory Guide 1.71</u>	5.2-26
5.2.4	FRACTURE TOUGHNESS	5.2-26
5.2.4.1	<u>Compliance With Code Requirements</u>	5.2-26
5.2.4.2	<u>Acceptable Fracture Energy Levels</u>	5.2-27
5.2.4.3	<u>Operating Limitations During Startup and Shutdown</u>	5.2-28
5.2.4.4	<u>Reactor Vessel Material Surveillance Program</u>	5.2-41
5.2.4.5	<u>Reactor Vessel Annealing</u>	5.2-45
5.2.5	AUSTENITIC STAINLESS STEEL	5.2-45

ARKANSAS NUCLEAR ONE
Unit 2

TABLE OF CONTENTS (continued)

<u>Section</u>	<u>Title</u>	<u>Page</u>
5.2.5.1	<u>Cleaning and Contamination Protection Procedures</u>	5.2-45
5.2.5.2	<u>Solution Heat Treatment Requirements</u>	5.2-46
5.2.5.3	<u>Material Inspection Program</u>	5.2-46
5.2.5.4	<u>Unstabilized Austenitic Stainless Steels</u>	5.2-47
5.2.5.5	<u>Avoidance of Sensitization</u>	5.2-47
5.2.5.6	<u>Retesting Unstabilized Austenitic Stainless Steels Exposed to Sensitizing Temperature</u>	5.2-48
5.2.5.7	<u>Compliance with Interim Position MTEB 5-1 on Regulatory Guide 1.31</u>	5.2-49
5.2.5.8	<u>Control of the Use of Sensitized Stainless Steel</u>	5.2-50
5.2.6	PUMP FLYWHEELS	5.2-50
5.2.6.1	<u>Compliance With Regulatory Guide 1.14</u>	5.2-50
5.2.6.2	<u>Additional Data and Analyses</u>	5.2-52
5.2.7	REACTOR COOLANT PRESSURE BOUNDARY LEAKAGE DETECTION SYSTEMS.....	5.2-53
5.2.7.1	<u>Leakage Detection Methods</u>	5.2-53
5.2.7.2	<u>Indication in Control Room</u>	5.2-57
5.2.7.3	<u>Limits For Reactor Coolant Leakage</u>	5.2-57
5.2.7.4	<u>Unidentified Leakage</u>	5.2-58
5.2.7.5	<u>Maximum Allowable Total Leakage</u>	5.2-58
5.2.7.6	<u>Differentiation Between Identified and Unidentified Leaks</u>	5.2-58
5.2.7.7	<u>Sensitivity and Operability Tests</u>	5.2-59
5.2.8	INSERVICE INSPECTION PROGRAM.....	5.2-59
5.2.8.1	<u>Provisions for Access</u>	5.2-60
5.2.8.2	<u>Equipment for Inservice Inspection</u>	5.2-61

ARKANSAS NUCLEAR ONE
Unit 2

TABLE OF CONTENTS (continued)

<u>Section</u>	<u>Title</u>	<u>Page</u>
5.2.8.3	<u>Recording and Comparing Data</u>	5.2-61
5.2.8.4	<u>Reactor Vessel Acceptance Standards</u>	5.2-62
5.2.8.5	<u>Coordination of Inspection Equipment with Access Provisions</u>	5.2-62
5.2.8.6	<u>Inservice Inspection of ASME Code Class 2 and 3 Components</u>	5.2-62
5.2.8.7	<u>Inservice Testing of ASME Code Class 1, 2, & 3 Pumps and Valves</u>	5.2-62
5.2.8.8	<u>Inservice Monitoring of Vibration and Loose Parts</u>	5.2-63
5.3	<u>THERMAL HYDRAULIC SYSTEM DESIGN</u>	5.3-1
5.3.1	ANALYTICAL METHODS AND DATA.....	5.3-1
5.3.1.1	<u>Steam Generator</u>	5.3-1
5.3.1.2	<u>Reactor Coolant Pump</u>	5.3-1
5.3.1.3	<u>Reactor Coolant Piping</u>	5.3-2
5.3.2	OPERATING RESTRICTIONS ON PUMPS.....	5.3-2
5.3.3	POWER-FLOW OPERATING MAP (BWR).....	5.3-2
5.3.4	TEMPERATURE-POWER OPERATING MAP (PWR).....	5.3-2
5.3.5	LOAD FOLLOWING CHARACTERISTICS.....	5.3-3
5.3.6	TRANSIENT EFFECTS.....	5.3-3
5.3.7	THERMAL AND HYDRAULIC CHARACTERISTICS TABLE.....	5.3-4
5.4	<u>REACTOR VESSEL AND APPURTENANCES</u>	5.4-1
5.4.1	PROTECTION OF CLOSURE STUDS.....	5.4-1
5.4.2	SPECIAL PROCESSES FOR FABRICATION AND INSPECTION.....	5.4-1
5.4.2.1	<u>Nondestructive Tests</u>	5.4-1
5.4.2.2	<u>Additional Tests</u>	5.4-2
5.4.2.3	<u>Baseline Examination</u>	5.4-3
5.4.3	FEATURES FOR IMPROVED RELIABILITY.....	5.4-4

ARKANSAS NUCLEAR ONE
Unit 2

TABLE OF CONTENTS (continued)

<u>Section</u>	<u>Title</u>	<u>Page</u>
5.4.4	QUALITY ASSURANCE SURVEILLANCE	5.4-4
5.4.5	MATERIALS AND INSPECTIONS	5.4-4
5.4.6	REACTOR VESSEL DESIGN DATA.....	5.4-4
5.4.6.1	<u>Design Basis</u>	5.4-4
5.4.6.2	<u>Reactor Vessel Description</u>	5.4-4
5.4.6.3	<u>Design Data</u>	5.4-5
5.4.6.4	<u>Evaluation</u>	5.4-5
5.4.7	REACTOR VESSEL SCHEMATIC (BWR).....	5.4-5
5.5	<u>COMPONENT AND SUBSYSTEM DESIGN</u>	5.5-1
5.5.1	REACTOR COOLANT PUMPS.....	5.5-1
5.5.1.1	<u>Design Bases</u>	5.5-1
5.5.1.2	<u>Description</u>	5.5-1
5.5.1.3	<u>Evaluation</u>	5.5-3
5.5.1.4	<u>Tests and Inspections</u>	5.5-4
5.5.2	STEAM GENERATOR	5.5-4
5.5.2.1	<u>Design Bases</u>	5.5-4
5.5.2.2	<u>Description</u>	5.5-5
5.5.2.3	<u>Evaluation</u>	5.5-7
5.5.3	REACTOR COOLANT PIPING	5.5-11
5.5.3.1	<u>Design Basis</u>	5.5-11
5.5.3.2	<u>Description</u>	5.5-12
5.5.3.3	<u>Evaluation</u>	5.5-12
5.5.3.4	<u>Tests And Inspections</u>	5.5-13
5.5.4	MAIN STEAM FLOW RESTRICTIONS.....	5.5-13

ARKANSAS NUCLEAR ONE
Unit 2

TABLE OF CONTENTS (continued)

<u>Section</u>	<u>Title</u>	<u>Page</u>
5.5.5	MAIN STEAM ISOLATION SYSTEM	5.5-13
5.5.5.1	<u>Design Bases</u>	5.5-13
5.5.5.2	<u>Description</u>	5.5-13
5.5.5.3	<u>Evaluation</u>	5.5-14
5.5.5.4	<u>Testing and Inspection</u>	5.5-14
5.5.6	REACTOR CORE ISOLATION COOLING SYSTEM	5.5-14
5.5.7	RESIDUAL HEAT REMOVAL SYSTEM.....	5.5-14
5.5.8	REACTOR COOLANT CLEANUP SYSTEM.....	5.5-14
5.5.9	MAIN STEAM LINE AND FEEDWATER PIPING.....	5.5-14
5.5.10	PRESSURIZER.....	5.5-14
5.5.10.1	<u>Design Bases</u>	5.5-14
5.5.10.2	<u>Description</u>	5.5-15
5.5.10.3	<u>Evaluation</u>	5.5-18
5.5.10.4	<u>Tests and Inspections</u>	5.5-19
5.5.11	QUENCH TANK (PRESSURIZER RELIEF TANK)	5.5-19
5.5.11.1	<u>Design Basis</u>	5.5-19
5.5.11.2	<u>Description</u>	5.5-19
5.5.11.3	<u>Evaluation</u>	5.5-20
5.5.12	VALVES	5.5-20
5.5.12.1	<u>Design Basis</u>	5.5-20
5.5.12.2	<u>Description</u>	5.5-20
5.5.12.3	<u>Evaluation</u>	5.5-21
5.5.12.4	<u>Tests and Inspections</u>	5.5-21
5.5.13	SAFETY AND RELIEF VALVES	5.5-21

ARKANSAS NUCLEAR ONE
Unit 2

TABLE OF CONTENTS (continued)

<u>Section</u>	<u>Title</u>	<u>Page</u>
5.5.13.1	<u>Design Basis</u>	5.5-21
5.5.13.2	<u>Description</u>	5.5-22
5.5.13.3	<u>Evaluation</u>	5.5-22
5.5.13.4	<u>Tests and Inspections</u>	5.5-23
5.5.14	COMPONENT SUPPORTS	5.5-23
5.5.14.1	<u>Design Basis</u>	5.5-23
5.5.14.2	<u>Description</u>	5.5-23
5.5.14.3	<u>Evaluation</u>	5.5-24
5.5.14.4	<u>Testing And Inspection</u>	5.5-24
5.6	<u>INSTRUMENTATION REQUIREMENTS</u>	5.6-1
5.6.1	TEMPERATURE	5.6-1
5.6.1.1	<u>Hot Leg Temperature</u>	5.6-1
5.6.1.2	<u>Cold Leg Temperature</u>	5.6-2
5.6.1.3	<u>Surge Line Temperature</u>	5.6-2
5.6.1.4	<u>Pressurizer Temperature</u>	5.6-2
5.6.1.5	<u>Spray Line Temperature</u>	5.6-2
5.6.1.6	<u>Relief Line Temperature</u>	5.6-2
5.6.1.7	<u>Quench Tank Temperature</u>	5.6-2
5.6.2	PRESSURIZER PRESSURE	5.6-2
5.6.2.1	<u>Protection</u>	5.6-2
5.6.2.2	<u>Control</u>	5.6-3
5.6.2.3	<u>Startup and Shutdown</u>	5.6-3
5.6.2.4	<u>Quench Tank Pressure</u>	5.6-3
5.6.3	LEVEL	5.6-3

ARKANSAS NUCLEAR ONE
Unit 2

TABLE OF CONTENTS (continued)

<u>Section</u>	<u>Title</u>	<u>Page</u>
5.6.3.1	<u>Control</u>	5.6-3
5.6.3.2	<u>Startup and Shutdown</u>	5.6-4
5.6.3.3	<u>Quench Tank Level</u>	5.6-4
5.6.4	REACTOR COOLANT LOOP FLOW.....	5.6-4
5.6.5	REACTOR COOLANT PUMP INSTRUMENTATION.....	5.6-4
5.6.5.1	<u>Temperature</u>	5.6-4
5.6.5.2	<u>Pressure</u>	5.6-5
5.6.5.3	<u>Motor Oil Reservoir Level</u>	5.6-5
5.6.5.4	<u>Reverse Rotation Switch</u>	5.6-5
5.6.5.5	<u>RCP Pump/Motor Vibration Monitoring</u>	5.6-5
5.6.5.6	<u>Motor Current SPDS Inputs</u>	5.6-5
5.7	<u>REFERENCES</u>	5.7-1
5.8	<u>TABLES</u>	5.8-1

ARKANSAS NUCLEAR ONE
Unit 2

LIST OF TABLES

<u>Table</u>	<u>Title</u>	<u>Page</u>
5.1-1	ORIGINAL DESIGN PARAMETERS OF REACTOR COOLANT SYSTEM	5.8-1
5.1-1A	DESIGN PARAMETERS (BEST ESTIMATE) OF REACTOR COOLANT SYSTEM.....	5.8-2
5.1-2	REACTOR COOLANT SYSTEM VOLUMES	5.8-3
5.1-3	REACTOR COOLANT SYSTEM PROCESS DATA POINT TABULATION.....	5.8-4
5.2-1	REACTOR COOLANT SYSTEM PRESSURE BOUNDARY CODE REQUIREMENTS	5.8-5
5.2-2	ACTIVE AND INACTIVE VALVES IN THE REACTOR COOLANT SYSTEM BOUNDARY.....	5.8-7
5.2-3	REACTOR COOLANT SYSTEM MATERIALS	5.8-18
5.2-4	CHEMICAL ANALYSES OF PLATE MATERIAL IN REACTOR VESSEL BELTLINE.....	5.8-20
5.2-5	CHARPY V-NOTCH AND DROP WEIGHT TEST VALVES - REACTOR VESSEL.....	5.8-21
5.2-6	CHARPY V-NOTCH TEST VALUES – STEAM GENERATOR NO. 1	5.8-22
5.2-7	CHARPY V-NOTCH TEST VALUES – STEAM GENERATOR NO. 2	5.8-23
5.2-8	REFERENCE NIL-DUCTILITY TRANSITION TEMPERATURE RT_{NDT} (°F) FOR REPLACEMENT PRESSURIZER.....	5.8-24
5.2-9	REACTOR COOLANT PIPE CHARPY RESULTS.....	5.8-25
5.2-10	MATERIAL REFERENCES FOR FRACTURE TOUGHNESS EVALUATION.....	5.8-27
5.2-11	SURVEILLANCE SPECIMENS PROVIDED FOR EACH EXPOSURE LOCATION	5.8-31
5.2-12	CAPSULE REMOVAL SCHEDULE.....	5.8-32
5.2-13	CONFORMANCE OF RCS/LOW PRESSURE SYSTEM INTERFACES WITH GENERAL DESIGN CRITERIA 14 AND 55	5.8-33
5.2-14	CHAT 12100 - VERIFICATION PROBLEMS	5.8-36

ARKANSAS NUCLEAR ONE
Unit 2

LIST OF TABLES (continued)

<u>Table</u>	<u>Title</u>	<u>Page</u>
5.2-15	BCH10026 EDGE COEFFICIENTS	5.8-36
5.2-16	BASELINE MECHANICAL PROPERTIES – REACTOR VESSEL SURVEILLANCE MATERIALS	5.8-38
5.2-17	CHEMICAL ANALYSIS OF REACTOR VESSEL SURVEILLANCE MATERIALS.....	5.8-39
5.2-18	TENSILE PROPERTIES - REACTOR VESSEL SURVEILLANCE MATERIALS.....	5.8-40
5.2-19	EQUIPMENT PROTECTED BY SAFETY VALVES	5.8-41
5.2-20	REACTOR VESSEL BELTLINE MATERIALS.....	5.8-43
5.2-20a	REVISED REACTOR VESSEL BELTLINE MATERIALS.....	5.8-43
5.2-21	ESTIMATES FOR RPV BELTLINE MATERIAL CvUSE UNIRRADIATED/INITIAL VALUES FOR THE TRANSVERSE (WEAK) DIRECTION.....	5.8-44
5.2-22	PREDICTIONS OF MINIMUM CHARPY UPPER SHELF ENERGY (CvUSE) FOR RPV BELTLINE MATERIALS 48 EFPY.....	5.8-45
5.2-22A	PREDICTED USE VALUES AT 54 EFPY (EOLE) FOR ANO-2.....	5.8-46
5.3-1	DELETED – SEE FSAR	5.8-47
5.3-2	ORIGINAL THERMAL AND HYDRAULIC DATA	5.8-47
5.4-1	REACTOR VESSEL QUALITY ASSURANCE PROGRAM, TESTS REQUIRED BY THE ASME CODE, SECTION III	5.8-49
5.4-2	REACTOR VESSEL PARAMETERS	5.8-50
5.4-3	REACTOR VESSEL CLOSURE STUD MATERIAL TENSILE STRENGTH AND TOUGHNESS DATA.....	5.8-50
5.5-1	REACTOR COOLANT PUMP ORIGINAL PARAMETERS	5.8-51
5.5-2	STEAM GENERATOR DESIGN PARAMETERS.....	5.8-53
5.5-3	STEAM GENERATOR TESTS.....	5.8-55
5.5-4	REACTOR COOLANT PIPING ORIGINAL DESIGN PARAMETERS.....	5.8-56
5.5-5	REACTOR COOLANT PIPING TESTS.....	5.8-57

ARKANSAS NUCLEAR ONE
Unit 2

LIST OF TABLES (continued)

<u>Table</u>	<u>Title</u>	<u>Page</u>
5.5-6	PRESSURIZER REPLACEMENT DESIGN PARAMETERS	5.8-58
5.5-7	PRESSURIZER TESTS	5.8-59
5.5-8	QUENCH TANK PARAMETERS.....	5.8-60
5.5-9	PRESSURIZER SPRAY VALVE PARAMETERS	5.8-60
5.5-10	PRESSURIZER SAFETY VALVE PARAMETERS.....	5.8-61
5.5-11	MAIN STEAM SAFETY VALVE PARAMETERS.....	5.8-62
5.5-12	MOVED TO TABLE 3.11-3.....	5.8-62
5.5-13	PRESSURIZER LEVEL CONTROL SETPOINTS.....	5.8-63
5.6-1	REACTOR COOLANT SYSTEM INSTRUMENTATION	5.8-64

ARKANSAS NUCLEAR ONE
Unit 2

LIST OF FIGURES

<u>Figure No.</u>	<u>Title</u>
5.1-1	REACTOR COOLANT SYSTEM ARRANGMENT - PLAN
5.1-2	REACTOR COOLANT SYSTEM ARRANGEMENT - ELEVATION
5.1-3	REACTOR COOLANT SYSTEM
5.2-1	CHARPY TEST RESULTS VESSEL FLANGE - FORGING (C-8001)
5.2-2	CHARPY TEST RESULTS BOTTOM HEAD - PLATE (C-8013)
5.2-3	CHARPY TEST RESULTS BOTTOM HEAD - PLATE (C-8014-1)
5.2-4	CHARPY TEST RESULTS INLET NOZZLE - FORGING (C-8015-1)
5.2-5	CHARPY TEST RESULTS INLET NOZZLE - FORGING (C-8015-2)
5.2-6	CHARPY TEST RESULTS INLET NOZZLE - FORGING (C-8015-3)
5.2-7	CHARPY TEST RESULTS INLET NOZZLE - FORGING (C-8015-3)
5.2-8	CHARPY TEST RESULTS OUTLET NOZZLE - FORGING (C-8016-1)
5.2-9	CHARPY TEST RESULTS OUTLET NOZZLE - FORGING (C-8016-2)
5.2-10	CHARPY TEST RESULTS INLET NOZZLE EXTENSION - FORGING (C-8019-1)
5.2-11	CHARPY TEST RESULTS INLET NOZZLE EXTENSION - FORGING (C-8019-2)
5.2-12	CHARPY TEST RESULTS INLET NOZZLE EXTENSION - FORGING (C-8019-3)
5.2-13	CHARPY TEST RESULTS INLET NOZZLE EXTENSION - FORGING (C-8019-4)
5.2-14	CHARPY TEST RESULTS OUTLET NOZZLE EXTENSION - FORGING (C-8020-1)
5.2-15	CHARPY TEST RESULTS OUTLET NOZZLE EXTENSION - FORGING (C-8020-2)
5.2-16	CHARPY TEST RESULTS UPPER SHELL - PLATE (C-8008-1)
5.2-17	CHARPY TEST RESULTS UPPER SHELL - PLATE (C-8008-2)
5.2-18	CHARPY TEST RESULTS UPPER SHELL - PLATE (C-8008-3)
5.2-19	CHARPY TEST RESULTS INTERMEDIATE SHELL PLATE (C-8009-1)
5.2-20	CHARPY TEST RESULTS INTERMEDIATE SHELL PLATE (C-8009-2)

ARKANSAS NUCLEAR ONE
Unit 2

LIST OF FIGURES (continued)

<u>Figure No.</u>	<u>Title</u>
5.2-21	CHARPY TEST RESULTS INTERMEDIATE SHELL PLATE (C-8009-3)
5.2-22	CHARPY TEST RESULTS LOWER SHELL - PLATE (C-8010-1)
5.2-23	CHARPY TEST RESULTS LOWER SHELL - PLATE (C-8010-2)
5.2-24	CHARPY TEST RESULTS LOWER SHELL - PLATE (C-8010-3)
5.2-25	CHARPY TEST RESULTS CLOSURE HEAD FLANGE FORGING (C-8002)
5.2-26	CHARPY TEST RESULTS CLOSURE HEAD PEELS - PLATE (C-8012)
5.2-27	CHARPY TEST RESULTS CLOSURE HEAD DOME - PLATE (C-8011)
5.2-28	C-E DESIGN CURVE OF NDTT INCREASE FOR IMPROVED RESIDUAL ELEMENT BELTLINE MATERIAL (550 °F IRRADIATION)
5.2-29	TYPICAL LOCATIONS OF SURVEILLANCE CAPSULE ASSEMBLIES
5.2-30	TYPICAL SURVEILLANCE CAPSULE ASSEMBLY
5.2-31	TYPICAL CHARPY IMPACT COMPARTMENT ASSEMBLY
5.2-32	TYPICAL TENSILE - MONITOR COMPARTMENT ASSEMBLY
5.2-33	REACTOR COOLANT PUMP 2P32A FLYWHEEL DYNAMIC TOUGHNESS FOR RATES BETWEEN $K = 10^4$ AND 10^5 KSI INCH/SECOND
5.2-33A	REACTOR COOLANT PUMPS 2P32B, C, AND D FLYWHEEL DYNAMIC TOUGHNESS FOR RATES BETWEEN $K = 10^4$ AND 10^5 KSI INCH/SECOND
5.2-34	REACTOR COOLANT SYSTEM MAXIMUM STRESS LEVELS - FAULTED CONDITION
5.2-35	REACTOR COOLANT PUMP DYNAMIC MODELS
5.2-36	REACTOR VESSEL SURVEILLANCE MATERIAL - BASELINE TEST PROGRAM RESULTS
5.2-37	REACTOR VESSEL SURVEILLANCE MATERIAL - BASELINE TEST PROGRAM RESULTS
5.2-38	REACTOR VESSEL SURVEILLANCE MATERIAL - BASELINE TEST PROGRAM RESULTS
5.2-39	REACTOR VESSEL SURVEILLANCE MATERIAL - BASELINE TEST PROGRAM RESULTS

ARKANSAS NUCLEAR ONE
Unit 2

LIST OF FIGURES (continued)

<u>Figure No.</u>	<u>Title</u>
5.2-40	REACTOR VESSEL SURVEILLANCE MATERIAL - BASELINE TEST PROGRAM RESULTS
5.2-41	REACTOR VESSEL SURVEILLANCE MATERIAL - BASELINE TEST PROGRAM RESULTS
5.2-42	REACTOR VESSEL SURVEILLANCE MATERIAL - BASELINE TEST PROGRAM RESULTS
5.2-43	REACTOR VESSEL SURVEILLANCE MATERIAL - BASELINE TEST PROGRAM RESULTS
5.2-44	REACTOR VESSEL SURVEILLANCE MATERIAL - BASELINE TEST PROGRAM RESULTS
5.2-45	REACTOR VESSEL SURVEILLANCE MATERIAL - BASELINE TEST PROGRAM RESULTS
5.2-46	DELETED
5.2-46A	DELETED
5.2-47	DELETED
5.2-48	STEAM GENERATOR PRESSURE COMPLETE LOSS OF TURBINE GENERATOR LOAD
5.2-49	OPTIMIZED SAFETY VALVE CAPACITIES
5.2-50	MAXIMUM REACTOR COOLANT SYSTEM PRESSURE VS TIME FOR WORST CASE LOSS OF LOAD INCIDENT
5.2-51	MAXIMUM REACTOR POWER VS TIME FOR WORST CASE LOSS OF LOAD INCIDENT
5.3-1	REACTOR COOLANT TEMPERATURE VS REACTOR POWER
5.3-2	DESIGN STEAM PRESSURE VARIATION WITH POWER
5.4-1	REACTOR VESSEL
5.4-2	REACTOR VESSEL CLOSURE STUD MATERIAL TOUGHNESS VS TEMPERATURE-HEAT 89616
5.4-3	REACTOR VESSEL CLOSURE STUD MATERIAL TOUGHNESS VS TEMPERATURE-HEAT 89229
5.5-1	REACTOR COOLANT PUMP

ARKANSAS NUCLEAR ONE
Unit 2

LIST OF FIGURES (continued)

<u>Figure No.</u>	<u>Title</u>
5.5-2	REACTOR COOLANT PUMP CONNECTIONS
5.5-3	REACTOR COOLANT PUMP SEAL AREA (SU MODEL)
5.5-3A	REACTOR COOLANT PUMP SEAL AREA (N9000 MODEL)
5.5-4	MOTOR - FLYWHEEL ASSEMBLY
5.5-5	ANTI-ROTATIONAL DEVICE
5.5-6	REACTOR COOLANT PUMP PERFORMANCE
5.5-7	STEAM GENERATOR
5.5-8	PRESSURIZER
5.5-9	PRESSURIZER LEVEL SET POINT PROGRAM
5.5-10	DELETED
5.5-11	QUENCH TANK
5.5-12	REACTOR VESSEL SUPPORTS
5.5-13	STEAM GENERATOR SUPPORTS INSTALLATION
5.5-14	REACTOR COOLANT PUMP SUPPORTS - LOWER
5.5-15	REACTOR COOLANT PUMP SUPPORTS - UPPER

ARKANSAS NUCLEAR ONE
Unit 2

UPDATE REFERENCE LIST

Sections and references listed below denote documents that contain additional cross reference information used to update the SAR.

<u>Section</u>	<u>Cross Reference</u>
5.2.1.5	Correspondence from Cavanaugh, AP&L, to Stolz, NRC, dated June 14, 1976. (2CAN067607).
5.2.8.8	Correspondence from Rueter, AP&L, to Stolz, NRC, dated August 31, 1977. (2CAN087708).
5.2.2.4	Correspondence from Rueter, AP&L, to Stolz, NRC, dated October 11, 1977. (2CAN107707).
5.2.2.4	Correspondence from Williams, AP&L, to Stolz, NRC, dated December 7, 1977. (2CAN127703).
5.5.2.3.1	Correspondence from Williams, AP&L, to Stolz, NRC, dated 5.5.2.3.2.1 April 28, 1978. (2CAN047832).
5.5.2.3.1	Correspondence from Williams, AP&L, to Stolz, NRC, dated June 9, 1978. (2CAN067802).
5.2.1.3	Correspondence from Williams, AP&L, to Stolz, NRC, dated June 14, 1978. (2CAN067812).
5.2.2.4	Correspondence from Williams, AP&L, to Stolz, NRC, dated June 30, 1978. (2CAN067844).
5.5.1.2	Correspondence from Williams, AP&L, to Stolz, NRC, dated September 1, 1978. (2CAN097801).
5.5.1.2	Correspondence from Williams, AP&L, to Stolz, NRC, dated October 18, 1978. (2CAN107811).
5.2.1.15	Correspondence from Trimble, AP&L, to Seyfrit, NRC, dated April 24, 1979. (0CAN047914).
5.2.7.7	Correspondence from Trimble, AP&L, to Seyfrit, NRC, dated August 24, 1979. (0CAN087912).
5.5.10.2	Correspondence from Cavanaugh, AP&L, to Eisenhut, NRC, dated October 17, 1979. (0CAN107904).
5.5.10.2	Correspondence from Cavanaugh, AP&L, to Reid, NRC, dated November 27, 1979. (2CAN117912).
5.6.1.1	Correspondence from Trimble, AP&L, to Reid, NRC, dated December 3, 1979. (2CAN127901).

ARKANSAS NUCLEAR ONE
Unit 2

UPDATE REFERENCE LIST (continued)

<u>Section</u>	<u>Cross Reference</u>
5.5.10.2	Correspondence from Trimble, AP&L, to Eisenhut, NRC, dated January 29, 1980. (0CAN018026).
5.5.10.2	Correspondence from Trimble, AP&L, to Eisenhut, NRC, dated January 31, 1980. (0CAN018032).
5.5.10.2	Correspondence from Cavanaugh, AP&L, to Seyfrit, NRC, dated February 5, 1980. (2CAN028001).
5.5.10.2	Correspondence from Trimble, AP&L, to Reid, NRC, dated February 22, 1980. (2CAN028008).
5.5.12.3	Correspondence from Steel, AP&L, to Eisenhut, NRC, dated March 24, 1980. (0CAN038003).
5.5.10.2	Correspondence from Trimble, AP&L, to Eisenhut, NRC, dated July 10, 1980. (0CAN078013).
5.2.2.4	Correspondence from Trimble, AP&L, to Clark, NRC, dated March 30, 1981. (2CAN038119).
5.2.7.1.3 5.5.10.2	Correspondence from Trimble, AP&L, to Seyfrit, NRC, dated March 31, 1981. (0CAN048102).
5.5.12.3	Correspondence from Clark, NRC, to Cavanaugh, AP&L, dated April 20, 1981. (2CNA048106).
5.5.14.1 5.5.14.2.3	Correspondence from Trimble, AP&L, to Novak, NRC, dated April 28, 1981. (2CAN048109).
5.2.8.1.3	Correspondence from Cavanaugh, AP&L, to Clark, NRC, dated May 13, 1981. (2CAN058106).
5.5.12.3	Correspondence from Trimble, AP&L, to Madsen, NRC, dated May 22, 1981. (0CAN058115).
5.2.8.1.4	Correspondence from Trimble, AP&L, to Seyfrit, NRC, dated August 18, 1981. (2CAN088111).
5.3.6	Correspondence from Trimble, AP&L, to Eisenhut, NRC, dated December 31, 1981. (0CAN128112).
5.5.1.2	Design Change Package 789, "Added Filter 2F-309," 1978. (2DCP780789).
5.5.11.2	Design Change Package, "Replace Quench Tank Press Transmitter," 1979.
5.5.10.2	Design Change Package 2164, "RCS Relief Valve Position Indication," 1979. (2DCP792164).

ARKANSAS NUCLEAR ONE
Unit 2

UPDATE REFERENCE LIST (continued)

<u>Section</u>	<u>Cross Reference</u>
5.5.10.2	Design Change Package 2167, "Pressurizer Heater Power Supply Ref. NUREG 0578," 1979. (2DCP792167).
5.5.1.3	Design Change Package 2198, "IDCR Temp. No. 2-79-98," 1979. (2DCP792198).
5.5.10.2	Design Change Package 2003, "RCS High Point Vents," 1980. (2DCP802003).
5.5.1.2	Design Change Package 2051, "RCP Oil Collection System," 1980. (2DCP802051).
5.6.1.1	Design Change Package 2064, "Provide Plant Computer with Averaged TH Inputs from CPC," 1980. (2DCP802064).
5.5.13.2	Design Change Package 83-2148, "Acoustic Monitoring System Replacement."
Table 5.5-6 Figure 5.5-8	Design Change Package 85-2157, "Pressurizer Level Nozzle Fouling."
5.6.3.2 Figure 5.3-1	Design Change Package 85-2152, Replace Pressurizer Level Transmitters."
5.3.5.5	Design Change Package 82-2086, "Q-Condensate Storage Tank."
5.5.13.2	Design Change Package 79-2164, "Acoustical Valve Monitoring System for Safety Valves."
5.3.1	Design Change Package 84-2022B, "Replacement of Station Battery 2D11."
Figure 5.1-3	Design Change Package 80-2123M, "SPDS Additional Computer Inputs."
Figure 5.1-3	Design Change Package 83-2080, "Remote Shutdown Appendix R."
Figure 5.1-3	Design Change Packages 85-2039 and 85-2039B, "Emergency Feedwater Actuation Bypass."
Figure 5.5-2	Design Change Package 84-2015, "Recorders for Unit 2 Controlled Bleed-off and Seal Staging Pressures."

Amendment 7

5.2.1.5	Design Change Package 87-2041, "Pressurizer Relief Valve and LTOP Piping Reanalysis and Modification," especially Calculation 87-D-2041-16, Revision 0, "Establishment of the Piping and Piping Support Load Combinations."
---------	---

ARKANSAS NUCLEAR ONE
Unit 2

UPDATE REFERENCE LIST (continued)

Section Cross Reference

Amendment 8

- Figure 5.5-2 Design Change Package 89-2016, "RCP Flexible Metal Hose Addition."
5.5.3.1 Design Change Package 85-2111 "RCP Vibration Monitoring System."
5.6.5.5
Table 5.5-1
Table 5.5-2 Technical Manual C490.0420 and Cycle 8 Reload Analysis Report.

Amendment 9

- Figure 5.1-3 Design Change Package 88-2026, "Pressurizer Pressure Transmitter Replacement."
Figure 5.1-3 Design Change Package 82-2072, "Addition of Pressurizer Spray Isolation Valves."
5.5.10.2
5.2.2 Design Change Package 82-2073, "ATWS Diverse Scram System."
5.2.2.5
5.6.2.1
Table 5.6-1
Figure 5.1-3
Figure 5.5-2 Design Change Package 89-2026, "RCP Flow Sensing Line Modifications."
Table 5.5-10 Plant Change 89-0734, "Flexdisc Conversion."

Amendment 10

- 5.5.10.2 Design Change Package 87-2047, "Pressurizer Heaters Removal/Replacement and Reconnection."
Table 5.3-2
Table 5.5-6
5.5.10.2 Design Change Package 83-2198, "Regulatory Guide 1.97 Electrical System Modifications."
5.6.5.1.4
5.5.12.3 Design Change Package 89-2020, "Pressurizer MOV Modifications."
5.5.13.2 Procedure 1015.03B, Rev. 29, Permanent Change 8, "Unit 2 Operations Log."
Table 5.2-1 Procedure 1092.023, Rev. 1, "ASME Section XI Visual Examinations VT-1, VT-2, VT-3, & VT-4."
Figure 5.1.3 Design Change Package 89-2042, "Generic Letter 88-17, Shutdown Cooling (SDC) Instrumentation and Alarms."

ARKANSAS NUCLEAR ONE
Unit 2

UPDATE REFERENCE LIST (continued)

<u>Section</u>	<u>Cross Reference</u>
<u>Amendment 11</u>	
5.1	Plant Engineering Action Request 92-0442, "Thot Reduction Evaluation."
5.2.1.4	Calculation 91-D-2016-02, "Class 2/3 Stress Calculation Pressurizer Tail Pipe."
5.2.1.4	Calculation 91-D-2016-05, "Safety Relief Valve Opening Forcing Function Analyses Using RELAP5."
5.2.1.4	Calculation 91-D-2016-06, "Pressurizer Relief Valve (LTOP) Low Pressure Liquid Blow Down Forcing Function."
5.2.1.4 5.2.2 5.2.3.3 5.2.3.3.B	Design Change Package 91-2016, "Pressurizer Code Safety Valve Leakage Remediation."
5.2.6 5.5.1.2 Table 5.5-1 Figure 5.2-33 Figure 5.2-33A Figure 5.5-2	Limited Change Package 91-6010, "RCP Motor Replacement."
5.2.7.1.1	Plant Change 91-8027, "Replacement of 2ME-5661 and 2ME-5665."
Figure 5.1-3 Figure 5.5-2	Design Change Package 88-2111, "ANO-2 Annunciator Upgrade Phase III."
Figure 5.1-3 Figure 5.5-2	Design Change Package 90-2036, "Unit 2 Plant Computer Replacement."
Figure 5.1-3	Condition Report 2-92-0350, "RCS RTD Locations."
Figure 5.1-3	Plant Change 89-8041, "Pressurizer High Point Vent Leakage Annunciator Deletion."
<u>Amendment 12</u>	
5.2.8.1.3 5.5.1.3	Evaluation of Health Physics Changes Required for Revised 10 CFR 20 Implementation
5.6.2.2 Table 5.6-1 Figure 5.1-3	Plant Change 92-8074, "Pressurizer Control Loop Setpoint Change"

ARKANSAS NUCLEAR ONE
Unit 2

UPDATE REFERENCE LIST (continued)

<u>Section</u>	<u>Cross Reference</u>
5.6.5.3 Figure 5.5-2	Plant Change 93-8047, "Reactor Coolant Pump 'B' Oil Level Transmitter Upgrade"
Figure 5.1-3	Design Change Package 92-2023, "Critical Applications Program Systems (CAPS) Migration to the Plant Computer"
Figure 5.1-3 Figure 5.5-2	Plant Change 91-8014 Revision 2, "Reactor Vessel Differential Pressure Loops Out of Service"

Amendment 13

5.2.1.6	Limited Change Package 95-6001, "Gear Change for MOVs 2CV-5236-1, 2CV-5254-2, and 2CV-5255-1"
5.2.8.8 Figure 5.1-3	Design Change Package 93-2006, "Unit 2 Vibration and Loose Parts Monitoring System Replacement"
5.5.12	Design Change Package 90-2015, "2R11 LPSI Valve Replacement 2CV-5037-1 and 2CV-5077-2"
5.6.5.6 Table 5.5-1 Figure 5.5-2	Plant Change 94-8049, "RCP 'Zero' and 90% Speed Interlock Removal"
Figure 5.1-3	Design Change Package 93-2007, "ANO-2 New Points to Plant Monitoring System"
Figure 5.1-3 Figure 5.5-2	Limited Change Package 94-6006, "Replacement of Panel 2CO4 RCS Temperature Indicators and RCP Differential Pressure Indicators"
Figure 5.5-2	Plant Change 94-8039, "2P32C and 2P32D Oil Level Transmitter Upgrade"

Amendment 14

5.1 5.2.2.3.2 Table 5.1-2 Table 5.2-19 Table 5.3-2 Table 5.5-2 Table 5.5-6 Figure 5.3-1 Figure 5.3-2	Limited Change Package 96-3355, "High Pressure Turbine First Stage Nozzle and Bucket Modification"
--	--

ARKANSAS NUCLEAR ONE
Unit 2

UPDATE REFERENCE LIST (continued)

<u>Section</u>	<u>Cross Reference</u>
5.2.1.5 5.3.5 5.6.1.1 5.6.3.1 Table 5.6-1 Figure 5.1-3	Design Change Package 94-2008, "Feedwater Control System Upgrade"
5.2.1.8.2	Condition Report 2-96-0176, "Auxiliary Spray Line Valve"
5.5.1.2	Plant Change 963478P201, "RCP Oil Collection Pans"
Table 5.2-8	Limited Change Package 95-6009, "Pressurizer Manway Cover Studs Replacement"
Table 5.5-1 Figure 5.5-3 Figure 5.5-3A	Design Change Package 963259D201, "Reactor Coolant Pump N9000 Seal Cartridge Installation"

Amendment 15

5.1 Table 5.6-1 Figure 5.3-1	Technical Specification Amendment 143, "Change to Operating Temperatures"
5.2.7.1.2 5.5.1.2	Procedure 2102.002, "Plant Heatup"
5.3.4 5.5.1.3 5.7 Table 5.1-1 Table 5.1-2 Table 5.1-3 Table 5.3-1 Table 5.5-2 Table 5.5-4	Engineering Request 975015D201, "MSIS Setpoint Reduction"
5.5.10.2	Engineering Request 85E007002, "Appendix R Safe Shutdown"
Table 5.5-2 Figure 5.1-3	Design Change Package 946012D201, "Containment Vent Header/Waste Gas System Modification"
Figure 5.1-3	Plant Change 975054P201, "Modification of RCS Refueling Level Instrument Tubing"

ARKANSAS NUCLEAR ONE
Unit 2

UPDATE REFERENCE LIST (continued)

Section Cross Reference

Amendment 16

5.1 Design Change Package 980642D210, "Replacement Steam Generator
5.2.1.5 Design/Qualification"

5.2.1.10

5.2.2

5.2.2.3

5.2.5.3.1

5.2.2.3.2

5.2.2.4

5.2.3.5

5.2.5.8

5.2.6.2

5.3.1.2

5.5.11.1

5.5.13.2

5.5.13.3

5.5.14.3

5.5.2.1

5.5.2.2

5.5.2.3.2

5.5.2.3.4

5.5.2.3.7

5.5.4

5.5.5.2

5.7

Table 5.1-1A

Table 5.1-2

Table 5.1-3

Table 5.2-1

Table 5.2.19

Table 5.3-2

Table 5.5-2

Table 5.5-3

Table 5.5-4

Table 5.5-6

Table 5.5-10

Table 5.5-11

Table 5.6-1

5.1 Engineering Request 980642I243, "Mechanical Support for the Replacement
5.2.1.1 Steam Generator Project"

5.2.1.4

5.2.1.5

5.2.1.9

5.2.1.10

5.2.1.10.1

5.2.1.10.2

ARKANSAS NUCLEAR ONE
Unit 2

UPDATE REFERENCE LIST (continued)

Section Cross Reference

5.2.1.15
5.2.2
5.2.2.3
5.2.2.3.1
5.2.2.3.2
5.2.2.3.3
5.2.3.3
5.2.3.5
5.2.3.6
5.2.4.1.2
5.2.5.1
5.2.6
5.2.8
5.2.9.1.3
5.2.8.8
5.5.1.2
5.5.1.3
5.5.10.2
5.5.11.1
5.5.11.2
5.5.14.2.2
5.5.14.2.3
5.5.2
5.5.3.3
5.5.4
5.5.5.2
5.5.7
Table 5.1-1
Table 5.1-2
Table 5.1-3
Table 5.2-1
Table 5.2-3
Table 5.2-6
Table 5.2-7
Table 5.2-19
Table 5.3-2
Table 5.5-1
Table 5.5-2
Table 5.5-3
Table 5.5-6
Table 5.5-8
Table 5.5-10
Table 5.5-11
Figure 5.1-1
Figure 5.1-2
Figure 5.2-34
Figure 5.3-1
Figure 5.3-2

ARKANSAS NUCLEAR ONE
Unit 2

UPDATE REFERENCE LIST (continued)

<u>Section</u>	<u>Cross Reference</u>
Figure 5.5-7 Figure 5.5-9 Figure 5.5-13	
5.1 5.2.2.4 5.5.13.2	Technical Specification 3/4.4.12, "Basis Update of LTOP Requirements to Account for Installation of the Replacement Steam Generators and Power Uprate"
5.2.1.5	Technical Specification Amendment 205, "Relocation of Miscellaneous Design Features from Technical Specifications to the SAR"
5.2.7.1.1	Design Change Package 002239N201, "Reactor Building Pressure and Oxygen Control"
5.5.10.2 Table 5.2-3 Table 5.5-1A Figure 5.5-8	Engineering Request 002796E201, "Leak Repair of Pressurizer Heater Nozzles"
5.5.10.2	Nuclear Change Package 980547N201, "Plant Protection System Setpoint Changes"
Table 5.1-3	Engineering Request 980564E203, "Non-LOCA Accident Analyses Supporting Replacement Steam Generators"
Table 5.2-12	Technical Specification Amendment 213, "Removal of the Second Reactor Vessel Specimen Capsule"
Table 5.2-3	Nuclear Change Package 002795N202, "Replacement of Alloy 600 RTD and Sample P/T Nozzles"
Table 5.6-1 Figure 5.3-1 Figure 5.5-9	Nuclear Change Package 980547N203, "Feedwater Control System and Reactor Regulation System Setpoint Changes"
Figure 5.1-3	Plant Change 975054P201, "Modification of RCS Refueling Level Instrument Tubing"

Amendment 17

Figure 5.5-9	Engineering Request ANO-1998-0547-043, "Power Uprate Condensate and Feedwater Setpoint Changes"
5.5.10.2	Engineering Request ANO-1999-1659-002, "Unit 2 Pressurizer Spray Block Valve Evaluation"
5.1 5.2.1.1	Engineering Request ANO-2000-2344-026, "Power Uprate Evaluation"

ARKANSAS NUCLEAR ONE
Unit 2

UPDATE REFERENCE LIST (continued)

<u>Section</u>	<u>Cross Reference</u>
5.2.2	
5.2.2.2	
5.2.2.3	
5.2.2.3.1	
5.2.2.3.2	
5.2.2.3.2.2.1	
5.2.2.3.2.2.2	
5.2.8.8	
5.5.13.1	
Table 5.1-1A	
Table 5.1-2	
Table 5.5-2	
Table 5.5-11	
Table 5.6-1	
Figure 5.3-2	
5.2.8	Unit 2 Technical Specification Amendment 233
5.2.8.7	
5.2.6.1	Unit 2 Technical Specification Amendment 241
5.2.4.1.4	Unit 2 Technical Specification Amendment 242
5.2.4.2	
5.2.4.3	
5.2.4.3.1	
5.2.4.3.2	
5.2.4.3.3	
5.7	
Table 5.2-12	
Table 5.2-21	
Table 5.2-22	
Figure 5.2-46	
Figure 5.2-46A	
Figure 5.2-47	
<u>Amendment 18</u>	
5.2.1.3	SAR Discrepancy 97-0385, "Addition of Reference to 10 CFR 50.55a"
5.5.3.1	Condition Report ANO-2-2003-0233, "Correction of RCS SSC Vibration
5.5.10.1	Frequency Range"
Figure 5.1-1	Engineering Request ER-ANO-1998-0642, "Drawing Number Revision"
Table 5.2-2	SAR Discrepancy 2-97-0326 Item #1, "Revise Table to be Consistent with the Definition of RCS Pressure Boundary Components"

ARKANSAS NUCLEAR ONE
Unit 2

UPDATE REFERENCE LIST (continued)

<u>Section</u>	<u>Cross Reference</u>
Table 5.2-13	SAR Discrepancy 2-97-0326 Item #2, "Revise Table to Include Addition of Low Temperature Over Pressure (LTOP) Boundary Valves"
Figure 5.5-2	Engineering Request ER-ANO-2004-0010, "Alternate Configuration of RCP Motor Lube Oil Strainer"
<u>Amendment 19</u>	
5.2.1.5 5.5.10.1	Condition Report CR-ANO-2-2003-1082, "Evaluation of Pressurizer Heater Nozzles With Respect to MNSA Clamp Installation"
5.2.1.5 5.2.8.1.3	License Document Change Request 2-1.3-0009, "Revisions Resulting from Implementation of ANO-2 Technical Specification Amendment 255"
5.7	License Document Change Request 2-5.7-0001, "Revisions Resulting from Implementation of ANO-2 Technical Specification Amendment 256"
5.6.2.3	Engineering Request ER-ANO-2002-0875-004, "Removal of the Shutdown Cooling Suction Valve Auto-Closure Function"
5.4.1 Figure 5.1-3	Engineering Request ER-ANO-2003-0245-017, "CEDM Cooling Shroud Upgrade"
5.2.1.5 5.2.4.1.4 5.2.4.2 5.2.4.3 5.2.4.3.2 5.2.4.3.3 5.2.4.3.4 5.3.6 5.5.2.3.2 5.7 Table 5.2-12 Table 5.2-22a	License Document Change Request 2-1.2-0049, "License Renewal"
Figure 5.5-2 Sh1	Engineering Request ER-ANO-2004-0747-000, "Application of Alternate Lube Oil Strainers for Reactor Coolant Pumps"
Figure 5.1-3 Sh2	Condition Report CR-ANO-2-2004-0597, "Valve Position Correction for 2RC-13 and 2RC-14"
Figure 5.5-2 Sh2	Condition Report CR-ANO-2-2004-1839, "Removal of Non-existent Drawing"

ARKANSAS NUCLEAR ONE
Unit 2

UPDATE REFERENCE LIST (continued)

<u>Section</u>	<u>Cross Reference</u>
<u>Amendment 20</u>	
5.1.1 5.2.2.1 5.5.1.2 Table 5.1-3 Figures – ALL	License Document Change Request 05-058, "Deletion/simplification of Excessive Detailed Drawings from SAR"
5.2.1.4 5.2.1.5 5.2.1.10.1 5.2.4.1.2 5.5.10.1 5.5.10.2 5.5.14.3 Table 5.1-1a Table 5.2-1 Table 5.2-3 Table 5.2-8 Table 5.3-2 Table 5.5-6 Table 5.5-7 Figure 5.2-34 Figure 5.5-8	Engineering Request ER-ANO-2002-0836-003, "ANO-2 Pressurizer Replacement"
5.2.8.1.3 5.5.2.3.4 5.7	Technical Specification Amendment 266, "Implementation of Steam Generator Tube Inspection Program in accordance with NEI 97-06"
5.5.10.2	Calculation CALC-85-S-00002-01, "EDG Load Capability"
Table 5.2-2	Engineering Request ER-ANO-2002-0836-004, "Deletion of Valves 2RC-1004 and 2RC-1005"
<u>Amendment 21</u>	
5.2.4.3.1 5.2.4.3.2 5.2.4.3.4 5.7 Table 5.2-12 Table 5.2-22 Table 5.2-22a	Condition Report CR-ANO-2-2007-0666, "Reactor Vessel Surveillance Program Update In Accordance With BAW-2399"
Table 5.2-3 Table 5.5-5	Engineering Change EC-608, "Alloy 690 Weld Overlays"
5.4.1	Engineering Change EC-592, "Reactor Vessel Closure Head Upgrade"

ARKANSAS NUCLEAR ONE
Unit 2

UPDATE REFERENCE LIST (continued)

<u>Section</u>	<u>Cross Reference</u>
<u>Amendment 22</u>	
5.3.1.2	TS Amendment 286, "Use of RCP Differential Pressure Flow"
<u>Amendment 23</u>	
5.5.1.2 Table 5.5-1	Engineering Change EC-23208, "Use of Silicon Carbide for RCP Vapor Stage Rotating Face"
Figure 5.1-3	Condition Report CR-ANO-2-2011-0793, "Correct Valve Type on SAR Drawing"
<u>Amendment 27</u>	
5.2.8.7	Licensing Basis Document Change LBDC 16-014, "TSTF-545 Adoption – Relocation of IST Program"
Table 5.2-11	Condition Report CR-ANO-2-2017-4808, "Capsule Location Editorial Correction"
<u>Amendment 28</u>	
Figure 5.5-2	Engineering Change EC-75848, "Correct Pump Orientation on Affected SAR Figures"
Table 5.2-12	Licensing Basis Document Change LBDC 18-038, "Capsule Specimen Withdrawal Schedule"
5.2.2.4 5.2.4.1.4 5.2.4.3.1 5.2.4.3.2 5.2.4.3.5 5.2.4.3.6 5.7 Table 5.2-22A	Engineering Change EC-69421, "Update SAR in accordance with TS Amendment 311"

ARKANSAS NUCLEAR ONE
Unit 2

RECORD OF REVISIONS

<u>PAGE #</u>	<u>AMENDMENT #</u>	<u>PAGE #</u>	<u>AMENDMENT #</u>	<u>PAGE #</u>	<u>AMENDMENT #</u>
TABLE OF CONTENTS		CHAPTER 5 (CONT.)		CHAPTER 5 (CONT.)	
5-i	28	5.2-7	28	5.2-51	28
5-ii	28	5.2-8	28	5.2-52	28
5-iii	28	5.2-9	28	5.2-53	28
5-iv	28	5.2-10	28	5.2-54	28
5-v	28	5.2-11	28	5.2-55	28
5-vi	28	5.2-12	28	5.2-56	28
5-vii	28	5.2-13	28	5.2-57	28
5-viii	28	5.2-14	28	5.2-58	28
5-ix	28	5.2-15	28	5.2-59	28
5-x	28	5.2-16	28	5.2-60	28
5-xi	28	5.2-17	28	5.2-61	28
5-xii	28	5.2-18	28	5.2-62	28
5-xiii	28	5.2-19	28	5.2-63	28
5-xiv	28	5.2-20	28	5.2-64	28
5-xv	28	5.2-21	28		
5-xvi	28	5.2-22	28	5.3-1	22
5-xvii	28	5.2-23	28	5.3-2	22
5-xviii	28	5.2-24	28	5.3-3	22
5-xix	28	5.2-25	28	5.3-4	22
5-xx	28	5.2-26	28		
5-xxi	28	5.2-27	28	5.4-1	21
5-xxii	28	5.2-28	28	5.4-2	21
5-xxiii	28	5.2-29	28	5.4-3	21
5-xxiv	28	5.2-30	28	5.4-4	21
5-xxv	28	5.2-31	28	5.4-5	21
5-xxvi	28	5.2-32	28		
5-xxvii	28	5.2-33	28	5.5-1	23
5-xxviii	28	5.2-34	28	5.5-2	23
5-xxix	28	5.2-35	28	5.5-3	23
5-xxx	28	5.2-36	28	5.5-4	23
5-xxxi	28	5.2-37	28	5.5-5	23
5-xxxii	28	5.2-38	28	5.5-6	23
		5.2-39	28	5.5-7	23
		5.2-40	28	5.5-8	23
CHAPTER 5		5.2-41	28	5.5-9	23
		5.2-42	28	5.5-10	23
5.1-1	20	5.2-43	28	5.5-11	23
5.1-2	20	5.2-44	28	5.5-12	23
		5.2-45	28	5.5-13	23
5.2-1	28	5.2-46	28	5.5-14	23
5.2-2	28	5.2-47	28	5.5-15	23
5.2-3	28	5.2-48	28	5.5-16	23
5.2-4	28	5.2-49	28	5.5-17	23
5.2-5	28	5.2-50	28	5.5-18	23
5.2-6	28			5.5-19	23

ARKANSAS NUCLEAR ONE
Unit 2

RECORD OF REVISIONS (continued)

<u>PAGE #</u>	<u>AMENDMENT #</u>	<u>PAGE #</u>	<u>AMENDMENT #</u>	<u>PAGE #</u>	<u>AMENDMENT #</u>
CHAPTER 5 (CONT.)		CHAPTER 5 (CONT.)		CHAPTER 5 (CONT.)	
5.5-20	23	5.8-31	28	F 5.2-5	20
5.5-21	23	5.8-32	28	F 5.2-6	20
5.5-22	23	5.8-33	28	F 5.2-7	20
5.5-23	23	5.8-34	28	F 5.2-8	20
5.5-24	23	5.8-35	28	F 5.2-9	20
		5.8-36	28	F 5.2-10	20
5.6-1	19	5.8-37	28	F 5.2-11	20
5.6-2	19	5.8-38	28	F 5.2-12	20
5.6-3	19	5.8-39	28	F 5.2-13	20
5.6-4	19	5.8-40	28	F 5.2-14	20
5.6-5	19	5.8-41	28	F 5.2-15	20
		5.8-42	28	F 5.2-16	20
5.7-1	28	5.8-43	28	F 5.2-17	20
5.7-2	28	5.8-44	28	F 5.2-18	20
		5.8-45	28	F 5.2-19	20
5.8-1	28	5.8-46	28	F 5.2-20	20
5.8-2	28	5.8-47	28	F 5.2-21	20
5.8-3	28	5.8-48	28	F 5.2-22	20
5.8-4	28	5.8-49	28	F 5.2-23	20
5.8-5	28	5.8-50	28	F 5.2-24	20
5.8-6	28	5.8-51	28	F 5.2-25	20
5.8-7	28	5.8-52	28	F 5.2-26	20
5.8-8	28	5.8-53	28	F 5.2-27	20
5.8-9	28	5.8-54	28	F 5.2-28	20
5.8-10	28	5.8-55	28	F 5.2-29	20
5.8-11	28	5.8-56	28	F 5.2-30	20
5.8-12	28	5.8-57	28	F 5.2-31	20
5.8-13	28	5.8-58	28	F 5.2-32	20
5.8-14	28	5.8-59	28	F 5.2-33	20
5.8-15	28	5.8-60	28	F 5.2-33A	20
5.8-16	28	5.8-61	28	F 5.2-34	20
5.8-17	28	5.8-62	28	F 5.2-35	20
5.8-18	28	5.8-63	28	F 5.2-36	20
5.8-19	28	5.8-64	28	F 5.2-37	20
5.8-20	28	5.8-65	28	F 5.2-38	20
5.8-21	28	5.8-66	28	F 5.2-39	20
5.8-22	28			F 5.2-40	20
5.8-23	28	F 5.1-1	20	F 5.2-41	20
5.8-24	28	F 5.1-2	20	F 5.2-42	20
5.8-25	28	F 5.1-3	23	F 5.2-43	20
5.8-26	28			F 5.2-44	20
5.8-27	28	F 5.2-1	20	F 5.2-45	20
5.8-28	28	F 5.2-2	20	F 5.2-46	20
5.8-29	28	F 5.2-3	20	F 5.2-46A	20
5.8-30	28	F 5.2-4	20	F 5.2-47	20

ARKANSAS NUCLEAR ONE
Unit 2

RECORD OF REVISIONS (continued)

<u>PAGE #</u>	<u>AMENDMENT #</u>	<u>PAGE #</u>	<u>AMENDMENT #</u>	<u>PAGE #</u>	<u>AMENDMENT #</u>
CHAPTER 5 (CONT.)		CHAPTER 5 (CONT.)		CHAPTER 5 (CONT.)	
F 5.2-48	20				
F 5.2-49	20				
F 5.2-50	20				
F 5.2-51	20				
F 5.3-1	20				
F 5.3-2	20				
F 5.4-1	20				
F 5.4-2	20				
F 5.4-3	20				
F 5.5-1	20				
F 5.5-2	28				
F 5.5-3	20				
F 5.5-3A	20				
F 5.5-4	20				
F 5.5-5	20				
F 5.5-6	20				
F 5.5-7	20				
F 5.5-8	20				
F 5.5-9	20				
F 5.5-10	20				
F 5.5-11	20				
F 5.5-12	20				
F 5.5-13	20				
F 5.5-14	20				
F 5.5-15	20				

5 REACTOR COOLANT SYSTEM

5.1 SUMMARY DESCRIPTION

The reactor is a pressurized water reactor with two coolant loops. The Reactor Coolant System (RCS) circulates water in a closed cycle, removing heat from the reactor core and internals and transferring it to a secondary (steam generating) system. In a Pressurized Water Reactor (PWR), the steam generators provide the interface between the reactor coolant (primary) system and the main steam (secondary) system. The steam generators are vertical U-tube heat exchangers in which heat is transferred from the RCS to the main steam system. The RCS is a closed system preventing the release of radioactive materials into the containment. The arrangement of the RCS is illustrated in Figures 5.1-1 and 5.1-2.

System pressure is controlled by the pressurizer, where steam and water are maintained in thermal equilibrium. Steam is formed by energizing immersion heaters in the pressurizer, or is condensed by the pressurizer spray to limit pressure variations caused by contraction or expansion of the reactor coolant.

The average temperature of the reactor coolant varies with power level and the fluid expands or contracts, changing the pressurizer water level.

The charging pumps and letdown control valves in the Chemical and Volume Control System (CVCS), Section 9.3.4, are used to maintain the programmed pressurizer water level. A continuous but variable letdown purification flow is maintained to keep the RCS chemistry within prescribed limits. The charging flow is also used to alter the boron concentration or chemical content of the reactor coolant.

Overpressure protection is provided by two spring-loaded ASME Code safety valves connected to the top of the pressurizer. These valves discharge to the quench tank, where the steam is released under water to be condensed and cooled. If the steam discharge exceeds the capacity of the tank, the tank is relieved to the containment atmosphere via a rupture disc. When the Reactor Coolant System is at low temperature a Low Temperature Overpressure Protection (LTOP) system provides protection from overpressurization.

Overpressure protection for the secondary side of the steam generators is provided by spring-loaded ASME Code safety valves located in the main steam lines upstream of the main steam isolation valves. Air-operated steam dump and bypass valves are provided to limit opening of the main steam safety valves following a load rejection.

Components and piping in the RCS are insulated with a material compatible with the temperatures involved to reduce heat losses and protect personnel from high temperatures. All insulation material used has a low soluble chloride and other halide content to minimize the possibility of stress corrosion of stainless steel. No aluminum insulation (foil or structural) has been used.

Design parameters of the RCS are listed in Table 5.1-1.

T_{cold} ramps as a function of power. T_{cold} increases from 545 °F at zero power to 551 °F at full power. Inconel 600 material concerns are evaluated for T_{hot} conditions. Reload and safety analyses bound this temperature range and remain conservative with respect to operating limits specified.

ARKANSAS NUCLEAR ONE
Unit 2

5.1.1 SCHEMATIC FLOW DIAGRAM

The principal coolant volumes of major components are listed in Table 5.1-2. The principal pressures, temperatures and flow rates of major components are listed in Table 5.1-3. Instrumentation provided for operation and control of the RCS is described in Chapter 7.

5.1.2 PIPING AND INSTRUMENT DIAGRAM

Figure 5.1-3 provides a simplified diagram of the RCS. The entire system is located within the containment. Fluid systems which are connected to the RCS and which are within the limits of the reactor coolant pressure boundary as defined in 10CFR50.55a are identified, and the appropriate piping and instrument diagrams in other sections of the SAR are referenced.

Two charging nozzles and one letdown nozzle are provided on the reactor coolant piping. Other reactor coolant loop penetrations are the four safety injection inlet nozzles, one in each reactor vessel inlet pipe; one outlet nozzle to the shutdown cooling system; two pressurizer spray nozzles; vent and drain connections; sample connections and instrument connections. RCS nozzles are shown in Figure 5.1-1.

The steam generator tubes and tube sheet constitute the barriers or points of separation between the reactor coolant (heat transport) system and the secondary (heat utilization) system.

5.1.3 ELEVATION DRAWING

Drawings are provided in Chapter 1 which show the relationship of the RCS to the surrounding concrete structures (See Figures 1.2-2 through 1.2-11).

5.2 INTEGRITY OF REACTOR COOLANT PRESSURE BOUNDARY

This section discusses the measures employed to provide and maintain the integrity of the Reactor Coolant Pressure Boundary (RCPB) throughout the facility design lifetime. The RCPB is defined in accordance with Section 50.2 of 10 CFR 50 to include all pressure-containing components such as pressure vessels, piping, pumps, and valves which are:

- A. Part of the Reactor Coolant System (RCS).
- B. Connected to the RCS, up to and including any and all of the following:
 - 1. The outermost containment isolation valve in system piping which penetrates the containment;
 - 2. The second of two valves normally closed during normal reactor operation in system piping which does not penetrate the containment.
 - 3. The RCS Code safety valves.

Components which are connected to the RCS and are part of the RCPB may be excluded from the above definition provided:

- A. For postulated failure of the component during normal reactor operation, the reactor can be shut down and cooled down in an orderly manner assuming makeup is provided by the reactor coolant makeup system only.
- B. The component is or can be isolated from the RCS by two valves (both closed, both open, or one closed and the other open). Each open valve must be capable of automatic actuation. Its closure time must be such that for postulated failure of the component during normal reactor operation, the reactor can be shut down and cooled down in an orderly manner assuming makeup is provided by the reactor coolant makeup system only.

5.2.1 DESIGN OF REACTOR COOLANT PRESSURE BOUNDARY COMPONENTS

The methods, procedures and criteria for the design of the RCS components are discussed in this section.

5.2.1.1 Performance Objective

The function of the RCS is to remove heat from the reactor core and internals and transfer it to the secondary system by the forced circulation of pressurized boric water which serves both as a coolant and neutron moderator. The RCS is designed for the normal operation of transferring 3044 MWt, (3026 MWt from the reactor core and 18 MWt from the reactor coolant pumps) to the steam generators.

The RCS also serves as a pressure boundary having a high degree of leak tightness during normal operation. The integrity of this pressure boundary is assured by appropriate recognition of operating, seismic and/or accident stress loadings.

ARKANSAS NUCLEAR ONE
Unit 2

The system design temperature and pressure are conservatively established and exceed the combined normal operating values and the anticipated operational transients (ANS N18.2 Condition I and II events). The change due to the anticipated operational transients also includes the effect of reactor core thermal lag, coolant transport time, system pressure drop and the characteristics of the code safety valves.

The plant NSSS system hydrostatic test was performed in accordance with Section III requirements at a hydrostatic test pressure of 1-1/4 times design pressure prior to initial operation. Components replaced within the NSSS system subsequent to the initial hydrostatic test are pressure tested within the system in accordance with ASME Section XI requirements. The number of cycles of hydrostatic testing are determined as part of the design process in accordance with the ASME Code.

System variations which affect the design parameters in normal, upset, emergency and faulted conditions are discussed in Section 5.2.1.5.

5.2.1.2 Design Parameters

The design parameters from the RCS are listed in Table 5.1-1.

5.2.1.3 Compliance With 10CFR50.55a

The codes and component classifications are listed in Table 5.2-1, and are in accordance with the provisions of 10CFR50.55a (except where specific relief has been granted by the NRC).

5.2.1.4 Applicable Code Cases

The following code cases have been applied to components within the RCPB:

<u>Component</u>	<u>Code Case</u>	<u>Subject</u>
Reactor Vessel Supports	1557	Steel Products Refined by Secondary Melting for Section III
Pressurizer	N-405-1	Socket Welds, Section III
Steam Generators	N-20-3	SB-163 Nickel-Chromium-Iron Tubing (Alloys 600 and 690) and Nickel- Iron-Chromium Alloy 800 at Specified Minimum Yield Strength of 40.0 ksi and Cold Worked Alloy 800 at a Yield Strength of 47.0 ksi, Section III, Division 1, Class 1
	N-474-1	Design Stress Intensities and Yield Strength for UNS NO6690 with Minimum Specified Yield Strength of 35 ksi, Class 1 Components, Section III, Division 1
	2142-1	F-Number Grouping for Ni-Cr-Fe Classification UNS NO6052 Filler Metal
	2143-1	F-Number Grouping for Ni-Cr-Fe Classification UNS W86152 Welding Electrode

ARKANSAS NUCLEAR ONE
Unit 2

<u>Component</u>	<u>Code Case</u>	<u>Subject</u>
Control Element Drive Mechanism	1337	Requirements for Special Type 403 Modified Forgings or Bars, Section III
	1334	Requirements for Corrosion Resisting Steel Bars and Shapes, Section III
	1588	Electro-etching of Section III Code Symbol
Reactor Coolant Pump	1604	Hydrostatic Testing of Pumps Constructed According to the Rules of Section III.
Piping	N-411	Use N-411 methodology to analyze seismic response (OBE and DBE) in analyzing RCS tributary piping, Pressurizer Code Safety Tail Pipe and LTOP piping.
PT/LTOP	N-641	This code case allows using an alternate means of determining LTOP and P/T fracture toughness but limits the maximum pressure in the vessel to 100% of the pressure using the KIC.

5.2.1.5 Design Transients

The design bases and normal system function in this section are those used for the integrated design of the RCS or those which apply to all of the system components. Design parameters for both normal and transient conditions are derived from the performance objectives of the system and its components.

The following design transients are used in the fatigue analyses required by the applicable codes. The basis for each transient is indicated and the number of occurrences assumed is to provide a system/component design which will not be limited by expected cyclic operation over the life of the plant. The design life is not dependent on years of service, but on fatigue cycles. A renewed operating license extends the license term from 40 years to 60 years for ANO-2. The actual numbers of transient occurrences were extrapolated to 60 years. The extrapolated numbers of occurrences do not exceed the numbers of occurrences selected for the original design. System integrity is further assured by using conservative methods of predicting the range of pressure and temperature for the transients. The list of transients is intended to include normal plant power range operation, controller or instrument failure, equipment malfunction, and operator errors which result in reactor trips. An explanatory discussion of each transient is also given. The applicable operating condition category as designated by the ASME Code Section III is also indicated in each case. The system and component service and test limits (operating condition category) have been established in accordance with design specification. Service limit designations Level A (normal conditions) and Level B (upset conditions) transients are based on nominal plant operating conditions exclusive of instrument uncertainties. Consistent with this, non-safety grade plant control systems (such as the Pressurizer Pressure Control System, Pressurizer Level Control System, Steam Dump & Bypass Control System, and Feedwater Control System) are assumed operational. Level C (emergency) and Level D (faulted) transients include the effect of response characteristics of the reactor protective and control systems. Additionally, the transients represent conservative estimates for design purposes only and may not be accurate representations of actual transients or actual procedures.

ARKANSAS NUCLEAR ONE
Unit 2

The transients listed include allowance for less severe transients, such as rod withdrawal incident or boron dilution incident. Component cyclic or transient limit programs are required by Technical Specification 6.5.5, and during operation a record is maintained of the number of transients which could have a significant effect on the cumulative usage factor. The number of cyclic or transient occurrences listed in SAR Section 5.2.1.5, items A, D, E, F, H, and I, are included in this program and are tracked to ensure components are maintained within the design limits.

Pressure and temperature transients resulting from these events are established by computer simulations of the RCS. Time-dependent parameters are included in the equipment specifications and used as the basis for fatigue design.

Fatigue analysis for each component of the RCS is performed in accordance with the applicable codes. The combined effects of the mechanical loads and thermal transients for each condition of the cyclic operation are evaluated. The evaluations are performed in a manner to yield the maximum range in stress intensity during the particular cyclic condition under consideration. In those cases where conservative results are produced, peak stresses due to pressure may be combined with those due to thermal transients by direct superposition. In addition, the results of analysis obtained for the most severe transient condition in a group may be applied in evaluating the cumulative effects of the entire group. Beginning with Cycle 15, the basis for these transients and the number of occurrences assumed were reevaluated to account for replacement of the steam generators. The following transients were considered in the fatigue analysis:

- A. Five hundred heatup and cooldown cycles (350 for the replacement steam generator and 80 cycles for the replacement pressurizer) during the design life of the components in the system with heating and cooling at a rate of 100 °F/hr between 70 °F and 545 °F (200 °F/hr between 70 °F and 653 °F for pressurizer heat up and cool down). The heatup and cooldown rate of the system is administratively limited to assure that these limits will not be exceeded. This is based on consideration of both historical plant transient history and projections of transient lifetime occurrences for the components. Category: Normal Condition.
- B. Fifteen thousand power change cycles (12,000 for the replacement steam generator) over the range of 15 percent to 100 percent of full load at five percent of full load per minute increasing and decreasing. This is based on consideration of both historical plant transient history and projections of transient lifetime occurrences for the components. Category: Normal Condition.
- C. One million cycles of normal cyclic variations (step changes) of ± 100 psi and ± 10 °F (± 20 °F for the replacement pressurizer) when at operating temperature and pressure. For the replacement steam generator primary and secondary manway studs/bolts, the normal cyclic variations of ± 50 psi and ± 5 °F apply when at operating temperature and pressure. Note that temperature and pressure fluctuations from 0% to 15% power are part of this category. This is selected based on one million cycles approximating an infinite number of cycles so that the limiting stress is the endurance limit. This is based on consideration of both historical plant transient history and projections of transient lifetime occurrences for the components. Category: Normal Condition.
- D. One cycle (ten cycles for the replacement pressurizer) of system hydrostatic testing at 3110 psig (3125 psia for the replacement pressurizer) and at a temperature at least 60 °F above the Nil Ductility Transition Temperature (NDTT) of the component having the highest NDTT value. This is based on one initial hydrostatic test. Note that when

ARKANSAS NUCLEAR ONE
Unit 2

system hydrostatic tests for repair or replacement items impose test pressure and temperature in conflict with the Technical Specification, ASME Code Section XI permits a system leakage test at nominal operating pressure and temperature. Category: Test Condition.

- E. Two hundred cycles (zero for the replacement steam generator and fifty cycles for the replacement pressurizer) of leak testing at 2,250 psia. Generally, leak testing at nominal operating pressure is performed in conjunction with normal plant operation. There is no requirement to analyze leak testing with respect to fatigue considerations for the steam generator. Category: Test Condition.
- F. Four hundred and eighty reactor trip transients (five hundred trip transients for the replacement pressurizer). This is based on 400 reactor trips from full load, 40 turbine trips from full load with a delayed reactor trip, and 40 complete loss of reactor coolant flow events (i.e., loss of power to the reactor coolant pumps). These transients exhibit similar thermal hydraulic characteristics and were combined into one transient via definition of a composite transient. Category: Upset Condition.
- G. Two hundred stress cycles of a seismic event equal to one-half the Design Basis Earthquake (DBE). The number of cycles is based on the postulation of five seismic events occurring during the life of the plant with 40 full cycles per occurrence of significant motion peaks. Category: Upset Condition.
- H. Five cycles of complete loss of secondary pressure from either steam generator while in modes 1, 2, or 3. This transient results from a steam line break. A steam line break is not considered credible. However, it is included to ensure that components will not fail should it happen. This transient is considered to represent all rare plant conditions which might produce a significant temperature change (e.g., a feedwater line break, inadvertent opening of the Steam Dump & Bypass Valves). The number of occurrences is arbitrary. Category: Emergency Condition.
- I. The design cycle or transient for spray operation is the opening and closing of either the main or auxiliary spray valve(s) with spray water to pressurizer $\Delta T > 200$ °F. The cyclic or transient limit for spray operation is one hundred pressurizer spray cycles per year with pressurizer to spray water $\Delta T > 200$ °F. If these cycles are exceeded, the acceptable number of cycles is based on determination of the cumulative usage factor for the spray nozzle and nozzle fatigue evaluations in accordance with ASME Section III. Category: Normal Condition.

Pressure and thermal stress variations associated with the above design transients are considered in the design of the RCS components, piping and supports, including surge and spray lines; of the letdown piping and valves up to and including the regenerative heat exchanger; and of all other valves and piping within the RCPB.

In addition, the loads resulting from the design transients are included in the design of major support foundations and interfacing support structures for the above equipment.

All components that are designed and fabricated as Class 1 vessels are analyzed in accordance with the ASME Code requirements. It is demonstrated that the maximum stress intensities and cumulative usage factors are in compliance with Code values. The analyses are performed for steady state and cyclic conditions required by the Certified Design Specifications. Certified Analytical Reports are required for the components. Verification of the adequacy of the calculations and compliance with Code and Design Specification Requirements are assured by an independent review.

ARKANSAS NUCLEAR ONE
Unit 2

Thermal stresses induced in the reactor vessel wall by gamma ray heating, in combination with stresses produced by other loading conditions, are considered in the design of the vessel. The stresses due to gamma ray heating are low in magnitude and do not contribute significantly to the maximum primary plus secondary stresses which are within design limits.

In addition to the operating and testing (transient) conditions listed above and included in the fatigue analyses, the loadings produced by the vibratory motion of the DBE and the dynamic effects resulting from postulated pipe rupture conditions were also applied in the design of components and supports of the RCS. These additional conditions were categorized as faulted conditions and, in combination with other coincident loadings, were appropriately evaluated by the applicable rules of ASME Code, Section III, Subsection NB, including Appendix F. The few load cycles associated with the faulted conditions are exempt from fatigue evaluations (cumulative effects) and, therefore, the small number of load cycles produced by the DBE and postulated pipe rupture conditions are not specified.

The following design loading combinations are applied in the design of all ASME Class 1 components and supports, as appropriate:

Loading Combination 1 - normal operating loads plus transients plus OBE loads;

Loading Combination 2 - normal operating loads plus DBE loads; and

Loading Combination 3 - normal operating load plus DBE loads plus pipe rupture loads.

The design stress limits applied in evaluating Loading Combination 1 are in accordance with the rules of ASME Code, Section III, Subsection NB, for Upset Conditions, except as noted below.

The ASME Class 1 piping and supports that are part of the Pressurizer Relief and LTOP piping system were treated as follows: For Loading Combination 1, where the transient loads included the short duration, dynamic effects of a safety valve discharge, the design stress limits applied are in accordance with the rules of ASME Code, Section III, Subsection NB, for Emergency Conditions.

The dynamic system analysis used to determine the loadings produced by the DBE and pipe rupture conditions is based upon elastic methods. Accordingly, the stress criteria applied in the design of components and supports for Loading Combinations 2 and 3 are also based upon elastic methods of analysis. The rules applied in evaluating Loading Combinations 2 and 3 are in accordance with the applicable paragraphs of ASME Code, Section III, Subsection NB, including Appendix F, for Faulted Conditions (elastic analysis).

For supports integral with the Nuclear Steam Supply System (NSSS) components, transient and steady state thermal conditions were considered. Original temperature distributions were obtained by use of a finite difference method programmed for digital computer solution. The code makes use of the general heat balance equations derived by Hellman, Habetler & Babrov. CE designation of the code is CHAT-12100 (see Section 5.2.1.10 and related Section 5.2.1.15). More recent analysis may have used other computer codes listed in Section 5.2.1.10.1.

In the design of the reactor vessel support columns both steady state and transient thermal effects were considered.

5.2.1.6 Identification of Active Pumps and Valves

Pumps and valves within the RCPB can be classified as either active or inactive components. Active components are those whose operability is relied upon to perform a safety function, as well as reactor shutdown function, during the transients or events considered in the respective operating condition categories. Inactive components are those whose operability, e.g., valve opening or closure, pump operation or trip, is not relied upon to perform the system function during transients or events considered in the respective operating condition categories. Thus, certain pumps and valves (classified as active components) within the RCPB are required not only to serve as pressure-retaining components (as in the case of passive components such as vessels and piping) but also to operate reliably to perform a safety function such as safe shutdown of the reactor and mitigation of the consequences of a pipe break accident under the loading combinations considered in design. Table 5.2-2 is a list which classified valves within the RCPB as either active or inactive. The letdown valve is isolated by the Safety Injection Actuation Signal (SIAS) in the event of a Loss of Coolant Accident (LOCA) (Refer to Section 7.3 for a discussion of SIAS and other engineered safety features signals). No pumps within the RCPB are classified as active per this discussion.

All containment isolation valves (including those which are active RCPB valves) were originally designed and tested by the manufacturer to close in a maximum of 20 seconds. Actual closing times are controlled by the Inservice Testing Program and Technical Specifications. All other active RCPB valves were originally designed and tested by the manufacturer for standard closing times, which for gates are twelve (12) inches per minute and for globes four (4) inches per minute.

The operator sizing is accomplished by calculating a maximum force, based on system operating parameters that the valve will have to close or open against. This is converted to stem torque required to move the disc at the required speed. An operator with adequate horsepower and torque output is then chosen for the given conditions. Testing is performed at ambient conditions.

Leak tight integrity is assured by testing by the manufacturer of all valves with water under pressure. Maximum allowable leakage permitted is 2 cc/hr/in of valve size. For containment isolation valves the above leak test is required and, in addition, a 65 psig air test is required with no discernible leakage permitted.

For inactive pumps and valves, as appropriate, the stress criteria for vessels, are applied in evaluating the emergency and faulted conditions (elastic analysis). These limits are consistent with the "Design by Analysis" method of NB-3200 of the ASME Code, Section III, which is applied in the design calculations.

5.2.1.7 Design of Active Pumps and Valves

For active components, additional requirements have been imposed on the design to assure operability during the faulted condition. As appropriate, these additional requirements consist of simulated test and/or supplementary calculations which demonstrate that the active component will perform its required function during the specified conditions. Where calculations are employed, the primary stresses produced by the faulted conditions are limited to the emergency condition limits of Subparagraph NB-3224.1 of the ASME Code, Section III in all regions of the active component where deformations may impair the required function.

ARKANSAS NUCLEAR ONE
Unit 2

For design conditions other than those explicitly addressed by the ASME Code, Section III and where design calculations are used to evaluate stresses and deformations in pumps and valves, the methods and criteria applied are in accordance with the Subarticle NB-3200 of the ASME Code, Section III. The calculations include the effects of gross and local structural discontinuities and the loadings produced by geometrical eccentricities. Current state-of-the-art analytical methods, including finite element techniques, are employed in the calculations.

For the active Class 1 safety injection check valves, additional calculations were performed to determine the amount of distortion associated with the pressure and temperature conditions for the faulted condition. These calculations demonstrated that the distortion was not sufficient to impair operability of the valves.

5.2.1.8 Inadvertent Operation of Valves

Valves not relied upon for performing action during transients or normal operating categories and located within (or interfaced with) the RCPB are classified as inactive components. These components, by definition, are therefore not required to perform a safety function and/or a reactor shutdown operation under the aforementioned circumstances. Inadvertent operation of these inactively classified valves will initiate automatic responses from the Reactor Protective System (RPS) and/or manual control room responses. In all cases, these automatic and/or manual responses will mitigate the potential compound consequences of inadvertent valve operation during transients or normal functioning categories.

For example, the inadvertent operation of any of the following list of valves will not compound the effects of normal operating events or transients.

The following valves interface the RCPB and the Chemical and Volume Control System (CVCS) (Section 9.3.4):

- A. Charging line valves 2CV4831-2, 2CV4827-2, and 2CV-4840-2;
- B. Auxiliary spray line valve 2CV4824-2; and,
- C. Letdown line valves 2CV4820-2 and 2CV4821-1.

The following valves are all located within the RCPB and can be remotely operated from the control room:

- D. Safety injection leakoff valves, 2CV-5021-1, 2CV5001-1, 2CV5061-2, 2CV5041-2 (See Section 6.3);
- E. Shutdown cooling suction valves 2CV5084-1, 2CV5086-2 (see Section 9.3); and,
- F. Pressurizer spray valves 2CV4652, 2CV4651 (see Figure 5.1-3).

5.2.1.8.1 Charging Line Valves (2CV4831-2, 2CV4827-2, 2CV4840-2)

The 2-inch motor-operated valves are normally open. Under normal or transient conditions, inadvertent closure of the globe valves 2CV-4831-2 and 2CV-4827-2 would have little effect on the plant conditions as a spring check valve would lift and bypass charging flow around valve 2CV-4827-2. If gate valve 2CV4840-2 inadvertently closed, charging would be accomplished through the HPSI header.

5.2.1.8.2 Auxiliary Spray Line Valve (2CV4824-2)

This 2-inch motor-operated globe valve is normally closed. The ultimate result of inadvertent opening of this valve would be a low pressure trip. The auxiliary spray line is used to cool the pressurizer during cooldown when the RCS pressure is below that required to operate the reactor coolant pumps. Inadvertent operation (closing) of this valve during pressurizer cooldown would slow pressurizer cooldown.

5.2.1.8.3 Letdown Line Valves (2CV4820-2 and 2CV4821-1)

These 2-inch motor-operated globe valves are normally open. Inadvertent closure of one of these valves during a normal sequence of operations would generate a high pressurizer level error. Low flow and pressure alarms in the CVCS would alert the operator immediately and the letdown line could be returned to service or the charging pump(s) stopped.

Under transient or emergency conditions, inadvertent operation will have no effect on reactor plant conditions. With an SIAS present, these valves cannot be inadvertently operated as the SIAS will override any signal from the control panel switch. The same is true for 2CV4821-1 on a CIS also.

5.2.1.8.4 Safety Injection Leakoff Valves (2CV5021-1, 2CV5001-1, 2CV5061-2, 2CV5041-2)

Operating category events would not be affected by unexplained operation of one of these normally closed 1-inch globe valves.

5.2.1.8.5 Shutdown Cooling Suction Valves (2CV5084-1, 2CV5086-2)

Inadvertent operation of one of these normally closed (locked closed) 14-inch motor operated gate valves would have no effect on operating events or sequences. These valves, in addition, are interlocked to prevent opening unless conditions are consistent with shutdown cooling system design parameters.

5.2.1.8.6 Pressurizer Spray Valves (2CV4652, 2CV4651)

These 3-inch motor-operated angle valves, which are part of the primary pressure control system, function normally in the automatic mode of operation. No serious consequence would result from inadvertent operation of these valves. For example, during a power excursion, if an operator acted to close a normally open valve, the final result would be a high pressure trip. During a ramp decrease in power, opening a normally closed spray valve would ultimately result in a low pressure trip.

5.2.1.9 Stress and Pressure Limits

The stress criteria applied in evaluating the emergency and faulted conditions for components of the RCPB within the scope of Subsection NB of the ASME Code Section III, are as follows:

A. Vessels

The rules of Paragraph NB-3224 are applied in evaluating emergency conditions.

ARKANSAS NUCLEAR ONE
Unit 2

The primary stress limits of Paragraph NB-3221 (Appendix F, F-1331 for the steam generators), using an S_m value equal to the lesser of 2.4 times the tabulated S_m value or 0.70 times the tensile strength, S_u , for materials included in Table I-1.2 and 0.70 times S_u for materials included in Table I-1.1, with material properties taken at the appropriate temperature, are applied in evaluating faulted conditions (elastic analysis).

B. Piping

The rules of Paragraph NB-3655 are applied in evaluating emergency conditions.

The rules of Paragraph NB-3655 are applied in evaluating faulted conditions (elastic analysis). As an alternate to Subparagraph NB-3655.1, the primary stress limits supplied in evaluating faulted conditions for vessels may be applied when the "Design by Analysis" method of NB-3200 is used.

5.2.1.10 Stress Analysis for Structural Adequacy

As discussed in Sections 3.9.1 and 3.6.3, elastic methods of analysis are normally employed in the system or subsystem analysis performed to establish the loadings applied in the design of components, piping, and supports. When an elastic system analysis is employed, elastic stress analysis methods are also applied in the design.

5.2.1.10.1 Computer Programs for Analysis of Major NSSS Components

The following computer programs were used on the major NSSS components:

A. TMCALC

This program is described in Section 3.7.3.4.2.

B. FORCE

This program is described in Section 3.7.3.4.2.

C. MEC-21

MEC-21, Piping Flexibility Analysis Program, was used for static analysis. This is a recognized program in the public domain. It is implemented at CE on the CDC-7600. The version used has been shown to give identical results with the IBM based version (Reference 5).

D. ANSYS

ANSYS is a general purpose element program with structural and heat transfer capabilities. This program was used for steady state and transient thermal analysis. The code is in the public domain. Additional verification is not required. The version used originally by CE was Engineering Analysis System UP144, Revision 2, CE-7600.

ANSYS was also used by Westinghouse Electric Company for structural and thermal analysis of the steam generators. The version used by Westinghouse Electric Company was ANSYS 5.5.

ARKANSAS NUCLEAR ONE
Unit 2

ANSYS was also used by Westinghouse Electric Company for the analysis of the Replacement Pressurizer. The version used by Westinghouse Electric Company was ANSYS 7.1 and ANSYS 8.1.

E. CHAT-12100

CHAT-12100 is a general purpose finite difference heat transfer program. This program was used for steady state and transient thermal analysis. The program has been verified by comparison with hand calculations. A sample comparison of program and hand calculations for four problems is given in Table 5.2-14.

F. SEAL SHELL II

SEAL SHELL II computes stresses and deformations of axisymmetric shells for pressure and thermal loads. The program is in the public domain as WAPD-TM-39B.

G. FLANGE FATIGUE PROGRAM - BCH10102

This program computes the redundant reactions, forces, moments, stresses and fatigue usage factors in a reactor vessel head, head flange, closure studs, vessel flange and upper vessel wall for pressure and thermal loadings. Classical shell equations are used in the interaction analysis.

H. NOZZLE FATIGUE PROGRAM – BCH 10105

This program computes the redundant reaction, forces, moments and fatigue usage in the primary nozzles.

I. EDGE COEFFICIENTS - BCH10026

This code calculates the coefficients for edge deformations of conical cylinders and tapered cylinders when subjected to axisymmetric unit shears and moments applied at the edges. A comparison of program results with hand solutions was used for verification. The results are given in Table 5.2-15.

J. GENERALIZED 4X4-BCH10124

This program computes the redundant reactions, forces, moments, stresses and fatigue usage factors for the reactor vessel wall at the transition from a thick to thinner section and at the bottom head juncture.

K. REINFORCEMENT ANALYSIS OF SKEWED PENETRATIONS AND NON-RADIAL NOZZLES - OBC10147

This program computes the limits of reinforcement for penetrations that are non-radial or skewed in a hemispherical head.

L. A THREE VARIABLE SUMMATION PROGRAM FOR COMPUTER THERMAL STRESSES - OBC10126

This program computes the stress at each time increment of a transient at various locations along a nozzle as a function of the thermal stress, k , and the product of the shear and moment, H and M with their respective coefficients C_1 and C_2 .

In general form: $\sigma = k + C_1 H + C_2 M$

ARKANSAS NUCLEAR ONE
Unit 2

M. WESTEMS

This program is a PC-based integrated diagnostics and monitoring system and stress analysis tool. It is modular in design, utilizing project-based models and a family of plug-in programmable components. This system is used by Westinghouse engineers to perform ASME design stress and fatigue analysis using NB-3200 criteria.

N. WECAN

WECAN is a Westinghouse Electric Company general purpose finite element program with structural and heat transfer capabilities. It was used for structural and thermal analysis of the steam generators. The versions used were WECAN 1995 and WECAN/Plus 1997.

Items G, H, J, K, and L have not been verified according to "Acceptability of Computer Programs Analysis of Mechanical Components and Equipment" dated 5/24/73, because the design preceded this interpretation of the design control measures of 10 CFR 50, Appendix B. Verification of these computer programs was performed at CE as standard engineering practice, but the results of this verification were not formally recorded. The user engineer examined the calculational results for reasonableness, compared them to other similar results, and checked the results by hand calculations when appropriate. Item N verification of the computer program was performed by Westinghouse consistent with the design control measures of 10 CFR 50, Appendix B.

CE supplied ASME Class 2 and 3 components were purchased in accordance with design and design quality assurance requirements existing at the time of purchase of the equipment in 1971. CE subcontractors for these components were not required to validate computer codes used in design by set procedures. Reliance was placed upon industry standards, on accepted engineering practices, and on the accumulated experience of the suppliers. These computer program verification measures taken by CE met the original design control measure requirements of 10 CFR 50, Appendix B then in effect. Since that time, CE has completed a program for recorded verification of the referenced computer programs, developed in conjunction with the Blue Hills Station Units 1 and 2 PSAR and described in Dockets 50-510 and 50-511.

5.2.1.10.2 Computer Programs for Stress Analysis of Piping

For stress analysis of piping not included in Section 5.2.1.10.1, the following computer programs were used:

A. ME 210 - Local Stresses in Cylindrical Shells Due to External Loading

ME 210 presents a method of analyzing and determining local stresses in cylindrical shells due to external moments and forces acting on rigid attachments of elliptical, circular or rectangular shape. This program is based on a paper "Local Stresses in Spherical and Cylindrical Shells due to External Loadings" by Wichman, Hopper & Mershon, published in Welding Research Council Bulletin No. 107, August 1965. Values from Bijlaard curves are obtained by interpolation procedures.

ARKANSAS NUCLEAR ONE
Unit 2

B. ME 602 - The Simplified Seismic Analysis of Small Diameter Piping Systems

ME 602 performs the seismic analysis of piping systems using the modified response spectrum method described in BP-TOP-1 (Revision 2). The program generates a set of tables of seismic spans, support reactions and stresses for various pipe sizes.

C. ME 604 - Nuclear Class 1 Piping Stress Analysis

This program is used to calculate piping stresses in accordance with the simplified method of NB-3650 of the ASME Section III Code.

The stresses are calculated in accordance with Equations 9 through 14 defined in Section NB-3650 of the ASME Code. The stresses and usage factor are printed out for each data point in the analysis.

D. ME 632 - Piping System Analysis

ME 632, developed by Bechtel Power Corporation, performs stress analysis of three-dimensional piping systems. The effects of thermal expansion, uniform load of the pipe, pipe contents and insulation, concentrated loads, movements of the piping system supports, and other external loads, such as wind and snow, may be considered.

A response spectrum analysis may be performed to analyze the effect of earthquake forces on the piping system. Time history analyses for transient effects of water hammer, steam hammer, or other impulsive type dynamic loading are also handled by the program.

E. ME 641 - Time History Analyzer

ME 641 produces time history listings and Calcomp 1036 or Zeta graphs for all the parameters in ME 632. The word parameter is used as a catchall for displacement, force, moment and stress. ME 641 can be run with ME 632 or it can stand alone as a separate program.

F. ME 643 - Thermal Stress Program

To determine the temperature and stress distributions within a body as a function of time when subjected to thermal and/or mechanical loads. The program is valid for axisymmetric or plane structures.

G. ME 909 - Spectra Curves Merging Program

This program envelops all appropriate response spectra curves for a given piping system. It also makes Calcomp 1036 or Zeta plots of these curves, and produces data cards for ME 632 seismic analysis.

H. MRI/STARDYNE

The MRI/STARDYNE, static and dynamic structural system which is developed by Mechanics Research, Inc., of Los Angeles, California, is available at CYBERNET Center of Control Data Corporation on the CDC 6600 machine.

ARKANSAS NUCLEAR ONE
Unit 2

The MRI/STARDYNE consist of a series of compatible computer programs which analyze linear elastic structural models under static or dynamic loads. It is used to calculate time history responses of a piping system under fluid transient loads.

I. ANSYS

The ANSYS, Engineering Analysis Computer Program, which was developed by Swanson Analysis Systems, Inc., is a general purpose finite element program featuring analysis capabilities for structures including static and dynamic analysis with elastic, plastic and creep properties.

It is used to calculate the time history responses of piping systems during a pipe break event.

J. PIPESTRESS (PS+CAEPIPE)

PIPESTRESS, developed by SST Systems, Inc., is a group of interrelated computer programs for performing linear elastic analysis of three-dimensional piping systems subjected to a variety of loading conditions. This program has advanced static and dynamic analysis capabilities including detailed uniform and multilevel response spectrum analyses, time history and fatigue calculations, and multiple load cases and combinations.

K. ME101

ME101, developed by Bechtel Power Corporation, is a family of computer programs that perform linear elastic analysis of piping systems using standard beam theory techniques. ME101 also performs static and dynamic load analysis of piping systems, effective weight calculations, and ASME Section III Nuclear Class 2 & 3 code stress checks. ME101 also provides stress evaluation of cylindrical shell, thermal transient across pipe wall, spectral merging, and ASME Section III Nuclear Class 1 Stress analysis.

The following computer codes have also been used in the stress analysis of piping (all computer programs are well recognized and program descriptions are available but not supplied in the remainder of the section):

- PISOL - EDS Nuclear Inc.
- NUPIPE - Nuclear Services Corporation
- SAPIPE - PMB Systems Engineering Inc.
- TPIPE - PMB Systems Engineering Inc.
- PISTAR - NUTECH Technology Inc.

All programs are well recognized and they all have sufficient history of use to justify their applicability and validity. Verification documents including program theory, solutions to test problems or bench mark problems, or comparison with known programs are available. They constitute a very bulky package however and for that reason were not submitted with the application.

ARKANSAS NUCLEAR ONE
Unit 2

Bechtel supplied ASME Class 1, 2 and 3 components were purchased in accordance with design and design quality assurance requirements existing at the time of purchase of the equipment. Bechtel subcontractors for these components were not required to validate computer codes used in design by set procedures. Reliance was placed upon industry standards, on accepted engineering practices, and on the accumulated experience of the suppliers.

5.2.1.11 Analysis Method for Faulted Condition

The dynamic system analysis used to establish loadings sustained by ASME Code Class 1 components and supports during the plant faulted conditions is based upon elastic methods. Accordingly, elastic methods of stress analysis and elastic design stress limits, in accordance with the appropriate paragraphs of ASME Code, Section III, Subsection NB, are also applied in the design calculations performed to demonstrate the adequacy of the components.

5.2.1.12 Protection Against Environmental Factors

The major components of the RCS are protected against environmental effects, including flooding and missiles. Refer to Chapter 3, particularly Sections 3.4 and 3.5, for a detailed discussion.

5.2.1.13 Compliance With Code Requirements

Detailed discussions of the analytical calculations are provided in Sections 3.6, 3.7 and 3.9, showing the manner in which loadings are developed for confirmation that the design requirements of the ASME Code, Section III, Subsection NB, are met.

5.2.1.14 Stress Analysis for Emergency and Faulted Condition Loadings

Elastic methods of stress analysis are used in evaluating the Emergency and Faulted Condition Loadings. The specific stress criteria applied is discussed in Section 5.2.1.9.

5.2.1.15 Stress Levels in Seismic Category 1 Systems

A discussion of Seismic Category 1 systems, analytical models and stress levels is presented in Section 3.7. The analysis of combined seismic and faulted conditions is included. Sketches showing details of the modeling are also included. The stress levels at points of high changes in flexibility in the RCS during the plant faulted condition, are presented on Figure 5.2-34.

The six components of force or moment (F_x , F_y , F_z , M_x , M_y , M_z) at the supports and various sections of the pressurizer surge line piping were computed separately for each of the two horizontal directions and in the vertical direction of seismic excitation by response spectrum dynamic analysis. The co-directional components of force or moment from one horizontal and the vertical directions of excitation were combined by absolute summation to define the seismic loading condition at the particular piping location for one horizontal and the vertical excitations. A second seismic loading condition was also defined by repeating the absolute sum combination for the other horizontal and the vertical excitations. Each load set was compared to, and shown to be less governing than, the seismic loadings specified for design of the piping. The load combinations were calculated and verified by hand. In no case has algebraic summation been used for combining the effects of horizontal and vertical seismic excitations for systems within the NSSS scope.

ARKANSAS NUCLEAR ONE
Unit 2

Time histories of the six components of force or moment (F_x , F_y , F_z , M_x , M_y , M_z) at various sections of the RCS main loop piping were computed separately for each of two horizontal directions and in the vertical direction of seismic excitation. Each component of force or moment from one horizontal direction of excitation was combined by absolute summation on a time basis with the corresponding co-directional component of force or moment from the vertical direction of excitation. The maximum combined value over all time of each of the six components of force or moment were chosen to define the seismic loading condition at the particular piping location for one horizontal and the vertical excitations. A second seismic loading condition was also defined by vertical excitations. Each load set was compared to, and shown to be less governing than, the seismic loadings specified for design of the piping.

Since the combination of loads was performed after the completion of the dynamic analysis portion of the computation, the appropriateness of the results of the combination was verified by field observation of the uncombined inputs and the combined output.

Stresses in pumps and valves in the RCPB have been determined in accordance with the ASME Code, Section III.

5.2.1.16 Analytical Methods Used to Evaluate Pump Speed and Bearing Integrity

Analytical methods are employed to assure that no critical speed is within ± 25 percent of normal operating speed. The shaft and bearings are designed to withstand any combination of the normal operating loads, anticipated transients, accident loads and the Design Basis Earthquake (DBE). Failures resulting from critical speed problems are not likely to result in a violation of the integrity of the RCPB. However, the pump vendor analyzes the entire reactor coolant pump/motor assembly and determines the fundamental and harmonic modes of lateral vibration of rotating elements of arbitrary flexural rigidity. The computational method is based on a transfer matrix representation of the rotor shaft which includes the effect of multiple supports with dissimilar elasticity and damping in the bearings and with a dissimilar elasticity and mass of the bearing supports. The natural frequencies, lateral deflections for the determination of rotor stresses, running clearances, and severity of vibration at the different resonant frequencies are calculated. Vibration amplitudes of the bearing supports are also calculated for determining support resonant frequencies and for obtaining an optimum design through modifications of the bearing and their supports.

For the analysis, the continuous rotating element is represented as a sequence of massless sections with constant bending stiffness and an equal number of concentrated masses between the massless sections. In addition, the computational model provides the option of adding masses of unbalance to any of the section masses to study vibration characteristics of the system under various conditions of unbalance.

Transfer equations relating deflections ψ , slopes θ , bending moments M , and shears V , at the two ends of a shaft section are derived from the beam equations and are given by:

$$V = dM/dx$$

$$M = EI \, d\theta/dx$$

$$\psi = d\psi/dx$$

ARKANSAS NUCLEAR ONE
Unit 2

Referring to Figure 5.2-35, which shows a typical beam segment, the following equilibrium equations can be written:

$$V_{i+1} = V_i + \omega^2 M_i \psi_i$$

$$M_{i+1} = M_i + V_i \ell_i + \omega^2 M_i \psi_i \ell_i$$

By successive integration, the slope and deflection relationships are derived:

$$\theta_{i+1} = \frac{\ell_i^2}{2EI_i} V_i + \frac{\ell_i}{EI_i} M_i + \theta_i + \frac{\omega^2 m_i \ell_i^2}{2EI_i} \psi_i$$

and

$$\psi_{i+1} = \frac{\ell_i^3}{6EI_i} V_i + \frac{\ell_i^2}{2EI_i} M_i + \ell_i \theta_i + \frac{\omega^2 m_i \ell_i^3}{6EI_i} \psi_i$$

These transfer equations can be conveniently represented by a 4 x 4 transfer matrix. When the contributions due to the mass of unbalance are added, the transfer matrix must be expanded to a 5 x 5 matrix.

This matrix describes any section, n , of a weightless shaft and a disk when the rotor is supported on rigid supports and with conditions of unbalance and mass moment of inertia included. Through pre-multiplication of the section matrices for successive beam elements, a transfer matrix for each bearing span is developed. Boundary conditions specified at each support location prescribe the slope, displacement, and moment across the support.

When the system is rotating with fluid lubricated bearings on elastic supports, the deflections calculated for rigid supports must be modified to include the deflections of the supports. These modifications are accomplished through the use of dynamic influence coefficients.

The assumptions, methods and detailed descriptions by which the necessary parameters and influence coefficients were calculated in the evaluation of pump speed and bearing integrity with fluid lubricated bearings on elastic supports are found in References 3, 6 and 7.

The supports themselves are represented as a combination of springs, masses, and dampers such that the dynamic stiffness of each support is defined at each speed. Since the system is rotating with fluid lubricated bearings on elastic supports, dynamic influence coefficients were calculated by applying a unit force of unbalance at an initial section of a span containing a support. The coefficients are obtained with the system rotating at the speed under consideration and all masses set equal to zero, except the unit force of unbalance at the support selected.

These influence coefficients are then related to the support reaction when they are substituted into the equation defining the differences in the distances at the ends of the section between the curve of the centerline of the rotor with the masses equal to zero and the bearing forces equal to those reactions which exist when the masses are their true value and rotating at the given speed and the curve of the centerline of the rotor with the masses at true value rotating at the given speed with corresponding bearing reactions, which is:

ARKANSAS NUCLEAR ONE
Unit 2

$$[f_{uv} - f_{u-1,v}] = \sum_{q=1}^{z+1} [C_{uvoq} - C_{u-1,voq}] R_{oq}$$

where

$f_{uv} - f_{u-1,v}$ is the difference in curves defined above

$C_{uvoq} - C_{u-1,voq}$ is the difference in the influence coefficients, in-lb

R_{oq} is the support reaction at section O of span q, lb

The rigid supports were modified to account for elastic supports by including damping and stiffness coefficients for the fluid film and support flexibility in the calculations. Figure 5.2-35 illustrates the procedure.

The analysis is performed for operating transient loading conditions. In addition, pump vibration levels are checked during the pump performance tests. Any evidence of critical speed problems would be detected during these tests.

5.2.1.17 Operation of Active Valves Under Transient Loading

Design of valves which form a part of the RCPB is discussed in Sections 5.2.1.6 and 5.2.1.7, and the design is based in part on the service consistent with the transients listed in Section 5.2.1.5.

All pumps and valves that are designed and fabricated as Class 1 are analyzed in accordance with the ASME Code requirements. It is demonstrated that the maximum stress intensities and cumulative usage factors are in compliance with Code values. The analyses are performed for steady state and cyclic conditions as required by the Design Specifications. Certified analytical reports are required for the components. Verification of the adequacy of the calculations and compliance with Code and Design Specification requirements are assured by an independent review.

System design thermal transients are used in the fatigue analyses required by the applicable codes. The basis for the number of occurrences is to provide system/component design which is not limited by expected cyclic operation over the life of the plant. The number of occurrences selected for design purposes far exceeds the expected number. System integrity is further assured by using conservative methods of predicting the range of pressure and temperature for the transients. The transients include normal plant power range operation, controller or instrument failure, equipment malfunction, and operator errors which result in reactor trips.

Fatigue analysis for each component of the RCS is performed in accordance with the applicable codes. The combined effects of the mechanical load and thermal transients for each condition of the cyclic operation are evaluated. The evaluations are performed in a manner which yields the maximum range in stress intensity during the particular cyclic condition under consideration. In those cases where conservative results are produced, peak stresses due to pressure may be combined with those due to thermal transients by direct superposition. In addition, the results of analysis obtained for the most severe transient condition in a group may be applied in evaluating the cumulative effects of the entire group.

ARKANSAS NUCLEAR ONE
Unit 2

Pressure and temperature transients resulting from these events are established by computer simulations of the RCS. Time-dependent parameters are included in the equipment specifications and used as the basis for fatigue design.

5.2.1.18 Field Run Piping

There is no field run piping in the RCPB.

5.2.1.19 Design of Reactor Coolant System and Lower Pressure System Interfaces

There are several points of interface with the RCS that have a design pressure less than the design pressure of the RCS. The degree of conformance of these interfaces with General Design Criteria 14 and 55 is given in Table 5.2-13.

5.2.2 OVERPRESSURE PROTECTION

Overpressure protection for the RCS and steam generator is accomplished by the pressurizer code safety valves, steam generator safety valves, and the RPS. The design is in accordance with ASME Section III, NB-7000. RCS low temperature overpressure protection is described in Section 5.2.2.4.

The two pressurizer safety valves are located on top of the pressurizer. They are totally enclosed, back pressure compensated, spring-loaded safety valves. Parameters for these valves are given in Table 5.5-10.

Overpressure protection for the shell side of the steam generators and the main steam line piping up to the main steam isolation valve is provided by spring-loaded, open-bonnet ASME Code safety valves discharging to the atmosphere. Safety valves are mounted outside the containment on each of the two main steam lines upstream of the steam line isolation valves. Parameters for these valves are given in Table 5.5-11.

The pressurizer safety valves pass sufficient pressurizer steam to limit the primary system pressure to less than 110 percent of design. An addendum to the ANO-2 Overpressure Protection Report verified the RCS pressure limit is not exceeded as a result of installation of the replacement steam generators and power uprate. The reactor is assumed to trip on a high pressurizer pressure signal. In determining the maximum steam flow through the pressurizer safety valves, the main steam safety valves are assumed to be operational. Conservative values for all system parameters, delay times, and core moderator coefficient are assumed. Overpressure protection is provided to the RCS considering pump head, flow pressure drops, and elevation heads.

The pressurizer safety valves discharge through the relief line piping into the quench tank. The design allowable backpressure for the pressurizer safety valves is 700 psig. This value is consistent with the current state-of-the-art for bellows sealed designs.

The pressure, mass flow rate, and forcing functions were determined for the Code Safety Relief Valve Discharge Piping System using a computer model to analyze the time history. The results of the backpressure analyses indicated that the maximum calculated backpressure, due to actuation of either the Low Temperature Overprotection System (LTOP) or the Code Safety Relief valves, did not exceed the relief valve discharge piping design pressure (700 psig) or the Pressurizer Code Safety Valves allowable backpressure (also 700 psig).

ARKANSAS NUCLEAR ONE
Unit 2

The peak backpressure on the pressurizer safety valves during overpressure conditions did not affect the pressurizer safety valve flow capacity. The downstream fluid-containing parts, including the bellows, are hydrostatically tested in the shop at 1,050 psig. For the bellows, this is equivalent to an at-temperature pressure of approximately 960 psig. The valve, therefore, will function to relieve its rated capacity up to 960 psig back pressure. Above this value the bellows may rupture, causing the disk to cycle closed and then open depending on the magnitude of the rupture and the characteristics of the valve.

In addition, a steam dump and bypass system is provided. The system utilizes steam dump valves and turbine bypass valves to accommodate certain load rejections without resulting in a reactor trip or lifting any main steam supply valves. The dump valves discharge to the atmosphere and the turbine bypass valves discharge to the main condenser. Normal operation utilizes the turbine bypass valves and downstream ADVs in automatic, set to actuate (open) on high steam pressure, which accommodates load rejections up to 49% power. The bypass valves are also utilized to control steam line pressure in hot standby, thereby removing decay heat from the reactor coolant system. This system is further described in Chapter 10.

5.2.2.1 Location of Pressure-Relieving Devices

The locations of pressure-relieving devices for the RCS and auxiliary and emergency systems connected to the RCS are shown on the respective piping and instrument diagram (Figures 5.1-3, 6.3-2, 9.3-4). The steam generator safety valves are shown in Figure 10.2-3. The diagrams also show connections to the discharge side of the pressure-relieving devices.

5.2.2.2 Mounting of Pressure-Relieving Devices

The mounting of pressure-relieving devices within the RCPB and on the main steam lines outside the containment is in accordance with the applicable provisions of the ASME Code, Section III.

The pressurizer safety valves are flange connected to nozzles on the pressurizer. The loads which the nozzles experience during normal plant operation and when the valves are relieving are included in the specification for the pressurizer.

In addition, limiting loads which may be applied to the outlet connections of the valves by the discharge piping are documented in calculations, and based upon these calculations the arrangement and support of this piping is such that the limiting loads are not exceeded for normal and relieving conditions.

For the main steam safety valves, the full discharge thrust loads of the valve have been combined with pressure, weight, seismic and thermal loads for computing stresses in the mounting nozzle and the header. Bending and torsional stresses in the main steam line were computed considering various combinations of the five safety valves discharging, resulting in bounding loads for the header and support. Supports and restraints have been provided in the pipe line to keep stresses within allowable limits.

5.2.2.3 Report on Overpressure Protection

Overpressure protection for the Reactor Coolant and Main Steam Systems has been evaluated for steam generator replacement and power uprate conditions and documented in a revised "Report on Overpressure Protection." In order to maintain sufficient margin following power

ARKANSAS NUCLEAR ONE
Unit 2

update, the report establishes PSV rated capacity according to ASME Section III, 1989 Edition Section NB-7734. This revised PSV capacity is based on the use of the Napier Factor, which is permitted by the later code. Discussions and analytical assumptions that follow provide the original sizing bases for the PSVs and MSSVs.

5.2.2.3.1 Introduction

Overpressure protection for the reactor vessel, steam generators, and RCS is in accordance with the requirements set forth in the ASME Boiler and Pressure Vessel Code, Section III. Overpressure protection is ensured by means of primary safety valves (pressurizer safety valves), secondary safety valves (main steam safety valves), and the RPS. Analysis of all reactor and steam plant transients causing pressure excursions is conducted. The worst case transient, loss-of-load, in conjunction with a delayed reactor trip is the design basis for the primary safety valves. The primary safety valves, secondary safety valves, and RPS maintain the RCS below 110 percent of design pressure during worst case transients. The secondary safety valves are sized to maintain steam pressure to less than 110 percent of steam line design pressure during the bounding transient (Loss of Condenser Vacuum). Table 5.2-19 summarizes equipment protected by these safety valves and the valve specifications as evaluated in the Report on Overpressure Protection. (See Tables 5.5-10 and 5.5-11 for current safety valve parameters).

5.2.2.3.2 Analysis

The loss of load event description which follows relates to the analysis assumptions and results utilized in the design sizing considerations of the primary and secondary safety valves. Section 15.1.7 presents a similar loss of load event. Changes in plant operation, replacement steam generators, and cycle specific considerations are assessed in Section 15.1.7 to ensure the primary and secondary safety valves will still maintain the maximum pressure following a loss of load within 110% of design pressure.

5.2.2.3.2.1 Method

CE has performed a parametric study to determine the design basis incident for sizing the primary safety valves. The design basis incident is a loss-of-load in conjunction with loss of condenser vacuum event parameters and a delayed reactor trip. The analysis is performed using digital computer codes which accurately model the thermal, hydraulic, and nuclear performances of the reactor coolant and steam systems. The digital codes used in the transient analysis include reactor kinetics, thermal and hydraulic performance of the RCS, and the thermal and hydraulic performance of the steam generators. The computer simulation includes effects of reactor coolant pump performance, elevation heads, inertia of surge line water and friction drop in the surge line. Highly conservative initial conditions and nuclear parameters are assumed for the parametric analysis. The performance of the digital codes employed in the analysis has been verified by transient data from operating plants.

5.2.2.3.2.2 Assumptions

- A. At the onset of the loss-of-load transient the reactor coolant and main steam systems are at maximum rated output plus a two percent uncertainty.

ARKANSAS NUCLEAR ONE
Unit 2

- B. Positive moderator coefficients between $+0.5 \times 10^{-4} \Delta K/K/^\circ F$ and $+1 \times 10^{-4} \Delta K/K/^\circ F$ are used in the loss-of-load analysis. The coefficient ($1 \times 10^{-4} \Delta K/K/^\circ F$) maximizes pressure/power excursions. The moderator coefficient used is substantially more positive than will occur in actual plant operation.
- C. A Doppler coefficient of $-.8 \times 10^{-5} \Delta K/K/^\circ F$ is used in the loss-of-load analysis.
- D. No credit is taken for letdown, charging, pressurizer spray, secondary dump and bypass, or feedwater addition after turbine trip in the loss-of-load analysis.
- E. The analysis reflects consideration of plant instrumentation error and safety valve setpoint errors.
- F. Plant pressure at the onset of the incident is 2,200 psia; the pressurizer water level is within normal operating limits.

5.2.2.3.2.2.1 Secondary Safety Valve Sizing

The discharge piping serving the secondary safety valves is designed to accommodate rated relief capacity without imposing unacceptable backpressure on the safety valves. The secondary safety valves are sized to pass a steam flow equivalent to the plant's ultimate power level. This limits steam generator pressure to 110 percent of steam generator design pressure during worst case transients. A plant's secondary safety valves typically lift at staggered set pressures. The valves are spring loaded safety valves procured in accordance with ASME Boiler and Pressure Vessel Code, Section III. [The original MSSVs were bellows type valves. These valves were subsequently replaced by safety valves which do not have bellows.] This type of safety valve was considered in reevaluation of the "Report on Overpressure Protection" performed for operation subsequent to replacement of the steam generators.

Figure 5.2-48 depicts the steam generator pressure transient for this loss-of-load incident. As can be seen in Figure 5.2-48; the steam generator pressure remains below 110 percent of design pressure during the incident.

5.2.2.3.2.2.2 Pressurizer Code Safety Valve Sizing

The reactor quench tank, inlet and discharge piping are sized to preclude unacceptable pressure drops and backpressure which would adversely affect valve operation.

The original design basis incident for sizing the primary safety valves was a loss of turbine-generator load in which the reactor is not immediately tripped. No credit is taken for any pressure-reducing devices except the primary safety valves and secondary safety valves. In reality, the incident would be terminated by a number of delayed reactor trips. These include:

- A. Steam generator low level trip;
- B. High pressurizer pressure trip, and;
- C. Manual trip.

In order to determine the effects beyond the point where delayed reactor trips would have terminated the incident, the calculation is allowed to continue until the pressurizer fills.

ARKANSAS NUCLEAR ONE
Unit 2

A series of loss-of-load studies are run with various sizes of primary safety valves. As can be seen in Figure 5.2-49, after the safety valve capacity increases to a certain size, additional increase in capacity has a negligible effect in reducing the maximum system pressure experienced during the loss-of-load transient. The primary safety valves are chosen so as to minimize the maximum pressure experienced during the loss-of-load transient. The minimum specified safety valve capacity is identified on Figure 5.2-49.

Figures 5.2-50 and 5.2-51 present curves of maximum RCS pressure and core power versus time for the loss of turbine generator load. As can be seen on Figure 5.2-50, the maximum pressure remains below 110 percent of design pressure during this worst case transient. Following turbine trip, the reactor power increases (See Figure 5.2-51) due to the conservative moderator and Doppler coefficients assumed. Reactor coolant temperature rises and expanding coolant causes a rise in pressure as the pressurizer steam space is compressed.

The first, second, and third banks of secondary safety valves open at approximately 4.5, 5, and 7 seconds, respectively. The secondary safety valves remove energy from the RCS and thus mitigate the pressure surge. The primary safety valves open at the RCS design pressure approximately five seconds after initiation of the upset condition.

The loss of load transient presented above is considered to be the original design basis transient for safety valve sizing only. The limiting design transients for overpressure protection which include the effects of the replacement steam generator are the loss of condenser vacuum event (see Section 15.1.7 for the analysis results).

The combined action of the primary and secondary safety valves and the RPS limits the RCS pressure to less than 110 percent of design pressure.

5.2.2.3.3 Conclusions

The reactor vessel, steam generators, and RCS are protected from over-pressurization in accordance with the guidelines set forth in the ASME Boiler and Pressure Vessel Code, Section III. Peak RCS and secondary system pressures are limited to 110 percent of design pressures.

Overpressure protection is afforded by primary safety valves, secondary safety valves, and the RPS.

5.2.2.4 Low Temperature Overpressure Protection

To protect the RCS from over-pressurization during low temperature conditions, Low Temperature Overpressure Protection (LTOP) design modifications were added. The physical modification was the addition of redundant LTOP relief valves 2PSV-4732 and 2PSV-4742, and two LTOP isolation valves [for each relief valve](#). LTOP over-pressurization events [due to energy addition and due to mass addition to the RCS](#) were analyzed with a relief valve setpoint of 430 psig to determine maximum transient pressure. The most limiting energy addition event [is a single idle RCP start with a secondary-to-primary temperature differential of 100 °F](#). The most limiting mass addition event [is the simultaneous injection to the RCS from one HPSI and three charging pumps](#). The [mass addition event with the peak transient pressure of 500.2 psia is the most limiting of the two events and, therefore, is the design basis for the LTOP system](#).

ARKANSAS NUCLEAR ONE
Unit 2

The LTOP relief valves are aligned via operator action during cooldown and isolated during heatup to support the Technical Specifications requirement that LTOP be enabled when any indicated RCS cold leg temperature is ≤ 220 °F. The LTOP modifications, including administrative controls, instrumentation alarms, procedures, and test requirements are described in Sections 7.6.1.3, Low Temperature Overpressure Protection (LTOP), and 7.6.2.3, LTOP.

An evaluation of the LTOP pressure-temperature limits, generated using the methodology of ASME Code Case N-641, has the following limitations that must be adhered to.

Both relief valves are aligned to the RCS for protection;

RCS heatup and cooldown rates are restricted in accordance with the Technical Specifications;

A secondary-to-primary temperature differential less than 100 °F, and an indicated pressurizer water volume less than 910 ft³ is maintained to ensure acceptable results following a single idle RCP start;

A maximum of one HPSI pump is capable of injecting into the RCS; and

RCP operation is restricted to no more than two RCPs at 70 °F $\leq T_c \leq 220$ °F and no more than three RCPs at $T_c > 220$ °F, where T_c is the highest indicated cold leg temperature.

The transient analysis has confirmed that the maximum discharge backpressure on the relief valve during the limiting overpressure transient is less than 50% of the set pressure. The potential for unstable valve cycling behavior is averted by maintaining LTOP relief valve backpressure less than 50% of the set pressure.

5.2.2.5 Diverse Scram System (DSS) Overpressure Protection

RCS overpressure protection due to an ATWS event is provided by the DSS which trips the reactor upon reaching a pressurizer pressure of 2450 psia nominal. Refer to Section 7.7.1.6 for a description of the DSS.

5.2.3 GENERAL MATERIAL CONSIDERATIONS

5.2.3.1 Material Specifications

The pressure-retaining ferritic and austenitic stainless materials for the major components in the RCS are listed in Table 5.2-3. Valves are fabricated from austenitic stainless steel. Material specifications for valves are given in Section 5.5.

To reduce irradiation embrittlement in service, low residual requirements were imposed on plate and weld material in the reactor vessel beltline. The content of this material as determined by chemical analysis is given in Table 5.2-4. Generic Letter 92-01, Revision 1, Supplement 1, requested licensees to locate all data relevant to the determination of vessel integrity. In response to the generic letter, the design and fabrication records were evaluated. As a result of this evaluation, it was determined that the “best-estimate” values for the copper and nickel content for the reactor vessel beltline material needed to be revised. Table 5.2-20a provides the new “best-estimate” chemistry values.

5.2.3.2 Compatibility With Reactor Coolant

Materials used in the pressure containing boundary of the RCS are listed in Table 5.2-3, and materials in contact with reactor coolant are described by an asterisk. These materials have been selected to minimize corrosion and have given satisfactory performance in operating reactor plants. Controls imposed on reactor coolant chemistry conform with recommendations of Regulatory Guide 1.44, "Control of Sensitized Stainless Steel."

5.2.3.3 Compatibility With External Insulation and Environmental Atmosphere

Materials used in the RCPB or exposed to reactor coolant have been selected to minimize corrosion and have shown satisfactory performance in other existing operating reactor plants. A listing of materials is given in Table 5.2-3. The table shows materials of component construction as well as internal surface material normally exposed to the reactor coolant. Valve materials in contact with the reactor coolant will generally be austenitic stainless steel, stellite or a design approved, low cobalt hard surfacing material equivalent to stellite such as Norem 04, Deloro 40, Deloro 50, etc. External nonmetallic insulation to be used on austenitic stainless steel components conforms with the recommendations of Regulatory Guide 1.36, "Nonmetallic Thermal Insulation for Austenitic Stainless Steels."

Some components of the RCPB and components adjacent to the RCS may be exposed to boric acid corrosion due to leakage of the reactor coolant (boric acid solutions) onto ferritic surfaces. Industry experience and testing in association with GL 88-05 indicate that dripping the boric acid through either calcium silicate insulation or fiberglass insulation, meeting USNRC Reg. Guide 1.36, will not quantitatively influence the boric acid corrosion, or rate thereof, of the carbon steel component. Based upon this information, nothing within the insulation will contribute to the potential effect of boric acid upon the integrity of the pressure boundary.

All piping and equipment within the RCPB, except the reactor vessel head, are insulated with stainless steel reflective insulation or fiberglass blanket insulation meeting Reg. Guide 1.36 Rev. 1 to eliminate the possibility of chloride stress corrosion. The reactor vessel head is insulated with stainless steel encapsulated calcia-alumina-ferrosilicate glass fiber. All other piping and equipment inside containment is insulated with either stainless steel reflective or stainless steel-jacketed conventional insulation. All insulation on ASME Code Section III, Class 1, 2, or 3 components is removable.

5.2.3.4 Chemistry of Reactor Coolant

Controlled water chemistry is maintained within the RCS. Control of the reactor coolant chemistry is the function of the CVCS and is described in Section 9.3.4. Water chemistry limits applicable to the RCS are described in detail in Section 9.3.4.

5.2.3.5 Compliance With Regulatory Guide 1.66

Components originally supplied by CE did not in all respects comply with the recommendations of Regulatory Guide 1.66. The nondestructive examination requirements imposed by CE for tubular products were those specified by Section III of the ASME Code.

ARKANSAS NUCLEAR ONE
Unit 2

5.2.3.6 Compliance with Regulatory Guide 1.71

Components originally supplied by CE did not comply with the specific requirements of Regulatory Guide 1.71. Performance qualifications, for personnel welding under conditions of limited accessibility were conducted and maintained in accordance with the requirements of ASME B&PV Code Sections III and IX. A requalification was required when (1) any of the essential variables of Section IX were changed or (2) when authorized personnel had reason to question the ability of the welder to satisfactorily perform to the applicable requirements. Production welding was monitored for compliance with the procedure parameters and welding qualification requirements were certified in accordance with Sections III and IX. Assurance of acceptable welds in areas of limited accessibility was verified by the performance of the required nondestructive examination.

5.2.4 FRACTURE TOUGHNESS

5.2.4.1 Compliance With Code Requirements

5.2.4.1.1 Reactor Vessel

Carbon and low-alloy steel materials which form a part of the pressure boundary meet the requirements of the ASME Code, Section III, Paragraph N-330 at a temperature of +40 °F. Charpy tests were performed and the results used to plot a transition curve of impact values vs. temperature extending from fully brittle to fully ductile behavior. The actual NDTT of inlet and outlet nozzles, vessel and head flanges and shell and head materials was determined by drop weight tests per ASTM E208. NDT was established by Charpy test. Drop weight tests were conducted and are presented in Table 5.2-5.

The maximum NDTT as obtained from the drop weight test is 30 °F. The maximum temperature corresponding to the 50 ft-lb value of the C_v fracture energy is 68 °F. The minimum upper shelf C_v energy value for the strong direction is 105 ft-lbs. The data for the weak direction was not obtained. The Charpy V-Notch results are shown in Figures 5.2-1 through 5.2-27.

5.2.4.1.2 Steam Generator, Pressurizer, and Reactor Coolant Piping

Impact properties of ferritic steel materials for the pressurizer and reactor coolant piping which form a part of the pressure boundary meet the requirements of the ASME Code per Table 5.2-1, at a temperature of 60 °F below the lowest service temperature. The results for the pressurizer and reactor coolant piping are presented in Tables 5.2-8 and 5.2-9. The impact properties for ferritic steel materials for the steam generators that form a part of the pressure boundary meet the requirement of the ASME Code, Section III, 1989 Edition, no addenda. The results for the steam generators are presented in Tables 5.2-6 and 5.2-7.

ARKANSAS NUCLEAR ONE
Unit 2

5.2.4.1.3 Location of Limiting Values

The identification and location of the material relating to the limiting values identified above are as follows:

Reactor Vessel Flange	Forging
Reactor Vessel Outlet Nozzle Extension	Forging
Closure Head Dome	Plate
Upper Shell Plate	Plate
Closure Head Dome	Plate

5.2.4.1.4 Reactor Vessel Beltline Materials

For 32 EFPY, the highest predicted adjusted reference temperature (ART) for the materials in the reactor vessel beltline is 113 °F. This value is based on Regulatory Guide 1.99, Revision 2 and includes a shift of 101 °F for an inside surface fluence of 3.791×10^{19} n/cm² at 32 EFPY. For 48 EFPY, the highest predicted ART for the materials in the reactor vessel beltline is 117 °F. This value is based on Regulatory Guide 1.99, Revision 2, and includes a shift of 105.1 °F for an inside surface fluence of 5.277×10^{19} n/cm² at 48 EFPY (Reference 24). For 54 EFPY, the highest predicted adjusted reference temperature ART for the materials in the reactor vessel beltline is 122 °F. This value is based on Regulatory Guide 1.99, Revision 2 and includes a shift of 110 °F for an inside surface fluence of 3.10×10^{19} n/cm² at 54 EFPY (Reference 25). Testing results of the unirradiated baseline samples from the reactor vessel surveillance program are in Table 5.2-16.

The minimum uppershell energy values for the unirradiated beltline region plates is 134 ft-lb for the strong direction (Table 5.2-5). The minimum uppershell energy for the weak direction is 125.5 ft-lb based on the baseline surveillance test results, (Table 5.2-16). Both the weld zone materials (weld and HAZ) had higher unirradiated uppershell energies (146 and 151.5 ft-lb, respectively). The minimum uppershell energy value accepted for continued reactor operation toward end of service life of the vessel is 50 ft-lb or greater, depending upon the results of the inservice inspection program.

5.2.4.2 Acceptable Fracture Energy Levels

Fracture toughness requirements for the reactor vessel are established in accordance with the applicable provisions of the ASME Code, Section III as discussed in Section 5.2.1.

In order to take into consideration irradiation effects, the design of the reactor internals and of the water annulus between the active core and vessel wall is such that, for reactor operation at the maximum expected output and an 80 percent plant capacity factor, the vessel fluence ($E > 1$ Mev) at the inner (wetted) clad surface will not exceed 3.791×10^{19} n/cm² for 32 EFPY nor 5.277×10^{19} n/cm² for 48 EFPY. The values of 32 EFPY and 48 EFPY are based on full power operation for 40 years and 60 years, respectively, assuming an 80 percent reactor capacity factor.

The fluence analysis is discussed in section 4.3.3.3.

ARKANSAS NUCLEAR ONE
Unit 2

The reactor vessel beltline region consists of steel having controlled residual element content. Based on the copper and nickel content in A-533B material, the maximum predicted ART for the predicted fluence is calculated to be 113 °F at 32 EFPY and 117 °F at 48 EFPY per Regulatory Guide 1.99, Revision 2. As of May 1988, the NRC issued Regulatory Guide 1.99, Revision 2 as an acceptable approach for calculating the effects of neutron radiation embrittlement of the low-alloy steels currently used for light water cooled reactor vessels. Previous shift predictions were based on Figure 5.2-28 (developed from the references given in Table 5.2-10).

The actual NDTT shift will be monitored and determined from the reactor vessel material surveillance program and the resulting operating limits can then be established throughout plant life.

5.2.4.3 Operating Limitations During Startup and Shutdown

Limitations on pressurization and heatup of the RCS are defined by the RCS material exhibiting the "lowest service temperature" until irradiation effects on the reactor vessel become more limiting. The maximum heatup and cooldown rate of the reactor vessel is specified to be 100 °F per hour for design evaluation purposes.

The maximum allowable RCS pressure at any temperature is based upon the stress limitations for brittle fracture considerations. These limitations are derived by using the rules contained in Section III of the ASME Code including Appendix G, Protection Against Nonductile Failure and the rules contained in 10 CFR 50, Appendix G, Fracture Toughness Requirements.

The reactor vessel beltline consists of six plates, the longitudinal welds in the intermediate and lower shell course, and the girth weld joining those two shell courses. In order to estimate the adjusted reference temperature after exposure to neutron irradiation, values are needed of the initial reference temperature (RT_{NDT}) and chemical content (copper and nickel content) for each of the beltline materials. The data used as the basis for estimating are shown in Table 5.2-20 and Table 5.2-20a. The copper and nickel contents were obtained from material certification test reports and supporting records. The initial RT_{NDT} was obtained from one of the following sources:

Longitudinal Weld Seams -

Generic value for submerged arc welds (Reference: "Evaluation of Pressurized Thermal Shock Effects due to Small Break LOCA's with Loss of Feedwater for the Combustion Engineering NSSS," Combustion Engineering, Inc., report CEN-189, December 1981).

Girth Weld and Plate C-8009-3 -

Pre-irradiation surveillance material tests in accordance with NB-2330 of the ASME Boiler and Pressure Vessel Code, Section III (see also Table 5.2-17).

Remaining Plates -

Estimated based on drop weight test and longitudinally oriented Charpy V-notch impact tests in accordance with Branch Technical Position MTEB 5-2, "Fracture Toughness Requirements," from NUREG-0800, USNRC Standard Review Plan, Section 5.3.2, Revision 1, July 1981.

ARKANSAS NUCLEAR ONE
Unit 2

Similar testing was not performed on all remaining material in the RCS. However, sufficient impact testing was performed to meet appropriate design code requirements and a conservative RT_{NDT} of 50 °F has been established for those materials.

The initial reference temperature, RT_{NDT} , of the reactor vessel and closure head flanges was determined using the certified material test reports for the two components. Because it could not be ascertained that the Charpy specimens were oriented normal to the principal working direction, paragraph B.1.1(3) (b) of Branch Technical Position MTEB 5-2 was followed. The material properties are summarized below:

<u>Component</u>	<u>Identification Number</u>	<u>NDTT</u>	<u>Tcv+20 °F</u>	<u>RT_{NDT}</u>
Vessel Flange	C-8001	30 °F	30 °F	30 °F
Closure Head Flange	C-8002	0 °F	30 °F	0 °F

Where Tcv is the lowest Charpy test temperature at which at least 50 ft-lb and 35 mils lateral expansion was exhibited, and 20 °F is added to Tcv following Branch Technical Position MTEB 5-2. As a result of fast neutron irradiation in the beltline region of the reactor vessel, there will be an increase in RT_{NDT} with operation. One technique used to predict the integrated fast neutron ($E \geq 1$ Mev) fluence of the reactor vessel is described in Section 5.2.4.2.

Since the neutron spectra and flux measured at the samples and reactor vessel inside radius should be nearly identical, the measured reference transition temperature shift for a sample can be applied to the adjacent section of the reactor vessel for later stages in plant life equivalent to the difference in calculated flux magnitude. The maximum exposure of the reactor vessel will be obtained from the measured sample exposure by application of the calculated azimuthal neutron flux variation. The maximum integrated fast neutron ($E \geq 1$ Mev) exposure of the reactor vessel including tolerance is computed to be 3.791×10^{19} n/cm² for 32 EFPY (5.277×10^{19} n/cm² for 48 EFPY) assuming operation at 2815 Mwt through Cycle 15 and 3026 Mwt for Cycle 16 to end of life and 80 percent load factor. The predicted RT_{NDT} shift for 32 EFPY and 48 EFPY are 101 °F and 105 °F, respectively, using the methods of Regulatory Guide 1.99, Revision 2. The actual shift in RT_{NDT} will be established periodically during plant operation by testing of reactor vessel material samples which are irradiated cumulatively by securing them near the inside wall of the reactor vessel as described in Section 5.2.4.4.2 and shown in Figure 5.2-29. To compensate for any increase in RT_{NDT} caused by irradiation, limits on the pressure-temperature relationship are periodically changed to stay within the stress limits during heatup and cooldown. During the first two years of reactor operation, conservatively high fluence of 1.8×10^{18} n/cm² is assumed which corresponds to 2,900 MWt and an 80 percent load factor. The corresponding RT_{NDT} shift is 20 °F, based on the curve shown in Figure 5.2-28. Thus, for this interval, the upper limit to the RT_{NDT} is (initial + shift) or 0 °F + 20 °F = 20 °F. As of May 1988, the NRC issued Regulatory Guide 1.99, Revision 2 as a means of predicting the shift in RT_{NDT} due to irradiation embrittlement. This guide describes general procedures acceptable to the NRC staff for calculating the effects of neutron radiation embrittlement of the low-alloy steels currently used for light water cooled reactor vessels.

5.2.4.3.1 32 EFPY P/T Limits (Refer to Section 5.2.4.3.5 for End of Life P-T Limits)

Calculations of ART were performed for operation out to 32 EFPY following Regulatory Position 1.1 of Regulatory Guide 1.99, Revision 2. The initial material properties given in Tables 5.2-20 and 5.2-20a, and a calculated peak vessel inside surface neutron fluence of 3.791×10^{19} n/cm² ($E > 1$ MeV) were used to compute the ART at the 1/4t (where t is vessel thickness) and 3/4t locations. The limiting (highest) ART values were 113 °F at the 1/4t and 99 °F at the 3/4t for plate C-8010-1 corresponding to 32 EFPY operation.

ARKANSAS NUCLEAR ONE
Unit 2

The limit lines in Technical Specification (TS) Figures 3.4-2A, 3.4-2B, and 3.4-2C are based on the following:

- A. The pressure/temperature (P/T) limit curves for the Arkansas Nuclear One Unit 2 (ANO-2) reactor vessel at 32 effective full power years (EFPY) of operation including an estimated increase in fluence due to a 7.5% power uprate, which was implemented at the beginning of Cycle 16. The data used to develop these operational limits are based on the evaluation of the ANO-2 reactor vessel surveillance capsule (BAW-2399, Ref. 21). Pressure-temperature limits are developed for normal heatup and cooldown operating conditions and inservice leak and hydrostatic (ISLH) test conditions. These new limits take into account the effects of irradiation on the reactor vessel materials. Details for the development of the P/T limit curves are in Reference 22.

10 CFR 50.60 requires that pressure/temperature (P/T) limits be established for reactor pressure vessels during normal operating and hydrostatic or leak rate testing conditions using the criteria of 10 CFR 50, Appendix G. Appendix G of 10 CFR 50 specifies that the requirements for these limits are the ASME Section XI, Appendix G limits. The new P/T analyses credit the use of Code Case N-641, "*Alternative Pressure-Temperature Relationship and Low Temperature Overpressure Protection System Requirements*" (January 27, 2000). Code Case N-641 permits the postulation of a circumferentially oriented flaw (in lieu of an axially oriented flaw) for the evaluation of the circumferential welds in RPV P/T limit curves. Code Case N-641 also permits the use of an alternate reference fracture toughness (K_{IC} fracture toughness curve instead of K_{IA} fracture toughness curve) for reactor vessel materials in determining the P/T limits.

Case N-641 for ANO-2 ensures an acceptable margin of safety. The approach is justified by consideration of the over-pressurization design basis events and the resulting margin to reactor vessel failure.

Pressure/temperature limits for the ANO-2 reactor vessel are calculated to satisfy the requirements of 10 CFR Part 50, Appendix G using analytical methods and acceptance criteria of the ASME Boiler and Pressure Vessel Code, Section XI, Appendix G and ASME Code Case N-640 for use of the K_{IC} fracture toughness curve and ASME Code Case N-588 for influence coefficient solution for K_{IT} and explicit method for calculating membrane correction factor (M_m). The methods and criteria employed to establish operating pressure and temperature limits are described below. The objective of these limits is to prevent non-ductile failure during normal operating conditions, including anticipated operational occurrences and system hydrostatic pressure and leak tests.

Of all the components of the RCPB that are subject to the requirements of 10 CFR 50, Appendix G, the only regions that regulate the pressure/temperature limits are the closure head flange, inlet and outlet nozzle, and beltline regions of the reactor vessel. The closure head region can be significantly stressed at relatively low temperatures due to mechanical loads resulting from bolt preload and pressure. High stresses, of the order of two to three times the shell membrane stress, can also occur at the inside corners of the reactor vessel nozzles due to local stress concentrations. Typically, the closure head and nozzle regions influence the pressure/temperature limits only during the first several service periods, prior to significant neutron embrittlement of the reactor vessel beltline materials. After several years of exposure to neutron irradiation, the increase in the RT_{NDT} of the beltline region materials is such that the RCPB

ARKANSAS NUCLEAR ONE
Unit 2

pressure/temperature limits are usually controlled by the beltline region of the reactor vessel. The pressure/temperature limits contained in this report are established by determining the minimum allowable pressure, as a function of fluid temperature, considering the closure head, the inlet and outlet nozzles, and the beltline regions of the reactor vessel.

The analytical procedures used to calculate P/T limits are based on linear elastic fracture mechanics methods for calculating stress intensity factors at the maximum depths of postulated semi-elliptical surface flaws.

The basic equation for allowable pressure is:

$$P_{\text{allow}} = \frac{K_{\text{IR}} - K_{\text{IT}}}{\text{SF} \times \hat{K}_{\text{IP}}}$$

where,

P_{allow}	=	allowable pressure
K_{IR}	=	reference stress intensity factor (K_{Ia} or K_{Ic})
K_{IT}	=	thermal stress intensity factor
\hat{K}_{IP}	=	unit pressure stress intensity factor (due to 1 psig)
SF	=	safety factor

For each analyzed transient and steady state condition, the allowable pressure is determined as a function of reactor coolant temperature considering postulated flaws in the reactor vessel beltline, inlet nozzle, outlet nozzle, and closure head. In the beltline region, flaws are presumed to be present at the 1/4t and 3/4t locations of the controlling material (shell plate or weld), as defined by the fluence adjusted RT_{NDT} . The nozzle flaw is located at the inside juncture (corner) of the nozzle. The closure head flange limit is not explicitly calculated. However, for the condition when the core is not critical, the uncorrected closure flange allowable pressure of 622 psig (20% of preservice hydrostatic test pressure of 3110 psig) is maintained as the limit for temperatures up to 150 °F (30 °F RT_{NDT} + 120 °F margin) per Table 1, item 2.b of 10 CFR 50, Appendix G. Above, 150 °F, the closure flange allowable pressure is 2500 psig. P/T limits for the beltline and nozzle regions are calculated using a factor of safety of 2 for normal operation and 1.5 for ISLH operation. These location specific P/T limits are calculated using the FRA-ANP proprietary computer code PTPC. The maximum allowable pressure at a particular fluid temperature is taken as the minimum value of allowable pressure calculated for each flaw location and operating condition, including steady state. A P/T limit curve is then constructed as the collection of points that define the maximum allowable pressures as a function of fluid temperature for a particular mode of reactor operation. The P/T limit curves provided in the TS are adjusted for sensor location but do not include instrument error. They are, "refined" as necessary to eliminate regions of negative slope by lowering the allowable pressure for temperatures less than that corresponding to the minimum pressure. The criticality limit temperature is obtained by satisfying the requirement of Item 2.d in Table 1 of 10 CFR 50, Appendix G. It requires the minimum temperature to be the larger of minimum permissible temperature for inservice system hydrostatic pressure test (taken as the leak test temperature corresponding to the ISLH limit pressure of 2500 psig with heatup and cooldown rates up to 10 °F/hr) or the RT_{NDT} of the closure flange material + 160 °F.

ARKANSAS NUCLEAR ONE
Unit 2

Primary aspects of the calculational procedures utilized in the development of P/T limits are discussed below.

Fracture Toughness

The fracture toughness of reactor vessel steels is expressed as a function of crack-tip temperature, T, indexed to the adjusted reference temperature of the material, RT_{NDT} . Pressure/temperature limits developed in accordance to ASME Code, Section XI, Appendix G utilize the expression for crack arrest fracture toughness,

$$K_{IA} = 26.8 + 1.233 \exp [0.0145 (T - RT_{NDT} + 160 \text{ } ^\circ\text{F})]$$

Exemptions to 10CFR50, Appendix G, that cite ASME Code Case N-640 (utilized in the generation of the P/T limits in the TS), utilize the crack initiation fracture toughness,

$$K_{IC} = 33.2 + 2.806 \exp [0.02 (T - RT_{NDT} + 100 \text{ } ^\circ\text{F})]$$

The upper shelf fracture toughness is limited to an upper bound value of 200 ksi $\sqrt{\text{in}}$. The crack-tip temperature needed for these fracture toughness equations is obtained from the results of a transient thermal analysis, described in BAW-2405 (Ref. 22).

- C. For plant heatup, the thermal stress is compressive at the reactor vessel inside wall and is tensile at the reactor vessel outside wall. Internal pressure creates a tensile stress at the inside wall as well as the outside wall locations. Consequently, the outside wall location has the larger total stress when compared to the inside wall. However, neutron embrittlement, (shift in material RT_{NDT} and reduction in fracture toughness) is greater at the inside location than the outside. Therefore, both the inside and outside flaw locations must be analyzed to assure that the most limiting condition is achieved.

For each analyzed transient and steady state condition, the allowable pressure is determined as a function of reactor coolant temperature considering postulated flaws in the reactor vessel beltline, inlet nozzle, outlet nozzle, and closure head. In the beltline region, flaws are presumed to be present at the 1/4t and 3/4t locations of the controlling material (shell plate or weld), as defined by the fluence adjusted RT_{NDT} .

The P/T curves provided in the TS are adjusted for sensor location but do not include instrument uncertainty. Protection against non-ductile failure is ensured by using these curves to limit the reactor coolant pressure. The P/T limits for normal heatup (including criticality core limits) at 32 EFPY are provided on the revised TS Figure 3.4-2A. The criticality limit temperature is 190 °F. It is based on the RT_{NDT} of the closure flange material (30 °F) plus 160 °F which is larger than the 175 °F value that corresponds to the ISH limit pressure of 2500 psig. Considering all the ramp and step cooldown transient scenarios, composite cooldown P/T limits for cooldown are shown in TS Figure 3.4-2B. The ISH P/T limits are shown in TS Figure 3.4-2C. Acceptable pressure and temperature combinations for reactor operation are below and to the right of the pressure-temperature limit curves.

For normal heatup operation, TS Figure 3.4-2A, four ramped heatup transient conditions are considered in the evaluation. These transient conditions are simulated by increasing the reactor coolant system (RCS) cold leg temperature from 50 °F to 560 °F at constant rates of 50, 60, 70 and 80 °F/hr. The ISH test condition contained in TS Figure 3.4-2C is also evaluated using the above RCS cold leg temperature ranges, at a ramp rate of 10 °F/hr.

ARKANSAS NUCLEAR ONE
Unit 2

For normal cooldown operation, TS Figure 3.4-2B, the following temperature dependant rates for ramped and stepped cooldown transients are considered in the evaluation. Except for these cooldown rates not including a margin for instrument uncertainty they are identical to those used in the previous TS P/T curves contained in the TSs. The assumptions also include that only two RCPs are in operation while in the LTOP region of the curves.

For 32 EFPY P/T Limits (Reference 22):

A maximum cooldown rate of 100 °F per hour (constant or 50 °F in any half hour period (step) for RCS cold leg temperatures between 50 °F and 560 °F.

For 48 EFPY P/T Limits (Reference 25):

<u>Actual RCS Cold Leg Temperature</u>	<u>Maximum Cooldown Rate</u>
$200\text{ }^{\circ}\text{F} < T_c$	100 °F/hr (constant) or 50 °F in any half hour period (step)
$120\text{ }^{\circ}\text{F} \leq T_c \leq 200\text{ }^{\circ}\text{F}$	60 °F/hr (constant) or 30 °F in any half hour period (step)
$T_c < 120\text{ }^{\circ}\text{F}$	25 °F/hr (constant) or 12.5 °F in any half hour period (step)

A step change is also included in the ramped and step cooldown transients to simulate the temperature change that occurs at the initiation of shutdown cooling when the last reactor coolant pump is secured.

- D. Results of the thermal and fracture mechanics analyses performed for the ANO-2 reactor vessel are presented in the form of P/T curves for (three) operating conditions; normal heatup, normal cooldown, and ISLH operations. These P/T curves are location adjusted to account for the differences between the controlling pressure location and the point of system pressure measurement in the pressurizer. They do not account for instrument error.

Protection against nonductile failure is ensured by using these curves to limit the reactor coolant pressure. Acceptable pressure and temperature combinations for reactor operation are below and to the right of the pressure-temperature limit curves.

Restrictions on allowable operating conditions and equipment operability requirements have been established to ensure that operating conditions are consistent with the assumptions of the accident analysis. Specifically, RCS pressure and temperature must be maintained within the heatup and cooldown rate dependent pressure/temperature limits established.

5.2.4.3.2 48 EFPY P/T Limits (Refer to Section 5.2.4.3.5 for End of Life P-T Limits)

Adjusted reference temperatures (ARTs) were calculated for all ANO-2 beltline materials out to 48 EFPY following Regulatory Positions 1.1 and 2.1 of Regulatory Guide 1.99, Revision 2. The initial material properties given in Tables 5.2-20 and 5.2-20a, and a calculated peak vessel inside

ARKANSAS NUCLEAR ONE
Unit 2

surface neutron fluence of 5.277×10^{19} n/cm² (E > 1 MeV) were used to compute the ART at the 1/4t and 3/4t locations. The limiting (highest) ART value is 117 °F at the 1/4 t and 104 °F at the 3/4t for plate C-8010-1 corresponding to 48 EFPY operation.

The pressure/temperature limit lines in Technical Specification Figures 3.4-2A, 3.4-2B, and 3.4-2C remain based on 32 EFPY of operation. Revised curves for extended operation will be prepared and submitted prior to reaching 32 EFPY. For license renewal, the pressure/temperature limits were evaluated to 48 EFPY using the methods described in Section 5.2.4.3.1 and were acceptable for operation (Reference 23). See Section 18.2.1.3 for further discussion.

5.2.4.3.3 Response to Generic Letter 92-01, Revision 1, Supplement 1

On May 19, 1995, the NRC issued Generic Letter 92-01, Revision 1, Supplement 1 to require licensees to identify, collect, and report any new data pertinent to the analysis of the structural integrity of their reactor pressure vessels (RPV) and to assess the impact of that data on their RPV integrity analyses relative to the requirements of 10 CFR 50.60, 10 CFR 50.61, Appendices G and H of 10 CFR 50, and any potential impact on low temperature overpressure (LTOP) limits or pressure/temperature (P/T) limits.

To fulfill the purpose of the supplement, the NRC has required licensees to provide the following information:

1. A description of those actions taken or planned to locate all data relevant to the determination of RPV integrity, or an explanation of why the existing data base is considered complete as previously submitted;
2. An assessment of any change in best-estimate chemistry based on consideration of all relevant data;
3. A determination of the need for use of the ratio procedure in accordance with the established Position 2.1 of Regulatory Guide 1.99, Revision 2, for those licensees that use surveillance data to provide a basis for the RPV integrity evaluation; and,
4. A written report providing any newly acquired data as specified above and (1) the results of any necessary revisions to the evaluation of RPV integrity in accordance with the requirements of 10 CFR 50.60, 10 CFR 50.61, Appendices G and H to 10 CFR 50, and any certification that previously submitted evaluations remain valid. Revised evaluations and certifications should include consideration of Position 2.1 of Regulatory Guide 1.99, Revision 2, as applicable, and any new data.

In response to the generic letter, the CEOG Reactor Vessel Working Group (RVWG) initiated a project to evaluate the design and fabrication records for CE reactor vessels. As a result of this evaluation, it was determined that the “best-estimate” values for the copper and nickel content for the reactor vessel beltline material needed to be revised. Table 5.2-20a provides the new “best-estimate” chemistry values. It should be noted that the “best-estimate” values were determined as the mean of measured values for the plate or weld. This is consistent with the definition provided in 10 CFR 50.61.

It should be noted that Position 2 of Regulatory Guide 1.99, Revision 2 is applicable “[w]hen two or more credible surveillance data sets become available from the reactor in question.” At that time, only one surveillance data set had been examined. This data set was the 97° surveillance

ARKANSAS NUCLEAR ONE
Unit 2

capsule. Battelle Columbus Laboratories issued a report on their examination, testing, and evaluation of the specimen on May 1, 1984, (Reference 18). In addition there are no "sister vessels" for the six beltline plates in ANO-2 (Reference 19). This regulatory position is therefore not applicable to ANO-2. Therefore, the adjusted Reference Temperatures will be calculated using Position 1.1 of Regulatory Guide 1.99, Revision 2.

Based on the information provided above, several vessel evaluations were performed to identify the impact on current limits. These evaluations include the determination of the limiting component, validating the current P/T and LTOP limits, determining the revised RT_{PTS} , and the decrease in the Upper Shelf Energy.

5.2.4.3.4 Evaluation of the Second ANO-2 Reactor Vessel Specimen and Summary of Results

10 CFR 50, Appendix H, "*Reactor Vessel Material Surveillance Program Requirements*," defines the material surveillance program required to monitor changes in the fracture toughness properties of ferritic materials in the reactor vessel beltline region resulting from exposure to neutron irradiation and the thermal environment. Fracture toughness test data is obtained from material specimens contained in capsules that are periodically withdrawn from the reactor vessel. This data permits determination of the conditions under which the vessel can be operated with adequate safety margins against non-ductile fracture throughout its service life.

The reactor vessel surveillance program for ANO-2 included six capsules designed to monitor the effects of neutron and thermal environment on the materials of the reactor pressure vessel core region. The capsules, which were inserted into the reactor vessel before initial plant startup, were positioned inside the reactor vessel between the core support barrel and the vessel wall. Capsule W-104 was irradiated in the 104° position during the time of irradiation in the reactor vessel (cycles 1 through 14).

Capsule W-104 was removed during the 2R14-refueling outage (Fall of 2000). The capsule contained Charpy V-notch (CVN) impact test specimens fabricated from one base metal plate (SA-533, Grade B, Class 1), heat-affected-zone (HAZ) material, a weld metal representative of the ANO-2 reactor vessel beltline region intermediate and lower shell longitudinal welds, and a Standard Reference Material (SRM). The SRM is a standard heat of SA-533, Grade B, Class 1 material. The tensile test specimens were fabricated from the same base metal plate, HAZ, and weld metal. The number of specimens of each material contained in Capsule W-104, the chemical compositions of the surveillance materials, and the location of the individual specimens within the capsule is contained in Framatome report BAW-2399 (reference 21). This document satisfies the reporting requirements established in 10 CFR 50, Appendix H.

All base metal CVN and tensile specimens were machined from the 1/4t location of the plate material. The base metal specimens were oriented such that the longitudinal axis of each specimen was perpendicular to the principal working direction of the plate (transverse orientation). The HAZ and weld metal specimens were oriented such that the longitudinal axis of each specimen was perpendicular to the weld seam. The CVN HAZ and weld metal specimens had the notch oriented parallel to the weld seam. Capsule W-104 contained dosimeter wires of copper, iron, nickel, titanium, sulfur, aluminum-0.17 weight percent cobalt (cadmium-shielded and unshielded), and uranium-238. Thermal monitors fabricated from four low-melting alloys were included in the capsule. The thermal monitors were sealed in quartz tubes and inserted in spacers.

ARKANSAS NUCLEAR ONE
Unit 2

10 CFR 50, Appendix G, also requires a minimum initial Charpy Upper Shelf Energy (C_VUSE) of 75 ft-lbs for all beltline region materials. The C_VUSE value requirements are to be obtained from Charpy V-notch specimens oriented in the transverse (weak) direction for base material and along the weld for weld material according to the ASME Code. Table 5.2-5 provides C_VUSE values for the longitudinal (strong) direction for the RPV beltline materials. In accordance with MTEB No. 5-2, Section B.1.2, if tests were only made on longitudinal specimens, the values should be reduced to 65% of the longitudinal values to estimate the transverse (weak) properties. Table 5.2-21 provides the RPV beltline material C_VUSE values for the transverse (weak) direction required by 10 CFR 50 Appendix G.

No action is required for a material that does not meet the initial 75 ft-lbs requirement provided that the irradiation embrittlement does not cause the C_VUSE to drop below 50 ft-lbs throughout the life of the vessel. Based on the results of the capsule analysis (at 15.7 EFPY and $2.937E+19$ n/cm²), the measured USE for ANO Unit 2 (W-104 capsule) surveillance materials do not fall below the 50 ft-lbs minimum requirement (Section 7 of BAW-2399, ref. 21). The measured percent decrease in C_VUSE for the surveillance base metal plate, weld metal, HAZ, and SRM are within reasonable agreement with the values predicted using Regulatory Guide 1.99, Revision 2.

Based on predictions of percentage decrease in C_VUSE values of beltline materials due to irradiation to 48 EFPY using Positons 1.2 and 2.2 with Figure 2 in Reg. Guide 1.99, Revision 2, it is expected that C_VUSE values will be maintained above the 50 ft-lb minimum, which is required by 10 CFR 50, Appendix G. As shown in Table 5.2-22 and independently confirmed under Section 4.2.1.2 of NUREG 1828, the lowest C_VUSE value conservatively predicted for all beltline materials at 48 EFPY is above the 50 ft-lb minimum requirement (limiting material is weld 2-203 A). C_VUSE analysis to 48 EFPY includes the current licensing period (32 EFPY) through the expiration of the period of extended operation for the ANO-2 reactor vessel.

The analysis of the reactor vessel material contained in the second surveillance capsule, Capsule W-104, removed for evaluation as part of the Arkansas Nuclear One Unit 2 Reactor Vessel Surveillance Program, led to the following conclusions:

The capsule received an average fast neutron fluence of 2.937×10^{19} n/cm² ($E > 1.0$ MeV).

The 30 ft-lb transition temperature for the Base Metal Plate C-8009-3, Heat C8182-2, in the transverse orientation, increased 53 °F after irradiation to 2.937×10^{19} n/cm² ($E > 1.0$ MeV). In addition, the C_VUSE for this material decreased 31%.

The 30 ft-lb transition temperature for the Weld Metal, C-8009-1/C-8009-2, Heat 83650 increased 17 °F after irradiation to 2.937×10^{19} n/cm² ($E > 1.0$ MeV). In addition, the C_VUSE for this material decreased 19%.

The 30 ft-lb transition temperature for the heat affected zone increased 113 °F after irradiation to 2.937×10^{19} n/cm² ($E > 1.0$ MeV). In addition, the C_VUSE for this material decreased 20%.

The 30 ft-lb transition temperature for the Standard Reference Material, HSST Plate 01, increased 132 °F after irradiation to 2.937×10^{19} n/cm² ($E > 1.0$ MeV). In addition, the C_VUSE for this material decreased 40%.

ARKANSAS NUCLEAR ONE
Unit 2

The measured upper-shelf energies for the Arkansas Nuclear One Unit 2 Capsule W-104 surveillance materials do not fall below the required 50 ft-lbs limit after the irradiation to 2.937×10^{19} n/cm² (E > 1.0 MeV).

The ART for the reactor vessel beltline region materials are calculated in accordance with Regulatory Guide 1.99, Revision 2. The ART is calculated by adding the initial RT_{NDT}, the predicted radiation-induced Δ RT_{NDT}, and a margin term to cover the uncertainties in the values of initial RT_{NDT}, copper and nickel contents, fluence, and the calculational procedures. The predicted radiation induced Δ RT_{NDT} is calculated using the respective reactor vessel beltline materials copper and nickel contents and the neutron fluence applicable to 32 EFPY and 48 EFPY including an estimated increase in flux due to a proposed power uprate. The 1/4t and 3/4t wall locations for each beltline material are determined by adding the thickness of the cladding to the distance into the base metal at the 1/4t and 3/4t locations. The 1/4t and 3/4t ART results for the ANO-2 reactor vessel beltline region materials applicable to 32 EFPY are presented in the Framatome Report BAW-2405 (Reference 22). The 1/4t and 3/4t ART results for the ANO-2 reactor vessel beltline region materials applicable to 48 EFPY were calculated to support the ANO-2 license renewal. Based on these results, the controlling beltline material for the ANO-2 reactor vessel is the lower shell plate C-8010-1. The applicability of 32 EFPY is also consistent with the removal schedule for the next capsule as shown in ANO-2 SAR Table 5.2-12.

The process used for fluence evaluation involving the W-104 capsule and current prediction was under BAW-2241. Framatome ANP, Inc. has developed a calculational based fluence analysis methodology in Topical Report BAW-2241P-A, Revision 1, "*Fluence and Uncertainty Methodology*" dated April 1999 which closely predicts the fast neutron fluence in the reactor vessel using surveillance capsule dosimetry or cavity dosimetry (or both) to verify the fluence predictions. This methodology was developed through a full-scale benchmark experiment which demonstrated that the accuracy of a fluence analysis that employs the Framatome ANP methodology would be unbiased and have a precision well within the U.S. Nuclear Regulatory Guide 1.190 limit of 20%.

The NRC safety evaluation report (SER) to BAW-2241P-A, Revision 1 concluded that "the proposed methodology is acceptable for referencing in licensing applications for determining the pressure vessel fluence of Westinghouse, CE, and B&W designed reactors." In addition, there were three limitations imposed on the SER for Revision 0 of the topical. These limitations involved analysis of reactor designs not included in the BAW-2241P-A database (e.g. partial length fluence assembly designs), changes in cross sections from those reviewed by the Staff, and any other changes in methodology. As discussed in BAW-2399 (ref. 21), none of these limitations are applicable to the analysis performed for ANO-2.

The Framatome ANP methodology was used to calculate the neutron fluence exposure to the 104° (W-104) capsule of the ANO Unit 2 nuclear reactor. The methodology was also used to estimate fluences on the inner surface of the reactor vessel, as well as at specified weld locations on the vessel surface. The fast neutron fluence (E >1.0 MeV) at each location was calculated in accordance with the requirements of Regulatory Guide 1.190. The energy-dependent flux on the capsule was used to determine the calculated activity of each dosimeter. Neutron transport calculations in two-dimensional geometry were used to obtain energy dependent flux distributions throughout the core. Reactor conditions were representative of an average over the Cycle 1-9 and 10-14 irradiation periods. These periods were separated in order to adequately represent a water temperature reduction that occurred between Cycles 9 and 10. Geometric detail was selected to explicitly represent the dosimeter holder and the reactor vessel.

ARKANSAS NUCLEAR ONE
Unit 2

The dosimetry of the W-104 capsule was located in the reactor for a total irradiation time of 5726 effective full power days (EFPDs) for cycles 1-14. The rated thermal power for the fourteen cycles was 2815 MWt. The fluence on the center of the capsule must be estimated in order to allow for analysis of the Charpy and tensile specimens. As a result, the entire Cycle 1-14 analysis results in a maximum capsule fluence of 2.937×10^{19} n/cm². Based on an extrapolated flux incorporating power uprate conditions, the projected 32 EFPY peak fast fluence of the ANO-2 reactor vessel beltline region clad surface was determined to be 3.791×10^{19} n/cm².

R.G. 1.99, Revision 2, Position 2.1 requires that if there is evidence that the copper/nickel content of the surveillance specimen differs from that of the vessel, the measured values of ΔRT_{NDT} should be adjusted by multiplying them by the ratio of the chemistry factor for the vessel material to that for the surveillance specimen. The surveillance data would be fitted to obtain the relationship of ΔRT_{NDT} to fluence by calculating the chemistry factor for the best fit by ratioing each adjusted ΔRT_{NDT} by its corresponding fluence factor. The results of the second specimen evaluation have been performed in accordance with this position and are reported in Table 3-2 of the BAW-2405 report (ref. 22).

A pressurized thermal shock (PTS) evaluation for the ANO-2 reactor vessel beltline materials was performed for 32 EFPY in accordance with 10 CFR 50.61. The results of the PTS evaluation are shown in Table 4-1 of the BAW-2405 report (ref. 22). These results demonstrate that the ANO-2 reactor vessel beltline materials will not exceed the PTS screening criteria before 32 EFPY. The controlling beltline material for the ANO-2 reactor vessel with respect to PTS is the lower shell plate C-8010-1, with a RT_{PTS} value of 118.8 °F that is well below the PTS screening criterion of 270 °F. The PTS evaluation for ANO-2 was extended to 48 EFPY to support the ANO-2 license renewal. The 48 EFPY results demonstrate that the ANO-2 reactor vessel beltline materials will not exceed the PTS screening criteria before 48 EFPY. The controlling beltline material for the ANO-2 reactor vessel with respect to PTS remains the lower shell plate C-8010-1, with a RT_{PTS} value of 122.6 °F that is well below the PTS screening criterion of 270 °F.

5.2.4.3.5 54 EFPY P/T Limits

Adjusted reference temperatures (ARTs) were calculated for all ANO-2 beltline materials out to 54 EFPY following Regulatory Positions 1.1 and 2.1 of Regulatory Guide 1.99, Revision 2. The initial material properties given in Tables 5.2-20 and 5.2-20a, and a calculated peak vessel inside surface neutron fluence of 4.98×10^{19} n/cm² ($E > 1$ MeV) were used to compute the ART at the 1/4t and 3/4t locations. The limiting (highest) ART value is 122 °F at the 1/4T and 109 °F at the 3/4T for plate C-8010-1 corresponding to 54 EFPY operation (Reference 25).

The pressure/temperature limit lines in Technical Specification Figures 3.4-2A, 3.4-2B, and 3.4-2C have been updated based on 54 EFPY of operation. The NRC approved the proposed updates to the ANO-2 RCS P/T limits via letter 2CNA111801 (Reference 26). The technical basis for the revised P/T limits is provided in Reference 25, which states that the proposed 54 EFPY heatup and cooldown limit curves were generated using ART values for the most limiting RPV beltline shell material, plus an additional margin, based on the NRC-approved generic P/T limits methodology documented in WCAP-14040-A (Reference 27). See Section 18.2.1.3 for further discussion.

5.2.4.3.6 Evaluation of the Third ANO-2 Reactor Vessel Specimen and Summary of Results

The third ANO-2 reactor vessel specimen, Capsule 284, was removed at the end of Cycle 24 at 29.24 EFPY per Table 5.2-12, and shipped to the Westinghouse Materials Center of Excellence Hot Cell Facility, where post-irradiation mechanical tests of the Charpy V-notch and tensile specimens were performed. The testing results are documented in Reference 28.

Note that much of the generic discussion regarding the reactor vessel specimens found in Section 5.2.4.3.4 applies to all six capsules. However, unlike the second specimen (Capsule 104°) described in Section 5.2.4.3.4, the third specimen does not contain SRM. The chemical composition and the arrangement of the various mechanical specimens in Capsule 284 are found in tables in Reference 28.

The analysis of the reactor vessel materials contained in surveillance Capsule 284°, the third capsule removed and tested from the ANO-2 reactor pressure vessel, led to the following conclusions:

Charpy V-notch test data were plotted using a symmetric hyperbolic tangent curve-fitting program. Appendix C of Reference 28 presents the CVGRAPH, Version 6.02, Charpy V-notch plots for Capsule 284° and previous capsules, along with the program input data.

Capsule 284° received an average fast neutron fluence ($E > 1.0$ MeV) of 3.67×10^{19} n/cm² after 29.24 effective full-power years (EFPY) of plant operation.

Irradiation of the reactor vessel Intermediate Shell Plate C-8009-3 Charpy specimens, oriented with the longitudinal axis of the specimen parallel to the major rolling direction (longitudinal orientation), resulted in an irradiated 30 ft-lb transition temperature of 86.2 °F and an irradiated 50 ft-lb transition temperature of 121.1 °F. This results in a 30 ft-lb transition temperature increase of 85.7 °F and a 50 ft-lb transition temperature increase of 98.9 °F for the longitudinally oriented specimens.

Irradiation of the reactor vessel Intermediate Shell Plate C-8009-3 Charpy specimens, oriented with the longitudinal axis of the specimen perpendicular to the major rolling direction (transverse orientation), resulted in an irradiated 30 ft-lb transition temperature of 100.5 °F and an irradiated 50 ft-lb transition temperature of 138.5 °F. This results in a 30 ft-lb transition temperature increase of 85.6 °F and a 50 ft-lb transition temperature increase of 96.0 °F for the transversely oriented specimens.

Irradiation of the Surveillance Program Weld Material (Heat # 83650) Charpy specimens resulted in an irradiated 30 ft-lb transition temperature of 8.2 °F and an irradiated 50 ft-lb transition temperature of 37.1 °F. This results in a 30 ft-lb transition temperature increase of 12.0 °F and a 50 ft-lb transition temperature increase of 26.3 °F.

Irradiation of the Heat-Affected Zone (HAZ) Material Charpy specimens resulted in an irradiated 30 ft-lb transition temperature of -56.4 °F and an irradiated 50 ft-lb transition temperature of -17.8 °F. This results in a 30 ft-lb transition temperature increase of 73.5 °F and a 50 ft-lb transition temperature increase of 69.8 °F.

ARKANSAS NUCLEAR ONE
Unit 2

The average upper-shelf energy of Intermediate Shell Plate C-8009-3 (longitudinal orientation) resulted in an average energy decrease of 37 ft-lb after irradiation. This decrease results in an irradiated average upper-shelf energy of 122 ft-lb for the longitudinally oriented specimens.

The average upper-shelf energy of Intermediate Shell Plate C-8009-3 (transverse orientation) resulted in an average energy decrease of 25 ft-lb after irradiation. This decrease results in an irradiated average upper-shelf energy of 109 ft-lb for the transversely oriented specimens.

The average upper-shelf energy of the Surveillance Program Weld Material (Heat # 83650) Charpy specimens resulted in an average energy decrease of 19 ft-lb after irradiation. This decrease results in an irradiated average upper-shelf energy of 132 ft-lb for the weld metal specimens.

The average upper-shelf energy of the HAZ Material Charpy specimens resulted in an average energy decrease of 19 ft-lb after irradiation. This decrease results in an irradiated average upper-shelf energy of 142 ft-lb for the HAZ Material.

Comparisons of the measured 30 ft-lb shift in transition temperature values and upper-shelf energy decreases to those predicted by Regulatory Guide 1.99, Revision 2 for the ANO-2 reactor vessel surveillance materials are presented in Table 5-10 of Reference 28.

Based on the credibility evaluation presented in Appendix D of Reference 28, the ANO-2 surveillance plate and the surveillance weld material (Heat # 83650) are both credible.

Based on the upper-shelf energy evaluation in Appendix E of Reference 28, all beltline materials contained in the ANO-2 reactor vessel exhibit adequate upper-shelf energy levels for continued safe plant operation and are predicted to maintain an upper-shelf energy greater than 50 ft-lb through the end of original license period (32 EFPY) as required by 10 CFR 50, Appendix G.

The maximum calculated 32 EFPY neutron fluence ($E > 1.0$ MeV) for the ANO-2 reactor vessel beltline using the Regulatory Guide 1.99, Revision 2 attenuation formula (i.e., Equation # 3 in Regulatory Guide 1.99) is as follows:

Calculated (32 EFPY): Vessel peak clad/base metal interface fluence = 3.02×10^{19} n/cm²
Vessel peak quarter-thickness (1/4T) fluence = 1.88×10^{19} n/cm²

Based on predictions of percentage decrease in C_V USE values of beltline materials due to irradiation to 54 EFPY using Positions 1.2 and 2.2 with Figure 2 in Reg. Guide 1.99, Revision 2, it is expected that C_V USE values will be maintained above the 50 ft-lb minimum, which is required by 10 CFR 50, Appendix G.

The ART for the reactor vessel beltline region materials are calculated in accordance with Regulatory Guide 1.99, Revision 2. The 1/4T and 3/4T ART results for the ANO-2 reactor vessel beltline region materials applicable to 54 EFPY are presented in Reference 25. Based on these results, the controlling beltline material for the ANO-2 reactor vessel is the lower shell plate C-8010-1. The applicability of 54 EFPY is also consistent with the removal schedule for the next capsule as shown in Table 5.2-12.

ARKANSAS NUCLEAR ONE
Unit 2

The Westinghouse methodology (Reference 27) was used to calculate the neutron fluence exposure to the 284 capsule of the ANO Unit 2 nuclear reactor. The methodology was also used to estimate fluences on the inner surface of the reactor vessel, as well as at specified weld locations on the vessel surface. The fast neutron fluence ($E > 1.0$ MeV) at each location was calculated in accordance with the requirements of Regulatory Guide 1.190. Based on an extrapolated flux incorporating power uprate conditions, the projected 54 EFPY peak fast fluence of the ANO-2 reactor vessel beltline region clad surface was determined to be 3.10×10^{19} n/cm².

A pressurized thermal shock (PTS) evaluation for the ANO-2 reactor vessel beltline materials was performed for 54 EFPY in accordance with 10 CFR 50.61. The results of the PTS evaluation are detailed in Section 4 of the Reference 29. These results demonstrate that the ANO-2 reactor vessel beltline materials will not exceed the PTS screening criteria before 54 EFPY. The controlling beltline material for the ANO-2 reactor vessel with respect to PTS is the lower shell plate C-8010-1, with a RT_{PTS} value of 122.4 °F that is well below the TS screening criterion of 270 °F.

5.2.4.4 Reactor Vessel Material Surveillance Program

5.2.4.4.1 Nil Ductility Transition Temperature Determination

The reactor vessel is designed and fabricated in such a manner that significant operational limitation will not be imposed on the RCS resulting from shifts in reactor vessel NDT temperature. The vessel material monitoring program will be conducted within the guidelines of ASTM E-185, "Recommended Practice for Surveillance Tests for Nuclear Reactor Vessels." The pre-irradiated NDT temperature of the reactor materials has been established using drop weight tests in accordance with ASTM E-208, and correlations have been made with Charpy impact specimen tests conducted in accordance with ASTM E-23. This correlation, along with the Charpy impact specimens irradiated in the surveillance program, will be used to monitor the NDTT shift of the vessel materials.

The test specimen used in establishing the unirradiated NDTT of the base metal were obtained from (1/4)T (where T is plate thickness) locations of sections of the plate used in the core region. The HAZ samples were taken from the (1/4)T locations of the same plate used for base metal tests. The weld metal samples were taken from the inner region of the deposited weld metal. The thermal history of the test materials is representative of similar materials in the reactor vessel. The impact properties of the specimen locations are representative of the material through the entire thickness. Use of the NDT values obtained from samples taken from the inner regions of the test materials represents a conservative approach for establishing the initial minimum operating temperature and the base for the predicted minimum operating temperature after irradiation because the advantages of the more favorable NDT properties of the surface regions are not taken into consideration.

Samples oriented in the WR (weak) direction are included in the Surveillance Program. Code requirements for initial operation are satisfied by analysis of samples in the RW (strong) direction only. The minimum upper shelf energy value that is acceptable for continued operation toward the end of service life of the vessel will be dependent upon the results of the inservice inspection program with respect to crack size and locations, and the service requirements of the vessel at that point in life, i.e., the fluence to which the materials have been exposed and the number and size of the flaws, if any.

5.2.4.4.2 Surveillance Program

The surveillance program will monitor the radiation induced changes in the mechanical and impact properties of the pressure vessel materials. Changes in the impact properties of the material will be evaluated by the comparison of pre- and post-irradiation Charpy impact test specimens. Changes in mechanical properties will be evaluated by the comparison of pre- and post- irradiation data from tensile test specimens. ASTM E-185 establishes the criteria which are followed in the conduct of the surveillance tests, and the surveillance program described herein satisfies the intent of the proposed Appendix H 10 CFR Part 50 as published in the Federal Register on July 3, 1971. The differences between the plant surveillance program and the requirements presented in Appendix H are the following:

A. Appendix H, Section II.C - Attachments to Reactor Vessel

The surveillance program allows for attachment of surveillance capsules to the inside wall of the reactor vessel in the beltline region. This modification to 10 CFR 50, Appendix H, Section II.C.2 was described in Topical Report CENPD-155-P, "CE Procedures for Design, Fabrication, Installation and Inspection of Surveillance Specimen Holder Assemblies," September 1974. The NRC reviewed CENPD-155-P and has considered all the procedures described therein as acceptable (See Reference 9).

B. Appendix H, Section II.C - Capsule Replacements

The surveillance capsule holders will permit installation of replacement capsule assemblies during those shutdown periods when the reactor internals are removed.

Three metallurgically different materials representative of the reactor vessel are investigated. These are base metal, weld metal, and weld HAZ material. A complete record of the chemical analysis, fabrication history and mechanical properties of all surveillance test materials is maintained.

The results of the chemical analyses for the six plates of the beltline region of the vessel are presented in Table 5.2-4. The weld chemistry is from an analysis of the longitudinal seam weld deposit from the lower shell course and is representative of the weldments in the beltline region. See also Table 5.2-20a.

Table 5.2-11 gives the type, quantity, location and orientation of the test specimens in each of the surveillance capsules. The test materials, taken from the materials used in the beltline of the reactor vessel, include base metal and HAZ from the same heat and weld metal. The manufacture of both the test materials and the test specimens has been carried out in accordance with the requirements of Paragraph 3.0 of ASTM E-185. A sufficient amount of base metal, weld metal and HAZ test material to provide two additional test specimens has been retained with full documentation and identification for the future evaluation should the need arise. Each of the test materials were analyzed for approximately 21 elements, including all those listed in Paragraph 3.1.3 of ASTM E-185. The pre-irradiation NDTT of each plate of the intermediate and lower vessel shell courses has been determined from the drop weight tests and correlated with Charpy impact tests.

ARKANSAS NUCLEAR ONE
Unit 2

Base metal specimens were fabricated from sections of that plate in the core region of the vessel which could become the limiting plate with respect to reactor operation during its lifetime. This material was selected on the basis of initial transition temperature, upper shelf energy, estimated increase in NDTT, considering chemical composition and fluence. HAZ samples were obtained by welding sections from the same plate used for base metal specimens to another plate from the core region. Weld metal specimens were fabricated from the deposited weld metal produced using the same heat of filler material and the same production welding conditions as those used in joining the intermediate and lower shell courses.

Seventy-two of a total of 120 base metal Charpy impact specimens are oriented in the WR (transverse) direction of the plate metals. The remaining 48 base metal specimens are oriented in the RW (longitudinal) direction. All 72 weld metal impact specimens are oriented perpendicular to the longitudinal axis of the weld seam as are all 72 HAZ impact specimens.

The materials used for weld metal and HAZ test specimens are adjacent to the test material used for ASME Code, Section III tests and are at least one plate thickness from any water quenched edge. The procedures used for making the shallow girth welds in the reactor vessel are followed in the preparation of the weld metal and HAZ test material. The procedures for inspection of the reactor vessel welds are followed for inspection of the welds in the test materials. The welded plates are heat treated to a condition representative of the final heat treated condition of the completed reactor vessel.

The test specimens will be placed within six corrosion resistant irradiation capsules to prevent deterioration of the test specimens during irradiation. The axial position of the capsules is bisected by the midplane of the core. The circumferential locations include the peak flux regions.

The location of the surveillance capsule assemblies is shown in Figure 5.2-29. A typical surveillance capsule assembly is shown in Figure 5.2-30. A typical tensile monitor compartment assembly is shown in Figure 5.2-32. The capsule assembly holders and holder attachments to the reactor vessel wall are designed to withstand the forces due to deadweight, flow, differential thermal expansion, and flow induced pressures at normal operation and anticipated transients. The structural and fatigue analyses are performed in accordance with the ASME Code, Section III. The capsule assemblies are contained within the capsule holders.

They are axially loaded by a locking device and held securely at various intervals against the inside surface of the holders to prevent relative motion. Each compartment enclosure of the capsule assembly is internally supported by the surveillance specimens and is externally pressure tested to 3,125 psi during final fabrication. Fission threshold detectors are inserted into each surveillance capsule to monitor the fast neutron flux. Ni, ALCO, Fe, U, S, Ti, and Cu with known Co content are used for this application because their effective threshold energies are in the low Mev range. Selection of threshold detectors is based on the recommendations of ASTM E-261, "Method for Measuring Neutron Flux by Radioactive Techniques." Activation of the specimen material may also be analyzed to determine the amount of exposure.

The capsule assemblies containing the individual surveillance specimens can be removed during reactor refueling. No provision has been made for insertion of additional surveillance capsules after the reactor becomes operational without fully removing the vessel internals.

ARKANSAS NUCLEAR ONE
Unit 2

The maximum temperature of the encapsulated specimens will be monitored by including in the surveillance capsules small pieces of low melting point eutectic alloys or pure metals individually sealed in separate containers. The melting point of the thermal monitors will be in the operating range of the reactor.

Correlation monitor specimens included in the surveillance capsules (Charpy V-notch specimens machined from standard reference material) will be irradiated along with the surveillance test specimens. The standard reference material has been obtained from the USAEC Heavy Section Steel Technology Program. Use of standard reference material test specimens will permit correlation of the post-irradiated data obtained in the course of this surveillance program with data obtained from other surveillance programs or irradiated experiments. In addition, changes in impact properties of the correlation monitors will provide a cross check on the neutron dosimetry.

The test specimens used for monitoring the neutron induced property changes of the reactor vessel materials will be positioned near the inside wall of the reactor vessel so that the flux spectrum, fluence, and temperature of the specimens resemble as closely as possible the irradiation conditions of the reactor vessel. (The neutron fluence of the test specimens is expected to be about 15 percent greater than that of the adjacent vessel wall at any given time). The NDTT changes of these specimens will, therefore, closely approximate the NDTT changes of the materials in the reactor vessel. The surveillance holder brackets are welded to the vessel cladding. The joint geometry, fillet welds on both sides of the brackets, plus the welding procedure assure that these welds will never penetrate through the stainless steel clad into the carbon steel base metal. In addition, the results of detailed stress analyses of the attachment vessel wall region demonstrate that stress intensities are well within acceptable limits. Therefore, the presence of these attachments will not jeopardize the safety of the vessel. The rectangular tubes that hold the assemblies are positioned relative to the centerline of the core. The specimens will remain in the reactor until desired fluence levels have been attained, at which time they will be removed and tested.

Test specimens removed from the surveillance capsules will be tested in accordance with ASTM Standard Test Methods for Tension and Impact Testing. The data obtained from testing the irradiation specimens will be compared with the unirradiated data and an assessment of the neutron induced property changes of the pressure vessel materials made. This assessment of the NDTT shift will be based on the temperature shift in the average Charpy curves, the average curves being considered representative of the material.

The mechanical properties of the unirradiated reactor vessel surveillance materials are summarized in Table 5.2-16 and their chemical content in Table 5.2-17. The NDTT's for the base metal (both longitudinal and transverse orientations), weld metal and HAZ materials were determined in accordance with ASTM E-208. The standard reference material NDTT was obtained from HSST program data (see Reference 13). The 30 ft-lb fix temperature, RT_{NDT} and upper shelf energy data were obtained from Charpy impact tests of the surveillance and reference materials. The impact data, including both impact energy and lateral expansion as a function of test temperature, are shown in Figures 5.2-36 through 5.2-45. Impact tests were conducted in accordance with ASTM E-23. Room temperature and elevated temperature properties of the surveillance materials are reported in Table 5.2-18. The tensile tests were conducted in accordance with ASTM E-8 and ASTM E-21. These unirradiated properties of the surveillance and reference materials will form the basis for subsequent analysis of the response of the reactor vessel to neutron irradiation.

ARKANSAS NUCLEAR ONE
Unit 2

The periodic analysis of the surveillance samples will permit the monitoring of the neutron radiation effects upon the vessel materials. If, with due allowance for uncertainties in the NDTT determination, the measured NDTT shift turns out to be greater than predicted, the appropriate limitations would be imposed on permissible operating pressure-temperature combination and transients to ensure that the existing reactor vessel stresses are low enough to preclude brittle fracture failure.

An in-place annealing operation (see Section 5.2.4.5) could be conducted, if required. A sufficient number of surveillance capsules are included in the surveillance program to determine the recovery in properties resulting from such an annealing treatment without the need for installation of additional unirradiated specimens.

All surveillance capsules are inserted into their designated holders during the final reactor assembly operation. Each capsule remains in the reactor for the tentative time period listed in Table 5.2-12.

5.2.4.5 Reactor Vessel Annealing

The chemical composition of the reactor vessel shell courses is given in Table 5.2-4. Use of this material in the reactor vessel beltline region makes it unlikely that in-place annealing of the vessel will be necessary to reduce the NDTT shift later in plant life. If such annealing should become necessary, however, it can be accomplished by utilizing reactor coolant pump heat to maintain the primary system temperature at approximately 640 °F for one week. At this temperature, there is greater mobility of the radiation induced defects and much of the ductility loss due to irradiation will be restored.

The preparation required for the annealing process consists of removing the fuel from the reactor vessel and replacing some standard instrumentation with special test instrumentation. RCS pressure would be maintained between 2,390 psia and 2,440 psia during the annealing process to provide adequate reactor coolant pump NPSH. Design pressures and temperatures throughout the plant are consistent with the annealing conditions and would not be violated.

5.2.5 AUSTENITIC STAINLESS STEEL

5.2.5.1 Cleaning and Contamination Protection Procedures

Specific requirements for cleanliness and contamination protection are included in the equipment specifications for components fabricated with austenitic stainless steel. In addition, any external nonmetallic insulation to be used on austenitic stainless steel components conforms with the recommendations of Regulatory Guide 1.36, "Nonmetallic Thermal Insulation for Austenitic Stainless Steels." The provisions described below indicated the type of procedures utilized for components originally supplied by Combustion Engineering to provide contamination control during fabrication, shipment and storage.

Contamination of 300 series austenitic stainless steels by compounds which can alter the physical or metallurgical structure and/or properties of the material was avoided during all stages of fabrication. Painting of 300 series stainless steels is prohibited. Grinding was accomplished with resin or rubber bonded aluminum oxide or silicon carbide wheels which were not previously used on materials other than austenitic-ferrite alloys. Outside storage of partially fabricated components was avoided and, in most cases, prohibited. Exceptions were made with certain structures provided they were dry, completely covered with a waterproof material, and kept above ground.

ARKANSAS NUCLEAR ONE
Unit 2

Internal surfaces of completed components were cleaned to produce an item which was clean to the extent that grit, scale, corrosion products, grease, oil, wax, gum, adhered or embedded dirt or extraneous material were not visible to the unaided eye. Cleaning was affected by either solvents (acetone or isopropyl alcohol) or inhibited water (30-200 ppm hydrazine or 0.5 - .75 w/o trisodium phosphate). Water conformed to the following requirements:

Halides

Chloride (ppm)	< 0.60
Fluoride (ppm)	< 0.40
Conductivity (μ mhos/cm)	< 5.0
pH	6.0 - 8.0
Visual clarity	No turbidity, oil or sediment

Prior to shipment, RCS components were packaged in such a manner that they have been protected from the weather, wind, water spray and any other extraneous environmental conditions encountered during shipment and subsequent site storage. The environment within the package and/or component was maintained clean and dry. In some instances, use of a dessicant-breather system was utilized. The shipment package was employed for site storage and was not removed until the component was installed within the containment. Once in the containment, with the shipping package removed, the component was maintained clean and dry, either by covering with a polyethylene cover, or placing in a clean area.

To prevent halide-induced, intergranular corrosion which could occur in aqueous environment with significant quantities of dissolved oxygen, solutions were inhibited via additions of hydrazine. Many experiments conducted by CE have proven this inhibitor to be completely effective. Operational chemistry specifications restrict concentrations of halides and oxygen, both prerequisites of intergranular attacks. (Refer to Section 9.3.4.)

5.2.5.2 Solution Heat Treatment Requirements

All raw austenitic stainless steel material, both wrought and cast, employed by CE in the fabrication of the major components in the RCS, is supplied in the annealed condition as specified by the pertinent ASTM or ASME Code; viz, 1850 - 2050 °F for ½ - 1 hour per inch of thickness and water quenched to below 700 °F. The time at temperature is determined by the size and type of component. For example, reactor coolant pump casings which are cast from CF8M are usually subject to more than one solution anneal and, therefore, the time at temperature is limited to ½ hour per inch of thickness.

Solution heat treatment is not performed on completed or partially-fabricated components. Rather, the extent of chromium carbide precipitation is controlled during all stages of fabrication as described in Section 5.2.5.5.

5.2.5.3 Material Inspection Program

Extensive testing on stainless steel mockups, fabricated using production techniques, has been conducted to determine the effect of various Combustion Engineering welding procedures on the susceptibility of unstabilized 300 series stainless steels to sensitization induced intergranular

ARKANSAS NUCLEAR ONE
Unit 2

corrosion. Only those procedures and/or practices demonstrated not to produce a sensitized structure are used by CE in the fabrication of RCS components. The ASTM Standard A393 (Strauss Test) is the criterion used to determine susceptibility to intergranular corrosion. This test has shown excellent correlation with a form of localized corrosion peculiar to sensitized stainless steels. As such, ASTM A393 is utilized as a go/no-go standard for acceptability.

As a result of the above tests, a relationship was established between the carbon content of T304 stainless steel and weld heat input. This relationship is used to avoid weld heat affected zone sensitization as described in Section 5.2.5.5 for CE fabricated components.

5.2.5.4 Unstabilized Austenitic Stainless Steels

The unstabilized grades of austenitic stainless steel with a carbon content of more than 0.03 percent used for components of the RCS are T304 and T316. These materials are furnished in the solution annealed condition. Combustion Engineering prohibits exposure of completed or partially-fabricated components to temperatures ranging from 800 °F to 1500 °F wherever possible. Exceptions may arise where valves contain stellite seats which cannot be quenched and the temperature range cannot be avoided during cooling.

Duplex, austenitic stainless steels, containing more than 5 v/o delta ferrite (weld metal, cast metal, weld deposit overlay), are not considered unstabilized since these alloys do not sensitize - that is, form a continuous network of chromium-iron carbides. Specifically, alloys in this category are:

CF8M	Cast Stainless Steels
CF8	
T308	Singly and combined.
T309	Stainless Steel weld filler
T312	metals. (Delta ferrite
T316	controlled to 5-18 v/o as deposited.

In duplex austenitic/ferritic alloys, chromium-iron carbides are precipitated preferentially at the ferrite/austenitic interfaces during exposure to temperatures ranging from 1,000 to 1,500 °F. This precipitate morphology precludes intergranular penetrations associated with sensitized 300 series stainless steels exposed to oxygenated or otherwise fault environments.

5.2.5.5 Avoidance of Sensitization

Exposure of unstabilized austenitic 3XX stainless steels to temperatures ranging from 800 to 1600 °F will result in carbide precipitation. The degree of carbide precipitation, or sensitization, depends on the temperature, the time at that temperature and, also, the carbon content. Severe sensitization is defined as a continuous grain boundary chromium-iron carbide network. This condition induces susceptibility to intergranular corrosion in oxygenated aqueous environments, as well as those containing halides. Such a metallurgical structure will readily fail the Strauss Test, ASTM A393. Discontinuous precipitates, i.e. an intermittent grain boundary carbide network, are not susceptible to intergranular corrosion in a PWR environment.

ARKANSAS NUCLEAR ONE
Unit 2

CE avoids weld heat affected zone sensitized austenitic stainless steels which will fail the Strauss Test (ASTM A393) by careful control of the following:

A. Weld Heat Input

A weld heat input of less than 60 kJ/inch is used during most fabrication stages of T304 stainless steel core support structure. Higher heat inputs are used in some heavy section weld joints. Freedom from weld HAZ sensitization in these higher heat input weldments is demonstrated with weld runoff samples produced at the time of component welding in material having a carbon content greater than or equal to the highest carbon content of those heats of steel being fabricated. Specimens so provided are subjected to the Strauss Test, ASTM A393.

B. Interpass Temperature

The interpass temperature in all multipass welds is controlled to 350 °F maximum. Carbon content is controlled at a maximum of 0.08 w/o in all sections of less than 1½-inch unstabilized austenitic stainless steel subject to welding.

C. Carbon Content

Tests have shown that T304 less than 1½ inches thick and having CE's controlled carbon content are not subject to sensitization when welded with processes having a heat input less than 100 kJ/inch. In heavier sections more than 1½ inches where the material section provides a large heat sink, carbon content is not limited to a level lower than that specified by ASTM or ASME - viz, 0.08 w/o.

When stainless steel safe ends are required on component nozzles or piping, fabrication techniques and sequencing require that the stainless steel piece be welded to the component after final stress relief. This is accomplished by welding an Inconel overlay on the end of the nozzle. Following final stress relief of the component, the stainless steel safe end is welded at the Inconel overlay, using Inconel weld rods.

Some carbide precipitation will occur as a result of welding annealed stainless steel piping, such as the pressurizer surge line, charging line and safety injection lines. Metallographic examination of such welds and HAZs is used to confirm that only discontinuous grain boundary precipitates are present.

5.2.5.6 Retesting Unstabilized Austenitic Stainless Steels Exposed to Sensitizing Temperature

Sensitization, which may be susceptible to intergranular corrosion, is avoided during welding as described in Section 5.2.5.5. Homogeneous or localized heat treatment of unstabilized stainless steels in the temperature range 800-1,500 °F is prohibited except in the case of the core support structure.

This complex structure is thermally stabilized at 900 ± 25 °F for seven hours after fabrication and prior to final machining. Such a treatment produces only minor, discontinuous precipitates.

ARKANSAS NUCLEAR ONE
Unit 2

In addition to thermocouple records during this heat treatment, a sample of T304 stainless steel having a carbon content greater than or equal to the highest carbon heat of material present in the structure is included as a monitor sample. After heat treatment, the monitor sample is subjected to the Strauss Test, ASTM A393, as well as a metallographic examination verifying freedom from sensitization.

5.2.5.7 Compliance with Interim Position MTEB 5-1 on Regulatory Guide 1.31

In order to preclude microfissuring in austenitic stainless steel welds, CE has complied with the requirements of the Interim Position (Branch Technical Position MTEB 5-1) on Regulatory Guide 1.31, Control of Stainless Steel Welding, in the following manner.

A. Major NSSS Components, Excluding Reactor Coolant Pumps

The delta ferrite content of A-7 austenitic stainless steel filler metal, except for 16-8-2, used by Combustion Engineering in the fabrication of major components of the RCS, has been controlled to 5-15 v/o. Delta ferrite content was predicted by magnetic measurement or chemical analysis, in conjunction with the Schaeffler or McKay Diagram, performed on undiluted weld deposits. In the case of the filler metal used with a non-consumable electrode processes, the delta ferrite content may have been predicted by chemical analysis of the rod, wire or consumable insert in conjunction with the stainless steel constitution diagram.

The ferrite requirement was met for each heat, lot or heat/lot combination of weld filler material.

The average delta ferrite content of production welds in the reactor internals is three percent with no indication less than one percent when measured by a calibrated ferrite measuring instrument. Measurement of production weld ferrite content is performed on an audit type basis.

The ferrite content of stainless welds in other major NSSS components has been controlled by the use of filler metal ferrite content.

B. NSSS Vendor Supplied Auxiliary Components and Reactor Coolant Pumps

Although Regulatory Guide 1.31 and interim position MTEB 5-1 were not issued at the time of purchase of most auxiliary components, CE did comply with the requirements of MTEB 5-1 for pneumatic operated and manual valves supplied for the safety injection system and CVCS.

The quality and structural adequacy of welds in other CE supplied auxiliary components were assured by the use of controls on materials, procedures and personnel. These controls were selected to be pertinent to the component functional safety level required and, generally, were imposed through the appropriate ASME Code.

5.2.5.8 Control of the Use of Sensitized Stainless Steel

A. Major NSSS Components, Excluding Reactor Coolant Pumps

CE originally complied with the requirements of Regulatory Guide 1.44 as described in Section 5.2.5.1 through 5.2.5.6, with the exception of the criteria used to demonstrate freedom from sensitization in fabricated unstabilized austenitic stainless steel components. CE uses the ASTM A393 Strauss Test, in lieu of the ASTM A262 Method E Modified Strauss Test, since the former test has shown through experimentation, excellent correlation with the type of corrosion observed in severely sensitized austenitic stainless steel components of NSSSs.

B. NSSS Vendor Supplied Auxiliary Components and Reactor Coolant Pumps

Although Regulatory Guide 1.44 was not issued at the time of purchase of most auxiliary components, the component suppliers were directed by CE to minimize sensitization of austenitic stainless steels by proper control of manufacturing processes for the pressurizer safety valves and CE supplied nuclear service pneumatic operated, motor operated and manual valves in the safety injection system and CVCS.

For other CE supplied auxiliary components, sensitization of austenitic stainless steel was minimized by the use of controls on materials procedures and personnel. These controls were imposed through the appropriate ASME Code and were reviewed by CE personnel. Specifically, austenitic stainless steel was supplied in the solution annealed condition. Also welding procedures were written in a manner to control heat input and minimize sensitization.

5.2.6 PUMP FLYWHEELS

5.2.6.1 Compliance With Regulatory Guide 1.14

This section consists of a discussion of the design, fabrication and testing of the reactor coolant pump flywheels in relation to the recommendations of Regulatory Guide 1.14. The results of an analysis of pump and flywheel performance during a LOCA are also discussed.

A. The material used to manufacture the motor flywheels for 2P32 B, C & D is pressure vessel quality Vacuum Improved Steel Plate (V.I.P.) produced to ASTM-A-533, Gr. B, CLI. The material used to manufacture the motor flywheel for 2P32A is Vacuum Improved ASTM-A-508 Class 5. The acceptance criteria for flywheel design are compatible with the safety philosophy of the Pressure Vessel Research Committee (PVRC) primary coolant pressure boundary criteria as appropriate considering the inherent design and functional requirement differences between the pressure boundary and the flywheel.

1. The NDTT of the material for motor flywheels 2P32B, C, & D, as obtained from the Dropweight Tests (DWT) performed in accordance with the specifications ASTM E-208, is +10 °F. The NDTT of the material for motor flywheel 2P32A as obtained from the DWT performed in accordance with the specification ASTM E-208 is -60°C (-76 °F).

ARKANSAS NUCLEAR ONE
Unit 2

2. The Charpy V-notch (Cv) upper shelf energy level in the weak direction for motor flywheels 2P32B, C, & D, as obtained per ASTM-A-370, is 63 Ft-Lb. At least three Cv specimens were tested from each plate or forging. The Charpy V-notch upper shelf energy level in the weak direction for motor flywheel 2P32A as obtained per ASTM-A-370 was determined to be greater than 115 Ft-Lbs. Thirty-eight Cv specimens were tested from the forging at various temperatures.
3. The minimum fracture toughness of the materials at the normal operating temperature of the flywheels for 2P32B, C, & D is equivalent to a dynamic stress intensity factor (K_{IC} dynamic) of at least 100 ksi root inches. Compliance has been demonstrated by use of a lower bound fracture toughness curve obtained from tests on the same type of material. The curve was translated along the temperature coordinate until the K_{IC} dynamic value of 45 ksi root inches is indicated at the NDT of the material, as obtained by dropweight tests. The lower bound fracture toughness curve is shown in Figure 5.2-33.

The extension of the RCP flywheel inspection to every 10 years used a different approach for determining the fracture toughness for flywheels 2P32B, C, & D (2CAN020202). In the material testing of original ANO-2 flywheels, the nil-ductility transition temperature (NDTT) was determined for the two applicable melts (-20 °F for Melt B5070 and 10 °F for Melt B5083). Charpy values were also determined at a temperature of 150 °F. Absorbed energies were greater than 100 ft-lbs for Melt B5070 and 63, 68, and 65 ft-lbs for Melt B5083. The reference nil-ductility temperature (RT_{NDT}) was used together with Figure A-4200 of ASME Code Section XI to determine the fracture toughness at the operating temperature of the flywheel. The 50 ft-lb transition temperature (TT_{50}) was estimated from the Charpy data at 150 °F and the conservative slope of the transition region of the Charpy impact energy curve, 2 °F per ft-lb, for the A-533, Grade B material. Using the Charpy values of 68 ft-lbs for Melt B5083, the results conclude that the K_{IC} value of 100 ksi root inch reported in the fracture mechanics evaluation of the ANO-2 RCP flywheel in Topical Report SIR-94-080-A (Ref. 3) is met by this analysis at a operating temperature of 112 °F. The flywheels were shown to operate at a minimum of 112 °F.

The minimum fracture toughness of the material at the normal operating temperatures of the flywheel for 2P32A is equivalent to a dynamic stress intensity factor (K_{IC} dynamic) of at least 100 ksi root inches. Compliance has been demonstrated by the use of a fracture toughness curve developed from 38 Charpy V-notch tests and appropriate correlations. Testing was performed on actual flywheel test samples taken from the forging. The fracture toughness curve is shown in Figure 5.2-33A.

4. Each finished flywheel was subjected to a 100 percent volumetric ultrasonic inspection from the flat surface per ASME Code, Section III. This inspection was performed on the flywheel after final machining and overspeed test. No loss of back reflection of 50 percent or more was found and no material repairs were performed.
5. The flywheels were flame cut. At least one-half inch of stock was left on the outer and bore radii, for machining to final dimensions.

ARKANSAS NUCLEAR ONE
Unit 2

6. The flywheels were subjected to a magnetic-particle examination per the ASME Code, Section III before final assembly. The inspection was performed on finished machined bores, key-ways, and on both flat surfaces to a radial distance of eight inches minimum beyond the final largest machined bore diameter but not including small drilled holes. There were no stress concentrations such as stamp marks, center punch marks, or drilled or tapped holes within eight inches of the edge of the largest flywheel bore. The examination showed no defects.
- B. The flywheels have been designed to withstand normal operating conditions, anticipated transients, and the design basis LOCA combined with the DBE.

The following criteria are satisfied:

1. The combined stresses, both centrifugal and interference, at normal operating speed do not exceed 30 percent of the minimum specified yield strength for the material selected in the direction of maximum stress.
 2. The design overspeed of the flywheel is 10 percent above the speed resulting from a turbine-generator overspeed event, or 125 percent of normal operating speed.
 3. The combined centrifugal and interference stresses at design overspeed do not exceed 35 percent of the minimum specified yield strength. Design overspeed is defined as turbine-generator overspeed plus 10 percent, or 125 percent, of normal operating speed.
 4. The motor and pump shaft and bearings will withstand any combination of normal operating loads, anticipated transients, and the design basis LOCA combined with the DBE.
- C. Each flywheel has been tested for one minute at design overspeed of 1,125 rpm.
- D. The flywheel is accessible for 100 percent in-place volumetric ultrasonic inspection. The flywheel-motor assembly is designed to allow such inspection with a minimum of motor disassembly.

5.2.6.2 Additional Data and Analyses

An assumed break in the suction piping will produce a high reverse flow through the pump. If power is interrupted, the pump will decelerate and be held by the anti-reverse rotation device described in Section 5.5.1.2. This device will prevent a pump/flywheel overspeed transient during a cold leg break in the suction piping.

An assumed break in the discharge piping will produce a high flow through the pump in the forward or normal direction. This flow will tend to accelerate the pump/motor/flywheel assembly during blowdown. The original analysis though conservative, has shown that the resultant maximum predicted speed under LOCA conditions to be 2,359 rpm, 260 percent of normal speed. It is known that a spinning steel disk may burst when the average tangential stress reaches a value between 0.6 and 0.9 times the material tensile strength (Reference 14). On this basis, the bursting speed for the Unit 2 flywheel would be between 2,704 and 3,311 rpm, or between 15 percent and 40 percent greater than the conservatively calculated maximum LOCA

ARKANSAS NUCLEAR ONE
Unit 2

overspeed. Analysis performed in preparation for replacement of the steam generators considered leak-before-break. This assumption reduced the original assumed break size, resulting in a maximum predicted pump/flywheel overspeed below that predicted under the original analysis.

A fracture mechanics analysis of the flywheel has also been performed. Assuming the predicted accident overspeed of 2,359 rpm and a K_{IC} of 150 ksi root inches (see Figure 5.2-33), the critical crack length is 1.8 inches. Postulating a crack initiating at the keyway, which is one inch deep, the crack extension required to reach the critical crack length is 0.8 inch. Current ultrasonic testing methods will detect flaws or cracks 0.5 inch in length, and the margin is thus 60 percent of the minimum detectable crack. The detailed evaluation of the reactor coolant pump overspeed during LOCA is presented in F.M. Stern's letter to R.C. DeYoung dated September 20, 1973.

5.2.7 REACTOR COOLANT PRESSURE BOUNDARY LEAKAGE DETECTION SYSTEMS

RCPB leakage detection systems are provided as required by General Design Criterion 30. This criterion requires, in part, that means be provided for detecting, and to the extent practical, identifying the location of the source of reactor coolant leakage. Detection systems with diverse modes of operation are provided to ensure adequate surveillance with sufficient sensitivity such that small increases in leakage rates, regardless of source, can be detected while the total leakage rate is still below a value consistent with safe plant operation.

5.2.7.1 Leakage Detection Methods

Several diverse methods are provided to alert the operator to the presence of leakage from the RCS. Detection of leaks can be accomplished by any one or a combination of the below listed means.

5.2.7.1.1 Containment Monitoring

Equipment is provided which continuously monitors the environmental conditions within the containment such that a background level is established which is representative of the normal level of leakage from the primary systems and components. Deviations from normal containment environmental conditions will provide positive indication in the control room of increases in leakage rates. The entire RCS is located within the containment and any coolant leakage to the containment atmosphere will be in the form of fluid and vapor. The fluid will drain to the sump and vapors will be condensed in the containment coolers and also reach the sump.

Containment parameters monitored to detect coolant leakage include gaseous and air particulate activity levels, containment sump level, humidity, and containment pressure and temperature.

RCS leakage in the containment will be monitored by the Containment Atmosphere Monitoring System (CAMS). CAMS continuously monitors airborne particulate and gaseous isotopes using an Air Particulate Detector (APD) and a radioactive gas detector. Changes in the reactor coolant leakage rate in the containment will cause changes in the control room indication of the containment atmosphere activities.

ARKANSAS NUCLEAR ONE
Unit 2

The Containment Atmosphere Monitoring System (CAMS) provides two functions. Its primary function is to identify RCS leakage. Its second function is to provide containment building pressure, oxygen, and hydrogen control during power operations (Modes 1-4). The CAMS is used to control RCB pressure. The design of the CAMS allows fresh air into the RCB to aid in maintaining oxygen level concentrations at levels acceptable for human occupancy.

The APD takes continuous flowing air samples from the containment atmosphere and measures the air particulate gamma radioactivity. The samples are drawn outside the containment, and are monitored by a gross gamma scintillation counter-filter paper detector assembly. The filter paper collects particulate matter on its constantly moving surface, which is viewed by a hermetically sealed combination scintillation crystal (NaI) photomultiplier. This monitor has a sensitivity of 1.5(-10) $\mu\text{Ci/cc}$ of Cs-137 in a 2.5 mr/hr background.

The filter paper mechanism and electromagnetic assembly which controls the filter paper movement are provided as an integral part of the detector unit.

The detector assembly is in a completely closed housing. The detector output is amplified by a preamplifier and transmitted to the radiation monitoring system cabinet in the control room. Lead shielding is provided to reduce the background radiation level to an intensity which does not interfere with the detector's sensitivity.

The activity is indicated on meters and recorded by a multipoint recorder. High-activity alarm indications are displayed on the radiation monitoring cabinets. Alarms provide operational status of supporting equipment such as pumps, motors and flow and pressure controllers.

The air particulate and radiogas monitor have a pump unit common to both monitors. The pump unit consists of:

- A. A pump to obtain the air sample;
- B. A flowmeter to indicate the flow rate;
- C. A flow control valve to provide flow adjustment; and,
- D. A flow alarm assembly to provide low and high flow alarm signals.

The radiogas monitor measures the gaseous beta radioactivity in the containment by taking the continuous air samples from the containment atmosphere. The samples first pass through the APD where particulate matter is removed, and then pass through a sealed system to a gas monitor assembly. After passing through the gas monitor the gas sample is normally returned to the containment atmosphere.

Each sample is constantly mixed in fixed, shielded volumes, where it is viewed by a beta sensitive scintillator. This monitor has a sensitivity of 1.0(-5) $\mu\text{Ci/cc}$ of Xe-133 in a 2.5 mr/hr background.

The detector is in a completely enclosed housing containing the beta-gamma G.M. tube mounted in a constant gas volume container. Lead shielding is provided to reduce the background radiation level to a point which does not interfere with the detector's sensitivity. A pre-amplified and impedance matching circuit is mounted at the detector.

ARKANSAS NUCLEAR ONE
Unit 2

The detector outputs are transmitted to the radiation monitoring system cabinets in the control room. The activity is indicated by meters and recorded by a multipoint recorder. High-activity alarm indicators are displayed on the control board annunciator in addition to the radiation monitoring system cabinets.

Changes in the containment sump water level are an indication of overall gross leakage from all water and steam systems within the containment. Containment water level is monitored by a containment sump level detection system and a reactor building flood level monitoring system which provide control room operators alarm and indication readout of containment water level.

The containment sump water level is monitored by the Plant Monitoring System (PMS). During Modes 1 through 4, the PMS utilizes an algorithm which calculates sump level increase rate-of-change and subsequently provides an alarm in the control room if the containment sump level increase exceeds one gallon per minute within one hour. The monitoring and alarming of the containment sump level rate of change along with the other reactor coolant pressure boundary leakage detection systems already in place in the ANO-2 containment ensures ANO-2 meets the guidelines of Regulatory Guide 1.45 (Reference 15). The ability to comply with the guidelines of RG 1.45 allows ANO-2 to reference Topical Report CEN-367-A (Reference 16) when relying on leak before break technology to preclude the need to protect against dynamic effects associated with the postulated rupture of piping. The NRC Safety Evaluation that approves the use of leak before break technology is documented in Reference 17.

Containment humidity monitoring provides another method of measuring overall gross leakage from all water and steam systems within the containment.

The basis of operation of these elements is the behavior of a hygroscopic solid. When dry lithium chloride is exposed to the atmosphere under average room conditions, it will absorb moisture and dissolve, forming a salt solution. If this solution is heated, the water tends to escape back to the atmosphere. A state of equilibrium is reached at a temperature where the tendency of water to escape is equal to the tendency of salt to absorb moisture. At this equilibrium point, the temperature of the salt and the saturated solution (temperature of the dewcell element) is a measure of the partial pressure of water vapor in the surrounding atmosphere, i.e. dewpoint temperature. The range of the dewpoint temperature measuring system is 0 to 100 °F. Dew cell accuracy is ± 1.5 °F.

Containment pressure and temperature provides a final method of detecting overall gross leakage from all water and steam systems within the containment.

5.2.7.1.2 Reactor Coolant Inventory Monitoring

RCPB leakage will be indicated by performing a primary coolant inventory. This inventory will be performed by the operator as required by the Technical Specifications. By measuring total inflow and total outflow with all other systems stable, a primary coolant leak of approximately one gpm can be detected.

Leakage will also be indicated by any of the following:

- A. Low pressurizer level and charging pump operation.

During normal operation only one positive displacement charging pump is operating. If gross leakage of reactor coolant occurred, the pressurizer level would decrease and cause another charging pump to start. Pressurizer level and charging pump operation are indicated in the control room.

ARKANSAS NUCLEAR ONE
Unit 2

B. High reactor drain tank level.

The reactor drain tank collects controlled bleed-off flow from the reactor coolant pump seals during plant heatup and cooldown, leakage from the reactor coolant pump gasket leakoffs, reactor head gasket leakoffs, safety injection tank check valve leakage, quench tank drain and leakage from auxiliary systems as well as the four reactor coolant loop drains.

5.2.7.1.3 Pressurizer Safety Valve Leakage

Overpressure protection of the RCS is provided by two spring-loaded safety valves mounted on top of the pressurizer. These valves are piped to the quench tank. Piping is provided with temperature sensors which read out in the control room. Any temperature increase will indicate leakage through the safety valves.

In addition, an acoustical valve monitoring system provides the control room operator with open/closed position indication of the safety valves on annunciator panel 2K10. This system is required by NUREG-0578, Item 2.1.3a.

5.2.7.1.4 Reactor Coolant Leakage to Other Systems

Coolant leakage to other systems is possible through several methods. Means to detect this leakage is provided as shown below.

A. Steam Generator Tube Leakage

Reactor coolant leakage through a steam generator tube may be detected several ways as described below. The steam generator sample monitors, main steamline monitors and condenser off-gas monitor all read out on the secondary system trend recorder on panel 2C14 in the control room.

Steam generator tube leakage is detected by the steam generator sample cooler radiation monitoring system. This system will detect leakage between the primary and secondary side of the steam generator by monitoring condensed steam out of the sample cooler before it enters the liquid waste management system. The system has a sensitivity of 3.0×10^{-7} $\mu\text{Ci/ml}$ of Cs-137 and is indicated in the control room and alarmed for high radiation level.

Steam generator tube leakage is also detected in the main condenser air discharge radiation monitoring system as described in Section 11.4.2.2. Presence of radioactivity in this line would indicate primary to secondary leakage in the steam generator. The predominant isotope detected is Xe-133 and the system will detect 1.0×10^{-5} $\mu\text{Ci/ml}$ of Xe-133. The monitor consists of a single channel with provisions for automatic control with indication in the control room.

Further indication of steam generator tube leakage is obtained by monitoring the steam generator blowdown system. The blowdown system is required to remove suspended solids and chemicals from the steam generator water. In the event of tube leakage the blowdown water could contain some fission products. To prevent this from being discharged a scintillation detector sensitive enough to detect 3.0×10^{-7} $\mu\text{Ci/ml}$ of Cs-137 is installed on the blowdown system. This system is instrumented for high radiation with indication in the control room.

ARKANSAS NUCLEAR ONE
Unit 2

Additional indication of steam generator tube leakage is obtained by monitoring the Main Steam Line Area Monitors. Each monitor channel consists of a Geiger-Mueller type detector with a range of 0.1 mR/h to 10,000 mR/h. Readout is provided in the control room on the control modules, chart recorder on 2C14, and the SPDS computer.

The most recent addition, and the one considered to be the most accurate indication of steam generator tube leakage, is the Steam Generator N-16 Monitoring System. Each monitoring channel consists of a scintillation type detector and computer control system. The computer control system has been programmed to provide indication of primary-to-secondary leakage in gallons per day whenever plant power is above 20%. The designed minimum detectable leakage is 5.25 GPD. The calculated leakrate is provided to the Plant Monitoring System where it is displayed in Leak Rate (GPD), Leak Rate (GPM), and Leak Rate Rate of Change. The Plant Monitoring System also provides three N-16 Monitoring System related alarms on 2K11.

B. Primary Coolant Leakage to the Service Water System

The service water circulates through the plant for cooling purposes. Since some components which are cooled could potentially allow leakage from the RCS, a monitoring system is provided which consists of one channel downstream of each pair of containment cooling coils and one channel downstream of each shutdown cooling heat exchanger. Every heat exchanger that has the possibility of releasing radiation to the service water system via a tube leak is monitored.

The monitor downstream of each pair of containment cooling coils and each shutdown cooling heat exchanger is sensitive enough to detect 5.0×10^{-6} $\mu\text{Ci/ml}$ of Cs-137. It is monitored in the control room and annunciates an alarm on indication of high radiation.

C. Primary Coolant Leakage to the Component Cooling Water System

The component cooling system circulates water in a closed loop cooling several plant processes including the reactor coolant pumps. Two component cooling system radiation monitors are provided which are sensitive enough to detect 5.0×10^{-6} $\mu\text{Ci/ml}$ of Cs-137 or equivalent amounts of other isotopes.

5.2.7.2 Indication in Control Room

Leakage from the RCPB may be detected by any of the methods discussed previously. All radiation monitors are indicated, recorded and alarmed in the control room. Containment humidity, pressure, temperature and sump level are indicated in the control room and recorded by the plant computer.

5.2.7.3 Limits For Reactor Coolant Leakage

Any leakage from the RCS is a serious problem with respect to inplant contamination. Although some leak rates on the order of gallons per minute may be tolerable regarding dose limits, leaks on the order of drops per minute through any of the walls of the RCS could be indicative of material failure. If depressurization, isolation and/or other safety measures are not taken promptly, these leaks could develop into larger leaks and possibly result in gross pipe failure. Therefore, a maximum allowable total leakage rate of 10 gpm is established by the Technical Specifications.

ARKANSAS NUCLEAR ONE
Unit 2

The maximum leakage rate specified in the Technical Specifications from unidentified sources (excluding normal evaporative losses) is 1 gpm.

5.2.7.4 Unidentified Leakage

The anticipated normal total leakage of reactor coolant from the RCPB is essentially zero.

The response times of the subsystems to departure from the normal leakage rate is presented in Section 5.2.7.1.

The maximum allowable leakage rate from unidentified leaks is established at 1 gpm in the Technical Specifications. This limitation is sufficiently above the minimum detectable leakage rate to provide indication of leakage and is held low to minimize the chance of a crack progressing in a potentially unsafe condition without detection.

- A. A through-wall crack having an equivalent diameter of approximately 0.04 inch to 0.05 inch would result in a leak at the assumed limit.
- B. There is no precise way of relating this to crack length. The longest crack which could be masked by a laminar flow and thus escape detection is three inches. This postulated 3-inch crack, if it propagated through the wall, would leak at a rate greater than 1 gpm. A through-wall crack three inches in length is approximately 12 percent of the critical crack length for an axial crack and about eight percent of the critical crack length for a circumferential crack.

5.2.7.5 Maximum Allowable Total Leakage

The maximum allowable total leakage as specified in the Technical Specifications is 10 gpm and the normal capacity of the CVCS is 132 gpm.

Normal drainage of the containment sump is achieved by gravity flow through a 4-inch pipe to the auxiliary building sump. The flow capacity is 180 gpm.

5.2.7.6 Differentiation Between Identified and Unidentified Leaks

Leakage detection systems have been designed to aid operating personnel in differentiating between possible sources of detected leakage within the containment atmosphere and to other systems and, to the extent possible, locating the general area of a leak. Containment entry for visual inspection is the only positive method of identifying the exact location and magnitude of a leak.

The primary means of identifying a RCPB leak within the containment is the containment atmosphere monitoring system. Increases in containment activity levels will indicate a leak in the RCPB. The capability of drawing monitoring samples from several containment locations allows localization of the general area of leakage since activity levels will be somewhat higher in the vicinity of the leakage source. If the containment humidity detector, pressure indicators, and temperature indicators detect increases in containment humidity, pressure, and temperature without corresponding increases in containment activity, the indicated source of leakage would normally be a non-radioactive system.

ARKANSAS NUCLEAR ONE
Unit 2

Tube failure or leakage in the steam generators is indicated by the methods described in Section 5.2.7.1.4. Leakage of the shutdown cooling heat exchangers, and containment cooling coils is detected as shown in Section 5.2.7.1.4. Leakage in any of the heat exchangers cooled by the component cooling system is indicated by the component cooling water radiation monitors, but identifying location by this method is not possible.

Less sensitive methods of leak detection such as unexplained increases in reactor makeup flow, and changes in containment sump level will provide positive indication of RCPB leakage. Leakage rates of the magnitude necessary to be detectable by these methods are expected to be noted first by the more sensitive radiation and moisture detection equipment.

5.2.7.7 Sensitivity and Operability Tests

Periodic testing of leakage detection systems will be conducted in order to verify the operability and sensitivity of detector equipment. These tests include installation calibrations and alignments, periodic channel calibrations, functional tests, and channel checks.

The CAMS will undergo complete detector calibrations upon installation using typical isotopes of interest for each of the channels to determine proper detector response. Subsequent periodic calibrations using detector check sources consisted of single-point calibrations to confirm detector sensitivity based on the known correlation between the detector response and the check source standard. This procedure will adequately measure instrument sensitivity since the geometry of the sampler cannot be significantly altered after the initial calibration. Channel checks to verify acceptable channel operability during normal operation and functional testing to verify proper channel response to simulated signals will also be conducted on a regular basis.

The humidity and temperature detectors and indicators will also be periodically checked to ensure proper operation. The humidity detector performance will be verified by comparison to actual measurements made by dry and wet bulb thermometers. Similarly the temperature detector performance will be verified by comparison to independent temperature measurement.

The sump level detector and indicator performance was verified during preoperational testing of the plant. A water source was introduced to the sump and the increase in sump level indicated was compared with local level measurements.

The RCPB leakage detectors were tested and calibrated by their respective manufacturers prior to installation and sensitivity curves will be provided.

5.2.8 INSERVICE INSPECTION PROGRAM

The RCPB has been designed and arranged to provide adequate clearances for inservice inspection. The design and arrangement conform to the requirements of paragraphs IS-141 and IS-142 of Section XI of the ASME Boiler and Pressure Vessel Code, 1971 Edition with Summer 1971 Addenda. Based on the date of issuance of the ANO-2 construction permit, 10 CFR 50.55a(g) mandated this edition of the Code for design and access provisions.

The Unit 2 Inservice Inspection program was developed using the criteria of 10 CFR 50.55a, Paragraph g. These require that the program use the code in effect six months prior to the issuance of a construction permit. This established the 1971 Edition and Summer 1971 Addenda of the ASME Boiler and Pressure Vessel Code, Section XI as the effective code.

ARKANSAS NUCLEAR ONE
Unit 2

The initial Inservice Inspection Program has been updated and modified as much as practicable to include the requirements of the Summer 1973 Addenda. The Summer 1973 Addenda reflect a number of significant state of the art advancements in ultrasonic testing.

The current Inservice Inspection Program is conducted in accordance with 10 CFR 50.55a(g) and Section XI of the applicable ASME Code.

5.2.8.1 Provisions for Access

5.2.8.1.1 Reactor Vessel and Closure Head

The reactor vessel and closure head welds are accessible for examination as follows:

A. From inside the vessel:

All longitudinal and circumferential shell welds;

Nozzle to vessel, nozzle to transition piece and transition piece to pipe welds;

Cladding in the cylindrical portion of the vessel, except those areas covered by surveillance capsules or internal structural attachments;

Internal structural attachments (visual examination);

The bottom head area is accessible from the inside, to the extent necessary to permit a determination of whether or not any mechanical or structural failure of reactor internals has occurred.

B. From outside the vessel:

The bottom head area, including meridional and circumferential seam welds;

Meridional and circumferential seam welds;

C. Cladding:

From outside the closure head;

Meridional and circumferential seam welds including head to flange weld;

Control element assembly and instrument tube welded and mechanical joints.

D. From flange faces:

Vessel to flange and head to flange welds;

Bolt holes and ligaments.

The reactor vessel and closure head access provisions described above have been incorporated into the design.

5.2.8.1.2 Primary Piping

Biological shielding around the transition piece-to-nozzle welds in the area of the reactor vessel limits access to these circumferential welds. The inspection of these welds is performed from the I.D. of the piping during the vessel examination. These volumetric examinations are performed using automated ultrasonic techniques.

Most piping and major components are provided with removable insulation in the areas of all welds and adjacent base metal requiring examination as defined by the ASME Section XI Code.

5.2.8.1.3 Steam Generators

All external welds on the steam generator which are required to be inspected in accordance with ASME Section XI are accessible and have removable insulation in the areas of the welds and adjacent base metal to gain access for inspection.

Access for the inspection of steam generator tubing is provided through the channelhead primary manway. An inservice inspection program for the steam generator tubing is consistent with NEI 97-06, Steam Generator Program Guidelines. This program of systematic periodic inspection of steam generator tubes is described fully in Section 6.5.9 of the Technical Specifications.

5.2.8.1.4 Other Components

All other components, including portions of the steam generators, pressurizer and primary piping are accessible for manual examination from the outside surface.

5.2.8.2 Equipment for Inservice Inspection

Remotely operated automated ultrasonic equipment will be used for the examination of the reactor vessel circumferential and longitudinal welds and the primary nozzle-to-shell welds.

5.2.8.3 Recording and Comparing Data

Volumetric and surface examination results will be recorded and compared with the results of pre-service and prior inservice examinations as required by the ASME Code, Section XI.

5.2.8.3.1 Automated Ultrasonic Examinations

The examination of the reactor vessel is conducted utilizing an automated system which manipulates the ultrasonic search units in such a manner as to provide complete volumetric coverage, where practical, of each weld and adjacent base material. The data will be acquired and stored in a format suitable for comparison with the recorded results of the pre-service and prior inservice examinations.

5.2.8.3.2 Manual Examinations

A written report will be provided for all manual ultrasonic examinations. The report will consist of recording the instruments used and settings as well as the procedures employed. Results of the examination will be in a format so that direct comparison between baseline and subsequent inservice examinations can be achieved.

ARKANSAS NUCLEAR ONE
Unit 2

5.2.8.3.3 Visual Examinations

A written report will be provided.

5.2.8.3.4 Surface

A written report will be provided.

5.2.8.3.5 Radiographic

Where applicable, a written report will be provided and the radiographic film retained.

5.2.8.4 Reactor Vessel Acceptance Standards

During the pre-service examinations, flaw indications, if present, were recorded in accordance with requirements of IS-233 of Section XI (1971 Edition through the Summer 1973 Addenda) in terms of location, size, shape, orientation and distribution within the component. Acceptability of the reactor vessel was established by applying the "rules" of the "Proposed Revision of IS-311 -- Standards for Examination Evaluations," Draft 7, dated September 28, 1972, and scheduled for incorporation in the Summer of 1973 Addenda.

Section XI Code activity will be reviewed and applicable sections will be incorporated into the Inservice Inspection Program insofar as acceptance criteria is affected.

5.2.8.5 Coordination of Inspection Equipment with Access Provisions

The CE Inservice Inspection Group developed and implemented the Inservice Inspection Program for the first inservice inspection interval. During the design and construction of the plant, CE coordinated the efforts of the Architect/Engineer and equipment vendors. By serving as the NSSS supplier as well as an inservice inspection vendor, CE was able to ensure that the inservice inspections could be performed.

Arkansas Nuclear One took over the Inservice Inspection Program from Combustion Engineering after the first interval.

5.2.8.6 Inservice Inspection of ASME Code Class 2 and 3 Components

An ESF (Engineered Safety Feature) in-service inspection program has been established for ASME Code Class 2 and 3 ESF systems' components that will provide a satisfactory degree of assurance of the integrity of the ESF systems.

5.2.8.7 Inservice Testing of ASME Code Class 1, 2, & 3 Pumps and Valves

A program for inservice testing of ASME Code Class 1, 2, & 3 pumps and valves will be carried out in accordance with Technical Specifications and 10 CFR 50.55a.

ARKANSAS NUCLEAR ONE
Unit 2

5.2.8.8 Inservice Monitoring of Vibration and Loose Parts

Vibrations within the RCS and reactor core are monitored by the Vibration and Loose Parts (V&LP) monitoring system. This system has vibration and acoustic channels, and consists of piezoelectric sensors, preamplifiers, a signal processor unit, and other peripheral equipment.

The sensors detect vibration from flow-induced or rotating-equipment sources, loose parts in the coolant systems, and other signals. The signals from these channels are compared with preset levels to generate alarms when abnormal conditions are detected. Various diagnostic equipment is available to further identify the source of the problem.

To provide optimum effectiveness of the V&LP, the transducers for the reactor primary system are placed on the lower vessel, upper vessel, and steam generators.

In the lower vessel, an accelerometer is positioned as close to the reactor vessel as is practical for inspection and replacement. An accelerometer is located in the upper vessel region to quantitatively monitor the control rod extensions and vessel internal for vibration. Location of this sensor is on the control rod drive extension tube protection shroud. The steam generators have accelerometers mounted on the steam generator channelhead.

The loose parts, and core internals channels monitor the major reactor primary system components in which an anomaly could occur. The selection provides a qualitative difference indication of vibration throughout the primary loop. The nuclear channels provide reactivity-related indication of fuel pin, control rod, and core structure motion. The core internals signals are obtained from the ex-core power range ion chamber buffer amplifiers.

The Vibration Loose Parts Monitoring System (VLPMS) uses piezoelectric sensors and preamps in containment for both vibration and acoustic monitoring. Sensor signals are input to the analog signal conditioning module which also provides power to the remote charge converter. The input signal to the computer is separated into two signals; one signal is band pass filtered and is used for analysis, the other is the wide band signal, which is used for monitoring the background noise and vibration.

By not alarming on relatively slow transients such as pump starts, the dual alarm method provides defense against false alarms. The fixed alarm prevents false alarms in low background noise situations where the floating alarm level is low and easily triggered. Additionally the fixed alarm may be used as a screening method in situations where the plant continues to operate with loose part indication.

The Loose Parts Monitoring Signal Conditioning System is rack mounted and consists of individual signal conditioning cards, one for each sensor channel. The key features of the system are:

- Capable of stand alone operation.
- Provides means to monitor the background vibration in all channels.

ARKANSAS NUCLEAR ONE
Unit 2

The system is comprised of four module types; Master Control Module, Signal Conditioning Module, Audio Monitor, and the Neutron Noise Module.

- The Signal Conditioning (SC) Module interfaces directly to the accelerometers and line drivers used to detect the acceleration caused by vibration or metallic impact.
- The Master Control Module is the communication device between the PC and the individual channel SC Modules. In the PC control mode, (set by switch on the front panel) the PC issues commands which set the full scale range and the floating and fixed setpoints. If any one of the SC Modules senses an alarm, the PC is triggered and the event data is captured. The module contains the relay used to provide alarm contacts to the plant annunciator.
- The Excore Nuclear Instrumentation Amplifier (Neutron Noise) module provides an amplified signal of the AC component that exists on the plant excore nuclear instrumentation signals.
- The Audio Monitor Module is an audio amplifier and speaker that permits the switching of 16 loose part channel inputs. Besides channel selection, the operator can select between wide band, filtered or recorded data.

If a loose part event occurs, the computer transfers the data from all data acquisition cards to the computer. If a loose part is determined, the computer stores the data on the hard disk. Time stamped data from each new event is added to a file and recorded on the hard drive for future analysis. The VLPMS provides the capability of loose parts audio recording through outputs from the Audio Monitor Module.

5.3 THERMAL HYDRAULIC SYSTEM DESIGN

5.3.1 ANALYTICAL METHODS AND DATA

The principal thermal and hydraulic data for the Reactor Coolant System (RCS) is included in Table 5.3-2. The effect on core flow rate of inoperative pumps is discussed in Section 5.3.4.

The reactor design described in Chapter 4 established hot and cold leg temperatures, minimum reactor coolant flow and maximum reactor vessel pressure drop. The thermodynamic and hydrodynamic data are used in the design of the steam generators, reactor coolant pumps, and reactor coolant piping. The data are covered in Table 5.3-2. The RCS temperature control program is shown in Figure 5.3-1. The secondary pressure as a function of power is shown in Figure 5.3-2.

5.3.1.1 Steam Generator

The steam generators are described in Section 5.5.2. The vertical U-tube steam generators are designed to transfer the design heat load from the reactor coolant to the secondary side, producing steam at warranted pressure and quality. The pressure drop on the reactor coolant side is determined by summing the losses due to friction in the tubes, the bend losses, tube sheet entrance and exit losses, and the inlet and outlet plenum and nozzle losses.

5.3.1.2 Reactor Coolant Pump

The design flow for the reactor coolant pump is established by the required reactor mass flow. This mass flow is converted to volumetric flow at the full power cold leg temperature to determine the pump design flow.

The maximum pressure loss at the design flow rate for the reactor vessel, original steam generator, and piping was determined by adding an allowance for uncertainty to the best estimate of each pressure drop. These maximum values were used to establish the reactor coolant pump design head. The reactor coolant pump was designed to produce a minimum reactor design flow at the maximum expected system pressure loss.

The original uncertainty associated with the flow rate measurement was established prior to the preoperational and startup tests on ANO-2. This uncertainty was based on performance and acceptance testing done at the pump vendor's facility and on the instrumentation used at that facility and at the Arkansas site in connection with flow measurement. The test measurements onsite yielded the best estimate reactor coolant flow rate to which the pre-determined uncertainty was applied to obtain the maximum and minimum values of flow rate. The flow rate itself originated in measurements of pressure differential across a pair of taps in each pump casing inlet and outlet. The individual loop flows were determined from plots of pump flow vs pump Δp developed from calibration measurements made at the vendor's test facility. The total system flow was obtained by summing the loop flows.

Reactor coolant flow rates are currently measured by calorimetric calculation or by using pump differential pressure instrumentation. Instrument and calibration uncertainties appropriate for each method are applied to acceptance criteria of flow surveillances.

ARKANSAS NUCLEAR ONE
Unit 2

5.3.1.3 Reactor Coolant Piping

The reactor coolant piping is designed to withstand the maximum expected reactor coolant pressure and temperature in accordance with the ASME Code, Section III. The piping is sized to provide reasonable fluid velocities which are below those which would cause significant erosion or cavitation.

5.3.2 OPERATING RESTRICTIONS ON PUMPS

The minimum RCS pressure at any given temperature is limited by required Net Positive Suction Head (NPSH) for the reactor coolant pumps during portions of plant heatup and cooldown. To ensure that the pump NPSH requirements are met under all operating conditions, an operating curve is used which gives permissible RCS pressure as a function of reactor coolant temperature.

The reactor coolant pump NPSH restriction on this curve is determined by using the NPSH requirement for one pump operation (maximum flow, hence, maximum required NPSH) and correcting it for pressure and temperature instrument errors and pressure measurement location. The NPSH required versus pump flow is supplied by the pump vendor. Pump operation below this curve is prohibited. At low reactor coolant temperatures and pressures, other considerations require that the minimum pressure versus temperature curve be above the NPSH curve.

5.3.3 POWER-FLOW OPERATING MAP (BWR)

Arkansas Nuclear One - Unit 2 is a PWR. This section is not applicable.

5.3.4 TEMPERATURE - POWER OPERATING MAP (PWR)

Plant flow is given as a percent of 4-pump flow. The maximum temperature of the hot leg and cold leg will be less than the maximum temperatures for design power at design flow. Reactor operation at power requires all four pumps to be operating. However, decay heat may be transferred to the steam generator with one (or more) pumps operating or under natural circulation conditions.

The adequacy of natural circulation for decay heat removal after reactor shutdown has been verified analytically and by tests on the Palisades reactor. The core ΔT in the analysis has been shown to be lower than the normal full power ΔT ; thus the thermal and mechanical loads on the core structure are less severe than normal design conditions.

To assess the margin available in a post-coastdown situation, a study was made assuming termination of pump coastdown 100 seconds after reactor trip, with immediate flow decay to the stable natural circulation condition. It should be recognized that pump rotation will continue for substantially longer than 100 seconds. With the maximum decay heat load 100 seconds after trip, the system will sustain stable natural circulation flow adequate to give a thermal power-to-flow ratio of less than 0.9.

Heat removed from the core during natural circulation may be rejected either by dumping to the main condenser or to the atmosphere; the rate of heat removal may be controlled to maintain core ΔT within allowable limits. The analytical techniques are verified by tests completed on the Palisades reactor (Docket No. 50-255).

Historical data removed. To review wording, refer to Section 5.3.4 of the FSAR.

ARKANSAS NUCLEAR ONE
Unit 2

5.3.5 LOAD FOLLOWING CHARACTERISTICS

The design features of the RCS influence its load following and transient response. The RCS is capable of following transients identified in Section 5.2.1, including a ramp change from 15 percent to 100 percent power at a rate of 5 percent per minute and at greater rates over smaller load change increments, up to a step change of 10 percent (as designed). These requirements are considered when sizing the pressurizer spray and heater capacities and control setpoints and the charging/letdown system control setpoints are selected through detailed computer simulation studies. In addition, the feedwater valve stroke speed and feedwater regulating system control setpoints are selected through computer analysis of these transients.

Finally, these transients are included in the equipment specification for each RCS component to ensure the structural integrity of the system.

Load changes are initiated by the operator at the load control portion of the electrohydraulic control system. The operator sets the desired load with the load selector. Different load change rates are selectable. The electrohydraulic control system alters the turbine control valve position while maintaining turbine speed and sensing first stage turbine pressure. Turbine first stage is also used by the Reactor Regulating System as indicative of turbine power. From this the RRS develops a reference reactor coolant temperature setpoint that can be used in the operators positioning of CEAs. The feedwater regulating system is a 3-element control system which senses changes in steam flow, feedwater flow and water level and acts to maintain level at the desired point.

Pressurizer pressure and level control systems respond to deviations from preselected setpoints caused by the expansion or contraction of the reactor coolant and actuate the spray or heaters and the charging or letdown systems as necessary to maintain pressure and coolant volume.

5.3.6 TRANSIENT EFFECTS

The effects of normal operating transients such as load changes and startup of an inactive loop, as well as the effects of anticipated operational occurrences such as loss of coolant flow, are considered in the fatigue analyses required by code on all RCS components (Refer to Section 5.2).

Concerns have been expressed regarding postulated pressurized thermal shock transients involving rapid overcooling of the reactor vessel with subsequent repressurization (NUREG-0737, Item II.K.2.13). The Unit 2 reactor vessel is a later generation vessel with controlled residual element weld and plate material. For such vessels, analysis indicates that no operator action is required to mitigate the consequences of a steam line break over 40 years of plant operation. This issue was resolved as documented in the Safety Evaluation Report issued June 5, 1984 (OCNA068413). Pressurized thermal shock of the ANO-2 reactor vessel has been evaluated for license renewal. All bellline material was demonstrated to be below the 10 CFR 61 screening criteria at 48 EFPY. Details of reactor vessel irradiation and EOL properties are in Section 5.2.4.

With regard to the small break LOCA analysis documentation requirements of NUREG-0737, Item II.K.2.13, ANO has referenced the C-E Owners Group report, CEN-189, "Evaluation of Pressurized Thermal Shock Effects due to Small Break LOCAs With Loss of Feedwater for Combustion Engineering NSSS," dated December 1981. The analytical results are contained in CEN-189 appendices, with the results for the ANO-2 vessel in Appendix G.

ARKANSAS NUCLEAR ONE
Unit 2

5.3.7 THERMAL AND HYDRAULIC CHARACTERISTICS TABLE

Principal thermal hydraulic characteristics are listed in Table 5.3-2.

5.4 REACTOR VESSEL AND APPURTENANCES

5.4.1 PROTECTION OF CLOSURE STUDS

To preclude damage to the closure stud threads the procedure utilized during reactor vessel head removal requires that reactor vessel studs be removed from the lower vessel flange, **plugs are installed in the vessel stud holes, and the studs are parked back in their respective holes in the vessel head flange** prior to reactor vessel head removal. The plugs are designed with a seal to prevent water from entering the stud hole during refueling. Removal of the reactor vessel studs from the lower vessel flange during the head removal operation therefore assures they will not be exposed to the borated refueling water. To prevent borated water spillage on the vessel head from entering the annuli around the studs when the head is installed, a concentric groove is machined in the reactor vessel head flange to form a drip line. The spillage is directed onto a chamfered portion of the vessel flange and to the refueling seal flange.

5.4.2 SPECIAL PROCESSES FOR FABRICATION AND INSPECTION

5.4.2.1 Nondestructive Tests

Prior to and during fabrication of the reactor vessel, nondestructive tests based upon Section III of the ASME Boiler and Pressure Vessel Code were performed on all welds, forgings, and plates as indicated below:

All full-penetration, pressure-containing welds were 100 percent radiographed to the standards of the ASME Code, Section III. Weld preparation areas, backchip areas, and final weld surfaces were magnetic-particle or dye-penetrant examined. Other pressure-containing welds, such as used for the attachments of nonferrous nickel-chromium-iron mechanism housing, vents, and instrument housings to the reactor vessel head, were inspected by liquid-penetrant tests of the root pass, the lesser of 1/3 of the thickness of each 1/2-inch of weld deposit, and the final surface. Additionally, the base metal weld preparation area was magnetic-particle examined prior to overlay with nickel-chromium-iron weld metal.

All forgings were inspected by ultrasonic testing, using longitudinal beam techniques. In addition, ring forgings were tested using shear wave techniques. Rejection under longitudinal beam inspection, with calibration so that the first back reflection was at least 75 percent of screen height, was based on indications causing complete loss of back reflection (when not associated with geometrical configuration).

All carbon-steel and low alloy forgings and ferritic welds were given a magnetic-particle examination after stress relief. Rejection was based on relevant indications of:

- A. Any cracks and linear indications;
- B. Rounded indications with dimensions greater than 3/16 inch;
- C. Four or more rounded indications in a line separated by less than 1/6 inch edge to edge;
- D. Ten or more rounded indications in any six square inches in the most unfavorable locations, with the major dimension of this area not to exceed six inches.

ARKANSAS NUCLEAR ONE
Unit 2

Plates were subjected to ultrasonic examination using straight beam techniques. Rejection was based on areas producing a continuous total loss of back reflection with a frequency and instrument adjustment that produced a minimum of 50 to a maximum of 75 percent of full scale reference back reflection from the opposite side of a sound area of the plate.

Any defect that showed a total loss of back reflection that could not be contained within a circle whose diameter was the greater of three inches or one-half the plate thickness was unacceptable. Two or more defects smaller than described above which cause a complete loss of back reflection were unacceptable unless separated by a minimum distance equal to the greatest diameter of the larger defect, unless the defects were contained within the area described above. Repair welds on plates are magnetic-particle or liquid-penetrant inspected, except those with a depth exceeding the lesser of 3/8 inch or 10 percent of plate thickness, which were radiographed.

Nondestructive testing of the vessel was performed throughout fabrication, with strict adherence to the nondestructive testing requirements of the ASME Code, Section III. Strict quality control was maintained in critical areas such as calibration of test instruments. Weld wire was checked for chemistry and weld rod, wire and flux were tested to requirements of the Code. The weld rods were prepared under metallurgical surveillance.

When final shape of a part of the vessel was of irregular geometry, ultrasonic examination for flaws was conducted after a preliminary machining to a suitable geometry.

All reactor vessel bolting material, regardless of size, was inspected both before and after threading by the wet magnetic-particle technique. In addition, bolting material greater than 2-inch nominal diameter was ultrasonically examined prior to threading by a straight beam radial scan over its entire surface. Bolting material which was greater than 4-inch nominal diameter was also examined prior to threading by an ultrasonic straight beam longitudinal scan over an entire end surface.

All inspections, equipment, calibration techniques and acceptance standards were in accordance with the requirements of the ASME Code, Section III.

Upon completion of all post-weld heat treatments, the reactor vessel was hydrostatically tested, after which all accessible ferritic weld surfaces, including those of welds used to repair material, were magnetic-particle inspected in accordance with the ASME Code, Section III.

5.4.2.2 Additional Tests

During design and fabrication of the reactor vessel, other tests and inspections not specifically included in the requirements of the ASME Code, Section III, were performed.

The supplier works with various ASME Code committees and is cooperating with the Pressure Vessel Research Committee program and other programs in developing information for reactor vessels relative to materials, inspection, and significance of flaws. The supplier also cooperates in the development of new and better steels for use in reactor vessels.

An analysis of major constituents was performed on both ends of each coil of carbon, low alloy, and stainless steel filler metal. Also a wet chemical analysis was made on each heat of carbon and low alloy filler metal.

ARKANSAS NUCLEAR ONE
Unit 2

During manufacture of the reactor vessel, quality control by the supplier in addition to, and in areas not covered by, the ASME Code, Section III, included such items as: (1) preparation of detailed purchase specifications requiring vacuum degassing for all ferritic plates, forgings, and bolting; (2) specification for fabrication of plates and forgings to provide control of material prior to receipt and during fabrication; (3) use of written instructions and manufacturing procedures which enable continual review based on past and current manufacturing experiences; (4) performance of chemical analysis of materials for welding, thereby providing continuous control over welding materials; and (5) test programs on fabrication of plates up to 15 inches thick to provide information about material properties as thickness increases.

All material was retested by the supplier on full thickness samples to code requirements. Longitudinal wave ultrasonic testing was performed on 100 percent of all plate material. Inspection was performed on plates with acceptable size ultrasonic indications during fabrication stages to evaluate the effects of fabrication upon the configuration and size of the indication.

Cladding for the reactor vessel is a continuous integral surface of corrosion-resistant material, having 7/32-inch nominal thickness, and a 1/8-inch minimum thickness. The detailed procedure used, i.e., type of electrodes, welding position, speed of welding, and nondestructive testing requirements, is in compliance with the ASME Code, Section III.

The cladding in completed reactor vessels has been examined and such tests have not shown the need for 100 percent ultrasonic examination for bond of weld-deposited cladding after fabrication. The clad surface is ultrasonically inspected, transverse to the direction of welding, for lack of bond at intervals of 12 inches or 1.4 times the base metal thickness, whichever is less. The clad surface is also dye-penetrant examined after a post-weld heat treatment for surface discontinuities. Also, all nonferritic weld surfaces are dye-penetrant inspected following the vessel hydrostatic test.

5.4.2.2.1 Arkansas In-Process Inspection

The ASME Code, Section XI, requires that volumetric examinations of pressure boundary welds be performed after the hydrostatic test to establish baseline information as a reference for future inservice examinations. Ultrasonic examination techniques were used during fabrication in addition to the radiography required for Class 1 vessel welds by the ASME Code Section III. This added in-process inspection was performed prior to final heat treatment of the weld to provide maximum assurance that unacceptable reflections requiring removal and repair would not be discovered during the baseline inspection performed after final heat treatment and hydrostatic test (The baseline inspection is discussed in Section 5.4.2.3).

Table 5.4-1 summarizes the reactor vessel inspection program during fabrication.

5.4.2.3 Baseline Examination

The reactor vessel for Unit 2 was given a baseline examination after the shop hydrostatic test, using remote manual ultrasonic test techniques equivalent to those intended for use during subsequent inservice examinations. This baseline examination constitutes the preservice examination required by Section XI for the purpose of comparison with the results of subsequent inservice inspections.

Indications which exceeded the equivalent limits of acceptability of the ASME code, Section III were repaired.

ARKANSAS NUCLEAR ONE
Unit 2

Baseline impact data for the reactor vessel surveillance program have been collected during baseline testing of surveillance specimens. These impact data include RT_{NDT} values for the limiting plate, a weld heat-affected-zone, and weld metal from the reactor vessel baseline region.

5.4.3 FEATURES FOR IMPROVED RELIABILITY

The quality assurance, in-process, and baseline examination programs described in Section 5.4.2 provide assurance of reactor vessel reliability.

5.4.4 QUALITY ASSURANCE SURVEILLANCE

The reactor vessel for Unit 2 was fabricated by Combustion Engineering, Inc. (CE), the NSSS supplier. The quality assurance program is described in the Quality Assurance Program Manual (QAPM).

5.4.5 MATERIALS AND INSPECTIONS

Reactor vessel materials are listed in Section 5.2, Table 5.2-3. Inspections are described in Section 5.4.2. Tensile strength and toughness data for the reactor vessel closure stud material is listed in Table 5.4-3 and in Figures 5.4-2 and 5.4-3.

5.4.6 REACTOR VESSEL DESIGN DATA

5.4.6.1 Design Basis

The reactor vessel is designed to contain the fuel assemblies, the Control Element Assemblies (CEAs), and the internals necessary for support of the core and for direction of coolant flow. The vessel is designed for the transients listed in Section 5.2.1.5 so that code allowable stress limits are not exceeded for the specified number of cycles.

5.4.6.2 Reactor Vessel Description

The reactor vessel is shown in Figure 5.4-1.

The reactor vessel is a right circular cylinder with two hemispherical heads. The lower head is welded to the vessel shell; the upper closure head can be removed to provide access to the reactor internals. The head flange is drilled to match the vessel flange stud bolt locations. The stud bolts are fitted with spherical crowned washers located between the closure nuts and the head flange to maintain stud alignment during head flexing due to boltup.

The vessel flange is a forged ring with a matched ledge on the inside surface to support the core support barrel. The flange is drilled and tapped to receive the closure studs and is machined to provide a mating surface for the reactor vessel closure seals. An externally tapered transition section connects the flange to the reactor vessel shell.

Sealing is accomplished by using two silver-plated, NiCrFe alloy, self-energized O-rings. The space between the two rings is monitored to detect any inner-ring coolant leakage.

Nozzles are provided on the closure head for nuclear instrumentation, Control Element Drive Mechanisms (CEDMs), and a vent.

ARKANSAS NUCLEAR ONE
Unit 2

The inlet and outlet nozzles are located radially on a common plane just below the vessel flange. Extra thickness in this vessel course provides the reinforcement required for the nozzles. Additional reinforcement is provided for the individual nozzle attachments. A boss located around the outlet nozzles on the inside diameter of the vessel wall provides a mating surface for the internal structure which guides the outlet coolant flow. This boss and the outlet sleeve on the core support barrel are machined to a common contour to minimize core bypass leakage. Shell sections are joined to the nozzle region by a transition section.

Snubbers, built into the lower portion of the reactor vessel shell, limit the amplitude of flow-induced vibrations in the core support barrel. Core stops are also built into the reactor vessel to limit the downward drop of the core if the core support barrel should fail. (Refer to Section 4.2.)

The reactor vessel is supported by three vertical columns below the vessel coolant nozzles as described in Section 5.5.14.

The vessel closure contains 54 studs, 6-1/2 inches in diameter with eight threads per inch. The stud material conforms to ASTM-A-540, Grade B24, with a minimum yield strength of 130,000 psi. The tensile stress in each stud, when elongated for operational conditions, is approximately 40,000 psi. Calculations show that 32 symmetrically distributed broken studs or four adjacent broken studs will result in O-ring leakage. Failure of at least 16 adjacent studs is necessary before the closure could fail by zippering open.

The vessel studs are stressed as they are elongated by the stud tensioners during the initial installation of the vessel head and during each refueling. Significant changes in the elongation properties of the studs could result in being unable to meet the acceptance criterion for elongation. Studs which fail to meet elongation requirements during the head installation, or receive damage to the threads, will be replaced before returning the vessel to pressure operations.

5.4.6.3 Design Data

Basic Reactor Coolant System (RCS) design parameters are listed in Table 5.1-1. Physical parameters of the Unit 2 reactor vessel are listed in Table 5.4-2.

5.4.6.4 Evaluation

It has been demonstrated by analysis in accordance with the ASME Code, Section III requirements for Class 1 vessels, that the reactor vessel is adequate for all normal operating and transient conditions during the life of the facility. The reactor vessel has been hydrostatically tested and has been tested using nondestructive techniques as specified in the ASME Code, Section III. Further assurance of the structural integrity of the reactor vessels is provided by the inservice inspection program, designed to meet the requirements of the ASME Code, Section XI.

5.4.7 REACTOR VESSEL SCHEMATIC (BWR)

The Arkansas Nuclear One - Unit 2 reactor is a Pressurized Water Reactor (PWR). This section of the standard format is not applicable.

ARKANSAS NUCLEAR ONE
UNIT 2

5.5 COMPONENT AND SUBSYSTEM DESIGN

5.5.1 REACTOR COOLANT PUMPS

5.5.1.1 Design Bases

In addition to the criteria described in Section 5.2, the reactor coolant pumps which circulate the reactor coolant through the Reactor Coolant System (RCS) are designed to:

- A. Provide sufficient moment of inertia to reduce the flow decay through the core upon loss of pump power, ensuring that fuel design limits are not exceeded;
- B. Prevent reverse rotation of the pump upon loss of pump power with the other pumps operating; and,
- C. Operate without cooling water for period up to ten minutes without incurring seal damage.

5.5.1.2 Description

The reactor coolant is circulated by four vertical, single bottom suction, horizontal discharge, centrifugal motor-driven pumps as shown in Figure 5.5-1. Figure 5.5-2 provides a simplified diagram of the reactor coolant pump. The design parameters for the pumps are given in Table 5.5-1.

The reactor coolant pump assembly consists of the pump case, rotating assembly containing the impeller which is keyed and locked to the shaft, the pump case cover, motor adapter and motor. The motor is connected to and supported by the pump case through the motor mount adapter. There are two openings on opposite sides of the motor mounts that provide access for assembly of the flanged rigid coupling between the motor and pump and for seal cartridge replacement.

The pump rotating assembly consists of impeller, water lubricated radial hydrostatic bearing rotor, seal coolant recirculating impeller and rotating elements of the seal cartridge assembly. The radial bearing, one of three used for pump motor shaft support, is located just above the pump impeller. The upper radial bearing and the axial thrust bearing are located on the motor shaft. The seal cartridge and recirculating impeller are located above the thermal barrier formed by the close clearance between the pump shaft and the pump case cover.

The pump case cover assembly includes the coiled tubing heat exchanger which cools the seal cartridge and thermal barrier, the seal cartridge assembly, the thermal barrier, the radial bearing stator and the upper and lower impeller labyrinth seals.

The seal cartridge consists of a four stage mechanical seal; three full pressure seals mounted in tandem and a fourth low pressure vapor seal designed to withstand system operating pressure when the pumps are not operating. A controlled bleed-off flow through the seals is used to cool the seals and to equalize the pressure drop across each seal. The controlled bleed-off flow is collected by either the reactor drain tank of the Boron Management System (BMS) or the volume control tank of the Chemical and Volume Control System (CVCS) during plant heatup and cooldown. During normal operations, controlled bleed-off is collected by the volume control tank. Leakage past the vapor seal is collected in the Waste Management System (WMS) through drainage to the reactor drain tank.

ARKANSAS NUCLEAR ONE UNIT 2

The seal cartridge assembly is cooled by circulating the controlled leakage through a coiled tube heat exchanger integral with the pump case cover. The seal coolant recirculation is done by the recirculating impeller located directly below the seal cartridge. The seals are capable of operation without cooling water for up to ten minutes without incurring damage. The seal cartridge concept reduces the time required for seal maintenance thereby lowering personnel radiation exposure time. The seal cartridge can be removed without draining the pump case. Details of the seal cartridge are shown in Figure 5.5-3.

Each seal is designed to accept the full operating pressure of the RCS; however, the first three seals of the cartridge assembly normally operate with a pressure differential equal to one-third of the operating pressure and with only a slight pressure differential across the vapor seal. The seal [rotating and stationary materials are described in Table 5.5-1](#).

The reactor coolant pump and motor assembly is supported by spring hangers attached to the four support lugs welded to the pump case. The spring hangers permit motion in the horizontal and vertical directions to compensate for thermal and seismic movement.

The pump motor assembly includes a once-through air cooler, motor and pump seal coolant heat exchangers, bearing lubrication and lube oil cooling systems, oil lift pumps, motor-pump shaft upper radial and axial support bearings, flywheel, and anti-rotation device. The cooling water to the motor coolers is supplied from the component cooling system. Two oil lift pumps, driven by a common 3 HP AC motor, are used to support the pump-motor shaft assembly during startup and during normal shutdown of the pumps. The motor-pump bearing support system includes a Kingsbury double acting thrust bearing and a radial hydrostatic bearing located above the pump impeller. The flywheel and motor-pump rotating assembly has a total moment of inertia of 136,400 lb_m-ft² sufficient to improve the coastdown characteristics of the pumps to meet the system requirements during a loss of pump power condition. The motor flywheel assembly is shown in Figure 5.5-4.

Each reactor coolant pump motor contains approximately 150 gallons of lube oil within its bearing lubrication system. To collect any lube oil leakage and prevent leakage from spreading, each pump has a reactor coolant pump oil collection system installed. To increase collection capacity of any oil from piping external to the motor (including flanged connections, gauges, and filler lines), collection pans and spray deflectors have been added to each motor.

The pumps include an anti-rotation device shown in Figure 5.5-5 to prevent reverse rotation caused by backflow through the impeller. The anti-reverse device will stop a pump when it decelerates from normal speed (900 rpm nominal) while the remaining pumps continue to operate. The device consists of concentric inner and outer races, a complement of sprags between those races, and a bearing to maintain concentricity between the races.

If reverse rotation of the motor shaft is attempted, the sprags wedge between the inner and outer races, preventing rotation. Rotation in the forward direction frees the sprags, and free forward rotation is thus permitted.

This is accomplished by having the line of action of the sprags inclined from a true radial line such that wedging occurs on reverse rotation by reducing the angle between the true radial line of action of the sprag. The outer race of the device is secured to the shaft such that it rotates with the shaft and the inner race is held stationary. The sprags rotate with the outer race and are shaped so that their centers of gravity are located such that centrifugal force causes the incline angle between a radial line and the sprag to increase and thereby produce clearance between the inner end of the sprags and the stationary inner race. Wear of the sprags and races is, therefore, eliminated for full-speed forward rotation.

ARKANSAS NUCLEAR ONE
UNIT 2

The pump performance curve is shown in Figure 5.5-6. The pump motor is conservatively sized at a higher horsepower rating to enable continuous operation at the flows resulting from 4-pump operation with 0.74 specific gravity water. The motors are designed to start and accelerate to speed under full load when 80 percent or more of their normal voltage is applied. The motors are contained within NEMA Standard Ng-1-1.20 drip-proof enclosures and are equipped with electrical insulation suitable for a zero to 100 percent humidity and radiation environment of 30 R/hr of gamma.

5.5.1.3 Evaluation

The reactor coolant pumps are sized to deliver flow that equals or exceeds the design flow rate utilized in the thermal hydraulic analysis of the RCS. Analysis of steady state and anticipated transients is performed assuming a conservative flow rate. Tests are performed to evaluate reactor coolant pump performance during the post-core load hot functional testing to verify adequate flow.

Leakage from the pump via the pump shaft is controlled by the shaft seal assembly. Coolant entering the seal chambers is cooled and collected in closed systems so that reactor coolant leakage to containment is essentially zero. The seal cavities are piped to funnel drains near each reactor coolant pump to collect any water vented off the cavity. In the event of seal malfunctions, instrumentation is provided to alert the operator to this potential problem.

The design overspeed of flywheel is 125 percent of rated speed. An overspeed test of each flywheel at the design overspeed was performed prior to assembly. Refer to the discussion of Regulatory Guide 1.14 in Section 5.2.6.

In the event of a break in the reactor coolant pump suction piping, the anti-reverse rotation device will prevent impeller rotation in the reverse direction. In the event of a discharge pipe break, increased flow through the pump will tend to accelerate the pump impeller. Further evaluation relating to the integrity of the flywheel is presented in response to Regulatory Guide 1.14 in Section 5.2.6.

Component cooling water to the reactor coolant pumps is not needed to assure (1) the integrity of the Reactor Coolant Pressure Boundary (RCPB), (2) the capability to shutdown the reactor and maintain it in a safe shutdown condition, or (3) the capability to prevent or mitigate the consequences of accidents which could result in potential off-site doses comparable to the guideline doses of 10 CFR 100. Low pump cooling flow to each pump is alarmed in the control room. Thermal lag in the reactor coolant pump and motor makes them relatively insensitive to loss of cooling water flow.

The Unit 2 pumps, by design and field experience, are not susceptible to a LOCA due to seal failure resulting from loss of seal cooling water. The pumps are equipped with four series-arranged face seals all of which are designed for 2,500 psi Δp . The maximum Δp across any one of the three main seals during normal operation is 750 psi. The loss of any single seal would result in a maximum Δp of approximately 1,100 psi. A seal leakage chamber structurally designed for 2,500 psia is provided to collect controlled seal leakage and conduct it to a closed system. The fourth face seal is provided as an integral part of the seal leakage chamber to prevent liquid or gaseous leakage from escaping to the atmosphere. This seal is designed to operate normally against a back pressure of 25 to 250 psia, and is capable of holding against full pressure (2,500 psia) in the static condition and during coastdown following failure of the three series-arranged main seals. When holding against 2,500 psia in the static condition, the seal leakage should not exceed the normal operating seal leakage.

ARKANSAS NUCLEAR ONE
UNIT 2

Four reactor coolant pumps with seals of similar design have been operated for up to 40 minutes with no component cooling water flow. While there was some increase in controlled seal leakage (to the closed system), the mechanical seals were subsequently dismantled and refurbished without finding major damage such as broken pieces in the seals. Therefore, a loss of component cooling water flow to the Unit 2 reactor coolant pumps for up to 40 minutes is not expected to result in a Loss of Coolant Accident (LOCA) due to seal failure.

In the event of an accident that causes actuation of containment isolation the reactor coolant pumps are stopped resulting in no requirement for component cooling water. The containment isolation signal is only given by two of four high containment pressure signals. High containment pressure can be reached by the following accidents: (1) a LOCA; (2) a major steam line break inside containment; or (3) a feedwater line break inside containment. In the event of these accidents, plant conditions may result in reactor coolant pumps being tripped and Component Cooling Water (CCW) containment isolation valves being closed. Emergency Operating Procedures provide guidance for opening CCW isolation valves and restoration of forced circulation when applicable criteria are satisfied.

5.5.1.4 Tests and Inspections

The reactor coolant pump pressure boundary was nondestructively inspected as required by the ASME Code, Section III, for Class 1 components. The pump casing inspections included complete radiography and liquid penetrant or ultrasonic testing. The pump received a hydrostatic pressure test with the reactor coolant system in the plant. Inservice inspection of the pump pressure boundary is performed during plant life in accordance with the ASME Code, Section XI.

All rotating parts of the pump were structurally and dynamically balanced in two planes. Where possible, balancing was done for the entire assembly.

The pump assembly was performance tested in the vendor's shop in accordance with the Standards of the Hydraulic Institute to verify hydraulic performance as well as the ability of the pumps to function as required by the specifications. The vibration levels were monitored during this test. Evidence of the pumps operating near a critical speed would have been noted as excessive vibration.

Full scale seal testing was performed at rated pressure, temperature, water chemistry and speed to demonstrate the capability of the seals to satisfactorily perform their design function.

5.5.2 STEAM GENERATOR

5.5.2.1 Design Bases

The steam generators are designed to

- A. Transfer the heat generated in the RCS to the secondary system;
- B. Provide steam to the secondary system at the design flow rate with a moisture content no greater than 0.1 percent during steady state operation with water at the normal operating level;

ARKANSAS NUCLEAR ONE
UNIT 2

- C. Meet the following conditions, in addition to the transients listed in Section 5.2:
1. Four thousand cycles of pressure differentials of 92 psi across the divider plate caused by starting and stopping the reactor coolant pumps (normal condition);
 2. One cycle of hydrostatic testing of the secondary side at 1,375 psig and of the primary side at 3125 psig (test condition);
 3. Eight hundred cycles of tube leak testing of the secondary side at 200 to 840 psi (test condition);
 4. Ten thousand two hundred cycles of adding 70 °F feedwater to the plant during heatup, hot standby, and cooldown conditions. Additional requirements include five hundred cycles of ramping power from 0 to 15 percent and five hundred cycles of ramping power from 15 to 0 percent power (evaluated separate from the plant loading and unloading transient cycles) (normal condition); and,
 5. Twenty cycles of adding 32 °F emergency feedwater with flow initiated after a loss of normal feedwater (emergency condition).
- D. Ensure that critical vibration frequencies will be well out of the forcing function frequency range expected during normal operation and during abnormal conditions. The tubing and tube supports are designed and fabricated with considerations given to both secondary side-flow induced vibrations and reactor coolant pump induced vibrations. In addition, the tubing and tube supports are designed so that the structural integrity of the pressure boundary (tubes) will be maintained during a postulated main steam line break event.

5.5.2.2 Description

The Nuclear Steam Supply System (NSSS) utilizes two steam generators (Figure 5.5-7) to transfer the heat generated in the RCS to the secondary system. The design parameters for the steam generators are given in Table 5.5-2. The steam generator is a vertical U-tube heat exchanger with the reactor coolant on the tube side and the secondary fluid on the shell side.

The steam generator design features and tube material have been developed and selected to minimize the potential for tube degradation. The design features minimize the potential for concentration of chemical species that can be detrimental to high nickel alloy tubing material. The tube material, tubing fabrication methods, and installation techniques provide tubes that are highly resistant to corrosion.

The steam generators are designed with the objective of minimizing crevices or contact areas between tubes and tubesheet or other internals. All tubes are initially tack expanded on the tube end, welded to the cladding, then expanded into the tube sheet for the full depth of the tube hole by the hydraulic expansion process. This process has the advantages of expanding the tube into essentially metal to metal contact with the tube hole without excessively cold working the tube wall, as might be done with a mechanical rolling process. The hydraulic expansion process provides more precise dimensional control than an explosive expansion. Also, hydraulic expansion is not subject to dynamic rebound. Strict tolerances and other quality control measures are applied to the expansion process to ensure that the tubes are expanded essentially over the full depth of the tubesheet.

ARKANSAS NUCLEAR ONE
UNIT 2

Tube support plates of the flat-contact broached trifoil tube hole design are used to support the tubes. The tube support plates are sized to provide sufficient strength that the tubes maintain structural integrity during a seismic event. The clearance between the tube and tube support and the spacing between the supports is sized to minimize the potential for excessive vibration of the tubes. The tube support plates are made of corrosion resistant Type 405 ferritic stainless steel. Use of this material prevents significant corrosion of the tube support plates and thus precludes tube denting. The tube hole design reduces the tube-to-tube support plate crevice area while providing for maximum steam and water flow in the open areas adjacent to the tube. The flat land contact provides additional dryout margin.

The U-tubes are fabricated of nickel-chromium-iron Alloy 690. The tubes undergo thermal treatment following tube-forming operations. The thermal treatment subjects the tubes to elevated temperatures for a prescribed period of time to improve the grain structure of the material. Thermally treated Alloy 690 has been shown in laboratory tests and operating nuclear power plants to be very resistant to primary water stress corrosion cracking (PWSCC) and outside diameter stress corrosion cracking (ODSCC).

Reactor coolant enters the steam generator through the 42-inch ID inlet nozzle, flows through 0.688-inch OD (0.040-inch average wall) tubes, and leaves through two 30-inch ID outlet nozzles. A divider plate in the channel head separates the inlet and outlet plenums. The channel head is a low alloy steel forging with low cobalt stainless steel cladding. The tubesheet is low alloy steel with the reactor coolant side of the tube sheet clad with Ni-Cr-Fe Alloy 690.

Feedwater enters the steam generator through the 18-inch Schedule 80 feedwater nozzle where it is distributed via an elevated feedwater distribution ring which directs the flow into the downcomer. The downcomer is the annular passage formed by the inner surface of the steam generator shell and the cylindrical wrapper that encloses the vertical U-tubes. The feedwater distribution ring is welded to the feedwater nozzle to minimize the potential for draining the ring. The connection between the nozzle and the feedwater ring is a thermal sleeve that minimizes the effect of cold feedwater addition transients on the feedwater nozzle. The feedwater ring is located above the elevation of the feedwater nozzle to minimize the time required to fill the feedwater nozzle during a cold water addition transient. The feedwater is discharged through inverted J-nozzles installed on the top of the ring. These features reduce the thermal fatigue loading on the feedwater nozzle, eliminate steady state thermal stratification in the feedwater nozzle and feedwater piping elbow at the feedwater nozzle entrance, and minimize the potential for bubble collapse water hammer generated in the feedwater distribution ring.

At the bottom of the downcomer, the secondary water is directed upward past the U-tubes where heat transferred from the reactor coolant side produces a steam water mixture. Anti-vibration bars installed in the U-bend portion of the tube bundle minimize the potential for excessive vibration. The anti-vibration bars are fabricated from Type 405 stainless steel. The construction minimizes the gaps between the anti-vibration bars and tubes.

Upon rising above the U-tube heat transfer surface, the steam water mixture enters centrifugal type separators. These impart a centrifugal motion to the mixture and separate the water from the steam. The water leaves the separator through the perforated separator housing and flows by gravity into the downcomer where it is mixed with the feedwater. Final drying of the steam leaving the centrifugal separators is accomplished by passing the steam through eight single-tier dryer banks. The moisture content of the outlet steam is no greater than 0.1 percent at design flow during steady state operation with water at the normal operating level.

ARKANSAS NUCLEAR ONE
UNIT 2

The steam generator shell is constructed of low alloy steel. Manways and handhole openings in the shell provide access to the steam generator internal structures. Manways on the inlet and outlet side of the channel head permit access to the tube sheet for inspection and tube plugging if required.

The steam generators are mounted on bearing plates which allow controlled lateral motion due to thermal expansion of the reactor coolant piping. The top of each steam generator is restrained from sudden lateral movement by keys and hydraulic snubbers mounted rigidly to the concrete structure.

The steam generators are located at a higher elevation than the reactor vessel. The elevation difference creates natural circulation capability sufficient to remove core decay heat following coastdown of all reactor coolant pumps.

5.5.2.3 Evaluation

Each steam generator is designed for the design transients listed in Sections 5.2 and 5.5.2.1 such that no component is stressed beyond the allowable limit as prescribed in the ASME Code, Section III.

Each steam generator is capable of withstanding these conditions for the prescribed number of cycles without exceeding the allowable cumulative usage factor as prescribed in the ASME Code, Section III.

5.5.2.3.1 Tube Vibration

Potential sources of tube excitation are considered, including primary fluid flow within the U-tubes, mechanically induced vibration, and secondary fluid flow on the outside of the U-tubes. The effects of primary fluid flow and mechanically induced vibration, including those developed by the reactor coolant pump, are acceptable during normal operation. The primary source of potential tube degradation due to vibration is the hydrodynamic excitation of the tubes by the secondary fluid. This area has been emphasized in both analyses and tests, including evaluation of steam generator operating experience.

Three potential tube vibration mechanisms related to hydrodynamic excitation of the tubes have been identified and evaluated. These include potential flow-induced vibrations resulting from vortex shedding, turbulence, and fluid-elastic vibration mechanisms.

Non-uniform, two-phase turbulent flow exists throughout most of the tube bundle. Therefore, vortex shedding is possible only for the outer few rows of the inlet region. Moderate tube response caused by vortex shedding is observed in some carefully controlled laboratory tests on idealized tube arrays. However, no evidence of tube response caused by vortex shedding is observed in steam generator scale model tests simulating the inlet region. Bounding calculations consistent with laboratory test parameters confirmed that vibration amplitudes would be acceptably small, even if the carefully controlled laboratory conditions were unexpectedly reproduced in the replacement steam generators.

Flow-induced vibrations due to flow turbulence are also small. As evaluated, the root mean square amplitudes are less than allowances used in tube sizing. These vibrations cause stresses that are below fatigue limits for the tubing material; therefore, neither unacceptable tube wear nor fatigue degradation due to secondary flow turbulence is anticipated.

ARKANSAS NUCLEAR ONE
UNIT 2

Fluid-elastic tube vibration is potentially more severe than either vortex shedding or turbulence because it is a self-excited mechanism. Relatively large tube amplitudes can feed back proportionally large tube driving forces if an instability threshold is exceeded. Tube support spacing in both the tube support plates and the anti-vibration bars in the U-bend region provides tube response frequencies such that the instability threshold is not exceeded for secondary fluid flow conditions for tubes effectively supported. This approach provides large margins against initiation of fluid elastic vibration for tubes effectively supported by the tube support system.

Pressure pulsations from the reactor coolant pumps and acoustic effects have been evaluated in the past for hydrodynamic excitation of the tubing, and experience has demonstrated that these mechanisms have minimal contribution to tube response.

The steam generator includes a number of features that minimize the potential for tube wear at tube supports and anti-vibration bars. Provisions to minimize the potential for wear include the spacing between the tube supports, the configuration of the broached hole through the support plate, the surface finish of the broached hole in the tube support plate, the clearance between the tube and the hole in the tube support plant, tube support plate material selection, and the configuration of the anti-vibration bar assemblies.

As outlined, analyses and tests demonstrate that unacceptable tube degradation resulting from tube vibration is not expected for the steam generators. Operating experience with steam generators having the same size tubes and similar flow conditions supports this conclusion.

5.5.2.3.2 Tube Corrosion

Several corrosion mechanisms have been identified in operating nuclear power plant steam generators that can result in unacceptable tube degradation. The ANO-2 steam generator design addresses these degradation mechanisms and provides a design that is very resistant to tube corrosion. Given that appropriate water chemistry is maintained, the steam generators are designed for a cumulative operating service of 40 years. The ANO-2 replacement steam generators (RSGs) were installed in 2000, thus their 40-year design life extends to 2040. License renewal extends the ANO-2 operating license to 2038, prior to the end of the design life of the RSGs.

Tube wastage is a corrosion mechanism that results in a general thinning of the tubing. This mechanism was associated with phosphate chemistry. The use of all volatile treatment (AVT) water chemistry has eliminated the occurrence of tube wastage.

Several features in the ANO-2 steam generator design minimize crevice areas and the deposition of contaminants from the secondary-side flow. Such crevices and deposits could otherwise produce a local environment allowing adverse conditions to develop and result in material corrosion.

Corrosion of carbon steel support plates in early model steam generators in some cases resulted in denting of the tubes. Corrosion of the plate can reduce the size of the drilled hole in the plate since the corrosion product has a larger specific volume than the original steel. Continued progression of the corrosion can lead to a tight crevice and a reduction of the tube diameter. These conditions result in a concentration of chemicals and higher stress in the tubes. This may result in stress corrosion cracking.

ARKANSAS NUCLEAR ONE UNIT 2

The use of corrosion resistant Type 405 ferritic stainless steel support plates precludes the denting of the tubes. The use of a trifoil hole minimizes the potential for concentration of chemicals at the interface between the tube and support plate. It provides high sweeping velocities at the tube and the tube support plate intersections. The sweeping velocities through the support plate reduce the sludge accumulation in the tube-to-tube support crevices. This support plate design contributes to a high circulation ratio. The higher circulation ratio results in increased flow in the interior of the bundle, as well as horizontal velocity across the tubesheet, which reduces the tendency for sludge deposition.

The tubes are tack expanded, welded at the tube end, and hydraulically expanded essentially over the full depth of the tubesheet. Expansion of the tube provides the capability to control secondary water ingress to the tube-to-tubesheet crevice. The transition between the expanded and unexpanded portions of the tube is a location of residual stress. The use of a roller to effect the expansion would leave a relatively high residual stress at the transition. The use of an explosive expansion would reduce the residual stress, but there would be less control on the vertical location of the transitions and the interference fit between the tubesheet and the tube. Therefore, roll expansion and explosive expansion are not used for the steam generator tubes. The use of a hydraulic expansion process in the steam generators produces residual stresses smaller than from other expansion methods in the transitions. Residual stresses are minimized by tight control of the pre-expansion clearance between the tube and tubesheet hole. The length of the expansion is carefully controlled to minimize the potential of an over-expanded condition above the tubesheet and the extent of unexpanded tube at the top of the tubesheet. Along with measurement of the tubesheet thickness, hydraulic expansion minimizes the crevice between the tube and tubesheet. These features minimize the potential for outside diameter stress corrosion cracking at the top of the tubesheet.

Thermally treated (TT) nickel-chromium-iron Alloy 690 used for the steam generator tubes is very resistant to corrosion in steam generator applications. Alloy 690TT has been proven through both laboratory testing and operational experience to provide increased corrosion resistance compared to mill annealed Alloy 600 with regard to PWSCC and ODSCC. Alloy 690TT has been determined to be the material of choice for steam generator application based on extensive industry testing.

Industry corrosion tests subjected the steam generator tubing material to simulated steam generator water chemistry. These tests indicated that the loss due to general corrosion over the 40-year operating design objective is small compared to the tube wall thickness. Testing to investigate the susceptibility of heat exchanger construction materials to stress corrosion in caustic and chloride aqueous solutions indicate the Alloy 690TT provides as good or better corrosion resistance as either Alloy 600 or nickel-iron-chromium Alloy 800. Alloy 690TT also resists general corrosion in severe operating water conditions.

High margins against primary water stress corrosion cracking exist with the specification of thermally treated Alloy 690 tubing. Alloy 690 is resistant to primary water stress corrosion cracking over the range of anticipated operating environments. The tubing is thermally treated according to a laboratory-derived treatment process.

5.5.2.3.3 Tube Plugging

The replacement steam generators, prior to installation, required one (1) tube to be plugged in Steam Generator B due to a over expansion beyond the tubesheet face and the removal of the expansion mandrel at the manufacturers facility. All tube plugging at the manufacturer's facility was performed in accordance with ASME Code, Section III. All tube plugging subsequent to installation of the steam generators is performed in accordance with ASME, Section XI. The plugging/repair limit for tubing is defined in the Technical Specifications.

ARKANSAS NUCLEAR ONE
UNIT 2

5.5.2.3.4 Allowable Tube Wall Degradation

The acceptance criteria for allowable tube wall degradation is defined in the Technical Specifications.

The program for the inservice inspection of steam generator tubing is in conformance with the guidance of NEI 97-06, Steam Generator Program Guidelines and the ASME Code, Section XI. ANO-2 TS 6.5.9 establishes requirements on the sample size and the inspection interval. ASME Code, Section XI establishes the standards for examination and allowable flaws in tubing.

The steam generator tubes, existing originally at their minimum wall thickness and reduced by a conservative general corrosion and erosion loss, provide an adequate safety margin (sufficient wall thickness) so that the maximum stress is less than the allowable stress limit, as defined by the ASME Code, Section III.

In addition to the analysis required by the ASME Code, an analysis (Reference 20) to establish the minimum wall thickness of the tubes using the guidance of Regulatory Guide 1.121 was performed for the steam generators. This analysis supports the allowable tube wall degradation as defined in the Technical Specifications. The Regulatory Guide 1.121 analysis is performed for loads corresponding to full power operation as well as the full range of normal operating transients and accident conditions. The limiting stresses for normal operation and operating transient conditions are the primary membrane stresses due to the primary to secondary pressure differential across the tube wall. For the Faulted plant condition, the postulated Level D Service conditions events are Loss of Coolant Accident, Main Steam Line Break, Main Feed Line Break, and Design Basis Earthquake. The tube integrity evaluation is performed for the blowdown loads in conjunction with the DBE loads. The initial conditions for these events correspond to 100% full power conditions, thus maximizing the resulting tube loadings.

Based upon the above, the most restrictive conditions were analyzed to determine the minimum allowable tube wall thickness for uniform tube wear and for wear over a limited axial extent at the tube support plate and anti-vibration bar intersections. The analyses confirm a defined structural limit of 57.5% allowable defect depth in the most limiting case and the 40% plugging limit for the tubing defined in the Technical Specifications. The tube wall is capable of meeting the applicable requirements with adequate allowance for eddy current measurement uncertainties and an assumed allowance for continued degradation.

5.5.2.3.5 Potential Effects of Tube Rupture

The postulated rupture of a steam generator tube results in leakage from the RCS to the main steam system. Radioactivity in the reactor coolant mixes with water in the shell side of the affected steam generator. This radioactivity is transported to the turbine and then to the condenser, or directly to the condenser via the main steam dump and bypass system. Non-condensable radioactive gases in the condenser are removed by the condenser vacuum pump air ejectors and released to the vent. The analysis of a postulated steam generator tube rupture is presented in Section 15.1.18.

Experience with PWR steam generators indicates that the probability of complete severance of a tube is remote. The material used to fabricate the U-tubes is a ductile Ni-Cr-Fe alloy. The more probable modes of tube failure are those which result in smaller leaks, as a result of the occurrence of small cracks in the tube, or those involving a larger break flow as a result of

ARKANSAS NUCLEAR ONE
UNIT 2

mechanical wear related to tube thinning. The tube wear is typically caused by fretting between a tube and a foreign object. Detection and control of steam generator tube leakage is described in Section 11.2.

5.5.2.3.6 Composition of Secondary Fluid

Radioactivity concentration in the secondary side of the steam generator is dependent upon the activity level of the RCS, the primary to secondary leak rate, and the operation of the steam generator blowdown system. An evaluation of shell side radioactivity concentration is given in Section 11.2.

The recirculating water within the steam generators will contain volatile additions necessary for proper pH chemistry control. These and other chemistry considerations of the main steam system are discussed in Sections 10.3 and 10.4. The all volatile treatment (AVT) control program minimizes the possibility of the tube wall thinning phenomenon. Successful AVT operation requires maintenance of low concentrations of impurities in the steam generator water. This reduces the potential for formation of highly concentrated solutions in low-flow zones, which is a precursor of corrosion. By restricting the total alkalinity in the steam generator and prohibiting extended operation with free alkalinity, the all volatile treatment program minimizes the possibility for intergranular corrosion in localized areas due to excessive levels of free caustic.

Laboratory testing shows that Alloy 690TT tubing is compatible with the AVT environment. Isothermal corrosion testing in high-purity water shows Alloy 690TT exhibiting normal microstructure tested at normal engineering stress levels is not susceptible to intergranular stress corrosion cracking in extended exposure to high-temperature water. These tests also show that no general type corrosion occurred. Field experience with Alloy 690TT tubing in operation since 1989 has been excellent.

5.5.2.3.7 Tests and Inspections

The steam generators are tested in accordance with ASME Code, Section III which requires the nondestructive tests during fabrication listed in Table 5.5-3.

During design and fabrication of the steam generator, additional operations beyond the requirements of the ASME Code, Section III were performed. These included ultrasonic testing for defects in tube sheet clad and ultrasonic testing of weld clad for bond integrity.

Hydrostatic tests of the primary and secondary sides of the steam generator have been conducted in accordance with the ASME Code, Section III. Leak tests were also performed. Following satisfactory performance of the hydrostatic tests, magnetic-particle inspections were made on all accessible welds.

Steam generator performance was verified during initial startup tests and was verified as part of post installation testing of the replaced steam generators.

5.5.3 REACTOR COOLANT PIPING

5.5.3.1 Design Basis

The reactor coolant piping is designed and analyzed for all transients specified in Section 5.2. Loading combinations and stress criteria associated with faulted conditions are presented in Section 5.2. In addition, certain nozzles are subjected to local transients which are included in

ARKANSAS NUCLEAR ONE
UNIT 2

the design and analysis of the areas affected. Thermal sleeves are installed in the surge nozzle, safety injection nozzles and charging nozzles to accommodate these additional transients. Principal parameters are listed in Table 5.5-4.

The piping is Seismic Category 1. Additional discussions on seismic and dynamic analysis and criteria for the reactor coolant piping are contained in Sections 3.7.3 and 3.9.1, respectively.

Vibration testing of reactor coolant piping is discussed in Section 14.1.1.5.

Reactor coolant piping vibrations are also monitored by the Vibration and Loose Parts (V&LP) monitoring system which is described in Section 5.2.8.8.

5.5.3.2 Description

Each of the two heat transfer loops contains five sections of pipe: one 42-inch internal diameter pipe between the reactor vessel outlet nozzle and steam generator inlet nozzle, two 30-inch internal diameter pipes from the steam generator's two outlet nozzles to the reactor coolant pumps suction nozzle, and two 30-inch internal diameter pipes from the pumps discharge nozzle to the reactor vessel inlet nozzles. These pipes are referred to as the hot leg, the suction legs, and the cold legs, respectively.

The other major piece of reactor coolant piping is the surge line, a 12-inch schedule 160 pipe between the pressurizer and the hot leg in Loop 2P32A/B. The arrangement of this piping is shown in Figure 5.1-1.

To minimize the possibility of stress corrosion cracking, the reactor coolant piping is fabricated from SA 516 GR 70 base material mill clad with Type 304L stainless steel. A minimum clad thickness of 1/8 inch is maintained. Small lines such as the surge lines, spray lines, and other small lines are stainless steel. Nozzles are shop fabricated with safe ends, to preclude dissimilar-metal field welds. Where stainless steel or Ni-Cr-Fe nozzle or safe end material is used, the safe ends are welded to the assembly after final stress relief to prevent furnace sensitization. Other precautions that are used in the shop and during field assembly of the piping are described in Section 5.2. In addition, to ascertain the integrity of the piping during plant life, necessary inservice inspections required by the ASME Code, Section XI are performed where required on the reactor coolant piping. To facilitate such inspections, longitudinal weld seams have been oriented at the 90-degree and 270-degree locations where feasible. Removable insulation is installed to provide access to the welds.

5.5.3.3 Evaluation

The piping is shop fabricated and shop welded into subassemblies to the greatest extent practicable to minimize the amount of field welding. Welding procedures and operations meet the requirements of Section IX of the ASME Boiler and Pressure Vessel Code. All welds are 100 percent radiographed and liquid-penetrant or magnetic-particle tested and all reactor coolant piping penetrations are attached in accordance with the requirements of ASME III. Cleanliness standards consistent with nuclear service are maintained during fabrication and erection. There are no dissimilar metal field welds.

Stress corrosion cracking of the stainless steel piping requires the presence of halides (chlorides and fluorides) or sulfates. The reactor coolant chemistry control described in Section 9.3.4 assures that the halide or sulfate concentration in the RCS is below the level required for the development of stress corrosion cracking. Other material considerations are addressed in Section 5.2.

ARKANSAS NUCLEAR ONE
UNIT 2

The transients for the piping design are listed in Section 5.2. The seismic design of the system is described in Section 3.7.

Thermal sleeves are installed in the surge line, charging and inlet shutdown cooling nozzles to reduce thermal shock effects from auxiliary systems. Clad sections of piping are fitted with safe ends for field welding to stainless steel components, i.e., the reactor coolant pumps and the surge line.

The 42- and 30-inch pipe diameters were selected to obtain coolant velocities which provide a reasonable balance between erosion-corrosion, pressure drop, and system volume. The surge line is sized to limit the frictional pressure loss through it during the maximum in-surge so that the pressure differential between the pressurizer and the heat transfer loops is no more than five percent of the system design pressure.

5.5.3.4 Tests and Inspections

Prior to and during fabrication of the piping, nondestructive testing based on the requirements of the ASME Code is applied. The component inspection program during fabrication and construction is summarized in Table 5.5-5.

Inservice inspection of the RCS piping is discussed in Section 5.2. Tests for RCS integrity following normal opening, modification or repair are specified in the Technical Specifications Section 4.4.10.1.

5.5.4 MAIN STEAM FLOW RESTRICTIONS

Each steam generator has a steam flow-limiting device (flow restrictor), consisting of seven venturis installed into integral holes in the steam outlet nozzle of the steam generator. The steam generator main steam outlet nozzle flow restrictor, in the event of a main steam line rupture, will limit the flow from a rupture. The restrictor reduces the rate of mass and energy release from the steam generators prior to closure of the main steam isolation valves in the event of a steam line break. If the steam line rupture is downstream of the main steam isolation valves, closure will terminate blowdown. If the rupture is upstream of the main steam isolation valves the steam generator associated with the ruptured line will continue blowing down until empty. The analysis of this accident is discussed in Section 15.1.14.

5.5.5 MAIN STEAM ISOLATION SYSTEM

5.5.5.1 Design Bases

The main steam line isolation system is designed for automatic or manual operation to isolate the steam generator secondary side from the main steam lines in the event of a main steam line rupture or for maintenance.

5.5.5.2 Description

Each main steam line is provided with an air-operated isolation valve outside containment (refer to Chapter 10). The valves are closed automatically by the occurrence of a low steam generator pressure signal or high high containment pressure which generates the main steam isolation signal (refer to Section 7.3).

ARKANSAS NUCLEAR ONE
UNIT 2

5.5.5.3 Evaluation

The system and its supports and restraints are designed to ensure that an inadvertent isolation or a main steam line rupture will not result in failure of any associated component, i.e., feedwater lines or intact steam line. The piping and associated supports and restraints of the main steam system from the steam generator to the downstream side of the isolation valves are Seismic Category 1 and are designed to ASME Section III, Class 2. Further safety considerations are discussed in Section 10.3.3.

5.5.5.4 Testing and Inspection

The components of the main steam isolation system are inspected visually where practicable. Additionally, the actuation signals, automatic and manual, are tested periodically to ensure operability of the valves and the actuation signals.

5.5.6 REACTOR CORE ISOLATION COOLING SYSTEM

This system is unique to BWRs and is not a part of the Unit 2 design.

5.5.7 RESIDUAL HEAT REMOVAL SYSTEM

As noted in Section 3.1 in the response to General Design Criterion 34, (10 CFR 50, Appendix A), residual heat removal is accomplished by the main steam system when the reactor coolant temperature is above 275 °F and by the shutdown cooling system at temperatures below 275 °F. The main steam system is described in Chapter 10. The shutdown cooling system is one of the process auxiliary systems and is described in Section 9.3.6.

The condensing shutdown mode is a BWR operating mode and is not applicable to Unit 2.

5.5.8 REACTOR COOLANT CLEANUP SYSTEM

This system is unique to BWR's and is not a part of the Unit 2 design. An analogous function for PWRs is provided by the Chemical and Volume Control System (CVCS), described in Section 9.3.4.

5.5.9 MAIN STEAM LINE AND FEEDWATER PIPING

The main steam system is not a part of the RCS in a PWR such as Unit 2. This piping is described in Chapter 10.

5.5.10 PRESSURIZER

5.5.10.1 Design Bases

The pressurizer is designed and analyzed for the transients specified in Section 5.2 and the following additional requirements. During heatup and cooldown of the plant, the allowable rate of temperature change for the pressurizer is 200 °F per hour as a design requirement.

ARKANSAS NUCLEAR ONE
UNIT 2

The pressurizer is designed to:

- A. Maintain RCS operating pressure;
- B. Compensate for changes in coolant volume during load changes;
- C. Contain sufficient volume to prevent draining the pressurizer as a result of reactor trip;
- D. Limit the water volume to minimize the energy release during LOCA;
- E. Prevent uncovering of the heaters by the out-surge of water following load decreases - 10 percent step decrease and five percent per minute ramp decrease;
- F. Provide sufficient volume to accept the reactor coolant in-surge resulting from a loss of load without the water level reaching the safety valve nozzles;
- G. Provide sufficient volume to yield acceptable pressure response to normal system volume changes during load change transients;
- H. Achieve a total coolant volume change and associated charging and letdown flows which are as small as practical and are compatible with the capacities of the volume control tank, charging pumps and letdown control valves during load following transients; and,
- I. Ensure that the minimum pressure observed during transients is above the setpoint of the safety injection actuation signal, and that the maximum pressure is below the high pressure trip.

The heater capacity is selected to provide an adequate pressurizer heatup rate during plant startup.

The pressurizer is Seismic Category 1.

5.5.10.2 Description

The pressurizer is shown in Figure 5.5-8 and the design parameters are given in Table 5.5-6.

The pressurizer is a cylindrical carbon steel vessel with stainless steel or Ni-Cr-Fe clad internal surfaces. A spray nozzle on the top head is used in conjunction with heaters in the bottom head to provide pressure control. Overpressure protection is provided by two safety valves. An acoustical valve monitoring system provides the control room operator with open/closed position indication of the safety valves on annunciator panel 2K10. This system is required by NUREG-0578, Item 2.1.3a. Pressurizer level control is discussed in Section 9.3.4. The pressurizer is supported by a cylindrical skirt welded to the bottom head. A surge line connects the pressurizer to the reactor coolant piping in loop 2P32A/B hot leg.

The pressurizer is designed and fabricated in accordance with the ASME Code listed in Table 5.2-1. The interior surface of the cylindrical shell and upper head is clad with weld deposited stainless steel. The lower head is clad with Ni-Cr-Fe alloy to facilitate welding of the Ni-Cr-Fe alloy heater sleeves to the shell. A stainless steel safe end is provided on the pressurizer nozzles after vessel final stress relief to facilitate field welds to the stainless steel surge line piping.

ARKANSAS NUCLEAR ONE UNIT 2

The total volume of the pressurizer is established by consideration of the factors given in Section 5.5.10.1. To account for these factors and to provide adequate margin at all power levels, the water level in the pressurizer is programmed as a function of average coolant temperature as shown in Figure 5.5-9. High or low water level error signals result in the control actions shown in Table 5.5-13 and described below.

Pressure is maintained by controlling the temperature of the saturated liquid volume in the pressurizer. At full load conditions, slightly more than one-half the pressurizer volume is occupied by saturated water, and the remainder by saturated steam. In order to maintain the programmed pressure the corresponding saturation temperature must be maintained. To maintain this temperature approximately one-third of the heaters are kept energized to compensate for heat losses through the vessel and to raise the continuous subcooled pressurizer spray flow to the saturation temperature.

During load changes, the pressurizer limits pressure variations caused by expansion or contraction of the reactor coolant. The average reactor coolant temperature is programmed to vary as a function of load as shown in Figure 5.3-1. A reduction in load is followed by a decrease in the average reactor coolant temperature to the programmed value for the lower power level. The resulting contraction of the coolant lowers the pressurizer water level causing the reactor system pressure to decrease. This pressure reduction is partially compensated by flashing of pressurizer water into steam. All pressurizer heaters are automatically energized on low system pressure, generating steam and further limiting pressure decrease. Should the water level in the pressurizer drop sufficiently below its setpoint, the letdown control valves close to a minimum value and additional charging pumps in the CVCS are automatically started to add coolant to the system and restore pressurizer level.

When steam demand is increased, the average reactor coolant temperature is raised in accordance with the coolant temperature program. The expanding coolant from the reactor coolant piping hot leg enters the bottom of the pressurizer through the surge line, compressing the steam and raising system pressure. The increase in pressure is moderated by the condensation of steam during compression and by the decrease in bulk temperature in the liquid phase. Should the pressure increase be large enough, the pressurizer spray valves open, spraying coolant from the reactor coolant pump discharge (cold leg) into the pressurizer steam space. The relatively cold spray water condenses some of the steam in the steam space, limiting the system pressure increase. The programmed pressurizer water level is a power dependent function. A high level error signal produced by an in-surge causes the letdown control valves to open, releasing coolant to the CVCS and restoring the pressurizer to the prescribed level. Small pressure and coolant volume variations are accommodated by the steam volume which absorbs flow into the pressurizer and by the water volume which allows flow out of the pressurizer.

The pressurizer heaters are single unit, direct immersion heaters which protrude vertically into the pressurizer through sleeves welded in the lower head. Each heater is internally restrained from high amplitude vibrations and can be individually removed for maintenance during plant shutdown.

Approximately one-third of the heaters are connected to proportional controllers which adjust the heat input as required to compensate for steady state losses and to maintain the desired steam pressure in the pressurizer. The remaining backup heaters are connected to on-off controllers. These heaters are normally de-energized but are turned on by a low pressurizer pressure signal or high level error signal. This latter feature is provided since load increases

ARKANSAS NUCLEAR ONE
UNIT 2

result in an in-surge of relatively cold coolant into the pressurizer, thereby decreasing the bulk water temperature. The CVCS acts to restore level, resulting in a transient pressure below normal operating pressure. To minimize the extent of this transient, the backup heaters are energized, contributing more heat to the water. A low-low pressurizer level signal de-energizes all heaters to protect the heaters should they uncover.

The pressurizer proportional heater feeders are furnished with power (watt) transducers providing an analog value of the circuit power to the Safety Parameter Display System. The magnitude of the power indicates the operational status and integrity of the heater bank.

To assure sufficient pressurizer control for natural circulation flow at hot standby following a loss of off-site power, the proportional heaters circuit breaker was modified to enable the operator to re-energize the proportional heaters from the diesel generator safety buses. The capability for manual transfer of 150 kW of pressurizer heaters to each safety bus following a loss of off-site power and an Safety Injection Actuation Signal (SIAS) originally existed. Operating procedures require that the operator monitor and maintain the diesel generator within its load limits. The 7-day rating will not be exceeded with the heaters actuated, thus giving ample time to determine loads that can be shed for continuous operation.

Establishing the adequacy of this modification from an operational and safety standpoint requires two separate justifications:

- A. Adequacy of 300 kW of pressurizer heaters for providing pressure control; and,
- B. Capability of each diesel generator to accept 150 kW of pressurizer heaters.

The 150 kW of pressurizer capacity powered from an assured power source will ensure, for 588,000 BTU/hr ambient losses, that RCS subcooling margin will be maintained ≥ 20 °F for a period of 45 hours following loss of off-site power. This time period includes a period of one-half hour at the beginning of the transient in which the heaters are unavailable.

Actual heat losses from the pressurizer, from startup testing data, is 596,000 BTU/hr or 8,000 BTU/hr greater than that assumed above. However, this 8,000 BTU/hr increase in losses would only require a 2.345 kW increase to offset this loss increase and, therefore, will have little impact on the 45 hours calculated above.

This calculation is conservative in that the actual heat losses would decrease during the transient as RCS pressure and temperature decreases, thereby heater capacity would more closely approach the pressurizer ambient losses and hence prolong the time to reach 20 °F margin to saturation.

The capability of the Unit 2 diesel generators to carry maximum ESF loads including 150 kW of pressurizer heaters is demonstrated by design calculation. See Section 8.3.1.1.7 and Table 8.3-1.

The pressurizer spray is supplied from each of the reactor coolant pump cold legs in loop 2P32A/B to the pressurizer spray nozzle. Automatic spray control valves control the amount of spray as a function of pressurizer pressure; both of the spray control valves function in response to the signal from the controller. To improve spray valve control and reliability, motor actuators have been installed in place of the hydraulic actuators on spray valves 2CV4651 and 2CV4652. Hand switches have been installed on panels 2C04 and 2C80 for remote manual spray valve control. Handswitch 2HS4655, with dual indicating lights, has been installed on

ARKANSAS NUCLEAR ONE
UNIT 2

Panel 2C04 to provide dual control of isolation valves 2CV4655 and 2CV4656. These valves were installed at management discretion to provide an operational contingency for a failed spray valve. The valves have no specified safety function to close, throttle or isolate flow. They are not credited in any accident analysis. Handswitch 2HS4653, with dual indicating lights, has been installed on Panel 2C04 to provide dual control of isolation valves 2CV4653 and 2CV4654. These valves were installed at management discretion to provide an operational contingency for a failed spray valve. The valves have no specified safety function to close, throttle or isolate flow. They are not credited in any accident analysis.

These components are sized to use the differential pressure between the pump discharge and the pressurizer to pass the amount of spray required to maintain the pressurizer steam pressure during normal load following transients. A small continuous flow is maintained through the spray lines at all times to keep the spray lines and the surge line warm to reduce thermal shock during plant transients. The continuous flow serves to keep the chemistry and boric acid concentration of the pressurizer water the same as that of the coolant in the heat transfer loops. An auxiliary spray line is provided from the charging pumps to permit pressurizer spray during plant heatup, or to allow cooling if the reactor coolant pumps are shut down.

In the event of an abnormal transient which causes a sustained increase in pressurizer pressure at a rate exceeding the control capacity of the spray, a high pressurizer pressure reactor trip will be initiated. This trip setpoint was increased to 2,362 psig, eliminating a 23 psig dynamic allowance for instrument response which test data demonstrated was not required.

To provide ample venting capacity for venting of non-condensable gases during long-term cooldown and following an accident, remotely operated high point vents were added to the RCS at the pressurizer and the reactor vessel. This is primarily to prevent the collecting non-condensable gases from interrupting natural circulation flow.

The Unit 2 analysis of combustible gas control in containment is given in Section 6.2.5. This analysis shows that Unit 2 is provided with hydrogen control systems which meet the design criteria of Regulatory Guide 1.7. The release of hydrogen through the RCS vents will not change the total volume of hydrogen released to the reactor building. Therefore, compliance with 10 CFR 50.44 will not be affected by addition of RCS vents.

The ESFAS pressurizer pressure bypass is provided to allow plant depressurization for maintenance and testing without undesired actuation of ESF equipment. This bypass must be initiated manually by switches in each protective channel and is possible only below the bypass permissive, which is less than 400 psia. This bypass is automatically removed before pressurizer pressure rises to 500 psia.

5.5.10.3 Evaluation

It is shown by analysis made in accordance with the requirements of the ASME Code, Section III that the pressurizer is adequate for all normal operating and transient conditions expected during the life of the plant. Following fabrication, the pressurizer was hydrostatically tested and then nondestructively tested in accordance with the ASME Code, Section III.

During hot functional testing, the transient performance of the pressurizer is checked by determining its normal heat losses and maximum pressurization and depressurization rates. This information is used in setting the pressure controllers.

ARKANSAS NUCLEAR ONE
UNIT 2

Further assurance of the structural integrity of the pressurizer during plant life is obtained from the inservice inspections performed in accordance with the ASME Code, Section XI and described in Section 5.2.

Overpressure protection of the RCS is provided by two ASME code spring-loaded safety valves.

5.5.10.4 Tests and Inspections

Prior to and during fabrication of the pressurizer, nondestructive testing was performed in accordance with the requirements of the ASME Code. The results of the pressurizer inspection program are summarized in Table 5.5-7.

5.5.11 QUENCH TANK (PRESSURIZER RELIEF TANK)

5.5.11.1 Design Basis

The quench tank is designed to receive and condense the normal discharges from the pressurizer safety valves and prevent the discharge from being released to the containment. The quench tank is sized to receive and condense discharges from the anticipated operational occurrences (AOOs) and not the extended blowdown that has been calculated during postulated accidents. The quench tank is not safety related (Q listed), and the quenching of the steam internal to the tank is not a required safety related function. The safety related function that must be ensured is the maintenance of a discharge flow path for the pressurizer safety valves and the Low Temperature Overpressure Protection (LTOP) relief valves. A rupture disk is provided on the quench tank that will release excess steam to the containment building and maintain the discharge flow path for the pressurizer safety valves and the LTOP relief valves.

The tank volume was originally based on the need to condense steam from the pressurizer safety valves resulting from a loss of load followed immediately by an uncontrolled rod withdrawal, with no coolant letdown or pressurizer spray. The calculated total (integral) steam release for these two consecutive events was originally 625 lbs.

Analyses have been completed which have resulted in a different release mass to the quench tank than the mass released to the pressurizer from the original quench tank sizing analysis. The Uncontrolled Rod Withdrawal from 1% Power transient now credits the CPC generated variable overpower trip for initiating a reactor trip, and the calculated pressure during this transient does not increase to the safety valve setpoints. The steam release resulting from a Loss of Load combined with a Loss of Condenser Vacuum transient is calculated to be 731 lbs of steam during this transient with the safety valve setpoints at the nominal value of 2500 psia. These analyses verified this mass addition to the quench tank would not result in pressures that would cause the rupture disc to burst.

5.5.11.2 Description

The tank, shown in Figure 5.5-11, is an austenitic stainless steel vessel suitable for prolonged contact with borated or demineralized water. Nozzles are provided for the safety valve discharge line, vents, drains, instrumentation, makeup water, nitrogen addition, and the rupture disc.

The tank is designed and fabricated in accordance with the ASME Code, Section VIII, Division 1. The design parameters are given in Table 5.5-8.

ARKANSAS NUCLEAR ONE
UNIT 2

The tank contains demineralized water and gas. During power operation, a nitrogen blanket is maintained on the tank. The sparger, spray header, nozzles and rupture disc fittings are stainless steel. The steam discharged into the quench tank from the pressurizer valves is discharged under water by the sparger to enhance condensation.

The contents of the quench tank are cooled by draining a portion of the contents and refilling with reactor makeup water. Quench Tank water level indication and high and low water level alarms are provided in the control room along with a 0-100 psig pressure indicator, temperature indicators, and alarms.

Leakage or discharge from the pressurizer safety valves is indicated and alarmed in the control room by temperature measurements and acoustical flow monitoring system in each valve pipe line to the quench tank header.

5.5.11.3 Evaluation

Evaluations beyond the requirements of the ASME Code, Section VIII, include the tank head in accordance with Welding Research Council Bulletin #95. Compliance with this reference results in a tank head which is thicker than Section VIII design methods.

The tank is analyzed to ensure that no tank or support failures will occur during a DBE and to ensure that the natural frequency of the tank is greater than 20 cps so that resonance will not occur. The sparger is analyzed for both seismic forces and blowdown forces.

5.5.12 VALVES

5.5.12.1 Design Basis

The safety-related function of valves within the RCPB is to act as pressure retaining boundaries and leaktight barriers during normal plant operation, accidents and seismic disturbances.

These valves are designed in accordance with ASME Code, Section III, Class 1 or Class 2 requirements, except as provided for in 10 CFR 50.55a(c)(2), and must withstand the effects of transients listed in Section 5.2, plus other transients associated with the location or service requirements. The valves must also meet Seismic Category 1 requirements. Backseats on manual and motor operated gate and globe valves can be used to minimize potential leakage. Functional requirements for each valve are detailed in the individual valve specifications.

Materials of construction are specified to ensure compatibility with the environment and contained fluids. Loadings and stresses for valves in Seismic Category 1 systems that require analysis are in accordance with Section 3.9.

5.5.12.2 Description

All valves in the RCS are constructed primarily of stainless steel. Other materials in contact with the coolant, such as for hard facing and packing, are compatible materials. Fasteners, packing glands and yoke fasteners are also constructed of stainless steel to eliminate corrosion.

There are two full capacity motor-operated spray valves in the RCS. The design parameters are given in Table 5.5-9. The spray valves are located near the top of the pressurizer. The valves are automatically operated by the pressurizer pressure control system to maintain pressurizer pressure control in conjunction with the pressurizer heater during load changes and expected transients.

ARKANSAS NUCLEAR ONE
UNIT 2

5.5.12.3 Evaluation

All valves within the RCPB are stress analyzed as required by ASME Code, Section III, Class 1, except as provided for in 10 CFR 50.55a(c)(2), taking into consideration cyclic loadings. Valve leakage is minimized by design features as discussed above.

The position of each valve on loss of actuating signal (failure position) is selected to ensure safe operation of the system and plant. System redundancy is considered when specifying the failure position of any given valve. Valve position indication is provided on the control panel for each of these valves necessary to ensure safe operation of the plant.

The only WASH-1400 Event V valve configurations at Unit 2 are located between the RCS high pressure piping and the low pressure injection system, and consist of two check valves in series with a motor operated isolation valve. To ensure integrity and protection of the low pressure piping, periodic leak tests are performed in accordance with the technical specification surveillance requirements. Additionally, pressure upstream of the first check valve off the RCS is alarmed in the control room. None of these valves have been known or found to lack integrity.

Gate valves in the RCS have backseats which can be used to limit stem leakage when in the open position. Globe valves are installed with flow entering the valve under the seat. This arrangement will reduce stem leakage during normal operation or when closed.

In addressing IE Bulletin 81-02 two Borg Warner motor operated valves in the ECCS vent line had to be evaluated for the ability to close against differential pressure. Installation of the LTOP system resulted in the removal and sparing of one of the two valves in question. The remaining valve, 2CV-4698-1, has been modified in accordance with Borg Warner instructions such that it is certified to open at differential pressures up to 2,585 psig, and to close at differential pressures up to 1,416.9 psig. Since the current use of 2CV-4698-1 is to provide one means of depressurizing the RCS to allow adequate High Pressure Safety Injection (HPSI) flow, it does not need to close against high differential pressures and the certified capability to close at differential pressures up to 1,416.9 psig is adequate. In addition, a valve of a different type has been installed in series with the ECCS vent valve.

5.5.12.4 Tests and Inspections

In addition to the hydrostatic test required by the ASME Code, Section III, valves are tested for seat leakage, packing leakage, and cyclic operation. They are checked for minimum wall thickness and end-to-end dimensions and for failure position.

5.5.13 SAFETY AND RELIEF VALVES

5.5.13.1 Design Basis

There are no power-operated relief valves in the RCS. The safety valves on the pressurizer are designed to protect the system, as required by Section III of the ASME Boiler Code.

The design basis for establishing the relieving capacity of the pressurizer safety valves is presented in Section 5.2.2.3.1. For the postulated transients presented in Chapter 15, the results indicate that the pressurizer will not go 'solid' and that the relieving capacity of the safety valves is sufficient to provide overpressure protection in accordance with Section III of the

ARKANSAS NUCLEAR ONE
UNIT 2

ASME Code. Safety valves on the steam side of each steam generator are designed to protect the steam system, as required by the ASME Code, Section III. They are conservatively sized to pass a steady state steam flow equivalent to the maximum expected power level.

5.5.13.2 Description

The RCS has two safety valves to provide overpressure protection. The design parameters are given in Table 5.5-10. These valves are flange mounted on the top of the pressurizer. Because these pressurizer relief valves are mounted directly on the pressurizer nozzles, there is no ASME Class 1 piping affected by them. They are direct acting, spring-loaded safety valves meeting ASME Code requirements. They have an enclosed bonnet and have a balanced bellows for superimposed back pressure.

The safety valves pass sufficient pressurizer steam to limit the reactor coolant system pressure to 110 percent of design (2,750 psig). An addendum to the ANO-2 Overpressure Protection Report verified the RCS pressure limit is not exceeded as a result of the installation of the replacement steam generators. Values for the system parameters, delay times and core moderator coefficient are given in Chapter 15.

During low temperature RCS operations, overpressure protection for the RCS is provided by two Low Temperature Overpressure Protection (LTOP) relief valves or an equivalent or larger opening in the RCS. Examples of RCS openings are removal of the steam generator primary manway on the hot leg, removal of the pressurizer code safety valve, removal of the pressurizer manway, or removal of the reactor vessel head. A single LTOP relief valve will prevent overpressurization of the RCS during the design basis overpressurization event such that the applicable pressure-temperature limits are not exceeded (See Section 7.6.1.3). Each LTOP relief valve is isolated from the RCS by two isolation valves. The LTOP valves are operator enabled during cooldown between 275 °F and 270 °F and isolated during heatup between 275 °F and 280 °F. The lift pressure for the LTOP valves is \leq 430 psig.

Overpressure protection for the shell side of the steam generators and the main steam line up to the inlet of the turbine stop valve is provided by 10 flanged, spring-loaded, direct acting, ASME Code safety valves which have open bonnets and discharge to atmosphere. Five of these safety valves are mounted on each of the main steam lines upstream of the steam line isolation valves but outside the containment. The opening pressure of the valves is set in accordance with ASME Code allowances. Parameters for the main steam safety valves are given in Table 5.5-11.

An acoustical valve monitoring system with redundant sensors on each safety valve is supplied to provide direct indication of safety valve position (i.e., open or closed) in accordance with Regulatory Guide 1.97. An alarm is provided in the control room to sound when either valve is opened, and analog indication will be displayed for each valve. The acoustic monitoring system has been tested and found to be seismically and environmentally qualified. The system sensor cables have been routed in channelized seismic Class 1 raceways, but the system is supplied with only single channel safety grade power which is consistent with the requirements of Regulatory Guide 1.97 category 2 variables.

5.5.13.3 Evaluation

Overpressure protection is discussed in Section 5.2.2. The ASME Code "Report on Overpressure Protection" is described in Section 5.2.2.3.1.

ARKANSAS NUCLEAR ONE
UNIT 2

5.5.13.4 Tests and Inspections

The valves are inspected during fabrication in accordance with ASME III Code requirements. The inlet is hydrostatically tested and the outlet is pneumatically tested. Seal leakage is checked by a steam test at 93 percent of set pressure. Set pressure and blowdown are adjusted using steam.

5.5.14 COMPONENT SUPPORTS

5.5.14.1 Design Basis

The criteria applied in the design of the RCS supports are that the necessary function of the supported equipment be achieved during all normal, earthquake, and LOCA conditions. The supports are designed to support and restrain the RCS components under the combined Design Basis Earthquake (DBE) and LOCA loadings in accordance with the stress and deflection limits listed in Section 3.6.

Analytical methods used to determine an adequate safety margin to brittle fracture are described in the CE Report, "Fracture Mechanics Procedures for Primary Component Support Toughness Evaluations."

5.5.14.2 Description

5.5.14.2.1 Reactor Vessel Supports

The reactor vessel is supported by three vertical columns located under the reactor vessel nozzles (see Figure 5.5-12). The columns are sufficiently flexible to allow radial thermal expansion of the vessel. Keyways on the sides of the integral support pads under the nozzles guide the vessel during thermal expansion and maintain the location of the vessel vertical centerline. A key on the lower vessel head provides additional seismic restraint.

5.5.14.2.2 Steam Generator Supports

The steam generator is supported at the bottom by a sliding base bolted to an integrally attached cylindrical skirt. The sliding base rests on low friction bearings which allow unrestrained thermal expansion of the RCS. Structural analysis has concluded that there will not be excessive movement of the bottom of the steam generator under the loads generated by a seismic event or BLPB.

A system of keys and snubbers located on the upper shell guide the top of the steam generator during expansion and contraction of the RCS and provide restraint during seismic events and following a BLPB or a steam line break.

The steam generator supports are shown in Figure 5.5-13.

5.5.14.2.3 Reactor Coolant Pump Supports

Each reactor coolant pump is provided with four vertical spring-type hangers which provide support for normal operation and seismic conditions. In addition each pump has two horizontal hydraulic snubbers to dampen torsional oscillation of the pump on the main coolant piping under seismic conditions. The CE report, "Fracture Toughness - Response to Item 1 Subtopic 4 of

ARKANSAS NUCLEAR ONE
UNIT 2

NRC's August 5, 1980 Letter," describes the fracture evaluation of the reactor coolant pump seismic snubber lugs. This evaluation compares the stress intensity factor computed assuming large flaws to the lower bound toughness suggested by NUREG-0577, and demonstrates an adequate safety margin against brittle fracture.

The reactor coolant pump supports are shown in Figures 5.5-14 and 5.5-15.

5.5.14.2.4 Pressurizer Supports

The pressurizer is supported by a cylindrical skirt welded to the pressurizer and bolted to the support structure. The skirt is designed to withstand dead weight and normal operating loads, seismic events, and LOCA.

5.5.14.3 Evaluation

The RCS supports are designed to the criteria for load combinations and stresses which are presented in Section 5.2. The criteria is used to determine the loads the support must react with as a result of the effects of pipe rupture and seismic conditions.

The design and construction of Arkansas components supports preceded the applicable dates for mandatory compliance to Subsection NF. In this regard, however, the supports which are an integral part of the reactor vessel, steam generator and pressurizer were designed to the stress limits of the parent vessel which were designed and constructed per the ASME Codes shown in Table 5.2-1. The same is true for the reactor coolant pump except that its applicable code is ASME Section III 1971 Edition. The reactor vessel column supports complied with the AISC Code, Manual of Steel Construction, seventh edition. The steam generator sliding base was originally analyzed in accordance with the 1971 ASME B&PV Code, Section III through Winter 1973 Addenda including Appendix F and Subsection NF.

5.5.14.4 Testing and Inspection

Tests were conducted on materials similar to that being used for the reactor vessel and steam generator sliding supports to demonstrate that the maximum static coefficient of friction does not exceed 0.15 at a design loading of 5,000 psi. All sliding supports were 100 percent liquid penetrant inspected at the vendor's shops. The steam generator base was ultrasonically and magnetic-particle inspected.

The steam generator snubbers were tested in the vendor's shop at the rated load capacity in both tension and compression. The piston creep velocities were measured during these tests for compliance with specification limits. Tests were also conducted for initiation of snubber action on both the tension and compression directions.

Supports integral to the RCS components received quality assurance inspections in accordance with the ASME Code, Section III, during fabrication.

During preoperational testing of the RCS, the support displacements were monitored for agreement with calculated displacements and/or clearances. Inservice inspections of supports which are integral with RCS components are conducted in accordance with the ASME Code, Section XI.

ARKANSAS NUCLEAR ONE
UNIT 2

5.6 INSTRUMENTATION REQUIREMENTS

The measurement channels necessary for operational control and protection of the Reactor Coolant System (RCS) are described below and listed in Table 5.6-1. A brief explanation of the purpose of each measurement channel is made and a summary of resulting actions is given. A detailed description of critical instrument channel actions may be found in Chapter 7.

Four independent measurement channels are provided for each parameter which initiates protective system action. Two independent signals are required to initiate protective action, thereby preventing spurious actions resulting from the failure of one measurement channel. The 2-out-of-4 arrangement results in a high degree of protective measurement channel reliability in terms of initiating action when required and avoiding unnecessary action from spurious signals. Two independent measurement channels are provided for parameters which are important to operational control. These control channels are separate from the protective measurement channels. To avoid control conflicts, control action is derived from only one channel at any time, while the second channel serves as a backup. This allows continued operation if one channel fails and permits maintenance on the accessible portion of the failed channel during operation.

5.6.1 TEMPERATURE

5.6.1.1 Hot Leg Temperature

Each of the two hot legs contains nine dual element narrow-range RTD channels to measure coolant temperature leaving the reactor vessel. Originally, there were five RTDs per hot leg. Four provided inputs to the safety-related Core Protection Calculators (CPCs) and the fifth provided an input to the Reactor Regulating System (RRS). During startup power testing, a hot leg temperature anomaly, characterized by flips in T_h , was observed in the CPCs. To provide a more representative temperature signal to the CPCs, four additional narrow range RTDs were installed on each hot leg opposite the existing RTDs. An average of the two RTD temperature signals is used by each CPC.

The hot leg temperature channels associated with the CPCs are monitored by the plant computer and are displayed in the control room. The second temperature element on Channels 3 and 4 provide signals to the Safety Parameters Display System (SPDS) and the RCS margin-to-saturation monitors. Margin-to-saturation is displayed on a 2-pen recorder in the control room.

One hot leg RTD channel per loop provides a signal to the Reactor Regulating System (RRS). This channel is also monitored by the plant computer and SPDS. The RRS uses hot leg (T_h) and cold leg (T_c) inputs to compute average temperatures for each loop. These are averaged again to produce an RCS average temperature (T_{avg}), which is displayed on a digital read-out in the control room. The RRS also generates a reference temperature signal (T_{ref}) based on turbine first stage pressure. Both T_{avg} and T_{ref} can be displayed and trended in the control room on the plant computer. The operator is responsible for ensuring that these two values are matched. In addition to the indication, this channel is alarmed on high temperature in the control room.

ARKANSAS NUCLEAR ONE
UNIT 2

5.6.1.2 Cold Leg Temperature

Each of the four cold legs contains three temperature measurement channels. The cold leg RTDs are located downstream of the reactor coolant pumps. Two RTDs from each cold leg (four per heat transfer loop) are used to furnish a cold leg coolant temperature signal to the CPCs. The second element on Channel 3 and 4 goes to the RCS saturation monitors (TSAT). Indication of all eight of these cold leg temperature measurements is provided in the control room.

The two cold leg temperature RTDs, one on each cold leg, are routed to a channel selector switch (one per heat transfer loop). This selector switch enables either cold leg temperature to be recorded on a wide-range temperature recorder in the main control room. The remaining channel of each loop provides a signal to generate the average temperature in the reactor regulating system.

5.6.1.3 Surge Line Temperature

This measurement channel provides an indication of surge line temperature in the control room. A low surge line temperature condition activates an alarm in the control room. A low temperature alarm during normal operation is an indication that the continuous spray rate has decreased.

5.6.1.4 Pressurizer Temperature

The pressurizer water phase RTD is located at an elevation below the top of the pressurizer heaters. This channel provides a wide-range temperature indication in the control room and is used during plant heatup and cooldown.

5.6.1.5 Spray Line Temperature

An RTD in each spray line provides a temperature indication and a low temperature alarm in the control room for each spray line. A low temperature alarm during normal operation is an indication that the continuous spray rate has decreased.

5.6.1.6 Relief Line Temperature

Temperatures in the primary safety valve discharge lines are measured and indicated in the control room. A high temperature in one of these lines is an indication that the associated valve may be leaking. High temperature alarms are provided to alert the operator to this condition.

5.6.1.7 Quench Tank Temperature

The temperature of the water in the quench tank is indicated in the control room. A high temperature alarm is provided to alert the operator to pressurizer code safety valve leakage.

5.6.2 PRESSURIZER PRESSURE

5.6.2.1 Protection

Four independent narrow range pressure and four independent wide range channels are provided for initiation of protective system action. The pressure transmitters are connected to the upper portion of the pressurizer via the upper level measurement nozzles and measure

ARKANSAS NUCLEAR ONE
UNIT 2

pressurizer vapor pressure. All four channels are indicated in the control room and separate high- and low-low pressure alarms in the control room are actuated by the reactor protective system.

The protection actions these pressure signals initiate are:

- A. Reactor trip on high primary system pressure (narrow range)
- B. Safety injection system actuation on low primary system pressure (wide range).
- C. Reactor trip on a low Departure from Nucleate Boiling Ratio (DNBR) (narrow range).
- D. Reactor trip on low primary system pressure (wide range).
- E. Containment Cooling System Actuation (wide range).

In addition, four non Class 1E pressure channels are provided as inputs to the DSS to initiate a reactor trip upon high pressurizer pressure due to an ATWS event.

5.6.2.2 Control

Two independent pressure channels provide wide range pressure signals for controlling the pressurizer heaters and spray valves. The output of one of these channels is manually selected to perform the control function. During normal operation, two small groups of heaters are proportionally controlled to offset heat losses. If the pressure falls below a low pressure setpoint, all of the heaters are energized. If the pressure increases above a high pressure setpoint, the spray valves are proportionally opened to increase the spray flow rate as pressure rises. The two channels are displayed and recorded in the main control room and are provided with high and low pressure alarms.

5.6.2.3 Startup and Shutdown

Two diverse restricted-range pressure measurement channels provide a control room indication of RCS pressure during plant startup and shutdown in the control room. They also provide pressure signals to the shutdown cooling suction isolation valves (that prevents opening above a selected setpoint) and the safety injection tank isolation valves (to ensure they are open).

5.6.2.4 Quench Tank Pressure

Quench tank pressure is indicated in the control room. A high pressure alarm is provided.

5.6.3 LEVEL

5.6.3.1 Control

Two temperature compensated pressurizer level channels (red and green) are used to provide two independent level signals for control of the pressurizer liquid level. These signals are used to de-energize the pressurizer heaters on low-low pressurizer level to prevent heater burnout, provide input to one pen of a two pen recorder in the control room (the other pen records level setpoint), and actuate high, low and low-low pressurizer level alarms in the control room. The temperature input for compensation of both channels is provided from one dual element RTD. Both channels are indicated in the control room.

ARKANSAS NUCLEAR ONE
UNIT 2

The liquid level in the pressurizer is programmed to vary as a function of average reactor coolant temperature and is computed by the reactor regulating system. If the level indication differs from the computed program level, the control system adjusts the Chemical and Volume Control System (CVCS) charging or letdown flow rates to correct the deviation.

5.6.3.2 Startup and Shutdown

Two safety-related, wide range temperature compensated pressurizer level channels are provided for main control room indication of pressurizer level during plant startup and shutdown. In addition, a black non-safety-related channel (also temperature compensated) is provided in the control room.

5.6.3.3 Quench Tank Level

Quench tank level is indicated in the control room. High and low level alarms are provided.

5.6.4 REACTOR COOLANT LOOP FLOW

Reactor coolant flow measurement is described in Chapter 7.

5.6.5 REACTOR COOLANT PUMP INSTRUMENTATION

The reactor coolant pumps and motors are equipped with the instrumentation necessary for proper operation and to warn of incipient failures. A description of the major instrumentation follows.

5.6.5.1 Temperature

5.6.5.1.1 Pump Seal Temperatures

The reactor coolant temperature in the lower seal cavity is fed to the plant computer. The pump seal temperature is also alarmed to alert the operators to a high temperature condition. A high temperature condition is an indication that the integral heat exchanger is not performing satisfactorily or is a backup indication that the component cooling water flow has decreased or supply temperature increased.

5.6.5.1.2 Motor Stator Temperatures

Each reactor coolant pump motor is provided with six RTDs embedded in the stator windings. The two highest reading RTDs chosen during pump testing are selected for input to the control room. One is connected to the plant computer and one is indicated and alarmed on a control panel. Should stator temperature exceed a predetermined limit, a high temperature alarm will be sounded in the control room. High temperature is detrimental to motor winding insulation life, and may be caused by high ambient temperature, reduction in the cooling airflow to the stator or inadequate time delay between successive starts of the motor.

5.6.5.1.3 Motor Bearing Temperature

Temperatures of the motor lower thrust, upper thrust, upper radial, and lower radial bearings are fed to the plant computer. The upper and lower motor thrust bearings are also displayed in the control room and annunciated if either thrust bearing temperature exceeds a safe value.

ARKANSAS NUCLEAR ONE
UNIT 2

5.6.5.2 Pressure

5.6.5.2.1 Pump Seal Pressures

The middle, upper, and vapor pump seal cavities in each pump are provided with pressure elements which generate a signal proportional to the pressure within the cavity. The pressure in the seals is displayed in the control room. Abnormally high pressure in the upper and middle seal cavities indicates a failed or failing lower or middle seal. A low pressure condition in the middle seal cavity indicates a failed or failing upper seal.

5.6.5.2.2 Motor Oil Lift Pump Discharge Pressure

This pressure measurement channel provides a local indication of oil lift pump discharge pressure.

5.6.5.3 Motor Oil Reservoir Level

Differential pressure transmitters are used to produce signals proportioned to the oil levels in the upper and lower motor oil reservoirs. These signals are used to annunciate low level alarms in the control room.

5.6.5.4 Reverse Rotation Switch

Reverse rotation of a reactor coolant pump is sensed by a reverse rotation switch. This switch actuates an alarm in the control room. Reverse rotation indicates failure of the mechanical anti-rotation device.

5.6.5.5 RCP Pump/Motor Vibration Monitoring

The vibration of the RCP motor shaft is monitored at the upper and lower guide bearings. The vibration of the pump shaft is monitored at the pump-half coupling hub. In addition, shaft axial position and vibration phase angle are monitored by probes placed in the pump coupling area. All HI and HI-HI alarms for each pump are reflashed to drive a common annunciator. The plant computer is utilized to provide a control room indication of the amplitude of each channel.

5.6.5.6 Motor Current SPDS Inputs

Each RCP motor feeder is furnished with a current transducer providing an analog value of pump motor current to the Safety Parameter Display System Computer. The magnitude of the current is related to pump/motor integrity, and pump load can indicate a saturated condition.

ARKANSAS NUCLEAR ONE
Unit 2

5.7 REFERENCES

1. Historical Data Removed – Refer to FSAR.
2. Deleted.
3. Bisplinghoff, R. L., Holt Ashley, and R. L. Halfman, Aero-Elasticity, Addison-Wesley Publishing Company, Inc., Cambridge, Mass., 1955.
4. Engle, Ward W. Jr., "A User's Manual for ANISN, A One-Dimensional Discrete Ordinate Transport Code with Anisotropic Scattering," K-1693, March 30, 1967.
5. Griffin, James H., "MEC-21, A Flexibility Analysis Program for the IBM7090 and 7094," July 14, 1964.
6. Guenther, T. G. and D. C. Lovejoy, "Analysis for Calculation Lateral Vibration Characteristics of Rotating Systems With Any Number of Flexible Supports - Part 2 - Application of the Method of Analysis," Journal of Applied Mechanics, December, 1961.
7. Koenig, E. C., "Analysis for Calculating Lateral Vibration Characteristics of Rotating Systems With Any Number of Flexible Supports - Part I - The Method of Analysis," Journal of Applied Mechanics, December, 1961.
8. Moody, F. J., "Maximum Two-Phase Blowdown From Pipes," Journal of Heat Transfer, August, 1966.
9. Letter from Olan D. Parr (NRC) to F. M. Stern (C-E), dated May 15, 1975.
10. Deleted.
11. Stephen, D. W., "Fast Neutron Attenuation by the P3MG, C-17 Shielding Method," CEND-302, July, 1967.
12. Deleted.
13. Witt, F. J., "Heavy Section Steel Technology Program Semiannual Progress Report," ORNL-4315, February 29, 1968.
14. Yudawa, S., D. P. Timo, and N. Rubio, Fracture Design Practice for Rotating Equipment, Vol. 5, Ch. 2, Academic Press, N.Y., 1969.
15. Regulatory Guide 1.45, Reactor Coolant Pressure Boundary Leakage Detection Systems, dated May 1973.
16. CEOG Topical Report CEN-367-A, Leak-Before Break Evaluation of Primary Coolant Loop Piping in Combustion Engineering Designed Nuclear Steam Supply System.
17. Letter 2CNA069601, Subject: Containment Leak Detection Capabilities with Permanent Reactor Vessel Seal Plate at Arkansas Nuclear One, Unit 2 (TAC NO. M90610), dated June 18, 1996.

ARKANSAS NUCLEAR ONE
Unit 2

18. Battelle Report, "Final Report on Examination Testing, and Evaluation of Irradiated Pressure Vessel Surveillance Specimens from the Arkansas Nuclear One Unit 2 Generating Plant to Arkansas Power and Light Company, " by Lowry, Landow, Failey, Jung, Manahan, and Denning, May 1, 1984.
19. ABB-CE Report A-PENG-ER-002, Revision 0, "The Reactor Vessel Group Records Evaluation Program Phase II Final Report for the ANO-2 Reactor Pressure Vessel Plates, Forgings, Welds, and Cladding. " October 1995.
20. "Regulatory Guide 1.121 Analysis for Arkansas Nuclear One Unit 2 Replacement Steam Generators," Westinghouse Proprietary Class 2 Report, WCAP 15406, July 2006.
21. "Analysis of Capsule W-104 Entergy Operations, Inc., Arkansas Nuclear One Unit 2 Power Plant, Reactor Vessel Material Surveillance Program," [BAW-2399](#), Framatome ANP, Inc., Lynchburg, Virginia, February 2005.
22. "Appendix G Pressure-Temperature Limits for 32 EFPY, Using ASME Code Cases for ANO-2", Summary Report BAW-2405, Framatome ANP, Inc., Lynchburg, Virginia, May 2005.
23. Framatome-ANP Calculation 32-5024781-00, "ANO-2 P-T Limits at 48 EFPY for License Renewal," March 2003 (Engineering Report A2-EP-2004-005, Revision 0).
24. Framatome-ANP Calculation 32-5024086-01, "ANO-2 Reactor Vessel Adjusted RT/NDT Values at 48 EFPY," May 2005.
25. [WCAP-18169-NP](#), "Arkansas Nuclear One Unit 2 Heatup and Cooldown Limit Curves for Normal Operation," December 2016 (Engineering Report [CALC-ANO2-EP-17-00002](#), Revision 0).
26. [US NRC](#), Letter to Richard L. Anderson (2CNA111801), "Arkansas Nuclear One, Unit 2 – Issuance of Amendment Re: Updating the Reactor Coolant System Pressure-Temperature Limits," November 27, 2018.
27. [WCAP-14040-A](#), "Methodology Use to Develop Cold Overpressure Mitigating System Setpoints and RCS Heatup and Cooldown Limit Curves," May 2004.
28. [WCAP-18166-NP](#), "Analysis of Capsule 284° from the Entergy Operations, Inc. Arkansas Nuclear One Unit 2 Reactor Vessel Radiation Surveillance Program," September 2016 (Engineering Report [CALC-ANO2-EP-17-00001](#), Revision 0).
29. [WCAP-18170-NP](#), "Arkansas Nuclear One Unit 2 End-of-License Extension Reactor Vessel Integrity Evaluation," January 2017 (Engineering Report [CALC-ANO2-EP-17-00003](#), Revision 0).

ARKANSAS NUCLEAR ONE
UNIT 2

Table 5.1-1

ORIGINAL DESIGN PARAMETERS OF REACTOR COOLANT SYSTEM*
(See Table 5.1-1a for revised best estimate design parameters)

Design Thermal Power, Mwt (Includes Net Heat Addition from Pumps)	2825
Btu/hr	9.644 x 10 ⁹
Design Pressure (except Steam Generator), psia	2500
Design Temperature (Except Pressurizer), °F ⁽¹⁾	650
Pressurizer Design Temperature, °F	700
Coolant Flow Rate, lb/hr	120.4 x 10 ⁶
Cold Leg Temperature, °F ⁽²⁾	553.5
Average Temperature, °F ⁽²⁾	583
Hot Leg Temperature, °F ⁽²⁾	612.5
Normal Operating Pressure, psia ⁽²⁾	2250
System Water Volume, ft ³ (Without Pressurizer)	8860
Pressurizer Water Volume, ft ³	600
Pressurizer Steam Volume, ft ³	600
Initial Hydrostatic Test Pressure of RCS Components at 100 °F (Except Reactor Coolant Pump), psia	3125
Initial Reactor Coolant Pump Hydrostatic Test Pressures, psia	
Casing and Cover	3342
Heat Exchanger Inner Coil - High Pressure	3750
Seal Flange	3750
Upper & Middle Seal Pressure Breakdown Device	4080

* See Chapter 3 for a description of the seismic analysis of reactor coolant system components. Seismic design loads for RCS components are presented in Table 3.7-8.

⁽¹⁾ Miscellaneous RCS piping associated with the pressurizer has a design temperature of 658 °F, and the pressurizer surge line has a design temperature of 700 °F.

⁽²⁾ The values listed represent historical operating conditions. The latest pressure-temperature analyses shall be utilized for determination of pressure-temperature design inputs.

ARKANSAS NUCLEAR ONE
UNIT 2

Table 5.1-1A

DESIGN PARAMETERS (BEST ESTIMATE) OF REACTOR COOLANT SYSTEM*

Design Thermal Power, MWt (Includes Net Heat Addition from Pumps)	3044
Btu/hr	10.389 x 10 ⁹
Normal Operating Pressure, psia (in Pressurizer)	2200
Coolant Flow Rate, gpm (at full power)	351,800
Temperature	
Cold Leg (coolant inlet), °F	551.0
Average Temperature, °F	580.0
Hot Leg (coolant outlet), °F	609.4
Maximum System Water Volume, ft ³ (Without Pressurizer)	9334
Pressurizer	
Normal Operating Temperature, °F	653
Water Volume, ft ³	680
Steam Volume, ft ³	520
Spray Flow, Maximum, gpm	513
Spray Flow, Continuous, gpm	1.5 (nominal)
Heaters (installed)	96
Installed Heater Capacity, kw	1263 (nominal)
Reactor Coolant Pump	
Normal Operating Pressure, psig	2215
Maximum Flow (One Pump Operation @ 70 °F), gpm	124,050
Flywheel (Motors 2P32B, C, & D)	ASTM A-533 Gr B Class 1
Flywheel (Motor 2P32A)	ASTM A-508 Class 5

* Table 5.1.1a parameters revised due to the steam generator and pressurizer replacements and the power uprate. Actual operating parameter values may vary from calculated values presented in table.

ARKANSAS NUCLEAR ONE
UNIT 2

Table 5.1-2

REACTOR COOLANT SYSTEM VOLUMES

<u>Component</u>	<u>Volume (Ft³)</u>
Reactor Vessel	4080
Steam Generators	3676
Reactor Coolant Pumps	448
Pressurizer	1200
Piping:	
Hot Leg	292
Cold Leg	782
Surge Line	26
Quench Tank	254

ARKANSAS NUCLEAR ONE
UNIT 2

Table 5.1-3

**REACTOR COOLANT SYSTEM
PROCESS DATA POINT TABULATION**

<u>Parameters Description</u>	<u>Units</u>	<u>Process Data Point Locations*</u>							
		<u>1</u>	<u>2</u>	<u>3</u>	<u>4</u>	<u>5</u>	<u>6</u>	<u>7</u>	<u>8</u>
RCS Pressure	psia	2200	2174	2258	2240	2258	2174	2258	2258
RCS Temperature	°F	649	579	551	579	551	579	551	551
Weight Flow	lb/hr (x10 ⁻⁶)	-	66.2	33.1	132.1	33.1	66.2	33.0	33.0
Volume Flow	gpm (x10 ⁻³)	-	176.4	88.3	352.3	88.1	175.9	87.9	88.0

*RCS Process Data Point Locations

- | | |
|--------------------------|--------------------------|
| 1. Pressurizer | 5. 2P32A Discharge |
| 2. 2E24A Steam Generator | 6. 2E24B Steam Generator |
| 3. 2P32B Discharge | 7. 2P32C Discharge |
| 4. Reactor Vessel | 8. 2P32D Discharge |

Values given are nominal. Actual operating pressure, temperatures, and flows may vary. Note the above pressures are static pressures.

Note: The above tabulation is the best estimate flow rate and pressure distribution at a plant power level of 2833 MWt with the replacement steam generators installed assuming no tubes are plugged.

For the original process data point locations indicated on the P&ID, refer to M-2230.

ARKANSAS NUCLEAR ONE
UNIT 2

Table 5.2-1

REACTOR COOLANT SYSTEM PRESSURE BOUNDARY CODE REQUIREMENTS

<u>Component</u>	<u>Codes and Classes</u>
Reactor Vessel	<ol style="list-style-type: none">1. ASME Boiler and Pressure Vessel Code, Section III, 1968 Edition through Summer 1970 Addenda.2. ASME Boiler and Pressure Vessel Code, Section XI, Rules for Inservice Inspection of Nuclear Power Plant Components. Qualification and certification of ultrasonic examination personnel performing inservice inspections shall be as required by the NRC, 1995 edition with addenda through 1996.
Replacement Steam Generators, Replacement Pressurizer	<ol style="list-style-type: none">1. ASME Boiler and Pressure Vessel Code, Section III, 1989 Edition, no Addenda.2. ASME Boiler and Pressure Vessel Code, Section XI, Rules for Inservice Inspection of Nuclear Power Plant Components.
Reactor Coolant Pump	<ol style="list-style-type: none">1. ASME Boiler and Pressure Vessel Code, Section III, Nuclear Power Plant Components, Class 1, 1971 Edition.2. ASME Boiler and Pressure Vessel Code, Section XI, Rules for Inservice Inspection of Nuclear Power Plant Components. Qualification and certification of ultrasonic examination personnel performing inservice inspections shall be as required by the NRC, 1995 edition with addenda through 1996.3. ASME Standard Code for Pumps and Valves on Nuclear Power Class 1, through Winter 1970 Addenda. (Construction Code for pump casings)
Pressurizer Spray and Safety Valves	<ol style="list-style-type: none">1. ASME Standard Code for Pumps and Valves on Valves Nuclear Power Class 1, through Winter 1970 Addenda.2. ASME Boiler and Pressure Vessel Code, Section XI, Rules for Inservice Inspection of Nuclear Power Plant Components. Qualification and certification of ultrasonic examination personnel performing inservice inspections shall be as required by the NRC, 1995 edition with addenda through 1996.

ARKANSAS NUCLEAR ONE
UNIT 2

Table 5.2-1 (continued)

<u>Component</u>	<u>Codes and Classes</u>
Piping and Valves	<ol style="list-style-type: none">1. ASME Boiler and Pressure Vessel Code, Section III, Nuclear Power Plant Components, Class 1, 1971 Edition through Summer 1971 Addenda.2. ASME Boiler and Pressure Vessel Code Section III, Nuclear Power Plant Components, Class 1, 1980 Edition (for fatigue analysis).3. ASME Boiler and Pressure Vessel Code Section XI, Rules for Inservice Inspection of Nuclear Power Plant Components. Qualification and certification of ultrasonic examination personnel performing inservice inspections shall be as required by the NRC, 1995 edition with addenda through 1996.
Control Element Drive Mechanisms	<ol style="list-style-type: none">1. ASME Boiler and Pressure Vessel Code, Section III, Nuclear Power Plant Components, Class 1, 1971 Edition through Winter 1972 Addenda.2. ASME Boiler and Pressure Vessel Code, Section XI, Rules for In Service Inspection of Nuclear Power Plant Components.

ARKANSAS NUCLEAR ONE
UNIT 2

Table 5.2-2

**ACTIVE AND INACTIVE VALVES IN THE
REACTOR COOLANT SYSTEM BOUNDARY**

Line	Valve Type	Component ID	Description	Classification A- Active I- Inactive	Normal Position	Post-LOCA Position
Safety Injection	Check	2SI-15A	SIT Tank 2T-2A Cold Leg Check Valve	A	Closed	Open
	Check	2SI-15B	SIT Tank 2T-2B Cold Leg Check Valve	A	Closed	Open
	Check	2SI-15C	SIT Tank 2T-2C Cold Leg Check Valve	A	Closed	Open
	Check	2SI-15D	SIT Tank 2T-2D Cold Leg Check Valve	A	Closed	Open
Leakage Control	Solenoid	2SV-5001-1	SIT Tank 2T-2A	I	Closed	Closed
	Solenoid	2SV-5021-1	SIT Tank 2T-2B	I	Closed	Closed
	Solenoid	2SV-5041-2	SIT Tank 2T-2C	I	Closed	Closed
	Solenoid	2SV-5061-2	SIT Tank 2T-2D	I	Closed	Closed
	Manual	2SI-47	2SV-5001-1 Bypass	I	Closed	Closed
	Manual	2SI-41	2SV-5021-1 Bypass	I	Closed	Closed
	Manual	2SI-59	2SV-5041-2 Bypass	I	Closed	Closed
	Manual	2SI-53	2SV-5061-2 Bypass	I	Closed	Closed
Safety Injection Tank	Motor	2CV-5003-1	SIT Tank 2T-2A Isolation	I	Open	Open
	Motor	2CV-5023-1	SIT Tank 2T-2B Isolation	I	Open	Open
	Motor	2CV-5043-2	SIT Tank 2T-2C Isolation	I	Open	Open
	Motor	2CV-5063-2	SIT Tank 2T-2D Isolation	I	Open	Open
	Check	2SI-16A	SIT Tank 2T-2A Check Valve	A	Closed	Open
	Check	2SI-16B	SIT Tank 2T-2B Check Valve	A	Closed	Open

ARKANSAS NUCLEAR ONE
UNIT 2

Table 5.2-2 (continued)

Line	Valve Type	Component ID	Description	Classification A- Active I- Inactive	Normal Position	Post-LOCA Position
Safety Injection Tank (continued)	Check	2SI-16C	SIT Tank 2T-2C Check Valve	A	Closed	Open
	Check	2SI-16D	SIT Tank 2T-2D Check Valve	A	Closed	Open
	Manual	2SI-5113A	2CV-5003-1 to 2SI-16A Pressure Point	I	Closed	Closed
	Manual	2SI-5133A	2CV-5023-1 to 2SI-16B Pressure Point	I	Closed	Closed
	Manual	2SI-5153A	2CV-5043-2 to 2SI-16C Pressure Point	I	Closed	Closed
	Manual	2SI-5173A	2CV-5063-2 to 2SI-16D Pressure Point	I	Closed	Closed
	Manual	2SI-5000A	2PT-5000 Root Valve	I	Open	Open
	Manual	2SI-5000B	2PT-5000 Root Valve	I	Open	Open
	Manual	2SI-5020A	2PT-5020 Root Valve	I	Open	Open
	Manual	2SI-5020B	2PT-5020 Root Valve	I	Open	Open
	Manual	2SI-5040A	2PT-5040 Root Valve	I	Open	Open
	Manual	2SI-5040B	2PT-5040 Root Valve	I	Open	Open
	Manual	2SI-5060A	2PT-5060 Root Valve	I	Open	Open
	Manual	2SI-5060B	2PT-5060 Root Valve	I	Open	Open
LPSI Header	Motor	2CV-5017-1	LPSI Header to Loop "A" Isolation Valve	A	Closed	Open
	Motor	2CV-5037-1	LPSI Header to Loop "B" Isolation Valve	A	Closed	Open
	Motor	2CV-5057-2	LPSI Header to Loop "C" Isolation Valve	A	Closed	Open
	Motor	2CV-5077-2	LPSI Header to Loop "D" Isolation Valve	A	Closed	Open

ARKANSAS NUCLEAR ONE
UNIT 2

Table 5.2-2 (continued)

Line	Valve Type	Component ID	Description	Classification A- Active I- Inactive	Normal Position	Post-LOCA Position
LPSI Header (continued)	Check	2SI-14A	LPSI Header to Loop "A" Check Valve	A	Closed	Open
	Check	2SI-14B	LPSI Header to Loop "B" Check Valve	A	Closed	Open
	Check	2SI-14C	LPSI Header to Loop "C" Check Valve	A	Closed	Open
	Check	2SI-14D	LPSI Header to Loop "D" Check Valve	A	Closed	Open
	Manual	2SI-1072A	"B" Piping Drain Valve	I	Closed	Closed
	Manual	2SI-1054	"C" Piping Drain Valve	I	Closed	Closed
	Manual	2SI-1052	"D" Piping Drain Valve	I	Closed	Closed
	Manual	2SI-1063A	"A" Piping Vent Valve	I	Closed	Closed
	Manual	2SI-1062A	"B" Piping Vent Valve	I	Closed	Closed
	Manual	2SI-5131	"A" Piping Drain Valve	I	Closed	Closed
	Manual	2SI-1020	"C" Piping Vent Valve	I	Closed	Closed
Manual	2SI-1018	"D" Piping Vent Valve	I	Closed	Closed	
HPSI Header	Motor	2CV-5015-1	HPSI Header #1 to Loop "A" Isolation Valve	A	Closed	Open
	Motor	2CV-5016-2	HPSI Header #2 to Loop "A" Isolation Valve	A	Closed	Open
	Motor	2CV-5035-1	HPSI Header #1 to Loop "B" Isolation Valve	A	Closed	Open
	Motor	2CV-5036-2	HPSI Header #2 to Loop "B" Isolation Valve	A	Closed	Open
	Motor	2CV-5055-1	HPSI Header #1 to Loop "C" Isolation Valve	A	Closed	Open

ARKANSAS NUCLEAR ONE
UNIT 2

Table 5.2-2 (continued)

Line	Valve Type	Component ID	Description	Classification A- Active I- Inactive	Normal Position	Post-LOCA Position
HPSI Header (continued)	Motor	2CV-5056-2	HPSI Header #2 to Loop "C" Isolation Valve	A	Closed	Open
	Motor	2CV-5075-1	HPSI Header #1 to Loop "D" Isolation Valve	A	Closed	Open
	Motor	2CV-5076-2	HPSI Header #2 to Loop "D" Isolation Valve	A	Closed	Open
	Check	2SI-13A	HPSI Header to Loop "A" Check Valve	A	Closed	Open
	Check	2SI-13B	HPSI Header to Loop "B" Check Valve	A	Closed	Open
	Check	2SI-13C	HPSI Header to Loop "C" Check Valve	A	Closed	Open
	Check	2SI-13D	HPSI Header to Loop "D" Check Valve	A	Closed	Open
	Manual	2SI-1048	"A" Piping Drain Valve	I	Closed	Closed
	Manual	2SI-1047	"B" Piping Drain Valve	I	Closed	Closed
	Manual	2SI-1050	"D" Piping Drain Valve	I	Closed	Closed
	Manual	2SI-1071	"C" Piping Drain Valve	I	Closed	Closed
	Manual	2SI-1026A	"A" Piping Vent Valve	I	Closed	Closed
	Manual	2SI-1026B	"B" Piping Vent Valve	I	Closed	Closed
	Manual	2SI-1026C	"C" Piping Vent Valve	I	Closed	Closed
	Manual	2SI-1026D	"D" Piping Vent Valve	I	Closed	Closed
	Manual	2SI-5014A	2FT-5014-1 Root Isolation	I	Open	Open
	Manual	2SI-5014B	2FT-5014-1 Root Isolation	I	Open	Open
	Manual	2SI-5014C	2FT-5014-1 Root Isolation	I	Open	Open

ARKANSAS NUCLEAR ONE
UNIT 2

Table 5.2-2 (continued)

Line	Valve Type	Component ID	Description	Classification A- Active I- Inactive	Normal Position	Post-LOCA Position
HPSI Header (continued)	Manual	2SI-5014D	2FT-5014-1 Root Isolation	I	Open	Open
	Manual	2SI-5034A	2FT-5034-1 Root Isolation	I	Open	Open
	Manual	2SI-5034B	2FT-5034-1 Root Isolation	I	Open	Open
	Manual	2SI-5034C	2FT-5034-1 Root Isolation	I	Open	Open
	Manual	2SI-5034D	2FT-5034-1 Root Isolation	I	Open	Open
	Manual	2SI-5054A	2FT-5054-2 Root Isolation	I	Open	Open
	Manual	2SI-5054B	2FT-5054-2 Root Isolation	I	Open	Open
	Manual	2SI-5054C	2FT-5054-2 Root Isolation	I	Open	Open
	Manual	2SI-5054D	2FT-5054-2 Root Isolation	I	Open	Open
	Manual	2SI-5074A	2FT-5074-2 Root Isolation	I	Open	Open
	Manual	2SI-5074B	2FT-5074-2 Root Isolation	I	Open	Open
	Manual	2SI-5074C	2FT-5074-2 Root Isolation	I	Open	Open
	Manual	2SI-5074D	2FT-5074-2 Root Isolation	I	Open	Open
HPSI to Shutdown Cooling	Manual	2SI-29A	HPSI Header #1 to SDC Block Valve	I	Open	Open
	Manual	2SI-1060A	HPSI Header #1 Drain Valve	I	Closed	Closed
	Manual	2SI-29B	HPSI Header #2 to SDC Block Valve	I	Open	Open
	Manual	2SI-1060B	HPSI Header #2 Drain Valve	I	Closed	Closed
	Manual	2SI-31	HPSI Header #2 to HPI Block Valve	I	Closed	Closed
	Manual	2SI-1058A	Penetration 2P-12 Test Connection	I	Closed	Closed
	Manual	2SI-1058B	Penetration 2P-13 Test Connection	I	Closed	Closed

ARKANSAS NUCLEAR ONE
UNIT 2

Table 5.2-2 (continued)

Line	Valve Type	Component ID	Description	Classification A- Active I- Inactive	Normal Position	Post-LOCA Position
HPSI to Shutdown Cooling (continued)	Check	2SI-27A	HPSI Header #1 to SDC	A	Closed	Closed/Open
	Check	2SI-27B	HPSI Header #2 to SDC	A	Closed	Closed/Open
	Check	2SI-28A	HPSI Header #1 to SDC	A	Closed	Closed/Open
	Check	2SI-28B	HPSI Header #2 to SDC	A	Closed	Closed/Open
	Motor	2CV-5101-1	HPSI Header #1 to SDC Isolation	A	Closed	Closed/Open
	Motor	2CV-5102-2	HPSI Header #2 to SDC Isolation	A	Closed	Closed/Open
	Check	2SI-26A	HPSI Header #1 to RB Isolation	A	Closed	Closed/Open
	Check	2SI-26B	HPSI Header #2 to RB Isolation	A	Closed	Closed/Open
	Motor	2CV-5105-1	HPSI Header #1 to SITs	A	Closed	Closed/Open
	Motor	2CV-5106-2	HPSI Header #2 to SITs	A	Closed	Closed/Open
	Manual	2SI-5105A	2PT-5105 Root Isolation Valve	I	Open	Open
	Manual	2SI-5105B	2PT-5105 Root Isolation Valve	I	Open	Open
	Manual	2SI-5106A	2PT-5106 Root Isolation Valve	I	Open	Open
	Manual	2SI-5106B	2PT-5106 Root Isolation Valve	I	Open	Open
Shutdown Cooling Suction	Motor	2CV-5084-1	SDC Isolation	I	Closed	Closed
	Motor	2CV-5086-2	SDC Isolation	I	Closed	Closed
	Relief	2PSV-5085	SDC Relief	I	Closed	Closed
	Manual	2SI-19	SDC to Refuel Canal Isolation	I	Closed	Closed
	Manual	2SI-5116A	SDC MOV Pressure Test Connection	I	Closed	Closed

ARKANSAS NUCLEAR ONE
UNIT 2

Table 5.2-2 (continued)

Line	Valve Type	Component ID	Description	Classification A- Active I- Inactive	Normal Position	Post-LOCA Position
Loop Drains	Manual	2RC-4A	"A" Cold Leg Loop Drain	I	Closed	Closed
	Manual	2RC-4B	"B" Cold Leg Loop Drain	I	Closed	Closed
	Manual	2RC-4C	"C" Cold Leg Loop Drain	I	Closed	Closed
	Manual	2RC-4D	"D" Cold Leg Loop Drain	I	Closed	Closed
	Manual	2RC-5A	"A" Cold Leg Loop Drain	I	Closed	Closed
	Manual	2RC-5B	"B" Cold Leg Loop Drain	I	Closed	Closed
	Manual	2RC-5C	"C" Cold Leg Loop Drain	I	Closed	Closed
	Manual	2RC-5D	"D" Cold Leg Loop Drain	I	Closed	Closed
	Manual	2RC-3	RCS Refueling Level Isolation	I	Closed	Closed
	Manual	2RC-3A	RCS Refueling Level Isolation	I	Closed	Closed
	Manual	2RC-4E	RCS Hot Leg Drain	I	Closed	Closed
	Manual	2RC-5E	RCS Hot Leg Drain	I	Closed	Closed
Letdown	Motor	2CV-4821-1	Letdown Isolation	A	Open	Closed
	Motor	2CV-4820-2	Letdown Isolation	A	Open	Closed
	Manual	2CVC-4820A	Letdown Isolation MOV Pressure Test Connection	I	Closed	Closed
	Manual	2CVC-4820B	Letdown Isolation MOV Pressure Test Connection	I	Closed	Closed
Charging	Motor	2CV-4840-2 ¹	Charging RB Isolation	I	Open/Closed	Open/Closed
	Motor	2CV-4831-2 ¹	"C" Loop Charging Isolation	I	Open/Closed	Open/Closed
	Motor	2CV-4827-2 ¹	"B" Loop Charging Isolation	I	Open/Closed	Open/Closed
	Check	2CVC-28B	"B" Loop Charging Check Valve	A	Open/Closed	Open/Closed
	Check	2CVC-28C	"C" Loop Charging Check Valve	A	Open/Closed	Open/Closed

ARKANSAS NUCLEAR ONE
UNIT 2

Table 5.2-2 (continued)

Line	Valve Type	Component ID	Description	Classification A- Active I- Inactive	Normal Position	Post-LOCA Position
Charging (continued)	Spring Check	2CVC-26	"B" Loop Charging Check Valve	I	Closed	Closed
	Manual	2CVC-27	"B" Loop Charging Check Valve Isolation	I	Open	Open
	Manual	2CVC-1186	"B" Loop Piping Drain Valve	I	Closed	Closed
	Manual	2CVC-1187	"B" Loop Piping Drain Valve	I	Closed	Closed
	Manual	2CVC-1188	"C" Loop Piping Drain Valve	I	Closed	Closed
	Manual	2CVC-1189	"C" Loop Piping Drain Valve	I	Closed	Closed
	Manual	2CVC-1197	Pressurizer Auxiliary Spray Line Drain	I	Closed	Closed
	Manual	2CVC-1198	Pressurizer Auxiliary Spray Line Drain	I	Closed	Closed
	Manual	2CVC-125	RCP Seal Injection Isolation	I	Closed	Closed
	Manual	2CVC-4840A	Charging RB Penetration Pressure Point Isolation	I	Closed	Closed
	Manual	2CVH-1	Regenerative Heat Exchanger (2E-23) Shell Vent	I	Closed	Closed
	Manual	2BM-91	Regenerative Heat Exchanger (2E-23) Shell Drain	I	Closed	Closed
	Manual	2BM-93	Regenerative Heat Exchanger (2E-23) Shell Drain	I	Closed	Closed
Auxiliary Spray	Motor	2CV-4824-2	Charging to Pressurizer Spray	I	Closed	Closed
	Check	2CVC-28A	Charging to Pressurizer Spray	A	Closed	Closed
Pressurizer Spray	Motor	2CV-4651 ¹	Pressurizer Spray Valve	I	Open/Closed	Closed
	Motor	2CV-4652 ¹	Pressurizer Spray Valve	I	Open/Closed	Closed
	Motor	2CV-4653 ¹	Pressurizer Spray Block Valve	I	Open	Open/Closed

ARKANSAS NUCLEAR ONE
UNIT 2

Table 5.2-2 (continued)

Line	Valve Type	Component ID	Description	Classification A- Active I- Inactive	Normal Position	Post-LOCA Position
Pressurizer Spray (continued)	Motor	2CV-4654 ¹	Pressurizer Spray Block Valve	I	Open	Open/Closed
	Motor	2CV-4655 ¹	Pressurizer Spray Block Valve	I	Open	Open/Closed
	Motor	2CV-4656 ¹	Pressurizer Spray Block Valve	I	Open	Open/Closed
	Manual	2RC-8A	Pressurizer Spray Bypass	I	Open	Open
	Manual	2RC-8B	Pressurizer Spray Bypass	I	Open	Open
	Manual	2RC-7A	PZR Spray Line Drain to RDT	I	Closed	Closed
	Manual	2RC-7B	PZR Spray Line Drain to RDT	I	Closed	Closed
	Manual	2RC-6A	PZR Spray Line Drain to RDT	I	Closed	Closed
	Manual	2RC-6B	PZR Spray Line Drain to RDT	I	Closed	Closed
	Manual	2RC-1002A	Pressurizer Spray Line Vent	I	Closed	Closed
	Manual	2RC-1002B	Pressurizer Spray Line Vent	I	Closed	Closed
	Manual	2RC-1003A	Pressurizer Spray Line Vent	I	Closed	Closed
	Manual	2RC-1003B	Pressurizer Spray Line Vent	I	Closed	Closed
Pressurizer Safety	Safety	2PSV-4633		I	Closed	Closed
	Safety	2PSV-4634		I	Closed	Closed
Pressurizer High Point Vent	Solenoid	2SV-4636-1		I	Closed	Open/Closed
	Solenoid	2SV-4636-2		I	Closed	Open/Closed
RV High Point Vent	Solenoid	2SV-4668-1		I	Closed	Open/Closed
	Solenoid	2SV-4668-2		I	Closed	Open/Closed
	Manual	2RC-1008A	RV Head Vent Line Drain	I	Closed	Closed
	Manual	2RC-1008B	RV Head Vent Line Drain	I	Closed	Closed

ARKANSAS NUCLEAR ONE
UNIT 2

Table 5.2-2 (continued)

Line	Valve Type	Component ID	Description	Classification A- Active I- Inactive	Normal Position	Post-LOCA Position
High Point Vent Line Discharge Header	Solenoid	2SV-4669-1	High Point Vent Line Discharge Header To Quench Tank	I	Closed	Open/Closed
	Solenoid	2SV-4670-2	High Point Vent Line Discharge Header To Atmosphere	I	Closed	Open/Closed
	Manual	2RC-4671A	2PT-4671 Root Valve	I	Open	Open
	Manual	2RC-4671B	2PT-4671 Root Valve	I	Open	Open
	Manual	2RC-1001	RV Head Vent Line Isolation	I	Open	Open
LTOP and ECCS Vent	Motor	2CV-4730-1	LTOP Isolation	I	Closed	Closed
	Motor	2CV-4731-2	LTOP Isolation	I	Closed	Closed
	Motor	2CV-4740-2	LTOP/ECCS Vent Isolation	I	Closed	Closed
	Motor	2CV-4741-1	LTOP Isolation	I	Closed	Closed
	Motor	2CV-4698-1	ECCS Vent Line Isolation	I	Closed	Closed
	Manual	2RC-4740A	ECCS Vent Line Vent	I	Closed	Closed
Sample Line	Solenoid	2SV-4639 ²	PZR Surge Line Sample	I	Open/Closed	Open/Closed
	Solenoid	2SV-4665 ²	RCS Sample	I	Open/Closed	Open/Closed
	Solenoid	2SV-5833-1 ²	RB Inboard Sample	I	Open/Closed	Open/Closed
	Solenoid	2SV-5843-2 ²	RB Outboard Sample	I	Open/Closed	Open/Closed
	Motor	2CV-4632 ²	PZR Steam Space Sample Isolation	I	Open/Closed	Open/Closed
	Manual	2RC-9 ²	RCS Hot Leg Sample Isolation	I	Open	Open
	Manual	2RC-10 ²	RCS Hot Leg Sample Isolation	I	Open	Open
	Manual	2RC-16 ²	2PDT-4602 / 2PDT-4603 Root Isolation	I	Open	Open
	Manual	2RC-11 ²	PZR Surge Line Sample Isolation	I	Open	Open

ARKANSAS NUCLEAR ONE
UNIT 2

Table 5.2-2 (continued)

Line	Valve Type	Component ID	Description	Classification A- Active I- Inactive	Normal Position	Post-LOCA Position
Sample Line (continued)	Manual	2RC-12 ²	PZR Surge Line Sample Isolation	I	Open	Open
	Manual	2RC-13 ²	PZR Steam Space Sample Isolation	I	Open	Open
	Manual	2RC-14 ²	PZR Steam Space Sample Isolation	I	Open	Open
	Manual	2RC-1000A ²	RCS Tygon Tube Level Isolation	I	Closed	Closed
	Manual	2RC-1000B ²	RCS Tygon Tube Level Isolation	I	Closed	Closed
	Manual	2PS-96 ²	RCS RB Penetration Sample Isolation	I	Open	Open
	Manual	2PS-1004 ²	RCS Sample RB Penetration Line Drain	I	Closed	Closed
	Manual	2PS-1006 ²	RCS Sample RB Penetration Line Drain	I	Closed	Closed
	Manual	2PS-5838A ²	RCS RB Penetration Test Isolation	I	Closed	Closed
	Manual	2PS-5839A ²	RCS RB Penetration Test Isolation	I	Closed	Closed

¹ Valves may be open or shut during normal operation or post-accident.

² Component may be excluded from RCPB based on SAR definition 5.2A.

ARKANSAS NUCLEAR ONE
UNIT 2

Table 5.2-3

REACTOR COOLANT SYSTEM MATERIALS

Reactor Vessel	
Shell	SA-533 Grade B, Class 1 Steel (8-5/8 in. minimum thickness)
Forgings	SA-508 Class 2
*Cladding	Weld Deposited Austenitic Stainless Steel (Type 304) or NiCrFe Alloy (equivalent to SB-168), 1/8 in. minimum
*Vessel Internals	Type 304 Austenitic Stainless Steel and NiCrFe Alloy
*Fuel Cladding	Zircaloy-4
*Control Element Drive Mechanism	
Housings	SA-182 Special Code Case 1337
Nozzles	Type 316 Stainless Steel
Pressurizer	
Shell	SA-508 Grade 3, Class 1
*Cladding	Austenitic Stainless Steel or NiCrFe Alloy (equivalent to SB-168, Alloy 690)
Steam Generator	
Primary Head	SA-508, Class 3a (forging)
*Primary Head Cladding	Weld Deposited Stainless Steel, Type 309L/308L
Tube Sheet	SA-508, Class 3a (forging)
*Tube Sheet Cladding	Weld Deposited NiCrFe Alloy (UNS N06052/W86152)
*Tubes	SB-163 Alloy UNS N06690 (thermally treated)
Shell	SA-508, Class 3a (forgings)
Reactor Coolant Pumps	
*Casing	ASME-SA-351 GR CF8M
*Internals	ASTM-A-351-69, Gr CF8
Wear Ring	CF8

* Indicates material exposed to reactor coolant.

ARKANSAS NUCLEAR ONE
UNIT 2

Table 5.2-3 (continued)

Reactor Coolant Piping	
*Pipe	SA-516 Grade 70
*Cladding	Austenitic Stainless Steel (Type 304), 3/16 in. nominal
*Surge Line	Austenitic Stainless Steel (Type 304)
*Valves	Stainless Steel ***
Weld Materials for Reactor Coolant Pressure Boundary	
Base Material	Weld Material
SA-533 Grade B, Class 1	SFA-5.5 E-8018**, C3; MIL-18193, B4
SA-508 Class 2 to SA-533 Grade B, Class 1	SFA-5.5 E-8018, C3
SA-508 Class 3a to SA-516 Grade 70	SFA-5.18 ER70S-6
NiCrFe Alloy	SFA-5.11 E-NiCrFe-3; SFA-5.14 ER-NiCrFe- 3, ENiCrFe-7
Austenitic Stainless Steel Cladding	SFA-5.9 ER-308, ER-309, ER-312 SFA-5.4 ER-308L, ER309L
SA-516 Grade 70	SFA-5.1 E-7018
SA-182 F1 to SA-516 Grade 70	SFA-5.1 E-7018
Alloy 690 Weld Overlays	SFA-5.14 ERNiCrFe-7A

* Indicates material exposed to Reactor Coolant. Hot leg piping is exposed locally to Reactor Coolant fluid at the replacement RTD nozzles.

** Special weld wire with low residual elements of copper and phosphorous was used for the reactor vessel core belt line region.

*** Bodies and bonnets of valves in systems exposed to reactor coolant will be constructed of corrosion resistant austenitic stainless castings or wrought steels. Typical grades used are SA-182 F316 and SA351-CF8M materials. Valve stems are typically corrosion resistant precipitation-hardened stainless steels such as 17-4PH. Discs and wedges are typically austenitic wrought or cast stainless steels and may be hard surfaced. Some valve discs and seats are constructed entirely of hard surfacing material. Non-pressure retaining valve components in contact with the RCS fluid may be constructed of other corrosion resistant materials such as Inconel. Non-pressure retaining valve parts that are not exposed to the RCS fluid may be constructed of various materials. Hard surfacing materials are typically Stellite or approved low cobalt equivalents such as Norem, Deloro, Everit 50, EB5150, or Colmonoy.

ARKANSAS NUCLEAR ONE
UNIT 2

Table 5.2-4

CHEMICAL ANALYSES OF PLATE MATERIAL IN REACTOR VESSEL BELTLINE

WEIGHT (PERCENT)

<u>Element</u>	<u>Lower Shell Plates</u>			<u>Intermediate Shell Plates</u>			<u>Weld</u>
	<u>1</u>	<u>2</u>	<u>3</u>	<u>4</u>	<u>5</u>	<u>6</u>	
Si	0.20	0.25	0.25	0.22	0.21	0.21	0.16
S	0.008	0.008	0.007	0.014	0.011	0.011	0.009
P	0.006	0.003	0.003	0.010	0.009	0.009	0.012
Mn	1.35	1.35	1.34	1.40	1.38	1.40	1.26
C	0.20	0.21	0.19	0.21	0.22	0.22	0.13
Cr	0.16	0.14	0.14	0.19	0.14	0.15	0.08
Ni	0.59	0.66	0.65	0.63	0.59	0.60	0.18
Mo	0.59	0.53	0.52	0.62	0.62	0.63	0.52
V	0.005	0.003	0.002	0.005	0.006	0.006	0.010
Cb	< 0.01	< 0.01	< 0.01	< 0.01	< 0.01	< 0.01	0.010
B	0.0001	0.0001	0.0002	< 0.001	< 0.001	< 0.001	0.0003
Co	0.010	0.010	0.009	0.013	0.011	0.012	0.012
Cu	0.08	0.07	0.07	0.12	0.08	0.08	0.05
Al	0.040	0.025	0.031	0.037	0.034	0.034	0.002
Ti	< 0.01	< 0.01	< 0.01	< 0.01	< 0.01	< 0.01	0.01
As	0.007	0.006	0.005	0.010	0.010	0.010	.017
Sn	0.003	0.003	0.003	0.007	0.005	0.005	0.004
Zr	< 0.001	< 0.001	< 0.001	0.001	0.001	0.001	0.002
N ₂	0.009	0.008	0.007	0.008	0.009	0.008	0.009
Pb							None Detected

ARKANSAS NUCLEAR ONE
UNIT 2

Table 5.2-5

CHARPY V-NOTCH AND DROP WEIGHT TEST VALUES - REACTOR VESSEL

Piece No. Reference Dwg.	Code No.	Material	Vessel Location	Drop Weight Results	Temperature of Charpy V-Notch		Minimum Upper Shelf Cv energy for Longitudinal Direction
					@ 30 ft - lb	@ 50 ft - lb	
<u>E-234-775</u>							
203-02	C-8001	SA-508 Cl. 2	Vessel Flange Forging	+30 °F	-50 °F	-20 °F	133
232-01	C-8013	"	Bottom Head Plate	-10 °F	-56 °F	-21 °F	137
232-02	C-8014	A-533-B Cl. 1	Bottom Head Plate	-20 °F	-40 °F	-1 °F	152
205-	C-8015-1	SA-508 Cl. 2	Inlet Nozzle Forging	+30 °F	-50 °F	-25 °F	148
	C-8015-2	"	Inlet Nozzle Forging	+10 °F	-50 °F	-25 °F	126
	C-8015-3	"	Inlet Nozzle Forging	+10 °F	-80 °F	-60 °F	140
	C-8015-4	"	Inlet Nozzle Forging	+30 °F	-60 °F	-30 °F	154
	C-8016-1	SA-508 Cl. 2	Outlet Nozzle Forging	0 °F	-60 °F	-38 °F	131
205-	C-8016-2	"	Outlet Nozzle Forging	-10 °F	-28 °F	+38 °F	114
205-03	C-8019-1	SA-508 Cl. 1	Inlet Nozzle Ex. Forg.	-40 °F	-40 °F	-20 °F	163
205-03	C-8019-2	"	Inlet Nozzle Ex. Forg.	-40 °F	-50 °F	-35 °F	154
205-03	C-8019-3	"	Inlet Nozzle Ex. Forg.	-20 °F	-48 °F	-35 °F	184
205-03	C-8019-4	"	Inlet Nozzle Ex. Forg.	-20 °F	-50 °F	-25 °F	145
205-07	C-8020-1	SA-508 Cl. 1	Outlet Nozzle Ex. Forg.	-30 °F	-30 °F	+10 °F	153
205-07	C-8020-2	"	Outlet Nozzle Ex. Forg.	-30 °F	-40 °F	+10 °F	148
215-01	C-8008-1	A-533 Gr. B. Cl. 1	Upper Shell Plate	0 °F	- 8 °F	+18 °F	153
215-01	C-8008-2	"	Upper Shell Plate	+10 °F	+24 °F	+68 °F	105
215-01	C-8008-3	"	Upper Shell Plate	0 °F	+34 °F	+56 °F	109
215-02	C-8009-1	A-533 Gr. B. Cl. 1	Inter. Shell Plate	-30 °F	-18 °F	+ 6 °F	146
215-02	C-8009-2	"	Inter. Shell Plate	0 °F	-24 °F	0 °F	142
215-02	C-8009-3	"	Inter. Shell Plate	-10 °F	- 8 °F	+32 °F	134
215-03	C-8010-1	"	Lower Shell Plate	-20 °F	+ 7 °F	+36 °F	138
215-02	C-8010-2	"	Lower Shell Plate	-30 °F	-27 °F	- 5 °F	144
215-03	C-8010-3	"	Lower Shell Plate	-30 °F	-34 °F	-10 °F	150
209-02	C-8002	SA-508 Cl. 2	Closure Hd Flng Forging	+10 °F	-80 °F	-52 °F	161
231-01 A, B, C, D	C-8012	A-533 Gr. B. Cl. 1	Closure Head Peels	+10 °F	-30 °F	-1 °F	139
231-02	C-8011	"	Closure Head Dome	+10 °F	-25 °F	+34 °F	110

ARKANSAS NUCLEAR ONE
UNIT 2

Table 5.2-6

CHARPY V-NOTCH TEST VALUES - STEAM GENERATOR NO. 1

<u>Test No.</u>	<u>Location</u>	<u>Material</u>	<u>Charpy V-Notch (ft-lb)</u>	<u>Test Temp (°F)</u>
6363-1-15 AC	Tube Sheet	SA-508-Cl. 3a	110-119-101	-5
6363-1-15 BC	Tube Sheet	SA-508-Cl. 3a	117-124-111	-5
7353-1-17 AC	Channel Head	SA-508-Cl. 3a	56-74-57	-5
7353-1-17 BC	Channel Head	SA-508-Cl. 3a	88-120-112	-5
7353-1-17 CC	Channel Head	SA-508-Cl. 3a	120-127-111	-5
7353-1-17 DC	Channel Head	SA-508-Cl. 3a	110-119-117	-5
82305 A	Inlet Nozzle	SA-508-Cl. 3a	128-133-130	10
82305 B	Inlet Nozzle	SA-508-Cl. 3a	115-136-116	10
82306 A	Outlet Nozzle	SA-508-Cl. 3a	128-133-135	-8
82306 B	Outlet Nozzle	SA-508-Cl. 3a	139-128-139	-8
7806.6 (Top)	Primary Manway Cover	SA 533 Type B Cl. 2	96.7-104.4-102.1	55
7806.6 (Bot)	Primary Manway Cover	SA 533 Type B Cl. 2	96.7-88.9-99.0	55

ARKANSAS NUCLEAR ONE
UNIT 2

Table 5.2-7

CHARPY V-NOTCH TEST VALUES - STEAM GENERATOR NO. 2

<u>Test No.</u>	<u>Location</u>	<u>Material</u>	<u>Charpy V-Notch (ft-lb)</u>	<u>Test Temp (°F)</u>
6363-2-15 AC	Tube Sheet	SA-508-Cl. 3a	115-128-123	-5
6363-2-15 BC	Tube Sheet	SA-508-Cl. 3a	135-129-131	-5
7353-2-17 AC	Channel Head	SA-508-Cl. 3a	148-134-162	15
7353-2-17 BC	Channel Head	SA-508-Cl. 3a	136-167-180	15
7353-2-17 CC	Channel Head	SA-508-Cl. 3a	157-147-116	15
7353-2-17 DC	Channel Head	SA-508-Cl. 3a	153-114-124	15
82305 A	Inlet Nozzle	SA-508-Cl. 3a	128-133-130	10
82305 B	Inlet Nozzle	SA-508-Cl. 3a	115-136-116	10
82307 A	Outlet Nozzle	SA-508-Cl. 3a	127-142-141	-8
82307 B	Outlet Nozzle	SA-508-Cl. 3a	144-135-142	-8
7806.6 (Top)	Primary Manway Cover	SA 533 Type B Cl. 2	96.7-104.4-102.1	55
7806.6 (Bot)	Primary Manway Cover	SA 533 Type B Cl. 2	96.7-88.9-99.0	55

ARKANSAS NUCLEAR ONE
UNIT 2

Table 5.2-8

REFERENCE NIL-DUCTILITY TRANSITION TEMPERATURE RT_{NDT} (°F) FOR REPLACEMENT PRESSURIZER

Part Description (Part Number*)	Material	RT_{NDT} (°F)	ANO Drawing Number
Bottom Head (9)	SA-508, Grade 3 Class 1	-10	M-2001-C11-204
Lower Shell (1)	SA-508, Grade 3 Class 1	-40	M-2001-C11-202
Upper Shell (1)	SA-508, Grade 3 Class 1	-20	M-2001-C11-202
Top Head (2)	SA-508, Grade 3 Class 1	-20	M-2001-C11-203
Surge Nozzle (11)	SA-508, Grade 3 Class 1	-10	M-2001-C11-208
Manway (8)	SA-508, Grade 3 Class 1	-10	M-2001-C11-207
Manway Cover (49)	SA-508, Grade 3 Class 1	-10	M-2001-C11-207
Safety Valve Nozzle (6)	SA-508, Grade 3 Class 1	-10	M-2001-C11-206
Spray Nozzle (4)	SA-508, Grade 3 Class 1	0	M-2001-C11-205
Support Skirt Trans Ring (10)	SA-508, Grade 3 Class 1	-20	M-2001-C11-204

* See ANO drawing M-2001-C11-218, Parts Identification, Materials and Related Requirements.

ARKANSAS NUCLEAR ONE
UNIT 2

Table 5.2-9

REACTOR COOLANT PIPE CHARPY RESULTS

<u>Ass'y No.</u>	<u>Code No.</u>	<u>Description</u>	<u>Material</u>	<u>Charpy V-Notch Values - Ft-Lb</u>			<u>°F</u>
501-02	M-1800-1	Pipe Section	SA516 Grade 70	44	33	38	+10
	M-1800-2	"	"	44	33	38	+10
	M-1800-3	"	"	30	37	42	+10
	M-1800-4	"	"	30	37	42	+10
501-04	M-1801-1	Pipe Section	SA516 Grade 70	44	33	38	+10
	M-1801-2	"	"	44	33	38	+10
	M-1801-3	"	"	30	37	42	+10
	M-1801-4	"	"	30	37	42	+10
501-06	M-1802-1	Pipe Section	SA516 Grade 70	30	31	30	+10
	M-1802-2	"	"	31	32	25	+10
	M-1802-3	"	"	30	31	30	+10
	M-1802-4	"	"	31	32	25	+10
501-08	M-1803-1	Pipe Section	SA516 Grade 70	38	45	44	+10
	M-1803-2	"	"	38	45	44	+10
	M-1803-3	"	"	38	45	44	+10
	M-1803-4	"	"	38	45	44	+10
	M-1803-5	"	"	52	40	47	+10
	M-1803-6	"	"	52	40	47	+10
	M-1803-7	"	"	52	40	47	+10
	M-1803-8	"	"	52	40	47	+10
501-10	M-1804-1	Elbow	SA516 Grade 70	31	21	36	+10
501-12	M-1805-1	Elbow	SA516 Grade 70	32	31	33	+10
501-14	M-1807-1	Elbow	SA516 Grade 70	37	35	33	+10

ARKANSAS NUCLEAR ONE
UNIT 2

Table 5.2-9 (continued)

<u>Ass'y No.</u>	<u>Code No.</u>	<u>Description</u>	<u>Material</u>	<u>Charpy V-Notch Values- Ft-Lb</u>			<u>°F</u>
501-16,20	M-1806-1	Elbow	SA516 Grade 70	31	33	31	+10
	M-1806-2	"	"	22	20	20	+10
	M-1806-3	"	"	36	45	40	+10
	M-1806-4	"	"	40	58	40	
501-18	M-1808-1	Elbow	SA516 Grade 70	37	35	33	+10
509-02	M-1809-1	Nozzle Forging	SA182-68 Grade F-1	25	34	27	-20
	M-1809-2	"	"	25	34	27	-20
	M-1809-3	"	"	25	34	27	-20
	M-1809-4	"	"	55	55	51	-20
507-02	M-1810-1	Nozzle Forging	SA182-68 Grade F-1	90	99	75	-20
	M-1810-2	"	"	90	99	75	-20
506-10	M-1811-1	Nozzle Forging	SA105-65 Grade II	40	45	37	+10
506-06	M-1812-1	Nozzle Forging	SA105-65 Grade II	40	45	37	+10
	M-1812-2	"	"	40	45	37	+10
	M-1812-3	"	"	40	45	47	+10
	M-1813-4	"	"	40	45	37	+10
506-02	M-1813-1	Nozzle Forging	SA-105-65 Grade II	40	45	37	+10
	M-1813-2	"	"	169	126	171	+10
507-07	M-1814-1	Nozzle Forging	SA105-65 Grade II	75	52	49	+10
508-02	M-1815-1	Nozzle Forging	SA105-65 Grade II	55	96	59	+10

ARKANSAS NUCLEAR ONE
UNIT 2

Table 5.2-10

MATERIAL REFERENCES FOR FRACTURE TOUGHNESS EVALUATION

ALL DATA LISTED BELOW ARE FOR MATERIAL WITH COPPER CONTENT LESS THAN 0.05%

<u>Data Point</u>	<u>Material</u>	<u>Fluence (n/cm²x10¹⁹)</u>	<u>NDTT Increase (°F)</u>	<u>Selected P</u>	<u>Chemistry %</u>		<u>Reference</u>
					<u>S</u>	<u>Cu</u>	
65	A533-B Plate	2.8	65	0.009	0.01	0.03	For Data Points 65-66 Hawthorne, J.R., "Improved Radiation Embrittlement Resistance in Commercially Produced A533-B Place and Weld Metal" given at ORNL for HSST Program Information Meeting, April 1, 1970.
66	A533-B Plate	2.8	40	0.009	0.01	0.03	
74	A533-B Plate	3.1	70	0.008	0.008	0.003	For Data Point 74 Hawthorne, J.R., "Demonstration of Improved Radiation Embrittlement Resistance of A-533-B Steel through Control of Selected Resistant Elements," NRL Report 7121, May 29, 1970.

ARKANSAS NUCLEAR ONE
UNIT 2

Table 5.2-10 (continued)

ALL DATA LISTED BELOW ARE FOR MATERIAL WITH COPPER CONTENT LESS THAN 0.10%

<u>Data Point</u>	<u>Material</u>	<u>Fluence (n/cm²x10¹⁹)</u>	<u>NDTT Increase (°F)</u>	<u>Selected P</u>	<u>Chemistry % S Cu</u>	<u>Reference</u>
50	A533-B Weld Sub Arc	0.5	0	0.010	0.014 0.09	For Data Points 50-51 Steele, L. E., et al., "Irradiation Effects on Reactor Structural Materials", NRL Memorandum Report 1937, Nov. 15, 1969.
51	A533-B Weld Sub Arc	2.4	90	0.010	0.014 0.09	
54	A533-B Electroslag	2.5	100	0.002	0.012 0.09	
35	A533-B Plate	0.2	0	0.008	0.015 0.09	For Data Points 35-39 Hawthorne J. R., and Potapovs, U. "Initial Assessments of Notch Ductility Behavior of A533 Pressure Vessel Steel with Neutron Irradiation", NRL Report 6772, Nov. 22, 1968.
36	A533-B Plate	2.0	80	0.008	0.015 0.09	
37*	A533-B Plate	2.0	90	0.008	0.015 0.09	
38	A533-B Plate	0.5	35	0.008	0.015 0.09	
39	A533-B Plate	2.0	75	0.008	0.015 0.09	
43	A533-B Plate	0.5	0	0.008	0.014 0.09	For Data Points 43-44 Steele, B. R. et al., "Irradiation Effects on Reactor Structural Materials", NRL Memorandum Report 1937, Nov. 1968.
44	A533-B Plate	2.4	85	0.008	0.014 0.09	

* Transverse Specimens

ARKANSAS NUCLEAR ONE
UNIT 2

Table 5.2-10 (continued)

ALL DATA LISTED BELOW ARE FOR MATERIAL WITH COPPER CONTENT LESS THAN 0.15%

<u>Data Point</u>	<u>Material</u>	<u>Fluence (n/cm²x10¹⁹)</u>	<u>NDTT Increase (°F)</u>	<u>Selected P</u>	<u>Chemistry %</u> <u>S</u> <u>Cu</u>		<u>Reference</u>
45	A533-B Plate	2.5	60	0.003	0.014	0.09	Steele, L.E., et al., "Irradiation Effects on Reactor Structural materials", NRL Memorandum Report 2027, Aug. 15, 1969.
32	A-533-B Plate	2.3	120	0.009	0.022	0.14	For Data Points 32-42 Hawthorne, J. R., and Potapovs, U. "Initial Assessment of Notch Ductility Behavior of A-533 Pressure Vessel Steel with Neutron Irradiation." NRL Report 6772, Nov. 22, 1968.
33	" "	2.3	95	0.010	0.023	0.14	
40	" "	1.7	70	0.008	0.015	0.12	
41	" "	1.7	85	0.008	0.019	0.11	
42	" "	1.8	50	0.008	0.018	0.12	
52	A-533-B Weld Sub Arc	0.5	105	0.010	0.014	0.14	For Data Points 50-53 Steele, L. E., et al., "Irradiation Effects on Reactor Structural Materials", RL Memorandum Report 1937, Nov. 15, 1968.
53	" "	2.4	210	"	"	"	
61	A-533-B Plate	5.0	80	0.012	0.016	0.14	For Data Points 61-63 Mager, T. R., and Thomas, F. O. "Heavy Section Steel Technical Report No. 5 (Nov. 1969) Evaluation by Linear Elastic Fracture Mechanics of Radiation Damage to Pressure Vessel Steels," Oct. 1969.
62	A-533-B Plate	4.0	135	0.012	0.016	0.14	
63	A-533-B Plate	1.0	85	0.012	0.016	0.14	

ARKANSAS NUCLEAR ONE
UNIT 2

Table 5.2-10 (continued)

ALL DATA LISTED BELOW ARE FOR MATERIAL WITH COPPER CONTENT LESS THAN 0.15% (continued)

<u>Data Point</u>	<u>Material</u>	<u>Fluence (n/cm²x10¹⁹)</u>	<u>NDTT Increase (°F)</u>	<u>Selected P</u>	<u>Chemistry %</u>		<u>Reference</u>
					<u>S</u>	<u>Cu</u>	
72	A-533-B Plate	2.8	125	0.009	0.01	0.13	For Data Points 72 & 73 Steele L. E., et al., "Irradiation Effects on Reactor Structural Materials," NRL Memorandum Report 2088, Feb. 15, 1970.
73	A-533-B Plate	2.8	140	0.009	0.01	0.13	
75*	A-533-B Plate	0.5	50	0.008	0.016	0.14	For Data Point 75 - Witt, F.J., Program Dir, Heavy Section Steel Tech. Program Semi-Annual Prog. Report for Period Ended 2/28/70 - ORNL - 4590 Oct. 1970.

* Specimens Taken at 3/8 T.

ARKANSAS NUCLEAR ONE
UNIT 2

Table 5.2-11

SURVEILLANCE SPECIMENS PROVIDED FOR EACH EXPOSURE LOCATION

Capsule Location on Vessel Wall (See Figure 5.4-1)	<u>Base Metal</u>		<u>Weld Metal</u>		<u>HAZ</u>		<u>Reference Impact (c)</u>	<u>Total Specimens</u>		
	<u>Impact</u>	<u>Tensile</u>	<u>Impact</u>	<u>Tensile</u>	<u>Impact</u>	<u>Tensile</u>		<u>Impact</u>	<u>Tensile</u>	
	T(a)	L(b)								
83°	12	12	3	12	3	12	3	-	48	9
97°	12	12	3	12	3	12	3	-	48	9
104°	12	-	3	12	3	12	3	12	48	9
263°	12	-	3	12	3	12	3	12	48	9
277°	12	12	3	12	3	12	3	-	48	9
284°	12	12	3	12	3	12	3	-	48	9
	-	-	-	-	-	-	-	-	-	-
	72	48	18	72	18	72	18	24	288	54

(a) T = Transverse

(b) L – Longitudinal

(c) Reference material correlation monitors

ARKANSAS NUCLEAR ONE
UNIT 2

Table 5.2-12

CAPSULE REMOVAL SCHEDULE

(Reference 21 with CEN-15 (A))

At the nearest scheduled refueling outage, reactor surveillance capsules shall be removed and surveillance specimens tested in accordance with the following schedule:

<u>Capsule Number</u>	<u>Capsule Location Code</u>	<u>Capsule Identification</u>	<u>Vessel Location</u>	<u>Removal Interval (EFPY) (Withdrawal Time)</u>
1	1	W-83	83°	Standby ^(a)
2	2	W-97	97°	1.69 (actual, EOC 2)
3	3	W-104	104°	15.7 (actual, EOC 14)
4	6	W-284	284°	29.24 (actual, EOC 24)
5	4	W-263	263°	Standby ^(a)
6	5	W-277	277°	Minimum of 40.00

Prior to changing removal intervals, NRC approval is required per 10 CFR 50, Appendix H, "Reactor Vessel Surveillance Specimen Withdrawal Schedules." Withdrawal schedules may be modified to coincide with those refueling outages or plant shutdowns most closely approaching the withdrawal schedule.

^(a) If required, Capsules designated as "Standby" under Removal Interval, will be repositioned to ensure that peak fluence is obtained prior to 60 years (54 EFPY). Upon issuance of the renewed license, the ANO-2 specimen capsule withdrawal schedule will be revised to withdraw and test a standby capsule to cover the peak fluence expected through the end of the period of extended operation (Reference 2CAN100302, 2CAN010401, and NUREG 1828).

ARKANSAS NUCLEAR ONE
UNIT 2

Table 5.2-13

CONFORMANCE OF RCS/LOW PRESSURE SYSTEM INTERFACES WITH GENERAL DESIGN CRITERIA 14 AND 55

<u>Point of Interface</u>	<u>Degree or Conformance</u>
Loop A Safety Injection & Shutdown Cooling	ECCS. The system meets the requirements on an “other defined basis” as it serves an engineered safeguards function and automatic isolation is inappropriate. A class CC check valve provides the first boundary; it is the first of two valves which are in series. From this point on the piping branches. The first branch is at the leakage relief line where valve 2SV-5001, a class CC normally closed solenoid valve, completes the RCS pressure boundary. The second branch is the S. I. Tank line where a class CC check valve completes the RCS pressure boundary. The third branch is the line from the H.P. headers where a class CC check valve completes the code boundary. The reactor coolant pressure boundary extends to the outboard containment isolation valves. The fourth branch is the line from the LP header where a class CC check valve completes the code boundary. The reactor coolant pressure boundary extends to the outboard containment isolation valve.
Loop B Safety Injection & Shutdown Cooling	ECCS. The system meets the requirements in the same manner as Loop A.
Loop C Safety Injection & Shutdown Cooling	ECCS. The system meets the requirements in the same manner as Loop A.
Loop D Safety Injection & Shutdown Cooling	ECCS. The system meets the requirements in the same manner as Loop A.
HPSI to Shutdown Cooling Suction (Hot Leg Injection)	GDC 55 requirements are met on an “other defined basis.” Each line has a check valve inside containment and a remote manually controlled valve outside containment. Penetration 2P13 also has an exterior manual gate valve which is locked closed. The exterior remote manually controlled isolation valves are normally closed and stay closed immediately following an accident. The reactor coolant pressure boundary extends to the outside containment isolation valves.

ARKANSAS NUCLEAR ONE
UNIT 2

Table 5.2-13 (continued)

<u>Point of Interface</u>	<u>Degree of Conformance</u>
Charging Lines to RCS Lines 2CCA-8-30" ID and 2CCA-6-30" ID; auxiliary spray line to 2CCA-15-4" in series	Complete conformance. GDC 55 requirements are met on an "other defined basis" as this penetration supports an engineered safeguards function. Check valves are located in each charging line and the auxiliary spray line (2CCA-26-2", 2CCA-27-2" and 2CCA-16-2" respectively) and are the first of two valves in series. These three lines converge to a single charging line which contains a remote manually controlled isolation valve outside containment. The RCPB extends to this valve.
Letdown line from RCS line 2CCA-3-30" ID	Complete conformance. Although the reactor coolant pressure boundary ends at the second isolation valve inside containment, this is considered a GDC 55 penetration based on the 10CFR50.2 definition of the RCPB. GDC 55 requirements are met with an automatically actuated isolation valve located outside containment as well as the inside isolation valves. Pressure rating is derated after the isolation valves immediately downstream of flow control valves 2SV4816 and 2SV4817; however, this section of piping is protected from overpressure by relief valve 2PSV-4822.
Shutdown Cooling Suction	Complete conformance. Although the reactor coolant pressure boundary ends at the second isolation valve inside containment, this is considered a GDC 55 penetration based on the 10CFR50.2 definition of the RCPB. The containment isolation valves are locked closed. The low pressure piping downstream of the second inside isolation valve is protected from overpressure by a relief valve which is an acceptable automatic isolation device in this configuration.
Reactor Drain Line from Line 2CCA-1-42" ID	Complete conformance. Two hand-operated normally-closed valves in series are provided.
Two Pressurizer Spray Line Drains from RCS Line 2CCA-15-1"	Complete conformance. Two hand-operated normally-closed valves in series are provided.

ARKANSAS NUCLEAR ONE
UNIT 2

Table 5.2-13 (continued)

<u>Point of Interface</u>	<u>Degree or Conformance</u>
Reactor Drain Line from Letdown Line 2CCA-12-2"	Complete conformance. Two hand-operated normally-closed valves in series are provided.
Reactor Drain Line from RCS Line 2CCA-5-30" ID	Complete conformance. Two hand-operated normally-closed valves in series are provided.
Reactor Drain Line from RCS Line 2CCA-7-30" ID	Complete conformance. Two hand-operated normally-closed valves in series are provided.
Reactor Drain Line from RCS Line 2CCA-9-30" ID	Complete conformance. Two hand-operated normally-closed valves in series are provided.
Refueling Level Indicator Connection from RCS Line 2CCA-1-42" ID	Complete conformance. Two hand-operated normally-closed valves in series are provided.
Code Safety Relief Valves	Complete conformance. Two parallel safety valves, 2PSV-4633 and 2PSV-4634 complete the RCS pressure boundary.
Reactor head vent line	Complete conformance. Two normally closed SOV isolation valves in series. 2SV-4668-1, 2SV-4668-2, 2SV-4669-1, 2SV-4670-2.
RCPs 2P32A, 2P32B, 2P32C and 2P32D	Complete conformance. Although the pump seals comprise the pressure boundary, the seal water return line meets GDC 55 requirements with an automatically actuated MOV inside containment and an automatically actuated AOV outside containment.
LTOP Isolation Valves and ECCS Vent Valve	Complete Conformance. Two normally closed MOV isolation valves in series. 2CV-4730-1 and 2CV-4731-2, 2CV-4740-2 and 2CV-4741-1, 2CV-4740-2 and 2CV-4698-1.

ARKANSAS NUCLEAR ONE
UNIT 2

Table 5.2-14

**CHAT 12100
VERIFICATION PROBLEMS**

Sample Comparison of Hand Calculated vs. CHAT 12100 Computer Solution of Various Heat Transfer Problems.

<u>Problem</u>	<u>Exact Solution (°F)</u>	<u>Chat 12100 (°F)</u>
One-Dimensional Steady State	683.04 708.28	683.1 708.3
One-Dimensional Steady State With Heat Generation	234.84 292.91	234.8 292.9
One-Dimensional Transient	61.0 23.0	61.3 23.0
Two-Dimensiona Transient	60.8 5.3	60.1 5.2

Table 5.2-15

BCH10026 EDGE COEFFICIENTS - VERIFICATION PROBLEM TAPERED CYLINDER CODE 588

	<u>Hand Solution</u>	<u>Computer Solution</u>
Φ11	175.5241	175.5953
Φ12	24.5300	24.5436
Φ13	82.5134	82.5813
Φ14	-25.7863	-25.8000
Φ21	-24.5302	-24.5309
Φ22	-4.8819	-4.8821
Φ23	-26.9108	-26.9119
Φ24	5.0702	5.0704
Φ31	-76.1764	-76.1005
Φ32	-24.8432	-24.8302

ARKANSAS NUCLEAR ONE
UNIT 2

Table 5.2-15 (continued)

	<u>Hand Solution</u>	<u>Computer Solution</u>
Φ33	-192.6883	-192.6260
Φ34	26.4359	26.4225
Φ41	-23.8048	-23.8044
Φ42	-4.6806	-4.6807
Φ43	-26.4355	-26.4364
Φ44	5.0413	5.0418
Φ11	390.6207	390.4546
Φ12	47.5828	47.5726
Φ13	173.2577	173.1834
Φ14	-47.1460	-47.1350
Φ21	-47.6839	-47.6633
Φ22	-7.5175	-7.5168
Φ23	-40.0857	-40.0788
Φ24	7.3109	7.3099
Φ31	-172.8609	-172.8380
Φ32	-39.9120	-39.9226
Φ33	-303.4592	-303.4984
Φ34	40.0410	40.0485
Φ41	-47.0557	-47.0360
Φ42	-7.2812	-7.2806
Φ43	-40.0505	-40.0443
Φ44	7.3636	7.3627

ARKANSAS NUCLEAR ONE
UNIT 2

Table 5.2-16

**BASELINE MECHANICAL PROPERTIES
REACTOR VESSEL SURVEILLANCE MATERIALS**

<u>Coded No.</u>	<u>Material</u>	<u>Orientation*</u>	<u>Drop Weight NDTT, °F</u>	<u>30 ft-lb Fix Temp. °F</u>	<u>50 ft-lb Fix Temp. °F</u>	<u>RT_{NDT} °F</u>	<u>Room Minimum Temp Upper Yield Shelf Energy ft-lb</u>	<u>Strength ksi</u>
C-8009-3	Plate	Transverse	0	10	40	0	125.5	70
C-8009-3	Plate	Longitudinal	0	3	24	0	154	69
C-8009-3	Heat-Affected Zone	Longitudinal	-10	-80	-50	-10	151.5	68
C-8009-1/ C-8009-2	Weld	Longitudinal	-10	0	14	-10	146	76
HSST Reference Material		Longitudinal	0	30	52	0	144.5	-

* Orientation with respect to major rolling direction in plate.

ARKANSAS NUCLEAR ONE
UNIT 2

Table 5.2-17

**CHEMICAL ANALYSIS OF REACTOR
VESSEL SURVEILLANCE MATERIALS**

<u>Chemical Element</u>	<u>Chemical Content (Weight Percent)</u>	
	<u>Base Metal (C-8009-3)</u>	<u>Weld Metal (C-8009-1/C-8009-2)</u>
Si	0.21	0.14
S	0.011	0.009
P	0.009	0.004
Mn	1.40	1.33
C	0.22	0.13
Cr	0.15	0.02
Ni	0.60	0.08
Mo	0.63	0.62
V	0.006	0.006
Cb	< 0.01	< 0.01
B	< 0.001	< 0.001
Co	0.012	0.003
Cu	0.08	0.04
Al	0.034	0.001
Ti	< 0.01	< 0.01
As	0.010	0.006
Sn	0.005	0.001
Zr	0.001	0.001
N ₂	0.008	0.005
Pb	Not Determined	Not Detected
W	< 0.01	< 0.01
O ₂	0.007	Not Determined

ARKANSAS NUCLEAR ONE
UNIT 2

Table 5.2-18

**TENSILE PROPERTIES
REACTOR VESSEL SURVEILLANCE MATERIALS**

<u>Material</u>	<u>Code No.</u>	<u>Orientation*</u>	<u>Test Temp. (°F)</u>	<u>Yield Strength (ksi)</u>	<u>Tensile Strength (ksi)</u>	<u>Uniform Elongation (%)</u>	<u>Total Elongation (%)</u>	<u>Reduction Of Area (%)</u>
Plate	C-8009-3	Longitudinal	71	69	90	8.6	27	69
Plate	C-8009-3	Longitudinal	250	64	83	8.0	24	73
Plate	C-8009-3	Longitudinal	550	57	85	8.5	23	69
Plate	C-8009-3	Transverse	71	70	91	9.3	25	70
Plate	C-8009-3	Transverse	250	66	85	7.9	22	69
Plate	C-8009-3	Transverse	550	57	84	8.4	23	65
HAZ	C-8009-3	Longitudinal	71	68	89	8.6	24	71
HAZ	C-8009-3	Longitudinal	250	62	81	6.9	23	72
HAZ	C-8009-3	Longitudinal	550	58	85	6.8	21	69
Weld	C-8009-3/ C-8009-2	Longitudinal	71	76	88	8.5	24	72
Weld	C-8009-1/ C-8009-2	Longitudinal	250	72	82	7.0	22	73
Weld	C-8009-1/ C-8009-2	Longitudinal	550	66	85	7.2	22	69

* Orientation with respect to the major rolling direction of the plate.

ARKANSAS NUCLEAR ONE
UNIT 2

Table 5.2-19

This table is historical. For current safety valve parameters, see Tables 5.5-10 and 5.5-11.

EQUIPMENT PROTECTED BY SAFETY VALVES

<u>Name</u>	<u>Design Pressure</u>	<u>Design Temp.</u>
Pressurizer	2500	700
Reactor Vessel	2500	650
Primary Side of Steam Generators	2500	650
Reactor Coolant Pump	2500	650
Reactor Piping ⁽¹⁾	2500	650
Steam Generators	1100	560
Main Steam Piping	1100	560

PRIMARY SAFETY VALVE (PRESSURIZER SAFETY VALVE) SPECIFICATIONS

	<u>Pressure</u>	<u>Temperature</u>
Normal Operating:	2235 psig	653 °F
Maximum Operating:	2260 psig	653 °F
Safety Valve Set Pressure:	2485 psig, +1%/-3%	
Min. Operating Press. Margin:	200 psi	
Accumulation:	3% set pressure	
Pressure Blowdown:	4% set pressure	
Pressure Sources:	Loss of Turbine Load	
Design Capacity/Rated Valve Capacity	395,000/419,000 lb/hr	
Basis of Design Capacity:	Loss of turbine load without reactor trip.	
Assumptions and Restrictions:	The only other pressure relieving devices which function are the main steam safety valves.	

Safety Valve Inlet Line Conditions

Press. Loss at Design Cap.: 50 psi
Flowing Fluid: Saturated Steam

Safety Valve Outlet Line Conditions

Normal Superimposed Backpress.: 100 Max
Normal Fluid Conditions: Gas

Valve Data

Manufacturer:	Crosby Valve and Gage Co.	
Catalog No.:	Special	
Connections:	<u>Inlet</u>	<u>Outlet</u>
Size	6" w/4" nozzle	6"
Type	Flanged	Flanged
Maximum Backpressure:	700 psig	Totally Enclosed Bonnet: Yes
Backpress. Compensation:	Yes	Orifice Size: 3.60 inches effective
Valve Press. Rating:	2485 psig	Gagging Device: Yes
Valve Temp. Rating:	700 °F	Flowing Fluid: Wet steam

⁽¹⁾ Miscellaneous RCS piping associated with the pressurizer has a design temperature of 658 °F, and the pressurizer surge line has a design temperature of 700 °F.

ARKANSAS NUCLEAR ONE
UNIT 2

Table 5.2-19 (continued)

This information is historical (see previous page). For current information, see Table 5.5-11.

SECONDARY SAFETY VALVE (MAIN STEAM SAFETY VALVE) SPECIFICATIONS

	<u>Pressure</u>	<u>Temperature</u>
Normal Operating:	900 psia	532
Maximum Operating:	1000 psia	556
Safety Valve Set Pressure:	See note.	
Accumulation:	3% of set pressure	
Blowdown:	5% of set pressure	
Min. Operating Press. Margin:	72 psi	
Pressure Sources	Loss of Turbine Load	
Design Capacity	1,551,847 lb/hr each @ 1200 psia	
Basis of Design Capacity:	Loss of turbine load without simultaneous reactor trip. Reactor trip on high pressurizer pressure.	
Assumptions and Restrictions:	The only other pressure relieving devices which function are the pressurizer safety valves.	

Safety Valve Inlet Line Conditions

Safety Valve Outlet Line Conditions

Press. Loss at Design Cap.:	7 psi	Normal Superimposed	
Flowing Fluid:	Saturated Steam	Backpress.:	0 psig
		Normal Fluid Conditions:	Air
		Maximum Backpressure:	225 psig

Valve Data

Manufacturer:	J.E. Lonergan Co.		
Catalog No.	V-1019 2T		
Connections:	<u>Inlet</u>	<u>Outlet</u>	
Size:	8	10x10	
Type:	ANSI B16.5	ANSI B16.5	
Rating:	900 psia	300 psia	
Valve Press. Rating:	1250 psig	Totally Enclosed:	No
Valve Temp. Rating:	650 °F	Gagging Device:	Yes
Backpress. Compensaton:	Yes	Orifice Size:	6.00 in. dia.
Flowing Fluid:	Wet Steam		

<u>Note:</u>	<u>Header 1 (+1% -3%)</u>	<u>Header 2</u>
	1 Valve 1078 psig	Same as header 1
	2 Valves 1105 psig	
	2 Valves 1132 psig	
	Total number of valves:	10

ARKANSAS NUCLEAR ONE
UNIT 2

Table 5.2-20

REACTOR VESSEL BELTLINE MATERIALS

<u>Component</u>	<u>Identification Number</u>	<u>Cu (%)</u>	<u>Ni (%)</u>	<u>RT_{NDT}</u>
Intermediate Shell Longitudinal Welds	2-203-A,B,C	0.05	0.18	-56 °F ⁽¹⁾
Lower Shell Longitudinal Welds	3-203-A,B,C	0.05	0.18	-56 °F ⁽¹⁾
Intermediate/Lower Shell Girth Welds	9-203	0.05	0.08	-10 °F
Intermediate Shell Plates	C-8009-1	0.12	0.63	-26 °F
	C-8009-2	0.08	0.59	0 °F
	C-8009-3	0.08	0.60	0 °F
Lower Shell Plates	C-8010-1	0.08	0.59	12 °F
	C-8010-2	0.07	0.66	-28 °F
	C-8010-3	0.07	0.65	-30 °F

(1) Generic value for submerged arc welds

Table 5.2-20a

REVISED REACTOR VESSEL BELTLINE MATERIALS

<u>Component</u>	<u>Identification Number</u>	<u>Cu (%)</u>	<u>Ni (%)</u>
Intermediate Shell Longitudinal Welds	2-203-A,B,C	0.046	0.082
Lower Shell Longitudinal Welds	3-203-A,B,C	0.046	0.082
Intermediate/Lower Shell Girth Welds	9-203	0.045	0.087
Intermediate Shell Plates	C-8009-1	0.098	0.605
	C-8009-2	0.085	0.600
	C-8009-3	0.096	0.580
Lower Shell Plates	C-8010-1	0.085	0.585
	C-8010-2	0.083	0.668
	C-8010-3	0.080	0.653

NOTE: The RTNDT values in Table 5.2-20 were not changed by the revised copper and nickel estimates.

ARKANSAS NUCLEAR ONE
UNIT 2

Table 5.2-21

**Estimates for RPV beltline material C_vUSE unirradiated/initial values for the Transverse (weak) direction
(ref SAR Section 5.2.4.3.3)**

RPV Beltline Material	Material I.D.	Unirradiated/Initial C _v USE Value (Transverse) (ft-lbs)	Comments
Intermediate Shell Plate	C-8009-1	94.9	Based on reduction to 65% of the C _v USE (longitudinal) value in SAR Table 5.2-5 and CEP-FTP-ANO2, Revision 0, Appendix E - RPV Beltline Materials in accordance with MTEB No. 5-2, Section B.1.2.
	C-8009-2	92.3	
	C-8009-3	87.1	
	C-8009-3 *	125.5 *	
Lower Shell Plate	C-8010-1	89.7	* Transverse value from SAR Table 5.2-16 for baseline surveillance material (plate C-8009-3) specimen.
	C-8010-2	93.6	
	C-8010-3	97.5	
Intermediate Shell Longitudinal Weld	2-203 A, B, & C	70.9	Based on 65% reduction of the unirradiated/initial C _v USE longitudinal value of the 109 ft-lb value obtained from ANO Engineering Report 92-R-2019-01 in accordance with MTEB No. 5-2, Section B.1.2.
Lower Shell Longitudinal Weld	3-203 A, B, & C	79.3	Based on 65% reduction of the unirradiated/initial C _v USE longitudinal value of the 122 ft-lb value obtained from ANO Engineering Report 92-R-2019-01 in accordance with MTEB No. 5-2, Section B.1.2.
Intermediate to Lower Shell Horizontal (Girth) Weld	9-203	94.9	Based on 65% reduction of the baseline surveillance material specimen unirradiated/initial C _v USE longitudinal value of the 146 ft-lb value obtained from ANO Engineering Report 92-R-2019-01 and SAR Table 5.2-16 (ref. TR-MCD-002 Report contained in CEP-FTP-ANO2, Revision 0, Appendix C – Evaluation of Baseline Specimens) in accordance with MTEB No. 5-2, Section B.1.2.
Weld Heat-Affected Zone (HAZ of Girth Weld)	HAZ of 9-203 at C-8009-3 side	98.5	Based on 65% reduction of the baseline surveillance material specimen unirradiated/initial C _v USE longitudinal value of the 151.5 ft-lb value obtained from SAR Table 5.2-16 (ref. TR-MCD-002 Report contained in CEP-FTP-ANO2, Revision 0, Appendix C - Evaluation of Baseline Specimens) in accordance with MTEB No. 5-2, Section B.1.2.

ARKANSAS NUCLEAR ONE
UNIT 2

Table 5.2-22

**Predictions of Minimum Charpy Upper Shelf Energy (C_vUSE) for RPV Beltline Materials to 48 EFPY
(Reference SAR Section 5.2.4.3.4)**

RPV Beltline Material	Material I.D.	% C _U (Note 1)	48 EFPY 1/4t Fluence (n/cm ²) (Note 1)	Unirradiated C _v USE Value (ft-lbs) (Note 1)	% Decrease Predicted in C _v USE (Notes 1, 2)	Predicted 48 EFPY C _v USE Value (ft-lbs) (Notes 1, 2, 3)
Intermediate Shell Plate	C-8009-1	0.098	3.188E+19	95	24.7	71
	C-8009-2	0.085	3.188E+19	92	23.0	71
	C-8009-3	0.096	3.188E+19	87	32.0*	59*
Lower Shell Plate	C-8010-1	0.085	3.192E+19	90	23.0	69
	C-8010-2	0.083	3.192E+19	94	22.8	72
	C-8010-3	0.080	3.192E+19	98	22.4	76
Intermediate Shell Longitudinal Weld	2-203 A	0.046	3.015E+19	71	24.2	54
	2-203 B	0.046	2.327E+19	71	22.7	55
	2-203 C	0.046	2.327E+19	71	22.7	55
Lower Shell Longitudinal Weld	3-203 A	0.046	3.020E+19	79	24.2	60
	3-203 B	0.046	2.331E+19	79	22.7	61
	3-203 C	0.046	2.331E+19	79	22.7	61
Intermediate to Lower Shell Horizontal (Girth) Weld	9-203	0.045	3.187E+19	95	24.3	72

Notes:

1. From Framatome-ANP Calculation 32-5024494-02, "Charpy Upper-Shelf Energy for ANO-2," May 2005.
2. The measured percent decrease in C_vUSE for the surveillance base metal plate and weld metal are within reasonable agreement with the values predicted using Regulatory Guide 1.99, Revision 2.
3. Predicted C_vUSE values independently confirmed in Section 4.2.1.2 of NUREG 1828 to be above the required 50 ft-lb minimum at 48 EFPY.

* Value predicted using Position 2.2 of Regulatory Guide 1.99, Revision 2.

ARKANSAS NUCLEAR ONE
UNIT 2

Table 5.2-22A
Predicted USE Values at 54 EFPY (EOLE) For ANO-2

Reactor Vessel Material and Identification Number		Wt % Cu ^(a)	EOLE 1/4T Fluence ^(b) (n/cm ² , E > 1.0 MeV)	Initial USE ^(a) (ft-lb)	Projected USE Decrease (%)	Projected EOLE USE (ft-lb)
Position 1.2^(c)						
Intermediate Shell Plate C-8009-1		0.098	3.06 x 10 ¹⁹	95	25.0	71.3
Intermediate Shell Plate C-8009-2		0.085	3.06 x 10 ¹⁹	93	25.0	69.8
Intermediate Shell Plate C-8009-3		0.096	3.06 x 10 ¹⁹	134	25.0	100.5
Lower Shell Plate C-8010-1		0.085	3.10 x 10 ¹⁹	89	25.0	66.8
Lower Shell Plate C-8010-2		0.083	3.10 x 10 ¹⁹	94	25.0	70.5
Lower Shell Plate C-8010-3		0.080	3.10 x 10 ¹⁹	97	25.0	72.8
Intermediate Shell Longitudinal Welds 2-203A, B, & C	Heat # Multiple	0.05	2.89 x 10 ¹⁹	110	24.5	83.1
Lower Shell Longitudinal Welds 3-203A, B, & C	Heat # 10120	0.046	2.94 x 10 ¹⁹	125	24.5	94.4
Intermediate to Lower Shell Girth Weld 9-203	Heat # 83650	0.045	3.05 x 10 ¹⁹	136	25.0	102.0
Upper Shell Plate C-8008-1		0.13	0.0367 x 10 ¹⁹	93	11.5	82.3
Upper Shell Plate C-8008-2		0.13	0.0367 x 10 ¹⁹	68	11.5	60.2
Upper Shell Plate C-8008-3		0.08	0.0367 x 10 ¹⁹	71	8.8	64.8
Upper Shell Longitudinal Welds 1-203A, B, & C	Heat # BOLA	0.02	0.0367 x 10 ¹⁹	92	8.8	83.9
Upper Intermediate Shell Girth Weld 8-203	Heat # 10137	0.22	0.0367 x 10 ¹⁹	105	18.5	85.6
	Heat # 6329637	0.21	0.0367 x 10 ¹⁹	107	18.5	87.2
	Heat # FAGA	0.03	0.0367 x 10 ¹⁹	118	8.8	107.6
Position 2.2^(d)						
Intermediate Shell Plate C-8009-3		0.096	3.06 x 10 ¹⁹	134	34.0	88.4
Upper Shell Plate C-8008-1		0.13	0.0367 x 10 ¹⁹	93	12.0	81.8
Intermediate to Lower Shell Girth Weld 9-203	Heat # 83650	0.045	3.05 x 10 ¹⁹	136	18.5	110.8

Notes:

- (a) Data taken from Table 3-1 of WCAP-18170-NP Revision 0 (CALC-ANO2-EP-17-00003 Revision 0).
- (b) The 1/4T fluence was calculated using the Regulatory Guide 1.99, Revision 2 correlation, and the Arkansas Nuclear One Unit 2 reactor vessel beltline wall thickness of 7.875 inches.
- (c) Percentage USE decrease values are based on Position 1.2 of Regulatory Guide 1.99, Revision 2, and were calculated by plotting the 1/4T fluence values on Figure 2 of the Regulatory Guide and using the material-specific Cu wt. % values. In calculating Position 1.2 percent USE decreases, the base metal and weld Cu weight percentages were conservatively rounded up to the nearest line in Regulatory Guide 1.99, Revision 2, Figure 2.
- (d) Percentage USE decrease is based on Position 2.2 of Regulatory Guide 1.99, Revision 2 using data from Table 5-10 of WCAP-18166-NP (CALC-ANO2-EP-17-00001 Revision 0). Regulatory Guide 1.99, Revision 2, Position 2.2 indicates that an upperbound line drawn parallel to the existing lines (in Figure 2 of the Guide) through the surveillance data points should be used in preference to the existing graph lines for determining the decrease in USE.

ARKANSAS NUCLEAR ONE
UNIT 2

Table 5.3-1

Historical Data Removed

Refer to FSAR

Table 5.3-2

ORIGINAL THERMAL AND HYDRAULIC DATA
(Design Full Power Conditions)

I. Reactor Vessel (See Table 5.1-1a for latest values)		
a.	Rated core thermal power (Mwt)	2815
b.	Design pressure (psia)	2500
c.	Operating pressure at outlet (psia)	2250
d.	Coolant outlet temperature (°F)	612.5
e.	Coolant inlet temperature (°F)	553.5
f.	Coolant outlet state	Subcooled
g.	Total coolant flow (10 ⁶ lb/hr)	120.4
h.	Core average coolant enthalpy	
	1. Inlet (Btu/lb)	551.5
	2. Outlet (Btu/lb)	631.6
i.	Average coolant density	
	1. Inlet (lb/ft ³)	46.6
	2. Outlet (lb/ft ³)	42.02
II. Steam Generators		
a.	Number of Units	2
b.	Primary Side (or tube side)	
	1. Design pressure/temperature (psia/°F)	2500/650
	2. Operating pressure (psia)	2250
	3. Inlet temperature (°F)	612.5
	4. Outlet temperature (°F)	553.5

ARKANSAS NUCLEAR ONE
UNIT 2

Table 5.3-2 (continued)

c. Secondary (or Shell Side)	
1. Design pressure/temperature (psia/°F)	1110/560
2. Full load steam pressure/temperature (psia/°F)	900/531.95
3. Zero load steam pressure (psia)	1000
4. Total steam flow per gen. (lb/hr)	6.32 x 10 ⁶
5. Full load steam quality (%)	99.8
6. Feedwater temperature, full power (°F)	452
III. Replacement Pressurizer	
a. Design pressure (psia)	2500
b. Design temperature (°F)	700
c. Operating pressure (psia)	2250
d. Operating temperature (°F)	653
e. Internal volume (ft ³)	1200
f. Heaters (maximum)	96
1. Type and Rating of Heaters (kw)	Immersion/13.16 ± 5%
2. Maximum heater capacity (kw) (96 Heaters)	1326
IV. Reactor Coolant Pumps	
a. Number of units	4
b. Type	Vert.-Cent.
c. Design capacity (gpm)	80,500
d. Design pressure/temperature (psia/°F)	2500/650
e. Operating pressure (psia)	2250
f. Type drive induction mot.	Squirrel cage
g. Total dynamic head (ft)	275
h. Rating, cold (hp)	6750 (nominal)
i. Rating, hot (hp) (nominal)	4800
j. Pump speed, rpm	900
V. Reactor Coolant Piping (original design values)	
a. Flow per loop (10 ⁶ lb/hr)	60.2
b. Pipe size (inside dia./wall thickness) (in.)	
1. Hot leg	42/4-5/16
2. Cold leg	30/3-1/4
c. Pipe design press./temp. (psia/°F) ⁽¹⁾	2500/650

⁽¹⁾ Miscellaneous RCS piping associated with the pressurizer has a design temperature of 658 °F, and the pressurizer surge line has a design temperature of 700 °F.

ARKANSAS NUCLEAR ONE
UNIT 2

Table 5.4-1

**REACTOR VESSEL QUALITY ASSURANCE PROGRAM
TESTS REQUIRED BY THE ASME CODE, SECTION III**

Forgings	
Flanges	UT, MT
Studs	UT, MT
Cladding	UT, PT
Nozzles	UT, MT
Plates	
Cladding	UT, PT
Welds	
Main seams	RT, MT
CRD head nozzle connection	PT
Instrumentation nozzles	PT
Main nozzles to shell	RT, MT
Cladding	UT, PT
Nozzle safe ends	RT, PT
Vessel support buildup	UT, MT
All welds - after hydrostatic test	MT, UT

ADDITIONAL TESTS
(Not Required by Code)

	<u>CE Requirements</u>	<u>Code Requirements</u>
Ultrasonic testing (UT)	UT of weld clad	None
Dye penetrant (PT)	PT test root each ½ inch and final layer of welds for partial penetration welds to control element drive mechanism head adapters and instrument tube connections	PT test of each 1/3 weld throat or ½ inch whichever is lesser N-462.4 (d) (1)
Baseline (UT)	Refer to Section 5.4.2.3	None

UT - Ultrasonic testing
MT - Magnetic particle testing
PT - Dye penetrant testing
RT - Radiographic testing

ARKANSAS NUCLEAR ONE
UNIT 2

Table 5.4-2

REACTOR VESSEL PARAMETERS

Minimum inside diameter	157
Height outside bottom head to CEDM nozzle flange (in.)	529-5/8
Inlet nozzles	Four 30-in. ID
Outlet nozzles	Two 42-in. ID
CEDM nozzles (number)	81
Instrumentation nozzles (number)	8

Table 5.4-3

**REACTOR VESSEL CLOSURE STUD MATERIAL
TENSILE STRENGTH & TOUGHNESS DATA**

Heat	Bar No.	Tensile PSI	Charpy V-Notch Impact Results at +10 °F					
			Ft. - Lbs			Lateral Expansion - Inches		
			No. 1	No. 2	No. 3	No. 1	No. 2	No. 3
89229	18	163,000	49	50	48	.028	.027	.029
89229	18-1	164,500	48	48	49	.026	.029	.029
89616	1	159,000	52	53	53	.028	.030	.029
89616	1-1	160,000	54	50	51	.030	.029	.029
89616	8	163,500	50	48	51	.027	.026	.030
89616	8-1	158,500	52	54	54	.031	.031	.030
89616	11	159,000	50	50	51	.029	.029	.028
89616	11-1	161,000	50	51	49	.031	.030	.027

ARKANSAS NUCLEAR ONE
UNIT 2

Table 5.5-1

REACTOR COOLANT PUMP ORIGINAL PARAMETERS

Number	4
Type	Vertical, Limited Leakage, Centrifugal
Shaft Seals, Type, Number	Mechanical, 4
Materials Stationary Face	Carbon CCP-72, CNFJ, Graphitar 114, or NMCC CNFJ
Rotating Face Body	ASTM-A-351 Gr CF8
Rotating Face Ring	Titanium Carbide, Kenna-Metal K 162-B or KZ-801 Vapor stage may be Silicon Carbide
Design Pressure, psig	2485
Design Temperature, °F	650
Normal Operating Pressure, psig	2235*
Normal Operating Temperature, °F	553.5*
Design Flow, gpm	80,500*
Total Dynamic Head, ft.	275
Maximum Flow (one-pump operation), gpm	115,000*
Dry Weight, lb	109,800
Flooded Weight, lb	191,800
Reactor Coolant Volume, ft ³	112
Material	
Shaft	ASTM A-182 Type F-304
Casing	ASTM A-351 Gr CF8M
Casing Wear Ring	ASTM A-351 Gr CF8
Hydrostatic Bearing	
Bearing	ASTM A-351 Gr CF8
Journal	ASTM A-351 Gr CF3A
Flywheel (Motors 2P32 B, C & D) (Motor 2P32A)	ASTM A-533 Gr B Class 1* ASTM A-508 Class 5
Motor	
Voltage, volts	6600
Frequency, hz/phase	60/3
Horsepower/Speed, Hot, hp/rpm	4800/900 (nominal)
Horsepower/Speed, Cold, hp/rpm	6750/900 (nominal)
Service Factor	1.15

ARKANSAS NUCLEAR ONE
UNIT 2

Table 5.5-1 (continued)

Instrumentation

On Motor		
Motor Shaft Vibration	4	
Reverse Rotation Switch	1	
Antireverse Device Bearing RTD	1	
Motor Stator RTD	6	
Bearing RTDs	4	
Oil RTDs	3	
Oil Filter Δ ps	3	
Oil Flow	3	
Oil Pressure	2	
Oil Level	2	
On Pump		
Seal Pressure	3	
Seal Temperature RTD	1	
Controlled Bleedoff Flow	1	
Controlled Bleedoff Temperature RTD	1	
Pump Shaft Vibration	2	
Shaft Axial Position	1	
Vibration Phase Angle	2	
Total Seal Assembly Leakage	(SU)	(N9000)
Three Pressure Seals Operating, gpm	1.10	1.0
Two Pressure Seals Operating, gpm	1.35	1.2
One Pressure Seal Operating, gpm	1.90	1.7

* See Table 5.1-1a for revised values.

ARKANSAS NUCLEAR ONE
UNIT 2

Table 5.5-2

STEAM GENERATOR DESIGN PARAMETERS

Number	2
Type	Vertical U-Tube
Number of Tubes	10637
Tubes Outside Diameter, in.	0.688
Tube Wall Thickness, in.	0.040
Heat Transfer Rate, each, Btu/hr	5.2968×10^9
Nozzles and Manways	
Primary Inlet Nozzle (1 ea.), ID, in.	42
Primary Outlet Nozzle (2 ea.), ID, in.	30
Steam Nozzle (1 ea.), ID, in.	34
Feedwater Nozzle (1 ea.), nominal, in.	18
Instrument Taps (14 ea.), ID, in.	0.75
Primary Manways (2 ea.), ID, in.	18
Secondary Manways (2 ea.), ID, in.	18
Secondary Handhole (2 ea.), ID, in.	
Lower Handholes (4 ea.)	8
U-Bend Handholes (2 ea.)	6
Tube Support Plate Inspection Ports (14 ea.)	3
Bottom Blowdown (2 ea.), nominal, in.	2 ⁽¹⁾
Sample Nozzle (1 ea.), nominal, in.	2
Reactor Coolant Side	
Design Pressure, psia	2514.7
Design Temperature, °F	650
Inlet Temperature, maximum (°F)	614.3
Outlet Temperature, maximum (°F)	554.7
Design Thermal Power (NSSS including RCP contribution), Mwt	3044
Coolant Flow-best estimate (ea.), lb/hr	66×10^6
Normal Operating Pressure, psia	2200
Coolant Volume, each, ft ³	1838
Secondary Side	
Design Pressure, psia	1114.7
Design Temperature, °F	560
Normal Operating Steam Pressure, Full Load-best estimate, psia	939
Normal Operating Steam Temperature, Full Load-best estimate, °F	536.8
Design Blowdown Flow, Continuous, ea., lb/hr	80,000
Steam Flow, Each-best estimate, lb/hr	6.83×10^6
Steam Moisture Content, Maximum, percent	0.10
Feedwater Temperature, °F (best estimate for design)	453
Number of Steam Separators, each	240
Number of Steam Dryers, each	8 Banks
Tube Sheet Design Differential Pressure, psi	1600

ARKANSAS NUCLEAR ONE
UNIT 2

Table 5.5-2 (continued)

Dimensions	
Overall Height, Including Support Skirt, in.	742 ⁽²⁾
Upper Shell Outside Diameter, in.	240.69
Lower Shell Outside Diameter, in.	169.75 ⁽³⁾ / 171.07 ⁽⁴⁾
Weights	
Dry, lb	1,167,000
Flooded, lb	1,789,600
Operating, lb	1,415,300

Notes:

- (1) Each nozzle may be machined to a 3.5 inch ID. One blowdown nozzle on each steam generator is capped.
- (2) Includes 1 inch allowance for field prep machining
- (3) Tubesheet, A barrel and lower B barrel
- (4) Upper B barrel and lower part of cone
- (5) Normal operating values based on full power $T_{\text{cold}} = 551 \text{ }^{\circ}\text{F}$

ARKANSAS NUCLEAR ONE
UNIT 2

Table 5.5-3

STEAM GENERATOR TESTS

<u>Component or Structure</u>	<u>Test</u>
Tube Sheet	
Forging	UT, MT
Cladding	UT, PT
Primary Head	
Forging	UT, MT
Cladding	UT, PT
Secondary Shell and Head	
Forging	UT, MT
Tubes	UT, ET
Nozzles (Forgings)	UT, MT
Studs	UT, MT
Welds	
Shell, circumferential	RT, MT
Cladding	UT, PT
Nozzles to shell	RT, MT
Tube-to-tube sheet	PT
Instrument connections	MT
Temporary attachments after removal	MT
All Accessible Welds - after hydrostatic test	MT
Nozzle safe ends	RT, (MT or PT)
Level Nozzles	MT

Key

UT = Ultrasonic Testing
MT = Magnetic-particle Testing
PT = Dye-penetrant Testing
RT = Radiographic Testing
ET = Eddy-current Testing

ARKANSAS NUCLEAR ONE
UNIT 2

Table 5.5-4

REACTOR COOLANT PIPING ORIGINAL DESIGN PARAMETERS

Number of loops				2
Flow per loop, lb/hr				60.2 x 10 ⁶
Pipe size				
Reactor outlet	ID/wall, in.	42/3-3/4		w/o clad
elbow	ID/wall, in.	42/4-1/8		w/o clad
Reactor inlet	ID/wall, in.	30/3		w/o clad
elbow	ID/wall, in.	30/3-1/4		w/o clad
Pump Suction	ID/wall, in.	30/2-1/2		w/o clad
elbow	ID/wall, in.	30/3		w/o clad
Surge line, nominal	ID/wall, in.	12		w/o clad
Design Pressure, psi				2500
Design Temperature, °F ⁽¹⁾				650
Velocity, Hot leg, ft/sec				41.4
Velocity, Cold leg, ft/sec				36.5

⁽¹⁾ Miscellaneous RCS piping associated with the pressurizer has a design temperature of 658 °F, and the pressurizer surge line has a design temperature of 700 °F.

ARKANSAS NUCLEAR ONE
UNIT 2

Table 5.5-5

REACTOR COOLANT PIPING TESTS

<u>Component</u>	<u>Test</u>
Fittings (castings)	RT, PT
Pipe (castings)	RT, PT, or MT
Nozzles (Carbon steel forgings)	(UT, MT)
Pipes and Elbows	
Carbon Steel Plate	UT, MT
Roll Bond Clad	UT, PT
Welds	
Circumferential	RT, PT or MT
Nozzles to pipe run	RT, MT or UT
Instrument connections	PT
Cladding	UT, PT
Vendor supplied piping and fittings	UT, PT
Field erected piping	PT
Safe Ends to Nozzles	RT, PT
Alloy 690 Weld Overlays	UT, PT

Key

UT = Ultrasonic Testing
MT = Magnetic-Particle Testing
PT = Dye-Penetrant Testing
RT = Radiographic Testing

ARKANSAS NUCLEAR ONE
UNIT 2

Table 5.5-6

REPLACEMENT PRESSURIZER DESIGN PARAMETERS

Design Pressure, psia	2500
Design Temperature, °F	700
Normal Operating Pressure, psia	2200
Normal Operating Temperature, °F	653
Internal Free Volume, ft ³	1200
Design Water Volume, Full Power, ft ³	680
Design Steam Volume, Full Power, ft ³	520
Maximum Heater Capacity, kw (96 Heaters)	1326
Spray Flow, Maximum gpm	513
Spray Flow, Continuous, gpm	1.5
Nozzles	
Surge Line (1 ea) nominal, in.	12, Schedule 160
Safety (3), ID, in.	6, Flanged
Safety valves (2)	
LTOP Vent (1)	
Spray (1) nominal, in.	4, Schedule 120
Heater Sleeves (96) ID, in.	0.905
Heaters 96 OD, in.	0.875
Instruments, Level (2) Nominal, in.	
Level, Top (2) nominal, in.	3/4, Schedule 160
Level, Bottom (2) nominal, in.	3/4, Schedule 160
Temperature (1) nominal	1, Schedule 160
Pressure (2) nominal, in.	3/4, Schedule 160
Vent (1) nominal, in.	3/4, Schedule 160
Dimensions	
Overall Length, including skirt and spray nozzle, in.	369-3/8
Outside Diameter, in.	106
Inside Diameter, in.	96.25
Cladding Thickness, in. (minimum)	0.22
Bottom Head Cladding thickness (Heater Sleeve Area), in. (minimum)	0.5
Dry Weight, Including Heaters, lb	161,146
Flooded Weight, Including Heaters, lb	239,302

ARKANSAS NUCLEAR ONE
UNIT 2

Table 5.5-7

PRESSURIZER TESTS

<u>Component</u>	<u>Test</u>
Heads	
Forging	UT, MT
Cladding	UT, PT
Shell	
Forging	UT, MT
Cladding	UT, PT
Heaters	
Tubing	UT, PT
Centering of elements	RT
End plug	UT, PT
Nozzle	UT, MT
Studs	UT, MT
Welds	
Shell, circumferential	RT, MT
Cladding	UT, PT
Nozzles	RT, MT
Nozzle safe ends	RT, PT
Instrument connections	PT
Support Skirt	RT, MT
Temporary attachments after removal	MT
All welds after hydrostatic test	MT or PT
Heater assembly, end plug weld	RT, PT

Key

UT = Ultrasonic Testing
 MT = Magnetic-Particle Testing
 PT = Dye-Penetrant Testing
 RT = Radiographic Testing

ARKANSAS NUCLEAR ONE
UNIT 2

Table 5.5-8

QUENCH TANK PARAMETERS

Design Pressure, psig	100
Design Temperature, °F	350
Internal Volume, ft ³	254
Blanket Gas	Nitrogen
Nozzles	
Pressurizer discharge (1) nominal, in.	10 Sch. 40
Demineralized water (1), in./rating	2/3000 lb SW Coupling
Rupture Disc (1) in.	18 Flanged
Drain, (1), in./rating	2/3000 lb SW Coupling
Temp. Instrument (1), in./rating	1/3000 lb SW Coupling
Level Instrument (2), in./rating	1/3000 lb SW Coupling
Vent (1), in./rating	2/3000 lb SW Coupling
Vessel Material	ASTM-SA-240 TP 304
Dimensions	
Overall Length, in.	169-3/8
Outside Diameter, in.	60
Dry Weight, lb	5,240
Flooded Weight	21,200

Table 5.5-9

PRESSURIZER SPRAY VALVE PARAMETERS

Design Temperature, °F	650
Design Pressure, psig	2485
Flow, gpm	375
Pressure Drop, psi	8.5 - 40
Material	ASTM-A-351 CF8M

ARKANSAS NUCLEAR ONE
UNIT 2

Table 5.5-10

PRESSURIZER SAFETY VALVE PARAMETERS

Design Pressure, psia	2500
Design Temperature, °F	700
Fluid	Saturated Steam, 10,000 ppm H ₃ BO ₃ , pH = 5.0
Set Pressure, psia	2500 ± 3% (see note)
Rated Capacity, lb/hr @ 3% accumulation (Napier corrected) each minimum	453,817
Type	Spring loaded-balanced bellows. Enclosed bonnet.
Accumulation, %	3
Backpressure Max. buildup/max. superimposed, psig	700/100
Blowdown, %	5.2 ± 2%
Materials	
Body	A 351 CF8M
Bonnet	A 105 Grade II
Nozzle	ASME SA-182 GR. F316
Disc	ASME SB-637 UNS-07718

Note: ± 3% utilized in accident analyses, ± 1% allowance utilized when adjusting lift setting.

ARKANSAS NUCLEAR ONE
UNIT 2

Table 5.5-11

MAIN STEAM SAFETY VALVE PARAMETERS

Design Pressure, psia	1100
Design Temperature, °F	560
Fluid	Saturated Steam
Set Pressure, psig ($\pm 3\%$) (see Note)	
2 Valves	1078
4 Valves	1105
4 Valves	1132
Total Nominal Capacity (10 Valves) lb/hr at 1200 psia	15,000,000
Accumulation, percent	3
Blowdown, percent	5
Maximum Allowable Backpressure	20% of Set Pressure
Materials	
Body	SA-105 Gr2
Flanges	
Size - Inlet/Outlet, in.	8/10 x 10
Rating - ASA Inlet/Outlet, lbs	1500/300

See also Table 10.3-1.

Note: $\pm 3\%$ utilized in accident analyses, $\pm 1\%$ allowance utilized when adjusting lift setting.

Table 5.5-12

MOVED TO TABLE 3.11-3

ARKANSAS NUCLEAR ONE
UNIT 2

Table 5.5-13

PRESSURIZER LEVEL CONTROL SETPOINTS

Pressurizer Level - Inches (Percent)	Action		
	One Pump	Two Pump	Three Pump
+38 (+13.2%)	High Level Error Alarm	High Level Error Alarm	High Level Error Alarm
+13 (+4.5%)	Energize all pressurizer heaters and backup signal to stop backup CP	Energize all pressurizer heaters and backup signal to stop backup CP and second operating CP	Energize all pressurizer heaters and backup signal to stop backup CPs
+11 (+3.8%)	All pressurizer heaters off	All pressurizer heaters off	All pressurizer heaters off
-4 (-1.4%)	Stop backup CP 1	Stop backup CP	-
-6 (-2.0%)	Stop backup CP 2	-	-
-9 (-3.1%)	Start backup CP 1	Start backup CP	-
-14 (-4.8%)	Start backup CP2	-	-
-15 (-5.2%)	Low Level Error Alarm and backup signal to start all CPs	Low Level Error Alarm and backup signal to start all CPs	Low Level Error Alarm and backup signal to start all CPs

ARKANSAS NUCLEAR ONE
UNIT 2

Table 5.6-1

REACTOR COOLANT SYSTEM INSTRUMENTATION

System Parameter & Location	Indication		Alarm ¹		Rec ¹	Control Function	Inst. Range	Normal Operating Value
	Local	Control Room	High	Low				
Pressurizer Temperature		*					0-700 °F	650 °F
Spray Line Temperature		*		*			0-700 °F	543 °F
Surge Line Temperature		*		*			0-700 °F	640 °F
Relief Line Temperature		*	*				0-300 °F	70-120 °F
Loop 1 Hot Leg Temp.		*	*		*	RRS	525-625 °F	609 °F
		*				PPS	525-675 °F	609 °F
Loop 1A Cold Leg Temp.		*	*		*	RRS, CEDMCS	525-625 °F	551 °F
		*				PPS	465-615 °F	551 °F
Loop 1B Cold Leg Temp.		*			*		0-600 °F	551 °F
		*				PPS	465-615 °F	551 °F
Loop 1 Temp.					* ⁴	TAVG/TREF	525-625 °F	580 °F
Loop 2 Hot Leg Temp.		*	*		*	RRS	525-625 °F	609 °F
		*				PPS	525-675 °F	609 °F
Loop 2A Cold Leg Temp.		*	*		*	RRS, CEDMCS	525-625 °F	551 °F
		*				PPS	465-615 °F	551 °F
Loop 2B Cold Leg Temp.					*		0-600 °F	551 °F
		*				PPS	465-615 °F	551 °F

ARKANSAS NUCLEAR ONE
UNIT 2

Table 5.6-1 (continued)

System Parameter & Location	Indication		Alarm ¹		Rec ¹	Control Function	Inst. Range	Normal Operating Value
	Local	Control Room	High	Low				
Loop 2 Temp.					* ⁴	TAVG/TREF	525-625 °F	580 °F
Quench Tank Temp.		*	*				0-300 °F	104 °F
Pressurizer Pressure		*	*	*	*	Proportional Heaters, Backup Heaters, Spray Valves	0-2500 psia	2200 psia
						Protective Functions (Safety-Related), RRS, SDBCS	0-3000 psia	2200 psia
	*		*			DSS	1500-2500 psia	2200 psia
				*		Shutdown Cooling & Safety Injection Tank Interlocks	0-1600 psia	
Quench Tank Pressure		*	*				0-100 psig	15 psia
Pressurizer Level		*	*	*	*	Proportional Heaters, Backup Heaters, Charging Pumps, Letdown Valves.	0-100% ²	60%

ARKANSAS NUCLEAR ONE
UNIT 2

Table 5.6-1 (continued)

System Parameter & Location	Indication		Alarm ¹		Rec ¹	Control Function	Inst. Range	Normal Operating Value
	Local	Control Room	High	Low				
Quench Tank Level		*	*	*			0-100% ³	> 75%
Reactor Coolant Pump Differential Pressure		*				COLSS	0-130psid	95 psid
Reactor Coolant Pump Speed						CPC ⁵ , PMS ⁶	0-920 rpm	900 rpm

¹ All alarms and recorders are in the control room unless otherwise indicated.

² Sensor Range 3-95%

³ Sensor Range 5-95%

⁴ This parameter is actually displayed and trended on the Plant Computer.

⁵ See Table 7.2-14

⁶ COLSS runs as an application on the PMS platform and cooperatively supports this range. PMS displays speeds beyond 920 rpm, but indicates bad quality since such speeds are beyond the capability of the equipment.

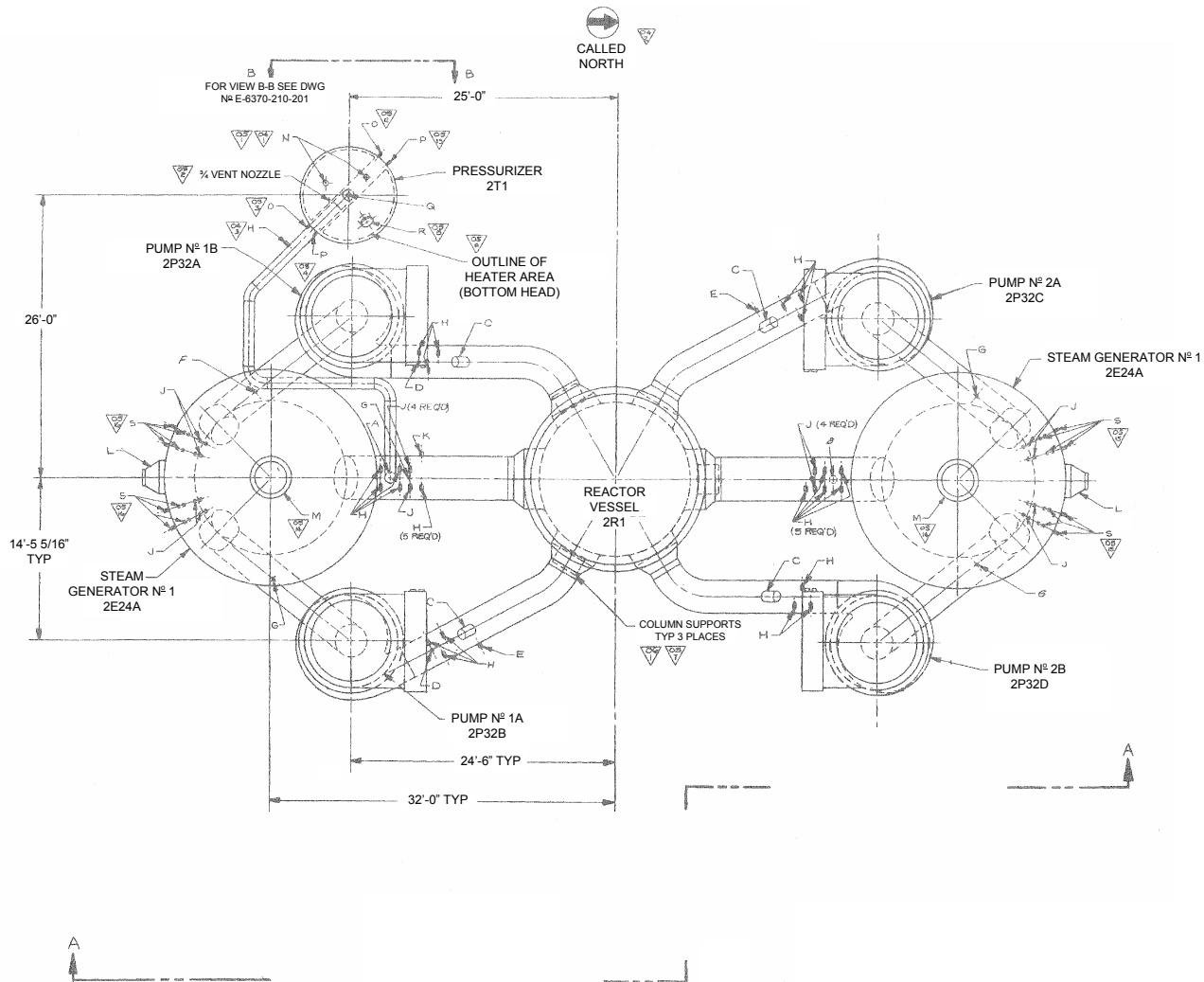

REACTOR COOLANT SYSTEM ARRANGEMENT PLAN

SAR FIGURE NO. 5.1-1

ARKANSAS NUCLEAR ONE
UNIT 2
RUSSELLVILLE, ARKANSAS



SCALE: NONE
DRAWN: ENTERGY
DESIGN: ENTERGY
CAD NO:

AMENDMENT 20

BASED ON DRAWING NO

SHEET

REV.

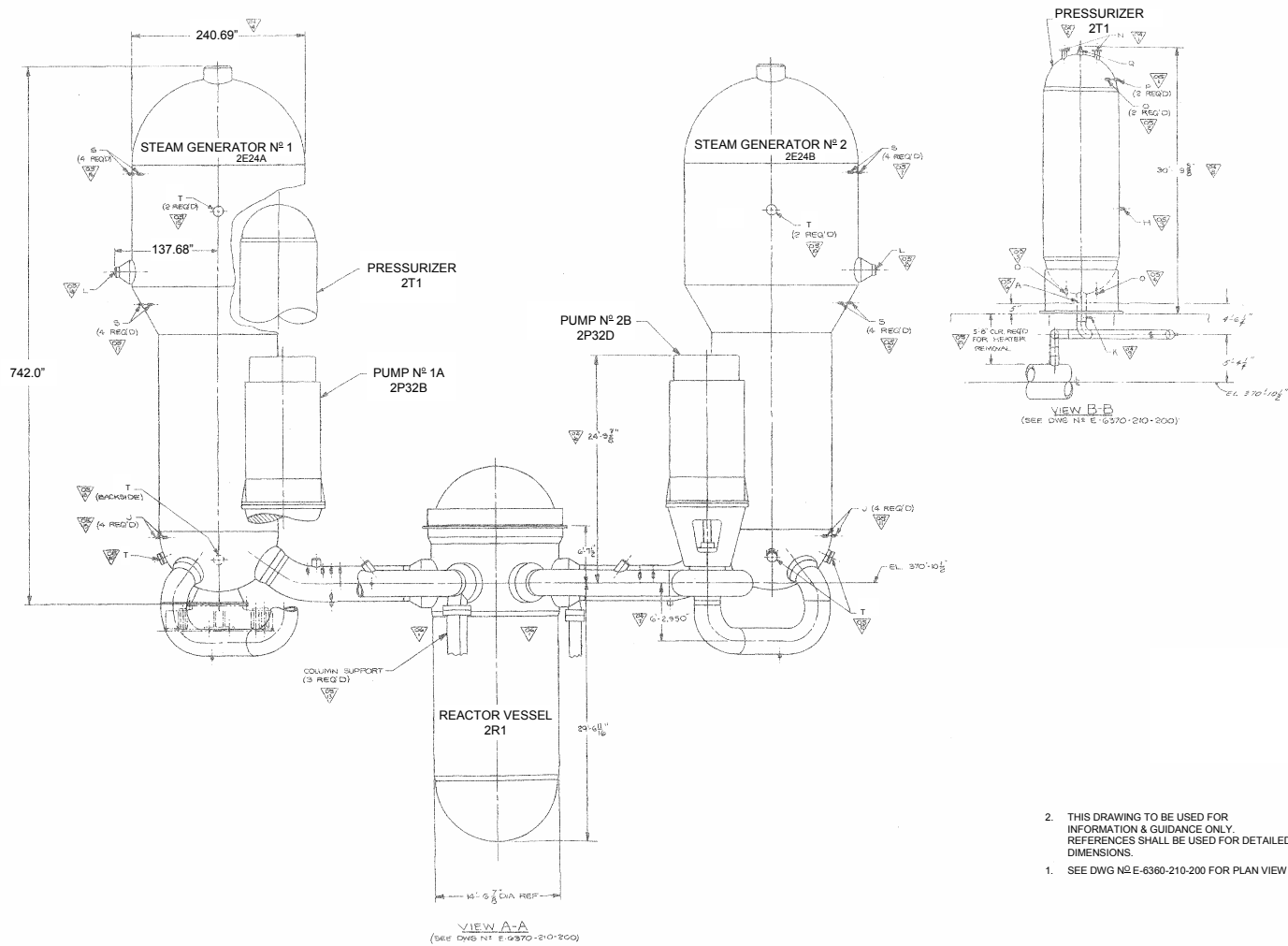

REACTOR COOLANT SYSTEM ARRANGEMENT ELEVATION

SAR FIGURE NO. 5.1-2

ARKANSAS NUCLEAR ONE
 UNIT 2
 RUSSELLVILLE, ARKANSAS



SCALE: NONE
 DRAWN: ENTERGY
 DESIGN: ENTERGY
 CAD NO:

AMENDMENT 20

BASED ON DRAWING NO	SHEET	REV.
---------------------	-------	------

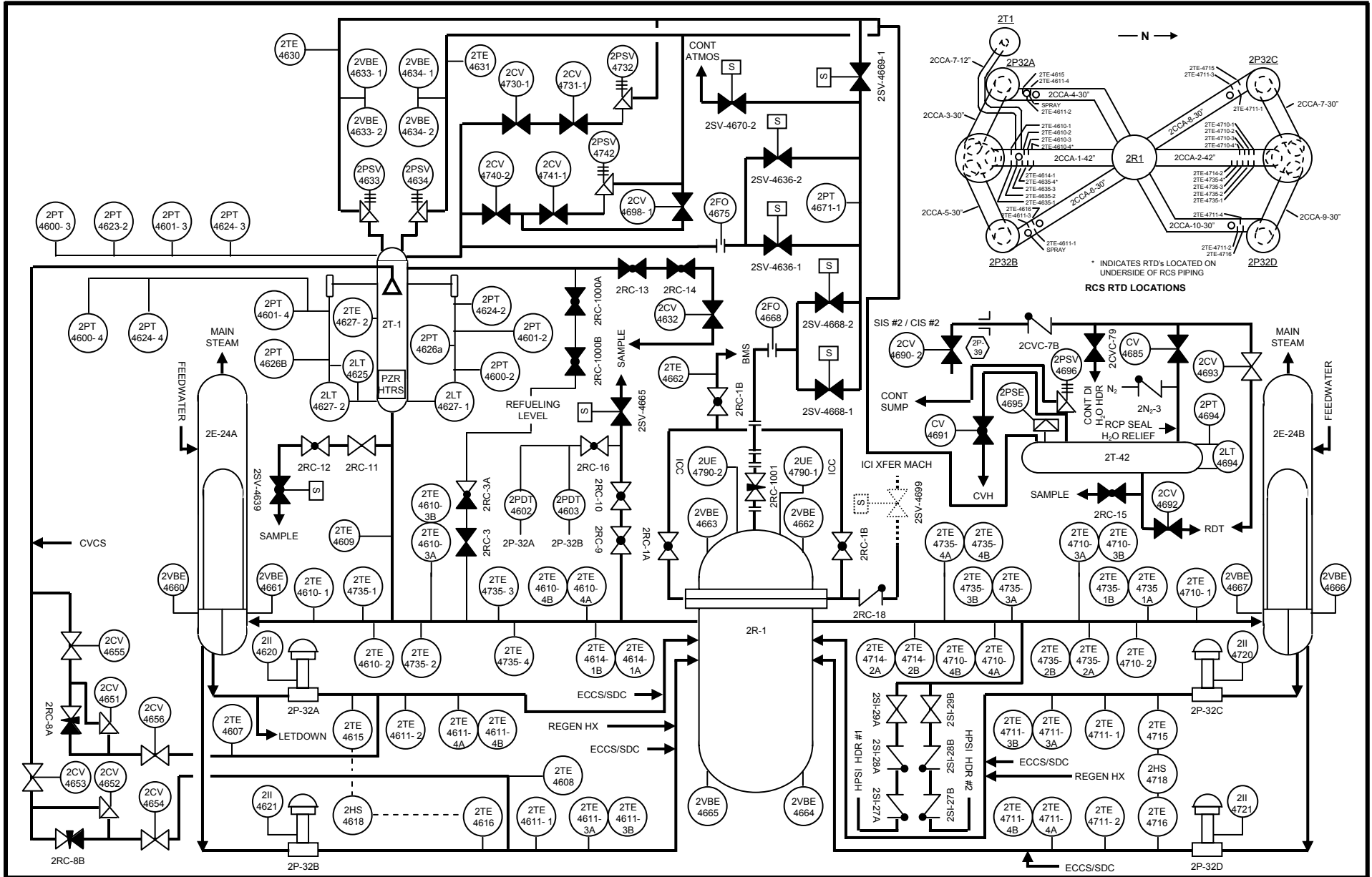

REACTOR COOLANT SYSTEM

SAR FIGURE NO. 5.1-3

ARKANSAS NUCLEAR ONE
UNIT 2
RUSSELLVILLE, ARKANSAS



SCALE:	NONE
DRAWN:	ENERGY
DESIGN:	ENERGY
CAD NO:	NONE

AMENDMENT 23

BASED ON DRAWING NO

SHEET

REV.

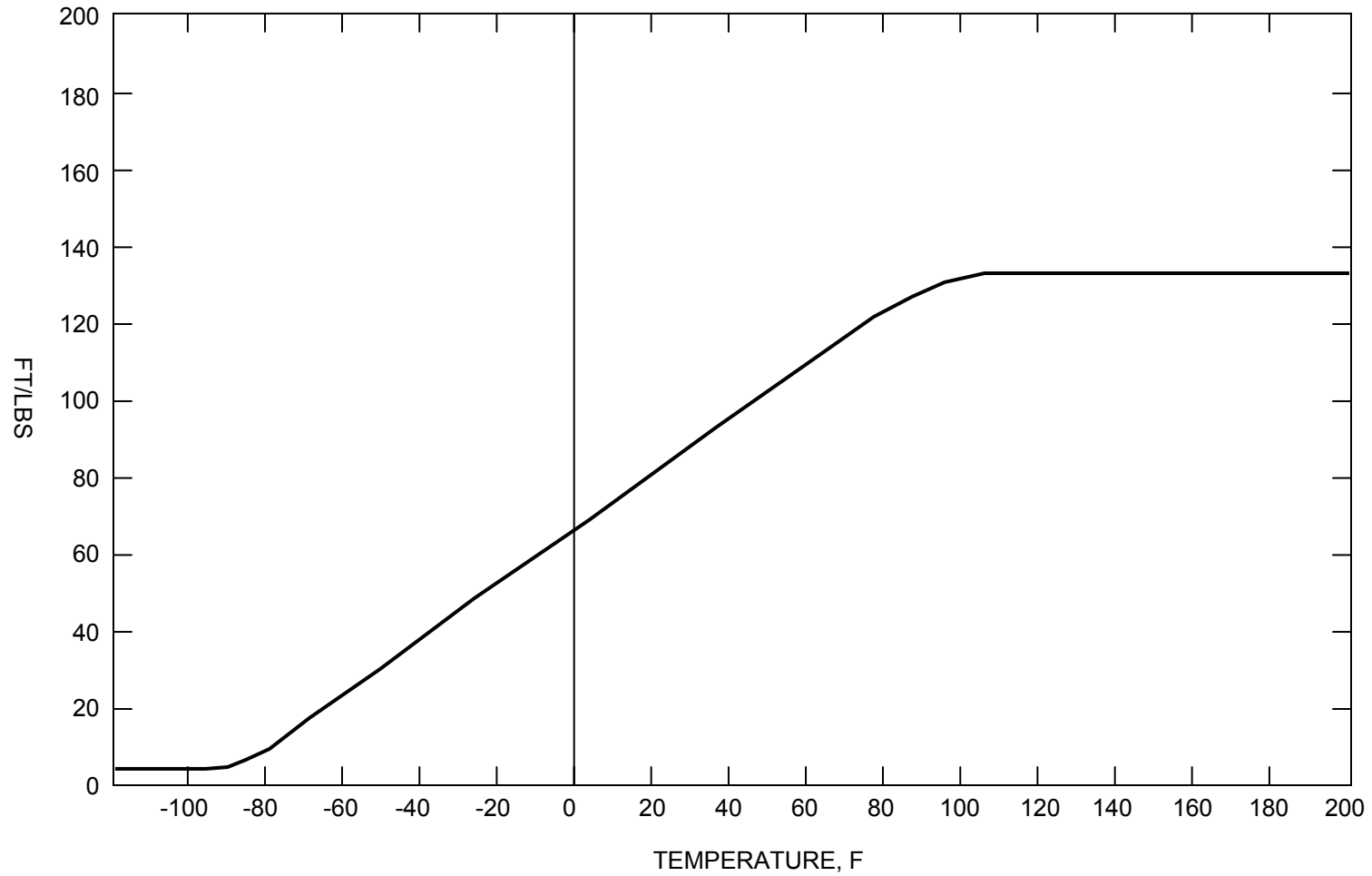

CHARPY TEST RESULTS VESSEL FLANGE – FORGING (C-1008)

SAR FIGURE NO. 5.2-1

ARKANSAS NUCLEAR ONE
 UNIT 2
 RUSSELLVILLE, ARKANSAS



SCALE: NONE
 DRAWN: ENERGY
 DESIGN: ENERGY
 CAD NO:

AMENDMENT 20

BASED ON DRAWING NO

SHEET

REV.

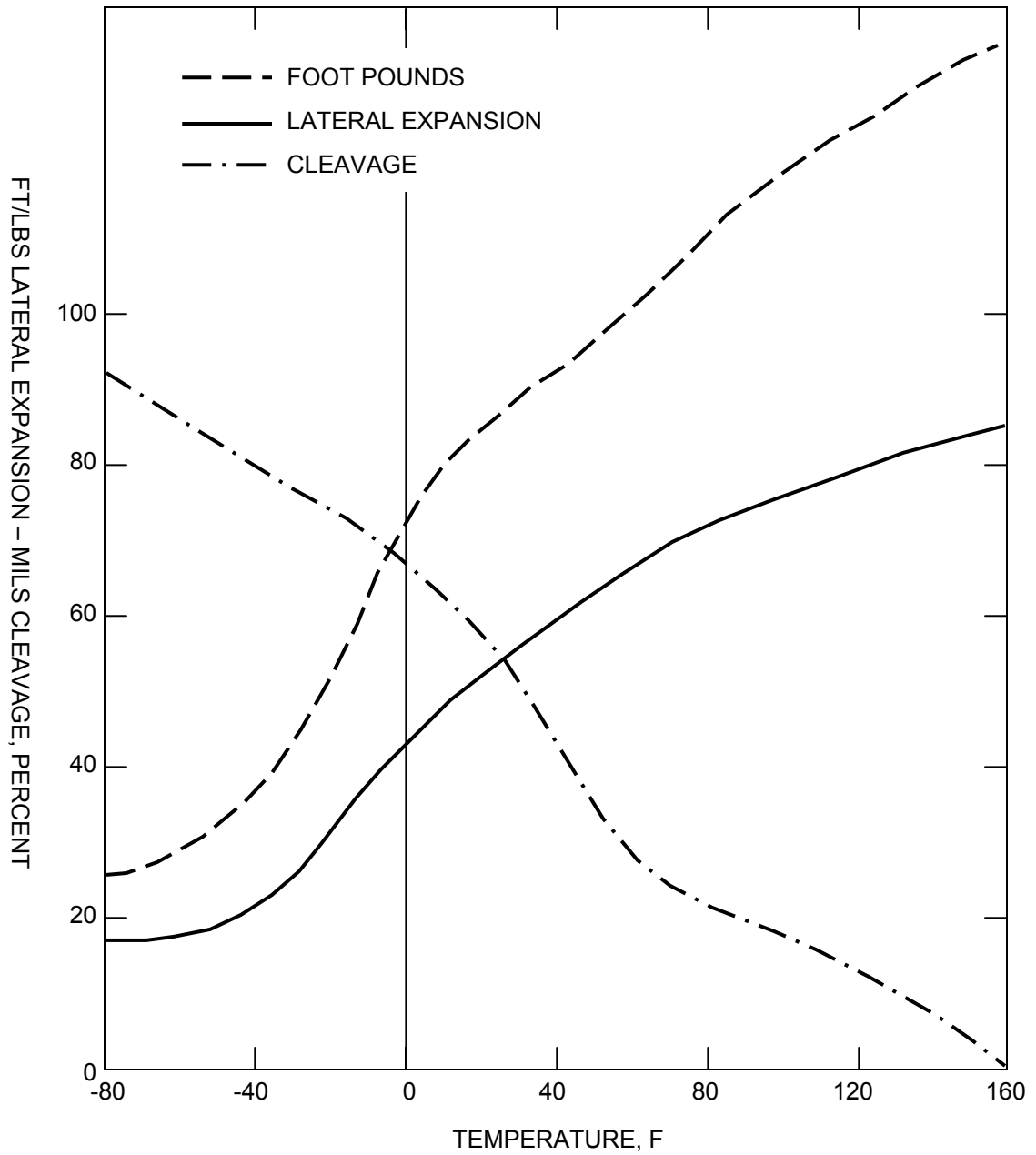

SAR FIGURE NO. 5.2-2

AMENDMENT 20

ARKANSAS NUCLEAR ONE
 UNIT 2
 RUSSELLVILLE, ARKANSAS



SCALE:	NONE
DRAWN:	ENERGY
DESIGN:	ENERGY
CAD NO:	N/A

CHARPY TEST RESULTS BOTTOM HEAD -
 PLATE (C-8013)

BASED ON DRAWING NO

SHEET

REV.

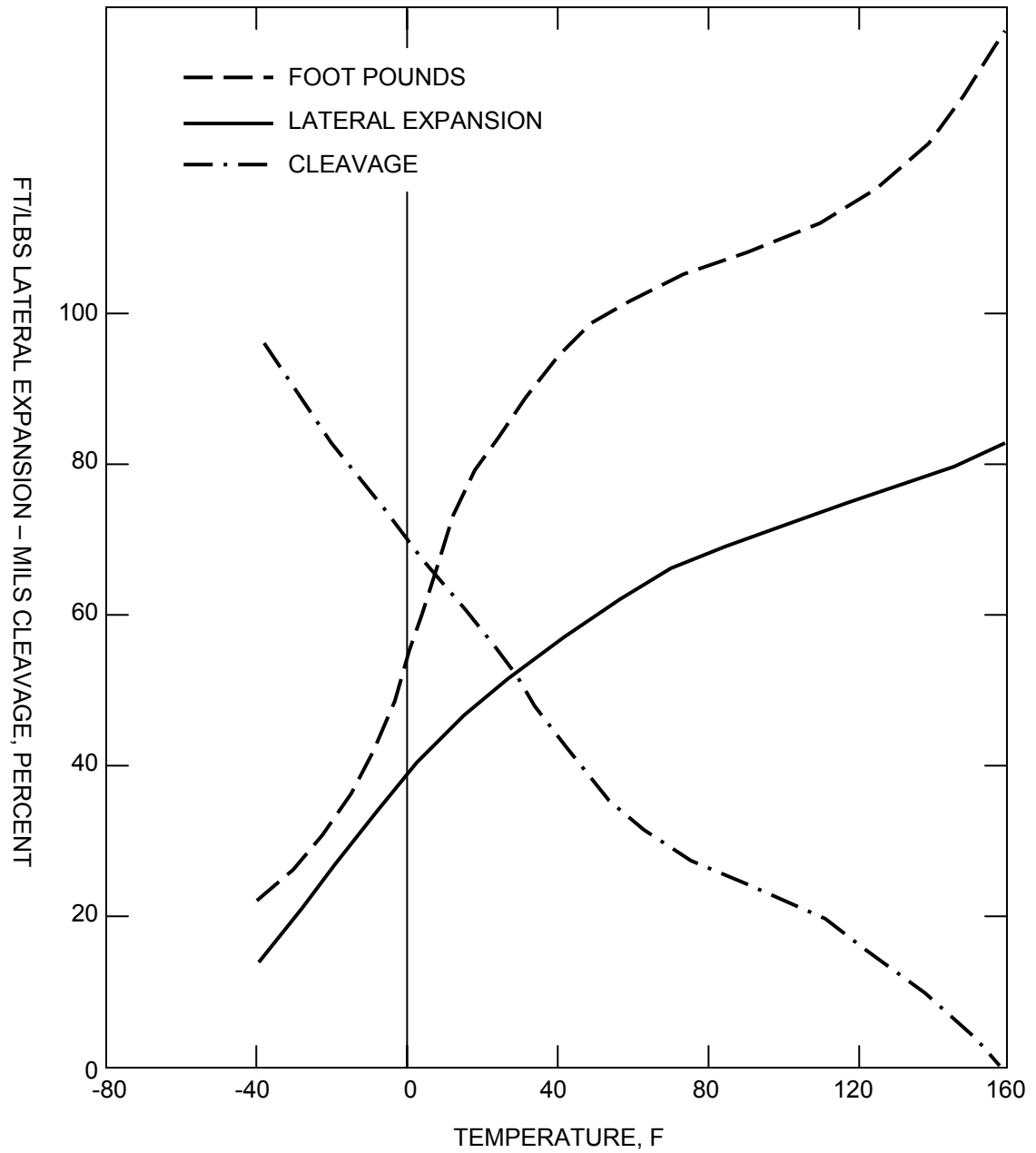

SAR FIGURE NO. 5.2-3

AMENDMENT 20

ARKANSAS NUCLEAR ONE
 UNIT 2
 RUSSELLVILLE, ARKANSAS



SCALE:	NONE
DRAWN:	ENERGY
DESIGN:	ENERGY
CAD NO:	N/A

CHARPY TEST RESULTS BOTTOM HEAD -
 PLATE (C-8014-1)

BASED ON DRAWING NO

SHEET

REV.

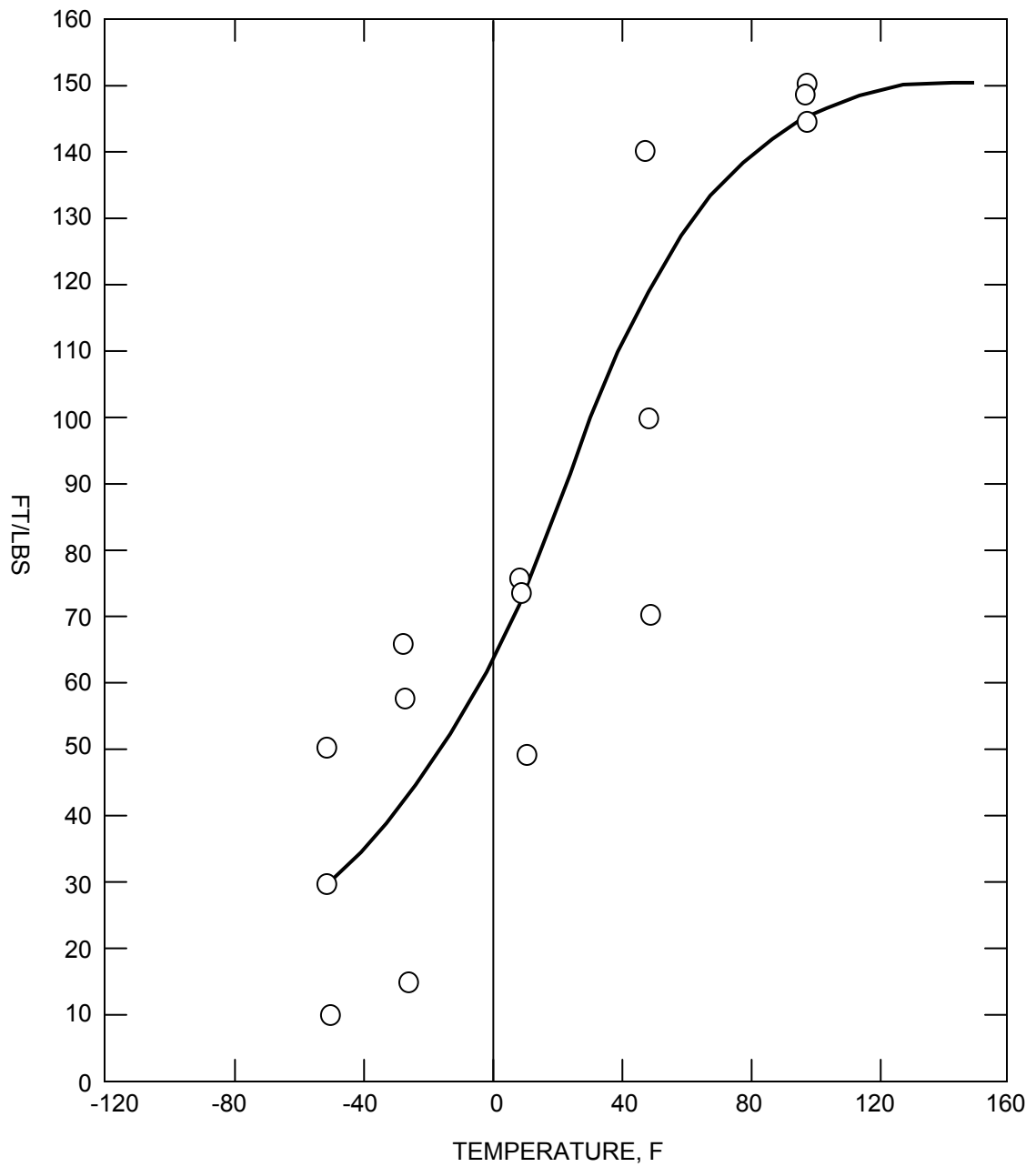

SAR FIGURE NO. 5.2-4

AMENDMENT 20

ARKANSAS NUCLEAR ONE
 UNIT 2
 RUSSELLVILLE, ARKANSAS



SCALE:	NONE
DRAWN:	ENERGY
DESIGN:	ENERGY
CAD NO:	N/A

CHARPY TEST RESULTS INLET NOZZLE –
 FORGING (C-8015-1)

BASED ON DRAWING NO

SHEET

REV.

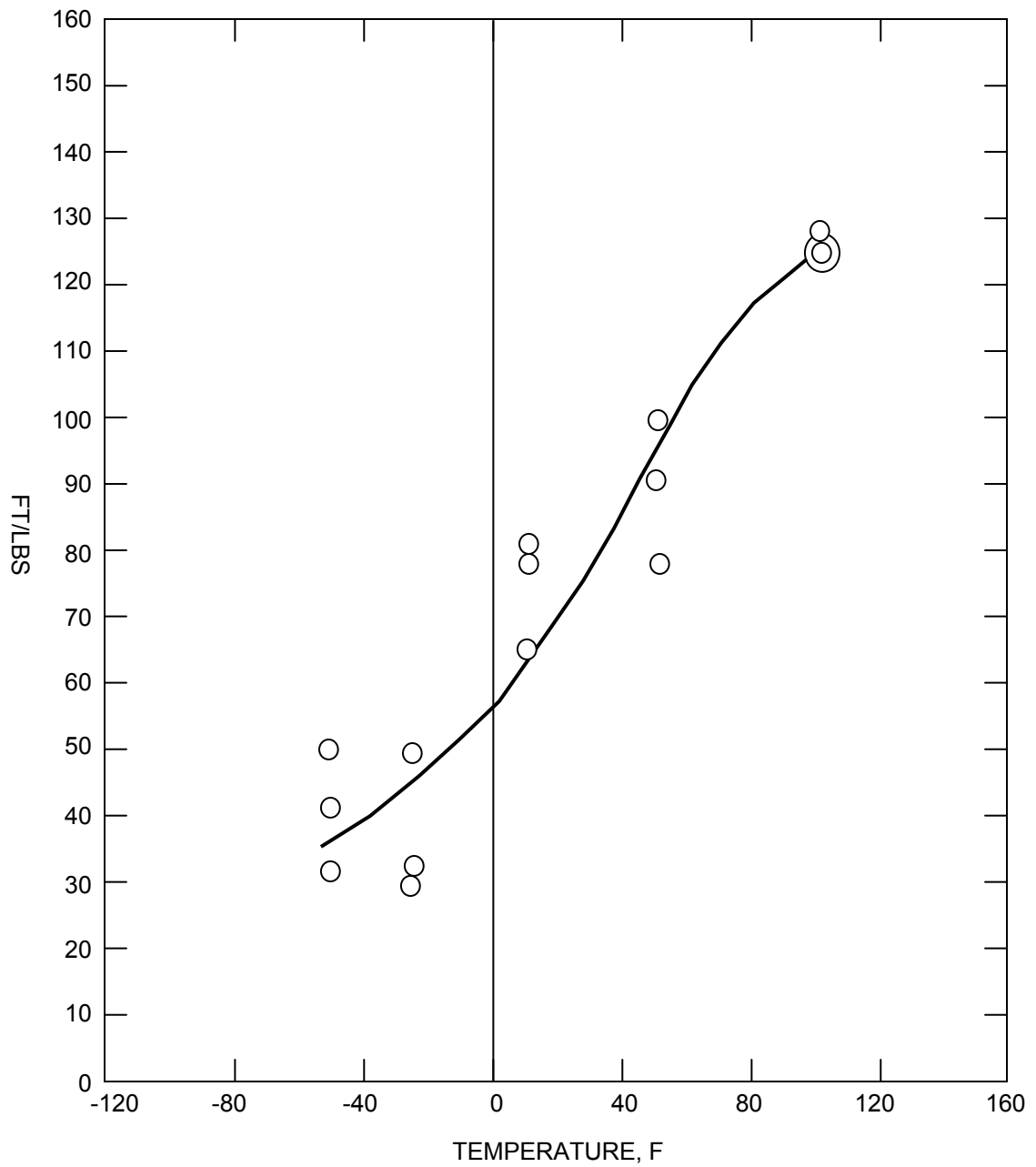

SAR FIGURE NO. 5.2-5

AMENDMENT 20

ARKANSAS NUCLEAR ONE
 UNIT 2
 RUSSELLVILLE, ARKANSAS



SCALE:	NONE
DRAWN:	ENERGY
DESIGN:	ENERGY
CAD NO:	N/A

CHARPY TEST RESULTS INLET NOZZLE –
 FORGING (C-8015-2)

BASED ON DRAWING NO

SHEET

REV.

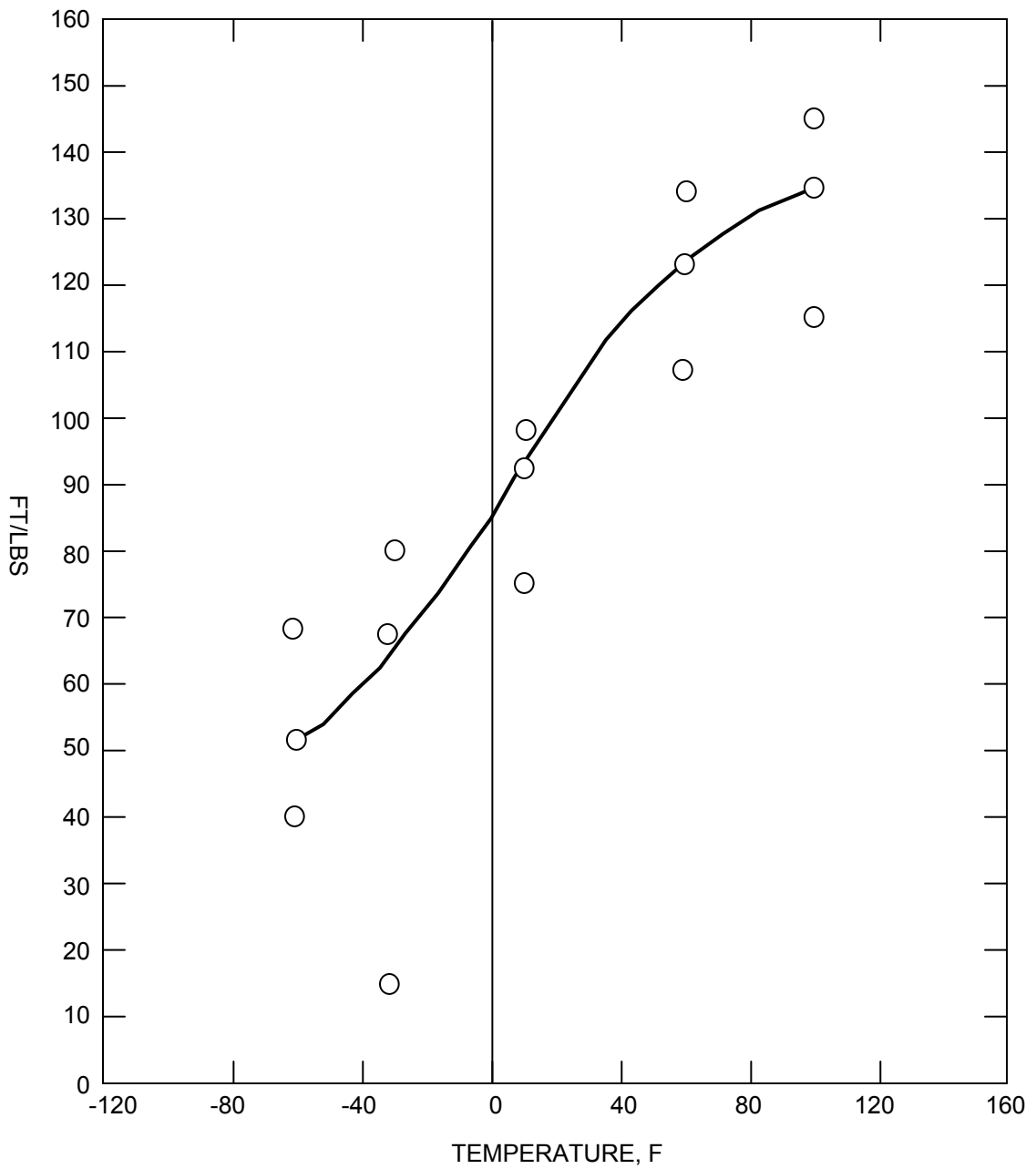

SAR FIGURE NO. 5.2-6

AMENDMENT 20

ARKANSAS NUCLEAR ONE
 UNIT 2
 RUSSELLVILLE, ARKANSAS



SCALE:	NONE
DRAWN:	ENERGY
DESIGN:	ENERGY
CAD NO:	N/A

CHARPY TEST RESULTS INLET NOZZLE –
 FORGING (C-8015-6)

BASED ON DRAWING NO

SHEET

REV.

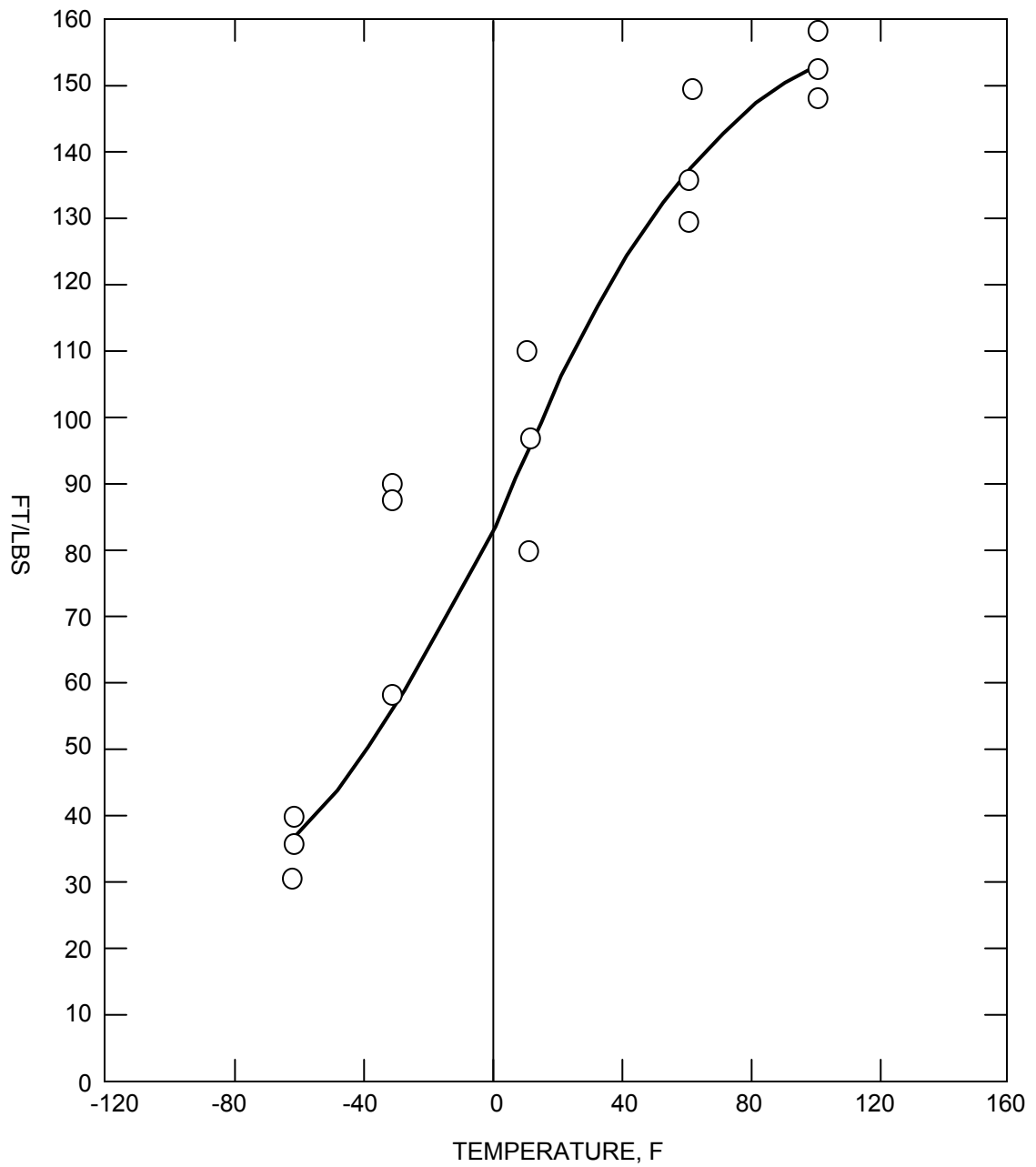

SAR FIGURE NO. 5.2-7

AMENDMENT 20

ARKANSAS NUCLEAR ONE
 UNIT 2
 RUSSELLVILLE, ARKANSAS



SCALE:	NONE
DRAWN:	ENERGY
DESIGN:	ENERGY
CAD NO:	N/A

CHARPY TEST RESULTS INLET NOZZLE –
 FORGING (C-8015-3)

BASED ON DRAWING NO

SHEET

REV.

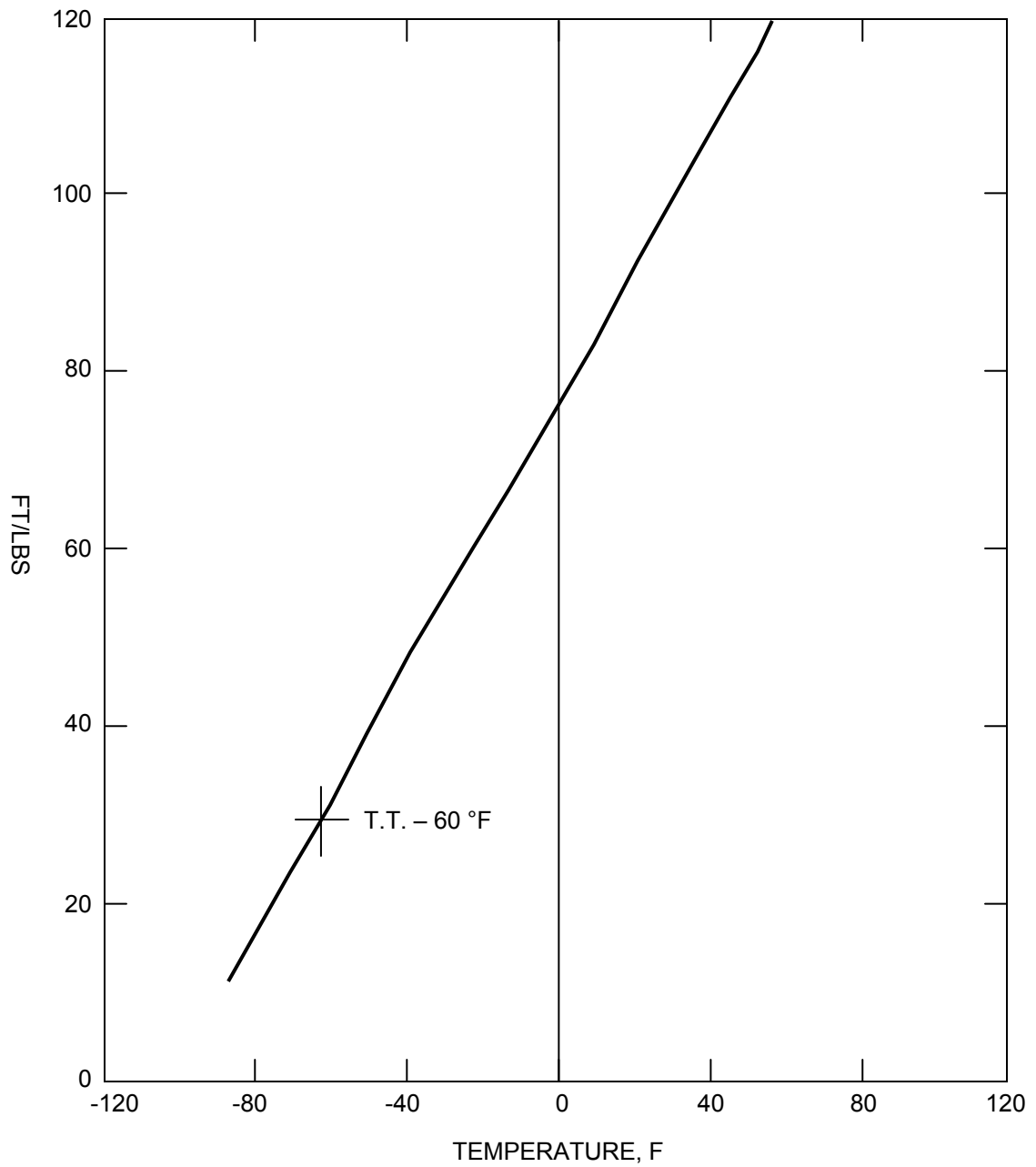

SAR FIGURE NO. 5.2-8

AMENDMENT 20

ARKANSAS NUCLEAR ONE
 UNIT 2
 RUSSELLVILLE, ARKANSAS



SCALE:	NONE
DRAWN:	ENERGY
DESIGN:	ENERGY
CAD NO:	N/A

CHARPY TEST RESULTS OUTLET NOZZLE –
 FORGING (C-8016-1)

BASED ON DRAWING NO

SHEET

REV.

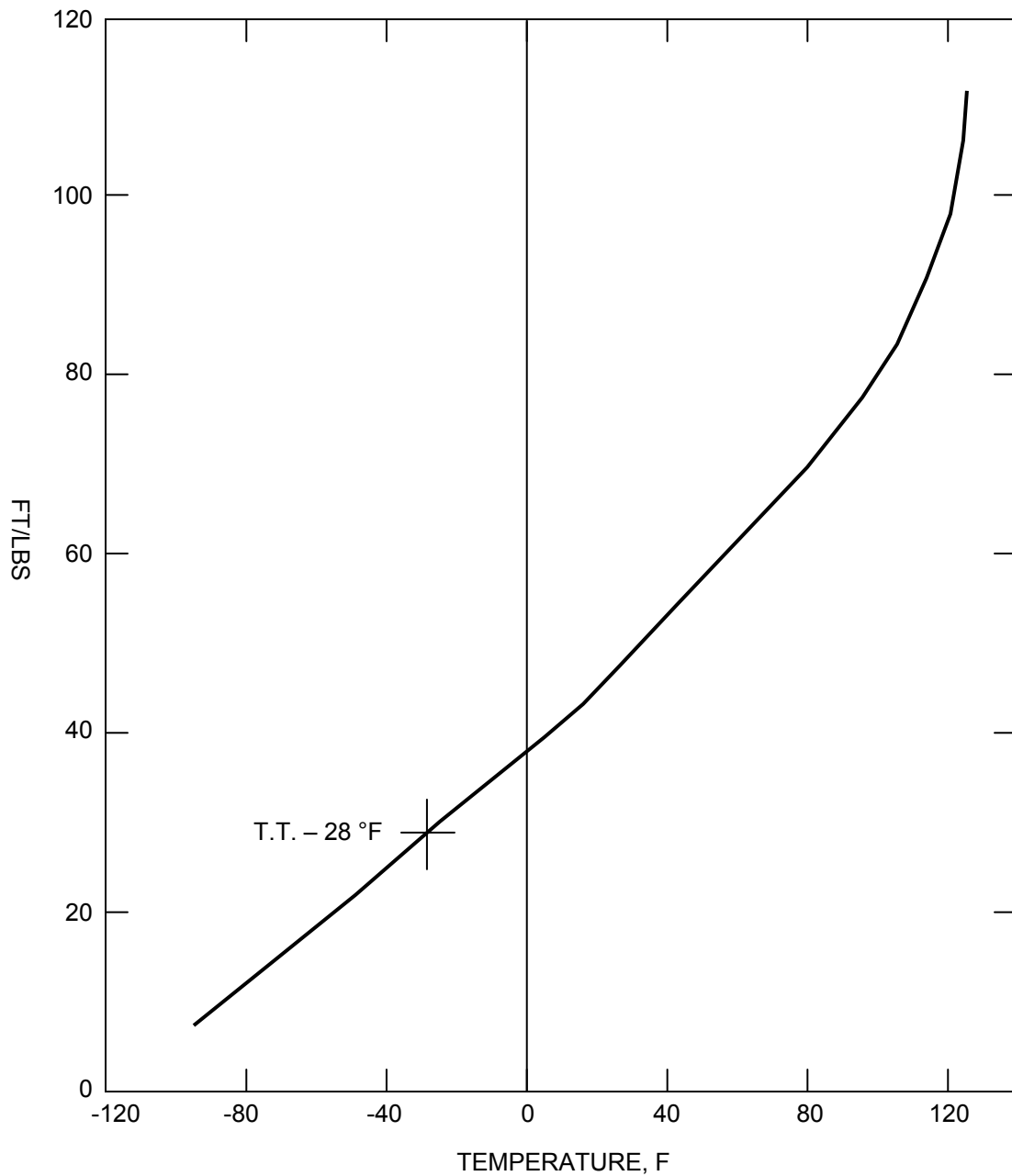

SAR FIGURE NO. 5.2-9

AMENDMENT 20

ARKANSAS NUCLEAR ONE
UNIT 2
RUSSELLVILLE, ARKANSAS



SCALE:	NONE
DRAWN:	ENERGY
DESIGN:	ENERGY
CAD NO:	N/A

CHARPY TEST RESULTS OUTLET NOZZLE –
FORGING (C-8016-2)

BASED ON DRAWING NO

SHEET

REV.

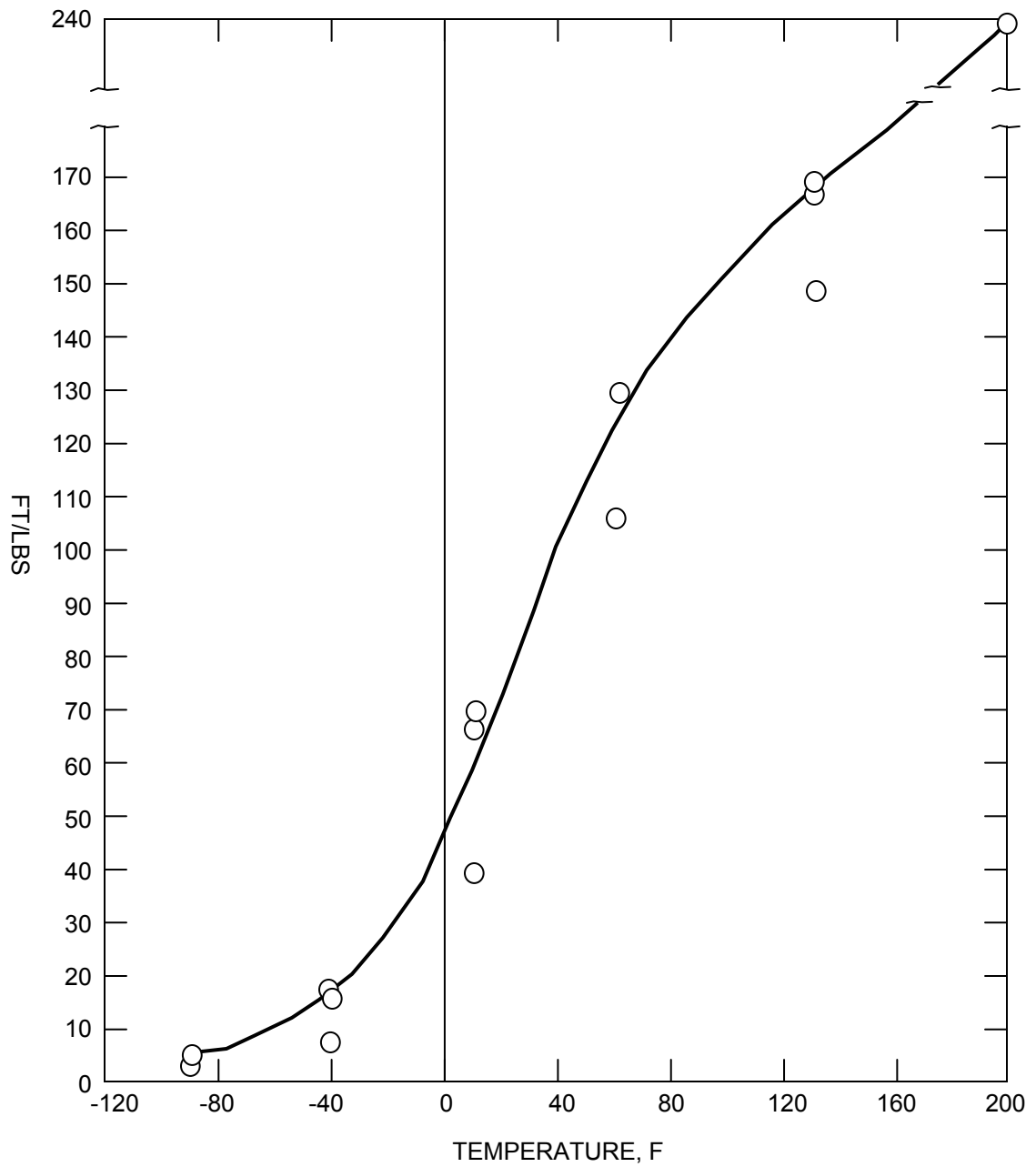

SAR FIGURE NO. 5.2-10

AMENDMENT 20

ARKANSAS NUCLEAR ONE
 UNIT 2
 RUSSELLVILLE, ARKANSAS



SCALE:	NONE
DRAWN:	ENERGY
DESIGN:	ENERGY
CAD NO:	N/A

CHARPY TEST RESULTS INLET NOZZLE
 EXTENSION - FORGING (C-8019-1)

BASED ON DRAWING NO

SHEET

REV.

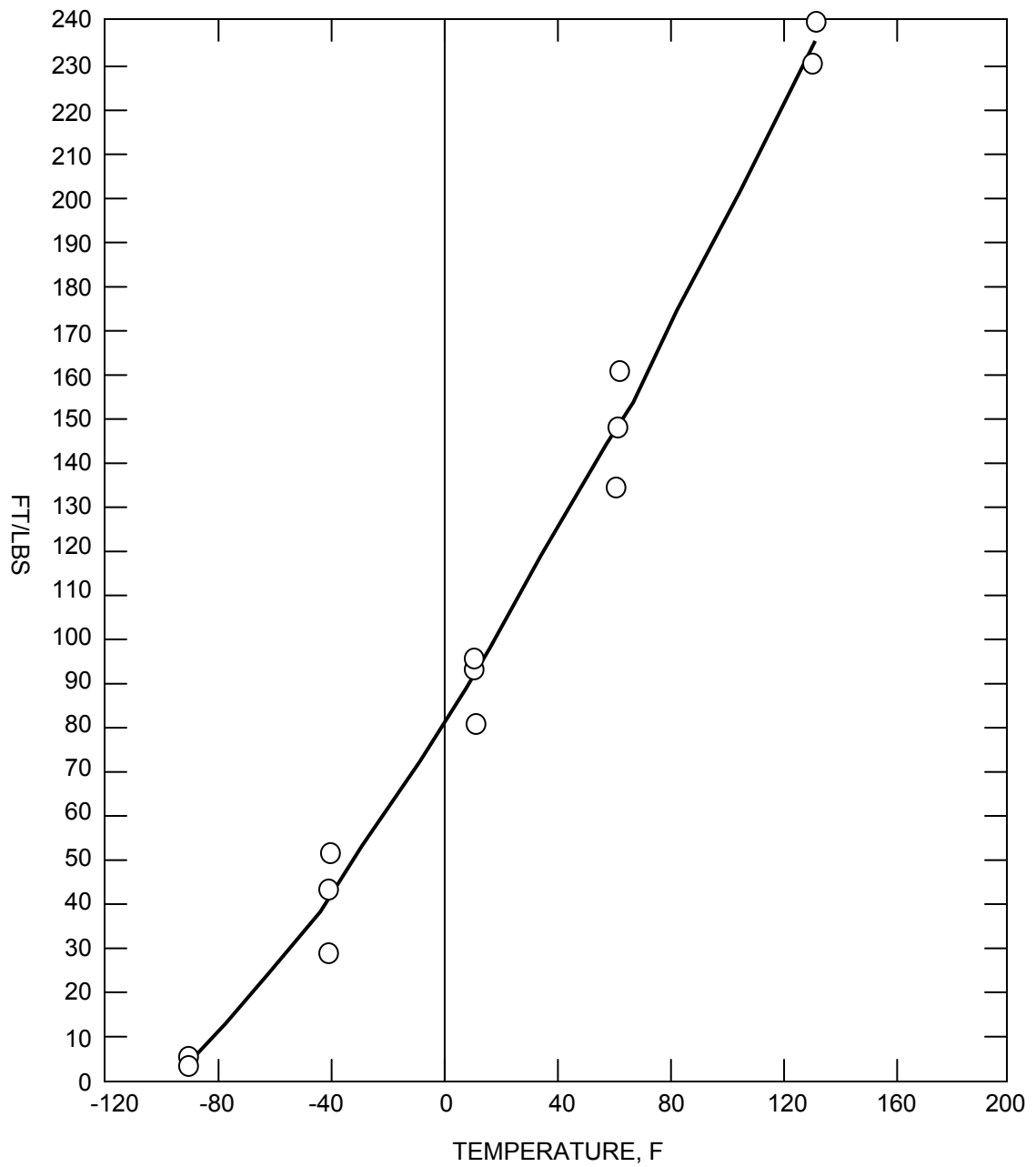

SAR FIGURE NO. 5.2-11

AMENDMENT 20

ARKANSAS NUCLEAR ONE
 UNIT 2
 RUSSELLVILLE, ARKANSAS



SCALE:	NONE
DRAWN:	ENERGY
DESIGN:	ENERGY
CAD NO:	N/A

CHARPY TEST RESULTS INLET NOZZLE
 EXTENSION – FORGING (C-8019-2)

BASED ON DRAWING NO

SHEET

REV.

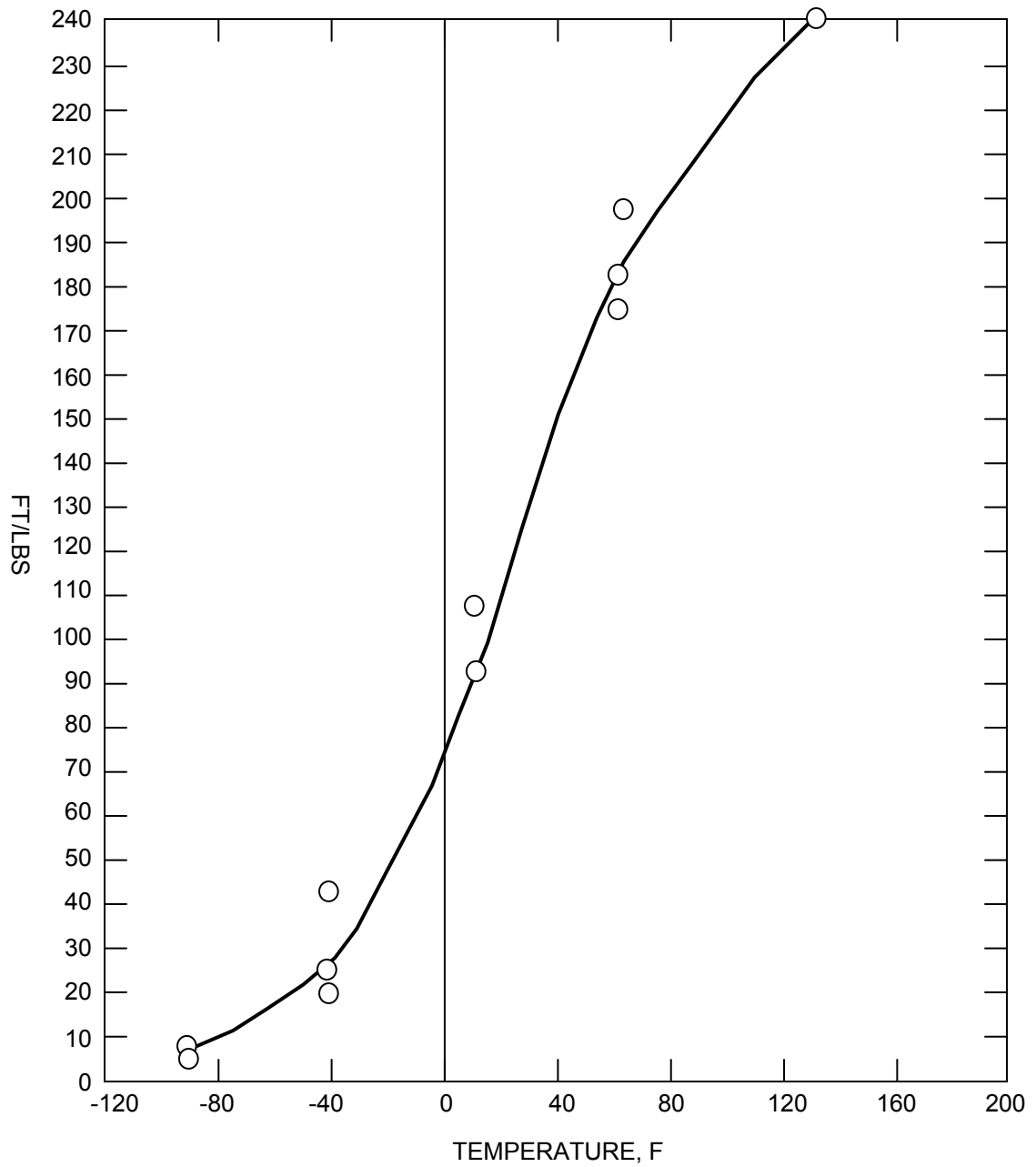

SAR FIGURE NO. 5.2-12

AMENDMENT 20

ARKANSAS NUCLEAR ONE
 UNIT 2
 RUSSELLVILLE, ARKANSAS



SCALE:	NONE
DRAWN:	ENERGY
DESIGN:	ENERGY
CAD NO:	N/A

CHARPY TEST RESULTS INLET NOZZLE
 EXTENSION – FORGING (C-8019-3)

BASED ON DRAWING NO

SHEET

REV.

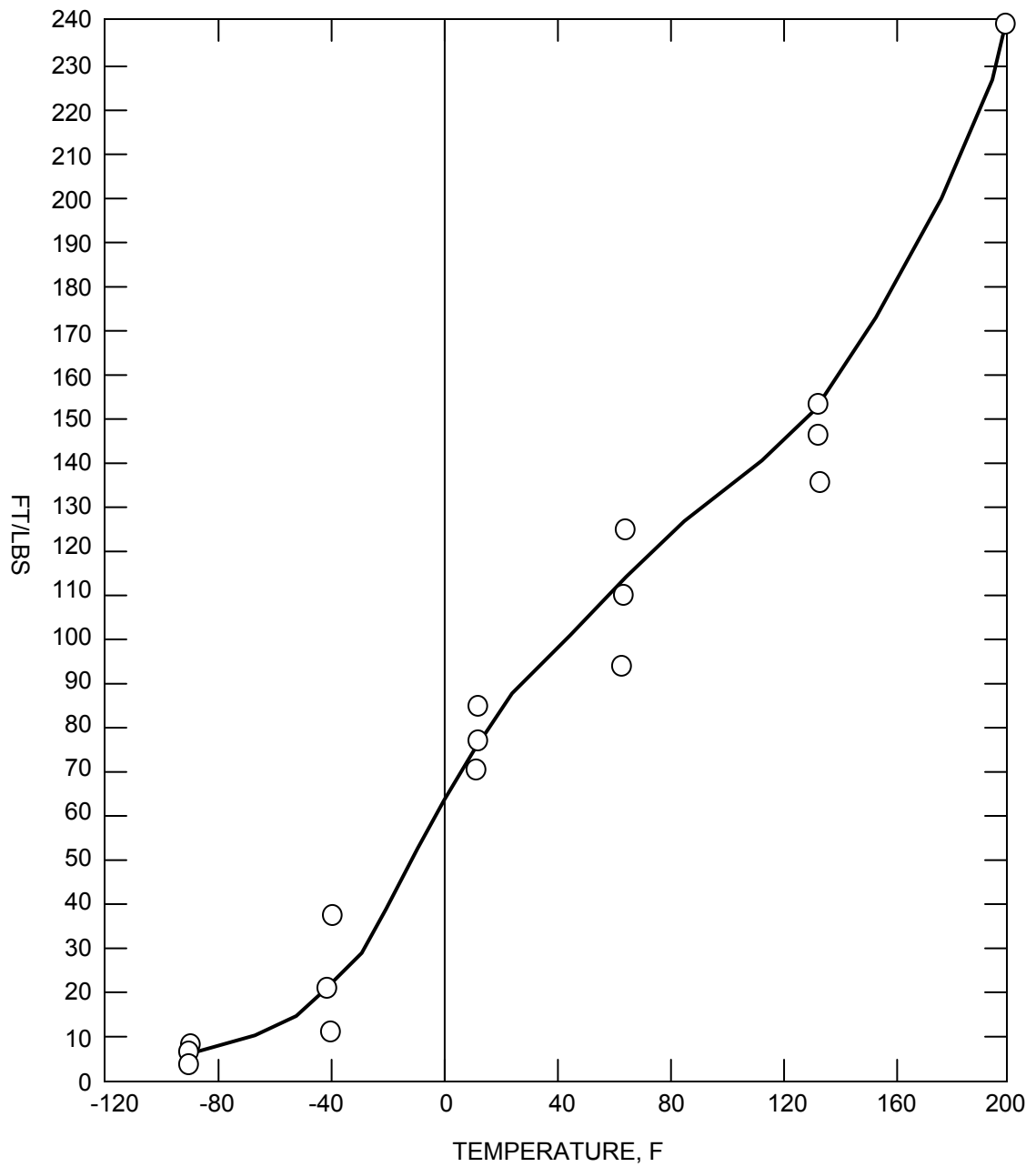

SAR FIGURE NO. 5.2-13

AMENDMENT 20

ARKANSAS NUCLEAR ONE
 UNIT 2
 RUSSELLVILLE, ARKANSAS



SCALE:	NONE
DRAWN:	ENERGY
DESIGN:	ENERGY
CAD NO:	N/A

CHARPY TEST RESULTS INLET NOZZLE
 EXTENSION – FORGING (C-8019-4)

BASED ON DRAWING NO

SHEET

REV.

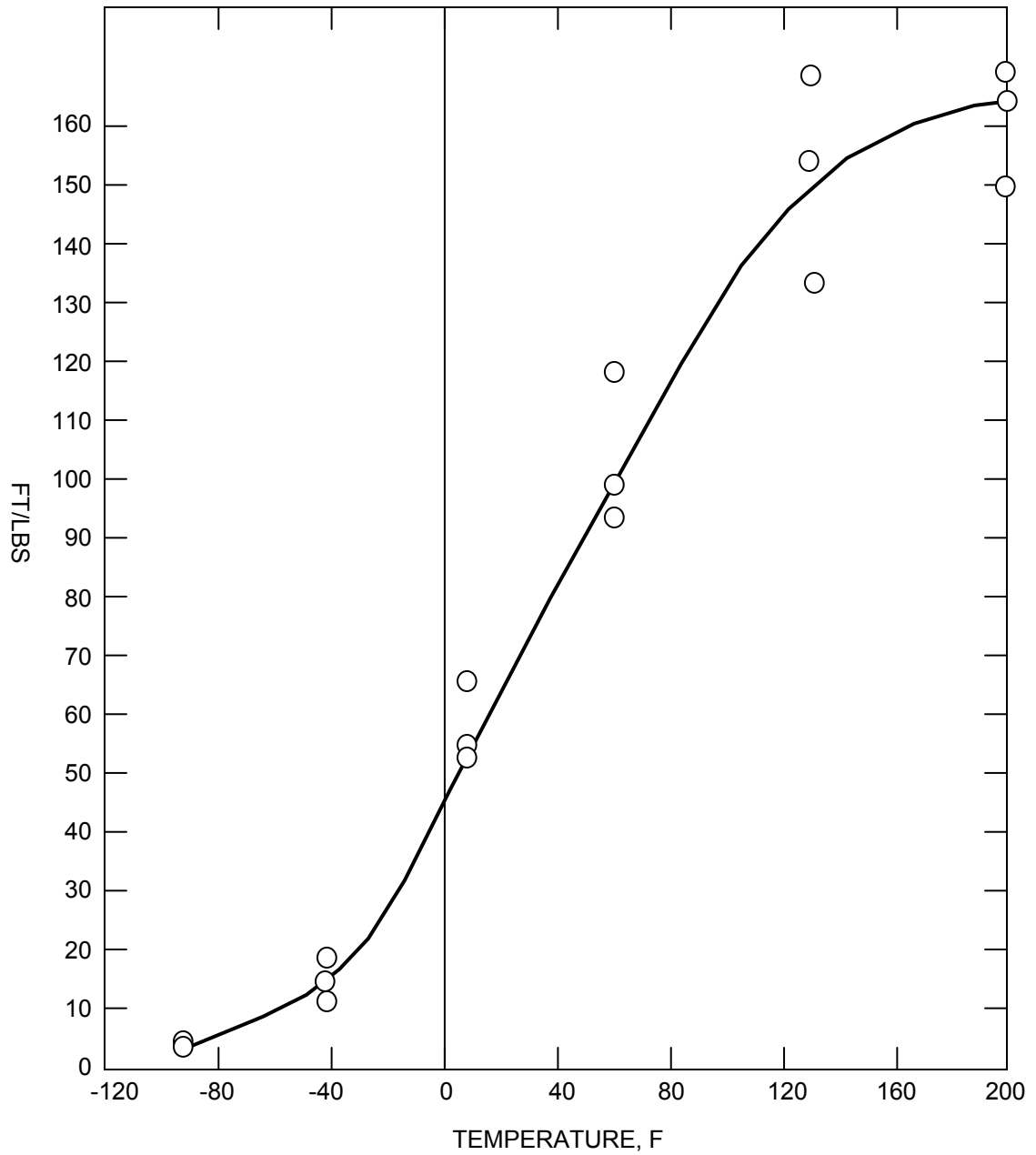

SAR FIGURE NO. 5.2-14

AMENDMENT 20

ARKANSAS NUCLEAR ONE
 UNIT 2
 RUSSELLVILLE, ARKANSAS



SCALE:	NONE
DRAWN:	ENERGY
DESIGN:	ENERGY
CAD NO:	N/A

CHARPY TEST RESULTS OUTLET NOZZLE
 EXTENSION – FORGING (C-8020-1)

BASED ON DRAWING NO

SHEET

REV.

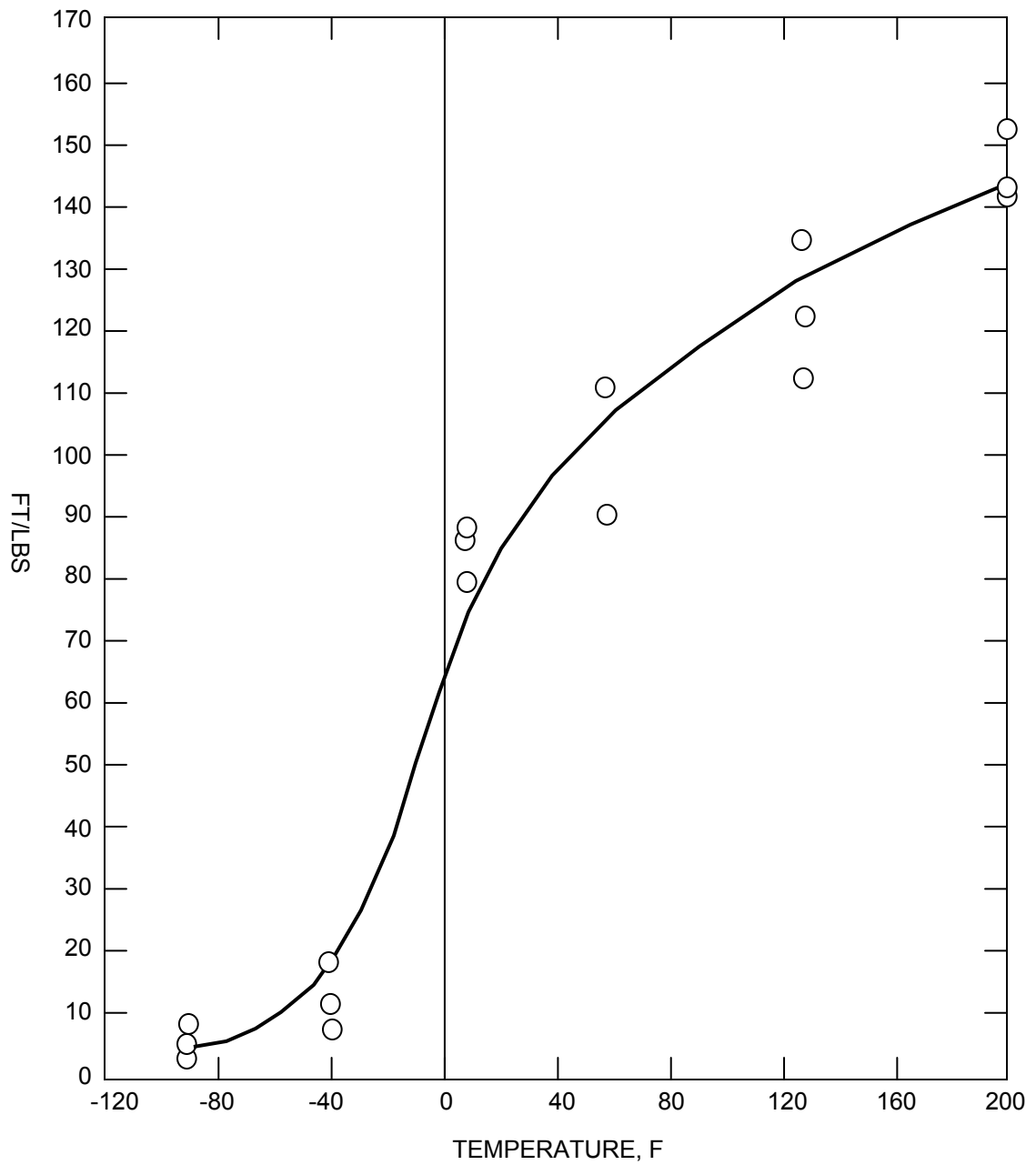

SAR FIGURE NO. 5.2-15

AMENDMENT 20

ARKANSAS NUCLEAR ONE
 UNIT 2
 RUSSELLVILLE, ARKANSAS



SCALE:	NONE
DRAWN:	ENERGY
DESIGN:	ENERGY
CAD NO:	N/A

CHARPY TEST RESULTS OUTLET NOZZLE
 EXTENSION - FORGING (C-8020-2)

BASED ON DRAWING NO

SHEET

REV.

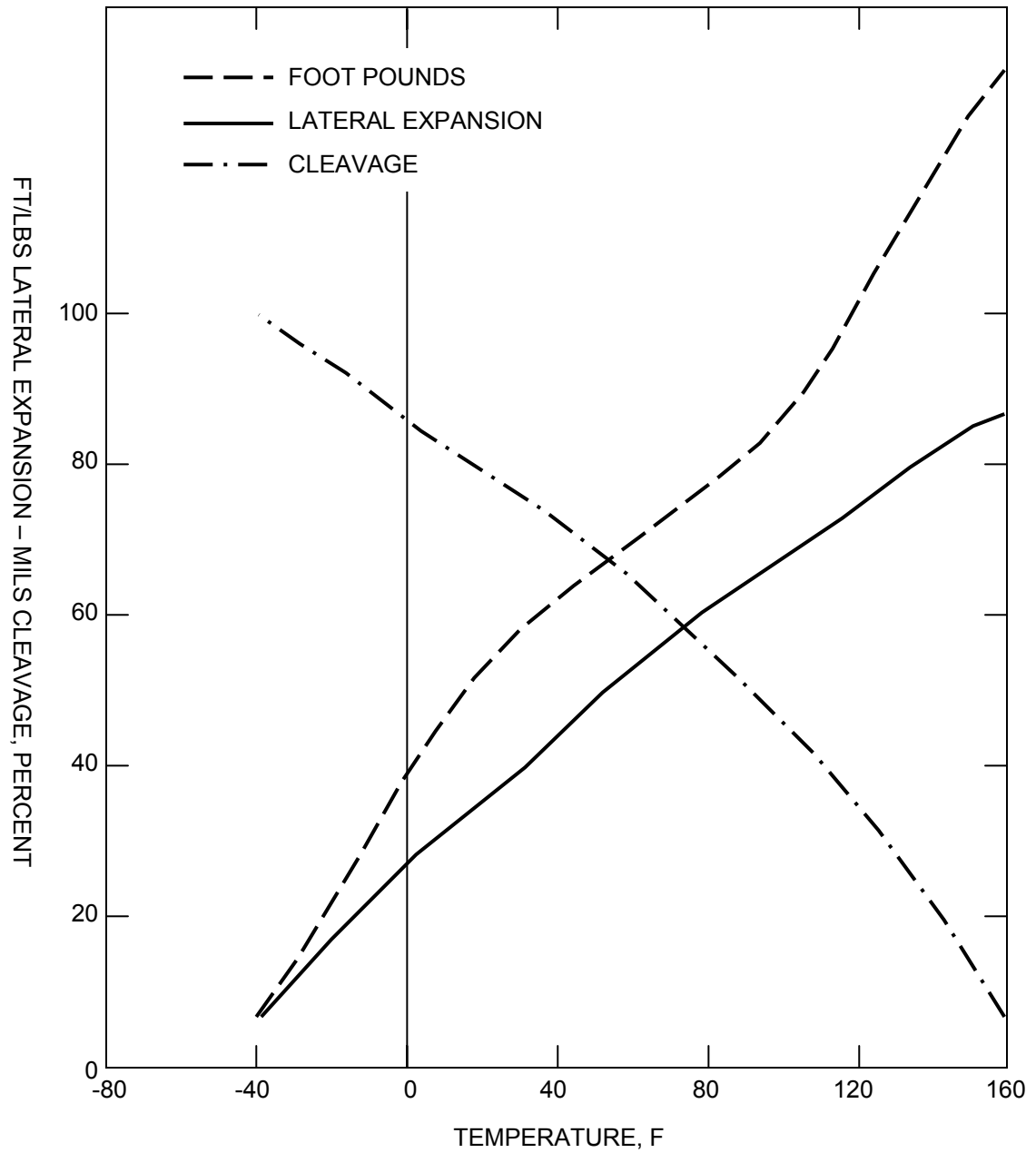

SAR FIGURE NO. 5.2-16

AMENDMENT 20

ARKANSAS NUCLEAR ONE
UNIT 2
RUSSELLVILLE, ARKANSAS



SCALE:	NONE
DRAWN:	ENERGY
DESIGN:	ENERGY
CAD NO:	N/A

CHARPY TEST RESULTS UPPER SHELL -
PLATE (C-8008-1)

BASED ON DRAWING NO

SHEET

REV.

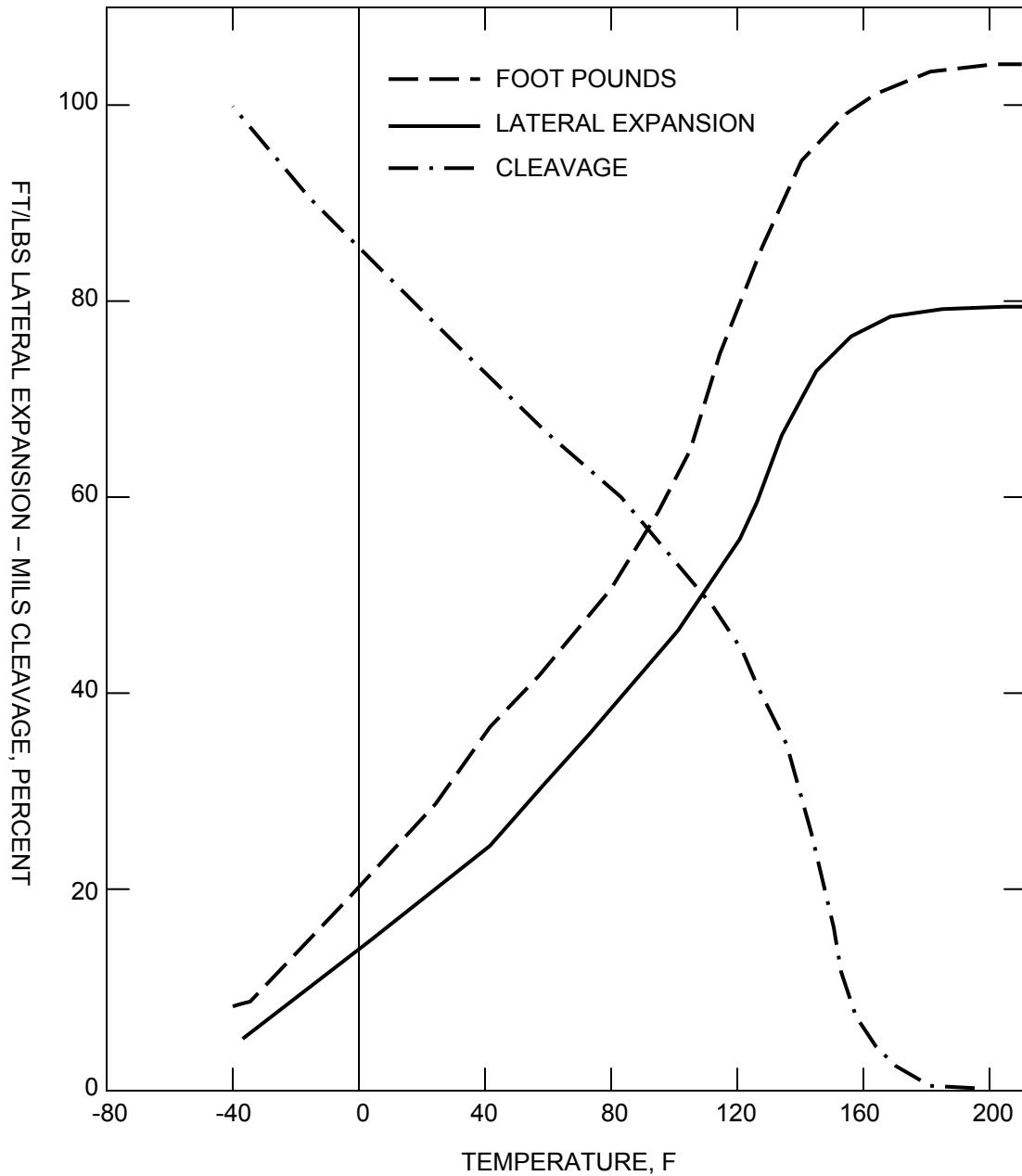

SAR FIGURE NO. 5.2-17

AMENDMENT 20

ARKANSAS NUCLEAR ONE
UNIT 2
RUSSELLVILLE, ARKANSAS



SCALE:	NONE
DRAWN:	ENERGY
DESIGN:	ENERGY
CAD NO:	N/A

CHARPY TEST RESULTS UPPER SHELL -
PLATE (C-8008-2)

BASED ON DRAWING NO

SHEET

REV.

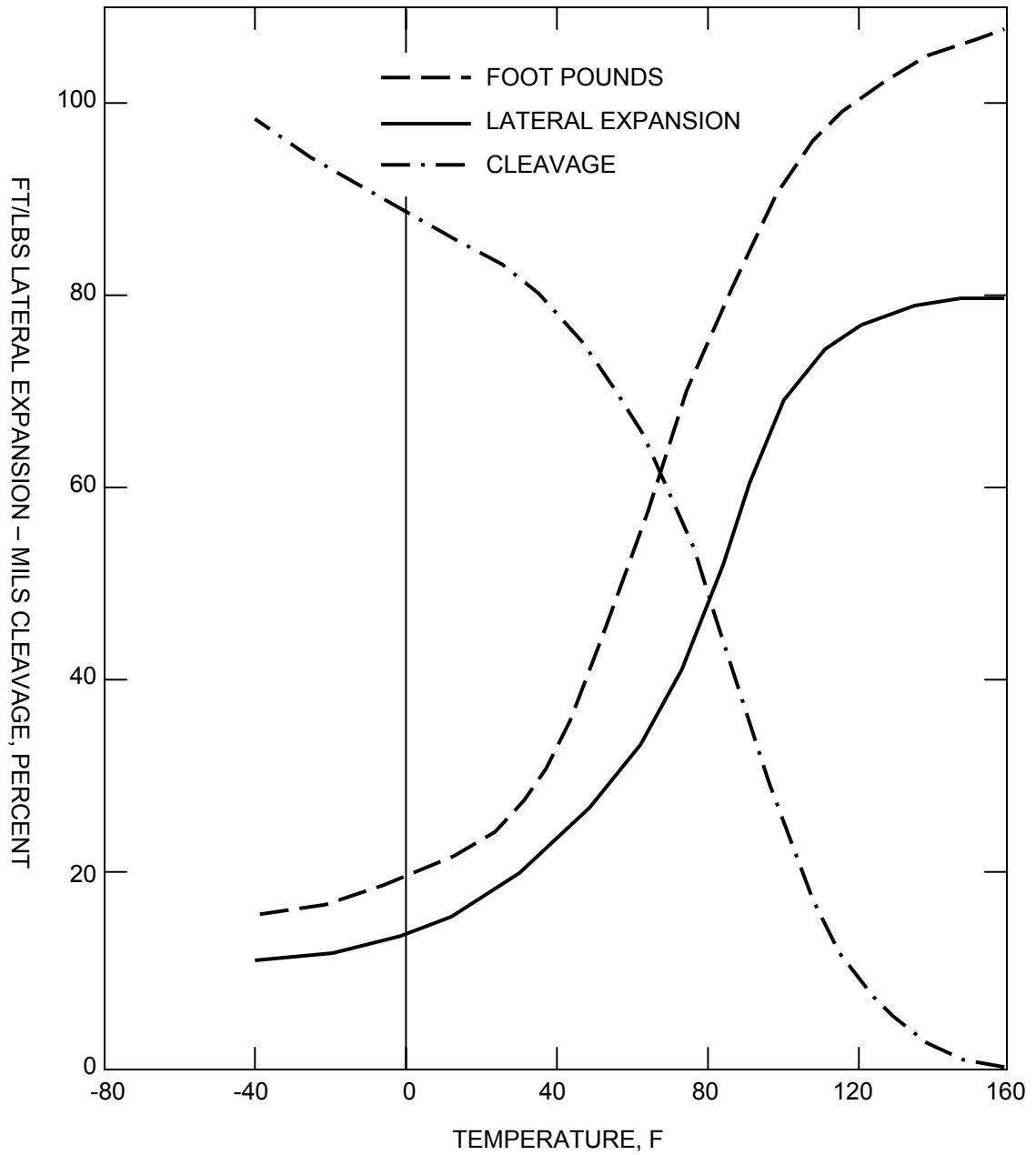

SAR FIGURE NO. 5.2-18

AMENDMENT 20

ARKANSAS NUCLEAR ONE
 UNIT 2
 RUSSELLVILLE, ARKANSAS



SCALE:	NONE
DRAWN:	ENERGY
DESIGN:	ENERGY
CAD NO:	N/A

CHARPY TEST RESULTS UPPER SHELL -
 PLATE (C-8008-3)

BASED ON DRAWING NO

SHEET

REV.

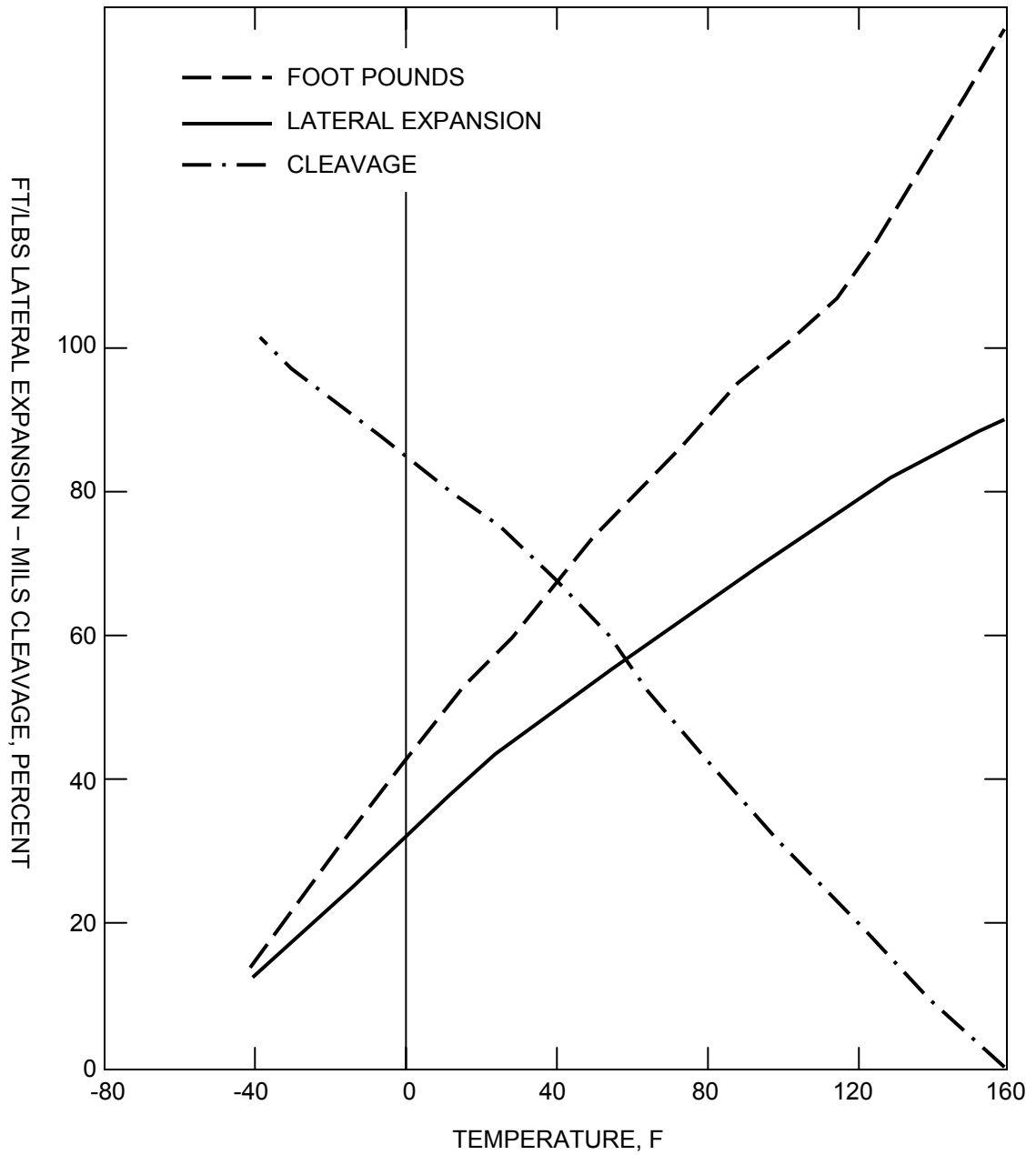

SAR FIGURE NO. 5.2-19

AMENDMENT 20

ARKANSAS NUCLEAR ONE
 UNIT 2
 RUSSELLVILLE, ARKANSAS



SCALE:	NONE
DRAWN:	ENERGY
DESIGN:	ENERGY
CAD NO:	N/A

CHARPY TEST RESULTS INTERMEDIATE
 SHELL - PLATE (C-8009-1)

BASED ON DRAWING NO

SHEET

REV.

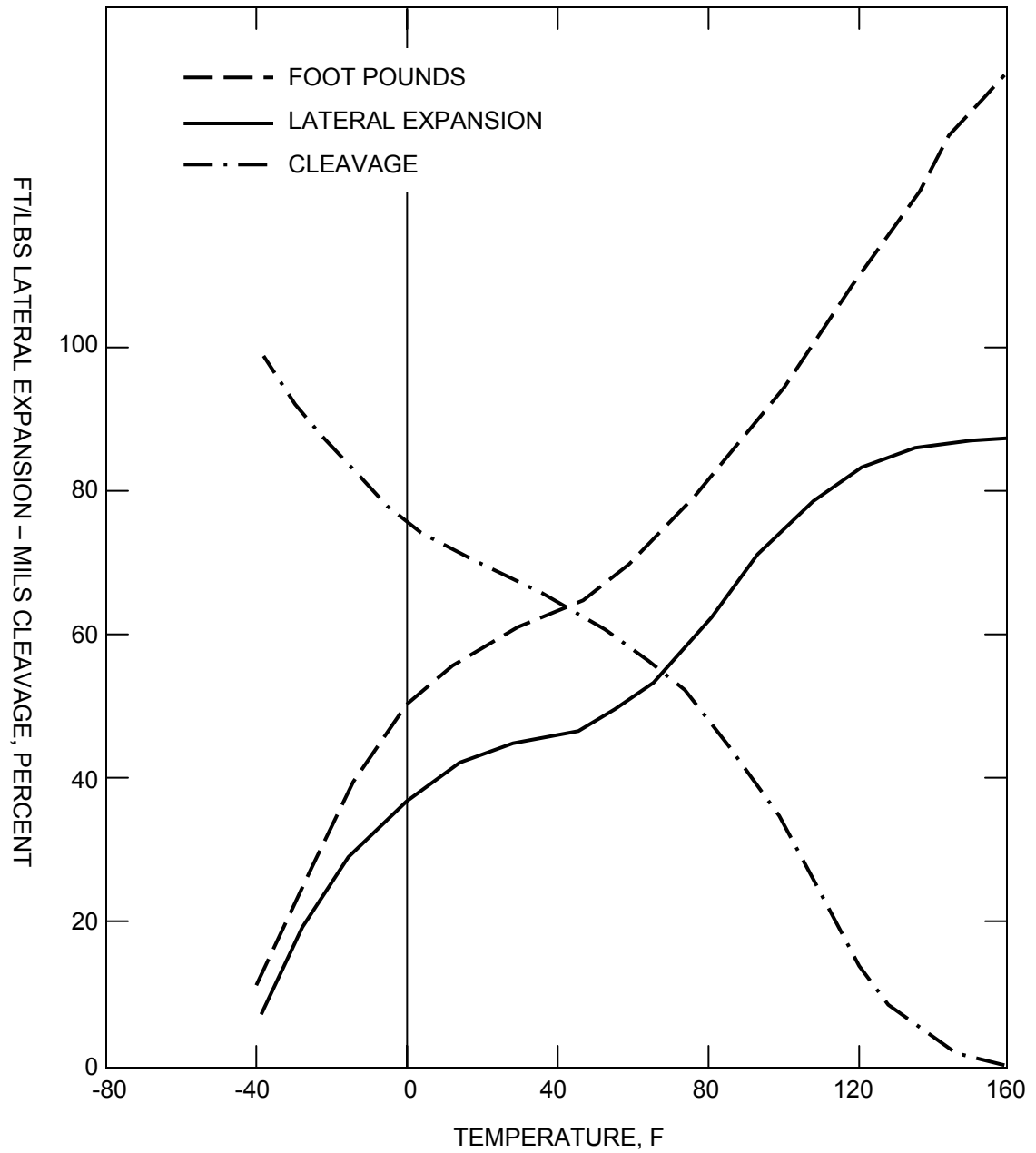

SAR FIGURE NO. 5.2-20

AMENDMENT 20

ARKANSAS NUCLEAR ONE
 UNIT 2
 RUSSELLVILLE, ARKANSAS



SCALE:	NONE
DRAWN:	ENERGY
DESIGN:	ENERGY
CAD NO:	N/A

CHARPY TEST RESULTS INTERMEDIATE
 SHELL - PLATE (C-8009-2)

BASED ON DRAWING NO

SHEET

REV.

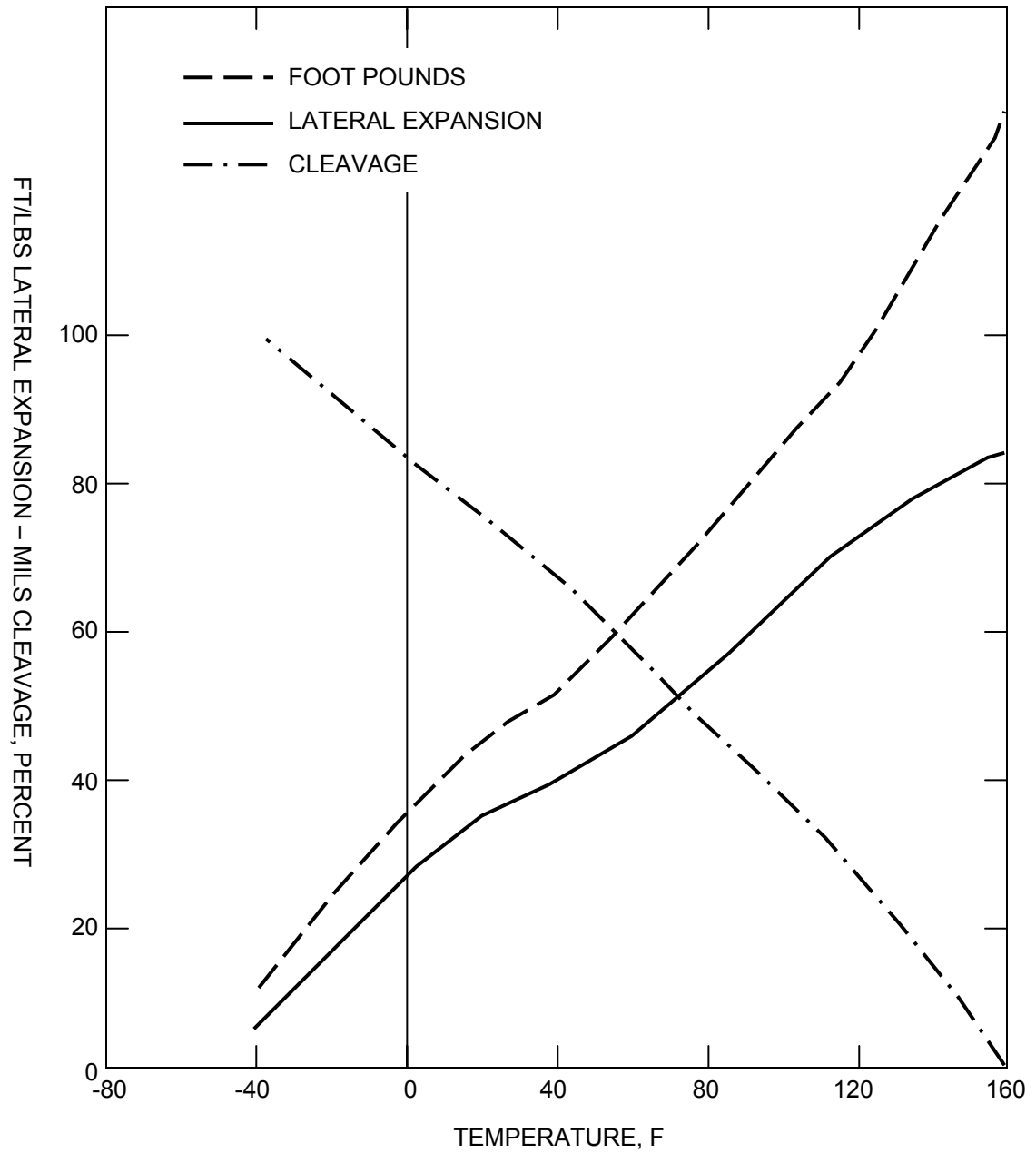

SAR FIGURE NO. 5.2-21

AMENDMENT 20

ARKANSAS NUCLEAR ONE
UNIT 2
RUSSELLVILLE, ARKANSAS



SCALE:	NONE
DRAWN:	ENERGY
DESIGN:	ENERGY
CAD NO:	N/A

CHARPY TEST RESULTS INTERMEDIATE
SHELL - PLATE (C-8009-3)

BASED ON DRAWING NO

SHEET

REV.

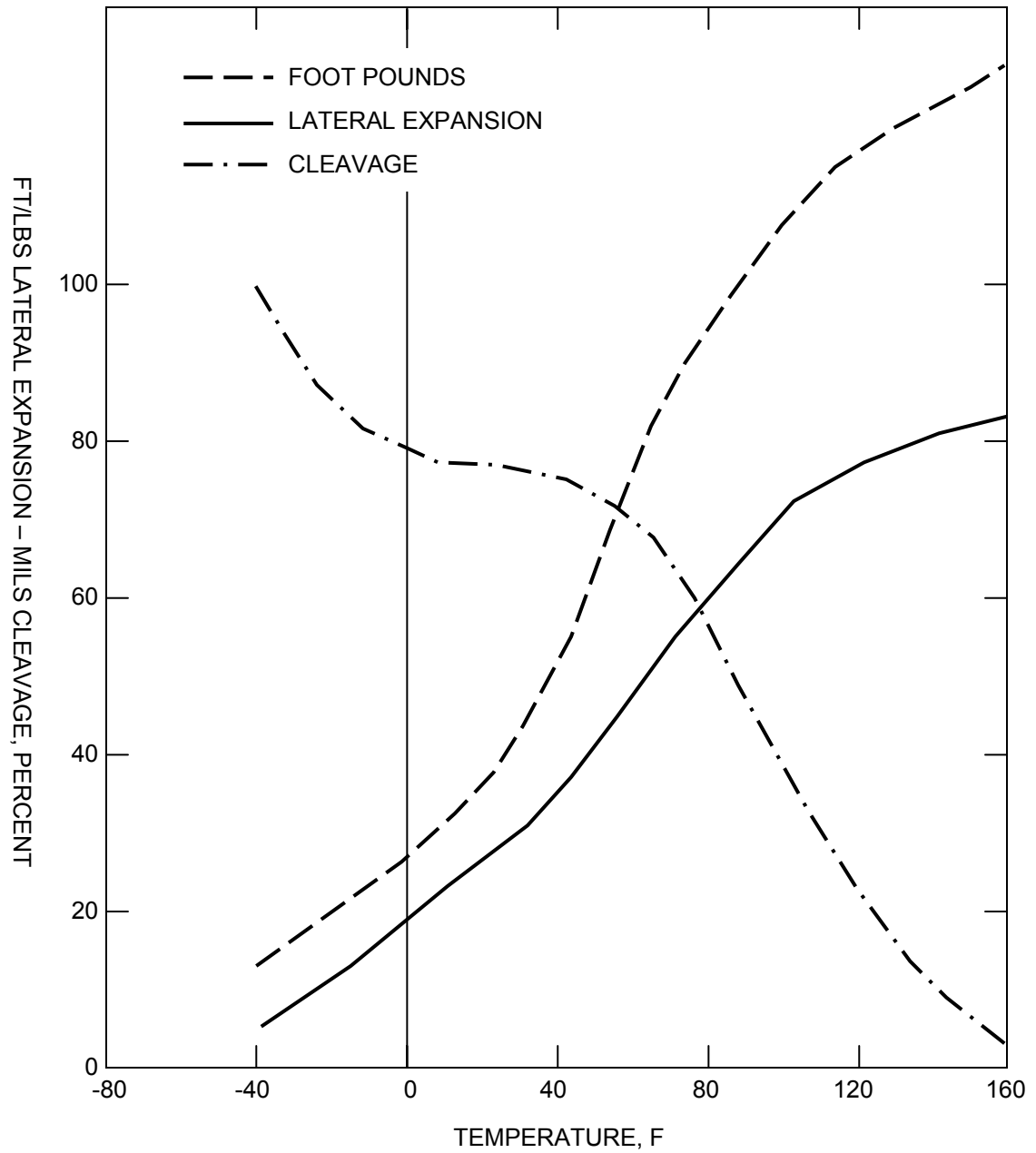

SAR FIGURE NO. 5.2-22

AMENDMENT 20

ARKANSAS NUCLEAR ONE
 UNIT 2
 RUSSELLVILLE, ARKANSAS



SCALE:	NONE
DRAWN:	ENERGY
DESIGN:	ENERGY
CAD NO:	N/A

CHARPY TEST RESULTS LOWER SHELL -
 PLATE (C-8010-1)

BASED ON DRAWING NO

SHEET

REV.

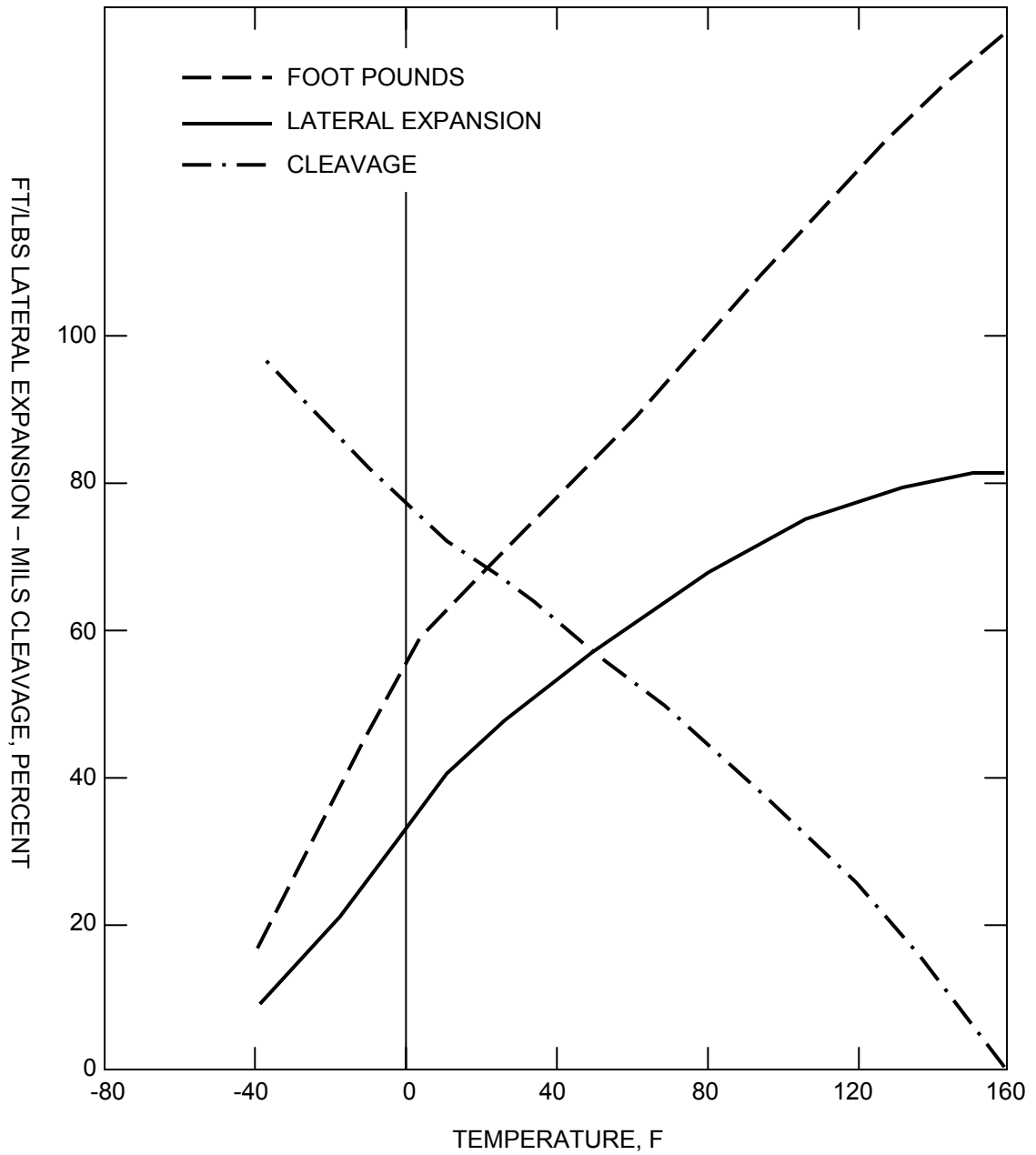

SAR FIGURE NO. 5.2-23

AMENDMENT 20

ARKANSAS NUCLEAR ONE
UNIT 2
RUSSELLVILLE, ARKANSAS



SCALE:	NONE
DRAWN:	ENERGY
DESIGN:	ENERGY
CAD NO:	N/A

CHARPY TEST RESULTS LOWER SHELL -
PLATE (C-8010-2)

BASED ON DRAWING NO

SHEET

REV.

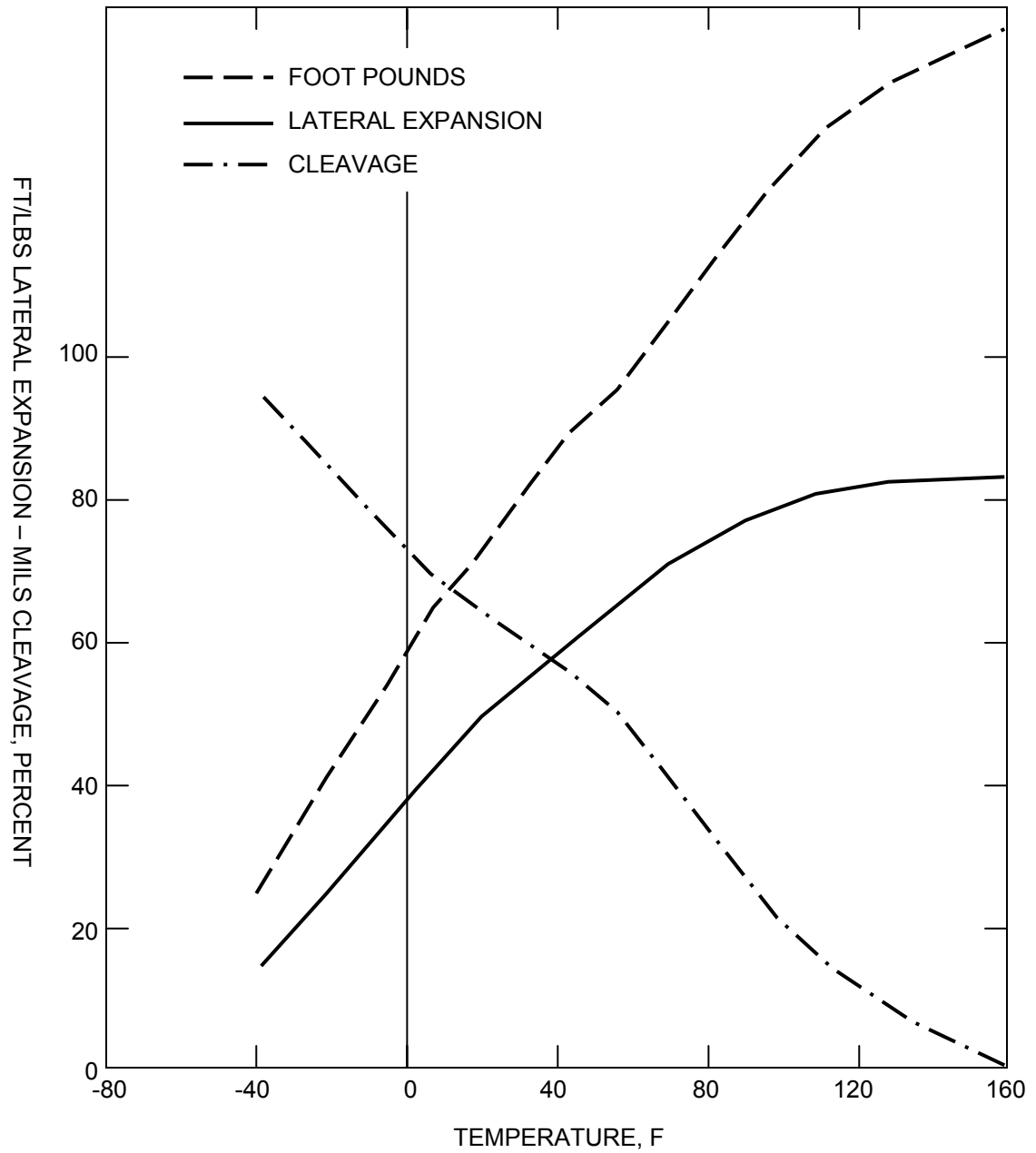

SAR FIGURE NO. 5.2-24

AMENDMENT 20

ARKANSAS NUCLEAR ONE
 UNIT 2
 RUSSELLVILLE, ARKANSAS



SCALE:	NONE
DRAWN:	ENERGY
DESIGN:	ENERGY
CAD NO:	N/A

CHARPY TEST RESULTS LOWER SHELL -
 PLATE (C-8010-3)

BASED ON DRAWING NO

SHEET

REV.

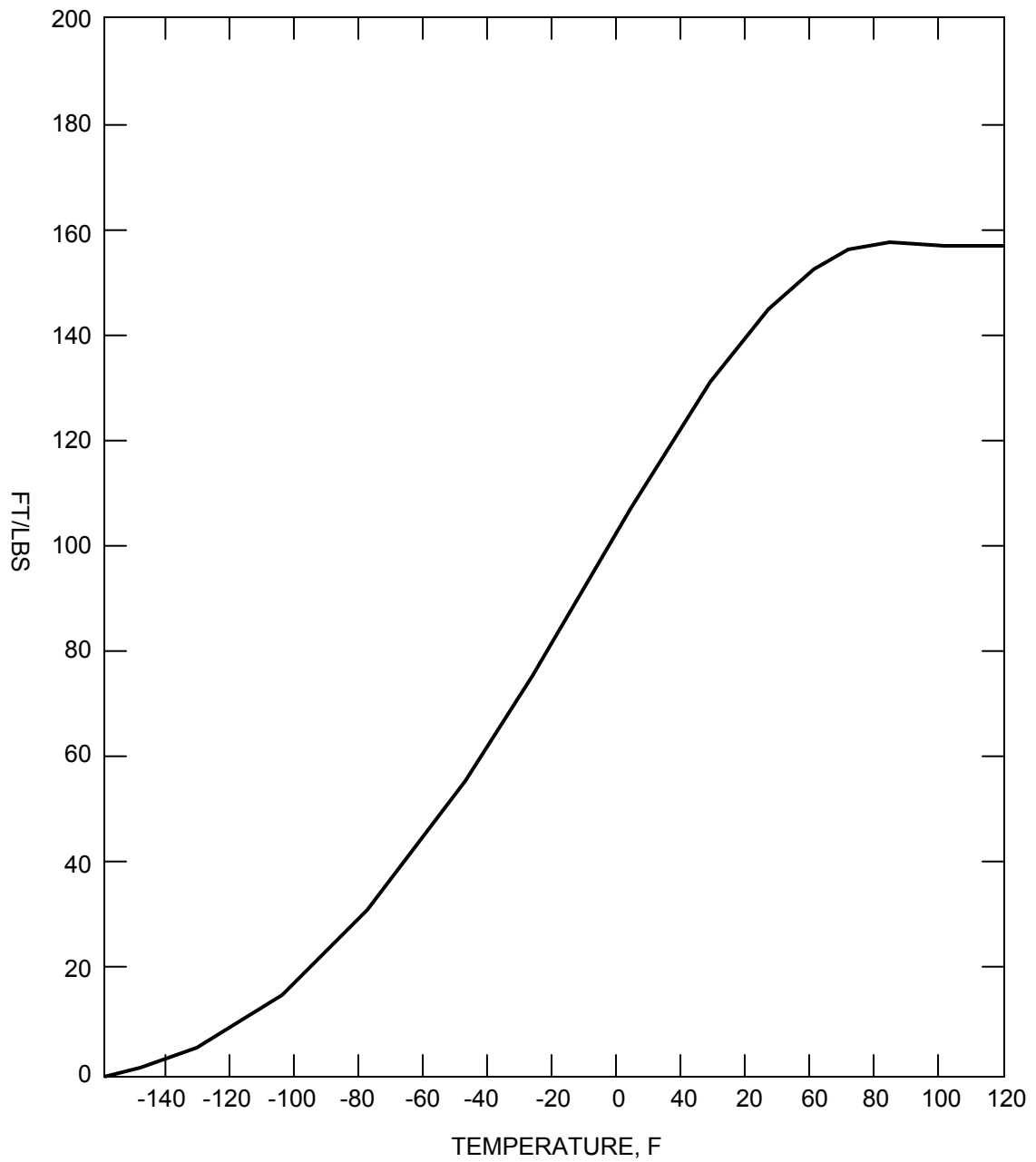

SAR FIGURE NO. 5.2-25

AMENDMENT 20

ARKANSAS NUCLEAR ONE
 UNIT 2
 RUSSELLVILLE, ARKANSAS



SCALE:	NONE
DRAWN:	ENERGY
DESIGN:	ENERGY
CAD NO:	N/A

CHARPY TEST RESULTS CLOSURE HEAD
 FLANGE – FORGING (C-8002)

BASED ON DRAWING NO

SHEET

REV.

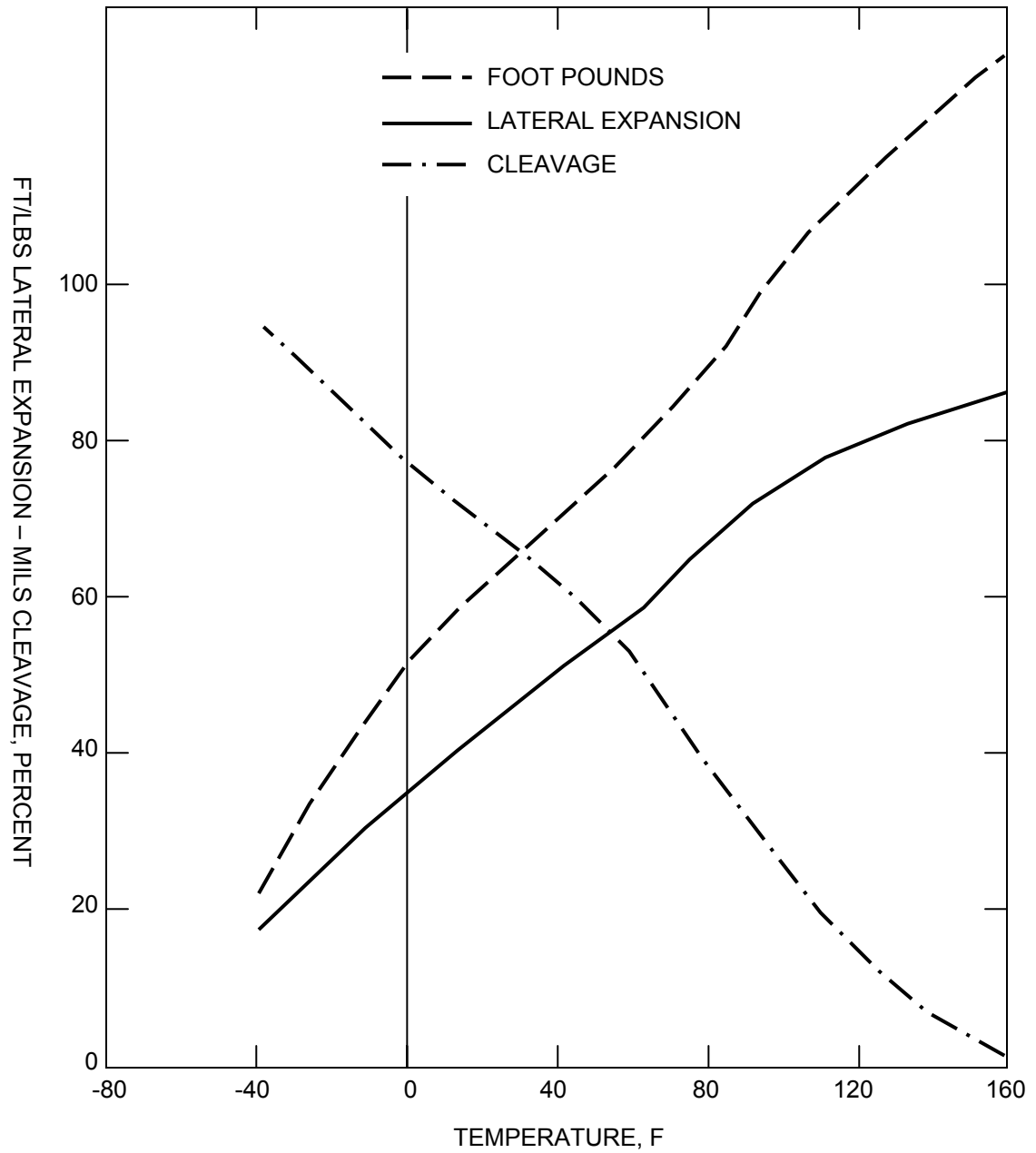

SAR FIGURE NO. 5.2-26

AMENDMENT 20

ARKANSAS NUCLEAR ONE
 UNIT 2
 RUSSELLVILLE, ARKANSAS



SCALE:	NONE
DRAWN:	ENERGY
DESIGN:	ENERGY
CAD NO:	N/A

CHARPY TEST RESULTS CLOSURE HEAD
 PEELS - PLATE (C-8012)

BASED ON DRAWING NO

SHEET

REV.

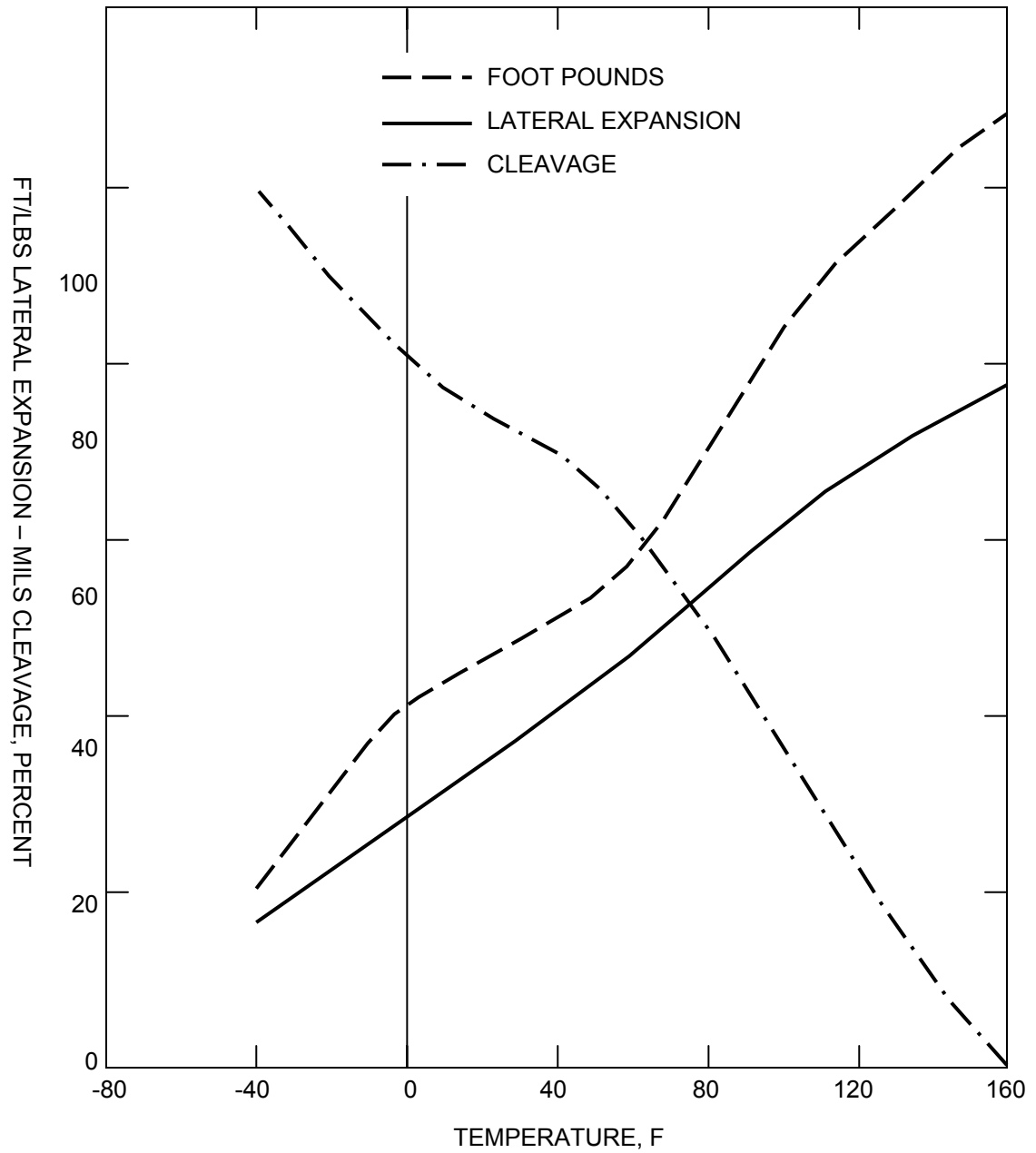

SAR FIGURE NO. 5.2-27

AMENDMENT 20

ARKANSAS NUCLEAR ONE
 UNIT 2
 RUSSELLVILLE, ARKANSAS



SCALE:	NONE
DRAWN:	ENERGY
DESIGN:	ENERGY
CAD NO:	N/A

CHARPY TEST RESULTS CLOSURE HEAD
 DOME - PLATE (C-8011)

BASED ON DRAWING NO

SHEET

REV.

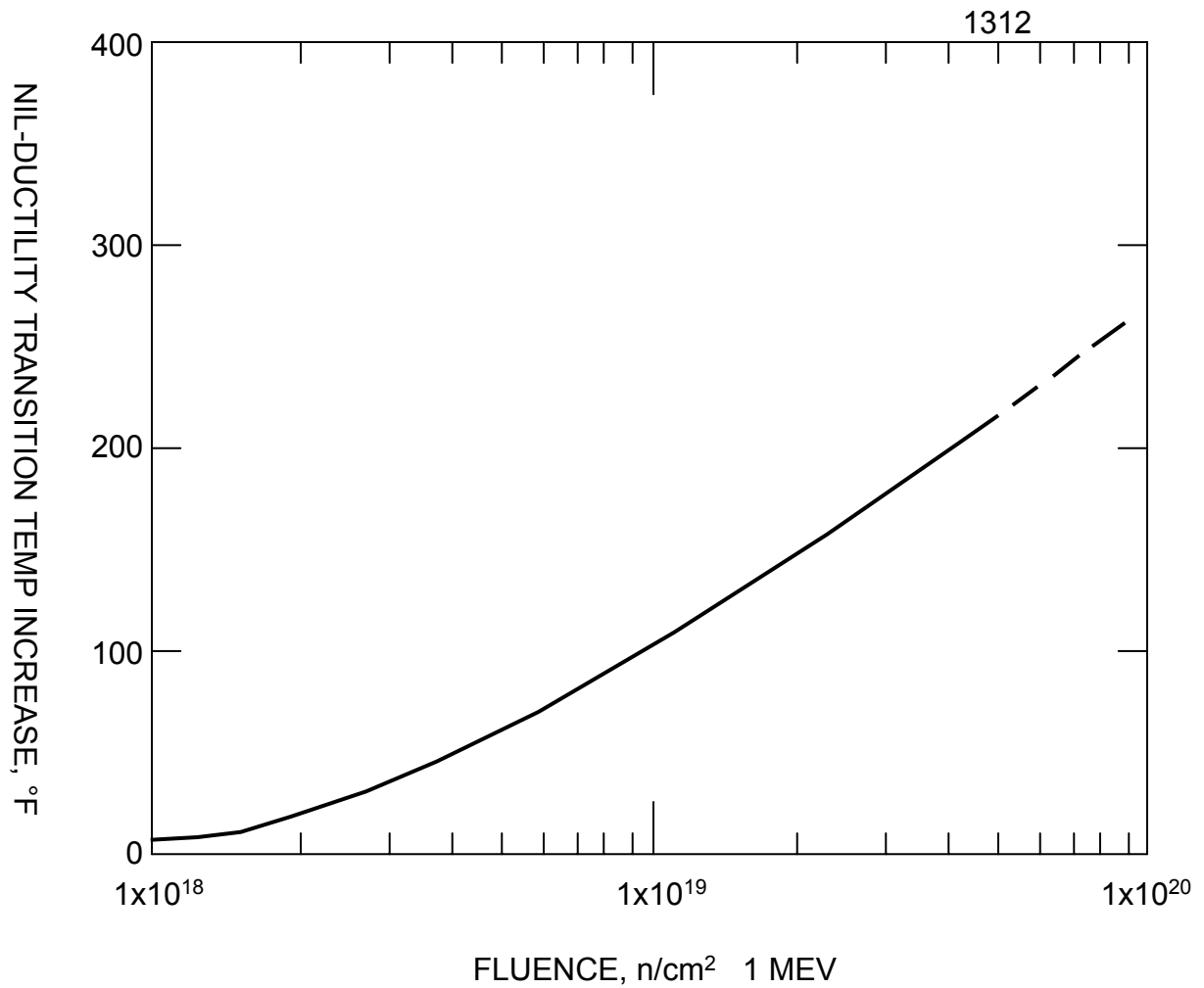

SAR FIGURE NO. 5.2-28

AMENDMENT 20

ARKANSAS NUCLEAR ONE
UNIT 2
RUSSELLVILLE, ARKANSAS



SCALE:	NONE
DRAWN:	ENERGY
DESIGN:	ENERGY
CAD NO:	N/A

C-E DESIGN CURVE OF NDTT INCREASE FOR
IMPROVED RESIDUAL ELEMENT BELTLINE MATERIAL
(550 °F IRRADIATION)

BASED ON DRAWING NO

SHEET

REV.

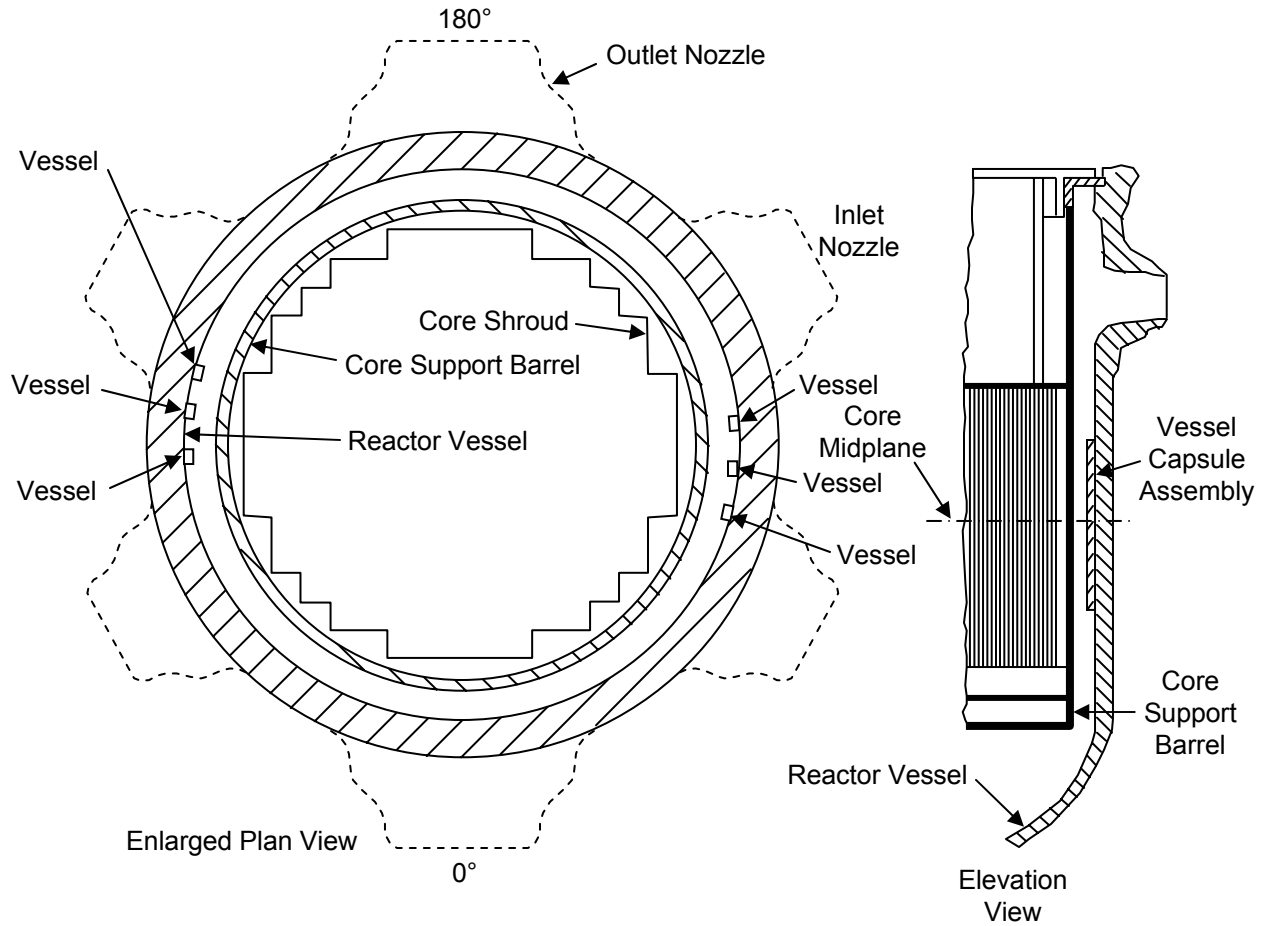

TYPICAL LOCATIONS OF SURVEILLANCE CAPSULE ASSEMBLIES

SAR FIGURE NO. 5.2-29

ARKANSAS NUCLEAR ONE
 UNIT 2
 RUSSELLVILLE, ARKANSAS



SCALE: NONE
 DRAWN: ENTERGY
 DESIGN: ENTERGY
 CAD NO:

AMENDMENT 20

BASED ON DRAWING NO

SHEET

REV.

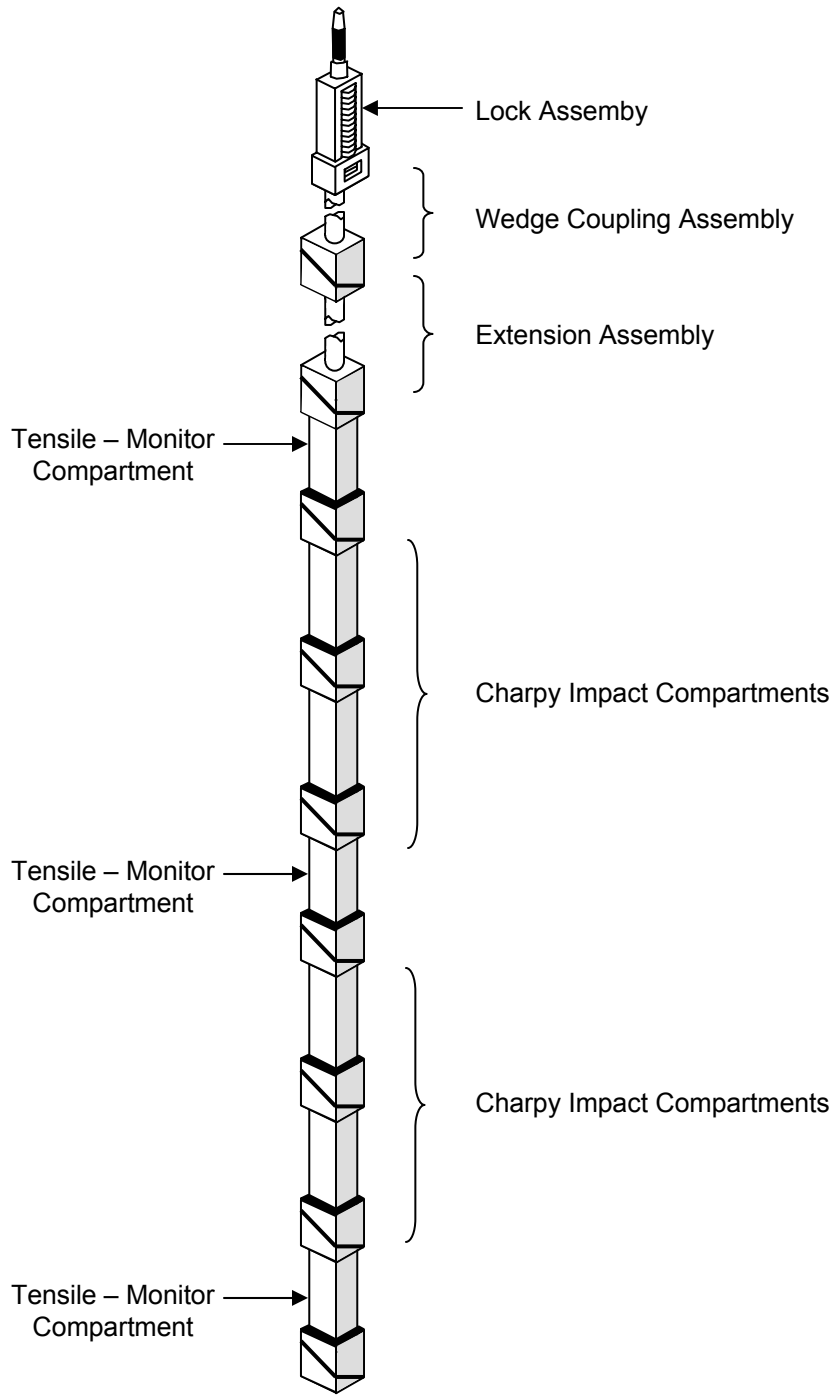

SAR FIGURE NO. 5.2-30

AMENDMENT 20

ARKANSAS NUCLEAR ONE
UNIT 2
RUSSELLVILLE, ARKANSAS



SCALE:	NONE
DRAWN:	ENERGY
DESIGN:	ENERGY
CAD NO:	N/A

TYPICAL SURVEILLANCE CAPSULE
ASSEMBLY

BASED ON DRAWING NO

SHEET

REV.

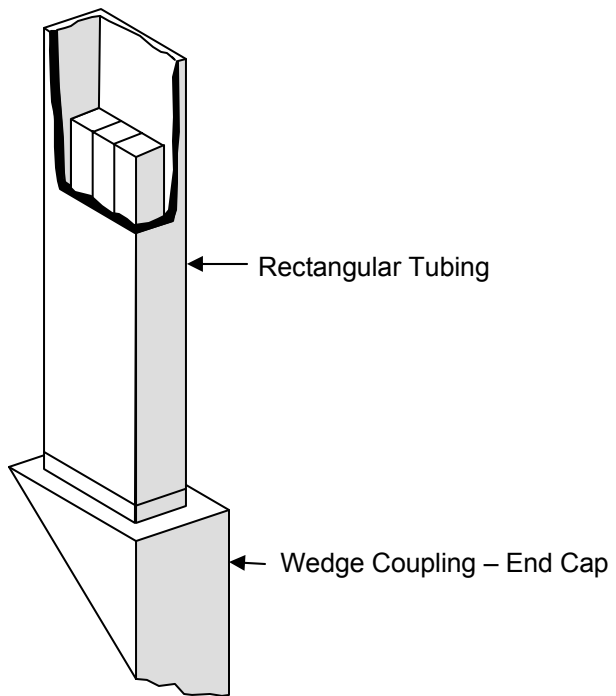
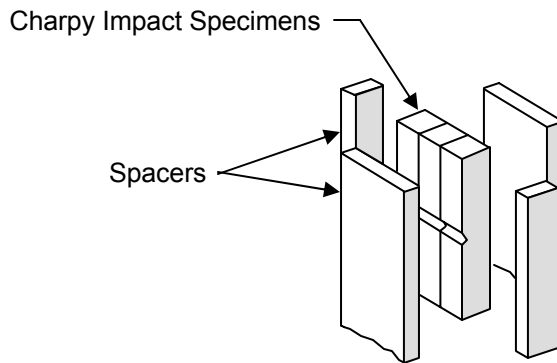
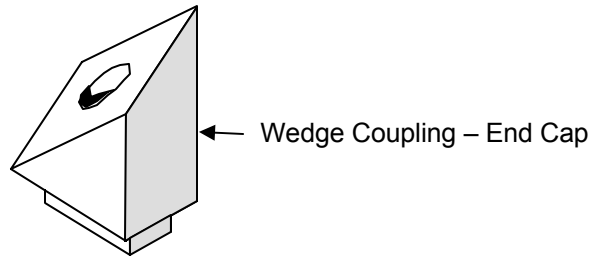

SAR FIGURE NO. 5.2-31

AMENDMENT 20

ARKANSAS NUCLEAR ONE
UNIT 2
RUSSELLVILLE, ARKANSAS



SCALE:	NONE
DRAWN:	ENERGY
DESIGN:	ENERGY
CAD NO:	N/A

TYPICAL CHARPY IMPACT COMPARTMENT
ASSEMBLY

BASED ON DRAWING NO

SHEET

REV.

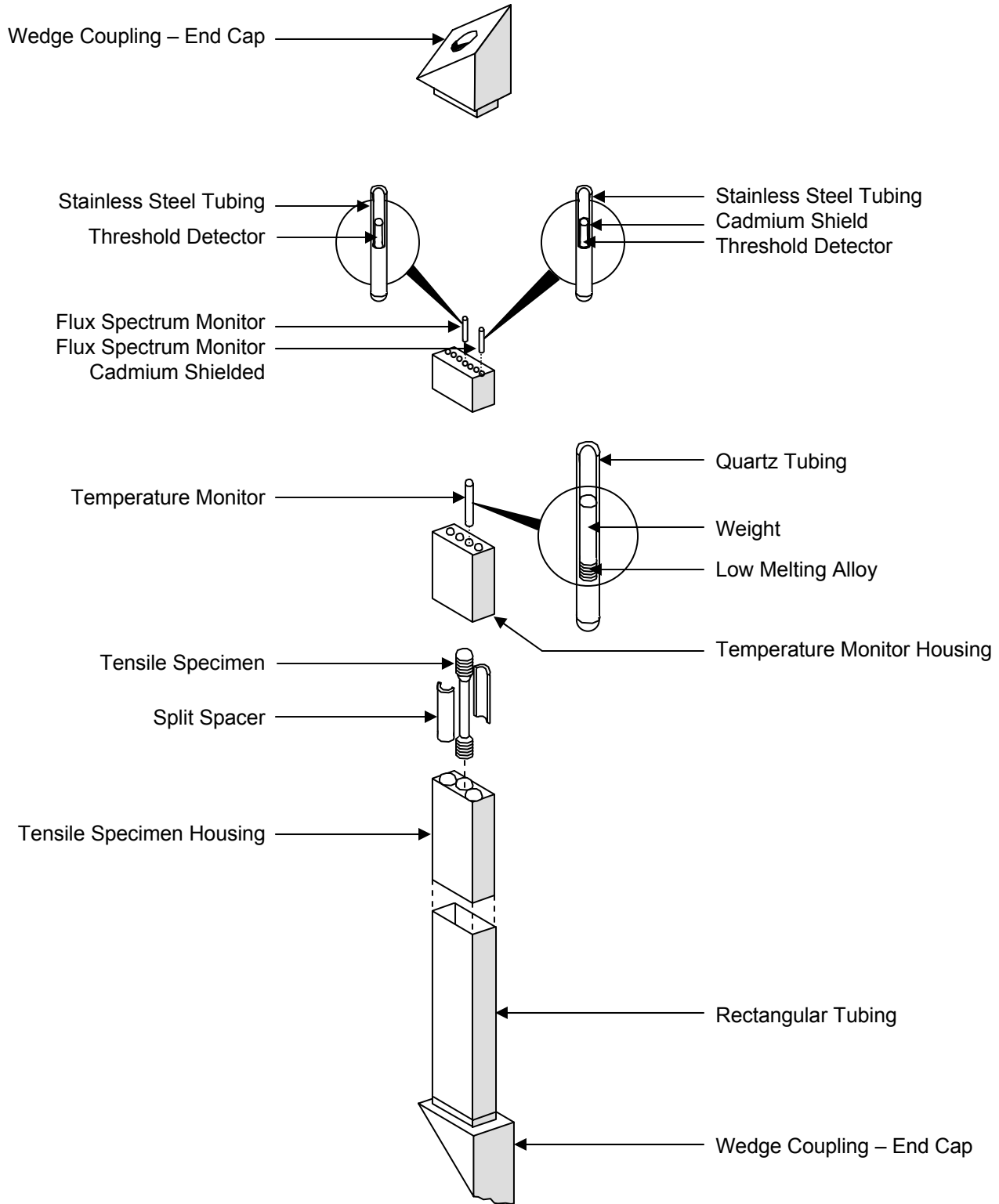

SAR FIGURE NO. 5.2-32

AMENDMENT 20

ARKANSAS NUCLEAR ONE
UNIT 2
RUSSELLVILLE, ARKANSAS



SCALE:	NONE
DRAWN:	ENERGY
DESIGN:	ENERGY
CAD NO:	N/A

TYPICAL TENSILE – MONITOR
COMPARTMENT ASSEMBLY

BASED ON DRAWING NO

SHEET

REV.

CHARPY TEST CALCULATED DYNAMIC TOUGHNESS
 K_{id} vs $(T - RT_{NDT})$

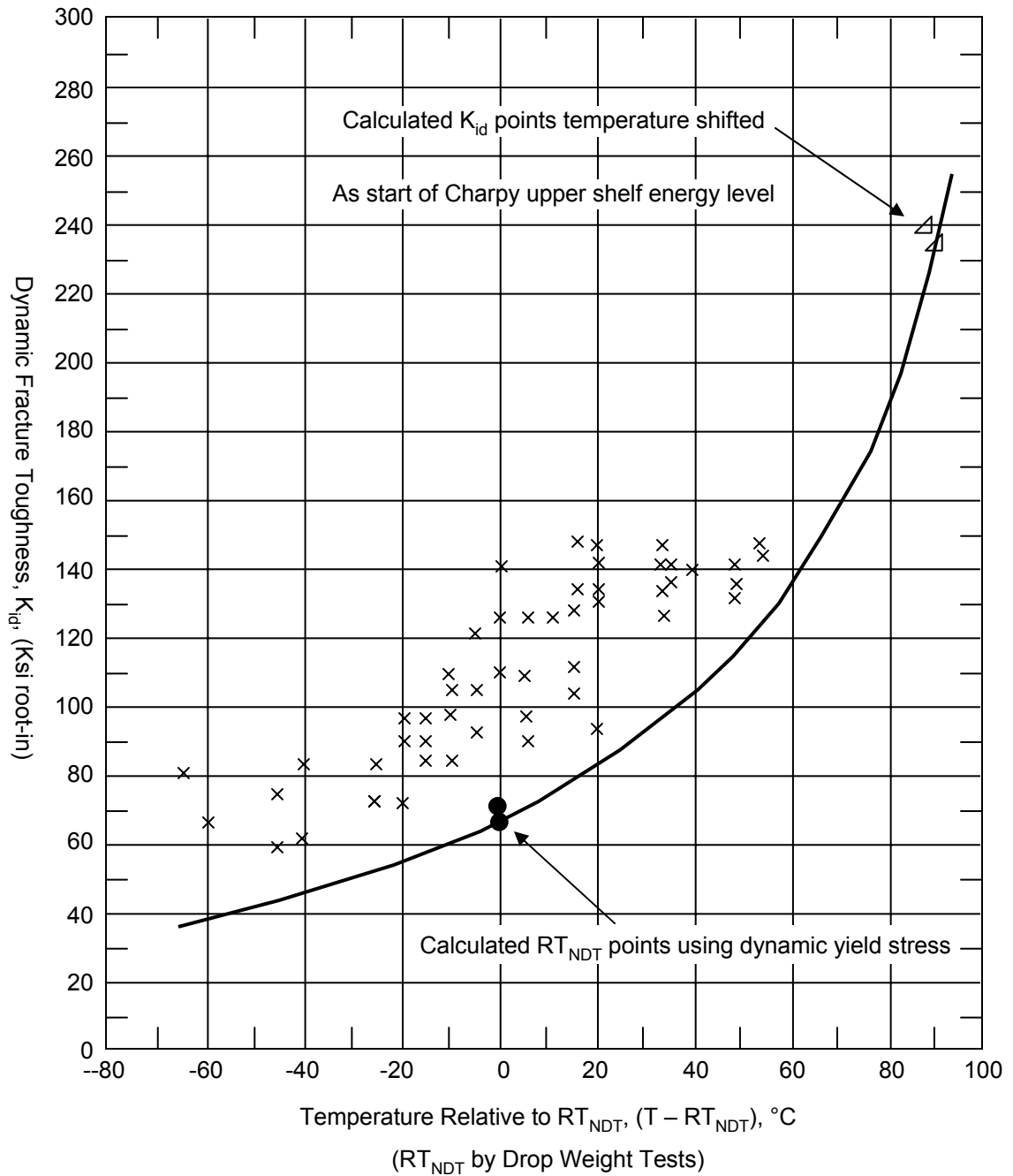

SAR FIGURE NO. 5.2-33

AMENDMENT 20

ARKANSAS NUCLEAR ONE
 UNIT 2
 RUSSELLVILLE, ARKANSAS



SCALE:	NONE
DRAWN:	ENERGY
DESIGN:	ENERGY
CAD NO:	N/A

REACTOR COOLANT PUMP 2P32A FLYWHEEL
 DYNAMIC TOUGHNESS FOR RATES BETWEEN $K = 10^4$
 AND 10^5 KSI INCH/SEC

BASED ON DRAWING NO

SHEET

REV.

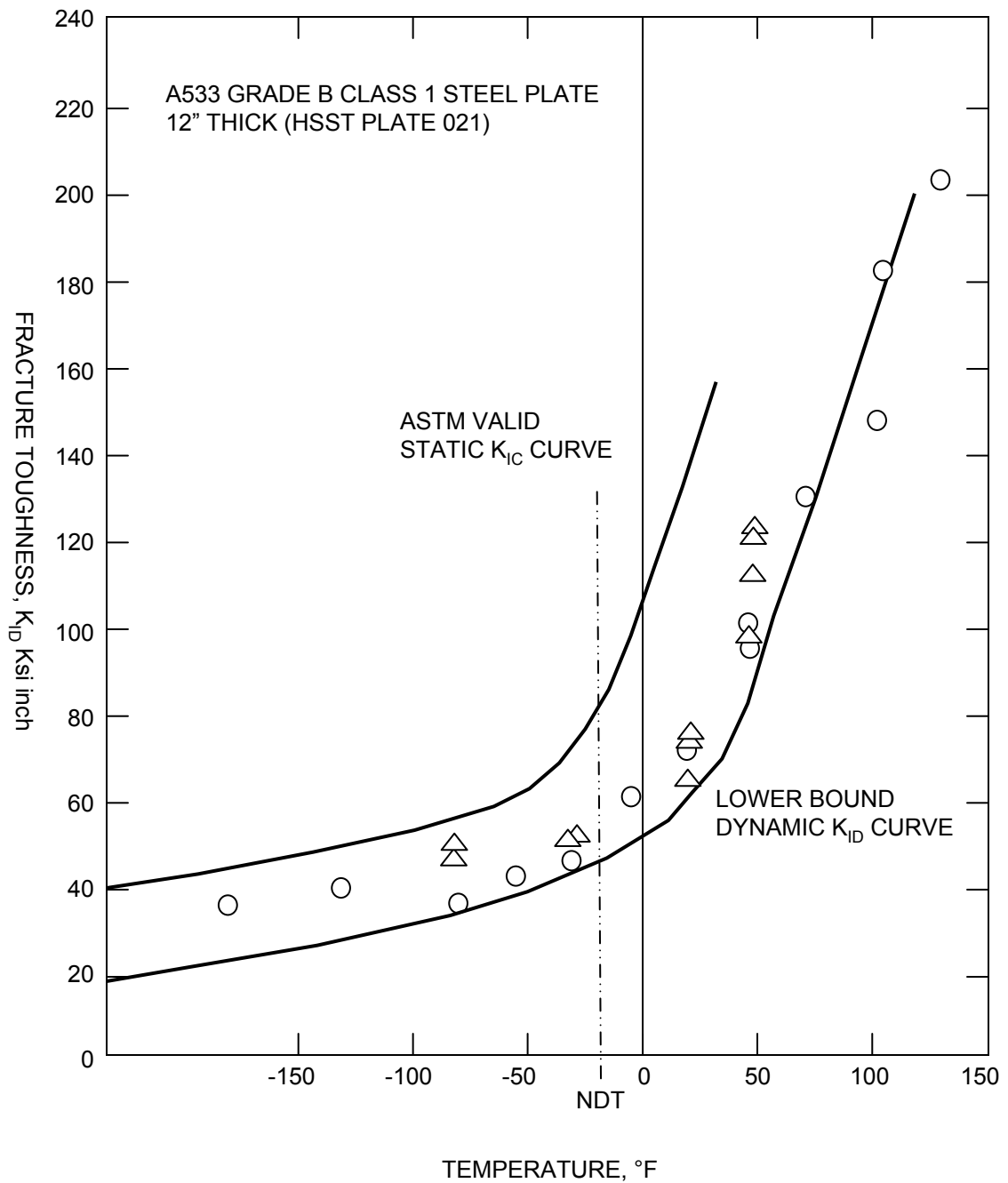

SAR FIGURE NO. 5.2-33A

AMENDMENT 20

ARKANSAS NUCLEAR ONE
UNIT 2
RUSSELLVILLE, ARKANSAS



SCALE:	NONE
DRAWN:	ENERGY
DESIGN:	ENERGY
CAD NO:	N/A

REACTOR COOLANT PUMP 2P32B, C, & D FLYWHEEL
DYNAMIC TOUGHNESS FOR RATES BETWEEN $K = 10^4$
AND 10^5 KSI INCH/SECOND

BASED ON DRAWING NO

SHEET

REV.

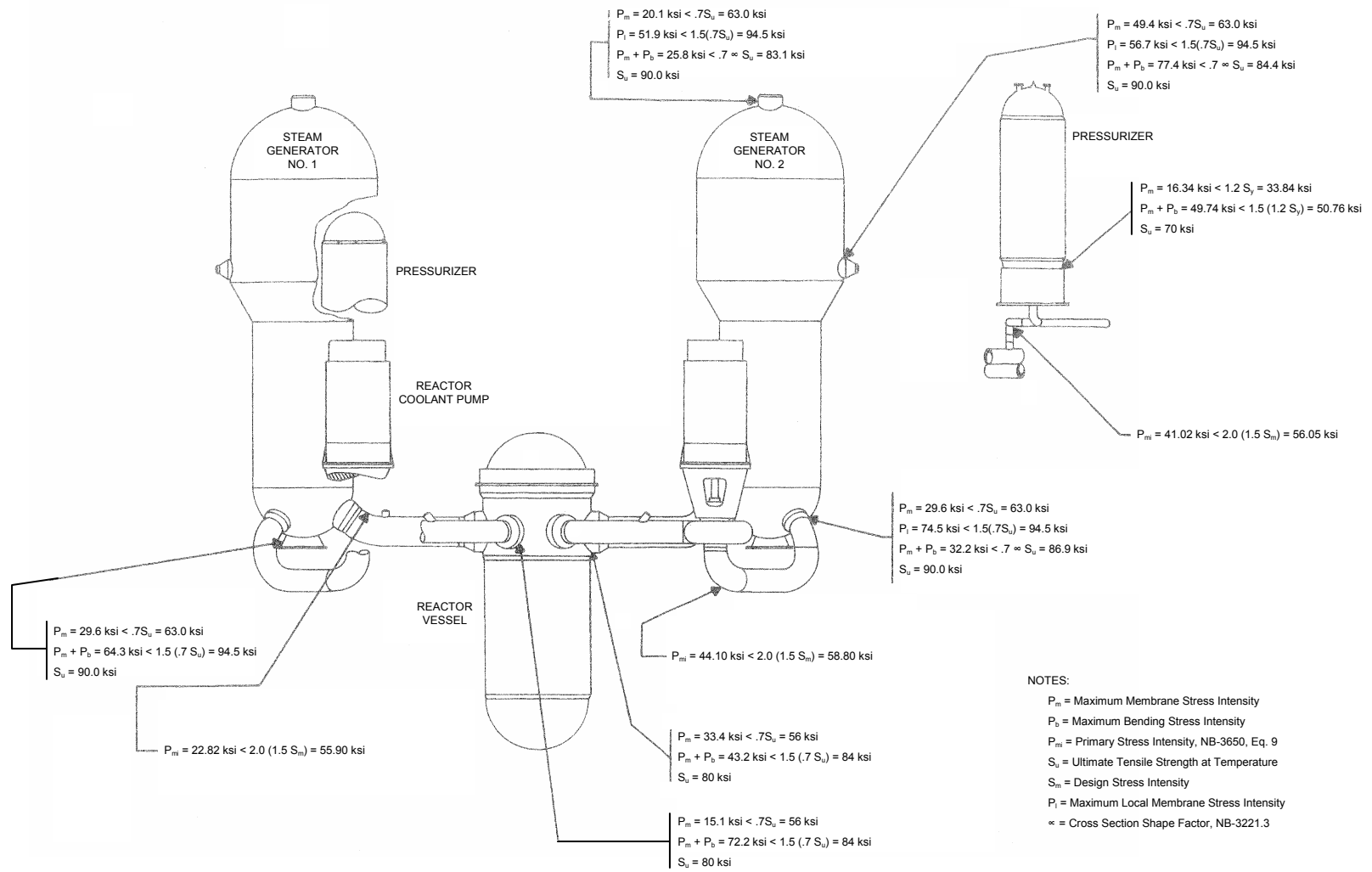

REACTOR COOLANT SYSTEM MAXIMUM STRESS LEVELS – FAULTED CONDITION

SAR FIGURE NO. 5.2-34

ARKANSAS NUCLEAR ONE
UNIT 2
RUSSELLVILLE, ARKANSAS



SCALE: NONE
DRAWN: ENTERGY
DESIGN: ENTERGY
CAD NO:

AMENDMENT 20

BASED ON DRAWING NO	SHEET	REV.
---------------------	-------	------

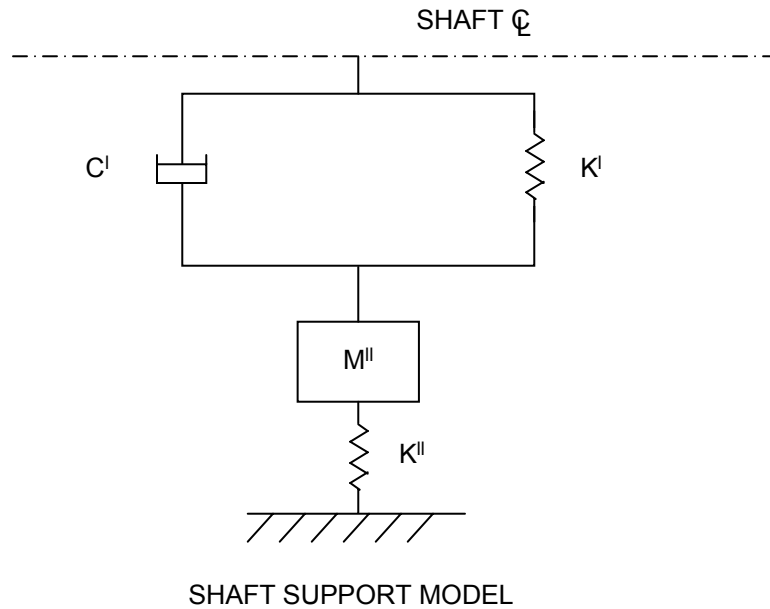
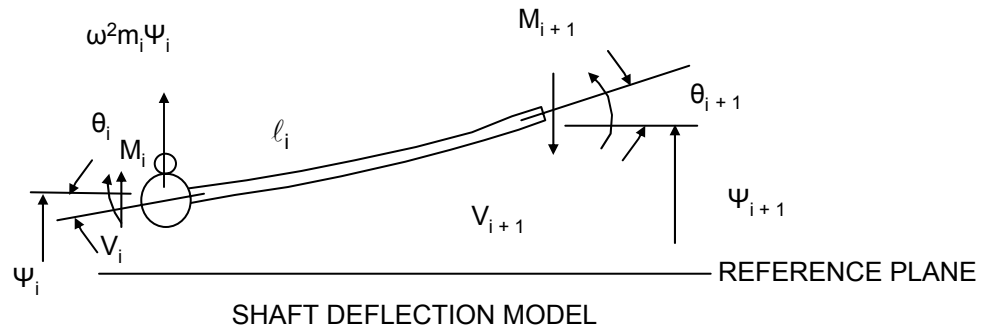

WHERE C_I = FLUID FILM DAMPING COEFFICIENT
 K^I = FLUID FILM STIFFNESS COEFFICIENT
 M^{II} = EFFECTIVE MASS OF THE BEARING SUPPORT
 K^{II} = BEARING SUPPORT STIFFNESS

SAR FIGURE NO. 5.2-35

AMENDMENT 20

ARKANSAS NUCLEAR ONE
 UNIT 2
 RUSSELLVILLE, ARKANSAS



SCALE:	NONE
DRAWN:	ENERGY
DESIGN:	ENERGY
CAD NO:	N/A

REACTOR COOLANT PUMP DYNAMIC MODELS

BASED ON DRAWING NO

SHEET

REV.

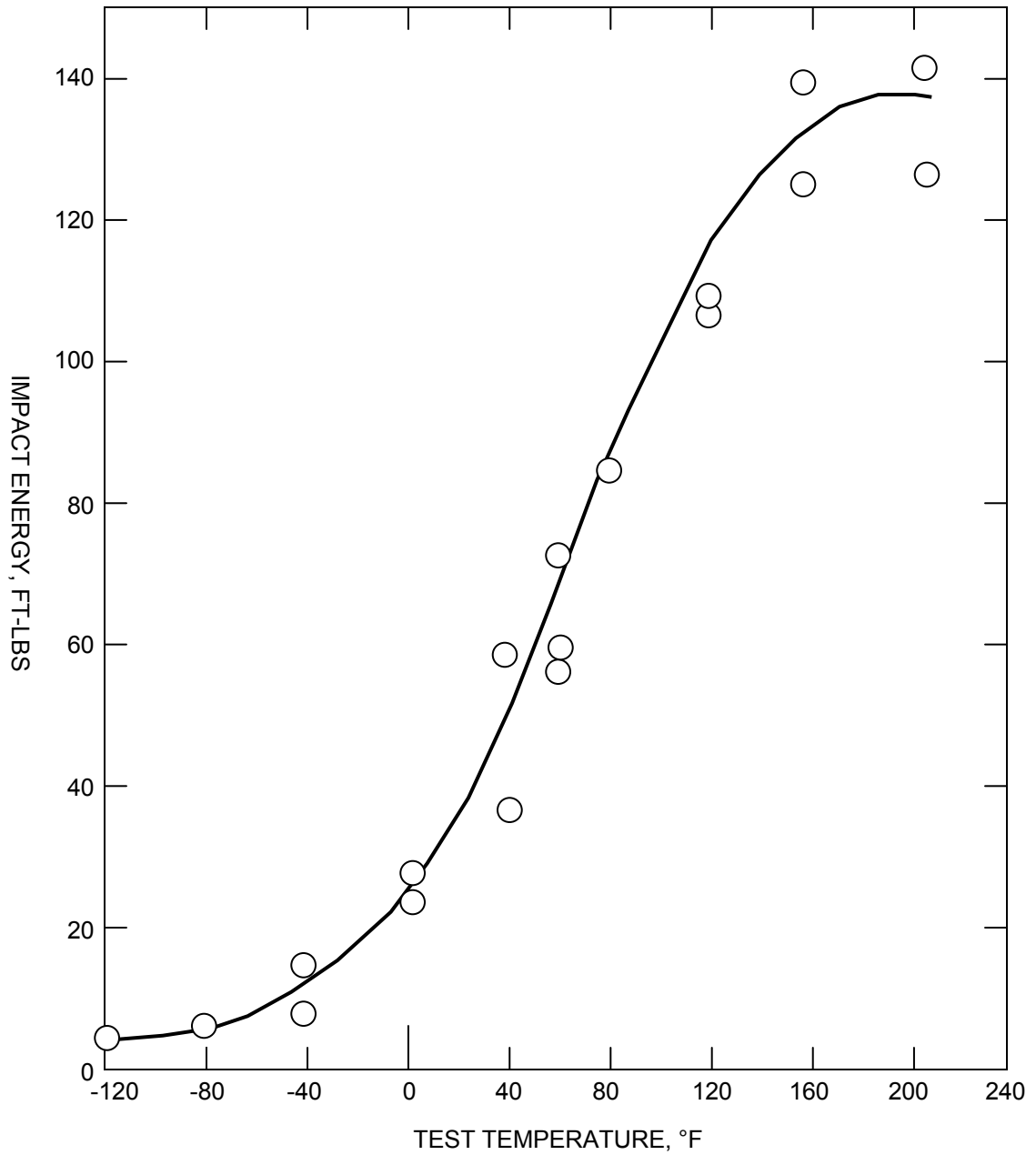

BASE METAL – WR (Transverse) – Plate C-8009-3
Impact Energy vs Temperature

SAR FIGURE NO. 5.2-36

AMENDMENT 20

ARKANSAS NUCLEAR ONE
UNIT 2
RUSSELLVILLE, ARKANSAS



SCALE:	NONE
DRAWN:	ENERGY
DESIGN:	ENERGY
CAD NO:	N/A

REACTOR VESSEL SURVEILLANCE MATERIAL
BASE LINE TEST PROGRAM RESULTS

BASED ON DRAWING NO

SHEET

REV.

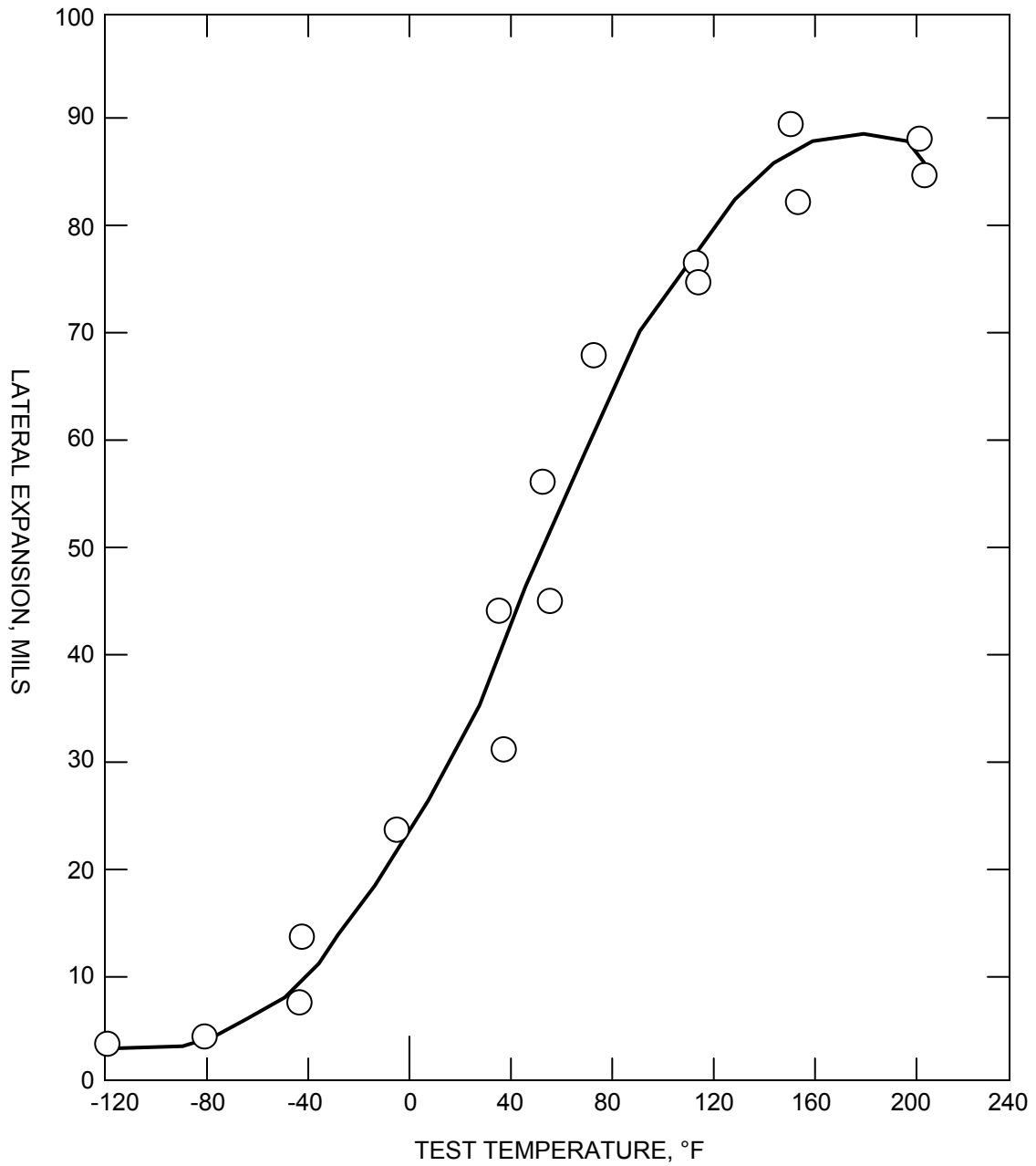

BASE METAL – WR (Transverse) – Plate C-8009-3
Lateral Expansion vs Temperature

SAR FIGURE NO. 5.2-37

AMENDMENT 20

ARKANSAS NUCLEAR ONE
UNIT 2
RUSSELLVILLE, ARKANSAS



SCALE:	NONE
DRAWN:	ENERGY
DESIGN:	ENERGY
CAD NO:	N/A

REACTOR VESSEL SURVEILLANCE MATERIAL
BASE LINE TEST PROGRAM RESULTS

BASED ON DRAWING NO

SHEET

REV.

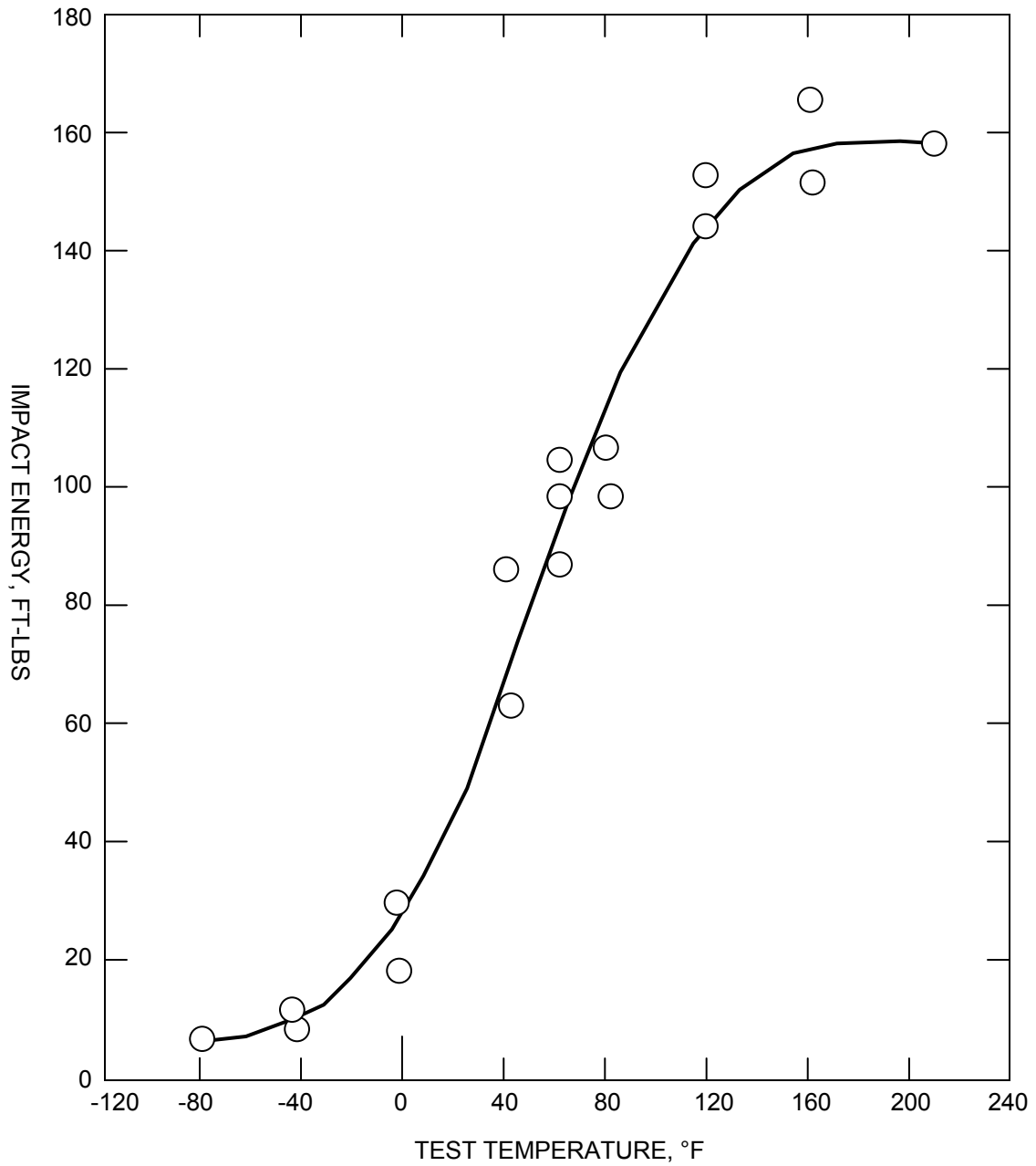

BASE METAL – WR (Transverse) – Plate C-8009-3
 Impact Energy vs Temperature

SAR FIGURE NO. 5.2-38

AMENDMENT 20

ARKANSAS NUCLEAR ONE
 UNIT 2
 RUSSELLVILLE, ARKANSAS



SCALE:	NONE
DRAWN:	ENERGY
DESIGN:	ENERGY
CAD NO:	N/A

REACTOR VESSEL SURVEILLANCE MATERIAL
 BASE LINE TEST PROGRAM RESULTS

BASED ON DRAWING NO

SHEET

REV.

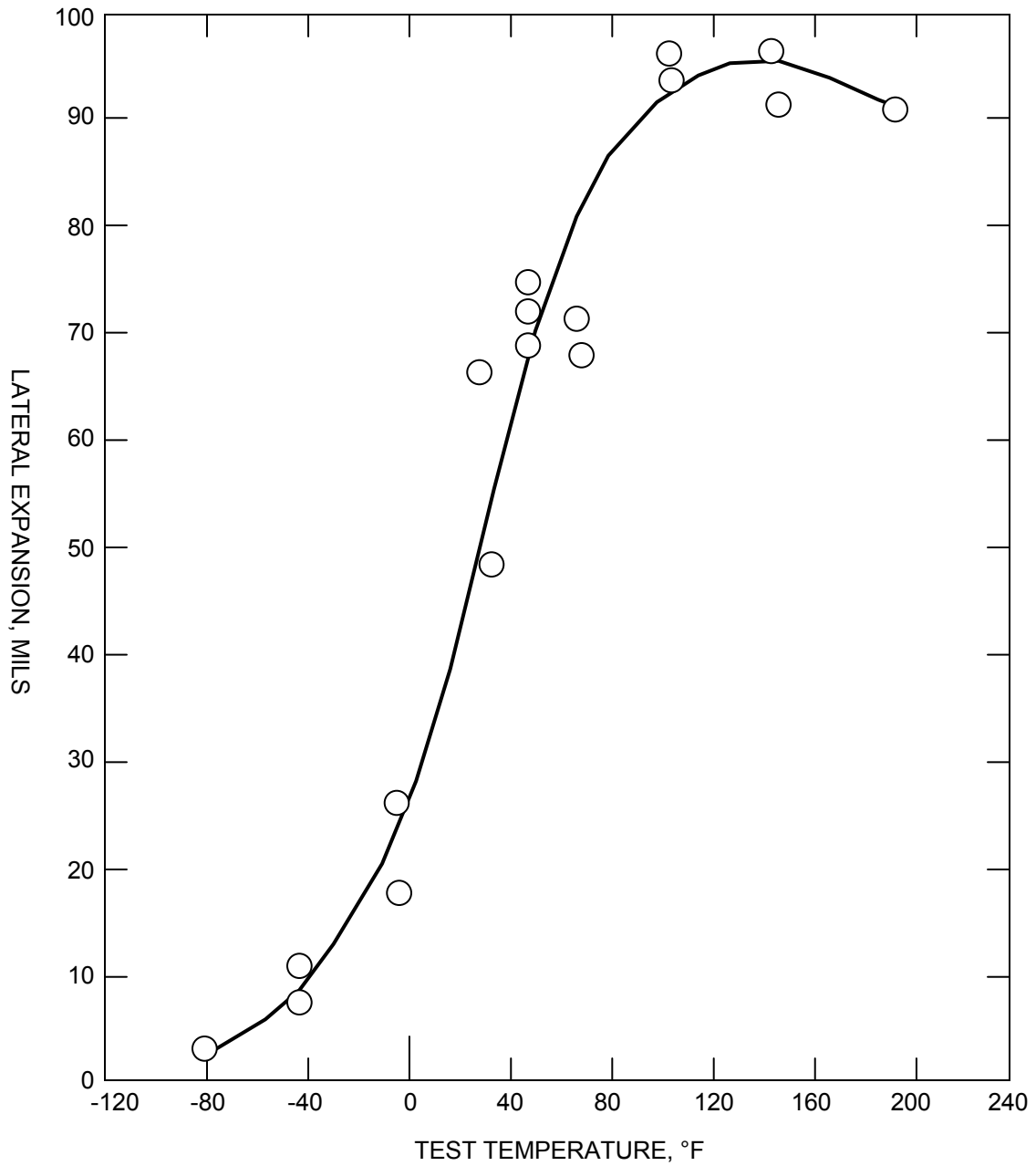

BASE METAL – WR (Transverse) – Plate C-8009-3
Lateral Expansion vs Temperature

SAR FIGURE NO. 5.2-39

AMENDMENT 20

ARKANSAS NUCLEAR ONE
UNIT 2
RUSSELLVILLE, ARKANSAS



SCALE:	NONE
DRAWN:	ENERGY
DESIGN:	ENERGY
CAD NO:	N/A

REACTOR VESSEL SURVEILLANCE MATERIAL
BASE LINE TEST PROGRAM RESULTS

BASED ON DRAWING NO

SHEET

REV.

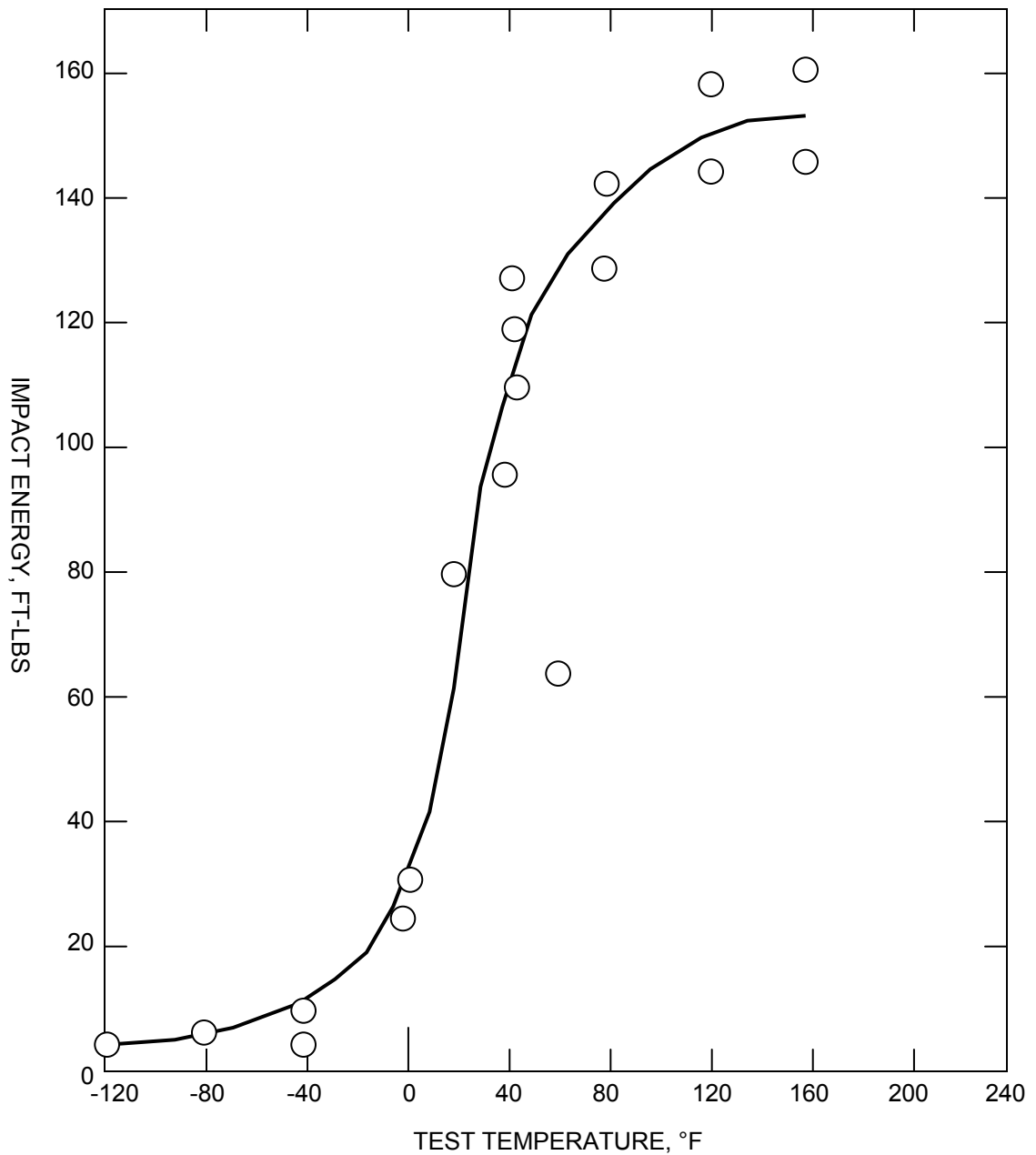

Weld Metal – Plate C-8009-1/C-8009-2
Impact Energy vs Temperature

SAR FIGURE NO. 5.2-40

AMENDMENT 20

ARKANSAS NUCLEAR ONE
UNIT 2
RUSSELLVILLE, ARKANSAS



SCALE:	NONE
DRAWN:	ENERGY
DESIGN:	ENERGY
CAD NO:	N/A

REACTOR VESSEL SURVEILLANCE MATERIAL
BASE LINE TEST PROGRAM RESULTS

BASED ON DRAWING NO

SHEET

REV.

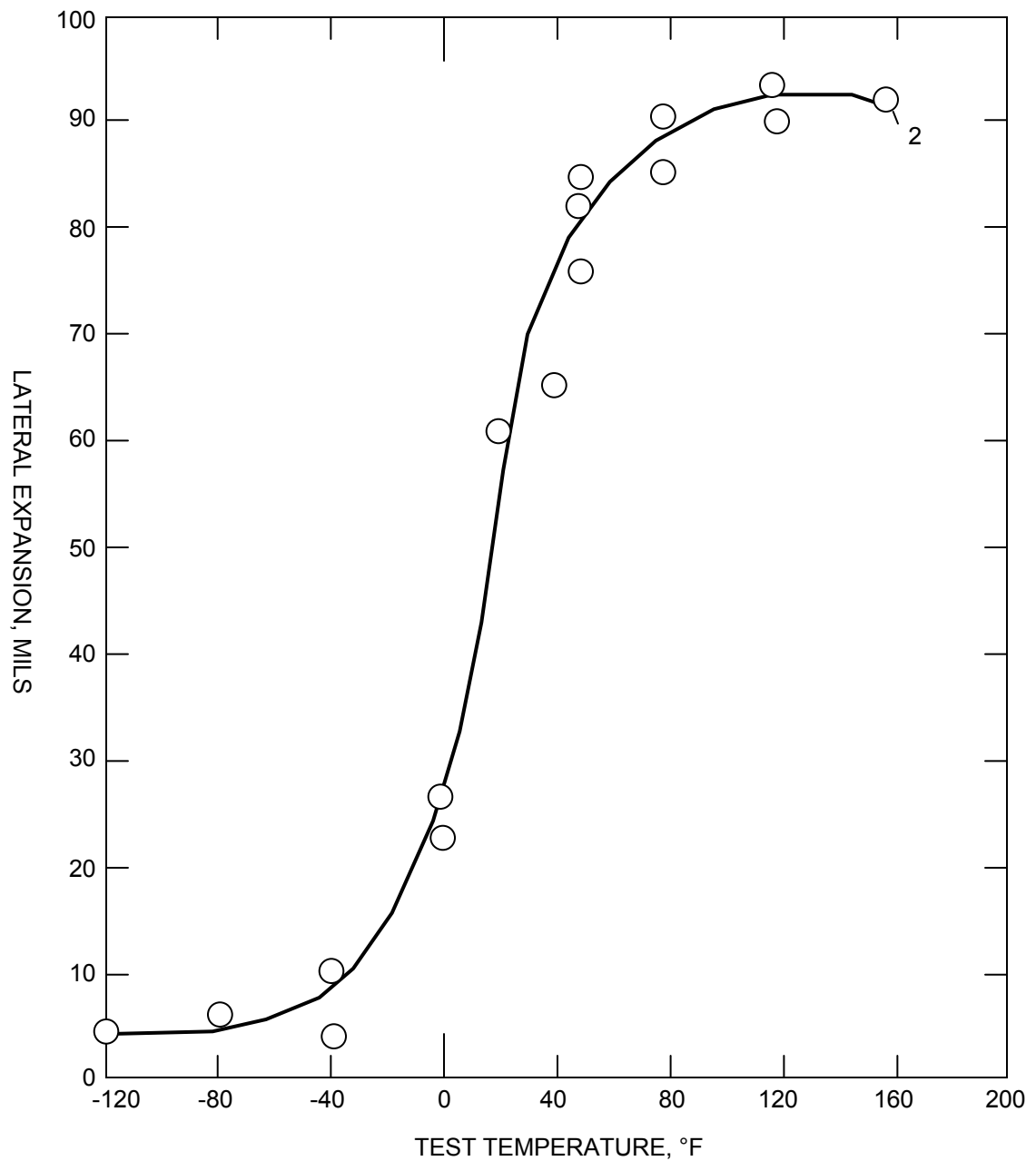

Weld Metal – Plate C-8009-1/C-8009-2
Lateral Expansion vs Temperature

SAR FIGURE NO. 5.2-41

AMENDMENT 20

ARKANSAS NUCLEAR ONE
UNIT 2
RUSSELLVILLE, ARKANSAS



SCALE:	NONE
DRAWN:	ENERGY
DESIGN:	ENERGY
CAD NO:	N/A

REACTOR VESSEL SURVEILLANCE MATERIAL
BASE LINE TEST PROGRAM RESULTS

BASED ON DRAWING NO

SHEET

REV.

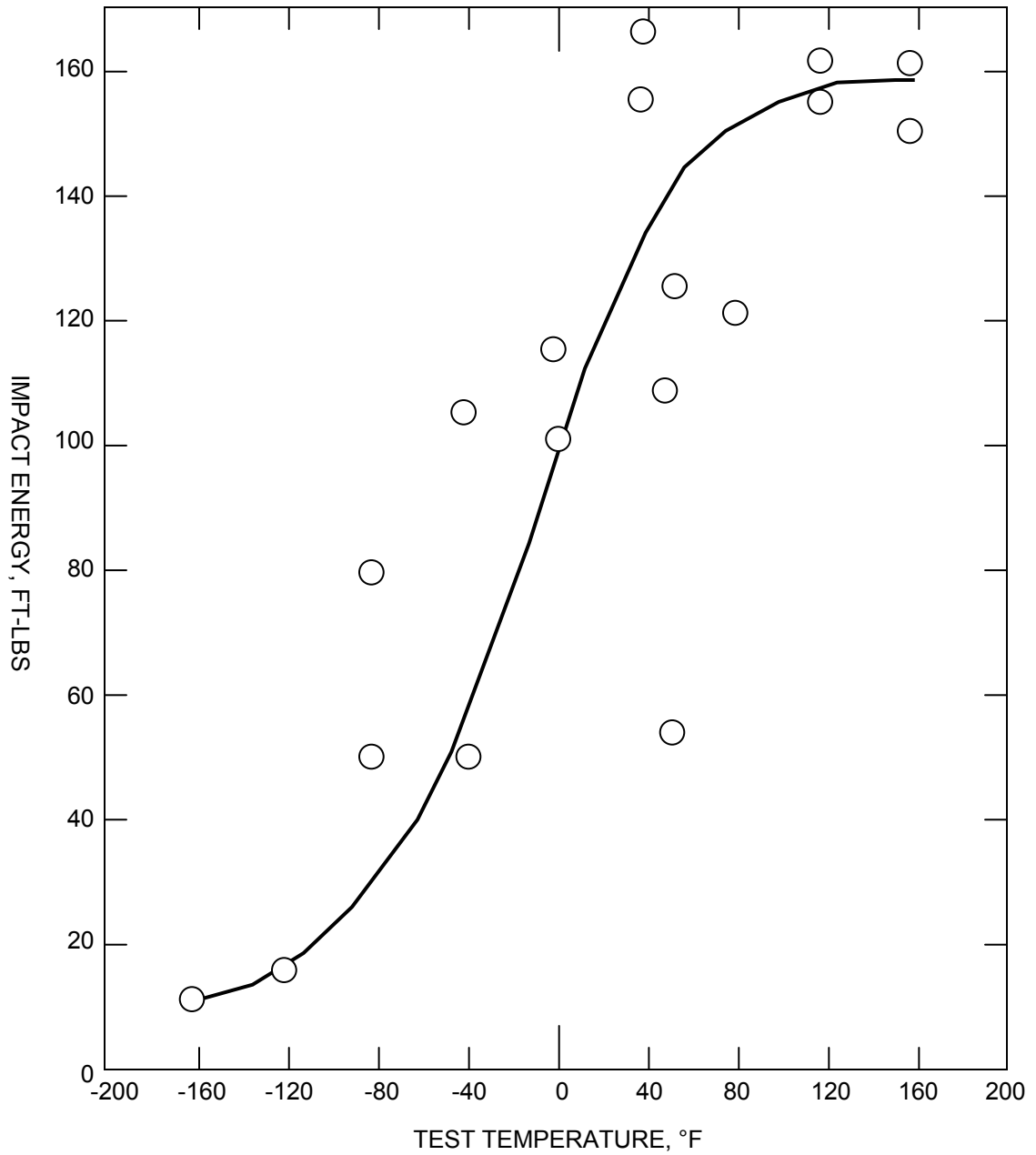

HAZ Metal Plate C-8009-3
Impact Energy vs Temperature

SAR FIGURE NO. 5.2-42

AMENDMENT 20

ARKANSAS NUCLEAR ONE
UNIT 2
RUSSELLVILLE, ARKANSAS



SCALE:	NONE
DRAWN:	ENERGY
DESIGN:	ENERGY
CAD NO:	N/A

REACTOR VESSEL SURVEILLANCE MATERIAL
BASE LINE TEST PROGRAM RESULTS

BASED ON DRAWING NO

SHEET

REV.

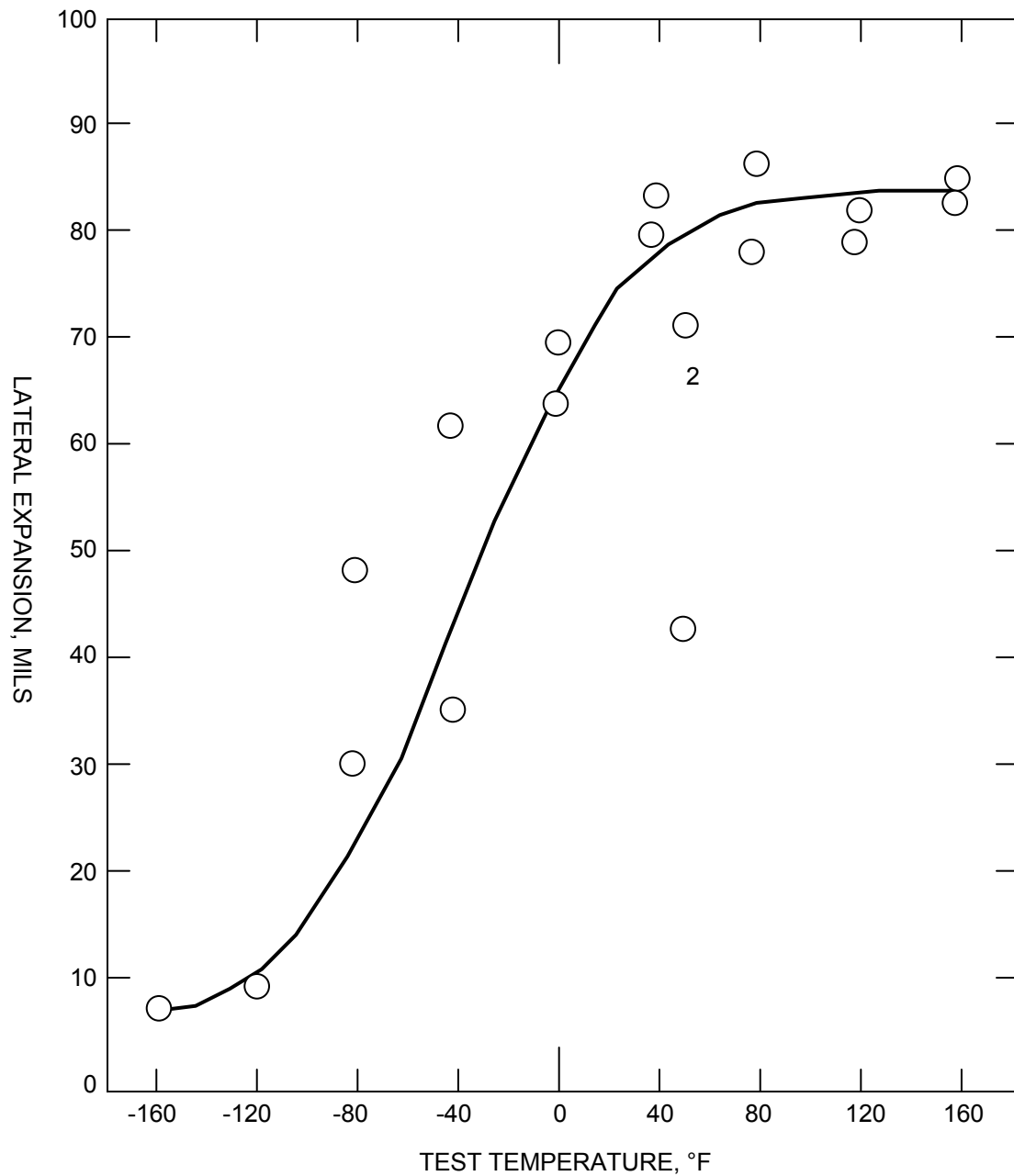

HAZ Metal Plate C-8009-3
Lateral Expansion vs Temperature

SAR FIGURE NO. 5.2-43

AMENDMENT 20

ARKANSAS NUCLEAR ONE
UNIT 2
RUSSELLVILLE, ARKANSAS



SCALE:	NONE
DRAWN:	ENERGY
DESIGN:	ENERGY
CAD NO:	N/A

REACTOR VESSEL SURVEILLANCE MATERIAL
BASE LINE TEST PROGRAM RESULTS

BASED ON DRAWING NO

SHEET

REV.

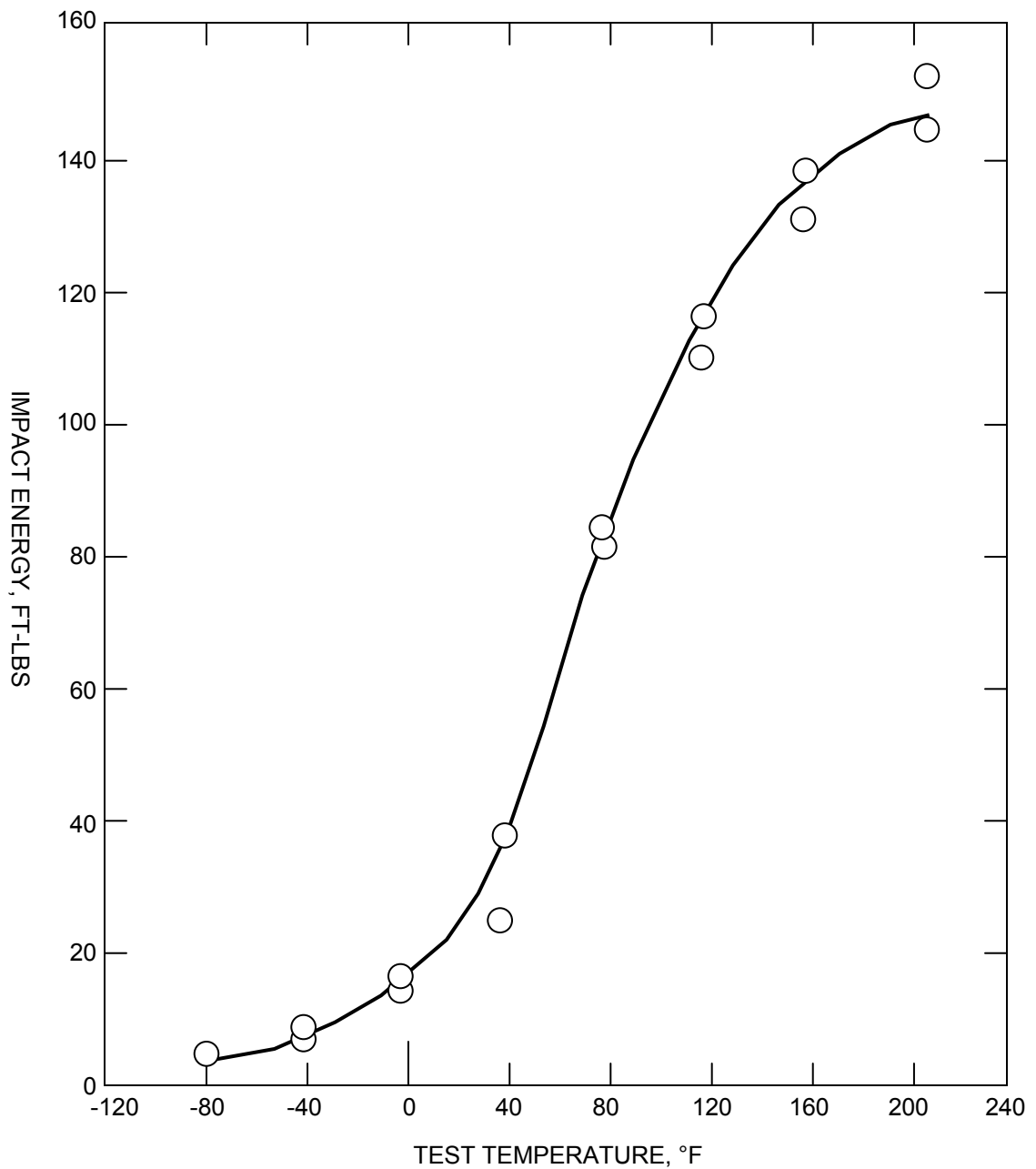

SRM (HSST Plate 01MY)
Impact Energy vs Temperature

SAR FIGURE NO. 5.2-44

AMENDMENT 20

ARKANSAS NUCLEAR ONE
UNIT 2
RUSSELLVILLE, ARKANSAS



SCALE:	NONE
DRAWN:	ENERGY
DESIGN:	ENERGY
CAD NO:	N/A

REACTOR VESSEL SURVEILLANCE MATERIAL
BASE LINE TEST PROGRAM RESULTS

BASED ON DRAWING NO

SHEET

REV.

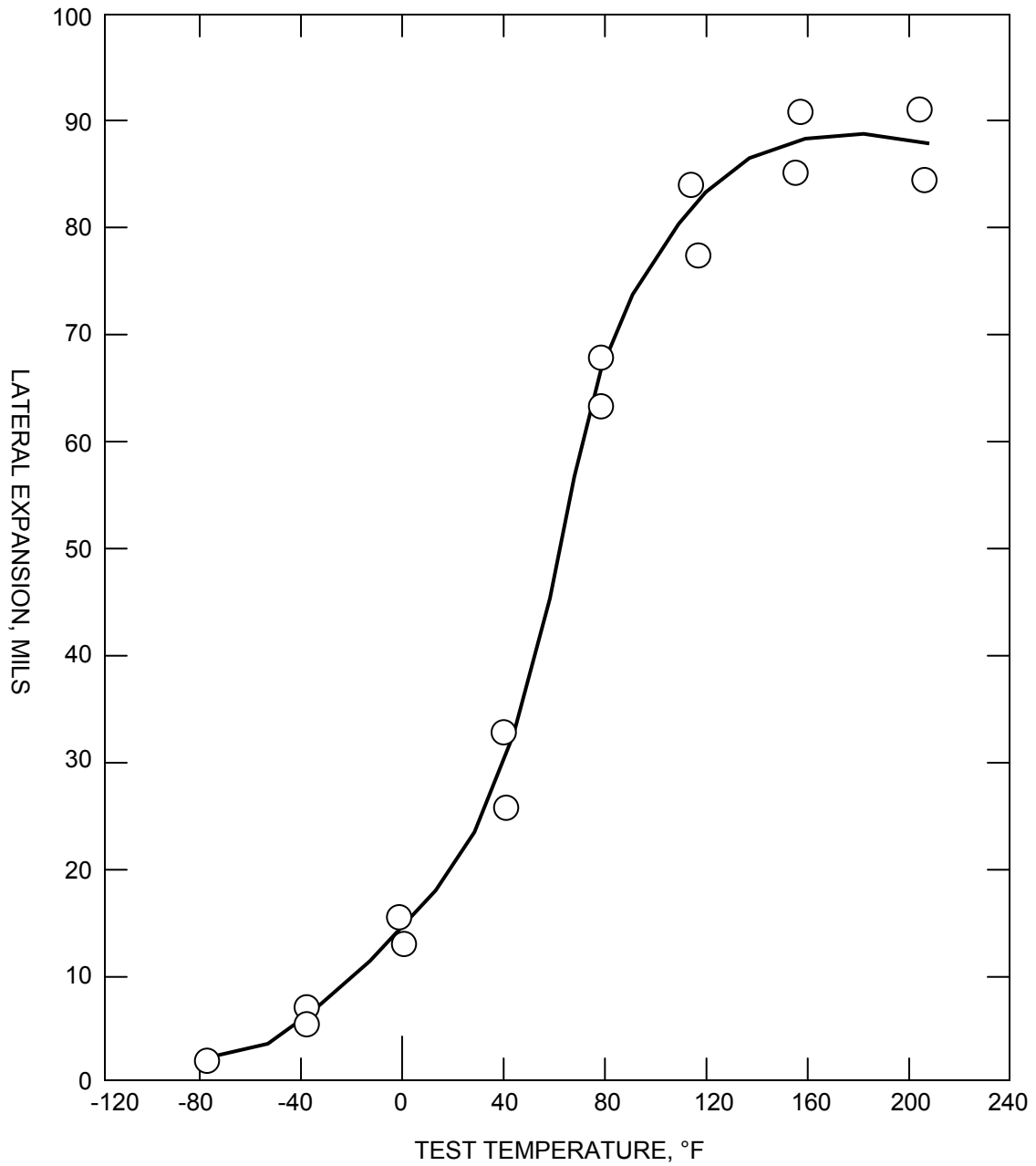

SRM (HSST Plate 01MY – Longitudinal)
Lateral Expansion vs Temperature

SAR FIGURE NO. 5.2-45

AMENDMENT 20

ARKANSAS NUCLEAR ONE
UNIT 2
RUSSELLVILLE, ARKANSAS



SCALE:	NONE
DRAWN:	ENERGY
DESIGN:	ENERGY
CAD NO:	N/A

REACTOR VESSEL SURVEILLANCE MATERIAL
BASE LINE TEST PROGRAM RESULTS

BASED ON DRAWING NO

SHEET

REV.

Figure 5.2-46 Deleted

SAR FIGURE NO. 5.2-46

AMENDMENT 20

ARKANSAS NUCLEAR ONE
UNIT 2
RUSSELLVILLE, ARKANSAS



SCALE:	NONE
DRAWN:	ENERGY
DESIGN:	ENERGY
CAD NO:	N/A

Arkansas Nuclear One Unit 2 Heatup Curve – 21 EFPY
Reactor Coolant System Pressure/Temperature Limits

DRAWING NO

SHEET

REV.

Figure 5.2-46a Deleted

SAR FIGURE NO. 5.2-46a

AMENDMENT 20

ARKANSAS NUCLEAR ONE
UNIT 2
RUSSELLVILLE, ARKANSAS



SCALE:	NONE
DRAWN:	ENERGY
DESIGN:	ENERGY
CAD NO:	N/A

Cooldown Curve – 21 EFPY Reactor
Coolant System Pressure/Temperature Limits

DRAWING NO

SHEET

REV.

Figure 5.2-47 Deleted

SAR FIGURE NO. 5.2-47

AMENDMENT 20

ARKANSAS NUCLEAR ONE
UNIT 2
RUSSELLVILLE, ARKANSAS



SCALE:	NONE
DRAWN:	ENERGY
DESIGN:	ENERGY
CAD NO:	N/A

RCS Pressure/Temperature Limits for Hydrostatic
Testing (Up to and Including 21 EFPY)

DRAWING NO

SHEET

REV.

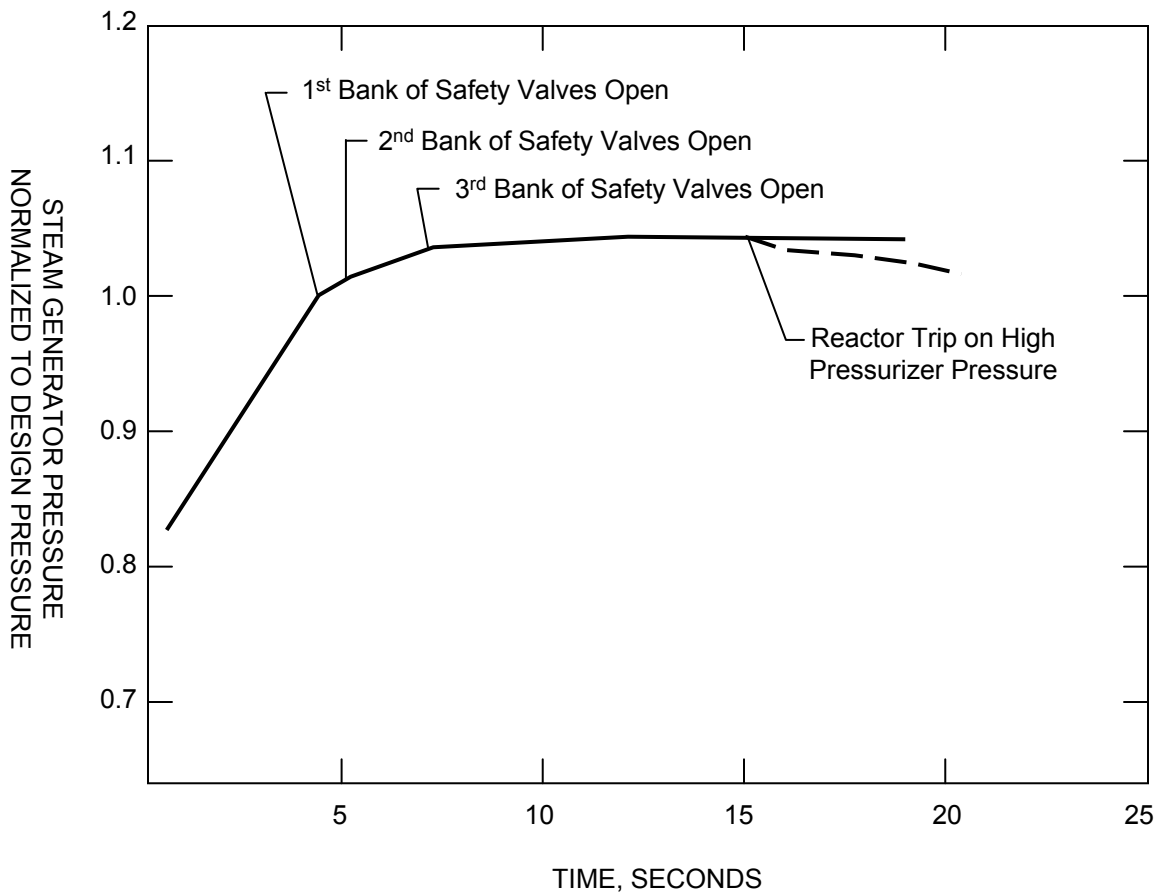

SAR FIGURE NO. 5.2-48

AMENDMENT 20

ARKANSAS NUCLEAR ONE
UNIT 2
RUSSELLVILLE, ARKANSAS



SCALE:	NONE
DRAWN:	ENERGY
DESIGN:	ENERGY
CAD NO:	N/A

STEAM GENERATOR PRESSURE
COMPLETE LOSS OF TURBINE LOAD

BASED ON DRAWING NO

SHEET

REV.

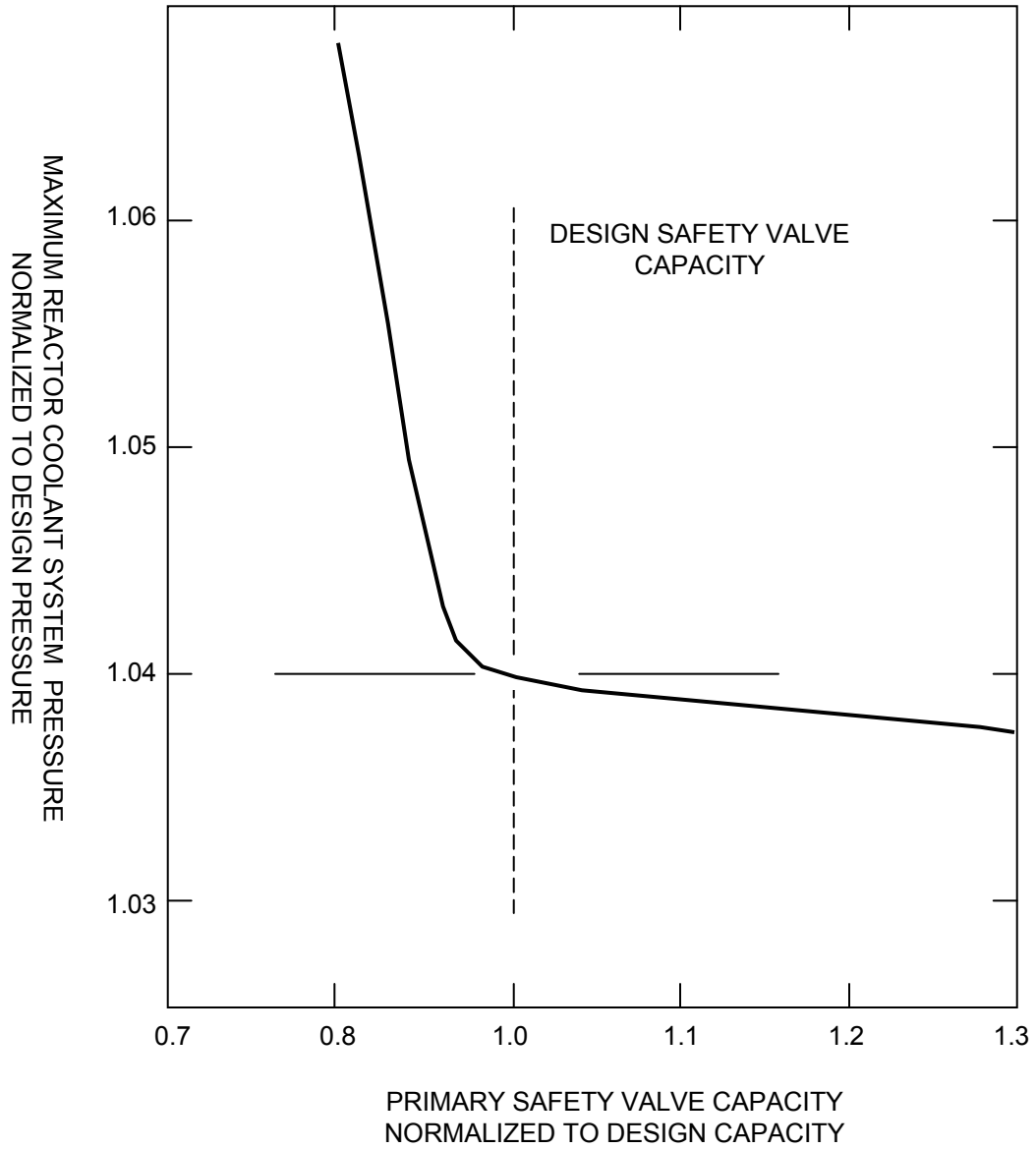

SAR FIGURE NO. 5.2-49

AMENDMENT 20

ARKANSAS NUCLEAR ONE
UNIT 2
RUSSELLVILLE, ARKANSAS



SCALE:	NONE
DRAWN:	ENERGY
DESIGN:	ENERGY
CAD NO:	N/A

OPTIMIZED SAFETY VALVE CAPACITIES

BASED ON DRAWING NO

SHEET

REV.

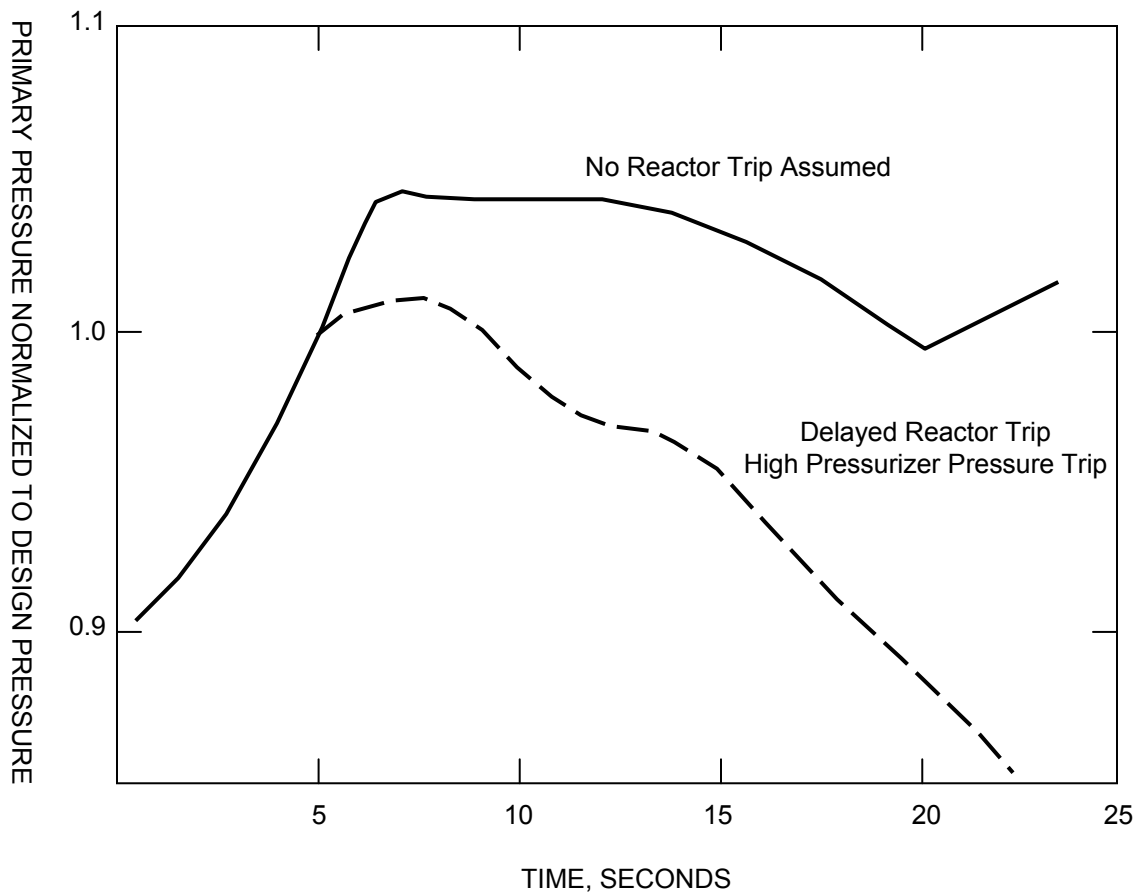

SAR FIGURE NO. 5.2-50

AMENDMENT 20

ARKANSAS NUCLEAR ONE
UNIT 2
RUSSELLVILLE, ARKANSAS



SCALE:	NONE
DRAWN:	ENERGY
DESIGN:	ENERGY
CAD NO:	N/A

MAXIMUM REACTOR COOLANT SYSTEM PRESSURE
VS TIME FOR WORST CASE LOSS OF LOAD INCIDENT

BASED ON DRAWING NO

SHEET

REV.

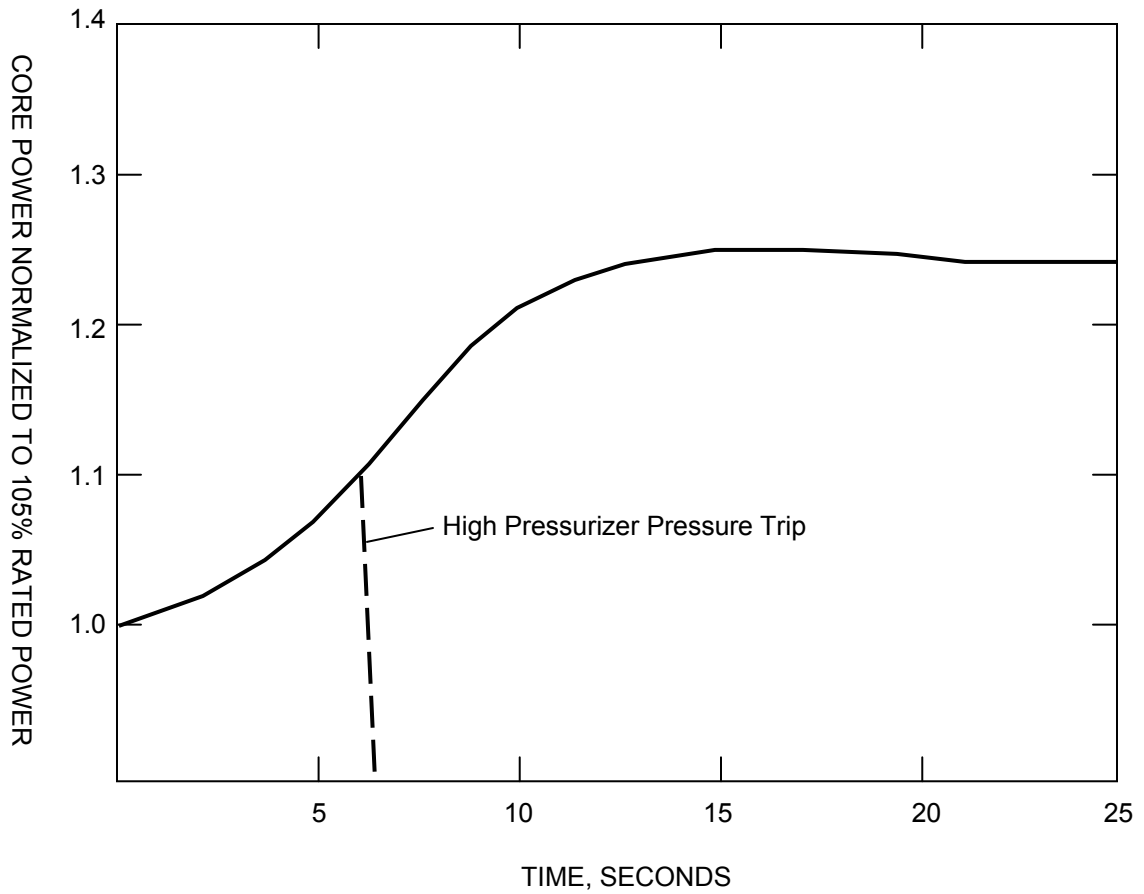

SAR FIGURE NO. 5.2-51

AMENDMENT 20

ARKANSAS NUCLEAR ONE
UNIT 2
RUSSELLVILLE, ARKANSAS



SCALE:	NONE
DRAWN:	ENERGY
DESIGN:	ENERGY
CAD NO:	N/A

MAXIMUM REACTOR POWER VS TIME FOR
WORST CASE LOSS OF LOAD INCIDENT

BASED ON DRAWING NO

SHEET

REV.

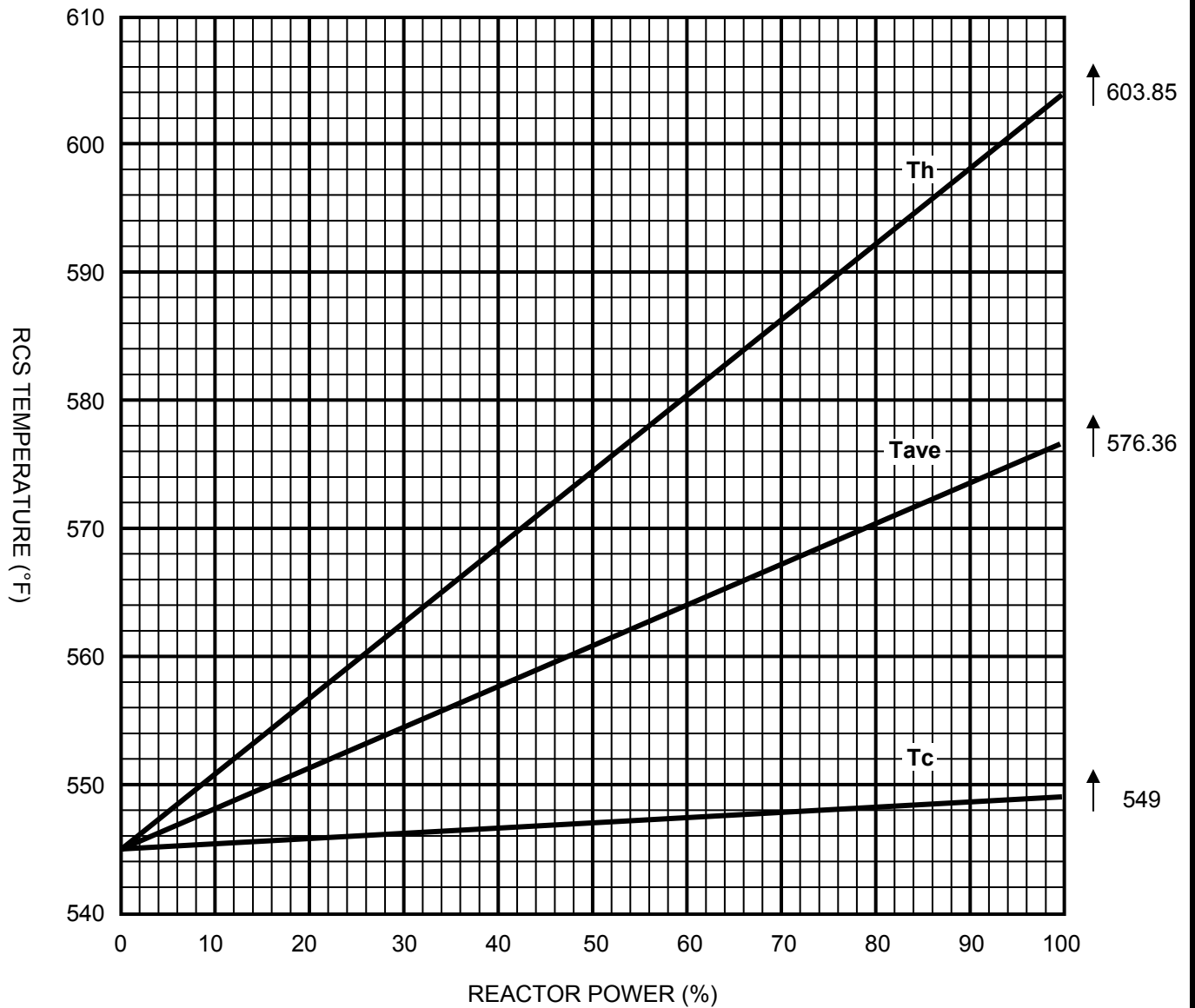

SAR FIGURE NO. 5.3-1

AMENDMENT 20

ARKANSAS NUCLEAR ONE
 UNIT 2
 RUSSELLVILLE, ARKANSAS



SCALE:	NONE
DRAWN:	ENERGY
DESIGN:	ENERGY
CAD NO:	N/A

REACTOR COOLANT TEMPERATURE VS
 REACTOR POWER

BASED ON DRAWING NO

SHEET

REV.

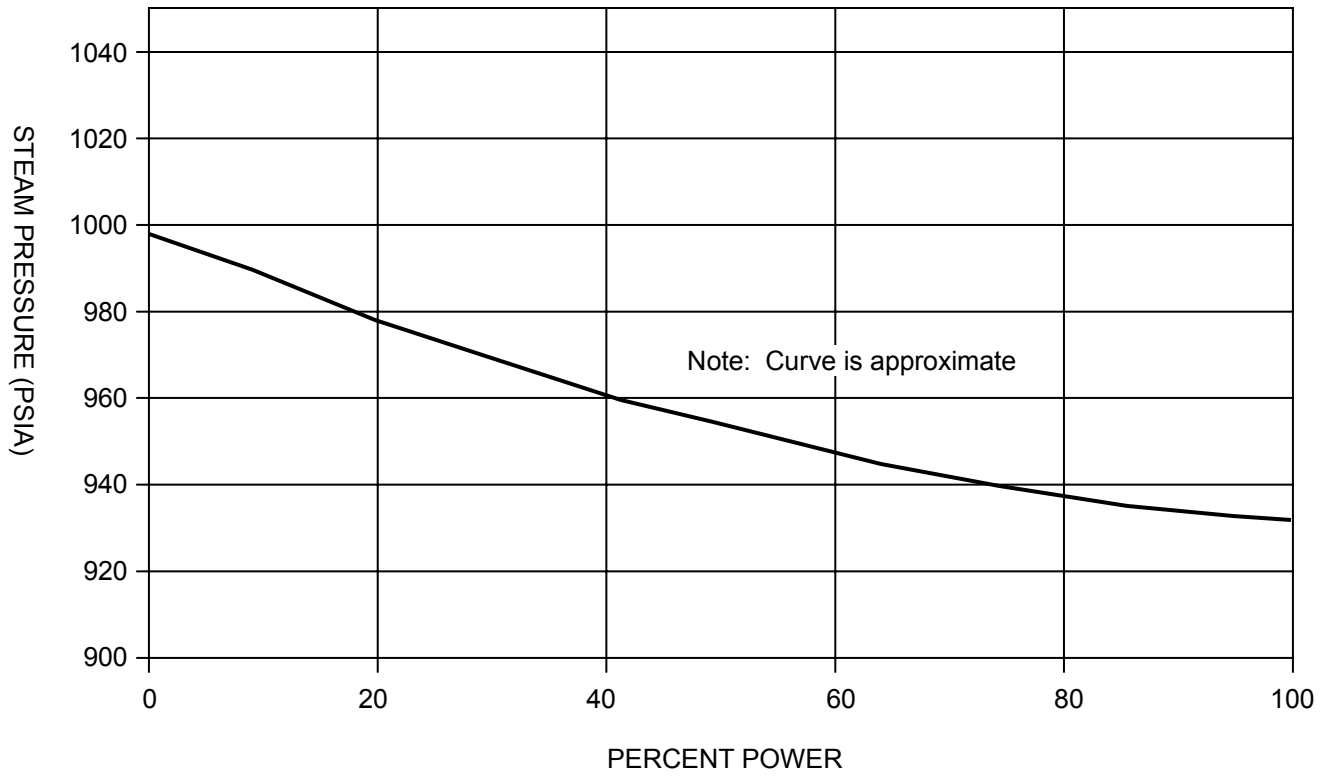

SAR FIGURE NO. 5.3-2

AMENDMENT 20

ARKANSAS NUCLEAR ONE
 UNIT 2
 RUSSELLVILLE, ARKANSAS



SCALE:	NONE
DRAWN:	ENERGY
DESIGN:	ENERGY
CAD NO:	N/A

DESIGN STEAM PRESSURE VARIATION
 WITH POWER

BASED ON DRAWING NO

SHEET

REV.

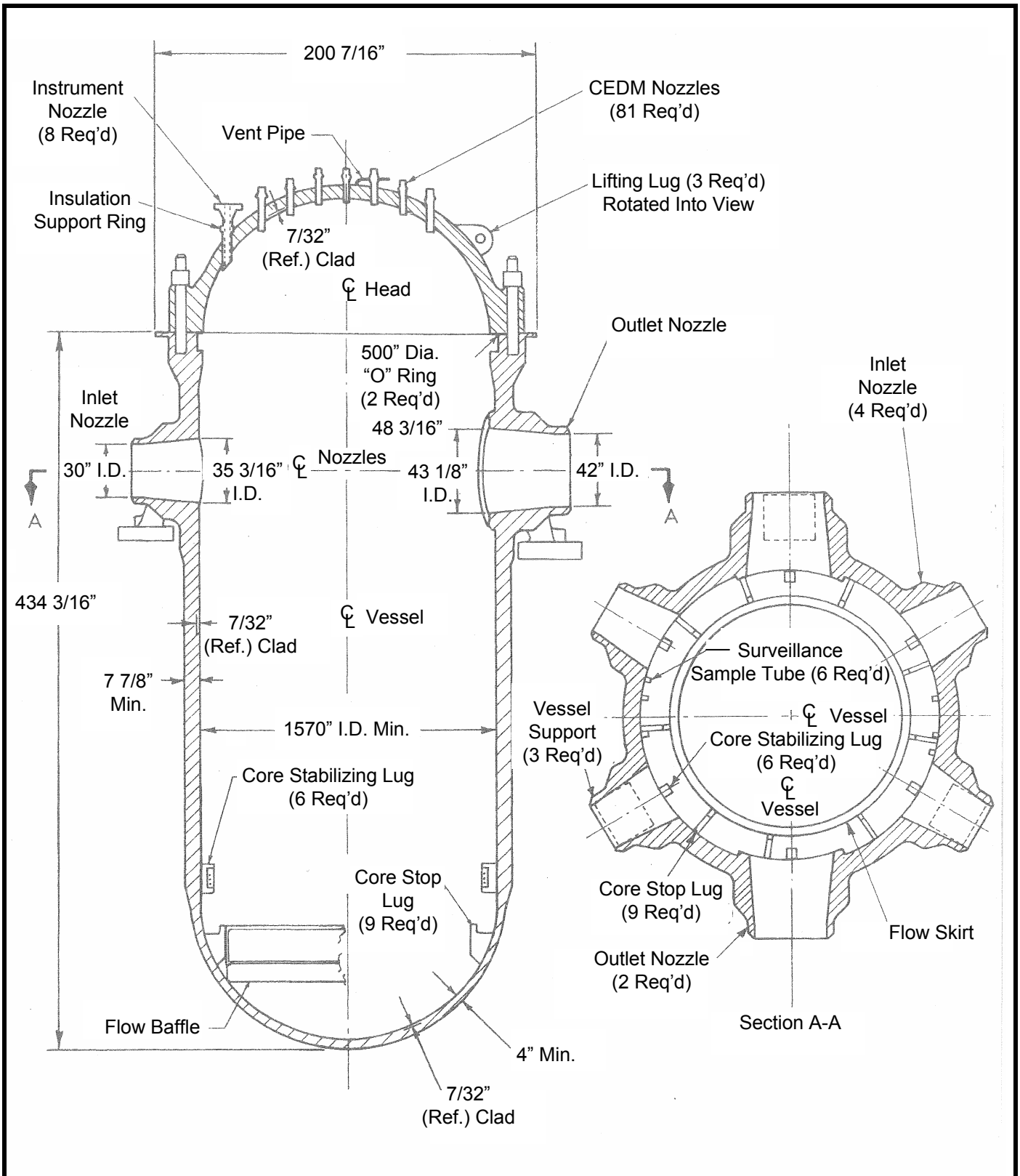

SAR FIGURE NO. 5.4-1

AMENDMENT 20

ARKANSAS NUCLEAR ONE
UNIT 2
RUSSELLVILLE, ARKANSAS



SCALE:	NONE
DRAWN:	ENERGY
DESIGN:	ENERGY
CAD NO:	N/A

REACTOR VESSEL

BASED ON DRAWING NO

SHEET

REV.

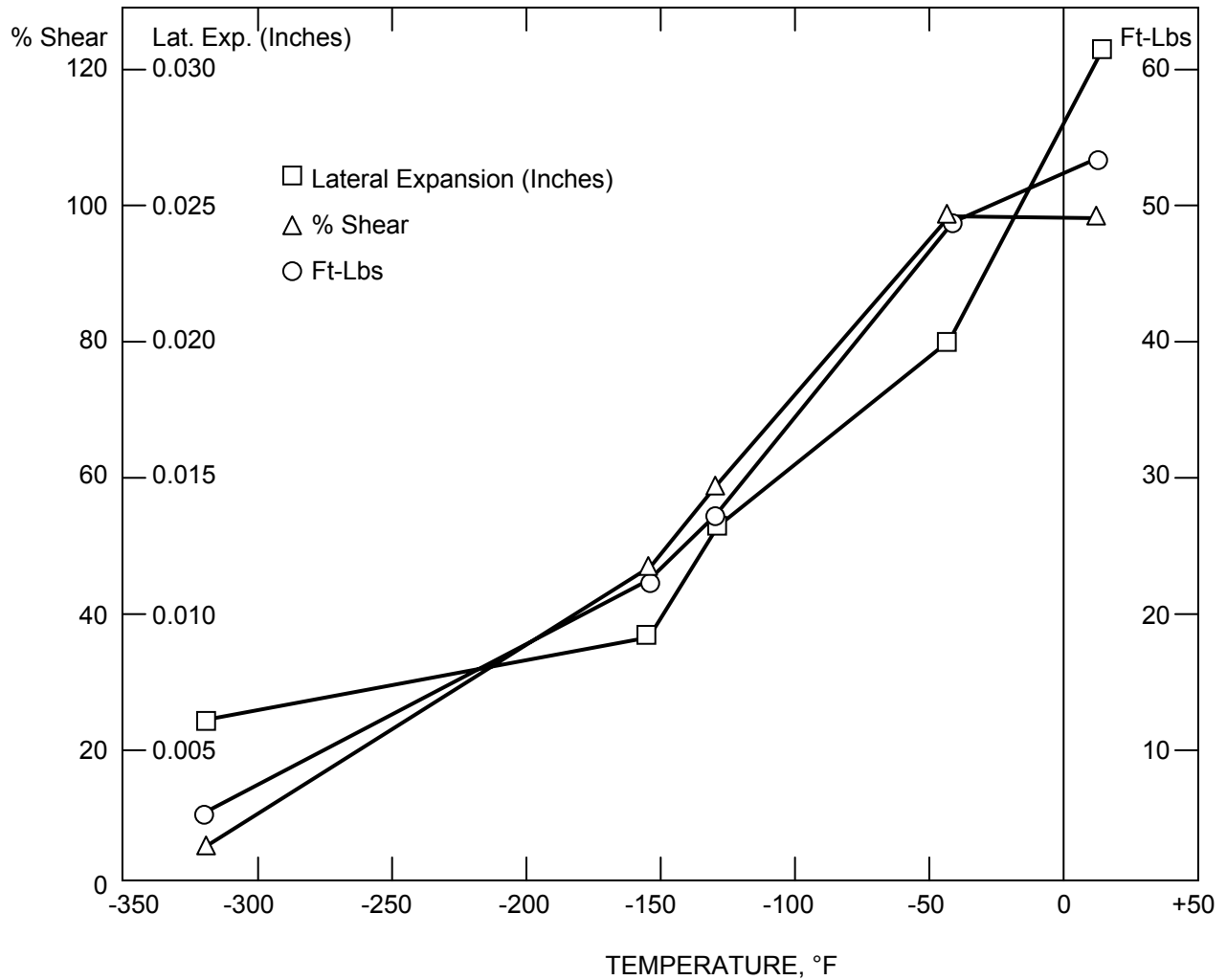

SAR FIGURE NO. 5.4-2

AMENDMENT 20

ARKANSAS NUCLEAR ONE
 UNIT 2
 RUSSELLVILLE, ARKANSAS



SCALE:	NONE
DRAWN:	ENERGY
DESIGN:	ENERGY
CAD NO:	N/A

REACTOR VESSEL CLOSURE STUD MATERIAL
 TOUGHNESS VS TEMPERATURE HEAT 89616

BASED ON DRAWING NO

SHEET

REV.

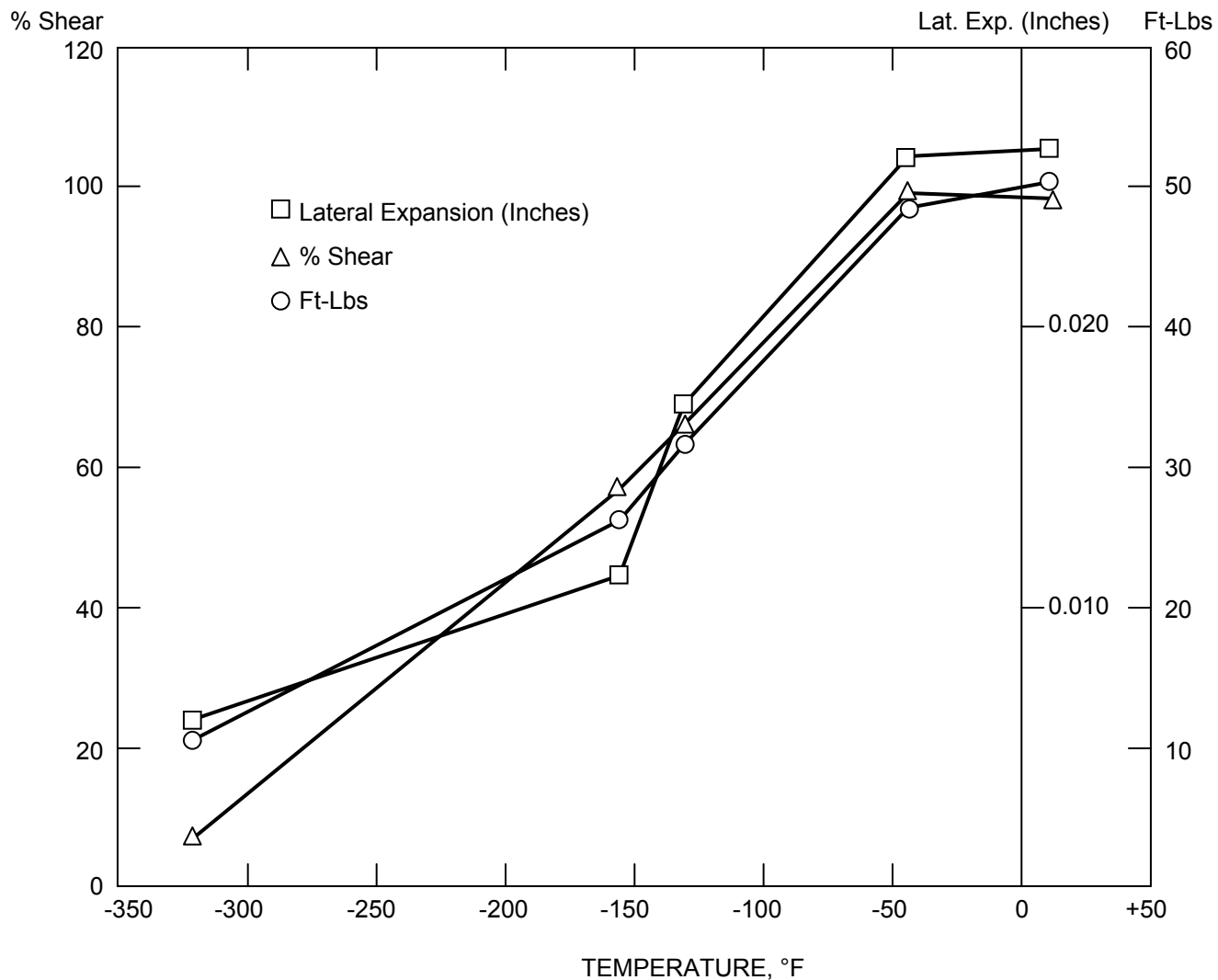

SAR FIGURE NO. 5.4-3

AMENDMENT 20

ARKANSAS NUCLEAR ONE
 UNIT 2
 RUSSELLVILLE, ARKANSAS



SCALE:	NONE
DRAWN:	ENERGY
DESIGN:	ENERGY
CAD NO:	N/A

REACTOR VESSEL CLOSURE STUD MATERIAL
 TOUGHNESS VS TEMPERATURE HEAT 89229

BASED ON DRAWING NO

SHEET

REV.

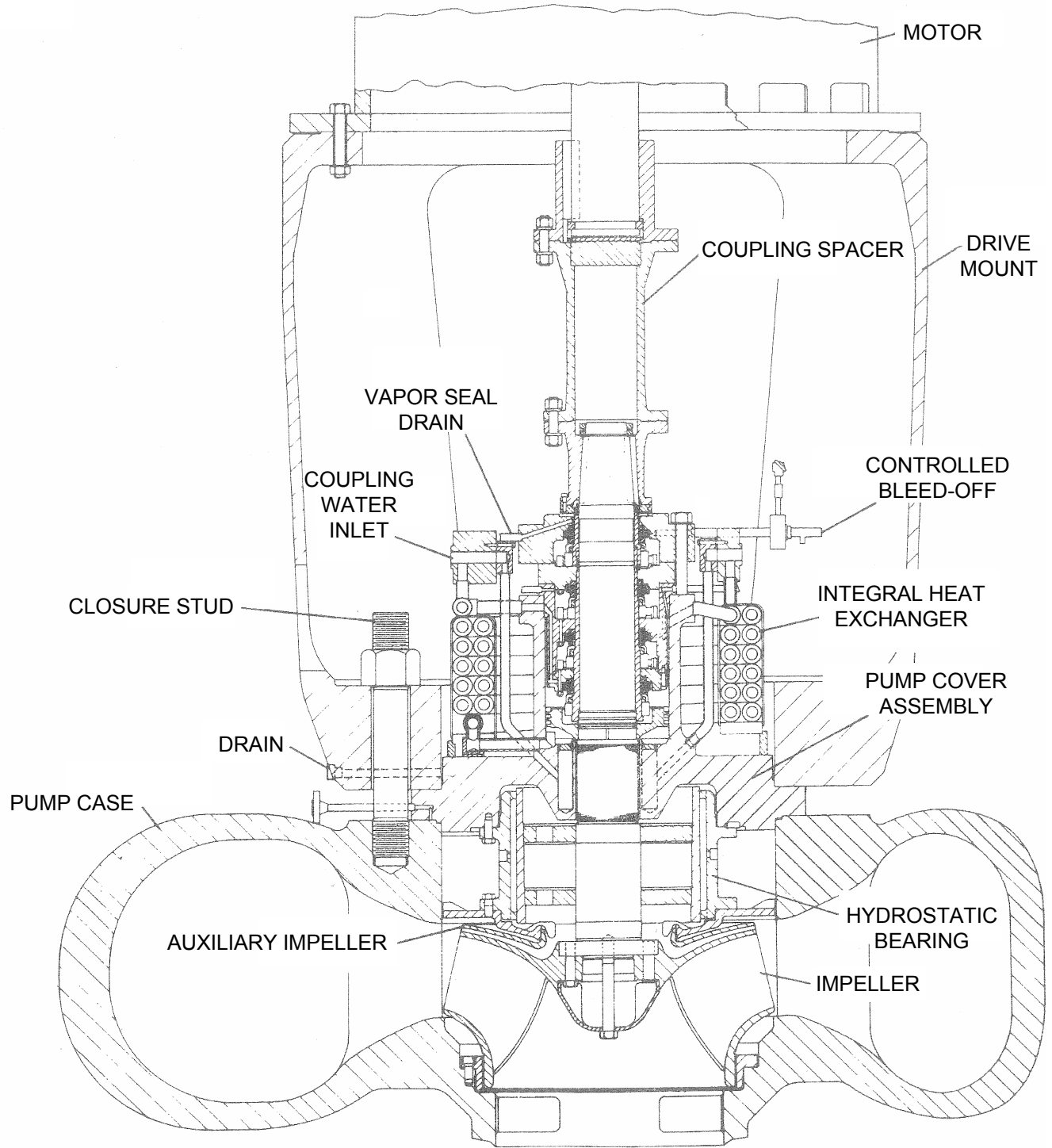

SAR FIGURE NO. 5.5-1

AMENDMENT 20

ARKANSAS NUCLEAR ONE
 UNIT 2
 RUSSELLVILLE, ARKANSAS



SCALE:	NONE
DRAWN:	ENERGY
DESIGN:	ENERGY
CAD NO:	N/A

REACTOR COOLANT PUMP

BASED ON DRAWING NO

SHEET

REV.

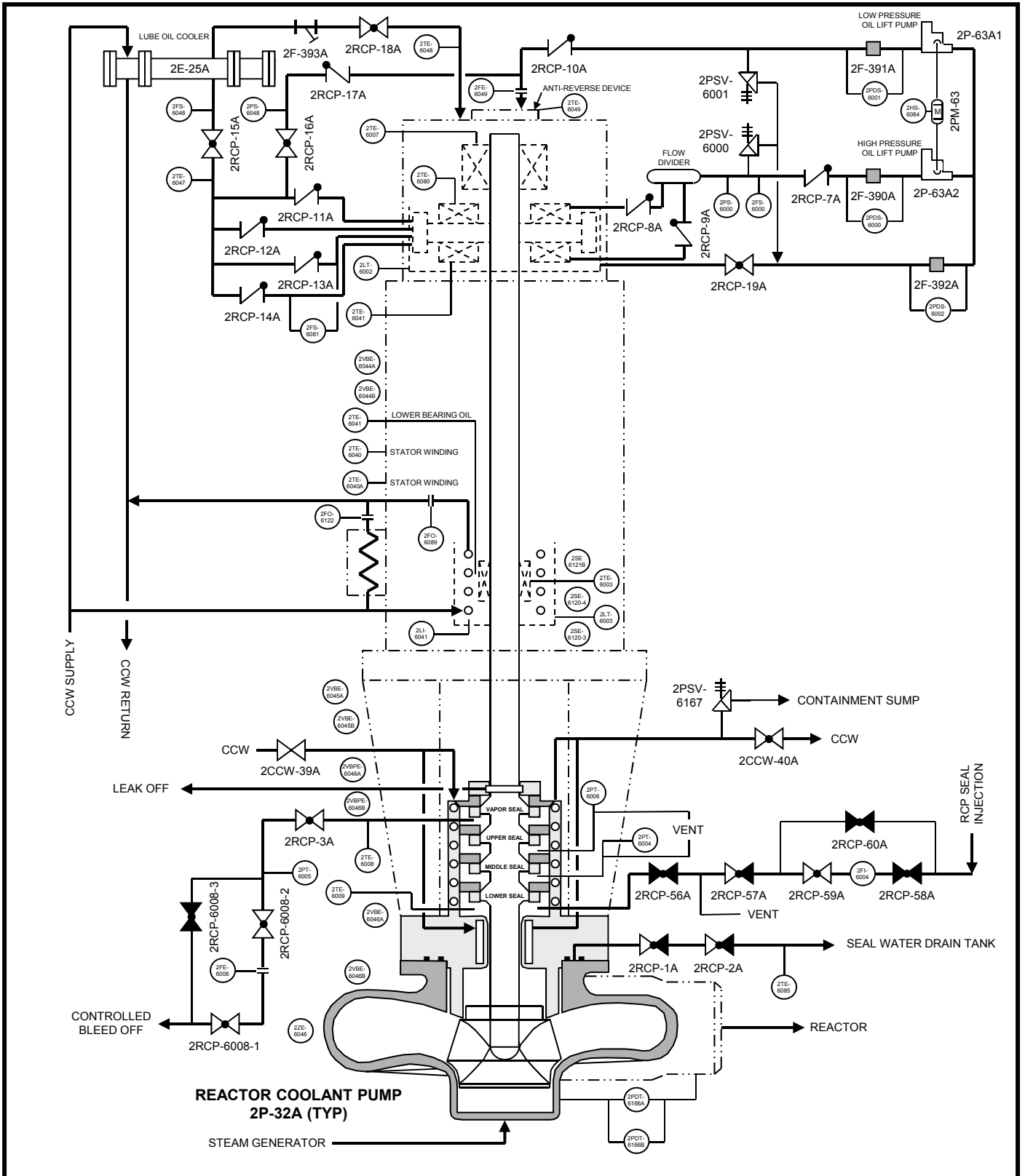

SAR FIGURE NO. 5.5-2

AMENDMENT 28

ARKANSAS NUCLEAR ONE
UNIT 2
RUSSELLVILLE, ARKANSAS



SCALE: NONE
DRAWN: ENTERGY
DESIGN: ENTERGY
CAD NO: N/A

REACTOR COOLANT PUMP CONNECTIONS

BASED ON DRAWING NO

SHEET

REV.

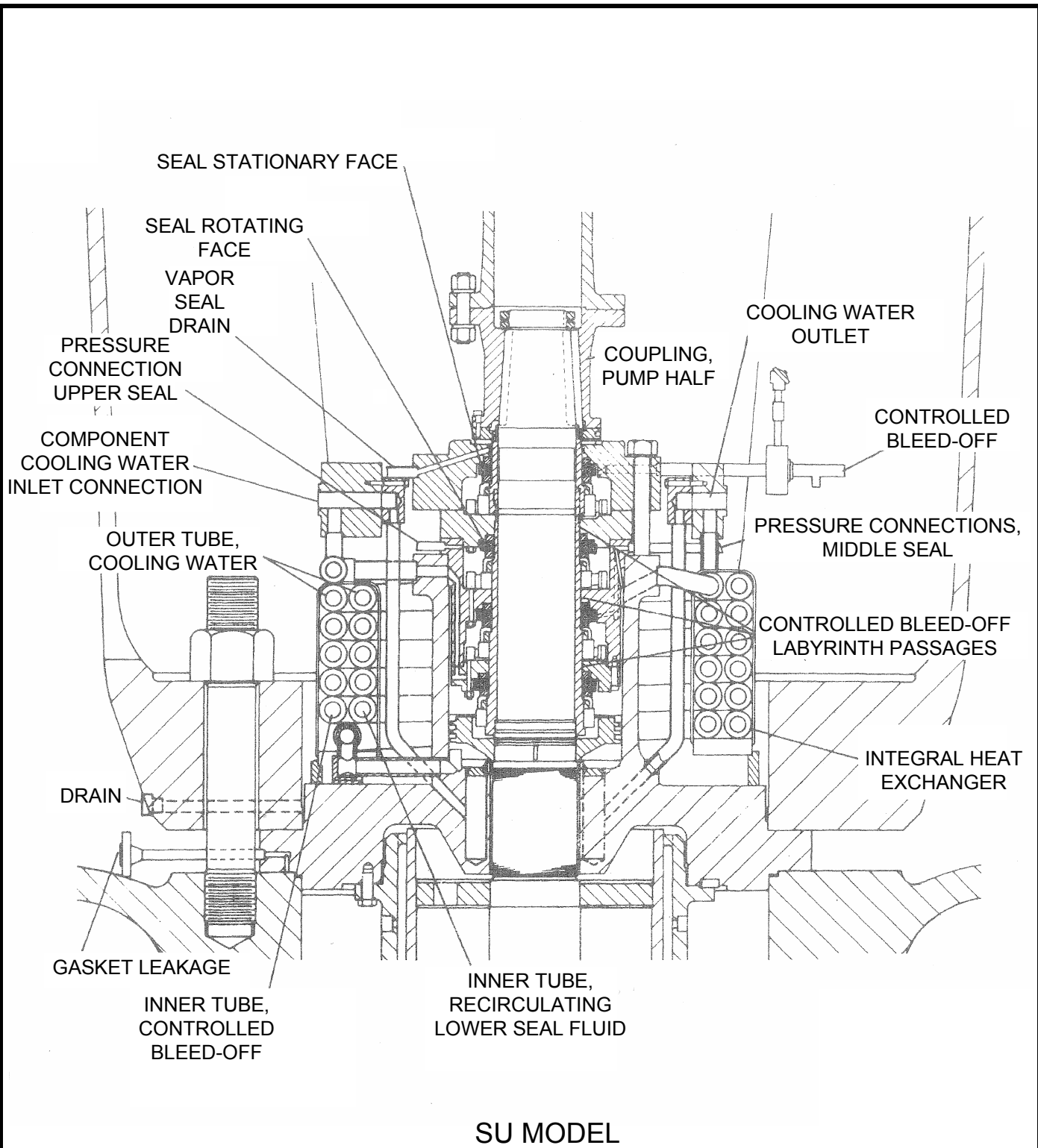

SAR FIGURE NO. 5.5-3

AMENDMENT 20

ARKANSAS NUCLEAR ONE
UNIT 2
RUSSELLVILLE, ARKANSAS



SCALE:	NONE
DRAWN:	ENERGY
DESIGN:	ENERGY
CAD NO:	N/A

REACTOR COOLANT PUMP SEAL AREA

BASED ON DRAWING NO

SHEET

REV.

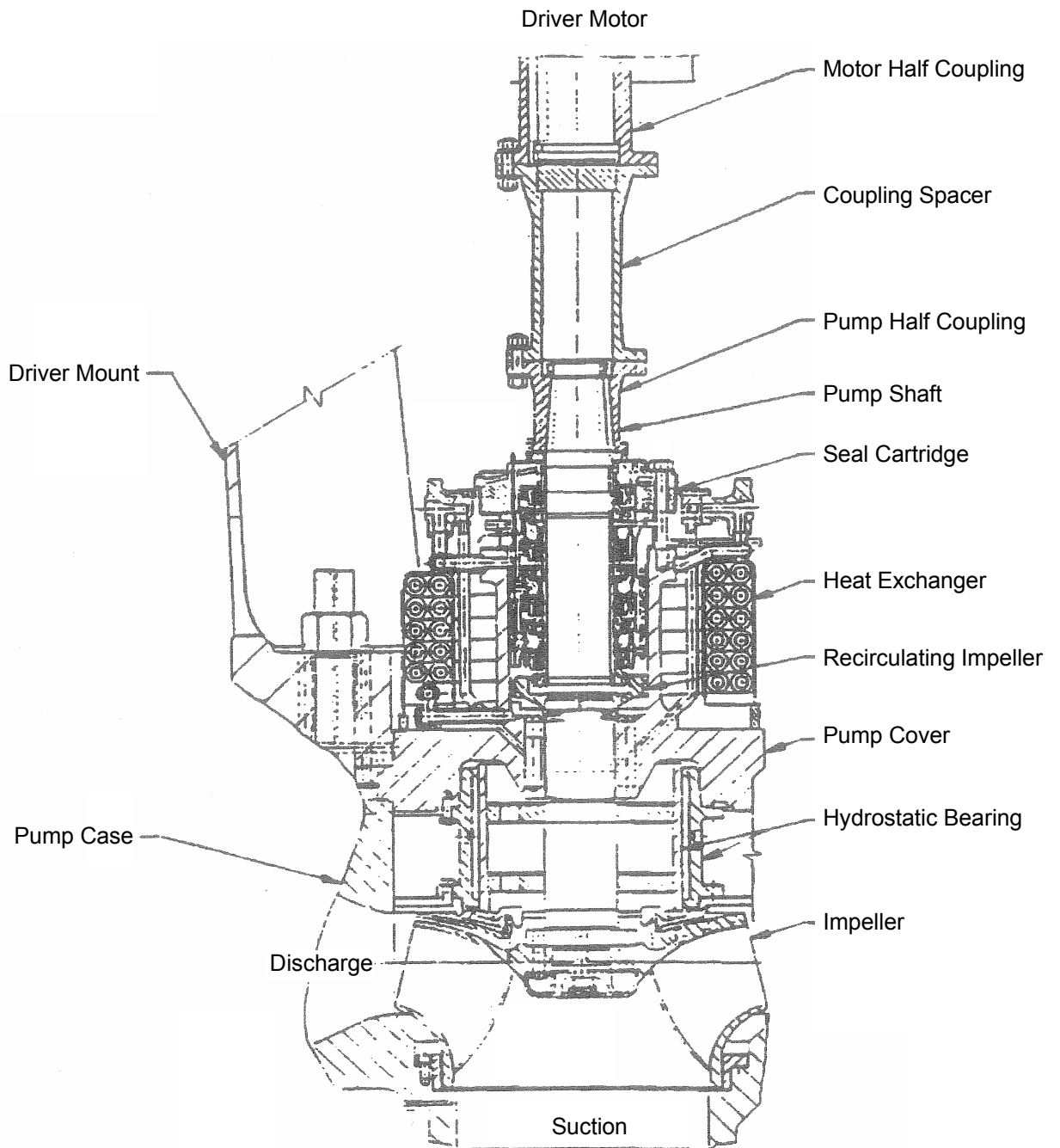

N9000 MODEL

SAR FIGURE NO. 5.5-3A

AMENDMENT 20

ARKANSAS NUCLEAR ONE
UNIT 2
RUSSELLVILLE, ARKANSAS



SCALE:	NONE
DRAWN:	ENERGY
DESIGN:	ENERGY
CAD NO:	N/A

REACTOR COOLANT PUMP SEAL AREA

BASED ON DRAWING NO

SHEET

REV.

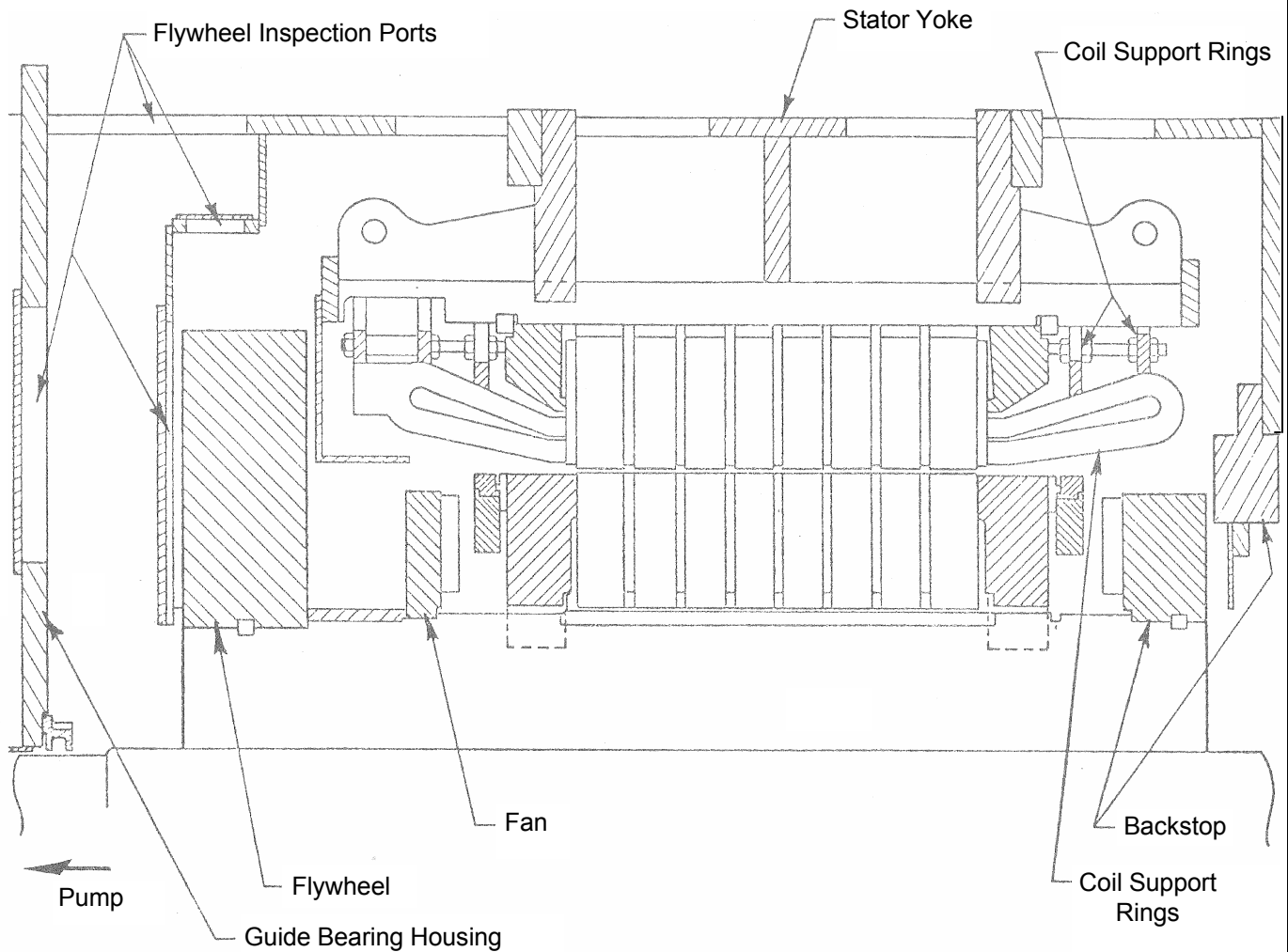

SAR FIGURE NO. 5.5-4

AMENDMENT 20

ARKANSAS NUCLEAR ONE
UNIT 2
RUSSELLVILLE, ARKANSAS



SCALE:	NONE
DRAWN:	ENERGY
DESIGN:	ENERGY
CAD NO:	N/A

MOTOR FLYWHEEL ASSEMBLY

BASED ON DRAWING NO

SHEET

REV.

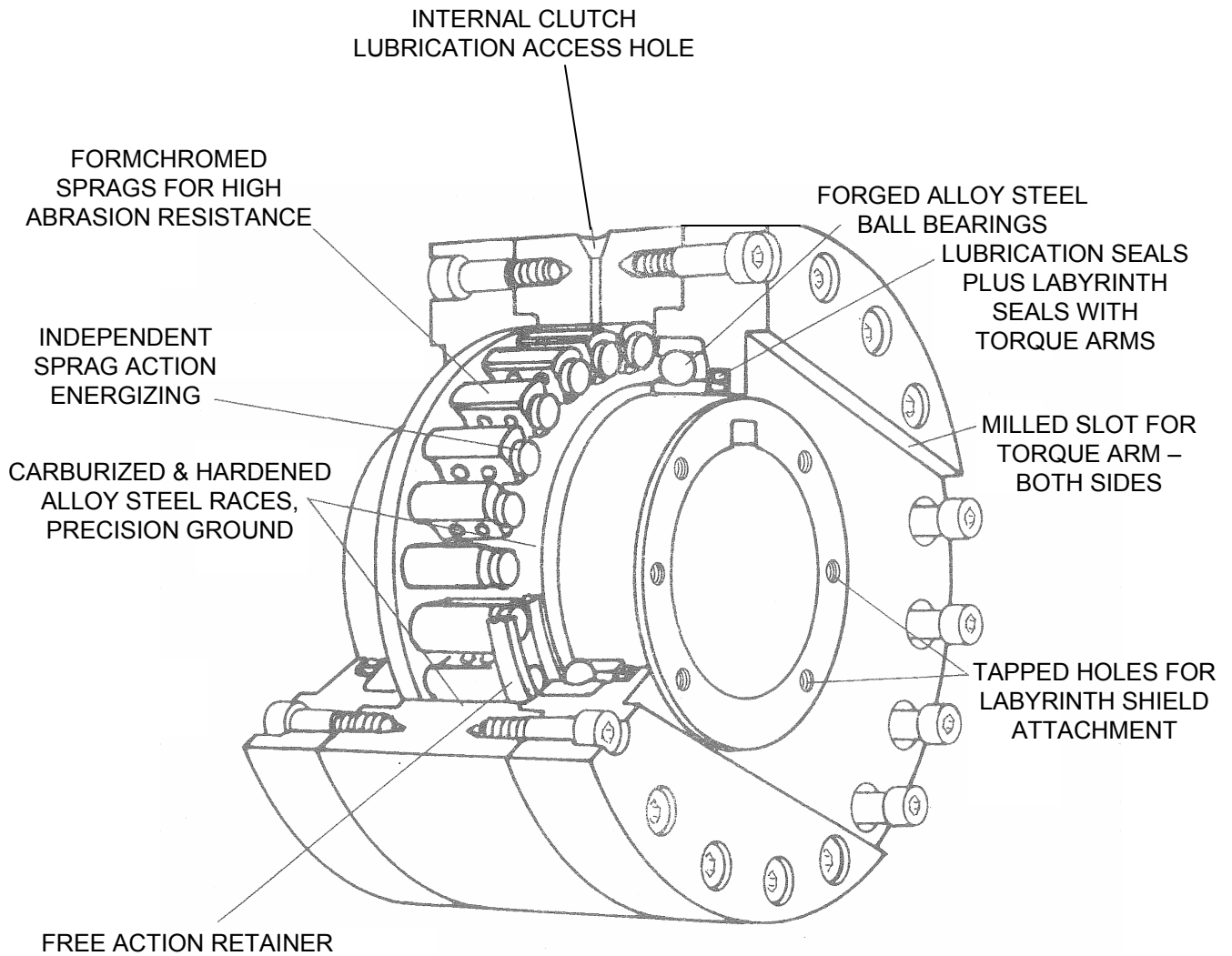

SAR FIGURE NO. 5.5-5

AMENDMENT 20

ARKANSAS NUCLEAR ONE
UNIT 2
RUSSELLVILLE, ARKANSAS



SCALE:	NONE
DRAWN:	ENERGY
DESIGN:	ENERGY
CAD NO:	N/A

ANTI-ROTATION DEVICE

BASED ON DRAWING NO

SHEET

REV.

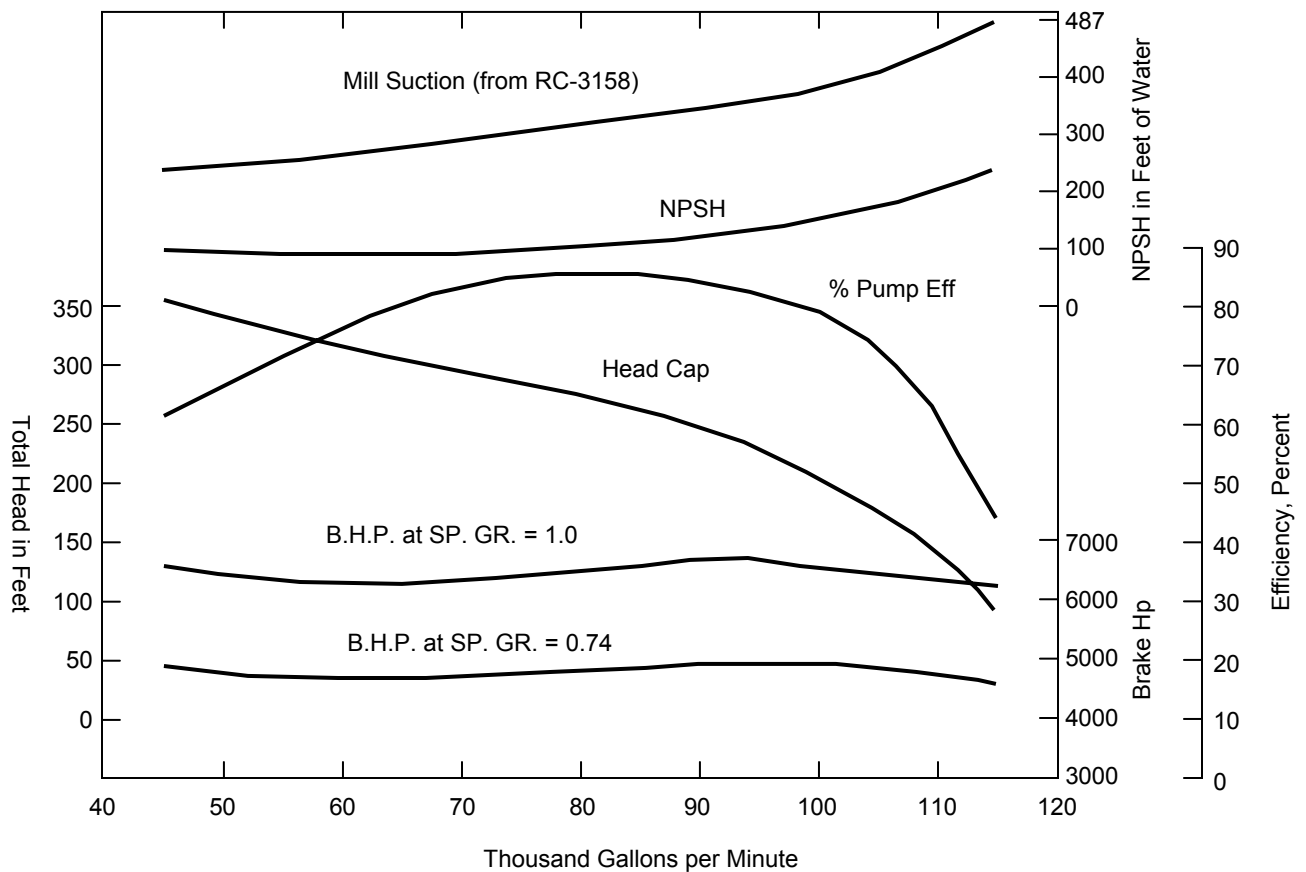

SAR FIGURE NO. 5.5-6

AMENDMENT 20

ARKANSAS NUCLEAR ONE
UNIT 2
RUSSELLVILLE, ARKANSAS



SCALE:	NONE
DRAWN:	ENERGY
DESIGN:	ENERGY
CAD NO:	N/A

REACTOR COOLANT PUMP PERFORMANCE

BASED ON DRAWING NO

SHEET

REV.

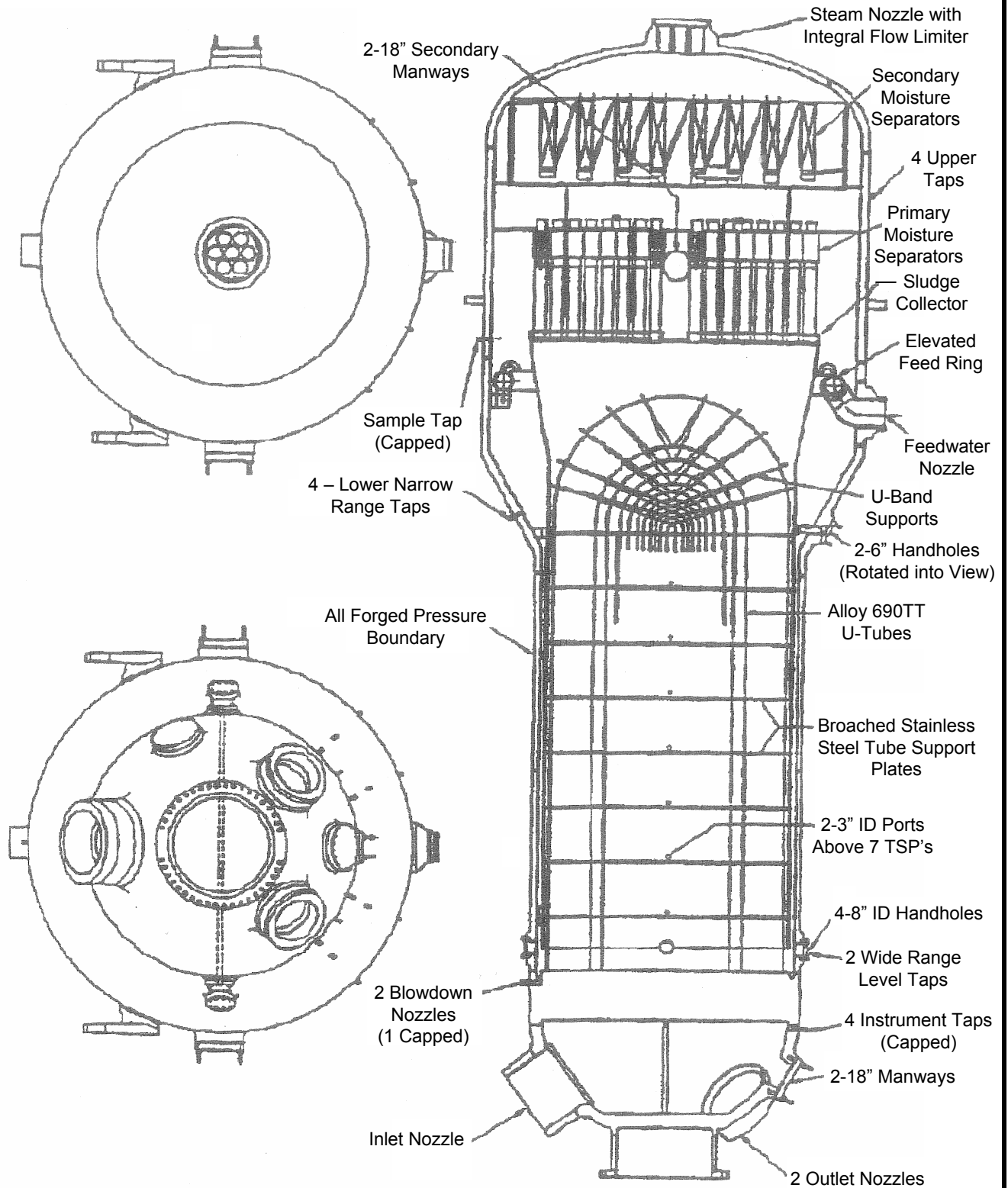

SAR FIGURE NO. 5.5-7

AMENDMENT 20

ARKANSAS NUCLEAR ONE
UNIT 2
RUSSELLVILLE, ARKANSAS



SCALE:	NONE
DRAWN:	ENERGY
DESIGN:	ENERGY
CAD NO:	N/A

STEAM GENERATOR

BASED ON DRAWING NO

SHEET

REV.

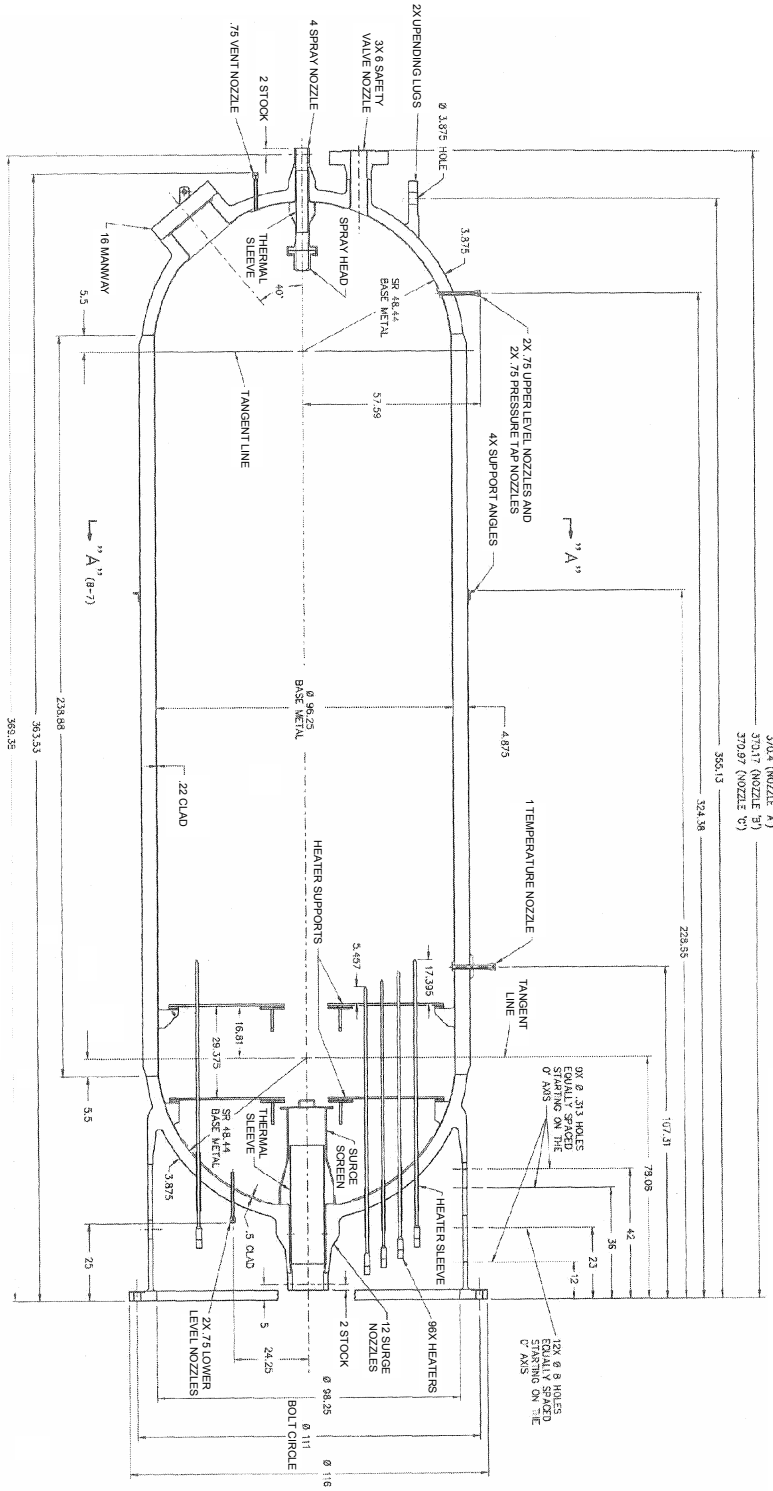

SECTIONAL ELEVATION
NOZZLES, LUGS, ETC. ROTATED INTO SECTION

SAR FIGURE NO. 5.5-8

AMENDMENT 20

ARKANSAS NUCLEAR ONE
UNIT 2
RUSSELLVILLE, ARKANSAS



SCALE:	NONE
DRAWN:	ENERGY
DESIGN:	ENERGY
CAD NO:	N/A

PRESSURIZER

BASED ON DRAWING NO

SHEET

REV.

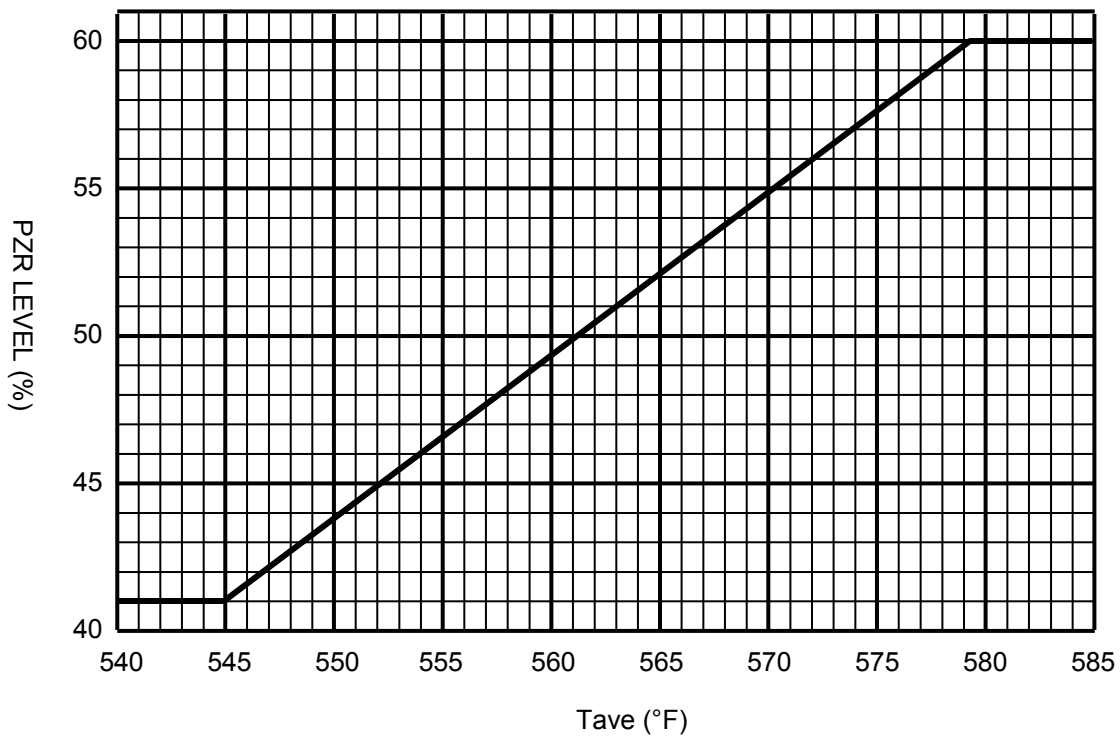

SAR FIGURE NO. 5.5-9

AMENDMENT 20

ARKANSAS NUCLEAR ONE
 UNIT 2
 RUSSELLVILLE, ARKANSAS



SCALE:	NONE
DRAWN:	ENERGY
DESIGN:	ENERGY
CAD NO:	N/A

PRESSURIZER LEVEL SETPOINT
 PROGRAM

BASED ON DRAWING NO

SHEET

REV.

DELETED

SAR FIGURE NO. 5.5-10

AMENDMENT 20

ARKANSAS NUCLEAR ONE
UNIT 2
RUSSELLVILLE, ARKANSAS



SCALE:	NONE
DRAWN:	ENERGY
DESIGN:	ENERGY
CAD NO:	N/A

PRESSURIZER LEVEL CONTROL SET
POINTS

DRAWING NO

SHEET

REV.

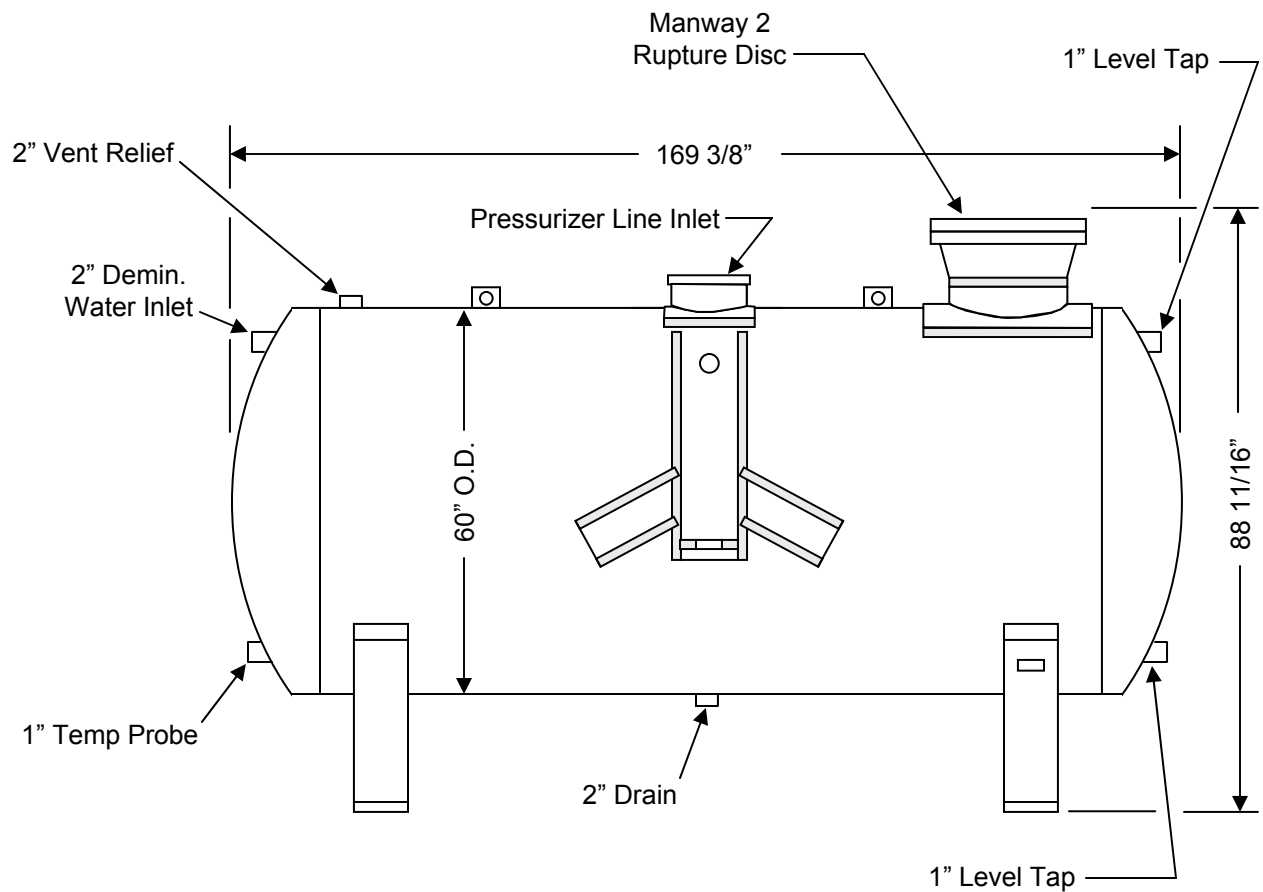

SAR FIGURE NO. 5.5-11

AMENDMENT 20

ARKANSAS NUCLEAR ONE
UNIT 2
RUSSELLVILLE, ARKANSAS



SCALE:	NONE
DRAWN:	ENERGY
DESIGN:	ENERGY
CAD NO:	N/A

QUENCH TANK

BASED ON DRAWING NO

SHEET

REV.

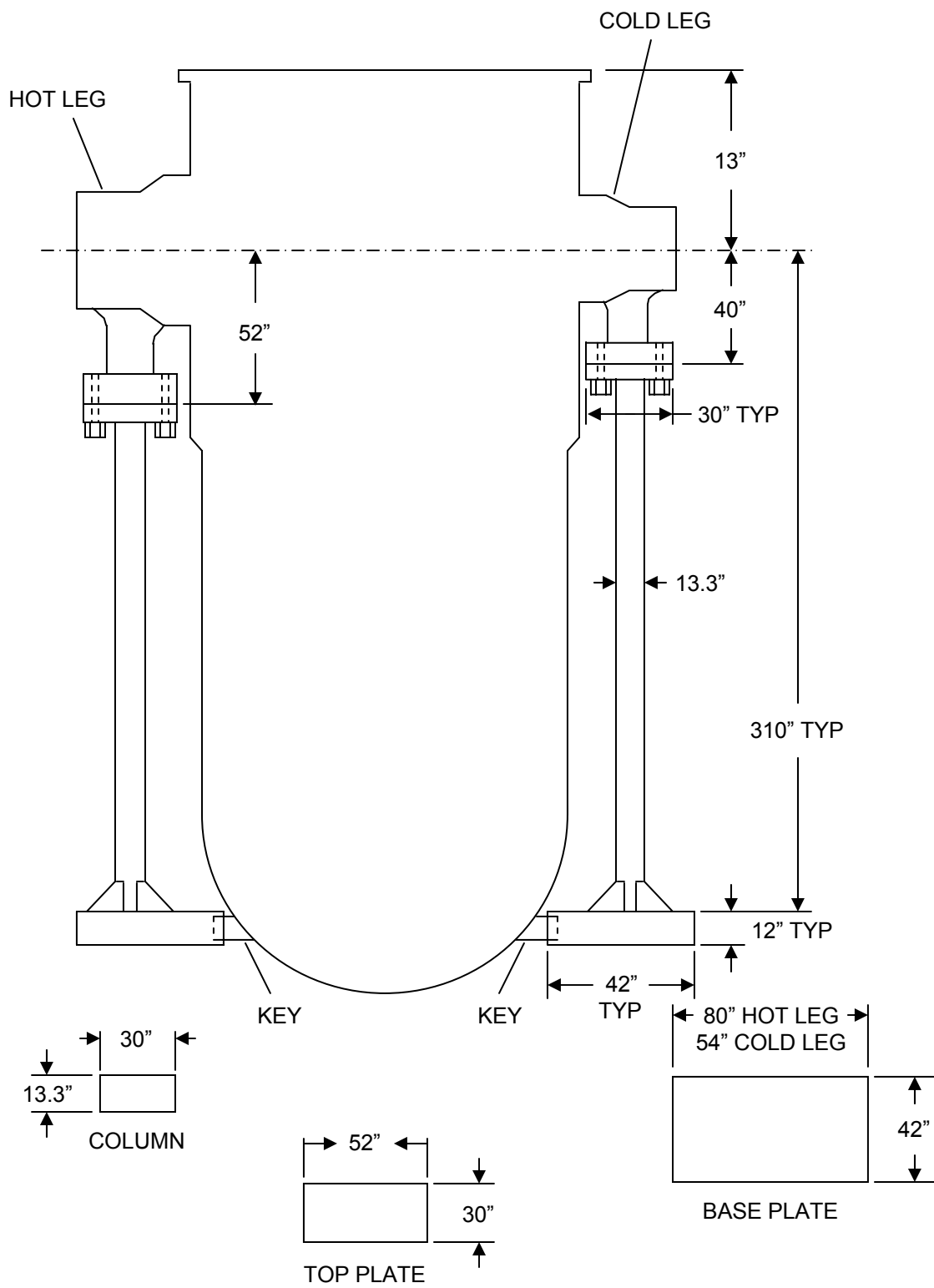

SAR FIGURE NO. 5.5-12

AMENDMENT 20

ARKANSAS NUCLEAR ONE
 UNIT 2
 RUSSELLVILLE, ARKANSAS



SCALE:	NONE
DRAWN:	ENERGY
DESIGN:	ENERGY
CAD NO:	N/A

REACTOR VESSEL SUPPORTS

BASED ON DRAWING NO

SHEET

REV.

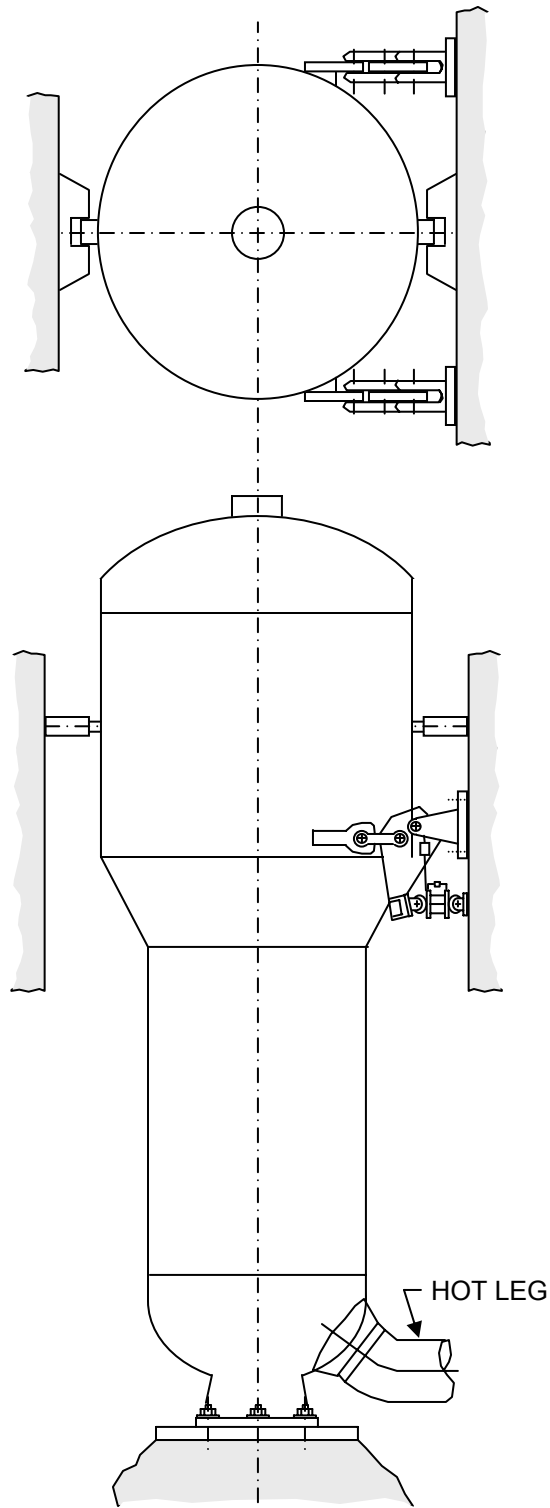

SAR FIGURE NO. 5.5-13

AMENDMENT 20

ARKANSAS NUCLEAR ONE
UNIT 2
RUSSELLVILLE, ARKANSAS



SCALE:	NONE
DRAWN:	ENERGY
DESIGN:	ENERGY
CAD NO:	N/A

STEAM GENERATOR SUPPORTS
INSTALLATION

BASED ON DRAWING NO

SHEET

REV.

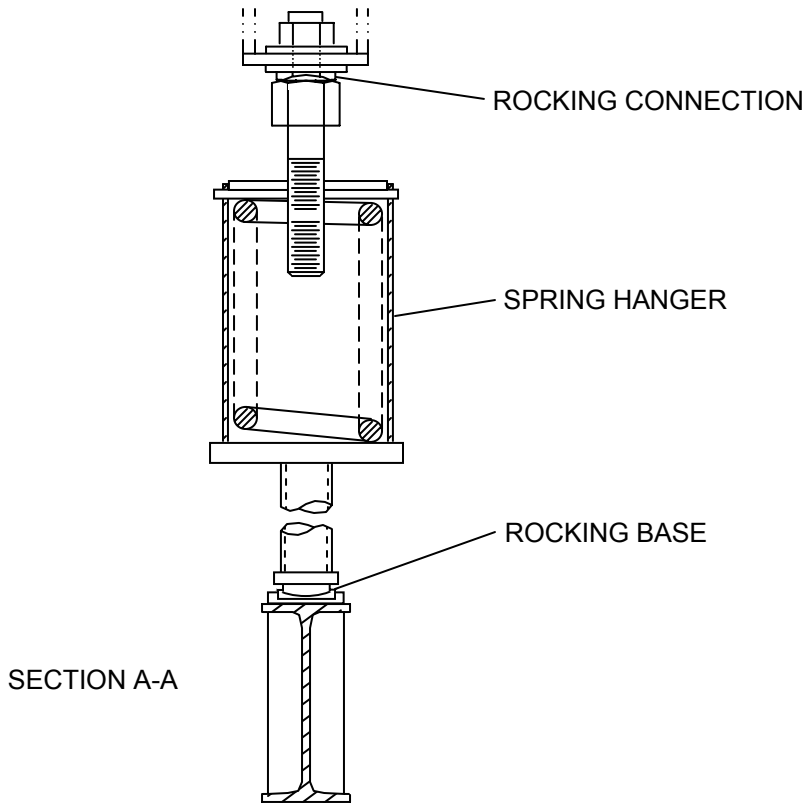
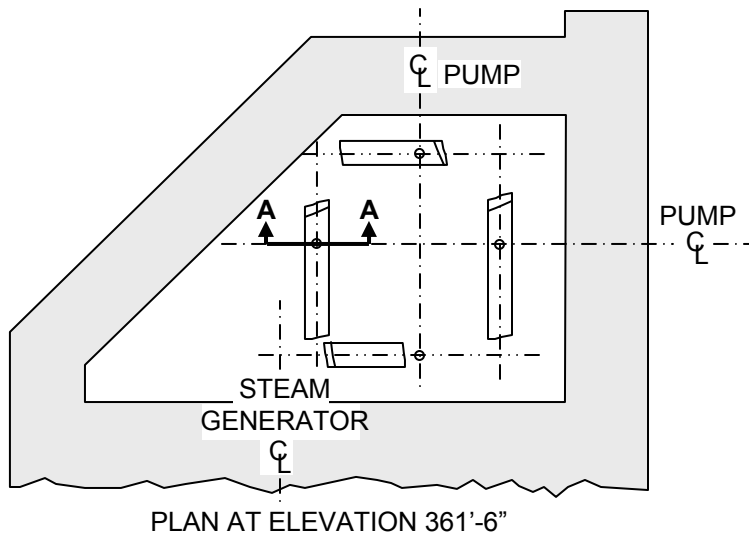

SAR FIGURE NO. 5.5-14

AMENDMENT 20

ARKANSAS NUCLEAR ONE
 UNIT 2
 RUSSELLVILLE, ARKANSAS



SCALE:	NONE
DRAWN:	ENERGY
DESIGN:	ENERGY
CAD NO:	N/A

REACTOR COOLANT PUMP SUPPORTS –
 LOWER

BASED ON DRAWING NO

SHEET

REV.

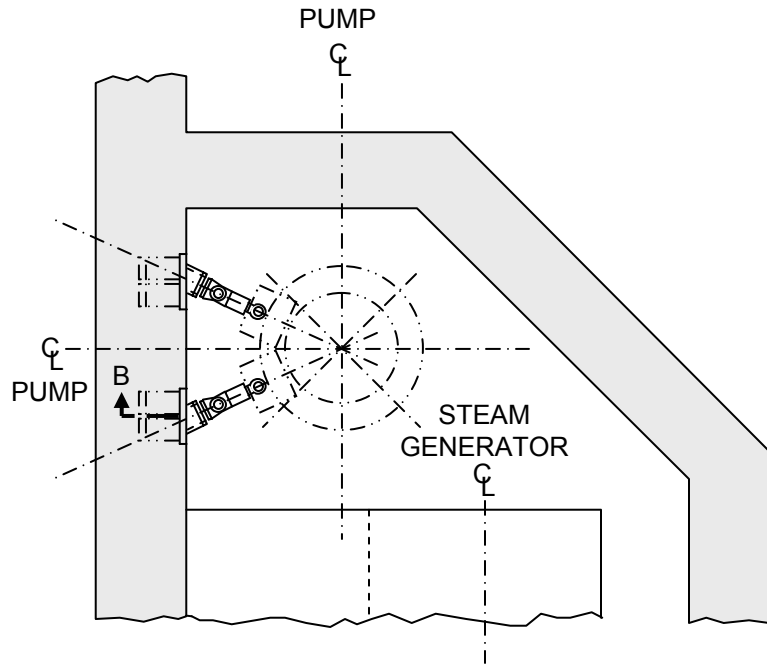

PLAN AT ELEVATION 390'-9"

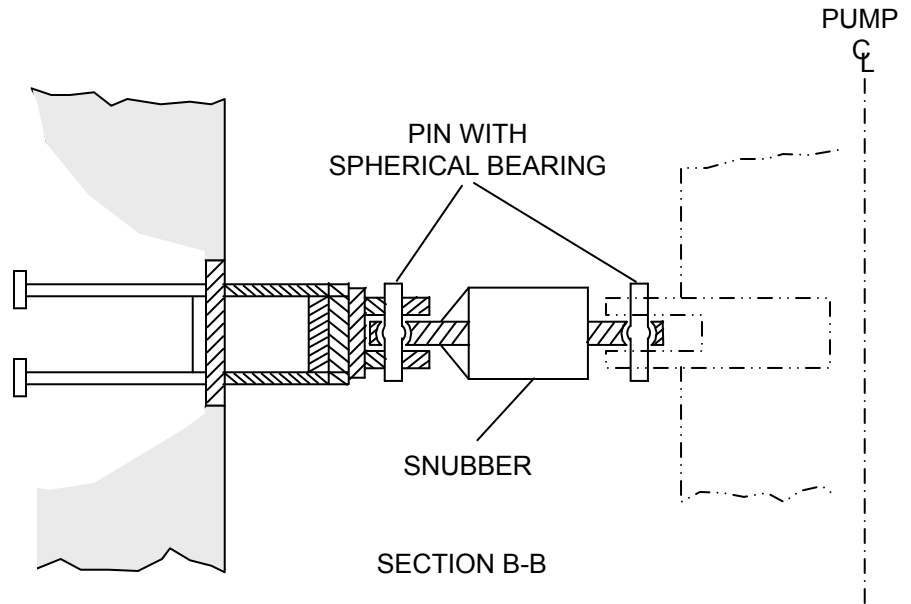

SAR FIGURE NO. 5.5-15

AMENDMENT 20

ARKANSAS NUCLEAR ONE
UNIT 2
RUSSELLVILLE, ARKANSAS



SCALE:	NONE
DRAWN:	ENERGY
DESIGN:	ENERGY
CAD NO:	N/A

REACTOR COOLANT PUMP SUPPORTS –
UPPER

BASED ON DRAWING NO

SHEET

REV.

ARKANSAS NUCLEAR ONE
Unit 2

CHAPTER 6

TABLE OF CONTENTS

<u>Section</u>	<u>Title</u>	<u>Page</u>
6	<u>ENGINEERED SAFETY FEATURES</u>	6.1-1
6.1	<u>GENERAL</u>	6.1-1
6.1.1	CONTAINMENT SYSTEM	6.1-1
6.1.2	SAFETY INJECTION SYSTEM.....	6.1-2
6.1.3	HABITABILITY SYSTEM.....	6.1-2
6.1.4	PENETRATION ROOMS VENTILATION SYSTEM	6.1-2
6.1.5	MAIN STEAM LINE ISOLATION SYSTEM	6.1-2
6.2	<u>CONTAINMENT SYSTEMS</u>	6.2-1
6.2.1	CONTAINMENT FUNCTIONAL DESIGN	6.2-1
6.2.1.1	<u>Containment Structures</u>	6.2-1
6.2.1.2	<u>Containment Building Subcompartment Structures</u>	6.2-17
6.2.1.3	<u>Tests and Inspections</u>	6.2-32
6.2.1.4	<u>Instrumentation Application</u>	6.2-34
6.2.1.5	<u>Assurance of Operational Readiness</u>	6.2-35
6.2.2	CONTAINMENT HEAT REMOVAL SYSTEMS.....	6.2-35
6.2.2.1	<u>Design Bases</u>	6.2-35
6.2.2.2	<u>System Design</u>	6.2-36
6.2.2.3	<u>Design Evaluation</u>	6.2-46
6.2.2.4	<u>Testing and Inspections</u>	6.2-47
6.2.2.5	<u>Instrumentation Requirements</u>	6.2-48
6.2.3	CONTAINMENT AIR PURIFICATION AND CLEANUP SYSTEMS	6.2-49
6.2.3.1	<u>Design Bases</u>	6.2-49
6.2.3.2	<u>System Design</u>	6.2-50

ARKANSAS NUCLEAR ONE
Unit 2

TABLE OF CONTENTS (continued)

<u>Section</u>	<u>Title</u>	<u>Page</u>
6.2.3.3	<u>Design Evaluation</u>	6.2-52
6.2.3.4	<u>Tests and Inspections</u>	6.2-54
6.2.3.5	<u>Instrumentation Requirement</u>	6.2-54
6.2.4	CONTAINMENT ISOLATION SYSTEMS.....	6.2-54
6.2.4.1	<u>Design Bases</u>	6.2-54
6.2.4.2	<u>System Design</u>	6.2-55
6.2.4.3	<u>Design Evaluation</u>	6.2-55
6.2.4.4	<u>Tests and Inspection</u>	6.2-56
6.2.5	COMBUSTIBLE GAS CONTROL IN CONTAINMENT.....	6.2-57
6.2.5.1	<u>Design Bases</u>	6.2-57
6.2.5.2	<u>System Design</u>	6.2-57
6.2.5.3	<u>Design Evaluation</u>	6.2-58
6.2.5.4	<u>Tests and Inspection</u>	6.2-60
6.2.5.5	<u>Instrumentation Requirements</u>	6.2-61
6.3	<u>EMERGENCY CORE COOLING SYSTEM</u>	6.3-1
6.3.1	DESIGN BASES.....	6.3-1
6.3.1.1	<u>Range of Coolant Ruptures</u>	6.3-1
6.3.1.2	<u>Fission Product Decay Heat</u>	6.3-1
6.3.1.3	<u>Reactivity Required for Cold Shutdown</u>	6.3-1
6.3.1.4	<u>Capacity to Meet Functional Requirements</u>	6.3-2
6.3.1.5	<u>Safety Injection Component Arrangement</u>	6.3-3
6.3.2	SYSTEM DESIGN.....	6.3-4
6.3.2.1	<u>System Schematic</u>	6.3-4
6.3.2.2	<u>Component Description</u>	6.3-4

ARKANSAS NUCLEAR ONE
Unit 2

TABLE OF CONTENTS (continued)

<u>Section</u>	<u>Title</u>	<u>Page</u>
6.3.2.3	<u>Applicable Codes and Classifications</u>	6.3-7
6.3.2.4	<u>Material Specifications and Compatability</u>	6.3-8
6.3.2.5	<u>Design Pressure and Temperatures</u>	6.3-8
6.3.2.6	<u>Coolant Quantity</u>	6.3-8
6.3.2.7	<u>Pump Characteristics</u>	6.3-8
6.3.2.8	<u>Heat Exchanger Characteristics</u>	6.3-8
6.3.2.9	<u>ECCS Flow Diagram</u>	6.3-8
6.3.2.10	<u>Relief Valves and Vents</u>	6.3-8
6.3.2.11	<u>System Reliability</u>	6.3-10
6.3.2.12	<u>Protection Provisions</u>	6.3-11
6.3.2.13	<u>Provisions for Performance Testing</u>	6.3-12
6.3.2.14	<u>Net Positive Suction Head</u>	6.3-12
6.3.2.15	<u>Control for Motor Operated Safety Injection Tank Isolation Valves</u>	6.3-13
6.3.2.16	<u>Motor Operated Valves and Controls (General)</u>	6.3-14
6.3.2.17	<u>Required Manual Actions</u>	6.3-15
6.3.2.18	<u>Process Instrumentation</u>	6.3-15
6.3.2.19	<u>Materials</u>	6.3-15
6.3.2.20	<u>System Operation</u>	6.3-15
6.3.2.21	<u>Interconnections With Other Systems</u>	6.3-18
6.3.2.22	<u>System Leakage</u>	6.3-19
6.3.3	PERFORMANCE EVALUATION.....	6.3-19
6.3.3.1	<u>Evaluation Model</u>	6.3-20
6.3.3.2	<u>ECCS Performance</u>	6.3-20
6.3.3.3	<u>Intentionally Left Blank</u>	6.3-25

ARKANSAS NUCLEAR ONE
Unit 2

TABLE OF CONTENTS (continued)

<u>Section</u>	<u>Title</u>	<u>Page</u>
6.3.3.4	<u>Fuel Rod Perforations</u>	6.3-25
6.3.3.5	<u>Evaluation Model</u>	6.3-25
6.3.3.6	<u>Fuel Clad Effects</u>	6.3-25
6.3.3.7	<u>ECCS Performance</u>	6.3-25
6.3.3.8	<u>Peaking Factors</u>	6.3-25
6.3.3.9	<u>Conformance With Acceptance Criteria</u>	6.3-26
6.3.3.10	<u>Effects of ECCS Operation on the Core</u>	6.3-26
6.3.3.11	<u>Use of Dual Function Components</u>	6.3-26
6.3.3.12	<u>Lag Times</u>	6.3-26
6.3.3.13	<u>Thermal Shock Considerations</u>	6.3-27
6.3.3.14	<u>Limits on System Parameters</u>	6.3-28
6.3.3.15	<u>Long-Term ECCS Performance</u>	6.3-28
6.3.4	TESTS AND INSPECTIONS	6.3-30
6.3.4.1	<u>System Testing</u>	6.3-30
6.3.4.2	<u>Component Testing</u>	6.3-31
6.3.5	INSTRUMENTATION REQUIREMENTS	6.3-31
6.3.5.1	<u>Actuation Signal Generation</u>	6.3-31
6.3.5.2	<u>System Instrumentation</u>	6.3-31
6.4	<u>HABITABILITY SYSTEMS</u>	6.4-1
6.4.1	HABITABILITY SYSTEMS FUNCTIONAL DESIGN	6.4-1
6.4.1.1	<u>Design Bases</u>	6.4-1
6.4.1.2	<u>System Description</u>	6.4-1
6.4.1.3	<u>Design Evaluation</u>	6.4-1
6.4.1.4	<u>Testing and Inspection</u>	6.4-2

ARKANSAS NUCLEAR ONE
Unit 2

TABLE OF CONTENTS (continued)

<u>Section</u>	<u>Title</u>	<u>Page</u>
6.4.1.5	<u>Instrumentation Requirement</u>	6.4-2
6.5	<u>PENETRATION ROOMS VENTILATION SYSTEM</u>	6.5-1
6.5.1	DESIGN BASES.....	6.5-1
6.5.2	SYSTEM DESIGN.....	6.5-1
6.5.3	DESIGN EVALUATION.....	6.5-5
6.5.4	TESTS AND INSPECTIONS.....	6.5-6
6.5.5	INSTRUMENTATION REQUIREMENTS.....	6.5-6
6.6	<u>REFERENCES</u>	6.6-1
6.7	<u>TABLES</u>	6.7-1

ARKANSAS NUCLEAR ONE
Unit 2

LIST OF TABLES

<u>Table No.</u>	<u>Title</u>	<u>Page</u>
6.2-1A	DELETED	6.7-1
6.2-1B	DELETED	6.7-1
6.2-1C	DELETED	6.7-1
6.2-1D	DELETED	6.7-1
6.2-2	DELETED	6.7-1
6.2-3	DELETED	6.7-1
6.2-4	DELETED	6.7-1
6.2-5	DELETED	6.7-2
6.2-6	DELETED	6.7-2
6.2-7	PRINCIPAL CONTAINMENT DESIGN PARAMETERS.....	6.7-2
6.2-8	INITIAL CONDITIONS FOR PRESSURE ANALYSIS.....	6.7-3
6.2-8A	ESF PERFORMANCE PARAMETERS AND NSSS ASSUMPTIONS FOR MASS AND ENERGY ANALYSIS (LOCA).....	6.7-4
6.2-8B	MASS AND ENERGY RELEASE DATA LIMITING CASE (LOCA).....	6.7-5
6.2-8C	DOUBLE-ENDED DISCHARGE LEG BREAK MASS AND ENERGY BALANCE	6.7-9
6.2-8D	CONTAINMENT HEAT SINK GEOMETRIC DATA FOR MAXIMUM CONTAINMENT PRESSURE ANALYSIS	6.7-10
6.2-8E	HEAT SINK THERMODYNAMIC DATA AND MATERIAL PROPERTIES	6.7-13
6.2-8F	ESF PERFORMANCE PARAMETERS AND CONTAINMENT INITIAL CONDITIONS FOR CONTAINMENT PRESSURE RESPONSE ANALYSIS (LOCA).....	6.7-14
6.2-8G	MAXIMUM CONTAINMENT PRESSURE AND TEMPERATURE RESULTS (LOCA).....	6.7-15
6.2-8H	SEQUENCE OF EVENTS DESIGN BASIS ACCIDENT	6.7-15
6.2-8I	CONTAINMENT AIR COOLER PERFORMANCE DATA, PER TRAIN	6.7-16

ARKANSAS NUCLEAR ONE
Unit 2

LIST OF TABLES (continued)

<u>Table No.</u>	<u>Title</u>	<u>Page</u>
6.2-8J	LOCA MAXIMUM CONTAINMENT PRESSURE AND TEMPERATURE RESULTS SUPPORTING TECHNICAL SPECIFICATION LIMITING CONDITIONS FOR OPERATION	6.7-16
6.2-9	DELETED	6.7-16
6.2-9A	ESF PERFORMANCE PARAMETERS AND NSSS ASSUMPTIONS MSLB CONTAINMENT ANALYSIS.....	6.7-17
6.2-9B	MASS AND ENERGY RELEASE DATA LIMITING CASE (MSLB).....	6.7-18
6.2-9C	MAXIMUM CONTAINMENT PRESSURE AND TEMPERATURE RESULTS (MSLB).....	6.7-26
6.2-9D	SEQUENCE OF EVENTS LIMITING CONTAINMENT PEAK PRESSURE ANALYSIS (MSLB)	6.7-27
6.2-10	DELETED	6.7-27
6.2-11	DELETED	6.7-27
6.2-11A	DELETED	6.7-27
6.2-12	DELETED	6.7-27
6.2-12A	DELETED	6.7-28
6.2-13	DELETED	6.7-28
6.2-13A	DELETED	6.7-28
6.2-13B	DELETED	6.7-28
6.2-14	DELETED	6.7-28
6.2-15	DELETED	6.7-28
6.2-16	DELETED	6.7-28
6.2-17	SUBCOMPARTMENT DESIGN DIFFERENTIAL PRESSURES	6.7-29
6.2-17A	SUBCOMPARTMENT DIFFERENTIAL PRESSURE RESULTS	6.7-30
6.2-17A.IV	SUBCOMPARTMENT DIFFERENTIAL PRESSURE RESULTS	6.7-37
6.2-17B	SUBCOMPARTMENT ANALYSIS FLOW AREAS AND COEFFICIENTS....	6.7-38
6.2-17C	BIOLOGICAL SHIELD PIPE PENETRATION MODEL NODAL VOLUMES .	6.7-44

ARKANSAS NUCLEAR ONE
Unit 2

LIST OF TABLES (continued)

<u>Table No.</u>	<u>Title</u>	<u>Page</u>
6.2-17D	MASS AND ENERGY RELEASE DATA FOR SUBCOMPARTMENT ANALYSES	6.7-45
6.2-18	CSS PUMP DATA	6.7-56
6.2-18A	DELETED	6.7-56
6.2-19	DELETED	6.7-56
6.2-20	REFUELING WATER TANK DATA.....	6.7-57
6.2-21	HISTORICAL SHUTDOWN COOLING HEAT EXCHANGER DATA	6.7-58
6.2-22	CCS AIR COOLER DATA	6.7-59
6.2-23	CONTAINMENT SPRAY SYSTEM SINGLE FAILURE ANALYSIS	6.7-60
6.2-24	CONTAINMENT COOLING SYSTEM SINGLE FAILURE ANALYSIS.....	6.7-61
6.2-24A	SUMMARY OF CONTAINMENT REGIONS NOT DIRECTLY SPRAYED....	6.7-62
6.2-25	EXPOSED COATINGS WITHIN CONTAINMENT	6.7-63
6.2-26	CONTAINMENT PENETRATION BARRIERS	6.7-64
6.2-27	HYDROGEN RECOMBINER CHARACTERISTICS	6.7-74
6.2-28	QUANTITIES OF ZINC, COPPER AND ALUMINUM IN CONTAINMENT	6.7-74
6.2-29	METAL CORROSION RATES ASSUMED FOR POST-ACCIDENT HYDROGEN GENERATION.....	6.7-75
6.2-30	DELETED	6.7-75
6.2-31	DELETED	6.7-75
6.2-32	DELETED	6.7-75
6.2-33	DELETED-SEE TABLE 6.2-26.....	6.7-75
6.2-34	MASS AND ENERGY RELEASE DATA FOR THE MINIMUM CONTAINMENT PRESSURE ANALYSIS FOR ECCS PERFORMANCE	6.7-76
6.2-35	CONTAINMENT PASSIVE HEAT SINK DATA FOR THE MINIMUM CONTAINMENT PRESSURE ANALYSIS FOR ECCS PERFORMANCE	6.7-80

ARKANSAS NUCLEAR ONE
Unit 2

LIST OF TABLES (continued)

<u>Table No.</u>	<u>Title</u>	<u>Page</u>
6.2-36	CONTAINMENT PASSIVE HEAT SINK MATERIAL PROPERTY DATA FOR THE MINIMUM CONTAINMENT PRESSURE ANALYSIS	6.7-81
6.2-37	DELETED	6.7-81
6.2-38	DELETED	6.7-81
6.2-39	DELETED	6.7-81
6.2-40	DELETED	6.7-81
6.2-41	DELETED	6.7-81
6.2-42	DELETED	6.7-81
6.2-43	DELETED	6.7-81
6.2-44	CONTAINMENT AIR COOLER HEAT REMOVAL CAPACITY PER TRAIN	6.7-81
6.3-1	SAFETY INJECTION SYSTEM COMPONENT PARAMETERS.....	6.7-82
6.3-2	DELETED	6.7-83
6.3-3	FAILURE MODE ANALYSIS	6.7-84
6.3-4	PROCESS INSTRUMENTS AVAILABLE DURING POST-LOCA CONDITIONS.....	6.7-92
6.3-5	DELETED	6.7-95
6.3-6	DELETED	6.7-95
6.3-7	DELETED	6.7-95
6.3-8	LAG TIMES FOR SAFETY INJECTION SYSTEM COMPONENTS	6.7-95
6.3-9	SYSTEM PARAMETERS AND INITIAL CONDITIONS FOR THE LARGE BREAK LOCA ECCS PERFORMANCE EVALUATION.....	6.7-96
6.3-10	DELETED	6.7-97
6.3-11	BREAK SPECTRUM FOR THE LARGE BREAK LOCA ECCS PERFORMANCE EVALUATION.....	6.7-97
6.3-12	VARIABLES PLOTTED AS A FUNCTION OF TIME FOR EACH BREAK OF THE LARGE BREAK LOCA ECCS PERFORMANCE EVALUATION	6.7-97

ARKANSAS NUCLEAR ONE
Unit 2

LIST OF TABLES (continued)

<u>Table No.</u>	<u>Title</u>	<u>Page</u>
6.3-13	VARIABLES PLOTTED AS A FUNCTION OF TIME FOR THE LIMITING BREAK OF THE LARGE BREAK LOCA ECCS PERFORMANCE EVALUATION.....	6.7-98
6.3-14	TIMES OF INTEREST FOR THE LARGE BREAK LOCA ECCS PERFORMANCE EVALUATION.....	6.7-99
6.3-15	PEAK CLADDING TEMPERATURES AND OXIDATION PERCENTAGES FOR THE LARGE BREAK LOCA ECCS PERFORMANCE EVALUATION.....	6.7-99
6.3-16	HIGH PRESSURE SAFETY INJECTION PUMP MINIMUM DELIVERED FLOW TO RCS (ASSUMING ONE EMERGENCY DIESEL GENERATOR FAILED)	6.7-100
6.3-17	SYSTEM PARAMETERS AND INITIAL CONDITIONS FOR THE SMALL BREAK LOCA ECCS PERFORMANCE EVALUATION	6.7-101
6.3-18	BREAK SPECTRUM FOR THE SMALL BREAK LOCA ECCS PERFORMANCE EVALUATION.....	6.7-102
6.3-19	PEAK CLADDING TEMPERATURES AND OXIDATION PERCENTAGES FOR THE SMALL BREAK LOCA ECCS PERFORMANCE EVALUATION.....	6.7-102
6.3-20	TIMES OF INTEREST FOR THE SMALL BREAK LOCA ECCS PERFORMANCE EVALUATION.....	6.7-103
6.3-21	LARGE AND SMALL BREAK LOCA COMPARISON OF RESULTS.....	6.7-103
6.3-22	VALVE POSITION.....	6.7-104
6.3-23	VARIABLES PLOTTED AS A FUNCTION OF TIME FOR EACH BREAK OF THE SMALL BREAK LOCA ECCS PERFORMANCE EVALUATION.....	6.7-106
6.3-24	DELETED	6.7-106
6.3-25	DELETED	6.7-106
6.3-26	DELETED	6.7-106
6.3-27	DELETED	6.7-106
6.3-28	SYSTEM PARAMETERS AND INITIAL CONDITIONS FOR THE POST-LOCA BORIC ACID PRECIPITATION ANALYSIS.....	6.7-107

ARKANSAS NUCLEAR ONE
Unit 2

LIST OF FIGURES

<u>Figure No.</u>	<u>Title</u>
6.2-1 – 6.2-2	DELETED
6.2-3A	CONTAINMENT AIR COOLER HEAT CAPACITY PER TRAIN AT DIFFERENT SERVICE WATER TEMPERATURES
6.2-3B	EMERGENCY COOLING POND TEMPERATURE VERSUS TIME (ASSUMED SOURCE FOR CONTAINMENT PEAK PRESSURE ANALYSIS)
6.2-3C	RPV CAVITY MODEL FOR CIRCUMFERENTIAL BREAKS
6.2-3D	STEAM GENERATOR CAVITY MODEL FOR HOT LEG CIRCUMFERENTIAL BREAKS
6.2-3E	STEAM GENERATOR CAVITY MODEL FOR HOT LEG SLOT BREAKS
6.2-3F	STEAM GENERATOR CAVITY MODEL FOR COLD LEG PUMP SUCTION CIRCUMFERENTIAL BREAKS
6.2-3G	DELETED
6.2-3H	STEAM GENERATOR CAVITY MODEL FOR COLD LEG PUMP SUCTION SLOT BREAKS (WEST ORIENTATION)
6.2-3I	STEAM GENERATOR CAVITY MODEL FOR COLD LEG PUMP DISCHARGE CIRCUMFERENTIAL BREAKS
6.2-3J	REACTOR CAVITY MODEL FOR COLD LEG SLOT BREAK SENSITIVITY STUDY
6.2-3K	REACTOR COOLANT PUMP RESTRAINT BEAMS
6.2-3L	STEAM GENERATOR CAVITY MODEL FOR COMPARE CODE ANALYSIS
6.2-3M	STEAM GENERATOR CAVITY MODEL FOR COMPARE CODE ANALYSIS
6.2-3N	STEAM GENERATOR CAVITY MODEL FOR COMPARE CODE ANALYSIS
6.2-4	DELETED
6.2-5 – 8D	DELETED
6.2-8E	CONTAINMENT PRESSURE VS. TIME LIMITING LOCA – DEDLS BREAK WITH LOSS OF ONE EDG
6.2-8F	CONTAINMENT TEMPERATURE VS. TIME LIMITING LOCA – DEDLS BREAK WITH LOSS ON ONE EDG
6.2-8G	CONTAINMENT LINER/CONCRETE TEMPERATURE PROFILES LIMITING LOCA – DEDLS BREAK WITH LOSS OF ONE EDG

ARKANSAS NUCLEAR ONE
Unit 2

LIST OF FIGURES (continued)

<u>Figure No.</u>	<u>Title</u>
6.2-8H	CONTAINMENT PRESSURE AND TEMPERATURE VS. TIME LIMITING MSLB – 0%, ONE SPRAY TRAIN FAILURE
6.2-9	BLOWDOWN MASS AND ENERGY FLOW RATES (DEDLS BREAK WITH FAILURE OF ONE EDG)
6.2-10	LIMITING LOCA MASS AND ENERGY RELEASE (REFLOOD AND POST REFLOOD) (DEDLS BREAK WITH FAILURE OF ONE EDG)
6.2-11	NORMALIZED REACTOR POWER VS TIME LIMITING LOCA – DEDLS BREAK WITH LOSS OF ONE EDG
6.2-12 – 13A	DELETED
6.2-14	CONTAINMENT ENERGY DISTRIBUTION – DEDLS BREAK WITH LOSS ON ONE EDG
6.2-15 - 16	DELETED
6.2-16A	PRESSURE RESPONSE FOR A 200 IN ² COLD LEG CIRCUMFERENTIAL BREAK IN THE RPV CAVITY WITHOUT VENTING
6.2-16B	PRESSURE RESPONSE FOR A 200 IN ² COLD LEG CIRCUMFERENTIAL BREAK IN THE RPV CAVITY WITH VENTING
6.2-16C	PRESSURE RESPONSE FOR A 200 IN ² COLD LEG CIRCUMFERENTIAL BREAK IN THE RPV CAVITY WITH VENTING
6.2-16D	PRESSURE RESPONSE FOR A 100 IN ² HOT LEG CIRCUMFERENTIAL BREAK IN THE RPV CAVITY WITHOUT VENTING
6.2-16E	PRESSURE RESPONSE FOR A 100 IN ² HOT LEG CIRCUMFERENTIAL BREAK IN THE RPV CAVITY WITH VENTING
6.2-16F	PRESSURE RESPONSE FOR A 100 IN ² HOT LEG CIRCUMFERENTIAL BREAK IN THE RPV CAVITY WITH VENTING
6.2-16G	PRESSURE RESPONSE FOR A 5.90 FT ² HOT LEG CIRCUMFERENTIAL BREAK IN THE SOUTH S.G. CAVITY
6.2-16H	PRESSURE RESPONSE FOR A 5.77 FT ² HOT LEG SLOT BREAK IN THE SOUTH S.G. CAVITY
6.2-16I	PRESSURE RESPONSE FOR A 9.82 FT ² COLD LEG PUMP SUCTION CIRCUMFERENTIAL BREAK IN THE SOUTH S.G. CAVITY
6.2-16J	PRESSURE RESPONSE FOR A 3.93 FT ² COLD LEG PUMP SUCTION SLOT BREAK (EAST ORIENTATION) IN THE SOUTH S.G. CAVITY

ARKANSAS NUCLEAR ONE
Unit 2

LIST OF FIGURES (continued)

<u>Figure No.</u>	<u>Title</u>
6.2-16K	PRESSURE RESPONSE FOR A 3.93 FT ² COLD LEG PUMP SUCTION SLOT BREAK (WEST ORIENTATION) IN THE SOUTH S.G. CAVITY
6.2-16L	PRESSURE RESPONSE FOR A 9.82 FT ² COLD LEG PUMP DISCHARGE CIRCUMFERENTIAL BREAK IN THE SOUTH S.G. CAVITY
6.2-16M	PRESSURE RESPONSE TO A HOT LEG SLOT BREAK IN THE BIOLOGICAL SHIELD PENETRATION
6.2-16N	PRESSURE RESPONSE TO A COLD LEG SLOT BREAK IN THE BIOLOGICAL SHIELD PENETRATION
6.2-16O	COLD LEG SLOT BREAK SENSITIVITY STUDY
6.2-16P	PRESSURE RESPONSE FOR A 9.82 FT ² COLD LEG PUMP DISCHARGE CIRCUMFERENTIAL BREAK IN THE SOUTH S.G. CAVITY USING COMPARE COMPUTER CODE
6.2-17	CONTAINMENT SPRAY SYSTEM
6.2-18	PLAN VIEW OF SPRAY HEADERS
6.2-19	SECTION VIEW OF SPRAY HEADERS
6.2-20	CONTAINMENT SPRAY PUMP CHARACTERISTICS
6.2-21	CONTAINMENT SPRAY NOZZLE CHARACTERISTICS
6.2-22	SPATIAL DROPLET SIZE DISTRIBUTION
6.2-23A	CONTAINMENT SUMP PLENUM
6.2-23B	CONTAINMENT SUMP STRAINERS
6.2-24	CONTAINMENT TEST CONNECTION
6.2-25	ANO-2 POST LOCA HYDROGEN
6.2-25A	ANO-2 POST LOCA HYDROGEN SOURCES
6.2-25B	ANO-2 POST LOCA H ₂ DUE TO CORROSION FROM SPRAY
6.2-26 – 29B	DELETED
6.2-30	CONTAINMENT SPRAY AND ECCS SPILLAGE FLOW RATES USED IN THE MINIMUM CONTAINMENT PRESSURE ANALYSIS FOR ECCS PERFORMANCE

ARKANSAS NUCLEAR ONE
Unit 2

LIST OF FIGURES (continued)

<u>Figure No.</u>	<u>Title</u>
6.2-31	CONDENSING HEAT TRANSFER COEFFICIENT FOR PASSIVE HEAT SINKS USED IN THE MINIMUM CONTAINMENT PRESSURE ANALYSIS FOR ECCS PERFORMANCE
6.2.32	DELETED
6.2-33	CONTAINMENT ATMOSPHERIC TEMPERATURE 0.4 DOUBLE-ENDED GUILLOTINE BREAK IN PUMP DISCHARGE LEG
6.2.34	CONTAINMENT SUMP TEMPERATURE 0.4 DOUBLE-ENDED GUILLOTINE BREAK IN PUMP DISCHARGE LEG
6.3-1A	STANDARD FISSION PRODUCT DECAY HEAT CURVE
6.3-1B	STANDARD FISSION PRODUCT DECAY HEAT CURVE
6.3-2	SAFETY INJECTION SYSTEM
6.3-3	LPSI PUMP CHARACTERISTICS
6.3-4	HPSI PUMP CHARACTERISTICS
6.3-5A-11	DELETED
6.3-12	LOCA SEQUENCE OF EVENTS DIAGRAM
6.3-13	DELETED
6.3-13a	1.0 DEG/PD BREAK CORE POWER
6.3-13b	1.0 DEG/PD BREAK PRESSURE IN CENTER HOT ASSEMBLY NODE
6.3-13c	1.0 DEG/PD BREAK LEAK FLOW RATE
6.3-13d	1.0 DEG/PD BREAK HOT ASSEMBLY FLOW RATE (BELOW HOT SPOT)
6.3-13e	1.0 DEG/PD BREAK HOT ASSEMBLY QUALITY
6.3-13f	1.0 DEG/PD BREAK CONTAINMENT PRESSURE
6.3-13g	1.0 DEG/PD BREAK MASS ADDED TO CORE DURING REFLOOD
6.3-13h	1.0 DEG/PD BREAK PEAK CLADDING TEMPERATURE
6.3-14a	0.8 DEG/PD BREAK CORE POWER
6.3-14b	0.8 DEG/PD BREAK PRESSURE IN CENTER HOT ASSEMBLY NODE

ARKANSAS NUCLEAR ONE
Unit 2

LIST OF FIGURES (continued)

<u>Figure No.</u>	<u>Title</u>
6.3-14c	0.8 DEG/PD BREAK LEAK FLOW RATE
6.3-14d	0.8 DEG/PD BREAK HOT ASSEMBLY FLOW RATE (BELOW HOT SPOT)
6.3-14e	0.8 DEG/PD BREAK HOT ASSEMBLY QUALITY
6.3-14f	0.8 DEG/PD BREAK CONTAINMENT PRESSURE
6.3-14g	0.8 DEG/PD BREAK MASS ADDED TO CORE DURING REFLOOD
6.3-14h	0.8 DEG/PD BREAK PEAK CLADDING TEMPERATURE
6.3-15a	0.6 DEG/PD BREAK CORE POWER
6.3-15b	0.6 DEG/PD BREAK PRESSURE IN CENTER HOT ASSEMBLY NODE
6.3-15c	0.6 DEG/PD BREAK LEAK FLOW RATE
6.3-15d	0.6 DEG/PD BREAK HOT ASSEMBLY FLOW RATE (BELOW HOT SPOT)
6.3-15e	0.6 DEG/PD BREAK HOT ASSEMBLY QUALITY
6.3-15f	0.6 DEG/PD BREAK CONTAINMENT PRESSURE
6.3-15g	0.6 DEG/PD BREAK MASS ADDED TO CORE DURING REFLOOD
6.3-15h	0.6 DEG/PD BREAK PEAK CLADDING TEMPERATURE
6.3-16a	0.4 DEG/PD BREAK LEG CORE POWER
6.3-16b	0.4 DEG/PD BREAK PRESSURE IN CENTER HOT ASSEMBLY NODE
6.3-16c	0.4 DEG/PD BREAK LEAK FLOW RATE
6.3-16d	0.4 DEG/PD BREAK HOT ASSEMBLY FLOW RATE (BELOW HOT SPOT)
6.3-16e	0.4 DEG/PD BREAK HOT ASSEMBLY QUALITY
6.3-16f	0.4 DEG/PD BREAK CONTAINMENT PRESSURE
6.3-16g	0.4 DEG/PD BREAK MASS ADDED TO CORE DURING REFLOOD
6.3-16h	0.4 DEG/PD BREAK PEAK CLADDING TEMPERATURE
6.3-16i	0.4 DEG/PD BREAK MID ANNULUS FLOW RATE
6.3-16j	0.4 DEG/PD BREAK QUALITY ABOVE AND BELOW THE CURVE

ARKANSAS NUCLEAR ONE
Unit 2

LIST OF FIGURES (continued)

<u>Figure No.</u>	<u>Title</u>
6.3-16k	0.4 DEG/PD BREAK CORE PRESSURE DROP
6.3-16l	0.4 DEG/PD BREAK SAFETY INJECTION FLOW RATE INTO INTACT DISCHARGE LEGS
6.3-16m	0.4 DEG/PD BREAK WATER LEVEL IN DOWNCOMER DURING REFLOOD
6.3-16n	0.4 DEG/PD BREAK HOT SPOT GAP CONDUCTIONS
6.3-16o	0.4 DEG/PD BREAK MAXIMUM LOCAL CLADDING OXIDATION PERCENTAGE
6.3-16p	0.4 DEG/PD BREAK HOT SPOT HEAT TRANSFER COEFFICIENT
6.3-16q	0.4 DEG/PD BREAK FUEL CENTERLINE, FUEL AVERAGE, CLADDING, AND COOLANT TEMPERATURE AT THE HOT SPOT
6.3-16r	0.4 DEG/PD BREAK HOT SPOT PIN PRESSURE
6.3-17a	0.3 DEG/PD BREAK CORE POWER
6.3-17b	0.3 DEG/PD BREAK PRESSURE IN CENTER HOT ASSEMBLY NODE
6.3-17c	0.3 DEG/PD BREAK LEAK FLOW RATE
6.3-17d	0.3 DEG/PD BREAK HOT ASSEMBLY FLOW RATE (BELOW HOT SPOT)
6.3-17e	0.3 DEG/PD BREAK HOT ASSEMBLY FLOW QUALITY
6.3-17f	0.3 DEG/PD BREAK CONTAINMENT PRESSURE
6.3-17g	0.3 DEG/PD BREAK MASS ADDED TO CORE DURING REFLOOD
6.3-17h	0.3 DEG/PD BREAK PEAK CLADDING TEMPERATURE
6.3-18a -19h	DELETED
6.3-20	PEAK CLADDING TEMPERATURE VERSUS BREAK SIZE FOR THE LARGE BREAK LOCA ECCS PERFORMANCE EVALUATION
6.3-21 – 22h	DELETED
6.3-23a	0.05 FT ² /PD BREAK CORE POWER
6.3-23b	0.05 FT ² /PD BREAK INNER VESSEL PRESSURE
6.3.23c	0.05 FT ² /PD BREAK BREAK FLOW RATE

ARKANSAS NUCLEAR ONE
Unit 2

LIST OF FIGURES (continued)

<u>Figure No.</u>	<u>Title</u>
6.3-23d	0.05 FT ² /PD BREAK INNER VESSEL INLET FLOW RATE
6.3-23e	0.05 FT ² /PD BREAK INNER VESSEL TWO-PHASE MIXTURE LEVEL
6.3-23f	0.05 FT ² /PD BREAK HEAT TRANSFER COEFFICIENT AT HOT SPOT
6.3-23g	0.05 FT ² /PD BREAK COOLANT TEMPERATURE AT HOT SPOT
6.3-23h	0.05 FT ² /PD BREAK CLADDING TEMPERATURE AT HOT SPOT
6.3-24a	0.04 FT ² /PD BREAK CORE POWER
6.3-24b	0.04 FT ² /PD BREAK INNER VESSEL PRESSURE
6.3-24c	0.04 FT ² /PD BREAK BREAK FLOW RATE
6.3-24d	0.04 FT ² /PD BREAK INNER VESSEL INLET FLOW RATE
6.3-24e	0.04 FT ² /PD BREAK INNER VESSEL TWO-PHASE MIXTURE LEVEL
6.3-24f	0.04 FT ² /PD BREAK HEAT TRANSFER COEFFICIENT AT HOT SPOT
6.3-24g	0.04 FT ² /PD BREAK COOLANT TEMPERATURE AT HOT SPOT
6.3-24h	0.04 FT ² /PD BREAK CLADDING TEMPERATURE AT HOT SPOT
6.3-25a	0.03 FT ² /PD BREAK CORE POWER
6.3-25b	0.03 FT ² /PD BREAK INNER VESSEL PRESSURE
6.3-25c	0.03 FT ² /PD BREAK BREAK FLOW RATE
6.3-25d	0.03 FT ² /PD BREAK INNER VESSEL INLET FLOW RATE
6.3-25e	0.03 FT ² /PD BREAK INNER VESSEL TWO-PHASE MIXTURE LEVEL
6.3-25f	0.03 FT ² /PD BREAK HEAT TRANSFER COEFFICIENT AT HOT SPOT
6.3-25g	0.03 FT ² /PD BREAK COOLANT TEMPERATURE AT HOT SPOT
6.3-25h	0.03 FT ² /PD BREAK CLADDING TEMPERATURE AT HOT SPOT
6.3-26	PEAK CLADDING TEMPERATURE VERSUS BREAK SIZE FOR THE SMALL BREAK LOCA ECCS PERFORMANCE EVALUATION
6.3-27 – 51h	DELETED

ARKANSAS NUCLEAR ONE
Unit 2

LIST OF FIGURES (continued)

<u>Figure No.</u>	<u>Title</u>
6.3-52	COMPARISON OF CORE BOIL-OFF RATE AND THE MINIMUM SIMULTANEOUS HOT AND COLD SIDE INJECTION FLOW RATE
6.3-53	BORIC ACID CONCENTRATION IN THE CORE VERSUS TIME
6.5-1	AIR FLOW DIAGRAM CONTAINMENT PENETRATION ROOM VENTILATION SYSTEM

ARKANSAS NUCLEAR ONE
Unit 2

UPDATE REFERENCE LIST (continued)

Sections and references listed below denote documents that contain additional cross reference information used to update the SAR.

<u>Section</u>	<u>Cross References</u>
6.3.3.15	Correspondence from Rueter, AP&L, to Stolz, NRC, dated March 31, 1977. (2CAN037718).
Table 6.3-22	Correspondence from Williams, AP&L, to Stolz, NRC, dated December 7, 1977. (2CAN127703).
6.2.2.2.1	Correspondence from Williams, AP&L, to Stolz, NRC, dated January 11, 1978. (2CAN017807).
Table 6.3-21, 6.3.3.2	Correspondence from Williams, AP&L, to Stolz, NRC, dated March 17, 1978. (2CAN037812).
6.3.2.2.4 6.3.3.15	Correspondence from Williams, AP&L, to Stolz, NRC, dated March 20, 1978. (2CAN037816).
6.3.2.20.2	Correspondence from Williams, AP&L, to Stolz, NRC, dated March 30, 1978. (2CAN037830).
6.3.3.2	Correspondence from Trimble, AP&L, to Seyfrit, NRC, dated August 16, 1979. (2CAN087910).
6.3.3.2	Correspondence from Trimble, AP&L, to Ross, NRC, dated August 27, 1979. (2CAN087916).
6.3.3.2	Correspondence from Trimble, AP&L, to Seyfrit, NRC, dated August 29, 1979. (2CAN087918).
6.3.3.2	Correspondence from Trimble, AP&L, to Eisenhut, NRC, dated January 25, 1980. (2CAN018020).
6.2.4.2	Correspondence from Trimble, AP&L, to Eisenhut, NRC, dated January 18, 1980. (0CAN018022).
6.2.1.3.3.1 Table 6.2-31 Table 6.2-32	Correspondence from Cavanaugh, AP&L, to Clark, NRC, dated September 11, 1980. (2CAN098013).
6.2.4.2	Design Change Package 2222, "Diverse Signals for Containment Isolation," 1979. (2DCP792222).
6.2.2.2.1	Correspondence from Trimble, AP&L, to Seyfrit, NRC, dated June 10, 1980. (0CAN068004, IEB 80-05)

ARKANSAS NUCLEAR ONE
Unit 2

UPDATE REFERENCE LIST (continued)

<u>Section</u>	<u>Cross References</u>
6.2.2.2.1	Design Change Package 2138, "Heat Trace Vent on RWT (2T-3)," 1980. (2DCP802138).
6.2.2.2.1	Design Change Package 2139, "Heat Trace Vent on NaOH Tank," 1980. (2DCP802139).
6.2.4.3	Correspondence from Williams, AP&L, to Howard, NRC, dated April 18, 1978. (2CAN047817).
6.2.4.3	Correspondence from Williams, AP&L, to Stolz, NRC, dated April 26, 1978. (2CAN047823)
Table 6.3-33	Correspondence from Williams, AP&L to Stolz, NRC, dated June 29, 1978. (2CAN067837)
6.7	Design Change Package 79-2105, "Redundant Main FW Isolation Valve."
6.2.1.1.2.6	Design Change Package 79-2105D, "Redundant Main FW Isolation Valve."
6.3.2.11.1 6.3.5.2.2 Table 6.3-1 Figure 6.3-2	Design Change Package 83-2216, "Upgrade Safety Injection Tank Level Indication."
6.4.1.1	Correspondence from Williams, AP&L, to Stolz, NRC, dated May 5, 1978. (0CAN057808).
Table 6.2-21	Design Change Package 80-2199, "Changeout of Shutdown Cooling Heat Exchanger Tube Bundle."
6.3.5.1.2	Design Change Package 85-2039, "PPS Bypass Modification."
6.2.2.5.2	Design Change Package 82-2162, "Baldor Motors Replacement."
6.3.5.1.1 6.3.5.1.2 6.3.5.2.2.B	Design Change Package 85-2039B, "Emergency Feedwater Actuation Bypass."
Figure 6.2-17	Design Change Package 79-2149, "Installation of Containment Pressure Indicator and Recorder."
Figure 6.2-17 Figure 6.3-2	Design Change Package 79-2172, "LPSI and CS Pumps Motor Bearing Temperature Monitor."
Figure 6.2-7	Design Change Package 80-2043F, "Construction of Post Accident Sampling System."
Figure 6.2-17	Design Change Package 80-2123M, "SPDS Additional Computer Inputs."

ARKANSAS NUCLEAR ONE
Unit 2

UPDATE REFERENCE LIST (continued)

<u>Section</u>	<u>Cross References</u>
Figure 6.2-17	Design Change Package 80-2165, "Modification to Sodium Hydroxide Storage Tanks."
Figure 6.2-17 Figure 6.3-2	Design Change Package 82-2142, "Permanent Pressure Gauges for Pump Operational Surveillances."
Figure 6.2-17 Figure 6.3-2	Design Change Packages 83-2003 and 83-2003A, "HPSI Minimum Flow Recirculation Line Modifications."
Figure 6.2-17	Design Change Package 83-2150, "Service Water Drain Valve Addition."
Figure 6.3-2	Design Change Packages 80-2201 and 2201B, "Replace 16 Electric Actuated EPG Ball Valves."
Figure 6.3-2	Design Change Package 86-2052, "SIT Valve Position Switch Qualified Seal."
Figure 6.5-1	Design Change Package 79-2135H, "High Range Gaseous Effluent Radiation Monitors."

Amendment 7

6.2.1.1.2.6 Table 6.2-13B	Correspondence from Williams, AP&L, to Stolz, NRC, dated January 31, 1978. (2CAN017827)
6.2.1.1.4 6.2.1.3 6.2.1.3.3.1 6.2.1.3.4 6.2.2.1.2	ANO-2 Technical Specification Amendment No. 16 dated October- 9, 1980.
6.2.1.3.3.1 6.2.1.3.4 Table 6.2-31	ANO-2 Technical Specification Amendment No. 86 dated July 28, 1988.
6.2.1.3.3 6.2.1.3.4 6.2.2.1.2 Table 6.2-31 Table 6.2-32 Figure 6.2-29A Figure 6.2-29B	AP&L Calculation 88E-0032-01, "ANO-2 DBA LOCA Containment Pressure/Temperature Response with Degraded Service Water Flow and Corrected SI Flow."
6.2.1.3.4	AP&L Engineering Report 88E-0132, "Effects of Revised LOCA Curves on the Environmental Qualifications of Equipment Located Inside Containment."
6.2.1.3.3.1	ANO-2 Technical Specification Amendment No. 84 dated May 16, 1988

ARKANSAS NUCLEAR ONE
Unit 2

UPDATE REFERENCE LIST (continued)

<u>Section</u>	<u>Cross References</u>
<u>Amendment 8</u>	
Figure 6.3-2	Design Change Package 87-2105, "SDC Flow Indicator 2FI-5091 added to Remote Shutdown Panel, 2C80."
Table 6.2-26	Design Change Package 89-2044, "Replacement of 2CV-8259-1 with Solenoid Valve."
<u>Amendment 9</u>	
6.2.1.3.3 6.2.2.1.2 Table 6.2-11A	AP&L Calculation 88E-0097-03, "Main Steam Line Break with Longer Rod Drop, Higher Air Cooler and Spray Set Point Pressure."
6.2.5.5	Design Change Package 86-2113, "ANO-2 Alarm Upgrade for Panels 2K01, 2K08, and 2K09."
Table 6.2-26	Design Change Package 88-2086, "MOVATS 2CV-4824-2."
Table 6.2-26	Design Change Package 82-2160, "2CV-1036-2, 2CV-1037-1, 2CV-1038-2, 2CV-1039-1 Replacement."
Figure 6.3-2	Operating Procedure 2104.040, Rev. 19, "Low Pressure Safety Injection System Operations (LPSI)."
6.3.2.20.6	Operating Procedure 2104.001, Rev. 16, "Safety Injection Tank Operations."
6.2.3 6.2.5 6.2.5.1 6.2.5.2.4 6.2.5.3 6.2.5.3.1.4 6.2.5.3.2 6.2.5.4 6.2.5.5 Table 6.2-26 Table 6.2-33 Table 6.3-4 Figure 6.2-25	ANO Calculation 89-E-0105-01, "Use of Hydrogen Purge System."
<u>Amendment 10</u>	
6.2.2.5.1 Figure 6.2-17 Figure 6.3-2 Figure 6.5-1	Design Change Package 88-2110, "ANO-2 Alarm Upgrade, Phase II."

ARKANSAS NUCLEAR ONE
Unit 2

UPDATE REFERENCE LIST (continued)

<u>Section</u>	<u>Cross References</u>
6.2.4.2 6.2.4.4 Table 6.2-26 Table 6.2-33	Condition Report 2-89-0472, "Corrections to Containment Isolation Valves."
6.3.2.10 Table 6.3-3 Figure 6.3-2	Design Change Package 88-2004, "LPSI System Overpressurization."
6.3.4.2	Operating Procedure 2104.040, Rev. 23, "Low Pressure Safety Injection System Operations."
6.5.4	Clarification to CPRVS Periodic Testing.
Table 6.2-18	Changes to CSS Material of Construction.
Table 6.2-26	Limited Change Package 90-6033, "MOV Modifications for 2CV-0340, 2CV-1040, 2CV-1050, and 2CV-1090".
Figure 6.2-17	Design Change Package 90-2029, "ANO-2 SWS Thermal Performance Monitoring."
Figure 6.3-2	Design Change Package 89-2042, "Generic Letter 88-17, Shutdown Cooling (SDC) Instrumentation and Alarms."
Figure 6.3-2	Limited Change Package 90-6032, "Safety Injection Tank Nitrogen Vent Valves."
Figure 6.5-1	Design Change Package 87-2006, "Penetration Room Differential Pressure Transmitters Removal."
<u>Amendment 11</u>	
6.2.2.2.1.B.7	Design Change Package 91-2016, "Pressurizer Code Safety Valve Leakage Remediation."
6.2.5.2.1	Design Change Package 91-2003, "ANO-2 Hydrogen Monitoring Modification."
6.2.5.3 Table 6.2-28 Table 6.2-29 Figure 6.2-25 Figure 6.2-25A Figure 6.2-25B	Calculation 91E-0088-1, "ANO-2 Post LOCA Hydrogen Generation."
Table 6.2-26	Design Change Package 91-2010, "Main Steam Motor Operated Valve Modification."

ARKANSAS NUCLEAR ONE
Unit 2

UPDATE REFERENCE LIST (continued)

<u>Section</u>	<u>Cross References</u>
Table 6.2-26	ANO-2 Technical Specifications Amendment 140, dated December 14, 1992. (2CNA129201)
Table 6.2-26	Limited Change Package 90-6018, "Valve Replacement on ANO-2 RCS Sample Line."
Table 6.3-4	Design Change Package 91-2013, "ANO-2 Narrow Range Containment Bldg. Pressure Transmitter Replacement."
Figure 6.2-17	Design Change Package 88-2111, "ANO-2 Annunciator Upgrade Phase III."
Figure 6.2-17 Figure 6.3-2	Design Change Package 90-2036, "Unit 2 Plant Computer Replacement."
Figure 6.3-2	Plant Engineering Action Request 91-7458, "Arrow Update."
Figure 6.3-2	Design Change Package 91-2012, "SDC Vortex Monitoring."
Figure 6.3-2	Plant Engineering Action Request 91-0321, "Auxiliary Building Floor Drains El. 317'."
Figure 6.5-1	Plant Engineering Action Request 90-0664, "Equipment Tagging Identification For Existing Components Associated with 2RE-8845-1 and 2RE-8846-2."
Figure 6.5-1	Design Change Package 91-2011, "ANO-2 HELB Dampers."
Figure 6.5-1	Limited Change Package 92-6005, "Valves For 2V1 and 2V2."
<u>Amendment 12</u>	
6.2.2.2.1.B.7	Limited Change Package 93-6027, "Permanent Modification to Ensure ANO-2 Reactor Building Sump Integrity"
6.3.2.2.6.A Figure 6.3-2	Design Change Package 93-2012, "High Pressure Safety Injection (HPSI) System Injection Valve Replacement."
6.5.5 Figure 6.5-1	Plant Change 93-8062, "Emergency Penetration Room Ventilation System Pulls To-Lock Annunciation Change."
Table 6.2-26	Design Change Package 93-2015, "Replacement of Containment Isolation Valves 2N2-1, 2SA-69, and 2BA-216."
Table 6.2-26	Limited Change Package 93-6026, "Removal of Safety Injection Actuation Signal (SIAS) from Two Valves"
Table 6.2-26	Limited Change Package 91-6016, "Motor Operated Valve Modifications on Emergency Feedwater System."

ARKANSAS NUCLEAR ONE
Unit 2

UPDATE REFERENCE LIST (continued)

<u>Section</u>	<u>Cross References</u>
Table 6.2.22	Procedure 1015.008 Revision 10, PC-3. Change Allowed throttling of several valves while on Shutdown Cooling.
<u>Amendment 13</u>	
6.2.1.1.2.6	Limited Change Package 95-6008, "MSIS Relays Single Failure Modification"
6.2.1.3.3 6.2.1.3.4 Table 6.2-26	Design Change Package 89-2049, "Service Water and Auxiliary Cooling Systems Water Hammer Mitigation"
6.3.2.20.2	Plant Change 94-8060, "Swing HPSI Pump Auto Start Interlock Modification"
Table 6.2-17B	Design Change Package 93-2008, "ANO-2 Steam Generator Platform Modification for Eddy Current Testing"
Table 6.2-26	Limited Change Package 95-6001, "Gear Change for MOV's 2CV-5236-1, 2CV-5254-2, and 2CV-5255-1"
Table 6.2-26	Limited Change Package 95-6014, "Penetration 2P-53 Modification"
Figure 6.2-17	Design Change Package 92-2002A, "RWT Recirculation Isolation Valve"
Figure 6.2-17 Figure 6.3-2	Design Change Package 93-2007, "ANO-2 New Points to Plant Monitoring System"
Figure 6.2-17	Limited Change Package 95-6011, "Modification to Prevent Pressure Locking of 2CV-5649-1 and 2CV-5650-2"
Figure 6.3-2	Design Change Package 90-2015, "2R11 LPSI Valve Replacement (2CV-5037-1 and 2CV-5077-2)"
Figure 6.3-2	Limited Change Package 93-6025, "ANO-2 HPSI Pump Room 'C' Floor Drain Modification"
Figure 6.3-2	Design Change Package 94-2002, "HPSI Injection Valve Replacement"
Figure 6.3-2	Design Change Package 95-2006, "LPSI Valve Replacement 2CV-5017-1 & 2CV-5057-2"
<u>Amendment 14</u>	
6.2.1.3.5	Design Change Package 93-2002, "Permanent Reactor Cavity Seal Plate Installation"
6.2.5.3.1 Table 6.2-28	Condition Report C-95-0088, "Revised Post-LOCA Hydrogen Generation Analyses"

ARKANSAS NUCLEAR ONE
Unit 2

UPDATE REFERENCE LIST (continued)

<u>Section</u>	<u>Cross References</u>
Table 6.2-29 Figure 6.2-25 Figure 6.2-25A Figure 6.2-25B	
Figure 6.2-17	Limited Change Package 963151L201, "Pressure Locking Modification on Containment Spray Valves 2CV-5612-1 & 2CV-5613-2"
Figure 6.3-2	Plant Change 974074P201, "2PSV-5085 Replacement"
<u>Amendment 15</u>	
6.2.1.1.2.6 6.2.1.3.3.4.3 6.2.1.3.3.4.4 Table 6.2-36 Table 6.2-37 Table 6.2-38 Table 6.2-39 Table 6.2-40 Table 6.2-41 Table 6.2-42 Table 6.2-43	Engineering Report, "MSIS Setpoint Reduction"
6.2.2.1 6.2.2.2.1 6.2.2.3.1 6.2.2.4.1 6.2.2.5.1 6.2.3.1 6.2.3.2.1 6.2.3.2.2 6.2.3.2.2.1 6.2.3.2.2.2 6.2.3.2.2.3 6.2.3.3.1 6.2.3.3.1.1 6.2.3.3.1.3 6.2.3.3.2 6.2.3.3.2.1 6.2.3.3.2.2 6.2.3.3.2.3 6.2.3.3.2.4 6.2.3.3.2.5 6.2.3.4 6.2.5.3.1.4 6.3.2.14 Table 6.2-18A	Design Change Package 973950D201, "NaOH Replacement with TSP"

ARKANSAS NUCLEAR ONE
Unit 2

UPDATE REFERENCE LIST (continued)

<u>Section</u>	<u>Cross References</u>
Table 6.2-19	
Table 6.2-23	
Table 6.2-28	
Table 6.2-29	
Table 6.3-4	
Figure 6.2-17	
Figure 6.2-26	
Figure 6.2-27	
Figure 6.3-12	
6.2.2.2.1	Plant Change 974346P201, "2PSV-5697 Flange Addition"
Figure 6.2-17	
6.3.2.14	Calculation 91E011601, "Revision to NPSH Availability to HPSI"
Table 6.2-18	
6.3.2.2.2	Plant Change 980274P201, "Setpoint Change on 2PS-4623-1 and
6.3.2.15	2PS-4623-2"
Table 6.2-26	Design Change Package 946012D201, "Containment Vent Header/Waste Gas System Modification"
Figure 6.2-17	Limited Change Package 963151L201, "Pressure Locking Modification on Containment Spray Valves"
<u>Amendment 16</u>	
6.2.1	Engineering Request 980486E201, "Containment Calculation Update"
6.6	
Table 6.2-1A	
Table 6.2-1B	
Table 6.2-1C	
Table 6.2-1D	
Table 6.2-2	
Table 6.2-10	
Table 6.2-11	
Table 6.2-11A	
Table 6.2-12	
Table 6.2-12A	
Table 6.2-13	
Table 6.2-13A	
Table 6.2-14	
Table 6.2-15	
Table 6.2-16	
Table 6.2-2	
Table 6.2-3	
Table 6.2-4	
Table 6.2-5	

ARKANSAS NUCLEAR ONE
Unit 2

UPDATE REFERENCE LIST (continued)

Section Cross References

Table 6.2-6
Table 6.2-7
Table 6.2-8
Tables 6.2-8A through 6.2-8J
Table 6.2-9
Tables 6.2-9A through 6.2-9D
Table 6.2-10
Table 6.2-11
Table 6.2-11A
Table 6.2-12
Table 6.2-12A
Table 6.2-13
Table 6.2-13A
Table 6.2-13B
Table 6.2-14
Table 6.2-15
Table 6.2-16
Table 6.2-23
Table 6.2-24
Table 6.2-30
Table 6.2-31
Table 6.2-32
Table 6.2-37
Table 6.2-38
Table 6.2-39
Table 6.2-40
Table 6.2-41
Table 6.2-42
Table 6.2-43
Figure 6.2-1
Figure 6.2-2
Figure 6.2-3A
Figure 6.2-3B
Figure 6.2-4
Figure 6.2-5
Figure 6.2-6
Figure 6.2-7
Figure 6.2-8
Figures 6.2-8A through 6.2-8H
Figure 6.2-9
Figure 6.5-10
Figure 6.2-11
Figure 6.2-12
Figure 6.2-13
Figure 6.2-13A
Figure 6.2-14
Figure 6.2-15
Figure 6.2-16

ARKANSAS NUCLEAR ONE
Unit 2

UPDATE REFERENCE LIST (continued)

<u>Section</u>	<u>Cross References</u>
Figure 6.2-28 Figure 6.2-29A Figure 6.2-29B	
6.2.1.1.3 6.2.1.2.3 Tables 6.2-8D through 6.2-8H Table 6.2-8J Table 6.2-9A Table 6.2-9C Table 6.2-9D Figures 6.2-8D through 6.2-8H	Nuclear Change Package 991864N201, "Containment Upgrade to 59 psig"
6.2.1.2.2 6.2.1.2.3 6.3.3.2.2 6.3.3.2.3 6.3.3.13.2 Table 6.3-13 Table 6.3-15 Table 6.3-19 Table 6.3-20 Table 6.3-25 Table 6.3-26 Table 6.3-27 Table 6.6-1 Figures 6.3-48A through 6.3-48S Figures 6.3-49A through 6.3-49H Figures 6.3-51A through 6.3-51H	Design Change Package 980642D210, "Replacement Steam Generator Design/Qualification"
6.2.1.2.2 6.2.1.2.3	Engineering Request 980529E201, "Steam Generator Subcompartment Pressurization Calculations"
6.2.1.3 6.2.1.3.2 6.2.1.3.3	Design Change Package 980642D202, "Containment Construction Opening for Steam Generator Replacement"
6.2.2 6.2.2.1 6.2.2.1.2 6.2.2.2 6.2.2.2.2 Table 6.2-22 Table 6.2-44	Nuclear Change Package 991522N201, "Containment Cooler Chilled Water Coil Replacement and Fan Pitch Change"

ARKANSAS NUCLEAR ONE
Unit 2

UPDATE REFERENCE LIST (continued)

<u>Section</u>	<u>Cross References</u>
6.2.2.2.1 Table 6.2-21	Engineering Request 991457E205, "Qualification of 4000 gpm Design Flow for 2E35A/B"
6.2.2.2.1	Design Change Package 980642D205, "Replacement of Insulation on Steam Generators"
6.2.2.2.1 Figure 6.2-17	Nuclear Change Package 974342N201, "Installation of Flanges on Containment Spray Relief Valves"
6.2.2.2.1 Table 6.2-23 Table 6.2-24	Nuclear Change Package 975122N201, "High-High Containment Pressure Isolation of Main Feedwater"
6.2.2.2.1	Technical Specification Amendment 205, "Relocation of Miscellaneous Design Features from the Technical Specifications to the SAR"
6.2.4.2	Engineering Request 991864E213, "Motor Operated Valves Inside Containment"
6.2.5.2 6.2.5.3 Table 6.2-28 Table 6.2-29 Figure 6.2-25 Figure 6.2-25A Figure 6.2-25B	Engineering Request 980567E202, "Containment Hydrogen Analysis"
6.3.2.4 6.3.2.19	Engineering Request 002357E201, "HPSI Injection Valve Plug Design Change"
6.3.2.11.3	Design Change Package 963242D202, "Inverter Replacement"
6.3.3.2.3 6.6 Table 6.3-19	Technical Specification Amendment 197, "Out-of-Core and Incore Detectors will Indicate Quadrant Power Tilt"
Table 6.2-26 Figure 6.3-2	Design Change Package 974814D201, "Installation of Thermal Relay Valves on Containment Penetrations"
Figure 6.2-17	Nuclear Change Package 991802N201, "Removal of Interlock Between the Sump and the Refueling Water Tank Valves"
Figure 6.2-17 Figure 6.3-2	Nuclear Change Package 003258N201, "HPSI Test Connections"

ARKANSAS NUCLEAR ONE
Unit 2

UPDATE REFERENCE LIST (continued)

<u>Section</u>	<u>Cross References</u>
<u>Amendment 17</u>	
6.3.4.2	Unit 2 Technical Specification Amendment 233
6.2.5	Unit 2 Technical Specification Amendment 245
6.2.5.1	
6.2.5.2.2	
6.2.1.1.3	Engineering Request ANO-2000-2344-026, "Power Uprate Evaluation"
6.2.1.1.3.1.2.2	
6.2.1.1.3.2.2.2	
6.2.1.1.3.4.1	
6.2.1.1.3.4.2	
6.2.1.1.3.4.3	
6.2.1.1.3.4.4	
6.2.1.1.3.4.7	
6.2.1.1.3.4.8	
6.2.1.1.3.4.9	
6.2.1.1.3.4.11	
6.2.2.2.1	
6.2.3.3.1.1	
6.3.2.14	
6.3.2.2.1	
6.3.3.1	
6.3.3.15	
6.3.3.2	
6.3.3.2.1	
6.3.3.2.2.1	
6.3.3.2.2.2	
6.3.3.2.2.3	
6.3.3.2.2.5	
6.3.3.2.2.6	
6.3.3.2.2.7	
6.3.3.2.2.7.1	
6.3.3.2.2.7.2	
6.3.3.2.3.1	
6.3.3.2.3.2	
6.3.3.2.3.3	
6.3.3.2.3.5	
6.3.3.2.3.6	
6.3.3.2.3.7	
6.3.3.2.3.7.1	
6.3.3.2.3.7.2	
6.6	
Table 6.2-34	
Table 6.2-35	
Table 6.3-9	
Table 6.3-11	

ARKANSAS NUCLEAR ONE
Unit 2

UPDATE REFERENCE LIST (continued)

Section Cross References

Table 6.3-12
Table 6.3-13
Table 6.3-14
Table 6.3-15
Table 6.3-16
Table 6.3-17
Table 6.3-18
Table 6.3-19
Table 6.3-20
Table 6.3-21
Table 6.3-23
Table 6.3-24
Table 6.3-25
Table 6.3-26
Table 6.3-27
Figure 6.2-30
Figure 6.2-32
Figure 6.2-33
Figure 6.2-34
Figure 6.3-13A
Figure 6.3-13B
Figure 6.3-13C
Figure 6.3-13D.1
Figure 6.3-13D.2
Figure 6.3-13E
Figure 6.3-13F
Figure 6.3-13G
Figure 6.3-13H
Figure 6.3-14A
Figure 6.3-14B
Figure 6.3-14C
Figure 6.3-14D.1
Figure 6.3-14D.2
Figure 6.3-14E
Figure 6.3-14F
Figure 6.3-14G
Figure 6.3-14H
Figure 6.3-15A
Figure 6.3-15B
Figure 6.3-15C
Figure 6.3-15D.1
Figure 6.3-15D.2
Figure 6.3-15E
Figure 6.3-15F
Figure 6.3-15G
Figure 6.3-15H
Figure 6.3-16A
Figure 6.3-16B

ARKANSAS NUCLEAR ONE
Unit 2

UPDATE REFERENCE LIST (continued)

Section Cross References

Figure 6.3-16C
Figure 6.3-16D.1
Figure 6.3-16D.2
Figure 6.3-16E
Figure 6.3-16F
Figure 6.3-16G
Figure 6.3-16H
Figure 6.3-16I
Figure 6.3-16J
Figure 6.3-16K
Figure 6.3-16L
Figure 6.3-16M
Figure 6.3-16N
Figure 6.3-16O
Figure 6.3-16P
Figure 6.3-16Q
Figure 6.3-16R
Figure 6.3-17A
Figure 6.3-17B
Figure 6.3-17C
Figure 6.3-17D.1
Figure 6.3-17D.2
Figure 6.3-17E
Figure 6.3-17F
Figure 6.3-18A
Figure 6.3-18B
Figure 6.3-18C
Figure 6.3-18D.1
Figure 6.3-18D.2
Figure 6.3-18E
Figure 6.3-18F
Figure 6.3-18G
Figure 6.3-18H
Figure 6.3-18I
Figure 6.3-18J
Figure 6.3-18K
Figure 6.3-18L
Figure 6.3-18M
Figure 6.3-18N
Figure 6.3-18O
Figure 6.3-18P
Figure 6.3-18Q
Figure 6.3-18R
Figure 6.3-18G
Figure 6.3-18H
Figure 6.3-19A
Figure 6.3-19B
Figure 6.3-19C

ARKANSAS NUCLEAR ONE
Unit 2

UPDATE REFERENCE LIST (continued)

Section Cross References

Figure 6.3-19D.1
Figure 6.3-19D.2
Figure 6.3-19E
Figure 6.3-19F
Figure 6.3-19G
Figure 6.3-19H
Figure 6.3-20
Figure 6.3-22A
Figure 6.3-22B
Figure 6.3-22C
Figure 6.3-22D
Figure 6.3-22E
Figure 6.3-22F
Figure 6.3-22G
Figure 6.3-22H
Figure 6.3-23A
Figure 6.3-23B
Figure 6.3-23C
Figure 6.3-23D
Figure 6.3-23E
Figure 6.3-23F
Figure 6.3-23G
Figure 6.3-23H
Figure 6.3-24A
Figure 6.3-24B
Figure 6.3-24C
Figure 6.3-24D
Figure 6.3-24E
Figure 6.3-24F
Figure 6.3-24G
Figure 6.3-24H
Figure 6.3-25A
Figure 6.3-25B
Figure 6.3-25C
Figure 6.3-25D
Figure 6.3-25E
Figure 6.3-25F
Figure 6.3-25G
Figure 6.3-25H
Figure 6.3-26
Figure 6.3-27A
Figure 6.3-27B
Figure 6.3-27C
Figure 6.3-27D.1
Figure 6.3-27D.2
Figure 6.3-27E
Figure 6.3-27F
Figure 6.3-27G

ARKANSAS NUCLEAR ONE
Unit 2

UPDATE REFERENCE LIST (continued)

Section Cross References

Figure 6.3-27H
Figure 6.3-27I
Figure 6.3-27J
Figure 6.3-27K
Figure 6.3-27L
Figure 6.3-27M
Figure 6.3-27N
Figure 6.3-27O
Figure 6.3-27P
Figure 6.3-27Q
Figure 6.3-27R
Figure 6.3-48A
Figure 6.3-48B
Figure 6.3-48C
Figure 6.3-48D
Figure 6.3-48E
Figure 6.3-48F
Figure 6.3-48G
Figure 6.3-48H
Figure 6.3-48I
Figure 6.3-48J
Figure 6.3-48K
Figure 6.3-48L
Figure 6.3-48M
Figure 6.3-48N
Figure 6.3-48O
Figure 6.3-48P
Figure 6.3-48Q
Figure 6.3-48R
Figure 6.3-48S
Figure 6.3-49A
Figure 6.3-49B
Figure 6.3-49C
Figure 6.3-49D
Figure 6.3-49E
Figure 6.3-49F
Figure 6.3-49G
Figure 6.3-49H
Figure 6.3-50A
Figure 6.3-50B
Figure 6.3-50C
Figure 6.3-50D
Figure 6.3-50E
Figure 6.3-50F
Figure 6.3-50G
Figure 6.3-50H
Figure 6.3-51A
Figure 6.3-51B

ARKANSAS NUCLEAR ONE
Unit 2

UPDATE REFERENCE LIST (continued)

<u>Section</u>	<u>Cross References</u>
Figure 6.3-51C Figure 6.3-51D Figure 6.3-51E Figure 6.3-51F Figure 6.3-51G Figure 6.3-51H Figure 6.3-52 Figure 6.3-53	
6.2.5.2.3 6.2.5.3.1.4	Condition Report ANO C-2001-0208
Table 6.3-22 Figure 6.3-2	Engineering Request ANO-2000-2804-011, "Addition of HPSI Bypass Line"
6.5.2	Engineering Request ANO-2000-2864-001, "Replacement Filter Evaluation" and Condition Report ANO-C-1998-0177
Figure 6.5-1	ANO Calculation 99-E-0017-01, "Acceptable Use of the PVRS System" and Condition Report ANO-2-2001-0093
<u>Amendment 18</u>	
6.2.1.1.3	License Basis Document Change 2-6.2-0089, "Minor Wording and Reference Correction Regarding Low Containment Pressure Events"
6.2.2.1.1	SAR Discrepancy 2-97-0493, "Clarification of Containment Spray System Design"
6.2.2.2.1	Condition Report CR-ANO-2-2003-1133, "Removal of Unnecessary Detail Regarding Containment Spray System Materials"
6.2.2.2.1 Figure 6.2-17	License Basis Document Change 2-6.2-0079, "Corrections Related to Containment Spray System Relief Valve 2PSV-5696"
6.2.3.2.2.2	Engineering Request ER-ANO-1999-1802, "Modification of RWT Outlet Valve Closure Logic"
6.2.3.3.1.1	SAR Discrepancy 2-96-0006, "Removal of Incorrect Assumptions Regarding Containment Spray Iodine Removal Constants"
Table 6.2-26	Licensing Document Change 2-3.11-0006, "Deletion of Specific Title Reference Regarding Plant Component Database"
Table 6.2-26	License Basis Document Change 2-6.2-0080, "Passport Implementation"
Table 6.2-26	Engineering Request ER-ANO-1998-1263, "Corrections to Penetration 2P-20 and 2P-37 Configuration"

ARKANSAS NUCLEAR ONE
Unit 2

UPDATE REFERENCE LIST (continued)

<u>Section</u>	<u>Cross References</u>
Figure 6.2-17	Condition Report CR-ANO-2-2003-0800, "Correction of 2T10 Recirculation Line Location and Seismic Flag Direction"
Figure 6.2-17	Engineering Request ER-ANO-2003-0221-000, "Isolation of Post Accident Sampling System"
Figure 6.3-2	License Basis Document Change 2-6.3-0057, "Corrections to Instrument Air Piping and Instrument Drawings Related to SDC Temperature and Flow Control Valves"
6.3.1.5 6.3.2.14 Table 6.3-1 Table 6.3-3 Figure 6.3-2	Engineering Request ER-ANO-2002-0528-005, "Removal of HPSI Pump Suction Check Valves"
<u>Amendment 19</u>	
6.3.2.7 Table 6.3-9	Engineering Request ER-ANO-2000-2804-017, "Modification of High Pressure Safety Injection Pump 2P-89C"
6.3.3.2.1 6.3.3.2.2.2 6.3.3.2.2.3 6.3.3.2.3.3 Table 6.2-34 Table 6.3-9 Table 6.3-14 Table 6.3-15 Table 6.3-17 Table 6.3-19 Table 6.3-20 Table 6.3-21 Table 6.3-23 Figures 6.3-13a through 6.3-13h Figures 6.3-14a through 6.3-14h Figures 6.3-15a through 6.3-15h Figures 6.3-16a through 6.3-16r Figures 6.3-17a through 6.3-17h Figures 6.3-20 Figures 6.3-23a through 6.3-23h Figures 6.3-24a through 6.3-24h Figures 6.3-25a through 6.3-25h Figures 6.3-26	Calculation A2-NE-2004-000, "ANO-2 Cycle 18 Reload Analysis Report"

ARKANSAS NUCLEAR ONE
Unit 2

UPDATE REFERENCE LIST (continued)

<u>Section</u>	<u>Cross References</u>
6.2.5.4	Technical Specification Amendment 254, "Deletion of Hydrogen Recombiners Requirements and Relocation of Hydrogen Analyzer Requirements to the Technical Requirements Manual"
6.2.4.2	Engineering Request ER-ANO-2004-0786-000, "Clarification of Function Regarding the SFP Transfer Gate Valve"
Table 6.2-26	Condition Report CR-ANO-C-2003-0242, "Reclassification of SG Secondary Penetrations"
6.3.2.2.2 6.3.2.15	License Document Change Request, "Generic Administrative Controls for SIT O/L Valves"
Figure 6.2-17	Condition Report CR-ANO-C-2004-2204, "Correction of Drawing Discrepancy Associated with Containment Spray System"
Figure 6.3-2	Condition Report CR-ANO-2-2004-1929, "Correction of Drawing Discrepancy Associated with High Pressure Injection System"

Amendment 20

6.2.1.2.3.2 6.2.5.2.1 6.3.2.1 6.3.2.2.6 Table 6.2-26 Figures – ALL (except Figures 6.3-13A through 6.3-17h, 6/3-20, and 6.3-32a through 6.3-26)	License Document Change Request 05-058, "Deletion/simplification of Excessive Detailed Drawings from SAR"
Table 6.2-25 Table 6.2-28	Condition Report CR-ANO-C-2004-0623, "Incorporate References to Existing Safety Related Qualified Coating Materials"
6.2.2.2.1 6.2.2.3.1 6.3.1.5 6.3.2.14 Table 6.2-8D Table 6.2-18 Table 6.2-35 Figure 6.2-23 Figure 6.2-23A Figure 6.2-23B	Engineering Calculation CALC-ANO-ER 06-022, "HELB and Seismic II/I Evaluation for Containment Sump GSI-191 Strainer and Plenum"
6.3.3.2.1 Table 6.3-19 Table 6.3-20 Table 6.3-21	Calculation CALC-ANO2-NE-06-00001, "ANO-2 Cycle 19 Reload Report"

ARKANSAS NUCLEAR ONE
Unit 2

UPDATE REFERENCE LIST (continued)

<u>Section</u>	<u>Cross References</u>
6.2.4.2	Calculation CALC-05-E-0014-01, "Thermal Analysis for Containment Isolation Valves 2CV-2061-2 and 2CV-2201-2"
6.2.2.2.1.B.8	Engineering Request ER-ANO-2006-0457-001, "Clarification of Present and Historical Piping Weld Methods"
6.2.2.1.1 6.2.2.2.1.A 6.2.2.2.1.B.2 6.2.2.4.1.B 6.2.2.4.1.G.5 6.2.3.1 6.2.3.2.1 6.2.3.4	Engineering Request ER-ANO-1997-3950, "Revised Receipt Testing Method for Trisodium Phosphate" and TS Amendment 194, "Removal of Reference to Dodecahydrate"
Table 6.3-4	Engineering Request ER-ANO-2003-0489-000, "Re-range Containment Wide Range Pressure Transmitters to Maintain Compliance with RG 1.97"
6.2.2.2.1.B.1	Engineering Change EC-897, "Containment Spray Pump Motor Replacement"

Amendment 21

6.2.2.1.B.1	Engineering Change EC-897, "Containment Spray Pump Motor Replacement"
6.3.3.2.1 6.3.3.2.2.1 6.3.3.2.2.3 6.3.3.2.3.1 6.3.3.2.3.3 6.6 Table 6.2-34 Table 6.3-9 Table 6.3-12 Table 6.3-14 Table 6.3-15 Table 6.3-17 Table 6.3-19 Table 6.3-20 Table 6.3-21 Figure 6.2-30 Figure 6.2-33 Figure 6.2-34 Figures 6.3-13a thru 6.3-17h Figures 6.3-20 Figures 6.3-23a thru 6.3-26	Calculation CALC-ANO2-NE-08-00001, "ANO-2 Cycle 20 Reload Analysis Report"

ARKANSAS NUCLEAR ONE
Unit 2

UPDATE REFERENCE LIST (continued)

<u>Section</u>	<u>Cross References</u>
6.2.2.1.1	Engineering Change EC-1640, "Replacement of TSP with NaTB"
6.2.2.2.1	
6.2.2.4.1	
6.2.3.1	
6.2.3.2.1	
6.2.3.2.2.2	
6.2.3.3.1.2	
6.2.3.4	
6.2.5.3.1.4	
Table 6.2-8D	
Table 6.2-18	
Table 6.2-25	Engineering Change EC-592, "Reactor Vessel Closure Head Upgrade"
Table 6.2-26	Engineering Change EC-5000120791, "Correction to Containment Penetration SAR Table"
6.2.2.2.1	Engineering Change EC-2244, "ECCS and Containment Sump NPSH Analysis Relating to GSI-191"
6.3.1.5	
6.3.2.14	
6.3.2.20.4	
Table 6.2-18	
Table 6.3-1	
Table 6.2-26	Engineering Change EC-5000120794, "Correction to List of Containment Penetrations"
Table 6.2-26	Engineering Change EC-5000120788, "Corrections to List of Containment Penetrations"
6.2.2.2.1.B.7	Engineering Change EC-4389, "Addition of Containment Sump Strainers"
Table 6.2-8D	
Table 6.2-35	
<u>Amendment 22</u>	
6.2.1.1.3.4.7	Calculation CALC-ANO2-NE-09-00001, "ANO-2 Cycle 21 Reload Report"
Table 6.2-26	Engineering Change EC-13434, "Revise SAR to Reconcile Penetrations 2P8, 2P66, and 2P67 with Design Documents"
<u>Amendment 23</u>	
6.2.3.2.2.2	Engineering Change EC-16240, "Modification of Sump/RWT Outlet Valve Sequencing"
6.3.4	License Document Change Request 10-042, "Incorporation of ASME Operations and Maintenance Code in accordance with 10 CFR 50.55a"
6.3.4.2	

ARKANSAS NUCLEAR ONE
Unit 2

UPDATE REFERENCE LIST (continued)

<u>Section</u>	<u>Cross References</u>
Figure 6.2-3K	Engineering Change EC-19533, "Permanent Removal of Wire Ropes from 2P-32A"
6.3.2.2.4 Figure 6.3-4	Engineering Change EC-26154, "Installation of 2P-89A Precision Pump Element and New Bearing Housings"
6.2.3.1 6.2.3.3.1.2 6.2.4.1 6.4.1.1	Engineering Change EC-10746, "Adoption of Alternate Source Terms"
<u>Amendment 24</u>	
6.2.1.3.3	Licensing Document Change Request 11-042, "Implementation of NEI 94-1, Revision 2 (ILRT Extension)"
Figure 6.2-3B	License Document Change Request 12-015, "Correct of Reactor Vessel Internals Program Title"
6.5.2 6.5.3	Condition Report CR-ANO-C-2012-0749, "Comprehensive Listing of SPING Monitored Release Points"
Table 6.2-26 Figure 6.2-17	Engineering Change EC-18780, "Modification of PASS Piping"
<u>Amendment 25</u>	
Figure 6.2-3K	Engineering Change EC-31124, "Reactor Coolant Pump Restraints Modification"
<u>Amendment 26</u>	
6.5.2	Condition Report CR-ANO-2-2014-1429, "Correct Discrepancy Associated with the Escape Hatch and Equipment Hatch Seal Penetrations"
6.2.2.1	Condition Report CR-ANO-2-2015-1806, "Resolve RWT Volume Typographical Error"
Figure 6.3-2	Engineering Change EC-48343, "Installation of FLEX Connections"
Figure 6.2-3K	Engineering Change EC-53398, "Modification of RCP Restraints"
<u>Amendment 27</u>	
6.4.1.4	Licensing Basis Document Change LBDC 16-014, "TSTF-545 Adoption – Relocation of IST Program"
Table 6.3-1	Engineering Change EC-72499, "LPSI Pump 2P-60B Motor Replacement"

ARKANSAS NUCLEAR ONE
Unit 2

UPDATE REFERENCE LIST (continued)

<u>Section</u>	<u>Cross References</u>
Table 6.2-26	Engineering Change EC-58842, "Common Feedwater Connection to EFW System"
<u>Amendment 28</u>	
Table 6.3-22	Licensing Basis Document Change LBDC 18-049, "Editorial Correction to LPSI Mini-Recirc Indicated Position"

ARKANSAS NUCLEAR ONE
Unit 2

RECORD OF REVISIONS

<u>PAGE #</u>	<u>AMENDMENT #</u>	<u>PAGE #</u>	<u>AMENDMENT #</u>	<u>PAGE #</u>	<u>AMENDMENT #</u>
TABLE OF CONTENTS		CHAPTER 6		CHAPTER 6 (CONT.)	
6-i	28	6.1-1	15		
6-ii	28	6.1-2	15	6.2-44	26
6-iii	28			6.2-45	26
6-iv	28	6.2-1	26	6.2-46	26
6-v	28	6.2-2	26	6.2-47	26
6-vi	28	6.2-3	26	6.2-48	26
6-vii	28	6.2-4	26	6.2-49	26
6-viii	28	6.2-5	26	6.2-50	26
6-ix	28	6.2-6	26	6.2-51	26
6-x	28	6.2-7	26	6.2-52	26
6-xi	28	6.2-8	26	6.2-53	26
6-xii	28	6.2-9	26	6.2-54	26
6-xiii	28	6.2-10	26	6.2-55	26
6-xiv	28	6.2-11	26	6.2-56	26
6-xv	28	6.2-12	26	6.2-57	26
6-xvi	28	6.2-13	26	6.2-58	26
6-xvii	28	6.2-14	26	6.2-59	26
6-xviii	28	6.2-15	26	6.2-60	26
6-xix	28	6.2-16	26	6.2-61	26
6-xx	28	6.2-17	26		
6-xxi	28	6.2-18	26	6.3-1	23
6-xxii	28	6.2-19	26	6.3-2	23
6-xxiii	28	6.2-20	26	6.3-3	23
6-xxiv	28	6.2-21	26	6.3-4	23
6-xxv	28	6.2-22	26	6.3-5	23
6-xxvi	28	6.2-23	26	6.3-6	23
6-xxvii	28	6.2-24	26	6.3-7	23
6-xxviii	28	6.2-25	26	6.3-8	23
6-xxix	28	6.2-26	26	6.3-9	23
6-xxx	28	6.2-27	26	6.3-10	23
6-xxxi	28	6.2-28	26	6.3-11	23
6-xxxii	28	6.2-29	26	6.3-12	23
6-xxxiii	28	6.2-30	26	6.3-13	23
6-xxxiv	28	6.2-31	26	6.3-14	23
6-xxxv	28	6.2-32	26	6.3-15	23
6-xxxvi	28	6.2-33	26	6.3-16	23
6-xxxvii	28	6.2-34	26	6.3-17	23
6-xxxviii	28	6.2-35	26	6.3-18	23
6-xxxix	28	6.2-36	26	6.3-19	23
6-xl	28	6.2-37	26	6.3-20	23
6-xli	28	6.2-38	26	6.3-21	23
6-xlii	28	6.2-39	26	6.3-22	23
6-xliii	28	6.2-40	26	6.3-23	23
6-xliv	28	6.2-41	26	6.3-24	23
6-xlv	28	6.2-42	26	6.3-25	23
6-xlvi	28	6.2-43	26	6.3-26	23

ARKANSAS NUCLEAR ONE
Unit 2

RECORD OF REVISIONS (continued)

<u>PAGE #</u>	<u>AMENDMENT #</u>	<u>PAGE #</u>	<u>AMENDMENT #</u>	<u>PAGE #</u>	<u>AMENDMENT #</u>
CHAPTER 6 (CONT.)		CHAPTER 6 (CONT.)		CHAPTER 6 (CONT.)	
6.3-27	23	6.7-19	28		
6.3-28	23	6.7-20	28	6.7-64	28
6.3-29	23	6.7-21	28	6.7-65	28
6.3-30	23	6.7-22	28	6.7-66	28
6.3-31	23	6.7-23	28	6.7-67	28
6.3-32	23	6.7-24	28	6.7-68	28
6.3-33	23	6.7-25	28	6.7-69	28
		6.7-26	28	6.7-70	28
6.4-1	27	6.7-27	28	6.7-71	28
6.4-2	27	6.7-28	28	6.7-72	28
		6.7-29	28	6.7-73	28
6.5-1	26	6.7-30	28	6.7-74	28
6.5-2	26	6.7-31	28	6.7-75	28
6.5-3	26	6.7-32	28	6.7-76	28
6.5-4	26	6.7-33	28	6.7-77	28
6.5-5	26	6.7-34	28	6.7-78	28
6.5-6	26	6.7-35	28	6.7-79	28
6.5-7	26	6.7-36	28	6.7-80	28
		6.7-37	28	6.7-81	28
6.6-1	21	6.7-38	28	6.7-82	28
6.6-2	21	6.7-39	28	6.7-83	28
6.6-3	21	6.7-40	28	6.7-84	28
6.6-4	21	6.7-41	28	6.7-85	28
6.6-5	21	6.7-42	28	6.7-86	28
6.6-6	21	6.7-43	28	6.7-87	28
6.6-7	21	6.7-44	28	6.7-88	28
		6.7-45	28	6.7-89	28
6.7-1	28	6.7-46	28	6.7-90	28
6.7-2	28	6.7-47	28	6.7-91	28
6.7-3	28	6.7-48	28	6.7-92	28
6.7-4	28	6.7-49	28	6.7-93	28
6.7-5	28	6.7-50	28	6.7-94	28
6.7-6	28	6.7-51	28	6.7-95	28
6.7-7	28	6.7-52	28	6.7-96	28
6.7-8	28	6.7-53	28	6.7-97	28
6.7-9	28	6.7-54	28	6.7-98	28
6.7-10	28	6.7-55	28	6.7-99	28
6.7-11	28	6.7-56	28	6.7-100	28
6.7-12	28	6.7-57	28	6.7-101	28
6.7-13	28	6.7-58	28	6.7-102	28
6.7-14	28	6.7-59	28	6.7-103	28
6.7-15	28	6.7-60	28	6.7-104	28
6.7-16	28	6.7-61	28	6.7-105	28
6.7-17	28	6.7-62	28	6.7-106	28
6.7-18	28	6.7-63	28	6.7-107	28

ARKANSAS NUCLEAR ONE
Unit 2

RECORD OF REVISIONS (continued)

<u>PAGE #</u> <u>AMENDMENT #</u>	<u>PAGE #</u> <u>AMENDMENT #</u>	<u>PAGE #</u> <u>AMENDMENT #</u>
CHAPTER 6 (CONT.)	CHAPTER 6 (CONT.)	CHAPTER 6 (CONT.)
F 6.2-1 20	F 6.2-18 20	F 6.3-15A 21
F 6.2-3A 20	F 6.2-19 20	F 6.3-15B 21
F 6.2-3B 24	F 6.2-20 20	F 6.3-15C 21
F 6.2-3C 20	F 6.2-21 20	F 6.3-15D.1 21
F 6.2-3D 20	F 6.2-22 20	F 6.3-15D.2 21
F 6.2-3E 20	F 6.2-23A 20	F 6.3-15E 21
F 6.2-3F 20	F 6.2-23B 20	F 6.3-15F 21
F 6.2-3G 20	F 6.2-24 20	F 6.3-15G 21
F 6.2-3H 20	F 6.2-25 20	F 6.3-15H 21
F 6.2-3I 20	F 6.2-25A 20	F 6.3-16A 21
F 6.2-3J 20	F 6.2-25B 20	F 6.3-16B 21
F 6.2-3K 26	F 6.2-26 20	F 6.3-16C 21
F 6.2-3L 20	F 6.2-30 21	F 6.3-16D.1 21
F 6.2-3M 20	F 6.2-31 20	F 6.3-16D.2 21
F 6.2-3N 20	F 6.2-32 20	F 6.3-16E 21
F 6.2-4 20	F 6.2-33 21	F 6.3-16F 21
F 6.2-5 20	F 6.2-34 21	F 6.3-16G 21
F 6.2-8E 20		F 6.3-16H 21
F 6.2-8F 20	F 6.3-1A 20	F 6.3-16I 21
F 6.2-8G 20	F 6.3-1B 20	F 6.3-16J 21
F 6.2-8H 20	F 6.3-2 26	F 6.3-16K 21
F 6.2-9 20	F 6.3-3 20	F 6.3-16L 21
F 6.2-10 20	F 6.3-4 23	F 6.3-16M 21
F 6.2-11 20	F 6.3-5A 20	F 6.3-16N 21
F 6.2-12 20	F 6.3-12 20	F 6.3-16O 21
F 6.2-14 20	F 6.3-13 20	F 6.3-16P 21
F 6.2-15 20	F 6.3-13A 21	F 6.3-16Q 21
F 6.2-16A 20	F 6.3-13B 21	F 6.3-16R 21
F 6.2-16B 20	F 6.3-13C 21	F 6.3-17A 21
F 6.2-16C 20	F 6.3-13D.1 21	F 6.3-17B 21
F 6.2-16D 20	F 6.3-13D.2 21	F 6.3-17C 21
F 6.2-16E 20	F 6.3-13E 21	F 6.3-17D.1 21
F 6.2-16F 20	F 6.3-13F 21	F 6.3-17D.2 21
F 6.2-16G 20	F 6.3-13G 21	F 6.3-17E 21
F 6.2-16H 20	F 6.3-13H 21	F 6.3-17F 21
F 6.2-16I 20	F 6.3-14A 21	F 6.3-17G 21
F 6.2-16J 20	F 6.3-14B 21	F 6.3-17H 21
F 6.2-16K 20	F 6.3-14C 21	F 6.3-18A 20
F 6.2-16L 20	F 6.3-14D.1 21	F 6.3-20 21
F 6.2-16M 20	F 6.3-14D.2 21	F 6.3-21 20
F 6.2-16N 20	F 6.3-14E 21	F 6.3-23A 21
F 6.2-16O 20	F 6.3-14F 21	F 6.3-23B 21
F 6.2-16P 20	F 6.3-14G 21	F 6.3-23C 21
F 6.2-17 24	F 6.3-14H 21	F 6.3-23D 21
F 6.2-18 20		

ARKANSAS NUCLEAR ONE
Unit 2

RECORD OF REVISIONS (continued)

<u>PAGE #</u> <u>AMENDMENT #</u>	<u>PAGE #</u> <u>AMENDMENT #</u>	<u>PAGE #</u> <u>AMENDMENT #</u>
CHAPTER 6 (CONT.)	CHAPTER 6 (CONT.)	CHAPTER 6 (CONT.)
F 6.3-23E	21	
F 6.3-23F	21	
F 6.3-23G	21	
F 6.3-23H	21	
F 6.3-24A	21	
F 6.3-24B	21	
F 6.3-24C	21	
F 6.3-24D	21	
F 6.3-24E	21	
F 6.3-24F	21	
F 6.3-24G	21	
F 6.3-24H	21	
F 6.3-25A	21	
F 6.3-25B	21	
F 6.3-25C	21	
F 6.3-25D	21	
F 6.3-25E	21	
F 6.3-25F	21	
F 6.3-25G	21	
F 6.3-25H	21	
F 6.3-26	21	
F 6.3-27	20	
F 6.3-27A	20	
F 6.3-28	20	
F 6.3-48A	20	
F 6.3-52	20	
F 6.3-53	20	
F 6.5-1	20	

6 ENGINEERED SAFETY FEATURES

6.1 GENERAL

The design, fabrication, testing and inspection of the core, Reactor Coolant Pressure Boundary (RCPB) and their protection systems give assurance of safe and reliable operation under all anticipated normal, transient, and accident conditions. Redundant systems have been provided as an Engineered Safety Feature (ESF) for additional protection. These ESFs have been designed to provide protection during:

- A. Any size pipe break up to and including the circumferential rupture of a reactor coolant pipe (assuming unobstructed discharge from both ends); and
- B. Any steam or feedwater line break.

The simultaneous occurrence of these two events is not postulated.

The release of fission products from the containment is limited in three ways.

- A. Blocking the potential leakage paths from the containment is accomplished by:
 - 1. A steel lined concrete containment with welded piping penetrations which forms a virtually leaktight barrier preventing the escape of fission products should a Loss of Coolant Accident (LOCA) occur; and,
 - 2. Isolation of process lines by the Containment Isolation System (CIS) which imposes double barriers for each line which penetrates the containment.
- B. Reducing the fission product concentration in the containment atmosphere is accomplished by a chemically treated spray which removes elemental iodine and coolant particulates from the containment atmosphere by a scrubbing action.
- C. Reducing the containment temperature and pressure, thereby limiting the driving potential for fission product leakage, is accomplished with the Containment Spray System (CSS) and with the Containment Cooling System (CCS).

The following discusses the ESF's which accomplish the preset goals and give assurance of safe and reliable operation.

6.1.1 CONTAINMENT SYSTEM

The general purpose of the containment system is to provide a barrier confining potential releases of radioactivity from severe accidents. This is accomplished by maintaining leaktightness within specified bounds. As a design feature, the containment system is provided primarily for the protection of public health and safety.

The system consists of the containment structure, containment heat removal systems, containment air purification and cleanup systems, CIS, and the containment combustible gas control systems. Details of the containment system are given in Section 6.2.

6.1.2 SAFETY INJECTION SYSTEM

The principal design basis for the Safety Injection System (SIS), as described in General Design Criterion 35, is met. Protection for the entire spectrum of Reactor Coolant System (RCS) break sizes is provided. Separate and independent flow paths are provided (with the exception of the LPSI header) and redundancy in active components ensures that the required functions will be performed even if a single failure occurs. Separate emergency power sources are supplied to the redundant active components and separate instrument channels are used to actuate the systems.

Pumps which must operate following the Design Basis Accident (DBA) include the safety injection, containment spray, and service water pumps. The performance of the system is discussed in Section 6.3 and Chapter 15.

6.1.3 HABITABILITY SYSTEM

Environmental protection systems for the control room are designed in accordance with General Design Criterion 19 as discussed in Section 6.4. Shielding is discussed in detail in Section 12.1. Ventilation is discussed in Section 9.4.1. Fire protection is discussed in Section 9.5.1.

6.1.4 PENETRATION ROOMS VENTILATION SYSTEM

Experience has shown that containment leakage is much more likely at penetrations than through the welded liner plate. A separate ventilation system for the penetration rooms has been provided to collect any post-LOCA leakage and exhaust it through filters and radiation monitors. A detailed description is provided in Section 6.5.

6.1.5 MAIN STEAM LINE ISOLATION SYSTEM

The main steam line isolation system is designed to protect the reactor and the containment in the event of a main steam line rupture at any point inside or outside of containment. A detailed description is given in Sections 7.3.1.1.11.4 and 10.3.3.

ARKANSAS NUCLEAR ONE
UNIT 2

6.2 CONTAINMENT SYSTEMS

6.2.1 CONTAINMENT FUNCTIONAL DESIGN

6.2.1.1 Containment Structure

6.2.1.1.1 Design Basis

The containment is designed to limit the release of radioactive material to the environment as a result of normal Reactor Coolant System (RCS) leakage as well as gross leakage following a postulated accident.

The principal design criteria established for nuclear power plant licensing are given in the 10 CFR 50, Appendix A, General Design Criteria for Nuclear Power Plants. These criteria establish minimum requirements for the design and performance of reactor containment in Section V, Criteria 50 through 57. The basic criterion used for design with regard to containment functional design for pressure and temperature accommodation is Criterion 50.

In addition, the containment is designed to accommodate design basis events that result in a low pressure inside containment. The operating conditions of the containment atmosphere must be controlled so that the maximum external-to-internal pressure differential achieved during these design basis events is less than the design differential pressure.

6.2.1.1.1.1 Postulated Accidents

Limiting design basis events are postulated to determine bounding structural loads on the containment structure. The events that were evaluated which result in high pressure inside containment were loss of coolant accidents (LOCA), main steam line breaks (MSLB), and events that result in low pressure inside containment such as inadvertent actuation of the containment heat removal system.

For the containment maximum pressure analysis, it is assumed that each postulated accident is concurrent with the most limiting single active failure in systems required to mitigate the effects of the accident. Under postulated simultaneous occurrences, such as a seismic event or local pipe break, effects are not explicitly evaluated in these sections except as they might affect the mass and energy release to containment. Containment response analyses of RCS pipe ruptures assume the loss of off-site power. Containment response analyses of main steam line ruptures assume that off-site power is available. The postulated accidents considered in the design of the containment include a spectrum of RCS pipe ruptures and main steam system pipe ruptures. The postulated RCS pipe ruptures are evaluated from an initial power level of 102% since that condition results in the maximum mass and energy addition to the containment. Since the secondary side inventory varies inversely with power level, the postulated secondary side breaks are evaluated for a spectrum of initial powers to ensure that the limiting initial condition is considered. The most severe accident is defined as the containment Design Basis Accident (DBA) which will also be used to develop the Environment Qualification (EQ) profile.

The original containment pressure/temperature analyses were performed for a spectrum of RCS and main steam line breaks (MSLB) to determine which break produced the highest containment pressure. RCS hot leg, pump suction and pump discharge pipe breaks ranging in size from 19.24 ft² to 0.5 ft² were analyzed. Main steam line pipe breaks ranging in size from 6.3 ft² to 1.575 ft² with power levels from 0 MWt to 2900 MWt were also analyzed. The FSAR

ARKANSAS NUCLEAR ONE
UNIT 2

presents the original spectrum of breaks considered. The break spectrum analysis demonstrated that the 9.82 ft² slot break in the RCS pump suction piping produced the highest containment pressure peak. This break was designated the containment design basis accident.

For the subsequent power uprate and replacement steam generator project the limiting accidents were again evaluated to determine the impact on peak containment pressure. For these evaluations the limiting events were evaluated for LOCA and MSLB events. For LOCA, a slot break with an area equivalent to a double-ended guillotine break was considered for the hot leg, pump suction, and pump discharge locations. For MSLB, the limiting break size for all cases except 0% power was a double-ended break of the main steam line. This limit is due to the design of the SG flow limiting venturi preventing entrainment at the higher power levels. For 0% power the break size was reduced until no entrainment occurred.

For the containment minimum pressure analysis, no systems are actuated to mitigate the event. The severity of the event is controlled by the allowed containment atmosphere conditions during plant operation and the performance of the containment heat removal system.

6.2.1.1.2 Acceptance Criteria

Analyses were performed to demonstrate that the plant configuration meets all applicable criteria.

For events that result in high pressure inside containment, the following criteria are used to judge the acceptability of these analyses:

- the maximum post-accident containment pressure shall be less than design pressure,
- the maximum post-accident containment liner temperature shall be less than design temperature, and
- the containment heat removal system shall reduce the post-accident containment pressure and temperature to an acceptably low level following an accident.

For events that result in low pressure inside containment, the maximum external-to-internal pressure difference shall be less than the design limit.

6.2.1.1.2.1 System Design

The design of the containment is based upon the mass and energy absorption capacity of the volume contained within the structure, the operation of the containment spray systems, and the containment heat removal systems (CHRS). Sections 3.8.1 and 3.8.3 describe the design of the steel-lined containment structure. The principal design parameters for the containment are given in Table 6.2-7.

6.2.1.1.3 Design Evaluation

The adequacy of the containment design is demonstrated in this section by determining the containment response to design basis events that result in high pressure inside containment and to design basis events that result in low pressure inside containment.

The following is a description of the general plant response to these events.

ARKANSAS NUCLEAR ONE UNIT 2

Events that Result in High Containment Pressure

The events that result in high containment pressure exert an outward pressure loading on the containment structure, as well as create an environment inside the containment that places a thermal load on the containment liner and challenges the environmental qualification of equipment inside the containment.

Analyses were also performed to determine the minimum post-LOCA containment pressure response. These analyses fulfill the 10CFR50.46 Appendix K requirement that the containment pressure used in the evaluation of ECCS performance not exceed a pressure calculated conservatively for that purpose. These analyses are summarized in Section 6.2.1.1.3.4.

Experience has shown that the conditions resulting from postulated LOCAs and MSLBs are limiting with regard to structural loading on the containment structure and environmental qualification of equipment inside containment. Additionally, previous analyses have shown that for LOCA the largest pipe breaks bound smaller breaks in the evaluation of maximum containment pressure. Historical information regarding previous design evaluations can be found in the FSAR.

Condensation of steam on the structures inside containment plays a major role in limiting the containment pressure increase. In addition, automatic reactor protective system (RPS) and engineered safety feature (ESF) actuations are taken in response to MSLBs and LOCAs inside containment. The following is an overview of these automatic actions:

When containment pressure exceeds the containment pressure high (CPH) setpoint, the following automatic signals are initiated:

- Reactor trip
- Safety Injection Actuation Signal (SIAS) – adds borated water to the reactor coolant system (RCS)
- Containment Isolation Actuation Signal (CIAS) – isolated non-essential lines penetrating the containment.
- Containment Cooling Actuation Signal (CCAS) – reduces containment pressure and temperature by means of containment atmosphere air coolers.

When containment pressure exceeds the Containment Pressure High-High (CPHH) setpoint, the following automatic actuation signal is initiated:

- Containment Spray Actuation Signal (CSAS) – reduces containment pressure and temperature by spraying cold borated water into the containment. Additionally, this signal initiates isolation of the Main Steam and Feedwater Systems allowing the affected steam generator to boil dry.

Safety injection systems and containment spray systems initially take suction from the refueling water tank (RWT). When the water level in the RWT reaches a certain elevation, the recirculation actuation signal (RAS) is generated and the source of water for the high-pressure safety injection (HPSI) pumps and the containment spray (CS) pumps transfers to the sump. In addition, service water flow is directed to the shutdown cooling heat exchangers to provide cooling to the containment spray water.

ARKANSAS NUCLEAR ONE
UNIT 2

Events That Result in Low Containment Pressure

There are events that result in a sudden pressure reduction inside containment (e.g., inadvertent actuation of the containment spray system). These events result in an inward loading on the containment structure. The design basis event for containment external pressure design has been determined to be the inadvertent actuation of the containment spray system. This analysis is described in Section 6.2.1.1.3.3.

6.2.1.1.3.1 LOCA Maximum Pressure Containment Analysis

The LOCA containment analysis is performed in two parts. The CEFLASH-4A and FLOOD3 computer codes calculated the mass and energy discharged from the RCS into the containment. This information was then used to determine the containment response using the COPATTA computer code. This subsection provides an overview of the analyses and a summary of the important results.

6.2.1.1.3.1.1 Mass and Energy Analysis

6.2.1.1.3.1.1.1 Methodology

In order to predict the peak containment pressure following an accident, energy sources are determined by the reactor manufacturer in the calculations of energy and mass release during postulated pipe break events.

The analytical simulation of the LOCA event is initiated from 102% power and is characterized by four distinct phases: blowdown, reflood, post-reflood, and long term cooldown. These phases, and the methodology used to analyze them, are described below.

Blowdown Phase

In the blowdown analysis, the following energy sources were considered: reactor coolant, safety injection water, core power transient and decay energy, core-to-coolant, primary metal-to-coolant, and steam generator forward and reverse heat transfer.

The LOCA causes a rapid depressurization of the RCS, which quickly falls below the shut-off heads of the HPSI and LPSI pumps. The safety injection pumps are the primary source of core cooling for the majority of the event and will start in response to either an SIAS or CPH or low pressurizer pressure signal. Once RCS pressure decreases below the pressure in the Safety Injection Tanks (SITs), the SIT check valves will open and SIT water will be discharged into the RCS.

This phase of the LOCA is simulated with the CEFLASH-4A computer code, Reference 9. The following assumptions were made in selecting input data for the code:

1. The model for fuel clad swelling and rupture was not used. The lack of clad swelling and rupture results in more fuel stored energy being transferred to the RCS coolant.
2. RCS volume was conservatively calculated based on the expansion of the reactor loop from cold to hot operating conditions.

ARKANSAS NUCLEAR ONE
UNIT 2

3. The time-dependent main feedwater addition was used to account for the hot feedwater added to the steam generators (SGs). This results in more energy on the secondary side of the SGs that must be transferred to the containment.
4. Since the containment mass and energy release does not require the radial detail to track the stored energy in the hot assembly, a core nodalization of 1 radial region and 5 axial regions is used. In solving the conduction equation, the fuel rod is divided into 9 sub-regions (7 for the fuel pellet, one for the pellet-cladding gap, and one for the cladding). The energy transfer regime at the rod surface conditions. All heat transfer regimes are permitted and are selected on a dynamic basis. Hence, the code varies the fuel/clad related properties as a function of localized conditions.
5. Core stored energy is based on average pellet and clad temperatures computed at core average linear heat rates combined with specific heat and summed for the core average stored energy component from the fuel rods.
6. FATES (Reference 10) information provided for input to CEFLASH-4A consists of maximum fuel centerline temperature as a function of linear heat rate (kw/ft) at up to 20 axial positions. The FATES related information is translated into five axial nodes for input to CEFLASH-4A.
7. The CEFLASH-4A code allows for only one wall per node in the metal-to-coolant heat transfer model. A lumped parameter wall heat model is employed which takes a weighted average of the thermal conductors in each node.
8. The CEFLASH-4A wall representation uses total heat capacitance of all the walls in the RCS which actually face the given node being modeled. This tends to keep the single-wall-model temperature elevated which conservatively maximizes the thermal driving force for wall-to-coolant heat transfer for all the walls actually in the RCS when they are represented by a single wall model.
9. The core-to-coolant heat transfer model considers extended nucleate boiling in the core. The Thom Nucleate Boiling correlation was used when the core surface is exposed to primary coolant. When nucleate boiling can no longer be supported, CEFLASH-4A considers a variety of transitional boiling or convective heat transfer correlation, depending on the localized conditions.
10. Heat Transfer across the steam generator tubes is modeled with the same heat transfer coefficient in both the forward and reverse directions.
11. Emergency feedwater flow is conservatively omitted since it would cool the secondary sides.

Reflood and Post-Reflood Phases for Cold Leg Breaks

Following the initial blowdown, the reactor is first refilled by the incoming safety injection flow, including SITs, and then reflooded as the core becomes quenched. The effect of the SGs on the mass and energy to containment is important for cold leg breaks after blowdown because the exiting steam passes through the SGs prior to exiting the RCS to the containment.

ARKANSAS NUCLEAR ONE
UNIT 2

The next phase of the transient simulation is the reflood phase, which is defined as the time period during which the coolant accumulating in the reactor vessel increases from the bottom of the active core to two feet below the top of the active core. At this point, the core is considered to be quenched and the entrainment reduces significantly.

The reflood and post-reflood phases of the LOCA are simulated using the NRC-approved FLOODMOD2 methodology, Reference 84. The FLOOD3 computer code, Reference 86 is used to implement this methodology. The important features implemented by the FLOOD3 code for this analysis are summarized below.

1. Intact and broken loops were treated individually.
2. Specific volumes of the fluids in the primary loop were varied with time.
3. A uniform methodology for both Reflood and Post-Reflood time frames was used.
4. A rigorous heat transfer scheme was used for treating the transfer of energy from the loop and steam generator walls to the fluid in the primary loop.
5. Containment backpressure was bounded conservatively.
6. Safety injection flow rates were computed explicitly.
7. The fluid in the vessel was heated mechanistically.
8. SIT and safety injection enthalpies were input separately.
9. Frothing analysis was performed internally.
10. Nominal RCS pressure drops are used and corrected accordingly for two-phase flow.

The decay heat modeled in FLOOD3 was representative of the ANSI/ANS 5.1-1979 $+2\sigma$ decay heat standard.

During the reflood and post-reflood phases, liquid entrainment in the exiting steam flow is calculated based on a carryout rate fraction (CRF), which is defined as the ratio of the mass flow rate out of the core to the mass flow rate into the core. The CRF varies as the coolant accumulates in the core during reflood. Specifically, the CRF is 0.05 until the core level reaches 1.5 ft. above the bottom of the active core. As the core level increases from 1.5 ft. to 2 ft., the CRF increases linearly from 0.05 to 0.80. The CRF is then held constant (0.80) until the core level increases to an elevation corresponding to 2 ft. below the top of the active core. Test data indicate that the CRF decreases significantly as the core level raises further to the top of the core. The methodology models a step decrease in the CRF to the value of 0.05 after the core level increases above the elevation corresponding to 2 ft. below the top of the active core.

Reflood steam release to the containment was considered to start immediately at the end of blowdown; that is, the reactor vessel lower plenum refill time was not considered. Full operation of the safety injection was considered; that is, all tanks and pumps were operable except for the EDG failure cases where only one safety injection train was considered operable. This maximizes the core flooding rate and hence the rate of steam release to the containment. For discharge leg breaks, one of the four safety injection legs was considered for spillage; for suction leg breaks no spillage was considered.

ARKANSAS NUCLEAR ONE UNIT 2

Although test data indicate that significant condensation of steam occurs at the safety injection location, the model accounts for only 50% condensation during the interval that the SITs are injecting and the annulus is predicted to be full. No credit was taken for condensation at the safety injection locations at other times.

During the post-reflood phase, the energy in the RCS and SGs was transferred to containment via the exiting break flow. The end of the post-reflood phase occurs when the RCS and SG inventory and heat structures have cooled to the point that the generation of steam is dominated by fission product decay heat.

Reflood and Post-Reflood Phases for Hot Leg Breaks

For the hot leg break, the mass and energy analysis ends at the end of the blowdown phase. Since there is no viable means for the exiting break flow to pass through the SGs prior to exiting the RCS to containment for a hot leg break, the reflood and post-reflood phases are not simulated.

Long-Term Cooling Phase

The long-term cooling phase of the LOCA completes the transient simulation of this event. In this phase, the analysis accounts for all residual energy in the primary and secondary systems and decay heat. This analysis is typically run until the containment temperature returns to its initial value.

Except as noted below, the mass and energy calculation and the containment response calculation are done in parallel using the COPATTA containment code.

The CONTRANS code, Reference 87, was used to calculate the heat addition from the reactor vessel, fuel, and internals. CONTRANS was also used to calculate the heat addition from the RCS loop and SGs starting from the primary fluid temperature at the end of post-reflood period for cold leg breaks. Residual energy was modeled as follows:

- Commencing with the end of blowdown, the residual energy associated with the pressurizer was added directly to the containment atmosphere.
- Commencing with the end of the post-reflood phase, the residual stored energy associated with the RCS loop and the SG was added directly to the containment atmosphere.
- Commencing with the end of the post-reflood phase, the residual energy associated with the reactor vessel upper head and its miscellaneous internal hardware was added directly to the containment atmosphere.

The resulting time dependent energy addition was used as an input to the COPATTA calculation and added to the reactor vessel or directly to the containment atmosphere. In this manner, all sources of energy were explicitly modeled.

The decay heat input to COPATTA during the long-term cooldown phase was based on Branch Technical Position (BTP) ASB 9-2. The normalized reactor power as a function of time for the entire transient is shown in Figure 6.2-11.

ARKANSAS NUCLEAR ONE
UNIT 2

6.2.1.1.3.1.1.2 Limiting Mass and Energy Data

Mass and energy release data were determined for double-ended slot breaks in three locations (hot leg, reactor coolant pump suction, and reactor coolant pump discharge) and two types of single failures (failure of one EDG and failure of one of the containment heat removal systems). All six cases assumed loss of off-site power at the time of the event. Table 6.2-8A provides the major assumptions for the mass and energy analysis.

The SIS is assumed to operate in its maximum heat removal mode for all RCS breaks where an EDG failure is not considered. Under this condition, the CHRS is assumed to take the most restrictive single failure. The most restrictive failure in the CHRS has been determined to be the loss of one containment spray train. For cases where the failure of an EDG is considered, the SIS and CHRS operate with a single train (one containment air cooler train, one containment spray train, and one SIS train).

Table 6.2-8B provides the mass and energy data for the limiting event (a double-ended discharge leg break with failure of one EDG). Table 6.2-8C shows the mass and energy distribution at the end of blowdown and the end of post reflood. This table also verifies that the mass and energy released from the RCS equals the mass and energy transferred to the containment.

6.2.1.1.3.1.2 Containment Response Analysis

6.2.1.1.3.1.2.1 Methodology

The mass and energy release data was used by the COPATTA computer code, Reference 88, to calculate the containment pressure and temperature response.

The containment parameters such as the design pressure and temperature, the net free internal volume and the containment surface areas are given in Tables 6.2-7, 6.2-8D, and 6.2-8E. As an additional conservatism, the volume occupied by the reactor coolant prior to the LOCA was included as occupied volume rather than free volume.

The ESF performance parameters and initial conditions within the containment are provided in Table 6.2-8F. These parameters were used in the COPATTA analysis. An overview of the COPATTA methodology is provided below.

COPATTA modeled the containment as three regions – one region modeled the containment atmosphere, another region modeled the containment sump, and the third region modeled the reactor vessel. Conditions in the atmosphere and the sump were determined by solving the conservation of energy and mass equations for each region.

The mass added to the containment from the break separates into a steam phase, which was added to the atmosphere region, and a liquid phase, which was added to the sump region. The water phase was assumed to be at the saturation temperature corresponding to the total containment pressure, while the steam phase was assumed to be at the partial pressure of the steam in the containment atmosphere. Thermal equilibrium between the air and steam in the containment atmosphere was assumed.

ARKANSAS NUCLEAR ONE
UNIT 2

Condensation of steam on the structural heat sinks occurred at the saturation temperature corresponding to the partial pressure of the steam phase. All condensate created in a particular time step was transferred immediately from the atmosphere to the sump, unless the steam in the atmosphere was superheated. During atmospheric superheat conditions, a maximum of 8% of the condensate was assumed to remain in the vapor region (i.e., be re-vaporized) rather than be transferred directly to the sump.

The various structures in the containment were modeled to interact with the containment atmosphere and the sump. The rate of heat transfer between the containment heat structures and the containment regions was determined by the surface area, the surface temperature, the heat transfer coefficient, the physical arrangement of the conducting masses, and the thermal properties of these masses. The heat transfer coefficient used during the turbulent blowdown phase of the event was determined using a modified Tagami correlation, References 74 and 75. After the blowdown phase, the heat transfer coefficient transitioned from the modified Tagami correlation to the Uchida correlation, Reference 76. With the exception of mass and energy transfer due to a boiling sump, heat transfer between the water in the sump and the containment atmosphere was not modeled.

The containment heat sink data specified for the heat transfer calculations during the LOCA are given in Tables 6.2-8D and 6.2-8E. Table 6.2-8D lists the geometric configuration of the heat sinks, including materials, thicknesses, and surface areas for concrete, steel, and steel-lined structures, and lengths for piping. The carbon steel surfaces are assumed to be covered with a mild thickness of appropriate protective coating. Conservatively determined thermodynamic properties and heat transfer coefficients used in the analyses are given in Table 6.2-8E. These data plus the geometric data completely specify the necessary heat sink parameters for the calculation of energy transfer to and within the structures of the containment during a LOCA.

An analysis has been performed to determine the effects of interface resistance at the containment liner to concrete interface on the heat transfer into the heat sinks. Experimental values of interface conductance vary from 100,000 Btu/hr-ft²-°F for joints prepared under laboratory conditions to 10 Btu/hr-ft²-°F for joints with extremely poor contact in a vacuum (References 12, 39, 40, 41, 44, 47, 48, and 68). Based on these data, a conductance of 100 Btu/hr-ft²-°F represents a conservatively low value for an interface in poor contact in air and therefore is suitable for modeling the concrete containment liner interface. Analysis has shown that by introducing an interface conductance of 100 Btu/hr-ft²-°F on all lined concrete heat sinks instead of assuming perfect contact, the peak containment pressure increases less than one percent. This is considered an unrealistic assumption because of the heat transfer to the concrete from the liner plate. The concrete is poured directly against the liner plate, so they should be bonded together over much of the surface. Liner plate anchors (continuous angles 15 inches on centers) will hold the plate in close contact, if it is not bonded, and prestressing the containment structure will put the liner plate in compression, further assuring intimate contact with the concrete. After a LOCA, the compression in the liner plate is further increased due to the elevated temperature in the plate. An interface conductance of 100 Btu/hr-ft²-°F was assumed for the DBA pressure transient analysis.

The containment atmosphere air cooler units, which are cooled by service water, remove energy from the vapor region of the containment. COPATTA determined the heat removal due to air cooler unit operation as a function of containment saturation temperature. The relationship of containment temperature versus cooler capacity is consistent with the manufacturer's performance data, see Figure 6.2-3A.

ARKANSAS NUCLEAR ONE
UNIT 2

The containment spray system removes energy from the atmosphere by injecting water into the atmosphere. The energy removed from the atmosphere is a function of the heatup of the spray droplets. COPATTA determined the heatup of the droplets from a spray efficiency relationship, which was a function of the ratio of steam mass to air mass. This relationship was developed in Reference 74 assuming a mean spray droplet diameter and fall distance of 1,000 microns and 20 ft. respectively (actual fall distance is more than 100 ft.). The heat removed from the atmosphere due to heating of the spray droplets and any condensate due to this cooling was added to the water in the sump.

COPATTA used the input from CONTRANS for the reactor vessel region to include the effects of heat transfer from the energy stored in the primary and secondary metal. This region was used only during the long-term cooldown phase – not during the initial mass and energy release phases (blowdown, reflood, and post-reflood) when the primary coolant system pressure is not in equilibrium with the containment atmosphere.

6.2.1.1.3.1.2.2 Analysis Results for Limiting Case

A series of cases were analyzed to determine the limiting break location and single failure combination. These analyses made use of the containment initial conditions and containment heat removal system performance described in Table 6.2-8F. Table 6.2-8G provides the results of those analyses. The limiting peak pressure was 57.6 psig, which occurred for a double-ended slot break at the discharge of the reactor coolant pump with the single failure of an emergency diesel generator. For the case above, the peak temperature was 285 °F. The maximum pressure is less than the maximum design pressure and the maximum temperature does not challenge the maximum design temperature of the containment structure. In addition to the limiting cases evaluated, runs were made to evaluate Limiting Conditions for Operation (LCO) action statements in the Technical Specifications. Table 6.2-8J documents the breaks evaluated.

Due to the limiting nature of a LOCA it is a more severe accident for design of containment than the MSLB. This is due to the larger release of mass and energy to the containment. Although the short term peak temperature is higher for MSLB the long term impact of the increased mass and energy release is a greater challenge to the containment. As such the DBA is defined as the most limiting LOCA, the Double Ended Discharge Leg Slot break (DEDLS).

Table 6.2-8H provides the sequence of events for the DBA and Figure 6.2-8E shows the transient pressure response. Figure 6.2-8F shows the transient atmosphere and sump temperatures for the DBA. Figures 6.2-8E and 6.2-8F also demonstrate that containment heat removal systems are sized adequately to reduce containment pressure and temperature to a low level following the accident and maintain this low level thereafter. The containment wall liner plate temperature peaks at 271 °F at 313 seconds. The containment wall temperature distribution is illustrated in Figure 6.2-8G.

6.2.1.1.3.2 Main Steam Line Break Maximum Pressure Containment Analysis

Similar to the LOCA, a MSLB inside containment is characterized by the rapid blowdown of steam into the containment due to the rupture in a main steam line. The location of this break is postulated to be at one of the SG outlet nozzles. The steam generator contains an integral flow restricting nozzle which effectively limits the break size to the venturi area or 1.9 ft². A full guillotine break was considered for all power levels except 0%, due to the venturi preventing entrainment from occurring for the higher power levels. For the limiting case at 0% power the

ARKANSAS NUCLEAR ONE UNIT 2

effective break size was reduced so that no entrainment occurred. The general response of the containment, the reactor protection system, and the engineered safety features to main steam line breaks is discussed in Section 6.2.1.1.3. The following discussion augments that discussion as it applies to MSLB events:

- Until the Main Steam Isolation Valves (MSIVs) close, the initial portion of the transient is characterized by the blowdown of both SGs. In this early phase of the event, steam continues to flow to the turbine. Following the reactor trip, which occurs on a CPH signal, the turbine stop valves close. During this portion of the transient, the main feedwater continues to feed the SGs with the main feedwater pumps and main feedwater water regulating valves at their initial speed and position.
- When the containment pressure exceeds the CPHH setpoint, CSAS occurs and initiates closure of the MSIVs, the Main Feedwater Isolation Valves (MFIVs), and the Backup MFIVs along with spray initiation. It also trips the main feedwater, condensate, and heater drain pumps.
- Following the closure of the MSIVs, the flow of steam to the containment from the intact SG and isolated steam line cease. Although the intact SG repressurizes due to heat transfer from the RCS and eventually becomes an energy source, its affect on the containment response is small after the MSIVs close.
- The contribution of main feedwater flow is reduced significantly when the pumps trip off on the CSAS signal.
- The 0% power cases assume that feedwater flow to the steam generators is from the AFW system at the initiation of the steam line break. Once the transient starts, flow to the intact steam generator is diverted to the ruptured steam generator.

Similar to the LOCA, the MSLB containment analysis is performed in two parts. The SGNIII computer code was used to determine the mass and energy discharged into containment. These data were used to determine the containment response using the COPATTA computer code. This subsection provides an overview of the analyses and a summary of the important results.

6.2.1.1.3.2.1 Mass and Energy Analysis

6.2.1.1.3.2.1.1 Methodology

The SGNIII computer code, Reference 90, was used to determine the mass and energy data. SGNIII is a coupled primary and secondary model that calculates a time dependent mass and energy release.

The RELAP5 MOD3 code, Reference 91, was used to calculate the contribution of main feedwater, including flashing, to the affected and intact SGs. The code simulated the main feedwater trains including the main feedwater, condensate, and heater drain pumps, various valves and feedwater heaters. No credit was taken for closure of the main feedwater regulating valves. The primary inputs to the RELAP5 MOD3 code were the transient pressures of the intact and affected SGs. The time dependent RELAP5 MOD3 outputs of feedwater flowrate and its associated enthalpy (to each SG) were input directly to SGNIII.

ARKANSAS NUCLEAR ONE
UNIT 2

The backup valves were built to the same code class as the piping in which they are installed (B31.1) but they have seismically qualified, Class 1E operators. Material traceability was required for the valve bodies. The valve actuation time is 18.5 seconds or less and they are located immediately upstream of the MFIVs. This assures that their performance meets or exceeds that of the existing valves which close within 25 seconds. The backup valves were installed during the first refueling outage. Annunciator alarms were added to notify operations should either backup valves' breaker open. See the FSAR analysis for additional details with respect to the reason for adding these valves.

While the mass and energy release analysis was conducted separately from the containment response analysis, the COPATTA containment code was used to predict the times for the containment pressure to reach the CPH and CPHH setpoints.

6.2.1.1.3.2.1.2 Limiting Mass and Energy Data

Mass and energy data were generated for a number of initial power levels and single failure combinations to determine the limiting condition. Except for the cases initiated from 0% power, a single break size was analyzed (guillotine break downstream of the SG nozzle). Due to the flow-limiting device in the outlet nozzle, this break size produced a break flow with no entrainment, which is the limiting condition for containment analysis. For cases initiated from 0% power, it was necessary to reduce the break size to achieve no entrainment.

Off-site power was assumed to be available throughout the transient for all cases analyzed. Although the loss of off-site power delays the actuation of containment heat removal systems, the influence of running RCPs on transferring RCS energy to the affected steam generator is a more dominant effect. The FSAR analysis contains a comparison of a loss of off-site power to an off-site power available case.

There are several trade-offs in determining the limiting initial conditions with regard to the power level versus inventory and feedwater flow inputs. As initial power level increases, RCS temperature and core decay heat increase resulting in more primary to secondary energy being present to boil-off the SG inventory. Main feedwater flowrate and enthalpy increase accordingly. However, initial SG inventory decreases with increasing initial core power. Therefore, the MSLB analysis included an evaluation of multiple power levels. The mass and energy sensitivity study included six power levels (102%, 94.8%, 75%, 50%, 25%, and 0% power).

Active component failures in the main feedwater and CHR systems were considered. Single active failures include the MFW or condensate pumps resulting in a failure to trip, MFIV or Backup MFIV failure to isolate, or containment spray or containment cooler failures. The single failure modes of the main and emergency feedwater systems are described in Tables 10.3-4 and 10.4-11, respectively.

The limiting case was determined to be a containment spray train failure for a MSLB initiated at 0% power. Table 6.2-9A provides the assumptions for the mass and energy analysis.

Table 6.2-9B provides the mass and energy data for the limiting event (a slot rupture of the main steam line initiated at 0% power with the failure of one containment spray train).

ARKANSAS NUCLEAR ONE
UNIT 2

6.2.1.1.3.2.2 Containment Response Analysis

6.2.1.1.3.2.2.1 Methodology

The mass and energy release data from SGNIII was used by the COPATTA computer code to calculate the containment pressure and temperature. The program model description and thermodynamic assumptions are nearly identical to that used for the LOCA maximum containment pressure analysis, which is described in Section 6.2.1.1.3.1.2.1. The primary differences between the LOCA and MSLB containment response analyses are:

- the reactor vessel region model is not employed in the MSLB analysis,
- the Uchida correlation is used for the heat transfer coefficient to the structural heat sinks in the MSLB, rather than the modified Tagami correlation, and
- ESF performance parameters (provided in Table 6.2-9A).

The containment parameters such as design pressure and temperature, the net free volume, and the containment surface areas are the same as those used for the LOCA maximum containment pressure analysis, which are described in Tables 6.2-7, 6.2-8D, and 6.2-8E. The containment initial conditions and containment heat removal system performance used are provided in Table 6.2-9A.

6.2.1.1.3.2.2.2 Analysis Results for Limiting Cases

Mass and energy data for various power levels and single failures were analyzed to determine the limiting case. Table 6.2-9C provides the summary of those cases and the maximum containment pressure and temperature. The limiting peak pressure was 57.4 psig for a slot break initiated from 0% power with the failure of one containment spray train with the corresponding peak containment temperature of 392 °F. The limiting peak pressure is less than the maximum design pressure of 59 psig. In addition to the limiting cases evaluated, an additional run was made to evaluate an allowable Limiting Condition for Operation in the Technical Specifications.

Table 6.2-9D provides a sequence of events and Figure 6.2-8H shows the transient pressure and temperature response for the limiting peak pressure case. Note that the containment atmosphere temperature is reduced very rapidly by the injection of containment spray. Since the containment structure is initially subcooled, steam will condense on its surface at a temperature that is governed by the partial pressure of the steam.

The condensing heat transfer correlation used in main steam line break analysis is the Uchida correlation described in References 88 and 76. For the time periods where condensing heat transfer is used, water is condensed on the heat sink and transferred directly to the sump at the temperature corresponding to the partial pressure of the steam phase, unless the steam in the atmosphere was superheated. During atmospheric superheat conditions, a maximum of 8% of the condensate was assumed to remain in the vapor region (i.e., be re-vaporized) rather than be transferred directly to the sump.

The design temperature for the containment liner is 300 °F. The qualification temperatures for safety-related equipment are provided in Section 3.11.

ARKANSAS NUCLEAR ONE
UNIT 2

The COPATTA code predicts vapor temperatures in excess of 300 °F for the initial minutes following pipe breaks that result in accidents with high blowdown enthalpy and hence high containment vapor superheat. This is primarily due to the conservative COPATTA code assumption that most (92%) steam condensed from the atmosphere during any calculational time interval is added to the sump liquid immediately at the end of the interval, and is not available to absorb additional heat from the superheated steam in the containment atmosphere.

Since condensation is a much more efficient heat transfer process than free convection for these conditions, it dominates the heat transfer between the containment vapor and structures. For conditions when the containment vapor is highly superheated the surfaces of the containment structures rapidly heat up to the saturation temperature corresponding to the partial pressure of steam in the vapor and follow the containment saturation temperature through the balance of the steam line blowdown period. Following the end of blowdown or the actuation of sprays, whichever occurs first, the containment vapor region rapidly de-superheats to the saturation conditions.

This has been demonstrated in Reference 69 where typical safety-related equipment were modeled as heat sinks in the containment using the COPATTA code and a similar main steam line break was analyzed. Heat transfer coefficients and spray start times were varied to determine their effects on equipment surface temperature.

The results of this study demonstrated that the equipment surface temperatures remained at or near the containment saturation temperature for the cases considered. The peak vapor region temperature obtained in these studies was 425 °F while the peak equipment temperature obtained was 255 °F which corresponds to the containment saturation temperature. The conclusion of this study was that the case which provided the highest containment steam pressure and hence the highest saturation temperature provides the design basis for containment temperature qualification.

6.2.1.1.3.3 Maximum Containment External-to-Internal Pressure Differential

The maximum external pressure loading on the containment has been evaluated assuming that the containment is subjected to an inadvertent actuation of the containment spray system. The pressure differential from outside to inside of the containment has been calculated assuming an inadvertent initiation of the containment spray system with 40 °F water.

Initial pressure, temperature, and relative humidity were varied to determine the conditions which would produce a maximum pressure differential across the containment wall of 5.0 psi. The resulting limits on initial pressure and relative humidity are reflected in the Technical Specifications. As noted in Section 3.8.1.3.1, the containment was checked for an external to internal load of 5.0 psi.

6.2.1.1.3.4 Minimum Containment Pressure Analysis for ECCS Performance Analysis

6.2.1.1.3.4.1 Introduction and Summary

Appendix K to 10 CFR 50 (Reference 31) lists the required and acceptable features of Emergency Core Cooling System (ECCS) evaluation models. Included in the list is the requirement that the containment pressure used in the evaluation of ECCS performance not exceed a pressure calculated conservatively for that purpose. This section presents the analysis that determined the minimum containment pressure that is used in the ANO-2 large break LOCA ECCS performance analysis presented in Section 6.3.3.2.

ARKANSAS NUCLEAR ONE
UNIT 2

6.2.1.1.3.4.2 Method of Calculation

The calculations reported in this section used the 1999 EM Version of Westinghouse's NRC-accepted large break LOCA evaluation model for Combustion Engineering-designed PWRs (Reference 6, Supplement 4-P-A). In the evaluation model, the CEFLASH-4A computer program (Reference 9) determines the mass and energy released to the containment during the blowdown phase of the postulated LOCA. The COMPERC-II computer program (Reference 11) determines both the mass and energy released to the containment during the refill/reflood phase of the LOCA and the minimum containment pressure response used in the ECCS performance analysis.

6.2.1.1.3.4.3 Input Parameters

The input for the minimum containment pressure analysis for ANO-2 presented herein is consistent with the input used in the large break LOCA ECCS performance analysis of Section 6.3.3.2 which used the results of this section.

6.2.1.1.3.4.4 Mass and Energy Release Data

The mass and energy released to the containment for the limiting large break LOCA, the 0.4 DEG/PD break (Double Ended Guillotine break in Pump Discharge), are listed as a function of time in Table 6.2-34. The quantity of safety injection fluid that spills from the break is discussed in Section 6.2.1.1.3.4.8.

6.2.1.1.3.4.5 Initial Containment Internal Conditions

The initial containment internal conditions used in the analysis are:

Temperature	60 °F (minimum)
Pressure	13.2 psia (minimum)
Relative Humidity	100% (maximum)

For each parameter, the conservative direction with respect to minimizing the containment pressure appears in parentheses.

6.2.1.1.3.4.6 Containment Volume

The net free containment volume used in the analysis is: 1,820,000 ft³ (maximum).

6.2.1.1.3.4.7 Active Heat Sinks

In order to conservatively maximize the heat removal capacity of the containment active heat sinks, the containment sprays and fan coolers were modeled to actuate in the shortest possible time following the LOCA and to operate at their maximum capacity.

The operating parameters used for the containment sprays are as follows:

Number of Pumps	2
Flow Rate	2515.5 gpm/pump
Actuation Time	20 sec after LOCA
Temperature	38 °F

ARKANSAS NUCLEAR ONE
UNIT 2

The operating parameters used for the fan coolers are as follows:

Number of Fan Coolers	4
Actuation Time	0 sec after LOCA
Heat Removal Capacity (per fan) vs. Containment Temperature	0 BTU/sec at 33 °F 28663 BTU/sec at 300 °F

6.2.1.1.3.4.8 Steam Water Mixing

The effect on containment pressure due to condensing containment steam with spilled ECCS water was calculated in the manner described in Section III.D.2 of Reference 6. The effective ECCS spillage rate is shown in Figure 6.2-30. The spillage rate was determined using the maximum flow rate from two high pressure and two low pressure safety injection pumps.

6.2.1.1.3.4.9 Passive Heat Sinks

The surface areas and thickness of all exposed containment passive heat sinks are listed in Table 6.2-35. The material properties used for the passive heat sinks are listed in Table 6.2-36.

For the analyses described in Section 6.2, performed to determine the peak containment pressure and temperature conditions which could be encountered under the various postulated accident conditions, a thorough review of the containment layout drawings was conducted to determine those components and structures which would serve as heat sinks, and calculations were performed to determine the exposed surface areas of these components and structures. However, since larger heat sink surface areas result in lower containment pressures and consequently, represent the more severe condition with regards to the ECCS performance analysis, the heat sink surface areas used in the ECCS performance analysis were conservatively higher than the calculated values. In determining the heat sink surface areas to be put into the ECCS performance analysis, the individual calculated areas were multiplied by a factor which ranged in value from approximately 1.1 to 1.7. For those heat sinks whose surface areas could be determined with a good deal of certainty, factors on the low end of this range were used. For example, the calculated concrete surface areas were multiplied by factors ranging from approximately 1.1 to 1.3. Due to the difficulty of assuring that all the steel sink surface areas have been accounted for, larger factors were used in determining these areas. For example, a factor of approximately 1.4 was used in determining the surface area of the polar crane, and a factor of approximately 1.6 was used in determining the surface areas of the refueling structure and restraint steel. The factors were selected to ensure that the heat sink parameters put into the ECCS performance model represent the worst case condition. Overall, the steel heat sink surface areas used in developing the ECCS performance analysis were approximately 50 percent higher than those used in developing the containment response model, and the concrete surface areas were approximately 15 percent higher.

6.2.1.1.3.4.10 Heat Transfer to Passive Heat Sinks

The condensing heat transfer coefficient between the containment atmosphere and the passive heat sinks was calculated in the manner described in Section III.D.2 and Figure III.D.2-2 of Reference 6. The variation on the condensing heat transfer coefficient used in the analysis is shown as a function of time in Figure 6.2-31. In addition, the following heat transfer coefficients were also used in the analysis:

ARKANSAS NUCLEAR ONE
UNIT 2

Containment Atmosphere to Sump Liquid	500 BTU/hr-ft ² °F
Sump Liquid to Base Slab	20 BTU/hr-ft ² °F
Containment Structure to Atmosphere	10 BTU/hr-ft ² °F

6.2.1.1.3.4.11 Results

For the limiting large break LOCA defined in Section 6.3.3.2.2.6, the 0.4 DEG/PD break, the minimum containment pressure response for use in the ECCS performance analysis is shown in Figure 6.3-16f. The responses of the containment atmosphere and containment sump temperatures are shown in Figures 6.2-33 and 6.2-34, respectively.

The containment response is used in the large break LOCA ECCS performance analysis presented in Section 6.3.3.2.

6.2.1.2 Containment Building Subcompartment Structures

6.2.1.2.1 Design Basis

The design basis for the containment subcompartments is provided in Section 3.6.

6.2.1.2.2 System Design

The design of the reactor and steam generator subcompartments considers applicable thermal, static, seismic, impingement force, and pressure loadings during a LOCA as described in Section 3.8.3. Subcompartment vents are provided to ensure that excessive pressure loadings are not placed upon compartment walls.

As a result of the reactor cavity seal plate modification described in Section 6.2.1.2.3.2.2, the subcompartment pressurization analyses credit the leak-before-break (LBB) methodology described in CEOG Topical Report CEN-367-A. The ability to reference the LBB topical report limits postulated ruptures of piping to branch line pipe breaks for protection against dynamic effects. The reactor cavity subcompartment does not contain any branch lines and no longer has to consider dynamic effects from such postulated ruptures. The steam generator subcompartment does contain branch lines that must be considered to rupture, but the previous analyses postulated larger pipe ruptures that remain bounding for consideration of dynamic effects. The following descriptions of subcompartment pressurization analyses for both the reactor cavity and steam generator cavities do not consider credit for the LBB methodology and are therefore bounding in light of the current licensing basis that allows the use of the LBB topical. Additional detailed analyses have not been performed for either the reactor cavity seal plate modification described in Section 6.2.1.2.3.2.3 based on the bounding nature of the following subcompartment pressurization analyses.

The consequences of pipe ruptures within containment subcompartments have been evaluated to size and select the compartment vents, design pressures, and necessary pipe restraints in order to maintain acceptable pressure transients inside the subcompartments.

ARKANSAS NUCLEAR ONE UNIT 2

Subcompartment pressure analyses were considered for the two steam generator compartments and the reactor cavity. The calculational techniques for these analyses are presented in detail in Section 6.2.1.2.3.2. The analysis described in Section 6.2.1.2.3.2 was used to establish the original design criteria for the primary and secondary shield walls that compose the reactor and steam generator cavities. A discussion of the mass and energy releases for short-term pressure analysis and the justification for selection of break location and break size are presented in Section 6.2.1.2.3.1.

The design pressures and the calculated transient differential pressure peaks of design significance and design pressures for each of the subcompartments analyzed are presented in Tables 6.2-17 and 6.2-17A respectively. Curves of pressure variation vs. time for hot and cold leg breaks in the reactor cavity, the biological shield pipe penetration, and the most restrictive steam generator cavity are given in Figures 6.2-16A through 6.2-16P. The design pressures of the biological shield pipe penetrations shown in Table 6.2-17 include the effects of localized jet impingement loads.

Subcompartments and compartment subdivisions were chosen as those larger containment volumes which are separated by significant constriction. The calculated gross vent areas were reduced by appropriate equipment blockage areas to accurately model the actual vent area. Moveable obstructions to flow such as insulation, ducts, plugs, etc., were conservatively assumed to remain intact, providing greatest flow restriction. Flow coefficients were chosen to provide conservative vent flow characteristics. In the case of significant flow restrictions, a flow coefficient representative of an orifice was used. Flow coefficients used are summarized in Table 6.2-17B.

For the reactor cavity work prior to LBB considerations, two sets of analyses were performed for each break case considered. Each of these sets is concerned with assumptions regarding the obstruction to cavity venting presented by the neutron shield. These assumptions are as follows:

1. The neutron shield remains intact throughout the transient, thereby precluding venting from the nozzle region to the middle region;
2. Portions of the neutron shield in the vicinity of the break (reference Table 6.2-17B for specific locations) are assumed to "blow-out" during the transient. The remainder of the neutron shield is assumed to stay intact throughout the transient.

Case I provides a conservative analysis for reactor vessel sideforce. Case II provides an analysis yielding conservative values for vessel overturning moments and uplift loads.

Break locations are chosen to render each case, i.e., Case I and Case II assumptions, conservative. Specifically, for the analyses employing Case I assumptions, the break location is postulated to occur in a location presenting the most restriction to vent flow out of the break compartments. Analyses employing Case II assumptions postulate the break location to be in an unsupported leg of the RCS. This provides the least restrictive path for vent flow from the break down to the middle region. Then, for each break case considered, the vessel sideforce obtained for Case I is combined with the vessel loads obtained from Case II to yield a loading combination. The results of one analysis are transported so that both sets of loads are applied to the vessel and support system as if they had been generated by a break in one location. This transportation is made so as to render the analyses performed for design of reactor vessel supports conservative.

ARKANSAS NUCLEAR ONE
UNIT 2

Calculations of compartment vent areas and volumes made for all analyses presented herein take no credit for increases in these parameters due to the assumptions regarding removal of movable obstructions, e.g., insulation.

Schematic drawings showing the nodalization of the reactor cavity and steam generator compartment and nodal net free volumes are given in Figures 6.2-3C through 6.2-3L. Table 6.2-17B tabulates flow coefficients and interconnecting flow path areas. As indicated in Figure 6.2-3C, the reactor cavity is subdivided into a total of 16 nodes: 12 in the nozzle region, three in the middle region, and one in the lower region. The 12 nodes of the nozzle region are separated by either the reactor coolant piping or the neutron shield support beams. The three nodes used to represent the middle region are separated by the reactor vessel column supports. Finally, the one node of the lower region represents the remainder of the cavity volume.

Four analyses were performed for the two breaks postulated to occur in the reactor cavity prior to LBB considerations. As discussed previously in this section, each of these analyses employs either Case I or Case II assumptions to the model illustrated in Figure 6.2-3C, locating the break in a position which will render the analyses conservative. This results in the following break locations:

	<u>Case I</u>	<u>Case II</u>
200 in ² Cold Leg Circumferential Break	Southeast Leg	Northeast Leg
100 in ² Hot Leg Circumferential Break	South Leg	South Leg

The results of these analyses are presented in Figures 6.2-16A through 6.2-16F.

The calculated transient pressure responses for each significant subcompartment analyzed, as listed in Table 6.2-17A, are below the allowable pressure values which the subcompartment walls can withstand.

The differential pressure loadings on the reactor vessel and steam generators and surrounding primary and secondary shield walls resulting from the subcompartment differential pressure transients described above are given in Table 6.2-17A.

Results of a nodalization study performed for reactor cavity modeling have been reported in previous amendments to this docket. This study showed the relative insignificant effect of increased nodalization in the nozzle region on maximum subcompartment pressures (viz. four percent increase in maximum calculated differential pressures going from six node base-case model to 12 nodes).

Although the model has evolved slightly since that time (due to finalization of design of the neutron shield support structure), the same conclusions still apply. Increasing the nodalization of the middle and lower regions is also of little consequence as these regions experience essentially the same pressure transient. (See Figures 6.2-16C and 6.2-16F.) This discussion, coupled with the discussion above pertaining to the choice of node locations, verifies the efficacy of the model described herein for calculating compartmental pressure responses.

ARKANSAS NUCLEAR ONE
UNIT 2

6.2.1.2.3 Design Evaluation

6.2.1.2.3.1 Subcompartment Differential Pressure Considerations

Differential pressure analyses were performed for the reactor cavity and the steam generator compartment prior to LBB considerations. The following spectrum of RCS pipe ruptures were considered for the reactor cavity analyses. Pipe ruptures for Unit 2 were postulated using the criteria and methods described in the Combustion Engineering topical report on pipe breaks, CENPD-168, Revision 1. The calculations described in CENPD-168, Revision 1, were performed utilizing the support and restraint characteristics of Unit 2.

- A. 100 sq. in. Hot Leg Circumferential Break
- B. 200 sq. in. Cold Leg Circumferential Break

The steam generator subcompartment analyses consider the following breaks:

- A. 5.90 sq. ft. Hot Leg Circumferential Break
- B. 5.77 sq. ft. Hot Leg Slot Break (Side)
- C. 9.82 sq. ft. Cold Leg Pump Suction Circumferential Break
- D. 3.93 sq. ft. Cold Leg Pump Suction Slot Break (Side-East Orientation)
- E. 3.93 sq. ft. Cold Leg Pump Suction Slot Break (Side-West Orientation)
- F. 9.82 sq. ft. Cold Leg Pump Discharge Circumferential Break

Mass and energy release rates for these breaks are presented in Table 6.2-17D.

For the biological shield pipe penetration compartment, the design basis pressure transients are calculated using the cold leg pump discharge and hot leg slot breaks, assuming that all of the blowdown mass and energy are released into the penetration compartment.

The pressurizer is located in the south steam generator compartment on a concrete slab. It does not have a compartment per se and thus the limiting break for design conditions are the double ended hot leg rather than the pressurizer spray or surge lines. The main steam lines are located above the secondary shield wall and thus blow down into the containment rather than into an identifiable subcompartment. No other high energy lines contain sufficient energy to create subcompartment differential pressures which are more limiting than the lines already discussed.

The differential pressure analyses for the reactor and steam generator cavities are performed according to the analysis model described in Section 6.2.1.2.3.2. The analysis described in Section 6.2.1.2.3.2 was used to establish the original design criteria for the primary and secondary shield walls that compose the reactor and steam generator cavities. A subsequent analysis (to evaluate the permanent installation of floor grating) for the steam generator cavities has been performed according to the analysis model described in Section 6.2.1.2.3.2.1. The analysis of the LOCA establishes the requirements for the internal containment design, specifying the capability to withstand the postulated ruptures and release of the reactor coolant

ARKANSAS NUCLEAR ONE UNIT 2

and associated energy sources without exceeding the design conditions. Subcompartment venting and pressure communication is used to ensure that pressure differentials developed will remain below the structural capability of the compartment walls.

Design structural loads are established with the combination of subcompartment peak differential pressure loading and jet forces calculated in accordance with Bechtel Topical Report, BN-TOP-2, Revision 2.

The theoretical mass and energy release rates that establish the design of these internal containment subcompartments were supplied by Combustion Engineering. The blowdown code used to provide mass and energy release data for the subcompartment analysis was CEFLASH-4. The CEFLASH-4 code is described in Reference 17. In CEFLASH-4, the discharge mass and energy release rate through the reactor coolant pipe break was separately determined for the subcooled and saturated critical flow regimes. Subcooled critical flow was determined from an extrapolation of Moody's results (Reference 57). The Henry/Fauske correlation for subcooled flow was not used. Critical flow during saturated (2-phase) blowdown was determined from an interpolation of tabular values of flow vs. pressure and enthalpy as determined by Moody.

A comparison of predicted break mass flow rates using a CEFLASH-4 model of the LOFT semi-scale loop for Test 823 and actual experimental break mass flow rates for Test 823 is presented in Figure III-10 of Reference 17. This figure shows that CEFLASH-4 slightly over predicted the mass and energy release rate at the break when a discharge coefficient of 0.6 was employed in the model. In order to ensure that the mass and energy release data for the Unit 2 subcompartment analysis would be conservative, a break discharge coefficient of 1.0 was used in the CEFLASH-4 model of the Unit 2 RCS.

Evaluation of the reactor vessel supports is based on a method for developing mass and energy release rates which differs from that described in the previous paragraphs. The release rates were generated from a modified version of the CEFLASH-4 computer code. One modification was made: The combination Henry-Fauske/Moody critical flow subroutine of the CEFLASH-4A computer code, described in CESSAR Section 6.2.1.1-4 was incorporated. Release rates for the reactor vessel supports analysis were obtained from this critical flow subroutine. Subcooled and low quality fluid blowdown rates were predicted by the Henry-Fauske correlation while the remainder of the 2-phase region flows was obtained from Moody. A flow discharge coefficient of 1.0 was used throughout.

Subcompartment differential pressures were calculated using the COPDA code. COPDA is described in Section 6.2.1.2.3.2. Initial conditions for each compartment were assumed to be the same as those used in the containment peak pressure analysis (see Table 6.2-8). The mass and energy release data supplied by Combustion Engineering is provided in Table 6.2-17D.

Subcompartment differential pressures were calculated using the COMPARE code to evaluate the effects of leaving floor grating installed at the top of the steam generator cavities at elevation 426' 6". The initial pressure and temperature for each compartment is assumed to be the same as those used in the containment peak pressure analysis (see Table 6.2-8). The relative humidity value for each compartment that is used in the COMPARE code analysis is conservative when compared to the same value stated in Table 6.2-8. The mass and energy release data supplied by Combustion Engineering is provided in Table 6.2-17D.

6.2.1.2.3.2 Containment Subcompartment Pressure Transient Analysis Model

Generally, the occurrence of a LOCA is postulated to result from a rupture of the RCS piping within subcompartments of the containment. A pipe rupture of this type results in the expulsion of high enthalpy water out of the ruptured pipe, flashing partly to steam. As the pressure builds up within the compartment, the steam-air-water mixture flows through openings into the main volume of the containment. The maximum differential pressure achieved between the compartments determines the design strength requirements of walls and supports between the compartments, and the forces exerted upon the RCS and containment equipment. The maximum pressure differential developed depends on the number and shape of the openings between the compartment, the volume of each compartment, and the blowdown rate from the broken pipe.

The following multi-compartment analysis technique (i.e., COPDA code) was developed to study the pressure transients in cavities and/or compartments inside and outside of the containment resulting from the depressurization of the primary coolant, steam and feedwater systems. The analysis is based on the solution of the conservation equations for mass and energy, the continuity equation and the equation of state for water.

The analysis permits the selection of the control volume and flow path configuration that results in the best representation of the pressure transients in the compartments along the flow paths from the break to the containment of the atmosphere. During each calculation-time-increment the time dependent blowdown data is added to the compartment containing the rupture. The conservation equations and the state equations for water are solved to determine the stagnation properties in the compartment. The momentum equation is then solved for each flow path to each connected compartment. The conservation and state equations are again solved to determine the compartment state conditions for the beginning of the next time increment.

The reactor vessel cavity modeling geometry depicting the nodal volumes and their boundary relationships are given in Figure 6.2-3C and 6.2-3J. Figures 3.8-13, 3.8-13a, 3.5-15, and 5.5-12 provide structural and component support details of the reactor pressure vessel cavity. The flow areas and flow coefficients used in the reactor vessel cavity analysis are given in Table 6.2-17B.I. The steam generator cavity modeling geometry depicting the nodal volumes and their boundary relationships are given in Figures 6.2-3D through 6.2-3I. Figures 3.8-13, 3.8-13a, 5.5-13, and 6.2-3K provide structural and component support details of the steam generator cavities. The flow areas and flow coefficients used in the steam generator cavity analysis are given in Table 6.2-17B.II. The biological shield wall piping penetrations nodal volumes are given in Table 6.2-17C. The flow areas and flow coefficients used in the biological shield wall analysis are given in Table 6.2-17B.III.

The procedure is repeated in sequence for each compartment except that the flow from the upstream compartments replaces the blowdown.

A. Initial Compartment Conditions

The masses of air and water as steam in the compartments are determined using the initial conditions of temperature, pressure, relative humidity and compartment volumes. The compartment specific humidity is obtained by:

$$SH = (RH)(SSH) \quad (6.2-11a)$$

ARKANSAS NUCLEAR ONE
UNIT 2

where

SH = specific humidity of compartment air, lbm steam/lbm air

RH = relative humidity of compartment, air

SSH = specific humidity of saturated air at compartment temperature, lbm steam/lbm air

The vapor pressure of the water is determined by:

$$PW = \frac{(SH)(PT)}{0.623 + SH} \quad (6.2-11b)$$

where

PW = vapor pressure of water at compartment temperature, psia

PT = total compartment pressure, psia.

The air pressure (PA) in the compartment is determined by:

$$PA = PT - PW \quad (6.2-11c)$$

The mass of air (MA) in each compartment is evaluated using the perfect gas law equation:

$$MA = \frac{144(PA)(V)}{(R/n)(T)} \quad (6.2-11d)$$

where

V = volume of compartment, cu. ft.

R = gas constant, 1545.3

T = compartment temperature, °F

n = molecular weight of air, 28.97 lbm/lb-mole

The mass of water (MS) in the compartment is:

$$MS = (MA)(SH) \quad (6.2-11e)$$

The energy of the air (UA) in each compartment (I) is calculated, using 0 °F as a base, by the equation:

$$UA(I) = (CV)(MA(I))(TP)$$

where

CV = specific heat of air at constant volume, 0.171 Btu/lbm-°F

TP = compartment temperature, °F

ARKANSAS NUCLEAR ONE
UNIT 2

The energy of the water vapor (US) in each compartment (I) is calculated by the equation:

$$US(I) = [MS(I)](UG) \quad (6.2-11g)$$

where

UG = internal energy of the steam evaluated from the saturated steam tables at the compartment temperature.

B. Conservation of Mass and Energy in Compartments

The inventory of the total mass and energy in the compartments is maintained from the inlet and exit flows during each time increment by the following equations:

$$MA(I) = \sum^N |MAI| - \sum^N |MAO| + MA'(I)$$

$$MW(I) = \sum^N |MWI| - \sum^N |MWO| + MW'(I)$$

$$MS(I) = \sum^N |MSI| - \sum^N |MSO| + MS'(I)$$

$$MV(I) = MW(I) + MS(I) \quad (6.2-11h)$$

$$MT(I) = MV(I) + MA(I)$$

$$UA(I) = \sum^N |UAI| - \sum^N |UAO| + UA'(I)$$

$$UW(I) = \sum^N (HI|MWI|) - \sum^N (HO|MWO|) + UW'(I)$$

$$US(I) = \sum^N (HGI|MSI|) - \sum^N (HGO|MSO|) + US'(I)$$

$$UV(I) = UW(I) + US(I)$$

$$UT(I) = UV(I) + UA(I)$$

where

MW(I) = mass of water in compartment (I), lbm

MV(I) = mass of water and steam in compartment (I), lbm

MT(I) = total mass in compartment (I), lbm

MAI = mass of air entering compartment, lbm

MAO = mass of air leaving compartment, lbm

MWI = mass of water entering compartment, lbm

MWO = mass of water leaving compartment, lbm

ARKANSAS NUCLEAR ONE
UNIT 2

MSI	=	mass of steam entering compartment, lbm
MSO	=	mass of steam leaving compartment, lbm
UAI	=	total energy of air entering compartment, Btu
UAO	=	total energy of air leaving compartment, Btu
HI	=	enthalpy of water entering compartment (I), Btu/lbm
HO	=	enthalpy of water leaving compartment (I), Btu/lbm
HGI	=	enthalpy of steam entering compartment (I), Btu/lbm
HGO	=	enthalpy of steam leaving compartment (I), Btu/lbm
UA(I)	=	energy in air in compartment (I), Btu
UW(I)	=	energy in water in compartment (I), Btu
US(I)	=	energy in steam in compartment (I), Btu
UV(I)	=	energy in vapor in compartment (I), Btu
UT(I)	=	total energy in compartment (I), Btu

Primed (') values refer to end of previous time step; all other values refer to current time step. N is equal to the total number of compartments used in the analysis. Essentially, an almost infinite number of compartments can be specified.

C. Compartment Pressure Calculations

The compartment pressure is calculated using the total mass and energy in the compartment after the flow from the upstream compartment and/or the blowdown has been added to the compartment inventory of mass and energy. A convergence procedure is used to arrive at the equilibrium thermodynamic conditions in the compartment using temperature as the search argument. The equilibrium thermodynamic state is considered to be determined when the search temperature provides properties such that the ratio of the difference between the trial energy balance and the energy inventory is less than 0.001. The state properties of the steam and water mixture at the search temperature are obtained from the saturation tables. The mass of steam is then determined by:

$$MS = [V - (MW)(VL)] / (VG) \quad (6.2-11i)$$

where

V	=	volume of compartment, cu. ft.
VL	=	specific volume of water, cu. ft./lbm
VG	=	specific volume of steam, cu. ft./lbm.

The mass of water (MW) is determined by:

$$MW = MV - MS \quad (6.2-11j)$$

ARKANSAS NUCLEAR ONE
UNIT 2

A trial energy balance (ETRIAL) is calculated:

$$\text{ETRIAL} = (\text{MS})(\text{UG}) + (\text{MW})(\text{UL}) + (\text{MA})(0.171)(\text{TP}) \quad (6.2-11k)$$

The procedure is repeated varying the value of the compartment temperatures (TP) until the relation:

$$(\text{UT} - \text{ETRIAL})/\text{UT} \leq 0.001$$

is satisfied.

If after establishing the thermodynamic equilibrium conditions $\text{MW} \leq 0$, the compartment is considered to be superheated. The equilibrium conditions are recalculated by setting the steam mass equal to the vapor mass and calculating the steam pressure at the search temperature by:

$$\text{PS} = 0.5961(\text{MS})(\text{T}/\text{V}) \quad (6.2-11l)$$

where

PS = pressure of steam, psia

T = compartment search temperature, °F

V = compartment volume, cu. ft.

$$0.5961 = R/(\text{mole weight})(144) = 1545.3/(18)(144)$$

The internal energy of the steam at the pressure and temperature is obtained from the superheat tables and a trial energy balance calculated by:

$$\text{ETRIAL} = (\text{MS})(\text{UG}) + (\text{MA})(0.171)(\text{TP}) \quad (6.2-11m)$$

The procedure is repeated varying the value of TP until the relation:

$$(\text{UT} - \text{ETRIAL})/\text{UT} \leq 0.001$$

is satisfied.

The total pressure in the compartment is the sum of the steam pressure and the air pressure (PA) with the latter being calculated by:

$$\text{PA} = (\text{MA})(\text{TP} + 459.688)(0.37/\text{V}) \quad (6.2-11n)$$

where

$$0.37 = R/(\text{mole weight})(144) = 1545.3/(28.97)(144)$$

D. Flow Calculation

A compressible fluid flow equation is used for the analysis of compartment pressures.

In the application of the compressible fluid flow equation, the flow is considered to be critical if the ratio of the pressure in the downstream compartment (Compartment 2) to the pressure in the upstream compartment (Compartment 1) is less than RC as obtained by:

ARKANSAS NUCLEAR ONE
UNIT 2

$$RC = \left[\frac{2}{1+K} \right]^{\frac{K}{K-1}} \quad (6.2-11o)$$

where K is the isentropic exponent for the air, steam and water mixture leaving the compartment. K is calculated by:

$$K = (KGF) \frac{PS(I)}{PT(I)} + (KA) \frac{PA(I)}{PT(I)} \quad (6.2-11p)$$

where

- KA = isentropic value of K for air of 1.4
- KGF = isentropic value of K for steam-water mixture
- PS(I) = steam pressure in Compartment I, psia
- PT(I) = total Compartment I pressure, psia
- PA(I) = air pressure in Compartment I, psia

The form of the flow equation is:

$$G = \left\{ (g_c)(K)(P1)(RHO1) \left(\frac{2}{K+1} \right)^{\frac{K+1}{K-1}} \right\}^{\frac{1}{2}} \quad (6.2-11q)$$

where

- RHO1 = MT(I)/VOL(I), lbm/cu. ft.
- VOL(I) = volume of Compartment I
- P1 = Compartment 1 pressure, psia
- g_c = acceleration of gravity, 32.174 ft/sec²

If the flow is subcritical, the form of the flow equation is:

$$G = \left\{ \frac{2(g_c)(P1)(RHO1)(K) \left(R^{\frac{2}{K}} - R^{\frac{K+1}{K}} \right)}{K-1} \right\}^{\frac{1}{2}} \quad (6.2-11r)$$

where

- G = mass flow, lbm/sq. ft-sec.
- R = P2/P1
- P2 = Compartment 2 pressure, psia

ARKANSAS NUCLEAR ONE
UNIT 2

The mass flow from Compartments 1 and 2 is calculated by:

$$\text{total: } MF = (G)(A)(C) \quad (6.2-11s)$$

$$\text{air: } MAF = (MF)[MA(I)/MT(I)]$$

$$\text{water: } MWF = (MF)[MW(I)/MT(I)]$$

$$\text{steam: } MSF = (MF)[MS(I)/MT(I)]$$

where

A = area of flow path, sq. ft.

C = coefficient calculated external to the code

MF = total flow mass, lbm/sec

MAF = air flow mass, lbm/sec

MWF = water flow mass, lbm/sec

MSF = steam flow mass, lbm/sec

The energy transferred by the flow (Btu) is calculated by:

$$\text{air: } UAF = (MAF)(CP)[TC(I)] \quad (6.2-11t)$$

$$\text{water: } UWF = (MWF)(HL)$$

$$\text{steam: } USF = (MSF)(HG)$$

where

UAF = air flow energy, Btu

UWF = water flow energy, Btu

USF = steam flow energy, Btu

TC(I) = compartment temperature, °F

CP = specific heat of air at constant pressure, Btu/lbm °F

HL = enthalpy of water at compartment temperature, Btu/lbm

HG = enthalpy of steam at compartment temperature, Btu/lbm

The COPDA code has the Moody critical, 2-phase flow model as an optional vent flow calculation technique. This technique is discussed and justified in References 57 and 58. The Moody option was used for the biological shield penetration analysis discussed in Section 6.2.1.2.2.

ARKANSAS NUCLEAR ONE
UNIT 2

E. Flow Coefficients

Two methods of determining flow coefficients were used in the subcompartment analyses described in Section 6.2.1.2.2. These are:

- A. Incompressible flow theory coefficients; and,
- B. Compressible orifice equations.

In general, incompressible flow theory is applicable when compressibility effects are unimportant (local Mach number, $M_L \leq .3$). For cases where flow is critical or near-critical at the exit of a subcompartment, compressibility effects become important and must be considered in determining flow coefficients.

The determination of loss factors from incompressible flow theory is well understood and documented. These loss factors have been determined by both analytical derivation (Reference 70) and by experiment (Reference 21). The factors are related to the pressure drop through a given flow region by $\Delta P = \sum_i 1/2 K_i V^2$ where ΔP = pressure loss, $\sum_i K_i$ = sum of loss factors, and V = fluid velocity. This can be related to a flow coefficient by using the incompressible Bernoulli equation obtaining $C=1/(\sum_i K_i)^{1/2}$. The incompressible loss factors used in these subcompartment analyses were obtained from References 21 and 52.

As discussed above, the critical flow regime requires consideration of compressibility effects on flow coefficients. This is primarily manifested in the reduction of the vena contracta effect and corresponding increase in flow coefficients. This has been analytically and experimentally determined by a number of investigators including Buckingham (Reference 43), Cunningham (Reference 45), Perry (Reference 62), and Sozzi (Reference 71). The relations obtained by Cunningham (Reference 52) for critical and subcritical sharp edged orifices have been programmed into the COPDA computer code and are used for critical and near critical vent flows in these analyses. These equations yield a flow coefficient (c) in the range of 0.85 for paths experiencing critical flow and 0.61 for subcritical flow.

A basic COPDA assumption is that the fluid velocities in the compartment are small when compared with the fluid velocities in the vents. Under these circumstances the inertial effects are negligible in comparison with the other "losses" in the system. In general, inertial effects are not important when the ratio of the subcompartment cross-sectional area is four-to-one or greater. Also, these effects are negligible when differential pressures are 20 psid or greater. Where the exit losses are small and the flow is incompressible the COPDA type analysis must be modified to include inertial effects. Therefore, consistent with the basic COPDA assumptions, the inertial effects are not considered in this analysis.

6.2.1.2.3.2.1 Steam Generator Subcompartment Reanalysis

The steam generator cavities have the provision for installing grating at the top of the cavities on elevation 426'6". The analysis described in Section 6.2.1.2.3.2 and associated results as shown in Tables 6.2-17A.II.a through 6.2-17A.II.f and Figures 6.2-16G through 6.2-16L did not account for the effects of having this grating installed. A subsequent analysis using the COMPARE computer code as the analysis tool was performed to determine the acceptability of having the grating installed on elevation 426'6".

ARKANSAS NUCLEAR ONE
UNIT 2

Generally, the occurrence of a LOCA is postulated to result from a rupture of the RCS piping within subcompartments of the containment prior to LBB considerations. A pipe rupture of this type results in the expulsion of high enthalpy water out of the ruptured pipe, flashing partly to steam. As the pressure builds up within the compartment, the steam-air mixture flows through openings into the main volume of the containment. The maximum differential pressure achieved between the compartments determines the design strength requirements of walls and supports between the compartments and the forces exerted upon the RCS and containment equipment. The maximum pressure differential developed depends on the number and shape of the openings (i.e., vents) between the compartments, the volume of each compartment, and the blowdown rate from the broken pipe.

The COMPARE computer code has provision for the transient calculation of conditions in a system of volumes connected by vents. Each volume is assumed to contain the stagnant homogeneous mixture of steam, air and water that will typically exist within a subcompartment during the course of a high energy line break (HELB) transient.

A quasisteady-state approximation, with a correction for fluid inertia effects, is used to represent the transient processes. Mass and energy inflow or outflow accounting, for each volume, is first accomplished for the particular time increment, assuming vent flows are constant.

Thermodynamic equilibrium is then assumed and state points determined. The resulting volume thermodynamic conditions are assumed to be constant and are used to calculate the new vent flows from or into volumes for the next time interval. This approach allows the transient to be calculated in an explicit manner without iteration or implicit matrix solution techniques.

6.2.1.2.3.2.1.1 Method of Analysis

A. Time Incrementation

The time increment is selected based on the rate change of a parameter (i.e., volumetric pressure). A rapidly changing pressure requires a smaller time increment so that a more adequate accounting for the effect of pressure (i.e., on vent flow) is obtained. The time increments utilized in the SG cavity COMPARE analysis are appropriate for the specified time intervals.

B. Volume Mass and Energy Changes

The COMPARE code accounts for mass and energy addition to a volume due to the blowdown from the postulated HELB. The code uses blowdown input data of water mass addition rate and water energy addition rate data points vs. time. The mass and energy addition rates vs. time are numerically integrated over the applicable time interval. The data used in the COMPARE analysis is found in Table 6.2-17D VIII.

C. Volume Thermodynamics

The COMPARE code treats each volume as though it were quasistatic which allows the volume mass and energy inventories, as affected by vent flow and blowdowns, to be taken. The thermodynamic state points, i.e., pressure and temperature, are then determined from the resulting specific internal energy and density of each volume.

ARKANSAS NUCLEAR ONE
UNIT 2

6.2.1.2.3.2.1.2 Steam Generator Subcompartment Reanalysis Model

The steam generator cavity model used in the COMPARE analysis consists of 22 volumes with 52 junctions. Each steam generator cavity is divided into the following three regions:

<u>Region</u>	<u>From Elevation</u>	<u>To Elevation</u>	<u>Description</u>
Lower	336'6"	366'8"	This region is from the floor of the steam generator cavity to the top of the steam generator support pedestal.
Middle	366'8"	397'6"	This region is from the top of the steam generator support pedestal to the elevation where the SG cavity narrows.
Upper	397'6"	426'6"	This region is from the elevation where the SG cavity narrows to the top of the SG cavity wall.

The steam generator cavity modeling geometry showing the nodal volumes and their relationship is given in Figures 6.2-3L through 6.2-3N. The figures identify the physical obstructions which were used to determine the volume boundaries.

The subcompartment analysis for the SG cavities (Figure 6.2-3I) used in the original evaluation (SAR Section 6.2.1.2.3.2) only modeled volumes in the south SG cavity with containment being the remaining volume.

The major differences between the original COPDA model and the COMPARE model are as follows:

- The north SG cavity is modeled as volumes in the analysis. This is justified since there are passageways that provide a flow path between the north and south cavities thereby causing the north cavity to become pressurized during the HELB transient.
- The annular region around the SG cavities (i.e., between the outer SG cavity walls and the containment building) is modeled as a separate volume.
- The containment region above the top of the SG cavity walls (>elev. 426'6") is modeled as a separate volume.

The 22 volume model is considered a more representative model for purposes of evaluating the pressure effects due to a HELB occurring in the south SG cavity.

6.2.1.2.3.2.1.3 Steam Generator Subcompartment Reanalysis Results

Steam Generator Cavity Wall Differential Pressure

The results of the steam generator cavity subcompartment pressure transient analysis using the COMPARE code and revised steam generator cavity models are that the original design criteria for the cavity walls (Table 6.2-17) is met with the grating installed on elevation 426'6" of the cavity walls. The calculated differential pressures between the internal steam generator cavity

ARKANSAS NUCLEAR ONE
UNIT 2

volumes and the surrounding containment building annulus is shown in Table 6.2-17A.IV. The peak pressures vs. time for the south steam generator cavity volumes are shown in Figure 6.2-16P. Since the maximum differential wall pressures are found in the south steam generator cavity, the peak pressures vs. time for the north cavity will not be depicted.

Steam Generator Cavity Grating

The pressure values calculated for the various volumes using the COMPARE code were converted to uplift forces that would be experienced by the cavity grating during a HELB. The grating at the top of the SG cavities (Elev. 426'6") is restrained to prevent the grating from lifting and possibly causing damage to the containment liner or other equipment/structures during a HELB. This grating should be maintained in a restrained condition when the plant is at power operations or when the possibility of a HELB exists.

6.2.1.2.3.2.2 Reactor Vessel Cavity Permanent Seal Plate Modification

A modification to the reactor cavity seal plate was completed during 1996. This modification was completed without reanalyzing the effects of RCS pipe breaks within the reactor vessel cavity but was justified using approved leak before break (LBB) methodology as described in CEN-367-A. The ability to reference the LBB topical report precludes the need to protect against the dynamic effects associated with the postulated rupture of piping (i.e., subcompartment pressurization). Also, during normal operation, the hatch covers will be removed, providing ventilation for the region below the seal plate and there are no subcompartment pressurization concerns for the refueling conditions when the hatch covers are in place.

6.2.1.2.3.2.3 Steam Generator Replacement

Steam generator replacement took place during 2R15. This modification was completed without reanalyzing the effects of RCS pipe breaks within the steam generator cavities. This was justified using approved leak before break (LBB) methodology as described in CEN-367-A. For the SG compartments, the original energy releases used in the analyses were based on an assumed 9.82 ft² cold leg RCS pump discharge circumferential break. This release was associated with the worst case failure of RCS main coolant loop piping. LBB capability eliminates consideration of those pipe ruptures associated with catastrophic failure of RCS main coolant loop piping, however, piping attached to the RCS main coolant loop was considered. New mass and energy release calculations were performed for the steam generator replacement. Mass and energy releases used in the current SG compartment analysis based on RCS main coolant loop failure conservatively bound the mass and energy release calculated using LBB assumptions. Therefore, the original steam generator subcompartment pressurization analysis bounds the design condition after SG replacement and power uprate. The previous descriptions pertaining to the subcompartment analysis for the steam generator cavities describe the analysis completed prior to the aforementioned modifications.

6.2.1.3 Tests and Inspections

This section provides information about the program of testing and inspection of the containment systems with regard to preoperational and post steam generator replacement testing and inservice surveillance to ensure continued integrity.

ARKANSAS NUCLEAR ONE
UNIT 2

6.2.1.3.1 Preoperational Testing

The ¼-inch steel liner plate forms the barrier to prevent leakage from the containment. All penetrations were continuously welded to the liner before the concrete was placed. Leak chase channels were installed on those liner plate seams where the liner plate is not readily accessible for inspection. The leak chase channels provide a means of leak testing inaccessible liner plate seams when access to the liner plate is blocked by interior concrete. No continuous leakage monitoring system is provided.

The steel liner plate is securely attached to the prestressed concrete containment and is an integral part of this structure. This containment is conservatively designed and rigorously analyzed for the extreme loading conditions of a DBA as well as for all other types of loading conditions that could be experienced. Thorough control was maintained over the quality of all material and workmanship during all stages of fabrication and erection of the liner plate and penetrations and during construction of the entire containment.

After the containment was completed, and all electrical and piping penetrations, equipment hatch, and personnel locks in place, the preoperational integrated leak test was performed. The containment was tested at 115 percent of the design pressure to prove structural integrity. The preoperational integrated leakage rate tests were conducted at design and reduced test pressures so that the reduced pressure test program can be used for subsequent periodic testing.

The design leak rate is not more than 0.1 percent by volume of the contained atmosphere in 24 hours at 54 psig. It has been demonstrated that, with good quality control during erection, this is a reasonable requirement.

All penetrations except the following are grouped in a few penetration areas:

- A. Permanent equipment hatch
- B. Personnel access lock
- C. Main steam and feedwater lines
- D. Emergency personnel lock
- E. Containment purge lines

The following guidelines were in place during the test: Should there be any indications of abnormal leakage, the source of excessive leakage will be located and such corrective action as necessary will be taken. This will consist of repair or replacement. Appropriate action will also be taken to minimize the possibility of the recurrence of excessive leakage, including such redesign as might prove to be necessary to protect public health and safety. Leak testing will be continued until a satisfactory leak rate has again been demonstrated.

The integrated leakage rate test can be performed at design pressure any time during the plant life, if required, providing that the enclosed systems have been prepared for test.

A considerable background of operating experience is being accumulated on containments and penetrations. Full advantage of the knowledge was taken in all phases of design, fabrication, installation, inspection, testing, and operation. Practical improvements in design and details were incorporated as they were developed, where applicable.

ARKANSAS NUCLEAR ONE
UNIT 2

For the foregoing reasons, it is concluded that a continuous leakage monitoring system is unnecessary. Since there is no such system provided, there can be no misoperation or malfunction which in itself might constitute a hazard. The steel-lined containment is self-sufficient, and, other than valves, locks and a hatch door, there are no operating parts. The containment boundary is extended only by penetrations that are further described and listed in Section 6.2.4.

Preoperational containment integrated leakage rate tests and local leakage rate tests were conducted in accordance with Appendix J to 10 CFR 50, "Reactor Containment Leakage Testing for Water Cooled Power Reactors," and References 24 and 35.

6.2.1.3.2 Post Steam Generator Replacement Testing

Following completion of the repair of the containment construction opening after replacement of the original steam generators, the restored containment was subjected to a post-repair/pre-service structural integrity test (SIT) and an integrated leak rate test (ILRT).

6.2.1.3.3 Inservice Surveillance

Periodic containment integrated leakage rate tests and local leakage rate tests are conducted in accordance with Appendix J to 10 CFR 50, "Reactor Containment Leakage Testing for Water Cooled Power Reactors," and ANSI/ANS-56.8-2002, "Containment System Leakage Testing Requirements." The test frequency for integrated and local leakage rate tests, the test methods used including sensitivity analysis, the requirements for the acceptability of observed performance and the bases for them, and the action to be taken in the event acceptability requirements are not met are defined and are in accordance with the above listed references. Additionally, if at any time it is determined that the acceptance criteria defined in the Technical Specifications and in 10 CFR 50, Appendix J, are exceeded, repairs shall be initiated immediately.

Containment isolation systems are discussed in Section 6.2.4. All containment penetrations have been provided with test vents and test connections to permit periodic testing of the isolation valves. Where plant operation is not interfered with, local testing of the containment penetration is permitted. The methods of testing and the degree of conformance to Appendix J of 10 CFR 50 are discussed in Section 6.2.4.

6.2.1.4 Instrumentation Application

The containment atmospheric pressure is continuously monitored by four pressure transmitters located inside the containment. The ESF actuation design details and logics associated with these pressure transmitters are discussed in Chapter 7.

Instrumentation also monitors other parameters of the containment atmosphere to identify pressure boundary leakage in the RCS. The leakage detection system is discussed in Section 5.2.7.

Airborne radiation inside the containment is monitored by the containment monitoring system. This system is also discussed in Section 5.2.7.

Liquid level indication is provided in the containment recirculation sump and is discussed in Section 6.2.2.

ARKANSAS NUCLEAR ONE
UNIT 2

6.2.1.5 Assurance of Operational Readiness

Established preoperational tests and inservice surveillance techniques are used to ensure that the containment systems will operate in the manner required if called upon. The containment leak rate tests and associated containment integrity test procedures are discussed in Section 6.2.1.3. The CHRStest and inspection procedures are discussed in Section 6.2.2.4. The operational integrity of the CIs is discussed in Section 6.2.4. In addition, each active containment system is composed of two or more trains, each of which is capable of meeting at least 100 percent of the required operational capacity for that system. The means by which a system achieves this functional redundancy is described in the system design for each ESF.

6.2.2 CONTAINMENT HEAT REMOVAL SYSTEMS

The functional performance objective of the CHRSts is to rapidly reduce the containment pressure and temperature after a postulated LOCA or Main Steam Line Break (MSLB) accident by removing thermal energy from the containment atmosphere. This function is performed by the Containment Spray System (CSS) and the Containment Cooling System (CCS). The CHRSts also assist in limiting off-site radiation levels by reducing the pressure differential between the containment atmosphere and the outside atmosphere, thereby reducing the driving force for leakage of fission products from the containment. These radiological evaluations are reported in Chapters 11 and 15. The CHRSts meet the requirements of GDC 38 as described in Section 3.1.4.

6.2.2.1 Design Bases

The CHRSts are designed to rapidly reduce the containment pressure and temperature following a LOCA or MSLB, and maintain these parameters at acceptably low levels as required by General Design Criterion 38. The sources and amounts of energy released to the containment which were used as the basis for the sizing of the CHRSt are given in Section 6.2.1.

The CHRSt are designed so that either of the following combinations of equipment will provide adequate heat removal to attenuate the post-accident pressure and temperature conditions imposed upon the containment following a LOCA or MSLB:

- A. both trains of the CSS; or,
- B. one train of CSS and one train of CCS.

The CSS also provides for iodine removal from the containment atmosphere by a combination of boric acid spray and a buffered pH solution. Therefore, at least one CSS must operate following a LOCA.

6.2.2.1.1 Containment Spray System

The CSS, shown in Figure 6.2-17, is designed to spray borated water into the containment in the event of a LOCA in order to suppress any resultant increase in containment pressure and temperature. The system is also designed to recirculate a buffered pH solution consisting of a combination of boric acid spray and Sodium Tetraborate (NaTB). The recirculation of this solution through the CSS is designed to reduce fission product iodine concentration in the containment atmosphere. This solution will retain the fission products in the containment sump water and thereby considerably reduce the potential of fission product leakage to the environs.

ARKANSAS NUCLEAR ONE
UNIT 2

The heat removal capacity of the flow from the two pumps provided is adequate to keep the containment pressure and temperature below design conditions for any size break in the RCS piping up to and including a double ended slot break of the reactor coolant pump suction pipe. Adequate quantities of buffering agent are mixed with the boric acid spray creating a buffered pH solution. This solution is recirculated through the CSS to reduce the airborne concentrations of radioactive forms of iodine, and to retain these in the containment sump.

Additionally, the system is designed such that a single failure of any active component will not degrade the system's ability to fulfill these design objectives.

The CSS is designed to Seismic Category 1 requirements. System components as appropriate are designed to meet ASME Code Section III Class 2 requirements.

6.2.2.1.2 Containment Cooling System

The CCS, shown in Figure 9.4-4, is designed to support the operation of the CSS to remove sufficient heat energy from the containment atmosphere following a postulated LOCA or MSLB accident to maintain the containment atmosphere pressure below design pressure. Section 6.2.1, Containment Functional Design, provides the assumptions as to the sources and amounts of energy considered in the analyses of the containment pressure transient following a LOCA or MSLB inside containment.

The CCS consists of two redundant trains with two air cooler units per train. Each train is designed to meet and exceed the heat removal capacity assumed in the safety analysis. The safety analysis assumptions are presented in Table 6.2-8I.

The system is designed such that a single failure of any component will not degrade the CHRS containment heat removal capability. The remaining heat removal capacity would be fulfilled by the two operating CSS loops.

The system is designed to Seismic Category 1 requirements.

6.2.2.2 System Design

Individual descriptions of each CHRS follow.

6.2.2.2.1 Containment Spray System

A. General Description

A flow diagram of the CSS is shown in Figure 6.2-17.

The CSS consists of two separate loops of equal capacity and is independently capable of meeting CHRS requirements. Each loop consists of a containment spray pump, shutdown cooling heat exchanger, spray header, isolation valves, and the necessary piping, instrumentation and controls. The loops are supplied with borated water from a common Refueling Water Tank (RWT).

Upon system activation, the containment spray pumps are started and deliver boric acid to the respective spray headers. The spray headers are located at the highest possible level in the containment to maximize heat and iodine removal. Each header conforms to

ARKANSAS NUCLEAR ONE UNIT 2

the shape of the containment dome. Figures 6.2-18 and 6.2-19 show details of the spray headers. The headers are located outside of and above the movable missile shield, and contain 131 spray nozzles each. During normal plant operation CSS piping is maintained full of water from the RWT to Elevation 505 feet, 0 inches (minimum) in the 6-inch diameter risers within containment. When low level is reached in the RWT, the Recirculation Actuation Signal (RAS) automatically transfers the containment spray pump suction to the containment sump by opening the recirculation line valves and closing the RWT outlet and pump minimum flow recirculation valves.

During the injection mode, prior to the start of recirculation, each spray train will deliver a minimum flow of 1875 gpm. At the start of recirculation, with suction from the containment sump, minimum spray flow increases to the nominal design minimum of 2,000 gpm.

Following the switchover of suction to the containment sump, the sump solution will contain boric acid and buffering agent. This mixture of boric acid and buffering agent will continue to remove post-accident energy and remove and retain fission product iodine as it is recirculated through the CSS. The buffering agent is stored in three containers constructed with wire mesh sides which allow the sprayed fluid to permeate the containers. These containers will become submerged in the sprayed fluid accumulating in the building allowing the buffering agent to dissolve. The buffering agent is used to raise the pH of the sump fluid to an equilibrium pH of 7.0 or greater. A pH of 7.0 or greater will assure that the iodine washed out of the reactor building atmosphere by the spraying action will not re-evolve from the liquid as it is sprayed back into the building.

In the recirculation mode, the spray water is cooled by the shutdown cooling heat exchangers prior to discharge into the containment. The shutdown cooling heat exchangers are cooled by the SWS which is described in Section 9.2.1.

All components of the system which come in contact with the system fluid are made of stainless steel to minimize the corrosive effects of the acid and caustic solutions present.

B. Component Descriptions

1. Containment Spray Pumps (2P35A, B)

The two containment spray pumps are vertical centrifugal pumps driven by direct coupled induction motors. Each pump is rated for 2,200 gpm flow at a head of 525 feet. Each pump will provide the flow necessary to remove in excess of 120 million Btu/hr from the containment following a LOCA. The characteristics of the pumps are shown in Figure 6.2-20 and pump design data are summarized in Table 6.2-18. The pumps are located at an elevation of 317 feet, 0 inches in the auxiliary building.

System design ensures compliance with the pump Net Positive Suction Head (NPSH) requirements of Regulatory Guide 1.1.

The sump inventory is considered subcooled when sump temperature is below saturation temperature corresponding to the minimum Technical Specification (TS) allowed containment pressure. When sump temperature is above the saturation temperature corresponding to the minimum TS allowed containment pressure the

ARKANSAS NUCLEAR ONE
UNIT 2

containment pressure is set equal to the liquid vapor pressure ($h_a - h_{vpa} = 0$). No credit is taken for increased containment pressure as a result of accident conditions.

$$NPSH_a = h_a - h_{vpa} + h_{st} - h_L$$

- h_a = absolute pressure in feet of liquid on the surface of the liquid level
- h_{vpa} = the head in feet corresponding to the vapor pressure of the liquid at the temperature being pumped.
- h_{st} = static height in feet that the liquid supply level is above or below the pump centerline or impeller eye.
- h_L = all suction line losses in feet including entrance losses and friction losses through pipe, valves and fittings, etc.

The pumps are driven by 450 HP motors rated 4,000 volts, 3-phase for use on a 4,160-volt, 3-phase, 60-Hz resistance grounded wye system. The motors have open drip-proof or weather protected enclosures and are provided with Class F insulation. The motors have a 1.15 service factor.

Power to these motors is supplied from the 4.16 kV buses which are part of the Class 1E electrical system. Power supply availability to these buses during all modes of station operation is discussed in Chapter 8.

The pumps are provided with minimum flow recirculation lines which permit a flow of 200 gpm from each pump to recirculate back to the RWT through a common line during the injection mode of operation. The RAS automatically closes two motor operated valves arranged in series in the common minimum flow line.

2. Buffering Agent Containers

Three buffering agent containers are placed in the base of containment. These containers function as a means of containing and measuring the amount of buffering agent in containment prior to any LOCA or MSLB. The containers are constructed with mesh wire sides which allow fluids collecting in the base of containment to permeate the containers and dissolve the buffering agent. The buffering agent is used to raise the pH of the sump fluid to an equilibrium pH of 7.0 or greater. A pH of 7.0 or greater will assure that the iodine washed out of the reactor building atmosphere by the spraying action will not re-evolve from the liquid as it is sprayed back into the building.

3. Sodium Hydroxide Tank (2T10)

The sodium hydroxide tank, located in the containment auxiliary building at elevation 355 feet, 4 inches, is a 10,000 gallon capacity stainless steel tank containing 30 w/o sodium hydroxide solution. The tank is designed to meet Seismic Category 1 requirements.

Note: The NaOH Addition System has been decommissioned. 2T10 has been abandoned in place.

ARKANSAS NUCLEAR ONE
UNIT 2

A ladder and manway are provided for internal inspection. A recirculation pump is provided to recirculate the tank solution prior to sampling, and to provide a filling and draining capability. The tank is vented to atmosphere.

The tank is provided with electric heaters with capacity in excess of that necessary to maintain the tank solution temperature above 50 °F and to provide protection against freezing for the tank as well as the vents. Heat tracing is included for additional freeze protection for the NaOH vents (0CAN068004).

4. Refueling Water Tank (2T3)

The RWT, located west of the containment auxiliary building at elevation 355 feet, 4 inches, is a 500,500 gallon capacity stainless steel tank containing a boric acid solution between 2500 and 3000 ppm boron. The tank was built to meet Seismic Category 1 requirements. Tank design data are summarized in Table 6.2-20. Tank level, temperature, and alarm instrumentation are discussed in Section 6.2.2.5.1.

The tank capacity is based on the requirement for filling the refueling canal and is in excess of the 384,000 gallons required for containment spray and safety injection during any postulated LOCA or MSLB. The minimum allowable level is provided in the Technical Specifications.

The tank is vented to atmosphere. A ladder and manway are provided for internal inspection.

Five electric immersion heaters are provided to maintain the tank liquid inventory above a temperature of 40 °F to prevent the boric acid from crystallizing out of solution. Three of the five heaters are required to maintain the tank liquid above 40 °F during the coldest expected ambient temperatures, providing protection against freezing for the tank as well as the vacuum vent. The tank is the only component essential to safe shutdown of the plant that is not housed within temperature controlled areas. Heat tracing is included as additional freeze protection for the RWT vent. (0CAN068004).

The RWT is built to the 1971 Edition of the ASME Boiler and Pressure Vessel Code, Section III, Class 2, including the Summer 1973 Addenda. However, the radiography for the first and second ring vertical seams, and the 1-2 and 2-3 girth seams of the tank is per the Summer 1974 Addenda of the 1974 Edition of the ASME Code. All other tank welds are radiographed per the 1971 Edition of the ASME Code, Summer 1973 Addenda.

5. Shutdown Cooling Heat Exchangers (2E35A, B)

The two shutdown cooling heat exchangers are located at Elevation 317 feet, 0 inches in the auxiliary building. They are of shell and U-tube design, with the cooling fluid being service water. The shutdown cooling heat exchangers are further described in Section 9.3.6. Historical design data for the shutdown cooling heat exchangers are given in Table 6.2-21.

The basis for selection of the tube side and shell side inlet temperature during the recirculation mode is given in Sections 6.2.1.1.4 and 9.2.1.3.

ARKANSAS NUCLEAR ONE
UNIT 2

6. Containment Spray Nozzles

Each containment spray header contains 131 hollow cone ramp bottom nozzles, each of which is capable of a design flow of 15.2 gpm (approximately 2000 gpm per train) with a 40 psi differential pressure. These nozzles have an approximately 3/8-inch spray orifice and will not be subject to clogging by particles that pass through the 1/16-inch sump strainer holes. The nozzles produce a mass equivalent drop size of approximately 880 microns at rated system conditions. During the injection mode, the reduced flow rate of 14.3 gpm per nozzle (1875 gpm per train) produces a slightly larger mass equivalent drop size of 925 microns. The spray solution will not interfere with nozzle performance at any temperature of interest in the containment. Each nozzle header is independently oriented to ensure full coverage of the containment volume outside the reactor cavity. Nozzle performance is shown in Figures 6.2-21 and 6.2-22.

7. Containment Sump

The containment sump is a small collection pit in the floor of the containment. The containment floor acts as a large collecting reservoir for the sump. The containment sump is designed to provide an adequate supply of water with a minimum amount of particulate matter to the CSS and the SIS. The bottom of the sump is at Elevation 331 feet, 6¼ inches in the containment. The minimum thickness of the concrete floor pad in the sump is 5 feet. An arrangement consisting of a series of strainer modules and a sump plenum that completely covers the sump is provided to prevent debris generated in a large break LOCA event from entering the sump without degrading ECCS and CSS pump performance. There are eight strainer modules connected to the west side of the plenum and fourteen modules connected to the east side of the plenum. The strainer modules are constructed from perforated plate with nominal opening size of 0.0625-inch diameter. The arrangement of the sump and plenum structure is shown in Figures 6.2-23A and 6.2-23B.

The plenum lower structural support channel is anchored to the containment floor and sealed with non-structural grout to prevent the entry of small, high density particles from entering the sump. The plenum has one small, screened opening at the containment floor level, on the east and west side of the plenum, to allow equipment leakage to drain into the sump. These two openings are provided with a fine mesh inner screen with a maximum diagonal opening size of 0.006 inches and a number 4 mesh (3/16 inch) outer screen which acts as an impingement barrier to protect the inner screen. The sump contains two box screens at the discharge of the floor drain lines that enter the sump. These box screens also utilize a fine mesh screen with a maximum diagonal opening size of 0.006 inches, and a number 4 mesh (3/16 inch) screen. The plenum is structurally designed to withstand the differential pressure developed within the plenum due to blowdown from subcompartment pressurization events described in Section 6.2.1. The strainers are designed for a differential pressure greater than the plenum.

The sump is divided into two compartments by a 3/8-inch thick steel plate with a 15 square foot screened opening which provides an interconnecting flow path between compartments. Debris that passes into the sump through the 0.0625-inch

ARKANSAS NUCLEAR ONE
UNIT 2

strainer openings will be drawn into the suction piping for the CCS and SIS. Such debris will be of small enough dimension to pass through any restriction in either system, and will eventually be pumped back into the containment.

Information on containment sump flow characteristics is contained in the report entitled "Hydraulic Model Studies of Containment Sump Recirculation Intakes," Western Canada Hydraulic Laboratories, April 1978. These original tests included models with only the vortex suppression grating on the suction piping. Subsequent to these tests, the strainers were replaced to address GSI-191 issues. Analysis of the replacement strainer internal head losses have been performed and include loss coefficients for the vortex suppression grating as determined by the Western Canada Hydraulics Laboratories tests. The pump NPSH analysis, which includes the strainer and sump pit internal head losses, has determined that acceptable margin remains for the pumps taking suction from the sump.

It is recognized that the greatest potential source of debris in the containment is insulation. Fiberglass blanket and all-metal stainless steel reflective insulation is used on the reactor coolant pressure boundary piping and vessels. Calcium silicate insulation, which is covered with stainless steel jacketing, is used to insulate other hot piping within the steam generator (SG) cavities in containment. Stainless steel jacketed cellular glass insulation is used on chiller piping outside the SG cavities to prevent condensation, e.g., chilled water piping to the CEDM cooling units.

Insulation is permanently attached to piping and vessels except at welds where it is removable for inservice inspection, as required. Special fasteners are used to secure removable panels. A postulated high energy pipe rupture could break loose removable panels. Guillotine or slot breaks could blow or whip loose permanently installed panels. Insulation falling into the reactor vessel cavity would be of minimal consequence. Strainers are provided over the refueling canal drains as indicated in Figure 9.1-1 to prevent clogging in the unlikely event that any large object fell into the canal. The strainer modules are mounted on floor supports that raise the strainer inlets approximately eight inches above the containment floor. It is unlikely that insulation panels which have fallen to the floor of the containment would be washed into the strainer modules. The containment sump was evaluated in accordance with GSI-191 criteria to determine the effects upon the available Net Positive Suction Head (NPSH), strainer structural design, and other limitations on strainer head loss. In response to NRC Generic Safety Issue (GSI) -191 and Generic Letter (GL) 2004-02 issues, additional strainer surface area has been added to the sump.

Two 24-inch normally open, motor operated valves are located on the pump suction lines within the sump.

The containment sump analysis during post accident conditions complies with the requirements of Generic Letter 2004-02 for addressing Generic Safety Issue 191, as detailed in ANO's compliance response to the Generic Letter. The updated design basis includes the following:

- a. Debris quantities generated by a LOCA are determined by analysis that establishes the distance from a break at which various insulation, coatings, and other detrimental materials are released. A limiting break is determined from this analysis based on the debris mixture that produces the most detrimental strainer head loss.

ARKANSAS NUCLEAR ONE
UNIT 2

- b. Chemical effects associated with the precipitation of aluminum compounds are evaluated for their impact on sump strainer head loss and reactor fuel assemblies.
- c. Strainer head loss due to debris and chemical precipitates was determined via scaled testing of strainer modules. The head loss test results were compared against available NPSH margin or strainer structural limits for acceptability.
- d. The NPSH margin for the HPSI and Containment Spray pumps were revised to include available margins as sump temperatures become sub-cooled. This allows determination of the sump water temperature range at which NPSH becomes less limiting to strainer allowable head loss than the 6.1 feet containment sump strainer structural limitation.
- e. Down Stream Effects are evaluated for components in the sump recirculation flow path to ensure the debris generated by a LOCA that can pass through the strainer's 0.0625-inch openings will not result in blockage or unacceptable wear.
- f. The reactor vessel internals, including fuel assemblies, are evaluated for potential detrimental effects from the debris generated by a LOCA that can pass through the strainer.

Access is provided to allow valve maintenance and level indication is provided as stated in Section 7.5.2.5.

8. Piping

Historically, all system piping of 10-inch diameter and larger was welded SA-358, Grade TP-304, Class 1. Piping of 8-inch diameter and smaller whose primary rating is 150 lb. was welded SA-312 Grade TP-304. Piping of 8-inch diameter and smaller whose primary rating is 300 lb. was either seamless SA-376 or SA-312 Grade TP-304. All system piping joints were welded except the containment spray pumps, spray nozzles, flow orifices, and relief valves 2PSV-5653, 2PSV-5654, 2PSV-5696, and 2PSV-5697. Alternate materials and flanges may be used in accordance with approved design documents.

9. Valves

All CSS valves are stainless steel with suitable trim to be compatible with the borated water service, and are rated for the required pressures and temperatures.

Motor operated valves have remote position indication and hand switches in the control room.

C. System Operation

The CSS is automatically actuated by a Containment Spray Actuation Signal (CSAS) from the Engineered Safety Features Actuation System (ESFAS). The CSAS is initiated by a coincidence of 2-out-of-4 high-high containment pressure signals and a Safety Injection Actuation Signal (SIAS). CSAS may also be initiated manually by pushbutton from the control room. The following equipment is actuated by the CSAS:

ARKANSAS NUCLEAR ONE
UNIT 2

1. Both containment spray pumps start (2P35A, B);
2. Both containment spray header isolation valves open (2CV-5612-1 and 2CV-5613-2);
3. Both trains of condensate (2P2A, B, C, D), heater drain (2P8A, B), and feedwater pumps (2P1A, B) stop.
4. Both main feedwater isolation (2CV1023-2, 2CV1073-2) and both backup valves (2CV-1024-1, 2CV-1074-1) close.
5. Both main steam isolation valves (2CV-1002, 2CV-1052) close.

All system components are lined up for emergency operation when the plant is at normal operating conditions.

A description of system operation after CSAS initiation is given in Section 6.2.2.2.1.A. When the level in the RWT reaches $6.0 \pm 0.5\%$ indicated level, the RAS is initiated automatically by two of four low level signals from tank mounted level switches.

The RAS automatically causes the following to occur:

1. Recirculation sump outlet valves open (2CV-5647-1, 2CV-5648-2, 2CV-5649-1, 2CV-5650-2);
2. CSS, High Pressure Safety Injection (HPSI) and Low Pressure Safety Injection (LPSI) pumps minimum flow line valves close (2CV-5628-2, 2CV-5672-1, 2CV-5673-1, 2CV-5123-1, 2CV-5124-1, 2CV-5126-1, 2CV-5127-1 and 2CV-5128-1);
3. LPSI pumps stop;
4. Service water flow to the shutdown cooling heat exchangers begins by opening of 2CV-1453-1 and 2CV-1456-2; and,
5. RWT outlet valves close (2CV-5630-1 and 2CV-5631-2).

During recirculation, water which has collected in the containment sump flows by gravity to the CSS pumps which return it to the containment spray headers via the shutdown cooling heat exchangers which reject containment spray fluid heat to the SWS. Provisions have been made to sample this fluid downstream of the shutdown cooling heat exchangers to monitor long-term fluid conditions, e.g., pH.

A break in the RCS, with the plant in the shutdown cooling mode (when CSS would not be immediately available), which would require initiation of the CSS for pressure, temperature, and activity control is not considered credible. However, design of the CSS will inherently accommodate this incredible event.

During shutdown cooling operations, CSS actuation would be achieved by manual initiation of CSAS by operator action after manually securing shutdown cooling. The time required for one operator to manually realign the CSS for spray operation of one train is conservatively estimated to be 20 minutes (three manual valves must be

ARKANSAS NUCLEAR ONE
UNIT 2

repositioned). Since containment pressure will be well below design pressure and iodine release is expected to be small, iodine leakage from the containment is not expected to be significant during this time. Even if the iodine inventory was high, it would not preclude operator action with the appropriate protective equipment, and no significant containment leakage would be expected during the short time required for manual lineup of the CSS.

6.2.2.2.2 Containment Cooling System

A. General Description

A flow diagram of the CCS is shown in Figure 9.4-4. The system consists of two trains which function to reduce temperature and pressure following any postulated LOCA. Each system loop consists of two cooling units, each of which discharges into a separate distribution plenum. Intake during normal operation is through a duct network which is common to all four units. The two distribution plenums are also connected to a duct network which distributes the discharge of the cooling units to different areas in the containment.

The SWS, which supplies cooling water to the cooling units during post-accident operation, is described in Section 9.2.1.

The cooling units distribution plenums and supply ducts are designed to Seismic Category 1 requirements, and are designed to maintain functional integrity in the post-LOCA containment environment. The intake plenums for each loop are bypassed upon receipt of a Containment Cooling Actuation Signal (CCAS) by automatic operation of bypass dampers in each of the four cooling units. Operation of the bypass dampers permits air intake without use of the intake plenums, which are designed to Seismic Category 2 requirements.

B. Component Descriptions

1. Emergency Cooling Units

Data for the emergency cooling units is presented in Table 6.2-22. The units are located on two levels in the containment outside the secondary shield wall. One unit from each system loop is at Elevation 357 feet, 0 inches, and one unit from each system loop is at Elevation 376 feet, 6 inches. All cooling units are located in the northwest quadrant of the containment. The units are approximately 10 feet wide by 20 feet long by 10 feet high. Each unit consists of one set of chilled water cooling coils to be used for normal cooling, one set of service water coils to be used for emergency cooling, and a single speed axial fan. A bypass damper is provided on top of the unit between the chilled water coils and the service water coils. The unit housings are designed to withstand a differential pressure of 2 psi and are equipped with pressure relief valves which are sized to prevent a buildup of differential pressure over 2 psi on the housing during the worst anticipated pressure transient in accordance with Section 7.0 of American Air Filter's AAF-TR-7101, "Topical Report on Design and Testing of Fan Cooler/Filter Systems for Nuclear Applications." The cooling units are designed to Seismic Category 1 requirements in accordance with Section 2.0 of the same topical report. The fan is mounted on top of the unit. The fan motors are of the type that have been tested in accordance

ARKANSAS NUCLEAR ONE
UNIT 2

with IEEE Report NSF/TCS/SC2-A, "Proposed Guide for Qualification Tests for Class IE Motors Installed Within the Containment of Nuclear Fueled Generating Stations" (now known as IEEE 334-1971).

The bypass damper opens automatically upon receipt of a CCAS or manually by handswitch from the control room.

The damper allows the saturated air in the containment to bypass the return air ducts and the chilled water cooling coils and to go through only the service water coils. The decrease in pressure drop due to the bypassing of the return air ducts and chilled water cooling coils permits the fan in the unit to handle the necessary quantity of air for emergency cooling purposes at the same speed as during normal operation.

Each fan has a back draft damper which prevents backflow through an idle unit.

2. Distribution Plenums and Ducts

Each distribution plenum receives air flow from two cooling units, one from each system loop. The plenums and the supply and recirculation ducts are designed to Seismic Category 1 requirements and to withstand a differential pressure of 2 psi. The plenums and the supply and recirculation ducts are equipped with the same type of pressure relief valves as the fan housings to prevent the buildup of pressure above 2 psid during the worst anticipated pressure transient in accordance with Section 7.0 of AAF-TR-7101. These plenums, supply, and recirculating ducts, will remain intact following a LOCA or steam line break accident to assure system operability. Analysis and tests have been performed in accordance with AAF-TR-7101, Section 7.0 to assure that the number, size, and location of the pressure relief vents is adequate to prevent pressure collapse of this ductwork.

C. System Operation

During normal operation, the cooling units will be operating with chilled water from the plant main chilled water system.

During emergency conditions, a CCAS will automatically place the system in operation.

A CCAS signal is caused by two of four low-low pressurizer pressure signals or two of four high containment pressure signals or manually by pushbutton in the main control room. A CCAS causes the following to occur:

1. Starts all four containment emergency cooling units;
2. Opens service water valves 2CV-1519-1, 2CV-1513-2, 2CV-1511-1 and 2CV-1510-2;
3. Opens bypass dampers on each cooling unit.

During emergency operation, air intake to the units is through the bypass dampers. Air is drawn through the service water cooling unit and fan and then discharged to the containment atmosphere via the distribution plenums and duct network.

ARKANSAS NUCLEAR ONE
UNIT 2

6.2.2.3 Design Evaluation

The capability of the CHRS to maintain containment pressure below design values during the DBA has been confirmed by the containment transient pressure analysis discussed in Section 6.2.1. Detailed evaluations of the capability of each heat removal system to perform its intended function are given in the following sections.

6.2.2.3.1 Containment Spray System

Analysis has shown that each loop of the CSS is capable of removing in excess of 120 million Btu/hr from the containment atmosphere following the DBA.

The system design is based on the temperature of the spray water droplets reaching equilibrium with the temperature of the containment. This occurs with spray water falling through the steam-air mixture within the containment. The spray nozzles will deliver droplets with an equivalent diameter of approximately 925 microns during the injection mode and 880 microns during recirculation with the spray system operating at design conditions and the containment at design pressure.

A minimum of 68 feet is provided between the spray nozzles and the highest obstruction in the containment, with the exception of the containment polar crane, to insure that the droplets reach thermal equilibrium during their fall.

Curves describing CSS and containment response following a design basis LOCA are presented in Section 6.2.1.

The containment spray pumps were shop tested in accordance with the ASME Power Test Code PTC 8.2 - Centrifugal Pumps. Pump performance data is given in Figure 6.2-20.

A single failure analysis has been made on all components of the CSS to show that a single failure of any active component will not degrade the system's capability to fulfill its design objectives. This analysis is shown in Table 6.2-23. All of the active components of the CSS, with the exception of the containment sump motor operated valves, are located outside the containment and therefore are not required to operate in the steam-air environment resulting from the accident. Additionally, system arrangement minimizes the possibility of missile damage to any system component. The overlapping heat removal capability of the CSS and the CCS is discussed in Section 6.2.1.

Two isolation valves have been provided in each recirculation line, which provide redundant means of halting flow from the sump to areas outside containment in the event excessive leakage develops in the recirculation system due to component deterioration. The isolation valves located inside the containment sump are protected from clogging by the series of sump strainers and protected from missile damage by being totally enclosed by the sump plenum and support structure.

Leakage of the containment sump fluid to areas outside the containment due to component deterioration in the recirculation piping from the sump to the CSS pumps will be confined to one of the three watertight ESF pump rooms. Excessive leakage into the pump rooms will be detected by a multiple contact detector located in each pump room, which will cause alarms to sound in the control room at successively higher room water levels. Appropriate operator action will then be taken to detect and isolate the source of the leakage.

ARKANSAS NUCLEAR ONE
UNIT 2

6.2.2.3.2 Containment Cooling System

Tests and analysis have confirmed that each train of the CCS is capable of removing in excess of 60 million Btu/hr from the containment atmosphere when operating at containment design conditions. A description of the analytical methods and models used to assess the performance of the CCS in post-DBA conditions is given in Section 6.2.1.

A single failure analysis for the CCS summarized in Table 6.2-24 shows that the system is designed to permit single failure of any active component without loss of the ability of the CHRS to fulfill its design function.

6.2.2.4 Testing and Inspections

The CHRSs were functionally tested in accordance with written procedures as outlined in Chapter 14 and are tested periodically as described in the following sections. These discussions lead to the surveillance Technical Specifications.

6.2.2.4.1 Containment Spray System

- A. Spray Pumps - The spray pumps are run at full flow by recirculating refueling water through the shutdown cooling heat exchangers and refueling water return line to the RWT. Pump performance can be compared to the original shop test performance curve. This type of testing requires only an adjustment for specific gravity and volume flow to extrapolate the expected performance under accident conditions.
- B. Buffering Agent (NaTB) – The concentration of the buffering agent is established at the time of initial container fill and is periodically checked by analysis of samples taken.
- C. Motor Operated Valves - Valves operated by the CSAS are tested by manually inducing the CSAS with pump operation blocked. In addition, these and all other system motor operated valves can be operated individually by switches from the control room. Valve position indication on the same control room panel is used to verify valve operability.
- D. Spray Header Nozzles - With the containment spray header inlet valves closed, low pressure air is blown through the test connection in each spray header. Air flow from each nozzle is indicated by the movement of a balloon held near the nozzle or by the movement of streamers attached to each nozzle prior to the test, or by use of thermography equipment. An alternative method which can be used is to introduce smoke into the spray header and observe each nozzle for flow.
- E. Alarms - Provision is made in the circuitry of the various system alarms to test the proper operation of the alarm circuitry with a test input. These circuits include the containment high pressure alarms, and the containment high-high pressure alarms.
- F. Integrated Functional Test - The entire system is functionally tested as a whole by means of the following procedure.
 - 1. Close the spray pump discharge stop check valve.
 - 2. Manually initiate service water flow to spray pump coolers.
 - 3. Manually initiate the corresponding CSAS and verify that all pumps and valves are operating as required.

ARKANSAS NUCLEAR ONE
UNIT 2

- G. Additive Concentrations - Periodic monitoring of the buffering agent is performed to ensure buffering of the spray water during recirculation mode can be accomplished. This provides assurance that the range of pH values given is not exceeded and prevention of re-evolution of iodine as stated in Section 6.2.3.3.1.2 is achieved.

The following verifications are performed to meet the requirements as stated and referenced above:

1. The RWT chemical concentrations are sampled (and adjusted when required) to assure that permissible concentrations are maintained.
2. The RWT temperatures are monitored and alarmed to ensure limits are not exceeded.
3. The containment atmosphere temperatures used in the analyses cannot be tested but are conservative for each given set of assumptions.
4. Since the minimum and maximum spray flow rates can not be tested by pumping fluid through the entire system, calculations have been performed to assure that actual flow rates will not exceed the limits assumed to determine the spray flow pH range.
5. The NaTB buffering agent is monitored to verify that the buffering agent containers hold the required amount of NaTB and that a sample from the buffering agent containers provides adequate pH adjustment of RWT water.

6.2.2.4.2 Containment Cooling System

The cooling units and distribution system were thoroughly tested prior to plant operation according to detailed preoperational test procedures.

Fan and coil performance under containment design conditions has been verified by actual tests of prototypes under simulated containment design conditions.

6.2.2.5 Instrumentation Requirements

The following sections provide descriptions of the instrumentation provided for the monitoring and actuation of each CHRS. Details of the design and logic of the instrumentation is discussed in Chapter 7.

6.2.2.5.1 Containment Spray System

Instrumentation required for the CSAS and the RAS is described in Section 7.3.

The CSS instrumentation has been designed to facilitate automatic operation, remote control, and continuous indication of system parameters.

All system motor operated valves are provided with position indication in, and are operable from the control room. This allows the operator to continuously monitor system status and remotely operate valves as necessary.

The RWT is equipped with a redundant level indication system.

ARKANSAS NUCLEAR ONE
UNIT 2

Six level transmitters are mounted on the RWT, all of which provide separate level indication in the control room. Two of these transmitters provide input to a low level alarm in the control room. The remaining four transmitters provide the basis for the RAS signal as further discussed in Section 7.3.

Temperature indication and alarm instrumentation are provided for the RWT.

Level switches are provided on the RWT which automatically de-energize the tank heaters when the level drops to a point exposing the elements.

Local temperature indicators are provided at the inlet to the shutdown cooling heat exchangers. A local pressure indicator is located on the common 24-inch diameter supply line from the RWT.

Two level transmitters, two locally mounted level indicators and one control room mounted level indicating switch with associated low-high level alarm are provided on each spray header to monitor spray riser level and to facilitate riser fill operation.

6.2.2.5.2 Containment Cooling System

Flow switches are provided at the outlet of each cooling unit which, upon low flow, will sound an alarm in the control room.

Position switches provide bypass damper position indication in the control room.

6.2.3 CONTAINMENT AIR PURIFICATION AND CLEANUP SYSTEMS

There are three systems which provide for containment air purification and cleanup.

- A. The CSS provides for fission product removal from the containment atmosphere following a postulated LOCA.
- B. The hydrogen recombiner system provides for removal of hydrogen from the containment atmosphere following a postulated LOCA.
- C. The Containment Purge System (CPS) provides for containment atmosphere purification for personnel access.

The CPS serves no safety function and is described in Section 9.4.5. The hydrogen recombiner system is discussed in Section 6.2.5. A description of the CSS and discussion of its function as a CHRS are presented in Section 6.2.2. This section describes and evaluates the fission product removal function of the CSS.

6.2.3.1 Design Bases

The design basis for the fission product cleanup capability of the CSS is to provide sufficient fission product removal and retention capability such that off-site radiation exposures resulting from a postulated LOCA are within the guidelines of 10 CFR 50.67. The Seismic Category I CSS provides heat removal capability as well as a scrubbing action on the containment atmosphere to remove airborne halogen and particulate fission products following a LOCA. The buffering agent is mixed with the boric acid spray as it fills the base of the building. This mixture of boric acid and buffering agent will continue to remove post-accident energy and remove

ARKANSAS NUCLEAR ONE
UNIT 2

fission product iodine as it is recirculated through the CSS. Adequate amounts of buffering agent are added to raise the sump fluid pH to ensure removal of elemental iodine from the containment atmosphere and to retain the iodine in the containment sump fluid.

In order to achieve the above objective, the following system requirements must be met.

- A. Sufficient TSP-C must be added to the sump solution before the recirculation of the sump solution occurs to assure that the iodine removed from the reactor building atmosphere by the spraying action will not re-evolve from the sump liquid as it is sprayed back into the building.
- B. The containment spray header and spray nozzles must be designed to provide maximum coverage of the containment atmosphere.

The CSS is designed to withstand the Design Basis Earthquake (DBE) without rupture or loss of function. The system is designed to be redundant and capable of withstanding a single active failure as required by General Design Criterion 41. To ensure reliability of the system throughout its life, the system is designed to be inspectable and testable to the extent practicable as required by General Design Criteria 42 and 43.

6.2.3.2 System Design

6.2.3.2.1 System Description

The CSS is shown in Figure 6.2-17. Section 6.2.2 contains general system and individual component descriptions as well as discussion of the CSS heat removal capability. System design characteristics applicable to the CSS fission product removal capability follow.

Each CSS loop is designed to deliver borated water to its respective containment header at a minimum flow rate of 1875 gpm during the injection mode and 2,000 gpm during recirculation. Each of the spray headers is located at the highest possible elevation in the containment, conforming to the shape of the containment dome, and providing the maximum possible coverage of the containment atmosphere by the spray droplets. The location of the headers provides an area-averaged droplet fall height of 104 feet. The spray system directly sprays approximately 79 percent of the total containment free volume. This value is based on conservatively assuming that significant obstructions to the main spray will result from the polar crane and bridge, various platforms, pressurizer, steam generators, floors, missile shield, and refueling machine. The entire containment dome and all volumes under directly sprayed gratings are assumed to be directly sprayed.

Of the remaining 21 percent of the containment free volume not directly sprayed, approximately 14 percent have good communication with the main spray while seven percent have restricted communication with the main spray. Although not directly sprayed, volumes such as those under the refueling machine, polar crane and bridge, and the lower portions of the steam generator compartments, where the reactor coolant pumps are located, have good communication with the directly sprayed volumes and account for 14 percent of the containment free volume. The seven percent of the containment free volume having restricted communication with the sprayed volumes includes volumes such as the reactor vessel cavity and those portions of the annular region between the secondary shield walls and the primary containment wall which are covered by the operating floor or other floors. Table 6.2-24A provides a summary of all containment regions not directly sprayed and the volumes of these

ARKANSAS NUCLEAR ONE
UNIT 2

regions. Additional mixing occurs between the directly sprayed region and the other volumes due to the recirculation provided by the containment fan cooling units described in Section 6.2.2. Air from the upper spaces is cooled and distributed to the lower regions where the spray access is obstructed.

The spray nozzles used are Sprayco model 1713A ramp bottom design, which deliver spray droplets of approximately 925 micron equivalent diameter with a 35 psi drop across the nozzles and 14.3 gpm per nozzle during injection and approximately 880 micron equivalent diameter at the system design condition of 40 psi drop across the nozzles and 15.2 gpm per nozzle during recirculation.

All CSS components which come in contact with the system fluid during storage or system operation are made of stainless steel to minimize the effect of corrosion. The material controls satisfy the recommendations of Regulatory Guide 1.44, "Control of the Use of Sensitized Stainless Steel," and Regulatory Guide 1.36, "Nonmetallic Thermal Insulation for Austenitic Stainless Steel."

A buffering agent is added to the spray fluid to adjust the pH of the spray fluid collected in the sump to an equilibrium pH of 7.0 or greater. A pH of 7.0 or greater will assure that the iodine removed from the reactor building atmosphere by the spraying action will not re-evolve from the sump liquid as it is sprayed back into the building. Also, the controls on the pH of the reactor containment spray are to ensure freedom from stress corrosion cracking of austenitic stainless steel components and welds of the containment spray system throughout the duration of a postulated accident to completion of cleanup.

6.2.3.2.2 System Operation

The CSS has two modes of operation which are initiated sequentially following system actuation. These are the injection mode and the recirculation mode.

6.2.3.2.2.1 Injection Mode

The CSS is actuated as described in Section 6.2.2. Upon system actuation, the containment spray pumps begin operation simultaneously with the opening of the valves to the spray headers. All other valves which must be opened or closed to assure proper system operation are in the proper (ESF) position as assured by administrative controls.

Each spray pump takes suction from the RWT through a header common to the associated train of SIS pumps. During injection with peak containment pressures, the minimum flow is 1875 gpm per header. The spray droplet size during injection is slightly larger than the nominal 880 microns.

6.2.3.2.2.2 Recirculation Mode

The injection mode will be terminated automatically by the RAS when low level in the RWT is reached. The RAS automatically opens the suction line valves from the containment sump, while closing the minimum flow line valves to the RWT and the RWT outlet valves. The RWT outlet valves closing and the sump outlet/isolation valves opening are coordinated so as to not adversely restrict the flow of water to the pumps while also providing enhanced margin against RWT vortexing. The RAS also opens service water system valves to allow service water flow through the shutdown cooling heat exchangers. The buffering agent is dissolved by the

ARKANSAS NUCLEAR ONE
UNIT 2

sprayed fluid and collected in the containment sump. The containment sump water is made up of boric acid water from the RWT, safety injection tanks, RCS and boric acid makeup tanks and buffering agent. The total amount of buffering agent added when mixed with the total inventory of sump water will yield sump water with a minimum pH of 7.0 at containment temperatures.

6.2.3.2.2.3 System Response

The CSS will deliver full rated flow through the spray nozzles within 56 seconds after the containment design basis LOCA, assuming loss of off-site power. The length of the injection period depends upon the number of ECCS and containment spray pumps running, the size and location of the LOCA or MSLB, and the volume of water in the RWT.

6.2.3.3 Design Evaluation

The CSS is safety-related and is designed to operate following a postulated LOCA. A high degree of system reliability is maintained through system quality control, by general equipment arrangement to provide access for inspection and maintenance and by periodic testing. A failure analysis has been performed on all active components of the system to show that the failure of any single active component will not prevent fulfilling the system design function. This analysis is presented in Table 6.2-23.

Because of the large surface area interface between the spray droplets and the containment atmosphere, the spray system serves as a removal mechanism for fission products postulated to be dispersed in the containment atmosphere. Radioiodine in its various forms is the fission product of primary concern in the evaluation of a postulated LOCA. The major benefit of the containment spray is its capacity to absorb molecular iodine from the containment atmosphere and thus reduce its release to the environment. Off-site thyroid doses are a function of both the rate of removal and the final equilibrium decontamination factor.

6.2.3.3.1 Containment Spray System Performance Evaluation

The performance evaluation of the containment spray system for the removal of iodine from the containment atmosphere requires the determination of spray removal constants and associated decontamination factors (DF) for the various forms of iodine. The calculation of spray removal constants is treated separately for the injection and recirculation modes to account for the change in spray conditions. These removal constants and decontamination factors are then used to demonstrate acceptable results for the calculation of dose consequences for the design basis loss of coolant accident (see Section 15.1.13).

6.2.3.3.1.1 Injection Mode

The analysis of the spray iodine removal during the injection mode is based on the assumption that:

- A. Only one out of two spray pumps is operating at a flow rate of 1875 gpm; and
- B. Containment pressure and temperature are conservatively assumed to remain at 59 psig and 266 °F throughout the injection mode.

ARKANSAS NUCLEAR ONE
UNIT 2

During the injection mode the pH of the spray water will be approximately 4.4, given the maximum RWT boron concentration of 3000 ppm. However, the fresh spray water from the RWT will contain no dissolved iodine and the spray removal constant, λ , for elemental iodine will not be dependent on pH. Based on the methodology of SRP 6.5.2 Rev. 2, the value of λ for elemental iodine during the injection mode is significantly larger than the value of 20 hr^{-1} permitted by the SRP. The spray removal constant for elemental iodine during the recirculation mode must be evaluated separately; see Section 6.2.3.3.1.2.

The removal of particulate forms of iodine by spray is primarily a mechanical rather than chemical process. The spray removal constant for particulate iodines is independent of pH. Based on the methodology of SRP 6.5.2 Rev. 2, the value of λ for particulate iodine is 3.97 hr^{-1} prior to recirculation, 4.24 hr^{-1} after recirculation up to a maximum decontamination factor (DF) of 50, after which the removal constant is reduced to 0.424 hr^{-1} . These values are applicable during both the injection and recirculation modes.

Organic forms of iodine are not assumed to be removed by the containment spray. A spray removal constant of 0 hr^{-1} is assumed for both the injection and recirculation modes.

6.2.3.3.1.2 Recirculation Mode

During the recirculation mode, the spray water will be buffered to a pH of more than 7.0 by the buffering agent. Because the sump water will contain dissolved iodine, the spray removal constant for elemental iodine will be dependent upon the spray pH during the recirculation mode.

Prior to the onset of recirculation while the sump is filling, the buffering agent in the three wire mesh baskets in the bottom on containment will be dissolving in the rising sump water. During this time and for a short period after the start of recirculation while additional mixing of the sump occurs, the pH of the sump water will continuously change, assuming different values which will be dependent upon the amount of buffering agent dissolved and the volume of water in the containment sump. The pH of the spray water drawn from the sump is expected to remain below 7.0 for only a short period following the start of sump recirculation. Once the spray pH reaches 7.0, it will continue to increase to less than 8, as water with higher than average buffering agent concentrations reaches the sump pit. As the higher concentration recirculation flow water returns to and mixes with the sump solution, the pH at the sump pit will fall to its final long term value. These transient conditions are expected to last only for a short time. The sump pH should exceed 7.0 within the first hour after the start of sump recirculation.

Calculations show that the Technical Specification minimum volume of buffering agent will ensure that after a LOCA, when all the water from the containment spray system and from the pipe break collects and mixes in the sump, its pH will be equal to or higher than 7.0. This minimum equilibrium sump pH calculation assumes maximum inventories of borated water at maximum boron concentrations consistent with the Technical Specifications. The maximum equilibrium sump pH is also calculated assuming the maximum possible buffering agent volume with the minimum inventories of borated water at minimum boron concentrations consistent with the Technical Specifications. The maximum equilibrium sump pH is approximately 8.0.

The final pH, with a minimum value greater than 7.0, will prevent the re-evolution of iodine during operation of the containment spray system in the recirculation mode. The short duration of spray at less than 7.0, just after the start of recirculation, does not significantly impact the long term cleanup of elemental iodine; consequently, the spray removal constant for the recirculation mode is calculated assuming a spray pH of 7.0.

ARKANSAS NUCLEAR ONE
UNIT 2

Based on the methodology of SRP 6.5.2 Rev. 2, the spray removal constant, λ , for elemental iodine during the injection mode, is significantly larger than the value of 20 hr^{-1} permitted by the SRP. Therefore, the use of a spray removal constant value of 20 hr^{-1} during the injection and recirculation modes is conservative for LOCA dose calculations. A post-recirculation spray removal constant of 0.0 is conservatively used until the time that the projected pH reaches a value of 7.0.

The extent of cleanup of elemental iodine by the spray is limited by the decontamination factor. Using the methodology of SRP 6.5.2 Rev. 2, the DF for elemental iodine is significantly larger than the value of 200 permitted by the SRP.

6.2.3.4 Tests and Inspections

Tests and inspections for the CSS are described in Section 6.2.2.

These tests provide adequate proof that the buffering agent containers and CSS will deliver the proper mixture of boric acid and buffering agent under accident conditions.

6.2.3.5 Instrumentation Requirement

A description of the instrumentation requirements of the CSS is given in Section 6.2.2.

6.2.4 CONTAINMENT ISOLATION SYSTEMS

The containment isolation systems provide the means of isolating fluid systems that pass through containment penetrations so as to confine to the containment any radioactivity that may be released following a postulated accident. ANO-2 does not have a particular system for containment isolation; however, isolation is achieved by applying common criteria to penetrations in the various fluid systems and by using containment pressure and, in some cases, a safety injection signal to actuate the appropriate valves.

6.2.4.1 Design Bases

The design basis for the CIS is to minimize the release of radioactive material from the containment by closing all fluid penetrations not serving accident consequence limiting systems, so that the site boundary thyroid and whole body doses from radioactive material escaping through the containment penetrations plus the doses from other sources during any postulated accident are within the limits of 10 CFR 50.67.

The containment isolation systems are designed in accordance with 10 CFR 50 Appendix A, General Design Criteria 54, 55, 56 and 57, and meet the leak testing criteria of 10 CFR 50, Appendix J. The applicable criterion for each penetration is shown in Table 6.2-26.

The containment isolation systems are also designed to withstand the design basis earthquake and the credible failure of any single active or passive component without loss of isolating capability.

Information concerning the criteria applied with respect to the number and location of isolation valves is contained in Section 6.2.4.2 below.

Since no fluid instrument lines penetrate the containment, no special isolation criteria need be considered for this type of penetration on Arkansas Nuclear One - Unit 2.

ARKANSAS NUCLEAR ONE
UNIT 2

6.2.4.2 System Design

The containment isolation systems are designed to provide at least a double barrier to the escape of radioactive material at each fluid penetration through the containment liner plate. The double barriers take the form of closed piping systems, both inside and outside containment, various types of isolation valves, and double resilient or compression seals.

Double barriers are provided to ensure that no single, credible failure or malfunction of an active or passive system component can result in loss of isolation or significant leakage.

A means of leak testing all barriers in fluid systems that serve a containment isolation function has been provided. The capability to periodically test the operability of all containment isolation valves which must operate to achieve isolation has also been provided.

Table 6.2-26 provides descriptive information concerning containment isolation barrier or valve arrangement and design for each containment fluid penetration, including the applicable General Design Criterion.

Schematic diagrams of each fluid penetration are shown on individual system diagrams as referenced in Table 6.2-26.

Containment isolation will be initiated by means of a Containment Isolation Actuation Signal (CIAS) and in some cases a Safety Injection Actuation Signal (SIAS). A CIAS occurs as a result of high containment pressure, or may be generated manually by pushbutton from the control room. A SIAS occurs as a result of low pressurizer pressure or high containment pressure. It may also be generated manually by pushbuttons from the control room. The instrumentation circuits that generate a CIAS and SIAS are described in Chapter 7.

A CIAS will cause all power operated containment isolation valves to close except those which are normally locked closed and those within the ESF systems and the CVCS charging system. Upon receipt of an SIAS, the CVCS charging system functions automatically to inject the contents of the boric acid makeup tanks into the RCS as described in Section 9.3.4.4.1. The outside containment isolation valve is located as close to containment as practical as required by General Design Criterion 55.

All automatic containment isolation valves that are activated by a CIAS or other ESF signal also have hand switches and position indication in the control room. All isolation valves and associated piping systems have been designed to operate under the expected dynamic forces resulting from intended or inadvertent closure under any operating condition.

Containment isolation valves that are located inside the containment are designed to function under the pressure-temperature conditions of both normal operation and the DBA. The expected pressure-temperature condition of normal operation is 14.7 psia and 110 °F. The pressure-temperature condition used for valve design inside the containment is 59 psig and 300 °F. Containment isolation valves located outside of containment are qualified to conditions specific to their location and application. The capability of valves designed to function in the post-DBA environment is discussed in Section 3.11.

6.2.4.3 Design Evaluation

The CIS is designed to present a double barrier to any flow path from the inside to the outside of the containment to meet the single failure criterion.

ARKANSAS NUCLEAR ONE UNIT 2

In all cases where two power operated isolation valves in series are used, channel separation is maintained. In all cases where check valves are used as automatic containment isolation valves, these valves are not used as the outermost isolation valve.

Adequate protection is provided for piping, valves, and vessels against dynamic effects and missiles which might result from plant equipment failures, including a postulated LOCA. Where system design permits, isolation valves inside the containment are located between the secondary shield and the inside containment wall. The secondary shield serves as the missile barrier. Containment isolation valves located outside containment are located as close to the containment as possible.

The containment purge system isolation valves need not be capable of closing against the flow and pressure inside the containment during a postulated DBA as they will remain closed until the plant is in operational Modes 5 and 6 as required by the Technical Specifications. These valves are qualified to remain closed against the DBA pressure. (2CAN047817, 2CAN047823)

6.2.4.4 Tests and Inspection

All components of the containment isolation systems were designed, fabricated, and tested under quality assurance requirements in accordance with 10 CFR 50, Appendix B. Nondestructive examination was performed on the components of the systems in accordance with the applicable codes described in Section 3.2.2.

The containment isolation systems are functionally tested under conditions of normal operation in accordance with the procedure outlined in Chapter 14.

The containment isolation systems are periodically tested to determine availability to perform the desired function.

Automatic isolation valves that receive a CIAS to close, where closure of the valve will not limit or restrict normal plant operation, are periodically functionally tested by the on-line testing capability described in Section 7.3. All other valves are periodically tested for CIAS electrical continuity.

All automatic isolation valves which are not tested during normal operation are functionally tested during each refueling shutdown.

Test connections and pressurizing means are provided to test each isolation valve or barrier for leak tightness. Either nitrogen or air is used as the pressurizing medium, depending on the physical location and service of each line. Testing frequencies are listed in the Technical Specifications.

Table 6.2-26 provides a list of containment penetrations, i.e., fluid system piping, instrument, electrical and equipment, and personnel access; and identifies the type of leak testing to be performed in accordance with 10 CFR 50, Appendix J.

ARKANSAS NUCLEAR ONE
UNIT 2

6.2.5 COMBUSTIBLE GAS CONTROL IN CONTAINMENT

Three systems were originally provided for combustible gas control in containment. They are the hydrogen recombiner system, the containment air recirculation system, and the containment atmosphere monitoring system. Subsequent evaluation determined that the containment cooling units or containment spray system provide adequate atmosphere mixing and that the containment recirculation fans are not needed.

6.2.5.1 Design Bases

For pressurized water reactors, such as Arkansas Nuclear One - Unit 2, the only combustible gas of consequence inside containment is hydrogen. For the remainder of this section, combustible gas and hydrogen may be treated as synonymous.

The systems provided for hydrogen control in containment are designed to limit the hydrogen gas concentration to a maximum of 3.9 v/o following any postulated LOCA, and meet the design criteria of Regulatory Guide 1.7, by providing the following:

- A. A redundant means of measuring the containment atmosphere hydrogen concentration using the containment atmosphere monitoring system.
- B. A redundant means of mixing the containment atmosphere to prevent concentration of hydrogen in the containment dome using the containment cooling units and/or the containment spray system. (See Section 6.2.2)
- C. A redundant means of controlling hydrogen gas concentrations without reliance on purging using the hydrogen recombiner system.

Sizing of the hydrogen recombiner system was based upon a hydrogen evolution rate consistent with the assumptions stated in Regulatory Guide 1.7 and as further discussed in Section 6.2.5.3.

Combustible gas control following a LOCA is accomplished by the recombiner system, manually started at a measured hydrogen concentration of approximately 2.0 v/o.

The systems used for hydrogen control in containment are designed to Seismic Category 1 requirements.

6.2.5.2 System Design

6.2.5.2.1 Containment Atmosphere Monitoring System

The containment atmosphere monitoring system consists of two redundant hydrogen gas analyzers, and two redundant radiation monitors. The function of the radiation monitors is discussed in Section 5.2.7.

The hydrogen analyzers are a flow-through type and provide, when placed in service, a continuous measurement of hydrogen concentration in containment.

The continuous sample for the monitoring system is drawn from a collection manifold.

ARKANSAS NUCLEAR ONE
UNIT 2

6.2.5.2.2 Containment Air Recirculation System

The containment air recirculation system is described in Section 9.4. The system is not credited in any design basis accident or transient analysis. It is not credited in the ANO-2 probabilistic risk assessment for accomplishing the hydrogen mixing function.

6.2.5.2.3 Hydrogen Recombiner System

The hydrogen recombiner system consists of two Westinghouse thermal hydrogen recombiners located within containment at Elevation 426 feet, 6 inches. These are convection flow, 100 scfm electric units rated at 75 kW each. They are designed to operate at 95 percent efficiency and each unit is capable of maintaining the hydrogen concentration in the containment below 3.9 v/o following any postulated LOCA. Each unit is powered by a separate ESF bus, and is designed to withstand the DBE without loss of function. Data describing the units is provided in Table 6.2-27. The recombiner efficiency can be affected by the density of the air. To assure that a 4% hydrogen concentration is not reached prior to the time that containment post LOCA pressure drops to a value at which 95% recombiner efficiency can be assured, operational hydrogen concentration in containment that may develop over time as a result of leakage from the RCS is monitored and appropriately controlled.

6.2.5.3 Design Evaluation

This evaluation includes the following:

- A. an evaluation demonstrating the functional requirements of the system; and,
- B. an analysis of hydrogen generation following a LOCA.

Systems provided for hydrogen control in the containment meet the same design, quality assurance, redundancy, power source and instrumentation requirements as for an engineered safety feature system, and do not introduce any additional safety problems which may affect containment integrity.

No single failure in the hydrogen control systems can prevent the minimum necessary control of hydrogen concentration from occurring.

Sizing of the hydrogen removal equipment was based upon a hydrogen generation model as presented in Section 6.2.5.3.1.

6.2.5.3.1 Sources of Hydrogen

Following a postulated LOCA, hydrogen gas may accumulate within the containment as a result of:

- A. the decomposition of water by radiolysis;
- B. a metal water reaction involving the zirconium fuel rod cladding and the reactor coolant; and/or,
- C. corrosion of metals within containment by the caustic containment spray solution.

ARKANSAS NUCLEAR ONE
UNIT 2

The assumptions used in calculating the amount of hydrogen produced from each source are the same as, or more conservative than, those suggested in Regulatory Guide 1.7. In the current analysis, the COGAP computer program (NUREG/CR-2847, Ref. 80) was used to calculate the hydrogen generation and resulting concentration as a function of time.

The following sections provide more specific information about the assumptions and methods used to predict hydrogen gas accumulation.

6.2.5.3.1.1 Radiolytic Hydrogen Generation

Water is decomposed into hydrogen and oxygen by the absorption of energy emitted by nuclides contained in fuel and those intimately mixed with the LOCA water. The quantity of hydrogen that is produced by radiolysis is a function of both the energy of ionizing radiation absorbed by the LOCA water and the net hydrogen radiolysis yield, $G(H_2)$, pertaining to the particular physical-chemical state of the irradiated water.

THE COGAP program utilizes a method that treats the sump water and core water separately to determine the total hydrogen radiolysis yield. Details of this methodology are found in Reference 80.

6.2.5.3.1.2 Chemical Hydrogen Generation

In addition to radiolysis, hydrogen is generated by chemical reactions occurring within the containment. The two primary sources of chemical hydrogen generation are (a) the zirconium-water reaction occurring at elevated fuel cladding temperatures and (b) the corrosion of metals in the alkaline environment of the post-DBA containment.

A. Zirconium - Water Reaction.

Zirconium reacts with steam according to the reaction

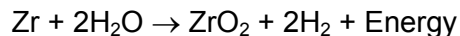

The hydrogen gas evolved from this reaction is calculated to be:

$$\frac{2.01 \text{ lbmole H}_2}{\text{lbmole Zr}} \times \frac{386 \text{ scf H}_2}{\text{lbmole H}_2} \times \frac{\text{lbmole Zr}}{91.22 \text{ lb Zr}} = 8.505 \frac{\text{scf H}_2}{\text{lb Zr}} \quad (6.2-25)$$

Where scf = Standard Cubic Feet at 70°F and 1 atm.

The ECCS, i.e., SIS, is designed to remove core heat at a rate that will prevent fuel rods from heating to the point where Zr-H₂O reactions will take place. The analysis of the LOCA shows that with the passive accumulators and the active elements of high pressure and low pressure safety injection, less than one percent of the zirconium cladding will react with water to generate hydrogen. In analyzing post-accident hydrogen generation, it has been conservatively assumed that five percent (more than 5 times the calculated rate) of the total mass of zirconium in Zircaloy-4 fuel cladding reacts. For a conservative estimate of 45,164 lb of Zircaloy-4 cladding which consists of 98.6 percent zirconium metal, this amounts to 2,227 lb of zirconium reacting. The total hydrogen generation from this source is then estimated to be 19,206 scf.

ARKANSAS NUCLEAR ONE
UNIT 2

The hydrogen that is generated from the Zr-H₂O reaction exits from the core at a temperature approximating the temperature required for the reaction itself to take place, 3,365 °F (Reference 56). At this temperature, the hydrogen would instantaneously react with the oxygen in the containment air to produce water; in fact, this very assumption is made in determining the total exothermic heat of the Zr-H₂O reaction. In this analysis, however, none of the chemically produced hydrogen from the Zr-H₂O reaction is assumed to recombine.

B. Corrosion of Metals in Containment

Hydrogen is formed by corrosion of metals in the containment. The significant portion of this source of hydrogen is from the corrosion of zinc, copper and aluminum by the alkaline containment spray solution. Table 6.2-28 gives the quantity of each material in the containment. Zinc in the containment is in two forms: zinc base paint and galvanized metals such as ductwork and cable trays.

The corrosion rates for zinc base paint, galvanized surfaces, aluminum, and copper used for design purposes are given in Table 6.2-29. These corrosion rates are based on conservatively high pH and temperature conditions. The pH values assumed have been adjusted to room temperature for consistency with the industry methods for reporting pH/corrosion rate relationships.

6.2.5.3.1.3 Other Sources of Hydrogen

During normal operation of the plant, hydrogen is dissolved in the primary system water. The concentration of hydrogen in primary coolant ranges from 10 - 50 scc/kg of coolant. In addition hydrogen is also present in the pressurizer during normal operation. The total amount of hydrogen in the primary system is taken to be 500 scf.

6.2.5.3.1.4 Post-Accident Hydrogen Concentration in Containment

The time dependent quantity of hydrogen in the containment (assuming no pre-existing hydrogen concentration) is given in Figure 6.2-25. The amount of hydrogen contributed from each source as a function of time is presented in Figure 6.2-25A and the amount generated from spray induced corrosion of each metal is shown in Figure 6.2-25B. Note that the calculated hydrogen generation from spray induced corrosion assumed conservative pH conditions based on spray and sump water buffering by the former NaOH system. The lower long term pH values associated with NaTB will result in lower hydrogen production.

The addition of RCS vents will not change the total volume of hydrogen released to the containment and therefore compliance with 10CFR50.44 is not affected by RCS venting.

As shown in Figure 6.2-25, the effect of one hydrogen recombiner placed in operation at about 3.5 days after the accident is sufficient to maintain hydrogen concentrations below allowable limits if there is no pre-existing hydrogen concentration.

6.2.5.4 Tests and Inspection

Historical data removed - To review exact wording please refer to Section 6.2.5.4 of the FSAR.

ARKANSAS NUCLEAR ONE
UNIT 2

All Seismic Category 1 components of the systems are designed, fabricated, installed and tested under quality assurance requirements in accordance with 10 CFR 50, Appendix B.

Hydrogen analyzers and radiation monitoring equipment are calibrated against known sources to verify their accuracy.

6.2.5.5 Instrumentation Requirements

Two hydrogen analyzers are provided for sampling of the containment atmosphere following beyond design basis events. Sample points are provided at various elevations inside the containment to ensure a representative sample. All containment isolation valves for this system provide position indication in and are operable from the control room. This allows the operator to continuously monitor system status and remotely operate valves as necessary.

The hydrogen recombiners are initiated manually from the control room.

6.3 EMERGENCY CORE COOLING SYSTEM

6.3.1 DESIGN BASES

The Emergency Core Cooling System (ECCS) or Safety Injection System (SIS) is designed to provide core cooling in the unlikely event of a Loss of Coolant Accident (LOCA). The cooling must prevent fuel melting or significant alteration of core geometry, limit the cladding metal-water reaction, and remove the energy generated in the core for an extended period of time following a LOCA. The SIS fluid must contain sufficient neutron absorber to maintain the core subcritical following a LOCA. In addition, the SIS functions to inject borated water into the Reactor Coolant System (RCS) to prevent fuel damage and to increase the shutdown margin of the core in the unlikely event of a steam line rupture. The system is actuated automatically.

6.3.1.1 Range of Coolant Ruptures

The SIS provides sufficient core cooling to accomplish the design requirements for all breaks in the RCS up to and including the double ended break in the largest reactor coolant pipe. A detailed discussion of the types of breaks is found in Section 6.3.3.

6.3.1.2 Fission Product Decay Heat

The fission product decay energy curve used in the design and accident analysis is the Proposed ANS Standard (Reference 16), with the addition of the uncertainties listed below. Included in the decay energy rate is the decay energy of the U-239 and Np-239 produced by neutron absorption in U-238. The standard decay energy rate for infinite reactor operation as a function of time after shutdown is shown in Figures 6.3-1A and 1B.

<u>Cooling Time t_s (sec)</u>	<u>Uncertainty, used in ECCS Evaluation</u>
$t_s < 10^3$	+ 20%, - 40%
$10^3 < t_s < 10^7$	+ 10%, - 20%
$t_s > 10^7$	+ 25%, - 50%

6.3.1.3 Reactivity Required for Cold Shutdown

The Refueling Water Tank (RWT) contains sufficient boric acid to provide shutdown margin for the reactor, cold, with all Control Element Assemblies (CEAs) out. Physics analytical methods are described in Section 4.3.3. Sampling of the system and RWT in accordance with the Technical Specifications ensures that the required boric acid content is present.

In addition to its emergency core cooling functions, the SIS functions to inject borated water into the RCS and increase shutdown margin following a rapid cooldown of the system as a result of a steam line rupture. Although there may be a brief return to criticality during this accident, critical heat flux conditions are not exceeded, and no core damage results. Refer to Section 15.1.4 for the analysis of the accident.

ARKANSAS NUCLEAR ONE
Unit 2

6.3.1.4 Capacity to Meet Functional Requirements

In addition to the requirements defined above, the following additional functional requirements are used for system design.

- A. The safety functions defined in Section 6.3.1 are accomplished assuming the failure of a single active component during the injection mode of operation or the single failure of an active or passive component during the recirculation mode of operation. For failure analysis, all necessary supporting systems including the emergency electrical power system are considered.
- B. The design of the SIS permits inspection and testing of components and subsystems to ensure their availability and proper operation.
- C. All components of the system and associated critical instrumentation which must be operated following a LOCA are designed to operate in the environment to which they would be exposed.
- D. The system is designated Seismic Category 1 and must be able to perform its function following an accident with combined LOCA and Design Basis Earthquake (DBE) loads.
- E. The system is designed to meet the requirements of Section 6.3.1 for the duration of a LOCA condition. During the short period of time following blowdown, the core must be rapidly refilled with borated water to remove sensible heat. This requirement is met by the injection of borated water from the safety injection tanks and from the refueling water tank.

6.3.1.4.1 Capacity to Meet Short-Term Cooling Requirements

The safety injection tanks, containing borated water pressurized by a nitrogen cover gas, constitute a passive system which automatically discharged into the RCS to provide core cooling and re-cover the core when the pressure falls below the tank pressure. Adequate fluid is contained in the tanks to accomplish this function, assuming one tank discharging through a cold leg break.

The refueling water tank fluid is injected into the RCS by two sets of full capacity pumps. Each set consists of one High Pressure Safety Injection (HPSI) pump and one Low Pressure Safety Injection (LPSI) pump. Each set of pumps is capable of performing this function with one of the injection nozzles discharging through a cold leg break.

6.3.1.4.2 Capacity to Meet Long-Term Cooling Requirements

Long-term cooling is accomplished by recirculating the water in the containment sump using the HPSI pumps. The switch from injection to recirculation occurs automatically. The recirculated sump water is injected to the core and the mechanism for residual heat removal is boil-off of fluid in the reactor vessel. For certain break sizes and break locations, this may result in a long-term buildup of solids in the reactor vessel. Accordingly, manual realignment procedures have been developed which establish a circulation flow through the reactor vessel to flush dissolved solids from the core region. These procedures, which are implemented between two and four hours post-LOCA, insure the continued operability of the ECCS for extended periods of time following a LOCA.

6.3.1.4.3 Sequence of Events Diagram

The sequence of events diagram shown in Figure 6.3-12 identifies each safety system required to function to cool the core. The diagram begins with the initiating event, LOCA and branches out to show the sequence of events required to achieve each required safety function. The safety functions are reactivity control, containment temperature, pressure and iodine control, emergency core cooling, establish containment and combustible gas control.

The following systems and components are required to operate in support of the engineered safety features identified on the sequence of events diagram:

- A. Engineered Safety Feature Actuation System (ESFAS)
- B. Emergency Power System
- C. Refueling Water System
- D. Containment Sump
- E. Service Water System

6.3.1.5 Safety Injection Component Arrangement

- A. The safety injection pumps are located in the auxiliary building. During Recirculation mode, these pumps take suction from the containment sump. As a result of NRC Generic Safety Issue (GSI) -191 and Generic Letter (GL) 2004-02, the containment sump strainer surface area has been increased to accommodate the amount of debris transported to the sump screen. HPSI pump NPSH requirements have been evaluated for the head loss across the replacement strainers. The evaluation has concluded the NPSHA is greater than the NPSHR. The required NPSH for the HPSI pumps is 19.4 feet at a flow rate of 900 gpm. For this design calculation, the sump inventory is considered subcooled when containment sump pressure is below the saturation temperature corresponding to minimum Technical Specification allowed containment pressure. No credit is taken for increased containment pressure as a result of accident conditions. The available NPSH is calculated at the pump suction. The calculation is made assuming high pressure safety injection and containment spray pump operation.

The NPSH required by the LPSI pumps is 25 feet at a flow rate of 5,000 gpm per pump during injection, when the pumps take suction from the refueling water tank. The calculation is made assuming HPSI and containment spray pump operation with RWT temperature of 110 °F. The LPSI pumps are not required during recirculation.

- B. Three separate watertight rooms are provided for the Engineered Safety Feature (ESF) equipment. The safety injection and containment spray pumps, the shutdown cooling heat exchangers, and the piping are arranged so that the passive failure of one pipe will not flood more than one room or cause the failure of more than one pump of each type.
- C. The four safety injection check valves are located as close as practical to the RCS cold leg piping. Each check valve leakage line is connected to the safety injection line immediately upstream of the safety injection check valve. The water in the safety injection piping is maintained at the refueling concentration by periodic circulation of refueling water through the safety injection piping.

ARKANSAS NUCLEAR ONE
Unit 2

- D. The safety injection tanks are located inside the containment area and are protected from missiles.

6.3.2 SYSTEM DESIGN

6.3.2.1 System Schematic

A simplified diagram of the safety injection system is shown in Figure 6.3-2. The major components of this system are the refueling water tank, three HPSI pumps, two LPSI pumps, four safety injection tanks, eight High Pressure Safety Injection (HPSI) valves, and four Low Pressure Safety Injection (LPSI) valves.

6.3.2.2 Component Description

The design parameters and codes for the major components are listed in Table 6.3-1. The components required to provide core protection for the complete spectrum of reactor coolant pipe breaks are defined in Section 6.3.3.

6.3.2.2.1 Refueling Water Tank

The RWT is an atmospheric tank containing borated water at greater than 40 °F to maintain the boric acid concentration in solution. The tank is vented through the overflow and the atmospheric vent. The vent is sized for tank integrity during all thermal and pumping transients.

The RWT is normally used to fill the refueling canal and transfer tube for refueling operations. Approximately 384,000 gallons are required to fill the refueling cavity to a depth of about 24 feet above the reactor vessel flange joint.

The volume of water required by the safety injection and containment spray systems is approximately 384,000 gallons. This provides sufficient water so that the ESF pumps can take suction from the RWT for a minimum of 30 minutes after initiation of emergency core cooling and provides adequate water for long-term recirculation. This requirement of 384,000 gallons is based upon all seven ESF pumps operating at their rated flows.

The water level in the containment after this water (384,000 gallons) has been introduced and excluding that in the reactor vessel cavity is approximately seven feet above the 336-foot, 6-inch containment floor. The safety injection tank contents of 5,920 ft³ is included in the inventory available for recirculation. For long-term core cooling, a continuous source of borated water is provided by recirculating water from the containment sump. This height of water will provide adequate NPSH for the ESF pumps even under boiling sump conditions.

6.3.2.2.2 Safety Injection Tanks

The four safety injection tanks are used to flood the core with borated water following a depressurization as a result of LOCA. The tank gas/water fractions, gas pressure, and outlet pipe size were the subject of a parametric study performed to determine the improvement in ECCS performance which could be effectively obtained over the results reported in the PSAR and were selected with NRC and ACRS review and approval.

The tanks contain borated water and are pressurized with nitrogen. The tank liquid level, boron concentration, and nitrogen cover pressure maintained in the tanks are as specified in the Technical Specifications.

ARKANSAS NUCLEAR ONE
Unit 2

Redundant and diverse level and pressure instrumentation is provided to monitor the tanks during plant operation, as discussed in Section 6.3.5. Provisions have been made for sampling, filling, draining, venting, and correcting boron concentration. The data summary for the safety injection tanks is given in Table 6.3-1.

In addition to the administrative controls placed on safety injection tank discharge valves, the motor operated isolation valves are provided with interlocks with the pressurizer pressure measurement channels to open the valves automatically prior to RCS pressure increasing above 700 psia, and to prevent inadvertent closure prior to or during an accident. Visual indication of valve position is provided in the control room.

When the RCS pressure increases above the safety injection tank pressure, but prior to the automatic opening of the safety injection tank discharge valves, the valves are opened by the operator, and power supply breakers to the discharge valves are open under administrative control.

6.3.2.2.3 Low Pressure Safety Injection Pumps

The LPSI pumps serve two functions. The first is to inject large quantities of borated water into the RCS during an emergency involving a large reactor coolant pipe rupture. Sufficient flow is delivered under these conditions to satisfy functional requirements described in Section 6.3.1.1. The second is to provide flow through the reactor core and shutdown cooling heat exchangers for shutdown cooling and residual heat removal during cold shutdown. The pump characteristics curve is presented in Figure 6.3-3.

The LPSI pumps are sized to provide adequate shutdown cooling flow. The flow available with a single LPSI pump is sufficient to maintain a core ΔT less than the full power ΔT , about 60 °F, at the initiation of shutdown cooling 3.5 hours after shutdown. Maintenance of the core at less than full power ΔT results in a lesser demand on the core structural design than does normal plant operation.

The design temperature for the LPSI pumps is derived from the temperature of the reactor coolant at the initiation of shutdown cooling, about 300 °F nominal plus the 60 °F ΔT mentioned above. The design pressure for the low pressure pumps is based upon the sum of the maximum pump suction pressure, which occurs at the initiation of shutdown cooling, and the pump shutoff head.

The LPSI pumps are single stage centrifugal units equipped with mechanical face seals backed up by a bushing and with leakoff provisions. To prolong seal life, a portion of the pump discharge is cooled by service water and is recirculated to the seals. The pumps are provided with drain and flushing connections to permit reduction of radiation levels before maintenance. The pressure containing parts are fabricated from stainless steel; the internals are selected for compatibility with boric acid solutions.

The pumps are provided with minimum flow protection to prevent damage when starting against a closed system. The pumps are protected from run-out damage by appropriate system valve adjustments and/or orifice sizing during the test program. The flow restricting orifice (2F0-5090) in the main header is sized as required to provide system resistance suitable for precluding excessive pump run-out.

The low pressure pump data are summarized in Table 6.3-1.

6.3.2.2.4 High Pressure Safety Injection Pumps

The HPSI pumps function to inject borated water into the RCS if a break occurs in the RCS boundary. For small breaks, RCS pressure remains high for long periods of time following the break. In this event, the HPSI pumps will provide sufficient flow to meet the criteria given in Section 6.3.1. The HPSI pumps are also used during recirculation to maintain a water circulation through the core for extended periods of time following a LOCA.

The HPSI pumps are sized such that one pump will deliver saturated water at a rate sufficient to maintain level in the reactor vessel, matching boiloffs from decay heat at the time the safety injection system switches to the recirculation mode, not less than 20 minutes after the accident. The [historical pump characteristic curve](#) is shown in Figure 6.3-4. [Current pump performance data is maintained in ANO testing documentation and calculations.](#)

Mechanical seals are used and are provided with leakoffs. The seals are externally cooled. The pumps are provided with drain and flushing connections to permit reduction of the radiation level before maintenance. The pressure containing parts of the pump are stainless steel with internals selected for compatibility with boric acid solutions. The materials selected are analyzed to ensure that differential expansion during the design transients can be accommodated.

The pumps are provided with minimum flow protection to prevent damage which could result from operation against a closed discharge. The HPSI pumps have been evaluated and are maintained to operate while recirculating through the minimum recirculation flow path following an accident without experiencing significant degradation. The pumps are protected from run-out damage by appropriate system valve adjustments and/or orifice sizing during the test program. The header isolation valves (2CV-5015-1, 2CV-5035-1, 2CV-5055-1, 2CV-5075-1 for high pressure header Number 1 and 2CV-5016-2, 2CV-5036-2, 2CV-5056-2, 2CV-5076-2 for high pressure header Number 2) can be used to throttle HPSI flow to each RCS cold leg. There is a manual globe valve upstream of each isolation valve that is throttled to balance flow among the injection headers. The flow restricting orifices in the main headers (2FO-5101 for Number 1 and 2FO-5102 for Number 2) are sized as required to provide system resistance suitable for precluding excessive pump run-out.

The design temperature for the HPSI pumps is based upon the saturation temperature of the reactor coolant at the containment design pressure, about 300 °F, plus a tolerance of 100 °F. This provides the design temperature of 400 °F. The design pressure for the high pressure pumps is based upon the sum of the containment spray pump shutoff head and the shutoff head of the high pressure pump.

The high pressure pump data are shown in Table 6.3-1.

6.3.2.2.5 Piping

The following piping is provided to deliver borated safety injection water from the safety injection tanks and from the RWT to the safety injection nozzles in the RCS cold legs:

- A. From each safety injection tank to its respective RCS cold leg safety injection nozzle;
- B. Redundant piping from the RWT and containment sump to the suction of the HPSI, LPSI and containment spray pumps;

ARKANSAS NUCLEAR ONE
Unit 2

- C. Redundant piping from the HPSI pump discharge to the HPI headers, each of the four safety injection nozzles; and,
- D. Piping from the LPSI pump discharge to the LPI header which feeds the four injection nozzles.

The safety injection system piping is fabricated of austenitic stainless steel and is designed to ASME Code Section III. Flexibility and seismic loading analyses are performed to confirm the structural adequacy of the system piping.

6.3.2.2.6 Valves

The location, type, and size of the valves, type of operator, and position of the valve (during the normal operating mode of the plant) are shown on P&ID M-2232. Pressure rating and code design classification are also shown. Relief valves are discussed in Section 6.3.2.10.

A. Actuator Operated Throttling and Stop Valves

The position of each valve on loss of actuating signal or power supply (failure position) is selected to ensure safe operation of any given valve. Valve position indication is provided in the control room as indicated on M-2232. A locking-type control switch in the control room and/or a manual override handwheel is provided where necessary for efficient and safe plant operation.

B. Manually Operated Valves

All manually operated valves with nominal sizes larger than two inches are provided with a double packed stem with an intermediate lantern ring with a leakoff connection.

Globe valves are installed with flow entering the valve under the seat where this arrangement will reduce stem leakage during normal operation. Globe valves are installed with flow entering the valve above the valve seat in the following cases:

1. Normally open globe valves used for equipment isolation (pumps, control valve, etc.) where the pressure gradient is opposite to the normal flow direction when the valve is closed; and,
2. Normally open valves between the SIS and any other system if the flow is normally into the SIS and if the valve is to be closed during recirculation.

C. Check Valves

All check valves are the totally enclosed type. Low pressure drop check valves with flow resistance characteristics equal to or less than a clearway swing check valve of the same size as the connecting pipe are used in the pump suction lines.

6.3.2.3 Applicable Codes and Classifications

See Table 6.3-1.

ARKANSAS NUCLEAR ONE
Unit 2

6.3.2.4 Materials Specifications and Compatability

The materials used in the construction of the SIS components are given in Table 6.3-1. Pressure boundary materials in contact with radioactive coolant are austenitic stainless steel, with stellite or equivalent material being used for valve seats or discs. The materials of construction used in both the active and passive components have been evaluated and in each case it has been concluded that the materials selected are both compatible with the most severe environmental condition they will be exposed to and in accord with all code requirements.

Material controls satisfy the recommendations of Regulatory Guide 1.44, "Control of Use of Sensitized Stainless Steel," and Regulatory Guide 1.36, "Nonmetallic Thermal Insulation for Austenitic Stainless Steel."

6.3.2.5 Design Pressure and Temperatures

The design temperatures and pressures of each component are given in Table 6.3-1. The basis for these values is discussed in Section 6.3.2.2.

6.3.2.6 Coolant Quantity

The safety injection tanks contain sufficient water to recover the core even if the entire contents of one tank is discharged through a pipe break and if all water injected prior to the end of RCS blowdown is assumed lost. The safety injection tank water volume is given in Table 6.3-1.

The RWT is the source for the safety injection pumps. The volume of water in the refueling tank is determined by the quantity necessary to fill the refueling canal during refueling. This volume exceeds the quantity of water which must be injected after a pipe rupture to ensure recirculation from the containment sump and that pump NPSH requirements are met. The RWT volume is given in Table 6.3-1.

6.3.2.7 Pump Characteristics

LPSI and HPSI pump characteristic curves are provided in Figures 6.3-3 and 6.3-4.

6.3.2.8 Heat Exchanger Characteristics

The shutdown cooling heat exchanger is described in the Containment Spray System (CSS) (Section 6.2.2) and shutdown cooling system (Section 9.3.6).

6.3.2.9 ECCS Flow Diagram

Figure 6.3-2 shows the flow paths for the SIS.

Historical data removed - to review the exact wording please refer to Section 6.3.2.9 of the FSAR.

6.3.2.10 Relief Valves and Vents

Protection against overpressurization of components within the SIS is provided by conservative design of the system piping, appropriate valving between high pressure sources and low pressure piping, and by relief valves. All lines within the high and low pressure systems from

ARKANSAS NUCLEAR ONE
Unit 2

the RCS up to and including the safety injection valves are designed for full RCS pressure. In addition, the high pressure header to which the charging pumps discharge is designed for full RCS pressure up to and including the header check valve. Relief valves are provided as required by applicable codes.

All relief valves are of the totally enclosed, pressure tight type with suitable provisions for gagging.

A tabulation of relief valves is provided below:

A. Safety Injection Tank Relief Valves

The relief valves on the safety injection tanks are sized to protect the tanks against the maximum fill rate of liquid or gas into the safety injection tanks. They discharged into the containment. The set pressure is 700 psig with a capacity of 150 gpm.

B. Check Valve Leakage Relief Valve

A backpressure compensated relief valve is provided on the safety injection test and leakage return line. This relief valve is sized to protect against overpressure of the line when filling a safety injection tank. It discharges into the reactor drain tank. The set pressure is 500 psig with a capacity of 40 gpm.

C. LPSI Relief Valve

This backpressure compensated valve protects the LPSI line against the pressure developed due to a sudden temperature increase. It discharges into the holdup tank. The set pressure is 500 psig with a capacity of 5 gpm.

D. HPSI Relief Valve

These valves are sized to protect the HPSI lines against the pressure developed due to a sudden temperature increase. They are backpressure compensated and discharge into the holdup tank. The set pressure is 1,950 psig with a capacity of 5 gpm.

E. HPSI Header Relief Valve

The HPSI header to which the charging pumps discharge is protected from the charging pump discharge pressure by this valve. It discharges into the holdup tank. The set pressure is 2,485 psig with a capacity of 160 gpm.

F. LPSI Header Relief Valve

The LPSI header downstream of the Shutdown Cooling Water Heat Exchangers is protected from potential overpressurization, originating from CVCS system via the LPSI purification cross-tie, by this valve. It discharges into the Boron Management System collection header. The valve set pressure is 500 psig with a capacity of approximately 42 gpm.

6.3.2.11 System Reliability

6.3.2.11.1 Safety Injection Tanks

The safety injection tanks containing borated water pressurized by a nitrogen cover constitute a passive injection system; that is, no outside operator action or electrical signal is required for operation. Each tank is connected to one reactor coolant cold leg by a separate line. Two check valves isolate the tank from the RCS during normal operation. When the RCS pressure falls below the tank pressure, the check valves open discharging the contents of the tank into the system. Adequate borated water is supplied to rapidly cover the core, with one tank assumed to be discharging through the break. The evaluation in Section 6.3.3 demonstrates the adequacy of the quantity of coolant supplied.

Controls and interlocks for the motor operated isolation valves on the safety injection tank discharge are discussed in Section 6.3.2.15.

6.3.2.11.2 High Pressure and Low Pressure Safety Injection Subsystems

Two redundant HPSI systems are provided. One pump and the associated four injection valves operate from one emergency diesel generator; the other pump and injection valves operate from the second emergency diesel generator. This ensures the automatic operation of one complete, full capacity system in the unlikely event of simultaneous loss of offsite power and the failure of any active component, including an emergency diesel generator.

Active components necessary for LPSI are sized and arranged to provide two subsystems each capable of providing the required flow. Two motor operated injection valves and one LPSI pump operate from each diesel generator. Therefore, LPSI flow will be available for injection even though an emergency diesel generator should fail simultaneously with the loss of offsite power.

Since the LPSI system is not required to operate during the recirculation mode of core cooling, passive components (piping) are not redundant. Administrative controls ensure that the shutdown cooling flow control valve, common to both subsystems, is locked open at all times when the plant is operating. In addition, a locked open, manual bypass valve in parallel with the air-operated valve is provided to ensure flow in the event of accidental closure of that valve.

6.3.2.11.3 Power Sources

Two independent electrical buses supply power to the SIS equipment. Each bus may receive power from:

- A. Plant turbine generator (normal power source);
- B. Plant startup power source (off-site power);
- C. Emergency diesel generators.

The initiation sensors, electrical controls, and electrical indication equipment normally receive power from four 120-volt AC buses. Two 125-volt ESF station batteries and six inverters are provided as a backup upon loss of all other sources of power.

ARKANSAS NUCLEAR ONE
Unit 2

Each plant transmission line has the capacity to supply sufficient power for all the ESF loads. Each of the two diesel generators has the capacity to supply power for one set of ESF equipment.

System reliability is achieved with the following:

- A. Two electrical buses, with each bus supplying power to a 100 percent capacity low pressure pump, a 100 percent capacity high pressure pump, associated valves and support systems. (Each support system contains two full capacity subsystems);
- B. Two sources of power, normal and standby to both buses, with automatic backup from the emergency diesel-generators; and,
- C. Two emergency diesel-generators, each capable of supplying power for the minimum ESF loads.

A detailed description of the power sources is given in Chapter 8.

6.3.2.11.4 Capacity to Maintain Cooling Following a Single Failure

The SIS is designed to meet its functional requirements even with the failure of a single active component during the injection mode of operation or with the single failure of an active or passive component during the recirculation mode of operation. By providing proper redundancy of equipment, even with the single failure noted above, the minimum required safety injection equipment is always available.

The following design features are provided in the system in order to meet the single failure criterion:

- A. Redundant HPSI and LPSI pumps.
- B. Redundant piping between containment sump and safety injection pump suction.
- C. Redundant HPSI headers.
- D. Four injection discharge points into the RCS.
- E. Three watertight rooms in the auxiliary building. Two rooms contain one HPSI pump, one LPSI, one containment spray pump and one shutdown cooling heat exchanger. The third room contains the common or shared HPSI pump.

A single failure analysis is given in Table 6.3-3.

6.3.2.12 Protection Provisions

The SIS is provided with protection from damage that could result from a LOCA by designing components to withstand the accident environment including missiles, coolant chemistry, high temperature and high pressure resulting from the accident and to withstand concurrent DBE and LOCA loadings.

6.3.2.12.1 Capability to Withstand Accident Environment

All SIS components and associated electrical equipment have been designed to withstand accident environmental conditions. The design of each component encompasses the most severe condition the equipment will encounter. A complete description of the equipment environmental qualification program is presented in Chapter 7.

6.3.2.12.2 Seismic Design

Since operation of the SIS, is essential following a LOCA, it is classified Seismic Category 1. The general design basis for Category 1 equipment is that it must be able to withstand the appropriate seismic loads plus other applicable loads without loss of design functions which are required to protect the public.

For the SIS, the components are designed to withstand the loads resulting from emergency operation following a LOCA, plus the stresses resulting from the DBE without loss of function.

Vessels which are connected to the ESF systems are supported and restrained to allow controlled movement during this load condition, and piping is designed to accept the imposed movements. Engineering calculations of the flexibility of the systems are performed to verify that the piping can accept these additional vessel movements and still remain within code allowable limits of stress.

Refer to Section 3.7 for details on seismic design and analysis methods.

6.3.2.13 Provisions for Performance Testing

The SIS is provided with the necessary connections such that proper operation of each active component can be determined. Recirculation lines are provided on each pump such that the pumps can be started during normal operation and pump performance determined. Provision for testing all check valves is provided either by pump operation or by the charging pump connection to the high pressure header. Additionally, the motor operated valves have position indication for testing.

The safety injection tanks and RWT are provided with sample connections to determine the boron content of each. This assures that fluid containing the proper boron content would be injected in the unlikely event of a LOCA.

6.3.2.14 Net Positive Suction Head

The HPSI and LPSI pumps are located in rooms in the lowest level of the auxiliary building. This location maximizes the available NPSH for the safety injection pumps.

The method of calculating NPSH is in agreement with the intent of NRC Regulatory Guide 1.1 in that no credit is taken for containment pressure increases due to accident conditions. Since the guide assumes no containment pressure increase above that present prior to a LOCA, boiling of water would occur at the peak temperatures predicted by the accident analysis, thus equilibrium between containment pressure and sump water at saturation conditions is modeled. Therefore, in determining available NPSH, the sump inventory is considered subcooled when sump temperature is below the saturation temperature corresponding to the minimum Technical Specification allowed containment pressure.

ARKANSAS NUCLEAR ONE
Unit 2

The NPSH available to the HPSI pumps during recirculation has been calculated based on piping drawings and on the following:

- A. Pipe and fitting losses;
- B. Total flow on one suction header of 3532.5 gpm, consisting of 2632.5 gpm for one containment spray pump and 900 gpm for one HPSI pump. However, due to differences in the suction pipe routing, the most limiting pump suction loss occurs when HPSI Pump C (2P-89C), with a lower maximum flow of 870 gpm, is aligned to the A train header.
- C. Assuming the single active failure of the B Train LPSI failing to trip after RAS
 - Impact to A Train NPSH is evaluated, since it will provide the needed safety function, even if the B Train pumps do not have adequate NPSH
 - Maximum flow through the sump strainer is 12,735 gpm
 - A Train Suction header flow is 3505.2 gpm consisting of CSS Pump A (2632.5 gpm) and HPSI Pump C (870 gpm)
 - Maximum pump suction loss is 4.296 feet for the C HPSI Pump when aligned to the A Train;
- D. The calculation of piping pressure drop and the conversion from psi to feet of water is a dynamic value which varies with sump temperature;
- E. Containment sump water level at Elevation 343.66 feet;
- F. HPSI pump inlet nozzles are located at an elevation of 319 feet, 7 inches;
- G. Containment pressure is equal to minimum TS allowed pressure prior to the accident. Elevated pressures resulting from the accident are not credited. When sump temperature exceeds the saturation temperature corresponding to the pre-accident containment pressure, the containment pressure is set equal to the saturation pressure of the containment sump water at the elevated temperature.

The calculation determines NPSH margin considering only the clean strainer head loss. Debris-related head loss is then compared to this margin to ensure positive margin exists. The NPSH required, as determined by the pump test curves furnished by the manufacturer, is 19.4 feet at 900 gpm and 18.8 feet at 870 gpm.

The limiting NPSH margin for the single failure of the B Train LPSI failure-to-stop following RAS is 0.984 feet for HPSI Pump C operating at maximum flow of 870 gpm aligned to the A Train.

The limiting NPSH margin for two train flow with both LPSI pumps secured is 1.8 feet for HPSI Pump C operating at maximum flow of 870 gpm aligned to the A Train.

6.3.2.15 Control for Motor Operated Safety Injection Tank Isolation Valves

Since it is essential that the isolation valves on the safety injection tanks be open whenever the RCS is at pressure, administrative control is provided to assure that these valves are open with power to the motor operators removed after RCS pressure exceeds safety injection tank

ARKANSAS NUCLEAR ONE
Unit 2

pressure. Additionally, interlocks are provided such that these valves, if left powered, will automatically open prior to RCS pressure increasing above 700 psia. Power is applied to the valve motor operators as necessary to complete valve travel. During a cooldown/depressurization of the RCS, after the valves are closed, power is removed from the operators and the breakers are opened and administratively controlled to prevent inadvertent opening and possible overpressurization of the RCS at low temperatures. A further description of valve control is found in Section 7.6.1.2.

Position indication in the control room is provided through sensors mounted on the valves. The circuit breakers associated with the safety injection tank isolation valves will be locked open during normal operation. These tank features ensure the availability of a flow path from the safety injection tanks. The valve controls and interlocks are designed to meet the intent of IEEE 279.

6.3.2.16 Motor Operated Valves and Controls (General)

In addition to the safety injection tank isolation valves, the following motor operated valves are included as part of the SIS or are present in the flow path:

HPSI injection valves	(8)
LPSI injection valves	(4)
HPSI pumps recirculation line valves	(3)
LPSI pumps recirculation line valves	(2)
Recirculation header isolation valve	(1)
RWT isolation valves	(2)
Containment sump isolation valves	(4)
Hot leg injection valves	(2)
HPSI header orifice bypass valves	(2)
Shutdown cooling isolation valves	(3)

The HPSI and LPSI injection valves are opened on receipt of an SIAS, as described in Section 6.3.2.20. The SIAS is described in Section 7.3, and the logic is designed to ensure that the minimum ESF required to meet the design bases given in Section 6.3.1 will be met.

The five isolation valves in the safety injection recirculation (mini-flow) lines and the recirculation header isolation valve are normally open and remain open during injection. The valves are automatically shut on receipt of a Recirculation Actuation Signal (RAS) to avoid returning the recirculating water from the containment sump to the refueling water tank. The RAS is described in Section 7.3.

The RWT isolation valves are normally open, fail-as-is valves. They receive an open signal on SIAS. These valves are closed automatically by the RAS.

The containment sump isolation valves are opened by the RAS, permitting the operating ESF pumps to take suction from the containment sump.

The hot leg injection valves are normally closed valves which are manually opened post-LOCA to accomplish core flushing. When the injection valves are opened, the normally open orifice bypass valves are manually closed to balance the injection flow between the hot leg and the cold leg. Section 6.3.3.15 discusses long-term ECCS performance.

The shutdown cooling isolation valves are described in Section 9.3.6. The controls for those valves are described in Section 7.6.

6.3.2.16.1 Other Power Operated Valves

Solenoid operated valves are installed in safety injection tank fill, drain, vent, and nitrogen supply lines as shown in Figure 6.3-2.

Finally, the air operated shutdown cooling flow control valve in the common LPSI line is a normally open, locked open, valve. The LPSI flow control valve fails open on loss of air. The associated air accumulator functions to maintain the valve in the open position if instrument air is degraded. Since inadvertent closure of this valve during injection would interrupt flow from the LPSI pumps, a second locked open manual valve is arranged in parallel with the first to ensure continuity of LPSI flow.

6.3.2.17 Required Manual Actions

No manual actions are required for the SIS to operate properly. The two modes of operation: injection and recirculation, are automatically initiated by SIAS and RAS signals, respectively, as outlined in Sections 6.3.2.20 and 7.3.

6.3.2.18 Process Instrumentation

The process instrumentation available to the operator in the control room to assist in assessing post-LOCA conditions is listed in Table 6.3-4. The type of instrument, parameter measured, instrument range and accuracy are listed in the table. Process instrumentation for monitoring SIS components is discussed in Section 6.3.5.2.

6.3.2.19 Materials

As discussed in Section 6.3.2.2, the pressure boundary components of the SIS are fabricated of austenitic stainless steel, and valve seats or discs are stellite or equivalent material. These materials are not subject to significant radiolytic or pyrolytic decomposition.

The only active components in the SIS exposed to the activity in recirculating fluid are the HPSI pumps. The pump and motor are designed for the anticipated heat and radiation field predicted for the recirculation mode of operation. Materials, such as the motor lubricating oil which may degrade, can be changed. As described in Section 6.3.2.2, the pumps can be isolated and flushed to allow maintenance while the system is operating, assuring continued safe operation.

6.3.2.20 System Operation

6.3.2.20.1 System Standby Condition

During normal plant operation, the SIS is maintained in standby, aligned for emergency operation. The status of the system is as shown in Figure 6.3-2.

6.3.2.20.2 Initiation of Safety Injection

Safety injection is automatically initiated upon a coincidence of 2-out-of-4 low-low pressurizer signals or 2-out-of-4 high containment pressure signals. Low pressurizer and high containment pressure conditions imply a LOCA. (See Section 7.3)

The reactor will be tripped by the Reactor Protective System (RPS). (See Section 7.3)

ARKANSAS NUCLEAR ONE
Unit 2

A. System Operation With Off-Site AC Power

The SIAS is accompanied by a reactor trip resulting in a turbine trip and generator trip. The power distribution system automatically transfers to the selected startup transformer. (See Chapter 8) Safety loads are sequenced onto the startup transformer in the same sequence as, and using the same circuitry as, loading on the diesel generators. The following equipment is simultaneously activated:

1. Two high-pressure safety injection pumps start,
2. Both low-pressure safety injection pumps start,
3. All eight high-pressure and all four low-pressure injection valves open,
4. The four safety injection check valve leakage pressure control valves close.

SIS components not listed above are lined up for emergency safety injection when the plant is at normal operating conditions, thus no signal input or operation is required for these components. Once the RCS pressure drops below safety injection tank pressure the safety injection tanks discharge their contents into the reactor coolant cold legs. The SIAS also isolates the letdown flow path.

B. System Operation Without Off-Site AC Power

The SIAS automatically starts the emergency diesel generators. If the transfer to the startup transformer is unsuccessful, all loads except for the first block in the loading sequence are disconnected automatically. Automatic loading commences as soon as operating voltage is available at the 4.16 kV ESF switchgear buses. The load sequencing for the emergency power supply is shown in Table 8.3-1.

Once one of the 4.16 kV ESF buses is energized from the emergency AC power supply, two LPI valves and the four high pressure injection valves are opened. Ten seconds later one high-pressure safety injection pump is started, with a LPSI pump started in approximately another five seconds. The starting sequence of the other diesel generator follows the same time sequence in operating safety injection system equipment. They also start the other HPSI and LPSI pumps.

6.3.2.20.3 Injection Mode of Operation

The safety injection pumps take suction from the suction headers, initially lined up to the RWT. The HPSI pumps deliver borated water to the HPSI headers, then into the RCS via the safety injection nozzles in the cold legs. The LPSI pumps discharge into the LPSI header and through the safety injection nozzles when reactor coolant pressure has decreased sufficiently. The coolant passes from the cold leg piping into the reactor vessel to cover and remove heat from the core.

For large pipe breaks, the RCS is depressurized and emptied rapidly. The safety injection tanks are a passive device in that they require no outside power or actuation signal. The driving head for injection is provided by the nitrogen gas pressure.

ARKANSAS NUCLEAR ONE
Unit 2

As coolant pressure falls below the sum of the tank pressure plus elevation head, the check valves in the lines connecting each tank to its associated cold leg open. Large quantities of borated water are rapidly injected into the RCS. The water rapidly covers and cools the core, limiting fuel cladding temperature and metal-water reaction.

Before the safety injection tanks have emptied, the safety injection pumps have started and provide sufficient flow to keep the core covered.

For smaller pipe breaks the RCS pressure falls less rapidly and the safety injection tanks do not come into play immediately. The HPSI pumps provide core cooling flow while pressure remains high. The LPSI pumps do not deliver coolant until system pressure has decreased below their shutoff head.

6.3.2.20.4 Recirculation Mode Initiation

Transfer to the recirculation mode of operation is initiated by low water level in the RWT, derived from the four independent level indicators on the RWT. The RAS shuts down the LPSI pumps, opens both containment sump recirculation line isolation valves, closes the minimum flow recirculation line isolation valves, and closes the refueling water tank discharge valves.

There is no single failure which would result in both LPSI pumps continuing to run following a RAS. Should one LPSI pump continue to run, it could experience inadequate NPSH and be damaged. The control room operator would be informed of the status of the LPSI pumps by Class 1E indication and thus would take action to manually secure an LPSI pump which had failed to trip following the RAS. Due to increased flow losses through the strainer and the common portion of that train's suction pipe, the HPSI pump on the train with a LPSI pump that continues to run after a RAS could also experience inadequate NPSH. Since no single failure would result in both LPSI pumps continuing to run following a RAS, the HPSI pump on the train opposite of the running LPSI pump would perform the required safety function.

The transfer to the recirculation mode can also be accomplished manually.

6.3.2.20.5 Recirculation Mode Operation

During recirculation, the HPSI pumps continue to operate taking suction directly from the containment sump. The shutoff head of the HPSI pumps is greater than the saturation pressure of the reactor coolant following any break for which system operation is required. The pumps are designed so that one pump provides sufficient flow to match decay heat boiloff at the time recirculation is initiated, assuming 25 percent spill through the break.

As RCS pressure permits, and the RAS signal is cleared, Shutdown Cooling System (SDCS) operation may be initiated to speed RCS cooldown. Alignment of the SDCS valves, termination of the corresponding containment sump pump operation, and closure of the corresponding containment sump train containment isolation valve would be required prior to starting a LPSI pump. The LPSI pump would then be aligned to take suction from the RCS shutdown cooling nozzle and return the fluid through a shutdown cooling heat exchanger to the RCS cold legs.

6.3.2.20.6 Safety Injection Operation During Shutdown Cooling

With the LTOPs in service, the Safety Injection Tank outlet valves may be open when their associated Safety Injection Tank pressure is less than 280 psig. When a SIT is pressurized greater than 280 psig, the associated outlet valve is closed and the outlet valve breaker is open.

ARKANSAS NUCLEAR ONE
Unit 2

In the unlikely event of a LOCA at this time, the operator would be alerted by a combination of the following alarms and/or indicators:

- Low pressurizer level alarm
- High containment pressure alarm
- Containment activity alarm
- Containment temperature alarm
- Containment sump level alarm
- Low volume control tank level alarm
- Shutdown cooling flow
- Shutdown cooling temperature
- Low RCS pressure

For large breaks, most of the above alarms and indications will be present. As break size decreases, so will the number of indications and alarms. For a break equal to or less than the capacity of one charging pump, sump level, containment activity, and containment temperature would increase, and volume control tank level would decrease.

When the operator is alerted to a loss of coolant condition, he will verify that the following functions have been performed as required.

- A. Safety injection tank isolation valves opened.
- B. HPSI and LPSI pumps started.
- C. HPSI and LPSI valves opened.
- D. Emergency diesels are started.
- E. Containment isolation has taken place.

These actions may be manually initiated from the control room.

If the break is very small, the HPSI pumps may increase RCS pressure. The operator will then throttle the HPSI valves to limit pressure rise, monitoring pressurizer pressure. In the case of a small break and as RCS pressure permits, the SDCS can be used for decay heat removal, with the safety injection pumps used for pressure control

6.3.2.21 Interconnections With Other Systems

The safety injection flow path to the reactor vessel is through a safety injection nozzle on each of the four RCS cold leg pipes. This provides four separate flow paths from the SIS to the reactor core. During shutdown cooling, the LPSI pumps take suction from the RCS through a nozzle on the hot leg pipe in loop 2P32 C/D. Two motor operated valves in this line are interlocked with two pressurizer pressure measurement channels, to preclude their being opened when RCS pressure is above the design pressure rating of the downstream piping. Refer to Section 7.6.1.1 for further description of the interlocks.

A connection is provided from the discharge side of the Chemical and Volume Control System (CVCS) charging pumps to one of the high pressure headers. Its primary purpose is to test the operation of the four safety injection check valves at the RCS when the RCS is pressurized.

ARKANSAS NUCLEAR ONE
Unit 2

The connection can be used to adjust boron concentration in the safety injection tanks and it also provides an alternate injection path for the charging pumps. Connections from the RWT to the CVCS are provided. These connections have three functions:

- A. to supply refueling water to the suction of the charging pumps;
- B. to permit borated water at refueling concentration to be added to the RWT from the CVCS; and,
- C. to permit small quantities of concentrated boric acid to be added to RWT for correction of the refueling water boron concentration.

Sample connections are provided on selected piping and on the RWT. Provisions are made for local sampling on readily accessible piping and for direct connection to the sampling system for piping that may be inaccessible after an accident or may contain high temperature or radioactive water. Sample connections are provided at the RWT and the safety injection tanks. (The safety injection tank drain header may be sampled from a drain line in the containment building. This sample can be used to check the boric acid concentration at any of the four safety injection check valves.)

Samples of water pumped through the safety injection pumps are available through the sampling system. A direct connection from the pump minimum flow lines to the sampling system is provided for this purpose. A connection to the sampling system is also provided on the shutdown cooling suction line.

A connection is provided from the safety injection tank drain header to the boron management system. Leakage through the four check valves in the safety injection lines adjacent to the reactor coolant loops can be bled to the boron management system through this connection.

A regulated nitrogen supply is provided to the safety injection tanks to maintain tank pressure during normal plant operation.

Drains are provided for radioactive liquids. Typical sources are valve and equipment leakoffs, pump drains and relief valve discharges.

6.3.2.22 System Leakage

During recirculation, the safety injection pumps take suction from the containment sump and return water to the RCS and hence to the core. Following a major LOCA, any system leakage may be radioactive and special care is taken to limit leakage outside the containment building.

Leakage to the ESF room will normally drain to the room. Should a gross gasket failure or equipment failure occur which cannot be directly isolated, the spillage will flow to the room.

6.3.3 PERFORMANCE EVALUATION

The performance evaluation of the ECCS during postulated LOCAs is discussed in this section.

ARKANSAS NUCLEAR ONE
Unit 2

6.3.3.1 Evaluation Model

The 1999 EM version of the Westinghouse large break LOCA evaluation model for Combustion Engineering designed PWRs, as described in Section 6.3.3.2.2 and its references, was used in performing the ECCS performance evaluation for a spectrum of large reactor coolant pipe breaks.

The S2M version of the Westinghouse CE small break LOCA evaluation model for Combustion Engineering designed PWRs, as described in Section 6.3.3.2.3 and its references, was used in performing the ECCS performance evaluation for a spectrum of small reactor coolant pipe breaks.

6.3.3.2 ECCS Performance

The results for the large break LOCA and small break LOCA ECCS performance evaluations are provided in this section. The methods and the technical justification are also discussed in this section.

6.3.3.2.1 Introduction and Summary

10 CFR 50.46 (Reference 1) provides the acceptance criteria for Emergency Core Cooling Systems (ECCS) for light water nuclear power reactors. The ECCS performance analysis presented in this section demonstrates that the ANO-2 ECCS design satisfies these criteria.

The analysis was performed for a spectrum of break sizes in the reactor coolant pump discharge leg. The limiting break size, that which results in highest peak cladding temperature, was identified as the 0.4 DEG/PD break (Double Ended Guillotine break in Pump Discharge). The results of the analysis demonstrate that, for a peak linear heat generation rate (PLHGR) of 13.7 kw/ft, the ANO-2 ECCS design meets the 10 CFR 50.46 Acceptance Criteria. Conformance is as follows:

Criterion (1) Peak Cladding Temperature. "The calculated maximum fuel element cladding temperature shall not exceed 2200 °F."

The ECCS performance analysis yielded a peak cladding temperature of 2144 °F for the 0.4 DEG/PD break described in Section 6.3.3.2.2.6.

Criterion (2) Maximum Cladding Oxidation. "The calculated total oxidation of the cladding shall nowhere exceed 0.17 times the total cladding thickness before oxidation."

The ECCS performance analysis yielded a maximum cladding oxidation of 0.1677 times the total cladding thickness before oxidation for the 0.04 ft²/PD break described in Section 6.3.3.2.3.6.

Criterion (3) Maximum Hydrogen Generation. "The calculated total amount of hydrogen generated from the chemical reaction of the cladding with water or steam shall not exceed 0.01 times the hypothetical amount that would be generated if all of the metal in the cladding cylinders surrounding the fuel, excluding the cladding surrounding the plenum volume, were to react."

The ECCS performance analysis yielded a maximum hydrogen generation of less than 0.01 times the hypothetical amount for the 0.4 DEG/PD break described in Section 6.3.3.2.2.6.

ARKANSAS NUCLEAR ONE
Unit 2

- Criterion (4) Coolable Geometry. "Calculated changes in core geometry shall be such that the core remains amenable to cooling."

The cladding swelling and rupture models which are part of the Westinghouse evaluation models for Combustion Engineering PWRs account for the effects of changes in core geometry if such changes are predicted to occur. Adequate core cooling was demonstrated with the predicted core geometry changes. The analysis was performed to the point where cladding temperatures were decreasing and the RCS was depressurized, thereby precluding any further cladding deformation. Therefore, a coolable geometry was demonstrated.

- Criterion (5) Long Term Cooling. "After any calculated successful initial operation of the ECCS, the calculated core temperature shall be maintained at an acceptably low value and decay heat shall be removed for the extended period of time required by the long-lived radioactivity remaining in the core."

The ECCS performance analysis showed that the rapid insertion of borated water from the safety injection tanks (SITs) and the safety injection pumps suitably limited the peak cladding temperature and cooled the core within a short period of time. Subsequently, the safety injection pumps would continue to supply cooling water from the refueling water tank (RWT) to remove heat from the long-lived radioactivity remaining in the core. When the RWT is nearly empty, the safety injection pumps would be lined up to recirculate water from the containment sump. See Section 6.3.1.4.2 for additional information on long term cooling.

6.3.3.2.2 Large Break Analysis

6.3.3.2.2.1 Evaluation Model

The large break LOCA ECCS performance analysis used the 1999 EM version of Westinghouse's NRC-accepted large break LOCA evaluation model for Combustion Engineering-designed PWRs (Reference 6, Supplement 4-P-A). The methodology for modeling the Next Generation Fuel (NGF) assembly design in ECCS Performance analyses using the 1999 EM is described in the CE 16 x 16 NGF Core Reference Report (Reference 93). Reference 94 denotes the topical report relevant to the 1999 EM for modeling the Optimized ZIRLO™ cladding. The following computer codes are used in the 1999 EM and are described in the references cited with additional descriptive information provided in Supplement 4-P-A of Reference 6: The CEFLASH-4A computer code (Reference 9) is used to perform the blowdown hydraulic analysis of the reactor coolant system (RCS) and the COMPERC-II computer code (Reference 11) is used to perform the RCS refill/reflood hydraulic analysis and to calculate the containment pressure. It is also used in conjunction with the methodology described in Reference 28 to calculate the FLECHT-based reflood heat transfer coefficients used in the hot rod heatup analysis. The HCROSS (Reference 81) and PARCH (References 81 and 27) computer codes are used to calculate steam cooling heat transfer coefficients. The hot rod heatup analysis, which calculates the peak cladding temperature and maximum cladding oxidation, is performed with the STRIKIN-II computer code (Reference 30). Core-wide cladding oxidation is calculated using the COMZIRC computer code (Appendix C of Supplement 1 of Reference 11). The initial steady state fuel rod conditions used in the analysis are determined using the FATES3B computer code (Reference 10).

ARKANSAS NUCLEAR ONE
Unit 2

6.3.3.2.2.2 Safety Injection System Parameters

As described in Section 6.3.2, the ANO-2 ECCS consists of three high pressure safety injection (HPSI) pumps, two low pressure safety injection (LPSI) pumps and four SITs. Each HPSI pump injects to one of two high pressure injection headers which feed each cold leg. The LPSI pumps inject to a common header which feeds each cold leg. Each SIT injects to a single cold leg. Two of the HPSI pumps and the LPSI pumps are automatically actuated by a safety injection actuation signal that is generated by either low pressurizer pressure or high containment pressure. The SITs automatically discharge when the RCS pressure decreases below the SIT pressure.

The large break LOCA analysis conservatively represents both the spillage of safety injection flow into the containment and the most limiting single failure of the ECCS. In the analysis, all the safety injection flow to the broken discharge leg was assumed to spill into the containment.

A study was performed to determine the most limiting single failure of ECCS equipment. The study analyzed no failure, failure of an emergency diesel generator, failure of a LPSI pump, and failure of a HPSI pump. Maximum safety injection pump flow rates were used in the no failure case; minimum safety injection pump flow rates were used in the emergency diesel generator, LPSI pump and HPSI pump failure cases. The most limiting single failure, i.e., the failure that resulted in the highest calculated peak cladding temperature, was determined to be no failure of ECCS equipment. No failure is the worst condition because it maximizes the amount of safety injection that spills into the containment. This acts to minimize containment pressure which, in turn, minimizes the rate at which the core is reflooded. The failure of either an emergency diesel generator or a LPSI pump is not the most limiting failure because, in both cases, there is sufficient safety injection pump flow to keep the reactor vessel downcomer filled to the cold leg nozzles. This maintains the same driving force for reflooding the core as for no failure, but results in less spillage into the containment.

Based on the design of the ANO-2 ECCS, the most limiting single failure and spillage considerations, the following safety injection flows into the RCS were used in the analysis for a discharge leg break: 75% of the flow from two HPSI pumps, 75% of the flow from two LPSI pumps, and 100% of the flow from three SITs. Consistent with the fact that no failure is the worst condition, maximum HPSI and LPSI pump flow rates were used in the analysis.

6.3.3.2.2.3 Core and System Parameters

The significant core and system parameters used in the large break LOCA analysis are presented in Table 6.3-9. The analysis accounts for up to 10% steam generator tube plugging per steam generator.

The fuel rod conditions that are listed in Table 6.3-9 are for the hot rod burnup that produced the highest calculated peak cladding temperature. These limiting initial fuel rod conditions were determined by performing burnup dependent calculations with STRIKIN-II using initial fuel rod conditions calculated by FATES3B. The calculations included the analysis of (1) UO₂ fuel with (a) ZIRLO™ cladding and no integral fuel burnable absorber (IFBA), and (b) ZIRLO™ cladding and zirconium diboride (ZrB₂) IFBA, and (2) Next Generation Fuel with (a) Optimized ZIRLO™ cladding and no IFBA, and (b) Optimized ZIRLO™ cladding and ZrB₂ IFBA.

ARKANSAS NUCLEAR ONE
Unit 2

6.3.3.2.2.4 Containment Parameters

Section 6.2.1.1.3.4 presents the minimum containment pressure analysis that was performed as part of the large break LOCA analysis. It identifies the containment parameters used in the analysis. The values for these parameters were chosen to minimize containment pressure in order to minimize the core reflood rate.

6.3.3.2.2.5 Break Spectrum

The break spectrum consisted of five guillotine breaks in the reactor coolant pump discharge leg ranging in size from a full double-ended break to a 0.3 double-ended break. Table 6.3-11 lists the specific break sizes that were analyzed.

As described in Reference 6, the reactor coolant pump discharge leg is the most limiting break location. The pump discharge leg break is limiting because both the core flow rate during blowdown and the core reflood rate are minimized for this location.

6.3.3.2.2.6 Results and Conclusions

The important results of this analysis are summarized in Table 6.3-15. Table 6.3-14 lists times of interest for the breaks analyzed. As noted in Table 6.3-11, results for each break are presented in Figures 6.3-13 through 6.3-17. For each break, the variables listed in Table 6.3-12 are plotted as a function of time. For the break with the highest peak cladding temperature (the 0.4 DEG/PD break), the additional variables listed in Table 6.3-13 are plotted. Peak cladding temperature versus break size is shown in Figure 6.3-20.

Based on the results of this analysis, it is concluded the ANO-2 ECCS design satisfies the Acceptance Criteria of 10CFR50.46 for a spectrum of large break LOCAs.

6.3.3.2.3 Small Break Analysis

6.3.3.2.3.1 Evaluation Model

The small break LOCA ECCS performance analysis used the S2M (Supplement 2 Evaluation Model) version of Westinghouse's NRC-accepted small break LOCA evaluation model for Combustion Engineering-designed PWRs (Reference 8, Supplement 2-P-A). The methodology for modeling the NGF assembly design in ECCS Performance analyses using the S2M EM is described in the CE 16 x 16 NGF Core Reference Report (Reference 93). Reference 94 denotes the topical report relevant to the S2M EM for modeling the Optimized ZIRLO™ cladding. In the S2M evaluation model, the CEFLASH-4AS computer program (Reference 83) is used to perform the hydraulic analysis of the RCS until the time the Safety Injection Tanks (SITs) begin to inject. After injection from the SITs begins, the COMPERC-II computer program (Reference 11) is used to perform the hydraulic analysis. However, COMPERC-II was not run in this analysis because the breaks sizes analyzed were too small for the SITs to begin injecting until after the peak cladding temperature was calculated to occur. The hot rod cladding temperature and maximum cladding oxidation are calculated by the STRIKIN-II computer program (Reference 30) during the initial period of forced convection heat transfer and by the PARCH computer program (Reference 27) during the subsequent period of pool boiling heat transfer. Core-wide cladding oxidation is conservatively represented as the rod-average cladding oxidation of the hot rod. The initial steady state fuel rod conditions used in the analysis are determined using the FATES3B computer program (Reference 10).

ARKANSAS NUCLEAR ONE
Unit 2

6.3.3.2.3.2 Safety Injection System Parameters

As described in Section 6.3.2, the ANO-2 ECCS consists of three HPSI pumps, two LPSI pumps, and four SITs. Each HPSI pump injects to one of two high pressure injection headers which feed each cold leg. The LPSI pumps inject to a common header which feeds each cold leg. Each SIT injects to a single cold leg. Two HPSI pumps and the LPSI pumps are automatically actuated by a safety injection actuation signal that is generated by either low pressurizer pressure or high containment pressure. The SITs automatically discharge when the RCS pressure decreases below the SIT pressure.

In the small break LOCA analysis it is assumed that offsite power is lost coincident with reactor trip and, therefore, the HPSI and LPSI pumps must await emergency diesel generator startup and load sequencing before they start. The total delay time assumed is 40 seconds from the time the pressurizer pressure reaches the SIAS setpoint to the time that the HPSI pumps are at speed and aligned to the RCS. For breaks in the reactor coolant pump discharge leg all safety injection flow delivered to the broken discharge leg is modeled to spill out the break.

An analysis of the possible single failures that can occur within the ECCS has shown that the most limiting single failure of ECCS equipment is the failure of an emergency diesel generator to start (Reference 8). This failure causes the loss of both a HPSI and LPSI pump and results in a minimum of safety injection water being available to cool the core.

Based on the above, credit for the following safety injection flows are taken in the small break LOCA analysis for a break in the reactor coolant pump discharge leg: 75% of the flow from one HPSI pump, 50% of the flow from one LPSI pump and 100% of the flow from three SITs. Table 6.3-16 presents the HPSI pump flow rate versus RCS pressure used in the small break LOCA analysis. Injection from the LPSI pump is not credited in the small break LOCA analysis since the RCS pressure did not decrease to the LPSI pressure range for the break spectrum analyzed. Likewise, injection from the SITs is not credited in the analysis for the break spectrum analyzed even though the RCS pressure decreased below the SIT pressure for the 0.05 ft²/PD break, which is the largest break size analyzed.

6.3.3.2.3.3 Core and System Parameters

The significant core and system parameters used in the small break LOCA analysis are presented in Table 6.3-17. The analysis accounts for up to 10% steam generator tube plugging per steam generator.

The fuel rod conditions that are listed in Table 6.3-17 are for the hot rod burnup that produced the maximum initial fuel stored energy. UO₂ fuel rods with (a) ZIRLO™ cladding and no integral fuel burnable absorber (IFBA), and (b) ZIRLO™ cladding and zirconium diboride (ZrB₂) IFBA, and Next Generation Fuel with (a) Optimized ZIRLO™ cladding and no IFBA and (b) Optimized ZIRLO™ cladding and ZrB₂ IFBA, were analyzed in determining the limiting fuel rod conditions.

6.3.3.2.3.4 Containment Parameters

The small break LOCA analysis does not use a detailed containment model. Therefore, other than the containment volume and the initial containment pressure, which are assumed to be 1,820,000 ft³ and 14.7 psia, respectively, no containment parameters are employed in the analysis.

ARKANSAS NUCLEAR ONE
Unit 2

6.3.3.2.3.5 Break Spectrum

The break spectrum consisted of three reactor coolant pump discharge leg break sizes, namely, 0.03, 0.04, and 0.05 ft²/PD breaks. Table 6.3-18 lists the specific break sizes that were analyzed.

The reactor coolant pump discharge leg was previously determined to be the limiting break location (Reference 8). It is limiting because it maximizes the amount of spillage from the safety injection system.

The 0.03 ft² to 0.05 ft² breaks are in the range of break sizes for which hot rod cladding heatup is terminated solely by injection from the HPSI pump. It is within this range that the limiting small break LOCA resides. Smaller breaks are non-limiting because the decreased break flow rate associated with the smaller break area results in later and less core uncover than for these breaks. Larger breaks are non-limiting because injection from the SITs will recover the core and terminate cladding heatup before the cladding temperature approaches the peak cladding temperature calculated for the limiting small break LOCA.

6.3.3.2.3.6 Results and Conclusion

The peak cladding temperatures and cladding oxidation percentages for the small break LOCA analysis are summarized in Table 6.3-19. Table 6.3-20 lists times of interest for the breaks analyzed. As noted in Table 6.3-18, results for the variables listed in Table 6.3-23 are plotted as a function of time in Figures 6.3-23a through 6.3-25h for the breaks analyzed. Peak cladding temperature versus break size is presented in Figure 6.3-26. Table 6.3-21 compares the LBLOCA results to the SBLOCA results.

Based on the results of the analysis, it is concluded that the ANO-2 ECCS design satisfies the Acceptance Criteria of 10 CFR 50.46 for a spectrum of small break LOCAs.

6.3.3.3 Intentionally Left Blank

6.3.3.4 Fuel Rod Perforations

Fuel rod cladding performance for the spectrum of breaks analyzed is discussed in Section 6.3.3.2.

6.3.3.5 Evaluation Model

This sections refers to a Boiling Water Reactor (BWR) and is not applicable.

6.3.3.6 Fuel Clad Effects

This section refers to a BWR and is not applicable.

6.3.3.7 ECCS Performance

This section refers to a BWR and is not applicable.

6.3.3.8 Peaking Factors

This section refers to a BWR and is not applicable.

6.3.3.9 Conformance With Acceptance Criteria

The analysis in Section 6.3.3.2 demonstrates compliance with 10 CFR 50.46.

6.3.3.10 Effects of ECCS Operation on the Core

Reference 50 describes testing of the chemical behavior of boric acid in austenitic stainless steels. Testing and analysis of the effect of initiation of safety injection on reactor vessel integrity are summarized in Section 6.3.3.13 and in the response to General Design Criterion 31 (see Section 3.1). Finally, the effect of safety injection on the reactor core has been studied extensively.

6.3.3.11 Use of Dual Function Components

The SIS consists of components utilized for the safety injection function only as well as components which are used in other systems. Those components which perform a safety injection function only are the safety injection tanks, the HPSI pumps, and associated piping, valves, and instrumentation. Components which serve a dual function are described below.

6.3.3.11.1 Refueling Water Tank

During refueling, borated water from this tank is used to fill the refueling pool and the transfer tube. During plant operation, the tank is aligned to the suction side of the HPSI, CS, and LPSI pumps. The volume in the tank is maintained in excess of that required for safety injection and containment spray system operation defined in Section 6.3.2.2.1.

6.3.3.11.2 LPSI Pumps

These pumps are used to circulate reactor coolant through the shutdown cooling heat exchangers for reactor cooldown and for decay heat removal during shutdown. During normal operation of the plant, the pumps are aligned for safety injection.

6.3.3.11.3 Shutdown Cooling Heat Exchangers

These heat exchangers provided cooling during reactor cooldown and for decay heat removal during shutdown. At all other times the heat exchangers are lined up for containment spray cooling.

Operating procedures and design features are provided so that the normal safety injection system lineup is not altered except under reduced RCS pressure conditions. Valve interlocks on the shutdown cooling suction line preclude initiation of shutdown cooling until reactor coolant pressure has been reduced to an appropriately low value. (See Section 9.3.6)

Thus, the utilization of shared components in the SIS does not jeopardize system operating availability and reliability.

6.3.3.12 Lag Times

The safety injection tanks automatically inject coolant when RCS pressure falls below safety injection tank pressure. With large breaks, rapid depressurization results in injection flow from the tanks before the safety injection pumps start.

ARKANSAS NUCLEAR ONE
Unit 2

For operation of actuator operated valves and pumps, there is a time delay following the rupture consisting of the time for the appropriate plant parameters to attain the SIAS setpoint, plus the time required for actuation or startup of the active component itself. The longest delay occurs when off-site power is lost. In this case, the emergency diesel generator starts automatically on SIAS or loss of the off-site power, reaching normal voltage in less than 15 seconds. ESF loads and supporting equipment loads are automatically sequenced at the times listed in Table 8.3-1. Motor operated valves receive power as soon as the diesel generators are up to speed. HPSI pumps receive power 10 seconds after diesel generators are up to speed. LPSI pumps receive power 15 seconds after diesel generators are up to speed. The operating time is <15 seconds for the high pressure header valves and < 20 seconds for the low pressure header valves. The HPSI and LPSI pumps attain full speed within five seconds when automatically load sequenced. Table 6.3-8 shows the times that each component starts and becomes operational and the time at which credit is taken for component operation in LOCA analyses. The safety injection tanks are passive devices requiring no actuation signal or electrical power. The safety injection tanks automatically discharge coolant into the RCS when the RCS pressure drops below 600 psig (minimum tank pressure) + elevation head of tanks.

6.3.3.13 Thermal Shock Considerations

6.3.3.13.1 Reactor Vessel

In order to evaluate possible effects of ECCS operation, a detailed analysis of a reactor vessel response to thermal shock was performed (Reference 36). The analysis concluded that the CE reactor vessels are capable of sustaining the thermal shock imposed by ECCS operation without gross failure.

Further work was performed to refine the surface heat transfer coefficient (Reference 18) and the brittle fracture model (Reference 19) used in the evaluation.

In 1973, the AEC established guidelines on thermal shock. A detailed analysis of a crack arrest under thermal shock was submitted to the AEC in September, 1973 as a Topical Report, CENPD-116, "Analysis of the Structural Integrity of C-E Reactor Vessel Subject to Emergency Core Cooling Conditions."

6.3.3.13.2 Safety Injection Nozzles

All the ECCS injection connections to the RCS piping are thermally sleeved. These sleeved ECCS nozzles are designed to meet the following requirements:

A. Large Reactor Coolant System Pipe Break

One injection of 40 °F water goes into the reactor coolant cold leg piping initially at the full power cold leg temperature and a system pressure of 200 psia or less with an initial flow rate of 20,000 gpm per nozzle. The initial flow rate decreases linearly over 30 seconds to 2,500 gpm per nozzle. Flow is then assumed to remain at 2,500 gpm per nozzle until an equilibrium temperature is reached.

B. Small Reactor Coolant System Pipe Break

Five injections of 40 °F water goes into the reactor coolant cold leg piping initially at the full power cold leg temperature and a system pressure of 1,240 psia. An initial rate of 350 gpm per nozzle for 90 seconds is assumed followed by the injection of 40 °F water at 60 psia at a rate of 2,500 gpm.

6.3.3.13.3 Safety Injection Components

The HPSI pumps are designed to withstand 10 cycles of thermal transients from 300 °F to 40 °F and from 40 °F to 300 °F in 5 to 10 seconds. The LPSI pumps are designed to withstand 10 cycles of an increase in temperature from 40 °F to 300 °F in 5 to 10 seconds. Designing for these transients provides protection against adverse effects arising from the initiation of flow through the SIS of water from the RWT at start of injection and switchover to recirculation from the containment sump following a LOCA.

6.3.3.14 Limits on System Parameters

Boron concentration in the RWT must be at least 2,500 ppm during power operation to ensure adequate cold shutdown margin. The required quantity is discussed in Section 6.3.2.2.1. Safety injection tank pressure must be at least 600 psig, and the tanks must contain sufficient water so that three of the four tanks will fill the reactor vessel to the top of the core. The water volume is given in Table 6.3-1.

6.3.3.15 Long-Term ECCS Performance

Long-term post-LOCA residual heat removal is accomplished by continuous boil-off of fluid in the reactor vessel until the fuel decay heat is sufficiently reduced to prevent boil-off. As borated water is delivered to the core region via safety injection and virtually pure water escapes as steam, unacceptably high concentrations of boric acid and other solution additives may accumulate in the reactor vessel unless a flush path is provided.

For a hot leg break, safety injection flow introduced via the cold legs will travel down the annulus, through the core, and out the break. Thus, a flushing path is established through the reactor vessel, precluding the buildup of solids in the core region. However, for a cold leg break, only that amount of injected water required for decay heat removal actually makes it to the core, because the remainder spills out the break. Therefore, because of the geometry of the RCS, there is no flushing through the core for a cold leg break until an alternate flow path is established.

A large cold leg break has been found to be the worst case for boric acid buildup. The differences in RCS pressure between large and small break LOCA result in several competing factors which affect the time that precipitation begins to occur. A high system pressure and temperature (small break) causes a higher rate of boil-off, resulting in a somewhat faster buildup of boric acid. However, this faster buildup rate at high pressure is more than offset by a substantial increase in boric acid solubility at the associated higher temperature. The net result is that the large break is the worst case.

A post-LOCA boric acid precipitation analysis was performed for a large cold leg break. The analysis used Westinghouse's NRC-accepted Post-LOCA Long Term Cooling Evaluation Model for Combustion Engineering-designed PWRs (Reference 92). In the evaluation model, the BORON computer program (Appendix C of Reference 92) is used to calculate the boric acid concentration in the core as a function of time following the large break LOCA. The Safety Evaluation Report documenting NRC acceptance of the post-LOCA long term cooling evaluation model, including the BORON computer program, is contained in Reference 92.

ARKANSAS NUCLEAR ONE
Unit 2

The analysis used a boric acid concentration of 27.6 wt% as the solubility limit of boric acid in the core. This is the solubility limit of boric acid in saturated water at atmospheric pressure. Atmospheric pressure is a conservative minimum value for the core pressure following a large break LOCA.

Important plant design data used in the post-LOCA boric acid precipitation analysis are listed in Table 6.3-28.

The post-LOCA boric acid precipitation analysis determined that a minimum flow rate of 250 gpm from a HPSI pump to both the hot and cold sides of the RCS, initiated between two and four hours post-LOCA, maintains the boric acid concentration in the core below the solubility limit of 27.6 wt% for the limiting large cold leg break. The analysis also determined that the potential for entrainment of the hot side injection by the steam flowing in the hot legs is terminated prior to two hours post-LOCA.

Figure 6.3-52 compares the core boil off rate with the minimum simultaneous hot and cold side injection flow rate of 250 gpm. It shows that the initiation of 250 gpm of hot and cold side injection at 5 hours post-LOCA provides a substantial and time-increasing flushing flow through the core. (Flushing flow is the difference between the HPSI pump flow rate to the side of the RCS opposite the break and the core boil off rate.) Figure 6.3-53 presents the core boric acid concentration as a function of time for the large cold leg break. It shows that, without simultaneous hot and cold side injection, the boric acid concentration in the core exceeds the solubility limit at approximately 7.3 hours post-LOCA. When 250 gpm of simultaneous hot and cold side injection is initiated at 5 hours post-LOCA, the maximum boric acid concentration in the core is 23.3 wt% at 5.9 hours post-LOCA, as compared to the solubility limit of 27.6 wt%. Figure 6.3-53 also shows that a flushing flow rate of 20 gpm started by 5 hours post-LOCA is sufficient to prevent the core boric acid concentration from reaching the solubility limit.

The long-term performance of the ECCS system was very conservatively designed to provide the required simultaneous hot and cold side injection flow rate. This design meets the following criteria:

- A. Provides redundant, safeguard-grade ability to initiate simultaneous hot and cold leg HPSI within four hours post-LOCA.
- B. Precludes inadvertent hot leg injection before two hours post-LOCA so that core reflood and steam venting are not impaired (this is done by removing power from 2CV-5102-2 and 2CV-5101-1 during normal operation).
- C. Ensures that a core through-flow is established independent of break location by balancing HPSI flow equally between the hot leg and cold legs.
- D. Provides the testing capability to verify integrity of the reactor coolant pressure boundary and demonstrate the availability of each hot leg injection flow path.
- E. Contains hardware and instrumentation qualified for post-LOCA environment.

The design consists of high resistance orifice bypass lines with isolation valves for cold leg HPSI injection and modulating valves in lines to the shutdown cooling suction line from the RCS to the HPSI discharge headers. This design was balanced during post-installation testing such that 50 percent of the HPSI flow is diverted to the hot leg and 50 percent to the cold legs.

ARKANSAS NUCLEAR ONE
Unit 2

Between two and four hours post-LOCA, the motor-operated valves on the hot leg injection lines are energized and opened while the motor-operated orifice bypass valves on each HPSI header are closed. This accomplished complete core flushing following a break at any location in the RCS piping. No determination of break location is needed since the flow path will satisfy cooling and flushing requirements under all break location conditions.

If the accident is a very small break requiring HPSI as an RCS inventory source, the RCS will have to be depressurized in order to allow the HPSI to operate. This will be accomplished by using the normal or Auxiliary Pressurizer Spray Systems or Pressurizer venting.

Any passive failure of HPSI piping inside the auxiliary building will be determined by the flow indicators on the HPSI discharge piping (2FI-5101-1 and 2FI-5102-2). Operator action can then be taken to isolate the failed HPSI train to prevent loss of recirculation fluid from containment. Any passive failures inside the reactor building do not require operator action since no fluid will be lost from containment and the redundant flow path will provide sufficient core through-flow for flushing.

The above described design provides more than adequate core flushing to prevent any boron precipitation and requires minimum operator action that can be implemented in minutes, although up to four hours is acceptable.

Table 6.3-22 provides a list of valves required for long-term cooling and includes the position of each valve during power operation, shutdown cooling, initial ECCS, recirculation ECCS, and long-term ECCS.

6.3.4 TESTS AND INSPECTIONS

During fabrication of the SIS components, tests and inspections were performed and documented in accordance with code requirements to assure high quality construction. As necessary, performance tests of components were performed in the vendor's facility. The SIS is designed and installed to permit inservice inspections and tests. Prior to initial plant startup, a comprehensive system of flow tests was performed to verify that the design performance of the system and individual components is attained. Periodic tests and inspections of the SIS components and subsystems are performed to ensure proper operation in the event of an accident. The scheduled tests and inspections are necessary to verify system operation since, during normal plant operation, SIS components are aligned for emergency operation and serve no other function. The tests defined permit a complete checkout on the subsystem and component level during normal plant operation. Satisfactory operability of the complete system may be verified during normal scheduled refueling shutdowns. Details of the planned pre-operational testing is presented in Chapter 14.

6.3.4.1 System Testing

The objective of this testing is to verify that the SIS will respond as required to perform its intended function. The tests are performed during each scheduled refueling shutdown. A test SIAS is applied to initiate operation of the system. The safety injection pump motors may be de-energized for this test. Circuit tests and pump starting and operation may be demonstrated at any time. The system test is considered satisfactory if control board indication and visual observations indicate that all components have received the test safety injection actuation signal in the proper sequence and timing. This verifies that the appropriate pump breakers have opened and closed, and that all valves have completed their travel. During reactor operation, the instrumentation channels used to initiate safety injection are checked during each shift while SIAS logic circuitry will be tested periodically as listed in the Technical Specification. The provisions of Regulatory Guide 1.22 are met.

ARKANSAS NUCLEAR ONE
Unit 2

6.3.4.2 Component Testing

In addition to the system level tests described in Section 6.3.4.1, tests to verify proper operation of the SIS components are also conducted. These tests supplement the system level tests by verifying acceptable performance of each active component in the SIS. The tests include cycling of all check valves to ensure proper operation and the checking of RWT level and the safety injection tank pressure and level instrumentation channels.

The safety injection pumps and valves are tested in accordance with the Edition and Addenda of the ASME [Operation and Maintenance](#) Code specified by 10 CFR 50 Section 50.55a(f).

6.3.5 INSTRUMENTATION REQUIREMENTS

6.3.5.1 Actuation Signal Generation

6.3.5.1.1 Safety Injection Actuation Signal

Initiation of safety injection is derived from four independent pressurizer pressure sensors and four independent containment pressure sensors. Coincident trip signals from 2-out-of-4 sensors for either parameter will automatically initiate safety injection. The operation of the SIS may be blocked only when RCS pressure is below the bypass permissive, which is less than 400 psia. Blocking of SIAS must be accomplished manually. The block is removed automatically before pressurizer pressure increases to 500 psia. The SIAS block and block removal design allows normal RCS cooldown without initiation of safety injection, at the same time prohibiting blocking of SIAS when the RCS is at operating pressure. (See Section 7.2.1.1.1.6)

6.3.5.1.2 Recirculation Actuation Signal

Four independent refueling water tank level transmitters provide signals for the RAS. Coincidence of 2-out-of-4 low water level signals or manual initiation in the control room will provide an RAS. The operation of RAS may be blocked below Mode 4 when RCS pressure is below the bypass permissive, which is less than 400 psia. Blocking of RAS must be accomplished manually and can only be accomplished concurrently with the blocking of SIAS. As with SIAS, the block is removed automatically before pressurizer pressure increases to 500 psia. The RAS block and block removal design requires RAS to be functional when SIAS is functional, at the same time providing a means to prevent inadvertent actuation of RAS.

6.3.5.2 System Instrumentation

The instrumentation provided for monitoring SIS components during normal plant operation and during SIS operation is discussed in this section. Instrumentation and indications providing information to the operator when system pressure is reduced is discussed in Section 6.3.2.20.

6.3.5.2.1 Pressure

A. LPSI Header Pressure

A pressure transmitter is located in the safety injection header. This pressure is indicated in the control room and provides confirmation of pump operation.

ARKANSAS NUCLEAR ONE
Unit 2

B. HPSI Header Pressure

Pressure transmitters are located in each HPSI header. These pressures are indicated in the control room and provide confirmation of pump operation.

C. Safety Injection Tank Pressure - Wide Range

A wide range pressure transmitter mounted on each safety injection tank permits readings of each tank's pressure in control room.

D. Safety Injection Tank Pressure - Narrow Range

Two narrow range pressure transmitters on each tank permit more accurate tank pressure measurement than the wide range. One transmitter alarms on high and low pressure and the other alarms on high-high and low-low pressure.

E. Safety Injection Check Valve Leakage Pressure

Pressure transmitters are located on each of four safety injection lines just upstream of the safety injection check valve adjacent to the reactor coolant loops. Leakage past these valves during plant operation will be indicated by an increase in pressure.

6.3.5.2.2 Level

A. Refueling Water Tank Level

Two instrument channels give control room indication of the water level in the RWT. Each indicator actuates an alarm on low water level in the tank.

B. Refueling Water Tank Level

Four additional level transmitters provide input to the RAS logic. The signal is initiated when any two of the four inputs indicate low tank water level. An operating bypass is provided to block RAS actuation in modes 4, 5, and 6 with pressurizer pressure below the bypass permissive, which is less than 400 psia.

C. Safety Injection Tank Level - Wide Range

Water level for each safety injection tank is indicated in the control room on the vertical display panel throughout the complete tank volume except for water above the upper tank tangent or below the lower tank tangent. Signal input for this indication is provided by a differential pressure transmitter. (Regulatory Guide 1.97, post-accident monitoring variable). Refer to Section 7.5.2.5 for analysis of post-accident monitoring instrumentation.

D. Safety Injection Tank Level - Narrow Range

Two narrow range level transmitters on each tank permit more accurate tank level than wide range. One transmitter alarms on high and low level and the other alarms on high-high and low-low level. Since operating water level must be maintained within a range which ensures proper operation of the tanks, alarms will be actuated if the tank water level falls below the minimum value or rises above the maximum value corresponding to the volumes listed in Table 6.3-1.

ARKANSAS NUCLEAR ONE
Unit 2

6.3.5.2.3 Valve Position

A. Safety Injection Tank Isolation Valve Position

Valve position is indicated in the control room by redundant indications. Indicator lights verify either the fully open or fully closed position. In addition, a separate valve position limit switch will sound an alarm in the control room if the valves are not fully open when pressurizer pressure is over 700 psia.

6.4 HABITABILITY SYSTEMS

The control room habitability systems include radiation shielding, redundant emergency air filtering and emergency air conditioning systems, radiation monitoring, lighting and fire protection equipment. These systems are described in detail in the applicable sections of this safety analysis report as referenced below. Fire protection and lighting systems are discussed fully in Sections 9.5.1 and 9.5.3 and are not further mentioned in this section.

6.4.1 HABITABILITY SYSTEMS FUNCTIONAL DESIGN

6.4.1.1 Design Bases

- A. The radiation exposure of control room personnel during any one of the postulated Design Basis Accidents (DBAs) discussed in Chapter 15 does not exceed the guidelines in 10 CFR 50, Appendix A, General Design Criterion 19 and 10 CFR 50.67.
- B. During any one of the postulated DBAs discussed in Chapter 15, the control room emergency air conditioning and emergency air filtering systems maintain the control room atmosphere at temperatures and humidities suitable for prolonged occupancy.
- C. Control room personnel are protected from prolonged exposure to smoke and/or noxious vapors.
- D. The control room is automatically isolated from outside air on high radiation.
- E. The control room emergency air conditioning and emergency air filtering systems meet design bases A, B, C and D assuming a loss of off-site power and the failure of a single active component.
- F. The control room and the control room emergency air conditioning and emergency air filtering systems are designed to withstand the Design Basis Earthquake (DBE).

6.4.1.2 System Description

The control room emergency air conditioning and emergency air filtering systems are discussed in Section 9.4.1.2.2, including a description of the operating modes, filters and components. Control room shielding is described in Section 12.1.2.7 and ventilation parameters are given in Section 12.2.2.3.

The Unit 2 control room is adjacent to and interconnected with the Unit 1 control room. Non-seismic Category 1 kitchen and sanitary facilities are part of the Unit 1 control room, but outside of the emergency ventilation system envelope, and are available to the Unit 2 operators. Food, potable water and portable sanitary facilities can be brought to the control room, as needed, by each shift.

6.4.1.3 Design Evaluation

The evaluation of the control room emergency air conditioning and emergency air filtering systems is presented in Sections 9.4.1.3 and 12.2.2. The evaluation of the control room shielding given in Section 15.1.13 shows that the dose received by any operator during the 30 days following a postulated LOCA, including ingress and egress, is less than the limits of 10 CFR 50 General Design Criterion 19.

ARKANSAS NUCLEAR ONE
Unit 2

6.4.1.4 Testing and Inspection

Testing and inspection of the control room emergency air conditioning and emergency air filtering systems and their associated fans and filters is discussed in Section 9.4.1.4. The Technical Specifications and [10 CFR 50.55a](#) prescribe inservice testing as well as the bases for the tests.

6.4.1.5 Instrumentation Requirement

Instrumentation for the control room emergency air conditioning and emergency air filtering systems is described in Section 9.4.1. Radiation monitoring is discussed in Sections 12.2 and 11.4.

6.5 PENETRATION ROOMS VENTILATION SYSTEM

6.5.1 DESIGN BASES

This system is designed to collect, monitor and process potential leakage in the penetration rooms and the Engineered Safety Features (ESF) pump rooms to minimize environmental activity levels resulting from post-Loss of Coolant Accident (post-LOCA) containment leaks. Experience has shown the containment leakage is more likely to occur at penetrations than through the liner plate or weld joints.

The design basis for the charcoal adsorber is to have a capability of removing 25 percent of the core iodine inventory. The 25 percent was derived using the standard assumption that during a DBA 50 percent of the halogens are released from the core and that 50 percent of this iodine that is released plates out within the containment. Although these assumptions were part of the design basis of the Penetration Room Ventilation System, it is not credited for iodine removal in the accident analyses.

Table 9.4-3 contains an analysis of each ESF air filtration system with respect to Regulatory Guide 1.52.

6.5.2 SYSTEM DESIGN

For the air flow control diagram, see Figure 6.5-1.

The penetration rooms ventilation system is designed to meet the following criteria:

- A. Seismic Category 1.
- B. A single failure will not cause a loss of function.
- C. Sufficient remote instrumentation and control are available to permit the operator to monitor and control equipment operation from the control room.
- D. Power is from the ESF buses in case of loss of off-site or onsite power.

The penetration rooms are formed adjacent to the outside surface of the containment by enclosing the area around the majority of the penetrations. The only penetrations which do not pass through this area are:

- A. both main steam lines;
- B. the containment equipment hatch (which contains a double gasketed closure);
- C. the containment escape lock;
- D. the fuel transfer tube;
- E. the containment purge lines;
- F. the containment sump penetration; and,
- G. the reactor drain tank discharge line.

ARKANSAS NUCLEAR ONE
Unit 2

The containment purge lines and containment sump penetrations are not considered a source of significant leakage because they are welded to the liner plate. The Reactor Drain Tank discharge line is not considered to be a source of significant leakage because it is embedded in the base slab. The main steam lines are not considered a source of significant leakage because they are connected to the liner plate by welding through flanged heads. The [containment escape lock](#) can be tested during normal operation [and the containment equipment hatch is tested prior to containment closure](#). There are double seals at each access opening. The fuel transfer tube opening is covered with a gasketed blind flange which is removed only during plant shutdown for transfer of fuel to the spent fuel pool. Also, the Reactor Drain Tank Discharge Line and Containment Sump Penetrations are located in HPSI pump rooms that are isolated by Safety Injection Actuation Signal (SIAS). See Section 3.8 for additional information.

Leakage into each of the penetration rooms is discharged to the containment flue (vent – see Figure 11.2-2) through a pair of filter assemblies (one standby) each consisting of a roughing filter, a High Efficiency Particulate Air (HEPA) filter, and a charcoal adsorber. The entire system is designed to operate under negative pressure up to the fan discharge which is downstream of the filters.

The design flow rate from the penetration rooms far exceeds the maximum anticipated containment leakage. The maximum anticipated leak rate of 0.1 percent per day amounts to approximately 1.25 scfm compared to a design evacuation rate of 2,000 scfm for the system.

The fan operating status and the radiation level of filter effluent are displayed in the control room and high radiation is annunciated. Filter differential pressure is displayed locally. The filter flow rate is displayed in the control room and a low flow rate is annunciated. The system may be actuated by an operator for testing during normal plant operation. A containment isolation signal actuates the system following a postulated accident.

Particulate filtration is achieved by a roughing filter and a HEPA filter. Adsorption filtration is accomplished by an activated charcoal adsorber.

Filters and adsorbers are designed to withstand a rough handling test in accordance with MIL-STD-282 without visible damage or decrease in filtration efficiency.

A check valve is provided at the discharge of each fan to prevent recirculation. Filter cross-connect valves were provided in the original design for the purpose of maintaining adequate cooling air from the operating fan through the idle filter train to prevent it from reaching an ignition temperature. Subsequent calculations have confirmed that a significant margin to ignition temperature will be maintained for 30 days post-LOCA with no convective (neither fans nor natural circulation) or conductive heat transfer from the charcoal adsorbers.

A description of the filters and adsorber is given in the following paragraphs:

Roughing Filter - The function of this filter is to remove relatively large granular or fibrous material which may be originally in the system or contained space or may be introduced during maintenance activity, and prevent this material from lodging in the HEPA filters, thus extending the useful life of the HEPA filters.

The roughing filters are designed to meet the following criteria.

ARKANSAS NUCLEAR ONE
Unit 2

A. Roughing Filter - Unit Type

1. The roughing filter is of sufficient capacity to handle the rated air flow at a face velocity not exceeding 300 feet/minute.
2. Media are two inches thick replaceable glass pads coated with suitable oil.
3. The pressure drop of these filters with clean pads under rated conditions, standard air, does not exceed 0.2-inch water gauge (W.G.).
4. This unit is used in conjunction with a medium efficiency filter in potentially radioactive service.

B. Roughing Filters - Medium Efficiency

1. The filter cells are of the throwaway cartridge type labeled Class 1 UL 900, of medium efficiency (80-85 percent by the dust spot method of testing).
2. Each unit has a capacity of not less than 1000 cfm with a face area of 24 x 24 inches. The depth does not exceed 11½ inches. The initial resistance at rated air flow does not exceed: 0.3-inch W.G. when clean, and 1-inch W.G. when dirty.
3. This unit is used in all potentially radioactive areas.

HEPA Filter - These cells serve to remove effectively all particulates from the airstream. They also prevent dirt reaching the charcoal cells which follow.

The HEPA filters are designed to meet the following criteria.

- A. Each filter cell is of the throwaway extended medium, open-faced, rectangular, water repellant, dry type, suitable for radioactive service, and is in compliance with Underwriter's Laboratories Standard UL 586 high efficiency air filter units, and AEC-HSB-306. The filters are satisfactory for operation up to 250 °F.
- B. The filters are of either glass fiber or glass fiber and asbestos paper, 0.015 inch minimum thickness, having a minimum base weight of 48 pounds per 3,000 square feet. The filter medium contains no more than five percent combustible or organic material, in accordance with MIL-F-51079A.
- C. The basic design criteria for this filter is set forth in Health and Safety Bulletin 306 (3-31-71) which incorporates U.S. Military Specification MIL-F-51068D captioned "Filter, Particulate, High Efficiency, Fire Resistant." The dust holding capacity to 2-inch W.G. final pressure drop is at least six pounds of NBS (96 percent Cottrell – four percent lint) precipitate fed in accordance with NBS Procedure on a 24 x 24 x 12-inch filter.

Charcoal Adsorber - These are designed to remove gaseous contaminants only. The charcoal is retained between perforated metal plates with 0.045 diameter holes spaced closely together. The effective open area is about 35 percent.

ARKANSAS NUCLEAR ONE
Unit 2

The charcoal adsorbers are designed to meet the following criteria.

- A. Each adsorber cell is of the unit tray or drawer type with a layer of charcoal, activated for trapping elemental iodine and radioiodine in the form of organic compounds.
- B. The adsorbers are constructed so the airflow through the adsorption bed is essentially in a vertical direction. The minimum depth of each bed is two inches. The effective face area of the filter is of such dimensions that the average velocity through the bed does not exceed 45 feet per minute at standard conditions for a gas charcoal "contact" or "dwell" time of approximately 0.25 second per 2-inch depth.

The description of major system components is given below:

Penetration Rooms Ventilation System

Fans

Type	Centrifugal
Capacity, CFM	2000

Motors

Type	Induction
Horsepower rating, hp	10
Voltage, V	460
Phase	3
Enclosure	Open drip-proof
Insulation class	B

Roughing Filters

Quantity per assembly	2
Rated flow per filter cell, CFM	1000
Type	Replaceable
Media	Glass fiber
Average Efficiency	80 percent
Rating basis	ASHRAE Std. 52-68 Test Method original, current revision for replacements
Rated pressure drop, unloaded, inches W.G.	0.54

HEPA Filters

Quantity per assembly	2
Rated flow per filter cell, cfm	1000
Type	High efficiency, dry
Media	Glass fiber (waterproof, fire retardant)
Frame	Chromized steel

ARKANSAS NUCLEAR ONE
Unit 2

Face guards	4 x 4 mesh galvanized hardware cloth
Separator	Aluminum
Seal	Polyurethane
Efficiency, percent	99.97 percent with 0.3 micron diameter DOP
Rating basis	MIL-STD-282
Rated pressure drop, unloaded, inches W.G.	1.0
Codes or Standards	Health and Safety Bulletin 306 UL-586 MIL-F-51079A MIL-F-51068D MIL-STD-282 ANSI-101.1-1972

Charcoal Adsorbers

Quantity per assembly	6 (2-inch trays)
Rated flow per filter cell, cfm	333.3
Type	Activated coconut shell, impregnated
Granular Size	10-14 mesh
Ignition temperature, °C	360
Charcoal per cell, ft ³	1.47
Maximum moisture content, percent	3
Gasketing material	ASTM-D-1056, GR SCE-43
Casting material	304 stainless steel
Efficiency, percent	99.9 percent elemental iodine at 25 °C, 70 percent relative humidity 99.5 percent methyl iodide at 25 °C, 70 percent relative humidity 99.9 percent Freon 112
Rating basis	RDT-M16-1T, June 1972
Retention time, sec	0.25
Rated pressure drop, inches W.G.	1.0
Codes	AEC-DP-1082, July 1967 RTD-M16-1T, June 1972 AEC-DP-1075

6.5.3 DESIGN EVALUATION

The system is provided with two fans and two filter assemblies. Both fans, discharging to the containment flue (vent), are controlled from the control room.

During normal plant operation, this system is held on standby with each fan aligned with a multi-filter assembly. A Containment Isolation Actuation Signal (CIAS) will actuate the fans. Control room instrumentation monitors operation. The system can be tested during normal operation.

ARKANSAS NUCLEAR ONE
Unit 2

6.5.4 TESTS AND INSPECTIONS

The system was given a preoperational test before the station produced power as described in Section 14.1.

Periodic performance tests, during normal plant operation, will consist of performance tests on exhaust fan flow rates, motor operation, valve operation, and filter testing as described below.

The HEPA filter and charcoal adsorber systems field acceptance test and retest frequency are shown in Table 1 of ANSI N45.8.3-1973.

A visual inspection of filters, adsorbers and mounting frames for obvious damage and defects precedes any test so that necessary repairs or corrections are made. This inspection is performed according to Appendix A of ANSI N45.8.3-1973.

A filter housing leakage rate test is conducted on each housing section after completion of all welding, but before weld touch up, and has to pass an internal air pressure test of 1.5 psi and an external air pressure test of 20-inch W.G. for a 5-minute period. All leaks shall be repaired and the section retested.

Testing of the HEPA filters and filter bank follows the recommended methods as specified in ANSI N-101.1-1972.

Each HEPA filter is tested with thermally generated DOP of uniform 0.3 micron droplet size in accordance with Edgewood Arsenal Manual Documents No. 136-300 - 195A and No. 136-300 - 175A. System efficiency is to be within tolerance of 99.97 percent when measured by means of a portable photometer upstream and downstream of the filter. A downstream concentration of greater than 0.03 percent (99.97 percent efficient) indicates that the integrated penetration reading is unsatisfactory and the individual cells and their gaskets must be tested to locate any leaks. Corrective action shall then be taken and the procedure repeated until the bank tests satisfactorily.

Testing of the charcoal adsorbers will follow the recommended methods as specified in Oak Ridge National Lab Manual, Nuclear Safety Information Center ORNL-NSIC-65 Design, Construction and Testing, of High Efficiency Air Filtration Systems for Nuclear Application by C.A. Burchstead and A.B. Fuller.

The charcoal adsorbers are tested by the use of Refrigerant-11 (R-11) introduced on the upstream side of the filters.

Instrumentation will provide for measuring the relative upstream and downstream concentrations of R-11. Leakage greater than 0.05 % across the adsorber banks will require corrective action.

6.5.5 INSTRUMENTATION REQUIREMENTS

On receipt of a CIAS, the 3-way electrically-operated solenoid valves mounted in the air lines to the pneumatic operators on the duct isolation dampers will be automatically de-energized, closing off the air supply to the operators. These isolation dampers are designed to fail-closed on loss of air pressure, providing sealed penetration rooms. Indicating lights in the control room show their position.

ARKANSAS NUCLEAR ONE
Unit 2

Both exhaust fans receive a CIAS. The power operated butterfly valve at the discharge of each filter opens when its respective fan starts. Since only one fan is required, one of the fans may be aligned as a standby. High temperature detectors set well below the charcoal ignition temperature are provided for alarms in the control room.

The discharge flow of each fan is monitored, and an alarm is provided if a low flow (less than 1,500 scfm) condition exists for 20 seconds after the fan is started. On receipt of the alarm, the operator will stop the fan and start the other fan.

ARKANSAS NUCLEAR ONE
Unit 2

6.6 REFERENCES

1. 10 CFR 50.46, "Acceptance Criteria for Emergency Core Cooling Systems for Light Water Nuclear Power Reactors".
2. Deleted.
3. Deleted.
4. Arkansas Nuclear One - Unit 2, PSAR Sections 14.10 and 14.A, Docket No. 50-368.
5. "Assessment of Oxidation Embrittlement of Zircaloy-4 Fuel Clad Samples While Exposed to Two Sided Oxidation," CENPD-84, January, 1973.
6. CENPD-132P, "Calculative Methods for the C-E Large Break LOCA Evaluation Model," August 1974.

CENPD-132P, Supplement 1, "Calculational Methods for the C-E Large Break LOCA Evaluation Model," February 1975.

CENPD-132P, Supplement 2-P, "Calculational Methods for the C-E Large Break LOCA Evaluation Model," July 1975.

CENPD-132, Supplement 3-P-A, "Calculative Methods for the C-E Large Break LOCA Evaluation Model for the Analysis of C-E and W Designed NSSS," June 1985.

CENPD-132, Supplement 4-P-A, "Calculative Methods for the CE Nuclear Power Large Break LOCA Evaluation Model," March 2001.
7. "Calculation Methods for the C-E Large Break LOCA Evaluation Model," CENPD-132, Supplement 2, July, 1975.
8. CENPD-137-P, "Calculative Methods for the C-E Small Break LOCA Evaluation Model," August 1974.

CENPD-137, Supplement 1-P, "Calculative Methods for the C-E Small Break LOCA Evaluation Model," January 1977.

CENPD-137, Supplement 2-P-A, "Calculative Methods for the ABB CE Small Break LOCA Evaluation Model," April 1998.
9. CENPD-133P, "CEFLASH-4A, A FORTRAN-IV Digital Computer Program for Reactor Blowdown Analysis," August 1974.

CENPD-133P, Supplement 2, "CEFLASH-4A, A FORTRAN-IV Digital Computer Program for Reactor Blowdown Analysis (Modifications)," February 1975.

CENPD-133, Supplement 4-P, "CEFLASH-4A, A FORTRAN-IV Digital Computer Program for Reactor Blowdown Analysis," April 1977.

CENPD-133, Supplement 5, "CEFLASH-4A, A FORTRAN77 Digital Computer Program for Reactor Blowdown Analysis," June 1985.

ARKANSAS NUCLEAR ONE
Unit 2

10. CENPD-139-P-A, "C-E Fuel Evaluation Model Topical Report," July 1974.
CEN-161(B)-P-A, "Improvements to Fuel Evaluation Model," August 1989.
CEN-161(B)-P, Supplement 1-P-A, "Improvements to Fuel Evaluation Model," January 1992.
11. CENPD-134P, "COMPERC-II, A Program for Emergency Refill-Reflood of the Core," August 1974.
CENPD-134P, Supplement 1, "COMPERC-II, A Program for Emergency Refill-Reflood of the Core (Modifications)," February 1975.
CENPD-134, Supplement 2, "COMPERC-II, A Program for Emergency Refill-Reflood of the Core," June 1985.
12. "Containment Pressure Analysis," NS-731-TN, Power and Industrial Division, Bechtel Corporation, San Francisco, California, December 1968.
13. "Containment Pressure Analysis, Response to USAEC-DRL Questions on Docket Nos. 50-329 and 50-330," Power and Industrial Division, Bechtel Corporation, San Francisco, California, November 3, 1969.
14. "Containment Pressure Analysis, Response to USAEC-DRL Questions on Docket Nos. 50-329 and 50-330," Power and Industrial Division, Bechtel Corporation, San Francisco, California, December 26, 1969.
15. Corrected Redirect and Rebuttal Testimony Submitted on Behalf of Combustion Engineering, Inc., Docket RM-50-1, April 1973.
16. "Decay Energy Release Rates Following Shutdown Uranium-Fueled Thermal Reactors," Proposed ANS Standard, October 1971.
17. "Description of Loss-of-Coolant Calculation Procedures," CENPD-26, August 23, 1971 (Proprietary).
"Description of Loss of Coolant Calculation Procedures," CENPD-26, Supplement 1, October 14, 1971 (Proprietary).
"Description of Loss of Coolant Calculation Procedures," CENPD-26, Supplement 2, (Proprietary).
"Description of Loss of Coolant Calculational Procedures," CENPD-26, Supplement 3, (Proprietary).
18. "Experiment of Determination of Limiting Heat Transfer Coefficients During Quenching of Thick Steel Plates on Water," CE Report A-68-10-2, December 13, 1968 (Submitted as a topical report).
19. "Finite Element Analysis of Structural Integrity of a Reactor Pressure Vessel During Emergency Core Cooling," CE Report A-70-19-2, January, 1970 (Submitted as a topical report).

ARKANSAS NUCLEAR ONE
Unit 2

20. "FLOOD/MOD 002 - KRK Code Description," Idaho Nuclear, November 2, 1972.
21. "Flow of Fluids Through Valves, Fittings, and Pipe," Technical Paper Number 410, Crane Company, 1973.
22. Deleted.
23. Deleted.
24. "Leakage Rate Testing of Containment Structures for Nuclear Reactors," ANSI N45.4-1972.
25. "Moisture Carryover During an NSSS Steam Line Break Accident," CENPD-80, issued February 16, 1973.
26. "One-Fifth Scale Intact Loop Post-LOCA Steam Relief Tests," CENPD-63, November, 1972.
27. CENPD-138P, "PARCH, A FORTRAN-IV Digital Program to Evaluate Pool Boiling, Axial Rod and Coolant Heatup," August 1974.

CENPD-138P, Supplement 1, "PARCH, A FORTRAN-IV Digital Program to Evaluate Pool Boiling, Axial Rod and Coolant Heatup (Modifications)," February 1975.

CENPD-138, Supplement 2-P, "PARCH, A FORTRAN-IV Digital Program to Evaluate Pool Boiling, Axial Rod and Coolant Heatup," January 1977.
28. "Reflood Heat Transfer: Application of FLECHT Reflood Heat Transfer Coefficients to CE's 16 x 16 Fuel Bundles," CENPD-213, January, 1976 (Proprietary).
29. "Steam-Water Mixing Test Program, Task D: Formal Report for Task A - One-Fifth Scale Broken Loop," CENPD-65, 1-26-73.
30. CENPD-135P, "STRIKIN-II, A Cylindrical Geometry Fuel Rod Heat Transfer Program," August 1974.

CENPD-135P, Supplement 2, "STRIKIN-II, A Cylindrical Geometry Fuel Rod Heat Transfer Program (Modifications)," February 1975.

CENPD-135, Supplement 4-P, "STRIKIN-II, A Cylindrical Geometry Fuel Rod Heat Transfer Program," August 1976.

CENPD-135P, Supplement 5, "STRIKIN-II, A Cylindrical Geometry Fuel Rod Heat Transfer Program," April 1977.
31. Appendix K - ECCS Evaluation Models, 10CFR50.46, "Acceptance Criteria for Emergency Core Cooling Systems for Light Water Nuclear Power Reactors," Federal Register, Vol. 39, No. 3, January 4, 1974.
32. "Supplement to the Status Report by the Directorate of Licensing in the Matter of Combustion Engineering, Inc., ECCS Evaluation Model Conformance to 10 CFR 50, Appendix K," November 13, 1974.
33. "System 80 PSAR - CESSAR - Appendix 6B," January 1974.

ARKANSAS NUCLEAR ONE
Unit 2

34. System 80 CESSAR PSAR, Amendment 31, June 9, 1975. Docket No. STN-50-470.
35. "Testing Criteria for Integrated Leak Rate Testing of Primary Containment Structures for Nuclear Power Plants," BN-TOP-1, Power and Industrial Division, Bechtel Corporation, San Francisco, California January 1972.
36. "Thermal Shock Analysis of Reactor Vessels Due to Emergency Core Cooling System Operation," CE Report A-68-9-1, March 15, 1968, (Submitted as Amendment 9 to Maine Yankee License Application, Docket No. 50-309).
37. Thermodynamic and Transport Properties of Steam, American Society of Mechanical Engineers, New York, New York (1967).
38. Deleted
39. Barzelay, Martin E., and George F. Holloway, "Effect of an Interface on Transient Temperature Distribution in Composite Aircraft Joints," National Advisory Committee for Aeronautics Technical Note 3824, Washington, D.C., April 1957.
40. Barzelay, Martin E. and George F. Holloway, "Interface Thermal Conductance of Twenty-Seven Riveted Aircraft Joints," NACA TN 3391, Washington, D.C., July 1957.
41. Barzelay, Martin E., "Range of Interface Thermal Conductance for Aircraft Joints," National Aeronautics and Space Administration, Washington, D.C., May 1960.
42. Deleted.
43. Buckingham, E., "Note on Contraction Coefficients on Jet of Gas," USNBS Journal of Research, Volume 6, 1931.
44. Clausing, A. M., "Practical Techniques for Estimating the Accessory of Finite-Difference Solutions to Parabolic Equations," Journal of Applied Mathematics, March 1973.
45. Cunningham, R. G., "Supercritical Compressible Flow Through a Squared Edge Orifice," Midwest Conference on Fluid Dynamics, 1950.
46. Eggleton, A. E. J., "A Theoretical Examination of Iodine Water Partition Coefficient," AERE(R)-4887, 1957.
47. Fenech and Henri, "Thermal Conductance of Metallic Surfaces in Contact," Massachusetts Institute of Technology Heat Transfer Laboratory Report NYO 2136, Cambridge, Massachusetts, May 1959.
48. Garabedian, P. R., Partial Differential Equations, Wiley, New York (1964).
49. Deleted
50. Griess, J. C. and Creek, G. C., "Design Considerations of Reactor Containment Spray Systems - The Stress Corrosion Cracking of Types 304 and 316 Stainless Steel in Boric Acid Solutions," ORNL-TM-2412, Part X, May 1971.

ARKANSAS NUCLEAR ONE
Unit 2

51. Hillard, R. K., et al, "Removal of Iodine and Particulates from Containment Atmospheres by Sprays - Containment Systems Experiment Interim Report," BNWL-1244, 1970.
52. Idel Chik, I. E., "Handbook of Hydraulic Resistance," AEC-TR-6630, 1960.
53. Kays, W. M., and A. W. London, Compact Heat Exchangers, 2nd Ed., McGraw-Hill Book Company, New York (1964).
54. Kolflat A., and W. A. Chittenden, "A New Approach to the Design of Containment Shells for Atomic Power Plants," Proceedings of the American Power Conference, Illinois Institute of Technology, 19, (1959), p. 651.
55. Malong, G. F., "Carryout Rate Correlation," (B&W), ANS Trans, Vol. 15, No. 2, 1972 Winter Meeting.
56. McLain, H. A., "Potential Metal-Water Reactions in Light-Water - Cooled Powered Reactors," ORNL-NSIC-23 (August 1968).
57. Moody, F. J., "Maximum Flow Rate of a Single Component, Two Phase Mixture," ASME Paper 64-HT-35, 1964.
58. Moody, F. J., "Maximum Two-Phase Vessel Blowdown From Pipes," Journal of Heat Transfer, 88, TRANS ASME, Series C, August 1966, p. 285.
59. Parsley, L. F. Jr., "Design Consideration of Reactor Containment Spray Systems - Part VI," ORNL TM 2412, Part 6, 1969.
60. Parsley, L. F. Jr., "Design Consideration of Reactor Containment Spray Systems - Part VII," ORNL TM 2412, Part 7, 1970.
61. Deleted
62. Perry, J. A. "Critical Flow Through Sharp Edged Orifices," Transactions ASME, October 1949.
63. Deleted
64. Poseday, W. F. and Gallagher, J. L. "Drop Size Distribution and Spray Effectiveness," Nuclear Technology, Vol. 10, April 1971.
65. Ranz, W. E. and Marshall, W. R. Jr., "Evaporation from Drops," Chem. Eng. Progr. 48, 141-46, 173-80 (1952).
66. Deleted
67. Richardson, L. C., et al, "CONTEMPT - A Computer Program for Predicting the Containment Pressure-Temperature Response to a Loss of Coolant Accident," IDO-17220, Phillips Petroleum Company, June 1967.
68. Schmitt, R. C., et al, "Simulated Design Basis Accident Results of the Carolinas Virginia Tube Reactor Containment - Final Report," UC80, Idaho Nuclear Corporation, December 1970.

ARKANSAS NUCLEAR ONE
Unit 2

69. Schoenhoff, H. M. and Braddy, R. W., "Containment and Safety-Related Equipment Transient Temperature Analysis Following a MSLB," Bechtel Power Corporation, May 1975.
70. Shames, Irving, H., Mechanics of Fluids, McGraw Hill Book Company, New York, 1967.
71. Sozzi, G. L., Sutherland, W. A., "Critical Flow of Saturated and Subcooled Water at High Pressure," presented at the Winter Annual Meeting of ASME, Houston, Texas, December, 1975.
72. Letter from J. F. Stolz (NRC) to J. D. Phillips (AP&L), March 29, 1977, Docket No. 50-368, "Requests for Information and Statement of Position."
73. Letter from D. C. Switzer (NNECO) to O.D. Parr (NRC) re: Millstone Nuclear Power Station, Unit 2 ECCS Re-evaluation, July 10, 1975, Docket No. 50-336.
74. Tagami, T., "Interim Report on Safety Assessment and Facilities Establishment - SAFE Project," Hitachi Ltd., Tokyo, Japan, February 28, 1966.
75. Tagami, T., et al, "Studies for Safety Analysis of Loss-of Coolant Accidents in Light Water Power Reactors," NSJ-TR-233, Japan Atomic Energy Research Institute, Japan, March 1968.
76. Uchida, H., et al, "Evaluation of Post-Incident Cooling Systems of Light Water Power Reactors," Third International Conference on the Peaceful Uses of Atomic Energy, New York, A/Conf. 28/P/436, (2965).
77. Zittel, H. E., "Radioactive Studies," ORNL-TM-1057, ORNL Nuclear Safety Research and Development Program Bi-Monthly Report for September-October 1967, (November 1967).
78. AP&L Calculation 89E-0040-03, ANO-2 FW Backup Block Valve Maximum Stroke Time.
79. ANO Calculation 91-E-0088-01, Rev. 0, "ANO-2 Post-LOCA Hydrogen Generation."
80. NUREG/CR-2847, "COGAP: A Nuclear Power Plant Containment Hydrogen Control System Evaluation Code", R. G. Gido, Los Alamos National Laboratory, Jan. 1983.
81. Enclosure 1-P-A to LD-81-095, "C-E ECCS Evaluation Model Flow Blockage Analysis," December 1981.
82. Letter from K. Kniel (NRC) to A. E. Scherer (CE), "Evaluation of Topical Reports CENPD-133, Supplement 3-P and CENPD-137, Supplement 1-P," September 27, 1977.
83. CENPD-133P, Supplement 1, "CE FLASH-4AS, A Computer Program for the Reactor Blowdown Analysis of the Small Break Loss of Coolant Accident," August 1974.

CENPD-133, Supplement 3-P, "CE FLASH-4AS, A Computer Program for the Reactor Blowdown Analysis of the Small Break Loss of Coolant Accident," January 1977.
84. NUREG-0800, "U.S. Nuclear Regulatory Commission Standard Review Plan," Revision 2, July 1981.
85. Not Used.

ARKANSAS NUCLEAR ONE
Unit 2

86. NUREG 75/112, "USNRC Safety Evaluation Report Related to the Preliminary Design of the Standard Reference System CESSAR System 80, December 1975.
87. CENPD-140-A, "Description of the CONTRANS Digital Computer Code for Containment Pressure and Temperature Transient Analysis," June 1976.
88. BN-TOP-3, "Performance and Sizing of Dry Pressure Containments," Rev. 4, Bechtel Topical Report, March 1983.
89. Not Used.
90. Combustion Engineering Letter DP-456, F. M. Stern to E. Case, "Chapter 6, Appendix 6B to CESSAR System 80 PSAR," August 19, 1974.
91. NUREG/CR5535 (draft), Carlson, K. E. et al, RELAP5/MOD3 Code Manual, Volumes I-IV, June 1990.
92. CENPD-254-P-A, "Post-LOCA Long Term Cooling Evaluation Model," June 1980.
93. [WCAP-16500-P-A, Rev. 0, "CE 16 x 16 Next Generation Fuel Core Reference Report," August 2007.](#)
94. [WCAP-12610-P-A and CENPD-404-P-A Addendum 1-A, "Optimized ZIRLO™," July 2006.](#)

ARKANSAS NUCLEAR ONE
Unit 2

Table 6.2-1A

DELETED

(Historical Information, See FSAR Table 6.2-1A)

Table 6.2-1B

DELETED

(Historical Information, See FSAR Table 6.2-1B)

Table 6.2-1C

DELETED

(Historical Information, See FSAR Table 6.2-1C)

Table 6.2-1D

DELETED

(Historical Information, See FSAR Table 6.2-1D)

Table 6.2-2

DELETED

(Historical Information, See FSAR Table 6.2-2)

Table 6.2-3

DELETED

(Historical Information, See FSAR Table 6.2-3)

Table 6.2-4

DELETED

(Historical Information, See FSAR Table 6.2-4)

ARKANSAS NUCLEAR ONE
Unit 2

Table 6.2-5

DELETED

(Historical Information, See FSAR Table 6.2-5)

Table 6.2-6

DELETED

(Historical Information, See FSAR Table 6.2-6)

Table 6.2-7

PRINCIPAL CONTAINMENT DESIGN PARAMETERS

<u>Characteristics</u>	<u>Data</u>
Containment maximum design pressure, psig	59
Containment maximum design temperature, °F	300
Internal dimension	
Cylindrical wall diameter, ft.	116
Cylindrical wall height, ft.	171.5
Curved dome height, ft.	37
Total height, ft.	208.5
Volume	
Gross internal volume, ft ³	2,042,000
Net free internal volume (minimum), ft ³	1,778,000
Containment design leak rate	
First 24 hr, % of containment free volume	0.1
After first day, % per day	0.05

ARKANSAS NUCLEAR ONE
Unit 2

Table 6.2-8

INITIAL CONDITIONS FOR PRESSURE ANALYSIS
(Information Maintained for Sub-compartment Pressurization Analysis)

<u>Characteristics</u>	<u>Data</u>
Reactor Coolant System	
NSSS Power Level, Mwt	2908
Coolant Pressure, psia	2250
Average Coolant Temperature, °F	586
Mass of Reactor Coolant System liquid, lbm	427,706
Mass of Reactor Coolant System steam, lbm	3551
Liquid plus steam energy, Btu (a)	254 x 10 ⁶
Internal liquid coolant volume, cu. ft.	9740
Internal steam volume, cu. ft.	555
Containment System	
Pressure, psia	14.7
Relative humidity, %	53
Inside temperature, °F	120
Outside temperature, °F	88
Refueling Water Tank (RWT) water temperature, °F	120
Safety injection tank water temperature, °F	120
Service Water temperature, °F	120
Stored Water	
Refueling Water Tank, cu. ft.	5,652
Four safety injection tanks, cu. ft.	

(a) All energies are relative to 32 °F

ARKANSAS NUCLEAR ONE
Unit 2

Table 6.2-8A

**ESF PERFORMANCE PARAMETERS AND NSSS ASSUMPTIONS
FOR MASS AND ENERGY ANALYSIS (LOCA)**

<u>PARAMETER</u>	<u>DATA</u>
<u>Initial NSSS Parameters</u>	
Reactor Power, MWt	3087
RCS Pressure, psia	2300
RCS Inlet Temperature, °F	556.7
RCS Flow Rate, gpm	322,000
SG Pressure, psia	1001.1
<u>ESF Performance Parameters</u>	
SIS (Loss of an Emergency Diesel Generator)	1 HPSI / 1 LPSI
SIS (Loss of One CHR System)	2 HPSI / 2 LPSI
SIT Pressure, psia	650
SIT Temperature, °F	140
RWT Temperature, °F	120
RWT Inventory, gal.	384,000

ARKANSAS NUCLEAR ONE
Unit 2

Table 6.2-8B

**MASS AND ENERGY RELEASE DATA
LIMITING CASE (LOCA)
(DEDLS Break With Loss of an Emergency Diesel Generator)**

Blowdown Phase (Release to Containment Atmosphere)					
Time (sec)	Mass Rate (lbm/hr)	Energy Rate (BTU/hr)	Enthalpy (BTU/lbm)	Integral Mass (lbm)	Integral (BTU)
0.00	0.000E+00	0.000E+00	549.88	0.000E+00	0.000E+00
0.01	2.700E+08	1.485E+11	549.88	7.950E+02	4.377E+05
0.02	2.654E+08	1.457E+11	548.93	1.536E+03	8.447E+05
0.03	2.681E+08	1.471E+11	548.92	2.276E+03	1.251E+06
0.04	2.722E+08	1.495E+11	549.23	3.027E+03	1.664E+06
0.05	2.737E+08	1.504E+11	549.35	3.787E+03	2.081E+06
0.06	2.726E+08	1.497E+11	549.27	4.546E+03	2.498E+06
0.07	2.710E+08	1.488E+11	549.15	5.300E+03	2.912E+06
0.08	2.712E+08	1.489E+11	549.22	6.053E+03	3.325E+06
0.09	2.745E+08	1.508E+11	549.48	6.796E+03	3.734E+06
0.10	3.777E+08	2.079E+11	550.48	7.675E+03	4.217E+06
0.15	4.015E+08	2.218E+11	552.41	1.314E+04	7.233E+06
0.20	3.951E+08	2.185E+11	553.02	1.868E+04	1.029E+07
0.25	3.981E+08	2.203E+11	553.42	2.419E+04	1.334E+07
0.30	3.925E+08	2.172E+11	553.37	2.969E+04	1.639E+07
0.35	3.890E+08	2.152E+11	553.29	3.512E+04	1.939E+07
0.40	3.844E+08	2.126E+11	553.16	4.048E+04	2.236E+07
0.45	3.824E+08	2.115E+11	553.09	4.581E+04	2.530E+07
0.50	3.806E+08	2.105E+11	553.06	5.111E+04	2.823E+07
0.60	3.733E+08	2.064E+11	553.03	6.153E+04	3.400E+07
0.70	3.694E+08	2.043E+11	553.22	7.185E+04	3.971E+07
0.80	3.550E+08	1.965E+11	553.46	8.193E+04	4.528E+07
0.90	3.502E+08	1.941E+11	554.23	9.167E+04	5.068E+07
1.00	3.436E+08	1.908E+11	555.31	1.013E+05	5.603E+07
1.50	2.939E+08	1.663E+11	565.90	1.456E+05	8.080E+07
2.00	2.663E+08	1.532E+11	575.45	1.844E+05	1.030E+08
2.50	2.315E+08	1.349E+11	582.73	2.188E+05	1.229E+08
3.00	2.015E+08	1.200E+11	595.35	2.486E+05	1.404E+08
3.50	1.854E+08	1.124E+11	606.16	2.755E+05	1.566E+08
4.00	1.646E+08	1.025E+11	622.71	2.999E+05	1.716E+08
5.00	1.387E+08	8.904E+10	642.19	3.417E+05	1.980E+08
6.00	1.099E+08	7.500E+10	682.23	3.763E+05	2.208E+08
7.00	8.133E+07	6.190E+10	761.12	4.028E+05	2.398E+08

ARKANSAS NUCLEAR ONE
Unit 2

Table 6.2-8B (continued)

Blowdown Phase (Release to Containment Atmosphere)					
<u>Time (sec)</u>	<u>Mass Rate (lbm/hr)</u>	<u>Energy Rate (BTU/hr)</u>	<u>Enthalpy (BTU/lbm)</u>	<u>Integral Mass (lbm)</u>	<u>Integral (BTU)</u>
8.00	5.025E+07	4.481E+10	891.57	4.213E+05	2.549E+08
9.00	2.598E+07	2.352E+10	905.25	4.314E+05	2.641E+08
10.00	3.435E+07	2.444E+10	711.61	4.388E+05	2.703E+08
11.00	4.567E+07	2.318E+10	507.57	4.501E+05	2.770E+08
12.00	3.825E+07	1.614E+10	421.94	4.620E+05	2.825E+08
13.00	3.603E+07	1.347E+10	373.95	4.712E+05	2.861E+08
14.00	1.197E+07	4.166E+09	347.99	4.763E+05	2.879E+08
14.10	1.089E+07	3.779E+09	346.98	4.766E+05	2.881E+08
14.20	9.717E+06	3.370E+09	346.82	4.769E+05	2.882E+08
14.30	8.490E+06	2.945E+09	346.89	4.772E+05	2.882E+08
14.40	7.196E+06	2.506E+09	348.20	4.774E+05	2.883E+08
14.50	5.782E+06	2.031E+09	351.30	4.776E+05	2.884E+08
14.60	4.232E+06	1.518E+09	358.73	4.777E+05	2.884E+08
14.70	2.556E+06	9.712E+08	380.03	4.778E+05	2.885E+08
14.80	1.160E+06	5.599E+08	482.86	4.779E+05	2.885E+08
14.90	0.000E+00	0.000E+00	482.86	4.779E+05	2.885E+08

Reflood and Post-Reflood Phases (Release to Containment Atmosphere)					
<u>Time (sec)</u>	<u>Mass Rate (lbm/hr)</u>	<u>Energy Rate (BTU/hr)</u>	<u>Enthalpy (BTU/lbm)</u>	<u>Integral Mass (lbm)</u>	<u>Integral (BTU)</u>
14.91	0.000E+00	0.000E+00	1303.68	0.000E+00	0.000E+00
15.00	4.512E+05	5.882E+08	1303.68	1.253E+01	1.634E+04
19.00	2.819E+06	3.642E+09	1292.17	1.866E+03	2.423E+06
20.80	3.259E+06	4.182E+09	1283.23	3.442E+03	4.451E+06
20.81	1.629E+06	2.091E+09	1283.23	3.446E+03	4.457E+06
22.90	1.639E+06	2.092E+09	1276.36	4.396E+03	5.671E+06
30.70	1.635E+06	2.066E+09	1263.86	7.945E+03	1.017E+07
34.60	1.627E+06	2.050E+09	1260.58	9.711E+03	1.240E+07
38.50	1.614E+06	2.030E+09	1258.05	1.147E+04	1.462E+07
42.40	1.600E+06	2.009E+09	1255.95	1.321E+04	1.680E+07
46.40	1.585E+06	1.987E+09	1254.01	1.498E+04	1.902E+07
50.30	1.570E+06	1.966E+09	1252.22	1.669E+04	2.116E+07
54.20	1.554E+06	1.944E+09	1250.48	1.838E+04	2.328E+07
58.10	1.539E+06	1.922E+09	1248.74	2.005E+04	2.538E+07
62.00	1.524E+06	1.900E+09	1247.03	2.171E+04	2.745E+07
65.90	1.508E+06	1.878E+09	1245.34	2.335E+04	2.949E+07

Table 6.2-8B (continued)

ARKANSAS NUCLEAR ONE
Unit 2

Reflood and Post-Reflood Phases (Release to Containment Atmosphere)

<u>Time (sec)</u>	<u>Mass Rate (lbm/hr)</u>	<u>Energy Rate (BTU/hr)</u>	<u>Enthalpy (BTU/lbm)</u>	<u>Integral Mass (lbm)</u>	<u>Integral (BTU)</u>
69.80	1.492E+06	1.856E+09	1243.92	2.498E+04	3.151E+07
73.59	1.477E+06	1.834E+09	1242.33	2.654E+04	3.346E+07
73.60	2.953E+06	3.669E+09	1242.33	2.654E+04	3.346E+07
78.60	2.773E+06	3.445E+09	1242.23	3.052E+04	3.840E+07
83.60	2.605E+06	3.238E+09	1242.83	3.425E+04	4.304E+07
88.60	2.460E+06	3.059E+09	1243.51	3.776E+04	4.740E+07
93.60	2.335E+06	2.905E+09	1244.02	4.109E+04	5.154E+07
98.60	2.230E+06	2.775E+09	1244.31	4.426E+04	5.548E+07
103.5	2.145E+06	2.669E+09	1244.33	4.723E+04	5.918E+07
108.5	2.072E+06	2.578E+09	1244.14	5.016E+04	6.282E+07
113.5	2.014E+06	2.464E+09	1223.85	5.299E+04	6.634E+07
118.5	1.925E+06	2.321E+09	1205.91	5.573E+04	6.966E+07
123.5	1.840E+06	2.202E+09	1196.17	5.834E+04	7.280E+07
128.4	1.765E+06	2.094E+09	1186.38	6.079E+04	7.572E+07
133.4	1.677E+06	1.982E+09	1181.61	6.319E+04	7.855E+07
138.4	1.590E+06	1.879E+09	1181.61	6.545E+04	8.122E+07
143.4	1.508E+06	1.782E+09	1181.59	6.760E+04	8.376E+07
148.3	1.432E+06	1.692E+09	1181.61	6.960E+04	8.613E+07
148.4	1.448E+06	1.692E+09	1168.48	6.964E+04	8.617E+07
148.5	1.791E+06	2.267E+09	1265.67	6.969E+04	8.623E+07
148.6	6.196E+05	8.007E+08	1292.34	6.971E+04	8.626E+07
148.7	8.926E+05	1.143E+09	1281.11	6.974E+04	8.629E+07
148.8	3.674E+05	4.606E+08	1253.69	6.975E+04	8.631E+07
148.9	2.995E+05	4.054E+08	1353.51	6.976E+04	8.632E+07
149.3	1.363E+05	1.987E+08	1458.57	6.977E+04	8.634E+07
149.6	3.668E+04	4.888E+07	1332.51	6.978E+04	8.635E+07
149.9	1.553E+05	1.911E+08	1230.51	6.980E+04	8.637E+07
150.2	3.985E+04	5.359E+07	1344.66	6.981E+04	8.638E+07
150.6	1.216E+05	1.523E+08	1253.14	6.982E+04	8.640E+07
151.0	7.171E+04	1.029E+08	1435.61	6.984E+04	8.642E+07
151.5	1.200E+05	1.456E+08	1213.3	6.986E+04	8.645E+07
152.0	6.707E+04	8.829E+07	1316.39	6.988E+04	8.647E+07
152.5	1.151E+05	1.530E+08	1328.37	6.990E+04	8.650E+07
152.5	0.000E+00	0.000E+00	1328.37	6.990E+04	8.650E+07

ARKANSAS NUCLEAR ONE
Unit 2

Table 6.2-8B (continued)

Reflood and Post-Reflood Phases (Spillage to the Sump and Condensation)					
<u>Time (sec)</u>	<u>Mass Rate (lbm/hr)</u>	<u>Energy Rate (BTU/hr)</u>	<u>Enthalpy (BTU/lbm)</u>	<u>Integral Mass (lbm)</u>	<u>Integral (BTU)</u>
14.91	0.000E+00	0.000E+00	101.65	0.000E+00	0.000E+00
20.79	0.000E+00	0.000E+00	101.65	0.000E+00	0.000E+00
20.80	2.257E+07	2.293E+09	101.62	6.269E+01	6.371E+03
22.80	2.087E+07	2.145E+09	102.81	1.165E+04	1.198E+06
25.80	1.878E+07	1.962E+09	104.46	2.730E+04	2.833E+06
27.80	1.761E+07	1.858E+09	105.55	3.709E+04	3.865E+06
31.90	1.556E+07	1.677E+09	107.79	5.481E+04	5.776E+06
35.90	1.391E+07	1.530E+09	110.00	7.026E+04	7.476E+06
41.90	1.190E+07	1.350E+09	113.44	9.010E+04	9.726E+06
45.90	1.077E+07	1.247E+09	115.79	1.021E+05	1.111E+07
51.90	9.298E+06	1.113E+09	119.71	1.176E+05	1.297E+07
55.90	8.431E+06	1.034E+09	122.63	1.269E+05	1.412E+07
61.90	7.262E+06	9.265E+08	127.58	1.390E+05	1.566E+07
65.90	6.556E+06	8.614E+08	131.38	1.463E+05	1.662E+07
71.90	5.589E+06	7.716E+08	138.06	1.556E+05	1.790E+07
93.90	0.000E+00	0.000E+00	138.06	1.556E+05	1.790E+07
114.9	0.000E+00	0.000E+00	276.47	1.556E+05	1.790E+07
115.0	9.551E+04	2.640E+07	276.47	1.556E+05	1.790E+07
120.0	1.566E+05	4.329E+07	276.45	1.559E+05	1.796E+07
130.0	2.658E+05	7.349E+07	276.47	1.566E+05	1.817E+07
140.0	4.258E+05	1.177E+08	276.48	1.578E+05	1.849E+07
148.3	5.385E+05	1.489E+08	276.48	1.590E+05	1.884E+07
152.5	0.000E+00	0.000E+00	276.48	1.590E+05	1.884E+07

Miscellaneous Stored Energy Release

<u>Source of Energy</u>	<u>Energy (BTU)</u>
Steam Generator	3.64E+07
RCS Loop	1.58E+07
Upper Head & Other Internals	1.13E+07
Pressurizer	1.15E+07

ARKANSAS NUCLEAR ONE
Unit 2

Table 6.2-8C

DOUBLE-ENDED DISCHARGE LEG BREAK MASS AND ENERGY BALANCE

	<u>Initial</u>	<u>Mass Balance End of Blowdown</u>	<u>End of Post Reflow</u>
RCS Coolant Inventory (lb)	457,272	38,809	104,953 ¹
Change in RCS Inventory (lb)	0	- 418,464	- 352,320
Mass Added by 3 SITs (lb)	0	59,409	272,118
Mass Added by SI Pumps (lb)	0	0	99,290
Break Flow to Atmosphere (lb) ²	0	477,864	573,682
Break Flow to Sump (lb) ²	0	0	150,215
Error (% Break Flow)		0.002	-0.023
	<u>Initial</u>	<u>Energy Balance End of Blowdown</u>	<u>End of Post Reflow</u>
RCS Coolant Inventory (Btu)	274,764,348	9,240,063	25,325,924 ³
Change in RCS Inventory (Btu)	0	- 265,524,285	- 249,438,423
Energy Added by 3 SITs (Btu)	0	6,512,712	25,239,601
Energy Added by SI Pumps (Btu)	0	0	8,741,500
Energy Added from Fuel (Btu)	0	13,761,000	36,316,542
Energy Added from RCS Walls (Btu)	0	8,460,860	16,060,463
Energy Added from SGs (Btu)	0	- 751,650	85,233,165
Break Flow to Atmosphere (Btu) ²	0	288,488,400	404,685,351
Break Flow to Sump (Btu) ²	0	0	13,224,949
Error (% Break Flow)		1.7	0.7

The mass balance and energy balance errors are defined in terms of percent of break flow.

¹ Value includes the mass remaining at the end of blowdown.

² EOPR values were taken from FLOOD3 output and do not reflect the redistribution of mass and energy to account for 50% condensation of steam flow when the SITs are injecting and the annulus is full.

³ Value includes the energy remaining at the end of blowdown.

ARKANSAS NUCLEAR ONE
Unit 2

Table 6.2-8D

**CONTAINMENT HEAT SINK GEOMETRIC DATA
FOR MAXIMUM CONTAINMENT PRESSURE ANALYSIS¹**

<u>Description</u>	<u>Material</u>	<u>Thickness (ft)</u>	<u>ASurface (ft²) or LPipe (ft)</u>
1. Containment Walls and Dome ²	Type B Coating	0.0005	56,059
	Steel	0.0208333	
	Air	0.01	
	Concrete	3.75	
2. Containment Walls ²	Type C Coating	0.00075	20,035
	Steel	0.0208333	
	Air	0.01	
	Concrete	3.75	
3. Refueling Canal ³	Stainless Steel	0.0208333	8,000
	Air	0.01	
	Concrete	4.00	
4. Steel Floor Structures	Type C Coating	0.0005	34,824
	Steel	0.0208333	
5. Steel Floor Structures	Type C Coating	0.0005	44,700
	Steel	0.0078125	
6. Concrete Floor Structures	Type C Coating	0.010667	11,500
	Concrete	1.096	
7. Base Slab and Sump	Type C Coating	0.010667	9,300
	Concrete	1.5	
8. Unlined Concrete Walls & Structures	Concrete	2.0	42,584
9. Uninsulated Concrete Walls	Type C Coating	0.005458	13,116
	Concrete	2.0	
10. Polar Crane Rail Support	Type D Coating	0.0005	8,542
	Steel	0.0625	
11. Trolley Steel	Type D Coating	0.00092	40,371
	Steel	0.01568	
12. Box Girders	Type D Coating	0.00092	6,020
	Steel	0.03125	
13. Elevator	Steel	0.002667	7,110
14. Main Steam Pipe and Restraints	Type C Coating	0.0005	4,600
	Steel	0.05208	
15. Spray Header and H ₂ Recombiner	Stainless Steel	0.01	2,101
16. Cable Trays	Steel	0.003458	11,620

ARKANSAS NUCLEAR ONE
Unit 2

Table 6.2-8D (continued)

<u>Description</u>	<u>Material</u>	<u>Thickness (ft)</u>	<u>A_{Surface} (ft²) or L_{Pipe} (ft)</u>
17. Conduit	Conduit	0.0104417	4,541
18. Refueling Apparatus	Stainless Steel	0.03125	2,075
19. Heating and Vent Ducts	Steel	0.0067167	22,690
20. Safety Injection Tanks	Type C Coating	0.0005	3,796
	Steel	0.1529	
21. Containment Walls and Dome with Stiffeners	Type B Coating	0.0005	575
	Steel	1.1975	
	Air	0.01	
	Concrete	2.57333	
22. Concrete Walls with Stiffeners	Type C Coating	0.00075	265
	Steel	1.27	
	Air	0.01	
	Concrete	2.50083	
23. Quench Tank Cylinder ³	Stainless Steel	0.0283	189
24. Quench Tank Ends ³	Stainless Steel	0.0342	39
25. Reactor Coolant Drain Tank Cylinder ³	Stainless Steel	0.0258	158
26. Reactor Coolant Drain Tank Ends ³	Stainless Steel	0.142	39
27. Missile Shield Platform	Type B Coating	0.00038	716
	Steel	0.02083	
	Air	0.00833	
	Concrete	2.0	
	Type C Coating	0.01067	
28. Missile Shield Structural Steel, Thin ^{2,3}	Type B Coating	0.00038	151
	Steel	0.02083	
29. Maintenance Structure and Missile Shield Structural Steel ^{2,3}	Type B Coating	0.00038	3142
	Steel	0.04167	
30. Safety Injection 2CCA 12 Inch Pipe ⁴	Water	0.4375	147 ft
	Stainless Steel	0.0938	
31. Safety Injection 2CCA 8 Inch Pipe ⁴	Water	0.2992	332 ft
	Stainless Steel	0.0599	
32. White Elephant Mast ^{2,3}	Type C Coating	0.00058	220
	Steel	0.0833	
33. White Elephant Other than Mast ^{2,3}	Type C Coating	0.00058	333
	Steel	0.0417	
34. Safety Injection 2CCA 6 Inch Pipe ⁴	Water	0.2292	18 ft
	Stainless Steel	0.0468	

ARKANSAS NUCLEAR ONE
Unit 2

Table 6.2-8D (continued)

<u>Description</u>	<u>Material</u>	<u>Thickness (ft)</u>	<u>A_{Surface} (ft²) or L_{Pipe} (ft)</u>
35. Safety Injection 2CCA 3 Inch Pipe ⁴	Water	0.1092	38 ft
	Stainless Steel	0.0365	
36. Fire Water 4 Inch Pipe ⁴	Water	0.1675	119 ft
	Steel	0.0198	
	Type B Coating	0.00038	
37. Fire Water 3 Inch Pipe ⁴	Water	0.1275	553 ft
	Steel	0.018	
	Type B Coating	0.00038	
38. Safety Injection 2FCB 12 Inch Pipe ⁴	Water	0.5	12 ft
	Stainless Steel	0.03125	
39. Safety Injection 2DCD 2 Inch Pipe ⁴	Water	0.0703	403 ft
	Stainless Steel	0.0287	
40. Safety Injection 2DCD 1 Inch Pipe ⁴	Water	0.0339	71 ft
	Stainless Steel	0.0208	
41. Polar Crane Walkway Plate ^{2,3}	Type D Coating	0.00092	791
	Steel	0.03125	
42. Buffering Agent Basket Tops ³	Stainless Steel	0.005	140
43. Buffering Agent Basket Bottoms ³	Stainless Steel	0.2083	108
44. Containment Sump Strainers	Stainless Steel	0.0063	12,900
45. Containment Sump Plenum	Stainless Steel	0.0332	1,705
46. Refueling Canal Deep End Strainers ²	Stainless Steel	0.0223	19

¹ Areas shown are those in contact with the containment atmosphere

² Thickness is effective as a result of combining similar thickness walls

³ One side of wall is exposed to containment atmosphere, one side is insulated

⁴ Water filled pipe exposed to containment atmosphere, dimensions are radial from center of pipe

ARKANSAS NUCLEAR ONE
Unit 2

Table 6.2-8E

HEAT SINK THERMODYNAMIC DATA AND MATERIAL PROPERTIES

<u>Material</u>	<u>Thermal Properties for Heat Sinks</u>	
	<u>Heat Capacity (Btu/ft³-°F)</u>	<u>Thermal Conductivity (Btu/hr-ft-°F)</u>
Type A Coating	N/A	N/A
Type B Coating	30	0.9
Type C Coating	33	0.1
Type D Coating	30	7.4
Concrete	30	0.8
Carbon Steel	54	25
Stainless Steel	54	10
Air	0.017	1.0
Conduit	42	62
Water	0.376	61

<u>Region</u>	<u>Heat Transfer Coefficients</u>
	<u>Heat Transfer Coefficient (Btu/hr-ft²-°F)</u>
Sump Liquid to Containment Atmosphere	0.0
Containment Sump and Floor to Sump Liquid	0.4
Heat Sink Surfaces Exposed to Outside Air	2.0
Sink Surfaces Exposed to Containment Atmosphere	Modified Tagami

ARKANSAS NUCLEAR ONE
Unit 2

Table 6.2-8F

**ESF PERFORMANCE PARAMETERS AND CONTAINMENT INITIAL CONDITIONS
FOR CONTAINMENT PRESSURE RESPONSE ANALYSIS (LOCA)**

<u>ESF SYSTEM</u>	<u>PERFORMANCE DATA</u>
<u>Containment Air Coolers</u>	
Actuation (CPH), psia	20.7
Actuation Delay Time, sec. ¹	52.0
Heat Removal per Train	See Table 6.2-81
Service Water Temperature, °F	See Figure 6.2-3B
 <u>Containment Spray</u>	
Actuation Signal (CPHH)	25.7
Actuation Delay Time, sec. ¹	60.0 ²
Flow Rate (pre-RAS) per pump, gpm	1875
Flow Rate (post-RAS) per pump, gpm	2000
Temperature (pre-RAS), °F	120
 <u>Shutdown Cooling Heat Exchangers</u>	
Heat Transfer Area, ft ²	5220 per unit
Overall Heat Transfer Coef., Btu/hr-ft ² -°F	155.5
Service Water Flow Rate (post-RAS), gpm	3350
Service Water Temperature, °F	See Figure 6.2-3B
 <u>INITIAL CONTAINMENT CONDITIONS</u>	
	<u>DATA</u>
Pressure, psia	15.5
Temperature, °F	140
Relative Humidity, %	0
Leakage	None
Outside Temperature, °F	90

¹ Assumes a loss of offsite power

² This includes 17.4 seconds fill time for spray header

ARKANSAS NUCLEAR ONE
Unit 2

Table 6.2-8G

MAXIMUM CONTAINMENT PRESSURE AND TEMPERATURE RESULTS (LOCA)

<u>Break Location</u>	<u>Break Size (ft²)</u>	<u>Single Failure</u>	<u>Pressure (psig)</u>	<u>Time of Peak Pressure (sec)</u>	<u>Temperature (°F)</u>
RCP Discharge	9.82	1 Containment Spray Train	56.9	143.8	284
RCP Discharge	9.82	1 EDG	57.6	148.6	285
RCP Suction	9.82	1 Containment Spray Train	53.1	61.4	285
RCP Suction	9.82	1 EDG	53.2	61.4	285
Hot Leg	19.24	1 Containment Spray Train	55.7	11.0	283
Hot Leg	19.24	1 EDG	55.7	10.8	283

Note: all breaks were double-ended slot

Table 6.2-8H

SEQUENCE OF EVENTS DESIGN BASIS ACCIDENT

<u>Time (sec)</u>	<u>Event Description</u>
0.0	Pipe rupture (9.82 ft ² DEDLS), reactor coolant system (RCS) depressurization begins.
0.6	Containment Air Cooling Actuation Setpoint (CPH)
1.1	Containment Spray Actuation Setpoint (CPHH)
8.0	Safety injection tanks begin injection into the RCS.
14.9	End of Blowdown.
14.9	Safety injection (HPSI) and (LPSI) pumps begin injection into the RCS.
52.6	Containment air coolers begin operation.
61.1	Containment sprays begin operation.
73.6	Safety injection tanks empty.
148.6	Containment reaches peak pressure (57.6 psig).
148.8	Containment reaches peak temperature (285 °F)
2707.62	Switchover to sump recirculation as RWT reaches low level.
2600000	End of Analysis

ARKANSAS NUCLEAR ONE
Unit 2

Table 6.2-8I

CONTAINMENT AIR COOLER PERFORMANCE DATA, PER TRAIN

<u>120 °F Service Water</u>		<u>110 °F Service Water</u>		<u>95 °F Service Water</u>	
Inlet Temp (°F)	Performance (Btu/hr)	Inlet Temp (°F)	Performance (Btu/hr)	Inlet Temp (°F)	Performance (Btu/hr)
120	0.0	110	0.0	95	0.0
130	1.78E+06	120	1.62E+06	105	1.35E+06
150	6.15E+06	150	7.96E+06	150	1.05E+07
180	1.49E+07	180	1.71E+07	180	2.01E+07
230	3.51E+07	230	3.80E+07	230	4.21E+07
286	6.12E+07	286	6.47E+07	286	6.98E+07

Table 6.2-8J

**LOCA MAXIMUM CONTAINMENT PRESSURE AND TEMPERATURE RESULTS
SUPPORTING TECHNICAL SPECIFICATION LIMITING CONDITIONS FOR OPERATION**

<u>Case</u> ^{1,2,3,4}	<u>Break Location</u>	<u>CS</u>	<u>CAC</u>	<u>Pressure (psia)</u>	<u>Temperature (°F)</u>
1	RCP Suction	1	1	53.2	284
2	RCP Discharge	1	1	57.4	285
3	RCP Suction	2	1	53.2	284
4	RCP Discharge	2	1	56.4	283
5	RCP Suction	2	0	53.2	285
6	RCP Discharge	2	0	56.9	284

Notes:

- 1 Loss of offsite power is considered.
- 2 No additional single failure is considered.
- 3 Both Emergency Diesel Generators are considered to operate.
- 4 Full Flow of both Safety Injection Trains Considered.

Table 6.2-9

DELETED

(Historical Information Replaced by Table 6.2-8D)

ARKANSAS NUCLEAR ONE
Unit 2

Table 6.2-9A

**ESF PERFORMANCE PARAMETERS AND NSSS ASSUMPTIONS
MSLB CONTAINMENT ANALYSES**

<u>ESF SYSTEM</u>	<u>PERFORMANCE DATA</u>
<u>Containment Air Coolers</u>	
Actuation (CPH), psia	20.7
Actuation Delay Time, sec. ¹	30
Heat Removal per Train	See Table 6.2-8I
Service Water Temperature, °F	See Figure 6.2-3B
<u>Containment Spray</u>	
Actuation Signal (CPHH)	25.7
Actuation Delay Time, sec. ¹	45.0 ²
Flow Rate (pre-RAS) per pump, gpm	1875
Flow Rate (post-RAS) per pump, gpm	2000
Temperature (pre-RAS), °F	120
<u>RPS/ESF Performance Parameters</u>	
Reactor Trip Actuation Signal,	
Containment Cooling Actuation Signal	Containment Pressure High
Containment Pressure High setpoint, psia	20.7
Containment Spray Actuation Signal	Containment Pressure High-High
Containment Pressure High-High setpoint, psia	25.7
CSAS Actuation Delay, sec.	1.6
MSIV Closure Time, sec.	3.5
MFIV Closure Time, sec.	25
Backup MFIV Closure Time, sec.	18.5
<u>INITIAL CONTAINMENT CONDITIONS</u>	
Pressure, psia	15.5
Temperature, °F	140
Relative Humidity, %	0
Leakage	None

¹ Assumes offsite power available

² This includes 17.4 seconds fill time for spray header

ARKANSAS NUCLEAR ONE
Unit 2

Table 6.2-9B

MASS AND ENERGY RELEASE DATA LIMITING CASE (MSLB)
(1.94 ft² Slot Break at 0% Power with Failure of One Containment Spray Train)

Time (sec)	Mass Rate (lbm/sec)	Energy Rate (BTU/sec)	Enthalpy (BTU/lbm)	Integral Mass (lbm)	Integral Energy (BTU)
0.00	4.37406E+03	5.19833E+06	1188.5	0.00000E+00	0.00000E+00
0.09	4.34957E+03	5.17021E+06	1188.7	3.92334E+02	4.66320E+05
0.19	4.33145E+03	5.14946E+06	1188.9	8.26279E+02	9.82183E+05
0.29	4.31468E+03	5.13027E+06	1189.0	1.25851E+03	1.49608E+06
0.39	4.29888E+03	5.11218E+06	1189.2	1.68913E+03	2.00814E+06
0.49	4.28343E+03	5.09447E+06	1189.3	2.11817E+03	2.51839E+06
0.59	4.26804E+03	5.07680E+06	1189.5	2.54568E+03	3.02687E+06
0.69	4.25315E+03	5.05969E+06	1189.6	2.97168E+03	3.53363E+06
0.79	4.23956E+03	5.04411E+06	1189.8	3.39626E+03	4.03875E+06
0.89	4.22499E+03	5.02733E+06	1189.9	3.81940E+03	4.54223E+06
0.99	4.21142E+03	5.01173E+06	1190.0	4.24115E+03	5.04410E+06
1.09	4.19822E+03	4.99656E+06	1190.2	4.66155E+03	5.54442E+06
1.19	4.18458E+03	4.98084E+06	1190.3	5.08060E+03	6.04319E+06
1.29	4.17189E+03	4.96624E+06	1190.4	5.49836E+03	6.54047E+06
1.39	4.15892E+03	4.95129E+06	1190.5	5.91484E+03	7.03628E+06
1.49	4.14617E+03	4.93659E+06	1190.6	6.33005E+03	7.53062E+06
1.59	4.13417E+03	4.92276E+06	1190.8	6.74403E+03	8.02355E+06
1.69	4.12232E+03	4.90911E+06	1190.9	7.15678E+03	8.51505E+06
1.79	4.11044E+03	4.89541E+06	1191.0	7.56834E+03	9.00519E+06
1.89	4.09893E+03	4.88214E+06	1191.1	7.97872E+03	9.49396E+06
1.99	4.08684E+03	4.86817E+06	1191.2	8.38794E+03	9.98141E+06
2.09	4.07544E+03	4.85501E+06	1191.3	8.79603E+03	1.04675E+07
2.19	4.06467E+03	4.84259E+06	1191.4	9.20297E+03	1.09523E+07
2.29	4.05352E+03	4.82971E+06	1191.5	9.60882E+03	1.14359E+07
2.39	4.04254E+03	4.81702E+06	1191.6	1.00136E+04	1.19182E+07
2.49	4.03244E+03	4.80538E+06	1191.7	1.04173E+04	1.23992E+07
2.59	4.02144E+03	4.79265E+06	1191.8	1.08199E+04	1.28790E+07
2.69	4.01092E+03	4.78049E+06	1191.9	1.12215E+04	1.33576E+07
2.79	3.99987E+03	4.76769E+06	1192.0	1.16219E+04	1.38350E+07
2.89	3.98922E+03	4.75535E+06	1192.1	1.20214E+04	1.43111E+07
2.99	3.97888E+03	4.74339E+06	1192.1	1.24197E+04	1.47860E+07
3.09	3.96861E+03	4.73149E+06	1192.2	1.28171E+04	1.52597E+07
3.19	3.95846E+03	4.71973E+06	1192.3	1.32134E+04	1.57322E+07
3.29	3.94824E+03	4.70789E+06	1192.4	1.36086E+04	1.62035E+07
3.39	3.93878E+03	4.69694E+06	1192.5	1.40029E+04	1.66737E+07
3.49	3.92825E+03	4.68471E+06	1192.6	1.43962E+04	1.71427E+07
3.59	3.91911E+03	4.67412E+06	1192.7	1.47885E+04	1.76106E+07
3.69	3.90888E+03	4.66224E+06	1192.7	1.51799E+04	1.80773E+07
3.79	3.89988E+03	4.65182E+06	1192.8	1.55703E+04	1.85430E+07
3.89	3.89039E+03	4.64081E+06	1192.9	1.59598E+04	1.90076E+07
3.99	3.88130E+03	4.63027E+06	1193.0	1.63483E+04	1.94711E+07
4.09	3.87161E+03	4.61900E+06	1193.0	1.67359E+04	1.99335E+07
4.19	3.86282E+03	4.60881E+06	1193.1	1.71226E+04	2.03949E+07
4.29	3.85434E+03	4.59897E+06	1193.2	1.75084E+04	2.08552E+07

ARKANSAS NUCLEAR ONE
Unit 2

Table 6.2-9B (continued)

<u>Time (sec)</u>	<u>Mass Rate (lbm/sec)</u>	<u>Energy Rate (BTU/sec)</u>	<u>Enthalpy (BTU/lbm)</u>	<u>Integral Mass (lbm)</u>	<u>Integral Energy (BTU)</u>
4.39	3.84508E+03	4.58821E+06	1193.3	1.78933E+04	2.13145E+07
4.49	3.83676E+03	4.57856E+06	1193.3	1.82774E+04	2.17728E+07
4.59	3.82762E+03	4.56793E+06	1193.4	1.86606E+04	2.22301E+07
4.69	3.81930E+03	4.55827E+06	1193.5	1.90429E+04	2.26864E+07
4.79	3.81093E+03	4.54854E+06	1193.6	1.94244E+04	2.31417E+07
4.89	3.80245E+03	4.53868E+06	1193.6	1.98050E+04	2.35960E+07
4.99	3.79478E+03	4.52979E+06	1193.7	2.01849E+04	2.40494E+07
5.09	3.78695E+03	4.52069E+06	1193.8	2.05639E+04	2.45019E+07
5.19	3.77888E+03	4.51130E+06	1193.8	2.09422E+04	2.49534E+07
5.29	3.77044E+03	4.50147E+06	1193.9	2.13196E+04	2.54040E+07
5.39	3.76277E+03	4.49256E+06	1194.0	2.16962E+04	2.58537E+07
5.49	3.75571E+03	4.48436E+06	1194.0	2.20721E+04	2.63025E+07
5.59	3.74752E+03	4.47481E+06	1194.1	2.24472E+04	2.67504E+07
5.69	3.74059E+03	4.46678E+06	1194.1	2.28216E+04	2.71974E+07
5.79	3.73254E+03	4.45739E+06	1194.2	2.31952E+04	2.76436E+07
5.89	3.72573E+03	4.44948E+06	1194.3	2.35681E+04	2.80889E+07
5.99	3.71860E+03	4.44117E+06	1194.3	2.39403E+04	2.85334E+07
6.09	3.71104E+03	4.43236E+06	1194.4	2.43117E+04	2.89770E+07
6.19	3.70469E+03	4.42499E+06	1194.4	2.46825E+04	2.94199E+07
6.29	3.69702E+03	4.41603E+06	1194.5	2.50525E+04	2.98619E+07
6.39	3.67939E+03	4.39579E+06	1194.7	2.54217E+04	3.03029E+07
6.49	3.63763E+03	4.34664E+06	1194.9	2.57871E+04	3.07394E+07
6.59	3.61855E+03	4.32423E+06	1195.0	2.61497E+04	3.11728E+07
6.69	3.60388E+03	4.30712E+06	1195.1	2.65108E+04	3.16043E+07
6.79	3.58996E+03	4.29091E+06	1195.3	2.68704E+04	3.20341E+07
6.89	3.57611E+03	4.27475E+06	1195.4	2.72287E+04	3.24623E+07
6.99	3.56334E+03	4.25988E+06	1195.5	2.75855E+04	3.28889E+07
7.09	3.54987E+03	4.24416E+06	1195.6	2.79411E+04	3.33140E+07
7.19	3.53590E+03	4.22783E+06	1195.7	2.82953E+04	3.37375E+07
7.29	3.52295E+03	4.21271E+06	1195.8	2.86482E+04	3.41595E+07
7.39	3.51106E+03	4.19885E+06	1195.9	2.89998E+04	3.45800E+07
7.49	3.49866E+03	4.18436E+06	1196.0	2.93502E+04	3.49990E+07
7.59	3.48624E+03	4.16984E+06	1196.1	2.96993E+04	3.54166E+07
7.69	3.47346E+03	4.15489E+06	1196.2	3.00472E+04	3.58328E+07
7.79	3.46161E+03	4.14103E+06	1196.3	3.03940E+04	3.62475E+07
7.89	3.44977E+03	4.12718E+06	1196.4	3.07395E+04	3.66609E+07
7.99	3.43802E+03	4.11344E+06	1196.5	3.10839E+04	3.70729E+07
8.09	3.42716E+03	4.10074E+06	1196.5	3.14271E+04	3.74835E+07
8.19	3.41593E+03	4.08760E+06	1196.6	3.17692E+04	3.78929E+07
8.29	3.40469E+03	4.07444E+06	1196.7	3.21101E+04	3.83009E+07
8.39	3.39319E+03	4.06096E+06	1196.8	3.24500E+04	3.87076E+07
8.49	3.38290E+03	4.04892E+06	1196.9	3.27888E+04	3.91131E+07
8.59	3.37244E+03	4.03668E+06	1197.0	3.31265E+04	3.95173E+07
8.69	3.36186E+03	4.02428E+06	1197.0	3.34631E+04	3.99202E+07
8.79	3.35120E+03	4.01178E+06	1197.1	3.37987E+04	4.03219E+07
8.89	3.34046E+03	3.99917E+06	1197.2	3.41332E+04	4.07225E+07
8.99	3.33087E+03	3.98795E+06	1197.3	3.44668E+04	4.11218E+07

ARKANSAS NUCLEAR ONE
Unit 2

Table 6.2-9B (continued)

<u>Time (sec)</u>	<u>Mass Rate (lbm/sec)</u>	<u>Energy Rate (BTU/sec)</u>	<u>Enthalpy (BTU/lbm)</u>	<u>Integral Mass (lbm)</u>	<u>Integral Energy (BTU)</u>
9.09	3.32097E+03	3.97634E+06	1197.3	3.47993E+04	4.15199E+07
9.19	3.31108E+03	3.96475E+06	1197.4	3.51308E+04	4.19169E+07
9.29	3.30123E+03	3.95318E+06	1197.5	3.54613E+04	4.23127E+07
9.39	3.29139E+03	3.94164E+06	1197.6	3.57909E+04	4.27073E+07
9.49	3.28145E+03	3.92996E+06	1197.6	3.61195E+04	4.31008E+07
9.59	3.27233E+03	3.91927E+06	1197.7	3.64471E+04	4.34933E+07
9.69	3.26306E+03	3.90839E+06	1197.8	3.67738E+04	4.38846E+07
9.79	3.25297E+03	3.89652E+06	1197.8	3.70996E+04	4.42748E+07
9.89	3.24402E+03	3.88601E+06	1197.9	3.74244E+04	4.46639E+07
9.99	3.23463E+03	3.87497E+06	1198.0	3.77484E+04	4.50519E+07
10.09	3.22635E+03	3.86527E+06	1198.0	3.80714E+04	4.54389E+07
10.19	3.21726E+03	3.85457E+06	1198.1	3.83935E+04	4.58248E+07
10.29	3.20779E+03	3.84343E+06	1198.2	3.87148E+04	4.62097E+07
10.39	3.19962E+03	3.83384E+06	1198.2	3.90351E+04	4.65936E+07
10.49	3.19102E+03	3.82373E+06	1198.3	3.93546E+04	4.69764E+07
10.59	3.18246E+03	3.81367E+06	1198.3	3.96732E+04	4.73582E+07
10.69	3.17394E+03	3.80365E+06	1198.4	3.99910E+04	4.77390E+07
10.79	3.16509E+03	3.79322E+06	1198.5	4.03079E+04	4.81188E+07
10.89	3.15666E+03	3.78330E+06	1198.5	4.06239E+04	4.84976E+07
10.99	3.14824E+03	3.77339E+06	1198.6	4.09391E+04	4.88753E+07
11.09	3.13986E+03	3.76352E+06	1198.6	4.12535E+04	4.92521E+07
11.19	3.13151E+03	3.75370E+06	1198.7	4.15670E+04	4.96279E+07
11.29	3.12354E+03	3.74432E+06	1198.7	4.18798E+04	5.00028E+07
11.39	3.11557E+03	3.73493E+06	1198.8	4.21917E+04	5.03767E+07
11.49	3.10727E+03	3.72515E+06	1198.9	4.25028E+04	5.07497E+07
11.59	3.09934E+03	3.71581E+06	1198.9	4.28131E+04	5.11217E+07
11.69	3.09144E+03	3.70651E+06	1199.0	4.31226E+04	5.14928E+07
11.79	3.08356E+03	3.69722E+06	1199.0	4.34313E+04	5.18629E+07
11.89	3.07567E+03	3.68791E+06	1199.1	4.37392E+04	5.22322E+07
11.99	3.06780E+03	3.67864E+06	1199.1	4.40464E+04	5.26005E+07
12.09	3.06053E+03	3.67008E+06	1199.2	4.43528E+04	5.29679E+07
12.19	3.05255E+03	3.66067E+06	1199.2	4.46584E+04	5.33344E+07
12.29	3.04529E+03	3.65212E+06	1199.3	4.49632E+04	5.36999E+07
12.39	3.03731E+03	3.64269E+06	1199.3	4.52673E+04	5.40646E+07
12.49	3.02996E+03	3.63403E+06	1199.4	4.55707E+04	5.44285E+07
12.59	3.02262E+03	3.62537E+06	1199.4	4.58733E+04	5.47914E+07
12.69	3.01525E+03	3.61668E+06	1199.5	4.61751E+04	5.51535E+07
12.79	3.00791E+03	3.60801E+06	1199.5	4.64763E+04	5.55147E+07
12.89	3.00058E+03	3.59936E+06	1199.6	4.67767E+04	5.58750E+07
12.99	2.99321E+03	3.59066E+06	1199.6	4.70763E+04	5.62345E+07
13.09	2.98660E+03	3.58286E+06	1199.7	4.73753E+04	5.65931E+07
13.19	2.97907E+03	3.57396E+06	1199.7	4.76735E+04	5.69509E+07
13.29	2.97241E+03	3.56611E+06	1199.7	4.79710E+04	5.73078E+07
13.39	2.96492E+03	3.55726E+06	1199.8	4.82679E+04	5.76639E+07
13.49	2.95814E+03	3.54924E+06	1199.8	4.85640E+04	5.80192E+07
13.59	2.92815E+03	3.51328E+06	1199.8	4.88590E+04	5.83732E+07
13.69	2.91804E+03	3.50133E+06	1199.9	4.91512E+04	5.87238E+07

ARKANSAS NUCLEAR ONE
Unit 2

Table 6.2-9B (continued)

<u>Time (sec)</u>	<u>Mass Rate (lbm/sec)</u>	<u>Energy Rate (BTU/sec)</u>	<u>Enthalpy (BTU/lbm)</u>	<u>Integral Mass (lbm)</u>	<u>Integral Energy (BTU)</u>
13.79	2.90795E+03	3.48941E+06	1200.0	4.94425E+04	5.90733E+07
13.89	2.89806E+03	3.47772E+06	1200.0	4.97327E+04	5.94216E+07
13.99	2.88814E+03	3.46600E+06	1200.1	5.00220E+04	5.97687E+07
14.09	2.87845E+03	3.45454E+06	1200.1	5.03103E+04	6.01147E+07
14.19	2.86887E+03	3.44320E+06	1200.2	5.05976E+04	6.04595E+07
14.29	2.85942E+03	3.43204E+06	1200.3	5.08839E+04	6.08032E+07
14.39	2.84987E+03	3.42073E+06	1200.3	5.11694E+04	6.11458E+07
14.49	2.84061E+03	3.40977E+06	1200.4	5.14538E+04	6.14873E+07
14.59	2.83134E+03	3.39880E+06	1200.4	5.17374E+04	6.18276E+07
14.69	2.82212E+03	3.38789E+06	1200.5	5.20200E+04	6.21669E+07
14.79	2.81293E+03	3.37701E+06	1200.5	5.23017E+04	6.25051E+07
14.89	2.80408E+03	3.36653E+06	1200.6	5.25825E+04	6.28422E+07
14.99	2.79529E+03	3.35612E+06	1200.6	5.28624E+04	6.31783E+07
15.09	2.78642E+03	3.34561E+06	1200.7	5.31415E+04	6.35133E+07
15.19	2.77749E+03	3.33503E+06	1200.7	5.34196E+04	6.38473E+07
15.29	2.76889E+03	3.32485E+06	1200.8	5.36969E+04	6.41803E+07
15.39	2.76031E+03	3.31469E+06	1200.8	5.39733E+04	6.45122E+07
15.49	2.75201E+03	3.30485E+06	1200.9	5.42489E+04	6.48431E+07
15.59	2.74339E+03	3.29463E+06	1200.9	5.45236E+04	6.51730E+07
15.69	2.73530E+03	3.28505E+06	1201.0	5.47975E+04	6.55020E+07
15.79	2.72738E+03	3.27566E+06	1201.0	5.50706E+04	6.58300E+07
15.89	2.71964E+03	3.26648E+06	1201.1	5.53429E+04	6.61570E+07
15.99	2.71173E+03	3.25710E+06	1201.1	5.56144E+04	6.64831E+07
16.09	2.70392E+03	3.24785E+06	1201.2	5.58852E+04	6.68083E+07
16.19	2.69651E+03	3.23907E+06	1201.2	5.61551E+04	6.71326E+07
16.29	2.68889E+03	3.23003E+06	1201.3	5.64244E+04	6.74560E+07
16.39	2.68133E+03	3.22106E+06	1201.3	5.66928E+04	6.77785E+07
16.49	2.67381E+03	3.21214E+06	1201.3	5.69606E+04	6.81002E+07
16.59	2.66662E+03	3.20361E+06	1201.4	5.72276E+04	6.84209E+07
16.69	2.65914E+03	3.19474E+06	1201.4	5.74938E+04	6.87408E+07
16.79	2.65197E+03	3.18623E+06	1201.5	5.77593E+04	6.90598E+07
16.89	2.64477E+03	3.17769E+06	1201.5	5.80241E+04	6.93780E+07
16.99	2.63783E+03	3.16945E+06	1201.5	5.82882E+04	6.96953E+07
17.09	2.63054E+03	3.16080E+06	1201.6	5.85516E+04	7.00117E+07
17.19	2.62377E+03	3.15276E+06	1201.6	5.88143E+04	7.03274E+07
17.29	2.61661E+03	3.14426E+06	1201.7	5.90763E+04	7.06422E+07
17.39	2.60996E+03	3.13637E+06	1201.7	5.93376E+04	7.09562E+07
17.49	2.60318E+03	3.12832E+06	1201.7	5.95982E+04	7.12694E+07
17.59	2.59627E+03	3.12011E+06	1201.8	5.98581E+04	7.15817E+07
17.69	2.58950E+03	3.11206E+06	1201.8	6.01174E+04	7.18933E+07
17.79	2.58286E+03	3.10418E+06	1201.8	6.03760E+04	7.22041E+07
17.89	2.57626E+03	3.09634E+06	1201.9	6.06339E+04	7.25141E+07
17.99	2.56962E+03	3.08844E+06	1201.9	6.08912E+04	7.28233E+07
18.09	2.56339E+03	3.08104E+06	1201.9	6.11478E+04	7.31318E+07
18.19	2.55692E+03	3.07336E+06	1202.0	6.14038E+04	7.34394E+07
18.29	2.55024E+03	3.06541E+06	1202.0	6.16591E+04	7.37463E+07
18.39	2.54389E+03	3.05786E+06	1202.0	6.19138E+04	7.40525E+07

ARKANSAS NUCLEAR ONE
Unit 2

Table 6.2-9B (continued)

<u>Time (sec)</u>	<u>Mass Rate (lbm/sec)</u>	<u>Energy Rate (BTU/sec)</u>	<u>Enthalpy (BTU/lbm)</u>	<u>Integral Mass (lbm)</u>	<u>Integral Energy (BTU)</u>
18.49	2.53756E+03	3.05034E+06	1202.1	6.21678E+04	7.43578E+07
18.59	2.53155E+03	3.04318E+06	1202.1	6.24213E+04	7.46625E+07
18.69	2.52522E+03	3.03566E+06	1202.1	6.26741E+04	7.49664E+07
18.79	2.51918E+03	3.02847E+06	1202.2	6.29262E+04	7.52695E+07
18.69	2.52522E+03	3.03566E+06	1202.1	6.26741E+04	7.49664E+07
18.79	2.51918E+03	3.02847E+06	1202.2	6.29262E+04	7.52695E+07
18.89	2.51307E+03	3.02121E+06	1202.2	6.31778E+04	7.55720E+07
18.99	2.50693E+03	3.01390E+06	1202.2	6.34288E+04	7.58737E+07
19.09	2.50100E+03	3.00685E+06	1202.3	6.36792E+04	7.61747E+07
19.19	2.49498E+03	2.99969E+06	1202.3	6.39289E+04	7.64750E+07
19.29	2.48915E+03	2.99275E+06	1202.3	6.41781E+04	7.67746E+07
19.39	2.48320E+03	2.98567E+06	1202.4	6.44267E+04	7.70734E+07
19.49	2.47741E+03	2.97878E+06	1202.4	6.46747E+04	7.73716E+07
19.59	2.47146E+03	2.97170E+06	1202.4	6.49221E+04	7.76691E+07
19.69	2.46565E+03	2.96478E+06	1202.4	6.51689E+04	7.79659E+07
19.79	2.45996E+03	2.95800E+06	1202.5	6.54152E+04	7.82620E+07
19.89	2.45435E+03	2.95132E+06	1202.5	6.56609E+04	7.85575E+07
19.99	2.44883E+03	2.94475E+06	1202.5	6.59060E+04	7.88522E+07
20.38	2.42713E+03	2.91890E+06	1202.6	6.68811E+04	8.00248E+07
20.78	2.40586E+03	2.89355E+06	1202.7	6.78474E+04	8.11870E+07
21.18	2.38497E+03	2.86866E+06	1202.8	6.88053E+04	8.23391E+07
21.58	2.36465E+03	2.84443E+06	1202.9	6.97550E+04	8.34814E+07
21.98	2.34486E+03	2.82083E+06	1203.0	7.06966E+04	8.46142E+07
22.38	2.32566E+03	2.79792E+06	1203.1	7.16305E+04	8.57376E+07
22.78	2.30771E+03	2.77650E+06	1203.1	7.25569E+04	8.68522E+07
23.18	2.29020E+03	2.75561E+06	1203.2	7.34763E+04	8.79584E+07
23.58	2.27285E+03	2.73490E+06	1203.3	7.43887E+04	8.90563E+07
23.98	2.25620E+03	2.71502E+06	1203.4	7.52943E+04	9.01460E+07
24.38	2.23971E+03	2.69532E+06	1203.4	7.61933E+04	9.12279E+07
24.78	2.22373E+03	2.67622E+06	1203.5	7.70859E+04	9.23021E+07
25.18	2.20832E+03	2.65780E+06	1203.5	7.79721E+04	9.33687E+07
25.58	2.19296E+03	2.63945E+06	1203.6	7.88522E+04	9.44279E+07
25.98	2.17805E+03	2.62162E+06	1203.7	7.97263E+04	9.54800E+07
26.38	2.16366E+03	2.60441E+06	1203.7	8.05945E+04	9.65250E+07
26.78	2.14924E+03	2.58715E+06	1203.8	8.14569E+04	9.75631E+07
27.18	2.13548E+03	2.57069E+06	1203.8	8.23137E+04	9.85945E+07
27.58	2.12181E+03	2.55433E+06	1203.9	8.31650E+04	9.96193E+07
27.98	2.10861E+03	2.53853E+06	1203.9	8.40110E+04	1.00638E+08
28.38	2.09570E+03	2.52307E+06	1203.9	8.48517E+04	1.01650E+08
28.78	2.08384E+03	2.50887E+06	1204.0	8.56873E+04	1.02656E+08
29.18	2.07317E+03	2.49608E+06	1204.0	8.65186E+04	1.03657E+08
29.58	2.06271E+03	2.48355E+06	1204.0	8.73456E+04	1.04653E+08
29.98	2.05221E+03	2.47098E+06	1204.1	8.81685E+04	1.05643E+08
30.38	2.04185E+03	2.45856E+06	1204.1	8.89872E+04	1.06629E+08
30.78	2.03165E+03	2.44634E+06	1204.1	8.98018E+04	1.07610E+08
31.18	2.02189E+03	2.43464E+06	1204.1	9.06124E+04	1.08586E+08
31.58	2.01194E+03	2.42270E+06	1204.2	9.14191E+04	1.09557E+08

ARKANSAS NUCLEAR ONE
Unit 2

Table 6.2-9B (continued)

<u>Time (sec)</u>	<u>Mass Rate (lbm/sec)</u>	<u>Energy Rate (BTU/sec)</u>	<u>Enthalpy (BTU/lbm)</u>	<u>Integral Mass (lbm)</u>	<u>Integral Energy (BTU)</u>
31.98	2.00230E+03	2.41114E+06	1204.2	9.22218E+04	1.10524E+08
32.38	1.99282E+03	2.39977E+06	1204.2	9.30208E+04	1.11486E+08
32.78	1.98338E+03	2.38845E+06	1204.2	9.38159E+04	1.12444E+08
33.18	1.97417E+03	2.37740E+06	1204.3	9.46073E+04	1.13397E+08
33.58	1.96503E+03	2.36643E+06	1204.3	9.53951E+04	1.14345E+08
33.98	1.95589E+03	2.35546E+06	1204.3	9.61792E+04	1.15290E+08
34.38	1.94721E+03	2.34506E+06	1204.3	9.69597E+04	1.16230E+08
34.78	1.93843E+03	2.33451E+06	1204.3	9.77367E+04	1.17165E+08
35.18	1.93014E+03	2.32457E+06	1204.4	9.85103E+04	1.18097E+08
35.58	1.92192E+03	2.31469E+06	1204.4	9.92806E+04	1.19025E+08
35.98	1.91368E+03	2.30480E+06	1204.4	1.00048E+05	1.19949E+08
36.38	1.90572E+03	2.29524E+06	1204.4	1.00811E+05	1.20869E+08
36.78	1.89776E+03	2.28569E+06	1204.4	1.01572E+05	1.21785E+08
37.18	1.89001E+03	2.27638E+06	1204.4	1.02330E+05	1.22697E+08
37.58	1.88223E+03	2.26703E+06	1204.4	1.03084E+05	1.23606E+08
37.98	1.87466E+03	2.25794E+06	1204.5	1.03835E+05	1.24511E+08
38.38	1.86699E+03	2.24872E+06	1204.5	1.04584E+05	1.25412E+08
38.78	1.85949E+03	2.23971E+06	1204.5	1.05329E+05	1.26309E+08
39.18	1.85216E+03	2.23090E+06	1204.5	1.06071E+05	1.27204E+08
39.58	1.84497E+03	2.22225E+06	1204.5	1.06810E+05	1.28094E+08
39.98	1.83758E+03	2.21337E+06	1204.5	1.07547E+05	1.28981E+08
40.38	1.83052E+03	2.20489E+06	1204.5	1.08280E+05	1.29865E+08
40.78	1.82347E+03	2.19641E+06	1204.5	1.09011E+05	1.30745E+08
41.18	1.81638E+03	2.18788E+06	1204.5	1.09739E+05	1.31622E+08
41.58	1.80947E+03	2.17958E+06	1204.5	1.10464E+05	1.32495E+08
41.98	1.80270E+03	2.17143E+06	1204.5	1.11186E+05	1.33365E+08
42.38	1.79572E+03	2.16303E+06	1204.6	1.11906E+05	1.34232E+08
42.78	1.78903E+03	2.15498E+06	1204.6	1.12623E+05	1.35095E+08
43.18	1.78255E+03	2.14720E+06	1204.6	1.13337E+05	1.35956E+08
43.58	1.77601E+03	2.13932E+06	1204.6	1.14049E+05	1.36813E+08
43.98	1.76932E+03	2.13127E+06	1204.6	1.14758E+05	1.37667E+08
44.38	1.76298E+03	2.12364E+06	1204.6	1.15464E+05	1.38518E+08
44.78	1.75639E+03	2.11572E+06	1204.6	1.16168E+05	1.39366E+08
45.18	1.75009E+03	2.10813E+06	1204.6	1.16869E+05	1.40211E+08
45.58	1.74375E+03	2.10050E+06	1204.6	1.17568E+05	1.41052E+08
45.98	1.73761E+03	2.09310E+06	1204.6	1.18264E+05	1.41891E+08
46.38	1.73132E+03	2.08554E+06	1204.6	1.18958E+05	1.42727E+08
46.78	1.72521E+03	2.07817E+06	1204.6	1.19649E+05	1.43559E+08
47.18	1.71923E+03	2.07097E+06	1204.6	1.20338E+05	1.44389E+08
47.58	1.71321E+03	2.06372E+06	1204.6	1.21025E+05	1.45216E+08
47.98	1.70729E+03	2.05660E+06	1204.6	1.21709E+05	1.46040E+08
48.38	1.70118E+03	2.04924E+06	1204.6	1.22390E+05	1.46861E+08
48.78	1.69543E+03	2.04230E+06	1204.6	1.23070E+05	1.47679E+08
49.18	1.68944E+03	2.03509E+06	1204.6	1.23747E+05	1.48495E+08
49.58	1.68378E+03	2.02828E+06	1204.6	1.24421E+05	1.49307E+08
49.98	1.67785E+03	2.02113E+06	1204.6	1.25093E+05	1.50117E+08
51.98	1.64972E+03	1.98723E+06	1204.6	1.28421E+05	1.54125E+08

ARKANSAS NUCLEAR ONE
Unit 2

Table 6.2-9B (continued)

<u>Time (sec)</u>	<u>Mass Rate (lbm/sec)</u>	<u>Energy Rate (BTU/sec)</u>	<u>Enthalpy (BTU/lbm)</u>	<u>Integral Mass (lbm)</u>	<u>Integral Energy (BTU)</u>
53.98	1.62263E+03	1.95456E+06	1204.6	1.31693E+05	1.58066E+08
55.98	1.59629E+03	1.92279E+06	1204.5	1.34911E+05	1.61943E+08
57.98	1.57090E+03	1.89216E+06	1204.5	1.38078E+05	1.65758E+08
59.98	1.54477E+03	1.86063E+06	1204.5	1.41193E+05	1.69510E+08
61.98	1.51939E+03	1.82999E+06	1204.4	1.44257E+05	1.73200E+08
63.98	1.49415E+03	1.79951E+06	1204.4	1.47271E+05	1.76830E+08
65.98	1.46941E+03	1.76963E+06	1204.3	1.50234E+05	1.80399E+08
67.98	1.44477E+03	1.73986E+06	1204.3	1.53148E+05	1.83908E+08
69.98	1.42065E+03	1.71071E+06	1204.2	1.56013E+05	1.87358E+08
71.98	1.39710E+03	1.68225E+06	1204.1	1.58831E+05	1.90751E+08
73.98	1.37413E+03	1.65447E+06	1204.0	1.61602E+05	1.94087E+08
75.98	1.35186E+03	1.62754E+06	1203.9	1.64327E+05	1.97369E+08
77.98	1.32995E+03	1.60104E+06	1203.8	1.67009E+05	2.00597E+08
79.98	1.30872E+03	1.57536E+06	1203.7	1.69648E+05	2.03774E+08
81.98	1.28782E+03	1.55006E+06	1203.6	1.72244E+05	2.06899E+08
83.98	1.26769E+03	1.52570E+06	1203.5	1.74799E+05	2.09974E+08
85.98	1.24777E+03	1.50159E+06	1203.4	1.77314E+05	2.13001E+08
87.98	1.22828E+03	1.47801E+06	1203.3	1.79790E+05	2.15980E+08
89.98	1.20934E+03	1.45507E+06	1203.2	1.82228E+05	2.18914E+08
91.98	1.19101E+03	1.43287E+06	1203.1	1.84628E+05	2.21801E+08
93.98	1.17287E+03	1.41091E+06	1203.0	1.86992E+05	2.24645E+08
95.98	1.15521E+03	1.38951E+06	1202.8	1.89320E+05	2.27445E+08
97.98	1.13812E+03	1.36882E+06	1202.7	1.91613E+05	2.30203E+08
99.98	1.12101E+03	1.34809E+06	1202.6	1.93872E+05	2.32920E+08
101.98	1.10421E+03	1.32773E+06	1202.4	1.96097E+05	2.35596E+08
103.98	1.08764E+03	1.30766E+06	1202.3	1.98289E+05	2.38231E+08
105.98	1.07138E+03	1.28796E+06	1202.2	2.00448E+05	2.40827E+08
107.98	1.05560E+03	1.26883E+06	1202.0	2.02575E+05	2.43383E+08
109.98	1.04002E+03	1.24995E+06	1201.9	2.04670E+05	2.45902E+08
111.98	1.02467E+03	1.23134E+06	1201.7	2.06734E+05	2.48383E+08
113.98	1.00978E+03	1.21330E+06	1201.5	2.08768E+05	2.50827E+08
115.98	9.94824E+02	1.19517E+06	1201.4	2.10773E+05	2.53235E+08
117.98	9.80480E+02	1.17778E+06	1201.2	2.12748E+05	2.55608E+08
119.98	9.66325E+02	1.16062E+06	1201.1	2.14695E+05	2.57946E+08
121.98	9.52647E+02	1.14404E+06	1200.9	2.16614E+05	2.60251E+08
123.98	9.39001E+02	1.12750E+06	1200.7	2.18505E+05	2.62522E+08
125.98	9.25650E+02	1.11131E+06	1200.6	2.20370E+05	2.64761E+08
127.98	9.12626E+02	1.09552E+06	1200.4	2.22208E+05	2.66968E+08
129.98	8.99943E+02	1.08014E+06	1200.2	2.24021E+05	2.69144E+08
131.98	8.86993E+02	1.06444E+06	1200.1	2.25808E+05	2.71288E+08
133.98	8.72774E+02	1.04721E+06	1199.9	2.27567E+05	2.73400E+08
135.98	8.58362E+02	1.02973E+06	1199.7	2.29299E+05	2.75477E+08
137.98	8.43380E+02	1.01157E+06	1199.4	2.31000E+05	2.77518E+08
139.98	8.28501E+02	9.93528E+05	1199.2	2.32672E+05	2.79523E+08
141.98	8.13477E+02	9.75315E+05	1199.0	2.34314E+05	2.81492E+08
143.98	7.98588E+02	9.57265E+05	1198.7	2.35926E+05	2.83424E+08
145.98	7.83754E+02	9.39282E+05	1198.4	2.37508E+05	2.85320E+08

ARKANSAS NUCLEAR ONE
Unit 2

Table 6.2-9B (continued)

<u>Time</u> <u>(sec)</u>	<u>Mass Rate</u> <u>(lbm/sec)</u>	<u>Energy Rate</u> <u>(BTU/sec)</u>	<u>Enthalpy</u> <u>(BTU/lbm)</u>	<u>Integral Mass</u> <u>(lbm)</u>	<u>Integral Energy</u> <u>(BTU)</u>
147.98	7.68857E+02	9.21223E+05	1198.2	2.39060E+05	2.87181E+08
149.98	7.53630E+02	9.02768E+05	1197.9	2.40583E+05	2.89004E+08
153.98	7.23124E+02	8.65795E+05	1197.3	2.43536E+05	2.92542E+08
157.98	6.91934E+02	8.27999E+05	1196.6	2.46367E+05	2.95930E+08
161.98	6.61424E+02	7.91006E+05	1195.9	2.49073E+05	2.99167E+08
165.98	6.27651E+02	7.50099E+05	1195.1	2.51651E+05	3.02250E+08
169.98	5.92266E+02	7.07254E+05	1194.2	2.54091E+05	3.05165E+08
173.98	5.54756E+02	6.61857E+05	1193.1	2.56386E+05	3.07903E+08
177.98	5.14895E+02	6.13640E+05	1191.8	2.58526E+05	3.10455E+08
181.98	4.72498E+02	5.62392E+05	1190.3	2.60501E+05	3.12807E+08
185.98	4.27696E+02	5.08287E+05	1188.4	2.62301E+05	3.14949E+08
189.98	3.84523E+02	4.56133E+05	1186.2	2.63922E+05	3.16873E+08
193.98	2.91549E+02	3.45261E+05	1184.2	2.65275E+05	3.18477E+08
197.98	2.23272E+02	2.64134E+05	1183.0	2.66296E+05	3.19686E+08
201.98	1.73870E+02	2.05549E+05	1182.2	2.67085E+05	3.20619E+08
205.98	1.44265E+02	1.70471E+05	1181.7	2.67708E+05	3.21355E+08
209.98	1.15010E+02	1.35859E+05	1181.3	2.68219E+05	3.21958E+08
213.98	9.53492E+01	1.12611E+05	1181.0	2.68638E+05	3.22453E+08
217.98	4.63631E+01	5.63722E+04	1215.9	2.69004E+05	3.22890E+08
221.98	1.56599E+01	1.91251E+04	1221.3	2.69093E+05	3.22998E+08
225.98	1.55860E+01	1.90374E+04	1221.5	2.69155E+05	3.23074E+08
229.98	1.54735E+01	1.89049E+04	1221.8	2.69217E+05	3.23150E+08
233.98	1.52978E+01	1.86908E+04	1221.8	2.69279E+05	3.23225E+08
237.98	1.53997E+01	1.88171E+04	1221.9	2.69340E+05	3.23300E+08
241.98	1.52202E+01	1.85993E+04	1222.0	2.69401E+05	3.23375E+08
245.98	1.53289E+01	1.87327E+04	1222.1	2.69462E+05	3.23450E+08
249.98	1.52291E+01	1.86121E+04	1222.1	2.69523E+05	3.23524E+08
253.98	1.51997E+01	1.85769E+04	1222.2	2.69584E+05	3.23599E+08
257.98	1.51410E+01	1.85062E+04	1222.3	2.69645E+05	3.23673E+08
261.98	1.51822E+01	1.85576E+04	1222.3	2.69706E+05	3.23747E+08
265.98	1.51688E+01	1.85420E+04	1222.4	2.69766E+05	3.23821E+08
269.98	1.50659E+01	1.84174E+04	1222.5	2.69827E+05	3.23895E+08
273.98	1.50791E+01	1.84345E+04	1222.5	2.69887E+05	3.23969E+08
277.98	1.51178E+01	1.84828E+04	1222.6	2.69948E+05	3.24043E+08
281.98	1.51285E+01	1.84971E+04	1222.7	2.70008E+05	3.24117E+08
285.98	1.50984E+01	1.84615E+04	1222.7	2.70068E+05	3.24191E+08
289.98	1.50688E+01	1.84265E+04	1222.8	2.70129E+05	3.24264E+08
293.98	1.50600E+01	1.84171E+04	1222.9	2.70189E+05	3.24338E+08
297.98	1.50193E+01	1.83688E+04	1223.0	2.70249E+05	3.24411E+08
301.98	1.49776E+01	1.83194E+04	1223.1	2.70309E+05	3.24485E+08
305.98	1.50507E+01	1.84105E+04	1223.2	2.70369E+05	3.24559E+08
309.98	1.50237E+01	1.83792E+04	1223.4	2.70429E+05	3.24632E+08
313.98	1.50138E+01	1.83690E+04	1223.5	2.70490E+05	3.24706E+08
317.98	1.49551E+01	1.82992E+04	1223.6	2.70550E+05	3.24779E+08
321.98	1.50274E+01	1.83896E+04	1223.7	2.70610E+05	3.24853E+08
325.98	1.50162E+01	1.83781E+04	1223.9	2.70670E+05	3.24926E+08
329.98	1.49510E+01	1.83004E+04	1224.0	2.70729E+05	3.24999E+08

ARKANSAS NUCLEAR ONE
Unit 2

Table 6.2-9B (continued)

Time (sec)	Mass Rate (lbm/sec)	Energy Rate (BTU/sec)	Enthalpy (BTU/lbm)	Integral Mass (lbm)	Integral Energy (BTU)
333.98	1.49896E+01	1.83500E+04	1224.2	2.70789E+05	3.25073E+08
337.98	1.49635E+01	1.83203E+04	1224.3	2.70849E+05	3.25146E+08
341.98	1.49140E+01	1.82618E+04	1224.5	2.70909E+05	3.25219E+08
345.98	1.49220E+01	1.82739E+04	1224.6	2.70969E+05	3.25292E+08
349.98	1.49598E+01	1.83225E+04	1224.8	2.71029E+05	3.25366E+08
353.98	1.48542E+01	1.81954E+04	1224.9	2.71088E+05	3.25439E+08
357.98	1.48970E+01	1.82499E+04	1225.1	2.71148E+05	3.25512E+08
361.98	1.48824E+01	1.82342E+04	1225.2	2.71208E+05	3.25585E+08
365.98	1.49201E+01	1.82825E+04	1225.4	2.71267E+05	3.25658E+08
369.98	1.48789E+01	1.82340E+04	1225.5	2.71327E+05	3.25731E+08
373.98	1.48699E+01	1.82249E+04	1225.6	2.71386E+05	3.25803E+08
377.98	1.48812E+01	1.82408E+04	1225.8	2.71445E+05	3.25876E+08
381.98	1.48683E+01	1.82268E+04	1225.9	2.71505E+05	3.25949E+08
385.98	1.48435E+01	1.81982E+04	1226.0	2.71564E+05	3.26022E+08
389.98	1.47732E+01	1.81137E+04	1226.1	2.71623E+05	3.26094E+08
393.98	1.48188E+01	1.81714E+04	1226.2	2.71683E+05	3.26167E+08
397.98	1.48211E+01	1.81760E+04	1226.4	2.71742E+05	3.26240E+08
400.00	1.48065E+01	1.81589E+04	1226.4	2.71772E+05	3.26276E+08

Table 6.2-9C

MAXIMUM CONTAINMENT PRESSURE AND TEMPERATURE RESULTS (MSLB)

<u>Power</u> ¹	<u>Failure</u>	<u>Peak Pressure</u>		<u>Peak Temperature</u>	
		(psig)	(sec)	(°F)	(sec)
102%	Main feedwater pump to trip	55.1	141.8	402	49.8
94.9%	Main feedwater pump to trip	54.7	150.0	401	49.7
75%	Condensate pump to trip	53.7	158.0	399	49.5
50%	Main feedwater pump to trip	55.2	182.4	397	49.1
25%	Condensate pump to trip	55.2	228.2	395	48.9
0%	Containment Spray Train	57.4	196.0	392	52.4
0% ²	1 Train of Containment Sprays and 1 Train of Containment Air Coolers (TS LCO case)	58.1	196.4	392	52.4

Note:

¹ All cases were double-ended guillotine breaks except the 0% Power case which was a slot break of 1.94 ft².

² This case does not represent the DBA. This case, however, does represent the limiting case for the Technical Specification (TS) Limiting Condition for Operation (LCO). In addition to the typical single failure peak containment pressure cases presented in the original FSAR, other cases have been assessed to determine the results of peak pressure conditions under the bounding TS LCO action statements (One CSS and one CCS available bounds two CSS available and two CCS out of service) for containment heat removal systems. The results of these additional analyses demonstrate that peak pressures are bounded by the containment design pressure of 59 psig.

ARKANSAS NUCLEAR ONE
Unit 2

Table 6.2-9D

**SEQUENCE OF EVENTS
LIMITING CONTAINMENT PEAK PRESSURE ANALYSIS (MSLB)**

(Slot break initiated from 0% power with failure of one containment spray train)

<u>Time (sec)</u>	<u>Event Description</u>
0.0	Start of Event
3.6	Containment Air Cooler Actuation Signal (CPH)
7.4	Containment Spray Actuation Signal (CPHH)
12.5	MSIV shuts
27.5	Backup MFIVs shut
33.6	Containment Air Coolers Start
52.4	Containment Spray Starts (time of peak containment temperature)
196.0	Time of Peak Containment Pressure
400.0	End of Analysis

Table 6.2-10

DELETED

(Historical Information Replaced by Table 6.2-8E)

Table 6.2-11

DELETED

(Historical Information Replaced by Tables 6.2-8A and 6.2-8F)

Table 6.2-11A

DELETED

(Historical Information Replaced by Tables 6.2-9A and 6.2-8D)

Table 6.2-12

DELETED

(Historical Information Replaced by Table 6.2-8G)

ARKANSAS NUCLEAR ONE
Unit 2

Table 6.2-12A

DELETED

(Historical Information Replaced by Table 6.2-9C)

Table 6.2-13

DELETED

(Historical Information Replaced by Table 6.2-8B)

Table 6.2-13A

DELETED

(Historical Information)

Table 6.2-13B

DELETED

(Historical Information Replaced by Table 6.2-9B)

Table 6.2-14

DELETED

(Historical Information)

Table 6.2-15

DELETED

(Historical Information)

Table 6.2-16

DELETED

(Historical Information Replaced with Table 6.2-8H)

ARKANSAS NUCLEAR ONE
Unit 2

Table 6.2-17

SUBCOMPARTMENT DESIGN DIFFERENTIAL PRESSURES

<u>Location</u>	<u>Compartment Design Pressure</u>
Reactor Cavity	160 psid*
Steam Generator Compartment	45 psid*
Biological Shield Pipe Penetration Cold Leg	1950 psid
Biological Shield Pipe Penetration Hot leg	2400 psid

* Based on hot leg break, pressures are uniformly applied to all walls

ARKANSAS NUCLEAR ONE
Unit 2

Table 6.2-17A

SUBCOMPARTMENT DIFFERENTIAL PRESSURE RESULTS

I. Reactor Cavity

- a. 200 in² Cold Leg Circumferential Break - Neutron Shield In Place (See Figure 6.2-16A)

<u>Nodal Volumes</u>	<u>Calculated Peak Differential Pressure (psid)</u>	<u>Approximate Time of Peak Pressure (Sec)</u>
1-7	80	0.05
2-8	80	0.05
3-9	60.5	0.055
4-10	4	0.045
5-11	6	0.055
6-12	53	0.055

- b. 200 in² Cold Leg Circumferential Break - Neutron Shield Partially "Blown-Out" (See Figures 6.2-16B and 6.2-16C)

<u>Nodal Volumes</u>	<u>Calculated Peak Differential Pressure (psid)</u>	<u>Approximate Time of Peak Pressure (Sec)</u>
1-7	46.5	0.05
2-8	4	0.06
3-9	0.5	0.06
4-10	49	0.05
5-11	75	0.05
6-12	75	0.05
13-14	2	0.07
13-15	2	0.07
14-15	0	-

ARKANSAS NUCLEAR ONE
Unit 2

Table 6.2-17A (continued)

c. 100 in² Hot Leg Circumferential Break - Neutron Shield In Place (See Figure 6.2-16D)

<u>Nodal Volumes</u>	<u>Calculated Peak Differential Pressure (psid)</u>	<u>Approximate Time of Peak Pressure (Sec)</u>
1-7	1	0.08
2-8	21.5	0.05
3-9	30.5	0.045
4-10	30.5	0.045
5-11	21.5	0.05
6-12	1	0.08

d. 100 in² Hot Leg Circumferential Break - Neutron Shield Partially "Blown-Out"
(See Figures 6.2-16E and 6.2-16F)

<u>Nodal Volumes</u>	<u>Calculated Peak Differential Pressure (psid)</u>	<u>Approximate Time of Peak Pressure (Sec)</u>
1-7	1	0.03
2-8	17	0.05
3-9	35	0.025
4-10	35	0.025
5-11	17	0.05
6-12	0.5	0.05
13-14	0	-
13-15	0	-
14-15	0	-

ARKANSAS NUCLEAR ONE
Unit 2

Table 6.2-17A (continued)

II. Steam Generator Compartment

a. 9.82 ft² Cold Leg Pump Suction Circumferential Break (See Figure 6.2-3F)

<u>Nodal Volumes</u>	<u>Calculated Peak Differential Pressure (psid)</u>	<u>Approximate Time of Peak Pressure (Sec)</u>
1-2	1.5	0.15
1-3	3.5	0.08
1-4, 5	12.5	0.09
1-10	21.0	0.15
2-3	3.5	0.08
2-5	14.0	0.09
2-10	22.5	0.16
3-10	20.0	0.16
4, 5-10	10.0	0.18
6-7	0.5	0.13
6-10	3.0	0.18
7-10	3.5	0.18
8-9	0.5	0.13
8-10	6.0	0.18
9-10	6.5	0.18

ARKANSAS NUCLEAR ONE
Unit 2

Table 6.2-17A (continued)

b. 5.90 ft² Hot Leg Circumferential Break (See Figure 6.2-3D)

<u>Nodal Volumes</u>	<u>Calculated Peak Differential Pressure (psid)</u>	<u>Approximate Time of Peak Pressure (Sec)</u>
1-2	9.0	0.08
1-3	6.5	0.06
1-4	9.2	0.08
1-5	7.3	0.08
1-10	14.5	0.10
2-4	0.2	0.03
2-10	5.8	0.15
3-5	0.9	0.10
3-10	8.5	0.15
4-5	2.0	0.15
4-10	5.5	0.15
5-10	7.5	0.15
6-7	0.2	0.12
6-10	2.0	0.13
7-10	2.0	0.13
8-9	0.3	0.01
8-10	3.0	0.15
9-10	3.0	0.15

ARKANSAS NUCLEAR ONE
Unit 2

Table 6.2-17A (continued)

c. 7.86 ft² Cold Leg Pump Suction Slot Break (East Orientation)

<u>Nodal Volumes</u>	<u>Calculated Peak Differential Pressure (psid)</u>	<u>Approximate Time of Peak Pressure (Sec)</u>
1-2	18.0	0.09
1-3	18.5	0.09
1-4	20.0	0.09
1-10	22.5	0.09
2-3	0.5	0.15
2-10	5.0	0.15
3-4, 5	1.5	0.15
3-10	4.5	0.15
4 ,5-10	3.0	0.15
6-10	1.5	0.15
7-10	2.0	0.15
8-10	2.0	0.15
9-10	2.5	0.15

d. 9.82 ft² Cold Leg Pump Discharge Circumferential Break (See Figure 6.2-31)

<u>Nodal Volumes</u>	<u>Calculated Peak Differential Pressure (psid)</u>	<u>Approximate Time of Peak Pressure (Sec)</u>
1-2	10.0	0.24
1-3	19.5	0.22
1-4	10.0	0.24
1-5	4.0	0.24
1-10	17.5	0.26
2, 4-10	8.0	0.30
3-5	24.0	0.22

ARKANSAS NUCLEAR ONE
Unit 2

Table 6.2-17A (continued)

d. 9.82 ft² Cold Leg Pump Discharge Circumferential Break (See Figure 6.2-3I) (continued)

<u>Nodal Volumes</u>	<u>Calculated Peak Differential Pressure (psid)</u>	<u>Approximate Time of Peak Pressure (Sec)</u>
3-10	36.5	0.24
4-5	6.0	0.26
5-10	13.5	0.30
6-10	3.5	0.40
7-10	3.5	0.40
8-10	5.0	0.32
9-10	5.0	0.32

e. 7.86 ft² Cold Leg Pump Suction Slot Break (West Orientation) (See Figure 6.2-3H)

<u>Nodal Volumes</u>	<u>Calculated Peak Differential Pressure (psid)</u>	<u>Approximate Time of Peak Pressure (Sec)</u>
1-2	5.5	0.08
1-3	1.5	0.05
1-5	6.0	0.08
1-6	8.5	0.08
1-11	11.5	0.08
2-5	1.0	0.15
2-11	6.5	0.15
3-4,6	7.0	0.09
3-5	5.0	0.08
3-11	10.0	0.09
4, 6-11	3.5	0.15
5-6	2.5	0.10
5-11	6.0	0.15

ARKANSAS NUCLEAR ONE
Unit 2

Table 6.2-17A (continued)

- e. 7.86 ft² Cold Leg Pump Suction Slot Break (West Orientation) (See Figure 6.2-3H)
(continued)

<u>Nodal Volumes</u>	<u>Calculated Peak Differential Pressure (psid)</u>	<u>Approximate Time of Peak Pressure (Sec)</u>
7-11	1.5	0.15
8-11	1.5	0.15
9-11	2.0	0.12
10-11	2.0	0.12

- f. 7.70 ft² Hot Leg Slot Break (See Figure 6.2-3E)

<u>Nodal Volumes</u>	<u>Calculated Peak Differential Pressure (psid)</u>	<u>Approximate Time of Peak Pressure (Sec)</u>
1-2	6.0	0.04
1-3	2.0	0.03
1-5	7.0	0.05
1-6	9.5	0.07
1-11	14.5	0.11
2-5	1.0	0.05
2-11	9.5	0.13
3-4, 6	8.5	0.10
3-5	6.0	0.08
3-11	14.0	0.11
4, 6-11	5.5	0.12
5-6	3.0	0.15
5-11	8.5	0.12
7-11	2.5	0.12
8-11	2.5	0.12

ARKANSAS NUCLEAR ONE
Unit 2

Table 6.2-17A (continued)

f. 7.70 ft² Hot Leg Slot Break (See Figure 6.2-3E) (continued)

<u>Nodal Volumes</u>	<u>Calculated Peak Differential Pressure (psid)</u>	<u>Approximate Time of Peak Pressure (Sec)</u>
9-11	3.5	0.12
10-11	3.5	0.12

III Biological Shield Pipe Penetration

<u>Break Type</u>	<u>Maximum Pressure (psia)</u>
5.77 ft ² Hot Leg Slot	1214.5
3.93 ft ² Cold Leg Slot	753.2

Table 6.2-17A.IV

<u>Nodal Volumes</u>	<u>Calculated Peak Differential Pressure (PSID)</u>	<u>Approximate Time of Peak Pressure (Sec)</u>
1-21	15.74	0.5
2-21	11.41	0.5
3-21	41.80	0.225
4-21	14.08	0.5
5-21	14.39	0.5
6-21	12.19	0.5
7-21	12.11	0.5
8-21	12.24	0.5
9-21	11.23	0.5
10-21	12.65	0.5
11-21	8.50	0.5
12-21	9.24	0.7
13-21	8.32	0.7
14-21	6.72	0.7
15-21	6.68	0.7
16-21	6.68	0.7
17-21	6.69	0.7
18-21	6.66	0.7
19-21	5.53	0.7
20-21	5.51	0.7

ARKANSAS NUCLEAR ONE
Unit 2

Table 6.2-17B

SUBCOMPARTMENT ANALYSIS FLOW AREAS AND COEFFICIENTS

I. Reactor Cavity

a. Flow Paths Insensitive to Break Location (See Fig. 6.2-3C).

<u>Flow From - To</u>	<u>Flow Area (ft²)</u>	<u>Flow Coefficient</u>
1-2	14.5	Orifice Flow
1-12	25	0.93 - Contraction and Expansion
1-17	23.5	Orifice Flow
2-3	29	0.93 - Contraction and Expansion
2-17	23.5	Orifice Flow
3-4	16.5	Orifice Flow
3-17	20.5	Orifice Flow
4-5	29.5	0.95 - Contraction and Expansion
4-17	20	Orifice Flow
5-6	14.5	Orifice Flow
5-17	24	Orifice Flow
6-7	26.5	0.94 - Contraction and Expansion
6-17	24	Orifice Flow
7-8	18.5	Orifice Flow
7-17	18.5	Orifice Flow
8-9	27.5	0.95 - Contraction and Expansion
8-17	18	Orifice Flow
9-10	10.5	Orifice Flow
9-17	26	Orifice Flow
10-11	28.5	0.95 - Contraction and Expansion
10-17	27	Orifice Flow
11-12	18.5	Orifice Flow
11-17	17	Orifice Flow
12-17	19	Orifice Flow
13-14	47	Orifice Flow
13-15	47	Orifice Flow
13-16	39	Orifice Flow
14-15	47	Orifice Flow
14-16	39	Orifice Flow
15-16	39	Orifice Flow

ARKANSAS NUCLEAR ONE
Unit 2

Table 6.2-17B (continued)

b. Flow Paths Sensitivity to Break Location (See Figure 6.2-3C)

Flow Path	Flow Area ⁽¹⁾ (ft ²)		100 in ² Hot Leg Circumferential Break	
	200 in ² Cold Leg Circumferential Break Case I - Neutron Shield Intact(2)	Case II - Neutron Shield Partially "Blown-Out"(3)	Case I - Neutron Shield Intact(4)	Case II-Neutron Shield Partially "Blown-Out"(5)
1-13	Blocked	1.5	Blocked	Blocked
2-14	Blocked	5.5	Blocked	1
3-14	Blocked	Blocked	Blocked	8
4-14	Blocked	Blocked	Blocked	7.5
5-14	Blocked	Blocked	Blocked	1.5
6-15	Blocked	Blocked	Blocked	Blocked
7-15	Blocked	Blocked	Blocked	Blocked
8-15	Blocked	Blocked	Blocked	Blocked
9-15	Blocked	Blocked	Blocked	Blocked
10-13	Blocked	Blocked	Blocked	Blocked
11-13	Blocked	8	Blocked	Blocked
12-13	Blocked	9	Blocked	Blocked

NOTES:

- (1) Orifice flow coefficients are used for the unblocked flow paths.
- (2) Break is postulated in the Southeast cold leg (see Figure 6.2-16A).
- (3) Break is postulated in the Northeast cold leg (see Figure 6.2-16B).
- (4) Break is postulated in the South hot leg (see Figure 6.2-16D).
- (5) Break is postulated in the South hot leg (see Figure 6.2-16E).

ARKANSAS NUCLEAR ONE
Unit 2

Table 6.2-17B (continued)

II. Steam Generator Compartment Models

a. Cold Leg Pump Suction Circumferential Breaks (See Figure 6.2-31)

<u>Flow From-To</u>	<u>Flow Area (ft²)</u>	<u>Flow Coefficient</u>
1-2	170.0	0.74 - Contraction & Expansion
1-3	115.0	0.71 - Contraction & Expansion
1-4	115.0	0.71 - Contraction & Expansion
1-5	170.0	0.74 - Contraction & Expansion
1-6	12.5	0.64 - Contraction & Expansion
1-7	11.0	0.64 - Contraction & Expansion
1-8	105.0	0.69 - Contraction & Expansion
1-9	105.0	0.72 - Contraction & Expansion
1-10	40.0	0.60 - Orifice
2-3	80.0	0.67 - Contraction, Expansion & 60° Turn
2-5	100.0	0.69 - Contraction & Expansion
2-7	90.0	0.60 - Orifice
2-9	130.5	0.80 - Contraction & Expansion
3-7	45.0	0.70 - Contraction & Expansion
3-9	53.0	0.74 - Contraction & Expansion
3-10	25.0	0.60 - Orifice
4-5	200.0	0.76 - Contraction & Expansion
4-6	50.0	0.66 - Contraction & Expansion
4-8	78.0	0.75 - Expansion
4-10	20.0	0.60 - Orifice
5-6	125.0	0.68 - Contraction & Expansion
5-8	316.5	0.87 - Contraction & Expansion
6-7	320.0	0.76 - Contraction & Expansion
6-10	300.0	0.85 - Contraction & Expansion
7-10	105.0	0.84 - Contraction & Expansion
8-9	465.0	0.86 - Contraction & Expansion
8-10	515.0	1.00 - Free Expansion
9-10	265.0	1.00 - Free Expansion

ARKANSAS NUCLEAR ONE
Unit 2

Table 6.2-17B (continued)

b. Cold Leg Pump Suction Slot (East Orientation) Breaks (See Figure 6.2-2J)

<u>Flow From-To</u>	<u>Flow Area (ft²)</u>	<u>Flow Coefficient</u>
1-2	80.0	0.67
1-3	170.0	0.74
1-4	100.0	0.69
1-7	90.0	0.60
1-9	130.5	0.80
2-3	115.0	0.71
2-7	45.0	0.70
2-9	53.0	0.74
2-10	25.0	0.60
3-4	170.0	0.74
3-5	115.0	0.71
3-6	12.5	0.64
3-7	11.0	0.64
3-8	105.0	0.69
3-9	105.0	0.72
3-10	40.0	0.60
4-5	200.0	0.76
4-6	125.0	0.68
4-8	316.5	0.87
5-6	50.0	0.66
5-8	78.00	0.75
5-10	20.0	0.60
6-7	320.0	0.76
6-10	300.0	0.85
7-10	105.0	0.84
8-9	465.0	0.86
8-10	515.0	1.00
9-10	265.0	1.00

ARKANSAS NUCLEAR ONE
Unit 2

Table 6.2-17B (continued)

c. Hot Leg and Cold Leg Pump Discharge Circumferential Breaks (See Figures 6.2-3G and 6.2-3L)

<u>Flow From-To</u>	<u>Flow Area (ft²)</u>	<u>Flow Coefficient</u>
1-2	115.0	0.71
1-3	115.0	0.71
1-4	170.0	0.74
1-5	170.0	0.74
1-6	12.5	0.64
1-7	11.0	0.64
1-8	105.0	0.69
1-9	105.0	0.72
1-10	40.0	0.60
2-4	200.0	0.76
2-6	50.0	0.66
2-8	78.0	0.75
2-10	20.0	0.60
3-5	80.0	0.67
3-7	45.0	0.70
3-9	53.0	0.74
3-10	25.0	0.60
4-5	100.0	0.69
4-6	125.0	0.68
4-8	316.5	0.87
5-7	90.0	0.60
5-9	130.5	0.80
6-7	320.0	0.76
6-10	300.0	0.85
7-10	105.0	0.84
8-9	465.0	0.86
8-10	515.0	1.00
9-10	265.0	1.00

Note: Subsequent analyses have updated some of the flow areas and flow coefficients to reflect changing and current configurations of structures and equipment (grating, etc.). The results demonstrate that peak pressure remains below design pressure for the cavities. The original model is retained here for historical purposes. The analyses are on file in the ANO Calculation Room.

ARKANSAS NUCLEAR ONE
Unit 2

Table 6.2-17B (continued)

d. Hot Leg Slot and Cold Leg Pump Suction Slot Breaks (West Orientation)
(See Figures 6.2-3H and 6.2-3K)

<u>Flow From-To</u>	<u>Flow Area (ft²)</u>	<u>Flow Coefficient</u>
1-2	115.0	0.71
1-3	340.0	0.95
1-5	170.0	0.74
1-8	11.0	0.64
1-10	105.0	0.72
1-11	20.0	0.60
2-5	80.0	0.69
2-8	45.0	0.70
2-10	53.0	0.74
2-11	25.0	0.60
3-4	115.0	0.71
3-6	170.0	0.74
3-7	12.5	0.64
3-9	105.0	0.69
3-11	20.0	0.60
4-6	200.0	0.76
4-7	50.0	0.66
4-9	78.0	0.75
4-11	20.0	0.60
5-6	100.0	0.69
5-8	90.0	0.60
5-10	130.5	0.80
6-7	125.0	0.68
6-9	316.5	0.87
7-8	320.0	0.76
7-11	300.0	0.85
8-11	105.0	0.84
9-10	465.0	0.86
9-11	515.0	1.00
10-11	265.0	1.00

III. Biological Shield Pipe Penetration Model

<u>Flow From-To</u>	<u>Flow Area (Ft²)</u>	<u>Flow Coefficient</u>
1-2	19	0.69 - Free Expansion & 90° Turn
1-3	19	1.00 - Free Expansion
2-5	160	1.00 - Free Expansion
3-4	575	0.61 - Orifice
4-5	1250	1.00 - Free Expansion

ARKANSAS NUCLEAR ONE
Unit 2

Table 6.2-17C

**BIOLOGICAL SHIELD PIPE PENETRATION MODEL
NODAL VOLUMES**

I. Hot Leg Penetration Model (ft³)

V1 = 107 - Hot Leg Penetration

V2 = 7,600 - RPV Cavity

V3 = 50,000 - Lower South S. G. Compartment

V4 = 50,000 - Upper South S. G. Compartment

V5 = 1.23 x 10⁶ - Containment Atmosphere

II. Cold Leg Penetration Model (ft³)

V1 = 193 - Cold Leg Penetration

V2 = 7,600 - RPV Cavity

V3 = 50,000 - Lower South S. G. Compartment

V4 = 50,000 - Upper South S. G. Compartment

V5 = 1.23 x 10⁶ - Containment Atmosphere

ARKANSAS NUCLEAR ONE
Unit 2

Table 6.2-17D

MASS AND ENERGY RELEASE DATA FOR SUBCOMPARTMENT ANALYSES

I. 5.77 ft² Hot Leg Slot Break

<u>Time (sec.)</u>	<u>Flow Rate (lb/sec.)</u>	<u>Enthalpy (Btu/lb)</u>
0.000	0	637.15
0.001	10694	636.95
0.005	36984	634.62
0.010	56626	634.61
0.015	56404	634.62
0.020	56302	634.65
0.030	56322	634.74
0.040	56520	634.81
0.050	56781	634.85
0.075	57034	634.76
0.100	56721	634.66
0.150	55112	634.35
0.200	53676	634.16
0.25	53514	634.21
0.30	53474	634.26
0.35	52489	634.15
0.40	51232	634.05
0.45	50864	634.13
0.50	51008	634.28
0.55	50679	634.38
0.60	50059	634.52
0.65	49618	634.76
0.70	49277	635.03
0.75	48910	635.31
0.80	48470	635.61
0.85	47985	635.94
0.90	47504	636.33
0.95	47045	636.80
1.00	46562	637.34
1.1	45576	638.69
1.2	44674	640.41
1.3	43703	642.27
1.4	42800	644.17
1.5	41964	646.17
2.0	37970	654.91
2.5	33898	665.56
3.0	31142	671.55
3.5	30894	663.24
4.0	30510	655.45

ARKANSAS NUCLEAR ONE
Unit 2

Table 6.2-17D (continued)

II. 100 in² Hot Leg Circumferential Break

Time (sec.)	(Flow from Reactor Vessel Side)		(Flow from Steam Generator Side)	
	Flow Rate (lb/sec.)	Enthalpy (Btu/lb)	Flow Rate (lb/sec.)	Enthalpy (Btu/lb)
0.000	0.0	637.20	0.0	637.20
.001	2327.0	637.10	2326.0	637.10
.003	4523.0	636.80	4523.0	636.80
.004	5608.0	636.50	5609.0	636.50
.005	5368.0	636.10	5372.0	636.10
.006	5066.0	635.80	5070.0	635.70
.007	5019.0	635.70	5020.0	635.70
.008	5038.0	635.70	5035.0	635.70
.009	5113.0	635.80	5107.0	635.80
.010	5233.0	636.00	5225.0	635.90
.012	5536.0	636.40	5520.0	636.30
.014	5859.0	636.90	5836.0	636.80
.016	6086.0	637.20	6064.0	637.10
.018	6175.0	637.30	6153.0	637.20
.020	6136.0	637.20	6119.0	637.20
.025	5747.0	636.70	5740.0	636.60
.030	5545.0	636.40	5546.0	636.40
.035	5724.0	636.70	5722.0	636.60
.040	5891.0	636.90	5886.0	636.80
.045	5840.0	636.80	5839.0	636.80
.050	5723.0	636.60	5727.0	636.60
.055	5665.0	636.60	5664.0	636.50
.060	5618.0	636.50	5609.0	636.50
.065	5542.0	636.40	5538.0	636.40
.070	5504.0	636.30	5507.0	636.30
.075	5466.0	636.30	5463.0	636.30
.080	5321.0	636.10	5312.0	636.10
.085	5520.0	635.90	5220.0	635.90
.090	5368.0	636.10	5375.0	636.20
.095	5569.0	636.40	5575.0	636.40
.100	5537.0	636.30	5540.0	636.40
.110	5235.0	635.90	5245.0	636.00
.120	5290.0	635.90	5283.0	636.00
.130	4882.0	635.40	4872.0	635.50
.140	4983.0	635.50	4983.0	635.60
.150	4880.0	635.40	4870.0	635.50
.200	4660.0	635.10	4659.0	635.20
.250	4439.0	634.70	4435.0	634.90
.300	4260.0	634.50	4253.0	634.60
.350	4221.0	634.40	4216.0	634.50
.400	4276.0	634.50	4272.0	634.60
.450	4343.0	634.60	4343.0	634.70
.500	4292.0	634.60	4288.0	634.60
.550	4284.0	634.60	4284.0	634.60

ARKANSAS NUCLEAR ONE
Unit 2

Table 6.2-17D (continued)

II. 100 in² Hot Leg Circumferential Break (continued)

	(Flow from Reactor Vessel Side)		(Flow from Steam Generator Side)	
Time (sec.)	Flow Rate (lb/sec.)	Enthalpy (Btu/lb)	Flow Rate (lb/sec.)	Enthalpy (Btu/lb)
.600	4308.0	634.70	4306.0	634.60
.650	4320.0	634.70	4321.0	634.60
.700	4293.0	634.70	4292.0	634.60
.750	4307.0	634.80	4309.0	634.70
.800	4323.0	634.90	4324.0	634.70
.850	4338.0	635.00	4341.0	634.80
.900	4333.0	635.10	4335.0	634.80
.950	4334.0	635.20	4339.0	634.90
1.000	4333.0	635.30	4338.0	635.00
1.100	4342.0	635.50	4349.0	635.10
1.200	4339.0	635.80	4348.0	635.30
1.300	4330.0	636.10	4341.0	635.50
1.400	4323.0	636.40	4335.0	635.80
1.500	4309.0	636.80	4323.0	636.10
2.000	4253.0	639.50	4280.0	638.20
2.500	4212.0	643.20	4263.0	641.40
3.000	4127.0	648.20	4215.0	645.70
3.500	3999.0	654.20	4107.0	651.20
4.000	3810.0	660.90	3932.0	657.50

ARKANSAS NUCLEAR ONE
Unit 2

Table 6.2-17D (continued)

III. 3.93 ft² Cold Leg Pump Suction Slot Break

<u>Time (sec.)</u>	<u>Flow Rate (lb/sec.)</u>	<u>Enthalpy (Btu/lb)</u>
0.000	0	554.69
0.001	12715	554.27
0.005	24458	549.72
0.010	31214	549.75
0.015	31176	549.79
0.020	31180	549.85
0.030	31297	550.02
0.040	54189	552.20
0.050	55794	552.38
0.075	54949	552.36
0.100	51880	552.09
0.150	52569	552.21
0.200	50788	552.07
0.25	52146	552.25
0.30	50446	552.12
0.35	50667	552.19
0.40	49868	552.17
0.45	49178	552.16
0.50	49245	552.24
0.55	48220	552.22
0.60	48288	552.32
0.65	47825	552.37
0.70	47357	552.43
0.75	47139	552.51
0.80	46632	552.58
0.85	46365	552.67
0.90	45978	552.75
0.95	45563	552.84
1.00	45240	552.94
1.1	44666	553.15
1.2	44212	553.39
1.3	43746	553.63
1.4	43260	553.88
1.5	42741	554.15
2.0	40149	555.43
2.5	37395	556.64
3.0	34984	557.62
3.5	33780	558.60
4.0	32521	559.52

ARKANSAS NUCLEAR ONE
Unit 2

Table 6.2-17D (continued)

IV. 200 in² Cold Leg Circumferential Break

Time (sec.)	(Flow from Reactor Vessel Side)		(Flow from Pump Side)	
	Flow Rate (lb/sec.)	Enthalpy (Btu/lb)	Flow Rate (lb/sec.)	Enthalpy (Btu/lb)
.000	0.0	554.70	0.0	554.70
.001	4069.0	554.20	4212.0	554.50
.002	7286.0	553.20	7958.0	553.90
.003	10060.0	552.70	10290.0	552.90
.004	11620.0	551.90	11100.0	551.70
.005	10200.0	551.20	9147.0	550.70
.006	8745.0	550.50	7792.0	550.10
.007	7569.0	550.00	7024.0	549.80
.008	7179.0	549.80	6963.0	549.70
.009	7505.0	549.90	6963.0	549.80
.010	7855.0	550.10	6954.0	549.80
.012	8060.0	550.20	8115.0	550.30
.014	9792.0	551.10	9488.0	550.90
.016	10920.0	551.70	10850.0	551.60
.018	11990.0	552.30	11960.0	552.20
.020	12760.0	552.80	12710.0	552.70
.022	13370.0	553.10	13400.0	553.10
.024	13890.0	553.40	13870.0	553.30
.026	14110.0	553.50	14100.0	553.40
.028	14270.0	553.60	14260.0	553.50
.030	14400.0	553.70	14400.0	553.60
.032	14530.0	553.80	14540.0	553.70
.034	14700.0	553.90	14730.0	553.80
.036	14900.0	554.00	14930.0	553.90
.038	15090.0	554.10	15130.0	554.00
.040	15230.0	554.20	15250.0	554.10
.042	15300.0	554.20	15330.0	554.20
.044	15300.0	554.20	15330.0	554.20
.046	15240.0	554.10	15250.0	554.10
.048	15060.0	554.00	15070.0	554.00
.050	14820.0	553.90	14810.0	553.80
.052	14560.0	553.70	14540.0	553.70
.054	14280.0	553.60	14240.0	553.50
.056	14050.0	553.50	14010.0	553.40
.058	13890.0	553.40	13850.0	553.30
.060	13790.0	553.30	13740.0	553.20
.062	13760.0	553.30	13720.0	553.20
.064	13800.0	553.30	13780.0	553.30
.066	13880.0	553.40	13890.0	553.30
.068	13980.0	553.40	14000.0	553.40
.070	14080.0	553.50	14100.0	553.40
.072	14140.0	553.50	14170.0	553.50
.074	14150.0	553.50	14180.0	553.50
.076	14090.0	553.50	14120.0	553.50

ARKANSAS NUCLEAR ONE
Unit 2

Table 6.2-17D (continued)

IV. 200 in² Cold Leg Circumferential Break (continued)

Time (sec.)	(Flow from Reactor Vessel Side)		(Flow from Pump Side)	
	Flow Rate (lb/sec.)	Enthalpy (Btu/lb)	Flow Rate (lb/sec.)	Enthalpy (Btu/lb)
.078	13950.0	553.40	13980.0	553.40
.080	13730.0	553.30	13740.0	553.30
.082	13420.0	553.10	13430.0	553.10
.084	13120.0	553.00	13120.0	553.00
.086	12830.0	552.80	12830.0	552.80
.088	12590.0	552.60	12580.0	552.60
.090	12350.0	552.50	12340.0	552.50
.092	12140.0	552.30	12130.0	552.30
.094	11990.0	552.30	11980.0	552.20
.096	11900.0	552.20	11900.0	552.20
.098	11880.0	552.20	11890.0	552.20
.100	11920.0	552.20	11930.0	552.20
.150	11690.0	552.10	11670.0	552.10
.200	11950.0	552.20	11940.0	552.30
.250	11920.0	552.20	11920.0	552.30
.300	12000.0	552.30	11990.0	552.40
.350	12070.0	552.30	12070.0	552.40
.400	11920.0	552.20	11910.0	552.40
.450	11920.0	552.20	11910.0	552.40
.500	11930.0	552.30	11920.0	552.50
.550	11900.0	552.20	11890.0	552.50
.600	11980.0	552.30	11970.0	552.60
.650	11920.0	552.30	11900.0	552.70
.700	11930.0	552.30	11910.0	552.70
.750	11920.0	552.30	11890.0	552.80
.800	11890.0	552.30	11860.0	552.90
.850	11910.0	552.30	11880.0	553.00
.900	11890.0	552.30	11850.0	553.10
.950	11890.0	552.30	11850.0	553.20
1.000	11880.0	552.30	11830.0	553.30
1.100	11870.0	552.30	11820.0	553.50
1.200	11860.0	552.40	11800.0	553.70
1.300	11850.0	552.40	11780.0	553.90
1.400	11870.0	552.50	11790.0	554.20
1.500	11880.0	552.50	11790.0	554.50
2.000	11900.0	552.90	11770.0	555.70
2.500	11830.0	553.40	11670.0	556.70
3.000	11640.0	553.90	11480.0	557.30
3.500	11400.0	554.30	11240.0	557.60
4.000	11040.0	554.70	10900.0	557.70

ARKANSAS NUCLEAR ONE
Unit 2

Table 6.2-17D (continued)

V. 5.90 ft² Hot Leg Circumferential Break

<u>Time</u> <u>(sec.)</u>	<u>(Flow from Reactor Vessel Side)</u>		<u>(Flow from Pump Side)</u>	
	<u>Flow Rate</u> <u>(lb/sec.)</u>	<u>Enthalpy</u> <u>(Btu/lb)</u>	<u>Flow Rate</u> <u>(lb/sec.)</u>	<u>Enthalpy</u> <u>(Btu/lb)</u>
0.0	0.0	637.15	0.0	637.15
0.005	18659	634.63	18877	634.68
0.008	29030	634.63	29070	634.61
0.010	28980	634.63	29059	634.62
0.015	28882	634.64	29015	634.60
0.020	28829	634.67	28927	634.58
0.030	28822	634.76	28744	634.54
0.040	28872	634.84	28791	634.58
0.050	28948	634.90	28944	634.66
0.075	29091	634.87	28914	634.71
0.100	28847	634.72	28707	634.70
0.150	27775	634.31	27933	634.37
0.200	27694	634.31	27725	634.28
0.250	27697	634.32	27555	634.26
0.300	26742	634.07	26822	634.06
0.350	26417	634.10	26456	634.00
0.400	26472	634.23	26409	634.11
0.450	25951	634.16	25970	634.09
0.500	25621	634.23	25664	634.11
0.550	25589	634.42	25594	634.28
0.600	25442	634.64	25447	634.46
0.650	25190	634.89	25206	634.67
0.700	24939	635.19	24968	634.94
0.750	24771	635.56	24796	635.27
0.800	24568	635.98	24593	635.66
0.850	24314	636.42	24345	636.07
0.900	24065	636.91	24099	636.53
0.950	23824	637.48	23859	637.05
1.000	23563	638.11	23600	637.63
1.100	23042	639.67	23084	639.08
1.200	22542	641.57	22592	640.93
1.300	22054	643.59	22107	642.93
1.400	21585	645.61	21627	644.95
1.500	21137	647.78	21179	647.09
2.000	18947	658.11	19154	654.54
2.500	16995	670.08	17163	663.47
3.000	15465	676.92	16021	665.71
3.500	15097	671.56	16230	649.89
4.000	15033	661.87	16095	642.06

ARKANSAS NUCLEAR ONE
Unit 2

Table 6.2-17D (continued)

VI. 9.82 ft² Cold Leg Pump Suction Circumferential Break

<u>Time</u> <u>(sec.)</u>	<u>(Flow from Reactor Vessel Side)</u>		<u>(Flow from Pump Side)</u>	
	<u>Flow Rate</u> <u>(lb/sec.)</u>	<u>Enthalpy</u> <u>(Btu/lb)</u>	<u>Flow Rate</u> <u>(lb/sec.)</u>	<u>Enthalpy</u> <u>(Btu/lb)</u>
0.0	0	554.69	0	554.69
0.005	19582	550.00	19582	550.10
0.010	38925	549.96	39035	550.34
0.015	38639	549.93	38988	550.53
0.020	38368	549.89	39105	550.66
0.030	37804	549.83	46768	551.18
0.040	37327	549.80	46442	551.12
0.050	36914	549.81	48592	551.35
0.075	35900	549.79	62262	553.00
0.100	34885	549.79	56459	552.56
0.150	32811	549.89	60811	554.13
0.200	30783	549.99	58443	555.12
0.250	28917	550.22	58057	556.46
0.300	27229	550.36	56180	557.69
0.350	25880	550.60	55231	559.06
0.400	24822	550.78	54442	560.47
0.450	24098	550.98	53590	561.86
0.500	23533	551.14	52811	563.27
0.550	22976	551.18	51020	564.51
0.600	22468	551.20	50331	565.83
0.650	21850	551.20	49393	567.05
0.700	21287	551.21	48921	568.16
0.750	20749	551.21	47500	569.20
0.800	20182	551.17	46988	570.19
0.850	19704	551.18	46535	571.11
0.900	19257	551.18	45991	571.96
0.950	18854	551.19	45381	572.71
1.000	18499	551.21	44773	573.39
1.100	17875	551.26	44032	574.59
1.200	17347	551.30	43175	575.52
1.300	16864	551.35	42398	576.27
1.400	16389	551.35	42030	576.93
1.500	15932	551.37	41366	577.42
2.000	14087	551.77	37981	579.73
2.500	12652	552.29	35065	583.37
3.000	12132	553.20	32796	589.29
3.500	11518	554.19	30758	599.24
4.000	11047	555.14	27985	617.27

ARKANSAS NUCLEAR ONE
Unit 2

Table 6.2-17D (continued)

VII. 3.93 ft² Cold Leg Pump Suction Slot Break

<u>Time</u> <u>(sec.)</u>	<u>Flow Rate</u> <u>(lb/sec.)</u>	<u>Enthalpy</u> <u>(Btu/lb)</u>	<u>Flow Rate</u> <u>(lb/sec.)</u>	<u>Enthalpy</u> <u>(Btu/lb)</u>
0.0		0.0		554.69
0.001		12408		554.34
0.005		30466		550.66
0.007		32937		550.17
0.010		39606		550.76
0.015		41926		550.97
0.020		42132		550.99
0.030		43036		551.09
0.040		45281		551.32
0.50		52746		552.05
0.075		57720		552.60
0.100		50817		552.14
0.150		53275		552.76
0.200		51784		553.14
0.250		53604		553.88
0.300		51008		554.28
0.350		50907		554.94
0.400		49704		555.53
0.450		49392		556.22
0.500		49172		556.93
0.550		47973		557.53
0.600		47724		558.22
0.650		46818		558.83
0.700		46489		559.47
0.750		45969		560.07
0.800		45611		560.67
0.850		45341		561.26
0.900		44897		561.83
0.950		44535		562.38
1.000		44268		562.91
1.100		43617		563.84
1.200		43164		564.66
1.300		42826		565.43
1.400		42376		566.10
1.500		41996		566.68
2.000		40163		568.85
2.500		38339		570.26
3.000		36486		572.05
3.500		34948		575.03
4.000		33833		580.55

ARKANSAS NUCLEAR ONE
Unit 2

Table 6.2-17D (continued)

VIII. 9.82 ft² Cold Leg Pump Discharge Circumferential Break

<u>Time (sec.)</u>	<u>Flow Rate (lb/sec.)</u>	<u>Enthalpy (Btu/lb)</u>
0	0	554.69
0.01	77219	549.73
0.02	75919	549.76
0.03	74960	549.89
0.04	74378	550.11
0.05	74116	550.35
0.06	74067	550.54
0.07	74168	550.71
0.08	74360	550.83
0.09	74603	550.93
0.10	74898	551.03
0.11	75260	551.17
0.12	75698	551.33
0.13	76188	551.48
0.14	76691	551.60
0.15	77182	551.70
0.16	77632	551.77
0.17	78029	551.81
0.18	78378	551.84
0.19	78673	551.86
0.20	88420	552.20
0.21	87523	552.18
0.22	87198	552.19
0.23	86463	552.18
0.24	85601	552.15
0.25	84967	552.14
0.26	84217	552.12
0.27	83472	552.11
0.28	83004	552.10
0.29	82667	552.11
0.30	82464	552.13
0.31	82345	552.16
0.32	82064	552.17
0.33	81661	552.18
0.34	81368	552.20
0.35	81039	552.22
0.36	80543	552.22
0.37	80209	552.24
0.38	80278	552.29
0.39	80490	552.35
0.40	80462	552.40
0.45	79215	552.58
0.50	79009	552.87
0.55	78912	553.19
0.60	78742	553.55

ARKANSAS NUCLEAR ONE
Unit 2

Table 6.2-17D (continued)

VIII. 9.82 ft² Cold Leg Pump Discharge Circumferential Break (continued)

<u>Time (sec.)</u>	<u>Flow Rate (lb/sec.)</u>	<u>Enthalpy (Btu/lb)</u>
0.65	78464	553.94
0.70	78114	554.37
0.75	77726	554.84
0.80	77311	555.35
0.85	76893	555.71
0.90	76478	556.49
0.95	76063	557.11
1.0	75747	557.80
1.1	75358	559.27
1.2	74952	560.79
1.3	74219	562.26
1.4	73196	563.66
1.5	71908	564.98
1.6	70640	566.29
1.7	69419	567.62
1.8	68460	568.90
1.9	67963	569.62
2.0	66737	569.74
2.2	63435	570.04
2.4	60942	570.98
2.6	58810	572.52
2.8	56341	573.60
3.0	54213	574.50
3.2	52644	576.01
3.4	50294	578.13
3.6	48077	581.40
3.8	45673	585.35
4.0	43440	590.37
4.2	41183	596.36
4.4	38787	602.74
4.6	36835	609.78
4.8	34776	616.70
5.0	33026	624.57

ARKANSAS NUCLEAR ONE
Unit 2

Table 6.2-18
CSS PUMP DATA

<u>Characteristics</u>	<u>Data</u>
Equipment numbers	2P35 A&B
Quantity	2
Type	Vertical, single stage centrifugal
Pumped fluid ⁽³⁾	Borated water containing sodium hydroxide (pH 4.5 - 10.9)
Design pressure, psig (internal)	400
Design temperature, °F	350
Design flow rate, gpm	2200
Design head, ft.	525
NPSH required at design flow rate, ft.	10
Maximum operating flow rate, gpm	2632.5 ⁽¹⁾
Head at maximum operating flow rate, ft.	493
NPSH required at maximum operating flow rate, ft.	12.5
Minimum available NPSH, ft.	18.88 ⁽²⁾
Shutoff head, ft.	610
Materials of construction	
Casing	Austenitic stainless steel
Impeller	Martensitic stainless steel
Shaft	Martensitic stainless steel
Driver	
Type	Induction motor
Service factor	1.15
Nameplate rating, HP	450
Voltage	4000
RPM	1780
Phase	3

⁽¹⁾ Maximum flow of 3200 gpm is credited following start of pumps during header fill phase. Maximum flow of 2632.5 gpm applies to sump recirculation condition.

⁽²⁾ Minimum available NPSH occurs during recirculation mode for two train alignment combined with a single failure of a LPSI pump failure-to-trip on RAS with NPSHa listed for the opposite train and the most limiting NPSH margin.

⁽³⁾ Sodium Hydroxide was the specification for the pumps, but has since been replaced with Sodium Tetraborate (NaTB) buffering agent.

Table 6.2-18A

DELETED

Table 6.2-19

DELETED

ARKANSAS NUCLEAR ONE
Unit 2

Table 6.2-20

REFUELING WATER TANK DATA

<u>Characteristics</u>	<u>Data</u>
Equipment Number	2T3
Quantity	One
Type	Vertical
Stored Material	Boric Acid 2500 ppm B (min) 3000 ppm B (max)
Design Pressure, psig	(Note 1)
Normal Operating Pressure, psig	0
Design Temperature, °F	150
Normal Operating Temperature, °F	40 - 110
Capacity, gal.	500,500
Material of Construction	Stainless Steel
Number of Heaters	5
Type of Heater	Electric Immersion

Note 1: Tank is designed to withstand an internal pressure equal to a column of water 10 ft. above the liquid level of the tank when full, and an internal vacuum of one ounce per square inch below atmospheric pressure.

ARKANSAS NUCLEAR ONE
Unit 2

Table 6.2-21

HISTORICAL SHUTDOWN COOLING HEAT EXCHANGER DATA

<u>Characteristics</u>	<u>Data</u>
Equipment Numbers	2E35A, B
Quantity	Two
Type	Shell & U-Tube
Design Duty, Btu/Hr	28×10^6
Overall Heat Transfer Coefficient, Btu/Hr-°F	1.08×10^6
 <u>Shell Side</u>	
Fluid	Service Water
Design Temperature, °F	250
Design Operating Temperature Inlet, °F	100
Design Operating Temperature Outlet, °F	111.9
Design Pressure, psig	150
Design Operating Flow, gpm	4,850
Pressure Loss at Design Flow, psi	10
Design Fouling Factor, (Hr/Ft ² -°F)/Btu	0.002
 <u>Tube Side</u>	
Fluid	Reactor or Sump Water
Design Temperature, °F	400
Design Operating Temperature, Inlet °F	144
Design Operating Temperature, Outlet °F	124.8
Design Pressure, psig	650
Design Operating Flow, gpm	3,000
Pressure Loss at Design Flow, psi	8
Design Fouling Factor, (Hr-Ft ² -°F)/Btu	0.0006
 <u>Materials of Construction</u>	
Shell	Carbon Steel
Tubes	Ebrite 26-1
Tubesheets	316L (Clad)

ARKANSAS NUCLEAR ONE
Unit 2

Table 6.2-22

CCS AIR COOLER DATA

<u>Characteristics</u>	<u>Data</u>
Equipment Number	2VSF1A, B, C, D
Quantity	four
Design heat removal rate, BTU/hr (per train) at design service water flow rate of 1250 gpm	See Table 6.2-44
Cooling fluid design temperature, °F	120
Cooling fluid	Service water
Emergency cooling coils: ⁽¹⁾	
number	eight per unit
tubes per coil	192
tube type	finned
tube material	90-10 cupronickel
Fans:	
number per unit	one
type	vaneaxial
blade material	steel
Fan motor:	
type	squirrel cage induction
service factor	1.0
nameplate rating, hp.	75
voltage	460
RPM	1180
Unit casing, material	steel
Design operating pressure, psig	59
Design operating temperature, °F	300
Design operating relative humidity, %	100

(1) For normal cooling coil data, see Section 9.4.2.

ARKANSAS NUCLEAR ONE
Unit 2

Table 6.2-23

CONTAINMENT SPRAY SYSTEM SINGLE FAILURE ANALYSIS

<u>Component</u>	<u>Malfunction</u>	<u>Comments and Consequences</u>
Refueling Water Tank Outlet Valve	Fails to open on SIAS Fails to close on RAS	Only one of two valves is required to open Only one of two valves is required to close
Refueling Water Tank Supply to CVCS Isolation Valve	Fails open	CVCS pressure boundary integrity is still maintained and RWT drains through charging pumps in addition to CSS, HPSI, and LPSI pumps
Containment Sump Isolation Valve	Fails to open on RAS	Both valves on <u>either</u> suction header are required to open
Spray Pump	Fails to start on CSAS	Only one of two pumps is required to start
Spray Pump Minimum Flow Isolation Valve	Fails to close on RAS	Only one of two valves in series is required to close to terminate minimum flow from each pump
	Premature RAS (partial)	A) Common valve (2CV-5628-2) - no single failure or partial RAS can close this valve B) Individual pump valves (2CV-5672-1, 2CV-5673-1) no single failure or partial RAS can close both valves
Spray Header Isolation Valve	Fails to open on CSAS	Only one of two valves is required to open

Note: For containment pressure protection considering MSLB in containment, single failure analysis Tables 6.2-23, 6.2-24, and 10.3-4 are combined with no more than one active single failure except for the Limiting Condition of Operation Action Statement cases as defined in SAR Tables 6.2-8J and 6.2-9C.

Table 6.2-23 applies to mitigation of LOCA. For main steam line or main feedwater line breaks both trains are required to mitigate.

ARKANSAS NUCLEAR ONE
Unit 2

Table 6.2-24

CONTAINMENT COOLING SYSTEM SINGLE FAILURE ANALYSIS

<u>COMPONENT</u>	<u>FAILURE</u>	<u>COMMENTS AND CONSEQUENCES</u>
Bypass damper	One damper fails to open after CCAS	CHRS heat removal requirements will be satisfied by the two trains of containment spray.
Vaneaxial fan	One fan fails to operate	CHRS heat removal requirements will be satisfied by the two trains of containment spray.
Distribution ducts	Duct collapse or flow is blocked by missile damage at one point in the distribution system.	CHRS heat removal requirements will be satisfied by the two trains of containment spray.

Note: For containment pressure protection considering MSLB in containment, single failure analysis Tables 6.2-23, 6.2-24, and 10.3-4 are combined with no more than one active single failure except for the Limiting Condition for Operation Action Statement cases as defined in SAR Tables 6.2-8J and 6.2-9C.

Table 6.2-24 applies to mitigation of LOCA. For main steam line or main feedwater line breaks both trains are required to mitigate.

ARKANSAS NUCLEAR ONE
Unit 2

Table 6.2-24A

SUMMARY OF CONTAINMENT REGIONS NOT DIRECTLY SPRAYED

Total Containment Volume Not Directly Sprayed	365,000 ft ³
I. Volumes having good communication with directly sprayed volumes:	
A. Under polar crane from El. 496' to first concrete (varies El. 357' to El. 428')	102,000 ft ³
B. Elevator El. 455' to El. 336'-6" (sides are open)	14,000 ft ³
C. Under missile shield from El. 426'-6" to el. 377'-6"	36,000 ft ³
D. Under reactor head laydown slab El. 405'-6" to operating floor, El. 357'-0"	34,000 ft ³
E. Under refueling machine, El. 403' to refueling canal floor, El. 362'-0"	7,000 ft ³
F. Lower portion of steam generator compartments from El. 366'-6" to El. 336'-6"	<u>55,000 ft³</u>
SUBTOTAL	248,000 ft ³
II. Volumes having restricted communication with directly sprayed volumes:	
A. Annular volumes between the secondary shield walls and the primary containment wall which are covered by concrete slabs (El. 357' and El. 374'-6")	79,000 ft ³
B. Under refueling canal floor, El. 361'-6" and 358' to El. 336'-6"	31,000 ft ³
C. Reactor vessel cavity and volume below the pressurizer base slab	<u>7,000 ft³</u>
SUBTOTAL	117,000 ft ³

ARKANSAS NUCLEAR ONE
Unit 2

Table 6.2-25

EXPOSED COATINGS WITHIN CONTAINMENT

<u>Category</u>	<u>Item Description</u>	<u>Surface Area, ft²</u>	<u>Type of Coating^(a)</u>
Liner Plate	Prime Total Liner Plate	79,000	Inorganic Zinc
	Finish Wainscot and Penetrations	19,034	Modified Phenolic or Epoxy
Structural Steel	Prime Structural Steel	22,000	Inorganic Zinc
	Finish Structural Steel	22,000	Modified Phenolic or Epoxy
Miscellaneous Metal	Prime Misc. Metal	37,000	Inorganic Zinc
	Finish Misc. Metal	37,000	Modified Phenolic or Epoxy
Concrete Walls	Prime Concrete, if required	1,000	Clear Primer for Concrete
	Surfacing Material	1,000	Modified Phenolic or Epoxy
	Special Coating for Surfacing Material	1,000	Modified Phenolic or Epoxy
Concrete Floors	Prime Concrete, if required	12,200	Clear Primer for Concrete
	Surfacing Material	12,200	Modified Phenolic or Epoxy
	Special Coating for Surfacing material	12,200	Modified Phenolic or Epoxy
Piping 3" and Larger	Prime Total 3" and Larger Carbon Steel Pipe and Fittings	9,780	Inorganic Zinc
Mechanical Equipment	Prime Polar Crane	47,551	Epoxy Primer
	Finish Polar Crane	47,551	Epoxy Enamel
	Prime RCP Motors	2,000	Inorganic Zinc
	Finish RCP Motors	2,000	Modified Phenolic or Epoxy
Electrical	Motor Control Centers	560	Electrostatic Plating
Piping 2" and Smaller	Prime Total 2" and Smaller Pipe and Fittings		Inorganic Zinc
	Finish 2" and Smaller Pipe and Fittings		
H&V Equipment	Containment Cooler Fans with Coils	2,400	Modified Phenolic or Epoxy
	Electric Fans	60	Modified Phenolic or Epoxy
	Reactor Cavity Supply Fans	110	Modified Phenolic or Epoxy
	CEDM Cooling Unit Fans	600	Baked-on Epoxy Primer
Mechanical Equipment	Prime the following: Safety Injection Tanks Refueling Machine and Motor Reactor Vessel Head Lift Rig Fuel Transfer Machine & Motor	3557	Inorganic zinc

^(a) Coatings installed during construction. Repairs of damaged coatings may use reformulated replacement coatings that contain materials different than the previous coatings, may not require a primer, and may not be the same type (e.g., inorganic). Although replacement coatings can decrease the zinc mass in the containment, analyses for post-accident conditions using previous zinc mass estimates are conservative. Coatings and repairs are governed by Specification ANO-A-2437.

ARKANSAS NUCLEAR ONE
Unit 2

Table 6.2-26
Containment Penetration Barriers

PENETRATION DATA				COMPONENT DATA													
PEN NO.	SAR FIG. NO. P&ID NO.	GEN DESN CRIT (4)	SERVICE/SYSTEM	LINE SIZE (IN.)	COMPONENT (9)	VALVE TYPE (1)	ACT TYPE (2)	LOCA-TION	NORM FLOW DIR.	ISOL. SIG.	MAXIMUM CLOSURE TIME (SEC) (10)	VALVE POSITION (3)				APP. J. TYPE TEST	
												NORM	SHUT DOWN	POST LOCA	PWR FLR		
2P1	10.2-3 M2206 Sh1	57 (12) ODB	Main Steam from S/G 2E24A	38	2CV-1010-1	GLB	AO	OUT	OUT	MSIS/ CSAS-1/2	3	O	C	C	C	N	
				8	2PSV-1002	REL	SA	OUT	OUT		C	C			N		
				8	2PSV-1003	REL	SA	OUT	OUT		C	C			N		
				8	2PSV-1004	REL	SA	OUT	OUT		C	C			N		
				8	2PSV-1005	REL	SA	OUT	OUT		C	C			N		
				8	2PSV-1006	REL	SA	OUT	OUT		C	C			N		
				2	2CV-1040-1	GAT	MO	OUT	OUT		C	C			C	FAI	N
				4	2CV-1000-1	GAT	MO	OUT	OUT		O	C			O	FAI	N
				10	2CV-1002	GAT	MO	OUT	OUT	MSIS-2	C	C			C	FAI	N
				1	2MS-55	GAT	M	OUT	OUT		O	O			O		N
1	2MS-74	GAT	M	OUT	OUT		O	O			O		N				
					Closed System			IN								N	
2P2	10.2-3 M2206 Sh1	57	Main Steam from S/G 2E24A	38	2CV-1060-2	GLB	AO	OUT	OUT	MSIS/ CSAS-1/2	3	O	C	C	C	N	
				8	2PSV-1052	REL	SA	OUT	OUT		C	C			N		
				8	2PSV-1053	REL	SA	OUT	OUT		C	C			N		
				8	2PSV-1054	REL	SA	OUT	OUT		C	C			N		
				8	2PSV-1055	REL	SA	OUT	OUT		C	C			N		
				8	2PSV-1056	REL	SA	OUT	OUT		C	C			N		
				2	2CV-1090-2	GAT	MO	OUT	OUT		C	C			C	FAI	N
				10	2CV-1052	GAT	MO	OUT	OUT	MSIS-1	C	C			C	FAI	N
				4	2CV-1050-2	GAT	MO	OUT	OUT		O	C			O	FAI	N
									Closed System			IN					
2P3	10.2-3 M2206-Sh1	57	Feedwater to S/G 2E24A	24	2CV-1024-1	GAT	MO	OUT	IN	MSIS/ CSAS-1	20	O	C	C	FAI	N	
					Closed System					IN							N
2P4	10.2-3 M2206 Sh1	57	Feedwater to S/G 2E24B	24	2CV-1074-1	GAT	MO	OUT	IN	MSIS/ CSAS-1	20	O	C	C	FAI	N	
					Closed System			IN								N	
2P5	6.3-2 M2232	55 ODB	HPSI to RCS Loop 2P32A	3	2CV-5015-1	GLB	MO	OUT	IN	SIS-1	-	C	C	O	FAI	N	
				3	2CV-5016-2	GLB	MO	OUT	IN	SIS-2-	-	C	C	O	FAI	N	
				3	2SI-13A	CHK	SA	IN	IN		-	-	-	-	-	-	N

ARKANSAS NUCLEAR ONE
Unit 2

Table 6.2-26 (continued)

PENETRATION DATA			COMPONENT DATA													
PEN NO.	SAR FIG. NO. P&ID NO.	GEN DESN CRIT (4)	SERVICE/SYSTEM	LINE SIZE (IN.)	COMPONENT (9)	VALVE TYPE (1)	ACT TYPE (2)	LOCATION	NORM FLOW DIR.	ISOL. SIG.	MAXIMUM CLOSURE TIME (SEC) (10)	VALVE POSITION (3)				APP. J. TYPE TEST
												NORM	SHUT DOWN	POST LOCA	PWR FLR	
2P6	9.4-4 M2261 Sh1	56 ODB	Containment Atmosphere Sample Return	2	2SV-8231-2	GLB	SO	OUT	IN	SIS-2, CIS-2	-	O	O	C (7)	O (5)	A,C
				2	2CV-8233-1	GAT	MO	IN	IN	SIS-1, CIS-1	-	O	O	C (7)	FAI	A,C
				1	2SV-8280-1	GLB	SO	OUT	IN	SIS-1, CIS-1	2	O	C	C	C	C
				-	CLOSED SYS	-	-	OUT	-	-	-	-	-	-	-	-
2P6	9.4-4 M2261 Sh1	56 ODB	Containment Atmosphere Sample Supply	2	2SV-8271-2	GLB	SO	OUT	OUT	SIS-2, CIS-2	-	O	O	C (7)	O (5)	A,C
				2	2SV-8273-1	GLB	SO	IN	OUT	SIS-1, CIS-1	-	O	O	C (7)	C	A,C
				1	2SV-8278-1	GLB	SO	OUT	OUT	SIS-1, CIS-1	2	O	C	C	C	C
				-	CLOSED SYS	-	-	OUT	-	-	-	-	-	-	-	-
2P7	9.3-2 10.2-8 M2237 Sh 1 M2206 Sh 1	57	S/G 2E24A Sample	½	2CV-5852-2 Closed System	GAT	MO	OUT IN	OUT	CIAS-2	20	O	O	C	FAI	N N
2P7	10.2-3 M2237 Sh 1 M2206 Sh 1	57	S/G 2E24B Sample	½	2CV-5859-2 Closed System	GAT	MO	OUT IN	OUT	CIAS-2	24.4	O	O	C	FAI	N N
2P8	9.3-2 M2237 Sh 1	55 ODB	PZR & RCS Samples	1	2SV-5843-2	GLB	SO	OUT	OUT	SIS-2, CIS-2	-	C	C	C (7)	C	A,C
				1/2	2SV-5833-1	GLB	SO	IN	OUT	SIS-1, CIS-1	-	C	C	C (7)	C	A,C
2P9	3.2-5 M2239 Sh 1	56	N2 Supply to SIT's	1 1	2CV-6207-2 2N2-18	GLB SCHK	AO SA	OUT IN	IN IN	SIS-2, CIS-2-	- -	C -	C -	C -	C -	A,C A,C
2P10	6.3-2 M2232	55 ODB	LPSI to RCS Loop 2P32B	6	2CV-5037-1	GLB	MO	OUT	IN	SIS-1	-	C	O/C	O	FAI	N
				6	2SI-14B	CHK	SA	IN	IN	-	-	-	-	-	-	-
2P11	6.3-2 M2232	55 ODB	HPSI to RCS Loop 2P32B	3	2CV-5035-1	GLB	MO	OUT	IN	SIS-1	-	C	C	O	FAI	N
				3	2CV-5036-2	GLB	MO	OUT	IN	SIS-2	-	C	C	O	FAI	N
				3	2SI-13B	CHK	SA	IN	IN	-	-	-	-	-	-	-
2P12	6.3-2 M2232	55 ODB	HPSI to Shutdown Cooling Suction	3	2CV-5101-1	GLB	MO	OUT	IN	-	-	C	-	C(7)	FAI	N
				3	2SI-26A	CHK	SA	IN	IN	-	-	-	-	-	-	-

ARKANSAS NUCLEAR ONE
Unit 2

Table 6.2-26 (continued)

PENETRATION DATA			COMPONENT DATA													
PEN NO.	SAR FIG. NO. P&ID NO.	GEN DESN CRIT (4)	SERVICE/ SYSTEM	LINE SIZE (IN.)	COMPONENT (9)	VALVE TYPE (1)	ACT TYPE (2)	LOCATION	NORM FLOW DIR.	ISOL. SIG.	MAXIMUM CLOSURE TIME (SEC) (10)	VALVE POSITION (3)				APP. J. TYPE TEST
												NORM	SHUT DOWN	POST LOCA	PWR FLR	
2P13	6.3-2 M2232	55 ODB	HPSI to Shutdown Cooling Suction	2	2SI-31	GAT	M	OUT	IN	-	-	LC	-	LC	-	N
				3	2CV-5102-2	GLB	MO	OUT	IN	-	-	C	-	C(7)	FAI	N
				3	2SI-26B	CHK	SA	IN	IN	-	-	-	-	-	-	-
2P14	9.3-4 M2231 Sh 1	55*	CVCS Letdown	2	2CV-4823-2	GAT	AO	OUT	OUT	CIS-2	-	O	O	C	C	A,C
				2	2CV-4821-1	GLB	MO	IN	OUT	CIS-1, SIS-1	-	O	O	C	FAI	A,C
2P15	6.3-2 M2232	55 ODB	LPSI to RCS Loop 2P32A	6 6	2CV-5017-1 2SI-14A	GLB CHK	MO SA	OUT IN	IN IN	SIS-1 -	- -	C -	O/C -	O -	FAI -	N N
2P16			Spare													A
2P17	6.2-17 M2236 Sh 1	56 ODB	Containment Spray Loop A	10	2CV-5612-1	GAT	MO	OUT	IN	CSAS-1	-	C	C	O	FAI	N
				2	2SA-85A	GAT	M	OUT	IN	-	-	LC	C	LC	-	N
				3	2BS-20A	GLB	M	OUT	IN	-	-	LC	C	LC	-	N
				10	2BS-5A	CHK	SA	IN	IN	-	-	-	-	-	-	-
2P18	9.3-4 M2231 Sh 1	55*	RCP Seal Water Ret.	3/4	2CV-4847-2	GLB	AO	OUT	OUT	CIS-2, SIS-2	-	O	O	C	C	A,C
				3/4	2CV-4846-1	GAT	MO	IN	OUT	CIS-1, SIS-1	-	O	O	C	FAI	A,C
				3/4	2PSV-1801	REL	SA	IN	OUT	-	-	-	-	-	-	-
2P19	9.1-1 M2235	56	Ref. Canal Recirc	3	2FP-34	GAT	M	OUT	OUT	-	-	LC	O/C	LC	-	A,C
				3	2FP-35	GAT	M	IN	OUT	OUT	-	-	LC	O/C	LC	-
2P20	9.2-1 M2210 Sh 3	57	Service Water to 2VCC 2A&B	12	2CV-1511-1	BTY	MO	OUT	IN	CCAS-1	-	C	C	O	FAI	N
				1	2SV-1511-1	GAT	SO	OUT	IN	-	-	O	O	O	O	N
				-	CLOSED SYS	-	-	IN	IN	-	-	-	-	-	-	-
2P21	9.2-1 M2210 Sh 3	57	Service Water from 2VCC 2A&B	12	2CV-1519-1	BTY	MO	OUT	OUT	CCAS-1	-	C	C	O	FAI	N
				-	CLOSED SYS	-	-	IN	IN	-	-	-	-	-	-	-
2P22			Spare													A
2P23	6.2-17 M2236 Sh 1	56 ODB	Containment Spray Loop B	10	2CV-5613-2	GAT	MO	OUT	IN	CSAS-2	-	C	C	O	FAI	N
				2	2SA-85B	GAT	M	OUT	IN	-	-	LC	C	LC	-	N
				3	2BS-20B	GLB	M	OUT	IN	-	-	LC	C	LC	-	N
				10	2BS-5B	CHK	SA	IN	IN	-	-	-	-	-	-	-
2P24	6.3-2 M2232	55 ODB	LPSI to RCS Loop 2P32D	6	2CV-5077-2	GLB	MO	OUT	IN	SIS-2	-	C	O/C	O	FAI	N
				6	2SI-14D	CHK	SA	IN	IN	-	-	-	-	-	-	-

ARKANSAS NUCLEAR ONE
Unit 2

Table 6.2-26 (continued)

PENETRATION DATA			COMPONENT DATA														
PEN NO.	SAR FIG. NO. P&ID NO.	GEN DESN CRIT (4)	SERVICE/SYSTEM	LINE SIZE (IN.)	COMPONENT (9)	VALVE TYPE (1)	ACT TYPE (2)	LOCA-TION	NORM FLOW DIR.	ISOL. SIG.	MAXIMUM CLOSURE TIME (SEC) (10)	VALVE POSITION (3)				APP. J. TYPE TEST	
												NORM	SHUT DOWN	POST LOCA	PWR FLR		
2P25	6.3-2 M2232	55 ODB	HPSI to RCS Loop 2P32D	3	2CV-5075-1	GLB	MO	OUT	IN	SIS-1	-	C	C	O	FAI	N	
				3	2CV-5076-2	GLB	MO	OUT	IN	SIS-2	-	C	C	O	FAI	N	
				3	2SI-13D	CHK	SA	IN	IN	-	-	-	-	-	-	-	-
2P26			Spare													A	
2P27	6.3-2 M2232	55*	Shutdown Cooling Suction	14	2CV-5038-1	GAT	MO	OUT	OUT	-	-	LC	O/C	LC	FAI	N	
				14	2CV-5086-2	GAT	MO	IN	OUT	-	-	LC	O/C	LC	FAI	N	
				2	2PSV-5087	REL	SA	IN	IN	-	-	-	-	-	-	-	-
2P28			Spare													A	
2P29	6.3-2 M2232	55 ODB	LPSI to RCS Loop 2P32C	6	2CV-5057-2	GLB	MO	OUT	IN	SIS-2	-	C	O/C	O	FAI	N	
				6	2SI-14C	CHK	SA	IN	IN	-	-	-	-	-	-	-	-
2P30	6.3-2 M2232	55 ODB	HPSI to RCS Loop 2P32C	3	2CV-5055-1	GLB	MO	OUT	IN	SIS-1	-	C	C	O	FAI	N	
				3	2CV-5056-2	GLB	MO	OUT	IN	SIS-2	-	C	C	O	FAI	N	
				3	2SI-13C	CHK	SA	IN	IN	-	-	-	-	-	-	-	-
2P31	11.3-1 M2215	56	Cont. Vent Header	2	2CV-2401-1	GAT	MO	IN	OUT	CIS-1,	-	C	C	C	FAI	A	
				2	Welded Cap			OUT	OUT	SIS-1							
2P32	10.2-3 M2206 Sh 1,2	57	S/G 2E24A Blowdown	4	2CV-1016-1 Closed System	GAT	AO	OUT IN	OUT	MSIS-1/2	8.2	O	O	O	C	N N	
2P33	6.3-2 M2232	56	SI Tank Drain	2	2SI-17	GAT	M	OUT	OUT	-	-	LC	C	LC	-	A,C	
				2	2CV-5082	GAT	MO	IN	OUT	-	-	C	C	C	FAI	A,C	
				3/4	2PSV-5000	REL	SA	IN	OUT	-	-	C	C	C	-	N	
				3/4	2SI-5115A	GLB	M	OUT	IN	-	-	LC	C	LC	-	A,C	
2P34	9.3-4 M2231 Sh 1	55 ODB	CVCS Charging Line	2	2CV-4840-2	GAT	MO	OUT	IN	-	-	O	O	O	FAI	N	
				1	2CVC-125	GAT	M	IN	IN	-	-	LC	C	LC	-	N	
				2	2CVC-28A	CHK	SA	IN	IN	-	-	-	-	-	-	-	N
				2	2CVC-28B	CHK	SA	IN	IN	-	-	-	-	-	-	-	N
				2	2CVC-28C	CHK	SA	IN	IN	-	-	-	-	-	-	-	N
2P35	10.2-3 M2206 Sh 1 M2204 Sh 4	57	EFW to S/G 2E24A	4	2CV-1038-2	GAT	MO	OUT	IN	EFAS/MSIS-2	35	O	O	O	FAI	N	
				4	2CV-1037-1	GAT	MO	OUT	IN	EFAS/MSIS-1	21.3	O	O	O	FAI	N	
				1	2EFW-14A Closed System	GLB	M	OUT IN	OUT			LC	LC	LC		N N	
				4	2CV-1070A	GLB	MO	OUT	IN	-	-	LC	LC	LC	FAI	N	

ARKANSAS NUCLEAR ONE
Unit 2

Table 6.2-26 (continued)

PENETRATION DATA			COMPONENT DATA														
PEN NO.	SAR FIG. NO. P&ID NO.	GEN DESN CRIT (4)	SERVICE/SYSTEM	LINE SIZE (IN.)	COMPONENT (9)	VALVE TYPE (1)	ACT TYPE (2)	LOCA-TION	NORM FLOW DIR.	ISOL. SIG.	MAXIMUM CLOSURE TIME (SEC) (10)	VALVE POSITION (3)				APP. J. TYPE TEST	
												NORM	SHUT DOWN	POST LOCA	PWR FLR		
2P36			Spare														A
2P37	9.3-2 M2237 Sh 1	56	Quench Tank/ RDT Vent	3/4	2SV-5878-1	GLB	SO	IN	OUT	CIS-1, SIS-1	-	C	C	C	C	A,C	
				3/4	2SV-5871-2	GLB	SO	OUT	OUT	CIS-2, SIS-2	-	C	C	C	C	A,C	
2P37	9.3-2 M2237 Sh 1	55	SI Tanks Sample	3/8	2SV-5876-2	GLB	SO	OUT	OUT	SIS-2, CIS-2	-	C	C	C	C	A,C	
				1/2	2SV-5872	GLB	SO	IN	OUT	-	-	C	C	C	C	A	
				1/2	2SV-5873	GLB	SO	IN	OUT	-	-	C	C	C	C	A	
				1/2	2SV-5874	GLB	SO	IN	OUT	-	-	C	C	C	C	A	
				1/2	2SV-5875	GLB	SO	IN	OUT	-	-	C	C	C	C	A	
2P38			Spare														A
2P39	5.1-3 M2230 Sh 2	56	Quench Tank Makeup & Demin Water Supply	2	2CV-4690-2	GAT	MO	OUT	IN	SIS-2, CIS-2	-	C	C	C	FAI	A,C	
				2	2CVC-78	CHK	SA	IN	IN	-	-	-	-	-	-	A,C	
2P40	9.5-1 M2219 Sh 2	56	Fire Water	3	2CV-3200-2	GAT	MO	OUT	IN	CIS-2, SIS-2	-	C	O	C	FAI	A,C	
				3	2FS-37	CHK	SA	IN	IN	-	-	-	-	-	-	A,C	
2P41	3.2-5 M2239 Sh 1	56	Nitrogen Supply	1	2CV-6213-2	GLB	AO	OUT	IN	CIS-2, SIS-2	-	C	O	C	C	A,C	
				1	2N2-1	SCHK	SA	IN	IN	-	-	-	-	-	-	A,C	
2P42	3.2-2 M2220 Sh 1	56	Plant Heating Return	3	2PH-45	GAT	M	OUT	OUT	-	-	LC	C	LC	-	A,C	
				3	2PH-44	GAT	M	IN	OUT	-	-	LC	C	LC	-	A	
2P43	9.3-1 M2218 Sh 1	56	Service Air Supply	3	2SA-68	GAT	M	OUT	IN	-	-	LC	C	LC	-	A,C	
				3	2SA-69	GAT	M	IN	IN	-	-	LC	C	LC	-	A,C	
2P44			Spare														A
2P45			Spare														A
2P46	9.3-1 M2218 Sh 5	56	Breathing Air Supply	2	2BA-217	GAT	M	OUT	IN	-	-	LC	C	LC	-	A,C	
				2	2BA-216	GAT	M	IN	IN	-	-	LC	C	LC	-	A,C	
2P47			Spare														A

ARKANSAS NUCLEAR ONE
Unit 2

Table 6.2-26 (continued)

PENETRATION DATA				COMPONENT DATA												
PEN NO.	SAR FIG. NO. P&ID NO.	GEN DESN CRIT (4)	SERVICE/ SYSTEM	LINE SIZE (IN.)	COMPONENT (9)	VALVE TYPE (1)	ACT TYPE (2)	LOCATION	NORM FLOW DIR.	ISOL. SIG.	MAXIMUM CLOSURE TIME (SEC) (10)	VALVE POSITION (3)				APP. J. TYPE TEST
												NORM	SHUT DOWN	POST LOCA	PWR FLR	
2P48	3.2-2 M2220	56	PH System	3 3	2PH-22 2PH-23	GAT GAT	M M	OUT IN	IN IN	- -	- -	LC LC	C C	LC LC	- -	A,C A
2P49			Spare													A
2P50			Spare													A
2P51	3.2-4 M2222 Sh 1	56	Chilled Water Inlet	6 6	2CV-3852-1 2AC-49	GAT CHK	AO SA	OUT IN	IN IN	CIS-1 -	- -	O -	O -	C -	C -	A,C A,C
2P52	9.2-6 M2234 Sh 1	56	CCW to RCP Coolers	10 10 3/4	2CV-5236-1 2CCW-38 2PSV-5249	BTY CHK REL	MO SA SA	OUT IN IN	IN IN IN	CIS-1 - -	- - -	O - -	O - -	C - -	FAI - -	A,C A,C A,C
2P53	M2218 Sh 6	56	Temp. Access	14 14	BLND FLNG BLND FLNG	- -	- -	IN OUT	- -	- -	- -	- -	- -	- -	- -	A,B A,B
2P54			Spare													A
2P55	9.2-1 M2210 Sh 3	57	Service Water to 2VCC-2C&D	12 - 1	2CV-1510-2 CLOSED SYS 2SV-1510-2	BTY - GAT	MO - SO	OUT IN OUT	IN - IN	CCAS-2 - -	- - -	C - O	C - O	O - O	FAI - O	N N N
2P56			Spare													A
2P57			Spare													A
2P58	9.4-4 M2261 Sh 1	56 ODB	Containment Atmosphere Sample Return	2 2 1 -	2SV-8261-2 2SV-8259-1 2SV-8260-2 CLOSED SYS	GLB GLB GLB -	SO SO SO -	OUT IN OUT OUT	IN IN IN -	CIS-2, SIS-2 CIS-1, SIS-1 CIS-2, SIS-2 -	- - 2 -	O O O -	O O C -	C(7) C(7) C -	C O(5) C -	A,C A,C C B
2P58	9.4-4 M2261 Sh 1	56 ODB	Containment Atmosphere Sample Supply	2 2 1 -	2SV-8263-2 2SV-8265-1 2SV-8262-2 CLOSED SYS	GLB GLB GLB -	SO SO SO -	OUT IN OUT OUT	OUT OUT OUT -	CIS-2, SIS-2 CIS-1, SIS-1 CIS-2, SIS-2 -	- - 2 -	O O O -	O O C -	C(7) C(7) C -	C O(5) C -	A,C A,C C B
2P59	3.2-4 M2222	56	Chilled Water Outlet	6 6 3/4	2CV-3851-1 2CV-3850-2 2PSV-3805	GAT GAT REL	AO MO SA	OUT IN IN	OUT OUT OUT	CIS-1 CIS-2 -	- - -	O O -	O O -	C C -	C FAI -	A,C A,C N

ARKANSAS NUCLEAR ONE
Unit 2

Table 6.2-26 (continued)

PENETRATION DATA				COMPONENT DATA															
PEN NO.	SAR FIG. NO. P&ID NO.	GEN DESN CRIT (4)	SERVICE/SYSTEM	LINE SIZE (IN.)	COMPONENT (9)	VALVE TYPE (1)	ACT TYPE (2)	LOCATION	NORM FLOW DIR.	ISOL. SIG.	MAXIMUM CLOSURE TIME (SEC) (10)	VALVE POSITION (3)				APP. J. TYPE TEST			
												NORM	SHUT DOWN	POST LOCA	PWR FLR				
2P60	9.2-6 M2234 Sh 1	56	CCW from RCP Coolers	10	2CV-5255-1	BTY	MO	OUT	OUT	CIS-1	-	O	O	C	FAI	A,C			
				10	2CV-5254-2	BTY	MO	IN	OUT	CIS-2	-	O	O	C	FAI	A,C			
				3/4	2PSV-5256	REL	SA	IN	IN	-	-	-	-	-	-	-	-	A,C	
2P61	M2218 Sh 2	56	Containment Test Conn. - Sensing	3/4 3/4	BLND FLNG 2IA-88	- GAT	- M	IN OUT	- -	- -	- -	- LC	- -	- LC	- -	- -	B(6) C(6)		
2P61	M2218 Sh 2	56	Containment Test Conn. - Impulse	3/4 3/4	BLND FLNG 2IA-89	- GAT	- M	IN OUT	- -	- -	- -	- LC	- -	- LC	- -	- -	B (6) C(6)		
2P62	M2218 Sh 3	56	Containment Test Conn.	6 6	BLND FLNG BLND FLNG	- -	- -	IN OUT	- -	- -	- -	- -	- -	- -	- -	- -	B(6) B(6)		
2P63	9.2-1 M2210 Sh 3	57	Service Water From 2VCC 2C&D	12 -	2CV-1513-2 CLOSED SYS	BTY -	MO -	OUT IN	OUT -	CCAS-2 -	- -	C -	C -	O -	FAI -	N N			
2P64	10.2-3 M2206 Sh 1,2	57	S/G 2E24B Blowdown	4	2CV-1066-1 Closed System	GAT	AO	OUT IN	OUT	MSIS-1/2	8.8	O	O	O	C	N N			
2P65	10.2-3 M2206 Sh 1 M2204 Sh 4	57	EFW to S/G 2E24B	4	2CV-1036-2	GAT	MO	OUT	IN	EFAS/ MSIS-2	35	O	O	O	FAI	N			
				4 1	2CV-1039-1	GAT	MO	OUT	IN	EFAS/ MSIS-1	21.1	O	O	O	FAI	N			
				4	2EFW-14B Closed System	GLB	M	OUT IN	OUT	-	LC	LC	LC	-	LC	LC	LC	FAI	N N N
				4	2CV-1070B	GLB	MO	OUT	IN	-	LC	LC	LC	-	LC	LC	LC	FAI	N N
2P66	6.2-17 M2236 Sh 1	56 ODB	Cont Sump to ESF Loop A	24	2CV-5649-1	GAT	MO	OUT	OUT	RAS-1	-	C	C	O	FAI	N			
				24	2CV-5647-1	GAT	MO	IN	OUT	RAS-1	-	O	O	O	FAI	N			
				1	PIPE CAP	-	-	OUT	-	-	-	-	-	-	-	-	-	N	
				1	PIPE CAP	-	-	OUT	-	-	-	-	-	-	-	-	-	-	N
2P67	6.2-17 M2236 Sh 1	56 ODB	Cont Sump to ESF Loop B	24	2CV-5650-2	GAT	MO	OUT	OUT	RAS-2	-	C	C	O	FAI	N			
				24	2CV-5648-2	GAT	MO	IN	OUT	RAS-2	-	O	O	O	FAI	N			
				1	PIPE CAP	-	-	-	OUT	-	-	-	-	-	-	-	-	N	
				1	PIPE CAP	-	-	-	OUT	-	-	-	-	-	-	-	-	-	N
2P68	11.2-1 M2213 Sh 1,8	56	Containment Sump Drain	4	2CV-2060-1	GAT	MO	IN	OUT	CIS-1, SIS-1	-	C	C	C	FAI	A,C			
				4	2CV-2061-2	BAL	AO	OUT	OUT	CIS-2, SIS-2	-	C	C	C	C	C	A,C		
				3/4	2PSV-2000	REL	SA	OUT	OUT	-	-	-	-	-	-	-	-	N	

ARKANSAS NUCLEAR ONE
Unit 2

Table 6.2-26 (continued)

PENETRATION DATA			COMPONENT DATA															
PEN NO.	SAR FIG. NO. P&ID NO.	GEN DESN CRIT (4)	SERVICE/SYSTEM	LINE SIZE (IN.)	COMPONENT (9)	VALVE TYPE (1)	ACT TYPE (2)	LOCATION	NORM FLOW DIR.	ISOL. SIG.	MAXIMUM CLOSURE TIME (SEC) (10)	VALVE POSITION (3)				APP. J. TYPE TEST		
												NORM	SHUT DOWN	POST LOCA	PWR FLR			
2P69	11.2-1 M2214 Sh 1	56	Reactor Drain Tank Discharge	4	2CV-2201-2	BAL	AO	OUT	OUT	SIS-2, CIS-2	-	C	O	C	C	A,C		
				4	2CV-2202-1	GAT	MO	IN	OUT	SIS-1, CIS-1	-	C	O	C	FAI	A,C		
				3/4	2PSV-2200	REL	SA	IN	OUT								N	
2V1 (8)	9.4-4 M2261 Sh 1	56	Containment Purge Inlet	54	2CV-8284-2	BTY	AO	OUT	IN	CIS-2, SIS-2	-	C	C	C	C	A,C		
				54	2CV-8283-1	BTY	AO	OUT	IN	SIS-1, CIS-1	-	C	C	C	C	A,C		
2V2 (8)	9.9-4 M2261 Sh 1	56	Containment Purge Outlet	54	2CV-8286-2	BTY	AO	OUT	OUT	CIS-2, SIS-2	-	C	C	C	C	A,C		
				54	2CV-8285-1	BTY	AO	OUT	OUT	SIS-1, CIS-1	-	C	C	C	C	A,C		
2C3	9.1-1 M2235	56	Fuel Transfer Tube	36	Blnd Flng	-	-	IN	-	-	-	-	-	-	-	-	A,B	
2C1	2E1,4-11,14,22-25,27, 28,32-36,41-45, 50, 51,53-55, 59-61,63,66 67,71 2E2,3, 12,13, 21,26,29-31,52, 56-58, 62,64, 65, 68-70,72,73 2E74	56	Bldg Access	-	Eq. Hatch	-	-	-	-	-	-	-	-	-	-	-	A,B	
2C2		56	Bldg Access		Esc. Hatch												A,B	
2C4		56	Bldg Access		Personnel Airlock													A,B
		56	Electrical Penetrations		Electrical Penetration (Module Type)													A,B
					Spares													A
2E74		56	Grounding Rod(s)														A	

ARKANSAS NUCLEAR ONE
Unit 2

Table 6.2-26 (continued)

CODES AND SYMBOLS		NOTES
<p>(1) Valve Type</p> <p>The following codes are used to identify valve type:</p> <p>CHK - Check GAT - Gate GLB - Globe BTY - Butterfly BAL - Ball REL - Relief SCHK - Stop Check BCK - Ball Check</p> <p>(2) Actuator Type</p> <p>The following codes are used to identify valve actuator types:</p> <p>AO - Air Operator SO - Solenoid Operator MO - Motor Operator M - Manual SA - Self Actuated</p>	<p>(3) Valve Position</p> <p>The following codes are used to identify different valve positions:</p> <p>O - Open LC - Locked Closed C - Closed FAI - Fail As Is</p> <p>(4) Design Criteria</p> <p>This column references the appropriate General Design Criteria of 10 CFR 50, Appendix A.</p> <p>ODB – Other Defined Basis</p> <p>* - Penetration is GDC 55 based on 10 CFR 50.2.</p> <p>Based on the definition in SAR Section 5.2, the reactor coolant pressure boundary ends before the penetration.</p>	<p>(5) Valves fail open in order to ensure the capability to sample the containment atmosphere for hydrogen in the event power to either ESF bus is lost.</p> <p>(6) These penetrations are in use during the Type A test. Type B or C tests will be conducted and applied to the Type A test results.</p> <p>(7) The valve positions represent conditions immediately following automatic actuation/isolation signals from the Engineering Safety Features Actuation System. These valves will/may be overridden and opened by the operator prior to or after the isolation signals.</p> <p>(8) These valves may not be opened during power operations, therefore, manual adjustments may be made prior to as-left Type C Appendix J tests.</p> <p>(9) Vents, drains and other similar connections that are not connected to another process system are not included as isolation barriers although they are a part of the isolation boundary. Where closed systems are identified as a barrier, the individual valves that form part of the closed system boundary are not listed separately.</p> <p>(10) All containment isolation valves were originally designed and tested by the manufacturer to close in a maximum of 20 seconds. Actual closing times are controlled by the Inservice Testing Program and Technical Specifications.</p>

ARKANSAS NUCLEAR ONE
Unit 2

Table 6.2-26 (continued)

NOTES

(11) **If** control, or solenoid valves are added to this table; **Then** notify Unit 2 Planning and Maintenance that an addition has been made to SAR Table 6.2-26, which will require:

- a. The following note to be inserted into the controlling plant database (such as equipment database/component database) Maintenance Notes for the newly added control valve, its actuator, and power and control circuit components, which states: Planner – If maintenance, repair, or replacement work is performed on this valve, it's actuator, it's control circuit, or it's power circuit, a full stroke test of the valve is required and stroke times verified to be within limits pursuant to TS 4.6.3.1.1, SAR Table 6.2-26, and the Inservice Testing Program. Ref. CR-2-98-0409.
- b. A review of any active work document which exists for the newly added control valve, its actuator, and power and control circuit components to ensure that they contain Post Maintenance Testing that complies with the requirements stated in the Maintenance Note referenced in requirement 1 above.
- c. A review of any active CM activity which exists for the newly added control valve, its actuator, and power and control circuit components, to ensure that the Post Maintenance Testing complies with the requirements stated in the Maintenance Note referenced in requirement 1 above.

If control or solenoid valves are deleted from this table; **Then** notify Unit 2 Planning, Unit 2 Maintenance, and Unit 2 Systems Engineering, that a deletion has occurred in SAR Table 6.2-26, which will require:

- a. The following note to be removed from the controlling plant database (such as equipment database/component database) Maintenance Notes for the deleted valve, its actuator, and power and control circuit components. Planner – If maintenance, repair, or replacement work is performed on this valve, it's actuator, it's control circuit, or it's power circuit, a full stroke test of the valve is required and stroke times verified to be within limits pursuant to TS 4.6.3.1.1, SAR Table 6.2-26, and the Inservice Testing Program. Ref. CR-2-98-0409.
- b. A review of any active work document which exists for the deleted control valve, its actuator, and power and control circuit components, to ensure the Post Maintenance Testing requirements are appropriate.
- c. A review of any active CM activity which exists for the deleted control valve, its actuator, and power and control circuit components, to ensure the Post Maintenance Testing requirements are appropriate.

(12) This penetration meets the requirements of GDC-57 with the exception of 2MS-55 and 2MS-74, which are maintained in the open position during power operations. These valves are steam trap isolations for the A SG steam supply to the EFW turbine and the ADV. Closing these valves during operation potentially challenges the operability of the steam driven EFW pump and ADV. The NRC has approved this configuration per OCNA040508.

ARKANSAS NUCLEAR ONE
Unit 2

Table 6.2-27

HYDROGEN RECOMBINER CHARACTERISTICS

<u>Parameter</u>	<u>Value</u>
Equipment number	2M55A,B
Quantity	Two
Type	Thermal hydrogen recombiner
Design pressure, psig	75 ⁽¹⁾
Design temperature, °F	1400 ⁽²⁾
Design capacity, SCFM	100
Design codes	IEEE Standard 279-1971 IEEE Standard 308-1971 IEEE Standard 344-1971
Hydrogen removal efficiency, percent	95
Heater Characteristics:	
Number of heaters	5 Banks
Capacity of heater, KW	15 (Max.)
Type of heater	Electric resistance

⁽¹⁾ The recombiners have been environmentally qualified to 85 psig and 316 °F.

⁽²⁾ This is the maximum operating temperature of the recombiner heaters.

Table 6.2-28

QUANTITIES OF ZINC, COPPER AND ALUMINUM IN CONTAINMENT

<u>Material</u>	<u>Surface Area (ft²)</u>	<u>Thickness (in)</u>
Aluminum	2,000	0.1
Copper	58,960	0.007
Zinc	115,000	0.004
Zinc Based Paint	210,000	0.003
Cupro-Nickel	132,440	0.007

The surface areas listed are conservative estimates of the total exposed surface areas of the material and include some margins for possible future additions.

The thickness values used as input to COGAP (Ref. 80) are larger than the thickness of material that will corrode to produce hydrogen during the 30 day time period of the analysis. This assures the maximum calculated hydrogen production.

Repairs of damaged coatings may use reformulated replacement coatings that contain materials different than the previous coatings, may not require a primer, and may not be the same type (e.g., inorganic). Although replacement coatings can decrease the zinc mass in the containment, analyses for post-accident conditions using previous zinc mass estimates are conservative. Coatings and repairs are governed by Specification ANO-A-2437

ARKANSAS NUCLEAR ONE
Unit 2

Table 6.2-29

**METAL CORROSION RATES ASSUMED FOR POST-ACCIDENT
HYDROGEN GENERATION**

Time Post LOCA (days)	Corrosion Rate in mils/year			
	<u>Aluminum</u>	<u>Zinc Paint</u>	<u>Zinc Metal</u>	<u>Copper/ Copper Alloys</u>
0 to 0.035	50.0	262	25.0	3.55
0.035 to 0.1	483	183	12.4	2.79
0.1 to 0.2	461	174	11.2	2.69
0.2 to 0.5	384	142	7.53	2.34
0.5 to 1.0	295	106	4.24	1.92
1.0 to 2.0	194	67.0	1.71	1.40
2.0 to 4.0	128	21.2	0.697	1.02
4.0 to 7.0	80.2	8.4	0.251	0.72
7.0 to 10.0	62.6	6.40	0.146	0.59
10.0 to 30.0	36.1	3.49	0.044	0.39

Table 6.2-30

DELETED

(Historical Information. Replaced by Table 6.2-8D)

Table 6.2-31

DELETED

(Historical Information)

Table 6.2-32

DELETED

(Historical Information. Replaced by Table 6.2-8J)

Table 6.2-33

PENETRATION INDEX

DELETED

(See Table 6.2-26)

ARKANSAS NUCLEAR ONE
Unit 2

Table 6.2-34

**MASS AND ENERGY RELEASE DATA FOR THE MINIMUM
CONTAINMENT PRESSURE ANALYSIS FOR ECCS PERFORMANCE
0.4 DEG/PD BREAK**

A. BLOWDOWN PHASE

Time (sec)	Mass Flow Rate, (lbm/sec)	Energy Release Rate, (Btu/sec)	Integral of Mass Flow Rate, (lbm)	Integral of Energy Release Rate, (Btu)
0.0000E+00	0.0000E+00	0.0000E+00	0.0000E+00	0.0000E+00
1.2812E-01	5.5782E+04	2.9333E+07	6.7729E+03	3.5329E+06
2.5664E-01	5.4585E+04	2.8880E+07	1.3836E+04	7.2609E+06
5.0174E-01	5.3680E+04	2.8494E+07	2.7063E+04	1.4274E+07
9.9899E-01	5.3165E+04	2.8265E+07	5.3636E+04	2.8393E+07
1.9990E+00	4.8740E+04	2.6054E+07	1.0534E+05	5.5946E+07
2.9990E+00	4.1332E+04	2.2309E+07	1.5003E+05	7.9943E+07
3.9990E+00	3.7148E+04	2.0343E+07	1.8898E+05	1.0110E+08
5.1000E+00	2.8477E+04	1.6049E+07	2.2500E+05	1.2105E+08
6.2024E+00	2.2013E+04	1.3207E+07	2.5253E+05	1.3704E+08
7.2024E+00	1.9972E+04	1.2391E+07	2.7340E+05	1.4980E+08
8.2024E+00	1.8651E+04	1.1703E+07	2.9266E+05	1.6183E+08
9.2024E+00	1.7587E+04	1.1019E+07	3.1075E+05	1.7318E+08
1.0216E+01	1.6693E+04	1.0446E+07	3.2804E+05	1.8401E+08
1.1216E+01	1.5688E+04	9.8872E+06	3.4427E+05	1.9419E+08
1.2215E+01	1.4348E+04	9.1962E+06	3.5928E+05	2.0372E+08
1.3215E+01	1.2986E+04	8.5220E+06	3.7294E+05	2.1257E+08
1.4215E+01	1.1518E+04	7.7742E+06	3.8517E+05	2.2072E+08
1.5205E+01	9.4822E+03	6.6633E+06	3.9572E+05	2.2797E+08
1.6207E+01	4.8602E+03	4.5330E+06	4.0359E+05	2.3378E+08
1.7205E+01	4.2466E+03	3.9134E+06	4.0767E+05	2.3776E+08
1.8205E+01	5.1236E+03	3.9701E+06	4.1242E+05	2.4174E+08
1.9205E+01	5.4478E+03	3.5811E+06	4.1773E+05	2.4555E+08
2.0205E+01	5.1268E+03	2.8328E+06	4.2311E+05	2.4879E+08
2.1205E+01	3.7789E+03	1.8265E+06	4.2766E+05	2.5113E+08
2.2205E+01	2.7570E+03	1.2115E+06	4.3092E+05	2.5263E+08
2.2834E+01	1.0778E+03	5.4007E+05	4.3232E+05	2.5325E+08

ARKANSAS NUCLEAR ONE
Unit 2

Table 6.2-34 (Continued)

B. REFLOOD PHASE (Values are for steam only)

Time (sec)	Mass Flow Rate, (lbm/sec)	Energy Release Rate, (Btu/sec)	Integral of Mass Flow Rate, (lbm)	Integral of Energy Release Rate, (Btu)
2.2834E+01	0.0000E+00	0.0000E+00	4.3232E+05	2.5325E+08
2.7834E+01	0.0000E+00	0.0000E+00	4.3232E+05	2.5325E+08
3.2834E+01	0.0000E+00	0.0000E+00	4.3232E+05	2.5325E+08
3.7834E+01	0.0000E+00	0.0000E+00	4.3232E+05	2.5325E+08
4.2834E+01	0.0000E+00	0.0000E+00	4.3232E+05	2.5325E+08
4.7834E+01	0.0000E+00	0.0000E+00	4.3232E+05	2.5325E+08
5.2834E+01	0.0000E+00	0.0000E+00	4.3232E+05	2.5325E+08
5.7834E+01	0.0000E+00	0.0000E+00	4.3232E+05	2.5325E+08
6.2834E+01	0.0000E+00	0.0000E+00	4.3232E+05	2.5325E+08
6.7834E+01	0.0000E+00	0.0000E+00	4.3232E+05	2.5325E+08
7.2834E+01	0.0000E+00	0.0000E+00	4.3232E+05	2.5325E+08
7.7834E+01	1.9147E+02	2.4933E+05	4.3297E+05	2.5410E+08
8.2834E+01	1.9344E+02	2.5180E+05	4.3393E+05	2.5535E+08
8.7834E+01	1.9192E+02	2.4973E+05	4.3490E+05	2.5660E+08
9.2834E+01	1.9047E+02	2.4775E+05	4.3585E+05	2.5785E+08
9.7834E+01	1.8929E+02	2.4616E+05	4.3680E+05	2.5908E+08
1.0283E+02	1.8862E+02	2.4519E+05	4.3775E+05	2.6032E+08
1.0783E+02	1.8755E+02	2.4372E+05	4.3869E+05	2.6154E+08
1.1283E+02	1.8675E+02	2.4259E+05	4.3963E+05	2.6275E+08
1.1783E+02	1.8601E+02	2.4156E+05	4.4056E+05	2.6396E+08
1.2283E+02	1.8526E+02	2.4050E+05	4.4149E+05	2.6517E+08
1.2783E+02	1.8468E+02	2.3967E+05	4.4241E+05	2.6637E+08
1.3283E+02	1.8416E+02	2.3890E+05	4.4333E+05	2.6757E+08
1.3783E+02	1.8441E+02	2.3915E+05	4.4426E+05	2.6876E+08
1.4283E+02	1.8338E+02	2.3773E+05	4.4518E+05	2.6996E+08
1.4783E+02	1.8292E+02	2.3706E+05	4.4609E+05	2.7114E+08
1.5283E+02	1.8257E+02	2.3652E+05	4.4701E+05	2.7233E+08
1.5783E+02	1.8225E+02	2.3604E+05	4.4792E+05	2.7351E+08
1.6283E+02	1.8195E+02	2.3557E+05	4.4883E+05	2.7469E+08
1.6783E+02	1.8165E+02	2.3511E+05	4.4974E+05	2.7586E+08
1.7283E+02	1.8135E+02	2.3465E+05	4.5065E+05	2.7704E+08
1.7783E+02	1.8104E+02	2.3418E+05	4.5155E+05	2.7821E+08
1.8283E+02	1.8090E+02	2.3392E+05	4.5246E+05	2.7938E+08
1.8783E+02	1.8205E+02	2.3533E+05	4.5336E+05	2.8055E+08

ARKANSAS NUCLEAR ONE
Unit 2

Table 6.2-34 (Continued)

B. REFLOOD PHASE (Values are for steam only) (continued)

Time (sec)	Mass Flow Rate, (lbm/sec)	Energy Release Rate, (Btu/sec)	Integral of Mass Flow Rate, (lbm)	Integral of Energy Release Rate, (Btu)
1.9283E+02	1.8100E+02	2.3390E+05	4.5427E+05	2.8172E+08
1.9783E+02	1.8037E+02	2.3301E+05	4.5517E+05	2.8289E+08
2.0283E+02	1.8012E+02	2.3262E+05	4.5607E+05	2.8406E+08
2.0783E+02	1.7996E+02	2.3235E+05	4.5697E+05	2.8522E+08
2.1283E+02	1.7981E+02	2.3208E+05	4.5787E+05	2.8638E+08
2.1783E+02	1.7967E+02	2.3182E+05	4.5877E+05	2.8754E+08
2.2283E+02	1.7952E+02	2.3156E+05	4.5967E+05	2.8870E+08
2.2783E+02	1.7938E+02	2.3131E+05	4.6057E+05	2.8985E+08
2.3283E+02	1.7924E+02	2.3106E+05	4.6146E+05	2.9101E+08
2.3783E+02	1.7910E+02	2.3081E+05	4.6236E+05	2.9216E+08
2.4283E+02	1.7896E+02	2.3056E+05	4.6326E+05	2.9332E+08
2.4783E+02	1.7881E+02	2.3030E+05	4.6415E+05	2.9447E+08
2.5283E+02	1.7866E+02	2.3004E+05	4.6504E+05	2.9562E+08
2.5783E+02	1.7851E+02	2.2977E+05	4.6594E+05	2.9677E+08
2.6283E+02	1.7835E+02	2.2950E+05	4.6683E+05	2.9792E+08
2.6783E+02	1.7817E+02	2.2921E+05	4.6772E+05	2.9907E+08
2.7283E+02	1.7799E+02	2.2891E+05	4.6861E+05	3.0021E+08
2.7783E+02	1.7888E+02	2.2998E+05	4.6950E+05	3.0136E+08
2.8283E+02	1.7829E+02	2.2916E+05	4.7039E+05	3.0251E+08
2.8783E+02	1.7794E+02	2.2866E+05	4.7129E+05	3.0365E+08
2.9283E+02	1.7766E+02	2.2823E+05	4.7217E+05	3.0479E+08
2.9783E+02	1.7736E+02	2.2778E+05	4.7306E+05	3.0593E+08
3.0283E+02	1.7709E+02	2.2736E+05	4.7395E+05	3.0707E+08
3.0783E+02	1.7704E+02	2.2724E+05	4.7483E+05	3.0821E+08
3.1283E+02	1.7696E+02	2.2707E+05	4.7572E+05	3.0934E+08
3.1783E+02	1.7687E+02	2.2689E+05	4.7660E+05	3.1048E+08
3.2283E+02	1.7678E+02	2.2671E+05	4.7749E+05	3.1161E+08
3.2783E+02	1.7668E+02	2.2654E+05	4.7837E+05	3.1274E+08
3.3283E+02	1.7659E+02	2.2636E+05	4.7925E+05	3.1388E+08
3.3783E+02	1.7650E+02	2.2617E+05	4.8014E+05	3.1501E+08
3.4283E+02	1.7640E+02	2.2599E+05	4.8102E+05	3.1614E+08
3.4783E+02	1.7631E+02	2.2581E+05	4.8190E+05	3.1727E+08
3.5283E+02	1.7621E+02	2.2563E+05	4.8278E+05	3.1840E+08
3.5783E+02	1.7611E+02	2.2544E+05	4.8366E+05	3.1952E+08

ARKANSAS NUCLEAR ONE
Unit 2

Table 6.2-34 (Continued)

B. REFLOOD PHASE (Values are for steam only) (continued)

Time (sec)	Mass Flow Rate, (lbm/sec)	Energy Release Rate, (Btu/sec)	Integral of Mass Flow Rate, (lbm)	Integral of Energy Release Rate, (Btu)
3.6283E+02	1.7601E+02	2.2526E+05	4.8454E+05	3.2065E+08
3.6783E+02	1.7592E+02	2.2508E+05	4.8542E+05	3.2178E+08
3.7283E+02	1.7582E+02	2.2489E+05	4.8630E+05	3.2290E+08
3.7783E+02	1.7571E+02	2.2470E+05	4.8718E+05	3.2403E+08
3.8283E+02	1.7561E+02	2.2451E+05	4.8806E+05	3.2515E+08
3.8783E+02	1.7551E+02	2.2433E+05	4.8894E+05	3.2627E+08
3.9283E+02	1.7540E+02	2.2414E+05	4.8981E+05	3.2739E+08
3.9783E+02	1.7530E+02	2.2394E+05	4.9069E+05	3.2851E+08
4.0283E+02	1.7519E+02	2.2375E+05	4.9157E+05	3.2963E+08
4.0783E+02	1.7508E+02	2.2356E+05	4.9244E+05	3.3075E+08
4.1283E+02	1.7497E+02	2.2336E+05	4.9332E+05	3.3187E+08
4.1783E+02	1.7486E+02	2.2317E+05	4.9419E+05	3.3298E+08
4.2283E+02	1.7475E+02	2.2297E+05	4.9507E+05	3.3410E+08
4.2783E+02	1.7463E+02	2.2276E+05	4.9594E+05	3.3521E+08
4.3283E+02	1.7528E+02	2.2354E+05	4.9681E+05	3.3633E+08
4.3783E+02	1.7486E+02	2.2294E+05	4.9769E+05	3.3744E+08
4.4283E+02	1.7464E+02	2.2261E+05	4.9856E+05	3.3856E+08
4.4783E+02	1.7448E+02	2.2235E+05	4.9944E+05	3.3967E+08
4.5283E+02	1.7434E+02	2.2212E+05	5.0031E+05	3.4078E+08
4.5783E+02	1.7420E+02	2.2189E+05	5.0118E+05	3.4189E+08
4.6283E+02	1.7405E+02	2.2166E+05	5.0205E+05	3.4300E+08
4.6783E+02	1.7389E+02	2.2140E+05	5.0292E+05	3.4411E+08
4.7283E+02	1.7372E+02	2.2113E+05	5.0379E+05	3.4521E+08
4.7783E+02	1.7353E+02	2.2083E+05	5.0466E+05	3.4632E+08
4.8283E+02	1.7328E+02	2.2047E+05	5.0552E+05	3.4742E+08
4.8783E+02	1.7316E+02	2.2026E+05	5.0639E+05	3.4852E+08
4.9283E+02	1.7312E+02	2.2017E+05	5.0726E+05	3.4962E+08
4.9783E+02	1.7306E+02	2.2004E+05	5.0812E+05	3.5072E+08
5.0283E+02	1.7298E+02	2.1990E+05	5.0899E+05	3.5182E+08
5.0783E+02	1.7291E+02	2.1975E+05	5.0985E+05	3.5292E+08
5.1283E+02	1.7284E+02	2.1961E+05	5.1071E+05	3.5402E+08
5.1783E+02	1.7276E+02	2.1947E+05	5.1158E+05	3.5512E+08
5.2283E+02	1.7269E+02	2.1932E+05	5.1244E+05	3.5622E+08

ARKANSAS NUCLEAR ONE
Unit 2

Table 6.2-35

**CONTAINMENT PASSIVE HEAT SINK DATA FOR THE
MINIMUM CONTAINMENT PRESSURE ANALYSIS FOR ECCS PERFORMANCE**

<u>Wall No.</u>	<u>Description</u>	<u>Material</u>	<u>Thickness, ft.</u>	<u>Surface Area, ft²</u>
1	Containment Walls and Dome ⁽¹⁾	Type B Coating Steel Concrete	0.0004 0.0225 3.56	62,050
2	Containment Walls ⁽¹⁾	Type A Coating Steel Concrete	0.0004 0.0224 3.78	20,000
3	Base Slab	Type C Coating Concrete	0.0107 10.5	10,000
4	Refueling Canal ⁽²⁾	Stainless Steel Concrete	0.0217 2.02	10,000
5	Sheet Metal and Pipes ^(1,2)	Galvanized Coating Steel	0.00008 0.0049	110,500
6	Concrete Walls and Floors ^(1,2)	Type C Coating Concrete	0.0063 1.38	28,000
7	Structural Steel ^(1,2)	Type A Coating Steel	0.0004 0.0349	119,300
8	Crane Girders ^(1,2)	Type D Coating Steel	0.0005 0.0098	67,000
9	Concrete ^(1,2)	Concrete	2.70	68,000
10	Stainless Steel ^(1,2)	Stainless Steel	0.0179	7,000
11.	Containment Sump Strainers	Stainless Steel	0.0063	12,900
12.	Containment Sump Plenum	Stainless Steel	0.0332	1,705
13.	Refueling Canal Deep End Strainers ⁽¹⁾	Stainless Steel	0.0223	19

Notes:

(1) Thickness is effective thickness as a result of combining similar thickness walls.

(2) One side of wall is exposed to containment atmosphere, one side is insulated.

ARKANSAS NUCLEAR ONE
Unit 2

Table 6.2-36

**CONTAINMENT PASSIVE HEAT SINK MATERIAL PROPERTY DATA FOR THE MINIMUM
CONTAINMENT PRESSURE ANALYSIS**

<u>Material</u>	<u>Thermal Conductivity, BTU/hr-ft-°F</u>	<u>Vol. Heat Capacity, BTU/ft³-°F</u>
Concrete	0.9	30
Steel	26	56
Stainless Steel	10	55.7
Galvanized Coating	64	41
Type A Coating	0.1	33
Type B Coating	0.9	30
Type C Coating	0.1	33
Type D Coating	7.4	30

Table 6.2-37 Through Table 6.2-43

DELETED

(Historical Information)

Table 6.2-44

CONTAINMENT AIR COOLER HEAT REMOVAL CAPACITY PER TRAIN

Train Capacity (two fan/coil units)					
<u>120 °F Service Water</u>		<u>110 °F Service Water</u>		<u>95 °F Service Water</u>	
Inlet Temp (°F)	Performance (Btu/hr)	Inlet Temp (°F)	Performance (Btu/hr)	Inlet Temp (°F)	Performance (Btu/hr)
130	> 2.5E+06	120	> 2.0E+06	105	> 1.8E+06
150	> 9.0E+06	150	> 1.0E+07	150	> 1.2E+07
180	> 2.0E+07	180	> 2.2E+07	180	> 2.5E+07
230	> 4.0E+07	230	> 5.0E+07	230	> 5.0E+07
286	> 7.5E+07	286	> 8.0E+07	286	> 8.5E+07
300	> 8.0E+07	300	> 8.5E+07	300	> 9.0E+07

ARKANSAS NUCLEAR ONE
Unit 2

Table 6.3-1

SAFETY INJECTION SYSTEM COMPONENT PARAMETERS

Refueling Water Tank

Quantity	1
Recommended Design Pressure, ft	10
Recommended Design Temperature, °F	150
Material	SA-240 -Gr 304 Stainless
Nominal Capacity, gal	500,500
Contained Liquid	Borated water 3000 ppm, max.
Liquid Temperature, °F, min.	40
Code	ASME III, Class 2
Seismic Category	I

Low Pressure Safety Injection Pumps

Quantity	2
Type	Single Stage, Centrifugal
Safety Classification	2
Code	Draft ASME Pump and Valve Code, Class 2
Design Pressure, psig	650
Design Temperature, °F	400
Design Flow Rate, gpm	3100
Design Head, ft	350
Maximum Flow Rate, gpm	5700
Head at Maximum Flow Rate, ft.	265
Materials	Stainless Steel ASTM-A-351 Gr CF8M
Seals	Mechanical
Motor Horsepower	450

ARKANSAS NUCLEAR ONE
Unit 2

Table 6.3-1 (continued)

High Pressure Safety Injection Pumps

Quantity	3
Type	Multistage, Centrifugal
Safety Classification	2
Code	Draft ASME Pump and Valve Code, Class 2
Design Pressure, psig	1950
Design Temperature, °F	400
Design Flow Rate, gpm	320
Design Head, ft.	2900
Maximum Flow Rate, gpm	900*
Head at Maximum Flow Rate, ft	1300*
Materials	Stainless Steel ASTM-A-351 Gr CF8M
Shaft Seal	Mechanical
Motor Horsepower	650

* These values are for HPSI pumps 2P-89A/B. The maximum flow rate for HPSI pump 2P-89C is 870 gpm with a corresponding head (at maximum flow rate) of 1250 ft.

Safety Injection Tanks

Quantity	4
Safety Classification	2
Code	ASME III, Class 2
Design Pressure, Internal/External, psig	700/0
Design Temperature, °F	200
Operating Temperature, °F	120
Normal Operating Pressure, psig	610
Minimum Operating Pressure, psig	600
Volume, Total, ft ³	1855
Volume, Liquid, ft ³	1480
Fluid	Borated Water, 3000 ppm Boron, max.
Material	Stainless Clad Carbon Steel

Table 6.3-2

DELETED

(Historical Information)

ARKANSAS NUCLEAR ONE
Unit 2

Table 6.3-3

FAILURE MODE ANALYSIS

HIGH PRESSURE SAFETY INJECTION
(Injection Mode)

<u>Component Identification and Quantity</u>	<u>Failure Mode</u>	<u>Effect on System</u>	<u>Method of Detection</u>	<u>Monitor</u>	<u>Remarks</u>
HPSI Loop Flow Indicator - 4	Malfunction	None	Comparison of Flow to other Flow Indicators and Valve Position Indicators.	CRI	
HPSI Valve - 8	Fails to open	Valve in ruptured loop--no effect Valve in non- ruptured loop partial flow loss but flow to core still greater than minimum required.	Flow Indication Pressure Indication Valve Position Indication.	CRI	
Pump Discharge Isolation Valve - 3	None	None, "Locked Open" valve	NA*		NA*
Pump Minimum Flow Recirculation Stop Valve - 3	None	None, "Locked Open" valve.	NA*		NA*
HPSI Pump - 3	a. Fails to Start	Loss of HPSI flow from 1 pump	Pump Motor Lights, Header Pressure	CRI	Flow from at least one pump available.
	b. Stops	Loss of HPSI flow 1 pump	Pump Motor Lights, Header Pressure	CRI	Flow from at least one pump available.
Pump Suction Isolation Valve - 2	None	None, "Locked Open" valve.	NA*		NA*

* Not applicable where no failure mode is indicated.

ARKANSAS NUCLEAR ONE
Unit 2

Table 6.3-3 (continued)

**HIGH PRESSURE SAFETY INJECTION
(Recirculation Mode)**

<u>Component Identification and Quantity</u>	<u>Failure Mode</u>	<u>Effect on System</u>	<u>Method of Detection</u>	<u>Monitor</u>	<u>Remarks</u>
HPSI Lines Connecting to RCS - 4	Rupture	<ol style="list-style-type: none"> 1. Break in ruptured loop--no effect. 2. Break not in ruptured loop--up to 50% of total flow may not reach the core 	Sump level alarms if outside containment. Nothing if inside.	CRI	2 HPSI pumps supplying coolant through two loops is sufficient to maintain core cooling.
HPSI Discharge Check Valve - 4	Fails Closed	<ol style="list-style-type: none"> 1. Valve in ruptured loop--no effect. 2. Valve in non-ruptured loop--at least 67% of HPSI flow from 2 pumps reaches core. 	Flow Indication, Pressure Indication.	CRI	Flow is sufficient to cool core
HPSI Loop Flow Indicator - 4	Malfunction	None	Comparison to flow other flow indicator and Valve Position Indicator.	CRI	Balancing of flow is not essential during long-term cooling. Flow is balanced during short term and not normally altered.
Check Valve Associated with HPSI Valves - 4	Fails Closed	<ol style="list-style-type: none"> 1. Valve in ruptured loop--no effect 2. Valve in non-ruptured loop--at least 67% of HPSI flow from 2 pumps reaches core. 	Flow Indication, Pressure Indication.	CRI	Flow is sufficient to cool core.

ARKANSAS NUCLEAR ONE
Unit 2

Table 6.3-3 (continued)

**HIGH PRESSURE SAFETY INJECTION
(Recirculation Mode) (continued)**

<u>Component Identification and Quantity</u>	<u>Failure Mode</u>	<u>Effect on System</u>	<u>Method of Detection</u>	<u>Monitor</u>	<u>Remarks</u>
HPSI Valve - 8	Fails Closed	Valve in ruptured loop--no effect Valve in non-ruptured loop--partial flow loss but flow to core still greater than minimum required.	Flow Indication, Pressure Indication, Valve Position Indication	CRI	
HPSI Pump Discharge Relief Valve - 3	Fails Open	Partial loss of HPSI flow.	None	CRI	Loss of flow will be insignificant
HPSI Line between Pump Discharge Isolation Valves and Safety Injection Valves	Rupture	Loss of HPSI flow from one pump.	Room Vent Radiation Monitor, Level Indication, Level Alarm, Sump Pump Operation, Flow Indication.	CRI	Affected HPSI pump must be stopped and header isolated. Backup HPSI is restarted.
Pump Discharge Isolation Valve - 3	Fails Closed	Loss of HPSI flow from 1 pump	Flow Indication, Pressure Indication.	CRI	At least 1 HPSI pump is available. Each pump is full capacity.
Pump Minimum Flow Recirculation Stop Valve - 3	Fails Closed	None, valve is not necessary after RAS.	None		
Pump Discharge Check Valve - 3	Fails Closed	Loss of HPSI flow from 1 pump	Flow Indication, Pressure Indication.	CRI	At least 1 HPSI pump is available.

ARKANSAS NUCLEAR ONE
Unit 2

Table 6.3-3 (continued)

**HIGH PRESSURE SAFETY INJECTION
(Recirculation Mode) (continued)**

<u>Component Identification and Quantity</u>	<u>Failure Mode</u>	<u>Effect on System</u>	<u>Method of Detection</u>	<u>Monitor</u>	<u>Remarks</u>
HPSI Pump - 3	a. Stops	Loss of HPSI flow from 1 pump.	Pump Motor Lights	CRI	At least 1 HPSI pump is available.
	b. Seal Failure	Slight reduction in output from affected pump.	None		
	c. Loss of seal coolant	Loss of HPSI flow from 1 pump.	None		Effect is not expected, but conservatively postulated.
Pump Suction Isolation - 2	Fails Closed	Loss of suction to 1 HP pump	Pressure Indication. Possible Flow Indication.	Local CRI	At least 1 HPSI pump is available.
Pump Suction Line Prior to Pump Isolation Valves	Rupture	Loss of suction to all pumps on header. Spillage into pump room until break is isolated.	Flow Indication, Pressure Indication, Room Vent Radiation Monitor, Level Indicator, Level Alarm, Sump Pump Operation.	CRI	RWT has been isolated at RAS. Requires isolation at containment sump. All pumps on the other header are available.
Safety Injection Pump Minimum Flow Recirc Stop Valve - 2	Fails Open	None	Valve Position	CRI	2 valves are in series
LPSI Valve - 4	Fails Closed	Valve in ruptured loop--no effect.	Valve Position, Flow Indication, Pressure Indication	CRI	Flow from 50% on LPSI pump is adequate.
		Valve not in ruptured loop--at least 50% of LPSI flow reached core.			

ARKANSAS NUCLEAR ONE
Unit 2

Table 6.3-3 (continued)

**LOW PRESSURE SAFETY INJECTION
(Injection Mode)**

<u>Component Identification and Quantity</u>	<u>Failure Mode</u>	<u>Effect on System</u>	<u>Method of Detection</u>	<u>Monitor</u>	<u>Remarks</u>
LPSI Segment to Shutdown Cooling Heat Exchange Isolation Valve - 1	None	None	NA	NA	
Flow Indicator Controller Stop Valve - 1	None	None	NA	NA	Fail open valve.
CVCS Crosstie to SDC/LPSI Line	Rupture	Loss of Heat Exchanger	Flooding, Aux. Sump Level, Penetration Vent Radiation Monitor.	Local CRI CRI	Protected by 2PSV-5082
Pump Discharge Isolation Valve - 2	None	None	NA	NA	
Pump Minimum Recirculation Stop Valve - 2	None	None	NA	NA	
Pump - 2	a. Fails to start	Loss of LPSI flow from one pump.	Pump Indication lights.	CRI	Other pump starts.
	b. Stops	Loss of LPSI flow from one pump.	Flow Indication.	CRI	Other pump starts simultaneously. Each pump is full capacity.
	c. Fails to stop with the RAS	Pumps may cavitate unless flow is reduced.	Flow Indicator fluctuations	CRI	Operator may stop pumps.
Pump Suction Isolation Valve - 2	None	None	NA	NA	

ARKANSAS NUCLEAR ONE
Unit 2

Table 6.3-3 (continued)

**SAFETY INJECTION TANK SEGMENT
(Injection Mode)**

<u>Component Identification and Quantity</u>	<u>Failure Mode</u>	<u>Effect on System</u>	<u>Method of Detection</u>	<u>Monitor</u>	<u>Remarks</u>
SI Tank Isolation Valve - 4	None	None, valve is Normally Open, Locked Open "Fail As Is" valve.	NA	NA	
Drain and Fill Isolation and Valve - 4	None	None, valve is "Fail Closed" valve.	NA	NA	
Check Valve Leakage Control Valve - 4	None	None, valve is "Fail Closed" valve.	NA	NA	
SI Tank Purge Valve - 4	None	None, valve is "Fail Closed" valve.	NA	NA	
N. Supply Line Stop Valve	None	Valve is "Fail Closed" valve.	NA	NA	

**SUCTION SEGMENT FOR SAFETY INJECTION
(Injection Mode)**

Refueling Water Tank Isolation Valve - 2	Inadvertently closed during use of tank.	Loss of suction to affected pumps.	Valve Position, Flow Indication.	CRI	
	Inadvertently opened during use of sump	None-Check valve restricts flow to RWT during recirculation.	Valve Position	CRI	Operator Error. Operator should detect abnormal valve position by indicator lights.

ARKANSAS NUCLEAR ONE
Unit 2

Table 6.3-3 (continued)

**SUCTION SEGMENT FOR SAFETY INJECTION
(Injection Mode) (continued)**

<u>Component Identification and Quantity</u>	<u>Failure Mode</u>	<u>Effect on System</u>	<u>Method of Detection</u>	<u>Monitor</u>	<u>Remarks</u>
Sump Isolation Valve - 2	a. Inadvertently opened during use of refueling water tank	None-RWT flows to sump until RAS if building pressure is low. None-Check valve restricts flow to RWT if building pressure is high. Potential flow from sump to RWT through mini-recirc line.	Valve Position, Possible loss of flow	CRI	Operator error. Operator should detect abnormal valve position by indicator lights and take action to terminate mini-recirc.
	b. Inadvertently closed during use of sump.	Loss of suction to one pump header.	Valve Position, Flow Indication.	CRI	

**SUCTION SEGMENT FOR SAFETY INJECTION
(Recirculation Mode)**

Suction Line - 2	Rupture	Leakage until break is isolated--full flow is available through the parallel leg.	Pump room sump pump operation	CRI	Require isolation of rupture at sump valves.
RWT Check Valve - 2	a. Fails Closed	None during long-term cooling	None	None	
	b. Fails Open	None--Isolation valve in series stops flow to RWT.			

ARKANSAS NUCLEAR ONE
Unit 2

Table 6.3-3 (continued)

**SUCTION SEGMENT FOR SAFETY INJECTION
(Recirculation Mode) (continued)**

<u>Component Identification and Quantity</u>	<u>Failure Mode</u>	<u>Effect on System</u>	<u>Method of Detection</u>	<u>Monitor</u>	<u>Remarks</u>
RWT Isolation Valve - 2	Inadvertently open during recirculation cooling	None--Check valve restricts flow to RWT.	Valve Position	CRI	Operator error. Operator should detect position indicator light and close valve.
Sump Isolation Valve - 2	Inadvertently closed during recirculation cooling	Loss of suction to 1 pump header.	Valve Position	CRI	Operator error. Full flow is available through parallel leg. Operator should detect position indicator light and open valve.
Suction Line Between Containment Wall and Isolation Valve - 2	Rupture	None-Isolation inside containment available	None	None	

Abbreviations used in Table 6.3-3 are:

- CRI - Control Room Indication
- HPSI - High-Pressure Safety Injection
- LPSI - Low-Pressure Safety Injection
- SIAS - Safety Injection Actuation Signal
- RAS - Recirculation Actuation Signal

- RW - Refueling Water
- Refueling Water Tank
- Reactor Coolant System
- Safety Injection System

ARKANSAS NUCLEAR ONE
Unit 2

Table 6.3-4

PROCESS INSTRUMENTS AVAILABLE DURING POST-LOCA CONDITIONS

<u>Parameter</u>	<u>Type of Instrument (Control Room)</u>	<u>Number of Channels</u>	<u>Range</u>
<u>Primary System</u>			
Pressurizer Pressure	Indicator	4	0 - 3000 psia
Pressurizer Level	Indicator	2	0 - 100%
<u>Secondary System</u>			
Steam Generator Level	Indicator	4/S.G	0 - 100%
Steam Generator Pressure	Indicator	4/S.G	0 - 1200 psia
Emergency Feedwater Flow	Indicator	1/Line	0 - 750 gpm
Emergency Feedwater Regulating Valves	Indicator	1/Valve	0 - 100%
Emergency Feedwater Pump Discharge Pressure	Indicator	1/pump	0 - 2000 psia
<u>Safety Injection System</u>			
HPSI Flow	Indicator	4	0 - 350 gpm
HPSI Pump Discharge Pressure	Indicator	2	0 - 2500 psig
LPSI Shutdown Cooling Flow	Indicator	1	0 - 8000 gpm
LPSI Pump Discharge Temperature	Recorder	2	0 - 400 °F

ARKANSAS NUCLEAR ONE
Unit 2

Table 6.3-4 (continued)

<u>Parameter</u>	<u>Type of Instrument (Control Room)</u>	<u>Number of Channels</u>	<u>Range</u>
<u>Safety Injection System (cont)</u>			
LPSI Pump Discharge Pressure	Indicator	1	0 - 600 psig
RWT Level	Indicator	4	0 - 100%
RWT Isolation Valve Position	Indicating Lights	1 pair/valve	Open/closed
SI Tank Isolation Valve Position	Indicating Lights Alarm	1 pair/valve 1/valve	Open/closed Not Fully Open
Sump Isolation Valve Position	Indicating Lights	1 pair/valve	Open/closed
<u>Containment Systems</u>			
Containment Isolation Valve Position	Indicating Lights	1 pair/valve	Open/Closed
Containment Spray Header Pressure	Indicator	2	0 - 600 psig
Containment Spray Header Flow	Indicator	2	0 - 3500 gpm
Shutdown Cooling Heat Exchanger Outlet Temperature	Indicator	2	0 - 400 °F
Containment Pressure	Indicator	4	0 - 27 psia
Containment Pressure	Indicator/Recorder	2/1	0 - 225 psia
Containment Temperature	Recorder	3	0-350 °F
<u>Radiation Monitoring</u>			
Containment High Range Radiation	Indicator	2	1 to 10 ⁸ rad/hr
Auxiliary Building Area	Indicator/Recorder	19	10 ⁻⁴ to 10 R/hr

ARKANSAS NUCLEAR ONE
Unit 2

Table 6.3-4 (continued)

<u>Parameter</u>	<u>Type of Instrument (Control Room)</u>	<u>Number of Channels</u>	<u>Range</u>
<u>Hydrogen Removal/Containment</u>			
Atmosphere Monitor	Indicator	2	10 ¹ - to 10 ⁶ cpm
Containment Purge Monitor	Indicator	1	10 ¹ - 10 ⁶ cpm
Hydrogen Recombiner Power	Indicator	1/recombiner	0 - 100 kw
Hydrogen Concentration	Indicator/Recorder	2	0 - 10%
Service Water Supply/Return Valve Position	Indicating Lights	1 pair/valve	Open/Closed
Containment Cooling Unit Bypass Damper Position	Indicating Lights	1 pair/valve	Open/Closed
Containment Sump Level	Indicator	1	0 – 100% (0 - 56")
Containment Flood Level	Indicator/Recorder	2/1	0 - 144"/ 0 – 100%

ARKANSAS NUCLEAR ONE
Unit 2

Table 6.3-5

DELETED

(Historical Information)

Table 6.3-6

DELETED

(Historical Information)

Table 6.3-7

DELETED

(Historical Information)

Table 6.3-8

**LAG TIMES FOR
SAFETY INJECTION SYSTEM COMPONENTS**

	<u>Starts</u>	<u>Fully Open or up to Speed</u>	<u>Taken Credit For in Analyses</u>
Diesel Generator	0 ⁽¹⁾	15 seconds	N/A
Low Pressure Header Valves	15 sec	< 30 seconds	N/A
High Pressure Header Valves	15 sec	< 35 seconds	N/A
HPSI Pumps	25 sec	30 seconds	40 seconds
LPSI Pumps	30 sec	35 seconds	Not sooner than 50 seconds

⁽¹⁾ Time 0 is when SIAS is initiated

ARKANSAS NUCLEAR ONE
Unit 2

Table 6.3-9

**SYSTEM PARAMETERS AND INITIAL CONDITIONS
FOR THE LARGE BREAK LOCA ECCS PERFORMANCE EVALUATION**

<u>Quantity</u>	<u>Value</u>	<u>Units</u>
Reactor power level (102% of rated power)	3087	Mwt
Peak linear heat generation rate (PLHGR) of the hot rod	13.7	kw/ft
PLHGR of the average rod in assembly with the hot rod	12.91	kw/ft
Gap conductance at the PLHGR ⁽¹⁾	2474	Btu/hr-ft ² -°F
Fuel centerline temperature at the PLHGR ⁽¹⁾	3172.9	°F
Fuel average temperature at the PLHGR ⁽¹⁾	1967.2	°F
Hot rod gas pressure ⁽¹⁾	401.79	psia
Moderator temperature coefficient at initial density	+ 0.5x10 ⁻⁴	Δρ/°F
RCS flow rate	118.0x10 ⁶	lbm/hr
Core flow rate	113.86x10 ⁶	lbm/hr
RCS pressure	2200	psia
Cold leg temperature	540.0	°F
Hot leg temperature	607.1	°F
Plugged tubes per steam generator	10	%
Low pressurizer pressure SIAS setpoint	1400	psia
Safety injection tank pressure (min/max)	550/650	psia
Safety injection tank water volume (min/max)	1000/1600	ft ³
LPSI pump flow rate (min, 1 pump at 40 psia)	3544.2	gpm
HPSI pump flow rate (min, 1 pump at 40 psia)	767.28	gpm

(1) These quantities correspond to the rod average burnup of the hot rod that yields the highest peak cladding temperature.

ARKANSAS NUCLEAR ONE
Unit 2

Table 6.3-10

INTENTIONALLY LEFT BLANK

Table 6.3-11

**BREAK SPECTRUM
FOR THE LARGE BREAK LOCA ECCS PERFORMANCE EVALUATION**

<u>Break Size, Type, and Location</u>	<u>Abbreviation</u>	<u>Figure No.</u>
1.0 Double-Ended Guillotine Break in Pump Discharge Leg	1.0 DEG/PD	6.3-13
0.8 Double-Ended Guillotine Break in Pump Discharge Leg	0.8 DEG/PD	6.3-14
0.6 Double-Ended Guillotine Break in Pump Discharge Leg	0.6 DEG/PD	6.3-15
0.4 Double-Ended Guillotine Break in Pump Discharge Leg	0.4 DEG/PD	6.3-16
0.3 Double-Ended Guillotine Break in Pump Discharge Leg	0.3 DEG/PD	6.3-17

Table 6.3-12

**VARIABLES PLOTTED AS A FUNCTION OF TIME FOR EACH BREAK OF THE LARGE
BREAK LOCA ECCS PERFORMANCE EVALUATION**

<u>Variable</u>	<u>Figure⁽²⁾ Designation</u>
Core Power	a
Pressure in Center Hot Assembly Node	b
Leak Flow Rate	c
Hot Assembly Flow Rate (Below and Above Hot Spot)	d
Hot Assembly Quality	e
Containment Pressure	f
Mass Added to Core During Reflood	g
Peak Cladding Temperature	h ⁽¹⁾

(1) For the limiting break, the temperature of the rupture node is also shown.

(2) Figures 6.3-13 through 6.3-17

ARKANSAS NUCLEAR ONE
Unit 2

Table 6.3-13

**VARIABLES PLOTTED AS A FUNCTION OF TIME FOR THE LIMITING BREAK OF THE
LARGE BREAK LOCA ECCS PERFORMANCE EVALUATION**

<u>Variable</u>	<u>Figure⁽¹⁾ Designation</u>
Mid Annulus Flow Rate	i
Quality Above and Below the Core	j
Core Pressure Drop	k
Safety Injection Flow Rate into Intact Discharge Legs	l
Water Level in Downcomer During Reflood	m
Hot Spot Gap Conductance	n
Maximum Local Cladding Oxidation Percentage	o
Fuel Centerline, Fuel Average, Cladding and Coolant Temperature at the Hot Spot	p
Hot Spot Heat Transfer Coefficient	q
Hot Pin Pressure	r

(1) Figures 6.3-13 through 6.3-17

ARKANSAS NUCLEAR ONE
Unit 2

Table 6.3-14

**TIMES OF INTEREST
FOR THE LARGE BREAK LOCA ECCS PERFORMANCE EVALUATION
(Seconds after Break)**

<u>Break</u>	<u>SI Tanks On</u>	<u>End of Bypass</u>	<u>Start of Reflood</u>	<u>SI Tanks Empty</u>	<u>Hot Rod Rupture</u>
1.0 DEG/PD	9.4	16.6	27.6	78.8	60.1
0.8 DEG/PD	10.3	17.5	28.4	79.7	52.8
0.6 DEG/PD	12.0	19.2	30.1	81.4	47.8
0.4 DEG/PD	15.1	22.8	33.5	85.1	76.7
0.3 DEG/PD	18.6	27.0	37.6	89.4	127.7

Table 6.3-15

**PEAK CLADDING TEMPERATURES AND OXIDATION PERCENTAGES
FOR THE LARGE BREAK LOCA ECCS PERFORMANCE EVALUATION**

<u>Break</u>	<u>Peak Cladding Temperature (°F)</u>	<u>Maximum Cladding Oxidation (%)</u>	<u>Maximum Core-Wide Oxidation (%)</u>
1.0 DEG/PD	2034	7.3	< 1
0.8 DEG/PD	2085	9.2	< 1
0.6 DEG/PD	2107	9.2	< 1
0.4 DEG/PD	2144	12.6	< 1
0.3 DEG/PD	1987	5.9	< 1

Note: These results reflect the Analysis of Record and do not include errors as reported annually in accordance with 10 CFR 50.46.

ARKANSAS NUCLEAR ONE
Unit 2

Table 6.3-16

**HIGH PRESSURE SAFETY INJECTION PUMP
MINIMUM DELIVERED FLOW TO RCS
(ASSUMING ONE EMERGENCY DIESEL GENERATOR FAILED)**

<u>RCS Pressure, psia</u>	<u>Flow Rate, gpm</u>
14.7	738.7
22	736.6
31	733.3
35	732.2
46	729.0
191	680.4
327	631.8
456	583.2
577	534.6
692	486.0
800	437.4
899	388.8
990	340.2
1071	291.6
1142	237.6
1201	172.8
1248	102.6
1269	54.0
1281	0.0

Notes:

1. The flow is assumed to be split equally to each of the four discharge legs.
2. The flow to the broken discharge leg is assumed to spill out the break.

ARKANSAS NUCLEAR ONE
Unit 2

Table 6.3-17

**SYSTEM PARAMETERS AND INITIAL CONDITIONS
FOR THE SMALL BREAK LOCA ECCS PERFORMANCE EVALUATION**

<u>Quantity</u>	<u>Value</u>	<u>Units</u>
Reactor power level (102% of rated power)	3087	MWt
Peak linear heat generation rate (PLHGR)	13.7	kW/ft
Axial shape index	-0.3	
Gap conductance at PLHGR ⁽¹⁾	1853	BTU/hr-ft ² -°F
Fuel centerline temperature at PLHGR ⁽¹⁾	3303	°F
Fuel average temperature at PLHGR ⁽¹⁾	2070	°F
Hot rod gas pressure ⁽¹⁾	710	psia
Moderator temperature coefficient at initial density	0.0x10 ⁻⁴	Δρ/°F
RCS flow rate	117.4x10 ⁶	lbm/hr
Core flow rate	113.3x10 ⁶	lbm/hr
RCS pressure	2200	psia
Cold leg temperature	556.7	°F
Hot leg temperature	621.1	°F
Plugged tubes per steam generator	10	%
MSSV first bank opening pressure	1130.9	psia
Low pressurizer pressure reactor trip setpoint	1400	psia
Low pressurizer pressure SIAS setpoint	1400	psia
HPSI Flow Rate	Table 6.3-16	gpm
Safety injection tank pressure	500	psia

Note (1) These quantities correspond to the rod average burnup of the hot rod that yields the maximum initial stored energy.

ARKANSAS NUCLEAR ONE
Unit 2

Table 6.3-18

**BREAK SPECTRUM
FOR THE SMALL BREAK LOCA ECCS PERFORMANCE EVALUATION**

<u>Break Size and Location</u>	<u>Abbreviation</u>	<u>Figure No.</u>
0.05 ft ² Break in Pump Discharge Leg	0.05 ft ² /PD	6.3-23
0.04 ft ² Break in Pump Discharge Leg	0.04 ft ² /PD	6.3-24
0.03 ft ² Break in Pump Discharge Leg	0.03 ft ² /PD	6.3-25

Table 6.3-19

**PEAK CLADDING TEMPERATURES AND OXIDATION PERCENTAGES
FOR THE SMALL BREAK LOCA ECCS PERFORMANCE EVALUATION**

<u>Break</u>	<u>Peak Cladding Temperature (°F)^(a)</u>	<u>Maximum Cladding Oxidation (%)^(b)</u>	<u>Hot Rod Oxidation (%)^(c)</u>
0.05 ft ² /PD	1992	13.18	< 0.73
0.04 ft ² /PD	2111	16.77	< 0.88
0.03 ft ² /PD	1971	12.42	< 0.69

(a) Acceptance criterion is 2200 °F.

(b) Acceptance criterion is 17%.

(c) Acceptance criterion is 1.0% core-wide cladding oxidation. Rod-average oxidation of the hot rod is given as a conservative representation of the core-wide cladding oxidation.

Note: These results reflect the analysis of record and do not include errors as reported annually in accordance with 10 CFR 50.46.

ARKANSAS NUCLEAR ONE
Unit 2

Table 6.3-20

**TIMES OF INTEREST
FOR THE SMALL BREAK LOCA ECCS PERFORMANCE EVALUATION
(Seconds after Break)**

<u>Break</u>	<u>HPSI Flow Delivered to RCS</u>	<u>LPSI Flow Delivered to RCS</u>	<u>SIT Flow Delivered to RCS</u>	<u>Peak Cladding Temperature Occurs</u>
0.05 ft ² /PD	190	(a)	1755	1625
0.04 ft ² /PD	224	(a)	(b)	1852
0.03 ft ² /PD	280	(a)	(b)	2273

(a) Calculation completed before LPSI flow delivery to RCS begins.

(b) Calculation completed before SIT injection begins.

Table 6.3-21

**LARGE AND SMALL BREAK LOCA
COMPARISON OF RESULTS**

	<u>Discharge Leg Break</u>	
	<u>Small</u>	<u>Large</u>
	0.04 ft ² /PD	0.4 DEG/PD*
Peak Cladding Temperature, °F	2111	2144
Maximum Cladding Oxidation, %	16.77	12.6
Maximum Core Wide Oxidation, %	< 0.88	< 1
Peak Linear Heat Generation Rate, kw/ft	13.7	13.7

* 0.4 DEG/PD = 0.4 Double Ended Guillotine at Pump Discharge.

ARKANSAS NUCLEAR ONE
Unit 2

Table 6.3-22

VALVE POSITION

<u>Valve Number</u>	<u>Power Operation</u>	<u>Shutdown Cooling</u>	<u>ECCS Inject. Initial</u>	<u>ECCS Inject. Recirculation</u>	<u>ECCS Long Term Cooling</u>
2CV-5630-1	O	O(1)	O	C	C
2CV-5631-2	O	O(1)	O	C	C
2CV-5647-1	O	O(1)	O	O	O
2CV-5648-2	O	O(1)	O	O	O
2CV-5649-1	C	C	C	O	O
2CV-5650-2	C	C	C	O	O
2CV-5628-2	O	O	O	C	C
2CV-5123-1	O	C	O	C	C
2CV-5124-1	O	C	O	C	C
2CV-5126-1	O	O(1)	O	C	C
2CV-5127-1	O	O(1)	O	C	C
2CV-5128-1	O	O(1)	O	C	C
2CV-5091	O	O*	O	O	O
2CV-5093	C	O*	C	C	C
2CV-5103-1	O	O	O	O	C
2CV-5104-2	O	O	O	O	C
2CV-5101-1	C	C	C	C	O
2CV-5102-2	C	C	C	C	O
2CV-5015-1	C	C	O	O	O
2CV-5016-2	C	C	O	O	O
2CV-5017-1	C	O	O	O	O
2CV-5055-1	C	C	O	O	O
2CV-5056-2	C	C	O	O	O
2CV-5057-2	C	O	O	O	O
2CV-5075-1	C	C	O	O	O
2CV-5076-2	C	C	O	O	O
2CV-5077-2	C	O	O	O	O
2CV-5035-1	C	C	O	O	O
2CV-5036-2	C	C	O	O	O
2CV-5037-1	C	O	O	O	O
2CV-4740-2	C	C(2)	C	C	C
2CV-4698-1	C	C(2)	C	C	C
2CV-5001-1	C	C	C	C	C
2CV-5021-1	C	C	C	C	C
2CV-5041-2	C	C	C	C	C
2CV-5003-1	O	C	O	O	O
2CV-5023-1	O	C	O	O	O
2CV-5043-2	O	C	O	O	O
2CV-5063-2	O	C	O	O	O
2CV-5084-1	C	O	C	C	C
2CV-5086-2	C	O	C	C	C
2CV-5038-1	C	O	C	C	C
2CV-5061-2	C	C	C	C	C
2BS-2A	O	O	O	O	O
2BS-2B	O	O	O	O	O

ARKANSAS NUCLEAR ONE
Unit 2

Table 6.3-22 (continued)

<u>Valve Number</u>	<u>Power Operation</u>	<u>Shutdown Cooling</u>	<u>ECCS Inject. Initial</u>	<u>ECCS Inject. Recirculation</u>	<u>ECCS Long Term Cooling</u>
2BS-25	C	C	C	C	C
2BS-26	O	O	O	O	O
2SI-1A	C	O	C	C	C
2SI-1B	C	O	C	C	C
2SI-2A	O	C	O	O	O
2SI-2B	O	C	O	O	O
2SI-4A	C	O(3)	C	C	C
2SI-4B	C	O(3)	C	C	C
2SI-5A	C	O	C	C	C
2SI-5B	C	O	C	C	C
2SI-6	O	O	O	O	O
2SI-18	C	C	C	C	C
2SI-17	C	C	C	C	C
2SI-20	C	C	C	C	C
2SI-29A	O	O(1)	O	O	O
2SI-29B	O	O(1)	O	O	O
2SI-32	C	C	C	C	C
2SI-33	C	C	C	C	C
2CVC-115	C	C	C	C	C
2SI-9A (4)	O	O	O	O	O
2SI-9B (4)	C	C	C	C	C
2SI-11A (4)	O	O	O	O	O
2SI-11B (4)	C	C	C	C	C
2SI-5091-1	O	O*	O	O	O
2SI-5091-2	O	O*	O	O	O
2SI-5091-3	O	C*	O	O	O
2SI-5093-1	O	O*	O	O	O
2SI-5093-2	O	O*	O	O	O
2SI-5093-3	C	O*	C	C	C
2SI-8A	O	O	O	O	O
2SI-8B	O	O	O	O	O

'O' – open 'C' – Closed *Modulating (open, closed or throttled)

- (1) May be closed in Mode 5 or 6 when ECCS operability is not required by Technical Specifications
- (2) May be open if pressurizer bubble is not maintained or if the RCS is depressurized to establish once through cooling. 2CV-4740-2 is open when LTOP relief is in service.
- (3) Closed for the heat exchanger not in service.
- (4) Alternate position if 2P-89C aligned to green train.

ARKANSAS NUCLEAR ONE
Unit 2

Table 6.3-23

**VARIABLES PLOTTED AS A FUNCTION OF TIME FOR EACH BREAK OF
THE SMALL BREAK LOCA ECCS PERFORMANCE EVALUATION**

<u>Variable</u>	<u>Figure⁽¹⁾ Designation</u>
Core Power	a
Inner Vessel Pressure	b
Break Flow Rate	c
Inner Vessel Inlet Flow Rate	d
Inner Vessel Two-Phase Mixture Level	e
Heat Transfer Coefficient at Hot Spot	f
Coolant Temperature at Hot Spot	g
Cladding Temperature at Hot Spot	h

(1) Figures 6.3-23 through 6.3-25

Table 6.3-24

Through

Table 6.3-27

DELETED

ARKANSAS NUCLEAR ONE
Unit 2

Table 6.3-28

**SYSTEM PARAMETERS AND INITIAL CONDITIONS
FOR THE POST-LOCA BORIC ACID PRECIPITATION ANALYSIS**

<u>Quantity</u>	<u>Value</u>	<u>Units</u>
Reactor power level (102% of rated power)	3087	MWt
RCS liquid mass (maximum)	493,000	lbm
RCS boron concentration (maximum)	2000	ppm
Boric acid makeup tanks		
liquid volume, total (maximum)	23,400	gal
Boric acid concentration (maximum)	3.5	wt%
Liquid temperature (minimum)	53	°F
Refueling water tank		
Liquid volume (maximum)	503,300	gal
Boron concentration (maximum)	3000	ppm
Liquid temperature (minimum)	38	°F
Safety injection tanks		
number (maximum)	4	--
Liquid volume per tank (maximum)	1600	ft ³
boron concentration (maximum)	3000	ppm
Liquid temperature (minimum)	40	°F
pressure (maximum)	700	Psia
Charging pumps		
number (maximum)	3	--
Flow rate per pump (maximum)	46	gpm
Flow rates for emptying the RWT		
HPSI pump flow rate (minimum)	724	gpm
LPSI pump flow rate (minimum)	3222	gpm
CS pump flow rate (minimum)	1875	gpm

Figures 6.2-1 – 6.2-2 Deleted
(See Reference 88)

SAR FIGURE NOS. 6.2-1

AMENDMENT 20

ARKANSAS NUCLEAR ONE
UNIT 2
RUSSELLVILLE, ARKANSAS



SCALE:	NONE
DRAWN:	ENERGY
DESIGN:	ENERGY
CAD NO:	N/A

DRAWING NO

SHEET

REV.

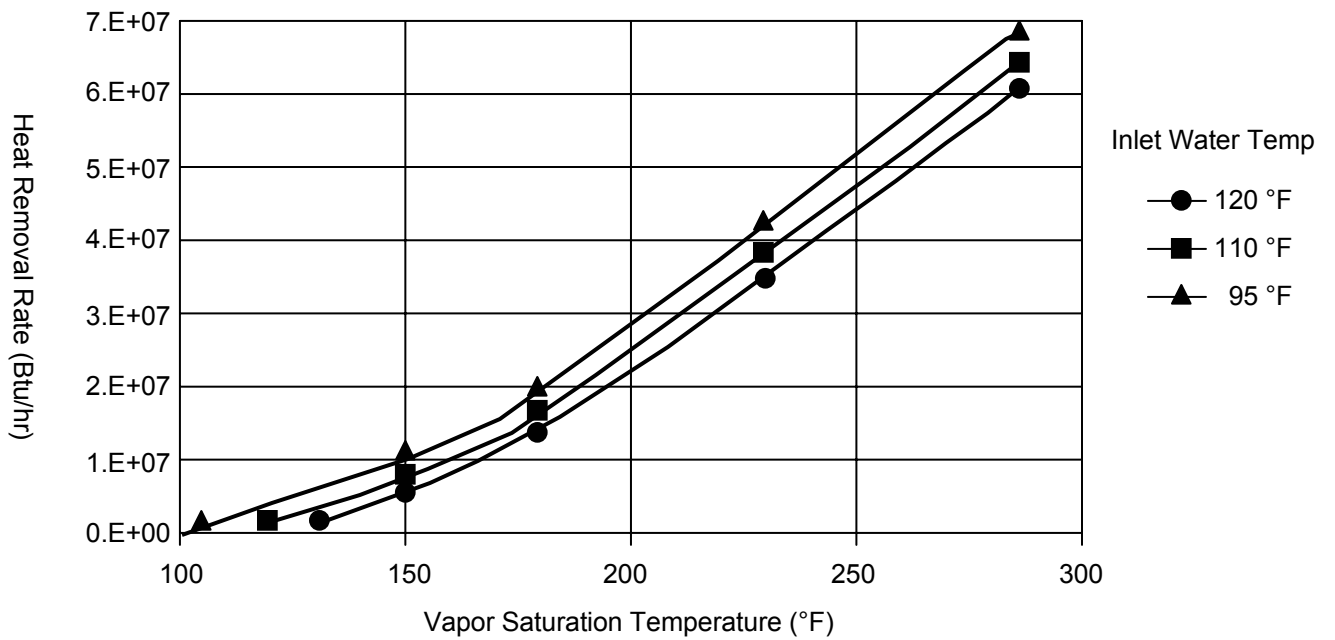

SAR FIGURE NO. 6.2-3A

AMENDMENT 20

ARKANSAS NUCLEAR ONE
UNIT 2
RUSSELLVILLE, ARKANSAS



SCALE:	NONE
DRAWN:	ENERGY
DESIGN:	ENERGY
CAD NO:	N/A

CONTAINMENT AIR COOLER HEAT CAPACITY PER TRAIN
AT DIFFERENT SERVICE WATER TEMPERATURES

DRAWING NO

SHEET

REV.

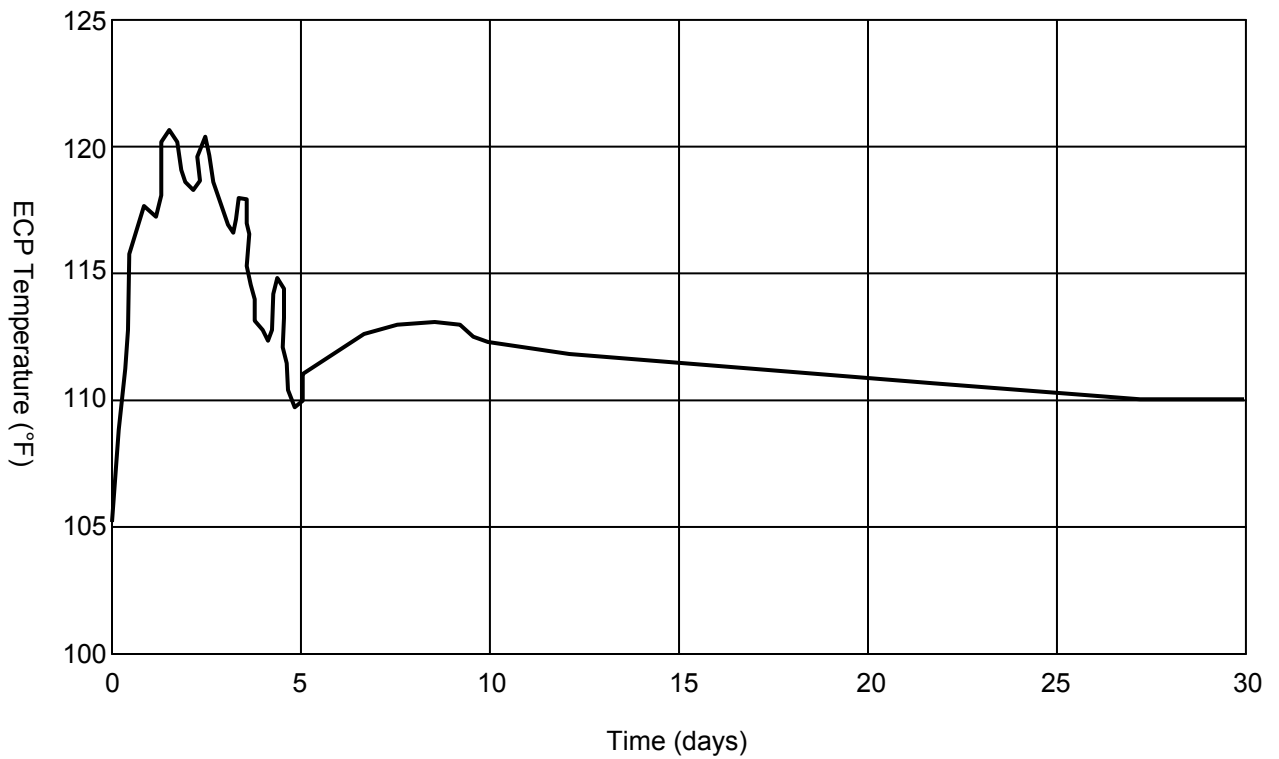

SAR FIGURE NO. 6.2-3B

AMENDMENT 24

ARKANSAS NUCLEAR ONE
 UNIT 2
 RUSSELLVILLE, ARKANSAS



SCALE:	NONE
DRAWN:	ENERGY
DESIGN:	ENERGY
CAD NO:	N/A

EMERGENCY COOLING POND TEMPERATURE VS TIME
 (ASSUMED SOURCE FOR CONTAINMENT PEAK
 PRESSURE ANALYSIS)

DRAWING NO	SHEET	REV.

V1 = 126 FT³
 V2 = 128 FT³
 V3 = 86 FT³
 V4 = V11 = 81 FT³ NOZZLE REGION
 V5 = 133 FT³ EL. 377'-6"
 V6 = 131 FT³ TO
 V7 = 95 FT³ EL. 365'-9"
 V8 = 91 FT³
 V9 = 122 FT³
 V10 = 132 FT³
 V12 = 99 FT³

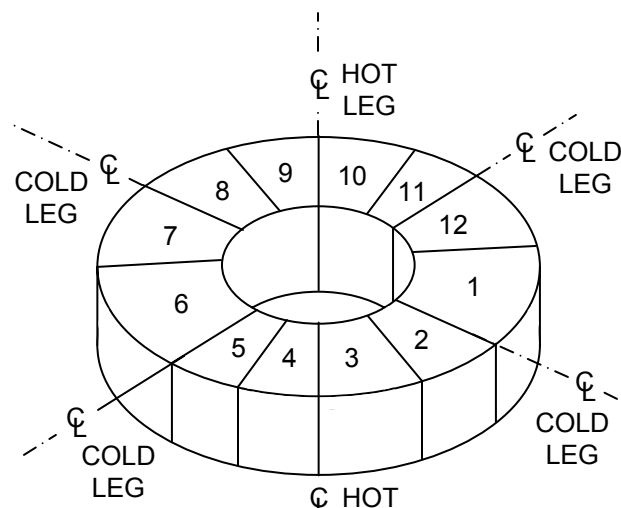

MIDDLE REGION
 EL. 364'-6"
 TO
 EL. 345'-1"
 V13 = V14 = V15 = 1156 FT³

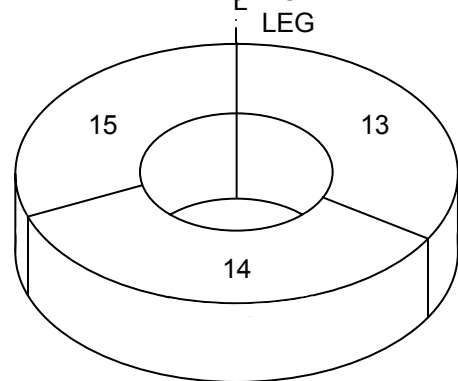

LOWER REGION
 EL. 345'-1"
 TO
 EL. 336'-6"
 V16 = 1413 FT³

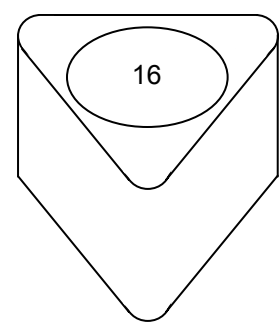

V17 = 1.77 X 10⁶ FT³

17 (CONTAINMENT)

SAR FIGURE NO. 6.2-3C

AMENDMENT 20

ARKANSAS NUCLEAR ONE
 UNIT 2
 RUSSELLVILLE, ARKANSAS



SCALE:	NONE
DRAWN:	ENERGY
DESIGN:	ENERGY
CAD NO:	N/A

RPV CAVITY MODEL FOR CIRCUMFERENTIAL BREAKS	DRAWING NO	SHEET	REV.

V8 = 14000 FT³
 V9 = 7450 FT³

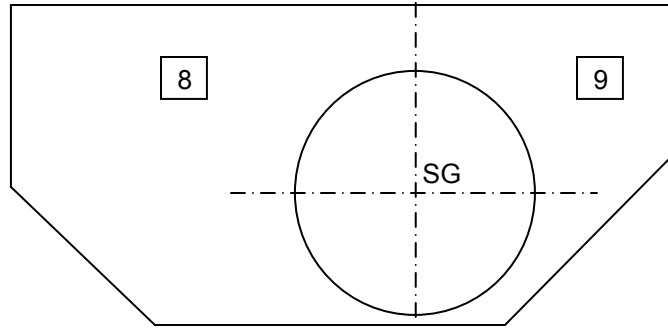

UPPER REGION
 EL. 396'-0"
 TO
 EL. 426'-6"

V1 = 5350 FT³
 V2 = 3650 FT³
 V3 = 1700 FT³
 V4 = 9400 FT³
 V5 = 4050 FT³

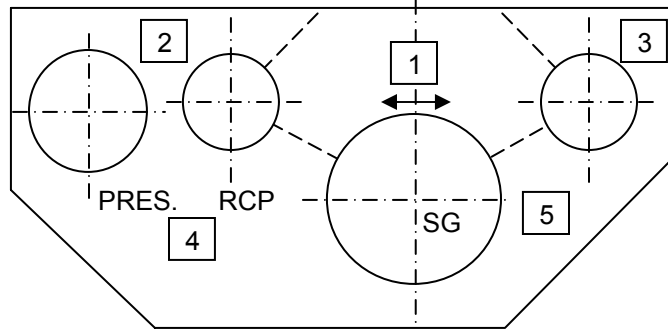

MIDDLE REGION
 EL. 366'-86"
 TO
 EL. 396'-0"

V6 = 19900 FT³
 V7 = 11650 FT³

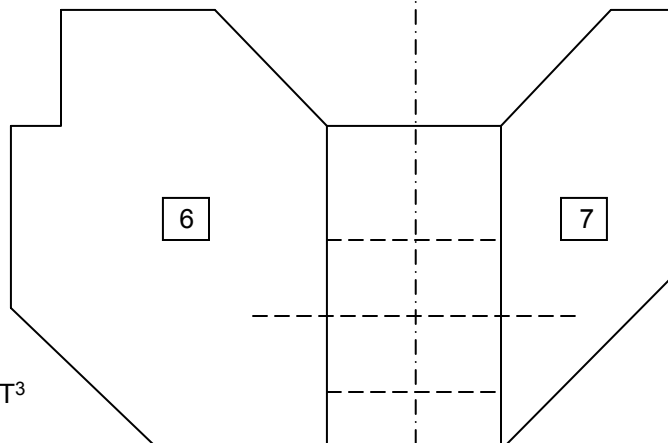

LOWER REGION
 EL. 336'-6"
 TO
 EL. 366'-8"

V10 = 1.7 X 10⁶ FT³

(10) CONTAINMENT

SAR FIGURE NO. 6.2-3D

AMENDMENT 20

ARKANSAS NUCLEAR ONE
 UNIT 2
 RUSSELLVILLE, ARKANSAS



SCALE:	NONE
DRAWN:	ENERGY
DESIGN:	ENERGY
CAD NO:	N/A

STEAM GENERATOR CAVITY MODEL FOR
 HOT LEG CIRCUMFERENTIAL BREAKS

DRAWING NO

SHEET

REV.

V9 = 14000 FT³
 V10 = 7450 FT³

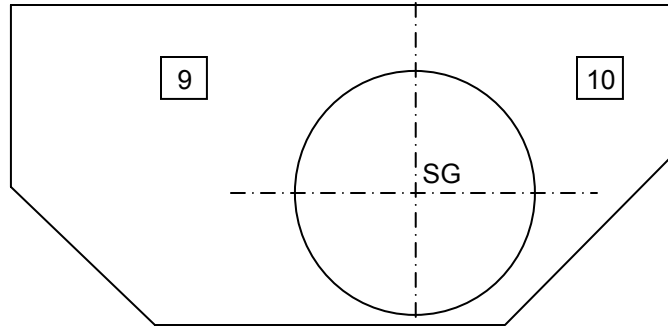

UPPER REGION
 EL. 396'-0"
 TO
 EL. 426'-6"

V1 = 2675 FT³
 V2 = 1700 FT³
 V3 = 2675 FT³
 V4 = 3650 FT³
 V5 = 4050 FT³
 V6 = 9400 FT³

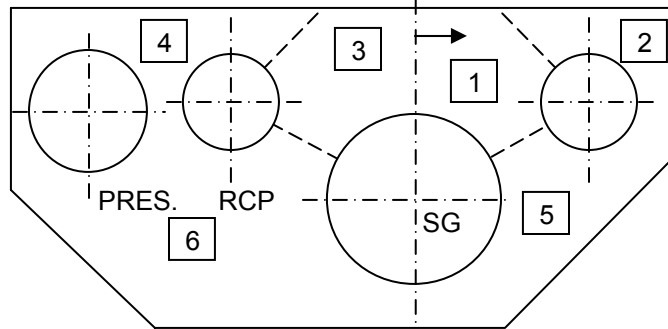

MIDDLE REGION
 EL. 366'-8"
 TO
 EL. 396'-0"

V7 = 19900 FT³
 V8 = 11650 FT³

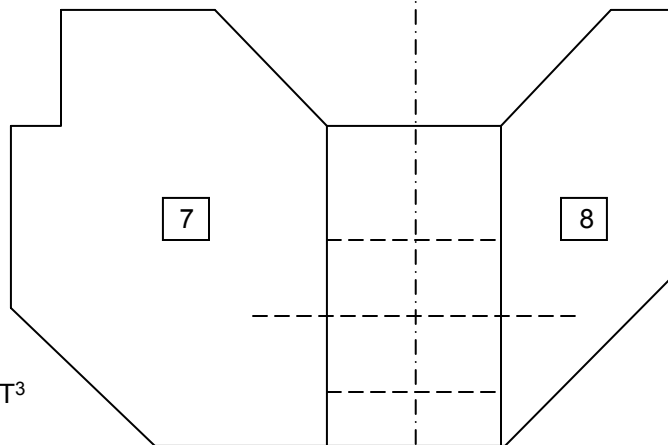

LOWER REGION
 EL. 336'-6"
 TO
 EL. 366'-8"

V11 = 1.7 X 10⁶ FT³

(11) CONTAINMENT

SAR FIGURE NO. 6.2-3E

AMENDMENT 20

ARKANSAS NUCLEAR ONE
 UNIT 2
 RUSSELLVILLE, ARKANSAS



SCALE:	NONE
DRAWN:	ENERGY
DESIGN:	ENERGY
CAD NO:	N/A

STEAM GENERATOR CAVITY MODEL FOR
 HOT LEG SLOT BREAKS

DRAWING NO

SHEET

REV.

V8 = 14000 FT³
 V9 = 7450 FT³

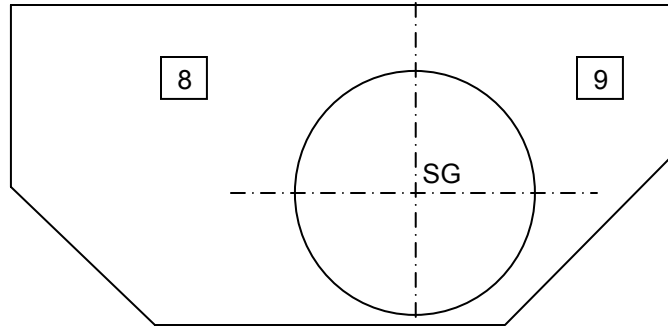

UPPER REGION
 EL. 396'-0"
 TO
 EL. 426'-6"

V1 = 5350 FT³
 V2 = 4050 FT³
 V3 = 1700 FT³
 V4 = 3650 FT³
 V5 = 9400 FT³

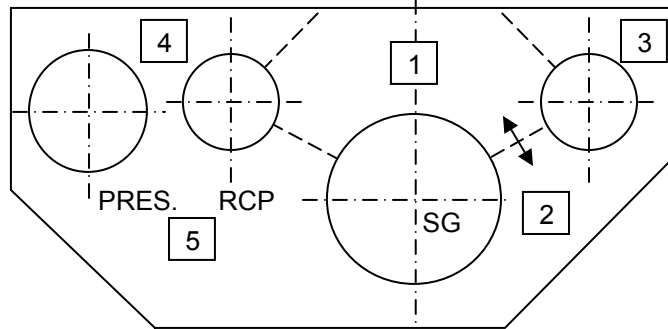

MIDDLE REGION
 EL. 366'-86"
 TO
 EL. 396'-0"

V6 = 19900 FT³
 V7 = 11650 FT³

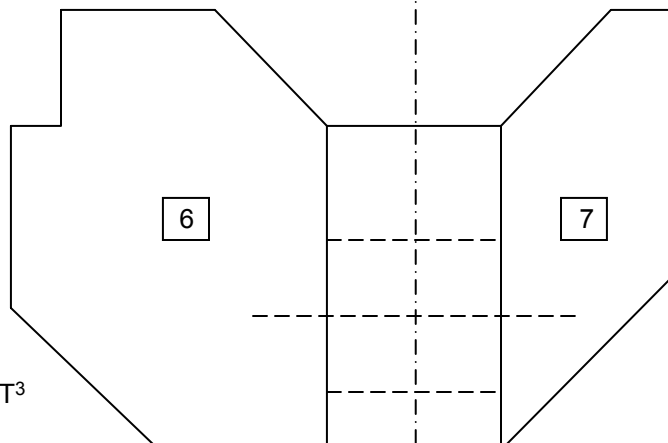

LOWER REGION
 EL. 336'-6"
 TO
 EL. 366'-8"

V10 = 1.7 X 10⁶ FT³

(10) CONTAINMENT

SAR FIGURE NO. 6.2-3F

AMENDMENT 20

ARKANSAS NUCLEAR ONE
 UNIT 2
 RUSSELLVILLE, ARKANSAS



SCALE:	NONE
DRAWN:	ENERGY
DESIGN:	ENERGY
CAD NO:	N/A

STEAM GENERATOR CAVITY MODEL FOR COLD
 LEG PUMP SUCTION CIRCUMFERENTIAL BREAKS

DRAWING NO

SHEET

REV.

Deleted

SAR FIGURE NO. 6.2-3G

AMENDMENT 20

ARKANSAS NUCLEAR ONE
UNIT 2
RUSSELLVILLE, ARKANSAS



SCALE:	NONE
DRAWN:	ENERGY
DESIGN:	ENERGY
CAD NO:	N/A

STEAM GENERATOR CAVITY MODEL FOR COLD LEG
PUMP SUCTION SLOT BREAKS (EAST ORIENTATION)

DRAWING NO

SHEET

REV.

V9 = 14000 FT³
 V10 = 7450 FT³

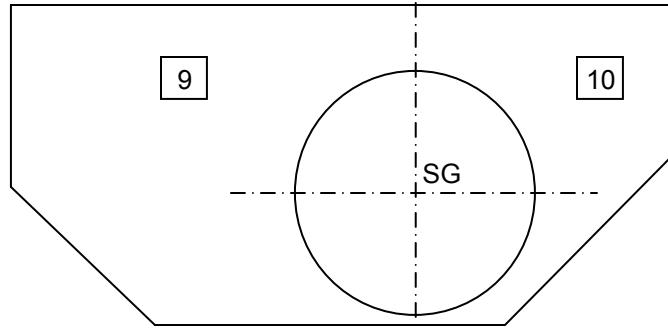

UPPER REGION
 EL. 396'-0"
 TO
 EL. 426'-6"

V1 = 2675 FT³
 V2 = 1700 FT³
 V3 = 2675 FT³
 V4 = 3650 FT³
 V5 = 4050 FT³
 V6 = 9400 FT³

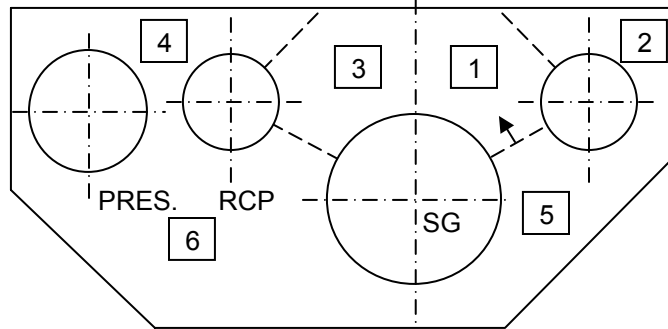

MIDDLE REGION
 EL. 366'-8"
 TO
 EL. 396'-0"

V7 = 19900 FT³
 V8 = 11650 FT³

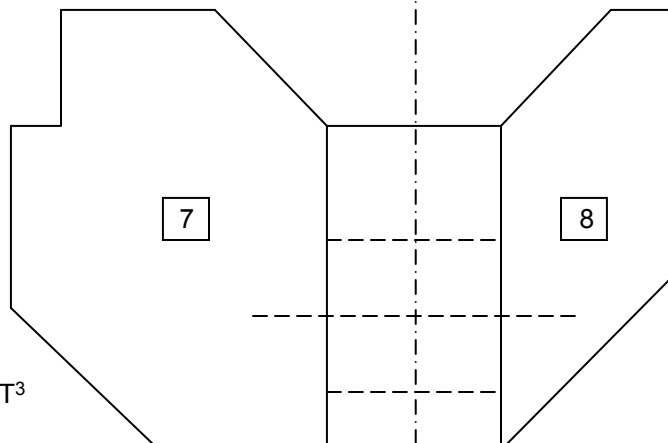

LOWER REGION
 EL. 336'-6"
 TO
 EL. 366'-8"

V11 = 1.7 X 10⁶ FT³

(11) CONTAINMENT

SAR FIGURE NO. 6.2-3H

AMENDMENT 20

ARKANSAS NUCLEAR ONE
 UNIT 2
 RUSSELLVILLE, ARKANSAS



SCALE:	NONE
DRAWN:	ENERGY
DESIGN:	ENERGY
CAD NO:	N/A

STEAM GENERATOR CAVITY MODEL FOR COLD LEG
 PUMP SUCTION SLOT BREAKS (WEST ORIENTATION)

DRAWING NO

SHEET

REV.

V8 = 14000 FT³
 V9 = 7450 FT³

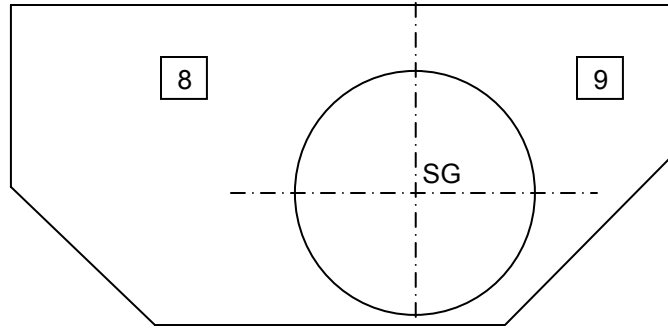

UPPER REGION
 EL. 396'-0"
 TO
 EL. 426'-6"

V1 = 5350 FT³
 V2 = 3650 FT³
 V3 = 1700 FT³
 V4 = 9400 FT³
 V5 = 4050 FT³

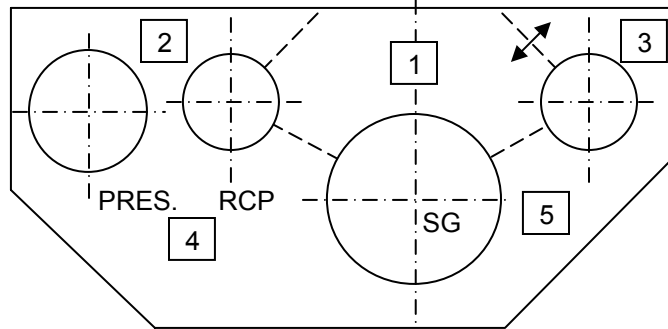

MIDDLE REGION
 EL. 366'-86"
 TO
 EL. 396'-0"

V6 = 19900 FT³
 V7 = 11650 FT³

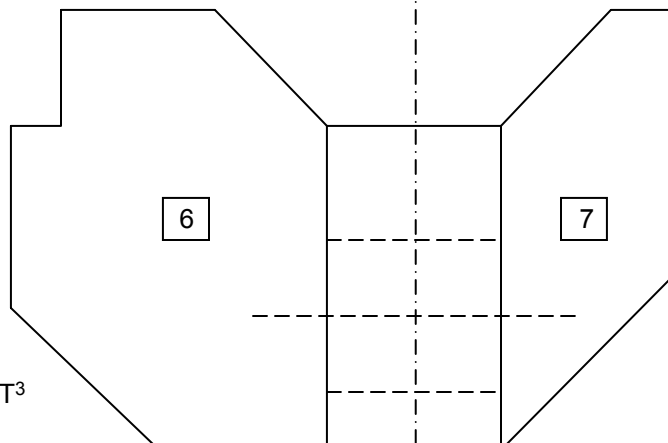

LOWER REGION
 EL. 336'-6"
 TO
 EL. 366'-8"

V10 = 1.7 X 10⁶ FT³

(10) CONTAINMENT

SAR FIGURE NO. 6.2-3I

AMENDMENT 20

ARKANSAS NUCLEAR ONE
 UNIT 2
 RUSSELLVILLE, ARKANSAS



SCALE:	NONE
DRAWN:	ENERGY
DESIGN:	ENERGY
CAD NO:	N/A

STEAM GENERATOR CAVITY MODEL FOR COLD LEG
 PUMP DISCHARGE CIRCUMFERENTIAL BREAKS

DRAWING NO

SHEET

REV.

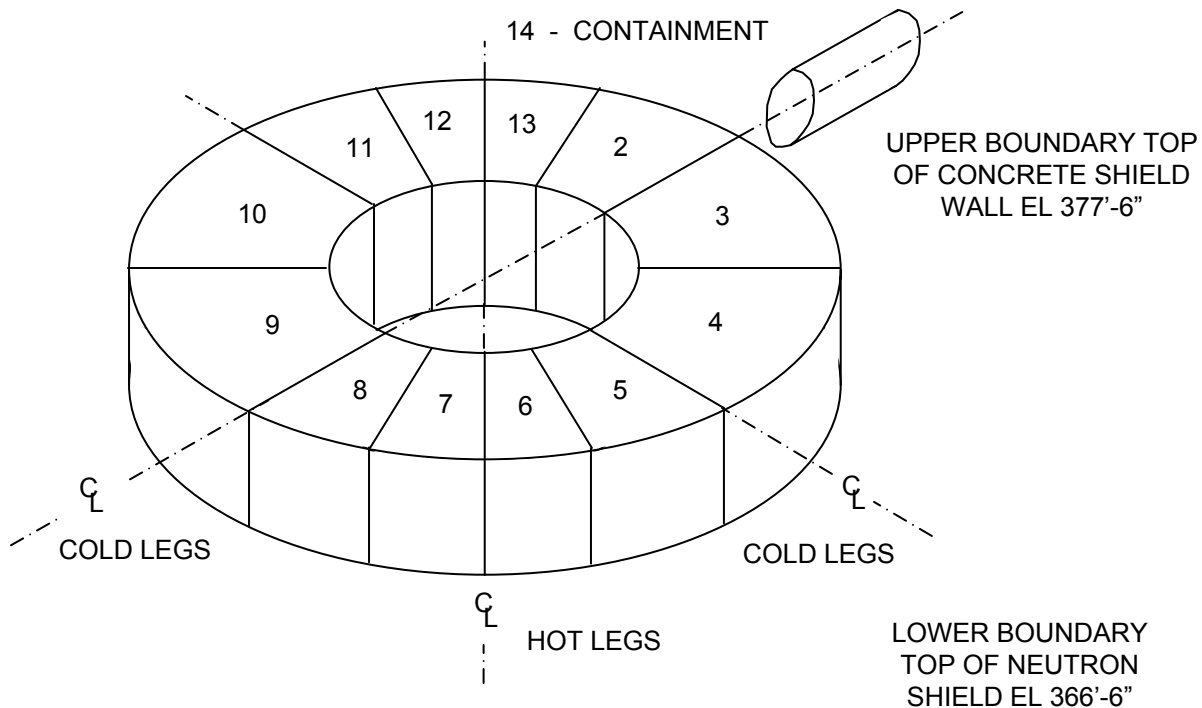

SAR FIGURE NO. 6.2-3J

AMENDMENT 20

ARKANSAS NUCLEAR ONE
 UNIT 2
 RUSSELLVILLE, ARKANSAS



SCALE:	NONE
DRAWN:	ENERGY
DESIGN:	ENERGY
CAD NO:	N/A

REACTOR CAVITY MODEL FOR COLD LEG
 SLOT BREAK SENSITIVITY STUDY

DRAWING NO

SHEET

REV.

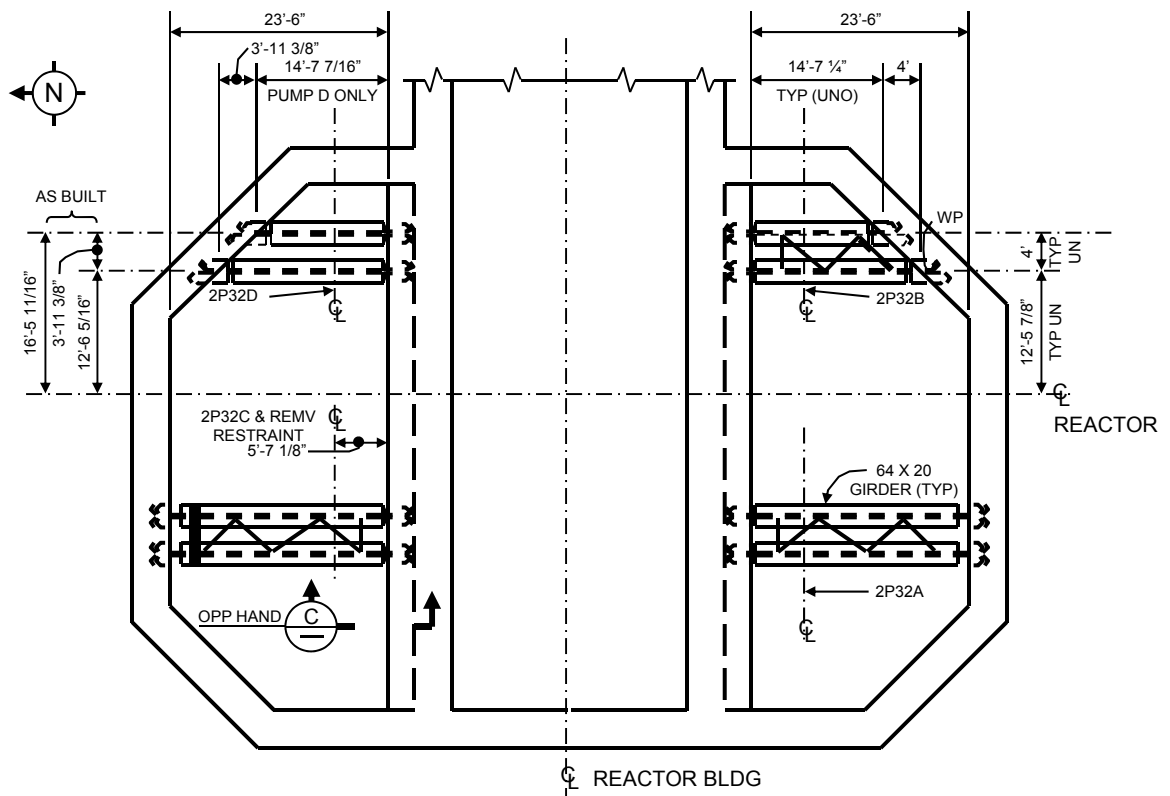

PLAN @ ELEVATION 403'-0"

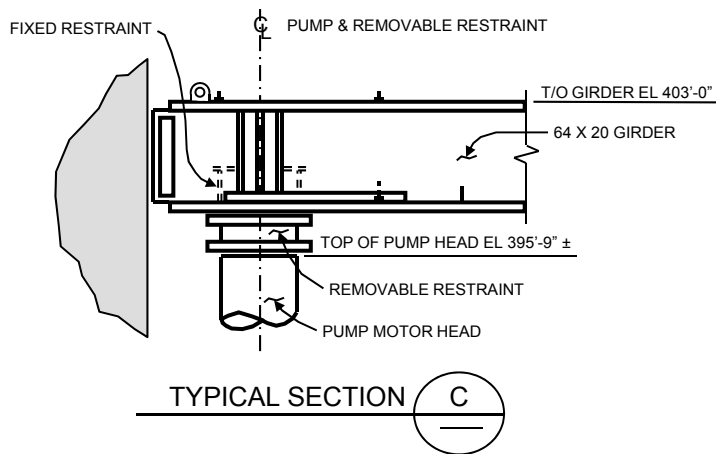

Note: 2P-32A, 2P32B, & 2P-32D Removable Restraints have been permanently removed. ST6x13.5 cross-bracing and welded plate fixed restraints on the WRG for 2P-32B & 2P-32D have been permanently removed.

SAR FIGURE NO. 6.2-3K

AMENDMENT 26

ARKANSAS NUCLEAR ONE
UNIT 2
RUSSELLVILLE, ARKANSAS



SCALE: NONE
DRAWN: ENTERGY
DESIGN: ENTERGY
CAD NO: N/A

REACTOR COOLANT PUMP RESTRAINT
BEAMS

DRAWING NO

SHEET

REV.

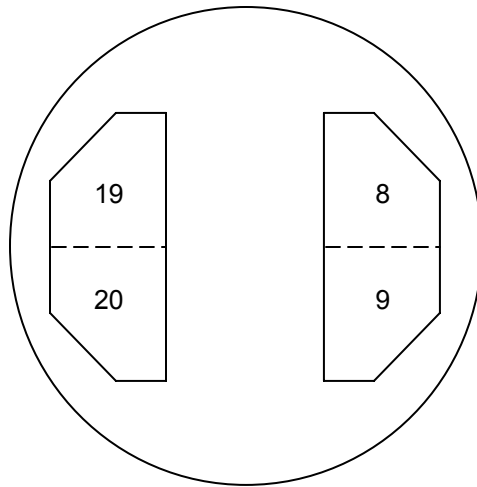

PLAN VIEW
 UPPER REGION
 EL. 397'-6"
 TO
 EL. 426'-6"

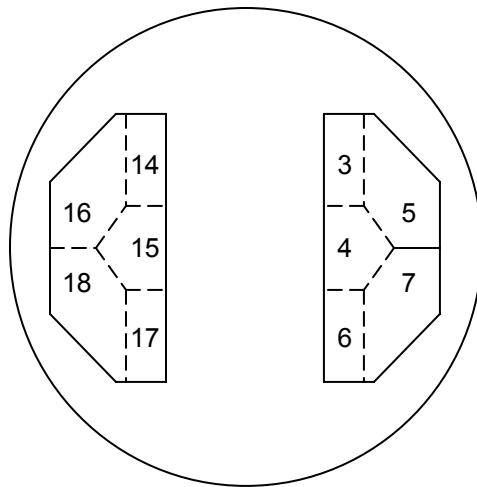

PLAN VIEW
 MIDDLE REGION
 EL. 366'-8"
 TO
 EL. 397'-6"

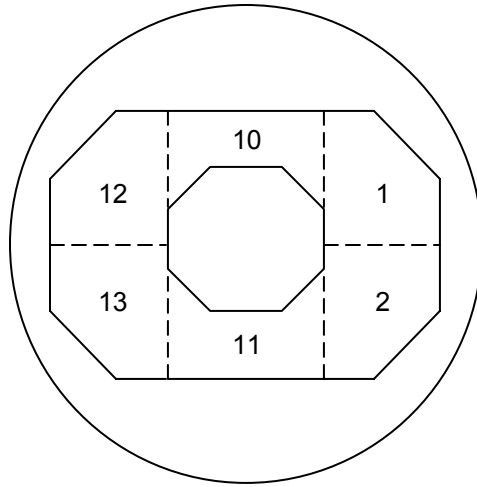

PLAN VIEW
 LOWER REGION
 EL. 336'-6"
 TO
 EL. 366'-8"

SAR FIGURE NO. 6.2-3L

AMENDMENT 20

ARKANSAS NUCLEAR ONE
 UNIT 2
 RUSSELLVILLE, ARKANSAS



SCALE:	NONE
DRAWN:	ENERGY
DESIGN:	ENERGY
CAD NO:	N/A

STEAM GENERATOR CAVITY MODEL FOR
 COMPARE CODE ANALYSIS

DRAWING NO

SHEET

REV.

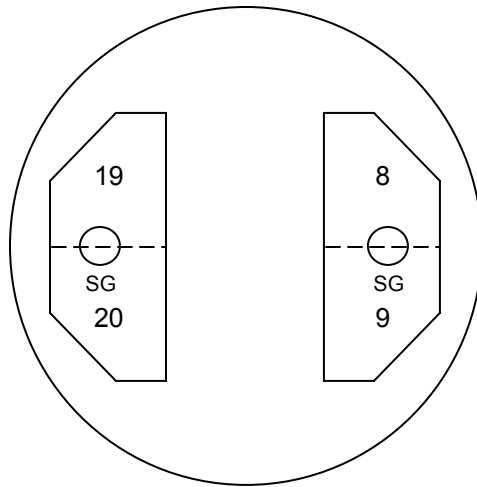

PLAN VIEW
 UPPER REGION
 EL. 397'-6"
 TO
 EL. 426'-6"

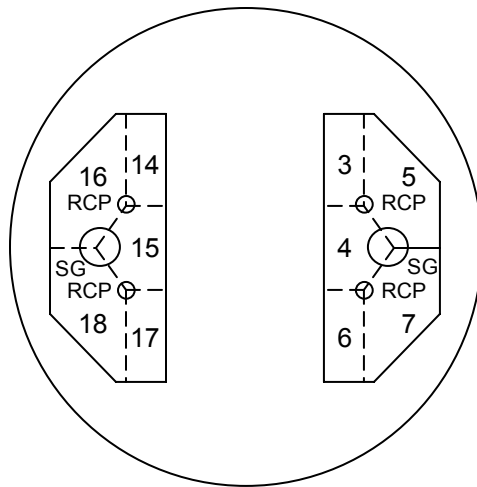

PLAN VIEW
 MIDDLE REGION
 EL. 366'-8"
 TO
 EL. 397'-6"

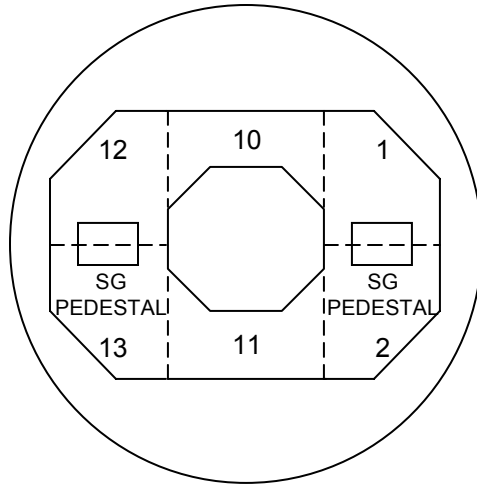

PLAN VIEW
 LOWER REGION
 EL. 336'-6"
 TO
 EL. 366'-8"

SAR FIGURE NO. 6.2-3M

AMENDMENT 20

ARKANSAS NUCLEAR ONE
 UNIT 2
 RUSSELLVILLE, ARKANSAS



SCALE:	NONE
DRAWN:	ENERGY
DESIGN:	ENERGY
CAD NO:	N/A

STEAM GENERATOR CAVITY MODEL FOR
 COMPARE CODE ANALYSIS

DRAWING NO

SHEET

REV.

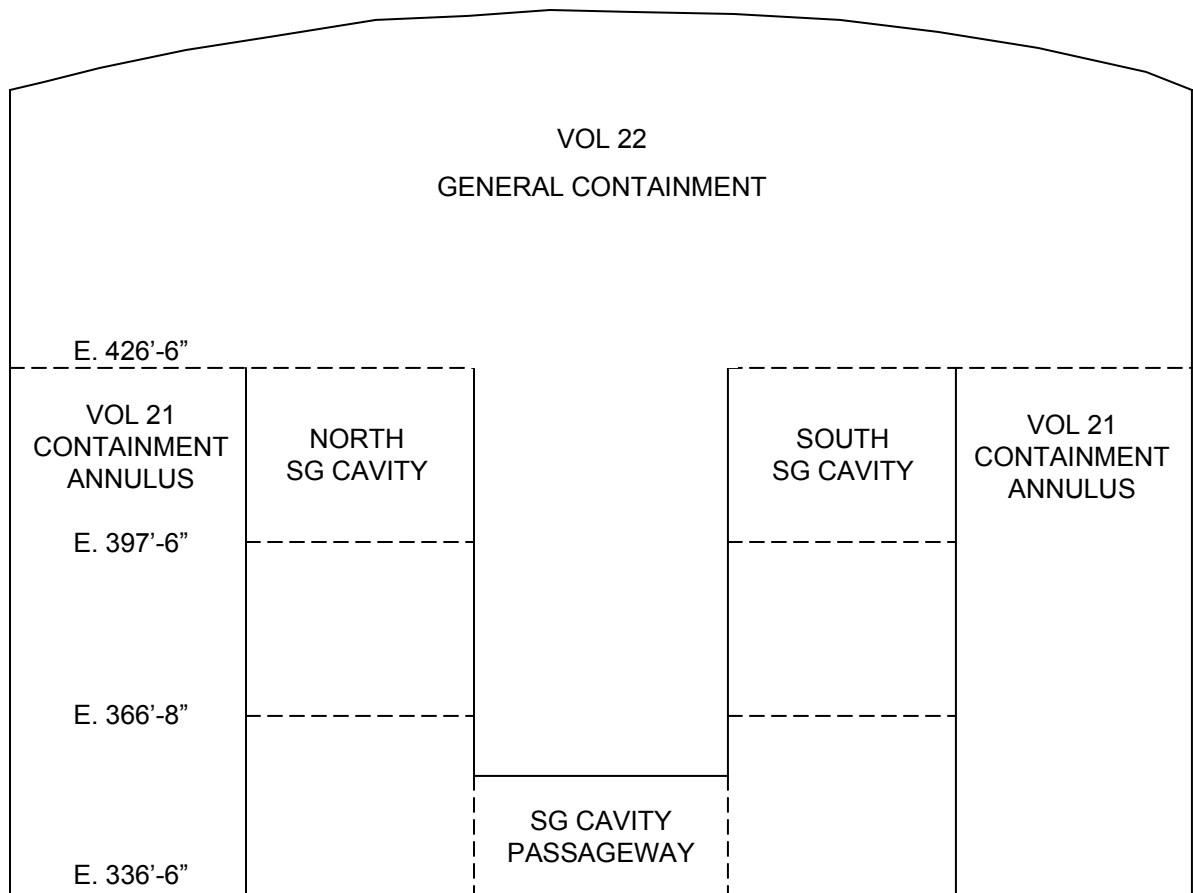

SIDE VIEW OF CONTAINMENT MODEL
LOOKING EAST

SAR FIGURE NO. 6.2-3N

AMENDMENT 20

ARKANSAS NUCLEAR ONE
UNIT 2
RUSSELLVILLE, ARKANSAS



SCALE:	NONE
DRAWN:	ENERGY
DESIGN:	ENERGY
CAD NO:	N/A

STEAM GENERATOR CAVITY MODEL FOR
COMPARE CODE ANALYSIS

DRAWING NO

SHEET

REV.

Deleted

SAR FIGURE NO. 6.2-4

AMENDMENT 20

ARKANSAS NUCLEAR ONE
UNIT 2
RUSSELLVILLE, ARKANSAS



SCALE:	NONE
DRAWN:	ENERGY
DESIGN:	ENERGY
CAD NO:	N/A

SHUTDOWN HEAT EXCHANGER DUTY

DRAWING NO

SHEET

REV.

Figures 6.2-5 – 6.2-8D Deleted
(see FSAR for Historical Data)

SAR FIGURE NOS. 6.2-5 – 6.2-8D

AMENDMENT 20

ARKANSAS NUCLEAR ONE
UNIT 2
RUSSELLVILLE, ARKANSAS



SCALE:	NONE
DRAWN:	ENERGY
DESIGN:	ENERGY
CAD NO:	N/A

DRAWING NO

SHEET

REV.

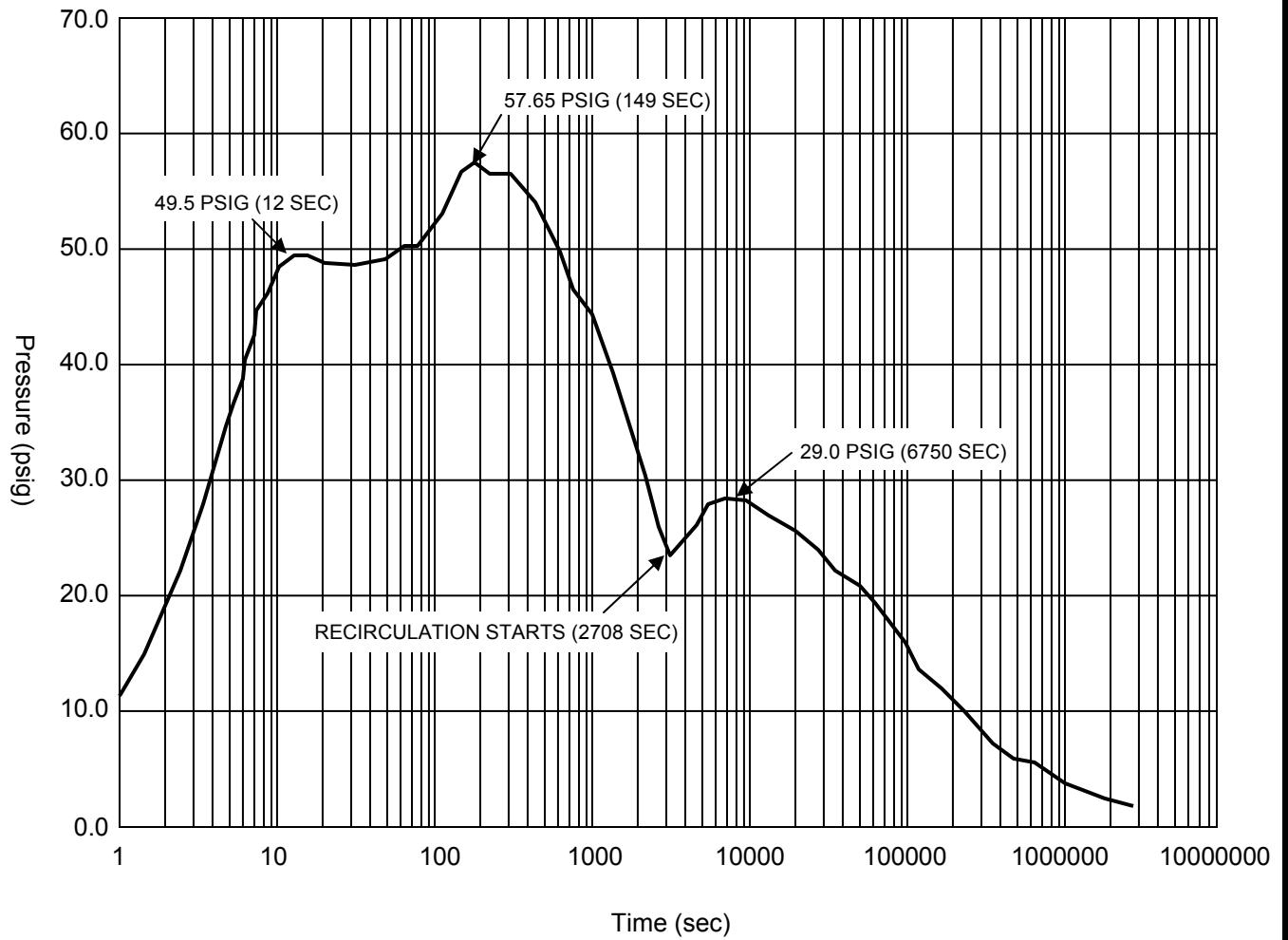

SAR FIGURE NO. 6.2-8E

AMENDMENT 20

ARKANSAS NUCLEAR ONE
 UNIT 2
 RUSSELLVILLE, ARKANSAS



SCALE:	NONE
DRAWN:	ENERGY
DESIGN:	ENERGY
CAD NO:	N/A

CONTAINMENT PRESSURE VS TIME LIMITING
 LOCA – DEDLS BREAK WITH LOSS OF ONE EDG

DRAWING NO

SHEET

REV.

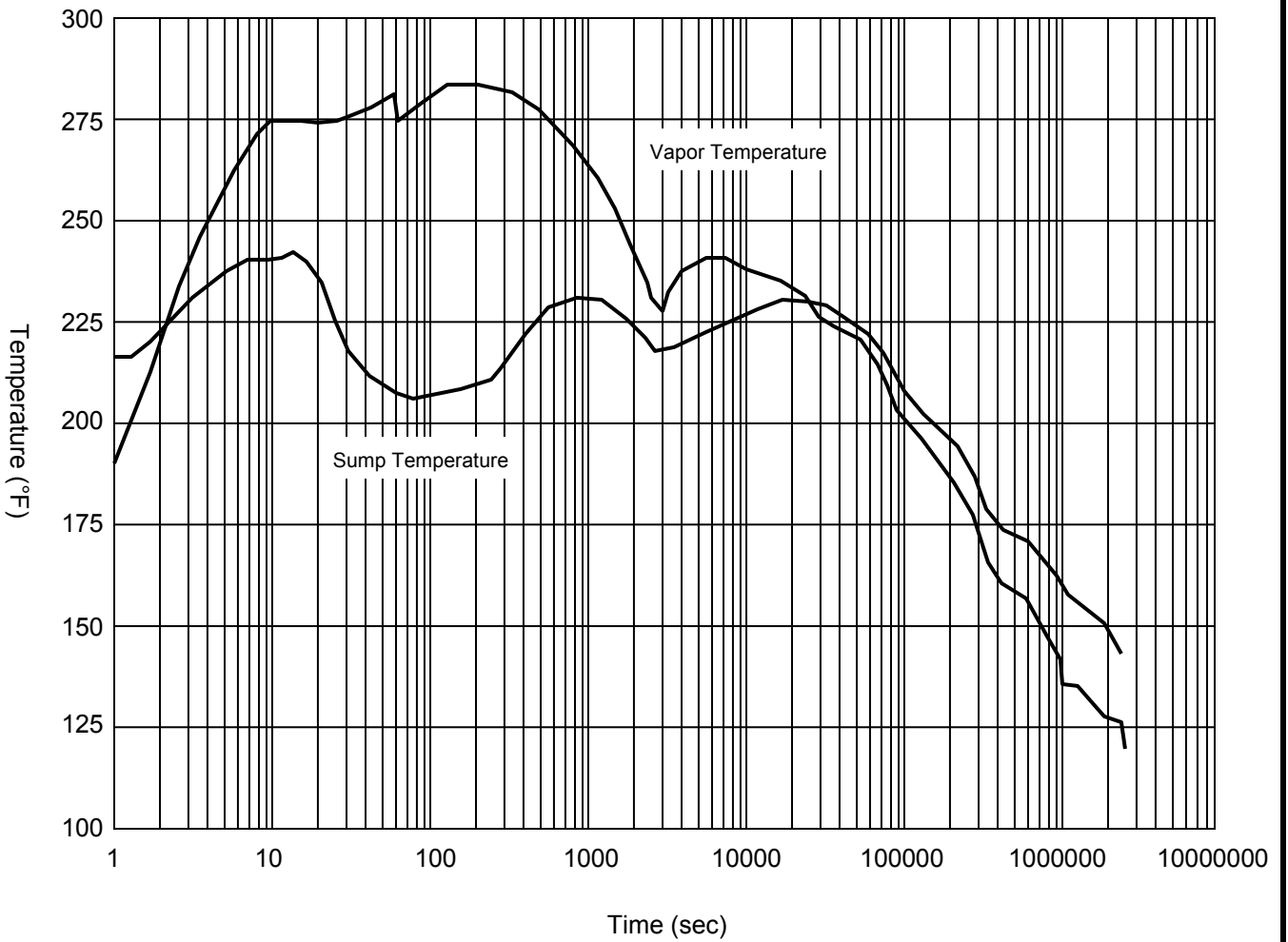

SAR FIGURE NO. 6.2-8F

AMENDMENT 20

ARKANSAS NUCLEAR ONE
 UNIT 2
 RUSSELLVILLE, ARKANSAS



SCALE:	NONE
DRAWN:	ENERGY
DESIGN:	ENERGY
CAD NO:	N/A

CONTAINMENT TEMPERATURE VS TIME LIMITING
 LOCA – DEDLS BREAK WITH LOSS OF ONE EDG

DRAWING NO

SHEET

REV.

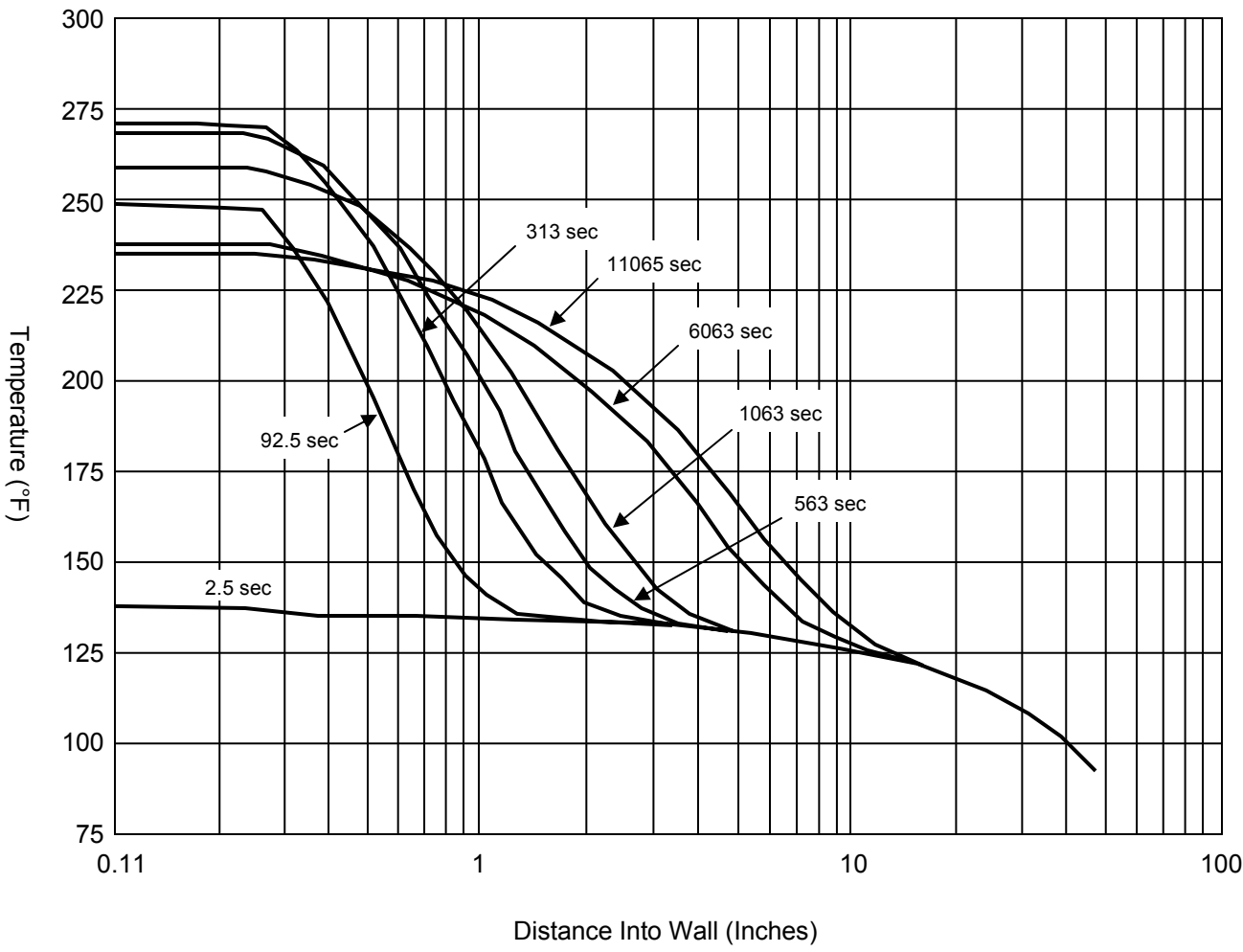

SAR FIGURE NO. 6.2-8G

AMENDMENT 20

ARKANSAS NUCLEAR ONE
 UNIT 2
 RUSSELLVILLE, ARKANSAS



SCALE:	NONE
DRAWN:	ENERGY
DESIGN:	ENERGY
CAD NO:	N/A

CONTAINMENT LINER/CONCRETE TEMPERATURE
 PROFILES LIMITING LOCA – DEDLS BREAK WITH LOSS
 OF ONE EDG

DRAWING NO	SHEET	REV.

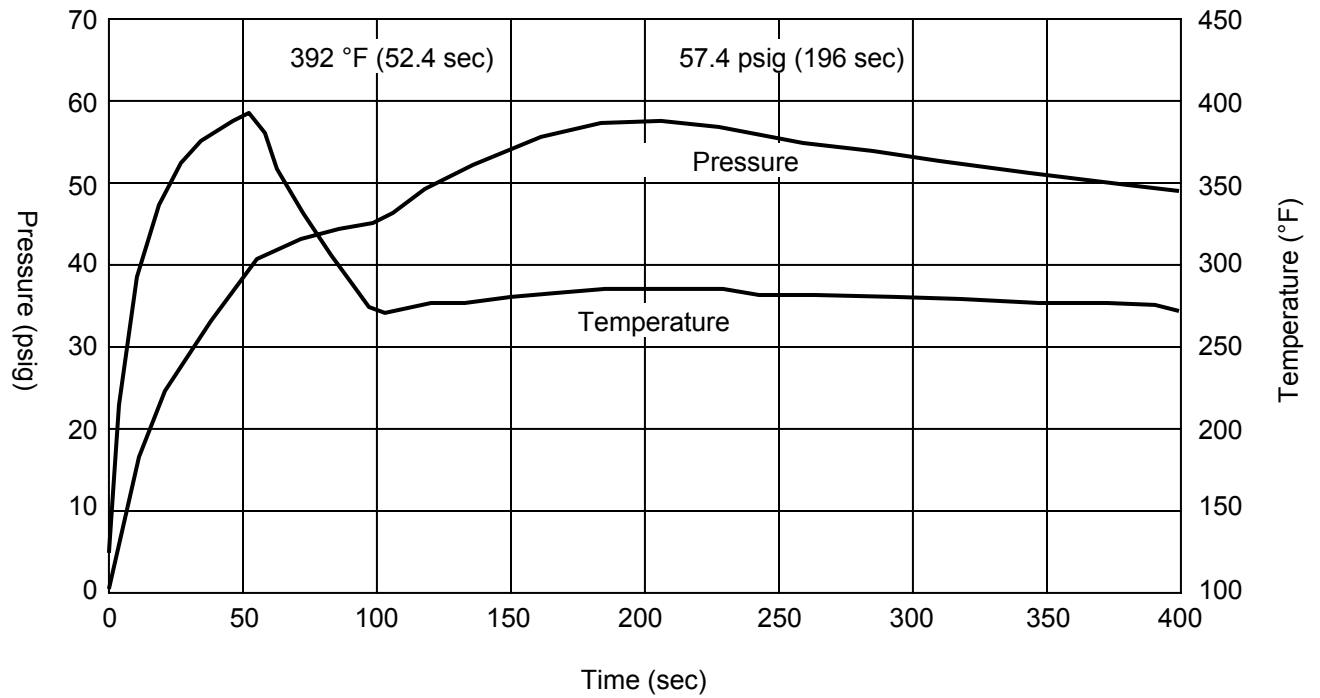

SAR FIGURE NO. 6.2-8H

AMENDMENT 20

ARKANSAS NUCLEAR ONE
 UNIT 2
 RUSSELLVILLE, ARKANSAS



SCALE:	NONE
DRAWN:	ENERGY
DESIGN:	ENERGY
CAD NO:	N/A

CONTAINMENT PRESSURE AND TEMPERATURE VS TIME
 LIMITING MSLB - 0% POWER ONE SPRAY TRAIN
 FAILURE

DRAWING NO

SHEET

REV.

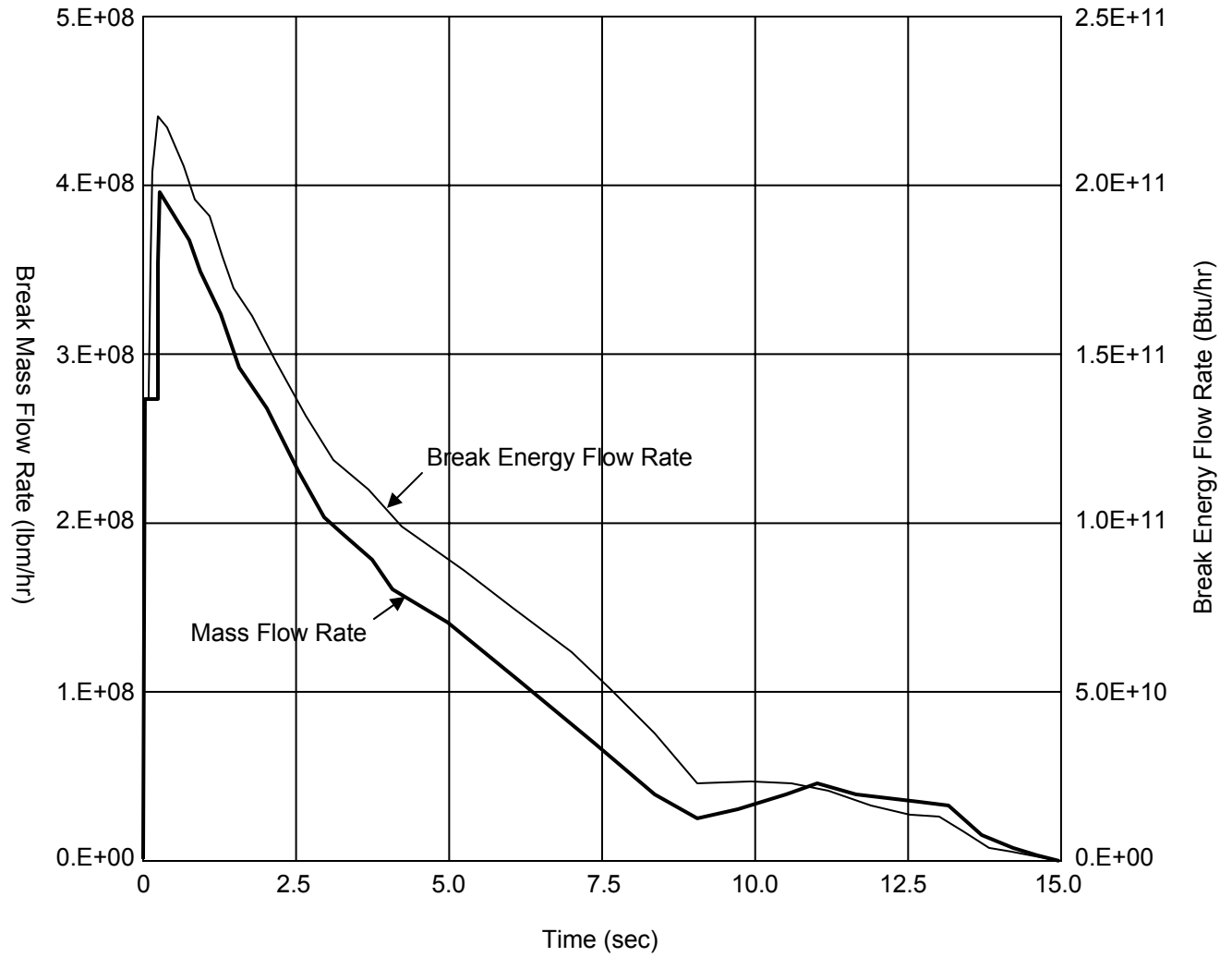

SAR FIGURE NO. 6.2-9

AMENDMENT 20

ARKANSAS NUCLEAR ONE
 UNIT 2
 RUSSELLVILLE, ARKANSAS



SCALE:	NONE
DRAWN:	ENERGY
DESIGN:	ENERGY
CAD NO:	N/A

BLOWDOWN MASS AND ENERGY FLOW RATES
 (DEDLS BREAK WITH FAILURE OF ONE EDG)

DRAWING NO

SHEET

REV.

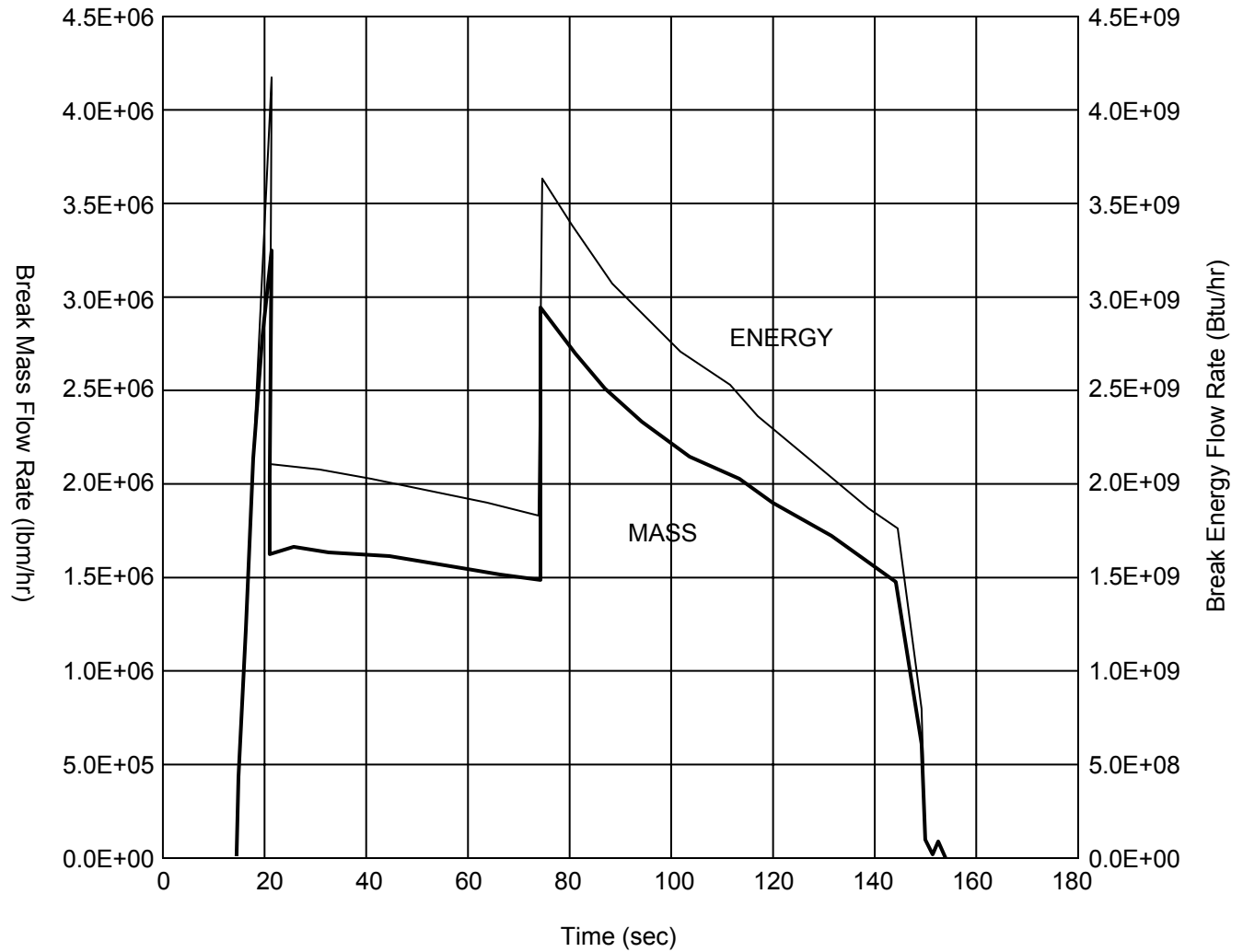

SAR FIGURE NO. 6.2-10

AMENDMENT 20

ARKANSAS NUCLEAR ONE
 UNIT 2
 RUSSELLVILLE, ARKANSAS



SCALE:	NONE
DRAWN:	ENERGY
DESIGN:	ENERGY
CAD NO:	N/A

LIMITING LOCA MASS AND ENERGY RELEASE
 (REFLOOD AND POST REFLOOD) (DEDLS BREAK WITH
 FAILURE OF ONE EDG)

DRAWING NO

SHEET

REV.

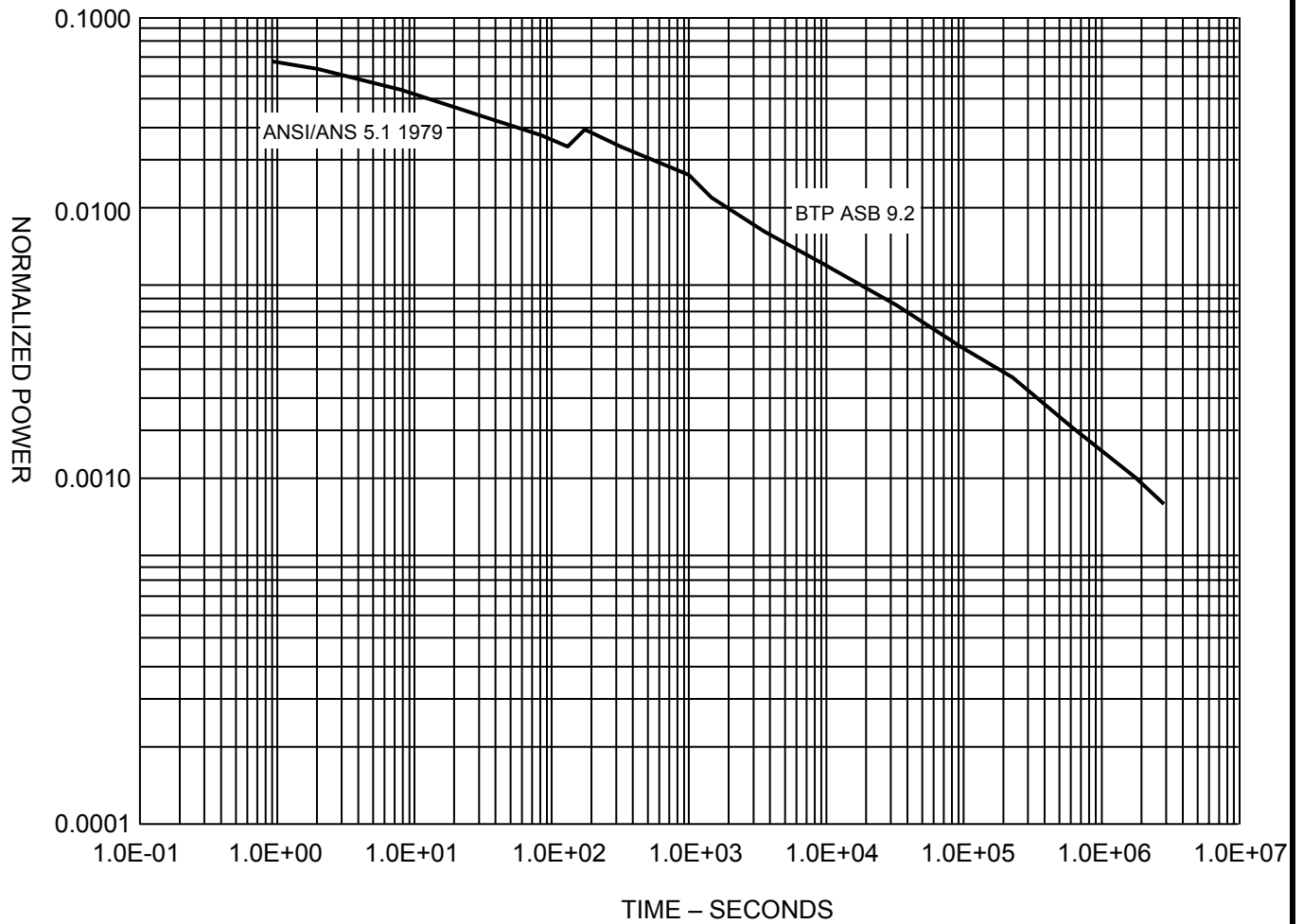

SAR FIGURE NO. 6.2-11

AMENDMENT 20

ARKANSAS NUCLEAR ONE
 UNIT 2
 RUSSELLVILLE, ARKANSAS



SCALE:	NONE
DRAWN:	ENERGY
DESIGN:	ENERGY
CAD NO:	N/A

NORMALIZED REACTOR POWER VS TIME LIMITING
 LOCA MASS AND ENERGY RELEASE - DEDLS BREAK
 WITH LOSS OF ONE EDG

DRAWING NO

SHEET

REV.

Figures 6.2-12 – 6.2-13a Deleted
 See FSAR for Historical Data

SAR FIGURE NOs. 6.2-12 – 6.2-13a

AMENDMENT 20

ARKANSAS NUCLEAR ONE
 UNIT 2
 RUSSELLVILLE, ARKANSAS



SCALE:	NONE
DRAWN:	ENERGY
DESIGN:	ENERGY
CAD NO:	N/A

DRAWING NO

SHEET

REV.

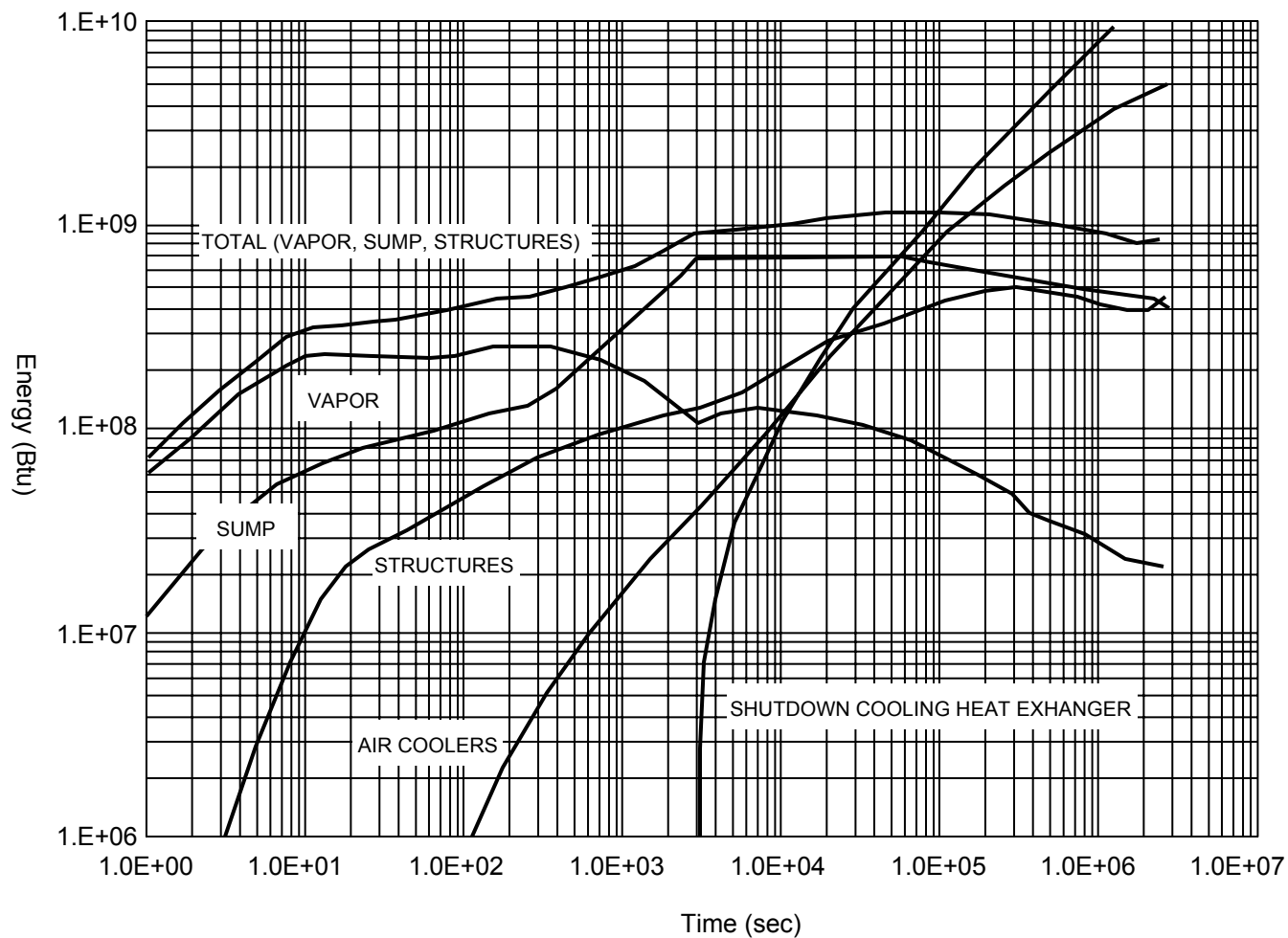

SAR FIGURE NO. 6.2-14

AMENDMENT 20

ARKANSAS NUCLEAR ONE
UNIT 2
RUSSELLVILLE, ARKANSAS



SCALE:	NONE
DRAWN:	ENERGY
DESIGN:	ENERGY
CAD NO:	N/A

CONTAINMENT ENERGY DISTRIBUTION –
DEDLS BREAK WITH LOSS OF ONE EDG

DRAWING NO

SHEET

REV.

Figures 6.2-15 – 6.2-16 Deleted
(see FSAR for Historical Data)

SAR FIGURE NOS. 6.2-15 – 6.2-16

AMENDMENT 20

ARKANSAS NUCLEAR ONE
UNIT 2
RUSSELLVILLE, ARKANSAS



SCALE:	NONE
DRAWN:	ENERGY
DESIGN:	ENERGY
CAD NO:	N/A

DRAWING NO

SHEET

REV.

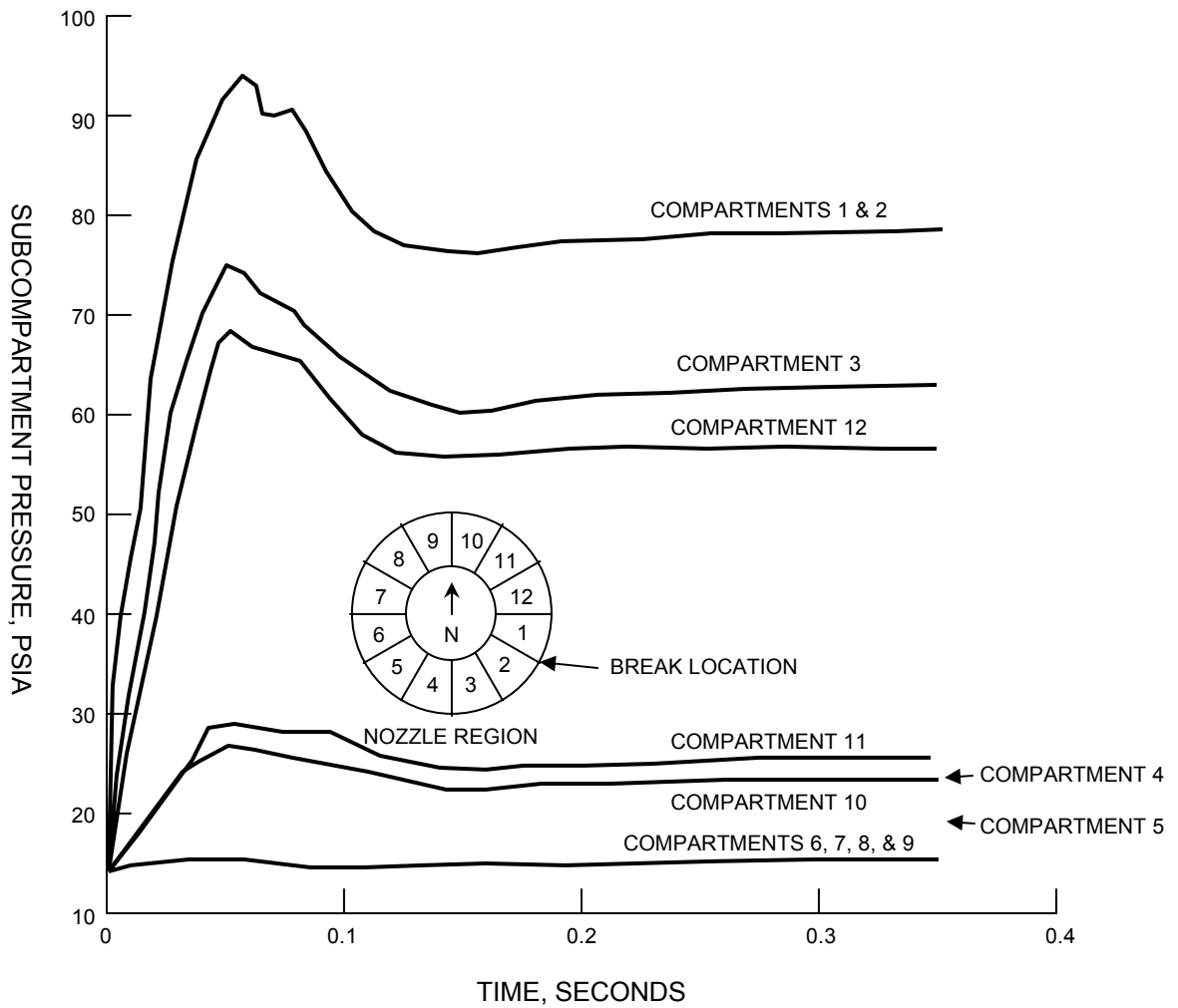

SAR FIGURE NO. 6.2-16A

AMENDMENT 20

ARKANSAS NUCLEAR ONE
UNIT 2
RUSSELLVILLE, ARKANSAS



SCALE:	NONE
DRAWN:	ENERGY
DESIGN:	ENERGY
CAD NO:	N/A

PRESSURE RESPONSE FOR A 200 IN² COLD LEG
CIRCUMFERENTIAL BREAK IN THE RPV CAVITY
WITHOUT VENTING

DRAWING NO

SHEET

REV.

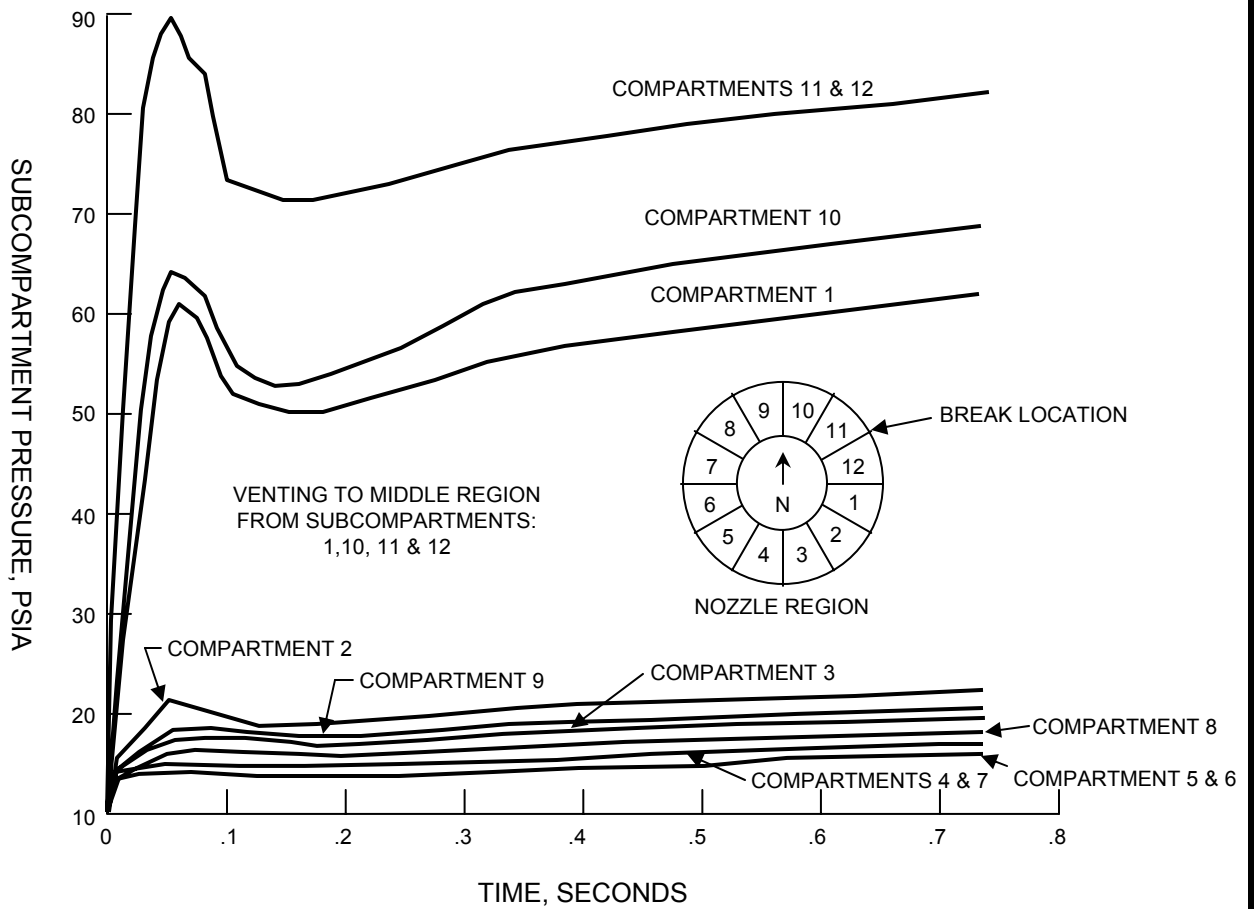

SAR FIGURE NO. 6.2-16B

AMENDMENT 20

ARKANSAS NUCLEAR ONE
UNIT 2
RUSSELLVILLE, ARKANSAS



SCALE:	NONE
DRAWN:	ENERGY
DESIGN:	ENERGY
CAD NO:	N/A

PRESSURE RESPONSE FOR A 200 IN² COLD LEG
CIRCUMFERENTIAL BREAK IN THE RPV CAVITY WITH
VENTING

DRAWING NO

SHEET

REV.

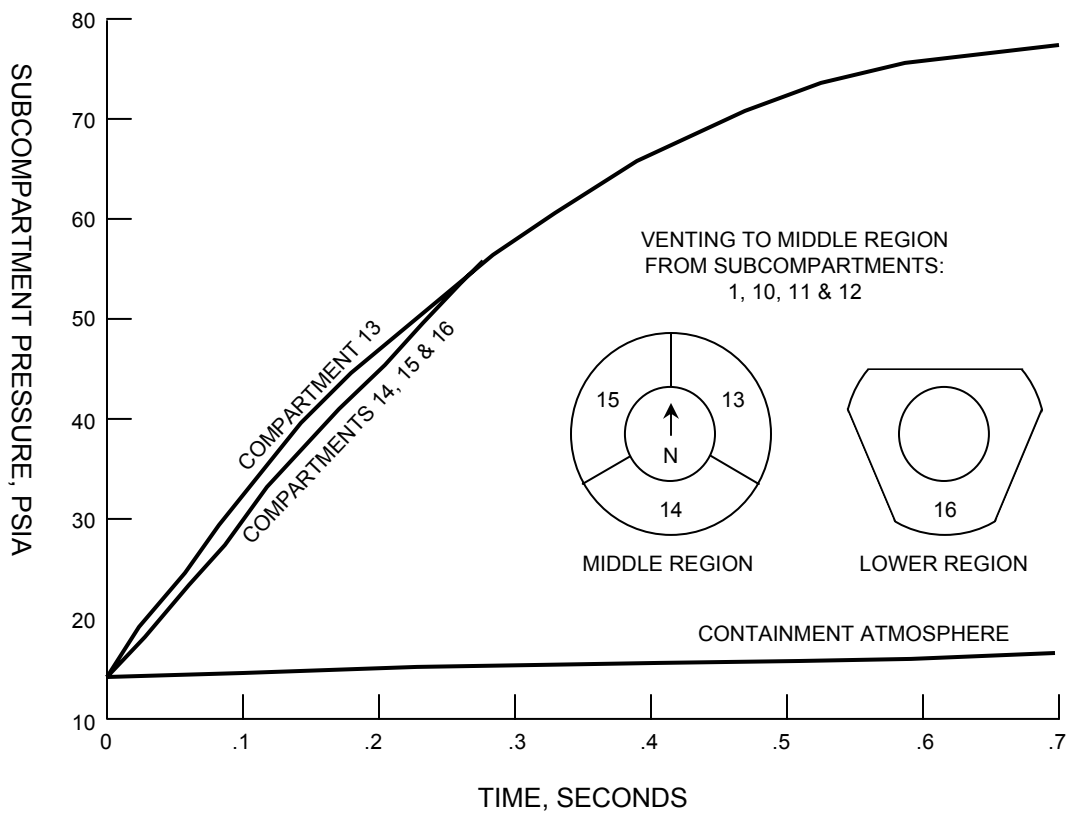

SAR FIGURE NO. 6.2-16C

AMENDMENT 20

ARKANSAS NUCLEAR ONE
UNIT 2
RUSSELLVILLE, ARKANSAS



SCALE:	NONE
DRAWN:	ENERGY
DESIGN:	ENERGY
CAD NO:	N/A

PRESSURE RESPONSE FOR A 200 IN² COLD LEG
CIRCUMFERENTIAL BREAK IN THE RPV CAVITY WITH
VENTING

DRAWING NO

SHEET

REV.

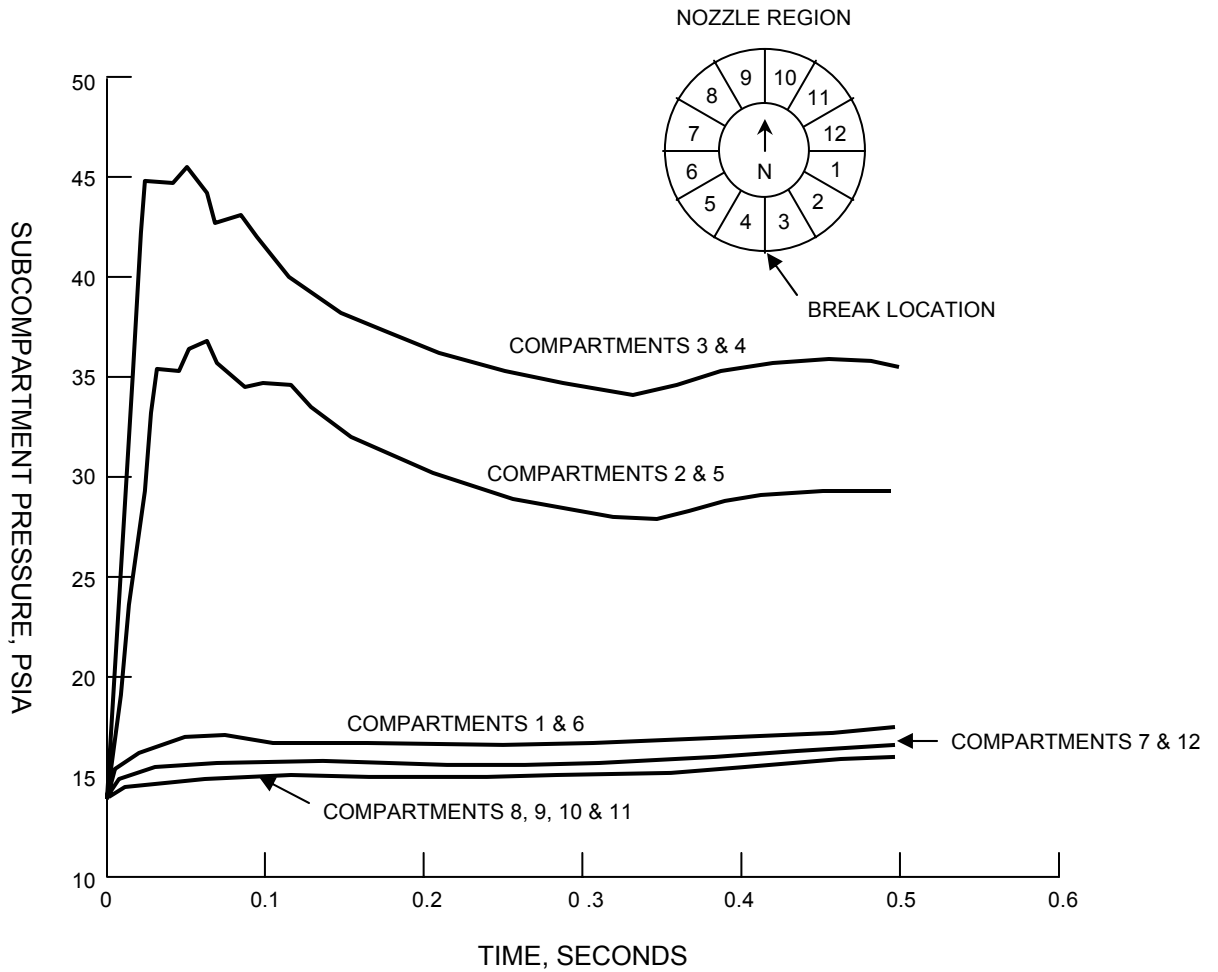

SAR FIGURE NO. 6.2-16D

AMENDMENT 20

ARKANSAS NUCLEAR ONE
UNIT 2
RUSSELLVILLE, ARKANSAS



SCALE:	NONE
DRAWN:	ENERGY
DESIGN:	ENERGY
CAD NO:	N/A

PRESSURE RESPONSE FOR A 100 IN² HOT LEG
CIRCUMFERENTIAL BREAK IN THE RPV CAVITY
WITHOUT VENTING

DRAWING NO

SHEET

REV.

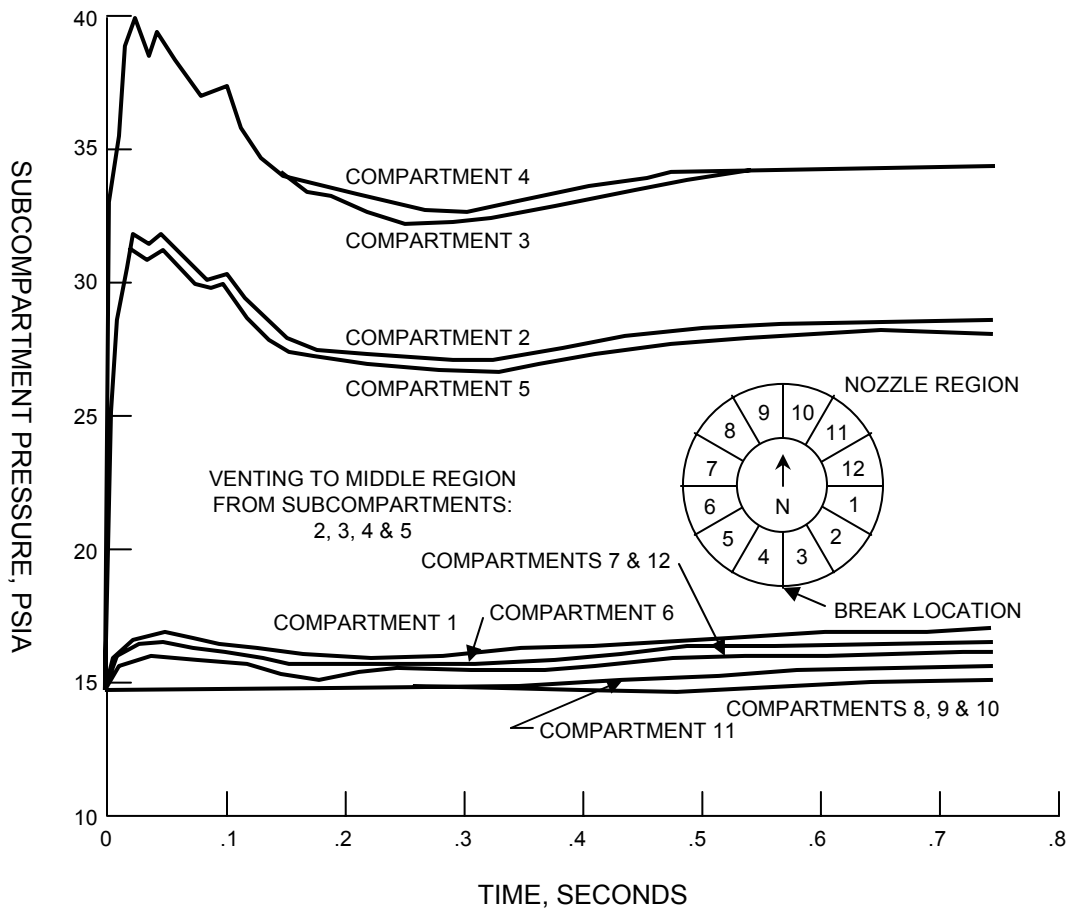

SAR FIGURE NO. 6.2-16E

AMENDMENT 20

ARKANSAS NUCLEAR ONE
UNIT 2
RUSSELLVILLE, ARKANSAS



SCALE:	NONE
DRAWN:	ENERGY
DESIGN:	ENERGY
CAD NO:	N/A

PRESSURE RESPONSE FOR A 100 IN² HOT LEG
CIRCUMFERENTIAL BREAK IN THE RPV CAVITY WITH
VENTING

DRAWING NO

SHEET

REV.

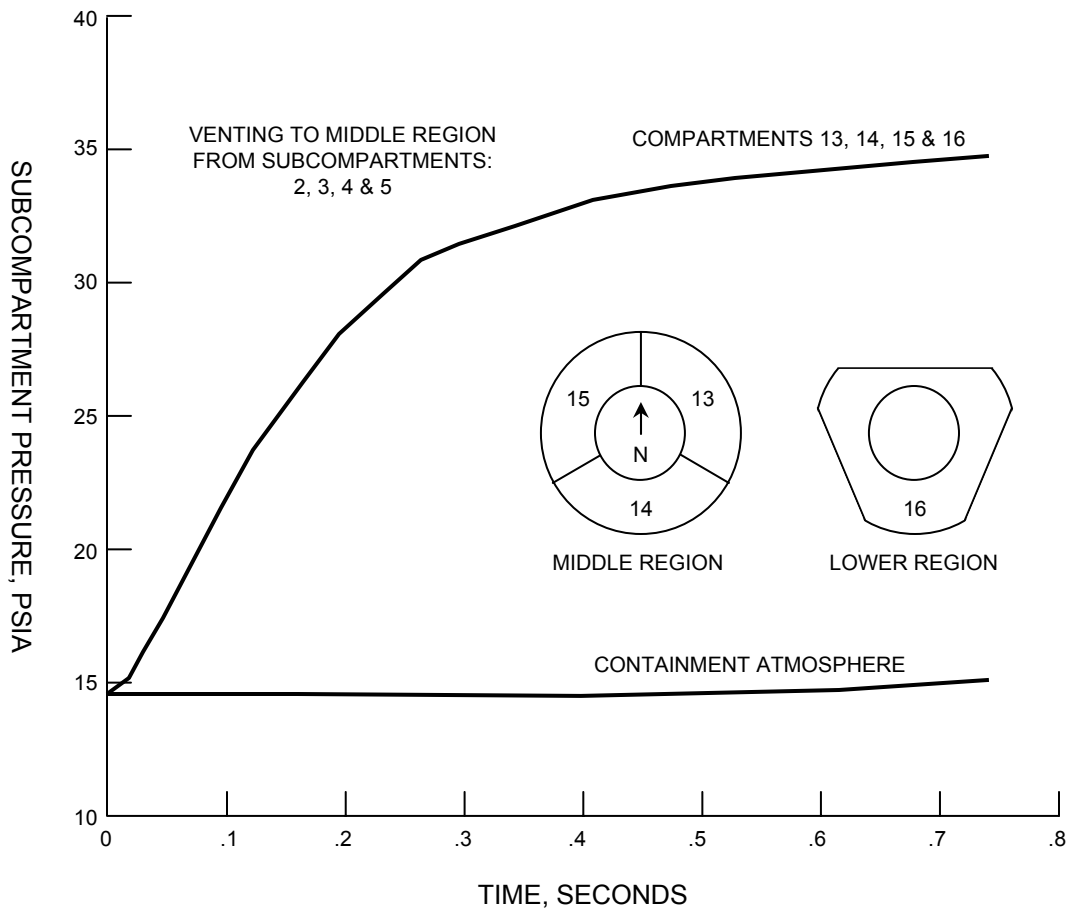

SAR FIGURE NO. 6.2-16F

AMENDMENT 20

ARKANSAS NUCLEAR ONE
 UNIT 2
 RUSSELLVILLE, ARKANSAS



SCALE:	NONE
DRAWN:	ENERGY
DESIGN:	ENERGY
CAD NO:	N/A

PRESSURE RESPONSE FOR A 100 IN² HOT LEG
 CIRCUMFERENTIAL BREAK IN THE RPV CAVITY WITH
 VENTING

DRAWING NO

SHEET

REV.

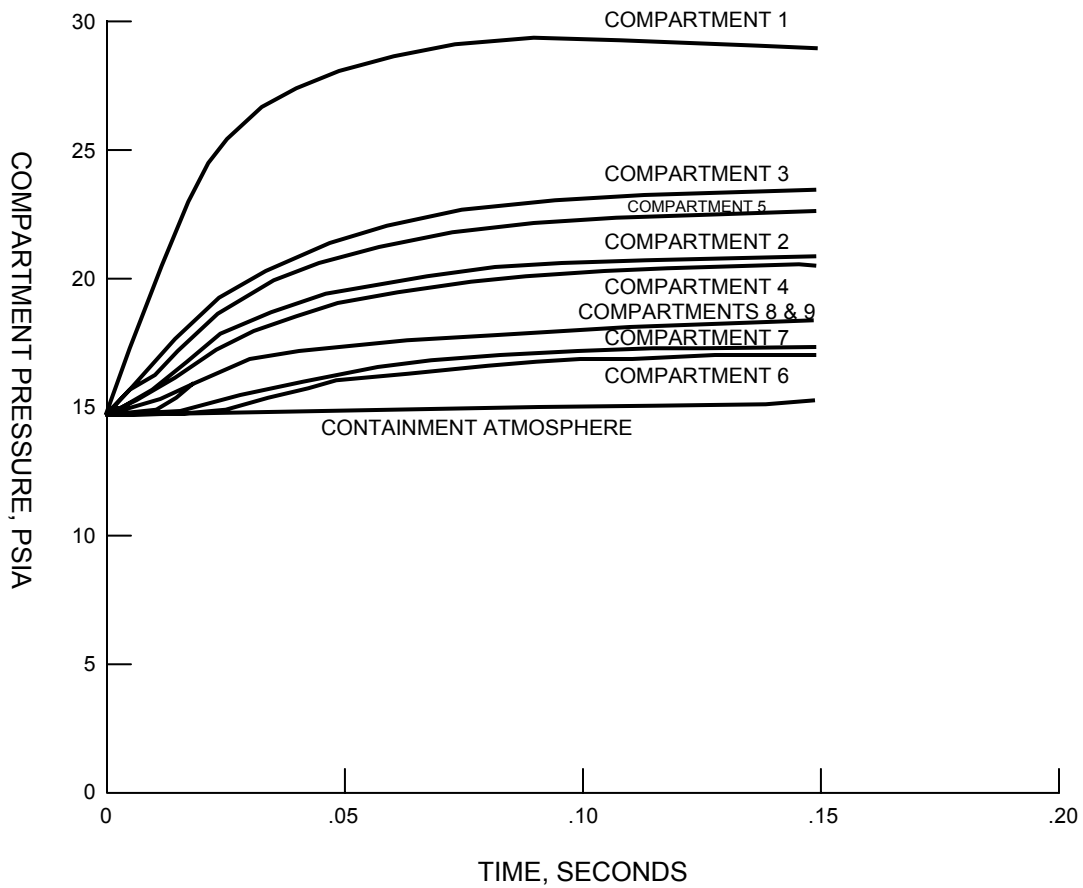

SAR FIGURE NO. 6.2-16G

AMENDMENT 20

ARKANSAS NUCLEAR ONE
 UNIT 2
 RUSSELLVILLE, ARKANSAS



SCALE:	NONE
DRAWN:	ENERGY
DESIGN:	ENERGY
CAD NO:	N/A

PRESSURE RESPONSE FOR A 5.90 FT² HOT LEG
 CIRCUMFERENTIAL BREAK IN THE SOUTH SG CAVITY

DRAWING NO

SHEET

REV.

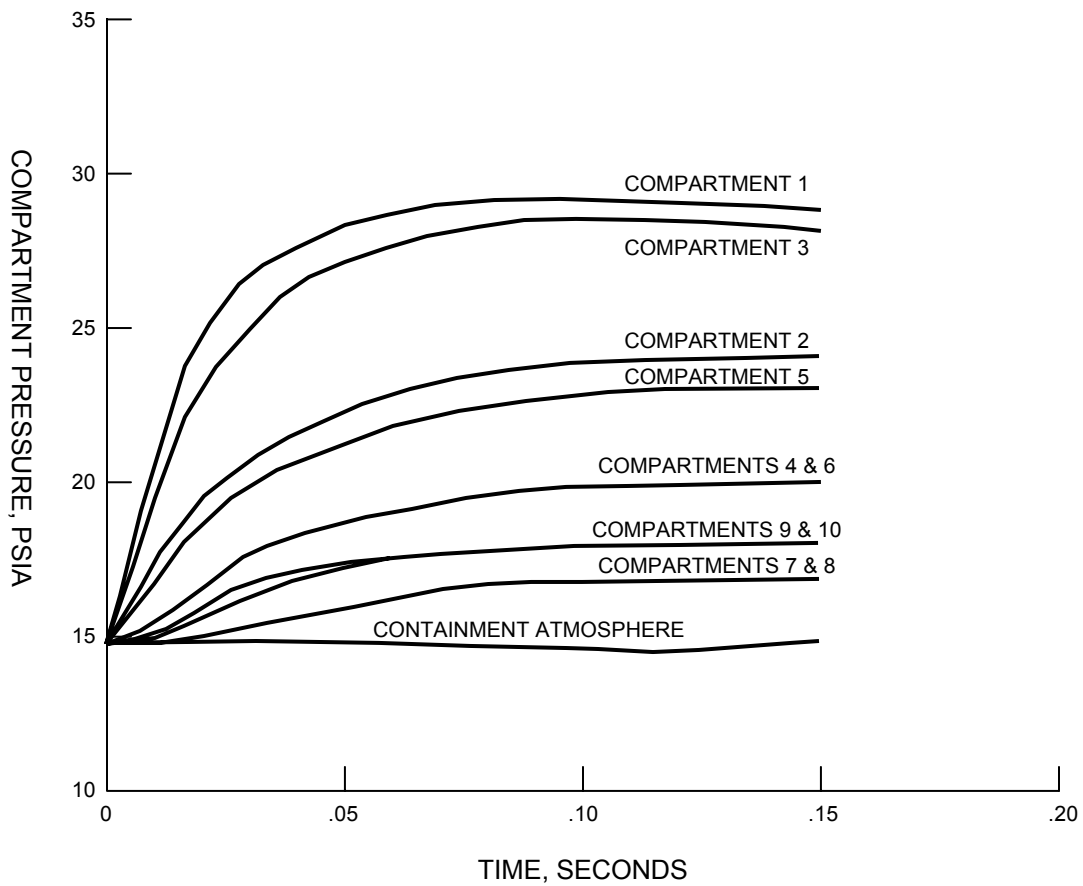

SAR FIGURE NO. 6.2-16H

AMENDMENT 20

ARKANSAS NUCLEAR ONE
 UNIT 2
 RUSSELLVILLE, ARKANSAS



SCALE:	NONE
DRAWN:	ENERGY
DESIGN:	ENERGY
CAD NO:	N/A

PRESSURE RESPONSE FOR A 5.77 FT² HOT LEG
 SLOT BREAK IN THE SOUTH SG CAVITY

DRAWING NO

SHEET

REV.

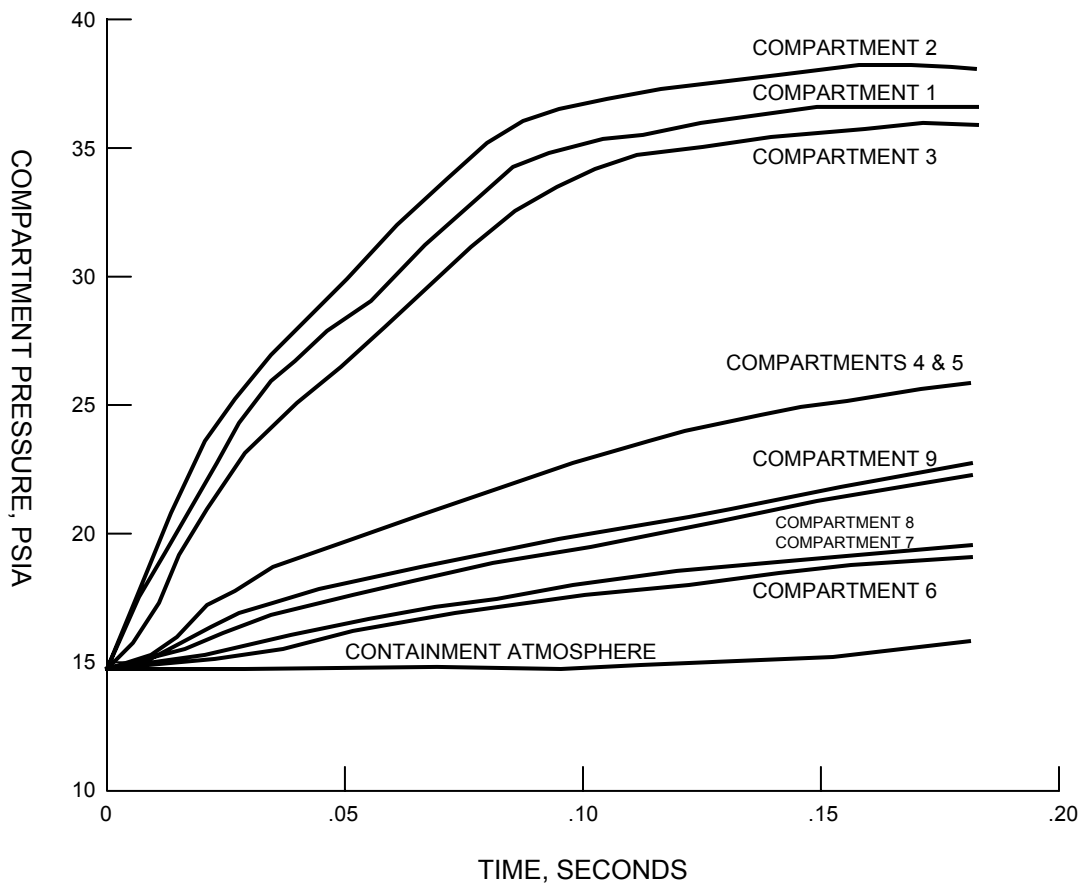

SAR FIGURE NO. 6.2-16I

AMENDMENT 20

ARKANSAS NUCLEAR ONE
 UNIT 2
 RUSSELLVILLE, ARKANSAS



SCALE:	NONE
DRAWN:	ENERGY
DESIGN:	ENERGY
CAD NO:	N/A

PRESSURE RESPONSE FOR A 9.82 FT² COLD LEG PUMP
 SUCTION CIRCUMFERENTIAL BREAK IN THE SOUTH SG
 CAVITY

DRAWING NO

SHEET

REV.

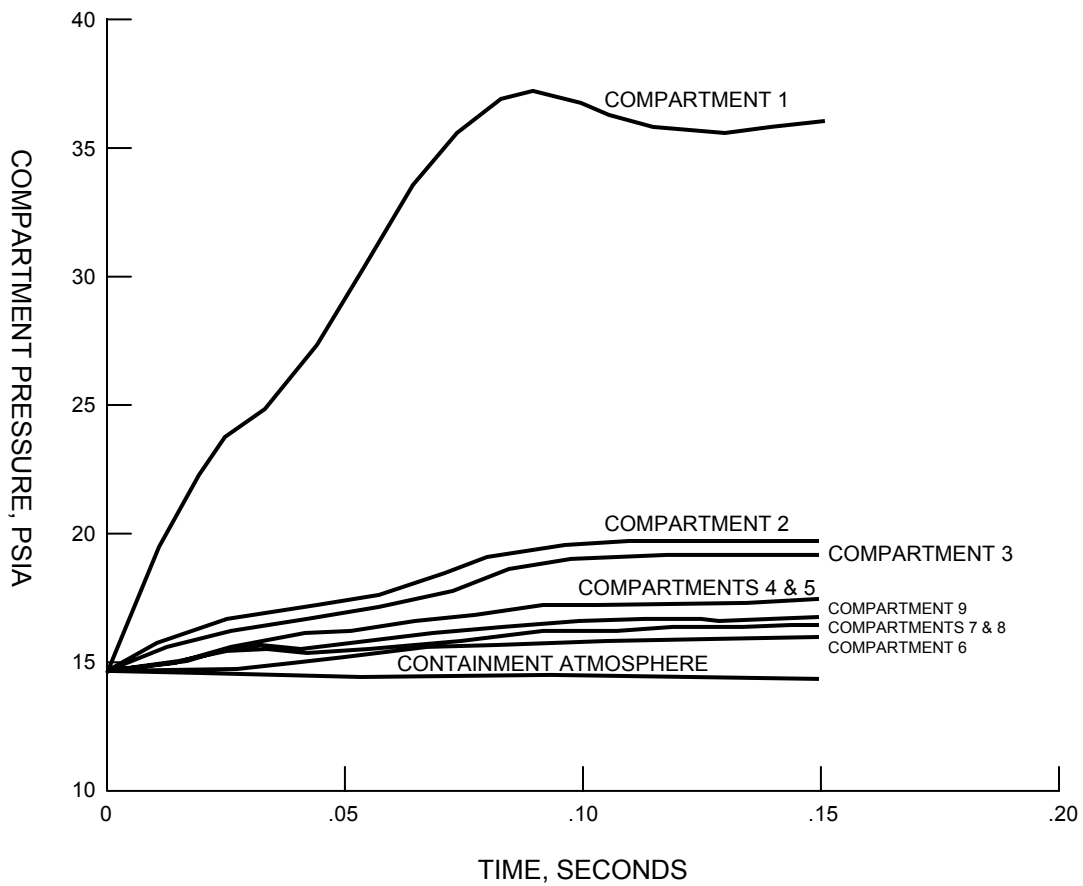

SAR FIGURE NO. 6.2-16J

AMENDMENT 20

ARKANSAS NUCLEAR ONE
 UNIT 2
 RUSSELLVILLE, ARKANSAS



SCALE:	NONE
DRAWN:	ENERGY
DESIGN:	ENERGY
CAD NO:	N/A

PRESSURE RESPONSE FOR A 3.93 FT² COLD LEG PUMP
 SUCTION SLOT BREAK (EAST ORIENTATION) IN THE
 SOUTH SG CAVITY

DRAWING NO

SHEET

REV.

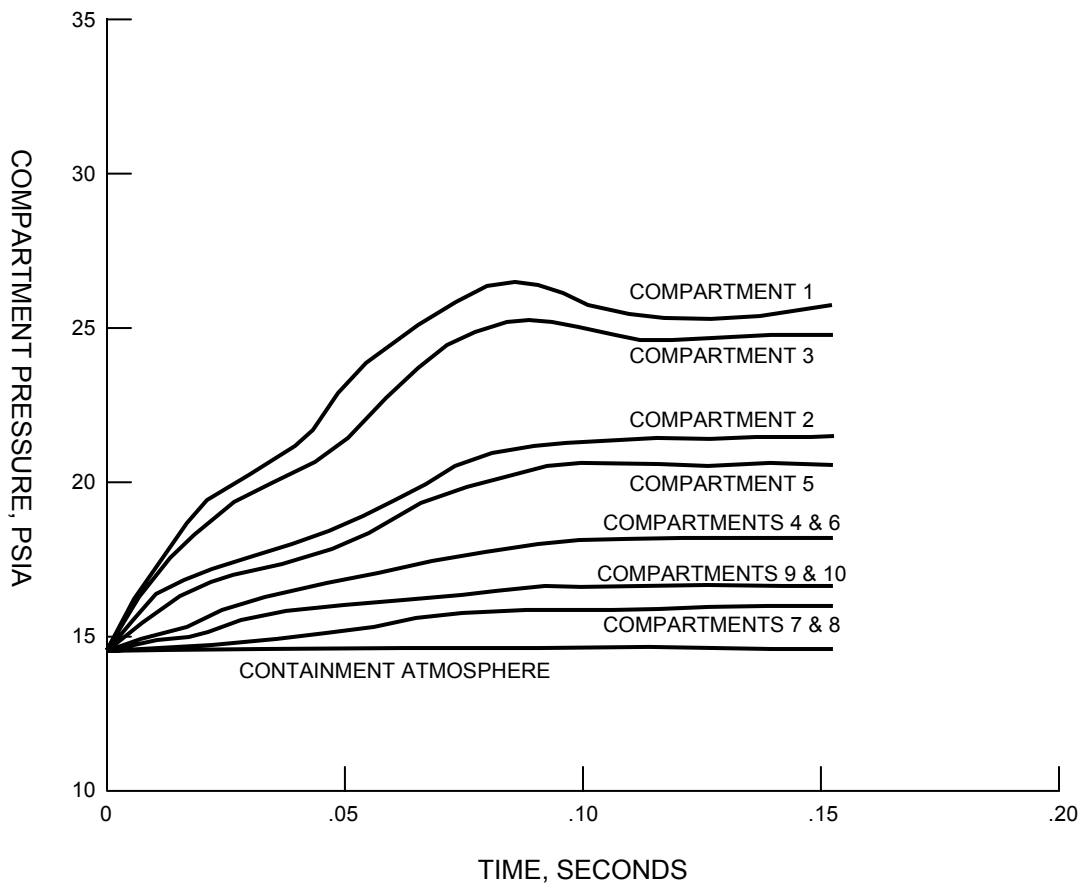

SAR FIGURE NO. 6.2-16K

AMENDMENT 20

ARKANSAS NUCLEAR ONE
 UNIT 2
 RUSSELLVILLE, ARKANSAS



SCALE:	NONE
DRAWN:	ENERGY
DESIGN:	ENERGY
CAD NO:	N/A

PRESSURE RESPONSE FOR A 3.93 FT² COLD LEG PUMP
 SUCTION SLOT BREAK (WEST ORIENTATION) IN THE
 SOUTH SG CAVITY

DRAWING NO

SHEET

REV.

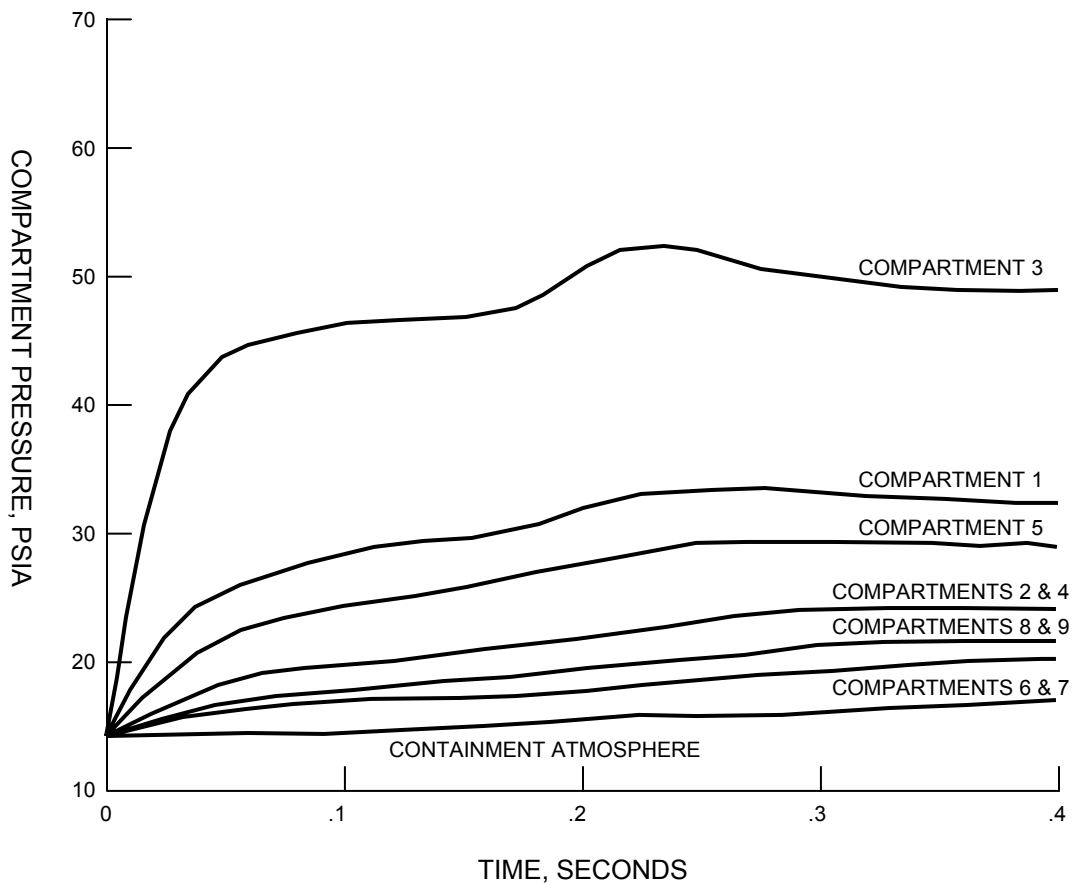

SAR FIGURE NO. 6.2-16L

AMENDMENT 20

ARKANSAS NUCLEAR ONE
 UNIT 2
 RUSSELLVILLE, ARKANSAS



SCALE:	NONE
DRAWN:	ENERGY
DESIGN:	ENERGY
CAD NO:	N/A

PRESSURE RESPONSE FOR A 9.82 FT² COLD LEG PUMP
 DISCHARGE CIRCUMFERENTIAL BREAK IN THE SOUTH
 SG CAVITY

DRAWING NO

SHEET

REV.

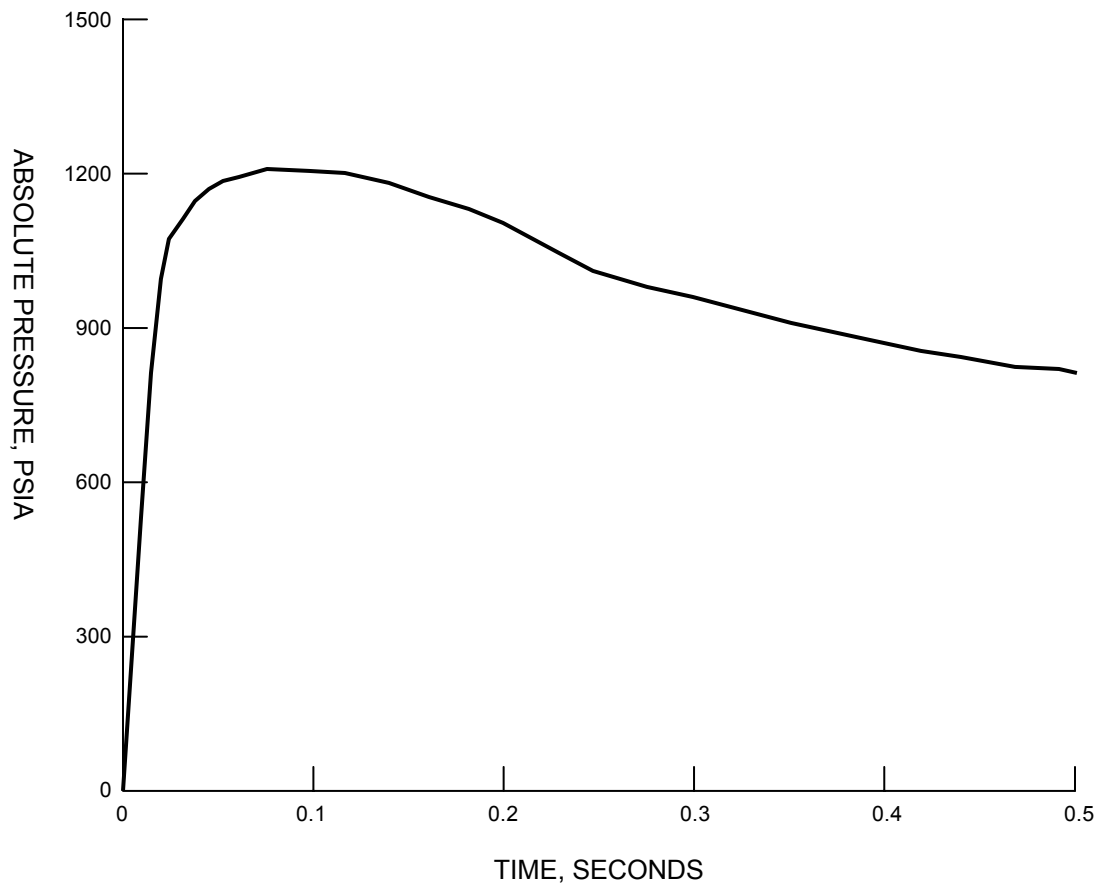

SAR FIGURE NO. 6.2-16M

AMENDMENT 20

ARKANSAS NUCLEAR ONE
 UNIT 2
 RUSSELLVILLE, ARKANSAS



SCALE:	NONE
DRAWN:	ENERGY
DESIGN:	ENERGY
CAD NO:	N/A

PRESSURE RESPONSE TO A HOT LEG SLOT
 BREAK IN THE BIOLOGICAL SHIELD PENETRATION

DRAWING NO

SHEET

REV.

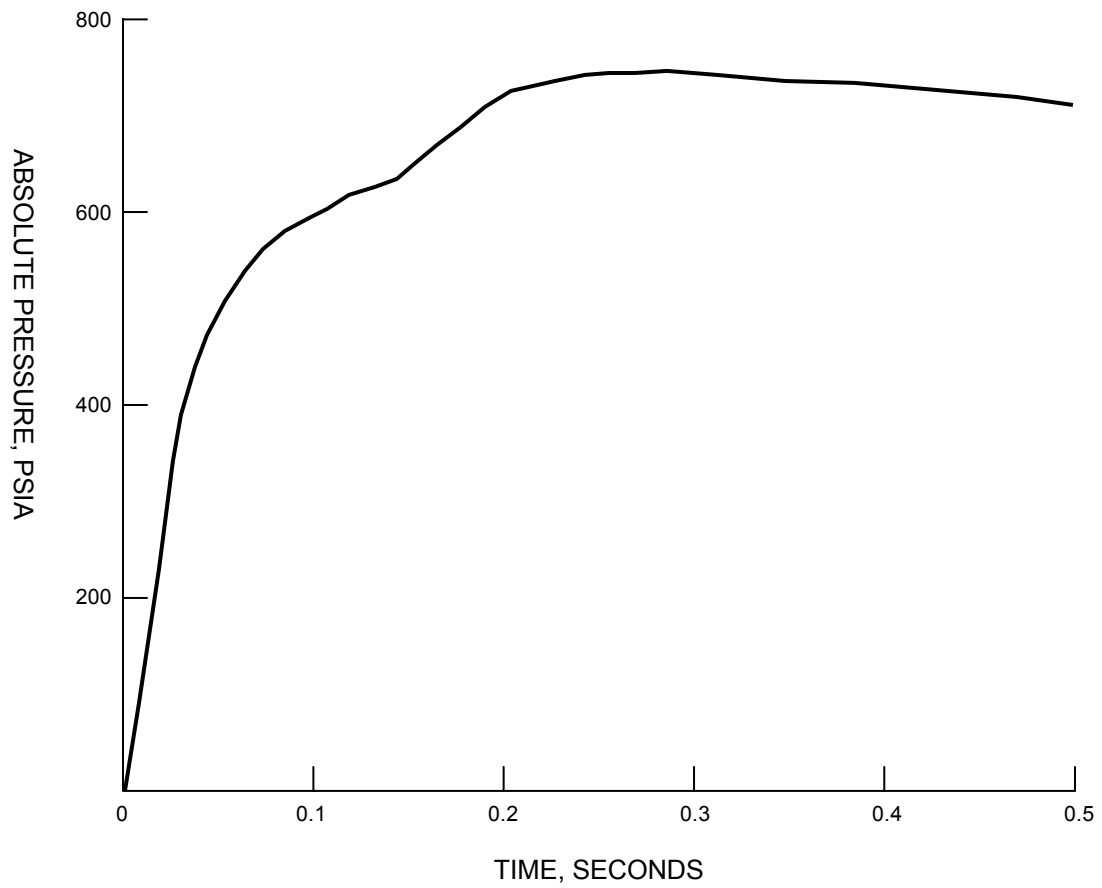

SAR FIGURE NO. 6.2-16N

AMENDMENT 20

ARKANSAS NUCLEAR ONE
 UNIT 2
 RUSSELLVILLE, ARKANSAS



SCALE:	NONE
DRAWN:	ENERGY
DESIGN:	ENERGY
CAD NO:	N/A

PRESSURE RESPONSE TO A COLD LEG SLOT
 BREAK IN THE BIOLOGICAL SHIELD PENETRATION

DRAWING NO

SHEET

REV.

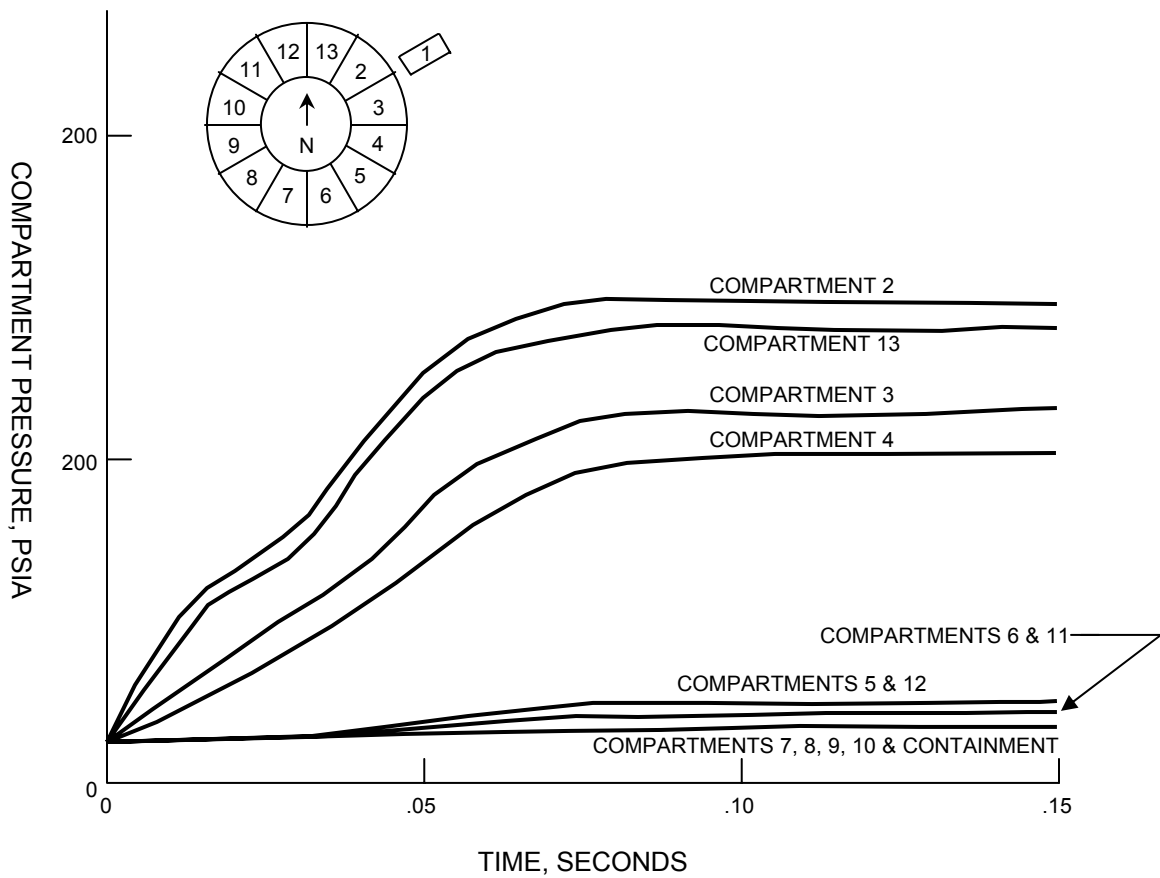

SAR FIGURE NO. 6.2-160

AMENDMENT 20

ARKANSAS NUCLEAR ONE
 UNIT 2
 RUSSELLVILLE, ARKANSAS



SCALE:	NONE
DRAWN:	ENERGY
DESIGN:	ENERGY
CAD NO:	N/A

COLD LEG SLOT BREAK SENSITIVITY STUDY

DRAWING NO

SHEET

REV.

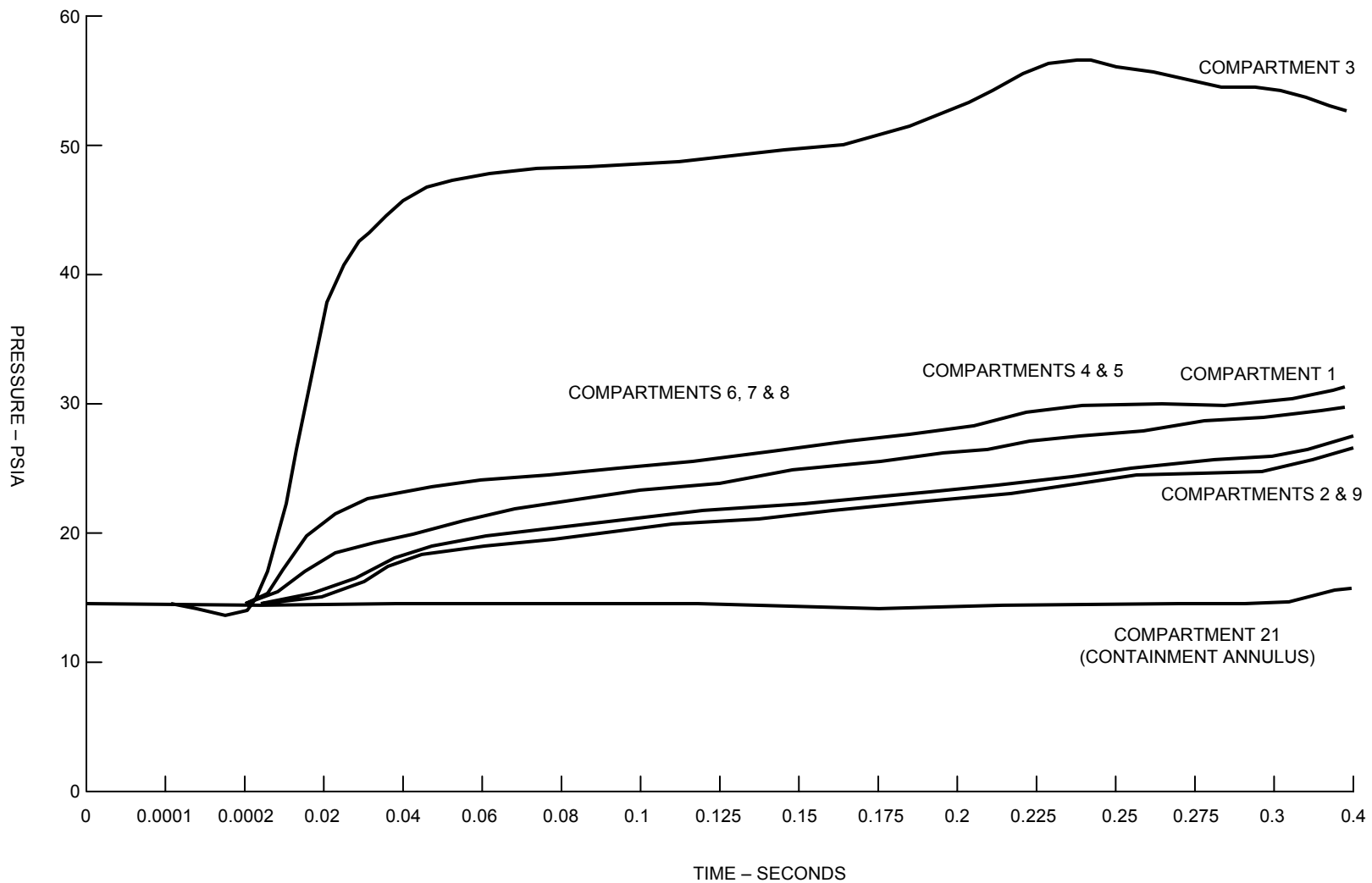

PRESSURE RESPONSE FOR A 9.82 FT² COLD LEG PUMP DISCHARGE CIRCUMFERENTIAL BREAK IN THE SOUTH SG CAVITY USING COMPARE COMPUTER CODE

SAR FIGURE NO. 6.2-16P

ARKANSAS NUCLEAR ONE
UNIT 2
RUSSELLVILLE, ARKANSAS



SCALE: NONE
DRAWN: ENTERGY
DESIGN: ENTERGY
CAD NO:

AMENDMENT 20

BASED ON DRAWING NO

SHEET

REV.

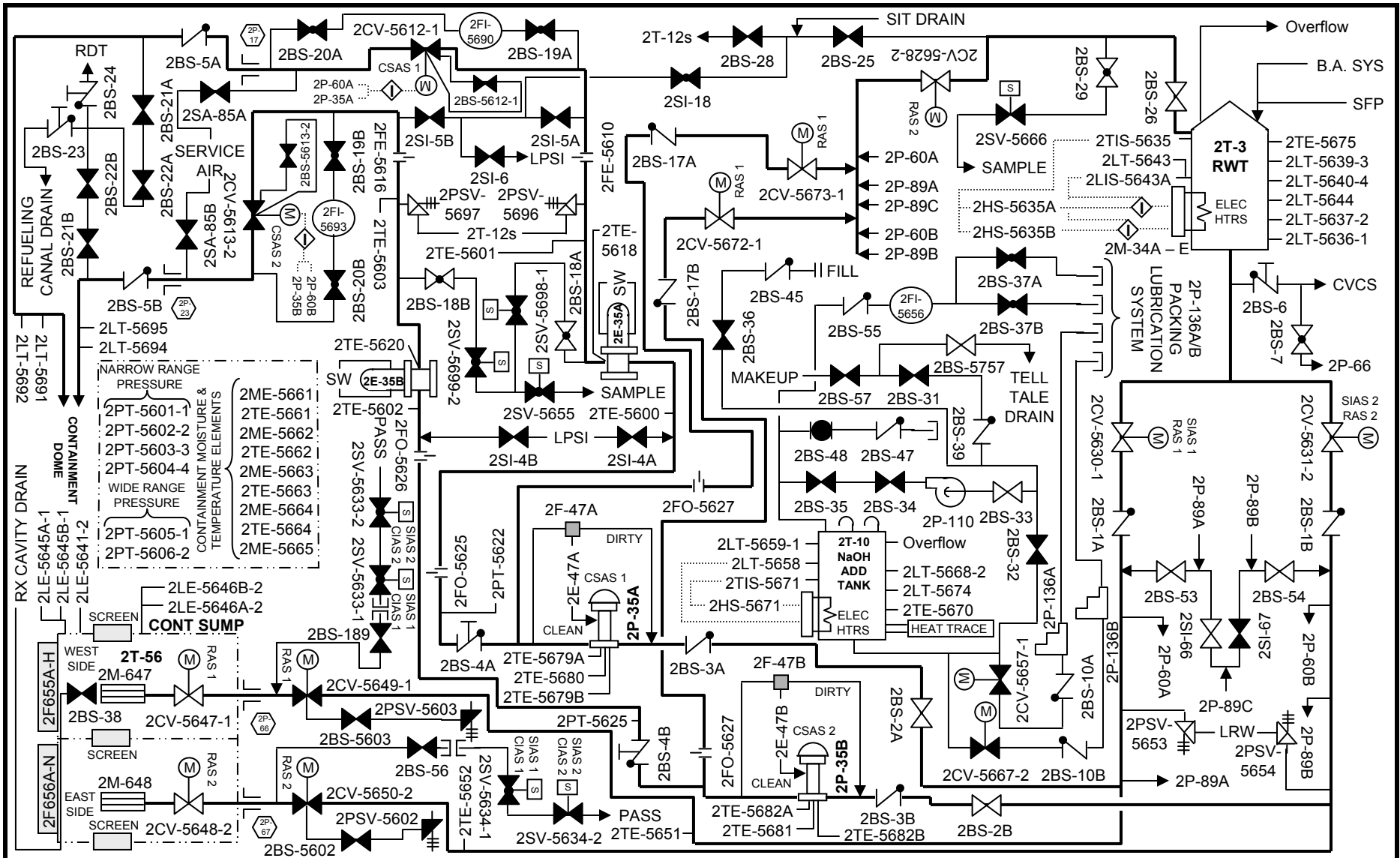

CONTAINMENT SPRAY SYSTEM

SAR FIGURE NO. 6.2-17

ARKANSAS NUCLEAR ONE
 UNIT 2
 RUSSELLVILLE, ARKANSAS



SCALE:	NONE
DRAWN:	ENERGY
DESIGN:	ENERGY
CAD NO:	

AMENDMENT 24

BASED ON DRAWING NO	SHEET	REV.
---------------------	-------	------

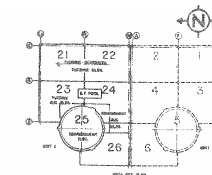
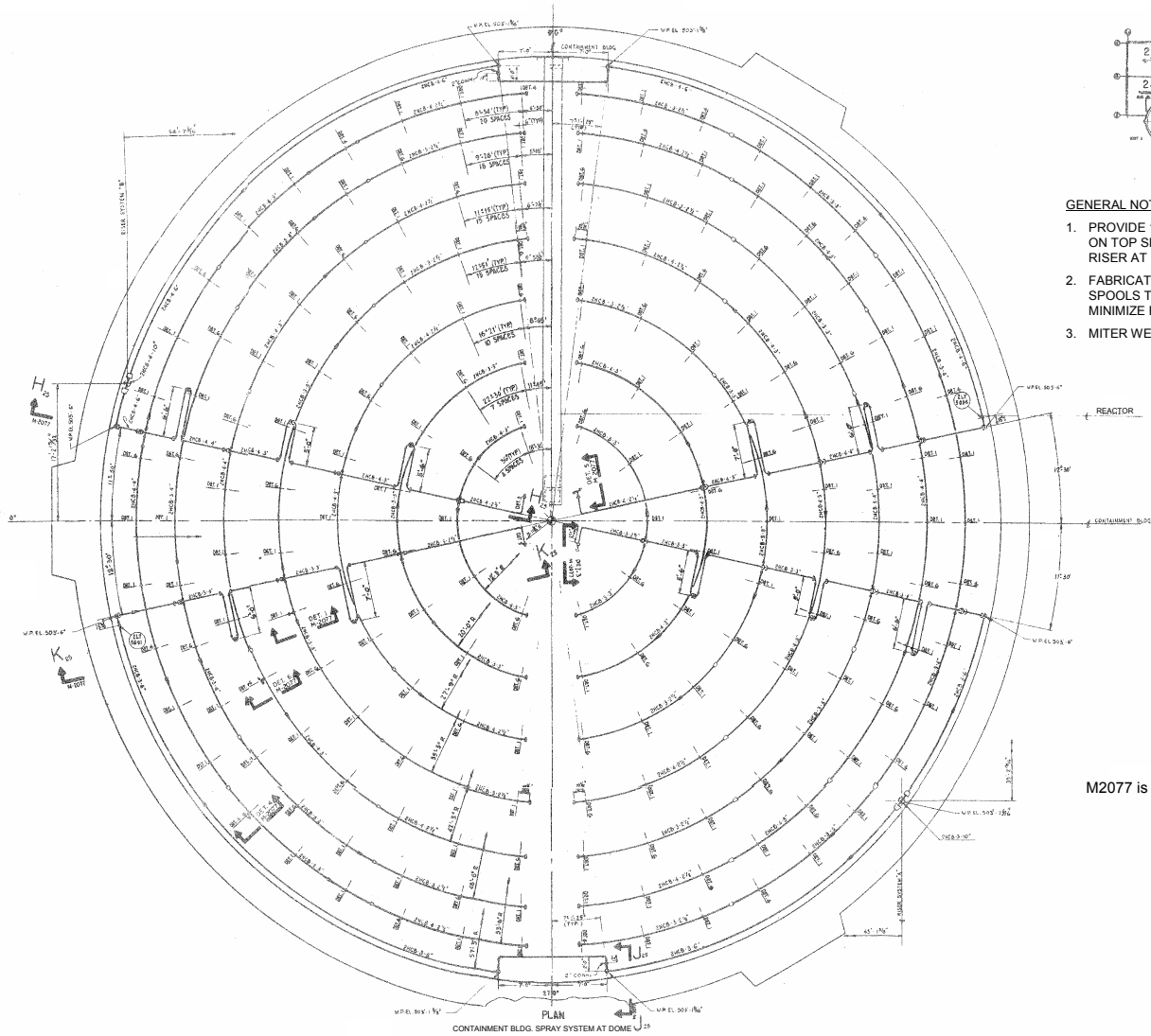

GENERAL NOTES

1. PROVIDE 1/8" DIA. WEEPHOLE ON TOP SIDE OF EACH 6" DIA. RISER AT ELEV. 513'-6"
2. FABRICATOR TO DESIGN SPOOLS TO MAX. LENGTHS TO MINIMIZE FIELD WELDS
3. MITER WELDS NOT TO BE USED.

M2077 is Fig. No. 6.2-19

PLAN VIEW OF SPRAY HEADERS

SAR FIGURE NO. 6.2-18

ARKANSAS NUCLEAR ONE
 UNIT 2
 RUSSELLVILLE, ARKANSAS



SCALE: NONE
 DRAWN: ENTERGY
 DESIGN: ENTERGY
 CAD NO:

AMENDMENT 20

BASED ON DRAWING NO	SHEET	REV.
---------------------	-------	------

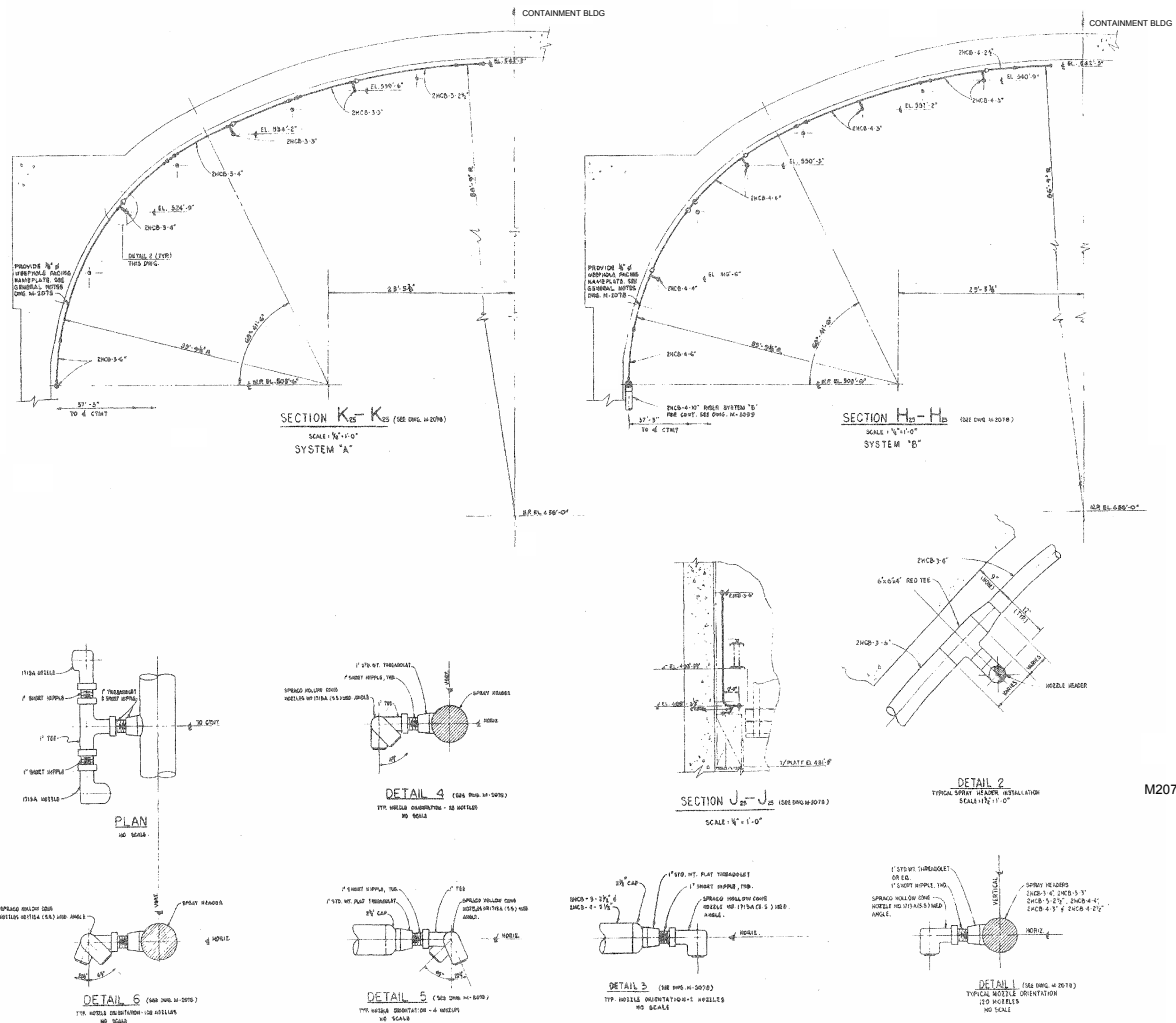

M2078 is Fig. No. 6.2-18

SECTION VIEW OF SPRAY HEADERS

SAR FIGURE NO. 6.2-19

ARKANSAS NUCLEAR ONE
UNIT 2
RUSSELLVILLE, ARKANSAS



SCALE:	NONE
DRAWN:	ENERGY
DESIGN:	ENERGY
CAD NO:	

AMENDMENT 20

BASED ON DRAWING NO	SHEET	REV.
---------------------	-------	------

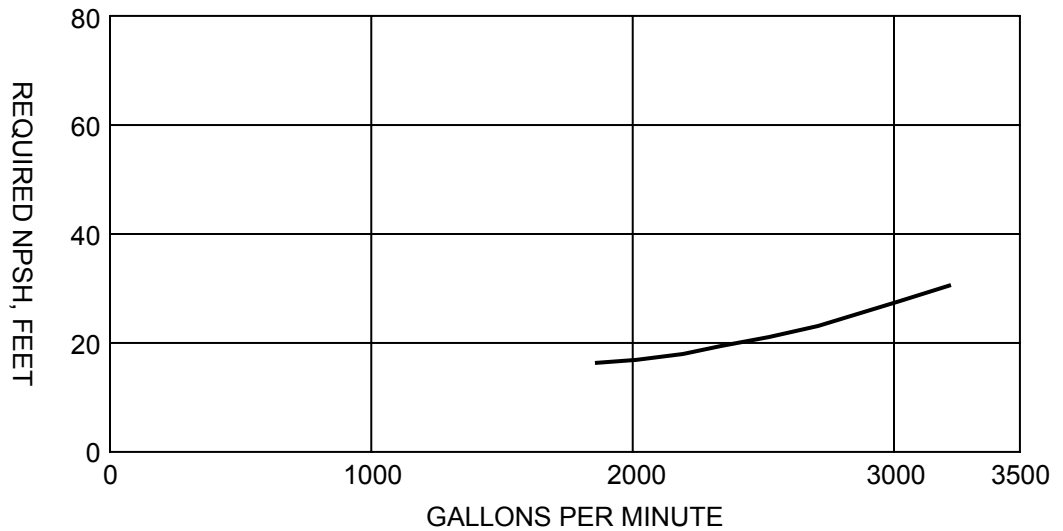
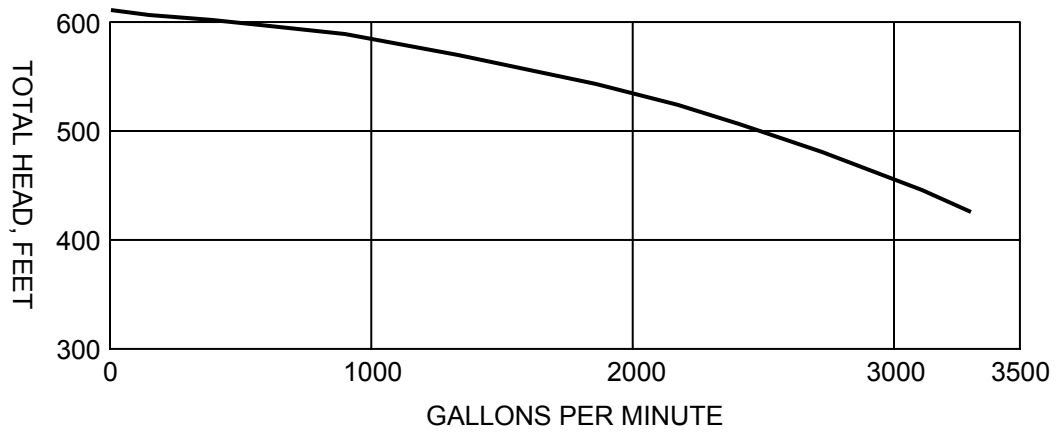
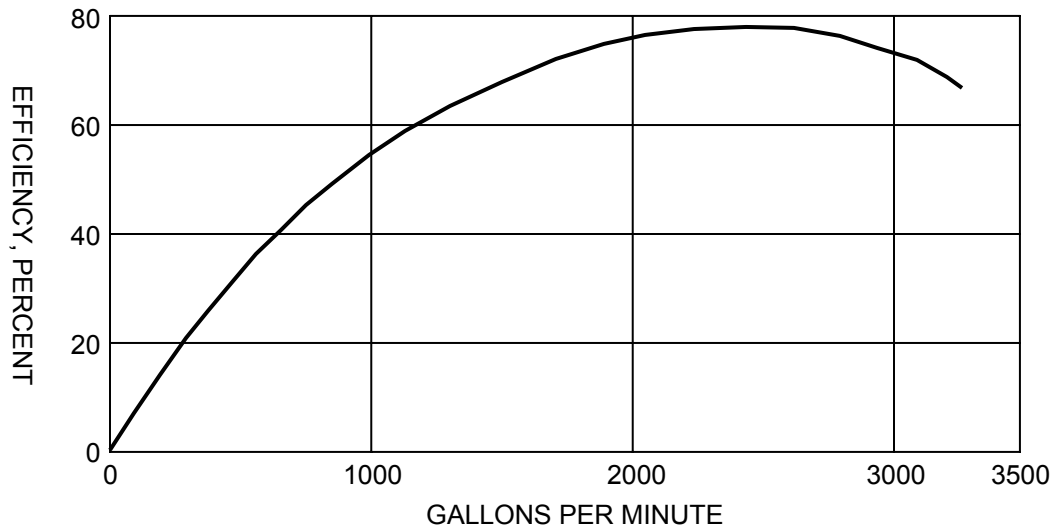

SAR FIGURE NO. 6.2-20

AMENDMENT 20

ARKANSAS NUCLEAR ONE
UNIT 2
RUSSELLVILLE, ARKANSAS



SCALE:	NONE
DRAWN:	ENERGY
DESIGN:	ENERGY
CAD NO:	N/A

CONTAINMENT SPRAY PUMP
CHARACTERISTICS

DRAWING NO

SHEET

REV.

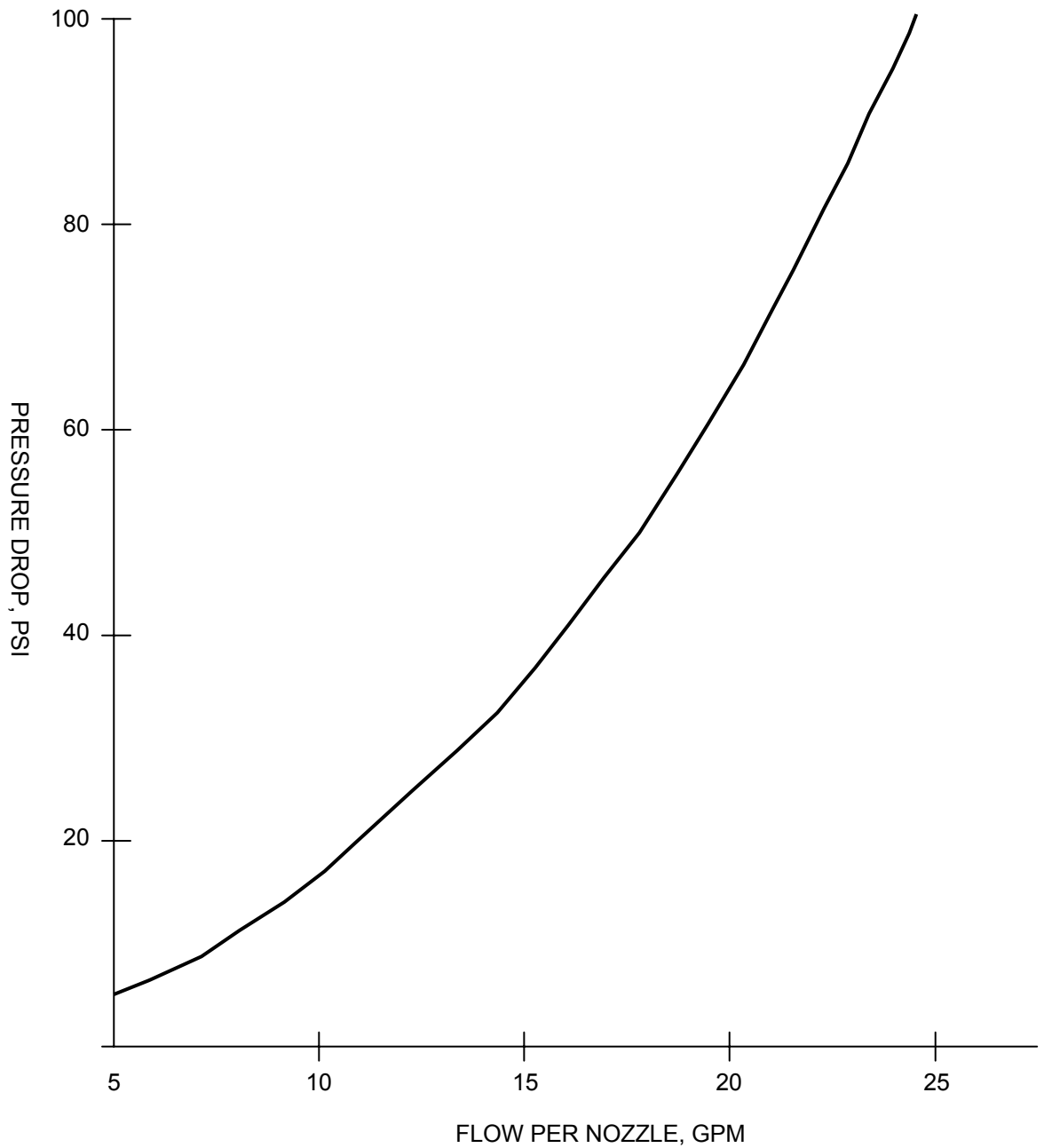

SAR FIGURE NO. 6.2-21

AMENDMENT 20

ARKANSAS NUCLEAR ONE
 UNIT 2
 RUSSELLVILLE, ARKANSAS



SCALE:	NONE
DRAWN:	ENERGY
DESIGN:	ENERGY
CAD NO:	N/A

CONTAINMENT SPRAY NOZZLE
 CHARACTERISTICS

DRAWING NO

SHEET

REV.

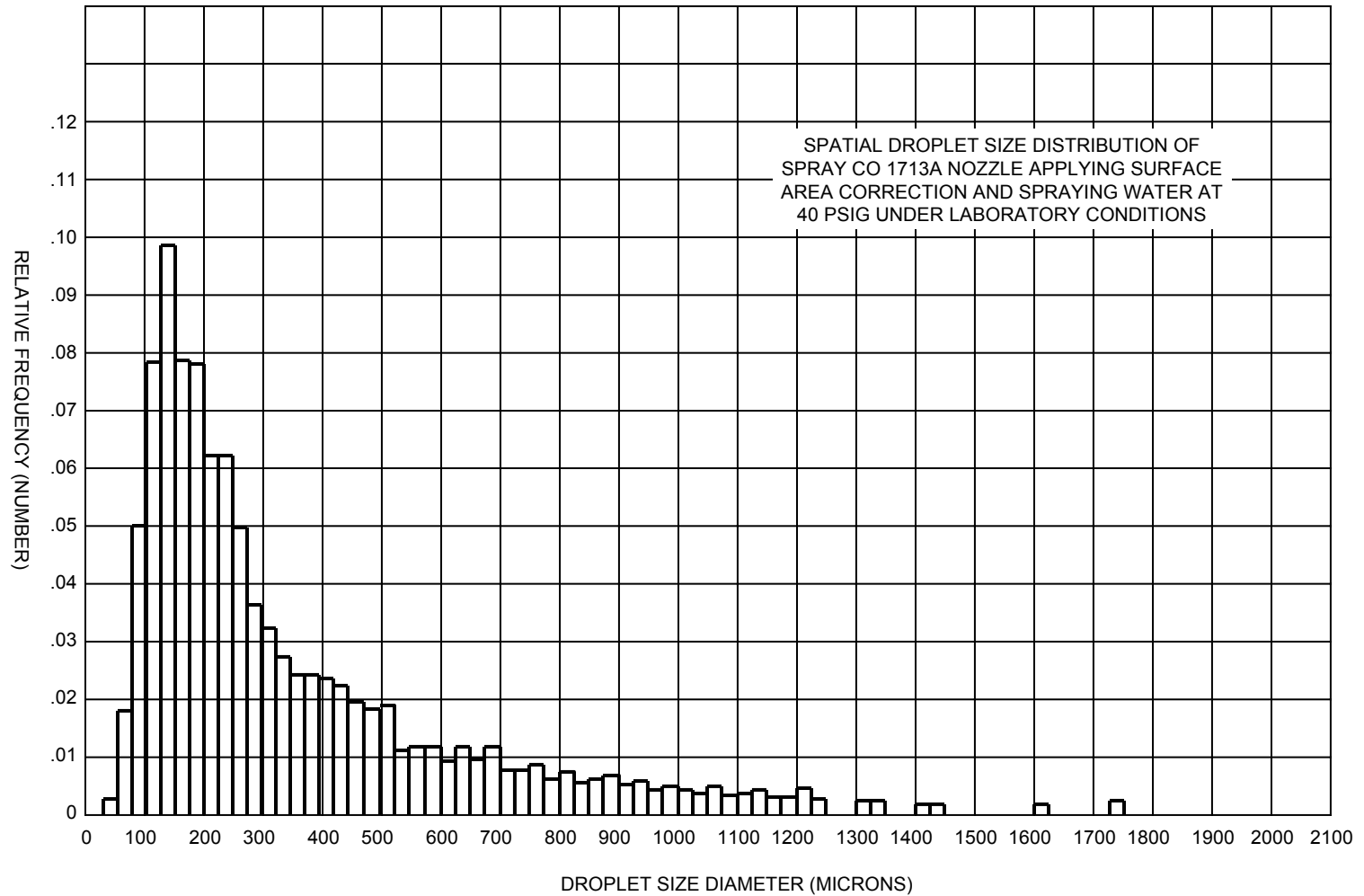

SPATIAL DROPLET SIZE DISTRIBUTION

SAR FIGURE NO. 6.2-22

ARKANSAS NUCLEAR ONE
 UNIT 2
 RUSSELLVILLE, ARKANSAS



SCALE: NONE
 DRAWN: ENTERGY
 DESIGN: ENTERGY
 CAD NO:

AMENDMENT 20

BASED ON DRAWING NO

SHEET

REV.

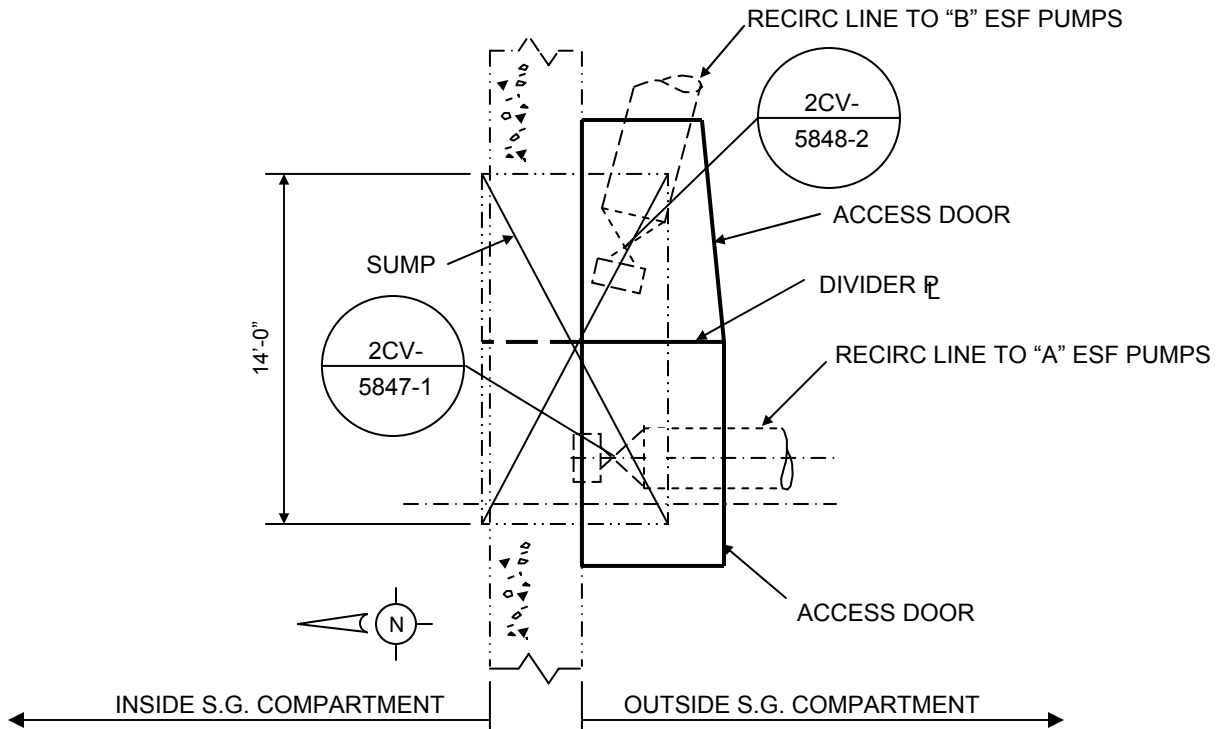

PLAN

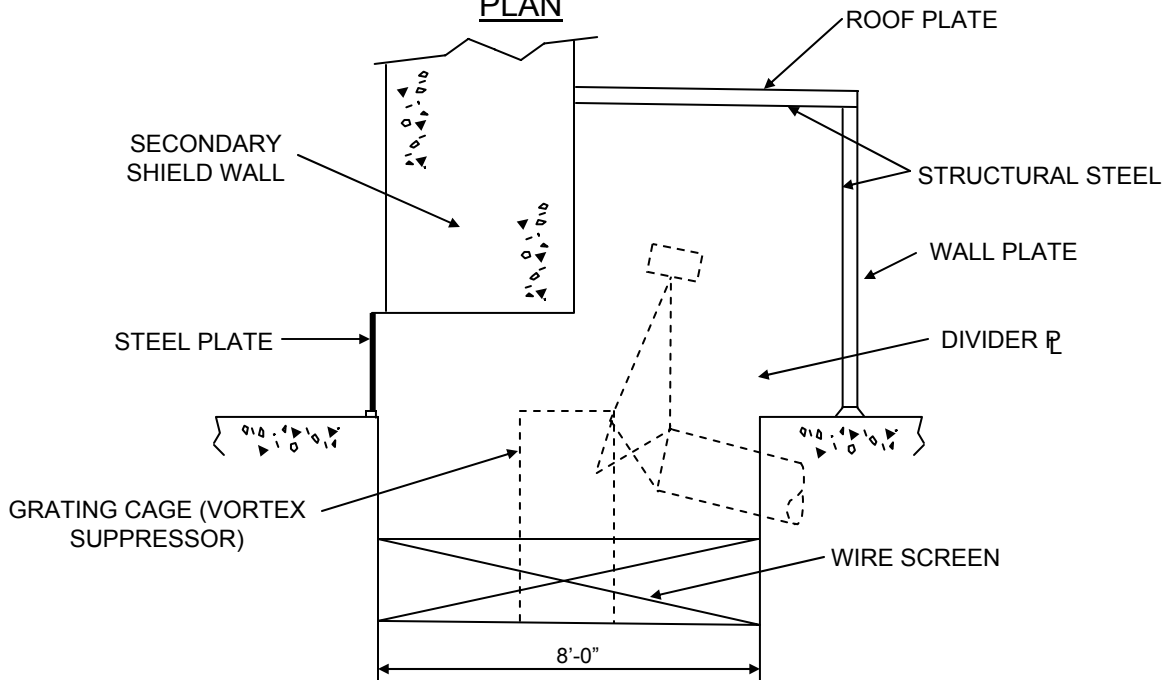

SECTION

SAR FIGURE NO. 6.2-23A

AMENDMENT 20

ARKANSAS NUCLEAR ONE
 UNIT 2
 RUSSELLVILLE, ARKANSAS



SCALE:	NONE
DRAWN:	ENERGY
DESIGN:	ENERGY
CAD NO:	N/A

CONTAINMENT SUMP PLENUM

DRAWING NO

SHEET

REV.

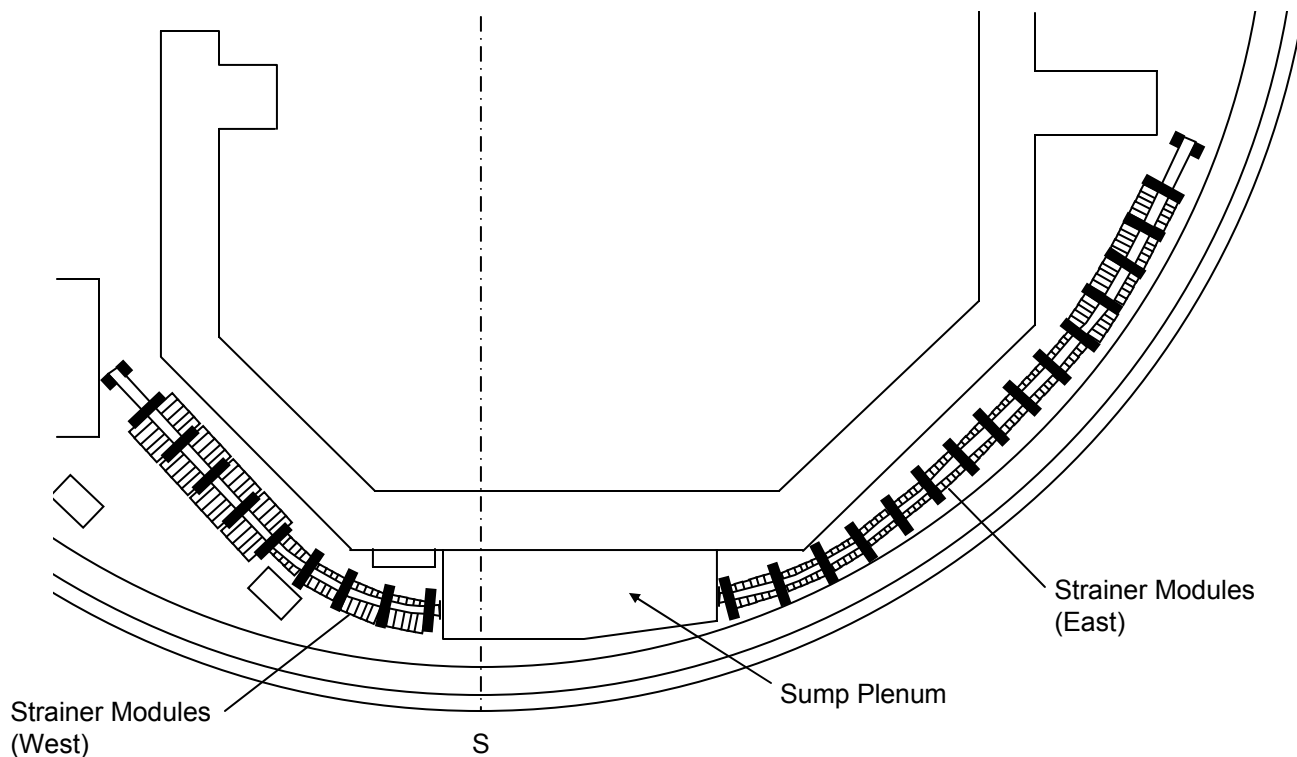

SAR FIGURE NO. 6.2-23B

AMENDMENT 20

ARKANSAS NUCLEAR ONE
 UNIT 2
 RUSSELLVILLE, ARKANSAS



SCALE:	NONE
DRAWN:	ENERGY
DESIGN:	ENERGY
CAD NO:	N/A

CONTAINMENT SUMP STRAINERS

DRAWING NO

SHEET

REV.

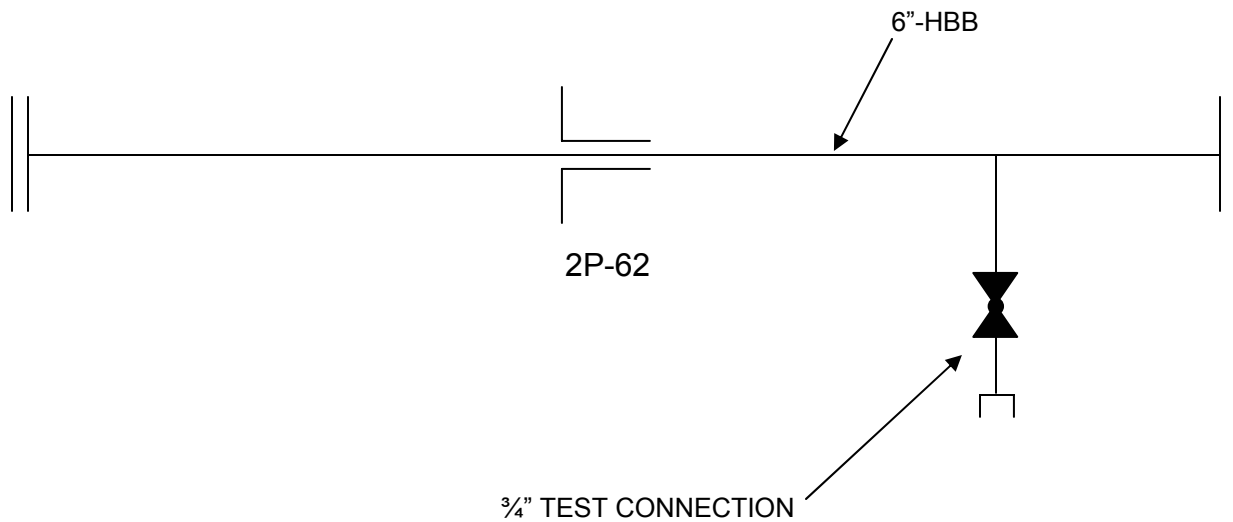

SAR FIGURE NO. 6.2-24

AMENDMENT 20

ARKANSAS NUCLEAR ONE
 UNIT 2
 RUSSELLVILLE, ARKANSAS



SCALE:	NONE
DRAWN:	ENERGY
DESIGN:	ENERGY
CAD NO:	N/A

CONTAINMENT TEST CONNECTION

DRAWING NO

SHEET

REV.

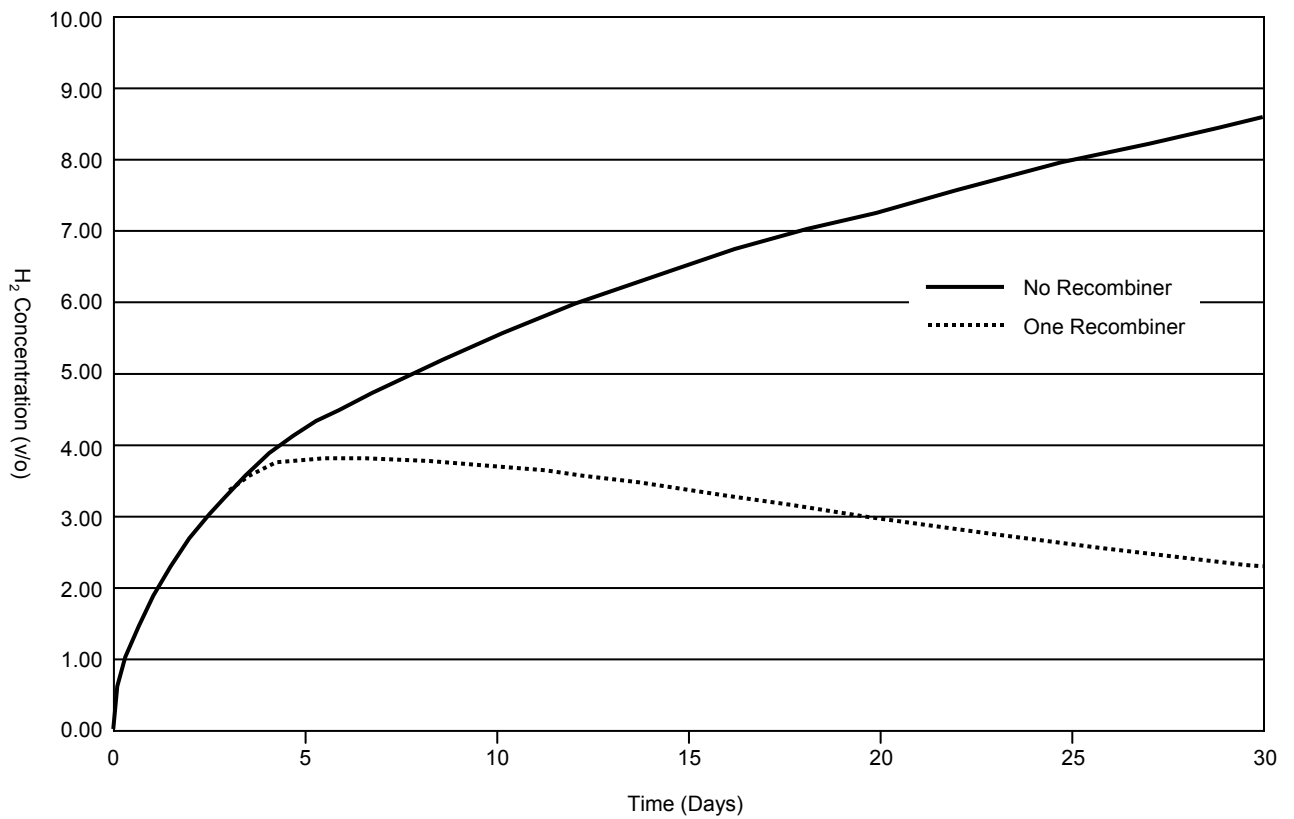

SAR FIGURE NO. 6.2-25

AMENDMENT 20

ARKANSAS NUCLEAR ONE
UNIT 2
RUSSELLVILLE, ARKANSAS



SCALE:	NONE
DRAWN:	ENERGY
DESIGN:	ENERGY
CAD NO:	N/A

ANO-2 POST LOCA HYDROGEN

DRAWING NO

SHEET

REV.

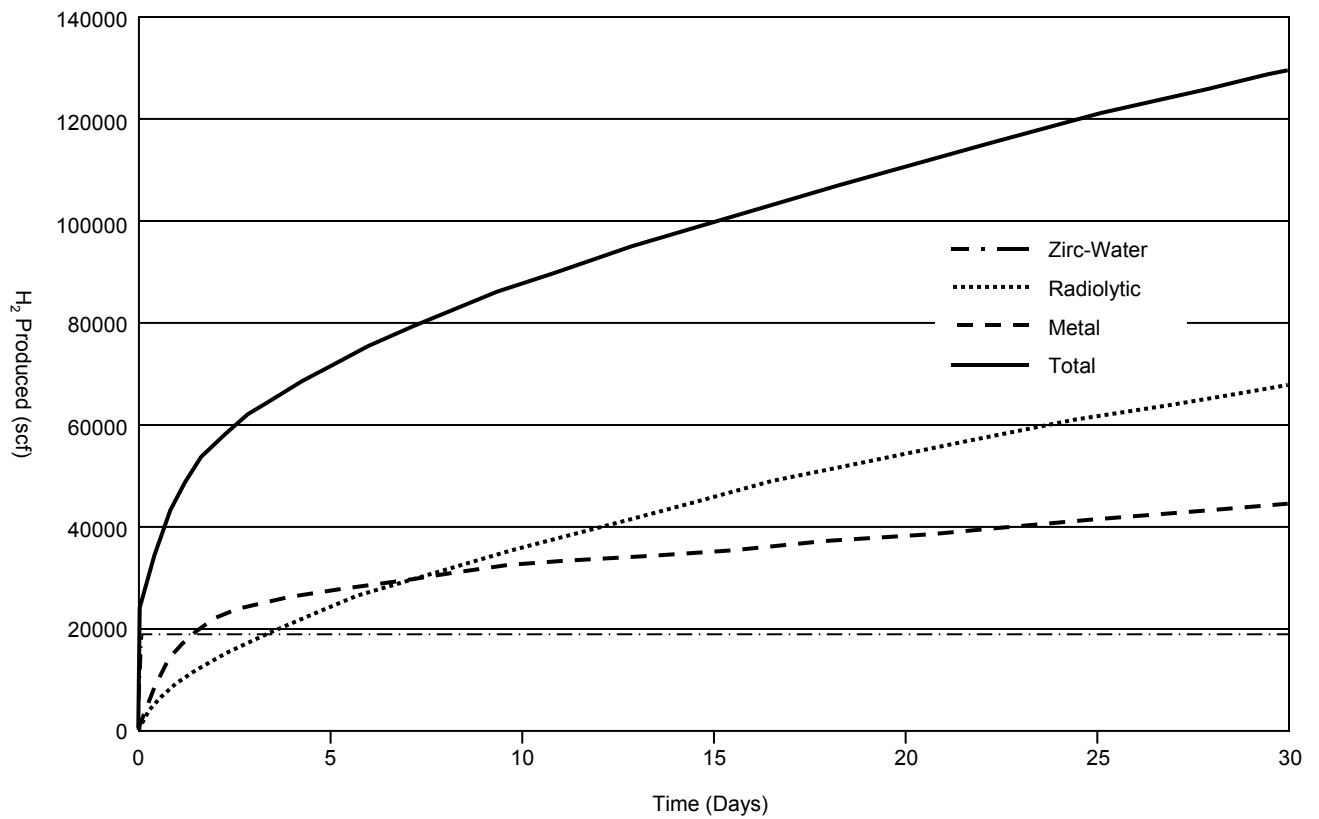

SAR FIGURE NO. 6.2-25A

AMENDMENT 20

ARKANSAS NUCLEAR ONE
UNIT 2
RUSSELLVILLE, ARKANSAS



SCALE:	NONE
DRAWN:	ENERGY
DESIGN:	ENERGY
CAD NO:	N/A

ANO-2 POST LOCA HYDROGEN SOURCES

DRAWING NO

SHEET

REV.

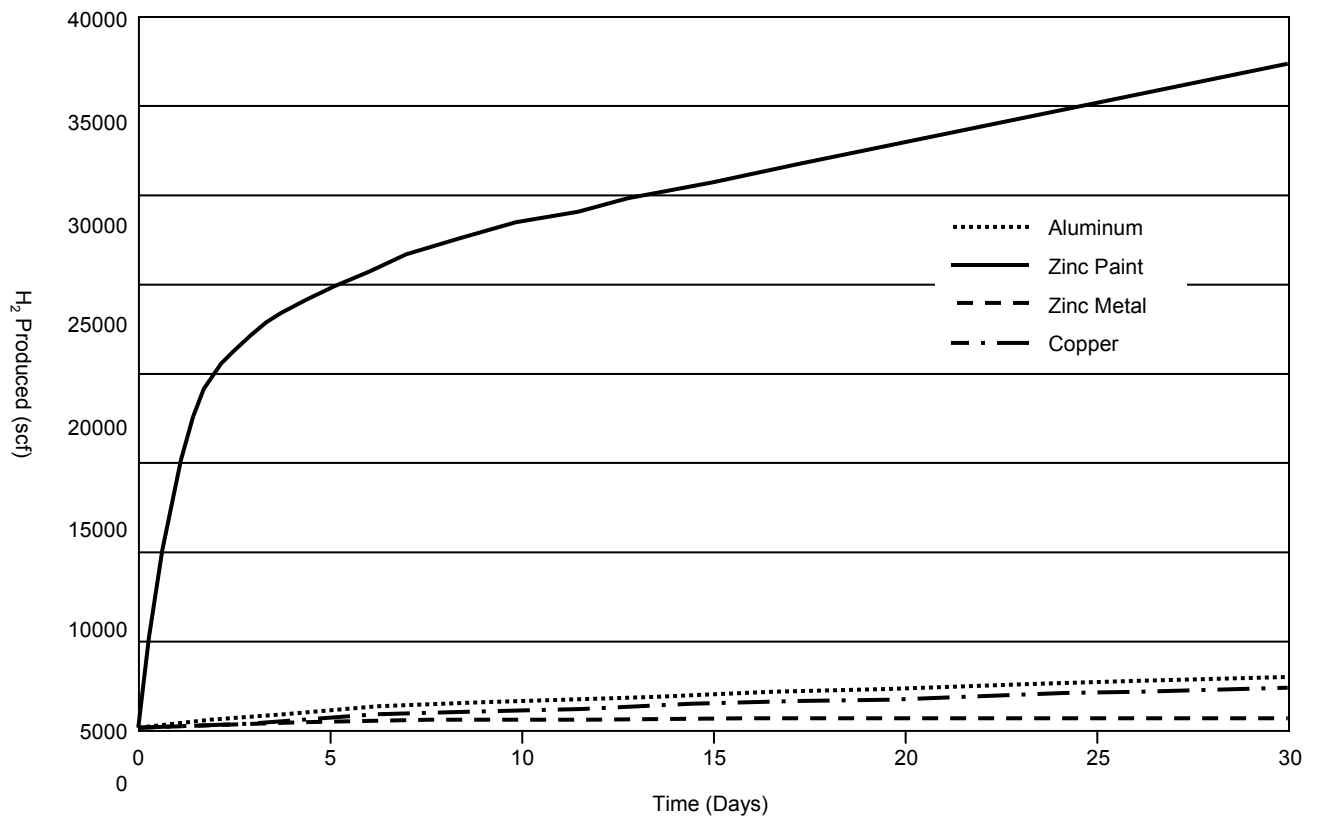

SAR FIGURE NO. 6.2-25B

AMENDMENT 20

ARKANSAS NUCLEAR ONE
 UNIT 2
 RUSSELLVILLE, ARKANSAS



SCALE:	NONE
DRAWN:	ENERGY
DESIGN:	ENERGY
CAD NO:	N/A

ANO-2 POST LOCA H₂ DUE TO CORROSION
 FROM SPRAY

DRAWING NO

SHEET

REV.

Figures 6.2-26 – 6.2-29b Deleted
 See FSAR for Historical Data

SAR FIGURE NOs. 6.2-26 – 6.2-29b

AMENDMENT 20

ARKANSAS NUCLEAR ONE
 UNIT 2
 RUSSELLVILLE, ARKANSAS



SCALE:	NONE
DRAWN:	ENERGY
DESIGN:	ENERGY
CAD NO:	N/A

DRAWING NO

SHEET

REV.

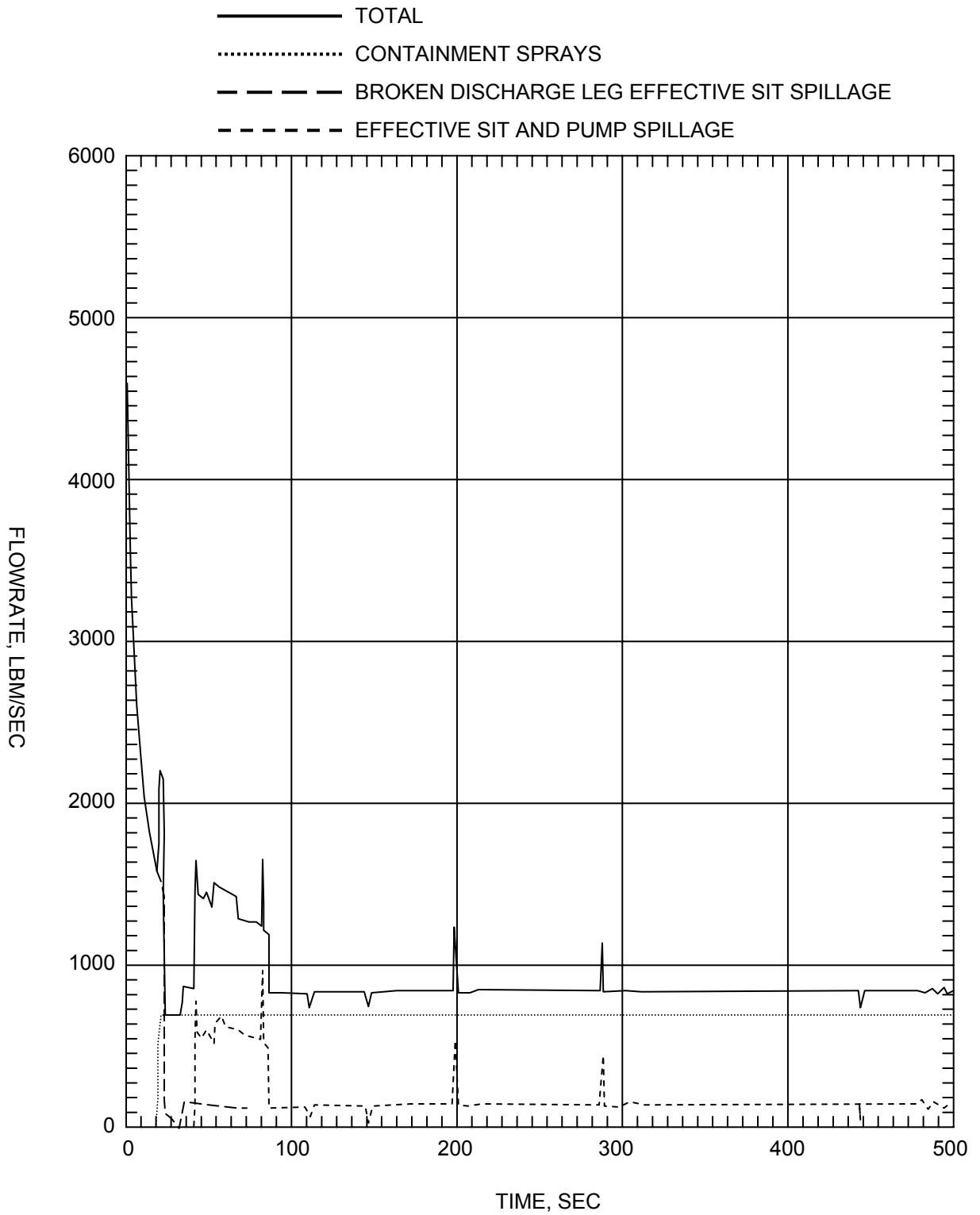

SAR FIGURE NO. 6.2-30

AMENDMENT 21

ARKANSAS NUCLEAR ONE
 UNIT 2
 RUSSELLVILLE, ARKANSAS



SCALE:	NONE
DRAWN:	ENERGY
DESIGN:	ENERGY
CAD NO:	N/A

CONTAINMENT SPRAY & ECCS SPILLAGE FLOW RATES
 USED IN THE MINIMUM CONTAINMENT PRESSURE
 ANALYSIS FOR ECCS PERFORMANCE

DRAWING NO

SHEET

REV.

CONDENSING HEAT TRANSFER COEFFICIENT

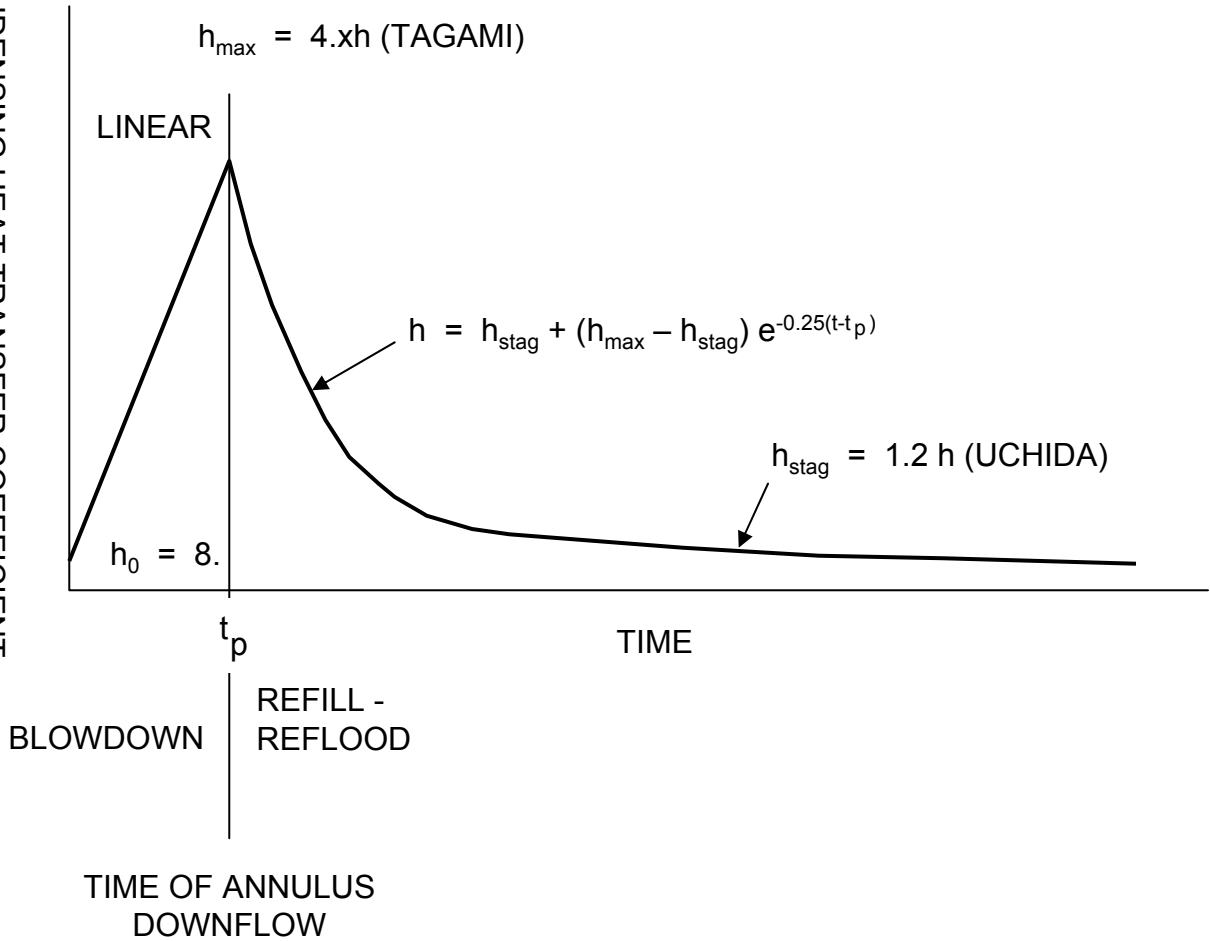

SAR FIGURE NO. 6.2-31

AMENDMENT 20

ARKANSAS NUCLEAR ONE
 UNIT 2
 RUSSELLVILLE, ARKANSAS



SCALE:	NONE
DRAWN:	ENERGY
DESIGN:	ENERGY
CAD NO:	N/A

CONDENSING HEAT TRANSFER COEFFICIENT FOR PASSIVE HEAT SINKS USED IN THE MINIMUM CONTAINMENT PRESSURE ANALYSIS FOR ECCS PERFORMANCE

DRAWING NO

SHEET

REV.

Figure 6.2-32 Deleted
See FSAR for Historical Data

SAR FIGURE NO. 6.2-32

AMENDMENT 20

ARKANSAS NUCLEAR ONE
UNIT 2
RUSSELLVILLE, ARKANSAS



SCALE:	NONE
DRAWN:	ENERGY
DESIGN:	ENERGY
CAD NO:	N/A

Minimum Containment Pressure for ECCS Performance
Analysis 0.6 Double-Ended Guillotine Break in Pump
Discharge Leg

DRAWING NO

SHEET

REV.

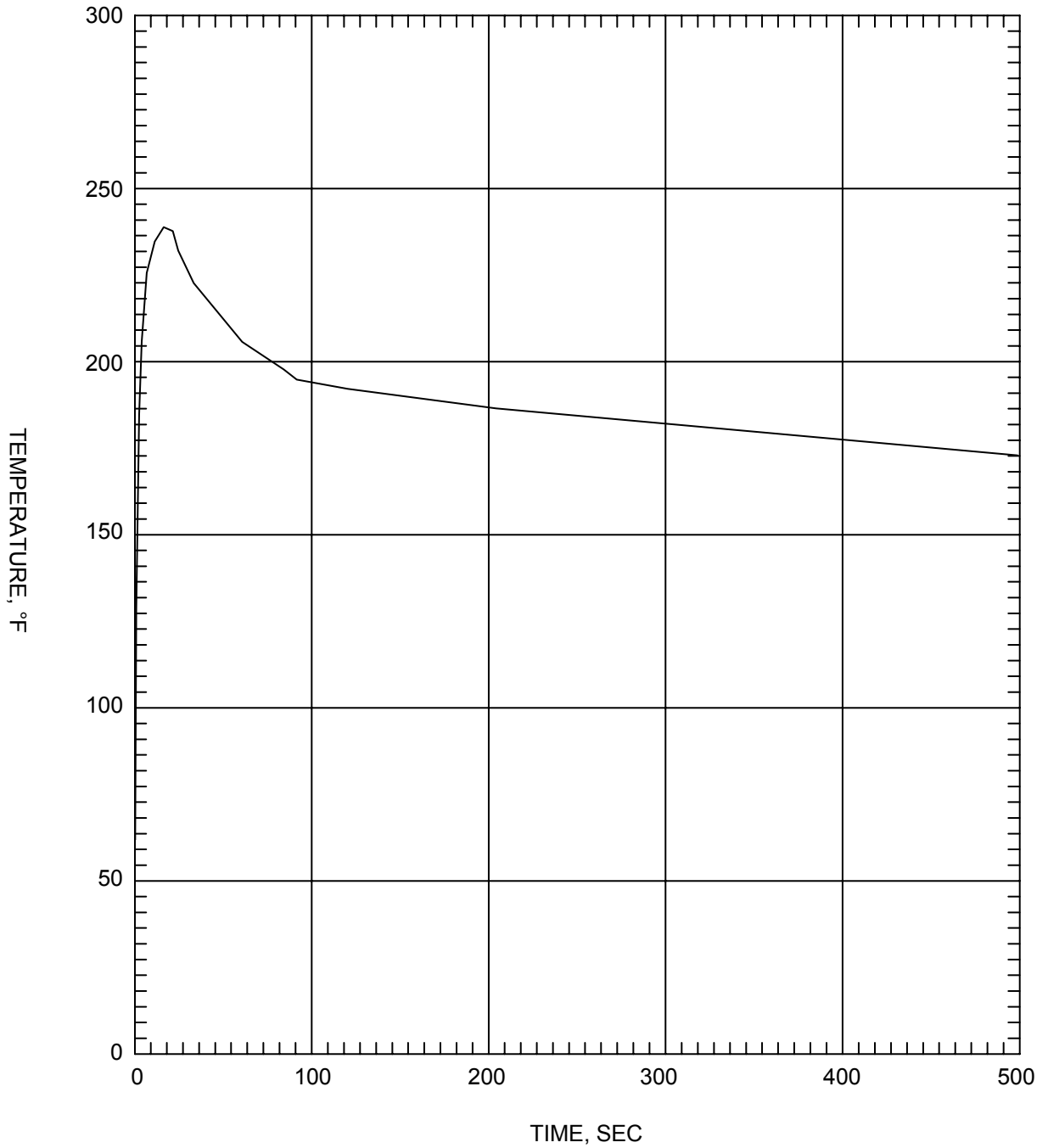

SAR FIGURE NO. 6.2-33

AMENDMENT 21

ARKANSAS NUCLEAR ONE
 UNIT 2
 RUSSELLVILLE, ARKANSAS



SCALE:	NONE
DRAWN:	ENERGY
DESIGN:	ENERGY
CAD NO:	N/A

CONTAINMENT ATMOSPHERIC TEMPERATURE
 0.4 DOUBLE-ENDED GUILLOTINE BREAK IN PUMP
 DISCHARGE LEG

DRAWING NO	SHEET	REV.

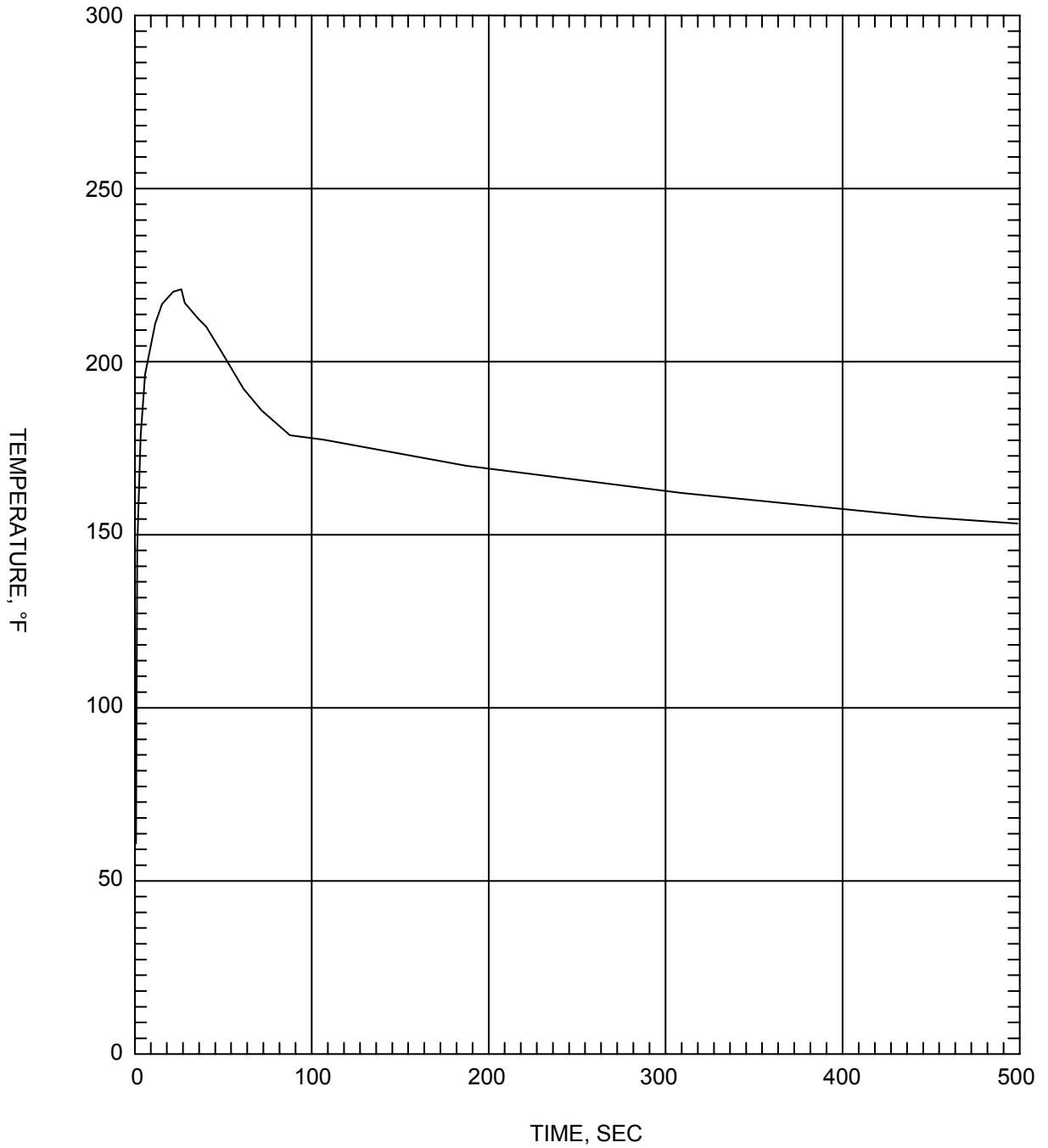

SAR FIGURE NO. 6.2-34

AMENDMENT 21

ARKANSAS NUCLEAR ONE
 UNIT 2
 RUSSELLVILLE, ARKANSAS



SCALE:	NONE
DRAWN:	ENERGY
DESIGN:	ENERGY
CAD NO:	N/A

CONTAINMENT SUMP TEMPERATURE 0.4 DOUBLE-
 ENDED GUILLOTINE BREAK IN PUMP DISCHARGE LEG

DRAWING NO	SHEET	REV.

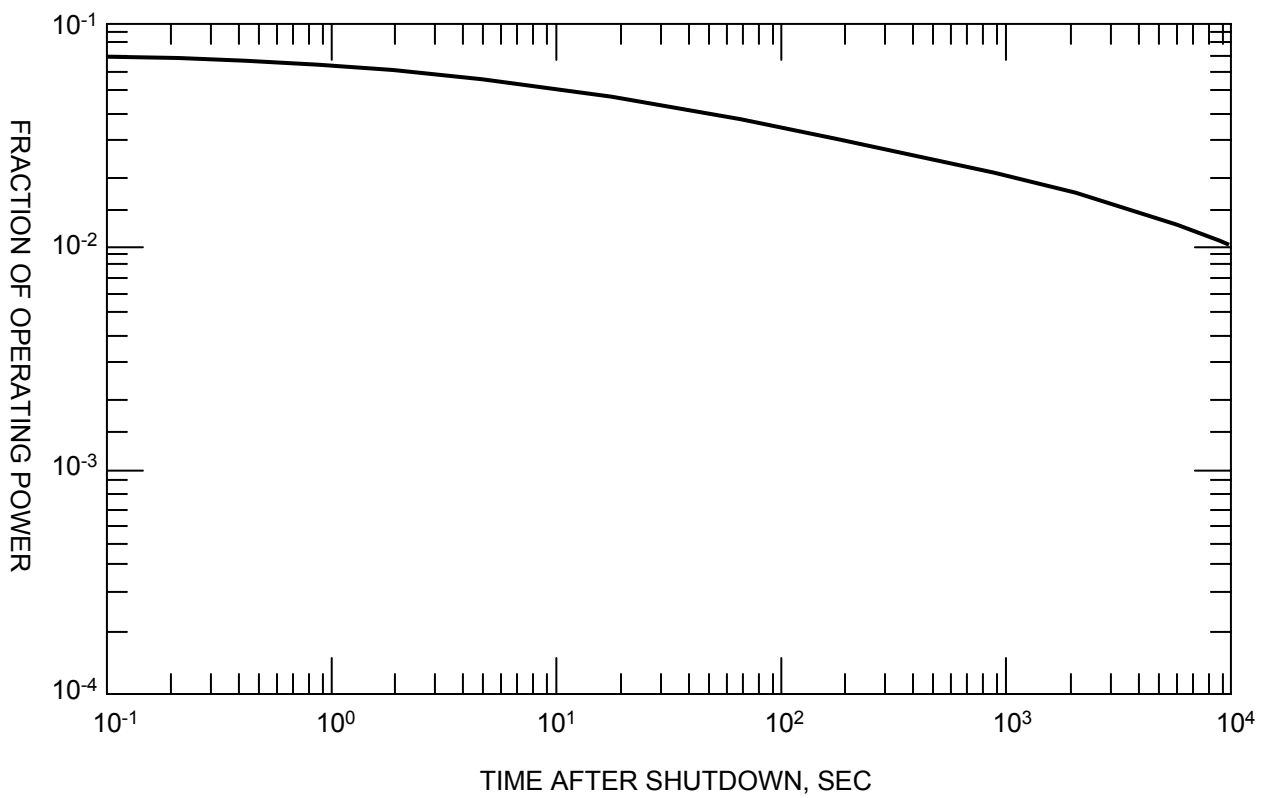

SAR FIGURE NO. 6.3-1A

AMENDMENT 20

ARKANSAS NUCLEAR ONE
 UNIT 2
 RUSSELLVILLE, ARKANSAS



SCALE:	NONE
DRAWN:	ENERGY
DESIGN:	ENERGY
CAD NO:	N/A

STANDARD FISSION PRODUCT DECAY
 CURVE

DRAWING NO

SHEET

REV.

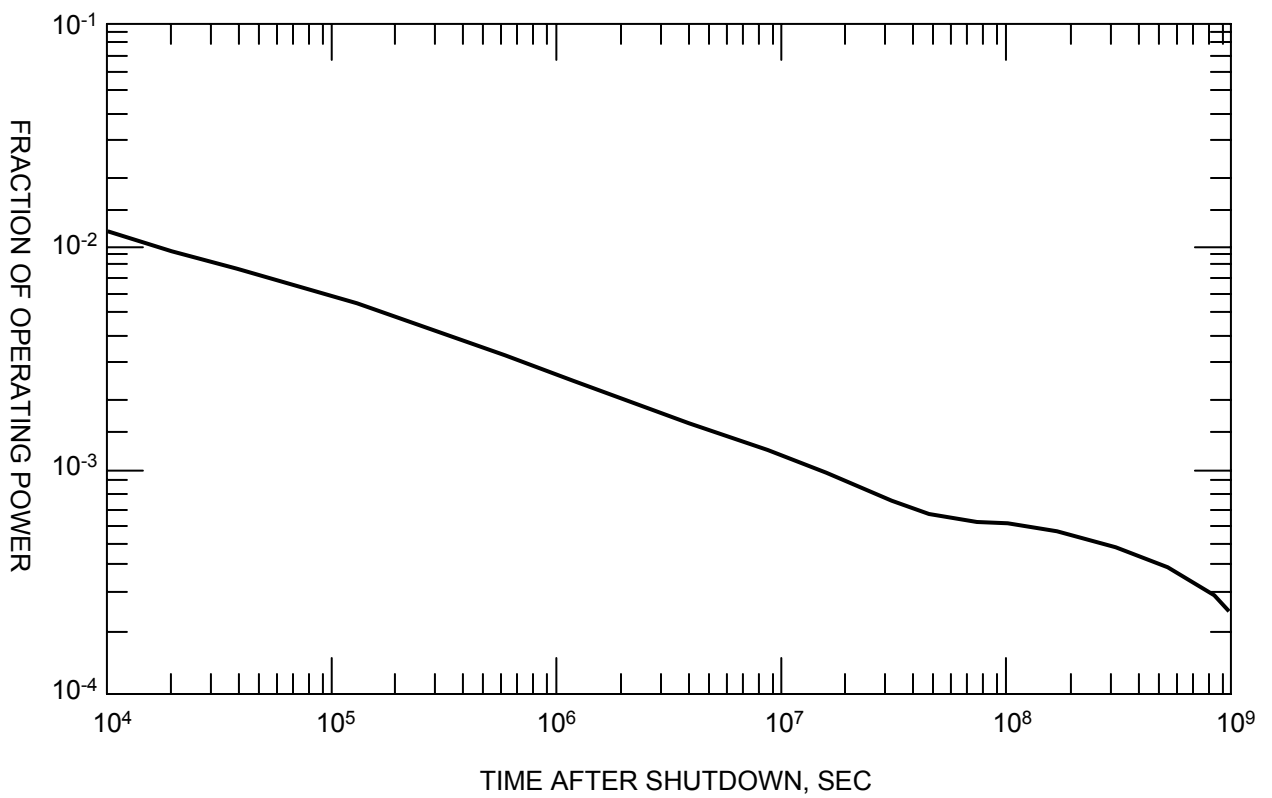

SAR FIGURE NO. 6.3-1B

AMENDMENT 20

ARKANSAS NUCLEAR ONE
 UNIT 2
 RUSSELLVILLE, ARKANSAS



SCALE:	NONE
DRAWN:	ENERGY
DESIGN:	ENERGY
CAD NO:	N/A

STANDARD FISSION PRODUCT DECAY HEAT
 CURVE

DRAWING NO

SHEET

REV.

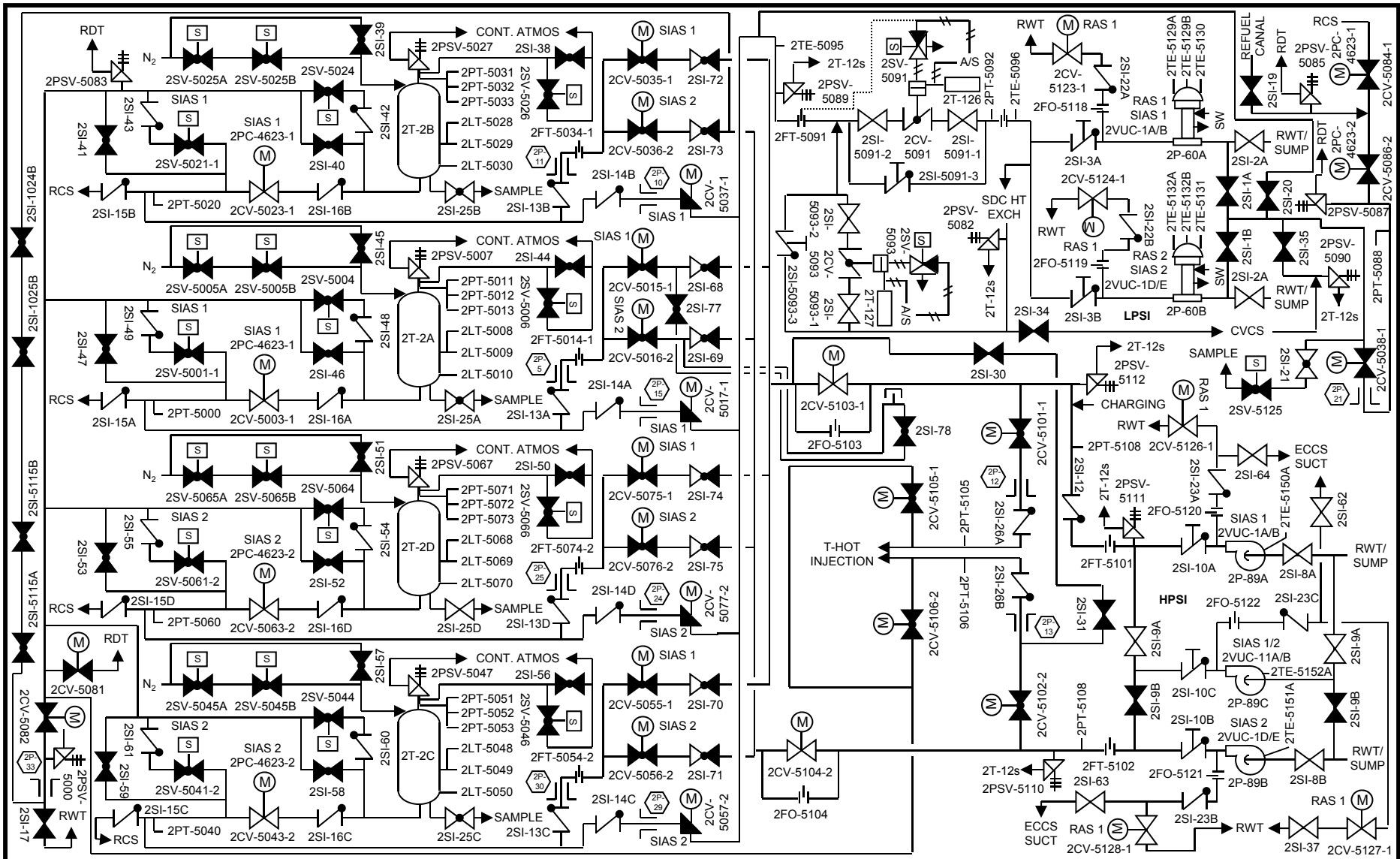

SAFETY INJECTION SYSTEM

SAR FIGURE NO. 6.3-2

ARKANSAS NUCLEAR ONE
UNIT 2
RUSSELLVILLE, ARKANSAS



SCALE: NONE
DRAWN: ENTERGY
DESIGN: ENTERGY
CAD NO:

AMENDMENT 26

BASED ON DRAWING NO SHEET REV.

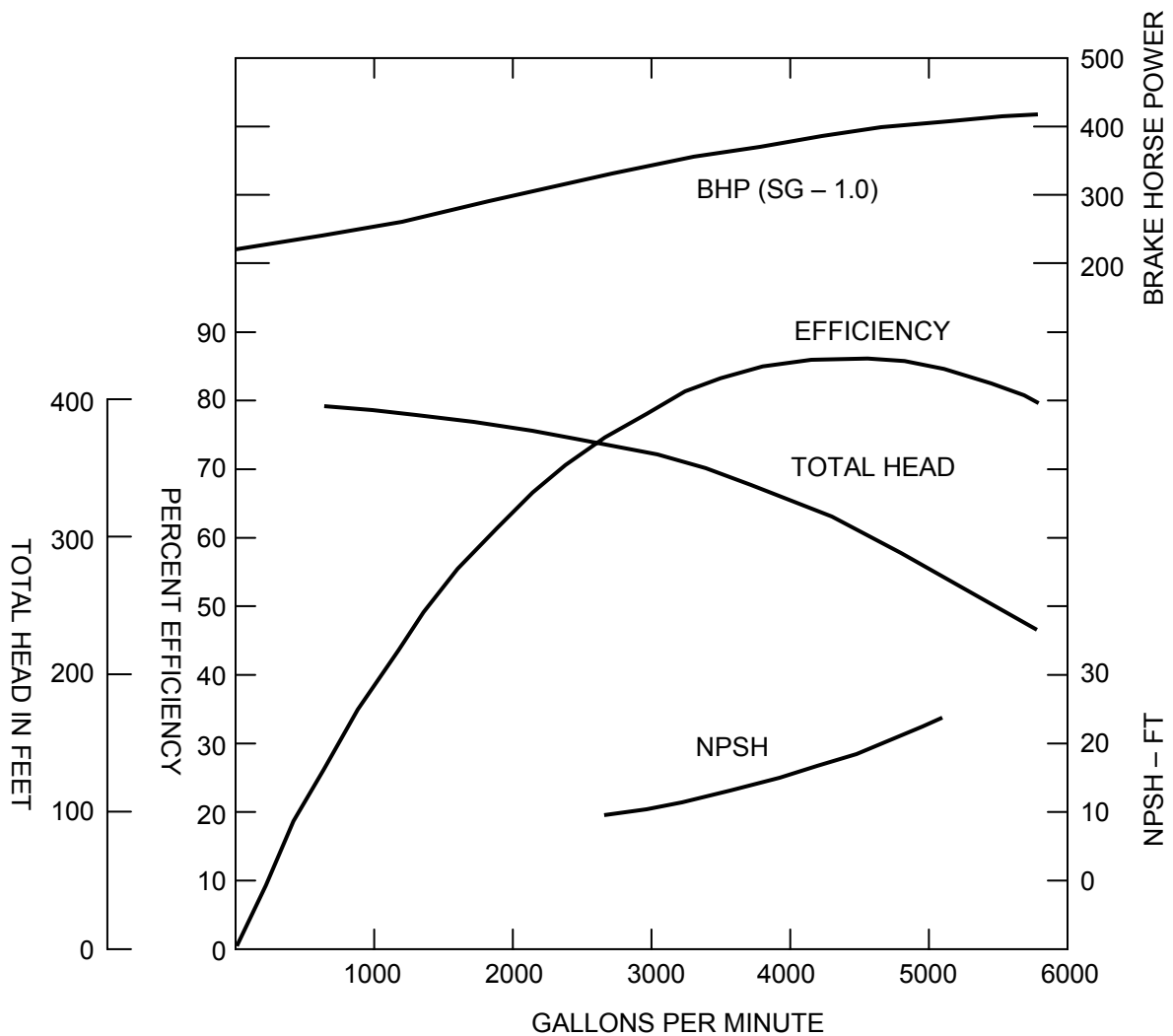

SAR FIGURE NO. 6.3-3

AMENDMENT 20

ARKANSAS NUCLEAR ONE
UNIT 2
RUSSELLVILLE, ARKANSAS



SCALE:	NONE
DRAWN:	ENERGY
DESIGN:	ENERGY
CAD NO:	N/A

LPSI PUMP CHARACTERISTIC

DRAWING NO

SHEET

REV.

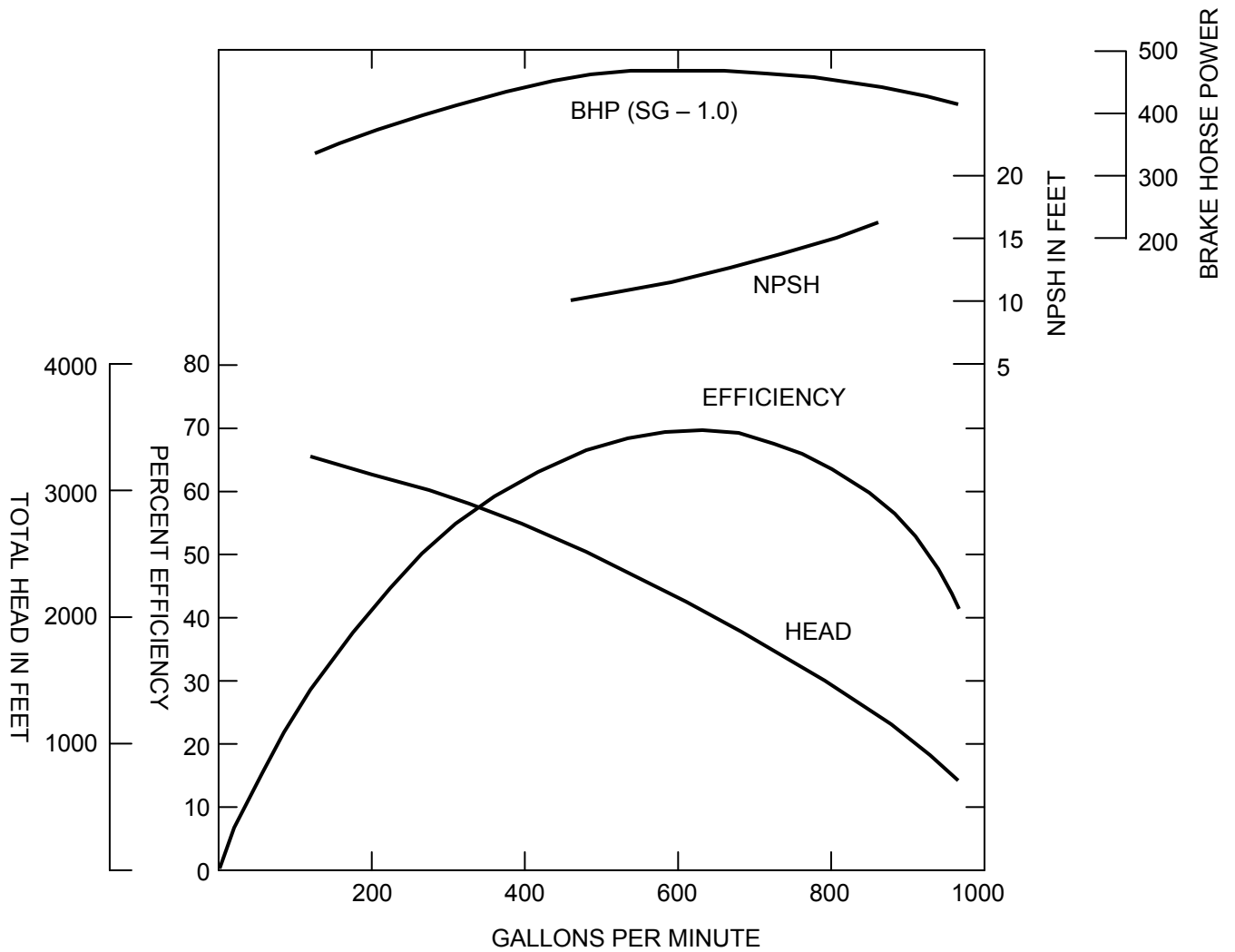

SAR FIGURE NO. 6.3-4

AMENDMENT 23

ARKANSAS NUCLEAR ONE
 UNIT 2
 RUSSELLVILLE, ARKANSAS



SCALE:	NONE
DRAWN:	ENERGY
DESIGN:	ENERGY
CAD NO:	N/A

HPSI PUMP CHARACTERISTIC
 (Historical – current pump performance data maintained in ANO testing documentation and calculations)

DRAWING NO	SHEET	REV.

Figures 6.3-5A – 6.3-11 Deleted
See FSAR for Historical Data

SAR FIGURE NOS. 6.3-5A – 6.3-11

AMENDMENT 20

ARKANSAS NUCLEAR ONE
UNIT 2
RUSSELLVILLE, ARKANSAS



SCALE:	NONE
DRAWN:	ENERGY
DESIGN:	ENERGY
CAD NO:	N/A

DRAWING NO

SHEET

REV.

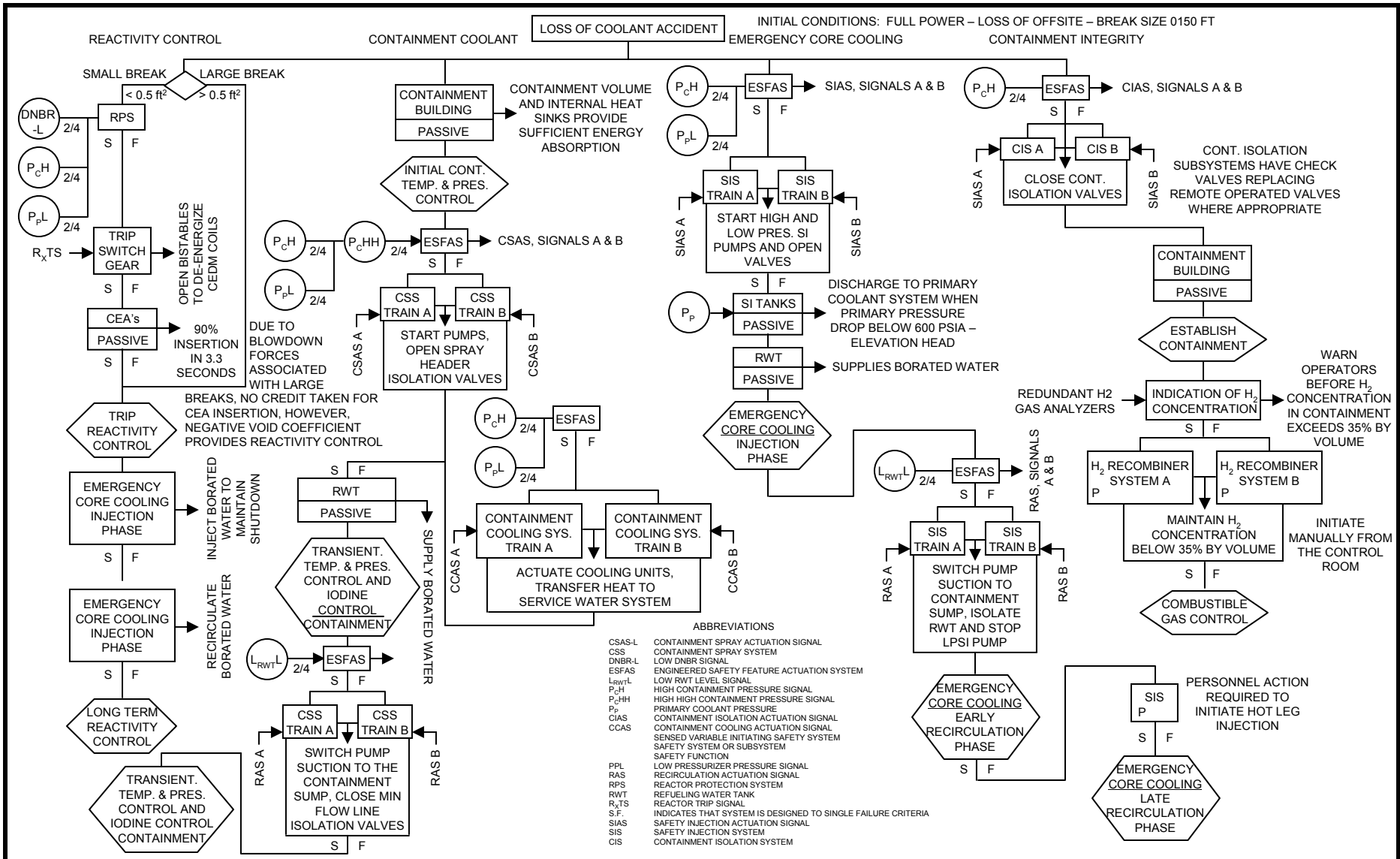

LOCA SEQUENCE OF EVENTS DIAGRAM

SAR FIGURE NO. 6.3-12

ARKANSAS NUCLEAR ONE
UNIT 2
RUSSELLVILLE, ARKANSAS



SCALE:	NONE
DRAWN:	ENERGY
DESIGN:	ENERGY
CAD NO:	

AMENDMENT 20		
BASED ON DRAWING NO	SHEET	REV.

Deleted
See FSAR for Historical Data

SAR FIGURE NO. 6.3-13

AMENDMENT 20

ARKANSAS NUCLEAR ONE
UNIT 2
RUSSELLVILLE, ARKANSAS



SCALE:	NONE
DRAWN:	ENERGY
DESIGN:	ENERGY
CAD NO:	N/A

GAP CONDUCTANCE AT BEGINNING OF
LIFE VS LINEAR HEAT RATE

DRAWING NO

SHEET

REV.

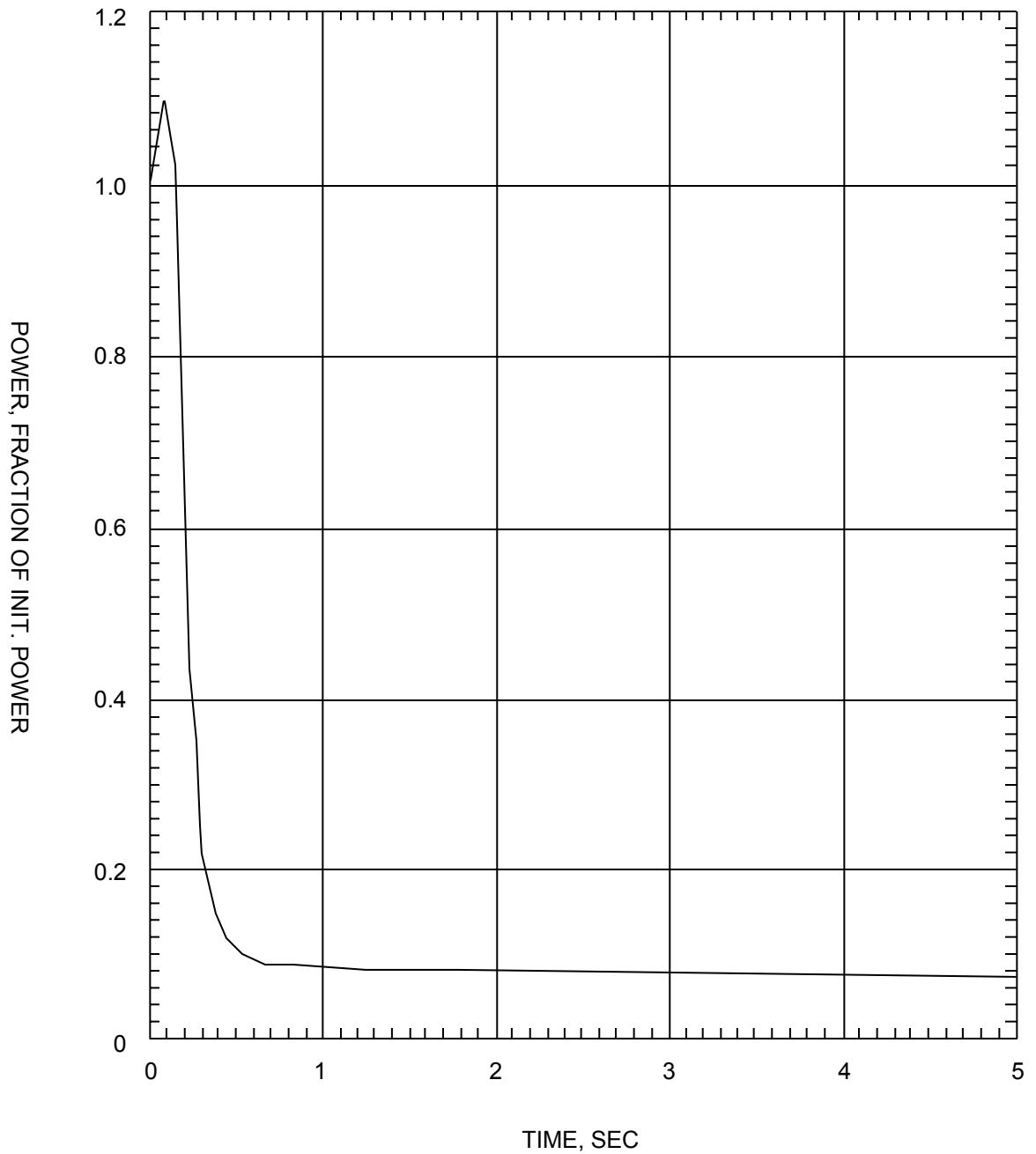

SAR FIGURE NO. 6.3-13a

AMENDMENT 21

ARKANSAS NUCLEAR ONE
 UNIT 2
 RUSSELLVILLE, ARKANSAS



SCALE:	NONE
DRAWN:	
DESIGN:	ENERGY
CAD NO:	

ANO-2 ECCS PERFORMANCE ANALYSIS FOR
 IMPLEMENTATION OF CE 16 X 16 NGF
 1.0 DEG/PD BREAK – CORE POWER

BASED ON DRAWING NO

SHEET

REV.

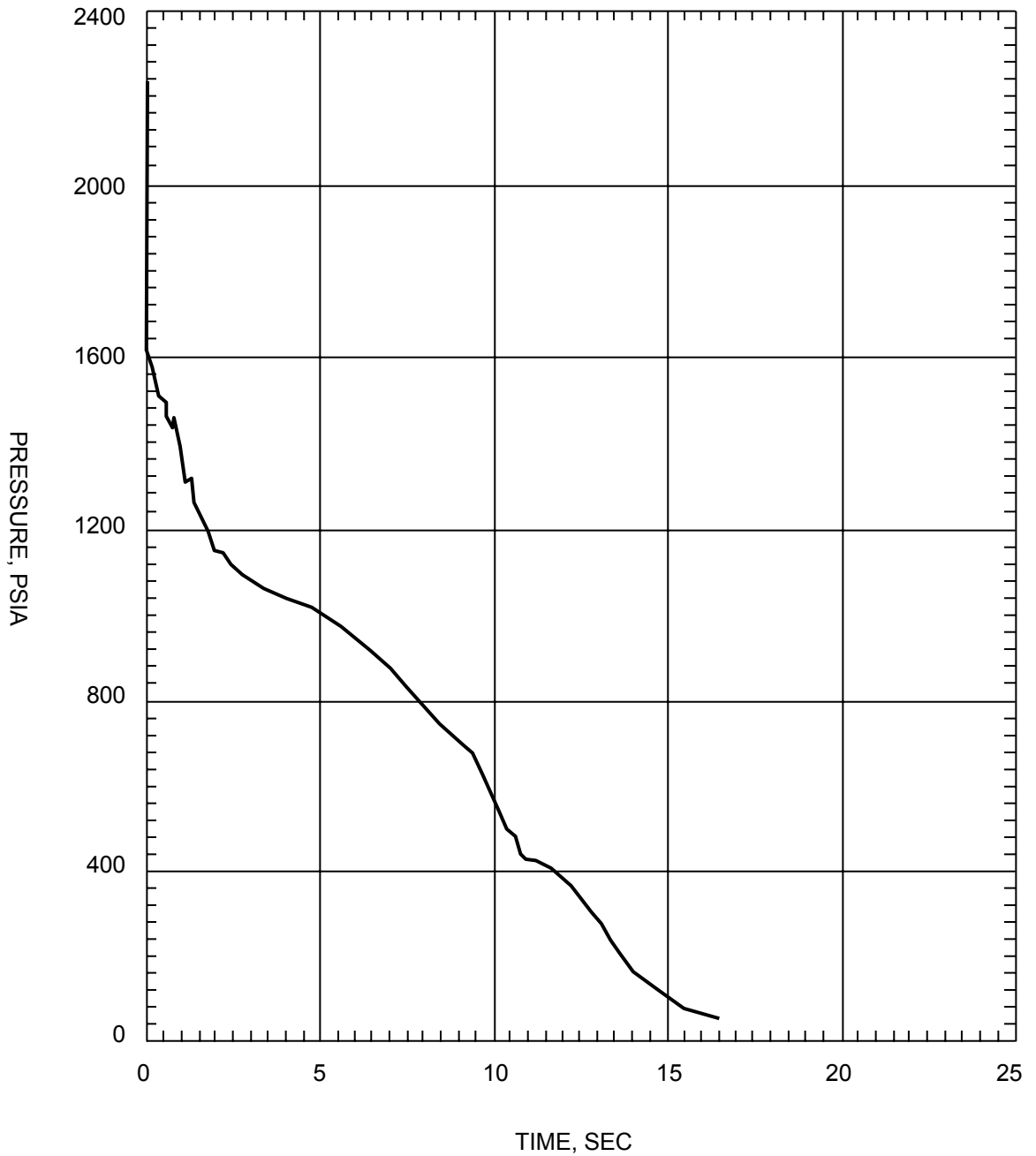

SAR FIGURE NO. 6.3-13b

AMENDMENT 21

ARKANSAS NUCLEAR ONE
 UNIT 2
 RUSSELLVILLE, ARKANSAS



SCALE:	NONE
DRAWN:	
DESIGN:	ENTERGY
CAD NO:	

ANO-2 ECCS PERFORMANCE ANALYSIS FOR
 IMPLEMENTATION OF CE 16 X 16 NGF - 1.0 DEG/PD
 BREAK - PRESSURE IN CENTER HOT ASSEMBLY NODE

BASED ON DRAWING NO

SHEET

REV.

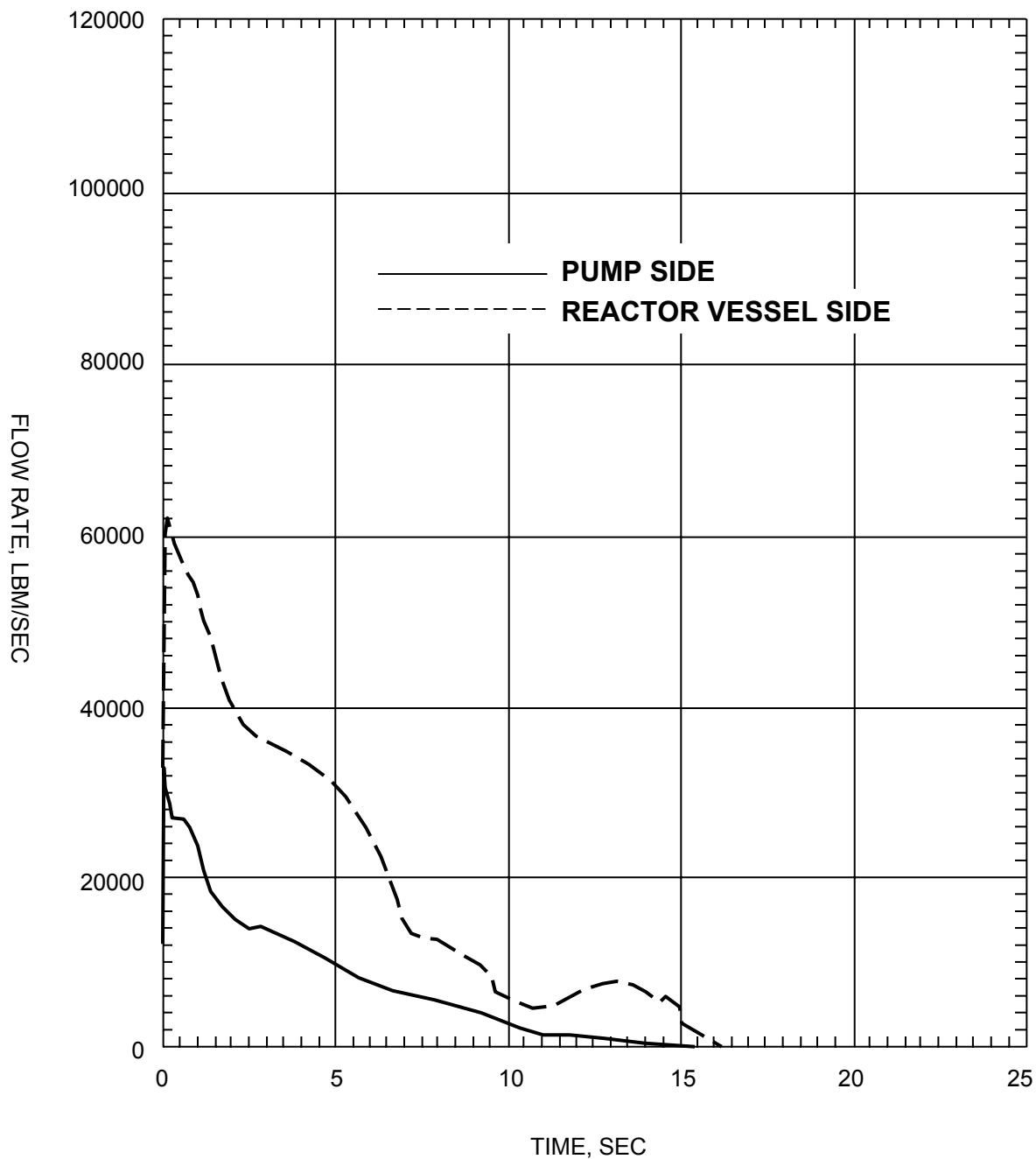

SAR FIGURE NO. 6.3-13c

AMENDMENT 21

ARKANSAS NUCLEAR ONE
 UNIT 2
 RUSSELLVILLE, ARKANSAS



SCALE:	NONE
DRAWN:	
DESIGN:	ENERGY
CAD NO:	

ANO-2 ECCS PERFORMANCE ANALYSIS FOR
 IMPLEMENTATION OF CE 16 X 16 NGF - 1.0 DEG/PD
 BREAK - LEAK FLOW RATE

BASED ON DRAWING NO

SHEET

REV.

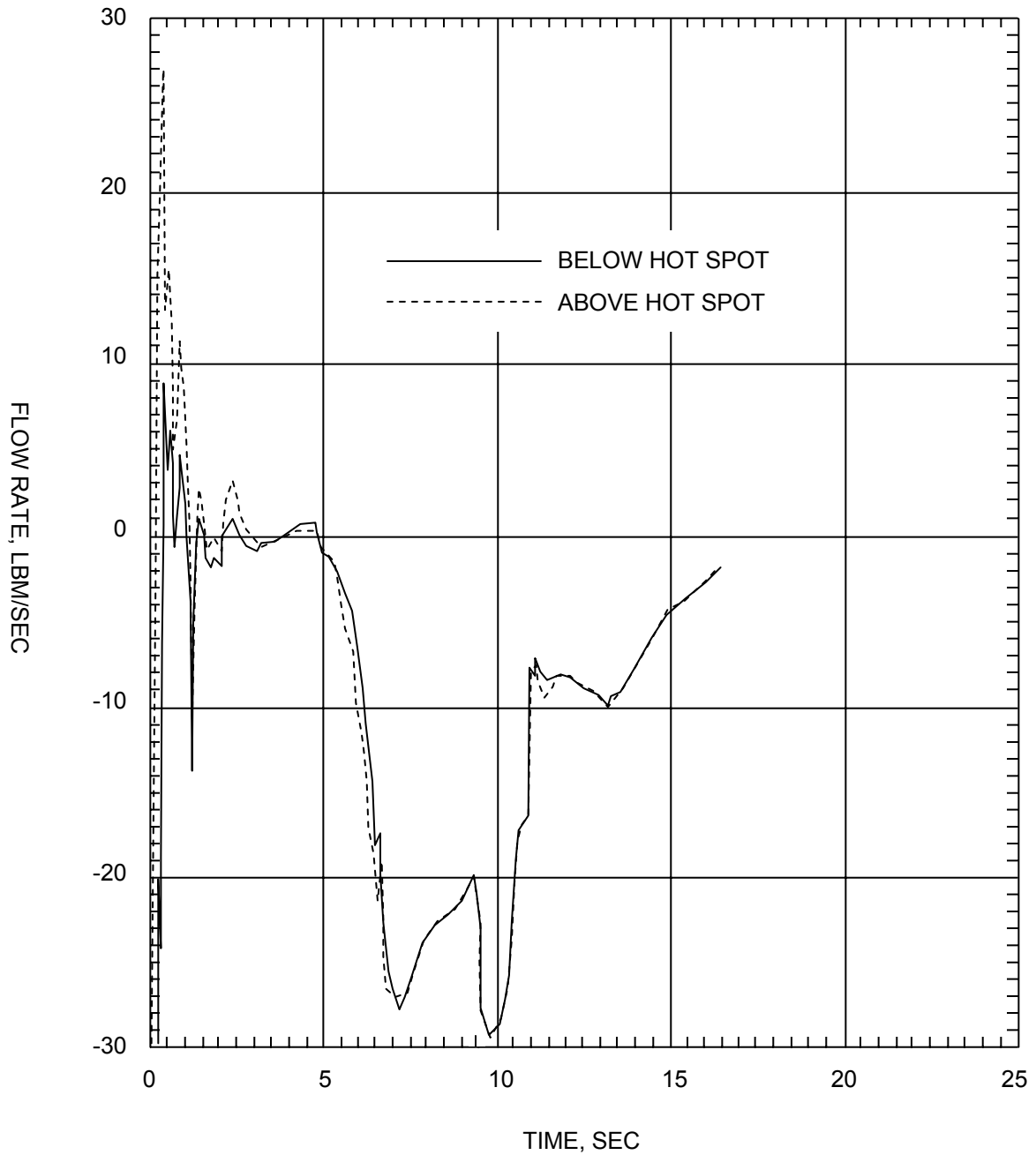

SAR FIGURE NO. 6.3-13d

AMENDMENT 21

ARKANSAS NUCLEAR ONE
 UNIT 2
 RUSSELLVILLE, ARKANSAS



SCALE:	NONE
DRAWN:	
DESIGN:	ENERGY
CAD NO:	

ANO-2 ECCS PERFORMANCE ANALYSIS FOR
 IMPLEMENTATION OF CE 16 X 16 NGF - 1.0 DEG/PD BREAK -
 HOT ASSEMBLY FLOW RATE (BELOW AND ABOVE HOT SPOT)

BASED ON DRAWING NO

SHEET

REV.

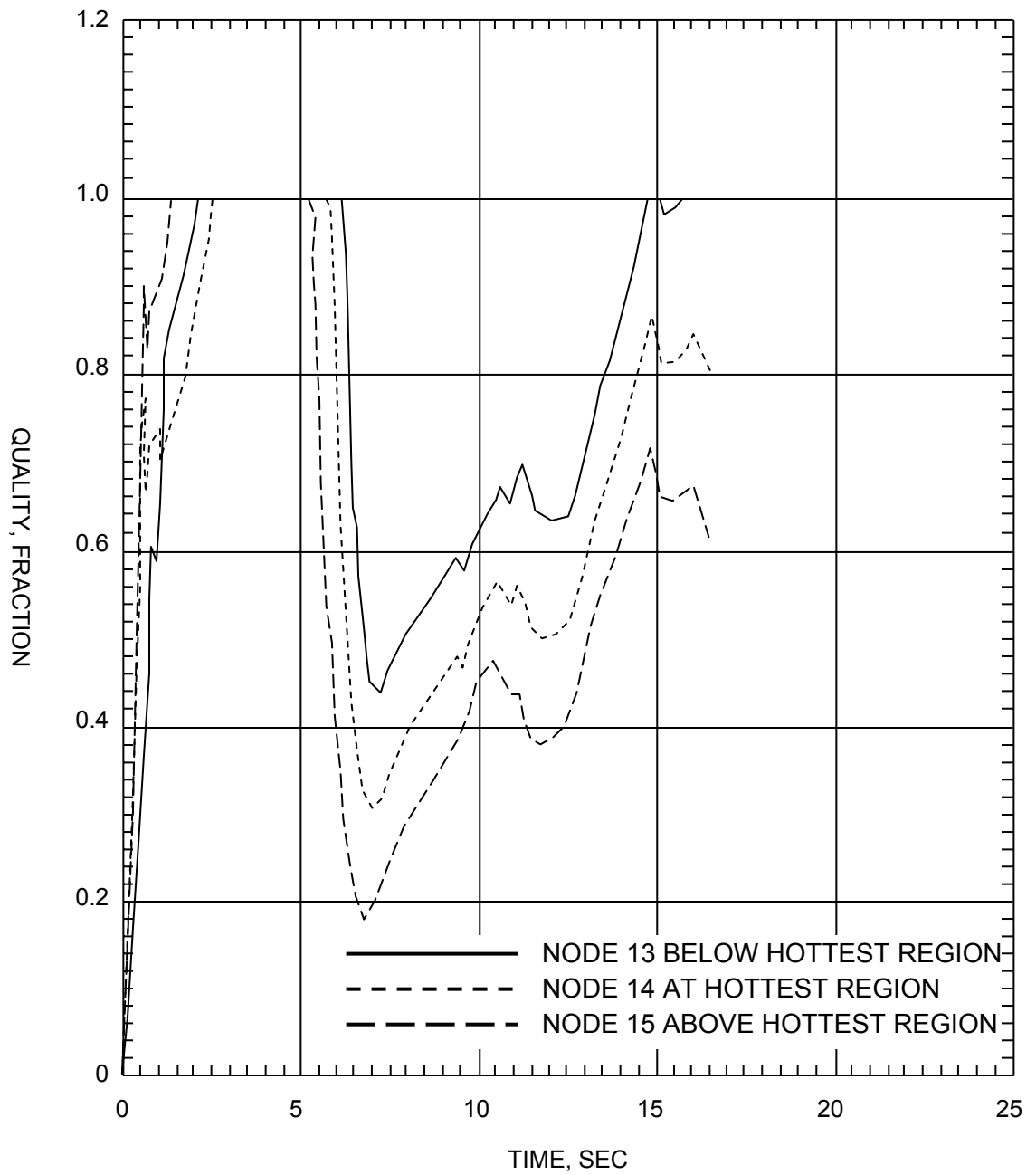

SAR FIGURE NO. 6.3-13e

AMENDMENT 21

ARKANSAS NUCLEAR ONE
 UNIT 2
 RUSSELLVILLE, ARKANSAS



SCALE:	NONE
DRAWN:	
DESIGN:	ENTERGY
CAD NO:	

ANO-2 ECCS PERFORMANCE ANALYSIS FOR
 IMPLEMENTATION OF CE 16 X 16 NGF - 1.0 DEG/PD
 BREAK - HOT ASSEMBLY QUALITY

BASED ON DRAWING NO

SHEET

REV.

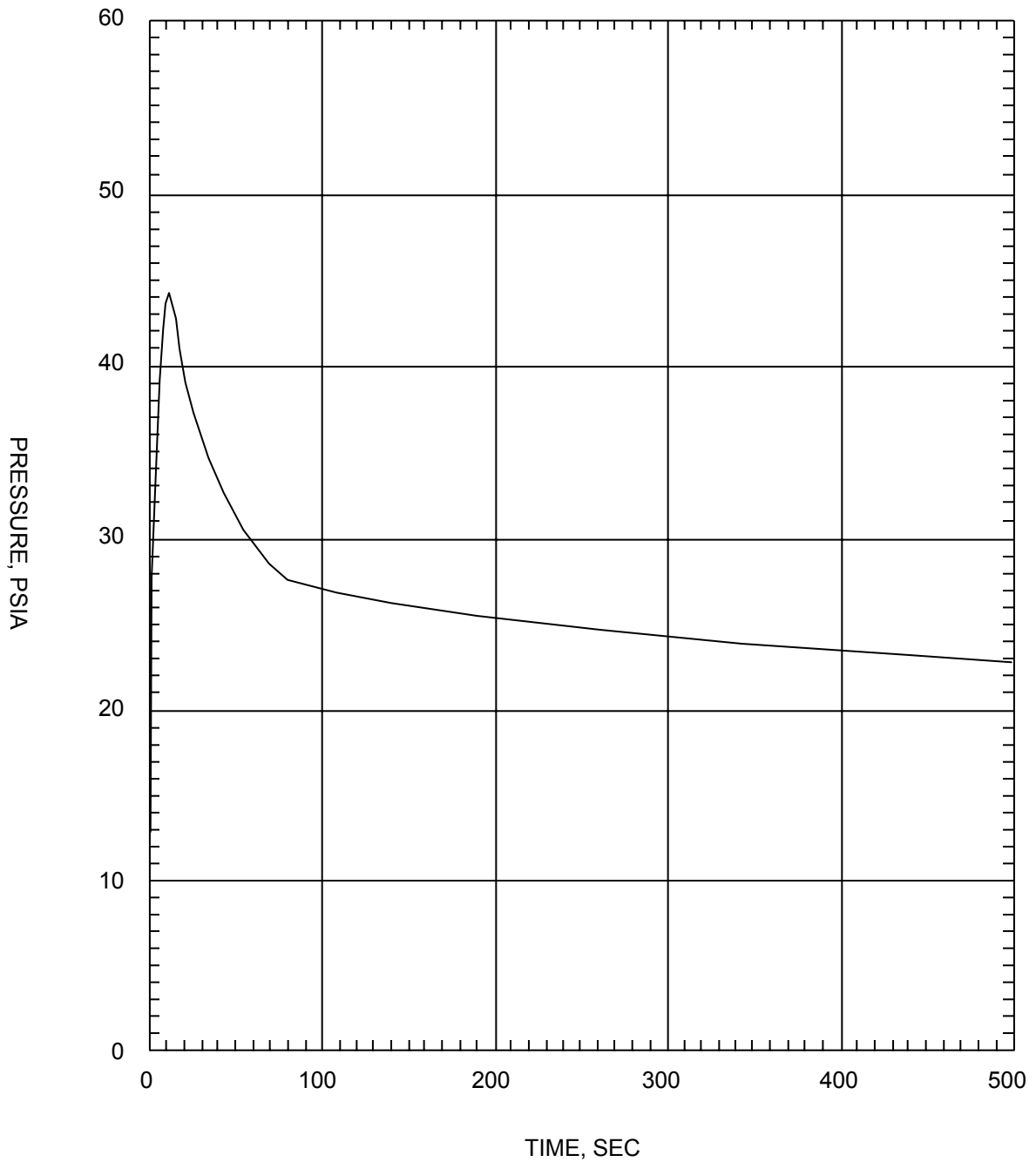

SAR FIGURE NO. 6.3-13f

AMENDMENT 21

ARKANSAS NUCLEAR ONE
 UNIT 2
 RUSSELLVILLE, ARKANSAS



SCALE:	NONE
DRAWN:	
DESIGN:	ENERGY
CAD NO:	

ANO-2 ECCS PERFORMANCE ANALYSIS FOR
 IMPLEMENTATION OF CE 16 X 16 NGF - 1.0 DEG/PD
 BREAK - CONTAINMENT PRESSURE

BASED ON DRAWING NO

SHEET

REV.

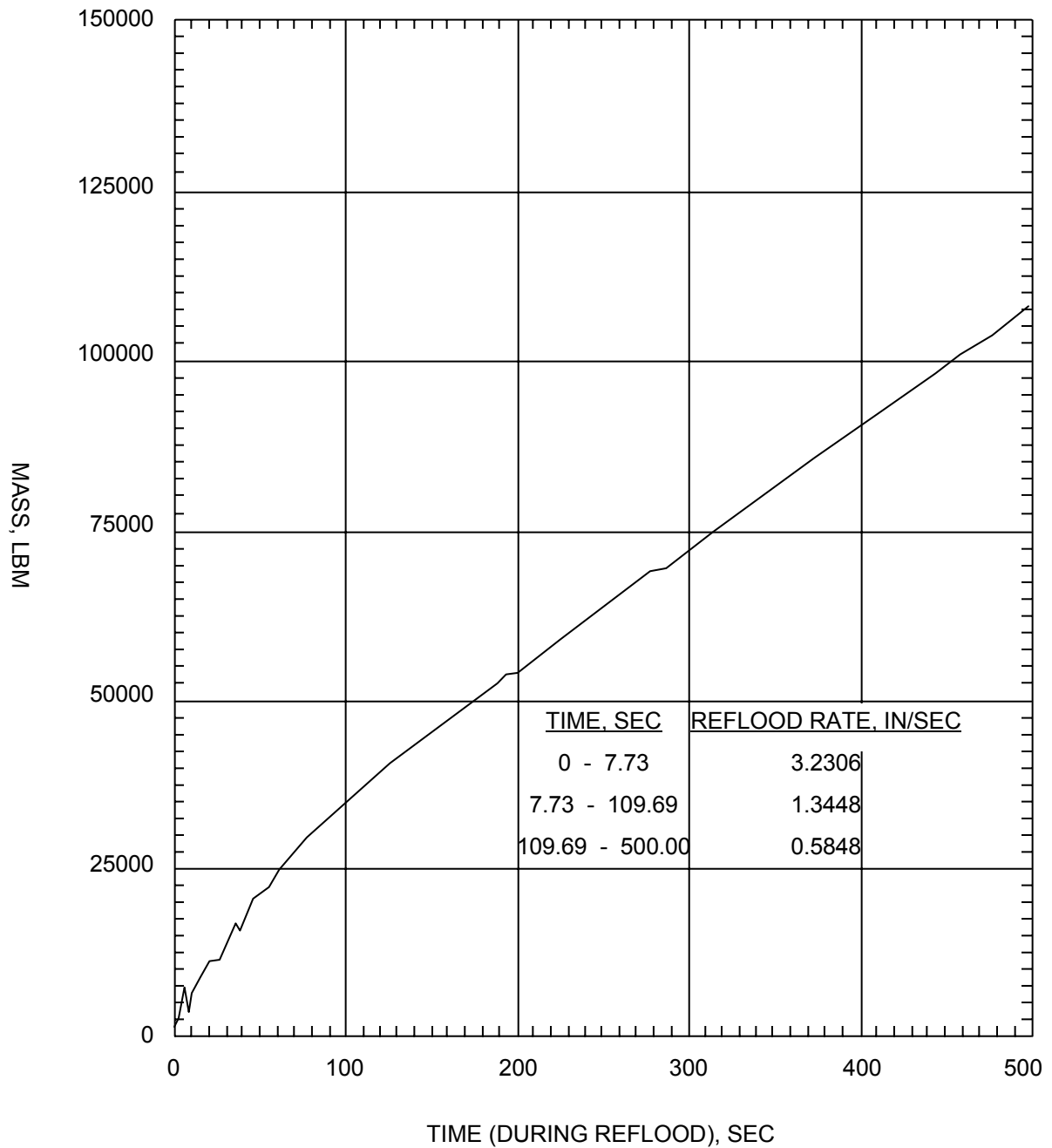

SAR FIGURE NO. 6.3-13g

AMENDMENT 21

ARKANSAS NUCLEAR ONE
 UNIT 2
 RUSSELLVILLE, ARKANSAS



SCALE:	NONE
DRAWN:	
DESIGN:	ENTERGY
CAD NO:	

ANO-2 ECCS PERFORMANCE ANALYSIS FOR
 IMPLEMENTATION OF CE 16 X 16 NGF - 1.0 DEG/PD
 BREAK - MASS ADDED TO CORE DURING REFLOOD

BASED ON DRAWING NO

SHEET

REV.

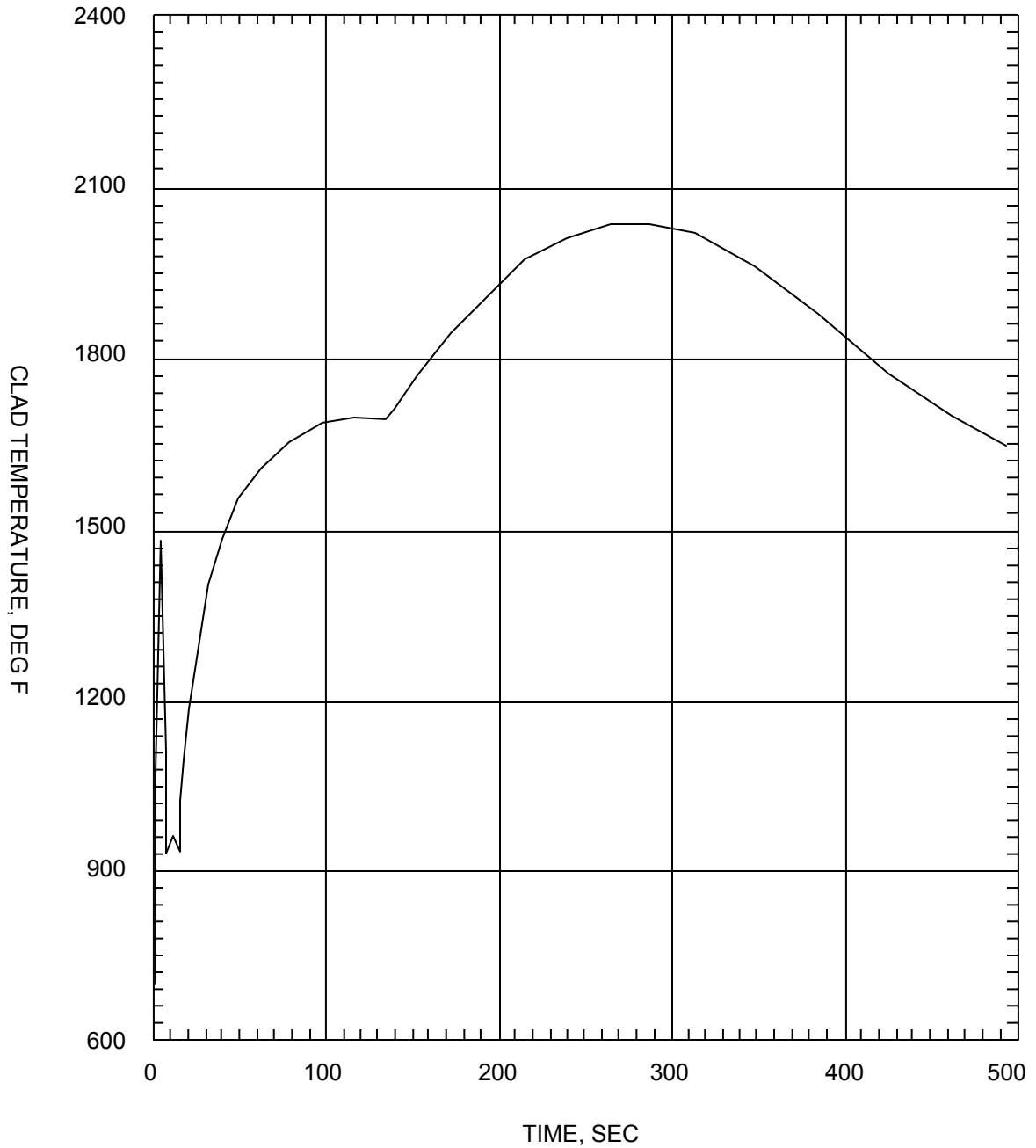

SAR FIGURE NO. 6.3-13h

AMENDMENT 21

ARKANSAS NUCLEAR ONE
 UNIT 2
 RUSSELLVILLE, ARKANSAS



SCALE:	NONE
DRAWN:	
DESIGN:	ENTERGY
CAD NO:	

ANO-2 ECCS PERFORMANCE ANALYSIS FOR
 IMPLEMENTATION OF CE 16 X 16 NGF - 1.0 DEG/PD
 BREAK - PEAK CLADDING TEMPERATURE

BASED ON DRAWING NO

SHEET

REV.

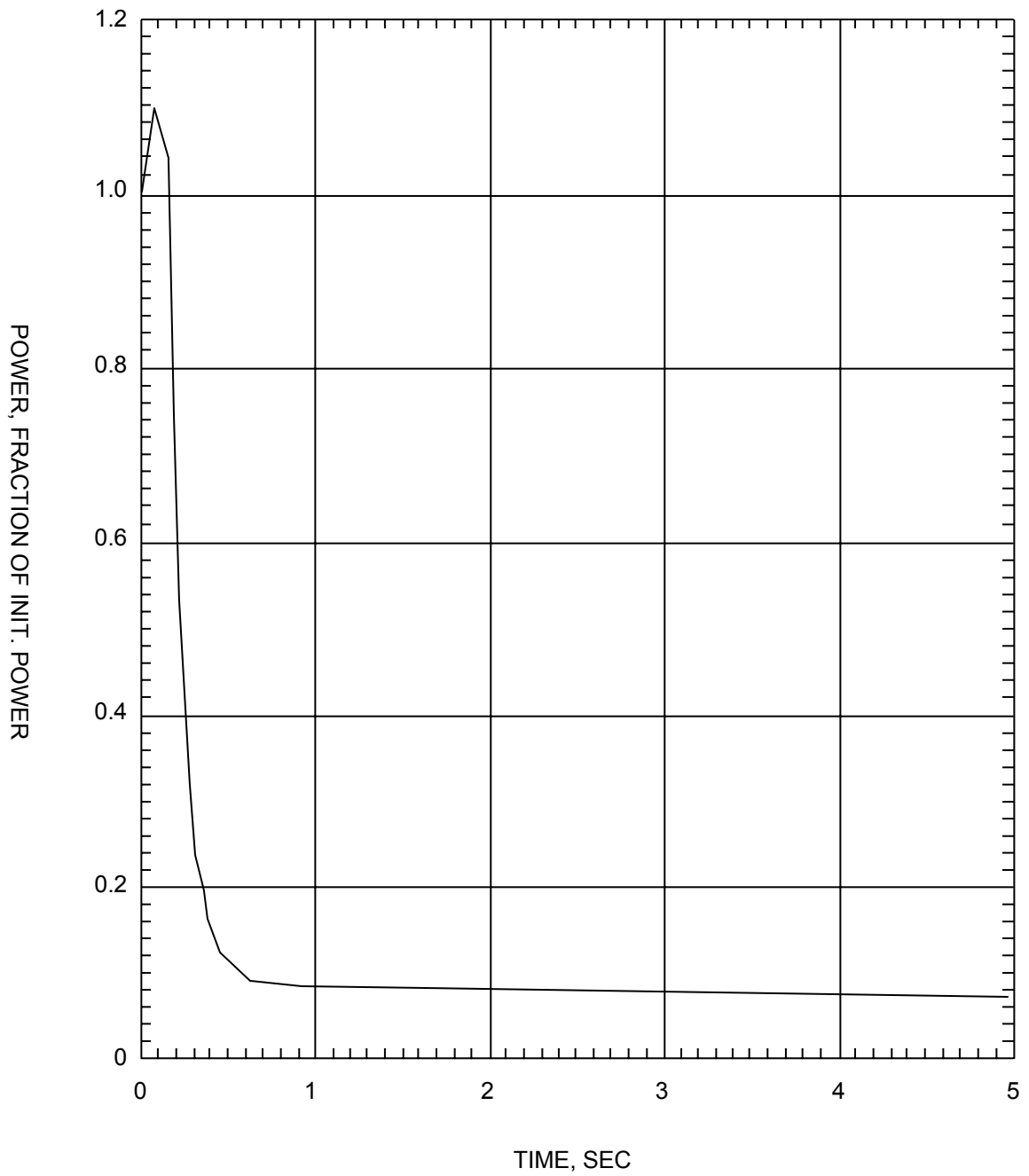

SAR FIGURE NO. 6.3-14a

AMENDMENT 21

ARKANSAS NUCLEAR ONE
 UNIT 2
 RUSSELLVILLE, ARKANSAS



SCALE:	NONE
DRAWN:	
DESIGN:	ENERGY
CAD NO:	

ANO-2 ECCS PERFORMANCE ANALYSIS FOR
 IMPLEMENTATION OF CE 16 X 16 NGF - 0.8 DEG/PD
 BREAK - CORE POWER

BASED ON DRAWING NO

SHEET

REV.

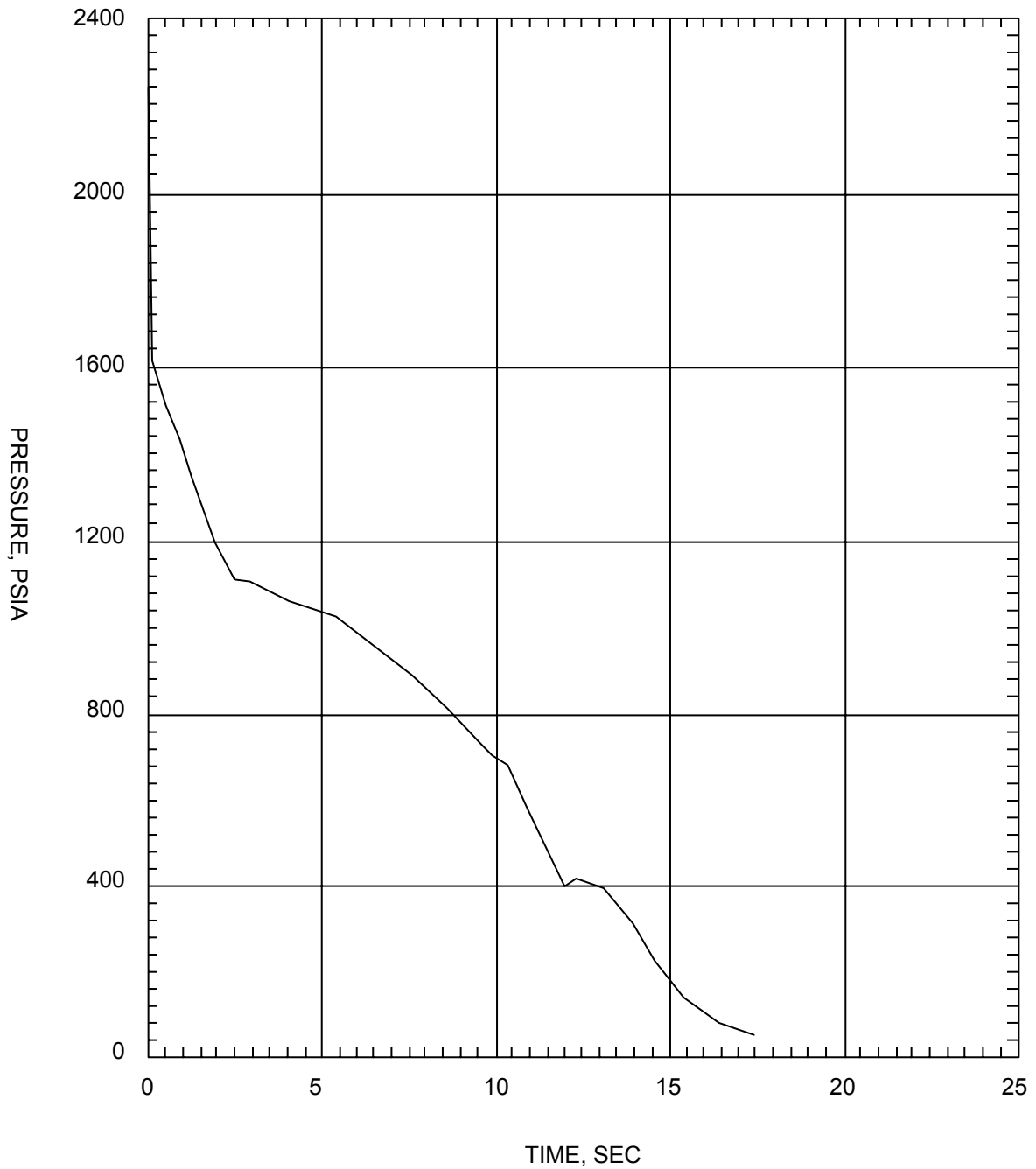

SAR FIGURE NO. 6.3-14b

AMENDMENT 21

ARKANSAS NUCLEAR ONE
 UNIT 2
 RUSSELLVILLE, ARKANSAS



SCALE:	NONE
DRAWN:	
DESIGN:	ENERGY
CAD NO:	

ANO-2 ECCS PERFORMANCE ANALYSIS FOR
 IMPLEMENTATION OF CE 16 X 16 NGF - 0.8 DEG/PD
 BREAK - PRESSURE IN CENTER HOT ASSEMBLY NODE

BASED ON DRAWING NO

SHEET

REV.

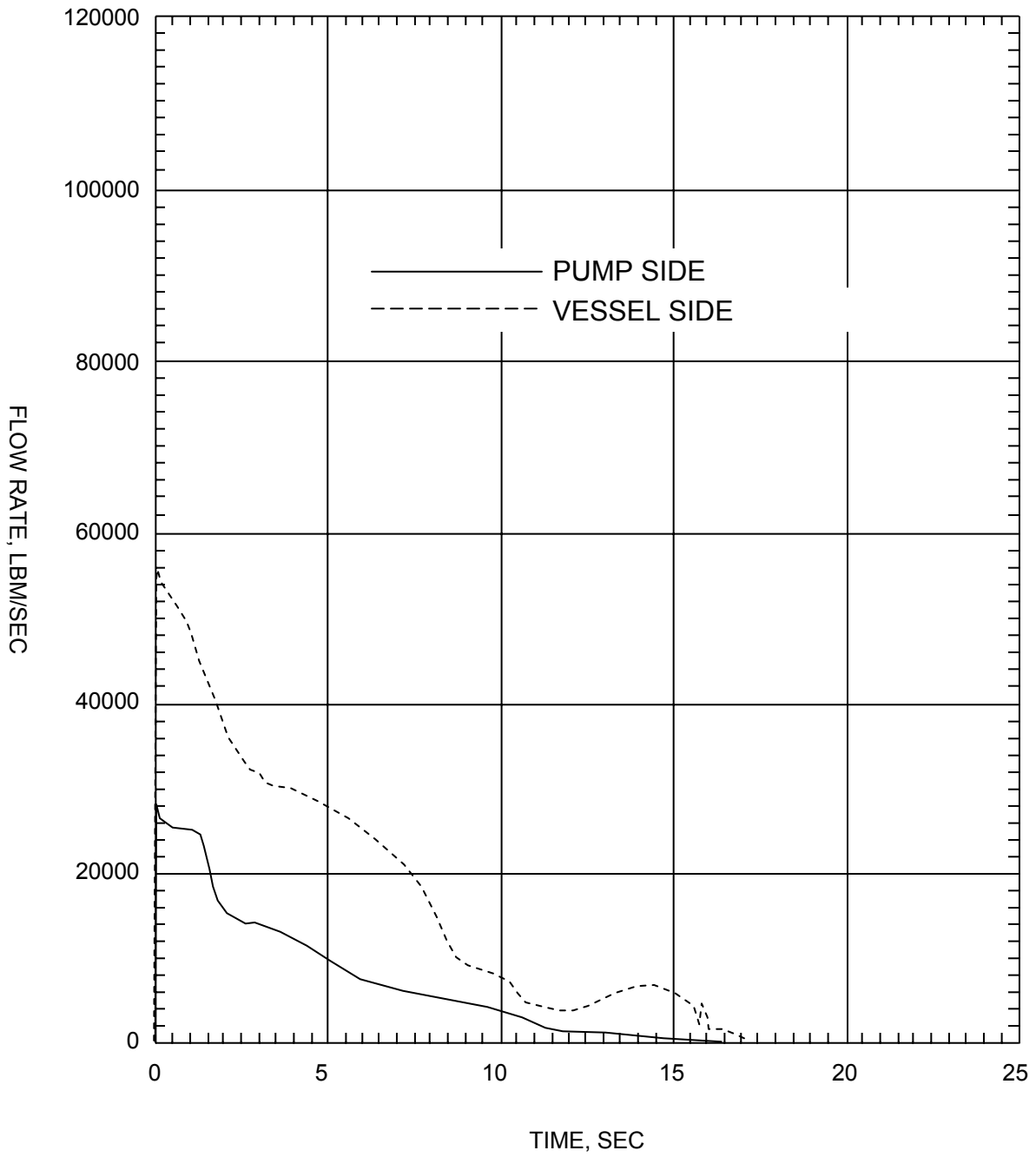

SAR FIGURE NO. 6.3-14c

AMENDMENT 21

ARKANSAS NUCLEAR ONE
 UNIT 2
 RUSSELLVILLE, ARKANSAS



SCALE:	NONE
DRAWN:	
DESIGN:	ENTERGY
CAD NO:	

ANO-2 ECCS PERFORMANCE ANALYSIS FOR
 IMPLEMENTATION OF CE 16 X 16 NGF - 0.8 DEG/PD
 BREAK - LEAK FLOW RATE

BASED ON DRAWING NO

SHEET

REV.

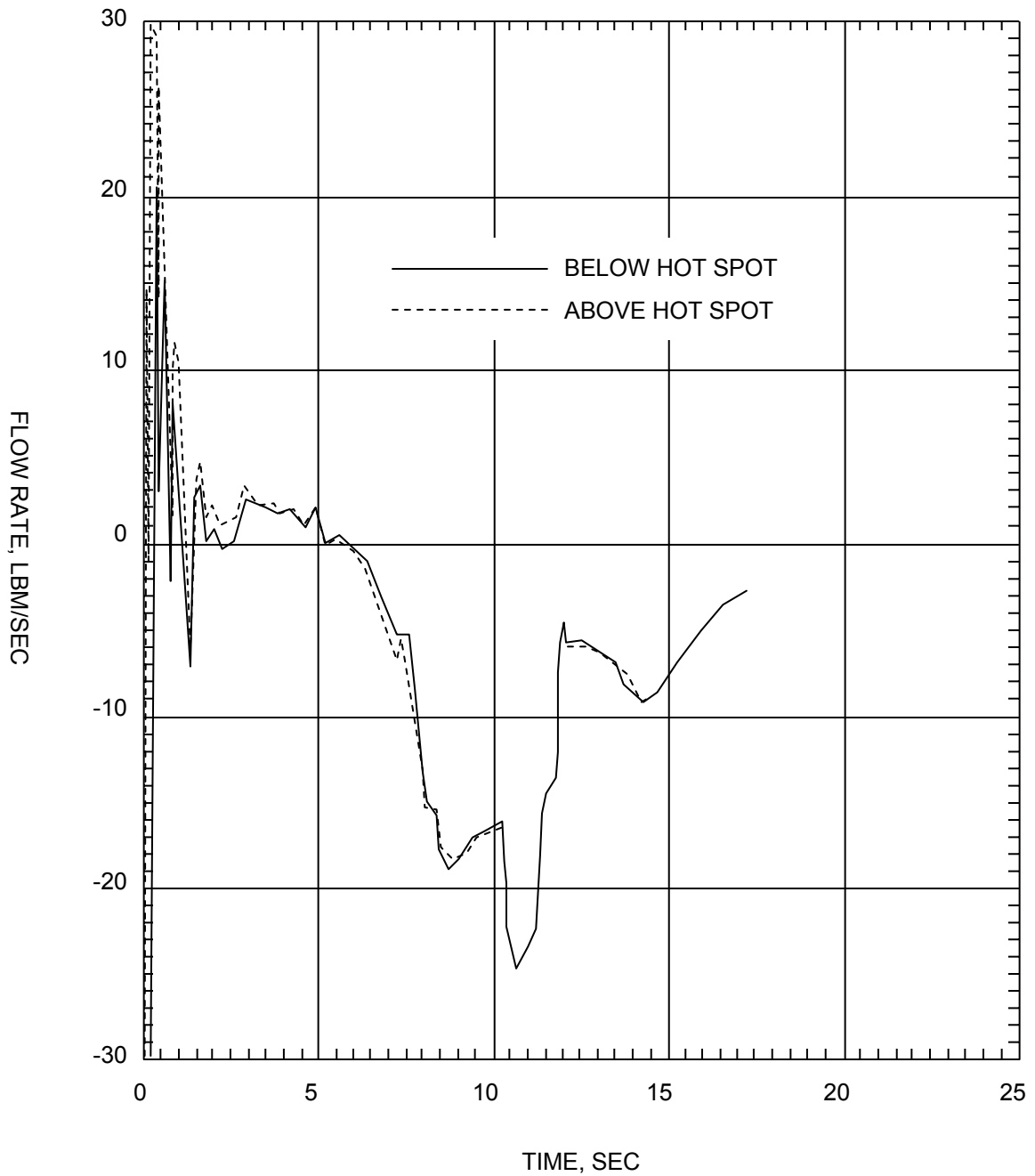

SAR FIGURE NO. 6.3-14d

AMENDMENT 21

ARKANSAS NUCLEAR ONE
 UNIT 2
 RUSSELLVILLE, ARKANSAS



SCALE:	NONE
DRAWN:	
DESIGN:	ENERGY
CAD NO:	

ANO-2 ECCS PERFORMANCE ANALYSIS FOR IMPLEMENTATION
 OF CE 16 X 16 NGF - 0.8 DEG/PD BREAK - HOT ASSEMBLY
 FLOW RATE (BELOW AND ABOVE HOT SPOT)

BASED ON DRAWING NO

SHEET

REV.

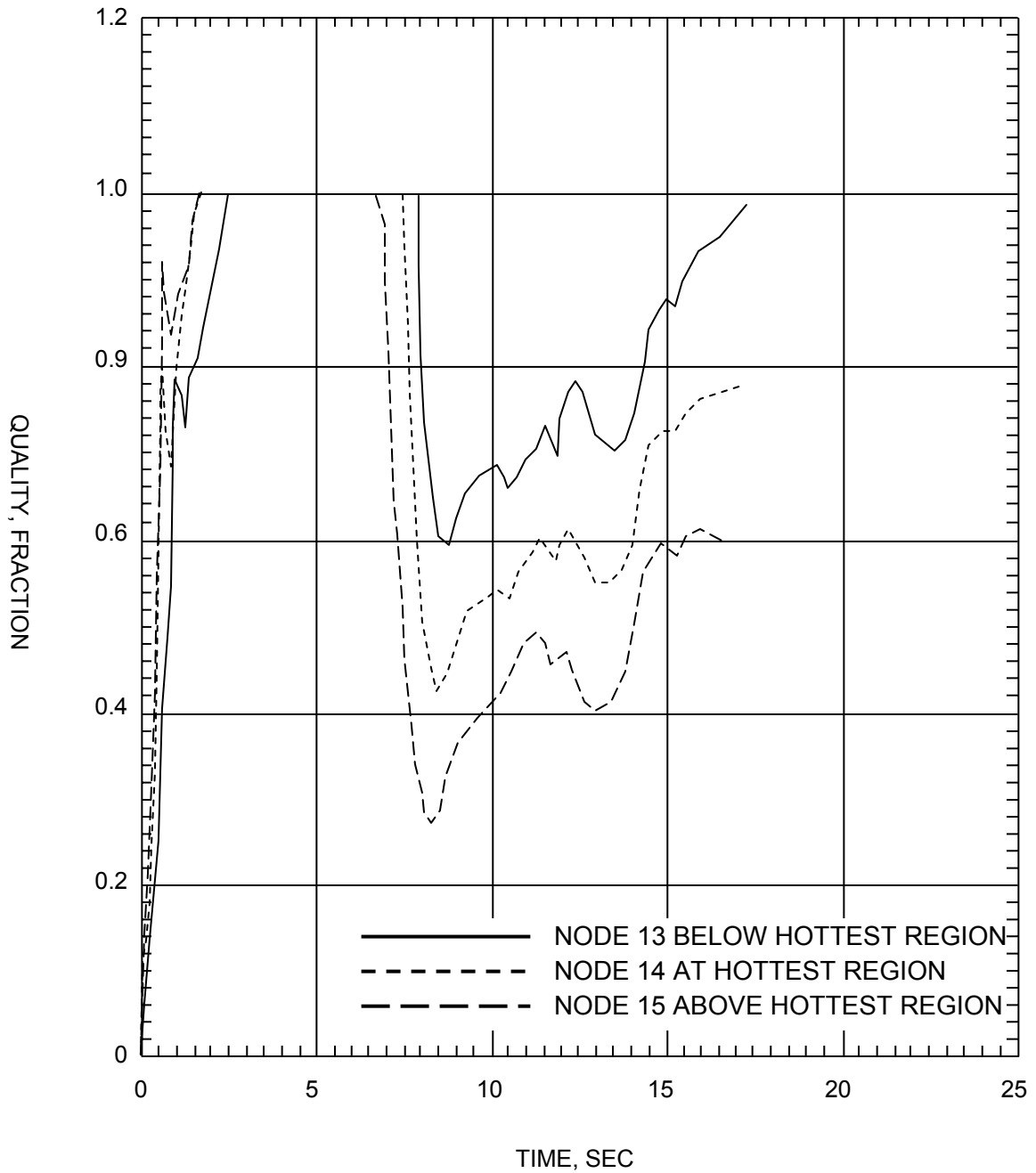

SAR FIGURE NO. 6.3-14e

AMENDMENT 21

ARKANSAS NUCLEAR ONE
 UNIT 2
 RUSSELLVILLE, ARKANSAS



SCALE:	NONE
DRAWN:	
DESIGN:	ENERGY
CAD NO:	

ANO-2 ECCS PERFORMANCE ANALYSIS FOR
 IMPLEMENTATION OF CE 16 X 16 NGF - 0.8 DEG/PD
 BREAK - HOT ASSEMBLY QUALITY

BASED ON DRAWING NO

SHEET

REV.

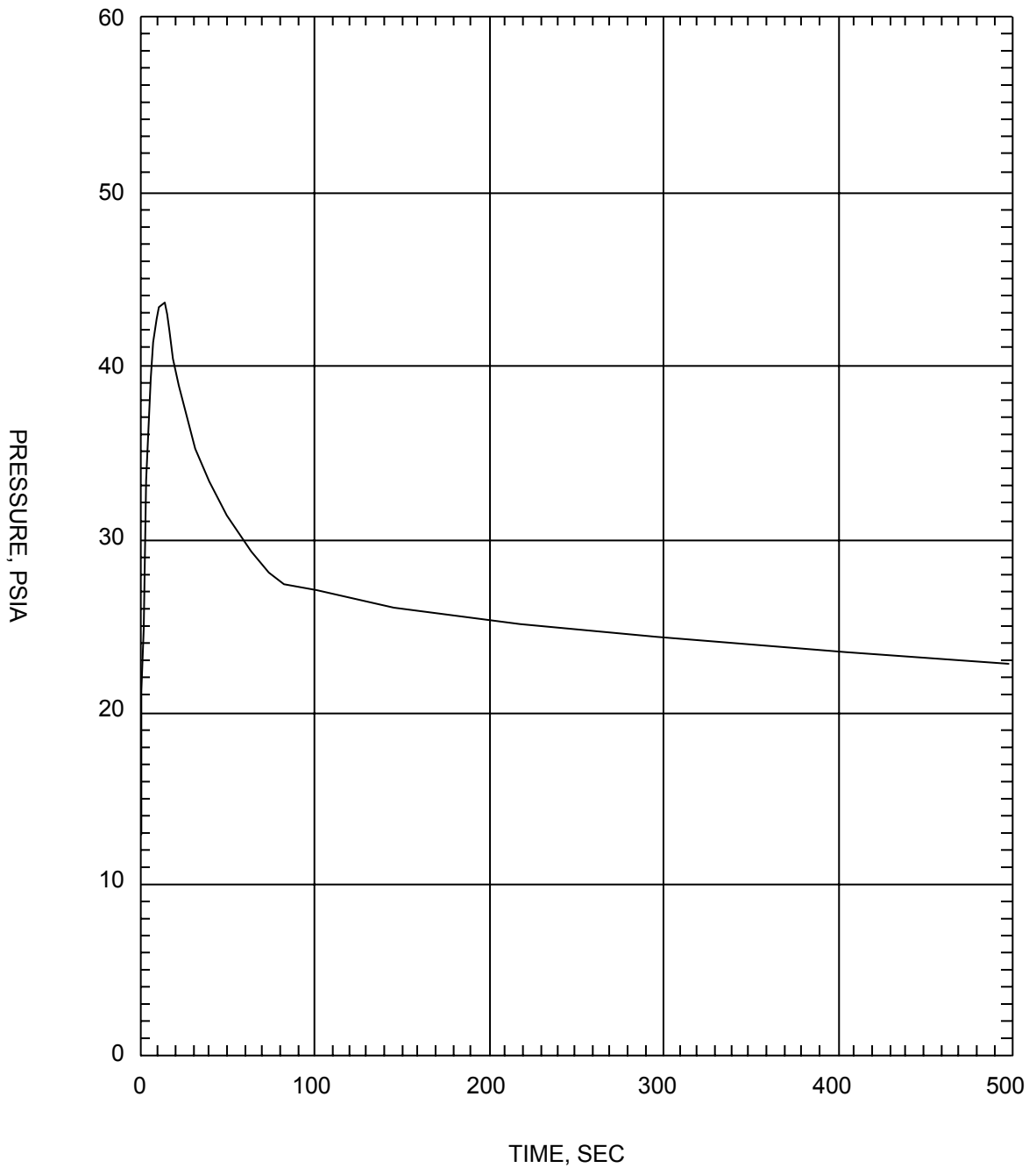

SAR FIGURE NO. 6.3-14f

AMENDMENT 21

ARKANSAS NUCLEAR ONE
 UNIT 2
 RUSSELLVILLE, ARKANSAS



SCALE:	NONE
DRAWN:	
DESIGN:	ENERGY
CAD NO:	

ANO-2 ECCS PERFORMANCE ANALYSIS FOR
 IMPLEMENTATION OF CE 16 X 16 NGF - 0.8 DEG/PD
 BREAK - CONTAINMENT PRESSURE

BASED ON DRAWING NO

SHEET

REV.

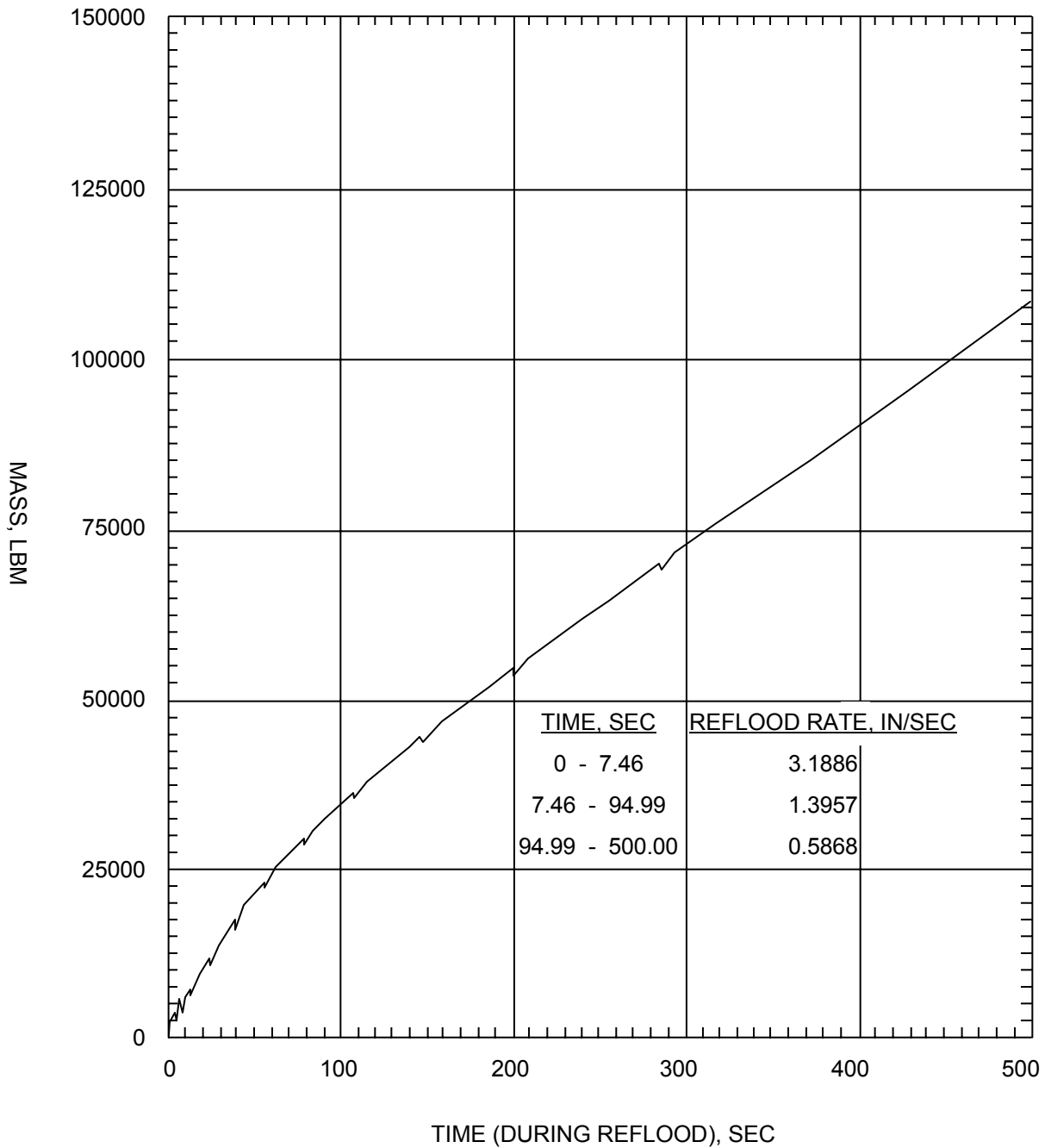

SAR FIGURE NO. 6.3-14g

AMENDMENT 21

ARKANSAS NUCLEAR ONE
 UNIT 2
 RUSSELLVILLE, ARKANSAS



SCALE: NONE
 DRAWN:
 DESIGN: ENTERGY
 CAD NO:

ANO-2 ECCS PERFORMANCE ANALYSIS FOR
 IMPLEMENTATION OF CE 16 X 16 NGF - 0.8 DEG/PD
 BREAK - MASS ADDED TO CORE DURING REFLOOD

BASED ON DRAWING NO

SHEET

REV.

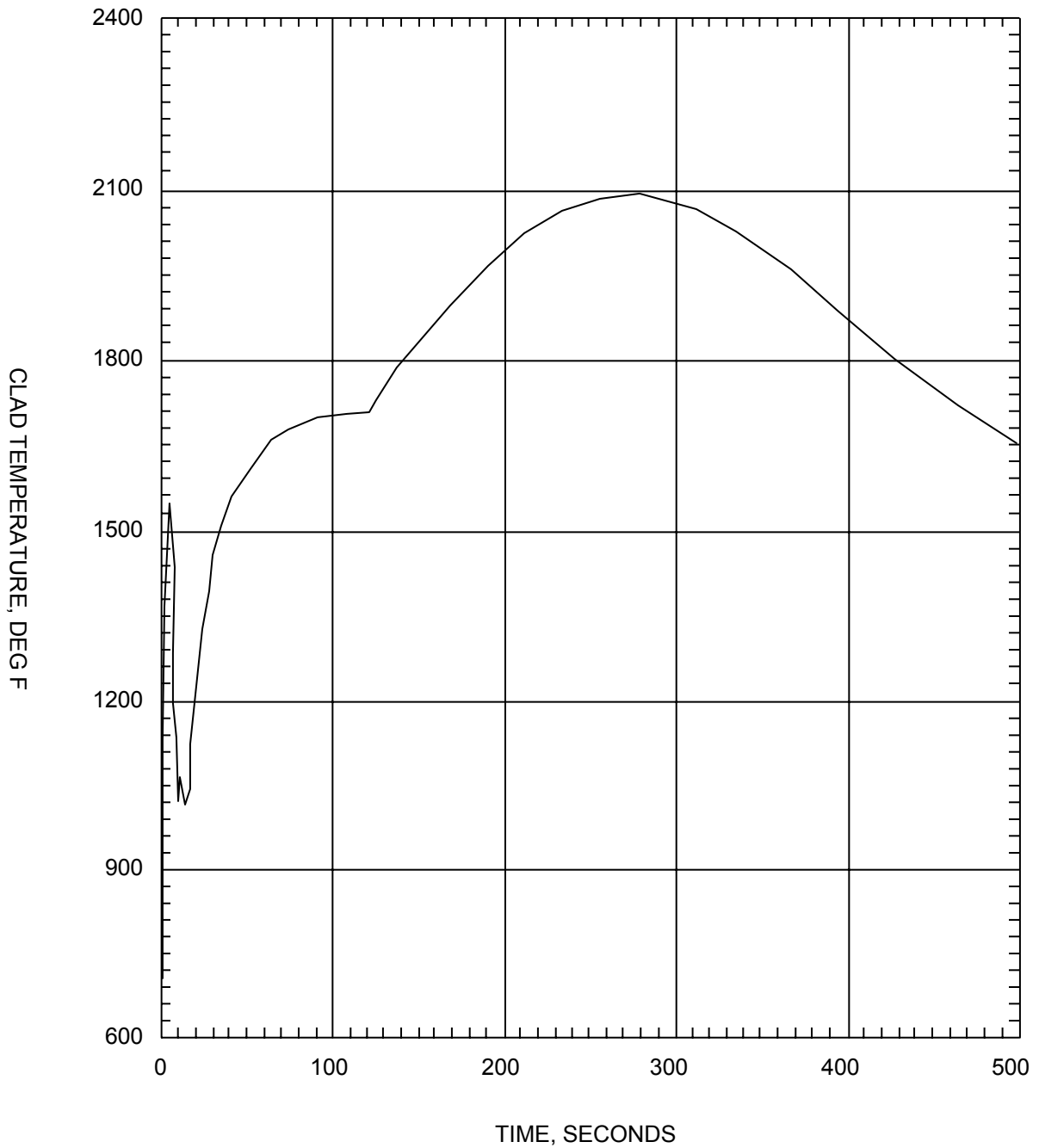

SAR FIGURE NO. 6.3-14h

AMENDMENT 21

ARKANSAS NUCLEAR ONE
 UNIT 2
 RUSSELLVILLE, ARKANSAS



SCALE:	NONE
DRAWN:	
DESIGN:	ENTERGY
CAD NO:	

ANO-2 ECCS PERFORMANCE ANALYSIS FOR
 IMPLEMENTATION OF CE 16 X 16 NGF - 0.8 DEG/PD
 BREAK - PEAK CLADDING TEMPERATURE

BASED ON DRAWING NO

SHEET

REV.

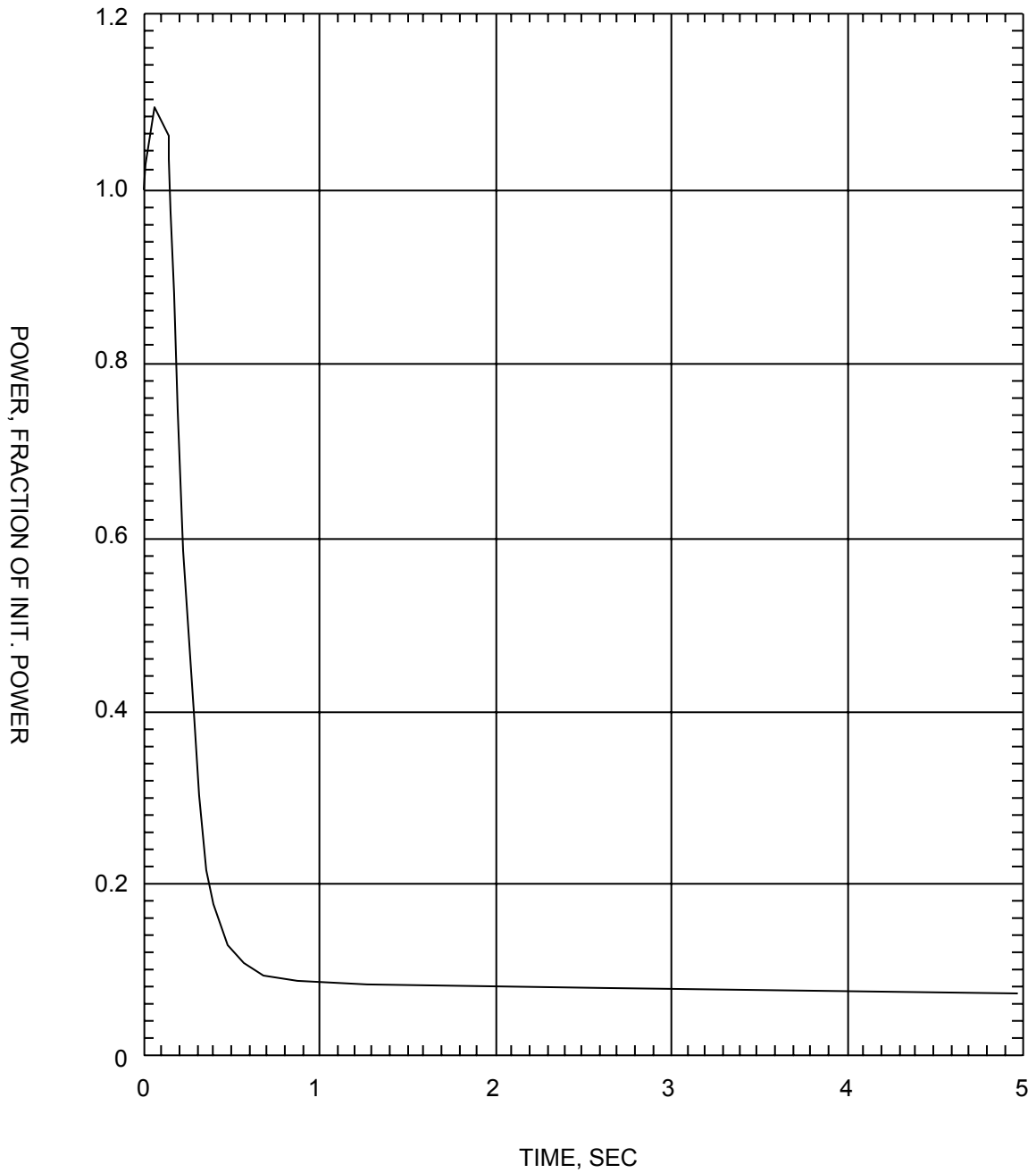

SAR FIGURE NO. 6.3-15a

AMENDMENT 21

ARKANSAS NUCLEAR ONE
 UNIT 2
 RUSSELLVILLE, ARKANSAS



SCALE:	NONE
DRAWN:	
DESIGN:	ENERGY
CAD NO:	

ANO-2 ECCS PERFORMANCE ANALYSIS FOR
 IMPLEMENTATION OF CE 16 X 16 NGF - 0.6 DEG/PD
 BREAK - CORE POWER

BASED ON DRAWING NO

SHEET

REV.

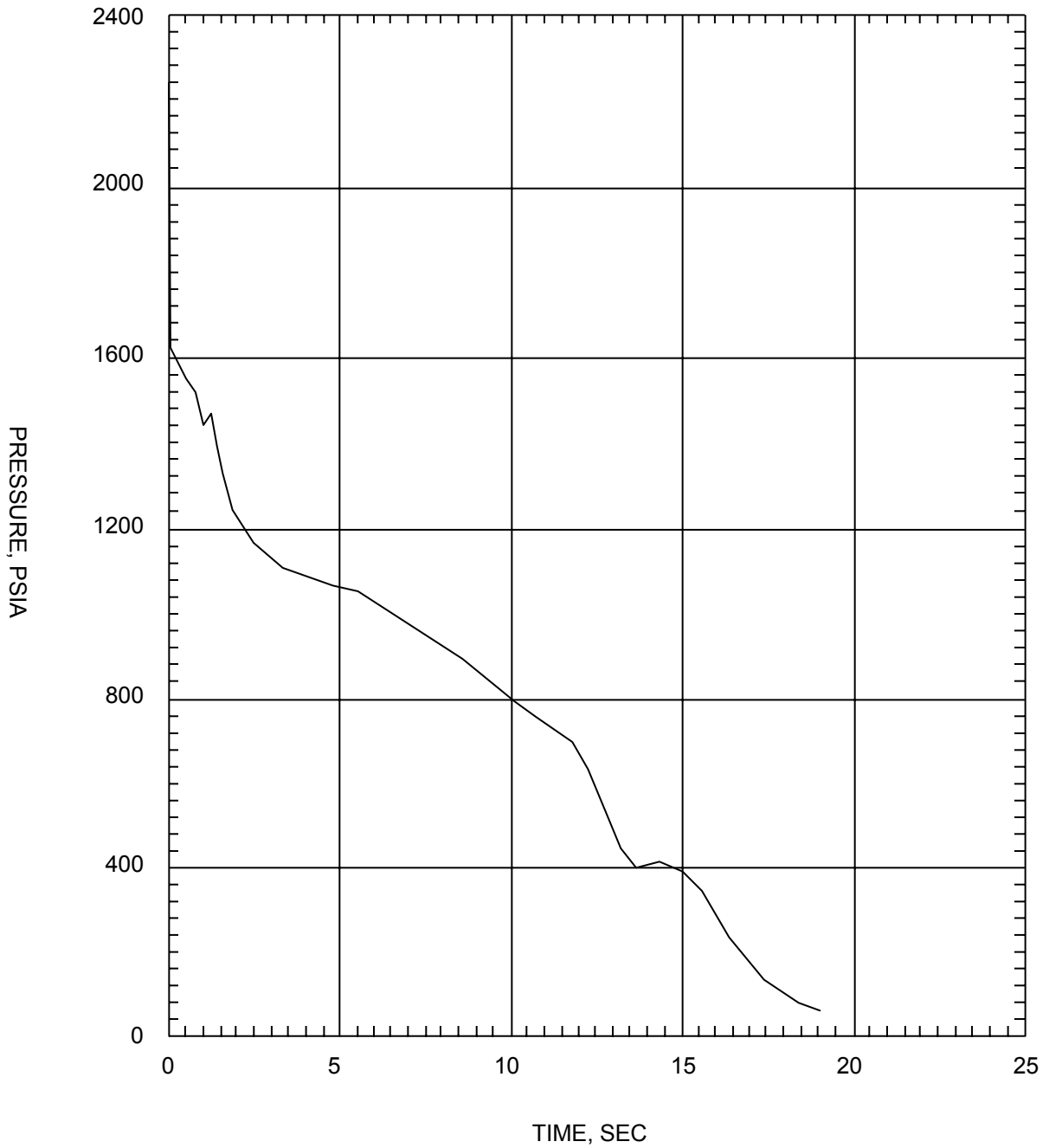

SAR FIGURE NO. 6.3-15b

AMENDMENT 21

ARKANSAS NUCLEAR ONE
 UNIT 2
 RUSSELLVILLE, ARKANSAS



SCALE:	NONE
DRAWN:	
DESIGN:	ENTERGY
CAD NO:	

ANO-2 ECCS PERFORMANCE ANALYSIS FOR
 IMPLEMENTATION OF CE 16 X 16 NGF - 0.6 DEG/PD
 BREAK - PRESSURE IN CENTER HOT ASSEMBLY NODE

BASED ON DRAWING NO

SHEET

REV.

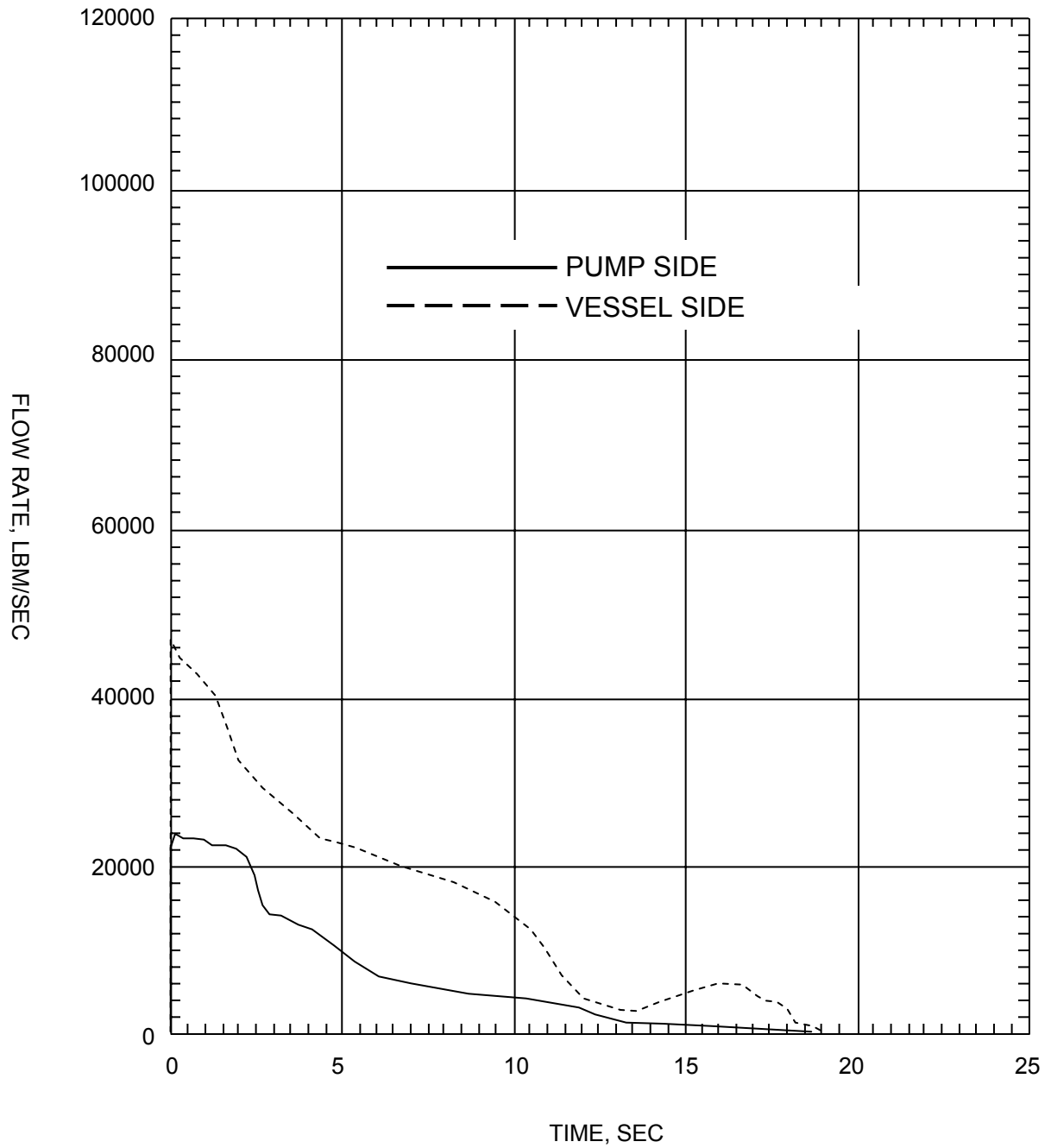

SAR FIGURE NO. 6.3-15c

AMENDMENT 21

ARKANSAS NUCLEAR ONE
 UNIT 2
 RUSSELLVILLE, ARKANSAS



SCALE:	NONE
DRAWN:	
DESIGN:	ENTERGY
CAD NO:	

ANO-2 ECCS PERFORMANCE ANALYSIS FOR
 IMPLEMENTATION OF CE 16 X 16 NGF - 0.6 DEG/PD
 BREAK - LEAK FLOW RATE

BASED ON DRAWING NO

SHEET

REV.

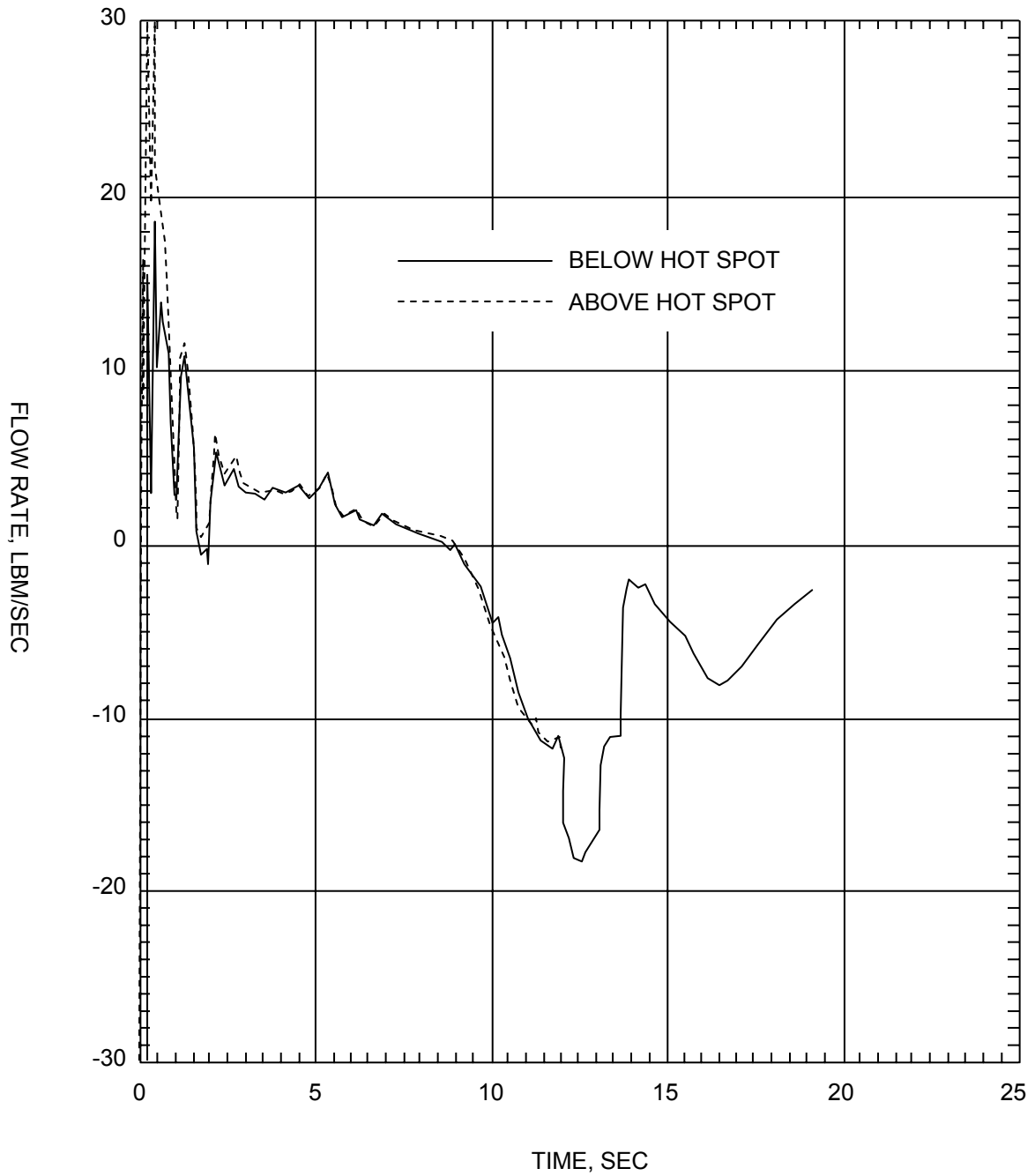

SAR FIGURE NO. 6.3-15d

AMENDMENT 21

ARKANSAS NUCLEAR ONE
UNIT 2
RUSSELLVILLE, ARKANSAS



SCALE:	NONE
DRAWN:	
DESIGN:	ENTERGY
CAD NO:	

ANO-2 ECCS PERFORMANCE ANALYSIS FOR IMPLEMENTATION
OF CE 16 X 16 NGF - 0.6 DEG/PD BREAK - HOT ASSEMBLY
FLOW RATE (BELOW AND ABOVE HOT SPOT)

BASED ON DRAWING NO

SHEET

REV.

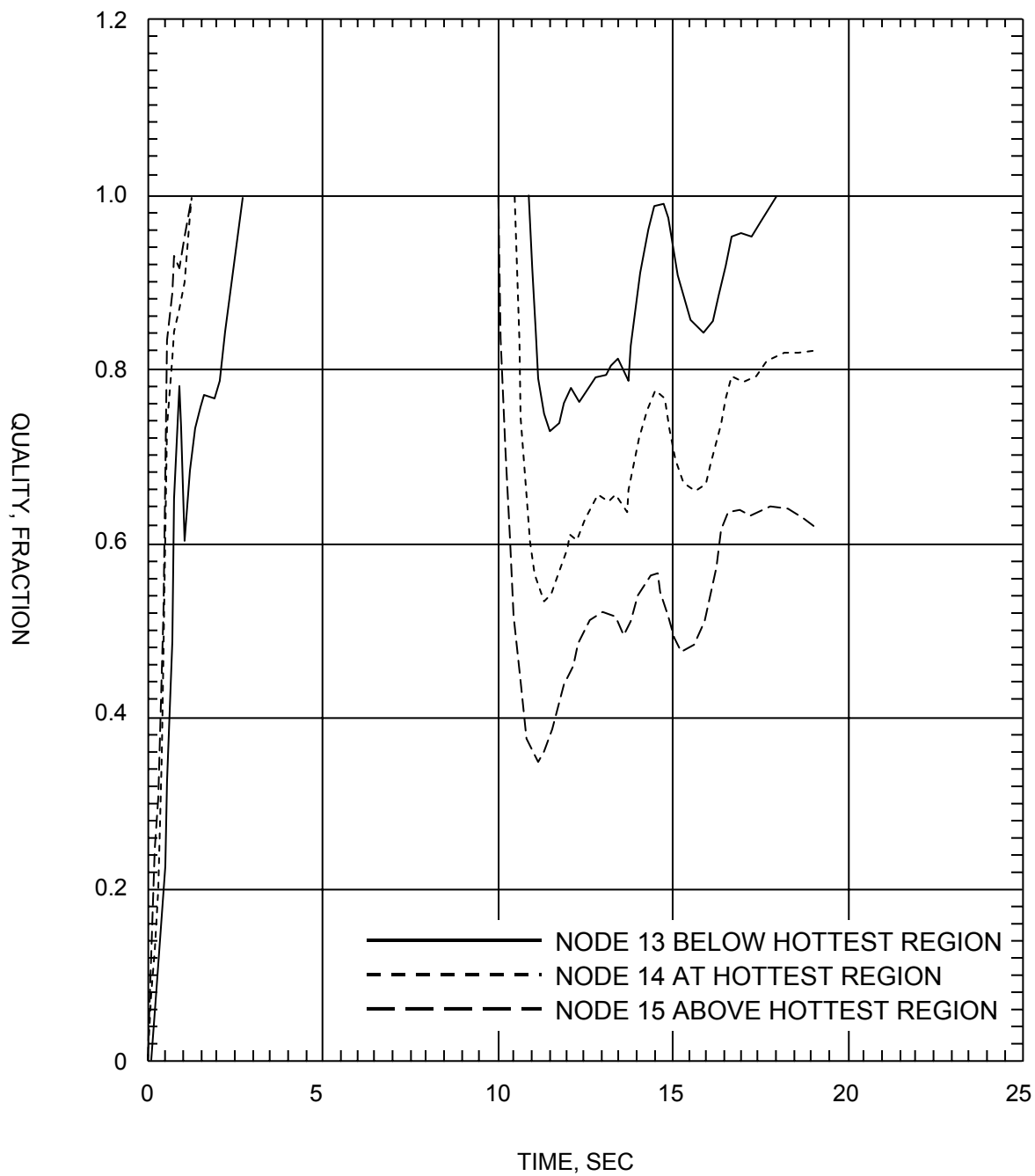

SAR FIGURE NO. 6.3-15e

AMENDMENT 21

ARKANSAS NUCLEAR ONE
UNIT 2
RUSSELLVILLE, ARKANSAS



SCALE:	NONE
DRAWN:	
DESIGN:	ENTERGY
CAD NO:	

ANO-2 ECCS PERFORMANCE ANALYSIS FOR
IMPLEMENTATION OF CE 16 X 16 NGF - 0.6 DEG/PD
BREAK - HOT ASSEMBLY QUALITY

BASED ON DRAWING NO

SHEET

REV.

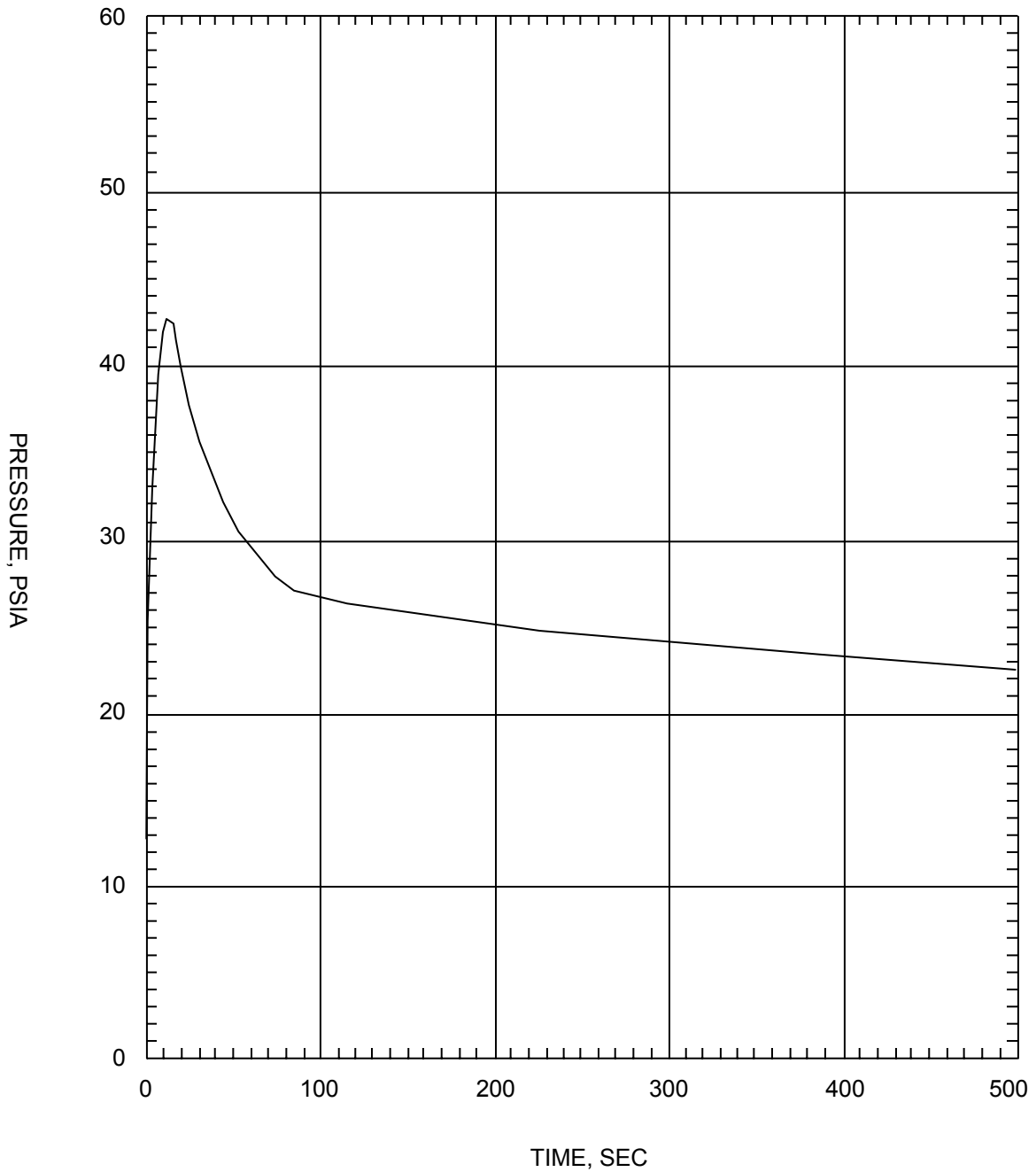

SAR FIGURE NO. 6.3-15f

AMENDMENT 21

ARKANSAS NUCLEAR ONE
 UNIT 2
 RUSSELLVILLE, ARKANSAS



SCALE:	NONE
DRAWN:	
DESIGN:	ENERGY
CAD NO:	

ANO-2 ECCS PERFORMANCE ANALYSIS FOR
 IMPLEMENTATION OF CE 16 X 16 NGF - 0.6 DEG/PD
 BREAK - CONTAINMENT PRESSURE

BASED ON DRAWING NO

SHEET

REV.

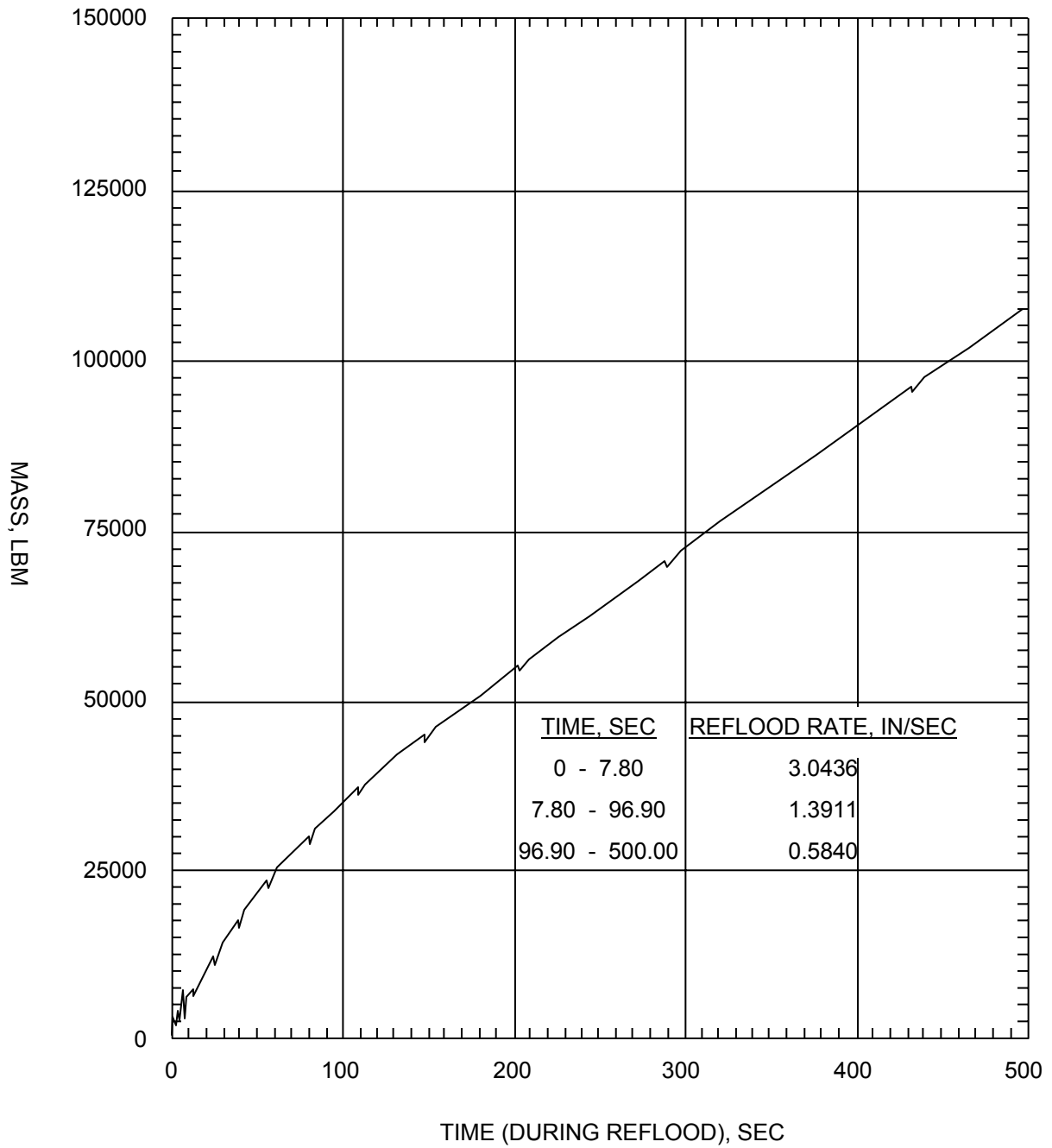

SAR FIGURE NO. 6.3-15g

AMENDMENT 21

ARKANSAS NUCLEAR ONE
UNIT 2
RUSSELLVILLE, ARKANSAS



SCALE:	NONE
DRAWN:	
DESIGN:	ENTERGY
CAD NO:	

ANO-2 ECCS PERFORMANCE ANALYSIS FOR
IMPLEMENTATION OF CE 16 X 16 NGF - 0.6 DEG/PD
BREAK - MASS ADDED TO CORE DURING REFLOOD

BASED ON DRAWING NO

SHEET

REV.

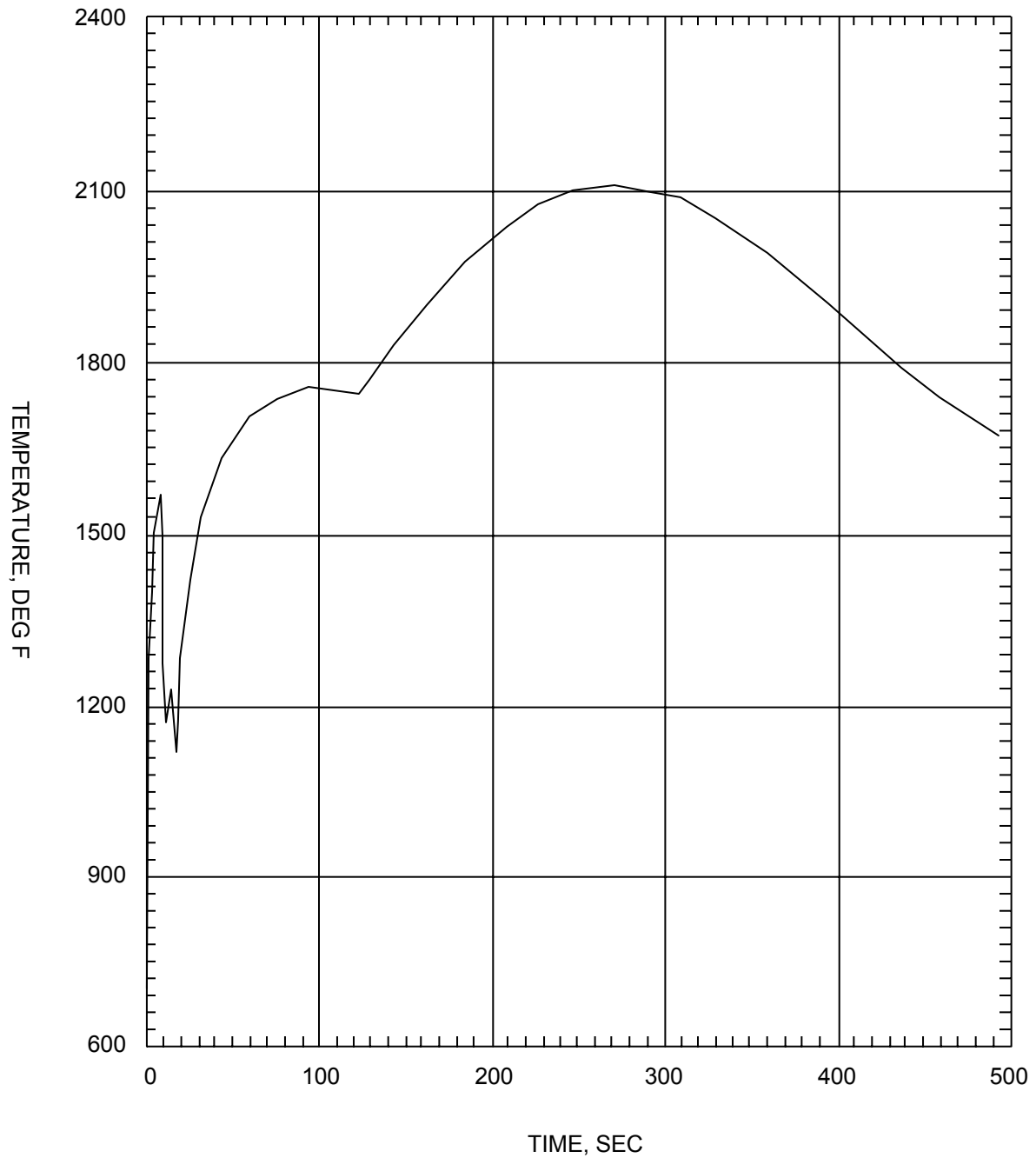

SAR FIGURE NO. 6.3-15h

AMENDMENT 21

ARKANSAS NUCLEAR ONE
 UNIT 2
 RUSSELLVILLE, ARKANSAS



SCALE:	NONE
DRAWN:	
DESIGN:	ENTERGY
CAD NO:	

ANO-2 ECCS PERFORMANCE ANALYSIS FOR
 IMPLEMENTATION OF CE 16 X 16 NGF - 0.6 DEG/PD
 BREAK - PEAK CLADDING TEMPERATURE

BASED ON DRAWING NO

SHEET

REV.

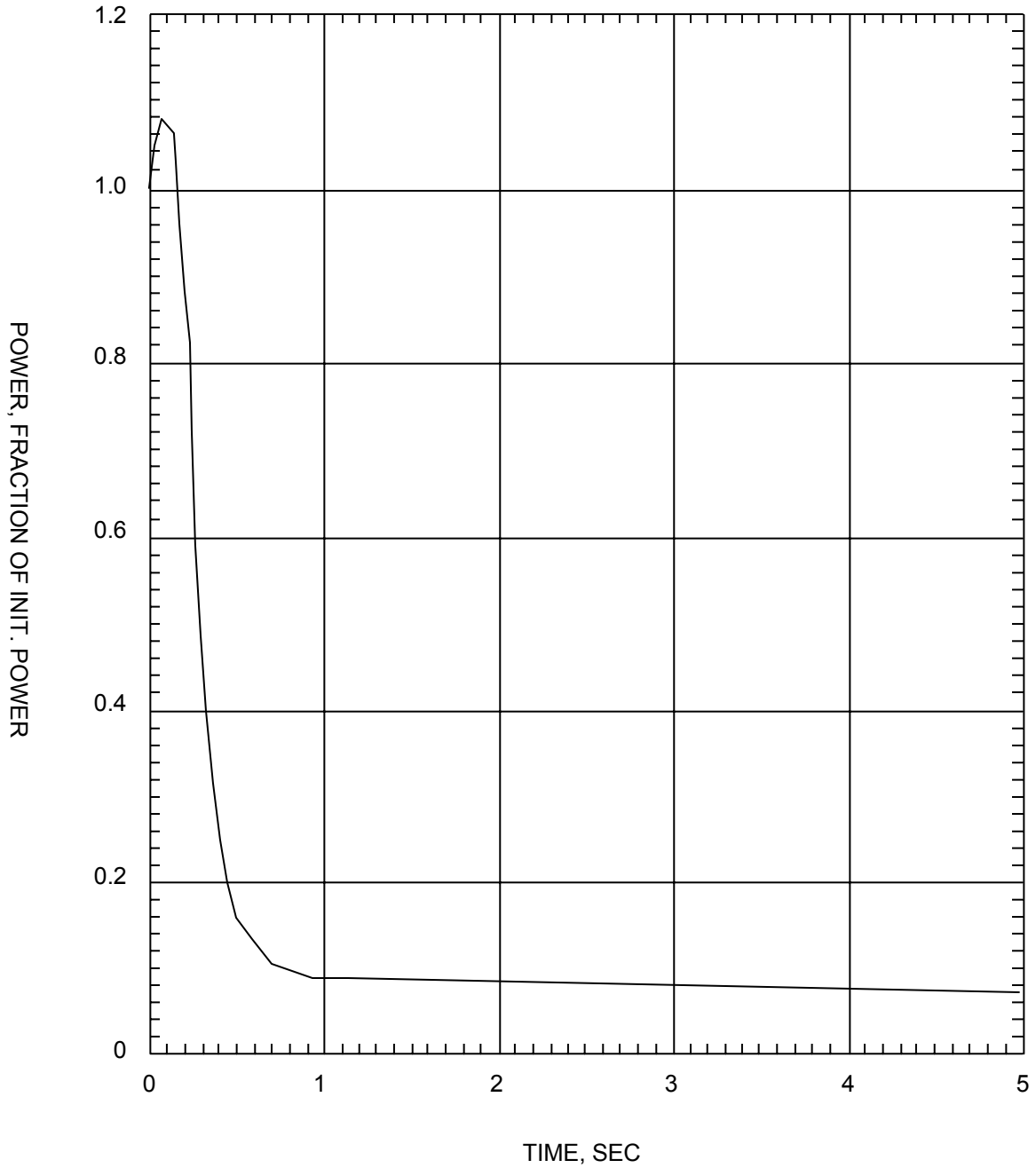

SAR FIGURE NO. 6.3-16a

AMENDMENT 21

ARKANSAS NUCLEAR ONE
 UNIT 2
 RUSSELLVILLE, ARKANSAS



SCALE:	NONE
DRAWN:	
DESIGN:	ENTERGY
CAD NO:	

ANO-2 ECCS PERFORMANCE ANALYSIS FOR
 IMPLEMENTATION OF CE 16 X 16 NGF - 0.4 DEG/PD
 BREAK - CORE POWER

BASED ON DRAWING NO

SHEET

REV.

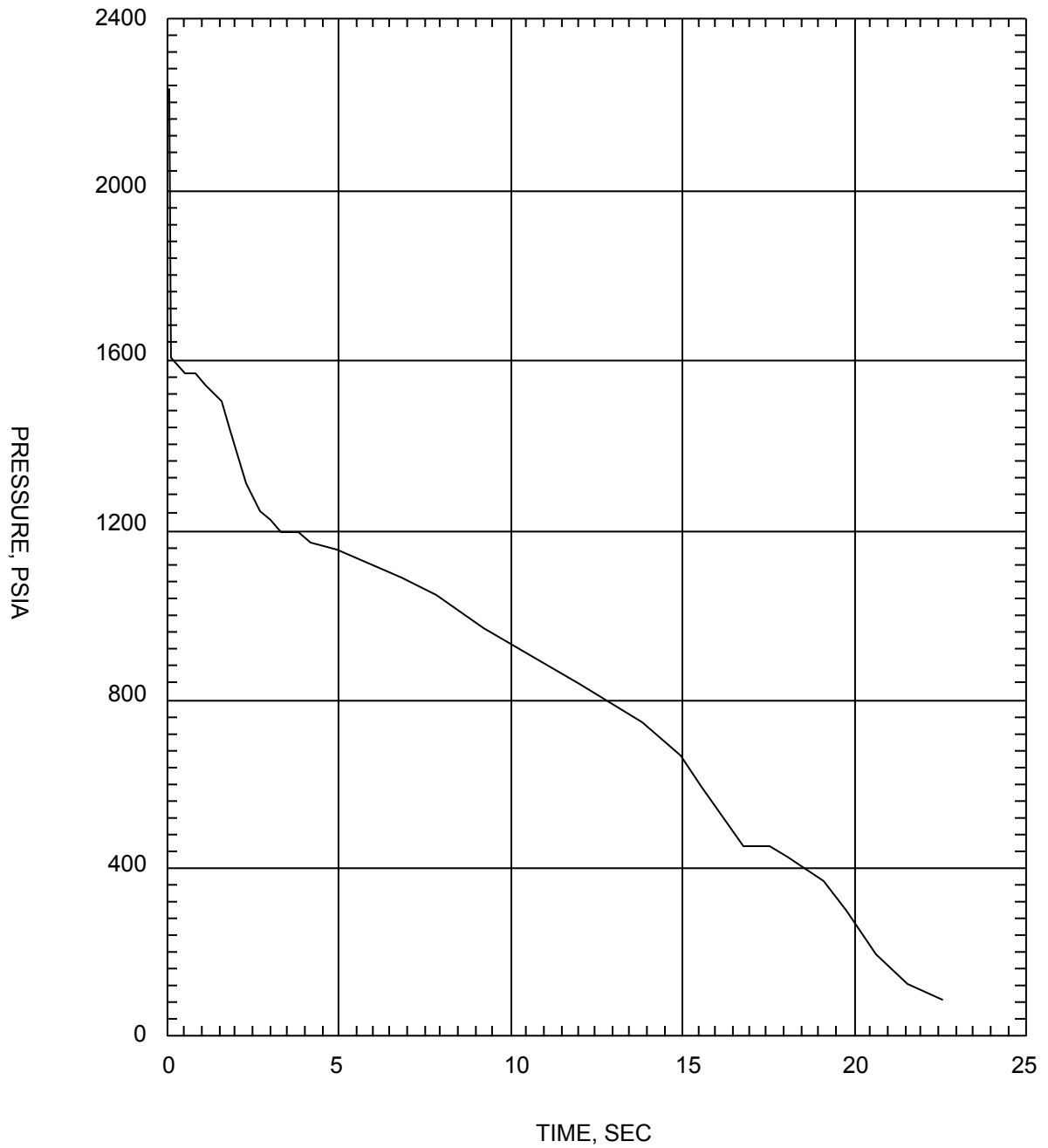

SAR FIGURE NO. 6.3-16b

AMENDMENT 21

ARKANSAS NUCLEAR ONE
 UNIT 2
 RUSSELLVILLE, ARKANSAS



SCALE:	NONE
DRAWN:	
DESIGN:	ENERGY
CAD NO:	

ANO-2 ECCS PERFORMANCE ANALYSIS FOR
 IMPLEMENTATION OF CE 16 X 16 NGF - 0.4 DEG/PD
 BREAK - PRESSURE IN CENTER HOT ASSEMBLY NODE

BASED ON DRAWING NO

SHEET

REV.

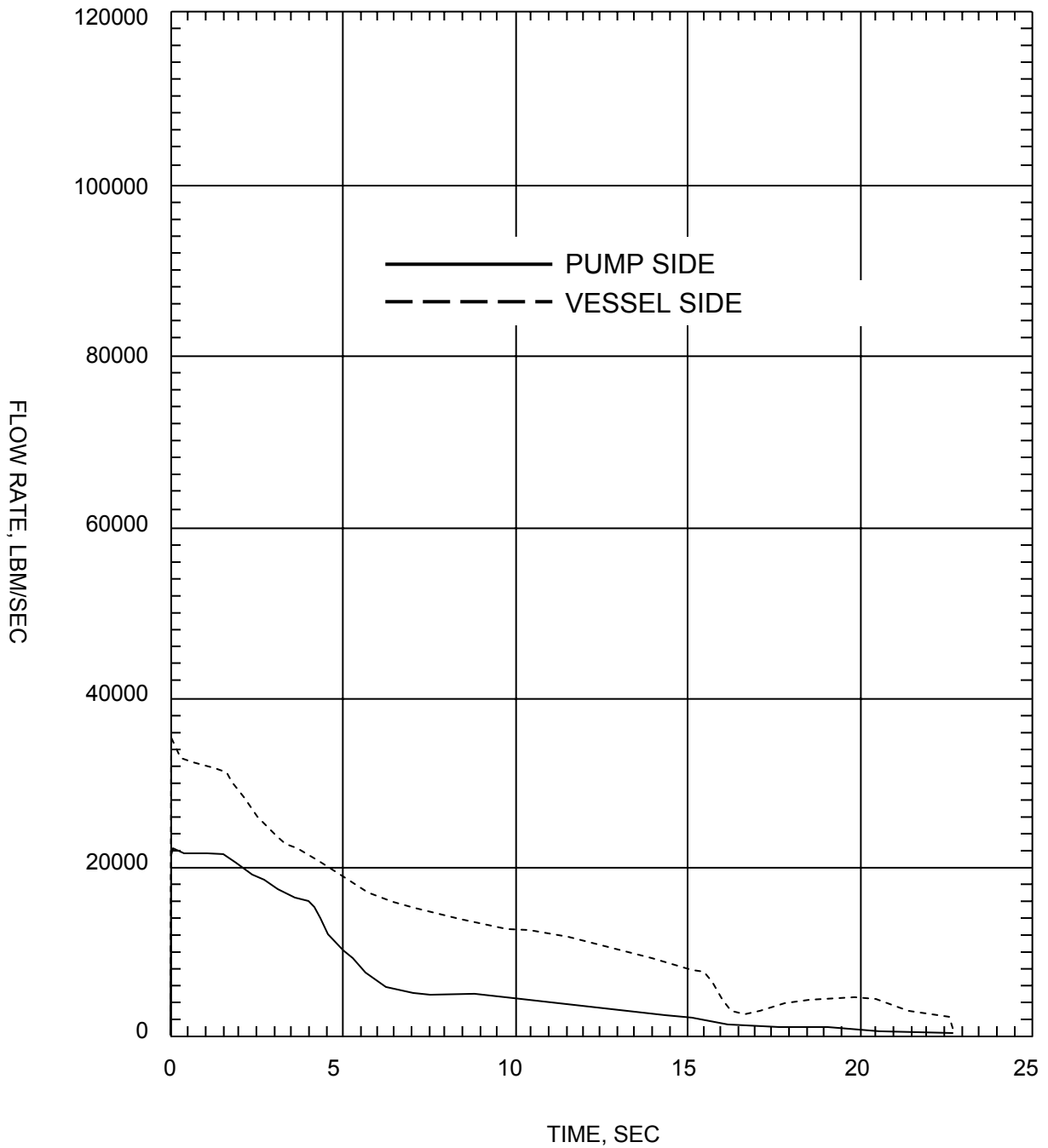

SAR FIGURE NO. 6.3-16c

AMENDMENT 21

ARKANSAS NUCLEAR ONE
 UNIT 2
 RUSSELLVILLE, ARKANSAS



SCALE:	NONE
DRAWN:	
DESIGN:	ENTERGY
CAD NO:	

ANO-2 ECCS PERFORMANCE ANALYSIS FOR
 IMPLEMENTATION OF CE 16 X 16 NGF - 0.4 DEG/PD
 BREAK - LEAK FLOW RATE

BASED ON DRAWING NO

SHEET

REV.

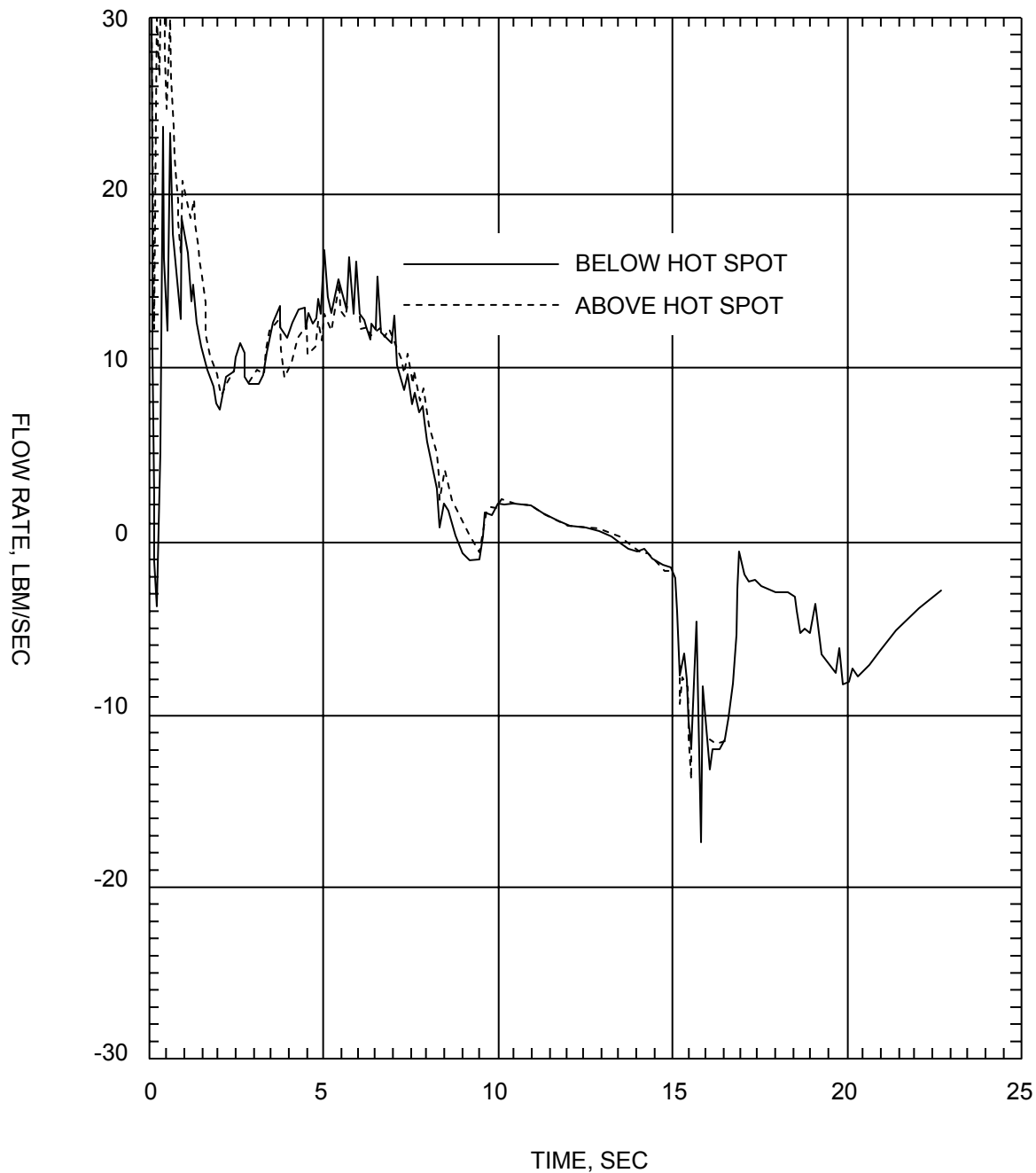

SAR FIGURE NO. 6.3-16d

AMENDMENT 21

ARKANSAS NUCLEAR ONE
 UNIT 2
 RUSSELLVILLE, ARKANSAS



SCALE:	NONE
DRAWN:	
DESIGN:	ENERGY
CAD NO:	

ANO-2 ECCS PERFORMANCE ANALYSIS FOR
 IMPLEMENTATION OF CE 16 X 16 NGF - 0.4 DEG/PD BREAK -
 HOT ASSEMBLY FLOW RATE (BELOW AND ABOVE HOT SPOT)

BASED ON DRAWING NO

SHEET

REV.

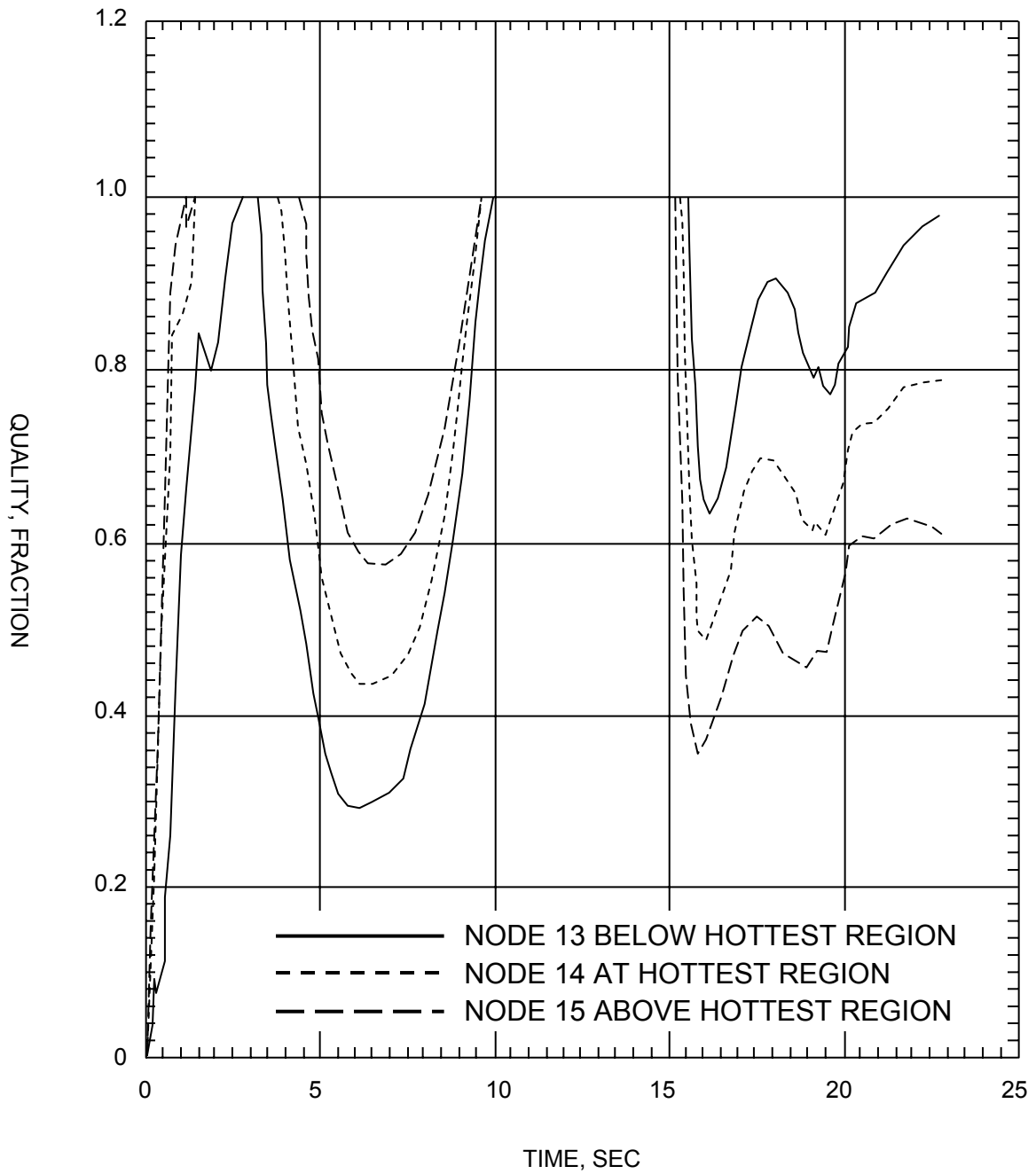

SAR FIGURE NO. 6.3-16e

AMENDMENT 21

ARKANSAS NUCLEAR ONE
UNIT 2
RUSSELLVILLE, ARKANSAS



SCALE:	NONE
DRAWN:	
DESIGN:	ENERGY
CAD NO:	

ANO-2 ECCS PERFORMANCE ANALYSIS FOR
IMPLEMENTATION OF CE 16 X 16 NGF - 0.4 DEG/PD
BREAK - HOT ASSEMBLY QUALITY

BASED ON DRAWING NO

SHEET

REV.

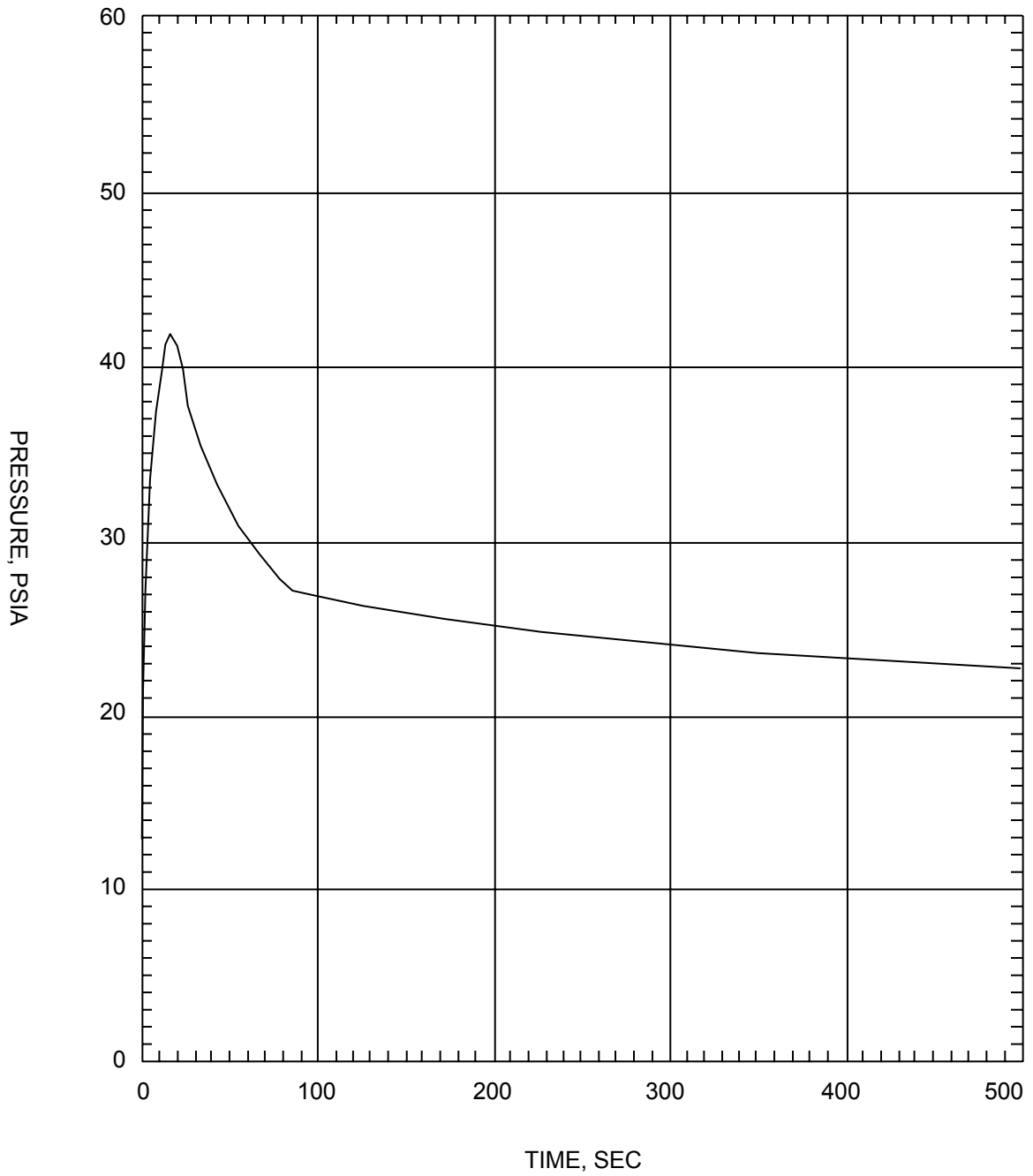

SAR FIGURE NO. 6.3-16f

AMENDMENT 21

ARKANSAS NUCLEAR ONE
 UNIT 2
 RUSSELLVILLE, ARKANSAS



SCALE: NONE

DRAWN:

DESIGN: ENTERGY

CAD NO:

ANO-2 ECCS PERFORMANCE ANALYSIS FOR
 IMPLEMENTATION OF CE 16 X 16 NGF - 0.4 DEG/PD
 BREAK - CONTAINMENT PRESSURE

BASED ON DRAWING NO

SHEET

REV.

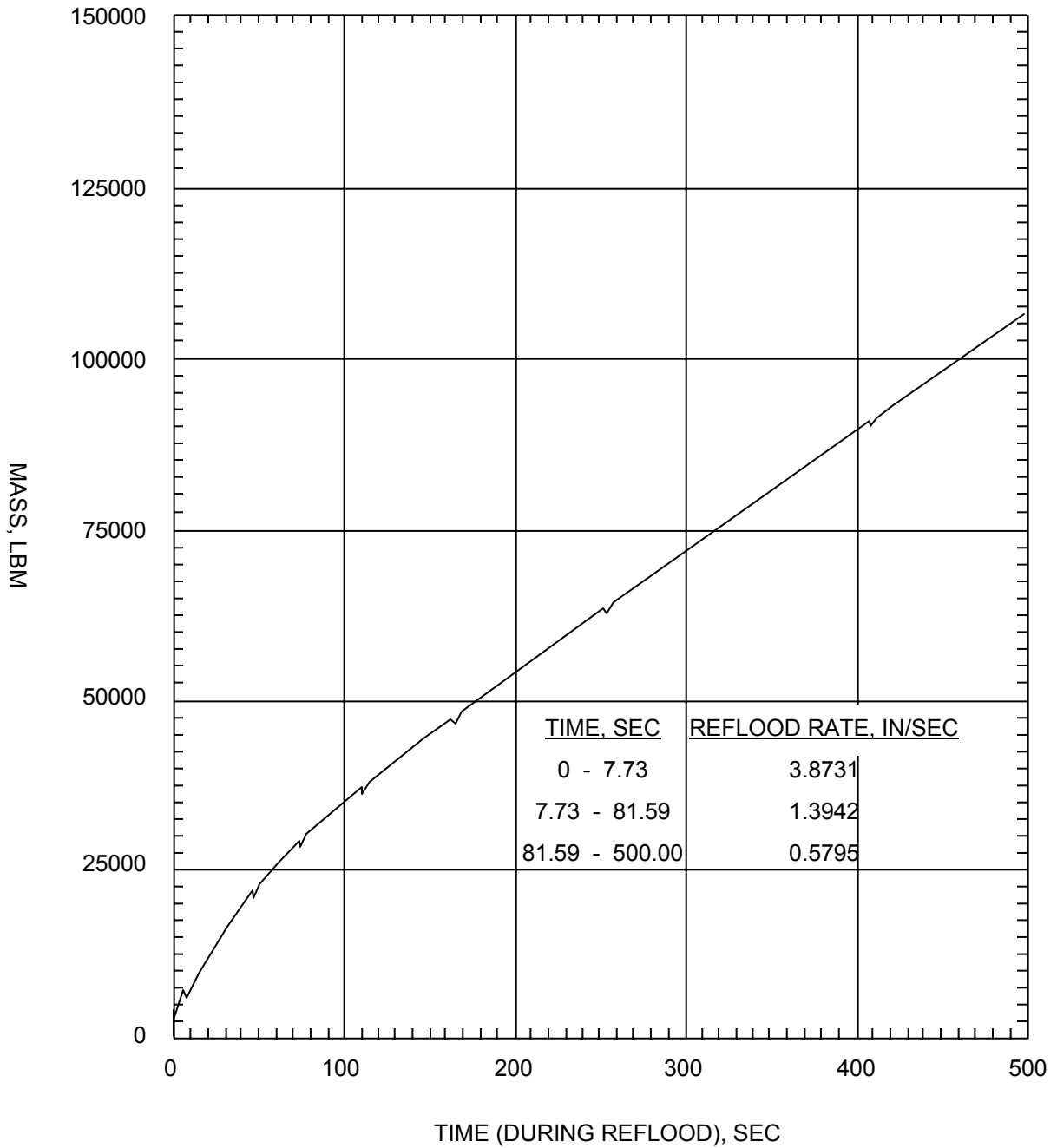

SAR FIGURE NO. 6.3-16g

AMENDMENT 21

ARKANSAS NUCLEAR ONE
UNIT 2
RUSSELLVILLE, ARKANSAS



SCALE: NONE
DRAWN:
DESIGN: ENTERGY
CAD NO:

ANO-2 ECCS PERFORMANCE ANALYSIS FOR
IMPLEMENTATION OF CE 16 X 16 NGF - 0.4 DEG/PD
BREAK - MASS ADDED TO CORE DURING REFLOOD

BASED ON DRAWING NO

SHEET

REV.

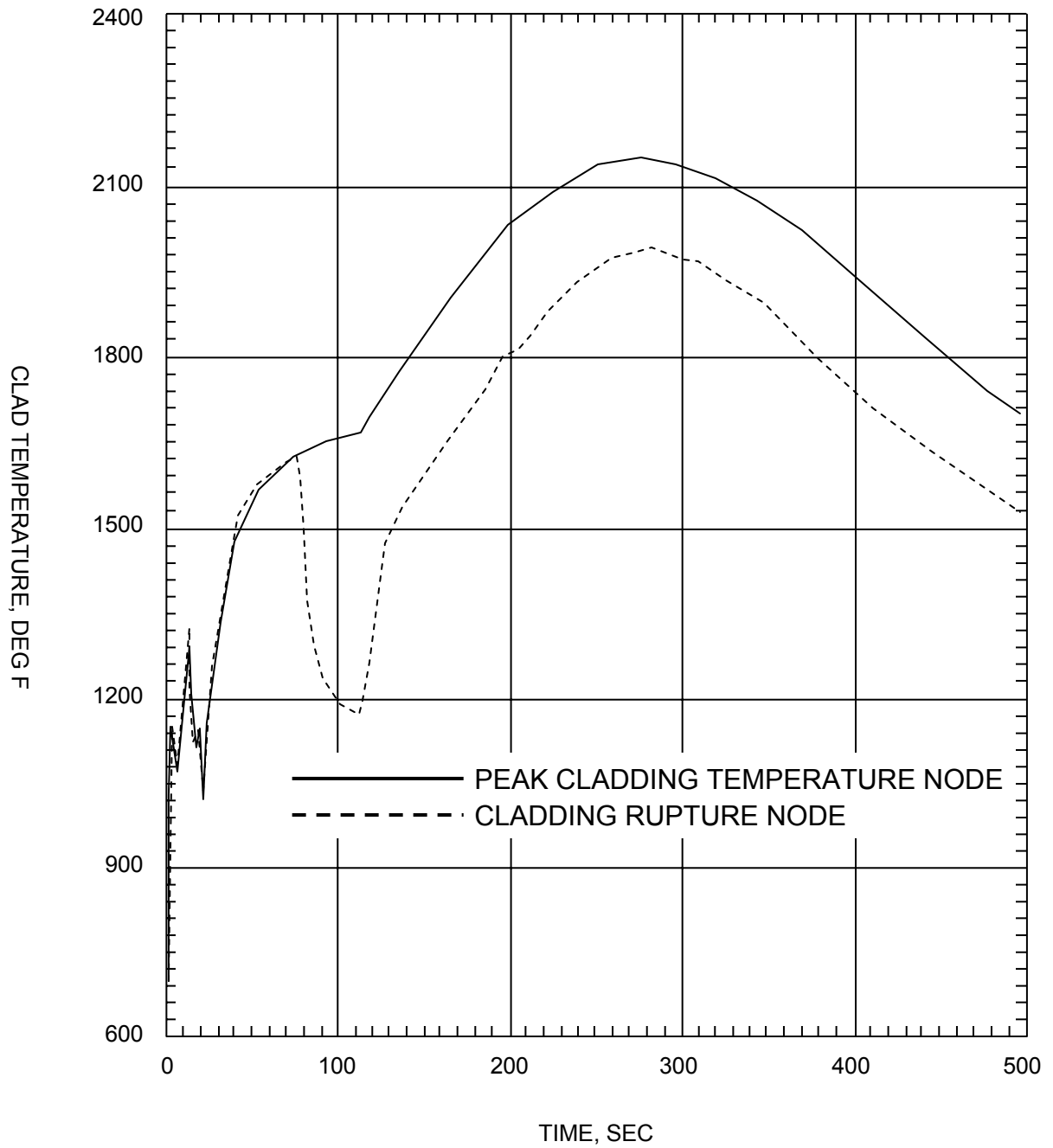

SAR FIGURE NO. 6.3-16h

AMENDMENT 21

ARKANSAS NUCLEAR ONE
UNIT 2
RUSSELLVILLE, ARKANSAS



SCALE:	NONE
DRAWN:	
DESIGN:	ENERGY
CAD NO:	

ANO-2 ECCS PERFORMANCE ANALYSIS FOR
IMPLEMENTATION OF CE 16 X 16 NGF - 0.4 DEG/PD
BREAK - PEAK CLADDING TEMPERATURE

BASED ON DRAWING NO

SHEET

REV.

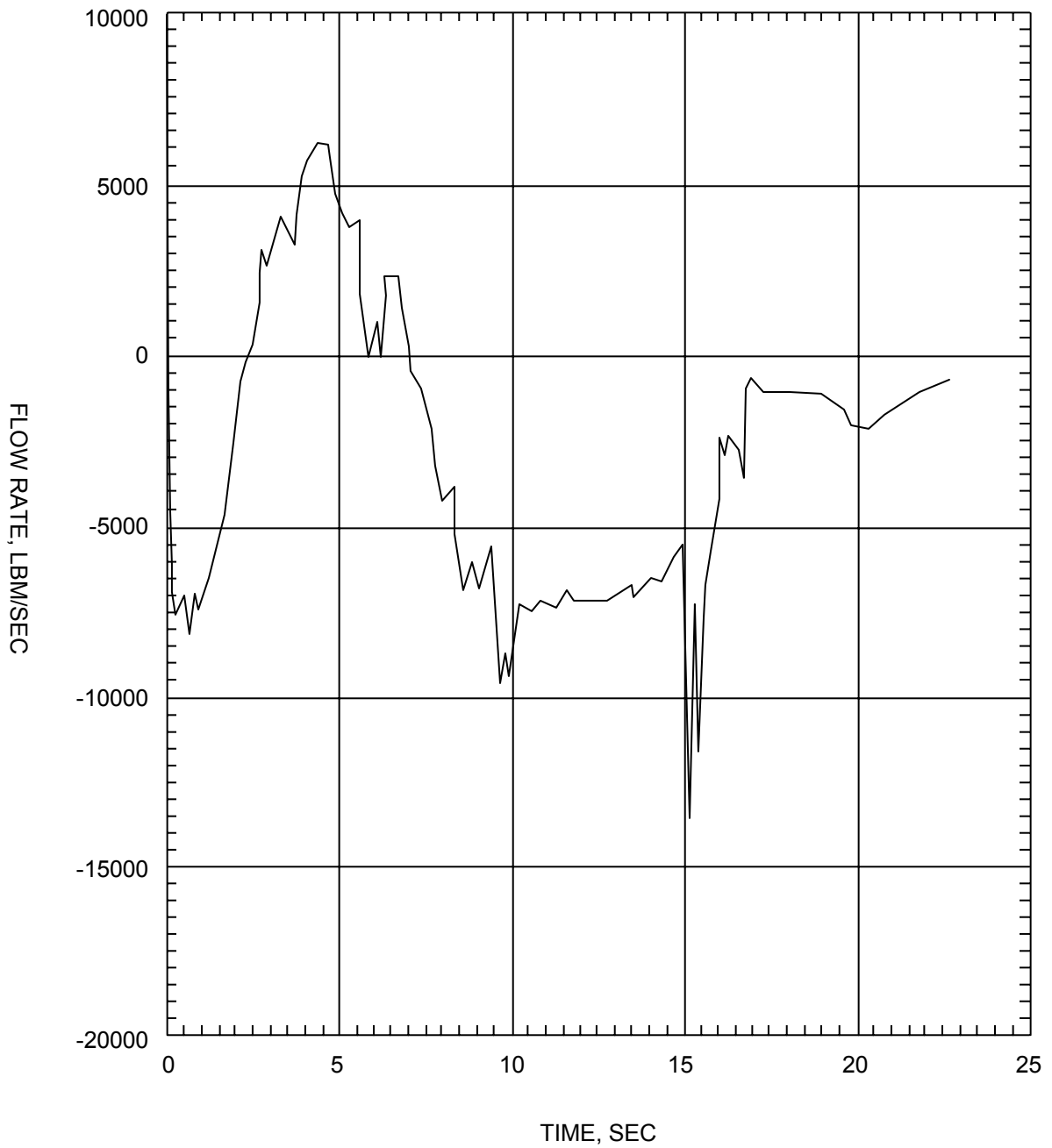

SAR FIGURE NO. 6.3-16i

AMENDMENT 21

ARKANSAS NUCLEAR ONE
UNIT 2
RUSSELLVILLE, ARKANSAS



SCALE:	NONE
DRAWN:	
DESIGN:	ENTERGY
CAD NO:	

ANO-2 ECCS PERFORMANCE ANALYSIS FOR
IMPLEMENTATION OF CE 16 X 16 NGF - 0.4 DEG/PD
BREAK - MID ANNULUS FLOW RATE

BASED ON DRAWING NO

SHEET

REV.

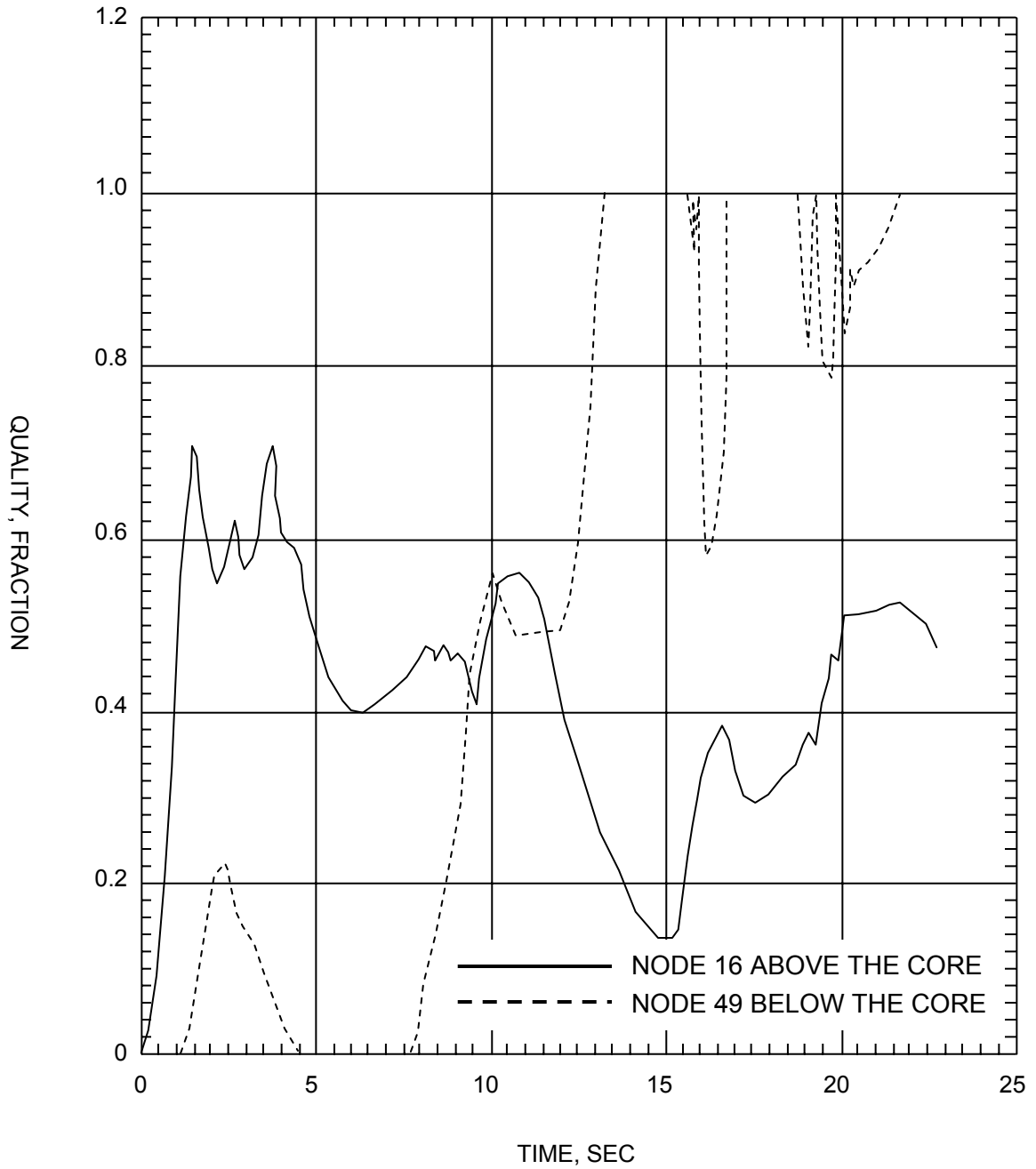

SAR FIGURE NO. 6.3-16j

AMENDMENT 21

ARKANSAS NUCLEAR ONE
 UNIT 2
 RUSSELLVILLE, ARKANSAS



SCALE:	NONE
DRAWN:	
DESIGN:	ENERGY
CAD NO:	

ANO-2 ECCS PERFORMANCE ANALYSIS FOR
 IMPLEMENTATION OF CE 16 X 16 NGF - 0.4 DEG/PD
 BREAK - QUALITY ABOVE AND BELOW THE CORE

BASED ON DRAWING NO

SHEET

REV.

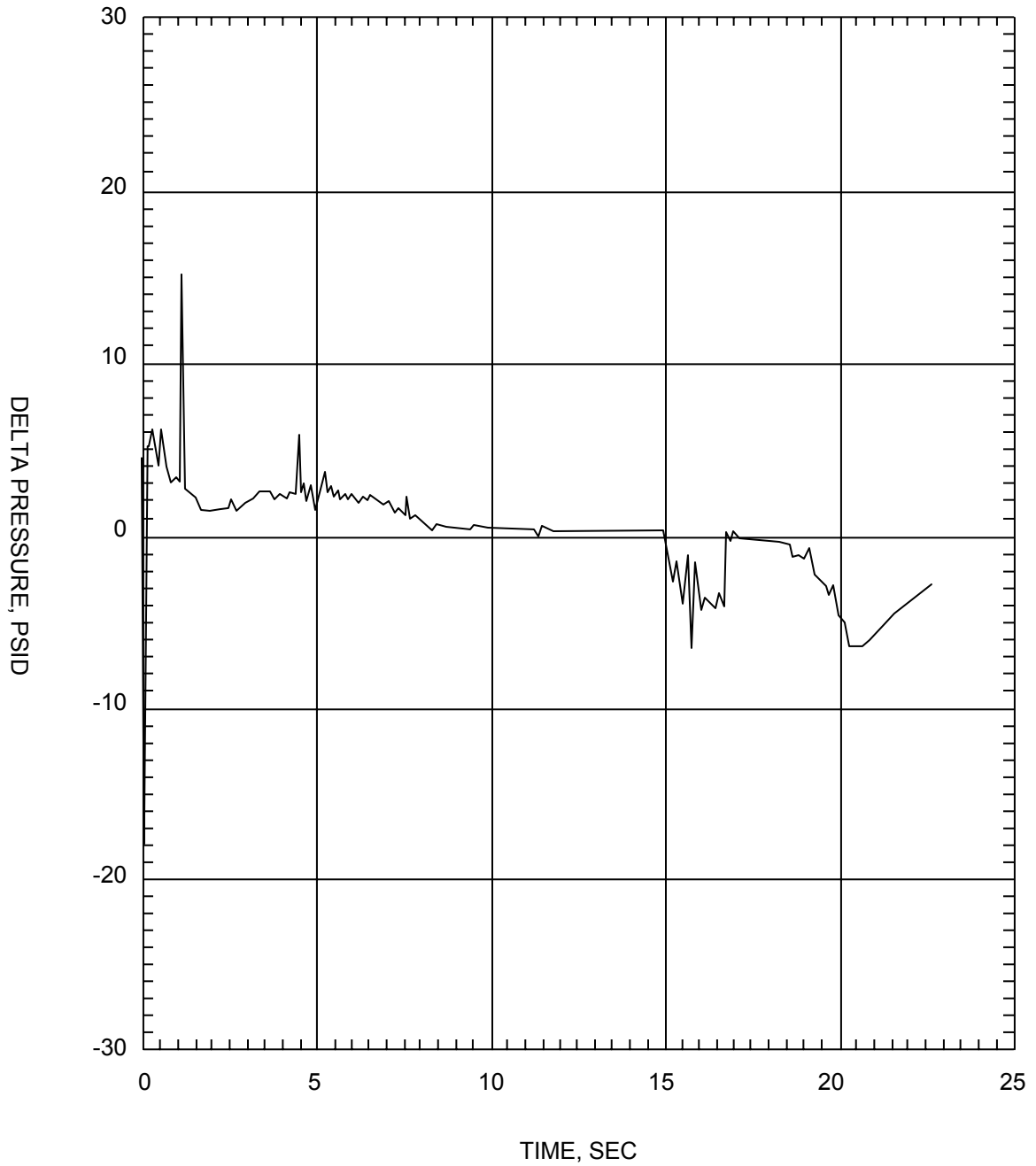

SAR FIGURE NO. 6.3-16k

AMENDMENT 21

ARKANSAS NUCLEAR ONE
 UNIT 2
 RUSSELLVILLE, ARKANSAS



SCALE:	NONE
DRAWN:	
DESIGN:	ENERGY
CAD NO:	

ANO-2 ECCS PERFORMANCE ANALYSIS FOR
 IMPLEMENTATION OF CE 16 X 16 NGF - 0.4 DEG/PD
 BREAK - CORE PRESSURE DROP

BASED ON DRAWING NO

SHEET

REV.

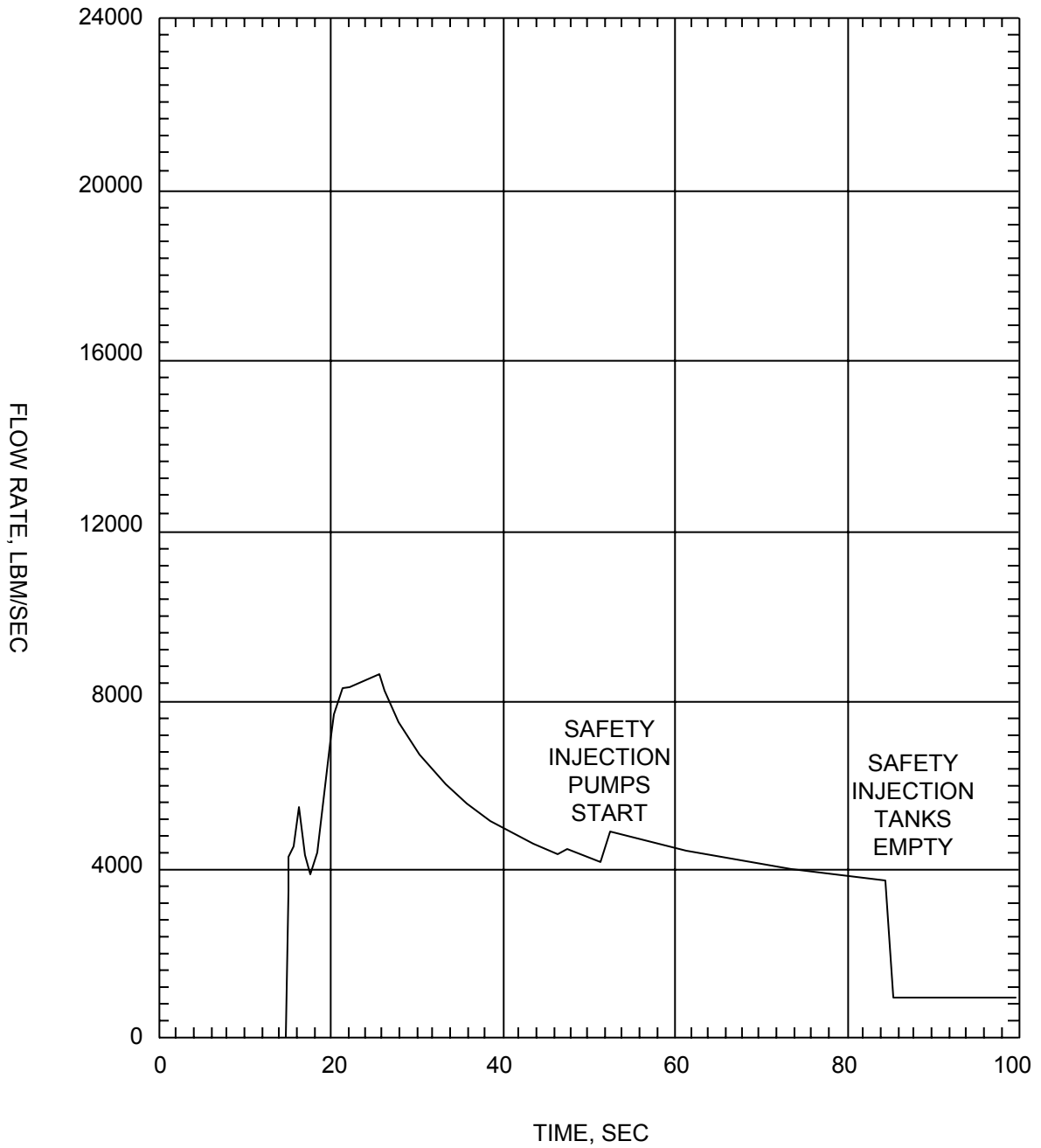

SAR FIGURE NO. 6.3-16I

AMENDMENT 21

ARKANSAS NUCLEAR ONE
UNIT 2
RUSSELLVILLE, ARKANSAS



SCALE:	NONE
DRAWN:	
DESIGN:	ENERGY
CAD NO:	

ANO-2 ECCS PERFORMANCE ANALYSIS FOR IMPLEMENTATION
OF CE 16 X 16 NGF - 0.4 DEG/PD BREAK - SAFETY INJECTION
FLOW RATE INTO INTACT DISCHARGE LEGS

BASED ON DRAWING NO

SHEET

REV.

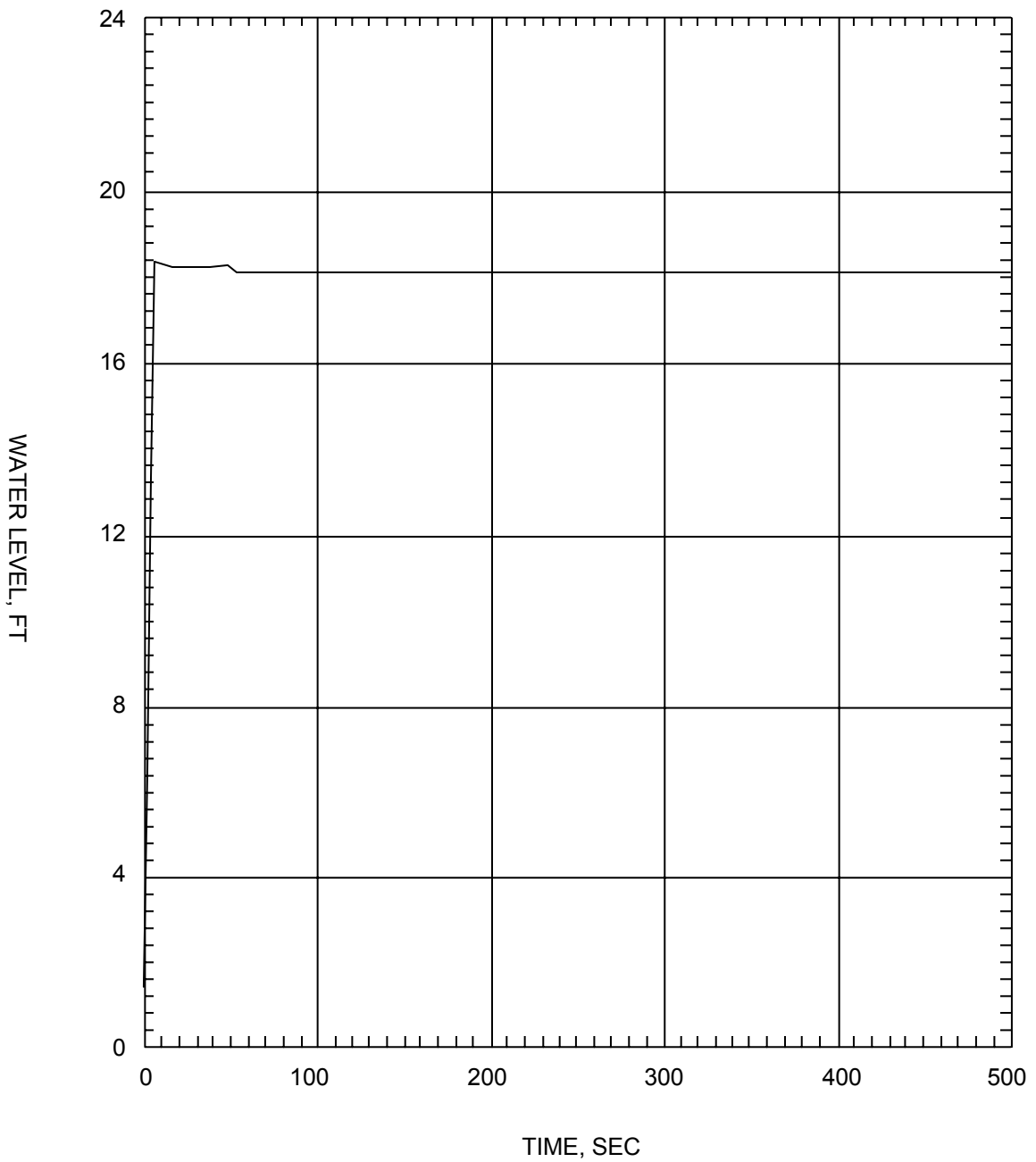

SAR FIGURE NO. 6.3-16m

AMENDMENT 21

ARKANSAS NUCLEAR ONE
 UNIT 2
 RUSSELLVILLE, ARKANSAS



SCALE:	NONE
DRAWN:	
DESIGN:	ENTERGY
CAD NO:	

ANO-2 ECCS PERFORMANCE ANALYSIS FOR
 IMPLEMENTATION OF CE 16 X 16 NGF - 0.4 DEG/PD BREAK
 - WATER LEVEL IN DOWNCOMER DURING REFLOOD

BASED ON DRAWING NO

SHEET

REV.

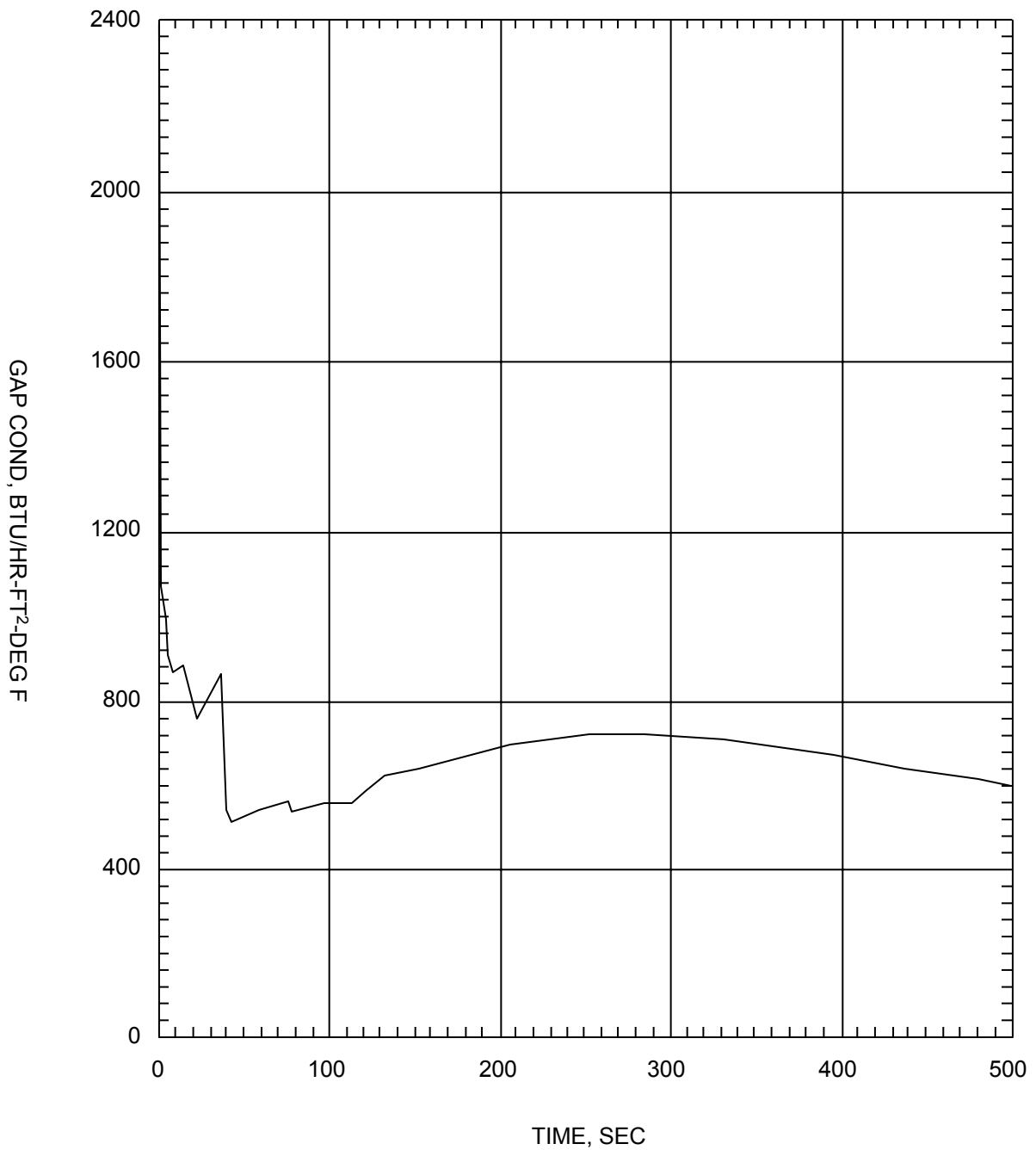

SAR FIGURE NO. 6.3-16n

AMENDMENT 21

ARKANSAS NUCLEAR ONE
 UNIT 2
 RUSSELLVILLE, ARKANSAS



SCALE:	NONE
DRAWN:	
DESIGN:	ENERGY
CAD NO:	

ANO-2 ECCS PERFORMANCE ANALYSIS FOR
 IMPLEMENTATION OF CE 16 X 16 NGF - 0.4 DEG/PD
 BREAK - HOT SPOT GAP CONDUCTANCE

BASED ON DRAWING NO

SHEET

REV.

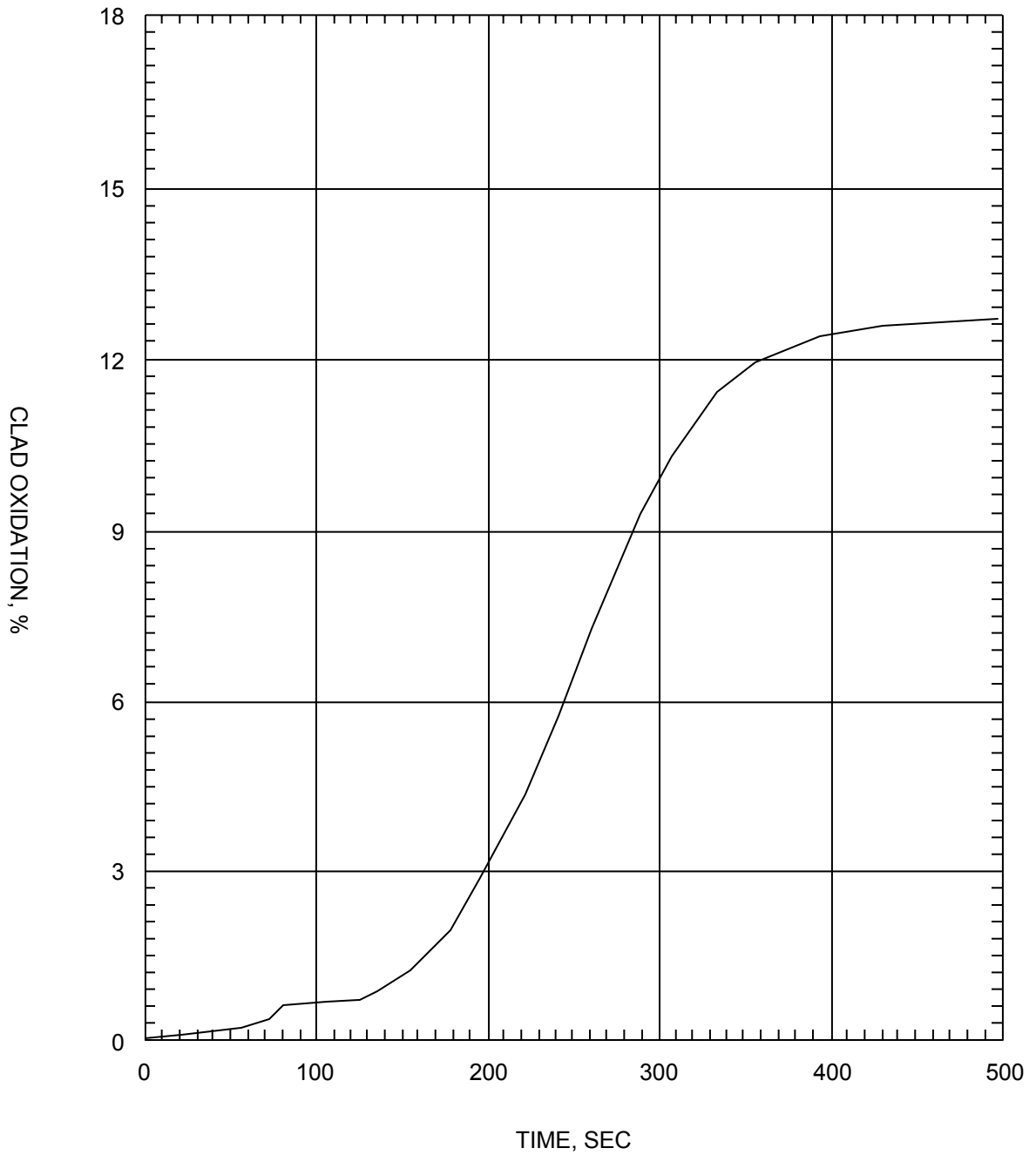

SAR FIGURE NO. 6.3-16o

AMENDMENT 21

ARKANSAS NUCLEAR ONE
 UNIT 2
 RUSSELLVILLE, ARKANSAS



SCALE:	NONE
DRAWN:	
DESIGN:	ENERGY
CAD NO:	

ANO-2 ECCS PERFORMANCE ANALYSIS FOR
 IMPLEMENTATION OF CE 16 X 16 NGF - 0.4 DEG/PD BREAK
 - MAXIMUM LOCAL CLADDING OXIDATION PERCENTAGE

BASED ON DRAWING NO

SHEET

REV.

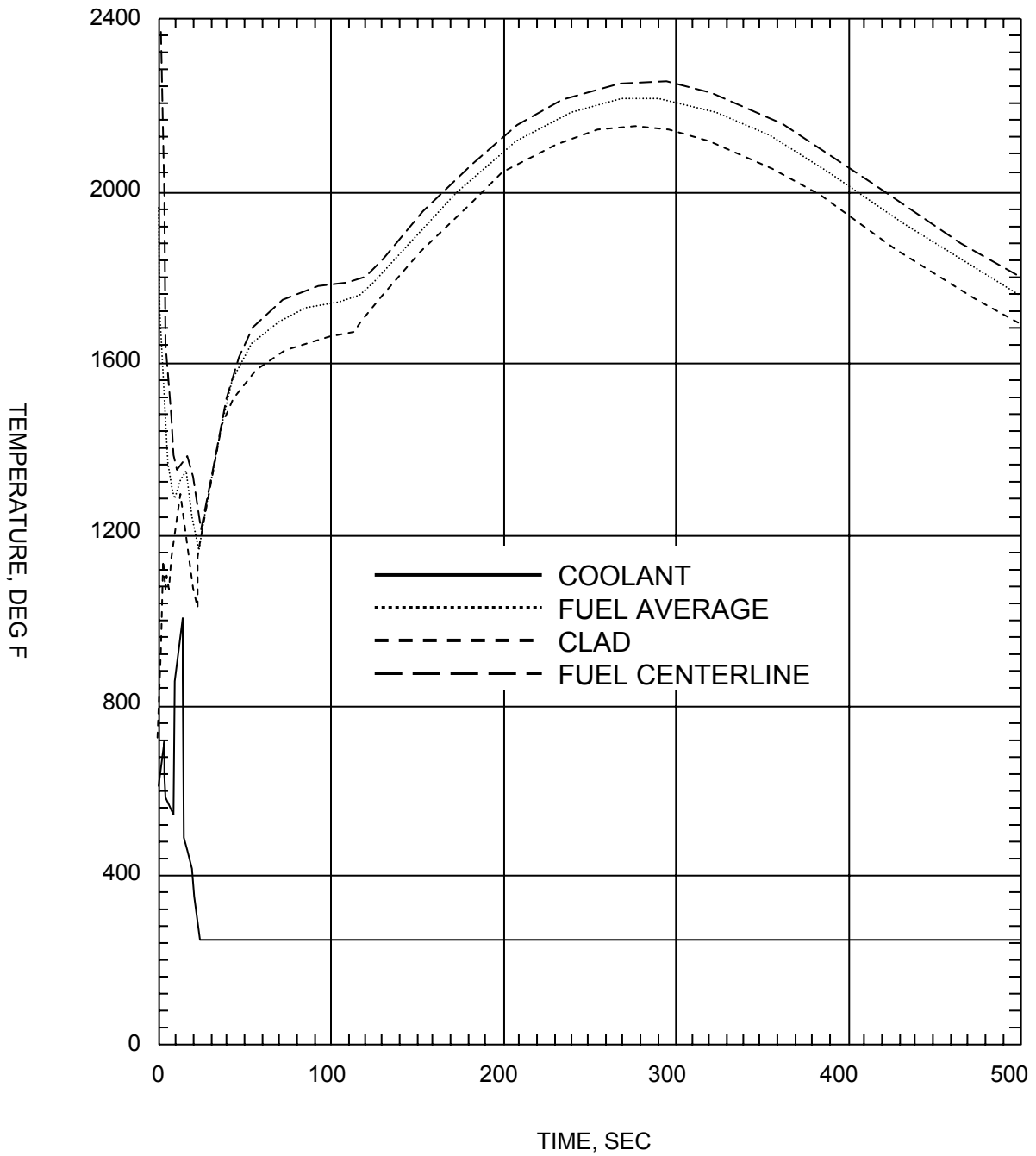

SAR FIGURE NO. 6.3-16p

AMENDMENT 21

ARKANSAS NUCLEAR ONE
UNIT 2
RUSSELLVILLE, ARKANSAS



SCALE:	NONE
DRAWN:	
DESIGN:	ENTERGY
CAD NO:	

ANO-2 ECCS PERFORMANCE ANALYSIS FOR IMPLEMENTATION OF CE 16 X 16 NGF - 0.4 DEG/PD BREAK - FUEL CENTERLINE, FUEL AVERAGE, CLADDING, AND COOLANT TEMPERATURE AT THE HOT SPOT

BASED ON DRAWING NO

SHEET

REV.

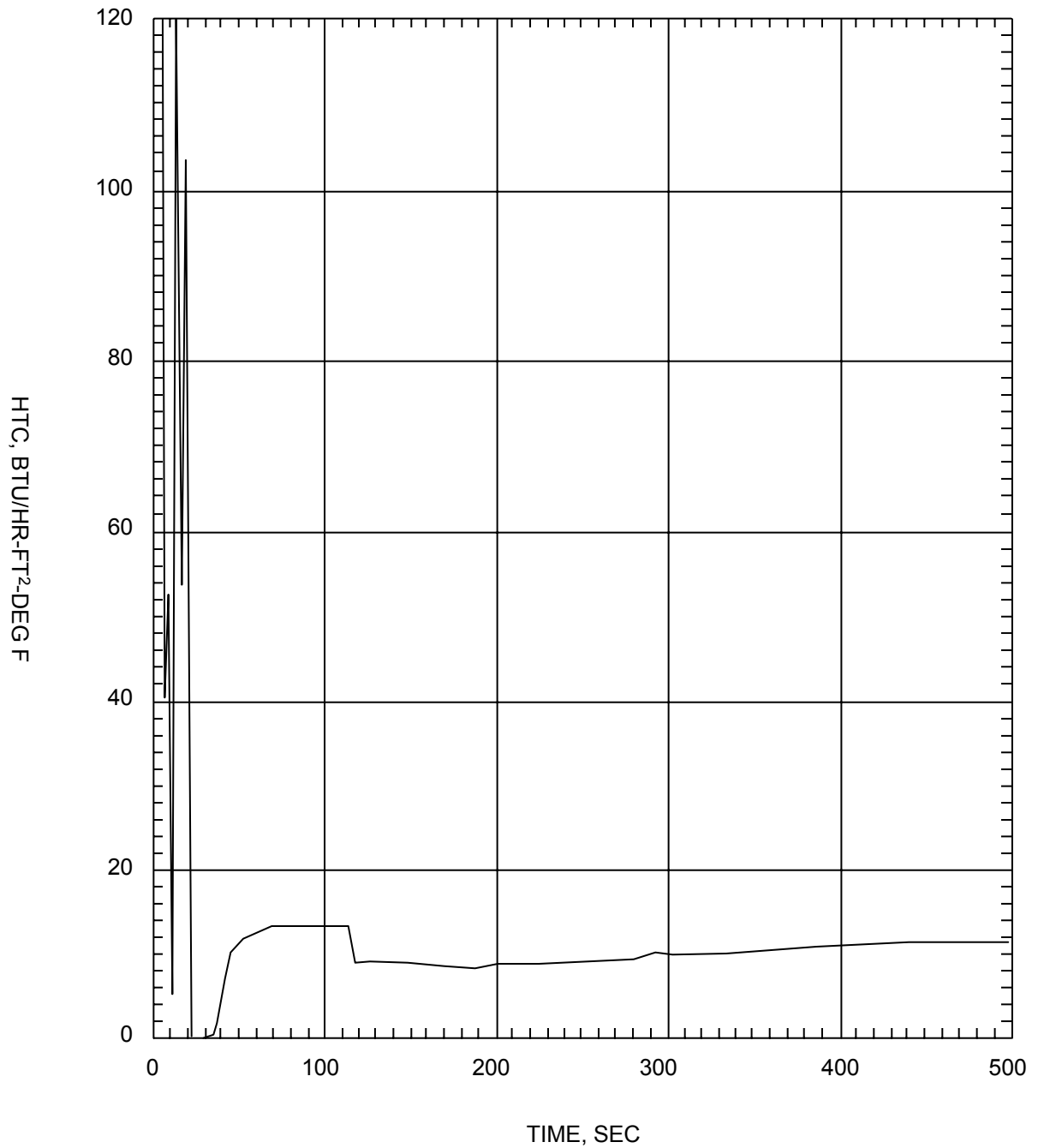

SAR FIGURE NO. 6.3-16q

AMENDMENT 21

ARKANSAS NUCLEAR ONE
 UNIT 2
 RUSSELLVILLE, ARKANSAS



SCALE:	NONE
DRAWN:	
DESIGN:	ENERGY
CAD NO:	

ANO-2 ECCS PERFORMANCE ANALYSIS FOR
 IMPLEMENTATION OF CE 16 X 16 NGF - 0.4 DEG/PD
 BREAK - HOT SPOT HEAT TRANSFER COEFFICIENT

BASED ON DRAWING NO

SHEET

REV.

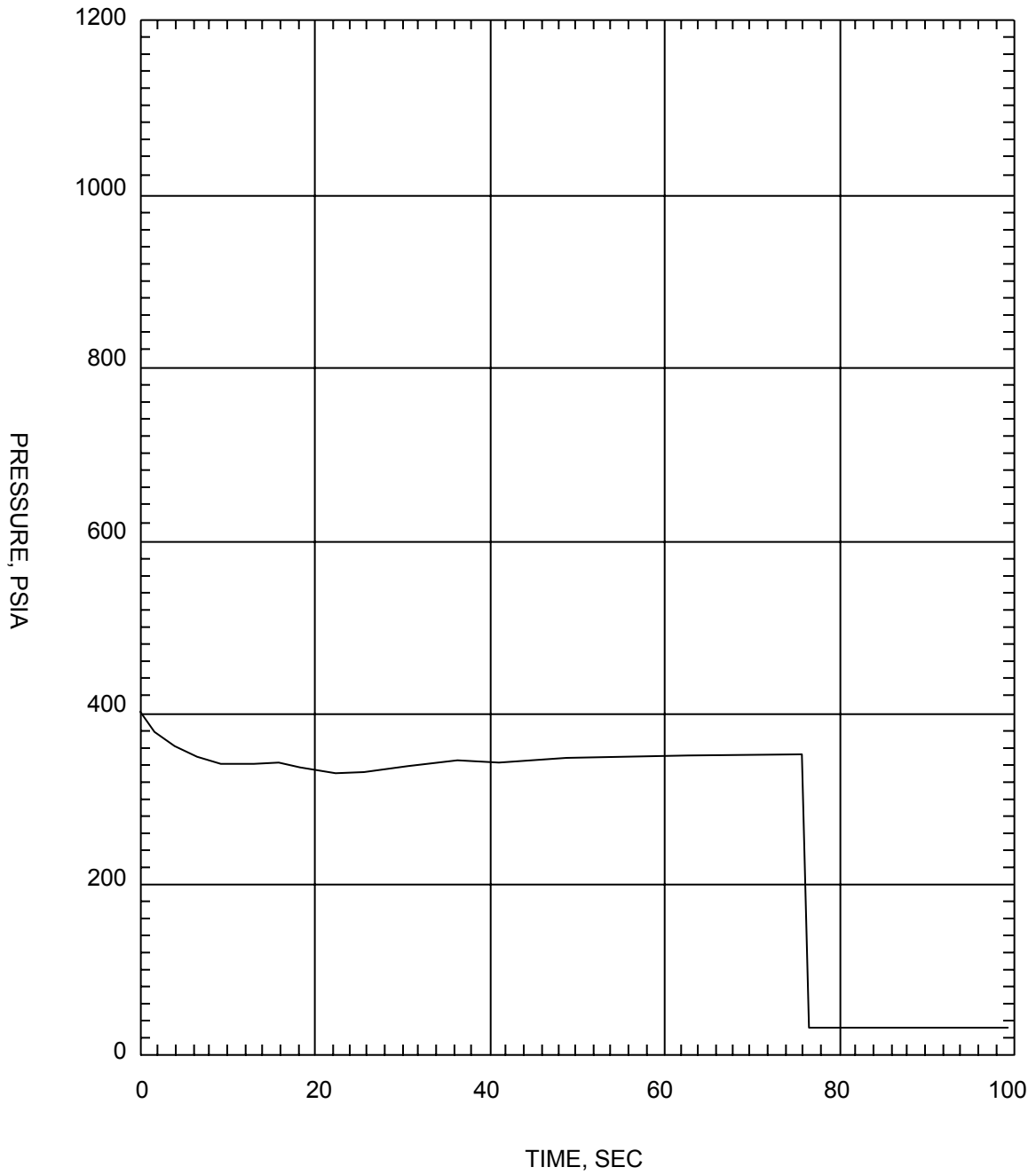

SAR FIGURE NO. 6.3-16r

AMENDMENT 21

ARKANSAS NUCLEAR ONE
UNIT 2
RUSSELLVILLE, ARKANSAS



SCALE:	NONE
DRAWN:	
DESIGN:	ENTERGY
CAD NO:	

ANO-2 ECCS PERFORMANCE ANALYSIS FOR
IMPLEMENTATION OF CE 16 X 16 NGF - 0.4 DEG/PD
BREAK - HOT SPOT PIN PRESSURE

BASED ON DRAWING NO

SHEET

REV.

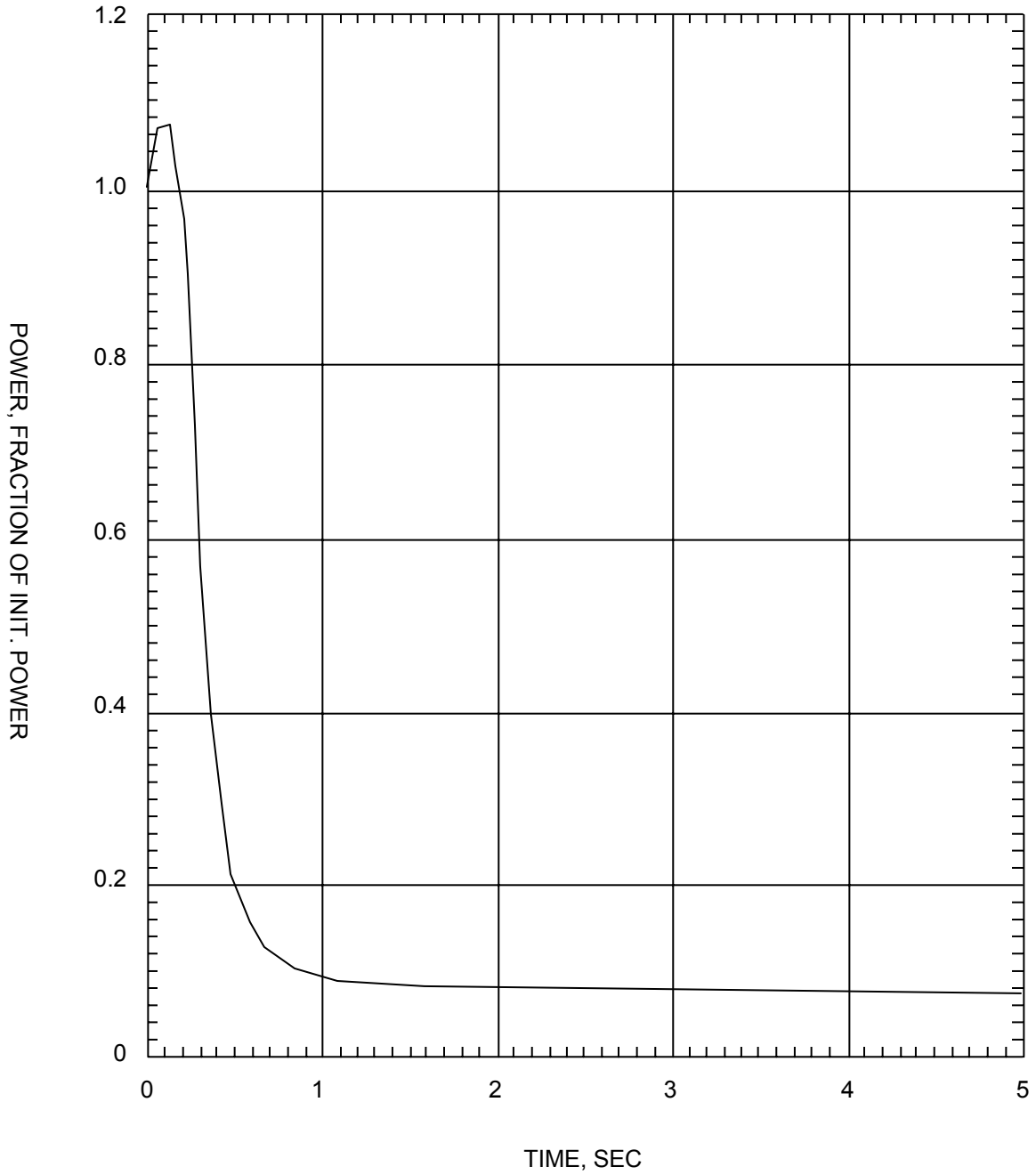

SAR FIGURE NO. 6.3-17a

AMENDMENT 21

ARKANSAS NUCLEAR ONE
 UNIT 2
 RUSSELLVILLE, ARKANSAS



SCALE:	NONE
DRAWN:	
DESIGN:	ENTERGY
CAD NO:	

ANO-2 ECCS PERFORMANCE ANALYSIS FOR
 IMPLEMENTATION OF CE 16 X 16 NGF - 0.3 DEG/PD
 BREAK - CORE POWER

BASED ON DRAWING NO

SHEET

REV.

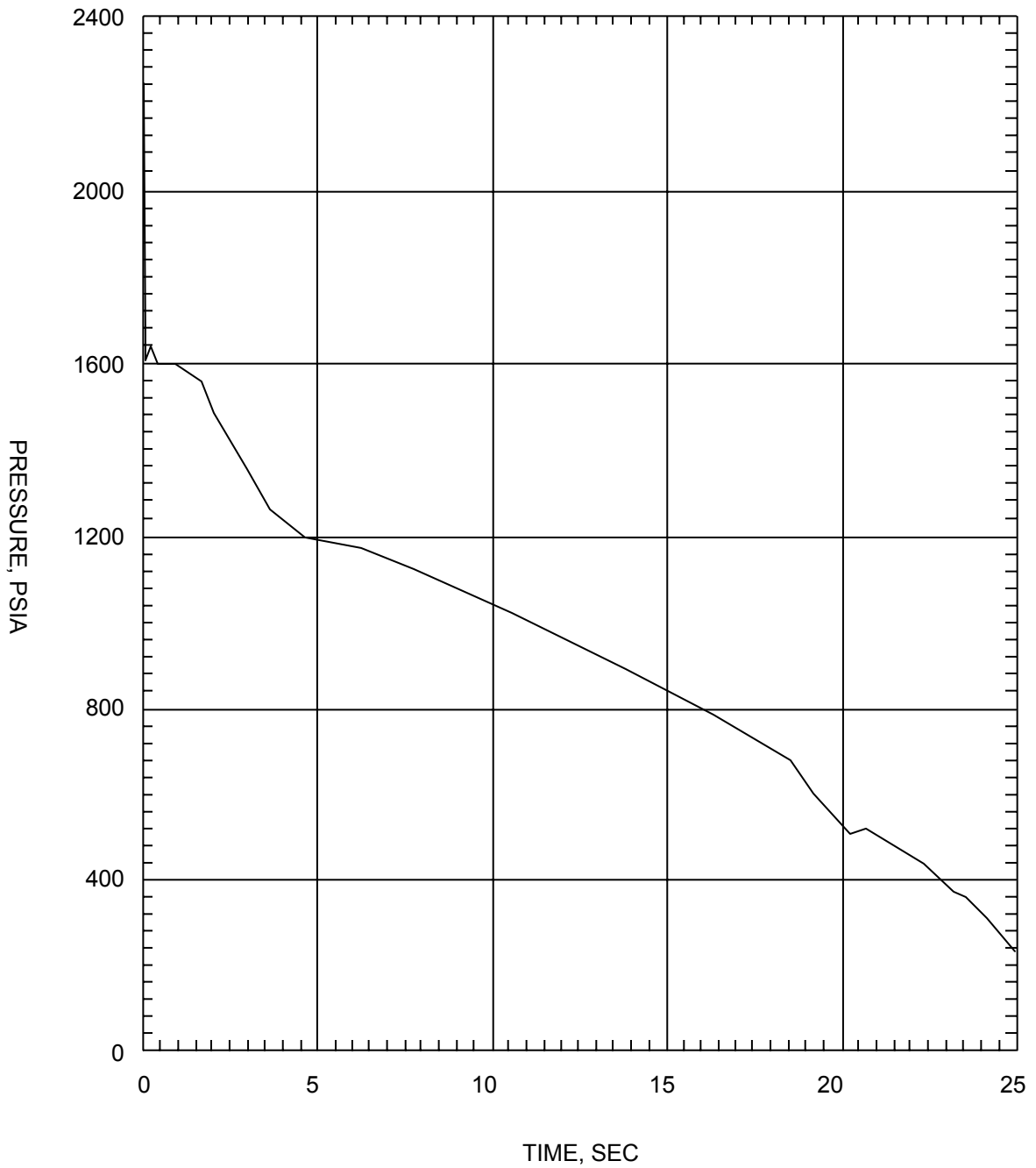

SAR FIGURE NO. 6.3-17b

AMENDMENT 21

ARKANSAS NUCLEAR ONE
 UNIT 2
 RUSSELLVILLE, ARKANSAS



SCALE:	NONE
DRAWN:	
DESIGN:	ENERGY
CAD NO:	

ANO-2 ECCS PERFORMANCE ANALYSIS FOR
 IMPLEMENTATION OF CE 16 X 16 NGF - 0.3 DEG/PD
 BREAK - PRESSURE IN CENTER HOT ASSEMBLY NODE

BASED ON DRAWING NO

SHEET

REV.

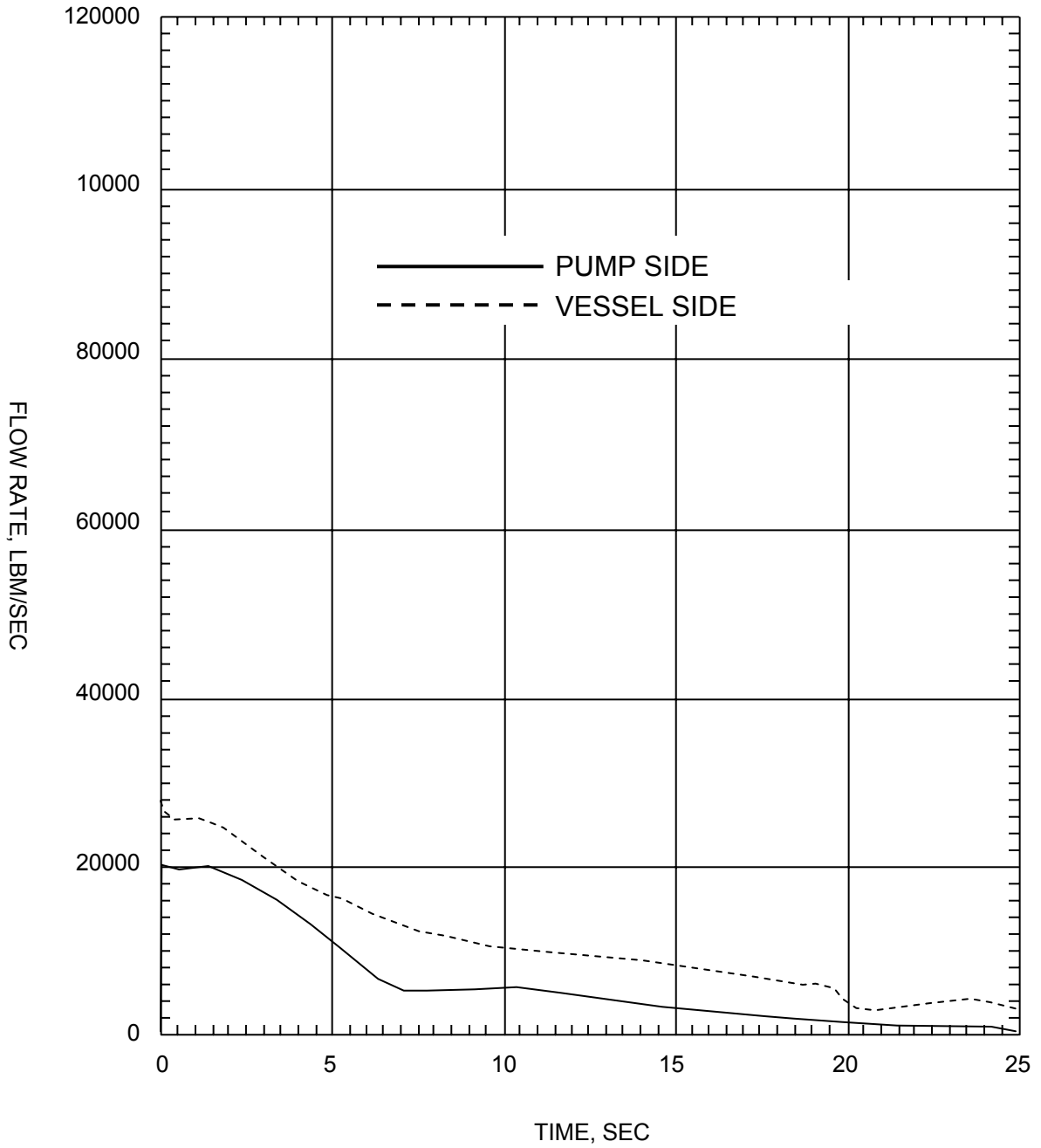

SAR FIGURE NO. 6.3-17c

AMENDMENT 21

ARKANSAS NUCLEAR ONE
 UNIT 2
 RUSSELLVILLE, ARKANSAS



SCALE:	NONE
DRAWN:	
DESIGN:	ENTERGY
CAD NO:	

ANO-2 ECCS PERFORMANCE ANALYSIS FOR
 IMPLEMENTATION OF CE 16 X 16 NGF - 0.3 DEG/PD
 BREAK - LEAK FLOW RATE

BASED ON DRAWING NO

SHEET

REV.

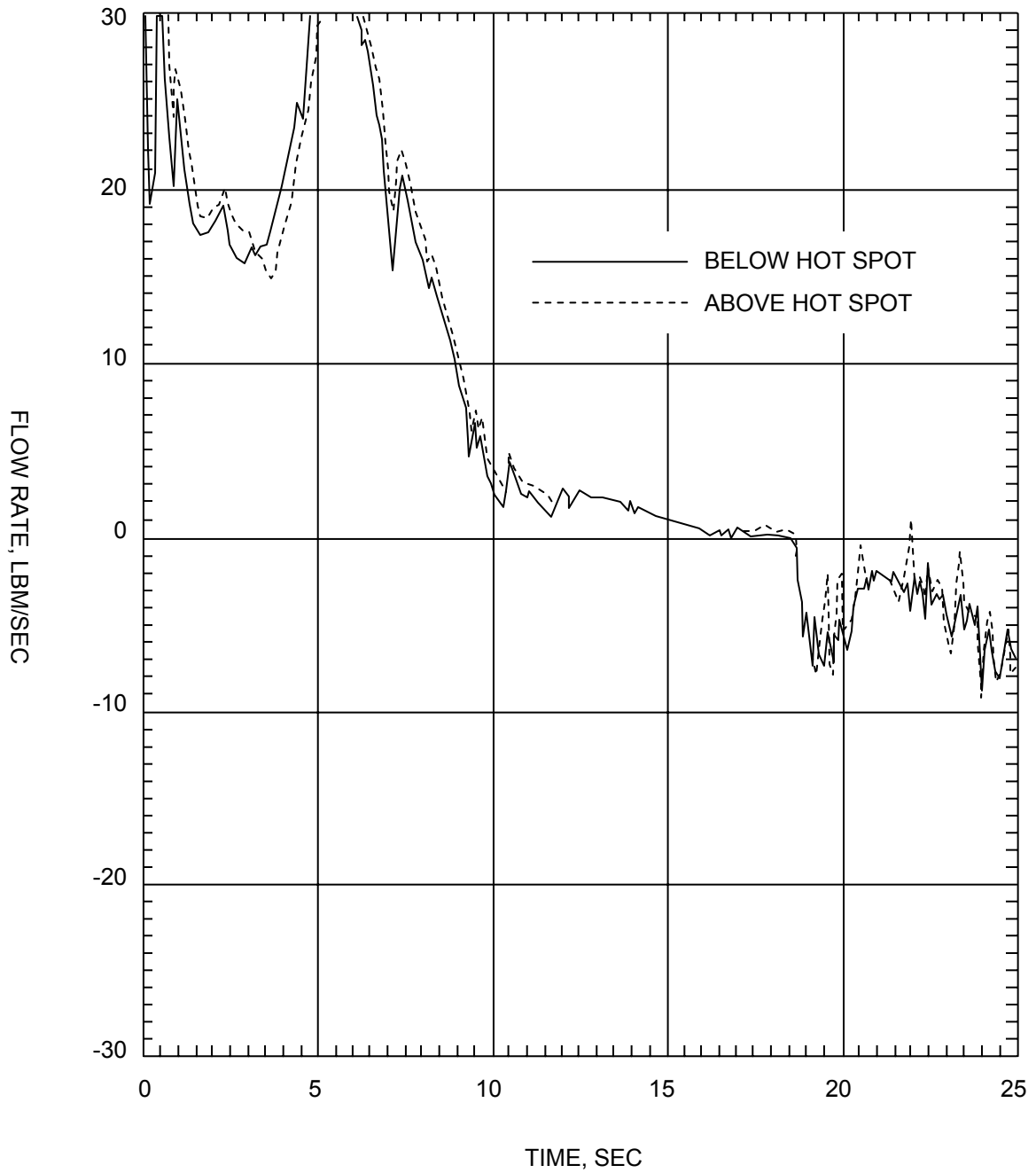

SAR FIGURE NO. 6.3-17d

AMENDMENT 21

ARKANSAS NUCLEAR ONE
UNIT 2
RUSSELLVILLE, ARKANSAS



SCALE:	NONE
DRAWN:	
DESIGN:	ENERGY
CAD NO:	

ANO-2 ECCS PERFORMANCE ANALYSIS FOR
IMPLEMENTATION OF CE 16 X 16 NGF - 0.3 DEG/PD BREAK -
HOT ASSEMBLY FLOW RATE (BELOW AND ABOVE HOT SPOT)

BASED ON DRAWING NO

SHEET

REV.

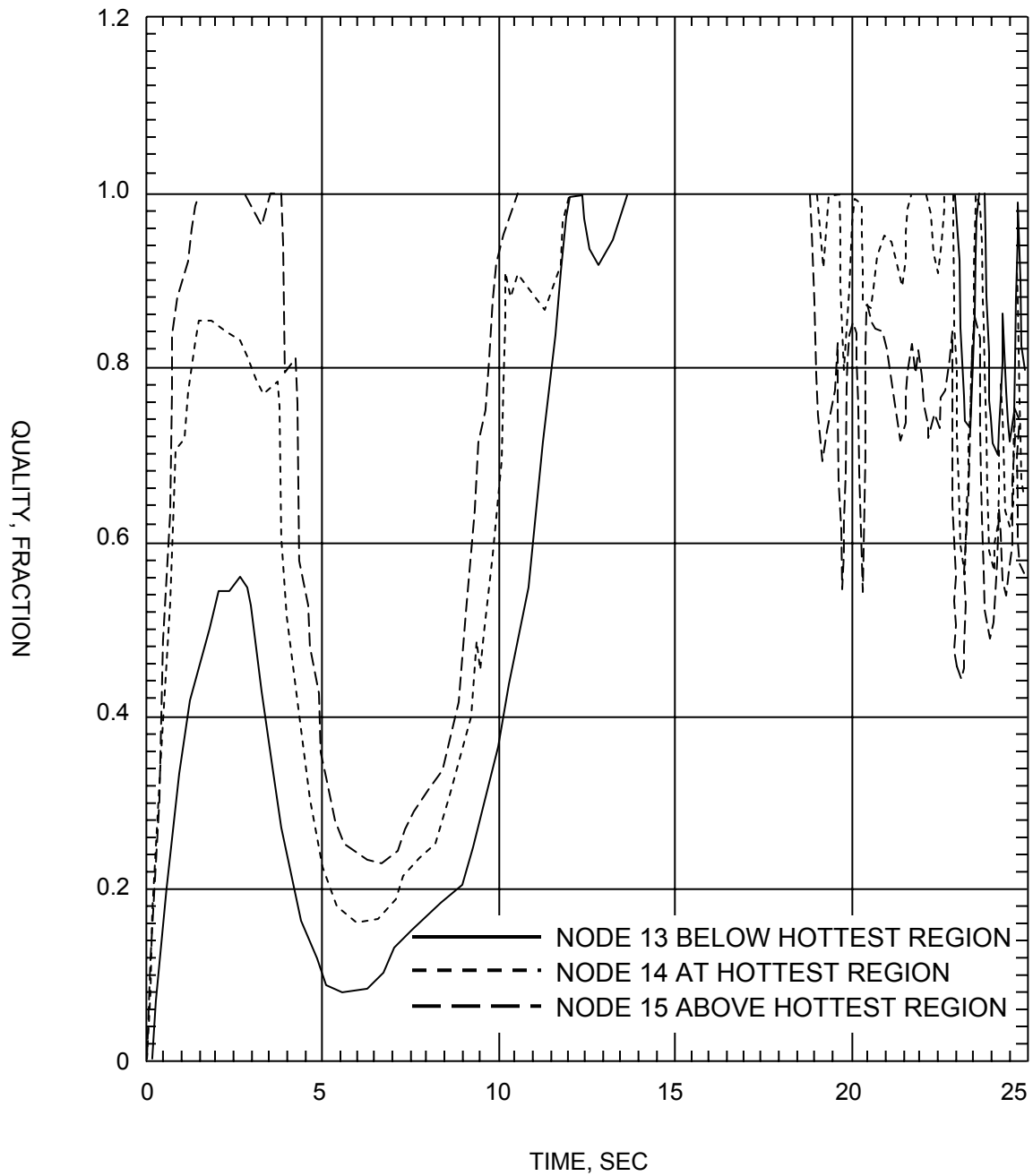

SAR FIGURE NO. 6.3-17e

AMENDMENT 21

ARKANSAS NUCLEAR ONE
 UNIT 2
 RUSSELLVILLE, ARKANSAS



SCALE:	NONE
DRAWN:	
DESIGN:	ENTERGY
CAD NO:	

ANO-2 ECCS PERFORMANCE ANALYSIS FOR
 IMPLEMENTATION OF CE 16 X 16 NGF - 0.3 DEG/PD
 BREAK - HOT ASSEMBLY QUALITY

BASED ON DRAWING NO

SHEET

REV.

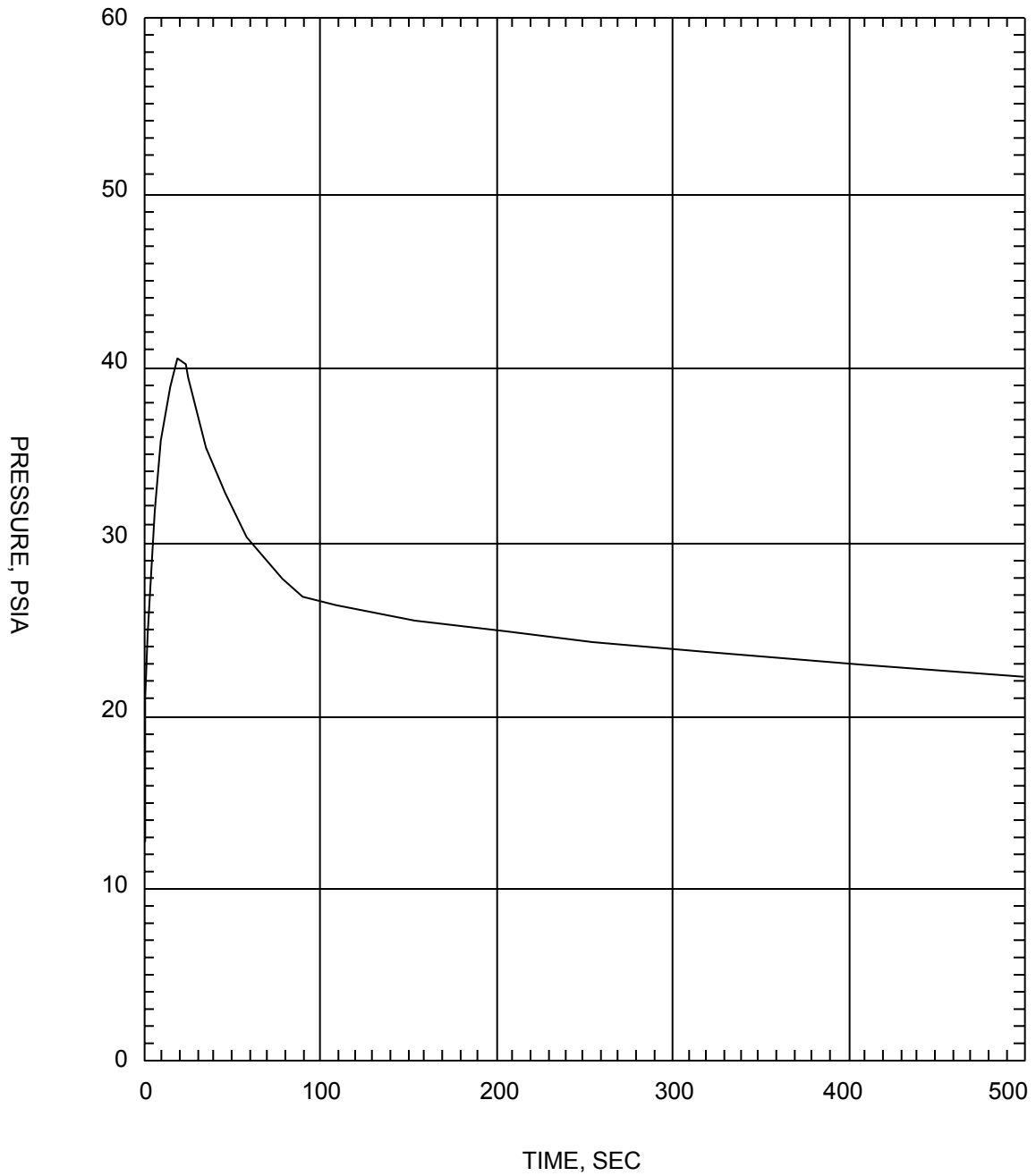

SAR FIGURE NO. 6.3-17f

AMENDMENT 21

ARKANSAS NUCLEAR ONE
 UNIT 2
 RUSSELLVILLE, ARKANSAS



SCALE:	NONE
DRAWN:	
DESIGN:	ENERGY
CAD NO:	

ANO-2 ECCS PERFORMANCE ANALYSIS FOR
 IMPLEMENTATION OF CE 16 X 16 NGF - 0.3 DEG/PD
 BREAK - CONTAINMENT PRESSURE

BASED ON DRAWING NO

SHEET

REV.

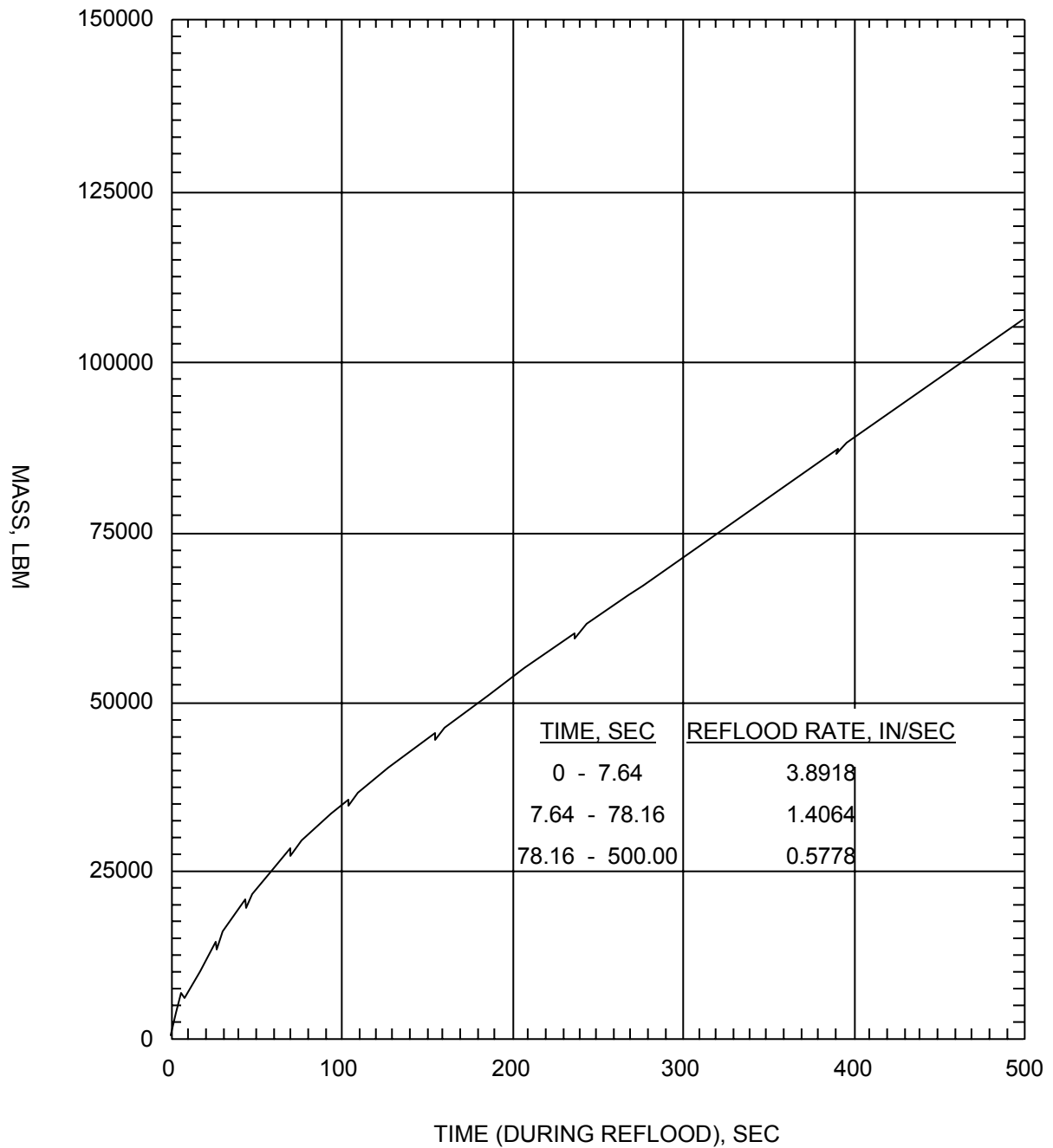

SAR FIGURE NO. 6.3-17g

AMENDMENT 21

ARKANSAS NUCLEAR ONE
UNIT 2
RUSSELLVILLE, ARKANSAS



SCALE:	NONE
DRAWN:	
DESIGN:	ENTERGY
CAD NO:	

ANO-2 ECCS PERFORMANCE ANALYSIS FOR
IMPLEMENTATION OF CE 16 X 16 NGF - 0.3 DEG/PD
BREAK - MASS ADDED TO CORE DURING REFLOOD

BASED ON DRAWING NO

SHEET

REV.

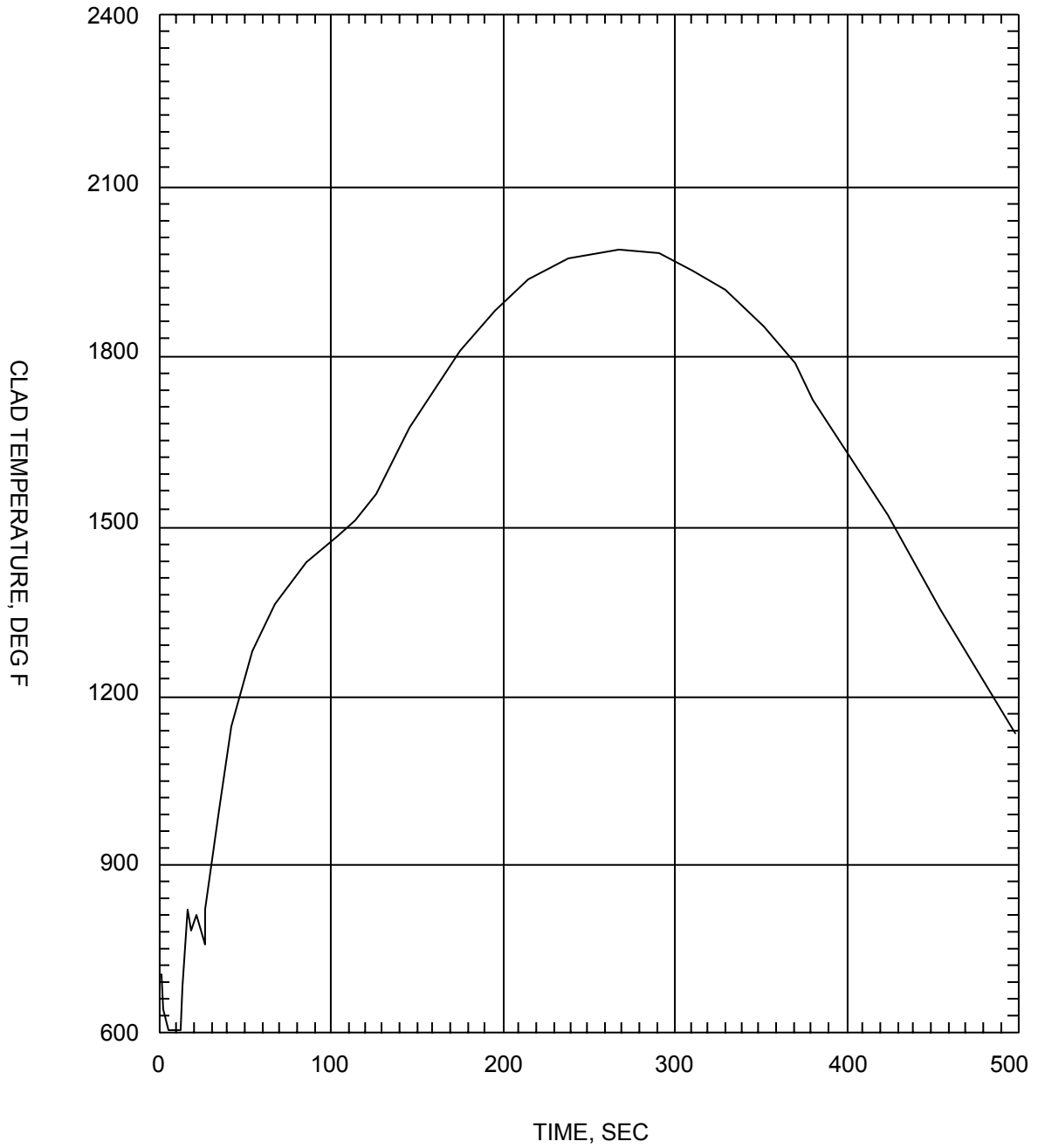

SAR FIGURE NO. 6.3-17h

AMENDMENT 21

ARKANSAS NUCLEAR ONE
 UNIT 2
 RUSSELLVILLE, ARKANSAS



SCALE:	NONE
DRAWN:	
DESIGN:	ENERGY
CAD NO:	

ANO-2 ECCS PERFORMANCE ANALYSIS FOR
 IMPLEMENTATION OF CE 16 X 16 NGF - 0.3 DEG/PD
 BREAK - PEAK CLADDING TEMPERATURE

BASED ON DRAWING NO

SHEET

REV.

Figures 6.3-18a – 6.3-19h Deleted
 See FSAR for Historical Data

SAR FIGURE NOS. 6.3-18a – 6.3-19h

AMENDMENT 20

ARKANSAS NUCLEAR ONE
 UNIT 2
 RUSSELLVILLE, ARKANSAS



SCALE:	NONE
DRAWN:	ENERGY
DESIGN:	ENERGY
CAD NO:	N/A

DRAWING NO

SHEET

REV.

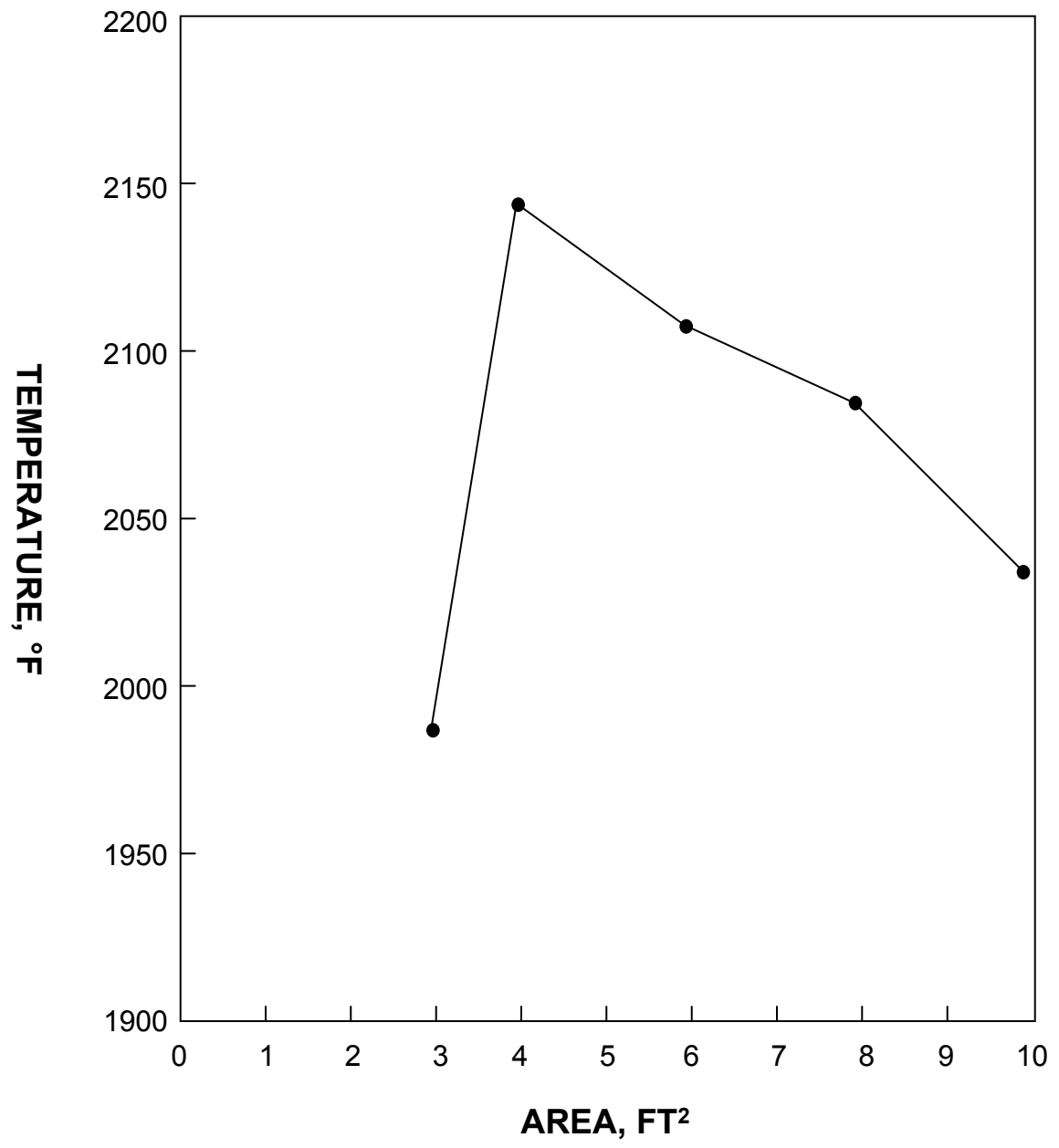

SAR FIGURE NO. 6.3-20

AMENDMENT 21

ARKANSAS NUCLEAR ONE
 UNIT 2
 RUSSELLVILLE, ARKANSAS



SCALE:	NONE
DRAWN:	
DESIGN:	ENERGY
CAD NO:	

ANO-2 ECCS PERFORMANCE ANALYSIS FOR IMPLEMENTATION OF CE 16 X 16 NGF - PEAK CLADDING TEMPERATURE VS BREAK SIZE FOR THE LARGE BREAK LOCA ECCS PERFORMANCE EVALUATION

BASED ON DRAWING NO	SHEET	REV.

Figures 6.3-21 – 6.3-22h Deleted
See FSAR for Historical Data

SAR FIGURE NOS. 6.3-21 – 6.3-22h

AMENDMENT 20

ARKANSAS NUCLEAR ONE
UNIT 2
RUSSELLVILLE, ARKANSAS



SCALE:	NONE
DRAWN:	ENERGY
DESIGN:	ENERGY
CAD NO:	N/A

DRAWING NO

SHEET

REV.

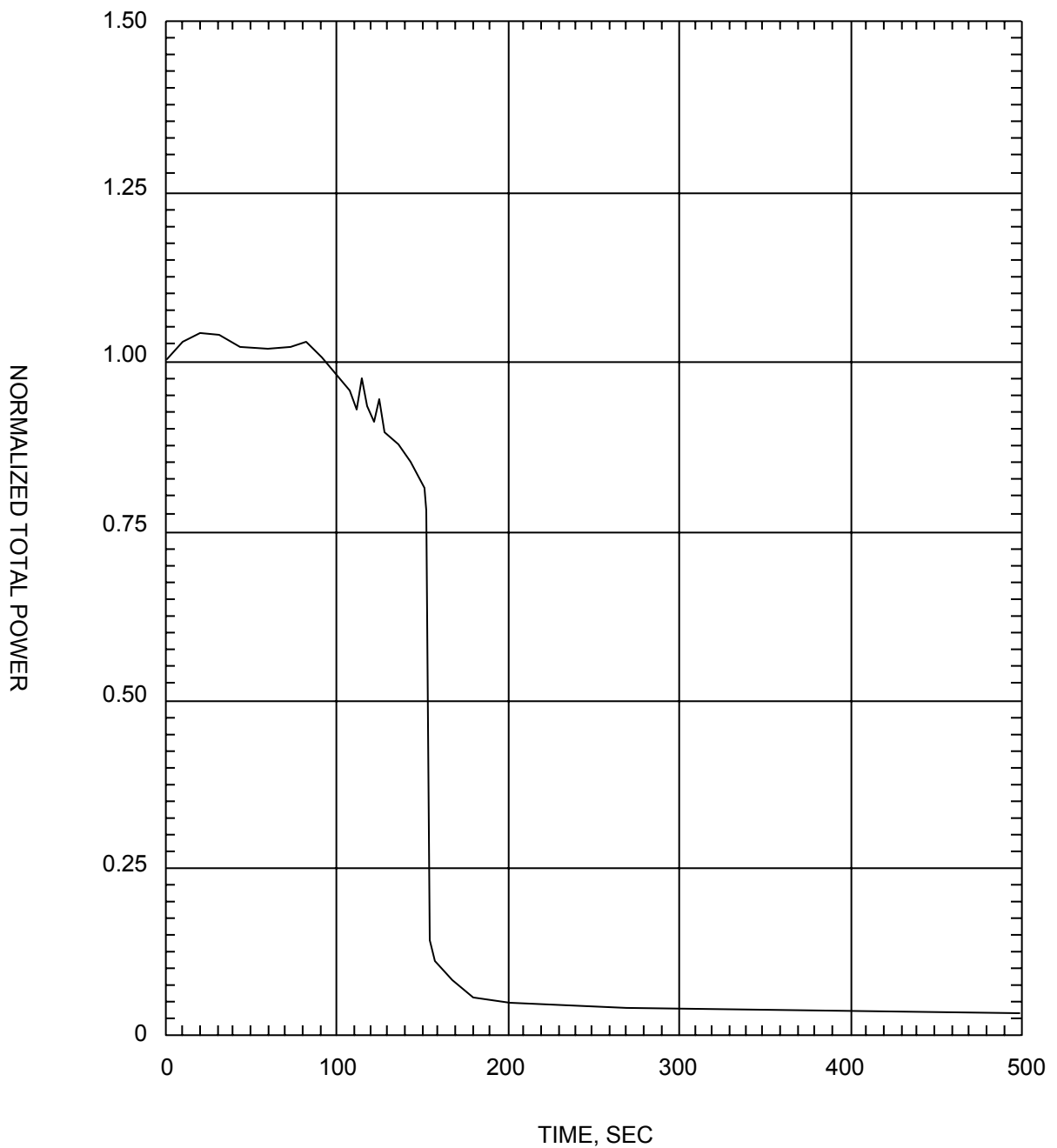

SAR FIGURE NO. 6.3-23a

AMENDMENT 21

ARKANSAS NUCLEAR ONE
UNIT 2
RUSSELLVILLE, ARKANSAS



SCALE:	NONE
DRAWN:	
DESIGN:	ENTERGY
CAD NO:	

ANO-2 ECCS PERFORMANCE ANALYSIS FOR
IMPLEMENTATION OF CE 16 X 16 NGF - 0.05 FT²/PD
BREAK - CORE POWER

BASED ON DRAWING NO

SHEET

REV.

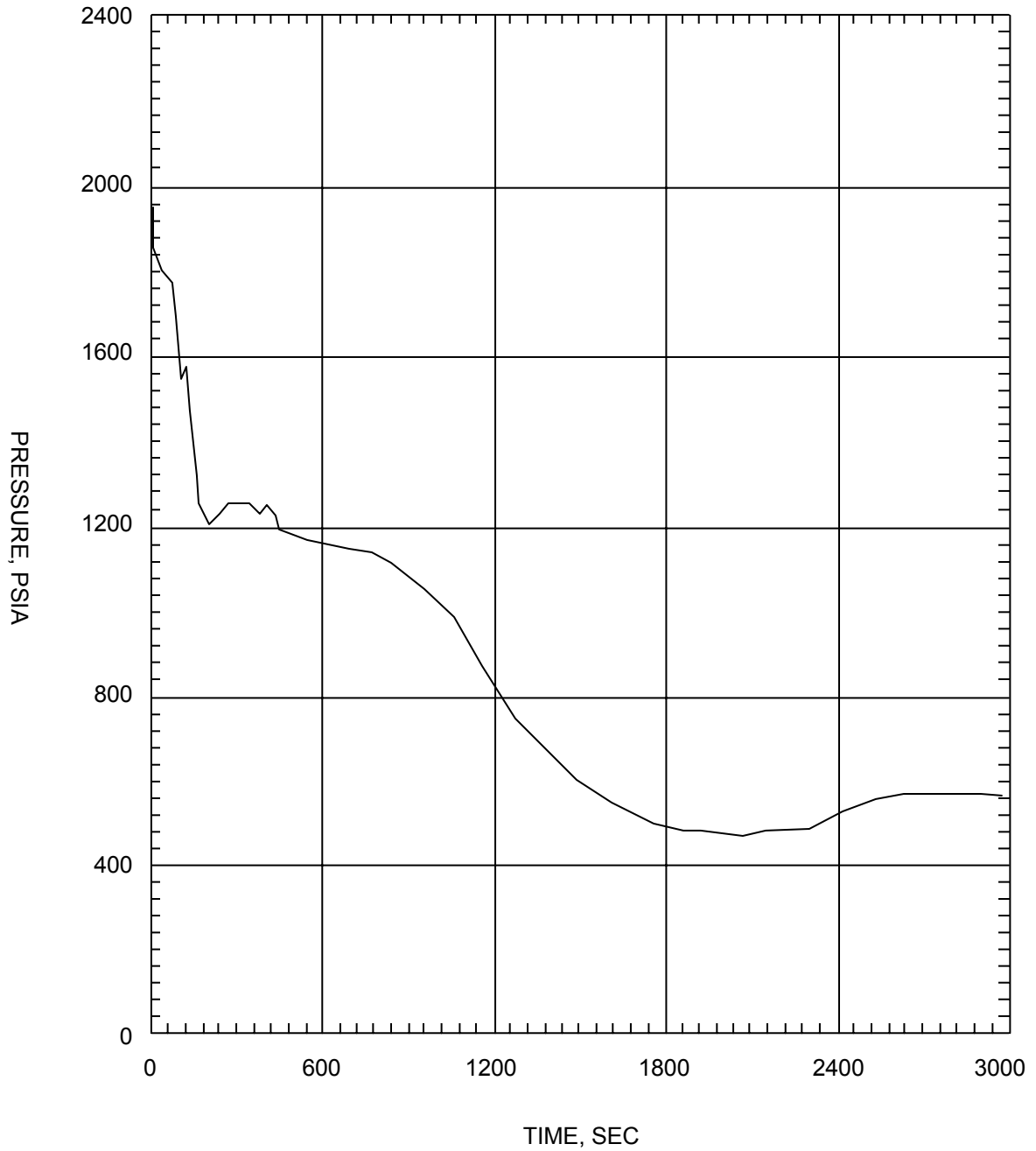

SAR FIGURE NO. 6.3-23b

AMENDMENT 21

ARKANSAS NUCLEAR ONE
 UNIT 2
 RUSSELLVILLE, ARKANSAS



SCALE:	NONE
DRAWN:	
DESIGN:	ENTERGY
CAD NO:	

ANO-2 ECCS PERFORMANCE ANALYSIS FOR
 IMPLEMENTATION OF CE 16 X 16 NGF - 0.05 FT²/PD
 BREAK - INNER VESSEL PRESSURE

BASED ON DRAWING NO

SHEET

REV.

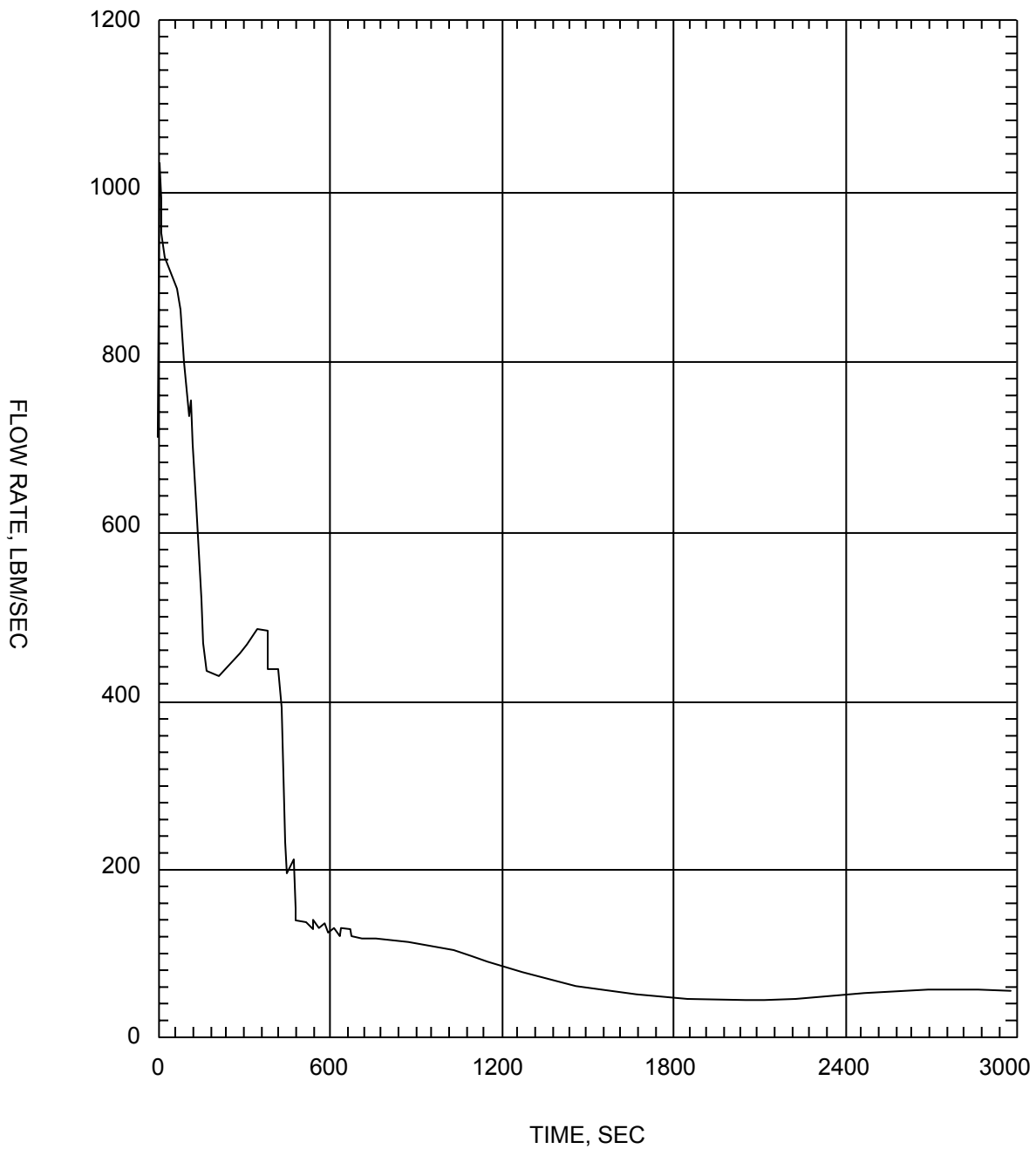

SAR FIGURE NO. 6.3-23c

AMENDMENT 21

ARKANSAS NUCLEAR ONE
UNIT 2
RUSSELLVILLE, ARKANSAS



SCALE:	NONE
DRAWN:	
DESIGN:	ENERGY
CAD NO:	

ANO-2 ECCS PERFORMANCE ANALYSIS FOR
IMPLEMENTATION OF CE 16 X 16 NGF - 0.05 FT²/PD
BREAK - BREAK FLOW RATE

BASED ON DRAWING NO

SHEET

REV.

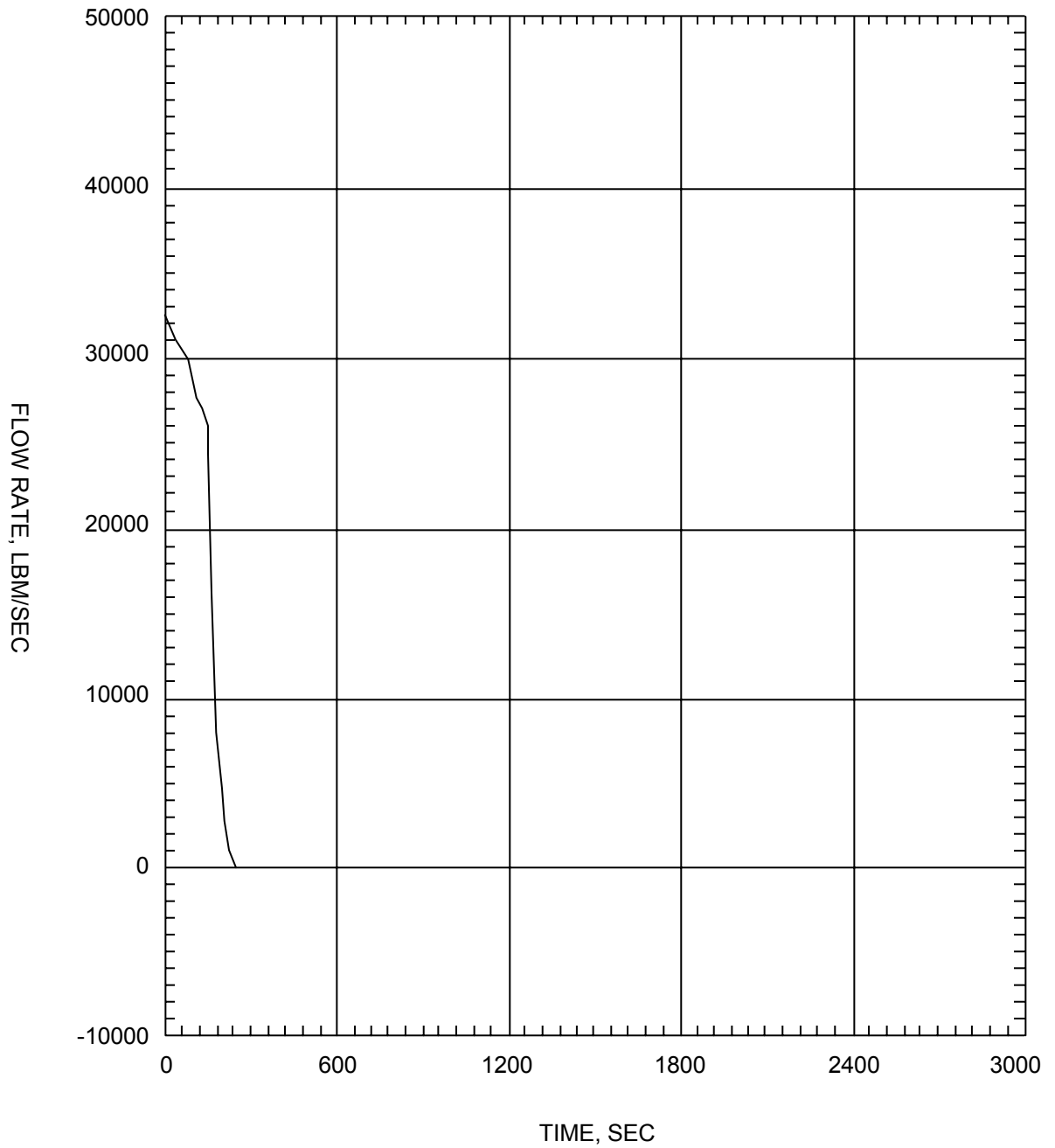

SAR FIGURE NO. 6.3-23d

AMENDMENT 21

ARKANSAS NUCLEAR ONE
UNIT 2
RUSSELLVILLE, ARKANSAS



SCALE:	NONE
DRAWN:	
DESIGN:	ENTERGY
CAD NO:	

ANO-2 ECCS PERFORMANCE ANALYSIS FOR
IMPLEMENTATION OF CE 16 X 16 NGF - 0.05 FT²/PD
BREAK - INNER VESSEL INLET FLOW RATE

BASED ON DRAWING NO

SHEET

REV.

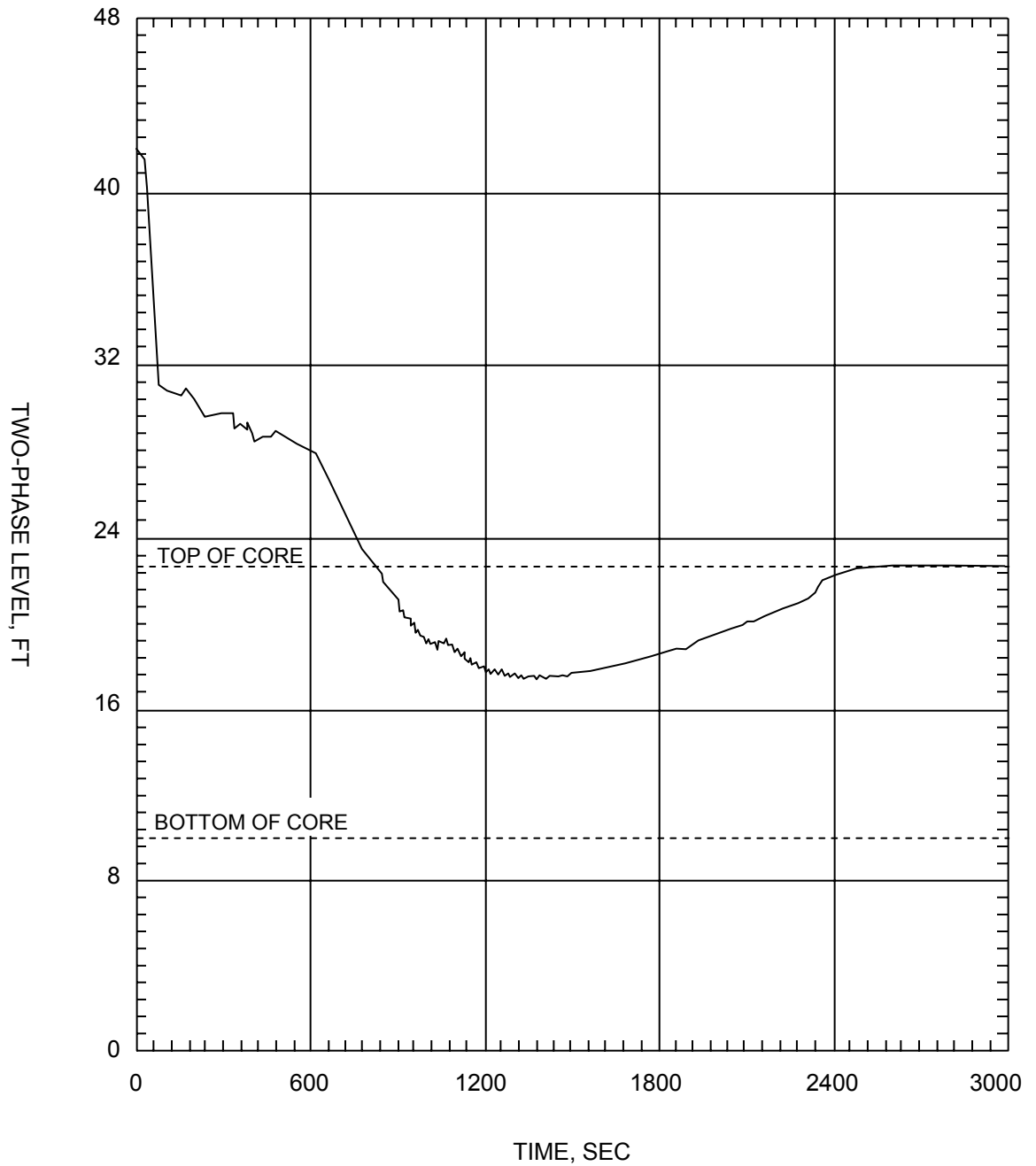

SAR FIGURE NO. 6.3-23e

AMENDMENT 21

ARKANSAS NUCLEAR ONE
 UNIT 2
 RUSSELLVILLE, ARKANSAS



SCALE:	NONE
DRAWN:	
DESIGN:	ENERGY
CAD NO:	

ANO-2 ECCS PERFORMANCE ANALYSIS FOR
 IMPLEMENTATION OF CE 16 X 16 NGF - 0.05 FT²/PD
 BREAK - INNER VESSEL TWO-PHASE MIXTURE LEVEL

BASED ON DRAWING NO

SHEET

REV.

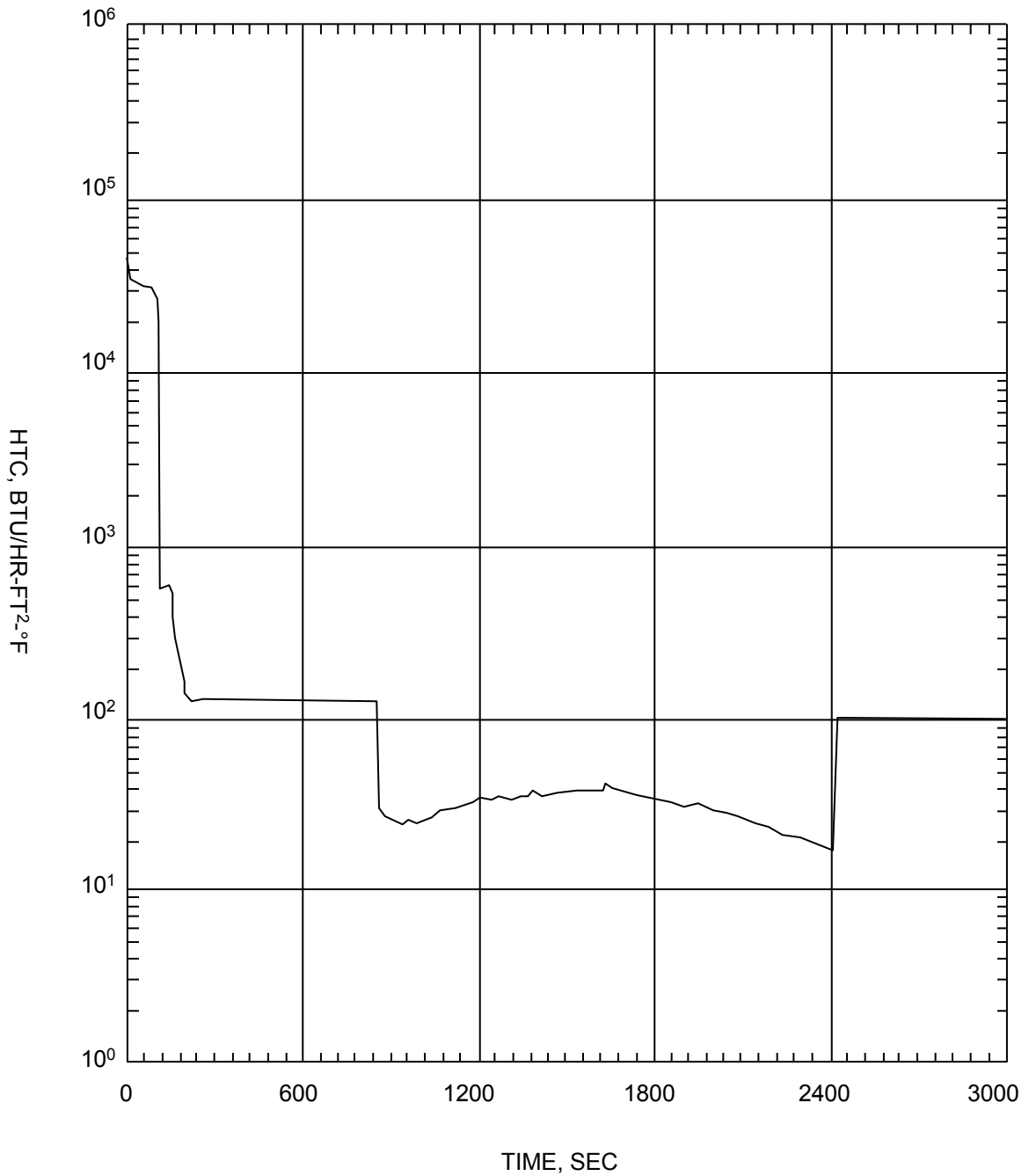

SAR FIGURE NO. 6.3-23f

AMENDMENT 21

ARKANSAS NUCLEAR ONE
UNIT 2
RUSSELLVILLE, ARKANSAS



SCALE:	NONE
DRAWN:	
DESIGN:	ENERGY
CAD NO:	

ANO-2 ECCS PERFORMANCE ANALYSIS FOR
IMPLEMENTATION OF CE 16 X 16 NGF - 0.05 FT²/PD
BREAK - HEAT TRANSFER COEFFICIENT AT HOT SPOT

BASED ON DRAWING NO

SHEET

REV.

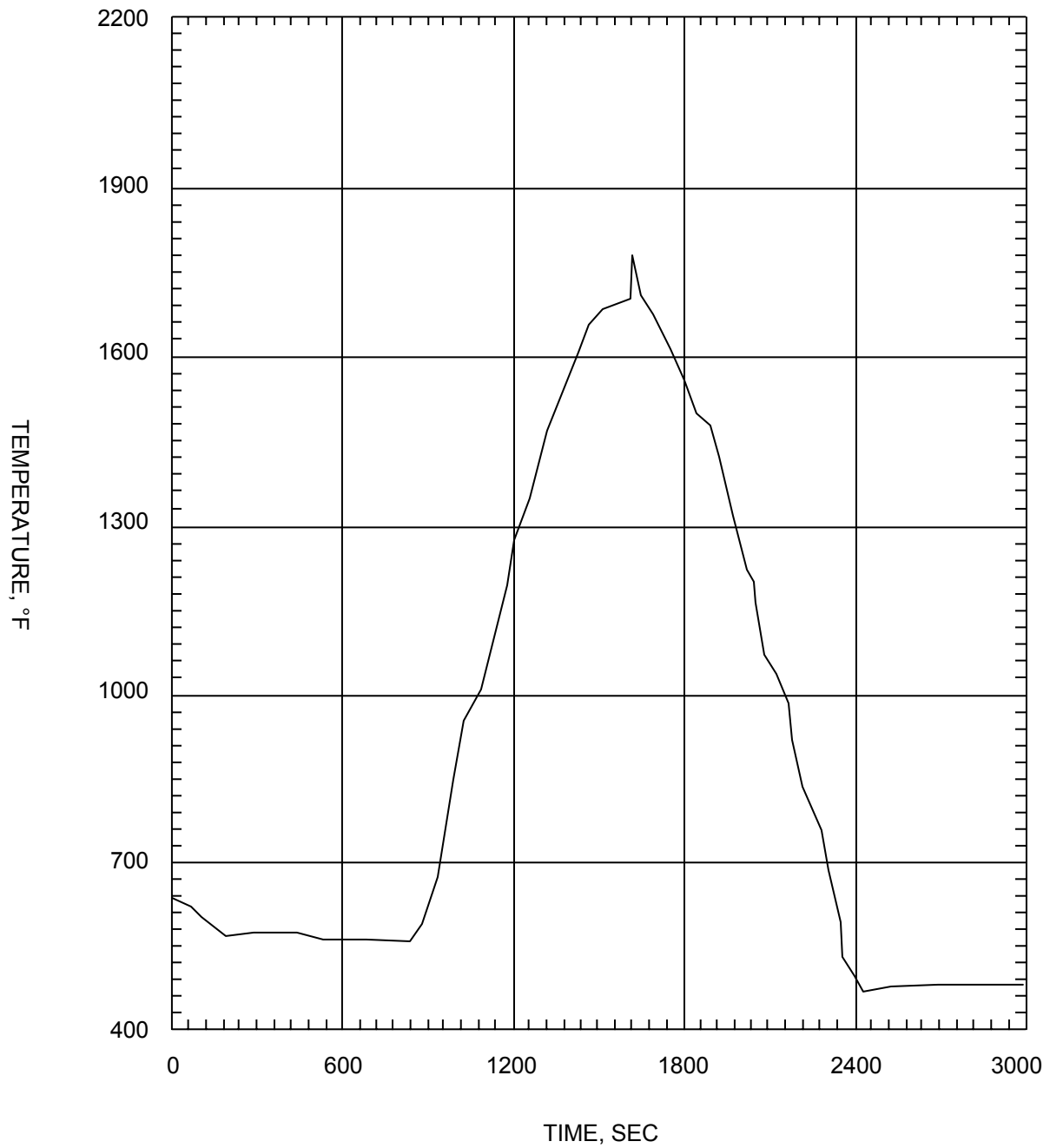

SAR FIGURE NO. 6.3-23g

AMENDMENT 21

ARKANSAS NUCLEAR ONE
 UNIT 2
 RUSSELLVILLE, ARKANSAS



SCALE:	NONE
DRAWN:	
DESIGN:	ENERGY
CAD NO:	

ANO-2 ECCS PERFORMANCE ANALYSIS FOR
 IMPLEMENTATION OF CE 16 X 16 NGF - 0.05 FT²/PD
 BREAK - COOLANT TEMPERATURE AT HOT SPOT

BASED ON DRAWING NO	SHEET	REV.

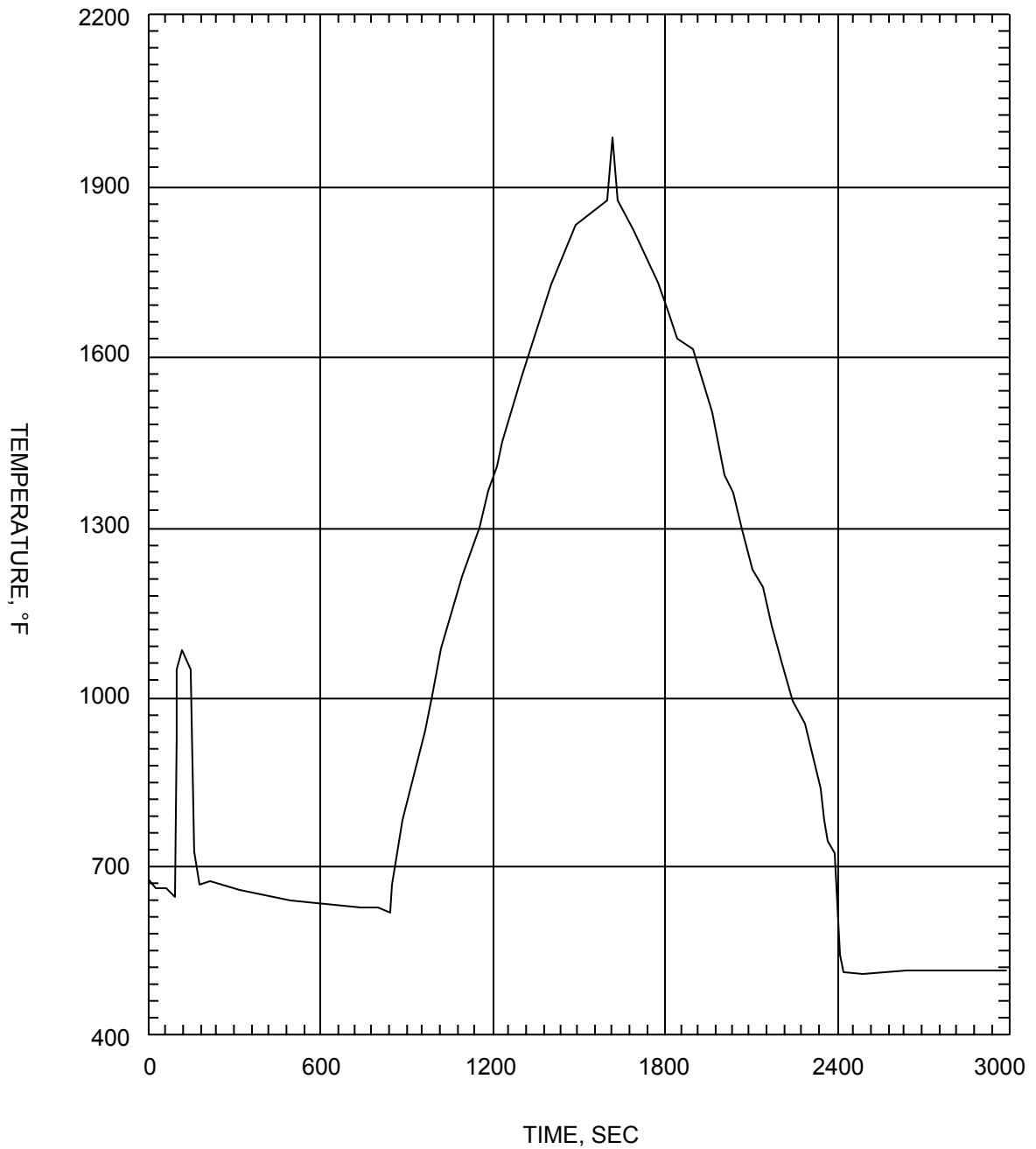

SAR FIGURE NO. 6.3-23h

AMENDMENT 21

ARKANSAS NUCLEAR ONE
 UNIT 2
 RUSSELLVILLE, ARKANSAS



SCALE:	NONE
DRAWN:	
DESIGN:	ENERGY
CAD NO:	

ANO-2 ECCS PERFORMANCE ANALYSIS FOR
 IMPLEMENTATION OF CE 16 X 16 NGF - 0.05 FT²/PD
 BREAK - CLADDING TEMPERATURE AT HOT SPOT

BASED ON DRAWING NO

SHEET

REV.

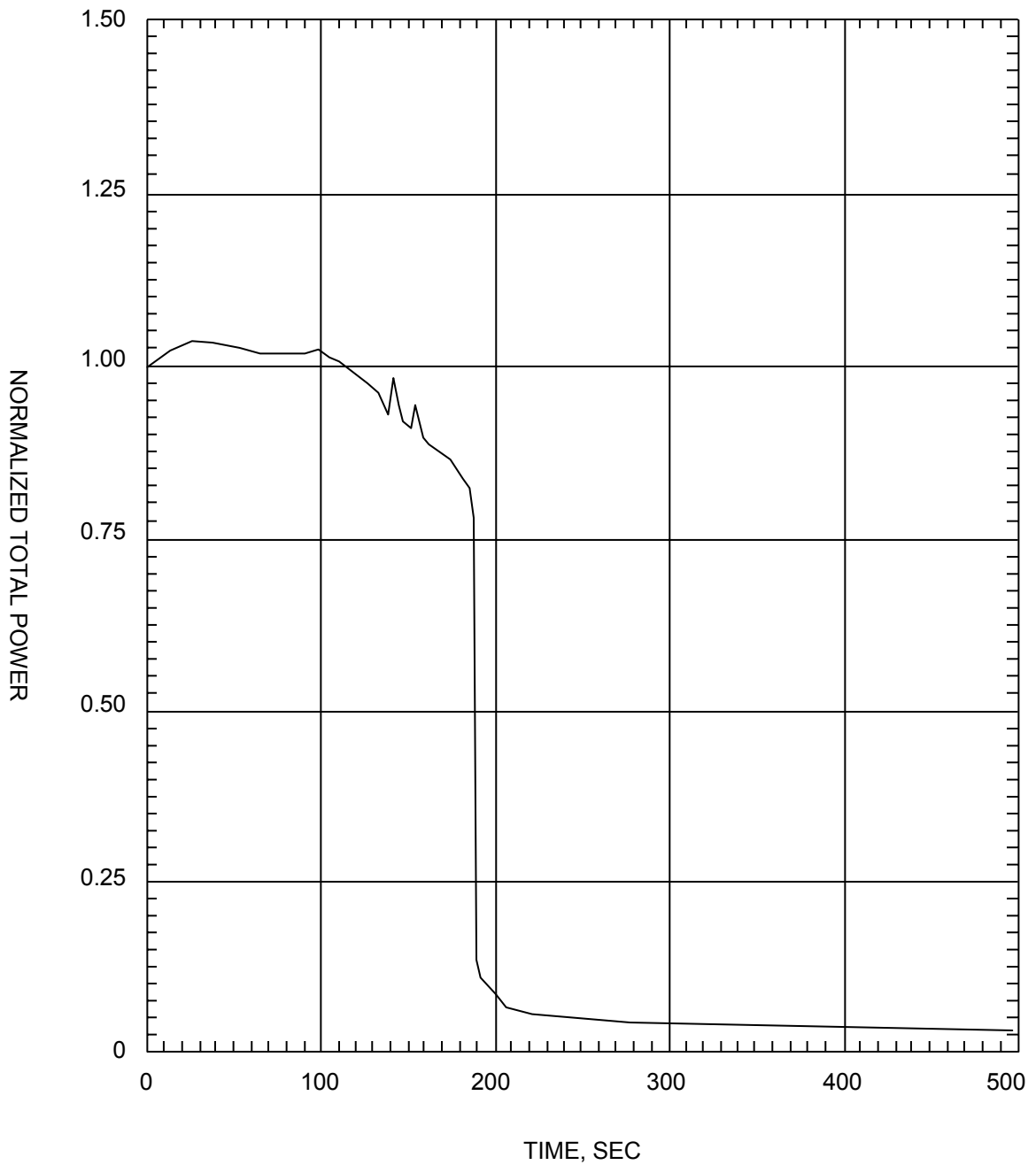

SAR FIGURE NO. 6.3-24a

AMENDMENT 21

ARKANSAS NUCLEAR ONE
 UNIT 2
 RUSSELLVILLE, ARKANSAS



SCALE:	NONE
DRAWN:	
DESIGN:	ENTERGY
CAD NO:	

ANO-2 ECCS PERFORMANCE ANALYSIS FOR
 IMPLEMENTATION OF CE 16 X 16 NGF - 0.04 FT²/PD
 BREAK - CORE POWER

BASED ON DRAWING NO

SHEET

REV.

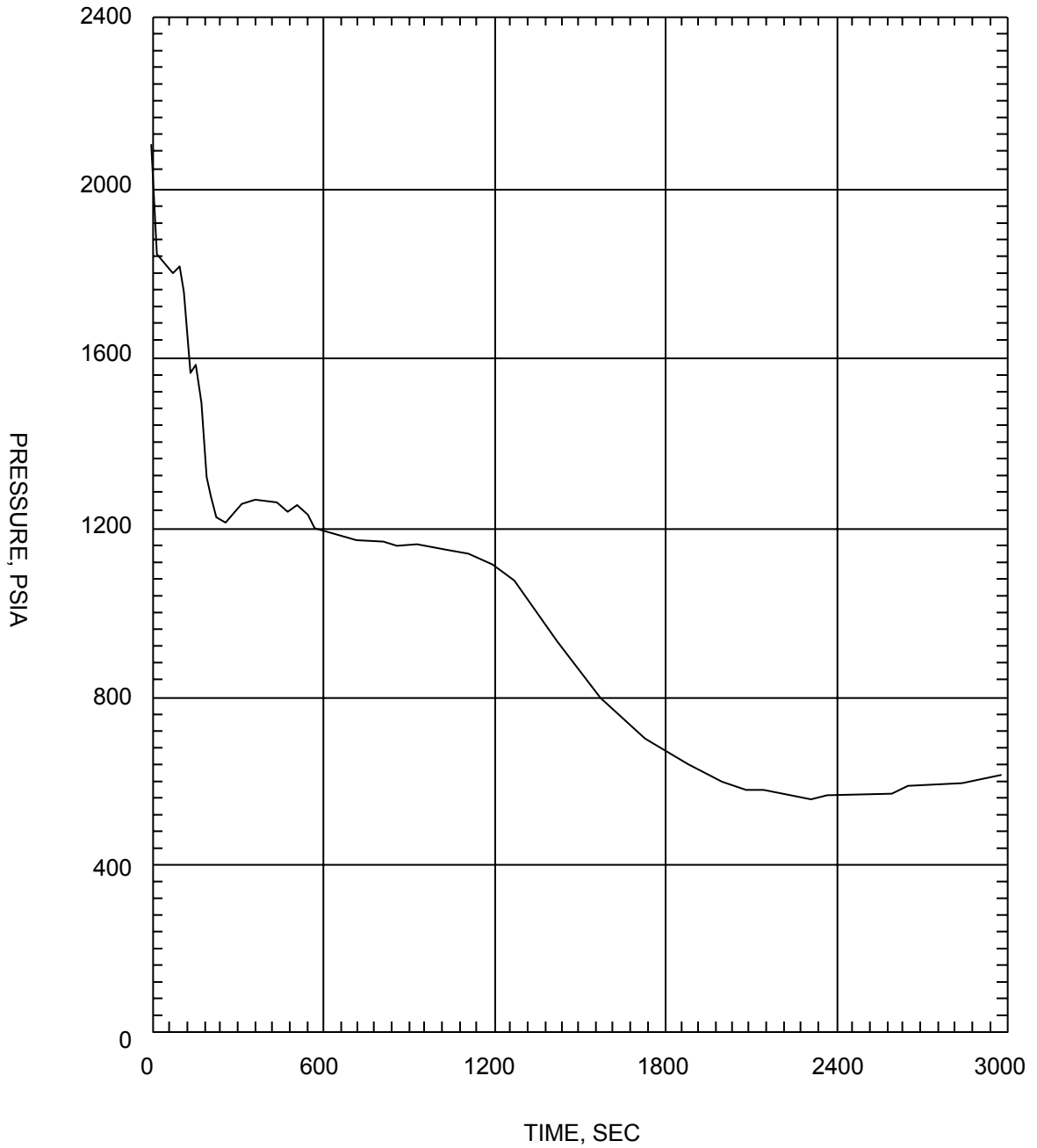

SAR FIGURE NO. 6.3-24b

AMENDMENT 21

ARKANSAS NUCLEAR ONE
 UNIT 2
 RUSSELLVILLE, ARKANSAS



SCALE:	NONE
DRAWN:	
DESIGN:	ENTERGY
CAD NO:	

ANO-2 ECCS PERFORMANCE ANALYSIS FOR
 IMPLEMENTATION OF CE 16 X 16 NGF - 0.04 FT²/PD
 BREAK - INNER VESSEL PRESSURE

BASED ON DRAWING NO

SHEET

REV.

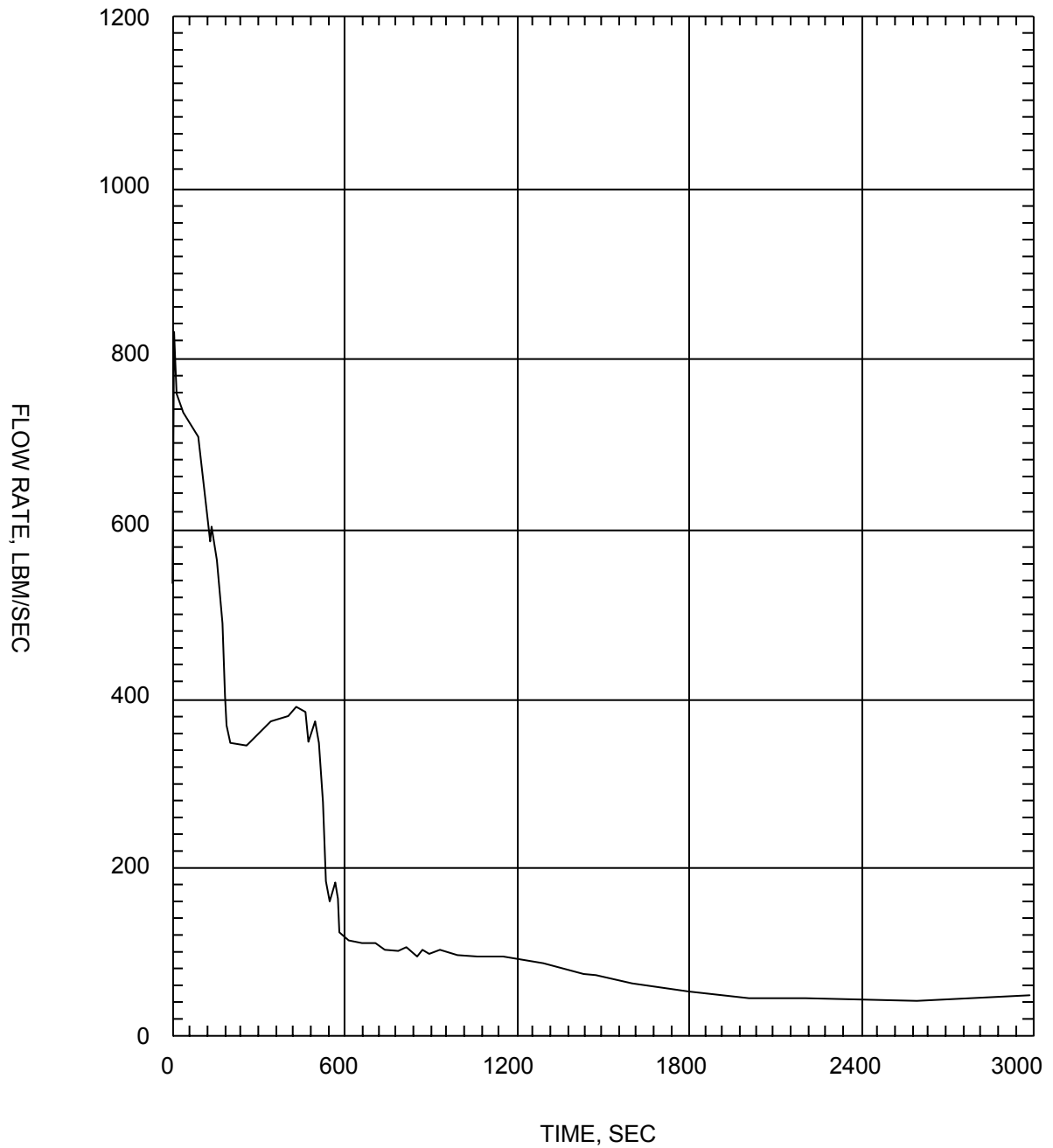

SAR FIGURE NO. 6.3-24c

AMENDMENT 21

ARKANSAS NUCLEAR ONE
UNIT 2
RUSSELLVILLE, ARKANSAS



SCALE:	NONE
DRAWN:	
DESIGN:	ENTERGY
CAD NO:	

ANO-2 ECCS PERFORMANCE ANALYSIS FOR
IMPLEMENTATION OF CE 16 X 16 NGF - 0.04 FT²/PD
BREAK - BREAK FLOW RATE

BASED ON DRAWING NO

SHEET

REV.

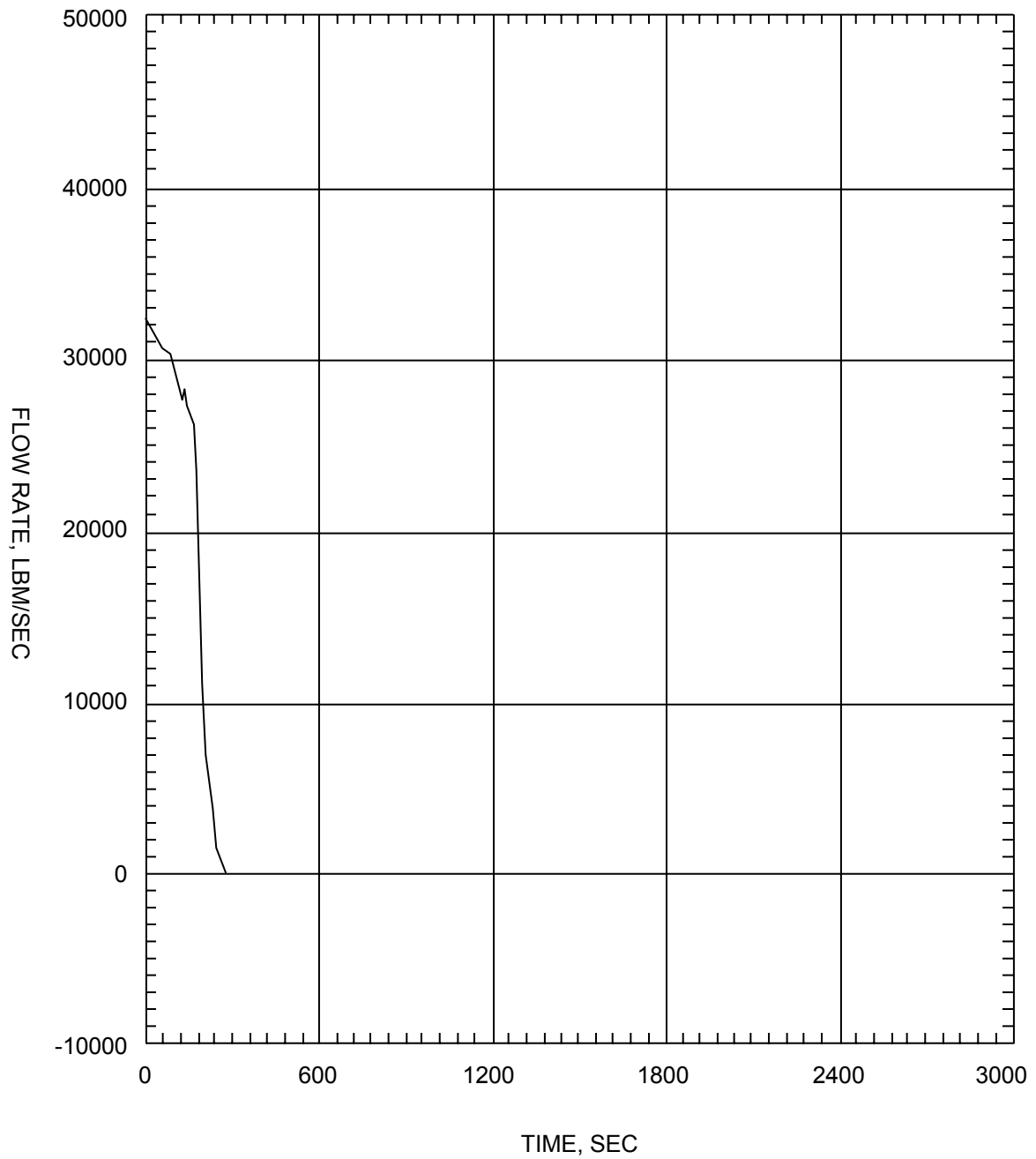

SAR FIGURE NO. 6.3-24d

AMENDMENT 21

ARKANSAS NUCLEAR ONE
 UNIT 2
 RUSSELLVILLE, ARKANSAS



SCALE:	NONE
DRAWN:	
DESIGN:	ENTERGY
CAD NO:	

ANO-2 ECCS PERFORMANCE ANALYSIS FOR
 IMPLEMENTATION OF CE 16 X 16 NGF - 0.04 FT²/PD
 BREAK - INNER VESSEL INLET FLOW RATE

BASED ON DRAWING NO

SHEET

REV.

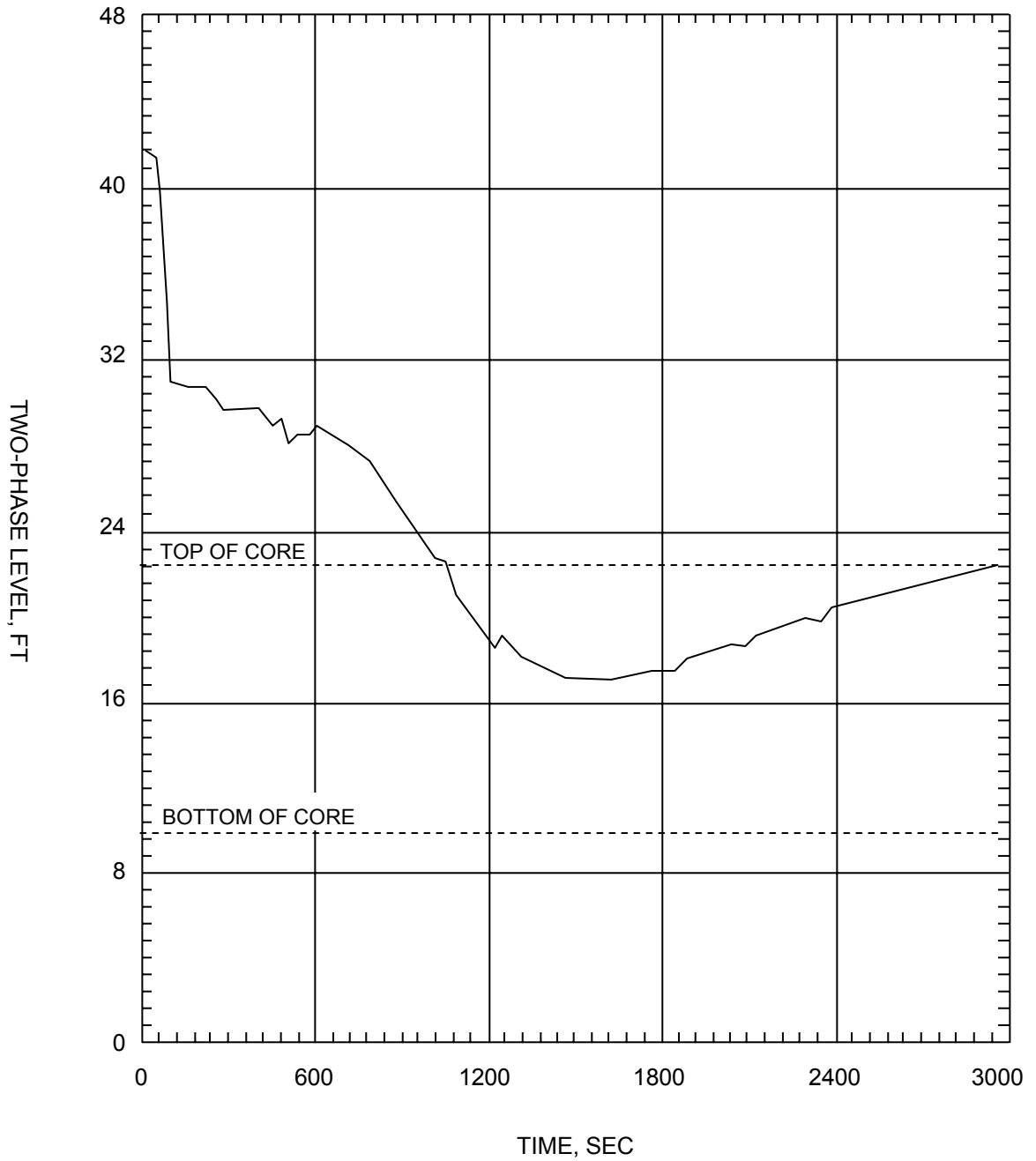

SAR FIGURE NO. 6.3-24e

AMENDMENT 21

ARKANSAS NUCLEAR ONE
 UNIT 2
 RUSSELLVILLE, ARKANSAS



SCALE:	NONE
DRAWN:	
DESIGN:	ENTERGY
CAD NO:	

ANO-2 ECCS PERFORMANCE ANALYSIS FOR
 IMPLEMENTATION OF CE 16 X 16 NGF - 0.04 FT²/PD
 BREAK - INNER VESSEL TWO-PHASE MIXTURE LEVEL

BASED ON DRAWING NO

SHEET

REV.

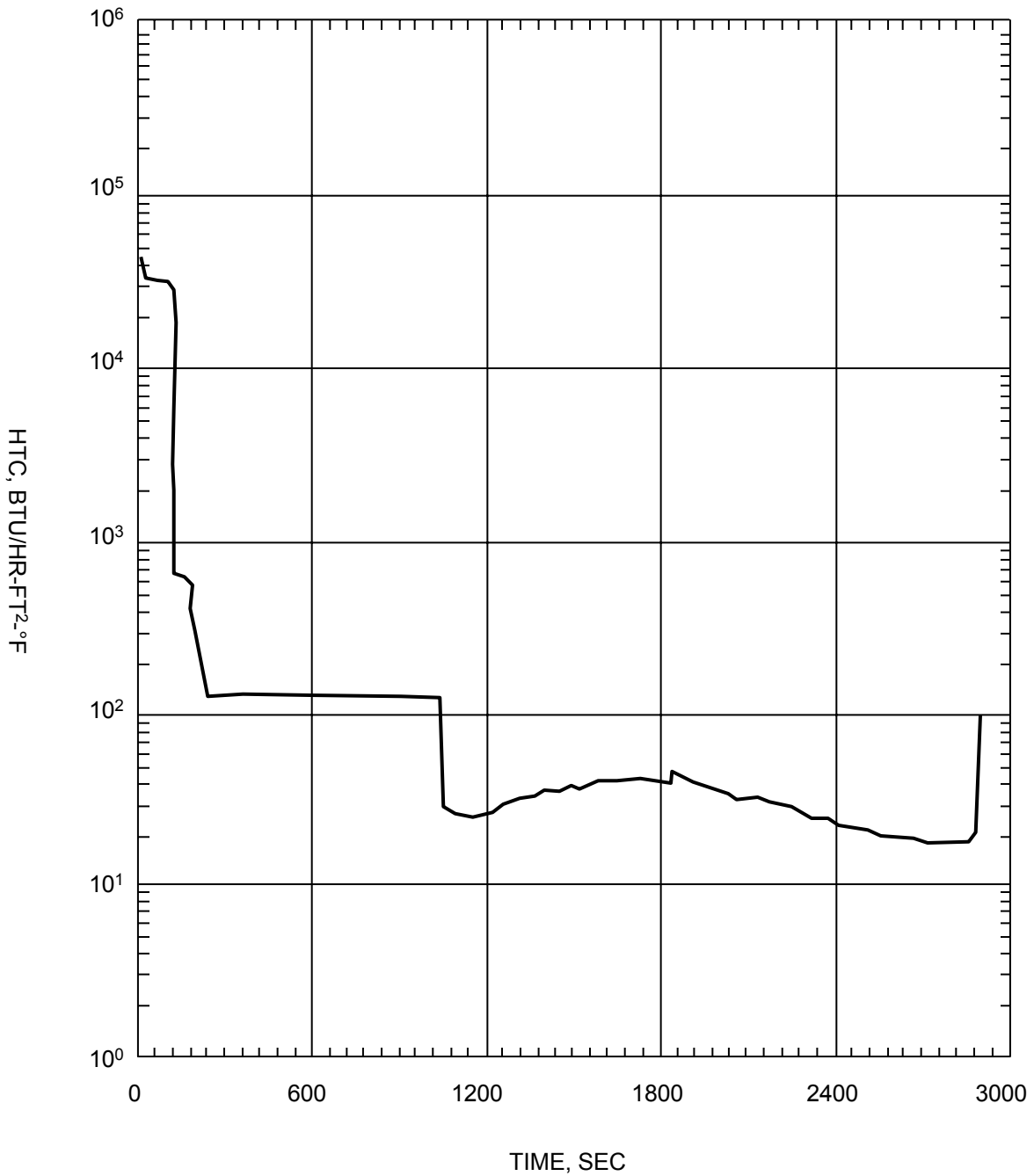

SAR FIGURE NO. 6.3-24f

AMENDMENT 21

ARKANSAS NUCLEAR ONE
 UNIT 2
 RUSSELLVILLE, ARKANSAS



SCALE:	NONE
DRAWN:	
DESIGN:	ENERGY
CAD NO:	

ANO-2 ECCS PERFORMANCE ANALYSIS FOR
 IMPLEMENTATION OF CE 16 X 16 NGF - 0.04 FT²/PD
 BREAK - HEAT TRANSFER COEFFICIENT AT HOT SPOT

BASED ON DRAWING NO

SHEET

REV.

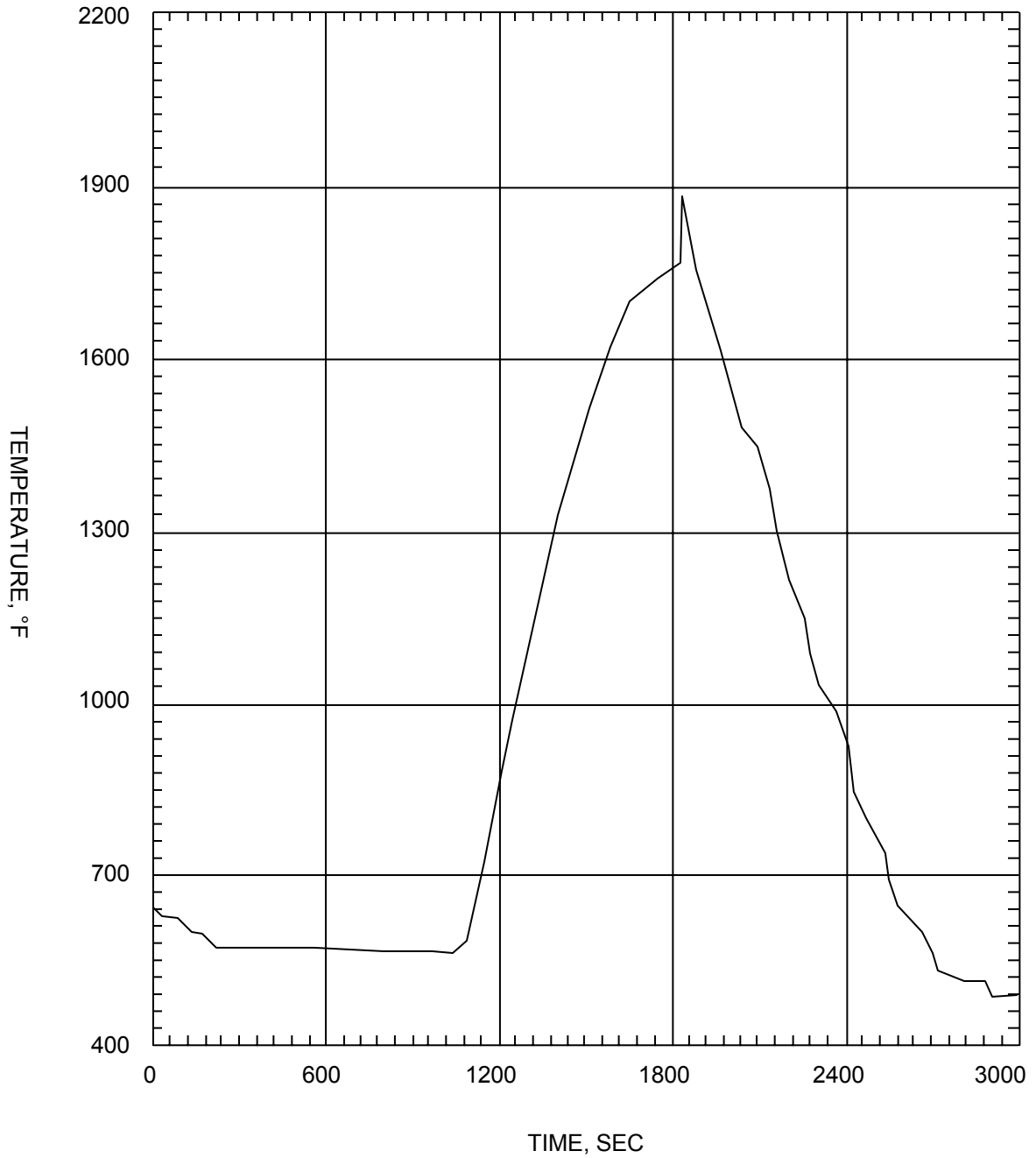

SAR FIGURE NO. 6.3-24g

AMENDMENT 21

ARKANSAS NUCLEAR ONE
 UNIT 2
 RUSSELLVILLE, ARKANSAS



SCALE: NONE

DRAWN:

DESIGN: ENTERGY

CAD NO:

ANO-2 ECCS PERFORMANCE ANALYSIS FOR
 IMPLEMENTATION OF CE 16 X 16 NGF - 0.04 FT²/PD
 BREAK - COOLANT TEMPERATURE AT HOT SPOT

BASED ON DRAWING NO

SHEET

REV.

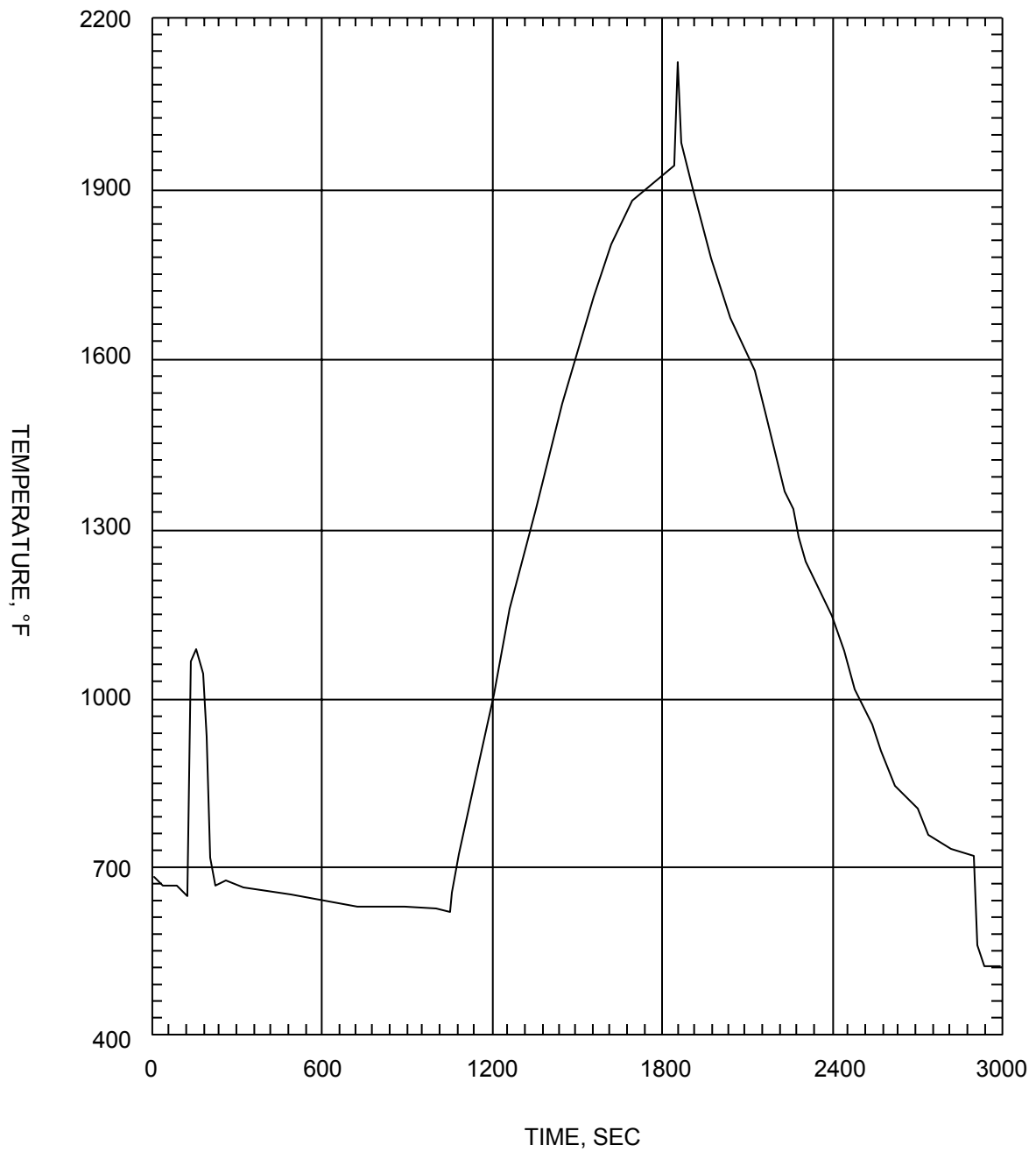

SAR FIGURE NO. 6.3-24h

AMENDMENT 21

ARKANSAS NUCLEAR ONE
 UNIT 2
 RUSSELLVILLE, ARKANSAS



SCALE:	NONE
DRAWN:	
DESIGN:	ENTERGY
CAD NO:	

ANO-2 ECCS PERFORMANCE ANALYSIS FOR
 IMPLEMENTATION OF CE 16 X 16 NGF - 0.04 FT²/PD
 BREAK - CLADDING TEMPERATURE AT HOT SPOT

BASED ON DRAWING NO

SHEET

REV.

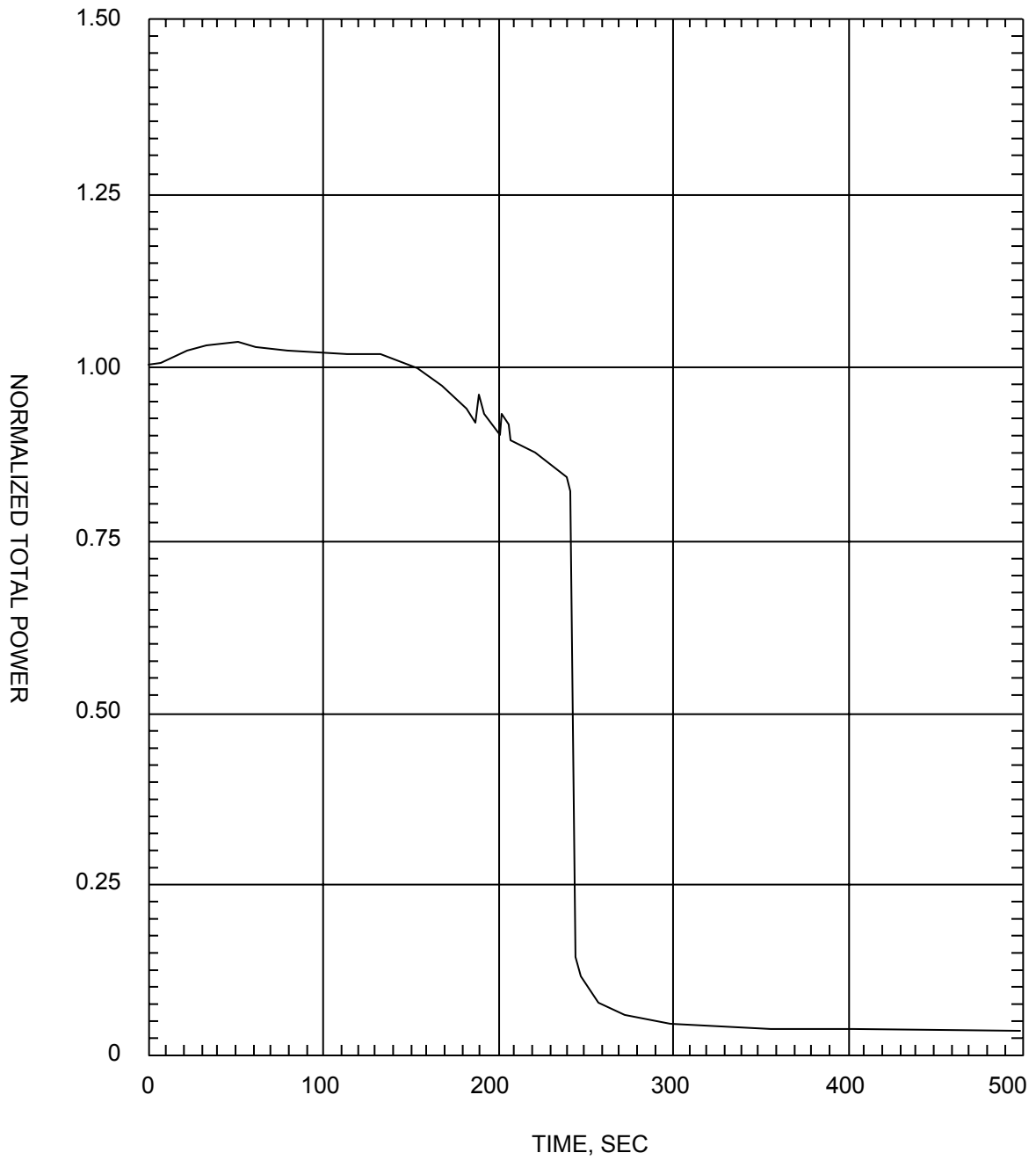

SAR FIGURE NO. 6.3-25a

AMENDMENT 21

ARKANSAS NUCLEAR ONE
 UNIT 2
 RUSSELLVILLE, ARKANSAS



SCALE:	NONE
DRAWN:	
DESIGN:	ENERGY
CAD NO:	

ANO-2 ECCS PERFORMANCE ANALYSIS FOR
 IMPLEMENTATION OF CE 16 X 16 NGF - 0.03 FT²/PD
 BREAK - CORE POWER

BASED ON DRAWING NO

SHEET

REV.

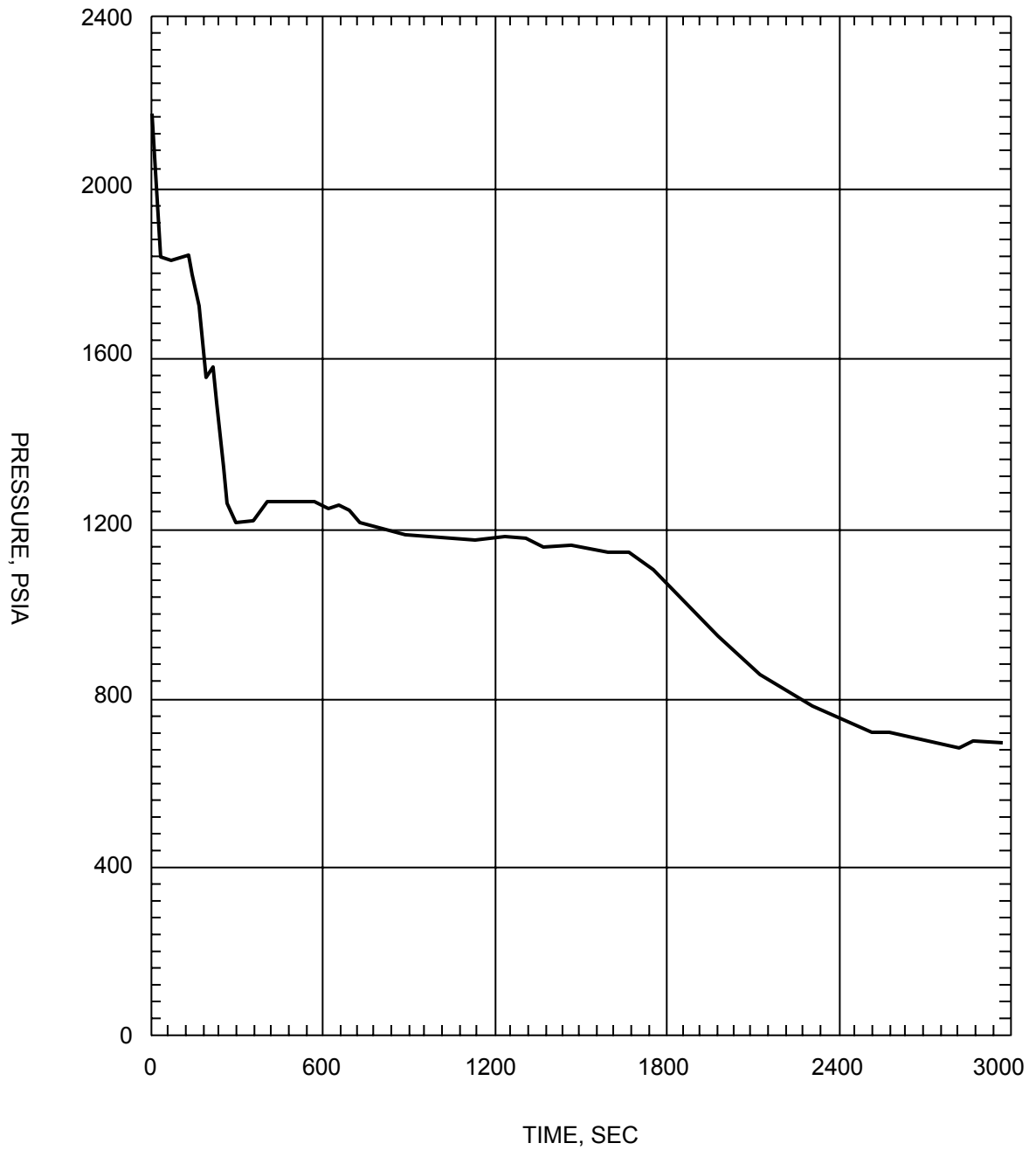

SAR FIGURE NO. 6.3-25b

AMENDMENT 21

ARKANSAS NUCLEAR ONE
UNIT 2
RUSSELLVILLE, ARKANSAS



SCALE:	NONE
DRAWN:	
DESIGN:	ENTERGY
CAD NO:	

ANO-2 ECCS PERFORMANCE ANALYSIS FOR
IMPLEMENTATION OF CE 16 X 16 NGF - 0.03 FT²/PD
BREAK - INNER VESSEL PRESSURE

BASED ON DRAWING NO

SHEET

REV.

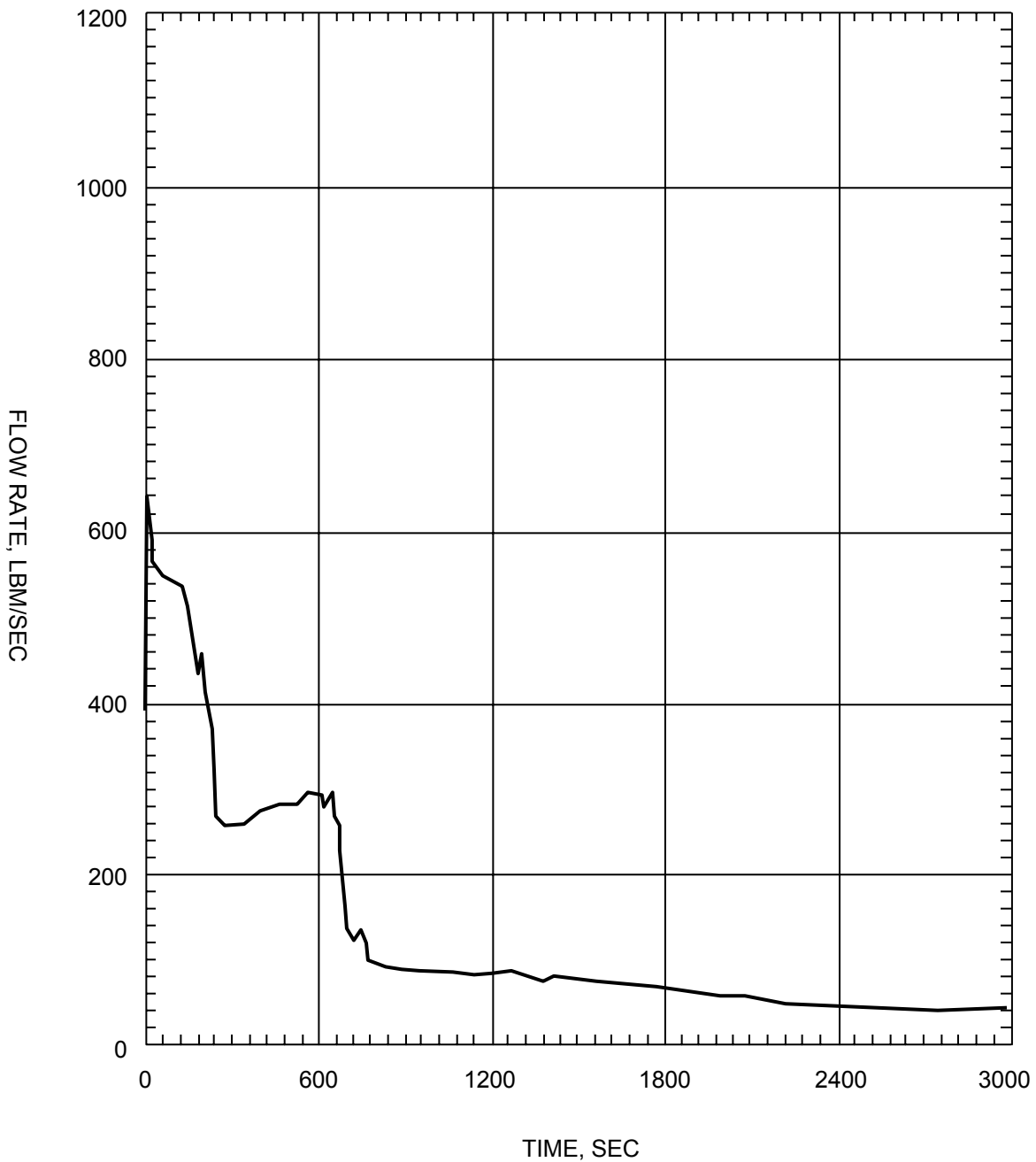

SAR FIGURE NO. 6.3-25c

AMENDMENT 21

ARKANSAS NUCLEAR ONE
 UNIT 2
 RUSSELLVILLE, ARKANSAS



SCALE:	NONE
DRAWN:	
DESIGN:	ENTERGY
CAD NO:	

ANO-2 ECCS PERFORMANCE ANALYSIS FOR
 IMPLEMENTATION OF CE 16 X 16 NGF - 0.03 FT²/PD
 BREAK - BREAK FLOW RATE

BASED ON DRAWING NO

SHEET

REV.

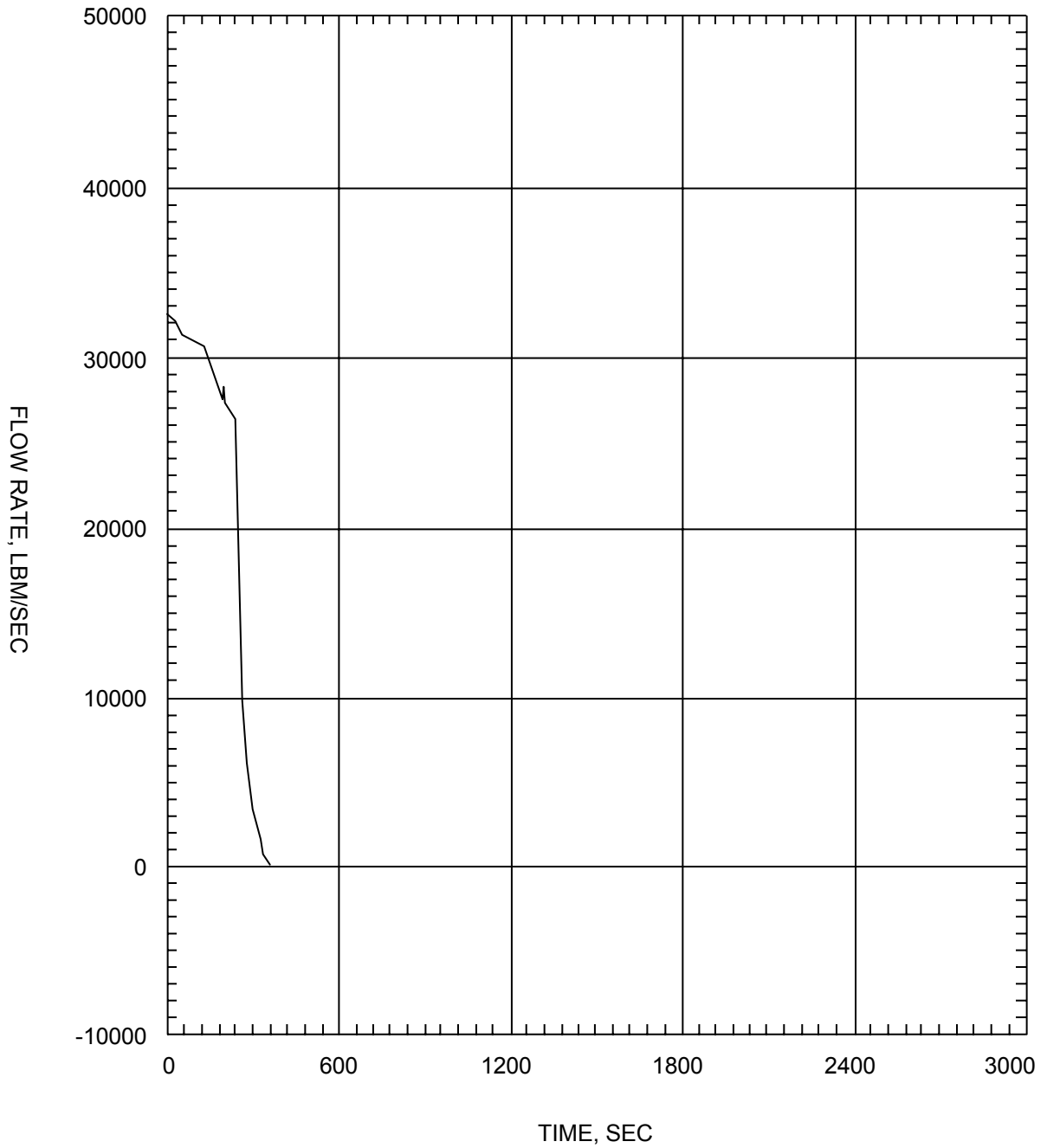

SAR FIGURE NO. 6.3-25d

AMENDMENT 21

ARKANSAS NUCLEAR ONE
UNIT 2
RUSSELLVILLE, ARKANSAS



SCALE:	NONE
DRAWN:	
DESIGN:	ENTERGY
CAD NO:	

ANO-2 ECCS PERFORMANCE ANALYSIS FOR
IMPLEMENTATION OF CE 16 X 16 NGF - 0.03 FT²/PD
BREAK - INNER VESSEL INLET FLOW RATE

BASED ON DRAWING NO

SHEET

REV.

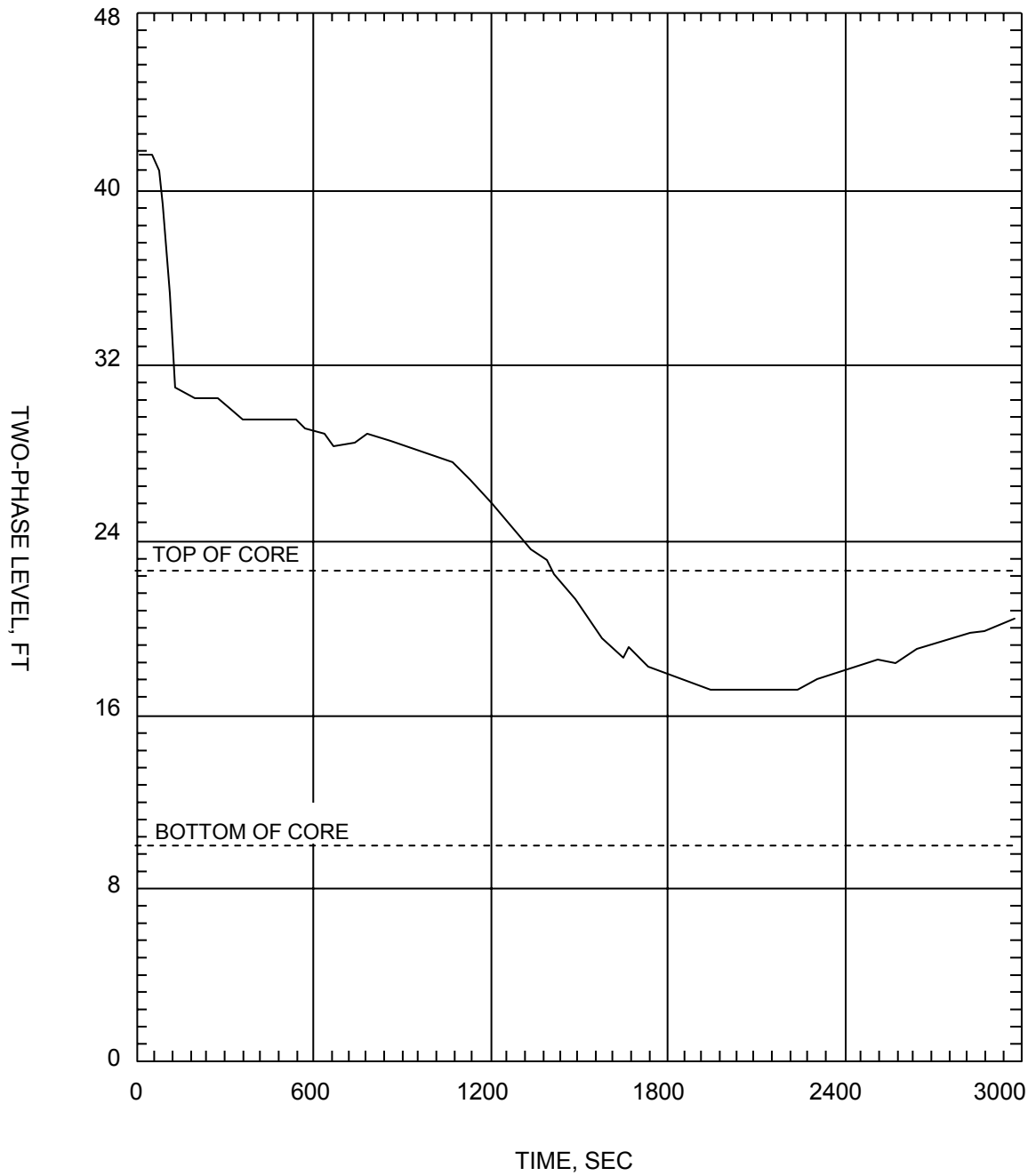

SAR FIGURE NO. 6.3-25e

AMENDMENT 21

ARKANSAS NUCLEAR ONE
 UNIT 2
 RUSSELLVILLE, ARKANSAS



SCALE:	NONE
DRAWN:	
DESIGN:	ENERGY
CAD NO:	

ANO-2 ECCS PERFORMANCE ANALYSIS FOR
 IMPLEMENTATION OF CE 16 X 16 NGF - 0.03 FT²/PD
 BREAK - INNER VESSEL TWO-PHASE MIXTURE LEVEL

BASED ON DRAWING NO

SHEET

REV.

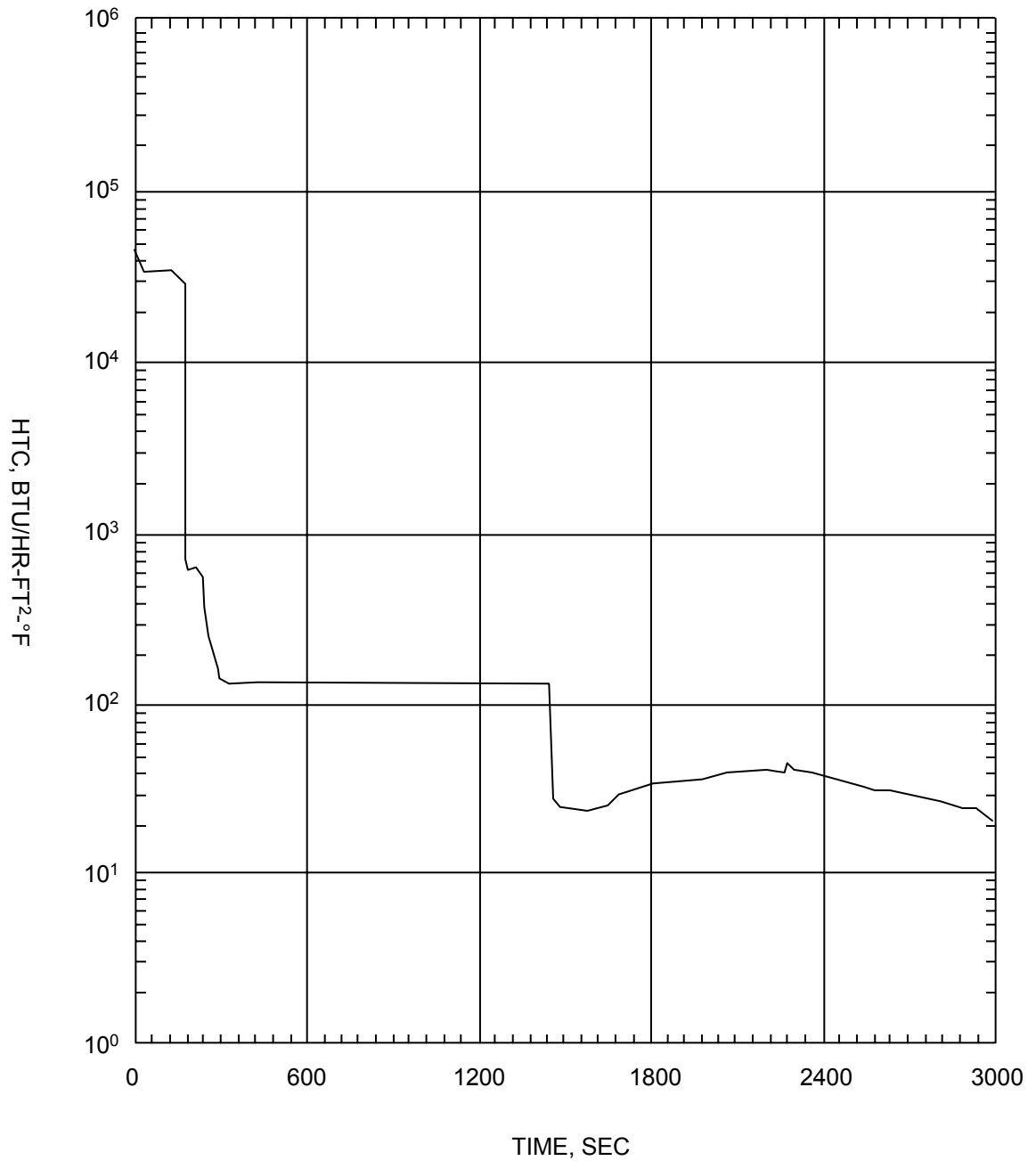

SAR FIGURE NO. 6.3-25f

AMENDMENT 21

ARKANSAS NUCLEAR ONE
UNIT 2
RUSSELLVILLE, ARKANSAS



SCALE:	NONE
DRAWN:	
DESIGN:	ENERGY
CAD NO:	

ANO-2 ECCS PERFORMANCE ANALYSIS FOR
IMPLEMENTATION OF CE 16 X 16 NGF - 0.03 FT²/PD
BREAK - HEAT TRANSFER COEFFICIENT AT HOT SPOT

BASED ON DRAWING NO

SHEET

REV.

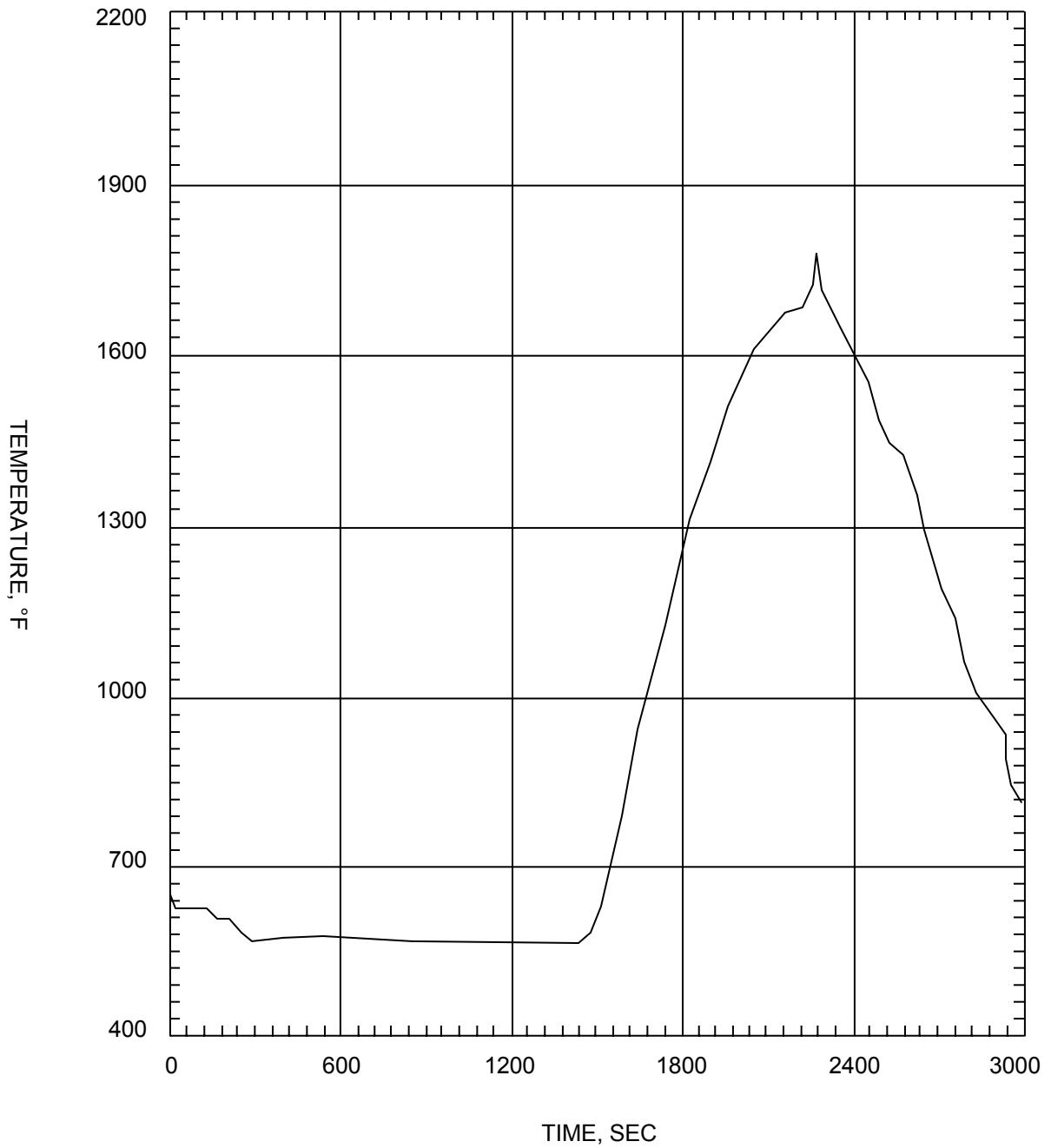

SAR FIGURE NO. 6.3-25g

AMENDMENT 21

ARKANSAS NUCLEAR ONE
 UNIT 2
 RUSSELLVILLE, ARKANSAS



SCALE:	NONE
DRAWN:	
DESIGN:	ENTERGY
CAD NO:	

ANO-2 ECCS PERFORMANCE ANALYSIS FOR
 IMPLEMENTATION OF CE 16 X 16 NGF - 0.03 FT²/PD
 BREAK - COOLANT TEMPERATURE AT HOT SPOT

BASED ON DRAWING NO

SHEET

REV.

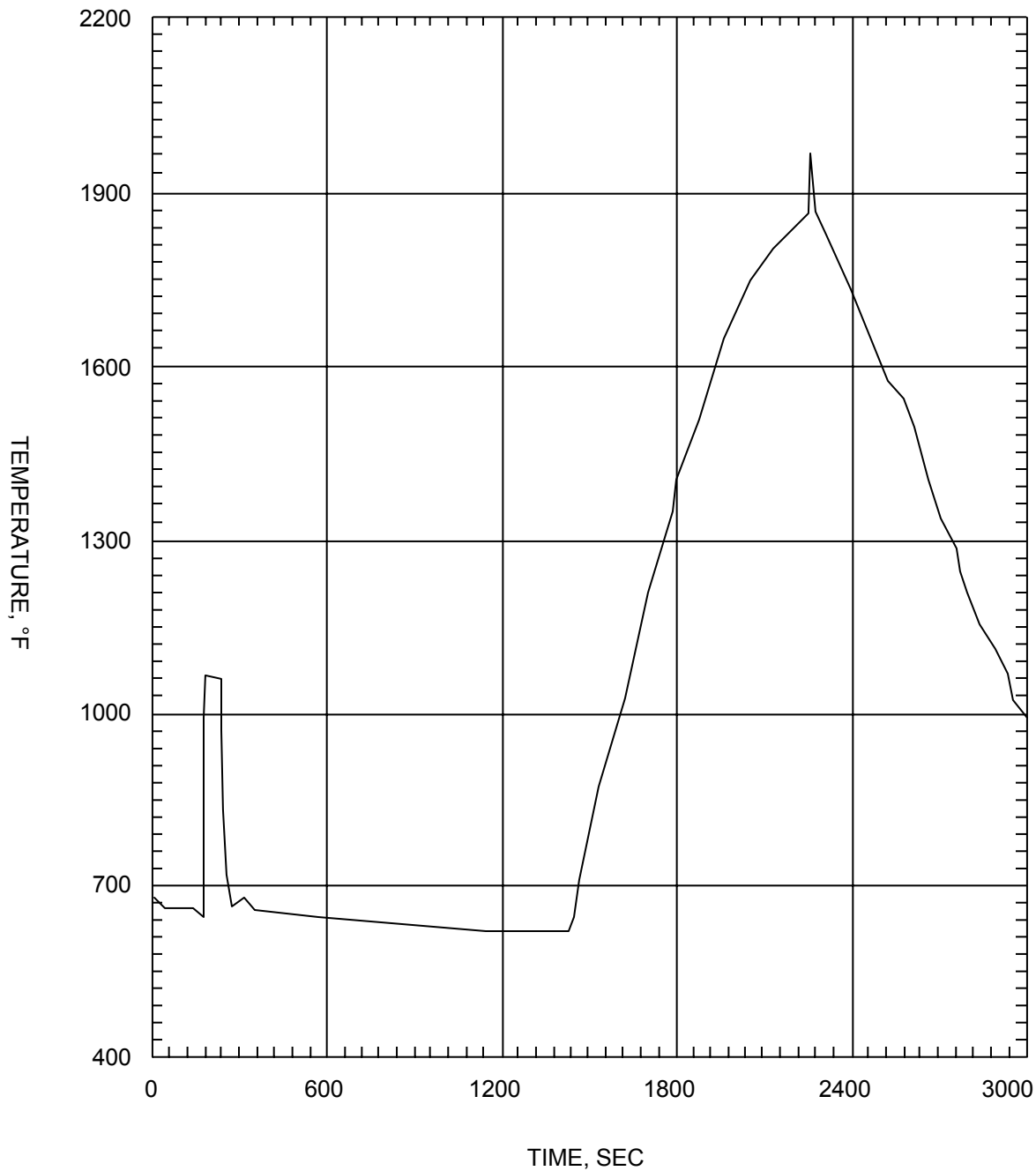

SAR FIGURE NO. 6.3-25h

AMENDMENT 21

ARKANSAS NUCLEAR ONE
 UNIT 2
 RUSSELLVILLE, ARKANSAS



SCALE:	NONE
DRAWN:	
DESIGN:	ENTERGY
CAD NO:	

ANO-2 ECCS PERFORMANCE ANALYSIS FOR
 IMPLEMENTATION OF CE 16 X 16 NGF - 0.03 FT²/PD
 BREAK - CLADDING TEMPERATURE AT HOT SPOT

BASED ON DRAWING NO

SHEET

REV.

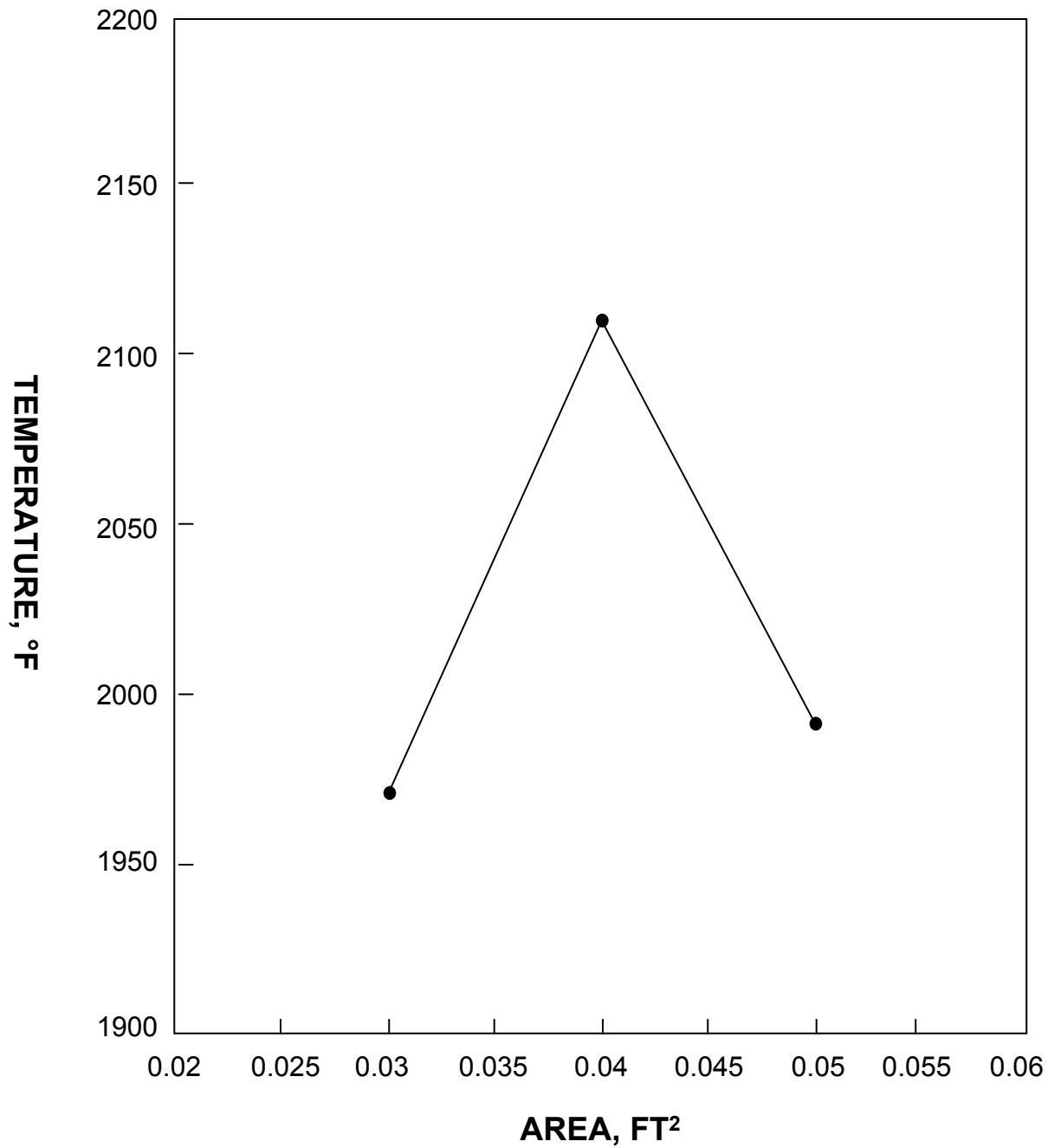

SAR FIGURE NO. 6.3-26

AMENDMENT 21

ARKANSAS NUCLEAR ONE
UNIT 2
RUSSELLVILLE, ARKANSAS



SCALE:	NONE
DRAWN:	
DESIGN:	ENTERGY
CAD NO:	

ANO-2 ECCS PERFORMANCE ANALYSIS FOR IMPLEMENTATION OF CE 16 X 16 NGF - PEAK CLADDING TEMPERATURE VS BREAK SIZE FOR THE SMALL BREAK LOCA ECCS PERFORMANCE EVALUATION

BASED ON DRAWING NO

SHEET

REV.

Figures 6.3-27 – 6.3-51h Deleted
See FSAR for Historical Data

SAR FIGURE NOS. 6.3-27 – 6.3-51h

AMENDMENT 20

ARKANSAS NUCLEAR ONE
UNIT 2
RUSSELLVILLE, ARKANSAS



SCALE:	NONE
DRAWN:	ENERGY
DESIGN:	ENERGY
CAD NO:	N/A

DRAWING NO

SHEET

REV.

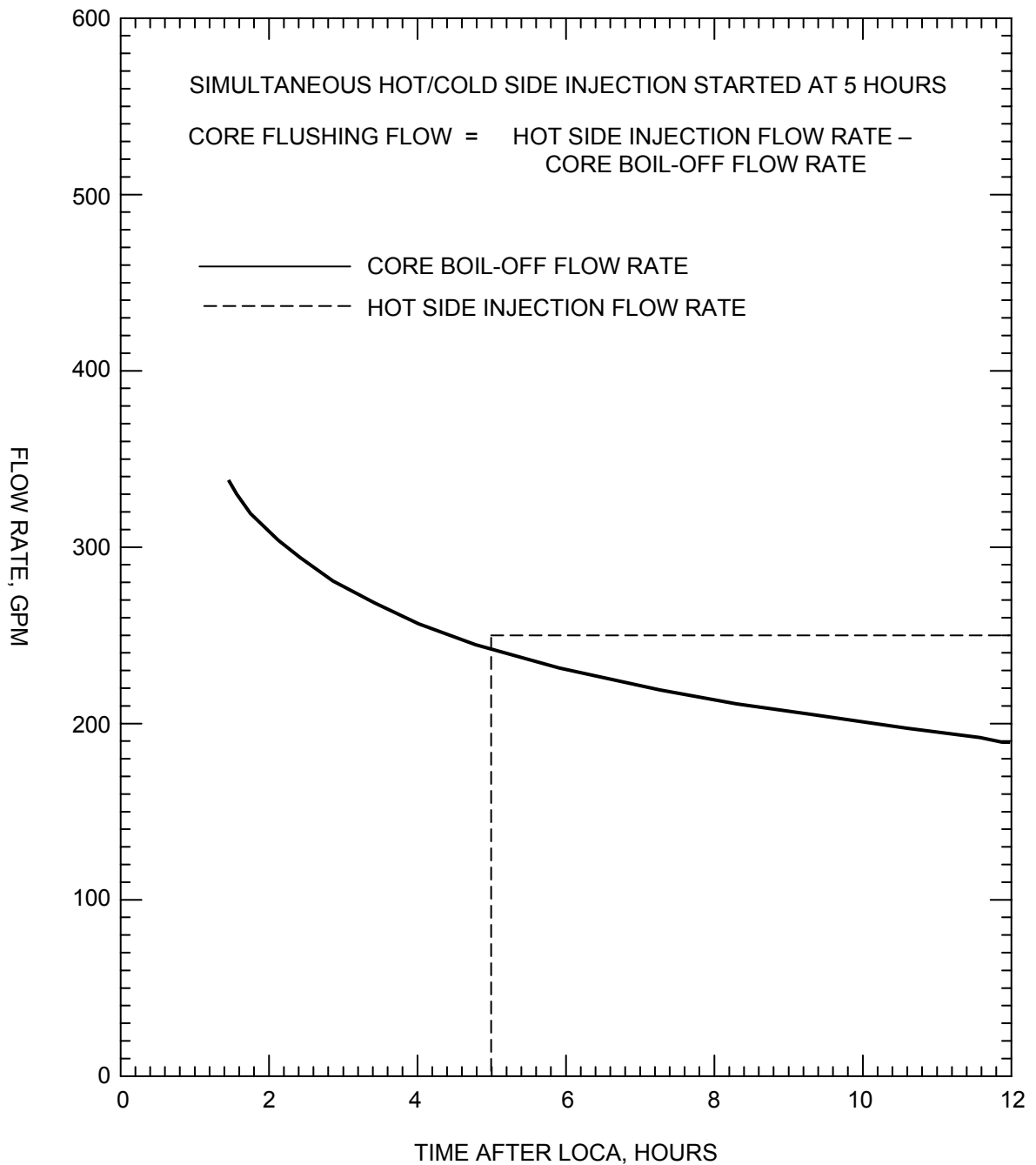

SAR FIGURE NOs. 6.3-52

AMENDMENT 20

ARKANSAS NUCLEAR ONE
UNIT 2
RUSSELLVILLE, ARKANSAS



SCALE:	NONE
DRAWN:	ENERGY
DESIGN:	ENERGY
CAD NO:	N/A

COMPARISON OF CORE BOIL-OFF RATE AND THE
MINIMUM SIMULTANEOUS HOT AND COLD SIDE
INJECTION FLOW RATE

DRAWING NO

SHEET

REV.

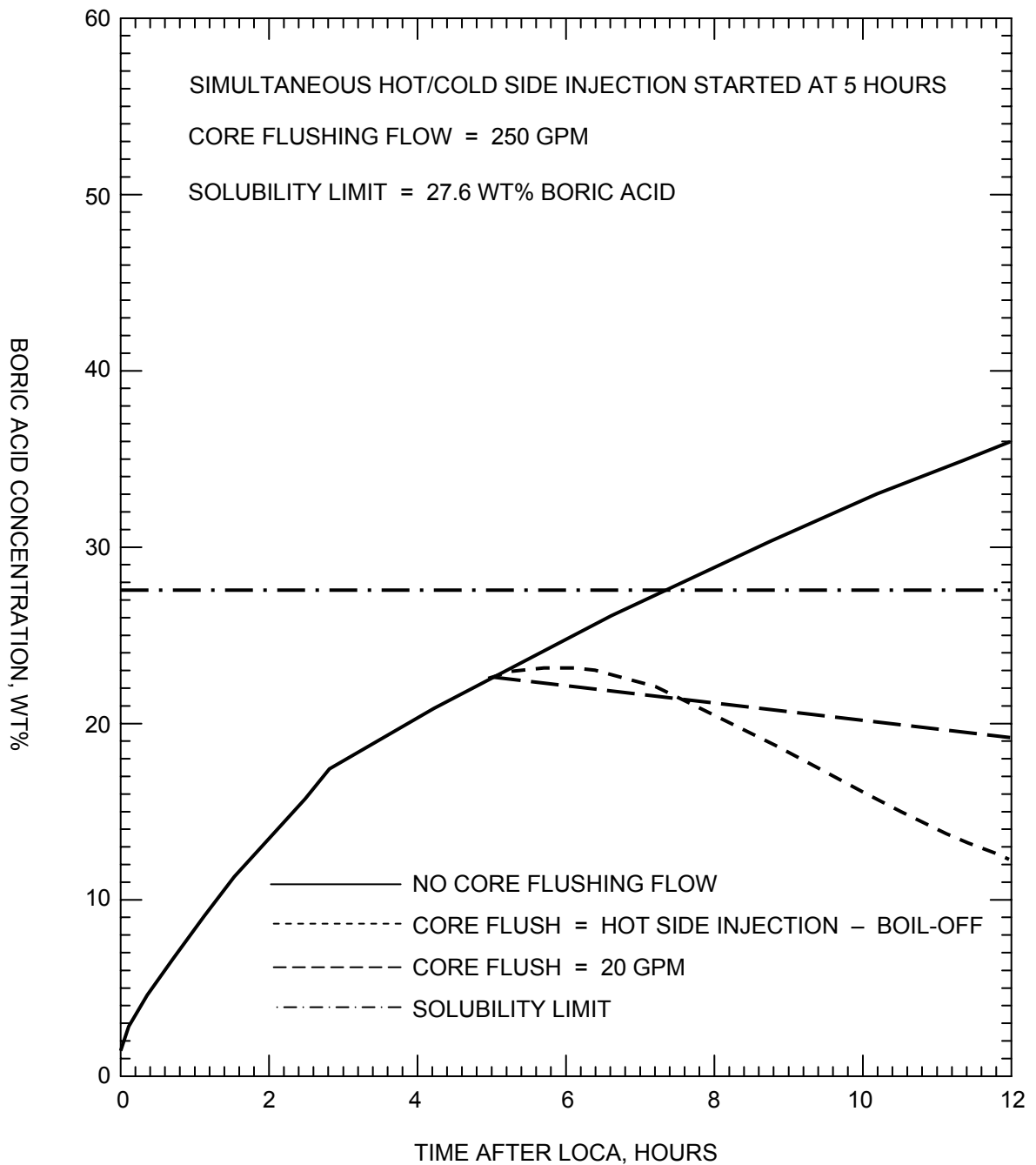

SAR FIGURE NOs. 6.3-53

AMENDMENT 20

ARKANSAS NUCLEAR ONE
 UNIT 2
 RUSSELLVILLE, ARKANSAS



SCALE:	NONE
DRAWN:	ENERGY
DESIGN:	ENERGY
CAD NO:	N/A

BORIC ACID CONCENTRATION IN THE CORE
 VS TIME

DRAWING NO

SHEET

REV.

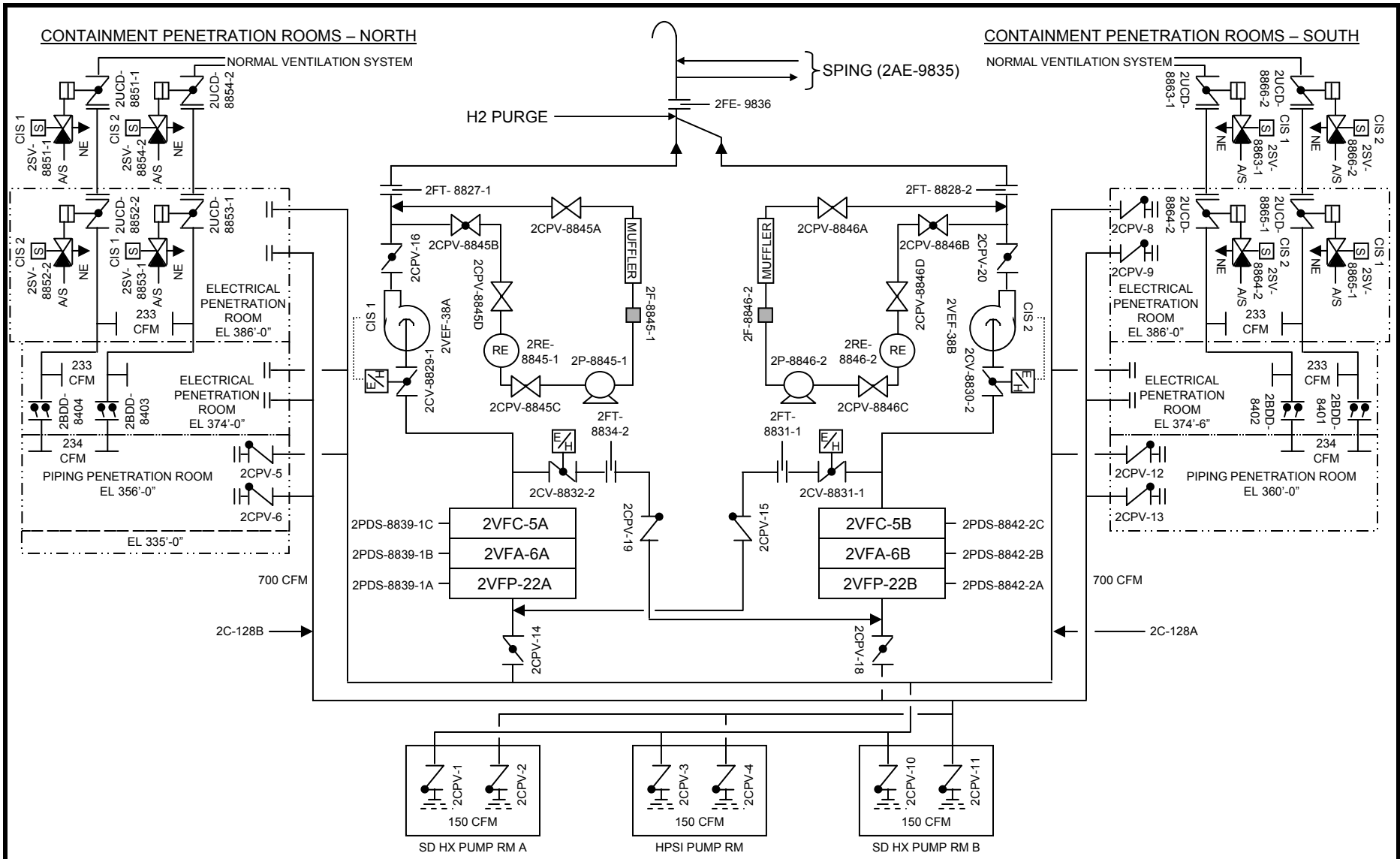

CONTAINMENT PENETRATION ROOM VENTILATION SYSTEM

SAR FIGURE NO. 6.5-1

ARKANSAS NUCLEAR ONE
 UNIT 2
 RUSSELLVILLE, ARKANSAS



SCALE:	NONE
DRAWN:	ENTERGY
DESIGN:	ENTERGY
CAD NO:	

AMENDMENT 20		
BASED ON DRAWING NO	SHEET	REV.

ARKANSAS NUCLEAR ONE
Unit 2

CHAPTER 7

TABLE OF CONTENTS

<u>Section</u>	<u>Title</u>	<u>Page</u>
7	<u>INSTRUMENTATION AND CONTROLS</u>	7.1-1
7.1	<u>INTRODUCTION</u>	7.1-1
7.1.1	IDENTIFICATION OF SAFETY-RELATED SYSTEMS	7.1-1
7.1.1.1	<u>Plant Protection System (PPS)</u>	7.1-1
7.1.1.2	<u>Systems Required for Safe Shutdown</u>	7.1-2
7.1.1.3	<u>Safety-Related Display Instrumentation</u>	7.1-2
7.1.1.4	<u>Other Systems Required for Safety</u>	7.1-2
7.1.1.5	<u>Comparison - Reactor Protective System</u>	7.1-3
7.1.2	IDENTIFICATION OF SAFETY CRITERIA	7.1-3
7.1.2.1	<u>Design Bases</u>	7.1-3
7.1.2.2	<u>Independence of Redundant Safety-Related Systems</u>	7.1-3
7.1.2.3	<u>Physical Identification of Safety-Related Equipment</u>	7.1-4
7.1.2.4	<u>Conformance to IEEE 317</u>	7.1-4
7.1.2.5	<u>Conformance to IEEE 323</u>	7.1-4
7.1.2.6	<u>Conformance to IEEE 336 (Regulatory Guide 1.30, Revision 0, August 1972)</u>	7.1-4
7.1.2.7	<u>Conformance to IEEE 338</u>	7.1-5
7.1.2.8	<u>Conformance to Regulatory Guide 1.22</u>	7.1-5
7.1.2.9	<u>Conformance to Regulatory Guide 1.47</u>	7.1-5
7.1.2.10	<u>Conformance to IEEE 379-1972</u>	7.1-8
7.1.2.11	<u>Conformance to Regulatory Guide 1.62</u>	7.1-8
7.1.2.12	<u>Conformance to Regulatory Position on the Application of the Single Failure Criterion to Manually Controlled Electrically Operated Valves</u>	7.1-8

ARKANSAS NUCLEAR ONE
Unit 2

TABLE OF CONTENTS (continued)

<u>Section</u>	<u>Title</u>	<u>Page</u>
7.2	<u>REACTOR PROTECTIVE SYSTEM (REACTOR TRIP SYSTEM)</u>	7.2-1
7.2.1	DESCRIPTION	7.2-1
7.2.1.1	<u>System Description</u>	7.2-1
7.2.1.2	<u>Design Bases</u>	7.2-112
7.2.2	ANALYSIS	7.2-114
7.2.2.1	<u>Introduction</u>	7.2-114
7.2.2.2	<u>Trip Bases</u>	7.2-116
7.2.2.3	<u>Design</u>	7.2-118
7.2.2.4	<u>Failure Modes and Effects Analysis</u>	7.2-126
7.3	<u>ENGINEERED SAFETY FEATURES SYSTEMS</u>	7.3-1
7.3.1	DESCRIPTION	7.3-2
7.3.1.1	<u>Engineered Safety Features Actuation System</u>	7.3-2
7.3.1.2	<u>Design Basis Information</u>	7.3-18
7.3.2	ANALYSIS	7.3-20
7.3.2.1	<u>Introduction</u>	7.3-20
7.3.2.2	<u>Design</u>	7.3-20
7.3.2.3	<u>Failure Modes and Effects Analysis</u>	7.3-27
7.4	<u>SYSTEMS REQUIRED FOR SAFE SHUTDOWN</u>	7.4-1
7.4.1	DESCRIPTION	7.4-1
7.4.1.1	<u>Emergency Power Systems</u>	7.4-1
7.4.1.2	<u>Emergency Feedwater Systems</u>	7.4-1
7.4.1.3	<u>Chemical and Volume Control System (Boron Addition Portion)</u>	7.4-1
7.4.1.4	<u>Service Water System</u>	7.4-2
7.4.1.5	<u>Emergency Shutdown From Outside the Control Room</u>	7.4-3

ARKANSAS NUCLEAR ONE
Unit 2

TABLE OF CONTENTS (continued)

<u>Section</u>	<u>Title</u>	<u>Page</u>
7.4.2	ANALYSIS	7.4-5
7.4.2.1	<u>Conformance to IEEE 279</u>	7.4-5
7.4.2.2	<u>Conformance to IEEE 308</u>	7.4-8
7.4.2.3	<u>Conformance to the Requirements of General Design Criterion 19</u>	7.4-8
7.4.2.4	<u>Consideration of Selected Plant Contingencies</u>	7.4-8
7.4.2.5	<u>Emergency Shutdown From Outside the Control Room</u>	7.4-9
7.5	<u>SAFETY-RELATED DISPLAY INSTRUMENTATION</u>	7.5-1
7.5.1	DESCRIPTION	7.5-1
7.5.1.1	<u>Plant Process Display Instrumentation</u>	7.5-1
7.5.1.2	<u>Reactor Protective System Monitoring</u>	7.5-1
7.5.1.3	<u>Engineered Safety Features Monitoring</u>	7.5-2
7.5.1.4	<u>CEA Position Indication</u>	7.5-2
7.5.1.5	<u>Post Accident Monitoring Instrumentation</u>	7.5-4
7.5.2	ANALYSIS	7.5-4
7.5.2.1	<u>Analysis of Plant Process Display Instrumentation</u>	7.5-4
7.5.2.2	<u>Analysis of Reactor Protective System Monitoring</u>	7.5-5
7.5.2.3	<u>Analysis of Engineered Safety Features Monitoring</u>	7.5-5
7.5.2.4	<u>Analysis of Control Element Assembly Position Indication</u>	7.5-6
7.5.2.5	<u>Analysis of Post-Accident Monitoring Instrumentation</u>	7.5-6
7.6	<u>ALL OTHER SYSTEMS REQUIRED FOR SAFETY</u>	7.6-1
7.6.1	DESCRIPTION	7.6-1
7.6.1.1	<u>Shutdown Cooling System Interlocks</u>	7.6-1
7.6.1.2	<u>Safety Injection Tank Isolation Valve Interlocks</u>	7.6-2
7.6.1.3	<u>Low Temperature Overpressure Protection (LTOP)</u>	7.6-4

ARKANSAS NUCLEAR ONE
Unit 2

TABLE OF CONTENTS (continued)

<u>Section</u>	<u>Title</u>	<u>Page</u>
7.6.1.4	<u>Other Systems</u>	7.6-5
7.6.2	ANALYSIS.....	7.6-5
7.6.2.1	<u>Shutdown Cooling System Interlocks</u>	7.6-5
7.6.2.2	<u>Safety Injection Tank Isolation Valve Interlocks</u>	7.6-7
7.6.2.3	<u>Low Temperature Overpressure Protection</u>	7.6-9
7.6.2.4	<u>Other Systems</u>	7.6-10
7.6.2.5	<u>Safety Parameter Display System (SPDS)</u>	7.6-11
7.7	<u>CONTROL SYSTEMS NOT REQUIRED FOR SAFETY</u>	7.7-1
7.7.1	DESCRIPTION.....	7.7-1
7.7.1.1	<u>Control Systems</u>	7.7-1
7.7.1.2	<u>Design Comparison</u>	7.7-8
7.7.1.3	<u>Core Operating Limit Supervisory System</u>	7.7-9
7.7.1.4	<u>Computer Systems</u>	7.7-16
7.7.1.5	<u>Ex-Core Neutron Flux Monitoring System</u>	7.7-17
7.7.1.6	<u>Diverse Scram System (DSS) with Diverse Turbine Trip (DTT)</u>	7.7-18
7.7.1.7	<u>Diverse Emergency Feedwater Actuation System (DEFAS)</u>	7.7-20
7.7.2	ANALYSIS.....	7.7-22
7.8	<u>TABLES</u>	7.8-1

ARKANSAS NUCLEAR ONE
Unit 2

LIST OF TABLES

<u>Table No.</u>	<u>Title</u>	<u>Page</u>
7.2-1	REACTOR PROTECTIVE SYSTEM BYPASSES	7.8-1
7.2-2	REACTOR PROTECTIVE SYSTEM MONITORED PLANT VARIABLE RANGES.....	7.8-2
7.2-3	REACTOR PROTECTIVE SYSTEM SENSORS.....	7.8-3
7.2-4	REACTOR PROTECTIVE SYSTEM INSTRUMENT RANGES AND MARGINS TO TRIP	7.8-4
7.2-5	PLANT PROTECTION SYSTEM FAILURE MODE AND EFFECTS ANALYSIS.....	7.8-5
7.2-6	DELETED.....	7.8-128
7.2-7	DELETED.....	7.8-128
7.2-8	DELETED.....	7.8-128
7.2-9	NSSS PARAMETERS AFFECTING DNBR FUEL DESIGN LIMIT, LOCAL POWER DENSITY LIMIT, AND MONITORED NSSS VARIABLES.	7.8-128
7.2-10	CORE PROTECTOR CALCULATOR – PRIORITY STRUCTURE	7.8-129
7.2-11	CONTROL ELEMENT ASSEMBLY CALCULATOR - PRIORITY STRUCTURE	7.8-132
7.2-12	OPERATOR'S MODULE DIGITAL METER DISPLAY PARAMETERS	7.8-134
7.2-13	CEAC SINGLE FAILURE ANALYSIS	7.8-135
7.2-14	DNBR/LPD CALCULATOR TRIP SYSTEM - INPUT DISPLAYS.....	7.8-136
7.2-15	DNBR/LPD CALCULATOR TRIP SYSTEM - OUTPUT DISPLAYS.....	7.8-136
7.2-16	DNBR/LPD CALCULATOR TRIP SYSTEM - STATUS DISPLAYS	7.8-137
7.2-17	DNBR/LPD CALCULATOR SYSTEM TESTS.....	7.8-138
7.3-1	ESFAS BYPASSES AND BLOCKS	7.8-139
7.3-2	DESIGN BASIS EVENTS REQUIRING ESFAS ACTION	7.8-140
7.3-3	MONITORED VARIABLES REQUIRED FOR ESFAS ACTION.....	7.8-141
7.3-4	ENGINEERED SAFETY FEATURES ACTUATION SYSTEM SENSORS ...	7.8-142

ARKANSAS NUCLEAR ONE
Unit 2

LIST OF TABLES (continued)

<u>Table No.</u>	<u>Title</u>	<u>Page</u>
7.3-5	SAFETY-RELATED SYSTEM INSTRUMENT RANGES, SETPOINTS, AND MARGINS TO ACTUATION	7.8-143
7.3-6	ESFAS MONITORED PLANT VARIABLE RANGES	7.8-145
7.5-1	PLANT PROCESS DISPLAY INSTRUMENTATION.....	7.8-146
7.5-2	ENGINEERED SAFETY FEATURE SYSTEMS MONITORING	7.8-150
7.5-3	R. G. 1.97 POST ACCIDENT MONITORING VARIABLES.....	7.8-152
7.7-1	COLSS MONITORED PLANT VARIABLES.....	7.8-166

ARKANSAS NUCLEAR ONE
Unit 2

LIST OF FIGURES

<u>Figure No.</u>	<u>Title</u>
7.2-1	TYPICAL MEASUREMENT CHANNEL FUNCTIONAL DIAGRAM (PRESSURIZER PRESSURE) WIDE RANGE
7.2-2	EX-CORE NEUTRON FLUX MONITORING SYSTEM
7.2-3	DELETED
7.2-4	TYPICAL VARIABLE SETPOINT OPERATION
7.2-5 – 7.2-12	DELETED
7.2-13	PLANT PROTECTION SYSTEM REMOTE CONTROL MODULE LAYOUTS
7.2-14	CEA POSITION SYSTEMS BLOCK DIAGRAM
7.2-15 – 7.2-25	DELETED
7.2-26	CORE PROTECTION CALCULATOR FUNCTIONAL BLOCK DIAGRAM
7.2-27	SYSTEM CONFIGURATION
7.2-28 – 7.2-31	DELETED
7.2-32	CORE PROTECTION CALCULATOR SYSTEM CEA CALCULATORS
7.2-33	CEA CALCULATOR BLOCK DIAGRAM
7.2-34	OPERATOR'S MODULE
7.2-35	DELETED
7.2-36	DELETED
7.2-37	REACTOR PROTECTIVE SYSTEM - TRIP INPUTS (TYPICAL FOR FOUR CHANNELS)
7.2-38	REACTOR PROTECTIVE SYSTEM - TRIP INPUTS (TYPICAL FOR FOUR CHANNELS)
7.2-39 – 7.2-42	DELETED
7.2-43	NORMAL DATA FLOW - CORE PROTECTION CALCULATORS
7.2-44 – 7.2-61	DELETED
FMEA DIAG. 1	PLANT PROTECTION SYSTEM INTERFACE LOGIC DIAGRAM
FMEA DIAG. 2	DELETED

ARKANSAS NUCLEAR ONE
Unit 2

LIST OF FIGURES (continued)

<u>Figure No.</u>	<u>Title</u>
FMEA DIAG. 2A	SAFETY CHANNEL BLOCK DIAGRAM
FMEA DIAG. 3 – 12	DELETED
FMEA DIAG. 13	RPS 2/4 LOGIC MATRIX SCHEMATIC
FMEA DIAG. 14	DELETED
FMEA DIAG. 15	TYPICAL CIAS-RAS-MSIS-EFAS TRIP PATH CIRCUIT
FMEA DIAG. 16	CSAS-SIAS-CCAS TRIP PATH CIRCUITS
FMEA DIAG. 17	DELETED
FMEA DIAG. 18	CE ESFAS ACTUATION RELAY CABINET SCHEMATIC DIAGRAM FOR TYPICAL ACTUATION SIGNAL
FMEA DIAG. 19	CHANNEL POWER DISTRIBUTION
FMEA DIAG. 19A	CHANNEL POWER DISTRIBUTION
7.3-1a – 7.4-2	DELETED
7.4-3	LOCAL PANEL 2080 REMOTE SHUTDOWN MONITORING
7.6-1	DELETED
7.6-2	DELETED
7.6-3	TYPICAL POST-TRIP RESPONSE
7.6-4	INADEQUATE SUBCOOLING MARGIN
7.6-5	LOSS OF PRIMARY-TO-SECONDARY HEAT TRANSFER
7.6-6	EXCESSIVE PRIMARY-TO SECONDARY HEAT TRANSFER
7.7-1	DELETED
7.7-2	FUNCTIONAL DIAGRAM OF THE CORE OPERATING LIMIT SUPERVISORY SYSTEM
7.7-3	CEDMCS - RPS INTERFACE BLOCK DIAGRAM
7.7-4	EXCORE INSTRUMENT DETECTOR SYSTEM
7.7-5	IN-CORE DETECTOR LOCATION

ARKANSAS NUCLEAR ONE
Unit 2

LIST OF FIGURES (continued)

<u>Figure No.</u>	<u>Title</u>
7.7-6	BANK P SUBGROUP POWER SWITCH AND CONTROL LOGIC RELATIONSHIPS
7.7-7	ACCEPTABLE OPERABLE ICI CONFIGURATIONS FOR CRITERIA II.A
7.7-8	ACCEPTABLE OPERABLE ICI CONFIGURATIONS FOR CRITERIA II.B

ARKANSAS NUCLEAR ONE
Unit 2

UPDATE REFERENCE LIST

Sections and references listed below denote documents that contain additional cross reference information used to update the SAR.

<u>Section</u>	<u>Cross References</u>
7.6.1.3	Correspondence from Rueter, AP&L to Stolz, NRC, dated October 11, 1977. (2CAN107707).
7.2.1.1.1.7	Correspondence from Trimble, AP&L, to Seyfrit, NRC, dated September 24, 1979. (0CAN097909).
7.3.1.1.1.1	Correspondence from Cavanaugh, AP&L, to Seyfrit, NRC, dated June 18, 1980. (0CAN068017).
7.6.1.3, 7.6.2.3	Correspondence from Trimble, AP&L, to Clark, NRC, dated December 1, 1980. (2CAN128007).
7.6.2.3	Correspondence from Trimble, AP&L, to Clark, NRC, dated March 30, 1981. (2CAN038119).
7.3.1.1.11.1, 7.4.1.5.1	Correspondence from Trimble, AP&L, to Seyfrit, NRC, dated March 31, 1981. (0CAN048102).
7.4.1.5.1	Design Change Package 851, "Steam Dump & Bypass System," 1979. (2DCP790851).
7.7.1.5	Correspondence from Marshall, AP&L, to Clark, NRC, dated August 19, 1982. (2CAN088201)
7.4.1.5	Correspondence from Marshall, AP&L, to Stolz, NRC, dated June 3, 1983. (0CAN068301)
7.2.1.1.2.5.3.4	Correspondence from Marshall, AP&L, to Seidle, NRC, dated September 12, 1983 (2CAN098308)
7.6.1.3.2	Correspondence from Trimble, AP&L, to Clark, NRC, dated March 30, 1981. (2CAN038119)
7.6.1.3	Correspondence from Rueter, AP&L, to Stolz, NRC, dated October 11, 1977. (2CAN107707)
	Correspondence from Trimble, AP&L, to Clark, NRC, dated December 1, 1980. (2CAN128007)
7.3	Design Change Package 79-2105, "Redundant Main FW is 0 Valve."
Table 7.5-1	Design Change Package 79-2149, "Containment Pressure Indicator Upgrade"

ARKANSAS NUCLEAR ONE
Unit 2

UPDATE REFERENCE LIST (continued)

<u>Section</u>	<u>Cross References</u>
7.6 7.8 7.9	Design Change Package 80-2123, "Safety Parameter Display System."
7.2	Design Change Package 84-2051 "Reactor Trip Breaker Response Time."
7.2	Design Change Package 84-2085 "CEDMCS Internal Modification."
7.7	Design Change Package 84-2011, "Reactor Vessel Level Monitoring Systems."
7.4	Design Change Package 85-2006, "PZR Heater Alternate SD."
7.9	Correspondence from Marshall, AP&L, to Eisenhut, NRC, dated April 30, 1984. (2CAN048402)
7.9	Correspondence from Marshall, AP&L, to Eisenhut, NRC, dated April 15, 1983. (0CAN048312)
Table 7.5-1	Design Change Package 83-2217, "Steam Generator Wide Range Level Indicators - Reg. Guide 1.97."
Table 7.5-2	Design Change Package 83-2216, "Upgrade Safety Injection Tank Level Indication."
Table 7.2-5 7.4.1.5.1	Design Change Package 86-2086B, "Q-Condensate Storage Tank," and 85-2039, "PPS Bypass Modification."
7.3.1.1.11.4 Figure 7.3-9	Design Change Package 81-2044, "Hangers for Redundant Main Feedwater Isolation Valves."
Figure 7.3-9	Design Change Package 81-2081, "Remove 2PD15-0722 and 2PD15-0728."
Figure 7.3-9	Design Change Package 83-2032, "MFW Pumps High Discharge Pressure Trip."
Figure 7.3-9	Design Change Package 83-2058, "Correction of Load Shedding Problems."
Figure 7.4-2	Design Change Package 83-2039A, "Service Water System Valve Replacement."
<u>Amendments 6 and 10</u>	
7.3.1.1.9.3 Figure 7.2-7 Figure 7.2-7A	Design Change Package 86-2018, "PPS Test Matrix Modification."
Table 7.7-1	Design Change Package 83-2213, "R.G. 1.97 MFW Flow Upgrade."

ARKANSAS NUCLEAR ONE
Unit 2

UPDATE REFERENCE LIST (continued)

<u>Section</u>	<u>Cross References</u>
7.2	Design Change Package 84-2051, "RPS Shunt Trip Bypass."
7.2	Design Change Package 84-2085, "CEDMCS Trip of the FWCS."
7.1.1.1.7 7.1.1.1.11 Table 7.2-1 Table 7.2-5(v) Table 7.2-5(y)	Design Change Package 85-2039, "RPS/ESFAS Steam Generator High/Low level and RWT Level Trip Bypass."
7.1.2.4.1 7.2.1.1.1.7 7.2.1.1.11 7.2.1.1.5 7.3.1.1.4 7.3.2.2.2 7.3.2.2.3.2 Table 7.2-1 Table 7.2-4 Table 7.2-5 Table 7.3-1 Figure 7.2-6 Figure 7.3-2a Figure 7.3-2b	Design Change Package 85-2039B, "Emergency Feedwater Actuation Bypass."
<u>Amendment 6</u>	
7.2	Design Change Package 86-2018, "RPS Test Power Supply Interlock."
Figure 7.3-9	Design Change Package 86-2114, "Annunciator Upgrade of 2K03, 2K10, and 2K11."
Figure 7.3-10	Design Change Package 86-2052, "Safety Injection Tank Valve Position Switch Qualified Seal."
<u>Amendment 8</u>	
Figure 7.3-9	Design Change Package 87-2060, "Deletion of 2HS-0401 and 2HS-0461."
Figure 7.3-10	Design Change Package 86-2093, "SDC Flow transmitter 2FT-5091 and Control Room Annunciator for SDG Flow Low."
7.2.1.1.2.6 7.2.2.3.2 7.3.1.1.2.1 7.3.2.2.2 7.7.1.4	Design Change Package 87-2033, "Removal of PPS Setpoints from Plant Computer."

ARKANSAS NUCLEAR ONE
Unit 2

UPDATE REFERENCE LIST (continued)

<u>Section</u>	<u>Cross References</u>
<u>Amendment 9</u>	
7.2.1 Figure 7.2-3 Figure 7.2-8 Table 7.2-10 through Table 7.2-13 Figure 7.2-11 Figure 7.2-13 through Figure 7.2-16a Figure 7.2-18 Figure 7.2-27 Figure 7.2-32 through Figure 7.2-61 7.5.1.4.2 7.5.2.2 7.5.2.4 FMEA Diagram #6 FMEA Diagram #19a	Design Change Package 85-2075D, "Core Protection Calculator Permanent Tie-Ins."
7.2.1.1.8 7.2.1.2 7.2.2.1.1 7.2.2.2.5 7.2.2.3.1 Figure 7.2-5 Table 7.2-5 Figure 7.2-22 7.7.1.6 FMEA Diagram #17	Design Change Package 85-2073, "ATWS Diverse Scram System."
Table 7.2-5 (O)	Design Change Package 88-2026, "Pressurizer Pressure Transmitter Replacement"
Figure 7.3-11 Figure 7.4-2	Design Change Package 86-2113, "ANO-2 Alarm Upgrade for Panels 2K01, 2K08, and 2K09."
Figure 7.4-2	Plant Change 90-8005, "Service Water Pump Motor Winding Temperature Setpoint Change."

ARKANSAS NUCLEAR ONE
Unit 2

UPDATE REFERENCE LIST (continued)

<u>Section</u>	<u>Cross References</u>
<u>Amendment 10</u>	
7.2.1.1.8 7.3.1.1 7.3.1.1.2.1 7.3.1.1.2.2 7.3.1.1.7 7.3.1.1.9.5 7.7.1 7.7.1.7 Table 7.2-5(J) Table 7.2-5(BZ) FMEA Diagram 1 FMEA Diagram 5 Figure 7.2-17 Figure 7.2-17A Figure 7.2-17B Figure 7.2-17C Figure 7.3-2B	Design Change Package 89-2053, "ATWS Diverse Emergency Feedwater Actuation System."
7.3.1.1.11.8 Figure 7.3-12	Design Change Package 89-2043, "Auxiliary Feedwater Pump Installation."
7.5.2.5.1 Table 7.5-3	Design Change Package 87-2096, "Dose Assessment System Upgrade."
7.6.1.2.1 7.6.1.3.2 Figure 7.3-10	Design Change Package 85-2024, "Setpoint Change for SIT Isolation Valves."
7.6.1.3.1 7.6.1.3.2	Procedure 1015.03B, Rev. 29, Permanent Change 8, "Unit Two Operations Log."
Table 7.5-3	Condition Report 1-89-0113, "Offsite Analysis of Post Accident pH Samples." Correspondence from Fisicaro, ANO, to the NRC, date November 15, 1991 (OCAN119101).
Table 7.5-3	Condition Report C-91-0017, "Reg. Guide 1.97 Active Damper Review."
Figure 7.2-20	Limited Change Package 90-6001, "Excore Detector Filter Installation."
Figure 7.3-7 Figure 7.3-9 Figure 7.3-11 Figure 7.3-12 Figure 7.4-2	Design Change Package 88-2110, "ANO-2 Alarm Upgrade, Phase II."

ARKANSAS NUCLEAR ONE
Unit 2

UPDATE REFERENCE LIST (continued)

<u>Section</u>	<u>Cross References</u>
Figure 7.3-10	Design Change Package 89-2042, "Generic Letter 88-17, Shutdown Cooling (SDC) Instrumentation and Alarms."
Figure 7.3-11	Design Change Package 87-2006, "Penetration Room Differential Pressure Transmitters Removal."
Figure 7.3-12 Figure 7.4-2	Plant Change 91-8007, "EFW Turbine Steam Admission Valve Limit Switch Adjustment."
Figure 7.4-1	Plant Change 91-8051, "2PC-4812 Hi/Low Alarm Setpoint Change."
Figure 7.4-2	Procedure 1628.013, Rev. 0, "Addition of Biocide to Unit 1 or Unit 2 Service Water."
Figure 7.4-2	Design Change Package 90-2027, "ACW Isolation Valve Override."
Figure 7.4-2	Plant Change 90-8038, "2PDIS-1426, -1432, -1438 Set Point Change."
Figure 7.4-3	Design Change Package 87-2105, "Shutdown Cooling Flow Indication on 2C80."
Figure 7.7-1	Design Change Package 86-2034, "RCS Refueling Level Indication System."
<u>Amendment 11</u>	
7.2.1.1.2.5.1.4	ANO Procedure 2312.037, Rev. 0, "3205 CPC System Software, Channel A."
7.2.1.1.2.5.1.4	ANO Procedure 2312.038, Rev. 0, "3205 CPC System Software, Channel B."
7.2.1.1.2.5.1.4	ANO Procedure 2312.039, Rev. 0, "3205 CPC System Software, Channel C."
7.2.1.1.2.5.1.4	ANO Procedure 2312.040, Rev. 0, "3205 CPC System Software, Channel D."
7.2.1.1.2.5.1.4	ANO Procedure 2312.041, Rev. 0, "3205 CPC System Software, CEAC1."
7.2.1.1.2.5.1.4	ANO Procedure 2312.042, Rev. 0, "3205 CPC System Software, CEAC 2."
7.6.1.3.1	ANO Procedure 1015.016, Rev. 11, "Unit Two Operations Forms."
7.6.2.5.3	ANO Procedure 2202.001, Rev. 1, "Standard Post Trip Actions."
7.6.2.5.5	Design Change Package 90-2036, "Unit 2 Plant Computer Replacement."
7.7.1.1.1	Plant Change 92-8031, "Reactor Regulating System Modifications."
7.7.1.1.9 Figure 7.3-10	Design Change Package 91-2012, "SDC Vortex Monitoring."

ARKANSAS NUCLEAR ONE
Unit 2

UPDATE REFERENCE LIST (continued)

<u>Section</u>	<u>Cross References</u>
7.7.1.6 Figure 7.2-5 FMEA Diagram #17	Design Change Package 92-2017, "DEFAS Enable Circuit."
Table 7.2-2 Table 7.2-4 Table 7.3-5 Table 7.3-6 Table 7.5-1	Design Change Package 91-2013, "ANO-2 Narrow Range Containment Bldg. Pressure Transmitter Replacement."
Table 7.2-4 Table 7.3-5	Design Change Package 92-2008, "Low Pressurizer Pressure Setpoint Change."
Table 7.5-3	ANO Procedure 1905.032, Rev. 3, "Use of the ND-60 Multichannel Analyzer."
Table 7.5-3	Limited Change Package 91-5018, "Installation of Position Indication on CV-7910."
Table 7.5-3	Condition Report C-91-0017, "Damper Position Indication."
Table 7.5-3	Limited Change Package 91-6023, "Installation of Position Indication Unit 2 EDG Outside Air Dampers."
Table 7.5-3	Limited Change Package 91-6007, "Installation of Position Indication for Outside Air Damper 2VSF-9."
Table 7.5-3	Design Change Package 90-1064, "Control Room Isolation Dampers CV-7905/-7907 Replacement."
Figure 7.3-6 Figure 7.3-9 Figure 7.4-1 Figure 7.4-2	Design Change Package 88-2111, "ANO-2 Annunciator Upgrade Phase III."
Figure 7.3-7	Limited Change Package 90-6036, "Revise Setpoints for 2LIS-5659-1, 2LT-5659-1, 2LIS-5668-2, and 2LT-5668-2."
Figure 7.3-10	Limited Change Package 91-6002, "SDC Suction Pressure Switch (2PIS-5088) Setpoint Change."
Figure 7.4-1	Design Change Package 88-2086, "Modifications to 2CV-4824-2."
Figure 7.4-2	ANO Procedure 1052.007, Rev. 13, "Secondary Chemistry Monitoring."
Figure 7.4-2	Plant Change 88-2904, "Two Service Water Pumps Running on the Same Bus."

ARKANSAS NUCLEAR ONE
Unit 2

UPDATE REFERENCE LIST (continued)

<u>Section</u>	<u>Cross References</u>
<u>Amendment 12</u>	
7.2.1.1.2.2 7.2.1.1.2.5.1.3 7.2.1.1.2.5.1.4 7.2.1.1.2.5.1.7 7.2.1.1.2.5.1.8 7.2.1.1.2.5.2 7.5.1.4.1 7.7.1.1.1 7.7.1.3.1 7.7.1.3.2 7.7.1.4 Table 7.5-1 Figure 7.2-14	Design Change Package 92-2023, "Critical Application Programs Systems (CAPS) Migration to the Plant Computer"
7.7.1.1.2 Table 7.5-1	Plant Change 92-8074, "Pressurizer Pressure Control Loop Setpoint Change"
7.7.1.1.6 Table 7.5-3	Design Change Package 89-2017, "Alternate AC Power Source"
7.7.1.1.7 7.7.1.1.7	Technical Specification Change Request 2-93-09 (2CAN109303) Design Change Package 92-2026, "B&W Incore Instrument Assembly Replacement"
Table 7.2-4 Table 7.5-1 Table 7.5-3 Figure 7.2-2 Figure 7.4-3	Engineering Action Request 93-0424, "Correcting Drawing Details"
Table 7.2-5 Figure 7.2-2 Figure 7.2-30	Licensing Information Request L93-0047, "Replace Start-up Excore Channels with Gamma Metrics Components"
Figure 7.3-9	Design Change Package 82-2055, "Removal of Annunciator Windows"
Figure 7.3-9	Design Change Package 91-2001, "Main Steam Isolation Valve (MSIV) Solenoid Operated Valve Logic Upgrade"
Figure 7.3-9	Limited Change Package 93-6020, "Turbine/Generator Instrumentation Upgrade"
Figure 7.3-10	Engineering Action Request 92-0632, "Drawing Note Revision"
Figure 7.3-11	Plant Change 93-8062, "Emergency Penetration Room Ventilation System Pull-to-Lock Annunciation Change"
Figure 7.4-3	Engineering Action Request 92-0528, "Correcting Drawing Details"

ARKANSAS NUCLEAR ONE
Unit 2

UPDATE REFERENCE LIST (continued)

<u>Section</u>	<u>Cross References</u>
<u>Amendment 13</u>	
7.2.1.1.2.5.1.3 Table 7.2-5(C) Table 7.2-5(D) Table 7.2-5(E) Figure 7.2-16 Figure 7.2-16A Figure 7.2-16B	Design Change Package 94-2016, "Weed RTD/Transmitter Replacement"
7.2 7.2.2.1.1 7.7.1.1.1 7.7.1.1.6 7.7 7.7-6	Design Change Package 94-2017, "Replacement of the Part Length Control Element Assemblies"
7.3.1.1.11.7	Plant Change 93-8062, "2VEF38A1 & 2VEF38B2 Pull to Lock Annunciation Change"
7.5.2.5.3 Table 7.2-5(D) Figure 7.2-5(E) Figure 7.2-16B Figure 7.5-3	Limited Change Package 94-6006, "Replacement of Panel 2CO4 RCS Temperature Indicators and RCP Differential Pressure Indicators"
7.7.1.5	Plant Change 94-8027, "Startup Excore System Enhancements"
Figure 7.3-7	Plant Change 94-8002, "Containment Spray Header Level Alarm Change"
Figure 7.3-9	Plant Change 95-8009, "2P8A and 2P8B Time Delay Relay Installation"
Figure 7.3-9	Limited Change Package 94-6027, "Main Feedwater Pumps Trip-Hardening"
Figure 7.3-10	Plant Change 94-8060, "Swing HPSI Pump Auto Start Interlock Modification"
Figure 7.3-12	Design Change Package 94-2013, "Replace SOV 2SV-0205 with MOV 2CV-0205-2"
Figure 7.4-1	Design Change Package 80-2037A, "Provide Reset for MISV & MSIV"
Figure 7.4-1	Plant Change 94-8003, "2T4 Volume Control Tank Operating Pressure Change"
Figure 7.4-2	Design Change Package 89-2049, "Service Water and Auxiliary Cooling Systems Water Hammer Mitigation"
Figure 7.4-2	Plant Change 95-8001, "Unit 2 SW Pump Discharge Strainer DP Switch Setpoint Change"

ARKANSAS NUCLEAR ONE
Unit 2

UPDATE REFERENCE LIST (continued)

<u>Section</u>	<u>Cross References</u>
<u>Amendment 14</u>	
7.2.1.1.2.5.2	Technical Specification 6.5, Amendment 160, "Quality Assurance, Security Plan, and Emergency Plan Requirements"
7.2.1.1.1.7	Limited Change Package 96-3355, "High Pressure Turbine First Stage Nozzle and Bucket Modification"
Table 7.2-2	
Table 7.2-4	
Table 7.2-6	
Table 7.3-5	
Table 7.3-6	
7.1.2.9.1	Technical Specification 3/4.3, Amendment 159, "Reactor Protection System and Engineered Safety Features Actuation System Operability Requirements"
7.2.1.1	
7.2.2.1.1.2.5.1.6	
7.2.1.1.5	
7.2.1.1.6	
7.2.1.1.7	
7.2.1.1.9.2	
7.2.2.3.2	
7.2.2.4	
7.3.1.1	
7.3.1.1.4	
7.3.1.1.5	
7.3.1.1.6	
7.3.2.3	
7.4.1.1.9.2	
Table 7.2-5	
Figure 7.2-5	
Figure 7.2-6	
Figure 7.2-10	
Figure 7.2-36	
Figure 7.2-37	
Figure 7.2-38	
Figure 7.3.2A	
FMEA Diagram 1	
FMEA Diagram 9	
FMEA Diagram 10	
FMEA Diagram 17	

ARKANSAS NUCLEAR ONE
Unit 2

UPDATE REFERENCE LIST (continued)

<u>Section</u>	<u>Cross References</u>
7.2.1.1.2.3 7.2.1.1.2.5.1.8 7.7.1.1.1 7.7.1.1.4 7.7.1.1.5 7.7.1.1.6 7.7.1.4 7.7.1.5 Table 7.7-1 Figure 7.2-2 Figure 7.2-20 Figure 7.2-22 Figure 7.2-30 Figure 7.3-9	Design Change Package 94-2008, "Feedwater Control System Upgrade"
Figure 7.3-6	Plant Change 96-8013, "CCW Cross Connect Valve and Pump Circuitry Modification"
Figure 7.3-9	Plant Change 963108P201, "Feed Pump Delta T Interlock"
Figure 7.3-12	Limited Change Package 89-6007, "ESF Timer Setpoint Change"
Figure 7.3-12	Design Change Package 96-3543D201, "Backup DC Source for Main Turbine Controls, EFW Controls, and Alarm Modification"
Figure 7.4-1	Plant Change 95-8085, "Control Channel Pressurizer Level Circuits Upgrade"
Figure 7.4-2	Plant Change 95-8067, "Service Water System Alarm Setpoints"
<u>Amendment 15</u>	
7.2.1.1.2.5.1.3 7.2.1.1.2.5.1.6 7.2.1.1.2.5.1.8 Table 7.2-1 Table 7.2-5 Figure 7.2-6 Figure 7.2-11 Figure 7.2-42 Figure 7.2-56	Engineering Request 981159N201, "High Log Power & CPC Trips Operating Bypass Bistable Setpoint Change"
7.2.1.1.1.7 Table 7.2-4 Table 7.2-5	Engineering Request 975015D201, "MSIS Setpoint Change"
7.2.1.1.9.8 Table 7.2-5	Plant Change 973744P201, "Addition of UV Trip Bypass to Reactor Trip Breaker"

ARKANSAS NUCLEAR ONE
Unit 2

UPDATE REFERENCE LIST (continued)

<u>Section</u>	<u>Cross References</u>
7.3	Calculation 91E011601, "Availability of NPSH to HPSI"
Table 7.2-2	Procedure 2102.004, "Change to Current Operation Temperatures"
Table 7.3-5 Table 7.5-2 Table 7.5-3 Figure 7.3-7	Design Change Package 973950D201, "NaOH Replacement with TSP"
Figure 7.3-9	Plant Change 973786N201, "MSR Tube Bundle Replacement"
Figure 7.3-9	Plant Change 973905N201, "Main Turbine Setback Circuit Removal"
<u>Amendment 16</u>	
7.2.1.1 7.2.1.1.1 7.2.2.2.10 7.2.2.2.9 7.3.1.2 Table 7.2-2 Table 7.2-4 Table 7.2-6 Table 7.2-7 Table 7.3-5 Table 7.3-6	Nuclear Change Package 980547N201, "Plant Protection System Setpoint Changes"
7.2.1.1.2 7.2.1.1.7 7.2.1.2 7.3.1.1 7.3.1.1.1 7.3.1.1.2 7.3.1.1.6 7.3.1.1.7 7.3.1.1.10 7.3.1.1.11 7.3.1.1.12 7.3.1.2 7.3.2.2 7.3.2.2.1 7.3.2.2.2 7.3.2.3 7.7.1.7 Table 7.2-5	Nuclear Change Package 973608N201, "PPS Indefinite Bypass"

ARKANSAS NUCLEAR ONE
Unit 2

UPDATE REFERENCE LIST (continued)

<u>Section</u>	<u>Cross References</u>
7.2.1.1.2 Figures 7.2-2 Figure 7.2-20 Figure 7.2-30	Nuclear Change Package 991508N201, "Safety Channel #4 Excore Detector Replacement"
7.2.1.1.2 Figure 7.2-2 Figure 7.2-20 Figure 7.2-30	Nuclear Change Package 991508N202, "Safety Channel 'C' Excore Detector Replacement"
7.3.1.1.11	Nuclear Change Package 991522N201, "Containment Cooler Chilled Water Coil Replacement and Fan Pitch Change"
7.3.1.1.11 Figure 7.3-12	Nuclear Change Package 975122N202, "Additional AFW Trip"
7.6.1.3 7.6.2.3	Technical Specification 3/4.4.12, "Basis Update of LTOP Requirements to Account for Installation of the Replacement Steam Generators and Power Uprate"
7.7.1.1.4 Table 7.2-2 Table 7.5-1 Table 7.5-3 Table 7.7-1	Nuclear Change Package 980547N203, "Feedwater Control System and Reactor Regulation System Setpoint Changes"
7.7.1.1.5 Figure 7.3-9	Nuclear Change Package 980547N204, "Steam Generator Replacement SDBCS Panel/Breaker Modification"
Table 7.3-2	Design Change Package 980642D210, "Replacement Steam Generator Design/Qualification"
Table 7.5-3	Technical Specification Amendment 218, "Removal of the PASS System"
Figure 7.2-22	Design Change Package 980642D209, "Disconnect and Reconnect of Small Bore Piping and Tubing to Support the Steam Generator Replacement Project"
Figure 7.3-7	Nuclear Change Package 991802N201, "Removal of Interlock between the Sump and the Refueling Water Tank Valves"
Figure 7.3-9	Engineering Request 991710E203, "Evaluation to Justify Use of the AFW System via the FWCS"
Figure 7.3-9	Engineering Request 992050E201, Evaluation of CS, FW, FWCS Systems for Steam Generator Replacement and Power Uprate"
Figure 7.4-2	Nuclear Change Package 980542N201, "Service Water and ACW Modifications for Power Uprate"

ARKANSAS NUCLEAR ONE
Unit 2

UPDATE REFERENCE LIST (continued)

<u>Section</u>	<u>Cross References</u>
<u>Amendment 17</u>	
7.2.1.1.2.4 7.2.1.1.2.5.1.8 7.3.1.2.C.9.A Figure 7.3-9	Engineering Request ANO-2000-2344-026, "Power Uprate Evaluation"
7.7.1.3.2	ANO Unit 2 Technical Specifications 2.1.1.1
Figure 7.3-9	Engineering Request ANO-1998-0547-043, "Condensate and Feedwater System Setpoint Changes due to Power Uprate"
7.3.1.1.11.7	ANO Calculation 99-E-0017-01, "Penetration Room Ventilation Room System"
Table 7.2-2 Table 7.2-4 Table 7.3-5 Table 7.3-6 Table 7.5-3	Engineering Request ANO-1998-0547-058, "Plant Protection System Setpoint Changes due to Power Uprate"
7.2.1.1.1.3 7.2.1.1.2.5.1.8	Unit 2 Technical Specification Amendment 238
Figure 7.3-6	Engineering Request ANO-2000-3316-002, "Uprate of Isophase Bus Cooling System Amperage Rating"
Figure 7.3-9	Engineering Request ANO-2001-0212-001, "Condensate Recirculation Valve and Controller Upgrade"
7.5.2.5.2 Table 7.5-3 Figure 7.2-2 Figure 7.2-20 Figure 7.2-30	Engineering Request ANO-1999-1508-003, "'A' Excore Detector Replacement"
7.6.1.3 7.6.1.3.2	Unit 2 Technical Specification Amendment 242

ARKANSAS NUCLEAR ONE
Unit 2

UPDATE REFERENCE LIST (continued)

<u>Section</u>	<u>Cross References</u>
<u>Amendment 18</u>	
Figure 7.2-7 Figure 7.2-13 Figure 7.2-17 Figure 7.2-17B Figure 7.2-17C Figure 7.2-18 Figure 7.2-19 FMEA Diagram 4 FMEA Diagram 5 FMEA Diagram 6 FMEA Diagram 7 FMEA Diagram 13	Condition Report ANO-C-1997-0282, "Revision of SAR Figure Titles"
7.2.1.1.2.3 Figure 7.2-2 Figure 7.2-20 Figure 7.2-30 FMEA Diagram 2 FMEA Diagram 2A	Engineering Request ER-ANO-1999-1508-020, "B Excore Channel Replacement"
Figure 7.3-9	License Basis Document Change 2-7.3-0036, "Revision of Secondary Heater Drain Pump Design Criteria"
Figure 7.3-7	Engineering Request ER-ANO-2003-0392-000, "Installation of New Model Containment Temperature Switch"
Figure 7.4-1	Engineering Request ER-ANO-2003-0089, "Letdown Backpressure Controller Setpoints"
7.2.1.1.2.5.1.8	Engineering Request ER-ANO-2002-0855-000, "Cross-Check of CPC RCP Speed Indications"
Figure 7.2-18 FMEA Diagram 6	SAR Discrepancy 2-98-0356, "Removal of Part Number Related to Pressurizer Pressure Channel EQ Splice and Connector"
Table 7.2-4	SAR Discrepancy 2-98-0338, "Correction of DNBR Reactor Trip Margin to Trip Value"
Figure 7.3-9	Engineering Request ER-ANO-1998-0642, "Revisions to Drawing M2401"
Figure 7.3-9	Engineering Request ER-ANO-1998-0405-012, "Upgrade of Heater Drain Pumps"
Table 7.5-3	Condition Report CR-ANO-2-2001-0073, "RG 1.97 RWT Indication Requirements"

ARKANSAS NUCLEAR ONE
Unit 2

UPDATE REFERENCE LIST (continued)

<u>Section</u>	<u>Cross References</u>
Table 7.5-3	SAR Discrepancy 2-98-0334, "Removal of Incorrect Area Radiation Instrumentation Ranges"
7.7.1.3.3.3	SAR Discrepancy 2-97-0610, "Clarification of CEA and Fuel Burnup Relationships with Regard to Power Conversion"
7.7.1.3.3.3	SAR Discrepancy 2-97-0609, "Clarification of Inoperable COLSS Detector Operations"
7.7.1.1.7	Engineering Request ER-ANO-2003-0762-000, "Replacement of Incore Location G-8 with ICI Plug"
7.2.1.1.2.5.1.3 7.2.1.1.2.5.1.4 7.2.1.1.2.5.1.5 7.2.1.1.2.5.1.7 7.2.1.1.2.5.1.8 7.2.1.1.2.5.1.9 Table 7.2-12 Table 7.2-17 Figure 7.2-33 Figure 7.2-34	SAR Discrepancy 2-97-0531 "Clarification of Periodic Testing and CPC Module Configuration, Including Typographical and Other Administrative Changes"
Figure 7.3-9	Engineering Request ER-ANO-2003-0394-001, "Revision of Setpoint for Condenser Vacuum Pressure Switch 2PS-0686"
Figure 7.2-6 FMEA Diagram 9	Engineering Request ER-ANO-1998-1159, "Modification of Log Power and CPC Bypass Permissive Setpoints"
Figure 7.2-17B Figure 7.2-17C Figure 7.2-18 Figure 7.2-19 Figure 7.2-22 Figure 7.4-1	Condition Report ANO-C-1991-0073, "Upgrade of LBD Change Process"
FMEA Diagram 12 FMEA Diagram 17	ANO-1 TS Amendment 159, "Indefinite Bypass of PPS Channels"
Figure 7.3-9	Engineering Request ER-ANO-1994-2008, "Feedwater Control System Upgrade"
Figure 7.3-9	Drawing Revision Request 92-10214, "Revisions to Drawing M2401 Sh4"
Figure 7.3-9	Engineering Request ER-ANO-2001-0212, "Revised Valve Closure Logic for MFW Pump Trip"

ARKANSAS NUCLEAR ONE
Unit 2

UPDATE REFERENCE LIST (continued)

<u>Section</u>	<u>Cross References</u>
Figure 7.3-9	Condition Report CR-ANO-2-2000-0089, "Correction to MFW Pump Lube Oil Pump 2P-27 Aux Contact Configuration"
Figure 7.3-9	Engineering Request ER-ANO-1994-6027, "Correction to As-Built Drawing Associated with DRN 95-1140"
Figure 7.3-10	Engineering Request ER-ANO-2002-0528, "Revision of Initiation Time for Hot Leg Injection"
Figure 7.3-11	Condition Report CR-ANO-C-1995-0229, "Revision of Heat Detector Setpoints for Control Room and Penetration Room Ventilation Fans"
Figure 7.4-2	Engineering Request ER-ANO-1998-0542, "Service Water Changes due to Power Uprate"
Figure 7.3-7	Engineering Request ER-ANO-1999-1802, "Modification of RWT Outlet Valve Interlocks"
<u>Amendment 19</u>	
Table 7.5-3	Engineering Request ER-ANO-2000-2804-017, "Modification of High Pressure Safety Injection Pump 2P-89C"
7.5.2.5.2 Table 7.5-3	Technical Specification Amendment 254, "Deletion of Hydrogen Recombiners Requirements and Relocation of Hydrogen Analyzer Requirements to the Technical Requirements Manual"
Figure 7.2-14 Figure 7.2-43	Engineering Request ER-ANO-2001-0469-002, "Replacement of Core Protection Calculator (CPC) Operator Modules"
7.7.1.1.7 Figure 7.7-7 Figure 7.7-8 Table of Contents	Engineering Report A2-NE-2005-003, Rev. 1, "Cycle 18 Core Reload Report"
7.6.1.1.1 7.6.1.1.2 7.6.1.3.2.A 7.7.1.1.9 Table 7.3-5 Figure 7.3-10 Sh2 Figure 7.3-10 Sh4 Table of Contents	Engineering Request ER-ANO-2002-0875-004, "Removal of The Shutdown Cooling Suction Valve Auto-Closure Function"

ARKANSAS NUCLEAR ONE
Unit 2

UPDATE REFERENCE LIST (continued)

<u>Section</u>	<u>Cross References</u>
<u>Amendment 20</u>	
7.1.2.11	License Document Change Request 05-058, "Deletion/simplification of Excessive Detailed Drawings from SAR"
7.2.1.1.1.12	
7.2.1.1.2.1	
7.2.1.1.2.2	
7.2.1.1.2.3	
7.2.1.1.2.5	
7.2.1.1.2.5.1.3	
7.2.1.1.2.5.1.4	
7.2.1.1.2.5.1.6	
7.2.1.1.2.5.1.8	
7.2.1.1.3	
7.2.1.1.4	
7.2.1.1.5	
7.2.1.1.6	
7.2.1.1.9	
7.2.1.1.9.3	
7.2.1.1.9.4	
7.2.1.1.9.5	
7.2.1.3	
7.2.2.3.2	
7.3.1.1	
7.3.1.1.1	
7.3.1.1.2.1	
7.3.1.1.2.3	
7.3.1.1.3	
7.3.1.1.4	
7.3.1.1.5	
7.3.1.1.6	
7.3.1.1.9.3	
7.3.1.1.9.6	
7.3.1.1.11.1	
7.3.1.1.11.2	
7.3.1.1.11.3	
7.3.1.1.11.4	
7.3.1.1.11.5	
7.3.1.1.11.6	
7.3.1.1.11.7	
7.3.1.1.11.8	
7.3.1.3	
7.3.2.2.2	
7.4.1.3	
7.4.1.4	
7.4.1.5	
7.6.1.1.1	
7.6.1.2.1	
7.6.1.2.2	

ARKANSAS NUCLEAR ONE
Unit 2

UPDATE REFERENCE LIST (continued)

<u>Section</u>	<u>Cross References</u>
7.6.2.2.1	
7.7.1.6	
7.7.1.7	
Table 7.2-5	
Figures – ALL (except Figures 7.2-14, 7.2-34, 7.2-43, 7.7-7, and 7.7-8)	
7.7.1.1.7	Engineering Request ER-ANO-2003-0399-003, "Modification of Reactor Internals Thimble Tubes"
Table 7.5-1	Engineering Request ER-ANO-2003-0489-000, ""Re-range Containment
Table 7.5-2	Wide Range Pressure Transmitters to Maintain Compliance with RG 1.97"
Table 7.5-3	
7.4.1.3.1	Condition Report CR-ANO-2-2006-08109, "Correction of Charging Header Connection to HPSI Header #1"
<u>Amendment 22</u>	
7.2.1.1.2.5.2	License Document Change Request 08-043, "Revise Discussion of Nuclear Software Expert"
7.6.2.5.2	Engineering Change EC-2711, "Safety Parameter Display System (SPDS)
7.6.2.5.4	Computer Replacement Project"
7.6.2.5.5	
Table 7.5-3	
7.2.1.1.2.4	TS Amendment 287, "DNBR Safety Limit"
7.2.2.1.1	
7.7.1.3.2	
Table 7.2-4	
7.7.1.3.3.1	TS Amendment 286, "Use of RCP Differential Pressure Flow"
<u>Amendment 23</u>	
7.6.1.3.2	License Document Change Request 10-042, "Incorporation of ASME Operations and Maintenance Code in accordance with 10 CFR 50.55a"
<u>Amendment 24</u>	
7.7.1.3.3.1	Engineering Change EC-32000, "Revise RCP Differential Pressure Instrument Tolerance"
7.7.1.3.3.1	License Document Change Request 12-021, "Correction of editorial errors in accordance with EN-LI-113 Steps 3.0[3](a) and 3.0[3](d)(1)"
Figure 7.4-3	Engineering Change EC-36113, "Remote Shutdown Panel Drawing Correction"

ARKANSAS NUCLEAR ONE
Unit 2

UPDATE REFERENCE LIST (continued)

<u>Section</u>	<u>Cross References</u>
<u>Amendment 25</u>	
Table 7.2-5	Condition Report CR-ANO-2-2012-0826, "MG Set Failure Mode Clarification"
<u>Amendment 26</u>	
7.7.1.5	Licensing Basis Document Change Request LBDCR 15-017, "ANO-2 SAR and TRM Updates Support Implementation of NFPA 805"
<u>Amendment 27</u>	
7.1.1.2 7.4.1.3	Engineering Change EC-64188, "Boric Acid Makeup System Classification"
7.7.1.1.7	Engineering Change EC-62439, "Cycle 26 Reload Report"
<u>Amendment 28</u>	
Table 7.5-3	Engineering Change EC-71778, "SPING Replacements"
7.6.1.3.1 7.6.1.3.2	Engineering Change EC-69421, "Update SAR in accordance with TS Amendment 311"

ARKANSAS NUCLEAR ONE
Unit 2

RECORD OF REVISIONS

<u>PAGE #</u>	<u>AMENDMENT #</u>	<u>PAGE #</u>	<u>AMENDMENT #</u>	<u>PAGE #</u>	<u>AMENDMENT #</u>
TABLE OF CONTENTS		CHAPTER 7 (CONT.)		CHAPTER 7 (CONT.)	
7-i	28	7.1-7	27	7.2-41	22
7-ii	28	7.1-8	27	7.2-42	22
7-iii	28			7.2-43	22
7-iv	28	7.2-1	22	7.2-44	22
7-v	28	7.2-2	22	7.2-45	22
7-vi	28	7.2-3	22	7.2-46	22
7-vii	28	7.2-4	22	7.2-47	22
7-viii	28	7.2-5	22	7.2-48	22
7-ix	28	7.2-6	22	7.2-49	22
7-x	28	7.2-7	22	7.2-50	22
7-xi	28	7.2-8	22	7.2-51	22
7-xii	28	7.2-9	22	7.2-52	22
7-xiii	28	7.2-10	22	7.2-53	22
7-xiv	28	7.2-11	22	7.2-54	22
7-xv	28	7.2-12	22	7.2-55	22
7-xvi	28	7.2-13	22	7.2-56	22
7-xvii	28	7.2-14	22	7.2-57	22
7-xviii	28	7.2-15	22	7.2-58	22
7-xix	28	7.2-16	22	7.2-59	22
7-xx	28	7.2-17	22	7.2-60	22
7-xxi	28	7.2-18	22	7.2-61	22
7-xxii	28	7.2-19	22	7.2-62	22
7-xxiii	28	7.2-20	22	7.2-63	22
7-xxiv	28	7.2-21	22	7.2-64	22
7-xxv	28	7.2-22	22	7.2-65	22
7-xxvi	28	7.2-23	22	7.2-66	22
7-xxvii	28	7.2-24	22	7.2-67	22
7-xxviii	28	7.2-25	22	7.2-68	22
7-xxix	28	7.2-26	22	7.2-69	22
7-xxx	28	7.2-27	22	7.2-70	22
7-xxxi	28	7.2-28	22	7.2-71	22
7-xxxii	28	7.2-29	22	7.2-72	22
7-xxxiii	28	7.2-30	22	7.2-73	22
		7.2-31	22	7.2-74	22
		7.2-32	22	7.2-75	22
CHAPTER 7		7.2-33	22	7.2-76	22
		7.2-34	22	7.2-77	22
7.1-1	27	7.2-35	22	7.2-78	22
7.1-2	27	7.2-36	22	7.2-79	22
7.1-3	27	7.2-37	22	7.2-80	22
7.1-4	27	7.2-38	22	7.2-81	22
7.1-5	27	7.2-39	22	7.2-82	22
7.1-6	27	7.2-40	22	7.2-83	22

ARKANSAS NUCLEAR ONE
Unit 2

RECORD OF REVISIONS (continued)

<u>PAGE #</u>	<u>AMENDMENT #</u>	<u>PAGE #</u>	<u>AMENDMENT #</u>	<u>PAGE #</u>	<u>AMENDMENT #</u>
CHAPTER 7 (CONT.)		CHAPTER 7 (CONT.)		CHAPTER 7 (CONT.)	
7.2-84	22	7.3-1	20	7.5-7	19
7.2-85	22	7.3-2	20	7.5-8	19
7.2-86	22	7.3-3	20	7.5-9	19
7.2-87	22	7.3-4	20		
7.2-88	22	7.3-5	20	7.6-1	28
7.2-89	22	7.3-6	20	7.6-2	28
7.2-90	22	7.3-7	20	7.6-3	28
7.2-91	22	7.3-8	20	7.6-4	28
7.2-92	22	7.3-9	20	7.6-5	28
7.2-93	22	7.3-10	20	7.6-6	28
7.2-94	22	7.3-11	20	7.6-7	28
7.2-95	22	7.3-12	20	7.6-8	28
7.2-96	22	7.3-13	20	7.6-9	28
7.2-97	22	7.3-14	20	7.6-10	28
7.2-98	22	7.3-15	20	7.6-11	28
7.2-99	22	7.3-16	20	7.6-12	28
7.2-100	22	7.3-17	20	7.6-13	28
7.2-101	22	7.3-18	20	7.6-14	28
7.2-102	22	7.3-19	20	7.6-15	28
7.2-103	22	7.3-20	20	7.6-16	28
7.2-104	22	7.3-21	20		
7.2-105	22	7.3-22	20	7.7-1	27
7.2-106	22	7.3-23	20	7.7-2	27
7.2-107	22	7.3-24	20	7.7-3	27
7.2-108	22	7.3-25	20	7.7-4	27
7.2-109	22	7.3-26	20	7.7-5	27
7.2-110	22	7.3-27	20	7.7-6	27
7.2-111	22			7.7-7	27
7.2-112	22	7.4-1	27	7.7-8	27
7.2-113	22	7.4-2	27	7.7-9	27
7.2-114	22	7.4-3	27	7.7-10	27
7.2-115	22	7.4-4	27	7.7-11	27
7.2-116	22	7.4-5	27	7.7-12	27
7.2-117	22	7.4-6	27	7.7-13	27
7.2-118	22	7.4-7	27	7.7-14	27
7.2-119	22	7.4-8	27	7.7-15	27
7.2-120	22	7.4-9	27	7.7-16	27
7.2-121	22			7.7-17	27
7.2-122	22	7.5-1	19	7.7-18	27
7.2-123	22	7.5-2	19	7.7-19	27
7.2-124	22	7.5-3	19	7.7-20	27
7.2-125	22	7.5-4	19	7.7-21	27
7.2-126	22	7.5-5	19	7.7-22	27
		7.5-6	19		

ARKANSAS NUCLEAR ONE
Unit 2

RECORD OF REVISIONS (continued)

<u>PAGE #</u>	<u>AMENDMENT #</u>	<u>PAGE #</u>	<u>AMENDMENT #</u>	<u>PAGE #</u>	<u>AMENDMENT #</u>
CHAPTER 7 (CONT.)		CHAPTER 7 (CONT.)		CHAPTER 7 (CONT.)	
7.8-1	28	7.8-46	28	7.8-91	28
7.8-2	28	7.8-47	28	7.8-92	28
7.8-3	28	7.8-48	28	7.8-93	28
7.8-4	28	7.8-49	28	7.8-94	28
7.8-5	28	7.8-50	28	7.8-95	28
7.8-6	28	7.8-51	28	7.8-96	28
7.8-7	28	7.8-52	28	7.8-97	28
7.8-8	28	7.8-53	28	7.8-98	28
7.8-9	28	7.8-54	28	7.8-99	28
7.8-10	28	7.8-55	28	7.8-100	28
7.8-11	28	7.8-56	28	7.8-101	28
7.8-12	28	7.8-57	28	7.8-102	28
7.8-13	28	7.8-58	28	7.8-103	28
7.8-14	28	7.8-59	28	7.8-104	28
7.8-15	28	7.8-60	28	7.8-105	28
7.8-16	28	7.8-61	28	7.8-106	28
7.8-17	28	7.8-62	28	7.8-107	28
7.8-18	28	7.8-63	28	7.8-108	28
7.8-19	28	7.8-64	28	7.8-109	28
7.8-20	28	7.8-65	28	7.8-110	28
7.8-21	28	7.8-66	28	7.8-111	28
7.8-22	28	7.8-67	28	7.8-112	28
7.8-23	28	7.8-68	28	7.8-113	28
7.8-24	28	7.8-69	28	7.8-114	28
7.8-25	28	7.8-70	28	7.8-115	28
7.8-26	28	7.8-71	28	7.8-116	28
7.8-27	28	7.8-72	28	7.8-117	28
7.8-28	28	7.8-73	28	7.8-118	28
7.8-29	28	7.8-74	28	7.8-119	28
7.8-30	28	7.8-75	28	7.8-120	28
7.8-31	28	7.8-76	28	7.8-121	28
7.8-32	28	7.8-77	28	7.8-122	28
7.8-33	28	7.8-78	28	7.8-123	28
7.8-34	28	7.8-79	28	7.8-124	28
7.8-35	28	7.8-80	28	7.8-125	28
7.8-36	28	7.8-81	28	7.8-126	28
7.8-37	28	7.8-82	28	7.8-127	28
7.8-38	28	7.8-83	28	7.8-128	28
7.8-39	28	7.8-84	28	7.8-129	28
7.8-40	28	7.8-85	28	7.8-130	28
7.8-41	28	7.8-86	28	7.8-131	28
7.8-42	28	7.8-87	28	7.8-132	28
7.8-43	28	7.8-88	28	7.8-133	28
7.8-44	28	7.8-89	28	7.8-134	28
7.8-45	28	7.8-90	28	7.8-135	28

ARKANSAS NUCLEAR ONE
Unit 2

RECORD OF REVISIONS (continued)

<u>PAGE #</u>	<u>AMENDMENT #</u>	<u>PAGE #</u>	<u>AMENDMENT #</u>	<u>PAGE #</u>	<u>AMENDMENT #</u>
CHAPTER 7 (CONT.)		CHAPTER 7 (CONT.)		CHAPTER 7 (CONT.)	
7.8-136	28	F 7.2-34	18		
7.8-137	28	F 7.2-35	20		
7.8-138	28	F 7.2-36	20		
7.8-139	28	F 7.2-37	20		
7.8-140	28	F 7.2-38	20		
7.8-141	28	F 7.2-39	20		
7.8-142	28	F 7.2-43	19		
7.8-143	28	F 7.2-44	20		
7.8-144	28				
7.8-145	28	FMEA DIAG #1	20		
7.8-146	28	FMEA DIAG #2	20		
7.8-147	28	FMEA DIAG #2A	20		
7.8-148	28	FMEA DIAG #3	20		
7.8-149	28	FMEA DIAG #13	20		
7.8-150	28	FMEA DIAG #14	20		
7.8-151	28	FMEA DIAG #15	20		
7.8-152	28	FMEA DIAG #16	20		
7.8-153	28	FMEA DIAG #17	20		
7.8-154	28	FMEA DIAG #18	20		
7.8-155	28	FMEA DIAG #19	20		
7.8-156	28	FMEA DIAG #19A	20		
7.8-157	28				
7.8-158	28	F 7.3-1A	20		
7.8-159	28				
7.8-160	28	F 7.4-3	24		
7.8-161	28				
7.8-162	28	F 7.6-1	20		
7.8-163	28	F 7.6-2	20		
7.8-164	28	F 7.6-3	20		
7.8-165	28	F 7.6-4	20		
7.8-166	28	F 7.6-5	20		
		F 7.6-6	20		
F 7.2-1	20				
F 7.2-2	20	F 7.7-1	20		
F 7.2-3	20	F 7.7-2	20		
F 7.2-4	20	F 7.7-3	20		
F 7.2-5	20	F 7.7-4	20		
F 7.2-13	20	F 7.7-5	20		
F 7.2-14	19	F 7.7-6	20		
F 7.2-15	20	F 7.7-7	19		
F 7.2-26	20	F 7.7-8	19		
F 7.2-27	20				
F 7.2-28	20				
F 7.2-32	20				
F 7.2-33	20				

7 INSTRUMENTATION AND CONTROLS

7.1 INTRODUCTION

The instrumentation and control systems which monitor and perform safety-related functions are discussed in Chapter 7. Complete descriptions and analyses of these systems are provided in Sections 7.2 through 7.6.

7.1.1 IDENTIFICATION OF SAFETY-RELATED SYSTEMS

The safety-related instrumentation and controls, including supporting systems, are identified below. The responsibility for design and supply of each system is identified as follows:

Combustion Engineering, Inc.	(CE)
Bechtel	(B)

7.1.1.1 Plant Protection System (PPS)

The PPS includes the electrical and mechanical devices and circuitry (from sensors to actuation device input terminals) involved in generating signals associated with the two protective functions defined below.

A. Reactor Protective System (Reactor Trip System) (CE)

The Reactor Protective System (RPS) is that portion of the PPS which generates signals that actuate reactor trip. A description of the RPS, detailing the functions of the system modules is found in Section 7.2.

B. Engineered Safety Features Actuation System (CE)

The Engineered Safety Features Actuation System (ESFAS) is that portion of the PPS which generates signals that actuate Engineered Safety Features (ESF). This system is a part of the ESF systems. Details of the actuation system modules are found in Section 7.3.

The ESF systems actuated by the ESFAS are listed below:

1. Containment Isolation System (CIS) (B)
2. Containment Spray System (CSS) (B)
3. Containment Cooling System (CCS) (B)
4. Safety Injection System (SIS) (CE)
5. Penetration Room Ventilation System (PRVS) (B)
6. Main Steam Isolation (MSI) (CE)
7. Emergency Feedwater (EFW) (CE)

The instrumentation and controls for ESF systems are described in Section 7.3. Supporting systems are discussed in Section 7.4.

ARKANSAS NUCLEAR ONE
Unit 2

7.1.1.2 Systems Required for Safe Shutdown

The systems required for safe shutdown include those systems which may be required to secure and maintain the reactor in a hot shutdown condition.

The systems are listed below:

- A. Emergency Power Systems (B)
 - 1. Emergency Diesel Generator (B)
 - 2. Fuel Oil Storage Transfer System (B)
 - 3. Emergency Power Distribution System (B)
- B. Emergency Feedwater System (B)
- C. Chemical and Volume Control System (CVCS) (CE)
(Boron Addition Portion)
- D. Service Water System (SWS) (B)

Note: A and B are required in the event normal power sources are unavailable. C is downgraded and not "required" for safe shutdown, but available.

The instrumentation and controls for the systems required for safe shutdown are described in Section 7.4.

Auxiliary systems vital to the proper functioning of safety-related systems are designed to the same criteria as those for the safety-related systems that they support, including compliance with applicable portions of IEEE 279-1971 and IEEE 308-1971. This compliance is shown in Section 7.4 and other applicable sections in the auxiliary systems description.

7.1.1.3 Safety-Related Display Instrumentation

The safety-related display instrumentation provides information to the operator to allow him to adequately monitor plant operating conditions and to perform any required manual safety functions.

Most of this instrumentation is supplied by CE. This instrumentation is described in Section 7.5.

7.1.1.4 Other Systems Required for Safety

Other systems required for safety include the interlocks required to prevent overpressurization of the Shutdown Cooling System and to assure safety injection is available. These are provided as listed below.

- A. Shutdown Cooling Interlocks (CE, B)
- B. Safety Injection Tank Isolation Valve Interlocks (CE, B)
- C. Refueling Interlocks (CE)

These systems are described in Section 7.6.

ARKANSAS NUCLEAR ONE
Unit 2

7.1.1.5 Comparison - Reactor Protective System

Historical data removed - To review the exact wording please refer to Section 7.1.1.5 through 7.1.1.8 of the FSAR.

7.1.2 IDENTIFICATION OF SAFETY CRITERIA

The design bases, criteria, regulatory guides, standards and other documents that are implemented in the design of the systems listed in Section 7.1.1 are included in each of the subsections describing the system (See Sections 7.2 through 7.6).

7.1.2.1 Design Bases

The design bases for the safety-related instrumentation and control of each safety-related system are presented in the section of this chapter that discusses the system to which the information applies. The criteria for systems required for safe shutdown are described in Chapters 8, 9, and 10 as appropriate.

In particular, the instrumentation and controls for the RPS and ESF systems conform to the following:

- A. Actuation systems conform to the IEEE Criteria for Nuclear Power Plant Protection Systems (IEEE 279-1971);
- B. Actuation systems are designed using the IEEE Trial - Use Criteria for the Periodic Testing of Nuclear Power Generating Station Protection Systems (IEEE 338-1971) as a guide;
- C. Systems are designed using the IEEE 336-1971, "Installation, Inspection and Testing Requirements for Instrumentation, and Electric Equipment during the Construction of Nuclear Power Generating Systems" as a guide;
- D. Design bases as described in Sections 7.2.1 and 7.3.1.2;
- E. Quality assurance procedures as described in the Quality Assurance Program Manual (QAPM);
- F. "General Design Criteria for Nuclear Power Plants," Appendix A to 10 CFR 50, July 7, 1971, as described in Sections 7.2.2 and 7.3.2.

7.1.2.2 Independence of Redundant Safety-Related Systems

Channels that provide signals for the same protective function are designed to meet the independence and separation requirements of Section 4.6 of IEEE 279-1971.

The cabling which is associated with redundant channels of vital circuits for the RPS and the ESFAS are physically separated to preserve the redundancy and to prevent a single event from causing multiple channel malfunction or interactions between channels.

Separation between redundant channels begins with the physical separation of the sensors. Separation of the wiring is discussed in Section 8.3.1.4.

ARKANSAS NUCLEAR ONE
Unit 2

Separation within the PPS cabinet is provided by barriers within the panel. These barriers within the cabinet run the full depth and full vertical dimension. All cabling entering each barriered section of the panel is separated as it enters the cabinet.

The reactor trip switchgear, which interrupts power to the coils of the Control Element Drive Mechanisms (CEDMs), is contained in a single cabinet which is separated into four sections to ensure separation of protection signals.

The ESFAS is provided with two independent and separate relay cabinets which maintain separation between the two actuation trains.

7.1.2.3 Physical Identification of Safety-Related Equipment

Physical identification is provided to enable plant personnel to recognize that RPS and ESF system equipment are safety-related.

The PPS cabinet is identified by a nameplate. A color coding scheme is used for identification of physically separated channels within the cabinet and channel wiring. The channel identification plates on each section of the PPS cabinet, front and back, shall be color coded as follows:

Channel 1:	Red
Channel 2:	Green
Channel 3:	Yellow
Channel 4:	Blue

Wiring bringing signal inputs into the PPS cabinet is color coded as listed above. Intercabinet wiring ducts or conduits will also be color coded. Identification of cables is made at the terminal points.

All nonpanel mounted protective components are identified with a name tag which provides the channel number and the suffix 1, 2, 3 and 4 to specifically identify the protective channel with which the component is identified.

For additional information concerning physical identification of safety equipment, see Section 8.3.1.5.

7.1.2.4 Conformance to IEEE 317

Conformance to IEEE 317 is discussed in Sections 8.3.1.1.13 and 8.3.1.2.

7.1.2.5 Conformance to IEEE 323

All RPS and ESFAS equipment is qualified for use using the intent of IEEE 323-1971 as a guide. Descriptions of the seismic and environmental qualification of Class 1E equipment are provided in Sections 3.10 and 3.11.

7.1.2.6 Conformance to IEEE 336 (Regulatory Guide 1.30, Revision 0 August 1972)

Information is provided throughout this report concerning installation, inspection and testing of equipment.

ARKANSAS NUCLEAR ONE
Unit 2

IEEE 336-1971, "Installation, Inspection, and Testing Requirements for Instrumentation and Electric Equipment During the Construction of Nuclear Power Generating Stations," is discussed in Section 8.3.1.3.

7.1.2.7 Conformance to IEEE 338

The RPS and ESFAS are periodically tested, using criteria described in IEEE 338-1971, "Periodic Testing of Nuclear Power Generating Station Protection Systems," as a guide. The response time test (Section 4.1 of IEEE 338) is checked during preoperational testing and as required by the Technical Specifications.

7.1.2.8 Conformance to Regulatory Guide 1.22

The RPS and ESFAS can both be fully tested during reactor operation. Conformance of the RPS and the ESFAS to the recommendations contained in Regulatory Guide 1.22, "Periodic Testing of Protection System Actuator Functions," is discussed in Sections 7.2.1.1.9 and 7.3.1.1.9, respectively.

7.1.2.9 Conformance to Regulatory Guide 1.47

7.1.2.9.1 Reactor Protective System and Engineered Safety Features Actuation System

The RPS and the ESFAS as described in Section 7.1.1.1 conform to the requirements of Regulatory Guide 1.47, "Bypassed and Inoperable Status Indication for Nuclear Power Plant Safety Systems." This conformance is described below.

Bypasses can be classified into two groups: operating bypasses and trip channel bypasses.

Operating bypasses include the RPS/ESFAS pressurizer pressure bypass, the RPS/ESFAS high/low steam generator level bypass, the ESFAS RWT level bypass, the high log power bypass and the DNBR/LPD trip bypass. The trip channel bypasses are those bypasses used for maintenance and testing. The trip channel bypasses are also provided to remove a trip channel from service for an extended period without affecting plant safety or availability in the event of an equipment failure not readily repairable or accessible. Both types of bypasses have the following features:

- A. All means of bypassing the PPS are expected to occur as frequently as once per year.
- B. Bypass indicators are located adjacent to or near the initiating switch. In addition, contacts are provided from each bypass logic circuit to the plant annunciator system for audible alarm.
- C. The bypass indicators are designed to meet safety system criteria such as: testability by varying input signals (using the PPS testing system) and observing the indicators and bistables; redundancy by supplying bypass and normal indicators in addition to plant annunciators; and channel separation by keeping the indicators within the channel boundaries.

ARKANSAS NUCLEAR ONE
Unit 2

- D. Credible failures occurring within the plant annunciation system are isolated at the switch or relay contact level in order to prevent them from affecting a bypass. In addition, permissives must also be in effect before the bypass can occur. Credible failures occurring at the bypass indicators will only affect one channel due to separation of channels.
- E. All bypass indicators and plant annunciators are capable of being tested during normal system operation.
- F. A single failure within a bypass channel can cause one of the following erroneous bypass indications:
 - 1. Operating Bypasses

Burned out bypass indicator lights. When the operator bypasses a channel, both normal and bypass indicators will be extinguished, but control room annunciators will function.
 - 2. Trip Channel Bypasses

Shorted bypass indicator contact. This will indicate a bypass condition, but the bypass will not be in effect. The operator can initiate and remove the bypass. Plant annunciator will still function.

Open circuit to bypass indicator or burned out indicator. The operator can still initiate and remove the bypass. It will be annunciated in the control room.

Operating Bypasses

The operating bypasses are used during routine startup and shutdown. These bypasses must be manually inserted. The RPS/ESFAS pressurizer pressure bypass and the RWT low level bypass utilize a permissive contact input generated by pressurizer pressure to insure the bypass is removed if plant conditions deviate from the point where the bypass is no longer safe. The RPS/ESFAS high/low steam generator level bypass utilizes a permissive contact input generated by RCS temperature to insure removal of the bypass prior to entering Mode 3. Once the bypasses are automatically removed, they will not be reinstated until the permissive conditions return and the bypass switch is returned to the bypass position. Indicator lamps are provided in the bypass circuit to monitor directly the application of the bypass. Indicator lamps are also provided to display the presence of the permissive signals. These indicator lamps are located on the PPS Remote operator's modules. Annunciation is provided on the main control boards if a bypass in any channel is instated.

Operating bypasses on the remote operator's modules include the RPS/ESFAS pressurizer pressure bypass, RPS/ESFAS high/low steam generator level bypass, ESFAS RWT level bypass, and the high logarithmic power bypass.

Trip Channel Bypasses

These bypasses are utilized to individually bypass channel trip inputs to the protection system logic for maintenance or testing. The trip channel bypasses are also provided to remove a trip channel from service for an extended period without affecting plant safety or availability in the

ARKANSAS NUCLEAR ONE
Unit 2

event of an equipment failure not readily repairable or accessible. The trip logic is converted from a 2-out-of-4 to a 2-out-of-3 logic for the parameters being bypassed. Only one channel for any one parameter may be bypassed at any one time. This is accomplished by electrically interlocking the manual bypass switches. These bypasses must be manually initiated and removed. Individual bypass indicator lights are provided locally at the PPS cabinet and at the remote operator's modules located in the control room. The wiring for these indicators is run within their respective channels so that faults in any one module will not affect the other channel bypass indication or bypass. A separate signal is provided to the plant annunciator when any trip channel bypass is present.

7.1.2.9.2 Auxiliary and Supporting Systems

In addition to the RPS and the ESFAS which conform to the requirements of Regulatory Guide 1.47, systems actuated or controlled by the protection system and auxiliary or supporting systems that must be operable to support the protection system have been designed to comply with Regulatory Guide 1.47, "Bypassed and Inoperable Status Indication for Nuclear Power Plant Safety Systems," as supplemented by the following statement:

Positions 2, 3(b) and 3(c) of Regulatory Guide 1.47 are supplemented as follows:

- A. The design criteria for the indication system (Position 2) reflects the importance of both providing accurate information for the operator and reducing the possibility for the indicating equipment to adversely affect the monitored safety systems. In developing the design criteria, the following were considered:
1. The bypass indicators have been arranged to enable the operator to readily assess the operating status of each safety system and determine whether continued reactor operation is permissible.
 2. When a protective function of a shared system can be bypassed, indication of that bypass condition should be provided in the control room of each affected unit. No shared systems have protective functions for Arkansas Nuclear One - Unit 2.
 3. Means by which the operator can cancel erroneous bypass indications, if provided, should be justified by demonstrating that the postulated causes of erroneous indication cannot be eliminated by another practical design. No means have been provided by which the operator could cancel a bypass indication until the condition which initiated the bypass has been corrected.
 4. The indication system has not been designed in conformance with criteria established for safety systems. Administrative procedures will not require immediate operator action based solely on the bypass indications.
 5. The indication system has been designed and will be installed in a manner which precludes the possibility of adverse effects on the plant's safety systems. Failure or bypass of a protection function will not be a credible consequence of failure occurring in the indication equipment and the bypass indication will not reduce the required independence between redundant safety systems.
 6. The indication system has the capability of assuring its operable status to the extent that the indicating and/or annunciating function can be verified. Administrative controls will be employed to ensure that the availability of the safety-related systems is not significantly degraded by the conduct of tests during plant operation.

ARKANSAS NUCLEAR ONE
Unit 2

Additional information on conformance to Regulatory Guide 1.47 is contained in Section 8.3.1.2.

7.1.2.10 Conformance to IEEE 379-1972

The instrumentation and processing electronics associated with the RPS and the ESFAS conform to the requirements of IEEE 379-1972, "IEEE Trial Use Guide for the Application of the Single Failure Criterion to Nuclear Power Generating Station Protective Systems." A discussion of the single failure criterion is provided in Sections 7.2.2.3.2 and 7.3.2.2.2.

7.1.2.11 Conformance to Regulatory Guide 1.62

Manual initiation of the RPS and ESFAS is in conformance with the requirements of Regulatory Guide 1.62, "Manual Initiation of Protective Actions." Manual initiation of the RPS is described in Sections 7.2.1.1.1.12 and 7.2.2.3.2. Manual initiation of the ESFAS is described in Section 7.3.2.2.2.

7.1.2.12 Conformance to Regulatory Position on the Application of the Single Failure Criterion to Manually Controlled Electrically Operated Valves

Fluid systems have been examined to identify all manually controlled electrically operated valves for which a single failure, including the failure of any active or passive electrical component, could result in a loss of system safety function. There are no such valves.

7.2 REACTOR PROTECTIVE SYSTEM (REACTOR TRIP SYSTEM)

7.2.1 DESCRIPTION

7.2.1.1 System Description

The Reactor Protective System (RPS) consists of sensors calculators, logic, switchgear and other equipment necessary to monitor selected Nuclear Steam Supply System (NSSS) conditions and to effect reliable and rapid reactor shutdown (reactor trip) if any one or a combination of the monitored conditions reach a limiting safety system setting. The system functions are to protect the core (fuel design limits) and Reactor Coolant System (RCS) pressure boundary for anticipated operational occurrences.

Four measurement channels, with electrical and physical separation, are provided for each parameter used in the generation of trip signals, with the exception of CEA positions. (See Sections 7.2.1.1.2.2 and 7.2.1.1.2.5) A 2-out-of-4 coincidence of like trip signals is required to generate a reactor trip signal.

These same features include the capability of the RPS to operate, if need be, with up to two channels out of service (one bypassed and another tripped) and still meet the single failure criteria. The only operating restriction while in this condition (effectively one-out-of-two logic) is that no provision is made to bypass another channel for periodic maintenance. The system logic must be restored to at least a two-out-of-three condition prior to removing another channel for maintenance.

A reactor trip signal serves to de-energize the Control Element Drive Mechanism (CEDM) coils, allowing the shutdown and regulating CEAs to drop into the core. Undervoltage relays in the Control Element Drive Mechanism Control System (CEDMCS) provide a simultaneous trip signal to the turbine and Feedwater Control System (FWCS). Since this trip is equipment protective only, it is not designed in accordance with criteria established for safety-related equipment.

A manual reactor trip is also provided.

Comparison of the trip setpoints and instrument ranges presented in Table 7.2-4 indicates that the RPS setpoints do not fall within the upper or lower 10 percent of the instrument range.

The Core Protection Calculator (CPC) System process inputs are monitored over their entire range of operation to compute the core DNBR and local power density. The acceptability of the CPC system input monitoring ranges is discussed in Section 7.2.1.1.2.5.

A discussion of the RPS seismic and environmental qualification is found in Sections 3.10.2 and 3.11.2, respectively.

A discussion of the RPS testability is found in Section 7.2.1.1.9.

7.2.1.1.1 Trips

7.2.1.1.1.1 High Linear Power Level

The high linear power level trip is provided to trip the reactor when indicated neutron flux power reaches a preset value. The flux signal used is the average of the three linear subchannel flux signals originating in the nuclear instrument safety channel. The allowable trip setpoint is shown in Table 7.2-4.

ARKANSAS NUCLEAR ONE
Unit 2

Pre-trip alarms are initiated below the trip value to provide audible and visual indication of approach to a trip condition.

7.2.1.1.1.2 High Logarithmic Power Level

The high logarithmic power level trip is provided to trip the reactor when indicated neutron flux power reaches a preset value. The flux signal used is the logarithmic power signal originating in each nuclear instrument safety channel. The allowable trip setpoint is shown in Table 7.2-4. The trip may be manually bypassed by the operator as shown in Table 7.2-1.

Pre-trip alarms are initiated below the trip value to provide audible and visual indication of approach to a trip condition. The trip bypass also bypasses the pre-trip alarms.

7.2.1.1.1.3 High Local Power Density

The high Local Power Density (LPD) trip is provided to trip the reactor when calculated core peak LPD reaches a preset value. The calculation of the peak LPD is performed by the CPCs, which compensate the calculated peak LPD to account for the thermal capacity of the fuel. A trip results if the compensated peak LPD reaches the preset value. The calculated trip assures a core peak LPD below the safety limit for peak fuel centerline temperature (°F). The allowable trip setpoint is given in Table 7.2-4. The effects of core burnup are considered in the determination of the LPD trip.

Pre-trip alarms are initiated below the trip value to provide audible and visual indication of approach to a trip condition.

7.2.1.1.1.4 Low DNBR

The low DNBR trip is provided to trip the reactor when the calculated Departure from Nucleate Boiling Ratio (DNBR) approaches the preset value. The calculation of DNBR is performed by the CPC based on core average power, reactor coolant pressure, reactor inlet temperature, reactor coolant flow, and the core power distribution. The calculated trip setpoint includes allowances for sensor and processing time delays and inaccuracies. These allowances ensure that a trip is generated within the CPC before the minimum DNBR is exceeded in the limiting coolant channel in the core during an anticipated operational occurrence.

Pre-trip alarms are initiated above the trip value to provide audible and visual indication of approach to a trip condition. The trip setpoint is listed in Table 7.2-4.

7.2.1.1.1.5 High Pressurizer Pressure

The high pressurizer pressure trip is provided to trip the reactor when measured pressurizer pressure reaches a preset value. The allowable trip setpoint is shown in Table 7.2-4.

Pre-trip alarms are initiated below the trip setpoint to provide audible and visual indication of approach to a trip condition.

7.2.1.1.1.6 Low Pressurizer Pressure

The low pressurizer pressure trip is provided to trip the reactor when the measured pressurizer pressure falls to a preset value. The allowable trip setpoint is shown in Table 7.2-4 for normal operation. At pressures within 200 psia above the trip setpoint, this trip setpoint can be manually decreased to 200 psia below the existing pressurizer pressure, to a minimum value of

ARKANSAS NUCLEAR ONE
Unit 2

100 psia. This ensures the capability of a trip when required during plant cooldown. The trip setpoint can be manually bypassed as shown in Table 7.2-1. The bypass is automatically removed as pressure is increased above a fixed value and the low pressure setpoint automatically increases, maintaining the fixed increment between the plant pressure and the setpoint. These values are shown in Table 7.2-4.

Pre-trip alarms are initiated above the trip setpoint.

7.2.1.1.1.7 Low Steam Generator Water Level

The low steam generator water level trip is provided to trip the reactor when measured steam generator water level falls to a preset value. Separate trips are provided from each steam generator. The allowable trip setpoint is shown in Table 7.2-4.

To assure that the accuracy of the level instrumentation is sufficient to initiate a timely trip during a steam generator blowdown such as during a steam or feedwater line break, an investigation was made of the effect on level sensing accuracy from rapid depressurization of the secondary side of the steam generator and the possible subsequent flashing of water in the reference leg of the level instrumentation.

Two cases were considered, the first being a change in secondary pressure representative of the range evaluated for the main steam line break accident from full power pressure to the low pressure trip. The second case involves a change in secondary pressure from an assumed zero power pressure to the same trip pressure. These represent the maximum change in pressure which could occur prior to another trip being generated, i.e. low pressure.

The level reference legs are connected to the steam generator via a small diameter pipe and a condensation pot. The pipe, the condensation pot and the level reference legs are un-insulated to enhance heat transfer to the surrounding environment. The initial temperature profile in the reference leg was conservatively calculated assuming that all of the liquid in the condensation pot and the liquid at the top of the level reference leg were at the saturation temperature for the initial steam generator pressure.

Additional assumptions in calculation of the temperature profile were that the containment atmosphere surrounding the reference leg is at 120 °F and that heat transfer to atmosphere was by natural convection with a conservatively low film heat transfer coefficient. With these assumptions temperature profiles were calculated for the full load and no load cases, respectively.

The effects of varying fluid pressure and flashing of the reference leg to steam have been considered. The effects of flashing in the reference leg were negligible. Ambient temperature effects on the reference leg were considered in the development of setpoints.

The trip setpoint can be manually bypassed as shown in Table 7.2-1. The bypass is automatically removed as reactor coolant temperature rises above a fixed value.

Pre-trip alarms are initiated above the trip setpoint.

7.2.1.1.1.8 Low Steam Generator Pressure

The low steam generator pressure trip is provided to trip the reactor when the measured steam generator pressure falls to a preset value. Separate trips are provided from each steam generator. The allowable trip setpoint during normal operation is shown in Table 7.2-4. At steam generator pressures within 200 psi above this setpoint, the operator has the ability of

ARKANSAS NUCLEAR ONE
Unit 2

manually decreasing the setpoint to 200 psia below the existing system pressure to permit plant cooldown. During any plant operations which cause an increase in steam generator pressure, the setpoint is automatically increased to 200 psia below steam generator pressure, until the setpoint reaches the normal operating setting.

Pre-trip alarms are initiated to provide audible and visual indication of approach to a trip condition.

7.2.1.1.1.9 High Containment Pressure

The high containment pressure trip is provided to trip the reactor when measured containment pressure reaches a preset value below the allowable limit shown in Table 7.2-4.

Pre-trip alarms are initiated to provide audible and visual indication of approach to a trip condition.

7.2.1.1.1.10 Loss of Load

The loss of load trip has been deleted from the RPS design.

7.2.1.1.1.11 High Steam Generator Level

A high steam generator water level trip is provided to trip the reactor when measured steam generator water level rises to a high preset value. Separate trips are provided from each steam generator. The design criterion for this trip is that a reactor trip will be initiated upon reaching the high water level trip setpoint to ensure that excessive moisture carryover will not occur. The high steam generator level allowable trip setpoint is shown in Table 7.2-4. The trip is an equipment protective trip only and is not required for plant safety.

Since credit is not taken for equipment protective trips in the safety analysis of the plant, they do not fall within the scope of IEEE 279-1971. However, in order to preserve uniformity of function and design, the high steam generator level trip function meets the design bases listed in Section 7.2.1.2. The high steam generator level trip is incorporated in the same manner as any other trip function, i.e., four separated, redundant, testable channels, and meets all the requirements of IEEE 279-1971.

The trip setpoint can be manually bypassed as shown in Table 7.2-1. The bypass is automatically removed as reactor coolant temperature rises above a fixed value.

Pre-trip alarms are initiated to provide audible and visual indication of approach to a trip condition.

7.2.1.1.1.12 Manual Trip

A manual reactor trip is provided to permit the operator to trip the reactor. Actuation of two adjacent pushbutton switches in the control room will cause interruption of the AC power to the CEDM power supplies. Two sets of trip pushbuttons are provided. These switches actuate the required sets of trip circuit breakers which directly interrupt power to the CEDMs. The pairs of switches AD and BC are located in the main control room on different panels. Actuation of either pair will effect a full reactor trip at the system level. This RPS manual trip initiation feature is in complete conformance with Regulatory Guide 1.62, "Manual Initiation of Protective Actions."

ARKANSAS NUCLEAR ONE
Unit 2

7.2.1.1.2 Initiation Circuits

7.2.1.1.2.1 Process Measurements

Various pressures, levels and temperatures associated with the NSSS and the containment building are continuously monitored to provide signals to the RPS trip bistables. All protective parameters are measured with four independent and isolated process instrument channels.

A typical protective channel, as shown in Figure 7.2-1, consists of a sensor and transmitter, instrument power supply and current loop resistors, indicating meter and/or recorder, and trip bistable/calculator inputs.

The piping, wiring, and components of each channel are physically and electrically separated from that of other like protective channels to provide independence. The output of each transmitter is typically an ungrounded current loop which has a live zero. The nuclear instruments provide a pulsed and current signal. The RCP speed sensors provide a pulsed signal. Signal isolation is provided for computer inputs and control board indicators. Each channel is powered from a separate vital bus.

7.2.1.1.2.2 Control Element Assembly Position Measurements

The position of each CEA is an input to the RPS. These positions are measured by means of two reed switch assemblies on each CEA.

Each reed switch assembly consists of a series of magnetically actuated reed switches spaced at intervals along the CEA housing and wired with precision resistors in a voltage divider network. A magnet attached to the CEA extension actuates the adjacent reed switches, causing voltages proportional to position to be transmitted for each assembly. The two reed switch assemblies and associated cables of each CEA are physically and electrically isolated from each other. Each reed switch position cable is enclosed in a flexible stainless steel sheath between the CEA and the connector bulkhead.

The position signals are used as inputs to the CPC system. (See Section 7.2.1.1.2.5 for further details.) Either set of reed switch assemblies on each CEA can be selected for monitoring in the control room through a selector switch.

The CEA position reed switch system is designed, manufactured, tested and installed to the identical design, quality assurance and testing criteria as the remainder of the signal generation and processing equipment for signals utilized by the RPS. The reliability of the CEA position signal is assured in two ways, by proper design and manufacture, as detailed above, and by proper utilization within the RPS.

Each CEA is instrumented by redundant CEA reed switch position transmitters.

The CEA Reed Switch Position Transmitter Assemblies (RSPTs) contain circuits which provide analog CEA position information to the CPCs and the CEA Calculators (CEACs) as described in Section 7.2.1.1.2.5. The RSPTs also contain three discrete CEA position switches which provide signals (contact closure) to the CEDMCS. The discrete CEA position switches provide information that the CEA has reached either its Upper Electrical Limit of Travel (UEL), its Lower Electrical Limit of Travel (LEL) or has tripped to its fully inserted rod bottom (DR) position. The UEL and LEL circuits provide signals to terminate CEA motion when these limits are reached.

ARKANSAS NUCLEAR ONE
Unit 2

Failure of these circuits to perform is not a safety-related concern since mechanical stops are provided. The rod bottom switch serves only to indicate that the CEA has reached its lower mechanical limit of travel and is fully inserted. None of these circuits are used to initiate a control action. Therefore, the independence criterion of Section 4.7.3 of IEEE 279 does not apply. The CEA position indication system is further described in Section 7.5.1.4.

The three discrete reed switch position signals are contained within the same RSPT housing as the analog CEA position signals but the circuits are physically separated with separate power supplies, reed switches and electrical wiring. Due to physical constraints in the reactor vessel head area, both the analog and digital signals are transmitted in separate conductors within the same cable assembly from the reactor vessel head to a point outside of containment. The discrete position information cable is then separated from the safety-related cable which goes to the CPCs. From this point to the CEDMCS the discrete position information cable is maintained separated from high voltage sources. The cables which provide the discrete position information signals originate from either Channel C or D. A total of 61 cables originate from Channel C. The remaining 20 cables originate from Channel D. (These two groups of cables are maintained separated and are routed in separate raceways. Power and control cables are excluded from these raceways.) The cabling then enters the CEDMCS in an area which is separated from the power section of the CEDMCS cabinet.

The method of cabling of the RSPTs is considered acceptable due to three major design provisions.

- A. The CEDMCS is decoupled from the reed switch cabling by means of relay isolation of the limit contacts and physical separation of the power portion of the CEDMCS from the limit switch interface.
- B. The interconnecting cabling is kept separated from power and control cables.
- C. The CPC system data acquisition equipment is designed to reject noise that might be coupled into signal lines.

The capability of the CPCs to reject noise was verified by suitable testing in an Electro Magnetic Interference (EMI) environment.

One set of the redundant signals for all CEAs is monitored by one CEAC and the other set of CEAs by the redundant CEAC.

The CEAs are arranged into control groups that consist of sets of CEAs that are symmetric about the core center. These groups are required to move together and should always indicate the same CEA position.

Each CEAC monitors the position of all CEAs within each control group. Should a CEA deviate from the group position, the CEACs will monitor the event, sound an annunciator and transmit appropriate "penalty" factors to the CPCs. This assures correct operation of the RPS as any credible failure of a CEA reed switch assembly will result in an immediate operator alarm.

The CEACs display the position of each regulating and shutdown CEA to the operator in a bar chart format on the Channel B or Channel C CPC operators module.

The CPCs utilize selected CEA position reed switch signals as a measure of subgroup and group CEA position. The CPCs assess CEA deviation information from each CEA calculator to modify calculation results in an appropriate manner should a deviating CEA be indicated by either CEAC.

ARKANSAS NUCLEAR ONE
Unit 2

The detailed signal paths of CEA position intelligence within the RPS are shown in Figure 7.2-32. Figure 7.2-14 details the overall signal paths of all CEA position information. As shown in Figure 7.2-14, a separate CEA position system, which counts the CEA motion demand pulses for each CEA, is utilized for the plant computer functions, including the Core Operating Limit Supervisory System (COLSS) function.

The plant computer calculates CEA group average positions. Individual and group positions are available for display on the plant computer.

7.2.1.1.2.3 Ex-Core Neutron Flux Measurements

The ex-core nuclear instrumentation includes neutron detectors located around the reactor core and signal conditioning equipment located in the auxiliary building. Neutron flux is monitored from source levels through full power and signal outputs are provided for reactor protection and for information display. There are six channels of instrumentation: two are startup channels and four are safety channels. See Figure 7.2-2.

The four safety channels provide neutron flux information from startup neutron flux levels to 200 percent of rated power covering a single range of approximately 10^{-8} to 200 percent power (10 decades). Each safety channel consists of three fission chambers, a preamplifier and a signal conditioning drawer containing power supplies, a logarithmic amplifier (including combination counting and mean square variation techniques), linear amplifiers, test circuitry and a rate-of-change of power circuit. These channels feed the RPS and provide information for rate of change of power display, DNBR, local power density, and overpower protection.

The detector assembly provided for each safety channel consists of three identical fission chambers stacked vertically along the length of the reactor core. The use of multiple subchannel detectors in this arrangement permits the measurement of axial power shape during power operation.

The fission chambers are mounted in holder assemblies which in turn are located in four dry instrument wells (thimbles) in the reactor cavity near the biological shield. The wells are spaced around the reactor vessel to provide optimum neutron flux information.

The preamplifiers for the fission chambers of safety channels "A", "B", "C", and "D" are mounted outside the Reactor Building in the Upper South (Rm 2137) Electrical Penetration Room, Upper North (Rm 2133) Electrical Penetration Room, Lower South (Rm 2111) Electrical Penetration Room, and Lower North (Rm 2112) Electrical Penetration Room, respectively. Physical and electrical separation of the preamplifiers and cabling between channels is provided.

7.2.1.1.2.4 Reactor Coolant Flow Measurements

A fuel design limit on DNBR is specified to protect the fuel cladding as discussed in Sections 4.4 and the Technical Specifications.

The PPS provides a trip on low DNBR, as discussed in Section 7.2.1.1.1.4, which ensures that this specified fuel design limit is not exceeded for anticipated operational occurrences. Since DNBR cannot be directly measured, it is calculated as a function of several physical parameters. One of these physical parameters is core coolant mass flow rate.

ARKANSAS NUCLEAR ONE
Unit 2

The mass flow rate is obtained in the RPS using the pump speed inputs from the four Reactor Coolant Pumps (RCPs), and the core inlet and outlet temperatures. The flow rate through each reactor coolant pump is dependent upon the rotational speed of the pump and the pump head. This relationship is typically shown in pump characteristic curves. Flow changes resulting from changes in the loop flow resistance occur slowly due to core crud buildup, increase in steam generator resistance, etc. Calibration of the pump speed signal, relating pump rotational speed to flow, will be performed periodically.

Flow reductions associated with pump speed reductions are more rapid than those produced from loop flow resistance changes. The pump rotational speed signal is converted to a pump flow using mathematical relationships based on pump characteristics and periodic loop flow calibrations.

For those flow transients discussed in Chapter 15, these mathematical relationships are shown to produce a conservative value of flow relative to the flow calculated with the pump transient.

The speed of each RCP motor is measured to provide a basis for calculation of reactor coolant flow through each pump. Two metal discs, each with 44 uniformly spaced holes about its periphery, are scanned by proximity devices. The metal discs are attached to the pump motor shaft, one to the lower portion. Each scanning device produces a voltage pulse signal, the frequency of which is proportional to pump speed. One revolution of the RCP shaft results in the production of 44 distinct pulses. The expected pulse amplitude is 10 volts. The pulse width is a function of the RCP speed. The expected pulse width at an operating speed of 891 rpm is 0.57 millisecond; the time between successive pulses will be 1.52 milliseconds.

These signals are transmitted to the CPCs which compute the flow rate. Adequate separation between probes is provided. The redundant RCP speed sensor circuits have been routed in conformance with Section 8.3.1.4.3. Each channel is powered from a separate vital AC bus. This assures the independence of the redundant speed signals and RPS channels.

The RCP speed measurements are calibrated based on the average time between every "Nth" pulse at a given value of pump speed, where N is adjustable. Since this time is a function of only the pump speed and the number of holes in the disc, recalibration of the pump speed signals will not be required. Periodic observations of the calculated pump speed signals will be performed to assure satisfactory operation of the electronics associated with the speed sensing system.

The loop flow rates (normalized to design flow rates) calculated for each pump are summed to give a normalized core mass flow rate. Further details are provided in Section 7.2.1.1.2.5.

A low DNBR trip, Variable Overpower Trip (VOPT), or RCP low speed trip will be initiated in the event of flow reduction transients caused by pump speed changes such as the 4-pump loss of coolant flow and the single RCP shaft seizure. (See Section 15.1.5) Anticipated flow reductions due to changes in the coolant loop resistance or pump wear occur more slowly and are small in magnitude. These reductions are monitored using instrumentation which is not part of the RCP speed sensing system.

This method for measurement of coolant mass flow rate satisfies Section 4.8 of IEEE 279-1971. It also satisfies the below listed design bases for the anticipated transients and postulated accidents considered in Chapter 15.

ARKANSAS NUCLEAR ONE
Unit 2

- A. A reactor trip will be initiated to ensure the minimum hot channel DNBR will not decrease below the DNBR SAFDL for any anticipated operational occurrence (see Section 15.1.5).
- B. The consequences of the postulated RCP shaft seizure will be no more adverse than the consequences reported in the safety analyses.

The RCP speed measurement system is designed, manufactured, tested and installed to the identical design, quality assurance and testing criteria as the remainder of the signal generation and processing equipment for signals utilized by the RPS.

7.2.1.1.2.5 Core Protection Calculators

General

Four independent CPCs are provided, one in each protection channel. Calculation of DNBR and local power density is performed in each CPC, utilizing the input signals described below. The DNBR and local power density so calculated are compared with trip setpoints for initiation of low DNBR trip (See Section 7.2.1.1.1.4) and a high local power density trip (See Section 7.2.1.1.1.3).

Two independent CEACs are provided as part of the CPC system to calculate individual CEA deviations from the position of the other CEAs in their subgroup.

As shown in Figure 7.2-26, each CPC receives the following inputs: core inlet and outlet temperatures, pressurizer pressure, RCP speed, ex-core nuclear instrumentation flux power (each subchannel from the safety channels), selected CEA position, and single CEA deviation penalty factors from the CEACs. Input signals are conditioned and processed. The following calculations are performed in the CPC and the CEACs:

- A. CEA group and subgroup deviations, single CEA deviations;
- B. Correction of ex-core flux power for shape annealing and CEA shadowing;
- C. Reactor coolant flow rate - from RCP speed;
- D. ΔT power - from reactor coolant temperature and flow information;
- E. Calibrated ex-core flux power - corrected ex-core flux power signals are summed and further compensated to agree with the ΔT power. Although the absolute value of ex-core power level is calibrated to ΔT power, the inherent fast time response of the ex-core signals to power transients is in no way modified;
- F. Axial power distribution - from the corrected ex-core flux power signals;
- G. Fuel rod and coolant channel planar radial peaking factors - selection of predetermined coefficients based on CEA positions;
- H. DNBR;
- I. Comparison of DNBR with a fixed trip setpoint;

ARKANSAS NUCLEAR ONE
Unit 2

- J. Local power density - setpoint value of core average power, which for existing power distribution, corresponds to the acceptable fuel design limit on kW/ft;
- K. Comparison of local power density with a fixed trip setpoint;
- L. CEA deviation alarm;
- M. Variable overpower and comparison of variable overpower with a Variable Overpower Trip (VOPT) setpoint;
- N. Reactor Coolant Pump (RCP) speed and comparison of RCP speed with a minimum RCP speed trip setpoint; and,
- O. Compensated cold leg temperature difference and comparison of the compensated cold leg temperature difference to a cold leg temperature difference trip setpoint.

Outputs of each CPC are:

- A. DNBR trip and pre-trip;
- B. DNBR margin (to control board indication);
- C. Local power density trip and pre-trip;
- D. Local power density margin (to control board indication);
- E. Calibrated neutron flux power (to control board indication);
- F. CEA Withdrawal Prohibit (CWP);
- G. Sensor failure; and,
- H. Core coolant mass flow rate.

Each calculator is mounted in specially designed cabinets with an operator's display and control module located on the main control board. From the four modules an operator can monitor all calculators, including specific inputs or calculated functions.

The design description presented herein makes a specific use of ex-core detectors for monitoring the axial power distribution and does not provide a means of monitoring the azimuthal tilt magnitude. However, the CPCs and associated hardware are designed with the capability of using specified in-core detectors for both axial power distribution and azimuthal tilt monitoring.

CPC DESIGN QUALIFICATION PROCESS

The CPCs are designed to initiate a reactor trip to insure that the DNBR and local power density fuel design limits are not exceeded for the design basis events specified in Section 7.2.2.1. The safety analysis in Chapter 15 provides analyses of the design basis events which require a low DNBR or high local power density trip. The design qualification process consists of a series of design analyses and tests. A description of the design qualification process is contained in the remainder of this section.

ARKANSAS NUCLEAR ONE
Unit 2

Chapter 15 Analyses

The assumptions made concerning the CPC characteristics in the Chapter 15 accident analyses are imposed upon the CPC design as functional requirements. These requirements include the capability of the CPC 1) to monitor conditions characteristic of the events which require a CPC trip in the accident analyses; 2) to conservatively calculate the minimum DNBR and maximum local power density which will occur during the events; and, 3) to initiate a low DNBR or high local power density trip consistent with the time response requirements of these events.

Chapter 7 Design Requirements

In addition to the requirements imposed by the Chapter 15 accident analysis, the CPC system functional requirements include all the RPS design requirements listed in Section 7.1.2.

CPC Functional Description

The CPC functional requirements consist of the requirements imposed by the Chapter 15 analysis and the requirements imposed by the Chapter 7 design requirements. The CPC software description, the CPC timing requirements, and the CPC hardware specification are generated from these functional requirements.

Reload Data Block

The Reload Data Block consists of a separate group of cycle-dependent parameters, most operating condition-dependent parameters, and CEA related parameters. Reload Data Block constants and disks were added in accordance with CEN-330-P-A and CEN-323-P-A. As part of each fuel cycle's design process, values for the Reload Data Block constants are evaluated for applicability, consistent with the cycle design, performance, and safety analyses. Any necessary changes to the RDB constants will be installed in compliance with CEN-323-P-A.

CPC Software Description

The CPC software description contains an algebraic representation of the calculations to be performed to calculate the low DNBR and high local power density. The CPC software description defines the algorithms and the CPC executive system, and the system time response requirements. Detailed software description of the CPC/CEAC system is provided in CEN-305-P and CEN-304-P respectively.

Software Design Qualification Procedure

The software design qualification procedure includes the following modules:

- A. CPC Software Description
- B. CPC Software Flow Charts and Code
- C. Phase I Software Module Testing
- D. Phase II Design Qualification Testing

ARKANSAS NUCLEAR ONE
Unit 2

The objective of the software design qualification procedure is to demonstrate that the specified calculations have been correctly implemented in the hardware system. Details of this procedure are discussed in CEN-39(A)-P-A.

7.2.1.1.2.5.1 System Description

7.2.1.1.2.5.1.1 General

There is a separate and independent calculator for each protective channel which provides two trip functions, DNBR and local power density, to a RPS logic channel.

The function of the CPC system is to monitor pertinent reactor core conditions and to provide an accurate, highly reliable means of initiating a reactor trip whenever the minimum core DNBR approaches the design limit or peak LPD approaches the fuel design limit, during reactor operation.

The DNBR and the local power density trip functions are calculated from monitored parameters by four redundant digital calculators. The digital calculators provide channel trip outputs when either the calculated DNBR or local power density reaches its respective trip setpoint. The calculator channel trip outputs are utilized by the RPS logic in the same manner as the direct parameter trips from the bistable comparators.

The entire RPS, of which the CPC system is a part, adheres to all applicable IEEE protection system design criteria as detailed in the design bases of Section 7.2.1.1.2.5.1.2.

The CPC system is similar in function to previously licensed analog calculator systems. Increased accuracy of calculation is provided with this system through the direct rather than inferred measurement of CEA position, by monitoring CEA deviation with redundant CEA calculators, and by the ability of a digital calculator to utilize more sophisticated correlations of measured data.

The functional integrity of the system is assured through the redundancy of the design combined with a comprehensive program of on-line monitoring of system performance through displays, operator readouts, and automatic monitoring features; and, a periodic test program that both verifies the functional integrity of each calculator and verifies the integrity of the stored programs in the calculator and the calculator memory, producing a hard copy printout of test results for logging and future reference.

7.2.1.1.2.5.1.2 Design Bases

The CPC system is designed to calculate core parameters and to initiate trip signals, when necessary.

The CPC system conforms to the criteria and requirements set forth in the following documents:

- A. 10CFR50, "Licensing of Production and Utilization Facilities," Appendix A, "General Design Criteria for Nuclear Power Plants."
- B. IEEE 279-1971, "Criteria for Protection Systems for Nuclear Power Generating Stations."

ARKANSAS NUCLEAR ONE
Unit 2

- C. IEEE 323-1971, "General Guide for Qualifying Class I Electric Equipment for Nuclear Power Generating Stations."
- D. IEEE 344-1971, "IEEE Guide for Seismic Qualifications of Class I Electric Equipment for Nuclear Power Generating Stations."

7.2.1.1.2.5.1.3 Hardware Design

System Configuration

The CPC system configuration is shown on Figure 7.2-27. There are five major functional groupings of the system equipment:

A. Signal Generation and Processing Equipment

The signal generation and processing equipment converts process parameters, such as pressure, into signals compatible with the calculator input subsystem. Each redundant channel of the system has separate, independent signal processing equipment.

B. CEA Calculators

A CEAC monitors the position of CEAs within each control group. There are two independent and redundant CEACs located in Protection Channels B and C, respectively. Each CEAC monitors one of the two redundant measurements of individual CEA position for each CEA. A penalty factor, derived from CEA deviation information, is an isolated output utilized as an input to each CPC. The CPC monitors both CEACs, utilizing the most conservative deviation information of both CEACs.

C. Core Protection Calculators

A CPC monitors process parameters from the signal generation and processing equipment, CEA deviation information from the CEAC, and CEA group position information from "target CEA" position transmitters. The CPC calculates a conservative measure of DNBR and local power density and provides a channel trip signal to the RPS should the respective trip limits be exceeded.

D. Calculator Operator's Module

An operator's module is provided for each protection channel at the main control board. The operator's module monitors the status and operation of a calculator in each channel. Display functions, annunciator lamps, operator communication interface, and administrative control functions are consolidated on this module.

E. Permanent Mass Storage Units

A permanent mass storage unit is provided in a portable test/maintenance cart. Testing of the calculator is accomplished quickly and accurately through the use of the permanent mass storage unit.

The relationship of the subsystems relative to the CEAC is shown in Figure 7.2-33. A similar structure exists for the CPCs.

ARKANSAS NUCLEAR ONE
Unit 2

The interconnection of CEACs and CPCs is shown in Figure 7.2-32. The outputs of the CEACs are isolated with fiber optic data links whose design precludes any electrical connection between the CEAC output and the CPC input.

The input CEA position signals to the CEAC from other channels are isolated with fiber optic isolators.

The isolation criteria for all forms of isolation are:

- A. No single credible failure at the isolator output shall affect the isolator input signal; and,
- B. No single credible failure at the isolator input shall be allowed to affect the functional integrity of the module connected to the isolator output. At most, a failure at the isolator input shall cause an erroneous signal at the isolator output.

Signal Generation and Process Equipment

Primary Pressure

There are four redundant pressurizer pressure instrument channels.

The piping, wiring and components of each channel are separated from that of the other channels to provide independence.

The output of the pressure transmitter is an ungrounded current loop which has a live zero.

The input signal to the CPC system is derived from a loop dropping resistor which provides a low impedance voltage signal source with a one to five volt range.

Signal isolation is provided for inputs to the plant computer and control board indicators.

Each channel is powered from a separate vital bus.

Hot Leg Temperature

Hot leg temperature is measured with a pair of precision RTD sensors. The output of the resistance to current converter (R/I) is an ungrounded current loop which has a live zero.

The input signal to the CPC system is derived from a pair of loop dropping resistors which provides a low impedance voltage signal source with a one to five volt range.

The wiring and mounting of components of each channel are separated from the other channels to provide independence.

Signal isolation is provided for inputs to the plant computer and control board indicators. Each channel is powered from a separate vital bus.

Cold Leg Temperature

The measurement of cold leg temperature is functionally identical to the measurement of hot leg temperature with the exception that two precision RTD sensors/channels and no averaging circuitry is used. A single dropping resistor is used in lieu of the pair used in the hot legs.

ARKANSAS NUCLEAR ONE
Unit 2

Ex-Core Neutron Flux Power

A block diagram of the ex-core neutron flux power measurement system is shown on Figure 7.2-2.

The four safety channels provide signals to each of the four channels of the CPC system.

Each safety channel consists of three fission chambers located axially along the core.

The output of each fission chamber is processed by a signal conditioning unit that provides a linear power signal of 0 to 10 volts corresponding to 0 to 200 percent power.

Reactor Coolant Flow

There are four redundant channels of reactor coolant flow measurement.

Reactor coolant flow is determined from the measurement of the speed of the RCPs.

Each RCP has four independent, separate proximity sensors mounted in the RCP motor housing.

The rotational speed of the RCP is measured by locating the proximity sensor near a disc that is attached to the shaft of the RCP motor. The disc has holes drilled at equidistant locations about its circumference. As the disc rotates, the proximity pickup senses the absence of metal at the location of each hole.

The signal processing equipment associated with the proximity sensor channel converts the signals from the sensor to voltage levels that correspond to the presence and absence of metal.

Each voltage pulse that corresponds to a disc hole passing the probe is then conditioned to a standard pulse of fixed duration and voltage magnitude by the pulse shaping unit. The pulse output of the pulse shaping unit is conditioned by a "divide by N" circuit and is then utilized as an input to the CPC.

CEA Position

The CEAs in the reactor core are arranged such that there are 20 sets of four symmetrically located CEAs. These symmetrical sets of four CEAs are designated as subgroups and are controlled by the CEDMCS. The center CEA is allocated to one of the 20 symmetrical subgroups for control purposes.

Each CEA has two Reed Switch Position Transmitters (RSPTs) assigned to provide information on the position of the CEA in the core. CEA position information is provided directly to the core protection calculators for one CEA in each four CEA subgroup. One CEA RSPT in each subgroup sends CEA position information to the CPC with a corresponding channel assignment. This CEA subgroup position information is used to calculate planar radial peaking factors. CEA deviation information is obtained in Channel B by isolating the Channel A signals and then routing them to Channel B for comparison. A second (redundant) measure of CEA deviation is obtained in Channel C by a similar allocation and buffering process for the redundant CEA RSPTs in Channels C and D. A functional diagram of the CEAC interface with the CPC system is presented as Figure 7.2-32.

ARKANSAS NUCLEAR ONE
Unit 2

Core Protection Calculator

Each CPC is a 32-bit mini-computer which is comprised of the following major components:

A. Central Processing Unit (CPU)

The CPU controls programmed sequence and performs arithmetic functions.

B. Memory

The memory stores programmed sequence and calculation results.

C. Data Input/Output Subsystem

The data input/output subsystem directs information into and out of the calculator.

Central Processing Unit

The CPU manages the resources provided by the data input/output subsystem and memory. The programmed sequences are stored in memory. The logical flow of the sequences is directed by the CPU. Periodic sequences are requested by the scheduler, which is activated by a real time clock. The CPU is equipped to cope with malfunctions within itself, its memory, and its source of power.

The CPU performs control, arithmetic, and logical functions. The CPU accesses instructions from protected memory, decodes the instruction, and executes the required operation. In addition to the control section, the CPU contains working registers and hardware for both fixed point and floating point arithmetic operations. The CPU also controls data transfers to and from the data input/output subsystem.

Power loss is detected in a manner which insures sufficient time to execute an orderly shutdown.

Upon loss of power, the power fail detection circuitry causes the CPU to set the system outputs in a fail-safe condition. The CPU then initiates an orderly shutdown.

The CPC meets General Design Criterion 23 by tripping a channel on loss of power or disconnection of the system.

The CEAC meets General Design Criterion 23 by setting the output in a fail condition on loss of power. The fail condition corresponds to the signal that would occur on a complete loss of power to the CEAC. Each CPC will detect the failed CEAC output and initiate an annunciator.

Any single random failure is acceptable as long as the failure is detectable during test and the interval between tests is chosen on the basis of failure rate to give acceptable overall system reliability.

The actions, which occur upon loss and restoration of power, are similar to an analog signal, e.g. steam generator level, which is connected to a bistable relay card (one per channel) in the Plant Protection System (PPS). The CPC provides a contact opening for each trip function, i.e. low DNBR and high local power density to a bistable relay card in the PPS. Should the analog signal representing steam generator water level exceed a preset limit, the bistable relay card initiates a channel trip by de-energizing three trip relays. Likewise, the corresponding bistable relay cards for low DNBR and high local power density act in the same manner when the CPCs provide an open trip contact.

ARKANSAS NUCLEAR ONE Unit 2

Within the PPS the contacts of the three trip relays on each bistable relay card form the 2/4 logic matrices. Four trip paths, which actuate the reactor trip switchgear, are constructed from the contacts of the matrix relays. The "lockout relay" which assures that a reactor trip goes to completion is placed in the final four trip paths of the RPS. The "lockout relay" must be manually energized to reset the reactor trip switchgear and allow the withdrawal of CEAs.

As a result, each analog process input or contact from the CPCs may return to its normal value or state when the corresponding normal conditions exist.

Memory

The calculator memory utilizes metallic oxide semiconductor (MOS) technology. The memory word length is 32 bits with an additional 5 bits utilized for error correction and detection. The memory is provided with battery backup and with a reload capability from Programmable Read Only Memory (PROM) for recovery from power interruptions. Memory integrity is monitored with hardware that monitors each memory read or write to allow detection and correction of single bit errors, detection of all double bit and some multiple bit errors. Memory protection is provided under the control of the software executive program. The memory protection hardware allows the establishment of predefined memory segments with predefined read, write or execute privileges by the various programs executing under the executive control. Violation of the established privileges will be detected and annunciated by the executive program.

Data Input/Output Subsystem

The data input/output subsystem controls the conversion and routing of data into and out of the CPU. The operation of the data input/output subsystem is controlled by the CPU and the executive program in protected memory.

Inputs

The input functions controlled by the data input/output subsystem controller are analog input conversion, digital input conversion, digital data link service, and pulse input conversion.

A. Analog Inputs

Analog inputs are converted to digital values by the analog input module. The analog input module utilizes electronic switches to select the appropriate signal for conversion and then utilizes an analog to digital converter to obtain conversion. The analog input module is designed to operate at a speed, accuracy and noise immunity that will meet the overall system response time and accuracy requirements. Reference voltage sources are provided for on-line calibration and diagnosis.

B. Digital Inputs

Digital inputs are handled as an input scan function by the data input/output subsystem. The contact inputs from the operator's modules, the CPU keyswitch, and the test switch input from the test panel are also periodically commanded to be read by the executive software. Contact input signals are converted to a logic level by an internal power supply and a contact bounce suppression circuit.

A detailed description of this function is provided in CEN-69(A)-P.

ARKANSAS NUCLEAR ONE
Unit 2

C. Pulse Inputs

The input signal from a reactor pump sensor is a voltage pulse whose frequency is proportional to the rotational speed of the RCP.

A pulse input module of the data input/output subsystem converts the frequency signal to a digital value by determining the time period that elapses between successive pulses.

D. CEA Calculator Data Links

The data links are isolated with fiber optic cable to assure that failures will not propagate in either direction across the data link.

The data link transfer is designed to allow functional independence of the CPC from the CEAC.

Outputs

A. Analog Outputs

Each redundant channel of the CPC system provides three continuous displays of calculated system outputs. The displays are DNBR margin, local power density margin, and calibrated neutron flux power.

B. Digital Outputs

Contact outputs are utilized for pretrip, trip and CWP, and annunciation and status indications.

C. Plant Computer Data Links

The data links are isolated with fiber optic cable to assure that no failures at the plant computer will affect the CPCs or the CEACs.

Both CEACs and CPCs respond in a similar manner during service of the plant computer data link, so that the CPC description is typical for a CEAC. However, each link is electrically isolated from the others and functions independently of the others.

Test/Maintenance Cart

A test/maintenance cart is utilized for off-line periodic testing. The test cart is not a portion of the on-line system and may be utilized for periodic testing or program loading only when the channel is bypassed. In the new system, the maintenance cart is not required for execution of the test programs, except memory verification.

In channels that have both a CEAC and a CPC, the calculator select switch on the PPS test panel enables the selected calculator, permitting only one calculator in a channel to have access to the test cart at one time.

A test maintenance cart is provided to facilitate software loading and testing. The test cart contains a disk on which is stored:

ARKANSAS NUCLEAR ONE
Unit 2

1. test data for the Maintenance Cart 'Periodic Test' Program execution;
2. expected results for the Maintenance Cart 'Periodic Test' cases;
3. a memory image for comparison to the on-line memory;
4. a memory file for reload of the calculator software;
5. off-line diagnostic programs.

The test cart also contains a terminal device for hard copy printout and keyboard interaction during testing.

Only one calculator may be tested at a time.

An interlock, with the channel bypass switch at the RPS logic, prevents initiation of a test unless the channel is bypassed.

CEA Calculator

There are two redundant CEACs that provide penalty factor information to each of the four CPCs.

The CEACs are separated and independent of each other and each receives CEA position information that is derived from separate position transmitters.

The CEACs interconnection is shown in Figure 7.2-32. The outputs of the CEACs are isolated with fiber optic cable whose design is such that there is no electrical connection between the CEAC output and the CPC input.

The input CEA position signals to the CEAC from other channels are isolated with fiber optic isolators.

The isolation criteria for all forms of isolation are:

- A. No single credible failure at the isolator output shall affect the isolator input signal; and,
- B. No single credible failure at the isolator input shall be allowed to affect the functional integrity of the system connected to the isolator output. At most, a failure at the isolator input shall cause an erroneous signal at the isolator output.

The hardware structure of the CEACs is similar to the structure of the CPCs.

Each CEAC is composed of the following subsystems: CPU, memory, and data input/output subsystem. The CEACs are 32-bit mini-computers.

Central Processing Unit

The CPU of the CEAC is identical to the CPU of the CPCs described in an earlier section also entitled, "Central Processing Unit," and supports all of the same features.

ARKANSAS NUCLEAR ONE
Unit 2

Memory

The memory system of the CEACs is identical to the memory of the CPCs, including protected memory for the application program.

Data Input/Output Subsystem

The data input/output subsystem controls the conversion and routing of input data to the CPU and the conversion and routing of output data from the CPU. The operation of the data input/output subsystem is under control of the CPU and the resident programs in memory.

Inputs

A. Analog

The analog input function of the CEAC is identical to that of the CPC.

B. Contacts

Contact input signals are converted to a logic level by an internal power supply and a contact bounce suppression circuit.

Outputs

A. Contact

Contact outputs are provided to the annunciators.

B. Data Link

A separate fiber optic isolated data-link is provided for each CPC and CEAC to the plant computer.

Operator's Module

An operator's module is provided for each protection channel. This module is mounted at the main control board.

The operator's module is designed to facilitate the monitoring of system status, the monitoring of all analog and digital plant signal values and key calculated variables, trip and pre-trip setpoints and the calibration of the system through the use of addressable constants.

The operator's module contains a Display Unit which has the capability of displaying alpha numeric data and character graphical data. The Display Unit is equipped with a touch sensitive screen which allows the operator to interact with the system for selection of displayed values, sets of values or graphs and for selection of data to be input for addressable constant changes.

Switches are mounted on the operator's module for the following functions:

1. enable data entry (keylock switch);
2. operating bypass of keylock switch less than the Log Power Bistable reset point;

ARKANSAS NUCLEAR ONE
Unit 2

3. selection of a CPC or CEAC for display or interaction (functions only in Channels B and C).

Specific operator's module displays are:

A. Menu

A master menu display screen is provided to assist the operator in choosing the appropriate display.

B. Technical Specification Channel Check

A display of six (6) point ID values to facilitate the operator's cross channel checking function is provided.

C. Point ID Display

A display of the current values of selected Point IDs is provided.

D. CEA Position Display (CEAC Only)

A series of character graphical displays of CEA position for all CEAs and CEA groups is provided.

E. Alarm/Status

A display is provided of detected CPC/CEAC problems to assist in diagnosis and repair.

F. Addressable Constant Check

A display of the addressable constant values to assist in verification of these values.

G. Interactive Displays

1. A display is provided to support the modification of addressable constants.
2. A display is provided to select specific groups of Point IDs for display.

Status lamps are provided on the operator's module to indicate the following conditions:

CPC Trouble

An indicator is illuminated when a CPC sensor goes out of range, when a failure is detected by the on-line diagnostic programs, when the watchdog timer is not reset, or when the CPC is placed in the test mode.

CEAC Trouble

An indicator is illuminated when a CEAC sensor goes out of range, when a CEA deviation is detected, when a failure is detected by the on-line diagnostic programs, when the watchdog timer is not reset, or when the CEAC is placed in the test mode.

ARKANSAS NUCLEAR ONE
Unit 2

Trip Bypass

An indicator is illuminated when the CPC is placed in an operating bypass when reactor power is less than the Log Power Bistable reset point.

CPU Unlock

If the CPC/CEAC console keylock switch is removed from the lock position, the CPU Unlock indicator illuminates and system software halts execution.

Function Enable Active

An indicator is illuminated when the CPC/CEAC operator's module touch screen (inputs) is enabled via the Function Enable Keylock Switch.

CPC/CEAC Calculator Select

A pushbutton indicator is illuminated to indicate selection of either the CPC or CEAC for Operator's Module Interaction (Channel B or C only).

CEAC INOP

An indicator is illuminated when a CEAC is set to an inoperative status in the CPC channel.

7.2.1.1.2.5.1.4 Software Structure

A. Executive Program

The executive program provides task scheduling and priority maintenance, interrupt service, startup service and input/output service:

1. Interrupt Service

The interrupt service module services the real-time clock interrupts that are counted to determine when a program should be scheduled. The interrupt service module notifies the task scheduler module of the occurrence of a real-time clock interrupt.

The interrupt service module also detects on-line internal interrupts that result from diagnostic traps in the CPU. Diagnostic traps include:

- AC power failure and restoration
- Integer arithmetic faults
- Floating point arithmetic faults
- Memory access violations
- Invalid instructions
- Certain misuse of the Commercial Instruction Set (not used in CPC)
- Memory system uncorrectable faults
- Privileged instruction execution violations

ARKANSAS NUCLEAR ONE
Unit 2

2. System Startup

The system startup module restarts the real-time program activity following the detection of an internal interrupt or fault condition. Upon the completion of periodic testing the reload process enables the initialization program which will cause the calculator outputs to remain in the fail safe state until the initialization process is complete.

3. Task Scheduler

The task scheduler module initiates the scheduled execution of periodic programs in a predefined priority order. The real-time clock interrupt is utilized as the real-time standard.

4. Input/Output Service

The input/output services modules request data input from a selected device, transfer the data to the appropriate memory locations and perform on-line diagnostic monitoring and annunciation on the external devices. The input/output services module responds to requests from other programs.

B. Applications Programs

The applications programs run under the supervision of the executive program. The applications programs are selected to run at rates consistent with the dynamic response criteria of the function it supports. The executive monitors this execution rate and annunciates when a program does not meet its scheduled frequency.

The applications programs are:

1. Operator Module Monitor

The operator module monitor program consists of two modules. A service module responsible for monitoring the operator module switch status, and a function module that performs the current function requested of the operators module. The operator module monitor communicates with the operator module by means of digital input/output service from the execution program and by means of data link service from the data link service program.

2. Initialization

The initialization program monitors key variables in the protection program data base and maintains the system outputs in a predetermined state following system startup until time dependent transients due to start up die out.

3. System Monitor

The system monitor programs the interface with the off-line test devices of the test cart during testing.

4. Data Link Service

The data link service program provides an interface between the serial, byte oriented asynchronous data links servicing the operator's module, CEACs and plant computer and the data base for the appropriate programs.

ARKANSAS NUCLEAR ONE
Unit 2

5. Idle

The idle program computes a checksum of protected memory and annunciates when the checksum does not compare to a predetermined value.

6. Protection Algorithm Programs

There are four protection algorithm programs. These programs and their functions are:

a) Flow Program

The flow program calculates the reactor coolant mass flow rate, performs trip and pre-trip comparisons and logic and performs the direct RCP speed trip comparison and logic.

b) Update Program

DNBR and power density values are updated. Neutron flux power is determined and calibrated to thermal power. The larger power is used in the calculation of hot channel heat flux distribution. A trip may be initiated if conditions are outside the wide band operating space. Dynamic updates on static DNBR and quality margin are performed. LPD margin, power density margin, and calibrated neutron flux power are sent to analog meters. Variable overpower trip is determined.

c) Power Distribution

Percent CEA subgroup withdrawals are calculated. Several penalty factors are determined, as is the CEA withdrawal prohibit flag.

Corrected excore neutron flux values are determined, including shadowing effects. A spline fit is used to determine core average axial power distribution, and pseudo hot pin power distribution is calculated.

d) Static DNBR Program

Hot pin flux distribution, hot pin ASI, and integrated one pin radial peak are calculated.

Fluid properties that are pressure dependent are calculated, and region dependent flow split and power corrections are determined.

Linear heat and hot channel flux distributions are calculated. DNBR distribution is determined, and then minimum static DNBR is calculated.

Plant Computer Data Link Task

The plant computer data link task is executed at a low priority. When executed, this task checks the plant computer status to determine if the plant computer is ready to receive data. If the plant computer is ready, a pre-determined set of data is transferred across the data links. Otherwise the task completes immediately with no data transfer performed.

ARKANSAS NUCLEAR ONE
Unit 2

Input Data

During on-line performance of the calculations, the calculators will derive their input data from the channel input sensors through the data input/output subsystem.

Each process input shall be sampled at a rate consistent with the dynamic response of the sensor and the rate of response requirements of each parameter for each anticipated operational occurrence. The maximum input sampling rate capability of the system is greater than that needed to support the time response requirement of the protective functions. This sampling rate includes the analog to digital conversion time with the multiplexer operating in a random address mode.

The input sensors and signal processing equipment will be calibrated after installation based upon vendor calibration data and functional testing.

Input Data Processing

The input sensor signals to the CPC and CEAC are read, converted to a digital format, and limit checked. When sensor limits are detected as being exceeded, this condition is indicated on the Operator's Module.

The CPC also monitors the CEAC input data, comparing the two redundant channels and monitoring the operability of the data link. When a CPC detects that a CEAC data link is inoperable, it indicates and annunciates this condition. When the CPC detects a significant discrepancy between the information provided by the two data links it also indicates and annunciates this condition.

The operator's module provides the capability to read all input parameters for a calculator so that the operator can compare their values between channels.

Digital Conversion and Accuracy

The output of the signal processing equipment is connected to a multiplexer and analog to digital converter for analog signals. Each protective channel has a separate multiplexer and analog to digital converter.

The accuracy of the signal conversion and program data manipulation will be accommodated by combining all measurement errors, calculational uncertainties, and operating allowances in the algorithms.

The measurement errors applicable to the subject trips' design are the uncertainties in the monitored NSSS variables resulting from sensor location, calibration and dynamic characteristic.

The calculational uncertainties considered can be categorized as follows:

- A. The uncertainties associated with the computational methods used to correlate monitored NSSS variables to NSSS parameters and to calculate trip parameters;
- B. The accuracy associated with the manipulation of numerical values within the CPC.

ARKANSAS NUCLEAR ONE
Unit 2

The operating allowances considered include the following:

- A. Allowances for maximum variation of unmonitored parameters that affect the margin to the fuel design limits;
- B. Allowances for deadbands on monitored variables. These deadbands can be considered as threshold magnitudes on certain variables within which a variation is allowed without affecting the margin to the fuel design limits;
- C. Allowances for the total trip response time associated with initiating a low DNBR and/or high LPD trip signal. The trip response time is the time from having a monitored variable change at the input side of a CPC to the time a trip signal is initiated;
- D. Allowances for the RPS logic time delay. This delay encompasses the time from when the trip units receive a trip signal to the time the trip circuit breakers open;
- E. Allowances for the time required to initiate CEA insertion;
- F. Allowances for the time required to effectively terminate the transient resulting from an anticipated operational occurrence.

Measurement error corrections are applied to the monitored variables in order to correctly accommodate the relationships among the NSSS variables that affect the fuel design limits. Calculation uncertainties are applied to the result of the individual algorithms. The algorithms employed are the result of extensive analysis employing the most recent design methods and the resulting correlations are chosen to be conservative with respect to the results obtained using the design methods. Application of calculational uncertainties in this manner also assures that the relationship among the NSSS parameters that affect the fuel design limits is accommodated in a conservative manner. Operating allowances for parameters not monitored by the CPCs are treated by simulating the unmonitored parameters as additional inputs which are always at their worst case operating limits. Deadband allowances on monitored variables are treated by assuming that the affected variables are at their worst case deadband limits.

Treating the above operating allowances in this manner again assures that the interrelationship of NSSS parameters on fuel design limits is conservatively predicted. Allowances for time delays associated with system operation are accommodated by using methods which project the monitored NSSS variables as function of time based on current and past values. This projection technique predicts the magnitudes of NSSS variables ahead in time by an amount equal to or greater than the total system delay time. The prediction methods are based on extensive analyses which account for total sensor, system and reactor dynamics during anticipated operational occurrences and are conservative with respect to the results of these analyses. Calculational uncertainties are applied to the implementation of these techniques in the manner described previously.

The following security measures assure that the algorithm coefficients and system constants entered into the computer memory have been correctly stored in the pre-assigned memory location.

- A. The change capability is restricted by a key switch controlled enable of the change value function on the operator's module with appropriate administrative controls.

ARKANSAS NUCLEAR ONE
Unit 2

- B. The operator's module software is designed such that data may be entered only into pre-selected memory locations.
- C. Following entry of the data, the operator may request verification by selecting the identification number of the constant on the operator's module. The data contained within that location and the number of the location will then be displayed. The data displayed may then be crosschecked against the data that was to be entered.
- D. The Maintenance Cart 'Periodic Test' program is structured to verify memory contents in two ways:
 - 1. Data values are entered and the computed results are checked against a pre-computed result stored in permanent mass storage.
 - 2. Each protected memory location is checked on a location by location basis against a pre-entered value in permanent mass storage.

Any deviation in the test results described in "1" or "2" above, will result in the affected channels being removed from service.

Input Data Checks

CEA position data is checked for sensor failure by the CEACs. The normal range of input signal is from +5 to +10 volts. Since the position signal is derived from a zero to +15 volt power supply, the majority of CEA sensor failures will result in an input signal that falls outside the normal signal range. When the CEAC detects an out-of-range sensor input value, an annunciator is initiated.

Penalty factors for out-of-sequence conditions and CEA deviation or subgroup deviation are applied within the DNBR and LPD algorithms to account for increase radial peaking resulting from CEA position misalignments. Each CPC receives CEA deviation penalty factors from both CEACs via optically isolated data links. Thus, each CPC has two common sets of CEA deviation data derived from two independent and isolated calculator channels.

When a CEA Calculator is brought off-line either due to a failure detected by on-line tests or by technician actions performed to periodically test, troubleshoot, diagnose and repair a CEAC, the CPC will detect that a CEAC data link is out of service and will annunciate that condition. The CPC will then utilize data from the redundant CEA Calculator. The Technical Specifications restrict the time period that a CEAC can remain out of service.

If a CEAC should be taken out of service coincident with its redundant counterpart, this condition will be recognized and indicated by the CPCs. In this situation, the CPCs will use a predetermined penalty factor.

All sensor values are checked against predetermined limits when read into the protection algorithms. If a sensor value approaches the limit of its usable range, the calculator will initiate an annunciator.

Timing

The CPC is designed to accommodate its design basis events including the consideration of sensor response times, integral CPC calculational delays and downstream RPS actuation delays.

ARKANSAS NUCLEAR ONE
Unit 2

Each calculator monitors the execution frequency of its internal functions and annunciates if these frequencies are not maintained. In addition, a watchdog timer on each calculator monitors the periodic operation of each calculator and provides annunciation and a channel trip if it is not reset within a predetermined fixed time period.

The CPC system's response time is verified consistent with the requirements of the Technical Specifications.

Initialization

The initialization of a CPC involves assurance of the integrity of the programs and constants stored in memory, loading the initialization data from Programmable Read Only Memory (PROM) or disk drive, and assuring that the calculator output assumes a trip condition and remains tripped for a time period that will allow the time history dependent data values to achieve a current status.

Program Modification

If program modification is required for the CPC system, the entire source program will be modified, reassembled and documented at offsite facilities. Assembler listings and source and object code of the program will be maintained as program documentation. Following program assembly, the new program will be loaded into a prototype calculator that is functionally identical to the field calculator. Static and dynamic testing will be performed on the prototype as described in CEN-39-(A)-P. Program performance during the prototype tests will be recorded, documented, and checked to assure that program performance meets the design bases requirements of function accuracy and response time. When the new program has successfully completed the prototype performance tests, a new Maintenance Cart 'Periodic Test' program will be written, assembled and loaded into the permanent mass storage device of the prototype calculator. Operation of the Maintenance Cart 'Periodic Test' program will be verified on the prototype calculator. Documentation of the test program and data will be maintained in an identical manner to the protection algorithms. The strict administrative procedures and documentation required for program modification are discussed further in CEN-39-(A)-P.

At the field, the following procedure will be used to load a new software version into a calculator.

- A. The channel to be modified must be bypassed at the RPS logic, converting the DNBR/LPD trip function to a 2-out-of-3 coincidence.
- B. Access to the calculator must be obtained through the use of key switch control at the PPS test panel. Actuation of this key switch will result in annunciation and a channel trip for a CPC; or, annunciation of a CEAC fail condition for a CEAC.
- C. The calculator must be taken off-line and enabled for program loading.
- D. The Executable image of the system that has been preassembled and verified at the prototype, will be loaded from the permanent mass storage unit.
- E. The Maintenance Cart 'Periodic Test' program will then be executed to verify program integrity.

ARKANSAS NUCLEAR ONE
Unit 2

- F. Following verification of the memory contents, a maintenance program may be executed to copy the verified memory contents into the EPROM loader. The EPROM loader and memory contents are then verified.
- G. Following successful completion of the Maintenance Cart 'Periodic Test', the calculator can then be brought on-line in.

Assurance that data have been correctly stored in the pre-assigned memory locations and that no other memory locations have been altered is obtained by utilizing testing functions and procedures following each data load and periodically throughout the life of the plant.

Testing assures that the stored programs and data are correct by:

- A. Verification that measured input data are stored in the correct location by addressing the data value through the operator's module and cross-checking this value with the other channels.

Hardcopy results of this step are produced by the personnel performing the test, in accordance with pre-established procedures. This printed verification of the input data is comparable to verification of the direct analog trip functions and previously licensed designs of analog calculated trip functions.

- B. Verification of the addressable constants by calling up the addressable constant by means of the operator's module and verifying the displayed value against the required value.

Hardcopy results of this step are produced by the personnel performing the test, in accordance with pre-established procedures. The results are comparable to hardcopy produced as a result of the testing of previously licensed analog calculator trip functions.

- C. All other data values are stored in or derived from data stored in memory.

Constant data stored in memory is automatically verified by:

1. A checksum calculation on the program file as it is loaded into the calculator.
2. Checksums calculated by the idle task on a continual basis.

- D. As an independent check on the memory values, each protection algorithm is run in a periodic testing environment. This test re-verifies memory. Hardcopy results are produced for each test of each protection algorithm.

7.2.1.1.2.5.1.5 System Security

Core Memory and Data Entry

The calculator utilizes on-line diagnostics to verify memory integrity.

Memory accesses by the programs are monitored by a hardware memory address translator (MAT). Memory is segmented into various functional elements and the calculator programs are assigned restricted access to the memory. Access privileges include:

ARKANSAS NUCLEAR ONE Unit 2

- Write - the ability of a program to enter data into a given segment of memory.
- read - the ability of a program to retrieve data from a given segment of memory.
- execute - the ability of a program to read an instruction from a memory segment and execute it.

Access privileges are defined during the software design consistent with each program's function: for example, a protection algorithm input data area would have access privileges of read but not write or execute for that program. A protection program instruction storage area would have read and execute privileges but not write privileges. A protection program output data area would have write but not read or execute privileges. Note that the same memory area may have different accesses allowed for different programs.

The executive program contains the access privileges for each program. When a program is scheduled for execution, its access privileges are defined to the MAT hardware by the executive. If the access privileges are violated by the program during execution, the executive will be notified of that condition. The executive will annunciate this occurrence and provide a channel trip for a CPC or will annunciate this occurrence and provide an out of service condition for a CEAC.

This method of access monitoring has the advantages of annunciation of access violation and the advantage of being able to detect a broader range of access violations when compared to a simple hardware write only memory protect scheme.

Data Input/Output Subsystem

The input data base derives its data from the data input/output subsystem during normal operation. Under control of the protection program, the central processing unit of the calculator will command the data input/output subsystem to convert a specific input parameter to a digital value and cause this value to be stored in a predetermined location in the input data base.

The memory access translator will prevent the CPU from altering the program instructions. This will assure that data values acquired from the data input/output subsystem are stored in the proper memory location.

Operator's Module

There are four operator's modules for the CPC system located on the PPS section of the main control board. There is one operator's module for each protection channel. The cabling and location of the modules adhere to four channel separation criteria. The CEACs are located in protection Channels B and C. The operator's module for Channels B and C have the capability of addressing either a CPC or a CEAC.

Data entry capability requires the enablement of this function with a key switch on the operator's module.

Regardless of the status of the operator's module, data cannot be entered into incorrect memory segments due to the operation of the memory access translator.

ARKANSAS NUCLEAR ONE
Unit 2

The operator communication software is designed such the data entry from the operator is restricted to the addressable constants. The software is designed such that it is impossible for the operator to alter any protected memory location or any non-protected memory location other than addressable constants. An operator request to alter any memory location other than an addressable constant is treated as an invalid request by the operator communications software. This design feature is independent and redundant to the memory access translator.

Physical Access

Physical access to the Core Protection Calculators and CEA Calculators shall be under key lock administrative control.

Program Integrity

Integrity of the system software is assured by a combination of administrative procedures and tests. These procedures and tests start at the earliest stages of the design process and extend throughout the life of the nuclear power plant.

Administrative control of the software generation process will begin at the start of design. A design specification will be prepared for each program or group of programs. The design specification will include a general description of each program module or subroutine, inputs and outputs, timing requirements and the detailed algorithms or steps required of the program. Each design specification will also include flow charts of sufficient detail to describe the logic of the programs.

The programmer will use the design specifications to generate the code for each program. The programmer will also generate a series of test cases for each program to verify the correctness of the binary object code produced. These test cases will exercise the program over the full range of inputs and through every branch in the program. Final verification that the programs meet their specifications will take place during the software commissioning phase of the design qualification test. The procedures and tests to be followed during software commissioning are described in CEN-39-(A)-P.

When the correctness of each program has been verified by thorough testing, the programmer will complete the documentation package by preparing a written description. The complete documentation package will then consist of the program description, flow charts, source-language listings and test cases. From this point on, the documentation package will be subject to an administrative procedure which must be followed for every change to the program. A program change is defined as any alternation, no matter how slight, of any portion of any program with the exception of changes to the addressable constants. The procedure will require the following actions to be performed in the sequence given:

- A. Change description and flow charts
- B. Change program listings and source programs
- C. Assemble or compile source programs
- D. Generate new test cases and test changed programs
- E. Update data for the periodic test program
- F. Generate new media of protection programs and periodic test programs with changes installed.

ARKANSAS NUCLEAR ONE
Unit 2

Program changes at the binary level will not be permitted.

Completed and tested programs will be loaded. When memory has been loaded, the access enable switch will be activated and the auto-restart routine will be started. The auto-restart routine will load addressable constants, address locations and initial data base values from protected memory into the unprotected (live) data area. When the system has been initialized, the periodic test program will be run.

Up-to-date copies of the documentation, i.e., descriptions, flow charts and listing, will be maintained at the plant site to assist in maintenance of the system. However, the only changes that will be performed onsite will be adjustments to "addressable" constant.

Testing of the programs is discussed in detail in CEN-39-(A)-P.

7.2.1.1.2.5.1.6 Bypasses

Operating Bypasses

The Low DNBR and High LPD trip computations are performed continuously regardless of whether or not the reactor is at power.

A provision exists for bypassing the trip output contacts when reactor power is less than the Log Power Bistable reset point.

This bypass is designed in accordance with IEEE 279-1971, Section 4.12 criteria. The design incorporates the following features:

- A. The bypass requires a key switch enable for each channel at the CPC operator's module. The bypass is manually initiated under administrative control.
- B. The bypass is automatically removed from each protection channel when the nuclear flux instrumentation for the channel indicates that reactor power is greater than the Log Power Bistable setpoint.

Indication of the bypass is designed in accordance with IEEE 279-1971, Section 4.13 criteria. The design incorporates the following indication design features:

- A. Indication of the bypass is given for each channel by a lamp on the CPC operator's module.
- B. Annunciation of the bypass is provided at the main control board.

Channel Bypasses

A provision exists for bypassing a single channel of the four protection channels for maintenance or test. The bypass is also provided to remove a trip channel from service for an extended period without affecting plant safety or availability in the event of an equipment failure not readily repairable or accessible. Following the bypass, the PPS logic will be in a 2-out-of-3 configuration for the bypassed trip parameters.

ARKANSAS NUCLEAR ONE
Unit 2

This bypass is implemented at the PPS and is designed to IEEE 279-1971 criteria. The design incorporates the following features as described in detail in Section 7.2.1.1.5:

- A. A hardware interlock prevents the plant operator from bypassing more than one of the four channels of any type of trip at one time.
- B. A key is required to gain access to the means for manually bypassing the protective channel.
- C. Indication of bypass or removal of any channel from service is given by lights and annunciation at the main control board.

7.2.1.1.2.5.1.7 Testing

The purpose of both the automatic and periodic testing of the CPC system is to contribute to high system reliability by means of failure detection and to call attention to system performance that is not within prescribed limits. The automatic and periodic tests provide a means of checking, with a high degree of confidence, the operational availability of system input sensors and all devices used to derive the final system output signal. The system tests are summarized in Table 7.2-17.

In compliance with Section 4.4 of IEEE 279-1971, a qualification program has been implemented to verify that the CPC system equipment meets the performance requirements, established to achieve system requirements, within all environmental constraints.

In addition, factory tests, design and performance qualification tests are implemented to assure that the installed protection system, with precision and reliability, performs its intended function.

Automatic On-Line Testing

The automatic on-line testing consists of three separate checks: (1) internal self-checking of the input data, (2) internal self-checking of the calculator, and (3) an external watchdog timer that monitors the execution of the cyclic scheduling mechanism. Although failures in the on-line system are expected infrequently, the automatic on-line testing is provided to assure high continuous system reliability beyond that provided in typical analog calculated trips.

The protection algorithms check the reasonability of input sensor data against predetermined maximum and minimum values.

The internal self-checking of the calculator consists of monitoring the calculator AC power supply, monitoring internal machine faults, monitoring memory error correction and detection, monitoring the memory access translator hardware and providing a "check-sum" comparison of protected memory. When the calculator detects a significant drop in the AC power supply voltage, the calculator will set its outputs in the fail-safe condition and initiate an annunciator. The calculator will then cause an orderly shutdown of its functions, placing the machine in the "wait" state. Restoration of power will cause the calculator to initiate execution of the auto-restart program followed by the initialization task.

As each calculator cycles through its programs the integrity of the memory is monitored by the error correction and detection hardware and the memory access translator hardware. Additional error detection and memory verification is accomplished on a time available basis. The Idle Time Loop task creates a checksum of the contents of consecutive memory locations and

ARKANSAS NUCLEAR ONE
Unit 2

compares the checksum against a pre-programmed constant. Detection of an error will initiate a CPC or CEAC failure annunciation. The Idle Loop Task runs when no higher priority task is enabled. If a checksum error occurs, the calculator sets the outputs in the fail-safe state and enters a non-interruptable wait state until the malfunction is repaired.

The software monitors the following internal machine faults:

- A. Fixed-point divide fault (division by zero or quotient overflow);
- B. Floating-point arithmetic fault (exponent overflow or underflow, division by zero);
- C. Memory parity error;
- D. Illegal instruction (non-existent operation code);
- E. Failure to meet the timing requirements of program timing and input sampling rates;
- F. Memory access protection violation/memory address translator violation; and,
- G. Instruction alignment faults.

If any of the above faults occurs, the software will attempt to recover by entering the auto-restart and initialization routines and will also generate an annunciator. While in the initialization routine, the outputs will remain in the fail-safe condition. If a successful recovery is made, the outputs will be reset, and calculations will continue. Error codes for the last three fault conditions will be stored and printed at the start of the periodic test. If recovery is not successful, the calculator will cycle through the initialization routing until the malfunction is repaired.

To provide a check on the system software and to detect time frame overruns for each software task routine, an external "watchdog timer" is installed as part of the data input/output subsystem. Thus, if the internal cyclic scheduling mechanism fails or if the calculator hangs in a non-interruptable state, the "watchdog timer" will time out and will light the CPC or CEAC failure light at the operator's module directly. The indication will latch until it is manually reset. Timeout of the watchdog timer will set the calculator outputs in the fail-safe condition.

Further on-line testing capability is provided by continuous status indication and information read out from each CPC. Continuous displays of the following information are provided to the operator:

- A. DNBR margin;
- B. Local power density margin; and,
- C. Calibrated neutron flux power.

Cross checking of the four channel displays can be made to assure the integrity of the calculator. The majority of the calculator failures will result in anomalous indications from the failed channel that can be readily detected by the operator during cross checking.

In addition, each protection channel is equipped with an operator's module which provides another level of assurance of the functional integrity of the calculator channels.

ARKANSAS NUCLEAR ONE Unit 2

Periodic Testing

IEEE 338-1971, "Trial Use Criteria for the Periodic Testing of Nuclear Power Generating Station Protection System," provides the guidance for development of procedures, equipment, and documentation of periodic testing. The basis for and the scope and means of periodic testing are described in this section.

The CPC system is periodically and routinely tested to verify its operability. A complete channel can be individually tested without initiating a reactor trip, and without violating the single failure criterion. The system can be checked from the sensor signal through the bistable contacts for low DNBR and high local power density in the PPS. Overlap in the checking and testing is provided to assure that the entire channel is functional.

The analyses and tests that are performed to demonstrate the reliability of the hardware and software design initially are addressed subsections which follow, "Environmental Qualification Testing," "Factory Testing" and "Design and Performance Qualification Testing." The minimum frequencies for checks, calibration, and testing of the CPC system have been included in the Technical Specifications.

Periodic testing of the CPC system is divided into two major categories: (1) on-line system tests, and (2) off-line performance/diagnostic tests. Off-line testing is further subdivided into two categories: performance testing and diagnostic testing. Performance testing is used to check the numerical accuracy of the calculations. Diagnostic testing is used as an aid to troubleshooting whenever the performance tests or the on-line tests (interchannel comparisons) indicate the presence of a failure.

On-Line System Test

The on-line portion of the periodic testing consists of comparisons of like parameters among the four protective channels. Comparisons are made using the digital displays on the operator's module and the analog meters on the control board. Comparisons of like analog and digital inputs give assurance that the analog and digital multiplexers and the A/D converters are functioning properly. These comparisons also give assurance that data are being properly entered into and retrieved from the data base. Comparison of intermediate and final calculated parameters verifies the performance of the protection algorithms and the analog display meters on the control board.

Off-Line Performance Test

Before off-line testing is initiated, the channel to be tested is bypassed at the PPS and the trip logic is changed to 2/3 for the DNBR and local power density trips. Interlocks are incorporated in the PPS to prevent bypassing more than one channel at a time. To initiate off-line testing, a key is required.

The performance test uses the calculator data base to verify numerical accuracy of the calculations. The data base, depicted in Figure 7.2-43, is divided into three areas, namely, raw input data, filtered input data and calculated values. The raw data area contains the last samples of raw analog and digital data. The filtered data area contains averaged input data, filtered input data, past samples of input data needed for dynamic compensation, and dynamically compensated data. The calculated values area contains intermediate and final calculated values and calibration constants which are updated periodically.

ARKANSAS NUCLEAR ONE
Unit 2

During performance testing, the test inputs are loaded directly into the data base. For each set of test inputs, the expected calculated results are also loaded and compared with the values calculated by the protection algorithms. If a test fails, the test program prints the expected results and the actual results on the hard copy device on the test cart (when restarted it proceeds to the next set of test data) and halts at that point unless restarted by the operator. Dynamic effects in the calculations are tested by loading the filtered data area of the data base with test values representing past values of time varying inputs.

From the standpoint of the calculator software structure, the performance tests are virtually identical to the on-line functions. Only two differences exist from the normal functions of the calculators. First, the calculator outputs are in a fail-safe condition for the duration of the tests, and second, the algorithms use predetermined data instead of the data input/output subsystem. The algorithms are executing in the test mode, however, and do not distinguish between the data sources.

Off-Line Diagnostic Tests

After a given failure is detected by a performance test, on-line test, or on-line diagnostic, hardware diagnostic programs are provided to aid in locating and correcting malfunctions.

Two types of hardware diagnostic programs are provided. The first set of diagnostic programs runs under the supervision of the system monitor task. These diagnostics, adapted to the specific hardware configuration, are activated by the system monitor. Each diagnostic program is executed within the framework of the system monitor. The first set of diagnostics provides a means of testing:

- A. Data Input/Output Subsystem - gives the ability to read the analog input reference voltage;
- B. Memory Protect - verifies the memory address translator's protect feature; and,
- C. Operator's Module - generates a test sequence.

The second set of diagnostics consists of independent stand-alone programs which provide a means of detecting and locating errors in the following system components:

- A. Central Processing Unit, Arithmetic Logic Unit, floating point instructions and Memory tests, exhaustively test CPU, logic, and arithmetic instructions, floating point instructions and tests memory for all known worst case data patterns and also insure that an instruction can be fetched from every location in memory;
- B. Real Time Clock - tests the interrupt functions;
- C. RS-232 ports - verifies input and output functions;
- D. Disc (Permanent Mass Storage) - verifies disc functional capability, I/O commands, and bulk storage integrity;
- E. Data Input/Output Subsystem - provides a means of testing I/O services and commands;
- F. Memory Address Translator - verifies memory access monitoring hardware;

ARKANSAS NUCLEAR ONE
Unit 2

- G. Loader Storage Unit - verifies reboot capability; and,
- H. EPROM Loader.

All diagnostics will be supplied so that they may be loaded via the disc.

Plant Computer Monitoring

No credit is taken for the operation of the plant computer in determining the reliability of the CPCs or in determination of the required interval for periodic testing.

The plant computer provides a backup monitoring capability (in addition to the plant operating personnel) by providing periodic comparisons of sensor channel inputs and checking of calculated results of the CPCs.

Failure of the plant computer will in no way affect the operation of the CPCs due to the following design provisions:

- A. The data links to the plant computer are isolated such that any credible failure at the plant computer will not affect the operation of the CPCs.
- B. All data transfers are controlled by the CPCs and data links allow only one way data transfer from the CPCs to the plant computer.
- C. The reliability of the CPC hardware and the periodic testing interval shall be specified such that loss of the plant computer will not adversely affect the overall reliability of the PPS.

Environmental Qualification Testing

The CPC system will be qualified for service in its expected environment by comprehensive testing. These qualification tests during design basis environmental conditions were performed on a type-test basis in accordance with the guidance set forth in IEEE 323-1971. The design basis environmental conditions include the following:

- A. Temperature and humidity; and,
- B. Seismic.

The test carts are excluded from the seismic testing. The annunciator lights on the operator's modules are not required to operate during a seismic disturbance.

In addition to the environmental and seismic testing, design qualification testing will be performed on a type test basis to demonstrate the adequacy of the CEA optical isolators*. These optical isolators must prevent any credible failure or event at the output wiring from propagating to, or degrading the input signals to the device. The devices must be qualified for the following conditions:

- A. Short circuit of signal leads: to each other, individually to ground and both to ground;
- B. Open circuit of signal leads; and,

ARKANSAS NUCLEAR ONE
Unit 2

- C. Application of the maximum credible potential to the output signal leads.

For Arkansas Nuclear One - Unit 2, isolated signal leads are connected to cabinets or equipment where the maximum available voltage is 120 volts AC or 125 volts DC.

The fiber optic data links will be qualified by analysis.

*Note: The paragraph above is historical information. CEA isolation amplifiers were removed by a hardware upgrade during refueling outage 2R7 and replaced with fiber optic isolators. See License Am-101.

Factory Testing

In addition to the equipment testing done in compliance with quality assurance requirements, the following tests are performed.

- A. System Integration Test

The CPC system equipment will be operated for a predetermined period at the plant site to verify their reliability prior to being placed into service.

- B. System Configuration

The CPC system will be configured at the factory. Acceptance tests are conducted on the configured system before system shipment.

Design and Performance Qualification Testing

The DNBR/LPD calculator system performance will be verified in accordance with CEN-39-(A)-P. Following installation at the plant site, preoperational tests are run to verify the installed integrity of the system and the correctness of the interconnecting wiring.

7.2.1.1.2.5.1.8 Analysis

Failure Mode and Effects Analysis

Analog voltage or contact openings indicate the status of each trip parameter for each channel of four channels. Separation and isolation is incorporated to assure independence of all redundant equipment.

The status of each trip parameter is checked at the bistable level of the RPS. When a parameter reaches its respective trip value, the bistable logic generates contact opening signals to the logic matrices.

Each input channel provides a contact opening signal to three of the six logic matrices. When two bistable channels indicate a trip condition for the same protection parameter, the logic matrix that is monitoring those channels will cause the four logic matrix relays to drop out, opening their respective contact in each of the four trip paths.

The trip circuit breaker control relay for each trip path responds to the contact opening signal by providing a contact opening and a contact closure signal to two reactor trip circuit breaker control circuits.

ARKANSAS NUCLEAR ONE
Unit 2

The actuation of the logic matrix relays for any one of the six logic matrices will result in the trip of all eight reactor trip circuit breakers. Only four reactor trip circuit breaker trips are required to generate a full reactor trip. This logic is arranged such that the trip path actuation logic is a selective 2-out-of-4 coincidence.

The reactor trip circuit breakers are arranged such that they will latch in the tripped state until they are manually reset. This design feature assures that all valid trip initiations will cause the reactor trip to proceed to completion.

Each of the four redundant CPCs provides a contact opening to the RPS at the bistable level.

- A. A failure of one of the CPCs in the tripped condition will cause the reactor trip logic to revert to a 1-out-of-3 coincidence. Three intact calculators remain to monitor the input parameters of which only one is required to operate to effect a reactor trip. If the failed channel is bypassed, then the reactor trip logic becomes 2-out-of-3. In this instance, the system can tolerate another single failure and still initiate a valid reactor trip.

A single failure of the CPC that results in a failure to initiate a reactor trip will not cause loss of functional capability since only two of the three remaining channels are required to effect a reactor trip.

Failures in the CPCs can be detected by one or more of the following methods.

1. Interchannel comparison of the continuous displays of DNBR margin, local power density margin and calibrated nuclear flux power from each of the operable CPCs.
 2. Interchannel comparison of intermediate calculated results from each of the operable CPC operator's modules.
 3. Through annunciators and/or trip signals generated as a result of the self test features or watchdog timer timeout.
 4. Through the performance of periodic testing of each CPC.
- B. A process sensor channel failure to a CPC may produce a channel trip if the failure is in the direction of the trip condition, or the failure may produce erroneous results in the output of a single calculator.

In either case, three intact channels remain. Only two channels are required to initiate a valid reactor trip.

Failures in the NSSS process sensor channels can be detected by one or more of the following methods.

1. Spurious trip or pre-trip of a CPC channel or by annunciators generated by sensor limit checking done by the on-line diagnostics.
2. Interchannel comparison of the continuous displays of DNBR margin, local power density margin and calibrated neutron flux power from each of the operable CPCs.

ARKANSAS NUCLEAR ONE
Unit 2

3. Interchannel comparison of the intermediate calculated results from each of the operable CPC operator's modules.
 4. Interchannel comparison of the input sensor values from the operator's module and control board mounted displays.
 5. Through the performance of periodic sensor tests and calibrations.
- C. A failure in a CEA reed switch position input to the CPCs will result in conditions identical to the results delineated in "B," for the calculator which utilizes this signal as an input.

In addition, the CEA position signal will be utilized by one of two redundant CEACs. The CEACs will detect the sensor failure in range as a CEA deviation. This deviation will result in penalizing all four CPC calculations in the conservative direction such that trip setpoints will be approached. This deviation will also be annunciated by the affected CEAC. The CEAC sensor failure lights are activated on detection of excessive CEA motion. Rate limits are different for up and down travel.

The optical isolator* is designed such that all credible single failures of the reed switch sensor channel input (including an open circuit, short circuit, or application of the maximum credible voltage of 120 volts AC) will result in, at most, an erroneous signal being processed by the isolated CEAC and passed on as a penalty factor that will result in more conservative calculations within the CPC.

Also, the optical isolator* output will not affect the accuracy of the input signal.

If the CEA reed switch position sensor fails in such a manner that the sensor signal is outside of the normal sensor range, the CEAC will annunciate the CEA sensor failure and process the CEA sensor value as if it was at its extreme limit of the normal range.

The normal range of the CEA reed switch sensor is fully inserted to fully withdrawn, corresponding to a signal range of +5 to +10 volts.

Major sensor failures will cause the sensor signal to indicate one extreme of the power supply voltage that powers it--either zero volts or +15 volts. An out-of-range sensor signal is defined as a signal that is greater than +10 volts or less than +5 volts.

*Note: The CEA isolation amplifiers were removed by a hardware upgrade during refueling outage 2R7 and replaced with fiber optic isolators. See License Am-101.

CEA reed switch position sensor channel failures can be detected by one or more of the following methods.

1. Comparison of the redundant sensor values between the two CEACs at the CPC operator's module. Each CEA has two redundant CEA reed switch position sensor channels that detect its position. One sensor channel is utilized as an input to one CEAC and the redundant sensor is utilized by the redundant calculator.
2. Comparison of CEA positions within a group as displayed to the operator as inches withdrawn or on a bar chart format on the operator's module displays.

ARKANSAS NUCLEAR ONE
Unit 2

3. Deviation annunciator from the CEAC.
 4. Sensor fail annunciator from the CPC or CEAC.
 5. Periodic tests and calibrations of the sensor channel.
- D. A failure of a CEAC may result in a spurious indication of a deviation or penalty factor.

This failure will result in causing the CPCs to assume a more conservative calculation of DNBR and local power density.

The redundant CEAC remains intact and its output is still read by the CPCs.

The CPC programs are designed to utilize the more conservative penalty factors of both CEACs. This feature assures that for any failure of a CEAC, the redundant calculator will still provide protection should a CEA-related incident occur that is more severe than the penalty factor and deviation that resulted from the failure.

CEAC failure can be detected by one or more of the following means:

1. Interchannel comparison of the sensor inputs and intermediate results between the two redundant CEACs.
 2. Annunciators generated as a result of on-line diagnostic.
 3. Annunciators generated by the CPCs which compare the CEAC outputs and announce any significant discrepancy.
 4. Malfunction of the CEAC operator's module.
 5. The performance of periodic testing of each CEAC.
- E. The eight data links between the two CEACs and the four CPCs utilize fiber optic coupling to provide the required isolation between calculators.

Each data link is designed such that any credible single failure including short circuit, open circuit, or application of the maximum credible voltage of 120 volts AC cannot affect the operational integrity of the CEAC. This feature is inherent in the operation of the isolator.

The operational integrity of the CPCs will not be compromised since the CPC utilizes the most conservative data of the two valid penalty factors from the two CEACs.

IEEE Criteria Analysis

IEEE 279 Criteria

The LDNBR trip and the HLPD trip as implemented in the CPCs meet the design criteria of IEEE 279-1971, "Criteria for Protective Systems for Nuclear Power Generating Stations."

ARKANSAS NUCLEAR ONE
Unit 2

The manners in which the design requirements are met are delineated below by a statement of the criteria, followed by a description of the pertinent design feature that assures conformance with the criteria.

IEEE 279-1971, Section 4.0

"4.1 General Functional Requirements"

"The nuclear power generating station protection system shall, with precision and reliability automatically initiate appropriate protective action whenever a condition monitored by the system reaches a preset level. This requirement applies for the full range of conditions and performance enumerated in Section 3(7), 3(8), and 3(9)."

The LDNBR trip and the HLPD trip meet the design requirements of IEEE 279-1971, Section 4.1, by monitoring NSSS parameters that can affect core heat flux and power density, by calculating current and projected values of DNBR and LPD, and by initiating a reactor trip within a sufficient time interval such that the minimum core DNBR shall be no less than its required value and the peak local power density shall not initiate centerline fuel melting for any anticipated operational occurrence.

"4.2 Single Failure Criterion"

"Any single failure within the protection system shall not prevent proper protective action at the system level when required."

The low DNBR trip and the high local power density trip meet the design requirement of Section 4.2 by utilizing the principle of redundancy as follows:

- A. Pertinent NSSS variables are monitored by redundant sensors and signal processors.
- B. The DNBR and local power density calculations are performed in redundant calculators.
- C. The signal to initiate a reactor trip is generated and transmitted to the RPS logic redundantly.
- D. The independence of each redundant channel from sensor to signal processor to the CPC to the PPS logic is assured by physical separation or barriering, separate redundant power sources for each channel, and by isolation devices at the channel outputs that prevent the propagation of credible failures from external systems into the channel.
- E. The integrity of each redundant channel is assured by a comprehensive testing program consisting of:
 1. Internal self testing features of the calculators that alarm fault conditions:
 - a. watchdog timers;
 - b. primary power failure detection and on-line diagnostics; and,
 - c. sensor range checking;

ARKANSAS NUCLEAR ONE
Unit 2

2. Periodic comparison between redundant channels of:
 - a. addressable contents for calculations;
 - b. calculational results; and,
 - c. input display meters;
3. Periodic testing of each trip channel to the criteria of IEEE 338-1971, "Trial Use Criteria for the Periodic Testing of Nuclear Power Generating Station Protection System":
 - a. input simulation with recording of computed results and comparison of results against known performance criteria;
 - b. verification of sensor integrity by interchannel comparison of similar parameters.

"4.3 Quality of Components and Modules"

"Components and modules shall be of a quality that is consistent with minimum maintenance requirements and low failure rates. Quality levels shall be achieved through the specification of requirements known to promote high quality, such as requirements for design, for the derating of components, for manufacturing, quality control, inspection, calibration and test."

The requirements of Section 4.3 are met by the LDNBR trip and the HLPD trip in the following ways:

- A. The calculators utilize digital integrated circuits of proven reliability. Digital devices are less sensitive to time and temperature effects than analog devices.
- B. The use of discrete components, such as capacitors and resistors, in the calculators is minimized, improving reliability and accuracy.
- C. All modules implementing the low DNBR trip and high local power density trip will be qualified for its specific design basis event environment to the design guide requirements of IEEE 323-1971, "General Guide for Qualifying Class I Electric Equipment for Nuclear Power Generating Stations."
- D. The manufacturing quality control and inspection is controlled in accordance with C-E requirements for Class 1E electrical equipment.
- E. Integrated system testing at the factory and in the field.

"4.4 Equipment Qualifications"

"Type test data or reasonable engineering extrapolation based on test data shall be available to verify that the protection system equipment shall meet, on a continuing basis, the performance requirements determined to be necessary for achieving system requirements."

ARKANSAS NUCLEAR ONE
Unit 2

The LDNBR trip and HLPD trip will meet the requirements of Section 4.4 by performance of type testing and analysis to the criteria of IEEE 323-1971, "General Guide for Qualifying Class I Electric Equipment for Nuclear Power Generating Stations." The type-test programs will include:

- A. Seismic testing to the criteria of IEEE 344-1971, "Guide for Seismic Qualification of Class I Electric Equipment for Nuclear Power Generating Stations"; and,
- B. Environmental testing simulating design basis temperature and humidity environment.

"4.5 Channel Integrity"

"All protection system channels shall be designed to maintain necessary functional capability under extremes of conditions (as applicable) relating to environment, energy supply, malfunctions, and accidents."

The CPCs LDNBR trip and HLPD trip meet the design requirements of Section 4.5 by assuring that:

- A. All channel equipment is qualified for ANO-2 design basis environment to IEEE 323 Criteria;
- B. Separated and independent power sources are provided for each channel. Each battery source is ungrounded and derived from a high reliability station battery through an inverter. Each calculator is provided with an AC fail detector that senses a low voltage condition, generates an alarm and initiates an orderly shutdown of the calculator. All calculator inputs to the RPS logic fail "safe" (in the tripped condition) on loss of power; and,
- C. Sensor location, equipment location and interconnecting cable routing for each channel are maintained independent from every other redundant channel through physical separation or barriering. Isolation devices are utilized at the calculator outputs. These measures assure that proper protective system action will not be prevented by malfunctions or accidents that may occur, even if these events occurred in one of the redundant channels.

"4.6 Channel Independence"

"Channels that provide signals for the same protective function shall be independent and physically separated to accomplish decoupling of the effects of unsafe environmental factors, electric transients, and physical accident consequences documented in the design basis, and to reduce the likelihood of interactions between channels during maintenance operations or in the event of channel malfunctions."

The requirements of Section 4.6 are met by the CPCs low DNBR trip and the HLPD trip in the following ways:

- A. CEA Position Information

Each CEA in the reactor core is monitored by two redundant CEA reed switch position transmitters. CEAs are generally controlled by subgroups of four CEAs due to core symmetry considerations. For this reason, one CEA reed switch position transmitter for each CEA in one core quadrant is utilized directly by one of four redundant CPCs

ARKANSAS NUCLEAR ONE
Unit 2

as representative of the position of that subgroup. The signal from this transmitter is also buffered through an optical isolator* and utilized by one CEAC to determine CEA deviation. The second reed switch transmitter for each CEA in that quadrant is utilized directly by the redundant CEAC. Following this allocation process through all four core quadrants will yield the system shown by Figure 7.2-32.

Each CEAC is physically and electrically separated from its redundant counterpart. Each CEAC transmits a set of CEA deviation data to each of the four CPCs through four fiber optically isolated data links.

The CEACs and the data links to the CPCs, including the use of deviation data by the CPCs, are designed so that no credible single failure can cause the CPC system to fail in an unsafe manner when both CEACs and two or more CPCs are initially in operation. Operability requirements for the system will be included in the Technical Specifications. The intent of Section 4.6 of IEEE 279-1971, which requires channel independence, is fulfilled as follows:

1. The physical independence required is achieved through the use of two separate measurements of each CEA position. These CEA positions are processed by two redundant CEACs which are located in two physically isolated channels of the CPC system.
2. Optical isolators* located in Channels A and D which transmit 20 CEA positions to the CEAC in Channels B and C, respectively, are designed such that open circuits, short circuits, or the application of the credible potential to the optical isolator output will not affect measurement Channel A or D and its CPC.
3. The electrical isolation required is achieved through the use of optical isolators in every signal line of the data links. Since there is no electrical connection across the fiber optic cable and since the dielectric breakdown voltage of the fiber optic cable far exceeds the maximum credible potential (120 volts a-c or 125 volts d-c), electrical transients cannot propagate from one channel to another. At most, electrical transients can produce only erroneous data within the confines of the isolated portion. Such erroneous data is provided for as described below.

*Note: The CEA isolation amplifiers were removed by a hardware upgrade during refueling outage 2R7 and replaced with fiber optic isolators. See License Am-101.

4. The CEACs and the data they transmit provide protection for the CEA-related anticipated operational occurrences defined in Section 7.2.2.1.1. The CEACs transmit data which is used to obtain a multiplier on the radial peaking factors stored in the CPCs. The CPCs limit this multiplier to a value greater than or equal to 1.0. A CEAC can only cause the CPCs to approach the trip setpoint; it can never cause a displacement in the unsafe direction. Erroneous data from a CEAC will cause either: (1) the trip setpoint to be approached if the erroneous penalty factor is greater than the existing penalty factor; (2) the utilization of the correct (higher) penalty factor from the other CEACs if the erroneous penalty factor is lower than the existing penalty factor.

ARKANSAS NUCLEAR ONE
Unit 2

5. Storage of the data from the CEACs in the CPC data base is under the control of the software in the CPCs. Therefore, a failure in one of the CEACs can never destroy all or part of the data base in any CPC.

Table 7.2-13 describes the actions taken for postulated single failures and demonstrates that the CPC system remains safe.

B. NSSS Process Information

All NSSS process information, including neutron flux measurements and RCP speed measurements utilize the following criteria to assure that no single event could negate a protective function:

1. Four (4) redundant physically separated sensors;
2. Physical separation or barriers between redundant cabling; and,
3. Physical separation or barriers between redundant signal processing equipment.

C. Plant Computer Data Links

Fiber optic isolated data links from each calculator to the plant computer are designed such that open circuits, short circuits or the application of the highest credible potential to the isolator output will not affect calculator performance and will not prevent any calculator from performing its intended function.

D. CEA Withdrawal Prohibit (CWP)

A CEA withdrawal prohibit (CWP) logic signal is transmitted to the CEDMCS when 2-out-of-4 coincidence conditions are met on high pressurizer pressure pre-trip, low DNBR pre-trip, or HLPD pre-trip. As shown in Figure 7.2-47, each CPC will send a single contact opening to the PPS when a pre-trip condition exists for LDNBR or HLPD. The PPS uses these four contacts from the four CPCs to control interposing or auxiliary logic relays which form a 2/4 logic matrix.

Channel independence is maintained as the CWP contact from the CPC in each redundant channel is directly wired to the auxiliary logic relay in the respective channel of the PPS. The contacts of the auxiliary logic relays are wired to form a 2-out-of-4 coincidence logic matrix.

A spare relay on the high pressurizer pressure bistable in each PPS channel is wired to form a similar 2/4 logic matrix. The two matrices, connected in series, form the required logical "OR" and provide an "open-contact" to the CEDMCS to initiate a CEA withdrawal prohibit interlock.

The CWP logic and relay/contact interfaces are manufactured and tested to meet all safety systems standards and design bases of the PPS. No single failure of CWP logic and interfaces will compromise the independence of the CPC channels or the PPS channels. Any credible failure at the CEDMS/PPS (Channel A) interface, including open/close circuit, application of 120 volts AC or 125 volts DC, cannot propagate the failure within the associated PPS and CPC channel and prevent any channel from performing its intended function. The CWP wiring is separated from the 240/139-volt AC power buses at the CEDMCS such that the application of this potential is not a credible event.

ARKANSAS NUCLEAR ONE
Unit 2

The CWP interlock prohibits the withdrawal of all regulating and shutdown CEAs in any group mode of control, regardless of any demand for motion by the operator. An unwarranted CWP initiation or a failure to initiate a CWP when required is not a control system action which requires protective action.

"4.7 Control and Protection System Interaction"

There are no interactions between the CPCs and CEACs and any control system. An interlock function for CWP is provided as discussed below. There are no interactions between the CPCs and CEACs and the plant computer including the CEA sequencing functions of the plant computer or the Core Operating Limit Supervisory System (COLSS).

Signals derived from the following protection system sensors are inputs to both the plant computer and the CPCs.

- A. pressurizer pressure - 1 per channel
- B. hot leg temperature - 2 per channel
- C. cold leg temperature - 2 per channel

Process instrumentation signals listed above enter the plant computer as analog inputs. These signals are isolated at the protection system in accordance with the requirements of IEEE 279-1971, Section 4.7.2. Therefore, no credible failure at the plant computer can prevent these signals from performing their protective function. The plant computer only monitors these signals.

The plant computer, including COLSS and the CPC system has no elements of software which are the same.

The COLSS software runs in the plant computer.

The COLSS programs receive input signals from sensors separate from the CPC system. No data is transmitted from the CPCs or CEACs for use by COLSS. No data can be transmitted from the plant computer or COLSS for use by the CPCs or CEACs.

There is no equipment which is common to the CPC system and any automatic control function of the plant computer.

Protective functions and plant computer control functions derive their inputs from separate sensors. For example, process measurements (pressurizer pressure, hot leg temperature, cold leg temperature, etc.) are each measured by six separate sensors: four for protection and two for control.

The requirements of Section 4.7.2 of IEEE 279-1971 are met by fiber optic isolation of the data links to the plant computer. These isolators ensure that no credible failure at the plant computer can prevent the CPC system from performing its intended function.

There are no programs and calculations in the plant computer and COLSS which are essentially the same as those included in the CPC system. As stated in Section 7.7.1.3, COLSS calculates the core power operating limits based on margin to DNBR and peak linear heat rate. COLSS uses the DNBR peak linear heat rate and core power level calculations to provide an indication

ARKANSAS NUCLEAR ONE
Unit 2

that is available to inform the operator of the margin to core power operating limits. The CPC system calculates the minimum hot channel DNBR and the power level corresponding to the limit on Local Power Density (LPD). These calculations are based on many of the same physical principles as the COLSS calculation. There are many differences in the mathematical techniques used to model the physical principles. Moreover, COLSS and the CPCs use different computers and programming languages.

The CPCs use the calculations to initiate a reactor trip when safety limits are reached.

"4.7.1 Classification of Equipment"

No portion of the CPCs, including the CEACs and their sensors, is used for both control and protective functions. No portion of the CPCs including the CEACs and their sensors is used in the CEA sequencing or COLSS functions.

"4.7.2 Isolation Devices"

No signals are transmitted from the CPCs and CEACs for control system use or for use by the CEA sequencing or COLSS functions. Signals which are transmitted to the plant computer for monitoring only are isolated by devices meeting the requirements of this section.

"4.7.3 Single Random Failure"

The CPCs and CEACs use sensors and systems which are independent from all control systems and the plant computer and COLSS. Therefore, any single failure in the plant computer, or in any control system, will have no effect whatsoever on the CPCs or CEACs.

"4.7.4 Multiple Failure Resulting from a Credible Single Event"

The CPCs and CEACs use sensors and systems which are independent from all control systems and the plant computer and COLSS. Therefore, any combination of multiple failures in the plant computer, COLSS or control systems will have no affect whatsoever on the CPCs or CEACs.

"4.8 Derivation of System Inputs"

"To the extent feasible and practical, protection system inputs shall be derived from signals that are direct measures of the desired variables."

The LDNBR trip and the HLPD trip meet the requirements of Section 4.8 by monitoring the pertinent parameters for each calculation as detailed in Table 7.2-9.

"4.9 Capability for Sensor Checks"

"Means shall be provided for checking, with a high degree of confidence the operational availability of each input sensor during reactor operation...."

The integrity of the low DNBR trip and the high local power density trip sensors is verified by cross checking between channels. For each CPC, the calculator values of DNBR margin, LPD margin and calibrated neutron flux power are continuously displayed for immediate comparison. At each operator's module, the values of input data, intermediate calculated results, and final calculated results are available on demand for four channel comparison. Input, output and

ARKANSAS NUCLEAR ONE
Unit 2

status indications available to the CPC system are summarized in Tables 7.2-14, 7.2-15, and 7.2-16. These channels bear a known relationship to each other, and this method ensures the operability of each sensor during reactor operation.

Section 4.9 of IEEE 279-1971 requires that means be provided for checking sensor inputs during reactor operation. Section 4.9 suggests the following ways of accomplishing this function:

- "(1) by perturbing the monitored variable; or
- (2) within the constraints of paragraph 4.11, by introducing and varying, as appropriate, a substitute input to the sensor of the same nature as the measured variable; or
- (3) by cross checking between channels that bear a known relationship to each other and that have readouts available."

The system design uses the method of (3) above for periodic testing of sensor inputs. Cross-checking like sensor inputs between channels not only verifies the integrity of the sensors, but also verifies proper operation of the input multiplexer, Analog-to-Digital (A/D) converter, I/O interface circuits and analog acquisition software.

A failure of the A/D converter which would produce errors (non-linearity) at other points in the range are detected by the cross-checking of sensor inputs. Sensor inputs normally provide enough points to cover the A/D converter range fully, e.g. process inputs - 1 to 5 volts, CEA positions - 5 to 10 volts, ex-core power - 0 to 10 volts.

Testing of the sensor inputs, in conjunction with the digital simulations and exercising of the trip output contacts, completely verifies the CPC system from input to output. Each test segment overlaps adjacent test segments to provide complete coverage. This overlap testing approach is the same one that is used in the testing of non-computed protective functions.

Cross channel checking provides the same level of confidence in the adequacy of the test as the other alternatives since:

- A. All input multiplexing switches are tested and verified;
- B. The A/D converter is verified over its entire range; and,
- C. The data handling software is verified.

The use of a dummy power signal to initiate a trip output re-verifies the dynamic operation of the system.

"4.10 Capability for Test and Calibration"

"Capability shall be provided for testing and calibrating channels and the devices used to derive the final system output from the various channel signals. For those parts of the system where the required interval between testing will be less than the normal time interval between generating station shutdowns, there shall be capability for testing during power operation."

The CPC system utilizes overlap testing to assure compliance with Section 4.10 of IEEE 279-1971.

ARKANSAS NUCLEAR ONE
Unit 2

First, sensor integrity is verified through utilization of control room displays to cross check channels that bear a known relationship to each other.

Next, the sensor signals and the data acquisition hardware and software are verified by cross channel checks of the signal inputs by comparison of those stored values with the corresponding values indicated on the control room displays. This process involves utilization of the operator's module to display measured signal values with the system functioning on-line.

The calibration of the data acquisition equipment including A/D converters is also verified by displaying the fixed value precision reference voltage supplied for each channel.

This portion of the test has verified that the sensors, data acquisition and calculator hardware, and software responsible for data acquisition are functioning properly.

The next step in periodic testing involves the verification that the data verified as properly measured and displayed in the first step is utilized correctly by each calculator to synthesize the correct output result from the measure inputs. This step involves the off-line performance test.

These tests involve utilizing sets of pre-calculated inputs to the calculator data base. By executing each program with predetermined inputs, the performance tests simulate varied input conditions. The output of each performance test is compared against predetermined results to assure that the calculator hardware and software properly execute the code for each protection algorithm to synthesize an output from the input variables. The first test step assures that input signals were properly measured and stored in the correct memory location. The second step assures that the calculator hardware and software retrieved the measured values correctly and properly synthesized the desired output from the input of the several measured values which were indirectly related to the desired output.

The final step in the test involves assurance that the data acquisition software and hardware responsible for initiating a channel trip functions properly. As described below, a dummy power signal is inserted that initiates a trip condition. This test is performed with the calculator on-line, but with the channel bypassed. Proper actuation of the trip contact completes the channel verification from input sensors to final output result. As can be seen from the above discussion, each test step overlaps the preceding step so that the linkage between each step in the verification process is maintained.

A. Interchannel Comparisons

With the CPC on-line, interchannel comparisons of "like" quantities are performed to determine the integrity of the sensors, A/D converters, the corresponding multiplexer channels and the calculated results. The calculated variable of DNBR, local power density and calibrated neutron flux power are continuously displayed on the main control board and may be readily cross-checked by the operator. Major calculator failures will be detected by discrepancies between the four channel display indicators.

The CPC operator's modules may also be used to provide displays of inputs, outputs, and selected intermediate calculated values so that the operator may make channel comparisons of the operable channels.

ARKANSAS NUCLEAR ONE
Unit 2

B. Digital Simulations and Diagnostics

A series of digital simulations with known inputs are performed sequentially in each CPC to verify the operation of the CPC software. In the channel under test, the CPC is placed off-line after the channel DNBR and local power density trips are bypassed from the PPS, changing the 2/4 protection logic to 2/3. Interlocks are designed in the RPS to prevent the bypassing of the same trip function in more than one channel at any one time.

The test program containing input data and predetermined output values is then executed followed by a "go"/"no go" verification of the calculated results against the predetermined values. Similar digital simulations are performed in each CEAC. The simulations are created to verify the software operation of the CEAC.

Administrative procedures and hardwired interlocks prohibit the testing of both CEACs simultaneously. For the brief time a CEAC is in test, the CPC in each safety channel ignores the input data from the CEAC under test by observing the status of information within the data format. Should a failure provide indications that both CEACs are in test, the CPCs will utilize the default CEA deviation penalty factor, which is stored as a value in protected memory.

The qualification tests prove that the CPC system performs all its intended functions including demonstration of correct action as a result of a combination of several parameters and verification of pre-trip and trip limits as required for periodic testing by IEEE 279-1971, Section 4.10. The intent of Section 4.10 of IEEE 279-1971 may be met by either verifying that the system software remains an exact duplicate of the one which passed qualification tests or by direct demonstration of multi-parameter effects and pre-trip and trip limits. The former is accomplished during software load by manually verifying checksums and by the idle task which continually verifies memory block checksums as the program executes. The latter is also done to provide redundant testing as described below.

The System Executive Task includes a sequence of software tests and a sequence of hardware tests as a part of the periodic channel test. Part of the software tests are designed to test the effect of sensor inputs on the protection programs, and to test the accuracy of the trip and pre-trip limits.

For each test, a definitive set of calculated variables and outputs will be compared to a stored set of constants which represent the correct results for the test. If an error occurs the expected and actual value of the affected variable will be printed on the Hard Copy Terminal/Device at the end of each test. In addition, erroneous results will be flagged. Since the same set of calculated variables will be checked and printed out for all tests run on a particular protection program, the effect of multiple parameters on a single output will be tested.

C. Dummy Power Signal Insertions

To exercise the CPC contact closure outputs, a dummy power signal from the ex-core nuclear instrumentation drawer is inserted using test potentiometers. The power signal is increased to trip the low DNBR and high local power density bistable relay card. The operator verifies that the CPC pre-trip and trip contacts function properly by observing the RPS trip and pre-trip indication lights.

ARKANSAS NUCLEAR ONE
Unit 2

D. Design Bases for Fault Detection, Fault Localization, and Fault Isolation and Repair Philosophy:

The CPC system has been designed to facilitate the recognition, location, replacement, repair and adjustment of malfunctioning components and modules as required by Section 4.21 of IEEE 279-1971. This is accomplished through on-line diagnostics, indicators and annunciators, periodic testing, and troubleshooting aids.

The on-line diagnostics are the first line of defense in the recognition and location of faults. A large number of single failures, though not all, are detected and indicated by the on-line diagnostics. The sensor range checks detect all sensor failures outside the normal range, certain multiplexer and A/D converter failures, certain CPU failures and all CEAC failures which cause the transmitted value of penalty factor to exceed the normal range. The memory checksum and hamming code checks detect and correct all single bit memory failures and recognize most memory module failures. The watchdog timer detects all failures which cause a program halt, tight loop or significant slowdown of instruction execution. Examples of failures detected by the watchdog timer include certain CPU and memory failures, certain CPU power supply failures and drift (slowdown) in the CPU clock. Slowdown of the CPU clock is also detected by the time-frame overrun checks in the operating system software. The arithmetic fault interrupts in the CPU detects floating point under-flow and over-flow and fixed point divide faults.

In addition to detecting faults, the on-line diagnostics point the technician to the general area of the fault by means of indicators and annunciators. For example, the sensor failure indication and annunciation would suggest to the technician that troubleshooting efforts be directed toward the sensors and input hardware (multiplexer and A/D converter).

Single failures which are not detected by the on-line diagnostics are detected during periodic testing. For example, a sensor failure within the normal range is detected by the cross-channel comparison of sensor inputs. Regardless of how the failure is initially detected, the next step in the process is detailed troubleshooting. The exact nature of the troubleshooting procedures will depend, to a large degree, on the skill, experience and resourcefulness of the individual technician. However the general procedure is as follows:

1. Bypass the affected channel.
2. Determine the general area of the fault from the on-line diagnostics or periodic test.
3. Troubleshoot that area using the appropriate diagnostic program and test equipment to isolate the fault.
4. Replace or repair the suspected faulty module or component.
5. Confirm fault diagnosis by verifying normal operation (rerun diagnostic program and periodic test).
6. Restore channel to on-line operation.

ARKANSAS NUCLEAR ONE
Unit 2

To assist the technician in the troubleshooting task, diagnostic software is provided to complement the normal test equipment (voltmeters, oscilloscope, etc.) for each of the following:

1. CPU
2. Memory
3. Input/Output chassis
4. Real time clock
5. Memory Address Translator
6. Disk
7. RS-232C ports
8. Loader Storage Unit
9. Floating Point Instructions
10. Operator's Module

The diagnostic programs may not identify failed components or modules explicitly, but they provide important information to aid the technician's diagnosis.

The repair philosophy for the CPC system may be stated as follows:

1. Recognize the fault.
2. Bypass the affected channel and isolate the fault to a replaceable module or component as rapidly as possible.
3. Replace or repair the faulty module or component.
4. Verify the correction of the fault.
5. Restore the channel to operation.

"4.11 Channel Bypass or Removal from Operation"

The system shall be designed to permit any one channel to be maintained and, when required, tested or calibrated during power operation without initiating a protective action at the systems level. During such operation the active parts of the system shall of themselves continue to meet the single failure criterion.

Exception: 1-out-of-2 systems are permitted to violate the single failure criterion during channel bypass provided that acceptable reliability of operation can be otherwise demonstrated. For example, the bypass time interval required for a test, calibration, or maintenance operation could be shown to be so short that the probability of failure of the active channel would be commensurate with the probability of failure of the 1-out-of-2 system during its normal interval between tests."

ARKANSAS NUCLEAR ONE
Unit 2

The LDNBR trip and HLPD trip meet the requirements of Section 4.11 in the following manner:

- A. The output contact from any one of the four CPCs may be bypassed at the PPS logic. This converts the PPS trip logic to 2-out-of-3, and the single failure criterion is met for this condition. Only one calculator output can be bypassed at any time. This condition is assured by a hardware interlock at the RPS logic.
- B. Testing of a CEAC places the CEAC function in an one-out-of-one situation during the test. In accordance with the requirements of Section 4.11, the Technical Specifications limit the time duration that the CEAC can be placed out of service.

"4.12 Operating Bypasses"

The LDNBR trip and the HLPD trip may be disabled for CEA drop and low power physics testing whenever reactor power is less than the Log Power Bistable reset point. The criteria of Section 4.12 are met by the following design provisions:

- A. Manual bypass by use of key lock switch;
- B. Bypass is automatically removed from each channel when the corresponding neutron flux measurement channel indicates that reactor power is greater than the Log Power Bistable Setpoint; and,
- C. The automatic bypass removal is designed to IEEE 279-1971 criteria.

"4.13 Indication of Bypasses"

"If the protective action of some part of the system has been bypassed or deliberately rendered inoperative for any purpose, this fact shall be continuously indicated in the control room."

Indication of test or bypass conditions or removal of any channel from service is given by lights and annunciators. Bypasses that are automatically removed at fixed setpoints are alarmed and indicated.

"4.14 Access to Means for Bypassing"

"The design shall permit the administrative control of the means for manually bypassing channels or protective functions."

A key is required to gain access to the means for bypassing a protective system channel. An interlock prevents the plant operator from bypassing more than one of four channels of any one type of trip at any one time. All bypasses are visually and audibly annunciated.

"4.15 Manual Initiation"

"Where it is necessary to change to a more restrictive setpoint to provide adequate protection for a particular mode of operation or set of operating conditions, the design shall provide positive means of assuring that the more restrictive setpoint is used. The devices used to prevent improper use of less restrictive setpoints shall be considered a part of the provision system and shall be designed in accordance with the other provisions of these criteria regarding performance and reliability."

ARKANSAS NUCLEAR ONE
Unit 2

Manual setpoint changes are not expected to be required during plant operation.

"4.16 Completion of Protective Action Once it is Initiated"

"The protection system shall be so designed that, once initiated, a protective action at the system level shall go to completion. Return to operation shall require subsequent deliberate operator action.

The RPS logic is designed to assure that a coincidence of two trip channel input signals from the CPCs will go to completion once a reactor trip is initiated. Operator action is required to clear the trip at the systems level of the RPS to return to operation.

"4.17 Manual Initiation"

"The protection system shall include means for manual initiation of each protective action at the system level (for example, reactor trip, containment isolation, safety injection, core spray, etc.) No single failure, as defined by the note following Section 4.2, within the manual, automatic, or common portions of the protection system shall prevent initiation of protective action by manual or automatic means. Manual initiation should depend upon the operation of a minimum of equipment."

Manual trip initiation is provided at the systems level of the RPS in accordance with criteria of Section 4.17. This manual trip initiation is independent of the CPCs.

"4.18 Access to Setpoint Adjustments, Calibration and Test Points"

"The design shall permit the administrative control of access to all setpoint adjustments, module calibration adjustments, and test points."

The DNBR/LPD system has been designed to permit administrative control of access to all setpoint adjustments, module calibration adjustments and test points. Key switch access has been designed for:

1. Enabling data entry of addressable constants.
2. Physical access to each calculator.

"4.19 Identification of Protective Actions"

"Protective actions shall be indicated and identified down to the channel level."

Indication lights are provided for all protective actions, including channel trips.

"4.20 Information Readout"

"The protection system shall be designed to provide the operator with accurate, complete, and timely information pertinent to its own status and to generating station safety. The design shall minimize the development of conditions which would cause meters, annunciators, recorders, alarms, etc., to give anomalous indications confusing to the operator."

The CPCs LDNBR trip and HLPD trip meet the criteria of Section 4.20 in the following manner:

ARKANSAS NUCLEAR ONE
Unit 2

- A. Continuous display of DNBR margin, local power density margin and calibrated nuclear power is provided with main control board meters for each channel;
- B. Status indication, test and bypass indication, and fault indication is provided at the main control board; and,
- C. A main control board mounted display with touch-screen interface is provided for each channel to allow the operator to address and display.
 - 1. Preselected calculation output;
 - 2. Any sensor input; and,
 - 3. The value of all addressable constants and all setpoints in calculator memory.

Means are provided to allow the operator to monitor all CPC system inputs and outputs. The specific displays that are provided for continuous monitoring of inputs are described in Table 7.2-14. Provisions for continuous monitoring of system outputs are listed in Table 7.2-15. System status indication that is provided is shown in Table 7.2-16.

The means provided for information readout in each CPC trip channel satisfy the information readout requirements of IEEE 279-1971, and are equivalent to the readout provided in the direct analog trips in the present design and the analog calculated trips of previously licensed designs such as Calvert Cliffs.

Section 4.20 of IEEE 279-1971 requires that the protection channel readout "...provide the operator with accurate, complete and timely information pertinent to its own status and to generating station safety." The CPC system meets these criteria with three distinct types of displays: system input displays, system internal status displays and system output displays.

System Input Displays

Each system input parameter, with the exception of CEA position, has an indicating device to allow the operator to ascertain the value of the input parameter and the status of the input value relative to the other redundant channels. Table 7.2-14 details these displays. Analog meter indication is provided for system temperature, system pressure, and neutron flux power level. This analog indication is similar to that provided for the direct analog trip parameters.

As an enhancement to the operator interface, all input parameters are range checked each time the parameter is utilized. The range check feature will alert the operator to a sensor failure out of range within a maximum of one second of the failure. The out-of-range condition alarm appears as a hardwired station annunciator window on the main control board and a red status lamp on the operator's module.

Reactor coolant flow is a parameter calculated from the RCP speed sensor input signals. Reactor coolant flow to RCP speed may be displayed on a digital display on the operator's module, upon command of the operator. The RCP speed signal is checked for out-of-range condition for the high limit only, since operating with a limit check only is in conformance with IEEE 279-1971, Section 4.20, which requires that the design "minimize the development of conditions which would cause meters, annunciators, recorders, alarms, etc., to give anomalous indications confusing to the operator."

ARKANSAS NUCLEAR ONE
Unit 2

CEA position input signals are displayed on the CEAC-1 or CEAC-2 Operator's Module on the Main Control Board.

Each Operator's Module can display:

1. Bar chart displays of CEA group position.
2. Bar chart displays of individual CEAs in a selected group.

The bar chart displays are supplemented with status indication of off-normal conditions and alphanumeric displays of group position and position of a deviating CEA.

The displays are functionally equivalent to that provided on previously licensed CE plants.

The information for each redundant sensor set and CEAC is provided at the two, redundant Operator's Modules for Channels B and C.

System Internal Status Displays

Station annunciators and operator's module status lamps are provided by each DNBR/LPR channel to alert the operator of abnormal system status. These alarms are initiated by calculator self checking features and an external watchdog timer. The status of the CPC system can be ascertained by utilizing the binary alarms and status lamps indicated in Table 7.2-16.

The on-line status information described above is provided in a binary alarm format to facilitate timely operator comprehension of overall system status. Once the operator has responded to the alarm condition, off-line diagnostics may be utilized to pinpoint the specific failure to minimize maintenance time and channel outage.

System Output Displays

Information on the status of CPC calculated DNBR and local power density relative to the reactor trip setpoints is provided by the system output displays. Analog meters of DNBR margin and local power density margin are provided for each redundant channel at the main control board. An analog meter of calibrated neutron flux power is also provided.

Station annunciators are provided that alert the operator if either the trip or pre-trip setpoints of any of the redundant channels is exceeded. There is a separate alarm for DNBR trip, LPD trip, DNBR pre-trip and LPD pre-trip.

The time required to make cross channel comparisons of continuously displayed parameters cannot be quantified as it is highly dependent on control board design and readout placement. However, the on-line sensor range checking performed by each calculator will result in an annunciation within one second of sensor failure to alert the plant operator.

Utilization of the operator's module to display intermediate calculated values of the system is not required to ascertain system status, but is provided to augment the system display capability and is utilized for testing. A listing of values that are capable of being displayed from the operator's module is provided in Table 7.2-12.

ARKANSAS NUCLEAR ONE
Unit 2

On-line hardcopy documentation is not provided to further augment the display capabilities because the inclusion of a non-essential electro- mechanical device in the on-line system would considerably lower the overall reliability and availability of the on-line system. Off-line hardcopy of periodic test results is provided. Since the hardcopy device is utilized off-line, when the channel is bypassed, the reliability and availability of the on-line system is not affected.

The CPC system satisfies the intent of Section 4.20 in the following manner.

Information presentation to the operator is divided into two classifications:

- A. Information requiring immediate operator attention; and
- B. Information not requiring immediate operator attention.

To satisfy the intent of Section 4.20 the information that falls into Category A is presented in a manner consistent with the following criteria:

- A. A simplified format of presentation is provided to allow fast operator comprehension; and,
- B. The total amount of Category A information is minimized to prevent operator confusion.

The information that is categorized as requiring immediate operator attention is that information necessary to ascertain the minimum number of operable protection channels in accordance with the Technical Specifications.

System failures and input data anomalies detected by the on-line diagnostics produce an immediate audible and visual alert to the operator by means of station annunciators.

The presentation is simple in format and allows easy operator comprehension of system status. This form of status indication is similar to that of other protection system trips.

Information utilized for maintenance failure diagnosis is categorized as information not requiring immediate operator attention.

To meet the intent of Section 4.21 of IEEE 279-1971 the CPC stores the reason for the system failure in memory. This error code may be printed out via the trip buffer report.

When the on-line system detects a failure or data anomaly, the immediate annunciation allows the operator to assess system status and to take appropriate action as required by plant procedures and the Technical Specifications.

Hard copy is not produced at this point in time as it is not required for immediate operator action. The immediate relevant action item for the operator is not what caused the failure but the fact that a failure occurred. The reasons for the failure are stored for printout at a more convenient time.

The detailed hardcopy documentation of the failure is produced by the off-line system test. This program is initiated upon demand of the operator in accordance with plant procedures and Technical Specification surveillance requirements. This maintenance philosophy is consistent with that of the remainder of the PPS and provides for a simplified operator interface. One option of the hardcopy documentation is a list of selected Point ID values at the time of a trip.

ARKANSAS NUCLEAR ONE
Unit 2

Automatic hardcopy documentation is not necessary for immediate operator action. Since the utilization of automatic on-line hardcopy would penalize the reliability and simplicity of the on-line system, the production of hardcopy failure documentation has been designed as an off-line function initiated by operator request.

"4.21 System Repair"

"The system shall be designed to facilitate the recognition, location, replacement, repair, or adjustment of malfunctioning components or modules."

Identification of a defective channel will be accomplished by observation of system status lights or by periodic testing as described. To facilitate the location, replacement, repair and/or adjustment of malfunctioning components or modules, hardware diagnostics are provided.

Replacement or repair of components or modules is accomplished with the affected channel bypassed. The affected trip function then operates in a 2-out-of-3 coincidence logic configuration.

"4.22 Identification"

"In order to provide assurance that the requirements given in this document can be applied during the design, construction, maintenance, and operation of the plant, the protection system equipment (for example, interconnecting wiring, components, modules, etc.) shall be identified distinctively as being in the protection system. In the installed equipments, components, or modules mounted in assemblies that are clearly identified as being in the protection system do not themselves require identification."

All equipment, including panels, modules, and cables associated with the CPC system will be marked in order to facilitate identification.

IEEE 323-1971

The CPC system will be tested to IEEE 323-1971 criteria.

IEEE 344-1971

The CPC system will be tested to IEEE 344-1971 criteria.

7.2.1.1.2.5.1.9 Interface Requirements

The CPC equipment for each channel of the CPC system is contained within a dedicated enclosure. The side walls of each enclosure will act as a physical barrier between these enclosures and the air space between these enclosures will act as a thermal barrier to prevent the possibility of a common event failure.

All designs, components, interfaces and devices which are part of the CPC system are designed to conform to appropriate protection system requirements. Section 4.9 of IEEE 279-1971 requires that the CPC system will "...automatically initiate appropriate protective action whenever a condition monitored by the system reaches a preset level." All elements of the CPC system whose operation is essential to automatic protective action conform to all protection system requirements. Those elements whose operation is not essential to automatic protective

ARKANSAS NUCLEAR ONE
Unit 2

action (e.g. test equipment, analog display), are designed to conform to those requirements which prevent degradation of the automatic protective action during design basis conditions (temperature, humidity, seismic disturbances, etc.).

The design requirements for the mass storage units and display terminal are justified for the following reasons:

- A. The channel to be tested must be bypassed at the PPS cabinet. There is a hardwired interlock at the CPC equipment that prevents testing unless the channel is bypassed.
- B. Test equipment utilized for testing or maintenance has its power source isolated from the vital power sources of other channels and from the non-vital instrument bus.
- C. Administrative procedures prevent the connection of any test equipment until the channel is bypassed. An example of test equipment that must meet these criteria is the hardcopy device furnished for documenting the results of periodic calculator testing and for loading of programs. Since the channel to be tested is bypassed, no failure of the hardcopy devices can prevent the remaining three channels from performing their required function.
- D. To assure that program loading occurs correctly, the calculators perform checksum calculations of software transmitted from the load device.

Either type of mass storage unit, disk or EPROM, contains checksum information. A periodically scheduled software program continually computes protected memory checksums and compares them against those loaded from the mass storage device. Any deviation, at load time or during subsequent on-line operation, causes a channel trip.

In addition to those items listed above, failure of the operator's module digital displays or annunciator lights during a seismic disturbance does not degrade automatic protective function. Operator's module displays and annunciator lamps are themselves tested before they are used in testing of the CPC system.

Interface design requirements for the power connections to the components and sensors associated with each CPC and CEAC are the same as those for the balance of the PPS and are described in Sections 8.3.1.4 and 7.1.2.2.

7.2.1.1.2.5.2 NRC Review of the Core Protection Calculators and Discussion of 27 Technical Positions

Because the Core Protection Calculator System (CPCS) was considered to be a first of a kind design, i.e. the use of digital computers to perform plant protection functions, the NRC staff performed an extensive review of the system. A large number of reference documents and correspondence were generated during this lengthy review. These have been listed in Section 7.2.1.1.2.5.3.

During the review, the NRC staff generated a number of staff positions (27 positions), which addressed their specific concerns regarding the CPC system design. The following is a summary of the NRC positions and the resolution of each item.

ARKANSAS NUCLEAR ONE
Unit 2

Position 1: Uncertainty Associated With the Algorithms

The NRC believes that it is necessary to experimentally qualify the adequacy of these uncertainties, specifically those associated with the synthesis of axial power distribution. The NRC requires that confirmatory measurements be performed during startup to demonstrate the adequacy of the axial power synthesis by comparing to in-core measurements and analysis for various power conditions.

Resolution

The calculational uncertainties associated with the CPC synthesized local power density are addressed in CENPD-170 and CENPD-145. The techniques used involved the generation of a large number (in excess of 4,200) of power distributions with the three-dimensional core simulators, ROCS and FLARE. The calculations simulated ex-core detector responses for a variety of static and transient core power distributions typical of first cycle operation of the Arkansas Nuclear One - Unit 2 reactor. Abnormal CEA configurations in which individual CEAs and CEA banks were mispositioned were also considered. The simulated detector signals, together with the CEA positions assumed in generating the power distributions of interest, were then processed by a FORTRAN version of the CPC algorithms to produce, for each case, a value of the maximum peaking factor. The algorithm constants employed by the CPCs, including rod shadowing, were calculated by the simulators from the core conditions employed in the simulators. The CPC synthesized peaking factor was then compared with the value produced by the simulator.

The errors between the synthesized and simulator peaking factors were evaluated for all cases involving normal CEA positions.

A maximum uncertainty factor of approximately 1.085 was realized at end of cycle. The uncertainty factor is the factor that must be applied to the CPC synthesized peaking factor to ensure that 95 percent of the true peaking factors are no larger than the calculated values at the 95 percent confidence level.

As noted above, the radial peaking factors used in the analysis corresponded to the calculated values. Thus the impact of the uncertainty on the true radial peaking factor (vs. the calculated value) is not included in the above factors. During startup, the radial peaking factors used in the CPCs were to be verified using in-core detector responses processed with the INCA code. Hence, the radial peaking factors will contain uncertainties associated with the INCA procedure reported in CENPD-145. These uncertainties are combined statistically with the errors reported above to arrive at an uncertainty factor of about 1.10 for the CPC processed peaking factors. The precise value to be applied during operation is based on results of the startup tests and simulator calculations which accurately model the ANO-2 reactor.

The assessment of the peaking factor accuracy for those cases involving CEA misalignment has been handled separately. In lieu of a statistical uncertainty factor, a sufficiently conservative penalty factor is employed to ensure the total peaking factors produced by the CPCs during a misalignment event will always be conservative relative to the actual values. Approximately 600 cases involving CEA misalignment were evaluated to demonstrate the conservatism of the penalty factor.

Of those cases presented for review, the CPCs consistently overestimated the total peaking factor relative to the value calculated by the simulators during the time the CEAs are misaligned. Following alignment, some azimuthal xenon oscillations occur that are not accommodated by

ARKANSAS NUCLEAR ONE
Unit 2

the CPCs, and, during this time, the CPC peaking factor estimate exclusive of uncertainty factors may be non-conservative. However, this effect was on the order of a few percent for the worst cases and was less than the tilt allowance plus the CPC uncertainty previously described. In addition, those cases for which the CPC calculation was slightly non-conservative can only occur for rod configurations associated with power levels well below the licensed value. Therefore, conditions involving non-normal CEA configurations can be accommodated without further increasing the peaking factor error to be incorporated into the CPCs.

The general method for determining the value of the uncertainty and penalty factors described above was found acceptable by the staff. However, the specific values for the uncertainty and penalty factors depend on simulator constants, e.g. rod and temperature shadowing factors, the shape annealing matrix, and boundary point powers, which are to be either calculated or verified during startup and preoperational tests. Although CE submitted a general startup test plan, the staff required a more detailed description of the program to assure that the CPC constants are verified in a manner consistent with the assumptions and applications in the CPC simulator uncertainty analysis. The test plan was required to include specific reactor configurations to be used in verifying each algorithm constant together with acceptance criteria for the difference between calculated and measured values with alternatives proposed, if acceptance criteria are exceeded. In addition, the number and type of cases to be employed to verify uncertainty and penalty factors were required. The tests performed need to be sufficient to demonstrate the conservatism in the approximations to theory required to implement algorithm constants, in particular shape annealing and rod shadowing factors. It was concluded that the inclusion of the above in the startup test program would satisfy the requirements of Position 1.

Although the precise value of the power distribution uncertainty cannot be verified prior to the completion of the startup test program, the staff determined that the concern expressed by Position 1 did not preclude issuance of an Operating License for the following reasons. First, an alternative system (COLSS) is available during startup testing to calculate required power distribution parameters. Secondly, the basic methodology and instrumentation used in previous Combustion Engineering plants to calculate ex-core axial off-set is similar to that employed by the CPCs; thus, errors in the calculated CPC synthesis uncertainty are not expected to be extreme. Third, the plant will operate at less than design power level during the startup verification of the CPC power distribution algorithm to accommodate with margin, credible inaccuracies in the CPC power distribution uncertainty.

Therefore, Position 1 remained outstanding at the issuance of the license with the results of the startup tests to provide the final resolution of this issue.

Position 2: Conservatism of the CPCS Response to Dropped Control Element Assemblies

The NRC requires three-dimensional transient power distribution studies be performed to assure that effects of dropped off-center CEAs are conservatively predicted by each of the four CPC channels. Our concerns are the adequacy of delta temperature power basis for rapid transients when ex-core sensors are not available.

Resolution

The staff (with assistance from its consultants at Brookhaven National Laboratory) completed a review of the equations used in the synthesis process (as presented in CENPD-170).

ARKANSAS NUCLEAR ONE
Unit 2

The specific application of the power distribution algorithms to the dropped off-center CEA transient was addressed. A review of the analysis by the staff led to the conclusion that the CPC methodology is adequate for conservatively predicting three-dimensional power distributions during this transient, thus satisfying the concerns of Position 2.

Position 3: I/I Converter Isolation Device

It is the NRC's position that the current-to-current (I/I) converter isolation devices be qualified in accordance with specified criteria, and that the results of the qualification tests be submitted for our review including the test plan, test set-up, test duration and acceptability requirements.

Resolution

Information from the process instrumentation sensors is used by the non-Class 1E plant computer and the CPCs. A current to current (I/I) isolation device is used to isolate the Class 1E from non-Class 1E circuits. The staff reviewed the qualification, test procedures and test report, and concluded that the isolation device (I/I) was qualified in accordance with the Commission's requirements and was acceptable.

Position 4: CEAC Separation Criteria at the Output of the Optical Isolator Cards

The NRC requires that the applicant identify their design basis events for the CEAC and verify that no credible single event either internal or external to the CEAC will result in loss of function.

Resolution

During the review the staff requested a demonstration that the output of the optical isolator cards within the CEAC met the single failure criteria. Card slots 11 through 15 of the MACS Universal Chassis within the CEAC encompass the output cards to Channels D, C, plant computer, B, and A, respectively. All five cards are located within a 3.5-inch section of the chassis.

A Failure Mode and Effects Analysis (FMEA) was performed in response to this concern. Based on the information provided in the FMEA, the effect of a single failure in the CEAC on the CPC was to reduce the auctioneering logic for CEA deviation (penalty factor) to a 1-out-of-1 in the CPC (not a loss of function).

In order to close Position 4, the staff required a satisfactory resolution of Position 26. (See "Resolution" of Position 26.)

Position 5: Cable Separation

The applicant identified an area where safety-related control rod drive position sensor cables are run together with non-safety cable. The applicant will re-evaluate this design and advise the staff as to its resolution.

The review of the process instrumentation for the CPCS revealed that all of the analog sensor signal processing for the entire RPS was being processed and housed within the Process Protection Cabinet 2C15. This cabinet is 16 feet long and 10 feet high and is physically separated into four redundant channels. During the drawing review an associated circuit problem was identified within the 2C15 cabinet. The concern expressed by the staff was the close proximity of the Class 1E and non-Class 1E wiring, and the susceptibility of the Class 1E circuits to noise or Electro-Magnetic Interference (EMI) from the non-Class 1E circuits. This concern was formalized as Safety Position 5.

ARKANSAS NUCLEAR ONE
Unit 2

Due to the physical constraints in the reactor vessel head area, both Class 1E and non-Class 1E signals (for CEA position) are transmitted within the same cable assembly from the reactor vessel head to a point outside containment. Within this cable assembly, six of the conductors are used for discrete position information (non-Class 1E) which is transmitted to the CEDMCS and three are inputs to the CPCS. For example, Channel "C" CPC has 61 CEAs; therefore, 366 conductors that are transmitted to the CPCS are non-Class 1E and 183 are Class 1E analog signals. It was noted that all of these conductors are contained in the same raceway, inside containment. Accordingly, the Class 1E conductors are dominated by non-Class 1E conductors and a concern for noise susceptibility existed.

In response to Position 5, a test program was proposed. A noise immunity qualification susceptibility test on the single channel CPC system was performed. This test determined the susceptibility of the system to EMI. A graph of susceptibility field strengths and corresponding frequencies was established as a baseline. The staff reviewed the test procedures, and test report, and concluded that the noise immunity tests were an acceptable subject to satisfactory completion of EMI measurements.

A commitment was made to measure the actual levels and frequencies of EMI onsite to confirm that these measurements fall within the acceptable range of the baseline graph. The results of the onsite measurements were submitted as part of the Startup Test Report. This resolved this particular concern.

Position 6: Position Isolation Amplifiers

It is the NRC's position that the isolation amplifiers be qualified in accordance with the specified criteria and that the results of the qualification tests be submitted for our review, including the test plan, test set-up, test procedures and acceptability requirements.

Resolution

The isolation amplifiers are located in Channels A and D which transmit 20 CEA position information to the CEACs in Channels B and C, respectively. These isolation amplifiers are used to maintain channel independence.

The staff reviewed the test procedures and test report and concluded that the position isolation amplifiers were qualified in accordance with the Commission's requirements and was acceptable.

Position 7: Protected Memory

The ANO-2 memory protection hardware causes instructions attempting to write into protected memory to be converted into read instructions. No safety credit is allowed for this feature unless failures in the system that result in attempts to write in protected memory are annunciated to the operator. Furthermore, if safety credit is desired, the NRC requires that a status lamp seal indicate the state of operation.

Resolution

During the review, the staff identified the fact that the design does not include means for alerting the operator to violations of protected memory. As a result, no safety credit would be given for this feature. This was agreed to and the issue was therefore resolved.

ARKANSAS NUCLEAR ONE
Unit 2

Position 8: Time Interval of Periodic Testing

- A. An acceptable analysis of the CPCS reliability will be developed in accordance with the requirements of Section 4.4 of IEEE Standard 279-1971 and Section 4.2 and 4.3(1) and (7) of IEEE Standard 338-1971. This analysis will provide the basis for evaluating the performance data obtained in Parts 8B and 8C, and for establishing and modifying the periodic test interval after the initial operation period.
- B. Completion of the supplemental qualification testing identified in the staff's July 7, 1976 letter and documentation of the system reliability during this test interval is required.
- C. During the first six months of operation, the periodic test interval should be significantly more frequent than the proposed 30 days. The interval could in part be based on the results of "A" and "B" above.

All failures during this period should be carefully recorded, classified and analyzed. At the end of the 6-month period, the performance of the CPCS should be analyzed using the model developed in "A" above and the operational reliability assessed. Based on these results, the test interval could then be modified.

Resolution

During the review of the periodic tests, the staff questioned the basis for the CPCS time interval of periodic testing. The CPCS design represents a new configuration for RPSs. In addition, many of the components in the CPCS (digital computers and I/O interfaces, CEA position transmitters, pump speed sensors and CEA isolation amplifiers) were being used for the first time in a protection system. Several were also first-of-a-kind designs. Therefore, the staff concluded that the past experience with analog protection systems could not be directly applied to the CPCS and required additional justification of the periodic test interval.

In conjunction with the CPC qualification test report, an evaluation of the CPCS reliability (to justify the test intervals for the CPCS periodic tests and for the CPCS system functional tests) was submitted. The staff reviewed the reliability analyses of the CPCS and concluded that the reports did not provide an acceptable basis for establishing the CPCS reliability and test intervals for periodic tests and system functional tests.

The staff believed that use of reliability analysis to establish the initial periodic test intervals was too difficult due to the lack of operating experience with digital computer equipment in safety systems applications. The lack of specific regulatory criteria for reliability evaluations and probabilistic analyses in the licensing review of safety instrumentation and control systems further complicated the development of an acceptable reliability analysis of the CPCS. As a result, they concluded that further reliability analysis would not provide useful information for resolving the initial periodic test interval concerns identified in Position 8. They decided to resolve the concerns regarding periodic testing and functional testing by establishing more conservative test intervals and additional CPCS surveillance requirements in the Technical Specifications until operating experience is gained. This was believed to be consistent with the approach used in previous safety reviews. Based on this Technical Specification approach, this matter was resolved.

ARKANSAS NUCLEAR ONE
Unit 2

Position 9: System Functional Testing

The applicant has not provided definitive and adequate procedures for periodically checking and verifying the functional operation of the CPCS in accordance with the requirements of General Design Criterion 21, "Protection System Reliability and Testability" and the guidelines of Section 4.3 of IEEE Standard 338-1971, "Criteria for the Periodic Testing of Nuclear Power Generating Station Protection Systems." To verify the functional performance of the CPCS and to insure adequate overlap, the periodic test program should be modified to include procedures for testing each trip function in each channel from sensor input to the CPCS to trip output to the reactor trip system. The procedures should be sufficient to verify that the protective action for each function will ensue for the expected extremes for each sensor.

Resolution

During the review of the periodic tests, the staff questioned the adequacy of the test procedures and the off-line tests for periodically checking and verifying the functional operation of the CPCS in accordance with the requirements of General Design Criterion 21 and Section 4.10 of IEEE 279-1971. They required that the periodic test program be modified to include procedures for testing each trip function in each channel from sensor input to the CPCS to trip output to the reactor trip system. It was felt that the proposed periodic tests were based on the overlap testing philosophy and were adequate for verifying the functional operation of the CPCS. However, the staff took the position that the proposed overlap tests are inadequate and that a functional operation check from CPCS sensor inputs to the trip output was required to adequately ensure that that CPCS is operational. They stated further that this test should be accomplished by injecting a test signal for each sensor input as close as practical to the sensor and monitoring for proper trip output when the trip setpoint is reached.

In response, a commitment was made to perform periodic functional operation checks from CPCS sensor inputs to the trip outputs. The test would be accomplished by injecting a test signal for each sensor input at the MACS input/output (MACS I/O) connectors of the CPCS and CEACS and monitoring for trip output when the setpoint is reached. This was found to be acceptable.

Position 10: Periodic Testing, Addressable Constants

For any changes to addressable constants, the test program will identify calculation errors which may or may not be actual errors. The NRC requires that the applicant develop practical techniques and procedures for verifying calculated results after changes to addressable constants.

Resolution

Changes were implemented in the CPCS off-line test program and test procedures to automatically accommodate changes to addressable constants when verifying CPCS program calculations. The staff reviewed and audited the changes to the periodic test programs and the off-line test procedures and they concluded that the techniques and procedures for using the off-line program were acceptable.

ARKANSAS NUCLEAR ONE
Unit 2

Position 11: Environmental Performance Qualification

and

Position 13: Sensor Qualification

In accordance with the requirements of IEEE Standard 279-1971, Sections 4.1, 4.3, and 4.4, and IEEE Standard 323-1971, Section 4.3, prior to initial operation, a satisfactory environmental test of the integrated system (exclusive of sensors) should be performed or an acceptable analysis clearly establishing the adequacy of component testing is required for staff evaluation. The staff's July 7, 1976 letter includes the requirements for this qualification testing.

For those unique sensors (RCP speed and CEA position) the applicant is required to submit documentation to verify their environmental performance qualification.

Resolution

The CPCS environmental qualification program was based upon the guidelines of IEEE 323-1971. In accordance with Section 4.3 of this standard, the CPCS equipment was qualified by type testing of components. The environmental test conditions for the CPCS components were determined by classifying and identifying safety equipment environmental design categories based upon equipment location and functional requirements. Test plans, test procedures, and the test reports were submitted for the following equipment:

- A. CPC central processing unit and MACS modules,
- B. CPC power supply,
- C. CEA position isolation amplifier,
- D. CPC operator's modules,
- E. RCP speed sensor and signal processor,
- F. CEA reed switch position transmitter, and
- G. Current-to-current isolation transmitters.

Based on the staff review of the information provided to demonstrate the radiation exposure qualification of the CEA RSPT, it was concluded that the CEA RSPTs met the environmental qualification requirements for radiation exposure and were acceptable. This resolved Position 13.

Based on the review of the results of the thermal tests of the process protective cabinets, it was concluded that the environmental conditions within the process protective cabinets will be maintained within the minimum CPCS environmental design conditions for the maximum ambient environmental design cabinets in the plant area where the plant protective cabinets are installed. On this basis, it was concluded that the CPCS equipment housed in the process protective cabinets met the environmental qualification requirement and was acceptable. This resolved Position 11.

ARKANSAS NUCLEAR ONE
Unit 2

Position 12: Electrical Noise and Isolation Qualification

Tests for electrical isolation separation and noise susceptibility will be required. The applicant will develop and submit for approval test plans and detailed procedures for these tests prior to their undertaking. In addition, due to the CPCS design and packaging, these tests should be performed on the fully configured integrated system or an acceptable analysis clearly establishing the adequacy of component testing is required for staff evaluation. The staff's July 7, 1976 letter provides supplemental details on this concern.

Resolution

The effects of exposure of the optical isolators to Radio Frequencies (RF) greater than 100 Megahertz (MHz) and the resultant effects upon the response of the CPCS were discussed.

The concern was responded to by performing a noise susceptibility test of radio frequencies from 35 MHz through 2GHz on the CPCS. During this test several susceptible frequencies were encountered within this range. However, at each susceptibility point, the CPCS responded in a fail-safe manner, i.e. a trip. At the frequency band of the radio transceivers (walkie-talkies) to be used in ANO-2 plant, extended tests were run at power levels up to 17 volts per meter to verify that the CPCS was not susceptible.

In response to Positions 5 and 12, a noise immunity qualification susceptibility test on the single channel CPC system was performed. This test determined the susceptibility of the system to EMI. A graph of susceptibility field strengths and corresponding frequencies was established as a baseline. The staff reviewed the test procedures, and test report, and concluded that the noise immunity tests were acceptable subject to satisfactory completion of EMI measurements.

A commitment was made (and license condition added) to measure the actual levels and frequencies of EMI onsite to confirm that these measurements range of the baseline graph. The results of the onsite measurements were submitted in the startup test report. It was the staff's opinion that the frequencies and levels of the radiated EMI, that the single channel was exposed to during the noise susceptibility test, were conservative with respect to the expected onsite measurements, thus justifying the initial operation of the CPCS.

Position 14: Seismic Qualifications

The staff has found the seismic qualification test plan not acceptable. Current criteria for multi-frequency input and sine beat tests for seismic qualification have been provided to the applicant. Submittal date for a satisfactory seismic qualification plan and review completion date have yet to be determined.

Resolution

Topical Report CENPD-182 was submitted for seismic qualification of electrical equipment for the NSSSs. This report included the seismic qualification of the CPCS equipment as follows:

- A. Temperature transmitter
- B. Current-to-current isolation transmitter
- C. CPC mass storage unit

ARKANSAS NUCLEAR ONE
Unit 2

- D. CPC MACS modules and unit CPU.
- E. CPC power supply
- F. CEA position isolation amplifier
- G. RCP speed signal processor
- H. CPC operator's module
- I. Temperature sensor
- J. RCP speed sensor
- K. CEA reed switch position transmitter

The staff requested additional information on the seismic qualification test configuration and test procedures used to verify the operability of the unique CPCS equipment. Based on the review of these procedures, it was concluded that the test configuration and test procedures were acceptable for verifying the functional operability of this equipment before, during, and after the seismic excitation.

The staff requested additional information to verify the adequacy of the seismic loads used for testing the CPCS equipment housed in the Plant Protection Cabinet (PPC), i.e. "A" through "G" on the preceding list. Information to support the ability of the PPC to survive the seismic events was also requested.

The staff reviewed the analysis for the Plant Protection Cabinet (PPC) and the testing for CPC modules and concluded that the analysis was acceptable to ensure structural integrity of PPC under seismic loads. However, the analysis was inconclusive for verifying the adequacy of testing input motions used for seismic qualification tests of CPC modules mounted on the PPC.

Additional information was provided. The staff reviewed the submittals and concluded that the seismic qualification of the CPCS components was acceptable for ANO-2 specific application and also that the seismic qualification programs for the other identified equipment was acceptable. This resolved Position 14.

Position 15: Addressable Constants

Any changes in addressable constants must be provided with adequate safeguards to protect against unreasonable entries. The proposed safeguards against unreasonable entries are basically administrative and are subject to human error. To enhance safety by minimizing human error and to utilize capabilities of the computer to audit the input, the staff requires that the computer program be modified to conduct reasonability tests and to reject unreasonable values of addressable constants as they are entered from the operator's module. The operator is to be notified upon failure of the reasonability test. Qualification testing of the modification must also be conducted.

Resolution

The staff concluded that all addressable constants had acceptable range limit checks with the exception of the Shape Annealing Matrix (SAM) components. (The staff required reasonability checks of addressable constants as a method for detecting gross errors upon operator entry.

ARKANSAS NUCLEAR ONE
Unit 2

Conceptually, the reasonability checks are the equivalent of the limits of an adjustable potentiometer in conventional analog hardwired type of protection systems.) The staff required the identification of acceptable range limits on the shape annealing matrix components based on ANO-2 design calculations.

As a result of the review of the response, the staff determined that the existing large range limits for the SAM components were acceptable and were not required to be more restrictive. The response demonstrated that the deviation of any single SAM component from its correct value will lead to increased conservatism in the prediction of the power distribution parameters. In addition, the administrative procedure employed when SAM components are entered into the CPCs was reviewed during Phase II testing and was found to be a significant deterrent to the entering of erroneous SAM components. With this information, Position 15 was resolved.

Position 16: Quality Assurance Plan

The results from the NRC's recent audits of the hardware and the software have served to focus the NRC's concerns upon the quality assurance program used for system development. Upon evaluation of these results, the NRC has concluded that Arkansas Power & Light is not complying with the quality assurance plan with regard to the following 10 CFR 50 criteria:

- A. Criterion 1, Quality Standards and Records, Appendix A - General Design Criteria for Nuclear Reactor Plants, and
- B. Appendix - Quality Assurance Criteria for Nuclear Power Plants and Reprocessing Plants.

The bases for this conclusion are deviations from stated positions, the lack of documented system software development guidelines, and design errors uncovered in our review to date.

As stated in Appendix B of 10 CFR 50, the Quality Assurance Program must be applied to the design, fabrication, construction and testing of the structures, systems, and components of the facility. It is our position that a Quality Assurance Plan is required for the core protection calculator system to embrace all activities from the current frozen design (as of November 24, 1975) to the final design of the installed system. An effective quality assurance program is required to minimize design errors and is an important component to the qualitative reliability of the system. The acceptability of the Quality Assurance Plan and the compliance with the plan must be assessed by the staff prior to the completion of the safety evaluation.

In addition to the criteria stated in Appendix B to 10 CFR 50, the staff desires to emphasize the positions entitled, "Performance Qualification of Software Change Procedures," with respect to the Quality Assurance Plan.

Resolution

It was concluded that the response to the staff's quality assurance concerns proposed a program which, if properly implemented, would comply with the applicable requirements of 10 CFR 50, Appendix B.

Based on an audit, it was concluded that the program was not being implemented properly.

ARKANSAS NUCLEAR ONE
Unit 2

Follow-up audits concluded that the quality assurance procedures were greatly improved. The designer provided an improved means for monitoring the operating system for changes to the core memory. This was accomplished by adding the capability of reading check-sum values via the Operator's Module. This design feature provides a definitive method for independent auditors to reassess the software quality and guard against unannounced changes to the core memory. The check-sum automatic audit program provides continuous on-line protection against hardware failures that cause memory faults as well as protection against unauthorized attempts to change any program. The staff independently analyzed the CPC and CEAC memory dumps and concurred with the check-sum values for each block of memory.

The Office of Inspection and Enforcement (OIE) of NRC conducted an inspection to verify the implementation of the quality assurance program for software design verification and qualification of software changes as conducted by Combustion Engineering in the design of the CPCS. Based on their inspection report, the Office of Inspection and Enforcement concluded that the implementation of the quality assurance program for software design verification and qualification of software changes was in accordance with the quality assurance program description of the CPCS and complied with the requirements of Safety Position 16.

Position 17: Performance Qualification Testing

For evaluation of dynamic test results, the NRC requires submittal of Fortran Codes test results for selected cases to permit comparison with CPCS performance qualification test results. In addition, the NRC requires that transient analyses be performed for selected dynamic test cases using the codes normally employed by Combustion Engineering for Chapter 15 transient analyses. This will enable the staff to determine if the time to trip output on the CPCS based on projected DNBR of 1.3 is reached. The trip signal input to the more sophisticated codes will be the time to trip for respective cases on the CPCS.

The staff will accept for review the Phase II test results previously obtained on the plant system. However, all software revisions since those tests must be implemented in accordance with qualified change procedures (per Position 19) and all Phase II test cases must be repeated on the FORTRAN version of the final program. If final test results are not essentially identical to previous results, a repeat of Phase II test on the plant system configuration will be required.

Resolution

See resolution of Position 24.

Position 18: Burn-In Test

The NRC finds the proposed duration of the burn-in test (three to six months) acceptable subject to their review of test ground rules and acceptance criteria which must be submitted in the form of the test plan before the test commences. The NRC requires that the software on the system during the test incorporate all design changes which have been identified prior to a new freeze on the design. The staff will require testing of the total system after installation of the CPCS and associated process instrumentation in the plant protection system cabinet number 2C15. Failure to incorporate this equipment for the burn-in test will necessitate a more extensive field test program for the entire system.

ARKANSAS NUCLEAR ONE
Unit 2

The staff has reviewed the supplemental response to Position 18, which deals with the burn-in test. Based on the new information presented and the additional testing proposed, the execution of the burn-in test with the frozen software is acceptable, subject to the conditions stated herein.

Conditions for Hardware Burn-In Test:

- A. A staff review of the test procedures to be used in hardware burn-in test is in progress. These procedures must be consistent with industrial practice for computer system testing and acceptable to the staff.
- B. Additional tests to demonstrate and evaluate the integrity of software and the integrated system are needed. The staff requires a minimum test period of two weeks, with the system operating continuously on live input signals in addition to satisfactory performance of static and dynamic test cases to demonstrate the integrity of the integrated system. This test must be conducted with the same configuration and the same environment as that used for the hardware burn-in test conducted with the frozen software. This is required to assure that problems encountered after installation of the system in a new environment (the ANO-2 site) do not interfere with evaluation of the final software.

Resolution

In response to the staff requirements, revised test procedures were submitted, additional integrated system testing at the plant site from February 11 to February 25, 1978 was performed and a test report, summarizing results of the testing at ANO-2 and the testing at Systems Engineering Laboratories during July 27 to August 7, 1977 was submitted.

The staff reviewed the cited submittals and the test logs were audited by a staff consultant. It was concluded that the test procedures incorporated the required modifications.

Four software coding errors were identified during the software burn-in period of Systems Engineering Laboratories. One of these errors involved a non-significant range-limit error for one of the addressable constants in the CPC. The other three errors were in the CEAC software and, it was felt, indicative of a need for more attention to the scope of CEAC testing for quality assurance of software modifications. Necessary software modifications were performed and the affected modules were Phase I retested. The changes were implemented on the single channel system at Windsor and the affected disk tracks were regenerated. The modifications necessitated a repeat of the 2-week software burn-in test in accordance with the test procedure.

The test configuration at the plant site incorporated the test panel from the Combustion Engineering signal channel test facility to provide the input signals to the integrated 4-channel system. Repeated auto-restarts were experienced on CPC Channel A during testing in a simulated static power condition. The problem was traced to the Interdata Universal Clock Module (UCM) which experienced intermittent loss of interrupts and was replaced on February 20, 1978. Since the failure did not necessitate a design change, test procedures did not require a restart of the test. CPC Channels B, C, and D and one of the CEA channels operated continuously for the 2-week period with no auto-restarts or other anomalies.

The staff noted that the test history of the CPCS has resulted in a number of clock problems. The periodic test program is designed to detect timing errors of the type previously encountered. This periodic test did not detect the above failure which was attributed to an intermittent loss of

ARKANSAS NUCLEAR ONE
Unit 2

interrupts. The periodic test intervals required by the Technical Specifications had been chosen with due regard to test failures, including the previous clock failures. In addition, the Technical Specifications require demonstration of calculator operability when three or more auto-restarts are experienced in a 12-hour interval. The staff believed that these provisions of the Technical Specifications provided adequate safeguards against the existence of undetected clock failures on more than one CPCS calculator at any given time.

The audit of test data and test logs did not reveal any records which were inconsistent with the results and conclusions of the integrated system burn-in report.

The staff concluded that the software burn-in test report and test results were acceptable.

Position 19: Qualification Of Software Change Procedures

Following are the primary requirements for qualification of software change procedures:

- A. All changes are to be performed strictly in accordance with the documented quality assurance which is to be available for review by the staff. The documentation must accurately reflect the status of the altered program.
- B. The FORTRAN version of the modified program is to be subjected to a complete static and dynamic test program to demonstrate conservatism with respect to trip requirements defined by the ANO-2 accident analysis.
- C. The assembly language version of the qualified FORTRAN is to be subjected to a static and dynamic test program on an acceptable test system. The test program is to include sufficient reactor simulated transient test cases, static test cases and single parameter transient test cases to demonstrate that the program response corresponds to its FORTRAN version. The test program is also to include testing of the man-machine interface.
- D. The software is to be transferred to the plant system in accordance with the utility's proposed procedures prior to the burn-in test. All four channels will again be subjected to static and dynamic test cases to demonstrate that the response is identical to that observed on the test bed system. This step is to demonstrate the adequacy of the quality assurance procedures for transfer from the test bed to the plant system.
- E. Step D need not be repeated for future software revisions. All software design changes and revisions to constants in memory (except addressable constant) are subject to documentation, review and approval by the Regulatory Staff.

Resolution

As part of the resolution of Position 19, the following items were required:

- A. An acceptable test program was required for demonstration of the following single channel test system capabilities:
 - 1. testing of interfaces between the CEAC, CPC, and operator's module,
 - 2. execution of either option for high power selection, and
 - 3. testing of multi-variable transients.

ARKANSAS NUCLEAR ONE
Unit 2

- B. Additional analyses, supported by test data, were required to complete the evaluation of the single channel test system as an acceptable test system for final qualification testing of modified CPC software.
- C. A license condition was included to prohibit changes to the qualified ANO-2 software until a change procedure has been fully qualified, and the Technical Specification were to address the software change restrictions, including documentation and submittal of information on all changes to the staff.
- D. An acceptable test program for final testing of modified software was required to assure that software changes do not result in errors or unexpected effects on the functional performances of the CPCS.

With respect to "A", the single channel test system is to be modified to enable multi-variable transients to be performed. This will be accomplished by a Dynamic Software Verification Test (DSVT) in which portions of the CPC executive and unused core are overlaid in order to process predefined time variant CPC inputs to the CPC protection algorithms and data base. Since the inputs can be synchronized with time in the same manner as the corresponding CPC FORTRAN test cases, test results can be compared to the FORTRAN test results without regard to the uncertainties associated with live inputs. Differences in results are then clearly due to software error or machine processing differences. Selected dynamic test cases for qualification of the DSVT program are defined and the test results are to be submitted. The DVST program would be used in lieu of Phase II type multi-variable live input cases for testing of future software modifications. Live input tests in the single variable mode would be retained.

All dynamic test cases were to be re-executed with the high power select option of the software in a normal state.

The single channel system is being modified to include a separate CEAC calculator (and data link) to the CPC. The resulting CPC/CEAC/operator's module configuration will permit testing of all interfaces. Test Case 21 (CEA drop) will be re-executed using the CEAC to generate and transmit the resulting penalty factors. The operator's module interface with the CPC and CEAC are also to be exercised.

The results were to be submitted later.

It was emphasized that all changes to the software design and non-addressable constants would be performed in accordance with 10 CFR 50.59 (including reporting requirements), i.e. the licensee would be responsible to determine if the software change requires a license amendment per 10 CFR 50.59 which must be submitted to the staff. This was considered to be in conflict with the original Position 19E and "D" of the above status summary.

Information was supplied to address the staff requirement ("B") for additional testing to demonstrate the dynamic response of the single channel system. A commitment was made to use the DSVT program executed on the single channel test system and on the Louisiana Power and Light CPCS to demonstrate that the dynamic response of the single channel system is identical to that of the CPCS. The Louisiana Power and Light CPCS hardware configured at Systems Engineering Laboratories in Ft. Lauderdale is a duplicate of the ANO-2 hardware and was chosen to minimize impact on the ANO-2 startup schedule. The execution of these tests was audited by a staff consultant and his audit report, confirmed execution in accordance with test procedures and anticipated results.

ARKANSAS NUCLEAR ONE
Unit 2

Summary:

The staff reviewed test commitments and found the proposed test commitments and modifications to the single channel test system to be an acceptable basis for resolution of the staff concerns expressed in "A" and "B" of the preceding status summary.

The staff slightly modified the position ("C"). It was decided with respect to Position 19E, that they would not require that all software changes be submitted to the staff and would permit the licensee to make a determination of the safety significance. However, all aspects of the software program which affect the margin to trip cannot be modified without prior NRC approval. In addition, a requirement was made that a software consultant who is fully qualified to evaluate the safety significance of proposed software changes be included on the On-Site Safety Review Committee. This requirement was reflected in the Technical Specifications, but relocated to the QA Manual Operations with approval of Amendment 160 to the Operating License. [The Nuclear Software Expert position on the OSRC was subsequently eliminated.](#)

A commitment was made to provide information which reflected a test program consistent with the upgraded single channel test capability. This test program was intended to satisfy "D" of the preceding status summary.

Position 19 remained outstanding, pending the submittal to and approval by the staff of the following:

- A. Revision of the Software Change Procedure
- B. Supplement to the Single Channel Qualification Test Report (including results of the DSVT tests).
- C. Designation of a qualified software consultant on the On-Site Safety Review Committee.
- D. A description of a noise test program to be used in the qualification of software changes. Also, a description of the noise synthesis capabilities of the single channel test facility.

With the exception of "B" above, commitments were made to provide the information requested and resolve the concerns prior to Mode 2 operation. Because of equipment acquisition and installation delays to the single channel test facility, the test report required in "B" was to be delayed beyond the start of Mode 2 operation. It was proposed that the concerns related to "B" be resolved prior to Mode 1 operation rather than Mode 2 operation. The staff found this acceptable provided that no modifications to the CPCS are defined and/or required during Mode 2 operation. Should a modification be required during Mode 2 operation, it was required that all facets of Position 19 be acceptably resolved prior to the execution of the modification.

Position 20: Data Link to Plant Computer

The CPCS is designed with a data link and a special program module in each protection computer to service the plant computer. These data links and programs are an addition to the traditional plant computer interconnects in analog, hardwired protection system which are also included in the ANO-2 RPS. It is the NRC's position that these data links and the plant computer service program do not satisfy the requirements of General Design Criterion 24, "Separation of Protection and Control Systems," and IEEE 279-1971, Section 4.7, "Control and

ARKANSAS NUCLEAR ONE
Unit 2

Protection System Interaction," regarding independence of protection systems. Therefore, the NRC will require that the plant computer service data links to the protection computers be removed and that the plant computer service routine be deleted from automatic program scheduling.

Resolution

Because this position was not acceptable to AP&L, a compromise to the original position was offered by the NRC staff as follows:

- A. Only one channel of the PPS (CPC & CEAC) would be allowed to communicate with the plant computer via a data link. The remaining three channels would not be allowed to communicate to the PCS. The one channel can be manually connected from the PPS to the PCS.
- B. This means only one CPC and one CEAC will be connected to the computer at any one time.

The compromise was proposed on the basis that it would allow the use of the PCS to automatically collect data for use in evaluating and confirming the CPCS design bases analyses and functional performance (this was identified as a primary function of the data links). At the same time, the compromise would resolve staff concerns regarding the CPCS independence and acceptably minimize the potential adverse effects of the additional CPCS design complexity required to implement that data link feature.

This compromise was rejected on the following bases:

- A. The proposed compromise would not allow the significant benefits afforded by the system as presently configured to be realized. Specifically, simultaneous data from all four CPC channels and both CEAC channels would not be available to support startup and inservice testing; comparison of data from all channels to detect an input or output change or early detection of sensor failure would not be possible; and, the increased periodic test interval by use of the computer would not be possible.
- B. The staff's bases for not accepting the use of the data links were that the data links "compromise the independence of the protection systems and add an unnecessary degree of complexity to the CPCS design." The proposed compromise in itself would increase the complexity of the design.
- C. The compromise would have an impact in terms of additional cost and schedule to make the changes noted in "B" above as well as changing the plant computer software and operating procedures.

An appeals meeting was held on August 16, 1977. At this meeting information was provided by the staff, and their consultant, in support of the removal of the data links. AP&L and Combustion Engineering presented information to support retention of the PCS data link feature.

In response to the appeal, the staff's position remained "that based upon General Design Criterion 24, regarding separation of protection and control systems, the data links should be removed." The staff also stated that they would evaluate alternate CPCS configurations which would allow the data links to be connected between the CPCS and the PCS in a limited manner. The staff identified two possible alternates as follows:

ARKANSAS NUCLEAR ONE
Unit 2

- A. The data links would be allowed to be connected to all six CPCS computers during startup operations for a sufficient period of time to allow for collection of data prior to the end of the startup testing phase of operations. Similar operation would be allowed on subsequent startups after refueling. To evaluate this alternative, we requested information describing (a) the specific uses and benefits of the PCS during this period which relied upon the data links; (b) the required duration of operation with the links connected; (c) the procedures for disconnecting the links at the end of this period; and (d) the test criteria and test methodology to be employed to ensure that the data links have been correctly implemented.

- B. The data links would be allowed to be utilized as described in Alternative A. In addition, at the end of the startup operations, three of the four channels would be disconnected from the PCS with the remaining channel connected and in continuous operation. Rotation of the connection link to the PCS among the four channels could also be done. To evaluate this alternative, the information required to evaluate Alternative A would also be required. In addition, the staff stated that they would require that a comprehensive long-term monitoring program of the data links be implemented to provide data to the staff to demonstrate the reliability of operation of the data links and to quickly detect anomalies or failures, subject to staff review and approval. In conjunction with the monitoring program, the staff stated that they would also conduct a review of the PCS software as it related to the data transmission between the CPCS and the PCS.

These alternatives were rejected on the bases that neither alternative would accommodate the PCS periodic assessment of CPCS calculations and the PCS surveillance of the CPCS functions. In lieu of the two alternatives, it was proposed that all CPC-PCS data links be connected and operable during power ascension and initial commercial operation. During this period, (a minimum of six months at a power level greater than 20 percent), the data links would be intensively monitored according to a pre-determined and mutually acceptable set of criteria and procedures. The acceptability of continued operation of the data links would be based on the outcome of the monitoring program.

The staff concluded that this alternate was essentially the equivalent of the original design for the PCS to CPCS data link feature and was, therefore, unacceptable as stated. In addition, the staff assumed that Alternate B, was completely unacceptable. Therefore, it was concluded that unless the first alternative was reconsidered, i.e. use of all the data links to collect data only during initial startup and startup after each refueling, and the information as required by the staff was provided, it would be required that the plant computer data links to the protection computers be removed and that the plant computer service program be deleted from automatic program scheduling in the CPCS.

It was agreed to use and operate the data links in accordance with the staff position. That is, all data links between the protection computers and the plant computers would be connected during startup and power ascension testing. Within 10 days after completion of the power ascension tests, the six data links would be removed.

The data links would be used during the startup and power ascension tests to obtain the data to be analyzed and used to verify the following calculated CPCS data base constants:

ARKANSAS NUCLEAR ONE
Unit 2

- Shape annealing factor matrix constants
- Boundary point power correlation constants
- CEA shadowing factors
- Temperature shadowing factors
- CEA deviation penalty factors

Upon completion of the data collection, the data link cables would be disconnected and stored in accordance with approved procedures for storage and handling of Class 1E electric equipment. After removal of the data link, CPCS operation would be verified by performing a periodic test of each CPC and CEAC.

The staff reviewed the information provided by the applicant for using the data links between the CPCS and plant computer system during initial startup and power ascension tests and at each refueling and also reviewed the procedures for disconnecting the links at the end of this period. Based on the information provided, it was concluded that the concerns regarding the data links from the CPCS to the plant computer system were resolved.

Subsequently the NRC agreed to allow permanent connection of the data links per SER (2CNA068103) as discussed in amendment 24 to the Facility Operating License as follows:

ANO-2 had proposed to permanently connect the plant computer, a non-safety grade computer, to the core protection calculators (CPC) and control element assembly calculators (CEAC), part of the safety grade protection system. A similar proposal was made during the operating license (OL) review but was rejected by the staff because of concerns that the connection added unnecessary complexity to the CPC/CEAC design, and that there might be an adverse indirect effect on the protection system if data from the plant computer were used in calibration of the CPC addressable constants. The issue was discussed in the NRC's safety evaluation report for ANO-2 OL, NUREG-0308, and in particular in relation to Position 20 of Table 7.1 of that document and its supplements.

The concern that data from the plant computer might be used to modify CPC addressable constants and thereby adversely affect the CPCs has been addressed by establishing controls on the modifications of CPC addressable constants in the Technical Specifications. Changes to addressable constants based on data from the plant computer may be made only upon approval of the On-Site Safety Review Committee.

The staff concern about the unnecessary complexity associated with the data link design at the time of OL review was a general concern rather than one based on a potential deficiency in the measures taken to physically isolate the plant computer from the CPCs and CEACs. The use of qualified optical isolation devices at both ends of the digital data links and use of qualified current-to-current isolation devices for the analog data links to the plant computer preclude the possibility of a fault in the plant computer being propagated to the CPCs or CEACs. Furthermore, the watch-dog timers are used to prevent delay in a needed CPC trip should an inordinate time be spent in processing data through the data links to the plant computer.

Although the existence of the data links adds some complexity to the CPC/CEAC design as stated in the OL SER (NUREG-0308), the NRC reconsidered the issue and believes that the possibility of an adverse impact on safety is remote. Also, the controls on CPC addressable constant modifications prevent an unacceptable impact on the CPCs from recalibration using plant computer data. The NRC, therefore, concluded that the permanent connection of the data links between the CPC/CEAC and the plant computer was acceptable.

ARKANSAS NUCLEAR ONE
Unit 2

Position 21: Check-Sum

and

Position 22: Timeout Error Detection for Penalty Factor Transmission

and

Position 23: Watchdog Timer

The NRC's review of the paper tape memory dump representing the frozen design revealed that the check-sum values are not the same in all redundant channels.

For consistency and inspection purposes, the NRC require that a procedure be implemented that will result in check-sum agreement between corresponding blocks of all redundant computer channels in the system. Furthermore, the checksums in each channel must be available for inspection purposes through the operator's module.

The NRC has also noted that the written instruction designed to transmit the penalty factor from each CEAC to each of the CPCs does not have an error response routine for Input/Output (I/O) timeout. Since all other I/O operations in the system have this feature, the NRC requires that the CEAC penalty factor write commands be likewise provided with error test and response routines.

A. Core Protection Calculator

The NRC requires an automatic (hardwired) trip of the associated protection channel upon timeout of the watchdog timer. From the safety review of the design information submitted to date, the NRC has concluded that a significantly larger number of the CPCs safety functions would be monitored if the watchdog timer reset command were moved from the clock interrupt handler to the trip sequence program. In the interest of safety the NRC requires that the watchdog timer be reset from this trip sequence program.

B. Control Element Assembly Calculator

Upon timeout of the watchdog timer, the NRC requires that the "fail bit" be set in the CEAC output. From the safety review of the design information submitted to date, the NRC has concluded that a significantly larger number of the CEACs safety functions would be monitored if the watchdog timer reset command were moved from the clock interrupt handler to the penalty factor algorithm module. In the interest of safety the NRC requires that the watchdog timer be reset from the penalty factor algorithm module.

Resolution

With respect to the automatic tests, it was required that the watchdog timer circuits and program be modified (Positions 21, 22, and 23). Additional program design changes to improve the automatic detection of arithmetic overflow and underflow errors were also identified. The final designs for the watchdog timer and for the program modifications were submitted for review.

ARKANSAS NUCLEAR ONE
Unit 2

In response to Position 21, the design was changed to make the check-sum (an automatic on-line test parameter) values the same for corresponding blocks in all redundant channels. This was accomplished by setting unused memory locations to zero prior to loading and linking the system software. A secondary benefit is derived from this change because any fault in the system that might attempt to use any of these memory locations will cause an immediate channel trip. This occurs because zero is an illegal instruction in this computer and a fault instruction interrupt causes a channel trip.

The staff concluded that the automatic on-line test features have been implemented without restricting the primary safety functions of the CPCS and that they provide additional capabilities for detecting equipment failures which do not exist in present designs for analog hardwired systems. Therefore, it was concluded that the automatic on-line testing for the CPCS complies with the staff requirements in Positions 22 and 23 and was acceptable.

Position 24: Phase II Test and Test Report

Upon review of the Combustion Engineering Topical Report CENPD-22, "Core Protection Calculator System (CPCS) Phase II Design Qualification Test Report," the NRC has concluded that the computer program has not been tested to quality standards commensurate with the importance of the safety functions to be performed. On this basis, the NRC finds the Phase II Test Report unacceptable, including the test procedures and acceptance criteria utilized for the tests. Furthermore, the test report is incomplete in the analysis of test cases. This has raised concerns about the functional adequacy of the system. Because of these deficiencies, the NRC does not consider the Phase II Test Report as an acceptable verification of the CPCS computer program.

Our major areas of concern are as follows (Sequence is of no significance; all concerns are of equal importance.):

- A. Of the 36 static test cases, 18 failed the stated acceptance criteria. Coding error was the prime cause of not satisfying criteria for 14 cases. For verification purposes, the coding error was deliberately inserted into the FORTRAN simulation program to generate erroneous simulation results to compare with the results produced by the CPCS. These procedures are unacceptable. Also, these actions are in direct violation of the stated test procedures described in the section entitled, "Design and Performance Qualification Testing" within Section 7.2.1.1.2.5.1.7.

From the test report, it appears that the coding errors of a fixed point multiplication overflow and a floating point multiplication underflow were detected in the execution of the static test cases with known coding errors in the computer program violates the test procedures stated in the previously referenced section.

Thus, because of the procedures used in the execution of the Phase II test cases (both static and dynamic test cases), the NRC finds the test results unacceptable. Also because of the large error tolerances used for evaluating acceptability of test results, the NRC concludes that the verification of the correct implementation of the CPCS protection algorithms is not shown in the test report.

The NRC requires that the verification of the correct implementation of the protection algorithms be conducted with procedures which as a minimum are described in Section 7.2.1.1.2.5.1.7. In addition, acceptance criteria must be specified and justified.

ARKANSAS NUCLEAR ONE
Unit 2

- B. As a result of the analysis of the test cases, several computer program changes have been proposed and are identified in the test report. In general, the test report does not provide the basis of change, such as test case results with explanations of why the change is required. In order to conduct an independent review of the proposed changes, the staff required the basis for all proposed changes to the program. This must include all changes identified in the test report along with supporting test cases and explanations such as the results for and explanation of dynamic test Cases 11 and 21.
- C. In the discussion on dynamic test acceptance criteria, it is assumed that the initial steady state deviations may be applied as a uniform bias throughout the transient. An analysis to support this assumption will be required.
- D. In the discussion of dynamic test Case 15, the 8-second delay in trip time is attributed to improper initial conditions of the test case. For this dynamic test case, it is not clear that the delay in trip is uniquely attributable to initial offset in parameters. The NRC requires that detailed information be provided to support this conclusion.
- E. The analyses of the selected dynamic test cases presented in the report are incomplete. Trip time data for each channel and the FORTRAN simulation trip time are presented, but the response comparisons are only conducted for the trip point. No quantitative evaluation of error and error time history between the state variables presented for the FORTRAN simulation and the corresponding CPCS state variables is made. The lack of this comparison does not allow for an assessment of the implementation adequacy of the dynamic algorithms. The NRC requires that a comparison of the response of principle state variables from the FORTRAN simulation be made with the corresponding state variables of the CPCS. The resulting error history should be sufficiently small (and acceptable to the staff) to demonstrate adequate implementation of the dynamic algorithms. Furthermore, a summary table of trip times for all of the dynamic test cases is required for review purposes.
- F. The ex-core detector readings presented in the description do not appear to include sufficient variation in relative magnitude to test all of the various correction options inherent in the local power density trip functional program. The NRC requires documentation to clearly demonstrate that the shape correction routines were all correctly implemented and tested.
- G. In evaluating the static test cases, the staff had difficulty in assessing test procedures, the input parameters used in the test cases and the analysis of the limited number of intermediate and output parameters presented for testing. In evaluating the input data that were used in the static test cases, the NRC found that the input has been modified for greater than 50 percent of the cases.

To evaluate the above problems, AP&L's test plan must be provided on which the Phase II test report is based. The test plan should include acceptance criteria, the procedures used in the testing, a description of and objectives of each test case, the input data to be used in each case, and especially the parameters and variables to be recorded and analyzed for each test case.

- H. The Phase II test report does not address a test observed by the staff during which a channel failed to trip. (Trip Report - Documentation of CPC Testing - November 24-26, 1975). The NRC requires an analysis of this case as part of the test program.

ARKANSAS NUCLEAR ONE
Unit 2

- I. Static Test Acceptance Criteria: The error bands specified for static test acceptance criteria must be clarified and justified. The clarification should include identification and qualification of error components comprising the overall uncertainty band, the description of how they are combined to obtain the overall uncertainty tolerance. All CPC error components inherent in the Phase II test configuration must be included in the analysis, i.e. analog to digital conversion error, simulator errors, noise effects, and processing error in the digital computation must be quantified and justified in supporting documentation.

Support data must be provided to justify the increase in acceptance criteria (+5 percent error) due to the Power Utility Plant Simulator (PUPS) output hardware, cabling, and noise effects.

- J. Dynamic Test Acceptance Criteria: The previous position of the staff on "Performance Qualification Testing" requires that transient analysis be performed for selected dynamic test cases using the codes normally employed for Chapter 15 transient analyses.

The required time of trip to prevent DNBR from going below 1.3 as determined by these analyses should be specified for applicable cases as one of the acceptance criteria.

- K. Scaling Errors: The staff requires evidence that steps have been taken to preclude additional errors in the scaled range of program variables such as occurred for Static Test Case 14.
- L. Round Off Errors: The staff requires further analysis of the Static Test Case 11 error. It is not clear why the results should be sensitive to an exact equality of two different instrument signals, since the inherent measurement error makes such a comparison meaningless. Discuss provisions which are being taken to assure that other errors of similar logic origin do not exist. The logic should be justified and the deviation in results due to this logic should be quantified.
- M. Auto-Restarts: The effect of recurring auto-restarts that occurred during the use of Test Procedures C and D should be discussed. The staff requires details of the program changes designed to resolve this problem. The staff also requires details of the testing planned to conclusively demonstrate that the problem is resolved.
- N. Dynamic Test Cases: A repetition of the dynamic tests will be required. The dynamic test cases are the primary basis for evaluation of the dynamic algorithms. The staff regards that it is necessary to demonstrate the qualification of the corrected design as identified by Position 18. All design changes cannot be adequately evaluated without this testing.

Resolution

The vendor developed a 2-phase test methodology based on individual program modules, whole program units and finally the entire system of programs running in real time with simulated reactor inputs.

ARKANSAS NUCLEAR ONE
Unit 2

An audit of the initial Phase I testing was conducted at the vendors plant. The filing and formality of data record numbering was considered inadequate; however, it was greatly improved in a later docketed Phase I Test Report. This report was to be replaced by a report that will apply to the ANO-2 final software.

The Phase II Test Report, CENPD-222, was reviewed by the staff and found to be unacceptable. The concerns were issued as Position 24. As a result, the following commitments/resolutions were submitted.

- A. A commitment was made to re-perform the Phase I and Phase II test series with the final CPC algorithms and executive system software.
- B. An attempt was made to document all software modifications from the "frozen" design, although the staff's review has identified several changes which were not clearly specified.
- C & D. A commitment was to include justifications in the Phase II Test Report on the final software design to satisfy concerns expressed in Items C and D of Staff Position 24.
- E. It was proposed that single variable transient tests on the channel system and on the configured four channel system be performed during Phase II testing to supplement the evaluation of dynamic algorithm implementation in response to the NRC concerns expressed in Item E of Position 24.
- F. An audit of the Phase I test results resolved this concern.
- G. It was agreed that a Phase II test plan be submitted prior to the Phase II test of the final design software. The staff will review the test plan to determine if the content is acceptable with respect to Item G of Position 24.
- H. A commitment was made to submit documentation which would explain the anomalies observed by the staff during testing of the computer protection system (refer to Item H of Position 24).
- I. A commitment was made to address all CPC error components pertinent to the Phase II acceptance criteria for static tests as required by Item I of Position 24. The acceptability of the response was to be evaluated during review of the Phase II test documentation which would contain this information.
- J. Exception was taken to Item J of Position 24, which indicates that transient analyses for selected dynamic test cases should be used to specify acceptance criteria for reactor trip times. However, a commitment was made to provide analyses using codes normally employed for Chapter 15 transient analyses. This was found acceptable since the submittals would enable the staff to make the desired trip time evaluation.
- K. Software modifications addressed the concerns regarding errors in the scaled range of variables as expressed in Item K of Position 24.
- L. A commitment was made to provide, during Phase II testing of the "frozen" software, additional analyses to address concerns about round off errors.

ARKANSAS NUCLEAR ONE
Unit 2

- M. Software modifications were made to address concerns about recurring automatic restarts that occurred due to out-of-range multiplicative values obtained during Phase II testing of the "frozen" software.
- N. Phase II dynamic testing will be reperformed on the configured four channel system with all changes from the "frozen design" incorporated.

The total acceptability of the final design software with respect to Position 24 concerns was evaluated based on the submittals and test programs committed by the applicant.

Phase II Test Plan:

The staff reviewed the final Phase II test plan, including acceptance criteria for test results, which is described in CEN-55(A)-P, and Supplement 1-P of that document. The primary objective of the Phase II testing was to verify that the CPC and CEAC algorithms have been properly integrated with executive software and the system hardware. Each of the system components are verified by separate Phase I testing and by hardware qualification testing prior to testing of the integrated system.

The Phase II test program consisted of 36 static test cases comprising a representative set of steady state operating conditions and 26 dynamic test cases consisting of a representative set of CPC design basis events, anticipated plant transients, and artificial single parameter transients. Acceptance criteria for the Phase II tests are defined based on a comparison of the CPC system response to the response predicted by the CPC FORTRAN simulation code of the CPC software for corresponding test cases. The acceptance band included a tolerance for steady state variations as described in CEN-55(A)-P.

The magnitudes of the expected ranges for each test case was quantified based on detailed analyses of the above effects, including runs for each test case on the CPC FORTRAN Simulation Program. The CPC processor uncertainty was obtained by comparison of input sweep test results obtained on the Windsor Single Channel Test Facility versus those obtained from the execution of the CPC FORTRAN Simulation Program.

The range of acceptable trip times for dynamic test cases was determined by the effects of the uncertainties considered for the static test cases plus the time offset for initiation of the transient in relation to the start of a CPC or CEAC computational cycle. The latter effect is large in comparison to other uncertainties.

In response to staff positions, analyses were performed for five selected dynamic test cases using Combustion Engineering design codes to determine the latest trip time required to prevent DNBR of less than 1.3. The analysis was not provided for dynamic Case 3, 1-out-of-3 reactor coolant pump loss of flow, since the system was not being qualified for part loop operation. (This analysis must be submitted if the system is to be qualified for part loop operation.)

Also in response to staff positions, a time history analysis of the CPC DNBR margin and LPD margin was obtained from the CPC FORTRAN Simulation Program to determine the range of time history response for five single parameter dynamic test cases.

The staff found the test plan acceptable and responsive to staff position 24G.

ARKANSAS NUCLEAR ONE
Unit 2

Phase II Test Results:

The staff reviewed the Core Protection Calculator Phase II Test Report for qualification of the ANO-2 final design software. The staff also conducted an audit of the Phase II test. The Phase II test program was performed in its entirety to supercede the earlier Phase II testing of "frozen" design software which was unacceptable to the staff.

Preliminary analysis of the Phase II test results revealed some deficiencies in the modeling of the system to generate the acceptance criteria. The tolerance bands of expected values were revised to reflect refinements in the simulation of the PUPS function, modeling of noise, and application of the input sweep test results. The staff reviewed the test results in comparison to both the original range of expected values provided in the Phase II test report. It was concluded that the adjustments were small and facilitated the analysis of test results without prejudice to the conclusions, and were, therefore, acceptable.

Test results for DNBR values in 20 of the 36 static test cases were outside of the acceptance range on one or more CPC channels, and required further analysis and explanation. Most of the out-of-range cases were attributed to noise amplitude either greater (low out-of-range) or less (high out-of-range) than assumed when computing the expected values. Four cases were further biased on the high out-of-range side by deviations in the PUPS analog outputs with higher values than expected. All static cases which were outside of the acceptance range were rerun on the Windsor Single Channel Test Facility and results were compared to outputs on the CPC FORTRAN Simulation Program for noise amplitude of zero on all inputs. The DNBR results were in close agreement and were acceptable to the staff.

Peak LPD results were within the expected ranges for 30 of the 36 static test cases. As for the DNBR results, noise was the primary factor responsible for the six out-of-range cases. This was confirmed by running these cases on the Windsor Single Channel Test Facility with fixed inputs. It was concluded that in all cases, the single channel result and CPC FORTRAN Simulation Program results were in acceptably close agreement.

As for the static test cases, initial measured DNBR values for dynamic test cases were affected by noise and PUPS output values different from those assumed when computing expected test results. Only five of the 26 dynamic test cases were within the expected range for initiation of the transients. Out-of-range LPD values were observed in four of the 26 dynamic test cases. Deviations were attributed to noise characteristics of the PUPS system and PUPS analog output uncertainties.

Sixteen of the 26 dynamic test cases met the acceptance criteria for time to trip or reset in all four channels. Out-of-range results for seven cases were shown to be due to noise and output uncertainties with the PUPS system.

Two cases, 23 and 25, were affected by fast CPU clocks in CPC channels A and B. The system surveillance performed during the software burn-in test revealed that the clocks which generate the interrupt signals were running fast, resulting in interrupts occurring at a 10 percent faster rate than intended. The impact of the increased interrupt rate on Phase II testing was analyzed and found to be small with significant impact only on the two cited cases. The dynamic algorithms include derivatives based on the design sampling rate; fast interrupts affect the sampling rate and result in erroneous derivative calculations. The cause of the problem was traced to faulty integrated circuits on CPU clock boards; the circuits were repaired. The periodic test is designed to test the clock and detect anomalies of the type described above.

ARKANSAS NUCLEAR ONE
Unit 2

Test Case 14, which was also out-of-range, is 100 percent to 90 percent step power decrease which results in DNBR increase with no trip output during the transient. Expected results were based on the final time at which the DNBR increases above 2.2. The DNBR did increase above 2.2 at approximately the expected time but dropped below that value much later in the transient (50 to 65 seconds) due to a series of downward spikes in DNBR. This was attributed to effects external to the CPC/CEAC system after extensive analysis of the case failed to reveal any software errors.

Dynamic test cases 17 through 22 are single variable transient tests. The time history of the DNBR and LPD output response compared well to the same cases performed on the CPC FORTRAN simulation.

Analyses were performed using design codes to determine the trip time response necessary to preclude violation of fuel design limits for five relatively limiting design basis events. The actual trip times obtained with the CPCs provided substantial margin over the trip times required.

Conclusions – Phase II Test Program:

The staff review of the Phase II test program included an evaluation of conformance to pertinent staff positions and previous commitments. It was concluded that Position 17 requirements for performance qualification testing were satisfied by the Phase II test program and this issue was resolved.

Position 24 staff concerns were also reviewed and resolved as follows:

Position 24A - The staff concluded that the Phase II test program is acceptable for verification of the correct implementation of the final design software.

Position 24B - Changes to the "frozen" design software were documented and justified, including a CEAC software correction and modification to one erroneous DNB constant which was discovered at the start of the Phase II testing. The documentation of software modifications was concluded to be acceptable.

Position 24C - The time history analysis provided in the Phase II test report acceptable for resolution of this staff concern.

Position 24D - The Phase II test report did not directly address concerns with dynamic test case 15 results during Phase II testing of "frozen" software. However, the satisfactory results of final software testing for this case were acceptable to alleviate this concern.

Position 24E - The analysis of dynamic test cases presented in the Phase II test plan and test report were acceptable for resolution of this position.

Position 24F - This concern was resolved earlier.

Position 24G - The Phase II test plan resolved this staff requirement.

Position 24H - An analysis of the problem defined by this staff position was provided. The software change and subsequent testing provided adequate assurance that the deficiency was corrected.

ARKANSAS NUCLEAR ONE
Unit 2

- Position 24I - Static test acceptance criteria in conjunction with the analysis provided in the Phase II test report was acceptable for resolution of this concern.
- Position 24J - Dynamic test acceptance criteria included transient analyses using design codes for selected test cases as required by this position. The results were acceptable.
- Position 24K - Phase II test results for final design software indicated that previous scaling errors were resolved.
- Position 24L - Software changes and subsequent testing adequately resolved this concern.
- Position 24M - Software changes and subsequent testing provided acceptable resolution of the recurring auto-restart problem.
- Position 24N - Dynamic test cases were repeated as required by this position.

The staff concluded that the final design test results were acceptable, subject to a satisfactory software burn-in test.

Although the integrated system test results were acceptable for qualification of the final design ANO-2 software implementation, the staff was still concerned about the effects of process noise on CPCS performance. The difficulties encountered in predicting the noise effects and the apparent sensitivity of the power calculations to the dynamic component of the thermal power algorithm were examples cited as pertinent to Position 12. The staff required that the impact of process noise on CPCS performance during the startup testing program be fully evaluated. Position 12 remained outstanding until such an evaluation was completed. The requirements for the resolution of Position 12 were stipulated in a condition to the operating license (see Position 12).

Position 25: Maintainability of the Core Protection Calculator System

IEEE 279-1971, Section 4.21, "System Repair," identifies maintainability as one of the requirements for the RPS. The discussions in Sections 7.2.1.1.2.5.1.8 and 7.2.1.1.2.5.1.7 did not adequately address the maintainability of the CPCS. Industrial experience with process computer systems had identified several concerns regarding maintainability of digital computer systems over the operating life of the plant. These concerns are summarized as follows:

- A. Lack of standardization in hardware and software design has led to difficulties in identifying second sources of parts supply.
- B. The short commercial life cycle of electronic parts compared to plant operating life has resulted in obsolescence of equipment and unavailability of spare parts.
- C. Suppliers' and users' lack of experience, trained technicians to maintain equipment.
- D. Incomplete maintenance and trouble shooting procedures and system documentation has made maintenance difficult.

ARKANSAS NUCLEAR ONE
Unit 2

As a result of these concerns, and since the ANO-2 represented the first system of its type for use in a RPS, the staff required that the CPCS maintainability plan for the life of the plant be documented and docketed for the Regulatory staff's review and evaluation. The plan was required to address the following:

- A. The maintenance actions, i.e. preparation, failure verification and fault location, replacement part procurement, repair and verification tests, required.
- B. The maintenance diagnostic and repair features, e.g. displays and controls, external accessibility, test points, cables and connectors, internal accessibility, manuals and test equipment.
- C. Hardware and software maintenance support to be provided by vendors (and/or others) and personnel qualification and training to support this maintenance service.
- D. Hardware and software maintenance to be provided to the applicant and personnel qualification and training to support this maintenance.

Resolution

In response to these concerns, information was provided describing the procedures for diagnosing CPCS failures. The staff determined that these procedures did not consider the maintainability plan of the CPCS for the life of the plant.

An overall maintainability plan for the CPCS was submitted. The information identified maintenance actions, diagnostic and repair features, personnel training, and other procedures which were to be implemented to ensure that the CPCS can be maintained consistent with the performance requirements of Sections 4.1 and 4.21 of IEEE 279-1971. This was subsequently found acceptable.

Position 26: Optical Isolator

It is the staff's position that as the optical isolator is to be utilized as an electrical isolation device, the applicant must demonstrate that any single credible fault (125-volt AC and 125-volt DC) applied to the device output will not degrade the operation of the circuit connected to the device input. Also, the application of the same credible fault must be applied to the input of the device with no degradation of the circuit connected to the device output.

Resolution

A test program was proposed for the optical isolators. The staff reviewed the procedures and concluded that they were acceptable. The staff also reviewed the test report, and concluded that the test results did not satisfy the acceptance criteria and thus the test report was not acceptable.

The applicant submitted a new test procedure, and test report, which included the design changes that would combat the failures experienced during the first qualification test. Also an analysis was performed to prove the functional correctness of the modifications made to the CPC system's Digital Input (DI) and Digital Output (DO) data link cards. The staff reviewed the analysis and test procedures and concluded that they were acceptable.

ARKANSAS NUCLEAR ONE
Unit 2

The staff also reviewed the test report, and expressed the following concern to the modifications made to the DI card:

- A. A fusible resistor was used to prevent the high energy source from initiating a resistor fire upon a fault. The concern was that the fusible resistor would not open fast enough to prevent a fault from exploding the input diode of the isolator. Also the repeatability of the test data for the modified design to perform its function upon application of a fault was a concern.
- B. A diode was installed back to back with the input diode of the isolator to prevent damage from the high reverse voltage that would be seen with a 120-volt AC fault. The concern here was the need for the diode modification and the potential requirement for periodic test.

The applicant submitted a new test procedure for evaluating the repeatability of test data on fault performance and to determine if periodic testing is necessary for the protection diode. This test procedure was reviewed and found acceptable.

On May 18, 1978 the staff met with Arkansas Power & Light Company and Combustion Engineering, Inc. in Windsor, Connecticut, to audit the optical isolator qualification test. The tests were conducted on the single channel CPC system in accordance with test procedures. The single channel was configured as a CEAC and a 120-volt AC was applied across the signal lead and the +12-volt return. No abnormal behavior was observed and the on-line diagnostic verified that Bit 7 did fail. Both the DI card and D0 card were pulled from the chassis, and the isolation impedance was verified to be greater than 20 Megohm. There was no evidence of damage on adjacent circuit boards. The cards were returned to the chassis and the system configured as a CPC, and a 120-volt AC was applied across the signal lead and the +12-volt DC supply. Again there was no evidence of damage to the board or the adjacent circuit boards.

An additional 16 tests were run to verify that the modified data link card could withstand the maximum credible fault. Eight tests were run with the back diode in the circuit, and then eight circuits were faulted with the diode removed. The test results demonstrated that the CPC data link isolation circuitry can successfully withstand the maximum credible fault without propagating the fault. It was also demonstrated that periodic testing of the reverse voltage diode circuit is not necessary.

The staff reviewed the test report and found it acceptable. Therefore it was concluded that all of the concerns in Position 26 were addressed and that the optical isolators were acceptable to be used as isolation devices in the CPCs.

Position 27: Periodic Testing of Isolation Devices

The unique design of the CPCS relies on many isolation devices, i.e. optical isolators for CEAC to CPC data transfer and CEA position signals, to maintain electrical independence among the protection channels. The ability of these devices to maintain the isolation among channels is one of the bases for accepting the design of the CPCS. It is the NRC's concern that failures of the isolation characteristics of these devices would seriously compromise the ability of the CPCS to function. The current periodic test procedures do not include provision for verifying that the isolation characteristics of these devices have not failed. Therefore, it is the NRC's position that periodic tests to verify the isolation characteristics of those isolation devices used to ensure channel independence should be performed. The NRC requires that a test procedure for periodically checking the isolation characteristics be submitted for NRC review and approval.

ARKANSAS NUCLEAR ONE
Unit 2

Resolution

Test procedures for periodically checking the isolation characteristics of the CEA position isolation amplifiers and of the optical isolators were submitted. The staff reviewed the test procedures for periodically checking the isolation characteristics of the optical isolators and concluded that they were acceptable. A specific concern regarding the adequacy of the CEA position isolation amplifier isolation tests was identified. In response to this concern, a revised test procedure was submitted to provide a more comprehensive test for periodic verification of the CEA position isolation amplifier input-to-output isolation characteristics. The staff reviewed these test procedures and concluded that they were acceptable.

The current CPC system is designed and installed consistent with the 27 positions above. A position by position analysis of the current CPC system is as follows:

Position 1: Uncertainty Associated with the Algorithms

The implementation of the current CPC system has no impact on the resolution of this position.

Position 2: Conservatism of the CPCs Response to Dropped Control Element Assemblies

The implementation of the current CPC system has no impact on the resolution of this position.

Position 3: I/I Converter Isolation Device

The implementation of the current CPC system has no impact on the resolution of this position.

Position 4: CEAC Separation Criteria at the Output of the Optical Isolator Card

The current implementation of the CPC system will exhibit the same failure mode as originally determined; that is the effect of a single failure in the CEAC on the CPC is to reduce the auctioneering logic for CEA deviation (penalty factor) to a 1 out of 1 in the CPC (not a loss of function).

The isolation provided in the current system between the CEAC and the CPC has been upgraded by the use of fiber optic cable as the isolation device. (See "Resolution" of Position 26).

Position 5: Cable Separation

The CPC system physical enclosure has been improved by moving the location of the system to a place which improves technician access. The CPC equipment has been relocated to this area from the 2C15 enclosure. The non-CPC equipment remains in the 2C15 enclosure. The cabling between the 2C15 enclosure and the new cabinet will be routed to maintain the current degree of separation between Class 1E channels and non-Class 1E equipment and wiring.

The noise immunity qualification testing program originally performed to resolve position 5 will be re-run to verify that the system remains immune to the existing site noise sources.

ARKANSAS NUCLEAR ONE
Unit 2

Position 6: Position Isolation Amplifiers

The current implementation of the CPC system utilizes fiber optic devices for CEA position signal isolation. Seismic and environmental qualification tests have been performed on the new devices.

Position 7: Protection Memory

The memory protection design of the current CPC system has been upgraded to provide annunciation of detected failures. Also, the diagnostic design has been expanded to include monitoring of inappropriate memory read and execute operations in addition to the write protect of the original design.

No safety credit is assumed for this function thus, the resolution of Position 7 remains unchanged.

Position 8: Time Interval of Periodic Testing

Position 8 reflected a concern on the part of the NRC staff during the initial CPC licensing that insufficient data existed to base the establishment of a periodic test interval on. Since that time, a considerable amount of operating experience has been developed upon which the current periodic test interval is based.

The current CPC system replaces the original CPC system with hardware of equal or better reliability. Thus, the current technical specification of testing intervals will be maintained for the current system.

Position 9: System Functional Testing

The current periodic test procedures are identical in function to the original procedures. Some detailed changes were made to accommodate changes in the test interfaces of the new equipment.

Position 10: Periodic Testing Addressable Constants

The current procedure for verification of addressable constant changes is identical in function to the original procedure. Some detailed changes have been made to incorporate changes in the operator's module hardware.

Position 11: Environmental Performance Qualification

and

Position 13: Sensor Qualification

The current implementation of the CPC system has no impact on the resolution of Position 13.

The qualification tests for the current equipment will be performed to the ANO-2 design basis conditions in accordance with IEEE-323-1971 to verify their adequacy.

ARKANSAS NUCLEAR ONE
Unit 2

Position 12: Electrical Noise and Isolation Qualification

The EMI/Noise Susceptibility tests will be re-performed to verify system adequacy. A resurvey of the site environment will also be performed. These tests will be performed in a manner essentially identical to the original system tests.

The position isolators will be analyzed to verify that the original isolation testing remains valid.

The CEAC to CPC data links will be analyzed to demonstrate their isolation capability since the current design utilizing fiber optic cable does not provide any path to conduct energy from the isolator input to output. The CPC and CEAC data links to the Plant Computer will be similarly analyzed to demonstrate the adequacy of the isolation.

Position 14: Seismic Qualification

Seismic qualification of the current CPC system will be performed in accordance with IEEE - 344-1971 to the ANO-2 design basis environment similar to that performed on the original system.

Position 15: Addressable Constant

The current implementation of the CPC system has no impact on the resolution of Position 15.

Position 16: Quality Assurance Plan

The current CPC system is designed, fabricated, integrated and tested in accordance with the appropriate requirements of 10 CFR 50, Appendix B.

The current CPC system software has been maintained consistent with the requirements of CEN-39-(A)-P which has been reviewed and approved by the NRC.

Position 17: Performance Qualification Testing

Complete Phase I and Phase II test programs will be run to verify the current CPC system in accordance with CEN-39-(A)-P developed in response to Position 19.

Position 18: Burn-in Test

The burn-in test required by position 18 was appropriate at that time as the ANO-2 CPC system was the first application of a new technology.

Since the time of the original position 18 test, three additional systems of a similar design were produced for the SONGS 2 and 3 plants and the Waterford Plant.

The CPC system was modernized for CE's Systems 80 Palo Verde Nuclear Generating Stations Units 1, 2, and 3. More current equipment was utilized for the computer, input/output system, data links and operator's module.

A burn-in test was not deemed necessary for Palo Verde due to the significant amount of operating experience accumulated with the CPC system.

ARKANSAS NUCLEAR ONE
Unit 2

A formal burn-in test will not be performed for the current CPC system. The operating experience available for the CPC system is adequate to base a periodic test interval on. The software and integrated system performance will be verified with tests performed in accordance with CEN-39-(A)-P.

The full system will be staged for Factory Acceptance Testing and will be restaged at the plant site prior to installation. During these staging periods, failure and repair records will be maintained and reviewed for the hardware. Software change requests generated during this period will be documented and maintained consistent with CEN-39-(A)-P.

Position 19: Qualification of Software Change Procedures

A new single channel will be qualified to reflect the hardware of the current system. A testing program functionally identical to that performed for the qualification of the System 80 CPC system will be performed to verify the adequacy of the single channel (Reference CEN 255).

The CPC system software will continue to be maintained in accordance with the criteria imposed in CEN-39-(A)-P.

Position 20: Data Link to Plant Computer

The current implementation of the CPC system does not have any impact on the resolution of Position 20.

Position 21: Checksum

and

Position 22: Timeout Error Detection for Penalty Factor Transmission

and

Position 23: Watchdog Timer

The current hardware and software have been designed such that a hardware watchdog timer monitors the execution frequency of each calculator.

In a CPC, the watchdog timer is periodically reset by software that is resident in the trip sequence subroutine. If the CPC does not reset the watchdog timer than the timer "times out" forcing the CPC outputs to a trip state. Annunciation of this occurrence is provided.

In a CEAC, the watchdog timer is periodically reset by software resident in the penalty factor algorithm module. When the CEAC fails to reset its watchdog timer the failure is annunciated. The CPCs will detect the CEAC data links in a non-operable condition and will also annunciate the occurrence. The CPC will use the other CEAC.

The current system satisfies the function requirements imposed by Positions 22 and 23.

Checksums in the current CPC system are the same for corresponding blocks of memory in each redundant channel in the CPCs.

All unused locations will be set to zero.

The current implementation satisfies the functional requirements of Position 21.

ARKANSAS NUCLEAR ONE
Unit 2

Position 24: Phase II Test Report

The current CPC system software will continue to be maintained consistent with the requirements of CEN-39-(A)-P which include the requirements for Phase II testing and documentation.

The current CPC system meets the requirements of Position 24.

Position 25: Maintainability of the Core Protection Calculator System

Procedures and plans for the maintenance of the CPC system are maintained for the current CPC system. Operating experience has shown that the CPC system can be maintained consistent with the performance requirements of Sections 4.1 and 4.21 of IEEE-279-1971 and therefore meet the requirements of Position 25.

Position 26: Optical Isolator

The current CPC system utilizes a fiber optic, non-conducting medium to isolate the CPC and CEAC data link.

Since there is no path for transmission of energy between input and output, the current CPC data links satisfy the fault requirements of Position 26. An analysis has been prepared to document the fault isolation capability of the fiber optic isolator consistent with the faults required by Position 26.

Position 27: Periodic Testing of Isolation Devices

Due to the inherent isolation capability of the fiber optic cable, periodic testing of the fault isolation capability will no longer be performed. As documented in the isolation analysis, the fiber optic cable retains its isolation capability for all design basis environmental conditions appropriate to its location including time dependent (aging) effects.

The CEA position isolation will continue to be tested consistent with established intervals in the technical specifications.

7.2.1.1.2.5.3 Additional Information

7.2.1.1.2.5.3.1 Supporting Documentation for CPC Licensing

The review of the CPCs involved much correspondence and topical reports including some proprietary information. The following is a chronological listing of additional information supplied to the Nuclear Regulatory Commission in support of the licensing of the CPCs.

Correspondence

Letter from Phillips, J. D. (AP&L) to A. Giambusso (NRC), 2CAN057505, May 16, 1975. Submits listing of AP&L disagreement with certain NRC positions.

Letter from Phillips, J. D. (AP&L) to A. Giambusso (NRC), 2CAN067508, June 19, 1975. Forwards CEN-20(A)-P. Responses to FSAR Questions 222.25 through 222.48 on the CPC system are included in this report.

ARKANSAS NUCLEAR ONE
Unit 2

Letter from Phillips, J. D. (AP&L) to A. Giambusso (NRC), 2CAN067509, June 19, 1975. Forwards CPC and CEAC functional block diagrams per response to FSAR Question 222.26 submitted in AP&L 6/20/75 letter to the NRC.

Letter from Cavanaugh, William (AP&L) to A. Giambusso (NRC), 2CAN077505, July 16, 1975. Submits Combustion Engineering's responses to NRC's comments on CEN-8(A)-P, Supplement 1, and a summary of AP&L's position on the precritical vibration monitoring program for ANO-2.

Letter from Phillips, J. D. (AP&L) to A. Giambusso (NRC), 2CAN077506, July 22, 1975. Notifies that AP&L must also appeal Question 222.20 regarding new requirements on the qualification of the post-accident monitoring instrumentation.

Letter from Cavanaugh, William (AP&L) to Robert S. Boyd (NRC), August 29, 1975. Forwards proprietary CPC hardware drawings.

Letter from Woodward, J. H. (AP&L) to Robert S. Boyd (NRC), 2CAN097505, September 10, 1975. Appeals certain FSAR questions regarding (1) request for a feedwater line break analysis in the accident section of the ANO-2 FSAR, and (2) request for plots of peaking factors and DNBR as a function of time during the return to power phase of the steam line break accident taking into account thermal hydraulic feedback effects and considering various degrees of thermal mixing of the reactor coolant from the intact steam generator and broken steam generator loops.

Letter from Cavanaugh, William (AP&L) to A. Schwencer (NRC), 2CAN107506, October 22, 1975. Discusses NRC questions directed to AP&L regarding the CPC system Topical Report CENPD-170-P.

Letter from Cavanaugh, William (AP&L) to A. Schwencer (NRC), 2CAN117501, November 3, 1975. Forwards CE proprietary material in response to FSAR Questions 241.6 and 241.32 regarding fuel rod pressurization and fuel rod cladding temperature during normal and anticipated operational occurrences.

Letter from Cavanaugh, William (AP&L) to A. Schwencer (NRC), November 12, 1975. Forwards responses to FSAR Questions 222.64, 222.68, 222.70, 222.72, 222.73, 222.76 and 222.79 regarding the CPC system. Some responses contain proprietary information.

Letter from Cavanaugh, William (AP&L) to A. Schwencer (NRC), November 26, 1975. Forwards partial response to NRC request for additional information related to the NRC review of CENPD-170-P.

Letter from Cavanaugh, William (AP&L) to A. Schwencer (NRC), December 4, 1975. Forwards responses to FSAR Questions 222.61, 222.62, 222.63, 222.67, 222.71, 222.77, 222.131, 222.136, 222.141, 222.144, 222.149, 222.155, 222.157 and 222.163 regarding the CPC system. Some responses contain proprietary information.

Letter from Cavanaugh, William (AP&L) to A. Schwencer (NRC), 2CAN127504, December 5, 1975. Discusses FSAR question response status.

Letter from Cavanaugh, William (AP&L) to A. Schwencer (NRC), December 10, 1975. Forwards responses to FSAR Questions 222.65 and 222.66 regarding the CPC system. Some responses contain proprietary information.

ARKANSAS NUCLEAR ONE
Unit 2

Letter from Cavanaugh, William (AP&L) to A. Schwencer (NRC), December 22, 1975. Forwards responses to FSAR Questions 222.59, 222.60, 222.69, 222.75, 222.80, 222.102, 222.113, 222.118, 222.120, 222.123, 222.125, 222.128, 222.134, 222.135, 222.137, 222.138, 222.139, 222.140, 222.142, 222.143, 222.146, 222.147, 222.148, 222.153, 222.154, 222.156, 222.158, 222.159, 222.160 and 222.161 regarding the CPC system. Some responses contain proprietary information.

Letter from Cavanaugh, William (AP&L) to J. F. Stolz (NRC), 2CAN017610, January 1976. Forwards additional copies of drawings requested by FSAR Question 222.97 with the exception of the PPS cabinet electrical schematics.

Letter from Cavanaugh, William (AP&L) to A. Schwencer (NRC), 2-016-3, January 9, 1976. Forwards responses to FSAR Questions 222.145 and (partial response to) 222.146 regarding the CPC system. Some of the response content contains proprietary information.

Letter from Cavanaugh, William (AP&L) to J.F. Stolz (NRC), 2-026-1, February 2, 1976. Responds to CPC system Questions 222.109 and 222.152.

Letter from Cavanaugh, William (AP&L) to J.F. Stolz (NRC), 2-026-5, February 17, 1976. Forwards response to FSAR Question 222.83.

Letter from Cavanaugh, William (AP&L) to J.F. Stolz (NRC), 2-036-3, March 4, 1976. Forwards responses to FSAR Questions 214.39, 214.41 and 214.42.

Letter from Cavanaugh, William (AP&L) to A. Schwencer (NRC), 2-036-8, March 12, 1976. Notifies that Combustion Engineering transmitted FORTRAN expected results for all 36 static test cases for the CPC system Phase II testing program. Contains some proprietary material.

Letter from Cavanaugh, William (AP&L) to J. F. Stolz (NRC), 2-056-6, May 12, 1976. Forwards responses to Arkansas Nuclear One - Unit 2 FSAR Questions 222.74, 222.132, 222.150, 222.151, 222.152, 222.162 and 222.164. Areas covered included expected results for selected Phase II dynamic test cases and CPC algorithm descriptions.

Letter from Cavanaugh, William (AP&L) to J. F. Stolz (NRC), 2-066-12, June 30, 1976. Forwards responses to FSAR Questions 222.126 and 222.127 regarding the CPC system. Responses contain some proprietary information.

Letter from Cavanaugh, William (AP&L) to Hazel Smith (NRC), 2-076-09, July 13, 1976. Forwards list of all proprietary transmittals made on Docket 50-368 since docketing of FSAR on 4/17/74.

Letter from Cavanaugh, William (AP&L) to J. F. Stolz (NRC), July 20, 1976.

Letter from Cavanaugh, William (AP&L) to J. F. Stolz (NRC), August 3, 1976.

Letter from Cavanaugh, William (AP&L) to J. F. Stolz (NRC), 2-086-9, August 6, 1976. Forwards responses to FSAR Questions 222.166 through 222.173. Areas covered included optical isolators, trip delay time for low DNBR trips, anticipated transients without scrams and areas described as most susceptible to common mode failures.

ARKANSAS NUCLEAR ONE
Unit 2

Letter from Cavanaugh, William (AP&L) to J. F. Stolz (NRC), 2-086-10, August 9, 1976. Confirms delivery on ANO-2 docket of two Systems Engineering Laboratories' manuals per response to Questions 222.166 and 222.167. Documents are proprietary.

Letter from Stolz, John F. (NRC) to Rueter D. A., (AP&L) September 22, 1976. Discusses CEA calculator separation criteria.

Letter from Rueter, Donald A. (AP&L) to J. F. Stolz (NRC), September 22, 1976.

Letter from Rueter, Donald A. (AP&L) to J. F. Stolz (NRC), September 24, 1976.

Letter from Rueter, Donald A. (AP&L) to J. F. Stolz (NRC), September 24, 1976.

Letter from Cavanaugh, William (AP&L) to Robert S. Boyd (NRC), September 30, 1976.

Letter from Rueter, Donald A. (AP&L) to J. F. Stolz (NRC), 2-096-19, September 30, 1976. Confirms delivery on ANO-2 docket on 9/24/76 of System Qualification Test Procedure for CE CPC system, dated 9/23/76.

Letter from Rueter, Donald A. (AP&L) to J. F. Stolz (NRC), October 8, 1976.

Letter from Rueter, Donald A. (AP&L) to J. F. Stolz (NRC), October 12, 1976.

Letter from Rueter, Donald A. (AP&L) to J. F. Stolz (NRC), 2-106-10, October 14, 1976. Forwards proprietary and nonproprietary versions of 16x16 Fuel Assembly Pluck Impact Test, 8/25/76 (TR-ESE-128P and TR-ESE-128NP).

Letter from Rueter, Donald A. (AP&L) to J. F. Stolz (NRC), 2-017-7, January 11, 1977. Forwards response to reissued FSAR Questions 222.170 and 222.171 regarding backup trips for anticipated events for which CPC system may provide initial trip action, and assessment of common mode failure potential of this system.

Letter from Rueter, Donald A. (AP&L) to J. F. Stolz, (NRC) 2-027-7, February 15, 1977. Discusses status of CPC position responses. Forwards reports: CPC Functional Description, Control Element Assembly Calculator Functional Description and CPC Software Modification From "Frozen" Design.

Letter from Rueter, Donald A. (AP&L) to J. F. Stolz (NRC), 2-027-10, February 25, 1977. Confirms submittal of test procedure regarding test plan for EMI/RFI noise test on CPCs.

Letter from Rueter, Donald A. (AP&L) to J. F. Stolz (NRC), February 25, 1977.

Letter from Rueter, Donald A. (AP&L) to J. F. Stolz (NRC), 2-037-3, March 9, 1977. Responds to NRC CPC task force request that relationship between CPC protection algorithms presented in CENPD-170-P, Appendix A, and CENPD-44(A)-P be clarified.

Letter from Arkansas Power & Light Company to J. F. Stolz (NRC), March 14, 1977. Discusses RSPT irradiation with regard to CPCs.

Letter from Arkansas Power & Light Company to J. F. Stolz (NRC), 2-037-7, March 14, 1977. Discusses CPC Staff Position 25.

ARKANSAS NUCLEAR ONE
Unit 2

Letter from Rueter, Donald A. (AP&L) to J. F. Stolz (NRC), March 28, 1977.

Letter from Rueter, Donald A. (AP&L) to J. F. Stolz (NRC), 2-047-8, April 11, 1977. Forwards response to Question 222.172 (reissued).

Letter from Rueter, Donald A. (AP&L) to J. F. Stolz (NRC), 2-047-14, April 25, 1977. Forwards "Documents, Data and Audits Required for Safety Review of Core Protection Calculator System." Discusses AP&L commitment to hardware "burn-in" test with "frozen design" software.

Letter from Rueter, Donald A. (AP&L) to J. F. Stolz (NRC), 2-047-14, April 25, 1977. Forwards response to Enclosure 1 of 3/29/77 letter regarding CPCs. "Documents, Data, and Audits Required for the Safety Review of the Core Protection Calculator System" is enclosed.

Letter from Rueter, Donald A. (AP&L) to J. F. Stolz (NRC), 2-057-7, May 25, 1977. Forwards EMI test report, CEN-52(A), on Combustion Engineering's single channel CPC system, fulfilling commitments made in the NRC Staff Safety Positions 5 and 12.

Letter from Rueter, Donald A. (AP&L) to J. F. Stolz (NRC), 2-057-8, May 25, 1977. Forwards system qualification final test report for the CPC system, CEN-51(A), documenting findings from five months of surveillance testing from November 11, 1976 through April 10, 1977, and summarizing system failure rate calculations.

Letter from Rueter, Donald A. (AP&L) to J. F. Stolz (NRC), 2-067-3, June 13, 1977. Submits additional information on CPC SER Positions 10 and 15. Forwards description of CPC design modifications.

Letter from Phillips, J. D. (AP&L) to Director of Nuclear Reactor Regulation (NRC) July 7, 1977. Discusses CPC Position 20.

Letter from Rueter, Donald A. (AP&L) to J. F. Stolz (NRC), 2-077-10, July 19, 1977. Notifies that the use of CEN-44(A)-P and CEN-45(A)-P, providing CPC and CEAC software functional descriptions, has led to four modifications to CPC functional description document.

Letter from Phillips, J. D. (AP&L) to Director of Nuclear Reactor Regulation (NRC) July 29, 1977. Forwards attachment, "Arkansas Nuclear One - Unit 2, Core Protection Calculators, Position 20."

Letter from Stolz, John F. (NRC) to William Cavanaugh (AP&L), September 7, 1977. Requests additional information with regard to CPCs.

Letter from Stolz, John F. (NRC) to William Cavanaugh (AP&L), September 16, 1977. Requests additional information on CPC system.

Letter from Boyd, Robert S. (NRC) to Arkansas Power & Light Company, September 20, 1977. Discusses CPC Position 20.

Letter from Cavanaugh, William (AP&L) to Director of Nuclear Reactor Regulation (NRC), October 25, 1977. Discusses CPC Position 20.

Letter from Stolz, John F. (NRC) to William Cavanaugh (AP&L), December 9, 1977. Discusses CPC system preoperational test for ANO-2.

ARKANSAS NUCLEAR ONE
Unit 2

Letter from Arkansas Power & Light Company to Director of Nuclear Reactor Regulation (NRC), January 10, 1978. Discusses CPC system Position 24.

Letter from Williams, Daniel H. (AP&L) to J. F. Stolz (NRC), 2-127-8, January 16, 1978. Forwards CEN-65(A)-P, containing slides, handouts and other material generated and used in support of NRC audit of CPC Phase I testing and design files held July 28 & 29, 1977. Also forwards other CPC-related material.

Letter from Williams, Daniel H. (AP&L) to J. F. Stolz (NRC), 2-018-15, January 18, 1978. Submits results of testing according to criteria in CEN-70(A) to demonstrate optical isolator characteristics. Addresses requirements for qualification of optical isolators as suitable isolation devices in the CPC system design.

Letter from Boyd, Robert S. (NRC) to Arkansas Power & Light Company, January 19, 1978. Discusses CPC Position 20.

Letter from Williams, Daniel H. (AP&L) to J. F. Stolz (NRC), 2-038-10, March 10, 1978. Discusses NRC November 21 & 22, 1977 review of CPC Phase II test report.

Letter from Williams, Daniel H. (AP&L) to J. F. Stolz (NRC), 2-038-27, March 27, 1978. Provides CPC documentation. Forwards CEN-57(A)-P, providing the CPC software specification document committed to in AP&L August 6, 1976 letter, and CEN-69(A)-P, containing executive software requirements.

Letter from Williams, Daniel H. (AP&L) to J. F. Stolz (NRC), 2-048-1, April 4, 1978. Forwards CEN-63(A), Supplement 1(P) regarding CPC supplemental shape annealing matrix information, and CEN-86(A)-P regarding test results of CPC integrated system burn-in test.

Letter from Williams, Daniel H. (AP&L) to Director of Nuclear Reactor Regulation (NRC), 2-058-11, May 11, 1978.

Letter from Williams, Daniel H. (AP&L) to Director of Nuclear Reactor Regulation (NRC), 2-058-12, May 17, 1978.

Letter from Williams, Daniel H. (AP&L) to J. F. Stolz (NRC), 2-068-3, June 7, 1978. Discusses test results of CPC system optical isolation feature per NRC Position 26 for CPCs. Forwards "Test Report of the Core Protection Calculator Data Link Reverse Voltage Diode and Repeatability Determination."

Letter from Williams, Daniel H. (AP&L) to J. F. Stolz (NRC), 2-068-42, July 3, 1978. Discusses CPC system. Includes assembler information and identification of acceptable range limits on shape annealing matrix components. Forwards "Test Procedure for EMI Site Survey of Arkansas Nuclear One - Unit 2 CPC System."

Letter from Trimble, David C. (AP&L) to J. F. Stolz (NRC), 2-049-8, April 17, 1979. Forwards proposed revision to Section 2.6 of CEN-39(A)-P, Revision 2, dated December 21, 1978, per April 10, 1979 telephone conversation.

ARKANSAS NUCLEAR ONE
Unit 2

Topical Reports

CENPD-145 and CENPD-145-P, "INCA -- A Method of Analyzing In-Core Detector Data in Power Reactors," April 1975.

CENPD-153, "Evaluation of Uncertainty in the Nuclear Form Factor by Self-Powered Fixed In-Core Detector Systems," August 1974.

CENPD-169, "COLSS -- Assessment of the Accuracy of PWR Operating Limits as Determined by the Core Operating Limit Supervisory Systems," Revision 1, July 1975.

CENPD-170 and CENPD-170-P, "CPC Assessment of the Accuracy of PWR Safety System Actuation as Performed by the Core Protection Calculators," Revision 1, July 1975.

CENPD-222-P, "Core Protection Calculator System Phase II Design Qualification Test Report," June 1976.

Combustion Engineering Topical Report, "System Qualification Test Procedure for Core Protection Calculator System," Revision 0, September 23, 1976.

Combustion Engineering Topical Report, "Environmental Qualification Test Report for the Reactor Coolant Pump Shaft Speed Sensor System," September 30, 1976.

CEN-39(A)-P, "CPC Protection Algorithm Software Change Procedure," October 1, 1976.

CEN-330-P-A, "CPC/CEAC Software Modifications for the CPC Improvement Program Reload Data Block," Combustion Engineering, Inc., October, 1987.

CEN-323-P-A, "Reload Data Block Constant Installation Guidelines," Combustion Engineering, Inc., September, 1986.

Combustion Engineering Topical Report, "Environmental Qualification Test Report for the 150" Reed Switch Position Transmitter and Bendix Electrical Connector," October 29, 1976.

Combustion Engineering Topical Report, "EMI Test Procedure for the Core Protection Calculator System," February 16, 1977.

CEN-44(A)-P, "Core Protection Calculator Functional Description," January 7, 1977. Supplement 1(P), May 16, 1977; Supplement 2(P), May 19, 1977; Supplement 3(P), September 2, 1977.

CEN-45(A)-P, "Core Element Assembly Calculator Functional Description," January 7, 1977.

CEN-51(A), "System Qualification Final Test Report for Core Protection Calculator System," May 9, 1977. Supplement 1(P), "Reliability Prediction Calculation for the Core Protection Calculator System," May 1977.

CEN-52(A), "EMI Test Report for the Core Protection Calculator," May 11, 1977.

CEN-53(A)-P, "CPC and CEAC Data Base Document," May 20, 1977. Supplement 1(P), June 28, 1977; Supplement 2(P), September 2, 1977.

ARKANSAS NUCLEAR ONE
Unit 2

CEN-55(A)-P, "Phase II Design Qualification Test Procedure," June 24, 1977. Supplement 1(P), July 18, 1977.

CEN-57(A)-P, "Core Protection Calculator Software Specification," June 27, 1977.

CEN-58(A)-P, "Control Element Assembly (CEAC) Software Specification," July 28, 1977.

CEN-60(A), "Core Protection Calculator Integrated System Burn-In Test Procedure," first issued November 18, 1977. Revision 3, February 6, 1978; Supplement 1, November 18, 1977.

CEN-61(A), "Test Procedures for the Periodic Verification of the Control Element Assemblies Position Isolation Assembly Isolation Properties," first issued September 28, 1977. Revision 1, January 1978.

CEN-62(A), "Test Procedure for the Periodic Verification of Optical Isolation in the Core Protection Calculator System," July 22, 1977.

CEN-63(A), "CPC/CEAC Startup Test Requirements for ANO-2," July 28, 1977. Supplement 1(NP), "Core Protection Calculator System Supplemental Shape Annealing Matrix Information," March 1, 1978.

CEN-64(A)-P, "CPCS -- Core Flow Stability Assessment," August 1977.

CEN-65(A)-P, "Core Protection Calculator System, Phase I Test Audit," July 28 and 29, 1977.

CEN-66(A)-P, "Reliability Calculation for the CPCS Sensor Input Module," August 16, 1977.

CEN-67(A)-P, "Core Protection Calculator System Program Assembly Listing," July 29, 1977.

CEN-68(A)-P, "Core Protection Calculator System, Phase II Test Audit," August 8 and 9, 1977.

CEN-69(A)-P, "Core Protection Calculator System, CPC/CEAC Executive System Software Specification," July 27, 1977.

CEN-70(A), "Test Procedure for the CPC Data Link Fault Isolation," August 12, 1977. Revision 1, "Test Procedure for the Core Protection Calculator Data Link Isolation Circuits," January 18, 1978.

CEN-71(A)-P, "Core Protection Calculator, Single Channel Qualification Test Report," October 19, 1977.

CEN-72(A)-P, "Core Protection Calculator System, Phase I Test Report," October 14, 1977.

CEN-73(A)-P, "Core Protection Calculator, Phase II Test Report," October 27, 1977.

CEN-74(A), "Isolation Test Report for the Core Protection Calculator System," November 14, 1977.

Combustion Engineering Topical Report, "Test Report for Thermal Test of the Process Protective Cabinet," January 1978.

ARKANSAS NUCLEAR ONE
Unit 2

CEN-84(A), "Test Report for the Core Protection Calculator Data Link Isolation Circuits," February 1978. Supplement 1, "Test Report of the Core Protection Calculator Data Link Reverse Voltage Diode and Repeatability Determination," May 24, 1978.

CEN-86(A)-P, "Core Protection Calculator Integrated System Burn-In Test Report," March 6, 1978.

CEN-92(A), "Test Procedure for the Core Protection Calculator Data Link Reverse Voltage Diode and Reliability Determination," May 4, 1978.

7.2.1.1.2.5.3.2 Further Documentation on Major Topic Areas (After Initial Licensing)

Due to the unique application of the CPCs, e.g. use of digital computers in plant protection systems, further staff review continued in this area resulting in additional information being supplied regarding Arkansas Nuclear One - Unit 2.

The following documentation provides a summary of the information on the major topic areas discussed.

A. Data Links (See also Position 20 discussion.)

Letter from Trimble, David C. to Robert A. Clark, 2-090-06, September 3, 1980. Discusses NRC concern regarding CPC/CEAC plant computer data link. Requests that data link operate permanently.

Letter from Clark, R. A. (NRC) to Cavanaugh, W. (AP&L) Docket SO-368, 2CNA068103, June 19, 1981. To the ANO-2 Operating License. Resolved position 20 via transmission of SER on Amendment 24.

Letter from Trimble, David C. to Robert A. Clark, 2R-0281-12, February 28, 1981. Discusses AP&L request that CPC/CEAC plant computer data links remain in use permanently.

B. Addressable Constants (See also Position 15 discussion.)

Letter from Trimble, David C. to Robert A. Clark, 2CAN058113, May 26, 1981. Documents understanding reached between NRC and AP&L regarding description of how CPC addressable constants are determined for referencing in bases to Arkansas Nuclear One - Unit 2 Technical Specifications.

Letter from Trimble, David C. to Robert A. Clark, 2CAN088103, June 10, 1981. Modifies September 20, 1979 response to NRC July 23, 1979 letter regarding secondary water chemistry program. Forwards proposed licensing amendment for implementation of program.

Letter from Trimble, David C. (AP&L) to Robert A. Clark (NRC), 2CAN098103, September 11, 1981. Forwards proprietary version of MSS-NA2-P, "Arkansas Nuclear One - Unit 2 Core Protection Calculator Addressable Constant Determination Methodology."

ARKANSAS NUCLEAR ONE
Unit 2

Letter from Trimble, David C. (AP&L) to Robert A. Clark (NRC), 2CAN098110, September 30, 1981. Forwards nonproprietary version of MSS-NA2, "Arkansas Nuclear One - Unit 2 Core Protection Calculator Addressable Constant Determination Methodology."

C. Software Modifications (See also Position 19 discussion.)

Letter from Trimble, David C. to Robert W. Reid, 2-050-04, May 6, 1980. Forwards safety evaluation of CPC Modification 2B/3 software changes.

CEN-308-P, "CPC/CEAC Software Modifications for the CPC Improvement Program," August, 1985.

7.2.1.1.2.5.3.3 Summary of CPC/CEAC Software Modifications for Cycle 2

The CPCs and the CEACs of ANO-2 Cycle 2 are basically identical hardware with a modified version of the software from that of Cycle 1. The software modifications are described in CEN-143(A)-P.

Since the Cycle 1 CPC/CEAC was reviewed extensively and approved, the NRC Staff's review effort of the Cycle 2 CPC/CEAC concentrated on the software modifications. The following is a list of software modifications.

- A. Addressable constants have been added for CEA shadowing factor adjustments, planar radial peaking factor adjustments, and boundary point power correlation coefficients. These addressable constants have been added to adjust CPC power distributions based on startup measurement tests. Cycle 1 operating experience has shown that this improves the accuracy in calculations of core power and power distribution.
- B. Some fixed numbers in the power distribution calculation (POWER) have been changed to data base constants. The original fixed numbers were based on Cycle 1 design conditions. Making them data base constants provides flexibility to change plant-specific or cycle dependent values without changing the CPC functional specifications.
- C. Planar radial peaking factors are now adjusted by a correction factor based on the Combustion Engineering value of a reactor parameter. This modification provides a more accurate calculation of power distribution for various core conditions.
- D. The boundary point power correlation has been simplified and the constant coefficients in the correlation have been made addressable. Cycle 1 startup experience has shown that the previous dependencies in the algorithm are not necessary.
- E. A pre-selected axial power distribution is now used during low power operation. This provides a conservatively independent axial power distribution at low power levels.
- F. The slope of the coolant temperature shadowing factor has been made an addressable constant. The slope was previously a non-addressable data base value. However, since the shadowing factor is verified during startup testing, the slope can be adjusted based on test measurements. This will result in more accurate CPC calculations of neutron flux and power distribution.

ARKANSAS NUCLEAR ONE
Unit 2

- G. The pump-dependent uncertainty on LPD is revised to be applied to the DNBR and LPD update program, UPDATE, instead of the trip sequence program. This change results in including the uncertainty in the LPD margin to the CPC operator's module.
- H. The DNBR and LPD pre-trip setpoints have been made addressable constants. This change adds flexibility in setting pre-trip alarm setpoints and allows for adjustment of the setpoint without a revision to the data base. The change does not require a change to the DNBR pre-trip logic. However, the LPD pre-trip setpoint has to be converted from the unit of kW/ft to percent of core average power density.
- I. Two new curve fits are used for the core coolant enthalpy/temperature ratio and the normalized specific volume as functions of pressure and temperature. The enthalpy/temperature ratio curve fit is good for the temperature range from 455 °F to 5 °F below saturation temperature. If the hot leg temperature is within 5 °F of the saturation temperature, the CPC will initiate the hot leg saturation trip.
- J. The Cycle 2 CPC now uses CETOP2/CE-1 for minimum DNBR calculations compared to CPCTH/W-3 used in ANO-2 Cycle 1. This modification creates the most impact on core operating thermal margin. CETOP2 is the fourth generation of the steady state thermal margin analysis code, TORC. The first generation TORC requires 3-stage core modeling to determine the hot channel minimum DNBR. The second generation simplified TORC (CENPD-206-P) requires 2-stage core modeling. The third generation CETOP-D uses 1-stage lumped channel modeling and transport coefficients for the treatment of crossflow and turbulent mixing between adjoining channels. CETOP-D also uses a prediction-correction method instead of the iteration method used in TORC to solve the conservation equations. The difference in modeling and solution technique results in a very large difference between the TORC and CETOP-D codes even though the same conservative equations are used. CETOP2 used in the CPC is the offspring of CETOP-D. CETOP2 uses constant transport coefficients rather than calculating them as is done in the CETOP-D. Any error resulting from this simplification is accommodated by an algorithm uncertainty factor applied to the CETOP2 core power to ensure that the CETOP2 calculated DNBR is conservative with respect to the CETOP-D with 95/95 probability/confidence level.

7.2.1.1.2.5.4 Reload Information

As part of the reload of Arkansas Nuclear One - Unit 2, information regarding the CPC (in particular, software changes noted in Section 7.2.1.1.2.5.5.3) is submitted as necessary to support conclusions that the plant will continue to meet the safety design bases.

For additional reload information, see the cycle-specific Reload Report.

7.2.1.1.2.6 Trip Generation

Signals from the trip parameter process measurement loops are sent to voltage comparator circuits (bistables) where the input signals are compared to predetermined trip values. Whenever a channel trip parameter reaches the trip value, the channel bistable de-energizes the bistable output relay.

ARKANSAS NUCLEAR ONE
Unit 2

In the case of trips generated by the CPCs an external trip contact deenergizes the bistable output relays. The bistable output relays are in the trip logic (see Section 7.2.1.1.3).

Variable setpoints are provided for the pressurizer and steam generator pressure bistables to permit a safe and orderly plant shutdown. In each protective channel, there is one reset switch for the low pressurizer pressure bistable and another reset switch for both of the low steam generator pressure bistables. As system pressure is decreased below its normal operating range and the trip setpoint is approached, the operator can manually reset the setpoint a fixed increment below the actual system pressure. By continuing to reset each time the pre-trip setpoint is reached, the plant can be cooled down and depressurized without causing any unnecessary protective actions. If system pressure rises above the point at which it was last reset, the trip setpoint will rise to provide protection. If system pressure is then reduced, the setpoint will hold and the operator must again reset the setpoint as the trip point is approached. Figure 7.2-4 illustrates this process for the steam generator setpoint based on design pressure of 900 psia. The actual setpoints are displayed on control board meters near the variable reset switches for each measurement channel.

The remaining trip bistable setpoints are adjustable from the PPS cabinet. Access is limited, however, by means of a key operated cover, with an annunciator indicating panel access. The annunciator indicates that the PPS cabinet has been entered, not that the setpoint adjustment panel cover has been opened. All bistable setpoints are capable of being read out on a meter located on the PPS cabinet.

Pre-trip bistables and relays are also provided.

7.2.1.1.3 Logic

The above trips are each generated in four channels, designated A, B, C and D. The RPS logic utilized these trip signals to generate, on a 2-out-of-4 basis, signals to the final actuation devices for a reactor trip.

Tripping of a bistable (or trip contact closure in the case of a calculated trip) results in a channel trip which is characterized by the de-energization of three trip relays. A trip of any two bistables in a group of four like protection trip paths will result in a trip of all four channels (A,B,C and D).

The contacts of the four sets of three trip relays in the four like protection channels have been arranged into six logic ANDs designated AB, AC, AD, BC, BD, and CD. This represents all possible 2-out-of-4 trip combinations for the four protection channels.

The contacts of the four sets of three trip relays in all other groups of four protection channels monitoring other selected NSSS parameters are arranged in a similar fashion.

The logic ANDs of identical trip designation are connected in series (Logic OR) to form a logic matrix. The six matrices are also designated AB, AD, AC, BC, BD and CD. Each logic matrix is connected in series with four parallel matrix relays.

Trip paths are formed by connecting contacts from one matrix relay in each of the six sets of matrix relays in series in an output relay circuit which controls power interruption to the actuation devices. The trip path initiation relays serve to de-energize the trip switchgear circuit breakers as discussed in Section 7.2.1.1.4.

ARKANSAS NUCLEAR ONE
Unit 2

7.2.1.1.4 Actuated Devices

The above logic causes the de-energizing of the four trip path initiation relays whenever any one of the logic matrices is de-energized as described. Each trip path initiation relay in turn will cause two trip circuit breakers in the trip switchgear to open.

Power input through the trip switchgear breaker contacts to the CEA holding coils comes from two full capacity motor generator sets so that the loss of either set does not cause a release of the CEAs. Each line passes through two trip circuit breakers (each actuated by a separate trip path) in series so that, although both sides of the branch lines must be de-energized to release the CEAs, there are two separate means of interrupting each side of the line. Upon removal of power to the CEDM power supplies, the CEAs are inserted into the reactor core by gravity.

Two sets of manual trip pushbuttons are provided to open the trip circuit breakers, if desired. The manual trip completely bypasses the trip logic. Both manual trip pushbuttons in a set must be depressed to initiate a reactor trip.

The trip switchgear is housed in a separate cabinet from the RPS. In addition to the trip circuit breakers, the cabinet also contains a bus tie breaker and current monitoring devices which indicate on the local status panels for testing.

7.2.1.1.5 Bypasses

The bypasses listed in Table 7.2-1 are provided to permit testing, startup, and maintenance.

The DNBR and local power density bypass, which bypasses the low DNBR and high local power density trips from the CPC, is provided to allow system tests at low power when pressurizer pressure may be low or reactor coolant pumps may be off. The bypass may be manually initiated and is automatically removed as shown in Table 7.2-1.

The RPS/ESFAS pressurizer pressure operating bypass is provided for two conditions: (1) system tests at low power and low pressure, and (2) heatup and cooldown with shutdown CEAs withdrawn. The bypass is manually initiated and is either manually or automatically removed as shown in Table 7.2-1.

The RPS/ESFAS High/Low Steam Generator Level Bypass is provided for system tests during shutdown conditions. The bypass is manually initiated and is either manually or automatically removed as shown in Table 7.2-1.

The high logarithmic power level operating bypass is provided to allow the reactor to be brought to the power range during a reactor startup. The bypass is manually initiated and is automatically removed as shown in Table 7.2-1.

The trip channel bypass is provided to remove a trip channel from service for maintenance or testing. The bypass is also provided to remove a trip channel from service for an extended period without affecting plant safety or availability in the event of an equipment failure not readily repairable or accessible. The trip logic is thus converted to a 2-out-of-3 basis for the trip type bypassed; other type trips which do not have a bypass in any of their four channels remain in a 2-out-of-4 logic.

ARKANSAS NUCLEAR ONE
Unit 2

The bypass is manually initiated and manually removed. This circuit, which is repeated for each type of trip, contains an electrical interlock which allows only one channel for any one type trip to be bypassed at one time.

All bypasses are annunciated visually and audibly to the operator.

7.2.1.1.6 Interlocks

The following interlocks are provided:

A. Trip Channel Bypasses

An interlock prevents the operator from bypassing more than one trip channel at a time for any one type trip. Different type trips may be simultaneously bypassed, either in one channel or in different channels. Since some parameters may be used in several different functional units, Technical Specifications require that when bypassing a parameter or functional unit in a channel, the operator must bypass all the interdependent parameters or trip units in the same channel.

B. Matrix Tests

During system testing an electrical interlock will allow only the matrix relays in one of the six matrix test modules to be held at a time. The same circuit will allow only one process measurement loop signal to be perturbed at a time. The matrix relay hold and loop perturbation switches are interlocked so that only one or the other may be done at any one time.

C. Nuclear Instrumentation Test

Placement of a nuclear instrument drawer calibration switch to other than the "OPERATE" position or removal of any level test switch from the "OFF" position will cause a power trip test interlock to trip low DNBR and high local power density bistables. Placement of a linear or logarithmic calibration switch to other than the "OPERATE" position will cause a channel high power level or high logarithmic power level trip.

D. Core Protection Calculator Test

The low DNBR and high local power density channel trips are interlocked such that they must be bypassed to test a CPC system.

E. Test Power Supply

A rotary switch ensures that power from the test power supply may be applied to only one channel at a time.

7.2.1.1.7 Redundancy

Redundant features of the RPS include:

- A. Four independent channels, from process sensor through and including channel trip relays. The CEA position input is from two independent channels;

ARKANSAS NUCLEAR ONE
Unit 2

- B. Six logic matrices which provide the 2-out-of-4 logic. Dual power supplies are provided for the matrix relays;
- C. Four trip paths, including four control logic paths and four trip path output relays;
- D. CEDM power from two power buses, including two full capacity motor generator sets;
- E. Two sets of manual trip switches (either set is sufficient to initiate a reactor trip); and,
- F. AC power for the system is derived from four separate 120-volt vital AC buses. DC power for reactor trip switchgear control is provided from two separate DC buses plus rectified AC derived from 2 additional AC buses.

The result of the redundant features is a system which meets the single failure criterion, which can be tested during reactor operation, and which can be shifted to 2-out-of-3 logic.

In order to alleviate concerns regarding redundant power supply independence, testing was performed on PPS power supplies. The purpose of this testing was to show that the DC power supplies involved, when auctioneered, will provide adequate separation between vital power buses and will perform that function in accordance with the criteria set forth in IEEE 279 and IEEE 323-1971. The benefit of a system with four independent and redundant channels is that the system can be operated, if need be, with up to two channels out of service (one bypassed and another tripped) and still meet the single failure criteria. The only operating restriction while in this condition (effectively one-out-of-two logic) is that no provision is made to bypass another channel for periodic testing or maintenance. The system logic must be restored to at least a two-out-of-three condition prior to removing another channel for maintenance.

7.2.1.1.8 Diversity

The system is designed to eliminate credible multiple channel failures originating from a common cause. The failure modes of redundant channels and the conditions of operation that are common to them are analyzed to assure that a predictable common failure mode does not exist. The design provides reasonable assurance that:

- A. The monitored variables provide adequate information during design basis events (Design basis events are listed in Sections 7.2.2.1.1 and 7.2.2.1.2.);
- B. The equipment can perform as required;
- C. The interactions of protective actions, control actions and the environmental changes that cause, or are caused by, the design basis events do not prevent the mitigation of the consequences of the event; and,
- D. The system will not be made inoperable by the inadvertent actions of operating and maintenance personnel.

In addition, the design is not encumbered with additional components or channels without reasonable assurance that such additions are beneficial.

The system incorporates functional diversity to accommodate the unlikely event of a common mode failure concurrent with any of the accident conditions listed in Section 7.2.2.1.2.

ARKANSAS NUCLEAR ONE
Unit 2

Protection from a postulated common mode failure during an ATWS event is accomplished by the Diverse Scram System (DSS). Conformance to 10CFR50.62, known as the ATWS Rule, requires that the RPS/RTS be diverse and independent from the DSS from sensor output to interruption of power to the control rods. In addition, the RPS/RTS must be diverse from the Diverse Emergency Feedwater Actuation System (DEFAS) since the DEFAS is an ATWS system that uses the same types of equipment as the DSS. (Reference Section 7.7.1.6 for the DSS and Section 7.7.1.7 for the DEFAS)

7.2.1.1.9 Testing

Provisions are made to permit periodic testing of the complete RPS, with the reactor operating at power or when shut down. These tests cover the trip actions from sensor input through the protective system and the trip switchgear. The system test does not interfere with the protective function of the system. The testing system meets the criteria of IEEE 338-1971, "IEEE Trial - Use Criteria for the Periodic Testing of Nuclear Power Generating Station Protection Systems" and of Regulatory Guide 1.22, "Periodic Testing of Protection System Actuator Functions." Jumpers or other temporary forms of bypassing are not used during testing.

The individual tests are described briefly below. Overlap between individual tests exists so that the entire RPS can be tested. Frequency of testing is given in the Technical Specifications.

7.2.1.1.9.1 Sensor Check

During reactor operation, the measurement channels providing an input to the RPS are checked by comparing the outputs of similar channels and cross-checking with related measurements.

During extended shutdown periods or refueling, these measurement channels (where possible) are checked and calibrated against known standards.

7.2.1.1.9.2 Trip Bistable Tests

Testing of the trip bistables is accomplished by manually varying the input signal up to or down to the trip setpoint level on one bistable at a time and observing the trip action.

The digital voltmeter indicates the value of the test signal and is compared with an NIST traceable meter. The circuit permits various rates of change of signal input to be used. Trip action (de-energizing) of each of the bistable trip relays is indicated by individual lights on the front of the cabinet, indicating that these relays operate as required for a bistable trip condition.

When one of the four bistables of a protective channel is in the tripped condition (versus being bypassed), a channel trip exists and is annunciated on the control room annunciator panel. In this condition, a reactor trip would take place upon receipt of a trip signal in one of the other three like trip channels.

The trip channel under test is therefore bypassed for this test, converting the RPS to a 2-out-of-3 logic for the particular trip parameter. In either case, full protection is maintained.

ARKANSAS NUCLEAR ONE
Unit 2

7.2.1.1.9.3 Core Protection Calculator Tests

The sensor inputs to each calculator are compared between units. Predetermined test data are then accessed by one calculator at a time via a test panel. The calculator outputs are then checked for specific values. Multiple tests can be performed to check each phase of the calculator program (see Section 7.2.1.1.2.5).

The checking of the trip relays for the calculator generated trips is conducted as described in Section 7.2.1.1.9.2.

7.2.1.1.9.4 Logic Matrix Test

This test is carried out to verify proper operation of the six 2-out-of-4 logic matrices, any of which will initiate a system trip for any possible 2-out-of-4 trip condition from the signal inputs from each measurement channel.

Only the matrix relays in one of the six logic matrix test modules can be held in the energized position during tests. If, for example, the A-B logic matrix hold switches are held actuated, actuation of the other matrix hold switches will have no effect upon their respective logic matrices.

Actuation of the switch will apply a test voltage to the test system hold coils of the double coil matrix relays. This voltage will provide the power necessary to hold the relays in their energized position when de-actuation of the bistable trip relay contacts in the matrix ladder being tested causing de-energization of the primary matrix relay coils.

The logic matrix to be tested is selected using the system channel trip select switch. Then while holding the matrix hold switch in its actuated position, rotation of the channel trip select switch will release only those bistable trip relays that have operating contacts in the logic matrix under test. The channel trip select switch applies a test voltage of opposite polarity to the bistable trip relay test coils so that the magnetic flux generated by these coils opposes that of the primary coil of the relay. The resulting flux will be zero, and the relays will release.

Trip action can be observed by illumination of the trip relay indicators located on the front panel and by loss of voltage to the four matrix relays, which is indicated by extinguishing the indicator lights connected across each matrix relay coil.

During this test, the matrix relay "HOLD" lights will remain on, indicating that a test voltage has been applied to the holding coils of the logic matrix module under test.

The test is repeated for all six matrices and for each actuation signal. This test will verify that the logic matrix relays will de-energize if the matrix continuity is violated. The opening of the matrix relays is tested in the trip path tests.

Each logic matrix test module provides the associated test circuitry for both the RPS and ESFAS logic matrices. The system channel trip select switch permits the selection of the desired actuation logic matrix to be tested.

ARKANSAS NUCLEAR ONE
Unit 2

7.2.1.1.9.5 Trip Path/Circuit Breaker Tests

Each trip path is tested individually by depressing a matrix hold switch (holding the matrix relays), selecting any trip position on the channel trip select switch (opening the matrix), and selecting a matrix relay on the matrix relay trip select switch (de-energizing one of the four matrix relays). This will cause one, and only one, of the trip paths to de-energize, causing two trip circuit breakers to open. CEDMs remain energized via the other trip circuit breakers.

The drop out lamps are used to provide additional verification that the matrix relay has been de-energized, i.e. the 6AB-1 matrix relay contact energizes the drop out lamp. Since the matrix test modules are also utilized for the Engineered Safety Features Actuation System (ESFAS) logic matrix testing, this drop out lamp is also shared via contacts 1AB-1 through 5AB-1. Proper operation of the actual trip path matrix relay contacts is verified by the trip path lamp located on the trip status panel.

Proper operation of all coils and contacts is verified by lights on a trip status panel; final proof of opening of the trip circuit breakers is the lack of indicated current through the trip breakers.

The matrix relay trip select switch is turned to the next position, re-energizing the tested matrix relay and allowing the trip breakers to be manually reset.

This sequence is repeated for the other three trip paths from the selected matrix. Following this the entire sequence is repeated for the remaining five matrices. Upon completion, all 24 matrix relay contacts and all four trip paths and breakers will have been tested.

7.2.1.1.9.6 Manual Trip Test

The manual trip feature is tested by depressing one of the four manual trip switches, observing a trip of two trip breakers, and resetting the breakers prior to depressing the next manual trip switch.

7.2.1.1.9.7 Bypass

The system bypasses, listed in Table 7.2-1, are tested by appropriate test circuitry. Testing includes both initiation and removal features.

7.2.1.1.9.8 Response Time Tests

These tests are performed according to Technical Specification requirements.

The capability exists to independently test the shunt and UV trip coils in-place and to obtain a response time for the reactor trip breakers (during periodic PPS channel testing) via the plant computer/sequence of events recorder. A spring-return-to-center switch is used to bypass the shunt trip in the "shunt bypass" position for testing the UV trip. Conversely, the undervoltage trip is bypassed in the "UV bypass" position for testing the shunt trip.

7.2.1.1.10 Vital Instrument Power Supply

The vital instrument power supply for the RPS is described in Section 8.3.1.1.6.

ARKANSAS NUCLEAR ONE
Unit 2

7.2.1.2 Design Bases

The RPS is designed to ensure adequate protection of the fuel, fuel cladding and RCS boundary during anticipated operational occurrences. In addition, the system is designed to assist the Engineered Safety Features (ESF) system in limiting the consequences of postulated accidents.

The system is designed on the following bases to assure adequate performance of its protective function.

- A. The system is designed in compliance with the applicable criteria, "General Design Criteria for Nuclear Power Plants," (Appendix A of 10CFR50, July 15, 1971).
- B. Instrumentation, function and operation of the system conforms to the requirements of IEEE 279-1971, "Criteria for Protective Systems for Nuclear Power Plants."
- C. System testing conforms to the requirements of IEEE 338-1971, "Trial Use Criteria for Periodic Testing of Nuclear Power Generating Station Protection Systems" and Regulatory Guide 1.22, "Periodic Testing of Protection System Actuation Functions."
- D. The system is designed to determine the following plant conditions in order to provide adequate protection during anticipated operational occurrences (see Table 7.2-4 for more details):
 - 1. Core power high;
 - 2. RCS pressure* high/low;
 - 3. Low DNBR in the limiting coolant channel in the core;
 - 4. High local power density in the limiting fuel rod in the core; and,
 - 5. Steam generator water level low.

*Further RCS over-pressurization protection is provided by the DSS (Section 7.7.1.6).

- E. The system is designed to determine the following generating station conditions in order to provide protective action assistance to the ESF system during accidents (see Table 7.2-4 for more details):
 - 1. Core power high;
 - 2. RCS pressure high/low;
 - 3. Steam generator pressure low; and,
 - 4. Containment pressure high.
- F. The system is designed to monitor all variables required to ensure adequate determination of the conditions given in "D" and "E" above, over the entire range of normal operation and transient conditions. The full power nominal values and the maximum and minimum values that can be sensed for each monitored plant variable are given in Table 7.2-2.

The type, number and location of the sensors provided to monitor these variables are given in Table 7.2-3. There is no spatial dependence resulting from the location of sensors.

ARKANSAS NUCLEAR ONE
Unit 2

- G. The system is designed to alert the operator when any monitored plant condition is approaching a condition that would initiate protective action.
- H. The system is designed so that protective action will not be initiated due to normal operation of the generating station.

Nominal full power values of monitored conditions and their corresponding allowable protective action (trip) setpoints are given in Table 7.2-4.

The selection of these trip setpoints is such that adequate protection is provided when all sensor and processing time delays and inaccuracies are taken into account.

The required ranges for instruments used in reactor protection, ESF, and other safety-related systems are a function of the most limiting values of the instrumented variables attainable during conditions where the instrumentation is required. These limiting values are obtained through analyses of normal plant operation, anticipated operational occurrences, and postulated accidents. In these analyses, possible degraded conditions of operable equipment are considered where these affect parameter ranges. The instrumentation ranges determined as described above are adequate to accommodate all conditions for which the reactor protection, ESF and other safety-related systems are intended to operate.

In determining setpoints for these safety-related systems, analyses of postulated events are performed to determine values for the process parameters where safety system actuation is required in order to prevent the violation of one or more safety limits. These values are then biased by a factor which includes allowances for measurement errors and uncertainties and drift. The biased values are used as setpoints in the safety systems.

Channel drift is accommodated both by Technical Specification surveillance requirements and by incorporated drift allowances in the biases applied to the safety system setpoints. The plant Technical Specifications include requirements for a periodic complete channel calibration. The setpoint bias includes an allowance for sensor drift for the calibration interval. In addition, a channel functional test is required by the Technical Specifications. This test includes the injection of a simulated process signal into each safety channel to verify the channel setpoint. Therefore, the setpoint bias includes an allowance for channel drift (excluding the sensors) over this time interval. The sensor and channel drift allowances are obtained by test and/or analysis. The Technical Specifications also require interchannel comparisons of sensor readings. This provides assurance that the drift allowances used are not exceeded during plant operation.

Since safety channel non-linearities are considered in formulating the setpoint biases, no additional criteria are required to determine what portion of the range of an instrument may be used for automatic initiation of a protective function. However, it is Combustion Engineering practice to avoid the use of the extreme upper and lower ends of an instrument range, where practicable.

- I. All system components are qualified for the environmental conditions addressed in Section 3.11. In addition, the system is capable of performing its intended function under the most degraded conditions of the energy supply, as addressed in Chapter 8.

ARKANSAS NUCLEAR ONE
Unit 2

- J. The system is designed with four independent and redundant channels. The benefit of a system that includes four independent and redundant channels is that the system can be operated, if need be, with up to two channels out of service (one bypassed and another tripped) and still meet the single failure criteria. The only operating restriction while in this condition (effectively 1-out-of-2 logic) is that no provision is made to bypass another channel for periodic testing or maintenance. The system logic must be restored to at least a 2-out-of-3 condition prior to removing another channel for maintenance.
- K. The RPS is powered by four independent 120 VAC vital power sources. RPS channel trips are generated by loss of vital AC to the CPC. With power maintained to the bistable power supplies, de-energization of the process loops using increasing signal setpoints results in inability of the channel to perform its safety function. De-energization of the power to channel A or D bistable power supplies results in a channel trip. For the DC bus failure scenario resulting in loss of the vital AC channel pairs, (1 and 3 for 2D01 de-energization) or (2 and 4 for 2D02 de-energization), RPS trips are generated by CPC channels (A and C) or channels (B and D). RPS trip also results from de-energization of trip paths (1 and 3) or (2 and 4). The RPS trip path logic is (TP1 or TP2) and (TP3 or TP4).

7.2.2 ANALYSIS

7.2.2.1 Introduction

The RPS is designed to provide the following protective functions:

- A. Initiate automatic protective action to ensure that acceptable RCS and fuel design limits are not exceeded during anticipated operational occurrences, and
- B. Initiate automatic protective action during accident conditions to aid the ESF systems in limiting the consequences of the accidents.

7.2.2.1.1 Anticipated Operational Occurrences

The anticipated operational occurrences that are accommodated by the system are those conditions of normal operation which are expected to occur one or more times during the life of the plant. In particular, the occurrences considered include single operator errors or single component or control system failures resulting in transients which could lead to a violation of acceptable plant and fuel design limits if protective action were not initiated.

The fuel design and Reactor Coolant Pressure Boundary (RCPB) limits used to define the RPS design are:

- A. The DNBR in the limiting coolant channel in the core, will not be less than [the DNBR SAFDL](#).
- B. The peak local power density, in the limiting fuel pin in the core, shall not be greater than the kW/ft safety limit corresponding to the onset of centerline fuel melting; and,
- C. The RCS pressure shall not exceed those values permitted by the ASME Code, Section III. In addition, the DSS (Section 7.7.1.6) provides further protection from RCS over-pressurization.

ARKANSAS NUCLEAR ONE
Unit 2

The anticipated operational occurrences that were used to determine the system design requirements are:

- A. Insertion or withdrawal of CEA groups, including:
 - 1. Uncontrolled sequential withdrawal of CEA groups;
 - 2. Out-of-sequence insertion or withdrawal of CEA groups; and,
 - 3. Excessive insertion of CEA groups.
- B. Insertion or withdrawal of CEA subgroups including:
 - 1. Uncontrolled insertion or withdrawal of a CEA subgroup;
 - 2. Dropping of a single CEA subgroup; and,
 - 3. Static misalignment of CEA subgroups comprising a designated CEA group.
- C. Insertion or withdrawal of a single CEA, including:
 - 1. Uncontrolled insertion or withdrawal of a single CEA;
 - 2. Dropped CEA;
 - 3. A single CEA sticking with the remainder of the CEAs in that group moving; and,
 - 4. A statically misaligned CEA.
- D. Excessive dilution of the soluble boron concentration, when CEAs are withdrawn;
- E. Excessive load demands;
- F. Change of forced reactor coolant flow, excluding RCP shaft shear or seizure;
- G. Inadvertent pressurization or depressurization of RCS, excluding a loss of coolant;
- H. Change of normal heat transfer capability between steam and the RCSs, including improper feedwater flow and loss of load; and,
- I. Loss of off-site power.

Prior to Cycle 12, ANO-2 had 8 part-length CEAs. These CEAs were replaced with full length CEAs. Insertion and withdrawal of these part-length CEAs were considered in determining the requirements of the system design.

7.2.2.1.2 Accidents

The accident conditions for which the system will take action are those unplanned events under any conditions that are expected to occur once during the life of several stations, and arbitrary combinations of unplanned events and degraded systems that are never expected to occur.

ARKANSAS NUCLEAR ONE
Unit 2

The consequences of most of these accidents will be limited by the ESF system; the RPS will function to assist in limiting these conditions for those accidents but does not have the major role in assuring that the plant is maintained within applicable limits. The accident conditions for which the RPS will provide protective action assistance are:

- A. LOCA, including double-ended rupture of the largest pipe in the RCS;
- B. Ejection of any single CEA;
- C. Steam system pipe rupture, including a double-ended rupture;
- D. Steam generator tube rupture; and,
- E. RCP shaft seizure.

7.2.2.2 Trip Bases

The RPS consists of 13 trips in each RPS channel. This includes two trips (one per steam generator) for each of the three steam generator parameters. Each trip will initiate the required automatic protective action utilizing 2-out-of-4 coincidence.

A brief description of the inputs and purpose of each trip is presented in Sections 7.2.2.2.1 through 7.2.2.2.10.

7.2.2.2.1 High Linear Power Level Trip

Input: Neutron flux power from the ex-core neutron flux monitoring system.

Purpose: To provide a reactor trip and assist the ESF system in the event of an ejected CEA accident, and to limit the maximum steady state power level in addition to the DNBR and high local power density trips.

7.2.2.2.2 High Logarithmic Power Level Trip

Input: Neutron flux power from the ex-core neutron flux monitoring system.

Purpose: To ensure the integrity of the fuel cladding and RCPB in the event of unplanned criticality from a shutdown condition, resulting from either dilution of the soluble boron concentration or withdrawal of CEAs. Automatic action will be initiated if CEAs are withdrawn. An alarm is provided to alert the operator to take appropriate action in the event of an unplanned criticality when all CEAs are inserted.

7.2.2.2.3 High Local Power Density Trip

Input:

- A. Neutron flux power and axial power distribution from the ex-core neutron flux monitoring system.
- B. Radial peaking factors from the CEA position measurement system (reed switch assemblies).

ARKANSAS NUCLEAR ONE
Unit 2

- C. ΔT power from coolant temperature and flow measurements.

Purpose: To prevent the linear heat (kW/ft) in the limiting fuel rod in the core from exceeding the fuel design limit in the event of any anticipated operational occurrence.

7.2.2.2.4 Low DNBR Trip

Input:

- A. Neutron flux power and axial power distribution from the ex-core neutron flux monitoring system.
- B. RCS pressure from pressurizer pressure measurement.
- C. ΔT power from coolant temperatures and flow measurements.
- D. Radial peaking factors from the CEA position measurement system (reed switch assemblies).
- E. Reactor coolant mass flow from RCP speed.
- F. Core inlet temperature from reactor coolant cold leg temperature measurements.

Purpose: To prevent the DNBR in the limiting coolant channel in the core from exceeding the fuel design limit in the event of any anticipated operational occurrence. In addition, this reactor trip will assist the ESF system in limiting the consequences of the accident conditions listed in Section 7.2.2.1.2.

7.2.2.2.5 High Pressurizer Pressure Trip

Input: Reactor coolant pressure from pressurizer pressure measurement.

Purpose: To help ensure the integrity of the RCS boundary for any event which could lead to an overpressurization of the RCS. Also, reference Section 7.7.1.6 for DSS protection of RCS over-pressurization.

7.2.2.2.6 Low Pressurizer Pressure Trip

Input: Reactor coolant pressure from pressurizer pressure measurement.

Purpose: To provide a reactor trip in the event of reduction in system pressure, in addition to the DNBR trip, and to provide a reactor trip to assist the ESF system in the event of a LOCA.

7.2.2.2.7 Low Steam Generator Water Level Trips

Input: Level of feedwater in each steam generator from differential pressure measurements.

Purpose: To provide protective action to ensure that there is sufficient time for actuating the emergency feedwater pumps to remove decay heat from the reactor in the event of a reduction of feedwater flow.

ARKANSAS NUCLEAR ONE
Unit 2

7.2.2.2.8 Low Steam Generator Pressure Trips

Input: Steam pressure in each steam generator.

Purpose: To provide a reactor trip to assist the ESF system in the event of a steam line rupture accident.

7.2.2.2.9 High Containment Pressure Trip

Input: Pressure inside reactor containment.

Purpose: To assist the ESF system by tripping the reactor in the event of a steam line rupture accident inside containment, coincident with the initiation of safety injection.

7.2.2.2.10 High Steam Generator Level

Input: Level of water in each steam generator from differential pressure measurements.

Purpose: To prevent excessive moisture carryover from the steam generators which could result in damage to the turbine generator. This trip is not required to fulfill the protective functions given in Section 7.2.2.1.

7.2.2.3 Design

7.2.2.3.1 General Design Criteria

Appendix A of 10CFR50, "General Design Criteria for Nuclear Power Plants," establishes minimum requirements for the principal design criteria for water-cooled nuclear power plants. This section describes how the requirements that are applicable to the RPS are satisfied.

Criterion 1: Quality Standards and Records

The quality assurance program for the plant is described in the Quality Assurance Program Manual. These procedures ensure that the system has been designed in accordance with required codes and standards.

Criterion 2: Design Bases for Protection Against Natural Phenomena

This criterion applies to earthquakes, tornadoes, floods, etc. The design bases for protection against earthquakes are described in Section 3.10. The RPS is protected from tornadoes and floods by being housed in Category I structures (see Sections 3.3 and 3.4).

Criterion 3: Fire Protection

See Section 3.1.

ARKANSAS NUCLEAR ONE
Unit 2

Criterion 4: Environmental and Missile Design Bases

Environmental design bases are described in Section 3.11. Missile design bases are described in Section 3.5.

Criterion 5: Sharing of Structures, Systems and Components

No RPS components are shared with any other reactor facilities.

Criterion 10: Reactor Design

The RPS, in conjunction with the plant control systems and Technical Specification requirements, provides sufficient margin to trip setpoints so that: (1) during normal operation protective action will not be initiated, and (2) during anticipated operational occurrences fuel design limits will not be exceeded. Typical margins for each trip parameter are shown in Table 7.2-4.

Criterion 12: Suppression of Reactor Power Oscillations

The axial power distribution is continually monitored by the RPS and factored into the Low DNBR and high local power density trips. This ensures that acceptable fuel design limits are not exceeded in the event of axial power oscillations. Allowances are made in the trip setpoints for azimuthal power tilts.

Criterion 13: Instrumentation and Control

Sensor ranges are sufficient to monitor all pertinent plant variables over the expected range of plant operation for normal and transient conditions. All variables that affect plant and fuel design limits are monitored by the RPS. The safety-related information readout for plant monitoring is described in Section 7.5.

Criterion 15: Reactor Coolant System Design

The high pressurizer pressure trip and high logarithmic power level trip are provided to help ensure the integrity of the RCPB. In addition, the DSS (Section 7.7.1.6) will ensure the integrity of the RCPB.

Criterion 20: Protection System Functions

The RPS monitors all plant variables that affect plant and fuel design limits. These limits are given in Section 7.2.2.1.1. A reactor trip will be initiated to prevent these limits from being exceeded for all the anticipated operational occurrences listed in Section 7.2.2.1.1.

Criterion 21: Protection System Reliability and Testability

Functional reliability is ensured by compliance with the requirements of IEEE 279-1971, as described in Section 7.2.2.3.2. Testing is in compliance with IEEE 338 and Regulatory Guide 1.22, and is described in Section 7.2.2.3.3.

ARKANSAS NUCLEAR ONE
Unit 2

Criterion 22: Protection System Independence

See Section 3.1.

Criterion 23: Protection System Failure Modes

The RPS is designed to fail into a safe state in the event of loss of power supply, disconnection of the system, or module removal, as noted in Section 7.2.2.3.2. Where protective action is required under adverse environmental conditions during postulated accidents, the components of the system are designed to function under such conditions.

Criterion 24: Separation of Protection and Control Systems

The protection system is separated from the control systems.

Criterion 25: Protection System Requirements for Reactivity Control Malfunctions

Open circuit of the signal leads has the same effect as a loss of signal.

The RPS is designed to ensure that acceptable fuel design and RCPB limits are not exceeded for the reactivity control malfunctions stated in Section 7.2.2.1.1.

Criterion 29: Protection Against Anticipated Operational Occurrences

The RPS is designed to ensure a very high probability of accomplishing the protective functions given in Section 7.2.2.1. Further RCS over-pressurization protection is provided by the DSS (Section 7.7.1.6).

7.2.2.3.2 Equipment Design Criteria

IEEE 279-1971, "Criteria for Protection Systems for Nuclear Power Generating Stations," establishes minimum requirements for safety-related functional performance and reliability of the RPS.

This section describes how these requirements listed in Section 4 of IEEE 279-1971 are satisfied.

"4.1 General Functional Requirement"

The RPS is designed to limit reactor fuel, fuel cladding and coolant conditions to levels within plant and fuel design limits. Instrument performance characteristics, response time, and accuracy are selected for compatibility with and adequacy for the particular function. Trip setpoints are established by analysis of the system parameters. Factors such as instrument inaccuracies, bistable trip times, CEA travel times, valve travel time, circuit breaker trip times, and pump starting times are considered in the design of the system.

ARKANSAS NUCLEAR ONE
Unit 2

"4.2 Single Failure Criterion"

The RPS is designed so that any single failure within the system will not prevent proper protective action at the system level. The wiring in the system is grouped so that no single fault or failure, including either an open or shorted circuit, will negate protective system operation. Signal conductors are protected and routed independently.

The following is an evaluation of the effects of specific single faults in the analog portion of the system:

- A. A loss of signal in a measurement channel initiates channel trip action for the low pressurizer pressure, low steam generator water level and low steam generator pressure trips;
- B. Shorting of the signal leads to each other has the same effect as a loss of signal. Shorting a lead to a voltage has no effect since the signal circuit is ungrounded;
- C. Single grounds of the signal circuit have no effect. Periodic checking of the system will provide assurance that the circuit remains ungrounded.

The following is an evaluation of the effects of specific single faults in the logic portion of the system:

- A. Inadvertent operation of the relays and relay contacts in the matrices will be identified by plant annunciation and indicating lights;
- B. Shorting of the pairs of contacts in the matrices will prevent the matrix relay sets from being released. Such shorts are detectable in the testing process by observing that the matrix relays cannot be dropped out. Testing is accomplished by successive opening of the logic matrix contact pairs;
- C. Shorting of the matrices to an external voltage has no effect since the matrix is ungrounded. Equipment is provided to detect grounds on the matrices;
- D. The logic matrices will each be supplied by two power sources. Loss of a single power source has no effect on operation. Loss of both power sources to a logic matrix initiates a reactor trip;
- E. Failure of a matrix relay to de-energize has no effect since there are six matrix relay contacts in series in the trip path and any one contact initiating trip action will cause the action to be completed;
- F. The failure of one trip breaker or control circuit has no effect since there are two trip breakers with independent control circuits in series, either of which will provide the necessary action;
- G. Single grounds or accidental application of potential to single leads in the trip path circuits have no effect since the circuit is ungrounded. Testing and observation of ground detectors will indicate these problems; and,

ARKANSAS NUCLEAR ONE
Unit 2

- H. The CEDM power supply circuits operate ungrounded so that single grounds have no effect. The CEDMs are supplied in two groups by separate pairs of power supplies to further reduce the possibility of a CEA being improperly held. The CEDM load requirements are such that the application of any other local available supply would not prevent CEA release.

"4.3 Quality Control of Components and Modules"

The quality assurance program is covered in the Quality Assurance Program Manual (QAPM). This program includes appropriate requirements for design review, procurement, inspection and testing to ensure that the system components shall be of a quality consistent with minimum maintenance requirements and low failure rates.

"4.4 Equipment Qualification"

The RPS meets the equipment requirements described in Sections 3.10 and 3.11.

"4.5 Channel Integrity"

Type testing of components, separation of sensors and channels, and qualification of cabling are utilized to ensure that the channels will maintain the functional capability required under applicable extremes of conditions relating to environment, energy supply, malfunctions and accidents.

Loss of or damage to any one path will not prevent the protective action. Sensors are piped so that blockage or failure of any one connection does not prevent protective system action. The process transducers located in the containment building are specified and rated for the intended service. Components which must operate during or after the LOCA are rated for the post-LOCA environment. Results of type tests are used to verify these ratings. In the control room the nuclear instrumentation and protective system trip paths are located in four compartments. Mechanical and thermal barriers between these compartments reduce the possibility of common event failure. Outputs from the components in this area to the control boards are isolated so that shorting, grounding, or the application of the highest available local voltage does not cause channel malfunction. Where signals originating in the RPS feed the computer, signal isolation is provided; where the RPS is feeding annunciators, isolation is ensured through the use of relay contacts.

"4.6 Channel Independence"

The locations of the sensors and the points at which the sensing lines are connected to the process loop have been selected to provide physical separation of the channels, thereby precluding a situation in which a single event could remove or negate a protective function. The routing of cables from protective system transmitters is arranged so that the cables are separated from each other and from power cabling to minimize the likelihood of common event failures. This includes separation at the containment penetration areas. In the control room, the four nuclear instrumentation and protective system trip channels are located in individual compartments. Mechanical and thermal barriers between these compartments minimize the possibility of common event failure. Outputs from the components in this area to the control boards are isolated so that shorting, grounding, or the application of the highest available local voltage do not cause channel malfunction.

ARKANSAS NUCLEAR ONE
Unit 2

The criteria for separation and physical independence of channels are based on the need for decoupling the effects of accident consequences and energy supply transients and for reducing the likelihood of channel interaction during testing or in the event of a channel malfunction.

The electrical power sources to the RPS and ESFAS sensors and signal process modules are described in Section 8.3.1.1.6.

A description of the method by which separation is maintained between redundant sensor signals throughout the system is described in Section 8.3.1.2, "Regulatory Guide 1.75 Compliance Analysis," and in Section 8.3.1.4, "Independence of Redundant Systems."

As stated in Section 8.3.1.4.6 (E) and (F), sensor signal cables are run in separate trays from other circuits such as power and control throughout the system.

Historical data removed - To review the exact wording please refer to Section 7.2.2.3.2 of the FSAR.

"4.7 Control and Protection System Interaction"

No portion of the RPS is used for both control and protection functions.

"4.8 Derivation of System Inputs"

This criterion requires that insofar as is practicable, system inputs are derived from signals that are direct measures of the desired variables. Variables which are measured directly include neutron flux, temperatures and pressures. Level information is derived from appropriate differential pressure measurements. Flow information is derived from RCP speed measurement.

"4.9 Capability for Sensor Checks"

RPS sensors are checked by cross-checking between channels. These channels bear a known relationship to each other, and this method ensures the operability of each sensor during reactor operation.

"4.10 Capability for Test and Calibration"

Testing is described in Section 7.2.1.1.9 and is in compliance with IEEE 338-1971 as discussed in Section 7.2.2.3.3.

"4.11 Channel Bypass or Removal from Operation"

Any one of the four protective system channels may be tested, calibrated, or repaired without detrimental effects on the system. Individual trip channels may be bypassed to effect a 2-out-of-3 logic on remaining channels. The single failure criterion is met during this condition.

Testing of each of the two CEA position input channels can be accomplished in a very brief time period. Probability of failure of the other system is acceptably low during such testing periods.

ARKANSAS NUCLEAR ONE
Unit 2

"4.12 Operating Bypasses"

Operating bypasses are provided as shown in Table 7.2-1. The operating bypasses are automatically removed when the permissive conditions are not met. The circuitry and devices which function to remove these inhibits are designed in accordance with IEEE 279-1971.

"4.13 Indication of Bypasses"

Indication of test or bypass conditions or removal of any channel from service is given by lights and annunciation. Bypasses that are automatically removed at fixed setpoints are alarmed and indicated.

"4.14 Access to Means for Bypassing"

An interlock prevents the plant operator from bypassing more than one of the four channels of any type trip at any one time. All bypasses are visually and audibly annunciated.

"4.15 Multiple Setpoints"

Manual reduction of setpoints for low pressurizer pressure and low steam generator pressure trip allows for the controlled reduction of pressurizer pressure and steam generator pressure during plant cooldown and depressurization, and are discussed in Sections 7.2.1.1.1.6 and 7.2.1.1.1.8. The setpoint reductions are initiated by control board mounted switches which, upon actuation, adjust the setpoint to a value which is a pre-selected distance below the operating pressure existing at the time the switch is actuated. A separate switch is provided for each protection channel.

This method of setpoint reduction provides positive assurance that the setpoint is never decreased below the existing pressure by more than a predetermined amount.

The setpoint is automatically increased by the Plant Protection System (PPS) as the measured pressure is increased.

"4.16 Completion of Protective Action Once It Is Initiated"

The system is designed to ensure that protective action (reactor trip) will go to completion once initiated. Operator action is required to clear the trip and return to operation.

"4.17 Manual Initiation"

A manual trip is effected by depressing either of two sets of trip switches. No single failure will prevent a manual trip.

"4.18 Access to Setpoint Adjustments, Calibration and Test Points"

An administratively controlled key is required for access to setpoint adjustments, calibration and test points. Access is also visually and audibly annunciated.

"4.19 Identification of Protective Action"

Indicating lights are provided for all protective actions, including identification of channel trips.

ARKANSAS NUCLEAR ONE
Unit 2

"4.20 Information Readout"

Means are provided to allow the operator to monitor all trip system inputs, outputs and calculations. The specific displays that are provided for continuous monitoring are described in Section 7.5. System status displays are provided.

"4.21 System Repair"

Identification of a defective channel will be accomplished by observation of system status lights or by testing as described in Section 7.2.1.1.9. Replacement or repair of components is accomplished with the affected channel bypassed. The affected trip function then operates in a 2-out-of-3 trip logic.

"4.22 Identification"

All equipment, including panels, modules, and cables associated with the trip system, will be marked in order to facilitate identification. Interconnecting cables will be color coded on a channel basis.

7.2.2.3.3 Testing Criteria

IEEE 338-1971, "Trial Use Criteria for the Periodic Testing of Nuclear Power Generating Station Protection Systems," September 1971, and Regulatory Guide 1.22, "Periodic Testing of Protection System Actuation Functions," provide guidance for development of procedures, equipment, and documentation of periodic testing. The basis for and the scope and means of testing are described in this section. Test intervals and their bases are included in the Technical Specifications. The organization for testing and for documentation is described in Chapter 13.

Since operation of the RPS will be infrequent, the system is periodically and routinely tested to verify its operability. A complete channel can be individually tested without initiating a reactor trip, without violating the single failure criterion, and without inhibiting the operation of the system. The system can be checked from the sensor signal through the power supply circuit breakers of the CEDMs. The RPS functional modules can be tested during reactor operation. The sensor can be checked by comparison with similar channels or channels that involve related information. Minimum frequencies for checks, calibration, and testing of the instrumentation are given in the Technical Specifications. Overlap in the checking and testing is provided to assure that the entire channel is functional. The use of individual trip and ground detection lights, in conjunction with those provided at the supply bus, provides assurance that possible grounds or shorts to another source of voltage will be detected.

The testing scheme is presented in detail in Section 7.2.1.1.9.

The response time from an input signal to the protection system trip bistables through the opening of the trip circuit breakers is verified by measurement during plant startup testing and periodically thereafter. Sensor responses are measured during factory acceptance tests and will be periodically re-measured to assure their continued adequate response.

ARKANSAS NUCLEAR ONE
Unit 2

7.2.2.4 Failure Modes and Effects Analysis

A failure modes and effects analysis for the RPS is provided in Table 7.2-5. It should be noted that this analysis was performed assuming three operable PPS channels with one channel in the bypass condition. It is intended to operate Arkansas Nuclear, One Unit 2 with all four channels operable under normal conditions. The analysis of Table 7.2-5 demonstrates for the more limiting case of three channels operable that the design criteria for the PPS are met.

ARKANSAS NUCLEAR ONE
UNIT 2

7.3 ENGINEERED SAFETY FEATURES SYSTEMS

The safety-related instrumentation and controls of the Engineered Safety Features (ESF) systems include: (1) the Engineered Safety Features Actuation System (ESFAS) which consists of the electrical and mechanical devices and circuitry (from sensors to actuation device input terminals) involved in generating those signals that actuate the required ESF system, and (2) the arrangement of components that perform protective actions after receiving a signal from either the ESFAS or the operator.

The ESFAS includes sensors to monitor selected generating station variables. Table 7.3-5 presents instrument ranges, nominal setpoints and margins to actuation for ESFAS sensors and for other safety-related system instrumentation. A comparison of the instrument ranges and actuation setpoints in this table indicates that, with two exceptions, none of the instrument setpoints will ever be within the upper or lower 10 percent of their range.

One exception is the variable low steam generator pressure setpoint. The variable feature of the low steam generator pressure setpoint is used during plant cooldowns to the cold shutdown condition to allow controlled steam generator pressure reductions during cooldown without initiating a Main Steam Isolation Signal (MSIS). During cooldowns, the setpoint is periodically manually reset to a pressure 200 psi below the existing generator pressure to provide continuing MSIS capability during the cooldown period. Accordingly, the trip setpoint can be reduced below 120 psia (the lower 10 percent of the instrument range) during the last portion of the plant cooldown evolution. The instrument error associated with this measurement channel has been included in the determination of the setpoint. This instrument error is valid over the entire range of operation of the steam generator pressure instrument.

The second exception is the Refueling Water Tank (RWT) low level signal which initiates the Recirculation Actuation Signal (RAS). The nominal setpoint is shown in Table 7.3-5. Instrument error is valid over the entire scale and has been included in determination of the setpoint. Since the RWT has a vortex breaker installed over the outlet line, no loss of suction due to entrainment of air is possible before the tank is empty.

The following actuation signals are generated by the ESFAS when the monitored variables reach the levels that are indicative of conditions which require signal initiation:

- A. Containment Isolation Actuation Signal (CIAS)
- B. Containment Spray Actuation Signal (CSAS)
- C. Containment Cooling Actuation Signal (CCAS)
- D. Main Steam Isolation Signal (MSIS)
- E. Safety Injection Actuation Signal (SIAS)
- F. Recirculation Actuation Signal (RAS)
- G. Emergency Feedwater Actuation Signal (EFAS)

The ESF system actuation device circuitry receives (1) actuation signals from the ESFAS or the operator, and (2) permissive signals based on conditions that affect ESF component performance. The signals from the ESFAS actuate the ESF system equipment. The permissive signals provide additional interlocks, blocks and sequencing necessary to provide proper ESF component operation, such as control switch not in "pull to lock", adequate bus voltage, MOV logic, and the EDG load sequencing logic.

ARKANSAS NUCLEAR ONE
UNIT 2

The ESF systems automatically actuated by signals from the ESFAS are:

- A. Containment Isolation System (CIS)
- B. Containment Spray System (CSS)
- C. Containment Cooling System (CCS)
- D. Safety Injection System (SIS)
- E. Penetration Room Ventilation System (PRVS)
- F. Main Steam Isolation System (MSIS)
- G. Emergency Feedwater (EFW) System

7.3.1 DESCRIPTION

ESFAS actuation circuits for all systems are described below in one section as these circuits, except for specific inputs, bypasses, and actuated devices, are identical. The specific instruments and controls associated with each system are discussed separately in Section 7.3.1.1.11.

7.3.1.1 Engineered Safety Features Actuation System

The actuation system consists of the sensors, logic and actuation circuits which monitor selected plant parameters and provide an actuation signal to each individual actuated component in the ESF system if these plant parameters reach pre-selected setpoints. The actuation system for each ESF system is identical, except that specific inputs (and bypasses where provided) vary from system to system and the actuated devices are different.

Two-out-of-four coincidence of like initiating trip signals from four independent measurement channels is required to actuate any ESF system. Each actuation system's initiation circuits and logic, including testing features, is similar to the logic for the Reactor Protective System (RPS), and is contained in the same physical enclosure, except for the EFAS which also contains initiation logic from the DEFAS housed in the DEFAS Cabinet. The combination of the ESFAS and RPS is termed the Plant Protection System (PPS).

These same features include the capability of the ESFAS to operate, if need be, with up to two channels out of service (one bypassed and another tripped) and still meet the single failure criteria. The only operating restriction while in this condition (effectively one-out-of-two logic) is that no provision is made to bypass another channel for periodic maintenance. The system logic must be restored to at least a two-out-of-three condition prior to removing another channel for maintenance.

A discussion of the ESF systems' seismic and environmental qualification is found in Sections 3.10.2 and 3.11.2, respectively.

A discussion of the ESF system testability is found in Section 7.3.1.1.9.

The ESFAS functional logic is shown in Figures 7.3-1a, b, and c and consists of bistables, bistable output relays, matrix relays, initiation channel output relays, manual testing controls, indicating lights, power supplies, and interconnecting wiring. In addition, the EFAS actuation logic contains diverse and independent actuation logic from the DEFAS (reference Section 7.7.1.7 for the DEFAS).

ARKANSAS NUCLEAR ONE
UNIT 2

7.3.1.1.1 Measurement Channels

Process measurement channels similar to those described in Section 7.2.1.1.2.1 are utilized to perform the following functions:

- A. Continuously monitor each selected generating station variable.
- B. Provide indication of operational availability of each sensor to the operator.
- C. Transmit analog signals to bistables within the ESFAS measurement channel.
- D. Compare the analog signals with protective preset levels in the bistables.
- E. Provide a variable setpoint where necessary for plant startup, shutdown, and low power testing.
- F. Provide wired logic for EFAS determination to either feed or block EFW based on secondary steam generator pressure and steam generator water level.

All protective parameters are measured with four independent process instrument channels.

A typical protective measurement channel is shown on Figure 7.2-1. The measurement channels consist of instrument sensing lines, sensors, transmitters, power supplies, isolation devices, indicators, computer inputs, current loop resistors, interconnecting wiring, operating bypasses, bistable relays, and bistable relay contacts (excluding interconnecting wiring).

Each measurement channel is separated from other like measurement channels to provide physical and electrical isolation of the signals to the ESFAS logic. The output of each transmitter is typically an ungrounded current loop which has a live zero. Signal isolation is provided for computer inputs and control board indicators.

Display information, which provides the operator with the operational availability of each measurement channel, is described in Section 7.5.

Signals from the protective measurement channels are sent to voltage comparator circuits (bistables) where the input signals are compared to predetermined setpoints. Whenever a channel parameter reaches the predetermined setpoint, the channel bistable de-energizes the bistable output relays. As established by the matrices, contacts of the bistable output relays form the ESFAS 2-out-of-4 coincidence logic. The bistable setpoints are adjustable from the front of the PPS cabinet. Access is limited, however, by means of a key operated cover, with an annunciator indicating cabinet access. All bistable setpoints are indicated on a meter on the PPS cabinet.

The ESFAS initiation signals are each generated in four channels, designated A, B, C, and D. Two-out-of-four coincidence of like initiating signals from four protective measurement channels generates all ESFAS initiation signals.

Tripping of a bistable results in a measurement channel trip characterized by the de-energization of three trip relays. De-energization of any two of the four like bistables results in de-energization of two sets of three trip relays.

ARKANSAS NUCLEAR ONE
UNIT 2

7.3.1.1.2 Logic

7.3.1.1.2.1 Matrix Logic

The Matrix logic performs the following:

- A. Forms 2-out-of-4 coincidence of like signals which have reached preset levels.
- B. Provides a means for manual bypassing of signals if permissive conditions are met.
- C. Provides channel and signal status information to the operator.

The contacts of the four sets of three trip relays have been arranged in six logic ANDs designated AB, AC, AD, BC, BD, and CD, which represent all possible 2-out-of-4 combinations for the four measurement channels. To form an AND circuit, the trip relay contacts of two like protective measurement channels are connected in parallel, i.e. one from A and one from B. This process is continued until all combinations have been formed. In cases where more than one plant parameter can initiate an ESF trip signal, the parallel pairs of trip relay contacts, each pair representing a monitored plant parameter, are connected in series (Logic OR) to form six logic matrices. The six matrices are also designated AB, AC, AD, BC, BD, and CD.

Each logic matrix is connected in series with a set of four parallel logic matrix output relays (matrix relays). Each logic matrix is powered from dual DC power supplies. Section 7.3 describes the power distribution system.

7.3.1.1.2.2 Initiation Logic

The initiating logic performs the following:

- A. Combines the six matrix output logic into four trip paths.
- B. Provides four ESFAS initiation signals to the ESFAS initiation logic located in two independent auxiliary relay cabinets (ARCs).

The ESFAS initiating logic is physically located in the PPS cabinet. The output contacts of the matrix relays are combined into four trip paths, one trip path per channel.

Each ESFAS trip path is formed by connecting six contacts, one matrix relay contact from each of the six logic matrices, in series. The six series contacts are in series with the trip path initiation relays (SSRA and SSRB) and a lockout relay. The lockout relay ensures that the trip path initiation relay remains de-energized upon initiation. The ESFAS trip paths do not have the lockout feature. The trip path initiation relay contacts form the ESFAS actuating logic.

7.3.1.1.2.3 Actuating Logic

The ESFAS actuating logic performs the following:

- A. Receives ESFAS signals from the ESFAS initiating logic (additionally, the ESFAS actuating logic receives DEFAS initiating signals):
- B. Forms selective 2-out-of-4 coincidence of like ESFAS trip paths;

ARKANSAS NUCLEAR ONE
UNIT 2

- C. Provides a means for manual initiation; and,
- D. Provides status information to the operator.

The ESFAS actuating logic is physically located in two ESFAS auxiliary relay cabinets. One cabinet contains the logic for ESF Load Group I equipment, while the other cabinet contains the logic for ESF Load Group II equipment. In addition, the EFAS actuation logic contains DEFAS initiation signal contacts arranged in a 2-out-of-2 logic as described in Section 7.7.1.7.

Four ESFAS initiation signal contacts are arranged in a selective 2-out-of-4 coincidence logic. Each signal except the Emergency Feedwater Actuation Signal (EFAS) (see Section 7.3.1.1.11.8.) also de-energizes the lock-out relays of its associated channel. The lock-out relays ensure that the signal is not automatically removed once initiated, with the exception of the EFAS. Receipt of two selective ESFAS initiation channel signals will de-energize the ESF subgroup relays, which generate the actuation channel signals. This process is done independently in both auxiliary relay cabinets, generating both Load Group I and II signals.

Section 7.3.1.1.2.4 describes the power distribution.

In a typical ESFAS logic, there are only two initiating circuits per channel (Steam Generator 1 and Steam Generator 2), and thus each matrix ladder consists of only two AND circuits in series which form the steam generator low auctioneering circuit. The four matrix relay outputs from each logic matrix again form four trip paths. Each trip path initiation relay, instead of controlling trip circuit breakers as in the RPS, controls a contact of the selective 2-out-of-4 circuit for the group actuation. Group actuation is described in Section 7.3.1.1.3.

Testing of each ESF subgroup of components is accomplished by use of a test module. Groups are selected such that testing may be accomplished without affecting normal plant operation.

The testing of the logic and trip paths is described in Section 7.3.1.1.9.

7.3.1.1.2.4 Power Supply Logic

The power supply logic:

- A. Maintains system level functions with single channel 120 VAC vital instrument power failures.
- B. Maintains system level functions with a specific power train single failure, de-energization of vital 120 VAC channel pairs (1 and 3) or (2 and 4). This power train de-energization results from failure of a 125 VDC bus causing de-energization of power sources to the two associated uninterruptible power sources.

MEASUREMENT CHANNEL POWER SUPPLIES

Single channel power sources are used in measurement channels A and D including both process and bistable power. Single channel power assures all functions trip with de-energization of the single channel power source.

With the exception of channels B and C RWT level, the process instrument channels have single channel power sources for the process input to the bistables and auctioneered power supplies for the bistables. RWT level channels B and C have power supplies auctioneered between load groups.

ARKANSAS NUCLEAR ONE
UNIT 2

The following summarizes the measurement channel response.

De-energization of Vital AC Channels 1 and 3

<u>Function</u>	<u>Parameter</u>		<u>Measurement Channel**</u>				<u>ESFAS Coincidence Logic</u>	
			<u>1</u>	<u>2</u>	<u>3</u>	<u>4</u>	<u>Channel Bypassed*</u>	<u>No Channel Bypassed</u>
SIAS	Containment Pressure	↑	T	O	F	O	1-out-of-1 logic	1-out-of-2 logic
SIAS	RCS Pressure	↓	T	O	T	O	A and C Trips	A and C Trips
CSAS	Containment Pressure	↑	T	O	F	O	1-out-of-1 logic	1-out-of-2 logic
CIAS	Containment Pressure	↑	T	O	F	O	1-out-of-1 logic	1-out-of-2 logic
MSIS	SG A Pressure	↓	T	O	T	O	A and C Trips	A and C Trips
MSIS	SG B Pressure	↓	T	O	T	O	A and C Trips	A and C Trips
CCAS	Containment Pressure	↑	T	O	F	O	1-out-of-1 logic	1-out-of-2 logic
CCAS	RCS Pressure	↓	T	O	T	O	A and C Trips	A and C Trips
RAS	RWT Level	↓	T	O	O	O	1-out-of-2 logic	1-out-of-3 logic
EFAS 1	SG A Level (LOW)	↓	T	O	T	O		
	SG A Pressure (LOW)	↓	T	O	T	O		
	SG A > SG B (ΔP)	↑	T	O	F	O	1-out-of-1 logic	1-out-of-2 logic
EFAS 2	SG B Level (LOW)	↓	T	O	T	O		
	SG B Pressure (LOW)	↓	T	O	T	O		
	SG B > SG A (ΔP)	↑	T	O	F	O	1-out-of-1 logic	1-out-of-2 logic

De-energization of Vital AC Channels 2 and 4

<u>Function</u>	<u>Parameter</u>		<u>Measurement Channel**</u>				<u>ESFAS Coincidence Logic</u>	
			<u>1</u>	<u>2</u>	<u>3</u>	<u>4</u>	<u>Channel Bypassed*</u>	<u>No Channel Bypassed</u>
SIAS	Containment Pressure	↑	O	F	O	T	1-out-of-1 logic	1-out-of-2 logic
SIAS	RCS Pressure	↓	O	T	O	T	B and D Trips	B and D Trips
CSAS	Containment Pressure	↑	O	F	O	T	1-out-of-1 logic	1-out-of-2 logic
CIAS	Containment Pressure	↑	O	F	O	T	1-out-of-1 logic	1-out-of-2 logic
MSIS	SG A Pressure	↓	O	T	O	T	B and D Trips	B and D Trips
MSIS	SG B Pressure	↓	O	T	O	T	B and D Trips	B and D Trips
CCAS	Containment Pressure	↑	O	F	O	T	1-out-of-1 logic	1-out-of-2 logic
CCAS	RCS Pressure	↓	O	T	O	T	B and D Trips	B and D Trips
RAS	RWT Level	↓	O	O	O	T	1-out-of-2 logic	1-out-of-3 logic
EFAS 1	SG A Level (LOW)	↓	O	T	O	T		
	SG A Pressure (LOW)	↓	O	T	O	T		
	SG A > SG B (ΔP)	↑	O	F	O	T	1-out-of-1 logic	1-out-of-2 logic
EFAS 2	SG B Level (LOW)	↓	O	T	O	T		
	SG B Pressure (LOW)	↓	O	T	O	T		
	SG B > SG A (ΔP)	↑	O	F	O	T	1-out-of-1 logic	1-out-of-2 logic

ARKANSAS NUCLEAR ONE
UNIT 2

- * Channel bypassed on operable power group.
- ** T = failed to safe state, F = unable to perform function (unable to trip or measure) and O = operable

MATRIX CHANNEL POWER SUPPLIES

Each ESFAS matrix ladder is powered by two matrix power supplies, one from each load group. Load group one powers the matrix output relay pair, 1 and 3. Load group two powers the matrix output relay pair, 2 and 4. The contact arrangement in the ladder network assures that both parallel contacts must open to de-energize both pairs of output relays.

The trip channel bypass is powered by two auctioneered power supplies, one from each load group. This arrangement ensures that a bypassed measurement channel will not trip as a result of loss of 120 VAC vital power to a bypassed channel.

INITIATING CHANNEL POWER SUPPLIES

Each trip path has a single channelized power supply. De-energization of a load group results in de-energization of trip paths (1 and 3) or (2 and 4).

ACTUATING CHANNELS (ARCs)

The two actuation channels (load groups I and II) consist of two trip legs. Load group I is actuated from 2C39, and Load group II is actuated from 2C40. Each actuation channel has two trip legs, one consisting of trip path 1 and 3 contacts in series and the second consisting of trip path 2 and 4 contacts in series. The power sources for each trip leg is auctioneered power supplies powered by load group I and II. Specifically, auctioneered power supplies for trip legs in 2C39, load group I, are powered by channel 1 and 2 of the vital AC system. Auctioneered power supplies for trip legs in 2C40, load group II, are powered by channel 3 and 4 of the vital AC system. With this power supply arrangement, an ESFAS actuation channel trip will not directly result from a single load group power supply de-energization.

7.3.1.1.3 Group Actuation

The components in each ESF system are placed into various groups. Components of each group are actuated by one group relay. Group relay contacts are in the power control circuit for the actuated components of each ESF system.

The logic described in Section 7.3.1.1.2 causes the opening of the contacts in a selective 2-out-of-4 circuit whenever any one of the logic matrices is de-energized. Upon opening of selective contacts in the 2-out-of-4 logic, the group relays de-energize and actuate the ESF system components.

Sequencing of component actuation, where required, is accomplished in the power control circuit of each actuated component. Sequencing is described in Sections 7.3.1.1.8 and 8.3.1.1.

7.3.1.1.4 Bypasses

Bypasses are provided as shown in Table 7.3-1. The trip channel bypass is identical to the RPS trip channel bypass (Section 7.2.1.1.5) and is employed for maintenance and testing of a channel.

ARKANSAS NUCLEAR ONE
UNIT 2

The bypass is also provided to remove a trip channel from service for an extended period without affecting plant safety or availability in the event of an equipment failure not readily repairable or accessible.

The RPS/ESFAS pressurizer pressure bypass is provided to allow plant depressurization without undesired actuation of ESF equipment. The bypass must be initiated manually by switches in each protective channel. Bypassing is not possible if pressurizer pressure is above the bypass permissive, which is less than 400 psia. Once a bypass has been initiated, it is automatically removed before pressurizer pressure rises to 500 psia. All bypasses are annunciated visually and audibly to the operator.

The RPS/ESFAS High/Low Steam Generator Level bypass is provided for system tests during shutdown conditions. The bypass must be initiated manually by switches in each protective channel. Bypassing is not possible if RCS temperature is above 200 °F. Once a bypass has been initiated, it is automatically removed if RCS temperature rises to 200 °F.

The ESFAS RWT Low Level bypass is provided for system tests during shutdown conditions. The bypass is paralleled to the RPS/ESFAS pressurizer pressure bypass and is instated and removed at the same signal levels.

7.3.1.1.5 Interlocks

The following interlocks are provided:

A. Trip Channel Bypasses

An interlock prevents the operator from bypassing more than one trip channel at a time for any one type trip. Different type trips may be simultaneously bypassed, either in one channel or in different channels. Since some parameters may be used in several different functional units, Technical Specifications require that when bypassing a parameter or functional unit in a channel, the operator must bypass all the interdependent parameters or trip units in the same channel.

B. Matrix Tests

During system testing, an electrical interlock will allow only the matrix relays in one of the six matrix test modules to be held at a time. The same circuit will allow only one process measurement loop signal to be perturbed at a time. The matrix relay hold and loop perturbation switches are interlocked so that only one or the other may be done at any one time.

C. Test Power Supply

A rotary switch ensures that power from the test power supply may be applied to only one channel at a time.

During system testing, an electrical interlock will allow only the matrix relays in one of the six matrix test modules to be held at a time. The same circuit will allow only one process measurement loop signal to be perturbed at a time. The matrix relay hold and loop perturbation switches are interlocked so that only one or the other may be used at any one time.

ARKANSAS NUCLEAR ONE
UNIT 2

7.3.1.1.6 Redundancy

Redundant features of the ESFAS include:

- A. Four independent channels, from process sensor through and including channel trip relays.
- B. Six logic matrices which provide the 2-out-of-4 logic. Dual power supplies are provided for each matrix. One power supply powers matrix output relays for trip paths 1 and 3. The second powers matrix output relays for trip paths 2 and 4.
- C. Four trip paths for each actuation signal.
- D. Four independent bistables to provide bypass permissive signals for each actuation signal which can be bypassed.
- E. Generation of each actuation signal in two output trains so that redundant system components may be actuated from separate trains.
- F. Two sets of manual trip pushbuttons for each actuation signal (one set on each auxiliary relay cabinet). Each set of pushbuttons actuates the components of the ESF train associated with that relay cabinet.
- G. AC power for the system provided from four separate buses. Power for control and operation of redundant actuated components comes from separate buses.

This redundancy enables the systems to meet the single failure criterion, to be tested during plant operation, and to be shifted to 2-out-of-3 logic.

The benefit of a system with four independent and redundant channels is that the system can be operated, if need be, with up to two channels out of service (one bypassed and another tripped) and still meet the single failure criteria. The only operating restriction while in this condition (effectively one-out-of-two logic) is that no provision is made to bypass another channel for periodic testing or maintenance. The system logic must be restored to at least a two-out-of-three condition prior to removing another channel for maintenance.

7.3.1.1.7 Diversity

The system is designed to eliminate credible multiple channel failures originating from a common cause. The failure modes of redundant channels and the conditions of operation that are common to them are analyzed to assure that a predictable common failure mode does not exist. The design provides assurance that:

- A. The monitored variables provide adequate information during the accidents;
- B. The equipment can perform as required;
- C. The interactions of protective actions, control actions and the environmental changes that cause, or are caused by, the design basis events do not prevent the mitigation of the consequences of the event; and,

ARKANSAS NUCLEAR ONE
UNIT 2

- D. The system will not be made inoperable by the inadvertent actions of operating and maintenance personnel.
- E. Reference section 7.3.1.1.2.4 for the system response to de-energization of vital AC channel pairs (1 and 3) or (2 and 4).

In addition, the design is not encumbered with additional components or channels without reasonable assurance that such additions are beneficial.

The system incorporates functional diversity to accommodate the unlikely event of a common mode failure with any of the accident conditions listed in Section 7.2.2.1.2.

Protection from a postulated common mode failure during an ATWS event is accomplished by the Diverse Emergency Feedwater Actuation System (DEFAS). Conformance to 10CFR50.62, known as the ATWS Rule, requires that the PPS/ESFAS be diverse and independent from the DEFAS from sensor output to (but not including) the final actuation device. In addition, the PPS/ESFAS must be diverse from the Diverse Scram System (DSS) since the DSS is an ATWS system that uses the same types of equipment as the DEFAS (reference Section 7.7.1.6 for the DSS and Section 7.7.1.7 for the DEFAS).

7.3.1.1.8 Sequencing

In the event of loss of off-site power during an accident, all emergency bus loads are automatically shed. Diesel generators are automatically started on SIAS. Essential ESF equipment is sequentially loaded. The sequencing operation is discussed in Section 8.3.1.1.

7.3.1.1.9 Testing

Provisions are made to permit periodic testing of the complete ESFAS. These tests cover the trip actions from sensor input through the protection system and the actuation devices. The system test does not interfere with the protective function of the system. The testing system meets the criteria of IEEE 338-1971, "IEEE Trial - Use Criteria for the Periodic Testing of Nuclear Power Generating Station Protection Systems," and of Regulatory Guide 1.22, "Periodic Testing of Protection System Actuation Functions." Jumpers or other temporary forms of bypassing are not used during testing.

The individual tests are described below. Overlap between individual tests exists so that the entire ESFAS can be tested. Frequency of testing is given in the Technical Specifications.

7.3.1.1.9.1 Sensor Checks

During reactor operation, the measurement channels providing an input to the ESFAS are checked by comparing the outputs of similar channels and cross-checking with related measurements.

During extended shutdown periods or refueling, these measurement channels (where possible) are checked and calibrated against known standards.

7.3.1.1.9.2 Trip Bistable Tests

Testing of the trip bistable is accomplished by manually varying the input signal to the trip setpoint level on one bistable at a time and observing the trip action.

ARKANSAS NUCLEAR ONE
UNIT 2

Varying the input signal is accomplished by means of a trip test circuit which consists of a test circuit used to vary the magnitude of the test signal similar to that supplied by the measurement channel to the bistable signal input. The trip test circuit is interlocked electrically so that it can be used in only one channel at a time. A switch is provided to select the measurement channel input and a pushbutton is provided to apply the test signal. An NIST traceable voltmeter indicates the value of the test signal. The test circuit permits various rates of change of signal input to be used. Trip action (de-energizing) of each of the bistable trip relays is indicated by individual lights on the front of the cabinet, indicating that the bistable trip unit and the trip relays operate as required for a trip condition.

When one of the four trip bistables of a protective channel is in the tripped condition (versus being bypassed), a channel trip exists and is annunciated on the control room annunciator panel. In this condition, an actuation signal would take place upon receipt of a trip signal in one of the other three like trip channels. Therefore, the trip channel under test is bypassed for this test, converting the PPS to a 2-out-of-3 logic for the particular trip parameter. In either case, full protection is maintained.

7.3.1.1.9.3 Logic Matrix Tests

This test is carried out to verify proper operation of the six 2-out-of-4 logic matrices, any of which will initiate one or more bonafide Engineered Safety Features System trip(s) for any possible 2-out-of-4 trip condition from the signal inputs from each measurement channel. The matrix output relay hold switch permits only one of the 2-out-of-4 logic matrices to be tested at a time.

Only the matrix relays in one of the six logic matrix test modules can be held in the energized position during tests. If for example, the A-B logic matrix hold switch is held in the hold or tripped position, actuation of the other matrix hold switches will have no effect upon their respective logic matrices. In addition, a selector switch is utilized to provide test power to only one bay at a time.

Actuation of a matrix hold switch will apply a test voltage to the test system hold coils of the selected double coil matrix relays. This voltage will provide the power necessary to hold the matrix relays in their energized position when the bistable trip relay contacts in the matrix ladder being tested open, thus causing de-energization of the primary matrix relay coils.

The logic matrix to be tested is selected using the system channel trip select switch. While holding the matrix hold switch in its actuated position, rotation of the system channel trip select switch will release only those bistable trip relays that have operating contacts in the logic matrix under test. The system channel trip select switch applies a test voltage of opposite polarity to the bistable trip relay test coils so that the magnetic flux generated by those coils opposes that of the primary coil of the relay. The resulting flux will be zero, and the relays will release.

Trip action can be observed by illumination of the trip relay indicators located on the front panel and by loss of voltage to the four matrix relays, which is indicated by extinguishing the indicator lights connected across each matrix relay coil.

During this test, the matrix relay "HOLD" lights will remain on, indicating that a test voltage has been applied to the holding coils of matrix relays of the logic matrix under test.

ARKANSAS NUCLEAR ONE
UNIT 2

The test is repeated for each actuation signal, by use of the system channel trip select switch, and for all six logic matrices. This test will verify that the logic matrix relays will de-energize, if the matrix continuity is violated. The opening of the matrix relays is tested in the trip path tests.

7.3.1.1.9.4 Trip Path/Initiation Channel Tests

Each trip path is tested individually by actuating a matrix hold switch (holding four matrix relays), selecting any trip position of the system channel trip select switch (opening the matrix), and selecting a position on the matrix relay trip select switch (de-energizing one of the four matrix relays in each ESFAS). This causes one of the initiation channels in each of the affected ESFAS's to de-energize. Proper operation of both initiation channel output relay coils and contacts is verified by monitoring the current through the appropriate leg(s) of the actuation logic selective 2-out-of-4 circuit(s).

The matrix relay trip select switch is turned to the next position, re-energizing the tested matrix relay(s) and allowing for the appropriate initiation channel(s) to be manually reset. This sequence is repeated for the other three trip paths from the selected matrix. The entire test sequence is repeated for the remaining five matrices. Upon completion of testing, all six matrices, all 24 matrix relay contacts and all eight initiation channel output relays for each ESFAS have been tested.

7.3.1.1.9.5 ESFAS Actuating Logic Tests

The selective 2-out-of-4 logic circuit of each ESFAS load group system is tested in a manner similar to the RPS trip breaker system (see Section 7.2.1.1.9.5). One current path of the selective 2-out-of-4 logic matrix is interrupted by opening one of the path contacts and loss of path current is verified. Every contact in both current paths is checked in this manner.

The manual trips are checked one at a time from their remote locations; the lockout contacts are checked via the group relay test system (Section 7.3.1.1.9.6) and the initiation relay contacts are checked as described in Section 7.3.1.1.9.4.

This test verifies the proper operation of the ESFAS actuating logic circuits.

In addition, the EFAS trip paths may be tested by manually tripping the associated DEFAS trip relay as described in Section 7.7.1.7.

7.3.1.1.9.6 ESFAS Actuating Device Test

Proper operation of the ESFAS group relays is accomplished by de-energizing the group relays one at a time via a test relay contact and verifying proper operation of all actuated components in that group. The design of the test system is such that one and only one group relay may be de-energized at one time. The test switch must be positioned to the group to be tested; selection of more than one group is impossible. The test circuit is electrically locked out upon actuation of a particular test group and another test group cannot be actuated for one minute after selecting another switch position. This time delay feature is a "stop and think" feature to assist the operator in conducting tests; should it not function and should the operator violate test procedures, the worst that could happen is inadvertent actuation of ESF components or an ESF system.

ARKANSAS NUCLEAR ONE
UNIT 2

Since this test causes the ESF components to actuate by interrupting the normal safety signal current to individual group relays, the propagation of a valid trip during testing will not be impeded, and the system will proceed to full actuation.

This test verifies the operation of the ESFAS group relays and the individual ESF component actuation devices.

7.3.1.1.10 Vital Instrument Power Supply

The vital instrument power supply for the ESFAS is described in Sections 8.3.1.1.6 and 7.3.1.1.2.4.

7.3.1.1.11 Actuated Systems

The ESF systems consist primarily of components and equipment maintained in a standby mode during normal operations. Actuating signals generated by the ESFAS are combined with ESF component permissive signals within the actuation device circuitry (e.g., control switch not in “pull to lock”, EDG load sequencing, etc.) to assure that the ESF systems provide the required protective functions. All valves which receive an ESF signal are designed not to return to their normal mode upon removal of the ESF signal. An additional reset action is required to return the valve to its normal mode.

The following sections describe the instrumentation and controls for each ESF system. Table 7.3-2 presents the design basis events which require specific ESFAS action. Table 7.3-3 presents the monitored variables required for ESFAS actuation.

7.3.1.1.11.1 Containment Isolation System

See Section 6.2.4 for a description of this system.

The system is composed of redundant load groups: Load Group I and Load Group II. The instrumentation and controls of the components and equipment in Load Group I are physically and electrically separate and independent of the instrumentation and controls of the components and equipment in Load Group II. Independence is adequate to retain the redundancy required to maintain equipment functional capability necessary to isolate the containment following those design basis events shown in Table 7.3-2 which require containment isolation.

The CIS is automatically actuated by a CIAS from the ESFAS. In addition, certain CIS valves are automatically actuated (closed) by a SIAS from the ESFAS. (See Table 6.2-26 for specific valves and Section 7.3.1.1.11.5 for SIAS initiation logic description.) This provides diverse signals for these valves for containment isolation.

The CIAS is initiated by 2-out-of-4 containment pressure signals. The measurement channels which generate the CIAS also provide signals to the SIAS, CSAS and CCAS. Manual initiation of the CIS is provided in the control room.

The safety-related display instrumentation for the CIS which provides the operator with sufficient information to monitor and perform the required safety functions is described in Section 7.5.

ARKANSAS NUCLEAR ONE
UNIT 2

7.3.1.1.11.2 Containment Spray System

See Section 6.2.2 for a description of the CSS.

The system is composed of redundant load groups: Load Group I and Load Group II. The instrumentation and controls of the components and equipment in Load Group I are physically and electrically separate and independent of the instrumentation and controls of the components and equipment in Load Group II. Independence is adequate to retain the redundancy required to maintain equipment functional capability following those design basis events shown in Table 7.3-2 which are mitigated by the CSS.

The CSS is automatically actuated by a CSAS from the ESFAS. The CSAS is initiated by coincidence of 2-out-of-4 high-high containment pressure signals and an SIAS signal. Manual initiation of the CSS is provided in the control room.

The SIAS and high-high containment pressure signals are combined in four AND circuits within the ESFAS initiating logic. The AND circuits prevent inadvertent operation of the CSS upon generation of an SIAS only. The CSAS actuating logic is separate from the SIAS logic.

The operating mode of the CSS is automatically changed by a RAS from the ESFAS. The RAS is generated by 2-out-of-4 low refueling water tank level signals. The RAS is described in Section 7.3.1.1.11.6.

7.3.1.1.11.3 Containment Cooling System

See Section 6.2.2 for a description of the CCS.

The system is composed of redundant load groups: Load Group I and Load Group II. The instrumentation and controls of the components and equipment in Load Group I are physically and electrically separate and independent of the instrumentation and controls of the components and equipment in Load Group II. Independence is adequate to retain the redundancy required to maintain equipment functional capability following those design basis events shown in Table 7.3-2.

The CCS instrumentation and controls are designed for one operating mode during emergency operating conditions and another operating mode during normal plant operation.

During emergency conditions, the operating mode of the CCS is automatically changed by a CCAS from the ESFAS. The CCAS is initiated by either 2-out-of-4 low pressurizer pressure signals or 2-out-of-4 high containment pressure signals.

Manual initiation of the CCS is provided in the control room.

Manual reduction of pressurizer pressure trip setpoints and the RPS/ESFAS pressurizer pressure bypass permit shutdown and depressurization of the RCS without automatic actuation of the CCS. Automatic CCS operation is actuated at the pressure shown in Table 7.3-5 during plant operation.

The CCAS automatically starts all four containment emergency air cooling fans, opens service water valves and opens bypass dampers on each cooling unit.

ARKANSAS NUCLEAR ONE
UNIT 2

The safety-related display instrumentation for the CCS which provides the operator with sufficient information to monitor and perform the required safety functions is described in Section 7.5.

7.3.1.1.11.4 Main Steam Isolation System

See Section 10.3 for a description of the Main Steam Isolation System (MSIS).

The system is composed of redundant load groups: Load Group I and Load Group II. The instrumentation and controls of the valves in Load Group I are physically and electrically separate and independent of the instrumentation and controls of the valves in Load Group II. Independence is adequate to retain the redundancy required to maintain equipment functional capability necessary to prevent blowdown of both steam generators following those design basis events shown in Table 7.3-2 which require main steam isolation.

The MSIS closes both main steam isolation valves and the four main feedwater isolation valves, stops both main feedwater pumps, stops all four condensate pumps, and stops the AFW pump.

The MSIS is initiated by 2-out-of-4 low steam generator pressure signals. The 2-out-of-4 logic is provided for each steam generator.

A manual control switch for each valve is provided in the control room to permit manual isolation of the main steam and feedwater lines.

System-level manual initiation of the MSIS is also provided in the control room.

Automatic main steam and feedwater isolation is initiated at a pressure setpoint as shown in Table 7.3-5 during normal operation. A variable setpoint is implemented to allow controlled pressure reduction during shutdown without initiating a MSIS. The pressure setpoint is automatically increased as the steam pressure is increased.

The safety-related display instrumentation for the MSIS, which provides the operator with sufficient information to monitor and perform the required safety functions, is described in Section 7.5.

7.3.1.1.11.5 Safety Injection System

See Section 6.3 for a description of the SIS.

The system is composed of redundant Load Groups: Load Group I and Load Group II. The instrumentation and controls of the components and equipment in Load Group I are physically and electrically separate and independent of the instrumentation and controls of the components and equipment in Load Group II. Independence is adequate to retain the redundancy required to maintain equipment functional capability following those design basis events shown in Table 7.3-2 which are mitigated by the SIS.

The SIS is automatically actuated by an SIAS from the ESFAS. The SIAS is initiated by either 2-out-of-4 low pressurizer pressure signals or 2-out-of-4 high containment pressure signals. Capability to bypass individual channels for these parameters to allow maintenance and testing is provided as discussed in Section 7.3.1.1.4.

ARKANSAS NUCLEAR ONE
UNIT 2

The measurement channels which generate low pressurizer pressure and high containment pressure signals also provide signals to the CCAS and CSAS. The measurement channels which generate the high containment pressure signals also provide signals to the CIAS.

Key locked control switches are provided in the control room to permit manual closing of the safety injection tank isolation valves for shutdown and depressurization. When pressurizer pressure rises above the setpoint, the valves are automatically opened (see Section 7.6).

Manual initiation of the SIS is provided in the control room.

The operating mode of the SIS is automatically changed by a RAS from the ESFAS. Generation of the RAS is described in Section 7.3.1.1.11.6.

Automatic SIS operation is actuated at a pressurizer pressure as shown in Table 7.3-5 during operation. During startup and shutdown operations, a variable setpoint is used as described in Section 7.2.1.1.1.6.

The safety-related display instrumentation for the SIS which provides the operator with sufficient information to monitor and perform the required safety functions, is described in Section 7.5.

7.3.1.1.11.6 Recirculation Actuation Signal

The RAS is generated by 2-out-of-4 low refueling water tank level signals. Capability to bypass individual channels to allow maintenance and testing is provided as discussed in Section 7.3.1.1.4. The sensors are physically separated. Instrumentation and High Pressure Safety Injection (HPSI) system designs are discussed in Sections 6.2.2.5.1 and 6.3.2.2.4, respectively.

The RAS automatically stops the low pressure safety injection pumps. The RAS also automatically changes the high pressure safety injection pump suction from the refueling water tank to the containment recirculation sump. This allows long term core cooling of the reactor core following a LOCA by recirculating water in the containment sump using the HPSI pumps. The recirculated sump water is injected to the core and the mechanism for residual heat removal is boil-off of fluid in the reactor vessel.

Manual initiation of the RAS is provided at the auxiliary relay cabinets which are located behind the main control panels in the control room.

Key locked control switches are provided for remote-manual operation of the containment sump isolation valves and the refueling water tank isolation valves. The locked open and locked closed positions of these valves are indicated and annunciated in the control room.

7.3.1.1.11.7 Penetration Room Ventilation System

See Section 6.5 for a description of the penetration room ventilation system.

Upon receipt of a CIAS, following an incident, the 3-way solenoid valves mounted in the air lines to the pneumatic operators on the penetration room ventilation duct isolation dampers are automatically de-energized, closing off the air supply to the operators. These isolation dampers are designed to fail-closed upon loss of instrument air pressure, providing sealed penetration rooms. Indicating lights in the control room show their closed position. Both fans receive a CIAS, however, only one fan is required.

ARKANSAS NUCLEAR ONE
UNIT 2

A motor operated valve which opens when the fan starts is provided at the suction of each fan. When one of the two fans is stopped, its respective valve is automatically closed to prevent recirculation through the idle fan.

In the original design of the penetration room ventilation system, if a fan fails or is stopped after it has been running for a prolonged period of time, a manually controlled recirculation valve can be opened from the control room to maintain adequate cooling air drawn by the operating fan through the idle filter train. Subsequent calculations have documented adequate cooling will be maintained even without the operation of these valves and air flow secured. Flow indication is provided in the control room for this recirculation cooling air as part of the original design.

This system is not utilized, i.e., taken credit for, in the calculation of off-site doses after an accident.

7.3.1.1.11.8 Emergency Feedwater System

See Section 10.4.9 for a description of the Emergency Feedwater (EFW) system.

The system is composed of redundant load groups: Load Group I and Load Group II. The instrumentation and controls of the components and equipment in Load Group I are physically and electrically separate and independent of the instrumentation and controls of the components and equipment in Load Group II. Independence is adequate to retain the redundancy required to maintain equipment functional capability necessary to automatically actuate the EFW system following those design basis events shown in Table 7.3-2 which require emergency feedwater.

The EFW system instrumentation and controls are designed for operation during all phases of plant operation. The system is designed to be operated manually, typically utilizing the auxiliary feedwater pump during normal transients such as startup, shutdown, and hot standby and automatically utilizing the emergency feedwater pumps during emergency situations such as steam line rupture, loss of normal feed and plant blackout.

The EFAS performs the following functions:

- A. Starts the emergency feedwater pumps;
- B. Determines whether a steam generator is intact;
- C. Opens the emergency feedwater valves to the intact steam generator; and,
- D. Prevents a high level condition in the intact steam generator(s) by closing the emergency feedwater valves when the water level is re-established above the low level trip setpoint.

The EFAS is initiated to Steam Generator 1 either by a low steam generator level coincident with no low pressure trip present on Steam Generator 1 or by a low steam generator level coincident with a differential pressure between the two steam generators with the higher pressure in Steam Generator 1 (an identical EFAS is generated for Steam Generator 2). The valve open logic, (TP1 or TP3) and (TP2 or TP4) (TPs de-energized), is not latched in the actuated state. Following initial actuation when the level is re-established above the low level actuation point, or when the proper pressure conditions are no longer met, the valve close logic,

ARKANSAS NUCLEAR ONE
UNIT 2

(TP1 and TP3) or (TP2 and TP4), closes the valves (TPs energized). When the conditions for valve opening are again met, or when the operator takes action, the valves are reopened. The pumps are latched on as shown whenever an EFAS signal occurs for either steam generator. The 2-out-of-4 logic is provided for each steam generator.

Manual control switches for the emergency feedwater pumps and emergency feedwater valves are provided in the control room.

A list of typical trip setpoints for EFW actuation is contained in Table 7.3-5.

The safety-related display instrumentation for the EFW system, which provides the operator with sufficient information to monitor and perform the required safety functions, are described in Section 7.5.

7.3.1.1.12 ESF Supporting Systems

The ESF supporting systems are listed below and described in the referenced sections.

- A. Service Water System (see Section 9.2.1).
- B. Electrical Power Distribution Systems (see Sections 8.3 and 7.3.1.1.2.4).

7.3.1.2 Design Basis Information

The ESFAS is designed to provide initiating signals for components which require automatic actuation following rupture of the reactor coolant pressure boundary or of a main steam line.

The systems are designed on the following bases to assure adequate performance of their protective functions.

- A. The system is designed in compliance with the applicable criteria, "General Design Criteria for Nuclear Power Plants" (Appendix A of 10CFR50, 1971).
- B. System testing conforms to the requirements of IEEE 338-1971, "Trial Use Criteria for Periodic Testing of Nuclear Power Generating Station Protection Systems" and Regulatory Guide 1.22, "Periodic Testing of Protection System Actuation Functions."
- C. IEEE 279-1971, "Criteria for Protection Systems for Nuclear Power Generating Stations," establishes specific protection system design bases. The following sections describe how these design bases listed in Section 3 of IEEE 279 are implemented.
 - 1. "Generating Station Conditions Which Require Protective Action"
 - Rupture of reactor coolant pipe
 - Rupture of small reactor coolant pipes or cracks in large reactor coolant pipe
 - Steam generator tube rupture
 - Steam line break
 - Minor secondary system pipe break

ARKANSAS NUCLEAR ONE
UNIT 2

2. "Generating Station Variables to be Monitored to Provide Protective Action"

- Reactor coolant system pressure
- Containment pressure
- Refueling water tank level
- Steam generator pressures
- Steam generator level

3. "The Number and Location of the Sensors Required to Monitor the Variables Listed in Basis (2)"

These variables are listed in Table 7.3-4.

4. "Prudent Operational Limits for Each Variable Listed in Basis (2) for Each Applicable Reactor Operation Mode"

The normal operation limits for each variable listed in basis (2) are provided in Table 7.3-5.

5. "The Margin, With Appropriate Interpretive Information, Between Each Operational Limit and the Level Considered to Mark the Onset of Unsafe Conditions"

This information is provided in Table 7.3-5.

6. "The Levels That When Reached Will Require Protective Action"

This information is provided in Table 7.3-5.

7. "The Range of Transient and Steady State Conditions of Both the Energy Supply and the Environment During Normal, Abnormal and Accident Circumstances Throughout Which the System Must Perform"

Systems components are qualified for the environmental conditions discussed in Section 3.11. In addition, the system is capable of performing its intended functions under the most degraded conditions of the electrical support system as discussed in Section 8.3.

8. "The Malfunctions, Accidents or Other Unusual Events Which Could Physically Damage Protection System Components or Could Cause Environmental Changes Leading to Functional Degradation of System Performance, and for Which Provisions Must Be Incorporated to Retain Necessary Protective Action"

The ESFAS is designed with consideration given to unusual events which could degrade system performance so that:

- a. A loss of power to the measurement channels and/or to the logic system causes acceptable system response. Section 7.3.1.1.2.4 further describes PPS response to loss of power events.

ARKANSAS NUCLEAR ONE
UNIT 2

- b. Any single failure within the system shall not prevent proper protective action at the system level. The single failure criterion is discussed in Section 7.3.2.2.2.
 - c. The environmental conditions under which the ESFAS shall be capable of performing its intended function are described in Section 3.11.2.
 - d. The seismic conditions under which the ESFAS shall be capable of performing its intended function are described in Section 3.10.
9. "Minimum Performance Requirements Including System Response Times, Accuracies, and Ranges of the Magnitude and Rates of Change of Sensed Variables to be Accommodated Until Proper Conclusion of the Protective Action is Assured"

The minimum performance requirements of the ESFAS are as follows:

- a. The ESFAS system response times are a portion of the total response time measured from when the monitored process parameter exceeds the actuation setpoint at the channel sensor until the actuated ESF equipment is capable of performing its safety function. The response times utilized in the Safety Analysis are listed in Chapter 15.
- b. The ranges of ESFAS monitored plant variables are provided in Table 7.3-6.

7.3.2 ANALYSIS

7.3.2.1 Introduction

The design of each of the ESF systems, including design bases and evaluation, is discussed in Chapter 6 and Chapter 10. The following analyses address the ESFAS and instrumentation only.

7.3.2.2 Design

As previously described, the major portion of the ESFAS is functionally identical to the RPS. The logic for the ESFAS and RPS, are located in the same enclosures and share a common logic testing scheme. Because of this, many of the responses to the requirements of the general design criteria, IEEE 279-1971 and IEEE 338-1971 are similar to the responses in Section 7.2.2.

7.3.2.2.1 General Design Criteria

Appendix A of 10CFR50, "General Design Criteria for Nuclear Power Plants," establishes minimum requirements for the principal design criteria for water-cooled nuclear power plants. This section describes how the requirements that are applicable to the ESFAS are satisfied.

Criterion 1: Quality Standards and Records

The quality assurance program for the plant is described in the Quality Assurance Program Manual (QAPM). These procedures ensure that the system has been designed in accordance with required codes and standards.

ARKANSAS NUCLEAR ONE
UNIT 2

Criterion 2: Design Bases for Protection Against Natural Phenomena

The design bases for protection against natural phenomena are described in Section 3.10 and 3.11.

Criterion 3: Fire Protection

See Section 3.1.

Criterion 4: Environmental and Missile Design Bases

Environmental design bases are described in Section 3.10. Missile design bases are described in Section 3.5.

Criterion 5: Sharing of Structures, Systems and Components

No ESFAS components are shared with any other reactor facilities.

Criterion 13: Instrumentation and Control

Sensor ranges are sufficient to monitor all pertinent plant variables over the expected range of plant operation for normal and transient conditions. The information shown in Table 7.5-2 is provided for the operator's use.

Criterion 20: Protection System Functions

ESF action will be initiated upon sensing the presence of accident conditions.

Criterion 21: Protection System Reliability and Testability

Functional reliability is ensured by compliance with the requirements of IEEE 279-1971, as described in Section 7.3.2.2.2. Testing is in compliance with IEEE 338-1971 and Regulatory Guide 1.22, and is described in Section 7.3.2.2.3.

Criterion 22: Protection System Independence

(See Section 3.1)

Four independent sensor channels are provided for all inputs. Two independent output paths are provided.

Criterion 23: Protection System Failure Modes

The ESFAS is designed to fail in a safe state in the event of loss of power. Loss of power responses are discussed in section 7.3.1.1.2.4. Failure modes of the ESF system components are discussed in Chapter 6 and Chapter 10.

ESFAS components are designed to function under adverse environmental conditions during postulated accidents, if required.

ARKANSAS NUCLEAR ONE
UNIT 2

Criterion 24: Separation of Protection and Control Systems

The protection system is separated from the control systems.

Criteria 34, 35, 37, 38, 40, 41, 43, 44, 46:

The actuation portion of these criteria are met by the ESFAS, which meets the requirements of IEEE 279-1971 and IEEE 338-1971. The single failure criterion is met for all ESF systems and the ESFAS is fully testable.

7.3.2.2.2 ESFAS Equipment Design Criteria

IEEE 279-1971, "Criteria for Protection Systems for Nuclear Power Generating Stations," establishes minimum requirements for safety-related functional performance and reliability of the ESFAS. This section describes how the requirements listed in Section 4 of IEEE 279 are satisfied.

"4.1 General Functional Requirement"

The ESFAS is designed to actuate the appropriate ESF systems, when required, to mitigate the effects of certain accidents. Instrument performance characteristics, response time, and accuracy are selected for compatibility with and adequacy for the particular function. Trip setpoints are established by analysis of the system parameters. Factors such as instrument inaccuracies, bistable trip times, valve travel time, and pump starting times are considered in establishing the margin between the trip setpoints and the safety limits. The time response of the sensors and protective systems are evaluated for abnormal conditions. Since all uncertainty factors are considered as cumulative for the derivation of these times, the actual response time may be more rapid. However, even at the maximum times, the system provides conservative protection.

There are no ESFAS sensors for which the trip setpoints are within five percent of the high or low end of the calibrated range.

"4.2 Single Failure Criterion"

The ESFAS is designed so that any single failure within the system shall not prevent proper protective action at the system level. No single failure will defeat more than one of the four protective channels associated with any one trip function. Section 7.3.1.1.2.4 describes a power source failure that impacts more than a single protective channel.

The following is an evaluation of the effects of specific single faults in the analog portion of the system:

- A. A loss of signal in a measurement channel initiates channel trip action for the low pressurizer pressure, low steam generator water level and low steam generator pressure trips;
- B. Shorting of the signal leads to each other has the same effect as a loss of signal. Shorting a lead to a voltage has no effect since the signal circuit is ungrounded;
- C. Single grounds of the signal circuit have no effect. Periodic checking of the system will provide assurance that the circuit remains ungrounded.

ARKANSAS NUCLEAR ONE
UNIT 2

The following is an evaluation of the effects of specific single faults in the logic portion of the system:

- A. Inadvertent operation of the relays and relay contacts in the matrices will be identified by plant annunciation and indicating lights;
- B. Shorting of the pairs of contacts in the matrices will prevent the matrix relay sets from being released. Such shorts are detectable in the testing process by observing that the matrix relays cannot be dropped out. Testing is accomplished by successive opening of the logic matrix contact pairs;
- C. Shorting of the matrices to an external voltage has no effect since the matrix is ungrounded. Equipment is provided to detect grounds on the matrices;
- D. The logic matrices will each be supplied by two power sources. Loss of a single power source has no effect on operation; however, a half leg actuation results. Loss of both power sources to a logic matrix initiates an actuation of the associated EFSAS functions;
- E. Failure of a matrix relay to de-energize has no effect since there are six matrix relay contacts in series in the trip path and any one contact initiating trip action will cause the action to be completed;
- F. The failure of one actuation channel (ARC) has no effect since there are two actuation channels with independent control circuits in parallel, either of which will provide the necessary action;
- G. Single grounds or accidental application of potential to single leads in the trip path circuits have no effect since the circuit is ungrounded. Testing and observation of ground detectors will indicate these problems; and,
- H. Single faults of actuation relays or actuation relay buses have no effect as a selective 2-out-of-4 logic is required for actuation. For single faults of a component or components within one of the two redundant actuation trains, actuation of the remaining trains components are sufficient for the protective action.

"4.3 Quality Control of Components and Modules"

The quality assurance program is described in the Quality Assurance Program Manual (QAPM). This program includes appropriate requirements for design, review, procurement, inspection, and testing to ensure that the system components shall be of a quality consistent with minimum maintenance requirements and low failure rates.

"4.4 Equipment Qualification"

The ESFAS meets the equipment requirements described in Sections 3.10 and 3.11.

ARKANSAS NUCLEAR ONE
UNIT 2

"4.5 Channel Integrity"

Type testing of components, separation of sensors and channels, and qualification of cabling are utilized to ensure that the channels will maintain the functional capability required under applicable extremes of conditions relating to environment, energy supply, malfunctions and accidents.

Loss of or damage to any one path will not prevent the protective action. Sensors are piped so that blockage or failure of any one connection does not prevent protective system action. The process transducers located in the containment building are specified and rated for the intended service. Components which must operate during or after the LOCA are rated for the LOCA environment. Results of type tests are used to verify these ratings. In the control room, protective system trip paths are located in four compartments. Mechanical and thermal barriers between these compartments reduce the possibility of common event failure. Outputs from the components in this area to the control boards are isolated so that shorting, grounding, or the application of the highest available local voltage does not cause channel malfunction. Where signals originating in the PPS feed the computer, signal isolation is provided; where the ESFAS is feeding annunciators, isolation is ensured through the use of relay contacts.

"4.6 Channel Independence"

The locations of the sensors and the points at which the sensing lines are connected to the process loop have been selected to provide physical separation of the channels, thereby precluding a situation in which a single event could remove or negate a protective function. The routing of cables from protective system transmitters is arranged so that the cables are separated from each other and from power cabling to minimize the likelihood of common event failures. This includes separation at the containment penetration areas. In the control room, protective system trip channels are located in individual compartments. Mechanical and thermal barriers between these compartments minimize the possibility of common event failure. Outputs from the components in this area to the control board are isolated so that shorting, grounding, or the application of the highest available local voltages do not cause channel malfunction.

The criteria for separation and physical independence of channels are based on the need for decoupling the effects of accident consequences and energy supply transients and for reducing the likelihood of channel interaction during testing or in the event of a channel malfunction.

Historical data removed - To review the exact wording please refer to Section 7.3.2.2.2 of the FSAR.

"4.7 Control and Protection System Interaction"

No portion of the ESFAS is used for both control and protection functions.

"4.8 Derivation of System Inputs"

ESFAS inputs are derived from signals that are direct measures of the desired variables. Variables which are measured directly include pressurizer, steam generator, and containment pressures. Refueling water tank and steam generator levels are derived from differential pressure measurements.

ARKANSAS NUCLEAR ONE
UNIT 2

"4.9 Capability for Sensor Checks"

ESFAS sensors are checked by cross-checking between channels. These channels bear a known relationship to each other, and this method ensures the operability of each sensor during reactor operation.

"4.10 Capability for Test and Calibration"

Testing is described in Section 7.3.1.1.9 and is in compliance with IEEE 338-1971 as discussed in Section 7.3.2.2.3.

"4.11 Channel Bypass or Removal From Operation"

Any one of the four protective system channels may be tested, calibrated, or repaired without detrimental effects on the system. Individual trip channels may be bypassed to effect a 2-out-of-3 logic on the remaining channels. The single failure criterion is met during this condition.

"4.12 Operating Bypasses"

Operating bypasses are provided as shown in Table 7.3-1. The operating bypasses are automatically removed when the permissive conditions are not met. The circuitry and devices which function to remove these inhibits are designed in accordance with IEEE 279-1971.

"4.13 Indication of Bypasses"

Indication of test or bypass conditions or removal of any channel from service is given by lights and annunciation. Bypasses that are automatically removed at fixed setpoints are alarmed and indicated.

"4.14 Access to Means for Bypassing"

An interlock prevents the plant operator from bypassing more than one of the four channels of any one type trip at any one time. All bypasses are visually and audibly annunciated.

"4.15 Multiple Setpoints"

Manual reduction of setpoints for main steam isolation and safety injection actuation CCAS is allowed for the controlled reduction of pressurizer pressure and steam generator pressure as discussed in Section 7.2.1.1.2.6. The setpoint reductions are initiated by a control board mounted pushbutton, which upon actuation adjusts the setpoint to a value a pre-selected distance below the operating pressure which exists at the time the pushbutton is actuated. A separate pushbutton is provided for each protection channel. This method of setpoint reduction provides positive assurance that the setpoint is never decreased below the existing pressure by more than a predetermined amount.

The setpoint will be automatically increased by the PPS as the measured pressure is increased.

"4.16 Completion of Protective Action Once It is Initiated"

The system is designed to ensure that protective action will go to completion once initiated. Operator action is required to clear the actuation signal and return to operation except for EFAS where the operator must clear the low steam generator water level to return to operation.

ARKANSAS NUCLEAR ONE
UNIT 2

"4.17 Manual Initiation"

In general a manual actuation can be initiated by depressing either of two sets of pushbuttons. Except for RAS, each set of pushbuttons will actuate both load groups. On EFAS and MSIS the eight EFW discharge valves are configured such that all four switches/buttons are necessary to send the manually initiated signals to all of the discharge valves. The RAS can be manually actuated by depressing both sets of pushbuttons on the two auxiliary relay cabinets. Each set of RAS manual pushbuttons will actuate the RAS components associated with the respective train (i.e. load group).

The remote manual switches de-energize the solid state relays, whose contacts interrupt power to the group relays. The remote manual switches are located in the control room. The switches are paired AB and CD, each pair located on a different control board. As shown in the above referenced figures, either pair is capable of actuating both auxiliary relay cabinets at the system level regardless of whether means are also provided downstream at the component level. The ESFAS manual initiation feature is in complete conformance with Regulatory Guide 1.62, "Manual Initiation of Protective Actions."

"4.18 Access to Setpoint Adjustments, Calibration and Test Points"

An administratively controlled key is required for access to setpoint adjustments, calibration and test points. Access is also visually and audibly annunciated.

"4.19 Identification of Protective Action"

Indication lights are provided for all protective actions, including identification of channel trips.

"4.20 Information Readout"

Means are provided to allow the operator to monitor all trip system inputs and outputs. The displays that are provided for continuous monitoring are described in Section 7.5. System status displays are provided.

"4.21 System Repair"

Identification of a defective channel will be accomplished by observation of system status lights or by testing as described in Section 7.3.1.1.9. Replacement or repair of components is accomplished with the affected channel bypassed. The affected trip function then operates in a 2-out-of-3 trip logic.

"4.22 Identification"

All equipment, including panels, modules, and cables associated with the actuation system, will be marked in order to facilitate identification. Interconnecting cables will be color coded on a channel basis.

7.3.2.2.3 Testing Criteria

IEEE 338-1971, "Trial Use Criteria for the Periodic Testing of Nuclear Generating Station Protection Systems," and Regulatory Guide 1.22, "Periodic Testing of Protection System Actuation Functions," provide guidance for development of procedures, equipment, and

ARKANSAS NUCLEAR ONE
UNIT 2

documentation of periodic testing. The basis for the scope and means of testing are described in this section. Test intervals and their bases are included in the Technical Specifications. Since actuation of the ESF systems is not expected during normal operation, the systems are periodically tested without initiating protective action, without violating the single failure criterion, and without inhibiting the operation of the systems.

The systems can be checked from the sensor signal through the actuated devices. The functional modules in the sensors system can be tested during reactor operation. The sensors can be checked by comparison with similar channels.

Those actuated devices which are not tested during reactor operation, e.g. main feedwater isolation valves, will be tested during scheduled reactor shutdowns to ensure that they are capable of performing the necessary functions. Minimum frequencies for checks, calibration and testing of the ESFAS instrumentation are given in the Technical Specifications. Overlap in the checking and testing is provided to ensure that the entire channel is functional. The use of individual trip and ground detection lights, in conjunction with those provided at the supply bus, ensure that possible grounds will be detected.

The response time from an input signal to protection system trip bistables through the opening of the actuation relays is verified by measurement during plant startup testing and periodically thereafter. Sensor responses are measured during factory acceptance tests and will be periodically remeasured, either independently or as part of the total instrument loop response time, to ensure their continued adequate timely response.

7.3.2.3 Failure Modes and Effects Analysis

A failure modes and effects analysis for the PPS, RPS, and ESFAS is provided in Table 7.2-5. It should be noted that this analysis was performed assuming three operable PPS channels with one channel in the bypass condition. Arkansas Nuclear One, Unit 2 is expected to operate with all four channels operable under normal conditions. The analysis of Table 7.2-5 demonstrates for the more limiting case of three channels operable that the design criteria for the PPS are met.

7.4 **SYSTEMS REQUIRED FOR SAFE SHUTDOWN**

This section describes the instrumentation and control systems which are required to maintain the reactor in a safe shutdown condition. These instrumentation and control systems are in many cases utilized in the performance of normal plant operations and as such cannot be exclusively identified for safe shutdown functions. Complete descriptions of these systems and their operation may be found in other sections of the Safety Analysis Report. Piping and instrumentation diagrams are included in other sections as referenced.

7.4.1 **DESCRIPTION**

7.4.1.1 **Emergency Power Systems**

The emergency power systems are described in Section 8.3.1.1.7. The design bases for electrical power systems are described in Sections 8.3.1.2, 8.3.1.4 and 8.3.2.2.

7.4.1.2 **Emergency Feedwater Systems**

The Emergency Feedwater (EFW) system is described in Section 10.4.9. Automatic initiation of the EFW system is described in Section 7.3.

7.4.1.3 **Chemical and Volume Control System (Boron Addition Portion)**

This portion of the CVCS has been downgraded and is available, but not required, for safe shutdown. The boron addition portion of the Chemical and Volume Control System (CVCS) is used during normal plant operation for long-term reactivity changes and during shutdown. The boric acid concentration is controlled during shutdown and cooldown to compensate for reactivity changes associated with a decreasing coolant temperature in order to ensure that a sufficient shutdown margin is maintained. Concentrated boric acid is mixed with demineralized water and injected into the RCS to achieve the desired coolant concentration by continuous letdown and makeup. The CVCS is discussed in Section 9.3.4.

The system instrumentation and controls utilized to affect long-term reactivity changes and achieve plant shutdown are discussed in the following sections.

7.4.1.3.1 **Initiating Circuits and Logic**

Boron addition and dilution are accomplished by the following methods:

- A. Coordinated control of the charging pumps, letdown control valves and letdown back pressure valves to adjust and maintain the correct pressurizer water level; and,
- B. Periodic sampling and adjustment of the boron concentration to compensate for the temperature decrease and other variables until shutdown concentration is reached.

The charging pumps are used to inject water and/or concentrated boric acid into the Reactor Coolant System (RCS) as required. With one pump normally in operation, the other charging pumps are automatically started by the pressurizer level control system as required (see Section 7.7.1).

ARKANSAS NUCLEAR ONE
Unit 2

Upon actuation of an SIAS, the charging pump suction is shifted from the volume control tank to the boric acid pump discharge for boric acid injection. The SIAS also unisolates a gravity feed line from the boric acid makeup tanks to the charging pump suction in case the boric acid pumps fail to start. A separate (diverse) flow path is also available from the refueling water tank. Should the charging line inside the reactor containment be inoperative for any reason, the line may be isolated outside of the reactor containment, and charging flow can be injected via Safety Injection Header 1.

Control board process indication and status instrumentation is provided to enable the operator to evaluate system performance and control system operation. This instrumentation is discussed in Section 7.5.

7.4.1.3.2 Interlocks, Sequencing and Bypasses

System operation is achieved by the coordinated operation of the charging pump and boric acid pump control circuits. The charging pump control circuit sequences charging pump operation in response to pressurizer water level control circuit requirements as discussed in Section 7.7.1.1.3. The boric acid pump control circuit sequences boric acid pump and valve operation to achieve the desired boric acid concentration (see Section 9.3.4).

Manual control of any portion of these systems can be achieved while allowing the remainder to continue functioning in automatic.

7.4.1.3.3 Redundancy and Diversity

Three charging pumps are provided. The charging pumps and supporting instrumentation are powered from two separate electrical buses. The charging pumps can take suction from either the volume control tank, the refueling water tank, or the boric acid makeup tank to supply borated water into the RCS. Additional information on the CVCS design is contained in Section 9.3.4.

7.4.1.3.4 Supporting System

The boron addition and charging subsystems use portions of the CVCS flow path and have instrumentation in common.

7.4.1.4 Service Water System

The Service Water System is described in Section 9.2.1. The safety-related portion of the service water system is composed of redundant load groups: Load Group I and Load Group II. The instrumentation and controls of the components and equipment in Load Group I are physically and electrically separate and independent of the instrumentation and controls of the components and equipment in Load Group II. Independence is adequate to retain the redundancy required to maintain equipment functional capability following design basis accidents.

The Service Water System instrumentation and controls are designed for operation during all phases of plant operation. The Service Water System is manually controlled from the control room in the normal operating mode. The operating mode of the Service Water System is automatically transferred to the emergency operating mode by a Safety Injection Actuation Signal (SIAS) or Main Steam Isolation Signal (MSIS) from the Engineered Safety Features

ARKANSAS NUCLEAR ONE
Unit 2

Actuation System (ESFAS). Generation of the SIAS and MSIS are described in Section 7.3.1.1.11.5, "Safety Injection System," and in Section 7.3.1.1.11.4, "Main Steam Isolation System." Service Water System indications and alarms are described in Table 9.2-6.

7.4.1.5 Emergency Shutdown From Outside the Control Room

In the unlikely event that the control room becomes inaccessible, sufficient instrumentation and controls are provided outside the control room to:

- A. Achieve prompt hot shutdown of the reactor;
- B. Maintain the unit in a safe condition during hot shutdown; and,
- C. Achieve cold shutdown of the reactor through the use of suitable procedures.

A remote shutdown panel is provided outside of the control room. The panel is designed to Seismic Class 1 requirements and is located in a Seismic Class 1 area. The panel includes instrumentation and controls as described in Sections 7.4.1.5.1 and 7.4.1.5.2.

Postulated conditions or events resulting in control room inaccessibility are not defined; however, it is assumed these circumstances are not attended by destruction of any equipment within the control room.

7.4.1.5.1 Hot Shutdown

Sufficient instrumentation and controls are provided to achieve and maintain hot shutdown of the reactor should the control room become inaccessible.

Display of the following Nuclear Steam Supply System (NSSS) parameters is provided at the remote shutdown panel:

- A. Neutron log power level;
- B. Neutron count rate, (0CAN068301);
- C. Reactor coolant temperature;
- D. Pressurizer pressure;
- E. Pressurizer level;
- F. Steam generator pressure;
- G. Steam generator level;
- H. Letdown temperature;
- I. Regenerative heat exchanger outlet temperature;
- J. Letdown pressure;
- K. Condensate storage tank level; and,
- L. Condenser vacuum.

ARKANSAS NUCLEAR ONE
Unit 2

Control of the following equipment is provided at the remote shutdown panel:

- A. Pressurizer spray control valves;
- B. Letdown control valves; and,
- C. Steam Dump and Bypass System (the available equipment enables the operator to prevent excessive cooldown under certain conditions coincident with control room inhabitability by shutting all Steam Dump and Bypass Control System Valves; control consists of an emergency off switch and emergency off/condenser vacuum interlock reset switch).

Manual control of the equipment listed below is provided at the appropriate switchgear, distribution center, or local control center:

- A. Reactor trip circuit breakers;
- B. Steam dump and bypass valves;
- C. Feedwater control valves;
- D. Reactor coolant pumps;

Certain pumps and valves in the charging system;

- F. Certain pumps and valves in the feedwater trains; and,
- G. Certain pumps and valves in the Service Water System.

Manual control of proportional pressurizer heaters is provided at local panels 2C117 and 2C118.

7.4.1.5.2 Cold Shutdown

Cold shutdown (Mode 5) can be achieved from outside the control room through the use of suitable procedures and by virtue of local control of the equipment listed below in conjunction with the instrumentation and controls described above.

Display of the following additional parameters is provided at the remote shutdown panel to facilitate bringing the plant to the cold shutdown condition:

- A. Letdown flow;
- B. Reactor coolant pump status;
- C. Volume control tank level;
- D. Volume control tank pressure;
- E. Shutdown cooling flow;
- F. RPS/ESFAS pressurizer pressure pretrip indication (four channels);

ARKANSAS NUCLEAR ONE
Unit 2

- G. Low steam generator pressure pretrip indication (four channels); and,
- H. RPS/ESFAS pressurizer pressure trip bypass indication (four channels).

Control of the following additional equipment is also provided at the remote shutdown panel to bring the plant to a cold shutdown condition:

- A. Auxiliary spray control valve;
- B. Shutdown cooling flow control valves;
- C. Letdown diversion control valve;
- D. Letdown backpressure control valve;
- E. Volume control tank vent valve;
- F. RPS/ESFAS pressurizer pressure trip setpoint reset, (four channels);
- G. RPS/ESFAS pressurizer pressure trip bypass, (four channels); and
- H. Low steam generator pressure trip setpoint reset, (four channels).

Local control of the equipment listed below in conjunction with the instrumentation and controls described above will permit the plant to be brought to a cold shutdown condition:

- A. Safety injection tank isolation valves;
- B. Safety injection loop isolation valves;
- C. Certain valves in the shutdown cooling system;
- D. Low pressure safety injection pumps;
- E. Certain valves in the CVCS; and,
- F. Certain valves in the boron management system.

7.4.2 ANALYSIS

7.4.2.1 Conformance to IEEE 279

IEEE 279-1971, "Criteria for Protection Systems for Nuclear Power Generating Stations," establishes minimum requirements for the reactor protective and engineered safety features instrumentation and control systems. The instrumentation and controls associated with the safe shutdown systems are not defined as a protective system in IEEE 279; however, many criteria of IEEE 279 have been incorporated in the design of the instrumentation and controls for safe shutdown systems. Conformance with the applicable portions of IEEE 279, Section 4, is discussed in the following sections. This analysis does not apply to the instrumentation associated with emergency shutdown from outside the control room.

ARKANSAS NUCLEAR ONE
Unit 2

"4.1 General Functional Requirements"

The instrumentation and controls of the safe shutdown systems enable the operator to:

- A. Determine when a condition monitored by display instrumentation reaches a predetermined level requiring action; and,
- B. Manually accomplish the appropriate safety actions.

"4.2 Single Failure Criterion"

The instrumentation and controls required for safe shutdown are designed and arranged such that no single failure can prevent a safe shutdown, even in the event of loss of off-site power. Single failures considered include electrical faults, e.g. open, shorted or grounded circuits, and physical events, e.g. fires, missiles, resulting in mechanical damage. Compliance with single failure criterion is accomplished by providing redundancy of power supplies, actuation circuits, and by separating the redundant elements electrically and physically to achieve the required independence. Each of the provisions is discussed below.

A. Redundancy

Each of the systems required for safe shutdown consists of redundant subsystems and/or components for maximum system reliability. The emergency power system consists of two redundant emergency diesel generator sets. Each of the redundant components has automatic and/or manual actuation circuits which are separate from those provided for its redundant counterpart. Redundant instrumentation is provided to monitor RCS conditions. Each steam generator is provided with separate pressure and level monitoring instrumentation.

B. Electrical Separation

Control power for redundant circuits is fed from separate 125-volt DC buses. Power for redundant pumps and valves is supplied from separate emergency diesel generators. Components are divided into two independent load groups. Electrical separation between the electrical load groups is discussed in Section 8.3.

C. Physical Separation

Protection against the possibility of mechanical damage to both redundant portions of any instrumentation and control system required for safe shutdown has been achieved by spatial separation and/or the provision of physical barriers between redundant elements.

Physical separation within control panels is achieved by providing spatial separation between redundant circuitry or by a fire barrier. This separation is provided between control switches, controllers, relays and wiring necessary to actuate and control redundant components.

Cable trays and conduits containing redundant wiring and cables necessary to actuate and control redundant components are physically separated as discussed in Section 8.3.1.4.

ARKANSAS NUCLEAR ONE
Unit 2

Redundant system pumps, piping and other components are physically separated to ensure that no single failure can cause damage to both redundant components. This separation afforded by component separation is maintained for redundant instrumentation which is mounted on the piping or components and which is required for safe shutdown.

The redundant wiring and circuitry of the instrumentation and control systems required for safe shutdown are marked and identified as described in Section 8.3.1.4.

"4.3 Quality Control of Components and Modules"

The quality control enforced during design, fabrication, shipment, field storage, installation and component checkout used for instrumentation and control components required for safe shutdown and the documentation of control is in accordance with the quality assurance program covered in the Quality Assurance Program Manual (QAPM).

"4.4 Equipment Qualification"

The instrumentation and controls necessary to achieve safe shutdown are designed to operate in the design ambient conditions in the area in which they are located. Components located in the control room, which is normally air conditioned, are designed to operate in the ambient conditions associated with loss of air conditioning for the time necessary to achieve safe shutdown. Environmental design and qualification of electrical and instrumentation equipment is discussed in Section 3.11. Seismic qualification and testing are discussed in Section 3.10.

"4.5 Channel Integrity"

Preoperational testing and inspection is performed to verify that all components, automatic and manual controls, and sequences of the integrated systems provided for safe shutdown accomplish the intended design function.

"4.6 Channel Independence"

Safe shutdown system channel independence is achieved by electrical and physical separation as described in Item 4.2.

"4.7 Control and Protection System Interaction"

This requirement is not directly applicable. The entire discussion involves control systems.

"4.8 Derivation of System Inputs"

The safe shutdown system monitoring signals are direct measures of the desired variables except that level information is derived from appropriate differential measurements and reactor coolant flow is derived from RCP speed.

"4.9 Capability for Sensor Checks"

The safe shutdown system monitoring sensors are checked by either perturbing the monitored variable, by introducing and varying a substitute input to the sensor similar to the measured variable, or by cross-checking between channels.

ARKANSAS NUCLEAR ONE
Unit 2

"4.10 Capability for Test and Calibration"

The instrumentation and control components required for safe shutdown which are not normally in operation will be periodically tested. All automatic and manual actuation and control devices will be tested to verify their operability. Periodic testing is described in Section 4 of the Technical Specifications.

"4.17 Manual Initiation"

The safe shutdown systems are manually actuated. No single failure will prevent safe shutdown.

"4.20 Information Readouts"

All safe shutdown system monitoring and control channels are indicated. See Section 7.5 for a discussion of safety related display instrumentation.

"4.21 System Repair"

The safe shutdown systems are actuated manually; therefore, replacement or repair of components can be accomplished in reasonable time when the systems are not actuated. Outage of system components for replacement or repair will be limited by the Technical Specifications.

"4.22 Identification"

Identification of redundant channels is as described in Sections 7.1.2 and 8.3.

7.4.2.2 Conformance to IEEE 308

The electrical circuitry associated with the safe shutdown systems conforms to IEEE 308, "IEEE Standard Criteria for Class IE Electric Systems for Nuclear Power Generating Stations." The safe shutdown systems are described in Section 8.3.

7.4.2.3 Conformance to the Requirements of General Design Criterion 19

As described in Section 7.4.1.5, local emergency control is provided to maintain the plant in the hot shutdown condition in the event that the control room must be abandoned. See Section 3.1.

7.4.2.4 Consideration of Selected Plant Contingencies

7.4.2.4.1 Loss of Instrument Air Systems

None of the essential control or monitoring instrumentation is pneumatic. Electrical instrumentation is powered from the emergency power system. Therefore, the loss of instrument air will not degrade instrumentation and control systems required for shutdown of the plant.

ARKANSAS NUCLEAR ONE
Unit 2

7.4.2.4.2 Loss of Cooling Water to Vital Equipment

None of the instrumentation and controls required for safe shutdown rely on cooling water for operation.

7.4.2.4.3 Turbine Trip and Loss of Off-Site Power

In the event of loss of off-site power associated with turbine trip, power for safe shutdown is provided by the onsite emergency power system. The description and analysis of the emergency power system are discussed fully in Section 8.3. The emergency diesel generators will provide power for operation of pumps and valves. The station batteries will provide DC power for operation of control and instrumentation systems required to actuate and control essential components.

7.4.2.5 Emergency Shutdown From Outside the Control Room

Equipment and arrangements described in Section 7.4.1.5 are in response to General Design Criterion 19 which requires certain functional capabilities outside of the control room that are met as described in the following sections.

7.4.2.5.1 Design Capability for Prompt Hot Shutdown and to Maintain Hot Shutdown

Should the control room become inaccessible, the reactor may be manually tripped from the control room as it is being evacuated or from the reactor trip switchgear cabinet. Hot shutdown conditions may be maintained external to the control room as described in Section 7.4.1.5 by control of pressurizer pressure and level, feedwater flow, and atmospheric steam dump.

7.4.2.5.2 Cold Shutdown Through Suitable Procedures

Cold shutdown of the reactor without access to the control room is possible by means of instrumentation and controls described in Section 7.4.1.5 and suitable procedures.

7.5 **SAFETY-RELATED DISPLAY INSTRUMENTATION**

7.5.1 **DESCRIPTION**

This section provides a description of that display instrumentation available to the operator enabling the operator to adequately monitor conditions in the reactor, the Reactor Coolant System (RCS), containment, and safety-related process systems, and to perform any required manual safety functions.

The display instrumentation is tabulated in the following categories:

A. **Plant Process Display Instrumentation**

Information available to the operator for monitoring conditions in the reactor and related systems.

B. **Reactor Protective System (RPS) Monitoring**

Information available to the operator for monitoring the status of the RPS.

C. **Engineered Safety Features (ESF) System Monitoring**

Information available to the operator for monitoring the status of each ESF system.

D. **Control Element Assembly (CEA) Position Indication**

Information available to the operator for monitoring the position of the CEAs.

E. **Post Accident Monitoring Instrumentation**

Information available to the operator for monitoring the status of the reactor during and following an accident.

7.5.1.1 **Plant Process Display Instrumentation**

Table 7.5-1 lists the significant process instrumentation which is provided to inform the operator of the status of the reactor plant. This information, which is used for the startup, operation, and shutdown of the plant, is provided on the main control board. The information is provided in a form that is useful to the operator and may be indicated, recorded, or monitored in conjunction with a controlling function. Alternate indication and control instrumentation is provided at local stations outside the control room to allow reactor shutdown and maintenance of the reactor in a safe condition during hot shutdown or cold shutdown should the control room become inaccessible (see Section 7.4.1.5).

7.5.1.2 **Reactor Protective System Monitoring**

Even though the RPS is automatic and does not require operator action, sufficient information is provided in the control room to allow the operator to confirm that a limiting safety system setting has been reached and a trip has taken place. This information consists of indication of (1) process parameters which initiate reactor trip; (2) trip, pretrip, and bypass lights; (3) audible alarms; (4) CEA position information; and, (5) trip switchgear circuit breaker position indication.

ARKANSAS NUCLEAR ONE
Unit 2

Operating bypass indication as described in Section 7.1.2.9 is provided on the remote modules which are located on the main control board. Individual trip channel bypass indication is provided locally at the Plant Protection System (PPS) as well as on the remote modules on the main control board (see Sections 7.2.1, 7.5.1.1 and 7.5.1.4).

7.5.1.3 Engineered Safety Features Monitoring

The Engineered Safety Features Actuation System (ESFAS) continuously monitors the various system input parameters and performs the actuation logic required to initiate safeguards should these inputs reach their trip setpoints. The ESF systems are designed such that their actuation occurs automatically in the event of an accident without the requirement for operator action.

After the automatic actuation of the ESF systems, they will continue to function properly without operator action. When the transfer of safety injection pump suction from the refueling water tank to the containment sump is required, the Recirculation Actuation Signal (RAS) will automatically actuate this transfer.

Post-accident information is available in the control room to allow the operator to monitor system performance. This information consists of valve position indication, pump operating status, flow indication, and indication of the process parameters which actuate ESF systems (see Section 7.5.1.5). In addition, four control modules, each associated with one channel of the PPS are located on the control board to provide indication of the pretrip, trip, and bypass condition of each of the actuation system input signals. Individual trip channel bypass indication is provided locally at the PPS as well as on the remote modules of the main control board.

7.5.1.4 CEA Position Indication

Two diverse, independent systems of CEA position indication provide CEA position information to the operator. The systems are the pulse counting CEA position indication system and the reed switch CEA position indication system. These systems are described below.

7.5.1.4.1 Pulse Counting CEA Position Indication System

The pulse counting CEA position indication system infers each CEA position by maintaining a record of the "RAISE" and "LOWER" control pulses sent to each magnetic jack Control Element Drive Mechanism (CEDM). The pulse counting CEA position signal associated with each CEA is reset to zero whenever the rod drop contact (located within the reed switch position transmitter housing) is closed. This permits the pulse counting system to automatically reset the position to zero whenever a reactor trip occurs or whenever a CEA is dropped into the core. This system is incorporated in the plant computer. A printout is available, on operator demand, of selected CEA positions. The plant computer also provides CEA deviation information.

The pulse counting CEA position indication system provides position information to CEA related alarm programs and the Core Operating Limit Supervisory System (COLSS) contained in the plant computer. The plant computer CEA and COLSS alarms can be displayed on the plant computer monitors and hard copy printouts are available on demand. The alarms are included in the system design to provide the operator with information required to maintain proper CEA control and to aid in the monitoring of CEA limits. The following alarms are provided by the pulse counting CEA position indication system:

ARKANSAS NUCLEAR ONE
Unit 2

A. Power Dependent Insertion Limits (PDIL) Alarms

An alarm is provided in the event CEA insertion exceeds predetermined limits required to maintain adequate shutdown margin and to ensure CEA insertion consistent with the CEA ejection analysis. Further definition of the PDIL function is provided in Section 7.7.1.4.

B. Pre-Power Dependent Insertion Limits (PPDIL) Alarm

This alarm is provided to advise the operator of an impending approach to PDIL.

C. Out of Sequence Alarm

An alarm is provided to alert the operator in the event the CEA groups are inserted in a sequence other than the pre-determined acceptable sequence.

D. CEA Deviation Alarm

An alarm is provided to alert the operator in the event the deviation in position between the highest and lowest CEA in any group exceeds a predetermined allowable deviation.

E. Core Operating Limit Supervisory System Alarms

The pulse counting CEA position indication system provides input data to COLSS. This data is used in the COLSS power distribution calculations and alarms are initiated in the event the affected COLSS limits are reached. The basis for the COLSS alarms is discussed in Section 7.7.1.3.2 and the use of the pulse count CEA position information is discussed in Section 7.7.1.3.3.3.

7.5.1.4.2 Reed Switch CEA Position Indication System

The reed switch CEA position indication system utilizes a series of magnetically actuated reed switches (reed switch position transmitters) to provide signals representing CEA position. Two independent reed switch position transmitters are provided for each CEA. The Reed Switch Position Transmitter (RSPT) provides an analog position indication signal and three physically separate discrete reed switch position signals. The analog position indication system utilizes a series of magnetically actuated reed switches spaced at 1½-inch intervals along the RSPT assembly and arranged with precision resistors in a voltage divider network. The RSPT is affixed adjacent to the CEDM pressure housing which contains the CEA extension shaft and actuating magnet. The analog output signal is proportional to the CEA position within the reactor core. The three discrete reed switch position signals are contact closure signals from three separately located reed switches. These signals are an upper electrical limit, a lower electrical limit and a rod drop contact.

The analog reed switch CEA position signals are input to the DNBR/LPD calculation system (see Sections 7.2.1.1.2.2 and 7.2.1.1.2.5). CEA position information is provided to the Core Protection Calculators (CPCs) directly and also to the CEA calculators (see Section 7.2.1.1.2.5). The CEA Calculators display CEA position to the operator in a bar chart format and in inches withdrawn on the CPC/CEAC operator's modules in Channels B and C on the main control board. In addition, a digital readout is provided which can be utilized to read the position of a CEA group and deviated CEA. The operator can address any analog position signal for display

ARKANSAS NUCLEAR ONE
Unit 2

on the operator's module. In addition to the displays, CEA deviation information is provided by the CEA calculators to the CPCs and a CEA deviation alarm. The CEA deviation alarm is provided to the the plant annunciator system in the event a CEA calculator indicates that the difference between the highest and lowest CEA positions in a group exceeds a predetermined allowable deviation. The CEA deviation information is used in the CPCs determination of power distribution as defined in Section 7.2.1.1.2.5. The power distribution is then factored into the low Departure from Nucleate Boiling Ratio (DNBR) and high local power density trip function. Pretrip alarms are initiated in the event the DNBR or local power density trip limits are approached. A pretrip alarm light is provided on the PPS control panel (both local and remote). Also, a pretrip alarm is provided to the plant annunciator system.

The three discrete CEA position switches provide signals (contact closure signals) to the Control Element Drive Mechanism Control System (CEDMCS) as shown in Figure 7.2-14. The signals are utilized to provide CEA limit indication on the main control board and also to provide input to the CEA control interlocks. Each of the three discrete reed switch contacts actuates an interface relay located within the CEDMCS. These relays provide contact signals for indication and control and, in the case of the rod drop switch, an additional contact signal is provided to the plant computer to set the pulse counting system (see Section 7.5.1.4.1). The upper and lower electrical limits indication appears as two separate lights on the CEDMCS Control Panel mounted on the main control board. The CEA drop indication is available on the SPDS CEA mimic display.

7.5.1.5 Post Accident Monitoring Instrumentation

Indications of plant variables are required by the control room operating personnel during accident situations to (1) provide information required to permit the operator to take preplanned manual actions to accomplish safe plant shutdown; (2) determine whether the reactor trip, safety-feature systems, and manually initiated safety systems and other systems important to safety are performing their intended functions (i.e., reactivity control, core cooling, maintaining reactor coolant system integrity, and maintaining containment integrity); and (3) provide information to the operators that will enable them to determine the potential for causing a gross breach of the barriers to radioactivity release (i.e., fuel cladding, reactor coolant pressure boundary, and containment) and to determine if a gross breach of a barrier has occurred. In addition to the above, indications of plant variables that provide information on operation of plant safety systems and other systems important to safety are required by the control room operating personnel during an accident to (1) furnish data regarding the operation of plant systems in order that the operator can make appropriate decisions as to their use and (2) provide information regarding the release of radioactive materials to allow for early indications of the need to initiate action necessary to protect the public and for an estimate of the magnitude of any impending threat.

7.5.2 ANALYSIS

7.5.2.1 Analysis of Plant Process Display Instrumentation

Plant process instrumentation is provided to give the operator sufficient information to monitor conditions in the plant and perform any operations that are required. The following design criteria were used in the selection of plant instrumentation:

ARKANSAS NUCLEAR ONE
Unit 2

- A. To provide continuous monitoring of process parameters required by the operator;
- B. To provide a permanent record of those parameters for which trend information is useful;
- C. To provide display information to the operator that is reliable, comprehensible, and timely;
- D. To provide multiple channels of indication for RPS and ESFAS process parameters to allow cross-checking of channels; and,
- E. To provide instrumentation display that adequately monitors the parameter over the range required for various conditions.

The information provided is sufficient to allow the operator to accurately assess the conditions within the plant systems and, in a timely manner, perform those appropriate actions to maintain the plant systems within the conditions assumed in the safety analysis, Chapter 15. In addition, the information allows cross-checking of RPS and ESFAS measurement channels to assure operational availability of these channels as discussed in Sections 7.2.1 and 7.3.1.

7.5.2.2 Analysis of Reactor Protective System Monitoring

Sufficient information is provided to allow confirmation that a trip has occurred and to determine the process parameter that has provided a trip input.

CEA insertion information can be determined by the operator after a trip by CEA Calculator Operator's Module Displays and CEA limit light indication (see Section 7.5.1.4).

Indication of neutron levels as well as other reactor and RCS information is provided for the operator in the control room.

The following design criteria were used in the selection of information that is provided to the operator:

- A. System conditions requiring operator attention during routine plant operations and at the time of reactor trip are displayed on the control board;
- B. Annunciation at the control board of all operations performed at the PPS cabinet affecting the function of the system;
- C. Annunciation and indication at the control board of any plant variables that are manually bypassed at the PPS cabinet; and,
- D. Indication of removal of a bypass.

7.5.2.3 Analysis of Engineered Safety Features Monitoring

Sufficient information is provided to the operator to allow monitoring of the status of the ESF systems. The following design criteria were used in the selection of information that is provided to the operator:

ARKANSAS NUCLEAR ONE
Unit 2

- A. System conditions requiring operator attention or action during routine plant operations are displayed and/or controlled at the control board;
- B. Annunciation at the control board of all operations performed at the cabinet affecting the function of the system;
- C. Indication of plant variables that are manually bypassed; and,
- D. Indication of automatic removal of bypasses.

Consistent with the above criteria, the information shown in Table 7.5-2 is provided for the operator's use.

The information provided is sufficient to allow the operator to determine that manual actuation of an ESF system is required and to confirm proper system operation after automatic initiation.

Input parameters used for actuation are indicated on the control board as are positive indications that pumps and valves have actuated and that flows have been established.

7.5.2.4 Analysis of Control Element Assembly Position Indication

CEA position indication is provided to allow the operator to easily determine the position of all of the CEAs within the reactor core. The information is presented in a form that can be easily assessed by the operator. He can easily determine that the CEAs are in the required position, that a CEA has dropped into the core, or that the CEA positions are as required after a reactor trip.

The CEA position indication system is designed to provide the following:

- A. Position readouts of all CEAs (multiple CEAC operator's module displays are required);
- B. A means of alerting the operator to deviation of CEAs within a group;
- C. A permanent record of the position of any or all CEAs;
- D. Separate "full-in" and "full-out" indication for each CEA; and,
- E. Redundant and diverse means of indicating CEA position.

7.5.2.5 Analysis of Post-Accident Monitoring Instrumentation

Table 7.5-3 lists the variables committed to by ANO and recommended by Regulatory Guide 1.97, Revision 3. The table includes the assigned category, range, redundancy, power supply, type of control room display, availability on the Safety Parameter Display System (SPDS), and comments.

ARKANSAS NUCLEAR ONE
Unit 2

7.5.2.5.1 Table Format

The power supply column specifies the type of available power as follows:

1E - instrument is powered from a qualified 1E power source.

UPS - instrument is powered from a battery backed uninterruptable power source

DG - instrument is powered from a source that is backed by the emergency diesel generators.

OP - instrument is powered from the normal offsite power source.

The SPDS column specifies whether the variable is available on the SPDS display. The SPDS display is located in both the Unit 1 and Unit 2 Control Rooms, the Technical Support Center, and the Emergency Offsite Facility.

Another type of Control Room Display is the Radiological Dose Assessment Computer System (RDACS). The RDACS is a computerized dose projection system which combines effluent release data with real time meteorological data. RDACS terminals are located in the same facilities as the SPDS.

7.5.2.5.2 Definition of Variables

The variables identified in Table 7.5-3 are divided into five types in accordance with Regulatory Guide 1.97. The definition for each type of variable is as follows:

Type A - Those variables which provide the primary information required to permit the control room operators to take specific manual actions for which no automatic control is provided, and that are required for a safety system to accomplish its safety function for design basis accident scenarios. Type A variables are plant specific and were selected based on a review of Emergency Operating Procedures to identify information essential for the direct accomplishment of specified safety functions. As a result of a review of the ANO-2 Emergency Operating Procedures, the following variables were identified as Type A:

RCS Hot Leg Water Temperature
RCS Pressure
Steam Generator Level
Steam Generator Pressure

HPSI System Flow has subsequently been upgraded to Type A

Type B - These variables provide information to indicate whether plant safety functions are being accomplished. Plant safety functions are defined as: reactivity control, core cooling, maintaining reactor coolant system integrity, and maintaining containment integrity.

Type C - These variables provide information to indicate the potential for breach of the barriers to fission product release. The barriers are defined as: fuel cladding, primary coolant pressure boundary, and containment.

ARKANSAS NUCLEAR ONE
Unit 2

Type D - These variables provide information to indicate the operation of individual safety systems and other systems important to safety. These variables help the operator make appropriate decisions in using the individual systems important to safety in mitigating the consequences of an accident.

Type E - These variables provide information for use in determining the magnitude of the release of radioactive materials and for use in assessing the consequences of such releases.

7.5.2.5.3 Evaluation Criteria

As recommended by Regulatory Guide 1.97, each variable type was evaluated based on the importance to safety of the measurement of the specific variable. The criteria are therefore separated into three categories for a graded approach as follows:

Category 1: provides the most stringent requirements and is intended for key variables. Type A, B and C key variables fall into this category.

Category 2: provides less stringent requirements and applies to instrumentation designated for indicating system operating status. Type D and E key variables fall into this category.

Category 3: provides requirements that will ensure that high quality off-the-shelf instrumentation is obtained and applies to backup and diagnostic instrumentation. This category is also used when the state-of-the-art will not support requirements for higher qualified instrumentation. All backup variables fall into this category.

The specific design and qualification criteria used to evaluate each variable, based on the category classification, are presented below:

Category 1:

Environmental Qualification - Currently installed instrumentation was evaluated to determine if, as a minimum, the equipment meets the requirements of IE Bulletin 79-01B and 10 CFR 50.49. This determination was based on having either actual environmental qualification documentation available or documentation on similar equipment available.

Seismic Qualification - Currently installed instrumentation was evaluated against the seismic qualification criteria used as a basis for the plant operating license. These criteria are described in Section 3.10. The ANO-2 seismic criteria are synonymous with the requirements for Class 1 equipment as defined in IEEE Standard 344-1971, 1975, or 1987. New instrumentation will be installed in accordance with the criteria specified.

Redundancy and Sensor Location - A response of "Yes" in the redundancy column indicates that redundant channels are available up to and including any isolation device and that the channels are both electrically independent and physically separate from each other and from non-safety equipment in accordance with IEEE Standard 279-1971. This standard was used as the basis for the ANO-2 operating license and meets the intent but not all the strict requirements for physical separation of redundant channels as defined in Regulatory Guide 1.75. Where applicable, the general sensor location is listed.

ARKANSAS NUCLEAR ONE
Unit 2

Power Supply - All Category 1 instruments are supplied with power from a Class 1E power supply. The ANO-2 Class 1E power system is designed to meet the requirements of IEEE 279-1971, IEEE 308-1971, 10CFR50 including Appendices A and B, and Regulatory Guide 1.6.

Quality Assurance - All instrumentation was, and will continue to be, purchased and installed in accordance with the provisions of the NRC approved Quality Assurance Program described in the Quality Assurance Program Manual.

Control Room Display and Recording - Continuous real-time display of at least one channel is provided in the Control Room. Recording of the instrument readout information is provided for at least one of the redundant channels, although this recording may be "Non-Q". It may also be used for the continuous display above if qualified. Variables which input to the SPDS may be displayed and/or trended on demand. Where it has been determined that direct and immediate trend or transient information is essential for operator information or action (type A variable), a continuous dedicated recorder is provided with redundant backup recording and trending available on SPDS and redundant dedicated indicators in the control room that can be utilized for trend information if necessary (one of the redundant dedicated indicators may be the continuous dedicated recorder listed above).

Category 2:

Environmental Qualification - Same as Category 1.

Seismic Qualification - No specific provision.

Redundancy - Not required.

Power Supply - Powered by DG or UPS, both considered to be highly reliable.

Quality Assurance - Same as Category 1.

Control Room Display - "On-demand" or continuous display is provided in the control room. No direct or immediate trend or transient information was determined to be essential for operator information or action.

Category 3:

Environmental Qualification - Not required.

Seismic Qualification - Not required.

Redundancy - Not required.

Power Supply - Powered by an available source of power.

Quality Assurance - Same as Category 1.

Control Room Display - Same as Category 2.

7.6 ALL OTHER SYSTEMS REQUIRED FOR SAFETY

7.6.1 DESCRIPTION

This section includes a description of those systems required for safety which have not been discussed in Sections 7.2 through 7.5. These systems include instrumentation to prevent overpressurization of low pressure systems.

7.6.1.1 Shutdown Cooling System Interlocks

7.6.1.1.1 Description

The Shutdown Cooling (SDC) System, described in Section 9.3.6, is designed as a low pressure system. The shutdown cooling suction line inside containment contains two normally closed, locked-closed, motor operated valves in series (2CV-5084-1 and 2CV-5086-2), ensuring that the low pressure piping is not exposed to normal Reactor Coolant System (RCS) pressure. Administrative controls, procedures and interlocks prevent opening these valves before the RCS has been depressurized.

Key locked control switches are provided in the control room to permit opening of the isolation valves. Interlocks prevent the valves from being opened unless the RCS pressure is below 350 psia. If a valve is open and RCS pressure rises above the setpoint, an alarm is received in the control room; however, operating limits are bounded by Section 3.6.1. All other interfaces between the RCS and systems with lower design pressures are addressed in Section 5.2.1.19.

Two independent and diverse pressurizer pressure measurement channels and bistables provide the permissive signals for SDC isolation valve interlocks. Pressure measurement channel 2PC-4623-1 supplies a permissive signal for SDC isolation valve 2CV-5084-1. This channel also supplies a permissive signal for two safety injection tank isolation valves, 2CV-5003-1 and 2CV-5023-1. Pressure measurement channel 2PS-4623-2 supplies a permissive signal for SDC isolation valve 2CV-5086-2. This channel also supplies a permissive signal for the other two safety injection tank isolation valves, 2CV-5043-2 and 2CV-5063-2. Isolation is provided between SDC valve interlocks and the Safety Injection Tank (SIT) valve interlocks by means of two interposing relays per pressure channel which are an integral part of the electronic bistable controller. One relay isolates SDC interlock and the other isolates the SIT interlocks. The instrument channels 2PC-4623-1 and 2PS-4623-2 are more fully described in Section 7.6.2.2.1.

Loss of electric power to either pressure measurement channel can cause the associated SDC valve mispositioned alarm to actuate. The logic for valve 2CV-5084-1 is identical with the exception of being served by pressure channel 2PC-4623-1.

7.6.1.1.2 Design Basis Information

The design basis for the shutdown cooling interlocks is to prevent an equipment fault or an operator action from producing an unsafe condition. The interlocks have no protective function as defined in IEEE 279-1971. However, using Section 3 of IEEE 279-1971 as a guideline, the following paragraphs respond to the provisions identified in Section 3 insofar as they are applicable:

ARKANSAS NUCLEAR ONE
Unit 2

- A. The interlocks will function to prevent opening the shutdown cooling line isolation valves whenever pressurizer pressure exceeds a preset value;
- B. Pressurizer pressure will be monitored to provide the required function;
- C. Two separate, physically independent and diverse pressure sensors located on separate pressurizer nozzles are provided, either of which will perform the required function;
- D. Operating procedures, administrative controls and the interlocks all serve to ensure that the isolation valves are not open when pressure in the RCS is greater than the design pressure of the shutdown cooling suction lines; and,
- E. When system pressure exceeds the setpoint and the valve is open, an alarm is received in the control room.

7.6.1.2 Safety Injection Tank Isolation Valve Interlocks

7.6.1.2.1 System Description

Four safety injection tanks are provided to flood the reactor vessel with borated water following RCS depressurization as a result of a Loss of Coolant Accident (LOCA). During normal plant operation, each Safety Injection Tank (SIT) is isolated from the RCS by two check valves in series. The safety injection tanks automatically discharge into the RCS if system pressure decreases below the SIT pressure.

It is essential that the isolation valves on the SITs remain open whenever the RCS is at pressure. To ensure that the SIT valves remain open, these fail-as-is valves are normally key locked open in the control room and one of the series of motor circuit breakers for each valve is locked open, effectively blocking power to the valve operator. Under normal operating conditions, the closed position of the valve is annunciated in the control room. In addition, a Safety Injection Actuation Signal (SIAS) "OPEN" signal is provided to each valve even though the valves are locked open.

The closing of a safety injection tank discharge valve can be accomplished by:

- A. Manual operation of a control switch in the control room; or
- B. Manual operation of a control switch at the Motor Control Center (MCC).

The control room switch is a maintained contact, key-operated switch; it is locked in the valve-open position.

These design features ensure that no single failure, including a hot short, will cause valve closure during normal reactor operations.

Visual indication of the open or closed status of the valve is provided by indicator lights, actuated by a separate set of stem mounted valve position limit switches. The indicator lights are powered from Class 1E 125-volt DC supply totally independent of the 480-volt AC valve operator power supply. In addition, the reactor coolant pressure signal is interlocked with a separate valve position limit switch to sound an alarm in the control room if the valves are not fully open when the pressurizer pressure is above 675 psia.

ARKANSAS NUCLEAR ONE
Unit 2

Pressurizer pressure interlocks are provided to automatically open these valves (should they be closed) when increasing RCS pressure reaches 675 psia. The interlocks are served by pressurizer pressure measurement channels 2PC-4623-1 and 2PS-4623-2, which also serve the SDC isolation valve interlocks.

7.6.1.2.2 Design Basis Information

The design basis for the safety injection tank isolation valve pressure interlocks is to provide a means of ensuring that the safety injection tanks are not isolated from the RCS when the system pressure exceeds a preset value. The interlocks have no protective function as defined in IEEE 279-1971. However, using Section 3 of IEEE 279-1971 as a guideline, the following discussion responds to the provisions identified in Section 3, insofar as they are applicable:

- A. The pressure interlocks shall function to open the safety injection tank isolation valves whenever pressurizer pressure exceeds a preset value;
- B. Pressurizer pressure shall be monitored to provide the required function;
- C. Two separate, physically independent pressure sensors on separate pressurizer nozzles shall be provided, either of which will perform the required function;
- D. Operating procedures, administrative controls and the interlocks all serve to ensure that the isolation valves are open when pressure in the RCS is greater than a preset value; and,
- E. No protective operator action is required. When system pressure exceeds the setpoint, the interlock functions to open the valves.

The design of the control circuits for the SIT isolation valves incorporates the following features:

- A. Automatic opening of the valves when either (1) the RCS pressure exceeds a pre-selected value, or (2) a safety injection signal has been initiated. Both signals are provided to the valves.
- B. In the event of loss of power supply, pressurizer pressure measurement channel output relays and also the SIAS group relays fail to the "SAFE" position generating a "VALVE OPEN" command signal.
- C. Visual indication of the open or closed status of the valves, actuated by sensors on the valves is provided in the control room. The indication is independent of the valve power supply.
- D. An audible and visual alarm is provided, actuated by a sensor on the valves when the valves are not in the fully open position and indicates the "SYSTEM INOPERABLE" status.
- E. A SIAS is provided to open the valves. There are no overrides or bypasses that would inhibit the SIAS signal and prevent the valves from opening when required.

7.6.1.3 Low Temperature Overpressure Protection (LTOP)

7.6.1.3.1 System Description

Two LTOP relief valves (2PSV-4732 and 2PSV-4742) are aligned via operator action during cooldown and isolated during heatup to support the Technical Specifications requirement that LTOP be enabled when any RCS cold leg temperature is ≤ 220 °F. The setpoint of the LTOP relief valve is less than or equal to 430 psig. Overpressure protection may also be provided by an equivalent 6.38 in² RCS opening.

The design requires only that the operator line up the low setpoint relief valves during cooldown and isolate during heatup. An alarm circuit is provided to alert the operator to align the relief valves as discussed in Section 7.6.2.3.

7.6.1.3.2 Design Basis Information

This system design meets the following criteria.

- A. LTOP Design Basis Event – The relief capacity of one relief valve (2PSV-4732 or 2PSV-4742) can accommodate mass or energy addition events. The limiting LTOP design basis event is the mass addition event. The analyses assume that the safety injection tanks (SITs) are either isolated or depressurized such that they are unable to challenge LTOP relief setpoints. The relief valves will be able to mitigate (1) the starting of the first reactor coolant pump when the indicated pressurizer water volume is < 910 ft³, and when the secondary water temperature of the steam generator is less than or equal to 100 °F above the RCS temperature (energy addition event), or (2) the simultaneous injection of one HPSI pump and all three charging pumps (mass addition event). Because the SDC system effectively becomes an extension of the RCS when SDC is in service, the LTOP relief valves act as overpressure protection devices for the SDC system. The transient analysis will confirm that the maximum discharge backpressure on the relief valve during the limiting overpressure transient is less than 50% of the set pressure of 430 psig. The potential for unstable valve cycling behavior is averted by maintaining LTOP relief valve backpressure less than 50% of the set pressure.
- B. Credit for Operator Action - No credit has been taken for operator action after the low setpoint relief valves have been lined up or an equivalent RCS opening has been established.
- C. Single Failure Criteria - In order that the RCS be protected from a single failure in the protection system, a redundant relief valve train is included in the protection system design. If redundancy is not available, an equivalent RCS opening is established.
- D. Testability - The capability to test the relief valves has been incorporated into the system design. The testing will be done to the guidelines contained in ASME OM Code.
- E. Seismic Design and IEEE 279 Criteria - The relief valve isolation valve control and alarm circuitry meets Seismic Category 1 and IEEE 279 criteria. Also, the overpressure protection relief valves meet Seismic Category 1 criteria (see Section 7.6.2.3 for further details).

ARKANSAS NUCLEAR ONE
Unit 2

7.6.1.4 Other Systems

Historical data removed - To review the exact wording please refer to Section 7.6.1.3 of the FSAR.

7.6.2 ANALYSIS

7.6.2.1 Shutdown Cooling System Interlocks

7.6.2.1.1 Requirements

There are no specific regulatory guides or general design criteria which apply to these interlocks.

The requirements of IEEE 279-1971 are written expressly for protection systems, and as such, they are not directly applicable to these interlocks. A discussion of the extent to which these interlocks comply with IEEE 279 is provided below:

The following discussion refers to the requirements set forth in the respective items of Section 4 of IEEE 279-1971;

"4.1 General Functional Requirement"

The interlocks have been designed as Class 1E circuits.

"4.2 Single Failure Criterion"

Any single failure leading to loss of one channel will not result in opening both of the valves installed in series. Loss of both interlock channels, coupled with violation of administrative controls and procedures is required to remove the pressure boundary between the RCS and the piping comprising the SDC suction lines.

"4.3 Quality Control of Components and Modules"

The sensors for these interlocks are subject to the same quality requirements that are imposed on protection system instrumentation.

"4.4 Equipment Qualification"

Type tests are performed on the instrumentation to assure operation during expected conditions of seismic activity.

"4.5 Channel Integrity"

The interlocks are only required to maintain functional capability in the normal plant operating environment. They serve no protective function during abnormal or accident situations, as defined in IEEE 279-1971.

"4.6 Channel Independence"

The pressure transmitters are located on separate pressurizer nozzles, and separation is maintained between channels.

ARKANSAS NUCLEAR ONE
Unit 2

"4.7 Control and Protection System Interaction"

The interlocks have no protective function during abnormal or accident situations, as defined in IEEE 279-1971. Thus, there is no control and protective system interaction.

"4.8 Derivation of System Inputs"

Pressurizer pressure is used as the signal for these interlocks.

"4.9 Capability for Sensor Checks"

The operational availability of the two pressure sensing channels can be determined by comparing their outputs when the pressure is in the range of interlock operation.

"4.10 Capability for Test and Calibration"

Since the interlocks will be in effect when the plant is at operating pressure, the capability of testing their function will be available by observing that the valve does not open when the hand switch is moved to the open position. Additional testing of the pressure interlock can be performed when the plant is shut down and in a reduced pressure condition by inserting a test signal to the bistable.

"4.11 Channel Bypass or Removal From Operation"

Removal of one instrument channel for testing does not compromise system reliability. Failure of the remaining instrument channel during a test outage would not create an unacceptable situation, since administrative controls (key locks) effectively preclude inadvertent opening of the valves by the operator.

"4.19 Identification of Protective Action"

The isolation function is indicated by the valve position indication.

"4.20 Information Readout"

The readout consists of two pressure indicators and position indication for each of the valves. This provides the operator with clear, concise information.

"4.21 System Repair"

The components are accessible for repair. One channel can be placed out of service without jeopardizing the isolation of SDC.

"4.22 Identification"

The instrumentation and cables associated with SDC interlocks will not be uniquely identified as such. The channels will, however, be identified to distinguish between redundant channels.

ARKANSAS NUCLEAR ONE
Unit 2

7.6.2.2 Safety Injection Tank Isolation Valve Interlocks

7.6.2.2.1 Requirements

Historical data removed - To review the exact wording please refer to Section 7.6.2.2.1 of the FSAR.

There are no specific regulatory guides or general design criteria which apply to these interlocks. However, instrument channels 2PS-4623-2 and 2PC-4623-1 provide permissive interlocks for SDC, as described in Section 7.6.1.1.1. 2PS-4623-2 and 2PC-4623-1 are, however, provided with separate switch contacts and setpoints for SDC interlocks and the SIT isolation valves. Either an SIAS or a manual control switch, e.g. 2HS-5023-1, "OPEN" signal will open the respective SIT isolation valve regardless of the switch status of any of the 2PC-4623-1 or 2PS-4623-2 interlock contacts. The above provisions ensure that no single failure of SDC isolation valves will prevent the opening of any one of the SIT isolation valves.

The requirements of IEEE 279-1971 are written expressly for protection systems, and as such, they are not directly applicable to these interlocks. A discussion of the extent to which these interlocks apply to this IEEE standard is provided below.

The following discussion refers to the requirements set forth in the respective items of Section 4 of IEEE 279-1971.

"4.1 General Functional Requirement"

The interlocks have been designed as Class 1E circuits and will function under abnormal and accident conditions.

"4.2 Single Failure Criterion"

Loss of the interlock channels, coupled with violation of administrative controls and procedures is required to prevent the isolation valves from opening as RCS pressure is increased or to permit closing a valve when at pressure. No single failure of an interlock channel can prevent system operation when it is required.

"4.3 Quality Control of Components and Modules"

The sensors for these interlocks are subject to the same quality requirements that are imposed on protection system instrumentation.

"4.4 Equipment Qualification"

Type tests (as described in Sections 3.10 and 3.11) are performed on the instrumentation to ensure operation during expected conditions of seismic activity.

"4.5 Channel Integrity"

The interlocks have been designed to maintain functional capability when exposed to accident environments. They will not preclude safety injection during accident conditions.

ARKANSAS NUCLEAR ONE
Unit 2

"4.6 Channel Independence"

The pressure transmitters are located on separate pressurizer nozzles, and separation is maintained between channels.

"4.7 Control and Protection System Interaction"

The interlocks automatically open the valves when RCS pressure reaches 675 psia.

"4.8 Derivation of System Inputs"

Pressurizer pressure is used as the signal for these interlocks.

"4.9 Capability for Sensor Checks"

The operational availability of the two pressure sensing channels can be determined by comparing their outputs when the pressure is in the range of interlock operation.

"4.10 Capability for Test and Calibration"

The capability of testing the interlock function at operating pressure is available. Additional testing of the pressure interlock can be performed when the plant is shut down and in a reduced pressure condition by inserting a test signal to the bistable.

"4.11 Channel Bypass or Removal from Operation"

Removal of one instrument channel for testing does not compromise system reliability. Failure of the remaining instrument channel during a test outage would not create an unacceptable situation, since administrative controls (key locks) effectively preclude inadvertent opening of the valves by the operator.

"4.19 Identification of Protective Action"

The isolation function is indicated by the valve position indication.

"4.20 Information Readout"

The readout consists of two pressure indicators and position indication for each of the valves. This provides the operator with clear, concise information.

"4.21 System Repair"

The components are accessible for repair. One channel can be placed out of service without jeopardizing the isolation of SDC.

"4.22 Identification"

The instrumentation and cables associated with SDC interlocks will not be uniquely identified as such. The channels will, however, be identified to distinguish between redundant channels.

ARKANSAS NUCLEAR ONE
Unit 2

7.6.2.3 Low Temperature Overpressure Protection

7.6.2.3.1 Requirements

The alarm circuit, which ensures that the control room operator is alerted if the temperature of the RCS drops below 270 °F and if any of the isolation valves are not fully open, meets the design basis and requirements of IEEE 279-1971, as delineated below.

Design Basis

The only variables which are needed to effect Low Temperature Overpressure Protection (LTOP) operation are pressure and temperature. The temperature inputs to the system logic are fully qualified channels and are physically separated from one another. The temperature limits (setpoints) selected are 270 °F and 280 °F. The dead-band allows sufficient time for the control room operator to open the valve so that the system is operable below 270 °F. The equipment has been seismically qualified to Arkansas Nuclear One - Unit 2 design basis requirements so it is able to withstand the anticipated transients for the system. The accuracies of the instrumentation are adequate for the appropriate operation of the system. The ranges of measured variables are sufficient to assure proper action is taken.

Design Requirements

The following discussion refers to the requirements set forth in the respective items of Section 4 of IEEE 279-1971.

"4.1 General Functional Requirement"

As no automatic function is performed by the system design, this requirement is not applicable.

"4.2 Single Failure Criterion"

The alarms for LTOP are on separate safety channels and are generated by redundant sensors.

"4.3 Quality Control of Components and Modules"

The quality control enforced for LTOP is in accordance with the quality assurance program covered in the Quality Assurance Program Manual (QAPM).

"4.4 Equipment Qualification"

All electrical components have been seismically qualified in accordance with design basis requirements.

"4.5 Channel Integrity"

The temperature inputs to the system logic are fully qualified channels and are physically separated from one another.

"4.6 Channel Independence"

Channel independence is achieved by physical and electrical separation.

ARKANSAS NUCLEAR ONE
Unit 2

"4.7 Control and Protection System Interaction"

1. Classification of Equipment - Not applicable.
2. Isolation Devices - Qualified isolators are utilized to isolate the LTOP alarm circuitry from the inputs to other systems.
3. Single Random Failure - The system has been designed to be immune to any single random failure. The failure of a control system will not affect the design.
4. Multiple Failures Resulting From a Credible Single Event - The failure of a control system will not affect this design.

"4.8 Derivation of System Inputs"

All inputs to the alarm logic come from direct measurements.

"4.9 Capability for Sensor Checks"

The alarm logic can be tested from the sensor to the alarm without compromising the RCS integrity.

"4.10 Capability for Test and Calibration"

The alarm logic can be tested from the sensor to the alarm and the isolation valves can be individually tested without compromising the system.

"4.11 Channel Bypass or Removal From Operation"

The isolation valves can be individually tested without compromising the system.

"4.18 Access to Setpoint Adjustments, Calibration, and Test Points"

All electrical setpoints can be administratively adjusted.

"4.20 Information Readout"

All indication is derived directly from the sensors. Indication is continuous.

"4.21 System Repair"

Any electrical malfunction can be identified and corrected.

"4.22 Identification"

All components are identified with unique identification.

7.6.2.4 Other Systems

Historical data removed - To review the exact wording please refer to Section 7.6.2.3 of the FSAR.

7.6.2.5 Safety Parameter Display System (SPDS)

The SPDS is a computer-based system designed to monitor and display to the operator a concise set of parameters from which the safety status of the plant can be readily and reliably ascertained. The system functions as the SPDS for both the ANO-1 and ANO-2 Control Rooms and provides plant status information for the Technical Support Center (TSC) and Emergency Operations Facility (EOF).

7.6.2.5.1 Background

The development of an SPDS began in 1979 as part of an in-house initiated EOP upgrade program and expanded the development early in 1980, in response to the "Lessons Learned" NUREGs 0578 and 0585. NUREG-0737, issued in October 1980, required the implementation of the plant SPDS. NUREG-0737 referenced NUREG-0696 for use as the criteria for design of the SPDS and Technical Support Center (TSC)/Emergency Response Facility (ERF) instrumentation systems. However, NUREG-0696 was not issued until March 1981, so several modifications were required to the original computer system design as a result of the new guidance. Supplement 1 of NUREG-0737 was issued in December 1982 to provide additional clarification to certain NUREG-0737 requirements.

Supplement 1 also promoted an integrated approach for the implementation of the SPDS, upgraded Emergency Operating Procedure (EOP), control room design reviews, emergency response facilities and Regulatory Guide 1.97 instrumentation reviews. The present SPDS computer system is designed to meet the objectives of the above referenced NRC documents as described in the ANO-2 SPDS safety analysis submitted to the NRC April 30, 1984 (2CAN048402).

The SPDS concept was to display a small but critical subset of the information already presented by control room instrumentation in order to minimize information overload. Critical safety functions identified by NUREG 0737, Supplement 1 were carefully identified and parameters for their display selected in order to provide the operators with a concise set of data to aid them in rapidly and reliably determining the safety status of the plant. Selection of these parameters was also coordinated with the development of the upgraded ANO-2 EOP.

7.6.2.5.2 Design Basis

In accordance with NUREG 0737, Supplement 1, the SPDS was designed to assist the operator in implementing the upgraded EOP. The ANO-2 EOP was developed to achieve timely and accurate safety status assessment either with or without the SPDS. The design of the specific SPDS graphic displays correspond to specific sections of the upgraded EOP, so the SPDS will complement the use of the upgraded EOP.

The basic configuration of the SPDS consists of redundant data acquisition, processing and display devices. The SPDS computers access the necessary input parameters from sensors in ANO-1 and ANO-2, process these signals, and provide displays to each control room as well as to the TSC and EOF. The SPDS performs no plant control action, but serves as a human-engineered data display system to aid the operator in rapidly and reliably determining plant safety status. The SPDS design should provide enhanced capabilities for responding properly to both anticipated and unanticipated plant conditions.

ARKANSAS NUCLEAR ONE
Unit 2

The SPDS design also includes displays in the TSC and EOF. This improves the operational aids available to the plant technical staff to assist them in evaluating transient conditions and providing guidance and direction to the operations staff. The TSC and EOF both have access to the large-scale data storage and retrieval capabilities of the SPDS to assist in event diagnosis and historical documentation.

Considerable effort has been expended during the initial design of the SPDS to incorporate human factors principles. In addition, the ANO Operations staff has played a vital role in the SPDS design and implementation to ensure that the system will be responsive to the needs of the operators during normal and emergency conditions. The SPDS was included in the scope of the Control Room Design Review (CRDR) program to formally evaluate the proper incorporation of human factors principles including equipment location, display formats and characteristics, operator interfaces and compatibility with the EOP.

The SPDS was designed to be isolated from electrical and electronic interference with equipment and sensors that are in use for safety systems and was reviewed with respect to IEEE Standard 384-1977, Section 6.2, and found to be in compliance with the isolation criteria. The specific methods of isolation include current transformers for the analog signals, and optical couplers and relays for the digital signals requiring interference isolation.

The SPDS was subjected to a verification and validation process to ensure that applicable requirements were met. This verification included a system requirements review and a design review based on the system requirements. Validation included testing and evaluation of the completed system, hardware and software, to ensure compliance with design, function, performance and interface requirements. The SPDS verification and validation process was performed and documented in accordance with NRC guidelines in NUREG-0737, Supplement 1.

A description of the ANO-2 SPDS was transmitted to the NRC as a part of the initial response to NUREG-0737 Supplement 1, dated April 15, 1983 (0CAN048312). The ANO-2 SPDS safety analysis was transmitted to the NRC by our letter 2CAN048402 dated April 30, 1984.

7.6.2.5.3 Basis for Parameter Selection and Displays

The EOPs for both ANO-1 and 2 have their origin in the Babcock & Wilcox Abnormal Transient Operating Guideline (ATOG) program. From this program it was determined, following a reactor trip and verification of shutdown, that there are three symptoms of primary interest to a pressurized water reactor operator to prevent core and reactor coolant system damage: 1) inadequate subcooling of the primary system inventory, 2) inadequate primary to secondary heat transfer, and 3) excessive primary to secondary heat transfer. These symptoms are important for the following reasons:

1. Inadequate primary inventory subcooling: If the operator knows the primary fluid is in a liquid state, he is assured that it is available and capable of removing heat from the core. If subcooling is lost, these issues are in doubt, and he is therefore directed to make every effort to regain subcooling.
2. Inadequate primary to secondary heat transfer: This symptom addresses the heat transfer coupling across the steam generator. It describes the ability of the system to keep the flow of energy moving from the reactor coolant system to the ultimate heat sink.

ARKANSAS NUCLEAR ONE
Unit 2

3. Excessive primary to secondary heat transfer: In this case, the symptom is indicative of a secondary side malfunction (e.g., loss of steam pressure control or steam generator overfill). The heat transfer is again unbalanced and the operator's attention is directed toward generic actions to restore this balance.

The ATOG pressure-temperature diagram (P-T Diagram) was developed to provide the above described information to the plant operator in a timely fashion with little or no effort on his part. The P-T Diagram is the top level display for the ANO-2 SPDS for this reason.

To further enhance the operator's ability to assess the plant's response to transients and to more precisely monitor specific safety functions, additional displays were developed for the ANO-2 SPDS. These additional displays were carefully created to be used in conjunction with the ANO-2 EOP which aid the operator in the implementation of this procedure as well as some select abnormal operating procedures. A description of the P-T diagram display and these additional displays is provided below. Implicit in the B&W ATOG program was the consideration of the five critical safety functions identified in NUREG-0737, Supplement 1. Correlation between the following described SPDS displays and the five critical safety functions are also discussed below.

Pressure-Temperature (P-T)

The P-T diagram basic features include a grid of RCS pressure versus RCS temperature with fixed curves showing the saturation line, a 30 °F margin to saturation line and the RCS NDT limits for normal operation. During power operation the Reactor Protection System (RPS) pressure trip limits are shown along with a normal transient window showing the minimum and maximum pressures and temperatures expected immediately following a trip. A small box will appear inside this window showing the expected pressure-temperature relationship for normal hot shutdown conditions. If no forced RCS flow is indicated, the single small box will be replaced by two boxes showing the expected T_{cold} and T_{hot} conditions during natural circulation at hot shutdown.

The dynamic elements of the display include a bar graph representation of steam generator levels, digital values of selected parameters displayed below the P-T grid, and points identifying T_{cold} and T_{hot} versus pressure. Following a reactor trip, the past plotted values of temperature versus pressure remain on the screen showing the trajectory which they are following. The values shown at the bottom of the screen are reactor building temperature and pressure, A and B steam generator pressures and the average of the five highest core exit thermocouple temperature.

Figures 7.6-3 through 7.6-6 show the SPDS P-T display for reactor trips under various conditions. These figures are based on a design RCS pressure of 2250 psia and T_{hot} of 615 °F.

A typical plant response to a reactor trip is shown in Figure 7.6-3. T_{cold} should merge with T_{hot} as the decay heat rapidly drops. Both temperatures should then move toward normal hot shutdown pressure and temperature conditions. If they do not, a departure from normal is indicated. If they move outside a larger normal transient limit area, the definite need for operator action is indicated.

ARKANSAS NUCLEAR ONE Unit 2

Each of the three basic symptoms discussed earlier leave their unique signature on the P-T diagram as displayed in Figures 7.6-4, 7.6-5 and 7.6-6. Use of this tool enables an operator's priority to be fixed on controlling the plotted parameters within target bounds. If successful, he will be able to bring the reactor to a safe condition. This will be the case regardless of whether or not he has properly diagnosed (or diagnosed at all) the event which has occurred. However, use of the SPDS in conjunction with the EOP does not discourage an operator from diagnosing the cause of the transient. The SPDS and EOP are based on directing the operator to take proper actions without diagnosis or with misdiagnosis.

Primary to Secondary Heat Transfer (PSHT)

The primary to secondary heat transfer display was designed to provide more detailed historical data on some of the parameters shown on the P-T diagram. This display specifically addresses the reactor core cooling and heat removal critical safety function. This display presents data in a scrolling trend versus time graph which results in a familiar, easily readable and understandable display.

This display has trends for average core exit temperature, loop average hot leg temperature, loop average cold leg temperature, saturation temperature for steam generator pressure, feedwater flow, steam generator level and steam generator pressure for both RCS loops.

This display will be particularly valuable in natural circulation conditions where RCS temperature can be closely monitored.

Reactivity Control (RHO)

The reactivity control display was provided to aid the operator in immediate verification that the reactor is indeed tripped and remains shutdown. This display specifically addresses the reactivity control critical safety function and has trends of wide range and source range neutron flux.

Steam Generator Tube Rupture (SGTR)

A steam generator tube rupture is treated as a unique event in both the Abnormal Transient Operating Guidelines and the EOP. This event is unique in that it has the potential for a direct release of radiation to the environment. The steam generator tube rupture display is designed to aid the operator in diagnosing a tube rupture, determining the affected generator, and cooling the plant down to a condition where the primary to secondary leakage can be terminated. This display shows trends of RCS hot leg temperature, steam generator levels, condenser off-gas and main steam line radiation.

RCS Inventory (RCSI)

The RCS inventory display is provided to aid the operator in assessment and maintenance of RCS inventory. This display specifically addresses the RCS integrity critical safety function. This display has trends of volume control tank level, pressurizer level, pressurizer pressure, narrow range containment sump level, charging flow, letdown flow and RCS average temperature.

ARKANSAS NUCLEAR ONE
Unit 2

Trends shown on this display may also aid in the diagnosis of the initiating event. For example, the behavior of RCS temperature while pressurizer level and pressure are decreasing is the key to differentiating between a small loss of coolant accident and an overcooling event. Both events will show decreasing pressure and pressurizer level; however, rapidly decreasing temperature would indicate an overcooling event while a constant or very slight decrease in temperature would indicate a loss of coolant.

Containment Conditions

The containment conditions display was developed to show containment parameters which may be useful in assessing and maintaining containment integrity. The display specifically addresses the containment integrity critical safety function. This display has trends of containment hydrogen concentration, and high range radiation, containment temperature, pressure and wide range containment water level.

The radioactivity control critical safety function is not specifically addressed by any single SPDS display; however, as discussed above, various radiation monitor indications are included on the appropriate displays.

Auxiliary Displays

In addition to the dedicated SPDS displays described above, there are auxiliary displays which may be selected. These are special purpose displays designed for operator convenience and assistance.

7.6.2.5.4 Hardware Description

The computer system was chosen primarily because of its flexibility, reliability, and maintainability. Flexibility is needed to permit the incorporation of future modifications without unwarranted difficulty. The computer hardware selected is similar to existing hardware already in use at ANO. This hardware has been proven to be reliable. Furthermore, Entergy Operations, Inc. personnel have considerable experience in maintaining this equipment which should improve the overall reliability of the system.

The computer system is an integrated network which is designed to perform the functions required for the ANO-1 SPDS, the ANO-2 SPDS, the Technical Support Center Data Display System, and the Emergency Operations Facility Data Display System. To achieve these functions, the SPDS computer accesses necessary input parameters from sensors in ANO-1 and ANO-2, processes these signals, and provides displays to each control room as well as to the TSC and the secondary TSC portion of the EOF. Suitable isolation is provided between the SPDS data acquisition system and class IE sensors. In each control room color graphic displays are provided for the operators. Color graphic displays are also provided in the TSC as well as the EOF. "Touch screen" controls are utilized on the color graphic displays to allow for rapid access of the information necessary to determine safety status of the plant.

Several features have been incorporated into the SPDS design in order to approach the availability goals specified in the NRC guidance and to allow for incorporation of future modifications while the system is operating. These features include redundant CPUs, redundant data acquisition hardware, redundant networks, and redundant color graphic displays in each control room. Except for the TSC equipment, which is powered from a diesel generator backed panel, the SPDS power is supplied from an uninterruptable power supply (UPS). The SPDS computer room is provided with its own air conditioning system.

ARKANSAS NUCLEAR ONE
Unit 2

7.6.2.5.5 Software Description

The operating system software for the SPDS is a real-time data acquisition system with alarm capabilities. Parts of this operating system and some of the associated application programs were modified by the ANO Computer Support Department to facilitate the special requirements of the SPDS.

The SPDS software provides applicable data over redundant networks to display units in the control room, EOF, and TSC. Each display unit generates appropriate screens and processes user commands.

ARKANSAS NUCLEAR ONE
UNIT 2

7.7 CONTROL SYSTEMS NOT REQUIRED FOR SAFETY

7.7.1 DESCRIPTION

The control and instrumentation systems whose functions are not essential for the safety of the plant include plant instrumentation and control equipment not addressed in Sections 7.1 through 7.6. The general descriptions given below permit an understanding of the reactor and important subsystem control methodology.

7.7.1.1 Control Systems

7.7.1.1.1 Reactor Control Systems

The reactor is controlled by reactivity adjustments with Control Element Assemblies (CEAs) and with boric acid dissolved in the reactor coolant. Rapid changes in reactivity are compensated for, or are initiated by, CEA movement. Long-term variations in reactivity due to fuel burnup and fission product concentration changes are controlled by manually adjusting the boric acid concentration.

The boron concentration in conjunction with CEAs must be controlled to ensure that adequate shutdown margin is maintained for the reactor. This margin is maintained while critical by preventing the boron concentration from decreasing to a point beyond which the corresponding CEA worth is insufficient to shut down the reactor with adequate margin (see Section 7.7.1.1.6).

The plant is capable of following ramp load changes between 15 to 100 percent of full power at a rate of five percent per minute and at greater rates over smaller load change increments up to a step change of 10 percent, except as limited by xenon. This is accomplished by manually moving one or more pre-selected groups of CEAs and/or adjusting boron concentration in response to the requirements of the temperature programmer.

The Control Element Drive Mechanism Control System (CEDMCS) receives manual group motion demand signals from the CEDMCS control panel and sequential permissive (group stop) signals from the Plant Computer. A motion demand signal with no existing group stop limits will allow DC voltage to be applied to the CEA coils in the proper levels and sequence for CEA motion. A reactor trip initiated by the Reactor Protective System (RPS) causes the input motive power to be removed from CEDMCS by the trip switchgear, which in turn causes all CEAs to be inserted by gravity. Thus, the CEDMCS is not required for safety (see Figure 7.7-3). There are three different modes of control of the CEAs available: manual individual, manual group, and manual sequential. The manual sequential mode of operation applies only to the regulating groups 1 through 5. (See Section 4.2)

Regulating CEAs, Groups 1 through 5, may be moved as a group in manual group mode or in manual sequential mode. Individual CEAs may be moved in manual individual control. During sequential group movement, when the moving group reaches a programmed low (high) position, the next group begins inserting (withdrawing), thus providing overlap in the motion of the regulating groups. The initial group stops upon reaching its lower (upper) limit. Applied successively to regulating groups 1 through 5, the procedure allows a smooth and continuous rate-of-change of reactivity. The CEDMCS accepts signals from the plant computer to effect this sequencing of the regulating CEA groups. The CEDMCS utilizes sequential permissive signals from the plant computer which are derived from the CEDMCS up-down pulse counters. There is no tie-in to the CEA reed switch assembly sensors used in the RPS.

ARKANSAS NUCLEAR ONE
UNIT 2

The shutdown and Groups P and 6 CEAs are moved in the manual individual or manual group control modes only. A selector switch permits withdrawal of no more than one of these groups at any time.

7.7.1.1.2 Reactor Coolant System Pressure Control System

The RCS pressure control system maintains system pressure within specified limits by the use of pressurizer heaters and spray valves.

During normal operation, two small groups of heaters are proportionally controlled to maintain operating pressure. If the pressure falls below the setpoint by approximately 50 psia, all of the backup heaters are also energized. Above the normal operating pressure range, the spray valves are proportionally opened to increase the spray flow rate as pressure rises. A small, continuous spray flow is maintained through the spray lines at all times to keep the lines warm and thereby reduce the thermal transient when the control valves open, and to ensure that the boric acid concentration in the coolant loops and pressurizer is in equilibrium.

A high pressurizer level energizes the backup heaters to minimize the subcooling during the largest insurge transients. A low pressurizer water level de-energizes all heaters, thereby providing heater protection.

Two channels of control are provided and the controlling channel is selected by means of a switch on the control board. Automatic control is normally used during operation but manual control of the heaters and the spray may be selected at any time.

7.7.1.1.3 Pressurizer Level Control System

The pressurizer is a surge tank which is provided to accommodate expansion and contraction of the reactor coolant due to temperature changes. Therefore, during normal operation, the pressurizer level is programmed as a function of the average coolant temperature. The pressurizer level control system controls the water level in the pressurizer to its programmed value by means of adding water to the RCS (by charging pumps) or by removing water from the system (through letdown valves).

Two channels of control are provided and the controlling channel is selected by means of a switch located on the control board. Automatic control is normally used, but manual control may be selected at any time. In the automatic mode, the level controller compares the measured and programmed level signals and generates a level error signal which modulates the letdown control valves to restore the level to the programmed value (see Table 5.5-13). Separate "ON-OFF" controllers start the backup charging pumps at low level error setpoints. One charging pump is operated continuously in order to provide makeup flow for pump seal leakage and to limit letdown temperature changes.

Backup control action is provided by several "ON-OFF" controllers. A high level error signal stops both backup charging pumps and activates an alarm. A low level error signal provides a backup signal to start all charging pumps and also activates an alarm.

The design bases for the pressurizer are described in detail in Section 5.5.10.1. The criteria which have been used to establish the pressurizer level program are as follows:

ARKANSAS NUCLEAR ONE
UNIT 2

- A. Sufficient water volume is maintained to prevent draining the pressurizer as a result of a reactor trip. The minimum pressure following a trip is limited to prevent actuating safety injection (This is an operational consideration.);
- B. Sufficient water volume is maintained to ensure that the pressurizer heaters will not be uncovered by an outsurge following RCS average temperature changes associated with load decreases, including 10 percent step load decreases and five percent per minute ramp load decreases between 100 and 15 percent power;
- C. The steam volume is sufficient to yield acceptable pressure response to normal load changes;
- D. The water volume is kept no greater than that assumed in the analysis of the LOCA (This is to ensure acceptable energy release and containment pressure during such an event.);
- E. The steam volume is large enough to accept the primary coolant insurge resulting from loss of load without the water level reaching the safety valves; and,
- F. During load following transients, the total charging and letdown flow rates are kept as small as possible and are compatible with the capacities of the volume control tank, charging pumps, and letdown valves.

To ensure operation consistent with the stated bases, the pressurizer water level is controlled automatically or manually, in accordance with a specified level control program, and the reactor coolant temperature is maintained at or below a specified value.

7.7.1.1.4 Feedwater Control System

The two steam generators are operated in parallel with each generator's Feedwater Control System (FWCS) maintaining its downcomer water level within acceptable limits. The FWCS for each steam generator consists of a low power mode and a high power mode. In the low power mode, the FWCS operates as a single element control system based on steam generator level. In the high power mode, the FWCS operates as a three-element control system based on steam generator level, feedwater flow, and main steam flow. The FWCS program logic develops a flow demand which controls the main and bypass control valves and feedwater pump speed to maintain steam generator levels at the desired setpoint.

The FWCS includes a High Level Override (HLO) mode in which the main and bypass feedwater regulating valves are closed upon the detection of high downcomer water level. This feature is designed to prevent excessive moisture carryover into the main turbine caused by high steam generator water levels. This signal is automatically removed when the abnormal condition clears.

The FWCS includes a Reactor Tripped Override (RTO) mode that is initiated upon a reactor trip. In the RTO mode the FWCS decreases the feedwater pump to a minimum speed, shuts the main feedwater control valve, and adjusts the bypass feedwater control valve. The RTO feature is designed to limit the possibility of overcooling the RCS after a reactor trip by limiting the post-trip feedwater flow rate.

ARKANSAS NUCLEAR ONE
UNIT 2

The manual control mode of each FWCS may be selected by the operator at any power level. When in manual control, the operator in the control room can utilize a master control station to simultaneously adjust valve positions and pump speed setpoints to maintain the generator downcomer level or, utilizing individual control stations, he can choose to control the valves and pump speed setpoints independently. Control at the master control station is the preferred manual operating mode since this minimizes operator control actions.

7.7.1.1.5 Steam Dump and Bypass Control System

This system is provided to improve plant availability by making full utilization of the dump/bypass valve capacity to remove Nuclear Steam Supply System (NSSS) thermal energy. This objective is achieved by the selective use of turbine bypass and atmospheric dump valves to avoid unnecessary reactor trips and to prevent the opening of secondary side safety valves whenever this can be averted by the controlled release of steam.

The steam dump and bypass control system compares the actual steam pressure and a steam pressure setpoint generated as a function of NSSS load (steam flow) to provide an error signal to a proportional-plus-integral-plus-derivative controller. The output signal from the controller is fed through a master control station to individual valve group opening demand programmers. These programmers generate signals for modulation of the valve groups in a sequential manner. From the programmers, a separate signal is sent to each valve control station. The valve control signals are sent to the valve actuators through individual gates responding to a redundant dump/bypass demand signal, ensuring that not more than one valve will open as the result of any single equipment failure or operator error.

A valve quick-opening demand signal is generated whenever the size of the load rejection is such that it cannot be accommodated with the normal valve modulation speed. This is determined on the basis of the magnitude and rate of change of a combination of the decrease in steam flow from the steam generators and the increase in pressurizer pressure. Redundant signals are generated and these signals are routed through independent channels to eliminate the possibility of opening more than one valve with any single equipment failure. The quick-opening signal is fed to a valve actuator only when that valve control station is in the automatic mode. Because the Steam Dump and Bypass Control System (SDBCS) is designed to provide the best possible transient response, the number of valves to which the quick-opening signal is applied is made to be a function of the magnitude and rate of change of steam flow and pressurizer pressure. The signal is blocked to the two upstream atmospheric dump valves on a reactor trip and to all dump and bypass valves if average temperature reaches a predetermined setpoint following a reactor trip.

The steam dump and bypass valves are discussed in Section 10.3. Two of the four atmospheric dump valves are located outside the containment upstream of the main steam isolation valves. These are fail-open valves, and are normally kept isolated by motor-operated gate valves. The balance of the dump and bypass valves are located downstream of the main steam isolation valves. The two upstream valves and their isolation valves are available to remove decay heat from the steam generator in the event of loss of off-site power. The decay heat is dissipated by venting steam to the atmosphere. In this way, the RCS may either be maintained at hot standby or hot shutdown or it may be cooled down.

ARKANSAS NUCLEAR ONE
UNIT 2

The atmospheric dump valves are controlled manually from either the control room by means of hand indicating controllers located on the control panel or locally. The isolation valves are controlled manually from either handswitches on the control panel and on the MCC, or locally via valve handwheels.

In the event of failure of both sets of valves, reactor decay heat will be removed through the main steam safety valves and the RCS will remain at hot shutdown. Cooldown can be accomplished through manual operation of the atmospheric dump valves. Each valve has a handwheel which can be operated locally.

7.7.1.1.6 Boron Control System

Boron concentration control is normally accomplished by manual dilution and boration as described in Section 9.3.4. During normal operation, boron concentration is measured by radiochemistry analysis.

7.7.1.1.7 In-Core Instrumentation System

The in-core instrumentation system is used to evaluate core power and temperature distributions, perform periodic calibrations of the out-of-core flux measurement system, and provide inputs to the Core Operating Limit Supervisory System (COLSS). This system is used for confirmation and calibration of neutron flux measurements.

There are 42 in-core monitoring assemblies spaced radially and axially to permit flux mapping of the core. (See Figure 7.7-5) At each of the selected locations, an instrument assembly is inserted into the center of the fuel assembly. Each instrument assembly contains five rhodium self-powered detectors placed at selected axial locations and an outlet thermocouple. The assemblies contain background detectors to provide a means of determining signal noise. The rhodium detectors produce a current proportional to the beta emission from a central rhodium wire following activation by neutron capture.

The plant computer system corrects the in-core detector signals for background pickup and changes in sensitivity with burnup. Chromel-Alumel thermocouples are positioned to read coolant exit temperatures from the fuel assemblies.

Detector assemblies are routed into the reactor vessel through eight in-core instrumentation nozzles in the reactor vessel head. An instrumentation support plate assembly within the reactor vessel guides the detector assemblies into selected fuel assemblies.

The fixed in-core instrumentation system is designed to perform the following functions:

- A. To determine the gross power distribution in the core at different operating conditions over the range from 10 to 125 percent average reactor power;
- B. To provide data to estimate the fuel burnup in each fuel assembly;
- C. To provide data for the evaluation of thermal margins in the core;
- D. To provide data which will be used to check that the core power distribution is consistent with calculated values;

ARKANSAS NUCLEAR ONE
UNIT 2

- E. To provide information to calibrate and to assure correct operation of the reactor protection and control systems; and,
- F. To provide signals for use in the COLSS.

When the incore instrumentation system is used to perform the functions listed above, it must consist of:

1. At least 75% of all incore detectors operable (165 detectors) with at least one incore detector in each quadrant at each level, and
2. At least 75% of all incore detector locations operable (33 locations), and
3. Sufficient operable incore detectors to perform at least six tilt estimates with at least one tilt estimate at each of three levels.

Section 15.1.15 describes the Fuel Misloading event and the analysis of record (AOR) for this event. The AOR allows for only one random failed incore instrument string (in addition to locations E8 and N8) during startup testing (Section 4.5.3.2) for each cycle. With additional strings of ICI failures, the results of the AOR could be invalidated. Specifically, if multiple failed ICI strings were located near a misloaded assembly, then some misloads that could result in fuel damage may not be detected. To prevent fuel damage, either the required overpower margin (ROPM) must be substantially increased, alternate requirements on ICI operability must be imposed, or both.

Additional ROM beyond the standard amount set aside in the reload setpoint analysis must be reserved if greater than 15% of the incore detector system becomes inoperable. This requirement applies regardless of whether the 15% threshold is exceeded before or after the 30% power distribution measurement is performed during initial startup. This additional ROM requirement is only necessary until the limiting portion of the cycle has past, as defined in the Fuel Misloading AOR.

If less than 41 incore detector strings were operable during the 30% power distribution measurements at initial startup during each cycle, then the following additional requirements ({i, ii} and/or {A,B}) must be satisfied at all times during the cycle, including during the power distribution measurement:

- i. Sufficient operable incore detectors to perform at least six tilt estimates on each of at least three levels.
- ii. All fuel assemblies except those with one or more full faces to the core shroud must satisfy one of the following criteria:
 - ii.a Be within one assembly of at least one operable ICI detector string (see Figure 7.7-7 for acceptable configurations).
 - ii.b Be within two assemblies of two operable ICI detector strings (see Figure 7.7-8 for acceptable configurations).

ARKANSAS NUCLEAR ONE
UNIT 2

If {i} was not satisfied during the 30% power distribution measurement, then one of the following actions must be completed prior to exceeding 50% power:

- A. Perform CEA symmetry checks for at least one CEA group having a CEA within two assemblies of the assembly not in compliance with {ii} above.
- B. Perform an evaluation to determine the ability of the incore detector system to detect average power asymmetry of at least 10% between quadrant 4 x 4 groups of assemblies with the actual operable incore detector pattern and make suitable adjustments to COLSS and CPCs to assure conservative indications of the DNBR and LHR margins.

If {i} is satisfied, but not {ii} during the power distribution measurement, then power ascension can proceed to 70% power before completing one of the above actions. If the non-compliance with {i} and/or {ii} occurs after the power distribution measurement, then one of the above actions must be completed within 14 EFPD upon discovery.

If these minimum conditions are not met, the incore instrumentation system is not used for the above listed applicable monitoring or calibration functions.

For a portion of Fuel Cycle 10 the incore instrumentation system was allowed to be used to perform the functions listed above with < 75% and \geq 50% of all incore detectors (< 165 and \geq 110 detectors) and detector locations (< 33 and \geq 22 locations) provided appropriate penalties were applied to the COLSS and CPCs.

The penalties were based on a full 1.0% increase in overall uncertainty on the CECOR F_{xy} measurement.

An operable incore detector location consists of a fuel assembly containing a fixed detector string with a minimum of three operable rhodium detectors.

A tilt estimate can be made from two sets of symmetric pairs of incore detectors. Two sets of symmetric pairs of incore detectors are formed by two pairs of diagonally opposite symmetric detectors, one incore detector per quadrant.

Operability of the incore instrumentation is demonstrated by the performance of a channel check within 24 hours prior to use and at least once per 7 days thereafter when required for monitoring the azimuthal power tilt, radial peaking factors, local power density or DNB margin. In addition, operability is demonstrated at least once per 18 months by the performance of a channel calibration operation which exempts the neutron detectors, but includes all electronic components. The neutron detectors are calibrated prior to installation in the reactor core.

Core power distribution information is available at 210 locations, and temperature distribution information is available at 42 locations throughout the core. The full system has more capability than is needed to verify power and temperature distributions and to calibrate the out-of-core neutron detectors.

The confirmation of power and temperature distribution and calibration of the out-of-core detectors are done on a periodic basis as specified in the Technical Specifications. The frequency is chosen to assure that all protective and control system settings, that depend on core burnup and thermal and hydraulic properties, are maintained at conservative values.

ARKANSAS NUCLEAR ONE
UNIT 2

7.7.1.1.8 Megawatt Demand Setter

This section has been intentionally deleted since the Megawatt Demand Setter System has been removed.

7.7.1.1.9 Shutdown Cooling System

The Shutdown Cooling (SDC) System is discussed in Section 9.3.6. The system instrumentation and controls necessary to bring the plant to a cold shutdown condition are discussed in the following sections.

The SDC System is manually initiated. SDC interlocks (see Section 7.6.2.1) prevent overpressurization of the low pressure portions of the system. The redundant isolation valves for the pump suction line are controlled by redundant control channels powered from separate supplies. The cooldown rate is adjusted by throttling the heat exchanger outlet valve, using the control board mounted hand indicating controller. The flow indicator controller maintains a constant total shutdown cooling flow rate to the core by adjusting the heat exchanger bypass flow to compensate for changes in flow rate through the heat exchangers.

Control board process indication and status instrumentation is provided to enable the operator to evaluate system performance and detect malfunctions. Control panel hand switches and valve position limit indicating lights are provided for the shutdown cooling isolation valves and the shutdown cooling heat exchanger inlet, outlet, and bypass valves. Control panel hand switches and valve position indicators are provided for the low pressure injection valves. Indication is provided of low pressure safety injection pump discharge header pressure and temperature, shutdown cooling heat exchanger outlet temperature, shutdown cooling injection flow and temperature, LPSI pump suction pressure (0 - 50 psig only), LPSI pump motor current, LPSI pump delta-P, RCS refueling level, and CET temperature. Low pressure safety injection pump operating status is also indicated on the control board.

The SDC System has been provided with electrical interlocks to prevent any possibility of overpressurizing the low pressure portions of the system. The redundant interlocks allow opening the isolation valves only when the RCS pressure is below a preset setpoint value. Section 7.6.2.1 contains a detailed description and analysis of the interlocks.

System sequencing is controlled manually by the operator in accordance with approved operating procedures.

SDC instrumentation has no bypass features which would allow an operator to jeopardize the protection afforded by the interlocks or allow degradation of any other control functions. Sufficient instrumentation is supplied to assure adequate system monitoring during all modes of system operation.

The SDC System utilizes the low pressure safety injection pumps and the service water system for heat removal. Either of the two pumps and either of the two heat exchangers are sufficient for proper system operation.

7.7.1.2 Design Comparison

Historical data removed. To review the exact wording please refer to Section 7.7.1.2 of the FSAR.

ARKANSAS NUCLEAR ONE
UNIT 2

7.7.1.3 Core Operating Limit Supervisory System

7.7.1.3.1 General

The COLSS consists of process instrumentation and algorithms used to continually monitor the limiting conditions for operation on:

- A. Peak linear heat rate;
- B. Margin to Departure from Nucleate Boiling (DNB);
- C. Total core power; and,
- D. Azimuthal tilt.

The COLSS continually calculates DNB margin, peak linear heat rate, total core power, and azimuthal tilt magnitude and compares the calculated values to the limiting condition for operation on these parameters. If a limiting condition for operation is exceeded for any of these parameters, a COLSS alarm is initiated and operator action is taken as required by the Technical Specifications.

The selection of limiting safety system settings, core power operating limits, and the azimuthal tilt operating limit are specified such that the following criteria are met:

- A. No safety limit will be exceeded as a result of an anticipated operational occurrence; and,
- B. The consequences of postulated accidents will be acceptable.

The Reactor Protective System (RPS) functions to initiate a reactor trip at the specified limiting safety system settings. The COLSS is not required for plant safety since it does not initiate any direct safety-related function during anticipated operational occurrences or postulated accidents. The Technical Specifications define the Limiting Conditions for Operation (LCO) required to ensure that reactor core conditions during operation are no more severe than the initial conditions assumed in the safety analyses and in the design of the low DNBR and high local power density trips. The COLSS serves to monitor reactor core conditions in an efficient manner and provides indication and alarm functions to aid the operator in maintenance of core conditions within the LCOs given in the Technical Specifications. When COLSS is out of service, certain technical specification action statements become applicable.

The COLSS algorithms are executed in the plant computer. The calculational speed and capacity of COLSS enables numerous separate plant operating parameters to be integrated into two more easily monitored parameters: (1) margin to a limiting core power (based upon margins to DNBR, peak linear heat rate and licensed power limits), and (2) azimuthal tilt. If COLSS were not provided, maintenance of reactor core parameters within the LCOs, as defined by the Technical Specifications, would be accomplished by monitoring and alarms on the separate non-safety-related process parameters utilized in the COLSS calculations. Therefore, the essential difference in utilizing COLSS in lieu of previous monitoring concepts is the integration of many separate process parameters into a few easily monitored parameters. The conciseness of the COLSS displays has distinct operational advantages, since the number of parameters that must be monitored by the operator is reduced.

ARKANSAS NUCLEAR ONE
UNIT 2

Sensor validity checks are performed by COLSS on those measured input parameters used in the COLSS calculations. The validity checks consist of checking sensor inputs against the following criteria:

- A. Sensor out of range; and,
- B. Deviations between like sensors:

The following options are available for dealing with non-valid sensors.

- A. Automatic replacement of the failed sensor by a redundant sensor (when available).
- B. In 4-pump operation, automatic replacement of a failed primary system sensor with its corresponding similar sensor (hot leg RTDs, cold leg RTDs in the same coolant loop).
- C. Automatic algorithm alteration for certain functional inputs by the generation of software flags when no redundant sensors are available.
- D. Substitution of constants for selected COLSS inputs (performed under administrative control).

In the event that a non-valid sensor is detected, an alarm to the operator is actuated and corrective action is automatically initiated (where applicable).

A more detailed discussion of sensor validity checks is included in the Combustion Engineering topical report entitled "Assessment of the Accuracy of PWR Operating Limit as Determined by the Core Operating Limit Supervisory System (COLSS)," CENPD-169, issued July, 1975.

Detailed process testing of COLSS is performed to assure proper system performance. While COLSS is off-line, sets of stored constants are substituted for live sensor inputs and COLSS is executed. Comparison of the results with known outputs is then made to assure continuity of all COLSS algorithms. While COLSS is on-line, hard copy printout of the COLSS input, intermediate calculated values and results are provided during the test. Comparison of this information with intermediate calculated values and results from an off-line COLSS program using the same input values can provide additional assurance of proper operability of the COLSS program. Testing will be performed under administrative control on a periodic basis to assure proper performance of COLSS. Since COLSS is not required for plant safety, COLSS testing requirements are not included in the Technical Specifications.

7.7.1.3.2 System Description

The core power distribution is continually monitored by COLSS and a core power operating limit based on peak linear heat rate is computed. Operation of the reactor at or below this operating limit power level ensures that the peak linear heat rate is never more adverse than that postulated in the loss of coolant analyses.

Core parameters affecting the margin to DNB are continually monitored by COLSS and a core power operating limit based on margin to DNB is computed. Operation of the reactor at or below this operating limit power level ensures that the most rapid DNB transient which can result from an anticipated operational occurrence will not result in a DNBR reduction to a value less than the DNBR SAFDL.

ARKANSAS NUCLEAR ONE
UNIT 2

The core power operating limit based on licensed power level is also monitored by COLSS. Operation of the reactor at or below this operating limit ensures that the total core power is never greater than that assumed as an initial condition in the accident analyses.

The core power and the core power operating limits based on peak linear heat rate, margin to DNB and licensed power level are continually indicated on the control board. The margin between the core power and the nearest core power operating limit is calculated by COLSS and is available for display in the Control Room. An alarm is initiated in the event that the COLSS calculated core power level exceeds a COLSS calculated core power operating limit.

In addition to the above calculations, the azimuthal flux tilt is calculated in COLSS. The azimuthal flux tilt is not directly monitored by the Plant Protection System (PPS). An azimuthal flux tilt allowance, based on the maximum tilt anticipated to exist during normal operation, is an input to the protection system and is used in the low DNBR and high local power density trip calculations. The azimuthal flux tilt is continually monitored by COLSS and an alarm is initiated in the event that the azimuthal flux tilt exceeds the azimuthal flux tilt allowance setting in the PPS.

The COLSS sensors provided for generating the input data required to compute the core power, the core power operating limits, and the azimuthal tilt, are given in Table 7.7-1. A functional block diagram of the COLSS is presented in Figure 7.7-2.

The algorithms below are executed in COLSS:

- A. Reactor Coolant Volumetric Flow Rate
- B. Core Power as determined by:
 - 1. Reactor coolant ΔT ;
 - 2. Secondary system calorimetric; and,
 - 3. Turbine first stage pressure.
- C. Core Power Distribution
- D. Core Power Operating Limit Based on Peak Linear Heat Rate
- E. Core Power Operating Limit Based on Margin to DNB

The algorithms are executed in the plant computer. Technical Specifications on the reactor core provide alternate means of monitoring the limiting conditions for operation in the event that the plant computer is out of service. Certain action statements are applicable when the plant computer is out of service.

Control board indication of the following COLSS parameters is continually available to the operator:

- A. Core power operating limit based on peak linear heat rate
- B. Core power operating limit based on margin to DNB

ARKANSAS NUCLEAR ONE
UNIT 2

- C. Total core power
- D. Core average axial shape index.

COLSS alarms are initiated for the following conditions.

- A. Core power exceeds a core power operating limit.
- B. Azimuthal flux tilt exceeds azimuthal flux tilt allowance.
- C. Azimuthal flux tilt exceeds Technical Specification azimuthal flux tilt limit.

In addition to the descriptions of COLSS algorithms given in Section 7.7.1.3.3, COLSS algorithm descriptions, a COLSS uncertainty analysis and a discussion of the treatment of COLSS input information is included in the COLSS Topical Report CENPD-169, issued July, 1975. Table 7.7-1 provides a listing of the types, quantities and ranges of sensors which provide input information for the COLSS algorithms.

7.7.1.3.3 Description of COLSS Algorithms

7.7.1.3.3.1 Reactor Coolant Volumetric Flow Rate

The margin to DNB is a function of the reactor coolant volumetric flow rate. The four reactor coolant pump rotational speed signals and pump differential pressure signals are monitored by COLSS and used to calculate the volumetric flow rate. The pump characteristics were determined from testing conducted at the pump vendors test facility. Correlations between the pump rotational speed, pump differential pressure, and the volumetric flow rate were developed. The 4-pump volumetric flow rates are summed to obtain the reactor's total volumetric flow rate.

Analyses performed in support of Amendment 286 to the Technical Specifications determined optimum values for COLSS flow algorithm constants and justified use of the COLSS flow algorithm as a reference quality flow indication. Either calorimetric calculations or COLSS indicated flow may be used to satisfy Technical Specification flow surveillances. The flow uncertainties associated with the revised, reference quality COLSS flow indication are accounted for in the DNBR power operating limit uncertainty analysis. Necessary allowances for core bypass flow, flow factors, reactor coolant temperature, etc. are factored into the value of flow used in the DNBR calculation.

Reactor coolant pump differential pressure and cold leg temperature instrumentation supplying input to the COLSS flow algorithm are periodically analyzed to identify anomalies that have the potential to impact the accuracy of the COLSS flow indication. Surveillance criteria consist of the following for differential pressure instruments:

- Verification that instrument quality indicated by the plant computer remains acceptable. Unacceptable or questionable instrument quality is monitored by COLSS cross checks of preferred and alternate instruments.
- The pump differential pressure (ΔP) instrumentation for each cold leg (preferred and alternate) are verified to remain constant within 1.0 psi of each other or each are individually verified to remain constant within 1.0 psi over time (i.e., between calibrations or over the course of the cycle).

ARKANSAS NUCLEAR ONE
UNIT 2

- At 100% power following refueling, average instrument readings are compared to equivalent average reading from the previous cycle and verified to agree within 1.0 psi.

If the above deviations exceed the specified tolerances, the impact of the difference are evaluated based on a sensitivity of 0.30% flow / psid. If non-conservative deviations beyond the specified tolerances can not be attributed to actual process changes, flow penalties are applied to reduce the COLSS indicated total flow rate.

Surveillance criteria consist of the following for cold leg temperature instruments:

- Verification that instrument quality indicated by the plant computer remains acceptable. Unacceptable or questionable instrument quality is monitored by COLSS cross checks of preferred and alternate instruments.
- The temperature instrumentation for each cold leg (preferred and alternate) is verified to remain constant within 2.0 °F of each other or each are individually verified to remain constant within 2.0 °F over time (i.e., over the course of the cycle).
- At 100% power following refueling, average instrument readings are compared to equivalent average readings from the previous cycle and verified to agree within 1.0 °F.

If the above deviations exceed the specified tolerances, the impact of the difference is evaluated based on a sensitivity of 0.07% flow / °F. If non-conservative deviations beyond the specified tolerances can not be attributed to actual process changes, flow penalties are applied to reduce the COLSS indicated total flow rate.

7.7.1.3.3.2 Core Power Calculation

The reactor coolant ΔT power and the secondary calorimetric power are computed in COLSS. The reactor coolant ΔT power is a less complex algorithm than the secondary calorimetric power and is performed at a more frequent interval. The secondary calorimetric power is used as a standard to periodically adjust the gain coefficient (technically, not a gain coefficient but an additive correction term) on the calculation of the reactor coolant ΔT power. This arrangement provides the benefits of the secondary calorimetric accuracy and the reactor coolant ΔT power dynamic response characteristics.

The reactor coolant ΔT power is calculated based on the reactor coolant volumetric flow rate, the reactor coolant cold leg temperature, and the reactor coolant hot leg temperature. A gain coefficient on the calculated ΔT power is periodically adjusted based on the secondary calorimetric power.

The secondary calorimetric power is based on measurements of feedwater flow rate, feedwater temperature, feedwater pump discharge pressure, steam flow and steam pressure. A detailed energy balance is performed for each steam generator. The energy output of the two steam generators is summed and allowances made for reactor coolant pump heat, pressurizer heaters, and primary and secondary system energy losses.

ARKANSAS NUCLEAR ONE
UNIT 2

7.7.1.3.3.3 COLSS Determination of Power Distribution

The determination of F_q^n , F_r^n , the power shape in the hottest channel, and the azimuthal tilt magnitude is performed based on in-core measurements of the flux distribution, processed by pre-programmed algorithms and stored constants. A brief description is given here of the data processing approach employed by COLSS to yield the desired power distribution information. This analysis is repeated at least once per minute, and thus represents continual on-line monitoring.

The core is regarded as being divided into several radial regions in the X-Y plane. The regions are selected taking into account the locations of the regulating CEA groups and the locations of the various generations of reload fuel. Within each region, a sufficient number of strings of fixed rhodium in-core detectors are assigned to the COLSS computation to provide a representative measure of the axial power distribution.

The dynamic response characteristic of the self-powered rhodium in-core detectors is a function of both prompt and delayed components of electrical current generated in the detector and cabling. The delayed portion of the current signal is governed by the decay of isotopes of rhodium having half-lives of 0.7 and 4.4 minutes. To provide the capability to compensate for the delayed portion of the signal, the COLSS power distribution determination includes a compensation algorithm for the in-core signals used as input to COLSS. The algorithm approximately represents the inverse of the in-core detector dynamic response, such that the combination of detector response and dynamic compensation produces a signal representative of the actual neutron flux response. The basis for the dynamic compensation is described in the Topical Report CENPD-169 on COLSS entitled "Assessment of the Accuracy of PWR Operating Limits as Determined by the Core Operating Limit Supervisory System (COLSS)."

The capability for signal filtering is provided through selection of algorithm constants. With the capability for dynamic compensation and filtering on the in-core signals, changes in local flux level during operational load follow transients are adequately represented by the COLSS power distribution determination.

Following correction of the fixed detector signals for background and burnup, five axially distinct retain-average power integrals, corresponding to the five rhodium detector segments, are constructed for each X-Y region, taking into account signal-to-power conversion factors, burnup in the surrounding fuel and the location of the CEAs. Multi-node axial power shapes are constructed from the appropriate set of axial power integrals using fits based on combinations of simple nodal shapes.

Employing tables of factors relating power in the hot pin to the region average F_q^n , F_r^n , the axial power profile in the hot pin, is computed for each region for use in the margin computation.

Mal-positioning of a CEA or CEA group, the uncontrolled insertion or withdrawal of a CEA or CEA group, or a dropped CEA will be detected by COLSS with inputs received from the pulse counting CEA position indicating system described in Section 7.5.1.4.1. It is noted that pulse counters do not automatically recognize these CEA deviations in all cases. In some cases, operator action to update the pulse counters to indicate the correct position is required. Should these deviations occur, adjustments to planar radial peaking factors are performed to ensure that the COLSS DNB and peak linear heat rate calculations remain valid. For most CEA deviations, the adjustments to the planar radial peaking factors cause COLSS to not execute the DNB and peak linear heat rate calculations. During these CEA deviations, power operating

ARKANSAS NUCLEAR ONE UNIT 2

limits are limited by Technical Specifications. The non-execution of the COLSS DNB and peak linear heat calculations are indicated on the plant computer. It is noted that COLSS only provides a monitoring function. The protective action for the CEA-related anticipated operational occurrences defined in Section 7.2.1.1.2.5 is provided by the CEAC/CPC system described in Section 7.2.1.1.2.5.

Flux tilts are detected by comparison, at various levels in the core, of signals from symmetrically located sets of fixed in-core detectors and the region-wise power distribution data modified appropriately before proceeding with the margin computation. In this way, postulated non-separable asymmetric xenon shifts are identified and reflected in the power distribution assessment. Radial xenon redistributions are accounted for through the use of a region-wise combination of local-to-average and axial data discussed above. Alarms are provided by COLSS when the xenon tilt exceeds the allowances for these effects carried in the Core Protection Calculators (CPCs) as penalties.

If an inoperable detector is identified during internal consistency checks of the data, the inoperable detector is deleted from the COLSS calculations.

The COLSS power distribution algorithms, region selection, and initial set of stored constants are validated during the preoperational phase by analytical means, including processing in-core instrument signals produced by a three-dimensional reactor simulation code, and comparing the COLSS power distribution assessment to that of the 3-D simulator. This is done for steady state and power maneuvering conditions, including simulations of conditions resulting from operator error.

After the inception of operation, periodic confirmation of the COLSS assessment of the power distribution, including the suitability of any updated stored constants, is obtained by comparison with a more detailed, off-line processing of an extensive in-core flux map produced by the fixed in-core instrument system. One means of analyzing the detailed flux map is to compare it with detailed calculations of the power distribution which include computations of the flux at the instrument location. Folding this together with other analyses of the ability of the detailed calculation to estimate the local pin-by-pin power distribution (see Section 4.3.3.1.2) enables an overall assessment of the COLSS power distribution error. This is factored into the margin assessment as noted in Section 7.7.1.3.4.

7.7.1.3.3.4 Core Power Operating Limit Based on Peak Linear Heat Rate

The core power operating limit based on peak linear heat rate is calculated as a function of the core power distribution (F_q). The power level that results from this calculation corresponds to the limiting condition for operation of peak linear heat rate.

7.7.1.3.3.5 Core Power Operating Limit Based on Margin to DNB

The core power operating limit based on margin to DNB is calculated as a function of the reactor coolant volumetric flow rate, the core power distribution, the maximum value of the four reactor coolant cold leg temperatures, and the RCS pressure. The W-3 correlation was used in Cycle 1 in conjunction with an iterative scheme to compute the operating limit power level. The power level that resulted from this calculation corresponded to the limiting condition for operation for DNB margin. The CE-1 critical heat flux correlation replaced the W-3 correlation for DNBR analysis subsequent to cycle 1.

ARKANSAS NUCLEAR ONE
UNIT 2

7.7.1.3.4 Calculation and Measurement Uncertainties

The uncertainties in COLSS algorithms can be categorized as:

- A. Uncertainties associated with the computation methods used to correlate the monitored variables to the calculated parameters; and,
- B. The measurement uncertainties associated with the COLSS process instrumentation.

Key algorithms used in COLSS are biased such that, for a fixed set of input values, the calculated parameter in COLSS is equal to or conservative with respect to the value of that same parameter calculated using standard design methods. Standard design methods are discussed in Chapters 4 and 15. Periodic checks are made throughout core life to assure that this objective is achieved.

Each input sensor to COLSS is automatically checked for an out of range condition before it is used in the COLSS calculation. In addition, allowances for measurement uncertainties are applied to the DNBR and (LPD) kW/ft power operating limits and to plant power to ensure that the COLSS-indicated margin to both of these operating limits is conservative.

7.7.1.4 Computer Systems

The ANO-2 computer system consists of the plant computer, and the Safety Parameter Display System (SPDS). The SPDS is discussed in Section 7.6.2.5; the plant computer is discussed in the following sections. These computer systems are designed and configured as general purpose facilities for plant monitoring, alarming and reporting purposes. They include the capability of direct interaction with plant control systems to provide permissive or control inputs to these systems based upon calculational determination of plant conditions.

The computer programs, exclusive of COLSS, which provide either a reactor monitoring or Plant Protection System (PPS) monitoring function are described below:

- A. The incore detector signals are used by the off-line computer code CECOR to calculate the spatial power distribution in the core including the tilt and power peaking factors.
- B. Power Dependent Insertion Limits (PDILs) are operating limits on allowable insertion of full length CEAs used on the Arkansas Nuclear One - Unit 2, and similar Combustion Engineering plants, to maintain operation consistent with shutdown margin (when the reactor is critical) and ejected CEA worth (when the reactor is critical) constraints. PDILs utilize reactor power and CEA position signals.
- C. Buffered output signals from each CPC channel (including calibrated ex-core neutron flux power and margin to DNBR and local power density trip setpoints) are sent to the computer.
- D. The post-trip review program monitors pre-selected process inputs at selected intervals before and after a reactor trip. This program provides a means of determining the cause of reactor trip.
- E. The sequence-of-events program monitors PPS bistable trip units and records status changes (channel trips) with a resolution of several milliseconds as a means of determining the cause of reactor trip.

ARKANSAS NUCLEAR ONE
UNIT 2

Each of these computer functions is intended to assist the plant operator in supervision or analysis of plant conditions.

None of these functions are required to ensure plant safety or permit plant operation.

The computer programs which provide input to plant control systems are described in the following paragraph:

- A. The CEA group sequencing program provides input to the CEDMCS in the form of permissive signals. These signals permit sequential insertion and withdrawal of regulating CEA groups 1 through 5 by the CEDMCS with a pre-programmed overlap between consecutive groups during the manual sequential mode of operation.

The computers monitor the following functions during sequential modes of CEA group operation: (1) withdrawal sequence which starts with Group 1 and ends with regulating group 5 in consecutively increasing numbers, and (2) the insertion sequence which starts with regulating group 5 and ends with Group 1 in consecutively decreasing numbers. Proper sequencing of the group necessitates that the preceding group reach a specified limit before the next group is permitted to move. One sequential permissive contact output is initiated for each regulating group when the permissive conditions for that group have been met. In addition to sequential permissive outputs for regulating groups 1 through 5, one contact output for out-of-sequence alarming is provided.

- B. The computers also provide normal CEA control limits for all CEAs. These limits include the upper (lower) group stops for full length CEAs. These control limits are provided to the CEDMCS to automatically terminate CEA motion upon reaching the CEA limits of travel.

Each of these computer functions is intended to enhance flexibility of plant operation. None are required to ensure plant safety or permit plant operation.

All other functions implemented in the computers are solely for operator and administrative convenience and involve neither the PPS nor plant control. None of the computer functions are required to ensure plant safety or permit plant operation.

7.7.1.5 Ex-Core Neutron Flux Monitoring System

The ex-core neutron flux monitoring system includes neutron detectors located around the reactor core and signal conditioning equipment located in the control room area. Neutron flux is monitored from source levels through full power operation, and signal outputs are provided for reactor protection and for information display. A total of six channels of instrumentation are furnished.

Two startup channels provide source level neutron flux information and boron dilution event monitoring for use during extended shutdown periods, initial reactor startup and startups after extended periods of reactor shutdown such as core refueling operations. Each channel consists of a detector assembly, an amplifier assembly, a signal processor, a boron dilution event monitor and associated cabling. One channel is electrically isolated from the control room with a buffer/isolator to provide alternate shutdown indication for fire protection. The detector assembly houses two fission chambers which have the capability to measure power range

ARKANSAS NUCLEAR ONE
UNIT 2

neutron flux in addition to source range neutron flux. The amplifier assembly is located outside containment and houses the electronics to condition the detector signals and provides outputs to the signal processor assembly. The signal processor drawer converts the amplifier signals into signals that represent source range count rate, reactor power level, and the rate of change of reactor power level. These parameters are transmitted to indicators, recorders, alarms, and the computer for display.

The boron dilution event monitor receives the source range count rate signal from the signal processor and provides an alarm when the count rate increases by an amount equal to the alarm ratio which is set into the shutdown monitor. This alarm is indicative of a reduction in shutdown margin either from an unplanned boron dilution or other causes. (2CAN088201)

Both startup channels provide readout, audio count rate information, and alarms only and have no direct control or protective functions.

Four safety channels provide neutron flux information from routine startup neutron flux levels to 200 percent of rated power covering a single range of approximately 10^{-8} to 200 percent power (10 decades). Each channel consists of three fission chambers, a preamplifier and a signal processing drawer containing power supplies, a logarithmic amplifier (including combination counting and mean square variation techniques), linear amplifiers, test circuitry and a rate of change of power circuit.

These channels feed the RPS and provide information for rate of change of power display, DNBR, local power density, and overpower protection. (see Sections 7.2.1.1.1.1, 7.2.1.1.1.2, 7.2.1.1.1.3, and 7.2.1.1.1.4)

The fission chambers in each RPS channel are stacked vertically to permit an axial power shape measurement. Each chamber is operated in the current mode with each chamber feeding a linear amplifier to provide neutron flux information in the power operating range of 1 - 200 percent power. The center chamber, operating also in the pulse counting mode, feeds the wide range logarithmic amplifier (from a preamplifier) to provide single range neutron flux information from routine startup neutron flux levels to 200 percent of rated power.

The neutron detectors are mounted in holder assemblies and located in instrument wells (thimbles) external to the reactor vessel. They are located as shown in Figure 7.7-4 such that optimum representative core neutron flux is monitored.

7.7.1.6 Diverse Scram System (DSS) with Diverse Turbine Trip (DTT)

The DSS is a functionally non-safety related system designed to prevent an Anticipated Transient Without Scram (ATWS) event by tripping the reactor upon pressurizer pressure greater than 2450 psia. An ATWS event is any RCS overpressurization Anticipated Operational Occurrence (AOO) concurrent with a common mode RPS/RTS failure that could lead to the over-stressing of RCS components beyond their designed stress limits, thereby resulting in a challenge to the RCS integrity. The over-stress limit is considered to be 3200 psia.

The DSS is designed in conformance with 10CFR50.62, known as the ATWS Rule, and is therefore diverse and independent from the existing RTS from transmitter output to final actuation device. The DSS is a 2-out-of-4 energize-to-actuate logic system that monitors pressurizer pressure. The system is designed as a highly reliable system such that no single failure will result in a spurious reactor trip.

ARKANSAS NUCLEAR ONE
UNIT 2

Installation of the DSS inherently provides for a DTT in compliance with 10 CFR 50.62. The DTT utilizes the existing CEDM undervoltage turbine trip circuitry which consists of four undervoltage channels configured in a selective 2-out-of-4 logic. When the DSS causes a reactor trip, it also results in a turbine trip because the DSS interrupts power to the Control Element Assembly (CEA) coils upstream of the rod power bus undervoltage relays in the Control Element Drive Mechanism Control System (CEDMCS). These relays actuate the turbine trip circuitry. All DTT components downstream of the DSS are diverse and independent from the RTS. Therefore, since the DSS is diverse and independent from the RTS, the entire DTT is also diverse and independent from the RTS.

The DSS is a 2-out-of-4 logic system designed to trip the reactor upon detection of pressurizer pressure greater than 2450 psia on any two channels. Each of the four pressurizer pressure signals is input to four 2-out-of-4 logic circuits. Upon actuation of the 2-out-of-4 logic circuits, power will be interrupted to the CEA coils by tripping a DSS contactor at the output of the non-safety related CEDM motor generator sets 2MG01 and 2MG02, thus resulting in a reactor trip. Both contactors must be tripped to trip the reactor, with trip channels 1 and/or 3 tripping the 2MG01 output DSS contactor and trip channels 2 and/or 4 tripping the 2MG02 output DSS contactor. A bypass breaker is provided around each DSS contactor to facilitate maintenance, testing, and start-up.

The DSS and DTT designs do not contain any Class 1E to non-Class 1E interfaces.

The DSS design consists of the following functional requirements:

- DSS utilizes a 2-out-of-4 logic system with pressurizer pressure as the parameter indicative of RCS over pressurization.
- The DSS setpoint and response time are coordinated with the RPS setpoints and response times so that a competing condition between the RPS and DSS is prevented.
- The DSS uses a micro-computer with solid state I/O modules as contrasted with the RPS which uses analog bistable trip units. The DSS is an energize-to-actuate system while the RPS is a de-energize-to-actuate system.
- DSS will trip the reactor upon pressurizer pressure exceeding a nominal setpoint of 2450 psia.
- DSS equipment is qualified for its environment due to AOO's.
- DSS is designed under the suitable Quality Assurance procedures consistent with the requirements and clarification of 10CFR50.62 contained in NRC Generic Letter 85-06.
- DSS logic power is separate and independent from the RPS power and is capable of providing uninterruptible power for a minimum of 15 minutes following the loss of its power source. Power for the DSS contactors is separate and independent from the RPS power and is supplied from a station non-1E UPS.
- Manual initiation of DSS is provided locally at cabinets 2C407 & 2C408 and 2C409 and remotely in the Control Room.
- The DSS is sealed-in upon an automatic or manual trip and must be manually reset.

ARKANSAS NUCLEAR ONE
UNIT 2

- The DSS is placed in service during Mode 1 operating conditions. However, the system may be taken out of service during Mode 1 for corrective maintenance or surveillance testing purposes.
- DSS includes capabilities to allow testing DSS at power.
- DSS includes features that provide alarms, plant computer data, and other operator interfaces to indicate system status and meet operability requirements.

In summary, the DSS (and inherently the DTT) is a highly reliable system designed to trip the reactor diversely and independently from the RTS due to common mode failures of the RTS during AOO's that could result in RCS overpressurization.

7.7.1.7 Diverse Emergency Feedwater Actuation System (DEFAS)

The DEFAS is a non-safety related system designed to mitigate the consequences of an Anticipated Transient Without Scram (ATWS) by initiating EFW during conditions indicative of an ATWS event. An ATWS event is any RCS overpressurization AOO concurrent with a common mode RPS/RTS failure that could lead to the overstressing of RCS components beyond their designed stress limits, thereby resulting in a challenge to the RCS integrity.

The DEFAS is designed in commitment to 10CFR50.62, known as the ATWS Rule. In conformance with the ATWS Rule, the DEFAS is diverse from the existing RTS from sensor output to the final actuation devices. The DEFAS is a 2-out-of-4 energize-to-actuate logic system that monitors steam generator level. The system is designed as a highly reliable system such that no single failure will result in spurious EFW actuation.

Functionally, the DEFAS will actuate EFW to a steam generator when the steam generator's level reaches a low-low setpoint after the Diverse Scram System (DSS) has actuated, and confirmation that a MSIS and EFAS have not been initiated.

Each steam generator is treated separately with each steam generator's four narrow range level signals being input to two 2-out-of-4 logic matrices in the DEFAS Cabinet 2C410. DEFAS-1 trip signals for EFW initiation to steam generator 1 (SG-1) are output from the two SG-1 2-out-of-4 logic matrices with trip signals being transmitted to each half of the EFAS-1 circuitry in Auxiliary Relay Cabinet A (2C39) and trip signals being transmitted to each half of the EFAS-1 circuitry in Auxiliary Relay Cabinet B (2C40). Likewise, DEFAS-2 trip signals for EFW initiation to steam generator 2 (SG-2) are output from the two SG-2 2-out-of-4 logic matrices with trip signals being transmitted to each half of the EFAS-2 circuitry in Auxiliary Relay Cabinet A (2C39) and trip signals being transmitted to each half of the EFAS-2 circuitry in Auxiliary Relay Cabinet B (2C40). The DEFAS cabinet output trip signals are only transmitted to the Auxiliary Relay Cabinets if a DSS actuation has occurred, indicating the existence of an ATWS event.

DEFAS interfaces with the safety related steam generator narrow range level instrument loops and the EFAS circuitry in the Auxiliary Relay Cabinets are accomplished via safety related fiber optic isolators.

The DEFAS 2-out-of-4 logic system outputs are actually configured as a 2-out-of-2 logic system which interfaces with each half of the EFAS actuation logic circuitry. A DEFAS trip signal generated in one trip path will only result in a half leg trip. The DEFAS logic in the Auxiliary Relay Cabinets is designed such that the loss of both trip paths is needed to de-energize the subgroup relays, resulting in EFW initiation.

ARKANSAS NUCLEAR ONE
UNIT 2

The DEFAS design consists of the following requirements:

- DEFAS initiates emergency feedwater flow for conditions indicative of an ATWS where the EFAS has failed.
- The DEFAS is not required to provide mitigation of an accident such as isolating feedwater flow to a ruptured steam generator.
- DEFAS will stop feedwater flow to the affected steam generator after reaching a pre-determined level setpoint at about 30 minutes after actuation; thereafter, manual operator intervention will control the system.
- DEFAS utilizes a 2-out-of-4 logic system with steam generator water level as the parameter indicative of the need for EFAS actuation.
- DEFAS interfaces with the actuated components via the Auxiliary Relay Cabinet relays. These relays are considered to be the final actuation devices and therefore they are not required to be diverse from the reactor trip system.
- DEFAS is blocked by the EFAS to prevent control/safety interactions and to disable DEFAS when the EFAS actuates.
- DEFAS is blocked by a main steam isolation signal to prevent control/safety interactions and to disable the DEFAS when conditions for MSIS exist.
- DEFAS is enabled by a signal from the DSS indicating DSS actuation due to an ATWS event.
- DEFAS includes capabilities to allow testing at power.
- DEFAS includes features that provide alarms, plant computer data, and other operator interfaces to indicate system status and meet operability requirements.
- Manual initiation of DEFAS is provided for each steam generator via control room panel switches.
- DEFAS setpoints and response times are coordinated with the existing PPS setpoints and response times so that a competing condition between the PPS and DEFAS is prevented.
- DEFAS interfaces with existing Class 1E sensors and output devices by a fiber optic isolation technique which has been approved by the NRC for nuclear plant safety related system application. The DEFAS is physically and electrically separated from the existing RTS. It does not degrade the existing separation criteria of the RTS.
- DEFAS equipment is qualified for its environment due to Anticipated Operational Occurrences.
- DEFAS is designed under suitable Quality Assurance procedures consistent with the requirements and clarification of 10 CFR 50.62 contained in NRC Generic Letter 85-06.

ARKANSAS NUCLEAR ONE
UNIT 2

- DEFAS logic power is separate and independent from the existing PPS power and is capable of providing uninterruptible power for up to one hour following the loss of its power source.
- The DEFAS is not required to be sealed-in, or locked-out, at the system level due to EFAS and MSIS control interactions. However, the 2-out-of-4 logic channels are sealed in upon receipt of a valid low steam generator level signal until a DEFAS high level setpoint is obtained.
- DEFAS uses a micro-computer with solid state I/O modules as contrasted with the PPS which uses analog bistable trip units. The DEFAS is an energize-to-actuate system while the PPS/EFAS is a de-energize-to-actuate system.
- The DEFAS is placed in service during Mode 1 operating conditions. However, the system may be taken out of service during Mode 1 for corrective maintenance or surveillance testing purposes.

In summary, the DEFAS is a highly reliable system designed to mitigate ATWS event consequences by providing a diverse means to initiate emergency feedwater, thereby minimizing the potential for a common mode failure affecting both the reactor trip system and the existing emergency feedwater actuation system.

7.7.2 ANALYSIS

The plant control systems and equipment are designed to provide high reliability during steady state operation and anticipated transient conditions.

The RPS analysis of Section 7.2.2 encompasses the failure modes of these control systems and demonstrates that these systems are not required for safety.

The accident analyses of Chapter 15 do not require these systems to remain functional.

ARKANSAS NUCLEAR ONE
Unit 2

Table 7.2-1

REACTOR PROTECTIVE SYSTEM BYPASSES

<u>Title</u>	<u>Function</u>	<u>Initiated By</u>	<u>Removed By</u>	<u>Notes</u>
DNBR and Local Power Density Bypass	Disable Low DNBR and High Local Power Density Trips	Key-Operated Switch (1 per channel) if power is $< 10^{-2}\%$	Automatic if power is $\geq 10^{-2}\%$	Allows low power testing
RPS/ESFAS Low Pressurizer Pressure/ Low RWT Level Bypass	Disables Low Pressurizer Pressure Trip, SIAS, and RAS	Spring Return Switch (1 per channel) if pressure is below bypass permissive (< 400 psia)	Automatic if Pressure is ≥ 500 psia	Allows plant cool down and depressurization
High Log Power Level Bypass	Disables High Logarithmic Power Level Trip	Pushbutton (1 per channel) if power is $> 10^{-4}\%$	Automatic if power is $\leq 10^{-4}\%$	Bypassed during reactor startup
Trip Channel Bypass	Disables any given Trip Channel	Manually by Controlled Access Switch	Same Switch	Interlocks allow only one channel for any type trip to be bypassed at one time.
RPS/ESFAS Steam Generator High/Low Level Bypass	Disables High/Low Steam Generator Level Trips and Emergency Feedwater Actuation	Spring Return Switch (1 per channel) if RCS Temperature is < 200 °F	Automatic if RCS Temperature is ≥ 200 °F	Allows testing at low power. High Steam Generator Level Bypass does not affect ESFAS

ARKANSAS NUCLEAR ONE
Unit 2

Table 7.2-2

REACTOR PROTECTIVE SYSTEM MONITORED PLANT VARIABLE RANGES

Monitored Variable	Minimum	(Full Power) Nominal	Maximum
Neutron Flux Power	10 ⁻⁸ % of full power	100% power	200% of full power
Cold Leg Temperature	465 °F	551 °F	615 °F
Hot Leg Temperature	525 °F	610 °F	675 °F
Pressurizer Pressure (Narrow Range)	1500 psia	2200 psia	2500 psia
Pressurizer Pressure (Wide Range)	0 psia	2200 psia	3000 psia
CEA Positions	full in	N/A	full out
Reactor Coolant Pump Speed	0 rpm	891 rpm	1500 rpm
Steam Generator Water Level	0%	70%	100%
Steam Generator Pressure	0 psia	943.9 psia	1200 psia
Containment Pressure	0 psia	15 psia	27 psia

ARKANSAS NUCLEAR ONE
Unit 2

Table 7.2-3

REACTOR PROTECTIVE SYSTEM SENSORS

Monitored Variable	Type	Number of Sensors	Location
Neutron Flux Power	Fission Chamber	12	Biological Shield
Cold Leg Temperature	Precision RTD	8	Cold Leg Piping
Hot Leg Temperature	Precision RTD	8	Hot Leg Piping
Pressurizer Pressure (Wide Range)	Pressure Transducer	4*	Pressurizer
Pressurizer Pressure (Narrow Range)	Pressure Transducer	4	Pressurizer
CEA Positions	Reed Switch Assemblies	2/CEA	Control Element Drive Mechanism
Reactor Coolant Pump Speed	Proximity Device	4/pump	Reactor Coolant Pump
Steam Generator Level	Differential Pressure Transducer	4/Stm. Gen	Steam Generators
Steam Generator Pressure	Pressure Transducer	4/Stm. Gen.*	Steam Generators
Containment Pressure	Pressure Transducer	4*	Containment Structure

* Common with Engineered Safety Features Actuation System

ARKANSAS NUCLEAR ONE
Unit 2

Table 7.2-4

REACTOR PROTECTIVE SYSTEM INSTRUMENT RANGES AND MARGINS TO TRIP

Reactor Trip	Instrument Range	Trip Setpoint	Full Power Nominal Value	Margin To Trip
High Logarithmic Power Level	10 ⁻⁸ - 200% Power	≤ 0.75% Power	N/A	N/A
High Linear Power Level	0 - 200% Power	≤ 110% Power	100% Power	10% Power
High Pressurizer Pressure	1500 - 2500 psia	≤ 2362 psia	2200 psia	162 psid
Low Pressurizer Pressure	0 - 3000 psia	≥ 1650 psia ²	2200 psia	550 psid
High Steam Generator Level ^{4,5}	0 - 100% ¹	≤ 85.8% ¹	70% ¹	15.8%
Low Steam Generator Level ⁵	0 - 100% ¹	≥ 22.2% ¹	70% ¹	47.8%
Low Steam Generator Pressure	0 - 1200 psia	≥ 751 psia ²	943.9 psia	192.9 psid
High Containment Pressure	0 - 27 psia	≤ 18.3 psia	15 psia	3.3 psid
Low DNBR	See Section 7.2.1.1.2.5	≥ 1.25 ³	1.65	0.40
High Local Power Density	See Section 7.2.1.1.2.5	≤ 21.0	≤ 12.1	≥ 8.9

*These are the setpoints required by the ANO-2 Technical Specifications.

- (1) Percentage of the distance between steam generator upper and lower level instrument nozzles.
- (2) These setpoints can be decreased manually as pressure is reduced and increase automatically as pressure is increased. The low pressurizer pressure trip can be manually bypassed below the bypass permissive, (< 400 psia). The bypass is automatically removed before pressure increases to 500 psia.
- (3) The CPC system calculated value of DNBR assures trip considering all sensor and processing time delays and inaccuracies (see Section 7.2.1.1.2.5 for additional information). It also accounts for the difference between the thermal hydraulic model, CHF correlations, and DNBR limit used in the reload design analysis and that used in the CPC System.
- (4) Not required for safety. This trip is equipment protective only.
- (5) The steam generator high/low trips can be manually bypassed when RCS temperature is below 200 °F. The bypass is automatically removed if RCS temperature increases to 200 °F.

ARKANSAS NUCLEAR ONE
Unit 2

TABLE 7.2-5

PLANT PROTECTION SYSTEM FAILURE MODES AND EFFECTS ANALYSIS								
No.	Name	Failure Mode	Cause	Symptoms and Local Effects Including Dependent Failures	Method of Detection	Inherent Compensating Provision	Effect Upon PPS	Remarks and Other Effects
				Measurement Channel	Reactor Flux	FMEA Diagrams 1 & 2A		
1)	Ex-Core Flux Monitor (68)	Low - all detectors (low, mid, and high)	Loss of H.V. power supply.	Loss of data, erroneous data. Affects local power density (LPD), departure from nucleate boiling ratio (DNBR) and calibrated nuclear power calculations. LPD and DNBR channel trips due to Nuclear Instrument System (NIS) trouble contacts.	Annunciating. Trip alarms on HI LPD and LOW DNBR. Nuclear instrument inoperative alarm. CPC sensor failure alarm. 3-channel comparison. Periodic manual test.	3-channel redundancy (4th channel bypassed). Nuclear instrument trouble bistable channel trip.	Makes reactor trip logic for LO DNBR and HI LPD 1-out-of-2 coincidence. Makes reactor trip logic for HI LOG PWR and HI LIN PWR 2-out-of-2 coincidence.	Reactor trip logic for HI LOG PWR, LO DNBR, HI LPD, and HI LIN PWR trips must be converted to 1-out-of-2 by placing appropriate bistables in affected channel in the tripped state.
		Low - one detector.	Breakdown in insulation resistance. Cable break.	Loss of data, erroneous data. Affects local power density (LPD), departure from nucleate boiling ratio (DNBR) and calibrated nuclear power calculations. Possible LPD and DNBR channel trips.	Annunciating. Pre-trip and trip alarms on HI LPD and LO DNBR. 3-channel comparison. Periodic manual test.	3-channel redundancy (4th channel bypassed). Channel trip.	Makes reactor trip logic for LO DNBR and HI LPD 1-out-of-2 coincidence. Makes reactor trip logic for HI LIN PWR and HI LOG PWR (mid detector only) 2-out-of-2 coincidence.	Reactor trip logic for HI LOG PWR (mid detector only), HI LIN PWR, LO DNBR, and HI LPD trips must be converted to 1-out-of-2 by placing appropriate bistables in affected channel in the tripped state.

ARKANSAS NUCLEAR ONE
Unit 2

TABLE 7.2-5 (continued)

No.	Name	Failure Mode	Cause	Symptoms and Local Effects Including Dependent Failures	Method of Detection	Inherent Compensating Provision	Effect Upon PPS	Remarks and Other Effects
				Measurement Channel	Reactor Flux	FMEA Diagrams 1 & 2A		
1)	Ex-Core Flux Monitor (68) (cont)	High	Detector shorts, continuous ionization.	Erroneous data. Affects LPD, DNBR, and calibrated nuclear power calculations. LPD, DNBR, and possible HI Linear PWR channel trips. For mid detector, possible additional HI LOG PWR channel trip.	Annunciating. Pre-trip and trip alarms on LPD, DNBR, HI LIN PWR, and HI LOG PWR (mid detector only). Possible Log rate alarm (mid detector only). CPC sensor failure alarm. 3-channel comparison. Periodic manual test.	3-channel redundancy (4th channel bypassed). Channel trip.	Makes reactor trip logic for HI LIN PWR, LO DNBR, HI LOG PWR (mid detector only), and HI LPD 1-out-of-2 coincidence.	Reactor trip logic for HI LOG PWR (mid detector only), HI LIN PWR, LO DNBR, and HI LPD trips must be maintained in 1-out-of-2 by placing appropriate bistables in affected channel in the tripped state.
2)	Ex-core Power Level (69)	Low Linear and Log outputs.	Loss of Low Voltage power supply.	Loss of data, erroneous data. Affects LPD, DNBR, Log and calibrated nuclear power calculations. LPD and DNBR channel trips due to NIS trouble alarm contacts.	Annunciating. Trip alarms on HI LPD and LOW DNBR. Nuclear instrument inoperative alarm. CPC sensor failure alarm. 3-channel comparison. Periodic manual test.	3-channel redundancy (4th channel bypassed) Nuclear instrument trouble bistable causes DNBR/LPD auxiliary channel trip.	Makes reactor trip logic for LO DNBR and HI LPD 1-out-of-2 coincidence. Makes reactor trip logic for HI LOG PWR and HI LIN PWR 2-out-of-2 coincidence.	Reactor trip logic for HI LOG PWR, LO DNBR, HI LPD, and HI LIN PWR trips must be converted to 1-out-of-2 by placing appropriate bistables in affected channel in the tripped state.

ARKANSAS NUCLEAR ONE
Unit 2

TABLE 7.2-5 (continued)

No.	Name	Failure Mode	Cause	Symptoms and Local Effects Including Dependent Failures	Method of Detection	Inherent Compensating Provision	Effect Upon PPS	Remarks and Other Effects
				Measurement Channel	Reactor Flux	FMEA Diagram 1		
2)	Ex-core Power Level (69) (cont)	Low Linear output.	Amplifier failure - Linear section.	Loss of data, erroneous data. Affects LPD, DNBR, and calibrated nuclear power calculations. Possible LPD and DNBR channel trips.	Annunciating. CPC sensor failure alarm. Pre-trip and trip alarms on HI LPD and LOW DNBR. 3-channel comparison. Periodic manual test.	3-channel redundancy (4th channel bypassed) Channel trip.	Makes reactor trip logic for LO DNBR and HI LPD 1-out-of-2 coincidence. Makes reactor trip logic for HI LIN PWR 2-out-of-2 coincidence.	Reactor trip logic for HI LIN PWR, LO DNBR, and HI LPD trips must be converted to 1-out-of-2 by placing appropriate bistables in affected channel in the tripped state.
		Low Log Output.	Amplifier failure - Log section.	Loss of data, erroneous data.	3-channel comparison. Periodic manual test.	3-channel redundancy (4th channel bypassed)	Makes reactor trip logic for HI LOG PWR 2-out-of-2 coincidence.	Reactor trip logic for HI LOG PWR trip must be converted to 1-out-of-2 by placing appropriate bistable in affected channel in the tripped state.
		High Linear Output.	Amplifier failure - Linear section.	Erroneous data. Affects LPD, DNBR, and calibrated nuclear power calculations. Possible LPD, DNBR, HI Linear PWR channel trips.	Annunciating. Pre-trip and trip alarms on LPD, DNBR and HI LIN PWR. CPC sensor failure alarm. Auto sensor validity test. 3-channel comparison. Periodic manual test.	3-channel redundancy (4th channel bypassed) Channel trip.	Makes reactor trip logic for HI LIN PWR, HI LPD, and LO DNBR 1-out-of-2.	Reactor trip logic for HI LIN PWR, LO DNBR, and HI LPD trips must be maintained in 1-out-of-2 by placing appropriate bistables in affected channel in tripped state.

ARKANSAS NUCLEAR ONE
Unit 2

TABLE 7.2-5 (continued)

No.	Name	Failure Mode	Cause	Symptoms and Local Effects Including Dependent Failures	Method of Detection	Inherent Compensating Provision	Effect Upon PPS	Remarks and Other Effects
				Measurement Channel	Reactor Flux	FMEA Diagram 1		
2)	Ex-core Power Level (69) (cont)	High Log output.	Amplifier failure - Log section.	Erroneous data. Possible HI LOG PWR channel trip.	Annunciating. Possible pre-trip and trip HI LOG PWR alarms. Possible Log Rate alarm. 3-channel comparison. Periodic manual test.	3-channel redundancy (4th channel bypassed). Channel trip.	Makes reactor trip logic for HI LOG PWR 1-out-of-2.	Reactor trip logic for HI LOG PWR trip must be maintained in 1-out-of-2 by placing appropriate bistable in affected channel in the tripped state.
				Measurement Channel	CPC Inputs	FMEA Diagram 1		
3)	Core Outlet Temperature T_{hot} (80)	Low	Power supply failure. Shorted RTD or cable. Temperature transmitter failure. Resistor short. I/I isolator failure.	Erroneous data. Reduces ΔT power calculation. Affects Quality Margin, LPD, DNBR, and RCS flow calculations.	Annunciating. Automatic sensor validity test (CPC sensor failure alarm). 3-channel comparison. Two T_{hot} measurements per channel.	3-channel redundancy (4th channel bypassed). CPC selects higher of neutron flux power and ΔT power for calculation of DNBR and LPD.	Makes reactor trip logic for LO DNBR and HI LPD 2-out-of-2.	Reactor trip logic for HI LPD and LO DNBR trips must be maintained in 1-out-of-2 by placing appropriate bistables in affected channel in tripped state.
		High	Open RTD or cable. Temperature transmitter failure. Resistor failure.	Erroneous data. Increases ΔT power calculation. Affects Quality Margin, LPD, DNBR, and RCS flow calculations. LO DNBR, HI LPD channel trips. Auxiliary LO DNBR, HI LPD channel trips due to Low Quality Margin.	Annunciating. Trip alarms on LO DNBR, HI LPD. Automatic sensor validity test (CPC sensor failure alarm). 3 channel comparison. Two T_{hot} measurements per channel.	3-channel redundancy (4th channel bypassed). Channel trip due to CPC auxiliary trip on Low Quality Margin.	Makes reactor trip logic for LO DNBR and HI LPD 1-out-of-2.	Reactor trip logic for HI LPD & LO DNBR trips must be maintained in 1-out-of-2 by placing appropriate bistables in affected channel in tripped state. CPC aux trips do not generate pre-trip alarms.

ARKANSAS NUCLEAR ONE
Unit 2

TABLE 7.2-5 (continued)

No.	Name	Failure Mode	Cause	Symptoms and Local Effects Including Dependent Failures	Method of Detection	Inherent Compensating Provision	Effect Upon PPS	Remarks and Other Effects
				Measurement Channel	CPC Inputs	FMEA Diagram 1		
4)	Core Inlet Temperature T _{cold} (82)	Low	Power supply failure. Shorted RTD or cable. Shorted resistor. Temperature transmitter failure. I/I isolator failure.	Erroneous data. Increases ΔT power and calibrated neutron flux power. The higher of these two affects LPD and DNBR calculations. LO DNBR, HI LPD channel auxiliary trips due to T _{cold} sensor input outside normal range.	Annunciating. Trip alarms on LO DNBR, HI LPD. Automatic sensor validity test (CPC sensor failure alarm). 3-channel comparison. Two T _{cold} measurements per channel.	3-channel redundancy (4th channel bypassed) Channel trip due to CPC LO DNBR, HI LPD auxiliary trip on T _{cold} outside normal range.	Makes reactor trip logic for LO DNBR and HI LPD 1-out-of-2.	Reactor trip logic for HI LPD and LO DNBR trips must be maintained in 1-out-of-2 by placing appropriate bistables in affected channel in the tripped state.
		High	Open RTD or cable. Temperature transmitter failure. Resistor failure.	Erroneous data. Decreases ΔT power and DNBR calculations. Affects LPD calculation. LO DNBR, HI LPD auxiliary trips due to T _{cold} sensor input outside normal range.	Annunciating. Trip alarms on LO DNBR, HI LPD. CPC sensor failure alarm. Auto sensor validity test. 3 channel comparison. Two T _{cold} measurements per channel.	3-channel redundancy (4th channel bypassed) Channel trip due to CPC auxiliary trip on T _{cold} outside normal range.	Makes reactor trip logic for LO DNBR and HI LPD 1-out-of-2.	Reactor trip logic for HI LPD and LO DNBR trips must be maintained in 1-out-of-2 by placing appropriate bistables in affected channel in the tripped state.

ARKANSAS NUCLEAR ONE
Unit 2

TABLE 7.2-5 (continued)

No.	Name	Failure Mode	Cause	Symptoms and Local Effects Including Dependent Failures	Method of Detection	Inherent Compensating Provision	Effect Upon PPS	Remarks and Other Effects
				Measurement Channel	CPC Inputs	FMEA Diagram 1		
5)	Reactor coolant pump flow (84)	Loss of signal.	Power supply, speed transmitter, or signal processor failure. Mechanical damage to sensor.	Loss of data. Reduces DNBR calculation. LO DNBR channel trip.	Annunciating. Pre-trip and trip alarms on LO DNBR. Automatic sensor validity test (CPC sensor failure alarm).	3-channel redundancy (4th channel bypassed) Channel trip.	Makes reactor trip logic for LO DNBR 1-out-of-2.	Reactor trip logic for LO DNBR trip must be maintained in 1-out-of-2 by placing appropriate bistables in affected channel in the tripped state.
6)	Non-target CEA position (149)	Other than actual position.	Shorted resistor. Power supply malfunction. Shorted reed switches.	Erroneous data input to one CEA calculator (CEAC). Possible penalty factor added to DNBR and LPD calculation in each CPC channel.	Annunciating. CEA deviation alarm. CWP alarm. Comparison with redundant CEAC.	Redundant CEAC.	Possible penalty factor will be applied to each CPC channel. DNBR and LPD operating margins will be reduced. Possible LO DNBR, HI LPD reactor trip.	One CEA calculator (CEAC) will detect CEA deviation and apply penalty to all CPCs.
		Excessive rate of change high or low.	Shorted resistor, power supply malfunction.	Erroneous data input to one CEAC.	Annunciating. Automatic sensor validity test (CEAC sensor failure alarm). Comparison with redundant CEAC.	CEAC uses last valid position if sensor failure is detected. Redundant CEAC.	None	One CEAC will detect CEA sensor failure based on rate of change of indicated position.

ARKANSAS NUCLEAR ONE
Unit 2

TABLE 7.2-5 (continued)

No.	Name	Failure Mode	Cause	Symptoms and Local Effects Including Dependent Failures	Method of Detection	Inherent Compensating Provision	Effect Upon PPS	Remarks and Other Effects
				Measurement Channel	CPC Inputs	FMEA Diagram 1		
6)	Non-target CEA position (149) (cont)	Off scale.	Broken wire, open reed switch, open resistor, electrical short, power supply malfunction.	Loss of data input to one CEAC.	Annunciating. Automatic sensor validity test (CEAC sensor failure alarm). Comparison with redundant CEAC.	CEAC uses last valid position if sensor failure is detected. Redundant CEAC.	None	One CEAC will detect CEA sensor failure based on rate of change of indicated position and/or input out of range.
				Measurement Channel	CPC Inputs	FMEA Diagram 1		
7)		Other than actual position - Low	Shorted resistor. Power supply malfunction. Shorted reed switches.	Erroneous data input to one CPC channel and one CEAC. Out of sequence or sub group deviation penalties applied to DNBR and LPD calculations (except for lead reg group CEA). LO DNBR and HI LPD channel trips.	Annunciating. Pre-trip and trip alarms on LO DNBR and HI LPD. Automatic sensor validity test (CEAC sensor failure alarm). 3-channel comparison.	3-channel redundancy (4th channel bypassed) Channel trip.	Makes reactor trip logic for LO DNBR and HI LPD 1-out-of-2.	Reactor trip logic for HI LPD and LO DNBR trips must be maintained in 1-out-of-2 by placing appropriate bistables in affected channel in the tripped state.
		Other than actual position - High	Shorted resistor. Power supply malfunction. Shorted reed switches.	Erroneous data input to one CPC channel and one CEAC.	Annunciating. Automatic sensor validity test (CEAC sensor failure alarm). 3-channel comparison.	3-channel redundancy (4th channel bypassed)	None	At power rod positions are normally all rods out (ARO). For other conditions, effects may be the same as for the Low failure mode.

ARKANSAS NUCLEAR ONE
Unit 2

TABLE 7.2-5 (continued)

No.	Name	Failure Mode	Cause	Symptoms and Local Effects Including Dependent Failures	Method of Detection	Inherent Compensating Provision	Effect Upon PPS	Remarks and Other Effects
				Measurement Channel	CPC Inputs	FMEA Diagram 1		
7)		Off scale	Broken wire, open reed switch, open resistor, electrical short, power supply malfunction.	Loss of data to one CPC channel and one CEAC. Possible Out of sequence or sub group deviation penalties applied to DNBR and LPD calculations (except for lead reg group CEA). Possible LO DNBR and HI LPD channel trips.	Annunciating. Automatic sensor validity test (CEAC sensor failure alarm and CPC sensor failure alarm). Possible pre-trip and trip alarms on LO DNBR and HI LPD. 3-channel comparison.	3-channel redundancy (4th channel bypassed) Possible channel trip.	Possibly makes reactor trip logic for LO DNBR and HI LPD 1-out-of-2.	Effects are similar to Low and High failure modes with the addition of a CPC sensor failure alarm.
8)	Control Element Assembly Calculator (88)	No data output	Loss of ac power, input/output failure. Data link failure. Arithmetic, logic, or memory failure.	Loss of one CEAC penalty factor inputs to each CPC channel. Loss of CEA position display from failed CEAC.	Annunciating. CEAC trouble alarm. Comparison of CEA position displays.	CPCs use either the output of the redundant CEAC or the last previous penalty factor from the failed CEAC, whichever is most conservative.	None	CEAC diagnostic routine or loss of data link sends failure flag to CPCs.
		Erroneous data output.	CEA position sensor failure, input/output failure. Data link failure. Arithmetic, logic, or memory failure.	Erroneous CEAC penalty factors applied to CPCs. Possible LO DNBR and HI LPD trips.	Annunciating. CEAC trouble alarm. Comparison of CEA position displays.	CPCs use the largest penalty factor from the two CEACs.	Possible LO DNBR and HI LPD reactor trip.	Assumes CEAC failure flag not generated. CPCs compare CEAC outputs and annunciate on significant difference.

ARKANSAS NUCLEAR ONE
Unit 2

TABLE 7.2-5 (continued)

No.	Name	Failure Mode	Cause	Symptoms and Local Effects Including Dependent Failures	Method of Detection	Inherent Compensating Provision	Effect Upon PPS	Remarks and Other Effects
				Measurement Channel	CPC Inputs	FMEA Diagram 1		
9)	Core Protection Calculator (89)	Tripped	Loss of ac power. Input/output failure. Arithmetic, logic, or memory failure. Sensor failure	Erroneous calculated results. Loss of CPC remote operator module display. CPC internal self testing and watchdog timer trip outputs on fault.	Annunciating. Pre-trip and trip alarms on LO DNBR and HI LPD. CPC failure alarm. 3-channel comparisons.	3-channel redundancy (4th channel bypassed) Channel trip.	Makes reactor trip logic for LO DNBR and HI LPD 1-out-of-2.	Computer shuts down in orderly sequence on loss of ac power and resumes normal operation with restoration of power. Reactor trip logic for HI LPD and LO DNBR trips must be maintained in 1-out-of-2 by placing appropriate bistables in affected channel in the tripped state.
		Stays in un-tripped state	Input/output failure. Arithmetic, logic or memory failure. Sensor failure.	Erroneous calculated results.	Non-Annunciating. 3 channel comparison. Periodic test.	3-channel redundancy (4th channel bypassed)	Makes reactor trip logic for LO DNBR and HI LPD 2-out-of-2.	Reactor trip logic for HI LPD and LO DNBR trips must be converted to 1-out-of-2 by placing appropriate bistables in affected channel in the tripped state.

ARKANSAS NUCLEAR ONE
Unit 2

TABLE 7.2-5 (continued)

No.	Name	Failure Mode	Cause	Symptoms and Local Effects Including Dependent Failures	Method of Detection	Inherent Compensating Provision	Effect Upon PPS	Remarks and Other Effects
				Measurement Channel	S/G Water Level	FMEA Diagram 1		
10)	SG No. 2 Level Signal (51) SG No. 1 Level Signal (55)	Low	Sensor failure, dc power supply failure, I/I isolator failure, open circuit, resistor failure, junction box failure.	Loss of data. Erroneous data. Low SG-1(2) level signal to associated channel bistables. SG-1(2) LO LVL bistable trips. SG-1(2) HI LVL bistable disabled.	Annunciating. Pre-trip and trip alarms on SG-1(2) LO LVL. 3-channel comparison.	3-channel redundancy (4th channel bypassed) Channel trip on SG-1(2) LO LVL.	Makes reactor trip and EFAS logic for SG-1(2) LO LVL 1-out-of-2 coincidence. Makes reactor trip logic for SG-1(2) HI LVL 2-out-of-2 coincidence.	Reactor trip and EFAS logic for SG LVL functions must be converted to 1-out-of-2 by placing the appropriate bistables in affected channel in the tripped state. Same response for SG-1 and SG-2.
		High	Sensor failure, I/I isolator failure. Resistor failure. Cable failure. Junction box failure.	Erroneous data. High SG-1(2) level signal to associated channel bistables. SG-1(2) HI LVL bistable trips. SG-1(2) LO LVL bistable disabled.	Annunciating. Pre-trip and trip alarms on SG-1(2) HI LVL. 3-channel comparison. Periodic test.	3-channel redundancy (4th channel bypassed) Channel trip on SG-1(2) HI LVL.	Makes reactor trip and EFAS logic for SG-1(2) LO LVL 2-out-of-2 coincidence. Makes reactor trip logic for SG-1(2) HI LVL 1-out-of-2 coincidence.	Reactor trip and EFAS logic for SG-1(2) LVL functions must be converted to 1-out-of-2 by placing the appropriate bistables in affected channel in the tripped state.

ARKANSAS NUCLEAR ONE
Unit 2

TABLE 7.2-5 (continued)

No.	Name	Failure Mode	Cause	Symptoms and Local Effects Including Dependent Failures	Method of Detection	Inherent Compensating Provision	Effect Upon PPS	Remarks and Other Effects
				RPS Operating Bypass	S/G Water Level	FMEA Diagram 1		
11)	SG-1&2 HI/LO LEVEL Operating Bypass Permissive (222)	Off	RTD open, temperature transmitter failure, bistable comparator failure, auxiliary relay card failure, Operating trip bypass switch failure.	Unable to bypass SG LVL trip functions in affected channel when $T_{hot} < 200$ °F or if bypass was previously in, it will be removed. SG LVL reactor trip and EFAS-1/2 channel functions remain or become active.	Periodic test. Bypass and/or Permissive lights on Remote Operator Module (ROM) go out. Possible pre-trip and trip alarms on one or more SG LVL functions during startup.	3-channel redundancy (4th channel bypassed) SG LVL HI/LOW channel trips are enabled.	Possibly makes reactor trip logic for one or more SG LVL functions 1-out-of-2 coincidence depending on plant conditions.	This bypass permits CEA testing during cold shutdown. T_{hot} signal faults can also produce consequences described for Item No. 3). For detailed component failure modes see items 20, 21, 22, and 23 (identical hardware).
		On	Bistable comparator failure (no trip). Auxiliary relay card failure (stuck closed contacts). Operating trip bypass switch failure.	SG LVL reactor trip and EFAS-1/2 channel functions for affected channel disabled.	Possible bypass annunciator. Bypass light and possibly permissive light on ROM. Periodic test.	3-channel redundancy (4th channel bypassed)	Makes reactor trip and EFAS logic for SG LVL functions 2-out-of-2 coincidence.	Operator may be able to remove bypass manually at ROM, otherwise, reactor trip and EFAS logic for SG LVL functions must be converted to 1-out-of-2 by placing the appropriate bistables in affected channel in the tripped state.

ARKANSAS NUCLEAR ONE
Unit 2

TABLE 7.2-5 (continued)

No.	Name	Failure Mode	Cause	Symptoms and Local Effects Including Dependent Failures	Method of Detection	Inherent Compensating Provision	Effect Upon PPS	Remarks and Other Effects
				RPS Operating Bypass	S/G Water Level	FMEA Diagram 1		
11a)	SG-1&2 HI/LO LEVEL Operating Bypass	Off	Loss of permissive (Item 11), auxiliary relay (AK-26) or driver, trip bypass opto-isolator failure.	SG LEVEL reactor trip and EFAS-1/2 channel functions remain or become enabled.	3-channel comparison ROM Bypass light off. Periodic test. Possible trip alarm(s) on HI or LO SG LEVEL depending on plant conditions.	3-channel redundancy (4th channel bypassed) Affected channel trip and EFAS functions are enabled.	Possibly makes HI/LO SG LEVEL reactor trip and EFAS-1/2 functions 1-out-of-2 coincidence depending on plant conditions.	Loss of permissive fault also produces consequences described for Item 11).
		On	Auxiliary relay (AK-26) or driver failure.	SG LEVEL reactor trip and EFAS-1/2 channel functions will be disabled.	Possible Bypass alarm. 3-channel comparison. ROM bypass light on. Periodic test.	3-channel redundancy (4th channel bypassed)	Makes SG LEVEL reactor trip and EFAS-1/2 functions 2-out-of-2 coincidence.	Logic for SG LEVEL reactor trip and EFAS-1/2 functions must be converted to 1-out-of-2 by placing the appropriate bistables in affected channel in the tripped state.

ARKANSAS NUCLEAR ONE
Unit 2

TABLE 7.2-5 (continued)

No.	Name	Failure Mode	Cause	Symptoms and Local Effects Including Dependent Failures	Method of Detection	Inherent Compensating Provision	Effect Upon PPS	Remarks and Other Effects
				Measurement Channel	PZR Pressure	FMEA Diagram 1		
12)	Wide Range PZR Pressure Signal (61)	High	Sensor failure, I/I isolator failure. Resistor failure. Junction box failure.	Erroneous data. High PZR press. signal to LO PZR PRESS bistable. LO PZR PRESS bistable disabled. Affects reactor trip, SIAS, CCAS, and CSAS functions.	3-channel comparisons. Periodic test.	3-channel redundancy (4th channel bypassed)	Makes reactor trip, CSAS enable, CCAS, and SIAS logic for LO PZR PRESS 2-out-of-2 coincidence.	Reactor trip and ESFAS logic for LO PZR PRESS must be converted to 1-out-of-2 by placing the appropriate bistable in affected channel in the tripped state.
		Low	Sensor failure, I/I isolator failure, dc power supply failure, open circuit. Resistor failure. Junction box failure.	Loss of data. Erroneous data. Low PZR press. signal to LO PZR PRESS bistable. LO PZR PRESS bistable trips. Causes channel trips on reactor trip, SIAS and CCAS functions. CSAS function is affected.	Annunciating. Pre-trip and trip alarms on LO PZR PRESS. 3-channel comparisons.	3-channel redundancy (4th channel bypassed) Channel trip.	Makes reactor trip, CSAS enable, CCAS, and SIAS logic for LO PZR PRESS 1-out-of-2 coincidence.	Reactor trip and ESFAS logic for LO PZR PRESS must be maintained in 1-out-of-2 by placing the appropriate affected channel bistable in the tripped state.
13)	Narrow Range PZR Pressure Signal (91)	High	Sensor failure, I/I isolator failure. Resistor failure. Junction box failure.	Erroneous data. High PZR press. Signal to HI PZR PRESS bistable and CPC. HI PZR PRESS bistable trips. CPC LO DNBR and HI LPD auxiliary channel trips due to PZR press. Sensor input outside operating range. CWP channel trip.	Annunciating. Pre-trip and trip alarm on HI PZR PRESS. Trip alarms on LO DNBR, HI LPD. CWP alarm. CPC sensor failure alarm. 3 channel comparison.	3-channel redundancy (4th channel bypassed) Automatic sensor validity test. Channel trips on HI PZR PRESS, LO DNBR, HI LPD.	Makes CWP and reactor trip logic for HI PZR PRESS, LO DNBR and HI LPD 1-out-of-2 coincidence.	Rx trip logic for HI PZR PRESS, HI LPD, & LO DNBR trips must be maintained in 1-out-of-2 by placing appropriate bistables in affected channel in tripped state.

ARKANSAS NUCLEAR ONE
Unit 2

TABLE 7.2-5 (continued)

No.	Name	Failure Mode	Cause	Symptoms and Local Effects Including Dependent Failures	Method of Detection	Inherent Compensating Provision	Effect Upon PPS	Remarks and Other Effects
				Measurement Channel	PZR Pressure	FMEA Diagram 1		
13)	Narrow Range PZR Pressure Signal (91) (cont)	Low	Sensor failure, I/I isolator failure, dc power supply failure, open circuit, resistor failure, junction box failure.	Loss of data. Erroneous data. Low PZR press. Signal to HI PZR PRESS bistable and CPC. HI PZR PRESS bistable disabled. CPC LO DNBR and HI LPD auxiliary channel trips due to PZR press. Sensor input outside operating range.	Annunciating. Trip alarms on LO DNBR, HI LPD. CPC sensor failure alarm. 3 channel comparison.	3-channel redundancy (4 th channel bypassed) Automatic sensor validity test. Channel trips on LO DNBR, HI LPD.	Makes reactor trip logic for HI PZR PRESS 2-out-of-2. Makes reactor trip logic for LO DNBR and HI LPD 1-out-of-2 coincidence.	Reactor trip logic for HI PZR PRESS, HI LPD, and LO DNBR trips must be converted to 1-out-of-2 by placing appropriate bistables in affected channel in the tripped state.
				Measurement Channel	S/G Pressure	FMEA Diagram 1		
14)	SG No. 2 Pressure Signal (27) SG No. 1 Pressure Signal (42)	Low	Sensor failure, I/I isolator failure, dc power supply failure, open circuit, resistor failure, junction box failure.	Loss of data. Erroneous data. Low SG-1(2) press. signal to associated channel bistables. SG-1(2) LO PRESS and SG-2>SG-1 (SG-1>SG-2) PRESS bistables trip. Channel trip for reactor trip, and MSIS actuation. Affects EFAS-1(2) function.	Annunciating. Pre-trip and trip alarms on SG-1(2) LO PRESS and SG-2>SG-1 (SG-1>SG-2) PRESS. 3-channel comparison.	3-channel redundancy (4th channel bypassed) Channel trip for reactor trip and MSIS. Two steam generators.	Makes reactor trip and MSIS logic for SG-1(2) LO PRESS 1-out-of-2 coincidence. Makes EFAS-1(2) logic 2-out-of-2 coincidence for initiation to an operable SG.	Reactor trip and ESFAS logic for SG-1(2) LO PRESS and SG-2>SG-1 (SG-1>SG-2) PRESS must be converted to 1-out-of-2 by placing the appropriate bistables in affected channel in the tripped state.

ARKANSAS NUCLEAR ONE
Unit 2

TABLE 7.2-5 (continued)

No.	Name	Failure Mode	Cause	Symptoms and Local Effects Including Dependent Failures	Method of Detection	Inherent Compensating Provision	Effect Upon PPS	Remarks and Other Effects
				Measurement Channel	S/G Pressure	FMEA Diagram 1		
14)	SG No. 2 Pressure Signal (27) SG No. 1 Pressure Signal (42) (cont)	High	Sensor failure, I/I isolator failure, resistor failure, junction box failure.	Erroneous data. High SG-1(2) press. signal to associated channel bistables. SG-1(2) LO PRESS disabled. SG-1>SG-2 (SG-2>SG-1) PRESS bistable trips. Affects reactor trip, MSIS, and EFAS functions.	Annunciating. Pre-trip and trip alarms on SG-1>SG-2 (SG-2>SG-1) PRESS. 3-channel comparison.	3-channel redundancy (4th channel bypassed)	Makes reactor trip and MSIS logic for SG-1(2) LO PRESS 2-out-of-2 coincidence. Makes EFAS-1(2) logic 2-out-of-2 coincidence for preventing initiation to a damaged SG.	Reactor trip and ESFAS logic for SG-1(2) LO PRESS and SG-2>SG-1 (SG-1>SG-2) PRESS must be converted to 1-out-of-2 by placing the appropriate bistables in affected channel in the tripped state.
				Measurement Channel	Containment Press	FMEA Diagram 1		
15)	Containment Pressure Signal (6)	High	Instrument loop component failure.	Erroneous data. High containment press. signal to HI CONT PRESS reactor trip and ESFAS channel bistables and to HI-HI CONT PRESS channel bistable. Reactor trip, ESFAS HI CONT PRESS, and HI-HI CONT PRESS bistables trip. Affects reactor trip, CIAS, SIAS, CCAS, and CSAS functions.	Annunciating. Pre-trip and trip alarms on RPS and ESFAS HI CONT PRESS and on HI-HI CONT PRESS. 3-channel comparison.	3-channel redundancy (4th channel bypassed) Channel trips initiated. 2-out-of-3 logic prevents inadvertent actuation of containment spray on a single channel failure.	Makes CSAS logic 1-out-of-2 coincidence. Makes reactor trip, CIAS, SIAS, and CCAS logic for HI CONT PRESS 1-out-of-2 coincidence.	Reactor trip and ESFAS logic for HI CONT PRESS and CSAS logic for HI-HI CONT PRESS must be maintained in 1-out-of-2 by placing the appropriate bistables in affected channel in the tripped state.

ARKANSAS NUCLEAR ONE
Unit 2

TABLE 7.2-5 (continued)

No.	Name	Failure Mode	Cause	Symptoms and Local Effects Including Dependent Failures	Method of Detection	Inherent Compensating Provision	Effect Upon PPS	Remarks and Other Effects
				Measurement Channel	Containment Press	FMEA Diagram 1		
15)	Containment Pressure Signal (6) (cont)	Low	Instrument loop component failure.	Loss of data. Erroneous data. Low containment press. signal to associated channel bistables. Reactor trip and ESFAS HI CONT PRESS bistables disabled. HI-HI CONT PRESS bistable disabled. Affects reactor trip, CIAS, SIAS, CCAS, and CSAS functions.	3-channel comparison. Periodic Test.	3-channel redundancy (4th channel bypassed)	Makes CSAS logic 2-out-of-2 coincidence. Makes reactor trip, CIAS, SIAS, and CCAS logic for HI CONT PRESS 2-out-of-2 coincidence.	Reactor trip and ESFAS logic for HI and HI-HI CONT PRESS must be converted to 1-out-of-2 by placing the appropriate bistables in affected channel in the tripped state.
16)	(221) [Deleted]							
				Measurement Channel	RWT Level	FMEA Diagram 1		
17)	Refueling Water Tank Level Signal (1)	Low	Instrument loop component failure.	Loss of data. Erroneous data. Low RWT level signal to REFUEL TANK LO LEVEL bistable. REFUEL TANK LO LEVEL bistable trips. Affects RAS function.	Annunciating. Pre-trip and trip alarm on REFUEL TANK LO LEVEL. 3-channel comparison.	3-channel redundancy (4th channel bypassed) Channel trip initiated.	Makes RAS logic 1-out-of-2 coincidence.	RAS logic must be maintained in 1-out-of-2 by placing the appropriate bistables in affected channel in the tripped state.
		High	Instrument loop component failure.	Erroneous data. High RWT level signal to REFUEL TANK LO LEVEL bistable. REFUEL TANK LO LEVEL bistable disabled. Affects RAS function.	3-channel comparison. Periodic Test.	3-channel redundancy (4th channel bypassed)	Makes RAS logic 2-out-of-2 coincidence.	RAS logic must be converted to 1-out-of-2 by placing the appropriate affected channel bistable in the tripped state.

ARKANSAS NUCLEAR ONE
Unit 2

TABLE 7.2-5 (continued)

No.	Name	Failure Mode	Cause	Symptoms and Local Effects Including Dependent Failures	Method of Detection	Inherent Compensating Provision	Effect Upon PPS	Remarks and Other Effects
				PPS Operating Bypass	RWT Lv/PZR Press	FMEA Diagram 1		
18)	LO RWT LEVEL/LO PZR PRESS Operating Bypass Permissive (59)	Off	WR PZR press. Signal failure high, bistable comparator (A25) failure, auxiliary relay (AK-21) or driver failure, loss of auxiliary logic power supply.	Unable to bypass LO RWT LEVEL RAS function and LO PZR PRESS reactor trip, SIAS, CCAS and CSAS functions in affected channel when $P_{PZR} < 400$ psi. If bypass was previously in, it will be removed. LO RWT LEVEL RAS function and LO PZR PRESS reactor trip, SIAS, CCAS and CSAS functions remain or become enabled.	3-channel comparison. ROM permissive light off. Periodic test. PPS trouble alarm if fault due to power supply failure. Possible trip alarm(s) on LO RWT LEVEL and/or LO PZR PRESS depending on plant conditions.	3-channel redundancy (4 th channel bypassed) Affected channel trip and ESFAS functions are enabled.	Possibly makes LO RWT LEVEL RAS function and LO PZR PRESS reactor trip, SIAS, CCAS, & CSAS functions 1-out-of-2 coincidence depending on plant conditions.	This bypass permits CEA testing during cold shutdown. WR P_{PZR} signal faults also produce consequences described for Item 12).
		On	WR PZR press. Signal failure low, open circuit, bistable comparator(A25) failure, auxiliary relay (AK-21) or driver failure.	Permissive will be present when plant conditions do not warrant it. During plant startup, bypass will not be automatically removed. Possible to have channel protective functions bypassed when still required.	3-channel comparison. ROM permissive light on. Periodic test.	3-channel redundancy (4 th channel bypassed) Manual operator action required to activate bypass.	During startup, makes LO RWT LEVEL RAS function and LO PZR PRESS reactor trip, SIAS, CCAS & CSAS functions 2-out-of-2 coincidence.	During startup, operator can manually remove bypass and restore PPS to 2-out-of-3. If fault occurs at power, there is no effect on PPS logic.

ARKANSAS NUCLEAR ONE
Unit 2

TABLE 7.2-5 (continued)

No.	Name	Failure Mode	Cause	Symptoms and Local Effects Including Dependent Failures	Method of Detection	Inherent Compensating Provision	Effect Upon PPS	Remarks and Other Effects
				PPS Operating Bypass	RWT Lvl/PZR Press	FMEA Diagram 1		
19)	LO RWT LEVEL/LO PZR PRESS Operating Bypass (60)	Off	Loss of permissive (Item 18), auxiliary relay (AK-22) or driver, trip bypass opto isolator failure.	LO RWT LEVEL RAS function and/or LO PZR PRESS reactor trip, SIAS, CCAS and CSAS channel functions remain or become enabled.	3-channel comparison. ROM bypass light off. Periodic test. Possible trip alarm(s) on LO RWT LEVEL and/or LO PZR PRESS depending on plant conditions.	3-channel redundancy (4th channel bypassed) Affected channel trip and ESFAS functions are enabled.	Possibly makes LO RWT LEVEL RAS function and LO PZR PRESS reactor trip, SIAS, CCAS and CSAS functions 1-out-of-2 coincidence depending on plant conditions.	Opto-isolator fault will affect either LO RWT LEVEL or LO PZR PRESS functions, not both. Loss of permissive fault also produces consequences described for Item 18).
		On	Auxiliary relay (AK-22) or driver.	LO RWT LEVEL RAS, LO PZR PRESS reactor trip, SIAS, CSAS, and CIAS channel functions will be disabled.	Possible Bypass alarm. 3-channel comparison. ROM bypass light on. Periodic test.	3-channel redundancy (4th channel bypassed)	Makes LO RWT LEVEL RAS function and LO PZR PRESS reactor trip, SIAS, CCAS and CSAS functions 2-out-of-2 coincidence.	Logic for LO RWT LEVEL RAS function and LO PZR PRESS reactor trip, SIAS, CCAS and CSAS functions must be converted to 1-out-of-2 by placing the appropriate bistables in affected channel in the tripped state.

ARKANSAS NUCLEAR ONE
Unit 2

TABLE 7.2-5 (continued)

No.	Name	Failure Mode	Cause	Symptoms and Local Effects Including Dependent Failures	Method of Detection	Inherent Compensating Provision	Effect Upon PPS	Remarks and Other Effects
				PPS Operating Bypass	RWT Lvl/PZR Press	FMEA Diagram 1		
20)	Pressurizer Pressure Auxiliary Bistable (BS-25)	Output energized	Failure of Input signal buffer, trip setpoint comparator, or setpoint power supply.	Energizes auxiliary relay AK-21. Generates permissive to LO RWT LEVEL/LO PZR PRESS operating bypass circuit. Same effect as Item No.18) On	Same as Item No.18) On.	Same as Item No.18) On.	Same as Item No.18) On.	Same as Item No.18) On.
		Output de-energized	Failure of Input signal buffer, trip setpoint comparator, setpoint power supply, DC/DC converter, trip output opto-isolator.	Deenergizes auxiliary relay AK-21. Removes permissive to LO RWT LEVEL/LO PZR PRESS operating bypass circuit. Same effect as Item No.18) Off.	3-channel comparison. ROM permissive light off. Periodic test. Possible trip alarm(s) on LO RWT LEVEL and/or LO PZR PRESS depending on plant conditions.	Same as Item No.18) Off.	Same effect as Item No.18) Off.	
21)	Aux Relay Card 24	AK-21 (K101) Coil open	Sustained overvoltage	Removes +12V from AK-22 and permissive light. Removes permissive to LO RWT LEVEL/LO PZR PRESS operating bypass circuit. Same effect as Item No. 18) Off.	Same as Item No. 20) Output Deenergized.	Same as Item No.18) Off.	Same effect as Item No. 18) Off.	
		AK-21 (K101) Coil short	Deterioration of insulation	Generation of permissive from aux bistable card BS-25 at <400 psi will cause AK-21 to draw excessive current & place a severe load on the relay driver. This may cause the relay coil to open or the driver to short or open. Loss of permissive signal. Same effect as Item No. 18) Off.	Same as Item No. 20) Output Deenergized.	Same as Item No. 18) Off.	Same as Item No. 18) Off.	

ARKANSAS NUCLEAR ONE
Unit 2

TABLE 7.2-5 (continued)

No.	Name	Failure Mode	Cause	Symptoms and Local Effects Including Dependent Failures	Method of Detection	Inherent Compensating Provision	Effect Upon PPS	Remarks and Other Effects
				PPS Operating Bypass	RWT Lvl/PZR Press	FMEA Diagram 1		
21)	Aux Relay Card 24 (cont)	AK-21 (K101) Contact open	Deterioration of contact	Same as open coil.	Same as open coil.	Same as open coil.	Same as open coil.	AK-21 uses one NO contact to provide +12V source to AK-22 (Aux relay card 23) and the ROM permissive light.
		AK-21 (K101) Contact short	Welded contact, stuck contact.	Generates permissive to LO RWT LEVEL/LO PZR PRESS operating bypass circuit. Same effect as Item No.18) On.	Same as Item No.18) On.	Same as Item No.18) On.	Same as Item No.18) On.	
		AK-21 Relay Driver (Q101) Off	Open transistor junction.	Deenergizes AK-21 coil. Loss of permissive. Same effect as Item No.18) Off.	Same as Item No. 20) Output Deenergized.	Same as Item No.18) Off.	Same as Item No.18) Off.	
		AK-21 Relay Driver (Q101) On	Emitter to collector short.	Energizes AK-21 coil. Generates permissive to LO RWT LEVEL/LO PZR PRESS operating bypass circuit. Same effect as Item No.18) On.	Same as Item No.18) On.	Same as Item No.18) On.	Same as Item No.18) On.	Shorted transistor may open due to increased current flow.
22)	Aux Relay Card 23	AK-22 (K101) Coil Open	Sustained overvoltage	Removes operating bypass from LO RWT LEVEL and LO PZR PRESS bistables. Removes +12V from ROM Bypass light applies it to Normal light. Opens contact to Bypass annunciator. Same effect as Item 19) Off.	Same as Item 19) Off.	Same as Item 19) Off.	Same as Item 19) Off.	

ARKANSAS NUCLEAR ONE
Unit 2

TABLE 7.2-5 (continued)

No.	Name	Failure Mode	Cause	Symptoms and Local Effects Including Dependent Failures	Method of Detection	Inherent Compensating Provision	Effect Upon PPS	Remarks and Other Effects
				PPS Operating Bypass	RWT Lvl/PZR Press	FMEA Diagram 1		
22)	Aux Relay Card 23 (cont)	AK-22 (K101) Coil short	Deterioration of insulation	Attempting to insert LO RWT/LO PZR PRESS operating bypass with permissive present will cause AK-22 to draw excessive current and place a severe load on the relay driver. This may cause the relay coil to open or the driver to short or open. Loss of bypass function. Same effect as Item No. 19) Off.	Same as Item No. 19) Off.	Same as Item No. 19) Off.	Same as Item No. 19) Off.	
		AK-22 (K101) Open contact to opto-isolators	Deterioration of contact, stuck contact.	Removal of +12V to trip bypass opto-isolators for LO RWT LEVEL and LO PZR PRESS bistables. LO RWT LEVEL RAS channel function and LO PZR PRESS reactor trip, SIAS, CCAS and CSAS channel functions remain or become enabled.	Periodic test. Possible trip alarm(s) on LO RWT LEVEL and/or LO PZR PRESS depending on plant conditions.	Same as Item 19) Off.	Same as Item 19) Off.	AK-22 uses 3 sets of contacts. Normal light remains lit. Bypass annunciator remains on.
		AK-22 (K101) Shorted contact to opto-isolators	Welded or stuck contact.	Applies +12V to trip bypass opto-isolators for LO RWT LEVEL and LO PZR PRESS bistables and to the ROM Bypass light. LO RWT LEVEL RAS channel function and LO PZR PRESS reactor trip, SIAS, CSAS, and CCAS channel functions become disabled.	3-channel comparison. ROM bypass light on. Periodic test.	Same as Item 19) On.	Same as Item 19) On.	Same as Item 19) On.

ARKANSAS NUCLEAR ONE
Unit 2

TABLE 7.2-5 (continued)

No.	Name	Failure Mode	Cause	Symptoms and Local Effects Including Dependent Failures	Method of Detection	Inherent Compensating Provision	Effect Upon PPS	Remarks and Other Effects
				PPS Operating Bypass	RWT Lvl/PZR Press	FMEA Diagram 1		
22)	Aux Relay Card 23 (cont)	AK-22 (K101) Open contact to ROM Normal Light	Deterioration of contact, stuck contact.	ROM Normal light does not come on when Bypass light goes out. No effect on LO RWT/LO PZR PRESS operating bypass operability.	3-channel comparison. ROM Normal light off.	3-channel redundancy (4th channel bypassed)	None	
		AK-22 (K101) Shorted contact to ROM Normal Light	Welded, stuck contact.	ROM Normal light stays on when Bypass light comes on. No effect on LO RWT/LO PZR PRESS operating bypass operability.	3-channel comparison. ROM Normal and Bypass lights on simultaneously.	3-channel redundancy (4th channel bypassed)	None	
		AK-22 (K101) Open contact to Bypass Annunciator	Deterioration of contact, stuck contact.	Bypass Annunciator does not actuate when channel is placed in bypass.	3-channel comparison. ROM Bypass light on with annunciator off. Periodic test.	3-channel redundancy (4th channel bypassed) ROM Bypass light uses separate contact.	None	
		AK-22 (K101) Shorted contact to Bypass Annunciator	Welded or stuck contact.	Bypass annunciator continuously actuated.	3-channel comparison. ROM Bypass light off with annunciator on. Periodic test.	3-channel redundancy (4th channel bypassed) ROM Bypass light uses separate contact.	None	

ARKANSAS NUCLEAR ONE
Unit 2

TABLE 7.2-5 (continued)

No.	Name	Failure Mode	Cause	Symptoms and Local Effects Including Dependent Failures	Method of Detection	Inherent Compensating Provision	Effect Upon PPS	Remarks and Other Effects
				PPS Operating Bypass	RWT Lvl/PZR Press	FMEA Diagram 1		
22)	Aux Relay Card 23 (cont)	AK-22 Relay Driver (Q101) Off	Open transistor junction.	Deenergizes AK-22 coil. Loss of LO RWT LEVEL/LO PZR PRESS bypass capability. Same effect as Item 19) Off.	Same as Item 19) Off.	Same as Item 19) Off.	Same as Item 19) Off.	
		AK-22 Relay Driver (Q101) On	Emitter to collector short.	If permissive is present, energizes AK-22 coil. Generates LO RWT LEVEL/LO PZR PRESS bypass without operator action.	Annunciating. Bypass alarm. 3-channel comparison. ROM Bypass light on. Periodic test.	3-channel redundancy (4th channel bypassed) Bypass will automatically be removed when LO PZR PRESS permissive is removed.	None.	Shorted transistor may open due to increased current flow.
23)	LO RWT LEVEL/LO PZR PRESS ROM Bypass Switch	Short in bypass position	Mechanical failure.	If permissive is present, generates LO RWT LEVEL/LO PZR PRESS bypass without operator action.	Annunciating. Bypass alarm. 3-channel comparison. ROM Bypass light on. Periodic test.	3-channel redundancy (4th channel bypassed) Bypass will automatically be removed when LO PZR PRESS permissive is removed.	None.	
		Open in bypass position	Mechanical failure.	Loss of LO RWT LEVEL/LO PZR PRESS bypass capability. Same effect as Item 19) Off.	Unable to bypass. ROM Bypass light not lit. Periodic test.	Same as Item 19) Off.	Same as Item 19) Off.	

ARKANSAS NUCLEAR ONE
Unit 2

TABLE 7.2-5 (continued)

No.	Name	Failure Mode	Cause	Symptoms and Local Effects Including Dependent Failures	Method of Detection	Inherent Compensating Provision	Effect Upon PPS	Remarks and Other Effects
				RPS Operating Bypass	Hi Log Power	FMEA Diagram 1		
24)	HI LOG POWER Operating Bypass Permissive (70)	Off	Log power signal failure low, NI Safety Channel bistable fails off, NI Safety Channel bistable relay failure, auxiliary relay AK-27 or driver failure, auxiliary logic power supply failure.	Unable to bypass HI LOG PWR reactor trip when power is above the Log Power Bistable Setpoint for the affected channel. If bypass was previously in, it will be removed. HI LOG PWR channel trip remains or becomes enabled.	Unable to bypass. 3-channel comparison. ROM Permissive light off. Periodic test. PPS trouble alarm if fault due to power supply failure. Possible trip alarm on HI LOG PWR depending on plant conditions.	3-channel redundancy (4th channel bypassed) Affected channel trip function enabled.	Possibly makes HI LOG PWR reactor trip logic 1-out-of-2 coincidence depending on plant conditions.	Log power signal failure will also produce consequences described for Items 1) and 2).
		On	Log power signal failure high, NI Safety Channel bistable fails on, NI Safety Channel bistable relay failure, auxiliary relay AK-27 or driver failure.	Permissive will be present when plant conditions do not warrant it. During plant shutdown, bypass will not be automatically removed. Possible to have channel HI LOG PWR reactor trip bypassed when it is required (below the Log Power Bistable Reset Point).	3-channel comparison. Periodic test. Hi Log Pwr Permissive alarm if bypass was not already inserted.	3-channel redundancy (4th channel bypassed) Bypasses are not automatically activated.	When shutting down, makes HI LOG PWR reactor trip logic 2-out-of-2 coincidence.	Bypass can be manually removed to restore HI LOG PWR reactor trip logic to 2-out-of-3.
25)	HI LOG POWER Operating Bypass (71)	Off	Loss of permissive (Item 24), ROM latching solenoid failure, ROM DC/DC convertor failure, HI LOG PWR bistable trip bypass opto-isolator failure.	Affected channel HI LOG PWR reactor trip function remains or becomes enabled.	Annunciating. Pre-trip and trip alarm on HI LOG PWR if reactor power is >0.75%. Possible Hi Log Pwr Permissive alarm. 3-channel comparison. ROM bypass light off. Periodic test. Unable to bypass.	3-channel redundancy (4th channel bypassed) Affected channel trip function is enabled.	If reactor power is > 0.75%, makes HI LOG PWR reactor trip logic 1-out-of-2 coincidence.	

ARKANSAS NUCLEAR ONE
Unit 2

TABLE 7.2-5 (continued)

No.	Name	Failure Mode	Cause	Symptoms and Local Effects Including Dependent Failures	Method of Detection	Inherent Compensating Provision	Effect Upon PPS	Remarks and Other Effects
				RPS Operating Bypass	Hi Log Power	FMEA Diagram 1		
25)	HI LOG POWER Operating Bypass (71) (cont)	On	High Log Power Bypass Switch stuck contact.	Affected channel HI LOG PWR reactor trip function is automatically bypassed when reactor power increases above the Log Power Bistable Setpoint. This effectively defeats the channel HI LOG PWR trip function at 1% power.	Annunciating. HI LOG PWR pre-trip alarm. 3-channel comparison. ROM bypass light on. Periodic test.	3-channel redundancy (4th channel bypassed)	During startup, makes reactor trip logic for HI LOG PWR 2-out-of-2 coincidence.	Reactor trip logic for HI LOG PWR must be converted to 1-out-of-2 by placing the appropriate bistable in the affected channel in the tripped state.
26)	HI LOG POWER Permissive Relay AK-27	Coil open	Sustained overvoltage.	Same as Item 24) Off.	Unable to bypass. 3-channel comparison. ROM Permissive light off. Periodic test. Possible trip alarm on HI LOG PWR depending on plant conditions.	Same as Item 24) Off.	Same as Item 24) Off.	
		Coil short	Deterioration of insulation.	Generation of permissive from NI safety channel above the Log Power Bistable Setpoint will cause AK-27 to draw excessive current and place a severe load on the relay driver. This may cause the relay coil to open or the driver to short or open. Loss of permissive signal results. Same effect as Item 24) Off.	Unable to bypass. 3-channel comparison. ROM Permissive light off. Periodic test. Possible trip alarm on HI LOG PWR depending on plant conditions.	Same as Item 24) Off.	Same as Item 24) Off.	

ARKANSAS NUCLEAR ONE
Unit 2

TABLE 7.2-5 (continued)

No.	Name	Failure Mode	Cause	Symptoms and Local Effects Including Dependent Failures	Method of Detection	Inherent Compensating Provision	Effect Upon PPS	Remarks and Other Effects
				RPS Operating Bypass	Hi Log Power	FMEA Diagram 1		
26)	HI LOG POWER Permissive Relay AK-27 (cont)	N.O. contact in bypass circuit open	Deterioration of contact, stuck contact.	Same as Item 24) Off.	Same as open coil.	Same as Item 24) Off.	Same as Item 24) Off.	
		N.O. contact in bypass circuit shorted	Welded or stuck contact.	Same as Item 24) On.	3-channel comparison. ROM bypass light remains on when permissive clears.	Same as Item 24) On.	Same as Item 24) On.	
		N.C. contact in Off light circuit shorted	Welded or stuck contact.	ROM HI LOG PWR Bypass Off light will not go out when bypass is actuated. No effect on bypass operability.	ROM Off light remains on concurrent with Bypass light. 3-channel comparison. Periodic test.	Affects indication only.	None	
		N.C. contact in Off light circuit open	Deterioration of contact, stuck contact.	If ROM HI LOG PWR bypass button is depressed without permissive present the Off light will go out until the button is released.	Periodic test.	Affects indication only.	None.	
		N.C. contact in annunciator circuit shorted	Welded or stuck contact.	When the HI LOG PWR permissive is generated, it will not be annunciated.	Periodic test.	Affects indication only. 3-channel redundancy (4th channel bypassed)	None.	
		N.C. contact in annunciator circuit open	Deterioration of contact, stuck contact.	HI LOG PWR Bypass Permissive annunciator will be on when actual permissive is not present.	Annunciating. Periodic test.	Affects indication only.	None.	

ARKANSAS NUCLEAR ONE
Unit 2

TABLE 7.2-5 (continued)

No.	Name	Failure Mode	Cause	Symptoms and Local Effects Including Dependent Failures	Method of Detection	Inherent Compensating Provision	Effect Upon PPS	Remarks and Other Effects
				RPS Operating Bypass	Hi Log Power	FMEA Diagram 1		
27)	High Log Power Manual Bypass Switch	Solenoid open	Mechanical failure of wire, sustained overvoltage.	HI LOG PWR Trip Bypass pushbutton will not latch in the ON position.	Attempting to place the affected channel in bypass.	Channel trip remains enabled.	If reactor power is increased >1%, bistable will trip making HI LOG PWR reactor trip logic 1-out-of-2 coincidence. (4th channel bypassed)	Channel can be bypassed by continuously holding in the HI LOG PWR Bypass pushbutton.
		Solenoid short	Deterioration of insulation.	Attempting to bypass the HI LOG PWR trip in the affected channel will reduce the output voltage of the auxiliary logic power supply and possibly produce associated faults. Bypass will not be actuated.	Attempting to place the affected channel in bypass. Possible PPS Trouble alarm.		If reactor power is increased >1%, bistable will trip making HI LOG PWR reactor trip logic 1-out-of-2 coincidence. (4th channel bypassed)	When pushbutton is released, power supply output should recover. See DC Power Distribution Failure of Auxiliary Logic Power Supply.
		N.O. contact in trip bypass circuit open	Mechanical failure, contact deterioration.	Same as Item 25) Off.	Same as Item 25) Off.	Same as Item 25) Off.	Same as Item 25) Off.	
		N.O. contact in trip bypass circuit shorted	Mechanical failure, welded contact.	Same as Item 25) On.	Same as Item 25) On.	Same as Item 25) On.	Same as Item 25) On.	

ARKANSAS NUCLEAR ONE
Unit 2

TABLE 7.2-5 (continued)

No.	Name	Failure Mode	Cause	Symptoms and Local Effects Including Dependent Failures	Method of Detection	Inherent Compensating Provision	Effect Upon PPS	Remarks and Other Effects
				RPS Operating Bypass	Hi Log Power	FMEA Diagram 1		
27)	High Log Power Manual Bypass Switch (cont)	N.C. contact in Bypass Off light circuit shorted	Mechanical failure, welded contact.	ROM HI LOG PWR Bypass Off light will not go out when bypass is actuated. No effect on bypass operability.	ROM Off light remains on concurrent with Bypass light. 3-channel comparison. Periodic test.	Affects indication only.	None.	
		N.C. contact in Bypass Off light circuit open.	Mechanical failure, contact deterioration.	ROM HI LOG PWR Bypass Off light goes out when permissive is generated. No effect on bypass operability.	ROM Off light goes off before bypass is actuated. 3-channel comparison. Periodic test.	Affects indication only.	None.	
		N.O. contact in annunciator circuit open	Mechanical failure, contact deterioration.	HI LOG PWR Bypass Permissive annunciator will not clear when bypass is actuated.	When bypass is actuated, permissive annunciator does not clear. Periodic test.	Affects indication only.	None.	
		N.O. contact in annunciator circuit shorted	Mechanical failure, welded contact.	HI LOG PWR Bypass Permissive annunciator will not alarm for the affected channel.	3-channel comparison. Periodic test.	Affects indication only.	None.	
		N.O. contact in pre-trip annunciator circuit open	Mechanical failure, contact deterioration.	HI LOG PWR pre-trip annunciator remains enabled. If power > pre-trip setpoint, alarm will be generated.	3-channel comparison. Periodic test.	Affects indication only.	None.	

ARKANSAS NUCLEAR ONE
Unit 2

TABLE 7.2-5 (continued)

No.	Name	Failure Mode	Cause	Symptoms and Local Effects Including Dependent Failures	Method of Detection	Inherent Compensating Provision	Effect Upon PPS	Remarks and Other Effects
				RPS Operating Bypass	Hi Log Power	FMEA Diagram 1		
27)	High Log Power Manual Bypass Switch (cont)	N.O. contact in pre-trip annunciator circuit shorted	Mechanical failure, welded contact.	HI LOG PWR pre-trip annunciator disabled at all times. If power > pre-trip setpoint with no bypass, alarm will not be generated.	3-channel comparison. Periodic test.	Affects indication only.	None.	
		DC/DC Converter failure.	Open, component failure.	Same as Item 25) Off.	Same as Item 25) Off.	Same as Item 25) Off.	Same as Item 25) Off.	
				RPS Operating Bypass	CPCs	FMEA Diagram 1		
28)	CPC Operating Bypass Permissive	Off	Log power signal failure high, NI Safety Channel bistable failure on, bistable relay failure, auxiliary relay AK-20 or driver failure.	Unable to bypass LO DNBR and HI LPD reactor trips when power is below the Log Power Bistable Reset Point for the affected channel. If bypass was previously in, it will be removed. LO DNBR and HI LPD channel trips remain or become enabled.	Unable to bypass. 3-channel comparison. Possible trip and pre-trip alarms on LO DNBR and HI LPD depending on plant conditions. Periodic test.	3-channel redundancy (4th channel bypassed) Affected channel trip functions enabled.	Below the Log Power Bistable reset point, may make LO DNBR & HI LPD trip logic 1-out-of-2 coincidence depending on plant conditions. Above the Log Power Bistable setpoint, no effect.	Log power signal failure will also produce consequences described for Items 1) and 2). This bypass permits CEA testing during shutdown. For detailed relay failures see Item 26).
		On	Log power signal failure low, NI Safety Channel bistable failure off, bistable relay failure, auxiliary relay AK-20 failure.	Permissive present when power above Log Power Bistable setpoint for the affected channel. During plant startup, bypass will not automatically remove. Possible to have LO DNBR & HI LPD trips bypassed when they are required.	3-channel comparison. Periodic test.	3-channel redundancy (4th channel bypassed) Bypasses do not activate automatically.	During reactor startup, makes LO DNBR and HI LPD reactor trip logic 2-out-of-2 coincidence.	Bypass can be manually removed at CPC Operator Module to restore LO DNBR & HI LPD Rx trip logic to 2-out-of-3. For detailed relay failures see Item 26).

ARKANSAS NUCLEAR ONE
Unit 2

TABLE 7.2-5 (continued)

No.	Name	Failure Mode	Cause	Symptoms and Local Effects Including Dependent Failures	Method of Detection	Inherent Compensating Provision	Effect Upon PPS	Remarks and Other Effects
				CWP Automatic Bypass		FMEA Diagram 1		
29)	CWP Automatic Bypass	Off	Same as Item 28) Off.	CPC CWP signal for the affected channel will be enabled when power is below the Log Power Bistable Setpoint.	3-channel comparison. Periodic test.	3-channel redundancy (4th channel bypassed). Not required for protection.	None.	This function is not credited in the safety analysis. Generated from same circuit as the CPC manual bypass permissive.
		On	Same as Item 28) On.	CPC CWP signal for the affected channel will be always be disabled.	3-channel comparison. Periodic test.	3-channel redundancy (4th channel bypassed) Not required for protection.	None.	
				Trip Channel Bypass	Channel A (Typical)			
30)	Trip Channel Bypass - Channel A (Typical)	Contact AXKB6-7 or AXK1-4 open	Deterioration of contact, stuck contact.	Bypasses of the affected function will not be indicated on the Remote Operator Module (ROM) or on the PPS Bistable Control Panel (BCP).	3-channel comparison. Periodic testing or when bypassing during operation.		No effect on logic matrices.	Contact used for annunciation only. AXK1 represents RPS only application. AXKB6 represents RPS and ESFAS application.
		Contact AXKB6-7 or AXK1-4 short	Welded contact, stuck contact.	Bypasses of the affected function will be continuously indicated on the ROM and on the BCP.	ROM and BCP bypass lights lit. Periodic testing.		No effect on logic matrices.	

ARKANSAS NUCLEAR ONE
Unit 2

TABLE 7.2-5 (continued)

No.	Name	Failure Mode	Cause	Symptoms and Local Effects Including Dependent Failures	Method of Detection	Inherent Compensating Provision	Effect Upon PPS	Remarks and Other Effects
				Trip Channel Bypass	Channel A (Typical)			
30)	Trip Channel Bypass – Channel A (Typical) (cont)	Contact AXKA6-5 or AXK1-5 open	Deterioration of contact, stuck contact.	Plant annunciator will indicate a bypass condition on the affected channel function at all times.	Annunciating. Affected channel function bypass alarm.		No effect on logic matrices.	Contact used for plant annunciation only.
		Contact AXKA6-5 or AXK1-5 short	Welded contact, stuck contact.	Plant annunciator will never indicate a bypass condition on the affected channel function.	Periodic test.		No effect on logic matrices.	
		Relay coil AXKA6 (AXKB6) open	Sustained overvoltage, mechanical failure.	Affected channel bistable cannot be bypassed for the RPS (ESFAS) function.	Periodic testing or when attempting to bypass.	Associated trip function remains or becomes enabled.	If the associated bistable is tripped, makes affected RPS (ESFAS) trip logic 1-out-of-3 coincidence.	ESFAS (RPS) function is not affected as a different relay bypasses the bistable contacts in the ESFAS (RPS) matrices.
		Relay coil AXKA6 (AXKB6) short	Deterioration of insulation.	No symptoms until an attempt is made to bypass the affected bistable. Excessive current will reduce the supply voltage possibly causing all bypasses in affected channel to be removed.	Periodic testing or when attempting to bypass.	Removal of bypass(es) enables associated trip function(s).	Removal of trip channel bypasses may result in channel trips for one or more functions depending on plant conditions.	
	Trip Channel Bypass (Typical)	Bypass switch AXS-1 Contact S1 in normally off position	Mechanical failure, contact deterioration.	Channel bistable cannot be bypassed for the affected function.	Periodic testing or when attempting to bypass.	Channel trip function is enabled.	If bistable is tripped, makes affected RPS or ESFAS trip logic 1-out-of-3 coincidence.	Same effect for BXS-1 Contact S2, CXS-1 Contact S3, and DXS-1 Contact S4.

ARKANSAS NUCLEAR ONE
Unit 2

TABLE 7.2-5 (continued)

No.	Name	Failure Mode	Cause	Symptoms and Local Effects Including Dependent Failures	Method of Detection	Inherent Compensating Provision	Effect Upon PPS	Remarks and Other Effects
				Trip Channel Bypass	Channel A (Typical)			
30)	Trip Channel Bypass – Channel A (Typical) (cont)	Bypass switch AXS-1 Contact S1 in normally on position	Mechanical failure, contact welded.	Channel bistable is bypassed regardless of the position of the switch.	Annunciating. Trip channel bypass alarm. ROM and BCP bypass lights. Periodic testing.	If an attempt is made to bypass the same function in another channel, both bypasses will be removed.	Makes affected RPS or ESFAS trip logic 2-out-of-3 coincidence.	
		Bypass switch AXS-1 Contact S2 (S3,S4) in normally off position	Mechanical failure, contact deterioration.	Will not be able to bypass the affected function in channel B (C,D).	Periodic testing or when attempting to bypass.	Channel trip function is enabled.	If bistable in channel B (C,D) is tripped, makes the affected RPS or ESFAS trip logic 1-out-of-3 coincidence.	Similar effect for BXS-1 Contacts S1, S3, & S4; CXS-1 Contacts S1, S2, & S4; or DXS-1 Contacts S1, S2, & S3.
		Bypass switch AXS-1 Contact S2 (S3,S4) in normally on position	Mechanical failure, contact welded.	Permissive for bistable 1 in channel B (C,D) bypass will be present even though channel A bistable 1 is in bypass. The circuit, however, will still not allow 2 channels in bypass simultaneously.	Periodic test.	A bypass on bistable 1 in channel B (C,D) will remove a bypass on bistable 1 in channel A.	None.	
				Bistable Circuits, RPS				
31)	RPS Bistable for: HI Cont Press(24), SG-1 HI LVL (135), SG-2 HI LVL (134), HI LIN PWR (72), HI LOG PWR (75)	Trip output de-energized (off)	Open circuit, Failure of: ± 15V power supply, Trip voltage comparator, Setpoint voltage supply, Trip setpoint potentiometer, Trip opto-isolator.	Bistable relays in RPS logic deenergize. Places a half trip in 3 coincidence logic matrices for the associated function.	Annunciating. Trip alarm on associated function. Periodic test.	3-channel redundancy (4th channel bypasses) Channel trip.	Makes the affected reactor trip logic 1-out-of-2 coincidence.	Affected reactor trip logic must be maintained in 1-out-of-2 by placing the appropriate bistable in the tripped state.

ARKANSAS NUCLEAR ONE
Unit 2

TABLE 7.2-5 (continued)

No.	Name	Failure Mode	Cause	Symptoms and Local Effects Including Dependent Failures	Method of Detection	Inherent Compensating Provision	Effect Upon PPS	Remarks and Other Effects
				Bistable Circuits, RPS				
31)	RPS Bistable for: HI CONT PRESS(24), SG-1 HI LVL (135), SG-2 HI LVL (134), HI LIN PWR (72), HI LOG PWR (75)	Trip output energized (on)	Failure of: ± 15V power supply, Trip voltage comparator, Setpoint voltage supply, Trip setpoint potentiometer, Trip opto-isolator.	Bistable relays in RPS logic will remain energized. Affected channel function is inoperative.	Periodic testing.	3-channel redundancy (4th channel bypasses)	Makes the affected reactor trip logic 2-out-of-2 coincidence.	Affected reactor trip logic must be converted to 1-out-of-2 by placing the appropriate bistable in the tripped state.
		Trip relay driver open	Open transistor.	One trip relay is deenergized. Places a half trip in one coincidence logic matrix.	Annunciating. Trip alarm on associated function. Periodic test.	3-channel redundancy (4th channel bypasses)	1 of 3 logic matrices is half tripped for the affected function. Makes reactor trip logic 1-out-of-2 using the affected channel and 2-out-of-3 using the unaffected channels.	Channel trip outputs to the other two logic matrices are unaffected.
		Trip relay driver short	Shorted transistor.	Trip relay does not deenergize on a trip condition. Effectively bypasses one logic matrix. If excessive current is drawn, may result in associated DC power supply failure. See DC power distribution faults.	Periodic test.	3-channel redundancy (4th channel bypasses)	1 of 3 logic matrices is disabled for the affected function. Makes trip logic 2-out-of-2 using the affected channel and 2-out-of-3 using the unaffected channels.	Affected reactor trip logic must be converted to 1-out-of-2 by placing the associated bistable in the tripped state.

ARKANSAS NUCLEAR ONE
Unit 2

TABLE 7.2-5 (continued)

No.	Name	Failure Mode	Cause	Symptoms and Local Effects Including Dependent Failures	Method of Detection	Inherent Compensating Provision	Effect Upon PPS	Remarks and Other Effects
				Bistable Circuits, RPS		FMEA Diagram 1		
31)	RPS Bistable for: HI CONT PRESS(24), SG-1 HI LVL (135), SG-2 HI LVL (134), HI LIN PWR (72), HI LOG PWR (75) (cont)	Trip relay coil shorted	Deterioration of insulation.	May cause relay driver to fail, as described above, due to excessive current. Relay contacts will not pick up, same effect as open coil.				
		Trip relay coil open	Sustained overvoltage, broken wire.	One bistable relay is in tripped condition. Same effect as open relay driver.	Same effect as open relay driver.	Same as open relay driver.	Same as open relay driver.	Same as open relay driver.
		Pre-trip output de-energized (off)	Open circuit, Failure of: ± 15V power supply, Pretrip voltage comparator, Setpoint voltage supply, Pretrip setpoint potentiometer, Pre-trip opto-isolator.	Pre-trip relays are deenergized.	Annunciating. Pre-trip alarm for affected function. Periodic test.		None. Indication only.	
		Pre-trip output energized (on)	Failure of: ± 15V power supply, Pre-trip voltage comparator, Setpoint voltage supply, Pre-trip setpoint potentiometer, Pre-trip opto-isolator.	Pre-trip relays do not deenergize on a pre-trip condition. No pre-trip annunciation for affected channel function.	Periodic test.		None. Indication only.	

ARKANSAS NUCLEAR ONE
Unit 2

TABLE 7.2-5 (continued)

No.	Name	Failure Mode	Cause	Symptoms and Local Effects Including Dependent Failures	Method of Detection	Inherent Compensating Provision	Effect Upon PPS	Remarks and Other Effects
				Bistable Circuits, RPS		FMEA Diagram 1		
31)	RPS Bistable for: HI CONT PRESS(24), SG-1 HI LVL (135), SG-2 HI LVL (134), HI LIN PWR (72), HI LOG PWR (75) (cont)	Pre-trip output energized (on)	Failure of: ± 15V power supply, Pre-trip voltage comparator, Setpoint voltage supply, Pre-trip setpoint potentiometer, Pre-trip opto-isolator.	Pre-trip relays do not deenergize on a pre-trip condition. No pre-trip annunciation for affected channel function.	Periodic test.		None. Indication only.	
		Pre-trip relay driver open	Open transistor.	Pre-trip relay deenergizes. Pre-trip annunciation on affected channel function.	Annunciating. Pre-trip alarm for affected function.		None. Indication only.	
		Pre-trip relay driver short	Shorted transistor.	Pre-trip relay does not deenergize on a pre-trip condition.	Periodic test.		None. Indication only.	
		Pre-trip relay coil open	Sustained overvoltage, broken wire.	Same as open relay driver.	Same as open relay driver.		None. Indication only.	
		Pre-trip relay coil short	Deterioration of insulation.	May cause relay driver to fail, as described above, due to excessive current. Relay contacts will not pick up, same effect as open coil.				

ARKANSAS NUCLEAR ONE
Unit 2

TABLE 7.2-5 (continued)

No.	Name	Failure Mode	Cause	Symptoms and Local Effects Including Dependent Failures	Method of Detection	Inherent Compensating Provision	Effect Upon PPS	Remarks and Other Effects
				Bistable, RPS/CWP		FMEA Diagram 1		
32)	RPS/CWP Bistable for HI PZR PRESS (65)	Trip output deenergized (off)	Same as Item 31)	Bistable relays in RPS and CWP logic deenergize. Places a half trip in 3 RPS logic matrices for HI PZR PRESS. Places a half trip in the CWP matrix.	Annunciating. HI PZR PRESS trip alarm. Periodic test.	3-channel redundancy (4th channel bypassed) Channel trip.	Makes the reactor trip and CWP logic for HI PZR PRESS 1-out-of-2 coincidence.	Reactor trip logic for HI PZR PRESS must be maintained in 1-out-of-2 by placing the appropriate bistable in the affected channel in the tripped state. CWP function is not credited in the safety analysis.
		Trip output energized (on)	Same as Item 31)	Bistable relays in RPS and CWP logic will remain energized. Affected channel reactor trip and CWP functions are inoperable.	Periodic testing.	3-channel redundancy (4th channel bypassed)	Makes the reactor trip and CWP logic for HI PZR PRESS 2-out-of-2 coincidence.	Reactor trip logic for HI PZR PRESS must be converted to 1-out-of-2 by placing the appropriate bistable in the affected channel in the tripped state.
		Trip relay, pre-trip relay, and relay driver faults	Same as Item 31)	Same as Item 31)	Same as Item 31)	Same as Item 31)	Same as Item 31)	

ARKANSAS NUCLEAR ONE
Unit 2

TABLE 7.2-5 (continued)

No.	Name	Failure Mode	Cause	Symptoms and Local Effects Including Dependent Failures	Method of Detection	Inherent Compensating Provision	Effect Upon PPS	Remarks and Other Effects
				Bistable, RPS/EFAS		FMEA Diagram 1		
33)	RPS/EFAS Bistable for LO SG-1 LVL (59) and LO SG-2 LVL (52)	Trip output deenergized (off)	Same as Item 31)	Bistable relays in RPS and EFAS-1(2) logic deenergize. Places a half trip in 3 RPS logic matrices for LO SG-1(2) LVL. Provides a channel EFAS-1(2) initiation signal if associated SG is not ruptured.	Annunciating. Trip alarm on LO SG-1(2) LVL. Periodic test.	3-channel redundancy (4th channel bypassed) Channel trip.	Makes the reactor trip and EFAS-1(2) logic for LO SG-1(2) LVL 1-out-of-2 coincidence.	Reactor trip and EFAS-1(2) logic for LO SG-1(2) LVL must be maintained in 1-out-of-2 by placing the appropriate bistable in the affected channel in the tripped state.
		Trip output energized (on)	Same as Item 31)	Bistable relays in RPS and EFAS-1(2) logic will remain energized. Affected channel reactor trip and EFAS-1(2) functions are inoperable.	Periodic test.	3-channel redundancy (4th channel bypassed)	Makes the reactor trip and EFAS-1(2) logic for LO SG-1(2) LVL 2-out-of-2 coincidence.	Reactor trip and EFAS-1(2) logic for LO SG-1(2) LVL must be converted to 1-out-of-2 by placing the appropriate bistable in the affected channel in the tripped state.
		Trip relay, pre-trip relay, and relay driver faults	Same as Item 31)	Same as Item 31)	Same as Item 31)	Same as Item 31)	Same as Item 31)	

ARKANSAS NUCLEAR ONE
Unit 2

TABLE 7.2-5 (continued)

No.	Name	Failure Mode	Cause	Symptoms and Local Effects Including Dependent Failures	Method of Detection	Inherent Compensating Provision	Effect Upon PPS	Remarks and Other Effects
				Bistable, ESFAS		FMEA Diagram 1		
34)	ESFAS Bistable for HI CONT PRESS (13)	Trip output deenergized (off)	Same as Item 31)	Bistable relays in ESFAS logic matrices deenergize. Places a half trip in 3 ESFAS logic matrices for HI CONT PRESS SIAS/CCAS, CIAS and CSAS actuation.	Annunciating. Trip alarm on HI CONT PRESS. Periodic test.	3-channel redundancy (4th channel bypassed) Channel trip. CSAS actuation requires coincident HI-HI CONT PRESS trip.	Makes the actuation logic for SIAS/CCAS, CSAS and CIAS on HI CONT PRESS 1-out-of-2 coincidence.	SIAS/CCAS, CSAS and CIAS actuation logic for HI CONT PRESS must be maintained in 1-out-of-2 by placing the appropriate bistable in the affected channel in the tripped state.
		Trip output energized (on)	Same as Item 31)	Bistable relays in ESFAS logic matrices remain energized. Effectively disables 3 ESFAS logic matrices for HI CONT PRESS actuation of SIAS/CCAS, CSAS and CIAS.	Periodic test.	3-channel redundancy (4th channel bypassed)	Makes the actuation logic for SIAS/CCAS, CSAS and CIAS on HI CONT PRESS 2-out-of-2 coincidence.	SIAS/CCAS, CSAS and CIAS actuation logic for HI CONT PRESS must be converted to 1-out-of-2 by placing the appropriate bistable in the affected channel in the tripped state.
		Trip relay, pre-trip relay, and relay driver faults	Same as Item 31)	Same as Item 31)	Same as Item 31)	Same as Item 31)	Same as Item 31)	

ARKANSAS NUCLEAR ONE
Unit 2

TABLE 7.2-5 (continued)

No.	Name	Failure Mode	Cause	Symptoms and Local Effects Including Dependent Failures	Method of Detection	Inherent Compensating Provision	Effect Upon PPS	Remarks and Other Effects
				Bistable, ESFAS		FMEA Diagram 1		
35)	ESFAS Bistable for HI-HI CONT PRESS (7)	Trip output deenergized (off)	Same as Item 31)	Bistable relays in ESFAS logic matrices deenergize. Places a half trip in 3 ESFAS logic matrices for HI-HI CONT PRESS actuation of CSAS.	Annunciating. Trip alarm on HI-HI CONT PRESS. Periodic test.	3-channel redundancy (4th channel bypassed) Channel trip. Concurrent automatic SIAS/CCAS signal is required to initiate the CSAS function.	Makes the actuation logic for CSAS 1-out-of-2 coincidence.	CSAS logic must be maintained in 1-out-of-2 by placing the appropriate bistable in the affected channel in the tripped state.
		Trip output energized (on)	Same as Item 31)	Bistable relays in CSAS logic matrices remain energized. Effectively disables 3 CSAS logic matrices.	Periodic test.	3-channel redundancy (4th channel bypassed)	Makes the actuation logic for CSAS 2-out-of-2 coincidence.	CSAS logic must be converted to 1-out-of-2 by placing the appropriate bistable in the affected channel in the tripped state.
		Trip relay, pre-trip relay, and relay driver faults	Same as Item 31)	Same as Item 31)	Same as Item 31)	Same as Item 31)	Same as Item 31)	
36)	ESFAS Bistable for REFUEL TANK LO LEVEL (2)	Trip output deenergized (off)	Same as Item 31)	Bistable relays in RAS logic matrices deenergize. Places a half trip in 3 RAS logic matrices.	Annunciating. Trip alarm on REFUEL TANK LO LEVEL. Periodic test.	3-channel redundancy (4th channel bypassed) Channel trip.	Makes the actuation logic for RAS 1-out-of-2 coincidence.	RAS logic must be maintained in 1-out-of-2 by placing the appropriate bistable in the affected channel in the tripped state.

ARKANSAS NUCLEAR ONE
Unit 2

TABLE 7.2-5 (continued)

No.	Name	Failure Mode	Cause	Symptoms and Local Effects Including Dependent Failures	Method of Detection	Inherent Compensating Provision	Effect Upon PPS	Remarks and Other Effects
				Bistable, ESFAS		FMEA Diagram 1		
36)	ESFAS Bistable for REFUEL TANK LO LEVEL (2) (cont)	Trip output energized (on)	Same as Item 31)	Bistable relays in RAS logic matrices remain energized. Effectively disables 3 RAS logic matrices.	Periodic test.	3-channel redundancy (4th channel bypassed)	Makes the actuation logic for RAS 2-out-of-2 coincidence.	RAS logic must be converted to 1-out-of-2 by placing the appropriate bistable in the affected channel in the tripped state.
		Trip relay, pre-trip relay, and relay driver faults	Same as Item 31)	Same as Item 31)	Same as Item 31)	Same as Item 31)	Same as Item 31)	
37)	ESFAS Differential Bistable for SG-1 > SG-2 PRESS (48) or SG-2 > SG-1 PRESS (39)	Trip output deenergized (off)	Open circuit, Failure of: ± 15V power supply, Trip comparator, - 10V setpoint supply, Trip setpoint potentiometer, Trip opto-isolator, Signal A buffer, Signal B buffer.	Deenergizes bistable relay in EFAS-1(2) actuation logic circuit for the affected channel. Provides permissive for channel EFAS-1(2) initiation on SG LO LVL regardless of SG operability.	Annunciating. Trip alarm on SG-1>SG-2 (SG-2>SG-1) PRESS. Periodic test.	3-channel redundancy (4th channel bypassed)	Makes EFAS-1(2) logic 2-out-of-2 coincidence for Feed Only Good Generator (FOGG) feature. Makes EFAS-1(2) logic 1-out-of-2 coincidence for allowing initiation to an operable SG on SG-1(2) LO LVL.	The tripped state of this bistable is preferred since it allows EFAS initiation. Since, however, both states of this bistable are used for safety-related functions, either the bypassed channel or the fault channel should be returned to service as soon as possible. Trip relay, pre-trip relay and relay driver faults result in the same effects described here. See Item 31) for fault details.

ARKANSAS NUCLEAR ONE
Unit 2

TABLE 7.2-5 (continued)

No.	Name	Failure Mode	Cause	Symptoms and Local Effects Including Dependent Failures	Method of Detection	Inherent Compensating Provision	Effect Upon PPS	Remarks and Other Effects
				Differential Bistable, ESFAS		FMEA Diagram 1		
37)	ESFAS Differential Bistable for SG-1>SG-2 PRESS (48) or SG-2 > SG-1 PRESS (39) (cont)	Trip output energized (on)	Failure of: ± 15V power supply, Trip comparator, -10V setpoint supply, Trip setpoint potentiometer, Trip opto-isolator, Signal A buffer, Signal B buffer.	Bistable relay in EFAS-1(2) actuation logic circuit for the affected channel remains energized. Channel EFAS-1(2) initiation will be disabled whenever SG-1(2) LO PRESS bistable is tripped.	Periodic test.	3-channel redundancy (4th channel bypassed)	Makes EFAS-1(2) logic 2-out-of-2 coincidence for allowing initiation to an operable SG. Makes EFAS-1(2) logic 1-out-of-2 coincidence for Feed Only Good Generator (FOGG) feature.	Placing the affected bistable in the tripped state is preferred since it allows EFAS initiation. Since, however, both states of this bistable are used for safety-related functions, either the bypassed channel or the fault channel should be returned to service as soon as possible. Trip relay, pre-trip relay and relay driver faults result in the same effects described here. See Item 31) for fault details.

ARKANSAS NUCLEAR ONE
Unit 2

TABLE 7.2-5 (continued)

No.	Name	Failure Mode	Cause	Symptoms and Local Effects Including Dependent Failures	Method of Detection	Inherent Compensating Provision	Effect Upon PPS	Remarks and Other Effects
				Variable Setpoint Bistable	S/G Pressure	FMEA Diagram 1		
38)	Variable Setpoint Bistable for SG-1 LO PRESS (45) and SG-2 LO PRESS (30)	Trip output deenergized (off)	Open circuit, Failure of bistable comparator (see Item 31), Failure of: Peak detector, step, min, or max adjust circuits, Subtractor/limiter circuit, trip setpoint output buffer, low setpoint comparator, reset circuit, DC/DC Converter.	Bistable relays in RPS, EFAS-1(2), and MSIS logic deenergize. Places a half trip in 3 RPS and 3 MSIS logic matrices for SG-1(2) LO PRESS. Channel EFAS-1(2) initiation will be disabled whenever SG-1>SG-2 (SG-2>SG-1) PRESS channel bistable is not tripped.	Annunciating. Trip alarm on SG-1(2) LO PRESS. Possible low variable setpoint alarm. Periodic test.	3-channel redundancy (4th channel bypassed)	Makes reactor trip and MSIS logic for SG-1(2) LO PRESS 1-out-of-2 coincidence. Makes EFAS-1(2) logic 2-out-of-2 coincidence for allowing initiation to an operable SG. Makes EFAS-1(2) logic 1-out-of-2 coincidence for FOGG.	Reactor trip and MSIS logic for SG-1(2) LO PRESS must be maintained in 1-out-of-2. EFAS trip logic for initiation must be converted to 1-out-of-2 by tripping the SG-1>SG-2 (SG-2>SG-1) bistable in the affected channel. See Item 37).
		Trip output energized (on)	Failure of bistable comparator (see Item 31), Failure of: Peak detector, step, min, or max adjust circuits, Subtractor/limiter circuit, trip setpoint output buffer, low setpoint comparator, reset circuit, DC/DC Converter.	Bistable relays in RPS, EFAS-1(2), and MSIS logic remain energized. Effectively disables 3 RPS and 3 MSIS logic matrices. Allows channel EFAS-1(2) initiation on SG-1(2) LO LVL regardless of SG pressure.	Periodic test.	3-channel redundancy (4th channel bypassed)	Makes reactor trip and MSIS logic for SG-1(2) LO PRESS 2-out-of-2 coincidence. Makes EFAS-1(2) logic 1-out-of-2 coincidence for allowing initiation to an operable SG. Makes EFAS-1(2) logic 2-out-of-2 coincidence for Feed Only Good Generator (FOGG).	Reactor trip and MSIS logic for SG-1(2) LO PRESS must be converted to 1-out-of-2 by placing the affected bistable in the tripped state. EFAS trip logic for initiation must be converted to 1-out-of-2 by tripping the SG-1>SG-2 (SG-2>SG-1) bistable in the affected channel. See Item 37).

ARKANSAS NUCLEAR ONE
Unit 2

TABLE 7.2-5 (continued)

No.	Name	Failure Mode	Cause	Symptoms and Local Effects Including Dependent Failures	Method of Detection	Inherent Compensating Provision	Effect Upon PPS	Remarks and Other Effects
				EFAS Channel Initiation		FMEA Diagram 1		
39)	EFAS-1 Channel Initiation Permissive Circuit (29)(35) EFAS-2 Channel Initiation Permissive Circuit (28)(34)	Off	SG-1(2) press. signal failure low, SG-1(2) LO PRESS bistable A11(A12) failed off, SG-1>SG-2 (SG-2>SG-1) PRESS bistable A19(A20) failed on, bistable relay/relay driver A11(12)-6 or A19(20)-6 failure.	The 3 EFAS-1(2) matrix relays in the affected channel remain energized in the presence of a SG-1(2) LO LVL bistable trip. This effectively disables the affected channel EFAS-1(2) function.	Periodic test.	3-channel redundancy (4th channel bypassed)	Makes EFAS-1(2) logic 2-out-of-2 coincidence for allowing initiation to an operable SG. Makes EFAS-1(2) logic 1-out-of-2 coincidence for FOGG.	For SG-1(2) press. signal faults see Item 14). For SG-1(2) LO PRESS bistable faults see Item 38). For SG-1>SG-2 (SG-2>SG-1) PRESS bistable faults see Item 37) For bistable relay related faults, see below.
		On	SG-1(2) press. signal failure high, SG-1(2) LO PRESS bistable A11(A12) failed on, SG-1>SG-2 (SG-2>SG-1) PRESS bistable A19(A20) failed off, bistable relay/relay driver A11(12)-6 or A19(20)-6 failure.	The 3 EFAS-1(2) matrix relays in the affected channel will deenergize in the presence of a SG-1(2) LO LVL bistable trip regardless of SG operability. This effectively disables the affected channel Feed Only Good Generator (FOGG) EFAS-1(2) function.	Periodic test.	3-channel redundancy (4th channel bypassed)	Makes EFAS-1(2) logic 1-out-of-2 coincidence for allowing initiation to an operable SG. Makes EFAS-1(2) logic 2-out-of-2 coincidence for Feed Only Good Generator (FOGG).	

ARKANSAS NUCLEAR ONE
Unit 2

TABLE 7.2-5 (continued)

No.	Name	Failure Mode	Cause	Symptoms and Local Effects Including Dependent Failures	Method of Detection	Inherent Compensating Provision	Effect Upon PPS	Remarks and Other Effects
				EFAS Channel Initiation		FMEA Diagram 1		
40)	EFAS-1 Channel Initiation Circuit (86) EFAS-2 Channel Initiation Circuit (85)	Off	Loss of permissive (Item 39), SG-1(2) level signal failure high, SG-1(2) LO LVL bistable A7(A8) failed on, bistable relay/relay driver A7(8)-6, A19-1, A19-2, A19-3 failure.	This effectively disables the affected channel EFAS-1(2) function.	Periodic test.	3-channel redundancy (4th channel bypassed)	Makes EFAS-1(2) logic 2-out-of-2 coincidence.	EFAS-1(2) logic must be converted to 1-out-of-2. For failed level signal, see Item 10). For failed bistable, see Item 33). For failed relays see below.
		On	SG-1(2) level signal failure low, SG-1(2) LO LVL bistable A7(A8) failed off, bistable relay/relay driver A7(8)-6, A19-1, A19-2, A19-3 failure.	With permissive present, channel EFAS-1(2) function will be initiated regardless of actual SG level.	Periodic test.	3-channel redundancy (4th channel bypassed)	Makes EFAS-1(2) logic 1-out-of-2 coincidence.	EFAS-1(2) logic must be maintained in 1-out-of-2 by tripping the affected channel.
41)	EFAS-1(2) SG-1(2) LO PRESS Bistable Relay A11(12)-6	N.C. contact closed	Stuck or welded contact, relay coil open or shorted, relay driver open.	EFAS-1(2) matrix relays in the affected channel will remain energized whenever the SG-1>SG-2 (SG-2>SG-1) PRESS channel bistable is not tripped. This would effectively disable the channel EFAS-1(2) initiation when both SGs are operable.	Periodic test.	3-channel redundancy (4th channel bypassed)	Makes EFAS-1(2) logic 2-out-of-2 coincidence for two operable SGs.	The EFAS-1(2) logic must be converted to 1-out-of-2 by tripping the SG-1>SG-2 (SG-2>SG-1) bistable in the affected channel. This also changes EFAS-1(2) FOGG feature to 2-out-of-2. See Item 37).

ARKANSAS NUCLEAR ONE
Unit 2

TABLE 7.2-5 (continued)

No.	Name	Failure Mode	Cause	Symptoms and Local Effects Including Dependent Failures	Method of Detection	Inherent Compensating Provision	Effect Upon PPS	Remarks and Other Effects
				EFAS Channel Initiation		FMEA Diagram 1		
41)	EFAS-1(2) SG-1(2) LO PRESS Bistable Relay A11(12)-6 (cont)	N.C. contact open	Stuck or deteriorated contact, relay driver shorted.	EFAS-1(2) matrix relays in the affected channel will deenergize whenever the SG-1(2) LO LVL channel bistable trips. Allows channel EFAS-1(2) initiation on SG-1(2) LO LVL regardless of SG pressure.	Periodic test.	3-channel redundancy (4th channel bypassed)	Makes EFAS-1(2) logic 1-out-of-2 coincidence for allowing initiation to an operable SG. Makes EFAS-1(2) logic 2-out-of-2 coincidence for FOGG feature.	EFAS trip logic for initiation must be maintained in 1-out-of-2 by tripping the SG-1>SG-2 (SG-2>SG-1) bistable in the affected channel. See Item 37).
42)	EFAS-1(2) SG-1>SG- 2 (SG- 2>SG-1) PRESS Bistable Relay A19(20)-6	N.O. contact open	Stuck or deteriorated contact, relay coil open or shorted, relay driver open.	EFAS-1(2) matrix relays in the affected channel will deenergize whenever the SG-1(2) LO LVL channel bistable trips. Allows channel EFAS-1(2) initiation on SG-1(2) LO LVL regardless of SG pressure.	Periodic test.	3-channel redundancy (4th channel bypassed)	Makes EFAS-1(2) logic 1-out-of-2 coincidence for allowing initiation to an operable SG. Makes EFAS-1(2) logic 2-out-of-2 coincidence for FOGG feature.	EFAS trip logic for initiation must be maintained in 1-out-of-2 by tripping the SG-1>SG-2 (SG-2>SG-1) bistable in the affected channel.
		N.O. contact closed	Stuck or welded contact, relay driver shorted.	EFAS-1(2) matrix relays in the affected channel will remain energized whenever the SG-1(2) LO PRESS channel bistable is tripped. This would disable the channel EFAS-1(2) initiation only when SG-1(2) pressure was low due to a rupture on the opposite SG.	Periodic test.	3-channel redundancy (4th channel bypassed)	FOGG circuit makes EFAS-1(2) logic 2-out-of-2 coincidence for initiation when the opposite SG is ruptured. With both SGs operable, EFAS-1(2) logic remains in 2-out-of-3.	EFAS-1(2) logic must be converted to 1-out-of-2 by tripping either the affected channel matrix relays or the bypassed channel.

ARKANSAS NUCLEAR ONE
Unit 2

TABLE 7.2-5 (continued)

No.	Name	Failure Mode	Cause	Symptoms and Local Effects Including Dependent Failures	Method of Detection	Inherent Compensating Provision	Effect Upon PPS	Remarks and Other Effects
				EFAS Channel Initiation		FMEA Diagram 1		
43)	EFAS-1(2) SG-1(2) LO LVL Bistable Relay A7(8)-6	N.O. contact open	Stuck or deteriorated contact, relay coil open or shorted, relay driver open.	EFAS-1(2) matrix relays in the affected channel will deenergize whenever the SG is operable. EFAS-1(2) channel initiation regardless of actual SG level.	Annunciating. Trip alarm. Periodic test.	3-channel redundancy (4 th channel bypassed)	Makes EFAS-1(2) logic 1-out-of-2 coincidence. FOGG feature remains in 2-out-of-3.	EFAS logic for must be maintained in 1-out-of-2 by tripping the SG-1(2) LO LVL bistable in the affected channel.
		N.O. contact closed	Stuck or welded contact, relay driver shorted.	EFAS-1(2) matrix relays in the affected channel will remain energized. EFAS-1(2) channel is disabled from feeding an operable SG with low water level.	Periodic test.	3-channel redundancy (4 th channel bypassed)	Makes EFAS-1(2) logic 2-out-of-2 coincidence.	EFAS-1(2) logic must be converted to 1-out-of-2 by tripping either the affected channel matrix relays or the bypassed channel.
				Variable Setpoint Bistable,	PZR Press.,	FMEA Diagram 1		
44)	Variable Setpoint Bistable for LO PZR PRESS (62)	Trip output de-energized (off)	Same as SG LO PRESS bistable, Item 38)	Affected channel bistable relays in RPS, CSAS, and SIAS/CCAS coincidence logic deenergize. Places a half trip in 3 RPS, 3 CSAS, and 3 SIAS/CCAS matrices for LO PZR PRESS.	Annunciating. Trip alarm on LO PZR PRESS. Possible low variable setpoint alarm. Periodic test.	3-channel redundancy (4 th channel bypassed) Channel trip.	Makes reactor trip, CSAS, and SIAS/CCAS logic for LO PZR PRESS 1-out-of-2 coincidence.	Reactor trip, CSAS, and SIAS/CCAS logic for LO PZR PRESS must be maintained in 1-out-of-2 by tripping the bistable in the affected channel.

ARKANSAS NUCLEAR ONE
Unit 2

TABLE 7.2-5 (continued)

No.	Name	Failure Mode	Cause	Symptoms and Local Effects Including Dependent Failures	Method of Detection	Inherent Compensating Provision	Effect Upon PPS	Remarks and Other Effects
				Variable Setpoint Bistable	PZR Press	FMEA Diagram 1		
44)	Variable Setpoint Bistable for LO PZR PRESS (62) (cont)	Trip output energized (on)	Same as SG LO PRESS bistable, Item 38)	Affected channel bistable relays in RPS, CSAS, and SIAS/CCAS coincidence logic remain energized. Effectively disables 3 RPS, 3 CSAS, and 3 SIAS/CCAS matrices for LO PZR PRESS.	Periodic test.	3-channel redundancy (4th channel bypassed) HI CONT PRESS also actuates SIAS/CCAS, and provides permissive for CSAS.	Makes reactor trip, CSAS, and SIAS/CCAS logic for LO PZR PRESS 2-out-of-2 coincidence.	Reactor trip, CSAS, and SIAS/CCAS logic for LO PZR PRESS must be converted to 1-out-of-2 by tripping the bistable in the affected channel.
				CPC/RPS Trip Circui		FMEA Diagram 1		
45)	LO DNBR Trip Circuit (92) HI LPD Trip Circuit (96)	Trip circuit open	Broken wire, CPC LO DNBR (HI LPD) trip contact failed open, NIS trouble trip circuit fault.	Channel bistable relays in RPS coincidence logic deenergize. Places a half trip in 3 RPS coincidence logic matrices for LO DNBR (HI LPD).	Annunciating. Trip alarm on LO DNBR (HI LPD). Periodic test.	3-channel redundancy (4th channel bypassed) Channel trip.	Makes reactor trip logic for LO DNBR (HI LPD) 1-out-of-2 coincidence.	Reactor trip logic for the affected function must be maintained in 1-out-of-2 by tripping the channel via the power trip test interlock. Note: this trips both the LO DNBR and HI LPD functions simultaneously.
		Trip circuit closed	CPC LO DNBR (HI LPD) trip contact failed closed, NIS trouble trip circuit fault.	Channel bistable relays in RPS coincidence logic remain energized for a trip condition. Affected channel function is inoperative.	Periodic test.	3-channel redundancy (4th channel bypassed)	Makes reactor trip logic for LO DNBR (HI LPD) 2-out-of-2 coincidence.	Reactor trip logic for the affected function must be converted to 1-out-of-2 by tripping the channel via the power trip test interlock. Note: this trips both the LO DNBR and HI LPD functions simultaneously.

ARKANSAS NUCLEAR ONE
Unit 2

TABLE 7.2-5 (continued)

No.	Name	Failure Mode	Cause	Symptoms and Local Effects Including Dependent Failures	Method of Detection	Inherent Compensating Provision	Effect Upon PPS	Remarks and Other Effects
				2-out-of-4 Coincidence Logic	Reactor Trip	FMEA Diagrams 1, 13		
46)	2/4 RPS Coincidence Logic for: SG-2 LO PRESS (41) SG-1 LO PRESS (50) HI CONT PRESS (26) SG-2 HI LVL (43) SG-1 HI LVL (44) SG-2 LO LVL (54) SG-1 LO LVL (58) LO PZR PRESS (64) HI PZR PRESS (67) HI LIN PWR (74) HI LOG PWR (77) LO DNBR (94) HI LPD (98)	Logic Matrix Off (e.g., AB Matrix) Logic Matrix On (e.g., AB Matrix)	Component failure, power supply pair failure. Component failure; one set of contacts failed closed.	All 4 matrix relays in the AB matrix deenergize. Opens all 4 RPS trip paths. All 8 reactor trip breakers open. Reactor trip occurs. The AB matrix relays will not deenergize when a reactor trip condition is sensed in the A and B channels. PPS will not initiate a reactor trip for signals originating only from A and B channels.	Annunciating. PPS trip alarm. Matrix power supply trouble alarm (for power supply faults only) Periodic test.	Reactor trip conditions sensed in the A&C channels or the B&C channels, will trip the reactor via the AC or BC matrices. (Channel D assumed bypassed).	Reactor protective system trip. Makes reactor trip logic for affected parameter a selective 2-out-of-3 coincidence.	Requires failure of two independent relay contacts or redundant power supplies in the affected matrix. RPS trip logic can be converted to 1-out-of-3 by tripping the bypassed channel or trip logic can be converted to 2-out-of-3 by removing the bypass from the bypassed channel and bypassing the affected channel.
47)	Matrix relay e.g. 6AB-1 or 6AB-2 or 6AB-3 or 6AB-4	Open coil	Sustained overvoltage.	Trip path with associated relay contact will deenergize. 2 of 8 reactor trip breakers will open. CEDMs will not deenergize.	Annunciating. RPS actuation alarm. PPS status panel indication.	RPS trip path logic is selective 2-out-of-4 coincidence.	The system has 1 of 2 parallel actuation paths open. Remaining RPS trip paths are unaffected.	Each trip path is formed by one set of contacts from each set of logic matrix relays.

ARKANSAS NUCLEAR ONE
Unit 2

TABLE 7.2-5 (continued)

No.	Name	Failure Mode	Cause	Symptoms and Local Effects Including Dependent Failures	Method of Detection	Inherent Compensating Provision	Effect Upon PPS	Remarks and Other Effects
				2-out-of-4 Coincidence Logic	Reactor Trip	FMEA Diagrams 1, 13		
47)	Matrix relay e.g. 6AB-1 or 6AB-2 or 6AB-3 or 6AB-4 (cont)	Shorted coil	Deterioration of insulation	The shorted coil may cause the relay driver to fail open or short. If the driver fails open, the symptoms will be the same as the open coil fault. If the driver fails short, the power supply will be shorted producing the same symptoms as loss of the power supply. See Item 165).				
48)	Matrix Relay Driver	On	Emitter to collector short.	One RPS trip path will not deenergize when a trip condition is detected by the associated 2/4 matrix.	Periodic test.	Selective 2-out-of-4 trip paths. Remaining matrix relays/trip paths are unaffected.	System will still respond to a valid trip condition.	The matrix relays in the other 2 unbypassed logic matrices are unaffected. A trip in either of these will cause a trip in all four trip paths.
		Off	Open transistor junction.	Same effect as open relay coil, Item 47).				
49)	Bypass Relay Contact (e.g. AB matrix, AXK1-1 or BXK1-1)	Contact short	Stuck or welded contact.	The AB logic matrix is not responsive to a concurrent trip of the A1 and B1 bistables.	Periodic test.	Reactor trip conditions sensed in the A&C channels or the B&C channels will trip the reactor via the AC or BC matrices. (Channel D assumed bypassed).	Makes reactor trip logic for affected parameter a selective 2-out-of-3 coincidence.	RPS trip logic can be converted to 1-out-of-3 by tripping the bypassed channel or trip logic can be converted to 2-out-of-3 by removing the bypass from the bypassed channel and bypassing the affected channel.

ARKANSAS NUCLEAR ONE
Unit 2

TABLE 7.2-5 (continued)

No.	Name	Failure Mode	Cause	Symptoms and Local Effects Including Dependent Failures	Method of Detection	Inherent Compensating Provision	Effect Upon PPS	Remarks and Other Effects
				2-out-of-4 Coincidence Logic	Reactor Trip	FMEA Diagrams 1, 13		
49)	Bypass Relay Contact (e.g. AB matrix, AXK1-1 or BXK1-1 (cont))	Contact open	Deterioration of contact, stuck contact.	It is not possible to bypass the contact of bistable A1 (B1) in one of three matrices. During PPS testing, the AB matrix will be half tripped when the affected bistable is tripped.	Periodic test.	Within a coincidence matrix, both channel contacts for a given trip are required to open to initiate a reactor trip.	During testing, makes reactor trip logic for the affected parameter a selective 1-out-of-3. If coincident channel is tripped, testing will cause a reactor trip.	No effect when channel is unbypassed. For bypass relay coil faults see Item 30), Trip Channel Bypass faults.
50)	Bistable Relay Contact (e.g. AB matrix, A1-1 or B1-1)	N.O. contact fails closed/N.C. contact fails open. (Form C contact)	Welded contact, stuck contact.	The AB matrix relays will not deenergize when the affected function trips in the A and B channels. AB trip path is inoperable for the affected function. Bistable Control Panel (BCP) LED will not light.	Periodic test.	The AC and BC matrices are still capable of deenergizing all four trip paths and tripping the reactor. (Channel D assumed bypassed)	Makes reactor trip logic for affected parameter a selective 2-out-of-3 coincidence.	RPS trip logic can be converted to 1-out-of-3 by tripping the bypassed channel or trip logic can be converted to 2-out-of-3 by removing the bypass from the bypassed channel and bypassing the affected channel.
		N.O. contact fails open/N.C. contact fails closed (Form C contact)	Welded contact, stuck contact.	The AB matrix is half tripped. If complementary bistable trips, a reactor trip will occur via all four trip paths. Bistable Control Panel (BCP) LED will be lit continuously.	Periodic test.	2-out-of-3 trip coincidence (4th channel bypassed). Matrix half trip.	Makes reactor trip logic for affected parameter a selective 1-out-of-3. (4th channel bypassed)	

ARKANSAS NUCLEAR ONE
Unit 2

TABLE 7.2-5 (continued)

No.	Name	Failure Mode	Cause	Symptoms and Local Effects Including Dependent Failures	Method of Detection	Inherent Compensating Provision	Effect Upon PPS	Remarks and Other Effects
				2-out-of-4 Coincidence Logic	Reactor Trip	FMEA Diagrams 1, 13		
50)	Bistable Relay Contact (e.g. AB matrix, A1-1 or B1-1) (cont)	N.O. contact fails open - high resistance .	Deterioration of contact.	The AB matrix is half tripped. If complementary bistable trips, a reactor trip will occur via all four trip paths.	Troubleshooting. This fault will not be detected until a reactor trip is inadvertently generated by tripping the complementary bistable individually.	2-out-of-3 trip coincidence (4th channel bypassed). Matrix half trip.	Makes reactor trip logic for affected parameter a selective 1-out-of-3. (4th channel bypassed)	PPS testing will not detect this fault as the N.C. contact used for the BCP LED will still function. For bistable relay coil faults see Item 31), RPS bistable circuit faults.
				2-out-of-4 Coincidence Logic	CSAS, SIAS, CCAS, and CIAS	FMEA Diagrams 1, 13, & 16		
51)	HI CONT PRESS 2/4 Coincidence Logic (15)	Logic matrix Off (e.g. AB matrix)	Multiple component failures.	Spurious actuation of SIAS, CCAS, and CIAS. Permissive available for actuation of CSAS on 2-out-of-3 HI-HI CONT PRESS (4th channel bypassed).	Annunciating. CIAS, SIAS, and CCAS alarms.		SIAS, CIAS, and CCAS actuation.	Requires failure of two parallel, redundant components in the logic matrix.
		Logic matrix On (e.g. AB matrix)	Component failure; one set of contacts failed closed.	AB logic matrix for HI CONT PRESS will not respond to a valid trip signal coincidence in the A and B channels. PPS will not initiate SIAS, CCAS, and CIAS for signals originating only from channels A and B.	Periodic test.	AC and BC coincidence matrices remain available to initiate SIAS, CIAS, and CCAS. (Channel D assumed bypassed).	Makes SIAS, CCAS, and CIAS logic for HI CONT PRESS a selective 2-out-of-3 coincidence.	SIAS, CCAS, and CIAS logic can be converted to 1-out-of-3 by tripping the bypassed channel or the logic can be converted to 2-out-of-3 by removing the bypass from the bypassed channel and bypassing the affected channel.

ARKANSAS NUCLEAR ONE
Unit 2

TABLE 7.2-5 (continued)

No.	Name	Failure Mode	Cause	Symptoms and Local Effects Including Dependent Failures	Method of Detection	Inherent Compensating Provision	Effect Upon PPS	Remarks and Other Effects
				2-out-of-4 Coincidence Logic	CSAS, SIAS, CCAS, and CIAS	FMEA Diagrams 1, 13, & 16		
52)	LO PZR PRESS 2/4 Coincidence Logic (127)	Logic matrix Off (e.g. AB matrix)	Multiple component failures.	Spurious actuation of SIAS and CCAS. Permissive available for actuation of CSAS on 2-out-of-3 HI-HI CONT PRESS (4th channel bypassed).	Annunciating. CCAS and SIAS alarms.		SIAS and CCAS actuation.	Requires failure of two parallel, redundant components in the logic matrix.
		Logic matrix On (e.g. AB matrix)	Component failure; one set of contacts failed closed.	AB logic matrix for LO PZR PRESS will not respond to a valid trip signal coincidence in the A and B channels. PPS will not initiate SIAS and CCAS for signals originating only from channels A and B.	Periodic test.	AC and BC coincidence matrices remain available to initiate SIAS and CCAS. (Channel D assumed bypassed).	Makes SIAS and CCAS logic for LO PZR PRESS a selective 2-out-of-3 coincidence.	SIAS and CCAS logic can be converted to 1-out-of-3 by tripping the bypassed channel or the logic can be converted to 2-out-of-3 by removing the bypass from the bypassed channel and bypassing the affected channel.
53)	HI-HI CONT PRESS 2/4 Coincidence Logic (9)	Logic matrix Off (e.g. AB matrix)	Multiple component failures.	All 4 CSAS trip paths open. If SIAS signal is present, containment spray will occur.	Periodic test. If fault is concurrent with SIAS signal, CSAS alarm will occur.	Containment spray requires concurrent SIAS signal.	CSAS actuation signal in all 4 trip paths.	Requires failure of two parallel, redundant components in the logic matrix.

ARKANSAS NUCLEAR ONE
Unit 2

TABLE 7.2-5 (continued)

No.	Name	Failure Mode	Cause	Symptoms and Local Effects Including Dependent Failures	Method of Detection	Inherent Compensating Provision	Effect Upon PPS	Remarks and Other Effects
				2-out-of-4 Coincidence Logic	CSAS	FMEA Diagrams 1, 13, & 16		
53)	HI-HI CONT PRESS 2/4 Coincidence Logic (9) (cont)	Logic matrix On (e.g. AB matrix)	Component failure; one set of contacts failed closed.	AB logic matrix for CSAS will not respond to a valid HI-HI CONT PRESS condition. PPS will not initiate CSAS for signals originating only from channels A and B.	Periodic test.	AC and BC coincidence matrices remain available to initiate CSAS. (Channel D assumed bypassed).	Makes CSAS logic a selective 2-out-of-3 coincidence.	CSAS logic can be converted to 1-out-of-3 by tripping the bypassed channel or the logic can be converted to 2-out-of-3 by removing the bypass from the bypassed channel and bypassing the affected channel.
				2-out-of-4 Coincidence Logic	MSIS	FMEA Diagrams 1, 13, & 15		
54)	2/4 Coincidence Logic for: SG-2 LO PRESS (32) or SG-1 LO PRESS (47)	Logic matrix Off (e.g. AB matrix)	Multiple component failures.	All 4 MSIS trip paths open. Spurious actuation of MSIS occurs.	Annunciating. MSIS alarm.		MSIS actuation.	Requires failure of two parallel, redundant components in the logic matrix.

ARKANSAS NUCLEAR ONE
Unit 2

TABLE 7.2-5 (continued)

No.	Name	Failure Mode	Cause	Symptoms and Local Effects Including Dependent Failures	Method of Detection	Inherent Compensating Provision	Effect Upon PPS	Remarks and Other Effects
				2-out-of-4 Coincidence Logic	MSIS	FMEA Diagrams 1, 13, & 15		
54)	2/4 Coincidence Logic for: SG-2 LO PRESS (32) or SG-1 LO PRESS (47) (cont)	Logic matrix On (e.g. AB matrix)	Component failure; one set of contacts failed closed.	AB logic matrix for MSIS will not respond to a valid SG-1(2) LOW PRESS condition. PPS will not initiate MSIS for signals originating only from channels A and B.	Periodic test.	AC and BC coincidence matrices remain available to initiate MSIS. (Channel D assumed bypassed).	Makes MSIS logic a selective 2-out-of-3 coincidence.	MSIS logic can be converted to 1-out-of-3 by tripping the bypassed channel or the logic can be converted to 2-out-of-3 by removing the bypass from the bypassed channel and bypassing the affected channel.
				2-out-of-4 Coincidence Logic	RAS	FMEA Diagrams 1, 13, & 15		
55)	REFUEL TANK LO LEVEL 2/4 Coincidence Logic (4)	Logic matrix Off (e.g. AB matrix)	Multiple component failures.	All 4 RAS trip paths open. Spurious actuation of RAS occurs.	Annunciating. RAS alarm.		RAS actuation.	Requires failure of two parallel, redundant components in the logic matrix.
		Logic matrix On (e.g. AB matrix)	Component failure; one set of contacts failed closed.	AB logic matrix for RAS will not respond to a valid RWT LO LEVEL condition. PPS will not initiate RAS for signals originating only from channels A and B.	Periodic test.	AC and BC coincidence matrices remain available to initiate RAS. (Channel D assumed bypassed).	Makes RAS logic a selective 2-out-of-3 coincidence.	RAS logic can be converted to 1-out-of-3 by tripping the bypassed channel or the logic can be converted to 2-out-of-3 by removing the bypass from the bypassed channel and bypassing the affected channel.

ARKANSAS NUCLEAR ONE
Unit 2

TABLE 7.2-5 (continued)

No.	Name	Failure Mode	Cause	Symptoms and Local Effects Including Dependent Failures	Method of Detection	Inherent Compensating Provision	Effect Upon PPS	Remarks and Other Effects
				2-out-of-4 Coincidence Logic	EFAS	FMEA Diagrams 1, 13, & 15		
56)	2/4 Coincidence Logic for: EFAS-1 (129) or EFAS-2 (128)	Logic matrix Off (e.g. AB matrix)	Multiple component failures.	All 4 EFAS-1(2) trip paths open. Spurious actuation of EFAS-1(2) occurs.	Annunciating. EFAS-1(2) alarm.	Feedwater Control System will compensate for excess feedwater.	EFAS-1(2) actuation.	Requires failure of two parallel, redundant components in the logic matrix.
		Logic matrix On (e.g. AB matrix)	Component failure; one set of contacts failed closed.	AB logic matrix for EFAS-1(2) will not respond to a valid condition. PPS will not initiate EFAS-1(2) for signals originating only from channels A and B.	Periodic test.	AC and BC coincidence matrices remain available to initiate EFAS-1(2). (Channel D assumed bypassed).	Makes EFAS-1(2) logic a selective 2-out-of-3 coincidence.	EFAS-1(2) logic can be converted to 1-out-of-3 by tripping the bypassed channel or the logic can be converted to 2-out-of-3 by removing the bypass from the bypassed channel and bypassing the affected channel.

ARKANSAS NUCLEAR ONE
Unit 2

TABLE 7.2-5 (continued)

No.	Name	Failure Mode	Cause	Symptoms and Local Effects Including Dependent Failures	Method of Detection	Inherent Compensating Provision	Effect Upon PPS	Remarks and Other Effects
				2-out-of-4 Coincidence Logic	CSAS, RAS, EFAS, AB (Typical)	FMEA Diagrams 13, 15, & 16		
57)	Logic Matrix Relay Contact CSAS A17-1 or B17-1 RAS A18-1 or B18-1 EFAS-1 A19-1 or B19-1 EFAS-2 A20-1 or B20-1	N.O. contact fails closed/N.C contact fails open N.O. contact fails open/N.C . contact fails closed N.O. contact fails open - high resistance	Welded, stuck contact. Welded, stuck contact. Deterioration of contact.	Same as Item 53), Item 55), or Item 56) Logic On fault. BCP LED will not light. The AB matrix is half tripped. If complementary bistable trips, the associated ESFAS function will occur via all four trip paths. BCP LED will be lit continuously. The AB matrix is half tripped. If complementary bistable trips, the associated ESFAS function will occur via all four trip paths.	Same as Item 53), Item 55), or Item 56) Logic On fault. Periodic test. Troubleshooting. This fault will not be detected until the ESFAS function is inadvertently actuated by tripping the complementary bistable individually.	Same as Item 53), Item 55), or Item 56) Logic On fault. 2-out-of-3 trip coincidence (4th channel bypassed). Matrix half trip. 2-out-of-3 trip coincidence (4th channel bypassed). Matrix half trip.	Same as Item 53), Item 55), or Item 56) Logic On fault. Makes affected ESFAS function logic a selective 1-out-of-3. (4th channel bypassed) Makes affected ESFAS function logic a selective 1-out-of-3. (4th channel bypassed)	2/4 Coincident logic matrices use Form C contacts. PPS testing will not detect this fault as the N.C. contact used for the BCP LED will still function.
58)	Logic Matrix Relay Bypass Contact CSAS AXK17-1 or BXK17-1 RAS AXK18-1 or BXK18-1 EFAS-1 AXK19-1 or BXK19-1 EFAS-2 AXK20-1 or BXK20-1	Contact shorts	Welded or stuck contact.	The AB logic matrix is not responsive to a concurrent trip of the A and B channel bistables.	Periodic test.	ESFAS trip conditions sensed in the A&C channels or the B&C channels can still initiate the affected ESFAS function via the AC or BC matrices. (Channel D assumed bypassed).	Makes logic for affected ESFAS function a selective 2-out-of-3 coincidence.	Affected ESFAS logic can be converted to 1-out-of-3 by tripping the bypassed channel or trip logic can be converted to 2-out-of-3 by removing the bypass from the bypassed channel and bypassing the affected channel.

ARKANSAS NUCLEAR ONE
Unit 2

TABLE 7.2-5 (continued)

No.	Name	Failure Mode	Cause	Symptoms and Local Effects Including Dependent Failures	Method of Detection	Inherent Compensating Provision	Effect Upon PPS	Remarks and Other Effects
				2-out-of-4 Coincidence Logic	CSAS, RAS, EFAS, AB (Typical)	FMEA Diagrams 13, 15, & 16		
58)	Logic Matrix Relay Bypass Contact CSAS AXK17-1 or BXK17-1 RAS AXK18-1 or BXK18-1 EFAS-1 AXK19-1 or BXK19-1 EFAS-2 AXK20-1 or BXK20-1	Contact opens	Deterioration of contact, stuck contact.	It is not possible to bypass the contact of associated channel A or B bistable in one of three matrices. During PPS testing, the AB matrix will be half tripped when the affected bistable is tripped.	Periodic test.	Within a coincidence matrix, both channel contacts for a given trip are required to open to initiate an ESFAS function.	During testing, makes affected ESFAS logic a selective 1-out-of-3. If coincident channel is tripped, testing will cause the affected function to actuate.	No effect when channel is unbypassed. For bypass relay coil faults see Item 30), Trip Channel Bypass faults.
59)	Logic Matrix Relay Contact CCAS/SIAS A6-9 or B6-9 A16-1 or B16-1 CIAS A16-1 or B16-1	N.O. contact fails close/N.C. fails open N.O. contact fails open/N.C. contact fails closed N.O. contact fails open - high resistance	Welded or stuck contact. Welded or stuck contact. Deterioration of contact.	Same as Item 51) or Item 52) Logic On fault. BCP LED will not light. The AB matrix is half tripped. If complementary bistable trips, the associated ESFAS function will occur via all four trip paths. BCP LED will be lit continuously. The AB matrix is half tripped. If complementary bistable trips, the associated ESFAS function will occur via all four trip paths.	Same as Item 51) or Item 52) Logic On fault. Periodic test. Trblshntng. Fault will not be detected until the ESFAS function is inadvertently actuated by tripping the complementary bistable individually.	Same as Item 51) or Item 52) Logic On fault. 2-out-of-3 trip coincidence (4th channel bypassed). Matrix half trip. 2-out-of-3 trip coincidence (4th channel bypassed). Matrix half trip.	Same as Item 51) or Item 52) Logic On fault. Makes affected ESFAS function logic a selective 1-out-of-3. (4th channel bypassed) Makes affected ESFAS function logic a selective 1-out-of-3. (4th channel bypassed)	2/4 Coincident logic matrices use Form C contacts. PPS testing will not detect this fault as the N.C. contact used for the BCP LED will still function.

ARKANSAS NUCLEAR ONE
Unit 2

TABLE 7.2-5 (continued)

No.	Name	Failure Mode	Cause	Symptoms and Local Effects Including Dependent Failures	Method of Detection	Inherent Compensating Provision	Effect Upon PPS	Remarks and Other Effects
				2-out-of-4 Coincidence Logic	CIAS,CCAS/SIAS, AB (Typical)	FMEA Diagrams 13, 15, & 16		
60)	Logic Matrix Relay Bypass Contact AXK6-9 or BXK6-9 AXK16-1 or BXK16-1	Contact shorts	Welded or stuck contact	The AB logic matrix is not responsive to a concurrent trip of the A and B channel bistables.	Periodic test.	ESFAS trip conditions sensed in the A&C channels or the B&C channels can still initiate the affected ESFAS function via the AC or BC matrices. (Channel D assumed bypassed).	Makes logic for affected ESFAS function a selective 2-out-of-3 coincidence.	Affected ESFAS logic can be converted to 1-out-of-3 by tripping the bypassed channel or trip logic can be converted to 2-out-of-3 by removing the bypass from the bypassed channel and bypassing the affected channel.
		Contact opens	Deterioration of contact, stuck contact.	It is not possible to bypass the contact of associated channel A or B bistable in one of three matrices. During PPS testing, the AB matrix will be half tripped when the affected bistable is tripped.	Periodic test.	Within a coincidence matrix, both channel contacts for a given trip are required to open to initiate an ESFAS function.	During testing, makes affected ESFAS logic a selective 1-out-of-3. If coincident channel is tripped, testing will cause the affected function(s) to actuate.	No effect when channel is un-bypassed. For bypass relay coil faults see Item 30), Trip Channel Bypass faults.
61)	LO PZR PRESS/HI CONT PRESS OR Function (18)	Logic Off Logic On	Multiple component failures Component failure	The LO PZR PRESS/HI CONT PRESS OR function consists of a series connection of N.O. contacts from the LO PZR PRESS and HI CONT PRESS bistables. See Items 59) and 60) for failure modes and effects for these contacts.				

ARKANSAS NUCLEAR ONE
Unit 2

TABLE 7.2-5 (continued)

No.	Name	Failure Mode	Cause	Symptoms and Local Effects Including Dependent Failures	Method of Detection	Inherent Compensating Provision	Effect Upon PPS	Remarks and Other Effects
				2-out-of-4 Coincidence Logic	MSIS, AB (Typical)	FMEA Diagrams 13, 15		
62)	Logic Matrix Relay Contact	N.O. contact fails close/N.C. fails open	Welded or stuck contact.	Same as Item 54), MSIS Logic Matrix On fault. BCP LED will not light.	Same as Item 54)	Same as Item 54)	Same as Item 54)	2/4 Coincident logic matrices use Form C contacts.
	A11-9 or B11-9	N.O. contact fails open/N.C. contact fails closed	Welded or stuck contact.	The AB matrix is half tripped. If complementary bistable trips, MSIS will actuate via all four trip paths. BCP LED will be lit continuously.	Periodic test.	2-out-of-3 trip coincidence (4th channel bypassed). Matrix half trip.	Makes MSIS logic for affected SG a selective 1-out-of-3. (4th channel bypassed)	
	A12-9 or B12-9	N.O. contact fails open - high resistance	Deterioration of contact.	The AB matrix is half tripped. If complementary bistable trips, MSIS will actuate via all four trip paths.	Troubleshooting. This fault will not be detected until the MSIS function is inadvertently actuated by tripping the complementary bistable individually.	2-out-of-3 trip coincidence (4th channel bypassed). Matrix half trip.	Makes MSIS logic for affected SG a selective 1-out-of-3. (4th channel bypassed)	PPS testing will not detect this fault as the N.C. contact used for the BCP LED will still function.

ARKANSAS NUCLEAR ONE
Unit 2

TABLE 7.2-5 (continued)

No.	Name	Failure Mode	Cause	Symptoms and Local Effects Including Dependent Failures	Method of Detection	Inherent Compensating Provision	Effect Upon PPS	Remarks and Other Effects
				2-out-of-4 Coincidence Logic	MSIS, AB (Typical)	FMEA Diagrams 13, 15		
63)	Logic Matrix Bypass Relay Contact AXKB11-9 or BXKB11-9 AXKB12-9 or BXKB12-9	Contact shorts Contact opens	Welded or stuck contact. Deterioration of contact, stuck contact.	The AB logic matrix is not responsive to a concurrent trip of the A and B channel bistables. It is not possible to bypass the contact of associated channel A or B bistable in one of three matrices. During PPS testing, the AB matrix will be half tripped when the affected bistable is tripped.	Periodic test. Periodic test.	SG-1(2) LO PRESS sensed in the A&C channels or the B&C channels can still actuate MSIS via the AC or BC matrices. (Channel D assumed bypassed). Within a coincidence matrix, both channel contacts for a given trip are required to open to actuate MSIS.	Makes MSIS logic for the affected SG a selective 2-out-of-3 coincidence. During testing, makes MSIS logic a selective 1-out-of-3. If coincident channel is tripped, testing will cause MSIS to actuate.	MSIS logic can be converted to 1-out-of-3 by tripping the bypassed channel or trip logic can be converted to 2-out-of-3 by removing the bypass from the bypassed channel and bypassing the affected channel. No effect when channel is un-bypassed. For bypass relay coil faults see Item 30), Trip Channel Bypass faults.
				2-out-of-4 Coincidence Logic	MSIS, AB (Typical)	FMEA Diagrams 1, 15		
64)	SG-1/SG-2 LO PRESS OR function (33)	Logic Off Logic On	Multiple component failures. Component failure.	The SG-1/SG-2 LO PRESS OR function consists of a series connection of N.O. contacts from SG-1/SG-2 LO PRESS bistables. See Items 62) & 63) for failure modes & effects.				

ARKANSAS NUCLEAR ONE
Unit 2

TABLE 7.2-5 (continued)

No.	Name	Failure Mode	Cause	Symptoms and Local Effects Including Dependent Failures	Method of Detection	Inherent Compensating Provision	Effect Upon PPS	Remarks and Other Effects
				2-out-of-4 Coincidence Logic	CSAS, EFAS, MSIS CIAS, CCAS/SIAS, AB (Typical)	FMEA Diagrams 13, 15, 16		
65)	Logic Matrix Relay Drivers (Transistors and associated components driving AB matrix relay coils)	On	Transistor short, emitter to collector.	Matrix relay will not deenergize when A & B channels trip. One ESFAS trip path will not deenergize when a trip occurs in only the A & B channels.	Periodic test.	Trip paths operate a selective 2-out-of-4 ESFAS actuation logic circuit.	Makes ESFAS actuation logic a selective 2-out-of-3 trip paths.	The matrix relays in the other 2 un-bypassed matrices are unaffected. A trip in either of these will cause a trip in all four trip paths. 4th channel bypassed.
		Off	Transistor junction open.	One of the four matrix relays will be deenergized causing the associated trip path to deenergize.	Annunciating. Trip path actuation alarm. Periodic test.	Trip paths operate a selective 2-out-of-4 ESFAS actuation logic circuit.	Makes ESFAS actuation logic a selective 1-out-of-3 trip paths.	ESFAS function will still actuate on 2-out-of-3 coincidence for any parameter.
66)	Logic Matrix Relays CSAS 3AB-1,2,3,4 RAS 4AB-1,2,3,4 EFAS-1 7AB-1,2,3,4 EFAS-2 8AB-1,2,3,4 MSIS 5AB-1,2,3,4 CIAS 1AB-1,2,3,4 CCAS/SIAS 2AB-1,2,3,4	Open coil Shorted coil	Sustained overvoltage. Mechanical break in coil winding. Insulation breakdown.	Same as open relay driver, Item 65). The shorted coil may cause the relay driver to fail open or short. If the driver fails open, the symptoms will be the same as the open coil fault. If the driver fails short, the power supply will be shorted producing the same symptoms as loss of the power supply See Item 164).				

ARKANSAS NUCLEAR ONE
Unit 2

TABLE 7.2-5 (continued)

No.	Name	Failure Mode	Cause	Symptoms and Local Effects Including Dependent Failures	Method of Detection	Inherent Compensating Provision	Effect Upon PPS	Remarks and Other Effects
				2-out-of-4 Coincidence Logic	CEA Withdrawl Prohibit (CWP)	FMEA Diagram 1		
67)	Core Protection Calculator CWP 2/4 Coincidence Logic (121)	Logic matrix On Logic matrix Off	Multiple component failures. Multiple component failures.	CPC CWP function is inoperative. CWP occurs. Inability to raise CEAs in any mode other than Manual Individual.	Periodic test. Annunciating. CWP alarm.	CWP function is not required for plant safety.	Loss of CPC CWP function. Actuation of CWP.	Either the logic on or logic off fault requires failure of two parallel, redundant components in the 2/4 logic matrix.
68)	HI PZR PRESS CWP 2/4 Coincidence Logic (150)	Logic matrix On Logic matrix Off	Multiple component failures. Multiple component failures.	HI PZR PRESS CWP function is inoperative. CWP occurs. Inability to raise CEAs in any mode other than Manual Individual.	Periodic test. Annunciating. CWP alarm.	CWP function is not required for plant safety.	Loss of HI PZR PRESS CWP function. Actuation of CWP.	Either the logic on or logic off fault requires failure of two parallel, redundant components in the 2/4 logic matrix.
69)	CWP OR Function (151)			The OR function for CWP consists of a series connection of the CPC CWP 2/4 relay matrix and the HI PZR PRESS CWP 2/4 relay matrix. See Items 67) and 68) for failure modes and effects for these matrices.				

ARKANSAS NUCLEAR ONE
Unit 2

TABLE 7.2-5 (continued)

No.	Name	Failure Mode	Cause	Symptoms and Local Effects Including Dependent Failures	Method of Detection	Inherent Compensating Provision	Effect Upon PPS	Remarks and Other Effects
				1-out-of-4 Coincidence Logic	PPS Alarms	FMEA Diagram 1		
70)	Trip Alarm (114), Pre-trip Alarm (115),(113) and Plant Computer (117),(116) for: Refuel Tank LO Level (3), SG-2(1) LO Press (31) (46),HI-HI Cont Press (8) HI Cont Press (14), (25), SG-2>SG-1 Press (40), SG-1>SG-2 Press (49), SG-2(1) HI LVL (136) ,(137), SG-2(1) LO LVL (53),(57), LO PZR Press (63), HI PZR Press (66), HI LIN PWR (73), HI LOG PWR (76),LO DNBR (93), HI LPD (97)	Off On	Relay coil or contact failure. Relay driver failure. Relay contact failure. Relay driver failure.	Trip, pre-trip, or plant computer input activated. Loss of alarm signal for a single channel. If protective action occurs, alarm will be generated via redundant channels.	Audible and visual PPS alarm in control room. Comparison with other plant indications. Periodic test.	 Redundant channels.	None. Makes alarm logic 1-out-of-2 (4th channel bypassed). No effect on PPS logic.	
71)	Relay Contact 6AB-1 or 6BC-1 or 6BD-1 or 6AC-1 or 6CD-1 or 6AD-1	Shorted	Welded or stuck contact.	A trip of the logic matrix associated with the failed contact will not cause deenergization of the affected trip path.	Periodic test.	Trip paths operate a selective 2-out-of-4 reactor trip circuit.	Makes reactor trip circuit logic a selective 2-out-of-3 for the affected matrix. For other matrices, the trip paths remain selective 2-out-of-4.	All four trip paths will deenergize if either of the other 2 un-bypassed 2/4 coincidence matrices trip. (4th channel assumed bypassed).

ARKANSAS NUCLEAR ONE
Unit 2

TABLE 7.2-5 (continued)

No.	Name	Failure Mode	Cause	Symptoms and Local Effects Including Dependent Failures	Method of Detection	Inherent Compensating Provision	Effect Upon PPS	Remarks and Other Effects
				Trip Path	RPS, Channel 1 (Typical)			
71)	Contact 6AB-1 or 6BC-1 or 6BD-1 or 6AC-1 or 6CD-1 or 6AD-1 (cont)	Open	Deterioration of contact, stuck contact.	One of the four RPS trip paths deenergize.	Annunciating. RPS actuation alarm.	Trip paths operate a selective 2-out-of-4 reactor trip circuit.	Makes reactor trip circuit logic a selective 1-out-of-3 or any 2-out-of-3 trip paths.	2-out-of-3 coincidence of the appropriate bistables is still required to produce a reactor trip. (4th channel bypassed).
72)	Either Vital Bus Circuit Breaker	Open, either or both contacts	Deterioration of contact, stuck contact.	Relay K-1 deenergizes which will cause one pair of UV coils to deenergize and one pair of shunt trip coils to energize. This causes one parallel pair of reactor trip breakers to open.	Annunciating. RPS actuation alarm. PPS status panel. PPS ROM.	CEDM power supplied through selective 2-out-of-4 reactor trip circuit.	Makes reactor trip circuit logic a selective 1-out-of-3 or any 2-out-of-3 trip paths.	2-out-of-3 coincidence of the appropriate bistables is still required to produce a reactor trip. (4th channel bypassed).
		Short both contacts	Welded contacts, mechanical failure.	The circuit breaker will not open should a fault occur in the AC portion of the trip path. Would cause associated vital bus AC power distribution breaker to open.	Periodic test.		No effect.	
		Short one contact	Welded contact	None.			No effect.	
73)	Resistor 2K ohms R1 or R3 R2 or R4	Open	Overvoltage, environmental effects.	The Bistable Control Panel (BCP) will fail to indicate the opening of one of the solid state relays in the RPS trip path.	Periodic test.		No effect upon the functional operation of the system.	Indication only.

ARKANSAS NUCLEAR ONE
Unit 2

TABLE 7.2-5 (continued)

No.	Name	Failure Mode	Cause	Symptoms and Local Effects Including Dependent Failures	Method of Detection	Inherent Compensating Provision	Effect Upon PPS	Remarks and Other Effects
				Trip Path	RPS, Channel 1 (Typical)			
73)	Resistor 2K ohms R1 or R3 R2 or R4 (cont)	Decrease in resistance	Overvoltage, environmental effects.	Indicator may be brighter than usual.		There are two equal value resistors in the circuit. The operating range of the indicator is such that it will operate indefinitely even with one of the resistors shorted out.	No effect upon the functional operation of the system.	Indication only.
		Increase in resistance	Overvoltage, environmental effects.	Indicator will be dimmer than usual.	Periodic test.		No effect upon the functional operation of the system.	Indication only.
74)	Fuses	Open	Transient overcurrent condition.	Trip path deenergizes.	Annunciating. RPS actuation alarm. PPS status panel. PPS ROM.	Trip paths operate a selective 2-out-of-4 reactor trip circuit.	Makes reactor trip circuit logic a selective 1-out-of-3 or any 2-out-of-3 trip paths.	2-out-of-3 coincidence of the appropriate bistables is still required to produce a reactor trip. (4th channel bypassed).
75)	SSR 3 or SSR 4	Input open	Voltage transient.	Output of SSR will open circuit and cause same effects as Item 72), Circuit Breaker Open.				
		Input short	Voltage transient.	The fuses in the trip path will open producing the effects described for Item 74), open fuse. It is possible the short could momentarily load the trip path power supply enough to cause other PPS trip paths using that power supply to deenergize.				

ARKANSAS NUCLEAR ONE
Unit 2

TABLE 7.2-5 (continued)

No.	Name	Failure Mode	Cause	Symptoms and Local Effects Including Dependent Failures	Method of Detection	Inherent Compensating Provision	Effect Upon PPS	Remarks and Other Effects
				Trip Path	RPS, Channel 1 (Typical)			
75)	SSR 3 or SSR 4 (cont)	Output short	Voltage transient overload.	One side of the current circuit to trip relay K-1 will not interrupt when the trip path trips. Will not prevent trip relay K-1 from functioning properly.	Periodic test.	There are two SSRs in the circuit. Either one can open the circuit that provides a trip to the selective 2-out-of-4 reactor trip circuit.	No effect on functional operation of the system.	
		Output open	Voltage transient overload.	Relay K-1 deenergizes which will cause one pair of UV coils to deenergize and one pair of shunt trip coils to energize. This causes one parallel pair of reactor trip breakers to open.	Annunciating. RPS actuation alarm. PPS status panel. PPS ROM.	CEDM power supplied through selective 2-out-of-4 reactor trip circuit.	Makes reactor trip circuit logic a selective 1-out-of-3 or any 2-out-of-3 trip paths.	2-out-of-3 coincidence of the appropriate bistables is still required to produce a reactor trip. (4th channel bypassed).
76)	250 ohm Resistor R5 or R6	Decrease in resistance	Overvoltage, environmental effects.	None.	Bench check.	There are two equal resistors in the series circuit. The operating range of the SSR is such that it will operate indefinitely even with one of the resistors shorted.	No effect on functional operation of the system.	
		Open	Overvoltage, environmental effects.	The PPS status panel will indicate that the trip path is deenergized even when it is not.	Periodic test.		No effect on functional operation of the system.	Indication only.
		Increase in resistance	Overvoltage, environmental effects.	No symptoms until the resistor has increased in value to about 2 K ohms. Above this value, the effects could be the same as those for an open resistor, above.				

ARKANSAS NUCLEAR ONE
Unit 2

TABLE 7.2-5 (continued)

No.	Name	Failure Mode	Cause	Symptoms and Local Effects Including Dependent Failures	Method of Detection	Inherent Compensating Provision	Effect Upon PPS	Remarks and Other Effects
				Trip Path	RPS, Channel 1 (Typical)			
77)	SSR 1 Remote Indication	Output open/ input open	Voltage transient overload.	The PPS status panel will indicate that the trip path is deenergized even when it is not.	Periodic test.		No effect on functional operation of the system.	Indication only.
		Input short	Voltage transient.	SSR output will probably open circuit (see effect for output open). R5 and R6 may limit current sufficiently to preclude blowing the trip path power supply fuses. If fuse does blow, effects of Item 74) apply.		Current limiting resistors R5 and R6.		
		Output short	Voltage transient.	The PPS status panel will not indicate a trip of the trip path channel.	Periodic test.		No effect on functional operation of the system.	Indication only.
78)	250 ohm Resistor R7 or R8	Decrease in resistance	Overvoltage, environmental effects.	No symptoms	Bench check.	There are two equal resistors in the series circuit. The operating range of the SSR is such that it will operate indefinitely even with one of the resistors shorted.		
		Open	Overvoltage, environmental effects.	The actuation reset indicator will be flashing when the PPS is in the test mode. Erroneous indication of trip path deenergization.	Periodic test.		No effect on functional operation of the system.	Indication only.

ARKANSAS NUCLEAR ONE
Unit 2

TABLE 7.2-5 (continued)

No.	Name	Failure Mode	Cause	Symptoms and Local Effects Including Dependent Failures	Method of Detection	Inherent Compensating Provision	Effect Upon PPS	Remarks and Other Effects
				Trip Path	RPS, Channel 1 (Typical)			
78)	250 ohm Resistor R7 or R8 (cont)	Increase in resistance	Overvoltage, environmental effects.	There will be no symptoms until the resistor has increased in value to about 2 K ohms. Above this value, the effects could be the same as those for an open resistor, above.				
79)	SSR 2 Test Reset Indicator	Output open, input open	Voltage transient overload.	The actuation reset indicator will be flashing when the PPS is in the test mode. Erroneous indication of trip path deenergization.	Periodic test.		No effect on functional operation of the system.	Indication only.
		Input short	Voltage transient.	SSR output will probably open circuit (see effect for output open). R7 and R8 may limit current sufficiently to preclude blowing the trip path power supply fuses. If fuse does blow, effects of Item 74) apply.		Current limiting resistors R7 and R8.	No effect on functional operation of the system.	Indication only.
		Output short	Voltage transient overload.	An RPS trip in the affected channel will not cause the PPS actuation reset indicator to flash when the test mode is selected.	Periodic test.		No effect on functional operation of the system.	Indication only.

ARKANSAS NUCLEAR ONE
Unit 2

TABLE 7.2-5 (continued)

No.	Name	Failure Mode	Cause	Symptoms and Local Effects Including Dependent Failures	Method of Detection	Inherent Compensating Provision	Effect Upon PPS	Remarks and Other Effects
				Trip Path, Engineered Safety Features	CIAS-RAS-MSIS- EFAS (Typical)	FMEA Diagram 15		
80)	Relay Contact AB contact (typical) (FMEA Diagram 13 & 15) CIAS-1 AB-1 RAS-4AB-1 MSIS-5 AB-1 EFAS-1-7AB-1 EFAS-2-8AB-1	Shorted	Welded contact	A trip of the logic matrix with the failed component will not cause de-energization of the trip path with the shorted contact.	Periodic PPS testing	The other three trip paths are not affected. In the affected trip path any of the other un-bypassed matrices will still de-energize the trip path upon receipt of a bona-fide trip.	One trip path is inoperative for that particular logic matrix. The other two un-bypassed matrices will still de-energize all four trip paths upon receipt of a bona-fide trip.	All four trip paths will deenergize if either of the other two un-bypassed 2/4 coincidence matrices trip. (4th channel assumed bypassed.)
		Open	Deterioration of contact	The trip path will be de-energized	Trip is annunciated on the plant annunciator	The other three trip paths are not affected	Selective 2-out-of-4 Actuation logic converts to 1 out-of-2 (opposite leg) or any 2-out-of-3	Actuation still requires a 2-out-of-3 coincidence of the appropriate bistables
81)	Fuse	Open	Transient overcurrent condition	The trip path will be de-energized	Trip is annunciated on the plant annunciator	The other three trip paths are not affected	Selective 2-out-of-4 Actuation logic converts to 1 out-of-2 (opposite leg) or any 2-out-of-3	Actuation still requires a 2-out-of-3 coincidence of the appropriate bistables
82)	Test SSR	Output open, input open, Input short	Overload, voltage transient	The actuation reset indicator will be flashing when the PPS is in the test mode, indicating that a trip path has been de-energized	Periodic PPS testing	Current limiting resistors R5 and R6 prevent malfunctioning of this component from affecting the functional operation of this circuit.	None	Safety function of circuit not impaired.

ARKANSAS NUCLEAR ONE
Unit 2

TABLE 7.2-5 (continued)

No.	Name	Failure Mode	Cause	Symptoms and Local Effects Including Dependent Failures	Method of Detection	Inherent Compensating Provision	Effect Upon PPS	Remarks and Other Effects
				Trip Path, Engineered Safety Features	CIAS-RAS-MSIS- EFAS (Typical)	FMEA Diagram 15		
82)	Test SSR (cont)	Output short	Voltage transient overload	The actuation reset indicator on the PPS will not flash when the trip path with the faulty component is exercised.	Periodic PPS testing		None	Safety function of circuit not impaired.
83)	Latching Circuit SSR (n/a for EFAS-1, EFAS-2)	Output open, Input open, Input short	Overload Voltage transient	The trip path will be de-energized.	Trip is annunciated on the plant annunciator.	The other three trip paths are not affected.	Selective 2-out-of-4 Actuation logic converts to 1-out-of-2 (opposite leg) or any 2-out-of-3.	Actuation still requires a 2-out-of-3 coincidence of the appropriate bistables.
	Latching Circuit SSR (n/a for EFAS-1, EFAS-2) (cont)	Output shorted	Voltage transient Overload	The trip circuit will not lock out and will track the state of the trip path contact string de-energizing whenever one or more of the contacts is open and energizing when they are all closed.	Periodic PPS testing		The trip circuit will not remain in the tripped condition but will follow the action of the series string of matrix relay contacts.	The Actuation circuits should not follow any fluctuating condition of a single trip path circuit. Under a trip condition with a channel in bypass all four trip paths will be de-energized & three will be latched in that state. The selective 2-out-of-4 actuation circuits will have three of their four contacts latched open with the fourth fluctuating between open and closed states.

TABLE 7.2-5 (continued)

ARKANSAS NUCLEAR ONE

Unit 2

No.	Name	Failure Mode	Cause	Symptoms and Local Effects Including Dependent Failures	Method of Detection	Inherent Compensating Provision	Effect Upon PPS	Remarks and Other Effects
				Trip Path, Engineered Safety Features	CIAS-RAS-MSIS-EFAS (Typical)	FMEA Diagram 15		
84)	250 ohm resistor R1 or R2 (latching ckt) (n/a for EFAS-1, EFAS-2)	Open	Environmental effects	The trip path will be de-energized.	Trip is annunciated on the plant annunciator.	The other three trip paths are not affected.	Selective 2-out-of-4 Actuation logic converts to 1-out-of-2 (opposite leg) or any 2-out-of-3.	Actuation still requires a 2-out-of-3 coincidence of the appropriate bistables.
		Decrease in resistance	Environmental effects	No symptoms	Bench check	Two equal resistors in the series circuit. The operating range of the SSR is such that it is still within limits if one of the resistors is shorted.	None	Safety function of circuit is not impaired.
		Increase in resistance	Environmental effects	There will be no symptoms until resistor has increased in value to about 2K OHMS. Values exceeding that will cause problems similar to those listed for the failed open mode.	For resistance equal to or greater than 2K a trip is annunciated.	The other three trip paths are not affected.	For resistance equal to or greater than 2K OHMS the Selective 2-out-of-4 actuation logic converts to 1-out-of-2 (opposite leg) or any 2-out-of-3.	Actuation still requires a 2-out-of-3 coincidence of the appropriate bistables.
85)	250 ohm resistor R3 or R4 (indicator ckt.)	Decrease in resistance	Environmental effects	No symptoms	Bench check	Two equal resistors in the series circuit. The operating range of the SSR is such that it is still within limits if one of the resistors is shorted.	None	Safety function of circuit is not impaired.

ARKANSAS NUCLEAR ONE
Unit 2

TABLE 7.2-5 (continued)

No.	Name	Failure Mode	Cause	Symptoms and Local Effects Including Dependent Failures	Method of Detection	Inherent Compensating Provision	Effect Upon PPS	Remarks and Other Effects
				Trip Path, Engineered Safety Features	CIAS-RAS-MSIS-EFAS (Typical)	FMEA Diagram 15		
85)	250 ohm resistor R3 or R4 (indicator ckt.) (cont)	Open	Mechanical failure	The PPS status panel and PPS remote module will indicate a trip for the affected function.	Periodic PPS testing		None	Safety function of circuit is not impaired.
		Increase in resistance	Environmental effects	There will be no symptoms until resistor has increased in value to about 2K OHMS. Values exceeding that will cause problems similar to those listed for the failed open mode.			None	Safety function of circuit is not impaired.
86)	250 ohm resistor R5 or R6 (test ckt.)	Decrease in resistance	Environmental effects	No symptoms	Bench check	Two equal resistors in the series circuit. The operating range of the SSR is such that it is still within limits if one of the resistors is shorted.	None	Safety function of circuit not impaired.
		Open	Mechanical failure	The actuation reset indicator will be flashing when the PPS is in the test mode indicating that a trip path has been de-energized.	Periodic PPS testing		None	Safety function of circuit not impaired.
		Increase in resistance	Environmental effects	There will be no symptoms until resistor has increased in value to about 2K OHMS. Values exceeding that will cause problems similar to those listed for the failed open mode.			None	Safety function of circuit not impaired.

ARKANSAS NUCLEAR ONE
Unit 2

TABLE 7.2-5 (continued)

No.	Name	Failure Mode	Cause	Symptoms and Local Effects Including Dependent Failures	Method of Detection	Inherent Compensating Provision	Effect Upon PPS	Remarks and Other Effects
				Trip Path, Engineered Safety Features	CIAS-RAS-MSIS-EFAS (Typical)	FMEA Diagram 15		
87)	Indicator SSR	Output open, Input open	Voltage transient	The PPS status panel and PPS remote module will indicate a trip for the affected function.	Periodic PPS testing		None	Safety function of circuit not impaired.
		Input fails Short	Voltage transient	The PPS status panel and PPS remote module will indicate a trip for the affected function.	Periodic PPS testing	Resistors in the input of the SSR limit the current that the SSR may draw from the circuit should the input of the SSR short.	None	Safety function of circuit not impaired.
		Output fails Short	Voltage transient	A bona fide trip for the function and channel affected will not be indicated on the PPS status panel and the PPS remote module.	Periodic PPS testing		None	Safety function of circuit not impaired.
88)	Remote Manual Trip Path P/B (n/a for RAS) (Reference items 132, 134, 136, and 138 for specific P/Bs)	Open	Mechanical Failure, deterioration of contact.	The trip path will be de-energized.	Trip is annunciated on the plant computer.	The other three trip paths are not affected.	Selective 2-out-of-4 Actuation logic converts to 1-out-of-2 (opposite leg) or any 2-out-of-3.	Actuation still requires a 2-out-of-3 coincidence of the appropriate bistables.

ARKANSAS NUCLEAR ONE
Unit 2

TABLE 7.2-5 (continued)

No.	Name	Failure Mode	Cause	Symptoms and Local Effects Including Dependent Failures	Method of Detection	Inherent Compensating Provision	Effect Upon PPS	Remarks and Other Effects
				Trip Path, Engineered Safety Features	CIAS-RAS-MSIS- EFAS (Typical)	FMEA Diagram 15		
88)	Remote Manual Trip Path P/B (n/a for RAS) (Reference items 132, 134, 136, and 138 for specific P/Bs)	Short	Mechanical failure	The trip path cannot be manually tripped.	Periodic PPS testing or when attempting to manually trip.	The other three trip paths are not affected.	The trip path is inoperative for that particular remote manual pushbutton and actuation is dependent upon a selective 2-out-of-the remaining three trip paths from their respective remote manual pushbuttons	Actuation still requires a 2-out-of-3 coincidence of the appropriate bistables. All four trip paths will still de-energize upon receipt of a bona-fide trip from the matrix circuits.
89)	Lockout Reset P/B (n/a for EFAS-1, EFAS-2)	Open	Mechanical failure, deterioration of contact	Once tripped, the affected trip path cannot be manually reset.	Periodic PPS testing or when attempting to reset a trip path. Trip path de-energized remains annunciated.	The other three trip paths are not affected.	Once tripped, the trip path cannot be manually reset. Selective 2-out-of-4 Actuation logic remains 1-out-of-2 (opposite leg) or any 2-out-of-3 after bistables have reset.	Actuation still requires a 2-out-of-3 coincidence of the appropriate bistables.

ARKANSAS NUCLEAR ONE
Unit 2

TABLE 7.2-5 (continued)

No.	Name	Failure Mode	Cause	Symptoms and Local Effects Including Dependent Failures	Method of Detection	Inherent Compensating Provision	Effect Upon PPS	Remarks and Other Effects
				Trip Path, Engineered Safety Features	CIAS-RAS-MSIS-EFAS (Typical)	FMEA Diagram 15		
89)	Lockout Reset P/B (n/a for EFAS-1, EFAS-2) (cont)	Short	Mechanical failure	The trip circuit will not lock out and will track the state of the trip path contact string de-energizing whenever one or more of the contacts is open and energizing when they are all closed.	Periodic PPS testing.		The trip circuit will not remain in the tripped condition but will follow the action of the series string of matrix relay contacts.	The Actuation circuits should not follow any fluctuating condition of a single trip path circuit. Under a trip condition with a channel in bypass all four trip paths will be de-energized and three will be latched in that state. The selective 2-out-of-4 actuation circuits will have three of their four contacts latched open with the fourth fluctuating between open and closed states.
				Trip Path, Engineered Safety Features	SIAS-CCAS-CSAS (Typical)	FMEA Diagram 16		
90)	Relay contact AB contact (typical) (FMEA diagram 13 & 16) SIAS/CCAS 2AB-1	Shorted	Welded contact	A trip of the logic matrix with the failed component will not cause de-energization of the trip path with the shorted contact.	Periodic PPS testing	The other three trip paths are not affected. In the affected trip path any of the other un-bypassed matrices will still de-energize the trip path upon receipt of a bona-fide trip.	One trip path is inoperative for that particular logic matrix. The other two un-bypassed matrices will still de-energize all four trip paths for the affected functions upon receipt of a bona-fide trip.	All four trip paths will deenergize if either of the other two un-bypassed 2/4 coincidence matrices trip. (4th channel assumed bypassed).

ARKANSAS NUCLEAR ONE
Unit 2

TABLE 7.2-5 (continued)

No.	Name	Failure Mode	Cause	Symptoms and Local Effects Including Dependent Failures	Method of Detection	Inherent Compensating Provision	Effect Upon PPS	Remarks and Other Effects
				Trip Path, Engineered Safety Features	SIAS-CCAS-CSAS (Typical)	FMEA Diagram 16		
90)	Relay contact AB contact (typical) (FMEA diagram 13 & 16) SIAS/CCAS 2AB-1	Open	Deterioration of contact	The trip path will be de-energized for SIAS and CCAS. The trip path for CSAS will be enabled but not tripped.	Trip is annunciated.	The other three trip paths are not affected.	Selective 2-out-of-4 Actuation logic converts to 1 out-of-2 (opposite leg) or any 2-out-of-3 for SIAS and CCAS. Affected trip path of CSAS has a permissive signal.	Actuation still requires a 2-out-of-3 coincidence of the appropriate bistables.
91)	Relay contact AB contact (typical) (FMEA diagram 13 & 16) CSAS 3AB-1	Shorted	Welded contact	A trip of the logic matrix with the failed component will not cause de-energization of the trip path with the shorted contact.	Periodic PPS testing	The other three trip paths are not affected. In the affected trip path any of the other un-bypassed matrices will still de-energize the trip path upon receipt of a bona-fide trip.	One trip path is inoperative for that particular logic matrix. The other two un-bypassed matrices will still de-energize all four trip paths for CSAS upon receipt of a bona-fide trip.	All four trip paths will deenergize if either of the other two un-bypassed 2/4 coincidence matrices trip. (4th channel assumed bypassed).
		Open	Deterioration of contact	For the affected CSAS trip path one of the two conditions for de-energizing will be present.	Periodic PPS testing.	The other three trip paths are not affected.	No effect unless an SIAS trip is also present. If SIAS is present Actuation logic for CSAS converts to 1-out-of-2 (opposite leg) or any 2-out-of-3.	Actuation still requires a 2-out-of-3 coincidence of the appropriate bistables and the presence of an SIAS trip.

ARKANSAS NUCLEAR ONE
Unit 2

TABLE 7.2-5 (continued)

No.	Name	Failure Mode	Cause	Symptoms and Local Effects Including Dependent Failures	Method of Detection	Inherent Compensating Provision	Effect Upon PPS	Remarks and Other Effects
				Trip Path, Engineered Safety Features	SIAS-CCAS-CSAS (Typical)	FMEA Diagram 16		
92)	SIAS Auxiliary Relay (10)	Open coil	Sustained overvoltage	For the affected CSAS trip path one of the two conditions for de-energizing will be present.	Periodic PPS testing.	The other three trip paths are not affected.	No effect unless a CSAS trip is also present. If CSAS trip is also present, a trip will be present in the affected CSAS trip path.	Actuation still requires a 2-out-of-3 coincidence of the appropriate bistables and the presence of an SIAS trip.
		Shorted coil	Deterioration of insulation	A shorted coil will cause the fuse(s) supplying the SIAS and CCAS trip paths in the affected channel to open. This will result in a trip in the SIAS and CCAS trip paths. For the affected CSAS trip path one of the two conditions for de-energizing will be present.	Trips are annunciated.	The other three trip paths are not affected.	For SIAS and CCAS the selective 2-out-of-4 Actuation logic converts to 1-out-of-2 (opposite leg) or any 2-out-of-3. If CSAS trip is also present, a trip will be present in the affected CSAS trip path.	Actuation still requires a 2-out-of-3 coincidence of the appropriate bistables and the presence of an SIAS trip.
93)	SIAS Auxiliary Relay Contact	Open	Deterioration of contact	For the affected CSAS trip path one of the two conditions for de-energizing will be present.	Periodic PPS testing.		No effect unless a CSAS trip is also present. If CSAS trip is also present, a trip will be present in the affected CSAS trip path	Actuation still requires a 2-out-of-3 coincidence of the appropriate bistables and the presence of an SIAS trip.

ARKANSAS NUCLEAR ONE
Unit 2

TABLE 7.2-5 (continued)

No.	Name	Failure Mode	Cause	Symptoms and Local Effects Including Dependent Failures	Method of Detection	Inherent Compensating Provision	Effect Upon PPS	Remarks and Other Effects
				Trip Path, Engineered Safety Features	SIAS-CCAS-CSAS (Typical)	FMEA Diagram 16		
93)	SIAS Auxiliary Relay Contact	Shorted	Welded contact	The CSAS trip path with the affected component will not respond to a trip from the logic matrix in which the faulty component is located.	Periodic PPS testing.		One CSAS trip path is inoperative. Actuation is dependent upon a selective 2-out-of-the remaining three trip paths for CSAS.	Actuation still requires a 2-out-of-3 coincidence of the appropriate bistables and the presence of an SIAS trip.
94)	Fuse	open	Transient overcurrent condition	The trip path will be de-energized.	Trip is annunciated.	The other three trip paths are not affected.	Selective 2-out-of-4 Actuation logic converts to 1 out-of-2 (opposite leg) or any 2-out-of-3 for SIAS and CCAS. Affective trip path of CSAS has a permissive signal.	Actuation still requires a 2-out-of-3 coincidence of the appropriate bistables.
95)	Test SSR	Output open, input open, input short	Overload, voltage transient	The actuation reset indicator will be flashing when the PPS is in the test mode, indicating that a trip path has been de-energized.	Periodic PPS testing	Current limiting resistors R5& R6 or R11 & R12 or R17 & R18 prevent malfunctioning of this component from affecting the functional operation of this circuit.	None	Safety function of circuit not impaired.

ARKANSAS NUCLEAR ONE
Unit 2

TABLE 7.2-5 (continued)

No.	Name	Failure Mode	Cause	Symptoms and Local Effects Including Dependent Failures	Method of Detection	Inherent Compensating Provision	Effect Upon PPS	Remarks and Other Effects
				Trip Path, Engineered Safety Features	SIAS-CCAS-CSAS (Typical)	FMEA Diagram 16		
95)	Test SSR	Output shorted	Voltage transient, overload	The actuation reset indicator on the PPS will not flash when the trip path with the faulty component is exercised.	Periodic PPS testing.		None	Safety function of circuit is not impaired.
96)	Latching circuit SSR	Output open, input open, input short	Overload voltage transient	The trip path will be de-energized.	Trip is annunciated.	The other three trip paths are not affected.	Selective 2-out-of-4 Actuation logic converts to 1-out-of-2 (opposite leg) or any 2-out-of-3.	Actuation still requires a 2-out-of-3 coincidence of the appropriate bistables.
		Output shorted		The affected trip circuit will not lock out and will track the state of the trip path contact string de-energizing whenever one or more of the contacts is open and energizing when they are all closed.	Periodic PPS testing	The other three trip paths are not affected.	The affected trip circuit will not remain in the tripped condition but will follow the action of the series string of matrix relay contacts for the affected function (SIAS CCAS, or CSAS permissive).	The Actuation circuits should not follow any fluctuating condition of a single trip path circuit. Under a trip condition with a channel in bypass all 4 trip paths will be de-energized and three will be latched in that state for the affected function. The selective 2-out-of-4 actuation circuits will have three of their four contacts latched open with the 4 th fluctuating between open and closed states.

ARKANSAS NUCLEAR ONE
Unit 2

TABLE 7.2-5 (continued)

No.	Name	Failure Mode	Cause	Symptoms and Local Effects Including Dependent Failures	Method of Detection	Inherent Compensating Provision	Effect Upon PPS	Remarks and Other Effects
				Trip Path, Engineered Safety Features	SIAS-CCAS-CSAS (Typical)	FMEA Diagram 16		
97)	250 ohm resistor (latching SSR) R1 or R2 or R7 or R8 or R13 or R14	Open	Mechanical failure	The trip path containing the affected component will be de-energized.	Trip is annunciated.	The other three trip paths are not affected.	Selective 2-out-of-4 Actuation logic converts to 1-out-of-2 (opposite leg) or any 2-out-of-3	Actuation still requires a 2-out-of-3 coincidence of the appropriate bistables.
		Decrease in resistance	Environmental effects	No symptoms	Bench check	Two equal resistors in the series circuit. The operating range of the SSR is such that it is still within limits if one of the resistors is shorted.	None	Safety function of circuit is not impaired.
		Increase in resistance	Environmental effects	There will be no symptoms until resistor has increased in value to about 2K ohms. Values exceeding that will cause problems similar to those listed for the failed open mode.	For resistance equal to or greater than 2K OHMS a trip is annunciated on the plant computer.		For resistance \geq 2K OHMS the Selective 2-out-of-4 Actuation logic converts to 1-out-of-2 (opposite leg) or any 2-out-of-3.	Actuation still requires a 2-out-of-3 coincidence of the appropriate bistables.
98)	250 ohm resistor (test SSR) R5 or R6 or R11 or R12 or R17 or R18	Open	Mechanical failure	The actuation reset indicator will be flashing when the PPS is in the test mode, indicating that a trip path has been de-energized.	Periodic PPS testing.		None	Safety function of circuit not impaired.

ARKANSAS NUCLEAR ONE
Unit 2

TABLE 7.2-5 (continued)

No.	Name	Failure Mode	Cause	Symptoms and Local Effects Including Dependent Failures	Method of Detection	Inherent Compensating Provision	Effect Upon PPS	Remarks and Other Effects
				Trip Path, Engineered Safety Features	SIAS-CCAS-CSAS (Typical)	FMEA Diagram 16		
98)	250 ohm resistor (test SSR) R5 or R6 or R11 or R12 or R17 or R18 (cont)	Decrease in resistance	Environmental effects	No Symptoms	Bench check	There are two equal resistors in the series circuit. The operating range of the SSR is broad enough to tolerate a short in one of the resistors.	None	Safety function of circuit not impaired.
		Increase in resistance	Environmental effects	There will be no symptoms until resistor has increased in value to about 2K ohms. Values exceeding that will cause problems similar to those listed for the failed open mode.			None	Safety function of circuit not impaired.
99)	250 ohm resistor (Indicator SSR) R3 or R4 or R9 or R10 or R15 or R16	Open	Mechanical failure	The PPS status panel and PPS remote module will indicate a trip for the affected function.	Periodic PPS testing.		None	Safety function of circuit not impaired.
		Decrease in resistance	Environmental effects	No symptoms	Bench check	There are two equal resistors in the series circuit. The operating range of the SSR is broad enough to tolerate a short in one of the resistors.	None	Safety function of circuit not impaired.

ARKANSAS NUCLEAR ONE
Unit 2

TABLE 7.2-5 (continued)

No.	Name	Failure Mode	Cause	Symptoms and Local Effects Including Dependent Failures	Method of Detection	Inherent Compensating Provision	Effect Upon PPS	Remarks and Other Effects
				Trip Path, Engineered Safety Features	SIAS-CCAS-CSAS (Typical)	FMEA Diagram 16		
99)	250 ohm resistor (Indicator SSR) R3 or R4 or R9 or R10 or R15 or R16 (cont)	Increase in resistance	Environmental effects	There will be no symptoms until resistor has increased in value to about 2K ohms. Values exceeding that will cause problems similar to those listed for the failed open mode.			None	Safety function of circuit not impaired.
100)	Indicator SSR	Output open, input open	Voltage transient	The PPS status panel and PPS remote module will indicate a trip for the affected function.	Periodic PPS testing.		None	Safety function of circuit not impaired.
		Input fails short	Voltage transient	The PPS status panel and PPS remote module will indicate a trip for the affected function.	Periodic PPS Testing	Resistors in the input of the SSR limit the current that the SSR may draw from the circuit should the input of the SSR short.	None	Safety function of circuit not impaired.
		Output fails	Voltage transient	A bona fide trip for the function and channel affected will not be indicated on the PPS status panel and the PPS remote module.	Periodic PPS testing.		None	Safety function of circuit not impaired.
101)	Remote Manual Trip Path P/B (Reference items 126, 128, and 130 for specific P/Bs).	Open	Mechanical failure, deterioration of contact	The affected trip path will be de-energized.	Trip is annunciated.	The other three trip paths are not affected.	Selective 2-out-of-4 Actuation logic converts to 1-out-of-2 (opposite leg) or any 2-out-of-3.	Actuation still requires a 2-out-of-3 coincidence of the appropriate bistables.

ARKANSAS NUCLEAR ONE
Unit 2

TABLE 7.2-5 (continued)

No.	Name	Failure Mode	Cause	Symptoms and Local Effects Including Dependent Failures	Method of Detection	Inherent Compensating Provision	Effect Upon PPS	Remarks and Other Effects
				Trip Path, Engineered Safety Features	SIAS-CCAS-CSAS (Typical)	FMEA Diagram 16		
101)	Remote Manual Trip Path P/B (Reference items 126, 128, and 130 for specific P/Bs). (cont)	Short	Mechanical failure	The trip path cannot be manually tripped.	Periodic PPS testing or when attempting to manually trip.	The other three trip paths are not affected.	The trip path is inoperative for that particular remote manual pushbutton and actuation is dependent upon a selective 2-out-of the remaining three trip paths from their respective remote manual pushbuttons.	Actuation still requires a 2-out-of-3 coincidence of the appropriate bistables. All four trip paths will still de-energize upon receipt of a bona-fide trip from the matrix circuits.
102)	Lockout reset P/B	Open	Mechanical failure, deterioration of contact	It will not be possible to reset the affected trip path once it is de-energized.	Periodic PPS testing or when attempting to reset the affected trip path. Trip path de-energized remains annunciated.		Once tripped, the trip path cannot be manually reset. Actuation logic remains 1-out-of-2 (opposite leg) or any 2-out-of-3 after bistables have reset.	Actuation still requires a 2-out-of-3 coincidence of the appropriate bistables.

ARKANSAS NUCLEAR ONE
Unit 2

TABLE 7.2-5 (continued)

No.	Name	Failure Mode	Cause	Symptoms and Local Effects Including Dependent Failures	Method of Detection	Inherent Compensating Provision	Effect Upon PPS	Remarks and Other Effects
				Actuators, RPS Trip	Path No.1 (Typical)	FMEA Diagram 1		
102)	Lockout reset P/B (cont)	Short	Mechanical failure	The affected trip circuit will not remain in the tripped condition but will follow the action of the series string of matrix relay contacts for the affected function (SIAS, CCAS, or CSAS (with permissive)).	Periodic PPS testing.		None	The Actuation circuits should not follow any fluctuating condition of a single trip path circuit. Under a trip condition with a channel in bypass all 4 trip paths will be de-energized and three will be latched in that state for the affected function. The selective 2-out-of-4 actuation circuits will have three of their four contacts latched open with the 4 th fluctuating between open and closed states.
103)	CEA Drop (111)	One CEA fails to drop	CEA mechanical failure		CEA position indication		Logic becomes 1-out-of-3.	
		Inadvertent CEA drop	CRDM coil failure	Possible change in calculated DNBR and local power density margins.	Annunciated. CEA deviation alarm, CEA position indication, dropped CEA indicator.		Reduced operating margins.	
		Inadvertent drop of four symmetric CEAs	CEDMCS logic element failure	Possible change in calculated DNBR and local power density margins.	CEA position indication, dropped CEA indicator.		Reduced operating margins.	

ARKANSAS NUCLEAR ONE
Unit 2

TABLE 7.2-5 (continued)

No.	Name	Failure Mode	Cause	Symptoms and Local Effects Including Dependent Failures	Method of Detection	Inherent Compensating Provision	Effect Upon PPS	Remarks and Other Effects
				Actuators, RPS Trip	Path No.1 (Typical)	FMEA Diagram 1		
104)	Open CEDM Power Supply (108)	No single failure modes.	One CEDM MG set, Trip circuit breaker or trip path actuates or fails to actuate.	A single failure of MG set or TCB will not initiate or prevent a reactor trip during routine operations. A single failure of DSS contactor or DSS bypass breaker will not initiate or prevent a reactor trip during routine operations.	Plant annunciation and status indicator lights for circuit breakers and phase current.	Redundant MG set, TCB's and trip paths.	None	May initiate reactor trip, turbine trip; or block steam bypass (if Tave is low). If single failure occurs during testing.*
105)	CEDM Bus Under-voltage (107)	Off	Shorted or opened UV relay coil.	Reduces turbine trip to 1/3 logic and steam bypass block to 1/3 logic.	Annunciated. UV indicator lights.		Logic becomes 1-out-of-3.	
		On	Mechanically jammed relay.	Turbine trip and steam bypass logic becomes 2/3 logic.	Not annunciated. Periodic testing.		Logic becomes 2-out-of-3.	
		Off	Shorted or opened UV relay coil while testing another UV relay	Initiates turbine trip and steam bypass block.	Plant reactor trip annunciator and UV indicator lights.			Steam bypass blocked only if T(ave) is low.
106)	Manual Trip (105)	No trip output	Mechanically jammed switch	Failure to open the two associated reactor trip circuit breakers (TCBs) when actuated.	Not annunciated. Periodic testing.	There are two sets of two pushbuttons.	Actuation logic converts to selective 2-out-of-3 for manual trip pushbuttons.	Redundant pair of manual trip pushbuttons available.
		Trip output	Wiring open or shorted.	The two associated TCBs open.	Annunciated. Breaker indication lights and phase current lights.	The other three trip paths are not affected.	Actuation logic converts to 1-out-of-2 (redundant pair of manual trip pushbuttons) or any 2-out-of-3.	A channel in bypass has no effect on the manual trip pushbuttons.

ARKANSAS NUCLEAR ONE
Unit 2

TABLE 7.2-5 (continued)

No.	Name	Failure Mode	Cause	Symptoms and Local Effects Including Dependent Failures	Method of Detection	Inherent Compensating Provision	Effect Upon PPS	Remarks and Other Effects
				Actuators, RPS Trip	Path No.1 (Typical)	FMEA Diagram 1		
107)	Actuation Relay (K1-K4) (FMEA diagram No. 14)	Coil open	Broken wire, sustained overvoltage	One trip circuit breaker opens in each of the two selective 2-out-of-4 Actuation circuits.	Annunciated. Breaker indication lights and phase current monitors.	Redundant trip paths	Both selective 2-out-of-4 actuation logics convert to 1-out-of-2 (opposite leg) or any 2-out-of-3.	With a channel in bypass actuation still requires a 2-out-of-3 coincidence of the appropriate bistables.
		Coil short	Deterioration of insulation.	One trip circuit breaker opens in each of the two selective 2-out-of-4 Actuation circuits.	Annunciated. Breaker indication lights and phase current monitors.	Redundant trip paths	Both selective 2-out-of-4 actuation logics convert to 1-out-of-2 (opposite leg) or any 2-out-of-3.	With a channel in bypass actuation still requires a 2-out-of-3 coincidence of the appropriate bistables.
		Output contact to under-voltage trip coil open.	Broken wire, contact failure	One trip circuit breaker opens in the affected selective 2-out-of-4 Actuation circuit.	Annunciated. Breaker indication lights and phase current monitors.	Redundant trip paths	The affected selective 2-out-of-4 actuation logic converts to 1-out-of-2 (opposite leg) or any 2-out-of-3.	With a channel in bypass actuation still requires a 2-out-of-3 coincidence of the appropriate bistables.
	Actuation Relay (K1-K4) (FMEA diagram No. 14) (cont)	Output contact to shunt trip coil closed	Contact failure, shorted contact	One trip circuit breaker opens in the affected selective 2-out-of-4 Actuation circuit.	Annunciated. Breaker indication lights and phase current monitors.	Redundant trip paths	The affected selective 2-out-of-4 actuation logic converts to 1-out-of-2 (opposite leg) or any 2-out-of-3.	With a channel in bypass actuation still requires a 2-out-of-3 coincidence of the appropriate bistables.

ARKANSAS NUCLEAR ONE
Unit 2

TABLE 7.2-5 (continued)

No.	Name	Failure Mode	Cause	Symptoms and Local Effects Including Dependent Failures	Method of Detection	Inherent Compensating Provision	Effect Upon PPS	Remarks and Other Effects
				Actuators, RPS Trip	Path No.1 (Typical)	FMEA Diagram 1		
107)	Actuation Relay (K1-K4) (FMEA diagram No. 14) (cont)	Output contact to under-voltage trip coil closed	Shorted contact, contact failure	The undervoltage trip coils will fail to open one trip circuit breaker in the affected selective 2-out-of-4 Actuation circuit when required, but the shunt trip coils will open the same trip circuit breakers.	Periodic testing	Channel has redundant trip path to shunt trip coils.	Logic for the affected RPS undervoltage trip converts to 2-out-of-3 selective. Logic for RPS shunt remains selective 2-out-of-4.	With a channel in bypass actuation still requires a 2-out-of-3 coincidence of the appropriate bistables.
		Output contact to shunt trip coil open	Contact failure, broken wire.	The shunt trip coils will fail to open one trip circuit breaker in the affected selective 2-out-of-4 Actuation circuit when required, but the undervoltage trip coils will open the same trip circuit breakers.	Periodic testing	Channel has redundant trip path to undervoltage trip coil.	Logic for the affected RPS shunt trip converts to 2-out-of-three selective. Logic for RPS undervoltage trip remains selective 2-out-of-4.	With a channel in bypass actuation still requires a 2-out-of-3 coincidence of the appropriate bistables.
108)	Manual Trip (1 or 2)	Contact to under-voltage trip coil open	Contact failure, broken wire	One trip circuit breaker opens in the affected selective 2-out-of-4 Actuation circuit.	Annunciated Breaker indication lights and phase current monitors.	Redundant manual trip pushbuttons. Automatic RPS selective 2-out-of-4 not affected.	With one TCB open the affected actuation logic for RPS trip converts to 1-out-of-2 (opposite leg) or any 2-out-of-3.	With a channel in bypass actuation still requires a 2-out-of-3 coincidence of the appropriate bistables.

ARKANSAS NUCLEAR ONE
Unit 2

TABLE 7.2-5 (continued)

No.	Name	Failure Mode	Cause	Symptoms and Local Effects Including Dependent Failures	Method of Detection	Inherent Compensating Provision	Effect Upon PPS	Remarks and Other Effects
				Actuators, RPS Trip	Path No.1 (Typical)	FMEA Diagram 1		
108)	Manual Trip (1 or 2) (cont)	Contact to shunt trip coil closed.	Contact failure, shorted contact	One trip circuit breaker opens in the affected selective 2-out-of-4 Actuation circuit.	Annunciated Breaker indication lights and phase current monitors.	Redundant manual trip pushbuttons. Automatic RPS selective 2-out-of-4 not affected.	With one TCB open the affected actuation logic for RPS trip converts to 1-out-of-2 (opposite leg) or any 2-out-of-3.	With a channel in bypass actuation still requires a 2-out-of-3 coincidence of the appropriate bistables.
		Contact to under-voltage trip coil closed	Contact failure, Shorted contact	The undervoltage trip coils will fail to open one trip circuit breaker in the affected selective 2-out-of-4 Actuation circuit when required, but the shunt trip coils will open the same trip circuit breakers.	Periodic testing.	Redundant manual trip pushbuttons. Manual trip of shunt coils not affected. Automatic RPS selective 2-out-of-4 not affected.	Logic for RPS undervoltage trip converts to 2-out-of-3 selective. Logic for RPS shunt trip remains selective 2-out-of-4.	With a channel in bypass actuation still requires a 2-out-of-3 coincidence of the appropriate bistables.
	Manual Trip (1 or 2) (cont)	Contact to shunt trip coil open	Contact failure, broken wire	The shunt trip coils will fail to open one trip circuit breaker in the affected selective 2-out-of-4 Actuation circuit when required, but the undervoltage trip coils will open the same trip circuit breakers.	Periodic testing.	Redundant manual trip pushbuttons. Manual trip of undervoltage coils not affected. Automatic RPS selective 2-out-of-4 not affected.	Logic for RPS shunt trip converts to 2-out-of-three selective. Logic for RPS undervoltage trip remains selective 2-out-of-4.	With a channel in bypass actuation still requires a 2-out-of-3 coincidence of the appropriate bistables.
108A)	HS/TEST Shunt trip/UV trip bypass Switch	Under-voltage Bypass Contact 4 Of HS/TEST Closed	Contact Failure, Shorted Contact	The undervoltage trip coils will fail to open one trip circuit breaker in the affected selective 2-out-of-4 actuation circuit when required, but shunt trip coils will open the same circuit breakers.	Testing sequence	Shunt trip not affected. Automatic RPS selective 2-out-of-4 not affected.	Logic for RPS undervoltage trip converts 2-out-of-3 selective. Logic for RPS shunt trip remains selective 2-out-of-4.	With a channel in bypass actuation still requires a 2-out-of-3 coincidence of the appropriate bistables.

ARKANSAS NUCLEAR ONE
Unit 2

TABLE 7.2-5 (continued)

No.	Name	Failure Mode	Cause	Symptoms and Local Effects Including Dependent Failures	Method of Detection	Inherent Compensating Provision	Effect Upon PPS	Remarks and Other Effects
				Actuators, RPS Trip	Path No.1 (Typical)	FMEA Diagram 1		
108A)	HS/TEST Shunt trip/UV trip bypass Switch	Shunt Bypass Contact 1 of HS/TEST Open	Contact Failure to the open state	The shunt trip coils will fail to open one trip circuit breaker in the affected selective 2-out-of-4 actuation circuit when required, but the undervoltage trip coils will open the same trip circuit breaker when demanded by PPS.	Periodic Testing	Undervoltage coil Trip not affected	Logic for RPS shunt trip converts to 2-out-of-3 selective. Logic for RPS undervoltage trip remains selective 2-out-of-4.	With a channel in bypass actuation still requires a 2-out-of-3 coincidence of the appropriate bistables.
		Shunt Bypass Contact 3 of HS/TEST Open	Contact Failure to the open state	The shunt trip coils will fail to open one trip circuit breaker in the affected selective 2-out-of-4 actuation circuit when required from manual pushbutton, but the undervoltage trip coils will open the same trip circuit breaker when demanded by pushbuttons.	Periodic Testing	Redundant manual trip pushbutton manual trip of undervoltage coil trip not affected. Automatic RPS selective 2-out-of-4 not affected.	Logic for RPS shunt trip converts to 2-out-of-3 selective. Logic for RPS undervoltage trip remains selective 2-out-of-4.	With a channel in bypass actuation still requires a 2-out-of-3 coincidence of the appropriate bistables.
109)	Under-voltage trip coil	Coil opens	broken wire, sustained overvoltage	One trip circuit breaker opens in the affected selective 2-out-of-4 Actuation circuit.	Annunciated. Breaker indication lights and phase current monitors.	Redundant trip paths.	Logic for the affected RPS selective 2-out-of-4 converts to 1-out-of-2 (opposite leg) or any 2-out-of-3.	With a channel in bypass actuation still requires a 2-out-of-3 coincidence of the appropriate bistables.
		Coil short	Deterioration of insulation	One trip circuit breaker opens in the affected selective 2-out-of-4 Actuation circuit.	Annunciated. Breaker indication lights and phase current monitors.	Redundant trip paths.	Logic for the affected RPS selective 2-out-of-4 converts to 1-out-of-2 (opposite leg) or any 2-out-of-3.	With a channel in bypass actuation still requires a 2-out-of-3 coincidence of the appropriate bistables.

ARKANSAS NUCLEAR ONE
Unit 2

TABLE 7.2-5 (continued)

No.	Name	Failure Mode	Cause	Symptoms and Local Effects Including Dependent Failures	Method of Detection	Inherent Compensating Provision	Effect Upon PPS	Remarks and Other Effects
				Actuators, RPS Trip	Path No.1 (Typical)	FMEA Diagram 1		
110)	Shunt trip coil	Coil open	Broken wire. Sustained overvoltage.	Local shunt coil trips	Periodic testing	Undervoltage trip coil.	None	
		Coil short	Deterioration of insulation	Shorted coil will cause breakers supplying 125 VDC to trip in turn causing undervoltage trip coil to lose voltage.	Annunciated. Breaker indication lights and phase current monitors.		Logic for the affected RPS selective 2-out-of-4 converts to 1-out-of-2 (opposite leg) or any 2-out-of-3.	With a channel in bypass actuation still requires a 2-out-of-3 coincidence of the appropriate bistables.
111)	125V DC BUS (1-4)	Low	Open, short, blown fuse	One trip circuit breaker opens in each of the two selective 2-out-of-4 Actuation circuits.	Annunciated. Breaker indication lights and phase current monitors.	None	Logic for RPS selective 2-out-of-4 converts to 1-out-of-2 (opposite leg) or any 2-out-of-3.	With a channel in bypass actuation still requires a 2-out-of-3 coincidence of the appropriate bistables.
112	480V AC 3 Phase Bus (1,2)	Low	Open, short, open input breaker	MG from unaffected bus has an increase in load.	Annunciated. Breaker indication lights, MG set voltage and current.	None	None	There are two MG sets for plant availability and they will have no effect on the RPS trip system.
113)	M (1,2) MG (1,2) 29-1/DSS 29-2/DSS 52-1/DSS 52-2/DSS	Output low	Motor or generator failure, MCB breaker failure, DSS bypass breaker or contactor failure.	Increased load on the unaffected MG.	Annunciated. Breaker indication lights, MG set voltage and current. DSS contactor and bypass breaker indication lights.		None	

ARKANSAS NUCLEAR ONE
Unit 2

TABLE 7.2-5 (continued)

No.	Name	Failure Mode	Cause	Symptoms and Local Effects Including Dependent Failures	Method of Detection	Inherent Compensating Provision	Effect Upon PPS	Remarks and Other Effects
				Actuators, RPS Trip	Path No.1 (Typical)	FMEA Diagram 1		
113)	M (1,2) MG (1,2) 29-1/DSS 29-2/DSS 52-1/DSS 52-2/DSS (cont)		Shorted output lines.	Increased load on the unaffected MG.	Annunciated. Breaker indication lights, MG set voltage and current. DSS contactor and bypass breaker indication lights.		None	Possible reactor shutdown if the short results in a loss of both MG sets.
114)	TCB (1-8) Main Breaker contacts	Closed	Mechanical short.	One trip circuit breaker in one RPS selective 2-out-of-4 will fail to open when required.	Periodic testing	Redundant selective 2-out-of-4 actuation logic.	RPS Actuation logic converts to selective 2-out-of-3 for the logic set with the failed trip circuit breaker.	With a channel in bypass actuation still requires a 2-out-of-3 coincidence of the appropriate bistables.
		Open	Mechanical short, broken wire	One trip circuit breaker in one RPS selective 2-out-of-4 will open.	Annunciated. Breaker indication lights and phase current monitors.		RPS Actuation logic converts to selective 1-out-of-2 (opposite leg) or any 2-out-of-3 for the logic set with the failed trip circuit breaker.	With a channel in bypass actuation still requires a 2-out-of-3 coincidence of the appropriate bistables.
115)	Bus Tie TCB-9	Open	Mechanical short, broken wire.	None	Periodic testing		None	
		Closed	Mechanical short.	None	Annunciated, breaker indication, lights.		None	

ARKANSAS NUCLEAR ONE
Unit 2

TABLE 7.2-5 (continued)

No.	Name	Failure Mode	Cause	Symptoms and Local Effects Including Dependent Failures	Method of Detection	Inherent Compensating Provision	Effect Upon PPS	Remarks and Other Effects
				Actuators, RPS Trip	Path No.1 (Typical)	FMEA Diagram 1		
116)	CEDM power supply under-voltage relays	Open	Shorted undervoltage relay or (open coil or contact).	Unwarranted channel trip for turbine trip and steam bypass block.	Annunciated. Indicating lights.		Logic for turbine trip and steam bypass block is 1-out-of-3 selective or 2-out-of-3.	
		Closed	Mechanically failed	Failure to initiate channel trip for turbine trip and steam bypass block when required.	Periodic testing	Redundant channel trip	Logic for turbine trip and steam bypass block is 2-out-of-3.	
117)	Current Monitoring	Low	Open or shorted sensor	None	Indicating light	None	None	
118)	Turbine controls (109)	Trips turbine	Electrical or hydraulic failure	Loss of Load trip has been deleted. Eventual reactor trip on High Pzr Pressure or Low SG Level.	Turbine trip is annunciated.		None	The loss of Load trip has been deleted from the RPS.
		Full open	Failed control system	Reactor power excursion, low T(ave), low pressure.	Annunciated. Low T(ave)-T(ref) alarm		Possible reactor trip	
		Fails to trip on reactor trip.	Failure of master relay to energize.	Low steam generator pressures resulting in MSIS, turbine output voltage.	Periodic testing	Manual turbine trip	None	
119)	SDBCS Steam Bypass System (110)	Off	Electrical power or air supply failure	Loss of steam bypass capability	Not annunciating. Periodic testing.			
		Fails to inhibit steam bypass	Logic relay failure	Quick opening of bypass valve(s) not inhibited when desired to reduce reactor transients.	Annunciated. Full open bypass valve indication.			

ARKANSAS NUCLEAR ONE
Unit 2

TABLE 7.2-5 (continued)

No.	Name	Failure Mode	Cause	Symptoms and Local Effects Including Dependent Failures	Method of Detection	Inherent Compensating Provision	Effect Upon PPS	Remarks and Other Effects
				Actuators, RPS Trip	Path No.1 (Typical)	FMEA Diagram 1		
119)	SDBCS Steam Bypass System (110) (cont)	Inadvertent steam bypass	Shorting of relay contact logic	Opens a steam bypass valve, increase in reactor power level.	Steam bypass valve position indicator.		Possible trip Lo S.G. pressure.	
120)	CEA Deviation Alarm (112)	Off	Shorted Input	Failure to annunciate when required.	Not annunciating, Periodic test	Redundant channel		Operator will be unaware of CEA deviation alarm failure until test.
		On	Open input	Unwarranted annunciation	Audible and visual PPS alarm in control room.		Nuisance	Operator must check system to determine if bone-fide condition exists or if there is a failure in the alarm circuit.
121)	Power Recorder (118)	High	Component failure	High recorder trace, EX-CORE vs calibrated power deviation alarm.	Deviation alarm.	redundant channels.	None-all output data from PPS buffered.	
		Low	Component failure	Low recorder trace, EX-CORE vs calibrated power deviation alarm.	Deviation alarm.	redundant channels.	None-all output data from PPS buffered.	
122)	CWP (119)	Off	Shorted control leads to CEA control system.	Failure to prohibit CEA motion when required.	Periodic tests.		None.	RPS trip is back-up.
		On	Open control leads to CEA control system.	Unwarrented CWP	CWP annunciation w/o input parameters alarming. Inability to move CEA's out		None	RPS trip is back-up.

ARKANSAS NUCLEAR ONE
Unit 2

TABLE 7.2-5 (continued)

No.	Name	Failure Mode	Cause	Symptoms and Local Effects Including Dependent Failures	Method of Detection	Inherent Compensating Provision	Effect Upon PPS	Remarks and Other Effects
				Actuators, RPS Trip	Path No.1 (Typical)	FMEA Diagram 1		
123)	Plant Computer (117) (Reference item No. 70).	Off	Loss of CPU, Loss of AC power.	No effect to PPS. All input/output data transmission is isolated. No credible failure can prevent the PPS from performing its intended function.	Annunciating. Plant computer.		None	
124)	RAS (5) Initiation relay	Short (Fail on)	Relay Failure, electrical short	Unable to de-energize a single RAS trip path in one train, when required.	Not annunciating. Indication lights. Periodic testing.	Two relays must fail to prevent a RAS trip path from de-energizing.	RAS selective 2-out-of-4 Actuation logic converts to a selective 2-out-of-3 for the train with the failed relay. The other train remains selective 2-out-of-4.	Two solid state relays per trip path. A single relay failing does not prevent required actuation. With a channel in bypass actuation still requires a 2-out-of-3 coincidence of the appropriate bistables.
		Open (Fail off)	Relay failure, loss of relay driver	Unwarranted RAS trip path actuation in one train.	Plant annunciation Indication lights. Periodic testing.	RAS actuation logic is selective 2-out-of-4.	RAS selective 2-out-of-4 Actuation logic converts to 1-out-of-2 (opposite leg) or any 2-out-of-3 for the train with the failed relay. The other train remains selective 2-out-of-4.	A single relay failing does not trip either A or B train. It only trips one of the four trip paths to a train. With a channel in bypass actuation still requires a 2-out-of-3 coincidence of the appropriate bistables.

ARKANSAS NUCLEAR ONE
Unit 2

TABLE 7.2-5 (continued)

No.	Name	Failure Mode	Cause	Symptoms and Local Effects Including Dependent Failures	Method of Detection	Inherent Compensating Provision	Effect Upon PPS	Remarks and Other Effects
				Actuators, RPS Trip	Path No.1 (Typical)	FMEA Diagram 1		
125)	CSAS (12) Initiation relay	Short (Fail on)	Relay failure, electrical short	Unable to de-energize a single CSAS trip path in one train, when required.	Not annunciated. Indication lights. Periodic testing.	Two relays must fail to prevent a CSAS trip path from de-energizing.	CSAS selective 2-out-of-4 Actuation logic converts to a selective 2-out-of-3 for the train with the failed relay. The other train remains selective 2-out-of-4.	Two solid state relays per trip path. A single relay failing does not prevent required actuation. With a channel in bypass actuation still requires a 2-out-of-3 coincidence of the appropriate bistables.
		Open (Fail off)	Relay failure, loss of relay driver.	Unwarranted CSAS trip path actuation in one train.	Plant annunciation. Indication lights. Periodic testing.	CSAS Actuation logic is selective 2-out-of-4.	CSAS selective 2-out-of-4 Actuation logic converts to 1-out-of-2 (opposite leg) or any 2-out-of-3 for the train with the failed relay. The other train remains selective 2-out-of-4.	A single relay failing does not trip either A or B train. It only trips one of the four trip paths to a train. With a channel in bypass actuation still requires a 2-out-of-3 coincidence of the appropriate bistables.

ARKANSAS NUCLEAR ONE
Unit 2

TABLE 7.2-5 (continued)

No.	Name	Failure Mode	Cause	Symptoms and Local Effects Including Dependent Failures	Method of Detection	Inherent Compensating Provision	Effect Upon PPS	Remarks and Other Effects
		Actuators	ESF Initiation	Relays & Remote Manual Trips	(typical)	FMEA Diagrams 1, 15, 16 & 18	(Note 1) Dwg. 6600-M2001-M3-7 Sht. 1 shows interposing relays for MSIS, EFAS-1 & EFAS-2	
126)	Remote Manual ESF CSAS (38)	Open	Mechanical failure, deterioration of contact	The CSAS trip path will be de-energized.	Annunciation. Indication lights.	The other three trip paths are not affected.	CSAS selective 2-out-of-4 Actuation logic converts to 1-out-of-2 (opposite leg) or any 2-out-of-3 for manual.	One manual switch per trip path.
		Short	Mechanical failure	The CSAS trip path cannot be manually tripped.	Periodic PPS testing or when attempting to manually trip.	Select other manual trip switch pair. Automatic CSAS not affected.	CSAS selective 2-out-of-4 Actuation logic converts to selective 2-out-of-3 for manual.	Selective 2-out-of-4 to actuate.
127)	CCAS (218) Initiation relay	Short (Fail on)	Relay failure, electrical short	Unable to de-energize a single CCAS trip path in one train, when required.	Not annunciated. Indication lights. Periodic testing.	Two relays must fail to prevent a CCAS trip path from de-energizing.	CCAS selective 2-out-of-4 Actuation logic converts to a selective 2-out-of-3 for the train with the failed relay. The other train remains selective 2-out-of-4.	Two solid state relays per trip path. A single relay failing does not prevent required actuation. With a channel in bypass actuation still requires a 2-out-of-3 coincidence of the appropriate bistables.

ARKANSAS NUCLEAR ONE
Unit 2

TABLE 7.2-5 (continued)

No.	Name	Failure Mode	Cause	Symptoms and Local Effects Including Dependent Failures	Method of Detection	Inherent Compensating Provision	Effect Upon PPS	Remarks and Other Effects
		Actuators	ESF Initiation	Relays & Remote Manual Trips	(typical)	FMEA Diagrams 1, 15, 16 & 18	(Note 1) Dwg. 6600-M2001-M3-7 Sht. 1 shows interposing relays for MSIS, EFAS-1 & EFAS-2	
127)	CCAS (218) Initiation relay (cont)	Open (Fail off)	Relay failure, loss of relay driver.	Unwarranted CCAS trip path actuation in one train.	Plant annunciation. Indication lights. Periodic testing.	CCAS Actuation logic is selective 2-out-of-4.	CCAS selective 2-out-of-4 Actuation logic converts to 1-out-of-2 (opposite leg) or any 2-out-of-3 for the train with the failed relay. The other train remains selective 2-out-of-4.	A single relay failing does not trip either A or B train. It only trips one of the four trip paths to a train. With a channel in bypass actuation still requires a 2-out-of-3 coincidence of the appropriate bistables
128)	Remote Manual ESF CCAS (216)	Open	Mechanical failure, deterioration of contact	The CCAS trip path will be de-energized.	Annunciation. Indication lights.	The other three trip paths are not affected.	CCAS selective 2-out-of-4 Actuation logic converts to 1-out-of-2 (opposite leg) or any 2-out-of-3 for manual.	One manual switch per trip path.
		Short	Mechanical failure	The CCAS trip path cannot be manually tripped.	Periodic PPS testing or when attempting to manually trip.	Select other manual trip switch pair. Automatic CCAS not affected.	CCAS selective 2-out-of-4 Actuation logic converts to selective 2-out-of-3 for manual.	Selective 2-out-of-4 to actuate.

ARKANSAS NUCLEAR ONE
Unit 2

TABLE 7.2-5 (continued)

No.	Name	Failure Mode	Cause	Symptoms and Local Effects Including Dependent Failures	Method of Detection	Inherent Compensating Provision	Effect Upon PPS	Remarks and Other Effects
		Actuators	ESF Initiation	Relays & Remote Manual Trips	(typical)	FMEA Diagrams 1, 15, 16 & 18	(Note 1) Dwg. 6600-M2001-M3-7 Sht. 1 shows interposing relays for MSIS, EFAS-1 & EFAS-2	
129)	SIAS (22) Initiation relay	Short (Fail on)	Relay failure, electrical short	Unable to de-energize a single SIAS trip path in one train, when required.	Not annunciated. Indicating lights. Periodic testing.	Two relays must fail to prevent a SIAS trip path from de-energizing.	SIAS selective 2-out-of-4 Actuation logic converts to a selective 2-out-of-3 for the train with the failed relay. The other train remains selective 2-out-of-4.	Two solid state relays per trip path. A single relay failing does not prevent required actuation. With a channel in bypass actuation still requires a 2-out-of-3 coincidence of the appropriate bistables.
		Open (Fail off)	Relay failure, loss of relay driver.	Unwarranted SIAS trip path actuation in one train.	Plant annunciation. Indication lights. Periodic testing.	SIAS Actuation logic is selective 2-out-of-4.	SIAS selective 2-out-of-4 Actuation logic converts to 1-out-of-2 (opposite leg) or any 2-out-of-3 for the train with the failed relay. The other train remains selective 2-out-of-4.	A single relay failing does not trip either A or B train. It only trips one of the four trip paths to a train. With a channel in bypass actuation still requires a 2-out-of-3 coincidence of the appropriate bistables
130)	Remote Manual ESF SIAS (23)	Open	Mechanical failure, deterioration of contact.	The SIAS trip path will be de-energized.	Annunciation. Indication lights.	The other three trip paths are not affected.	SIAS selective 2-out-of-4 Actuation logic converts to 1-out-of-2 (opposite leg) or any 2-out-of-3 for manual.	One manual switch per trip path.

ARKANSAS NUCLEAR ONE
Unit 2

TABLE 7.2-5 (continued)

No.	Name	Failure Mode	Cause	Symptoms and Local Effects Including Dependent Failures	Method of Detection	Inherent Compensating Provision	Effect Upon PPS	Remarks and Other Effects
		Actuators	ESF Initiation	Relays & Remote Manual Trips	(typical)	FMEA Diagrams 1, 15, 16 & 18	(Note 1) Dwg. 6600-M2001-M3-7 Sht. 1 shows interposing relays for MSIS, EFAS-1 & EFAS-2	
130)	Remote Manual ESF SIAS (23) (cont)	Short	Mechanical failure	The SIAS trip path cannot be manually tripped.	Periodic testing or when attempting to manually trip.	Select other manual trip switch pair. Automatic SIAS not affected.	SIAS selective 2-out-of-4 Actuation logic converts to selective 2-out-of-3 for manual.	Selective 2-out-of-4 to actuate.
131)	CIAS (17) Initiation relay	Short (Fail on)	Relay failure, electrical short	Unable to de-energize a single CIAS trip path in one train, when required.	Not annunciated. Indicating lights. Periodic testing.	Two relays must fail to prevent a CIAS trip path from de-energizing.	CIAS selective 2-out-of-4 Actuation logic converts to a selective 2-out-of-3 for the train with the failed relay. The other train remains selective 2-out-of-4.	Two solid state relays per trip path. A single relay failing does not prevent required actuation. With a channel in bypass actuation still requires a 2-out-of-3 coincidence of the appropriate bistables.
		Open (Fail off)	Relay failure, loss of relay driver.	Unwarranted CIAS trip path actuation in one train.	Plant annunciation. Indication lights. Periodic testing.	CIAS Actuation logic is selective 2-out-of-4.	CIAS selective 2-out-of-4 Actuation logic converts to 1-out-of-2 (opposite leg) or any 2-out-of-3 for the train with the failed relay. The other train remains selective 2-out-of-4.	A single relay failing does not trip either A or B train. It only trips one of the four trip paths to a train. With a channel in bypass actuation still requires a 2-out-of-3 coincidence of the appropriate bistables

ARKANSAS NUCLEAR ONE
Unit 2

TABLE 7.2-5 (continued)

No.	Name	Failure Mode	Cause	Symptoms and Local Effects Including Dependent Failures	Method of Detection	Inherent Compensating Provision	Effect Upon PPS	Remarks and Other Effects
		Actuators	ESF Initiation	Relays & Remote Manual Trips	(typical)	FMEA Diagrams 1, 15, 16 & 18	(Note 1) Dwg. 6600-M2001-M3-7 Sht. 1 shows interposing relays for MSIS, EFAS-1 & EFAS-2	
132)	Remote Manual ESF CIAS (78)	Open	Mechanical failure, deterioration of contact.	The CIAS trip path will be de-energized.	Annunciation. Indication lights.	The other three trip paths are not affected.	CIAS selective 2-out-of-4 Actuation logic converts to 1-out-of-2 (opposite leg) or any 2-out-of-3 for manual.	One manual switch per trip path.
		Short	Mechanical failure	The CIAS trip path cannot be manually tripped.	Periodic testing or when attempting to manually trip.	Select other manual trip switch pair. Automatic CIAS is not affected.	CIAS selective 2-out-of-4 Actuation logic converts to selective 2-out-of-3 for manual.	Selective 2-out-of-4 to actuate.
133)	MSIS (37) Initiation Relay (Note 1)	Short (Fail on)	Relay Failure Electrical Short	Unable to de-energize an MSIS trip path in one train, when required.	Not Annunciated. Indicating lights. Periodic Testing.	Two relays must fail to prevent an MSIS trip path from de-energizing for both trains.	MSIS selective 2-out-of-4 Actuation logic converts to selective 2-out-of-3 for the train with failed relay contact. The other train remains selective 2-out-of-4.	
		Open (Fail off)	Relay failure. Loss of relay driver.	Unwarranted MSIS trip path actuation in one train.	Plant annunciation. Indication lights. Periodic testing.	MSIS Actuation logic is selective 2-out-of-4.	MSIS selective 2-out-of-4 Actuation logic converts to 1-out-of-2 (opposite leg). The other train remains 2-out-of-4 selective.	A half leg actuation results with no actuation outputs.
134)	Remote Manual ESF MSIS (56)	Open	Mechanical failure, deterioration of contact.	The MSIS trip path will be de-energized.	Annunciation. Indication lights.	The other three trip paths are not affected.	MSIS selective 2-out-of-4 Actuation logic converts to 1-out-of-2 (opposite leg) or any 2-out-of-3 for manual.	One manual trip switch per trip path.

ARKANSAS NUCLEAR ONE
Unit 2

TABLE 7.2-5 (continued)

No.	Name	Failure Mode	Cause	Symptoms and Local Effects Including Dependent Failures	Method of Detection	Inherent Compensating Provision	Effect Upon PPS	Remarks and Other Effects
		Actuators	ESF Initiation	Relays & Remote Manual Trips	(typical)	FMEA Diagrams 1, 15, 16 & 18	(Note 1) Dwg. 6600-M2001-M3-7 Sht. 1 shows interposing relays for MSIS, EFAS-1 & EFAS-2	
134)	Remote Manual ESF MSIS (56) (cont)	Short	Mechanical failure.	The MSIS trip path cannot be manually tripped.	Periodic testing or when attempting to manually trip.	Select other manual trip switch pair. Automatic MSIS not affected.	MSIS selective 2-out-of-4 Actuation logic converts to selective 2-out-of-3 for manual.	Selective 2-out-of-4 to actuate.
135)	EFAS-1 (133) Initiation relay (Note 1)	Short (Fail on)	Relay failure electrical short	Unable to de-energize an EFAS-1 trip path in one train, when required.	Not annunciated. Indicating lights. Periodic testing	Two relays must fail to prevent an EFAS-1 trip path from de-energizing.	EFAS-1 selective 2-out-of-4 Actuation logic converts to selective 2-out-of-3 for the train with the failed relay contact. The other train remains 2-out-of-4 selective.	
		Open (Fail off)	Relay failure, loss of relay driver	Unwarranted EFAS-1 trip path actuation in one train.	Plant annunciation. Indication lights. Periodic testing.	EFAS-1 Actuation logic is selective 2-out-of-4.	EFAS-1 selective 2-out-of-4 Actuation logic converts to 1-out-of-2 (opposite leg) or any 2-out-of-3 for the train with the failed relay. The other train remains selective 2-out-of-4.	
136)	Remote Manual ESF EFAS-1 (79)	Open	Mechanical failure, deterioration of contact.	The EFAS-1 Trip path will be de-energized.	Annunciation. Indication lights.	The other three trip paths are not affected.	EFAS-1 selective 2-out-of-4 Actuation logic converts to 1-out-of-2 (opposite leg) or any 2-out-of-3 for manual.	One manual trip switch per trip path.

ARKANSAS NUCLEAR ONE
Unit 2

TABLE 7.2-5 (continued)

No.	Name	Failure Mode	Cause	Symptoms and Local Effects Including Dependent Failures	Method of Detection	Inherent Compensating Provision	Effect Upon PPS	Remarks and Other Effects
		Actuators	ESF Initiation	Relays & Remote Manual Trips	(typical)	FMEA Diagrams 1, 15, 16 & 18	(Note 1) Dwg. 6600-M2001-M3-7 Sht. 1 shows interposing relays for MSIS, EFAS-1 & EFAS-2	
136)	Remote Manual ESF EFAS-1 (79) (cont)	Short	Mechanical failure	The EFAS-1 trip path cannot be manually tripped.	Periodic testing or when attempting to manually trip.	Select other manual trip switch pair. Automatic EFAS-1 not affected.	EFAS-1 selective 2-out-of-4 Actuation logic converts to selective 2-out-of-3 for manual.	Selective 2-out-of-4 to actuate.
137)	EFAS-2 (132) Initiation relay (Note 1)	Short (Fail on)	Relay failure electrical short	Unable to de-energize a single EFAS-2 trip path in one train, when required.	Not annunciated. Periodic testing.	Two relays must fail to prevent an EFAS-2 trip path from de-energizing.	EFAS-2 is the same as EFAS-1 item 135 for the short (Fail on) case.	EFAS-2 is the same as EFAS-1 item 135 for the short (Fail on) case.
		Open (Fail off)	Relay failure, loss of relay driver	Unwarranted EFAS-2 trip path actuation in one train.	Plant annunciator. Indicator lights. Periodic testing.	EFAS-2 Actuation logic is selective 2-out-of-4.	EFAS-2 is the same as EFAS-1 item 135 for the open (Fail off) case.	EFAS-2 is the same as EFAS-1 item 135 for the open (Fail off) case.
138)	Remote Manual ESF EFAS-2 (81)	Open	Mechanical failure, deterioration of contact.	The EFAS-2 trip path will be de-energized.	Annunciation. Indication lights.	The other three trip paths are not affected.	EFAS-2 selective 2-out-of-4 Actuation logic converts to 1-out-of-2 (opposite leg) or any 2-out-of-3 for manual.	One manual trip switch to actuate.
		Short	Mechanical failure	The EFAS-2 trip path cannot be manually tripped.	Periodic testing or when attempting to manually trip.	Select other manual trip switch pair. Automatic EFAS-2 not affected.	EFAS-2 selective 2-out-of-4 Actuation logic converts to selective 2-out-of-3 for manual.	Selective 2-out-of-4 to actuate.

ARKANSAS NUCLEAR ONE
Unit 2

TABLE 7.2-5 (continued)

No.	Name	Failure Mode	Cause	Symptoms and Local Effects Including Dependent Failures	Method of Detection	Inherent Compensating Provision	Effect Upon PPS	Remarks and Other Effects
			Actuators	ESF Selective 2-out-of-4	(typical)	FMEA Diagram 18		
139)	SSR-1 (contact 1A Train A) SSR-2 (contact 1B Train B) for CCAS (219), CSAS (204), RAS (200), SIAS (206), CIAS (208),	Contact open	Overload, broken wires, voltage transient	Unwarranted trip path actuation in one train.	Annunciated.	Redundant trip paths.	Selective 2-out-of-4 actuation logic converts to 1-out-of-2 (opposite leg) or any 2-out-of-3 for the train with the failed relay contact. Other train remains selective 2-out-of-4.	With a channel in bypass a 2-out-of-3 coincidence of the appropriate bistables is still required to obtain an actuation.
		Contact short	Voltage transient, overload.	Failure to initiate a trip of a single trip path in one train when required.	Non-annunciated. Periodic testing.	Redundant trip paths.	Selective 2-out-of-4 actuation logic converts to selective 2-out-of-3 for the train with the failed relay contact. The other train remains 2-out-of-4 selective.	With a channel in bypass a 2-out-of-3 coincidence of the appropriate bistables is still required to obtain an actuation.
		Both contacts open	Component failure in trip path.	Unwarranted trip path actuation in both trains	Annunciated.	Redundant trip paths	Selective 2-out-of-4 actuation logic converts to 1-out-of-2 (opposite leg) or any 2-out-of-3 for both trains.	With a channel in bypass a 2-out-of-3 coincidence of the appropriate bistables is still required to obtain an actuation.
		Both contacts short	Component failure in trip path.	Failure to initiate a trip of a single trip path in both trains when required.	Non-annunciated. Periodic testing.	Redundant trip paths	Selective 2-out-of-4 actuation logic converts to selective 2-out-of-3 for both trains.	With a channel in bypass a 2-out-of-3 coincidence of the appropriate bistables is still required to obtain an actuation.

ARKANSAS NUCLEAR ONE
Unit 2

TABLE 7.2-5 (continued)

No.	Name	Failure Mode	Cause	Symptoms and Local Effects Including Dependent Failures	Method of Detection	Inherent Compensating Provision	Effect Upon PPS	Remarks and Other Effects
			Actuators	ESF Selective 2-out-of-4	(typical)	FMEA Diagram 18		
140)	120 VAC Vital Bus circuit breaker for ARCs	Low	Breaker fails open	Loss of two D.C. power supplies in one ESFAS cabinet, each of which is auctioneered to a redundant D.C. power supply.	Annunciation.	Redundant D.C. power supply.	None	
		Fails closed	Breaker fails closed	No impact on normal operation. Loss of overcurrent protection for one 28 VDC power supply. Power supply may be overstressed and fail open.	Periodic test Power supply failure is annunciated.	Redundant D.C. power supply	None	
141)	28 VDC power supply	Fails off	Component failure	Loss of one of two redundant power supplies for one set of component actuation relays.	Annunciation	Redundant D.C. power supply.	None	
142)	Power supply annunciation relay	Open coil	Sustained overvoltage, broken wire	Spurious annunciation of power supply failure.	Annunciation		None	
		Shorted coil	Deterioration of insulation.	Output of one 28 VDC power supply will be shorted. Power supply will be overstressed and will probably fail off.	Annunciation of power supply failure.	Redundant D.C. power supply.	None	
143)	Auctioneering diode	Fails open	Overstress, open circuit, mechanical failure	Loss of one of two redundant power supplies for one set of component actuation relays.	Annunciation	Redundant D.C. power supply.	None	
		Fails shorted	Overstress, internal failure	Loss of isolation between two 28 VDC power supplies.	Periodic test		None	

ARKANSAS NUCLEAR ONE
Unit 2

TABLE 7.2-5 (continued)

No.	Name	Failure Mode	Cause	Symptoms and Local Effects Including Dependent Failures	Method of Detection	Inherent Compensating Provision	Effect Upon PPS	Remarks and Other Effects
			Actuators	ESF Selective 2-out-of-4	(typical)	FMEA Diagram 18		
144)	Manual Actuation Pushbutton	Fails open	Mechanical damage, open circuit, contact deterioration	One leg of the Actuation circuit for the ESF function will open up. Power for actuation relays will be supplied via opposite leg of circuit.	Annunciation	Opposite leg of actuation circuit will supply power to actuation relays.	Manual ESF actuation becomes 1-of-1. Selective 2-out-of-4 actuation logic converts to 1-out-of-2 (opposite leg).	With a channel in bypass a 2-out-of-3 coincidence of the appropriate bistables is still required to obtain an actuation.
		Fails closed	Contact welded, mechanical damage	The manual actuation pushbutton will not open one leg of the actuation circuit when required.	Periodic test		Manual actuation of the ESF function will not be possible from the ESF cabinets. Manual actuation from the trip path pushbuttons not affected. Automatic actuation not affected.	
145)	Annunciation diodes	Fail open	Overstress, Open lead, Mechanical damage	One leg of the Actuation circuit for the ESF function will open up. Power for actuation relays will be supplied via opposite leg of circuit.	Annunciation	Opposite leg of actuation circuit will supply power to actuation relays.	Manual ESF actuation becomes 1-of-1. Selective 2-out-of-4 actuation logic converts to 1-out-of-2 (opposite leg).	With a channel in bypass a 2-out-of-3 coincidence of the appropriate bistables is still required to obtain an actuation.
		Fail short	Overstress, internal failure	Voltage drop across diodes goes to zero, spurious annunciation of one actuation circuit leg opening up.	Annunciation		None	

ARKANSAS NUCLEAR ONE
Unit 2

TABLE 7.2-5 (continued)

No.	Name	Failure Mode	Cause	Symptoms and Local Effects Including Dependent Failures	Method of Detection	Inherent Compensating Provision	Effect Upon PPS	Remarks and Other Effects
			Actuators	ESF Selective 2-out-of-4	(typical)	FMEA Diagram 18		
146)	Actuator circuit indicator lamp	Fails off	Filament burnout, mechanical failure	Spurious visual indication that one leg of the actuator circuit has opened up.	Indication		None	
147)	Lockout reset pushbutton	Fails open	Contact deterioration, mechanical damage, open circuit	Unable to reset one leg of the actuation circuit after test or an actuation. Other leg can still be reset, which will reenergize lockout relay in affected leg.	Indication	Reset pushbutton in other leg of actuation circuit.	None	
		Fails closed	Contact welded, mechanical failure	No impact during normal operation, after auto actuation. If actuation is caused by using manual actuation pushbutton, actuation relays will automatically reset.	Periodic test	Automatic actuation and manual initiation capabilities not affected.	The ESF function cannot be manually actuated from the ESF cabinet of the affected train.	Automatic ESF actuation and manual ESF initiation from the initiation circuit not affected.
148)	Lockout relay coil	Fails open	Open winding mechanical damage	One leg of the Actuation circuit for the ESF function will open up. Power for actuation relays will be supplied via opposite leg of circuit.	Annunciation	Opposite leg of actuation circuit will supply power to actuation relays.	Manual ESF actuation becomes 1-of-1. Selective 2-out-of-4 actuation logic converts to 1-out-of-2 (opposite leg).	With a channel in bypass a 2-out-of-3 coincidence of the appropriate bistables is still required to obtain an actuation.
		Fails shorted	Insulation breakdown, mechanical failure	One group of actuation relays will be shorted out and will deenergize. The circuit breaker for the affected group will probably open on high current.	Annunciation	Only one of the two groups of actuation relays will be deenergized. The full ESF function will not be actuated.	Partial ESF actuation in the affected train.	

ARKANSAS NUCLEAR ONE
Unit 2

TABLE 7.2-5 (continued)

No.	Name	Failure Mode	Cause	Symptoms and Local Effects Including Dependent Failures	Method of Detection	Inherent Compensating Provision	Effect Upon PPS	Remarks and Other Effects
			Actuators	ESF Selective 2-out-of-4	(typical)	FMEA Diagram 18		
149)	Lockout relay surge protection diode	Fails shorted	Overstress, internal failure	Same as above	Same as above	Same as above	Same as above	
		Fails open	Broken wire, diode failure	Loss of surge protection for lockout relay. Possible damage to relay due to inductive kick when relay de-energizes. Relay may fail open.			None	
150)	Lockout relay N.O. contacts	Fails open	Open circuit, contact deterioration	One leg of the Actuation circuit for the ESF function will open up. Power for actuation relays will be supplied via opposite leg of circuit.	Annunciation	Opposite leg of actuation circuit will supply power to actuation relays.	Manual ESF actuation becomes 1-of-1. Selective 2-out-of-4 actuation logic converts to 1-out-of-2 (opposite leg).	With a channel in bypass a 2-out-of-3 coincidence of the appropriate bistables is still required to obtain an actuation.
		Fails closed	Contact welded, mechanical damage	No impact during normal operation, after auto actuation. If actuation is caused by using manual actuation pushbutton, actuation relays will automatically reset.	Periodic test	Automatic actuation and manual initiation capabilities not affected.	The ESF function cannot be manually actuated from the ESF cabinet of the affected train.	Automatic ESF actuation and manual ESF initiation from the initiation circuit not affected.
151)	One Actuation Relay Fails RAS (201), CSAS (205), CCAS (220), SIAS (207), CIAS (209)	Coil open	Open lead, open winding, mechanical damage	The equipment controlled by the actuation relay will be actuated in the train with the failed relay.	Status indicator for affected equipment		Only the equipment controlled by a single actuation relay will be actuated. A full ESF actuation will not occur.	

ARKANSAS NUCLEAR ONE
Unit 2

TABLE 7.2-5 (continued)

No.	Name	Failure Mode	Cause	Symptoms and Local Effects Including Dependent Failures	Method of Detection	Inherent Compensating Provision	Effect Upon PPS	Remarks and Other Effects
			Actuators	ESF Selective 2-out-of-4	(typical)	FMEA Diagram 18		
151)	One Actuation Relay Fails RAS (201), CSAS (205), CCAS (220), SIAS (207), CIAS (209)	Coil shorted	Insulation failure, mechanical short	Will cause circuit breaker supplying power to actuating relays associated with either the pump or valve group to be tripped.	Annunciation. Indicating lights status indicators for affected equipment.		All equipment controlled by that group of actuation relays will be actuated. A full ESF actuation will not occur. Actuation logic for selective 2-out-of-4 converts to 1-out-of-2 (opposite leg).	
152)	Actuation relay surge protection diode	Fails open	Broken wire, diode failure	Loss of surge protection to actuation relay. Possible damage to relay due to inductive kick when relay deenergizes. Relay may fail open.			None	
		Fails shorted	Overstress Internal failure	Same as item 148 (shorted)	Same as item 148 (shorted)	Same as item 148(shorted)	Same as item 148 (shorted)	
153)	Test relay	Coil open or short	Coil failure, broken wire, short across coil	Failure to test the affected actuation relay (and equipment controlled by it) when required.	Periodic testing		None.	
		Contact open	Contact failure, broken wire	Unwarranted trip of the affected actuation relay.	Indicating lights.	Partial actuation of one train of the ESF function.	Only the equipment controlled by a single actuation relay will be actuated. A full ESF actuation will not occur.	

ARKANSAS NUCLEAR ONE
Unit 2

TABLE 7.2-5 (continued)

No.	Name	Failure Mode	Cause	Symptoms and Local Effects Including Dependent Failures	Method of Detection	Inherent Compensating Provision	Effect Upon PPS	Remarks and Other Effects
			Actuators	ESF Selective 2-out-of-4	(typical)	FMEA Diagram 18		
153)	Test relay (cont)	Contact shorted	Contact failure, short	Failure to test the affected actuation relay (and equipment controlled by it) when required.	Periodic testing		None.	
154)	Circuit breaker in D.C. path	Fails short	Welded contact, mechanical failure	Loss of overcurrent protection for one leg of one train of actuation.	Bench tests		None	
		Fails open	Deterioration of contact, mechanical failure	Power return line for one group of actuation relays (pump or valve group) in one train opens up. The equipment associated with the actuation relays is energized.	Annunciation. Indicating lights.	Partial actuation of the ESF.	All of the equipment controlled by that group of actuation relays will be actuated. A full ESF actuation will not occur. Actuation logic for selective 2-out-of-4 converts to 1-out-of-2 (opposite leg).	

ARKANSAS NUCLEAR ONE
Unit 2

TABLE 7.2-5 (continued)

No.	Name	Failure Mode	Cause	Symptoms and Local Effects Including Dependent Failures	Method of Detection	Inherent Compensating Provision	Effect Upon PPS	Remarks and Other Effects
			Actuators	ESF Selective 2-out-of-4	Interposing Relays, DEFAS-1 & 2 Trip Relay contacts & DEFAS-1 & 2 Bypass Switches	MSIS, EFAS-1, EFAS-2	(Note 1) Dwg. 6600-M2001-M3-7 Sht. 1 shows interposing relays for MSIS, EFAS-1 & EFAS-2 and the DEFAS 1 & 2 interface For EFAS-1 & 2	
155)	SSR contact 1A, 2A, 3A, 4A, 1B, 2B, 3B, or 4B (Note 1)	Contact open	Overload, broken wires, voltage transient	Unwarranted trip path actuation in one train.	Annunciated.		Selective 2-out-of-4 actuation logic converts to 1-out-of-2 (opposite leg) or any 2-out-of-3 for the train with the failed relay contact. Interposing relays cycle with 1-out-of-2 logic for the train with the failed open contact. The other train remains selective 2-out-of-4.	
		Contact short	Voltage transient, overload	Failure to initiate a trip of a single trip path in one train when required.	Non-annunciated. Periodic testing.	Redundant trip paths Redundant trains	Selective 2-out-of-4 actuation logic converts to selective 2-out-of-3 for the train with the failed relay contact. The interposing relays actuate, cycle open, with selective 2-out-of-3 logic. The interposing relays actuate, cycle closed, with 1-out-of-1 logic for the faulted leg, or 2-out-of-2 logic with the non-faulted leg. The other train remains selective 2-out-of-4.	For a bona-fide trip the other three channels will cause actuation of the components controlled by the selective 2-out-of-3. There are two trains of actuation for each ESF function and the other train will cause a full actuation of the ESF function.

ARKANSAS NUCLEAR ONE
Unit 2

TABLE 7.2-5 (continued)

No.	Name	Failure Mode	Cause	Symptoms and Local Effects Including Dependent Failures	Method of Detection	Inherent Compensating Provision	Effect Upon PPS	Remarks and Other Effects
			Actuators	ESF Selective 2-out-of-4	Interposing Relays, DEFAS-1 & 2 Trip Relay contacts & DEFAS-1 & 2 Bypass Switches	MSIS, EFAS-1, EFAS-2	(Note 1) Dwg. 6600-M2001-M3-7 Sht. 1 FMEA Diagram 1 EFAS-1 & 2 and the DEFAS 1 & 2 interface For EFAS-1 & 2	
157)	Auxiliary Logic Actuation Relay (interposing relay) MSIS, EFAS-1 (213), EFAS-2 (212) (Note 1)	Coil opens	Broken wire, mechanical damage.		Indication Annunciated on plant annunciator.		The interposing relay de-energizes causing the equipment controlled by it to actuate.	
		Coil shorts – lead to lead	Breakdown of insulation.	Will cause circuit breaker supplying power to actuating relays associated with either the pump or valve group and one interposing relay to be tripped.	Annunciation. Indicating lights. Status indicators for affected equipment.		All of the equipment controlled by the interposing relay and the group of actuation relays will be actuated. A full ESF actuation will not occur. Actuation logic for selective 2-out-of-4 converts to 1-out-of-2 (opposite leg).	

ARKANSAS NUCLEAR ONE
Unit 2

TABLE 7.2-5 (continued)

No.	Name	Failure Mode	Cause	Symptoms and Local Effects Including Dependent Failures	Method of Detection	Inherent Compensating Provision	Effect Upon PPS	Remarks and Other Effects
			Actuators	ESF Selective 2-out-of-4	Interposing Relays, DEFAS-1 & 2 Trip Relay contacts & DEFAS-1 & 2 Bypass Switches	MSIS, EFAS-1, EFAS-2	(Note 1) Dwg. 6600-M2001-M3-7 Sht. 1 shows interposing relays for MSIS, EFAS-1 & 2 and the DEFAS 1 & 2 interface For EFAS-1 & 2	
158)	DEFAS-1 contacts (K528-2,10) (K728-2,10) in EFAS-1 logic (Note 1)	Contact open	Broken wire mechanical failure	2-out-of-2 DEFAS-1 actuation logic is half tripped.	Indication Annunciation		DEFAS actuation logic converts to 1-out-of-1 (opposite leg) for the train with the failed relay contact. The actuation logic for the other train remains unaffected.	EFAS1 remains functional.
		Contact shorted	Mechanical failure	Not annunciated		Redundant trains	Contact in affected trip leg will not open when required by DEFAS-1 logic. The affected train of EFAS-1 will not fully actuate. The second train will fully actuate when required by the DEFAS-1 logic.	
159)	DEFAS-2 contacts (K628-2,10) (K828-2,10) in EFAS-2 logic (Note 1)	Contact open	Broken wire, mechanical failure	2-out-of-2 DEFAS-2 Actuation logic is half tripped.	Indication Annunciation		Same as item 158 for contact open failure mode.	Same as item 158 for contact open failure mode.

ARKANSAS NUCLEAR ONE
Unit 2

TABLE 7.2-5 (continued)

No.	Name	Failure Mode	Cause	Symptoms and Local Effects Including Dependent Failures	Method of Detection	Inherent Compensating Provision	Effect Upon PPS	Remarks and Other Effects
			Actuators	ESF Selective 2-out-of-4	Interposing Relays, DEFAS-1 & 2 Trip Relay contacts & DEFAS-1 & 2 Bypass Switches	MSIS, EFAS-1, EFAS-2	(Note 1) Dwg. 6600-M2001-M3-7 Sht. 1 shows interposing relays for MSIS, EFAS-1 & 2 and the DEFAS 1 & 2 interface For EFAS-1 & 2	
159)	DEFAS-2 contacts (K628-2,10) (K828-2,10) in EFAS-2 logic (Note 1) (cont)	Contact shorted	Mechanical failure	Not annunciated		Redundant trains	Contact in affected trip leg will not open when required by DEFAS-2 logic. The affected train of EFAS-2 will actuate. The second train will fully actuate when required by the DEFAS-2 logic.	
160)	DEFAS-1 Bypass switch contact (S52B-NO2, C2), (S82B-NO2, C2) (Note 1)	Fails open	Mechanical failure			Redundant trip legs	Cannot bypass DEFAS-1 logic in affected trip leg. The bypass in the other trip leg will prevent any EFAS-1 actuation relays from de-energizing.	The bypassing of an RPS or ESF measurement channel has no effect on the DEFAS-1 logic.
		Fails closed	Mechanical failure			Redundant trains	DEFAS-1 trip contact in affected trip leg will be bypassed by the shorted contact of the bypass switch. The DEFAS-1 logic will not cause a trip of EFAS-1 in the affected train. The second train will trip when required by the DEFAS-1 logic.	The bypassing of an RPS or ESF measurement channel has no effect on the DEFAS-1 logic.

ARKANSAS NUCLEAR ONE
Unit 2

TABLE 7.2-5 (continued)

No.	Name	Failure Mode	Cause	Symptoms and Local Effects Including Dependent Failures	Method of Detection	Inherent Compensating Provision	Effect Upon PPS	Remarks and Other Effects
				DC Power Distribution, PPS Cabinet	Bistable Annunciator Power Supply	FMEA Diagrams 19 & 19A		
160A)	Channel Bistable Annunciator Power Supply (PS-C)	No output	Failure internal to supply, open fuse to power supply.	Pre-trip, trip, and bypass indicators on PPS Bistable Control Panel (BCP) and the Remote Operators Module will fail to indicated condition of bistable for that channel.	Annunciating. PPS Trouble alarm. Periodic test.		None.	Indication only.
		Low output voltage	Failure internal to supply.	Symptoms will depend upon the severity of the undervoltage. The system may operate normally or may exhibit the same symptoms as for no output.	Same as loss of output, if undervoltage is severe enough.		None.	Indication only.
		High output voltage	Failure internal to supply.	Symptoms will depend upon the severity of the overvoltage. The system may operate normally or component failures may be induced that result in an erroneous display.	If errors are induced in the display, periodic testing will detect the problem.		None.	Indication only.

ARKANSAS NUCLEAR ONE
Unit 2

TABLE 7.2-5 (continued)

No.	Name	Failure Mode	Cause	Symptoms and Local Effects Including Dependent Failures	Method of Detection	Inherent Compensating Provision	Effect Upon PPS	Remarks and Other Effects
			Actuators	ESF Selective 2-out-of-4	Interposing Relays, DEFAS-1 & 2 Trip Relay contacts & DEFAS-1 & 2 Bypass Switches	MSIS, EFAS-1, EFAS-2	(Note 1) Dwg. 6600-M2001-M3-7 Sht. 1 shows interposing relays for MSIS, EFAS-1 & 2 and the DEFAS 1 & 2 interface For EFAS-1 & 2	
161)	DEFAS-2 Bypass switch contact (S53B-NO2,C2) (S83B-NO2,C2) (Note 1)	Fails open	Mechanical failure			Redundant trip legs	Cannot bypass DEFAS-2 logic in affected trip leg. The bypass in the other trip leg will prevent any EFAS-2 actuation relays from de-energizing.	The bypassing of an RPS or ESF measurement channel has no effect on the DEFAS-2 logic.
		Fails closed	Mechanical failure			Redundant trains	DEFAS-2 trip contact in affected trip leg will be bypassed by the shorted contact of the bypass switch. The DEFAS-2 logic will not cause a trip of EFAS-2 in the affected train. The second train will trip when required by the DEFAS-2 logic.	The bypassing of an RPS or ESF measurement channel has no effect on the DEFAS-2 logic.
				DC Power Distribution, PPS Cabinet	Bistable Bypass Power Supplies	FMEA Diagrams 19 & 19A		
161A)	Trip Channel Bypass Power Supply (PS-D or PS-E)	No Output	Failure internal to supply, open fuse to power supply.	No operational symptoms.	Annunciating. PPS trouble alarm. Periodic test.	2 power supplies (D&E), one in the affected channel & one in an adjacent channel are auctioneered. Either power supply is capable of supplying the entire load.	None.	Bypass circuits in the affected channel are dependent upon the continued operation of the remaining supply.

ARKANSAS NUCLEAR ONE
Unit 2

TABLE 7.2-5 (continued)

No.	Name	Failure Mode	Cause	Symptoms and Local Effects Including Dependent Failures	Method of Detection	Inherent Compensating Provision	Effect Upon PPS	Remarks and Other Effects
				DC Power Distribution, PPS Cabinet	Bistable Bypass Power Supplies	FMEA Diagrams 19 & 19A		
	Trip Channel Bypass Power Supply (PS-D or PS-E) (cont)	Low output voltage	Failure internal to supply.	No operational symptoms. The auctioneered power supply will pick up and maintain load.	Periodic test.	Auctioneered power supplies.	None.	Bypass circuits in the affected channel are dependent upon the continued operation of the remaining supply.
		High output voltage	Failure internal to supply.	<p>Symptoms will depend upon the ability of the components to tolerate the overvoltage. Two possibilities exist:</p> <p>a. One or more supplied components fails open, making it impossible to bypass the affected function(s).</p> <p>b. Two or more supplied components fails short. This would reduce the supply voltage to essentially zero, making it impossible to bypass any bistables in the affected channel.</p>	<p>Periodic test.</p> <p>Periodic test.</p>		<p>Unable to trip channel, bypass the affected function.</p> <p>Unable to bypass any bistables in the affected channel.</p>	If an active bypass is lost, channel trip symptoms may occur.

ARKANSAS NUCLEAR ONE
Unit 2

TABLE 7.2-5 (continued)

No.	Name	Failure Mode	Cause	Symptoms and Local Effects Including Dependent Failures	Method of Detection	Inherent Compensating Provision	Effect Upon PPS	Remarks and Other Effects
				DC Power Distribution, PPS Cabinet	Channel Auxiliary Logic Power Supplies	FMEA Diagrams 19 & 19A		
162	Channel Aux Logic Power Supply (PS-F)	No output.	Failure internal to supply, open fuse to power supply.	<p>The CEA withdrawl prohibit (CWP) matrix is partially enabled.</p> <p>In the affected channel, it will not be possible to generate the following operating bypasses:</p> <ul style="list-style-type: none"> a. LO RWT LEVEL/LO PZR PRESS b. HI LOG POWER c. CPC d. SG LEVEL (T_{HOT}) <p>The Power Trip Test circuit will generate channel trips for LO DNBR and HI LPD.</p>	Annunciating. PPS trouble alarm, trip alarms on LO DNBR and HI LPD.	3 Channel redundancy. (4th channel bypassed) Channel trips enabled.	Makes reactor trip logic for LO DNBR and HI LPD 1-out-of-2 coincidence. Makes CWP logic 1-out-of-2 coincidence.	<p>The loss of operating bypasses may result in additional channel trips depending on plant conditions.</p> <p>Operating bypasses in other channels are unaffected thus inhibiting any trip action for the function(s) in question.</p>
		Low output voltage.	Failure internal to supply.	Symptoms will depend upon the severity of the undervoltage. The system may operate normally or may exhibit the same symptoms as for no output.	Same as loss of output if undervoltage is severe enough, otherwise, periodic test.			
		High output voltage.	Failure internal to supply.	Symptoms will depend on the ability of the supplied components to tolerate the overvoltage condition. Depending on how many components fail, one or more bypass functions in the affected channel may be disabled.	Periodic test.	3 Channel redundancy. (4th channel bypassed) Channel trips enabled.	One or more operating bypasses in the affected channel are disabled.	

ARKANSAS NUCLEAR ONE
Unit 2

TABLE 7.2-5 (continued)

No.	Name	Failure Mode	Cause	Symptoms and Local Effects Including Dependent Failures	Method of Detection	Inherent Compensating Provision	Effect Upon PPS	Remarks and Other Effects
				DC Power Distribution, PPS Cabinet	Trip Path Power Supplies	FMEA Diagrams 19 & 19A		
163)	Trip Path Power Supply (PS-H)	No output	Failure internal to supply, open fuse to power supply.	The trip paths for the RPS and all ESFAS functions will deenergize in the affected channel. This will open one side of all the selective 2-out-of-4 actuation and reactor trip circuits.	Annunciating. Trip path actuation alarms. PPS trouble alarm.	Selective 2-out-of-4 actuation circuits.	Makes ESFAS actuation and RPS trip circuits a selective 1-out-of-3 or any 2-out-of-3 trip path coincidence.	A 2-out-of-3 channel coincidence is still required to actuate remaining trip paths. (4th channel bypassed)
		Low output voltage	Failure internal to supply.	Symptoms will depend upon the severity of the undervoltage. The system may operate normally or may exhibit the same symptoms as for no output. Undervoltage could only affect some of the trip paths.	Annunciating. Actuation alarms for any deenergized trip paths. Periodic test.	Selective 2-out-of-4 actuation circuits.	If undervoltage is severe enough, makes the affected trip circuits a selective 1-out-of-3 or any 2-out-of-3 trip path coincidence.	
		High output voltage	Failure internal to supply.	Symptoms will depend on the ability of the supplied components to tolerate the overvoltage condition. Could cause the inputs of some of the trip path SSRs to fail. See entries for ESFAS and RPS trip paths.	Periodic test.	Selective 2-out-of-4 actuation circuits.		Failure of the input side of the solid state relay can only result in the opening of the output side. This is the trip condition.

ARKANSAS NUCLEAR ONE
Unit 2

TABLE 7.2-5 (continued)

No.	Name	Failure Mode	Cause	Symptoms and Local Effects Including Dependent Failures	Method of Detection	Inherent Compensating Provision	Effect Upon PPS	Remarks and Other Effects
				DC Power Distribution, PPS Cabinet	ESF 2-out-of-4 Coincidence Logic Power Supplies	FMEA Diagrams 19 & 19A		
164)	ESF Matrix Power Supplies (PS-M or PS-N or PS-P)	No output	Failure internal to supply, open fuse to power supply. Diode in output of supply open.	One half of the matrix relays for all ESF functions in the affected 2/4 matrix (e.g. AB) will be deenergized. Two trip paths for each ESF function will be deenergized, opening one leg of each ESF selective 2-out-of-4 actuation logic circuit.	Annunciating. Trip path actuation alarm, PPS trouble alarm. Open diode fault will generate only the trip path actuation alarm.	2/4 coincidence matrix relays are divided into two groups of two relays. Each group of two is powered from a different power supply. Selective 2-out-of-4 actuation logic.	Two trip paths for all ESF functions will be tripped. Both trip paths affect the same leg of the selective 2-out-of-4 actuation logic. Makes ESF actuation logic 1-out-of-2 of the remaining trip paths.	A 2-out-of-3 channel coincidence is still required to actuate remaining trip paths. (4th channel bypassed)
		Low output voltage	Failure internal to supply.	Symptoms will depend upon the severity of the undervoltage. The system may operate normally or may exhibit the same symptoms as for no output.	If any trip paths are deenergized, trip path actuation alarms will result. Periodic test.	Trip condition will cause voltage to be removed from matrix relay coils.	One or more ESF functions may have half-tripped actuation circuits.	A 2-out-of-3 channel coincidence is still required to actuate remaining trip paths. (4th channel bypassed)
		High output voltage	Failure internal to supply.	Symptoms will depend on the ability of supplied components to tolerate the overvoltage condition. Symptoms may be: a. Normal operation. b. Causes one or more matrix relay drivers to fail shorted, resulting in inability to deenergize the affected matrix relay on a trip. c. Causes one or more of the matrix relay drivers or matrix relays to fail open. This will cause a trip in each associated trip paths.	Periodic test. Annunciating. Trip path actuation alarm(s).	Selective 2-out-of-4 actuation logic. Because of the arrangement of the matrix relays into two groups of two, a maximum of two trip paths for any function can be actuated.	For the affected ESF function(s), makes actuation logic a selective 2-out-of-3. For the affected ESF function(s), makes actuation logic either a 1-out-of-2 coincidence or a selective 1-out-of-3 depending on the number of faults.	A 2-out-of-3 channel coincidence is still required to actuate remaining trip paths. (4th channel bypassed)

ARKANSAS NUCLEAR ONE
Unit 2

TABLE 7.2-5 (continued)

No.	Name	Failure Mode	Cause	Symptoms and Local Effects Including Dependent Failures	Method of Detection	Inherent Compensating Provision	Effect Upon PPS	Remarks and Other Effects
				DC Power Distribution, PPS Cabinet	RPS 2-out-of-4 Coincidence Logic Power Supplies	FMEA Diagrams 19 & 19A		
165)	RPS Matrix Power Supplies (PS-J or PS-K or PS-L)	No output	Failure internal to supply, open fuse to power supply. Diode in output of supply open.	One half of the matrix relays in the affected RPS 2/4 matrix (e.g. AB) will be deenergized. Two RPS trip paths will be deenergized, opening one leg of the selective 2-out-of-4 RPS trip actuation circuit.	Annunciating. Trip path actuation alarm, PPS trouble alarm. Open diode fault will generate only the trip path actuation alarm.	2/4 coincidence matrix relays are divided into two groups of two relays. Each group of two is powered from a different power supply. Selective 2-out-of-4 actuation logic.	Two trip paths will be tripped. Both trip paths affect the same leg of the selective 2-out-of-4. Makes RPS actuation logic 1-out-of-2 of the remaining trip paths.	A 2-out-of-3 channel coincidence is still required to actuate remaining trip paths. (4th channel bypassed)
		Low output voltage	Failure internal to supply.	Symptoms will depend upon the severity of the undervoltage. The system may operate normally or may exhibit the same symptoms as for no output.	If any trip paths are deenergized, trip path actuation alarms will result. Periodic test.	Trip condition will cause voltage to be removed from matrix relay coils.	RPS actuation logic may be half tripped.	A 2-out-of-3 channel coincidence is still required to actuate remaining trip paths. (4th channel bypassed)
	RPS Matrix Power Supplies (PS-J or PS-K or PS-L) (cont)	High output voltage.	Failure internal to supply.	Symptoms will depend on the ability of supplied components to tolerate the overvoltage condition. Symptoms may be: a. Normal operation. b. Causes one or two matrix relay drivers to fail shorted, resulting in inability to deenergize the affected matrix relay on a trip. c. Causes one or two of the matrix relay drivers or matrix relays to fail open. This will cause a trip in each associated trip paths.	Periodic test. Annunciating. Trip path actuation alarm(s).	Selective 2-out-of-4 actuation logic. Because of the arrangement of the matrix relays into two groups of two, a maximum of two trip paths can be actuated.	Makes RPS actuation logic a selective 2-out-of-3. Makes the RPS actuation logic either a 1-out-of-2 coincidence or a selective 1-out-of-3 depending on the number of faults.	A 2-out-of-3 channel coincidence is still required to actuate remaining trip paths. (4th channel bypassed)

ARKANSAS NUCLEAR ONE
Unit 2

TABLE 7.2-5 (continued)

No.	Name	Failure Mode	Cause	Symptoms and Local Effects Including Dependent Failures	Method of Detection	Inherent Compensating Provision	Effect Upon PPS	Remarks and Other Effects
				DC Power Distribution, PPS Cabinet	Bistable Power Supplies	FMEA Diagrams 19 & 19A		
166)		<p>Low output voltage.</p> <p>High output voltage</p>	<p>Failure internal to supply.</p> <p>Failure internal to supply.</p>	<p>No operation symptoms.</p> <p>Symptoms will depend on the ability of the supplied components to tolerate the overvoltage condition. Symptoms may be:</p> <p>a. Normal operation.</p> <p>b. One or more bistables or bistable relays fail in the non-tripped state.</p> <p>c. One or more bistables or bistable relays fail in the tripped state.</p>	<p>If the undervoltage is severe enough, PPS trouble alarm. Periodic test.</p> <p>Periodic test.</p> <p>Annunciating. Pre-trip and trip alarms.</p>	<p>Auctioneered power supplies for Channel B and C only.</p> <p>Channel A or D could trip.</p> <p>3 channel redundancy. (4th channel bypassed)</p> <p>3 channel redundancy. (4th channel bypassed) Channel trip.</p>	<p>None.</p> <p>Makes RPS and/or ESFAS function logic for the affected parameter(s) 2-out-of-2 coincidence.</p> <p>Makes RPS and/or ESFAS function logic for the affected parameter(s) 1-out-of-2 coincidence.</p>	<p>Affected reactor trip and/or ESFAS logic function logic must be converted to 1-out-of-2 by placing the appropriate bistable(s) in the tripped state.</p> <p>Affected reactor trip and/or ESFAS logic function logic must be maintained in 1-out-of-2 by placing the appropriate bistable(s) in the tripped state.</p>

ARKANSAS NUCLEAR ONE
Unit 2

TABLE 7.2-5 (continued)

No.	Name	Failure Mode	Cause	Symptoms and Local Effects Including Dependent Failures	Method of Detection	Inherent Compensating Provision	Effect Upon PPS	Remarks and Other Effects
				DC Power Distribution, PPS Cabinet	Bistable Power Supplies	FMEA Diagrams 19 & 19A		
166A)	Channel B or C Bistable Power Supplies (Ch B or D - PS-A) or (Ch A or D - PS-B)	No output	<p>Failure internal to supply, open fuse to power supply.</p> <p>Diode in output of supply open.</p> <p>De-energization of vital bus (1 and 3) for 2D01 fault or (2 and 4) for 2D02 fault.</p>	<p>No operational symptoms.</p> <p>Channel B or C functions with increasing signal setpoint rendered inoperable if signal source power supply is de-energized.</p>	<p>Annunciating. PPS trouble alarm.</p> <p>Annunciating. PPS trouble alarm.</p>	<p>Two power supplies, one in the same channel as the bistables and one in the adjacent channel, are auctioneered. Either power supply is capable of supplying the entire load.</p> <p>Channel A and D bistable power supplies are not auctioneered to provide safe failure states for de-energization of vital bus (1 and 3) or (2 and 4).</p> <p>3-Channel redundancy (4th channel bypassed)</p>	<p>None.</p> <p>De-energization of vital bus (1 and 3) or (2 and 4) places RAS in 1-out-of-2 logic, EFAS/FOGG logic in 1-out-of-1 logic, and trips RPS and other ESFAS functions with decreasing signal by AC or BD matrix. ESFAS functions with increasing signal setpoints half trip with 1-out-of-1 logic.</p>	<p>Bistables and bistable relays in the affected channel are dependent upon the continued operation of the remaining supply.</p> <p>ESFAS channel B and C measurement channel inputs for RWT level have auctioneered power supplies.</p> <p>For EFAS/FOGG, the DC bus failure scenario causes either channel A or D to fail to the EFW position and either channel B or C to fail to the FOGG position.</p>

ARKANSAS NUCLEAR ONE
Unit 2

TABLE 7.2-5 (continued)

No.	Name	Failure Mode	Cause	Symptoms and Local Effects Including Dependent Failures	Method of Detection	Inherent Compensating Provision	Effect Upon PPS	Remarks and Other Effects
				DC Power Distribution, PPS Cabinet	Bistable Power Supplies	FMEA Diagrams 19 & 19A		
166B)	Channel A or D Bistable Power Supplies (PS-A)	No output	<p>Failure internal to supply, open fuse to power supply.</p> <p>Diode in output of supply open.</p> <p>De-energization of vital bus channel A or D.</p>	Channel A or D bistable relays in PPS logic matrices de-energize. Places a half trip in 3 PPS logic matrices for all functions.	Annunciating. PPS trouble alarm.	Channel A and D bistable power supplies are not auctioneered to provide safe failure states for de-energization of vital bus (1 and 3) or (2 and 4). 3-Channel redundancy (4th channel bypassed).	De-energization of vital bus (1 and 3) or (2 and 4) places RAS in 1-out-of-2 logic, EFAS/FOGG logic in 1-out-of-1 logic, and trips RPS and other ESFAS functions with decreasing signal by AC or BD matrix. ESFAS functions with increasing signal setpoints half trip with 1-out-of-1 logic.	Bistables and bistable relays in the affected channel are dependent upon the continued operation of the remaining supply. ESFAS channel B and C measurement channel inputs for RWT level have auctioneered power supplies.

* CLARIFYING REMARK: Related entries (i.e. #104, #112, #113) governing context is single failure directly related to CEDM power opening (or low output) based on supporting the safety function of removing power / dropping CEAs / tripping. Beyond said governing context, it is acknowledged that OE has evidenced single failure vulnerability (but with trip result noted as already bounded in FMEA Table) for initiating trip from MG high output scenarios, which can unload unaffected MG with it tripping on low output along with affected MG subsequently failing on high output resulting in simultaneous loss of both MGs and inadvertent/initiated trip (noting no single failure vulnerability relative to supporting the safety function).

ARKANSAS NUCLEAR ONE
Unit 2

Table 7.2-6

DELETED

Table 7.2-7

DELETED

Table 7.2-8

DELETED

Table 7.2-9

**NSSS PARAMETERS AFFECTING DNBR FUEL DESIGN LIMIT,
LOCAL POWER DENSITY LIMIT, AND MONITORED NSSS VARIABLES**

<u>Parameter</u>	<u>Variable</u>
Core Average Power*	Neutron Flux Power* Cold Leg Temperature* Hot Leg Temperature*
Radial Peaking Factor*	CEA Positions*
Normalized Axial Power Distribution*	Neutron Flux Power* CEA Group Positions*
Reactor Coolant System Flow	Reactor Coolant Pump Speed Cold Leg Temperature Pressurizer Pressure
Reactor Coolant System Pressure	Pressurizer Pressure
Reactor Coolant Inlet Temperature	Cold Leg Temperature

* Affect local power density also.

ARKANSAS NUCLEAR ONE
Unit 2

Table 7.2-10

CORE PROTECTOR CALCULATOR – PRIORITY STRUCTURE

<u>Priority Level</u>	<u>Program</u>	<u>Initiated By</u>	<u>Function</u>
1.	System Executive	Defined in Section 1A through 1D	(1) Interrupt Processing (2) Priority Level Maintenance (3) Input - Output Servicing
A.	Power Fail	Machine Malfunction Interrupt (1) Power Fail	(1) Trip Calculator Output (Annunciator by the PPS) (2) Place the machine in a Wait State
B.	Auto-Restart/ Error Control	(1) Machine Malfunction Interrupt (a) Parity Error (b) Power Restore (2) Fixed Point Divide Fault Interrupt (3) Floating Point Arithmetic Fault Interrupt (4) Illegal Instruction Interrupt (5) System Monitor Program Exit (6) Memory Address Translator	(1) Trip Calculator Output (Annunciator by PPS) (2) Store Reason for Restart (3) Disable Clock (This causes Watchdog Timer annunciation) (4) Set Initialize Flag (5) Load Initialization Database into Non-protected Memory from Protected Memory, Verify the Database (6) Pass control to the Initialization Task via the Task Dispatcher (7) Initialize through Task Dispatcher. Record Data in journal
C.	Input - Output	(1) Call from Initialization Task Call from System Monitor Task (2) Call from System Monitor Task (3) Call from Auto-Reload Task Call from System Monitor Task (4) Call from Protection Program	(1) Initialize the Real Time Clock to a predefined state (2) Read a Block of Data from Disc into Memory (3) Provide Input - Output Capability (4) Provide Analog and Digital Inputs and Outputs. Service the Operator's Module

ARKANSAS NUCLEAR ONE
Unit 2

Table 7.2-10 (continued)

<u>Priority Level</u>	<u>Program</u>	<u>Initiated By</u>	<u>Function</u>
D.	Task Scheduler	Real Time Clock Interrupt	(1) Enable, Dispatch, and Terminate Tasks according to predefined priority and cycle rate
		Exit from any System Tasks except the System Monitor	(2) Periodically Reset Watchdog Timer
2.	Software Levels	Priority Task Dispatcher	(1) Protection Algorithms (2) Service Operator's Module (3) Off-Line Tests (4) On-Line Tests (5) Initialization
A.	Operator's Module Scan Monitor Task	Task Dispatcher	(1) Detect and Verify Operator Requests (2) Build Function Requests for the Operator's Module (3) Enable System Monitor Task when Switch is set on the System Test Panel
B.	Coolant Mass Flow Program	Task Dispatcher	Protection Algorithm
C.	DNBR and Power Density Update	Task Dispatcher	Protection Algorithm
D.	Power Distribution Program	Task Dispatcher	Protection Algorithm
E.	Static DNBR and Power Density Program	Task Dispatcher	Protection Algorithm
F.	Operator's Module Function Monitor Task	Task Dispatcher	(1) Service Requests passed by the Operator's Module Scan Monitor Task (2) Periodically Update Operator's Module Display

ARKANSAS NUCLEAR ONE
Unit 2

Table 7.2-10 (continued)

<u>Priority Level</u>	<u>Program</u>	<u>Initiated By</u>	<u>Function</u>
G.	Initialization	Task Dispatcher	<ul style="list-style-type: none"> (1) Restart the Real Time Clock (2) Enable the Idle Time Loop Task (3) Verify that Time-Dependent Transients have died out (4) Reset Trip Outputs to initiate on-line operation
H.	System Monitor Task (Periodic Test)	Task Dispatcher	<ul style="list-style-type: none"> (1) Set Trip Outputs (2) Load, Schedule, and Execute hardware and software periodic tests (3) Print out error codes for previous three restarts (4) Print out results of periodic tests (5) Invoke auto-restart upon exit
I.	Plant Computer Data Link Task	Task Dispatcher	<ul style="list-style-type: none"> (1) Output sensor inputs and three calculated variables to Plant Computer
J.	Serial Data Output Task	Task Dispatcher	<ul style="list-style-type: none"> (1) Output data to serial ports as required by task and requested by executive
K.	Idle Time Loop Task	Task Dispatcher	<ul style="list-style-type: none"> (1) Compute Checksum for protected memory (2) Test unprotected memory locations to provoke possible errors

ARKANSAS NUCLEAR ONE
Unit 2

Table 7.2-11
CONTROL ELEMENT ASSEMBLY CALCULATOR – PRIORITY STRUCTURE

Priority Level	Program	Initiated By	Function
1.	System Executive	Defined in Section 1A through 1D	<ul style="list-style-type: none"> (1) Interrupt Processing (2) Priority Level Maintenance (3) Input - Output Servicing
A.	Power Fail	Machine Malfunction Interrupt <ul style="list-style-type: none"> (a) Power Fail 	<ul style="list-style-type: none"> (1) Set Outputs to Fail Safe Condition (2) Place the machine in a Wait State
B.	Auto-Restart/ Error Control	<ul style="list-style-type: none"> (1) Machine Malfunction Interrupt <ul style="list-style-type: none"> (a) Parity Error (b) Power Restore (2) Fixed Point Divide Fault Interrupt (3) Floating Point Arithmetic Fault Interrupt (4) Illegal Instruction Interrupt (5) System Monitor Program Exit (6) Memory Address Translator 	<ul style="list-style-type: none"> (1) Set Outputs to Fail-Safe Operation (2) Store Reason for Restart (3) Disable Clock (This causes Watchdog Timer annunciation) (4) Set Initialize Flag (5) Load Initialization Data Base into Non-protected Memory from Protected Memory, Verify the Data Base (6) Pass control to the Initialization Task via the Task Dispatcher (7) Initialize after executive records event through task dispatcher
C.	Input - Output Services	<ul style="list-style-type: none"> (1) Call from Initialization Task Call from System Monitor Task (2) Call from System Monitor Task (3) Call from Auto-Reload Task Call from System Monitor (4) Call from Protection Program 	<ul style="list-style-type: none"> (1) Initialize the Real Time Clock to a predefined state (2) Read a Block of Data from Disc into Memory (3) Provide Teletype Input - Output Capability Task (4) Provide Analog and Digital Inputs and Outputs. Service the Operator's Module
D.	Task Scheduler	<ul style="list-style-type: none"> Real Timer Clock Interrupt Exit from any System Tasks except the System Monitor 	<ul style="list-style-type: none"> (1) Enable, Dispatch, and Terminate Tasks according to predefined priority and cycle rate (2) Periodically Reset Watchdog Timer

ARKANSAS NUCLEAR ONE
Unit 2

Table 7.2-11 (continued)

<u>Priority Level</u>	<u>Program</u>	<u>Initiated By</u>	<u>Function</u>
2.	Software Priority Levels	Task Dispatcher	<ul style="list-style-type: none"> (1) Protection Algorithms (2) Service Operator's Module (3) Off-Line Tests (4) On-Line Tests (5) Initialization
A.	Operator's Module Scan Monitor Task	Task Dispatcher	<ul style="list-style-type: none"> (1) Detect and Verify Operator Requests (2) Build Function Requests for the Operator's Module Function Task (3) Enable System Monitor Task when Switch is set on the System Test Panel
B.	CEAC Penalty Factor Algorithm	Task Dispatcher	Protection Algorithm
C.	CEA Position Display	Task Dispatcher	Operator Module Position if CEA display requested on operator module
D.	Operator's Module Function Monitor Task	Task Dispatcher	<ul style="list-style-type: none"> (1) Service Requests passed by the Operator's Module Scan Monitor Task (2) Periodically Update Operator's Module Display
E.	Initialization	Task Dispatcher	<ul style="list-style-type: none"> (1) Restart the Real Time Clock (2) Enable the Idle Time Loop Task (3) Verify that Time-Dependent Transients have died out (4) Reset Trip Outputs to initiate on-line operation
F.	Plant Computer Data Link Task	Task Dispatcher	Output sensor inputs and one calculated variable to Plant Computer
G.	Serial Data Output Task	Task Dispatcher	Output serial data to ports as requested by application programs through the executive
H.	Idle Time Loop Task	Task Dispatcher	<ul style="list-style-type: none"> (1) Computer Checksum for protected memory (2) Test unprotected memory locations by attempting to force errors

ARKANSAS NUCLEAR ONE
Unit 2

Table 7.2-12

OPERATOR'S MODULE DIGITAL METER DISPLAY PARAMETERS

Inputs

Reactor Coolant Pump Speeds, Hot Leg Temperatures, Cold Leg Temperatures, Primary Pressure, Ex-Core Neutron Flux Signals, CEA Positions

Calculated Values

Compensated DNBR, Static DNBR, Reactor Core Max Flow Rate, Compensated Cold Leg Temperatures, Local Power Density, Calibrated Neutron Flux Power, Maximum Peaking Factor, Integral Radial Peaking Factor, Penalty Factors, Total Thermal Power, CEA Deviation

Addressable Constants

Azimuthal Tilt Constant, Calculation Constants for ΔT Power Determination, Reactor Coolant Flow Calculation Constants

Specific Operator's Module Displays as follows:

10 (ten) points to allow the operator to check/verify the current values of addressable constants (all values on the display screen).

Technical specification check - simultaneous display of 6 points which must presently be done once per hour per channel.

Displays of CEAC rod positions (CEAC OM display only).

Auto restart and sensor failure log displays. The displays will give the failed sensor number/PID and some descriptive information for the PID.

CPC - There are 9 PIDs associated with auto restart which correspond to flags and status words giving the restart codes. There are 4 PIDs corresponding to sensor failure status words whose values indicate failed sensors.

CEAC - There are 5 PIDs associated with auto-restart and failed sensors.

A display screen providing the capability of changing the values of addressable constants.

A display screen providing the capability of displaying the values of pre-selected PIDs (default PIDs) i.e., more than one value would be displayed on the screen.

A display screen providing the capability of defining a group of PIDs whose values are to be displayed on a single screen i.e., a User Group set of PIDs.

An alarm/status screen to pinpoint specific CPC/CEAC problems when the corresponding CPC/CEAC Trouble Light is lit.

The capability of choosing displays via a master menu to specific screens will be provided. Values on the screen being displayed will be updated at a constant rate.

ARKANSAS NUCLEAR ONE
Unit 2

Table 7.2-13

CEAC SINGLE FAILURE ANALYSIS

<u>Single Failure</u>	<u>Results</u>
1. CEAC failure - loss of power, failure detected by on-line diagnostics	Each of the four CPCs uses the most conservative value of either the output of the redundant CEAC or the previous penalty factor from the failed CEAC.
2. CEAC failure - erroneous data (penalty factor too low).	Each of the four CPCs uses the largest penalty factor from the operable CEAC and each CPC annunciates any discrepancy between CEACs.
3. CEAC failure - erroneous data (penalty factor too high)	Each of the four CPCs uses the erroneous high penalty factor which causes an approach to the trip setpoint; each CPC annunciates the discrepancy between CEACs.
4. CEAC failure - "in-test" bit stuck "on".	Each of the four CPCs uses the penalty factor from the other CEAC which is correct; each CPC annunciates the "in test" condition from the failed CEAC.
5. CEAC position transmitter failure	Possible erroneous data from one CEAC which produces results as in 2 or 3 above; CEAC annunciates sensor failure.
6. CEAC failure producing short circuit, open circuit or application of maximum credible potential at sending end of two data links.	Optical isolators prevent failure from propagating to other calculators; data failures and results fall under one of categories 1, 2, 3 or 4 above.
7. CPC failure producing short circuit, open circuit or application of maximum credible potential at receiving end of two data links.	Optical isolators prevent failure from propagating to CEACs or other CPCs; both CEACs and three CPCs remain intact and perform all safety functions.
8. Catastrophic failure (e.g., fire) in Channel B (or Channel C) causing destruction of both CPC & CEAC.	Physical isolation (including fire-proof barriers) and optical isolators prevent catastrophic failure from propagating to other channels; one CEAC and three CPCs (or two CPCs if one of the remaining channels is bypassed) remain intact ensuring a trip if required. Data failures from CEAC which failed and results fall under one of Categories 1, 2, 3 or 4 above.

ARKANSAS NUCLEAR ONE
Unit 2

Table 7.2-14

DNBR/LPD CALCULATOR TRIP SYSTEM - INPUT DISPLAYS

<u>Parameter</u>	<u>Type of Readout</u>	<u>Number of Channels</u>	<u>Range</u>	<u>Accuracy</u>	<u>Location</u>
Pressurizer Pressure	4 Indicators (1 per Channel)	4	1500-2500 psia	± 2%	Control Room
Coolant Temp (Hot Leg, Loops 1 and 2)	4 Indicators (1 per Channel)	4	525-675 °F	± 2%	Control Room
Coolant Temp (Cold Leg, Loops 1 and 2)	4 Indicators (1 per Channel)	4	465-615 °F	± 2%	Control Room
Neutron Flux Power Level (Safety Channels)	4 Indicators (Summed Sub-Channel Signal, 1 per Channel)	4	10 ⁻⁸ to 100%	± 2%	Control Room
CEA Position	2 Operator's Display Modules	2	Full In- Full Out	± 2%	Control Room
Reactor Coolant Pump Speed	4 Digital Displays on 4 DNBR/LPD Operator's Module, 1 per Channel	16 4 Channels per Pump	0-1200 rpm	± 2%	Control Room

Table 7.2-15

DNBR/LPD CALCULATOR TRIP SYSTEM - OUTPUT DISPLAYS

<u>Parameter</u>	<u>Type</u>	<u>Type of Readout</u>	<u>Number of Channels</u>	<u>Range</u>	<u>Accuracy</u>	<u>Location</u>
DNBR Margin	Output	Indicator	4	0-100%	± 2%	Control Room
Local Power Density Margin	Output	Indicator	4	0-100%	± 2%	Control Room
Calibrated Neutron Flux Power	Output	Indicator	4	0-125% Power	± 2%	Control Room

ARKANSAS NUCLEAR ONE
Unit 2

Table 7.2-16

DNBR/LPD Calculator Trip System - Status Displays

<u>Status Indication</u>	<u>Type of Indication</u>	<u>Number of Channels</u>	<u>Location</u>
DNBR Channel Trip	Annunciator	1	Control Room
	Status Lamp	4	
	O.M. Display	4	
DNBR Channel Pre-trip	Annunciator	1	Control Room
	Status Lamp	4	
	O.M. Display	4	
Local Power Density Trip	Annunciator	1	Control Room
	Status Lamp	4	
	O.M. Display	4	
Local Power Density Pre-trip	Annunciator	1	Control Room
	Status Lamp	4	
	O.M. Display	4	
CPC Sensor Failure	Annunciator	1	Control Room
	CPC Trouble		
	Status Lamp	4	
DNBR/LPD Bypass	O.M. Display	4	Control Room
	Annunciator	1	
	Status Lamp	4	
Core Protection Calculator Failure	O.M. Display	4	Control Room
	Annunciator	1	
	CPC Trouble		
CEA Calculator Failure	Status Lamp	4	Control Room
	Annunciator	1	
	CEAC Trouble		
CEAC Sensor Failure	Status Lamp	2	Control Room
	Annunciator	1	
	O.M. Display	2	
Core Protection Calculator in Test	O.M. Display	4	Control Room
	Status Lamp	4	
	CPC Trouble		
CEA Calculator in Test	O.M. Display	2	Control Room
	Status Lamp	2	
	CEAC Trouble		
CEA Deviation	O.M. Display	2	Control Room
	Status Lamp	2	
	Annunciator	1	

ARKANSAS NUCLEAR ONE
Unit 2

Table 7.2-17

DNBR/LPD Calculator System Tests

<u>Test</u>	<u>Type</u>	<u>Test Method</u>	<u>Failure Detection Coverage</u>
1	Automatic On-line	Sensor Reasonability Checks of Input Data	Transducer, Signal Conditioning and Multi-Plexer Channel Failure
2	Automatic On-line	Power (Voltage) Level Check	Loss of Vital Bus Power
3	Automatic On-line	Watchdog Timer	Software Execution Time and Real Time Clock Failures
4	Automatic On-line	Memory Parity and Program "Check-Sum"	Protected and Non-Protected Memory Failures
5	Periodic On-line	Cross Channel Comparisons of DNBR, Local Power Density, and Calibrated Nuclear Power via Control Board Meters	Transducer, Signal conditioning, Data Input/Output subsystem and CPU and Memory Failures
6	Periodic On-line	Cross Channel Comparisons of Input Data, Intermediate Calculated Values and Calculated Values	Transducer, Signal Conditioning, Data Input/Output Subsystem, CPU and Memory, and CEAC/CPC Communication Links Failures
7	Periodic On-line	Dummy Power Signal Insertions	CPC Pre-trip, Trip Contacts and CWP Contact Failures
8	Periodic Off-line	Digital Performance Simulations	Verification of Static and Dynamic Operation of System Software, Communication Links CPC/CEAC, and System Hardware
9	Periodic Off-line	CPU and Memory Diagnostics	Central Processing Unit, Core Memory, and Watchdog Timer Failures
10	Automatic On-line	Cross Channel Comparisons of Safety Channel Data and Calculated Values by the Plant Computer Note: No credit taken for Test 10 in reliability analysis.	Transducer, Signal Conditioning, Data Input/Output Subsystem, CPU and Memory and CEAC/CPC Communication Links Failures

ARKANSAS NUCLEAR ONE
Unit 2

Table 7.3-1

ESFAS BYPASSES AND BLOCKS

<u>Title</u>	<u>Function</u>	<u>Initiated By</u>	<u>Removed By</u>	<u>Notes</u>
Trip Channel Bypass	Disables any given trip channel	Manually by controlled access switch	Same switch	Interlocks allow only one channel for any type trip to be bypassed at one time
RPS/ESFAS Low Pressurizer Pressure Bypass	Disables SIAS and CSAS, CCAS, RAS, RPS (Low PRZ Pressure)	Spring Return Switch (1 per channel) if pressure is below bypass permissive (< 400 psia)	Automatic before pressurizer pressure is ≥ 500 psia	Restricted to Modes 4, 5, and 6
Penetration Room Ventilation Fan Bypass	Permits stopping second fan after CIS	Manually by controlled access switch	Same switch	Associated suction valve closes automatically to prevent recirculation
Emergency Feedwater Isolation Bypass	Allows emergency feedwater to an intact steam generator following an MSIS	EFAS	Lack of need for emergency feedwater to intact steam generator	
RPS/ESFAS Steam Generator High/Low Level Bypass	Disables EFAS	Spring Return Switch (1 per channel) if RCS Temperature is < 200 °F	Automatic if RCS Temperature is ≥ 200 °F	
RWT Low Level Bypass	Disables RAS, SIAS, CCAS, CSAS, RPS (Low PRZ Pressure)	Spring Return Switch (1 per channel) if pressure is below bypass permissive (< 400 psia)	Automatic before pressurizer ≥ 500 psia	Application restricted to Modes 4, 5, and 6

ARKANSAS NUCLEAR ONE
Unit 2

Table 7.3-2

Design Basis Events Requiring ESFAS Action

<u>Design Basis Events</u>	<u>Penetration Room Ventilation Actuation</u>	<u>Containment Isolation Actuation</u>	<u>Containment Spray Actuation</u>	<u>Containment Cooling Actuation</u>	<u>Main Steam Isolation Actuation</u>	<u>Safety Injection Actuation</u>	<u>Emergency Feedwater Actuation</u>	<u>Recirculation Actuation</u>
Loss of Reactor Coolant - Large Break	*	*	*	*		*		*
Loss of Reactor Coolant - Small Break ⁽¹⁾	*	*	*	*		*	*	*
Steam Generator Tube Rupture					*(2)	*		
Steam Line Break - Inside Containment	*	*	*	*	*	*	*	
Steam Line Break - Outside Containment					*	*	*	
Loss of Main Feedwater							*	

(1) Includes CEA Ejection

(2) Manual actuation

ARKANSAS NUCLEAR ONE
Unit 2

Table 7.3-3

MONITORED VARIABLES REQUIRED FOR ESFAS ACTION

<u>Variable</u>	<u>Penetration Room Ventilation Actuation</u>	<u>Containment Isolation Actuation</u>	<u>Containment Spray Actuation</u>	<u>Containment Cooling Actuation</u>	<u>Main Steam Isolation Actuation</u>	<u>Safety Injection Actuation</u>	<u>Emergency Feedwater Actuation</u>	<u>Recirculation Actuation</u>
Pressurizer Pressure			*	*		*		
Containment Pressure	*	*	*	*		*		
Steam Generator Pressure					*		*	
Refueling Water Tank Level			*	*		*		*
Steam Generator Level							*	

ARKANSAS NUCLEAR ONE
Unit 2

Table 7.3-4

ENGINEERED SAFETY FEATURES ACTUATION SYSTEM SENSORS

<u>Monitored Variable</u>	<u>Type</u>	<u>Number of Sensors</u>	<u>Location</u>
Pressurizer Pressure	Pressure Transducer	8*	Pressurizer
Containment Pressure	Pressure Transducer	4*	Containment Structure
Steam Generator Pressure	Pressure Transducer	4/Stm Gen*	Steam Generator
Refueling Water Tank Level	Differential Pressure Transducer	4	Refueling Water Tank
Steam Generator Level	Differential Pressure Transducer	4/Stm Gen*	Steam Generator

* Shared with reactor protective system

ARKANSAS NUCLEAR ONE
Unit 2

Table 7.3-5

SAFETY-RELATED SYSTEM INSTRUMENT RANGES, SETPOINTS, AND MARGINS TO ACTUATION

<u>Actuation Signal</u>	<u>Instrument Range</u>	<u>Full Power Nominal Value</u>	<u>Normal Operating Range</u>	<u>Actuation Setpoint</u>	<u>Margin to Actuation</u>
SIAS and CCAS					
Low Pressurizer Pressure	0 - 3000 psia	2200 psia	2175 - 2225 psia	≥ 1650 psia ^{1,3}	525 - 575 psid
or					
High Containment Pressure	0 - 27 psia	15 psia	13.2 – 16.1 psia	≤ 18.3 psia ³	2.2 – 5.1 psid
CSAS					
High-High Containment Pressure and SIAS	0 - 27 psia	15 psia	13.2 – 16.1psia	≤ 23.3 psia ³	7.2 – 10.1 psid
RAS					
Low Refueling Water Tank Level	0 - 100%	94%	91.7 - 100%	$6\% \pm 0.5\%$ ³	85.7 - 94%
MSIS					
Low Steam Generator Pressure	0 - 1200 psia	943.9 psia	900 - 1000 psia	≥ 751 psia ³	149 - 249 psid
CIAS					
High Containment Pressure	0 - 27 psia	15 psia	13.2 – 16.1 psia	≤ 18.3 psia ³	2.2 – 5.1 psid

ARKANSAS NUCLEAR ONE
Unit 2

Table 7.3-5 (continued)

SAFETY-RELATED SYSTEM INSTRUMENT RANGES, SETPOINTS, AND MARGINS TO ACTUATION

<u>Actuation Signal</u>	<u>Instrument Range</u>	<u>Full Power Nominal Value</u>	<u>Normal Operating Range</u>	<u>Actuation Setpoint</u>	<u>Margin to Actuation</u>
EFAS					
Low Steam Generator Pressure	0 - 1200 psia	943.9 psia	900 - 1000 psia	≥ 751 psia ³	149- 249 psid
Steam Generator Level - Low	0 - 100%	70%	50 – 75%	≥ 22.2% ³	27.8 – 52.8
Differential Steam Generator Pressure	N/A ²	0 psid	0 psid	≤ 90 psid ³	90 psid
Emergency Feedwater Pump Suction Pressure (Service Water Swap Over)	0 - 25 psig	> 19.7 psig	>19.7 psig	5 psig	14.7 psig
Pressurizer Pressure Interlocks					
Low Pressure (SIT Valves)	0 - 1600 psia	2200 psia	2175 - 2225 psia	≥ 700 psia ³	1475 - 1525 psia
Low Low Pressure (SDC Valves)	0 - 1600 psia	2200 psia	2175 - 2225 psia	≤ 350 psia	1875 - 1925 psia

- (1) These setpoints can be manually reduced as pressure is reduced during a plant cooldown. The setpoints are automatically increased as pressure increases. See Sections 7.2.1.1.1.6, 7.2.1.1.1.8, 7.3, 7.3.1.1.4, and 7.3.1.1.11.4.
- (2) The differential steam generator pressure signal is produced by a bistable utilizing signals from both steam generators' pressure measurement channels with ranges from 0 - 1200 psia.
- (3) These values are the setpoints required by the ANO Unit 2 Technical Specifications.

ARKANSAS NUCLEAR ONE
Unit 2

Table 7.3-6

ESFAS MONITORED PLANT VARIABLE RANGES

<u>Monitored Variable</u>	<u>Minimum</u>	<u>Full Power (Nominal)</u>	<u>Maximum</u>
Pressurizer Pressure	0 psia	2200 psia	3000 psia
Containment Pressure	0 psia	15 psia	27 psia
Steam Generator Pressure	0 psia	943.9 psia	1200 psia
Refueling Water Tank Level	2'4" (0%)	42'-0"(94%)	44'9"(100%)
Steam Generator Level	0%	70%	100%

ARKANSAS NUCLEAR ONE
Unit 2

Table 7.5-1

PLANT PROCESS DISPLAY INSTRUMENTATION

<u>Parameter</u>	<u>Class**</u>	<u>Type of Readout (Control Room)</u>	<u>Number of Channels</u>	<u>Range</u>
Pressurizer Pressure	3A	Indicator	4	1500 - 2500 psia
*Pressurizer Pressure ⁽¹⁾	2B	Indicator	4	0 - 3000 psia
Pressurizer Pressure	1A	Indicator	2	0 - 1600 psia
Pressurizer Pressure	3C	Recorder	2	0 - 2500 psia
Pressurizer Pressure	3C	Indicator/ Control	2	0 - 2500 psia
*Containment Pressure ⁽¹⁾	1B	Indicator	2	0 - 225 psia
	3D	Recorder	1	0 - 225 psia
Containment Pressure ⁽¹⁾	2B	Indicator	4	0 - 27 psia
	3D	Recorder	1	0 - 27 psia
*Steam Generator Pressure ⁽¹⁾	2B	Indicator	4/S.G.	0 - 1200 psia
*Steam Generator Level ⁽¹⁾	2A	Indicator	4/S.G.	0-100% (Narrow Range)
Steam Generator Level	3C	Indicator/ Control	1/S.G.	0-100% (Narrow Range)
*Steam Generator Level	1B	Indicator	1/S.G.	1.42 – 41.67 ft.(Wide Range)
*Steam Generator Level	1B	Indicator/ Recorder	1/S.G.	1.42 – 41.67 ft (Wide Range)
Pressurizer Level	3C	Recorder	1	0 – 100%
*Pressurizer Level ⁽¹⁾	1A	Indicator/ Control	2	0 – 100%
*Pressurizer Code Safety ⁽¹⁾⁽²⁾ Valve Position	3D	Alarm	2	Open/Close

ARKANSAS NUCLEAR ONE
Unit 2

Table 7.5-1 (continued)

<u>Parameter</u>	<u>Class**</u>	<u>Type of Readout (Control Room)</u>	<u>Number of Channels</u>	<u>Range</u>
*Pressurizer Code Safety ⁽¹⁾⁽²⁾ Valve Position	3D	Alarm	2	Open/Close
Coolant Temperature (Hot Leg, Loops 1 & 2)	2A	Indicator	4	525 – 675 °F
Coolant Temperature ⁽¹⁾ (Cold Leg, Loops 1 & 2)	2A 3C	Indicator/ Recorder	4 2	465 – 615 °F 0 – 600 °F
T _{avg} Coolant Temperature		Plant Computer CRT Digital Indicator	1 ⁽³⁾	525 – 625 °F
Local Power Density Margin ⁽¹⁾	1A	Indicator	4	0 – 25 kW/FT
Local Power Density Margin	3C	Indicator	1	0 – 125%
DNBR Margin ⁽¹⁾	1A	Indicator	4	0 – 10%
DNBR Margin	3C	Indicator	1	0 – 125%
Neutron Flux Level Rate of Change	1A	Indicator	4	-1 to +7 DPM
Neutron Flux Level (S/U Channels)	3A	Indicator (Boron Dilution Monitor) Indicator (Log Power)	2 2	0.1 to 10 ⁴ CPS 10 ⁻⁸ to 100% power
Neutron Flux Level (S/U Channels)	3C	Recorder (2 pen)	2	1 to 10 ⁶ CPS
Neutron Flux Power Level (Safety Channels)	1A	Indicator Plant Computer CRT	4 4	10 ⁻⁸ to 200% power 10 ⁻⁸ to 200% power
Neutron Flux Power Level (Safety Channels)	1A	Recorder	4	0 – 200% power

ARKANSAS NUCLEAR ONE
Unit 2

Table 7.5-1 (continued)

<u>Parameter</u>	<u>Class**</u>	<u>Type of Readout (Control Room)</u>	<u>Number of Channels</u>	<u>Range</u>
Neutron Flux Power Level ⁽¹⁾ (C.P. Calculators)	1A	Recorder	4	0 – 200% power
Boric Acid Flow	3C	Recorder	1	0 – 30 gpm
Makeup Water Flow	3C	Recorder	1	0 – 150 gpm
Letdown Temperature	3C	Indicator	2	50 – 200 °F
Letdown Pressure	3C	Indicator	1	0 – 600 psig
Charging Pump Discharge Pressure	3D	Indicator	1	0 – 3000 psig
Charging Flow	3C	Indicator	1	0 - 150 gpm
Shutdown Cooling Heat Exchanger Outlet Temperature	3C	Indicator	2	0 – 400 °F
Shutdown Cooling/Containment Spray Header Pressure	3C	Indicator	2	0 - 600 psig
Containment Temperature	3D	Recorder	3	0 - 350 °F
Containment (High Range) Radiation	1A	Indicator	2	1 to 10 ⁺⁸ R/HR
Main Steam Line Radiation	3D	Indicator	1/Steam Line	0.1 – 10,000 mR/hr
RCS Subcooling Margin Monitors	1A	Indicator	2	0 - 200 °F
Loose Parts Monitoring	3D	Indicator	8	-

ARKANSAS NUCLEAR ONE
Unit 2

Table 7.5-1 (continued)

* Indicates Post-Accident Monitoring Instrumentation

⁽¹⁾Indicates display instrumentation which is available to monitor Limiting Conditions for Operations (LCO) in addition to the bases defined in Section 7.5.2.1.

⁽²⁾As a result of redundancy provided for this instrumentation, Technical Specifications permit operations with some channels inoperable.

⁽³⁾Value displayed is the average of two loop T_{avg} channels.

****Qualification of Circuitry**

1 - Completely Class 1E

2 - Channels A and B completely Class 1E
Channels C and D non-Class 1E

3 - Non-Class 1E

****Qualification of Indicating Instrumentation**

A - Instrument Class 1C - Environmentally Class 1 for control room environment.
Seismically Class 1 for DBE except only required to operate after DBE, not during.

B - Instrument Class 1C - Same as above except required to operate during and after DBE.

C - Instrument Class 2B - Environmentally similar to 1C above, but documentation not required.
Seismically required to operate during and after DBE.

D - Instrument Class 3 - Standard commercial instrument.

ARKANSAS NUCLEAR ONE
Unit 2

Table 7.5-2
ENGINEERED SAFETY FEATURE SYSTEMS MONITORING

<u>Parameter</u>	<u>Type of Readout (Control Room)</u>	<u>Number of Channels</u>	<u>Range</u>
<u>Containment Isolation</u>			
Containment Isolation Valve Position	Indicating Lights	1 pair/valve	Open/Closed
<u>Containment Spray</u>			
Pump Circuit Breaker Position	Indicating Lights	1 pair/pump	Open/Closed
Shutdown Cooling Heat Exchanger Outlet Temperature	Indicator	2	0 - 400 °F
Spray Header Pressure	Indicator	2	0 - 600 psig
Spray Header Isolation Valve Position	Indicating Lights	1 pair/valve	Open/Closed
Spray Header Flow	Indicator	2	0 - 3500 gpm
<u>Containment Conditions</u>			
Hydrogen Concentration	Indicator	2	0 - 10%
	**Recorder	2	0 - 10%
Containment Pressure	Indicator	2	0 - 225 psia
	**Recorder	1	0 - 225 psia
<u>Recirculation</u>			
RWT Isolation Valve Position	Indicating Lights	1 pair/valve	Open/Closed
Containment Recirculation Sump Isolation Valve Position	Indicating Lights	1 pair/valve	Open/Closed
Containment Flood Level	Indicator	2	0 - 144"
	**Recorder	1	0 - 100%

ARKANSAS NUCLEAR ONE
Unit 2

Table 7.5-2 (continued)

<u>Parameter</u>	<u>Type of Readout (Control Room)</u>	<u>Number of Channels</u>	<u>Range</u>
<u>Recirculation (continued)</u>			
Containment Sump Level	Indicator	1	0 - 100% (0-56")
Refueling Water Tank Level	Indicator	4	0 - 100%
	**Recorder	1	0 - 100%
<u>Main Steam Isolation</u>			
Main Steam Isolation Valve Position	Indicating Lights	1 pair/valve	Open/Closed
<u>Safety Injection</u>			
High Pressure Safety Injection Flow	Indicator	4	0 - 350 gpm
High Pressure Safety Injection Pump Discharge Header Pressure	Indicator	2	0 - 2500 psig
Safety Injection Valve Position	Indicating Lights	1 pair/valve	Open/Closed
Safety Injection Tank Level	*Indicator	1/Tank	0 - 100%
	Indicator	2/Tank	72 - 96%
Safety Injection Tank Pressure	Indicator	1/Tank	0 - 700 psig
Safety Injection Tank Pressure	Indicator	2/Tank	500 - 700 psig
Low Pressure Safety Injection Pumps Discharge Pressure	Indicator	1	0 - 600 psig
Safety Injection Header Pressure	Indicator	4	0 - 2500 psig
Low Pressure Safety Injection Pump Discharge Temperature	Recorder	2	0 - 400 °F

*Indicates Post-Accident Monitoring Instrumentation for SIT level.

**Recorder is not qualified.

ARKANSAS NUCLEAR ONE
Unit 2

Table 7.5-3

R.G. 1.97 POST ACCIDENT MONITORING VARIABLES

<u>TYPE CODE</u>	<u>() DENOTES R.G. 1.97 TERMINOLOGY</u>	<u>CATEGORY</u>	<u>RANGE</u>	<u>REDUNDANCY</u>	<u>POWER SUPPLY</u>	<u>CR DISPLAY</u>	<u>SPDS</u>	<u>COMMENTS</u>
<u>TYPE "A" VARIABLES</u>								
A01	RCS Hot Leg Water Temp	1	125 – 625 °F	Yes (2 Channels)	1E	2 Indicators	Yes (1 Channel)	
			150 – 750 °F	Yes (4 Channels- 2/hot leg)	1E	SPDS	Yes	Used as input to "Degrees of Subcooling"
			525 – 675 °F	Yes (4 Channels- 2/hot leg)	1E	2 Indicators	Yes	
			525 – 625 °F	Yes (2 Channels)	1E	1 Dual Pen Recorder	No	
A02	RCS Pressure	1	0 - 3000 psia	Yes (2 Channels)	1E	2 Indicators 1 Recorder	Yes	
A03	Steam Generator Level	1	17.4" above tube sheet to 498.4" above tube sheet	Yes (2 Channels/SG)	1E	2 Dual Indicators (1SG Channel/ Indicator) 1 Dual Pen Recorder (1SG Channel/Pen)	Yes	
A04	Steam Generator Pressure	1	0 - 1200 psia (-15 - 1185 psig)	Yes (2 Channels/SG)	1E	4 Indicators (1/Channel/SG) 1 Dual Pen Recorder (1SG Channel/Pen)	Yes	
A06	Flow in HPSI System	1	0 - 1000 GPM (Design = 900 GPM)	1 Indicator Per Loop	1E	1 Indicator Per Loop	No	Also Available on PMS

ARKANSAS NUCLEAR ONE
Unit 2

Table 7.5-3 (continued)

<u>TYPE CODE</u>	<u>() DENOTES R.G. 1.97 TERMINOLOGY</u>	<u>CATEGORY</u>	<u>RANGE</u>	<u>REDUNDANCY</u>	<u>POWER SUPPLY</u>	<u>CR DISPLAY</u>	<u>SPDS</u>	<u>COMMENTS</u>
<u>TYPE "B" VARIABLES</u>								
<u>Reactivity Control</u>								
B01	Neutron Flux	1	10 ⁻⁸ % to 100% F.P. (Indicators) 1 to 10 ⁶ CPS (Recorder)	Yes (2 Channels)	1E	2 Indicators 1 Recorder	Yes (1 Channel)	
	CEA (Control Rod) Position	3	Full In or Not Full In	N/A	UPS	SPDS	Yes	
	RCS Soluable Boron Conc	3	--	N/A	N/A	N/A	No	See Note 1
	RCS Cold Leg Water Temp	3	150 – 750 °F	4 Channels (1/Cold Leg)	1E/UPS	SPDS	Yes	Used as input to "Degrees of Subcooling"
<u>Core Cooling</u>								
	RCS Hot Leg Water Temp	1	---	---	---	---	---	See previous listing
	RCS Cold Leg Water Temp	3	---	---	---	---	---	See previous listing
	RCS Pressure	1	---	---	---	---	---	See previous listing
	Core Exit Temp	3	---	---	---	---	---	See listing below
B09	Coolant Inventory	1	Fuel Alignment plate to top of Dome	Yes (2 Channels)	1E	CRT (ICC micro processor)	Yes	
B10	Degrees of Subcooling	2	0 – 200 °F	Yes (2 Channels)	1E	2 Indicators 1 Recorder	Yes	

ARKANSAS NUCLEAR ONE
Unit 2

Table 7.5-3 (continued)

<u>TYPE CODE</u>	<u>() DENOTES R.G. 1.97 TERMINOLOGY</u>	<u>CATEGORY</u>	<u>RANGE</u>	<u>REDUNDANCY</u>	<u>POWER SUPPLY</u>	<u>CR DISPLAY</u>	<u>SPDS</u>	<u>COMMENTS</u>
<u>TYPE "B" VARIABLES (continued)</u>								
<u>Maintaining RCS Integrity</u>								
	RCS Pressure	1	---	---	---	---	---	See previous listing.
B12	Containment Sump Water Level (Narrow Range-Sump)	2	0 - 100% (0 - 56")	N/A	1E	1 Indicator	Yes	
B12	Containment Water Level (Wide Range)	1	0 - 100 (0 - 144")%	Yes (2 Channels)	1E	2 Indicators 1 Recorder	Yes	
B13	Containment Pressure	1	0-225 psia (-14.7 – 210.3 psig)	Yes (2 Channels)	1E	2 Indicators 1 Recorder	Yes	
<u>Maintaining Containment Integrity</u>								
B14	Containment Isolation Valve Position	1	Closed/Not Closed	Yes	1E	Lights (2/Valve)	No	See Note 2
	Containment Pressure	1	---	---	---	---	---	See previous listing

ARKANSAS NUCLEAR ONE
Unit 2

Table 7.5-3 (continued)

<u>TYPE CODE</u>	<u>() DENOTES R.G. 1.97 TERMINOLOGY</u>	<u>CATEGORY</u>	<u>RANGE</u>	<u>REDUNDANCY</u>	<u>POWER SUPPLY</u>	<u>CR DISPLAY</u>	<u>SPDS</u>	<u>COMMENTS</u>
<u>TYPE "C" VARIABLES</u>								
<u>Fuel Cladding</u>								
C01	Core Exit Temp	1	0 – 2300 °F	Yes (2 Channels)	1E	CRT (ICC Microprocessor)	Yes	
	Radioactivity Concentration or Radiation Level in Circulating Primary Coolant	3	10 ⁻⁴ uCi/gm to 10 Ci/gm	N/A	OP	N/A	No	See Note 1
	Analysis of Primary Coolant (Gamma Spectrum)	3	10 ⁻⁴ uCi/ml to 10 Ci/ml	N/A	OP	N/A	No	See Note 1
<u>Reactor Coolant Pressure Boundary</u>								
	RCS Pressure	1	---	---	---	---	---	See previous listing.
	Containment Pressure	1	---	---	---	---	---	See previous listing
	Containment Sump Water	---	---	---	---	---	---	See previous listing
	Level - Narrow Range	2						
	Wide Range	1						
	Containment Area Radiation Monitors	3	---	---	---	---	---	See listing Type "E"
C08	Effluent Radioactivity Noble Gas Effluent from Condenser Air Removal System Exhaust	3	10 ⁻⁶ uCi/cc to 10 ⁻² uCi/cc based on Kr-85	N/A	DG	1 Indicator 1 Recorder	Yes	

ARKANSAS NUCLEAR ONE
Unit 2

Table 7.5-3 (continued)

<u>TYPE CODE</u>	<u>() DENOTES R.G. TERMINOLOGY</u>	<u>CATEGORY</u>	<u>RANGE</u>	<u>REDUNDANCY</u>	<u>POWER SUPPLY</u>	<u>CR DISPLAY</u>	<u>SPDS</u>	<u>COMMENTS</u>
<u>TYPE "C" VARIABLES (continued)</u>								
<u>Containment</u>								
	RCS Pressure	1	---	---	---	---	---	See previous listing
C10	Containment Hydrogen Concentration	3	0 – 10% Vol.	Yes (2 Channels)	1E	2 Indicators 1 Recorder	Yes	See Note 3
	RCS Pressure	1	---	---	---	---	---	See previous listing.
	Containment Pressure	1	---	---	---	---	---	See previous listing
C12	Containment Effluent Radio activity-Noble Gases from Identified Release Points	2	1.0E ⁻⁶ uCi/cc to 1.0E ⁵ uCi/cc 0-110% Vent Design Flow	N/A	OP	CRT (RDACS Computer)	No	
C14	Effluent Radioactivity Noble Gases from Bldgs	2	1.0E ⁻⁶ uCi/cc to 1.0E ⁵ uCi/cc 0-110% Vent Design Flow	N/A	OP	CRT (RDACS Computer)	No	
<u>TYPE "D" VARIABLES</u>								
<u>Residual Heat Removal (RHR) or Decay Heat Removal System</u>								
	SDC System Flow (RHR System Flow)	2	0 - 8000 GPM (Design = 3100 GPM)					See "LPI Flow" (Type Code D07) and "Containment Spray Flow" (D22)
D02	SDC Heat Exchanger (RHR Heat Exchanger) Outlet Temp	2	0 – 400 °F	N/A	DG	2 Indicators (1/Containment Spray Line)	Yes	

ARKANSAS NUCLEAR ONE
Unit 2

Table 7.5-3 (continued)

<u>TYPE CODE</u>	<u>() DENOTES R.G. 1.97 TERMINOLOGY</u>	<u>CATEGORY</u>	<u>RANGE</u>	<u>REDUNDANCY</u>	<u>POWER SUPPLY</u>	<u>CR DISPLAY</u>	<u>SPDS</u>	<u>COMMENTS</u>
<u>TYPE "D" VARIABLES (continued)</u>								
<u>Safety Injection Systems</u>								
D03		3	8.75% - 91.25% (Bottom to Top)	N/A	DG	4 Indicators (1/Tank)	Yes	
D03		3	0 - 700 psig	N/A	DG	4 Indicators (1/Tank)	Yes	
D04		2	Closed/ Not Closed	N/A	1E	8 Lights (2/Valve)	No	
D05		2	0 - 150 GPM (Design = 132 GPM)	N/A	DG	1 Indicator	Yes	
D07		2	0 - 8000 GPM (Design = 5700 GPM)	N/A	DG	1 Indicator	Yes	
D08		1	5.25 - 94.75% (Bottom to Top)	Yes (4 Channels)	1E	4 Indicators 1 Recorder	Yes	See Note 7
<u>Primary Coolant System</u>								
D09		3	0 - 600 amps	N/A	OP	4 Meters (1/Pump)	Yes	
D10		2	Closed/ Not Closed	N/A	DG	2 Indicators (1/Safety Valve)	Yes	

ARKANSAS NUCLEAR ONE
Unit 2

Table 7.5-3 (continued)

<u>TYPE CODE</u>	<u>() DENOTES R.G. 1.97 TERMINOLOGY</u>	<u>CATEGORY</u>	<u>RANGE</u>	<u>REDUNDANCY</u>	<u>POWER SUPPLY</u>	<u>CR DISPLAY</u>	<u>SPDS</u>	<u>COMMENTS</u>
<u>TYPE "D" VARIABLES (continued)</u>								
<u>Primary Coolant System (continued)</u>								
D11	Pressurizer Level	1	3% - 95% (Top to Bottom)	Yes (2 Channels)*	1E	2 Indicators	Yes	Temperature input for compensation is provided from one (1) dual element RTD
D12	Pressurizer Heater Status	2	Power (watts)	N/A	DG	SPDS	Yes	
D13	Quench Tank Level	3	5 - 95% (Top to Bottom)	N/A	DG	1 Indicator	Yes	
D14	Quench Tank Temperature	3	0 – 300 °F	N/A	DG	1 Indicator	Yes	
D15	Quench Tank Pressure	3	0 - 100 psig Design = 100 psig	N/A	DG	1 Indicator	Yes	
<u>Secondary System (Steam Generator)</u>								
	Steam Generator Level	1	---	---	---	---	---	See previous listing
	Steam Generator Pressure	2	---	---	---	---	---	See previous listing
D18	Safety/Relief Valve Positions	2	Closed/ Not Closed	N/A	DG	2 Lights/ Valve	Yes	
D19	Main Feedwater Flow	3	0 - 7.6 X 10 ⁶ lb/hr (0 - 110% Design)	N/A	DG	2 Dual Pen Recorders (1 Pen/Recorder/MF Pump)	Yes	

ARKANSAS NUCLEAR ONE
Unit 2

Table 7.5-3 (continued)

<u>TYPE CODE</u>	<u>() DENOTES R.G. 1.97 TERMINOLOGY</u>	<u>CATEGORY</u>	<u>RANGE</u>	<u>REDUNDANCY</u>	<u>POWER SUPPLY</u>	<u>CR DISPLAY</u>	<u>SPDS</u>	<u>COMMENTS</u>
<u>TYPE "D" VARIABLES (continued)</u>								
<u>Auxiliary Feedwater or Emergency Feedwater System</u>								
D20	Emergency Feedwater (Auxiliary Feedwater) Flow	1	0 - 750 GPM (Design = 575 GPM)	Yes (4 Channels) (1/Leg)	1E	4 Indicators (1/Channel)	Yes	
D21	Condensate Storage Tank Level	3	0 - 100%	N/A	1E	1 Indicator 1 Recorder	Yes	CST T41B
<u>Containment Cooling Systems</u>								
D22	Containment Spray Flow	2	0 - 3500 GPM (Design = 2200 GPM)	N/A	DG	2 Indicators 1/Containment Spray Line)	Yes	
D23	Heat Removal by CCS (the Containment Fan Heat Removal System)	3	On - Off	N/A	1E	8 Lights (2/Fan Breaker)	No	RB Cooling Fan Bkr. Status
D24	Containment Atmosphere Temp.	3	0 - 350 °F	N/A	OP/UPS	SPDS	Yes	
<u>Chemical and Volume Control System</u>								
	Makeup Flow-In	2						See previous listing "Boric Acid Charging Flow"
D27	Letdown Flow-Out	2	0 - 150 GPM (Design = 132 GPM)	N/A	DG	1 Indicator	Yes	
D28	Volume Control Tank (Makeup Tank) Level	2	Top to Bottom	N/A	DG	1 Indicator	Yes	

ARKANSAS NUCLEAR ONE
Unit 2

Table 7.5-3 (continued)

<u>TYPE CODE</u>	<u>() DENOTES R.G. 1.97 TERMINOLOGY</u>	<u>CATEGORY</u>	<u>RANGE</u>	<u>REDUNDANCY</u>	<u>POWER SUPPLY</u>	<u>CR DISPLAY</u>	<u>SPDS</u>	<u>COMMENTS</u>
<u>TYPE "D" VARIABLES (continued)</u>								
<u>Cooling Water System</u>								
D30	Service Water (Component Cooling Water) Flow to ESF System	2	0 - 200 psig	N/A	1E	2 Indicators	No	Service Water Header Pressure
			Closed/ Not Closed	N/A	1E	2 Lights/Valve	No	Service Water Valve Position
<u>Radwaste Systems</u>								
D31	High Level Radioactive Liquid Tank Level	3	13.3 - 86.7% (Top to Bottom)	N/A	DG	4 Indicators (1/Tank)	No	
<u>Ventilation Systems</u>								
D33	Emergency Ventilation Damper Position	2	Closed/ Not Closed	N/A	DG	2 Lights	No	1/Both CR. Isol Redundant Dampers
			Not Closed	N/A	DG	1 Annunciator	No	Both Unit 1 CR Isol Redundant Dampers
			Open/Close	N/A	1E	2 Lights	No	Outside Air Damper For VSF-9 (CV-7910)
			Open/Not Open	N/A	1E	Annunciator	No	Outside Air Damper Unit 2 EDGS
			Open/Not Open	N/A	DG	2 Lights	No	1/ea Intake structure damper
			Flow/No Flow	N/A	DG	1 Annunciator	No	1/ea Intake structure Damper, valve position

ARKANSAS NUCLEAR ONE
Unit 2

Table 7.5-3 (continued)

<u>TYPE CODE</u>	<u>() DENOTES R.G. 1.97 TERMINOLOGY</u>	<u>CATEGORY</u>	<u>RANGE</u>	<u>REDUNDANCY</u>	<u>POWER SUPPLY</u>	<u>CR DISPLAY</u>	<u>SPDS</u>	<u>COMMENTS</u>
<u>TYPE "D" VARIABLES (continued)</u>								
<u>Power Supplies</u>								
D34	Status of Standby Power and Other Energy Sources Important to Safety	2	Voltages; Breaker position; etc.	N/A	Various	SPDS	Yes	
<u>TYPE "E" VARIABLES</u>								
E01	Containment Area Radiation-High Range	1	1R/hr to 10 ⁸ R/Hr Gamma	Yes	1E	2 Indicators 1 Recorder	Yes	
<u>Area Radiation</u>								
E02	Radiation Exposure Rate (inside bldgs. or areas where access is required to service equipment important to safety)	3	10 ⁻² R/hr to 10 ⁺³ R/hr; 10 ⁻⁴ R/hr to 10 ⁺¹ R/hr	N/A	DG	23 Indicators 1 Recorder	Yes	
<u>Airborne Radioactive Materials Released From Plant</u>								
	Containment or purge effluent	3	---	---	---	---	---	See Previous listing
	Auxiliary Bldg. (including any bldg. containing primary system gases, e.g., waste gas decay tank)	3	---	---	---	---	---	See Previous listing
	Condenser Air Removal System Exhaust	2	1.1E ⁻⁷ uCi/cc to 1.3E ⁵ uCi/cc 0-110% Vent Design Flow	N/A	OP	CRT (RDACS Computer)	No	

ARKANSAS NUCLEAR ONE
Unit 2

Table 7.5-3 (continued)

<u>TYPE CODE</u>	<u>() DENOTES R.G. 1.97 TERMINOLOGY</u>	<u>CATEGORY</u>	<u>RANGE</u>	<u>REDUNDANCY</u>	<u>POWER SUPPLY</u>	<u>CR DISPLAY</u>	<u>SPDS</u>	<u>COMMENTS</u>
<u>TYPE "E" VARIABLES (continued)</u>								
<u>Airborne Radioactive Materials Released From Plant (continued)</u>								
	Common Plant Vent Discharging Any of the Above Release (if containment purge is included)	2	1.0E ⁻⁶ uCi/cc to 1.0E ⁵ uCi/cc 0-110% Vent Design Flow	N/A	OP	CRT (RDACS Computer)	No	
E08	Vent from Steam Generator Safety Relief Valves or Atmospheric Dump Valves	2	.066 uCi/cc to 6.55E ³ uCi/cc (Xe-133 D.E.)	N/A	1E	2 Indicators	Yes	
<u>Particulates and Halogens</u>								
	All identified plant release points (except steam generator safety relief valves or atmospheric steam dump valves and condenser air removal system exhaust).	3	10 ⁻³ uCi/cc to 10 ² uCi/cc 0-110% vent Design flow	N/A	OP	CRT (RDACS Computer)	No	See Note 4
<u>Environs Radiation and Radioactivity</u>								
	Airborne Radiohalogens and Particulates	3	10 ⁻⁹ uCi/cc to 10 ⁻³ uCi/cc	N/A	N/A	N/A	N/A	Portable sampling
	Plant and Environs Radiation	3	10E ⁻³ R/hr to 10E ³ R/hr Photons; 10 ⁻³ RADS/hr to 50 RADS/hr	N/A	N/A	N/A	N/A	Portable Instrumentation
	Plant and Environs Radioactivity	3	Isotopic Analysis	N/A	N/A	N/A	N/A	See Note 5

ARKANSAS NUCLEAR ONE
Unit 2

Table 7.5-3 (continued)

<u>TYPE CODE</u>	<u>() DENOTES R.G. 1.97 TERMINOLOGY</u>	<u>CATEGORY</u>	<u>RANGE</u>	<u>REDUNDANCY</u>	<u>POWER SUPPLY</u>	<u>CR DISPLAY</u>	<u>SPDS</u>	<u>COMMENTS</u>
<u>TYPE "E" VARIABLES (continued)</u>								
<u>Meteorology</u>								
		3	0 - 360° ± ½% full scale starting speed .75 mph; damping ratio - .6; distance constant - 1m	N/A	OP	CRT (RDACS Computer)	No	Instruments have Unit 1 Numbers
			0 - 100 mph accuracy greater of ± 1% or ± 0.15 mph starting threshold 0.6 mph distance constant 5 ft	N/A	OP	CRT (RDACS Computer)	No	Instruments have Unit 1 Numbers
		3	-3 to 5 °C Temp Difference; 0 - 40° - Wind Direction sigma	N/A	OP	CRT (RDACS Computer)	No	Instruments have Unit 1 Numbers
<u>Accident Sampling Capability (Analysis Capability on Site)</u>								
		3	---	N/A	N/A	N/A	N/A	See Note 1
			Gross Activity 1 uCi/ml to 10 Ci/ml					
			Gamma Spectrum (isotopic analysis)					
			Boron Concentration 0 - 6000 PPM					

ARKANSAS NUCLEAR ONE
Unit 2

Table 7.5-3 (continued)

<u>TYPE CODE</u>	() DENOTES R.G. <u>1.97 TERMINOLOGY</u>	<u>CATEGORY</u>	<u>RANGE</u>	<u>REDUNDANCY</u>	<u>POWER SUPPLY</u>	<u>CR DISPLAY</u>	<u>SPDS</u>	<u>COMMENTS</u>
<u>TYPE "E" VARIABLES (continued)</u>								
<u>Accident Sampling Capability (Analysis Capability on Site) (continued)</u>								
	Chloride content							
	Dissolved hydrogen or Total Gas							
	Dissolved Oxygen							
	pH 1-13 (Analysis Capability Offsite, 0CAN119101)							
	Containment Air Grab Sample	3	--	N/A	N/A	N/A	N/A	See Note 1
	Hydrogen Content 0-10% Vol							
	Oxygen Content							
	Gamma Spectrum ⁵ (Isotopic Analysis)							

ARKANSAS NUCLEAR ONE
Unit 2

Table 7.5-3 (continued)

R.G. 1.97 POST ACCIDENT MONITORING VARIABLES

- NOTE 1: Parameter not required during events involving > 5% clad failure. Relief from maintaining a post accident sampling system (PASS) was obtained in ANO-2 Technical Specification Amendment 218 (2CNA080005). As part of the relief approval, RG 1.97 and NUREG 0737 requirements concerning PASS capability are no longer applicable. However, sampling capability must continue to be maintained for those fuel accident events involving \leq 5% clad failure. This capability exists via non-PASS sampling locations and systems. Contingency plans must also be maintained to support RCS and containment atmosphere sampling efforts under post-accident conditions, assuming sample location dose rates are such that samples can be safely obtained and analyzed. These contingency plans are contained within various Emergency Plan, Chemistry, Radiological, and Operating procedures, including the Severe Accident Management Guidelines. It should be noted, however, that sampling intended to support fuel damage assessment is no longer required for RCS chlorides, RCS oxygen, RCS dissolved hydrogen (total gas), or containment atmosphere oxygen content.
- NOTE 2: Containment building isolation valves listed in Table 6.2-26 of the ANO-2 SAR were evaluated. This evaluation excluded check valves, locked closed manual valves which are part of a passive boundary and valves which are locked closed and administratively controlled shut. Redundancy is satisfied by GDC 55, 56, or 57.
- NOTE 3: Category 3 instrument for beyond design basis accidents only (reference October 2003 revision to 10 CFR 50.44, ANO Commitment #17975)
- NOTE 4: Each Super Particulate Iodine Noble Gas (SPING) monitor which inputs to the Radiological Dose Assessment Computer System has the capability to measure halogen and particulate activity as it is accumulated on a sample media. The SPING microcomputer then calculates the gross radiohalogen and particulate sample concentration based on the rate of increase of activity on the filter media. If necessary to further define the analysis or to extend the range, an isotopic analysis of the filter media can be performed by plant radiochemistry personnel.
- NOTE 5: DELETED
- NOTE 6: DELETED
- NOTE 7: Only two of the four indicators are fully Reg. Guide 1.97 qualified devices.

ARKANSAS NUCLEAR ONE
Unit 2

Table 7.7-1

COLSS MONITORED PLANT VARIABLES

<u>Monitored Parameters</u>	<u>COLSS Sensors</u>	<u>Numbers of Sensors</u>	<u>Sensor Range</u>
Core Volumetric Flow	RCP Rotational Speed	2 per pump	0 - 1000 rpm
	RCP Differential Pressure	2 per pump	0 - 130 psid
Core Power			
Primary Calorimetric	Cold Leg Temperature	1 per cold leg	465 – 615 °F
	Hot Leg Temperature	1 per hot leg	525 – 675 °F
Secondary Calorimetric	Feedwater Flow*	2 per generator	0 – 7.6 X 10 ⁶ lbm
	Steam Flow*	2 per generator	0 – 7.6 X 10 ⁶ lbm
	Feedwater Pressure	1 per generator	0 - 3000 psig
	Feedwater Temperature	2 per generator	0 – 550 °F
	Blowdown Flow	1 per generator	0 – 300 gpm
	S/G Pressure	4 per generator	0 – 1200 psia
Core Power Distribution	In-Core Monitoring System	42 In-Core assemblies each containing 5 axially stacked detectors	0 - 10 ¹⁴ nv
	CEA Position	1 per CEA	0 - 150 inches
Reactor Coolant Pressure	Pressurizer Pressure	2 (on pressurizer)	1500-2500 psia
Turbine Power	Turbine First Stage Pressure	2 (on Turbine)	0 - 800 psia

* For feedwater flow-based secondary calorimetric, steam flow is a derived input parameter based on feedwater and blowdown flow rates. For steam flow-based secondary calorimetric, feedwater flow is a derived input parameter based on steam and blowdown flow rates.

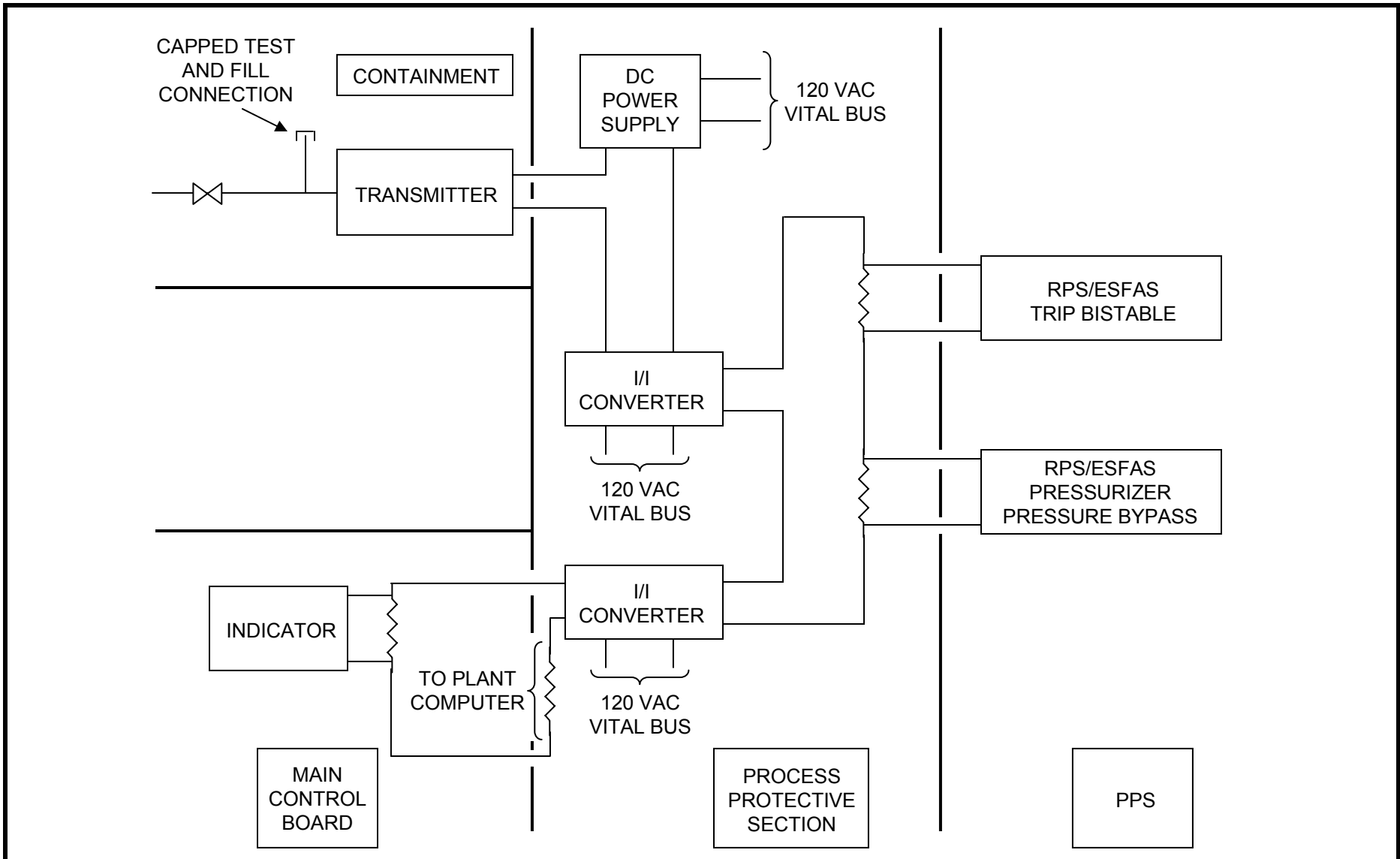

TYPICAL MEASUREMENT CHANNEL FUNCTIONAL DIAGRAM
(PRESSURIZER PRESSURE) WIDE RANGE

SAR FIGURE NO. 7.2-1

ARKANSAS NUCLEAR ONE
UNIT 2
RUSSELLVILLE, ARKANSAS



SCALE: NONE
DRAWN: ENTERGY
DESIGN: ENTERGY
CAD NO:

AMENDMENT 20

BASED ON DRAWING NO	SHEET	REV.

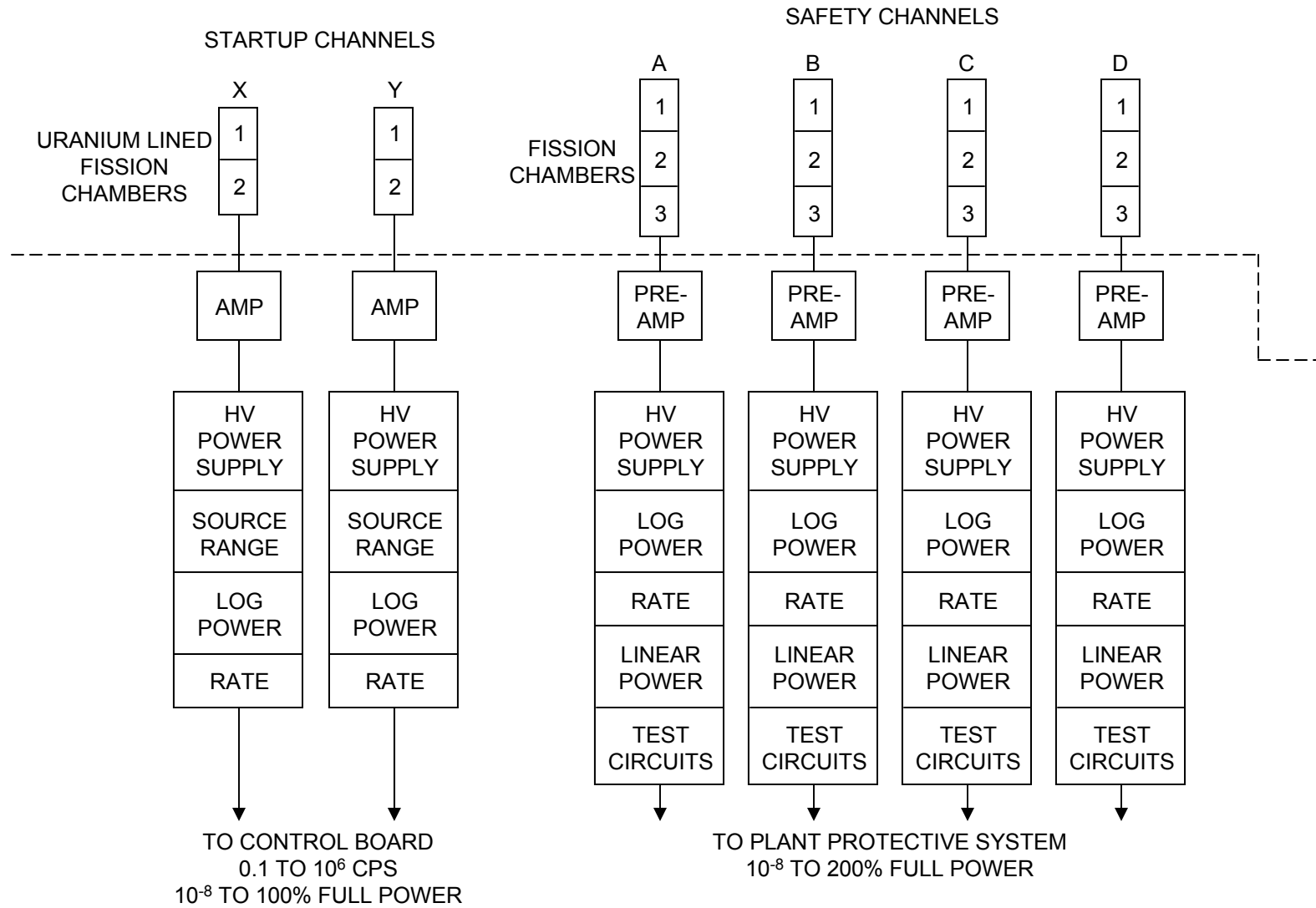

EXCORE NEUTRON FLUX MONITORING SYSTEM

SAR FIGURE NO. 7.2-2

ARKANSAS NUCLEAR ONE
 UNIT 2
 RUSSELLVILLE, ARKANSAS



SCALE: NONE
 DRAWN: ENTERGY
 DESIGN: ENTERGY
 CAD NO:

AMENDMENT 20

BASED ON DRAWING NO

SHEET

REV.

DELETED

SAR FIGURE NO. 7.2-3

AMENDMENT 20

ARKANSAS NUCLEAR ONE
UNIT 2
RUSSELLVILLE, ARKANSAS



SCALE:	NONE
DRAWN:	ENERGY
DESIGN:	ENERGY
CAD NO:	N/A

CORE PROTECTION CALCULATOR SYSTEM
BLOCK DIAGRAM

DRAWING NO

SHEET

REV.

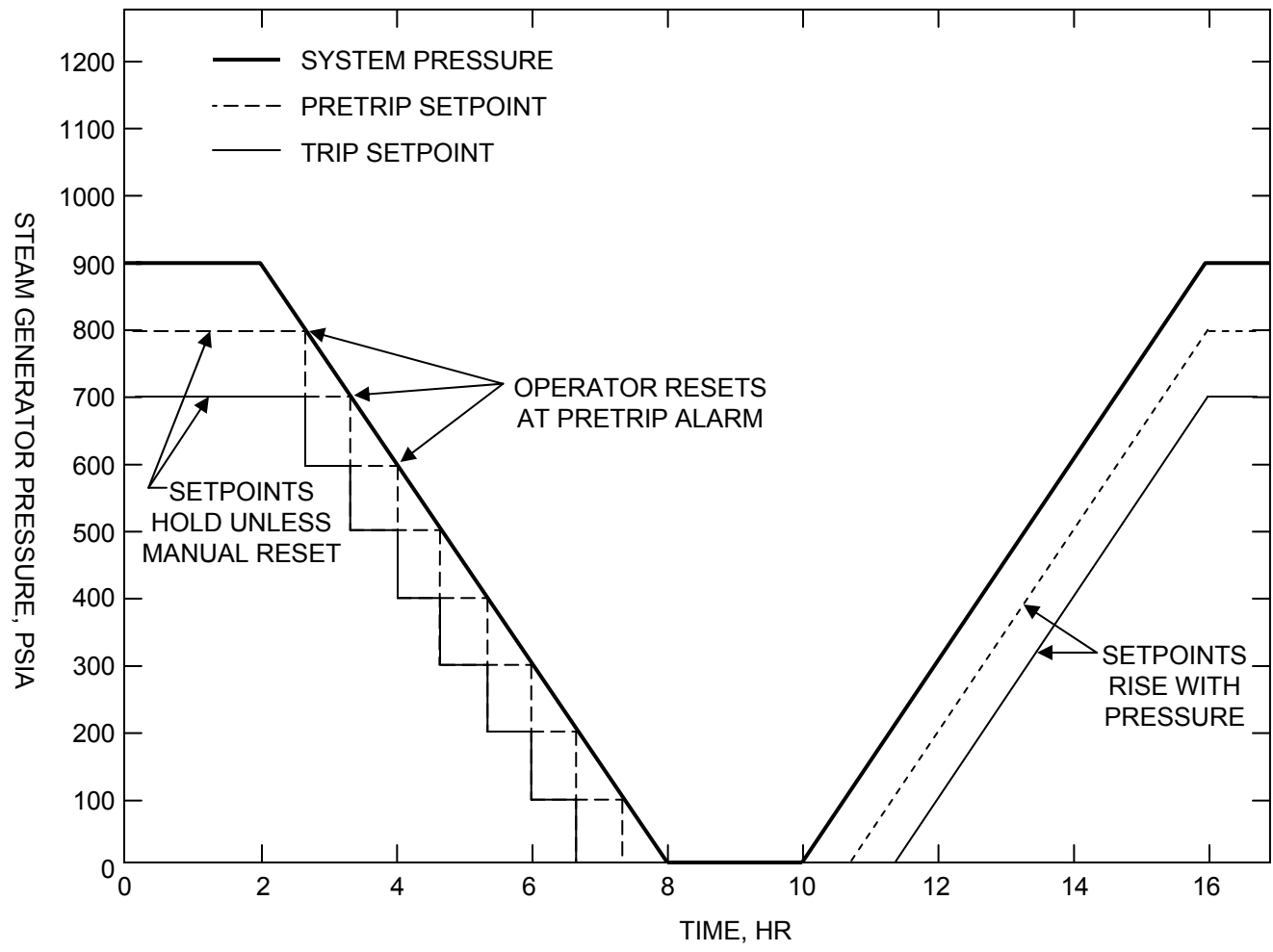

TYPICAL VARIABLE SETPOINT OPERATION

SAR FIGURE NO. 7.2-4

ARKANSAS NUCLEAR ONE
 UNIT 2
 RUSSELLVILLE, ARKANSAS



SCALE: NONE
 DRAWN: ENTERGY
 DESIGN: ENTERGY
 CAD NO:

AMENDMENT 20

BASED ON DRAWING NO

SHEET

REV.

Figures 7.2-5 – 7.2-12 Deleted

SAR FIGURE NOs. 7.2-5 – 7.2-12

AMENDMENT 20

ARKANSAS NUCLEAR ONE
UNIT 2
RUSSELLVILLE, ARKANSAS



SCALE:	NONE
DRAWN:	ENERGY
DESIGN:	ENERGY
CAD NO:	N/A

DRAWING NO

SHEET

REV.

DEPTH 7 1/4"

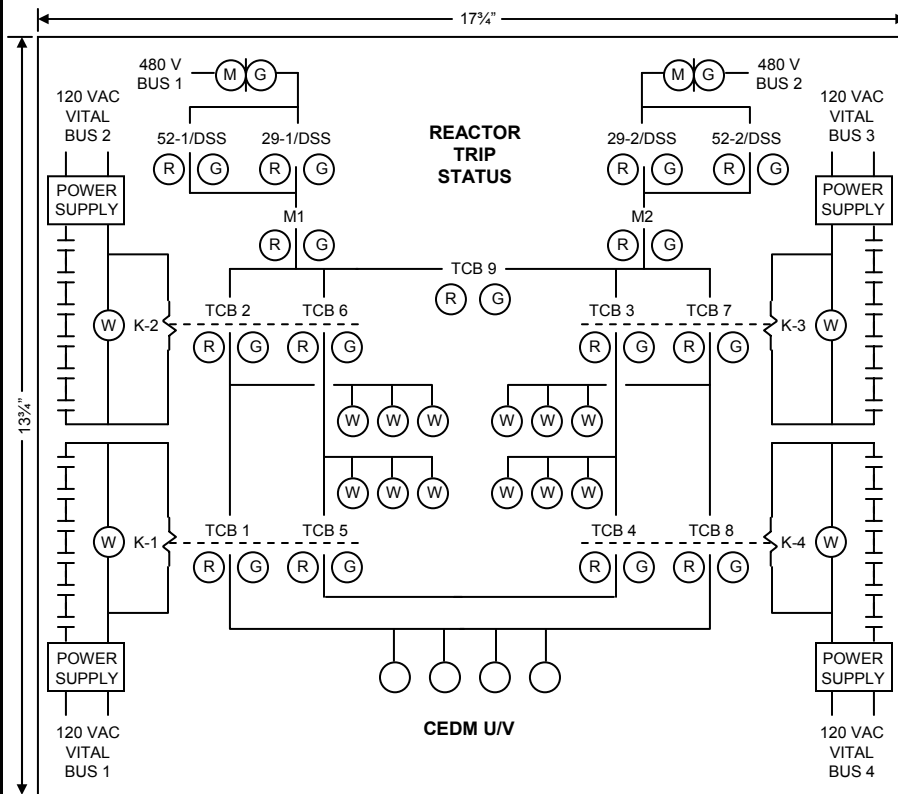

**PLANT PROTECTION SYSTEM
REMOTE REACTOR TRIP
STATUS PANEL**

CHANNEL A

REACTOR PROTECTION

HI LIN	HI LOG	HI LOCAL	LOW	HI PZR	LO PZR	LO SG-1	LO SG-2
POWER	POWER	POWER	DNBR	PRESS	PRESS	LVL	LVL
P	T						
BYPASS							

HI SG-1	HI SG-2	LO SG-1	LO SG-2	HI CONT	LAMP TEST	
LEVEL	LEVEL	PRESS	PRESS	PRESS	TEST	RESET

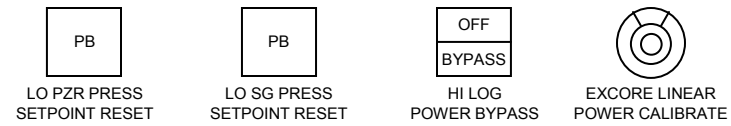

ENGINEERED SAFETY FEATURES

HI CONT	HH CONT	LO RWT	HI SG-1	HI SG-2
PRESS	PRESS	LVL	ΔP	ΔP
P	T			
BYPASS				

NO. 1 TRIP PATHS

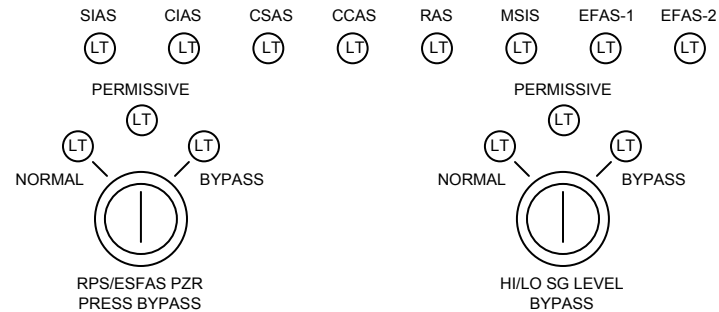

DEPTH 13 1/4"

**PLANT PROTECTION SYSTEM
REMOTE CONTROL MODULES
(TYP OF 4 CHANNELS)**

PLANT PROTECTION SYSTEM REMOTE CONTROL MODULE LAYOUTS

SAR FIGURE NO. 7.2-13

ARKANSAS NUCLEAR ONE
UNIT 2
RUSSELLVILLE, ARKANSAS



SCALE: NONE
DRAWN: ENTERGY
DESIGN: ENTERGY
CAD NO:

AMENDMENT 20

BASED ON DRAWING NO	SHEET	REV.
---------------------	-------	------

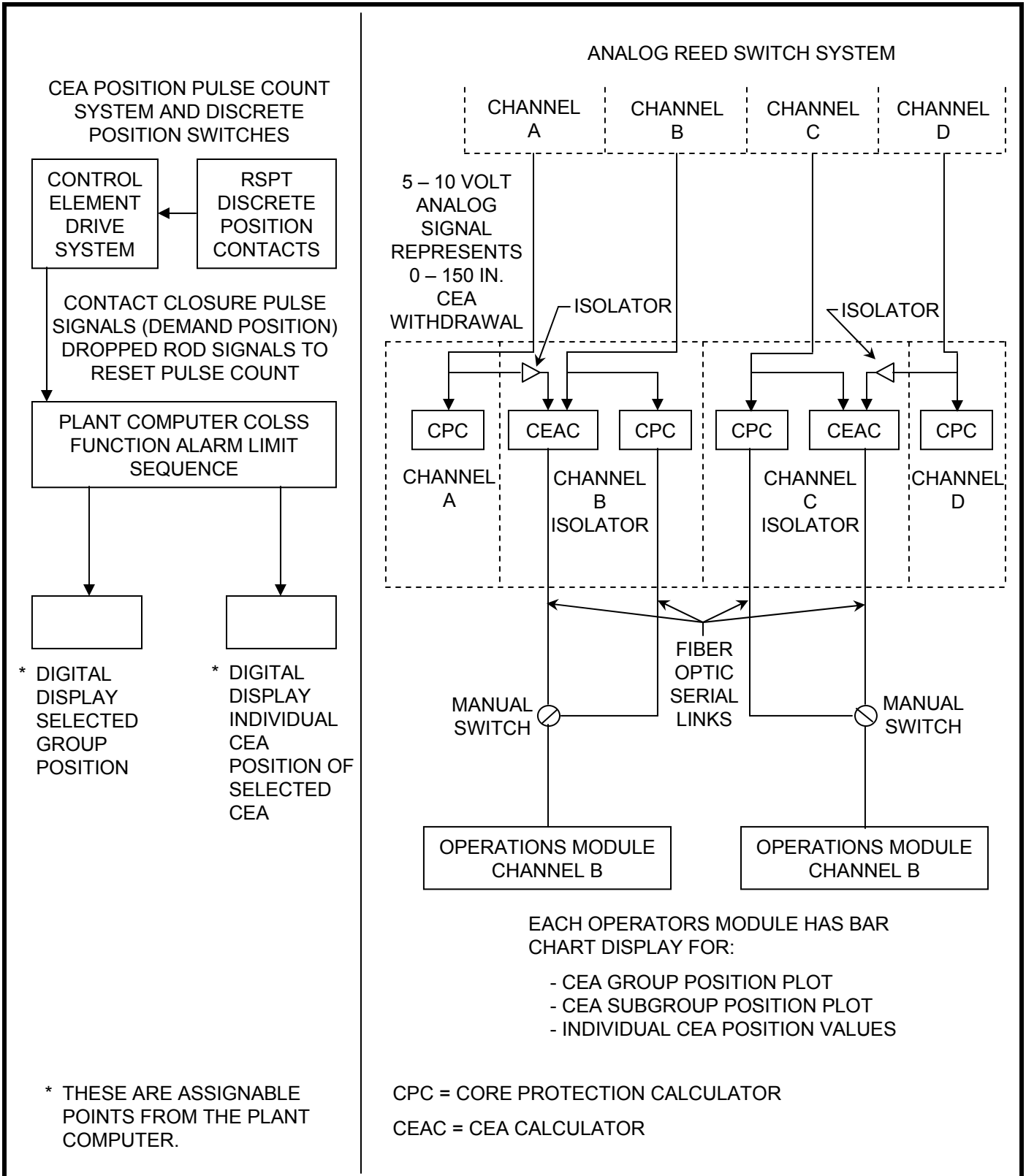

SAR FIGURE NO. 7.2-14

AMENDMENT 19

ARKANSAS NUCLEAR ONE
UNIT 2
RUSSELLVILLE, ARKANSAS



SCALE:	NONE
DRAWN:	ENERGY
DESIGN:	ENERGY
CAD NO:	N/A

CEA POSITION SYSTEMS BLOCK DIAGRAM

DRAWING NO

SHEET

REV.

Figures 7.2-15 – 7.2-25 Deleted

SAR FIGURE NOS. 7.2-15 – 7.2-25

AMENDMENT 20

ARKANSAS NUCLEAR ONE
UNIT 2
RUSSELLVILLE, ARKANSAS



SCALE:	NONE
DRAWN:	ENERGY
DESIGN:	ENERGY
CAD NO:	N/A

DRAWING NO

SHEET

REV.

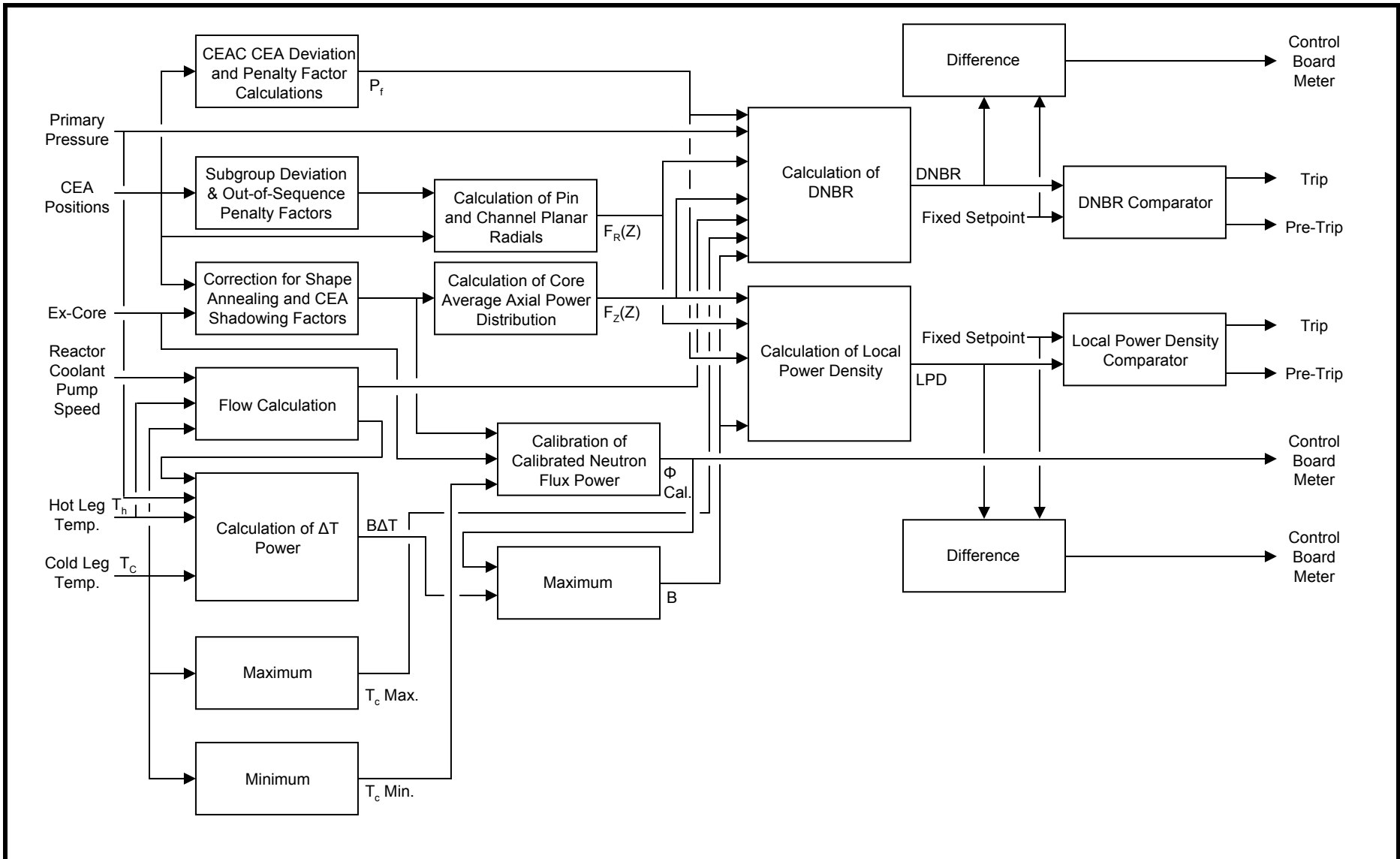

CORE PROTECTION CALCULATOR FUNCTIONAL BLOCK DIAGRAM

SAR FIGURE NO. 7.2-26

ARKANSAS NUCLEAR ONE
 UNIT 2
 RUSSELLVILLE, ARKANSAS



SCALE: NONE
 DRAWN: ENTERGY
 DESIGN: ENTERGY
 CAD NO:

AMENDMENT 20

BASED ON DRAWING NO	SHEET	REV.
---------------------	-------	------

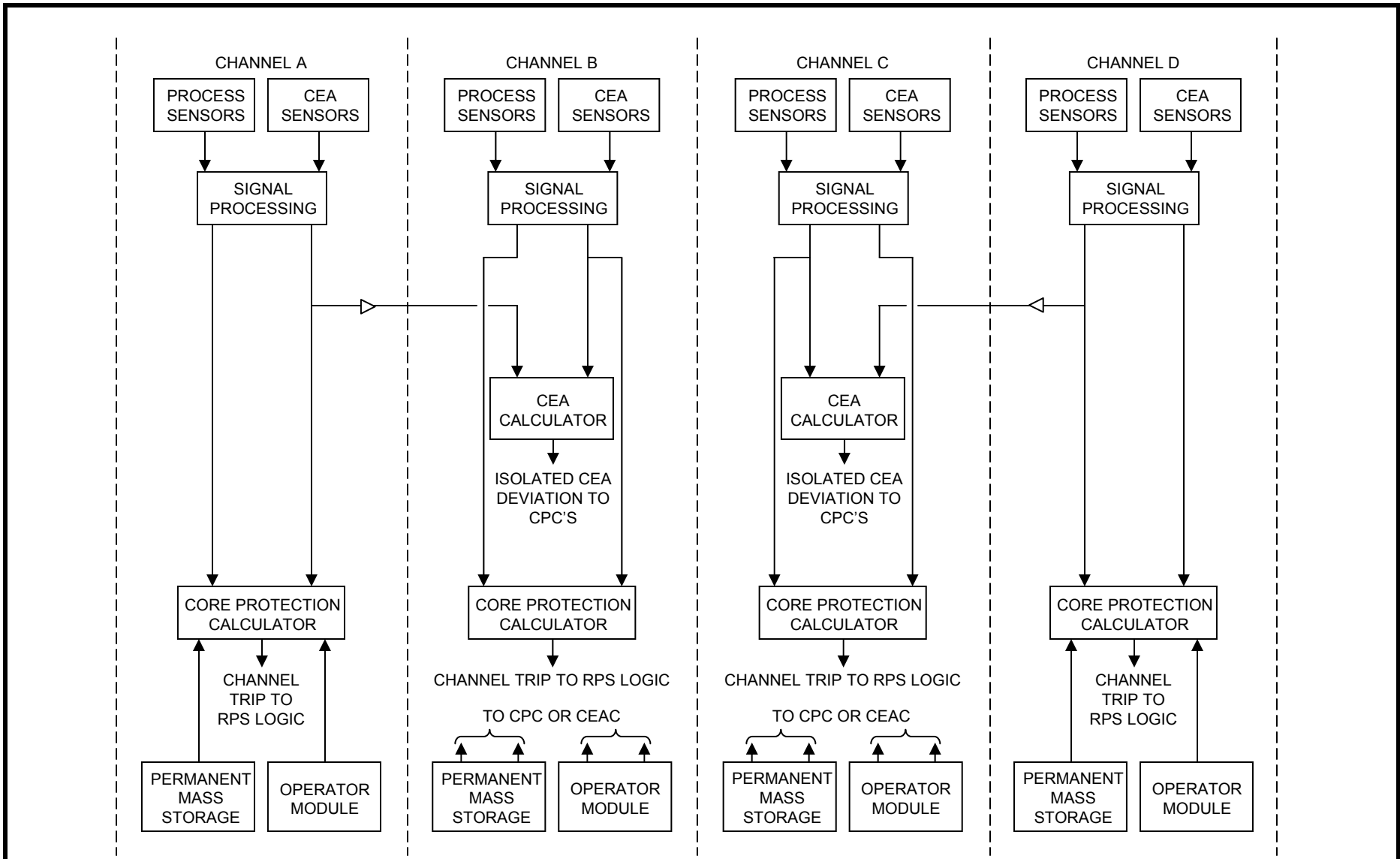

SYSTEM CONFIGURATION

SAR FIGURE NO. 7.2-27

ARKANSAS NUCLEAR ONE
 UNIT 2
 RUSSELLVILLE, ARKANSAS



SCALE:	NONE
DRAWN:	ENERGY
DESIGN:	ENERGY
CAD NO:	

AMENDMENT 20		
BASED ON DRAWING NO	SHEET	REV.

Figures 7.2-28 – 7.2-31 Deleted

SAR FIGURE NOS. 7.2-28 – 7.2-31

AMENDMENT 20

ARKANSAS NUCLEAR ONE
UNIT 2
RUSSELLVILLE, ARKANSAS



SCALE:	NONE
DRAWN:	ENERGY
DESIGN:	ENERGY
CAD NO:	N/A

DRAWING NO

SHEET

REV.

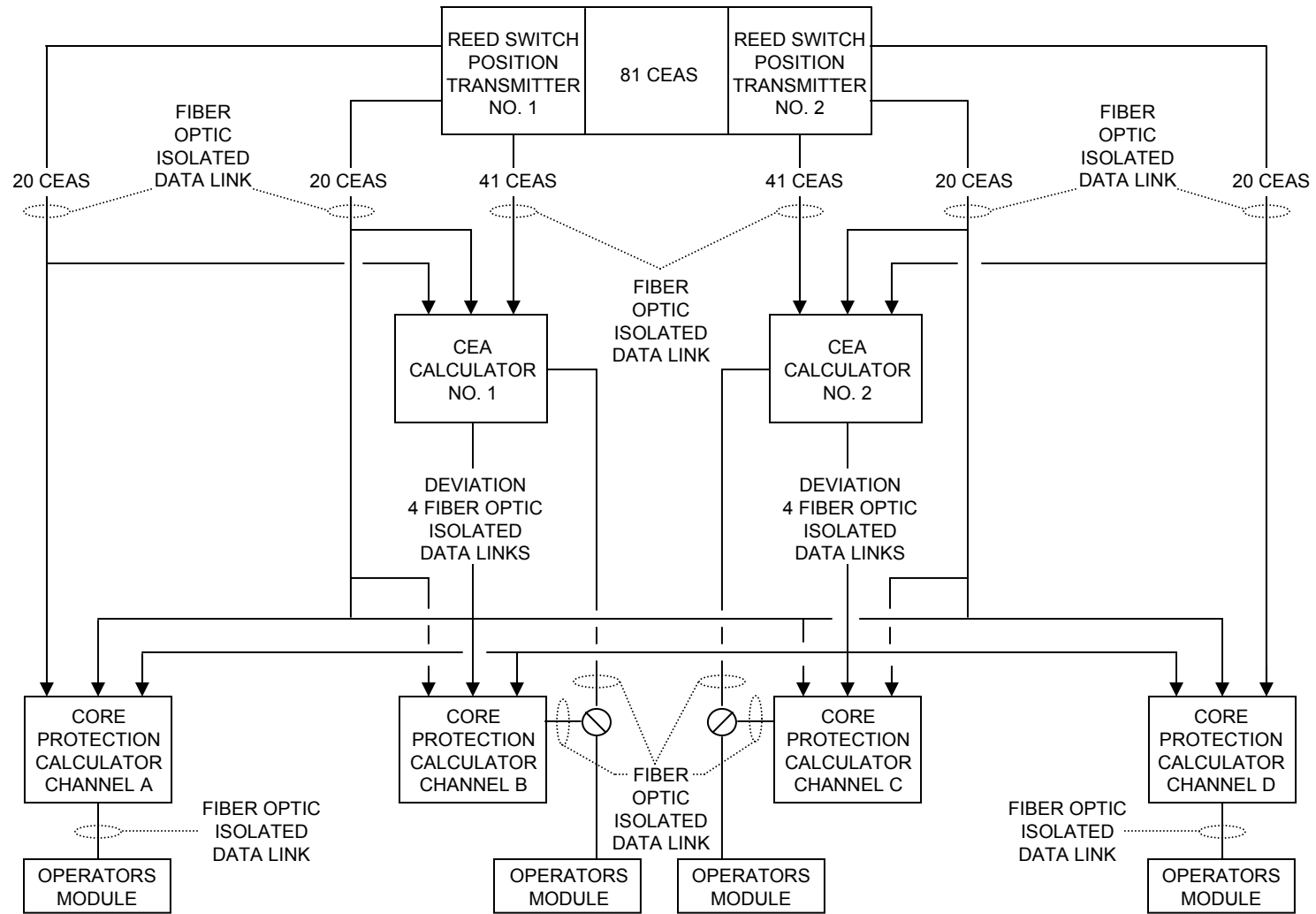

CORE PROTECTION CALCULATOR SYSTEM CEA CALCULATORS

SAR FIGURE NO. 7.2-32

ARKANSAS NUCLEAR ONE
 UNIT 2
 RUSSELLVILLE, ARKANSAS



SCALE: NONE
 DRAWN: ENTERGY
 DESIGN: ENTERGY
 CAD NO:

AMENDMENT 20

BASED ON DRAWING NO	SHEET	REV.
---------------------	-------	------

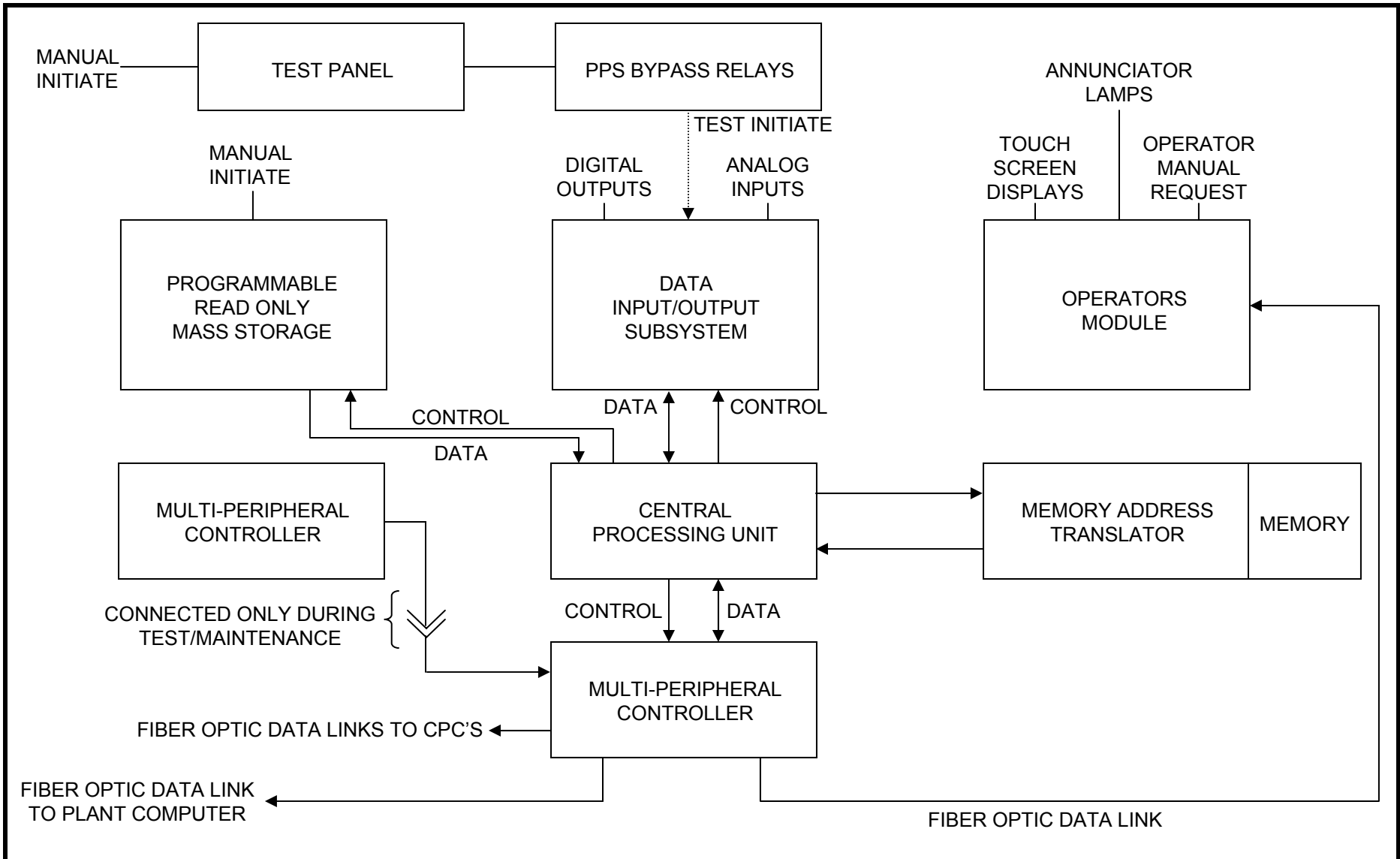

CEA CALCULATOR BLOCK DIAGRAM

SAR FIGURE NO. 7.2-33

ARKANSAS NUCLEAR ONE
 UNIT 2
 RUSSELLVILLE, ARKANSAS



SCALE: NONE
 DRAWN: ENTERGY
 DESIGN: ENTERGY
 CAD NO:

AMENDMENT 20

BASED ON DRAWING NO

SHEET

REV.

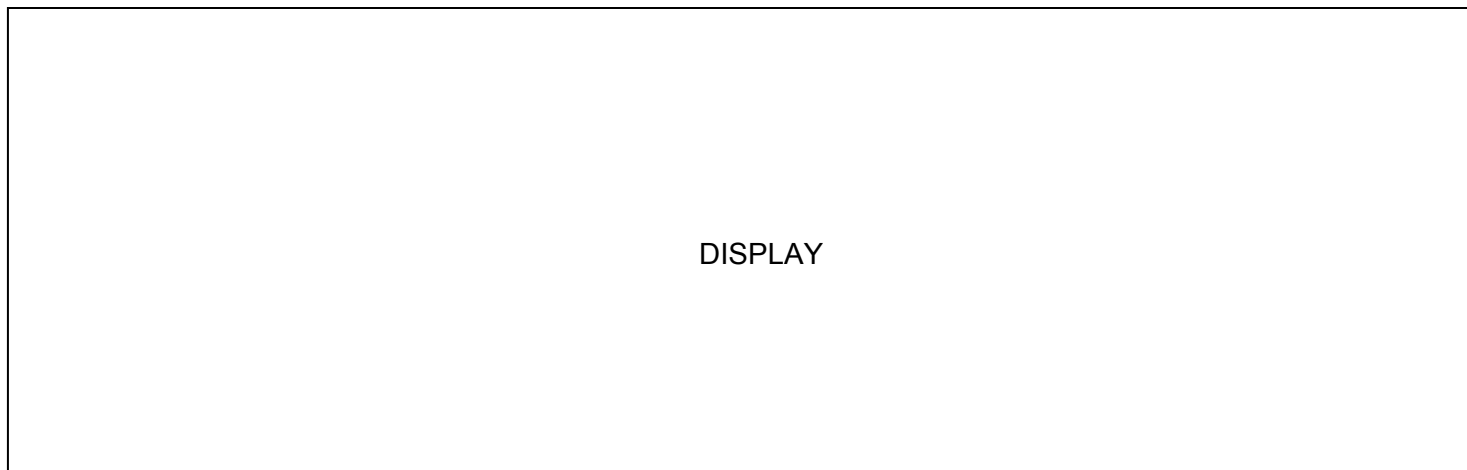
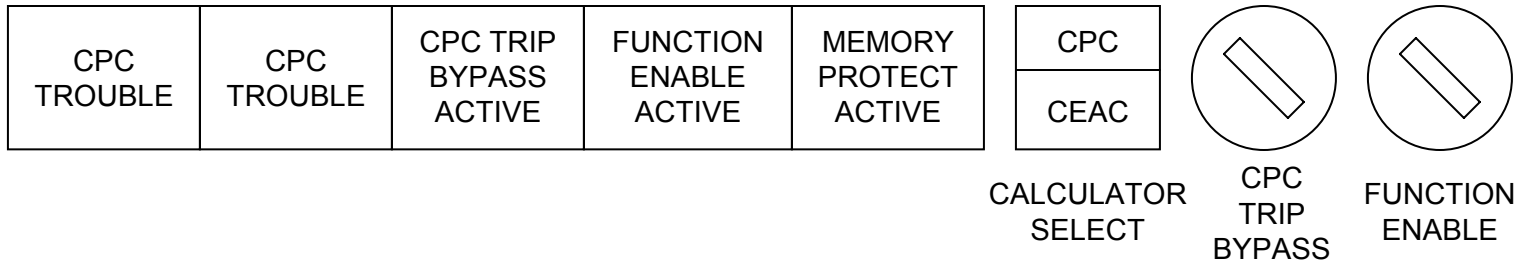

OPERATOR'S MODULE			SAR FIGURE NO. 7.2-34					
ARKANSAS NUCLEAR ONE UNIT 2 RUSSELLVILLE, ARKANSAS				AMENDMENT 18				
				SCALE: NONE	BASED ON DRAWING NO		SHEET	REV.
				DRAWN: ENTERGY				
				DESIGN: ENTERGY				
		CAD NO: N/A						

DELETED

SAR FIGURE NO. 7.2-35

AMENDMENT 20

ARKANSAS NUCLEAR ONE
UNIT 2
RUSSELLVILLE, ARKANSAS



SCALE:	NONE
DRAWN:	ENERGY
DESIGN:	ENERGY
CAD NO:	N/A

OPTICAL ISOLATOR

DRAWING NO

SHEET

REV.

DELETED

SAR FIGURE NO. 7.2-36

AMENDMENT 20

ARKANSAS NUCLEAR ONE
UNIT 2
RUSSELLVILLE, ARKANSAS



SCALE:	NONE
DRAWN:	ENERGY
DESIGN:	ENERGY
CAD NO:	N/A

REACTOR PROTECTIVE SYSTEM CHANNEL

DRAWING NO

SHEET

REV.

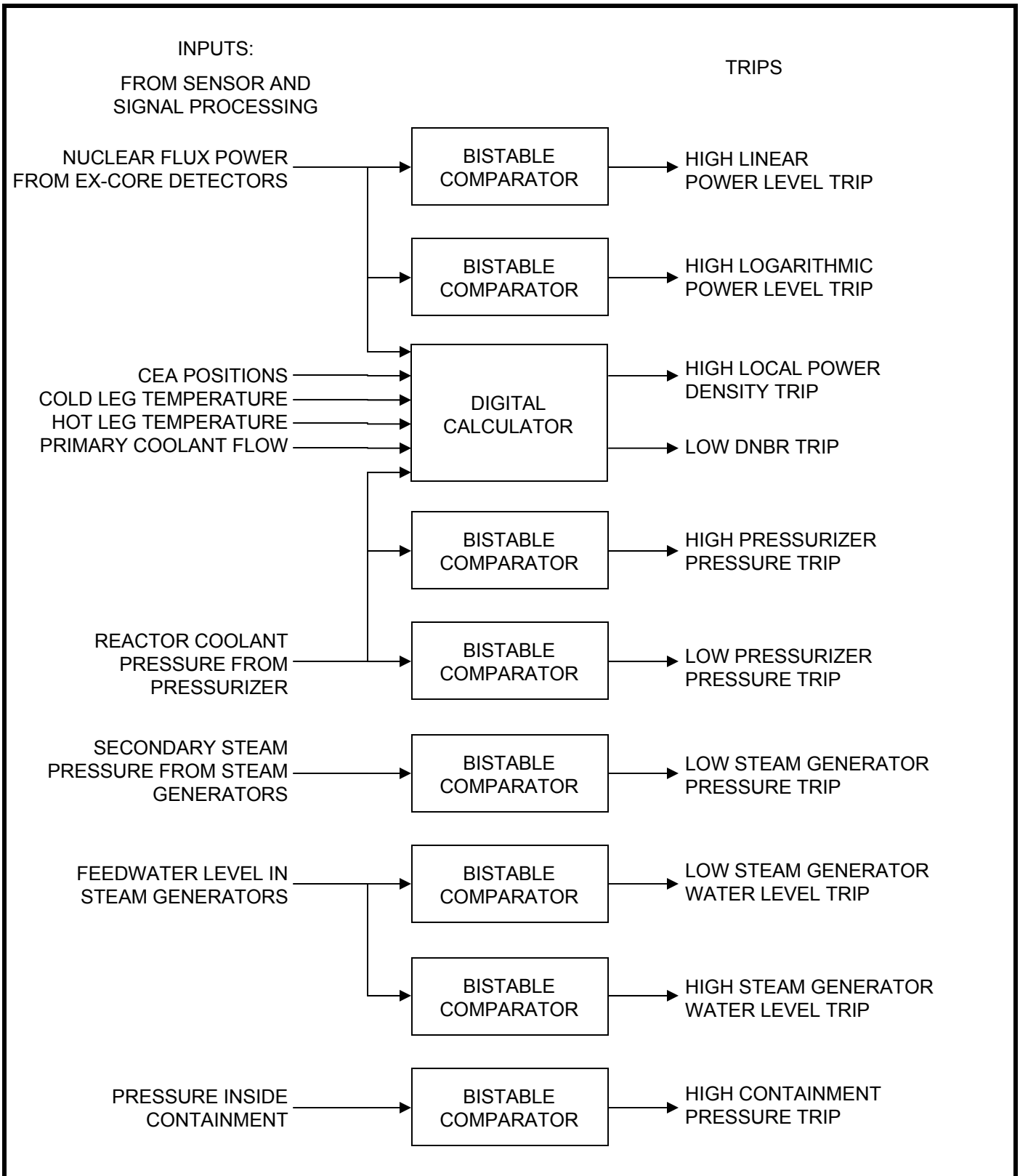

SAR FIGURE NO. 7.2-37

AMENDMENT 20

ARKANSAS NUCLEAR ONE
UNIT 2
RUSSELLVILLE, ARKANSAS



SCALE:	NONE
DRAWN:	ENERGY
DESIGN:	ENERGY
CAD NO:	N/A

REACTOR PROTECTIVE SYSTEM TRIP INPUTS
(TYPICAL FOR FOUR CHANNELS)

DRAWING NO	SHEET	REV.

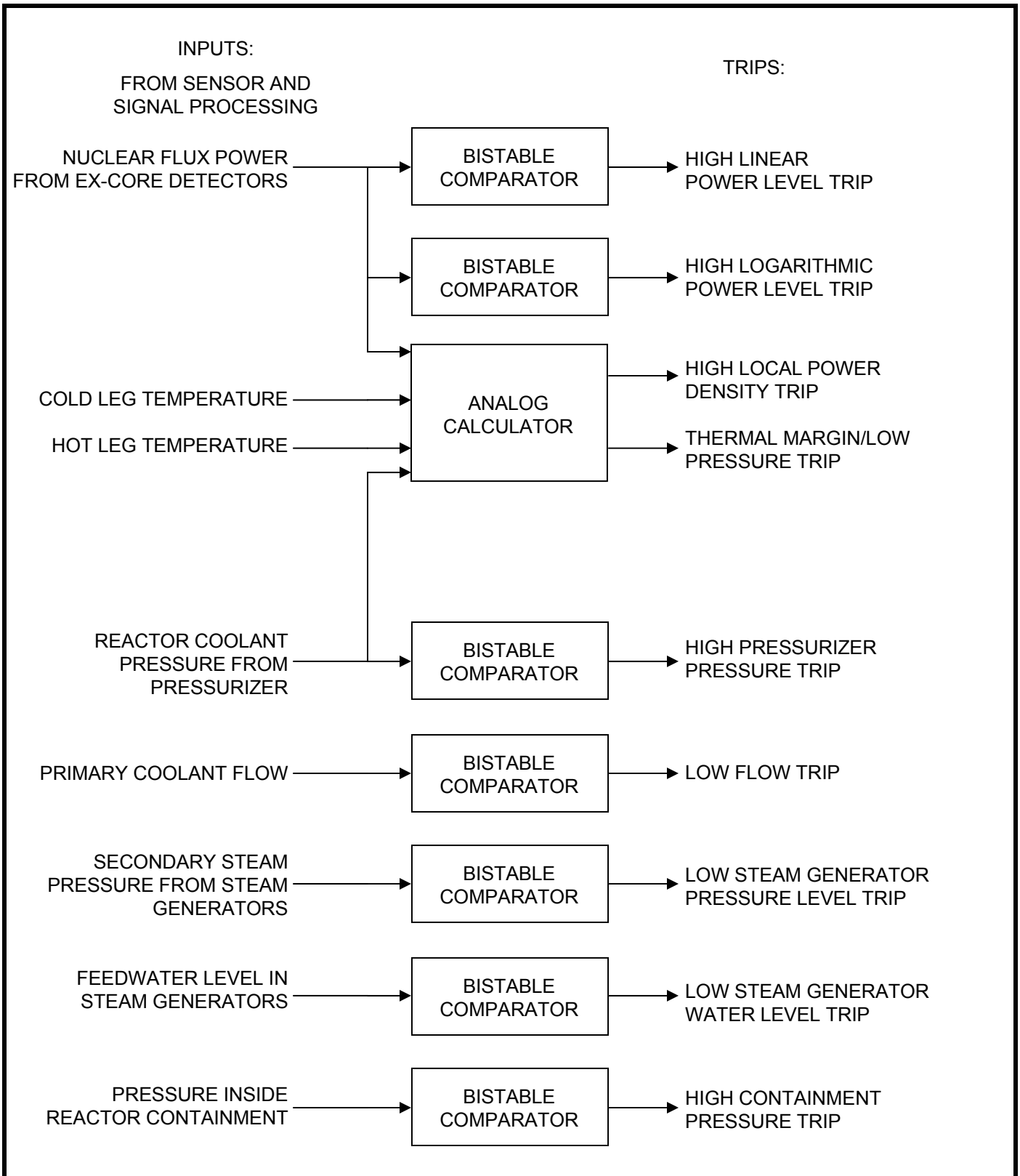

SAR FIGURE NO. 7.2-38

AMENDMENT 20

ARKANSAS NUCLEAR ONE
UNIT 2
RUSSELLVILLE, ARKANSAS



SCALE:	NONE
DRAWN:	ENERGY
DESIGN:	ENERGY
CAD NO:	N/A

REACTOR PROTECTIVE SYSTEM TRIP INPUTS
(TYPICAL FOR FOUR CHANNELS)

DRAWING NO	SHEET	REV.

Figures 7.2-39 – 7.2-42 Deleted

SAR FIGURE NOS. 7.2-39 – 7.2-42

AMENDMENT 20

ARKANSAS NUCLEAR ONE
UNIT 2
RUSSELLVILLE, ARKANSAS



SCALE:	NONE
DRAWN:	ENERGY
DESIGN:	ENERGY
CAD NO:	N/A

DRAWING NO

SHEET

REV.

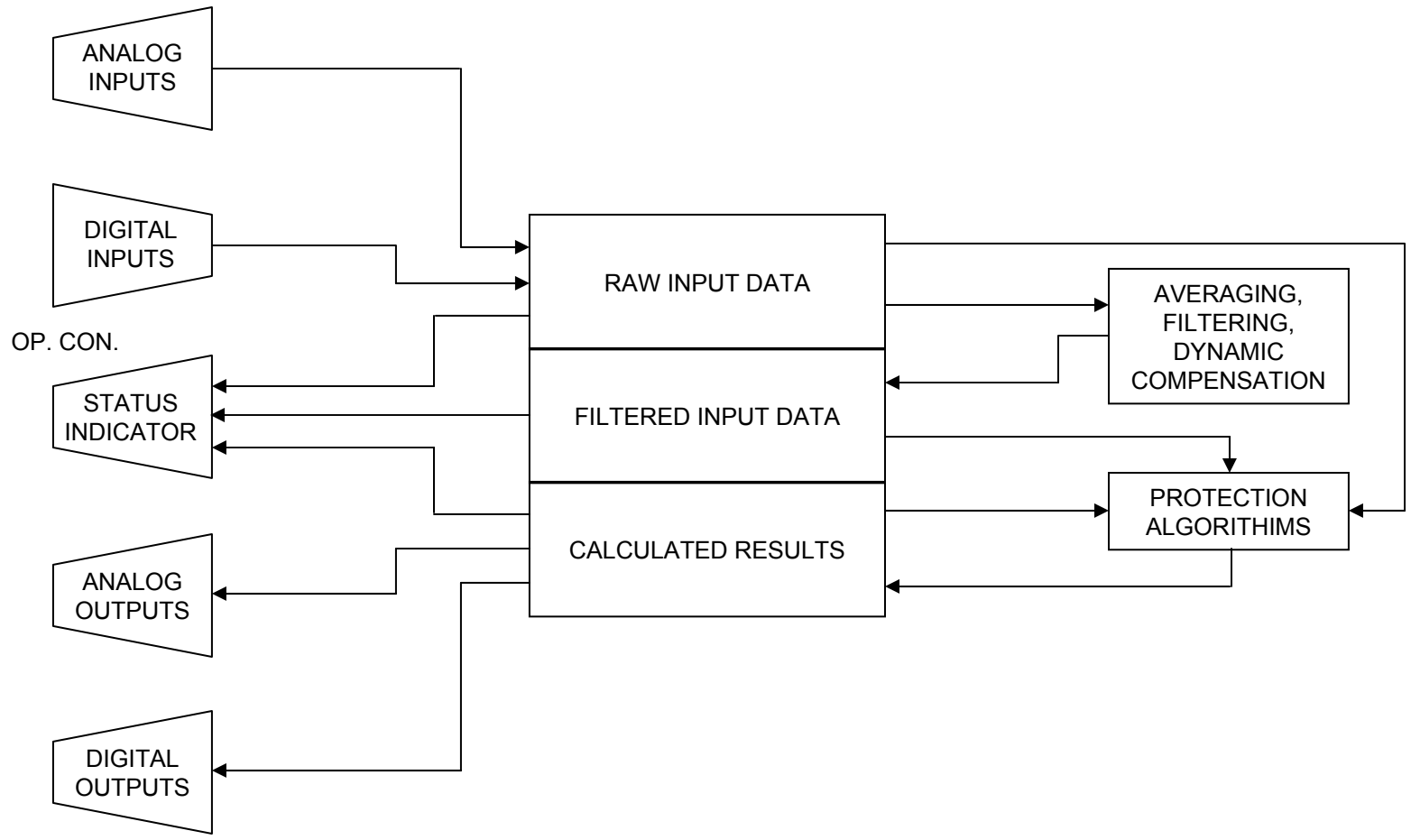

NORMAL DATA FLOW CORE PROTECTION CALCULATORS

SAR FIGURE NO. 7.2-43

ARKANSAS NUCLEAR ONE
 UNIT 2
 RUSSELLVILLE, ARKANSAS



SCALE:	NONE
DRAWN:	ENERGY
DESIGN:	ENERGY
CAD NO:	N/A

AMENDMENT 19

BASED ON DRAWING NO

SHEET

REV.

Figures 7.2-44 – 7.2-61 Deleted

SAR FIGURE NOS. 7.2-44 – 7.2-61

AMENDMENT 20

ARKANSAS NUCLEAR ONE
UNIT 2
RUSSELLVILLE, ARKANSAS



SCALE:	NONE
DRAWN:	ENERGY
DESIGN:	ENERGY
CAD NO:	N/A

DRAWING NO

SHEET

REV.

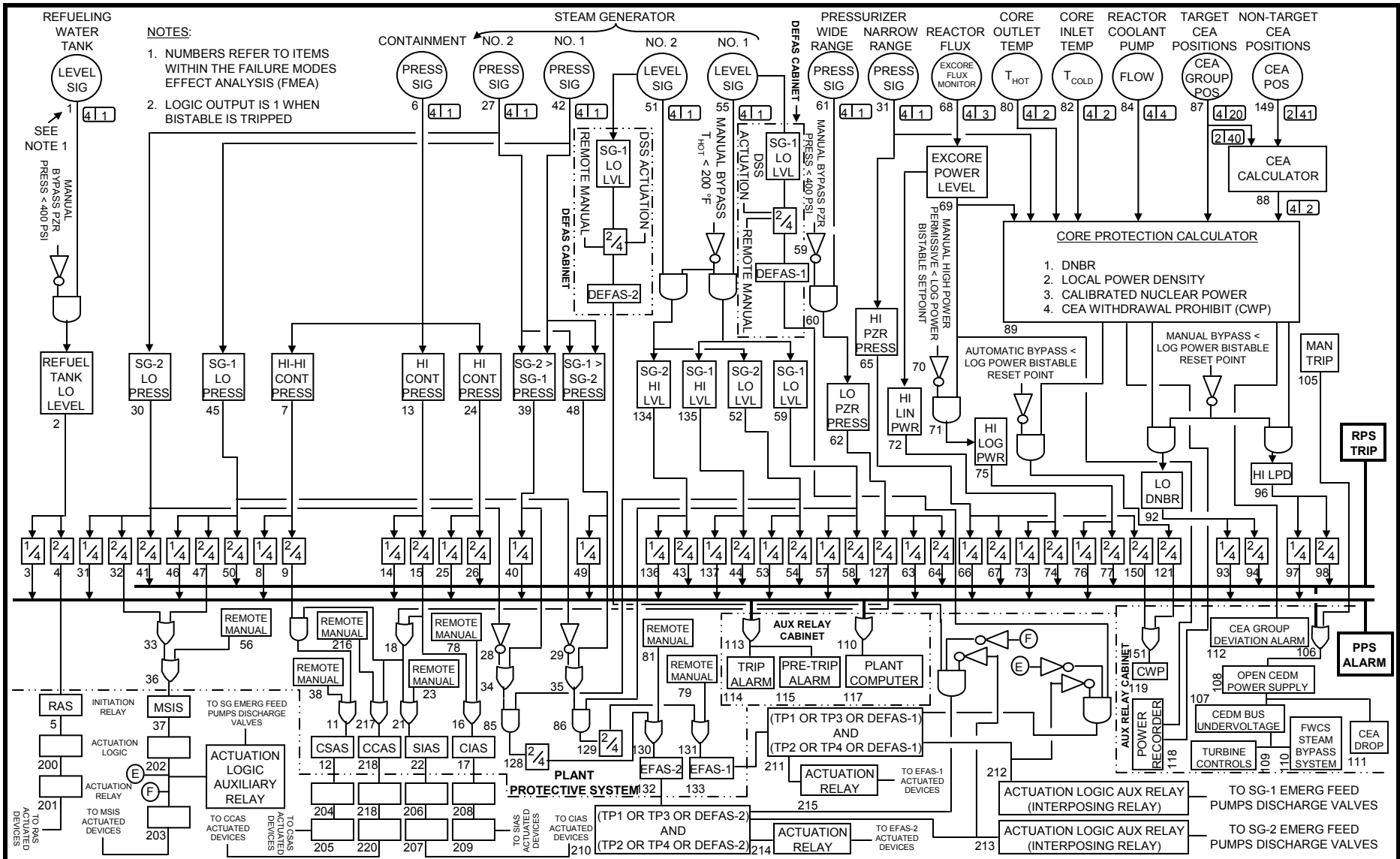

PLANT PROTECTIVE SYSTEM INTERFACE LOGIC DIAGRAM

SAR FIGURE NO. FMEA-1

ARKANSAS NUCLEAR ONE
 UNIT 2
 RUSSELLVILLE, ARKANSAS



SCALE:	NONE
DRAWN:	ENTERGY
DESIGN:	ENTERGY
CAD NO:	

AMENDMENT 20		
BASED ON DRAWING NO	SHEET	REV.

DELETED

SAR FIGURE NO. FMEA-2

AMENDMENT 20

ARKANSAS NUCLEAR ONE
UNIT 2
RUSSELLVILLE, ARKANSAS



SCALE:	NONE
DRAWN:	ENERGY
DESIGN:	ENERGY
CAD NO:	N/A

SAFETY CHANNEL BLOCK DIAGRAM

DRAWING NO

SHEET

REV.

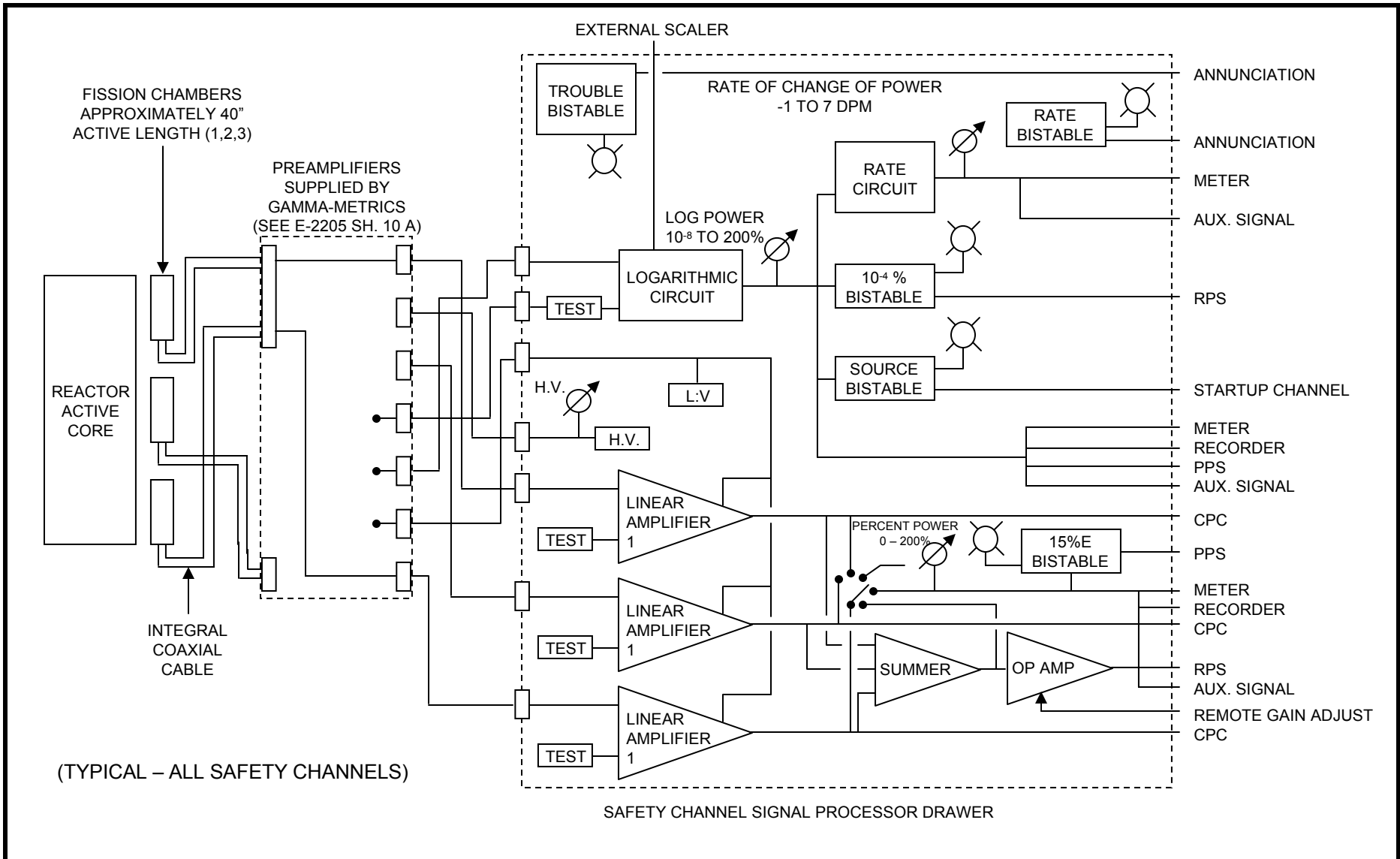

SAFETY CHANNEL BLOCK DIAGRAM

SAR FIGURE NO. FMEA-2A

ARKANSAS NUCLEAR ONE
 UNIT 2
 RUSSELLVILLE, ARKANSAS



SCALE: NONE
 DRAWN: ENTERGY
 DESIGN: ENTERGY
 CAD NO:

AMENDMENT 20

BASED ON DRAWING NO

SHEET

REV.

Figures FMEA-3 – FMEA-12 Deleted

SAR FIGURE NOS. FMEA-3 – FMEA-12

AMENDMENT 20

ARKANSAS NUCLEAR ONE
UNIT 2
RUSSELLVILLE, ARKANSAS



SCALE:	NONE
DRAWN:	ENERGY
DESIGN:	ENERGY
CAD NO:	N/A

DRAWING NO

SHEET

REV.

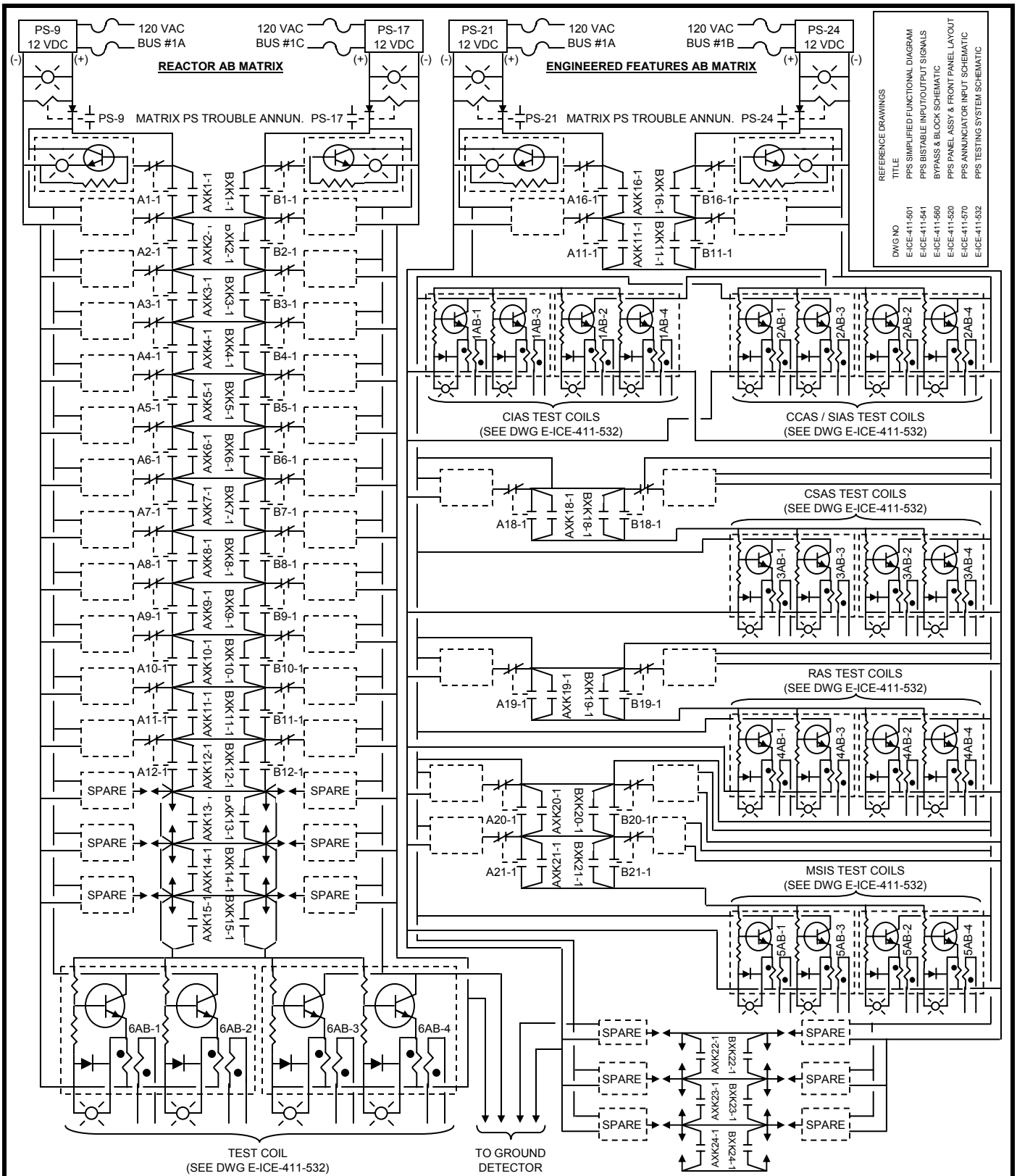

SAR FIGURE NO. FMEA-13

AMENDMENT 20

ARKANSAS NUCLEAR ONE
UNIT 2
RUSSELLVILLE, ARKANSAS



SCALE: NONE
DRAWN: ENTERGY
DESIGN: ENTERGY
CAD NO: N/A

RPS 2/4 LOGIC MATRIX SCHEMATIC

BASED ON DRAWING NO

SHEET

REV.

DELETED

SAR FIGURE NO. FMEA-14

AMENDMENT 20

ARKANSAS NUCLEAR ONE
UNIT 2
RUSSELLVILLE, ARKANSAS



SCALE:	NONE
DRAWN:	ENERGY
DESIGN:	ENERGY
CAD NO:	N/A

RPS TRIP PATH

DRAWING NO

SHEET

REV.

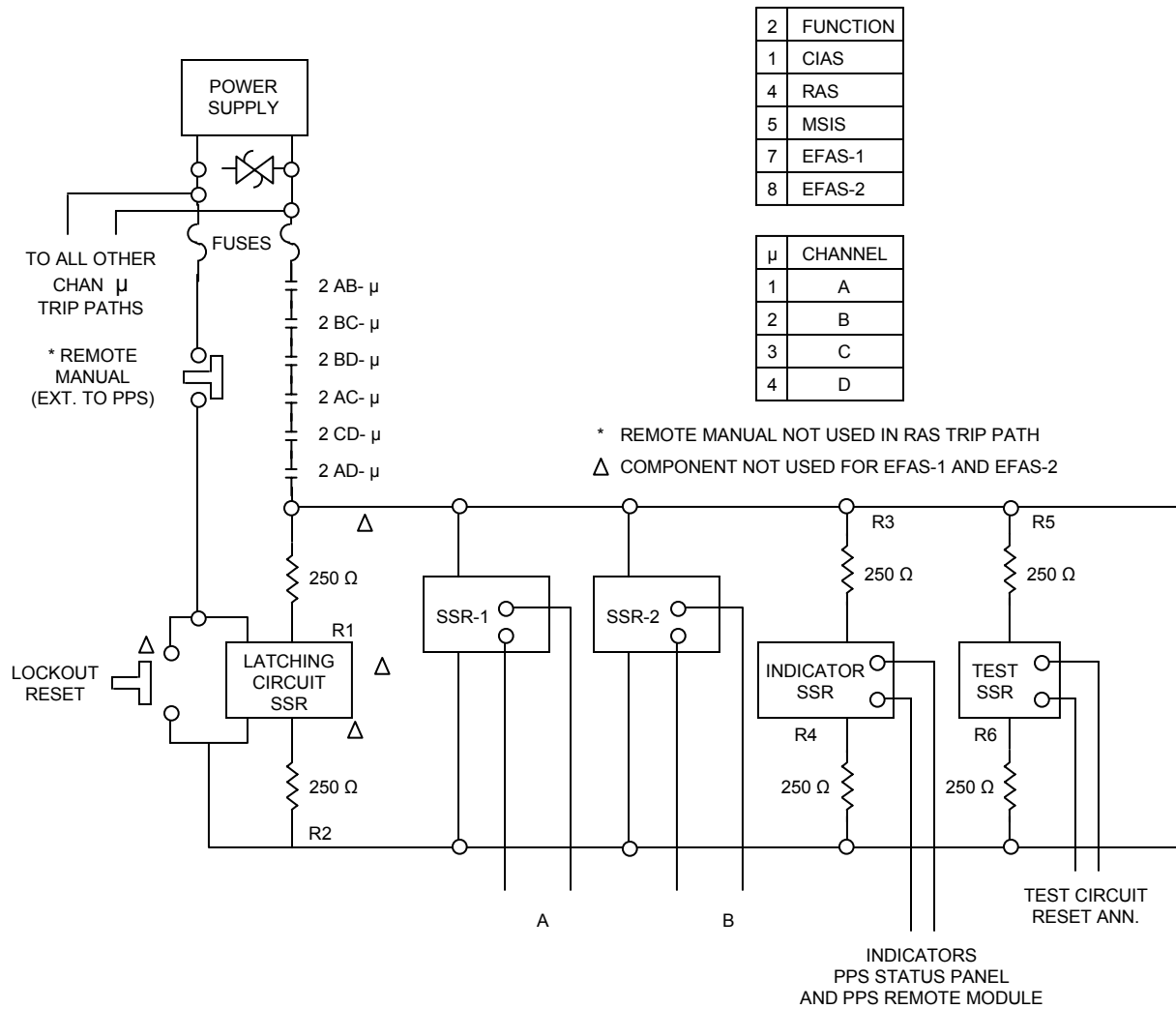

TYPICAL CIAS – RAS – MSIS – EFAS TRIP PATH CIRCUIT

SAR FIGURE NO. FMEA-15

ARKANSAS NUCLEAR ONE
 UNIT 2
 RUSSELLVILLE, ARKANSAS



SCALE: NONE
 DRAWN: ENTERGY
 DESIGN: ENTERGY
 CAD NO:

AMENDMENT 20

BASED ON DRAWING NO

SHEET

REV.

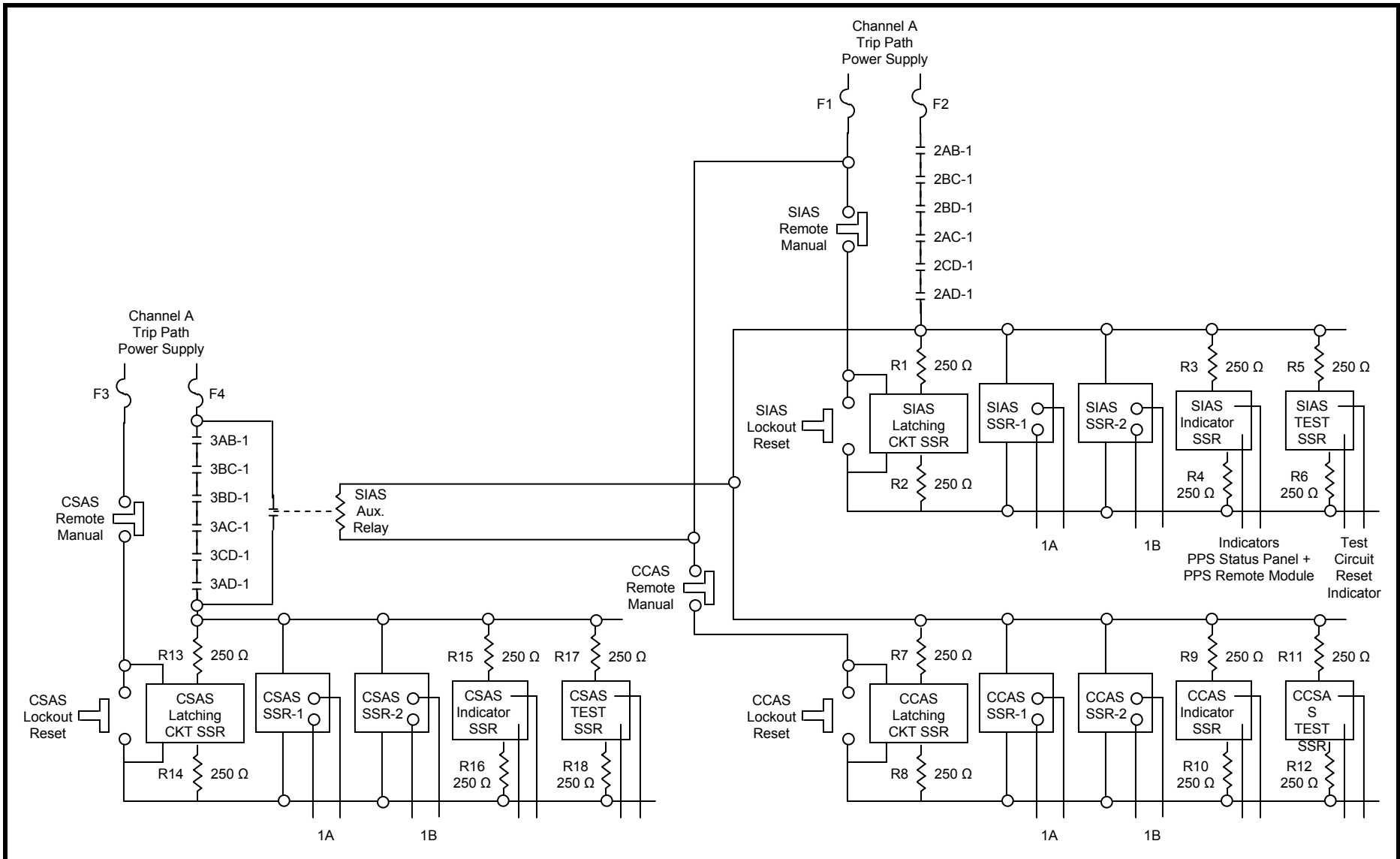

CSAS – SIAS – CCAS TRIP PATH CIRCUITS

SAR FIGURE NO. FMEA-16

ARKANSAS NUCLEAR ONE
 UNIT 2
 RUSSELLVILLE, ARKANSAS



SCALE: NONE
 DRAWN: ENTERGY
 DESIGN: ENTERGY
 CAD NO:

AMENDMENT 20

BASED ON DRAWING NO	SHEET	REV.
---------------------	-------	------

DELETED

SAR FIGURE NO. FMEA-17

AMENDMENT 20

ARKANSAS NUCLEAR ONE
UNIT 2
RUSSELLVILLE, ARKANSAS



SCALE:	NONE
DRAWN:	ENERGY
DESIGN:	ENERGY
CAD NO:	N/A

PLANT PROTECTIVE SYSTEM FUNCTIONAL
DIAGRAM

DRAWING NO

SHEET

REV.

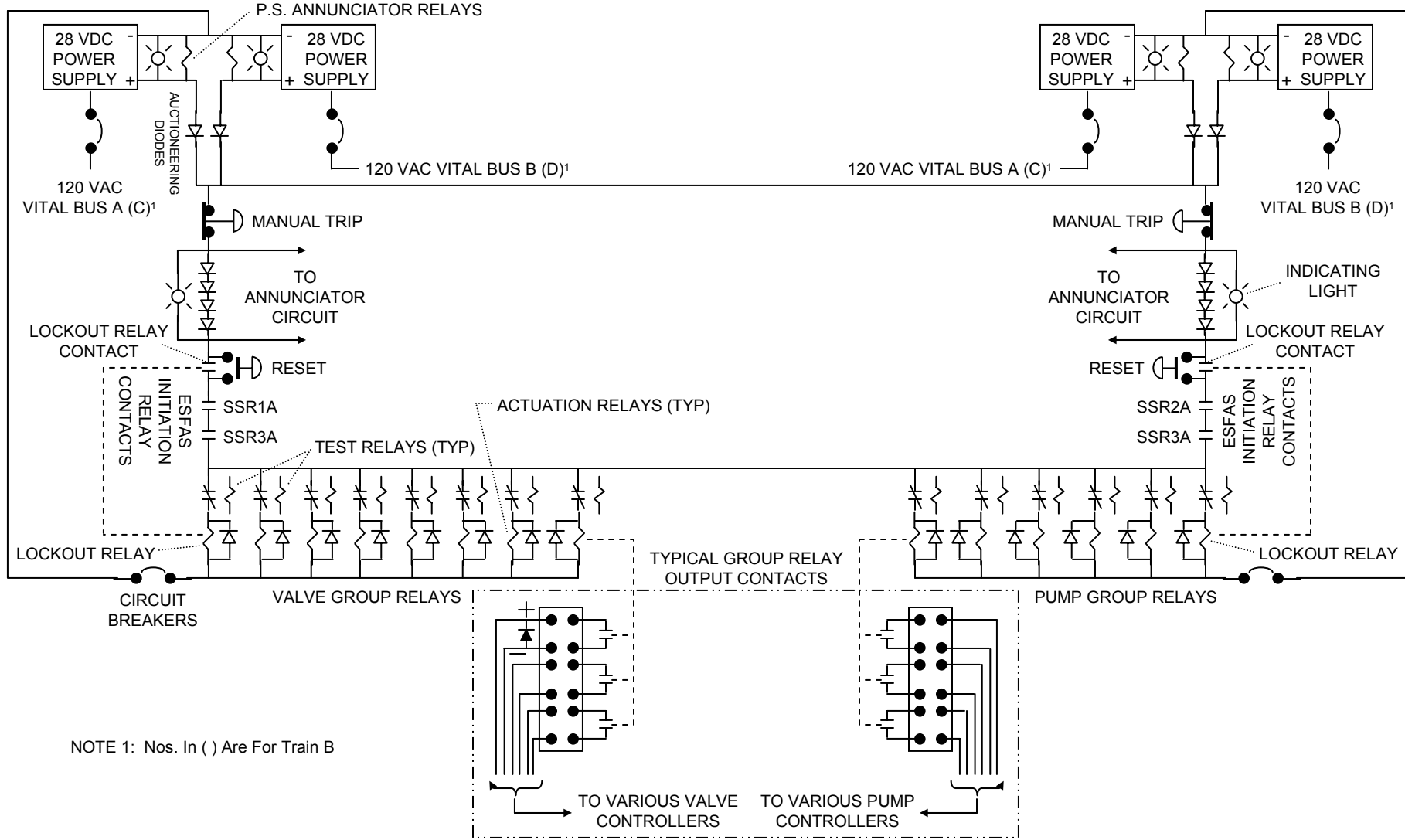

NOTE 1: Nos. In () Are For Train B

CE ESFAS ACTUATION RELAY CABINET SCHEMATIC DIAGRAM FOR TYPICAL ACTUATION SIGNAL SAR FIGURE NO. FMEA-18

ARKANSAS NUCLEAR ONE
 UNIT 2
 RUSSELLVILLE, ARKANSAS



SCALE:	NONE
DRAWN:	ENTERGY
DESIGN:	ENTERGY
CAD NO:	

AMENDMENT 20

BASED ON DRAWING NO	SHEET	REV.

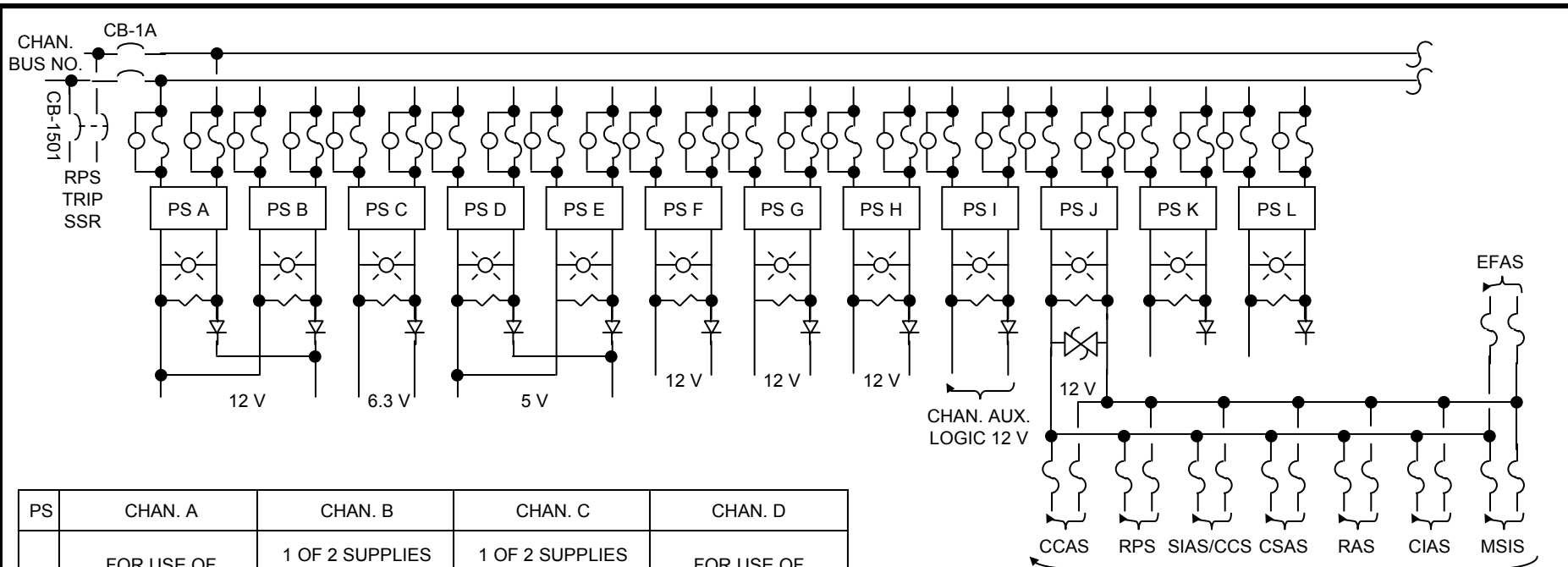

PS	CHAN. A	CHAN. B	CHAN. C	CHAN. D
A	FOR USE OF CHAN. A BISTABLE	1 OF 2 SUPPLIES AUCT. FOR USE OF CHAN. B BISTABLES	1 OF 2 SUPPLIES AUCT. FOR USE OF CHAN. C BISTABLES	FOR USE OF CHAN. D BISTABLE
B	1 OF 2 SUPPLIES AUCT. FOR USE OF CHAN. B BISTABLES	1 OF 2 SUPPLIES AUCT. FOR USE OF CHAN. A BISTABLES	1 OF 2 SUPPLIES AUCT. FOR USE OF CHAN. D BISTABLES	1 OF 2 SUPPLIES AUCT. FOR USE OF CHAN. C BISTABLES

POWER SUPPLY USAGE CHART

CHANNEL TRIP PATH CIRCUITS

PS	CHAN. A	CHAN. B	CHAN. C	CHAN. D
A	1	4	5	8
B	2	3*	6*	7
C	45	46	47	48
D	49	52	53	56
E	50	51	54	55
F	33	36	39	42
G	35	38	41	44
H	34	37	40	43
I	9	12	15	18
K	10	13	16	19

POWER SUPPLY IDENTIFICATION CHART

CHANNEL POWER DISTRIBUTION		SAR FIGURE NO. FMEA-19		
ARKANSAS NUCLEAR ONE UNIT 2 RUSSELLVILLE, ARKANSAS		AMENDMENT 20		
		SCALE: NONE	DRAWN: ENTERGY	DESIGN: ENTERGY
		BASED ON DRAWING NO	SHEET	REV.

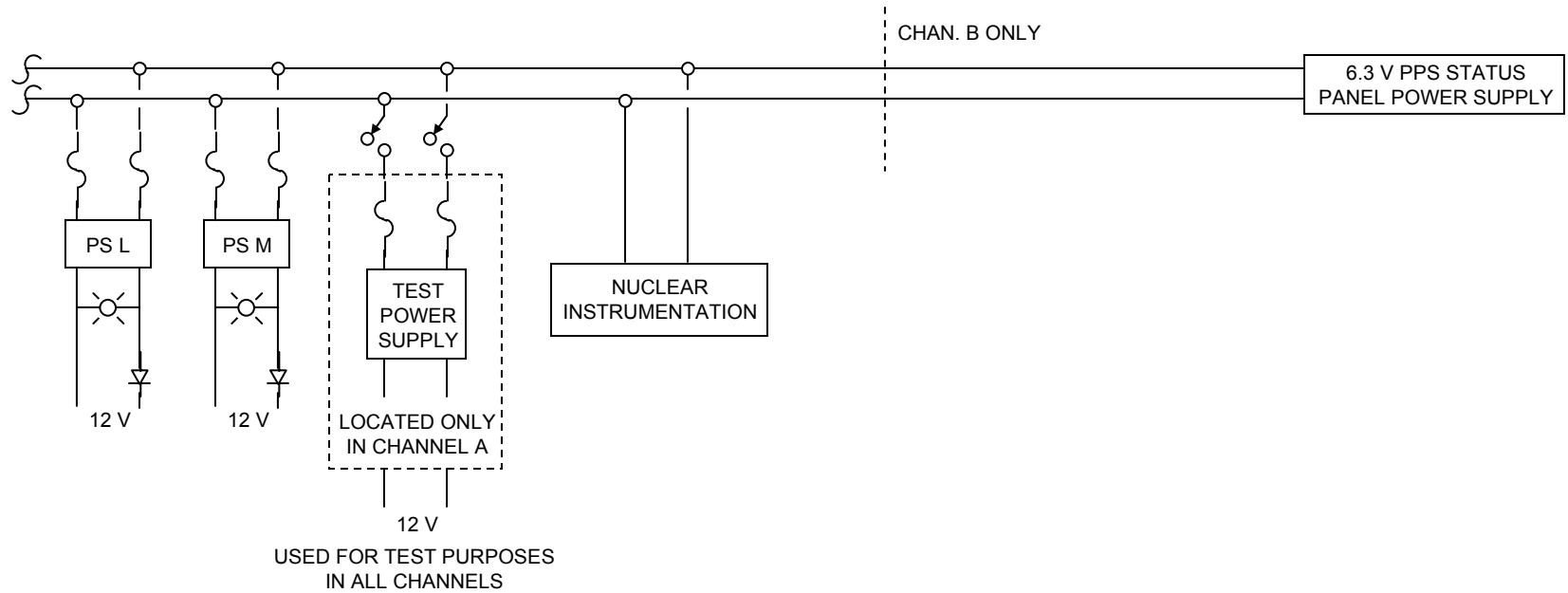

PS	CHAN. A	CHAN. B	CHAN. C	CHAN. D
D	1 OF 2 SUPPLIES AUCT. FOR USE OF CHAN. A BYPASS CKT.	1 OF 2 SUPPLIES AUCT. FOR USE OF CHAN. B BYPASS CKT.	1 OF 2 SUPPLIES AUCT. FOR USE OF CHAN. C BYPASS CKT.	1 OF 2 SUPPLIES AUCT. FOR USE OF CHAN. D BYPASS CKT.
E	1 OF 2 SUPPLIES AUCT. FOR USE OF CHAN. A BYPASS CKT.	1 OF 2 SUPPLIES AUCT. FOR USE OF CHAN. B BYPASS CKT.	1 OF 2 SUPPLIES AUCT. FOR USE OF CHAN. C BYPASS CKT.	1 OF 2 SUPPLIES AUCT. FOR USE OF CHAN. D BYPASS CKT.

PS	CHAN. A	CHAN. B	CHAN. C	CHAN. D
L	11	14	17	20
M	21	24	27	30
N	22	25	28	31
P	23	26	29	32

CHANNEL POWER DISTRIBUTION

SAR FIGURE NO. FMEA-19A

ARKANSAS NUCLEAR ONE
UNIT 2
RUSSELLVILLE, ARKANSAS



SCALE: NONE
DRAWN: ENTERGY
DESIGN: ENTERGY
CAD NO:

AMENDMENT 20

BASED ON DRAWING NO	SHEET	REV.

Figures 7.3-1A – 7.4-2 Deleted

SAR FIGURE NOS. 7.3-1A – 7.4-2

AMENDMENT 20

ARKANSAS NUCLEAR ONE
UNIT 2
RUSSELLVILLE, ARKANSAS



SCALE:	NONE
DRAWN:	ENERGY
DESIGN:	ENERGY
CAD NO:	N/A

DRAWING NO

SHEET

REV.

2HS-1042A	SDBCS Emergency Off	2HS-9110-1	Pressurizer Pressure Set Point Reset #1	2HS-9111-3	RPS/ESFAS Pressurizer Pressure Bypass with ON/OFF #3
2HS-1043A	SDBCS Emergency Off/Condensator Vacuum Interlock Reset	2HS-9110-2	Pressurizer Pressure Set Point Reset #1	2HS-9111-4	RPS/ESFAS Pressurizer Pressure Bypass with ON/OFF #4
2HS-4824-2A	Aux. Pressurizer Spray Valve	2HS-9110-3	Pressurizer Pressure Set Point Reset #1	2HS-9112-1	Steam Generator A/B Pressure Set Point Reset #1
2HS-4826A	Letdown Valve	2HS-9110-4	Pressurizer Pressure Set Point Reset #1	2HS-9112-2	Steam Generator A/B Pressure Set Point Reset #2
2HS-4837A	Volume Control Tank Vent Valve	2HS-9111-1	RPS/ESFAS Pressurizer Pressure Bypass with ON/OFF #1	2HS-9112-3	Steam Generator A/B Pressure Set Point Reset #3
		2HS-9111-2	RPS/ESFAS Pressurizer Pressure Bypass with ON/OFF #2	2HS-9112-4	Steam Generator A/B Pressure Set Point Reset #4

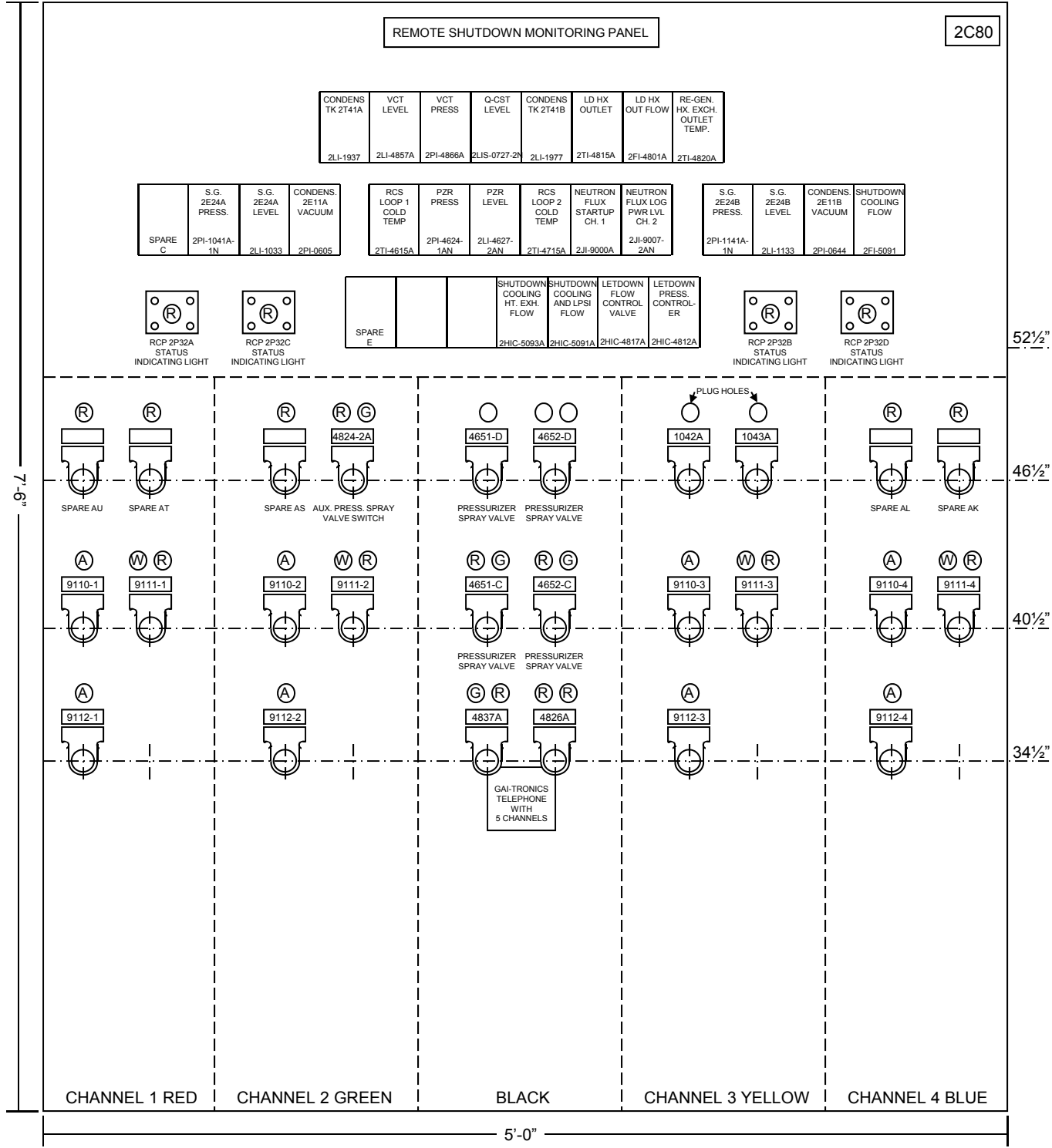

SAR FIGURE NO. 7.4-3

AMENDMENT 24

<h1 style="margin: 0;">ARKANSAS NUCLEAR ONE</h1> <p style="margin: 0;">UNIT 2 RUSSELLVILLE, ARKANSAS</p>		SCALE:	NONE
		DRAWN:	ENTERGY
		DESIGN:	ENTERGY
		CAD NO.:	N/A
REMOTE SHUTDOWN PANEL	DRAWING NO	SHEET	REV.

Deleted

SAR FIGURE NO. 7.6-1

AMENDMENT 20

ARKANSAS NUCLEAR ONE
UNIT 2
RUSSELLVILLE, ARKANSAS



SCALE:	NONE
DRAWN:	ENERGY
DESIGN:	ENERGY
CAD NO:	N/A

DRAWING NO

SHEET

REV.

Deleted

SAR FIGURE NO. 7.6-2

AMENDMENT 20

ARKANSAS NUCLEAR ONE
UNIT 2
RUSSELLVILLE, ARKANSAS



SCALE:	NONE
DRAWN:	ENERGY
DESIGN:	ENERGY
CAD NO:	N/A

DRAWING NO

SHEET

REV.

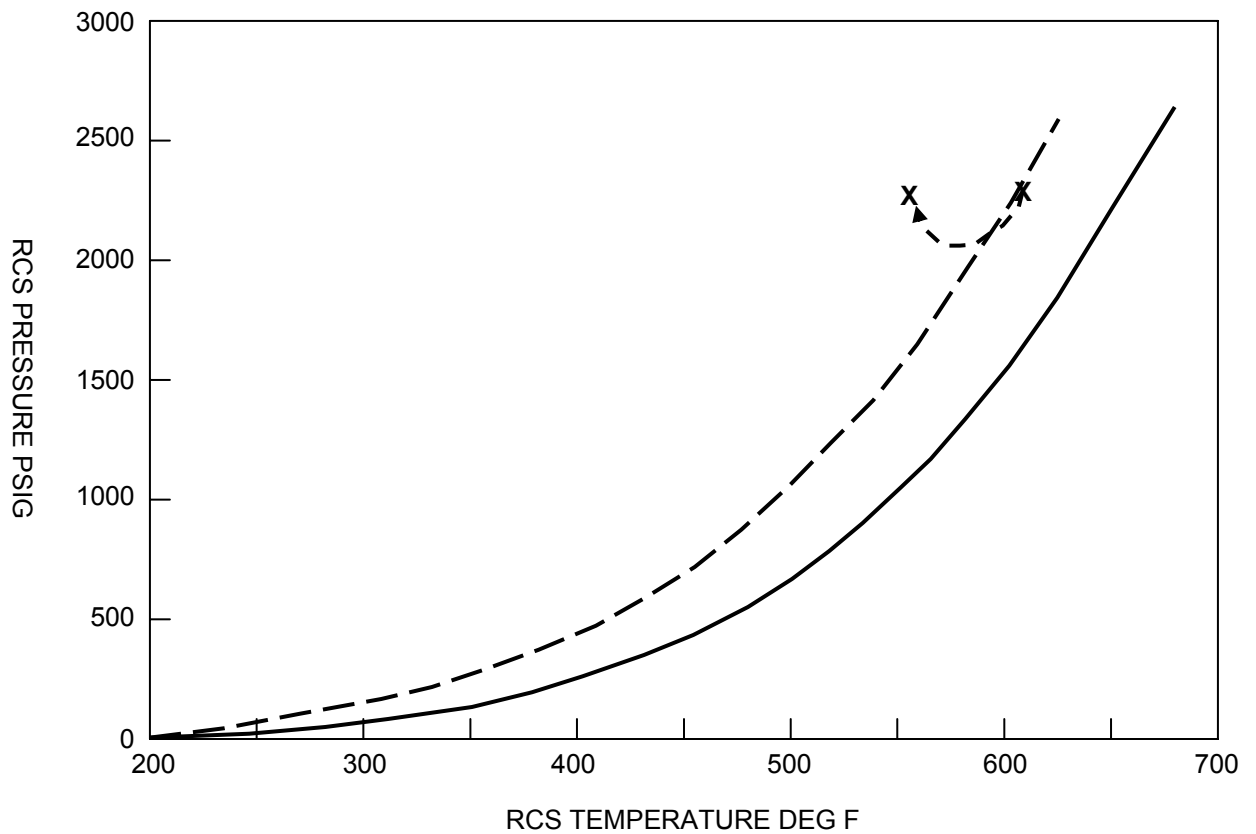

SAR FIGURE NO. 7.6-3

AMENDMENT 20

ARKANSAS NUCLEAR ONE
 UNIT 2
 RUSSELLVILLE, ARKANSAS



SCALE:	NONE
DRAWN:	ENERGY
DESIGN:	ENERGY
CAD NO:	N/A

TYPICAL POST TRIP RESPONSE

DRAWING NO

SHEET

REV.

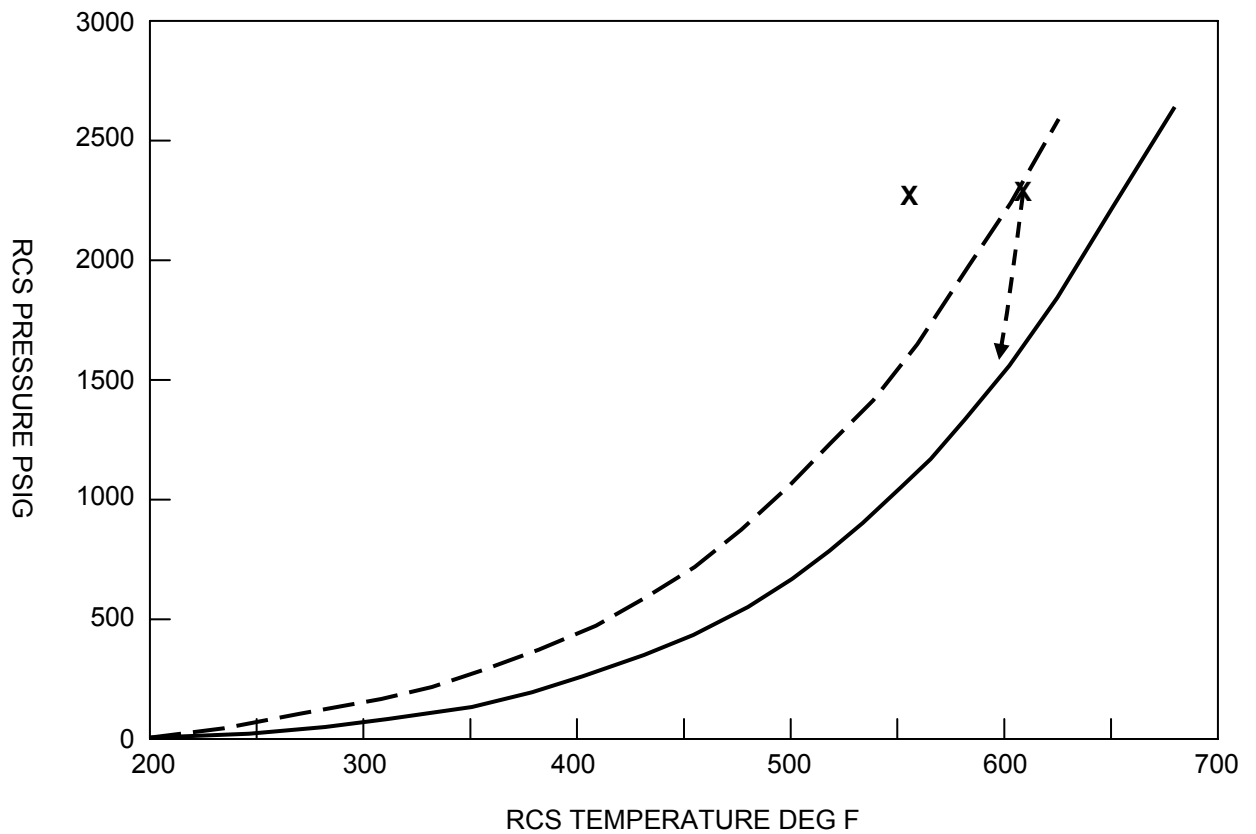

Inadequate Subcooling Margin: T_{hot} is not progressing toward its target values; in fact, it has rapidly dropped through the subcooled margin line. This condition is diagnosed as loss of adequate primary inventory subcooling, or simply “inadequate subcooling margin.”

SAR FIGURE NO. 7.6-4

AMENDMENT 20

ARKANSAS NUCLEAR ONE
 UNIT 2
 RUSSELLVILLE, ARKANSAS



SCALE:	NONE
DRAWN:	ENERGY
DESIGN:	ENERGY
CAD NO:	N/A

INADEQUATE SUBCOOLING MARGIN

DRAWING NO

SHEET

REV.

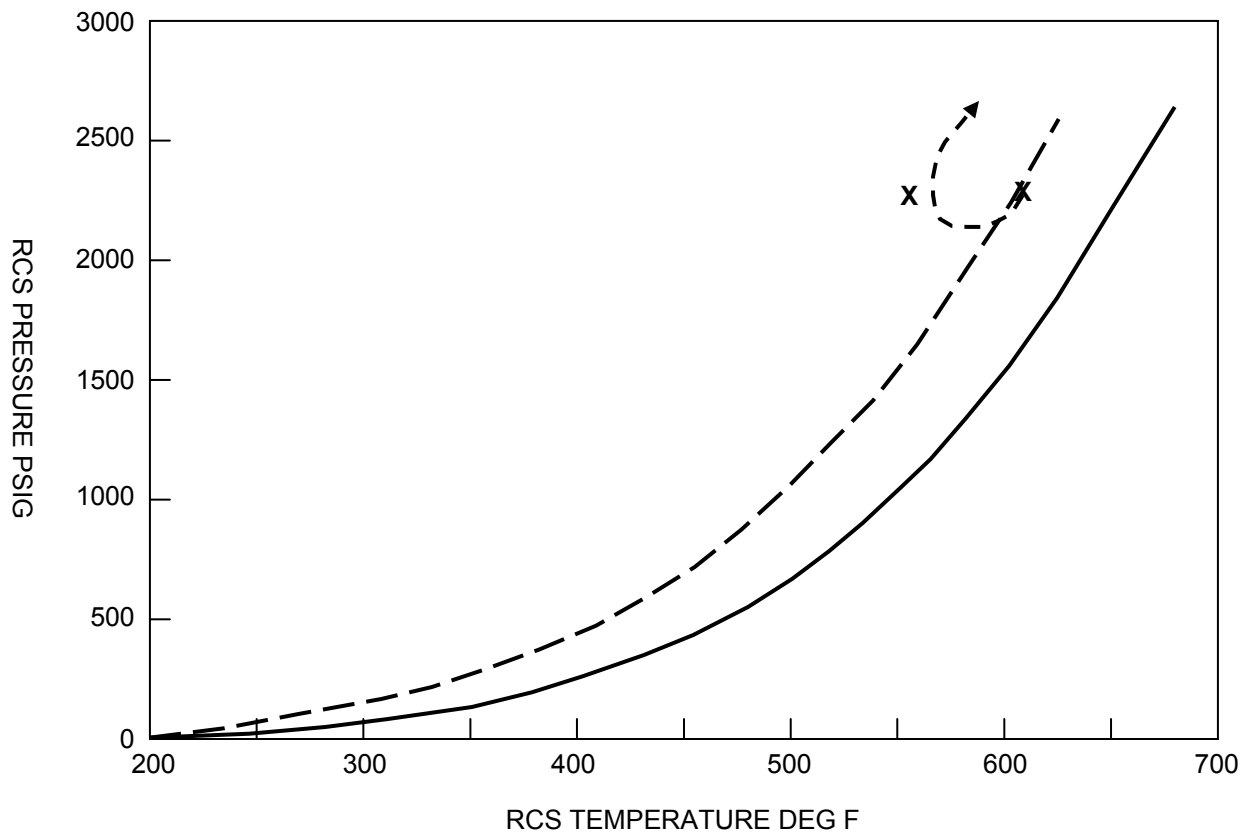

Loss of Primary-to-Secondary Heat Transfer: T_{hot} is increasing as steam generator T_{sat} is decreasing. The ΔT between the two is growing larger. The secondary is no longer removing heat and has lost coupling with the primary. This condition is diagnosed and treated as loss of (inadequate) primary-to-secondary heat transfer.

SAR FIGURE NO. 7.6-5

AMENDMENT 20

ARKANSAS NUCLEAR ONE
UNIT 2
RUSSELLVILLE, ARKANSAS



SCALE:	NONE
DRAWN:	ENERGY
DESIGN:	ENERGY
CAD NO:	N/A

LOSS OF PRIMARY TO SECONDARY HEAT TRANSFER

DRAWING NO

SHEET

REV.

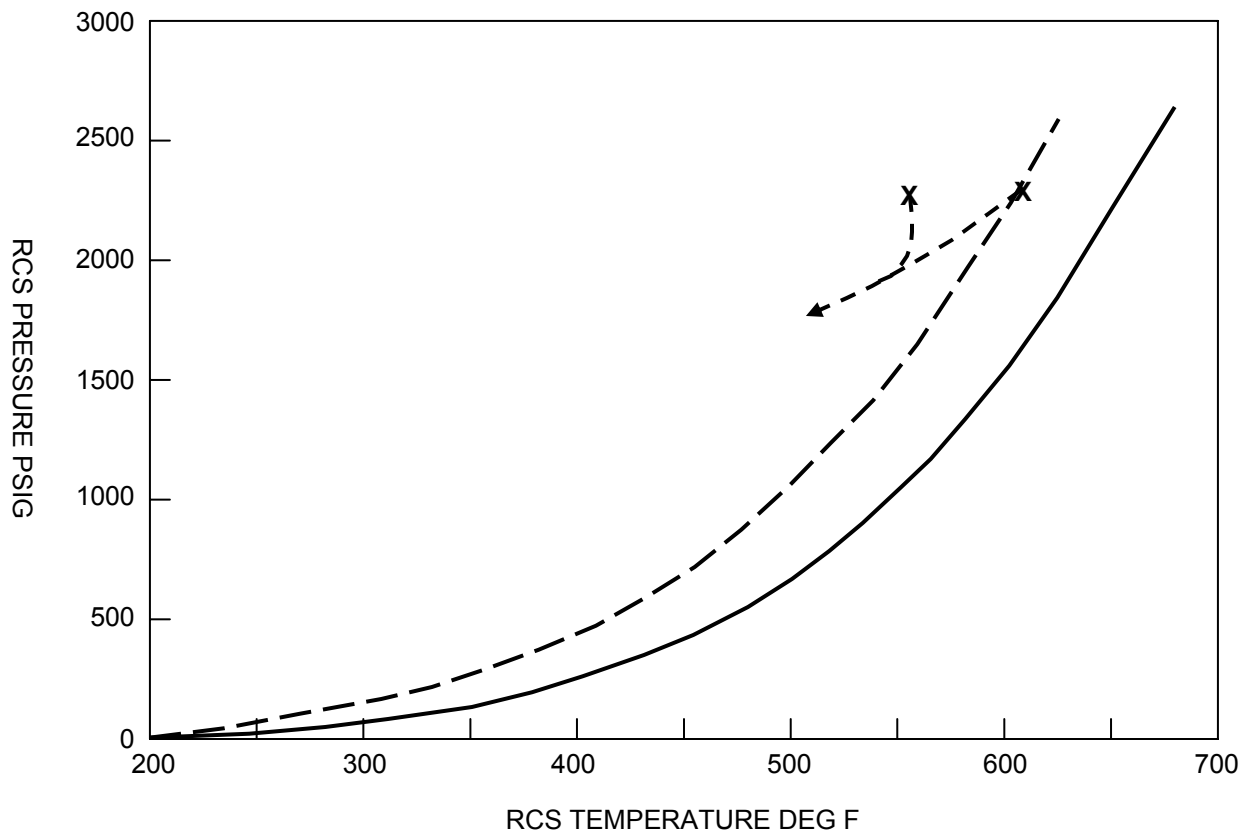

Excessive Primary-to-Secondary Heat Transfer: Steam generator T_{sat} has decreased below its established limit. T_{hot} and T_{cold} have reached equal values, but both have gone out of the post-trip window following steam generator T_{sat} . This condition is diagnosed and treated as excessive primary-to-secondary heat transfer.

SAR FIGURE NO. 7.6-6

AMENDMENT 20

ARKANSAS NUCLEAR ONE
UNIT 2
RUSSELLVILLE, ARKANSAS



SCALE:	NONE
DRAWN:	ENERGY
DESIGN:	ENERGY
CAD NO:	N/A

EXCESSIVE PRIMARY TO SECONDARY HEAT TRANSFER

DRAWING NO

SHEET

REV.

Deleted

SAR FIGURE NO. 7.7-1

AMENDMENT 20

ARKANSAS NUCLEAR ONE
UNIT 2
RUSSELLVILLE, ARKANSAS



SCALE:	NONE
DRAWN:	ENERGY
DESIGN:	ENERGY
CAD NO:	N/A

DRAWING NO

SHEET

REV.

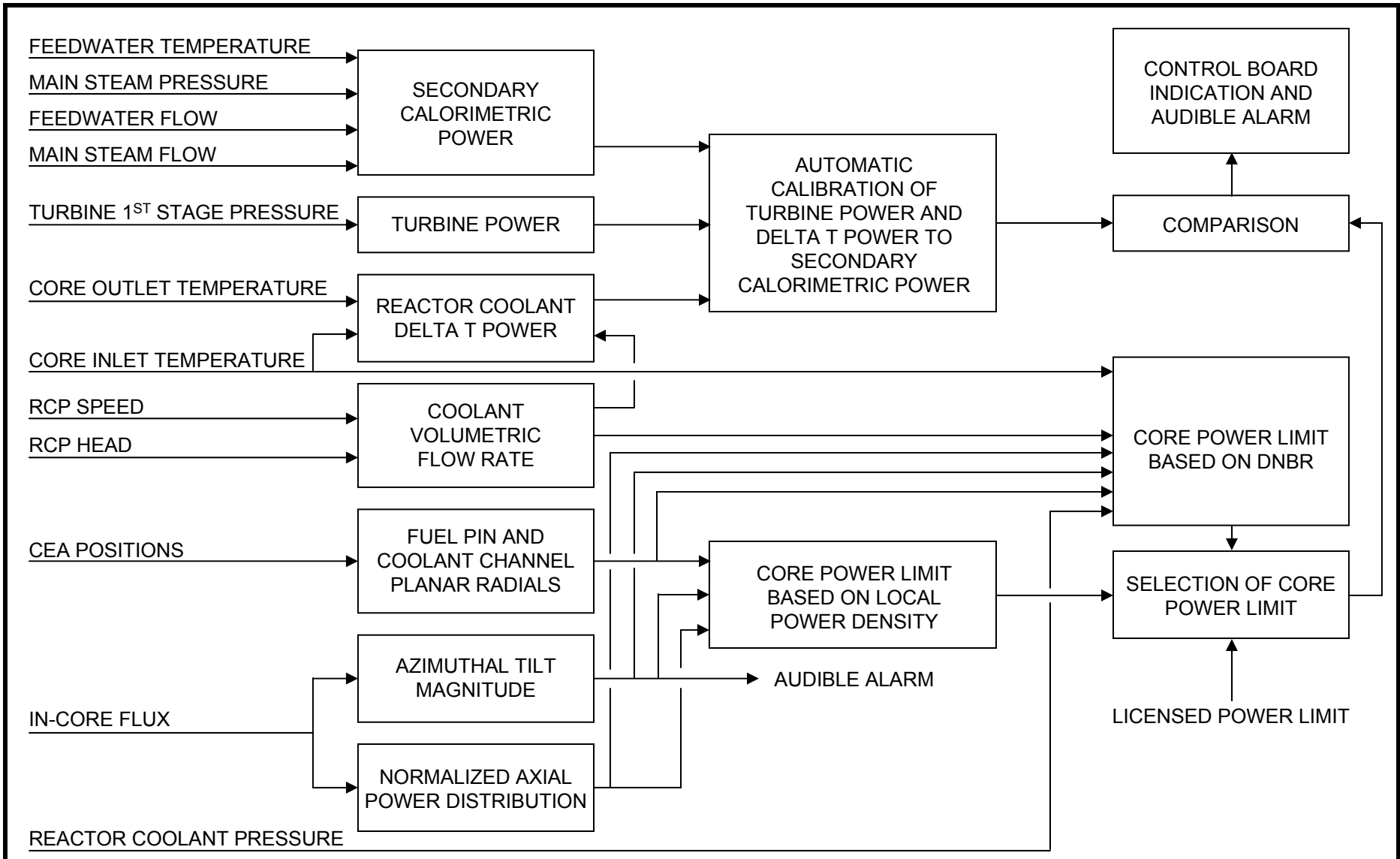

FUNCTIONAL DIAGRAM OF THE CORE OPERATING LIMIT SUPERVISORY SYSTEM

SAR FIGURE NO. 7.7-2

ARKANSAS NUCLEAR ONE
UNIT 2
RUSSELLVILLE, ARKANSAS



SCALE: NONE
DRAWN: ENTERGY
DESIGN: ENTERGY
CAD NO:

AMENDMENT 20

BASED ON DRAWING NO	SHEET	REV.

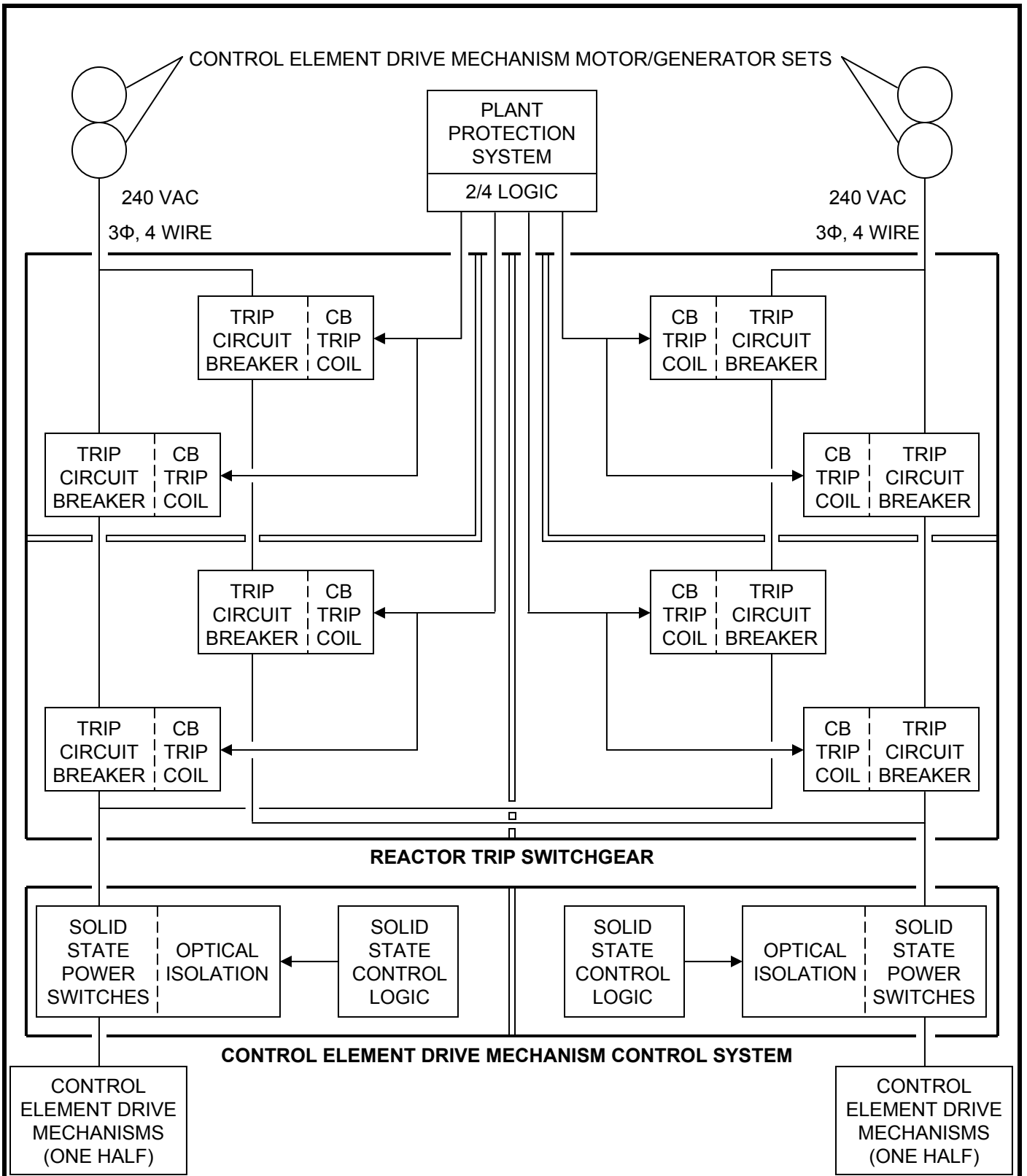

SAR FIGURE NO. 7.7-3

AMENDMENT 20

ARKANSAS NUCLEAR ONE
UNIT 2
RUSSELLVILLE, ARKANSAS



SCALE:	NONE
DRAWN:	ENERGY
DESIGN:	ENERGY
CAD NO:	N/A

CEDMCS - RPS INTERFACE BLOCK DIAGRAM

DRAWING NO

SHEET

REV.

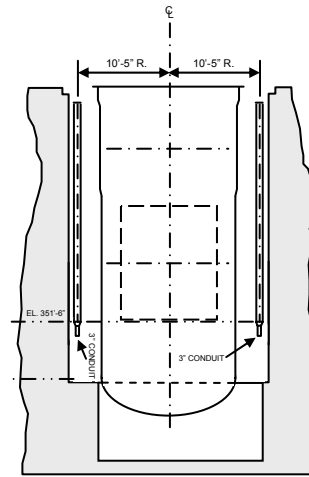
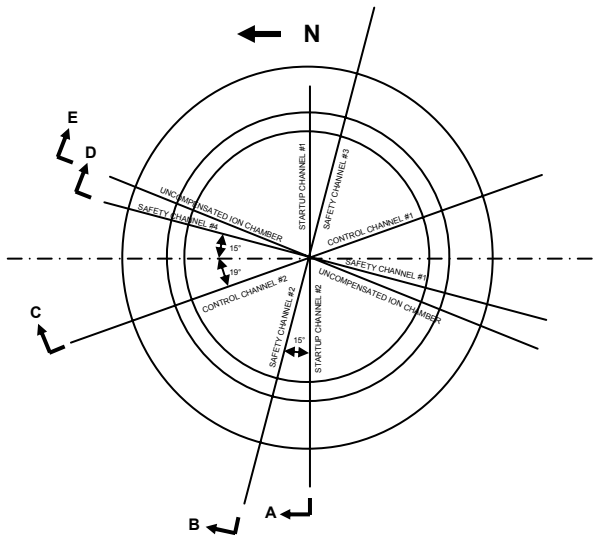

SECT. E
UNCOMPENSATED ION CHAMBER

- REFERENCE DWGS:
 C-2172 MISC. STEEL DETAILS & SECTIONS (SHT. 3)
 E-2873 CONDUIT & TRAY LAYOUT; CONTAINMENT BLDG., AREA 25, EL. 336'6"
 M-2368 FLOOR PENETRATIONS, AREA 25, EL. 357'-0" & BELOW
 VENDOR PRINT DWG. 6600-M-2001-K2-17-1, DETECTOR & HOLDER ASSY.

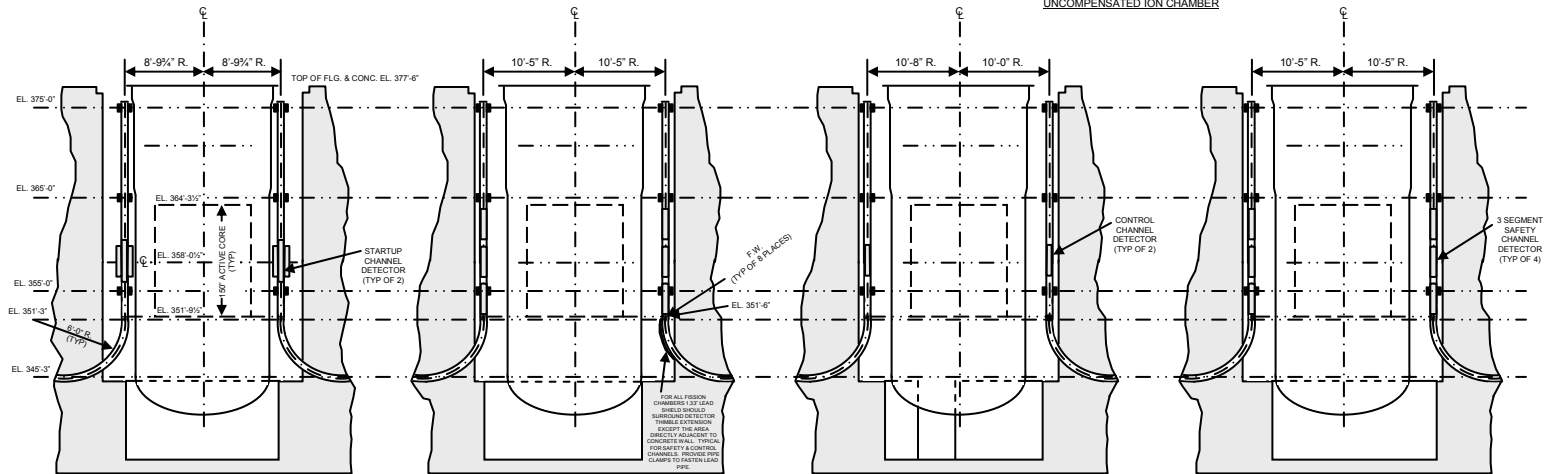

SECT. A
STARTUP CHANNEL 2 & 1

SECT. B
SAFETY CHANNEL 2 & 3

SECT. C
CONTROL CHANNEL 2 & 1

SECT. D
SAFETY CHANNEL 4 & 1

EXCORE INSTRUMENT DETECTOR SYSTEM

SAR FIGURE NO. 7.7-4

ARKANSAS NUCLEAR ONE
 UNIT 2
 RUSSELLVILLE, ARKANSAS



SCALE: NONE
 DRAWN: ENTERGY
 DESIGN: ENTERGY
 CAD NO:

AMENDMENT 20

BASED ON DRAWING NO	SHEET	REV.
---------------------	-------	------

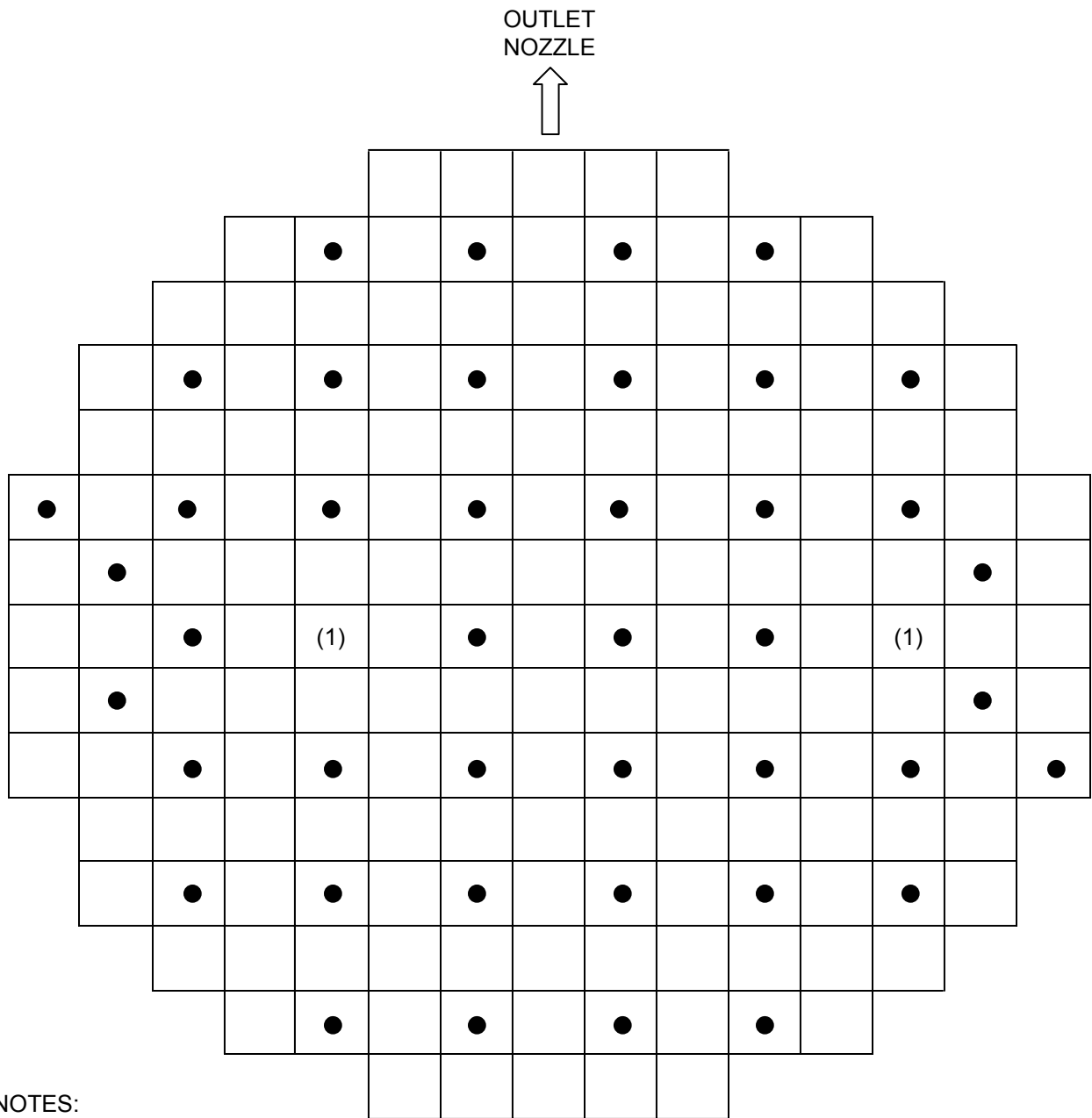

NOTES:

1. (1) – LOCATIONS E8 AND N8 REPLACED WITH VESSEL LEVEL PROBES.
2. ● - IN-CORE DETECTOR LOCATIONS.

SAR FIGURE NO. 7.7-5

AMENDMENT 20

ARKANSAS NUCLEAR ONE
UNIT 2
RUSSELLVILLE, ARKANSAS



SCALE:	NONE
DRAWN:	WESTINGHOUSE
DESIGN:	ENERGY
CAD NO:	

IN-CORE DETECTOR LOCATION

BASED ON DRAWING NO

SHEET

REV.

1

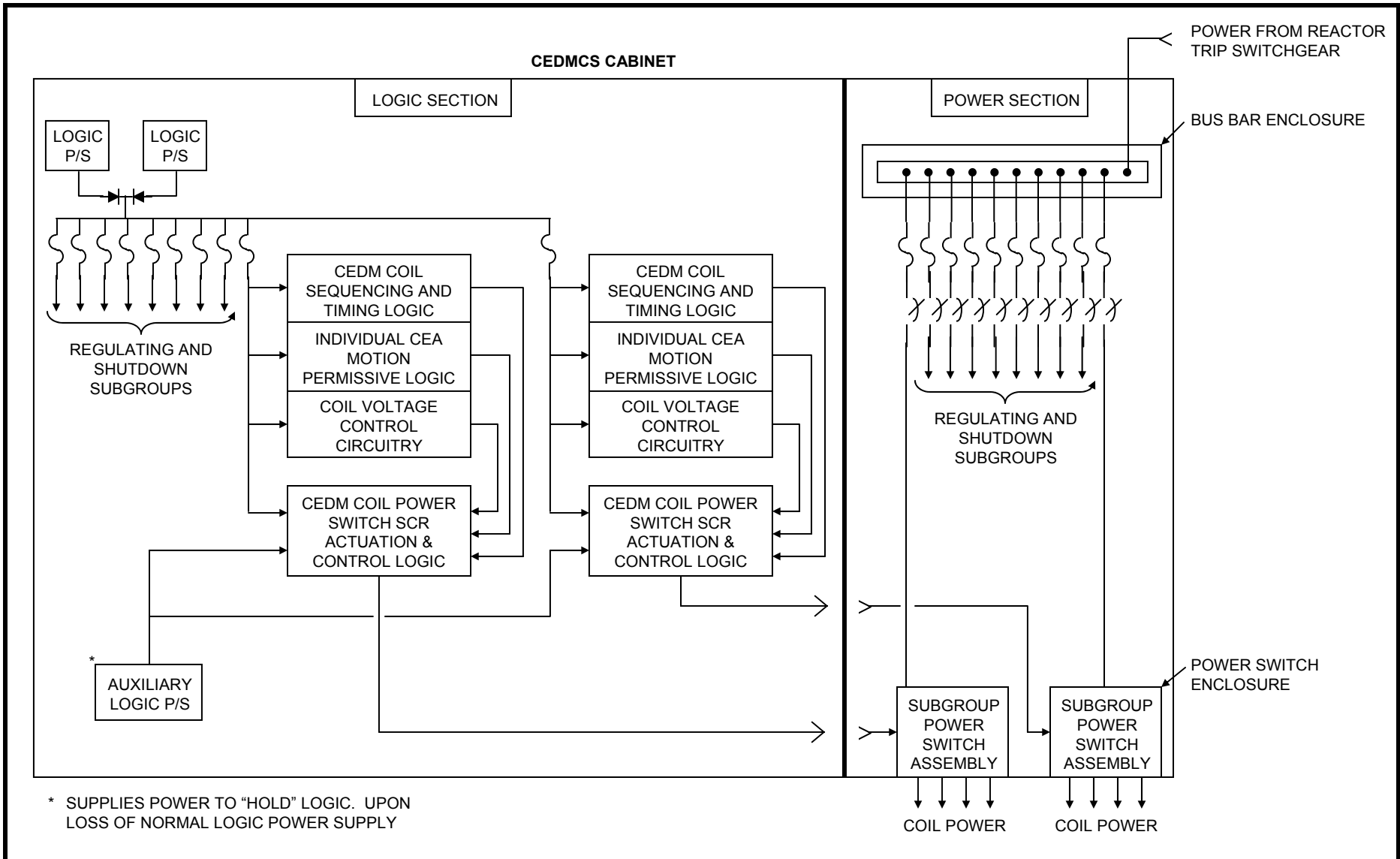

BANK P SUBGROUP POWER SWITCH AND CONTROL LOGIC RELATIONSHIPS

SAR FIGURE NO. 7.7-6

ARKANSAS NUCLEAR ONE
 UNIT 2
 RUSSELLVILLE, ARKANSAS



SCALE: NONE
 DRAWN: ENTERGY
 DESIGN: ENTERGY
 CAD NO:

AMENDMENT 20

BASED ON DRAWING NO	SHEET	REV.

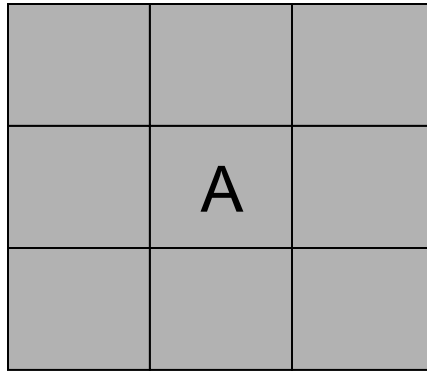

Note

This figure shows what is meant by being within one assembly of an operable ICI string. For Assembly A, any operable ICI string located anywhere in the shaded region above is considered to be within one assembly of A for the purpose of meeting Criterion ii.a.

SAR FIGURE NO. 7.7-7

AMENDMENT 19

ARKANSAS NUCLEAR ONE
UNIT 2
RUSSELLVILLE, ARKANSAS



SCALE: NONE

DRAWN:

DESIGN: ENTERGY

CAD NO:

ACCEPTABLE OPERABLE ICI
CONFIGURATION FOR CRITERIA II.A

BASED ON DRAWING NO

SHEET

REV.

1

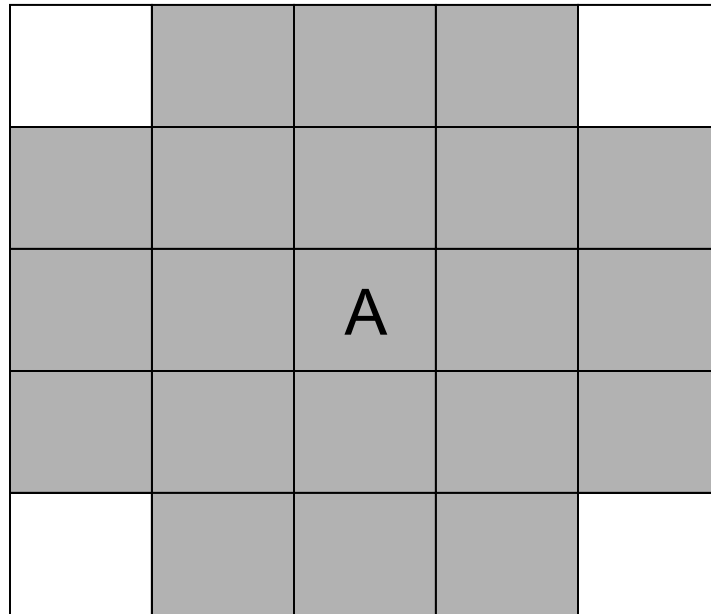

Note

This figure shows what is meant by being within two assemblies of an operable ICI string. For Assembly A, any operable ICI string located anywhere in the shaded region above is considered to be within two assemblies of A for the purpose of meeting Criterion ii.b.

SAR FIGURE NO. 7.7-8

AMENDMENT 19

ARKANSAS NUCLEAR ONE
UNIT 2
RUSSELLVILLE, ARKANSAS



SCALE:	NONE
DRAWN:	
DESIGN:	ENERGY
CAD NO:	

ACCEPTABLE OPERABLE ICI
CONFIGURATION FOR CRITERIA II.B

BASED ON DRAWING NO

SHEET

REV.

1

ARKANSAS NUCLEAR ONE
Unit 2

CHAPTER 8

TABLE OF CONTENTS

<u>Section</u>	<u>Title</u>	<u>Page</u>
8	<u>ELECTRIC POWER</u>	8.1-1
8.1	<u>INTRODUCTION</u>	8.1-1
8.1.1	UTILITY GRID AND ITS INTERCONNECTIONS	8.1-1
8.1.2	ONSITE ELECTRIC SYSTEM	8.1-1
8.1.3	REACTOR PROTECTION AND ENGINEERED SAFETY FEATURE LOADS	8.1-2
8.1.4	DESIGN BASES FOR SAFETY-RELATED ELECTRIC SYSTEMS	8.1-2
8.2	<u>OFF-SITE POWER SYSTEM</u>	8.2-1
8.2.1	DESCRIPTION	8.2-1
8.2.1.1	<u>Single Line Diagrams</u>	8.2-1
8.2.1.2	<u>Transmission Lines</u>	8.2-1
8.2.1.3	<u>Switchyard</u>	8.2-5
8.2.1.4	<u>Reliability</u>	8.2-7
8.2.2	ANALYSIS	8.2-8
8.3	<u>ONSITE POWER SYSTEMS</u>	8.3-1
8.3.1	AC POWER SYSTEMS	8.3-1
8.3.1.1	<u>Description</u>	8.3-1
8.3.1.2	<u>Analysis</u>	8.3-36
8.3.1.3	<u>Conformance With Appropriate Quality Assurance Standards</u>	8.3-54
8.3.1.4	<u>Independence of Redundant Systems</u>	8.3-57
8.3.1.5	<u>Physical Identification of Safety-Related Equipment</u>	8.3-63
8.3.1.6	<u>Grid Undervoltage Protection (Millstone 2 and ANO Events)</u>	8.3-63
8.3.2	DC POWER SYSTEMS	8.3-72

ARKANSAS NUCLEAR ONE
Unit 2

TABLE OF CONTENTS (continued)

<u>Section</u>	<u>Title</u>	<u>Page</u>
8.3.2.1	<u>Description</u>	8.3-72
8.3.2.2	<u>Analysis</u>	8.3-76
8.3.3	ALTERNATE AC POWER SOURCE	8.3-79
8.3.3.1	<u>System Description</u>	8.3-79
8.3.3.2	<u>Alternate AC Generator</u>	8.3-79
8.3.3.3	<u>Instrumentation & Control System</u>	8.3-81
8.3.3.4	<u>Power Distribution</u>	8.3-81
8.3.3.5	<u>Testing & Peaking Operations</u>	8.3-82
8.4	<u>TABLES</u>	8.4-1

ARKANSAS NUCLEAR ONE
Unit 2

LIST OF TABLES

<u>Table No.</u>	<u>Title</u>	<u>Page</u>
8.3-1	DIESEL LOAD TABLE	8.4-1
8.3-2	RATINGS OF CLASS 1E ELECTRICAL DISTRIBUTION EQUIPMENT	8.4-6
8.3-3	STORAGE AREAS FOR CLASS 1E ELECTRICAL EQUIPMENT	8.4-11
8.3-4A	125-VOLT DC BATTERIES 2D11 LOAD CHART	8.4-12
8.3-4B	125-VOLT DC BATTERIES 2D12 LOAD CHART	8.4-13
8.3-5	125-VOLT DC STATION BATTERY 2D11 EMERGENCY DUTY CYCLE	8.4-14
8.3-6	125-VOLT DC STATION BATTERY 2D12 EMERGENCY DUTY CYCLE	8.4-15
8.3-7	4.16 kV ENGINEERED SAFETY FEATURES SYSTEM SINGLE FAILURE ANALYSIS	8.4-16
8.3-8	480-VOLT ENGINEERED SAFETY FEATURES SYSTEM SINGLE FAILURE ANALYSIS	8.4-19
8.3-9	120/208-VOLT INSTRUMENT AC SYSTEM SINGLE FAILURE ANALYSIS	8.4-20
8.3-10	120-VOLT VITAL AC SYSTEM SINGLE FAILURE ANALYSIS	8.4-21
8.3-11	125V DC ENGINEERED SAFETY FEATURE SYSTEM SINGLE FAILURE ANALYSIS	8.4-22
8.3-12	SINGLE FAILURE ANALYSIS OF TRANSFER TO PREFERRED POWER SOURCE UPON UNIT TRIP	8.4-23

ARKANSAS NUCLEAR ONE
Unit 2

LIST OF FIGURES

<u>Figure No.</u>	<u>Title</u>
8.1-1	ELECTRIC SYSTEM MAP
8.1-2	MIDDLE SOUTH UTILITIES SYSTEM MAP
8.1-3	SOUTHWEST POWER POOL SYSTEM MAP
8.2-1	SYSTEM CONNECTIONS
8.2-2	500-161 KV SUBSTATION ONE LINE DIAGRAM
8.2-3	500 KV SWITCHYARD AUXILIARY POWER
8.2-4	DELETED
8.3-1	STATION SINGLE LINE DIAGRAM
8.3-2 – 8.3-5	DELETED
8.3-6	LOW VOLTAGE SAFETY SYSTEMS POWER SUPPLIES SINGLE LINE DIAGRAM
8.3-7 – 8.3-16	DELETED
8.3-17	LIGHTING DISTRIBUTION SYSTEM
8.3-18	LIGHTING DISTRIBUTION SYSTEM

ARKANSAS NUCLEAR ONE
Unit 2

UPDATE REFERENCE LIST

Sections and references listed below denote documents that contain additional cross reference information used to update the SAR.

<u>Section</u>	<u>Cross References</u>
8.3.1.6	Correspondence from Ziemann, NRC, to Phillips, AP&L, dated August 13, 1976. (1CNA087616).
8.3.1.4.2.2.2	Correspondence from Rueter, AP&L, to Stolz, NRC, dated August 30, 1977. (0CAN087709).
8.3.1.1.8.10	Correspondence from Williams, AP&L, to Stolz, NRC, dated December 30, 1977. (2CAN127715).
8.3.1.6	Correspondence from Williams, AP&L, to Stolz, NRC dated January 24, 1978. (2CAN017820).
8.3.1.1.8.8, 8.3.1.6	Correspondence from Williams, AP&L, to Stolz, NRC, dated March 30, 1978. (2CAN037830).
8.3.1.1.8.11.2	Correspondence from Williams, AP&L, to Stolz, NRC, dated January 19, 1979. (0CAN017911).
8.3.1.1.2	Design Change Package 2126, "Installation of Prohibit Interlock to Startup Transformer 2," 1979. (2DCP792126).
8.3.1.1.8.4	Design Change Package 2167, "Pressurizer Heater Power Supply Ref. NUREG-0578, 2.1.1," 1979. (2DCP792167).
8.3.1.1.8.4	Design Change Package 2131, "Addition Instrument AC Power," 1980 (2DCP802131).
8.3.1.1.8.8	Design Change Package 2046, "Defeat U/V Trip When on DG Power," 1981. (2DCP812046).
8.3.1.1.8.8 8.3.1.1.9.6 Table 8.3-1	Correspondence from Stolz, NRC, to Cavanaugh, AP&L, dated August 10, 1977. (2CNA087704).
8.3.1.1.8.8 8.3.1.1.9.6 Table 8.3-1	Correspondence from Stolz, NRC, to Cavanaugh, AP&L, dated August 19, 1977. (2CNA087708).
8.3.1.1.13	Correspondence from Williams, AP&L, to Hall, NRC, dated May 18, 1978. (2CAN057804).
8.3.1.6.4	Correspondence from Williams, AP&L, to Stolz, NRC, dated January 24, 1978. (2CAN017820).

ARKANSAS NUCLEAR ONE
Unit 2

UPDATE REFERENCE LIST (continued)

<u>Section</u>	<u>Cross References</u>
8.3.1	Design Change package 79-2126A, "Remove Selector Switch C10 to delete DCP.
8.3	Design Change Package 82-2012, "Deletion of BAM PP Room Cooler."
8.3	Design Change Package 83-2018A, "Electrical Support - C (swing) Pump Disconnect Switch."
8.3	Design Change Package 84-2058, "SIAS and MSIS Isolate SW from CCW Coolers."
8.3.1.2	EAR 85-162, 85-332 and EE 85-099, "Evaluation on Safety Significance of tray covers or barriers per guidelines of IEEE 384."
8.3.2.1	Design Change Package 84-2022, A, B, "Station Batteries."
8.3.2.1.1	
8.3.2.1.2	
8.3.2.1.5	
8.3.2.2.1	
Table 8.3-1	
Table 8.3-2	
Table 8.3-4a	
Table 8.3-4b	
Table 8.3-5	
Figure 8.3-6	
Figure 8.3-16	
Figure 8.3-66	
Table 8.3-1	Design Change Package 83-2045, "ESFAS Start Alarm Modifications on Service Water Pumps."
Figure 8.3-2	Design Change Package 79-2132, "Data Logger for Monitoring Generator Stator Temperature."
Figure 8.3-22	
Figure 8.3-6	Design Change Package 82-2169, "Replace MCC Breakers to Battery Chargers."
Figure 8.3-8	
Figure 8.3-11	
Figure 8.3-15	
Figure 8.3-16	
Figure 8.3-66	
Figure 8.3-6	Design Change Package 80-2123E, "Parameter Instrumentation Safety System (SPDS)."
Figure 8.3-8	
Figure 8.3-14	
Figure 8.3-16	
Figure 8.3-61	
Figure 8.3-62	

ARKANSAS NUCLEAR ONE
Unit 2

UPDATE REFERENCE LIST (continued)

<u>Section</u>	<u>Cross References</u>
Figure 8.3-7 Figure 8.3-17 Figure 8.3-20	Design Change Package 80-2143G, "Post Accident Sampling System Electrical Drawings."
Figure 8.3-9 Figure 8.3-10 Figure 8.3-11 Figure 8.3-13 Figure 8.3-14 Figure 8.3-15	Design Change Package 83-2039A, "Service Water System Valve Replacement."
Figure 8.3-17	Design Change Package 79-2137, "Cooling Tower Water Treatment Facility and Installation."
Figure 8.3-19 Figure 8.3-60 Figure 8.3-61	Design Change Package 79-2117, "Condenser Hotwell Sampling System Sodium Analyzers."
Figure 8.3-19	Design Change Package 79-2181, "Power Feed Change to the Recirculation Valves."
Figure 8.3-19 Figure 8.3-55 Figure 8.3-56 Figure 8.3-65 Figure 8.3-66	Design Change Package 82-2004, "Waste Gas Monitoring Panels."
Figure 8.3-20 Figure 8.3-66	Design Change Package 84-2060, "Steam Dump to Atmosphere Valves 2CV-1001 and 2CV-1051."
Figure 8.3-33 Figure 8.3-34	Design Change Package 79-2167, "Manual Loading of Pressurizer Heaters."
Figure 8.3-34 Figure 8.3-67	Design Change Package 79-2126, "Manual Pre-Select of Either Unit to Startup Transformer #2."
Figure 8.3-34 Figure 8.3-45 Figure 8.3-109	Design Change Package 81-2052, "Provide Load Shedding for Unit 2 on Transfer to ST #2."
Figure 8.3-44	Design Change Package 83-2053, "Solid State Undervoltage Relay Modification."
Figure 8.3-44	Design Change Package 85-2091, "480 V Bus Undervoltage."
Figure 8.3-47	Design Change Package 80-2043H, "Post Accident Sampling System (Schemes and Logic)."

ARKANSAS NUCLEAR ONE
Unit 2

UPDATE REFERENCE LIST (continued)

<u>Section</u>	<u>Cross References</u>
Figure 8.3-54 Figures 8.3-59 through 8.3-67	Design Change Package 79-2082, "Fire Protection System."
Figure 8.3-54	Design Change Package 83-2037, "Fire Protection Service Water Pump Motors."
Figure 8.3-56 Figure 8.3-57 Figure 8.3-61 Figure 8.3-62 Figure 8.3-66 Figure 8.3-67 Figure 8.3-77	Design Change Package 79-2135B, "Gaseous Effluent Radiation Monitoring System."
Figure 8.3-56 Figures 8.3-61 through 8.3-67 Figure 8.3-77 Figure 8.3-79	Design Change Package 80-2043D, "Installation of Embedded Conduit in PASS Building."
Figure 8.3-56	Design Change Package 80-2165C, "Modification to NaOH Storage Tanks - Heat Tracing."
Figure 8.3-56 Figure 8.3-63 Figure 8.3-64	Design Change Package 82-2113B, "PASS MOV's Electrical Design."
Figure 8.3-59 Figure 8.3-61 Figure 8.3-63 Figure 8.3-64	Design Change Package 81-2004B, "Unit 2 Service Water Flowmeter Addition."
Figure 8.3-60 Figure 8.3-65	Design Change Package 81-2103, "Fire Alarm System Smoke Detector Installation."
Figure 8.3-61	Design Change Package 79-2195, "Cold Lab (Atomic Absorption Unit Installation)."
Figure 8.3-61	Design Change Package 82-2050, "Install Flow Transmitters to Main Feedwater Lines."
Figure 8.3-61 Figure 8.3-62 Figure 8.3-66 Figure 8.3-67	Design Change Package 83-2017, "Rerouting of 2DG1 Associated Red Cables out of Fire Zone 2100Z."

ARKANSAS NUCLEAR ONE
Unit 2

UPDATE REFERENCE LIST (continued)

<u>Section</u>	<u>Cross References</u>
Figure 8.3-62 Figure 8.3-67	Design Change Package 80-2085A, "Main Steam Radiation Monitoring."
Figure 8.3-62	Design Change Packages 80-2123A, 80-2123C, and 80-2123J, "Safety Parameter Display System."
Figure 8.3-62 Figure 8.3-66 Figure 8.3-67 Figure 8.3-78	Design Change Package 83-2080, "Remote Shutdown Appendix R."
Figure 8.3-62	Design Change Package 83-1163, "Regulatory Guide 1.97 Electrical System Modifications."
Figure 8.3-63	Design Change Package 79-2172, "LPSI and CS Pumps Motor Bearing Temperature Monitor."
Figure 8.3-64	Design Change Package 83-2206, "Relabel Feedwater Pump Permissive Start Panel."
Figure 8.3-65	Design Change Package 80-2196A, "Cross Connect Between ANO-1 and 2 Instrument Air Supply to Aux Building."
Figure 8.3-67	Design Change Package 78-1492L, "High Range Gaseous Effluent Radiation Monitors."
Figure 8.3-67 Figure 8.3-76 Figure 8.3-77	Design Change Package 79-2129, "Redundant Critical Applications Program Computer System (CAPS)."
Figure 8.3-67 Figure 8.3-71	Design Change Package 79-2149, "Installation of Containment Pressure Indicator."
Figure 8.3-67	Design Change Package 80-2123M, "SPDS Additional Computer Inputs."
Figure 8.3-67 Figures 8.3-69 through 8.3-71 Figure 8.3-74 Figure 8.3-75	Design Change Package 83-2217, "Reg. Guide 1.97 Steam Generator Level Upgrade."
Figure 8.3-67 Figure 8.3-71	Design Change Package 85-2152, "Pressurizer Level Transmitter Replacement."
Figures 8.3-69 through 8.3-71	Design Change Package 79-2088, "Fire Breaks for Cable Trays and Conduits."

ARKANSAS NUCLEAR ONE
Unit 2

UPDATE REFERENCE LIST (continued)

<u>Section</u>	<u>Cross References</u>
Figures 8.3-71 through 8.3-73	Design Change Package 80-2201B, "Replace 16 Electric Actuated Ball Valves."
Figure 8.3-72	Design Change Package 79-2164, "Acoustical Valve Monitoring System for Safety Valves."
Figure 8.3-75 Figure 8.3-78	Design Change Package 79-2226B, "Relocate Laydown Storage Area for CEDM Duets."
<u>Amendment 6</u>	
8.3.1.2	Regulatory Guide 1.63, "Calculation GE-85E-00060-01."
8.3.1.1.8.4 8.3.1.1.8.8 8.3.1.6.2 8.3.1.6.5 Figure 8.3-33 Figure 8.3-34 Figure 8.3-45 Figure 8.3-109	Design Change Package 83-2058, "ANO-2 Millstone Load Shedding Modifications."
8.3.1.1.7 8.3.1.1.8.10	Design Change Package 83-2194, "EDG Backup Flashing System"
8.3.1.1.8.3 8.3.1.1.9.4 8.3.1.1.9.5	Design Change Package 83-2006, "Interlocks on Common Safety-Related Pumps."
8.3.1.2 Figure 8.3-18 Figure 8.3-24 Figure 8.3-25 Figure 8.3-33 Figure 8.3-34 Figure 8.3-49	Design Change Package 83-2198, "Isolation of SPDS Non-Class 1E Circuits," (Item B.6 of Regulatory Guide 1.75, Section 3.8, Compliance).
<u>Amendments 7 and 10</u>	
8.3.2.1.2	Design Change Package 84-2106B, "2D32 Battery Charger Replacement."
<u>Amendment 7</u>	
Table 8.3-1 Table 8.3-2 Figure 8.3-6 Figure 8.3-15 Figure 8.3-16 Figure 8.3-18 Figure 8.3-79	Design Change Package 84-2106B, "2D32 Battery Charger Replacement."

ARKANSAS NUCLEAR ONE
Unit 2

UPDATE REFERENCE LIST (continued)

<u>Section</u>	<u>Cross References</u>
Figure 8.3-108	Design Change Package 86-2052, "Safety Injection Tank Valve Position Switch Qualified Seal."
Figure 8.3-109	Design Change Package 84-2063, "Potter and Brunfield Relays."
<u>Amendment 8</u>	
Figure 8.3-4	Calculation 89E-0003-01, "Effect of Additional Load on Administration Building with Respect to ANO-2 Millstone Analysis."
Figure 8.3-8 Figure 8.3-9 Figure 8.3-12 Figure 8.3-13	Design Change Package 89-2046, "Increased Motor Ratings on 2CV5017, 2CV5037, 2CV5057 and 2CV5077."
Figure 8.3-42	Design Change Package 88-2052, "Addition of 500 ohm Resistors Across 127-2A3/XA and 127-2A3/XB."
Figure 8.3-78	Design Change Package 87-0273, "Replacement of Module 'B' in Electrical Penetration Assembly 2WR42-3."
8.3.1.2 Figure 8.3-19 Figure 8.3-67 Figure 8.3-70 Figure 8.3-74 Figure 8.3-75 Figure 8.3-79	Design Change Package 85-2111, "RCP Vibration Monitor."
8.3.1.1.99 Table 8.3-1	Calculation No. 85S-0002-01, Rev. 2, and NDS Calculation No. 89-E-0144-01, Rev. 0.
Figure 8.3-9 Figure 8.3-11 Figure 8.3-13 Figure 8.3-15 Figure 8.3-63	Design Change Package 86-2110, "2R6 Service Water Figure Piping Replacement."
Table 8.3-12	DCP 85-2134, "SIAS Removal."
8.3.1.1.8.11.14	Procedure 1412.044, Rev. 2, "480 VAC K-Line Circuit Breakers with Overcurrent Trip Device OD-5."
<u>Amendment 9</u>	
Table 8.3-1 Figure 8.3-19 Figure 8.3-57 Figure 8.3-66 Figure 8.3-67 Figure 8.3-77	Design Change Package 85-2075C, "CPC Temporary Power and Room Modifications."

ARKANSAS NUCLEAR ONE
Unit 2

UPDATE REFERENCE LIST (continued)

<u>Section</u>	<u>Cross References</u>
8.3.1.1.7 Figure 8.3-24 Figure 8.3-25 Figure 8.3-39 Figure 8.3-49	Design Change Package 83-2173, "Breaker 2A308/408 Interlock."
8.3.1.1.8.10 8.3.1.2 8.3.2.2.1 Figure 8.3-18 Figure 8.3-23 Figure 8.3-24 Figure 8.3-32 through 8.3-40 Figure 8.3-40 Figure 8.3-42 through 8.3-45 Figure 8.3-47 Figure 8.3-49 Figure 8.3-52 Figure 8.3-57 Figure 8.3-65	Design Change Package 86-2113, "ANO-2 Alarm Upgrade for Panels 2K01, 2K08, and 2K09."
8.3.1.6.5	Procedure 2107.001, Rev. 29, "Electrical System Operations."
Figure 8.3-109	Design Change Package 86-2116A, "Motor Operator Modification to 2CV 1023-2, 2CV-1024-1, 2CV-1073-2 and 2CV-1074-1."
Figure 8.3-18 Figure 8.3-57 Figure 8.3-66 Figure 8.3-77	Design Change Package 85-2075D, "Core Protection Calculator Permanent Tie-Ins."
Figure 8.3-19 Figure 8.3-57 Figure 8.3-77 Figure 8.3-79	Design Change Package 85-2075A, "CPC Room."
Figure 8.3-19 Figure 8.3-20 Figure 8.3-60 Figure 8.3-65 Figure 8.3-67 Figure 8.3-70	Design Change Package 85-2073, "ATWS Diverse Scram System."
Figure 8.3-19 Figure 8.3-67 Figure 8.3-77	Design Change Package 85-2057, "Dose Assessment System Upgrade."

ARKANSAS NUCLEAR ONE
Unit 2

UPDATE REFERENCE LIST (continued)

<u>Section</u>	<u>Cross References</u>
Figure 8.3-43 Figure 8.3-50	Plant Change 89-0727, "Replacement of 2A11-1, 2A11-2, 2A12-1 and 2A12-2 Time Delay Relays with Currently Available Nuclear Grade Equivalents."
Figure 8.3-53	Design Change Package 79-2025, "Maintenance Facility and Turbine Deck Expansion."
Figure 8.3-56 Figure 8.3-65 Figure 8.3-69 Figure 8.3-71 Figure 8.3-79	Design Change Package 82-2072, "Addition of Pressurizer Spray Isolation Valves."
Figure 8.3-61	Plant Change 87-3322, "Add a Section of Cable Tray to Protect Existing Cables."
Figure 8.3-61	Plant Change 84-0357, "Main Chiller Flow Switch."
Figure 8.3-62	Design Change Package 86-1006, "Safety System Diagnostic Instrumentation."
Figure 8.3-66	Plant Change 88-0074, "Retag Duplicated Conduit Number C0847 as C0848."
Figure 8.3-67	Plant Change 83-1512, "Label Instrument Ground Cables for 2C336-1, 2, 3, 4 and Seal Interconnecting Conduits."
Table 8.3-1	ANO Calculation 89-E-0105-01, "Use of Hydrogen Purge System."
<u>Amendment 10</u>	
8.3.1.1.3	Correspondence from Fisicaro, ANO, to the NRC, dated July 12, 1991. (2CAN079102).
8.3.1.1.4	Plant Change 90-8084, "2CV-1000-1 and 2CV-1050-2 Cable Replacement."
8.3.1.2 8.3.2.1.9 Figure 8.3-16 Figure 8.3-66	Design Change Packages 86-2143, "Battery 2D12 Replacement," and 86-2106A, "Charger 2D31 AC Feeder Breaker Replacement."
8.3.1.2 Figure 8.3-18 Figure 8.3-27 Figure 8.3-42 Figure 8.3-45 Figure 8.3-46 Figure 8.3-47 Figure 8.3-49 Figure 8.3-108	Design Change Package 88-2110, "ANO-2 Alarm Upgrade, Phase II."

ARKANSAS NUCLEAR ONE
Unit 2

UPDATE REFERENCE LIST (continued)

<u>Section</u>	<u>Cross References</u>
8.3.1.2	Design Change Package 89-2030, "2D13 Station Battery Replacement."
8.3.2.1.1	
Table 8.3-2	
Figure 8.3-6	
Figure 8.3-16	
Figure 8.3-66	
8.3.1.6.5	QAP-18I-91, "Unit 2 Electrical Distribution."
Figure 8.3-1	Design Change Package 89-2043, "ANO-2 Auxiliary Feedwater Pump Installation."
Figure 8.3-4	
Figure 8.3-26	
Figure 8.3-30	
Figure 8.3-35	
Figure 8.3-59	
Figure 8.3-60	
Figure 8.3-65	
Figure 8.3-2	Design Change Package 85-2148, "Main Generator Protection Modification."
Figure 8.3-22	
Figure 8.3-67	
Figure 8.3-6	Limited Change Package 91-6008, "125V DC Batteries 2D11 and 2D12 Main Fuse Replacement."
Figure 8.3-16	
Figure 8.3-8	Design Change Package 86-2116D, "MOV Actuator Change on 2CV-4821."
Figure 8.3-8	Design Change Package 90-2017, "MOV Modifications for 2CV-5103, 5104, 5105, 5106."
Figure 8.3-9	
Figure 8.3-12	
Figure 8.3-13	
Figure 8.3-10	Design Change Package 90-2003, "MOV Modifications for 2CV-1510, 2CV-1525, 2CV-1526..."
Figure 8.3-13	
Figure 8.3-14	
Figure 8.3-15	
Figure 8.3-11	Limited Change Package 90-6022, "ANO-2 Boric Acid System Heat Trace Panels Removal."
Figure 8.3-13	
Figure 8.3-79	
Figure 8.3-18	Design Change Package 86-2116B, "MOV Actuator Change for 2CV-4740-2."
Figure 8.3-18	Design Change Package 87-2096, "Dose Assessment System Upgrade."
Figure 8.3-18	Design Change Package 89-2053, "ATWS Diverse Emergency Feedwater Actuation System (DEFAS)."
Figure 8.3-19	
Figure 8.3-57	
Figure 8.3-66	

ARKANSAS NUCLEAR ONE
Unit 2

UPDATE REFERENCE LIST (continued)

<u>Section</u>	<u>Cross References</u>
Figure 8.3-79	
Figure 8.3-30	Design Change Package 90-2027, "ACW Isolation Valve Override."
Figure 8.3-30	Plant Change 90-8045, "EDG Room Exhaust Fans Circuit Enhancements."
Figure 8.3-44	Plant Change 90-8030, "Correct Duplicate Annunciator Tag Number 2K136."
Figure 8.3-53	Plant Change 90-8019, "Telephone System Upgrade."
Figure 8.3-53	Plant Change 90-8022, "Cooling Tower Aviation Warning Light System Flasher Replacement."
Figure 8.3-55	Plant Change 87-3748, "Temporary Power Distribution Disconnects."
Figure 8.3-63	
Figure 8.3-59	Design Change Package 87-2006, "Penetration Room
Figure 8.3-61	Differential Pressure Transmitters Removal."
Figure 8.3-62	
Figure 8.3-65	
Figure 8.3-66	
Figure 8.3-67	
Figure 8.3-59	Design Change Package 90-2029, "SWS Thermal Performance Monitoring."
Figure 8.3-63	
Figure 8.3-64	
Figure 8.3-69	
Figure 8.3-59	Plant Change 90-8079, "Detector 2XSH-3251B Guard."
Figure 8.3-62	Design Change Package 85-2116, "Evacuation System Upgrade."
Figure 8.3-64	
Figure 8.3-65	
Figure 8.3-66	
Figure 8.3-65	Plant Change 90-8029, "Provide Indication on 2C14 for Door 237."
Figure 8.3-67	Design Change Package 85-2070, "Turbine Building Drain Line Radiation Monitor."
Figure 8.3-67	Limited Change Package 91-6004, "Computerized Hold Card Network."
Figure 8.3-76	
Figure 8.3-77	
Figure 8.3-69	Design Change Package 89-2042, "Generic Letter 88-17, Shutdown Cooling (SDC) Instrumentation and Alarms."

ARKANSAS NUCLEAR ONE
Unit 2

UPDATE REFERENCE LIST (continued)

<u>Section</u>	<u>Cross References</u>
Figure 8.3-75	Design Change Package 88-2046, "Rosemount 1153A Pressure Transmitter Replacement."
<u>Amendment 11</u>	
8.2.1	ANO Procedure 1015.016, Rev. 10, "Unit Two Operations Forms."
8.3.1.1	
8.3.1.1.8.1	
8.3	ANO Procedure 1000.043, Rev. 13, "Steam Generator Water Chemistry Monitoring Unit II."
8.3.1.1.13.H	Plant Change 91-8059, "Cathodic Protection System Notes and Details."
8.3.1.1.8.11.6	Design Change Package 85-2134, "SIAS Removal From UAT
Table 8.3-12	4160 Volt Breakers & EDG Start Failure."
Figure 8.3-32	
Figure 8.3-51	
Figure 8.3-52	
8.3.1.2	Plant Change 91-8080, "Class IE/Non-Class IE Separation Discrepancies."
Figure 8.3-65	
Figure 8.3-66	
Table 8.3-1	Calculation 85S-00002-01, Rev. 6, "EDG Load Calculation."
Table 8.3-2	Design Change Package 86-2106, "Replace Battery Charger."
Table 8.3-2	Design Change Package 92-2003, "Unit 2 CPT Change-Out."
Figure 8.3-5	Plant Engineering Action Request 91-7312, "Electrical
Figure 8.3-25	Drawing Errors for the EDG (Unit 2)."
Figure 8.3-43	
Figure 8.3-50	
Figure 8.3-52	
Figure 8.3-5	Design Change Package 91-2012, "SDC Vortex Monitoring."
Figure 8.3-27	
Figure 8.3-61	
Figure 8.3-63	
Figure 8.3-66	
Figure 8.3-6	Design Change Package 92-2017, "DEFAS Enable Circuit."
Figure 8.3-16	
Figure 8.3-60	
Figure 8.3-6	Design Change Package 90-2036, "Unit 2 Plant Computer Replacement."
Figure 8.3-16	
Figure 8.3-17	

ARKANSAS NUCLEAR ONE
Unit 2

UPDATE REFERENCE LIST (continued)

<u>Section</u>	<u>Cross References</u>
Figure 8.3-62 Figure 8.3-76	
Figure 8.3-10 Figure 8.3-14 Figure 8.3-30 Figure 8.3-60 Figure 8.3-61 Figure 8.3-62 Figure 8.3-78 Figure 8.3-109	Design Change Package 91-2010, "Main Steam Motor Operated Valve Modification."
Figure 8.3-11	Limited Change Package 91-6017, "MOV Actuator
Figure 8.3-14	Modifications for Service Water System Valves: 2CV-1513-2 and 2CV-1519-1."
Figure 8.3-17	Design Change Package 92-2013, "Cooling Tower Chemical Addition."
Figure 8.3-17	Plant Engineering Action Request 88-3031, "Review Incinerator As-Built Electrical Information."
Figure 8.3-17 Figure 8.3-60	Design Change Package 92-2012, "Ion Chromatograph."
Figure 8.3-17 Figure 8.3-60	Limited Change Package 91-6025, "Outage Support Facility, Unit 2 Storeroom."
Figure 8.3-20	Design Change Package 80-2003, "RCS High Point Vent."
Figure 8.3-20	Design Change Package 88-2111, "ANO-2 Annunciator Upgrade Phase III."
Figure 8.3-39 Figure 8.3-44	Limited Change Package 92-6011, "2B5 & 2B6 Undervoltage Relays Replacement."
Figure 8.3-49	Plant Change 88-2904, "Two Service Water Pumps Running on the Same Bus."
Figure 8.3-54	Plant Change 90-8065, "2P4A, B, and C Discharge Pressure Indicating Switches Power Supply."
Figure 8.3-56 Figure 8.3-57 Figure 8.3-60 Figure 8.3-65 Figure 8.3-72	Design Change Package 91-2003, "ANO-2 Hydrogen Monitoring Modification."

ARKANSAS NUCLEAR ONE
Unit 2

UPDATE REFERENCE LIST (continued)

<u>Section</u>	<u>Cross References</u>
Figure 8.3-57	Limited Change Package 91-6007, "Installation of Position Indication for Outside Air Damper 2VSF-9."
Figure 8.3-59	Plant Change 92-8026, "Removal of Regenerate Waste Radiation Detector & Monitor."
Figure 8.3-60 Figure 8.3-61	Design Change Package 92-2019, "Addition of N16 Monitors on Main Steam Lines."
Figure 8.3-60	Plant Change 91-8036, "Hydrazine Bulk Tank Addition."
Figure 8.3-60	Design Change Package 92-2014, "ANO-2 Morpholine Addition System."
Figure 8.3-61 Figure 8.3-62 Figure 8.3-67 Figure 8.3-79	Design Change Package 92-2007, "Nitrogen Supply System for ANO-2 RB Electrical Penetrations."
Figure 8.3-62 Figure 8.3-77	Design Change Package 81-2021, "Power Supply to CAPS Computer."
Figure 8.3-63 Figure 8.3-64	Design Change Package 92-2002, "RWT Recirculation Modification."
Figure 8.3-66	Plant Change 91-8028, "Deletion of Smoke Detector 2XSH-3277."
Figure 8.3-66	Limited Change Package 91-6023, "Installation of Position Indication Unit 2 EDG Outside Air Dampers."
Figure 8.3-67	Plant Change 89-8001, "Reroute Cable to 2RE-8750-1."
Figure 8.3-72	Plant Change 87-2120, "Relabel Conduit to Eliminate Numbering Duplication."
Figure 8.3-79	Plant Change 90-8054, "Assign Number to Cable Tray."
<u>Amendment 12</u>	
8.2.1.3 Figure 8.2-3	Design Change Package 90-1051, "ANO-1 Black Battery"
8.3.1.1.9.9	Calculation 91-D-2003, "Emergency Diesel Generator (EDG) Capacity Ratings"
8.3.1.1.13.G	Design Change Package 93-2005, "Electrical Penetration Modules"
8.2.1.3 8.2.1.4 Figure 8.3-1	Design Change Package 92-2021, "Installation of Voltage Regulators for Offsite Power Sources"

ARKANSAS NUCLEAR ONE
Unit 2

UPDATE REFERENCE LIST (continued)

<u>Section</u>	<u>Cross References</u>
Figure 8.3-3 Figure 8.3-21 Figure 8.3-36	
8.3.1.1.8.11.8 8.3.1.1.8.4 8.3.1.1.9.4 8.3.1.1.9.5 Figure 8.3-1 Figure 8.3-5 Figure 8.3-24 Figure 8.3-25 Figure 8.3-32 Figure 8.3-36 Figure 8.3-39 Figure 8.3-40 Figure 8.3-49 Figure 8.3-66 Figure 8.3-67	Design Change Package 89-2017, "Alternate AC Power Source"
Table 8.3-1	Calculation 85-S0000201, "ANO-2 Diesel Generators Loading Calculation"
Table 8.3-2	Procedure 2403.002 Revision 4, PC-1, "Safety Related Battery Bank Performance Test"
Table 8.3-4A Table 8.3-4B Table 8.3-5 Table 8.3-6	Revision to Battery Loading Calculation
Figure 8.2-2 Figure 8.3-1 Figure 8.3-3 Figure 8.3-21 Figure 8.3-23 Figure 8.3-36	Design Change Package 92-2021, "Installation of Voltage Regulators for Offsite Power Sources"
Figure 8.3-1 Figure 8.3-59 Figure 8.3-66	Design Change Package 89-1022 "Alternate AC Power Source (1R11 Outage Work)"
Figure 8.3-3 Figure 8.3-5 Figure 8.3-7 Figure 8.3-16 Figure 8.3-18 Figure 8.3-20 Figure 8.3-22	Design Change Package 92-2023, "Critical Applications Programs Systems (CAPS) Migration to the Plant Computer"

ARKANSAS NUCLEAR ONE
Unit 2

UPDATE REFERENCE LIST (continued)

<u>Section</u>	<u>Cross References</u>
Figure 8.3-23	
Figure 8.3-24	
Figure 8.3-25	
Figure 8.3-32	
Figure 8.3-33	
Figure 8.3-34	
Figure 8.3-36	
Figure 8.3-40	
Figure 8.3-41	
Figure 8.3-42	
Figure 8.3-44	
Figure 8.3-47	
Figure 8.3-49 through 8.3-52	
Figure 8.3-5	Limited Change Package 93-6011, "Service Water Pump 2P4A Cable Replacement"
Figure 8.3-34	Plant Change 93-8016, "Replacement of Two Breaker Control Switches"
Figure 8.3-45	Schematic Diagram 480 Volt Load Center Transformers Feeder ACBs
Figure 8.3-54	Design Change Package 89-2001, "ANO Unit 2 Intake Structure (HVAC) Deficiencies"
Figure 8.3-56	Limited Change Package 91-6001, "Install Temperature Controls on Sodium Hydroxide Tank Level Lines"
Figure 8.3-56	Plant Change 92-8008, "Valves Operator Replacement"
Figure 8.3-56	Plant Change 93-8009, "Replacement of Pneumatic Waste Gas Compressor Discharge Isolation Valves with Manual Valves"
Figure 8.3-60	Limited Change Package 94-6004, "Main Feedwater Regulating Valves (MFRVs) Modification"
Figure 8.3-61 Figure 8.3.62	Design Change Package 92-2015, "Chemistry Point Addition to Plant Computer"
Figure 8.3-67	Limited Change Package 93-6015, "Controlled Access Network for Entergy Radiological Information System"
<u>Amendment 13</u>	
8.1.4 8.3.1.1.3 8.3.1.1.8.5 8.3.3	Design Change Package 92-2011, "Alternate AC (AAC) Generator System"

ARKANSAS NUCLEAR ONE
Unit 2

UPDATE REFERENCE LIST (continued)

<u>Section</u>	<u>Cross References</u>
Table 8.3-7	
8.1.4	Limited Change Package 94-6006, "Replacement of Panel 2CO4 RCS Temperature Indicators and RCP Differential Pressure Indicators"
8.3.1.1.8.11.1 Figure 8.3-2 Figure 8.3-22 Figure 8.3-32 Figure 8.3-33 Figure 8.3-34 Figure 8.3-35	Design Change Package 94-2024, "Generator Sequential Tripping/Trip Hardening"
8.3.1.2	Design Change Package 93-2013, "2C69 Control Room Console Upgrade"
8.3.1.2 Figure 8.3-19 Figure 8.3-29	Design Change Package 93-2019, "Fuses for Control Room Circuits"
Figure 8.3-2 Figure 8.3-22	Design Change Package 91-2018, "Turbine Generator Monitoring"
Figure 8.3-4 Figure 8.3-61	Design Change Package 93-2014, "ANO-2 Main Chiller Replacement"
Figure 8.3-8 Figure 8.3-9 Figure 8.3-12 Figure 8.3-13 Figure 8.3-109 Figure 8.3-110	Limited Change Package 92-6022, "GL 89-10 MOV Electrical Modifications"
Figure 8.3-8 Figure 8.3-12	Design Change Package 95-2004, "CEDM and Reactor Cavity Damper Replacement"
Figure 8.3-8 Figure 8.3-12	Design Change Package 95-2006, "LPSI Valve Replacement 2CV-5017-1 & 2CV-5057-2"
Figure 8.3-9	Design Change Package 90-2015, "2R11 LPSI Valve Replacement (2CV-5037-1 Figure 8.3-13 and 2CV-5077-2)"
Figure 8.3-9 Figure 8.3-13	Design Change Package 94-2002, "HPSI Injection Valve Replacement"
Figure 8.3-11 Figure 8.3-60 Figure 8.3-65	Design Change Package 89-2049, "Service Water and Auxiliary Cooling Systems Water Hammer Mitigation"

ARKANSAS NUCLEAR ONE
Unit 2

UPDATE REFERENCE LIST (continued)

<u>Section</u>	<u>Cross References</u>
Figure 8.3-16	Plant Change 95-8017, "2DO2 - Addition of Ground Fault Sensors"
Figure 8.3-39 Figure 8.3-49	Design Change Package 89-2017, "Station Blackout Alternate AC System"
Figure 8.3-36	Plant Change 95-8073, "Startup Transformer #2 Regulator Timer Bypass"
Figure 8.3-53	Limited Change Package 93-6009, "Electric Mods for Central Support Building Site Preparations"
Figure 8.3-53	Plant Change 93-8050, "Alternate AC-Generator Relocation of Plant Services"
Figure 8.3-53	Limited Change Package 94-6016, "IDEAS Computer Room"
Figure 8.3-54	Design Change Package 88-2109, "Card Reader Upgrade"
Figure 8.3-54	Design Change Package 90-2023, "IDEAS Computer Room"
Figure 8.3-54 Figure 8.3-67 Figure 8.3-76 Figure 8.3-77	Design Change Package 93-2007, "ANO-2 New Points to Plant Monitoring System"
Figure 8.3-54	Limited Change Package 95-6005, "Intake Structure Exhaust Fan Damper Motors Power Modifications"
Figure 8.3-59 Figure 8.3-64	Design Change Package 92-2002A, "RWT Recirculation Isolation Valves"
Figure 8.3-59 Figure 8.3-109 Figure 8.3-110	Design Change Package 94-2013, "Replace SOV 2SV-0205 with MOV 2CV-0205-2"
Figure 8.3-59	Plant Change 95-8022, "Gauge Panel for 2P-7A"
Figure 8.3-61 Figure 8.3-62	Plant Change 94-8007, "ANO - Maintenance Building Hot Meal Facility Removal"
Figure 8.3-64	Limited Change Package 94-6027, "Main Feedwater Pumps Trip Hardening"
Figure 8.3-65	Plant Change 95-8089, "Relocation of 2T4 Tank Room Locked High Radiation Wire Mesh Door 241"
Figure 8.3-66 Figure 8.3-67	Design Change Package 87-2024, "SPING - Boric Acid Mix Room HVAC"
Figure 8.3-69	Design Change Package 94-2016, "Weed RTD/Transmitter Replacement"

ARKANSAS NUCLEAR ONE
Unit 2

UPDATE REFERENCE LIST (continued)

<u>Section</u>	<u>Cross References</u>
Figure 8.3-69	Plant Change 94-8039, "2P32C and 2P32D Oil Level Transmitter Upgrade"
Figure 8.3-110	Design Change Package 94-2003, "2R11 Electrical Penetration Modifications"
<u>Amendment 14</u>	
8.3.1.2	Design Change Package 94-2008, "Feedwater Control System Upgrade"
Figure 8.3-19	
Figure 8.3-50	
Figure 8.3-57	
Figure 8.3-60	
Figure 8.3-62	
Figure 8.3-66	
Figure 8.3-67	
Figure 8.3-71	
Figure 8.3-73	
Figure 8.3-75	
Figure 8.3-76	
Figure 8.3-77	
8.3.1.2	Plant Change 96-2001, "Removal of 50GS Relays 2B-7 & 2B-8"
Figure 8.3-7	
Figure 8.3-29	
Figure 8.3-47	
Figure 8.3-108	
Figure 8.3-1	Limited Change Package 963501L201, "2P3A Motor Replacement"
Figure 8.3-3	
Figure 8.3-2	Plant Change 95-8064, "Main Generator, Unit Aux, and SU3 Watthour Meter Replacement"
Figure 8.3-22	
Figure 8.3-23	
Figure 8.3-3	
Figure 8.2-3	Plant Change 95-8050, "ANO Switchyard Battery Disconnect"
Figure 8.3-8	Plant Change 94-8046, "Miscellaneous Overload Heater Changes"
Figure 8.3-16	Plant Change 96-8044, "2D01 - Addition of Ground Fault Sensors"
Figure 8.3-17	Plant Change 95-8097, "Warehouse Overhead Door"
Figure 8.3-18	Design Change Package 963543D201, "Backup DC Source for Main Turbine Controls, EFW Controls, and Alarm Modification"
Figure 8.3-20	
Figure 8.3-19	Plant Change 962054P201, "Cross Between 2Y3 & 2Y4"
Figure 8.3-19	Plant Change 96-8002, "2SV-0386 Power Source Separation"
Figure 8.3-64	

ARKANSAS NUCLEAR ONE
Unit 2

UPDATE REFERENCE LIST (continued)

<u>Section</u>	<u>Cross References</u>
Figure 8.3-23	Plant Change 963228P201, "Startup #3 Metering Change to Regulate Voltage Input"
Figure 8.3-53	Design Change Package 92-2001, "High Level Waste Storage"
Figure 8.3-54	Design Change Package 93-2007, "Charging Pump Discharge Check Valve Replacement"
Figure 8.3-55	Plant Change 973855P201, "New Radwaste Processing Equipment Power Installation"
Figure 8.3-62 Figure 8.3-67	Plant Change 973932P201, "Relocation of OCC to CA2"
Figure 8.3-65	Plant Change 95-8047, "2SV-5934 & 2SV-5936 Removal"
Figure 8.3-66	Plant Change 94-8041, "Diesel Room Thermostat Relocation"
Figure 8.3-68 Figure 8.3-69 Figure 8.3-70	Plant Change 96-8031, "Vibration and Loose Parts Monitor Replacement"
Figure 8.3-73	Plant Change 963125P201, "Removal of 2TE-8371 From CEDM Cooling Duct"
<u>Amendment 15</u>	
8.3	Condition Report 2-97-0199, "Change to Penetration Protection Wording"
8.3.1.1.1 8.3.2.2.1 Figure 8.3-1 Figure 8.3-2 Figure 8.3-3 Figure 8.3-7	Plant Change 980159P301, "Change to Voltage Taps for ST#2 Transformer"
8.3.1.1.13G	Design Change Package 962006D202, "Electrical Penetration Upgrade for 2WR-42-3"
8.3.1.2 Figure 8.3-41	Design Change Package 89-2017, "Alternate AC Power Source Project"
8.3.1.2 8.3.2.1 8.3.2.1.2 8.3.2.2.1 Table 8.3-1	Design Change Package 963242D201, "Vital AC System Upgrade"

ARKANSAS NUCLEAR ONE
Unit 2

UPDATE REFERENCE LIST (continued)

<u>Section</u>	<u>Cross References</u>
Table 8.3-2	
Table 8.3-4A	
Table 8.3-4B	
Table 8.3-11	
Figure 8.3-6	
Figure 8.3-8	
Figure 8.3-11	
Figure 8.3-12	
Figure 8.3-15	
Figure 8.3-16	
Figure 8.3-66	
8.3.1.4.6.1	Condition Report 2-98-0168, "Removal of Fire Barrier Penetration Seal Details"
Figure 8.3-87	
Figure 8.3-88	
Figure 8.3-89	
Figure 8.3-90	
Figure 8.3-95	
Figure 8.3-95A	
8.3.1.6.1	Plant Change 980912N201, "Loss of Voltage Relay Setpoint Change"
8.3.3.2.3.2	Design Change Package 92-2011, "Alternate AC Generator"
8.3.3.2.3.5	
8.3.3.2.3.6	
Table 8.3-1	Calculation 85S0000201, "Diesel Generators Loading"
Table 8.3-1	Design Change Package 973950D201, "NaOH Replacement with TSP"
Figure 8.3-9	
Figure 8.3-12	
Figure 8.3-13	
Figure 8.3-55	
Figure 8.3-109	
Figure 8.3-1	Plant Change 963329P301, "Permanent Bypass of Startup #2 4160V Current Limiting Reactor"
Figure 8.3-3	
Figure 8.3-23	
Figure 8.3-10	Engineering Request 973976E201, "60PA Equivalent Replacement"
Figure 8.3-11	Plant Change 963219P201, "Maintain Power to 2RE-8540 & 2RE-8233"
Figure 8.3-15	
Figure 8.3-17	
Figure 8.3-66	
Figure 8.3-14	Design Change Package 963523D202, "MOV Modification for 2CV1026, 2CV1039, 2CV1076, 2CV1039, 2CV1037, & 2CV1036"
Figure 8.3-110	

ARKANSAS NUCLEAR ONE
Unit 2

UPDATE REFERENCE LIST (continued)

<u>Section</u>	<u>Cross References</u>
Figure 8.3-15 Figure 8.3-66	Plant Change 973967P301, "Power Supply for VSF-9"
Figure 8.3-17 Figure 8.3-53	Design Change Package 963559D301, "Computer/Telephone Room Power & AC Hardening"
Figure 8.3-18	Condition Report 2-99-0073, "Breaker Size Correction for 2D2224"
Figure 8.3-18 Figure 8.3-20	Design Change Package 963543D201, "Backup DC Source for Main Turbine Controls, EFW Controls, and Alarm Modification"
Figure 8.3-18 Figure 8.3-19 Figure 8.3-55 Figure 8.3-56 Figure 8.3-64 Figure 8.3-65 Figure 8.3-66 Figure 8.3-67 Figure 8.3-68 Figure 8.3-71 Figure 8.3-72	Design Change Package 946012D201, "Containment Vent Header/Waste Gas System Modification"
Figure 8.3-26 Figure 8.3-26A Figure 8.3-32 Figure 8.3-33 Figure 8.3-34	Design Change Package 963089D202, "Replacement of the Transformer Position Breakers for Buses 2A2 & 2H2"
Figure 8.3-58	Plant Change 980882N301, "Diesel Fuel Vault Security Door Modification"
Figure 8.3-108	Plant Change 980274P201, "Setpoint Change on 2PS-4623-2 & 2PC-4623-1"
<u>Amendment 16</u>	
8.1.2 8.2.1 8.2.1.2 8.2.1.2.1 8.2.1.3 8.2.2 Figure 8.2-1 Figure 8.2-2 Figure 8.2-4 Figure 8.3-1 Figure 8.3-21	Engineering Request 973922A301, "Improvements for Offsite Power Source ST#2"

ARKANSAS NUCLEAR ONE
Unit 2

UPDATE REFERENCE LIST (continued)

<u>Section</u>	<u>Cross References</u>	
8.1.2	Engineering Request 973922A302, "Renaming of the ANO-Morrilton East 161 kV Line"	
8.2.1		
8.2.1.2		
8.2.1.2.1		
8.1.2.1.1		
8.2.1.3		
8.2.1.4		
Figure 8.2-1		
Figure 8.2-4		
Figure 8.3-1		
Figure 8.3-21		
8.3.1.1.3		Design Change Package 963089D203, "2A3 Bus Circuit Breaker Replacement"
Figure 8.3-1		
Figure 8.3-5		
Figure 8.3-26		
Figure 8.3-26A		
Figure 8.3-27		
Figure 8.3-39		
Figure 8.3-40		
Figure 8.3-45		
Figure 8.3-49		
8.3.1.1.6	Design Change Package 963242D202, "Inverter Replacement"	
8.3.1.1.8		
8.3.1.2		
8.3.2.2.1		
8.12		
Table 8.3-2		
Table 8.3-4A		
Figure 8.3-6		
Figure 8.3-8		
Figure 8.3-10		
Figure 8.3-11		
Figure 8.3.12		
Figure 8.3-15		
Figure 8.3-16		
Figure 8.3-18		
Figure 8.3-66		
8.3.1.1.3	Nuclear Change Package 983608N201, "PPS Indefinite Bypass"	
8.3.1.1.8		
Table 8.3-3		
Table 8.3-10		
Table 8.3-11		
Table 8.3-12		

ARKANSAS NUCLEAR ONE
Unit 2

UPDATE REFERENCE LIST (continued)

<u>Section</u>	<u>Cross References</u>
8.3.1.1.8 Table 8.3-2 Figure 8.3-1 Figure 8.3-4 Figure 8.3-5 Figure 8.3-25 Figure 8.3-39	Nuclear Change Package 963089N201, "Removal of 2X31 and Upgrade 2A3 Bus Bracing"
8.3.1.1.8 Table 8.3-2 Figure 8.3-1 Figure 8.3-4 Figure 8.3-5 Figure 8.3-25 Figure 8.3-39	Nuclear Change Package 963089N202, "Bus Brace 2A4"
8.3.1.2.4 Table 8.3-2 Figure 8.3-10 Figure 8.3-11	Nuclear Change Package 963474N201, "MCC Cubicle Replacements"
8.3.1.2.4	Nuclear Change Package 002370N201, "Electrical Upgrade"
8.3.2 Figure 8.3-7 Figure 8.3-10 Figure 8.3-15 Figure 8.3-60 Figure 8.3-61	Engineering Request 980642I243, "Mechanical Support for the RSG Project" Nuclear Change Package 980542N201, "Service Water and ACW Modifications for Power Uprate"
Figure 8.3-16	Engineering Request 003240E201, "Evaluation to Replace Overcurrent Tripping Device"
Figure 8.3-26 Figure 8.3-32 Figure 8.3-33 Figure 8.3-34	Design Change Package 963089D201, "Replacement of the 4.16 and 6.9 kV Supply Breakers on 2H1 and 2A1"
Figure 8.3-49	Engineering Request 991744E202, "Equivalency Evaluation for SBM CS for EDGs"
Figure 8.3-49 Figure 8.3-51 Figure 8.3-52	Nuclear Change Package 003132N201, "Replacement of EDG Timing Relays"
Figure 8.3-50	Nuclear Change Package 003056N201, "2K09 Annunciator Window G1 to K1"

ARKANSAS NUCLEAR ONE
Unit 2

UPDATE REFERENCE LIST (continued)

<u>Section</u>	<u>Cross References</u>
Figure 8.3-50 Figure 8.3-52	Nuclear Change Package 003194N201, "2K127 Annunciator Correction - 'A' EDG"
Figure 8.3-54	Engineering Request 992222E201, "Service Water Conduit Fire Wrap"
Figure 8.3-54	Plant Change 974196P201, "Chlorination Booster Pump Removal"
Figure 8.3-54	Plant Change 980066P201, "Traveling Screen Upgrades"
Figure 8.3-59	Plant Change 963212P201, "Regen Waste System Upgrade"
Figure 8.3-66	Plant Change 974603P201, "EDG Fuel Oil Day Tank Level Switches"
Figure 8.3-67	Nuclear Change Package 002998N201, "CREVS Tripping of Non-Q Fans and Cooler"
Figure 8.3-68 Figure 8.3-70 Figure 8.3-78	Nuclear Change Package 991508N201, "Safety Channel #4 Excure Detector Replacement"
Figure 8.3-68 Figure 8.3-79	Nuclear Change Package 991508N202, "Safety Channel 'C' Excure Detector Replacement"
Figure 8.3-71 Figure 8.3-72	Design Change Package 980642D209, "Disconnect and Reconnect of Small Bore Piping and Tubing to Support the Steam Generator Replacement Project"
<u>Amendment 17</u>	
8.3.1.1.8.11.2 8.3.1.1.8.4	Engineering Request ANO-1997-3922-003, "Interlock Scheme for Unit 1 Fast Transfer to Startup #2"
8.3.1.1.1 8.3.1.1.13.D 8.3.1.2.4.A 8.3.1.2.4.B Figure 8.3-1 Figure 8.3-2	Engineering Request ANO-2000-2344-026, "Power Uprate Evaluation"
8.3.1.1.1 Figure 8.3-1 Figure 8.3-2	Engineering Request ANO-2000-3316-002, "Uprate of Isophase Bus Cooling System Amperage Rating"
Figure 8.3-53	Engineering Request ANO-1996-3230-027, "Unit 2 Condenser Tube Bundle Replacement"
Figure 8.3-61 Figure 8.3-62	Engineering Request ANO-2000-3265-001, "Installation of Local Feedwater Oxygen Analyzers"

ARKANSAS NUCLEAR ONE
Unit 2

UPDATE REFERENCE LIST (continued)

<u>Section</u>	<u>Cross References</u>
Figure 8.3-1 Figure 8.3-4	Engineering Request ANO-1998-0405-012, "Heater Drain Pump Power Uprate Impacts"
Figure 8.3-49 Figure 8.3-51 Figure 8.3-52	Engineering Request ANO-1998-1013-001, "Replacement of Unit 2 Emergency Diesel Generator Timers"
8.3.1.1.8.8 8.3.1.6.1 8.3.1.6.2 8.3.1.6.3 8.3.1.6.5	Engineering Request ANO-1998-0912-002, "Degraded Voltage Relay Setpoint Changes"
Figure 8.3-2 Figure 8.3-22	Engineering Request ANO-2000-2365-002, "Relay Setting Block Removal"
Figure 8.3-68 Figure 8.3-69 Figure 8.3-79	Engineering Request ANO-1998-1508-003, "Unit 2 Safety Channel "A" Exore Detector Replacement"
Table 8.3-1	Engineering Calculation 85-S-00002-01, "Emergency Diesel Calculation"
<u>Amendment 18</u>	
Figure 8.3-80 Figure 8.3-83 Figure 8.3-84 Figure 8.3-85 Figure 8.3-86	Condition Report ANO-C-1997-0282, "Revision of SAR Figure Titles"
Figure 8.3-68 Figure 8.3-69 Figure 8.3-71 Figure 8.3-75 Figure 8.3-78	Engineering Request ER-ANO-1999-1508-020, "Excore Channel Replacement"
Figure 8.3-53	Engineering Request ER-ANO-1996-3230, "Temporary Power to Unit 2 Tube Pull Pit Area"
8.3.1.6.2	Engineering Request ER-ANO-1999-1801, "Addition of 22 KV Voltage Regulator in the ANO-2 Switchyard"
Figure 8.3-54 Figure 8.3-63	Engineering Request ER-ANO-2002-0268-000, "Replacement of 2VEF-25A Power Cable"
8.3.1.2.5 Table 8.3-2	Engineering Request ER-ANO-2003-0224-001, "Increase in Maximum Float Voltage for Battery 2D-12"

ARKANSAS NUCLEAR ONE
Unit 2

UPDATE REFERENCE LIST (continued)

<u>Section</u>	<u>Cross References</u>
8.3.1.1.5	SAR Discrepancy 2-98-0088, "Correction of Alternate Power Feeds to 2Y-1 and 2Y-2, 120 V Instrument AC Panels"
8.3.2.2.1	Condition Report CR-ANO-2-2003-0703-005, "Correction of IEEE Battery Testing Standard"
Table 8.3-1	SAR Discrepancy 2-98-0124, "Corrections to EDG Load Table"
Table 8.3-1	License Basis Document Change 2-8.4-0002, "Changes to EDG Loading"
Figure 8.3-43	Condition Report CR-ANO-2-2002-0235, "Correction of EDG Lockout Relay Type"
Figure 8.3-50	Condition Report CR-ANO-2-2001-0955, "Annunciator 2K10-H2 Reflash"
Figure 8.3-25	License Basis Document Change 2-8.3-0355, "Correction of Contact Development for the 4160 V Ammeter Transfer Switch"
Figure 8.3-16	License Basis Document Change 2-8.3-0360, "Wiring Connection Correction"
Figure 8.3-22	Engineering Request ER-ANO-1999-2227-001, "Removal of Generator Frequency Chart Recorders"
Figure 8.3-50	Engineering Request ER-ANO-2002-0630-001, "Addition of Contact to Channels 1/2 Margin to Saturation Low Alarm"
Figure 8.3-40	Engineering Request ER-ANO-1998-1050, "Addition of E-2098 Connection Drawings to the ANO-2 SAR"
8.3.1.1.9.4 8.3.1.2.1 8.3.1.2.9	SAR Discrepancy 2-98-0092, "Clarification of Key Switches and Interlocks Associated with 4160V Vital ESF buses"
8.3.1.1.8.4 8.3.1.1.8.8 8.3.1.1.9.6 8.3.1.2.5	SAR Discrepancy 2-98-0089 and 2-98-0090, "Clarification of Voltage Limits and Bus Transfer Arrangement With Regard to 4160 V and 480 V Load Shedding Schemes"
Table of Contents	
Figure 8.3-17 Figure 8.3-53	Engineering Request ER-ANO-2000-2587-009, "Installation of New Portable Security Buildings"
Figure 8.3-110	Engineering Request ER-ANO-2000-2624-001, "Installation of Emergency Power Cross-Connect for ECCS Vent Valves 2CV-4740-2 and 2CV-4698-1"
Figure 8.3-62	Engineering Request ER-ANO-1999-1894, "Installation of Sample Coolers and 120 VAC Power Supply in FW Metals Probe Cabinet 2C-411"

ARKANSAS NUCLEAR ONE
Unit 2

UPDATE REFERENCE LIST (continued)

<u>Section</u>	<u>Cross References</u>
Figure 8.3-1	Engineering Request ER-ANO-2003-0893-001, "Description Revision of ANO-1 Main Transformers"
Figure 8.3-3	Engineering Request ER-ANO-1998-0624-001, "Reclassification of RCP Differential Pressure Instruments"
Figure 8.3-5	Engineering Request ER-ANO-2003-0689, "Service Water Pump Motor Cable Replacement"
Figure 8.3-6 Figure 8.3-16	Engineering Request ER-ANO-2000-2654, "Replacement of 125VDC Breaker Overcurrent Trip Devices"
Figure 8.3-8	Engineering Request ER-ANO-2002-1971, "Addition of Note 9 Associated with Breaker 51L1"
Figure 8.3-16	Engineering Request ER-ANO-2001-0816, "Revisions Associated With 125VDC Bus Ground Reference Meters"
Figure 8.3-19	Engineering Request ER-ANO-1996-2029, "Upgrade of MFW Recirculation Valves"
Figure 8.3-27	Engineering Request ER-ANO-1998-0642, "Steam Generator Replacement"
Figure 8.3-31 Figure 8.3-37 Figure 8.3-38 Figure 8.3-93 Figure 8.3-94 Figure 8.3-112	Condition Report ANO-C-1991-0073, "Upgrade of LBD Change Process"
Figure 8.3-44	Drawing Revision No. 95-5948, "MDR Relay Model Number Revision"
Figure 8.3-45 Figure 8.3-57 Figure 8.3-109	Engineering Request ER-ANO-1997-5122, "Correction of K102 Connections"
Figure 8.3-51 Figure 8.3-52 Figure 8.3-66	Engineering Request ER-ANO-1998-1013, "Emergency Diesel Generator Timer Replacement"
<u>Amendment 19</u>	
Figure 8.3-10 Figure 8.3-62	Engineering Request ER-ANO-2003-0042-000, "Installation of Alternate Power Supply for SPDS Computer Room Cooler 2VUC-30"
Figure 8.3-52	Parts Equivalency Evaluation 5752, "Alternate Relay Contact Block for the Emergency Diesel Generator"

ARKANSAS NUCLEAR ONE
Unit 2

UPDATE REFERENCE LIST (continued)

<u>Section</u>	<u>Cross References</u>
8.3.1.1.4	Engineering Request ER-ANO-2000-3333-064, "Justification for XLPE as an Acceptable Equivalent for EPR Insulation on 480 Volt Power Cables"
8.2.1 8.3.1.1.8.1	Engineering Request ER-ANO-2003-0705-000, ""Startup Transformer #2 Backfeed Capability in Modes 3 and 4"
Figure 8.3-26A	Condition Report CR-ANO-2-2004-0936, "Device/Termination Point Number Correction and Clarification of Contact Type"
Figure 8.3-73	Engineering Request ER-ANO-2003-0245-017, "CEDM Cooling Shroud Upgrade"
Figure 8.3-50	License Document Change Request 2-8.3-0393, "Correction to DRN 94-12318"
8.3.1.2.5 Table 8.3-2	Engineering Request Er-ANO-2003-0224-001, "Restoration of 2D-12 Battery Bank Float Voltage to Original Value"
Figure 8.3-60 Figure 8.3-61 Figure 8.3-62 Figure 8.3-66 Figure 9.5-1 Sh2 Figure 9.5-1 Sh4	Engineering Request ER-ANO-2000-2478-201, "Removal of Inactive Air "Maintenance Devices from Various Fire Water Valves"
Figure 8.3-19	Condition Report CR-ANO-C-2004-2204, "Drawing Administrative Error"
Figure 8.3-1	Engineering Request ER-ANO-2003-0893-001, "Transformer Rating and Impedance Revision"
Figure 8.2-2	Engineering Request ER-ANO-2005-0050-000, "Switchyard Initiative Project"
Figure 8.3-8 Figure 8.3-12 Figure 8.3-108 Sh 1A & 1G	Engineering Request ER-ANO-2005-0064-000, "Installation of Revised Containment Building Overcurrent Protection Devices"
Figure 8.3-66 Figure 8.3-79	Engineering Request ER-ANO-2003-0041-000, "Letdown Isolation Valve Cable Re-route Through Alternate Fire Zone"
Figure 8.3-54	Engineering Request ER-ANO-2003-0689-000, "Service Water Pump 2P-4B Cable Replacement"
Figure 8.3-52	Engineering Request ER-ANO-2000-2768-002, "EDG Exhaust Fan Interlock Removal"
Figure 8.3-26	Condition Report CR-ANO-C-2005-0800, "Correction of Administrative Error"

ARKANSAS NUCLEAR ONE
Unit 2

UPDATE REFERENCE LIST (continued)

<u>Section</u>	<u>Cross References</u>
<u>Amendment 20</u>	
8.3.1.1.3 8.3.1.1.4 8.3.1.1.7 8.3.1.1.8.1 8.3.1.1.8.2 8.3.1.1.8.3 8.3.1.1.8.5 8.3.1.1.8.11 8.3.1.1.8.11.11 8.3.1.2.6 8.3.1.2.9 8.3.1.4.6 8.3.2.1 8.3.2.1.4 Figures – ALL	License Document Change Request 05-058, "Deletion/simplification of Excessive Detailed Drawings from SAR"
Figure 8.3-1	Engineering Request ER-ANO-2003-0893-006, "Installation of New Type Lightning Arrestor Associated with the Main Transformers"
8.1.4 8.2.1.3 8.2.1.4 Figure 8.2-3	Engineering Request ER-ANO-2005-0032-000, "Modification of ANO Switchyard DC System"
8.3.1.1.3 8.3.1.1.4 8.3.1.1.6 8.3.2.1.5	Condition Report CR-ANO-2-2004-1171, "Clarification of Cable Insulation and Jacket Types"
8.3.1.1.1	Engineering Request ER-ANO-2006-0453-000, "Replacement of 'A' Main Transformer"
8.3.1.1.9.9	Engineering Request ER-ANO-2005-0149-004, "Revision to EDG Service Water Design Flow"
Table 8.3-4A Table 8.3-4B Table 8.3-5 Table 8.3-6	Calculation CALC-86-E-0020-01, "Revision in 2D11 Battery Loads"
Table 8.3-1	Condition Report CR-ANO-C-2006-0100, "2B5 and 2B6 Load Center Transformer Losses"

ARKANSAS NUCLEAR ONE
Unit 2

UPDATE REFERENCE LIST (continued)

<u>Section</u>	<u>Cross References</u>
<u>Amendment 21</u>	
Figure 8.2-3	Condition Report CR-ANO-C-2007-1358, "500 KV Drawing Editorial Correction"
8.3.1.1.10	Engineering Change EC-897, "Containment Spray Pump Motor Replacement"
Table 8.3-2	Engineering Change EC-897, "125 VDC Breaker Replacements"
8.3.1.1.8.3	Condition Report CR-ANO-2-2008-1078, "Revise Requirements for Non-Essential Boration Systems"
<u>Amendment 22</u>	
8.3.1.1.8.4	Engineering Request EC-14661, "Clarification of Startup Transformer 1 and 2 Operation and Use"
8.3.1.2.5	Engineering Request EC-16505, "Clarification of Station Battery Type"
<u>Amendment 23</u>	
8.3.3.2.3.2	Engineering Change EC-20107, "Clarification of EDG Start Attempt Requirements"
8.3.1.1.10 8.3.1.2.5	Condition Report CR-ANO-2-2010-1756, "Clarification of Breaker Space Heater Requirements" and Condition Report CR-ANO-2-2010-1828, "Clarification of Battery Room Exhaust Fan Code Class"
Table 8.3-1	Engineering Change EC-27946, "Clarification of Battery Charger Trains"
<u>Amendment 23</u>	
8.3.2.1.3 Table 8.3-2 Figure 8.3-6	Engineering Request ER-ANO-2000-2654-001-1, "Install Short Circuit Protection Fuses on DC Buses Feeds to 2Y-13, 2Y-1113, and 2Y-24"
Table 8.3-1	Engineering Change EC-20793 "Automatic Restart of 2VEF-49, 2VEF-61, 2VUC-2A, 2VUC-2B, 2VUC-2C, and 2VUC-2D Following LOOP"
<u>Amendment 24</u>	
Figure 8.3-1	Licensing Document Change Request 11-041, "Correct drawing labels associated with 6900 V Buses and Startup Transformers."
8.3.1.1.9.9	License Document Change Request 12-015, "Correct of Reactor Vessel Internals Program Title"
8.3.1.2.4.D 8.3.1.1.1	Engineering Change EC-32243, "Correction of 2B-15C1 Breaker Type" Engineering Change EC-20037, "Main Transformer Replacement"

ARKANSAS NUCLEAR ONE
Unit 2

UPDATE REFERENCE LIST (continued)

<u>Section</u>	<u>Cross References</u>
<u>Amendment 25</u>	
8.3.2.1.1 8.3.2.1.9	License Document Change Request 13-023, "Addition of Details for Station Vital Batteries"
8.3.1.6.3	License Document Change Request 13-029, "Update to Reflect New Organizational Structure"
8.2.1.4	Condition Report CR-ANO-2-2013-0904, "Incorporate Consistent References to Maximum Probably Flood Language"
8.3.3.2.3.2	Engineering Change EC-46940, "Install AACDG Redundant Air Compressor"
Table 8.3-1	Engineering Change EC-51967, "Switchgear Room Cooling Requirements"
<u>Amendment 26</u>	
8.3.2.1	Condition Report CR-ANO-2-2015-0597, "Addition of 125 VDC System Details"
8.3.1.2.5 8.3.1.4.2.2.2 8.3.1.4.6	Licensing Basis Document Change Request LBDCR 15-017, "ANO-2 SAR and TRM Updates Support Implementation of NFPA 805"
8.2.1.4.F	Engineering Change EC-51913, "Startup 2 Transformer Flood Protection"
8.2.1.2	Condition Report CR-ANO-C-2015-2353, "Resolve Inconsistencies Between ANO-1 and ANO-2 Chapter 8 Language"
<u>Amendment 27</u>	
Table 8.3-1	Engineering Change EC-72499, "LPSI Pump 2P-60B Motor Replacement"
8.3.1.1.8.10	Engineering Change EC-367, "#2 Emergency Diesel Generator Governor Replacement"
Figure 8.3-1	Engineering Change EC-59247, "Common Feedwater System Electrical Connections"
8.1.2 8.2.1 8.3.1.1.1 8.3.1.1.2 Figure 8.3-1	Engineering Change EC-22985, "Replacement of ANO-2 Unit Auxiliary Transformer"

ARKANSAS NUCLEAR ONE
Unit 2

UPDATE REFERENCE LIST (continued)

<u>Section</u>	<u>Cross References</u>
<u>Amendment 28</u>	
8.2.1.3 8.2.1.4	Engineering Change EC-73661, "Enable Open Phase Detection on Startup Transformers"
Figure 8.2-1 Figure 8.2-2	Engineering Change EC-79360, "New Pleasant Hill 161 kV Substation"

ARKANSAS NUCLEAR ONE
Unit 2

RECORD OF REVISIONS

<u>PAGE #</u>	<u>AMENDMENT #</u>	<u>PAGE #</u>	<u>AMENDMENT #</u>	<u>PAGE #</u>	<u>AMENDMENT #</u>
TABLE OF CONTENTS		CHAPTER 8		CHAPTER 8 (CONT.)	
8-i	28	8.1-1	27	8.3-31	27
8-ii	28	8.1-2	27	8.3-32	27
8-iii	28	8.1-3	27	8.3-33	27
8-iv	28			8.3-34	27
8-v	28	8.2-1	28	8.3-35	27
8-vi	28	8.2-2	28	8.3-36	27
8-vii	28	8.2-3	28	8.3-37	27
8-viii	28	8.2-4	28	8.3-38	27
8-ix	28	8.2-5	28	8.3-39	27
8-x	28	8.2-6	28	8.3-40	27
8-xi	28	8.2-7	28	8.3-41	27
8-xii	28	8.2-8	28	8.3-42	27
8-xiii	28			8.3-43	27
8-xiv	28	8.3-1	27	8.3-44	27
8-xv	28	8.3-2	27	8.3-45	27
8-xvi	28	8.3-3	27	8.3-46	27
8-xvii	28	8.3-4	27	8.3-47	27
8-xviii	28	8.3-5	27	8.3-48	27
8-xix	28	8.3-6	27	8.3-49	27
8-xx	28	8.3-7	27	8.3-50	27
8-xxi	28	8.3-8	27	8.3-51	27
8-xxii	28	8.3-9	27	8.3-52	27
8-xxiii	28	8.3-10	27	8.3-53	27
8-xxiv	28	8.3-11	27	8.3-54	27
8-xxv	28	8.3-12	27	8.3-55	27
8-xxvi	28	8.3-13	27	8.3-56	27
8-xxvii	28	8.3-14	27	8.3-57	27
8-xxviii	28	8.3-15	27	8.3-58	27
8-xxix	28	8.3-16	27	8.3-59	27
8-xxx	28	8.3-17	27	8.3-60	27
8-xxxi	28	8.3-18	27	8.3-61	27
8-xxxii	28	8.3-19	27	8.3-62	27
8-xxxiii	28	8.3-20	27	8.3-63	27
8-xxxiv	28	8.3-21	27	8.3-64	27
8-xxxv	28	8.3-22	27	8.3-65	27
8-xxxvi	28	8.3-23	27	8.3-66	27
8-xxxvii	28	8.3-24	27	8.3-67	27
8-xxxviii	28	8.3-25	27	8.3-68	27
8-xxxix	28	8.3-26	27	8.3-69	27
		8.3-27	27	8.3-70	27
		8.3-28	27	8.3-71	27
		8.3-29	27	8.3-72	27
		8.3-30	27	8.3-73	27

ARKANSAS NUCLEAR ONE
Unit 2

RECORD OF REVISIONS (continued)

<u>PAGE #</u>	<u>AMENDMENT #</u>	<u>PAGE #</u>	<u>AMENDMENT #</u>	<u>PAGE #</u>	<u>AMENDMENT #</u>
CHAPTER 8 (CONT.)		CHAPTER 8 (CONT.)		CHAPTER 8 (CONT.)	
8.3-74	27	F 8.3-1	27		
8.3-75	27	F 8.3-2	20		
8.3-76	27	F 8.3-6	23		
8.3-77	27	F 8.3-7	20		
8.3-78	27	F 8.3-17	20		
8.3-79	27	F 8.3-18	20		
8.3-80	27				
8.3-81	27				
8.3-82	27				
8.4-1	27				
8.4-2	27				
8.4-3	27				
8.4-4	27				
8.4-5	27				
8.4-6	27				
8.4-7	27				
8.4-8	27				
8.4-9	27				
8.4-10	27				
8.4-11	27				
8.4-12	27				
8.4-13	27				
8.4-14	27				
8.4-15	27				
8.4-17	27				
8.4-17	27				
8.4-18	27				
8.4-19	27				
8.4-20	27				
8.4-21	27				
8.4-22	27				
8.4-23	27				
F 8.1-1	20				
F 8.1-2	20				
F 8.1-3	20				
F 8.2-1	28				
F 8.2-2	28				
F 8.2-3	21				
F 8.2-4	20				

ARKANSAS NUCLEAR ONE
Unit 2

8 ELECTRIC POWER

8.1 INTRODUCTION

The off-site transmission system, the transmission switching station, and the onsite distribution system are designed to provide electric power to the necessary plant electric equipment under all foreseeable combinations of plant operation and electric power source availability. The electrical system for Arkansas Nuclear One - Unit 2 is designed to be electrically independent of Unit 1, except as described in Section 8.1.4.F, and to provide adequately reliable power sources for all electrical equipment for startup, normal operation, safe shutdown and all emergency situations.

8.1.1 UTILITY GRID AND ITS INTERCONNECTIONS

The electric system for Entergy Arkansas, Inc. (formerly Arkansas Power & Light Company) extends over an area that provides service to over 610,000 customers in 62 of Arkansas' 75 counties. The system consists of over 4,690 miles of transmission lines ranging from 115 to 500 kV. The grid configuration for Arkansas Power & Light, as of December 31, 1976, is depicted in Figure 8.1-1. The current system configuration for Entergy Arkansas, Inc. is similar.

Entergy Arkansas, Inc. is a wholly owned subsidiary of the Entergy system (formerly Middle South Utilities), which operates as an entity with a highly integrated system consisting of hydro, fossil-fired, and nuclear fueled generating plants. Figure 8.1-2 depicts the Middle South Utilities system as of January 1, 1978. The current Entergy transmission system is similar.

Entergy Arkansas, Inc. benefits from over 50 points of interconnection either directly or through the Entergy system. At the time Unit 2 was licensed, these points of interconnection were with the following systems: Oklahoma Gas & Electric Company; Southwestern Electric Power Company; Gulf States Utilities Company; Central Louisiana Electric Company; Mississippi Power Company; Union Electric Company; Empire District Electric Company; Missouri Utilities; Tennessee Valley Authority; Southwestern Power Administration; Arkansas Electric Cooperative Corporation; and Associated Electric Cooperatives, Inc. This configuration is depicted in Figure 8.1-3, the Southwest Power Pool as of December 31, 1972. The current Entergy interconnections with the grid are similar although the names of the interconnecting systems may have changed.

8.1.2 ONSITE ELECTRIC SYSTEM

Figure 8.3-1 shows the single line diagram arrangement of the station. ANO-2 generates electrical power at 22 kV which is fed through an isolated phase bus to the Unit 2 main transformer bank. The main transformer bank, consisting of three single-phase transformers, steps the output voltage up to 500 kV at which level it is delivered to the station switchyard. The 500 kV switchyard is a 2-bus design consisting of two breakers each for Unit 1 and Unit 2 generators and a breaker and one-half for each line. The 500 kV station switchyard includes three outgoing lines: one line to the Mabelvale substation, one line to the Fort Smith substation, and one line to the Pleasant Hill substation (see Figure 8.3-1).

A bus tie autotransformer bank consisting of three single phase autotransformers interconnects the 500 kV and 161 kV systems in the station switchyard. The 161kV switchyard at the generating station is also of ring bus design and includes one line to the Russellville East 161 kV substation and one line to the Pleasant Hill 161 kV substation. The 22 kV tertiary

ARKANSAS NUCLEAR ONE
Unit 2

winding of the autotransformer bank supplies Startup Transformer 3 which is electrically similar to the unit auxiliary transformer. Startup Transformer 2, which serves both units, is supplied from the 161 kV ring bus.

Auxiliary power for normal plant operation is supplied by the main generator through the unit auxiliary transformer. Auxiliary power for main generator startup and shutdown can be supplied by either of the two startup transformers. In the event of non-availability of these two power sources, power to the ESF buses can be furnished by the two fully redundant emergency diesel generator sets. A 120-volt uninterruptible AC power system has been provided for reactor protection and Engineered Safety Feature (ESF) control channels. This consists of six inverters and four distribution panels; one designated for each of the four redundant protective channels.

Three banks of 125-volt batteries, two Class 1E and one non-Class 1E along with their own battery chargers and control panels, provide the necessary DC power sources for the plant.

8.1.3 REACTOR PROTECTION AND ENGINEERED SAFETY FEATURE LOADS

The ESF loads are shown on Table 8.3-1. The ride-through M-G sets and the reactor trip switchgear associated with the Reactor Protective System (RPS) are covered in Section 8.3.

8.1.4 DESIGN BASES FOR SAFETY-RELATED ELECTRIC SYSTEMS

The electrical system for ANO-2 has been designed to be electrically independent of Unit 1 and provide adequately reliable power sources for all electrical equipment for startup, normal operation, safe shutdown, and handling of all emergency situations. Any special design bases that are applicable to specific components are included in the appropriate sections of the SAR. The following criteria, guides and standards have been used in the system and equipment design.

- A. Components of the system have been sized for operation under normal and emergency conditions.
- B. No single component failure will prevent operation of the required ESF.
- C. Redundant sources of power have been provided to ensure satisfactory operation of equipment as required under normal and emergency conditions.
- D. The system has been arranged in such a manner as to make it possible to test all safety-related equipment.
- E. Electrical and physical separation of cables and equipment associated with redundant elements of the safety-related circuits has been provided.
- F. The electrical system of Unit 2 is independent of Unit 1, with the exception of Startup Transformer 2, which is common, and the Alternate AC Generator, which is shared by both Units (see Section 8.1.2). The backup power supplies for 120-volt AC to the switchyard are provided from Unit 1.
- G. Class 1E electrical equipment has been seismically qualified in accordance with IEEE344-1971, 1975, or 1987.

ARKANSAS NUCLEAR ONE
Unit 2

- H. All components of the electrical power distribution system have been designed using the applicable sections of ANSI, NEMA, IEEE and the National Electric Code as a guide.
- I. General Design Criteria 17 and 18 of Appendix A to 10CFR50 have been complied with.*
- J. Regulatory Guide 1.6 (dated 3/10/71) - Independence Between Redundant Standby (Onsite) Power Sources and Between Their Distribution Systems; Regulatory Guide 1.9 (dated 3/10/71 - Selection of Diesel Generator Set Capacity for Standby Power Supplies; and Regulatory Guide 1.32 (dated 8/11/72) - Use of IEEE 308-1971 "Criteria for Class 1E Electrical Systems for Nuclear Power Generating Stations" have been complied with.*
- K. IEEE 279-1971 - Criteria for Protection Systems for Nuclear Power Generating Stations has been complied with.
- L. IEEE 308-1971 - Criteria for Class 1E Electric Systems for Nuclear Power Generating Stations have been complied with.
- M. IEEE 336-1971 - Installation, Inspection and Testing Requirements for Instrumentation & Electric Equipment During the Construction of Nuclear Power Generating Stations has been complied with.
- N. IEEE 379-1972 - Trial-Use Guide for the Application of the Single-Failure Criterion to Nuclear Power Generating Station Protection Systems has been complied with.
- O. The electrical system is provided with Grid Undervoltage Protection (Millstone 2 Event).
- P. 10 CFR 50.63, Regulatory Guide 1.155, and associated Alternate AC Power Source Guidelines and requirements of NUMARC 87-00, Revision 1, have been complied with regarding Station Blackout. See Section 8.3.3 for supplemental information.

* A discussion of the foregoing criteria and regulatory guides is included in Sections 8.3.1.2 and 8.3.2.2.

Additionally, monitoring of certain parameters of the electrical power system is designed to conform to Regulatory Guide 1.97.

ARKANSAS NUCLEAR ONE
Unit 2

8.2 OFF-SITE POWER SYSTEM

8.2.1 DESCRIPTION

Unit 2 generates electrical power at 22 kV which is fed through an isolated phase bus to the Unit 2 main transformer bank, consisting of three single-phase transformers, where it is stepped up to 500 kV transmission voltage and delivered to the station switchyard. The 500 kV switchyard is a 2-bus design consisting of two breakers each for Unit 1 and Unit 2 generators and a breaker and one-half for each line. The 500 kV station switchyard includes three outgoing 500 kV lines; one 500 kV line 86.74 miles in length, to the Mabelvale EHV Substation, one 500 kV line 93.82 miles in length, to the Fort Smith O.G. & E. EHV Substation and one 500 kV line 32.62 miles in length, to the Pleasant Hill EHV Substation (see Figure 8.2-1).

A bus tie autotransformer bank consisting of three single phase autotransformers interconnects the 500 kV and 161 kV systems in the station switchyard. The 161 kV switchyard at the generating station is a ring bus design and includes one line to the Russellville East 161 kV Substation and one line to the Pleasant Hill 161 kV Substation. The 22 kV tertiary of the autotransformer bank supplies Startup Transformer 3 which is electrically similar to the unit auxiliary transformer. Startup Transformer 2, which is capable of serving both units, is supplied from the 161 kV ring bus. When in Mode 5 or Mode 6, the Unit Auxiliary Transformer can be aligned to supply offsite power by removing isophase bus disconnects and backfeeding through the main transformers. ANO has also committed to make this backfeed available within approximately 24 hours of the unit being off-line and a loss of the primary offsite power source during an NRC approved 30-day maintenance AOT for Startup #2 (Reference 0CAN119904 and 0CNA040011). This could require a backfeed in Modes 3 or 4 until the unit could be placed safely in cold shutdown or the primary offsite source is restored.

8.2.1.1 Single Line Diagrams

Figures 8.2-2, 8.2-3, 8.3-1, and 8.3-6 are single-line diagrams of the switchyard, station buses and circuits.

8.2.1.2 Transmission Lines

The extra high voltage and high voltage transmission system which connects to the switchyard and to the plant involves:

- A. Approximately 24 miles of two parallel 500 kV single circuit lines with triple-bundle phase conductors on metal towers from the ANO EHV Substation, south to a junction with the existing Mabelvale-O.G. & E. 500 kV line at a point four miles east of Danville, Arkansas, including crossings of the McClellan-Kerr Arkansas River Navigation System. The two lines are parallel to each other and separated by 140 feet on common 320-foot wide right-of-way, except at the Arkansas River crossing where the parallel lines are separated by 220 feet due to the 190-foot tall river crossing structures.
- B. Approximately 32.62 miles of 500 kV single circuit line with triple-bundle phase conductors on metal towers on 180-foot wide right-of-way from the ANO EHV Substation, southeast to the Pleasant Hill Substation north of Morrilton, Arkansas.

ARKANSAS NUCLEAR ONE
Unit 2

- C. Approximately 12 miles of single circuit shielded 161 kV line on Steel towers and wood H-frame structures on 100-foot wide right-of-way from the ANO EHV Substation, southeast to the existing Russellville East 161 kV Substation, east of Russellville, Arkansas. The 1.83 mile steel tower portion is constructed on double circuit structures together with "D." below.
- D. Approximately 34 miles of single circuit shielded 161 kV line on steel towers and wood H-frame structures on 100-foot wide right-of-way from the ANO EHV Substation east to the Pleasant Hill Substation.
- E. One span (622 feet) of single circuit shielded 500 kV tie line with triple-bundle phase conductors on metal towers from the 500 kV switchyard to the plant transformer yard for Unit 1. The conductor is a three-bundle 954 MCM 45/7 strand ACSR and the shield wire 7 #7 alumoweld cable.
- F. Two spans (920 feet) of single circuit shielded 500 kV tie line with triple-bundle phase conductors on metal towers from the 500 kV switchyard to the plant transformer yard for Unit 2. The conductor is a three-bundle 954 MCM 45/7 strand ACSR and the shield wire 7 #7 alumoweld cable.
- G. Five spans (1,237 feet) of single circuit shielded 161 kV tie line on steel single pole structures from the 161 kV switchyard to the plant transformer yard. The conductor is a 336.4 MCM 26/7 strand ACSR and the shield wire 3/8-inch steel cable.

Single circuit metal towers of the two parallel Arkansas Nuclear One-Jct. Mabelvale-O.G. & E. 500 kV lines on the same right-of-way will afford the advantages of added reliability, least overall height, quicker restoration in event of failure and safer conditions during maintenance. Self supporting steel structures of the single circuit 500 kV design are installed in both lines north of McClellan-Kerr Arkansas River Navigation System. Guyed aluminum towers of the single circuit 500 kV design are installed south from the McClellan-Kerr Arkansas River Navigation System to the point of interconnection with the Mabelvale-O.G. & E. 500 kV line. The conductor is three bundle 954 MCM 45/7 strand ACSR and the shield wire 7 #7 alumoweld cable. The land traversed by the lines varies from flat, rolling hills to rugged terrain in the vicinity of Spring Mountain.

The ANO-Pleasant Hill 500 kV line parallels the other two 500 kV lines immediately north of the plant switchyard on common 460-foot wide right-of-way for a distance of 1.51 miles and parallels the ANO-Pleasant Hill 161 kV line north of Russellville for a distance of 4.44 miles. The two lines are separated by 110 feet on common 250-foot wide right-of-way. Self-supporting steel structures of the single circuit 500 kV design are installed in the paralleled section of the line. Guyed aluminum towers of the single circuit 500 kV design are installed on the remaining section. The conductor is a three-bundle 954 MCM 45/7 strand ACSR and the shield wire 7 #7 alumoweld cable. The land traversed by the line varies from flat, rolling hills to semi-rugged terrain in the vicinity of Crow Mountain.

The two 161 kV lines are double-circuited on a common single steel tower line north from the ANO switchyard a distance of 1.83 miles. The two lines then separate toward their respective destinations.

ARKANSAS NUCLEAR ONE
Unit 2

The southernmost ANO-Russellville East 161 kV line extends east 10.17 miles to the existing Russellville East Substation where the line connects to the 161 kV system. The structures of the 161 kV line beyond the double circuited section are of wood H-frame design. The conductor is 1534 MCM 42/19 ACAR and the shield wire is 3/8-inch 7-strand galvanized steel.

The northernmost ANO-Pleasant Hill 161 kV line, leaving the double-circuited steel tower line north of the ANO switchyard, traverses a distance of 32.02 miles east to the site of the Pleasant Hill 161 kV substation where the line interconnects with AP&L's 161 kV system. The structures are wood H-frame. The conductor is 1024 MCM 24/13 strand ACAR and the shield wire 3/8 inch galvanized steel strand.

The right-of-way of the 500 kV and 161 kV transmission lines, immediately north of the plant, are not common and do not cross. They are separated by a distance, at the closest point of approach, that will ensure a single structural failure on any of the three 500 kV lines in this section would not affect operation of the 161 kV circuits. A single structural failure on either or both of the 161 kV lines in this section would not affect operation of the 500 kV circuits.

The ANO-Pleasant Hill 500 kV line crosses over the ANO-Pleasant Hill 161 kV line northeast of Russellville. A single structural failure on the ANO-Pleasant Hill 500 kV line at this crossover would cause an outage on both lines due to high speed clearing of faults by breaker action, but would not affect operation of the two parallel 500 kV lines or the remaining 161 kV line to Russellville.

Operating problems on the 500 kV lines out of the plant switchyard, due to rugged terrain, vibration or galloping conductor problems, icing or heavy load conditions, and high thunderstorm occurrence rates were all considered in design of the lines. The 500 kV structures exceed requirements of the National Electrical Safety Code heavy loading conditions with the appropriate safety factors, in that the structures are also designed for 100 mile per hour winds with a 1.10 safety factor and 1-inch radial ice on conductors with a 1.10 safety factor. Additional torsional or stringing loads are also included in the structure design. The regional isokeraunic level (thunderstorm-days per year) is approximately 57. No outages due to lightning had been recorded on the 86.74 mile long ANO-Mabelvale 500 kV line since it was energized in 1972, and only one outage due to lightning (April 27, 1973) was recorded on the 93.82 mile long ANO-Fort Smith (O.G. & E.) 500 kV line up to the time of licensing. Field tests have verified that no vibration or conductor problems exist on either 500 kV circuit.

AP&L had 413.75 miles of 500 kV line in operation at the time of licensing. The ANO-Pleasant Hill and the Pleasant Hill to Mayflower 500 kV lines add an additional 61.08 miles to the 500 kV system.

8.2.1.2.1 Crossovers

Figure 8.2-1 shows six specific incidents of transmission lines crossing other transmission lines that connect directly to the ANO plant switchyard. Five of these transmission lines are owned and operated by Entergy Arkansas, Inc. and one by Southwestern Power Administration. Three of these crossings involve lines owned and operated by Entergy Arkansas, Inc. and Southwestern Power Administration and three of these crossings involve lines owned and operated wholly by Entergy Arkansas, Inc. These crossings are discussed as follows:

- A. The Southwestern Power Administration double circuit 161 kV line crosses over the ANO-Russellville East 161 kV line northeast of ANO (see Figure 8.2-4, Detail 1A). A shield wire, conductor or structure failure on the Southwestern Power Administration line in this vicinity could cause an outage to this offsite power source, however, four alternate sources would still be in service to feed the ANO switchyard.

ARKANSAS NUCLEAR ONE
Unit 2

- B. The Southwestern Power Administration double circuit 161 kV line crosses over the ANO-Pleasant Hill 161 kV line northeast of ANO (see Figure 8.2-4, Detail 2A). A shield wire, conductor or structure failure on the Southwestern Power Administration line in this vicinity could cause an outage to this offsite power source, however, four alternate sources would still be in service to feed the ANO switchyard.
- C. The Southwestern Power Administration double circuit 161 kV line crosses under the ANO-Pleasant Hill 500 kV line northeast of ANO (see Figure 8.2-4, Detail 3A). A shield wire, conductor or structure failure on the Southwestern Power Administration line in this vicinity would not cause an outage to this offsite power source.
- D. The ANO-Pleasant Hill 500 kV line crosses over the ANO-Pleasant Hill 161 kV line northeast of Russellville (see Figure 8.2-4, Detail 4A). A shield wire, conductor or structure failure on the 500 kV line in the vicinity of this crossing probably would cause an outage to both of these offsite power sources. However, there would still be three off-site power sources in service to feed the ANO switchyard.
- E. The two parallel ANO-Jct. Mabelvale-O.G. & E. 500 kV lines cross over the Dardanelle Dam-Dardanelle-Danville 161 kV line northeast of Danville, Arkansas (see Figure 8.2-4, Detail 5A). A shield wire, conductor or structure failure on either of the 500 kV lines at this crossing would operate switches at Dardanelle Dam and Danville substations, thereby isolating the loss of service to the 161 kV system and, assuming that the parallel 500 kV circuit was intact, there would be four off-site power sources in service to feed the ANO switchyard.
- F. The Pleasant Hill-Mayflower 500 kV line crosses over the ANO-Pleasant Hill 161 kV line north of Morrilton (see Figure 8.2-4, Detail 4A). A shield wire, conductor, or structure failure on the 500 kV line in the vicinity of this crossing probably would cause an outage to this 161 kV off-site power source, however, four alternative sources would still be in service to feed the ANO switchyard.

8.2.1.2.2 Shared Rights-of-Way

There are three separate examples where two off-site lines are parallel to each other on separate structures sharing the same right-of-way. These examples are individually discussed below:

- A. The 24 miles of two parallel 500 kV single circuit transmission lines on metal towers exit the ANO switchyard north, then turn west and south to a point northeast of Danville, Arkansas. The two lines are parallel to each other and separated by 140 feet on common 320-foot wide right-of-way except at the Arkansas River crossing where separation is 220 feet and right-of-way is 460 feet wide due to the 190-foot tall structures. Both circuits of the approximately 5.57 mile parallel section north of the river are composed of steel structures which vary in height from 70 to 110 feet. Structures are placed essentially opposite each other with a maximum differential elevation at the base of approximately 36 feet. Should one of these parallel lines go down it would not effect either the towers or conductors of the parallel line. On the 17.67-mile parallel section south of the river, guyed aluminum towers are installed on 140-foot separation. Tower heights vary from 75 to 115 feet on both circuits. The towers are offset slightly longitudinally. Four guy cables on each structure extend toward the parallel line and toward the edge of right-of-way. Failure in the anchorage,

ARKANSAS NUCLEAR ONE
Unit 2

guy cables or loss due to vandalism could result in structural failure to either line and could cause a structure to fall into the structure guys or conductors of the parallel line. This could result in an outage to both of these parallel off-site power sources. However, there would still be three offsite power sources to feed the ANO switchyard.

- B. The ANO-Pleasant Hill 500 kV single circuit transmission line exits the plant north on metal towers and parallel the twin lines of the ANO-Jct. Mabelvale-O.G. & E. 500 kV line, a distance of 1.51 miles. Towers will vary in height from 70 to 110 feet with a maximum differential elevation at the base of approximately 46 feet. Tower separation will be 140 feet east of the more easterly of the twin lines now exiting the plant. Structures will be essentially opposite structures of the east twin line. In the event of a structure failure, only one circuit would be damaged leaving four offsite power sources in service feeding the ANO switchyard.

- C. The ANO-Pleasant Hill 500 kV line parallels the ANO-Pleasant Hill 161 kV line northeast of Russellville, Arkansas. These lines are parallel on 250-foot common right-of-way with a line separation of 110 feet for a distance of approximately 4.44 miles. The 500 kV line is on metal towers with a phase-to-phase separation of 30 feet, 3 inches and varies in height from 70 to 150 feet. The 161 kV line is on wooden structures with a phase-to-phase separation of 14 feet, 6 inches and poles vary in height from 55 to 85 feet. A total of 37 wooden structures and 23 metal structures are involved in this parallel section. A structure failure on the wooden 161 kV line would not cause an outage on the 500 kV line, but a structural failure on the 500 kV line could cause an outage to both circuits. In this event three offsite power sources would still be in service to feed the ANO steam electric station switchyard.

8.2.1.3 Switchyard

The ANO switchyard consists of a 500 kV yard and a 161 kV yard connected by a 600 MVA autotransformer bank with a 22 kV tertiary winding.

The 500 kV portion of the yard has two main buses. Both generators are connected to the main buses by double breaker bays. The three 500 kV transmission lines and the autotransformer are connected to the main buses by two breaker-and-a-half bays. Mabelvale and Ft. Smith transmission lines are on one bay and Pleasant Hill and the autotransformer are on the other bay.

The 161 kV portion of the switchyard is a 4-element ring bus. The four elements connected to this 161kV ring bus include the ANO-Russellville East 161 kV transmission line, the ANO-Pleasant Hill 161 kV transmission line, the ANO 500/161 kV autotransformer, and the 161 kV line which feeds an automatic voltage regulator in the switchyard which then feeds Startup Transformer 2 in the plant. The ring bus is arranged so the autotransformer and the lines to Startup Transformer 2 are not connected to a common 161 kV breaker. Likewise the two 161 kV transmission lines are not connected to a common 161 kV breaker.

The 22 kV tertiary winding of the autotransformer is connected to two 22 kV breakers. One breaker feeds an automatic voltage regulator in the switchyard which then feeds Startup Transformer 1 in the plant via underground 22 kV cable. The other breaker feeds an automatic voltage regulator in the switchyard which then feeds Startup Transformer 3 in the plant also via underground 22 kV cable.

ARKANSAS NUCLEAR ONE
Unit 2

The 161 kV yard is separated from the autotransformer by two 161 kV circuit breakers. Therefore, the failure of any one of the 161 kV breakers will trip the adjacent breakers and interrupt only one of the plant off-site power sources. The 500 kV lines and the autotransformer will remain available. Conversely, the failure of a 500 kV breaker which feeds the autotransformer will trip the two 161 kV breaker connected to the autotransformer, but will not interrupt the 161 kV circuit to the plant.

Each breaker in the switchyard has a separate control circuit and a failure of one circuit to operate properly will not affect any other breaker control circuit.

Protective relaying on the autotransformer consists of a primary and a backup relaying scheme. The primary relaying scheme uses transformer differential relays. The backup relaying scheme uses two sets of distance and directional ground overcurrent relays. One set looks into the autotransformer from the 161 kV side. The other set looks into the autotransformer from the 500 kV side. The primary and backup schemes do not have in common any components such as protective relays, current transformers, potential transformers, trip coils, or DC thermal breakers. Therefore, the failure of one scheme to operate properly will not affect the operation of the other scheme. Both schemes initiate the local breaker failure scheme.

Protective relaying on the 161 kV circuit to the plant also consists of a primary and a backup relaying scheme. The primary scheme uses bus differential relays and the backup scheme uses distance and directional ground overcurrent relays. Again, the two schemes do not have any components in common, so that a failure in one scheme will not affect the operation of the other scheme. Both schemes initiate the local breaker failure scheme. Additional protective relaying on the 161 kV circuit to the plant includes overvoltage protection and sudden pressure relaying for the 161 kV automatic voltage regulator. All of these protective relaying schemes on the 161 kV circuit to the plant operate lockout relays in the switchyard which operate Startup Transformer 2 lockout relays in the plant. This results in the opening of the 161 kV breakers to de-energize the Startup Transformer 2 circuit to the plant and results in the automatic transfer of plant auxiliary loads from Startup Transformer 2 to Startup Transformer 3, if the plant auxiliary loads were being served from Startup Transformer 2.

Protective relaying on Startup Transformer 2 and 3 also consists of Open Phase Detection. NRC Bulletin 2012-01 discusses the possibility that an open phase condition, with or without accompanying ground faults, located on the high-voltage side of a transformer connecting a GDC 17 offsite power circuit to the plant electrical system, could result in a degraded condition in the on-site power system. To address this issue, redundant Open Phase Detection systems monitor the power supply circuits to Startup Transformers 2 and 3. Startup Transformers 2 and 3 are monitored for open phase conditions affecting one or two phases, with or without a ground fault. The relays initiate alarms in the main control room when an open phase condition is detected. In the event of an open phase condition, the Open Phase Detection system will initiate a trip of the affected transformer to isolate the distribution system buses from the open phase condition.

The control power for the 500 kV and 161 kV switchyard breakers is supplied from two 125 volt DC battery banks and their respective battery chargers located in the switchyard control building. Manual switches are provided to allow either battery bank to carry the entire switchyard load if the other battery is unavailable. The battery charger for Battery Bank #2 is also a battery eliminator and can carry the entire switchyard load if either or both battery banks are unavailable. Three sources of AC power are available for the battery chargers. These are: (1) the auxiliary power transformers on the 22 kV bus; (2) the plant 480-volt load center bus "B3"; and (3) the plant 480-volt engineered safeguard bus "B6". Figure 8.2-3 show how these sources may be connected to the battery chargers.

ARKANSAS NUCLEAR ONE
Unit 2

The switchyard DC control bus is isolated from ground, and detectors are provided to alarm when a ground exists on either the positive or negative bus. All equipment will function properly when one side of the DC bus is grounded. If either battery charger fails, its associated battery is designed to carry its respective switchyard DC load without interruption for a minimum of eight hours.

8.2.1.4 Reliability

Reliability considerations to minimize the probability of power failure due to faults in the network interconnections and associated substations are as follows:

- A. The 500 kV lines are designed to carry the full output of ANO-Units 1 and 2.
- B. The 500 kV transmission lines are single circuit and the towers are designed as recommended by ASCE paper No. 3269.
- C. System stability will be maintained on simultaneous tripping of the main generators of Units 1 and 2.
- D. The high voltage systems are protected from lightning and switching surges by lightning protection equipment and by overhead electrostatic shield wires.
- E. Primary and backup relaying are provided for each circuit along with local circuit breaker backup switching. These provisions permit the following:
 - 1. Any circuit can be switched under normal or fault switching without affecting another circuit.
 - 2. Any single circuit breaker can be isolated for maintenance without interrupting the power or protection to any circuit.
 - 3. Short circuits on a section of main bus will be isolated without interrupting service to any circuit, other than that connected to the faulty bus section.
 - 4. Circuit protection is insured by redundant relaying.
- F. De-energizing of the 500-161 kV switchyard will be required at flood elevation of 356.5 feet. At this flood elevation, it will additionally be necessary to de-energize and bypass the 161 kV voltage regulator to Startup Transformer 2. In order to maintain a source of offsite power at flood elevations above 356.5 feet, it will be necessary to install temporary connections over the 161 kV switchyard to connect Startup Transformer 2 directly to the 161 kV Pleasant Hill transmission line. These temporary connections will be in the form of jumpers, which are sized and stored onsite. In the event of a flood, these jumpers would be installed by local office or plant personnel prior to flood waters reaching the site. This operation would take two men approximately three hours. All the equipment connections necessary to maintain offsite power are above the 361-foot design flood elevation or procedural controls have been established to ensure appropriate flood protection is verified prior to an external flood impacting site-specific SSCs. This offsite power source is provided with lightning arrester protection and shielding. This Pleasant Hill line has a minimum clearance of 17 feet above the 361-foot elevation.

ARKANSAS NUCLEAR ONE
Unit 2

- G. Additional redundant relaying is provided for each Startup Transformer to detect open phase conditions and protect the transformers.

In the event of loss of normal and preferred auxiliary power, the ESF loads will be supplied from the emergency power source. Unit 2 will have two separate and independent sources of offsite and onsite power capable of supplying the ESF loads.

8.2.2 ANALYSIS

System studies have been conducted to test the performance of the Arkansas Power & Light Company/Entergy System in both the steady-state mode and under transient conditions. The conditions studied included, but were not limited to: outages of multiple circuit lines using common towers; coincidental, but not simultaneous, loss of one transmission line and one generator, or of two generators; or of two transmission lines (for additional studies, see Section 8.3.1.6).

The results of these studies indicate that under steady state conditions no loss of power would occur, and adequate system voltage and acceptable loading of equipment would be maintained. Under the transient conditions, the studies indicate that the system is transiently stable and no loss of power or cascading type conditions would occur.

Historical data removed-To review the exact wording, please refer to Section 8.2.2 of the FSAR.

The availability of the three 500 kV lines at the ANO switchyard can be predicted by examining the history of the existing 500 kV transmission grid.

Using data from the 1966-1972 period on six 500 kV lines with a cumulative mileage of 740 miles, the frequency duration, and causes of outages on the three 500 kV lines to ANO should be as follows: the ANO-Ft. Smith Line will have an average of .98 outages per year; the ANO-Mabelvale will have an average of .93 outages per year; and the ANO-Pleasant Hill Line will have an average of 0.34 outages per year. The following table gives the causes and duration of outages.

<u>Cause</u>	<u>Percent of Outages</u>	<u>Average Duration of Outages</u>
Tornados or High winds	11	189 hours
Lightning	40	1 hour
Equipment Failure	35	5.79 hours
Unknown	13	1.14 hours
Operator Error	1	.13 hour

ARKANSAS NUCLEAR ONE
UNIT 2

8.3 ONSITE POWER SYSTEMS

8.3.1 AC POWER SYSTEMS

8.3.1.1 Description

Figure 8.3-1 shows a single line diagram of the AC power system for Unit 2. With the Unit operating at power, the onsite AC power system consists of the Unit 2 Main Generator, the Unit Auxiliary Transformer, two diesel generators, one black-out diesel generator and the 6.9 kV, 4.16 kV, 480-volt and 120/208-volt AC distribution systems.

8.3.1.1.1 Main Generator and Main Transformer

The steam turbine driven main generator delivers AC power at 22 kV to the main transformer bank and the Unit Auxiliary Transformer (UAT). Power is stepped up to 500 kV for transmission to the switchyard and stepped down to 6.9 kV and 4.16 kV for the station auxiliaries during normal operating conditions.

The main generator is connected to the main transformers and the unit auxiliary with a forced air-cooled isolated phase bus system. The portion of the bus and its supporting structure which is located outdoors is designed to withstand maximum fault duty in a 70 mile per hour wind, combined with rain and/or snow.

A description and rating of the main generator and the isolated phase bus are as follows:

Main Generator

Output, MVA	1133.3 @ 0.95PF
Voltage, kV	22
Speed, rpm	1800
Phases	3
Frequency, Hz	60
X"d	26.5% (sat)
SCR	0.58
Cooling	Hydrogen up to 60 psig for rotor Water up to 125 psig for stator
Excitation	Compact alterrex

Isolated Phase Bus

Rated Current @ 22kV

Main generator bus	29,000 A For Normal Loads 30,000 A For Peak Loads
Main transformer delta bus	17,320 A
Auxiliary transformer bus	1700 A

The main transformer bank consists of three single-phase 430 MVA transformers. The outdoor location of the transformer bank, east of the turbine building contains firewalls separating the transformers along with an automatic water deluge system which is discussed in Section 9.5.1.

ARKANSAS NUCLEAR ONE
UNIT 2

Description and rating of the main transformer bank are as follows:

<u>Main Transformers:</u>	<u>3 Single-Phase Units, rated</u>
Output, MVA	430 (55 °C rise)
Frequency, Hz	60
Impedance, %	11.33 (average of three)
Low Voltage, kV	22.5
High Voltage, kV	512.5
Connection	Delta – Grd. Wye
Cooling Class	FOA

The main transformers are equipped with sampling valves for periodic testing of the transformer oil. Test switches are provided for testing sudden pressure relays on the transformer, and all protective relays and instruments have provision for inservice testing and calibration.

8.3.1.1.2 Unit Auxiliary Transformer, Startup Transformers and 6900-Volt Systems

The UAT and Startup Transformer 3 are physically and electrically similar and both are located east of the Unit 2 turbine building, in the transformer area. Firewalls separate the two transformer pads and an automatic water deluge fire protection system is provided (for discussion, see Section 9.5.1).

The three winding unit auxiliary transformer provides normal operating power to all of the station auxiliary loads. The high voltage winding is connected to the main generator isolated phase bus while the two low voltage windings supply the 6.9 kV buses 2H1 & 2H2 and the 4.16 kV buses 2A1 & 2A2.

The three winding Startup Transformer 3 provides startup, shutdown, and post-shutdown power to all of the auxiliary loads. The high voltage winding is connected to the 22 kV tertiary of the bus-tie autotransformer bank located in the switchyard. The two low voltage windings supply the 6.9 kV and 4.16 kV buses.

The three winding Startup Transformer 2 is common to Units 1 and 2 and is physically located east of the Unit 1 turbine building in the transformer area.

The high voltage winding is connected to the 161 kV ring bus located in the switchyard while the low voltage windings are connected to the Unit 1 and 2, 6.9 kV buses H1, H2 and 2H1, 2H2, respectively, and the 4.16 kV buses A1, A2 & 2A1, 2A2, respectively.

Each transformer is adequate for carrying all Engineered Safety Features (ESF) load groups under emergency conditions. Ratings of the transformers are as follows:

ARKANSAS NUCLEAR ONE
UNIT 2

Unit Auxiliary Transformer & Startup Transformer 3

High Voltage winding H:	<u>Startup Transformer 3</u>	<u>Unit Auxiliary Transformer (UAT)</u>
Output, MVA	35.2/46.8/58.5	37.2/49.6/62.0
Voltage, Kv	21.5	20.96
Low Voltage winding X:		
Output, MVA	19.7/26.2/32.8	21.6/28.8/36.0
Voltage, kV	6.9	6.9
Low Voltage winding Y:		
Output, MVA	15.5/20.6/25.7	15.6/20.8/26.0
Voltage, kV	4.16	4.16
<u>Z IMPEDANCE %</u>		
H-X	6.74 (19.7 MVA, 21.5 kV Base)	8.32 (@ 21.6 MVA)
H-Y	8.99 (15.5 MVA, 21.5 kV Base)	9.51 (@ 15.6 MVA)
X-Y	17.23 (15.5 MVA Base)	18.90 (@ 15.6 MVA)
Cooling Class	OA/FA/FOA (SU #3)	ONAN/ONAF1/ONAF2 (UAT)
Taps Available	Two 2 ½% above rated voltage	Two 2 ½% below rated voltage

Startup Transformer 2

High Voltage winding H:	
Output, MVA	27/36/45
Voltage, kV	157
Low Voltage winding X:	
Output, MVA	15/20/25
Voltage, kV	6.9
Low Voltage winding Y:	
Output, MVA	12.6/16.8/21
Voltage, kV	4.16
<u>Z IMPEDANCE%</u>	
H-X	5.03 (15 MVA, 157 kV Base)
H-Y	4.84 (12.6 MVA, 157 kV Base)
X-Y	8.91 (12.6 MVA Base)
Cooling Class	OA/FA/FOA
Taps Available	Two – 2 ½% above rated voltage

ARKANSAS NUCLEAR ONE
UNIT 2

Two 6,900-volt buses, designated as 2H1 and 2H2, have been provided. During normal operation, each bus will be fed from the 6.9 kV winding of the UAT. During plant startup and shutdown, the buses will be fed from the 6.9 kV secondary winding of Startup Transformer 3.

8.3.1.1.3 4,160-volt Auxiliary System

Four 4,160-volt buses have been provided. Each of the two main buses, designated as 2A1 and 2A2, provides power to non-ESF, 4 kV auxiliary motors, feeders to 480-volt non-ESF load centers, and a feeder to one of the two 4,160-volt ESF buses. Normally, these buses will be fed from the 4,160-volt winding of the UAT. During plant startup and shutdown, the buses will be fed from the 4,160-volt winding of Startup Transformer 3.

The two 4,160-volt ESF buses, 2A3 and 2A4, supply equipment essential for the safe shutdown of the plant. These buses are capable of being supplied from either the UAT, Startup Transformer 3 or Startup Transformer 2 via the 4,160-volt non-ESF buses 2A1 and 2A2.

Upon loss of normal and preferred power sources, each of the two 4,160-volt ESF buses is energized from its respective diesel generator. Bus load shedding, bus transfer to the diesel generator, and pickup of critical loads is automatic. The details are covered in Section 8.3.1.1.8.8. In accordance with 10 CFR 50.63, the Station Blackout Rule, an Alternate AC Power Source can be manually aligned to either safety bus 2A3 or 2A4. This system compensates for the simultaneous failure of the normal, preferred, and both emergency diesel power sources. See Section 8.3.3 for additional information.

The 4.16 kV and the 6.9 kV switchgear are comprised of 3-phase, indoor, metal-clad switchgear assemblies with drawout-type magnetic Air Circuit Breakers (ACB) except for the main supply breakers. The main supply breakers for the non-ESF buses are retrofitted vacuum circuit breakers. The ESF switchgear for 2A3 is equipped with retrofitted vacuum circuit breakers that have been upgraded from 250 to 350 MVA interrupting capacity. The Alternate AC Switchgear (Bus 2A9) is of similar construction; however, it utilizes drawout vacuum circuit breakers in a stacked configuration.

A 1200 A spare circuit breaker with a storage cubicle is provided for the ESF 4.16 kV switchgear 2A3 and 2A4. This spare circuit breaker is interchangeable with any of the circuit breakers in lineups 2A3 or 2A4.

The circuit breakers operate from 125-volt DC control power which is supplied from the DC power system as described in Section 8.3.2.1. These breakers are provided with "OPERATE", "TEST", and "WITHDRAWN" positions. Manual electrical and manual mechanical closing and tripping provisions with mechanical "CLOSE" and "TRIP" indicators are also provided. Each breaker can be controlled from either of two locations:

- A. Control room (remote); or
- B. Switchgear (local).

ARKANSAS NUCLEAR ONE
UNIT 2

Power cables for the 4.16 kV system are shielded copper conductors rated 5 kV, 90 °C or greater with flame-resistant insulation and jacketing materials capable of withstanding the worst case environmental conditions to which the cable could be exposed. The conductors are sized to carry the maximum available short circuit current for the time required for the circuit breaker to clear the fault. They are also sized for continuous operation at 125 percent of nameplate full load current. All 4.16 kV system cables including those used in non-ESF circuits have been designed for operation under:

- A. Ambient temperature of 40 °C with relative humidity of 50 percent increasing to temperature of 45 °C with 100 percent relative humidity for periods up to one week; and
- B. Forty years integrated radiation dose at 1×10^7 rads at a radiation level of 100 rads/hr.

All of the safety-related distribution equipment, including raceway systems, was designed to meet the seismic requirements for Class 1E electric equipment as discussed in Section 3.10. The 4.16 kV switchgear is not seismically qualified in the racked-down configuration.

The 4,160-volt ESF switchgear is located within a Seismic Category 1 structure and is protected from potential missile hazards. Physical separation and isolation has been maintained in the location and installation of the ESF switchgear for the redundant systems. Switchgear 2A3 is separated from its counterpart 2A4 by a fire-rated door.

8.3.1.1.4 480-Volt Auxiliary System

The 480-volt system consists of a series of load centers that feed Motor Control Centers (MCCs), the loads fed from these load centers and MCCs, and interconnecting cables.

Each load center consists of a transformer and a 480-volt switchgear assembly. The load centers are arranged in pairs with one tie breaker between pairs for non-ESF buses and two tie breakers for ESF buses 2B5 and 2B6.

The load centers, designated 2B5 and 2B6, and eight of the MCCs, designated 2B51 thru 2B54 and 2B61 thru 2B64 supply all of the 480-volt Class 1E loads. During transfer to the emergency power supply, loss of voltage will trip all starter fed loads on these buses. Only the Class 1E loads will start automatically on the return of bus voltage. The non-ESF loads must be started manually.

The load centers switchgear assemblies include metal enclosed, drawout type ACB's. The circuit breakers are 3-pole, electrically operated, have mechanical "CLOSE" and "TRIP" indicators and have provision for manual operation. They are provided with "OPERATE", "TEST", and "WITHDRAWN" positions and have visual indication for each position. Electric operation is from 125-volt DC control power furnished from the DC power supply systems as described in Section 8.3.2.1.

The main incoming breakers, tie breakers and motor starter breakers of the load centers can be controlled from the control room (remote) and the switchgear. All other breakers can be controlled only at the switchgear. Mechanical and electrical interlocks have been provided as described in Section 8.3.1.1.9.4 to ensure safe and proper functioning of all Class 1E devices.

ARKANSAS NUCLEAR ONE
UNIT 2

The 480-volt MCCs are comprised of magnetic feeder breakers, thermal-magnetic branch breakers, and combination motor starters consisting of 3-pole, molded case circuit breakers, magnetic NEMA Size 1 and larger, full voltage motor starters, 480/120-volt control transformers, and control devices. Some motor starters have control push buttons or one or more selector switches as required.

Combination starters for motor-operated valves, pump motors and fan motors are equipped with three single-pole ambient compensated thermal overload relays and heater elements.

Cables for the 480-volt power and control systems are rated 600-volt, 90 °C or greater with flame-resistant insulation and jacketing materials capable of withstanding the worst case environmental conditions to which the cable could be exposed. The copper conductors are sized to carry the maximum available short circuit current for the time required for the circuit breaker to clear a fault. They are also sized for continuous operation at 125 percent of nameplate full load current.

The ESF 480-volt distribution equipment is designed to meet the seismic requirements for Class 1E electric equipment as discussed in Section 3.10. Load center transformers, load center buses, and MCC buses have adequate capacity to supply the momentary and continuous loads connected to the 480-volt buses.

The ESF load centers and MCCs are located within Seismic Category 1 structures and are protected from potential missile hazards to minimize exposure to mechanical damage. Physical separation has been maintained in the location and arrangement of the redundant systems and components. Load center 2B5 is physically separated from its redundant counterpart, load center 2B6. Likewise, MCCs 2B51, 2B52, 2B53 and 2B54 are separated from their redundant counterparts, 2B61, 2B62, 2B63, and 2B64, by physical separation and fire barriers or fire walls.

Other non-ESF load centers and MCCs are located throughout the plant in areas of electrical load concentration.

8.3.1.1.5 120/208-Volt Instrument AC System

Four 120/280-volt distribution panels (2Y1, 2Y2, 2Y3 and 2Y4) have been provided for control and instrumentation and power supplies to non-ESF equipment.

Two buses (2Y1 and 2Y2) have alternate supplies from two ESF motor control centers via one of two 480-120/208-volt step-down transformers. Upon the loss of either source or transformer, the affected bus can be cross-tied to the other bus and its supply and transformer through tie breakers.

ARKANSAS NUCLEAR ONE
UNIT 2

Each instrument AC supply includes the following:

A. One transformer:

Output, kVA	30 (For 2Y1, 2Y2) & 75 (For 2Y3 & 2Y4)
Type	Dry, indoor
Phases	3
Frequency, Hz	60
High Voltage, V	480
Low Voltage, V	208Y/120
Taps	Four 2.5% below normal Two 2.5% above normal

B. Distribution panel with:

1	-	Main breaker, 3-pole, 225A
1	-	tie breaker, 3-pole, 225A - (Applicable for 2Y1 & 2Y2 only)
42	-	distribution breakers, single pole, current rating as required
1	-	undervoltage relay to detect and annunciate the loss of voltage, (Applicable for 2Y1 & 2Y2 only).
-	-	

8.3.1.1.6 120-Volt Uninterruptable AC Power System

A 120-volt uninterruptable AC power system has been provided to supply the reactor protection and ESF control and instrumentation channels. This power supply system consists of six inverters and four distribution panels which provide an independent power source to each redundant protective channel. Each inverter has two sources of power supply:

- A. An ESF battery bank (2D11 or 2D12) as the normal source; and,
- B. An ESF MCC (2B51, 2B53, 2B54, 2B61, or 2B64) as the emergency standby source.

Essential equipment such as nuclear instruments and nuclear auxiliary instruments have been connected to these four redundant panels. These four channels are commonly referred to as vital AC systems. The plant computer is connected to a seventh inverter unit. The system is arranged so that any type of single failure or fault will not prevent proper protective action of the Plant Protective System (PPS) at the system level.

Cables for the 120-volt AC power and control systems are rated 600-volt, 90 °C or greater with flame-resistant insulation and jacketing materials capable of withstanding the worst case environmental conditions to which the cable could be exposed, and copper conductors sized to carry the maximum available short circuit current for the time required by the circuit breaker or fuse to clear the fault. These cables are sized for continuous operation at 125 percent of nameplate full-load current.

ARKANSAS NUCLEAR ONE
UNIT 2

8.3.1.1.7 Emergency Power Supply System

The entire emergency power supply system is designed to provide redundant emergency power sources capable of furnishing adequate power to safely shut down the reactor, remove reactor residual heat, and maintain the unit in a safe shutdown condition upon the loss of preferred power with or without a coincident design basis event. The emergency power supply system is a safety-related system.

Two emergency diesel generator units are designed to generate and supply the required emergency power to the redundant 4.16 kV ESF buses, 2A3 and 2A4. These buses supply all of the safety-related loads and those non-safety-related loads for which it is desirable to have manually switched access to the diesel generators.

The emergency power supply system consists of two identical diesel generator units, accessories, fuel storage and transfer systems, interconnecting cables and instrumentation. Each diesel generator set is a complete package unit with all auxiliaries (excluding a DC voltage supply) required to make it a self-sufficient power source capable of automatic starting and loading.

The diesel generator units are Model 38TD8-1/8 manufactured by the Fairbanks Morse Division of Colt Industries. They are rated at 3,250 kW (7-day rating). Reliability, quick response and load acceptance capability have been demonstrated by a series of tests performed on a similar unit. The test results are documented in IEEE Paper 69 CP 177-PWR, "Fast Starting Diesel Generators for Nuclear Plant Protection." Currently, nine units of the same model and rating are installed at the operating nuclear power stations listed below:

<u>Station</u>	<u>Utility</u>	<u>Number of Units</u>
Peach Bottom 2	Philadelphia Electric Co.	2
Hatch 1	Georgia Power Co.	3
Duane Arnold	Iowa Electric Light & Power Co.	2
Millstone 2	Northeast Utilities	2

Historical data removed - To review the exact wording, please refer to Section 8.3.1.7 of the FSAR.

The generators have open drip-proof frames, Class B insulation and are wye connected, synchronous type with static, solid-state excitation systems, capable of carrying full-rated load continuously without exceeding its rated temperature rise above 50 °C ambient. Each diesel generator is furnished with automatic field flashing equipment for quick voltage buildup during the startup sequence. The automatic voltage regulators provide steady state voltage regulation within ± 1.0 percent for any load from no load to full load.

A 24-volt DC backup field flashing system is provided for each diesel generator to assure voltage building for manual starting from the diesel generator rooms in the event of loss of the normal 125-volt DC flashing source. This backup system is non-class 1E.

ARKANSAS NUCLEAR ONE
UNIT 2

The air starting system and the fuel oil storage and transfer systems are covered in detail in Sections 9.5.6 and 9.5.4, respectively. Flooding of the diesel fuel transfer pumps is precluded by operator action. Hydrologic studies, detailed in Section 2.4.4, predict that at least two days of warning will be available prior to the flood level reaching the watertight door to the underground storage vault. The watertight door, to the underground storage vault has an intrusion alarm that annunciates when it is open.

When a flood warning is received, all watertight doors will be shut and the alarm panel will be carefully monitored to ensure that watertight integrity is not endangered. Since all Class 1E electrical systems, which are below the potential maximum flood level of 361 feet, are located inside watertight buildings, closing of watertight doors will protect all Class 1E equipment.

Cooling water to the diesel generator heat exchangers is supplied from the Service Water System (SWS) as described in Section 9.5.5.

A separate air cooling system consisting of air inlet louvers and two exhaust fans has been provided for each diesel generator room as described in Section 9.4.2.4. Each diesel generator room has its own combustion air intake and exhaust system as described in Section 9.5.9.

Each diesel generator unit is designed to start automatically upon receipt of a start signal, attain rated speed and rated voltage within 15 seconds of receiving the start signal, and automatically accept ESF loads in sequence as shown in Table 8.3-1 or manually applied loads required for shutdown without off-site power. Each diesel generator is capable of sequentially starting all required motors and accelerating them to full load operation after receiving the start signal.

Diesel generator 2K4A supplies power to 4.16 kV bus 2A3, and diesel generator 2K4B supplies power to 4.16 kV bus 2A4.

The diesel generator controls are designed for automatic as well as manual operation. The manual control is from one of two locations: the control room (remote) or the diesel generator room (local). The choice of location is selected by a "LOCAL-REMOTE" hand switch on the diesel generator control panel (2E12 or 2E22). Placing the "LOCAL-REMOTE" switch in "LOCAL" position permits manual regulation and control of the generator from the diesel generator room only. This mode is indicated in the control room. Placing the "LOCAL-REMOTE" switch in the "REMOTE" position permits regulation and control of the generator from the control room only. This switch is for selection of generator control location only; it does not affect diesel engine starting either in manual or automatic.

A 3-position key-operated "AUTO-START-LOCKOUT" hand switch, with key removable in "AUTO" position only, is provided on the diesel generator control panel. This switch selects the starting mode for the diesel engine. Placing this switch in "LOCKOUT" will prevent automatic or manual starting of the diesel from any location. With the switch in the "LOCKOUT" position, an alarm will be initiated in the control room to indicate that the diesel generator is "NOT AVAILABLE". Placing this switch in the "START" position will initiate diesel starting.

With the "AUTO-START-LOCKOUT" switch in the "AUTO" position, the diesel engine can be started manually from the control room. The "LOCAL-REMOTE" switch should be in the "REMOTE" position to provide regulation and control of the generator in this situation.

ARKANSAS NUCLEAR ONE
UNIT 2

Also, with the "AUTO-START-LOCKOUT" switch in the "AUTO" position, the diesel engine will start automatically on an undervoltage condition on the respective 4160 or 480-volt ESF buses, or upon receipt of a Safety Injection Actuation Signal (SIAS).

Voltage relays and speed-sensing devices are provided to prevent loading.

The diesel generators are wye-connected with the neutral of each grounded through its own continuously rated transformer-resistor combination. The grounding transformer-resistor combination is mounted in a well-ventilated metal-enclosed housing.

Provisions have been made for manually synchronizing the diesel generator with the incoming power source for test purposes. The sync-check relay is provided to prevent remote manual closing of the diesel generator breaker if: (1) there is no synchronism between the diesel generator and energized bus 2A3/2A4, or (2) the diesel is not running. The relay will permit manual closing of the diesel generator breaker if the bus 2A3/2A4 is dead and diesel generator voltage is established. The same type of interlock, i.e. sync-check, is provided in the bus 2A3/2A4 normal supply breakers. This relay will permit manual closing of the breakers 2A309/2A409 if: (1) there is synchronism between the bus 2A1/2A2 and bus 2A3/2A4, or (2) bus 2A3/2A4 is dead and 2A1/2A2 is live or (3) 2A1/2A2 is dead and 2A3/2A4 is live. Since the automatic transfer made is a dead bus transfer, automatic synchronization is not provided. Each diesel engine has been provided with a preheat system which maintains adequate engine temperature to ensure fast starts. The preheat system includes a 15 kW jacket coolant heater and a 6 kW lubricating oil heater. Each heater is energized from a 480-volt ESF MCC. Interlocks have been provided to de-energize the lube oil and jacket coolant pre-heat systems upon starting of the respective diesel generators.

Control circuits for each diesel generator operate from separate 125-volt DC systems supplied from separate station batteries as described in Section 8.3.2.1.1. The ESF 125-volt DC systems are Class 1E electric systems.

Each diesel generator is capable of starting and carrying the maximum ESF loads required under postulated accident conditions. After the automatic starting and loading sequence is complete, (See Table 8.3-1.) each diesel generator will have a reserve capacity which is the difference between the diesel generator rating and the total load shown in Table 8.3-1. Additional loads may be manually started at the discretion of the operator, with such additional loading limited by the rated capacity of the diesel generators. A wattmeter, a varmeter, and an ammeter have been provided for continuous indication of diesel generator loading. Administrative control will be exercised to prevent loading the diesel generators over their rated capacities.

All of the emergency power supply system components are designed to meet the seismic requirements for Class 1E electric equipment as described in Section 3.10. Components of the emergency power supply system are located within Seismic Category 1 structures and are protected from potential missile hazards and fire. Physical separation and isolation have been maintained in the location and installation of equipment for redundant systems. Each diesel generator is housed in a separate concrete room in the auxiliary building at the 369-foot elevation. Normal access to one generator is through the room of the other. A watertight door separates these two rooms.

ARKANSAS NUCLEAR ONE
UNIT 2

8.3.1.1.8 Specific Details of Onsite AC Power System

8.3.1.1.8.1 Power Supply Feeders

Figure 8.3-1 shows the network configuration. Power supply for the 6.9 kV and 4.16 kV bus sections can be obtained from either of the two startup transformers or from the UAT. The startup transformers are the offsite, or preferred, power sources. When in Modes 3 through 6, the Unit Auxiliary Transformer can be aligned as an offsite power source with the isophase bus disconnects removed and backfeeding through the main transformers. Flexibility of power supply is provided by connecting each of the four main bus sections to more than one source of power. Non-segregated, metal-enclosed, 6900- and 4,160-volt buses have been used for these feeders to improve reliability of supply.

ESF bus 2A4 is connected to non-ESF bus 2A2 through current limiting reactor 2X32. ESF bus 2A3 is connected to non-ESF bus 2A1. These two buses are also connected to the associated emergency diesel generator units. Power cables described in Section 8.3.1.4.2.2.3 have been used for these feeders.

Outgoing feeders from the two ESF buses are connected to the two 480-volt ESF load centers 2B5 and 2B6 through two 1,000 kVA step-down transformers. These two load centers in turn, feed all eight 480-volt ESF motor control centers. One feeder each from ESF MCCs 2B51 and 2B61 connect to 120/208-volt AC instrument buses 2Y1, 2Y2, 2Y3 and 2Y4 through four step-down transformers. One emergency standby feeder is provided from 480-volt ESF MCCs for each of the six 120-volt vital AC inverters as shown in Figure 8.3-6.

8.3.1.1.8.2 Busing Arrangement

Figure 8.3-1 shows the busing arrangement of the station for 6.9 kV, 4.16 kV and 480-volt load centers.

Two sections of 6900-volt switchgear, designated as 2H1 and 2H2 have been provided with no tie between the sections. Similarly, the main non-ESF 4,160-volt switchgear has been divided into two sections, designated as 2A1 and 2A2 with no tie.

Two completely redundant bus sections designated 2A3 and 2A4 have been provided for the 4,160-volt ESF system.

The two ESF 480-volt load centers have main breakers, tie breakers, MCC feeder breakers, and motor feeder breakers.

Single line diagrams of the 120-volt vital AC buses and 208/120-volt instrument AC buses are shown in Figure 8.3-6.

8.3.1.1.8.3 Loads Supplied From Each Bus

The design criterion governing the assignment of extra redundant loads (the third high pressure safety injection pump, the third service water pump, and the third charging pump and associated valves) is to maximize the availability of one of each type pump in each ESF channel under all conditions. Power supplies to the service water and high pressure injection pumps are electrically and mechanically interlocked so that no more than one pump of each type can be supplied from each ESF channel when normal power supply is not available (2A3 & 2A4 being

ARKANSAS NUCLEAR ONE
UNIT 2

supplied from the emergency diesel generators). The third pumps can be fed from either ESF channel through circuit breakers on the associated channel bus. Interlocks ensure that the third pump will not be connected to both ESF channel buses simultaneously, as described in Section 8.3.1.1.9.4.

8.3.1.1.8.4 Manual and Automatic Interconnections Between Buses, Buses and Loads, and Buses and Supplies

No automatic interconnections between buses or buses and loads have been provided for the two non-ESF 6.9 kV buses 2H1 and 2H2. Loads can be connected to the respective buses by manual control only.

Provisions have been made for manual and automatic transfer of buses between power supplies. Under normal operating conditions, supply to the two 6.9 kV bus sections is derived from the UAT. In the event of a loss of the UAT, transfer to either of the two startup transformers is capable of being accomplished automatically through protective relays as discussed below.

Normal bus transfers used on startup or shutdown of the main turbine generator unit are manual "live bus" transfers, i.e. the incoming source feeder circuit breaker is closed onto the energized bus section. After closing the circuit breaker of the incoming transformer, the supply breaker of the other transformer, is automatically tripped when the operator releases the control switch handle of the incoming breaker, resulting in transfers without power interruption. Synchroscope and synchronizing switches are employed to avoid paralleling sources which are out-of-phase.

Should the UAT become unavailable during normal power operation, manual transfer of full house loads to Startup Transformer 3 is acceptable without load shedding.

Emergency bus transfers, used on the loss of normal unit sources, are automatic fast bus transfers, i.e., the normal source feeder circuit breaker is tripped and, simultaneously, the emergency preferred source circuit breaker closes resulting in a transfer within a few cycles. The selection of one of the two startup transformers for emergency preferred duty is by means of duty selector switches in the control room. The duty selector switches determine which startup transformer is the first preferred backup.

Both Unit 1 and Unit 2 are prevented from automatic transfer to Startup Transformer 2 during normal power operations for all buses except Buses A1/A3 (Unit 1) and 2A1/2A3 (Unit 2). Procedures administratively control Unit 1 and Unit 2 access to Startup Transformer 2. Procedures may allow other fast transfer capabilities to Startup Transformer 2 for specifically analyzed conditions and restrictions defined in approved Engineering Calculations and Evaluations.

If full house load is automatically transferred to Startup Transformer 3 or 2 upon a unit trip, sufficient load is shed to insure no unnecessary Millstone degraded grid voltage isolations occur.

In the event that fast transfer is required with a safety signal, certain additional non-vital loads are shed. All ESF loads will be sequenced in accordance with Table 8.3-1. (For additional information, see Section 8.3.1.6, "Grid Undervoltage Protection.")

ARKANSAS NUCLEAR ONE
UNIT 2

The non-ESF 4,160-volt system, 2A1 and 2A2, is identical to the 6900-volt system as regards the interconnections between buses, buses and loads, and buses and supplies.

Non-vital load centers on buses 2A1 and 2A2 will load shed anytime a SIAS actuation is present and feeder breakers from Startup Transformer 2 or 3 are closed.

The ESF buses 2A3 and 2A4 have been provided with a 4.16 kV cable interconnection with one breaker at each end of the tie. As described in Section 8.3.1.1.9.4, this interconnection is completely manual. Administrative control will be exercised so that this interconnection is used only during shutdown (Modes 5 and 6) or under post-accident emergency conditions. Automatic connection between the ESF buses and associated loads is covered in Section 8.3.1.1.8.8.

Automatic connection between the 4,160-volt ESF buses and the preferred source is achieved through the interconnection between the non-ESF 4,160-volt buses and the respective ESF 4,160-volt buses. Automatic connection between the ESF 4,160-volt buses and the associated diesel generator is discussed in Section 8.3.1.1.8.8.

As regards the 480-volt load centers and MCCs, there is no provision for automatic interconnection between buses. The ESF 480-volt loads identified in Table 8.3-1 are automatically connected to the respective buses on receipt of the appropriate ESFAS signal. Provision has been made to automatically close the main feeder breaker to the ESF load centers 2B5 and 2B6 upon receipt of an ESF signal unless these breakers have been locked out for maintenance. The tie breakers between the two ESF buses 2B5 and 2B6 are equipped with Kirk-key manual interlocks so as to prevent paralleling of the two redundant ESF sources.

No cross-channel electrical interlocking using breaker auxiliary contacts have been employed in the design. However, circuit breakers that can be racked out have been designed so that the auxiliary contacts used for interlocking will operate with the breaker in the operating position only. In the test/withdrawn positions, these contacts will remain in the position corresponding to the breaker "TRIP" position. Hence, disabling of one component by racking out the associated breaker will not render other components inoperable.

There is no arrangement of manual or automatic interconnection of the four 120-volt AC vital instrument buses. If the normal 125-volt DC sources fail, the inverters will be automatically switched to the emergency standby AC ESF source.

The two 120/208-volt AC instrument buses, 2Y1 and 2Y2, which are fed from redundant ESF motor control centers have provision for manual interconnection in the event of failure of one supply source. However, Kirk-key interlocks ensure that the two redundant supply sources are not paralleled.

8.3.1.1.8.5 Interconnections Between Safety- and Non-Safety-Related Buses

4.16 kV ESF bus 2A4 is connected to the 4.16 kV non-ESF bus 2A2 through a current limiting reactor. 4.16 ESF bus 2A3 is connected directly to 4.16 kV non-ESF bus 2A1. The implementation of the Station Blackout Rule (10CFR50.63) provided a connection between the non-safety related 4160 volt bus 2A9 and the safety related buses 2A3 and 2A4. No interconnection has been provided between the 480-volt ESF and non-ESF load centers.

ARKANSAS NUCLEAR ONE
UNIT 2

8.3.1.1.8.6 Redundant Bus Separation

Separation of redundant buses has been accomplished through provision of fire-proof compartments or barriers. The two redundant diesel generators are housed in separate fire-resistant Seismic Category 1 structures, physically separated so that they are not vulnerable to a common hazard such as fire or flooding. The same is applicable in respect to the two 4,160 volt ESF switchgear lineups, 2A3 and 2A4; the two redundant load centers, 2B5 and 2B6; the two redundant groups of MCCs, 2B51, 2B52, 2B53, and 2B54 and 2B61, 2B62, 2B63 and 2B64; and the six redundant vital 120-volt AC inverters 2Y11, 2Y13, 2Y1113, 2Y22, 2Y24, and 2Y2224. Distribution panels 2RS1, 2RS2, 2RS3 and 2RS4 are likewise separated such that they are not vulnerable to a common fire or flood, or are otherwise evaluated for acceptable consequences.

8.3.1.1.8.7 Equipment Capacities

Ratings of all safety-related electrical equipment are shown in Table 8.3-2.

Equipment capacities have been conservatively selected keeping an adequate margin of safety. The two redundant diesel generators each have adequate capacity to supply all ESF and vital instrument loads required for safe shutdown of the reactor. Table 8.3-1 lists all of the ESF loads connected to each of the diesel generators under emergency conditions.

Historical data removed - To review the exact wording, refer to Section 8.3.1.1.8.7 of the FSAR.

8.3.1.1.8.8 Automatic Tripping and Loading of Buses

Each incoming supply breaker to the 6900-volt buses 2H1 and 2H2 and the non-ESF 4,160-volt buses 2A1 and 2A2 has been provided with an undervoltage relay to trip the incoming breaker if the voltage of the respective transformer source falls below a preset value. Failure of a fuse on the primary or secondary of a potential transformer will only initiate an alarm and not a false tripping. This has been achieved by monitoring the voltages on the 6900-volt and 4,160-volt windings of the transformers. Tripping of a supply breaker to these buses will initiate an automatic fast transfer of the buses to the preferred source (if available) as described in Section 8.3.1.1.8.4.

If the fast transfer fails, transfer to the preferred power source (if available) will be made by shedding all loads and then reconnecting and sequencing applicable loads on the ESF buses. Manual re-starting of other loads is permissible by the operator whenever bus voltages at load centers 2B5/2B6 can be maintained above the reset of the Millstone 92* percent undervoltage relays. In addition, for the above described fast transfer failure with preferred source available, all motor loads connected to the 6900 and 4160 volt non-ESF buses are shed automatically. No provision for automatic loading of these buses has been made.

The 4,160-volt ESF buses, 2A3 and 2A4, have been provided with undervoltage relays to monitor the voltage condition on these buses. If loss of voltage on these buses is sensed by the associated undervoltage relays, all loads except the ESF load centers 2B5 and 2B6 will be shed and the emergency diesel generators started automatically. When the diesel generator has attained rated speed and voltage (within 15 seconds after the start signal), the loads will be connected to the bus automatically per the loading sequence shown in Table 8.3-1. The undervoltage protection circuitry is blocked when ESF buses are powered by the diesel generators. This assures that load shedding of the ESF buses will not occur in the unlikely event of degraded voltage from the emergency diesel generator.

ARKANSAS NUCLEAR ONE
UNIT 2

The emergency diesel generators will be started by an SIAS signal or an undervoltage condition on the respective 4160 or 480-volt ESF buses. If the preferred source is available and an SIAS signal is present, the ESF loads on buses 2A3 and 2A4 will be started in sequence. In the event the preferred source is not available and an SIAS signal is not present, permissible loads will be started in sequence on diesel power. If an SIAS signal is present, only the ESF loads will be started. The diesel generator or generators will attain rated speed and voltage in sequence but will not be connected to the ESF bus or buses if the preferred power source continues to be available.

The 480-volt ESF load centers 2B5 and 2B6 will not be shed by the load shedding undervoltage relays on buses 2A3 and 2A4. However, if the 4,160-volt primary or 480-volt secondary breaker of these load centers was open, but not locked out for maintenance, an SIAS will cause these breakers to be automatically closed.

Under normal operating conditions (absence of ESF signal) when the voltage at the ESF load centers 2B5/2B6 drops to the dropout of the Millstone 92* percent Undervoltage Relays and remains low for eight seconds, the associated diesel generator is started and the incoming breakers (preferred source breakers 152-309 and 152-409) to ESF buses 2A3 and 2A4 will be tripped, thus isolating the ESF buses from the degraded system. Loads on buses 2A3 and 2A4 will be restarted in sequence in accordance with applicable conditions in Table 8.3-1.

* NOTE: This is a nominal value. Refer to Unit 2 TS for allowable values.

All loads connected to the 480-volt ESF MCCs will be de-energized when voltage is lost on the 4,160-volt ESF buses. Loads shown in Table 8.3-1 will be automatically re-energized when voltage is restored to these buses by the diesel generator. (2CNA087704, 2CNA087708)

Loads connected to the ESF buses can be manually reconnected by the operator.

Automatic tripping by protective relays is discussed in Section 8.3.1.1.8.11. For additional information, see Section 8.3.1.6, "Grid Undervoltage Protection."

8.3.1.1.8.9 Safety-Related Equipment Identification

All safety-related equipment has been marked, tagged and identified in accordance with its respective train or channel marking. This is discussed under Section 8.3.1.5.

8.3.1.1.8.10 Instrumentation and Control Systems with Assigned Power Supply

Equipment has been provided in the control room for each diesel generator for manual starting, manual stopping, synchronization, frequency and voltage regulation. A "REMOTE-LOCAL" selector switch has been provided on the diesel generator control panel. Local manual starting during diesel generator testing, manual stopping, governor and voltage regulation and automatic or manual regulator selection have been provided on the diesel generator control panel. Operation of any of these local functions is made permissive only when the "REMOTE-LOCAL" selector switch is in the "LOCAL" position. The "LOCAL" position of this switch is indicated by an amber light in the control room. All safety operations of the diesel generator are independent of the "REMOTE-LOCAL" selector switch. The DC control power source for the diesel instrumentation and control system is of the same channel as the associated diesel generator.

ARKANSAS NUCLEAR ONE
UNIT 2

Each diesel generator is equipped with the following alarms.

A. Local (Diesel Generator Room) Alarms

Lubricating oil, low pressure
Jacket water, low and high temperature
Cooling water, expansion tank, low level
Starting air, low pressure, compressor inoperable
Lubricating oil low and high temperature
Overspeed trip
Service water, low pressure
Crankcase pressure high
Jacket water, low pressure
Auxiliary switch not in AUTO
Engine start failure
Neutral overvoltage
Differential trip
Loss of excitation
Automatic regulator trip
Field ground
Regulator shutdown Normal Flashing Disabled
Control voltage failure
EDG Not Available
[Governor slow start mode \(2DG2 only\)](#)

B. Remote (Control Room) Alarms

Engine/Gen Trouble (operates on any jacket coolant level low, jacket water low temperature, jacket water pressure low, neutral overvoltage, auxiliary switches not in AUTO, lubrication oil low temperature, normal flashing disabled, automatic regulator trip, regulator shutdown, and start failure).

Potential Engine Failure (operates on lubrication oil pressure low, lubrication oil temperature high, crankcase pressure high, jacket water temperature high, service water low pressure trip, loss of excitation, differential trip, overspeed trip, and field ground).

Auto Start Command

Generator breaker not closed (operates when the breaker close signal is present without the breaker closing).

EDG not available (operates on generator breaker racked out, LSA (below 250 rpm) fail to reset, LSB (below 8 psi jacket water) fail to reset remote stop signal, shutdown relay not reset, generator breaker pull to lock, local DG start not in auto, CSI locked, DG breaker L.O., [fast/slow start switch in slow \(2DG2 only\)](#))

ARKANSAS NUCLEAR ONE
UNIT 2

Diesel Generator Start Failure (operates on any starting malfunction).

Start Air Trouble (operates on compressor inoperable or low air pressure trouble alarmed on local annunciator).

Fuel System Trouble (operates for any fuel system related trouble alarmed on local annunciator).

Fuel Oil Day Tank Level High/Low

Electrical instruments have been provided in the control room and at the diesel generator for surveillance of generator voltage, current, frequency, power, and reactive volt amperes. The breaker status of each 4.16 kV breaker of the ESF system is displayed by red and green indicating lamps in the control room, and local indication at the switchgear has been provided for breaker status.

In addition to the specific local and remote alarms described above for the diesel generator, audible and visual alarms will be initiated in the control room to alert the operator to the following conditions of the safety-related electric equipment:

- A. Lockout relays in operated position;
- B. Operation of overload devices for 4160-V motor circuit breakers;
- C. Auto-trip of circuit breakers;
- D. Auto-close of circuit breakers of preferred and standby sources;
- E. Control power not available and/or lockout relay coil failure; or,
- F. "Pull-to-lock" position of control switches and/or breaker not in operating position.

Alarm circuitry and diesel generator control circuitry information with regard to Diesel Generator 1 is provided below. (Diesel Generator 2 is similar).

Conditions that render the diesel generator incapable of responding to an automatic emergency start signal include:

- A. Local control switch RSI in lockout position;
- B. SDR (shutdown relay) energized or not reset;
- C. LSA (low speed switch) not reset (closed below 250 rpm);
- D. LSB (low speed switch) not reset (closed below 250 rpm);
- E. Lockout relay 186-2DG1 for 2DG1 energized or not reset;
- F. CS1-2DG1 control switch for diesel in pull-to-lock;
- G. ACB control switch in pull-to-lock position;
- H. Loss of 125-volt DC control power; and,
- I. Diesel generator breaker not available.
- J. [Fast/slow start switch in slow \(2DG2 only\)](#)

ARKANSAS NUCLEAR ONE
UNIT 2

Insufficient starting air pressure also prevents diesels from starting, but low air pressure is alarmed at approximately 220 psi. However, the diesel can be started at a lower pressure.

The following wording on the annunciator window in the control room that is alarmed corresponds to the conditions listed above "A" through "J".

- A. Alarmed locally and in the control room as "2DG1 NOT AVAIL".
- B. Each of the conditions which pick up the SDR (shutdown relay) including start failure, engine overspeed, and low lubrication oil pressure is alarmed on the local panel. In addition, the start failure and low lubrication oil pressure are alarmed in the control room as follows:
 - Low oil pressure is alarmed as part of "ENGINE/GEN POTENTIAL FAILURE."
 - Start Failure is alarmed as "START FAILURE."
- C. The low speed switch (LSA) is part of the control room alarm "ESF SYSTEM INOP ELECT SYSTEM," and "2DG1 NOT AVAILABLE."
- D. The low speed switch (LSB) is part of the control room alarm "ESF SYSTEM CH1 INOP ELECT SYSTEM," and "2DG1 NOT AVAILABLE."
- E. Alarmed in the control room as "GENERATOR L.O. RELAY TRIP."
- F. Alarmed locally and in the control room as "2DG1 NOT AVAIL."
- G. Alarmed in the control room as part of "MULTIPLE ESF SYS INOPERABLE," and "2DG1 NOT AVAILABLE."
- H. Alarmed locally and in the control room as "2DG1 NOT AVAIL."
- I. Alarmed locally and in the control room as "2DG1 NOT AVAIL."
- J. Alarmed locally and in the control room as "2DG2 NOT AVAIL." (2DG2 only)

When a diesel generator is manually stopped after a test, an interlock is provided which prevents automatic restart for 60 seconds following the shutdown.

Other alarm signals also causing the same annunciator to alarm include:

- A. "ENGINE/GEN TROUBLE" - All alarms which are also found on the local annunciator (2K127/2K131):
 1. Jacket water level low;
 2. Jacket water pressure low;
 3. Neutral overvoltage;
 4. Auxiliary switch not in auto;

ARKANSAS NUCLEAR ONE
UNIT 2

5. Jacket water temperature low;
 6. Lube oil temperature low;
 7. Normal flash disabled;
 8. Regulator automatic trip;
 9. Regulator Shutdown; and
 10. Start Failure.
- B. "POTENTIAL ENGINE FAILURE" - All alarms which are also found on the local annunciator (2K126/2K130):
1. Lube oil pressure low;
 2. Lube oil temperature high;
 3. Crankcase pressure high;
 4. Jacket water temperature high;
 5. Service water pressure low;
 6. Loss of excitation;
 7. Differential trip;
 8. Overspeed; and,
 9. Field ground.
- C. "FUEL SYSTEM TROUBLE" - All alarms which are also found on the local annunciator (2K128/2K132):
1. Fuel storage tank level low;
 2. Fuel transfer pump differential pressure high; and,
 3. Fuel transfer pump inoperable.
- D. "2DG1 NOT AVAIL" - All alarms which are also found on the local annunciator (2K134/2K135):
1. EDG1 (2) - Not Available
 2. CF1 - control voltage failed;
 3. CF2 - control voltage failed;
 4. CF3 - control voltage failed; and,
 5. CF4 - control voltage failed.
 6. [Governor slow start mode \(2DG2 only\)](#)
- E. "GENERATOR L.O. RELAY TRIP" - Only alarm is from the lockout relay.

ARKANSAS NUCLEAR ONE
UNIT 2

F. "START AIR TROUBLE" - All alarms which are also found on the local annunciator (2K129/2K133):

1. Compressor inoperable;
2. Starting air pressure low Tank A (C); and,
3. Starting air pressure low Tank B (D).

There are no conditions rendering the diesel generator incapable of responding to an automatic emergency signal which are not alarmed in the control room.

8.3.1.1.8.11 Electric Circuit Protection System

The entire electric circuit protection system has been designed for selective tripping of circuit breakers, thus limiting the loss of power to the affected circuit only. Fused switches of the type that would leave one or more phases energized following an overcurrent or short-circuit condition have not been used. One exception in this is the non-ESF 4,160-volt main chiller motors 2VCH1A and 2VCH1B. The starters for these two motors have been provided with fuses for protection. The following paragraphs describe the protection system in detail.

8.3.1.1.8.11.1 Main Generator Protection System (Normal Source)

This system comprises protections which lead to unit shutdown. These protections in turn are arranged in two functionally redundant groups as described below:

A. Protective Relays

<u>Group I</u>	<u>Group II</u>
1. Generator differential 287 (1)	Unit Differential 387 (2)
2. Main Transformer, Sudden Pressure Relay 363 (1)	Generator Neutral Over-Voltage 259N (2)
3. Unit Auxiliary Transformer Differential 187 at (3,4)	Unit Auxiliary Transformer Sudden Pressure Relay No. 1, 163 (3,4)
4. Unit Auxiliary Transformer Sudden Pressure Relay No. 2 (3,4)	Unit Aux. Transformer, Neutral O/C, 6.9 and 4.16 kV, 151G-ATX & ATY (3,4)
5. Antimotoring Relay 232-1(7) [Trips 286-G2-8 only]	Turbine Trip Contact 2 (5, 6)

A. Protective Relays (continued)

<u>Group I</u>	<u>Group II</u>
6. Turbine Trip Contact 1 (5,7)	EHC Master Trip Bus [Trips 286-G2-3 and -4 only] (8)
7. Generator volts/hertz (259/281-1, -2)	Anti-Motoring Relay 232(5)
8. EHC Master Trip Bus (6) [Trips 286-G2-1 and -2 only]	Output Breaker 5130/5134 Failure to Trip
9. Loss of Field Relay 240	
10. Overexcitation J4K	
11. Negative Sequence 246	
12. Backup Impedance 221	

ARKANSAS NUCLEAR ONE
UNIT 2

B. Lockout Relays

<u>Group I</u>	<u>Group II</u>
286-G2-1	286-G2-3
286-G2-2	286-G2-4
286-G2-8	286-G2-9

C. Lockout Auxiliary Relays

<u>Group I</u>	<u>Group II</u>
286-G2-1/X1	286-G2-3/X1
286-G2-1/X2	286-G2-3/X2

Protective relays from one group are backed up by protective relays from the other group, thus making the protective system functionally redundant for most faults. The numbers in parentheses refer to the relays in one group which act as backup for relays in the other group. The DC supplies to the two groups are derived from different batteries.

The lockout relays in each group perform the following functions:

- A. Trip the turbine;
- B. Initiate transfer to the preferred source transformer;
- C. Trip 500 kV, 4.16 kV and 6.9 kV (unit auxiliary) breakers and the field breaker;
- D. Trip cooling equipment of main and unit auxiliary transformer; and,
- E. Trip the diesel generator breaker to the ESF buses 2A3/2A4, if the diesel generator was in parallel with the system for test purposes and the UAT was in service.

8.3.1.1.8.11.2 Preferred Source Protection System

Startup Transformer 2 is common to both Units 1 and 2. The following protective relays have been provided as part of Unit 1: differential relay (instantaneous), 6.9 kV and 4.16 kV neutral overcurrent relays (inverse time), and sudden gas pressure relay.

The above relays or the switchyard ST #2 lockout relays will energize the Startup Transformer 2 lockout relay which will initiate the following:

- A. Trip the associated incoming feeder breakers to buses 2H1, 2H2, 2A1, and 2A2;
- B. Initiate transfer to Startup Transformer 3; and,
- C. Trip the diesel generator breaker to the ESF buses 2A3/2A4, if the diesel generator was under test in parallel with Startup Transformer 2 supplying the auxiliary system.

Startup Transformer 3 has been provided with protective and lockout relays identical to those described for Startup Transformer 2. The operations initiated by the lockout relay are as follows:

ARKANSAS NUCLEAR ONE
UNIT 2

- A. Trip the associated incoming feeder breakers to buses 2H1, 2H2, 2A1, and 2A2;
- B. Initiate transfer to Startup Transformer 2; and,
- C. Trip the diesel generator breaker to the ESF buses 2A3/2A4, if the diesel generator was under test in parallel with Startup Transformer 3 supplying the auxiliary system.

Both Unit 1 and Unit 2 are prevented from automatic transfer to Startup Transformer 2 during normal power operations for all buses except Buses A1/A3 (Unit 1) and 2A1/2A3 (Unit 2). Procedures administratively control Unit 1 and Unit 2 access to Startup Transformer 2. Procedures may allow other fast transfer capabilities to Startup Transformer 2 for specifically analyzed conditions and restrictions defined in approved Engineering Calculations and Evaluations.

8.3.1.1.8.11.3 6900 and 4,160-volt Non-ESF Buses 2H1, 2H2, 2A1 and 2A2

Each of the buses has been provided with a lockout relay which can be operated by any one of the following relays provided on each incoming feeder breaker to the respective buses:

- A. Phase overcurrent relays (3) (inverse time); or,
- B. Ground overcurrent relay (inverse time).

The bus lockout relays have been arranged to:

- A. Trip all the incoming supply breakers to the affected bus section; and,
- B. Prevent closing the incoming supply breakers until the associated lockout relay is reset.

Shedding of all motor loads connected to these buses upon operation of the bus lockout relays is effected by undervoltage relays as described in Section 8.3.1.1.8.8.

The inverse time overcurrent relays on the incoming breakers have been set so that the bus lockout relays can operate only if a fault on an outgoing feeder is not cleared by the associated breaker or there is a fault on the bus itself.

8.3.1.1.8.11.4 Protection of Non-ESF 6900-Volt and 4,160-volt Load Center and Motor Feeders

The following protective relays have been provided for each of these feeders:

- A. Phase overcurrent relays (3) (inverse time) with instantaneous elements for short-circuit protection;
- B. Ground sensor (instantaneous); and,
- C. Differential relays (3) (instantaneous), (for motors above 3,000 HP only).

ARKANSAS NUCLEAR ONE
UNIT 2

In the case of load center feeders, the phase overcurrent relays have been arranged to trip the feeder circuit breaker. In the case of motor feeders, the middle-phase overcurrent relay has been set low for "overload alarm" and the two outer-phase overcurrent relays have been connected to trip the breaker on a stalled rotor condition and any overload above two times full load current with time delay.

The ground sensor relay has a very sensitive setting and can detect ground faults down to 15A, thus affording good protection to the associated motor and cables. The instantaneous protection has been set to ensure that:

- A. The faulted section is isolated selectively;
- B. The short-time current withstand capability of the cable is not exceeded; and,
- C. Damage at the point of fault is minimized.

A short-circuit on any feeder will result in instantaneous tripping of the associated circuit breaker.

8.3.1.1.8.11.5 ESF 4,160-volt Buses 2A3 and 2A4

Each of these two buses has been provided with a lockout relay which can only be operated by the phase overcurrent relays (3) (inverse time) provided on the incoming feeder (from non-ESF bus 2A1/2A2) circuit.

The bus lockout relay has been arranged to:

- A. Trip out the incoming supply breaker from the non-ESF bus, the bus-tie breaker and the diesel generator breaker; and,
- B. Prevent closing the above-referenced breakers until the lockout relay is reset.

Shedding of motor loads connected to the buses will be effected by the bus undervoltage relays as described in Section 8.3.1.1.8.8. No automatic reloading of these buses can occur since the off-site supply feeder breaker and the diesel generator breaker will be locked out by the bus lockout relay.

The inverse time overcurrent relays on the incoming breaker have been set to ensure that the bus lockout relay can be operated only if a fault on an outgoing feeder is not cleared by the associated breaker or there is a fault on the bus itself. The ground overcurrent relay 151N-309/409 will only trip the incoming feeder breaker 2A309/2A409 since the ESF 4,160-volt system is designed to operate continuously with a single ground fault when the diesel generator is supplying the loads.

ARKANSAS NUCLEAR ONE
UNIT 2

8.3.1.1.8.11.6 Protection of the Diesel Engine Generator System

Two relays, diesel engine shutdown and diesel generator lockout, are provided for each unit, located on the diesel generator local control panels and local generator switchgear, as follows:

A. Diesel Engine Shutdown Relay

The following abnormal conditions will operate this relay and shut down the engine and trip the generator circuit breaker:

1. Engine overspeed;
2. Low lube oil pressure (time delayed) composed of three pressure switches, providing 2-out-of-3 coincident logic; or,
3. Engine failure to start (see Section 9.5.6 for discussion).

B. Diesel Generator Lockout Relay

The following abnormal conditions will operate this relay and trip the generator circuit breaker and generator excitation:

1. Generator differential current relay;
2. Generator phase overcurrent relay with voltage restraint;
3. Generator loss of field relay;
4. Generator anti-motoring relay; or,
5. Diesel engine shutdown relay.

Operation of the generator differential current relay will also shut down the diesel engine, via the engine governor.

During the accident mode, on an SIAS, protective devices A.1, A.2, A.3, B.1 and B.5 are operational; all others are bypassed.

Protective trip bypass devices and circuitry are designed to comply with IEEE 279-1971, except bypass surveillance, which is not required to function during either accident or seismic mode periods and is classified non-Class 1E.

The occurrence of abnormal conditions, excessive values, or unit malfunctions is monitored on the local control panels and in the control room.

The diesel generator units are normally held in the standby status; however, a unit may be locked out of service by operating either lockout relay. Manual resetting of both lockout relays is required before the unit can be returned to the standby status. The out-of-service status of a unit is alarmed in the control room.

ARKANSAS NUCLEAR ONE
UNIT 2

The trip settings of the unit protective devices are coordinated with those downstream on the main buses and feeder circuits to permit isolation of system faults and overloads without tripping the diesel generator circuit breaker.

8.3.1.1.8.11.7 Ground Fault in the 4,160-volt ESF System

With the diesel generator operating and with the ESF bus disconnected from the preferred source, a single ground fault in the 4,160-volt system will not result in any tripping action. The diesel generator and the ESF loads will continue to function. However, an alarm will be initiated under this condition. The high impedance neutral grounding equipment of each diesel generator is continuously rated.

With the diesel generator in parallel with the system, a single ground fault in any of the outgoing feeder circuits will cause instantaneous tripping of the affected circuit due to the higher levels of ground fault current permitted by the UAT, Startup Transformer 2, or Startup Transformer 3 neutral resistors.

The diesel generator can be paralleled with the main non-ESF 4,160-volt system for testing purposes. To isolate the diesel generator in the event of a fault in the non-ESF 4,160-volt system, the following relays have been provided for the incoming breaker from the non-ESF bus 2A1/2A2:

- A. Phase directional overcurrent relays (3); and,
- B. A ground directional overcurrent relay.

These relays have been set to assure that selective tripping occurs with regard to the relays provided for the diesel generator.

8.3.1.1.8.11.8 ESF 4,160-volt Bus-Tie Breakers

The electrical interlock, maintenance and operational bypasses, and administrative control to allow the tie breakers to be used only during shutdown (Modes 5 and 6) or under post-accident emergency conditions are described in Section 8.3.1.1.9.4. However, in order to isolate the faulted bus section if the tie breakers were used under the described conditions, the following relays have been provided for each tie-breaker:

- A. Phase overcurrent relays (3) (inverse time); and,
- B. Ground overcurrent relay (inverse time).

8.3.1.1.8.11.9 ESF 4,160-volt Motor and Load Center Feeders

Following protective relays have been provided for each of these feeders:

- A. Phase overcurrent relays (inverse time) with three instantaneous elements for short-circuit protection; and,
- B. A ground sensor (instantaneous).

ARKANSAS NUCLEAR ONE
UNIT 2

In the case of load center feeders, the phase overcurrent relays have been arranged to trip the respective breaker. In the case of motor feeders, the middle phase overcurrent relay has been set low for "overload alarm" and the two outer phase overcurrent relays have been connected to trip the breaker on a stalled rotor condition and any overload above two times the full load current with time delay.

The ground sensor relay cannot trip the diesel generator breaker on ground fault if the diesel generator is operating independently of the main system as described in Section 8.3.1.1.8.11.7. A short-circuit in any feeder will result in instantaneous tripping of the associated circuit breaker.

8.3.1.1.8.11.10 Non-ESF 480-Volt System

The incoming breakers to all non-ESF 480-volt load centers have been provided with the following relays:

- A. Phase overcurrent relays (inverse time) (2); and,
- B. A ground overcurrent relay (inverse time).

These relays have been coordinated with the overload and short-circuit relays provided on the ongoing feeder circuits and the rating of the load center transformer.

Feeders to 480-volt non-ESF MCCs have been protected by ACBs, each provided with a direct-acting, dual-magnetic trip element having short time and long time elements. These have been coordinated with the protections provided on the MCCs outgoing feeders.

The 480-volt MCC combination motor controllers have been provided with an instantaneous trip element (for short-circuit protection) and ambient compensated thermal overload relays for each phase. The overload elements have been set to protect the connected motor and the instantaneous element to protect the connected cable.

8.3.1.1.8.11.11 ESF 480-Volt System

The protective system for the ESF 480-volt system is identical to that described for the non-ESF 480-volt system in Section 8.3.1.1.8.11.10 with the following additional features:

- A. When required to operate in the accident mode, thermal overloads for safety-related valves are bypassed by contacts of auxiliary relays. These relays are supplied from Class 1E 125-volt DC and are held energized during the non-accident mode. The torque limiting devices, however, are bypassed in all operating modes by valve position switches, adjusted to open at nearly 100 percent travel of the valve in the direction of the safety function. This ensures that motor operated valve movement in the direction of the safety function will be continued if the power supply failed and was restored during mid-travel.
- B. Surveillance of the bypass status for overload and torque limiting devices is not provided because safety functions of the valves themselves have not been bypassed and because the valve motors have been sized for the duty under the accident mode.

ARKANSAS NUCLEAR ONE
UNIT 2

8.3.1.1.8.11.12 120/208-Volt Instrument AC System

The outgoing feeders are each typically provided with a single-pole 20 A (There are some breakers larger than 20 amps.) thermo-magnetic trip element while the main and tie feeders are rated at 225 A and have an instantaneous trip and an adjustable short delay setting of 6-14 cycles. This ensures that a fault on any feeder circuit will result in the tripping of the associated breaker only.

8.3.1.1.8.11.13 120-Volt Vital AC System

The 120-volt vital AC system is ungrounded. The outgoing feeders are each provided with a 2-pole thermomagnetic trip element.

8.3.1.1.8.11.14 The Scheme For Testing the Power Systems During Power Operation

Operational and periodic tests, including inservice tests, have been performed after installation on the power and control circuits and components, including protective relays, meters, and instruments. All protective relays, meters, and instruments have provisions for inservice testing and calibration. Circuit breaker, control circuits and protective device design have features that allow periodic testing.

Each diesel generator is equipped with means for starting periodically to test for readiness, means for synchronizing the unit onto the bus without interrupting the service, and for loading.

Administrative control will ensure that both diesel generator units are not load tested simultaneously.

8.3.1.1.9 Diesel Generators

8.3.1.1.9.1 Starting Initiating Circuits

Each diesel generator can be started automatically either by an SIAS or by the undervoltage relays on the respective 4160- or 480-volt ESF buses. If both diesel generators are available, both will start automatically. If an ESF bus undervoltage relay senses a dead bus, the diesel generator will be automatically started and connected to its respective bus.

8.3.1.1.9.2 Starting Mechanism and System

Each diesel engine has been furnished with two completely independent air starting systems. Each air starting system has the capacity to crank the engine five times without the use of the air compressor. All operations necessary to maintain the starting system in a ready condition are entirely automatic and self-initiated. The compressors are driven by AC motors with automatic start-stop control.

The diesel engine starting system has been designed to start and operate automatically except when in lockout position. A local and remote manual starting and stopping arrangement has also been provided for emergency and testing purposes. Local operation can be done only by deliberate operator action since a key-locked three position "START-AUTO-LOCKOUT" selector switch, with key removable only in the "AUTO" position has been provided.

ARKANSAS NUCLEAR ONE
UNIT 2

8.3.1.1.9.3 Tripping Devices

When the diesel generator has started on an SIAS, other engine protective devices except "low lube oil pressure," and "overspeed," the "generator differential current relay" and the "diesel engine shutdown relay," will not be able to trip the engine. Diesel generator protective relays have been arranged to trip the engine provided that the nature of the fault will prevent the generator from performing its function satisfactorily. Local manual engine tripping can be done only by the three position key-locked selector switch as mentioned in Section 8.3.1.1.9.2 or by the emergency manual stop button on the engine skid. Remote engine tripping is disabled when the unit is in SIAS operation. Tripping of the ACB when in SIAS operation can only be accomplished by pulling-to-lock the remote control switch in the control room.

8.3.1.1.9.4 Interlocks

Both 4.16 KV ESF bus tie breakers cannot be closed when one of the diesel generator breakers or one of the ESF bus feeder breakers are closed for both 2A3 and 2A4 and with the "Operational Bypass" key switch in either tie breaker cubicle in the "NORM" position. Electrical interlocks in both "Close" and "Trip" control circuits prevent the cross connection of the safety buses. The normal logic is such that closure of the tie breakers can only occur when at least one bus is disconnected from both its normal and emergency power sources. The "Trip" circuit contains an "Operational Bypass" key switch that is administratively controlled to allow cross connection during refueling operations or extreme emergencies. The "Close" circuit contains a "Maintenance Bypass" key switch to allow remote closing of the tie breakers when the control system for the Alternate AC Power Source (Section 8.3.3) is out of service. This "Maintenance Bypass" also allows for a local manual response to a station blackout with a concurrent failure of the computer based control system for the Alternate AC Generator.

The third High Pressure Safety Injection (HPSI) pump motor (4,160-volt), the third service water pump motor (4,160-volt), and the third charging pump motor (480-volt MCC) can be fed from either ESF bus. The third HPSI pump motor and the third service water pump motor each have two interlocked feeder breakers, one from each safety channel.

The DC control power for the 4,160-volt breakers are supplied from the independent ESF DC systems respectively, i.e. ESF Channel 1 breakers are supplied with control power from the ESF Channel 1 DC system and ESF Channel 2 breakers are supplied with control power from ESF Channel 2 DC system. (See Section 8.3.2.1.6 for further discussion on DC system independence.)

To prevent tying the two ESF systems together, the two breakers feeding the double-fed motor for the HPSI pump is mechanically interlocked by means of Kirk-Keys, so that only one of these two breakers can be closed at any time. The service water pumps are interlocked electrically using two control switches in the control room with a single interchangeable control handle to electrically operate non-fused disconnect switches. These hand switches also provide the electrical interlock with the 4160 volt switchgear such that only one of the two 4160 volt breakers can be electrically closed at a time, thus preventing the connection of pump 2P4B to both ESF channels simultaneously through their respective control circuits.

The third charging pump motor has two 480 volt starters, one from each safety channel, and two down stream contactors in 2C383. The hand switches for these starters are equipped with only one handle (removable only from the stop position) in 2C09. In addition, the two downstream contactors are electrically interlocked to prevent the simultaneous closure of both at the same

ARKANSAS NUCLEAR ONE
UNIT 2

time. Each of the two starters derives its control power from an individual 120-volt AC control power transformer located in the starter compartment. Independence is maintained due to the individual power source for each of the two interlocked contactors in 2C383, one from each safety channel. The use of key-locked switches and mechanically interlocked control switches in the case of all the three double-fed motors has resulted in a design totally free of any interconnecting wiring between the two safety channels.

Interlocks have been provided in the closing and tripping circuits of individual breakers to protect against the following conditions:

- A. Automatic energizing of electric devices under maintenance. This has been achieved by means of a pull-to-lock feature in the individual control switches. In the case of ESF breakers, the pull-to-lock condition is alarmed audibly and visually to the operator.
- B. Closing a breaker with the associated lockout relay in the operated position.
- C. Connecting two sources out of synchronism. This has been achieved by inserting in the close circuit of each source breaker a contact of the applicable synchronizing switch. The fast autotransfer between normal and preferred sources uses a contact of a synchronizing check relay in the closing circuit.
- D. Closing the diesel generator breaker by the local control switch (electrical) if the associated 4,160-volt ESF bus is energized.
- E. Autoclosing the diesel generator breaker without first isolating the ESF bus. This has been prevented by the use of a normally closed auxiliary contact of the incoming feeder breaker in the closing circuit of the diesel generator circuit breaker.
- F. Automatic connection of the ESF loads without voltage on the associated ESF bus. This has been ensured by a contact of the bus voltage sensing relays in the closing circuits of the individual breakers.

8.3.1.1.9.5 Permissives

- A. To start the emergency diesel engine:
 - 1. Local selector switch in "AUTO" or "START" position;
 - 2. Diesel engine shutdown relay is reset.
 - 3. Diesel generator lockout relay in reset position; and,
 - 4. Neither the diesel generator ACB remote control switch or the diesel engine remote control switch is in the pull-to-lock position.

- B. To trip the emergency diesel engine when the unit is on "AUTO" operation:

This is covered in Section 8.3.1.1.9.3 above.

ARKANSAS NUCLEAR ONE
UNIT 2

- C. To close the diesel generator ACB:
 - 1. Manual - Remote:
 - a. Diesel generator lockout relay in reset position;
 - b. Associated 4.16 kV ESF lockout relay in reset position;
 - c. Synch turned to "on" position.
- D. To close 4.16 kV ESF bus tie breakers:
 - 1. Electrical interlocks in the "Close" and "Trip" circuits of each tie breaker as described in Section 8.3.1.1.9.4.
- E. To close 480-volt ESF load centers bus tie breakers:
 - 1. Kirk-key transfer as described in Section 8.3.1.1.9.4.
- F. To close 120-volt, instrument bus (2Y1-2Y2) tie breaker:
 - 1. Kirk-key transfer as described in Section 8.3.1.1.9.4.
- G. To close ACBs to third pump (service water pump, HPSI and charging system):
 - 1. HPSI (Kirk-Key transfer as described in Section 8.3.1.1.9.4)
 - 2. Service Water Pump (Handswitch and disconnect switch line-up as described in Section 8.3.1.1.9.4)
 - 3. Charging Pump (as described in Section 8.3.1.1.9.4)

8.3.1.1.9.6 Load Shedding Circuits

Discussions of load shedding are included in Section 8.3.1.1.8.8, "Automatic Tripping and Loading of Buses" and Section 8.3.1.6, "Grid Undervoltage Protection."

8.3.1.1.9.7 Testing

Each diesel generator is equipped with a means for starting periodically to test for readiness, a means for synchronizing the unit onto the bus without interrupting the service, and for loading.

The following types of tests will be performed periodically on each diesel generator:

- A. Starting;
- B. Load acceptance;
- C. Design loading;
- D. Load rejection; and,
- E. Functional.

(For exact tests and their frequency, see the Technical Specifications)

ARKANSAS NUCLEAR ONE
UNIT 2

8.3.1.1.9.8 Fuel Storage and Transfer System

The diesel fuel storage and transfer system is detailed in Section 9.5.4.

8.3.1.1.9.9 Basis For Diesel Generator Sizing

Table 8.3-1 lists all ESF loads and non-ESF loads which were used in sizing the diesel generator. This table shows the quantities of various loads, the number of each load that can be connected to the ESF bus, the rating of each load in HP, the actual loading in HP of each load, the loading sequence step number and other details.

The continuous rating of each diesel generator was based on the total calculated consumption of all loads, ESF and non-ESF, that have to be powered by the system under Design Basis Accident (DBA) or for safe shutdown conditions. The calculated consumption in HP of each motor or heater was based on conservative design calculations under the expected flow and pressure conditions, pump run-out condition or manufacturers' recommendations.

Each diesel generator has the following rating:

- 2850 Kw - 8,760 hrs. (continuous)
- 3100 kW - 2,000 hrs.
- 3135 kW - 2-out-of-24 hours overload capability
- 3250 kW - 7 days
- 3500 kW - 30 minutes

Maximum continuous diesel loads are based upon nominal design service water flow of 800 gpm and a nominal service water temperature of 85 °F. The loading listed above may not be achievable at elevated service water temperatures. Operation of the EDGs, using service water at the anticipated worse case ECP temperature profile, has been evaluated against the EDG emergency load profile. The evaluation concludes that the load profile can be met with excess margin at design fouling conditions and with allowances for tube plugging. EDG capability under actual emergency conditions is procedurally assured by monitoring air scavenging and lube oil temperatures.

8.3.1.1.10 Cooling and Heating Systems

Cooling and heating systems provided for Class 1E equipment are described in Section 9.4.

Space heaters are provided for enclosed panels, switchgear cubicles, and all totally enclosed motors with the exception of explosion proof motors, which may not have space heaters. Open drip-proof and weather protected motors rated 250 HP and above also have space heaters.

A jacket coolant preheat system and a lubricating oil preheat system are provided for the emergency diesel generator engine to keep each in readiness to start.

8.3.1.1.11 Instrumentation and Control System With Assigned Power Supply

See Section 8.3.1.1.8.10 for a detailed discussion.

ARKANSAS NUCLEAR ONE
UNIT 2

8.3.1.1.12 Diesel Loading

Table 8.3-1 shows the automatic and manual loading sequence of the emergency power supply system. All essential loads will be started automatically by their respective ESF actuation signals in a predetermined step-by-step loading sequence. Equipment which may require manual startup will only be started after the initial automatic sequential loading. As explained in Section 8.3.1.1.13, motor sizes for safety-related loads such as pumps, fans, etc. are based on vendor's recommendations and confirmed by prototype tests and preoperational trial runs. The horsepower ratings are conservative in relation to their functional performance requirements. The duration of time each safety-related load is required to be in operation is given in Table 8.3-1 along with the size of load, etc.

8.3.1.1.13 Design Criteria for Class 1E Equipment Parameters

Design criteria are discussed below for certain parameters of the Class 1E equipment.

A. Motor Size

Motor sizes have been selected based on calculations of load-torque requirements or on the basis of equipment (pump, fan, compressor, etc.) suppliers' recommendations.

In all cases motor rated horsepower will be greater than the connected pump or fan load and not less than the associated runout pump load.

Field tests have proved the capability of all motors to run design loads without exceeding design temperature limits.

B. Motor Starting Torque

Motors generally have been designed for normal starting torque and low starting current as per NEMA Class B. They are capable of delivering full load torque with 75 percent rated voltage available across the terminals and can accelerate with the load to rated speed with only 80 percent rated voltage. The ability of the motors to develop the required torque and perform the duty cycle has been demonstrated by actual load test at vendors' factories and during preoperational tests.

C. Motor Insulation

Insulation systems have been selected based on the particular ambient conditions to which the insulation will be exposed. For Class 1E motors located within the containment, the insulation system has been selected to withstand the postulated accident environment. In general, all Class 1E motors have Class B, or better, insulation and are suitable for high humidity operating conditions.

ARKANSAS NUCLEAR ONE
UNIT 2

D. Interrupting Capacities

The interrupting capacities of the protective equipment have been determined as follows:

1. Switchgear

In the calculation of medium voltage switchgear interrupting capacities, ANSI C37.010-1979 has been followed. The power system, alternate AC generator (large diesel), and connected motor contributions have been considered in determining the fault level.

2. Load Centers, Motor Control Centers and Distribution Panels

Load centers, MCCs, and distribution panel circuit breakers have a symmetrical rated interrupting current as great as the calculated total available symmetrical current at the point of application. Determination of symmetrical currents has been calculated in accordance with procedures of ANSI C37.13-1981 for low voltage circuit breakers.

E. Electric Circuit Protection

Refer to Section 8.3.1.1.8.11 for criteria regarding the electric circuit protection.

F. Grounding Requirements

Equipment and system grounding is designed in accordance with IEEE 80, "Safety in AC Substation Grounding," and IEEE 142-1956, "Grounding of Industrial Power Systems." The system has been designed with neutral grounding for detection and clearance of ground faults. The neutral of the diesel generator is grounded through a combination grounding transformer and resistor. This will permit the diesel generator to function continuously under emergency conditions with a single ground fault in the 4,160-volt ESF system.

The neutrals of the 4160- and 6900-volt windings of the unit auxiliary transformer and Startup Transformers 2 and 3 have been grounded through low ohmic resistors.

Neutrals of all load center transformers are solidly grounded. All motor and equipment frames are also solidly connected to ground with conductors of adequate capacity to carry the maximum ground fault current.

Secondaries of current and potential transformers have been grounded in accordance with IEEE 52-1951, "Application Guide for Grounding of Instrument Transformer Secondary Circuits and Cases."

G. Electrical Penetrations

All electrical penetrations are of modular design with header plates of stainless steel (for high voltage) or carbon steel (for low voltage). The existing Amphenol-SAMS modules have dual pressure seals (while the Conax replacement modules have four O-rings) and a retaining ring arrangement with the header plates. All conductors are hermetically sealed to modules and terminate in pigtails or connectors. The header plate assembly

ARKANSAS NUCLEAR ONE
UNIT 2

bolts to a weld neck flange that is welded to the nozzle through the containment wall. Pressure seals between each header plate and its flange are provided by two O-rings. Dynamic module seals and/or O-rings, and header plate O-rings are continuously under positive nitrogen pressure of approximately 60 psig for Amphenol - SAMS modules, to ensure that moisture will not affect the electrical integrity of the Amphenol-SAMS Electrical Penetration Assemblies (EPAs). Nitrogen Pressure of 0-65 psig is available to the Conax-Buffalo EPAs, as required, for leakage monitoring only. The EPAs will be leak rate tested periodically in accordance with the Technical Specifications.

High voltage penetration conductors are equipped with bushing type terminations. The low voltage power and control modules are provided with pigtails. Instrumentation modules have multi-conductor shielded pigtails and coaxial modules have a flush connector outboard and pigtails with coaxial connectors, or coaxial pigtails with coaxial connectors.

In the event of an accident some systems are required to function under adverse environmental conditions to initiate or monitor engineered safety features. Typical components related to some of these systems are electrical penetration assemblies. During an accident event these assemblies are exposed to high levels of pressure and superheated containment conditions which they must be able to withstand without loss of function.

The following paragraphs describe historical analyses pertaining to the MSLB. The MSLB analyses completed for the new Westinghouse steam generators along with power uprated conditions produce lower temperatures than those presented below due to the flow limiting devices installed in the outlet of the new steam generator nozzles (refer to SAR section 6.2). As a result, the historical analyses that follow are considered bounding for the new Westinghouse steam generators and power uprated conditions.

In order to examine the influence of accident events on safety-related component temperatures an analysis was conducted with the Bechtel COPATTA computer code. For the analysis, a typical containment penetration was modeled as a slab, with a 1/16-inch steel cover, 2-inch air gap to a simulated cable consisting of 0.1-inch insulation and 0.2-inch thick copper core. The outside surface is covered with organic paint of 0.006-inch thickness.

For reasons of high containment superheated temperature conditions during a Main Steam Line Break (MSLB) event (exceeding 400 °F), a transient temperature analysis was performed to determine the effect of superheat on safety-related equipment. The calculations were carried out using assumptions for containment initial conditions, heat removal systems, blowdown data and condensing heat transfer coefficients that maximize heat transfer to exposed components. A 60 percent break area MSLB with a realistic spray initiation time of 56 seconds produced a temperature of 410 °F at 46 seconds. The surface temperature of the electrical penetration reached a peak value of 255 °F which is well below the design temperature of 300 °F. This substantial difference in containment vapor temperature and component temperature is due to the fact that the energy transferred into the heat sinks is a function of the heat transfer mechanism. Energy transfer into heat sinks is a maximum as long as the heat sink surface temperature is lower than T(SAT) since condensation occurs. When the heat sink temperature equals T(SAT), energy transfer is restricted to convective heat transfer which is significantly lower than heat transfer by condensation. Therefore, this change in

ARKANSAS NUCLEAR ONE
UNIT 2

heat transfer mechanism is responsible for heat sink surface temperatures following containment saturation temperature and exceeds it only if superheated conditions prevail over a longer time period than those under consideration. This result implies that maximum heat sink temperatures are produced by an accident that furnished the highest saturation temperature and hence saturation pressure. This accident event is the DBA LOCA which is therefore the design basis for safety-related equipment qualification.

The double-ended pump suction break is the DBA producing a peak saturation temperature of 289 °F at 150 seconds. Therefore, the surface temperature of the electrical penetrations approach T(SAT) do not exceed 289 °F over the entire accident time period.

Since the equipment design temperature is 300 °F, well above DBA peak saturation temperature, the electrical penetration assemblies will function as designed during and after a DBA or MSLB. The EPAs were designed and engineered according to IEEE 317-1971 and meet the intent of IEEE 323-1971 (2CAN057804). The environmental qualification of the original penetrations was in accordance with Division of Operating Reactors (DOR) Guidelines contained in IE Bulletin 79-01B. Replacement penetrations are qualified in accordance with 10 CFR 50.49.

Similar analyses for other types of safety-related equipment, including cables, instruments, motors, motor controllers and motor operated valves, were performed for a spectrum of main steam line and Reactor Coolant System (RCS) pipe breaks. These analyses are conservative for Arkansas Nuclear One - Unit 2 and clearly demonstrate the relationship between surface temperature and saturation temperature described above for the EPAs. These analyses are discussed in Topical Report BN-TOP-3, Revision 3, and are described in detail in Reference 22 to that report.

The exception to the above temperature relationships occurs when high temperature water or steam impinges directly on a component. The high energy pipe break analyses described in Chapter 3 do not take credit for the functioning of any component which is subjected to direct impingement when evaluating the consequences of the pipe break. This includes the MSLB and LOCA analyses.

To assure that EPAs continue to maintain adequate integrity during their service life, they will be periodically leak tested in accordance with 10 CFR 50, Appendix J.

H. Cathodic Protection

Cathodic protection has been provided for all exterior surfaces of underground coated steel pipes and tanks. The cathodic protection system is of the impressed current type utilizing anodes in buried canisters. Permanent corrosion monitoring stations, including zinc reference electrodes, have been provided at significant locations for periodic testing of buried pipes, tanks, and the containment liner base plate.

ARKANSAS NUCLEAR ONE
UNIT 2

8.3.1.2 Analysis

The Class 1E electric system is designed to ensure that any of the design basis events listed in IEEE 308 will not prevent operation of the minimum number of ESF loads and protective devices required to safely shut down the reactor and to maintain a safe post-shutdown condition. The system was designed to meet the requirements of IEEE 279-1971, IEEE 308-1971, IEEE 387-1972, 10CFR50 General Design Criteria 17 and 18, and Regulatory Guides 1.6 and 1.9.

General Design Criteria 17 and 18 are covered in detail in Section 3.1. The environmental qualification program is described in detail in Section 3.11.

The following design aspects illustrate the extent of conformance with Regulatory Guides 1.6, 1.9, 1.47, 1.63 and 1.75, IEEE 308-1971, IEEE 279-1971, IEEE 379-1972 and IEEE 387-1972.

8.3.1.2.1 Regulatory Guide 1.6

- A. The electrically powered safety loads, AC and DC, have been separated into two redundant load groups such that loss of either group will not prevent the minimum safety functions from being performed.
- B. Each AC load group has a connection to the preferred (off-site) power source and to an emergency (onsite) power source. The emergency power source has no automatic connection to the other redundant load group. Electrical Interlocks in both "Close" and "Trip" control circuits prevent the cross connection of the safety buses of Units 1 and 2.
- C. Each DC load group has a separate battery and battery charger. No automatic connection has been provided between the battery charger combination of one group and the combination of the other redundant load group.
- D. The two redundant emergency sources have no provision for automatic paralleling. Manual paralleling of the two diesel generators is possible only through the two non-ESF 4,160-volt buses 2A1 and 2A2. If the emergency sources are the only sources of power during an emergency, they will be automatically isolated from each other and the main system.
- E. No provision exists for automatically connecting one load group to the other or transferring loads between redundant power sources.
- F. The tie-breakers that connect the two 4.16 KV ESF buses are equipped with electrical interlocks in both the "Close" and "Trip" control circuits to prevent the cross connection of the two buses. Both 4.16 KV ESF bus tie breakers cannot be closed when one of the diesel generator breakers or one of the ESF bus feeder breakers are closed for both 2A3 and 2A4 and with the "Operational Bypass" key switch in either tie breaker cubicle in the "NORM" position. "Operational Bypass" key switches are provided in the tie-breaker cubicles to allow cross connection during refueling operations or extreme emergencies. The function of the tie-breakers and bypasses are further described in Section 8.3.1.1.9.4.
- G. Each emergency power source consists of a single generator driven by a single prime mover.

ARKANSAS NUCLEAR ONE
UNIT 2

8.3.1.2.2 Regulatory Guide 1.9

The emergency diesel generators are each rated as shown in Section 8.3.1.1.9.9. Table 8.3-1 provides the different loading combinations.

- A. Preoperational tests are discussed in Chapter 14.
- B. Preoperational tests have verified the capability of each diesel generator set to start and accelerate to rated speed all of the needed ESF and emergency shutdown loads in the required sequence.

During the period of load application or during the period of load removal, the generated voltage and frequency were maintained within limits which do not degrade the performance of the loads below their minimum requirements.

The overspeed device of the diesel generator has been designed to withstand without damage speeds up to 125 percent of normal rated speed. Also, the overspeed trip device is set sufficiently high to ensure that the unit will not trip on full short time load rejection.

- C. Each diesel generator has adequate capacity to start and accelerate the largest single load out of sequence, with all other loads running.

8.3.1.2.3 Regulatory Guide 1.47

- A. Protective Action System

The following features describe the "bypassed and inoperable" status indication for the protection action system, which includes the actuated equipment and the actuation devices.

1. One annunciator window has been provided for each of the seven redundant ESF systems to indicate the unavailability of a system. There are seven windows for the red channel system level indication on annunciator 2K07 on panel 2C17. Likewise, there are seven windows for the green channel system level indication on annunciator 2K04 on panel 2C16.

In the event of inoperability of more than one system in either ESF channel, two windows have been provided for each channel to annunciate multiple system inoperability.

2. The windows for the red and green channel indications are demarcated and grouped by specific systems on their respective annunciators for easy operator identification.
3. Unavailability of a protection action system will be alarmed when any component in the respective system and channel has been deliberately rendered inoperable.

ARKANSAS NUCLEAR ONE
UNIT 2

4. The group of devices that are connected to the common window is identified from the applicable P&IDs and electrical system drawings. This ensures that any auxiliary or supporting device that is necessary for the proper functioning of the system is included in the alarm.
5. All control switches and indicating lights have been grouped on the control panel on the basis of the ESF system with which they are associated.
6. Within each ESF system grouping, the switches and lights are further subgrouped (identified by background color or colored framework) according to the color the indicating lights will turn to after an automatic actuation signal operation. This will aid the operator to locate at a glance any failed component after an automatic actuation signal.
7. Under normal operating conditions, when a protection action system unavailability alarm is indicated on a window, the operator identifies the disabled component by looking at the concerned system area on the control panel. One or more of the following conditions will identify the disabled component:
 - a. Control switch in pulled-to-lock position;
 - b. Control switch in "OFF"/override position;
 - c. Amber light "ON"; or,
 - d. Both red and green lights "OFF".

B. Power System

The deliberately induced inoperability status of the power system (AC and DC) components is indicated by alarm windows on annunciator 2K01 on panel 2C10 for the red and green channels. Diesel generator "NOT AVAIL" alarm windows or annunciators 2K08 and 2K09 on panels 2C33-1 and 2C33-2 include the inoperable condition of the supporting systems required for satisfactory functioning of the unit. Power system components, the inoperability of which may render several ESF systems inoperable simultaneously, are connected to a master alarm window located under the seven windows described in "A" above.

8.3.1.2.4 Regulatory Guide 1.63

The electric penetrations were purchased in 1972 and meet the intent of the requirements of IEEE 317-1971. Regulatory Guide 1.63, dated October 1973, was not considered in the design of the electric penetrations. Therefore, the electric penetrations are not in full compliance with Regulatory Guide 1.63. Originally secondary (back-up) overcurrent and short circuit protection was provided for some circuits but not for others. FSAR Amendment No. 34, in response to NRC Question 222.93, revised the design basis and requires backup protection for all circuits. The backup protection is not in full compliance with Regulatory Guide 1.63 in regard to IEEE 279 requirements concerning electrical independence, online testability, bypassing, or manual initiation. The secondary protective device provides backup for the primary protective device in the same electrical circuit and therefore the above features of IEEE 279 cannot be met.

ARKANSAS NUCLEAR ONE
UNIT 2

The electric penetration assemblies are not equipped with self-fusing characteristics. Penetration conductors which are not de-energized during reactor operation are protected by Technical Specification external circuit breakers and/or fuses that provide primary and secondary short circuit protection. The primary and backup protective devices protect the penetration conductors against maximum short circuit conditions as defined by IEEE 317 conductor damage curves. In addition, at least one of the series protective devices provides reasonable protection from overload conditions. The Technical Specifications require that the trip setpoints of the primary and backup breakers, described under items A, B, C, D, G, and I below, be checked periodically. The plant procedures will list all the applicable breakers and their setpoints.

There are nine basic types of circuits that penetrate the containment. A description of each type and its degree of compliance to Regulatory Guide 1.63 follows:

A. 6900-Volt AC

These electric penetrations provide power to the Reactor Coolant Pump (RCP) motors and are fed from non-Class 1E switchgear located in the non-Category 1 turbine building. Overcurrent and ground fault relays are provided for the primary circuit breaker as well as for the backup or 6900-volt bus feeder circuit breaker. Since the 6900-volt cables are all single conductor size 500 kcmil, shielded, and since the shield is grounded at each end of each run, only line-to-ground faults are considered to be credible. The bus feeder breaker provides complete backup protection for all line-to-ground faults. Also, limited backup protection against overloads, line-to-line and 3-phase faults is provided by the backup bus feeder breaker.

Diversity of DC control power has been provided for operation of the primary and the backup circuit breakers for the reactor coolant pump motors. Primary breakers (feeder breakers to RCP motors) on bus 2H1 are supplied from DC panel 2D21 (fed from DC control center 2D01 - red), and the primary breakers on bus 2H2 are supplied from DC panel 2D22 (fed from DC control center 2D02 - green). Backup breakers (bus feeder breakers) on 2H1 and 2H2 are supplied from DC panel 2D25 (fed from the DC control center 2D03 - black).

Two 500-kcmil cables per phase are used to supply each RCP motor through two 750-kcmil penetration conductors per phase. Maximum fault current available at the penetration is approximately 45,000 amps. At this fault current, the primary breaker will trip in approximately 0.09 second (5.6 cycles). If the primary breaker fails to operate, the backup breaker will trip in less than 1 second. Based on IEEE 317 conductor damage curve, the 750 kcmil penetration conductors can withstand 45,000 amps for approximately 1.4 seconds.

B. 480-Volt AC From Load Centers

These electric penetrations supply non-Class 1E loads in the containment. All load center circuit breakers are qualified for Class 1E service, but those supplying these loads within the containment are located in non-Category 1 structures. The electrical penetration conductors are the same size or one size larger than the cables supplying the power circuits. The load center main bus circuit breaker is equipped with current transformers, phase and ground fault relays. This provides complete protection against ground faults and limited protection for phase-to-phase and 3-phase faults.

ARKANSAS NUCLEAR ONE
UNIT 2

Backup protection for circuits fed from 480-volt load centers is provided by a series breaker located in the respective load center. Diversity of DC control power has been provided by supplying the primary and the backup breakers from separate DC control centers.

Primary breakers on load centers 2B7 and 2B8 (for MCCs 2B71 and 2D81, respectively) are supplied from DC panel 2D25 (fed from DC control center 2D03 - black). The backup breaker on load center 2B7 is supplied from DC panel 2D21 (fed from DC control center 2D01 - red), and the backup breaker on load center 2B8 is supplied from DC panel 2D22 (fed from DC control center 2D02 - green). Both primary and backup breakers are located outside the containment.

Two 350-kcmil cables per phase are used to supply each MCC (inside containment) through two 350-kcmil penetration conductors fed from the load center breakers. Maximum available fault current at the penetration is less than 20,000 amps. At this fault current both the primary and backup load center breakers will trip in approximately 18 cycles. Based on prototype tests the 350 kcmil penetration conductors can withstand 35,613 amps for 30 cycles and 20,000 amps (interpolated by use of I^2t) for approximately 95 cycles.

C. 480-Volt AC From Motor Control Centers

Class 1E and non-class 1E motor control centers supply all circuits of this type that penetrate the containment.

In general, one of the two series breakers for these circuits is a thermal-magnetic breaker. Whether a thermal-magnetic or a magnetic-only breaker is utilized, at least one of the two series breakers provides reasonable overload protection, and both provide maximum short circuit protection. Both breakers are located within the source MCC (outside the containment.)

Maximum available fault current at the penetration is 5,000 amps RMS. At this fault current both the primary and the backup MCC breakers will trip in approximately one-half cycle. Based on prototype tests the penetration conductors can withstand 5,000 amps for 1-½ cycles.

D. 480-Volt AC From Lighting Panels

These electric penetrations supply non-class 1E loads in the containment. The electrical penetrations are the same size or one size larger than the cables supplying the power circuits. Primary protection is provided by thermal magnetic breakers located in lighting panel 21PA. Backup protection is provided by a breaker located in MCC 2B15. The primary and backup breakers are non-class 1E breakers which are located outside containment.

The primary breakers provide overload protection for the penetration conductors and both breakers provide maximum short circuit protection. At the maximum fault current of 5,000 amps RMS, both the primary and backup breakers will trip in approximately one-half cycle. Based on prototype test, the penetration conductors can withstand 5,000 amps for 1 ½ cycles.

ARKANSAS NUCLEAR ONE
UNIT 2

E. 120-Volt AC Control Circuits From MCCs

All 120-volt AC control circuits are fed by Number 14 AWG conductors or larger.

Circuits of this type penetrating the containment are fed from control transformers located within individual MCC starter cubicles. There are six different sizes of transformers used: 50VA, 100 VA, 150 VA, 200 VA, 250 VA, and 300 VA. The maximum short circuit currents available to the circuits supplied by the transformers listed below are as follows:

<u>Transformer</u>	<u>% Impedance</u>	<u>Max. S C Current</u>
100 VA	8.02%	10.39A
150 VA	5.50%	22.73A
200 VA	5.17%	32.24A
250 VA	3.64%	57.23A
300 VA	3.61%	69.25A

The impedance values provided above are nominal and are provided to demonstrate adequate protection on typical circuits with fuses listed below. Short circuit currents listed above were conservatively calculated assuming an infinite bus.

Primary protection for these circuits is provided by a fuse in the hot leg secondary of the transformer. These fuses are sized as follows:

<u>Transformer</u>	<u>Fuse Rating</u>
100 VA	1 AMP
150 VA	2 AMPs
200 VA	3 AMPs
250 VA	3 AMPs
300 VA	3 or 4 AMPs

As the maximum available short circuit current from a 50 VA transformer is much less than the continuous current rating of the conductor, no backup protection is required for these circuits. Backup protection is provided for the 100 VA, 150 VA, 200 VA, 250 VA, and 300 VA transformer circuits in the form of an additional fuse identical to, and in series with, the primary fuse. These additional fuses are located within the MCC starter cubicles. The control circuit overcurrent protection provided will assure adequate protection for all current ranges, limiting the penetration conductor's temperature in short circuit conditions to below its 250 °C short circuit rating.

F. 120-Volt AC Circuits

These electric penetrations supply Class 1E and non-Class 1E loads in the containment. In all cases the primary protective device is a fuse located in control panels and terminal boxes. The fuses will blow in less than one-half cycle at the maximum available fault current of 5,000 amps at the penetration. The penetration conductors can withstand 5,000 amps for 1 ½ cycles.

ARKANSAS NUCLEAR ONE
UNIT 2

The backup protective device is a molded case circuit breaker or fuse. Either the circuit breaker or fuse will interrupt the current in less than one-half cycle at the maximum available fault current of 5,000 amps at the penetration. Both provide maximum fault protection and at least one provides reasonable overload protection.

G. 125-Volt DC Circuits

In all cases the DC circuits are ungrounded. Each polarity of the DC circuit is fused. A DC short circuit would only have to blow one fuse to clear the fault. Either fuse could be considered the primary protective device and the other fuse could be considered the backup protective device. The fuses will blow in less than one-half cycle at the maximum available fault current of 5,000 amps at the penetrations. The penetration conductors can withstand 5,000 amps for 1½ cycles.

Motors and lighting circuits are fed from two series connected 2-pole circuit breakers located at class 1E and non-class 1E DC control centers. At least one of the two series breakers provides overload protection and both provide maximum short circuit protection. These circuit breakers will trip in less than one-half cycle at a fault current of considerably less than the 5,000-amp short-circuit rating of the penetration conductors. Both provide maximum fault protection and at least one provides reasonable overload protection.

H. Instrumentation Circuits

The maximum short circuit currents available from the instrumentation circuits are well below the damage threshold of the penetration conductors for these circuits.

I. CEDM Power

Each Control Element Drive Mechanism's (CEDMs) set of coils is fed from a non-Class 1E 240-volt AC 4-pole circuit breaker rated at 10 amps for phases A, B, and C, and 30 amps for the neutral and located outside of containment. Backup protection is provided by 3-pole, non-Class 1E, 40-amp subgroup circuit breakers also located outside of containment. The maximum available short circuit current at the penetration is 1,732 amps. For this short circuit current the primary and backup breakers will trip in one-third cycle. The penetration conductors can withstand 5,000 amps for 1 ½ cycles and 1,732 amps for approximately 13 cycles (interpolated by use of I²t).

8.3.1.2.5 Regulatory Guide 1.75

Regulatory Guide 1.75, dated February 1974, was not used in the design of the electrical system. Most of the electrical equipment such as emergency diesel generators, 4,160-volt switchgear, 480-volt load centers, MCCs, DC distribution equipment, batteries, battery chargers, electrical penetrations, DC inverters, and main control boards, were purchased prior to the issuance of this guide. Engineering and design of the NSSS-supplied cabinets were also essentially complete before the issue date of Regulatory Guide 1.75. Most of the raceways were designed and installation started before February 1974.

ARKANSAS NUCLEAR ONE
UNIT 2

However, the design criteria used for separation of redundant devices and circuits meet the requirements of the guide except for minor deviations. An effort has been made to separate the non-Class 1E wiring from the Class 1E wiring within the main control boards, since the timing of their manufacture was not too late to consider this requirement of the guide. Additionally, fuses have been installed in certain non-Class 1E circuits in order to limit the available fault currents to a level below the thermal damage threshold of the wiring. The four PPS process measurement input channels and accompanying vital bus power distribution channels meet the physical independence criteria of Revision 2 of Regulatory Guide 1.75 with the exceptions justified in accordance with section 5.1.1.2 of the regulatory guide.

The following describes the extent of conformance to the various requirements of the guide, with the paragraph numbers corresponding to the paragraph numbers of Regulatory Guide 1.75, Appendix 1. An evaluation performed concluded that the omission of cable tray covers or barriers is not safety significant although their use as recommended in IEEE 384-1974 is a good engineering practice and should continue.

3 DEFINITIONS

3.2 ASSOCIATED CIRCUITS

Non-Class 1E circuits that share power supplies with Class 1E circuits have been isolated from the Class 1E circuits by the isolation devices described in Section 3.8 below. Non-Class 1E circuits that share the same main control panels and instrument cabinets as Class 1E circuits have been designed as described in Paragraphs 5.6.5 and 5.7 below.

3.8 ISOLATION DEVICE

The following devices have been used as isolation devices in the design of the system:

A. Between Redundant Channels

1. AC Power Circuits (4,160-volt and 480-Volt)

Two Class 1E metal-clad power circuit breakers that are normally locked open by key interlocks, as described in Section 8.3.1.1.9.4, located in separate rooms, have been used to separate 4,160-volt and 480-volt redundant power sources. It is not possible to tie any of the redundant system buses together unless one of the redundant sources has been rendered inoperable. Use of these ties will be permitted, by administrative control, only under a post-accident emergency condition or during shutdown.

The breakers for the "third pumps" at 4,160-volt and 480-volt levels are described in Section 8.3.1.1.9.4.

Two Class 1E manual transfer switches have been used to transfer the 480 VAC power supply to battery chargers 2D31B and 2D32B between the redundant 480 volt power sources. The transfer switches are break-before-make which prevents a possible tie between the redundant buses. The switches are locked in the normal position during power operations and use of the transfer switch will be permitted, by administrative controls, only during shutdown.

ARKANSAS NUCLEAR ONE
UNIT 2

2. DC Power Circuits

These redundant systems are completely independent.

3. 120-Volt AC and 125-Volt DC Control Circuits, and 120-Volt AC Vital Power Circuits

These redundant systems are completely independent.

B. Between Class 1E and Non-Class 1E Circuits

1. 4,160-volt and 480-Volt Load Center Power Circuits

One Class 1E breaker serves the non-Class 1E loads for these circuits. These are actuated by fault current and have provision for remote electrical trip as well as local manual trip.

2. DC Power Circuits

One Class 1E breaker serves the non-Class 1E computer inverter and two Class 1E breakers are used in series for all other circuits.

3. 125-Volt DC 120-Volt AC Control Circuits

Different contacts of a switch, or a relay, are used to provide isolation between Class 1E and non-Class 1E control circuits. Also, similar separation is accomplished by using a relay coil for one type of circuit and a contact of the relay for the other circuit.

4. 120-Volt Vital AC Circuits

Individual loop power supplies provide isolation between 120-volt input circuits and low level output circuits. Buffers provide isolation between low level loops connected to the computer.

5. 480-Volt MCC Power Circuits

Many of the non-Class 1E loads fed from Class 1E sources are automatically tripped by a Safety Injection Actuation Signal (SIAS). Exceptions include, but are not limited to, pressurizer heaters, RCP oil lift pumps, panels 43LA, 27LA and 21PC, instrument transformers 2X13 and 2X14, Control Room condenser 2VE6, cooling tower supply feeder, Control Room emergency cooling fan, 2X104 level transmitter, battery charger 2D33, inverters 2Y25 and 2Y26, pressurizer spray valves and elevators. In addition, the boric acid heat tracing transformers receive a SIAS trip signal via non-Q contactors.

ARKANSAS NUCLEAR ONE
UNIT 2

6. SPDS Computer Inputs

The qualified isolating devices separating electrically the non-class 1E SPDS computer input circuits from class 1E circuits, have been located within switchgear cubicles or control/distribution panel where each input originates. Maximum care was exercised to install these devices, providing required distance separation between these isolators and class 1E components. Also outgoing black cable wiring connected to an isolation device has been separated from class 1E wiring as stated in the response to Section 5.6.5B of Regulatory Guide 1.75.

4.6 Non-Class 1E Circuits

4.6.1 The extent of conformance of non-Class 1E circuits is discussed under Paragraphs 5.1.3, 5.1.4, 5.6.2 and 5.7 below.

4.6.2 There are no non-Class 1E circuits that are considered as associated circuits.

5 SPECIFIC SEPARATION CRITERIA

5.1 CABLES AND RACEWAYS

5.1.1 Whereas it is a general design practice not to use cable splices in raceways, an exception is taken in the area of electrical penetrations where cables are spliced to electrical penetration pigtail extensions and in specific cases of non-Class 1E power cables with long runs.

5.1.1.2 Based on guidance provided in Section 5.1.1.2 of Regulatory Guide 1.75 and analysis performed, separation distances less than those recommended in Sections 5.1.3 and 5.1.4 have been justified for circuits operating below 600 volts.

5.1.2 IDENTIFICATION

Raceway markers are installed at each end of all tray sections and at each end of all runs of exposed conduit. Additional markers are installed where conduit or trays pass through walls or floors and where the length of Class 1E runs makes intermediate identification necessary. Within the containment, the raceway numbers are stenciled with ink.

5.1.3 CABLE SPREADING AREA AND MAIN CONTROL ROOM

A. Between Redundant Channels

The recommended separation distances are met by using open cable trays wherever practical. Separation distances less than those recommended in Section 5.1.3 were found to be acceptable based on the guidance provided in Section 5.1.1.2 of Regulatory Guide 1.75. A separation of metal enclosed raceways by a minimum of one inch was not a design requirement. However, a review of the general plant area and cable spreading room was made. All situations which are in the following categories were identified and documented.

ARKANSAS NUCLEAR ONE
UNIT 2

1. Conduits of one channel, including pull cans, which did not meet minimum separation requirements with conduits of another channel.
2. Conduits of one channel which did not meet separation requirements with cable trays of another channel.

All of the above cases were reviewed to determine if the cables in the raceways served redundant components. It was found that there was only a limited number of these situations, less than 10. All but one of these situations were justified either by cables being low energy (instrumentation), area of contact being minute, or by the cables not touching the sides of the pull cans, thus offering a sufficient air gap. For conduit EC2286 and tray EC123, the cables in the tray will be provided with an adequate thermal barrier for at least one foot on either side of the area where separation is less than one inch. Potential effects of fires on redundant equipment required for safe shutdown are discussed in detail in the fire hazards analysis as described in Section 9.5.1.

B. Between Class 1E and Non-Class 1E Raceways.

As described in Section 8.3.1.4.3, non-Class 1E cables are routed in separate raceways, but minimum separation distances, as specified in Regulatory Guide 1.75 were not a design requirement. However, a minimum vertical separation of seven inches is maintained for the majority of trays with a few exceptions as close as one inch. A minimum horizontal separation of three inches has been maintained with most trays being separated by distances greater than three inches. Separation distances less than those recommended in Section 5.1.3 were found to be acceptable based on the guidance provided in Section 5.1.1.2 of Regulatory Guide 1.75.

5.1.4 GENERAL PLANT AREAS

- A. Between Redundant Channels. Conformance is identical to the description in 5.1.3(A) above.
- B. Between Class 1E and Non-Class 1E Raceways.

Non-Class 1E cables are routed in separate raceways from Class 1E cables wherever practicable. However, in a limited number of locations where cable tray serves a Class 1E MCC, Class 1E and non-Class 1E cables share the same tray separated by a metal barrier. In no instance are they intermingled. Further, the non-Class 1E cables, after leaving the shared tray, continue to their destination in non-Class 1E raceway only. Separation provided between conduits and between cable tray and conduit was not a design requirement. The fire hazards analysis described in Section 9.5.1 evaluated the potential effects on safe shutdown capability for fires in non-Class 1E as well as Class 1E raceways that could expose safe shutdown related cabling.

ARKANSAS NUCLEAR ONE
UNIT 2

The specific situations investigated and identified in 5.1.3(A) and (B) include situations in general plant areas as well.

The separation distances between non-Class 1E and Class 1E raceways, described in 5.1.3(B) and 5.1.4(B) above, are an improvement over the commitment in the Preliminary Safety Analysis Report, designed to increase the reliability of Class 1E circuits.

5.3 DC SYSTEM

5.3.1 Each battery room has its own independent ventilation system. Additionally, all exhaust fans are Class 1E. Failure of the fans is detected by low flow switches and alarmed in the control room.

The maximum safe period of operation with an inoperative ventilation system is calculated on the basis of the following worst case assumptions:

- A. Batteries 2D11 & 2D13 are under float charge at 2.25 volts per cell. 2D11 has 58 LCR-31 cells and 2D13 has 60 LCR-31 cells.
- B. The ambient temperature is 120 °F and the electrolyte temperature is 120 °F.
- C. The maximum permissible hydrogen concentration is to be limited to four percent of the room volume.

From the hydrogen evolution calculations, the worst case hydrogen concentration is shown to be in the small battery room which houses 2D12. The hydrogen evolution for the worst case assumptions is calculated to be 1.26 cubic feet per hour for the 58 cell battery. At this evolution rate, the time required to reach a 4% level would be approximately 35 hours.

Within this time period, alternate means of ventilation, e.g. installation of portable exhaust fans, can be arranged by administrative control. The battery room door could also be opened periodically to improve hydrogen dispersion.

5.6 MAIN CONTROL BOARDS

The following consoles and vertical panels comprise the main control board located in the control room.

Consoles: 2C01, 2C02, 2C03, 2C04, 2C09, 2C69A, 2C69B, 2C100

Vertical Panels: 2C10, 2C11, 2C12, 2C14, 2C16, 2C17, 2C22, and 2C33

Of the above, consoles 2C01, 2C69A, 2C69B, and 2C100 and vertical panels 2C10, 2C11, 2C12 and 2C22 are non-Class 1E. The remaining vertical panels and consoles contain both Class 1E and non-Class 1E devices and circuits.

ARKANSAS NUCLEAR ONE
UNIT 2

The fire hazards analysis described in Section 9.5.1 considered the potential effects on safe shutdown capability of a fire damaging all wiring within an individual console, panel, or subpanel and the risk of fire spread between them. This analysis concluded that such a fire would not cause loss of safe shutdown capability.

5.6.2 INTERNAL SEPARATION

Redundant devices and circuits are separated by a distance of six inches or by a barrier.

5.6.5 NON-CLASS 1E WIRING

The following design features have been incorporated to insure that a problem in any non-Class 1E wiring will not degrade the reliability of the Class 1E wiring:

- A. A minimum of six inches separation has been maintained, wherever possible.
- B. In a control console or panel where a majority of wires are Class 1E, the non- Class 1E wires have been installed in metallic wireways where practical.

In a control console or panel where a majority of wires are non-Class 1E, the Class 1E wires have been installed in metallic wireways where practical.

- C. Terminal blocks for Class 1E circuits are separated from the terminal blocks for non-Class 1E circuits by a distance of six inches or by a metal barrier.
- D. Non-Class 1E circuits entering a control console or panel containing both Class 1E and non-Class 1E devices and circuits have been evaluated. In those circuits where the available fault currents exceed the thermal damage threshold of the wiring, and a minimum of six inch separation is not maintained, fuses have been installed. These fuses are sized to limit the conductor's temperature to below its thermal withstand ability thereby; insuring the reliability of the Class 1E wiring will not be degraded.

5.7 Instrument Cabinets

A. NSSS-Supplied Instrument Cabinets

The following panels are included in this category:

2C15	Process Protective Panel
2C23	Plant Protection System Panel
2C39, 2C40	Engineered Safety Features Auxiliary Relay Cabinets

ARKANSAS NUCLEAR ONE
UNIT 2

2C70 thru 2C73	Control Element Drive Mechanism Control System Cabinets
2C29	Steam Dump and Bypass Cabinet
2C75	Reactor Trip Switchgear Cabinet

Of the above, cabinets 2C29 and 2C70 thru 2C73 are non-Class 1E. The remaining cabinets contain both Class 1E and non-Class 1E devices and circuits.

Though Regulatory Guide 1.75 was not used as a design basis for Arkansas Nuclear One - Unit 2, the Class 1E circuits and panels are designed in accordance with the majority of the requirements of Regulatory Guide 1.75.

Electrical independence of redundant safety-related systems is described in Section 7.1.2.2. This independence is amplified in Sections 7.2.2.3.2 and 7.3.2.2.2 and is in accordance with General Design Criterion 21 as indicated in Section 3.1.

Cables entering or leaving the Class 1E cabinets have been separated into Class 1E and non-Class 1E circuits. The Class 1E field cables are identified by color coding and are run in separate external cable trays or ducts separate from the non-Class 1E cables.

B. Radiation Monitoring Cabinet 2C25

Compliance is accomplished by separating redundant Class 1E channels from each other by locating each channel in a separate panel compartment. Isolation and separation of Class 1E from non-Class 1E circuitry is provided within each compartment. Class 1E circuitry is provided with a wire/cable covering that readily distinguishes it from non-Class 1E.

C. Local Instrument Racks/Cabinets

Separation criteria for redundant channel devices and wiring meet the requirements.

Non-Class 1E wiring is not separated from Class 1E wiring at the racks/cabinets but is separated in the external cable circuits. This is considered acceptable since the non-Class 1E wiring associated with such Class 1E wiring are low energy circuits such as annunciators or computer inputs.

D. Power Supply Cabinets (2C21A and 2C21B) and Remote Shutdown Panel (2C80)

The separation criteria followed are identical to that described in Sections 5.6.2 and 5.6.5 above. Safe shutdown related instrumentation was included in the fire hazards analysis described in Section 9.5.1 in evaluating the potential effects of fire on safe shutdown capability.

ARKANSAS NUCLEAR ONE
UNIT 2

E. The following cabinets are non-Class 1E:

- 2C27A Feedwater Control System A
- 2C27B Feedwater Control System B/Reactor Regulating System
- 2C27C Feedwater Control System Common/Reactor Regulating System

5.8 SENSORS AND SENSOR-TO-PROCESS CONNECTIONS

Redundant Class 1E sensors and their connections to the process system are located with sufficient physical separation to prevent a single design basis event from causing multiple channel malfunctions.

8.3.1.2.6 IEEE 308-1971: "Class 1E Electric Systems for Nuclear Power Generating Stations."

The Class 1E electric systems meet the intent of and are in conformance with, all of the criteria in IEEE 308-1971. The principal and supplementary design criteria were used in the development of the AC and DC power systems, vital instrumentation, and control power systems as demonstrated below.

A. Principal Design Criteria

1. Design basis events, both natural and postulated, have been defined; Class 1E electric systems design was developed and equipment purchased such that their safety-related functions can be performed, in the respective operating environment, under normal and DBE conditions.
2. The quality of the Class 1E electric system's output is such that all electrical loads are able to function in their intended manner, without damage or significant performance degradation.
3. Control and indicating devices, required to switch between the preferred and standby power supplies and to control the standby power supply system, are provided inside and outside the control room.
4. All Class 1E electric system components are identified, along with the proper channel assignment.
5. Class 1E electric equipment is physically located in Seismic Category 1 structures and separated from its redundant counterpart to prevent the occurrence of common mode failures.
6. Equipment qualification by analysis, tests, successful use under similar conditions, or a justifiable combination of the foregoing ensures that the performance of safety-related functions was demonstrated under normal and DBE conditions.
7. Tables 8.3-7 through 8.3-12 depict the single failure analysis and the failure mode analysis for the Class 1E electric systems.

ARKANSAS NUCLEAR ONE
UNIT 2

B. Supplementary Design Criteria

1. The design features described in Section 8.3.1 demonstrate the following:

- a. AC power systems include power supplies, a distribution system and load groups arranged to provide AC electric power to the Class 1E loads. Sufficient physical separation, electrical isolation and redundancy have been provided to prevent the occurrence of common failure modes in the Class 1E systems.

The electric loads have been separated into two redundant groups.

The safety actions by each group of loads are redundant and independent of the safety actions provided by the redundant counterparts.

Each of the load groups has access to both a preferred and a standby power supply.

- b. The preferred and the standby power supply do not have a common failure mode. Adequate protective relaying has been included to isolate the standby sources from the preferred power sources in order to preserve the availability of the standby sources.

2. Distribution System

- a. All distribution circuitry is capable of starting and sustaining required loads under normal and DBE conditions.
- b. Physical isolation between redundant counterparts ensures independence.
- c. Local and remote control and indicating components monitor distribution circuits at all times.
- d. Auxiliary devices that are required to operate dependent equipment are supplied from a related bus section to prevent loss of electric power in one load group from causing the loss of equipment in another load group.
- e. All Class 1E electrical circuits have the provision for isolation from non-Class 1E circuits through circuit breakers located in Class 1E structures.

3. The preferred power supply derives power from two alternative sources.

- a. Energy in sufficient quantities is available for normal, standby, and emergency shutdown conditions.
- b. Off-site power is available to start and sustain all required loads.
- c. As described in B.3.a. above, the alternate power source is available from the distribution network shown in Figure 8.3-1.
- d. Surveillance on the availability and status of the preferred power supply is maintained to ensure readiness when required.

ARKANSAS NUCLEAR ONE
UNIT 2

4. The standby power supply consists of two diesel generators, connected to the ESF 4,160-volt AC buses. Each diesel generator represents a complete, independent source of standby power.
 - a. The redundant standby power supplies provide energy for the emergency and ESF systems when the preferred power supply is not available.
 - b. Independence of the two standby power systems ensures that a failure of either standby power source will not jeopardize the capability of the remaining standby power source to start and run the required Class 1E loads.
 - c. Each diesel generator is available for service within the time specified upon loss of the preferred power supply.
 - d. Status indicators in the control room and remotely located provide monitoring and alarm for the surveillance of all vital functions for each diesel generator with respect to standby and operating modes.
 - e. Sufficient fuel is provided at the site to sustain the operation of one EDG continuously for at least seven days. Off-site supplies of fuel are available for transportation to the site within this time.
 - f. Automatic and manual controls are provided for the selection, disconnection, distribution, and starting of all loads supplied by the standby power sources.
 - g. Automatic devices disconnect and isolate failed equipment and indication to this effect is provided.
 - h. Test starting and loading can be accomplished during normal station operation.

For the analysis of the DC system, see Section 8.3.2.2.1.

8.3.1.2.7 IEEE 379-1972: "Application of the Single-Failure Criterion to Nuclear Power Generating Station Protection Systems."

A. Para 5.2: Undetectable Failures

In the single failure analysis presented in Tables 8.3-7 through 12, no undetectable failures have been identified. This is based on the fact that all components of the electrical power system have been fully checked for correctness of ratings, connections and installation during the preoperational tests. All failures in the electrical system are considered to be detectable single failures.

B. Para 5.3: Common Mode Failures

Common mode failures due to system design were identified and eliminated during the design stage. However, common mode failures resulting from manufacturing and maintenance errors, certain unanticipated design shortcomings and factors not considered in the design basis are difficult to identify and eliminate. However, the following actions have been taken to minimize the effects of such common mode failures:

ARKANSAS NUCLEAR ONE
UNIT 2

1. Administrative controls will ensure that after any maintenance operation, the availability and operability of each system will be checked.
2. Component/equipment design deficiencies and malfunctions observed and reported to date from various plants have been investigated and measures taken to correct such problems if applicable to the equipment used in this plant.

C. Para 6.5: Type 2 and Type 3 Single Failure Analysis:

Conformance with IEEE 279-1971 is discussed in Section 8.3.1.2. Independence of redundant systems is discussed in Section 8.3.1.4. Environmental qualification is discussed in Section 3.11.

D. Para 6.6: Overall System Failure Analysis

The descriptions in Sections 8.3.1.1.8.4 and 8.3.1.1.9.4 show that design features ensure that all interconnections between redundant channels meet the single failure criterion.

8.3.1.2.8 IEEE 387-1972: "Trial Use Criteria for Diesel Generator Units Applied as Standby Power Supplies for Nuclear Power Generating Stations."

- A. The diesel generator units have been provided with surveillance systems to indicate occurrence of abnormal, pretrip or trip conditions. Periodic tests in accordance with the Technical Specifications are performed on the power and control circuits and components including protective relays, meters, and instruments to demonstrate that the emergency power supply equipment and other components that are not exercised during normal operation of the station are operable. The operational tests are performed at scheduled intervals to test the ability to start the system and run under load for a period of time long enough to establish that the system can meet its performance specifications.

Tests are performed on each diesel generator unit to check the following:

1. Engine cooling water and air starting systems;
2. Diesel generator starting, loading, and tripping; and,
3. Testing of protective relays, governor settings, and alarms.

8.3.1.2.9 IEEE 279-1971: "Criteria for Protection Systems for Nuclear Power Generating System."

- A. Separation and independence has been maintained between all redundant systems including the raceways so that any component failure in one ESF channel will not disable any component in the other ESF channel.
- B. A failure analysis of the Class 1E system demonstrates that a single component failure within the systems will not prevent satisfactory performance of the minimum ESF loads required for safe shutdown and maintenance of a safe post-shutdown condition.

ARKANSAS NUCLEAR ONE UNIT 2

Tables 8.3-7 through 8.3-12 provide analysis of failure of Class 1E electrical equipment at the system level as well as at the component level.

Interlocks (key operated switches) have been employed to allow cross connection of the redundant ESF power buses. Cross connection of the redundant buses is only allowed under strict administrative controls during refueling operations or extreme emergencies. The redundant power buses 2A3 and 2A4, 2B5 and 2B6, etc. are designed to prevent tying the two diesel generator systems together. Key switches and interlocks to allow cross connect are described in section 8.3.1.1.9.5.

The single failure analyses are based on physical independence between the redundant systems. This independence is shown by the physical separation of redundant equipment and electrical raceway on the layout design drawings.

- C. Standard production tests were performed on all safety-related electric equipment in accordance with applicable standards.
- D. Seismic test reports and analyses have been submitted by manufacturers that have qualified the safety-related electric equipment to meet seismic requirements in accordance with the individual specifications. Section 3.10 covers the details.
- E. All safety-related electrical equipment that must operate in a hostile environment are described in Section 3.11. Conditions under which this equipment is required to operate include high radiation, pressure, humidity, and temperature. Furthermore, they are required to withstand earthquake loading conditions as stipulated in respective specifications. A detailed analysis of these conditions is given under Section 3.10. All Class 1E equipment has been designed to meet its functional requirements under conditions produced by the design basis events. Necessary certifications to this effect have been obtained from the manufacturers, as part of the quality assurance program. Qualification tests or analyses have been performed and the results documented. These documents confirm that the equipment will perform satisfactorily under the conditions stipulated for the duration of time and to the extent of loading that might be called for as a result of any design basis event. More detailed information regarding the environmental qualification program is described by Nuclear Program #71.

Manually Controlled Electrically Operated Valves

A review of safety-related equipment and their interfaces with nonsafety-related equipment was conducted to identify manually controlled electrically operated valves the failure of which could degrade an ESF system to unacceptable levels. None were identified.

8.3.1.3 Conformance With Appropriate Quality Assurance

All safety-related electrical equipment was designed, manufactured and installed under the approved quality assurance program. Conformance with the requirements of IEEE 336-1971 and NRC Quality Assurance Criteria enumerated in Appendix B to 10CFR50 was ensured through implementation of a field quality control program covering relevant aspects of installation, inspection and testing of such equipment and systems including documentation of the same as outlined below.

ARKANSAS NUCLEAR ONE
UNIT 2

8.3.1.3.1 Procurement

Various measures were established to ensure control of purchased material, equipment, and services. These included Technical Specifications, selection of vendors, approval of vendor's quality assurance and quality control programs, and vendor's shop inspection prior to release of equipment for shipping.

The following general documentation was obtained from suppliers of Class 1E electric equipment:

- A. Exceptions to material or fabrication specifications or codes, with explanations;
- B. Design drawings;
- C. Quality control inspection and test procedures;
- D. Analysis or test reports certifying that the equipment meets the seismic requirements stated in the procurement document; and,
- E. Schedule of quality control tests.

Also obtained from the equipment suppliers was confirmation and/or certified test reports that the equipment meets specified applicable NEMA, ANSI, and IEEE Standards.

8.3.1.3.2 Field Storage and Handling

Various types of storage areas were utilized for Class 1E electric equipment, during the construction phase.

- A. Outdoor Storage - Outdoor storage consists of well-protected, well-drained areas separated from the actual construction area so that interference with traffic and work operation was avoided. The area was maintained free of weeds and debris.
- B. Weatherproof Storage - Weatherproof storage consisted of outdoor storage utilizing weatherproof, flame-resistant covering. Materials and equipment were placed on pallets or cribbing and did not come in contact with the ground or water.
- C. Indoor Storage - Indoor storage consisted of structurally sound metal buildings or equivalent frame structures which were weathertight, well ventilated and lighted.
- D. Indoor Heated Storage - Indoor heated storage was similar to above except it was heated.

The type of field storage provided for Class 1E electric equipment and materials is identified in Table 8.3-3.

To preserve their integrity and prevent physical, mechanical and/or electrical damage while in storage, an inspection and maintenance program using written procedures was followed during handling, storage, and installation of all Class 1E equipment. The procedures included special handling equipment to be used, lift points, etc., and special receiving inspection requirements. When controlled storage was required, a tag was provided on the equipment to indicate the type of storage.

ARKANSAS NUCLEAR ONE
UNIT 2

8.3.1.3.3 Inspection and Installation

An inspection program was enforced to ensure the equipment was located, installed, assembled and/or connected in strict accordance with the latest approved-for-construction drawings, installation specifications and field quality control procedures. All inspections and tests were performed in accordance with these requirements and the results documented. Marking or other status indicators such as stamps, tags, labels, routing cards, and traceable records were used to ensure that the status of inspection and tests performed upon individual items was known or readily determinable.

This inspection program also included checking for the required separation of redundant ESF, reactor protection, and the balance of Class 1E electrical system cables and components, and for proper termination and marking of these cables.

8.3.1.3.4 Testing

Elaborate test procedures were planned and implemented as part of the quality assurance program to ensure that completed installation would conform to design requirements. Procedures and instructions were prepared and approved by qualified test personnel. Tests conducted on individual equipment include electrical continuity, insulation resistance, phase rotation, circuit functioning, high voltage tests and such tests as required to ensure that the installation has been made in accordance with design requirements. Accuracy of test instruments was ensured through periodic calibration. All test results were documented and evaluated. Non-conformance of equipment was identified and corrected. Final verification was conducted to ensure the elimination of all deficiencies, temporary connections and testing arrangements.

8.3.1.3.5 Records

The following quality assurance records were prepared and maintained for field work as required by the quality assurance program:

- A. Quality assurance construction manuals and inspection procedures;
- B. Material certifications;
- C. Inspection and test reports;
- D. Schematic, block, and connection diagrams used to indicate inspection acceptance and operating status;
- E. Qualified special process procedures;
- F. Personnel qualification records;
- G. Nonconformance reports and corrective actions;
- H. Nondestructive test reports and radiographs;
- I. Records of weld repairs;

ARKANSAS NUCLEAR ONE
UNIT 2

- J. Raceway installed, cable pulled and connect cards;
- K. Receiving inspection reports; and,
- L. Audit reports

8.3.1.4 Independence of Redundant Systems

8.3.1.4.1 General

The redundant systems are designed to be physically independent of each other so that failure of one train or channel will not jeopardize safe shutdown of the reactor.

The Class 1E electric systems are designed to ensure that any of the design basis events listed in IEEE 308-1971 will not prevent operation of the minimum number of ESF equipment required to safely shutdown the reactor and to maintain a safe post-shutdown condition.

The Class 1E power system is designed to meet the requirements of IEEE 279-1971, IEEE 308-1971, 10 CFR 50, including Appendices A and B, and Regulatory Guide 1.6. ESF loads are separated into two completely redundant load groups. Each load group has adequate capacity to start and operate a sufficient number of ESF loads to safely shut down the reactor, without exceeding fuel design limits or reactor coolant pressure boundary limits, during normal operation or design basis event. As required by IEEE 308 and 10 CFR 50 General Design Criterion 17, each redundant ESF load can be powered by both onsite and off-site power supplies. Two diesel generators, one on each ESF bus, will furnish the required onsite emergency ESF power supply requirements. Consistent with Regulatory Guide 1.6, no provision exists for automatically transferring loads between the redundant power sources. Further, the redundant load groups cannot be automatically connected to each other, nor can the two emergency power sources be paralleled automatically. Separation and independence have been maintained between all redundant systems, including the raceways, so that any component failure in one ESF channel will not disable the other ESF channel.

8.3.1.4.2 Design Criteria and Bases

8.3.1.4.2.1 Cable Derating and Cable Tray Fill

Cable sizes for all ESF loads have been selected with an ampacity equal to or greater than that recommended in published IPCEA Standards. Motor feeder cable selection is based on 100 percent load factor and continuously rated for 125 percent of full load current for 6.9 kV, 4.16 kV and 480-volt switchgear-fed motors and for 460-volt motors fed from MCCs.

In general, cable trays are limited to a fill of 40 percent of their total cross-sectional areas. Tray fills greater than 40 percent by cross section have been evaluated to ensure that cable damage, either mechanical or thermal, will not take place.

ARKANSAS NUCLEAR ONE
UNIT 2

8.3.1.4.2.2 Cable Routing In Congested Areas and/or Hostile Environment

8.3.1.4.2.2.1 Mechanical Damage (Missile) Zone

Cable trays and conduits of redundant systems have been routed or provided with protective barriers in such a way that no locally generated force or missile can disable both redundant systems. In the absence of confirming analysis to support less stringent requirements, in rooms containing high pressure piping or high pressure steam lines, a minimum separation of 20 feet or a 6-inch thick reinforced concrete wall has been provided between trays or exposed conduits containing cables of redundant systems.

8.3.1.4.2.2.2 Cable Routing Criteria

During plant construction, cable was routed in accordance with the criteria described below. Subsequently, a detailed fire hazards analysis has been performed, and additional protective features installed as described in Section 9.5.1 to assure that a fire will not cause loss of redundant safe shutdown systems.

- A. Where there is potential for accumulation of large quantities of oil or other combustible fluids, through leakage or rupture, routing of ESF system cables has been avoided as far as practical. Where such routing has been unavoidable, only one of the redundant systems of cables has been allowed and these cables are routed in conduits or covered trays. Administrative controls and fire protection features have been established as described in Section 9.5.1 to prevent the accumulation of combustible materials.
- B. In general, cable trays of redundant systems typically have a minimum horizontal separation of three feet. Deviations from this recommended separation distance have been evaluated and determined acceptable for non-safe shutdown cables. Separation of safe shutdown required cables was analyzed per requirements of NFPA 805 (10 CFR 50.48) which are more restrictive than Regulatory Guide 1.75, and modifications were made or determined to be acceptable.
- C. Vertical stacking of redundant cable trays has been avoided whenever possible. Where trays of redundant systems are stacked one above the other, a 5-foot minimum vertical separation has typically been provided. Deviations from this recommended separation distance have been evaluated and determined acceptable for non-safe shutdown cables. Separation of safe shutdown required cables was analyzed per requirements of NFPA 805 (10 CFR 50.48) which are more restrictive than Regulatory Guide 1.75, and modifications were made or determined to be acceptable.
- D. Non-safety and safety features trays have not been considered redundant to each other. However, where a non-safety features tray has been interposed either horizontally or vertically between redundant safety features trays or conduits, it has been considered as a potential fire pathway or exposure source to safety features trays or conduits. Therefore, the fire hazards analysis described in Section 9.5.1 considered such non-safety trays as providing a fire exposure source or a pathway for fire propagation between redundant safety divisions; where these could lead to loss of safe shutdown functions, protective features were provided as described in Section 9.5.1.

ARKANSAS NUCLEAR ONE
UNIT 2

- E. The minimum horizontal and vertical separation and/or barrier requirements in the cable spreading room are generally as stated in the preceding paragraphs, except that the minimum horizontal and vertical separation between redundant system trays is typically one foot and three feet, respectively, in accordance with Regulatory Guide 1.75. Separation distances less than those recommended in Section 5.1.3 were found to be acceptable based on Section 5.1.1.2 of Regulatory Guide 1.75. Since this separation may not provide adequate protection for large exposure fires, additional protective features were provided for the cable spreading room as described in Section 9.5.1.

8.3.1.4.2.2.3 Cable Reliability

This section describes activities related to cable reliability for the cables originally procured for installation at ANO-2. Subsequent purchases are evaluated with respect to qualification tests per the requirements of the environmental qualification program described in Nuclear Program #71.

Qualification tests have been performed on the original critical types to demonstrate compliance with the following design requirements.

- A. Radiation resistance with exposure of 3.3×10^7 rads of total radiation dose if located within the containment or 1×10^7 rads if located elsewhere.
- B. Withstand the post-accident environment conditions after a radiation dosage described in "A." above with the conductor carrying full rated current for the circuit.
- C. Prototype conductors were required to pass IPCEA Standard S-19-81 flame tests. Additionally, completed cables were given a 7-minute flame test as detailed below.

Six samples of each cable (five in the case of 5 and 8 kV power cables) were mounted on a vertical steel type ladder tray, eight feet long and three inches deep with a 6-inch rung separation. The cables were placed with a half diameter separation between each cable and between cable and side wall. A ribbon type burner 10 inches wide, 7,000 Btu/hour/inch, with means for air and gas control was mounted horizontally in front of cables under test, 12 inches above the lower end of the tray. The burner was adjusted to provide a 14 to 16-inch flame with a flame temperature of 1,400 to 1,500 °F at the point of impingement on the cable for seven minutes.

A 120/240-volt single phase test circuit with indicating lamps, relays, and timers were used to indicate insulation failure during the test.

In the case of 5 kV and 8 kV power cables, three single conductor cables of same size were twisted with not less than one complete turn and placed in the center of the tray.

Only those cables which did not propagate flame were considered acceptable.

- D. Insulating and jacket material water absorption resistance characteristics in accordance with IPCEA Standard S-19-81, Section 3.13.3, in addition to the capability to withstand the containment spray.

ARKANSAS NUCLEAR ONE
UNIT 2

8.3.1.4.3 Separate Cable Trays for Safety and Non-Safety Related Cables

Non-safety-related cables and safety-related cables do not share the same raceway. All ESF raceways have a channel number code and a color identification and all ESF cable jackets are color coded (4,160-volt cables have a colored marker) to ensure that one cable tray or conduit does not contain cables of more than one color coded channel.

This means that non-ESF cables are not routed with any red, green, yellow, orange, or blue jacketed cables. Additionally, a non-ESF cable is not routed in a raceway that is color coded. Color coded raceways contain only cables with jacket colors or color markers that correspond to the raceway color codes.

8.3.1.4.4 Cable and Cable Tray Markings

Cables installed in cable trays are grouped on the basis of their functions and/or voltages. In other words, the 6,900-volt power cables, 4,160-volt power cables, 480-volt power and control cables and instrumentation cables are grouped and physically separated from each other. Cables, conduits and trays have been identified by color and markers. Circuit schedules have been prepared to give a permanent record of the routing and terminations of all cables. The coding of circuits provide easy identification of the associated system. All cables have this code number permanently fixed with markers at both ends. These markers have a channel identification plus a color mark corresponding to the channel color. Further, non-critical cables are identified by black jackets and safety-related cables by color coded jackets. Exceptions to the preceding statement are 4,160-volt safety-related cables, some of which have black jackets. All the 4,160-volt safety-related, black jacketed cables (mostly installed during initial construction) are identified at both ends with a permanent channel number code and corresponding color dot. Typically, new 4,160-volt safety-related cables are color coded like all other safety-related cables.

In addition to visual inspection during and following installation, 4,160-volt safety-related, black jacketed cable routings have been electronically traced to ensure that these cables have been installed in the correct channelized raceway for their entire length. The results of this electronic signal tracing are documented. The electronic tracing was performed during initial construction but is not performed for post-commercial operation modifications due to energized circuit danger and routing verification.

There are three 4,160-volt safety-related trays in the plant design. The closest separation between any combination of trays 1, 2 and 3 occurs between trays 1 and 3 at a distance of approximately 12 feet in a non-missile area.

Raceways are identified by raceway markers installed at the ends of each tray section and at the ends of each run of embedded and exposed conduit. Additional markers are installed where conduit and trays pass through walls or floors and where the length of Class 1E runs make intermediate identification necessary. Approximately 20 percent of the safety-related tray sections are longer than 15 feet, and, except for a few cases, they are less than 25 feet.

ARKANSAS NUCLEAR ONE
UNIT 2

Raceway markers inside the containment are stenciled on the raceway surface, using permanent marker ink of an appropriate color. All characters comprising a marker are stenciled in the respective channel color, eliminating any need for a separate color dot. Raceway markers for areas outside the containment are adhesive backed vinyl containing black characters on a yellow background, with an appropriate color spot added for safety-related raceway channel identification.

Raceway design was substantially complete and to a considerable degree installed before issuance of Regulatory Guide 1.75. Cable tray markers are installed in some cases at intervals exceeding 15 feet. Conduit markers have been installed with due consideration for verification of installation conformance with the separation criteria.

Referencing the channel number/color tabulation below, a typical installation would be a channel one tray having tray markers with a red color spot and a fill of red jacketed cables with red color coded markers.

The following table lists the tray marker code cable jacket color and cable marker code for the 480-volt power and control cables and instrumentation cables.

<u>Channel Number</u>	<u>Channel Color Identification</u>	<u>Tray Marker Color Spot</u>	<u>600-Volt Cable Jacket color</u>	<u>Cable Marker Color Spot</u>
1	Red	Red	Red	Red
2	Green	Green	Green	Green
3	Yellow	Silver on Yellow background	Yellow	Silver on Yellow background
4	Blue	Blue	Blue	Blue
5*	Orange	Orange	Orange	Orange

* Channel 5 is for power cables only, which are red/green. (See Section 8.3.1.1.9.4)

In a limited number of sizes of instrumentation/control/power cables where proper colored cables were not available, a different colored or black cable was used with appropriate color markers to identify the channel.

8.3.1.4.5 Spacing of Wiring and Components Associated with Class 1E Electric System in Control Boards, Etc.

Redundant Class 1E control and instrument wiring internal to the control board was provided with a minimum of 6-inch free air separation from that of a redundant counterpart. Where this was not possible, barriers or metal conduits have been installed to achieve the desired separation. The same practice has been followed in regard to cable entry to the control board or panel enclosures. Separate terminal blocks or sockets are used inside the control panel or relay rack for termination of redundant cables. All internal wiring associated with one redundant circuit has been bundled together, color coded and separated from its counterpart bundle with clearance as mentioned above. Since this separation and method of providing barriers may not provide adequate protection for a large fire in the cabinet, the fire hazards analysis described in Section 9.5.1 considered that a fire consumed all of the wiring within a panel or sub-panel, and evaluated the effect on safe shutdown capability. Protective features were provided as described in Section 9.5.1.

ARKANSAS NUCLEAR ONE
UNIT 2

8.3.1.4.6 Additional Criteria

The following additional criteria have been applied in the design of the electric system.

- A. Channel separation between the reactor protection channels and also between the ESF channels will be maintained through the electrical penetrations by using one of the four electrical penetration rooms for each channel.
- B. The ESF 4,160-volt switchgear, 480-volt load centers and MCCs have been located within a Seismic Category 1 structure area to minimize exposure to mechanical, fire and water damage. This equipment has been properly coordinated electrically to permit safe operation of the equipment under normal and short circuit conditions.
- C. The redundant emergency diesel generators are located within separate Seismic Category 1 rooms with flood and fire doors to minimize exposure to mechanical, fire and water damage. Likewise the redundant batteries and DC control centers are located in separate Seismic Category 1 rooms.
- D. 480-volt MCCs have been located indoors in the areas of electrical load concentration. Those associated with the turbine generator auxiliary system have been located below the turbine generator operating floor level. Those associated with the Nuclear Steam Supply System (NSSS) have been located to minimize their exposure to mechanical, fire and water damage.
- E. The cables installed in cables trays have been grouped on the basis of their functions and/or voltages.

Separate cable tray, conduit and penetration systems have been furnished for the following classes of cable: 8 kV, 5 kV, and 600-volt power; and, control and instrumentation cables. Medium voltage power cables are run in the top trays, with 600-volt power and control, and instrumentation cables in the lower trays.

All redundant buses and cables for essential systems, i.e., the ESF and the systems required for the safe shutdown of the plant, and for the balance of the plant have been run, as far as practical, by alternate routes.

- F. Shielded instrumentation cables and thermocouple cables have been run in different trays than those used for power and control cables.
- G. The UAT and Startup Transformer 3 are located out of doors and are separated by a fire wall. Lightning arresters have been used where applicable for lightning protection. All outdoor transformers are protected by automatic water spray systems to extinguish oil fires quickly and prevent the spread of fire.
- H. Non-segregated, metal-enclosed 6900 and 4,160-volt buses have been used for all major bus runs where large blocks of power are to be carried.
- I. All cable entries into a panel, excluding floor blockouts and sleeves, will be sealed with a nonflammable material to prevent moisture, dust, and dirt from entering the panel. Floor blockouts and sleeves beneath a panel in fire rated floors will be sealed to prevent fire from entering or leaving the panel through these openings for a fire duration that is adequate for the fire hazards involved. Refer to the Fire Hazards Analysis for a complete discussion of penetration seals.

ARKANSAS NUCLEAR ONE
UNIT 2

8.3.1.4.7 Conformance to Separation Criteria

Historical data removed. To review the exact wording, please refer to Section 8.3.1.4.7 of the FSAR.

8.3.1.5 Physical Identification of Safety-Related Equipment

All Class 1E equipment such as 4,160-volt switchgear, 480-volt load centers, 480-volt MCCs, emergency diesel generators, batteries, battery chargers, DC control centers inverters, DC and AC distribution panels, and control panels have been identified with color coded markers matching the respective cable and raceway systems in accordance with Section 8.3.1.4.5.

The physical identification of all safety-related cables, trays and conduits insofar as the channel to which they belong has been covered in detail in Section 8.3.1.4.5.

In general, all terminal blocks within the main control boards and instrument cabinets are color coded with the assigned color for the respective redundant channels. All other control boards and switchgear, MCCs and relay racks contain circuits from only one channel; therefore, color coding of the terminal blocks is not necessary. Separation between Class 1E and non-Class 1E wiring within this equipment is maintained as described in Section 8.3.1.2.

8.3.1.6 Grid Undervoltage Protection (Millstone 2 and ANO Events)

On July 20, 1976, an event occurred at Millstone 2 which involved power system undervoltage problems.

Based upon the Millstone event, each licensee was requested to supply information regarding the design of the Class 1E electrical distribution system, including a description of the load shedding features, definition of the facility operating limits, and a description of any proposed actions or modifications.

AP&L responded to the request for information by providing analyses which demonstrated the adequacy of the ANO-2 design.

Subsequently, the NRC developed a number of positions with respect to this subject. During the time frame of the NRC questions/positions and the AP&L responses, a significant related undervoltage event occurred at ANO. This event, along with requirements from the Millstone event led to several modifications of the ANO-2 electrical design. The following lists the NRC positions along with the ANO-2 responses and subsequent design changes.

8.3.1.6.1 NRC Position/ANO Responses

Position 1: Second Level of Under- or Over-Voltage Protection With a Time Delay

NRC required that a second level of voltage protection for the onsite power system be provided and that this second level of voltage protection will satisfy the following criteria:

- A. The selection of voltage and time setpoints will be determined from an analysis of the voltage requirements of the safety-related loads at all onsite system distribution levels;

ARKANSAS NUCLEAR ONE
UNIT 2

- B. The voltage protection will include coincidence logic to preclude spurious trips of the off-site power source;
- C. The time delay selected will be based on the following conditions:
 - 1. The allowable time delay, including margin, will not exceed the maximum time delay that is assumed in the FSAR accident analyses;
 - 2. The time delay will minimize the effect of short duration disturbances from reducing the availability of the off-site power source(s); and,
 - 3. The allowable time duration of a degraded voltage condition at all distribution system levels will not result in failure of safety systems of components.
- D. The voltage monitors will automatically initiate the disconnection of off-site power sources whenever the voltage setpoint and time delay limits have been exceeded;
- E. The voltage monitors will be designed to satisfy the requirements of IEEE 279-1971, "Criteria for Protection Systems for Nuclear Generating Stations"; and,
- F. The Technical Specifications will include limiting conditions for operation, surveillance requirements, trip setpoints with minimum and maximum limits, and allowable values for the second level voltage protection monitors.

Position 1: Response

- A. Two levels of voltage protections for the onsite power system have been provided as follows:
 - 1. Two inverse-time undervoltage relays on each 4,160-volt safety bus with a nominal voltage setting of 78* percent (of motor base voltage) and time dial setting of 1.0.

With the above voltage and time settings, the undervoltage relays will initiate load shedding and starting of the associated diesel generator in 1.0 second (approximately) upon total loss of power. The isolation of the safety-related buses will be delayed approximately 2.0 seconds to permit the off-site power to supply the safety-related loads in the event of failure of a fast transfer.
 - 2. One instantaneous undervoltage relay on each safety-related 480-volt safety bus voltage to below its settings, will isolate the safety system at the 4,160-volt level subject to a delay of 8 seconds. The purpose of this relay is to isolate safety loads when the voltage degrades to a level unsatisfactory for their continuous operation. A second relay will be added to each bus 2B5/2B6 to provide the required coincidence logic.
- B. The 78* percent undervoltage relays described in A.1 are connected in parallel. Operation of either relay will isolate the safety buses from the off-site source. This has been done to prevent the possibility of the failure of one of these relays (if the two relays were connected in series) to drop out resulting in a failure to isolate the safety buses upon loss of off-site source.

ARKANSAS NUCLEAR ONE
UNIT 2

After the addition of a second 92* percent (of 460 volts) undervoltage relay of each 480-volt bus 2B5/2B6, the contacts of the two 92* percent undervoltage relays on the respective buses will be connected in series to provide the required coincidence logic.

- C. As stated in A.1, the maximum delay upon total loss of power is 3.0 seconds (approximately) to power the safety buses from off-site source with or without a safety signal. The diesel generator is started by a safety signal independently and would accept the safety loads in the predetermined sequence in a maximum of 15 seconds.

The above timings are within the limits assumed in the FSAR accident analysis.

1. The 92* percent undervoltage relay was delayed 10.0 seconds. This time setting was revised to 8.0 seconds with a new solid-state undervoltage relay. This delay is adequate to prevent spurious operation of the relay when motors start on the safety-related 4160 or 480-volt buses. However, a review of the 6.9 kV motor accelerating conditions revealed that this time delay was not adequate. Therefore, an interlock will be added to prevent operation of the timer when a reactor coolant pump is started. (2CAN037830)
 2. Under the conditions that were identified by the new system analyses the safety-related equipment will function satisfactorily.
- D. The voltage monitors will automatically initiate the disconnection of the off-site power sources whenever the voltage and time setpoints have been exceeded.
- E. The voltage monitors and the associated circuitry are designed as Class 1E circuits in accordance with IEEE 279-1971. (2CAN037830)
- F. The Technical Specification will address these requirements.

* NOTE: These values are historical in nature. Refer to Unit 2 TS for allowable values.

Position 2: Interaction of Onsite Power Sources With Load Shed Feature

NRC requires that the current system designs automatically prevent load shedding of the emergency buses once the onsite sources are supplying power to all sequenced loads on the emergency buses. The design will also include the capability of the load shedding feature to be automatically reinstated if the onsite source supply breakers are tripped. The automatic bypass and reinstatement feature will be verified during the periodic testing identified in Position 3.

Position 2: Response

The design will be modified to prevent load shedding of the emergency buses when the diesel generators are supplying power, provided a safety signal is present.

Position 3: Onsite Power Source Testing

NRC requires that the Technical Specifications include a test requirement to demonstrate the full functional operability and independence of the onsite power sources at least once per 18 months during shutdown. The Technical Specifications will include a requirement for tests simulating loss of off-site power in conjunction with a Safety Injection Actuation Signal. Proper operation shall be determined by:

ARKANSAS NUCLEAR ONE
UNIT 2

- A. Verifying that on loss of off-site power the emergency buses have been de-energized and that the loads have been shed from the emergency buses in accordance with design requirements.
- B. Verifying that on loss of off-site power the diesel generators start from ambient condition on the autostart signal, the emergency buses are energized with permanently connected loads, the autoconnected emergency loads are energized through the load sequencer, and the system operates for five minutes while the generators are loaded with the emergency loads.

Position 3: Response

The Technical Specifications include a requirement for tests at least once every 18 months during shutdown that verify items A and B of position 3.

8.3.1.6.2 Description of Changes

Circuit Changes

- A. Fast transfer to off-site source with a safety signal: (2CAN017820)
 - 1. Shed two heater drain pumps and two main chillers only. See Section 8.3.1.6.5.
 - 2. Sequence idle ESF loads (per Table 8.3-1).
 - 3. Delay certain ESF 480-volt loads (per Table 8.3-1).
 - 4. Block load shedding feature on the 4,160-volt safety buses when the diesel generators are supplying these buses, provided a safety signal is present.
- B. Off-site source available but fast transfer fails:
 - 1. Shed all non-ESF and ESF loads.
 - 2. Sequence ESF loads to off-site source (per Table 8.3-1).
 - 3. Delay certain ESF 480-volt loads (per revised Table 8.3-1).
- C. Delete slow transfer.
- D. Reduce the time setting of the 92* percent undervoltage relay to 8.0 seconds.
- E. Trip 3 condensate pumps (one remains running) and additional load as described on fast transfer to Startup Transformer 2 (see Section 8.3.1.6.5).
- F. Block the operation of the 92* percent undervoltage relay during start of reactor coolant pump.

ARKANSAS NUCLEAR ONE
UNIT 2

Hardware Changes

- A. Increase cable sizes for two 480-volt loads.
- B. Increase size of control transformers in 89 Size 1 starters.
- C. Add auxiliary relays in 11 starters.
- D. Replace the existing 92 percent undervoltage relays with solid-state undervoltage relays.

Administrative Procedures

- A. If system frequency falls to 59.5 Hz, manually isolate the safety buses (Synchronize the diesel generator and trip the off-site source breaker).**
- B. During plant startup, auxiliary loads should be transferred to the unit auxiliary transformer prior to exceeding 13,400 KVA of the connected load.***
- C. To prevent unwarranted plant trips, operator action should be initiated as follows:
 - 1. If ESF bus voltage degrades to a point which would challenge the millstone relays, monitor voltages. If voltage degrades to an unacceptable value, isolate the safety buses (one at a time) by synchronizing the diesel generator and tripping the incoming feeder breaker from 2A1 to 2A2.*

*NOTE: This is a nominal value. Refer to Unit 2 TS for allowable values.

**NOTE: During periods of grid disturbances (not gradual decreases) the diesel generators should be left in the E.S. standby condition.

***NOTE: This load limit no longer applies to operation on Startup Transformer 3 due to addition of the 22KV Voltage Regulator in the switchyard in 1994.

- 2. If only one 500 KV or 161 KV transmission line is connected to the ring bus (indicative of degradation of available fault load to less than 2000 MVA or 610 MVA respectively) and a plant trip occurs, the 2B5/2B6 millstone relays will probably actuate.

8.3.1.6.3 Conformance to IEEE 279

The following briefly describes how the ANO-2 Millstone modifications conform to the requirements of each section of IEEE 279.

A. General Functional Requirements

The devices and equipment used are qualified for Class 1E application and the performance of the devices is highly reliable. The system is designed so that the protective action is automatically initiated as the system reaches preset levels.

ARKANSAS NUCLEAR ONE
UNIT 2

B. Single Failure Criterion

The two load groups are provided with redundant protective actuation control systems. Also, wiring for each of the two control systems is routed in separate Class 1E raceways.

C. Quality of Components and Modules

The devices used for the two protection systems are qualified for Class 1E application.

D. Equipment Qualifications

The available type test data for Class 1E components qualifications confirms the required satisfactory performance of the protection equipment under the environmental conditions stated in Sections 3.7 and 3.9 of the IEEE 279-1971.

E. Channel Integrity

The protective systems proposed have been designed for fail-safe operation. The devices and circuitry used are Class 1E and therefore will remain operational under extreme environmental, energy supply and accident conditions.

F. Channel Independence

The equipment, devices, and raceways for one Class 1E system are independent and physically separated from the other system. The circuits for the two Class 1E protective systems are also routed in separate raceways.

G. Control and Protection System Interactions

All the equipment is considered part of the protection system which is designed to meet the requirements of IEEE 279 with the exception of the RCP starting bypass initiation signal, i.e. the contact from which the bypass signal is initiated. The signal, however, is isolated from the Class 1E portions of the system by a Class 1E buffer relay. For further details, refer to our response to Item 6.

H. Isolation Devices

Isolation devices are not used as the systems are completely Class 1E.

I. Single Random Failure and Multiple Failures Resulting From a Credible Single Event

There are no single failure points as the systems are completely Class 1E, separate, and redundant.

J. Derivation of System Inputs

The undervoltage relays proposed at the 480-volt ESF buses will measure the system degraded conditions directly and initiate the protective action at the system level within its respective load group.

ARKANSAS NUCLEAR ONE
UNIT 2

K. Capability for Sensor Checks

The 92* percent undervoltage relays have been provided with functional test switches. Periodic testing will ensure the sensors' operational capability.

L. Capability for Test and Calibration

The system has the capability for testing. Calibration of devices is discussed elsewhere in the FSAR.

M. Channel Bypass or Removal From Operation

Systems have the capability to be tested inservice without initiating a protective action at the system level and also continue to meet the single failure criterion.

N. Operating Bypass

The protective action to the two systems is automatically bypassed during starting of the RCP motors. The operating bypasses are Class 1E.

O. Indication of Bypass

The bypasses will be alarmed in the control room to indicate that the bypass failed to reset. Bypasses using the test switches are not alarmed in the control room.

P. Access to Means for Bypassing

Manual bypass of protective action is provided through test switches. The access to the test switches will be under the administrative control of Operations.

Q. Multiple Setpoints

The protective devices are set at one setpoint only.

R. Completion of Protective Action Once It is Initiated

Once the protective action has been initiated the off-site source is automatically disconnected and the onsite source (diesel) is made available within a short time. The protective action will go to completion once initiated.

* NOTE: This is a nominal value. Refer to Unit 2 TS for allowable values.

S. Manual Initiation

Manual control is provided on each of the two breakers for connecting or disconnecting the off-site and onsite sources to the auxiliary power systems. Manual initiation requires operation of a minimum number of switches.

ARKANSAS NUCLEAR ONE
UNIT 2

T. Access to Setpoints Adjustment Calibration and Test Points

Access to setpoint adjustment, calibration, and test points is controlled administratively by Operations and is limited to qualified personnel.

U. Identification of Protective Action

The breakers for the off-site and onsite sources have indications in the control room to identify the protective actions and that the breakers are closed.

V. Information Readout

Sufficient monitoring has been provided in the control room which will enable the operator to know the deteriorating conditions of the system.

W. System Repair

Periodic testing of the system will ensure the detection of the malfunction of components or modules. Plug in type of components are used where possible so that the faulty units can be replaced, repaired or adjusted expeditiously. Also, the system protective action is designed such that the failure of one undervoltage relay will not disable protective action.

X. Identification

The equipment and wiring of the two protective systems have been identified as red and green channels.

8.3.1.6.4 Technical Specifications

As part of the resolution of this issue, the Technical Specifications were revised to include the undervoltage relay settings and requirements for surveillance testing and limiting conditions for operation. See the Technical Specifications for further information.

8.3.1.6.5 1983 Load Shedding Modifications

The ANO-2 load shedding schemes have been modified to remove unnecessary shedding of loads in the non-IE areas of the ANO-2 electrical distribution system. Supporting analyses of computer load flow studies justify removal of SIAS actuated load shedding for all equipment with the exception of:

- 2P8A Feedwater Heater Drain Pump "A"
- 2P8B Feedwater Heater Drain Pump "B"
- 2VCH1A Main Chiller "A"
- 2VCH1B Main Chiller "B"

The load flow studies (Calculation 83-2058-01) show that full ANO-2 loads may be accommodated on Startup Transformer 3 as long as at least two 500 kV lines are in service. In the event of a unit trip, fast transfer to Startup Transformer 3 with all remaining loads is possible with at least one 500 kV line (2000 MVA) available. The unit will be able to function indefinitely in either of these two cases without the likelihood of Millstone degraded grid voltage actuations.

ARKANSAS NUCLEAR ONE
UNIT 2

In the case of a fast transfer to Startup Transformer 3 with a concurrent Safety Injection Actuation Signal (SIAS), the transfer with unit trip would apply for initial conditions with immediate shedding of the loads listed above ($T = 0$). As the ESF loads sequence on ($T = 10, \dots, 90$), starting voltages are maintained above minimum transient allowables. After each step and in steady state, the transient voltage recovers above the 92%* Millstone trip setpoint before the eight second time delay has expired. Thus, removal of SIAS load shedding from all non-ESF equipment, except the above listed loads, is justified. Removal of the SIAS load shedding will not cause unnecessary Millstone actuation and facilitates plant recovery from SIAS conditions by allowing retention of the unit condenser and turbine bypass valving as a shutdown heat sink.

Other load flow studies analyzed the load shedding scenarios of Startup Transformer 2 (see Calculation 83-2058-02). In this case, the existing shedding schemes are retained with the following exceptions: only one of two circulating water pumps will be tripped, the SIAS shedding override of the Startup Transformer 2 load shedding schemes (2H09 and 2A16) is removed, and a Startup Transformer 2 load shedding bypass means is installed in the 2H23 and 2A111 switchgear cubicles. A fast transfer to Startup Transformer 2 by ANO-2 after a trip will initiate shedding of:

- One out of two circulating water pumps
- Two out of four reactor coolant pumps
- Three out of four condensate pumps
- Two out of two heat drain pumps
- Two out of two main chillers

Analysis of this situation shows that steady state voltages are acceptable. The retaining of one of two circulating water pumps is necessary to provide a shutdown heat sink. Analysis of a fast transfer to Startup Transformer 2 with a concurrent SIAS signal requires initial conditions ($T = 0$) of loads remaining after unit trip, since the load shedding of two of four reactor coolant pumps is no longer blocked by SIAS. As the ESF loads sequence on ($T = 10, \dots, 90$), starting voltages are maintained above minimum transient allowables. After each step and in steady state ($T > 90$), the transient voltage recovers above the 92%* Millstone trip setpoint before the eight second time delay has expired. Thus, removal of the SIAS load shedding override of the ST2 load shedding scheme and the retaining of one of two circulating water pumps running is justified. Again, no unnecessary Millstone actuations would likely occur under these conditions and the ability of the unit to achieve orderly shutdown is enhanced by the availability of the unit condenser as a shutdown heat sink.

* NOTE: These are historical values. Refer to Unit 2 TS for allowable values.

The bypass means provided to defeat Startup Transformer 2 load shedding is a key-operated switch and monitoring light combination provided on cubicles 2H23 and 2A111. During a shutdown of ANO-2, auxiliary electrical loads must be transferred to either Startup Transformer 3 or Startup Transformer 2. When Startup Transformer 3 is not available, Startup Transformer 2 load shedding is bypassed prior to transfer of auxiliary loads to avoid the reactor trip that would otherwise occur upon shedding of any of the reactor coolant pumps. The procedure for transferring electrical loads to Startup Transformer 2 includes steps to assure that voltage on the ESF buses does not drop below the Millstone trip setpoint. The bypass switches also provide a means to administratively control loading of Startup Transformer 2 when ANO-2 is in cold shutdown and degraded grid voltage conditions are not present.

ARKANSAS NUCLEAR ONE
UNIT 2

8.3.2 DC POWER SYSTEMS

8.3.2.1 Description

The DC system has been designed to provide a source of reliable continuous power for control, instrumentation, RPS, ESFAS, and other loads for startup, operation, and shutdown under normal and emergency conditions.

The DC system consists of three 125-volt batteries, each with its own battery charger (plus a spare for each of the two ESF DC buses), DC control center, and distribution panels.

The Class 1E 125 VDC system consists of two independent, physically and electrically separated 125 volt batteries designated 2D11 and 2D12 which provide DC power to the 125 VDC control centers 2D01 and 2D02, respectively, along with associated distribution panels. Four 400 amp battery chargers (two associated with each DC electrical train) serve as normal supplies to the DC control centers with the associated battery floating on the bus. 2D31A and 2D31B are Red Train battery chargers. 2D32A and 2D32B are Green Train battery chargers. One battery charger per train is normally in service supplying its associated 125 VDC control center while the other charger in each train remains in standby, except when swapping battery chargers or during maintenance and/or testing activities. Battery chargers 2D31A and 2D32A are supplied from the respective same-train 480-volt ESF MCCs. Battery chargers 2D31B and 2D32B are normally fed from the respective same-train 480-volt ESF MCCs, but can be fed from the opposite train 480-volt ESF MCC via manual transfer switches in order to support electrical maintenance activities during unit outage. The batteries supply important DC loads without interruption should the battery chargers fail.

The non-Class 1E 125 VDC system consists of a single (black) train 125 VDC battery designated 2D13 which provides power to control center 2D03. Battery charger 2D33 serves as the normal supply to 2D03 with battery 2D13 maintained in a float condition. Charger 2D33 is fed from Class 1E 480 VAC MCC 2B64. The battery supplies the load without interruption should the battery charger fail.

8.3.2.1.1 Batteries

Each of the batteries, designated 2D11, 2D12, and 2D13 consists of cells assembled in heat and shock resisting, polycarbonate, noncombustible jars. They are of the lead-acid type with lead-calcium grid construction. The batteries are mounted on racks made of structural steel members. All battery racks meet the Seismic Category I requirements stated in Section 3.10. Batteries 2D11 and 2D12 consist of 58 cells and are rated at 2064 A-hr for an 8-hour rate of discharge to 1.81 volts per cell at 77 °F. Battery ratings are given in Table 8.3-2. 2D11 and 2D12 have been designed to meet the duty cycle requirements shown in Tables 8.3-5 and 8.3-6, without use of the charger and without decreasing the voltage below 105 volts (1.81 volts per cell) at 60 °F ambient. The 125-volt DC loads supplied from batteries 2D11 and 2D12 are shown in Table 8.3-4A and 8.3-4B, respectively.

According to the battery manufacture, a float current of less than 2 amps indicates that the battery is at least 98% charged. Since only a 98% charge can be assumed, a 2% design margin factor is maintained in the battery sizing calculations to ensure 100% battery capacity is maintained.

ARKANSAS NUCLEAR ONE
UNIT 2

The safety related batteries are sized per IEEE 485-1983. The minimum design limit for electrolyte temperature is 60 °F. The batteries are sized to include a temperature correction factor to compensate for the possibility of a 60 °F operating temperature. The batteries are also sized to include an aging factor to ensure adequate end of life battery capacity exists. In addition, the batteries are sized to include a design margin factor to account for factors other than aging and temperature. These margins are maintained under the Margin Management program.

Optimal long term battery performance is obtained by maintaining a float voltage greater than or equal to the minimum established design limits provided by the battery manufacturer, which corresponds to 127.6 V (calculated based on 2.20 V * 58 cells) at the battery terminals, or 2.20 Vpc. This is the minimum design limit for battery terminal float voltage established by the battery manufacturer and provides adequate over-potential, limiting the formation of lead sulfate and self discharge, which could eventually render the battery inoperable.

Batteries 2D11 and 2D12 are mounted on a 2-step rack with a single tier on the front step and two tiers on the rear step. Each battery is sized to provide the maximum simultaneous combination of steady state loads and peak loads for the periods as shown on the emergency duty cycle (Tables 8.3-5 and 8.3-6). Peak capacity of each battery will meet peak current demand for a minimum period of one minute. The total ampere hour capacity of the battery will also meet the 8-hour rate as shown in these tables. Voltage will not fall below 105 volts (1.81 volts per cell) during any peak or continuous load condition. The batteries are sized to comply with the IEEE standard shown in its respective table.

Battery 2D13 consists of 60 cells and is rated at 2175 A-hr for an 8-hour rate of discharge to 1.75 volts per cell at 77 °F. The battery is mounted on a 2-step rack with a single tier on the front step and two tiers on the rear step. The 125-volt DC battery 2D13 and associated control center are not required for the safe shutdown of the reactor, and as such, are not designed as a Class 1E system. Emergency oil pumps associated with the main turbine generator and other non class 1E loads are supplied from this DC system. Loss of this 125-volt DC supply is annunciated.

8.3.2.1.2 Battery Chargers

The 1E 125 VDC chargers, designated as 2D31A, 2D31B, 2D32A, and 2D32B (one standby backup per power train) and the non-1E 125 VDC charger, designated as 2D33, are of the thyristor full-wave rectifier constant average voltage type. The ratings of the chargers are given in Table 8.3-2. They are convection cooled, rated for continuous operation at 122 °F ambient. Each charger is rated at 400 A and suitable for float charging or equalizing the 125 volt DC battery. The chargers operate from 460-volt, 3-phase, 60 Hz supplies from 480-volt Class 1E MCCs. Each charger is designed to prevent the battery from discharging back into any internal charger load in case of AC power supply failure or charger malfunction. The chargers may be used as battery eliminators so that they can supply 125 volt DC power if the associated battery has to be taken out of service for testing or becomes unavailable for any reason. Load sharing and transfer controls are provided for load transfer between the two battery chargers on each of the class 1E power trains. Other than during load transfers or maintenance, only one battery charger per power train will be energized.

ARKANSAS NUCLEAR ONE
UNIT 2

Each of the DC buses in the redundant DC control centers 2D01 and 2D02 is connected to a separate battery charger. The battery chargers are supplied from separate and redundant Class 1E MCCs which are designed to be energized automatically from their associated diesel generator in the event of a coincident loss of normal and preferred power sources. The backup charger on each train can be switched in by operator action to replace the normal battery charger.

Each charger is capable of supplying the normal DC load while maintaining the battery in a charged condition. Tables 8.3-4A and 8.3-4B show the loads on the Class 1E batteries, 2D11 and 2D12, for an emergency duty cycle discharge without AC power available. Four separate DC power sources are provided for the reactor trip switchgear. Red and green power is supplied from separate batteries. Yellow and blue power is supplied from separate battery eliminators connected to the yellow and blue 120-volt AC distribution panels.

8.3.2.1.3 DC Control Centers

The 125-volt DC control centers 2D01, 2D02, and 2D03 are comprised of freestanding NEMA Type 1 enclosures with gasketed doors and cover plates. DC control centers 2D01 and 2D02 have been provided with drawout type circuit breakers with fuses to provide overcurrent protection. DC control center 2D03 includes molded case breakers with adjustable magnetic trip settings on each pole.

8.3.2.1.4 Distribution Panels

Four DC distribution panels, designated as 2D21, 2D22, 2D23, and 2D24 have been provided. Distribution panels 2D23 and 2D24 supply the DC requirements of all safety-related redundant loads. The other two panels 2D21 and 2D22 supply the requirements of all non-safety-related devices. In each channel, an autotransfer switch has been provided to ensure that DC supplies to all connected loads do not fail in the unlikely event of battery failure or if the battery has to be taken out for testing. There is a remote possibility of an inadvertent battery discharge in the event of a fault or overload condition on any of the non-class 1E circuits supplied by panels 2D21 or 2D22 coinciding with a failure of the primary class 1E breaker which protects that circuit. Such a discharge would be detected by bus undervoltage alarm and indication in the control room. Also provided are DC distribution panels 2RA1 and 2RA2, which supply 125-volt DC to Reactor Trip Switchgear trip circuits and 2B5/2B6 undervoltage relays.

8.3.2.1.5 System Operation

The 125-volt DC ESF systems are identified on the single-line meter and relay diagrams and the schematic diagrams in a manner similar to that described in Section 8.3.1.5. Each DC system operated ungrounded with a ground fault detector relay is set to annunciate the first ground on either the positive or the negative leg of the system. The annunciator provides an opportunity for corrective action before a second ground might occur. Single ground faults will not cause a DC circuit failure. With an arrangement of this type, two grounds are required before any of the circuit protective devices operate.

One undervoltage relay is provided on each bus section to initiate an alarm if voltage on the bus drops to a preset value. A charger failure relay provided on each charger detects and annunciates failures in AC power input and DC power output. Each safety bus has a "battery not available" alarm which annunciates blown battery fuses or an open battery disconnect switch.

ARKANSAS NUCLEAR ONE
UNIT 2

Cables for the DC power and control systems are rated 600-volt, 90 C or greater with flame-resistant insulation and jacketing materials capable of withstanding the worst case environmental conditions to which the cable could be exposed, and copper conductors sized to carry the maximum available short circuit current for the time required by the primary circuit breaker to clear the fault. They are also sized for continuous operation at not less than 125 percent of nameplate full load currents. Additional information on cables and raceways for the DC power supply systems is provided in Section 8.3.1.4.5.

8.3.2.1.6 Equipment Separation and Redundancy

The 125-volt DC system is designed to meet the Seismic Category 1 requirement stated in Section 3.10. The two redundant batteries and their related accessories are located in separate rooms in the auxiliary building which is designed as a Seismic Category 1 structure, and they are protected from potential missile hazards. The third battery 2D13 has been installed in the same room as battery 2D11. The safety-related DC loads have been grouped into two redundant load groups such that the loss of either group will not prevent the minimum safety function from being performed.

Complete separation and independence have been maintained between components and circuits of the two 125-volt ESF DC systems, including the raceways. For the raceway separation criteria, see Sections 8.3.1.4.5 and 8.3.1.4.6. Because of the physical and electrical separation provided for the batteries, chargers, distribution equipment and wiring for the 125-volt DC ESF systems, a single failure at any point in either system will not disable both 125-volt DC systems. The single failure analysis for the 125-volt DC systems is given in Table 8.3-11.

8.3.2.1.7 Ventilation

Each class 1E 125-volt DC system battery and its related charger and the distribution equipment are located in a separate ventilated room. The ventilating fans for the battery rooms are powered from ESF MCCs of the respective channels.

8.3.2.1.8 Identification of Safety Loads and Time of Operation

Tables 8.3-4A and 8.3-4B identify the safety-related DC loads and the length of time they would be operable in the event of loss of all AC power.

8.3.2.1.9 Inspection, Servicing, Testing, Installation, and Qualification

The station batteries and their associated equipment are easily accessible for inspection, servicing and testing. Servicing and testing will be performed on a routine basis in accordance with the manufacturer's recommendations and the Technical Specifications. Typical inspection includes visual inspection for leaks, corrosion, or other deterioration, and checking all batteries for voltage, specific gravity, level of electrolyte, and temperature. At the time of installation, rated discharge acceptance tests were made to verify that the battery capacity meets the manufacturer's rating.

A Non-Class IE metering system is provided for batteries 2D11 and 2D12 for a means of accurately measuring the battery charging current when the battery is fully charged. The battery charging current can be used in lieu of the specific gravity parameter to declare the battery operable following a discharge test.

ARKANSAS NUCLEAR ONE
UNIT 2

Each battery cell case is marked with a high and low electrolyte level line. The minimum electrolyte level is determined by the low electrolyte level line on the battery case.

The 125-volt DC system components were purchased and installed under a strict quality assurance program. Certified records of quality assurance inspection and tests performed during production were obtained from the equipment manufacturer. The equipment has been qualified by both tests and satisfactory operation at other operating stations.

The qualification of the 125-volt DC system equipment meets the requirements of IEEE 323-1971.

The battery test program was conducted in accordance with the ANO-2 Technical Specifications and the Combustion Engineering Standard Technical Specifications (March 15, 1975 version).

8.3.2.2 Analysis

The 125-volt DC Class 1E electrical systems are designed to meet the requirements of IEEE 279-1971, IEEE 308-1971, 10CFR50 General Design Criteria 17 and 18, and Regulatory Guides 1.6 and 1.32. They will also meet the requirements for the design basis events described and evaluated in Chapter 15.

8.3.2.2.1 Compliance with Design Criteria and Guides

The following analysis of the Class 1E DC system demonstrates compliance with General Design Criteria 17 and 18, Regulatory Guides 1.6 and 1.32, and IEEE 308-1971.

Criterion 17

The two systems which supply the 125-volt DC power to redundant Class 1E load groups from the two separate 125-volt DC buses are electrically independent and physically separated from each other. Each of the two systems has adequate capacity to supply the 125-volt DC power for the safety-related loads required to safely shut down the reactor.

Criterion 18

As described in Section 8.3.2.1.5, the Class 1E DC system is designed to permit appropriate periodic inspection and testing.

Regulatory Guide 1.6

As described in Section 8.3.1.2, the Class 1E DC system is designed with sufficient independence to perform its safety functions assuming a single failure.

Regulatory Guide 1.32

The battery chargers have been sized to furnish electric energy for the largest combined demands of the various steady state loads while restoring the battery from the minimum charged state to the fully charged state, irrespective of the status of the plant during which these demands occur.

ARKANSAS NUCLEAR ONE
UNIT 2

IEEE Standard 308-1971

For the analysis per Principal Design Criteria of IEEE Standard 308-1971, see Section 8.3.1.2. The following presents an analysis per Supplementary Design Criteria as applicable to the Class 1E DC system.

The Class 1E DC system provides DC electric power to the Class 1E DC loads and for control and switching of the Class 1E systems. Physical separation, electrical isolation, and redundancy have been provided to prevent the occurrence of common failure modes. The design of the Class 1E DC system includes the following features.

- A. The DC system is separated into two main redundant systems.
- B. The safety actions by each group of loads are independent of the safety actions provided by its redundant counterpart.
- C. Each DC redundant subsystem includes power supplies that consist of one battery and two battery chargers (one used as a standby backup).
- D. Redundant batteries cannot be interconnected.
- E. The batteries are arranged to prevent a common mode failure.

Each distribution circuit is capable of transmitting sufficient energy to start and operate all required loads in that circuit. Distribution circuits to redundant equipment are independent of each other. The distribution system is monitored to the extent that it is shown to be ready to perform its intended function. The DC auxiliary devices required to operate equipment of a specific AC load group have been supplied from the same load group.

Each battery supply is continuously available during normal operation and following a loss of power from the AC system, to start and operate all required loads.

Instrumentation is provided to monitor the status of the battery supply as follows:

- A. DC bus undervoltage alarm (control room);
- B. Battery current indication (battery room);
- C. DC voltage indication (battery room);
- D. DC ground indication (control room); and,
- E. Battery not available (control room; safety buses only).

The batteries will be maintained in a fully charged condition and will have sufficient stored energy to operate all necessary circuit breakers and provide an adequate amount of energy for all required emergency loads.

The battery charger of one redundant subsystem is independent of the battery charger for the other redundant system. Instrumentation has been provided to monitor the status of the battery charger as follows:

ARKANSAS NUCLEAR ONE
UNIT 2

- A. Output voltage at charger;
- B. Output current at charger;
- C. Breaker position indication at charger; and,
- D. Charger malfunction alarm in control room, including input AC undervoltage, DC undervoltage, DC overvoltage, and output breaker open.

Each battery charger has an input AC and output DC circuit breaker for isolation of the charger. Each battery charger power supply has been designed to prevent the AC supply from becoming a load on the battery due to a power feedback as the result of the loss of AC power to the chargers.

Equipment of the Class 1E DC system are protected and isolated by fuses or circuit breakers in case of short circuit or overload conditions. Indications have been provided to identify equipment that is made unavailable per the following:

<u>Event</u>	<u>Available Indication</u>
A. Battery charger AC input breaker trip	Charger malfunction alarm
B. Battery charger DC output breaker trip	Charger malfunction alarm
C. DC control center feeder trip	DC panel undervoltage alarm
D. Distribution circuit breaker trip	Individual equipment alarm
E. Inverter DC feeder breaker trip	Inverter malfunction alarm
F. Inverter output AC breaker trip	Inverter trouble alarm
G. Blown battery fuses or open battery disconnect	Battery not available (safety buses only)

Periodically the battery charger AC supply breaker is opened to verify the load carrying ability of the battery.

Dependable power supplies have been provided for the RPS and ESFAS. Two independent DC and four independent AC power supplies have been provided for control and instrumentation of these systems. The independent DC supplies have been provided by distribution circuits from each of two redundant DC distribution panels. Independent AC supplies have been provided by the six inverters and four associated 120-volt AC vital buses. Refer to Section 8.3.1.1.6 for further description of these vital instrument AC power supplies.

IEEE Standard 450-1980

Operational procedures for normal maintenance, testing and replacement comply with IEEE Standard 450-1980 to the extent practical. The acceptability of any deviations from the recommendations of the standard will be evaluated by Engineering. Acceptance tests were made in accordance with the standard. The batteries will be tested, serviced, and inspected at regular intervals, as outlined in Section 8.3.2.1.9, to ensure that batteries and associated equipment are maintained in a satisfactory condition.

Batteries will be replaced when their capacity, as determined in Section 6.5 of the standard, drops to 80 percent of the manufacturer's rating. Records are maintained in accordance with the recommendations in the standard.

ARKANSAS NUCLEAR ONE
UNIT 2

8.3.3 ALTERNATE AC POWER SOURCE

8.3.3.1 System Description

The Alternate AC (AAC) power source consists of a 4160 volt generator which utilizes a diesel engine as its prime mover, electrical power distribution, control, and instrumentation as well as necessary support systems. With the exception of the Bulk Fuel Oil Storage System, the AAC system is independent of plant systems. The basic configuration and function of the AAC power source is to provide sufficient AC power to safely shut down either unit at ANO following a station blackout. A station blackout is defined as a total loss of all AC power on either unit. This includes the simultaneous loss of the normal, preferred, and emergency AC power sources. The generator set can also be used to supply certain non-safety related, but operationally important, loads during other plant events.

8.3.3.2 Alternate AC Generator

8.3.3.2.1 Building

With the exception of the power distribution switchgear, all of the major components are located in the AAC Generator Building. The building is a steel frame, pre-cast concrete panel structure designed and built to the Uniform Building Code. The building is divided into an electrical equipment area, which also serves as the local operations station, and an engine room. This building houses the engine generator set, fuel oil transfer pump, fuel oil day tank, air start system, engine generator control cabinets, HVAC, and fire protection systems.

8.3.3.2.2 Engine Generator Set

The engine generator set consists of a diesel engine and matching generator mounted on a rigid steel frame. The package has a continuous rating of 4400 kW at 4160 volts, 60 hertz, 0.8 PF. The machines prime rating, which equates to a 2 hour rating, is 4840 kW (110% of the continuous rating). The engine generator set is a Caterpillar Model 3616 TA.

The prime mover is a 16 cylinder 'V' configuration, 4 cycle, fuel injected, turbocharged diesel engine that operates at 900 RPM. The generator is a Kato Engineering Company Model 8P11-4000, 4 pole synchronous, air cooled generator rated at 4400 kW continuously with class F insulation. This generator utilizes a permanent Magnet Generator (PMG) pilot excitor, a Kato voltage regulator, and is configured for a 4160 volt, 3 Phase, resistance grounded neutral power distribution system.

8.3.3.2.3 SUPPORT SYSTEMS

8.3.3.2.3.1 Cooling System

The cooling system is made up of two separate cooling circuits, each with its own gear driven pump, and air cooled radiator. One circuit is for the jacket water, cylinder heads and turbocharger. The other is for the aftercooler and oil coolers. Both cooling circuits utilize a 50% mixture of glycol and demineralized water with rust inhibitors and other chemical additives. Both cooling circuits maintain a constant flow through the engine and contain temperature control valves which partially bypass the radiator to maintain a constant temperature into the engine. The air cooled radiators are mounted in the same housing and are of a forced air design. The radiator is located immediately to the west of the building. Integral to the cooling system are the "keep warm" system, a glycol drain/fill pump and tank, and the expansion tank.

ARKANSAS NUCLEAR ONE
UNIT 2

8.3.3.2.3.2 Air Start System

The air start system is made up of two 100% capacity air compressors, air dryer system, and two air receiver/storage tanks along with the piping to the engine generator package skid. The air receivers are internally coated and the piping is stainless steel to avoid corrosion and the introduction of corrosion products into the air stream. The two air receiver tanks independently contain sufficient energy, when fully charged, to attempt 5 engine starts. A start attempt refers to the normal cranking duration of approximately 3 to 4 seconds as documented in Engineering Change 20107. The system down stream of the air receivers is configured such that no single active failure will prevent starting attempts. The air receivers may be isolated from each other when necessary for maintenance. The remaining "in-service" receiver will be available for starting the generator.

8.3.3.2.3.3 Fuel Oil System

The fuel oil system consists of a gear driven pump, an AC motor driven pump, a DC motor driven pump, a fuel oil transfer pump, a day tank, a fuel oil cooler, valves, and piping. The gear driven fuel oil pump draws fuel from the approximately 600 gal. day tank and supplies the fuel injection header. The fuel injectors draw from this header to fuel the engine and cool themselves then return the excess fuel to the day tank. The excess fuel is cooled by an air cooler located within the engine room. The AC driven fuel pump serves to provide fuel during and immediately after engine starting and as a back up for failure of the gear driven pump. The DC driven pump serves as a backup for the AC pump. The minimum level in the bulk fuel oil storage tank includes a sufficient quantity of fuel to operate the AAC machine at full rated load for a minimum of 4½ days.

Fuel oil is transferred from the bulk fuel oil storage tank via a fuel transfer pump located in the AAC Generator Building. This transfer pump can simultaneously fill the day tank and supply the engine at full load. Additionally, a bypass valve on the bulk storage tank can be opened that will gravity feed the engine mounted fuel oil pumps.. In this mode the excess fuel is returned to the day tank and any overflow is returned to the bulk storage tank.

8.3.3.2.3.4 HVAC, Combustion Air, Exhaust

The building design includes the necessary heating, ventilation, air conditioning, exhaust, and combustion air systems for the proper operation of the generator set. The Engine Room Ventilation System is comprised of three separate exhaust fans. One exhaust fan is a small fan for basic ventilation and fuel oil fume control. The other two are thermostatically controlled and provide adequate ventilation during the operation of the engine generator set. Outside air, drawn through motor operated louvers, flows across the generator and the engine and is exhausted by these fans. Under design outside air conditions, the temperature within the room will remain within the engine generator ratings. Heating, provided by unit heaters and the engine keep warm system, will maintain the temperature above a value where engine starting could be jeopardized.

Filtered air drawn from outside by the turbocharger is utilized for engine combustion. The engine exhaust is also discharged from the building after passing through a silencer. The combustion air intake and exhaust are located on the roof of the building to avoid drawing the exhaust into the intake filters.

ARKANSAS NUCLEAR ONE
UNIT 2

8.3.3.2.3.5 125 Volt DC System/120 VAC UPS System

A 125 Volt DC power system for the AAC Building made up of a battery, battery charger, and distribution equipment has been provided. The battery bank is comprised of valve-regulated (sealed) lead-acid batteries mounted in a rack located in the electrical equipment room. The battery is sized to operate the Programmable Logic Controller (PLC), control and instrumentation system, the DC fuel oil pump, essential circuit breakers, and equipment protective devices. The duty cycle assumes a 30 minute period prior to the starting of the machine after the loss of building power as part of a station blackout. During this period the computer based control system will remain functional. Critical control equipment located in Unit 2 is powered by a source independent of either units preferred, normal, or safety related power sources.

A separate 120 VAC Uninterruptible Power Supply for the AAC Building (made up of battery, battery charger, and inverter) has also been provided. This package unit provides power for the PC and Monitor which interface with the PLC at the building and also provides uninterruptible control power to the AAC Building 480 VAC Switchgear that transfers the building from preferred offsite power to generator power.

8.3.3.2.3.6 480 Volt Auxiliary Power

The 480 volt power distribution system for the AAC Building is normally aligned to an offsite 13.8kV source. Upon loss of this normal source, the building will automatically transfer to the AAC generator once it is started manually. The loss of power in the building is indicated in the Control Room. The instrumentation and control systems remain operable for several hours on the building batteries without building power. The engine generator set can be started remotely without AC power, requiring only DC power. The local manual start does not require any power. The 480 volt system is sized to carry the expected loads during engine generator operations at rated load.

8.3.3.3 Instrumentation & Control System

The instrumentation and control system for the AAC power source is an integrated Programmable Logic Controller and personal computer based control system. This system uses a fiber optic data and command transmissions network and is tied into the plant computer as well as the site Local Area Network. This system provides the operations staff the ability to control, monitor, collect data, and trend the performance of the machine from the Control Room as well as locally in the AAC building. This AAC machine can be started and aligned to either of the safety buses by local manual action in the event of failure of the PLC-PC control system. The primary man-machine interface will be through touch screens and computers located in the Unit 2 Control Room and the AAC Building.

8.3.3.4 Power Distribution

The 4160 volt power is distributed to either safety related bus and/or to one non-safety related bus in either unit through bus 2A9 located in Unit 2. Bus 2A9 is located on elevation 372' of the Turbine Building adjacent to the 6900 and 4160 volt offsite power buses. Through remote manual operation of the circuit breakers in 2A9, the power can be aligned to 1A1, 1A3/1A4, 2A1, or 2A3/2A4. Final re-energization of safety bus 1A3, 1A4, 2A3, or 2A4 is accomplished by operator action within the respective unit's Control Room. The AAC Generator is sized to carry the largest load from any of the four safety buses plus its support and auxiliary system loads with considerable margin.

ARKANSAS NUCLEAR ONE
UNIT 2

8.3.3.5 Testing & Peaking Operations

The AAC Generator can be synchronized with the offsite power source for the purpose of testing and peaking operations. This provides the ability to conduct surveillance, post maintenance, and performance testing. The use of the AAC machine for system peaking is acceptable under controlled conditions that limit its vulnerability to failures on the transmission system.

ARKANSAS NUCLEAR ONE
UNIT 2

Table 8.3-1

DIESEL LOAD TABLE

The below load profile represents an approximation of the actual worst case loads and their duration on the diesel generators during each emergency condition. For actual load configuration control, see Calculation No. 85-S-00002-01.

Equipment	KV	No. Of Component Per Diesel	Component H.P. Rating (KW/KVA)	Actuation Signal	Component Start Times (Sec.) (1)	DIESEL GENERATOR LOADING CONDITIONS						
						Condition I Loss of Coolant With Loss of Offsite Power		Condition II Main Steam Line Ruptures With Loss Of Offsite Power		Condition III Loss of Offsite Power		
						HP ⁽⁸⁾ (KW/KVA)	Duration	HP (KW/KVA)	Duration	HP (KW/KVA)	Duration	
Motor Operated Valves [DG #1/DG #2] (4)	.48	80/70	180/170 (Approx)	VARIOUS	0							
Load Center Transf. ⁽¹¹⁾	2X25	4.16	1	(1000)	AUTO	0	(20.3)	30 days	(20.3)	30 days	(20.3)	30 days
	2x26	4.16	1	(1000)	AUTO	0	(24.1)	30 days	(24.1)	30 days	(24.1)	30 days
Service Water Pump (A or C)	4.16	1	800	EFAS - SIAS - MSIS	4.5	790	30 days	790	30 days	790	30 days	
Service Water Pump (B)	4.16	1	800	EFAS - SIAS - MSIS	6							
HPSI Pump (A)	4.16	1	600	SIAS	10	530	30 days	530	2 hours			
HPSI Pump (B)	4.16	1	600	SIAS	10	530	30 days	530	2 hours			
HPSI Pump (C)	4.16	1	600	SIAS								
LPSI Pump (A/B)	4.16	1	450	SIAS (START) RAS (STOP)	15	240	2 hours	240	2 hours	400	(3)	
Containment Cooling Fans	.48	2	75	CCAS	18.2	150	30 days	150	30 days	150	30 days	
Containment Spray Pumps	4.16	1	450	CCAS	22.7	420	30 days	420	30 days			
Charging Pump (A or B)	.48	1	100	SIAS	50	58	21 hours	70	30 days			
Charging Pump (C)	.48	1	100	SIAS	60	58	21 hours	70	21 hours	70	30 days	
Charging Pump Room Unit Coolers (Interlocked with charging pumps)	.48	2	5	SIAS	50/60	10	21 hours	10	30 days	70 10	21 hours 30 days	

ARKANSAS NUCLEAR ONE
UNIT 2

Table 8.3-1 (continued)

Equipment	KV	No. Of Component Per Diesel	Component H.P. Rating (KW/KVA)	Actuation Signal	Component Start Times (Sec.) (1)	DIESEL GENERATOR LOADING CONDITIONS					
						Condition I Loss of Coolant With Loss of Offsite Power		Condition II Main Steam Line Ruptures With Loss Of Offsite Power		Condition III Loss of Offsite Power	
						HP ⁽⁸⁾ (KW/KVA)	Duration	HP (KW/KVA)	Duration	HP (KW/KVA)	Duration
Emergency Diesel Generator Exhaust Fans	.48	2	15	AUTO	70	30	30 days	30	30 days	30	30 days
Switchgear Room Exhaust Fans	.48	1	25	MANUAL		25	30 days	25	30 days	25	30 days
Boric Acid Makeup Pumps (Diesel #2 Only)	.48	2	25	SIAS	70	50	5 hours	50	21 hours	50	21 hours
Intake Structure Exhaust Fans	.48	1	10	SIAS - MSIS	70	10	30 days	10	30 days	10	30 days
Penetration Room Exhaust Fans	.48	1	10	CIAS	70	10	30 days	10	30 days		
Switchgear Room Unit Coolers ⁽⁵⁾	.48	2	5	SIAS - AUTO	80	10	30 days	10	30 days	10	30 days
Shutdown Heat Exchanger Room Unit Coolers	.48	3	10	SIAS	80	20	30 days	20	30 days	20	30 days
HPSI Pump Room Unit Coolers	.48	1	5	SIAS	80	5	30 days	5	⁽³⁾		
Auxiliary Bldg. Elec. Equip Rm. Unit Coolers (DG #1/DG #2)	.48	2	5/1	SIAS	80	10/2	30 days	10/2	30 days	10/2	30 days
Emergency Feedwater Pump (Diesel #1 Only)	4.16	1	600	EFAS	85	600	⁽⁹⁾	600	⁽⁹⁾	600	⁽⁹⁾
Emergency Feedwater Pump Room Unit Coolers (Diesel #1, [Diesel #2])	.48	1	10	AUTO	85 [90]	10	30 days	10	30 days	10	30 days
NSS Instrument AC Panels	.48	2	(105)	AUTO	-	37.5	30 days	37.5	30 days	37.5	30 days
120V Regulated Ins Bus Loads ⁽¹⁰⁾	.48	2	⁽¹⁰⁾	AUTO	-						
Battery Charger ⁽⁷⁾	.48	1	(60.3)	AUTO		60.3		60.3		60.3	
Battery Charger (Non 1E, Diesel #2 Only) ⁽⁷⁾	.48	1	(60.1)	AUTO		(60.1)		(60.1)		(60.1)	
Control Room Emergency Air Filter Fan	.48	1	5	AUTO		5	30 days	5	21 hours	5	30 days

ARKANSAS NUCLEAR ONE
UNIT 2

Table 8.3-1 (continued)

Equipment	KV	No. Of Component Per Diesel	Component H.P. Rating (KW/KVA)	Actuation Signal	Component Start Times (Sec.) (1)	DIESEL GENERATOR LOADING CONDITIONS					
						Condition I Loss of Coolant With Loss of Offsite Power		Condition II Main Steam Line Ruptures With Loss Of Offsite Power		Condition III Loss of Offsite Power	
						HP ⁽⁸⁾ (KW/KVA)	Duration	HP (KW/KVA)	Duration	HP (KW/KVA)	Duration
Turbine Turning Gear Oil Pump (DG #2 Only)	.48	1	40	SIAS - OFF			40	5 days	40	5 days	
Turbine Turning Gear (DG #2 Only)	.48	1	60	SIAS - OFF			60	5 days	60	5 days	
Oil Lift Pump (T.G. Bearing)	.48	3	5	SIAS - OFF			15	5 days	15	5 days	
Main Feedwater Pump Turbine Turning Gear	.48	1	1.5	SIAS - OFF			1.5	5 days	1.5	5 days	
Main Feedwater Pump (AC Lube Oil Pump)	.48	1	20	SIAS - OFF			20	5 days	20	5 days	
Containment Building Recirc. Fans	.48	2	15	MANUAL		14.2	30 days				
Boric Acid Makeup Tank and Pipe Heaters	.48	4	(74)	SIAS - OFF		(10)	30 days	(24)	30 days	(24)	
Electrical Room Unit Coolers	.48	1	3	MANUAL		3	30 days	3	30 days	3	
Computer Inverter ⁽¹⁰⁾	.48	1	(30)	AUTO							
Control Room Emergency Air Conditioners											
Compressor	.48	1	50	MANUAL							
Cooler Fan	.48	1	10	MANUAL		10	30 days	10	30 days	10	
Unit Heater	.48	1	(50)	MANUAL		(50)	30 days	(50)	30 days	(50)	
Non-1E inverter (Diesel #1 Only)	.48	1	(40)	AUTO		(20.0)	30 days	(20.0)	30 days	(20.0)	
Hydrogen Recombiners	.48	1	(75)	MANUAL							
Battery Room Exhaust Fans ⁽¹²⁾	.48	1	2.5	AUTO		2.5	30 days	2.5	30 days	2.5	
Diesel Oil Transfer Pumps	.48	1	2	AUTO		2	30 days	2	30 days	2	
Hydrogen Purge System Seal Water pump	.48	1	1	MANUAL							

ARKANSAS NUCLEAR ONE
UNIT 2

Table 8.3-1 (continued)

Equipment	KV	No. Of Component Per Diesel	Component H.P. Rating (KW/KVA)	Actuation Signal	Component Start Times (Sec.) (1)	DIESEL GENERATOR LOADING CONDITIONS					
						Condition I Loss of Coolant With Loss of Offsite Power		Condition II Main Steam Line Ruptures With Loss Of Offsite Power		Condition III Loss of Offsite Power	
						HP ⁽⁶⁾ (KW/KVA)	Duration	HP (KW/KVA)	Duration	HP (KW/KVA)	Duration
Turbine Turning Gear Oil Pump (DG #2 Only)	.48	1	40	SIAS-OFF				40	5 days	40	5 days
Turbine Turning Gear (DG #2 Only)	.48	1	60	SIAS-OFF				60	5 days	60	5 days
Diesel Generator Starting Air Compressors	.48	2	5	AUTO			10	10		10	
Reactor Coolant Pump Oil Lift Pumps	.48	2	3	MANUAL			6	6		6	
Cavity Cooling Fans (5 H.P. Running)	.48	1	40	MANUAL							
Pressurizer Proportional Heaters	.48	13	(13.16)	MANUAL			(179.6)	(179.6)		(179.6)	
Electrical Equipment Room Exhaust Fans	.48	1	25	AUTO	90		25	30 days	25	30 days	25 30 days
Total Expected Maximum Load in KW = (Hp x .746)/Efficiency ⁽²⁾							3036		3040		2350
Diesel Generator 1											
Diesel Generator 2							2495		2560		2041

NOTES:

- (1) Sequencing of the diesel generator loads is accomplished by time delay relays on the individual components. This column gives the delay setpoints of the individual relays. The time delays start after:
- a) The diesel generator supply breaker to the ESF bus closes to re-energize the bus (15 sec. maximum).
 - b) The particular EFAS signal is received.

ARKANSAS NUCLEAR ONE
UNIT 2

Table 8.3-1 (continued)

- (2) In determining diesel loading conditions, manufacturer's test data and system operating conditions were utilized. On components for which manufacturer's test data was not yet available, the motor horsepower ratings were used to ensure conservativeness of design. Table 8.3-1 does not list all loads connected to the ANO-2 Emergency Diesel Generator. However, the total expected maximum load (KW) values were derived from the total load, for all EDG loads, indicated in EDG calc. #85S-00002-01.
- (3) The reactor coolant system pressure will be increased above the shutoff head of the safety injection pumps shortly after the main steam line rupture. These loads can be secured by the operator after the low system pressure signal has cleared. For the LOOP condition, no load should be present due to the LPSI pumps until shutdown cooling is established some time after 2 hours.
- (4) Due to the short duration of these loads, their loading values were not considered for Diesel Continuous Rating.
- (5) Switchgear Room Unit Coolers will auto re-start following LOOP if running previous to loss of power.
- (6) Capability to re-energize heaters (when the diesel generators are supplying power) is included.
- (7) Battery charger rating for worst case charger, 2D31B, 400A current limit at 125 VDC (Non-1E charger, 2D33, rated 400A current limit at 125 VDC). Load assumes diesel generator is started after an 8-hour emergency duty cycle discharge of battery. Assume 1HP = 1KVA.
- (8) Condition 1, Loss of Coolant Accident (LOCA) with loss of offsite power, actually includes the Small Break Loss of Coolant Accident (SBLOCA) condition. Both conditions are addressed in Calculation No. 85S-00002-01, and the equipment HP values shown in the table reflect the worst case loading of the two conditions.
- (9) Full EFW flow is assumed during the first 2 hours of either accident condition. Operator action is generally credited with controlling flow beyond the 2 hour time frame.
- (10) The 1E inverter loads are assumed to be zero for all periods because the battery charger loading is assumed to be at maximum output and this conservatively accounts for all DC loads, including inverters, throughout all load periods.
- (11) The load shown for load center transformers 2X25 & 2X26 represent transformer losses only. The actual connected load on these transformers is represented by the loads on specific components downstream.
- (12) There are 3 EDG backed Battery Room Exhaust Fans. Fan 2VEF61 is connected to EDG #1, and Fans 2VEF65 and 2VEF49 are connected to EDG #2. 2VEF61 and 2VEF65 have 2.5 HP motors, but the motor for 2VEF49 is 3 HP. Fans 2VEF49 and 2VEF61 will auto re-start following LOOP if running previous to loss of power

ARKANSAS NUCLEAR ONE
UNIT 2

Table 8.3-2

**RATINGS OF CLASS 1E
ELECTRICAL DISTRIBUTION EQUIPMENT**

<u>DIESEL GENERATOR</u>	<u>2 Units, each rated</u>	
Rating, KW (continuous)	2850	
Starting time to rated speed and voltage, Sec	15	
Power Factor, lagging	0.80	
Frequency, Hz	60	
Voltage, KV	4.16	
Overload Capacity, % (2 hours in any 24 hours)	10.0	
Largest motor to be started, HP	800 (service water pump)	
Cooling Water available: River Water		
Normal/Max Temperature, °F	72/120	
Minimum Temperature, °F	33	
Supply Pressure, psig	60 to 90	
Inlet Air Temperatures:		
Max °F	113; 40% - 60% R.H.*	
Minimum, °F	15*	
<u>4160V SWITCHGEAR</u>	<u>Bus 2A4</u>	<u>Bus 2A3</u>
Rated Maximum Voltage, KV	4.76	4.76
Nominal MVA	250	350
Rated Voltage Factor (K)	1.24	1.19
Rated Bus Continuous Current, A rms	1200	1200
Rated Short Circuit Current, A rms (at Max Voltage)	29,000	41,000
Closing and Latching Capability, A rms	58,000	78,000
Control Voltage, V dc	125	125

* These values are contained in the original procurement specification. Subsequent design calculations document acceptability of maximum temperature at 120 °F.

ARKANSAS NUCLEAR ONE
UNIT 2

Table 8.3-2 (continued)

480V LOAD CENTERS AND TRANSFORMERS

TRANSFORMER

Output, KVA	1000		
Type	Sealed dry, gas filled		
Temperature rise, °C	150 above 30 avg.		
H.V. Winding			
rated voltage, KV	4.16		
connection	delta		
BIL rating, KV	60		
L.V. Winding			
rated voltage, V	480		
connection	wye		
BIL rating, IV	30		
Taps no load full capacity			
above rated voltage, %	Two - 2½		
below rated voltage, %	Two - 2½		
Impedance, % (on rated KVA)	8		
Circuit Breakers			
Control Voltage, V d-c	125		
<u>Frame Size</u>	<u>Interrupting Rating</u>		<u>Rated</u>
<u>Amperes</u>	<u>RMS Sym. Amperes</u>		<u>Volts a-c</u>
	<u>With</u>	<u>Without</u>	
	<u>Instantaneous Trip</u>	<u>Instantaneous Trip</u>	
225	22,000	14,000	480
600	30,000	22,000	480
1600	50,000	42,000	480

ARKANSAS NUCLEAR ONE
UNIT 2

Table 8.3-2 (continued)

480V MOTOR CONTROL CENTERS

Circuit Breakers

Voltage Rating, V	600
Frame Size, A	100 through 250
Interrupting Rating, A rms Symmetrical @ 480 V	22,000 or greater

Magnetic Motor Controller (NEMA - Size 1)

Voltage Rating, V	600
Control Circuit Voltage, V a-c	120
Control Transformer	Single Phase
Voltage ratio	480/120
Volt ampere Capacity, VA	50 min

Buses

Short circuit current, A symmetrical	22,000
Main, current capacity, A	600 @ 50 °C
Vertical, Current capacity, A	300 @ 50 °C
Neutral, Current capacity, A	300 @ 50 °C

BATTERY CHARGERS

5 Units, each rated

2D31A, 2D31B
2D32A, 2D32B
2D33

Input

Voltage, V	416 – 506 VAC
Frequency, Hz	60 ± 3%

Output

Float Voltage, V	123- 135 VDC (adjustable)
Equalizing Charge, V	132 – 142 VDC (adjustable)
d-c current, A	400
Continuous Battery Load, A	≈ 200A (red & green train)* ≈ 12A (non-1E)*
Voltage Regulation, %	0.50

*Reference Calculations 86-E-0020-01, 86-E-0020-02, and 92-E-0072-07 for actual loads.

ARKANSAS NUCLEAR ONE
UNIT 2

Table 8.3-2 (continued)

<u>BATTERIES</u>	<u>2D11</u>	<u>2D12</u>	<u>2D13</u>
Capacity, amp-hr (at 77 °F to end of discharge voltage)	2064	2064	2175
Cells per battery	58	58	60
Voltages			
Equalize (2.33 – 2.50 V/cell)	135.1 – 145.0	135.1 – 145.0	139.8 – 150.0
Floating (2.20 – 2.25 V/cell)	127.6 – 130.5	127.6 – 130.5	132.0 – 135.0
End of discharge	105	105	105
Cell voltage, V	1.81	1.81	1.75

125V D-C CONTROL CENTERS

Circuit Breakers

Voltage Rating, V d-c	250
Poles	2
Minimum Interrupting Rating @ 250 V d-c, A d-c	10,000

Fuses

Voltage Rating, V d-c	500
Minimum Interrupting Rating @ 500 V d-c, A d-c	100,000

Buses

Short Circuit Current, A d-c	10,000
Horizontal Continuous rating, A	1200
Vertical Continuous rating, A	600

STATION INVERTERS

6 Units, each rated

Output Rating

Output (at Load P.F.), KVA	10
Load Power Factor	0.8 to unity
Output Volts, V a-c	120
Output Frequency, Hz	60
Output Circuit	Single Phase 2-Wire, Ungrounded

Input Rating

Normal Input	
Voltage, VDC	100-142
Interrupting Rating A @ 250 VDC	10,000

Frequency Regulation

Commercial power available	Synchronous
Free running, Hz	60 ± ½%

ARKANSAS NUCLEAR ONE
UNIT 2

Table 8.3-2 (continued)

STATION INVERTERS (continued)

Voltage Regulation (Steady State), %	± 1
Total Harmonic Distortion, % rms volts	5
Efficiency, %	80 or better

120V VITAL AC PANELS

4 Units, each rated

Service, V	208/120
Number of outgoing circuits	18
Circuit Breakers, A	20
Bus Bar Rating, A	225
Short Circuit Rating, A	5000

125V DC DISTRIBUTION PANELS

4 Units, each rated

Number of outgoing circuit	18
Service, V dc	125
Short Circuit Rating, A	10,000 OR GREATER
Bus Bar Rating, A	225

125V DC MOTOR CONTROL CENTERS

Circuit Breakers	
Voltage Rating	250 VDC
Frame Size, Amps	10, 20, and 25
Interrupting Rating, Amps @ 250 VDC	10,000
Starters	
Single-speed, FVR	
Voltage rating, volts DC	250
Buses	
Short circuit current, Amps	42,000
Main, current capacity, Amps	
horizontal	600
vertical	300
Ground, Amps	600

ARKANSAS NUCLEAR ONE
UNIT 2

Table 8.3-3

**STORAGE AREAS FOR
CLASS IE ELECTRIC EQUIPMENT**

<u>Storage</u>	<u>Equipment</u>
Outdoor	Power and control cables on the reels Electrical cable tray and conduit
Weatherproof	5-kV switchgear 480-V load centers 480-V motor control centers 125-V d-c control centers
Indoor	Preferred instrument ac equipment 125-V station batteries and chargers Control boards, consoles, and cabinets except NSS cabinets Electrical connectors Electrical conduit and cable tray fittings, and hardware Anchor bolts and fasteners Instrumentation cables Class I motors
Indoor heated	Diesel engine generators Motor controllers and other electrical devices

ARKANSAS NUCLEAR ONE
UNIT 2

Table 8.3-4A

125-VOLT DC BATTERIES 2D11 LOAD CHART

#	Load Center Circuit Breaker	Equipment Tag	LOAD (amps)						
			<u>1 min</u>	<u>29 min</u>	<u>1 min</u>	<u>29 min</u>	<u>60 min</u>	<u>359 min</u>	<u>1 min</u>
1.	72-0111	(Spare)	0	0	0	0	0	0	0
2.	72-0112	(Spare)	0	0	0	0	0	0	0
3.	72-0113	2Y11	84	84	84	84	84	84	84
4.	72-0114	2Y13	75	75	75	75	75	0	0
5.	72-0121	2D27	120	0	46	0	0	0	0
6.	72-0122	2RA1	6	0	0	0	0	0	0
7.	72-0123	2D31A	0	0	0	0	0	0	0
8.	72-0124	(Spare)	0	0	0	0	0	0	0
9.	72-0131	2Y1113	0	0	0	0	0	0	0
10.	72-0132	(See 72-0133)	0	0	0	0	0	0	0
11.	72-0133	2D21	144	40	40	40	40	40	40
12.	72-0133	2D23	53	20	20	20	20	20	37
13.	72-0133	2D31B	0	0	0	0	0	0	0
14.	72-0134	2Y25	193	193	193	193	0	0	0
15.	72-0141	(Inst. Comp.)	0	0	0	0	0	0	0
16.	72-0142	(See 72-0133)	0	0	0	0	0	0	0
TOTAL OF LOADS			675	412	458	412	219	144	161

Note: This emergency duty cycle curve represents an approximation of the actual loads on station battery 2D11. For the most current emergency duty cycle curve, review the controlled engineering calculations.

ARKANSAS NUCLEAR ONE
UNIT 2

Table 8.3-4B

125-VOLT DC BATTERIES 2D12 LOAD CHART

#	Load Center <u>Circuit Breaker</u>	<u>Equipment Tag</u>	LOAD (amps)				
			<u>1 min</u>	<u>30 min</u>	<u>90 min</u>	<u>360 min</u>	<u>1 min</u>
1.	72-0211	SPARE	0	0	0	0	0
2.	72-0212	SPARE	0	0	0	0	0
3.	72-0213	2Y22	76	76	76	76	76
4.	72-0214	2Y24	70	70	70	0	0
5.	72-0221	2D26	126	112	1	1	1
6.	72-0222	2RA2	6	0	0	0	0
7.	72-0223	SPARE	0	0	0	0	0
8.	72-0224	2D32	0	0	0	0	0
9.	72-0231	2Y2224	0	0	0	0	0
10.	72-0232	See 72-0233	0	0	0	0	0
11.	72-0233	2D22	128	30	30	30	30
.		2D24	53	20	20	20	37
.		2D32B	0	0	0	0	0
12.	72-0234	SPACE	0	0	0	0	0
13.	72-0241	INST. COMP	0	0	0	0	0
14.	72-0242	See 72-0223	0	0	0	0	0
TOTAL OF LOADS			459	308	197	127	144

Note: This emergency duty cycle curve represents an approximation of the actual loads on station battery 2D12. For the most current emergency duty cycle curve, review the controlled engineering calculations.

ARKANSAS NUCLEAR ONE
UNIT 2

Table 8.3-5

125-VOLT DC STATION BATTERY 2D11 EMERGENCY DUTY CYCLE

EMERGENCY DUTY CYCLE BATTERY 2D11

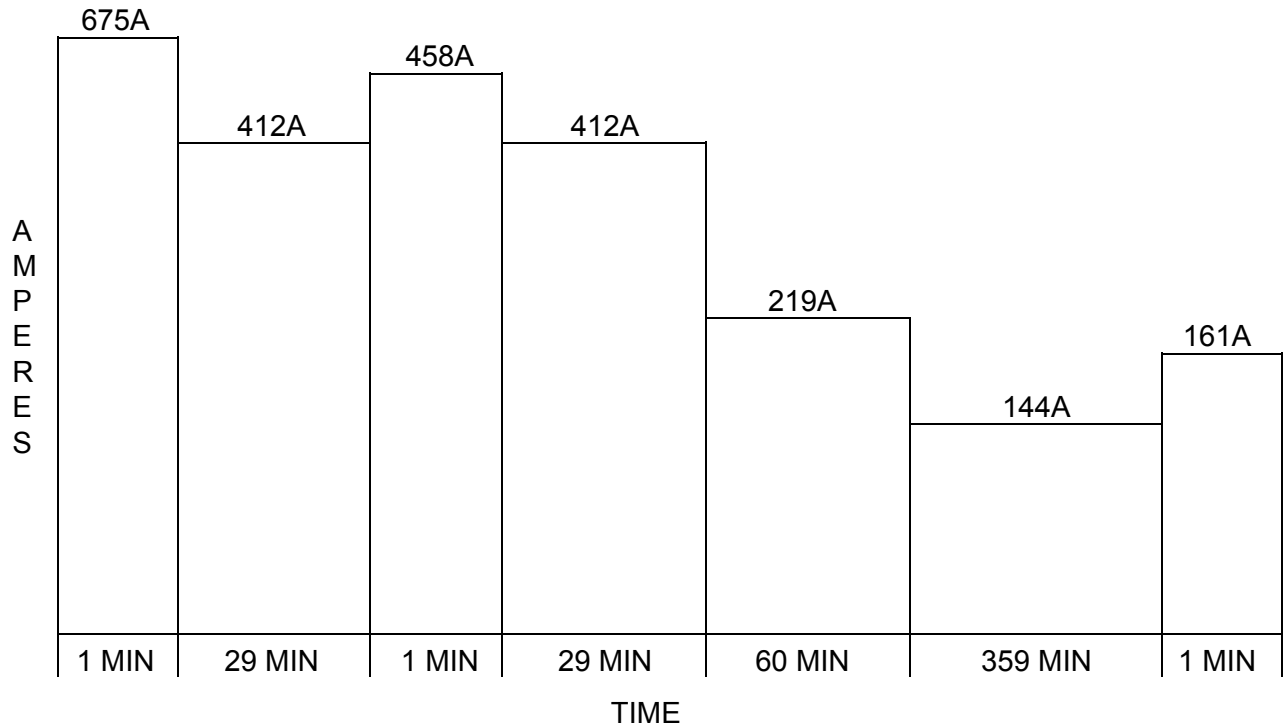

NOTES

1. Battery sizing includes factors for 80% end of life and 60 °F minimum operating temperature per IEEE 485-1983. These factors are in addition to the actual loads indicated above.
2. This emergency duty cycle curve represents an approximation of the actual loads on station battery 2D11. For the most current emergency duty cycle curve, review the controlled engineering calculations.

ARKANSAS NUCLEAR ONE
UNIT 2

Table 8.3-6

125-VOLT DC STATION BATTERY 2D12 EMERGENCY DUTY CYCLE

EMERGENCY DUTY CYCLE BATTERY 2D12

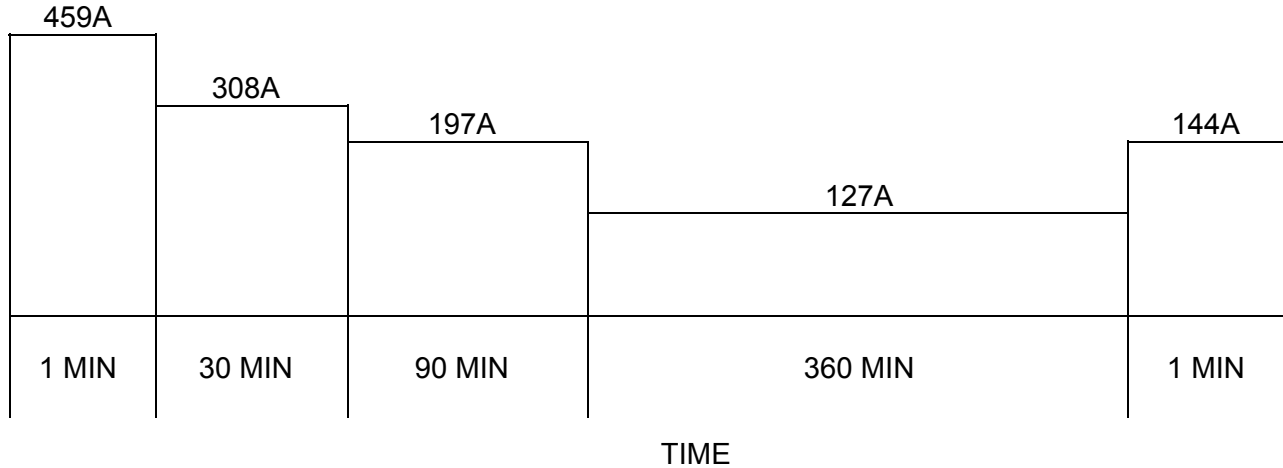

NOTES

1. Battery sizing includes factors for 80% end of life and 60 °F minimum operating temperature per IEEE 485-1983. These factors are in addition to the actual loads indicated above.
2. This emergency duty cycle curve represents an approximation of the actual loads on station battery 2D12. For the most current emergency duty cycle curve, review the controlled engineering calculations.

ARKANSAS NUCLEAR ONE
UNIT 2

Table 8.3-7

4.16 kV ENGINEERED SAFETY FEATURES SYSTEM SINGLE FAILURE ANALYSIS

<u>FAILURE</u>	<u>CAUSE</u>	<u>CONSEQUENCES AND COMMENTS</u>
1. 4.16kV Power to bus 2A3 or 2A4	a. Failure of the associated DG (diesel generator) to start.	<p>a. Failure of the DG to start will result in the loss of one complete ESF actuation channel. The redundant DG will start and supply the redundant ESF loads.</p> <p>The reliability of the DG to start has been enhanced considerably by the following design features:</p> <p>Starting Signal: SIAS backed-up by under voltage relays on 4.16 kV Bus.</p> <p>Starting System: Two air starting systems for each DG</p>
	b. Failure of the DG to develop rated speed and voltage	b. The consequences will be identical to item a. A static excitation system has been used to improve reliability and to ensure fast voltage build-up.
	c. Failure of DG ACB 2A308/2A408 to autoclose	c. Consequences will be identical to item a. Electrical circuits have been designed so that failure of a single relay does not prevent autoclosing of the DG ACB.
	d. Bus fault on bus 2A3/2A4	d. A bus fault will lead to the operation of the bus lock-out relay. The redundant bus will provide the power to the redundant ESF loads.
	e. Loss of associated dc control power source.	e. DC control power to the two redundant 4.16 kV ESF systems supplied from the two redundant batteries. Loss of control power to any one system will not prevent the redundant system from performing the safety function.

ARKANSAS NUCLEAR ONE
UNIT 2

Table 8.3-7 (continued)

<u>FAILURE</u>	<u>CAUSE</u>	<u>CONSEQUENCES AND COMMENTS</u>
	f. Failure of a tie/feeder breaker	<p>f. The two tie breakers between the two busses 2A3 and 2A4 are mechanically locked out during plant operation. These can be used only during post-accident emergency situations when the preferred source is not available and one of the two diesels cannot be started. A failure of one of the two tie breakers cannot affect both redundant systems. One system can, however, be lost if a tie breaker develops a fault, or a fault on a feeder cable is not cleared by the association feeder breaker. This will lead to the operation of the bus lockout relay. Under this condition, the redundant 4.16 kV bus will supply the redundant ESF loads.</p> <p>The Alternate AC Power Source is electrically connected between the two tie breakers. Therefore, the tie breaker on the selected bus must be closed in response to a station blackout (Item 3 below).</p> <p>The ESF System is designed to operate without isolating any component on a single ground fault. As multi-phase faults are relatively few in number, reliability to complete safety functions is greatly increased.</p> <p>The tie/feeder breaker can also be used during shutdown (Modes 5 and 6).</p>
2. 4.16 kV Load (Load Center, Service Water Pump, etc.)	<p>a. Failure of Associated ACB to autoclose</p> <p>b. Stalled Motor</p> <p>c. Feeder Cable Fault</p>	<p>a,b,c. The redundant load on the redundant bus will perform the safety function.</p> <p>The load center feeder breakers are not tripped by load shedding relays. They remain connected to the bus so that they are instantly energized when the DG ACB auto closes. In order to guard against an accidental tripping, however, these breakers have an auto-close signal from the SIAS.</p>

ARKANSAS NUCLEAR ONE
UNIT 2

Table 8.3-7 (continued)

<u>FAILURE</u>	<u>CAUSE</u>	<u>CONSEQUENCES AND COMMENTS</u>
3. 4.16 kV Power to bus 2A3 and 2A4	<p>a. Non-mechanistic failures as defined in the Station Blackout Rule (10CFR50.63) Loss of all AC Power, Station Blackout</p> <p>b. Loss of Offsite Power and simultaneous failures of both Emergency Diesel Generators due to any combination of Items 1.a.-e. above.</p>	<p>This is recognized as a beyond design basis event, is outside of the accident analysis, and beyond the single failure criteria. However, due to the installation of the Alternate AC Power Source per 10CFR50.63, manual operator actions are available to respond to a total loss of AC Power.</p> <p>Within 10 minutes of procedurally declaring a Station Blackout, the operators will start and align the Alternate AC Power Source to either of the safety related 4160 volt buses 2A3 or 2A4. This will energize the selected bus and convert the consequences and operator responses to this scenario to ones similar to Item 1.a. above.</p>

ARKANSAS NUCLEAR ONE
UNIT 2

Table 8.3-8

480-VOLT ENGINEERED SAFETY FEATURES SYSTEM SINGLE FAILURE ANALYSIS

<u>FAILURE</u>	<u>CAUSE</u>	<u>CONSEQUENCES AND COMMENTS</u>
1. 480 Power to bus 2B5 to 2B6	a. Failure of associated load center transformers	Any of the four events a,b,c or d will cause the loss of 480 Volt ESF loads on one channel. The redundant 480 Volt load center bus will supply the redundant ESF loads.
	b. 4.16 kV Cable Fault	
	c. Bus Fault	
	d. Failure of any Load Breaker to clear a fault.	
	e. Loss of dc control power source.	The redundant 480V ESF load centers are supplied from the redundant batteries. A single failure will not result in the loss of control power to both redundant systems.
2. 480V MCC Feeders	a. Feeder Cable Fault	Any of the events a, b, or c will result in the loss of 480V power to the ESF loads connected to the affected MCC. The redundant loads connected to the redundant MCC will perform the safety function.
	b. MCC Bus Fault	
	c. Failure of any MCC load feeder breaker to clear a fault.	
3. 480 Volt Loads	a. Feeder cables Fault	The result will be the loss of the affected actuated component. The redundant component on the other channel will perform the safety function.
	b. Stalled Motor	

ARKANSAS NUCLEAR ONE
UNIT 2

Table 8.3-9

120/208-VOLT INSTRUMENT AC SYSTEM SINGLE FAILURE ANALYSIS

<u>FAILURE</u>	<u>CAUSE</u>	<u>CONSEQUENCES AND COMMENTS</u>
1. Power to bus 2Y1/2Y2	a. Failure of associated transformer 2X11/2X12	Any of these five events will result in the loss of power to the 120/208V loads on one channel. The unaffected bus will supply the redundant ESF The tie breakers between buses 2Y1 and 2Y2 are mechanically interlocked with the incoming feeder breakers (see Figure 8.3-6) to prevent tying the two diesel generator systems together. Since the two tie breakers are locked out during plant operation, a fault on one cannot affect both redundant systems
	b. Cable fault	
	c. Failure of any load breaker to clear fault	
	d. Bus Fault	
	e. Fault on the tie breaker	
2. Any distribution feeder	Cable fault	This will result in loss of power to the connected loads. The redundant loads on the unaffected channel are adequate to insure safety.

ARKANSAS NUCLEAR ONE
UNIT 2

Table 8.3-10

120-VOLT VITAL AC SYSTEM SINGLE FAILURE ANALYSIS

<u>FAILURE</u>	<u>CAUSE</u>	<u>CONSEQUENCES AND COMMENTS</u>
1. 120 VAC Power to buses 2RS1, 2RS2, 2RS3, 2RS4	a. Bus Fault b. Cable Fault c. Failure of a distribution breaker to clear a fault	The result will be the loss of 120 volt vital ac power supply to one of the four channels of the protection system. As a 2 out-of-3 with the fourth channel bypassed criteria is used in all the logic circuits, the remaining channels ensure safe shutdown. The 120 volt vital AC system has been designed as an ungrounded system. The reliability of any channels is consequently greatly enhanced.
2. Any distribution feeder	Cable Fault	This will result in the loss of power to the connected loads. The redundant loads in the remaining three channels are adequate to ensure safety.
3. De-energization of (2RS1 and 2RS3) or (2RS2 and 2RS4)	2D01 or 2D02 bus fault	Loss of vital instrument power to two channels of vital AC results in the RPS failing safe (reactor trips). ESFAS functions with increasing signal setpoint remain operable with one channel tripped and one channel unable to function. ESFAS functions with decreasing signal setpoints fail to their actuated position. Loss of power to the instrumentation for one load group results.

ARKANSAS NUCLEAR ONE
UNIT 2

Table 8.3-11

125-VOLT DC ENGINEERED SAFETY FEATURE SYSTEM SINGLE FAILURE ANALYSIS

<u>FAILURE</u>	<u>CAUSE</u>	<u>CONSEQUENCES AND COMMENTS</u>
1. 125V DC power to bus 2D01 or 2D02	<ul style="list-style-type: none"> a. Bus Fault b. Failure of Load Breaker to clear fault 	<p>The bus fault is assumed to cause a secondary plant trip that results in loss of 480 VAC to the faulted train due to loss of control voltage to the secondary plant, offsite switchgear, on-site switchgear, and EDG. Thus, both vital AC inverters on the faulted train de-energize. In the event of the loss of one DC bus, the redundant bus will supply control power to the ESF loads of the non-faulted train/load group including two vital AC inverters.</p>
2. Battery Charger	<ul style="list-style-type: none"> a. 480V Power Supply Failure b. Charger Fault 	<p>The battery charger is the normal source of DC power. If there is a charger failure, the battery will provide the DC power without interruption. The batteries are sized to meet all ESF load requirements to ensure safe shutdown.</p>
3. Loss of any Control Center breaker	<ul style="list-style-type: none"> a. Cable Fault b. Bus Fault in the Distribution Panel <p style="margin-left: 40px;">Distribution Feeder fault not cleared by associated breaker in the distribution panel.</p>	<p>Loss of power to one of the redundant 125V DC distribution panels will result in loss of control power to the connected ESF loads. The redundant loads connected to the redundant DC system will ensure safe shutdown.</p>
4. Loss of any Distribution Feeder	<ul style="list-style-type: none"> a. Cable Fault 	<p>The fault will be isolated by the associated breaker in the distribution panel. Connected loads on that feeder circuit will lose 125V DC control power. The redundant loads supplied by DC control power from the redundant DC system will provide the ESF function for the disabled circuits.</p>

ARKANSAS NUCLEAR ONE
UNIT 2

Table 8.3-12

**SINGLE FAILURE ANALYSIS OF TRANSFER
TO PREFERRED POWER SOURCE UPON UNIT TRIP**

<u>FAILURE</u>	<u>CAUSE</u>	<u>CONSEQUENCES AND COMMENTS</u>
1. DC power supply lockout relays 286-G2-1&2 or DC power supply to lockout relays 286-G2-3&4	<ul style="list-style-type: none"> a. Loss of DC associated distribution panel b. Control DC fuse failure 	No effect. The duplicate set of lockout relays powered from its associated DC distribution panel will perform all emergency functions and ensure transfer to the preferred power source. Fast transfer will take place if offsite power is available. If the preferred power source is not available, the undervoltage relays on the 4.16 KV ESF buses will start the diesel generators (DG) automatically and meet the load requirements.
2. Damage raceways to panel 2C20 or 2C10	Earthquake or foreign objects falling on the non-class IE raceways	This is the worst case failure. Complete destruction of all non-class 1E cables will disable control circuits of unit auxiliary and preferred source switchgear. Hence, tripping of unit auxiliary transformer No. 2 breaker or transfer to the preferred source cannot occur. Undervoltage relays 127-2A3/2A4-1 on 4.16 KV. ESF busses 2A3/2A4 isolate the DG busses by tripping the incoming feeder breakers 2A309/2A409. Consequently, the functioning of the safety related loads will not be affected.
3. Unit auxiliary transformer No.2 breaker 2A112/2A212	Mechanical failure to trip on trip signal	This will lead to the lockout of one of the bus sections 2A1/2A2. The remaining bus section will be transferred to the preferred source.
4. De-energization of switchgear control power	<ul style="list-style-type: none"> a. Loss of DC associated distribution panel b. Control DC fuse/circuit breaker 	Loss of single power train. The second power train applies control DC independent of the faulted train.

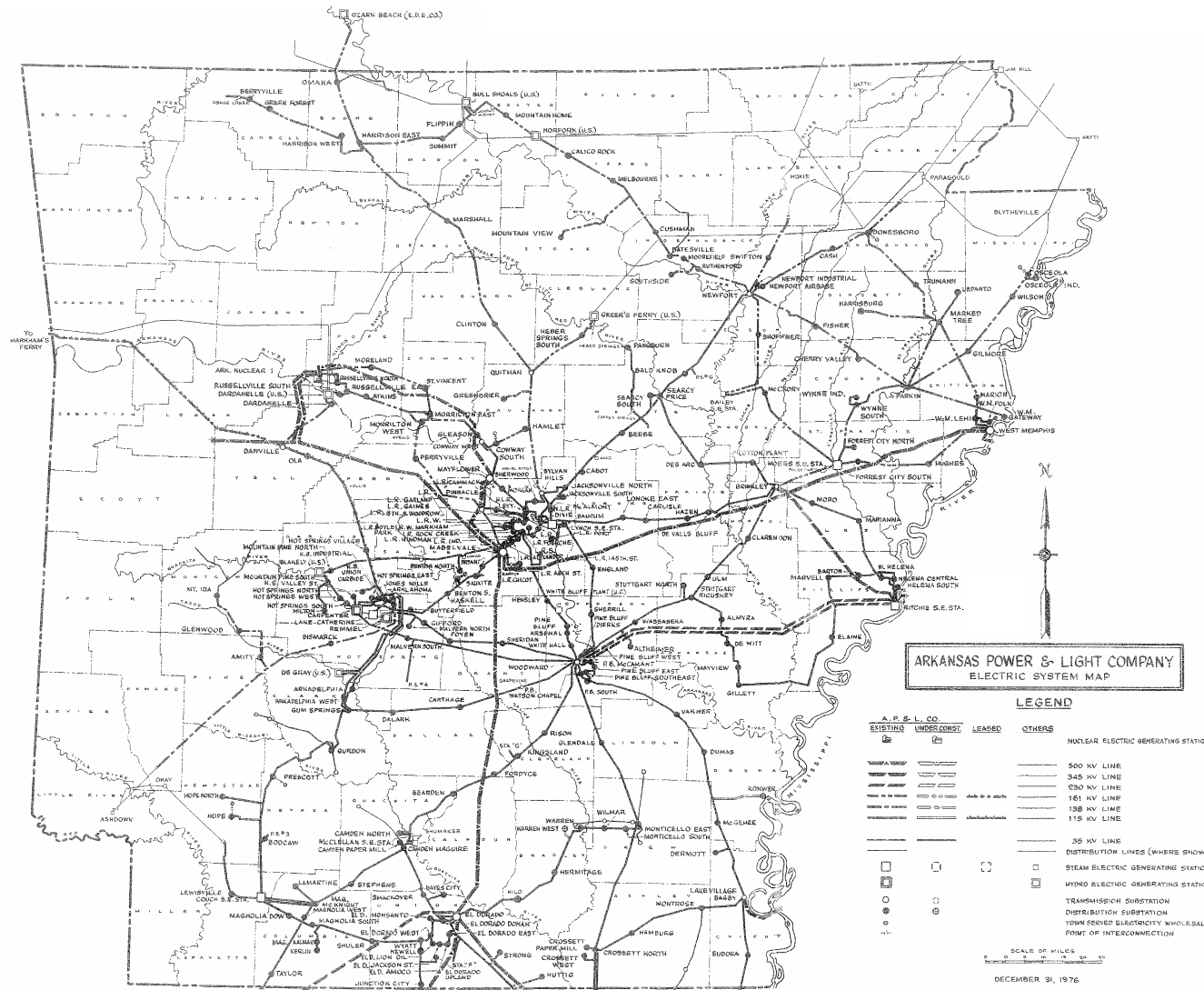

ELECTRIC SYSTEM MAP

SAR FIGURE NO. 8.1-1

ARKANSAS NUCLEAR ONE
UNIT 2
RUSSELLVILLE, ARKANSAS



SCALE: NONE
 DRAWN: ENTERGY
 DESIGN: ENTERGY
 CAD NO:

AMENDMENT 20

BASED ON DRAWING NO

SHEET

REV.

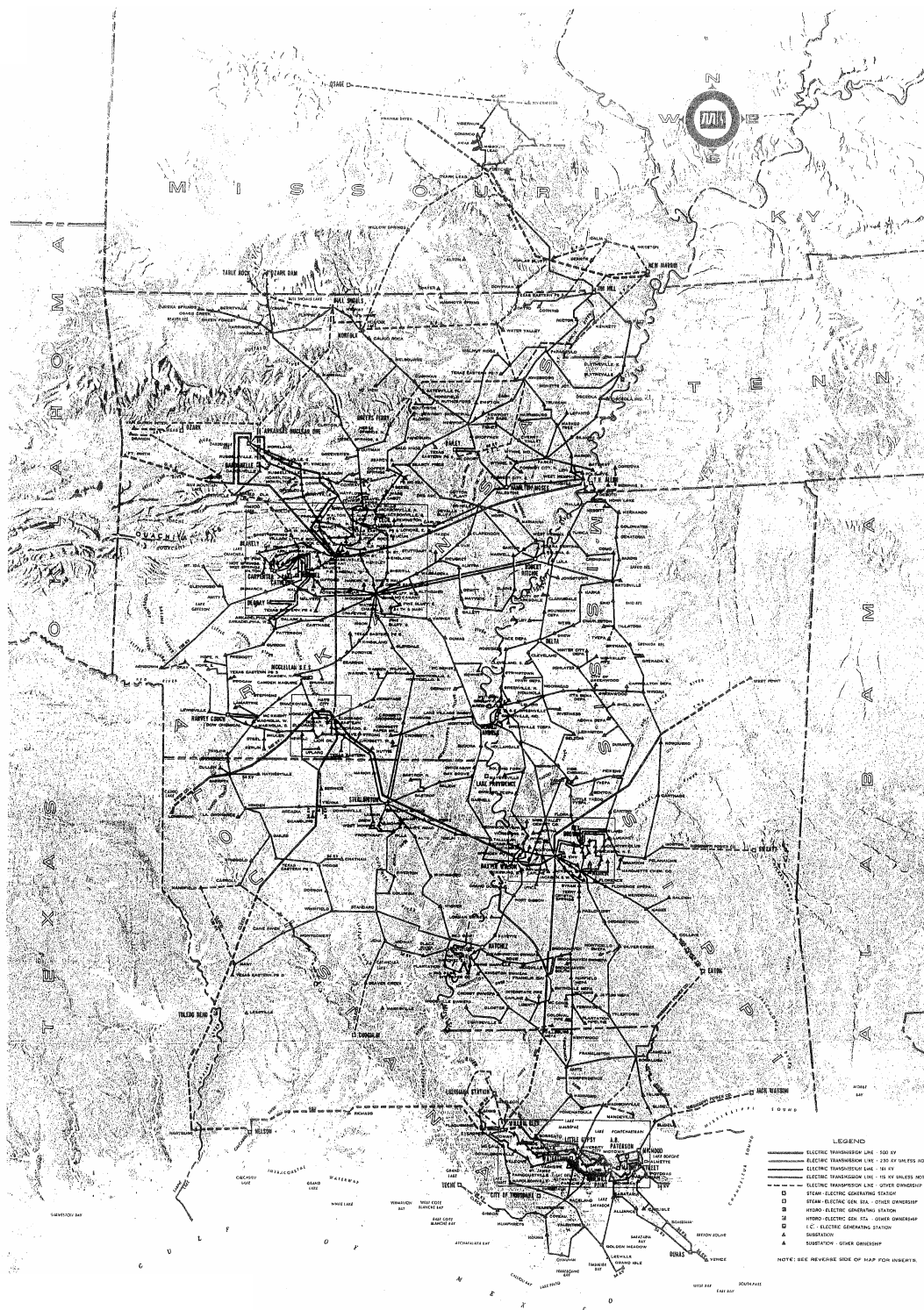

THE MIDDLE SOUTH UTILITIES SYSTEM

ARKANSAS POWER & LIGHT CO. • ARKANSAS-MISSOURI POWER CO. • LOUISIANA POWER & LIGHT CO.
 MISSISSIPPI POWER & LIGHT CO. • NEW ORLEANS PUBLIC SERVICE INC. • MIDDLE SOUTH SERVICES INC.

SAR FIGURE NO. 8.1-2

AMENDMENT 20

ARKANSAS NUCLEAR ONE
 UNIT 2
 RUSSELLVILLE, ARKANSAS



SCALE:	NONE
DRAWN:	ENERGY
DESIGN:	ENERGY
CAD NO:	N/A

THE MIDDLE SOUTH UTILITIES SYSTEM

DRAWING NO

SHEET

REV.



SOUTHWEST POWER POOL

SAR FIGURE NO. 8.1-3

ARKANSAS NUCLEAR ONE
 UNIT 2
 RUSSELLVILLE, ARKANSAS



SCALE: NONE
 DRAWN: ENTERGY
 DESIGN: ENTERGY
 CAD NO:

AMENDMENT 20

BASED ON DRAWING NO

SHEET

REV.

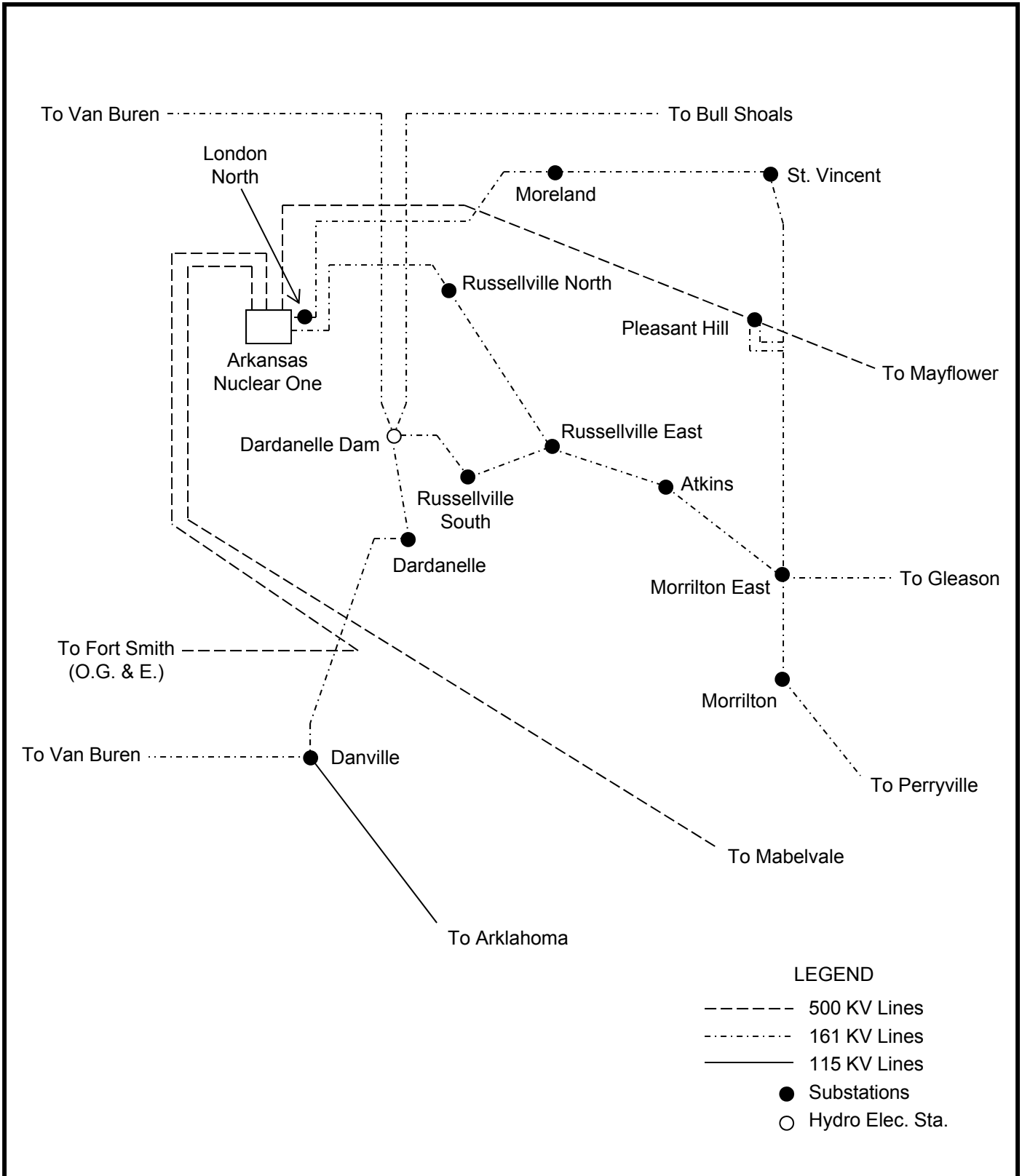

LEGEND

- 500 KV Lines
- 161 KV Lines
- 115 KV Lines
- Substations
- Hydro Elec. Sta.

SAR FIGURE NO. 8.2-1

AMENDMENT 28

ARKANSAS NUCLEAR ONE
 UNIT 2
 RUSSELLVILLE, ARKANSAS



SCALE:	NONE
DRAWN:	ENERGY
DESIGN:	ENERGY
CAD NO:	N/A

SYSTEM CONNECTIONS

DRAWING NO

SHEET

REV.

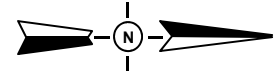
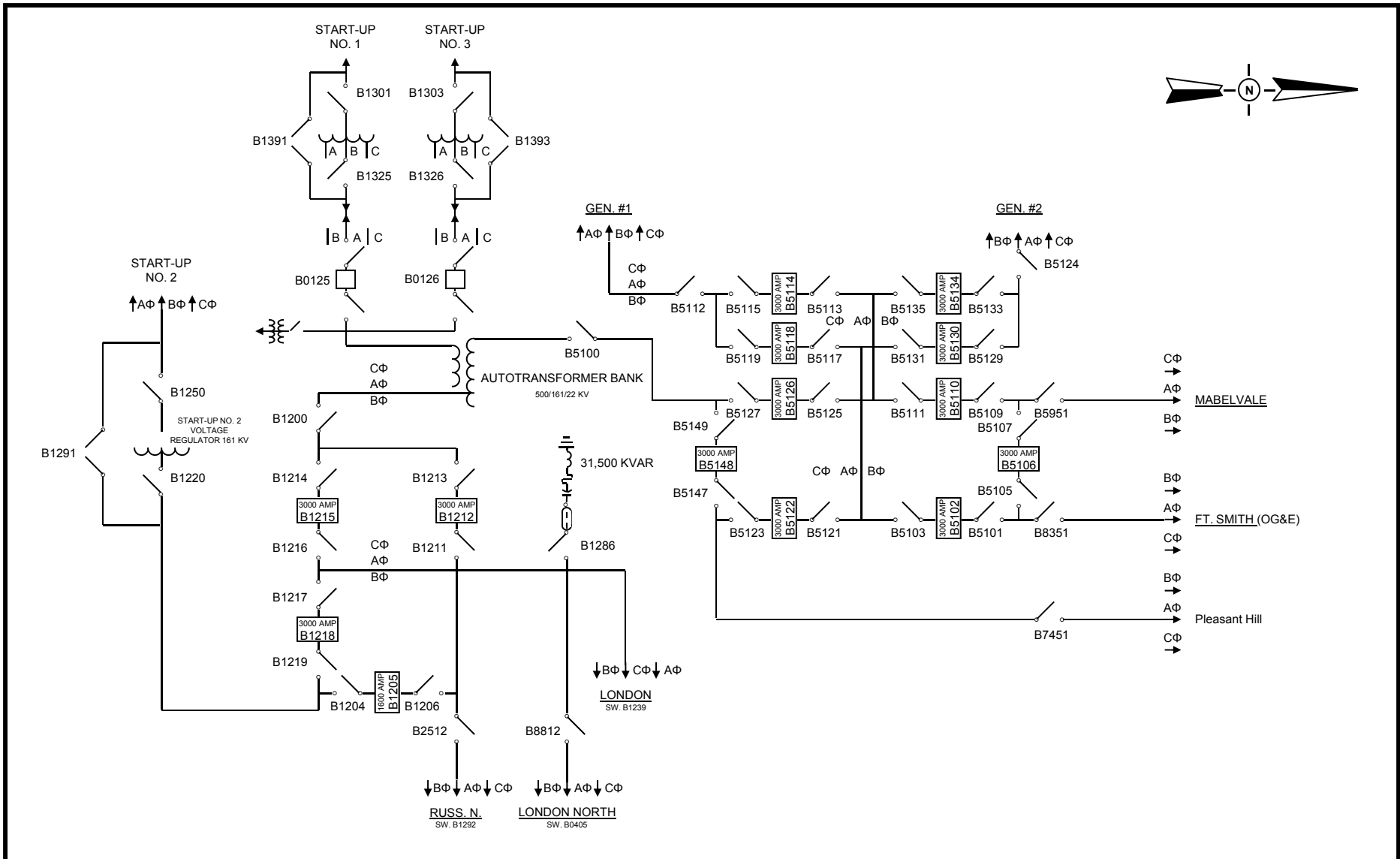

500 – 161 KV SUBSTATION ONE LINE DIAGRAM

SAR FIGURE NO. 8.2-2

ARKANSAS NUCLEAR ONE
 UNIT 2
 RUSSELLVILLE, ARKANSAS



SCALE: NONE
 DRAWN: ENTERGY
 DESIGN: ENTERGY
 CAD NO:

AMENDMENT 28

BASED ON DRAWING NO

SHEET

REV.

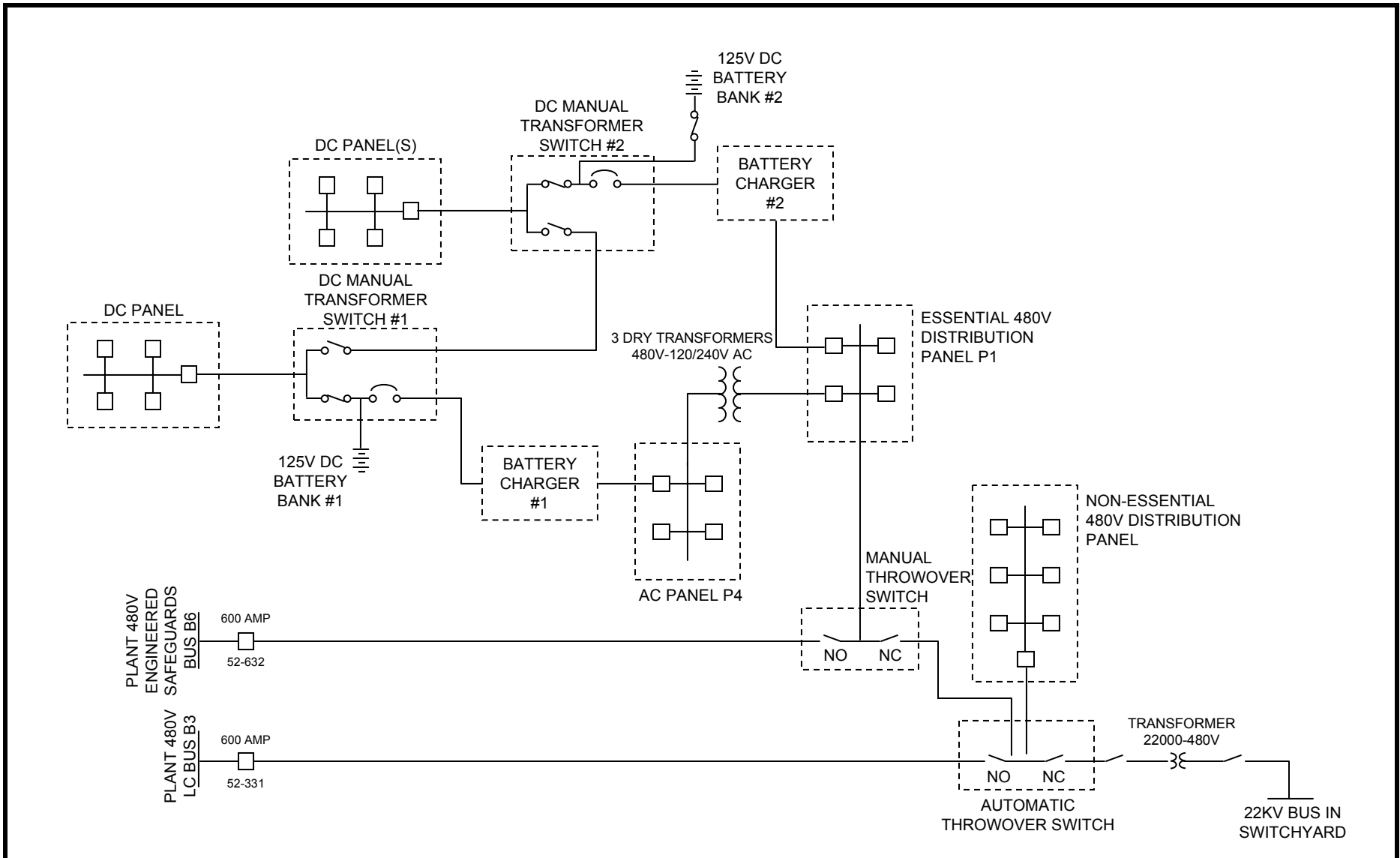

500 KV SWITCHYARD AUXILIARY POWER

SAR FIGURE NO. 8.2-3

ARKANSAS NUCLEAR ONE
 UNIT 2
 RUSSELLVILLE, ARKANSAS



SCALE: NONE
 DRAWN: ENTERGY
 DESIGN: ENTERGY
 CAD NO:

AMENDMENT 21

BASED ON DRAWING NO	SHEET	REV.
---------------------	-------	------

Deleted

SAR FIGURE NO. 8.2-4

AMENDMENT 20

ARKANSAS NUCLEAR ONE
UNIT 2
RUSSELLVILLE, ARKANSAS



SCALE:	NONE
DRAWN:	ENERGY
DESIGN:	ENERGY
CAD NO:	N/A

TRANSMISSION LINE CROSSINGS OVER
OFFSITE POWER SOURCES

DRAWING NO

SHEET

REV.

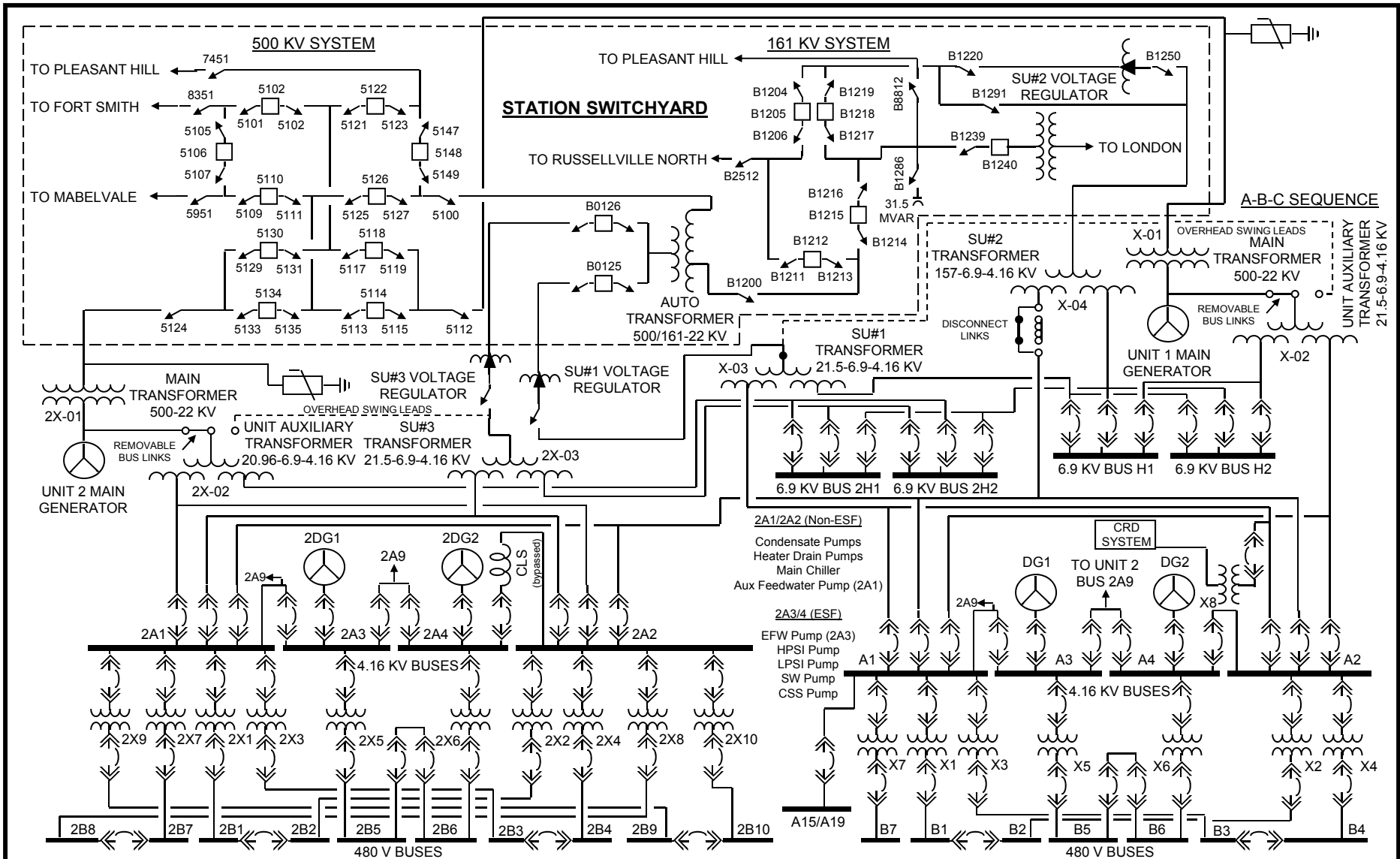

STATION SINGLE LINE DIAGRAM

SAR FIGURE NO. 8.3-1

ARKANSAS NUCLEAR ONE
 UNIT 2
 RUSSELLVILLE, ARKANSAS



SCALE:	NONE
DRAWN:	ENERGY
DESIGN:	ENERGY
CAD NO:	

AMENDMENT 27		
BASED ON DRAWING NO	SHEET	REV.

Deleted

SAR FIGURE NOs. 8.3-2 – 8.3-5

AMENDMENT 20

ARKANSAS NUCLEAR ONE
UNIT 2
RUSSELLVILLE, ARKANSAS



SCALE:	NONE
DRAWN:	ENERGY
DESIGN:	ENERGY
CAD NO:	N/A

DRAWING NO

SHEET

REV.

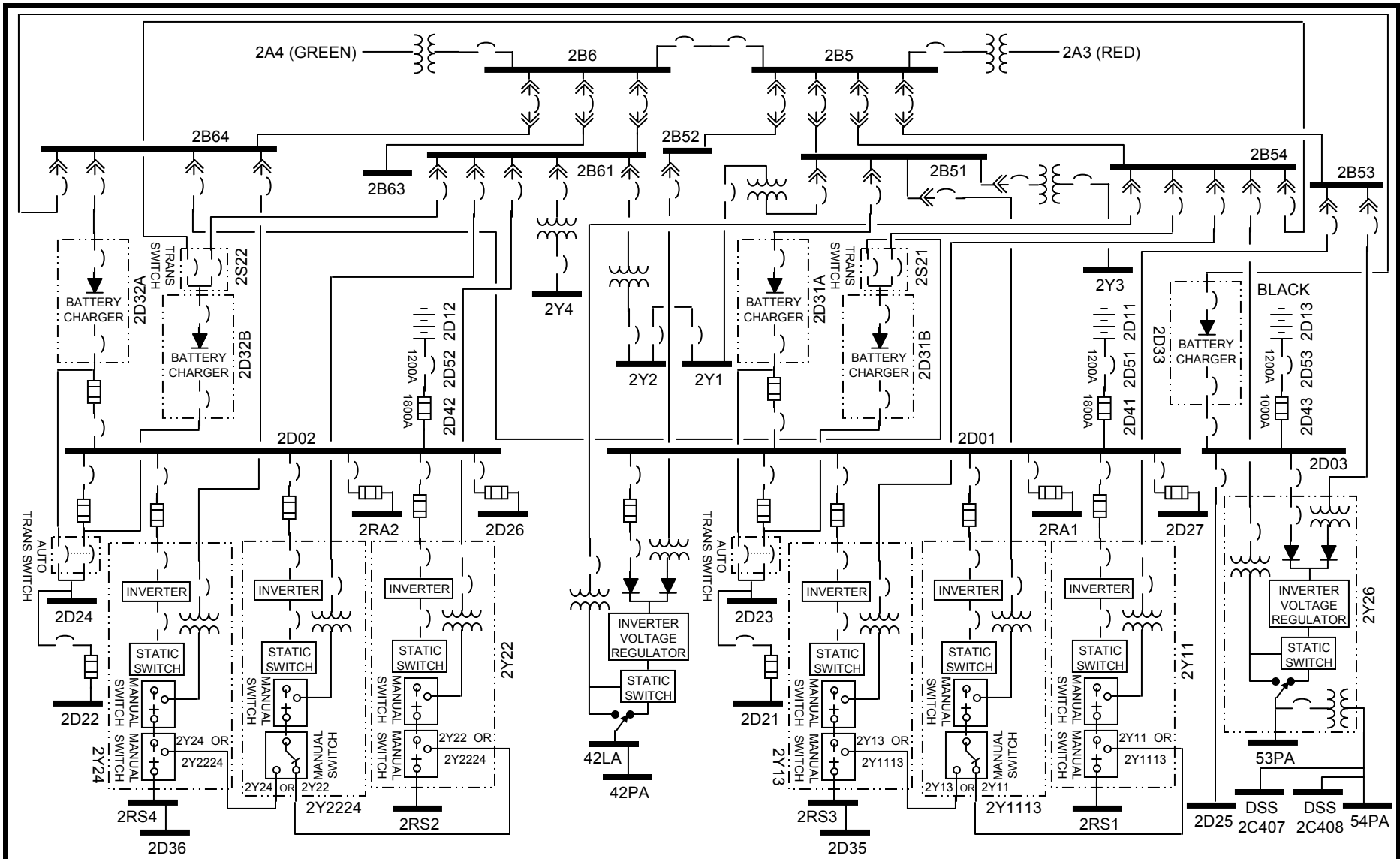

LOW VOLTAGE SAFETY SYSTEM POWER SUPPLIES

SAR FIGURE NO. 8.3-6

ARKANSAS NUCLEAR ONE
 UNIT 2
 RUSSELLVILLE, ARKANSAS



SCALE: NONE
 DRAWN: ENTERGY
 DESIGN: ENTERGY
 CAD NO:

AMENDMENT 23

BASED ON DRAWING NO	SHEET	REV.
---------------------	-------	------

Deleted

SAR FIGURE NOs. 8.3-7 – 8.3-16

AMENDMENT 20

ARKANSAS NUCLEAR ONE
UNIT 2
RUSSELLVILLE, ARKANSAS



SCALE:	NONE
DRAWN:	ENERGY
DESIGN:	ENERGY
CAD NO:	N/A

DRAWING NO

SHEET

REV.

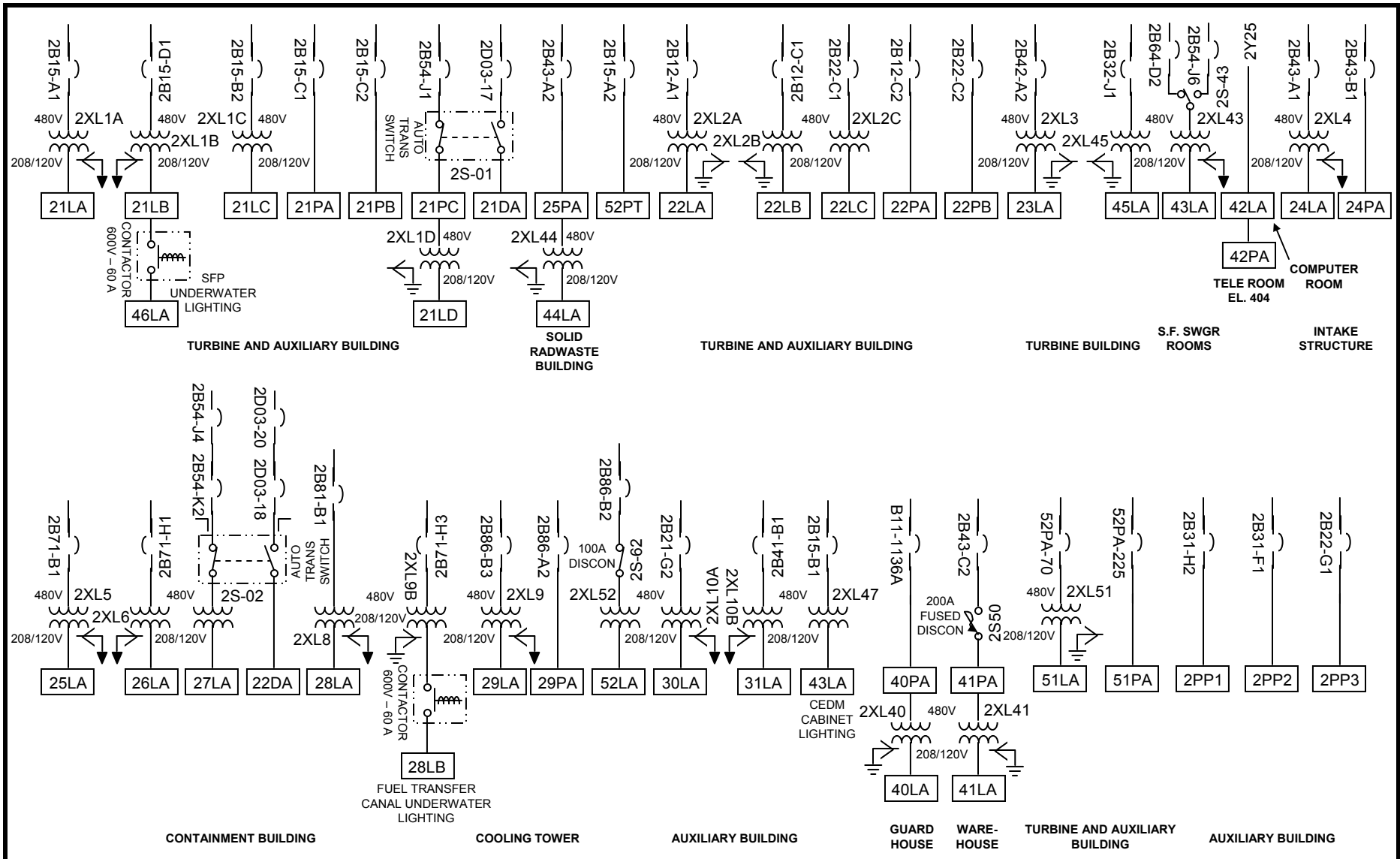

LIGHTING DISTRIBUTION SYSTEM

SAR FIGURE NO. 8.3-17

ARKANSAS NUCLEAR ONE
 UNIT 2
 RUSSELLVILLE, ARKANSAS



SCALE:	NONE
DRAWN:	ENERGY
DESIGN:	ENERGY
CAD NO:	

AMENDMENT 20		
BASED ON DRAWING NO	SHEET	REV.

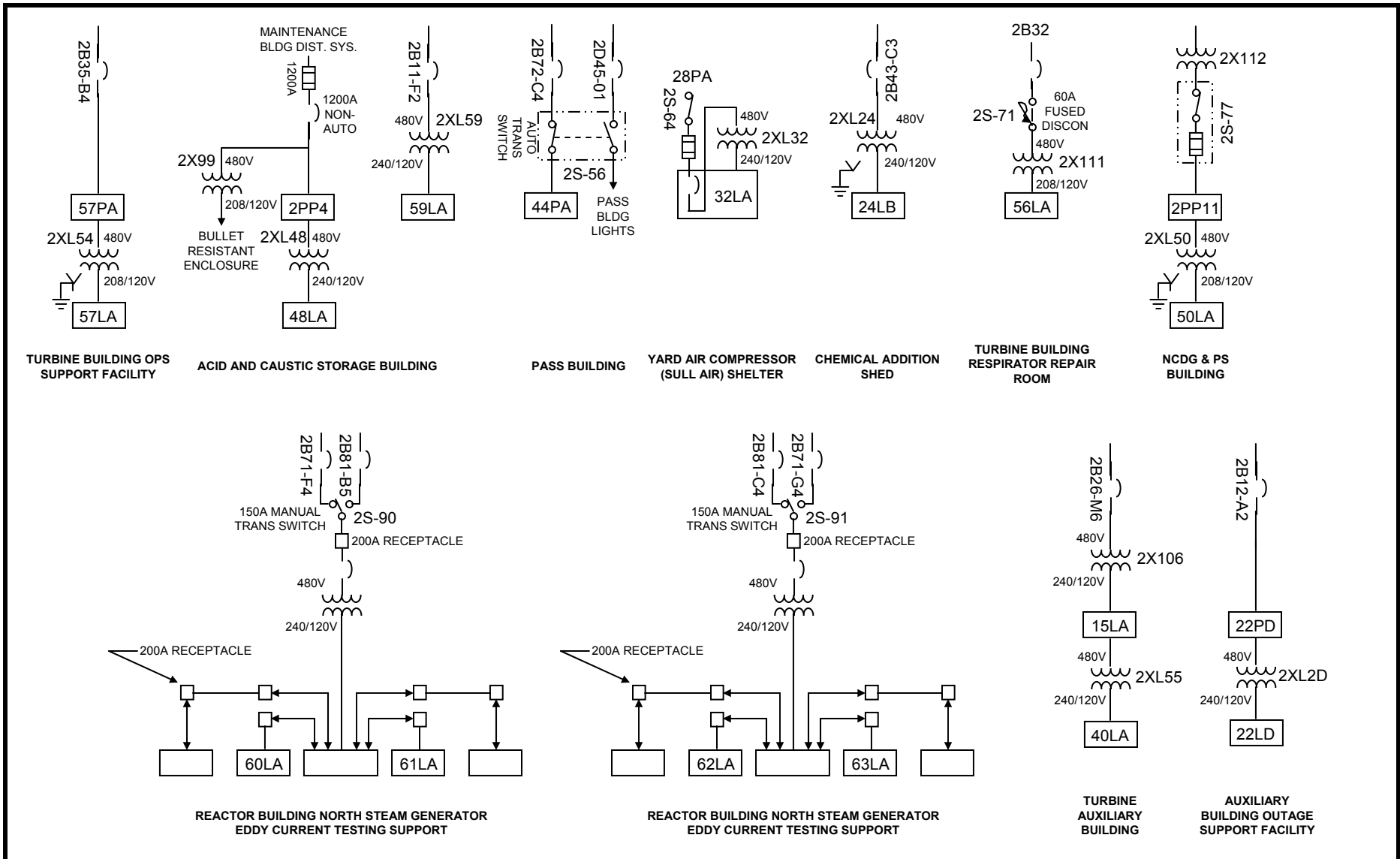

LIGHTING DISTRIBUTION SYSTEM

SAR FIGURE NO. 8.3-18

ARKANSAS NUCLEAR ONE
 UNIT 2
 RUSSELLVILLE, ARKANSAS



SCALE:	NONE
DRAWN:	ENERGY
DESIGN:	ENERGY
CAD NO:	

AMENDMENT 20		
BASED ON DRAWING NO	SHEET	REV.

ARKANSAS NUCLEAR ONE
Unit 2

CHAPTER 9

TABLE OF CONTENTS

<u>Section</u>	<u>Title</u>	<u>Page</u>
9	<u>AUXILIARY SYSTEMS</u>	9.1-1
9.1	<u>FUEL STORAGE AND HANDLING</u>	9.1-1
9.1.1	NEW FUEL STORAGE	9.1-1
9.1.1.1	<u>Design Bases</u>	9.1-1
9.1.1.2	<u>Facility Description</u>	9.1-2
9.1.1.3	<u>Safety Evaluation</u>	9.1-2
9.1.2	SPENT FUEL STORAGE.....	9.1-3
9.1.2.1	<u>Design Bases</u>	9.1-3
9.1.2.2	<u>Facilities Description</u>	9.1-4
9.1.2.3	<u>Nuclear Considerations</u>	9.1-8
9.1.2.4	<u>Testing and Inspection</u>	9.1-13
9.1.2.5	<u>Instrumentation Applications</u>	9.1-13
9.1.2.A	<u>VSC-24 Dry Spent Fuel Storage</u>	9.1-13
9.1.2.B	<u>Holtec Dry Spent Fuel Storage</u>	9.1-14
9.1.2.C	<u>Cask Transfer Facility</u>	9.1-15
9.1.3	FUEL POOL SYSTEM (SPENT FUEL POOL COOLING AND CLEANUP SYSTEM)	9.1-16
9.1.3.1	<u>Design Basis</u>	9.1-16
9.1.3.2	<u>System Description</u>	9.1-16
9.1.3.3	<u>Safety Evaluation</u>	9.1-22
9.1.3.4	<u>Testing and Inspection</u>	9.1-23
9.1.3.5	<u>Instrumentation Application</u>	9.1-23
9.1.4	FUEL HANDLING SYSTEM.....	9.1-24
9.1.4.1	<u>Design Bases</u>	9.1-24

ARKANSAS NUCLEAR ONE
Unit 2

CHAPTER 9

TABLE OF CONTENTS (continued)

<u>Section</u>	<u>Title</u>	<u>Page</u>
9.1.4.2	<u>System Description</u>	9.1-25
9.1.4.3	<u>System Evaluation</u>	9.1-33
9.1.4.4	<u>Testing and Inspection</u>	9.1-38
9.1.4.5	<u>Refueling Interlocks</u>	9.1-39
9.2	<u>WATER SYSTEMS</u>	9.2-1
9.2.1	SERVICE WATER SYSTEM.....	9.2-1
9.2.1.1	<u>Design Bases</u>	9.2-2
9.2.1.2	<u>System Description</u>	9.2-3
9.2.1.3	<u>Safety Evaluation</u>	9.2-9
9.2.1.4	<u>Tests and Inspections</u>	9.2-11
9.2.1.5	<u>Instrument Applications</u>	9.2-11
9.2.2	COMPONENT COOLING WATER SYSTEM.....	9.2-12
9.2.2.1	<u>Design Bases</u>	9.2-13
9.2.2.2	<u>System Description</u>	9.2-14
9.2.2.3	<u>Safety Evaluation</u>	9.2-14
9.2.2.4	<u>Tests and Inspections</u>	9.2-15
9.2.2.5	<u>Instrumentation Applications</u>	9.2-16
9.2.3	DEMINERALIZED WATER SYSTEM.....	9.2-16
9.2.3.1	<u>Design Bases</u>	9.2-16
9.2.3.2	<u>System Description</u>	9.2-17
9.2.3.3	<u>Safety Evaluation</u>	9.2-17
9.2.4	POTABLE AND SANITARY WATER SYSTEM.....	9.2-17
9.2.4.1	<u>Design Bases</u>	9.2-17

ARKANSAS NUCLEAR ONE
Unit 2

CHAPTER 9

TABLE OF CONTENTS (continued)

<u>Section</u>	<u>Title</u>	<u>Page</u>
9.2.4.2	<u>System Description</u>	9.2-18
9.2.4.3	<u>System Evaluation</u>	9.2-18
9.2.4.4	<u>Tests and Inspections</u>	9.2-19
9.2.4.5	<u>Instrumentation Applications</u>	9.2-19
9.2.5	ULTIMATE HEAT SINK.....	9.2-19
9.2.5.1	<u>Design Bases</u>	9.2-19
9.2.5.2	<u>System Description</u>	9.2-20
9.2.5.3	<u>Safety Evaluation</u>	9.2-23
9.2.5.4	<u>Tests and Inspections</u>	9.2-27
9.2.5.5	<u>Instrument Application</u>	9.2-27
9.2.6	CONDENSATE STORAGE AND TRANSFER SYSTEM	9.2-27
9.2.6.1	<u>Design Bases</u>	9.2-27
9.2.6.2	<u>System Description</u>	9.2-28
9.2.6.3	<u>Safety Evaluation</u>	9.2-29
9.2.6.4	<u>Tests and Inspections</u>	9.2-29
9.2.6.5	<u>Instrument Application</u>	9.2-29
9.3	<u>PROCESS AUXILIARIES</u>	9.3-1
9.3.1	COMPRESSED AIR SYSTEM	9.3-1
9.3.1.1	<u>Design Bases</u>	9.3-1
9.3.1.2	<u>System Description</u>	9.3-1
9.3.1.3	<u>Safety Evaluation</u>	9.3-2
9.3.1.4	<u>Tests and Inspections</u>	9.3-2
9.3.1.5	<u>Instrument Applications</u>	9.3-3

ARKANSAS NUCLEAR ONE
Unit 2

CHAPTER 9

TABLE OF CONTENTS (continued)

<u>Section</u>	<u>Title</u>	<u>Page</u>
9.3.2	PROCESS SAMPLING SYSTEM.....	9.3-3
9.3.2.1	<u>Design Bases</u>	9.3-3
9.3.2.2	<u>System Descriptions</u>	9.3-4
9.3.2.3	<u>Design Evaluation</u>	9.3-7
9.3.2.4	<u>Inspection and Tests</u>	9.3-8
9.3.2.5	<u>Instrument Application</u>	9.3-8
9.3.3	EQUIPMENT AND FLOOR DRAINAGE SYSTEMS	9.3-9
9.3.3.1	<u>Design Bases</u>	9.3-9
9.3.3.2	<u>System Description</u>	9.3-9
9.3.3.3	<u>Safety Evaluation</u>	9.3-11
9.3.3.4	<u>Tests and Inspections</u>	9.3-11
9.3.3.5	<u>Instrumentation Applications</u>	9.3-12
9.3.4	CHEMICAL AND VOLUME CONTROL SYSTEM.....	9.3-12
9.3.4.1	<u>Design Bases</u>	9.3-12
9.3.4.2	<u>System Functional Description</u>	9.3-13
9.3.4.3	<u>System Description</u>	9.3-18
9.3.4.4	<u>System Evaluation</u>	9.3-24
9.3.4.5	<u>Instrument Application</u>	9.3-29
9.3.5	FAILED FUEL DETECTION SYSTEM	9.3-29
9.3.6	SHUTDOWN COOLING SYSTEM.....	9.3-29
9.3.6.1	<u>Design Bases</u>	9.3-29
9.3.6.2	<u>System Description</u>	9.3-30
9.3.6.3	<u>Safety Evaluation</u>	9.3-32

ARKANSAS NUCLEAR ONE
Unit 2

CHAPTER 9

TABLE OF CONTENTS (continued)

<u>Section</u>	<u>Title</u>	<u>Page</u>
9.3.6.4	<u>Testing and Inspection</u>	9.3-33
9.3.6.5	<u>Instrumentation Application</u>	9.3-34
9.4	<u>AIR CONDITIONING, HEATING, COOLING, & VENTILATION SYSTEMS</u> .	9.4-1
9.4.1	CONTROL ROOM.....	9.4-1
9.4.1.1	<u>Design Bases</u>	9.4-1
9.4.1.2	<u>System Description</u>	9.4-3
9.4.1.3	<u>Safety Evaluation</u>	9.4-7
9.4.1.4	<u>Inspection and Testing Requirements</u>	9.4-8
9.4.2	AUXILIARY BUILDING.....	9.4-9
9.4.2.1	<u>Fuel Handling Floor Radwaste Area</u>	9.4-10
9.4.2.2	<u>Auxiliary Building Radwaste Area</u>	9.4-10
9.4.2.3	<u>Non-Contaminated Areas</u>	9.4-10
9.4.2.4	<u>Emergency Diesel Generator Rooms</u>	9.4-10
9.4.2.5	<u>Control Room and Computer Room</u>	9.4-10
9.4.2.6	<u>Battery Rooms and Battery Equipment Rooms</u>	9.4-10
9.4.2.7	<u>Switchgear Rooms</u>	9.4-11
9.4.2.8	<u>Cable Spreading Room and Electrical Equipment Room No. 2108</u>	9.4-11
9.4.2.9	<u>Electrical Equipment (MG) Room No. 2076</u>	9.4-12
9.4.2.10	<u>Ventilation Equipment Room</u>	9.4-12
9.4.2.11	<u>Main Steam Line Enclosure</u>	9.4-12
9.4.2.12	<u>Elevator-Machine Room</u>	9.4-12
9.4.2.13	<u>Boiler Room Area</u>	9.4-12
9.4.2.14	<u>Heat Exchanger and Pipeway Area</u>	9.4-12

ARKANSAS NUCLEAR ONE
Unit 2

CHAPTER 9

TABLE OF CONTENTS (continued)

<u>Section</u>	<u>Title</u>	<u>Page</u>
9.4.2.15	<u>Electrical Equipment Room No. 2091</u>	9.4-13
9.4.2.16	<u>Component Descriptions</u>	9.4-13
9.4.3	RADWASTE AREA	9.4-23
9.4.3.1	<u>Design Bases</u>	9.4-23
9.4.3.2	<u>System Description</u>	9.4-23
9.4.3.3	<u>Safety Evaluation</u>	9.4-33
9.4.3.4	<u>Inspection and Testing Requirements</u>	9.4-33
9.4.4	TURBINE BUILDING.....	9.4-34
9.4.4.1	<u>Design Bases</u>	9.4-34
9.4.4.2	<u>System Description</u>	9.4-34
9.4.4.3	<u>Inspection and Testing Requirements</u>	9.4-34
9.4.5	CONTAINMENT BUILDING	9.4-35
9.4.5.1	<u>Design Bases</u>	9.4-35
9.4.5.2	<u>System Description</u>	9.4-35
9.4.5.3	<u>Safety Evaluation</u>	9.4-40
9.4.5.4	<u>Inspection and Testing Requirements</u>	9.4-40
9.4.6	INTAKE STRUCTURE	9.4-40
9.4.7	ALTERNATE AC GENERATOR BUILDING.....	9.4-41
9.5	<u>OTHER AUXILIARY SYSTEMS</u>	9.5-1
9.5.1	FIRE PROTECTION SYSTEM - CODES AND STANDARDS	9.5-1
9.5.1.1	<u>Design Bases</u>	9.5-1
9.5.1.2	<u>System Description</u>	9.5-2
9.5.1.3	<u>Safety Evaluation</u>	9.5-7

ARKANSAS NUCLEAR ONE
Unit 2

CHAPTER 9

TABLE OF CONTENTS (continued)

<u>Section</u>	<u>Title</u>	<u>Page</u>
9.5.1.4	<u>Tests and Inspections</u>	9.5-12
9.5.1.5	<u>Fire Protection Plan</u>	9.5-13
9.5.2	COMMUNICATION SYSTEMS	9.5-23
9.5.2.1	<u>Design Basis</u>	9.5-23
9.5.2.2	<u>Description</u>	9.5-24
9.5.2.3	<u>Inspection and Testing</u>	9.5-25
9.5.3	LIGHTING SYSTEM.....	9.5-25
9.5.3.1	<u>Design Bases</u>	9.5-25
9.5.3.2	<u>System Description</u>	9.5-26
9.5.3.3	<u>Tests and Inspection</u>	9.5-26
9.5.4	DIESEL GENERATOR FUEL OIL STORAGE AND TRANSFER SYSTEM..	9.5-26
9.5.4.1	<u>Design Bases</u>	9.5-26
9.5.4.2	<u>System Description</u>	9.5-27
9.5.4.3	<u>Design Evaluation</u>	9.5-29
9.5.4.4	<u>Tests and Inspection</u>	9.5-30
9.5.5	DIESEL GENERATOR COOLING WATER SYSTEM.....	9.5-30
9.5.5.1	<u>Design Bases</u>	9.5-30
9.5.5.2	<u>System Description</u>	9.5-30
9.5.5.3	<u>Design Evaluation</u>	9.5-32
9.5.5.4	<u>Tests and Inspection</u>	9.5-32
9.5.5.5	<u>Instrumentation Applications</u>	9.5-32
9.5.6	DIESEL GENERATOR STARTING SYSTEM.....	9.5-33
9.5.6.1	<u>Design Bases</u>	9.5-33

ARKANSAS NUCLEAR ONE
Unit 2

CHAPTER 9

TABLE OF CONTENTS (continued)

<u>Section</u>	<u>Title</u>	<u>Page</u>
9.5.6.2	<u>System Description</u>	9.5-33
9.5.6.3	<u>Design Evaluation</u>	9.5-34
9.5.6.4	<u>Tests and Inspection</u>	9.5-35
9.5.6.5	<u>Instrumentation Applications</u>	9.5-35
9.5.7	DIESEL GENERATOR LUBRICATION SYSTEM.....	9.5-36
9.5.7.1	<u>Design Bases</u>	9.5-36
9.5.7.2	<u>System Description</u>	9.5-36
9.5.7.3	<u>Design Evaluation</u>	9.5-37
9.5.7.4	<u>Tests and Inspection</u>	9.5-37
9.5.7.5	<u>Instrumentation Applications</u>	9.5-37
9.5.8	SEISMIC CATEGORY 1 VALVES.....	9.5-37
9.5.9	DIESEL GENERATOR COMBUSTION AIR INTAKE AND EXHAUST SYSTEM.....	9.5-37
9.5.9.1	<u>Design Bases</u>	9.5-37
9.5.9.2	<u>System Description</u>	9.5-37
9.5.9.3	<u>Design Evaluation</u>	9.5-38
9.5.9.4	<u>Test and Inspections</u>	9.5-38
9.6	<u>REFERENCES</u>	9.6-1
9.7	<u>TABLES</u>	9.7-1
9A	<u>FIRE PROTECTION PROGRAM</u>	9A-1
9A.1	<u>PROGRAM DESCRIPTION</u>	9A-1
9A.2	<u>SCOPE AND APPLICABILITY</u>	9A-1
9A.3	<u>ORGANIZATION AND RESPONSIBILITY</u>	9A-1
9A.4	<u>ADMINISTRATIVE CONTROLS AND PROCEDURES</u>	9A-1

ARKANSAS NUCLEAR ONE
Unit 2

CHAPTER 9

TABLE OF CONTENTS (continued)

<u>Section</u>	<u>Title</u>	<u>Page</u>
9A.5	<u>FIRE HAZARDS ANALYSIS</u>	9A-1
9A.6	<u>SAFETY EVALUATION REPORTS</u>	9A-2
9A.7	<u>SAFE SHUTDOWN SYSTEMS</u>	9A-2
9A.8	<u>FIRE PROTECTION SYSTEMS</u>	9A-2
9A.9	<u>QUALITY ASSURANCE</u>	9A-2
9A.10	<u>FIRE BRIGADE</u>	9A-2
9B	<u>FIRE HAZARDS ANALYSIS REPORT</u>	9B-1
9C	<u>SAFE SHUTDOWN CAPABILITY ASSESSMENT</u>	9C-1
9D	<u>FIRE PROTECTION SYSTEM ADMINISTRATIVE REQUIREMENTS</u>	9D-1
9D.1	<u>ADMINISTRATIVE REQUIREMENTS</u>	9D-1
9D.1.1	FIRE BRIGADE	9D-1
9D.1.2	TRAINING	9D-1

ARKANSAS NUCLEAR ONE
Unit 2

LIST OF TABLES

<u>Table No.</u>	<u>Title</u>	<u>Page</u>
9.1-1	FUEL POOL SYSTEM PROCESS FLOW DATA.....	9.7-1
9.1-2	FUEL POOL WATER CHEMISTRY	9.7-2
9.1-3	ORIGINAL DESIGN DATA FOR FUEL POOL SYSTEM COMPONENTS....	9.7-3
9.1-4	FUEL POOL SYSTEM INSTRUMENTATION	9.7-5
9.1-5	SINGLE FAILURE MODE ANALYSIS OF THE FUEL HANDLING EQUIPMENT.....	9.7-6
9.1-6	DELETED	9.7-8
9.1-7	FUEL ASSEMBLY PARAMETERS USED IN SFP AND NFV CRITICALITY ANALYSES.....	9.7-8
9.1-8	DELETED	9.7-8
9.1-9	DELETED	9.7-8
9.1-10	APPENDIX B SUPPLEMENT TO GENERIC LICENSING TOPICAL REPORT EDR-1 FOR SPENT FUEL HANDLING CRANE L-3 SUMMARY OF PLANT SPECIFIC CRANE DATA	9.7-9
9.2-1	DELETED	9.7-19
9.2-2	SERVICE WATER SYSTEM TRAVELING WATER SCREEN DATA	9.7-19
9.2-3	SERVICE WATER PUMP DATA.....	9.7-20
9.2-4	SERVICE WATER BASKET STRAINER DATA.....	9.7-21
9.2-5	SERVICE WATER SYSTEM SINGLE FAILURE ANALYSIS	9.7-22
9.2-6	SERVICE WATER SYSTEM INDICATION AND ALARMS	9.7-26
9.2-7	COMPONENT COOLING WATER PUMP DATA.....	9.7-27
9.2-8	COMPONENT COOLING WATER SYSTEM HEAT EXCHANGER DATA...	9.7-28
9.2-9	COMPONENT COOLING WATER SYSTEM SURGE TANK DATA.....	9.7-29
9.2-10	COMPONENT COOLING WATER SYSTEM INDICATION AND ALARMS..	9.7-30
9.2-11	RAW WATER HOLDUP TANK DATA	9.7-31
9.2-12	DOMESTIC WATER PUMPS DATA	9.7-31

ARKANSAS NUCLEAR ONE
Unit 2

LIST OF TABLES (continued)

<u>Table No.</u>	<u>Title</u>	<u>Page</u>
9.2-13	DOMESTIC WATER PRESSURE TANK DATA.....	9.7-32
9.2.14	DOMESTIC WATER STORAGE HEATER DATA.....	9.7-32
9.2-15	DOMESTIC HOT WATER CIRCULATING PUMP DATA.....	9.7-33
9.2-16	CONDENSATE STORAGE TANK DATA.....	9.7-33
9.2-17	LITTLE ROCK METEOROLOGY - TEMPERATURE ANALYSIS	9.7-34
9.2-18	LITTLE ROCK METEOROLOGY - EVAPORATION ANALYSIS	9.7-34
9.2-19	DELETED.....	9.7-34
9.2-20	DELETED.....	9.7-34
9.3-1	PRIMARY SAMPLING SYSTEM SAMPLE POINT DESIGN DATA.....	9.7-35
9.3-2	SECONDARY SAMPLING SYSTEM SAMPLE POINT DESIGN DATA	9.7-36
9.3-3	WASTE GAS ANALYZER SYSTEM SAMPLE POINT DESIGN DATA	9.7-37
9.3-4	REACTOR COOLANT AND REACTOR MAKEUP WATER CHEMISTRY ...	9.7-38
9.3-5	CHEMICAL AND VOLUME CONTROL SYSTEM PARAMETERS.....	9.7-39
9.3-6	SCHEDULE OF WASTE GENERATION	9.7-39
9.3-7	CHEMICAL AND VOLUME CONTROL SYSTEM PROCESS FLOW DATA	9.7-40
9.3-8	DESIGN TRANSIENTS - REGENERATIVE AND LETDOWN HEAT EXCHANGERS AND CHARGING NOZZLE.....	9.7-44
9.3-9	REGENERATIVE HEAT EXCHANGER DESIGN DATA.....	9.7-46
9.3-10	LETDOWN HEAT EXCHANGER DESIGN DATA.....	9.7-47
9.3-11	PURIFICATION FILTER DESIGN DATA	9.7-48
9.3-12	PURIFICATION AND DEBORATING ION EXCHANGERS DESIGN DATA	9.7-48
9.3-13	VOLUME CONTROL TANK DESIGN DATA.....	9.7-49
9.3-14	CHARGING PUMPS DESIGN DATA.....	9.7-49
9.3-15	BORIC ACID MAKEUP TANKS DESIGN DATA.....	9.7-50

ARKANSAS NUCLEAR ONE
Unit 2

LIST OF TABLES (continued)

<u>Table No.</u>	<u>Title</u>	<u>Page</u>
9.3-16	BORIC ACID BATCHING TANK DESIGN DATA	9.7-50
9.3-17	BORIC ACID MAKEUP PUMPS DESIGN DATA	9.7-51
9.3-18	CHEMICAL ADDITION TANK DESIGN DATA.....	9.7-51
9.3-19	CVCS PROCESS RADIATION MONITOR DESIGN DATA.....	9.7-51
9.3-20	DELETED	9.7-51
9.3-21	SINGLE FAILURE ANALYSIS - CHEMICAL AND VOLUME CONTROL SYSTEM.....	9.7-52
9.3-22	CHEMICAL AND VOLUME CONTROL SYSTEM INSTRUMENT APPLICATION	9.7-57
9.3-23	SHUTDOWN COOLING MODE DESIGN PARAMETERS	9.7-60
9.3-24	SHUTDOWN COOLING HEAT EXCHANGER DATA.....	9.7-60
9.3-25	SHUTDOWN COOLING SYSTEM INSTRUMENT APPLICATION.....	9.7-61
9.4-1	SINGLE FAILURE ANALYSIS - CONTROL ROOM EMERGENCY AIR CONDITIONING SYSTEM.....	9.7-63
9.4-2	SINGLE FAILURE ANALYSIS - EMERGENCY DIESEL GENERATOR ROOM VENTILATION SYSTEMS.....	9.7-64
9.4-3	CONFORMANCE OF ATMOSPHERE CLEANUP SYSTEMS (ACS) WITH RESPECT TO EACH POSITION OF U.S. NRC REGULATORY GUIDE 1.52 DATED JUNE 1973	9.7-65
9.5-1	FIRE WATER PUMP DATA	9.7-73
9.5-2	DELETED	9.7-73
9.5-3	FIRE HOSE STATIONS	9.7-73
9.5-4	FIRE AND SMOKE MONITORING, DETECTION AND ALARM SYSTEM DEVICES.....	9.7-73
9D-1	FIRE DETECTION INSTRUMENTS.....	9D-11
9D-2	FIRE HOSE STATIONS	9D-12

ARKANSAS NUCLEAR ONE
Unit 2

LIST OF FIGURES

<u>Figure No.</u>	<u>Title</u>
9.1-1	FUEL POOL SYSTEM
9.1-2	FISSION PRODUCT DECAY HEAT CURVE
9.1-3	DOSE RATE AXIALLY FROM TOP OF SPENT FUEL ASSEMBLY IN WATER 2825 Mwt PLANT
9.1-4	DOSE RATE FROM SIDE OF SPENT FUEL ASSEMBLY IN WATER 2825 Mwt PLANT
9.1-5	DELETED
9.1-6	REFUELING MACHINE
9.1-7	DELETED
9.1-8	REACTOR VESSEL HEAD LIFTING RIG
9.1-9	UPPER GUIDE STRUCTURE LIFT RIG
9.1-10	CORE SUPPORT BARREL LIFT RIG ASSEMBLY
9.1-11	SURVEILLANCE CAPSULE RETRIEVAL TOOL
9.1-12	SPENT FUEL POOL REGION 2 STORAGE RACK "SPACER POCKET" DESIGN-PLAN VIEW
9.1-13	SPENT FUEL POOL ARRANGEMENT UNIT 2
9.1-14	AUXILIARY BUILDING FUEL HANDLING ARRANGEMENT
9.1-15	SPENT FUEL POOL WATER SURFACE PATH
9.1-15A	SPENT FUEL POOL WATER SURFACE PATH (PLAN VIEW)
9.1-16	DELETED
9.1-17	DELETED
9.1-18	SPENT FUEL POOL REGION 1 STORAGE RACK CELL LAYOUT
9.1-19	FUEL POOL COOLING SYSTEM HEAT REMOVAL CAPACITY WITH POOL TEMPERATURE = 120 °F
9.1-20	FUEL POOL COOLING SYSTEM HEAT REMOVAL CAPACITY WITH POOL TEMPERATURE = 150 °F
9.2-1A	SERVICE WATER

ARKANSAS NUCLEAR ONE
Unit 2

LIST OF FIGURES (continued)

<u>Figure No.</u>	<u>Title</u>
9.2-1B	AUXILIARY COOLING WATER
9.2-2	TYPICAL SERVICE WATER PUMP PERFORMANCE CURVE
9.2-3	DELETED
9.2-4	DELETED
9.2-5	DELETED
9.2-6	COMPONENT COOLING WATER SYSTEM
9.2-7A	CONDENSATE STORAGE
9.2-7B	PLANT MAKEUP, CONDENSATE TRANSFER, AND DOMESTIC WATER
9.2-7C	SUMP PUMPS
9.2-8	DELETED
9.2-9	COOLING POND SURROUNDING AREA TOPOGRAPHICAL MAP
9.2-10	EMERGENCY COOLING POND TYPICAL SECTION
9.2-11	DELETED
9.2-12	HISTOGRAM OF PROBABLE MAXIMUM PRECIPITATION
9.2-13	SPILLWAY RATING CURVE
9.2-14	DESIGN BASIS HEAT REJECTION TO THE COOLING POND
9.2-15	HEAT LOAD - UNIT 1 SAFE SHUTDOWN
9.2-16	HEAT LOAD - UNIT 2 DBA
9.2-17	DELETED
9.2-18	DELETED
9.2-19	ORIGINAL DBA ECP OUTLET TEMPERATURE
9.2-20	ECP TEMPERATURE - UNIT 2 DBA AND UNIT 1 SHUTDOWN
9.2-21	EMERGENCY COOLING POND TEMPERATURE – UPDATED ANALYSIS
9.2-22	DELETED

ARKANSAS NUCLEAR ONE
Unit 2

LIST OF FIGURES (continued)

<u>Figure No.</u>	<u>Title</u>
9.3-1	SERVICE, BREATHING, AND INSTRUMENT AIR
9.3-2	SAMPLING SYSTEMS
9.3-3	DELETED
9.3-4	CHEMICAL AND VOLUME CONTROL SYSTEM
9.3-5	DELETED
9.4-1	CONTROL ROOM VENTILATION AND MISCELLANEOUS AUXILIARY BUILDING VENTILATION
9.4-2	DELETED
9.4-3	DELETED
9.4-4	CONTAINMENT BUILDING
9.4-5	DELETED
9.4-6	DELETED
9.5-1	FIRE WATER
9.5-2 – 9.5-7	DELETED
9.5-8	EMERGENCY DIESEL GENERATOR AUXILIARIES
9.5-9	DELETED
9.5-10	DELETED

ARKANSAS NUCLEAR ONE
Unit 2

UPDATE REFERENCE LIST

Sections and references listed below denote documents that contain additional cross reference information used to update the SAR.

<u>Section</u>	<u>Cross References</u>
9.5.1	Correspondence from Rueter, AP&L, to Stolz and Davis, NRC, dated August 30, 1977. (0CAN087709).
9.5.1	Correspondence from Rueter, AP&L, to Davis, NRC, dated September 21, 1977. (0CAN097712).
9.5.1	Correspondence from Williams, AP&L, to Davis, NRC, dated January 1978. (0CAN017819).
9.5.1	Correspondence from Vassallo, NRC, to Cavanaugh, AP&L, dated August 30, 1978. (2CNA087826).
9.5.1	Correspondence from Williams, AP&L, to Stolz, NRC, dated January 15, 1979. (2CAN017909).
9.2.1.2.3.1, 9.2.2.2, 9.2.3.2.1, 9.2.4.3, 9.3.1.2, 9.3.2.2.1, 9.3.2.2.2, 9.3.3.2.2, 9.3.4.2.1, 9.3.4.3.12, 9.3.4.4.1, 9.3.4.5, 9.4.3.2.1, 9.4.4.2, 9.5.1	Correspondence from Trimble, AP&L, to Seyfrit, NRC, dated March 21, 1979. (0CAN037915).
9.3.4.4.1	Correspondence from Trimble, AP&L, to Seyfrit, NRC, dated August 1, 1979. (2CAN087901).
9.2.5.2.1.1	Correspondence from Trimble, AP&L, to Seyfrit, NRC, dated March 31, 1980. (0CAN038014).
9.3.4.4.1	Correspondence from Trimble, AP&L, to Eisenhut, NRC, dated March 31, 1980. (0CAN038022).
9.3.4.3.13	Correspondence from Trimble, AP&L, to Clark, NRC, dated March 30, 1981. (0CAN038119).
9.4.2	Correspondence from Trimble, AP&L, to Seyfrit, NRC, dated March 31, 1981. (0CAN048102).

ARKANSAS NUCLEAR ONE
Unit 2

UPDATE REFERENCE LIST (continued)

<u>Section</u>	<u>Cross References</u>
9.2.1.2.2.1 9.2.1.2.2.4	Correspondence from Trimble, AP&L, to Madsen, NRC, dated May 22, 1981. (0CAN058114).
9.3.4.3.13	Correspondence from Trimble, AP&L, to Clark, NRC, dated July 2, 1981. (2CAN078103).
9.2.1.2.2.1 9.2.1.2.2.4	Correspondence from Trimble, AP&L, to Michelson, NRC, dated November 23, 1981. (0CAN118106).
9.5.4.2	Design Change Package 147, "Raise vents on emergency diesel fuel tanks T57A & B above the overflow on T25 and provide high level alarm," 1974. (0DCP740147).
9.4.1.1.2	Design Change Package 474, "Unit 1, Unit 2 Interconnections, Control Room Ventilation," 1976. (0DCP760474).
9.4.1.1.2	Design Change Package 496, "Control Room Emergency Ventilation System," 1977. (0DCP770496).
9.2.3.2.1	Design Change Package 527, "Add Return Line from Neutralizing Tank Discharge Filter," 1977. (0DCP770527).
9.2.3.2.1	Design Change Package 251, (title not available), 1978. (2DCP780251).
9.4.1.1.2	Design Change Package 260, "Halon Fire Extinguisher in Unit 2 CR," 1978. (2DCP780260).
9.4.1.1.2	Design Change Package 569, "Units 1 & 2 Control Rm. HVAC Interlock," 1978. (0DCP780569).
9.4.1.1.2	Design Change Package 593, "Reliability Inter-tie Unit 1 & Unit 2 Control Rm.," 1978. (0DCP780593).
9.3.4.2.5 9.3.4.3.8	Design Change Package 614, "Adding of Unit 1 to Unit 2 inter-tie on the boric acid mixed tanks," 1978. (0DCP780614).
9.5.2.2	Design Change Package 632, (title not available), 1978. (2DCP780632).
9.5.4.2	Design Change Package 636, "DG Day Tank Level Switch Contact Addition for BUP Protection," 1978. (2DCP780636).
9.3.4.4.1	Design Change Package 729, "Facilitate Redundant Boration Path," 1978. (2DCP780729).
9.2.6.2	Design Change Package 738, (title not available), 1978. (2DCP780738).
9.2.3.2.2	Design Change Package 745, (title not available), 1978. (2DCP780745).

ARKANSAS NUCLEAR ONE
Unit 2

UPDATE REFERENCE LIST (continued)

<u>Section</u>	<u>Cross References</u>
9.3.4.3.13	Design Change Package 769, "Relocation of 2PSV4943," 1978. (2DCP780769).
9.5.3.2	Design Change Package 770, "Adding Battery Operated Emer. Lights - CR," 1978. (2DCP780770).
9.3.4.2.3	Design Change Package 781, "RCS Cleanup Modifications," 1978. (2DCP780781).
9.3.2.2.1	Design Change Package 793, "Add Bypass for 2PCV5939," 1978. (2DCP780793).
9.4.1.2.1	Design Change Package 832, "Annunciator Panel Cooling, Control Room," 1979. (2DCP790832).
9.3.2.3	Design Change Package 2020, "Revise Cont. Isolation 2SV5843 to Allow Sampling While CIAS Signal Present," 1980. (2DCP802020).
9.2.3.5	Design Change Package 2063, "Addition of Flow Indication to Test NaOH Injection Check Valves," 1980. (2DCP802063).
9.1.3.2 9.1.3.3.1	Design Change Package 2086, "Spent Fuel Storage Rack Modification," 1980. (2DCP802086).
9.3.3.2.3	Design Change Package 2088, "Install drain to keep water from collecting and impairing venting operations," 1980. (2DCP802088).
9.2.3.2.2	Design Change Package 2139, "Heat Trace Vent on NaOH Tank," 1980. (2DCP802139).
9.2.5.3	Design Change Package 2151, "Sluice Gates for ECP," 1980. (2DCP802151).
9.2.1.2.1	Design Change Package 2180, "Service Water Flush Connection," 1980. (2DCP802180).
9.2.1.2.2.4 Figure 9.2-1	Design Change Package 2004, "Service Water System Modification," 1981. (2DCP812004).
9.2.2.5	Design Change Package 2074, (title not available), 1981. (2DCP812074).
9.3.2.2.4	Correspondence from Trimble, AP&L, to Eisenhut, NRC, dated March 31, 1980. (0CAN038022)
9.5	Design Change Package 79-2149, "Containment Pressure IND Upgrade."
9.4.2	Design Change Package 80-2051, "RCP Oil Collection System."

ARKANSAS NUCLEAR ONE
Unit 2

UPDATE REFERENCE LIST (continued)

<u>Section</u>	<u>Cross References</u>
9.4.2	Design Change Package 81-2063, "HP Area Renovation Work."
9.1.4	Design Change Package 82-2075, "Refueling Machine Modifications."
9.2.3	Design Change Package 82-2033, "Panel 2K11 Annunciator Upgrade."
9.2 9.4 9.7	Design Change Package 82-2012, "Deletion of BAM PP Room Coolers."
9.2	Design Change Package 83-2006, "Additional Disconnect Switch Outside Zones 2100Z and 2101AA."
9.3	Design Change Package 83-2018A, "Electrical Support C (Swing) Pump Disconnect Switch."
9.5.1.2.2	Design Change Package 83-2037, "Fire Protection Service Water Pump Motors."
9.5	Design Change Package 84-2069, "Emergency Lighting Appendix R."
9.5.1 9.5.1.3.3	Correspondence from Marshall, AP&L, to Eisenhut, NRC, dated July 1, 1982 (OCAN078202).
9.5.1 9.5.1.3.3	Correspondence from Marshall, AP&L, to Stolz/Miller, NRC, dated August 15, 1984 (OCAN088404).
9.1 9.6 Table 9.1-6 Table 9.1-7 Table 9.1-8 Table 9.1-9 Figure 9.1-12 Figures 9.1-12 A&B Figure 9.1-15 Figure 9.1-15A Figure 9.1-16 Figure 9.1-17 Figure 9.1-18	Design Change Package 83-2021, "Spent Fuel Pool Rerack." "Spent Fuel Pool Rerack Licensing Submittal," (OCAN118205), Arkansas Power And Light Company - Arkansas Nuclear One - Unit 1 & 2, November, 1982.
9.3.2.2.1 Figure 9.3-2	Design Change Package 82-2058A, "Install Steam Generator Secondary System Sample Panel 2C377."
9.5.1 Figure 9.3-1 Figure 9.5-1	Design Change Package 80-2069, "Turbine Generator Fire Protection."

ARKANSAS NUCLEAR ONE
Unit 2

UPDATE REFERENCE LIST (continued)

<u>Section</u>	<u>Cross References</u>
9.5.1.2.2	Design Change Package 83-2045, "ESFAS Start Alarm Modifications on Service Water Pumps."
9.5.4.2 Figure 9.5-8	Design Change Package 82-2145, "EDG Fuel Oil and EDG Starting Air."
Figure 9.1-1	Design Change Package 82-2042, "Annunciator 2K05 Upgrade."
Figure 9.2-1	Design Change Package 79-2187, "Modification to Condenser Vacuum Pump Coolers."
Figure 9.2-1	Design Change Package 81-2004A, "Unit 2 Service Water System."
Figure 9.2-1	Design Change Package 81-2004C, "Unit 2 Service Water Piping Change."
Figure 9.2-1	Design Change Package 81-2004H, "Service Water System."
Figure 9.2-1	Design Change Package 81-2089, "Installation of Nuclear Service Strainers on 2E47A&B, 2E52A&B and 2E53A,B&C."
Figure 9.2-1	Design Change Package 82-2040, "Service Water System, Chemical Cleaning Implementation."
Figure 9.2-1	Design Change Package 83-2150, "Service Water Drain Valve Addition."
Figure 9.2-1	Design Change Package 84-2049, "Service Water Pipe Replacement to 2VUC-6B."
Figure 9.2-6 Figure 9.2-7 Figure 9.3-1 Figure 9.3-3	Design Change Package 79-2117, "Condenser Hotwell Sampling System Sodium Analyzers."
Figure 9.2-6 Figure 9.2-7 Figure 9.3-2	Design Change Package 82-2058, "Add T-Caps or Isolation Valve to Support the SG Secondary Sample Panel."
Figure 9.2-6 Figure 9.4-2	Design Change Package 82-2078, "Radiation Chemistry Sample Room Air Conditioner."
Figure 9.2-6 Figure 9.3-2 Figure 9.3-3	Design Change Package 83-2001, "Mass Transport-Corrosion Monitoring Sample Points."
Figure 9.2-7	Design Change Package 82-2051, "Tie-In Line From Neutralizing Tank (2T-87) to Regen. Tank (2T-92)."
Figure 9.2-7	Design Change Package 84-2071, "Q CST Yard Piping."

ARKANSAS NUCLEAR ONE
Unit 2

UPDATE REFERENCE LIST (continued)

<u>Section</u>	<u>Cross References</u>
Figure 9.2-7	Design Change Package 85-2129, "Plant Makeup 2T-49 Acid Injection Drain."
Figure 9.3-1	Design Change Package 79-2133, "Breathing Air System for Unit 2 Reactor Building."
Figure 9.3-1	Design Change Package 79-2137, "Cooling Tower Water Treatment Facility."
Figure 9.3-1	Design Change Package 79-2163, "Installation of Automatic Isolation Valve to Maintenance Facility Instrument Air Header."
Figure 9.3-1	Design Change Package 79-2180, "Instrument Air Supply System."
Figure 9.3-1 Figure 9.3-2 Figure 9.3-4 Figure 9.4-4	Design Change Package 80-2043F, "Construction of Post Accident Sampling System."
Figure 9.3-1	Design Change Package 80-2196, "Install Air Supply to Aux. Building."
Figure 9.3-1	Design Change Package 82-2058B, "Instrument Air to SG Pane 2C-37."
Figure 9.3-1	Design Change Package 84-2065A, "EPG Ball Valve Actuator Replacement."
Figure 9.3-1	Design Change Package 86-2136, "Removal of Service Air Outlet 2SA-5004."
Figure 9.3-2 Figure 9.3-4	Design Change Package 79-2186, "RCS and CVCT Sampling Systems."
Figure 9.3-2 Figure 9.4-4	Design Change Package 82-2082, "Installation of PASS Flow Instrumentation (RCS, CAS, Chilled Water)."
Figure 9.3-2	Design Change Package 82-2113B, "PASS MOV's (2CV-5962, 63, 65, 67, 69) Electrical Design."
Figure 9.3-2	Design Change Package 85-2104, "Removal of PASS pH/Boron and Chloride Analyzers."
Figure 9.3-3	Design Change Package 82-2057, "Condenser Tubesheet Sample System Modification."
Figure 9.3-4	Design Change Package 82-2142, "Permanent Pressure Gauges for Pump Operational Surveillances."
Figure 9.3-4	Design Change Package 83-2129, "Charging Pump Discharge Flanges."
Figure 9.4-1	Design Change Package 80-2123A, "Add Air Conditioning to Critical Functions and Parameters Computer Room."

ARKANSAS NUCLEAR ONE
Unit 2

UPDATE REFERENCE LIST (continued)

<u>Section</u>	<u>Cross References</u>
Figure 9.4-2 Figure 9.4-4	Design Change Package 79-2135H, "High Range Gaseous Effluent Radiation Monitors."
Figure 9.4-2	Design Change Package 79-2221, "Add Temperature Switch to Wall of CPC Room."
Figure 9.4-4	Design Change Package 80-2123M, "SPDS Additional Computer Inputs."
Figure 9.5-1	Design Change Package 83-2038A, "Hose Station Outside CEDM Room."
Figure 9.5-1	Design Change Package 87-1038, "Intake Structure Hose Reel."
Figure 9.5-8	Design Change Package 82-2079, "Install Emergency Diesel Generator Cross-Connect in the EDG Storage Building."
<u>Amendment 6</u>	
9.1.1.3	Correspondence from Enos, AP&L, to Knighton, NRC, dated January 29, 1986 (2CAN018607)
9.2.1.2.2.2	Design Change Package 83-2006, "Service Water Pump Modifications."
9.2.2.5	Design Change Package 83-2013, "CCW Loop I Temperature Alarm Control."
9.3.4.3.1.13	Design Change Package 86-2147, "Remove Therman Relief Valves 2PSV-4923, 24 & 33."
9.5.1.2.2 Figure 9.5-1	Design Change Package 83-2171, "Containment Cable Spreading Area Suppression System Modification."
9.3.2 9.3.2.1 9.3.2.2.3 9.3.2.4 9.3.2.5 Table 9.3-3 Figure 9.3-2 Figure 9.3-4	Design Change Package 82-2004, "ANO-2 Waste Gas Panels"
9.2.6.3	Design Change Package 82-2086B, "Q-Condensate Storage Tank."
Table 9.3-23	Design Change Package 80-2199, "Changeout of Shutdown Cooling Heat Exchange Tube Bundle."
9.3.2.5	Plant Change (PC) 86-3666

ARKANSAS NUCLEAR ONE
Unit 2

UPDATE REFERENCE LIST (continued)

<u>Section</u>	<u>Cross References</u>
9.3.4.3.5	Design Change Request (DCR) #568, "VCT Hydrogen Supply from Unit 1 High Purity Hydrogen System."
9.4.2.3 9.5.1.2.2 9.5.1.3.5	Design Change Package 81-2063, "Health Physics and Chemistry Lab Renovation."
9.4.2.8.1 9.4.2.16 9.5.1.2.1 9.5.1.2.2 Figure 9.2-7 Figure 9.4-1 Figure 9.5-4	Design Change Package 85-2075, "Addition of CPC Room, No. 2098-C
Figure 9.3-1	Design Change Package 86-2026, "Replacement of ANO-2 Instrument Air Filters."
Figure 9.5-1 Figure 9.5-5	Design Change Package 87-1038," Unit 1 Intake Structure Fire Hose Reel." Design Change Package 86-2137, "CO ² Fire Protection System Panel Relocation."
Figure 9.3-1	Plant Change 86-5893
<u>Amendment 7</u>	
9.3.4.2.3 9.3.4.3.7 9.3.4.3.15 9.3.4.4.1 Table 9.3-5 Table 9.3-15 Table 9.3-17	ANO-2 Technical Specification Amendment 82, dated March 11, 1988
9.3.4.3.15 Table 9.3-16	Memorandum ANO-89-2-00129, ANO Licensing Document Change Report Form - ANO-2 FSAR Section 9.3.4.3.15
9.1.4.1.2 9.1.4.2 9.1.4.2.5 9.1.4.3.2 9.1.4.3.3 9.1.4.5.3 Table 9.1-5 Figure 9.1-5 Figure 9.1-7	Design Change Package 87-2051, "Refueling Equipment - Reactor Side."

ARKANSAS NUCLEAR ONE
Unit 2

UPDATE REFERENCE LIST (continued)

<u>Section</u>	<u>Cross References</u>
9.2.1.2.2.6 9.2.1.4 9.2.1.5 Figure 9.2-1 Figure 9.2-5	Design Change Package 85-2174, "Modification of Service Water System."
<u>Amendment 8 & 9</u>	
9.2.1.2.2.5 Table 9.5-2 Figure 9.2-1	Design Change Package 86-2110, "2R6 Service Water Piping Replacement."
<u>Amendment 8</u>	
Figure 9.2-1	Plant Change 88-2221 "Addition of Branch Connection from ACW for Backwater Supply to Portable DIs."
Figure 9.2-1	Plant Change 86-3352 "Flow Indicator Added to Service Water Outlet on SFP Cooler."
Figure 9.2-1	Design Change Package 86-2110 "Removal of Handswitches 2HS-1451-2, 1452-2 and 1450-1."
Figure 9.3-4	Design Change Package 86-2093 "VCT Level Transmitter 2LT-4857 and Letdown Flow Transmitter 2FT-4801 Replacement with EQ Transmitters."
Figure 9.3-4	Design Change Package 88-2088 "Addition of VCT Level Transmitter and Referencing."
9.1.4.2.1 9.1.4.2.14 Figure 9.1-6	Design Change Package 87-2008, "Replacement of Refueling Machine Control Console and TV System."
Table 9.2-5 Table 9.5-2 Figure 9.2-1	Design Change Package 88-2092, "Removal of Service Water System Control Valves."
9.5.3.2	Plant Change 87-1151, Lighting - Unit II."
<u>Amendment 9</u>	
Figure 9.1-1	Plant Change 89-0586, "Removals of Spent Fuel Cooling Start-up Strainers Located in the Suction Lines to the 2P-40 Pumps."
Figure 9.2-1 Figure 9.2-5 9.2.1.2.2.6 9.2.1.4 9.2.1.5	Design Change Package 88-2105, "ANO-2 Flow Element - Service Water Pump Test."

ARKANSAS NUCLEAR ONE
Unit 2

UPDATE REFERENCE LIST (continued)

<u>Section</u>	<u>Cross References</u>
Figure 9.2-1 9.2.1.2.2.5 9.5.5.5 Table 9.5-2	Design Change Package 86-2110A, "Loop II Service Water Valves."
9.2.1.2.2.3 Table 9.2-4	Plant Change 90-8038, "2PDIS-1426, -1432, -1438 Set Point Change."
Figure 9.2-5 Figure 9.5.2	Design Change Package 88-2022, "Opening Between "A" and "C" Charging Pump Rooms."
Figure 9.2-7 Figure 9.4-1 Figure 9.5-1 Figure 9.5-4 9.4.2.8.A 9.4.2.16 9.5.1.2.2	Design Change Package 85-2075A, "CPC Room."
Figure 9.2-7	Procedure 2106.015, Rev. 10, "Condensate Transfer System."
Figure 9.3-2	Design Change Package 88-2091, "PASS Dissolved Hydrogen Analyzer Modification."
9.3.2.2.3	Design Change Package 86-2072, "H ² and O ² ANalyzer Setpoint Change."
Table 9.3-22	Design Change Package 88-2087, "Replacement of 2P36C Suction Pressure Switch."
Figure 9.4-1 Figure 9.4-2	Design Change Package 85-2075D, "Core Protection Calculator Permanent Tie-Ins."
Figure 9.4-1 Figure 9.4-4 Figure 9.5-8 9.5.5.5 9.5.6.2 9.5.6.3 9.5.6.5 9.5.7.5 9.5.9.3 Table 9.4-3	Design Change Package 86-2113, " ANO-2 Alarm Upgrade for Panels 2K01, 2K08, and 2K09."
9.2.1	ANO Calculation 89-E-0105-01, "Use of Hydrogen Purge System," and ANO

ARKANSAS NUCLEAR ONE
Unit 2

UPDATE REFERENCE LIST (continued)

<u>Section</u>	<u>Cross References</u>
9.2.1.2.2.4 9.4.5.2 Table 9.4-3 Table 9.5-2	Calculation 89-E-0089-01, "Post-LOCA Hydrogen Containment Purge Dose Calculation."
Figure 9.5-1 Figure 9.5.5	Design Change Package 86-2131, "Operations Support Facility."
Table 9.5-2	Design Change Package 82-2160, "2CV-1036-2, 2CV-1037-1, 2CV-1038-2, 2CV-1039-1 Replacement," and Design Change Package 83-2056, "79-01B Replacement of 2CV-1025-1 and 2CV-1075-1 Actuators."
Figure 9.5-3	Limited Change Package 90-6007, "Respirator Shop Sprinkler System Expansion."
Figure 9.5-1 Figure 9.5-3 Figure 9.5-5	Design Change Package 86-2090A, "H.P. Renovation Work."

Amendment 9A

Figure 9.5-5 Figure 9.2-8	Design Change Package 79-2025 "Addition of Maintenance Facility and Turbine Deck Expansion."
Appendices 9A - 9D	Generic Letters 86-10 and 88-12.

Amendment 10

9.1.3.2 9.1.3.3.1 9.1.3.5 Table 9.1-4 Figure 9.1-1	Plant Change (PC) 86-4910, "2K11-K6 Fuel Pool Pumps Discharge Header Pressure Low Elimination."
9.2.1.2.1 9.2.1.2.2.1	Procedure 1628.013, Rev. 0, "Addition of Biocide to Unit 1 or Unit 2 Service Water."
9.2.1.3	Correction to how the ECP sluice gate is locked open.
9.2.1.5 Figure 9.2-1	Design Change Package 84-2083, "Control Room Emergency Air Conditioning System Modifications."
9.2.1.5 Table 9.2-6 Figure 9.2-1 Figures 9.4-1 through 9.4-3	Design Change Package 88-2110, "ANO-2 Alarm Upgrade, Phase II."

ARKANSAS NUCLEAR ONE
Unit 2

UPDATE REFERENCE LIST (continued)

<u>Section</u>	<u>Cross References</u>
9.2.3.2.1 9.2.3.5 9.3.2.2.2 Figure 9.2-7 Figure 9.3-2 Figure 9.3-3	Design Change Package 85-2084, "Removal of Silica Analyzers from 2C145 II and 2C301."
9.2.4.2	Design Change Package 88-2043, "ANO Sewage Treatment Plant."
9.3.1.2	Plant Change 89-0093, "CO Contamination Alarm - Unit II."
9.3.2.2.1 9.3.2.2.2 9.3.2.3 9.3.2.5	Procedure 1000.043, Rev. 13, "Steam Generator Water Chemistry Monitoring Unit II."
9.3.4.2.3	Procedure 2102.010, Rev. 22, "Plant Shutdown and Cooling."
9.3.6.5 Table 9.5-2	Design Change Package 89-2042, "Generic Letter 88-17, Shutdown Cooling (SDC) Instrumentation and Alarms."
9.5.1.2.2 9.5.1.3.4 Figure 9.5-1 Figure 9.5-5	Design Change Package 80-2067, "Deluge System West of Control Room."
9.5.1.5.2.1 9.5.1.5.2.3 9.5.1.5.4 9.5.1.5.5.4 9.5.1.5.7	Fire Protection Program clarifications.
9.5.2.2	Design Change Package 85-2116, "Evacuation System Upgrade."
9.5.2.2	Plant Change 90-8019, "Telephone System Upgrade."
Table 9.1-2 Table 9.3-4	Quality Assurance Audit QAP-22-90, "Nuclear Chemistry."
Table 9.2-5 Table 9.2-6 Figure 9.2-1	Design Change Package 90-2027, "ACW Isolation Valve Override."
Table 9.3-8	Engineering Action Request 88-0226, "Design Transients - Regenerative Heat Exchangers."
Table 9.3-14	Plant Change 89-0504, "2P-36B Cylinder Block Modification."

ARKANSAS NUCLEAR ONE
Unit 2

UPDATE REFERENCE LIST (continued)

<u>Section</u>	<u>Cross References</u>
Table 9.5-2 Figure 9.2-1	Design Change Package 84-2083A, "ANO-2 Control Room Emergency A/C Modifications."
Table 9.5-2	Plant Change 89-8034, "Replace 2SV-2400-2."
Table 9.5-2	Plant Engineering Action Request 91-0184, "Reverse 2SV-1060-1A and 2SV-1060-2A Tag Numbers."
Table 9.5-3 Figure 9.5-1 Figure 9.5-6	Design Change Package 83-2131, "Fire Protection System Zone 2154-E Hose Station."
Figure 9.2-1	Plant Change 86-3973, "Upgrade Data Acquisition Capabilities for Testing the Shutdown Cooling Heat Exchangers."
Figure 9.2-1 Figure 9.2-6 Figure 9.3-2 Figure 9.4-2 Figure 9.4-4	Design Change Package 89-2024, "Recorder Upgrade."
Figure 9.2-1 Figure 9.5-8	Design Change Package 90-2029, "SWS Thermal Performance Monitoring."
Figure 9.2-1	Plant Change 90-8017, "Installation of a Loop Seal in 2VUC-21's Drain Line."
Figure 9.2-1	Plant Change 90-8018, "Install Side-Stream Corrosion Racks on ACW."
Figure 9.2-1	Plant Change 90-8069, "Installation of Drain Valves for Boundary Leak Testing."
Figure 9.2-7	Design Change Package 85-2070, "Turbine Building Drain Line Radiation Monitor."
Figure 9.2-7	Plant Change 90-8006, "Outside Auxiliary Building Sump Level Switch Replacement."
Figure 9.3-1 Figure 9.5-1	Plant Change 89-8027, "Service Air Connection to 2UAV-3207."
Figure 9.3-1 Figure 9.5-1	Plant Change 89-8038, "Service Air Connection to 2UAV-3217."
Figure 9.3-4	Procedure 2106.016, Rev. 28, "Condensate, Feedwater and Steam Systems."

ARKANSAS NUCLEAR ONE
Unit 2

UPDATE REFERENCE LIST (continued)

<u>Section</u>	<u>Cross References</u>
Figure 9.3-4	Plant Change 87-2701, "Blank Flange Nitrogen Connection to Volume Control Tank."
Figure 9.3-4	Limited Change Package 89-6008, "Flange Addition to 2PSV-4878 Relief Valve."
Figure 9.3-4	Limited Change Package 90-6022, "ANO-2 Boric Acid System Heat Trace Panels Removal."
Figure 9.4-1	Design Change Package 86-2031, "Fire Damper Replacement."
Figure 9.4-1	Engineering Action Request 91-535, "Correction of HVAC Subsystems Drawing Errors."
Figure 9.4-4	Limited Change Package 90-6015, "N2Supply to H2 Analyzers."
Figure 9.5-1	Plant Change 89-0707, "Conversion of Reliable Dry Pipe Valve to Wet Pipe Valve."
Figure 9.5-1	Plant Change 90-8067, "Connect 2PS-3329 to Wiring Circuit on Cabinet 2C-234."
Figure 9.5-1	Plant Change 91-8031, "Install 2½" Gate Valve on Fire Water System for Future Use."
Figure 9.5-8	Plant Change 89-0490, "2K-4NB Air Roll System."
9A.4	ANO-2 Technical Specifications Amendment 114, dated February 4, 1991. (OCAN029101)
9D	Addition of Fire Protection Related Technical Specifications Bases
<u>Amendment 11</u>	
9.1.2.1	Correspondence From Livingston, Westinghouse, to McKinney, EOI, dated February 17, 1992. (LAL-92-005)
9.1.3.2.1	Condition Report 2-89-0053, "Pall-Trinity Filter Data."
Table 9.1-3	
Table 9.3-11	
9.1.4.2.7	Limited Change Package 91-6026, "ANO-2 Reactor Vessel Head Shield System."
9.1.4.3.2	
Figure 9.1-8	
9.1.4.2.10	ANO Procedure 1506.002, Rev. 4, "Control Component Handling."
9.2.1.2.1	ANO Procedure 1052.007, Rev. 13, "Secondary Chemistry Monitoring."

ARKANSAS NUCLEAR ONE
Unit 2

UPDATE REFERENCE LIST (continued)

<u>Section</u>	<u>Cross References</u>
9.2.1.2.1 9.2.1.2.2 9.4.1.1.2 9.5.9.3 Figure 9.2-1 Figure 9.2-3	Design Change Package 90-2023, "Sodium Bromide/Sodium Hypochlorite System Addition."
9.3.1.1	Condition Report C-90-0025, "Instrument Air Dewpoint."
9.3.2.1	ANO Procedure 1000.043, Rev. 13, "Steam Generator
9.5	Chemistry Monitoring Unit II."
9.3.2.2.2 Figure 9.3-2 Figure 9.3-3	Design Change Package 92-2012, "Ion Chromatograph."
9.3.2.5 Figure 9.3-3	Plant Change 92-8011, "Condensate Pump Discharge pH Monitor Installation."
9.3.4.2.4 Table 9.1-2 Table 9.3-4	QAP-22-90, "Nuclear Chemistry."
9.3.6.5 Table 9.3-25	Design Change Package 91-2012, "SDC Vortex Monitoring."
9.4.3.2.1	ANO Procedure 2104.035, Rev. 8, "Fuel Handling and Radwaste Area Ventilation."
9.4.6 Figure 9.4-3	Design Change Package 89-2001, "ANO Unit 2 Intake Structure HVAC Deficiencies."
9.5.1.5.2	ANO Procedure 5120.302, Rev. 2, "Control of Ignition Sources."
9.5.5.5	Design Change Package 86-2113, "Alarm Upgrade for Panels 2K01, 2K08, and 2K09."
9.5.6.2	Design Change Package 89-2004, "ANO-2 Diesel Generator Air Start Pressure Switch Replacement."
9.5.6.3	Design Change Package 85-2134, "SIAS Removal From UAT 4160 Volt Breakers & EDG Start Failure."
Table 9.2-1	ANO Procedure 2104.029, Rev. 37, "Service Water System Operations."

ARKANSAS NUCLEAR ONE
Unit 2

UPDATE REFERENCE LIST (continued)

<u>Section</u>	<u>Cross References</u>
Table 9.2-1 Table 9.2-3	Condition Report 2-91-0353, "Thermal Performance Design Parameters Discrepancy."
Table 9.2-3 Figure 9.2-2	Limited Change Package 91-6021, "Rebuild/Repair 2P-4 Service Water Pumps."
Table 9.5-2 Figure 9.3-4	Plant Change 91-8040, "2PSV-4913 Removal."
Table 9.5-2 Figure 9.3-2	Limited Change Package 90-6018, "Valve Replacement on ANO-2 RCS Sample Line."
Figure 9.2-1	Plant Change 90-8065, "2P-4A, B, and C Discharge Pressure Indicating Switches Power Supply."
Figure 9.2-1 Figure 9.2-7 Figure 9.3-1 Figure 9.3-2 Figure 9.3-3 Figure 9.4-4 Figure 9.5-8	Design Change Package 88-2111, "ANO-2 Annunciator Upgrade Phase III."
Figure 9.2-1	Plant Engineering Action Request 91-0287, "Removal of 2ACW-1137 From P&ID M-2211."
Figure 9.2-6 Figure 9.3-3	Plant Change 91-8015, "Corrosion Product Samplers on the Feedwater System."
Figure 9.2-6 Figure 9.3-4 Figure 9.4-1 Figure 9.4-4 Figure 9.5-8	Design Change Package 90-2036, "Unit 2 Plant Computer Replacement."
Figure 9.2-6	Design Change Package 92-2010, "Unit 2 CCW Modifications to Mitigate the Effects of an ISLOCA."
Figure 9.2-7	Plant Engineering Action Request 91-7302, "Correct P&ID to Match Field."
Figure 9.2-7	Plant Engineering Action Request 90-0138, "Make-up Water Degasifier Sample Valve."
Figure 9.2-7 Figure 9.5-5	Plant Change 91-8079, "Chemistry Department Room Modification."
Figure 9.2-7	Plant Change 90-8037, "Upgrade of Domestic Water Piping to the Circulating Water Pumps."

ARKANSAS NUCLEAR ONE
Unit 2

UPDATE REFERENCE LIST (continued)

<u>Section</u>	<u>Cross References</u>
Figure 9.2-7	Design Change Package 79-2004, "Maintenance Facility Interface With Domestic Water System."
Figure 9.3-1	Design Change Package 79-2014, "Addition of Service Air Hose Connections."
Figure 9.3-1	Plant Engineering Action Request 91-7222, "Change 2IA-5045 From Globe to Gate Valve on P&ID."
Figure 9.3-2	Plant Engineering Action Request 91-7262, "Deletion of Valves 2PS-124 and 2PS-126 From P&ID M-2237 Sh. 4."
Figure 9.3-3	Plant Change 87-0350, "Revise Secondary Sampling System Alarm Setpoints."
Figure 9.3-3	Plant Change 88-2194, " 'B' Main Feedwater Line Continuous Sample."
Figure 9.3-3	Plant Engineering Action Request 91-7310, "Correction of Unit 2 SAR Figure."
Figure 9.3-4	Limited Change Package 90-6019, "Modification to Charging Pump Lube Water System."
Figure 9.3-4	Plant Engineering Action Request 91-7344, "Deletion of Valve 2H2-5 From SAR Figure."
Figure 9.3-4	Plant Change 92-8006, "2P-64A, B, C Seal Water System Upgrade."
Figure 9.4-1	Limited Change Package 91-5018, "Installation of Position Indication on CV-7910."
Figure 9.4-1	Limited Change Package 91-6007, "Installation of Position Indication for Outside Air Damper 2VSF-9."
Figure 9.4-1	Limited Change Package 91-6023, "Installation of Position Indication Unit 2 EDG Outside Air Damper."
Figure 9.4-2	Design Change Package 91-2011, "ANO-2 HELB Dampers."
Figure 9.4-2	Plant Change 90-8043, "Change-Out of 2FC-8408, 2FY-8408, & 2FY-8315A."
Figure 9.4-3 Figure 9.5-3	Plant Change 91-8077, "H.P. Room Modification at El. 354' 0"."
Figure 9.4-3 Figure 9.5-2	Plant Change 91-8076, "H.P. Room Modification at El. 335' 0"."
Figure 9.4-4	Plant Change 91-8029, "Containment Cooler RTD Installation."

ARKANSAS NUCLEAR ONE
Unit 2

UPDATE REFERENCE LIST (continued)

<u>Section</u>	<u>Cross References</u>
Figure 9.4-4	Design Change Package 91-2003, "ANO-2 Hydrogen Monitoring Modification."
Figure 9.4-4	Plant Change 92-8070, "Blind Flange Installation in 2HBC-107-2" Piping."
Figure 9.4-4	Limited Change Package 92-6005, "Valves For 2V1 and 2V2."
Figure 9.4-4	Plant Change 90-8071, "Replace Carbon Steel Piping in PASS H ² Cabinets with Stainless Steel."
Figure 9.4-6	Design Change Package 90-1064, "Control Room Isolation Dampers CV-7905/CV-7907 Replacement."
Figure 9.5-1	Design Change Package 79-2085C, "Firewater System Modifications."
Figure 9.5-1	Plant Change 89-7011, "CO ₂ Nozzle/Covers."
Figure 9.5-1	Plant Change 91-8047, "Remove a Section of Pipe From Warehouse #3 Sprinkler System."
Figure 9.5-1	Plant Change 92-8023, "Provide Sprinkler Coverage in Storage Room 2232 Mezzanine Area."
Figure 9.5-1	Design Change Package 89-2025A, "New Fire Protection Sprinkler System for Warehouse No. 4."
Figure 9.5-1	Design Change Package 85-1031A, "ANO-1 Start-Up Boiler Building."
Figure 9.5-1	Plant Change 91-8034, "Remove Hose Stations in Mezzanine Area of Maintenance Facility."
Figure 9.5-1	Plant Change 92-7012, "Outage Support Trailer's Sprinkler System."
Figure 9.5-1	Condition Report 2-92-0120, "Depict Post Indicator Valve 2FS-804 Inactive."
Figure 9.5-1	Plant Change 90-7006, "Convert Dry Pipe Valve UAV-3200 to Wet Pipe Suppression System Warehouse #2."
Figure 9.5-1	Design Change Package 91-1021, "Controlled Access Number 3."

Amendment 12

9.1.4.2.15	Plant Change 92-8048, "Refueling Machine Pneumatic Control Panel Replacement
9.1.4.3.2	
9.1.4.3.3	Evaluation of Health Physics Changes Required for Revised 10 CFR 20 Implementation
9.3.2.2.4	
9.4.1.3	

ARKANSAS NUCLEAR ONE
Unit 2

UPDATE REFERENCE LIST (continued)

<u>Section</u>	<u>Cross References</u>
9.2.1.2.2.2 9.2.1.2.2.4 9.2.1.2.2.5 9.2.1.2.3.7 9.2.1.3 9.2.1.5 9.2.1.A.8 9.5.8 Table 9.2-6 Table 9.5-2	Corrections to Service Water System Description Discrepancies
9.2.1.3 9.2.3 9.2.3.1 9.2.3.2.1 9.2.3.2.2 9.2.3.4 9.2.3.5 9.2.4.2 9.2.6 9.2.6.2 9.2.6.3 9.2.6.5	Covers for Floor Openings in the Intake Structure Licensing Information Request L93-0041, "Revision of ANO-2 SAR Sections That Describe the Plant Make-up and Domestic Water System
9.3.2.1	Procedure 1000.043 Revision 14, "Steam Generator Water Chemistry Monitoring Unit 2"
9.3.2.2.1 Figure 9.2-7 Figure 9.3-2	Plant Change 91-8069, "Drain for Panel 2C377 - Steam Generator Sample Panel"
9.3.2.3 Figure 9.3-2	Limited Change Package 93-6026, "Removal of Safety Injection Actuation Signal from Two Steam Generator Sample Isolation Valves"
9.3.4.2.2 9.3.4.3.12 9.3.4.4.1 Table 9.3-20 Table 9.3-21 Table 9.3-22	Design Change Package 89-2017, "Alternate AC Power Source Project"
9.4.1.1.2	Condition Report 2-91-0057, "ANO-2 Safety Analysis Report", Subject - Control Room Habitability
9.5.1.4.1 9.5.1.4.4 9.5.1.5.2.1.D 9A.1 9D	ANO-2 Technical Specification Amendment 158

ARKANSAS NUCLEAR ONE
Unit 2

UPDATE REFERENCE LIST (continued)

<u>Section</u>	<u>Cross References</u>
9.5.1.5.1	Quality Assurance Manual Operations Revision 15
9.5.3.1 9.5.8	Plant Change 93-8046, "Spent Fuel Pool Underwater Lighting"
9A.7 9B 9C	Fire Protection Program Description Clarifications
Table 9.5-2 Figure 9.3-1	Design Change Package 93-2015, "Replacement of Containment Isolation Valves 2N2-1, 2SA-69, 2BA-216."
Table 9.5-2 Figure 9.3-1	Plant Change 93-8009, "Replacement of Pneumatic Waste Gas Compressor Discharge Isolation Valves 2CV-2447 and 2CV-2457 with Manual Valves"
Figure 9.2-1 Figure 9.3-4 Figure 9.4-4	Design Change Package 92-2023, "Critical Applications Programs Systems (CAPS) Migration to the Plant Computer"
Figure 9.2-1	Plant Change 93-8045, "Instrument Piping Change"
Figure 9.2-1	Drawing Revision Notice 94-01582, "Service Water Piping and Instrument Diagram Note"
Figure 9.2-6	Plant Change 92-8084, "CCW Corrosion Coupon Racks"
Figure 9.2-6	Plant Change 93-8019, "2PCV-5384 Pressure Sensing Line Alteration"
Figure 9.2-7	Plant Change 92-8081, "Service Water Chemical Cleaning"
Figure 9.2-7	Plant Change 93-8037, "Heat Trace Upgrade"
Figure 9.2-7	Procedure 2106.014 Revision 3, PC-2, "Domestic Water System Operations"
Figure 9.3-1	Design Change Package 93-2003, "Permanent Piping Installation for Vendor Supplied Liquid Radioactive Waste System"
Figure 9.3-1	Plant Change 90-8074, "Removal of Unused Controller from 2VCC-26"
Figure 9.3-1	Plant Change 92-8008, "Valve Operator Replacement"
Figure 9.3-2	Plant Change 92-8086, "Inline Filters for the Blowdown Radiation Monitors"
Figure 9.3-3	Design Change Package 92-2016, "ANO-2 Secondary Sample Room Chemistry Monitor Addition"

ARKANSAS NUCLEAR ONE
Unit 2

UPDATE REFERENCE LIST (continued)

<u>Section</u>	<u>Cross References</u>
Figure 9.3-3	Design Change Package 92-2015, "Chemistry Point Addition to Plant Computer"
Figure 9.3-4	Plant Change 91-8074, "Elapsed Time Meters for Charging Pumps"
Figure 9.4-1 Figure 9.4-6	Condition Report C-93-0076, "Document As-Built Location of Smoke Detector QS-7905"
Figure 9.4-2	Plant Change 93-8014, "Provide Cooling to Radiation Monitors"
Figure 9.4-4	Design Change Package 91-2003, "ANO-2 Hydrogen Monitoring Modification"
Figure 9.4-4	Procedure 2104.044 Revision 21, PC-1 and Revision 22, PC-2, "Containment Hydrogen Control Operations". Valve Position Changes.
Figure 9.4-4	Drawing Revision Notice 93-01580, "Service Water System Operations"
Figure 9.5-1	Plant Change 92-7070, "Install Isolation Valve on Hydrant H-6 "
Figure 9.5-8	Plant Change 92-8024, "Emergency Diesel Generator (EDG) Air Compressor Unloader Drain Valves"
Figure 9.5-8	Plant Change 92-8045, "Diesel Generator Fuel Oil Pump Suction Pressure Gauge"
<u>Amendment 13</u>	
9.2.1.2.2 Figure 9.2-1	Design Change Package 93-2022, "Operation of the Unit 2 Service Water Corrosion Inhibitor Injection System"
9.2.1.2.2.4 Figure 9.1-1 Figure 9.2-1	Plant Change 93-8069, "SW Radiation Element Piping Modifications"
9.2.1.2.3.7 Figure 9.2-1	Design Change Package 89-2049, "Service Water and Auxiliary Cooling Systems Water Hammer Mitigation"
9.2.5.2.1.1 Figure 9.2-11	Limited Change Package 93-6013, "Emergency Cooling Pond Spillway Modifications"
9.3.1.1 9.3.1.2 Figure 9.3-1	Plant Change 92-8038, "Redundant Train Dryer for Instrument Air"
9.3.3.2.1	Limited Change Package 93-6025, "ANO-2 HPSI Pump Room 'C' Floor Drain Modification"

ARKANSAS NUCLEAR ONE
Unit 2

UPDATE REFERENCE LIST (continued)

<u>Section</u>	<u>Cross References</u>
9.3.4.3.9	Limited Change Package 90-6022, "Boric Acid System Heat Trace Panel 2C329 & 2C332 Removal"
9.3.4.3.14	Plant Change 94-8031, "Removal of CVCS Flow Control Valves Packing Leak Figure 9.3-4 Off Lines"
9.3.4.3.15 9.3.4.4.1 Figure 9.3-4	Plant Change 93-8038, "Boric Acid Heat Trace Upgrade"
9.3.6.2.2	Design Change Package 90-2015, "2R11 LPSI Valve Replacement 2CV-5037-1 and 2CV-5077-2"
Table 9.3-22	Plant Change 95-8004, "Installation of Permanent Pressure Gauge on Letdown Figure 9.3-4 System"
Table 9.3-22 Figure 9.3-4	Plant Change 95-8041, "Installation of Local Pressure Indicator on the VCT"
Figure 9.1-1 Figure 9.2-1 Figure 9.3-1	Design Change Package 92-2002A, "RWT Recirculation Isolation Valves"
Figure 9.2-1	Plant Change 90-8018, "Install Side Stream Corrosion Rack on ACW"
Figure 9.2-1	Plant Change 92-8009, "Service Water Corrosion Monitoring"
Figure 9.2-1 Figure 9.2-6 Figure 9.2-7 Figure 9.3-1 Figure 9.3-4 Figure 9.4-4	Design Change Package 93-2007, "ANO-2 New Points to Plant Monitoring System"
Figure 9.2-1	Plant Change 93-8071, "Auxiliary Cooling Water Valves"
Figure 9.2-1	Limited Change Package 94-6021, "SW Pump Vacuum Orifice Installation"
Figure 9.2-1	Limited Change Package 94-6035, "Service Water Pipe Replacement 8" Valve Installation"
Figure 9.2-1	Plant Change 94-8036, "ACW to EHC Cooler Piping Change to Stainless Steel"
Figure 9.2-1	Plant Change 95-8014, "Addition of Misc. Sample and Vent Valves to SWC Skid"

ARKANSAS NUCLEAR ONE
Unit 2

UPDATE REFERENCE LIST (continued)

<u>Section</u>	<u>Cross References</u>
Figure 9.2-6 Figure 9.3-3	Plant Change 93-8002, "Corrosion Product Samplers for the Steam Generator Blowdown System"
Figure 9.2-6	Plant Change 94-8033, "EHC Cooler Piping"
Figure 9.2-7	Plant Change 89-1062, "Removal of Water Heater 2M-174"
Figure 9.2-7	Plant Change 90-8051, "Relocation of Seal Water Pressure Switches 2PS-7147, 2PS-7157, 2PS-7167"
Figure 9.2-7	Plant Change 93-8024, "Molar Ratio Control"
Figure 9.2-7	Plant Change 93-8050, "Alternate AC-Generator Relocation of Plant Services"
Figure 9.3-1	Limited Change Package 95-6007, "Replacement of Normal Control Room Chillers"
Figure 9.3-1	Limited Change Package 95-6014, "Penetration 2P-53 Modification"
Figure 9.3-2 Figure 9.3-4	Limited Change Package 94-6028, "ANO-2 Gaseous Waste System Modification"
Figure 9.3-3	Plant Change 95-8003, "2M-126A/B/C/D Upgrade"
Figure 9.3-4	Plant Change 87-0350, "Secondary Sampling System Alarm Setpoint"
Figure 9.3-4	Plant Change 92-8083, "Boric Acid Makeup Pump Discharge Pressure Sensing Line Modification"
Figure 9.3-4	Design Change Package 94-2007, "Replace Charging Pump Discharge Check Valve"
Figure 9.3-4	Plant Change 95-8045, "Charging Pump Packing, Plunger, and Seal Water Return Pressure Control Valve Modification"
Figure 9.3-4	Plant Change 95-8082, "Capping of Stem Leak-off Lines for CVCS Valves"
Figure 9.4-1	Design Change Package 89-2048, "Appendix A Fire Barrier Upgrades"
Figure 9.4-1 Figure 9.4-3	Design Change Package 90-2053, "Control Room Expansion Facility"
Figure 9.4-1	Limited Change Package 92-5032, "VSF-9 Silencer Installation"
Figure 9.4-2	Plant Change 92-8016, "Removal of Decon Sink and Exhaust Hood from Hot Tool Room"
Figure 9.4-1	Plant Change 92-8079, "2RITS-8750-1 Recorder Output Change"

ARKANSAS NUCLEAR ONE
Unit 2

UPDATE REFERENCE LIST (continued)

<u>Section</u>	<u>Cross References</u>
Figure 9.4-1	Plant Change 93-8012, "Instrument Air Component Filters"
Figure 9.4-2	Design Change Package 87-2024, "SPING - Boric Acid Mix Room HVAC"
Figure 9.4-2	Plant Change 94-8050, "Abandon Various Unit Heaters"
Figure 9.4-4	Plant Change 91-8029, "Containment Cooler RTD Installation"
Figure 9.4-4	Design Change Package 95-2004, "CEDM and Reactor Cavity Damper Replacement"
Figure 9.4-4	Plant Change 95-8051, "Deletion of 2TI-8360, -8366, -8376, and -8382 Local Temperature Indicators"
Figure 9.4-7	Plant Change 90-8071, "Replace Carbon Steel & PA H2 Analysis Cabinet Stainless Steel"
Figure 9.5-1	Design Change Package 91-1021, "Controlled Access Number 3"
Figure 9.5-1	Limited Change Package 94-5022, "Service Water Crossover Valve Logic"
Figure 9.5-1	Plant Change 94-7038, "Disconnect Fire Sprinkler Piping from Trailor 51"
Figure 9.5-1	Plant Change 95-8039, "Replace Obsolete Three Way Valve on Fire Water Control Valves 2UAV-3270 and 2UAV-3271"
Figure 9.5-8	Plant Change 93-8063, "Removal of Sample Valves 2ED-2800C & 2ED-2820C"
Figure 9.5-8 Figure 9.5-9	Plant Change 94-8013, "EDG High Point Vent"

Amendment 14

9.1	Design Change Package 92-2001, "High Level Waste Storage"
9.1.2.2	
9.1.2.A	
9.1.4.1.1	
9.1.4.2.10	
9.1.4.2.1.7	Design Change Package 93-2002, "Permanent Reactor Cavity Seal Plate Installation"
9.1.4.3.2	
9.1.4.5.1	Limited Change Package 974098L201, "Refueling Machine Limit Switches and Bypasses Modification"
9.2.1.2.2.1	Design Change Package 86-2110A, "Loop II Service Water Valve"

ARKANSAS NUCLEAR ONE
Unit 2

UPDATE REFERENCE LIST (continued)

<u>Section</u>	<u>Cross References</u>
9.2.1.2.2.5	Replacements”
9.2.2.2 9.2.2.5 Table 9.2-10 Figure 9.2-6	Plant Change 96-8013, “CCW Cross Connect Valve & Pump Circuitry Modification”
9.3.1.1 9.3.1.2 9.3.1.3 Table 9.2-10 Figure 9.2-2 Figure 9.2-6 Figure 9.3-1	Limited Change Package 96-6002, “Instrument Air Compressor Replacement”
9.2.1.2.2.1 Figure 9.2-1	Plant Change 963548P201, “Service Water Chemical Injection Relocation to Forebay”
9.2.5.2.1.2 Figure 9.2-1	Plant Change 96-2043, “Pig Launch Station Installation on Service Water Emergency Cooling Pond Return Line”
Figure 9.1-1	Plant Change 96-8015, “Removal of Vent Valve 2FP-1009”
Figure 9.2-1	Plant Change 962030P201, “Service Water Drain Down Connection”
Figure 9.2-1	Plant Change 962031P201, “Service Water Replacement 2HBC-85-1”
Figure 9.2-1	Plant Change 96-8016, “Service Water Squeeze Valve Modification”
Figure 9.2-7	Limited Change Package 94-6034, “Modification 80-11 24B-219, 24B-220, 24B-241, 24B-242, 26B-9, & 26B-10”
Figure 9.3-4	Plant Change 95-8035, “Boric Acid Batching Tank Level Indicator Installation”
Figure 9.4-4	Plant Change 963125P201, “Removal of 2TE-8371 from CEDM Cooling Duct”
Figure 9.3-1	Plant Change 94-8014, “Nitrogen Bottle Addition to Instrument Air System”
Figure 9.3-1	Limited Change Package 96-6002, “Instrument Air Compressor Replacement”
Figure 9.3-2	Plant Change 95-8047, “2SV-5934 & 2SV-5936 Removal”
Figure 9.3-2	Plant Change 962051P201, “Setpoint Calibration on 2RR-1057 & 2RE-0645”
Figure 9.3-4	Design Change Package 94-2007, “Charging Pump Discharge Check Valve Replacement”

ARKANSAS NUCLEAR ONE
Unit 2

UPDATE REFERENCE LIST (continued)

<u>Section</u>	<u>Cross References</u>
Figure 9.3-4	Plant Change 95-7080, "Installation of Permanent Line from 2P-39A & 2P-39B to T-6"
Figure 9.4-1	Plant Change 95-8026, "Setpoint Change for MG Set Room"
Figure 9.4-2	Plant Change 92-8063, "Connection of LRW Vent Line to Duct Work"
Figure 9.4-2 Figure 9.4-4	Plant Change 95-8052, "Containment Depressurization System"
Figure 9.5-1	Limited Change Package 94-5022, "Service Water Crossover Valve Logic"
Figure 9.5-1	Plant Change 95-8006, "Fire Brigade Training Building Fire Hose Station Removal"
Figure 9.5-1	Plant Change 963345P201, "COMA Sprinkler System Connection"
Figure 9.5-1	Plant Change 973938P201, "Addition of Wet Pipe Sprinkler System to Bulk Storage Warehouse #12"
<u>Amendment 15</u>	
9.1.3.1 9.1.3.3.1 Table 9.1-3 Figure 9.2-1	Condition Report 2-96-0078, "Fuel Pool Cooling System Design Basis"
9.1.4.2.10	Procedure 1402.133, "Operation of Spent Fuel Crane, L-3"
9.1.4.2.15 9.1.4.2.15.1 9.1.4.2.15.2	Plant Change 963254D201, "In-Mast Sipping Modification"
9.2.1 9.2.1.2.3.1	Condition Report 1-96-0650, "Emergency Cooling Pond Inventory"
9.2.1.2.2 Figure 9.2-1	Design Change Package 973806N301, "Intake Structure Trash Troughs and Baskets"
9.3.2.1 9.3.2.2.3 9.3.2.5 Table 9.3-1 Table 9.3-3 Figure 9.2-6 Figure 9.3-1 Figure 9.3-2 Figure 9.3-4	Design Change Package 946012D201, "Containment Vent Header/Waste Gas System Modification"

ARKANSAS NUCLEAR ONE
Unit 2

UPDATE REFERENCE LIST (continued)

<u>Section</u>	<u>Cross References</u>
9.3.2.1 9.3.2.2.4	Procedure 1617.009, "Panel 2C357 Valve Alignment"
9.3.2.3 Figure 9.3-2	Plant Change 974326P201, "Removal of 2CV5859-2 & 2CV5852-2 Limit Switches"
9.4.2.6 9.4.2.16	Design Change Package 963242D202, "Vital 120 VAC Upgrade"
9.5.7.2	Procedure 2305.049, "Occasional EDG Starts Without Prelube"
9D.1.3 9D.3.3 9D.5.3	Procedure 1000.120, "Fire Watch Program"
9D.2.1.A.2	Procedure 1000.152, "Fire Pump Suction Requirements"
Table 9.1-4	Plant Change 974820P201, "Setpoint Change for SFP System High Temperature Alarm"
Table 9.2-1	Procedure 2311.002, "Design Service Water Flow Requirement for 2VUC6B"
Table 9.2-2	Plant Change 973806P301, "Traveling Screen System Control Upgrade"
Figure 9.1-1	Plant Change 963203P201, "Addition of Level Gauge to SFP"
Figure 9.2-1 Figure 9.3-1	Design Change Package 963230D201, "Condenser Tube Bundle Replacement"
Figure 9.2-1	Plant Change 96-8016, "Modification to Service Water Squeeze Valve"
Figure 9.2-1	Plant Change 973673P201, "Local Analog D/P Indication for 2F6A, B, & C"
Figure 9.2-1	Plant Change 974899P201, "Plant Computer Room HVAC Modification"
Figure 9.2-5	Design Change 973950D201, "NaOH Replacement with TSP"
Figure 9.2-6 Figure 9.2-7 Figure 9.3-1	Plant Change 963091P201, "CCW Chemical Addition Pot" Design Change Package 92-2001, "Addition of Demineralized Water and Service Air Connections"
Figure 9.2-7 Figure 9.5-1	Design Change Package 92-2011, "Alternate AC Generator"
Figure 9.2-7	Procedure 2106.014, "Domestic Water System Operations"
Figure 9.3-1	Design Change Package 963254D201, "In-Mast Sipping Modification"

ARKANSAS NUCLEAR ONE
Unit 2

UPDATE REFERENCE LIST (continued)

<u>Section</u>	<u>Cross References</u>
Figure 9.3-1	Engineering Request 962034P201, "Air Bank Isolation Valves"
Figure 9.3-1	Engineering Request 991332N201, "Equipment Hatch Test Connection Mod"
Figure 9.3-1	Plant Change 958007P201, "Stator Leak Monitoring System Installation"
Figure 9.3-2	Plant Change 980243P201, "2PSI62 Replacement"
Figure 9.3-3	Plant Change 958033P202, "Hydrazine Analyzer Replacement"
Figure 9.4-1 Figure 9.4-4	Design Change Package 942021D201, "Replacement of Control Room Radiation Monitor"
Figure 9.4-3 Figure 9.4-4	Plant Change 94-8006, "Pneumatic Controller Replacement"
Figure 9.5-8	Engineering Request 963205L201, "Removal of EDG Exhaust Hoods and Installation of Drains"

Amendment 16

9.1.1.3	Technical Specification Amendment 205, "Relocation of Miscellaneous Design Features from Technical Specifications to SAR"
9.1.2.2 9.1.2.3 9.6	Technical Specification Amendment 224, "Storage of Less Reactive Fuel Assemblies in a Cross-Hatch Configuration"
9.1.4.5.1	Nuclear Change Package 974094N201, "Upgrade of Refueling Machine Control Console Computer"
9.2.1 9.2.1.2.1 9.2.1.5 Table 9.2-1 Table 9.2-5 Table 9.2-6 Figure 9.2-1	Nuclear Change Package 980542N201, "Service Water and ACW Modifications for Power Uprate"
9.2.1.2.2 Figure 9.2-1	Nuclear Change Package 991782N201, "Service Water Pipe Replacement to Emergency Control Room Chillers"
9.2.6.3 9.3.6.2.1 9.3.6.2.2 9.3.6.3 Table 9.3-5	Design Change Package 980642D210, "Replacement Steam Generator Design/ Qualification"

ARKANSAS NUCLEAR ONE
Unit 2

UPDATE REFERENCE LIST (continued)

<u>Section</u>	<u>Cross References</u>
Table 9.3-9 Table 9.3-10 Table 9.3-23	
9.3.1.2	Nuclear Change Package 980547N201, "Steam Generator Replacement and Power Uprate Setpoint Plant Protection System Modifications"
9.3.2	Technical Specification Amendment 218, "Elimination of the PASS System"
9.3.2.2.2 Figure 9.3-3	Nuclear Change Package 973954N201, "Startup Boiler DI Outlet Sample to Online IC"
9.3.4.4	Engineering Request 980567E202, "Containment Hydrogen Analysis"
9.3.6.2 Table 9.2-1 Table 9.3-23 Figure 9.2-22	Engineering Request 991457E205, "Qualification of 4000 gpm Design Flow for 2E35A/B"
9.4.2.16 Table 9.3-4B Figure 9.4-1	Design Change Package 963242D202, "Inverter Replacement"
9.4.3.1 9.4.3.2.3 9.4.5.2 Table 9.4-3	Engineering Request 002864E201, "Evaluation of Filter Specification Change"
9.4.5.1 9.4.5.2 9.4.5.3 Figure 9.4-4 Figure 9.4-5	Nuclear Change Package 991522N201, "Containment Cooler Chilled Water Coil Replacement and Fan Pitch Change"
9.5.4.2 Figure 9.5-8	Plant Change 974603P201, "EDG Fuel Oil Day Tank Level Switches"
9.5.5.3	Plant Change 980066P201, "Traveling Screen Upgrades"
Table 9.2-1	Nuclear Change Package 980406N201, "Main Generator Hydrogen Cooler Replacement"
Table 9.2-1	Nuclear Change Package 981243N201, "Replacement of Steam Generator Blowdown Heat Exchangers"
Table 9.3-2	Engineering Request 992085E201, "Evaluations of Pressure/Temperature Calculations for RSG and Power Uprate"

ARKANSAS NUCLEAR ONE
Unit 2

UPDATE REFERENCE LIST (continued)

<u>Section</u>	<u>Cross References</u>
Table 9.3-5 Table 9.3-9 Table 9.3-10	Engineering Request 002392E201, "Change in Normal Letdown Temperature for the Chemical and Volume Control System"
Figure 9.2-1	Engineering Request 002409E201, "Isolation of Service Water Flow to HPSI Pumps"
Figure 9.2-1	Plant Change 963505P101, "Sodium Bromide/Sodium Hypochlorite System Upgrade"
Figure 9.2-3	Plant Change 973958P201, "Intake Stop Log Guide Debris Barriers"
Figure 9.2-6	Engineering Request 002990E201, "Throttle Isophase Bus Cooler Valves"
Figure 9.2-7	Commercial Change 975009C201, "2T-24 Acid Tank Replacement"
Figure 9.3-1	Plant Change 963212P201, "Regen Waste System Upgrade"
Figure 9.3-2	Nuclear Change Package 963197N201, "Sodium Analyzer Upgrade"
Figure 9.3-4	Engineering Request 991499E201, "VCT Level Discrepancy"
Figure 9.3-4	Design Change Package 974814D201, "Installation of Thermal Relief Valves on Containment Penetrations"
Figure 9.4-1	Design Change Package 980039D102, "Hydrogen Purge Flow Indication Abandoned in Place"
Figure 9.4-4	Nuclear Change Package 002239N201, "Reactor Building Pressure and Oxygen Control"
Figure 9.4-4	Nuclear Change Package 003104N201, "Removal of Reactor Building Cooler Temperature Elements"
Figure 9.5-4	Nuclear Change Package 963089N201, "Removal of 2X31 and Upgrade of 2A3 Bus Bracing"
Figure 9.5-4	Nuclear Change Package 963089N202, "Bus Brace 2A4"
Figure 9.5-8	Nuclear Change Package 003056N201, "2K09 Annunciator Window G1 to K1"
<u>Amendment 17</u>	
9.3.1.2 Figure 9.3-1	Engineering Request ANO-2002-0011-000, "Unit 1 and Unit 2 Instrument Air Cross-Connected Configuration"
9.3.6.4	Unit 2 Technical Specification Amendment 233

ARKANSAS NUCLEAR ONE
Unit 2

UPDATE REFERENCE LIST (continued)

<u>Section</u>	<u>Cross References</u>
9.4.5.2 Figure 9.4-4	Unit 2 Technical Specification Amendment 245
Figure 9.2-1	Engineering Request 02869N201, "Enhancements to the ANO Unit 2 Electro-Hydraulic (EH) Tank 2T-38"
9.1.2.2 9.1.3.1 9.1.3.2 9.1.3.3.1 9.2.1.1 9.2.2.1 9.3.4.2.4 9.3.4.3 9.3.4.4.1 9.3.6.3 9.4.1.1.2 Table 9.1-6 Table 9.3-10 Table 9.3-5 Table 9.3-8 Table 9.3-9 Figure 9.1-19 Figure 9.1-20 Figure 9.1-22	Engineering Request ANO-2000-2344-026, "Power Uprate Evaluation"
Figure 9.2-6 Table 9.4-3	Engineering Request ANO-2000-2864-001, "Replacement Filter Evaluation" and Condition Report ANO-C-1998-0177
Figure 7.3-6	Engineering Request ANO-2000-3316-002, "Uprate of Isophase Bus Cooling System Amperage Rating"
Figure 9.3-3	Engineering Request ANO-2000-3265-001, "Installation of Local Feedwater Oxygen Analyzers"
Figure 9.2-6	Engineering Request ANO-1998-0405-012, "Heater Drain Pump Power Uprate Impacts"
Figure 9.3-3 Figure 9.1-2	Engineering Request ANO-2001-0704-001, "Change Valve Position for 2FP-5A and 2FP-5B"
Figure 9.2.6	Technical Requirements Manual revision to Section 3.9.3 and Bases Section 3.9.3
Figure 9.2-7	Engineering Request ANO-1998-0507-001, "2DW-214 and 2DW-215 Changed to Normal Closed"

ARKANSAS NUCLEAR ONE
Unit 2

UPDATE REFERENCE LIST (continued)

<u>Section</u>	<u>Cross References</u>
Figure 9.2-22	Engineering Request ANO-1998-0406-001, "Changes to the Stator Water Coolers"
Figure 9.2-6	Engineering Request ANO-2000-2670-001, "Connections Added to Component Cooling Water Loop II Supply and Return Lines"
Figure 9.2-1	Condition Report ANO-C-2002-0143, "Identified Drawing Reference Coordinates were Incorrect"
Figure 9.2-1 Figure 9.2-6	Engineering Request ANO-2002-0454-001, "Addition of Vacuum Breaker Valves to the Auxiliary Cooling Water Discharge Lines"
Figure 9.3-3	Unit 2 Technical Specification Amendment 232
Figure 9.3-4	Engineering Request ANO-1999-1397-004, "Pressure Relief Valve Replacements"
Figure 9.3-3	Engineering Request ANO-2000-3266-001, "Main Feedwater Hydrazine Analyzers"
Figure 9.3-3 Figure 9.4-1	Engineering Request ANO-2000-2956-003, "Control Room Emergency AC Drain System Sealing"
Figure 9.3-1	Engineering Request ANO-2000-3134-001, "Instrument Air Dryer Assembly Replacement"
Figure 9.3-3	Engineering Request ANO-1996-3197-003, "Unit 2 Sodium Analyzer Upgrade"
Figure 9.3-1	Condition Report ANO-1-2001-0759, "Loss of Instrument Air"
Figure 9.3-1	Condition Report ANO-2-2001-0680, "Drawing Discrepancy"
Figure 9.3-4	Engineering Request ANO-1999-2191-001, "Installation of Unit 2 Letdown Pulsation Dampener"
Figure 9.3-3	Condition Report ANO-2-2001-1393, "Drawing Discrepancy"
9.3.4.3.6 Table 9.3-14	Engineering Request ANO-2002-0383-000, "Charging Pump Block Modification"
9.3.1 9.3.1.1 9.3.1.2 9.3.1.5	Engineering Request ANO-2000-3151-003, "Abandoned Breathing Air Compressor"
9.4.1.2.3	Engineering Request ANO-2000-2864-004, "Equivalency Evaluation for Filters"

ARKANSAS NUCLEAR ONE
Unit 2

UPDATE REFERENCE LIST (continued)

<u>Section</u>	<u>Cross References</u>
Figure 9.4-4	Engineering Request ANO-2001-0672-001, "Reactor Cavity RTD High Temperature Correction"
9.4.1.3	Condition Report ANO-C-2001-0244, "2VSF-9 Flow Switches"
Figure 9.4-4	Condition Report ANO-2-2001-1321, "Drawing Discrepancy"
9.4.2.7 Figure 9.4-1	Engineering Request ANO-2002-0141-0001, "2VEF-56A and 2VEF-56B Control Circuit Modification"
<u>Amendment 18</u>	
9.3.4.4.1 9.3.6.2.1	SAR Discrepancy 2-97-0235, "Shutdown Cooling Initiation Temperature"
9.4.5.1 9.4.5.2	SAR Discrepancy 2-97-0691, "Clarification of Containment Cooling System Design Basis"
9.1.4.1.1 9.1.4.2 9.1.4.2.10 Table 9.1-10	Engineering Request ER-ANO-2000-2688, "Fuel Handling Crane L3 Upgrade"
Figure 9.2-4	Condition Report ANO-C-1997-0282, "Revision of SAR Figure Titles"
9.5.1.2.1	License Basis Document Change 2-3.11-0006, "Deletion of Specific Title Reference Regarding Plant Component Database"
Figure 9.3-2	Engineering Request ER-ANO-1998-1263, "Corrections to Penetration 2P-20 and 2P-37 Configuration"
9.3.2.1 Figure 9.3-1 Figure 9.3-2 Figure 9.3-4 Figure 9.4-4	Engineering Request ER-ANO-2003-0221-000, "Isolation of Post Accident Sampling System"
Table 9.3-7 Table 9.3-22	Engineering Request ER-ANO-2003-0089, "Letdown Backpressure Controller Setpoints"
9.1.4.3.1	SAR Discrepancy 2-97-0647, "Use of Upender for Fuel Transfer"
Figure 9.1-1	Engineering Request ER-ANO-2002-1024, "Revise Normal Position of Valve 2GCH-46"
9.1.4.2.10	Engineering Request ER-ANO-2000-3333-030, "Dry Fuel Cask Movement"
Figure 9.2-7	Condition Report CR-ANO-2-2003-0500, "Correction of Drawing Reference"

ARKANSAS NUCLEAR ONE
Unit 2

UPDATE REFERENCE LIST (continued)

<u>Section</u>	<u>Cross References</u>
9.2.1.2.2.2 Table 9.2-3	Engineering Request ER-ANO-2001-0038-002, "Upgrade of ANO-2 Service Water Pumps"
9.2.1.1	SAR Discrepancy 2-97-0750, "Clarification of Design Service Water Temperature"
Figure 9.3-1	Condition Report CR-ANO-2-2003-0185, "Valve Labeling Discrepancy"
9.4.2.16	Engineering Request ER-ANO-2002-0092-000, "Upgrade of Electrical Equipment Room Cooler 2VUC-21"
9.4.1.1.2	ANO Letter to NRC 2CAN010205, "Commitment to Maintain ANO-2 Control Room Inleakage"
9.4.2.3 9.4.2.7 9.4.2.16 Figure 9.4-1	SAR Discrepancy 2-97-0687, "Ventilation Drawing Corrections"
Figure 9.4-4	Condition Report CR-ANO-2-2003-0054, "Correction to Valve Positions"
9.5.1.5.8.15	License Basis Document Change 2-9.4-0100, "Relocation of Fire Protection Audit Requirements to QAPM"
9.4.3.2.1	SAR Discrepancies 2-98-0283 and 2-97-0690, "Clarifications and Corrections associated with Electrical Equipment Room Coolers 2VUC-25A/B"
9.4.2.7	SAR Discrepancy 2-97-0747, "Clarification of Switchgear Room Exhaust Fans with Regard to Tornado Missiles"
9.4.1.1.2 9.4.1.2.2 9.4.1.3	Condition Report CR-ANO-1-2003-0623-004, "Clarification of Control Room Makeup Air Flow from Fans VSF-9 and 2VSF-9"
Figure 9.5-8	Engineering Request ER-ANO-2002-0852, "Removal of EDG Temperature Indication Handswitch"
9.5.1.2.2	License Basis Document Change 2-9.5-0102, "Clarification of Fire System Compliance with 10 CFR 50.48"
9.5.1.5.1.B 9A.3	License Basis Document Change 2-9.5-0103, "Administrative Corrections"
9D.1.2 9D.5.2	License Basis Document Change 2-9D.1-0003, "Deletion of Non-Existent Fire Detection Circuits"

ARKANSAS NUCLEAR ONE
Unit 2

UPDATE REFERENCE LIST (continued)

<u>Section</u>	<u>Cross References</u>
9D.5.1 9D.5.3	License Basis Document Change 2-9D-0004, "Compensatory Measures for Degraded Fire Barriers"
9.1.2.1 9.1.2.2 9.1.2.3 Table 9.1-7 Table 9.1-7A Figure 9.1-16 Figure 9.1-17 Table of Contents	2SER250 (2CNA090301) Dated September 3, 2003, "SFP Alternate Loading Pattern"
9.2.1 9.4.2.8 9.4.2.16 Figure 9.2-1 Figure 9.2-22 Figure 9.4-1	Engineering Request ER-ANO-2000-2998-010, "Abandonment of Cable Spreading Room Air Conditioning Unit 2VUC-3A"
Figure 9.2-22	Engineering Request ER-ANO-2003-0787-003, "Updated EDG Service Water Flow Requirements"
Figure 9.2-7	Condition Report CR-ANO-C-2002-0077-004, "Line Class Correction Associated with AACDG Domestic Water Piping"
Figure 9.3-2	Condition Report CR-ANO-2-2002-1557, "2PS-78 Corrected to Normally Closed Configuration"
Figure 9.3-1	Engineering Request ER-ANO-1995-8071-001, "Removal of Level Indicators from 2T-145 and 2T-146"
Figure 9.3-4	Engineering Request ER-ANO-1997-3977-021, "Removal of Boric Acid System Piping Thermal Relief Valves"
Figure 9.3-1	Engineering Request ER-ANO-2003-0555-000, "2AI-154 Revised to Normally Closed Configuration"
Figure 9.4-4	SAR Discrepancy 2-97-0525, "Deletion of Note 6 from Drawing M2261 SH1"
Figure 9.4-3	Engineering Request ER-ANO-2003-0218-000, "Turbine Building Unit Coolers Temperature Control Setpoint Change"
Figure 9.4-1	Condition Report CR-ANO-1-2003-0393, "Drawing Relocation Relating to VSF-9 Flow Switch FS-7806"
Figure 9.4-1	Condition Report CR-ANO-C-2003-0607, "Drawing Relocation Relating to VSF-9 Flow Switch FS-7806"

ARKANSAS NUCLEAR ONE
Unit 2

UPDATE REFERENCE LIST (continued)

<u>Section</u>	<u>Cross References</u>
Figure 9.5-1	Condition Report CR-ANO-2-2001-1347, "Drain Valve 2FS-3225L Depiction"
Figure 9.5-8	Engineering Request ER-ANO-2002-1143-000, "Addition of EDG Instrument Isolation Valves"
Figure 9.5-1	License Basis Document Change 2-9.5-0104, "Addition of Hydrolator Valve to Drawing M2219"
Table 9.1-1 Figure 9.1-19 Figure 9.1-20 Figure 9.2-1	Engineering Request ER-ANO-2003-0539-000, "Modification of SFP Heat Exchanger Service Water Flow Restricting Device"
Figure 9.3-3	License Basis Document Change 2-9.3-0157, "Revise Drawing Against Operational Configuration"
Figure 9.5-1	Engineering Request ER-ANO-2002-0883-000, "Alternate Configuration for Dry Pipe Firewater Valve"
9.1.2.A 9.1.2.B 9.1.4.1.1 Table of Contents	Engineering Request ER-ANO-2000-3333-010, "Use of Dry Fuel Storage Casks of Holtec Design"
9.1.4.3.2	License Basis Document Change 2-9.1-0048, "Clarification of CEA Coupling and Uncoupling Operations"
9.3.4.3.4	License Basis Document Change 2-9.3-0163, "Revision of Ratio of Resins Contained in the Letdown Purification Demineralizers"
9.3.2.2.1 Figure 9.2-7 Figure 9.3-2	Engineering Request ER-ANO-1996-1011, "Installation of In-Line Sensors to Monitor RCS Sample Fluids"
Figure 9.3-1	Engineering Request ER-ANO-1999-1894, "Installation of Sample Coolers and 120 VAC Power Supply in FW Metals Probe Cabinet 2C-411"
Figure 9.2-7	Condition Report ANO-C-1991-0073, "Upgrade of LBD Change Process"
Figure 9.2-11 Figure 9.4-1 Figure 9.4-2 Figure 9.5-1	Condition Report ANO-C-1997-0282, "Addition of SAR Figure Label to Drawing"
9.2.3 9.2.3.2.1 9.2.3.2.2	License Basis Document Change 2-9.2-0147, "Revised Terminology from Abandoned-in-Place to Removed-from-Service."

ARKANSAS NUCLEAR ONE
Unit 2

UPDATE REFERENCE LIST (continued)

<u>Section</u>	<u>Cross References</u>
Figure 9.3-1	Engineering Request ER-ANO-1998-0642, "Deleted Support 2CCA-14-H5 Under Steam Generator Replacement Project"
Figure 9.3-1	Drawing Change Request 93-10494, "P&ID Connector Revision"
Figure 9.3-2 Figure 9.3-3	Condition Report CR-ANO-2-1999-0324, "Primary Sample Valves Revised to Normally Closed"
Figure 9.5-1	Engineering Request ER-ANO-2003-0793, "Evaluation of Service Water Flow to LPSI Seal Cooler"
Figure 9.5-3	Engineering Request ER-ANO-1994-6012, "Modification of Waste Gas and Containment Vent Header"
Figure 9.5-5	Engineering Request ER-ANO-1994-8016, "Modification of Chemistry Area HVAC System"
<u>Amendment 19</u>	
Figure 9.5-1	Condition Report CR-ANO-2-2004-0413, "Fires System Valve Label Correction"
Figure 9.2-22	Engineering Request ER-ANO-2000-2804-017, "Modification of High Pressure Safety Injection Pump 2P-89C"
Figure 9.5-8	Condition Report CR-ANO-2-2004-0182, "Illustration of Flow Orifices on P&ID"
9.3.2.1	Engineering Request ER-ANO-2003-0221-000, "Isolation of Post Accident Sampling System"
9.1.4.2.9	Engineering Request ER-ANO-2004-0172-000, "Clarification of Spent Fuel Handling Equipment Components"
Figure 9.2-1	Engineering Request ER-ANO-2003-0627-000, "Throttle Capability Provision for 2ACW-27"
Table 9.1-2	Condition Report CR-ANO-2-2004-0870, "Revision of Minimum Boron Concentration in the Spent Fuel Pool"
9.1.1.3	License Document Change Request 2-9.1-0067, "Generic Administrative Controls for SFP Crane Hoist Disconnect Switch"
Figure 9.1-1	Engineering Request ER-ANO-2004-0487-000, "Update Component and Label Designations for Spent Fuel Pool Structures"
Figure 9.2-22	Engineering Request ER-ANO-2003-0793-001, "U2 SDC-Minimum Service Water Flow to LPSI Pump Seal Coolers"

ARKANSAS NUCLEAR ONE
Unit 2

UPDATE REFERENCE LIST (continued)

<u>Section</u>	<u>Cross References</u>
9.5.4.1	Condition Report CR-ANO-2-2003-0821, "Clarification of EDG Mission Time Based on Stored Fuel Oil Inventory"
Table 9.1-5	Engineering Request ER-ANO-2004-0786-000, "Clarification of Function Regarding the SFP Transfer Gate Valve"
9.5.1.5.6.E	License Document Change Request 2-9.5-110, "Expansion of Pre-Fire Plan Locations Described in the SAR"
9.3.4.4.1	Condition Report CR-ANO-2-2004-1891, "Clarification of Shutdown Cooling Inservice Pressure Limit"
Figure 9.2-6	Condition Report CR-ANO-2-2004-1858, "Correction of Valve Position Illustration"
Figure 9.4-4 Sh2	Engineering Request ER-ANO-2003-0393-000, "Removal of Containment Atmosphere Monitors High/Low Flow Trip"
Figure 9.2-22	Engineering Request ER-ANO-2003-0787-000, "Minimum Service Water Flow to Shutdown Cooling Room Coolers"
Figure 9.4-4 Sh1	Engineering Request ER-ANO-2002-0884-000, "Containment Cooler Air Flow Switch Replacement"
Figure 9.2-1	Engineering Request ER-ANO-2004-0606-000, "Replacement of ACW Piping"
9.3.6.2.1 9.3.6.2.3 9.3.6.3	Engineering Request ER-ANO-2002-0875-004, "Removal of the Shutdown Cooling Suction Valve Auto-Closure Function"
Figure 9.4-1 Sh1	Engineering Request ER-ANO-2004-0288-000, "Control Room Cooler VUC-9 Upgrade"
9.1.1.2 9.1.2.2 9.4.2.4 9.5.9 Figure 9.2-4 Figure 9.2-5	License Document Change Request 2-1.2-0048, "Deletion/replacement of Excessive Detailed Drawings from SAR"
9.1.4.3.2 9.4.5.2	Engineering Request ER-ANO-2003-0245-017, "CEDM Cooling Shroud Upgrade"
Table 9.3-8	License Document Change Request 2-1.2-0049, "License Renewal"
Figure 9.5-1 Sheets 2 & 4	Engineering Request ER-ANO-2000-2478-201, "Removal of Inactive Air Maintenance Devices from Various Fire Water Valves"

ARKANSAS NUCLEAR ONE
Unit 2

UPDATE REFERENCE LIST (continued)

<u>Section</u>	<u>Cross References</u>
9.4.2.4 Figure 9.4-1 Sh2 Figure 8.3-52 Sh3	Engineering Request ER-ANO-2000-2768-002, "EDG Exhaust Fan Interlock Removal"
9.2.2	Engineering Request ER-ANO-1993-8002, "Installation of SG Blowdown Corrosion Product Sample Coolers"
9.3.1.1	License Document Change Request 2-9.3-0168, "Correction of Typographical Error"
Figure 9.3-2 Sh1 Figure 9.3-4 Sh1	Condition Report CR-ANO-2-2003-1180, "Modification of the Gaseous Radwaste System"
Figure 9.2-11	Condition Report CR-ANO-C-2005-1230, "Emergency Cooling Pond Drawing Discrepancies"
Figure 9.4-4 Sh2 Figure 9.4-4 Sh4	Condition Report CR-ANO-2-2005-0218, "Administrative Errors Correction to CAMS Drawings"
Figure 9.2-3	Condition Report CR-ANO-2-2004-1839, "Label Discrepancy Correction"
Figure 9.3-3 Sh2	License Document Change Request 2-9.3-0170, "Secondary Sampling System Valve Position Drawing Correction"
Figure 9.2-1 Sh2	Engineering Request ER-ANO-2005-0278-000, "Throttling of Shutdown Cooling Heat Exchanger Outlet Valves"
Figure 9.3-3 Sh10	Engineering Request ER-ANO-1996-3197-203, "MFW Sodium Concentration Analyzer Replacement"
Figure 9.2-7 Sh3 Figure 9.3-2 Sh2	Engineering Request ER-ANO-1996-1011-002, "Primary Sample System Modifications"
Figure 9.2-1 Sh3	Condition Report CR-ANO-C-2004-2204, "Correction of Service Water System Drawing Discrepancy"

Amendment 20

9.1.3.2	License Document Change Request 05-058, "Deletion/simplification of Excessive Detailed Drawings from SAR"
9.1.4.2	
9.1.4.2.4	
9.2.1.1	
9.2.1.2.2	
9.2.1.2.2.5	
9.2.1.2.3	
9.2.1.2.3.1	
9.2.1.2.3.2	

ARKANSAS NUCLEAR ONE
Unit 2

UPDATE REFERENCE LIST (continued)

<u>Section</u>	<u>Cross References</u>
9.2.1.2.3.3	
9.2.1.2.3.4	
9.2.1.2.3.5	
9.2.1.2.3.6	
9.2.1.3	
9.2.2.1	
9.2.3.2.1	
9.2.4	
9.2.4.2	
9.2.4.5	
9.2.5.2.1	
9.2.5.2.1.2	
9.2.5.2.1.3	
9.2.6	
9.3.2.2.2	
9.3.2.3	
9.3.4.1.2	
9.3.4.3.15	
9.3.4.4.1	
9.4	
9.4.1.1	
9.4.1.1.1	
9.4.2	
9.4.3.2.1	
9.4.3.2.2	
9.4.3.2.3	
9.4.4.2	
9.5.1.2.1	
9.5.5	
9.5.7	
Table 9.2-1	
Table 9.3-7	
Table 9.4-3	
Figures – ALL (except Figures 9.1-19 and 9.1-20)	
9.2.6.2	Engineering Request ER-ANO-2006-0389-000, “Use of QCST as Emergency
9.2.6.3	Feedwater Suction Source”
9.1.2.B	Technical Specification Amendment 261, “Restrictions on SFP Parameters during Loading of Dry Fuel Casks”
9.2.5.2.1.2	License Document Change Request 07-026, “Administrative Correction of ECP Intake Screen Type”
9.2.5.2.1.1	Calculation CALC-91-E-0099-13, “Emergency Cooling Pond (ECP) Hydrographic Survey”

ARKANSAS NUCLEAR ONE
Unit 2

UPDATE REFERENCE LIST (continued)

<u>Section</u>	<u>Cross References</u>
9.2.5.2.1.1 9.2.5.3	Engineering Request ER-ANO-2006-0109-000, "Evaluation of the ECP"
9.2.2 9.2.2.2 9.2.2.5	Engineering Request ER-ANO-2000-2670-004, "Component Cooling Water System Modification"
9.4.1.2.3	Engineering Request ER-ANO-2000-2865-000, "Standards Replaced by ASME AG-1"
9.4.2.7	Calculation CALC-2-M-3600-30, "Switchgear Room Cooling Design"
9.4.6	Calculation CALC-89-D-2001-05, "Intake Structure Ventilation"
9.5.1.2.2	Engineering Request ER-ANO-2004-0644-000, "Modification of Unit 2 MFW Pump Lube Oil Reservoir Area to a Fixed Water Spray System"
Table 9.3-11	Engineering Request ER-ANO-2006-0226-000, "Use of Cartridge Equivalent for Purification Filters"
Table 9.3-8	Calculation CALC-86-E-0036-250, "Regenerative Heat Exchanger Thermal Transient Cycles"
9D.3.1.C	Procedure Revision OP 1000.152, "Compensatory Actions for Reactor Building Cable Spreading Area Fire Detection System"
<u>Amendment 21</u>	
9.2.1.2.2.2 Table 9.2-3	Engineering Calculation CALC-89-E-0044-03, "Service Water Pump Suction Requirements"
9.2.1.2.1 9.2.1.3 9.2.1.5	Engineering Request ER-ANO-2005-0148-001, "Installation of Prescreens at the ANO-2 Service Water Intake"
9.5.1.5.8 9D.6.2	License Document Change Request 07-070, "Employee Alignment-Related Organizational Changes"
9.5.1.5.1 9A.4 9D.6.2	Condition Report CR-HNQ-2007-0151, "Employee Alignment-Related Organizational Changes"
9.1.1.3 9.1.2.1 9.1.2.2 9.1.2.3 9.1.3.1 9.1.3.2	Engineering Change EC-419, "Use of Metamic Insert Panels in the Spent Fuel Pool"

ARKANSAS NUCLEAR ONE
Unit 2

UPDATE REFERENCE LIST (continued)

<u>Section</u>	<u>Cross References</u>
9.1.4.3.3 9.6 Table 9.1-7 Table 9.1-7A Figure 9.1-12 Figure 9.1-12A Figure 9.1-12B Figure 9.1-13 Figure 9.1-18	
9.2.5.2.1.1	Engineering Request ER-ANO-2005-0481-000, "Removal of Emergency Cooling Pond Tarpaulin"
9.2.1.2.2.3 Table 9.2-4	Engineering Request ER-ANO-2006-0248-000, "SW Pump Strainer Operability Limits"
9.5.1.2.2	Engineering Change EC-897, "Containment Spray Pump Motor Replacement"
9.1.4.3.2 Figure 9.4-4	Engineering Change EC-592, "Reactor Vessel Closure Head Upgrade"
9.2.2.1 Table 9.2-8	Engineering Change EC-1922 (with ECN-7298), "CCW Heat Exchanger Modification"
9D 9D.1 9D.1.1 9D.1.2 9D.1.3 9D.2 9D.2.1 9D.2.2 9D.2.3 9D.3 9D.3.1 9D.3.2 9D.3.3 9D.4 9D.4.1 9D.4.2 9D.4.3 9D.5 9D.5.1 9D.5.2 9D.5.3 9D.6 9D.6.1 9D.6.2	Condition Report CR-ANO-C-2007-0266, "Relocation of Fire System Requirements from SAR and OP-1000.152 to TRM"

ARKANSAS NUCLEAR ONE
Unit 2

UPDATE REFERENCE LIST (continued)

<u>Section</u>	<u>Cross References</u>
Table 9D-1 Table 9D-2	
9.4.2.6	Engineering Change EC-8023, "Revision to Battery Room Air Flow Balance"
Figure 9.1-1	Engineering Change EC-4389, "Addition of Containment Sump Strainers"
<u>Amendment 22</u>	
9.D	Condition Report CR-ANO-2-2008-2286, "Typographical Correction"
9.2.5.2.1 9.2.5.2.1.1	Condition Report CR-ANO-C-2008-1728, "ECP Natural Drainage Area"
9.2.5.3	Engineering Change EC-10985, "Evaluation of ECP Inventory Losses"
9.2.5.2.1.1 9.2.5.2.1.3 9.2.5.3 9.6 Figure 9.2-10 Figure 9.2-12 Figure 9.2-13	Engineering Change EC-443, "Construction of New ECP Spillway"
Figure 9.2-1B	Engineering Change EC-7037, "Installation of Additional Manual Valve in ACW Return to Service Water"
9.2.5.2.1.1 9.2.5.2.1.3	Condition Report CR-ANO-C-2010-0286, "Correction of Typographical Errors Associated with EC-443"
<u>Amendment 23</u>	
9.4.2.16	Licensing Basis Document Change LBDC 10-037, "Remove Reference to Ventilation System Insulation Class"
Figure 9.2-7C	Licensing Basis Document Change LBDC 10-043, "Labeling Correction Associated with Figure 9.2-7C"
9.1.4.2	License Document Change Request 10-053, "Incorporation of NEI 08-05 Heavy Load Information"
9.2.6 9.3.4.1.1 Table 9.3-4 Figure 9.3-4	Engineering Change EC-20413, "Installation of Zinc Injection Skid"

ARKANSAS NUCLEAR ONE
Unit 2

UPDATE REFERENCE LIST (continued)

<u>Section</u>	<u>Cross References</u>
9.2.1.2.2.6 9.2.1.4 9.2.1.5 9.3.6.4	License Document Change Request 10-042, "Incorporation of ASME Operations and Maintenance Code in accordance with 10 CFR 50.55a"
9.3.2.1 9.3.2.2.4	Engineering Change EC-18780, "Modification of PASS Piping"
9.1.3.1.D 9.1.4.3.3.B	License Document Change Request 11-025, "Change in Required Water Level Above Single Fuel Pin"
9.4.1.1.2	Engineering Change EC-10746, "Adoption of Alternate Source Terms"
9.5.1.3.1	Engineering Change EC-5868, "Remove SAR Detail Contained in the Fire Hazards Analysis (which is part of the SAR)"
Figure 9.1-1	Engineering Change EC-29637, "Change Cask Loading Pit and Fuel Tilt Pit Transfer Pumps from Temporary to Permanent"
<u>Amendment 24</u>	
9.2.1.1 9.2.5.1 9.2.5.3 9.6 Table 9.2-17 Table 9.2-18 Figure 9.2-21	License Document Change Request 12-015, "Correct of Reactor Vessel Internals Program Title"
9.4.3.2.2 9.4.3.3.1	Condition Report CR-ANO-C-2012-0749, "Comprehensive Listing of SPING Monitored Release Points"
Figure 9.2-7A	Engineering Change EC-26210, "Modification of Plant Makeup Water System"
9.3.2.1 9.3.2.2.4	Engineering Change EC-18780, "Modification of PASS Piping"
Figure 9.4-4	Engineering Change EC-33710, "Seismic Monitoring System Upgrade"
<u>Amendment 25</u>	
Figure 9.4-4	Licensing Basis Document Change LBDC 13-001, "Clarification of Seismic Monitoring Requirements"
9.5.1.5.4 9.5.1.5.5.2 9.5.1.5.7	License Document Change Request 13-029, "Update to Reflect New Organizational Structure"

ARKANSAS NUCLEAR ONE
Unit 2

UPDATE REFERENCE LIST (continued)

<u>Section</u>	<u>Cross References</u>
9.1.2.C	Engineering Change EC-45077, "Cask Transfer Facility"
Figure 9.2-6	Engineering Change EC-48544, "Administrative Changes to Drawings"
Table 9.2-5	Engineering Change EC-51967, "Switchgear Room Cooling Requirements"
9.4.3.2.3	Engineering Change EC-50604, "2VUC-20B Motor Replacement"
<u>Amendment 26</u>	
9.5.1.2.1	Engineering Change EC-54256, "NFPA 10 Code Compliance Report Revision"
9.5.1.2.2	
Figure 9.2-7A	Engineering Change EC-56334, "Correct Normal Valve Position on Drawing"
Figure 9.5-1	Engineering Change EC-46343, "Fire Protection for Expanded Protected Area"
9.5.1	Licensing Basis Document Change Request LBDCR 15-017, "ANO-2 SAR and TRM Updates Support Implementation of NFPA 805"
9.5.1.1	
9.5.1.2.1	
9.5.1.2.2	
9.5.1.3.1	
9.5.1.3.2	
9.5.1.3.3	
9.5.1.3.5	
9.5.1.5	
9.5.1.5.2	
9.5.1.5.2.1	
9.5.1.5.2.2	
9.5.1.5.2.3	
9.5.1.5.4	
9.5.1.5.5.2	
9.5.1.5.6	
9.5.1.5.7	
9.5.1.5.8.6	
9.5.1.5.8.7	
9.5.1.5.8.11	
9.5.3	
9.5.3.2	
9A.1	
9A.6	
9A.7	
9D.1.2	
9.1.2.C	Engineering Change EC-46199, "New Cask Transfer Facility"
9.3.2.1	Engineering Change EC-35406, "Abandonment of Old Unit 1 Instrument and Service Air Compressors"

ARKANSAS NUCLEAR ONE
Unit 2

UPDATE REFERENCE LIST (continued)

<u>Section</u>	<u>Cross References</u>
9.1.3.5 Figure 9.1-1	Engineering Change EC-48348, "Installation of SFP FLEX Instrumentation"
Figure 9.1-1	Engineering Change EC-48343, "Installation of FLEX Connections"
9.3.1.3	Condition Report CR-ANO-2-2015-1301, "Revise Instrument Air Compressors Environmental Information"
9.5.1.2.2	Engineering Change EC-48711, "CEDM/Computer Room Incipient Fire Detection Installation"
Figure 9.3-4	Engineering Change EC-42529, "FLEX Installations"
9.1.2.2	Condition Report CR-ANO-C-2015-4180, "Address Items Stored in the SFP"
9.3.2.1 9.3.2.2.4	Engineering Change EC-61368, "PASS Permanent Pipe Caps"
<u>Amendment 27</u>	
9.3.1.1 9.3.1.3 Figure 9.3-1	Engineering Change EC-58331, "2C-27B Instrument Air Compressor Replacement"
9.5.1.3.5	Condition Report CR-ANO-C-2016-0974, "Correct Locations for Securing Fire Suppression Pumps"
9.1.4.2	Licensing Basis Document Change LBDC 16-038, "Use of AE Volumetric Exam for Tripods"
Figure 9.1-19 Figure 9.1-20	Engineering Change EC-71623, "SFP Decay Heat Removal Curves Revision"
9.2.2.1 Table 9.2-8	Engineering Change EC-63596, "Component Cooling Water 2E-28B Replacement"
9.2.1.2.2.4 Table 9.3-24	Engineering Change EC-64005, "Shutdown Cooling Heat Exchangers Replacement"
9.2.6	Engineering Change EC-58247, "Installation of Common Feedwater System"
9.5.4.1	Condition Report CR-ANO-C-2016-5016, "Clarification of EDG Fuel Oil Inventory during External Flood"
9.5.1.2.2	Engineering Change EC-22985, "Replacement of ANO-2 Unit Auxiliary Transformer"

ARKANSAS NUCLEAR ONE
Unit 2

UPDATE REFERENCE LIST (continued)

<u>Section</u>	<u>Cross References</u>
<u>Amendment 28</u>	
9.2.2.1	Condition Report CR-ANO-2-2017-4120, "Clarify CCW Heat Removal Capability"
Figure 9.3-2	Engineering Change EC-75848, "Correct Pump Orientation on Affected SAR Figures"
9.2.2 9.3.1.1 9.3.1.2 9.3.1.5 Table 9.2-10 Figure 9.2-6 Figure 9.3-1	Engineering Change EC-31620, "Removal of 2C-3 Service Air Compressor and Associated Equipment"
9.1.1.2 9.2.1.3	Licensing Basis Document Change LBDC 18-032, "Transfer of Redacted Information to New SAR Section"
Figure 9.3-1	Engineering Change EC-73442, "Instrument Air Dryer 2M-76 Replacement"
9.1.4.2.11	Engineering Change EC-75759, "Replacement Reactor Vessel Head Stud Tensioners"
9.4.2.16	Engineering Change EC-69520, "New CPC Room Chillers Replacement"
9.4.5.4	Licensing Basis Document Change LBDC 18-048, "Clarification of Containment HVAC Visual Inspections"
9.3.2.1	Engineering Change EC-71778, "SPING Replacements"
9.2.1.2.3.7	Licensing Basis Document Change LBDC 19-010, "Clarification of Service Water Valve Time Delay"

ARKANSAS NUCLEAR ONE
Unit 2

RECORD OF REVISIONS

<u>PAGE #</u>	<u>AMENDMENT #</u>	<u>PAGE #</u>	<u>AMENDMENT #</u>	<u>PAGE #</u>	<u>AMENDMENT #</u>
TABLE OF CONTENTS		TABLE OF CONTENTS		CHAPTER 9 (continued)	
9-i	28	9-xlvi	28	9.1-24	28
9-ii	28	9-xxviii	28	9.1-25	28
9-iii	28	9-xxix	28	9.1-26	28
9-iv	28	9-l	28	9.1-27	28
9-v	28	9-li	28	9.1-28	28
9-vi	28	9-lii	28	9.1-29	28
9-vii	28	9-liii	28	9.1-30	28
9-viii	28	9-liv	28	9.1-31	28
9-ix	28	9-lv	28	9.1-32	28
9-x	28	9-lvi	28	9.1-33	28
9-xi	28	9-lvii	28	9.1-34	28
9-xii	28	9-lviii	28	9.1-35	28
9-xiii	28	9-lix	28	9.1-36	28
9-xiv	28	9-lx	28	9.1-37	28
9-xv	28	9-lxi	28	9.1-38	28
9-xvi	28	9-lxii	28	9.1-39	28
9-xvii	28	9-lxiii	28	9.1-40	28
9-xxviii	28	9-lxiv	28	9.1-41	28
9-xxix	28	9-lxv	28	9.1-42	28
9-xx	28				
9-xxi	28			9.2-1	28
9-xxii	28	CHAPTER 9		9.2-2	28
9-xxiii	28			9.2-3	28
9-xxiv	28	9.1-1	28	9.2-4	28
9-xxv	28	9.1-2	28	9.2-5	28
9-xxvi	28	9.1-3	28	9.2-6	28
9-xxvii	28	9.1-4	28	9.2-7	28
9-xxviii	28	9.1-5	28	9.2-8	28
9-xxix	28	9.1-6	28	9.2-9	28
9-xxx	28	9.1-7	28	9.2-10	28
9-xxxi	28	9.1-8	28	9.2-11	28
9-xxxii	28	9.1-9	28	9.2-12	28
9-xxxiii	28	9.1-10	28	9.2-13	28
9-xxxiv	28	9.1-11	28	9.2-14	28
9-xxxv	28	9.1-12	28	9.2-15	28
9-xxxvi	28	9.1-13	28	9.2-16	28
9-xxxvii	28	9.1-14	28	9.2-17	28
9-xxxviii	28	9.1-15	28	9.2-18	28
9-xxxix	28	9.1-16	28	9.2-19	28
9-xl	28	9.1-17	28	9.2-20	28
9-xli	28	9.1-18	28	9.2-21	28
9-xlii	28	9.1-19	28	9.2-22	28
9-xliii	28	9.1-20	28	9.2-23	28
9-xliv	28	9.1-21	28	9.2-24	28
9-xlv	28	9.1-22	28	9.2-25	28
9-xlvi	28	9.1-23	28	9.2-26	28

ARKANSAS NUCLEAR ONE
Unit 2

RECORD OF REVISIONS (continued)

<u>PAGE #</u>	<u>AMENDMENT #</u>	<u>PAGE #</u>	<u>AMENDMENT #</u>	<u>PAGE #</u>	<u>AMENDMENT #</u>
CHAPTER 9 (continued)		CHAPTER 9 (continued)		CHAPTER 9 (continued)	
9.2-27	28	9.4-7	28	9.5-11	27
9.2-28	28	9.4-8	28	9.5-12	27
9.2-29	28	9.4-9	28	9.5-13	27
		9.4-10	28	9.5-14	27
9.3-1	28	9.4-11	28	9.5-15	27
9.3-2	28	9.4-12	28	9.5-16	27
9.3-3	28	9.4-13	28	9.5-17	27
9.3-4	28	9.4-14	28	9.5-18	27
9.3-5	28	9.4-15	28	9.5-19	27
9.3-6	28	9.4-16	28	9.5-20	27
9.3-7	28	9.4-17	28	9.5-21	27
9.3-8	28	9.4-18	28	9.5-22	27
9.3-9	28	9.4-19	28	9.5-23	27
9.3-10	28	9.4-20	28	9.5-24	27
9.3-11	28	9.4-21	28	9.5-25	27
9.3-12	28	9.4-22	28	9.5-26	27
9.3-13	28	9.4-23	28	9.5-27	27
9.3-14	28	9.4-24	28	9.5-28	27
9.3-15	28	9.4-25	28	9.5-29	27
9.3-16	28	9.4-26	28	9.5-30	27
9.3-17	28	9.4-27	28	9.5-31	27
9.3-18	28	9.4-28	28	9.5-32	27
9.3-19	28	9.4-29	28	9.5-33	27
9.3-20	28	9.4-30	28	9.5-34	27
9.3-21	28	9.4-31	28	9.5-35	27
9.3-22	28	9.4-32	28	9.5-36	27
9.3-23	28	9.4-33	28	9.5-37	27
9.3-24	28	9.4-34	28	9.5-38	27
9.3-25	28	9.4-35	28		
9.3-26	28	9.4-36	28	9.6-1	24
9.3-27	28	9.4-37	28	9.6-2	24
9.3-28	28	9.4-38	28		
9.3-29	28	9.4-39	28	9.7-1	28
9.3-30	28	9.4-40	28	9.7-2	28
9.3-31	28	9.4-41	28	9.7-3	28
9.3-32	28			9.7-4	28
9.3-33	28	9.5-1	27	9.7-5	28
9.3-34	28	9.5-2	27	9.7-6	28
		9.5-3	27	9.7-7	28
9.4-1	28	9.5-4	27	9.7-8	28
9.4-2	28	9.5-5	27	9.7-9	28
9.4-3	28	9.5-6	27	9.7-10	28
9.4-4	28	9.5-7	27	9.7-11	28
9.4-5	28	9.5-8	27	9.7-12	28
9.4-6	28	9.5-9	27	9.7-13	28
		9.5-10	27		

ARKANSAS NUCLEAR ONE
Unit 2

RECORD OF REVISIONS (continued)

<u>PAGE #</u>	<u>AMENDMENT #</u>	<u>PAGE #</u>	<u>AMENDMENT #</u>	<u>PAGE #</u>	<u>AMENDMENT #</u>
CHAPTER 9 (continued)		CHAPTER 9 (continued)		CHAPTER 9 (continued)	
9.7-14	28	9.7-59	28	F 9.1-20	27
9.7-15	28	9.7-60	28	F 9.2-1A	20
9.7-16	28	9.7-61	28	F 9.2-1B	22
9.7-17	28	9.7-62	28	F 9.2-2	20
9.7-18	28	9.7-63	28	F 9.2-3	20
9.7-19	28	9.7-64	28	F 9.2-4	20
9.7-20	28	9.7-65	28	F 9.2-5	20
9.7-21	28	9.7-66	28	F 9.2-6	28
9.7-22	28	9.7-67	28	F 9.2-7A	26
9.7-23	28	9.7-68	28	F 9.2-7B	20
9.7-24	28	9.7-69	28	F 9.2-7C	23
9.7-25	28	9.7-70	28	F 9.2-8	20
9.7-26	28	9.7-71	28	F 9.2-9	20
9.7-27	28	9.7-72	28	F 9.2-10	22
9.7-28	28	9.7-73	28	F 9.2-11	20
9.7-29	28			F 9.2-12	22
9.7-30	28	9A-1	26	F 9.2-13	22
9.7-31	28	9A-2	26	F 9.2-14	20
9.7-32	28			F 9.2-15	20
9.7-33	28	9B-1	12	F 9.2-16	20
9.7-34	28			F 9.2-17	20
9.7-35	28	9C-1	12	F 9.2-18	20
9.7-36	28			F 9.2-19	20
9.7-37	28	9D-1	26	F 9.2-20	20
9.7-38	28			F 9.2-21	24
9.7-39	28	F 9.1-1	26	F 9.2-22	20
9.7-40	28	F 9.1-2	20		
9.7-41	28	F 9.1-3	20	F 9.3-1	28
9.7-42	28	F 9.1-4	20	F 9.3-2	28
9.7-43	28	F 9.1-5	20	F 9.3-3	20
9.7-44	28	F 9.1-6	20	F 9.3-4	26
9.7-45	28	F 9.1-7	20	F 9.3-5	20
9.7-46	28	F 9.1-8	20		
9.7-47	28	F 9.1-9	20	F 9.4-1	20
9.7-48	28	F 9.1-10	20	F 9.4-2	20
9.7-49	28	F 9.1-11	20	F 9.4-3	20
9.7-50	28	F 9.1-12	21	F 9.4-4	25
9.7-51	28	F 9.1-13	21	F 9.4-5	20
9.7-52	28	F 9.1-14	20	F 9.4-6	20
9.7-53	28	F 9.1-15	20		
9.7-54	28	F 9.1-15A	20	F 9.5-1	26
9.7-55	28	F 9.1-16	20	F 9.5-2	20
9.7-56	28	F 9.1-17	20	F 9.5-8	20
9.7-57	28	F 9.1-18	21	F 9.5-9	20
9.7-58	28	F 9.1-19	27	F 9.5-10	20

9 AUXILIARY SYSTEMS

The auxiliary systems discussed in this chapter are those supporting systems which are required to ensure the safe operation, protection or servicing of the major unit systems and, principally, the Reactor Coolant System. In some cases the dependable operation of several systems is required to fulfill the above requirements and, additionally, certain systems are required to operate under emergency conditions. The extent of the information provided for each system is commensurate with the relative contribution of, or reliance placed upon the system in relation to the overall plant safety.

The majority of the active components within these systems are located outside of the containment. Those systems with connecting piping or duct work between the containment and the reactor auxiliary building are equipped with containment isolation valves as described in Section 6.2.4.

9.1 FUEL STORAGE AND HANDLING

Design criteria for the fuel storage and handling equipment in the spent fuel pool storage facility are specified to meet the intent of Regulatory Guides 1.13 and 1.29.

Under conditions of the normal loads augmented by the Design Basis Earthquake (DBE), no equipment failure will result in the breaching of the cladding of more than one spent fuel bundle, or result in a condition of criticality due to destruction of the geometry of the fuel storage arrays. Assurance is provided by designs which prevent components, under seismic conditions, from falling into the stored fuel. More than one load cannot be moved over the spent fuel at the same time if the combined weight is greater than 2000 pounds.

9.1.1 NEW FUEL STORAGE

9.1.1.1 Design Bases

The new fuel storage rack is designed to:

- A. Store 63 fuel assemblies;
- B. Provide sufficient spacing between the fuel assemblies to maintain a subcritical array during flooding with non-borated water;
- C. Maintain a subcritical array under all design loadings, including the DBE;
- D. Preclude the possibility of a fuel assembly being placed between the new fuel cavities;
- E. Maintain a subcriticality of at least five percent for the simultaneous occurrence of Design Bases "B" and "C";
- F. Maintain a subcriticality of at least two percent in the event of optimum moderation due to envelopment in a uniformly dense aqueous foam.

ARKANSAS NUCLEAR ONE
Unit 2

9.1.1.2 Facility Description

The method of transferring new fuel into the fuel handling building and placing it into the new fuel storage racks is discussed in Section 9.1.4.

The new fuel storage racks consist of 63 square cavities fixed together in a large array. The internal dimensions of the cavities (8.56 inches x 8.56 inches) are sufficient to hold one fuel assembly in a vertical position. [See Section 2.8.3 for further information.](#)

The supporting structure is designed to limit deflections so that subcriticality is maintained under all anticipated loadings. The clearance between structural framing members is small enough to prevent the wedging of a fuel assembly between adjacent cavities.

The new fuel is subjected to a maximum ambient temperature of 120 °F.

There is not sufficient room in the new fuel racks to store all the fuel assemblies for a full core load. New fuel assemblies may also be stored in the spent fuel racks which are described in Section 9.1.2.

9.1.1.3 Safety Evaluation

The new fuel in the storage racks is subcritical by at least five percent under the assumption of flooding with non-borated water.

The new fuel storage racks are designed in accordance with the American Institute of Steel Construction (AISC) Specification for the Design, Fabrication and Erection of Structural Steel for Building and meets ANSI Standard N18.2, Paragraph 5.7.4.1.

Lateral loads exerted on the rack support structure are resisted by a vertical bracing system which transmits these forces to the concrete floor or through horizontal members into the concrete walls via anchor bolts. Lateral movement of the rack with any number of fuel assemblies is prevented by these supports for all anticipated loadings.

Structural deformation of the racks is limited to ensure that adequate edge to edge spacing between assemblies is maintained to prevent inadvertent criticality.

The new fuel storage racks are Seismic Class 1, i.e., designed to withstand loads that may be induced by earthquake and tornados.

The storage facility design precludes inadvertent placement of fuel assemblies in any location except specified storage locations.

The principal method for the criticality analysis of the new fuel vault is the three-dimensional Monte Carlo code MCNP4a. MCNP4a is a continuous energy three-dimensional Monte Carlo code developed at the Los Alamos National Laboratory. MCNP4a was selected because it has been used previously and verified for criticality analyses and has all of the necessary features for this analysis. MCNP4a calculations used continuous energy cross-section data based on ENDF/B-V.

ARKANSAS NUCLEAR ONE
Unit 2

The following conservative modeling assumptions were used in the analyses:

- All structural materials of the new fuel storage racks, refuel canal racks, and the fuel handling equipment are conservatively neglected and replaced with water.
- The distance between the new storage racks and the surrounding concrete walls, measured from the center of the outer storage locations range between about 44 inches to 100 inches. In the analysis, a distance of 40 inches was used on all sides. This is conservative since it places the concrete walls closer to the fuel, resulting in increased neutron reflection from these walls.
- For all full density water calculations, the models use the bounding assumption regarding manufacturing tolerances, i.e. maximum fuel enrichment, maximum fuel density, and minimum assembly pitch (if applicable).
- A bounding nominal fuel density of 10.522 g/cm³ and a bounding active length of 150 inches are used for the fuel types analyzed.
- Tolerances for fuel enrichment and fuel density are assumed values based on industry standards.
- The fuel pellet density is conservatively used for the stack density.

Considering new fuel assemblies described by the parameters shown in Table 9.1-7 with enrichments of up to 4.95 weight percent U-235, K_{eff} is calculated to be 0.9765, which is less than 0.98, for postulated conditions of envelopment of the entire array with a uniform low density aqueous foam, and, 0.9215, which is less than 0.95, under conditions of flooding by unborated room temperature water. The calculated K_{eff} includes a conservative allowance for uncertainties.

Regulatory Position 3 of Regulatory Guide 1.13 requires that "Interlocks should be provided to prevent cranes from passing over stored fuel...when fuel handling is not in progress." The only device capable of placing loads over the new fuel racks is the 4-ton capacity fuel transfer hoist. This hoist is used for fuel handling and may be used to move other loads over the SFP if under proper supervision, administrative controls, and in compliance with Technical Specifications. The hoist may also be used to lift loads in excess of 2000 pounds, but they cannot be moved over the SFP. The hoist disconnect switch is open under administrative control is open under administrative control to control operation of the hoist.

9.1.2 SPENT FUEL STORAGE

9.1.2.1 Design Bases

The spent fuel pool design satisfies the following criteria:

- A. Safe storage is provided for approximately one core and eleven reload batches of spent fuel assemblies (including Control Element Assemblies (CEAs)), new fuel stored under water during core reloading and the spent fuel shipping cask.
- B. Handling equipment includes protection devices such as travel limits and interlocks to minimize the probability of damage to fuel assemblies or handling equipment.

ARKANSAS NUCLEAR ONE
Unit 2

- C. Spacing of fuel in the storage rack ensures a subcriticality of at least five percent assuming: (1) the storage configurations described in Technical Specification Table 3.9-1 are maintained and fuel assemblies contain enrichments no greater than 4.95 weight percent U-235 described by the parameters shown in Table 9.1-7; (2) the consideration of structural, fuel assembly position, and fuel parameter tolerances; (3) an allowance for calculational and manufacturing uncertainties; and (4) no credit for fixed integral poisons within the fuel assemblies. In addition, credit was taken for soluble boron in the pool water to offset the effects of postulated accidents and to maintain $K_{\text{eff}} < 0.95$.
- D. Sufficient pool water level is maintained at all times to ensure that the pool surface dose rate does not exceed 5 mrem/hr. Shielding is further discussed in Chapter 12.
- E. The spent fuel rack is designed such that its natural frequency is above the normal range of earthquake critical frequencies and the structure will withstand design basis earthquake loadings.

9.1.2.2 Facilities Description

The spent fuel storage racks provide 988 storage locations in a rectangular array for spent fuel assemblies or other items (e.g. incore detectors) which require long term submerged storage. The racks are comprised of four modules, containing 81 fuel storage locations each, in a 9 x 9 array; four modules, containing 90 fuel storage locations each, in a 9 x 10 array; two modules containing 80 fuel storage locations, in an 8 x 10 array; and, two modules containing 72 fuel storage locations, in an 8 x 9 array. Region 1 and Region 2 storage rack cell layouts are shown in Figures 9.1-18 and 9.1-12, respectively. All twelve modules are free standing structures and are arranged as shown in Figure 9.1-13. The spent fuel pool is lined with type 304L stainless steel.

Non-fuel irradiated components are stored in the Spent Fuel Pool for radioactive decay until such time as they can be shipped offsite. An inventory of these items is maintained.

Each fuel storage module is made up of rectangular storage cells which are capable of accepting one fuel assembly. The cells are open at the top and bottom to provide a flow path for convective cooling of spent fuel assemblies through natural circulation. The fuel storage cells are structurally connected to form storage modules which provide the assurance that the required minimum fuel assembly spacing is maintained for all design conditions including the DBE.

All welded construction is used in fabrication of the fuel storage cells and in the interconnection of cells to form each module. The fuel storage modules are constructed of type 304 stainless steel. The all welded construction ensures the structural integrity of the storage modules and provides assurance of smooth snag free paths in the storage cells so that it is highly improbable that a fuel assembly could become stuck in the racks.

Structural and Seismic Considerations

The purpose of the seismic and stress analysis is to analyze the spent fuel racks under various loading conditions. The racks are evaluated for both operating basis earthquake (OBE) and safe shutdown earthquake (SSE) conditions and meet Seismic Category I requirements. A detailed stress analysis is performed to verify the acceptability of the critical load components

ARKANSAS NUCLEAR ONE
Unit 2

and paths under normal and faulted conditions. The racks rest freely on the pool floor and are evaluated to ensure that under various loading conditions they do not impact each other, nor do they impact the pool walls.

Seismic Analysis

The dynamic response of the fuel rack assemblies during a seismic event is the condition which produces the governing loads and stresses on the structure. The dynamic response, internal stresses, and loads are obtained from a seismic analysis which is performed in two phases. The first phase is a time history analysis on a simplified nonlinear finite element model. The second phase is an analysis of a detailed rack assembly finite element model. The damping values used in the seismic analysis are two percent damping for OBE and four percent damping for SSE as specified in NRC Regulatory Guide 1.61.

The simplified nonlinear finite element model is used to determine the fuel rack response for the structural characteristics of a submerged rack assembly. The nonlinearities of the fuel rack assembly, which are accounted for in the model, are in the gaps between the fuel cell and the fuel assembly, the boundary conditions of the fuel rack support locations, and the energy losses at the support locations. Additionally, gaps between the rack and pool walls were included in the single rack models, and gaps between the racks were included in full pool models which included representation for all twelve racks simultaneously.

For the Region 2 racks, the WECAN computer program was used to determine the nonlinear time history response of the fuel assembly/fuel rack system. The fuel assembly to cell impact loads, and overall rack response were obtained from the nonlinear time history results.

The detail model for the Region 2 racks is a three-dimensional finite element representation of a rack assembly consisting of discrete three-dimensional beams interconnected at a finite number of model points. The results of the nonlinear time history model are incorporated in the detail model. Since the detail model does not account for the nonlinear effect of a fuel rack assembly, the internal loads and stresses for the rack assembly obtained from this model are corrected by load correction factors. The load correction factor is derived from the nonlinear model results and is applied to the components in the stress analysis. The responses of the model from accelerations in three directions are combined by the Square Root Sum of the Squares method in the stress analysis. The loads in two major components (support pad assembly and fuel cell) are examined, and the maximum loaded section of each of these components is found. These maximum loads from the detail model are corrected by the nonlinear load correction factors and used in the stress analysis to obtain the stresses within the rack assembly.

The Region 1 racks were evaluated to determine the nonlinear time history response of the assembly/fuel rack system, and also for the whole pool multi rack configuration. Similar to the analysis of the Region 2 racks, the fuel assembly to cell impact loads and overall rack responses were obtained from the nonlinear time history results.

The detailed models for the Region 1 racks consist of three-dimensional finite element representations of the rack assemblies using shell and beam elements. The detailed models were used to determine equivalent structural properties for the simplified nonlinear models, and also to determine stresses and displacements using results from the nonlinear analyses as input. A thermal analysis of the Region 1 rack was also performed using the detailed model.

ARKANSAS NUCLEAR ONE
Unit 2

Fuel Rack Structural Analysis

The stress analysis for the racks is performed using the load combinations specified in the "NRC Position for Review and Acceptance of Spent Fuel Storage and Handling Application."

The thermal loads due to rack expansion relative to the pool floor are negligible since the support pads are not structurally restrained in the lateral direction. The major seismic loads are produced by the operational basis earthquake (OBE) and safe shutdown earthquake (SSE) events.

It is noted from the seismic analysis that the magnitude of stresses vary considerably from one geometrical location to the other in the model. Consequently, the maximum loaded cell assembly, grid assembly, and the leveling pad assembly are analyzed. Such an analysis envelopes the other areas of the rack assembly.

For the Region 2 racks, the detailed models considered a single cell. Because of structural symmetry of the cell assembly about the x and y axes, the x and y direction horizontal seismic events produce identical loads. Consequently, the margins of safety for the multi-direction (x and y directions simultaneously) seismic event is computed by multiplying the unidirectional loads by $\sqrt{2}$. The loads described in the seismic analysis section are adjusted by load modification factors obtained from the nonlinear analysis.

For the Region 1 racks, the detailed models were for the full racks, and the maximum x and y directions horizontal seismic load effects from the nonlinear models were applied and combined by SRSS.

The computed stresses from all the rack analyses are below the allowable stresses as required by the NRC Position Paper.

Fuel Handling Crane Uplift Analysis

A fuel handling crane uplift analysis demonstrates that the racks can withstand the maximum 3000 pound uplift load of the fuel handling crane without violating the criticality acceptance criteria. In this analysis the uplift load is assumed to be applied to a fuel cell. Resulting stresses are within acceptable limits, and there is no change in rack geometry of a magnitude which causes the criticality acceptance criteria to be violated.

Fuel Bundle/Module Impact Evaluation

An analysis is performed to evaluate the effect of an impact load due to fuel assembly and fuel storage cell interaction during a seismic event. The fuel rack system consists of an array of cells which form the fuel rack structure and fuel assemblies. The fuel rack system is located in the spent fuel pool and is submerged in water.

Since the fuel assembly is stored within the cell, the gap between the fuel assembly grid and cell changes (i.e., opens and closes) during a seismic event. From the equation of motion for such a system it is evident that the fuel rack system is nonlinear. This condition necessitates the performance of a transient dynamic analysis.

The mathematical features of the nonlinear fuel rack model facilitate the determination of the fuel assembly/cell interaction and hydrodynamic mass (fluid mass) effects on the fuel rack response during seismic excitation.

ARKANSAS NUCLEAR ONE
Unit 2

The effect of fuel assembly and fuel storage cell impact force on the rigid body displacements is obtained from the nonlinear analysis. The analysis is conducted with a minimum coefficient of friction of 0.2, and it is shown that the rigid body displacement is minimal. Thus, impact between adjacent rack modules or between a rack module and the pool wall is precluded.

The fuel assembly and fuel storage cell impact forces obtained from the nonlinear analysis are used to evaluate the effects on the fuel rack structure and fuel assembly structure. These loads are within the allowable limits of the fuel rack module material and fuel assembly materials. Therefore, there is no damage to the fuel assembly or fuel rack module due to impact loads.

The fuel racks are analyzed for the normal and faulted load combinations in accordance with the "NRC Position for Review and Acceptance of Spent Fuel Storage and Handling Applications."

The major normal and upset condition loads are produced by the operational basis earthquakes (OBE). The thermal stresses due to rack expansion relative to the pool floor are negligible since the support pads are not structurally restrained in the lateral direction.

The faulted condition loads are produced by the safe shutdown earthquakes (SSE) and a postulated fuel assembly drop accident.

The stresses for the SSE load combinations are below the allowable stresses as required by the ASME B&PV Code, Section III, Subsection NF.

For the postulated fuel assembly drop accident, the acceptance criteria is that the impact resulting from the drop of the fuel assembly will either not cause permanent damage in the active fuel region, or that the consequences of damage in the active fuel region are shown by a criticality analysis that the neutron multiplication factor does not exceed 0.95. For the Region 1 racks, such damage from the fuel assembly drop accident was shown to extend slightly into the active fuel region; however, a subsequent criticality analysis demonstrated acceptability.

In summary, the results of the seismic and structural analyses show that the ANO spent fuel storage racks meet all the structural acceptance criteria adequately.

Pool Structural Analysis

The existing structures were analyzed for the modified fuel rack loads using the STARDYNE finite element computer program. The finite element models consisted of the pool walls and floor, foundation walls, cask laydown area, and fuel transfer canal area with the lowest elevation of 335'-0" assumed as a fixed boundary. The pool walls and floor slabs are modeled utilizing two layers of three dimensional solid "brick" elements with three degrees of freedom per node. In order to permit recovery of cube surface stresses, extremely thin quadrilateral membrane elements coincident with the nodes forming the surface of the solid elements were utilized. Recovery of these stresses along with cube centroidal stresses permitted the calculation of the required resultant forces and moments for an American Concrete Institute Code evaluation. The foundation walls were modeled using only one layer of brick elements through the thickness.

The pool liner was not modeled since it is not acceptable to count on its stiffness contribution to the overall pool capacity. However, stress evaluation of this component was conducted using results obtained from the computer analysis.

ARKANSAS NUCLEAR ONE
Unit 2

In order to correctly represent boundary conditions, modeling of the floor diaphragms and shear walls attached to the spent fuel pool was accomplished utilizing STARDYNE matrix elements.

Section 9.1.4.2.10 discusses design features which prevent movement of the spent fuel cask over the spent fuel racks. The postulated cask drop incident on the racks is therefore not addressed.

During loading of spent fuel assemblies for shipment, the spent fuel shipping cask is located in the cask loading pit to allow the required minimum water level covering over spent fuel being transferred. After placing the cask cover on the cask, the unit is transferred to the cask work platform or washdown area by the fuel handling crane.

Interlocks on the spent fuel handling machine prevent movement of a fuel assembly into the pool walls. Limit switches prevent raising fuel where less than 9.5 feet separate the top of the active fuel and the surface of the pool water. The maximum dose rate at the water surface will be less than 5 mrem/hr and is calculated using the most active fuel assembly 100 hours after shutdown. The concrete walls of the fuel transfer canal and spent fuel pool and the structure of the spent fuel handling machine will supplement the water shielding and limit the maximum continuous radiation dose level in working areas to less than 2.5 mrem/hr. The machine cannot physically raise fuel more than one foot above the interlock setpoint if the interlock should fail and there is no operator action. Design of the spent fuel grapple prohibits accidental release of fuel. A wall separates the fuel pool from the cask loading pit.

9.1.2.3 Nuclear Considerations

The spent fuel rack design described herein employs two separate and different arrays. The smaller array, referred to as Region 1, uses Metamic®, a fixed poison absorber, in a "flux trap" design. The larger array, Region 2, utilizes a "spacer pocket" design.

Criticality Analytical Methodology

The principal method for the criticality analysis of the storage racks is the three-dimensional Monte Carlo code MCNP4a. MCNP4a is a continuous energy three-dimensional Monte Carlo code developed at the Los Alamos National Laboratory. MCNP4a was selected because it has been used previously and verified for criticality analyses and has all of the necessary features for this analysis. MCNP4a calculations used continuous energy cross-section data based on ENDF/B-V and ENDF/B-VI libraries.

Fuel depletion analyses during core operation were performed with CASMO-4 (using the 70-group cross-section library), a two-dimensional multi-group transport theory code based on capture probabilities. CASMO-4 is also used to determine the isotopic composition of the spent fuel. In addition, the CASMO-4 calculations are restarted in the storage rack geometry yielding the two-dimensional infinite multiplication factor (k_{inf}) for the storage rack to determine the reactivity effect of fuel and rack tolerances, temperature variation, depletion uncertainty, and to perform various studies. For all calculations in the spent fuel pool racks, the Xe-135 concentration in the fuel is conservatively set to zero.

Fuel assembly and rack geometry mechanical tolerances are evaluated through a statistical combination of the reactivity associated with each tolerance. The maximum k_{eff} is determined from the MCNP4a calculated k_{eff} , the calculational bias, the temperature bias, and the applicable uncertainties and tolerances (bias uncertainty, calculational uncertainty, rack tolerances, fuel

ARKANSAS NUCLEAR ONE
Unit 2

tolerances, depletion uncertainty). In the geometric models used for the calculations, each fuel rod and its cladding were described explicitly and reflecting or periodic boundary conditions were used in the radial direction which has the effect of creating an infinite radial array of storage cells.

Criticality Analysis

The objective of this analysis is to ensure that the effective neutron multiplication factor (k_{eff}) is less than or equal to 0.95 with the storage racks fully loaded with fuel of the highest permissible reactivity and the pool flooded with borated water at a temperature corresponding to the highest reactivity. In addition, it is demonstrated that the k_{eff} is less than 1.0 under the assumed accident of the loss of soluble boron in the pool water, i.e. assuming unborated water in the spent fuel pool. The maximum calculated reactivities include a margin for uncertainty in reactivity calculations, including manufacturing tolerances, and are calculated with a 95% probability at a 95% confidence level.

Applicable codes, standards, and regulations or pertinent sections thereof, include the following:

- *Code of Federal Regulations*, Title 10, Part 50, Appendix A, General Design Criterion 62, Prevention of Criticality in Fuel Storage and Handling.
- USNRC Standard Review Plan, NUREG-0800, Section 9.1.2, Spent Fuel Storage, Rev. 3, July 1981.
- USNRC letter of April 14, 1978, to all Power Reactor Licensees – OT Position for Review and Acceptance of Spent Fuel Storage and Handling Applications, including modification letter dated January 18, 1979.
- L. Kopp, Guidance on the Regulatory Requirements for Criticality Analysis of Fuel Storage at Light – Water Reactor Power Plants, NRC Memorandum from L. Kopp to T. Collins, August 19, 1998.
- USNRC Regulatory Guide 1.13, Spent Fuel Storage Facility Design Basis, Rev. 2 (proposed), December 1981.
- ANSI ANS-8.17-1984, Criticality Safety Criteria for the Handling, Storage and Transportation of LWR Fuel Outside Reactors.
- Code of Federal Regulation 10 CFR 50.68, Criticality Accident Requirements (for soluble boron).

ANO Unit 2 currently complies in whole with 10 CFR 50.68(b).

Criticality of fuel assemblies in the spent fuel storage racks is prevented by the design of the rack which limits fuel assembly interaction, and by establishing loading restrictions for Region 1 and Region 2 storage racks. Technical Specification Table 3.9-1 shows the loading restrictions for the Region 1 and Region 2 racks, the peripheral cells for Region 2, and rack interface allowances.

To assure the true reactivity will always be less than the calculated reactivity, the following conservative design criteria and assumptions were employed:

ARKANSAS NUCLEAR ONE
Unit 2

1. Moderator is borated or unborated water at a temperature in the operating range that results in the highest reactivity, as determined by the analysis.
2. Neutron absorption in minor structural members is neglected, i.e., spacer grids are replaced by water.
3. The effective multiplication factor of an infinite radial array of fuel assemblies was used in the analyses, except for the assessment of certain abnormal/accident conditions or where neutron leakage is inherent, such as for the analysis of the peripheral rack cells.
4. The B₄C loading in the neutron absorber panels is nominally 30.5 wt%, with an uncertainty of +0.5/-1.0 wt%.
5. The presence of burnable absorbers (B₄C, Gadolinium, Erbium, IFBA) in fresh fuel is neglected. This is conservative as burnable absorbers would reduce the reactivity of the fresh fuel assembly.
6. When multiple enrichments are used within an assembly, the average enrichment is used for all fuel pins, i.e. distributed enrichments are neglected.

Calculations have been performed to qualify the Region 1 racks for storage of fuel assemblies with a maximum nominal initial enrichment of 4.95 wt% ²³⁵U. The criticality analyses for Region 1 of the spent fuel storage pool demonstrate that for the defined acceptance criteria, the maximum k_{eff} is less than 1.0 without credit for soluble boron and less than 0.95 with credit taken for soluble boron.

Calculations have been performed to qualify the Region 2 racks for storage of fuel assemblies with a maximum nominal initial enrichment of 4.95 wt% ²³⁵U which have accumulated a minimum burnup of 46.8 GWD/MTU or fuel of initial enrichment, burnup and cooling time combinations depicted in Tech Spec Table 3.9-1. Additionally, the spent fuel configuration is qualified to store lower burned fuel on the rack periphery, which have accumulated a minimum burnup of 33.3 GWD/MTU or fuel of initial enrichment and burnup combinations depicted in Tech Spec Table 3.9-1. It is also demonstrated that a checkerboard of empty storage locations and fresh fuel assemblies with a maximum nominal enrichment of 4.95 wt% ²³⁵U is acceptable. The criticality analyses for Region 2 of the spent fuel storage pool demonstrate that for the defined acceptance criteria, the maximum k_{eff} is less than 1.0 without credit for soluble boron and less than 0.95 with credit taken for soluble boron.

Rack interface calculations have been performed to include spent and fresh fuel loading patterns within the same rack and between interfacing racks (Region 2-Region 2 and Region 1-Region 2) to determine acceptability. Results of these interface calculations and a description of acceptable loading patterns are depicted in Tech Spec Table 3.9-1.

Credit for soluble boron is required to ensure k_{eff} is maintained less than 0.95 and the required soluble boron concentrations are less than the Technical Specifications requirement of > 2000 ppm.

ARKANSAS NUCLEAR ONE
Unit 2

Postulated Spent Fuel Storage Criticality Accidents

Most accident conditions will not result in an increase in K_{eff} of the rack. However, there are accidents that can be postulated to increase reactivity. For these accident conditions, the double contingency principle of ANS N16.1-1975 is applied. This states that it is unnecessary to assume two unlikely, independent, concurrent events to ensure protection against a criticality accident. Thus, for accident conditions, the presence of soluble boron in the storage pool water can be assumed as a realistic initial condition since its absence would be a second unlikely event.

A fuel assembly dropped on top of the rack will not deform the rack structure pertinent for criticality. The rack structure is such that an assembly positioned horizontally on top of the rack is more than twelve inches away from the upper end of the active fuel region of the stored assemblies. This distance precludes interaction between the dropped assembly and the stored fuel.

A vertical drop of a fuel assembly onto the top of a Region 1 rack may damage the neutron absorbers around the cells. For conservatism, the top 20 inches of the Metamic® material covering the active fuel length were assumed to be replaced with water in all fuel cells. Results show that the maximum k_{eff} including bias and uncertainties remains below regulatory limits. It is also possible to vertically drop a fuel assembly into a location that might be occupied by another assembly or that might be empty. Such a vertical impact would at most cause a small compression of the stored assembly, if present, or result in a small deformation of the baseplate for an empty cell. These deformations could potentially increase reactivity. However, the reactivity increase would be small compared to the reactivity increase created by the misloading of a fresh assembly and is therefore bounded by the misloading accident.

An inadvertent drop of an assembly between the outside periphery of the rack and the pool wall cannot occur. The distance between all the rack modules and to the pool walls is less than the width of a fuel assembly.

The fuel assembly misplacement accident was considered for all storage configurations. The misplacement of a fresh unburned fuel assembly of the highest permissible reactivity could, in the absence of soluble poison result in exceeding the regulatory limit ($k_{\text{eff}} < .95$). This could occur if a fresh fuel assembly of the highest permissible initial enrichment (4.95 wt% U-235) were to be inadvertently loaded into a storage cell which is intended to store spent fuel assemblies or remain empty. Soluble boron in the spent fuel pool water, for which credit is permitted under these accident conditions, would assure that the reactivity is maintained substantially less than the design limitation. Calculations confirm that the required boron concentration to maintain k_{eff} less than 0.95 is less than the Technical Specification requirement of > 2000 ppm.

For fuel storage applications, water is usually present. An "optimum moderation" accident is not a problem in spent fuel pool storage racks because the rack design prevents the preferential reduction of water density between the cells of a rack (e.g., boiling between cells).

ARKANSAS NUCLEAR ONE
Unit 2

Acceptance Criterion for Criticality and Other Considerations

Fuel pool piping is designed with siphon breakers to ensure that no postulated failure would result in uncovering the fuel. Appropriate pool cooling temperature and level alarms are provided. Backup cooling or makeup water may be provided from the Refueling Water Tank (RWT), boric acid makeup tanks, or Service Water System (SWS).

The spent fuel storage facility is located in the containment auxiliary building adjacent to the east side of the containment. The pool is a Seismic Class 1 structure. Controlled ventilation exhausting through carbon and HEPA filters is provided in this area.

Series isolation dampers are not provided for the fuel storage area ventilation system because the system must remain in operation following the fuel handling accident (see Section 15.1.23). Since the fuel handling area is not tornado missile protected, fuel handling during tornado watch periods is administratively prohibited. In addition, the system is not Seismic Category 1 based on the fact that a seismic event and a fuel handling accident were not postulated to occur simultaneously. Furthermore, the building siding is not Seismic Category 1.

Shielding and radiological controls are discussed in Chapter 12. Location of the spent fuel pool is such that, of the spent fuel and new fuel, only new fuel is transported across the pool. Spent fuel casks are not carried over any area of the pool. No other fuel handling activities have to be carried out above the pool. Loads may be transported over the SFP if under the proper supervision, administrative controls, and in compliance with Technical Specifications.

In accordance with Position 5.b of Regulatory Guide 1.13, the fuel pool is designed to withstand, without leakage which would uncover the fuel, the impact of the heaviest load to be carried by the overhead fuel handling crane, L-3, from the maximum height to which it can be lifted. Using the missile penetration techniques described in Section 3.5.4.1, an analysis was performed to determine the penetration of a fuel element and grapple dropped from the maximum hoisting height of the fuel handling crane to the fuel pool floor. A maximum 4-inch penetration in the 5-foot, 9-inch thick floor slab was calculated using the following extremely conservative assumptions:

- A. No credit was taken for kinetic energy lost due to splashdown wave formation;
- B. No credit was taken for deceleration due to viscous drag in the water;
- C. No credit was taken for obstruction in the fuel pool such as the fuel rack structure;
- D. A perpendicular impact was assumed with no credit taken for impingement at some obtuse angle due to the lateral motion of the traversing crane at the time of drop;
- E. No credit was taken for kinetic energy lost due to liner plate perforation; and,
- F. No credit was taken for deformation or plastic strain energy absorption by the fuel element upon impact.

More than 90 percent of the fuel pool floor area is protected by the fuel storage racks and cooling piping. In the unlikely event that a fuel element was dropped from the maximum height possible and it did strike the fuel pool floor, the damage to the floor would not be significant or result in leakage in excess of the normal pool makeup capacity.

ARKANSAS NUCLEAR ONE
Unit 2

9.1.2.4 Testing and Inspection

The spent fuel racks are a Seismic Class 1, Quality Class 2 structure and are manufactured in accordance with the requirements of an approved Appendix B Quality Assurance Program. Alignment of the racks and spent fuel handling equipment is periodically checked prior to handling fuel assemblies by operation of the systems with the use of a dummy fuel assembly which has the same weight, center of gravity, exterior size and end geometry as a fuel assembly.

9.1.2.5 Instrumentation Applications

Temperature, water level, and radiation monitoring and alarm instrumentation are provided in the control room and/or locally to verify that the decay heat from the spent fuel assemblies is being removed. The location of the area radiation monitoring in the fuel handling area is discussed in Chapter 12. An indication of the radiation in the area is given by the high radiation alarms.

9.1.2.A VSC-24 Dry Spent Fuel Storage

The Independent Spent Fuel Storage Installation (ISFSI) is a passive, dry cask storage system consisting of a concrete cask storage pad located within a separate fence inside the site controlled area, portions of the site rail system for movement of components between the pad and the plant train bay, and the support equipment to lift and transport the cask from the spent fuel pool to its assigned storage location. The ISFSI is expandable to meet future site storage requirements. One dry cask storage system utilized is Sierra Nuclear Corporation's Ventilated Storage Cask (VSC) system. The VSC is comprised of a metal basket, the Multi-assembly Sealed Basket (MSB) that contains the fuel, a transfer cask, the MSB Transfer Cask (MTC), and a concrete outer shell, the Ventilated Concrete Cask (VCC). These components are Safety Related as described in the NRC approved SAR and Certificate of Compliance (C of C) for Dry Spent Fuel Storage Casks under 10 CFR 72.214. Since the dry fuel storage cask system has been independently reviewed and approved for use by the NRC, apart from the reactor licenses, the full description of the system is in other documents. These include the VSC SAR, the VSC C of C, the ANO site specific VSC Specifications and Drawings, the NRC Safety Evaluation Report (SER), and ANO Engineering Report 95-R-0015-01. Equipment used with the VSC system include non safety related impact limiters that are positioned at the bottom of the Cask Loading Pit (CLP), safety related impact limiters that attach to the bottom of the MTC, a work platform that holds the MTC over the CLP for welding of the MSB following fuel loading, a MTC dolly, a VCC rail car, and an air pallet system that is used to move the VCC from the storage pad to the VCC rail car and back with a loaded MSB. The MTC dolly is used to transport the MTC to and from the Auxiliary Building to the Turbine Building in the train bay.

The ANO ISFSI cask storage pad for the VSC-24 system is not seismically qualified, but has been analyzed and designed to support the postulated worst case static cask loading conditions. The storage pad is a 2' thick reinforced concrete slab with reinforced 8" deep by 2'0" wide haunches around the perimeter of the pad. The pad is 45'0" wide by 135'0" long. The pad is located within the ANO security fence approximately 500 feet east of the Auxiliary Building. The pad area was undercut four (4) feet and filled with compacted low plasticity fill material to significantly reduce any potential differential movement of the pad due to plasticity characteristics of the soil. The design basis earthquake for the site is specified at ground level (elevation 354'), and the top of the pad is at 356'-8", therefore, amplification of the seismic loading on the cask by the pad is not significant.

ARKANSAS NUCLEAR ONE
Unit 2

9.1.2.B Holtec Dry Spent Fuel Storage

The other dry fuel storage system utilized is Holtec International's HI-STORM system. The HI-STORM system is comprised of a metal basket, the Multi-Purpose Canister (MPC) that contains the fuel, an on-site transfer cask (HI-TRAC 125D), and a concrete and steel storage container (HI-STORM 100S). These components are classified as important to safety (ITS) as described in the NRC approved SAR and Certificate of Compliance (CoC) for the Holtec dry fuel storage cask system licensed under 10 CFR 72.214. These components are treated as safety related (Q) at ANO. Since the dry fuel storage cask system has been independently reviewed and approved for use by the NRC apart from the site reactor licenses, the full description of the system is in other documents. These documents include the Holtec CoC, Holtec Safety Analysis Report (SAR), NRC Safety Evaluation Report (SER) and ANO Engineering Request 2000-3333-010.

Ancillary equipment used with the Holtec system include: 1) a work platform that holds the HI-TRAC over the spent fuel pool cask loading pit for welding of the MPC closure lids following fuel loading, 2) a HI-TRAC Yoke for lifting and moving the HI-TRAC, 3) MPC lifting cleats for lowering the MPC into the HI-STORM, and 4) an on-site cask transporter (split railcar), an air pallet system that is used to move the HI-STORM assembly on the cask storage pad and the ISFSI cask storage pad.

The ANO ISFSI cask storage pad for the Holtec system, which is classified as not important to safety (non-Q), was seismically designed and qualified to support the worst case casks loading conditions. The storage pad is an approximately 3 feet thick reinforced concrete slab. One section is 55 feet wide by 190 feet long and a second section is 41 feet wide by 95 feet long. The pad is located north of the VSC-24 ISFSI pad and west of the eastern most security fence and bounded by railroad tracks on the west.

Prior to loading or unloading a cask in the SFP, a SFP criticality analysis has to be performed to ensure the SFP criticality requirements are satisfied.

Holtec HI-STORM 100 MPC-32 Criticality Controls

The MPC-32 complies with 10 CFR 50.68 criticality requirements when the cask loading pit gate is open to the spent fuel pool.

The methods used in the analysis of the MPC-32 include MCNP4a and CASMO-4. The base assembly analyzed was CE 16 x 16 fuel assemblies.

The analyses assumes the most reactive fuel and moderator temperature, no credit for the presence of control rod assemblies, and no credit was taken for soluble boron present in the water for normal operations. The analysis also conservatively assumed the ANO-2 spent fuel with initial enrichments up to 5.0 wt%. The neutron absorption of fuel length material in the active fuel region was taken where both Metamic and Boral poison material were evaluated. Credit was taken for 3 years of decay time and for fuel assembly burnup. Credit was taken for soluble boron only under accident conditions.

The result of these analyses is a 95 percent probability/95 percent confidence level of k_{eff} less than 0.95 for storage of spent fuel in the MPC-32 while it is in the SFP cask loading pit with the cask loading pit gate open. This is assured through the spacing of fuel assemblies per the

ARKANSAS NUCLEAR ONE
Unit 2

storage requirements described in Technical Specification Figure 3.9-1, where the loading equation for the graph is the minimum required burnup (GWd/MTU) and is equal to 9 times the fuel assembly average enrichment minus 16.

When evaluating postulated accidents associated with loading/unloading any design of dry casks, the double contingency principle of ANS N16.1-1975 is applied, which specifies that at least two unlikely independent and concurrent events are required to produce a criticality accident. Therefore, for accident conditions, the presence of soluble boron up to 2000 ppm in the SFP water can be assumed as a realistic initial condition since its absence would be a second unlikely event. The MPC-32 is analyzed such that $k_{\text{eff}} \leq 0.95$ can be easily met for postulated accidents, since any reactivity increase will be much less than the negative worth of the dissolved boron.

The effects of credible abnormal and accident reactivity conditions previously analyzed for pool racks were evaluated for the HI-STORM 100 MPC-32. None of the abnormal or accident conditions identified cause the reactivity of the MPC-32 to exceed the limiting reactivity value ($k_{\text{eff}} \leq 0.95$) considering the presence of the Unit 2 Technical Specification minimum soluble boron.

9.1.2.C Cask Transfer Facility

The ANO Cask Transfer Facility (CTF) Component Number DFS-CTF-1 is a passive reinforced concrete structure, which will support the stack-up configuration of a fully-loaded HI-TRAC, mating device, and HI-STORM during MPC transfer operations from the HI-TRAC into the HI-STORM. In addition, the CTF may be used to load an empty MPC into an empty HI-TRAC. The CTF is basically a 12'-8" x 12'-8" by approximately 14 feet deep cavity in the ground. The cavity is constructed from 4,500 psi at 28 days concrete. Lateral seismic restraints are installed in the cavity to assist in energy absorption and transferring loads to the surrounding soil. The CTF also has a concrete apron around the CTF cavity structure.

A Vertical Cask Transporter (VCT) is used to carry the HI-STORM overpack and straddle the CTF while lowering the overpack into the CTF cavity as well as carry the HI-STORM overpack to the new or existing ISFSI Pads. The Low Profile Transporter (LPT) is used to carry the loaded HI-TRAC from Auxiliary Train Bay to the loading dock, or the turning pads (DFS-PAD-1/2) from where the VCT will carry the HI-TRAC to the CTF and position it for stack-up. When transitioning the VCT across the approach slab to the top slab of the CTF, the site may choose to place down a 3/4" thick plate. The VCT is capable of traversing over this plate.

The ANO CTF (DFS-CTF-1) supports the stack-up configuration of a fully-loaded HI-TRAC, mating device, and HI-STORM during MPC transfer operations. The CTF consists of a below grade passive reinforced concrete structure, (4) removable upper lateral restraints, and (4) removable lower lateral restraints. The lateral restraints (wedges) are used to secure the HI-STORM in position and transfer lateral loads, which may result from a seismic event into the surrounding soil.

The CTF also includes a removable handrail system, which was installed around the perimeter of the CTF Cavity for personnel protection. The CTF includes a removable work platform, which provides access for personnel to facilitate the stack-up configuration of a fully-loaded HI-TRAC, mating device, and HI-STORM during MPC transfer operations. In addition, the CTF includes a personnel access ladder, which facilitates installation of the lower lateral restraints. The CTF is protected from inclement weather by the Non-Safety Related CTF Building which consists of a

ARKANSAS NUCLEAR ONE
Unit 2

metal building and concrete shallow foundation. The CTF Building envelopes and encloses the stack-up configuration of a fully-loaded HI-TRAC, mating device, and HI-STORM during MPC transfer operations.

The CTF has been designed to accommodate both the HI-STORM 100S, Version C, and HI-STORM 100S (232), which are currently in use at ANO. The CTF will accommodate the combined loads of a fully-loaded HI-STORM 100S, Version C with high density concrete shielding during both placement and retrieval.

9.1.3 FUEL POOL SYSTEM (SPENT FUEL POOL COOLING AND CLEANUP SYSTEM)

9.1.3.1 Design Basis

The fuel pool system is designed to:

- A. maintain the pool temperature less than or equal to approximately 150 °F during full core offload conditions, while removing a heat load of less than or equal to 38.10 MBTU/hr. The cooling system's heat removal capacity as a function of service water temperature is depicted in Figures 9.1-19 and 9.1-20. Refueling operations are administratively controlled in order to minimize the potential of exceeding a pool temperature of 150 °F during a full core discharge whenever service water system temperature is elevated.
- B. maintain purity and optical clarity of the fuel pool water;
- C. maintain purity of the water in the refueling cavity and in the refueling water tank; and,
- D. maintain the water level a minimum of 9.5 feet above the top of the active fuel of a full fuel assembly (9.0 feet above the top of the active fuel of an individual fuel pin) during fuel handling and storage operations.

9.1.3.2 System Description

The simplified diagram of the fuel pool system is shown in Figure 9.1-1. The system process flow data is shown in Table 9.1-1. The cooling portion of the fuel pool system is a closed loop system consisting of two half capacity pumps for normal duty and one full capacity heat exchanger. The fuel pool water is drawn from the fuel pool near the surface and is circulated by the fuel pool pumps through the fuel pool heat exchanger where heat is rejected to the service water system.

From outlet of the fuel pool heat exchanger, the cooled fuel pool water is returned to the top of the fuel pool via distribution header at the opposite end of the pool from the intake. It has been demonstrated by CE that return of the cooled fuel pool water to the top, as opposed to the bottom, of the pool does not increase the probability of an accident.

The heat removal capacity of the ANO-2 fuel pool cooling system as a function of service water temperature is depicted in Figures 9.1-19 and 9.1-20. During the cooler months of the year when refueling is typically scheduled, the system's heat removal capacity at a pool temperature of 150 °F exceeds the maximum theoretical heat load associated with a full core discharge. Refueling operations are administratively controlled in order to minimize the potential of exceeding a pool temperature of 150 °F during a full core discharge whenever service system temperature is elevated. The administrative controls include evaluation of decay heat loads

ARKANSAS NUCLEAR ONE
Unit 2

using the guidelines of ASB 9-2, Residual Decay Energy for Light Water Reactors for Long Term Cooling. Station administrative controls ensure that the heat removal capacity of the pool is sufficient for future core offloads given the type and enrichment of fuel, and the number of assemblies to be offloaded.

The clarity and purity of the water in the fuel pool, refueling cavity, and refueling water tank are maintained by the purification portion of the fuel pool system. The purification loop consists of the fuel pool purification pump, ion exchanger, filters, strainers, and an installed connection for a floating skimmer. The purification flow is drawn from the suction piping and can be aligned to three different levels within the fuel pool. A basket strainer is provided in the purification line to the pump suction to remove any relatively large particulate matter. The fuel pool water is circulated by the pump through a filter, which removes particulates larger than 5 micron size, and through an ion exchanger to remove ionic material. Connections to the refueling water tank and refueling water cavity are provided for purification and makeup. Fuel pool water chemistry is given in Table 9.1-2.

Makeup to the fuel pool is provided from the CVCS via the blending tee, the refueling water tank via the purification pumps, or the BMS holdup tanks if chemistry specifications are met. In an emergency, Seismic Category I makeup is available from either service water system loop. The boric acid makeup tanks are also available for boration of the spent fuel pool. Overflow protection is provided by transferring the fuel pool water on high level alarm to the refueling water tank or one of the BMS holdup tanks via the purification pump.

The fuel pool system is manually controlled from a local control panel. High fuel pool temperature and high and low fuel pool water level alarms are annunciated in the control room. Spent resins from the fuel pool ion exchanger are sluiced to the solid waste management system as described in Section 11.5.2. Local sample connections are provided on the influent and effluent of the fuel pool purification filters and the fuel pool ion exchanger effluent for verifying purification performance.

Local Fuel Bundle Thermal-Hydraulic Assumptions and Considerations

A local fuel bundle thermal-hydraulic analysis was performed to determine the maximum fuel clad temperatures which may occur as a result of using the spent fuel racks in the Arkansas spent fuel pool. Conservative assumptions were incorporated into the bounding local thermal hydraulic analysis, such that actual decay heat loads are lower than calculated. The local thermal hydraulic analysis predicated decay heat loads using ORIGEN2 based methodology.

Included among the key assumptions used in the analysis are:

- All passive losses (i.e., conduction through walls and slab or losses from the surface) are completely neglected. This conservatively maximizes the net heat load, thereby maximizing both global and local temperatures.
- All calculations are performed with the hydraulic resistance of the most resistive fuel assembly type assigned to every rack storage location. This conservatively maximizes the overall hydraulic resistance of the rack.
- The calculated fuel assembly hydraulic resistance parameters are worsened to ensure an analysis that bounds any small deviations in fuel assembly and rack geometry. The two calculated parameters, permeability and inertial resistance factor, are conservatively worsened by 10%.

ARKANSAS NUCLEAR ONE
Unit 2

- The bottom plenum gap (i.e., between the floor and the rack base plate) is conservatively modeled as less than the actual value. This ensures that the effects of additional flow restrictions around rack pedestals and bearing pads are bounded in the model.
- No downcomer flow is assumed to exist between the rack modules.
- Flow through the flux trap gaps are conservatively neglected in the analysis.
- The model credits conservatively lower rack-to-wall gaps instead of the actual values. This conservatively maximizes the downcomer flow resistance and ensures that the calculations will encompass slight positional deviations in the as-installed rack configuration.
- The large flow holes in the rack base plate at the non-pedestal rack cell locations are not credited. This conservatively reduces the water flow area into the storage cells, thereby increasing the hydraulic resistance. This increased flow resistance is applied to all the cells in the SFP racks.
- The hydraulic resistance of every rack cell in the spent fuel storage rack includes the inertial resistance that would result from a dropped fuel assembly lying across the top of the rack. This conservatively increases the total rack cell hydraulic resistance and bounds the thermal-hydraulic effects of a fuel assembly dropped anywhere in the spent fuel storage area.
- All the freshly discharged fuel assemblies are assumed to be located together at the center of the spent fuel pool, conservatively maximizing the local decay heat generation rates.
- For the bounding peak fuel cladding computations, the maximum local water temperature (at the fuel rack cell exit) and peak heat flux (typically near the mid-height of the active fuel region) are considered to occur co-incidentally. The superposition of these two maximum values ensures that the calculated peak fuel cladding temperature bounds the fuel cladding temperature anywhere along the length of the fuel assembly.
- Bounding maximum allowable SFP bulk water temperature of 150 °F is used in the analysis.
- For calculating the peak cladding temperature, the cladding superheat is based on the design basis hydraulic diameter and the fuel rod outside diameter used for the calculation of the resistance to water flow in the storage cell.

Description of Analytical Method and Types of Calculations Performed

The spent fuel pool storage racks are loaded with spent fuel assemblies. There are water gaps, also called downcomers, between the racks and the walls of the SFP. The rack pedestals maintain a water gap, also called the bottom plenum, between the floor of the spent fuel pool and the rack base plates. These gaps allow water flow from the area above the rack through the downcomers, into the bottom plenum and into the bottom of the rack cells. An elevation

ARKANSAS NUCLEAR ONE
Unit 2

view of a typical model is sketched in Figure 9.1-15 where the flow paths are indicated by arrows. Each cell shown actually corresponds to a row of cells that are located at the same distance from the pool walls. This is more clearly shown in a plan view, Figure 9.1-15A.

The decay heat generated by the fuel assemblies stored in the racks induces a buoyancy-driven water flow upward through the fuel rack cells. Cooler water is supplied to the bottom of the rack cells through the downcomers and the bottom plenum. Quantification of the coupled flow and temperature fields in the spent fuel storage racks is accomplished through the use of a Computational Fluid Dynamics (CFD) analysis. The CFD analysis is performed utilizing the FLUENT fluid flow and heat transfer modeling program.

A three-dimensional model of the spent fuel pool area is made using FLUENT. The regions in the SFP occupied by the fuel racks loaded with heat generating fuel assemblies are modeled as a porous media region. Flow through the narrow fuel assembly passages is laminar and governed by Darcy's Law.

Navier-Stokes equations of fluid motion along with the energy conservation equation are solved to obtain the local flow field and the steady-state temperature distribution in the SFP. Buoyancy effects and turbulence effects are included in the CFD analysis. Turbulence effects are modeled by relating time-varying "Reynolds Stresses" to the mean bulk flow quantities using the standard k- ϵ model. As stated in the previous paragraph, the flow through the fuel rack will be laminar and turbulence effects are "turned off" in the porous media region.

The decay heat generated by the spent fuel assemblies stored in the fuel racks is included in the model as a volumetric decay heat generation in the porous media region.

Once the spatial temperature distribution in the spent fuel storage area is obtained from the CFD solution, the difference between the cladding surface temperature and the local water temperature (also called the cladding superheat) is conservatively calculated from the principles of laminar flow heat transfer. The cladding superheat is added to the CFD computed peak local water temperature to obtain a bounding cladding surface temperature.

Acceptance Criteria

The criteria used to determine the acceptability of the design from a thermal-hydraulic viewpoint are summarized as follows:

- The bounding peak local water temperature in the spent fuel pool storage cell must be less than the local saturation temperature of water when normal forced cooling is available.
- The bounding peak fuel cladding temperature for the hottest spent fuel assembly, determined by adding the bounding temperature difference between cladding material and water in the rack to the maximum local water temperature, should be less than the local saturation temperature of water. If the fuel cladding temperature exceeds the local saturation temperature of water, it must be shown that departure from nucleate boiling (DNB) will not occur.

ARKANSAS NUCLEAR ONE
Unit 2

Rack/Pool Thermal Hydraulics – Design Bases

The Spent Fuel Pool and Pool Cooling Systems are designed to keep the pool water temperature below 120 °F for normal operations and below 150 °F for the maximum normal condition, which is a full core discharge during refueling operations. During the cooler months of the year when refueling is typically scheduled, the system's heat removal capacity at a pool temperature of 150 °F exceeds the maximum theoretical heat load associated with a full core discharge. Refueling operations are administratively controlled in order to minimize the potential of exceeding a pool temperature of 150 °F during a full core discharge whenever service system temperature is elevated. The administrative controls include evaluation of decay heat loads using the guidelines of ASB 9-2, Residual Decay Energy for Light Water Reactors for Long Term Cooling. Station administrative controls ensure that the heat removal capacity of the pool is sufficient for future core offloads given the type and enrichment of fuel, and the number of assemblies to be offloaded.

Since bounding calculations have been performed for the local thermal hydraulic analysis and bulk temperature limits are satisfied through a combination of administrative controls and cooling system performance curves, a maximum theoretical heat load of up to 38.10 MBTU/hr can now be accommodated.

Design Evaluation

During normal operation, the Spent Fuel Pool Cooling System can typically maintain the pool water at temperatures below 120 °F by recirculating spent fuel cooling water from the spent fuel pool through pumps and a cooler and back into the pool. However, operation at fuel pool temperatures above 120 °F that could result from elevated service water temperatures or equipment outages is acceptable. For the maximum theoretical heat load, the system can maintain pool temperature at or below 150 °F assuming a service water inlet temperature that is representative of the cooler months of the year when refueling is typically scheduled. Refueling operations are administratively controlled in order to minimize the potential of exceeding a pool temperature of 150 °F during a full core discharge whenever service water system temperature is elevated.

The clarity and purity of the water in the fuel pool, refueling cavity, and refueling water tank are maintained by the purification portion of the fuel pool system.

Maximum dose rates from a spent fuel assembly as a function of the water height above the top of the active fuel are shown in Figure 9.1-3 and for horizontal water distances in Figure 9.1-4 for various decay times based on core power level of 2,815 MWt. Long-term operation and infinite irradiation are assumed for the dose rate calculation. An axial power distribution with maximum power at the top and bottom of the fuel was used for the axial dose rate calculations while an axial peak of 1.47 was used for the radial (side) dose rate calculations for shielding requirements as described in Section 12.1. Additionally, both cases assumed a maximum radial fuel assembly peaking factor of 1.40. The decay times are not representative of any particular point in the refueling cycle and are only given to show the dose rate variation with time. Other decay times between two days and 60 days can be obtained by interpolation between the existing points. The existing points can also be adjusted proportionately for other power levels and final assembly peaking factors.

ARKANSAS NUCLEAR ONE
Unit 2

9.1.3.2.1 Component Description

All piping, valves, instruments, and components are located in the auxiliary building. Design data for the major components are listed in Table 9.1-3.

A. Fuel Pool Heat Exchanger

The fuel pool heat exchanger is a horizontal shell and tube design with a two pass tube side. A slight pitch, three degrees above the horizontal, is provided for complete draining of the heat exchanger. The service water circulates through the shell side, and pool water circulates through the tube side.

B. Fuel Pool Purification Filters

The fuel pool purification filters are located upstream of the fuel pool ion exchanger to remove any particulates in the pool water. Due to the possible buildup of high activity in the filter, the unit has been designed and installed to provide for removal of the contaminated element assembly with remotely operated handling equipment. The filter drains to the drain collection header in the waste management system.

C. Fuel Pool Ion Exchanger

Fuel pool ion exchanger removes ionic matter from the water. Mixed bed resin is used with the anion resin converted to the borate form and the cation resin in the hydrogen form. The units are provided with all connections required to replace resins by sluicing. The ion exchanger contains a flow distributor on the inlet to prevent channeling of the resin bed and a resin retention element on the discharge to preclude discharge of resin with the effluent.

D. Fuel Pool Purification Pump Suction Strainer

The fuel pool purification pump suction strainer prevents any relatively large particulates from entering the purification pump. The strainer has a drain connection allowing local draining.

E. Fuel Pool Ion Exchanger Strainer

The wye strainer removes particles larger than 149 microns from the purification flow. Blowdown is directed to the spent resin tank in the solid waste system.

F. Fuel Pool Pumps

There are two fuel pool pumps installed for parallel operation. Under normal operating conditions, one pump is operating and one pump is in standby. The pumps are provided with mechanical seals. To increase seal life and reduce maintenance, the seals are cooled by circulating a portion of the pump discharge flow to the seals which returns to the pump suction. The seals are provided with leakoff vent and drain connections.

ARKANSAS NUCLEAR ONE
Unit 2

G. Fuel Pool Purification Pump

The fuel pool purification pump is used for purification and skimming operations. Mechanical seals minimize shaft leakage. To increase seal life and reduce maintenance, the seals are cooled by circulating a portion of the pump discharge flow to the seals which returns to the pump suction. The seals are provided with leakoff vent and drain connections. The internal wetted surfaces of the pump are stainless steel.

H. Piping and Valves

All the piping used in the fuel pool system is stainless steel with welded connections throughout, except for flanged connections at the suction and discharge of the pumps.

All the valves in the fuel pool system are stainless steel, 150-pound class.

9.1.3.3 Safety Evaluation

9.1.3.3.1 Cooling System

Depending upon actual fuel pool heat load and service water inlet temperature, either one or two fuel pool pumps and the fuel pool heat exchanger are in service. The system is manually controlled and the operation monitored locally. The fuel pool temperature high alarm and the fuel pool water level switch high and low level alarms are annunciated in the control room.

In addition to the normal makeup available from the CVCS, the refueling water tank, and the BMS holdup tanks, Seismic Class 1 makeup to the spent fuel pool is available from the service water system. Two redundant paths are provided, one from each of the service water headers, to ensure that makeup is available to the spent fuel pool under all operating or accident conditions. The service water makeup piping is piped to the pool and the valves are located such that minimal operator action is required to initiate makeup from either or both service water headers. This design satisfies the requirement of Regulatory Guide 1.13 for a Seismic Class 1 makeup system and backup source of makeup water.

The spent fuel pool system cooling piping and the service water lines to and from the fuel pool heat exchanger were analyzed and designed to withstand the forces associated with the DBE through the addition of Category 1 supports where required. This design meets the requirement of Regulatory Guide 1.29. The purification piping is not designed to Seismic Class 1 requirements. Additionally, Seismic Class 1 cooling is provided to the spent fuel pool by allowing the pool to boil and supplying adequate makeup to maintain spent fuel pool level.

In accordance with Regulatory Guide 1.13, the fuel pool piping is arranged so that the pool cannot be inadvertently drained to uncover the fuel. All fuel pool piping is arranged to prevent gravity draining the fuel pool. To prevent siphoning of the fuel pool, the fuel pool cooling intake, discharges and purification suction lines have ½-inch holes, respectively, six inches below the normal water level. The purification suction line from the refueling canal also has a siphon breaker.

ARKANSAS NUCLEAR ONE
Unit 2

9.1.3.3.2 Purification System

The purification loop is normally run on an intermittent basis when required by the fuel pool water conditions. It is possible to operate with either the ion exchanger or filter bypassed. Local samples permit analysis of ion exchanger and filter efficiencies.

Spent filters and ion exchanger resins are removed to the solid waste system described in Section 11.5 for eventual disposal.

9.1.3.4 Testing and Inspection

Historical data removed; see Section 9.1.3.4 of the FSAR.

Prior to transferring spent fuel to the pool, the system was tested to verify satisfactory flow characteristics through the equipment, to demonstrate satisfactory performance of pumps and instruments, to check for leak tightness of piping and equipment, and to verify proper operation of controls. Also, the overall cooling capability is checked during initial refueling by analyzing pool temperature versus quantity of fuel transferred into the pool and comparing with expected performance.

Since the active components of the system are in either continuous or intermittent use during normal plant operation, no periodic tests are required. Data is taken and periodic visual inspections and preventive maintenance are conducted, as necessary. This periodic inspection will also verify adequate heat transfer, purification efficiency and component differential pressures.

9.1.3.5 Instrumentation Application

Instrumentation is provided to monitor fuel pool temperature and water level together with significant temperatures and pressures around the cooling and purification loops. Alarms annunciated in the control room are provided for fuel pool water level and fuel pool temperature.

A tabulation of originally installed instrument channels is included in Table 9.1-4.

NRC Order EA-12-051, "Issuance of Order to Modify Licenses with regard to Reliable Spent Fuel Pool Instrumentation," required plants to provide reliable SFP instrumentation in partial response to the March 2011 Fukushima accident. NRC interim staff guidance JLD-ISG-2012-03 endorsed NEI 12-02, "Industry Guidance for Compliance with NRC Order EA-12-051," as an acceptable approach for satisfying the requirements of Order EA-12-051. Primary and backup SFP level instruments have been installed which output in the Control Room. The level instruments aid in the monitoring and maintenance of SFP level to support operation of the SFP cooling system, provide radiation shielding for personnel on the SFP operating deck, and to ensure the fuel remains covered. The instruments are powered from battery-backed vital 120 VAC power and each have a backup battery source installed.

9.1.4 FUEL HANDLING SYSTEM

9.1.4.1 Design Bases

9.1.4.1.1 System

The fuel handling system is used for the handling and storage of fuel assemblies and Control Element Assemblies (CEAs), and for the required assembly, disassembly, and storage of reactor internals. As appropriate, the fuel handling equipment includes interlocks, travel limiting features, and other protective devices to minimize the possibility of mishandling or equipment malfunction that could result in inadvertent damage to a fuel assembly and potential fission product release.

The refueling water is the coolant during spent fuel transfer. The spent fuel storage pool is provided with a spent fuel pool cooling and purification system discussed in Section 9.1.3.

Conducting all spent fuel transfer and storage operations underwater, except with dry fuel storage system casks, ensures adequate shielding during refueling and permits visual control of the operation at all times. The fuel handling system also provides for the disassembly, handling, and reassembly of the reactor vessel closure head, and incore instrumentation.

9.1.4.1.2 Fuel Handling Equipment

The principal design criteria for the fuel handling equipment (refueling machine, fuel transfer equipment, spent fuel handling, and new fuel elevator) are as follows:

- A. The stresses under the combined deadweight, live and DBE loads shall not exceed the allowable stress of the material per AISC requirements.
- B. The load bearing members of the equipment shall withstand the loading induced by the design bases earthquake vertical and horizontal seismic loadings which are considered as acting simultaneously on this equipment in conjunction with the combined deadweight and live loads without exceeding minimum material yield stresses as specified by AISC. Where required, keepers shall be provided to preclude derailment of equipment under seismic loading.
- C. Grapples and mechanical latches which carry fuel assemblies or CEAs shall be mechanically interlocked against accidental opening.
- D. Equipment shall be provided with locking devices or restraints to prevent parts, fasteners, or limit switch actuators from becoming loose. In those cases where a loosened part or fastener can drop into, or is not separated by a barrier from, or whose rotary motion will propel it into the water of the refueling cavity or spent fuel pool, these parts and fasteners shall be lockwired or otherwise positively captured.
- E. The refueling machine shall be capable of removing and installing a fuel assembly at each operating location at the most adverse combined tolerance condition for the equipment, core internals and fuel assemblies.
- F. A positive mechanical stop shall prevent the fuel from being lifted above the minimum safe water cover depth and shall not cause damage or distortion to the fuel or the refueling machine when engaged at full operating hoist speed.

ARKANSAS NUCLEAR ONE
Unit 2

- G. The refueling machine hoist shall be provided with a load measuring device with a visual display of the load. If an overload occurs, hoisting is interrupted by an overload cutoff limit set less than or equal to 100 pounds more than the expected nominal weight of the load being lifted (i.e., the fuel assembly, one CEA, the grapple, and, in the "fuel plus hoist box" region, the hoist box). If an underload occurs during lowering, motion is interrupted by an interlock set sufficiently below the nominal fuel assembly weight to protect the fuel assembly from grid-to-grid interactions (plus allowances for the grapple and the fuel hoist, where applicable).
- H. In the event of loss of power, the equipment and its load shall remain in a safe condition.
- I. Equipment remaining within the containment is capable of withstanding, without damage, the internal building test pressure.

9.1.4.2 System Description

The fuel handling system is an integrated system of equipment, tools and procedures for refueling the reactor. The system is designed for safe handling and storage of fuel assemblies from receipt of new fuel to shipping of spent fuel.

The equipment is normally used at approximately 18-month intervals for a period of approximately three weeks; the system is designed to operate continuously without maintenance or service during this time. The fuel handling crane and the spent fuel handling machine may be used on a monthly basis.

The major components of the system are the refueling machine, the fuel transfer equipment, the spent fuel handling machine, the new fuel elevator, and the containment temporary storage rack. The refueling machine moves fuel assemblies into and out of the core and between the core and the transfer equipment. The fuel transfer equipment tilts fuel assemblies from the vertical position to the horizontal, shuttles them from the refueling pool in the containment through the containment wall into the spent fuel pool and returns them to the vertical position. The spent fuel handling machine handles fuel between the transfer equipment and the fuel storage racks in the spent fuel pool. The new fuel elevator lowers the new fuel assemblies down into the spent fuel pool where they are accessible to the spent fuel handling machine. Fuel assemblies may be stored in the containment temporary storage rack during fuel shuffling before being transferred to the core or the spent fuel pool.

Special tools and lifting rigs are also used for disassembly of reactor components and are included in the refueling system.

NUREG-0612, Control of Heavy Loads at Nuclear Power Plants, contains the NRC guidance to ensure that load handling systems are designed and operated such that their probability of failure is low and appropriate for the critical tasks in which they are employed. ANO has implemented the NUREG-0612 Phase I guidance for these load handling systems. In a Safety Evaluation issued in October 1984 (OCNA108406), the NRC concluded that the Phase I requirements of NUREG-0612 had been satisfied for ANO. In a June 26, 1985 generic letter (Generic Letter 85-11) (OCNA068520), the NRC further concluded that the NUREG-0612 Phase II effort was considered complete. Further evaluation was performed pursuant to NEI 08-05, Industry Initiative on Control of Heavy Loads, which verified that the Unit 2 Reactor Vessel Closure Head Load Drop Analysis demonstrates allowable stress limits per ASME Section III, Appendix F, with acceptable piping deformation.

ARKANSAS NUCLEAR ONE
Unit 2

The reactor vessel head and internals lifting tripod is classified as a special lifting device in accordance with NUREG-0612, which requires special lifting devices to meet ANSI N14.6-1978.

ANSI N14.6 specifies either a Magnetic Particle or a Dye Penetrant Test as part of the inspections for this tripod. For ANO these NDE methods have been revised to include Acoustic Emission (AE). ANSI N14.6 specifies the NDE to be performed prior to use. The AE monitoring method begins as the load is applied to the tripod. The recorded ultrasonic sound provides a warning of an existing flaw to allow the safe removal of the load from the tripod prior to failure. The application of the AE methodology has been determined to be acceptable in accordance with the requirements of 10 CFR 50.59.

9.1.4.2.1 Refueling Machine

The refueling machine is shown in Figure 9.1-6. The refueling machine is a traveling bridge and trolley which is located above the refueling canal and rides on rails set in the concrete on each side of the refueling canal. Motors on the bridge and trolley position the machine over each fuel assembly location within the reactor core or fuel transfer carrier. The hoist assembly contains a grappling device which, when rotated by the actuator mechanism, engages the fuel assembly to be removed. The hoist assembly and grappling device are raised and lowered by a cable attached to the hoist winch. After the fuel assembly has been raised into the refueling machine, the refueling machine transports the fuel assembly to its designated location.

The controls for the refueling machine are mounted on a console which is located on the refueling machine trolley. Coordinate location of the bridge and trolley is indicated at the console by digital readout devices which are driven by encoders coupled to the guide rails through rack and pinion gears. The hoist vertical location is provided by a tag-line actuated encoder to the machine control console for control functions and digital readout.

During withdrawal or insertion of either a fuel assembly, or a fuel assembly with a control element inserted, the load on the hoist cable is monitored at the console to ensure that movement is not being restricted. Limits are such that damage to the assembly is prevented.

Locking between the grapple and the elements is provided by the engagement of the grapple actuator arm in axial channels running the length of the fuel hoist assembly. Therefore, it is not possible to uncouple even with inadvertent initiation of an uncoupling signal to the actuator assembly. The drives for both the bridge and the trolley provide close control for accurate positioning, and brakes are provided to maintain the position once achieved. In addition, interlocks are installed so that movement of the refueling machine is not possible when the hoist is withdrawing or inserting an assembly. After operation of the hoist a console mounted bypass button must be pressed to allow movement of the bridge or trolley.

For operations at the core, the bottom of the hoist assembly is equipped with a spreading device to move the surrounding fuel assemblies to their normal core spacing to ensure clearance for fuel assemblies being installed or removed. An anti-collision device at the bottom of the mast assembly prevents damage should the mast be inadvertently driven into an obstruction, and a positive mechanical up stop is provided to prevent the fuel from being lifted above the minimum safe water cover depth. A system of points and scales serves as a backup for the remote repositioning readout equipment. Manually operated handwheels are provided for bridge, trolley and winch motions in the event of power loss. Manually operated handwheels for the bridge, trolley, and winch may also be used for equipment checkouts, accessing areas that otherwise

ARKANSAS NUCLEAR ONE
Unit 2

are electrically interlocked out, making minor adjustments in position and various other evolutions, when necessary. Such evolutions, if performed with or in close proximity to active fuel, are performed in an administratively controlled manner as dictated by procedures. Outward motion of hoist in core region by using winch handwheel is prohibited administratively because overload protection is defeated. Manual operation of the grappling device is also possible in the event that air pressure is lost.

9.1.4.2.2 Transfer Carriage

A transfer carriage conveys the fuel assemblies between the refueling canal and the spent fuel pool. Fuel assemblies are placed in the transfer carriage in a vertical position, lowered to the horizontal position, moved through the fuel transfer tube on the transfer carriage, and restored to the vertical position in the spent fuel pool.

Wheels support the carriage and allow it to roll on tracks within the transfer tube. The track sections at both ends of the transfer tube are supported from the pool floor and permit the carriage to be properly positioned in the upending mechanism. The carriage is driven by steel cables connected to the carriage, and through sheaves to its driving winch mounted in the fuel handling area. A 2-pocket fuel carrier is mounted on the carriage and is pivoted for tilting by the upending machines. The load in the transfer cables is displayed at the master control console. An overload will interrupt the transfer operation. Manual override of the overload cutout allows completion of the transfer. The supports for the replaceable rails on which the transfer carriage rides are welded to the 36-inch diameter transfer tube. The rail assemblies are fabricated to a length which will allow them to be lowered for installation in the transfer tube. No rails are installed in the valve on the spent fuel pool side of the transfer tube.

9.1.4.2.3 Upending Machine

Two upending machines are provided: one in the refueling canal and the other in the spent fuel pool. Each consists of a structural support base from which is pivoted an upending straddle frame which engages the 2-pocket fuel carrier. When the carriage with its fuel carrier is in position within the upending frame, the pivots for the fuel carrier and the upending frame are coincident. Hydraulic cylinders, attached to both the upending frame and the support base, rotate the fuel carrier between the vertical and horizontal position as required by the fuel transfer procedure. Either hydraulic cylinder acting alone can perform the upending operation; either can be isolated in the event of its failure. A long tool is also provided to allow manual rotation of the fuel carrier in the event that both cylinders fail or hydraulic power is lost.

9.1.4.2.4 Fuel Transfer Tube and Valve

A fuel transfer tube extending through the containment wall connects the refueling canal with the spent fuel pool as shown in Figure 9.1-1. During reactor operation, the transfer tube is closed by means of a manually operated valve located in the spent fuel pool side of the transfer tube and a blind flange located inside the containment. Prior to filling the refueling canal, the blind flange is removed. After a common water level is reached between the refueling canal and the spent fuel pool, the valve is opened. The procedure is reversed after refueling is completed.

The 36-inch diameter transfer tube is contained in a 42-inch diameter penetration which is sealed to the containment. The transfer tube and penetration sleeves are sealed to each other by welding rings and bellows type expansion joints.

ARKANSAS NUCLEAR ONE
Unit 2

The transfer tube valve is attached to the spent fuel pool end of the transfer tube. The valve is supported in such a manner to allow for horizontal movement along the centerline of the transfer tube. The manual operator for the valve is designed to allow for movement of the valve due to thermal expansions and still permit operation. The valve stem extends above the spent fuel pool water level and is designed for manipulation from within the auxiliary building.

9.1.4.2.5 CEA Change Mechanism

This section has been intentionally deleted due to the removal of the CEA change mechanism.

9.1.4.2.6 Fuel Handling Tools

Two fuel handling tools are used to move fuel assemblies in the spent fuel pool area. A short tool is provided for dry transfer of new fuel, and a long tool is provided for underwater handling of both spent and new fuel in the spent fuel pool. The short tool is used with the new fuel hoist (2L-35) and the long tool is operated manually from the walkway on the spent fuel handling machine.

9.1.4.2.7 Reactor Vessel Head Lifting Rig

The reactor vessel head lifting rig is shown in Figure 9.1-8. This lifting rig is composed of a removable three part lifting frame and a column and skirt assembly which is attached to the reactor vessel closure head. The skirt assembly supports the three hoists for handling the hydraulic tensioners, the studs, washers and nuts, and links the lifting frame with the reactor vessel head. There is also a support frame with a circular monorail and trolleys installed to support a Reactor Vessel Head Shielding System.

9.1.4.2.8 Reactor Internals Handling Equipment

Two lifting rigs are used to remove either the upper guide structure or the core support barrel from the reactor vessel and to raise and lower the incore instrumentation support plate assembly.

The upper guide structure lifting rig is shown in Figure 9.1-9.

This lifting rig consists of a delta spreader beam which supports three columns providing attachment points to the upper guide structure. Attachment to the upper guide structure is accomplished manually from the working platform. The integral in-core instrumentation hoist connects to an adaptor which is manually attached to the in-core instrumentation structure. The in-core instrumentation is then lifted by the crane hook. The upper clevis assembly, which is common to this and the core support barrel lifting rig, is installed prior to lifting of the structure by the crane hook. Correct positioning is ensured by attached bushings which mate to the reactor vessel guide pins.

The core support barrel lifting rig, shown in Figure 9.1-10 is provided to withdraw the core barrel from the vessel for inspection purposes. The upper clevis assembly is a tripod shaped structure connecting the lifting rig to the containment crane lifting hook. The lifting rig includes a spreader beam providing three attachment points which are threaded to the core support barrel flange. This is accomplished manually from the refueling machine bridge or the auxiliary gantry crane bridge. Correct positioning of the lifting rig is ensured by attached guide bushings which mate to the reactor vessel guide pins.

ARKANSAS NUCLEAR ONE
Unit 2

9.1.4.2.9 Spent Fuel Handling Machine

The spent fuel handling machine is a traveling bridge and trolley, located over the spent fuel pool, which rides on rails set in the concrete sides of the spent fuel pool. Motors on the bridge and trolley position the machine over the spent fuel assembly storage racks, the new fuel elevator, the cask loading pit, and the upending machine in the spent fuel pool.

An auxiliary crane, 2L35, is used to transfer new fuel from the new fuel storage pit to the new fuel elevator. The spent fuel handling machine hoist assembly contains a grappling device which, when rotated by the actuator mechanism, engages the fuel assembly to be moved. Once the fuel assembly is grappled, a cable and hoist winch raises the fuel assembly. The machine then transports the fuel assembly from the upending machine to the spent fuel storage racks (spent fuel) or from the new fuel elevator to the upending machine (new fuel).

The controls for the spent fuel handling machine are mounted on a console which is located on the spent fuel handling machine trolley. Coordinate locations of the bridge and the trolley are indicated by the pointer and target systems.

During withdrawal or insertion of either a fuel assembly or a fuel assembly with a control element inserted, the load on the hoist cable is monitored to ensure that movement is not being restricted. Limits are such that damage to the assembly is prevented.

Positive locking is provided between the handling tool and the assembly to prevent inadvertent uncoupling. The drives for both the bridge and the trolley provide close control for accurate positioning. In addition, interlocks are installed so that movement of the spent fuel handling machine is not possible when the hoist is withdrawing or inserting an assembly.

Manually operated handwheels are provided for bridge, trolley and winch motions in the event of a power loss. Manually operated handwheels for the bridge, trolley, and winch may also be used for equipment checkouts, accessing areas that otherwise are electrically interlocked out, making minor adjustments in position and various other evolutions, when necessary. Such evolutions, if performed with or in close proximity to active fuel, are performed in an administratively controlled manner as dictated by procedures. Outward motion of hoist by using winch handwheel is not recommended because overload protection is defeated.

9.1.4.2.10 Auxiliary Building Crane

A 130-ton capacity single failure proof bridge crane, designated L3, is provided to handle the spent fuel shipping cask in the Unit 1 and 2 auxiliary buildings. The L3 crane transports the spent fuel cask to and from the rail car located in the train bay at Elevation 354' and to the Unit 1 and Unit 2 cask loading pits. Auxiliary 15-ton capacity and 4-ton capacity hoists are also provided on the L3 crane. Unit 1 and Unit 2 new fuel may be handled by the L3 crane or the separate 4-ton capacity monorail bridge crane, 2L35, at the north end of the Unit 2 auxiliary building. The 130 ton main hoist is designed to NUREG-0554 criteria and Table 9.1-10 provides site specific information regarding Unit 2 compliance with Ederer's Generic Topical Report for single-failure-proof cranes.

Figure 9.1-14 shows the Unit 2 fuel handling area. The cask is hoisted in the railroad bay through a hatch at Elevation 404 feet. It is carried north from the hatch to the cask loading pit where it is lowered into the pit for loading by the spent fuel handling machine. After loading the cask with spent fuel, the cask is lifted from the cask loading pit, transported to the hatch, and

ARKANSAS NUCLEAR ONE
Unit 2

lowered to the railroad bay. This arrangement is such that the cask is never carried over the spent fuel pool. Because the crane is single failure proof, a postulated cask drop is not a credible event; therefore, any affect on plant operation as described in SAR section 15.1.23 is not anticipated to occur and the structural integrity of the spent fuel cask will not be impaired. The only safety-related equipment over which the cask must be carried is the relay room between column lines A2 and C2 and 4 and 5 shown in Figure 9.1-14. The floor slab at Elevation 404 feet is the relay room ceiling.

Safety features, inherent with single failure proof crane design, are provided to ensure that the cask can be moved above the relay room ceiling. Additional features as described below are provided to ensure that the cask will never be carried over the spent fuel pool to satisfy the requirements of Regulatory Guide 1.13.

Regulatory Position 5.b of Regulatory Guide 1.13 states that "provisions should be made to prevent this crane (the fuel handling bridge), when carrying heavy loads (the spent fuel cask), from moving in the vicinity of stored fuel." Based on this, the fuel handling floor was arranged as shown in Figure 9.1-14 and the crane was provided with a control system interlock and a crane power limit as shown in Figure 9.1-14 and described below.

The combination of layout and safety controls limits the incidents involving heavy loads in the vicinity of stored fuel to five concurrent failures:

- A. Failure of the operator to stop the crane;
- B. Failure of the limit switch control interlock to stop the crane;
- C. Failure of the bridge braking system to de-energize on loss of power;
- D. Failure of the crane hoist, and,
- E. All administrative controls must fail.

Because the spent fuel crane is designed as single failure proof, item D above is not considered a credible failure. Also, a concurrent occurrence of these five failures is not considered credible, the design meets the requirements of Regulatory Guide 1.13.

An analysis was performed on the 3-foot, 6-inch thick reinforced concrete relay room ceiling slab, located below the cask travel path between column lines A2 and C2 as shown on Figure 9.1-14. The analysis was performed to demonstrate that a postulated cask drop would not damage any safety-related equipment located in the relay room. The analysis followed an energy absorption method which is identical to that described in Reference 1. The energy input to the relay room ceiling slab was based on a 260 kip cask weight, 92-inch cask diameter and a drop height of one inch. This considers that the main hoist is designed such that the maximum load motion following a single wire rope failure is less than 1.5 feet and the maximum kinetic energy of the load will be less than that resulting from one inch free fall of the maximum critical load.

The analysis indicated that the one way slab would respond in an elastoplastic region with a ductility ratio of approximately nine, which is less than the maximum of 30 indicated in Table 4-4 of Reference 1.

A typical section of the relay room ceiling slab is shown in Section A Figure 3.8-17 at Elevation 404 feet between column lines 4 and 5.

ARKANSAS NUCLEAR ONE
Unit 2

Trolley track limit switches are provided to confine the east-west travel of the trolley to that required for cask loading during cask handling.

Layout of the fuel handling area in the auxiliary building is such that the spent fuel cask are never required to transverse the spent fuel pool during removal of spent fuel elements. Diverse electrical interlocks (a limit switch and a power disconnect from the main contact rails) are provided to the fuel handling crane to prevent an inadvertent transverse of the pool with a cask.

The electrical interlocks, crane, and crane rails are designed to stop the fuel handling crane from full speed, assuming that one electrical interlock fails and that no operator action is taken. At full speed the crane travels a maximum of 25 fpm resulting in a minimal pendulum-like swing of the cask. The runway interlocks (limit switch and power disconnect from the main contact rails) are positioned to interrupt the power and/or apply the brake to bring the crane to a stop with sufficient margin to ensure that the cask will not encroach on the spent fuel pool.

In addition, the crane control system is such that the operator can operate the bridge, trolley, and hoist at any speed up to rated speed from the crane pendant control station or remote control unit.

Redundant crane controls and safety features are not generally provided. However, diverse safety features do provide redundant protection against postulated accidents. The crane control system is a fail safe design and safety features are common mode and single failure proof in mitigating postulated accidents.

To drop the cask in the spent fuel pool, the following must occur:

- The operator must fail to stop the crane;
- The runway travel interlock must fail to stop the crane;
- The bridge must fail to brake on loss of power; and,
- The crane hoisting system must fail completely.
- All administrative controls must fail.

Crane interlock preoperational testing is described in the Technical Specifications.

In order to transverse the floor area on Elevation 404' just north of the Railcar Loading Hatch (Figure 9.1-14); the VSC-24 transfer cask with a loaded canister will utilize four slings. While not located over a safety related system, component, or structure, that section of spent fuel floor is 1 foot, 9 inches thick and not designed to withstand the static weight or drop of the cask. Instead of using a yoke to lift the loaded cask, the redundant slings are attached from the four trunnions of the transfer cask to the L-3 main hook. This dual path sling arrangement provides compliance with NUREG-0612 Section 5.1 regarding alternative measures to increase crane reliability by providing increased safety factor, redundant load paths, etc.

Section 15.1.23 presents the results of an analysis of off-site doses for a fuel cask drop of 50 feet into the railroad bay.

9.1.4.2.11 Stud Tensioners

Three hydraulically operated stud tensioners are used to apply and remove the preload on the reactor vessel head closure studs. These tensioners are suspended from pneumatic hoists which are attached to the head lift rig. The tensioner assemblies, when placed over the studs, rest upon the reactor vessel head flange. An internal socket is attached to the studs by engagement with the stud upper threads and when hydraulic pressure is applied to the stud tensioner pistons, the studs are elongated a predetermined amount. After the closure nuts are seated, the hydraulic pressure is released which results in the preload necessary to maintain the seal between the reactor vessel and reactor vessel head.

9.1.4.2.12 Surveillance Capsule Retrieval Tool

A retrieval tool is used during the refueling shutdown for manual removal of the irradiated capsule assemblies of the reactor vessel materials surveillance program described in Section 5.2.4.4. The surveillance capsule retrieval tool is shown in Figure 9.1-11. The tool is operated from a position on the carriage walkway of the refueling machine. Access to the capsule assembly is achieved by inserting the tool through 3-inch diameter retrieval holes in the core support barrel flange provided at each capsule assembly radial location. A female acme thread at the end of the retrieval tool is mated to the surveillance capsule lock assembly by turning the retrieval tool handle. A compressed spring in the lock assembly exerts a high frictional force at the retrieval tool lock assembly interface to prevent disengagement during retrieval.

The overall length of the tool is 549 inches. The tool consists of two parts to facilitate storage. The upper portion is a 2-inch diameter tube and handle. The lower portion of the tool is also a 2-inch tube with a 1-inch outer diameter at the connector end. A 3/4-inch diameter hole in the upper end of the tool permits the polar crane to assist with the retrieval procedure and prevents inadvertent dropping of the tool. The tool is made of aluminum and has a dry weight of 40 pounds.

9.1.4.2.13 CEA Uncoupling Tool

This tool consists basically of two concentric tubes with a conical lead in at the end to facilitate engagement with the CEDM extension shafts. When installed, pins attached to the outer tube are engaged with the extension shaft outside diameter and the pins carried by the inner tube are inserted in the inner operating rod of the extension shaft. The inner tube of the tool is then lifted and rotated relative to the outer tube which compresses a spring allowing the gripper to release, thus separating the extension shaft from the CEA. The extension shaft is then handled by the tool.

9.1.4.2.14 Underwater Television

A high resolution closed circuit television system is provided to monitor the fuel handling operations inside the containment. The camera is mounted on the refueling machine mast so that the fuel assembly can be sighted prior to and during grappling and removal from the core. The system may be used for core alignment verification. A TV monitor is provided at the refueling machine control console. If required for remote surveillance or inspection, the camera could be unbolted from its mount on the mast and handled separately.

9.1.4.2.15 Failed Fuel Detection

9.1.4.2.15.1 In-Mast Sipping

The In-Mast Sipping Skid, installed by DCP 96-3254-D201, is connected to the hoist box, and monitors the water surrounding the test assembly. As the hoist box is raised (containing the suspect fuel assembly), water is drawn off from the surrounding area. This water is then passed through a water-gas separator, where the water is directed back into the Refueling Canal. The gasses that have been stripped from the coolant are directed through a scintillation detector. There, the gasses are analyzed for activity which corresponds to energy levels associated with Krypton and Iodine. Local indication is provided to personnel should these fission product gasses be detected. After the gasses have been analyzed, they are routed to the Refueling Canal.

9.1.4.2.16 Hydraulic Power Package

The hydraulic power package provides the motive force for raising and lowering the upender with the fuel carrier. It consists of a stand containing a motor coupled to a hydraulic pump, a sump reservoir, valves and the necessary hoses to connect the power package to the hydraulic cylinders on the upender. The valves can be aligned to actuate either or both upenders. The hydraulic fluid may be either borated or non-borated water.

9.1.4.2.17 Refueling Pool Seal

The annular space between the reactor vessel flange and the bottom of the fuel transfer canal is sealed off prior to removal of the reactor closure head by placement of eight gasketed seal plate access covers. These covers are bolted to the permanent seal plate which is welded to the shield ring embedded in the annulus shield wall and to the reactor vessel flange seal ledge. Leak rate is monitored during refueling to ensure that no sudden change in water level will occur.

9.1.4.2.18 Containment Temporary Storage Rack

The containment temporary storage rack consists of a stainless steel rack designed to store up to four (4) new or spent fuel assemblies in containment during refueling. The nominal center-to-center assembly spacing is 17.812 inches.

9.1.4.3 System Evaluation

9.1.4.3.1 SystemOperation

A. New Fuel Transfer

After arrival in the auxiliary building, new fuel assemblies are removed from their shipping containers and placed in the new fuel storage racks or into the new fuel elevator and then into the spent fuel storage pool. Transfer to the new fuel storage racks or to the new fuel elevator is accomplished by using the short fuel handling tool attached to the 4-ton hoist of the new fuel crane, 2L35.

ARKANSAS NUCLEAR ONE
Unit 2

During reactor refueling operations, the new fuel is removed from the new fuel storage racks and transferred to the new fuel elevator in the spent fuel pool, if necessary. This operation is accomplished using the new fuel crane and the short fuel handling tool.

The new fuel elevator lowers the fuel assembly down into the spent fuel pool where the spent fuel handling machine transfers the fuel assembly to the spent fuel pool storage racks or upending mechanism. Interlocks are provided to prevent the spent fuel handling machine from lowering the fuel assembly unless the upender is in the vertical position. During an in-core fuel shuffle, a new fuel assembly has been placed in the upending mechanism and then a spent fuel assembly is removed from the other position of the fuel carrier and transferred to a designated position in the spent fuel storage racks using the spent fuel handling machine.

B. Spent Fuel Transfer

After a period of time in which the spent fuel decay heat and radioactivity level have decreased, the spent fuel handling machine transfers the assemblies from the storage racks to the spent fuel cask. The cask loading area is connected to the pool by a gate sized to allow passage of the tool with fuel element attached. The spent fuel assemblies are then transferred underwater and loaded into the cask using the spent fuel handling machine. Once loading is complete, the loaded cask is cleaned to remove any radioactive material and residual coolant. After the washdown is complete, the spent fuel cask is loaded into a transporter for shipment or storage.

9.1.4.3.2 Refueling Procedure

Prior to refueling, the plant is shutdown and cooled to refueling temperature. During the cooldown, preparations are begun for the refueling operation.

Refueling operations are initiated by disconnecting the CEDM cooling shroud two upper ductwork expansion joints (2M-249A and 2M-249B), piping, and electrical connections. The missile shield is then moved to allow access to the reactor vessel head area. CEDM, RVLMS, and incore detector cabling is disconnected and the reactor vessel head maintenance structure removed with duct work attached and stored. Insulation from the vessel head flange is then removed and the vessel vent line spool disconnected. The eight (8) hatch covers and gaskets are installed on the seal plate and are leak tested to prevent water from entering the lower portion of the reactor vessel cavity when the refueling canal is flooded. The stud tensioners are employed to remove the preload on the vessel head studs. The nuts and some of the studs are removed.

Two alignment pins are inserted in the north and south stud hole locations to assist in subsequent operations. Plugs are installed in any remaining stud hole locations to protect the empty stud holes.

Lead shielding blankets may be installed, if necessary, at designated locations around the vessel head in order to minimize radiation exposure. The number of studs removed from the head and the number of lead shielding blankets used will be such that the total rated capacity of the reactor building polar crane (150 tons) is not exceeded. A lifting frame is then installed on the head assembly and, by means of the polar crane, the head is removed to its storage location.

ARKANSAS NUCLEAR ONE
Unit 2

The fuel transfer tube connects the refueling canal with the spent fuel pool. During reactor operation, the transfer tube is closed by a manually operated valve in the fuel pool and a double gasketed blind flange inside the containment. The flange is removed and, after a common water level is reached, the valve is opened preparatory to the refueling.

The upper guide structure lift rig is installed on and locked to the upper guide structure. The CEDM drive shaft extensions are disconnected from their CEAs and are then removed with the vessel upper guide structure. The instrumentation support plate is then raised and secured. The upper guide structure is removed from the vessel and installed on its storage pads.

Provision is made in the refueling canal for the temporary storage of the upper guide structure. After this is removed from the vessel, the refueling machine hoist mechanism is positioned at the desired location over the core. Alignment of the hoist to the top of the fuel assembly is accomplished through the use of a digital readout system. After the fuel hoist is lowered, minor manual adjustments can be made to properly position the hoist if misalignment is indicated. The operator then energizes the actuator assembly which rotates the grapple at the bottom of the hoist and locks the fuel assembly to the hoist. The hoist motor is started and the fuel assembly withdrawn into the fuel hoist box assembly so that the fuel is protected during transportation to the fuel upender. The grapple is designed to preclude inadvertent disengagement as the fuel assembly is lifted vertically from the core. When the fuel has been withdrawn out of the grapple zone, positive locking between the grapple and the fuel assembly is established so that uncoupling is prevented even in the event of inadvertent initiation of an uncoupling signal to the assembly. After removal from the core, the spent fuel assembly is moved underwater to the transfer area of the pool. The spent fuel assembly is lowered into the transfer carriage in the refueling canal.

The upending machine lowers the spent fuel assembly to the horizontal position after which a cable drive transports the carriage on tracks through the transfer tube into the spent fuel pool.

Once received in the spent fuel pool, another upending mechanism returns the transfer carrier to the vertical position. The spent fuel handling machine then removes the spent fuel assembly from the transfer carriage and transports it to the spent fuel rack.

After a new fuel assembly has been moved from the new fuel storage racks or the spent fuel pool storage racks and placed in the upending mechanism by the spent fuel handling machine, the new fuel assembly is carried through the transfer tube to the refueling canal where the refueling machine picks it up and places it in its proper position in the core. A spent fuel assembly being reloaded would be handled in the same manner.

Refueling can be performed by a core shuffle or core offload/reload. In the case of the shuffle, the refueling machine is used to shuffle fuel within the core in accordance with the fuel management scheme. In the core offload/reload, all fuel assemblies are removed from the core to the spent fuel storage racks, then those scheduled for operation in the next cycle are transferred back to the reactor vessel. CEAs can be shuffled in either the refueling canal or the spent fuel pool.

See section 9.1.4.2.15 for failed fuel monitoring during fuel handling operations.

At the completion of the refueling operation, the transfer valve is manually closed. The upper guide structure is reinserted in the vessel and the in-core instrumentation support plate is lowered into position. The CEA drive shaft extensions are reconnected to their respective

ARKANSAS NUCLEAR ONE
Unit 2

CEAs. The upper guide structure lift rig is removed from the upper guide structure. The water in the refueling pool is lowered, utilizing at least one of the shutdown cooling pumps. The head is then lowered until the drive shaft extensions are engaged by the CEDMs. Lowering of the head is continued until it is seated. Then the studs are installed in the lower vessel flange, the two alignment pins are removed with studs installed in the vessel flange holes, and the head is bolted down, and the transfer tube blind flange installed. The eight (8) hatch covers and gaskets are unbolted and removed from the seal plate and stored. The missile shield is then moved to its furthest west position. The vessel maintenance structure is placed on the vessel head with the polar crane. CEDM power, CEDM, RVLMS, and incore instrumentation cabling is reconnected and the missile shield returned to its normal position directly over the reactor vessel. The CEDM cooling duct expansion joints (2M-249A and 2M-249B) are connected to the CEDM shroud ducts. Piping for the vessel head vent and CEDM cooling chill water is reinstalled.

9.1.4.3.3 Safety Evaluation

A. Cask Handling

See Section 9.1.4.2.10.

B. Fuel Handling

Direct communication between the control room and the refueling machine console is available whenever changes in core geometry are taking place. This provision allows the control room operator to inform the refueling machine operator of any impending unsafe condition detected from the main control board indicators during fuel movement.

Operability of the fuel handling equipment including the bridge and trolley, the lifting mechanisms, the upending machines, the transfer carriage, and the associated instrumentation and controls is ensured through the implementation of preoperational tests and routines. Prior to the first actual fuel loading, the equipment is cycled through its operations using dummy fuel. In addition, the equipment has the following special features:

1. Provision for seismic loading is made by structural design and arrangement of the equipment. Where required, mechanical means (clips, guide rolls, etc.) are utilized to prevent overturning or derailing of the equipment during an earthquake.
2. The bumper ring mounted on the refueling machine mast interrupts the bridge and trolley should the mast be driven into an obstruction. This feature prevents damage to either the refueling machine or to members or components into which it may be driven.
3. The two major systems of the overall fuel handling system (refueling machine and fuel transfer system) are electrically interlocked with each other to assist the operator in properly conducting the fuel handling operation. Failure of any of these interlocks in the event of operator error will not result in damage to more than one fuel assembly. The radiological consequences associated with the activity release from an entire assembly is discussed in Section 15.1.

ARKANSAS NUCLEAR ONE
Unit 2

4. Mechanical interlocks are provided for operation when handling fuel assemblies. They include positive mechanical locking of the refueling machine grapple to the fuel assembly and a positive mechanical stop to prevent raising a fuel assembly above the minimum depth of water.
5. Miscellaneous special design features which facilitate handling operations include: a dual wound transfer system motor to permit applying an increased pull on the transfer carriage in the event it becomes stuck; a viewing port in the refueling machine trolley deck to provide visual access to the reactor for the operator; electronic and visual indication of the refueling machine position over the core; a protective shroud into which the fuel assembly is drawn by the refueling machine; transfer system upenders manual operation by a special tool in the event that the hydraulic system becomes inoperative; removal of the transfer system components from the refueling pool for servicing without draining the water from the pool. Manual operated handwheels for the bridge, trolley, and winch are provided in the event of a loss of power and may also be used for equipment checkouts, accessing areas that otherwise are electrically interlocked out, making minor adjustments in position and various other evolutions. Such evolutions are performed in an administratively controlled manner when performed in close proximity to active fuel.
6. The fuel transfer tube is sufficiently large to provide natural circulation cooling of a fuel assembly in the unlikely event that the transfer carriage should be stopped in the tube. The manual operator for the fuel transfer tube isolation valve extends from the valve to the operating deck. Also, the valve operator has enough flexibility to allow for operation of the valve even with thermal expansion of the fuel transfer tube.
7. Travel stops in both the refueling and spent fuel handling machines restrict withdrawal of the spent fuel assemblies. This results in the maintenance of a minimum water cover of 9.5 feet over the active portion of the fuel assembly resulting in a radiation level of 5 mrem/hr or less at the surface of the water. The depth of water surrounding the fuel transfer canal, transfer tube and spent fuel storage pool will be sufficient to limit the maximum continuous radiation levels in working areas to 2.5 mrem/hr.
8. A closed circuit television system is provided on the refueling machine to allow visual observation.
9. The spent fuel handling machine is designed to Seismic Class 1 requirements to preclude structural failure of this machine in the area of the spent fuel pool. This design ensures compliance with the positions set forth in Regulatory Guide 1.13.
10. Fuel reconstitution equipment will contain hard stops to restrict withdrawal of individual fuel pins from fuel assemblies and maintain a minimum water cover of 9.0 feet over the active fuel portion of the individual fuel pin. The net affect of handling a single fuel pin with reduced water cover relative to a complete fuel assembly is a dose rate at the surface of the water that still remains well below 5 mrem/hr.

ARKANSAS NUCLEAR ONE
Unit 2

As discussed above and in Section 9.1.4.2.10, handling in the area of the spent fuel pool is minimized as much as possible in accordance with Regulatory Guide 1.13.

Additionally, criticality safety evaluations show that two fuel assemblies with enrichments up to 5.0 weight percent U-235 described by the parameters shown in Table 9.1-7 can be transported in the fuel carrier while maintaining the required criteria, i.e., the 95 percent probability / 95 percent confidence level reactivity is less than 0.95. This analysis assumes a credit for 400 ppm soluble boron. In the evaluation of a dropped assembly next to the carrier containing two fuel assemblies, credit is assumed for 1000 ppm soluble boron, as allowed by the double contingency principle which states it shall require two unlikely, independent, concurrent events to produce a criticality accident. By crediting soluble boron, the criteria of K_{eff} less than 0.95 is maintained for this postulated accident.

Criticality evaluations of the containment temporary storage rack show that new fuel assemblies with enrichments up to 5.0 weight percent U-235 described by the parameters shown in Table 9.1-7 can be safely stored while maintaining K_{eff} less than 0.95 for both normal and accident conditions. In the evaluation of a dropped assembly next to the containment temporary storage rack, credit is assumed for 1000 ppm soluble boron, as allowed by the double contingency principle which states it shall require two unlikely, independent, concurrent events to produce a criticality accident.

9.1.4.3.4 Single Failure Mode Analysis

A single failure mode analysis of the fuel handling equipment is provided in Table 9.1-5.

9.1.4.4 Testing and Inspection

During manufacture at the vendor's plant, various in-process inspections and checks are required including certification of materials and heat treating, and liquid penetrant or magnetic particle inspection of critical welds. Following completion of manufacture, compliance with design and specification requirements is determined by assembling and testing the equipment in the vendor's shop. Utilizing a dummy fuel assembly and a dummy CEA, each having the same weight, center of gravity, exterior size and end geometry as an actual assembly, all equipment is run through several complete operational cycles. In addition, the equipment is checked for its ability to perform under the maximum limits of loads, fuel mis-location and misalignment. All traversing mechanisms are tested for speed and positioning accuracy. All hoisting equipment is tested for vertical functions and controls, rotation, and load misalignment. Hoisting equipment is also tested to 125 percent of maximum working load. Setpoints are determined and adjusted and the adjustment limits are verified. Equipment interlock function, and backup systems operations are checked. Those functions having manual operation capability are exercised manually. During these tests, the various operating parameters such as motor speed, voltage, and current, hydraulic system pressures, and load measuring accuracy and setpoints are recorded. At the completion of these tests, the equipment is checked for cleanliness and the locking of fasteners by lockwire or other means is verified.

The equipment is again tested after final installation and the results compared to the results of tests performed at the vendor's plants.

This allows determination of any changes in adjustment and condition which may have occurred in transit to the site. In addition, this post-installation testing permits determination of characteristics which are unique to the actual installation and therefore cannot be duplicated in

ARKANSAS NUCLEAR ONE
Unit 2

the vendor's shop test. Each component is inspected and cleaned prior to installation. Recommended maintenance, including any necessary adjustments and calibrations, is performed prior to equipment operation. Preoperational tests also include checks of all control circuits including interlocks and alarm functions.

9.1.4.5 Refueling Interlocks

Mechanical stops and positive locks have been provided to prevent damage to or dropping of the fuel assemblies. In the design of the refueling machine, positive locking between the grapple and the elements is provided by the engagement of the actuator arm in vertical channels in the hoist assembly so that relative rotational movement and uncoupling is not possible, even with inadvertent initiation of an uncoupling signal to the actuator assembly. Therefore, failure of an electrical interlock will not result in the dropping of a fuel assembly.

The following list identifies and defines the function of the interlocks contained in the fuel handling equipment. In no case has a method been provided to directly inform the operator that an interlock is inoperative. However, in most cases a redundant device has been provided to perform the same function as the interlock or to present information to the operator allowing him to deduce that an interlock has malfunctioned.

9.1.4.5.1 Refueling Machine

A. Refueling Machine Hoist Interlock

Interrupts hoisting of a fuel assembly if the load increases above the overload setpoint. The hoisting load is visually displayed so that the operator can manually terminate the withdrawal operation if an overload occurs and the hoist continues to operate.

B. Refueling Machine Hoist Interlock

Interrupts hoisting of a fuel assembly when the correct vertical position is reached.

A mechanical up-stop has been provided to physically restrain the hoisting of a fuel assembly above the elevation which would result in less than the minimum shielding water coverage.

C. Refueling Machine Hoist Interlock

Interrupts insertion of a fuel assembly if the load decreases below the underload setpoint.

The load is visually displayed so that the operator can manually terminate the insertion operation if an underload occurs and the hoist continues to operate.

D. Refueling Machine Hoist Interlock

Interrupts lowering of the hoist under a no load condition when installing a fuel bundle.

The weighing system interlock is backed up by an independent slack cable switch which terminates lowering under a no-load condition.

ARKANSAS NUCLEAR ONE
Unit 2

E. Refueling Machine Movement Interlock

Denies movement of the bridge and trolley while the fuel hoist is operating.

An additional circuit is provided which, after initiation of a hoisting operation, requires that a separate switch be actuated before normal operation of the movement drives is possible.

F. Refueling Machine Hoist Interlock

Hoisting is denied during movement of the bridge and/or trolley. No backup or additional circuitry is provided for this interlock.

G. Refueling Machine Movement Interlock

Denies motion of the bridge and/or trolley with the spreader extended.

The underwater TV system can be used by the operator to determine whether the spreader has been raised, and lights on the control console indicate whether the spreader is withdrawn or extended.

H. Refueling Machine Mast Anti-Collision Interlock

Stops movement of the bridge and/or trolley when the collision ring on the mast is contacted and deflected.

Redundant switches are provided to minimize the possibility of this interlock becoming inoperative and slow bridge and trolley speeds are mandatory for movement of the refueling machine in areas other than its normal travel route which might contain obstructions. Travel limits also restrict running the mast into the pool wall.

I. Refueling Machine Hoist Speed Interlock

Mandatory slow hoisting speed while fuel assembly is within the core and not in a clear water position. The fuel assembly is considered in clear water position when it is within the core but is positioned such that spacer grid interaction is not possible.

During insertion and withdrawal, the change in hoist speed can be monitored by observation of the hoist vertical position indicator. A change in the sound of the hoist will accompany the change in hoist speed.

J. Refueling Machine Hoist Interlock

Interrupts hoisting of a fuel assembly if the load increases above the drag overload during engagement of the hoist box. The hoisting load is visually displayed so that the operator can manually terminate the withdrawal operation if an overload occurs and the hoist continues to operate.

ARKANSAS NUCLEAR ONE
Unit 2

9.1.4.5.2 Transfer System

A. Transfer System Winch Interlock

Terminates winching of the fuel carriage through the transfer tube if the load increases above the overload setpoint.

The winching load is visually displayed so that the operator can manually terminate the transfer operation if an overload occurs and the interlock fails. An overload is indicated by a light on the control panel and by an audible alarm.

B. Transfer System Winch Interlock

Prevents the winch from attempting to pull the fuel carriage through the transfer tube with an upender in a vertical position. If this interlock fails and a transfer signal is initiated, winching will be terminated when the load increases above the overload setpoint.

C. Transfer System Upender Interlock

Rotation of the upender is denied while the refueling machine is at the upender station.

Failure of this interlock while the refueling machine is at the upending station will allow an upending signal by the transfer equipment operator at the station only to initiate rotation of the fuel carrier by the upender. In the event that this signal is erroneously initiated while the fuel assembly is being lowered from or raised into the refueling machine, a bending load will be applied to the fuel bundle.

D. Transfer System Upender Interlock

Rotation of the upender is denied unless the fuel carrier is correctly located for upending.

Failure of this interlock will

1. with the fuel carrier in the transfer tube allow the upender to rotate with no effect on the carrier or fuel bundle, and
2. with the fuel carrier partially in the upender, attempt to but not be successful in rotating the carrier since a mechanical lock prevents premature carrier rotation.

E. Isolation Valve Interlock

Contacts are provided in the control system of the transfer system which, when connected to a limit switch on the isolation valve, will prevent movement of the fuel carrier unless the valve is fully opened.

If this switch is not provided, or if provided this interlock fails with the valve partially closed, the fuel carrier will contact the valve and winching will be terminated by an overload signal. No damage to the fuel assembly will result since the fuel assembly is enclosed in the carrier.

ARKANSAS NUCLEAR ONE
Unit 2

9.1.4.5.3 CEA Change Machine

This section has been intentionally deleted due to the removal of the CEA change mechanism.

9.1.4.5.4 Spent Fuel Handling Machine

A. Spent Fuel Handling Machine Hoist Interlock

Interrupts hoisting if the load increases above the overload setpoint.

Since the tool is manually controlled by the operator, failure of the tool to move or reduction in tool speed as a result of an overload can be sensed by the operator if the interlock becomes inoperative.

B. Spent Fuel Handling Machine Hoist Interlock

Interrupts lowering if the load decreases to below the underload setpoint.

Since the tool is manually controlled, a slack cable condition can be visually determined by the operator and hoisting terminated.

C. Spent Fuel Handling Machine Translation Interlock

Speed is restricted to low speed unless the load is in the full up position, at which time fast speed is allowed.

If this interlock fails, the mandatory slow speed restriction is removed. However, since the translation speed controls are infinitely variable, the operator can run at slow speed when the interlock malfunction is recognized.

D. Spent Fuel Handling Machine Translation Interlock

Zone switches protect against running the load into walls or the gate of the storage area.

No backup or additional circuitry is provided for this interlock. However, the operator has direct vision of the tool and the attached load so that translation can be terminated if an interlock fails to operate.

9.1.4.5.5 New Fuel Elevator

A. New Fuel Elevator Hoist Interlock

Interrupts lowering if the load decreases below the underload setpoint.

ARKANSAS NUCLEAR ONE
UNIT 2

9.2 WATER SYSTEMS

9.2.1 SERVICE WATER SYSTEM

The Service Water System (SWS), shown in Figure 9.2-1, provides water for the following equipment:

- A. Cooling water for the following Engineered Safety Features (ESF) equipment:
 - 1. Emergency Diesel Generator Heat Exchangers 2E20A and B, 2E63 A and B, 2E64 A and B;
 - 2. Switchgear Rooms Unit Coolers 2VUC2A, B, C, and D;
 - 3. Control Room Emergency Condensing Units 2VE1A & 1B;
 - 4. Auxiliary Building Shutdown Heat Exchanger Room Unit Coolers 2VUC1A, B, C, D, E, F;
 - 5. Auxiliary Building High Pressure Safety Injection (HPSI) Pump Room Unit Coolers 2VUC11A, B;
 - 6. Containment Spray Pump Coolers 2E47A, B;
 - 7. Low Pressure Safety Injection (LPSI) Pump Coolers 2E52A, B;
 - 8. HPSI Pumps Inboard and Outboard Bearing Jacket Coolers and Seal Coolers 2E53A and D (2P89A), 2E53B and E (2P89B), and 2E53C and F (2P89C);
 - 9. Shutdown Cooling Heat Exchangers 2E35A, B;
 - 10. Auxiliary Building Charging Pump Room Coolers 2VUC7A, B, C;
 - 11. Containment Cooling Unit Service Water Coils 2VCC2A, B, C, D;
 - 12. Auxiliary Building Emergency Feedwater Pump Room Unit Coolers 2VUC6A, B;
 - 13. Auxiliary Building Electrical Equipment Unit Coolers 2VUC19A, B & 2VUC20A, B;
 - 14. Post-Accident Hydrogen Analysis Panels 2C128A, B.
- B. Alternate water supply for the Emergency Feedwater Pumps 2P7A, B.
- C. Cooling water for the following plant auxiliary equipment:
 - 1. Fuel Pool Heat Exchanger 2E27;
 - 2. Component Cooling Water Heat Exchangers 2E28A, B, C;
 - 3. Condenser Vacuum Pump Coolers 2E46A, B;

ARKANSAS NUCLEAR ONE
UNIT 2

4. Control Room Chillers 2VCH2A, B;
 5. Turbine-Generator Lube Oil Coolers 2E15A, B;
 6. Turbine-Generator Electro-Hydraulic Fluid Coolers 2E16A, B;
 7. Turbine-Generator Stator Liquid Coolers 2E50A, B;
 8. Main Generator Hydrogen Coolers 2E13A, B;
 9. Exciter Air Cooler 2E14;
 10. Steam Packing Exhauster Condenser 2E10;
 11. Main Chiller Condensers 2E-112A,B with or without Service Water System Booster Pumps 2P147A, B;
 12. Auxiliary Building Cable Spreading Room Unit Cooler 2VUC3A (Abandoned in place);
 13. Heater Drain Pump Area Cooler 2VUC3B;
 14. Auxiliary Building Electrical Equipment Room Unit Cooler 2VUC21;
 15. Steam Generator Blowdown Heat Exchangers 2E68A, B;
 16. Auxiliary Building Extension Chillers 2VCH3A, B; and,
 17. Regenerative Waste Evaporator Packages 2M89A, B.
- D. Makeup water to cooling tower basin.
- E. Emergency makeup to spent fuel pool.
- F. Makeup to the Emergency Cooling Pond.

9.2.1.1 Design Bases

Continuation of the minimum required cooling water flows to the ESF equipment served by the system and continuation of the availability of water supplies to the emergency feedwater pumps is essential to assure safe operation and shutdown of the plant. Accordingly, the portions of the system required to deliver these flows are designed to meet Seismic Category 1 requirements.

The portions of the SWS essential to a safe shutdown of the plant, including pumps, strainers, piping and valves were designed to meet the requirements of Section III Class 3 of ASME Boiler and Pressure Vessel Code. The containment penetrations are ASME Code Section III Class 2. The remaining portions of the system were designed to ANSI B31.1.0, Power Piping Code.

The system is designed to use the Dardanelle Reservoir as the water supply during normal operation. An alternate water supply for the system is available from the Emergency Cooling Pond (ECP), which can be used during normal plant shutdown operation and postulated Design

ARKANSAS NUCLEAR ONE
UNIT 2

Basis Accident (DBA) recovery. The system design includes allowance for corrosion and provides for inhibition of organic fouling of the system water passages sufficient to prevent long-term degradation of system design capability.

The original design of the SWS during normal operating conditions with the water source being the Dardanelle Reservoir was based on the following expected temperature ranges.

<u>Period</u>	<u>Average Temperature °F</u>
December through March	48
April, May, October, November	64
June through September	80
Design water temperature	85

Operating experience has resulted in Dardanelle Reservoir exceeding the original design water temperature during summer months; however, safety-related equipment cooled by the SWS has been determined to be capable of fulfilling required functions up to the maximum potential temperature (see Section 9.2.5.3).

The maximum temperature of service water supplied from the ECP is 116 °F. This maximum temperature is a result of Unit 2 DBA and a concurrent safe shutdown of Unit 1, the temperature bounds a Unit 1 DBA and concurrent safe shutdown of Unit 2 or a concurrent shutdown of both units.

9.2.1.2 System Description

9.2.1.2.1 General Description

A diagram of the SWS is shown in Figure 9.2-1. The components comprising the system are two traveling water screens preceded by bar grates, three pumps, three basket strainers, and the required interconnecting piping, heat exchangers, valves, and instrumentation. During normal plant operation, water is supplied from the Dardanelle Reservoir through the bar grates and traveling water screens. Prescreens are installed downstream of the traveling water screens in the existing stop log slots located in the SW fore bay area. The water entering the system has biocide added by the Unit 1 Sodium Bromide/Sodium Hypochlorite System. Biocide may also be added to the Service Water System using metered pumps for injection.

The system consists of two independent Seismic Category 1 flow paths (designated Loop I and Loop II) and two non-Seismic Category 1 flow paths. The Seismic Category I flow paths supply two independent trains of 100 percent capacity ESF equipment as well as providing an alternate water supply for the emergency feedwater pumps and an emergency source of makeup for the spent fuel pool. The two non-Seismic Category 1 flow paths are the auxiliary cooling system which supplies cooling water to various non-safety-related portions of the plant, and the path supplying component cooling water heat exchangers and main chiller condensers. The portion of the service water piping supplying water to the spent fuel cooling heat exchangers was analyzed for SSE loading.

The Seismic Category 1 flow paths are normally isolated from each other, and are isolated from the Seismic Category 2 portions of the system by automatic closure of isolation valves upon the initiation of a Safety Injection Actuation Signal (SIAS) or Main Steam Isolation Signal (MSIS). The Seismic Category 2 systems can be supplied with water from either Seismic Category 1 train during normal operation.

ARKANSAS NUCLEAR ONE
UNIT 2

An alternate source of water, the ECP, is provided for the system, and can be utilized in the event that the normal supply from the Dardanelle Reservoir is unavailable. Water is supplied to the system from the pond by gravity flow through a single 42-inch diameter line to the service water pump compartments in the intake structure. After having circulated through the SWS, the emergency cooling pond water is directed back to the pond via a 30-inch diameter return line.

The Dardanelle Reservoir is the source of water for the system during normal cold shutdown operations and will also be used as the preferred system source of supply during accident conditions as described in Section 9.2.1.2.3.7.

The SWS components inside the intake structure include the service water pump columns and motors, block walls between the pump motors, basket strainers, service water pump discharge piping and associated valve operators, intake sluice gates and the gate operators, and SWS sodium bromide/sodium hypochlorite piping. The intake structure also contains the bar gates, traveling water screens, prescreens, and screen wash water piping at the intake structure. Units 1 and 2 screen wash systems are tied together as described in Section 9.2.1.2.2.1.

9.2.1.2.2 Component Descriptions

9.2.1.2.2.1 Traveling Water Screens, Screen Wash, Corrosion Inhibitor Injection System, and Biocide Addition System

One traveling water screen is installed in each of two independent flow paths to the service water pumps. Data for these screens is shown in Table 9.2-2. The screens are cleaned periodically using the Unit 1 screen wash pumps discharging into high velocity spray nozzles which clean the debris from the screens as they travel past the nozzles. The debris can be sluiced to trash collection baskets outside the intake structure.

The Unit 1 Sodium Bromide/Sodium Hypochlorite System injects a biocide into the Unit 2 intake structure in the forebay or through three separate spargers located downstream of each of the three intake structure sluice gates on the Service Water bay side. Biocide may also be added to the Service Water System using metered pumps for injection.

To help limit biological fouling such as flow blockage from bivalve mollusks, Corbicula (Asiatic clams), a biocide is added at the intake structure in sufficient concentration to kill the mollusks. The service water intake bays are inspected and cleaned at least once every refueling outage to prevent clam buildup and fouling. In addition, flow measurement orifices and instrumentation have been added to several of the auxiliary building coolers. Where permitted by cooler fitting design, most of the 1/2-inch and 3/4-inch cooler piping have been replaced with 316L stainless steel 1-inch lines. Much of the service water supply and return carbon steel piping has been replaced with 316L stainless steel piping. Flow measurements are periodically taken and trended to detect any possible developing flow blockage from biological fouling.

The traveling water screen systems are classified Seismic Category 2, and in case of failure service water supply will be manually transferred to the ECP.

The Corrosion Inhibitor Injection System injects corrosion inhibitor and dispersant for control of suspended solids into each service water bay using metered pumps for injection. Corrosion rates are monitored by using test coupons.

ARKANSAS NUCLEAR ONE
UNIT 2

9.2.1.2.2.2 Service Water Pumps

Nominal design data for each of the three interchangeable service water pumps are listed in Table 9.2-3 and performance curves are shown in Figure 9.2-2.

The power supplies to the pump motors are electrically interlocked so that when the emergency diesel generators are in operation and supplying power to the pumps, no more than one pump will operate from each ESF channel (red or green).

Unfused disconnect switches are utilized for service Water Pump 2P4B. One of the disconnects is fed from red 4160V Switchgear 2A303 and the other from green 4160V Switchgear 2A403. The disconnects are operated from the control room using two control switches that have one removable and interchangeable handle. This allows the closure of only one disconnect switch at any time. These switches also provide an electrical interlock with the 4160V switchgear such that only one of the two 4160V breakers can be electrically closed at a time. Thus, the connection of pump 2P4B to both ESF channels simultaneously through their respective control circuits is prevented. The pumps were designed in accordance with the standards of the Hydraulic Institute and Section III Class 3 of ASME Boiler and Pressure Vessel requirements.

The following elevations provide descriptive information of the pump suction conditions:

Dardanelle Reservoir	normal water level - Elev. 338'-0"
Dardanelle Reservoir	low water level - Elev. 336'-0"
Service Water Pump Compartment	bottom - Elev. 322'-6"
Service Water Pump Suction Impeller Eye	inlet - Elev. 324'-9"
Service Water Pump Inlet Bell	inlet - Elev. 323'-6.5"
Service Water Pump	required submergence - 8'-0"
Available submergence at	low water level - 12'-5.5"
Minimum Water Level to Satisfy Submergence	Elevation - Elev. 331'-6.5"
Emergency Cooling Pond	normal water level - Elev. 347'-0"
Emergency Cooling Pond	minimum water level - Elev. 346'-7.2" (346.6')
Emergency Cooling Pond	bottom - Elev. 341'-4.8" (341.4')
Top of water supply pipe from the ECP	- Elev. 341'-6"

The service water pump motors are located at Elevation 366 feet which is five feet above the probable maximum flood level. Each service water pump and associated motor is located inside a Seismic Category 1 structure and is protected from the others by a concrete wall.

Each pump is sized to deliver 100 percent of water requirements during accident shutdown conditions. During normal operation, two pumps are in service, one supplying water to each ESF loop. Pump 2P4A is connected directly to SWS Loop I, and pump 2P4C is connected directly to SWS Loop II, pump 2P4B can be connected to either SWS loop by opening motor operated valves. The third pump is normally aligned to one of the two operating loops and serves as a standby.

ARKANSAS NUCLEAR ONE
UNIT 2

9.2.1.2.2.3 Service Water Basket Strainers

Data for the three identical service water basket strainers are shown in Table 9.2-4. One strainer is installed in the discharge line of each service water pump. Differential pressure across the strainers can be monitored in the control room. A high differential pressure alarm in the control room indicates when a strainer is clogged. The associated pump must then be shut down after the standby pump is brought into operation so that the clogged strainer may be cleaned.

9.2.1.2.2.4 Piping

Seismic Category 1 piping 6 through 24 inches in diameter is predominantly seamless carbon steel with some sections of stainless steel pipe. Essentially all piping four inches and smaller is 316L stainless steel, except the Loop II emergency spent fuel pool makeup line. Piping 26 inches in diameter and larger is seam welded carbon steel. The exterior surfaces of all buried pipe are covered with a double wrapping consisting of fibrous-glass mat and bonded coal tar saturated asbestos felt.

9.2.1.2.2.5 Valves and Sluice Gates

All valves that open or close automatically upon emergency diesel generator start, Safety Injection Actuation Signal (SIAS), Main Steam Isolation Signal (MSIS), Recirculation Actuation Signal (RAS) or Containment Cooling Actuation Signal (CCAS) are motor operated valves. Motor operated gate valves with the exception of the inlet valves to the Shutdown Heat Exchanger Room Unit Coolers 2VUC-1A, 1B, 1C, 1D, 1E and 1F, are provided at the inlet to each room unit cooler served by the system, and either open automatically upon the starting of their associated fans or remain locked open. The inlet valves to the Shutdown Heat Exchanger Room Unit Coolers are manually operated.

Motor operated gate valves are provided at the inlet to the low pressure safety injection and spray pump coolers. The isolating valves in the discharge lines from the heat exchangers are manually operated except for those on the discharge lines from the containment cooling coils, and the emergency diesel generator heat exchangers, which are motor operated.

Valves necessary for isolating system loops during SWS pump switching operations are motor operated butterfly valves. All power operated valves have control switches and associated position indicating lights located in the control room. Selector switches are provided in Motor Control Centers (MCCs). Local mechanical position indicators are also provided.

Check valves are provided at the discharge of each service water pump to prevent back flow through an idle pump. Globe valves have been provided at the outlet of all room and pump coolers, except for the HPSI pump coolers, to allow the establishment of proper flows through these parts of the system.

Water flow from the Dardanelle Reservoir or the ECP is controlled by sluice gates in the intake structure openings at opposite ends of each compartment. The three sluice gates in the intake structure from the ECP are normally closed. The three Dardanelle Reservoir supply sluice gates are normally open.

The sluice gates are provided with cast iron guides on each side and are designed to withstand the total thrust due to water pressure and wedging action. The guides are machined on all contact surfaces with a groove machined the entire length of the guide. The disc has a

ARKANSAS NUCLEAR ONE
UNIT 2

machined tongue to mate with the guides. The guides are of sufficient length to retain and support at least one-half the disc in the full open position. The sluice gates are motor operated, powered from the ESF electrical system, and the entire assembly is designed to meet Seismic Category 1 requirements.

Maintenance of sluice gate stems and operators can be performed above normal water level. Maintenance of the guides and wedge portion of the gate located below the normal water level will be carried out by a diver or, if necessary, after dewatering the pump compartment. Major work will be done during plant shutdown. At this time, the service water forebay can be isolated from the Dardanelle Reservoir with stop logs and dewatered. The ECP can be isolated from the service water pump compartments by a sluice gate located at the ECP.

9.2.1.2.2.6 Venturies and Associated Equipment

Two 20 inch venturies constructed of 316L stainless steel are installed in the service water system. A venturi is installed in each loop header of the service water system to provide an accurate hydraulic measurement of the service water pumps. This measurement will assist in determining pump degradation. Hydraulic analysis of the service water pumps is part of ANO Unit 2 Inservice Testing Program required by ASME OM Code. An additional venturi is installed in the Auxiliary Cooling Water System to assist in this measurement. Measurement of flow in gallons per minute through these venturies is accomplished by local flow instrumentation utilizing differential pressure.

MHI flow straighteners were installed upstream of the venturies to improve the accuracy of the flow measurement.

9.2.1.2.3 System Operation

The following modes of operation have been considered:

- A. normal power operation;
- B. startup;
- C. cold shutdown with outside power;
- D. cold shutdown without outside power;
- E. hot shutdown with outside power;
- F. hot shutdown without outside power; and,
- G. ESF actuation.

9.2.1.2.3.1 Normal Operation

During normal plant operating conditions, water flow is through both Seismic Category 1 loops and the Seismic Category 2 portions of the system. Two pumps are required to deliver the flow for this mode. Water supply for the system during normal operation is from the Dardanelle Reservoir. The third pump will act as a standby for the two in operation, and will be periodically put in service to equalize wear between all three pumps.

Differential pressure indicating switches mounted across each service water basket strainer can be monitored from the control room and the strainers are cleaned as necessary. The differential pressure switches will also sound an alarm on high ΔP , indicating a clogged strainer. The standby pump and its associated clean strainer will then be brought into service, and the clogged strainer basket will be removed and cleaned manually.

ARKANSAS NUCLEAR ONE
UNIT 2

Upon loss of pressure in either loop, a low pressure alarm will sound in the control room. Switchover to the standby pump is done manually.

Discharge from the system is channeled to the cooling tower basin as makeup, to the Dardanelle Reservoir via the Unit 1 outfall, or the ECP.

The amount of cooling tower basin makeup is controlled by a level indicating controller, 2LIC-1207 mounted in the cooling tower basin which controls an air operated modulating control valve, 2CV-1460, located in the 30-inch service water discharge line to the Unit 1 outfall. All water not required as makeup to the cooling tower basin is either returned to the Dardanelle Reservoir or the ECP.

9.2.1.2.3.2 Startup

During startup, two pumps are in operation with both loops supplying water. The water source is the Dardanelle Reservoir.

9.2.1.2.3.3 Cold Shutdown With Off-Site Power

In this mode, two pumps are in operation with both loops supplying flows. The water source is the Dardanelle Reservoir.

9.2.1.2.3.4 Cold Shutdown Without Off-Site Power

In this mode, power for the system is supplied from the emergency diesel generators. Each Seismic Category 1 loop and associated pump and essential power operated valves will be powered by one diesel generator unit. Two pumps will be in operation with both loops supplying flows. The water source is the Dardanelle Reservoir.

9.2.1.2.3.5 Hot Shutdown With Off-Site Power

In this mode, two pumps will be in operation with both loops supplying water. The water source is normally the Dardanelle Reservoir.

9.2.1.2.3.6 Hot Shutdown Without Off-Site Power

In this mode, power for the pumps and essential power operated valves will be provided by the emergency diesel generators. Two pumps will be in operation supplying water. The water source is the Dardanelle Reservoir.

9.2.1.2.3.7 ESF Actuation

A SIAS causes actuation of ESF equipment as a result of postulated accident conditions and causes automatic startup of both emergency diesel generators. The SIAS causes the following to occur:

- A. automatic starting of two of the three SWS pumps;
- B. isolation of all Seismic Category 2 portions from the system; and,
- C. initiation of water flow to the ESF equipment.

ARKANSAS NUCLEAR ONE
UNIT 2

During this mode, two pumps are in operation, one supplying each loop of ESF equipment.

A CCAS or MSIS causes automatic opening of valves 2CV-1511-1, 2CV-1510-2, 2CV-1513-2 and 2CV-1519-1, allowing service water to flow through the four containment service water cooling coils.

To eliminate the possibility of severe water hammer in voided containment service water cooling coils piping, containment service water cooling coil inlet valves 2CV-1511-1 and 2CV-1510-2 are controlled by a logic that includes a time delay to keep the valves closed immediately after the CCAS or MSIS and undervoltage is detected at bus MCC2B54 or MCC2B63, respectively.

The undervoltage at MCC2B54 or MCC2B63 would indicate a loss of service water pump flow to the respective service water loop.

A time delay before the valves begin to open allows emergency diesel generators to start, the service water pumps to sequence on, and the voided containment coolers piping to slowly refill through 1" diameter normally open bypasses around 2CV-1511-1 and 2CV-1510-2.

The outlet valves, 2CV-1519-1 and 2CV-1513-2, are interlocked with their respective inlet valves and begin to open when the inlet valves are greater than zero but less than 10% open. This keeps the containment service cooling coil piping filled and prevents water hammer during valve actuation.

There is no time delay if undervoltage is not detected.

The Emergency Feedwater Actuation Signal (EFAS) causes automatic starting of two of the three SWS pumps to supply service water to the emergency feedwater pump room coolers and to provide an assured source of emergency feedwater if needed.

The RAS causes automatic opening of valves 2CV-1453-1 and 2CV-1456-2 thus allowing service water flow through the two shutdown cooling heat exchangers.

During normal operation, the source of water for the system is the Dardanelle Reservoir. Under accident conditions the SWS discharge is automatically changed to the ECP upon the initiation of an SIAS or MSIS. The SWS discharge can be switched back to the Dardanelle Reservoir by remote manual operation of the control switches by overriding the SIAS or MSIS. Dardanelle Reservoir water is circulated through the system for the time period required to shift the source from the Reservoir to the ECP, which also serves to maximize pond inventory. Switchover of service water suction to the ECP is a manual action. The sluice gate motor operators have been sized to open or close within a maximum of five minutes.

9.2.1.3 Safety Evaluation

The SWS serves two identical (full capacity) loops of ESF equipment, each consisting of one shutdown cooling heat exchanger, one emergency diesel generator, one emergency feedwater pump, one train of room and pump coolers for ESF equipment, and two containment service water cooling coils. Only one loop of these components is required for shutdown of the plant after any postulated accident condition. A failure analysis for the system is given in Table 9.2-5.

ARKANSAS NUCLEAR ONE UNIT 2

Each loop supplying water to ESF equipment has been designed to Seismic Category 1 requirements. Both loops are isolated from each other and from Seismic Category 2 parts of the system by automatic closure of the system isolation valves upon the initiation of a SIAS or MSIS or by normally closed manually operated valves (with the exception of the spent fuel pool heat exchanger return line, which is isolated by check valves). This prevents a failure in one Seismic Category 1 loop from affecting the other loop, and any failures in the Seismic Category 2 parts will not affect either Seismic Category 1 loop.

System capability under power failure conditions is assured by automatic switching of the system to operation from preferred power upon failure of the normal power source and automatic switching of the system to the emergency diesel generators upon failure of both normal and preferred power sources. Channel separation is provided for the control systems and power supplies to each train as further described in Chapter 8.

The sluice gate at the ECP is normally locked open. It is not required to perform any active function during and/or following postulated accident conditions.

Each SWS loop is capable of supplying 100 percent of the required cooling water flows thus meeting the single-failure criterion. This provides the basis for the Technical Specifications with regard to limiting conditions for operation and surveillance.

The effect of long-term corrosion of the system water passages is minimized sufficiently through the use of materials compatible with the river water, adequate material thickness corrosion allowances and external wrapping of buried piping to prevent failure of any component due to the effects of corrosion for the duration of the life of the plant. Fouling of components is prevented by the traveling water screens, prescreens, service water strainers, and biocide addition to the water. [See Section 2.8.1.4 for more information.](#)

Since the sluice gates can be opened or closed in approximately five minutes, sufficient time is available to operate all six Unit 2 sluice gates before the water level falls below the minimum submergence required by the service water pumps.

Three full capacity service water pumps are provided. In the event any one pump is out of service, the remaining two pumps will provide cooling water for the two redundant essential loops. An active failure of one of the two remaining pumps or a piping failure in the SWS will not prevent the safe shutdown of the plant.

In the event of a passive failure in an essential loop header, any associated branch supply or return line or a heat exchanger connected to an essential loop, the subject loop is isolated and secured. The other essential loop with redundant heat exchangers is fully capable of effecting a safe plant shutdown. No single failure of an active or passive component can lead to a Loss of Coolant Accident (LOCA).

A leak in the SWS will be found in several ways. If a break occurs in a main supply header, a decrease in service water pressure in the header will be detected and alarmed. If a break occurs in a line serving an individual component, high cooled fluid outlet temperatures or low service water flow will be detected and alarmed. In addition, a high level alarm in the auxiliary building sump will initiate a search for the source of water causing this condition. The design of the plant and of the SWS incorporates protection from degradation of the ESF equipment due to passive failures in the system.

ARKANSAS NUCLEAR ONE
UNIT 2

All components of ESF equipment located in the intake structure whose operation could be degraded by flooding have been located in the 366-foot level of the intake structure so that a service water pipe or strainer rupture in the 354-foot level room will not affect these components. The 354-foot level room in the intake structure is provided with three openings in the floor to provide access to the service water bays. Two of the openings are provided with deck grating. The third opening (center) is provided with solid checker plate. The deck grating provides sufficient open area to pass the maximum flow of water that could occur from a single failure of any SWS pipe or component in the room.

All components of ESF equipment at Elevation 317 feet in the auxiliary building are located in three separate watertight rooms, so that any postulated piping failure in a service water loop will not render components of the second SWS loop inoperable, or damage other ESF equipment not related to the SWS.

For a safety evaluation of the system water supplies, see Section 9.2.5.

9.2.1.4 Tests and Inspections

Historical data removed - To review the exact wording, please refer to Section 9.2.1.4 of the FSAR.

The hydraulic performance of each service water pump is verified at intervals required by ASME OM Code utilizing the service water and auxiliary cooling water venturis to determine flow rates or degradation of service water pump capacities.

The integrity and capability of all components in the system are monitored by alternating the operation of the components within the system during normal plant operating conditions. Periodic testing of the emergency control functions of the system is conducted as described in the Technical Specifications 3/4.7.3. All equipment, piping, valves and instruments are arranged so that they can be visually inspected, except for the buried pipeline which can be pressure tested.

9.2.1.5 Instrument Applications

The traveling screens are provided with a differential pressure indication to ensure the screen wash system is manually activated when necessary. The differential pressure can be measured across the traveling screen or across the traveling screen and prescreen in combination. A level indicating controller in the cooling tower basin controls modulating control valve 2CV-1460 which controls makeup water flow to the cooling tower basin.

Alarms actuated by flow indicating switches in the shutdown cooling heat exchanger outlet lines will indicate the loss of adequate service water flows through this equipment. Service water inlet and outlet temperatures to each emergency diesel generator can be monitored for periodic heat exchanger testing using installed thermowells.

The discharge header from each pair of containment service water cooling coils is fitted with a flow detector. Each detector actuates a low flow alarm in the control room if a CCAS or MSIS signal is present, resulting in an alarm annunciation in the event of a loss of cooling water flow through either pair of containment cooling coils.

ARKANSAS NUCLEAR ONE
UNIT 2

The instrumentation provided for indication and alarm functions is listed in Table 9.2-6. In addition to the instrumentation listed in this table, pressure indicator test connections are provided where required for testing and balancing the system.

Ultrasonic flowmeter spool pieces and instrumentation were added to the service water portion of the following equipment:

- A. Emergency Switchgear Room Coolers - 2VUC 2A-2D
- B. EFW Pump Room Coolers - 2VUC 6A & B
- C. Charging Pump Room Coolers - 2VUC 7A, B & C
- D. HPSI Pump Room Coolers - 2VUC 11A & B
- E. Shutdown Cooling Heat Exchanger Room Coolers 2VUC-1A, 2VUC-1B, 2VUC-1C, 2VUC-1D, 2VUC-1E, and 2VUC-1F

Flow instrumentation consisting of venturis and local flow indicators were added to the main headers of Loop 1 and 2 of the service water system and to the auxiliary cooling water system as part of the Inservice Testing Program required by ASME OM Code.

Provisions for temperature measurement instrumentation were installed to meet the requirements of Generic Letter 89-13.

An annubar flow instrument tap location was added to the service water portion of Control Room Emergency Air Conditioning Condensing Unit 2VE1A.

A flow element is located in the Service Water supply to the main chiller condensers, 2E-112A and B. A local flow readout is provided as well as a low flow signal to isolate the SW to the main chiller condensers.

9.2.2 COMPONENT COOLING WATER SYSTEM

The Component Cooling Water (CCW) System shown in Figure 9.2-6 is a closed cycle system that provides cooling water to the following components.

- Reactor Coolant Pump (RCP) Motor Coolers
- RCP Lube Oil Coolers
- RCP Seal Cooling
- Secondary Sampling System Panels
- Condensate Pump Motor Bearings
- Heater Drain Pump Motor Bearings
- Heater Drain Pump Seal Coolers
- Reactor Coolant Sample Cooler
- Steam Generator Sample Coolers
- Safety Injection and Shutdown Cooling Sample Cooler
- Waste Gas Compressor Units
- Isophase Bus Coolers

ARKANSAS NUCLEAR ONE
UNIT 2

Letdown Heat Exchanger
Main Feedwater Pump Lube Oil Coolers
Primary Sample Panel Chiller
Feedwater Sample Coolers
Condenser Hotwell Sample Panel
Primary Sample Panel Chiller
Radiation Chemistry Sample Room Cooler
Startup and Blowdown Demineralizer Sample Panel Coolers
Steam Generator Blowdown Corrosion Product Sample Coolers
Boric Acid Concentrator (BAC) Condenser*
BAC Distillate Cooler*
BAC Gas Condensate Cooler*
Waste Concentrator Condenser*
Waste Concentrator Gas Condensate Cooler*
Waste Concentrator Distillate Cooler*
BAC Steam Condensate Pump Jacket Cooling*
Waste Concentrator Steam Condensate Pump Jacket Cooling*

*Currently not in use.

The original design of the system was a two loop operation with a swing pump and a swing heat exchanger to support the two loops. An evaluation has been performed to justify also operating the system with the two loops cross-connected as an alternate, preferable configuration.

9.2.2.1 Design Bases

The CCW System is designed to remove heat from components in various reactor auxiliary systems which carry radioactive or potentially radioactive fluids and require higher water quality conditions than offered by the SWS. It provides a monitored intermediate barrier between reactor auxiliary system fluids and the SWS, and reduces the probability of leakage of reactor coolant into the service water.

The system was originally designed to remove the maximum heat loads developed by the components served with a designed CCW heat exchanger outlet temperature of 95 °F. The design calculations assumed a service water temperature of 85 °F and flow rate of 4,600 gpm through each CCW heat exchanger.

The system is designed to permit the use of corrosion inhibitors for the prevention of long-term corrosion and organic fouling of the water passages in the system.

The pumps were designed and fabricated in accordance with the Standards of the Hydraulic Institute, ANSI and ASTM. The CCW heat exchangers were designed and fabricated in accordance with ASME Boiler and Pressure Vessel Code, Section VIII. CCW heat exchanger A was designed and fabricated in accordance with TEMA standards for Class R heat exchangers, and CCW heat exchangers B and C were fabricated in accordance with TEMA standards for Class C heat exchangers. The CCW surge tanks were designed and fabricated in accordance with API-620.

ARKANSAS NUCLEAR ONE
UNIT 2

The entire system except for containment penetrations and associated isolation valves is designed to meet Seismic Category 2 requirements. Containment penetration piping and associated isolation valves are designed to meet Seismic Category 1 requirements.

The containment penetration piping was designed, fabricated and installed in accordance with Section III, Class 2 of ASME Boiler and Pressure Vessel Code. All other system piping was fabricated and installed in accordance with ANSI B31.1.0 Code for Power Piping.

9.2.2.2 System Description

The CCWS consists of two interconnected loops (Loops I and II). Each loop is equipped with a pump, a heat exchanger, a surge tank, piping, instrumentation and controls. Loops I and II are interconnected at the entrance and outlet of the heat exchangers with a third parallel heat exchanger which serves as a standby for either loop. Similarly, a third pump is connected in parallel with the pumps in each loop, also serving as a standby. For the majority of plant life, the system has been operated as two independent loops. An evaluation has been made to allow the loops to be operated as a single loop with the two loops cross-tied. This was desirable to reduce operation and maintenance costs to operate Loop I which has very few active loads.

The system is of the closed cycle type with the same fluid being continuously recirculated through both loops by one of the three CCWS pumps. A positive pressure is maintained at all points in the system by the elevated CCWS surge tanks. The tanks also provide for the expansion and contraction of water inventory of each loop during plant startup, shutdown and changes in load during operation.

Each loop is provided with a bypass pressure control valve which maintains a constant differential pressure across all system components, thus assuring constant flow to each component under various conditions and system modes of operation. With the loops cross-connected, only one of the bypass pressure control valves is needed to maintain the differential pressure.

Makeup water is supplied to the system from the condensate storage tank through the condensate transfer pump, and enters the system via the surge tanks. Makeup flow is controlled by level switches mounted on each surge tank which open or close air operated valves depending upon water level in the tank.

As originally designed, the loads on Loop II were required to be in continuous service during all periods of normal plant operation and Loop I was needed for intermittent use. With the system cross-connected, the system will function with either the Loop II pump or the swing pump in operation or standby. Either the Loop II or swing pump will automatically start upon loss of pressure in the discharge line of the operating pump. With the loops cross-connected, the Loop I pump and heat exchanger cannot be used due to the potential for the automatic actuation of the cross-connected valves isolating Loop II.

Data for the CCW pumps and heat exchangers are listed in Tables 9.2-7 and 9.2-8, respectively. Data for the CCW surge tanks are listed in Table 9.2-9.

9.2.2.3 Safety Evaluation

None of the components served by the CCW System are required for a safe shutdown following a postulated DBA.

ARKANSAS NUCLEAR ONE UNIT 2

Preceding the original issuance of Safety Guide 29 in June, 1972 NRC published in April, 1972 its safety evaluation of Unit 2. The review concluded that the auxiliary systems design basis, functions and preliminary design were acceptable. Evaluated were the design, fabrication, construction, and testing criteria, and expected performance characteristics of the plant structures, systems and components important to safety to determine that they were in accord with the Commission's General Design Criteria, Quality Assurance Criteria, Safety Guides and other appropriate rules, codes, standards, and the departures from these criteria, codes and standards were identified and justified. The design of the CCW System proceeded on the basis that none of the components served by it would be required following a postulated DBA. The CCW System was not required, at the time of the Construction Permit, to be designed to Seismic Category 1 requirements and was not built as a Seismic Category 1 system. Further discussion of the CCW cooling water supply to the letdown heat exchanger and the reactor coolant pumps can be found in Sections 9.3.4.4.1 and 5.5.1.3, respectively. As indicated in these sections, a Seismic Category 1 cooling water supply is not required for these components.

The only portions of the CCW System which are related to shutdown of the plant under any of the postulated accident conditions are the two containment penetrations including the associated isolation valves. These assemblies form part of primary containment, and therefore are designed to meet Seismic Category 1 requirements and single failure criteria.

The standby CCW heat exchanger and CCW pump(s) increase system availability and permit repair and maintenance of one heat exchanger and/or one pump while the system is in operation.

Radiation monitoring provided in the inlet line to the heat exchanger in each loop will alarm in the control room, should the radioactivity level in the loop rise above a preset limit. In this event, the atmospheric 3-way vent valve on the surge tank will be manually operated to switch the vent from atmosphere to the auxiliary building radwaste area ventilation system.

As the operating pressure of the SWS at the CCW heat exchangers is higher than that of the CCW System at the same point, any leakage is therefore from the SWS into the CCW System.

In the event the system does become contaminated, provisions have been made to drain the system to the Waste Management System (WMS).

9.2.2.4 Tests and Inspections

Each component was inspected and cleaned prior to installation into the system. Major components of the system such as pumps, tanks and heat exchangers are accessible for periodic inspection during plant operation.

Instruments were calibrated during pre-operational testing. Automatic controls were tested for actuation at the proper setpoints. Alarm functions were checked for operability and limits during preoperational testing. The relief valves were set and checked.

The system was operated and tested initially with regard to flow paths, flow capacity and mechanical operability.

ARKANSAS NUCLEAR ONE
UNIT 2

9.2.2.5 Instrumentation Applications

Level switches are provided on each surge tank to permit automatic makeup to the system by operation of valves 2CV-5210 and 2CV-5214. The standby pumps will automatically start to supply the system when a low pressure condition is detected. Flow indicating switches are provided in the outlet from the reactor coolant pump motor and lube oil coolers, and seal cooling lines to prevent starting of these pumps in the event of insufficient CCW flow. To prevent a low flow alarm condition when the CCW System is intentionally not in service, an interlock has been added to the system which defeats the low flow alarm when the respective reactor coolant pump is in the "pull-to-lock" position. An additional interlock is provided in Loop I to prevent a high/low temperature alarm when the loop is intentionally not in service. During cross-connect operation, the low flow alarm for Loop I will be disabled. Table 9.2-10 lists the CCW instrument indicating and alarm functions.

In addition to the applications noted above, pressure test connections have been located at various points in the system to facilitate initial system balance and periodic inspection during operation.

9.2.3 DEMINERALIZED WATER SYSTEM

The Plant Makeup and Domestic Water System (PMU) is shown in Figure 9.2-7. Most of the original Plant Makeup Demineralizer Water System has been removed from service. Due to changes in demineralized water technology, it has become more economical to use an outside vendor to supply the plant with demineralized water. The vendor is under contract to supply makeup water of the required quality and flowrate. The water contract quality specifications are upgraded as improvements in technology occur. Water of the required quality is provided for the following purposes:

- A. reactor coolant makeup;
- B. steam generator feedwater makeup;
- C. CST makeup;
- D. CCW makeup;
- E. sampling system; and,
- F. resin sluicing in the radwaste system.

The PMU has no safety function.

9.2.3.1 Design Bases

Plant Makeup water is currently supplied by an outside Vendor using state of the art equipment.

ARKANSAS NUCLEAR ONE
UNIT 2

9.2.3.2 System Description

9.2.3.2.1 General Description and System Operation

Most of the original demineralization equipment has been removed from service due to the cost of upgrading this system to meet the current water quality requirements of the plant. The major components still in use are the acid tank, caustic tank, the neutralization tank and the associated piping, valves and controls for these systems. Normally, demineralized water from the vendor's Mobile Water Treatment Facility is routed to the Makeup Water Degasification system for oxygen removal before being transferred to the Condensate storage tanks. See Figure 9.2-7A.

9.2.3.2.2 Component Description

The descriptions of the original PMU Water Treatment Filters, Demineralizer Trains, and Demineralizer Regeneration Equipment components that have been removed from service have been deleted.

Waste collected in the Unit 2 neutralizing tank, 2T-87, which normally consists of sample drains from panel 2C377, is discharged to the Regenerative Waste Tanks. The neutralizing tank, a 10,000 gallon fiberglass vessel, was sized for two successive regenerations of the entire makeup demineralizer train.

9.2.3.3 Safety Evaluation

The PMU is designed to produce demineralized water at a rate corresponding to the maximum continuous requirements of the plant.

Loss of the PMU is not critical until the volume in the condensate storage tank reaches that required for reactor decay heat removal per Section 9.2.6.1. An alarm will alert the operator prior to this condition being reached.

9.2.4 POTABLE AND SANITARY WATER SYSTEM

Potable and sanitary water is supplied by the PMU as shown in Figure 9.2-7B. Water of quality acceptable for human consumption is supplied to plumbing fixtures, and makeup water is supplied to the plant heating system and chilled water systems. The system has no safety function.

9.2.4.1 Design Bases

The domestic water portion of the PMU is designed to supply 80 gpm of treated water with one pump in operation. This capacity is sufficient to meet anticipated demands from domestic water service and makeup supplies for the plant heating system and chilled water system. All components of the system are designed to meet Seismic Category 2 requirements.

The system is also designed in accordance with all requirements of the National Plumbing Code regarding water supplies for human consumption. All pressurized tanks were designed and fabricated in accordance with the ASME Code, Section VIII.

ARKANSAS NUCLEAR ONE
UNIT 2

9.2.4.2 System Description

The domestic water portion of the PMU, shown in Figure 9.2-7B, consists of the following:

- A. an 8-inch supply line from the Russellville City Water System;
- B. raw water holdup tank (T61);
- C. domestic water pumps (2P10A, B);
- D. domestic water pressure tank (2T44);
- E. domestic water storage heater (2E43);
- F. domestic hot water circulating pump (2P30); and,
- G. interconnecting piping and controls.

All components of the system with the exception of the raw water holdup tank are located at Elevation 370 feet of the auxiliary building. The raw water holdup tank is located outdoors.

Water is supplied to the raw water holdup tank from the Russellville City Water System via an 8-inch line. Flow to the tank is controlled by a tank mounted level switch which operates a control valve in the supply line. Water from the tank then flows by gravity to the domestic water pumps which operate periodically to maintain the level in the domestic water pressure tank. The instrument air system and tank mounted pressure controller maintain an air pressure in the domestic water pressure tank of 60 psig. A 3-inch line from this tank provides cold water supply for all plant domestic water services. The domestic hot water supply is provided by the domestic water storage heater and the domestic hot water circulating pump, which continuously circulates water in the loop through the water heater.

Drains for sanitary service are directed to the ANO sewage treatment plant.

Data for the individual components of the system is shown in tables as follows:

Raw Water Hold-up Tank (T-61)	Table 9.2-11
Domestic Water Pumps (2P10A, B)	Table 9.2-12
Domestic Water Pressure Tank (2T44)	Table 9.2-13
Domestic Water Storage Heater (2E43)	Table 9.2-14
Domestic Hot Water Circulating Pump (2P30)	Table 9.2-15

9.2.4.3 System Evaluation

The domestic water portion of the PMU does not serve any safety-related function and is not required for safe shutdown of the plant.

The design of the piping system ensure that impurities cannot enter the system by backflow and furthermore, that backflow into the Russellville City Water System is not possible. Location of major system components in areas far removed from possible sources of radiological contamination and maintenance of a 40 to 60 psig internal pressure throughout the system precludes the possibility of radiological contamination within the plant.

ARKANSAS NUCLEAR ONE
UNIT 2

The system is conservatively designed to provide quantities of water adequate to enable proper functioning of the plumbing fixtures in all parts of the plant, and to meet the maximum requirements of makeup to the plant heating system and chilled water systems.

9.2.4.4 Tests And Inspections

Historical data removed - To review the exact wording, please refer to Section 9.2.4.4 of the FSAR.

9.2.4.5 Instrumentation Applications

Instrumentation for automatic and manual control of the system is provided as described in Section 9.2.4.2 and as shown in Figure 9.2-7A and 9.2-7B.

9.2.5 ULTIMATE HEAT SINK

The plant ultimate heat sink consists of two water sources:

- A. The Emergency Cooling Pond (ECP) with the following associated Seismic Category 1 reinforced concrete structures:
 - 1. Pipe inlet structure (see Section 9.2.5.2.1.2)
 - 2. Pipe outlet structure (see Section 9.2.5.2.1.2); and,
- B. The Dardanelle Reservoir with the associated Seismic Category 1 reinforced concrete service water intake structure (see Section 9.2.5.2.2).

The service water intake structure serves both the ECP and the Dardanelle Reservoir.

9.2.5.1 Design Bases

The design basis of the ultimate heat sink is to provide sufficient heat removal capability and reliability for a minimum of 30 days to permit and maintain individual or simultaneous shutdown of Unit 1 and Unit 2.

The shutdown modes considered for ECP sizing purposes were as follows:

- A. normal shutdown of Unit 1 only;
- B. normal shutdown of Unit 2 only;
- C. simultaneous normal shutdown of Unit 1 and Unit 2;
- D. simultaneous normal shutdown of Unit 1 and emergency shutdown of Unit 2 following a LOCA in Unit 2; or,
- E. simultaneous normal shutdown of Unit 2 and emergency shutdown of Unit 1 following a LOCA in Unit 1

The greatest heat load occurs during mode (D) above which was used for sizing the ECP.

ARKANSAS NUCLEAR ONE
UNIT 2

The design basis safety functions of the ultimate heat sink are assured following:

- A. the most severe natural phenomena associated with the site location, including earthquake, tornado, flood or drought, taken individually;
- B. site-related events, such as canal blockage, ice formation, transportation accidents, oil spills, or fires that historically have occurred or that may occur during the plant lifetime; and,
- C. any single failure of a man-made structure, including failure of the Dardanelle Dam, or any upstream dam or dams.

The ultimate heat sink must meet the design requirements noted above while limiting plant returning cooling water temperature to less than 116 °F, the maximum allowable inlet water temperature taking into account the rate at which the heat energy must be removed, the cooling water flow rate, and the capabilities of the respective heat exchangers.

9.2.5.2 System Description

The ultimate heat sink consists of two independent water sources, the ECP and the Dardanelle Reservoir. The following sections provide descriptive information for each source.

9.2.5.2.1 Emergency Cooling Pond

The ECP portion of the ultimate heat sink consists of the pond, the pond inlet and pond outlet structures, associated piping to and from tie points to the SWS, pond spillway to the Dardanelle Reservoir, and the 225-acre^{Note 1} watershed area necessary to maintain the minimum required water level in the pond. A topographic map of the pond area is provided in Figure 9.2-9. Details of the design and construction of the above noted parts of the ECP are provided in the following sections.

Provisions have been made to manually make up for evaporative water loss in the pond by supplying Russellville City water or Lake Dardanelle Water via service water pumps to maintain the minimum required pond water level as set forth in the Technical Specifications.

Note 1: The natural surface drainage area during site construction was approximately 225 acres. No credit is taken for drainage area in the ECP inventory analyses; therefore, it is not required to maintain a minimum 225 acre drainage area (Reference CR-ANO-C-2008-1728).

9.2.5.2.1.1 Pond Construction

The ECP is located entirely within the site boundary, and comprises an area of approximately 14 acres. The minimum average pond level is maintained at a depth of 5.2 feet for a total water volume of approximately 70 acre-feet. The ECP, in general, is excavated in impervious clay strata with the bottom of the pond about 4 to 16 feet above rock. Weathered shale which extends to or above the pond bottom is excavated to a depth of two feet below the pond bottom and replaced with well compacted impervious clay material. The pond sides are handled in a similar manner as required. Stability analyses as described in Section 9.2.5.3 were performed to verify the integrity of the pond during both normal conditions and DBE conditions. The side slopes of the dike and pond are 2.5 horizontal to 1.0 vertical.

ARKANSAS NUCLEAR ONE
UNIT 2

A typical section of the pond is shown in Figure 9.2-10.

The minimum spillway crest elevation is 347 feet, which is below the existing ground. The spillway is a reinforced concrete ogee shaped structure located approximately 60 feet downstream of the original spillway. The original spillway was constructed within the pond embankments at the west end of the north bank and was replaced with the concrete spillway due to erosion concerns. Earth dikes are constructed on either side of the location of the original spillway, and along a portion of the southeast pond perimeter. Additionally, similarly constructed embankments were added to form a channel to the reinforced concrete spillway. The inside face and the top of the dikes are lined with rip-rap. The top of the dikes are at Elevation 353 feet providing a nominal freeboard of 2 feet 6¾ inches during flood conditions as discussed in Section 9.2.5.2.1.3. The added embankments have a crest at Elevation 354 feet.

Placement of the rip-rap adjacent to the spillway was accomplished using clam shell bucket type equipment. First, a 6-inch layer of bedding material was placed. Then a 1½-foot thick rip-rap layer was placed on top of the bedding material. Both the rip-rap and the bedding material have a resistance to abrasion of 26 percent loss of material as measured by the Los Angeles Abrasion Test. Gradation of the rip-rap is as follows: Maximum 1,000 pounds; 25 percent greater than 300 pounds; 45 percent to 75 percent from 10 to 300 pounds; 25 percent less than 10 pounds; sand and rock dust less than five percent; specific gravity 2.5 or greater. Gradation of bedding material is from 3/16 to 3½ inches. These gradations are based on the requirements of the Department of the Interior, Bureau of Reclamation's Book "Design of Small Dams," First Edition, Page 207.

Additional rip-rap was placed all around the pond to prevent wave action from causing erosion of the banks of the pond.

Earth fill for embankments and backfill consists of red silty or sandy clay from required excavation, free of gravel, cobbles, boulders, or pockets of silt, sand or other non-plastic material. Embankment material was placed in 8-inch loose layers, moisture conditioned and compacted to 95 percent of maximum dry density as determined by the Modified Compaction Procedure ASTM Test Designation D-1557. Per EC-443, for the embankments added with the reinforced concrete ogee spillway, it was demonstrated that the embankment material placed in 8-inch loose lifts, compacted to 90 percent of maximum dry density, provided adequate stability and met permeability requirements.

Natural surface drainage (drainage area, 225 acres^{Note 1}) is used for initial fill as well as makeup for evaporation losses. In the event of a prolonged drought period, the pond minimum water volume of 70 acre-feet can be maintained by supplying makeup water from the Russellville water supply line to the plant site. A spillway is provided for the overflow of excess water, and is further described in Section 9.2.5.2.1.3.

Note 1: The natural surface drainage area during site construction was approximately 225 acres. No credit is taken for drainage area in the ECP inventory analyses; therefore, it is not required to maintain a minimum 225 acre drainage area (Reference CR-ANO-C-2008-1728).

ARKANSAS NUCLEAR ONE
UNIT 2

9.2.5.2.1.2 Intake and Discharge Pipes and Related Pond Structures

Separate intake and discharge water lines are used for supplying pond water to the Unit 1 and Unit 2 SWSs. The 42-inch diameter line to the Unit 2 SWS inlet structure is a gravity flow line running approximately 2,200 feet underground and is covered on exterior surfaces with a double wrapping of fibrous-glass mat and bonded coal tar-saturated asbestos felt to prevent corrosion.

The 30-inch diameter return line to the pond from Unit 2 SWS valves 2CV-1541-1 and 2CV-1560-2 also runs underground and is coated in the same manner. It is a pressure line utilizing the service water pump discharge pressure. Both intake and discharge pipes are welded carbon steel, SA-155 Grade KC-60, or equivalent substitution, Class 2, with a 0.375-inch nominal wall thickness.

The separate intake lines for Units 1 and 2 originate from adjacent Seismic Category 1 inlet structures located on the pond perimeter. Discharge lines from each unit terminate in adjacent Seismic Category 1 outlet structures located on the pond perimeter at the opposite end of the kidney shaped pond from the inlet structures.

Design methods and design criteria for the pipe inlet and outlet structures are described in Sections 3.8.4 and 3.8.5, and details are shown in Figure 3.8-25.

Screens are provided in the inlet structure to prevent inclusion of soil or foreign objects in the water delivered from the pond. The inlet screens consist of two screens in series each of 12 gauge stainless steel wire with 3/8-inch openings. Provisions have been made for access to clean these screens periodically.

A distribution weir as shown in Figure 2.5-21 is provided near the pond outlet structures to distribute the discharge evenly across the surface.

9.2.5.2.1.3 Spillway

The spillway is provided for the overflow of excess water in the pond. The spillway is a reinforced concrete ogee shaped design, located at the east end of the pond, approximately 60 feet downstream of the location of the original spillway. The original spillway is left in place.

The pond spillway is designed to accommodate one-half the maximum probable rainfall, based on a total rainfall of 19.5 inches in two hours. A histogram of the spillway design basis rainfall is given in Figure 9.2-12.

The spillway rating curve is shown in Figure 9.2-13, and was developed following the methodology of the Bureau of Reclamations publication "Design of Small Dams," Third Edition.

The maximum water surface, for the design flow rate of 1,063 cfs, has been determined by a hydraulic analysis to be approximately Elevation 350 feet, 5¼ inches. The indicated maximum water surface relative to the original spillway was estimated to be at Elevation 350 feet, to which a freeboard of three feet was added to arrive at a crest elevation of 353 feet for the dikes. The increased maximum height of the pond during the design storm results from abandoning the original spillway in place, with no modifications. The new spillway was designed with the consideration that the top layers of articulated blocks would be removed from the original spillway. The blocks were left intact to alleviate future potential erosion concerns, with the result of a reduction in the efficiency of the new spillway. The three foot freeboard originally provided

ARKANSAS NUCLEAR ONE
UNIT 2

was based on standard practice at the time of original construction with no consideration for actual wave-height and wind setup calculations for the ECP. From EC-443, a maximum rise in the water surface from the design wind of 90 mph was conservatively estimated to be 0.13 feet and the significant wave height was conservatively estimated to be 1.88 feet. Combined, this gives an estimated maximum wave height to be considered of 2.01 feet. This is less than the nominal 2 feet 6³/₄ inch freeboard provided with the pond level at 350 feet 5¹/₄ inch.

9.2.5.2.2 Dardanelle Reservoir

Section 2.4 provides a detailed description of the characteristics of the Dardanelle Reservoir portion of the plant ultimate heat sink while Section 3.8.4 covers the design criteria and design methods for the Seismic Category 1 service water intake structure.

The Dardanelle Reservoir is the source of cooling water for the SWS's of both Unit 1 and Unit 2 during normal operating conditions. Switchover from the reservoir to the pond may be accomplished by actuation of the motor operated sluice gates in the SWS intake structure, and either remote manual actuation of the SWS discharge valves if the ECP is used for normal shutdown or automatic actuation of the SWS discharge valves during accident conditions.

9.2.5.3 Safety Evaluation

During any normal or abnormal plant shutdown operation, the design objectives of the plant ultimate heat sink are assured through the availability of the ECP, together with the associated intake and discharge piping. The Dardanelle Reservoir provides the primary heat sink during normal plant operation, while the emergency cooling pond may provide the seismic Category I backup source for plant safe shutdown if necessary under normal or accident conditions.

The design basis for heat rejection to the ECP is a LOCA in Unit 2 and a concurrent normal shutdown of Unit 1.

ECP performance has been analyzed in accordance with Regulatory Guide 1.27, Revision 1. ECP performance was simulated using a numerical cooling pond model with the following main characteristics:

- A. Two layers, with horizontal temperature gradients.
- B. Initial mixing and mixing between layers is simulated by a single entrainment coefficient.
- C. Horizontal dispersion is neglected.

Pond temperatures were originally analyzed using the worst 1-day average meteorology followed by the worst 30-day average meteorology for Little Rock for the period of record (1930-1973). Worst meteorology is defined as those conditions resulting in maximum pond outlet temperature. To determine whether the Little Rock long-term meteorological data is representative of conditions at the plant site, a comparison was made of simultaneous data taken by the onsite instrumentation and the Little Rock data. Since maximum pond temperatures are expected only during summer months, the period April 1 through September 30, 1972 was used for this study. A digital computer program was used to compute the daily and 30-day running average equilibrium temperatures and evaporation rates for each location.

ARKANSAS NUCLEAR ONE UNIT 2

Because only temperature and wind speed data were taken at the site, the Little Rock relative humidity, solar radiation, and cloud cover were also used in the site calculations. Pond performance was simulated using the worst case meteorology for both the site and Little Rock. It was found that the peak pond outlet temperature, based on site data, was 6.5 °F higher than the peak pond outlet temperature based on Little Rock data. Brady's wind speed function (Reference 9) was used for this temperature analysis.

The maximum pond outlet temperature, based on worst case Little Rock meteorology for the period 1930-1973 and Brady's wind speed function, was computed to be 123 °F, including the effects of diurnal fluctuations. The worst case 1-day and 30-day meteorology conditions are summarized in Table 9.2-17. Adjustment for the difference between site and Little Rock data results in an estimated peak pond outlet temperature of 129.5 °F.

The 129.5 °F peak pond temperature, which was determined in a revised analysis performed in accordance with Revision 1 of Regulatory Guide 1.27, is 9.5 degrees higher than the temperature determined in the previous analysis. As a result of this temperature increase, a study was conducted to determine the impact of these higher temperatures on the safety-related equipment which is cooled by the SWS and required to function throughout the post-LOCA recovery period. Both Unit 1 and Unit 2 equipment were included in this study. The pond temperature versus time curve shown in Figure 9.2-19 was sent to the suppliers of each of the equipment involved.

As a result of this study, some of the equipment was re-rated for the higher temperatures based on existing test data. For the remainder of the equipment, additional testing was performed and/or equipment modifications were made to ensure that this equipment will function properly throughout the period of elevated pond temperatures.

Required modifications to the control room emergency air conditioning system which were made to meet operating requirements with the above maximum pond temperature are described in Section 9.4.1.

Further analysis of ECP response, consistent with Regulatory Guide 1.27, Revision 1, with a computer model which has been benchmarked against an operating cooling pond and more accurately reflects pond behavior has yielded a much lower peak temperature of 120.8 °F or 121 °F (Ref.18). This computer model maintains the assumptions utilized in the previous model except the discharge water is assumed to be pulled from all layers of the pond not just the top layer. The meteorology was reviewed to ensure compliance with the Regulatory Guide was maintained. Changes to the meteorological data used related to the inclusion of diurnal fluctuations for the first five days of the event to verify the peak pond temperature had been attained.

The most recent analysis was performed in accordance with Regulatory Guide 1.27, Revision 2, accepted methodology using a meteorological data record that also includes local and site observed data. This analysis has yielded a lower peak temperature of approximately 116 °F (115.8 °F) (Reference 20). This analysis uses the record of observed ECP temperatures (approximately 33 years) to identify the period of highest ECP temperature (July, 1980). Regional meteorological data supplemented by local data was then used to demonstrate that the surface heat exchange model reproduces the ECP temperature observations. Wind speed reduction calibration methods of local (met tower) and regional (Little Rock) wind speed data were used to reproduce local temperature observations to eliminate the need for a temperature correction of 6.5 °F between the site and Little Rock data.

ARKANSAS NUCLEAR ONE
UNIT 2

The heat loads used in this analysis are shown in Figures 9.2-14 through 9.2-16, with the resulting most recent temperature profile shown in Figure 9.2-21.

Pond evaporation losses were analyzed using the worst 30-day meteorology with respect to natural evaporation rate and dew point depression. Total pond evaporative water loss during the 30 days of operation after the postulated LOCA was computed to be 24 inches, or 28.2 acre-feet. The emergency cooling pond inventory loss analysis includes the effect of evaporative losses, safe shutdown unit condensate requirements, spent fuel pool makeup requirements, sluice gate leakage, system boundary valve leakage, two hours fire pump usage, the impact on pond inventory due to transferring service water system discharge and suction from the lake to the pond, piping leakage, and seepage (Ref. 20). Margins are maintained such that the minimum pond depth for proper hydraulic performance (cooling capability) is computed at 18 inches. Operator action is credited, as allowed by Regulatory Guide 1.27, to increase pond inventory analysis during the transfer of the Service Water System to the pond. Specifically, pump returns are transferred to the pond shortly after a loss of lake event and pump suctions are transferred later in the event depending on pump bay level. In the time frame between the transfer of the returns and suctions to the pond, lake water is pumped into the pond increasing level. This additional water is required, along with that maintained by technical specifications to ensure a 66.9 inch pond depth which corresponds to a 30 day supply of cooling water (Ref. 20).

The required Net Positive Suction Head (NPSH) for each service water pump at 9,500 gpm is 33 feet. The available NPSH at 9,500 gpm, 130 °F and an initial ECP level of Elevation 346 feet is 51.4 feet. At Elevation 342 feet, 6 inches, which is the minimum level expected under worst case meteorological conditions at the end of 30 days, the NPSH available is 50.8 feet at a temperature of 111 °F.

The stability of the pond side slopes was investigated under normal operating conditions and under a seismic loading of 0.2 g ground acceleration.

For normal operating conditions a factor of safety of 1.5 was required, and for the above-mentioned seismic condition a factor of safety of 1.1 was considered acceptable. The varying depth to bedrock below the bottom of the pond was taken into consideration in the analyses.

Stability analysis design strength parameters for the pond slopes were based on residual shear strengths obtained from drained direct shear tests on undisturbed samples of overburden soils.

These are as follows:

Unit weight of soil above ground water table	124 lb./cu.ft.
Submerged unit weight of soil	62 lb./cu.ft
Consolidated drained direct shear strength	$s = 200 + p \tan (23^\circ)$

(s is the shear strength in pounds per square foot and p is the normal pressure in pounds per square foot on the plane on which the shear strength is measured).

The analyses were made in accordance with the Modified Swedish Slip Circle method, known as the "Method of Slices." It was assumed that the water and earth pressures on the sides of each slice are in balance. The earthquake load used in the analysis was the DBE with 0.2 g

ARKANSAS NUCLEAR ONE
UNIT 2

ground acceleration acting on the mass of soil and water in the slope. The added embankment slopes for the reinforced concrete spillway were analyzed using the Simplified Bishop Method, the Simplified Janbu Method, and Spencer's Method. These methods are also part of the family of the "Method of Slices," and together produce equivalent or more conservative results compared with the Modified Swedish Slip Circle Method. For the added embankments, an effective DBE acceleration of 0.355g was used, which was determined from an updated seismic soil-structure interaction analysis relative to the 0.2g ground acceleration.

The results of the above analyses indicate that soil slopes of 2.5 horizontal to 1.0 vertical will be adequately stable under the conditions stated above. Combinations with other natural phenomena and/or site related events are considered less critical and, therefore, are not considered in the analyses.

Section 2.2 discusses Industrial, Transportation and Military Facilities. Based on flight routes and airport locations, the likelihood of an aircraft crash at the site is remote. The operation of the existing rail spur is not considered a credible origin for an ECP incapacitating accident as it is used only infrequently and it is removed from the vicinity of the ECP. As discussed in Section 2.2.2.4, it is not possible for large floating objects in the Dardanelle Reservoir to enter the plant site area. Therefore, it is not credible for the ECP to be damaged by large floating objects such as a ship or barge. The physical remoteness of the ECP to the avenues of bulk petroleum transportation makes massive fouling of the heat sink surface by an oil spill incredible. Vehicles delivering diesel fuel oil to the site will not enter the area of the ECP and, therefore, are not a source of an oil spill from an undefined accident involving the delivery vehicle. In as much as the ECP and related equipment are largely heat resistant or noncombustible, a fire would have minimal impact upon safe shutdown cooling. A gas line rupture event is discussed in Section 2.2.2.1 and was found to have no adverse consequences.

Should it become necessary to use fire fighting equipment while the pond is being used concurrently for plant shutdown, a 2,500 gpm fire pump may be operated for two hours without reducing the normal pond water inventory by more than 1.1 percent (a decrease in pond level of approximately 0.79 inch) assuming an initial depth of 6 feet.

The results of permeability tests made in the field as well as tests made in the laboratory indicate that little or no water losses due to seepage are to be expected.

If a leak in the underground piping to or from the pond were to occur, it would be indicated by the appearance of water on the surface of the ground and/or by a collapse and erosion of the soil long before the water level in the pond is reduced significantly. A leak equivalent to a 2-inch diameter unrestricted hole in a pipe buried 13 feet underground will cause a ground collapse or water appearance at the surface in one hour or less. In the event this occurs at night and goes unnoticed for six hours, about 9,000 cubic feet of water will be lost. This will reduce the pond level by 0.18 inch. SW piping leakage is not accounted for in the design basis ECP inventory analysis.

Makeup from normal rainfall is expected to be well in excess of that required to offset losses due to normal evaporation and leakage from all sources. It is considered that possible layers of ice on the pond surface would not cause flow blockage of the cooling water system. Since the use of oil-base insect sprays in the area surrounding the pond will be minimal, small amounts of this spray which might settle on the surface of the cooling pond will have a negligible effect on its performance.

ARKANSAS NUCLEAR ONE
UNIT 2

Due to the very shallow depth of the pond and the six feet of normal freeboard, no wave action will top the pond banks with the exception of the spillway, and the minor losses at this point will be more than offset by normal makeup due to rainfall.

9.2.5.4 Tests and Inspections

Prior to startup of Unit 2, pond performance was verified during shutdown operations of Unit 1. Periodic inspections of the pond area will be made during the life of the plant to detect leakage or erosion which may endanger the safety function of the pond.

9.2.5.5 Instrument Application

The water level in the pond will be monitored daily to ensure that it is above the minimum level specified in the Technical Specifications. The level will be read from a permanently installed device in the pond and recorded by plant personnel. Since changes in water level will be small from day to day, more than sufficient time will be available to observe dangerous trends, e.g. decreasing water level, and take appropriate action.

To ensure that water level measurements are accurate, soundings will be made annually to determine if the pond bottom elevation has changed.

9.2.6 CONDENSATE STORAGE AND TRANSFER SYSTEM

The condensate storage and transfer system, shown in Figure 9.2-7A and 9.2-7B, stores and supplies water for the following services:

- A. condenser hotwell makeup;
- B. emergency feedwater suction supply;
- C. CCW makeup;
- D. sample panel and sink;
- E. hydrazine and ammonium hydroxide tanks;
- F. generator stator cooling water system;
- G. emergency diesel generator expansion tanks;
- H. zinc injection skid; and
- I. common feedwater system.

9.2.6.1 Design Bases

The condensate storage and transfer system is designed to have sufficient capacity to supply all anticipated normal condensate makeup requirements for the plant while retaining a volume of at least 160,000 gallons. This water volume is adequate to bring the reactor to a hot shutdown condition at a cooldown rate of 75 °F per hour with 1-hour hot standby time allowed.

Condensate storage tank water is maintained above a nominal temperature of 80 °F to minimize the thermal shock to the steam generators during emergency feedwater injection.

ARKANSAS NUCLEAR ONE
UNIT 2

All components of the system are designed to meet Seismic Category 2 requirements. The condensate storage tanks are stainless steel and were designed and constructed in accordance with the American Petroleum Institute, API-650, "Standard for Welded Steel Tanks for Oil Storage."

9.2.6.2 System Description

The condensate storage and transfer system consists of two condensate storage tanks (2T41A, B), two condensate transfer pumps (2P9A, B), and associated piping, controls, and instrumentation.

A Makeup Water Degasification System that is normally in use has been added to remove oxygen from the makeup water prior to being transferred to the Condensate Storage Tanks. In addition to removing oxygen from the makeup water, demineralized water is recycled through the degasifier in order to maintain a low level of oxygen in the condensate storage system. The Degasification system is located in a building just west of the Unit-1 condensate storage tank (T-41).

The condensate storage tanks are located outdoors in the area adjacent to the northwest side of the containment. The condensate transfer pumps are located in the turbine building at Elevation 335 feet.

The EFW pumps are normally aligned to the safety-grade storage tank T-41B (QCST). One Unit 2 condensate storage tank is normally on-line and directly connected to the condenser. With the EFW pumps aligned to the QCST, the Unit 2 condensate storage tanks can be cross-connected to provide the largest possible volume of water for condensate supply.

The hotwell level was designed to be automatically controlled by the makeup and reject valves. The hotwell level is now manually controlled by Operations and the automatic system is not used due to the potential of increasing condensate oxygen levels and contaminating the Condensate Storage Tanks. The condensate tank levels are also manually controlled by Operations. The controls for automatically maintaining CST levels have been either defeated or not used. These controls did not function adequately to meet the needs of the plant.

Each condensate storage tank is provided with an internal steam heating coil which is used in periods of cold weather, maintaining the tank water temperature above a nominal 80 °F. Data for the condensate storage tanks are listed in Table 9.2-16. The condensate transfer pumps are horizontal centrifugal type, each rated to discharge 50 gpm at 80 feet total head.

All piping connected to the tanks is enclosed in heated pipe trenches to prevent freezing during subfreezing outdoor temperature conditions. All piping connected to the tanks is stainless steel to minimize corrosion problems.

Tank level indication is displayed in the control room on a level recorder.

A low level switch annunciates an alarm in the control room which is selectable to either CST. The level switch setpoint is set at greater than 80 percent indicated level.

ARKANSAS NUCLEAR ONE
UNIT 2

9.2.6.3 Safety Evaluation

As discussed in Section 9.2.3, the PMU is designed to produce demineralized water at a rate in excess of the anticipated normal condensate makeup consumption. Therefore, the condensate storage tank volume is maintained above an indicated level of 80 percent by manual control. The minimum volume setpoint of 160,000 gallons ensures that sufficient water is available to maintain the RCS at hot standby conditions for one hour with steam discharge to atmosphere concurrent with total loss of off-site power.

With the tank at its 160,000 gallon setpoint (80 percent), there is sufficient volume for about four hours of decay heat removal or one hour of hot standby operation before a 99,000 gallon volume is reached, at which point cooldown toward cold shutdown would begin.

Freezing of the tank water is prevented by the installed steam heating coil, fed from either the Unit 1 startup boiler or Unit 2 turbine extraction steam. Freezing at tank nozzles and piping is prevented by location of all nozzles and piping in heated trenches. The reactor makeup water tank is heated in exactly the same manner. Both tanks have low temperature alarms which annunciate in the control room.

The condensate storage and transfer system is a Seismic Category 2 system. The QCST is the preferred source of water for the EFW system. The QCST has a 30 minute (minimum) supply of EFW protected by a tornado missile shield wall, giving operators ample time to align the EFW pump suction to the Service Water System. The Unit 2 Condensate Storage Tanks 2T-41A and B (CSTs) can be connected to the Unit 2 EFW system or isolated from the system by closed double isolation valves.

The water in the condensate storage tank is not normally radioactive. However, in the event of primary-to-secondary leakage due to a steam generator tube leak it is possible for the CFS to become radioactively contaminated. A full discussion of the radiological aspects of primary-to-secondary leakage, including anticipated operating concentrations of radioactive contaminants, means of detection of radioactive contamination, and anticipated releases to the environment is presented in Section 10.4.8.

In the event of a tank rupture, some water would be drained to the turbine building drainage system, and the balance would flow toward the Dardanelle Reservoir.

Long-term system degradation due to corrosion is prevented by the use of stainless steel components in the system. The condensate storage tank, and piping to the PMU, condenser hotwell and emergency feedwater pump is type 304 stainless steel.

9.2.6.4 Tests and Inspections

Tank contents are sampled to ensure maintenance of water quality required by the steam generators.

9.2.6.5 Instrument Application

A level switch and alarm is provided to alert the operators whenever the tank level falls below setpoint as described in Section 9.2.6.2.

9.3 PROCESS AUXILIARIES

9.3.1 COMPRESSED AIR SYSTEM

Compressed air is supplied by the Instrument and Service Air Systems as shown in Figure 9.3-1. The Instrument and Service Air Systems provide all plant compressed air for pneumatic instruments and valves and for service air outlets located throughout the plant which will be used for operation of pneumatic tools and other requirements. The Instrument and Service Air System are not required for the safe shutdown of the plant.

The Breathing Air System is designed to provide compressed air for use in air-fed respirators in Controlled Access areas. The Breathing Air System is not required for the safe shutdown of the plant.

9.3.1.1 Design Bases

The air compressors are designed to supply air at a nominal pressure of 100 psig, with pressure reduced, as necessary, at the point of use for various service requirements. The rated capacity of each of the two instrument air compressors is 484 scfm at 125 psig discharge pressure and 553 scfm at 100 psig discharge pressure. This rating is based on the total instrument air demand for the Nuclear Steam Supply System (NSSS) and the balance of the plant. The service air compressor has the capacity to deliver 100 scfm at 100 psig discharge pressure to supply average service air requirements for reactor refueling operation and miscellaneous uses in the plant.

Each of the two instrument air filters and instrument air dryers are sized to treat the total instrument air quantity required (up to 533 scfm) for the Instrument Air System and delivers dry air having a dew point of at least 18 °F below the minimum local ambient temperature onsite (Ref. ISA Quality Standard for Instrument Air S7.3-1975).

All parts of the system, with the exception of the containment penetrations, are designed to meet Seismic Category 2 requirements, and were fabricated and installed in accordance with ANSI B31.1.0, Code for Power Piping. The containment isolation valves and piping between these valves are designed to meet Seismic Category 1 requirements and were fabricated and installed in accordance with ASME Code, Section III, Class 2. The air receivers and instrument air dryer towers were designed and fabricated in accordance with ASME Code, Section VIII.

The Breathing Air compressor is designed to supply air at a nominal pressure of 100 psig, with pressure reduced, as necessary, at the point of use for respirator requirements. A connection to the Instrument Air cross-connect between Units 1 and 2 is provided to enable Breathing Air to backup Instrument Air.

9.3.1.2 System Description

The Instrument Air System consists of two oil-free air compressors (2C27A, B), two air receivers (2T88A, B), two dual tower air dryers (2M70 and 2M76), two air filters (2F173A, B), instruments, piping, and valves. One of the two 100 percent capacity compressors is required to be in operation for normal operation and normal startup or shutdown of the plant, while the other one serves as a standby. The Unit 1 and Unit 2 Instrument Air Systems have interconnection capabilities; these interconnections are operated as desired for split or common system operation.

ARKANSAS NUCLEAR ONE
Unit 2

The Service Air System consists of a rotary screw air compressor (2C-43) and an air receiver (2T-148), instruments, piping, and valves. Compressor 2C-43 serves as the primary service air compressor for both Unit 1 and Unit 2. During periods of high usage additional capacity can be installed at temporary compressor connection points.

Compressed air for instrument air use passes through a drying unit and an air filter before being distributed to the instrument air piping system. The arrangement of the filters allows cleaning or changing of filters while the unit is in operation by diverting the air flow through the other parallel filter. The air dryer in use automatically alternates flow of air through each of the chambers to permit automatic drying of the desiccant in one chamber while the other chamber is in service.

The Breathing Air System consists of one compressor (C-30) that is designed to supply compressed air to be used in Breathing Air respirators in ANO-1 & 2 Controlled Access Areas. The Breathing Air System is shown schematically on Figure 9.3-1.

9.3.1.3 Safety Evaluation

The Instrument and Service Air Systems are required for normal operation and startup of the plant. However, all pneumatically operated devices in the plant which are essential for safe shutdown are designed to assume a fail-safe position upon loss of air supply. Therefore, the Instrument and Service Air Systems are not required to effect a safe shutdown of the plant or for an ESF component to perform its intended function and the systems are, accordingly, designed to meet seismic Category 2 requirements. A discussion of loss of the Instrument and Service Air Systems is presented in Section 15.1.34, including a list of safety-related pneumatic valves and their failure modes. Containment penetration piping is provided with double isolation valves to prevent radioactive releases from the containment following a postulated LOCA. Pressure points are provided to check the integrity of the penetration piping.

Required instrument air dewpoint is monitored by periodic system testing. Additionally, the following system features contribute to maintaining the required instrument air quality:

- A. air compressor inlet filters;
- B. oil-free compressors;
- C. air dryers with high humidity alarm; and,
- D. filters installed after the air dryers

The compressors are designed for full capacity operation with a maximum inlet air temperature of 122 °F.

The Breathing Air System is not required for the safe shutdown of the plant. In the event of a Breathing Air compressor failure, the air receiver tanks (T-120 and T-118) are designed to contain enough air to allow the worker on breathing air to get to a non-respirator environment.

9.3.1.4 Tests and Inspections

Historical data removed; see Section 9.3.1.4 of the FSAR.

The “lag” and “lead” instrument air compressors are periodically rotated by increasing the setpoint of the “lag” compressor to the “lead” setting and verifying that it starts automatically. The existing “lead” compressor is then placed in standby by decreasing its setpoint to the “lag” setting.

ARKANSAS NUCLEAR ONE
Unit 2

9.3.1.5 Instrument Applications

Pressure switches sensing the air pressure in the air receiver are provided for automatic control of the compressors. The instrumentation for monitoring the Instrument and Service Air Systems includes:

- A. high air temperature alarms;
- B. low oil pressure alarms;
- C. motor over current alarms;
- D. header low pressure alarms;
- E. instrument air high moisture alarm;
- F. air dryer high temperature and valve failure alarms; and,
- G. local pressure and temperature indication.

9.3.2 PROCESS SAMPLING SYSTEM

Process sampling is accomplished by a Primary Sampling System (PSS), a Secondary Sampling System (SSS), and a Waste Gas Analyzer System (WGAS). A description of the equipment comprising these systems is presented in this section.

9.3.2.1 Design Bases

The PSS is designed to collect samples of fluids contained in the Reactor Coolant System (RCS) and associated auxiliary system process streams, as listed in Table 9.3-1, for analysis by the plant operating staff. Chemical and radiochemical analyses are performed on the samples as appropriate to determine boron concentration, fission and corrosion product activity levels, residual hydrazine, phosphate, sulphite, and radiation levels in the steam generators, crud concentration, dissolved gas concentration, chloride concentration, pH, lithium and conductivity levels, and gas compositions in various vessels. The results of the analyses are used to regulate boron concentration, monitor fuel rod and steam generator tube integrity, evaluate ion exchanger and filter performance, specify chemical additions to the various systems, and maintain the proper hydrogen and nitrogen overpressure in the volume control tank. The PSS is designed to permit sample collection during all modes of operation from full power to cold shutdown without requiring access to the containment. Water chemistry requirements for the PSS are given in Section 9.3.4 for reactor coolant and Section 10.3.5 for steam generator water.

The Secondary Sampling System (SSS) is designed to collect samples from the Makeup Water System, the turbine cycle, and the Circulating Water System (CWS) as listed in Table 9.3-2. Water quality analyses are performed on these samples as appropriate to determine pH and conductivity levels, silica, dissolved oxygen, sodium, and residual hydrazine concentrations. The hydrazine and pH analyzers are used to monitor the hydrazine concentration and pH level in the main feedwater lines with alarm initiation upon the occurrence of abnormal conditions. Ammonium hydroxide, an amine, and/or hydrazine is added to establish the desired pH range (see Table 10.3-2). Output signals from other analyzers are used to initiate alarms in the event of abnormal conditions. The Waste Gas Analyzer System (WGAS) provides the capability to monitor the gas space of the tanks and equipment listed in Table 9.3-3. A hydrogen oxygen analyzer panel is provided to monitor free oxygen and free hydrogen during degassing operations. Manual grab sampling is the backup method of monitoring.

ARKANSAS NUCLEAR ONE
Unit 2

The Post Accident Sampling System (PASS) is designed to determine the types and quantities of fission products released to the containment in the liquid and gas phase, and provide information on coolant chemistry and containment hydrogen while minimizing personnel exposure to increased radiation levels which could exist during and subsequent to a nuclear accident. The PASS consists of piping, tubing, valves, components and instrumentation mounted in a sample station with an accompanying control panel. The equipment enables remote analysis of the reactor coolant and containment air and remote collection of the reactor coolant and containment air samples for subsequent analysis. Liquid samples for the PASS may be obtained from the reactor coolant hot leg and containment sump. Pressurizer gas and liquid samples can be aligned to the post accident sampling system. However, the samples are not aligned due to code compliance issues regarding associated PASS sample valves. The containment atmosphere is monitored for radionuclide isotopic and hydrogen analyses. For more detailed information on containment hydrogen analysis, see Section 6.2.5.

Note: NRC letter (0CNA080005) dated 8/17/2000, eliminated the requirement for PASS from the ANO Units 1 and 2 Technical Specifications (TSs). ER-ANO-2003-0221-000 isolated PASS components by maintaining closed PASS boundary valves and de-energizing Unit 1 liquid solenoid valves SV-1440 and SV-1443. The PASS is no longer used and will be isolated from the plant, but remains part of the plant configuration management process. Therefore, PASS components still appear in LBDs. The design bases of PASS have not changed. Should the PASS be put back into service, the PASS would perform its design function [as long as Reg. Guide 1.97 compliant PASS building ventilation monitoring is restored](#). Note: PASS sample lines for Containment Spray and containment air (Hydrogen Purge) have been permanently capped. PASS nitrogen supply line connected to the liquid nitrogen bulk storage tank (2T-138) has also been permanently capped.

9.3.2.2 System Descriptions

9.3.2.2.1 Primary Sampling System

The PSS collects samples from the RCS and auxiliary systems as listed in Table 9.3-1, and brings them to a common location in the sample room in the auxiliary building. Figure 9.3-2 shows a schematic diagram of the PSS.

The high pressure, high temperature samples from the RCS pass through a run of piping long enough to ensure a minimum 90-second decay of short-lived radioactivity, including N-16, before the fluid leaves the containment. The samples are then cooled to a nominal temperature of 105 °F in the reactor coolant sample cooler and then reduced in pressure by means of manually set throttling valves.

The reactor coolant samples may be collected in a detachable sample container for gas analysis.

Samples taken from the Safety Injection System (SIS) and Shutdown Cooling (SDC) System are at intermediate temperatures and pressures and are cooled in the safety injection and shutdown cooling sample cooler, reduced in pressure by means of manually set throttling valves in the sampling room.

Low temperature, low pressure liquid samples from the Chemical and Volume Control System (CVCS) are routed directly to the sampling room.

ARKANSAS NUCLEAR ONE
Unit 2

All of the PSS liquid sampling lines except the steam generator water sample are connected to a common header and discharged to the Waste Management System (WMS). RCS and CVCS sample streams may be returned to the Volume Control Tank. Temperature, pressure, and flowrate indication of all of the above samples is provided in the sampling room.

To obtain a representative sample, the lines are purged for an appropriate amount of time prior to diverting the flow to the sample sink, where the sample is drawn off at a flow rate of 0.6 gpm. System pressure provides the motive force for the purging flow. The sample sink is of stainless steel construction with a raised edge to retain any splashed fluid. The sink area is provided with a hood equipped with an exhaust ventilator exhausting to the plant vent system. Demineralized water is provided at the sample sink to flush and clean the sink. The sink drains by gravity through a water trap to the WMS. In addition to the above, in-line sensors and display units are available to monitor the RCS sample water for hydrogen, oxygen, pH, and conductivity concentrations.

Steam generator water samples are monitored on a continual basis from each steam generator. The system draws samples from the blowdown line for use in chemistry control. The samples are first cooled in the steam generator sample coolers and then reduced in pressure by means of manually set throttling valves. The pressure, temperature, and flow rate of each of the steam generator water samples is indicated in steam generator blowdown sample panel 2C377. In addition, each sample is continually monitored for specific conductivity, cation conductivity, pH, sodium concentration, and radiation. Should any of these parameters rise above operating limits, an alarm is activated at the sample panel and in the control room. Demineralized water is provided to allow cleansing of the measuring cells and cation exchange columns. Sample effluent flow from the steam generators can be routed to either the turbine building sump or the neutralizer tank 2T-87 depending on secondary activity levels. The only exceptions are the flows to the hot lab sample sink and the radiation monitors, which return to the MFP seal tank. The sample sink flows may also return to the WMS. The alignment of the sample panel 2C377 drain path is controlled by the use of spectacle flanges. This arrangement prevents cross-connection between contaminated and non-contaminated systems from being established only by changes in valve positions. Capability to obtain a grab sample from either steam generator is also provided.

9.3.2.2.2 Secondary Sampling System

The SSS, shown on Figure 9.3-2, consists of primary coolers, secondary coolers, sample panels, automatic analyzers, multi-point recorders, interconnecting tubing, and controls as required for continual monitoring of the turbine cycle and makeup water system. In addition, an Ion Chromatograph Analyzer is used to analyze feedwater, main steam, condensate, steam generators, heater drains, and SU/BD demineralizer inlet and outlet. Sample points and inlet conditions of these sampling systems are listed in Table 9.3-2. The temperature control of the high temperature samples is accomplished by two stages of cooling. The first stage of cooling is through roughing coolers (or primary coolers) to bring the temperature of sample to 140 °F, followed by second stage coolers (or secondary coolers) to cool samples to 77 °F or appropriate level as required for the analyzers.

The temperature control of the low temperature samples of 140 °F or below is accomplished through the secondary coolers only. The CCWS removes the heat from the primary and secondary coolers. Pressure control valves are provided to reduce pressure and also to maintain a constant pressure to the analyzers. Relief valves are provided to protect the equipment.

ARKANSAS NUCLEAR ONE
Unit 2

The automatic analyzers of sodium and hydrazine are provided with 3-way solenoid valves which may be used to supply demineralized water to the analyzers to keep them wet whenever the systems fail to operate or are taken out of service. Pre-collection purging is provided for high pressure sample lines to purge the system whenever necessary to obtain representative samples. Capability to obtain a grab sample for all sample points is provided. Uncontaminated drains from the sample lines are collected and returned to the condenser.

The sodium analyzer added to the secondary sample system provides the capability of detecting contaminants entering the feed stream via condenser tube inleakage, secondary demineralizer exhaustion, or heat exchanger inleakage from heating systems charged with sodium nitrite.

9.3.2.2.3 Waste Gas Analyzer System (WGAS)

The WGAS, which consists of one instrument panel, provides the capability to monitor the tanks and equipment listed in Table 9.3-3 for free oxygen and hydrogen. This monitoring capability is backed-up by the capability for analysis of manual grab samples.

The WGAS displays the free oxygen and hydrogen concentrations and alarms at or below the lower flammable gas concentration range.

The WGAS will also alarm on high sample temperature and low sample flow.

The WGAS has been designed so that the panel can monitor the discharge flow, and therefore the suction source, from either waste gas compressor during degassing operations. The operating range of the panel is 20-300 psig. A back pressure regulator on the compressor discharge allows near instantaneous sampling of the waste gas. The panel can also sample each of the waste gas decay tanks as long as tank pressure exceeds 20 psig. Grab samples are the back-up method for obtaining hydrogen and oxygen concentrations when the analyzer is not operable. Grab samples are the primary method used for analyzing the spent resin tank and the liquid holdup tanks and the waste gas decay tanks when decay tank pressure is less than 20 psig.

9.3.2.2.4 Post-Accident Sampling System (PASS)(OCAN038013)

The PASS building and equipment was constructed to permit prompt, safe, remote sampling of primary systems and containment air during accident (and in some cases normal) conditions. Shielded sample lines and remotely controlled analyzers, MOVs, and solenoid valves are provided to minimize dose and reduce the time required for sampling. Samples are available from the following locations: hotleg, containment sump, and containment air. Pressurizer gas and liquid samples can be aligned to the post accident sampling system. However, the samples are not aligned due to code compliance issues regarding associated PASS sample valves. Note: PASS sample lines for Containment Spray and containment air (Hydrogen Purge) have been permanently capped. PASS nitrogen supply line connected to the liquid nitrogen bulk storage tank (2T-138) has also been permanently capped.

Sample lines leading to (and in some cases from) PASS analyzers and equipment have been insulated and in the case of containment air, heat traced, in an effort to reduce temperature depression. Liquid samples remain at or near system pressure and temperature until exiting the area of the radionuclide detector. These liquid samples are then cooled (not depressurized)

ARKANSAS NUCLEAR ONE
Unit 2

and pass through an inline hydrogen detector. After exiting the hydrogen detector, the samples are depressurized and flow is then diverted to the desired destination (i.e. containment building during accident conditions).

During design and construction, special consideration was given to radii and bends in sample lines to reduce the potential for crud traps and line losses.

Several shielded, portable grab sample vessels have also been provided in the event that it becomes necessary for analytical test to be performed offsite. The capability exists to obtain grab samples of either containment air or reactor coolant liquid samples.

Flushing water is provided for liquid sample lines to reduce radiation levels in the analyzer rooms. Purge air is available to reducing radiation levels in containment air sample lines. Therefore, should it become necessary to perform maintenance, the radiation levels can be reduced significantly.

The PASS facility is equipped with a separate, packaged, air conditioning system which includes a dedicated exhaust system. Air exiting the building passes through filters to remove particulates and radioactive iodines. Radioactive material that may penetrate these filters is monitored prior to exiting the PASS building stack.

9.3.2.3 Design Evaluation

The sampling systems are not essential for safe plant shutdown and serve no emergency function during operation. The PSS (other than the steam generator water sample) is operated intermittently; sample lines are therefore normally closed with no flow. The isolation valves both inside and outside containment (except the steam generator water sample lines) are solenoid operated valves with position indicating lights in the sampling and control rooms which fail closed on loss of operating power. The outside isolation for the safety injection tanks sampling and all RCS sampling isolation valves inside and outside containment receive a Containment Isolation Actuation Signal (CIAS) and a Safety Injection Actuation Signal (SIAS) to close. A CIAS override capability is provided to permit RCS sampling capability at all times during an accident sequence. The overridden condition is annunciated on main control board 2C16 in the control room.

The steam generator water samples are monitored continuously from each steam generator. The steam generator sample line isolation valves inside and outside of the containment are motor operated, fail-as-is valves with indicating lights located in the control room. The outside isolation valves receive a CIAS to assure closure in the event of a Loss of Coolant Accident (LOCA) or Main Steam Line Break (MSLB) inside containment.

All sample piping and valves, except RCS sample piping and valves, are designed and fabricated in accordance with the same piping and valve codes as the systems to which they are connected, up to and including the first isolation valve.

The sampling nozzles on the RCS contain integral 3/16-inch diameter orifices. As such, in the event of a severance of one of the RCS sample lines during normal reactor operation, the reactor can be shut down and cooled down in an orderly manner using normal makeup from the CVCS.

ARKANSAS NUCLEAR ONE
Unit 2

RCS sample lines and sample lines which penetrate the containment (up to and including the outside isolation valve) are designed in accordance with ASME Code, Section III Class 2. The balance of the system is tubing designed to ANSI B31.1.0. All sample coolers are designed and fabricated in accordance with the ASME Code, Section VIII.

The sample coolers are located in a shielded area outside of the containment. The sample coolers for both PSS and SSS receive their cooling water from the CCW System.

The sampling systems are designed to minimize any hazard to operating personnel or public safety. Thermal insulation is provided to protect personnel from contact with high temperature parts. All sample coolers are designed to limit the temperature of the fluid samples to a maximum of 115 °F for safe handling. The pressure of each sample is reduced to approximately one atmosphere. Pressure relief protection is provided to avoid damage to components.

The PSS sample room is shielded as described in Section 12.1. It is an enclosed room with controlled ventilation and drainage to confine any leakage or spillage of radioactivity. All PSS grab samples are collected within a vented sample hood to exhaust any gaseous leakage to the gas collection header. Any liquid leakage is collected in the sink and drained to the WMS for processing. Any leakage from the system inside containment is collected in the containment sump.

The SSS contains no radioactive streams and thus presents no hazard to public safety. Design conditions for the various sample points are listed in Tables 9.3-1, 9.3-2, and 9.3-3. Local indicators are provided to permit manual control of sampling operations to ensure that samples are at suitable pressures and temperatures before flow is diverted to the sample sink.

9.3.2.4 Inspection and Tests

The materials and nondestructive examinations used in the process sampling system are in accordance with the applicable design codes as delineated in Section 9.3.2.3 above.

Proper operation of the process sampling system was demonstrated during preoperational testing by establishing the appropriate sample flow for each sample point. All automatic analyzers were calibrated and their output results were verified.

The sampling systems are inspected during normal operation by observing proper operation of the components while samples are being drawn. The malfunction of analyzers will be observed by inappropriate readouts on the recorders or by alarms.

9.3.2.5 Instrument Application

The PSS and SSS use local pressure, temperature, and flow indicators to facilitate manual operation and to determine sample conditions before samples are drawn. Radiation elements continuously monitor each steam generator sample for primary-to-secondary tube leaks. The output is available on a trend recorder in the control room and the plant computer. A high radiation alarm in the main control room warns of radioactivity in excess of limits given in Section 11.4.2.1.4 in the steam generator sample.

Every sample point in SSS for continual monitoring is provided with an individual alarm at each sample panel.

ARKANSAS NUCLEAR ONE
Unit 2

Alarms for the WGAS are displayed locally and in the control room to indicate the presence of high oxygen and/or hydrogen concentration.

9.3.3 EQUIPMENT AND FLOOR DRAINAGE SYSTEMS

9.3.3.1 Design Bases

- A. The design bases are as follows. The design and arrangement of the non-radioactive drainage systems assure that no infiltration of potentially radioactively contaminated materials will occur.
- B. The WMS collects liquid wastes, at atmospheric pressure, from equipment and floor drainage of the containment, the auxiliary building and from decontamination, laboratory, and waste treatment areas. All such drainage is conveyed by gravity to sealed sumps and pumped from there to the waste tanks, or is conveyed directly to the waste tanks.
- C. Sump pumps are designed to discharge at a flow rate adequate for preventing sump overflow during normal anticipated drainage periods.
- D. Where deemed necessary to provide venting for any liquid radwaste collection system drainage line, the highest portion of the horizontal run of pipe is continued to an elevation and location where connection can be made to the gaseous radwaste system.
- E. Systems which are not potentially radioactive are provided for the collection and disposal of roof drainage, storm drainage, sanitary drainage, oily waste, acid waste, and clean drainage.

9.3.3.1.1 Codes and Standards

Equipment and floor drainage collection piping from the areas of potential radioactivity and the gravity collection system piping are constructed in accordance with ANSI B31.1.0 (1967), Power Piping. All other drainage systems comply with the requirements of the National Plumbing Code as regards permits, materials of construction, installation, tests, inspections, and approval. All drainage systems comply with the intent of the following sections of Title 29, Chapter XVII, Part 1910 (Occupational Safety and Health Standards) of the Code of Federal Regulations, as set forth in the Federal Register, Volume 37, Number 202, and dated October 18, 1972: Sections 1910.96, 1910.106, 1910.141, 1910.151, 1910.156, and 1910.159 (c)(3).

9.3.3.2 System Description

The equipment floor drainage systems consist of collection piping, equipment drains, floor drains, vents, traps, cleanouts, and collection sumps. The arrangement is such that the non-radioactive drain systems serve only non-restricted areas where no radioactivity is present, exclusive of the water closet and urinal wastes in the access control area which are collected by the sanitary system. The nature of the sanitary system makes it unlikely that radioactive wastes would enter the sanitary system through this path.

ARKANSAS NUCLEAR ONE
Unit 2

9.3.3.2.1 Component Description

COLLECTION PIPING - In areas of potential radioactivity, the collection system piping for the liquid waste system is stainless steel. Where deemed necessary to maintain atmospheric pressure in the radwaste drainage collection system, relief valves are provided to the Gaseous Radwaste System (GRW). Offsets in the piping are provided where necessary for radiation shielding. The fabrication of the piping provides for a uniform slope which induces waste to flow in the piping at a velocity of not less than two feet per second. Long horizontal drainage piping runs are kept to a minimum in order to minimize problems of elevation, slope, and interference with the layout of other equipment and to provide efficient removal of large volume waste discharges such as those resulting from activation of the Fire Protection System (FPS). Equipment drainage piping is terminated a few inches above the finished floor. The final connections are made after the equipment is installed in its proper location.

AUXILIARY BUILDING DRAINS - The auxiliary building drains are run so that leakage in one Engineered Safety Features (ESF) drain does not flow into the rooms of the other train through the drains. Components and floor drains drain into a separate sump which is fitted with a sump pump.

EQUIPMENT DRAINS - Equipment which discharges waste at a pressure in excess of atmospheric is separated from the drain by an air gap. Connection to other equipment discharge piping varies as required, from solid to open (air gap) types.

FLOOR DRAINS - All floor drains are installed with grates (except the HPSI pump room "C" floor drain). The tops of the grates are flush with the low point elevation of the finished floor. Floor drains in areas of potential radioactivity are welded directly to the collection piping and are provided with threaded, T-handle plugs of the same material, to facilitate selective liquid waste collection and maintenance of system integrity. Floor drains in areas not restricted due to potential radioactivity are provided with caulked or threaded connections.

TRAPS - Inlets to all drainage systems, except those in areas of potential radioactivity and those in rainwater and gravity collection service, are provided a water seal, in the form of a vented P-trap to minimize entry into the building of vermin, foul odors, and toxic, corrosive, or flammable vapors. Air pressure vent lines to the outside atmosphere are provided downstream of the P-traps to prevent excessive backpressures which could cause blowout or siphonage of the water seal. No traps are installed at inlets in areas of potential radioactivity for two reasons. The first is the tendency for radioactive particulates to accumulate in the traps. The second is the difficulty of maintenance, cleaning, and retention of the water seal.

Loop seals are also provided in the equipment drains from the Control Room Emergency Air Handling Units to provide an air seal to prevent unfiltered air inleakge.

CLEANOUTS - Cleanouts are provided in all collection system piping, when practicable, where the change of direction in horizontal runs is 90 degrees, at offsets where the aggregate change is 135 degrees or greater, and at maximum intervals of 50 feet. Cleanouts are welded, threaded, and caulked directly to the piping and located with their covers flush with the finished floor or wall.

ARKANSAS NUCLEAR ONE
Unit 2

9.3.3.2.2 System Operation

GENERAL - The various subsystems drain directly to the appropriate collection point by gravity. Sump pumps are started automatically when a predetermined high level in the sump is reached.

POTENTIALLY RADIOACTIVE DRAINAGE - Fluids conveyed by potentially radioactive drainage systems either flow by gravity to sealed sumps in the respective building and are pumped thence to waste tanks, or flow by gravity directly to waste tanks.

ROOF DRAINAGE - The roof drainage system collects water resulting from precipitation on all building roofs and open area ways within the buildings, and conveys it to the storm drainage system.

STORM DRAINAGE - The storm drainage system collects rainwater from the roof drainage system, rainwater and irrigation run-off from surfaces outside the buildings, and subsoil drainage water.

SANITARY DRAINAGE - The sanitary drainage system collects liquid wastes and some entrained solids discharged by plumbing fixtures located in areas not restricted due to radiation hazard and conveys them to a sewage treatment facility located on the plant site.

OILY WASTE - The oily waste system collects liquid waste which enters floor drains located in areas which are not restricted due to a radiation hazard and where capability for oil spillage exists, and conveys it to a sealed interceptor of approved design. The clarified effluent from the interceptor is conveyed to a suitable point of connection to the gravity collection system piping.

ACID WASTE - The acid waste system collects liquid waste containing chemicals and corrosive substances discharged by laboratory fixtures or equipment, or which enter floor drains located in areas not restricted due to radiation hazard, and conveys it to a dilution/neutralization tank of approved design. The effluent from the tank is conveyed to a suitable point of connection to the gravity collection system piping.

GRAVITY COLLECTION - The gravity collection system collects liquid waste that is discharged by equipment, or which enters floor drains located in areas not normally restricted due to radiation hazard, and which contains no oil, detergent, acid, or other objectionable contaminants, and conveys it to a grease traps that are sealed of approved design. The clarified effluent from the interceptor is conveyed to the intake canal.

9.3.3.3 Safety Evaluation

Since this system has no safety design bases, no safety evaluation is provided. Section 9.3.3.2 provides an assessment of system design and operation.

9.3.3.4 Tests and Inspections

Historical data removed - To review the exact wording, please refer to Section 9.3.3.4 of the FSAR.

OPERATION TESTING CAPABILITY - The operability of equipment and floor drainage systems dependent on gravity flow can be checked by normal usage. Portions of these systems dependent upon pumps to raise liquid waste to gravity drains may be checked through instrumentation and alarms registry in the control room.

9.3.3.5 Instrumentation Applications

Level indication and alarms in the control room are provided for those sumps in the auxiliary building which serve safety features pumps rooms. Level indication, in addition to the level-operated switch used for pump control, is provided for all sumps in the containment and the auxiliary building to provide backup indication of the presence of large leaks and to provide information as to the source of leakage.

9.3.4 CHEMICAL AND VOLUME CONTROL SYSTEM

9.3.4.1 Design Bases

9.3.4.1.1 Functional Requirements

The CVCS is designed to perform the following functions:

- A. maintain the chemistry and purity of the reactor coolant during normal operation and during shutdowns, including crud burst cleanup;
- B. maintain the required volume of water in the RCS by compensating for coolant contraction or expansion resulting from changes in reactor coolant temperature and for other coolant losses or additions;
- C. provide a controlled path for discharging fluid to the BMS;
- D. control the boron concentration in the RCS in order to maintain acceptable CEA configuration, compensate for reactivity changes associated with burnup and major changes in coolant temperature and xenon concentration, and provide the required shutdown margin to maintain the reactor subcritical;
- E. provide auxiliary pressurizer spray for operator control of pressure during the final stages of shutdown and to allow pressurizer cooling;
- F. provide a means for functionally testing the check valves which isolate the SIS from the RCS;
- G. provide continuous measurement of reactor coolant fission product activity;
- H. collect reactor coolant pump seal controlled bleedoff;
- I. leak test the RCS;
- J. inject concentrated boric acid into the RCS upon a Safety Injection Actuation Signal (SIAS);
- K. automatically divert the letdown flow to the BMS when the volume control tank is at the highest permissible level; and,
- L. provide an alternate means for filling the RCS.

ARKANSAS NUCLEAR ONE
Unit 2

- M. A soluble zinc compound may be added to the reactor coolant as a means to inhibit corrosion of primary system materials and components, and to control radiation fields. The compound used may be either natural zinc or zinc depleted of ⁶⁴Zn. When used, the target system zinc concentration is normally maintained to a concentration no greater than 40 ppb.

9.3.4.1.2 Design Criteria

The CVCS is designed in accordance with the following criteria.

- A. Accept the letdown when the reactor coolant is heated at the administrative rate of 75 °F/hr and to provide the required makeup using two of three charging pumps when the reactor coolant is cooled at the rate of 75 °F/hr.
- B. Supply reactor makeup water or accept excess coolant as power decreases or increases.
- C. Allow design transients of ± 10 percent of full power step changes and ramp changes of ± 5 percent of full power per minute between 15 and 100 percent power.
- D. Provide sufficient capacity to accommodate the inventory change resulting from a full to zero power decrease with no makeup system operation, assuming that the volume control tank level is initially in the normal operating level band.
- E. Provide a means for maintaining activity in the RCS within the appropriate limits, assuming one percent failed fuel condition and continuous full power operation.
- F. Maintain the reactor coolant chemistry within the limits specified in Table 9.3-4.
- G. Provide boron addition to the reactor coolant by using one charging pump at a rate sufficient to counteract the maximum reactivity increase due to cooldown at 75 °F/hr and maximum xenon decay.
- H. The regenerative heat exchanger and the letdown heat exchanger are designed to withstand the design transients discussed in Section 9.3.4.3.
- I. To accommodate the environmental design conditions of the CVCS given in Section 3.11.
- J. Bring the reactor coolant to refueling boron concentration.

Components of the CVCS are designed in accordance with applicable codes discussed in Section 9.3.4.3.

9.3.4.2 System Functional Description

9.3.4.2.1 Normal Operation

The CVCS is shown on Figure 9.3-4. The system parameters are given in Table 9.3-5.

Normal operation includes hot standby operation and power generation when the RCS is at normal operating pressure and temperature.

ARKANSAS NUCLEAR ONE
Unit 2

Coolant flow from the cold leg in loop 2P32A of the RCS passes through the tube side of the regenerative heat exchangers for an initial temperature reduction. The cooled fluid is reduced to the operating pressure of the letdown heat exchanger by one or both letdown control valves, 2CV-4816 or 2CV-4817. The final reduction to the operating temperature and pressure of the purification system is made by the letdown heat exchanger and one or both letdown backpressure valves 2CV-4810 or 2CV-4811. The flow then passes through a filter, one or more letdown ion exchangers and a strainer and is sprayed into the volume control tank (VCT).

The charging pumps take suction from the volume control tank and pump the coolant into the RCS. One charging pump is normally in operation and one letdown control valve is controlled to maintain pressurizer level at the desired value. Normally this maintains an exact balance between letdown flow rate plus reactor coolant pump bleedoff flow rate and charging flow rate. The charging flow passes through the shell side of the regenerative heat exchanger for recovery of heat from the letdown flow before being returned to the RCS.

Typically, a letdown flow of 40 gpm is normal purification operation, a letdown flow of 84 gpm is intermediate purification operation and a letdown flow of 128 gpm is maximum purification operation.

A makeup system provides for changes in reactor coolant boron concentration and for reactor coolant chemistry control. Concentrated boric acid solution, prepared in an electrically heated batching tank, is stored in one of the two boric acid makeup tanks. Two boric acid makeup pumps are available to transfer the concentrated boric acid either to the VCT or to the suction of the charging pumps. RCS boron concentration is increased by adding a predetermined amount of boric acid. Reducing the RCS boron concentration is accomplished by adding reactor makeup water. To add to the VCT with no concentration change, concentrated boric acid solution is transferred for mixing with reactor makeup water in a predetermined ratio to produce the desired boron concentration. The controlled boric acid solution is then directed to the charging pump suction header or into the VCT. A chemical addition tank is used to transfer chemical additives to the suction of the charging pumps.

The volume of water in the RCS is automatically controlled by water level instrumentation mounted on the pressurizer. The pressurizer level setpoint is programmed to vary as a function of reactor power in order to minimize the transfer of fluid between the RCS and the CVCS during power changes. This linear relationship is shown in Figure 5.5-9. Reactor power is determined by the reactor coolant average temperature across a steam generator. A level error signal is obtained by comparing the programmed level setpoint with the measured pressurizer water level.

Water level control is achieved by automatic control of the constant speed charging pumps and the letdown control valves in accordance with the pressurizer level control program. On-off control of pumps and high and low level alarms are functions of the error signal and the indicated mode of pump operation as shown in Table 5.5-13. (This signal also controls pressurizer heaters as discussed in Section 5.5.10.) The letdown control valves are controlled by an integrating controller to maintain pressurizer level. Normally one valve is used but both may be in service. Letdown flow normally equals total charging pump flow minus the total reactor coolant pump controlled bleedoff flow. Only one charging pump is usually operated, but 2 or 3 pump operation can be selected for higher purification flow, if desired. Proper level can normally be maintained by valve positioning; large changes in pressurizer water level due to power changes or abnormal operations result in changes of charging pump operation as well.

ARKANSAS NUCLEAR ONE
Unit 2

The volume in the VCT is normally controlled manually. Makeup to the VCT is provided by the chemical addition subsystem as described above. Letdown flow is diverted to the BMS as needed to maintain VCT level. Letdown flow is automatically diverted to the BMS when the highest permissible VCT water level is reached. An automatic VCT level control system also exists. If the makeup system is set to the automatic mode of operation, a volume control tank low level signal will cause a preset solution of concentrated boric acid and reactor makeup water to be introduced into the volume control tank.

A low-low level signal automatically closes the outlet valve on the volume control tank and switches the charging pump suction to the Refueling Water Tank (RWT).

The chemistry and purity of the reactor coolant are controlled to ensure the following.

- The plant is accessible for maintenance and operation without excessive radiation exposure to the operating personnel.
- Long-term operation of the plant is achieved without excessive fouling of heat transfer surfaces.
- The corrosion rate of the materials in contact with the reactor coolant is kept at a minimum.

9.3.4.2.2 Plant Startup

Plant startup is the series of operations which bring the plant from a cold shutdown condition to a hot standby condition at normal operating pressure and zero power temperature with the reactor critical at a low power level.

The charging pumps and letdown backpressure valves are used during initial phases of RCS heatup to maintain the RCS pressure until the pressurizer steam bubble is established. One charging pump will normally operate during plant startup to cool the letdown fluid to maintain design pressure and temperature limits in the letdown portion of the system.

During the heatup, the pressurizer water level is controlled using the backpressure control valves and the letdown control valves. The letdown flow is diverted to the BMS as necessary to accommodate RCS volume expansion during heatup. The volume control tank is initially purged with nitrogen or hydrogen and a hydrogen overpressure is established.

Within the limitations placed on the shutdown margin, the boric acid concentration may be reduced during heatup.

Compliance with the shutdown margin limitations is verified by sample analysis.

9.3.4.2.3 Plant Shutdown

Plant shutdown is accomplished by a series of operations which bring the reactor plant from a hot standby condition at normal operating pressure and zero power temperature to a cold shutdown for maintenance and/or refueling.

ARKANSAS NUCLEAR ONE
Unit 2

Prior to plant cooldown, letdown is diverted to the vacuum degasifier and the degasified reactor coolant is returned to the Volume Control Tank (VCT) or the gas space of the VCT is vented to the GWS to reduce dissolved hydrogen concentration and fission gas activity. The letdown flow rate may be increased to accelerate the degasification, ion exchange and filtration processes. Control of system chemistry via ion exchange or chemical addition is used to control corrosion product transport and contaminants.

The RCS boron concentration needed to maintain the required shutdown margin is determined prior to cooldown of the plant. The volumes of concentrated boric acid and demineralized water needed to obtain this RCS boron concentration are also determined. As the cooldown is begun, the volume shrinkage is compensated by addition of concentrated boric acid and demineralized water to ensure the required boron concentration is maintained. This is done to assure that sufficient shutdown margin exists throughout the cooldown period.

During the cooldown, the charging pumps, letdown control valves, and letdown backpressure valves are used to adjust and maintain the pressurizer water level. All or a portion of the charging flow may be used for auxiliary spray to cool the pressurizer in the event reactor coolant pumps are secured.

Connections have been provided to allow for RCS cleanup while on shutdown cooling with the RCS depressurized.

9.3.4.2.4 Corrosion Control by Reactor Coolant System Chemistry

Chemistry control of the reactor coolant consists of removal of oxygen by hydrazine/carbohydrazide scavenging during startup, reduction of oxygen concentration during power operation by maintaining excess hydrogen concentration in the reactor coolant, and pH control by control of lithium. A chemical addition tank uses reactor makeup water to transfer hydrazine/carbohydrazide or lithium hydroxide to the suction side of the charging pumps for injection into the RCS, while hydrogen concentration in the RCS is controlled by maintaining a hydrogen overpressure in the volume control tank.

During the preoperational test period, 30 to 50 ppm hydrazine was maintained in the reactor coolant whenever the reactor coolant temperature was below 150 °F. This was done to prevent the halide-induced corrosion attack of stainless steel surfaces which can occur in the presence of significant quantities of dissolved oxygen. During the initial heatup, any dissolved oxygen is scavenged by hydrazine, thus eliminating one necessary ingredient for halide-induced corrosion. Elimination of oxygen on heatup also minimizes the potential for general corrosion. At higher temperatures, hydrazine decomposes, not necessarily completely, producing ammonia and a high pH which aids in the development of passive oxide films on RCS surfaces that minimize corrosion product release. This high pH was maintained throughout the preconditioning period by maintaining 1-2 ppm lithium in the RCS. The corrosion rates of Ni-Cr-Fe Alloy-600 and -300 series stainless steels decrease with time when exposed to prescribed reactor coolant chemistry conditions. Rates approach low steady state values within approximately 200 days. The high pH condition produced by high ammonia concentration (to 50 ppm) and lithium (1-2 ppm) minimizes corrosion product release and assists in the rapid development of the passive oxide film. Most of the film is established within seven days at hot, high pH conditions.

High hydrazine concentration is currently not required to inhibit halide-induced corrosion, but hydrazine/carbohydrazide, added in appropriate concentrations, is still used during heatup to scavenge oxygen. This assures complete removal of oxygen on heatup while minimizing

ARKANSAS NUCLEAR ONE
Unit 2

ammonia and nitrogen generation when hot and at power. When at power, oxygen is controlled to a very low concentration by maintaining excess dissolved hydrogen in the coolant. The excess hydrogen forces the water decomposition/synthesis reaction in the reactor core to water rather than hydrogen and oxygen. Any oxygen in the makeup water is also removed by this process.

Since operating with a basic pH control agent results in lower general corrosion release rates from the RCS materials and because the alkali metal lithium is generated in significant quantities by the core neutron flux through the reaction $B-10(n,\alpha)Li-7$, lithium is selected as the pH control agent. The production rate of lithium from this reaction is higher at the beginning of core life and decreases with core lifetime in proportion to the decrease in boron concentration. However, even though lithium is the choice for pH control, there exists a threshold for accelerated attack on zircaloy at approximately 35 ppm lithium. Therefore, the lithium concentration is controlled within a coordinated boron/lithium band that at the highest concentration is at least a factor of 10 below the threshold. This provides a wide margin between the upper operating limit and the threshold for attack in the event any concentrating phenomena exist. In the case of replacement steam generators, Westinghouse has evaluated starting a refueling cycle with lithium values higher than 3.5 ppm for a limited time (≤ 17 EFPDs). As long as lithium does not exceed 3.8 ppm there are no adverse effects on zircaloy corrosion. There is a positive effect on reduction of nickel transport from the new steam generators.

Early in core life, lithium production is the greatest and periodic removal by ion exchange is required to control the concentration below the upper limit. Late in core life lithium additions can be necessary to maintain lithium in the control band. Lithium is removed along with cesium by intermittent operation of an ion exchanger while a second ion exchanger is operated continuously for the removal of fission and corrosion products.

Concentrations of fluorides and chlorides in the coolant are maintained at low levels by reactor coolant purification and demineralized makeup water addition.

The resin beds remove soluble nuclides by the ion exchange mechanism. Insoluble particles are removed by a cartridge type prefilter located upstream of the ion exchanger. A strainer downstream of the ion exchangers protects against the gross release of resin to the coolant in the event of an ion exchanger retention element failure.

9.3.4.2.5 Reactivity Control

The boron concentration is controlled to obtain optimum CEA positioning; to compensate for reactivity changes associated with changes in coolant temperature, core burnup, and xenon concentration variations; and to provide shutdown margin for maintenance and refueling operations or emergencies.

To change boron concentration, the makeup system supplies either reactor makeup water or concentrated boric acid to the charging pump suction header or the volume control tank. If needed to maintain an appropriate level in the VCT, the letdown stream is diverted to the BMS ("feed and bleed" technique). Toward the end of a core cycle, to minimize the quantities of waste water produced due to feed and bleed operations, one of the letdown ion exchangers is used to reduce the RCS boron concentration. The capability of the CVCS for changing the RCS boron concentration is shown in Table 9.3-5.

ARKANSAS NUCLEAR ONE
Unit 2

Two boric acid makeup tanks and two boric acid pumps are available to supply boric acid to the RCS via the volume control tank and/or charging pumps. There are four modes of makeup system operation, all of which supply either the VCT or the charging pump suction header. In the dilute mode, a preset quantity of reactor makeup water is added at a preset rate. In the borate mode, a preset quantity of concentrated boric acid is introduced at a preset rate. In the manual mode, the flow rates of the reactor makeup water and the concentrated boric acid are preset manually to give any boric acid solution between zero and concentrated boric acid. This mode is normally used to makeup to the RCS at the existing RCS boron concentration. An automatic mode also exists, although it is normally not used. In this automatic mode, a preset boric acid solution would be automatically mixed and added when the VCT automatic makeup setpoint is reached. The preset solution concentration would be adjusted periodically by the operator to match the boric acid concentration being maintained in the RCS.

Boron is initially added to the CVCS using the boric acid batching tank. Reactor makeup water is added to the tank via the reactor makeup water pumps, and the fluid is heated by immersion heaters. Boric acid powder is added to the heated fluid while the mixer agitates the fluid. The tank design allows preparation of a boric acid concentration as high as 12 weight percent; however, the control point for the discharge piping heat trace is selected for a maximum concentration of 8.1 w/o.

Electric immersion heaters maintain the temperature of the solution in the boric acid batching tank high enough to preclude precipitation. The boric acid is then gravity drained to one of the boric acid makeup tanks. A schedule of waste generation is given in Table 9.3-6.

9.3.4.3 System Description

The major components of the CVCS are discussed in this section. The original design transients for the regenerative and letdown heat exchangers are listed in Table 9.3-8.

9.3.4.3.1 Regenerative Heat Exchanger

The regenerative heat exchanger, located in the containment above floor Elevation 352 feet conserves RCS thermal energy by transferring heat from the letdown stream to the charging stream. The heat exchanger is designed to maintain a letdown outlet temperature below 450 °F under all normal operating conditions. The design characteristics of the regenerative heat exchanger are given in Table 9.3-9.

9.3.4.3.2 Letdown Heat Exchanger

The letdown heat exchanger, located in the auxiliary building on floor Elevation 335 feet, uses component cooling water to cool the letdown flow from the outlet temperature of the regenerative heat exchanger to a temperature compatible with long-term operation of the purification system ion exchangers. The unit is sized to cool the maximum letdown flow rate from the maximum outlet temperature of the regenerative heat exchanger (450 °F) to the maximum allowable temperature of the ion exchanger resins (140 °F). To prevent possible damage to the heat exchanger by excessive component cooling water flow, the flow control valves are preset to limit the flow to 1,200 gpm maximum. The cooling water flow rate is indicated locally and alarmed on high flow in the control room. The design characteristics of the letdown heat exchanger are given in Table 9.3-10.

9.3.4.3.3 Purification Filters

The purification filters, located in the auxiliary building on floor elevation 335 feet, remove insoluble particulates from the reactor coolant prior to entering the ion exchanger. Only one unit at a time is used. The units are designed to pass the maximum letdown flow without exceeding the allowable differential pressure across the filter cartridge in the maximum fouled condition. Parallel filters are provided to assure cleanup capability following a crud burst. Due to the buildup of high activity levels during normal operation, the units are designed for remote removal of the contaminated cartridge assembly. The design characteristics of the filters are given in Table 9.3-11.

9.3.4.3.4 Purification and Deborating Ion Exchangers

The three mixed bed letdown ion exchangers are each sized for the maximum letdown flow rate. Two of the ion exchangers perform purification of the RCS letdown. One ion exchanger is used intermittently to control the lithium and cesium concentration in the RCS and another for normal operation. The units contain both anion and cation resins in a ratio specified by Chemistry and are provided with all connections required to replace and mix the resins by liquid and air sluicing. The third letdown (deborating) ion exchanger is identical to the purification ion exchangers in size and construction and is sized to contain sufficient anion resin (if needed) to control the RCS boron concentration from 30 ppm to the concentration at the end of core cycle. The design characteristics of the ion exchangers are given in Table 9.3-12. The three ion exchangers are located in the auxiliary building on floor Elevation 335 feet.

9.3.4.3.5 Volume Control Tank

The volume control tank, located in the auxiliary building on floor Elevation 354 feet, accumulates letdown water from the RCS to maintain the desired hydrogen concentration in the reactor coolant and to provide a reservoir of reactor coolant for the charging pumps. The tank is sized to store sufficient liquid volume below the normal operating band to allow a swing from full power to zero power without makeup to the volume control tank and such that sufficient useful volume is above the normal operating band to permit the accumulation of approximately 500 gallons of water during dilution operations. The accumulated water is normally sufficient to provide normal plant leakage makeup between dilution operations. The tank is provided with hydrogen and nitrogen gas supplies and a vent to the GWS to enable venting of hydrogen, nitrogen and fission product gases.

The volume control tank is initially purged with nitrogen or hydrogen and a hydrogen overpressure is established. The design characteristics of the volume control tank are given in Table 9.3-13. The Unit 2 volume control tank hydrogen supply is provided by a connection to the high purity hydrogen supply located in Unit 1.

9.3.4.3.6 Charging Pumps

The charging pumps, located in the auxiliary building on floor Elevation 335 feet, take suction from the volume control tank on the floor level above and return the purification flow to the RCS during plant steady state operations. Normally one pump is running to balance the letdown purification flow rate plus the reactor coolant pump controlled bleedoff flow rate. The second and third pumps are automatically started or stopped as pressurizer level decreases or increases due to plant load transients.

ARKANSAS NUCLEAR ONE
Unit 2

The pumps are positive displacement type with an integral leakage collection system. Vent, drain and flushing connections are provided to minimize radiation levels during maintenance operations. The pressure containing portions of the pump and internals are austenitic or precipitation hardened stainless steel materials for compatibility with boric acid. The pump design characteristics are given in Table 9.3-14. Flow from these pumps is immediately available. This allows the operator finer control over pressurizer level.

9.3.4.3.7 Boric Acid Makeup Tanks

Two boric acid makeup tanks, located on auxiliary building floor level 386 feet, provide a source of boric acid solution for injection into the RCS and for makeup to the spent fuel pool and the refueling water tank. Each tank normally stores boric acid in concentrations up to 3.5 weight percent. The combination of the boric acid makeup tanks and the RWT contain sufficient boric acid to bring the plant to a cold shutdown condition. The design characteristics of the tanks are given in Table 9.3-15.

9.3.4.3.8 Boric Acid Batching Tank

The boric acid batching tank, located on auxiliary building floor level 404 feet, and above the boric acid makeup tanks, is used for the preparation of concentrated boric acid which is batch gravity drained to the makeup tanks. The tank is designed to permit handling of up to 12 weight percent boric acid. An intertie is provided to the Unit 1 boric acid mix tank to prevent delays caused by limited boric acid batching capacities on Units 1 and 2.

The tank is heated and insulated and receives demineralized water for mixing the boric acid solution. Sampling provisions, mixer, temperature controller and electric immersion heaters are an integral part of the batching system. The design characteristics of the tanks are given in Table 9.3-16.

9.3.4.3.9 Boric Acid Makeup Pumps

The boric acid makeup pumps, located in the auxiliary building on the floor at Elevation 369 feet, take suction from the overhead boric acid makeup tanks and provide boric acid to the makeup subsystem and to the charging pump suction header. The capacity of each pump is greater than the combined capacity of all three charging pumps. The boric acid makeup pumps are also used to recirculate makeup tank contents, to pump from one makeup tank to the other, and to supply makeup to the RWT and the spent fuel pool. The pumps are single stage centrifugal pumps with mechanical seals and liquid and vapor leakage collection connections. The design characteristics of the pumps are given in Table 9.3-17.

9.3.4.3.10 Chemical Addition Tank

The chemical addition tank, located on auxiliary building floor Elevation 404 feet, provides a means to inject chemicals into the charging pump suction header. Reactor makeup water is supplied for chemical dilution and flushing operations. The design characteristics of the tank are given in Table 9.3-18. The tank size and reactor makeup water pump capacity are based on the maximum service requirement of hydrazine/carbohydrazide injection for oxygen scavenging on plant startup, and limiting CVCS lithium concentrations to acceptance levels.

9.3.4.3.11 Process Radiation Monitor

The process radiation monitor, described in Section 11.4, is in the one-half inch line bypassing the purification filter, and provides a continuous recording in the control room of reactor coolant gross gamma radiation and specific fission product gamma activity. A high alarm indicates an increase in coolant activity above the setpoint within five minutes of the event. This monitor is sensitive enough to provide for early detection of fuel element failure. Table 9.3-19 gives the design characteristics of the pressure boundary of the monitor.

9.3.4.3.12 Boronometer

This section has been deleted.

9.3.4.3.13 Relief Valves

To assure safe operation of the CVCS, overpressure protection is provided by relief valves throughout the system. The following is a description of the relief valves in the system.

A. Intermediate pressure letdown relief valve, 2PSV-4822

The relief valve downstream of the letdown control valves protects the intermediate pressure letdown piping and letdown heat exchanger from overpressure. The valve has sufficient capacity to pass flow from the upstream components. The relief valve set pressure is 600 psig, 50 psi below the design pressure (650 psig) of the intermediate pressure letdown piping and letdown heat exchanger.

B. Low pressure letdown relief valve, 2PSV-4800

The relief valves downstream of the letdown backpressure control valves protect the low pressure piping, purification filters, ion exchangers and letdown strainer from overpressure. The valve capacity is equal to capacity of intermediate pressure letdown relief valve 2PSV-4822. The set pressure is equal to the design pressure (200 psig) of the low pressure piping and components.

C. Charging pump discharge relief valves, 2PSV-4855, 2PSV-4845, 2PSV-4835

The relief valves on the discharge side of the charging pumps are sized to pass the maximum rated flow of the associated pump with maximum backpressure without exceeding the maximum rated total head for the pump assembly. The valves are set to open when the discharge pressure exceeds the RCS design pressure (2485) by 10 percent.

D. Charging pump suction relief valves, 2PSV-4834, 2PSV-4844, 2PSV-4854

The relief valves on the suction side of the charging pumps are sized to pass the maximum fluid thermal expansion rate that would occur if the pump were operated with the suction and discharge isolation valves closed. The set pressure is less than design pressure of charging pump suction piping.

ARKANSAS NUCLEAR ONE
Unit 2

E. Charging line thermal relief valve

The relief valve on the charging line downstream of the regenerative heat exchanger is sized to relieve the maximum fluid thermal expansion rate that would occur if hot letdown flow continued after charging flow was stopped by closing the charging line distribution valves. The valve is a spring-loaded check valve.

F. Volume control tank relief valve, 2PSV-4867

The relief valve on the volume control tank is sized to pass a liquid flow rate equal to the sum of the following flow rates: the maximum operating flow rate from the reactor coolant pump controlled bleedoff line; the maximum letdown flow rate possible without actuating the high flow alarm on the letdown flow indicator; the design purge flow rate of the sampling system; and the maximum flow rate that the boric acid makeup system can produce with relief pressure in the volume control tank. The set pressure is equal to the design pressure of the volume control tank.

G. Reactor makeup water relief valve, 2PSV-4943

The relief valve on the reactor makeup water system is sized to pass the maximum capacity of the reactor makeup water pumps with the volume control tank pressure at its design value. The set pressure is less than the volume control tank design pressure (75 psig) to ensure that the valve will open before the volume control tank relief valve opens.

H. Volume control tank gas supply relief valve, 2PSV-4838

The relief valve is sized to exceed the combined maximum capacity of the nitrogen and hydrogen gas regulators. The set pressure is lower than the volume control tank design pressure.

I. Reactor coolant pump controlled bleedoff header relief valve, 2PSV-4836

The relief valve at the reactor coolant pump controlled bleedoff header allows the controlled bleedoff flow to continue to the quench tank in the event that a valve in the line to the volume control tank is closed and does not serve an overpressure protection function. The valve is sized to pass the flow rate required to assure closure of one excess flow check valve in the event of failure of the seals in one reactor coolant pump plus the normal bleedoff from the other reactor coolant pumps. The maximum relief valve opening pressure is less than the controlled bleedoff high pressure alarm.

J. Heat traced piping thermal relief valves

Relief valves are provided for portions of the CVCS that are heat traced and which can be individually isolated. Other areas of the piping have been analyzed to show that thermal relief valves are not required. The set pressure is equal to or less than the design pressure of the system piping. Each valve is sized to relieve the maximum fluid thermal expansion rate that could occur if maximum duplicate heat tracing power were inadvertently applied to the isolated line.

ARKANSAS NUCLEAR ONE
Unit 2

9.3.4.3.14 Piping and valves

The piping of the CVCS is austenitic stainless steel. The cooling water side of the letdown heat exchanger is carbon steel. All piping is in accordance with ASME Code Section III, Class 2 or ANSI B31.1.0, as applicable.

All valves except the diaphragm-type have backseats which can be used to limit steam leakage when in the open position. Diaphragm-type valves are used to prevent radioactive gas leakage from the volume control tank and also for resin sluicing operations for the ion exchangers. Manually operated valves for radioactive service with nominal sizes larger than two inches are provided with a double-packed stem and intermediate lantern ring with a leakoff connection. All actuator operated valves for liquid service with a double-packed stem and intermediate lantern ring are provided with stem leakoffs.

9.3.4.3.15 Electrical Heaters

Redundant electrical heat tracing is installed on all piping, valves, and other line-mounted components that may potentially contain concentrated boric acid solution for a significant period of time. The heat tracing is designed to prevent precipitation of boric acid due to cooling. The boric acid system requires heat tracing only in the boric acid batching tank, the piping through the batching strainers and the piping up to the boric acid makeup tanks.

The heat tracing is designed to maintain the fluid temperature of the traced components above the saturation temperature of 103 °F for an 8.1 w/o boric acid solution. A heat trace control setpoint of 120 °F was selected to maintain the boric acid solution approximately 17 °F above this saturation temperature.

Two independent full capacity strap-on heater banks are installed on each boric acid makeup tank. The heaters are sized to compensate for heat loss through the tank insulation to the surroundings when the tank is filled to its maximum operating level with boric acid at its maximum temperature. Each heater bank is operated by an independent controller. The maximum boric acid concentration has been limited to 3.5 w/o so the heaters are not required for a makeup tank to be considered operable.

The batching tank is provided with corrosion resistant electrical immersion heaters. The heaters are sized to supply sufficient heat in six hours to increase the temperature of 500 gallons of 12 w/o boric acid solution from 40 °F to 160 °F, including the heat of solution required to dissolve the boric acid granules. The boric acid is not added to the tank until the demineralized water temperature exceeds the final saturation temperature by at least 20 °F.

9.3.4.3.16 Thermal Insulation

Thermal insulation is required for conservation of heat and to protect personnel from contact with high temperature piping, valves, and components. Equipment and sections of the system that are insulated are the regenerative heat exchanger, the charging and auxiliary spray lines downstream of the regenerative heat exchanger and the letdown line from the reactor coolant loop to the letdown heat exchanger. Thermal insulation on these sections is designed to limit the insulation surface temperature to 140 °F based on ambient temperature of 80 °F and the maximum expected piping and component temperature. Electrically heat traced piping, valves, pumps and other components are insulated to limit the insulation surface temperature to 140 °F based on an ambient temperature of 80 °F and the controlled component temperature.

ARKANSAS NUCLEAR ONE
Unit 2

Thermal insulation on the batching tank is designed to limit heat losses to 15.0 Btu/hr-ft² based on a tank temperature of 160 °F and an ambient temperature of 70 °F. Thermal insulation that does not cause chloride stress corrosion or that contains a chloride stress corrosion inhibitor is used on all stainless steel surfaces and on any insulated surfaces adjacent to stainless steel surfaces where moisture from that insulation could reach the stainless steel.

9.3.4.4 System Evaluation

9.3.4.4.1 Performance Requirements and Capabilities

The normal amount of boric acid stored solution contained in the combined volumes of the BAMTs and the RWT is sufficient to bring the plant to a cold shutdown condition at any time during plant life. The RWT is also an emergency source of borated water.

The charging pumps are used to inject concentrated boric acid into the RCS. With one pump normally in operation, the other charging pumps are automatically started by the pressurizer level control or by the SIAS.

During normal operation, the charging pumps draw suction from the VCT. However, upon initiation of a SIAS, valves 2CV-4820-2 and 2CV-4821-1 automatically close isolating letdown which feeds into the VCT. Any charging pumps that are not already operating automatically start and charging pump suction is switched to the boric acid makeup pump discharge. The SIAS signals both boric acid makeup pumps to start and opens 2CV-4916-2 (the emergency boration valve) and 2CV-4920-1 and 2CV-4921-1 (the gravity feed valves). Therefore, if the boric acid makeup pumps are not available, the charging pumps are lined up for gravity feed from the boric acid makeup tanks. This system is shown on Figures 9.3-4. Should the charging line inside the containment be inoperative for any reason, the line may be isolated outside of the containment, and the charging flow may be injected via the SIS. The malfunction or failure of one active component does not reduce the ability to borate the RCS since an alternate flow path is always available for emergency boration.

The capability of the CVCS to borate is not compromised by stopping letdown flow. Because safe shutdown can be achieved without letdown flow, this portion of the CVCS, which includes the letdown heat exchanger, has no specific requirement to function for post-accident operation. It is for this reason that the component cooling water system serving the letdown heat exchanger is designated Seismic Class 2 and not Class 1. Further, for accidents which involve an SIAS or CIS, the letdown line is automatically isolated by these signals.

The following discussion demonstrates that the letdown loop of the CVCS is not required to achieve cold shutdown.

Three effects must be accounted for in any cooldown. These are: a) accommodating the reactivity change caused by reducing the moderator temperature, b) accommodating the reactor coolant shrink, and c) ensuring sufficient coolant is available for pressurizer control. Without the letdown loop, these effects are handled as follows:

- A. At End of Cycle (EOC) (the limiting case), the initial RCS boron concentration is small (assumed to be 0 ppmB) and the RCS boron concentration necessary to meet shutdown margin requirements at hot shutdown is on the order of 800 ppmB (this value is determined for each reload cycle and shown to be less than the concentration

ARKANSAS NUCLEAR ONE
Unit 2

that can be achieved by the CVCS). During cooldown, the RCS is brought to the required boron concentration by charging from the Boric Acid Makeup Tank (BAMT) and the RWT. Below 275 °F the shutdown cooling system is placed into operation and further boron additions may be accomplished by feed and bleed.

- B. The total RCS shrink from power operation to the hot shutdown cooling window is approximately 15,000 gallons. The required volumes from the BAMTs and the RWT that make up this volume depend on the concentrations of these sources. The BAMT concentration ranges from 3.0 to 3.5 w/o boric acid. The RWT concentration ranges from 2500 - 3000 ppmB. When the concentrations of both sources are at their minimum values, about 10,870 gallons from the BAMTs are required prior to shifting to the RWT. With the maximum concentrations in both sources, only about 7,170 gallons are required from the BAMTs. These required volumes, adjusted to accommodate instrument uncertainty and tank residual volume are specified in the ANO-2 Technical Requirements Manual.
- C. The pressurizer level is maintained at the hot standby level during the cooldown, and therefore pressurizer pressure control is accomplished. The necessary coolant to satisfy the requirements for pressurizer spray (depressurization) is supplied from the BAMTs or the RWT via the charging pumps through the auxiliary spray line, and is included in the volumes cited above.

The assumptions used to demonstrate the ability to place the unit on shutdown cooling without the letdown loop are as follows:

- A. The limiting case is at EOC, because rod worth and boron worth are less, hence more boron addition is required to attain the necessary shutdown margin. The initial RCS boron concentration is assumed to be 0 ppmB, and the reactor is assumed to have been at 100 percent steady state power immediately prior to shutdown.
- B. The pressurizer level during power operation prior to shutdown is assumed to be 910 cubic feet.
- C. The reactor coolant pumps are not available.
- D. The RWT is available with a volume as required by Technical Specifications and a boron concentration of $\geq 2,500$ ppmB.
- E. RCS temperature control is accomplished by use of the atmospheric dump valves.
- F. The combined volume of the two BAMTs contain between 7,170 gallons (3.5 w/o boric acid in BAMT with 3000 ppmB in RWT) and 10,870 gallons (3.0 w/o boric acid in BAMT with 2500 ppmB in RWT).
- G. Pressurizer pressure control is accomplished via the auxiliary spray line.
- H. Boric acid entering the pressurizer is not assumed to mix with the reactor coolant.
- I. The most reactive CEA is stuck out of the core.
- J. Off-site power is lost and not regained.
- K. Cooldown is slow enough so that the pressurizer remains at saturated conditions.

ARKANSAS NUCLEAR ONE
Unit 2

An adequate procedure to place the unit on shutdown cooling is outlined below. This procedure relates to the preceding discussion of requirements and assumptions used to evaluate the loss of letdown during a plant cooldown. It is not intended to be a generic method for cooldown to cold shutdown.

- A. The required BAMT volume, based on the total RCS shrink volume, to achieve cold shutdown is calculated. The volumes to be provided from the BAMT and RWT necessary to supply the RCS contraction volume vary, based on the concentrations of these boric acid sources.
- B. Charging of the calculated BAMT feed volume is initiated via the charging pumps, and a plant cooldown is initiated.
- C. After all the BAMT feed volume is introduced to the RCS, charging pump suction is shifted to the RWT, and the remaining RCS shrink is accommodated from the RWT.
- D. Throughout the cooldown, charging to the RCS will be intermittent as necessary to maintain pressurizer level.
- E. The RCS is placed on shutdown cooling at < 275 °F, 280 psia.
- F. After shutdown cooling is initiated, boration to the cold shutdown boron concentration may be completed by charging from the BAMTs or the RWT.
- G. On shutdown cooling, only water with a greater boric acid concentration than that of the RCS is supplied, thus the RCS concentration will increase and remain above the Technical Specification required shutdown boron concentration (not necessary as long as Technical Specification requirements are met).

Utilization of the procedure above assures that greater than the minimum shutdown margin is maintained throughout the cooldown cycle.

If the letdown temperature exceeds the maximum operating temperature of the resin in the ion exchanger (140 °F) the flow will automatically bypass the ion exchangers and the process radiation monitor.

The charging pumps, boric acid makeup pumps, boric acid makeup tank heaters and all related automatic control valves are connected to an emergency bus should the normal power supply system fail. There are two emergency diesel generator sets available for this service and the components are aligned to the diesels as designed below:

<u>Component</u>	<u>Diesel 1</u>	<u>Diesel 2</u>
Charging Pump 2P36A	X	
Charging Pump 2P36B		X
Charging Pump 2P36C	(1 or 2)	
Boric acid pump No. 2P39A		X
Boric acid pump No. 2P39B		X
Boric acid gravity feed valve 2CV-4921-1	X	

ARKANSAS NUCLEAR ONE
Unit 2

<u>Component</u>	<u>Diesel 1</u>	<u>Diesel 2</u>
Boric acid gravity feed valve 2CV-4920-1	X	
Boric acid makeup tank No. 2T6A heater No. 2M43A		X
Boric acid makeup tank No. 2T6A heater No. 2M43C	X	
Boric acid makeup tank No. 2T6B heater No. 2M43B	X	
Boric acid makeup tank No. 2T6B heater No. 2M43D		X
Heat tracing system No. 1	X	
Heat tracing system No. 2		X
Boric acid makeup pump supply valve 2CV-4916-2		X
Volume control tank discharge valve 2CV-4873-1	X	
Letdown stop valve 2CV-4820-2		X
Letdown stop valve 2CV-4821-1	X	
Controlled bleedoff stop valve 2CV-4847-2		X
Boric acid recirculation valve 2CV-4903-2		X

Heat tracing is required only in those sections of the boric acid makeup system that normally contain greater than 3.5 w/o boric acid solution. The boric acid batching tank, the piping through the batching strainer and the piping up to the BAMTs is heat traced. Automatic temperature controls and independent alarm circuits are included in the heat tracing system.

The heat tracing is appropriately sectionalized taking into account system redundancy requirements and components that may be removed from the system for maintenance. Each heat tracing section has a duplicate full capacity set of heater elements and controls. An independent alarm system is provided with temperature sensors appropriately spaced within each section to detect a malfunction of the operating heat tracing anywhere within that section. Each sensor is annunciated separately on a local panel. A malfunction anywhere in the heat tracing annunciates an alarm in the control room. In the event of a malfunction, switchover to the redundant heat tracing for the affected section is done manually. The separate alarm system provides annunciation at the control room in the event of loss of electric power to the heat tracing.

Flush and back flush connections are provided to prevent crud buildup in tank bottom lines. Frequently used, manually operated valves located in high radiation or inaccessible areas are provided with extension stem handwheels terminating in low radiation and accessible control areas. Manually operated valves are provided with locking provisions if unauthorized operation of the valve is considered a potential hazard to plant operation or personnel safety.

Leakage can be detected by the gamma sensitive area radiation monitors which are located in strategic areas throughout the plant. The gamma flux level seen by each detector is indicated, annunciated and recorded in the control room. Any significant leakage from the CVCS annunciates one of these alarms.

The CVCS can also monitor the total RCS water inventory. With no leakage in the RCS, the level in the volume control tank remains constant during steady state plant operation. Therefore, a decreasing level in the volume control tank alerts the operator to a possible leak. A more detailed discussion of leakage detection systems is presented in Section 5.2.7.

9.3.4.4.2 Single Failure Analysis

A single failure analysis for the CVCS is shown in Table 9.3-21. At least one failure is postulated for each major component. Additionally, various line breaks throughout the system are also considered. In each case the possible cause of such a failure is presented as well as the local effects, detection methods and compensating provision.

9.3.4.4.3 Testing and Inspection

Each component is inspected and cleaned prior to installation in the system. Demineralized water is used to flush the system.

Instruments were recalibrated during startup testing. Automatic controls were tested for actuation at the proper setpoints. Alarm functions were checked for operability and limits during preoperational testing. The safety valve settings were checked.

The system was operated and tested initially with regard to flow paths, flow capacity and mechanical operability. Pumps were tested at the vendor's plant to demonstrate head and capacity.

Prior to preoperational testing, the components of the CVCS were tested for operability. The components and subsystems checked include the following:

- A. operation of all automatic and remote controlled valves;
- B. operation of boric acid makeup pumps;
- C. operation of nitrogen and hydrogen pressurization systems;
- D. charging pump operational check;
- E. check of miscellaneous valve function, alarms and interlocks;
- F. instrumentation on the boric acid makeup tanks, volume control tank and boric acid batching tank; and
- G. inspection of all valves for proper flow direction.

The system was tested for integrated operation during preoperational testing. Any defects in operation that could affect plant safety were corrected before fuel loading. As part of normal plant operation, tests and inspections, data tabulation and instrument calibrations are made to evaluate the condition and performance of the CVCS equipment. Data are taken periodically during normal plant operation to confirm heat transfer capabilities and purification efficiency.

The charging pumps permit leak testing of the RCS during plant startup operations and connections are provided to install a hydrostatic test pump in parallel with the charging pumps.

A charging pump can be used to check the operability and leak tightness of the check valves which isolate the RCS from the SIS.

9.3.4.4.4 Natural Phenomena

The CVCS components are located in the auxiliary building and the containment and, therefore, would not be subject to the natural phenomena described in Chapter 3 other than seismic which is discussed in Section 3.7. The auxiliary building arrangement of major CVCS components is shown in the floor plan figures in SAR Chapter 1.

9.3.4.5 Instrument Application

Table 9.3-22 lists the parameters used to monitor the CVCS.

9.3.5 FAILED FUEL DETECTION SYSTEM

Prompt detection of failed fuel is accomplished by the process radiation monitor in the letdown stream of the CVCS (see Section 9.3.4.3.11).

9.3.6 SHUTDOWN COOLING SYSTEM

9.3.6.1 Design Bases

9.3.6.1.1 Functional Requirements

The Shutdown Cooling (SDC) System in conjunction with the main steam and main or emergency feedwater systems is designed to reduce the temperature of the reactor coolant in post-shutdown periods from normal operating temperature to the refueling temperature.

The steam and feedwater systems are utilized in the initial phase of cooldown. SDC functions to reduce the coolant temperature to the refueling temperature.

The SDC heat exchangers are used during recirculation following a LOCA. Heat is removed from the recirculating containment sump water by means of shutdown cooling heat exchangers. Flow through the heat exchanger is provided by the containment spray pumps.

9.3.6.1.2 Design Criteria

The design requirements for the SDC System (in conjunction with the main steam and feedwater system) are as follows.

- A. The functional requirements (Section 9.3.6.1.1) must be met assuming the failure of a single active component during injection or the single failure of an active or passive component during recirculation following a LOCA.
- B. System components whose design pressure and temperature are less than the RCS design limits are provided with overpressure protection devices and two isolation valves in series. System discharge from overpressure protection devices is collected in a closed system.
- C. The components of the SDC System are designed in accordance with ASME Code, Section III as shown in Section 3.2.2.
- D. Materials are selected to preclude system performance degradation due to the effects of short and long-term corrosion.

ARKANSAS NUCLEAR ONE
Unit 2

General Design Criterion 34 requires that a residual heat removal system capable of performing its design function in the event of a single failure be provided. Both the redundant safety-related EFW system, described in Section 10.4.9, and the SDC System are designed to provide this residual heat removal capability. The operating relationship between these two systems in meeting the General Design Criterion 34 requirement is described in Section 9.3.6.2.1.

9.3.6.2 System Description

9.3.6.2.1 Functional Description

The historical system design parameters are given in Table 9.3-23.

The SDC System, in part, is shown on Figures 5.1-3, 6.3-2, and 6.2-17.

During shutdown cooling, reactor coolant is circulated by a LPSI pump through a shutdown cooling heat exchanger to the LPSI header and returned to the RCS through the four safety injection nozzles. The circulating fluid flows through the core, out the shutdown cooling nozzle in the reactor vessel outlet (hot leg) pipe, and back to the LPSI pumps. Shutdown cooling is initiated after the RCS conditions drop below the design pressure and temperature of the shutdown cooling equipment. At this time, the system is aligned for shutdown cooling.

The two valves in the suction line nearest the RCS are interlocked to prevent opening whenever the RCS pressure is above the design pressure of the SDC System. Each valve is independently controlled by separate instrumentation channels. The interlocks on these valves are further described in Section 7.6.

The SWS is the heat sink to which the reactor coolant residual heat is rejected. Each shutdown heat exchanger receives cooling water to its shell side from a separate SWS essential header.

To minimize thermal shock on the LPSI pumps, shutdown heat exchangers and piping, a low flow can be established by opening the warmup recirculation valve. The LPSI pumps are then warmed to reactor coolant temperature by cracking open one low pressure injection valve. The shutdown cooling heat exchangers are warmed by slowly opening the heat exchanger discharge throttle valve. When the shutdown cooling heat exchangers are warmed up (approximately 15 minutes), the remaining three low pressure injection valves are opened.

The SDC System may be placed in operation when RCS temperature is less than 275 °F, and the cooldown rate is limited to the rates allowed by the Technical Specifications. The cooldown rate is controlled by adjusting the flow rate through the exchangers with the throttle valve on the discharge of heat exchangers. The shutdown cooling flow indicator-controller maintains a constant total shutdown cooling flow rate to the core by adjusting the heat exchanger bypass flow to compensate for changes in flow rate through the heat exchangers. During initial cooldown the temperature differences for heat transfer are large, thus only a portion of the total shutdown flow is diverted through the heat exchangers. As cooldown proceeds the temperature differences become less and the flow rate through the heat exchangers is increased. The flow is increased periodically until the system reaches refueling temperature.

Shutdown cooling is continued through the entire period of plant shutdown to maintain RCS temperatures within Technical Specification requirements.

ARKANSAS NUCLEAR ONE
Unit 2

9.3.6.2.2 Components

The shutdown cooling heat exchangers are used to remove decay and sensible heat during cooldowns and cold shutdown. The characteristics of heat exchangers in the shutdown cooling mode are given in Table 9.3-24.

The design temperature and pressure for the shutdown cooling heat exchangers are established on the same basis as the LPSI pumps (see Section 6.3).

The LPSI pumps are used as part of the SDC System. During all periods of plant operation when SIS operability is required, the LPSI pumps are aligned for emergency core cooling operation.

Manual isolation valves are provided to isolate equipment for maintenance. Throttle valves are provided for remote control of heat exchanger tube side flow. Check valves in the discharge of the LPSI pumps prevent shutdown cooling reverse flow through the LPSI pumps. Manual valves have backseats which can be used to limit stem leakage when in the open position.

Pressure relief valves are provided to protect sections of piping from overpressure.

All SDC piping is austenitic stainless steel. All piping joints and connections are welded except for a minimum number of flanged connections which are used to facilitate maintenance.

9.3.6.2.3 Interface with Other Systems

- A. Safety Injection System - During the shutdown cooling mode of heat removal the LPSI pumps are aligned to take suction from the reactor hot leg pipe and discharge through the shutdown cooling heat exchangers. The LPSI header returns flow to the RCS.
- B. Reactor Coolant System - Temperature control during plant cooldown and refueling is accomplished by recirculating reactor coolant through a shutdown cooling heat exchanger. During normal operation, two closed valves provide isolation from the RCS. The two isolation valves are also provided with pressure interlocks which prevent opening these valves whenever the RCS pressure increases above the design pressure of the SDC System.
- C. Service Water System - The SWS provides the heat sink to which the residual heat is rejected. Service water flows through the shell side of the shutdown cooling heat exchangers and also functions to cool the shaft seals on the LPSI pumps as they circulate the heated reactor coolant.
- D. Containment Spray System - During normal operation the containment spray pumps are aligned to discharge through the shutdown cooling heat exchangers. This is the required alignment for emergency operation (operation following a LOCA). During shutdown cooling, the heat exchangers are isolated from the containment spray system.

ARKANSAS NUCLEAR ONE
Unit 2

9.3.6.3 Safety Evaluation

No single failure of an active component during residual heat removal will result in permanent loss of cooling capability. The RCS can be brought to refueling temperature using a LPSI pump and one shutdown heat exchanger.

An analysis of the SDC System has been performed to verify system capability to bring the reactor to a cold shutdown condition (less than 200 °F) within the Technical Specification time requirements of 36 hours, assuming the most limiting single active failure. The failure assumed is the loss of one emergency diesel generator and results in a one pump/one shutdown heat exchanger condition which is the slowest cooldown mode.

The total time required to bring the RCS from hot standby to cold shutdown was determined to be less than the Technical Specification requirement of 36 hours.

If one of the valves in the suction line to the LPSI pumps is closed when either LPSI pump is started or if one of the suction valves is closed while either LPSI pump is running, such condition will be alarmed in the control room. The operator can then open the valve to correct the situation. Similar pumps at another facility have been known to operate without suction for about an hour with only non-catastrophic damage to the seals.

A loss of instrument air to the shutdown cooling system will not result in a loss of cooling ability. The air-operated shutdown cooling valve 2CV-5093 is equipped with a hand wheel which permits its opening upon loss of instrument air. In addition, a manual bypass valve is provided.

A single failure of a passive component in the low pressure portion of the SDC System during residual heat removal may result in the interruption of the cooldown but will not result in a loss of core cooling. In the event of such a failure, SDC can be isolated and decay heat removed by the main steam and feedwater systems. The RCS may be maintained in this condition while repairs are effected.

With the reactor vessel head removed, continued core cooling in the event of a passive failure in the low pressure portion of the SDC System is provided by manual alignment and initiation of the SIS to fill the refueling canal. The safety injection tank isolation valves and High Pressure Safety Injection (HPSI) control valves may be opened, the HPSI pumps started and SDC isolated until the failure is repaired. The temperature of the refueling canal water rises until the evaporative loss equals core decay heat. The containment fan coil units may be used to remove the evaporative heat. These actions are initiated from the control room and will provide the continuation of core cooling.

For long-term performance of SDC without degradation due to corrosion, only materials compatible with the pumped fluid and with the CSS chemical additives are used. The possibility of chloride-induced stress corrosion of austenitic stainless steel is minimized by water chemistry control and the use of insulation material with a low soluble chloride content. During long-term operation following a LOCA, potential chloride stress corrosion due to recirculation of the containment sump water is minimized since SDC is not highly stressed.

Since SDC is essential for a safe shutdown of the reactor, it is a Seismic Category 1 system and designed to remain functional in the event of a design basis earthquake.

ARKANSAS NUCLEAR ONE
Unit 2

Components of the system are located within the auxiliary building and the containment and therefore are not subject to natural perturbations other than seismic.

Inadvertent overpressurization of the SDC suction piping is precluded by the use of interlocks installed on the two shutdown cooling isolation valves providing the boundary with the RCS. The instrumentation, control, and electric equipment pertaining to shutdown cooling valves have been designed to those portions of IEEE 279-1971 and IEEE 308-1971 that are applicable. Redundant and diverse pressure sensors (2PC-4623-1 and 2PS-4623-2), which are physically and electrically separated, are used to prevent opening the motor-operated valves to prevent over-pressurization of SDC. This instrumentation also provides an alarm when the isolation valves are opened and RCS pressure is rising to ensure a double boundary exists during operation. The power to the valve motors, sensors, and control system electronics are from physically and electrically separated and redundant power supply systems as required in IEEE 308-1971. See Sections 7.6.2.1, 8.3.1.2, 8.3.1.4 and 8.3.2.2 for further details.

Initiation of shutdown cooling is under strict administrative controls. For this reason, the ability to place SDC into operation solely from the control room is not provided. Prior to initiation of SDC, communication is established between the local operator and the control room operator. The valve lineup must be accomplished locally. The LPSI pumps and the shutdown cooling flow control valves (used to maintain proper flow through the reactor core and to maintain the proper cooldown rate) are controlled from the control room.

Because of the redundancy of the EFW system, the ability to place SDC into operation in the event of a single failure within SDC is not required. A passive failure of the shutdown cooling line would interrupt normal shutdown cooling via the shutdown cooling heat exchangers. Such an occurrence would not present any safety problems. Should the event occur prior to initiation of shutdown cooling, the plant may still be cooled to 300 °F and held at that temperature until a repair can be affected. Should the event occur while SDC is in operation, the RCS may be pressurized as required to permit operation of a reactor coolant pump; when coolant temperature approaches 300 °F due to residual decay heat input, the steam generators may be used to control system temperature by dumping steam as necessary until the inoperative line is repaired.

In addition to the above, it should be noted that, of the components required to operate in initiating shutdown cooling, only the two shutdown cooling isolation valves, 2CV-5084-1 and 2CV-5086-2 (shown in Figure 6.3-2) are located inside the containment building. Handwheels are provided on these valves to allow for local operation in the event an electrical failure in the valve operators or the associated cabling precludes remote operation of these valves. These valves are located such that shutdown dose rates will not preclude local operation.

9.3.6.4 Testing and Inspection

Historical data removed; refer to Section 9.3.6.4 of the FSAR.

To ensure availability of SDC, components of the system are periodically tested. As described in Section 6.3.4, the LPSI pumps and valves associated with the SIS are tested in accordance with the Edition and Addenda of the ASME Operation and Maintenance Code specified by 10 CFR 50 Section 50.55a(f). These system and component tests together with shutdown cooling heat exchanger thermal performance data taken during refueling are sufficient to demonstrate the operability of SDC.

ARKANSAS NUCLEAR ONE
Unit 2

9.3.6.5 Instrumentation Application

The operation of the SDC System is controlled and monitored using installed instrumentation. The instrumentation is used to monitor heat removal, cooldown rate, and shutdown cooling flow. The following instrumentation is provided with control room indication:

- A. Temperature measurement at the shutdown cooling heat exchanger inlet and heat exchanger outlet; temperature of the common mixed flow from the heat exchanger outlet and the heat exchanger bypass. A two channel recorder tracks the temperature of the heat exchanger bypass flow and the mixed bypass and heat exchanger outlet flow to facilitate control of the RCS cooldown rate.
- B. Pressure measurement at the LPSI header and shutdown cooling heat exchanger inlet.
- C. Shutdown cooling flow rate is automatically controlled by a flow indicating controller. Total shutdown cooling flow is measured and the shutdown cooling heat exchanger bypass flow automatically adjusted to maintain a constant total flow in response to operator control of heat exchanger flow. A high/low flow alarm is produced by the indicating controller to the annunciator. The alarm warns the operator of possible vortexing which could result in a loss of suction to the LPSI pumps.
- D. A common high/low level alarm is provided for two independent RCS level loops.
- E. A CET indicator will give the operator indication of the reactor coolant temperature in the reactor vessel up until the time the head is removed for refueling. A CET high temperature alarm will be produced by the indicator.
- F. LPSI pump suction pressure (0-50 psig only) and LPSI pump discharge header pressure. These indications are alarmed to warn the operator of unacceptable pressure fluctuations that may be indicative of a degradation or loss of SDC. LPSI pump delta-P is also indicated.
- G. LPSI pump motor current. This parameter will be alarmed to warn the operator of unacceptable fluctuations in motor current which signify possible vortexing conditions that could result in a loss of suction to the LPSI pump.

Instrumentation used to monitor shutdown cooling is listed in Table 9.3-25.

ARKANSAS NUCLEAR ONE
UNIT 2

9.4 AIR CONDITIONING, HEATING, COOLING, AND VENTILATION SYSTEMS

9.4.1 CONTROL ROOM

9.4.1.1 Design Bases

The heating, ventilating, and air conditioning systems for the control room are designed to provide a suitable environment for equipment and station operator comfort and safety.

The ventilation systems and equipment are designed in accordance with the recommended practices of the American Society of Heating, Refrigerating, and Air Conditioning Engineers Guide, the Air Moving and Conditioning Association, and the National Fire Protection Association. The ductwork is designed and fabricated in accordance with the Sheet Metal and Air Conditioning Contractors' National Association (SMACCNA) standards. Radioactivity limits and radiation protection are discussed in Section 12.1.

Full capacity redundant systems are provided to ensure that the failure of any single component will not prevent the fulfilling of the design functions. Protection against tornado missiles is described in Table 3.5-1.

9.4.1.1.1 Normal Conditions

The normal control room air conditioning system serves the control room and computer room. The control room and computer room air is recirculated in order to maintain cleaner air and to economize on cooling and heating loads. The free air space serviced by the normal ventilation system is estimated to be 41,500 cubic feet. Adequate filtered fresh air makeup is provided in the system. The control room and computer room air conditioning system design is based on the wall transmission, lighting, occupancy, and equipment loads with a room ambient temperature of 75 °F Dry Bulb (DB) and 50 percent Relative Humidity (RH).

The control room recirculation exhaust fans provide a means for clearing smoke or other airborne contaminants from within the room, and are designed to exhaust the room at the rate of 10 air changes per hour.

9.4.1.1.2 Emergency Conditions

On detection of high radiation or high chlorine concentration, the common control room for Units 1 and 2 is isolated by dampers on all supply and return ducts, except for the filtered outside air used for pressurization to minimize unfiltered air inleakage. The control room emergency ventilation system design is based on the combined Unit 1 and Unit 2 heat gains from safety-related control equipment, occupancy and lighting load. The free air space serviced by the emergency ventilation system is estimated to be 40,000 cubic feet.

The wall transmission load is included based on a 105 °F DB temperature for areas surrounding the control rooms. The emergency air conditioning system provides a recirculation rate of 15 air changes per hour.

The control room emergency air filtering system is based on a minimum of three room air changes per hour for the combined control room volume. The filter banks are sized for maximum efficiency.

ARKANSAS NUCLEAR ONE
UNIT 2

The original DBA maximum emergency cooling pond temperature of 129.5 °F discussed in Section 9.2.5.3 exceeded preliminary estimates of the peak pond temperature. The Change required the replacement of the Unit 1 and Unit 2 emergency air conditioning units VUC-9 and 2VUC-9 with larger units capable of operating with 129.5 °F cooling water. The new control room emergency air conditioning units (2VUC-27A & B), are located in the Unit 2 control room and provide emergency air conditioning to both Unit 1 and Unit 2 control rooms. Seismically supported duct work has been added for air distribution to the Unit 1 control room.

In conjunction with installation of new control room emergency air conditioning units, an intertie has been provided from loop #2 of the Unit 1 service water system to the air conditioning condensing units 2VE-1A & B, to provide an alternate source of service water to the emergency air conditioning system.

Redundant, quick acting chlorine detectors are provided at the control room outside air intake. Detector signals initiate automatic isolation of the common control room and provide an audible alarm in both sections of the control room in case of high chlorine gas concentration in the air. These detectors are able to detect and signal a step increase in chlorine concentration of zero to 15 ppm within five seconds (based upon 66 percent response). Control room isolation is accomplished within five seconds after the detector trip signal is received. The emergency air filtration system is manually initiated.

The two chlorine detector loops are separated and channelized to meet IEEE 279-1971 requirements. One detector is also located in the sodium bromide & sodium hypochlorite building. An alarm is initiated locally at the entrance door.

Chlorine detection system design features are consistent with the recommendations of Regulatory Guide 1.95, "Protection of Nuclear Power Plant Control Room Operators Against an Accidental Chlorine Release," February, 1975. However, since elemental chlorine is no longer stored or used on site or within a 5 mile radius of the plant site, the Reg Guide recommendation for Seismic Category I designation is not necessary for ANO design requirements. A postulated seismic event concurrent with transport failure and release of chlorine or other toxic gas offsite is considered an incredible event.

The control room is designed to minimize air leakage by pressurizing the room with of outside air through either of the two emergency air filter trains. Self-contained breathing apparatus are available in the control room for use during an emergency.

Total unfiltered air leaking into the control room for the condition of control room isolation is assumed to be 250 cfm consistent with NRC letter 2CAN031001. This leakage includes 10 cfm leakage attributed to ingress and egress of plant personnel through the control room doors during accident conditions.

The control room emergency air conditioning system and the emergency air filtering system are designed to meet the following criteria:

- A. The systems are designed as Seismic Category 1 systems.
- B. The systems are designed to include the capability of withstanding a single failure without loss of function.

ARKANSAS NUCLEAR ONE
UNIT 2

9.4.1.2 System Description

9.4.1.2.1 Normal Conditions

The system schematic is shown on Figure 9.4-1. The control room and computer room are normally air conditioned by two 100 percent capacity air conditioning units receiving chilled water from two 100 percent capacity chillers. One air conditioning unit and one chiller are normally running, with the others in standby status isolated from the system by shutoff dampers and valves. The standby system is available for manual actuation in the event of failure of the operating system. Fan failure is monitored by a flow switch at the unit with an indicating light in the control room.

Adequate air flow is diverted to the false ceiling above the control room to aid in cooling the annunciator panels.

9.4.1.2.2 Emergency Conditions

The control room emergency air conditioning system consists of two unit coolers in the control room and two water cooled compressor condensing units near the control room to serve both Unit 1 and Unit 2 control rooms and the Electrical Equipment Room No. 2150. Although essential control room equipment is qualified for long term operation in temperatures at least as high as 104 °F (see section 3.11), the control room emergency cooling system was originally sized to provide much lower temperatures. As originally sized, either combination of unit cooler and compressor condensing unit would maintain 84 °F DB maximum temperature during control room isolation and/or loss of off-site power. In the event of a DBA, or sensing of high radiation or chlorine, either unit cooler and its respective condensing unit is manually started. In the event of high radiation or chlorine the control room is completely isolated from both the outside air and adjacent rooms, except for the filtered outside air used for pressurization to minimize unfiltered air inleakage.

The control room isolation dampers in the supply and return ductwork are spring loaded such that they fail closed upon loss of air or power. The single supply and single return isolation dampers are each actuated by either of two solenoid valves. Each of the two solenoid valves is supplied by separate Engineered Safety Features (ESF) DC power. This arrangement is shown in Figure 9.4-1.

The emergency air filtering system consists of two redundant filter trains, both of which are located outside the Unit 1 section of the control room. Due to space limitations, the two filter trains are designed differently. One filter train (2VSF-9) consists of a centrifugal fan, roughing filters, HEPA filters, and a 4-inch deep bed charcoal adsorber rated for 2,000 cfm. The other train (VSF-9) consists of a centrifugal fan, one filter unit assembly rated for 2,000 cfm with an outside air filter unit rated for 333 cfm, each with the necessary roughing filters, HEPA filters and 2-inch charcoal tray adsorber. Both VSF-9 and 2VSF-9 were originally designed to provide ~333 cfm outside air to minimize unfiltered air inleakage to the combined control room envelope (CRE), which was in turn based upon providing greater than or equal to 0.5 volume changes per hour based upon Standard Review Plan 6.4, Rev. 2 (July 1981). However, the actual outside air drawn by 2VSF-9 is ~465 cfm, as measured during control room tracer gas testing. Calculations have been performed that indicate that even with the higher 2VSF-9 makeup air flow rate, operation of VSF-9 with 333 cfm makeup air is still limiting in terms of control room radiation dose (1CAN060302). For either train, the outside air will be filtered through four inches of charcoal adsorber and the recirculation air will go through at least two inches of charcoal bed. The emergency air filtering trains are isolated by shutdown dampers during plant

ARKANSAS NUCLEAR ONE
UNIT 2

normal operation. To prevent loss of pressurization, the outside air dampers on the filter trains are each equipped with a bottled reserve air supply which ensures that in the event an emergency recirculation fan fails, the outside air damper can be closed even with loss of instrument air. The emergency air filtering system is started automatically when the control room is isolated on a high radiation signal or a high chlorine signal. Since the air in the combined control room is mixed by the emergency air conditioning system, contamination entering any section of the control room will be cleaned up by the emergency air filtering system. This arrangement is shown on Figure 9.4-1.

9.4.1.2.3 Component Descriptions

A description of the major system components is given below:

Normal Control Room Air Conditioning System

Fans

Type	Centrifugal
Capacity, cfm	21,300

Motor

Type	Induction
Horsepower rating, hp	30
Voltage, V	460
Phase	3
Enclosure	Open drip-proof
Insulation class	B

Heating Coil

Type	Hot water
Capacity, Btu/hr	119,000

Cooling Coil

Type	Chilled water
Capacity, Btu/hr	800,000

Reheat Coil

Type	Electric
Capacity, kW	11.2

Computer Room

Heating Coil

Type	Hot water
Capacity, Btu/hr	101,500

Reheat Coil

Type	Electric
Capacity, kW	11.2

ARKANSAS NUCLEAR ONE
UNIT 2

Normal Control Room Recirculation - Exhaust System

Fans

Type	Vaneaxial
Capacity, cfm	20,000

Motors

Type	Induction
Horsepower rating, hp	10
Voltage, V	460
Phase	3
Enclosure	Open drip-proof
Insulation class	F

Control Room Emergency Air Conditioning System

Fans

Type	Centrifugal
Capacity, cfm	9,900

Motor

Type	Induction
Horsepower rating, hp	7.5
Voltage, V	460
Phase	3
Enclosure	Open drip-proof
Insulation class	B

Heating Coil

Type	Electric
Capacity, kW	40

Cooling Coil

Type	Direct Expansion
Capacity, Btu/hr	316,000

Compressor Condensing Unit

Capacity, tons	29 tons
Refrigerant	R-12
Condenser	Water cooled
Compressor power rating, kW	37

ARKANSAS NUCLEAR ONE
UNIT 2

Control Room Emergency Air Filtering System

Fans

Type	Centrifugal
Capacity, cfm	2,000

Motors

Type	Induction
Horsepower rating, hp	5
Voltage, V	460
Phase	3
Enclosure	Open drip-proof
Insulation class	B

Roughing Filter

Quantity per assembly	2 (2VFP-35) 1 (VFP-15) 1 (VFP-15A)
Rated flow per filter cell, cfm	1,000 (2000 for VFP-15)
Type	Replaceable
Media	Glass fiber
Average efficiency, %	80
Rating basis	ASHRAE Std. 52-68 test method (current revision for VFP-15)
Rated pressure drop, unloaded, in.W.G.	0.45 (0.57 for VFP-15)

HEPA Filters

Quantity per assembly	2 (2VFA-10) 2 (VFA-3) 1 (VFA-3A)
Rated flow per filter cell, cfm	1000 (2VFA-10) 1000 (VFA-3) 333 (VFA-3A)
Type	High efficiency, dry
Media	Glass fiber (water-proof, fire retardant)
Frame	Chromized steel original, T-409 for replacements
Face guards	4X4 mesh galvanized hardware cloth
Seal	Polyurethane
Efficiency	99.97% with 0.3 micron diameter DOP
Rating basis	MIL-STD-282
Rated pressure drop, unloaded, in. W. G.	1.0
Codes	Health and Safety Bulletin 306 (not applicable to VFA-3) Replacements for VSF-3 meet UL-586 and Design Basis of ASME AG-1 MIL-F-51079A (original only for VFA-3) MIL-F-51068D (original only for VFA-3) MIL-STD-282

ARKANSAS NUCLEAR ONE
UNIT 2

Charcoal Adsorbers

	<u>2VFC-10</u>	<u>VFC-2</u>	<u>VFC-2A</u>
Design	4" Vert bed	2" tray	2" tray
Quantity per assembly	1	6	1
Rated flow per filter cell, cfm	2,000	333	333
Type (all)	Activated coconut shell, impregnated		
Granular size (all)	10-14 mesh		
Ignition temperature (all)	360 °C		
Gasketing material (all)	ASTM-D-1056, GR SCE-43		
Casing material (all)	304 stainless steel		
Efficiency % at 25 °C, 70% RH			
elemental iodine	99.99	99.9	99.9
methyl iodide	99.8	99.5	99.5
Rating basis (all)	RDT-M16-IT		
Retention time per 2" bed, sec	0.25	0.25	0.25
Rated pressure drop, inches W.G.	1.5	1.0	1.0
Codes (all)	AEC-DP-1082, July 1967 RTD-M16-IT AEC-DP-1075		

9.4.1.3 Safety Evaluation

In the event that both of the normal air conditioning systems fail, they will be shut down. As originally sized, the emergency unit cooler and compressor condensing units would then maintain a maximum temperature in the combined Unit 1 and Unit 2 control rooms of 84 °F DB. Control room equipment is qualified to operate at long term temperatures of a least 104 °F (see Section 3.11).

The normal control room air conditioning system is continuously monitored with alarms for high radiation and high chlorine. In the event of high radiation or high chlorine, the normal air conditioning systems of both Unit 1 and Unit 2 automatically de-energize and the common control room is completely isolated from both the outside air and adjacent rooms, except for the filtered outside air used to pressurize the control room to minimize unfiltered air inleakage.

The actuation level for high radiation is sufficiently below hazardous radiation levels (see Section 12.2) to minimize operator dose during an accident and is sufficiently above normally experienced background levels to minimize spurious actuations. For detection of chlorine in the supply ducts, see the detailed description in section 9.4.1.1.2.

Filtration of the air inside the control room is accomplished by the emergency air filtering system so that the limits of Criterion 19 of 10 CFR 50, Appendix A are not exceeded. An alarm for excessive pressure drop across the filters of the emergency filtering system will be actuated at one inch across the roughing filter, three inches across the HEPA filter or 1.15 inches across the charcoal adsorber. Fan failure is monitored by a flow switch with an indicating light in the Control Room. On an indication of fan failure, the standby unit will be manually started.

ARKANSAS NUCLEAR ONE
UNIT 2

The control room supply and return air ductwork is equipped with ionization type detectors to alarm in the control room on the presence of visible or invisible products of combustion in the ventilation system. If smoke is present in the supply duct, the detector will initiate a signal to close the control room isolation dampers and de-energize the supply and recirculation fans. If smoke is trapped in the control room after isolation, the operator may override the exhaust isolation damper to open and purge the room with the exhaust air. If smoke is generated from within the control room, the detector in the return duct will initiate a signal to open the exhaust dampers for purging the control room.

These automatic features associated with the ventilation smoke detectors are considered to be system enhancements that are not essential to supporting the habitability safety function. Protection from prolonged exposure to smoke and/or noxious vapors is assured by the availability of self-contained breathing apparatus in the control room and the ability of control room operators to detect smoke or other vapors, manually isolate the control room envelope, and then restore the control room atmosphere by manipulating the control room ventilation system.

The Unit 1 control room, which is adjacent to the Unit 2 control room, is protected by a Halon 1301 flooding system in the subfloor and false ceilings. In the unlikely event Halon 1301 should enter the control room environment, it will not adversely affect the charcoal beds. It is also highly unlikely that the charcoal beds would be exposed to Halon 1301 since the emergency filter systems designed to remove radioactivity from the control room air following an accident are equipped with dampers in the closed position both upstream and downstream of the filter assembly.

A highly unlikely total discharge of Halon 1301 into the communicating Unit 1 and Unit 2 control room area atmospheres, with subfloor covers and false ceiling tiles removed, would result in a concentration of 1.96 percent if no ventilation or leakage existed. This would have no adverse effects; even the design concentration of six percent in the ceiling and subfloors is considered to be a very low level of toxicity and can be breathed for four or five minutes by personnel with no observable effects. After investigation of the cause of the discharge, the Halon can be released to the atmosphere by the ventilation system. The ventilation of control room areas will dilute the concentration to undetectable proportions. In the event of a slow leak to the system discharge header, the normal ventilation will dilute the concentration to undetectable proportions.

A small fraction of Halon 1301 will be pyrolyzed when the fire is extinguished, resulting in hydrogen fluoride and hydrogen bromide concentrations of less than 100 ppm. The decomposition products and the remaining Halon 1301 will be evacuated and exhausted to the atmosphere outside the building.

The emergency control room air conditioning system and the emergency air filtering system are designed to include the capability of withstanding a single failure without loss of function (see Table 9.4-1). Conformance to Regulatory Guide 1.52 is provided in Table 9.4-3.

9.4.1.4 Inspection and Testing Requirements

All components of the control room air conditioning system are accessible for periodic inspection and maintenance during plant operation.

Periodic visual inspections, during plant operation, will be performed on the components of all operating systems to check for damaged filters, faulty bolting and gasketing, excessive fan vibration, motor overheating, control malfunctioning, etc.

ARKANSAS NUCLEAR ONE
UNIT 2

Periodic operational tests will be performed on all the standby components for normal plant operation to assure their proper functional capability.

Operational tests will be performed, during plant shutdown, on all the ESF unit coolers and related control systems to assure their proper functional capability.

The HEPA filter and charcoal adsorber of the control room emergency air filtering system are tested and qualified in the shop and after installation in the same manner as the filtering systems furnished for the penetration rooms ventilation system (Section 6.5.4).

Historical data removed; see Section 9.4.1.4 of the FSAR.

9.4.2 AUXILIARY BUILDING

The auxiliary building is served by separate ventilation systems for each of the following areas:

- A. fuel handling floor radwaste areas
- B. auxiliary building radwaste areas
- C. non-contaminated areas
- D. emergency diesel generator rooms
- E. control room and computer room
- F. battery rooms and battery equipment rooms
- G. switchgear rooms
- H. cable spreading room and Electrical Equipment Room No. 2108
- I. CPC Room No. 2098-C
- J. Electrical Equipment (MG) Room No. 2076
- K. ventilation equipment room
- L. main steam line enclosure
- M. elevator-machine room
- N. boiler room area
- O. heat exchanger and pipeway area
- P. Electrical Equipment Room No. 2091

Series isolation dampers are not provided for the ventilation systems in the Emergency Core Cooling System (ECCS) and auxiliary building rooms since no credit is taken for such isolation in the accident analysis described in Section 15.1.13. These ventilation systems are not Seismic Category 1 based on the fact that a seismic event and a fuel handling accident were not postulated to occur simultaneously. In addition, the building siding is not Seismic Category 1.

To meet the requirement of NUREG-0578, Item 2.1.8.b, stack radiation monitoring capability was installed on the auxiliary building ventilation exhaust stack. The installation consists of an isokinetic probe installed in the exhaust stack, necessary piping (3/4-inch) to the sampling station, valving, charcoal and particulate filters, a radiation monitor, pump, and flow indicator. The radiation monitor is mounted external to the pipe and consists of a radiation detector, preamplifier and a remote power supply/readout device.

ARKANSAS NUCLEAR ONE
UNIT 2

9.4.2.1 Fuel Handling Floor Radwaste Area

See Section 9.4.3 for a detailed description.

9.4.2.2 Auxiliary Building Radwaste Area

See Section 9.4.3 for a detailed description.

9.4.2.3 Non-Contaminated Areas

The non-contaminated areas include the outage control center, SPDS computer room, and the health physics offices. The air from the work areas, the health physics offices, the storage rooms and the false ceiling area is recirculated through an air conditioning multi-zone unit while the air from all the other areas is exhausted to the atmosphere. Makeup air is supplied from the turbine building and the atmosphere.

9.4.2.4 Emergency Diesel Generator Rooms

Each of the two emergency diesel generator rooms has a separate ventilation system (two exhaust fans for each room) to ensure adequate ventilation and safe operation of the diesel generators. The air from the diesel generator rooms is discharged directly to the atmosphere through the roof. The air intakes, shutoff dampers, exhaust fans, ductwork supports and the temperature controls are designed to meet Seismic Category 1 requirements and are protected from tornado generated missiles. The exhaust fans discharge air directed away from the air intakes at a sufficiently high velocity (28 fps) to preclude short circuiting of exhaust air into the room.

The exhaust fans in the emergency diesel generator rooms are started and the outside air dampers open at any time the room air temperature is above the setpoint.

In case one exhaust fan in either room fails the second fan will maintain the room at 115 °F DB with an outside air temperature of 95 °F or 120 °F with an outside air temperature of 100 °F.

A single failure analysis has been made on all active and passive components of the emergency diesel generator room ventilation systems to show that failure of any single component will not prevent fulfilling of the design functions. This analysis is shown in Table 9.4-2.

9.4.2.5 Control Room and Computer Room

See Section 9.4.1 for a detailed description.

9.4.2.6 Battery Rooms and Battery Equipment Rooms

The supply air to the two battery rooms is transfer air from the auxiliary building. The supply air to the two corresponding equipment rooms is from one of the two auxiliary building radwaste area supply air handling units. Each battery room and its corresponding equipment room is served by an independent battery room exhaust system. The exhaust systems are designed to remove air from the high point of each battery room at the minimum rate of 11 air changes an hour. Each exhaust system is equipped with an air flow switch to alarm in the control room when the exhaust fan is operating and the discharge air flow is not established. An indicating light in the control room shows each exhaust fan status. With either exhaust system out of

ARKANSAS NUCLEAR ONE
UNIT 2

service, it would take approximately 1½ days (worst case) for battery room hydrogen concentrations to approach the four percent flammability limit. The air flow alarms will therefore provide the operator with sufficient time to investigate the cause of the alarm and take necessary measures to restore exhaust flow well before flammable limits would be approached.

The exhaust systems also provide ventilation to maintain 105 °F in the rooms during normal plant operation. Some of the ESF equipment in Battery Equipment Room Nos. 2097 and 2099 is designed to operate in maximum ambient temperature of 122 °F. The exhaust systems for these rooms are designed to Seismic Category 1 requirements. They are protected from tornado missiles and the effects of high energy pipe ruptures and will maintain the room at 120 °F maximum during emergency conditions.

9.4.2.7 Switchgear Rooms

Each of the two cooling units (designed as Seismic Category 1) located in each of the two switchgear rooms consists of a low efficiency filter, a cooling coil (constructed in accordance with ASME Code Section III, Class 3) and a centrifugal type direct-driven fan. The unit takes air from the switchgear room and returns cooled air to the same area. One of the two cooling units in each switchgear room is a standby. The unit coolers in one switchgear room are connected to one SWS loop and the unit coolers in the other room are connected to the other SWS loop. The unit coolers utilize service water with welded guard piping on the service water supply and return lines to the units. The coolers are designed to maintain normal room temperature at 110 °F DB maximum in case the 85 °F service water is available.

Each switchgear room is also equipped with an exhaust fan designed to Seismic Category 1 requirements. In the event the switchgear room temperature rises above 120 °F, an annunciation will be received in the control room and operations will start the exhaust fan to ventilate the air from the switchgear room to the health physics office area. The exhaust fans are not required for safe shutdown after a tornado.

9.4.2.8 Cable Spreading Room and Electrical Equipment Room No. 2108

The cable spreading room air conditioning package unit is located outside of the room and was originally designed to take air from the turbine building and returns cooled air to the cable spreading room. The cable spreading room cooling unit has since been abandoned in place. The electrical equipment room package unit takes air from the room and returns cooled air to the same area. Each of these units consist of a centrifugal type fan, a refrigerant cooling coil and a water cooled compressor condensing unit. The electrical equipment unit is designed to utilize auxiliary cooling water and is designed to maintain the room at the temperature of 95 °F DB maximum.

9.4.2.8.A CPC Room No. 2098-C

Two package computer room HVAC units provide environmental control by recirculating air within the room. Each of the units consist of a centrifugal type fan, a refrigerant cooling coil, electric reheater coil, self generating humidifier, two compressors, and a remote located air cooled condenser. Each unit is sized to meet the room cooling load. Two units are used to provide redundancy. A microprocessor controller, mounted integral to the units, controls the units to maintain the desired room temperature and humidity conditions.

ARKANSAS NUCLEAR ONE
UNIT 2

9.4.2.9 Electrical Equipment (MG) Room No. 2076

Each of the two MG room unit coolers takes air from the room and returns cooled air to the same area. The units utilize chilled water and are on the control and computer room chilled water system. The unit coolers are designed to maintain the room at the temperature of 105 °F DB maximum.

9.4.2.10 Ventilation Equipment Room

The ventilation equipment room is equipped with a centrifugal supply fan that starts when an increase in room air temperature above 75 °F DB is sensed by an electric temperature controller and through interlock starts an exhaust fan. The room is equipped with two electric heaters to maintain the room temperature of 60 °F during shutdown periods.

9.4.2.11 Main Steam Line Enclosure

The main steam line enclosure is equipped with a vaneaxial type exhaust fan that starts when the air temperature within the enclosure is above 100 °F DB as sensed by an electric air temperature controller. The fan stops when the air temperature drops to 95 °F DB. Outside air is supplied through a wall louver.

9.4.2.12 Elevator-Machine Room

The elevator-machine room ventilation unit consists of a mixing box with mixing dampers, a roll type filter, an electric heating coil and a centrifugal type supply fan. The air from the room is exhausted to the atmosphere through a relief damper. The electric heating coil is a 2-stage type coil. The room air temperature is sensed by a 2-stage electric thermostat. With a decrease in room temperature below 50 °F DB, Heating Stage 1 is energized. Heating Stage 2 is energized when the room temperature drops to 45 °F DB. The supply fan runs all the time. The air is recirculated during the winter and the room is supplied with 100 percent outside air during summer.

9.4.2.13 Boiler Room Area

The boiler room is equipped with two exhaust fans controlled by separate thermostats. On an increase in room temperature above 88 °F DB, one of the exhaust fans in the boiler room starts. The second fan starts when the room temperature reaches 100 °F DB. Outside air is drawn into the room through wall louvers. The boiler room area is maintained at a minimum of 60 °F DB by means of hot water unit heaters mounted on the inside surface of exterior walls.

9.4.2.14 Heat Exchanger and Pipeway Area

The heat exchanger and pipeway area ventilation system is equipped with a supply air handling unit and a vaneaxial type exhaust fan. The supply unit consists of a roll type filter, a heating coil, a cooling coil and a centrifugal fan. The unit takes air from the atmosphere and serves these areas through a ductwork system. The ventilation air from these areas is exhausted through a ductwork system by the vaneaxial exhaust fan.

The ventilation system for these areas is designed to maintain suitable ambient temperatures of 60 °F DB minimum and 105 °F DB maximum during winter and summer, respectively. The supply air handling unit and exhaust fan are interlocked such that the exhaust fan will not start unless the supply unit is running.

ARKANSAS NUCLEAR ONE
UNIT 2

9.4.2.15 Electrical Equipment Room No. 2091

There are two unit coolers in Electrical Equipment Room No. 2091 (one standby). Both units are connected to one electrical bus. In the event of a Design Basis Accident (DBA), a SIAS signal will start both unit coolers and one unit cooler is manually stopped from the control room.

In addition, there are two redundant ventilation fans in Room No. 2091 to provide emergency cooling. Both fans will start on an increase in room temperature above 120 °F DB, and will stop when the room temperature is cooled down to 115 °F.

9.4.2.16 Component Descriptions

Non-Contaminated Area Supply System

Fan (2VSF-10)	
Type	Centrifugal
Capacity, cfm	5100
Motor	
Type	Induction
Horsepower rating, hp	10
Voltage, V	480
Phase	3
Enclosure	Open drip-proof
Heating Coil	
Type	Hot water
Capacity, Btu/hr	169,000
Pre-Cooling Coil	
Type	Chilled water
Capacity, Btu/hr	165,000
Cooling coil	
Type	Chilled water
Capacity, Btu/hr	175,000
Filter	
Type	Automatic roll
Media	Glass fiber blanket
Efficiency, %	85

ARKANSAS NUCLEAR ONE
UNIT 2

Controlled Access Entry Area Supply System

Fan (2VSF-51)

Type	Centrifugal
Capacity, cfm	1525

Motor

Type	Induction
Horsepower Rating, HP.	1
Voltage, V	480
Phase	3

Cooling Coil

Type	Chilled Water
Capacity, Btu/hr.	120,000

Non-Contaminated Area Exhaust System

Fan (2VEF-9)

Type	Centrifugal
Capacity, cfm	1605

Motor

Type	Induction
Horsepower rating, hp	1/3
Voltage, V	480
Phase	3

Emergency Diesel Generator Rooms Exhaust System

Fan (2VEF-24A,B,C,&D)

Type	Propeller
Capacity, cfm	43,885

Motor

Type	Induction
Horsepower rating, hp	15
Voltage, V	460
Phase	3
Enclosure	Totally enclosed air over

ARKANSAS NUCLEAR ONE
UNIT 2

Health Physics Offices Supply System

Fan (2VSF-36)

Type	Centrifugal
Capacity, cfm	1380

Motor

Type	Induction
Horsepower rating	5
Voltage, V	480
Phase	3

Cooling Coil

Type	Chilled Water
Capacity, Btu/hr.	103,500 Btu/hr.

Heating Coil

Type	Hot Water
Capacity, Btu/hr.	52,500 Btu/hr.

Battery Room No. 2102 and Battery Equipment Room No. 2097 Exhaust Fan

Fan (2VEF-49)

Type	Vaneaxial
Capacity, cfm	1,600

Motors

Type	Induction
Horsepower rating, hp	3
Voltage, V	460
Phase	3

Enclosure Totally enclosed air over

Battery Room No. 2103 and Battery Equipment Room No. 2099 Exhaust Fan

Fan (2VEF-61 and 2VEF-65)

Type	Tubeaxial
Capacity, cfm	3,300

Motor

Type	Induction
Horsepower rating, hp	2
Voltage, V	460
Phase	3

Enclosure Totally enclosed air over

ARKANSAS NUCLEAR ONE
UNIT 2

Switchgear Rooms Unit Coolers

Fans (2VUC-2A,B,C,&D)

Type	Centrifugal
Capacity, cfm	4,350

Motors

Type	Induction
Horsepower rating, hp	5
Voltage, V	480
Phase	3
Enclosure	Open drip-proof

Cooling Coils

Type	Service water
Capacity, Btu/hr	53,000 with 120 °F supply water 85,000 with 85 °F supply water

Filters

Type	Replaceable
Media	Glass fiber
Efficiency, %	55

Switchgear Rooms Exhaust Fans

Fans (2VEF-56A&B)

Type	Vaneaxial
Capacity, cfm	15,000

Motors

Type	Induction
Horsepower rating, hp	25
Voltage, V	460
Phase	3
Enclosure	Totally enclosed

ARKANSAS NUCLEAR ONE
UNIT 2

Cable Spreading Room and Electrical Equipment Room No. 2108 Air Conditioning Units

Fan (2VUC-3A*)

Type	Centrifugal
Capacity, cfm	4,800

Motor

Type	Induction
Horsepower rating, hp	3
Voltage, V	460
Phase	3
Enclosure	Open drip-proof

Heating Coils

Type	Electric
Capacity, kW	10

Cooling Coils

Type	Direct expansion
Capacity, Btu/hr	101,000

Compressor

Type	Hermetic
Power drawn, kW	10.8
Refrigerant	R-22

* The cable spreading room air conditioning unit 2VUC-3A has been abandoned in place.

Fan (2VUC-21)

Type	Centrifugal
Capacity, cfm	4,800

Motor

Type	Induction
Horsepower rating, hp	3
Voltage, V	460
Phase	3
Enclosure	Open drip-proof

Heating Coils

Type	None
Capacity, kW	N/A

ARKANSAS NUCLEAR ONE
UNIT 2

Cooling Coils	
Type	Direct expansion
Capacity, Btu/hr	121,000

Compressor	
Type	Hermetic
Power drawn, kW	8.8
Refrigerant	R-22

CPC Room No. 2098-C HVAC System

Fans	
Type	Centrifugal
Capacity, cfm	5,000

Motors	
Type	Induction
Horsepower rating, hp	3.75
Voltage, V	460
Phase	3
Enclosure	Open, Drip-Proof

Heating Coils	
Type	Electric
Capacity, kW	15

Cooling Coils	
Type	Direct Expansion
Capacity, MBtu/hr	120.0

Humidifiers	
Type	Infrared
Capacity, lb/hr	11

Filters	
Type	Replaceable
Media	Glass fiber
Rating	MERV 8

Compressor	
Type	Digi-Scroll
Refrigerant	R-407C

ARKANSAS NUCLEAR ONE
UNIT 2

Electrical Equipment (MG) Room No. 2076 Unit Coolers

Fans (2VUC-17A&B)

Type	Centrifugal
Capacity, cfm	3,000

Motors

Type	Induction
Horsepower rating, hp	2
Voltage, V	460
Phase	3
Enclosure	Open drip-proof

Cooling coil

Type	Chilled water
Capacity Btu/hr	100,000

Filter

Type	Replaceable
Media	Glass fiber
Efficiency, %	55

Ventilation Equipment Room Supply Fan

Fan (2VSF-24)

Type	Centrifugal
Capacity, cfm	13,000

Motor

Type	Induction
Horsepower rating, hp	10
Voltage, V	460
Phase	3
Enclosure	Open drip-proof

Chemical Storage Room Exhaust System

Fan (2VEF-78)

Type	Centrifugal
Capacity, cfm	450

Motor

Type	Induction
Horsepower Rating, hp	1/6
Voltage, V	120
Phase	1
Enclosure	Open, drip-proof

ARKANSAS NUCLEAR ONE
UNIT 2

Main Steam Line Enclosure Exhaust Fan

Fan (2VEF-36)

Type	Axial
Capacity, cfm	17,300

Motor

Type	Induction
Horsepower rating, hp	3
Voltage, V	460
Phase	3
Enclosure	Totally enclosed fan cooled

Elevator-Machine Room Supply System

Fan (2VSF-28)

Type	Centrifugal
Capacity, cfm	3,300

Motor

Type	Induction
Horsepower rating, hp	2
Voltage, V	460
Phase	3
Enclosure	Totally enclosed fan cooled

Heating coil

Type	Electric
Capacity, kW	16.2

Filter

Type	Replaceable
Media	Glass fiber
Efficiency, %	55

ARKANSAS NUCLEAR ONE
UNIT 2

Boiler Room Area Exhaust System

Fans (2VEF-50A&B)

Type	Propeller
Capacity, cfm	4,000

Motors

Type	Induction
Horsepower rating, hp	0.5
Voltage, V	460
Phase	3
Enclosure	Open drip-proof

Heat Exchanger and Pipeway Area Supply System

Fans (2VSF-41)

Type	Centrifugal
Capacity, cfm	16,000

Motors

Type	Induction
Horsepower rating, hp	25
Voltage, V	480
Phase	3
Enclosure	Open drip-proof

Heating Coil

Type	Hot water
Capacity, Btu/hr	933,000

Cooling Coil

Type	Chilled water
Capacity, Btu/hr	611,000

Filter

Type	Automatic roll
Media	Glass fiber blanket
Efficiency, %	85

ARKANSAS NUCLEAR ONE
UNIT 2

Heat Exchanger and Pipeway Area Exhaust System

Fan (2VEF-52)

Type	Axial
Capacity, cfm	17,375

Motor

Type	Induction
Horsepower rating, hp	10
Voltage, V	460
Phase	3
Enclosure	Totally enclosed fan cooled

Electrical Equipment Room No. 2091 Unit Coolers

Fans (2VUC-19A & B)

Type	Centrifugal
Capacity, cfm	5,760

Motors

Type	Induction
Horsepower rating, hp	5
Voltage, V	480
Phase	3
Enclosure	Open drip-proof

Cooling Coils

Type	Service water
Capacity, Btu/hr	67,000 with 120 °F supply water 78,000 with 85 °F supply water

Filters

Type	Replaceable
Media	Glass fiber
Efficiency, %	55

Electrical Equipment Room No. 2091, Ventilating Exhaust Fans

Fans (2VEF-63 and 64)

Type	Vaneaxial
Capacity, cfm	9,000

Motors

Type	Induction
Horsepower, HP	25
Voltage, V	480
Phase	3
Enclosure	TEAO

ARKANSAS NUCLEAR ONE
UNIT 2

9.4.3 RADWASTE AREA

The radwaste area consists of the auxiliary building radwaste area and the fuel handling floor radwaste area.

9.4.3.1 Design Bases

The fuel handling floor radwaste area and the auxiliary building radwaste area have similar design bases.

Each of the above two areas is served by a separate ventilation system.

The supply systems are designed to maintain the temperature of all areas inside the building at 105 °F DB when outdoor air is at summer design conditions of 95 °F DB and 50 percent relative humidity and at 60 °F DB when outdoor air is at winter design condition of 6 °F DB.

The systems are designed to maintain the temperature at a minimum of 60 °F DB, using electric heaters mounted on the inside surface of exterior walls, when the outdoor air is at winter design condition and the plant is shut down.

The exhaust systems are designed to prevent release of airborne radioactive material to the environment. They are designed to maintain the preferred direction of air flow from spaces with low potential radioactivity into spaces of progressively higher potential radioactivity.

The systems are designed to treat exhaust air before releasing it to the atmosphere. Automatic continuous radiation monitoring is provided for the exhaust ducts as described in Section 11.4.2. The systems are designed for continuous operation.

See Section 6.5.2 for the basic design criteria of the roughing filter, HEPA filter, and charcoal adsorber, with the following exceptions. Replacement medium efficiency roughing filters are 80% efficient with initial resistance not to exceed 0.56 inch W.G. clean and a face area of 23-3/8" x 23-3/8". Replacement HEPA filters are in compliance with and meet the basic design criteria of ASME AG-1 in lieu of AEC-HSB-306, MIL-F-51079A, and MIL-F-51068D and are not evaluated for dust holding capacity.

9.4.3.2 System Description

9.4.3.2.1 Auxiliary Building Radwaste Area

Two Radwaste Supply Fans (2VSF-7A and 2VSF-7B) supply the Unit 2 Auxiliary Building Radwaste Area. 2VSF-7A serves Elevations 354, 372, 386, as well as both DC Bus Equipment Rooms, 2B63 Room, and the Boric Acid Makeup Pump Area. 2VSF-7B serves Elevations 317, 335 and the corridor behind Door 340.

Each unit consists of a roll type filter, a heating coil, a cooling coil and a centrifugal type fan. The unit takes air from the atmosphere and serves the different elevations through a ductwork system.

ARKANSAS NUCLEAR ONE
UNIT 2

The ventilation air from the spaces is exhausted to a containment flute (vent) through a multi-filter unit consisting of a roughing filter, a HEPA filter, a charcoal adsorber and two vaneaxial type fans, one of which serves as a standby.

The exhaust duct system is equipped with isolation dampers in order to isolate the multifilter unit and the fans for maintenance purposes.

The supply air handling units and exhaust fans are interlocked such that the supply fans will not start unless one of the exhaust fans is running.

The auxiliary building radwaste area is also equipped with the following Engineered Safety Features (ESF) unit coolers which are designed as Seismic Category 1:

- A. Shutdown heat exchanger rooms unit coolers (Elevation 317 feet)
- B. High Pressure Safety Injection (HPSI) pump room unit coolers (Elevation 317 feet)
- C. Charging pumps area unit coolers (Elevation 335 feet)
- D. Emergency feedwater pumps area unit coolers (Elevation 335 feet)
- E. Electrical Equipment Room No. 2096 unit coolers (Elevation 372 feet)
- F. Electrical Equipment Room No. 2150 unit coolers (Elevation 404 feet)

Each of the above unit coolers consists of a fan-coil unit containing a low efficiency filter, a cooling coil and a centrifugal type direct-driven fan. The unit coolers take air from the area served and return cooled air to the same area.

There are two shutdown heat exchanger rooms. Three unit coolers (one standby) are located in each room. The standby unit in each room is manually operated from the control room. The other two unit coolers in each room are interlocked with the pumps inside the room and are connected to one SWS loop and one electrical bus in one room and to the other SWS loop and electrical bus in the second room.

There are two unit coolers in the HPSI pump room. The unit coolers are interlocked with the pump inside the room and one unit cooler is connected to one SWS loop and one ESF bus and the second unit cooler is connected to the other SWS loop, and the other ESF bus.

The purge air systems of the two shutdown heat exchanger rooms and the HPSI pump room are aligned during normal plant operation. In the unlikely event of a DBA, the isolation is assured by a Safety Injection Actuation Signal (SIAS) to each isolation valve. The purge air system will be put in operation if personnel access into the rooms is desired. After purging is completed, the radiation level inside the room is verified with portable monitors before entering. The purge air is obtained from the surrounding controlled access area and is exhausted through the Radwaste Area Ventilation System. The Purge Air System is designed to purge each room independently.

There are three rooms in the charging pump area with one unit cooler in each room. The unit coolers are interlocked with the pumps inside the area. In two of the three rooms, one unit cooler is connected to one SWS loop and one electrical bus, and the other unit cooler in the third room is connected to both SWS loops mentioned above and can be manually switched from the control room to either one. This unit is also connected to both electrical buses.

ARKANSAS NUCLEAR ONE
UNIT 2

There are two unit coolers in the emergency feedwater pumps area. These unit coolers are interlocked with the pumps in the area with one unit cooler connected to one SWS loop and one ESF bus and the second unit cooler connected to the other SWS loop and ESF bus.

There are two unit coolers in Electrical Equipment Room No. 2096 (one standby). Both units are connected to one electrical bus. In the event of a DBA, an SIAS signal will start both unit coolers and one unit cooler is manually stopped from the control room.

There are two unit coolers in Electrical Equipment Room No. 2150 which utilize refrigerant from the two water cooled compressor condensing units for the control room (2VE-1A, B). In the event of a DBA, either unit cooler can be manually started and is interlocked to automatically start the associated compressor condensing unit. Either unit cooler and its associated condensing unit will maintain a 95°F DB maximum ambient temperature during a DBA.

Electrical Equipment Room 2150 also contains an air conditioning packaged unit for use during normal operation to provide more efficient cooling for cabinets containing terminal connections for the Core Protection Calculators (CPCs) and other systems.

9.4.3.2.2 Fuel Handling Floor Radwaste Area

The fuel handling and storage floor is served by a separate ventilation system. The ventilation system maintains a slight vacuum in this area. In the event of high radiation measured on the floor, the ventilation system will continue to operate to remove the contamination from the space to avoid the spread of airborne radioactive particles to other areas.

One supply air handling unit serves the fuel handling floor radwaste area.

The unit consists of a roll type filter, a heating coil, and a centrifugal type fan. The unit takes air from the atmosphere and serves the fuel handling floor radwaste area through a ductwork system.

The ventilation air from the spaces is exhausted to a containment flue (vent – see Figure 11.2-2) through a multi-filter unit consisting of a roughing filter, a HEPA filter, and a charcoal adsorber, and two vaneaxial type fans, one of which serves as a standby.

9.4.3.2.3 Component Description

Fuel Handling Floor Radwaste Area Supply System

Fan (2VSF-4)

Type

Centrifugal

Airflow, cfm

See P&ID M-2262

Motor

Type

Induction

Horsepower rating, hp

40

Voltage, V

480

Phase

3

Enclosure

Open drip-proof

Insulation class

B

ARKANSAS NUCLEAR ONE
UNIT 2

Heating Coil

Type	Hotwater
Original design capacity, Btu/hr	2,332,800

Filter

Type	Automatic roll
Media	Glass fiber blanket
Efficiency, %	85

Fuel Handling Floor Radwaste Area Exhaust System

Fans (2VEF-14A&B)

Type	Vaneaxial
Airflow, cfm	See P&ID M-2262

Motors

Type	Induction
Horsepower rating, hp	100
Voltage, V	460
Phase	3
Enclosure	Totally enclosed air over
Insulation class	F

Roughing Filters

Quantity per assembly	21
Design rated flow per filter cell, cfm	2,000
Type	Replaceable
Media	Glass filter
Average efficiency %	80
Rating basis	ASHRAE STD 52-68
	Test method original, current revision for replacements
Design rated press. drop, unloaded, in. W.G.	0.54 original, ≤ 0.56 for replacements

HEPA Filters

Quantity per assembly	27
Design rated flow per filter cell, cfm	1,500
Type	High efficiency, dry
Media	Glass fiber (waterproof, fire retardant)
Frame	Chromized steel original, T-409 for replacements
Face guards	4 x 4 mesh galvanized hardware cloth
Separator	None
Seal	Neoprene
Efficiency, %	99.97% with 0.3 micron diameter DOP

ARKANSAS NUCLEAR ONE
UNIT 2

Rating basis	MIL-STD-282
Design rated pressure drop, unloaded, in. W.G.	1.0 original, ≤ 1.3 for replacements
Codes or Standards	Health and Safety Bulletin 306 original, ASME AG-1 for replacements UL-586 MIL-F-51079A original, ASME AG-1 for replacements MIL-F-51068D original, ASME AG-1 for replacements MIL-STD-282, ANSI-101.1-1972

Charcoal Adsorbers

Quantity per assembly	2" Vertical Bed
Flow per filter cell, cfm	See Figure 9.4-2
Type	Activated coconut shell, impregnated
Granular size	10-14 mesh
Ignition temperature	360 °C
Charcoal per cell, lbs	7,560
Maximum moisture content, %	3
Casing material	304 stainless steel
Efficiency, %	99.9% elemental iodine at 25 °C, 70% RH 99.5% methyl iodide at at 25 °C, 70% RH 99.9% Freon-112

Rating basis	RDT-M16-1T
Retention time, sec	0.25
Rated pressure drop, inches W.G.	1 \pm 0.2
Codes	AEC-DP-1082, July 1967 RTD-M 16-IT, June 1972 AEC-DP-1075

Auxiliary Building Radwaste Area Supply System

Fans (2VSF-7A&B)

Type	Centrifugal
Airflow, cfm	See P&ID M-2262

Motors

Type	Induction
Horsepower rating, hp	40
Voltage, V	480
Phase	3
Enclosure	Open drip-proof
Insulation class	B

Heating Coil

Type	Hot water
Original design capacity, Btu/hr	1,300,000 and 1,750,000

ARKANSAS NUCLEAR ONE
UNIT 2

Cooling Coil

Type	Chilled water
Original design capacity, Btu/hr	685,000 and 920,000

Filter

Type	Automatic roll
Media	Glass fiber blanket
Efficiency, %	85

Auxiliary Building Radwaste Area Exhaust System

Fans (2VEF-8A&B)

Type	Vaneaxial
Airflow, cfm	See P&ID M-2262

Motors

Type	Induction
Horsepower rating, hp	125
Voltage, V	480
Phase	3
Enclosure	Totally enclosed air over
Insulation class	F

Roughing Filters

Quantity per assembly	27
Design rated flow per filter cell, cfm	2,000
Type	Replaceable
Media	Glass fiber
Average efficiency %	80
Rating basis	ASHRAE STD 52-68
	Test Method original, current revision for replacments
Design rated press. drop, unloaded, in. W.G.	0.54 original, \leq 0.56 for replacements

HEPA Filters

Quantity per assembly	36
Design rated flow per filter cell, cfm	1,500
Type	Glass fiber (waterproof, fire retardant)
Frame	Chromized steel original, T-409 for replacements
Face guards	4 x 4 mesh galvanized hardware cloth
Separator	None
Seal	Neoprene
Efficiency, %	99.97% with 0.3 micron diameter DOP
Rating basis	MIL-STD-282
Design rated press. drop, unloaded, in. W.G.	1.0 original, \leq 1.3 for replacements

ARKANSAS NUCLEAR ONE
UNIT 2

Codes or Standards	Health and Safety Bulletin 306 original, ASME AG-1 for replacements, UL-586 MIL-F-51079A original, ASME AG-1 for replacements MIL-F-51068D original, ASME AG-1 for replacements MIL-STD-282, ANSI-101.1-1972
--------------------	--

Charcoal Adsorbers

Quantity per assembly	2" Vertical Bed
Flow per filter cell, cfm	See P&ID M-2262
Type	Activated coconut shell, impregnated
Granular Size	10-14 mesh
Ignition temperature	360 °C
Charcoal per cell, lb	10,225
Maximum moisture content, %	3
Casing material	304 stainless steel
Efficiency, %	99.9% elemental iodine at 25 °C, 70% RH 99.5% methyl iodide at 25 °C, 70% RH 99.9% Freon-112
Rating basis	RDT-M16-IT
Retention time, sec	0.25
Design rated pressure drop, inches W.G.	1 ± 0.2
Codes	AEC-DP-1082, July 1967 RTD-M16- , June 1972 AEC-DP-1075

Auxiliary Building Shutdown Cooling Heat Exchanger Room Unit Coolers

Fans (2VUC-1A,B,C,D,E,&F)

Type	Centrifugal
Capacity, cfm	11,300

Motors

Type	Induction
Horsepower rating, hp	10
Voltage, V	480
Phase	3
Enclosure	Open drip-proof
Insulation class	F

Cooling Coils

Type	Service water
Capacity, Btu/hr	119,000 with 120 °F supply water 209,000 with 85 °F, supply water

ARKANSAS NUCLEAR ONE
UNIT 2

Filters

Type	Replaceable
Media	Glass fiber
Efficiency, %	55

HPSI Pump Room Unit Coolers

Fans (2VUC-11A&B)

Type	Centrifugal
Capacity, cfm	8,100

Motors

Type	Induction
Horsepower rating, hp	5
Voltage, V	480
Phase	3
Enclosure	Open drip-proof
Insulation class	F

Cooling Coils

Type	Service water
Capacity, Btu/hr	95,000 with 120 °F supply water 163,000 with 85 °F supply water

Filters

Type	Replaceable
Media	Glass fiber
Efficiency,%	55

Emergency Feedwater Pump Room Unit Coolers

Fans (2VUC-6A&B)

Type	Centrifugal
Capacity, cfm	10,800

Motors

Type	Induction
Horsepower rating, hp	10
Voltage, V	480
Phase	3
Enclosure	Open drip-proof
Insulation class	F

ARKANSAS NUCLEAR ONE
UNIT 2

Cooling Coils

Type	Service water
Capacity, Btu/hr	190,500 with 120 °F supply water 190,500 with 85 °F supply water

Filters

Type	Replaceable
Media	Glass fiber
Efficiency, %	55

Charging Pump Room Unit Coolers

Fans (2VUC-7A,B,&C)

Type	Centrifugal
Capacity, cfm	4,300

Motors

Type	Induction
Horsepower rating, hp	5
Voltage, V	480
Phase	3
Enclosure	Open drip-proof
Insulation class	F

Cooling Coils

Type	Service water
Capacity, Btu/hr	63,200 with 120 °F supply water 76,800 with 85 °F supply water

Filters

Type	Replaceable
Media	Glass fiber
Efficiency, %	55

Electrical Equipment Room No. 2150 Unit Coolers

Fans (2VUC-25A&B)

Type	Centrifugal
Capacity, cfm	2,900

ARKANSAS NUCLEAR ONE
UNIT 2

Motors

Type	Induction
Horsepower rating, hp	3
Voltage, V	480
Phase	3
Enclosure	Open drip-proof
Insulation class	B

Cooling Coils

Type	Direct Expansion
Capacity, Btu/hr	57,500

Filters

Type	Replaceable
Media	Glass fiber
Efficiency, %	55

Electrical Equipment Room No. 2096 Unit Coolers

Fans (2VUC-20A&B)

Type	Centrifugal
Capacity, cfm	1,100

Motors

Type	Induction
Horsepower rating, hp	1
Voltage, V	480
Phase	3
Enclosure	Open drip-proof (2VUC-20A) Totally Enclosed Non Ventilated (2VUC020B)
Insulation class	F (2VUC-20A) H (2VUC-20B)

Cooling coils

Type	Service water
Capacity, Btu/hr	10,500 with 120 °F supply water 15,000 with 85 °F supply water

Filters

Type	Replaceable
Media	Glass fiber
Efficiency, %	55

ARKANSAS NUCLEAR ONE
UNIT 2

9.4.3.3 Safety Evaluation

9.4.3.3.1 Auxiliary Building Radwaste Area

In case of failure of either of the two supply systems, the exhaust system will remain in operation to prevent leakage of air to adjacent areas and provide the desired direction of air movement. The standby exhaust fan provides additional reliability by ensuring continuous ventilation of the areas, and precluding any overheating of the charcoal filter.

The fans are statically and dynamically balanced. Fan ratings are in accordance with AMCE Standard Test-Code 210. The ductwork is leak tested, and the entire systems are balanced, adjusted, and tested for performance.

Allowable leakage in percentage of the designed flow is as follows:

Radwaste Area Exhaust Ductwork	2% or less
Radwaste Area Supply Ductwork	5% or less

The standby ESF unit coolers in the auxiliary building radwaste area ensure continuous cooling in the areas where they are located following a DBA.

The containment flue (vent – see Figure 11.2-2) for the auxiliary building radwaste area exhaust is monitored for gaseous and particulate radioactivity as discussed in Section 11.4. The radiation levels are indicated, recorded and alarmed in the control room. In the event of high radiation, the operator can stop both supply and exhaust systems and isolate the multi-filter unit via hand switches located in the control room.

9.4.3.3.2 Fuel Handling Floor Radwaste Area

The safety evaluation of the fuel handling floor radwaste area is similar to that of the auxiliary building radwaste area except that the former has only one supply system and is not equipped with any ESF unit coolers.

9.4.3.4 Inspection and Testing Requirements

See Section 6.5.4 for testing requirements of the HEPA filters and charcoal adsorbers.

The systems were given a preoperational test before the station produced power. The components of the systems are accessible for periodic inspection.

Periodic visual inspections during plant operation, will be performed on the components of all operating systems to check for damaged filters, faulty bolting and gasketing, excessive fan vibration, motor overheating, control malfunctioning, etc.

Periodic operational tests will be performed on all the standby components for normal plant operation to assure their proper functional capability.

Operational tests will be performed, during plant shutdown, on all the ESF unit coolers and related control systems as described in Section 14.1 to assure their proper functional capability.

ARKANSAS NUCLEAR ONE
UNIT 2

9.4.4 TURBINE BUILDING

9.4.4.1 Design Bases

The heating, ventilating and air conditioning systems for the turbine building are designed to provide a suitable environment temperature between 60 °F DB and 105 °F DB for equipment and personnel. Airborne radioactivity levels inside the turbine building are not considered significant (see Section 12.2.2.4). The exhaust air from this area is released into the atmosphere without any special treatment.

Summer outside design conditions is 95 °F DB and 79 °F WB. For winter they are 6 °F DB.

The ventilating systems and equipment are designed in accordance with the recommended practices of the American Society of Heating, Refrigerating, Ventilating, and Air Conditioning Engineers Guide, the Air Moving and Conditioning Association, and the National Fire Protection Association. The ductwork is designed and fabricated in accordance with the Sheet Metal and Air Conditioning Contractors National Association (SMACCCNA) standards.

9.4.4.2 System Description

Ventilation air for the turbine building is supplied by 34 supply fans. All supply fans are equipped with roll type filters and mixing dampers.

Fourteen of the supply fans are equipped with heating coils. The turbine building is also provided with hot water unit heaters mounted on the inside surface of exterior walls. These heaters will operate during winter shutdown to maintain the building at 60 °F DB. The building is also equipped with six chilled water unit coolers serving various areas (condensate pumps, main feed water pumps and feedwater heater drain pumps).

Air in the building is exhausted through roof ventilators and through exhaust fans in various areas (switch gear, lube oil, pumps area and store room) within the building. The fans are manually controlled from motor control centers located in the turbine building.

9.4.4.3 Inspection and Testing Requirements

The systems were given a preoperational test before the station produced power.

All temperature controls were tested and calibrated before operation.

The fans were statically and dynamically balanced. Fan ratings are in accordance with AMCA Standard Test-Code 210. The ductwork is leak tested, and each system is balanced, adjusted, and tested for performance.

The components of the systems are accessible for periodic inspection.

Periodic visual inspections, during plant operation, will be performed on the components of all operating systems to check for damaged filters, faulty bolting and gasketing, excessive fan vibration, motor overheating, control malfunctioning, etc.

Periodic operational tests will be performed on all the standby components for normal plant operation to assure their proper functional capability.

ARKANSAS NUCLEAR ONE
UNIT 2

9.4.5 CONTAINMENT BUILDING

9.4.5.1 Design Bases

The Containment Cooling System (CCS) design is based on equipment and piping heat gain to maintain an ambient air temperature in the containment within the limits of Technical Specifications during normal plant operation. For capacity see Section 9.4.5.2.

The CCS will also remove heat energy from the containment atmosphere in the event of a LOCA in order to suppress any resultant increase in containment pressure and temperature. For capacity see Table 6.2-22.

During shutdown conditions a containment purge is made to lower containment atmosphere activity below 10 CFR 20 limits for personnel access to the containment building. The purge duration required to reduce containment atmosphere activity to ambient levels is affected by such factors as failed fuel, RCS leakage, and duration of activity accumulation. Section 11.3.6.2 discusses the original estimated annual releases from containment purges.

9.4.5.2 System Description

The system schematic is shown on Figure 9.4-4.

The CCS utilizes four cooling units located in the containment outside the secondary shielding. Each cooling unit is equipped with a vaneaxial type fan and two sets of coils. One is a chilled water coil for normal cooling and the other is a service water coil for emergency cooling following a postulated DBA. Ductwork distributes air from the cooling units to lower areas of the building, steam generator cavities and the reactor cavity. The air then flows upward through the building and is picked up by return ductwork just below the crane rail. Three drain ports are provided on the bottom of each cooling unit for normal condensate removal. Emergency condensate is removed via a sump, located in the fan section of the unit. The drains are sized to remove condensate from the units during normal and post-accident operation.

A single vaneaxial fan is mounted vertically on top of each cooling unit. The fan motors are of the type that have been tested in accordance with IEEE Report No. NSF/TCS/SC2-A, "Proposed Guide for Qualification Tests for Class 1 Motors Installed within the Containment of Nuclear Fueled Generating Stations." A bypass damper is provided on top of the unit between the chilled water coils and the service water coils. The damper is a positive opening type that will open on a Containment Cooling Actuation Signal (CCAS) when the containment pressure reaches a nominal value of 18.3 psia. The damper allows the steam-air mixture in the containment to bypass the return air duct and the chilled water cooling coils and to go through only the service water coils. The position of the damper is indicated in the control room. The decrease in pressure drop due to the bypassing of the return air ducts and chilled water cooling coils will permit the fan in the unit to handle the necessary quantity of air for cooling purposes at the same speed as required for normal operation.

The containment has four recirculation fans with separate duct systems. The fans take suction from the dome and discharge air to a minimum elevation of 376 feet. The fans are started by the operator with control switches located in the control room. The ducts are provided with duct relief valves, designed in accordance with AAF TR-7101, for protection from pressure transients. The fans, the fan supports and the duct supports were originally designed to meet Seismic Category 1 requirements, however, they are not being maintained as seismic Category 1. The containment recirculation system is not credited in any accident or transient analysis. It is not credited for the hydrogen mixing function in the ANO-2 probabilistic risk assessment (see Section 6.2.5).

ARKANSAS NUCLEAR ONE
UNIT 2

The normal purge supply system for containment accessibility consists of a centrifugal type fan, a hot water heating coil and roll type filter. The purge exhaust system consists of a vaneaxial fan, a roughing filter, a HEPA filter and a charcoal absorber. All components of the purge system, except interior ducts and two isolation valves, are located outside the containment. Ducts are provided inside the containment for adequate distribution. The normal purge system discharge to the atmosphere is monitored for radioactive material and alarmed to prevent release exceeding acceptable limits.

The containment is equipped with four cooling units to cool the Control Element Drive Mechanism (CEDM) shroud. The units are mounted on the removable missile shield at Elevation 426 feet, 6 inches and are ducted down to the shroud. Three units operate continuously during normal conditions with one unit as a standby. The cooling units consist of a fan-coil unit containing a cooling coil and a centrifugal type fan. The units use chilled water and are on the main chilled water system.

The reactor cavity cooling system is designed to take air from the CCS ductwork and supply it around the reactor cavity area. The system is equipped with two vaneaxial type fans. One fan operates continuously with the other as a standby.

Following the postulated DBA, a potentially major source of hydrogen production results from the decomposition of water by radiolysis. The elimination of the hydrogen in the containment is accomplished by two hydrogen recombiners (see Section 6.2.5). Hydrogen samplers indicate the concentration of hydrogen in the containment.

A description of the major system components is given below:

Containment Purge Supply System

Fan (2VSF-2)	
Type	Centrifugal
Capacity, cfm	40,000
Motor	
Type	Induction
Horsepower rating, hp	60
Voltage, V	480
Phase	3
Enclosure	Open drip-proof
Insulation class	B
Heating Coil	
Type	Hot water
Capacity, Btu/hr	2,332,800
Filter	
Type	Automatic roll
Media	Glass fiber blanket
Efficiency, %	85

ARKANSAS NUCLEAR ONE
UNIT 2

Containment Purge Exhaust System

Fan (2VEF-15)

Type	Vaneaxial
Capacity, cfm	40,000

Motor

Type	Induction
Horsepower rating, hp	75
Voltage, V	480
Phase	3
Enclosure	Totally enclosed air over
Insulation class	F

Roughing Filter

Quantity per assembly	21
Rated flow per filter cell, cfm	2,000
Type	Replaceable
Media	Glass fiber
Average efficiency %	80
Rating basis	ASHRAE STD 52-68 Test Method original, current revision for replacements
Rated pressure drop, unloaded, in. W.G.	0.54 original, \leq 0.56 for replacements

HEPA Filter

Quantity per assembly	27
Rated flow per filter cell, cfm	1,500
Type	High efficiency, dry
Media	Glass fiber (waterproof, fire retardant)
Frame	Chromized steel original, T-409 for replacements
Face guards	4 x 4 mesh galvanized hardware cloth
Separator	None
Seal	Neoprene
Efficiency, %	99.97% with 0.3 micron diameter DOP
Rating basis	MIL-STD-282
Rated pressure drop, unloaded, in. W.G.	1.0 original, \leq 1.3 for replacements
Codes of Standards	Health and Safety Bulletin 306 original, ASME AG-1 for replacements UL-586, MIL-F-51079A original, ASME AG-1 for replacements MIL-F-5168D original, ASME AG-1 for replacements MIL-STD-282, ANSI-101.1-1972

ARKANSAS NUCLEAR ONE
UNIT 2

Charcoal Adsorber

Quantity per assembly	2" Vertical Bed
Rated flow per filter cell, cfm	40,000
Type	Activated coconut shell, impregnated
Granular size	10-14 mesh
Ignition temperature	360 °C
Charcoal per cell, lb.	7,560
Maximum moisture content, %	3
Casing material	304 stainless steel
Efficiency, %	99.9% elemental iodine at 25 °C, 70% RH 99.5% methyl iodide at 25 °C, 70% RH 99.9% Freon 112
Rating basis	RDT-M16-1T
Retention time, sec	0.25
Rated pressure drop, inches W.G.	1 ± 0.2
Codes	AEC-DP-1082, July 1967
RTD-M16-1T, June 1972	
AEC-DP-1075	

Containment Cooling Units

Fans (2VSF-1A,B,C&D)

Type	Vaneaxial
Capacity, cfm	27,000

Motor

Type	Induction
Horsepower rating, hp	75
Voltage, V	460
Phase	3
Enclosure	Totally enclosed air over
Insulation class	RN

Normal Cooling Coil

Type	Chilled Water
Number	Four per unit
Tubes per coil	96
Tube type	Finned
Tube material	90-10 cupronickel
Capacity, Btu/hr	1.66 (+6)

Emergency Cooling Coil

See Table 6.2-22

ARKANSAS NUCLEAR ONE
UNIT 2

Containment Recirculating Fans

Fans (2VSF-31A, B, C, & D)

Type	Vaneaxial
Capacity, cfm	5,000
Minimum Flow	4,500

Motors

Type	Induction
Horsepower rating, hp	15
Voltage, V	460
Phase	3
Enclosure	Totally enclosed air over
Insulation class	RN

CEDM Cooling Units

Fans (2VSF-35A, B, C, & D)

Type	Centrifugal
Capacity, cfm	21,050
Static pressure, inches W.G.	8.5
Brake horsepower, bhp	40
RPM	1775

Motors

Type	Induction
Horsepower rating, hp	50
Voltage, V	460
Phase	3
Enclosure	Totally enclosed air over
Insulation class	F

Cooling Coils

Type	Chilled water
Capacity, Btu/hr	729,200

Reactor Cavity Booster Fans

Fans (2VSF-34A&B)

Type	Vaneaxial
Capacity, cfm	12,000

Motors

Type	Induction
Horsepower rating, hp	40
Voltage, V	460
Phase	3
Enclosure	Totally enclosed air over
Insulation class	RN

ARKANSAS NUCLEAR ONE
UNIT 2

9.4.5.3 Safety Evaluation

The CCS, along with the CSS, provides the design heat removal capacity for the containment following a postulated LOCA as described in Section 6.2.2.

A single failure analysis is presented in Section 6.2.2.

The casing design for the cooling units is of a special nature to preclude the possibility of pressure wave collapse as described in Section 6.2.2.2 with quick opening relief valves incorporated into the design to maintain post-accident operability. The relief valves are provided on the unit housing and the supply air ducts. They are designed to relieve the housing when pressure differential exceeds 0.3 psid. The cooling units are located outside the secondary shield at elevations above the water level in the containment at post-accident conditions and below concrete floor slabs. In these locations, the cooling units are protected from missiles, flooding, and from foreign objects falling into or being sucked into the units through the bypass damper. The concrete floor slabs shield the bypass damper openings from the spray water. The condensate is removed in a manner that allows for the required heat removal capacity of the coils to be maintained.

Also, the locations provide shielding so that the design radiation dose level allows maintenance, repair, and inspections to be performed during power operation.

The containment purge system will operate only if required. The containment isolation valves of the purge system will be closed otherwise. The containment isolation functions of these valves are discussed in Section 6.2.4.

9.4.5.4 Inspection and Testing Requirements

Active components of the cooling units will normally be in service. Valving on the cooling coils can be periodically cycled, thus placing the standby coils into service periodically during power operation.

Periodic visual inspections, during plant [shutdown](#), will be performed on the components of all operating systems to detect excessive fan vibration, motor overheating, control malfunctioning, etc.

Operational tests will be performed, during plant shutdown, on all the ESF containment cooling units and related control systems to assure their proper functional capability.

The HEPA filter and charcoal adsorber are tested in the same manner as that furnished for the penetration rooms ventilation system (see Section 6.5.4).

9.4.6 INTAKE STRUCTURE

The Intake Structure Ventilation System utilizes 100 percent outside air. During normal operation, the intake structure can be ventilated by exhaust fans 2VEF-25A&B at 20,000 cfm each in the summer or by 7000 cfm fan 2VEF-32 in the winter. Both vaneaxial fans are located in a missile shield on the roof and exhaust air from the upper level ductwork.

ARKANSAS NUCLEAR ONE
UNIT 2

Exhausted air is replaced by outside air entering a missile protected opening in the roof and fully louvered doors. The fans are switched automatically by indoor thermostats.

Electric unit heaters 2VUE-39 through 2VUE-42 on the upper level and 2VUE-43 through 2VUE-46 on the lower level are set to prevent the rooms from dropping below 60 °F in the winter although the safety-related equipment is qualified down to 6 °F.

During a DBA, engineered safeguard signals (MSIS and SIAS) automatically start both 2VEF-25A & B to ventilate the rooms to maintain safe equipment operating temperature.

Natural convection cooling is credited for events where forced ventilation is not available.

9.4.7 ALTERNATE AC GENERATOR BUILDING

Refer to Section 8.3.3 for the description of the HVAC system for the AAC Generator Building.

ARKANSAS NUCLEAR ONE
UNIT 2

9.5 OTHER AUXILIARY SYSTEMS

9.5.1 FIRE PROTECTION SYSTEM (FPS) - CODES AND STANDARDS

The FPS is designed in accordance with applicable codes and regulations of the State of Arkansas and applicable sections of Title 29, Chapter XVIII, Part 1910 (Occupational Safety and Health Standards) of the Code of Federal Regulations, as set forth in the Federal Register Volume 37, Number 202, and dated October 18, 1972. It is designed in substantial compliance with the requirements of the Nuclear Energy Property Insurance Association (NEPIA), the National Fire Codes of the National Fire Protection Association, General Design Criterion 3 of 10 CFR 50, Appendix A, and NFPA 805, "Performance-Based Standard for Fire Protection for Light Water Reactor Electric Generating Plants, 2001 Edition," in accordance with 10 CFR 50.48(c).

9.5.1.1 Design Bases

Fire protection for ANO-2 was originally designed and installed to satisfy requirements of building codes, and portions of OSHA, NFPA and NEPIA guidelines. This resulted in the use of fire barriers, fire doors, fire and smoke detectors, sprinkler and deluge water systems, and hose stations. As a result of the Browns Ferry fire of March 1975, the ANO fire protection program has been improved. Many changes were made to satisfy NRC criteria in BTP9.5-1 (1976) and other staff positions including 10 CFR 50, Appendix R, Sections G, J, O, and L by reference from G.3. Subsequently, a license amendment request was submitted and approved to transition from Appendix R to the requirements of NFPA 805.

The ANO-2 fire protection program includes the following:

- A. Structures, systems and components important to safety are designed and located to minimize, consistent with other safety requirements, the fire hazard. Noncombustible and heat resistant materials are used wherever practical throughout the unit. This requirement is in compliance with 10 CFR 50, Appendix A, General Design Criterion 3, Fire Protection.
- B. The Fire Protection System (FPS) is designed to minimize the effects of fires on structures, systems and components important to safety, in accordance with 10 CFR 50, Appendix A, General Design Criterion 3, Fire Protection. It is designed to provide adequate capability to fight the fire hazard encountered in all plant areas.
- C. The FPS is designed so that pipe rupture or inadvertent operation does not cause loss of function of plant structures, systems and components important to safety, in compliance with 10 CFR 50, Appendix A, General Design Criterion 3, Fire Protection.
- D. Procedural controls are established to limit the use of combustible materials and to prevent potentially hazardous situations. A description of these controls is contained in Section 9.5.1.5.4.
- E. Hydraulically balanced automatic sprinkler systems, ordinary or extra hazard automatic sprinkler systems, and hydraulically designed automatic water spray systems are installed in all areas with a high fire potential, or where such protection is required due to a high concentration of safe shutdown related cabling.

ARKANSAS NUCLEAR ONE
UNIT 2

- F. Inside hose connections, hose reels, and manual fire-fighting equipment are provided. A fire brigade is staffed and trained in order to provide prompt response to fires and to backup automatic suppression systems. A description of the fire brigade training and staffing is contained in Section 9.5.1.5.2.
- G. Portable fire extinguishers are provided throughout normally accessible areas of the plant in accordance with applicable NFPA, OSHA, property insurer and NRC regulations and recommendations.
- H. Alarms are provided in the control room upon activation of automatic fire protection systems. Fire and smoke monitoring and detection systems are installed in safety-related areas and in ventilation exhaust ductwork. These systems alarm in the control room and, if personnel can be in the vicinity, locally.
- I. In areas where redundant safe shutdown related cabling are in close proximity to each other such that they could both be damaged in a fire, additional protective measures are provided such as thermal barriers, cable coating, or extensive fast-acting directed water spray systems.
- J. A fire protection water supply system jockey pump is provided to minimize cycling of the main fire pumps.

9.5.1.2 System Description

9.5.1.2.1 General Description

The plant fire protection system is comprised of diversified monitoring, detection, alarm, suppression, and extinguishment facilities particularly selected to protect the area or equipment from damage by fire, and include, among other things, the following major features:

- A. Fire protection water supplies, yard mains and hydrants.
- B. Automatic wet sprinklers, hydraulically designed, ordinary and extra hazard.
- C. Deluge and pre-action systems, hydraulically designed.
- D. Water spray systems, hydraulically designed.
- E. Standpipes and hose reels.
- F. Automatic CO₂ extinguishing system and automatic Halon 1301 suppression system.
- G. Portable fire extinguishers.
- H. Fire and smoke monitoring, detection and alarm systems.
- I. Fire barriers, seals, and penetrations.

A simplified schematic is provided in Figure 9.5-1.

Equipment and components that are required for fire protection have been designated as "F Listed" in the controlling plant database (such as equipment database/component database).

ARKANSAS NUCLEAR ONE
UNIT 2

9.5.1.2.2 Component Description

The components of the plant fire protection system are selected to provide comprehensive protection against fire hazards throughout the plant with greatest emphasis placed on the risk of fire in the component's immediate location. The following provides a general description of the plant fire protection systems that may be credited to support a basis for engineering equivalency evaluations (EEEE), defense-in-depth (DID), or risk. Detection and suppression systems required for EEEE, DID, or risk are specifically noted in the Fire Hazards Analysis.

FIRE PROTECTION WATER SUPPLIES, YARD MAINS, AND HYDRANTS - The fire protection water supplies and pumps are shared between the two plants. Water for fire protection service is supplied at 125 psig to the 12-inch cast iron, cement-lined yard main encircling the plant. The fire water pumps, one 2,500 gpm automatic electric motor driven pump and one automatic diesel engine driven pump draw suction from the Dardanelle Reservoir or Emergency Cooling Pond (ECP) for fire protection. The diesel engine driven pump has a day tank containing enough diesel oil for eight hours of operation. The day tank has provisions for refilling from the 185,000 gallon diesel oil bulk storage tank (T25). A jockey pump automatically maintains yard main pressure between 118 and 134 psig. Should pressure fall to 110 psig, the motor driven pump will start automatically. Should system pressure fall to 90 psig, the engine driven pump will start automatically. Both pumps will continue to run until shut off manually. Fire water pump data is provided in Table 9.5-1. The yard main is provided with post indicator valves for sectional control. Two-way hydrants, with individual curb box valves are provided at 250 to 300-foot intervals. Hose houses and equipment (with the exception of fire axes), under guidance contained in NFPA 24, "Standard for the Installation of Private Fire Service Mains and Their Appurtenances," (1995), are provided at each hydrant.

WET PIPE SYSTEMS - Automatic wet sprinklers, hydraulically designed under guidance contained in NFPA 13, "Standard for Installation of Sprinkler Systems," (several editions), are provided for areas under the turbine generator operating floor. The system is hydraulically balanced to provide a 0.30 gpm per square foot density for any, including the most remote, 3,000 square feet of floor area and at the same time be capable of providing a minimum of 0.20 gpm per square foot density for any area up to a maximum of 10,000 square feet. (2CAN087706)

Wet pipe systems, arranged on ordinary hazard pipe schedule with 100 to 130 square feet per head spacing, except as noted above, are provided under guidance contained in NFPA 13, (several editions), to protect the following areas and equipment:

- A. the clean and dirty lube oil storage tanks room;
- B. the storage rooms at Elevations 354 and 335 feet in the turbine building between Columns A2 and B2;
- C. the area under the turbine generator on the side of the turbine pedestal where oil piping runs are located, under all intermediate floors, and all areas to which oil may spread in the event of an oil line break;
- D. heating and boiler room;
- E. secondary chemistry lab;
- F. storage and janitor rooms;

ARKANSAS NUCLEAR ONE
UNIT 2

- G. waste filler storage room;
- H. chemistry laboratory;
- I. secondary sampling system room;
- J. the Pit No. 1 containing the turbine hydraulic oil coolers and reservoir in the turbine building basement Elevation 320 feet;
- K. the area from Column line D to F and Column line 5 to 6, including the area under the platforms for the main feedwater pumps in the turbine building basement;
- L. the turbine generator lube oil reservoir;
- M. hot instrument shop;
- N. decontamination room;
- O. chemical storage area;
- P. storage area Elevation 354 feet in the auxiliary building between Column lines K2 and J2, and 1 and 2.6
- Q. general access area, Elevation 317 feet (east wall area), protection of SWS pump motor cables;
- R. HPSI, LPSI, containment spray pump, Elevation 317 feet (east wall area), protection of SWS pump motor cables; and,
- S. the west wall of general access area 2073, Elevation 354 feet, auxiliary building, in the vicinity of the Emergency Diesel Generator Jacket cooler valves.

The Technical Requirements Manual (TRM) includes a listing of the required sprinkler systems.

The wet-pipe sprinkler systems have fusible heads that activate when exposed to excessive heat. The activation temperature is 160 °F where the ceiling temperature is not expected to exceed 100 °F and 212 °F in rooms where higher temperatures are expected. Flow of water through alarm check valves energizes local alarms and registers an alarm condition on the audible-visual fire annunciator panel in the control room. Once initiated, wet sprinkler system operation is terminated manually by shutting an external gate valve.

DELUGE AND PREACTION SPRINKLER SYSTEMS, AND FIXED WATER SPRAY SYSTEMS - Deluge and Preaction Sprinkler Systems, and Fixed Water Spray Systems are hydraulically designed in accordance with NFPA 13 and NFPA 15, "Standard for Water Spray Fixed Systems for Fire Protection," (several editions). These systems are provided to protect the following equipment:

- A. Deluge Sprinkler Systems
 - 1. The hydrogen seal oil unit;
 - 2. The diesel fuel tank storage vaults

ARKANSAS NUCLEAR ONE
UNIT 2

B. Preaction Systems

1. The emergency diesel generator rooms and associated day tank enclosures;
2. The turbine generator bearings;
3. The four auxiliary building electric penetration rooms;
4. The four ESF penetration areas in the containment; and
5. The Service Water System (SWS) pump motors in the Intake Structure.

C. Fixed Water Spray Systems

1. Cable spreading room;
2. Corridor #2139 (behind control room) manual operation;
3. Corridor 2104, 2105, and 2109 (diesel generator room and lower south electrical penetration room access corridors);
4. The unit auxiliary transformer; ([hydraulically designed to NFPA 15 \(2012\) Code](#))
5. Startup Transformer 3;
6. Main Transformers A, B, C; and
7. The feedwater pumps lube oil reservoir.

The TRM includes a listing of the required sprinkler systems.

Automatic deluge and water spray system operation is initiated by various means for each system. The following summarizes the actuation method for control valves on deluge, preaction, and water spray systems in safety-related areas:

<u>System</u>	<u>Method of Actuation</u>
Cable spreading room spray system	Any one line heat detector and one smoke detector
Corridor 2104, 2105, and 2109 spray system	Any one line heat detector and one smoke detector
Diesel generator rooms preaction	Any one smoke detector and one systems flame detector
Auxiliary building electrical penetration rooms preaction systems	Any one smoke detector
Containment penetration areas preaction system valve	Any one smoke detector and any one heat detector for the outside control; the outside motor operated valve must be actuated from the Control Room

A manual preaction system for the four containment penetration areas is utilized to prevent diluting the borated containment sump inventory with unborated water.

ARKANSAS NUCLEAR ONE
UNIT 2

CO₂ TOTAL FLOODING SYSTEM - The CO₂ total flooding system for the turbine generator exciter housing (not required for compliance with 10 CFR 50.48) is designed under guidance contained in NFPA 12, "Standard on Carbon Dioxide Extinguishing Systems," and NFPA 70, "National Electric Code," (1977). The system is activated automatically in response to heat actuated detectors or manually and will flood the exciter housing with CO₂ to extinguish the fire. The system is designed to provide a 35 percent CO₂ concentration, as required by NEPIA, for the duration of the turbine spindown. The system is connected to and supplied from CO₂ storage tank, T-108 in Unit 1.

HALON 1301 SUPPRESSION SYSTEM - The HALON 1301 Suppression System for the CPC Room (No. 2098-C) is designed under guidance contained in NFPA 12A, "Standard on Halon 1301 Extinguishing Systems," 1985. The system is activated automatically in response to smoke detectors, or manually, and will flood the CPC room with HALON 1301 to extinguish the fire. The system is designed to provide a 5 percent HALON 1301 concentration for a duration of ten minutes. The system is connected to and supplied from HALON storage tanks, 2T-158A and 2T-158B.

STANDPIPES AND HOSE REELS - Wet standpipes for fire hoses are designed under guidance contained in NFPA 14, "Standard of the Installation of Standpipe and Hose Systems," (1983). Standpipes are installed within or adjacent to stair towers and other points not greater than one hundred feet apart in all normally accessible areas in plant buildings. Four-inch standpipes are provided for multiple hose connections and two and one-half inch standpipes are provided for single hose connections. The standpipe hose connections are equipped with one and one-half inch hose valves, reducers, and not more than 100 feet of one and one-half inch woven jacket lined hose. Except in areas of potential electrical fire, adjustable spray nozzles are provided; in areas of electrical fire potential, spray nozzles are the type rated by Underwriter's Laboratories for electrical fires. The hose stations in containment are supplied by standpipes that are dry and normally isolated by valves outside containment. These valves can be opened locally or by remote control from the control room. Wet standpipe supplying hose reels through manually operated hose valves are available for manual control of fire; however, hose stations in containment are dry pipe.

Fire hose station locations are identified in the Fire Zone Summaries Section of the FHA.

PORTABLE FIRE EXTINGUISHERS - Portable fire extinguishers for manual extinguishment of fires are provided throughout normally accessible areas of the plant in accordance with OSHA regulations and NFPA 10, "Standard for Portable Fire Extinguishers," (2007 Edition) and NEPIA recommendations.

FIRE AND SMOKE MONITORING, DETECTION AND ALARM SYSTEM - Fire and smoke monitoring, detection, and alarm is accomplished by ionization (I), infrared flame (F), photoelectric (High Sensitivity Smoke Detectors), air sampling, and heat responsive or heat actuated devices (HAD). Required fire or smoke detectors are listed in the TRM.

Heat and smoke collectors have been installed over the smoke detectors in containment to improve their sensitivity.

The fire and smoke monitoring, detection, and alarm devices are activated by the several stages of fire. Ionization detectors alarm at the presence of invisible combustion gases during the incipient stage of fire. Thermal detectors react to the attainment of a high fixed temperature or rapid rise in ambient temperature (in excess of 15 °F per minute) and provide alarm service as

ARKANSAS NUCLEAR ONE
UNIT 2

well as release service for certain automatic systems as discussed above. The protecto-wire line type heat detectors actuate when the wire reaches 190 °F; the protecto-wire is crisscrossed on top of the cable trays and clamped to alternate sides of the tray every 18 inches. (1CAN037914) Infrared flame detectors respond to the infrared energy and flicker rate generated by a flame. These detectors have a 5-second time delay to minimize false actuations. Air sampling detection systems detect invisible particulates created by thermal degradation during the true incipient or overheating stage of a fire, providing very early warning detection. The selection, placement, and spacing of fire monitoring, detection, and alarm devices is based on the design configuration and employment of the area together with draft condition due to natural or forced ventilation. All fire monitoring, detection and alarm devices are supervised for reliability. Monitoring circuits are provided for each of the electric motor driven and diesel driven fire pumps. Such alarm signals register on the audible-visual fire annunciator panel in the control room.

MANUAL FIRE FIGHTING EQUIPMENT - In addition to hose stations and portable extinguishers, manual fire-fighting equipment has been provided to assist fire brigade fire fighting activities. This equipment includes:

- A. Portable radio communication equipment;
- B. Portable smoke exhaust units with flexible ductwork;
- C. Emergency self-contained breathing apparatus;
- D. Battery powered sealed beam portable lights; and,
- E. Fire-fighting foam and foam nozzle.

The use of this equipment in specific fire areas/zones is contained in the ANO Pre-Fire Plan.

SAFETY EQUIPMENT AREA COMPONENTS - Plant fire protection equipment located in areas containing safety-related equipment is provided with components which have been selected to minimize the risks of inadvertent operation. (Additionally, drip-proof or weather protected motors are installed on safety-related equipment pumps and electrical equipment where feasible to minimize the possibility of damage should fire-fighting operations be required.) Wet pipe sprinkler systems are not used in safety-related system pump rooms.

9.5.1.3 Safety Evaluation

9.5.1.3.1 Design Considerations Minimizing the Potential for Fires

In accordance with NFPA 805, a risk-informed, performance-based analysis was performed that ensures key safety functions (i.e., reactivity control, inventory and pressure control, decay heat removal, and vital auxiliaries) will be maintained in the event of a fire. See the Fire Hazards Analysis for more detail.

The design of the FPS was considered in the analysis as a means to minimize the effects of fires and to provide the capability to extinguish a fire encountered in any of the plant fire hazard areas. The basic fire prevention and protection is achieved by physical separation of systems or by fire barriers between such installations.

ARKANSAS NUCLEAR ONE
UNIT 2

Non-combustible and fire resistant materials are used wherever practical throughout the plant buildings, particularly in areas containing critical portions of the plant such as the containment, control room and components of the ESF. Fire barriers which are adequate for the hazard isolate the lube-oil room, control room, cable spreading room, computer room, emergency diesel generator rooms, battery rooms, auxiliary boiler room, fuel oil storage, and the principal electrical switchgear areas. Fire barriers which are adequate for the hazard also separate the Unit 2 turbine generator from the Unit 1 turbine generator below the operating floor (Elevation 386 feet), Unit 2 auxiliary building from Unit 1 auxiliary building below Elevation 386 feet, and Unit 2 turbine building from Unit 2 auxiliary building in Seismic Category 1 areas. Precast concrete fire barriers separate the three main transformers and the Unit Auxiliary Transformer (UAT) from the Startup Transformer 3 and both the Unit Auxiliary and Startup Transformers 3 from the adjacent turbine building wall. Fire resistant fluid is used in switchgear, transformers, and hydraulic systems inside buildings. The high pressure turbine generator lube oil lines are enclosed within guard piping. The battery rooms are ventilated as described in Section 9.4.2.6 preventing the buildup of explosive mixtures of hydrogen and oxygen.

Combustible loading calculations that provide an estimate of current fire zone/area combustible loading are listed in the corresponding fire zone/area summaries contained in the FHA, SAR Appendix 9B.

The reactor coolant pumps are provided with oil collection drip pans, spray deflectors and drain lines with a holding tank to collect and drain oil that might leak from reactor coolant oil reservoirs, external piping, flanged connections, oil gauges, or filler lines.

In general, redundant components of ESF are installed in locations physically separated from each other in order to prevent fire, should it occur, from spreading from one train to the other. In many cases, redundant ESF components are separated from each other by fire barriers that prevent the spread of fire from one component to its redundant counterpart. Penetrations of fire barriers are protected to a fire rating equivalent to that of the fire barrier or evaluated using the guidance of Generic Letter 86-10. Ventilation penetrations of fire barriers are provided with 3-hour rated dampers or fire doors, when necessary. Doorway penetrations have 3-hour fire rated doors, or have evaluations to confirm they are adequate for the hazards. Cable tray penetrations are protected with fire seals of a design that has passed tests for a 3-hour rating, or have evaluations to confirm they are adequate for the hazards. Piping and conduit penetrations are sealed around the outside. Large conduits are also sealed on the inside. Critical fire doors are locked or provided with electrical supervision to alarm if left opened or they are surveilled to verify they are closed. The prevention of the spread of fire is based on the hazards involved, or to allow time for manual suppression response.

In the unlikely event that the FPS does not function, fire barriers would contain the fire within the hazard area and prevent the spread of fire to other areas.

The potential magnitude of a fire in the control room is limited by the following factors:

- A. Materials used in control room construction are noncombustible.
- B. ESF and RPS control cables and switchboard wiring are constructed of materials that have passed the flame tests described in Insulated Power Cable Engineers Association Publication S-61-502 and National Electric Manufacturers Association Publication WC 5-1961.

ARKANSAS NUCLEAR ONE
UNIT 2

- C. Furniture in the control room is of mostly metal construction.
- D. Combustible supplies such as log books, records, procedures, manuals, etc., are limited to those required for plant operation.
- E. Smoke detectors are provided in the control room.
- F. All areas of the control room are readily accessible for fire extinguishing.
- G. Adequate fire extinguishers are provided, and a hose station is conveniently located near the control room.
- H. The control room is occupied at all times by a qualified person who has been trained in fire extinguishing techniques.

Flammable materials in the control room are distributed to the extent that a fire is unlikely to spread. A fire, if started, will be of such a small magnitude that it can be extinguished by the operator using a hand fire extinguisher. The resulting smoke and vapors will be removed by the control room ventilation system.

Fire in a section of a control board or critical instrument equipment is considered credible; however, due to use of barriers or physical separation, and the limited amount of combustible material in an isolated section, evacuation of the control room will most likely not be required following any fire.

To prevent a fire, or the effects of a fire, originating outside the control room from spreading inside, all wall and floor openings are sealed to preclude the free passage of products of combustion into the room.

9.5.1.3.2 Prevention of Unsafe Conditions

Requirements to ensure that operation of the FPS will not produce conditions unsafe to personnel or detrimental to the equipment protected are as follows:

- A. All areas within the plant served by sprinkler or water spray systems are adequately drained to prevent water flooding.
- B. The shutoff head of the fire pumps (165 psig for the main and diesel fire pumps and 175 psig for the jockey fire pump) is below system static test pressure (200 psig).

Design features to minimize conditions unsafe to personnel are provided as follows:

- A. Rooms and areas relying on manual fire protection are accessible with respect to radiation, such that personnel fighting the fire will not be exposed to radiation in excess of that expected for the zone or area in which the safety equipment is located.
- B. None of the above areas contain enough combustible material to produce heat that would render the room or area inaccessible.

ARKANSAS NUCLEAR ONE
UNIT 2

- C. Thermal anti-sweat insulation, with U.L. listings of 25 for flamespread, 5 for fuel contributed, and 40 for smoke generated, is provided for service to the emergency feedwater pump rooms and switchgear rooms serving ESF. The emergency feedwater pump turbine is covered with an insulated, removable galvanized steel shell.
- D. Insulation, with U.L. listings of 25 for flamespread and for fuel contributed and 50 for smoke generated, is provided for ductwork above the ceiling of the control room.
- E. The ventilation system of the control room is arranged to isolate the control room from the effects of fire or toxic agents originating outside the control room. Penetrations are sealed to preclude the free passage of products of combustion into the room. The control room is equipped with Halon 1211 and carbon dioxide portable fire extinguishers for manual extinguishing of fires in the panels and elsewhere in the control room. Each portable extinguisher has a capacity of 20 pounds of carbon dioxide and are U.L. listed. The total discharge of carbon dioxide from these extinguishers would result in a concentration of approximately one percent carbon dioxide by volume if no ventilation or leakage existed. The ventilation of the control room area will dilute the concentration to undetectable proportions.

Ventilation provided for the control room, computer room and Control Element Drive Mechanism (CEDM) equipment room protects occupants against toxic agents and is discussed in Section 9.4.1. Ventilation for the turbine and auxiliary buildings is discussed in Section 9.4.

- F. The turbine building roof is equipped with U.L. listed automatic smoke and heat vents on the ratio of one square foot of venting area to each 100 square feet of turbine floor area.

9.5.1.3.3 Fire Hazards Analysis

The purpose of the Fire Hazards Analysis (FHA) is to evaluate potential fire hazards and appropriate fire protection systems and features used to mitigate the effects of fire in any plant location.

In order to evaluate the potential effects of major fires on redundant safe shutdown equipment, the plant was divided into fire areas that are separated by 3-hour or adequate for the hazard fire rated barriers. The fire areas were further divided into fire zones by masonry partitions, non-combustible partitions, or clear space. All safety-related circuitry and equipment within each fire zone was analyzed along with the potential fire loading within the zone. The potential for a fire to cause loss of safe shutdown functions was evaluated.

If needed, modifications were made to assure that a fire during any operational mode and plant configuration will not prevent the plant from achieving and maintaining the fuel in a safe and stable condition.

As allowed by 10 CFR 50.48(c), ANO-2 revised the fire protection licensing basis to comply with NFPA 805 (2CAN121202). The NRC issued a Safety Evaluation Report approving the revised license (2CNA021502).

For additional information see SAR Appendix 9B.

ARKANSAS NUCLEAR ONE
UNIT 2

9.5.1.3.4 Seismic Design Criteria

Those portions of the FPS installed within ESF equipment rooms and Corridor No. 2139, west of the Control Room are supported in accordance with Seismic Category 1 requirements. All other portions of the FPS are designed to meet Seismic Category 2.

9.5.1.3.5 Potential Adverse Effects of Fire System Operation

An analysis has been performed to demonstrate that actuation of an auxiliary building sprinkler system or a rupture of a fire water pipe will not result in impairment of redundant safety-related equipment or jeopardize the ability to bring the plant to a safe shutdown condition.

To minimize the likelihood of inadvertent actuation, fire protection actuation circuits are provided with diverse detection methods, such as use of preaction systems requiring heat to open the fusible link heads and then a separate signal from smoke, heat, or flame detectors to actuate the control valve. Water spray systems will require a signal from both of two diverse detection circuits to open the control valve; these systems use smoke detectors and line type heat detectors. For any of these suppression systems, a signal from any one of the detection circuits alarms in the control room so operator action can be taken.

ESF redundant trains are physically separated so that the probability of losing more than one train of an ESF system because of an external event, such as a fire, is reduced.

If a fire were to occur in one diesel generator room, the fire wall between the diesel generators will protect the other diesel generator room. Redundant ESF pumps are located in separate compartments in the auxiliary building. Redundant ESF piping and electrical circuitry are physically separated. Redundant channels of reactor protection circuitry are also physically separated. As noted in Section 9.5.1.3.3, additional protective features were provided to preserve the separation between redundant safety-related cabling.

The design of fire fighting systems is such that their rupture or inadvertent operation will not jeopardize the capability of safety-related structures, systems, and components.

Operation of a section of the auxiliary building sprinkler system will not result in safety equipment impairment, since wet sprinkler system protection is excluded from rooms containing ESF switchgear or safety features pumps and motors. Since each section of the sprinkler system is independently activated, the operation of all or a significantly large group of auxiliary building sprinklers is not a likely event.

Spray shields have been installed in fire zones 2109-U and 2137-I to protect Motor Control Centers (MCCs) 2B51 and 2B61, respectively, from damage due to water spray.

The drainage from the secondary sampling room, chemistry leak system, and waste filler storage area are combined. Additionally, the secondary chemistry lab, storage and janitor room drainage are combined. As a result of these combinations, annunciators indicate the actuation of fire systems for the combined areas.

The potential for degradation of ESF equipment by flooding due to failures in fire water piping was considered in the design of the FPS and in the design of the rooms and buildings containing ESF equipment. Outflows from fire water piping can be stopped by shutting down the [electric](#) fire pump from the control room or the intake structure, [and the diesel fire pump from](#)

ARKANSAS NUCLEAR ONE
UNIT 2

the intake structure. A system failure causing more water loss than the jockey pump could replenish (90 gpm) will be detected in the control room by the annunciation of fire pump actuation without any indication of sprinkler or deluge system actuation.

The indications available to the operators which would indicate a fire main rupture condition are:

- A. operation of one or both fire pumps without a central fire annunciator control panel alarm;
- B. fire main water flow alarm without a central and local fire annunciator control panel alarm; or
- C. operation of auxiliary building sump pumps followed by a high sump level alarm.

Any oil-water mixture in the diesel generator rooms is drained away by the floor drainage system. Back flow preventers are installed in the drain line from each room to prevent the possibility of oil and water flow from one room to the other. The only situations in which automatic or inherent design features might require supplementary operator action to ensure protection of safety-related systems are a fire main rupture in the auxiliary building, or actuation of water spray systems. The following describes how the failure or system actuation would be detected and corrective steps taken by operators:

- A. The auxiliary building fire main is generally routed through the central corridors of each floor of the auxiliary building. If a fire main rupture occurred on any floor at or above grade level, it is anticipated that no substantial water accumulation would occur on these floors since most of the water would drain down the stairwells to below grade. Floor drains further limit water accumulation. The limiting safety-related components located below grade, for which flooding protection must be provided, are the safety injection pump and spray pump motors. Flooding protection is provided by compartmentalization of safety injection pumps and spray pumps into separate rooms to prevent loss of more than one redundant train. The operators will have sufficient time to determine that a fire main rupture has occurred and then isolate the ruptured portion of the fire main before any safety-related system has been degraded below minimum requirements.
- B. Actuation of water sprays will alarm in the control room. The safety concern is the same as for the fire main break; however, considerable time would be required before flooding could occur. The operators will have more than enough time to verify that no fire exists or that the fire has been extinguished and then close the isolation valve to the system.

9.5.1.4 Tests and Inspections

Historical data removed - To review the exact wording, please refer to Section 9.5.1.4 of the FSAR.

9.5.1.4.1 Fire Pumps

The pumps are given periodic operational and performance surveillance tests as required by Appendix 9D.

ARKANSAS NUCLEAR ONE
UNIT 2

9.5.1.4.2 Post-Operational Testing

The plant fire protection system is inspected and tested in accordance with surveillance requirements and frequencies specified in Appendix 9D.

9.5.1.5 Fire Protection Plan

The Arkansas Nuclear One Fire Protection Program was developed to define the organizational responsibilities, procedural controls, fire brigade staffing and training, and the quality assurance provisions that have been established for both Unit 1 and Unit 2. The following sections comprise the elements of the Arkansas Nuclear One Fire Protection Plan.

9.5.1.5.1 DELETED

9.5.1.5.2 Fire Brigade Training

The Arkansas Nuclear One Fire Brigade Training Course assures that the capability to fight potential fires is established and maintained. The program consists of initial classroom instruction outlined in the Plant Procedures and periodic instruction in the form of classroom sessions, fire drills and practice in fire fighting. This training is intended for all Fire Brigade members.

9.5.1.5.2.1 Classroom Instruction

- A. The initial classroom instruction includes the following:
1. The course identifies the various classes of fires and types of combustibles involved, citing examples of specific materials in each class. This identification and location of all such hazards cannot be realistically covered in the initial classroom training. The training does cover some specific hazard locations but its thrust is to generate awareness in the training of what types of materials constitute a hazard. The trainee can then relate this information to materials he sees in the plant during his normal work.
 2. The course covers the types of fire fighting equipment utilized on site and explains the use of each type. The general locations of the equipment are also discussed. Familiarization of the trainees with plant layout including access and egress routes to each area is discussed.
 3. The course discusses or demonstrates the use of available fire-fighting equipment and each trainee has the opportunity to utilize the equipment. The curriculum includes training in fighting structural fires and flammable liquid fires. The principles utilized in planning a fire attack are discussed also. The instruction includes a discussion of utilizing water in combating electrical fires. The proper extinguishing methods and agents to be utilized in combating all four classes of fires are covered and specific examples are cited where appropriate to illustrate techniques.
 4. The course discusses in detail the action to be taken when a fire is discovered, the reporting requirements for fires, the actions to be taken by the individuals or groups on site at the time and provides information on contacting appropriate outside fire-fighting organizations, as outlined in the Plant Procedures.

ARKANSAS NUCLEAR ONE
UNIT 2

5. The proper use of the installed communications equipment is either common knowledge, e.g. telephone use, or is covered during the new employee's initial orientation, e.g. public address system use. The installed plant lighting system is normally on and in the event it is lost, the emergency lights activate automatically. Portable lights are available for firefighting use. The installed ventilation system is operated by qualified operators.

The initial training addresses the principle of ventilation in the fire-fighting. The discussion includes vertical and horizontal ventilation, where to ventilate and distribution of personnel when ventilating.

If the trainee does not routinely receive instruction outside the fire protection course, the following will be presented in the fire protection course:

- a. Hands-on training in the use of self-contained breathing equipment.
- b. Nomenclature, normal use, emergency use, donning, and storage of the breathing equipment.
- c. Changing out of air bottles on breathing equipment.

The course discusses methods of escaping from a fire zone should the air supply become expended.

6. The initial training course discusses the need for organization and coordination in fire-fighting operations. More effectual leadership is developed through presentations on the tactics utilized in fire-fighting. This is done by discussing several different fire scenarios with the trainees once the concepts and considerations of making a fire attack have been covered. The pre-fire plans and procedures are used as a basis.
7. One part of the course consists of a discussion regarding smoke and toxic products of combustion. The use of self-contained breathing apparatus is emphasized.
8. Training is provided in fighting fires in windowless structures such as those that could occur in ANO.
9. Leadership training is provided such that any individual completing the course is capable of taking charge at the scene of the fire.
10. One part of the presentation includes the principles and techniques involved in structural fire-fighting. This includes types of fires -- incipient, free burning, smoldering; thermal balance; heat and smoke movements; types of attack; visibility; need for breathing apparatus; and, tactics. Utilizing the principles learned in this part of the course, the brigade members can apply them to an actual fire inside a structure.

ARKANSAS NUCLEAR ONE
UNIT 2

11. The course covers in detail the provisions of the procedure on fire brigade organization and training in the general fire plan. The provisions of those procedures not related to fire-fighting are not discussed nor are the various pre-fire plans. The periodic training program is the form utilized for familiarization with the pre-fire plan.
 12. The initial fire brigade training course is maintained up-to-date with regard to modifications to the fire-fighting equipment provided and to the installed fire protection systems. Changes in pre-fire plans are covered in the periodic training course.
- B. The instruction is provided by individuals who are knowledgeable, experienced and trained in the subject matter presented.
 - C. The initial training course is intended for Fire Brigade members. No individual will be placed on the Fire Brigade unless he has completed the Initial Classroom Training.
 - D. Training is conducted in accordance with Appendix 9D and will repeat the content of the Fire Brigade Training Course over a 2-year period.

9.5.1.5.2.2 Practice

Practice sessions are held for fire brigade members on the proper method of fighting various types of fires similar to those which could occur in Arkansas Nuclear One. These sessions provide fire brigade members with experience in actual fire extinguishment and the use of emergency breathing apparatus under strenuous conditions. These practice sessions are provided at intervals not exceeding one year for each fire brigade member.

9.5.1.5.2.3 Drills

Fire brigade drills are performed at the plant.

- A. Each drill is assessed for effectiveness by a person knowledgeable in fire-fighting tactics. Among items considered are:
 1. Time elapse from start of drill to announcing of fire, as appropriate.
 2. Time required for minimum expected fire brigade members to respond.
 3. Time required for full fire brigade response.
 4. What equipment was broken out for use at the fire scene.
- B. The drills also include observation of the brigade's performance in a discussion with the brigade members. The observation and discussions serve to provide the evaluator with an indication of each brigade member's knowledge in his role in a fire, conformance with plant procedures, and use of equipment.
- C. The drills include simulated use of appropriate equipment in the areas, and types of fires or conditions are varied from drill to drill such that brigade members are trained in fighting fires in safety-related areas containing significant fire hazards (moderate or

ARKANSAS NUCLEAR ONE
UNIT 2

greater heat loads) with the exception of the Containment Building. The pre-fire plans and procedures are used as a basis for these drills. Table top drills are not utilized in lieu of actual drills.

The situation selected for drills simulates the size and arrangement of a fire which could reasonably occur in the zone selected, allowing for fire development due to the time required to respond, to obtain equipment, and organize for the fire, assuming loss of the automatic protection system within the zone, if any.

- D. Assessment of the Fire Brigade Leader's direction of the fire-fighting effort is performed as described in "B" above.
- E. Fire drills are performed at varying intervals such that all fire brigade members participate in a drill at least semi-annually to meet the requirements of NFPA 600, "Standard for Industrial Fire Brigade." At least one drill per shift is scheduled to be performed on a "back shift." At least one drill per year is unannounced for each shift. At least once per year an attempt is made to hold a drill with the Fire Brigade and the London Fire Department.
- F. The drills conducted at Arkansas Nuclear One are pre-planned to accomplish certain objectives. A critique of each drill is generated by an individual knowledgeable in fire-fighting tactics, and copies are distributed to appropriate management personnel. Drills are normally observed by an individual knowledgeable in fire-fighting tactics with the assistance of other selected personnel as required.

9.5.1.5.2.4 Records

Records of all formal training provided to each fire brigade member are maintained and are available for review.

9.5.1.5.2.5 London Fire Department

Information is available to the London Fire Department for use in their training programs. This information includes basic radiation principles, typical radiation hazards, and precautions to be taken in a fire involving radioactive materials in the plant.

9.5.1.5.3 General Employee Fire Prevention Training

Personnel are instructed on the proper handling of accidental events such as leaks or spills of flammable materials that are related to fire prevention. In addition, all plant contractor personnel are indoctrinated in appropriate administrative procedures which implement the Fire Protection Program and the emergency procedures relative to fire protection.

9.5.1.5.4 Control of Combustibles

Administrative controls minimize the amount of combustibles that a safety-related area may be exposed to. The following discussion describes the controls developed.

- A. Plant Procedures govern the handling, use and storage of combustibles in the plant. They specify the quantities of flammable and combustible liquids which may be stored in various buildings and set requirements regarding the handling, storage, and use of all combustible materials.

ARKANSAS NUCLEAR ONE
UNIT 2

- B. The Plant Procedures contain guidance regarding location, allowable quantities, types of materials allowed, and other factors affecting the transit fire loading in the plant. All work in the NFPA 805 defined power block is reviewed to assess the impact of fire protection by the Cognizant Supervisor and/or Operations. Where any questions arise regarding additional fire protection measures needed, the suitability of materials, storage arrangement, etc., Fire Protection personnel are consulted.
- C. The Plant Procedures contain specific requirements to minimize the fire hazard associated with waste, scrap, rags, oil spills, or combustibles resulting from work activity in the NFPA 805 defined power block. These requirements consider the type of hazards involved and specify one or more of the following actions as appropriate:
 - 1. Timely removal of all waste, debris, scrap, rags, oil spills or other combustibles resulting from the work activity. Removal is effected upon the completion of the work activity or the end of the shift, whichever is sooner (NFPA 805 Section 3.3.1.2(3)).
 - 2. Properly storing the material to minimize the hazard.
 - 3. Insuring that the zone is continually manned or frequently inspected while the hazard is present.
 - 4. Periodic surveillance is made throughout the plant in an effort to control the accumulation of combustibles.
 - 5. Wood used in the plant is treated with a fire retardant or is pressure treated fire retardant lumber or evaluated by Design Engineering/Fire Protection.

9.5.1.5.5 Control of Ignition Sources

9.5.1.5.5.1 Administrative Controls

Administrative Controls are instituted to protect safety-related equipment from fire damage or loss resulting from work involving ignition sources, such as welding, cutting, grinding or open flame work. Controls prohibit the use of open flame or combustion smoke for leak testing. Smoking is prohibited in all Entergy enclosed facilities.

9.5.1.5.5.2 Control of Welding, Cutting, Grinding and Open Flame Work

- A. The Plant Procedures control all cutting, welding, grinding, and other open flame operations. Prior to beginning any cutting, welding, burning, or other open flame operations, the workers must have a Hot Work Permit issued by the Cognizant Supervisor and/or Operations.
- B. The Plant Procedures require that the Cognizant Supervisor and/or Fire Protection personnel be responsible for having the work site inspected prior to work commencement and determining the precautions necessary for the safe performance of the work. Where any questions arise in regard to fire protection, Fire Protection personnel should be contacted.

ARKANSAS NUCLEAR ONE
UNIT 2

The Plant Procedures assure that the following precautions are accomplished:

1. The Cognizant Supervisor and/or Operations assure that all movable combustible material below and within a 35-foot radius of the cutting, welding, grinding, or open flame work is removed, if feasible to do so.
2. Where the above requirements cannot be met, the Cognizant Supervisor and/or Operations assures that all combustible materials within a radius of 35 feet and below the cutting, welding, grinding, or open flame work are protected in accordance with NFPA-51B, "Standard for Fire Protection During Welding, Cutting and Other Hot Work," Item 3-3.2.

The Cognizant Supervisor has the option of requiring a fire watch, if needed, to meet the requirements of NFPA-51B or to satisfy himself that the job can be accomplished without undue hazard to equipment or personnel.

In the event the Cognizant Supervisor determines a fire watch is not needed, concurrence must be obtained from the Shift Manager or Fire Protection personnel.

If the fire watch is deemed necessary by the above paragraph, the duties of that person(s) are defined in accordance with NFPA-51B.

3. In accordance with the provisions of NFPA-51B, the Cognizant Supervisor assures himself that the cutting and welding equipment to be used is in satisfactory operating condition and in good repair.
4. Welding, cutting, grinding, or open flame work to be performed on any pressurized system or any tank, vessel, or piping which may contain residual combustible vapors, is performed in accordance with NFPA-51B. Where appropriate, the use of suitable instrumentation in verifying a safe atmosphere is required.

9.5.1.5.5.3 Leak Testing

The Plant Procedures provide for the strict control of open flame work, regardless of the purpose. Thus, no special procedure for a specific application is needed.

9.5.1.5.5.4 Smoking and Ignition Source Restrictions

Smoking is prohibited in all Entergy enclosed facilities.

9.5.1.5.6 Plant Procedures (Firefighting)

The Plant Procedures cover such items as notification of the fire, fire emergency procedures, and coordination of fire-fighting activities with off-site fire departments. The Plant Procedures identify:

- A. Actions to be taken by individuals discovering the fire, such as, notification of control room, attempt to extinguish fire and actuation of local fire protection systems.
- B. The specific actions required of the control room operator when a fire is reported.
- C. The people required to report to the scene of the fire when a fire is announced.

ARKANSAS NUCLEAR ONE
UNIT 2

- D. Means of immediately alerting the Fire Brigade upon report of a fire or receipt of an alarm on the control room annunciator panel.
- E. Actions to be taken by the Fire Brigade after notification, by the control room, of a fire, including location to assemble.

A set of pre-fire plans is available which provide the Fire Brigade Leader with information, which with his training, allows him to make intelligent fire ground decisions and specify the responsibilities to the fire brigade members for the selection of fire-fighting equipment and transportation to the scene of the fire.

The operation of installed fire protection systems is covered in the Fire Brigade Training Course. Pre-planned strategies, incorporated in the pre-fire plans, are available for all safe shutdown zones and zones presenting a hazard to safe shutdown equipment. Copies of the pre-fire plans are provided in the both unit control rooms, both unit simulators, and the fire brigade lockers. Other copies may be distributed as needed.

F. Pre-fire plans

1. Each plan identifies any hazardous combustibles located in the zone concerned or any combustibles of an unusual nature which might be encountered.
2. The plan lists fire-fighting equipment available in the vicinity of the fire zone and a plan of the area is incorporated to identify their location. No attempt is made to identify such extinguishers thus fitted for the particular material in the area, unless a material with unique extinguishing requirements is present. The fire brigade members receive training in the selection of extinguishing agents for various types of fires. The pre-fire plan should contain no more information than is absolutely necessary. To load it with information with which the plant personnel are quite familiar detracts from the usability of the document.
3. The pre-fire plans provide guidance in selecting the most favorable direction from which to attack fires in the particular zone. Specific instructions, as to which way to attack from, are not provided, due to the many different types of fire situations which may occur in a given zone.

Many factors are considered when providing guidance regarding directions from which to attack the fire. Among these are accessibility, protection of personnel, drainage, ventilation, availability of equipment, potential fire configurations within the zone, etc.

Each pre-fire plan includes a plan view of the fire area on which all means of access and egress are marked. Fire-fighting equipment locations are identified, major items of equipment are shown, and other significant features are depicted.

Where locked doors are involved, they are specifically identified in the pre-fire plans and means of accessing them is specified.

4. The pre-fire plans include the location of the various systems and equipment controls which might be of value during a fire attack.

ARKANSAS NUCLEAR ONE
UNIT 2

5. The pre-fire plans include a listing of exposures which may need to be protected or they are shown on attached arrangement drawings. In addition, the plan discusses hazards which might be present, such as drums of combustible liquids, and state what action is required to negate or minimize the hazards. For example, solvent drums should be kept cool to prevent overpressure rupture or an internal vapor air explosion.
 6. The plant pre-fire plans provide the Fire Brigade Leader with the type of radiological hazards present. Any personnel hazards of toxic nature not included in the combustion gases or ordinary materials are either listed in the pre-fire plans or shown on attached drawings. In addition, the plant utilizes the hazardous materials identification system developed by NFPA, and as described in the NFPA Code 704M, "Standard System for the Identification of the Hazards of Materials for Emergency Response," where significant quantities of toxic materials are normally present.
 7. The pre-fire plans discuss the means available for ventilating the zones concerned.
- G. General instructions for operators and general plant personnel are set forth in the Plant Procedures.
- Instructions for the control room operators have been discussed in "B" above. General plant personnel are required to report to their work center, or if that area is involved, to an alternate assembly area.
- H. The validity of the pre-fire plans is tested by drills and at such drills all aspects of the plan are reviewed with the fire brigade and the discussion of the plan is concluded.
 - I. The Plant Procedures define the organization and outline coordination with outside fire departments.
 - J. The Plant Procedures assure that the responsibilities of each Fire Brigade position corresponds with actions required as outlined in the procedures.
 - K. The Plant Procedures assure that the responsibility of the Fire Brigade to the operation of the plant do not conflict with their responsibilities during a fire emergency.

9.5.1.5.7 Fire Brigade – Organization and Composition

The Fire Brigade consists of five trained individuals established each shift and is onsite 24 hours a day, seven days a week. The Fire Brigade consists of five personnel who have received full training. Upon arrival at the scene, the Fire Brigade Leader assesses the situation, instructs his brigade members and extinguishes the fire. He also reports his assessment to the control room. He requests the control room to supply him assistance if he does not think his team can control the situation. In this event, the control room operator contacts the London Fire Department and any other outside agency he believes should respond.

At the beginning of each shift, a Fire Brigade is selected. Each position of the brigade corresponds to a position title. Specific instructions as to command control, fire hose laying, applying extinguishant, advancing support supplies to the fire, communication with the control room coordination with outside fire department are covered in general in the initial classroom training course. Those fire zones which have pre-fire plans contain specific instruction in the areas above applicable for that specific zone.

ARKANSAS NUCLEAR ONE
UNIT 2

The Fire Brigade Leader communicates directly with the Control Room. Response activities requiring coordination or authorization by Operations are provided in the Plant Procedures and/or Pre-fire Plans.

Each Fire Brigade member, at least once every two years, must satisfactorily complete a physical examination for performing strenuous duties. This requirement is enforced to effectively screen out personnel with heart or respiratory disorders and preclude these personnel from Fire Brigade duties.

The recommendation in NFPA 27 and the standards contained in the associated Appendix were considered in the organization, training, and functioning of the Fire Brigade.

9.5.1.5.8 Quality Assurance Program for Fire Protection

This quality program is to ensure that the fire protection systems for safety-related areas are controlled in accordance with applicable NRC regulations, industrial standards and codes, policies, rules, procedures, and licensing documents. The quality program is implemented through approved procedures. The effectiveness of the fire protection program is verified through surveillances and scheduled audits conducted by the Quality Organization, under the cognizance of the SRC. General requirements for this program are also described in Section G.1 of the QAPM. Personnel performing inspections need not be certified to ANSI N45.2.6, when inspections are performed on equipment not listed on the Q-list.

Employees whose duties and responsibilities are related to this fire protection program at or in support of the nuclear plant are to participate in appropriate training programs to assure that suitable proficiency is achieved and maintained in the work they are performing.

Fire protection training for plant personnel is included as part of industrial safety in the General Employee Training Program. Personnel are periodically retrained in industrial safety in accordance with approved procedures. Personnel assigned to the plant Fire Brigade are to receive additional indoctrination and training to assure their capability to fight fires is established and maintained. The Manager, Training has the overall responsibility for these training programs.

9.5.1.5.8.1 Design Control

Sections B.2 and B.3 of the QAPM are applicable for design control activities pertaining to fire protection systems.

9.5.1.5.8.2 Procurement Document Control

Sections B.4 and B.5 of the QAPM are applicable for procurement control activities pertaining to fire protection systems. When these items are not associated with the Q-list, the procurement document is to include the requirement that items be U.L. listed or F.M. approved for fire protection use, where applicable, in accordance with approved procedures.

9.5.1.5.8.3 Instructions, Procedures, and Drawings

Sections A.1.d and B.1.c of the QAPM are applicable to instructions, procedures and drawings pertaining to fire protection systems.

ARKANSAS NUCLEAR ONE
UNIT 2

9.5.1.5.8.4 Document Control

Section B.14 of the QAPM is applicable for the control of quality program documents related to fire protection.

9.5.1.5.8.5 Control of Purchased Material, Equipment, and Services

The control of purchased fire protection-related materials, equipment, and services is described in Sections B.4 and B.5 of the QAPM, with the following exceptions. For the procurement of fire protection-related items or services not associated with the Q-list, the vendor/contractor qualification criteria (including periodic reassessment of their program) is not required. Non-conformances dispositioned repair or use-as-is by the vendor are to be submitted to and accepted by ANO only when so designated on the procurement document.

9.5.1.5.8.6 Identification and Control of Materials, Parts, and Components

Section B.6 of the QAPM is not applicable to the identification and control of materials, parts and components pertaining to fire protection systems. The identification and control of materials, parts, and components are conducted in accordance with existing procurement and materials management procedures and practices.

9.5.1.5.8.7 Control of Special Processes

Section B.11 of the QAPM is not applicable for the control of special processes, as applicable to fire protection systems. The control of special processes for the maintenance of the fire protection system is performed in accordance with applicable approved procedures and practices.

9.5.1.5.8.8 Inspection

Inspection activities applicable to the fire protection system are described in Section B.12 of the QAPM with the exception of Section G.1, when inspections are performed on equipment not associated with the Q-list. Personnel performing inspections need not be certified to ANSI N45.2.6.

In addition to the provisions of the QAPM, inspections and surveillances are addressed in applicable portions of the SAR for each nuclear unit.

9.5.1.5.8.9 Test Control

A test program is to be established and implemented to ensure that testing is performed and verified on applicable systems and components to demonstrate conformance with design and system readiness requirements. The tests are to be performed in accordance with written test procedures and test results evaluated for conformance to the test objectives.

The control of testing activities is described in Section B.8 of the QAPM. Surveillance testing requirements are identified in the Safety Analysis Report for each nuclear unit.

ARKANSAS NUCLEAR ONE
UNIT 2

9.5.1.5.8.10 Control of Measuring and Test Equipment

Section B.9 of the QAPM is not applicable for the control of measuring and test equipment. No particular measuring and test equipment controls have been identified in BTP-APCSB 9.5-1, Rev. 2. Measuring and test equipment is controlled in accordance with applicable approved procedures and practices.

9.5.1.5.8.11 Handling Storage and Shipping

Section B.7 of the QAPM is not applicable for the handling, storage, and shipping of fire protection-related materials and equipment. Handling, storage, and shipping activities are controlled in accordance with applicable approved procedures and practices.

9.5.1.5.8.12 Inspection, Test, and Operating Status

Measures are established to provide for the identification of items that have satisfactorily passed required inspections and tests and are documented per approved instructions or procedures.

Section B.10 of the QAPM is applicable for identifying the inspection, test, and operating status of the fire protection system.

9.5.1.5.8.13 Nonconforming Material, Parts, and Components

The control of nonconforming materials, parts and components related to the fire protection system is described in Sections A.6, B.6, and B.13 of the QAPM. Vendor non-conformances are to be submitted to ANO only when so designated on the procurement document.

9.5.1.5.8.14 Corrective Actions

A corrective action system is established to ensure that conditions adverse to fire protection, such as failures, malfunctions, deficiencies, deviations, defective components, uncontrolled combustible materials, and non-conformances, are promptly identified, reported, and corrected.

Corrective action activities are controlled as described in Sections A.6 and B.13 of the QAPM with the exception that vendors furnishing fire protection items not associated with the Q-list are not required to be listed on the QSL.

9.5.1.5.8.15 Quality Assurance Records

Records which furnish evidence that the criteria enumerated in this program are being met for activities affecting the fire protection program are to be prepared and maintained as described in Section B.15 of the QAPM.

9.5.2 COMMUNICATION SYSTEMS

The communication systems are composed of internal (in-plant) and external services.

9.5.2.1 Design Basis

Voice and non-voice communication systems are provided for reliable communication during plant startup, operation, shutdown, and maintenance under normal conditions.

ARKANSAS NUCLEAR ONE
UNIT 2

In-plant communications, including radio systems, are provided for use with the remote shutdown panel.

Since none of the communication systems are required for the actuation of any safety-related system, they have all been designed for non-Class 1E service.

9.5.2.2 Description

Communication systems provide audio and visual transmission of information, data exchange, and data gathering. Voice communications include:

- A. In-plant Computerized Branch Exchange (CBX) and public address;
- B. In-plant 4-channel intercommunications and public address;
- C. Commercial telephone;
- D. ANO radio system;
- E. Entergy Dispatcher's Network;
- F. Direct NRC telephone link (NRC ENS Hotline);
- G. Direct NRC telephone link (NRC HPN Hotline).
- H. Industrial two-way radios

Non-voice communications include:

- A. Closed circuit television security system;
- B. Plant evacuation warning system; and,
- C. Plant security intrusion and entry alarms.

The CBX is a three switch, direct dial, private automatic telephone exchange powered by normal non diesel backed power with an 8 hour battery backup supply at each switch. The public address system is powered by a battery charger with battery backup. The following additional features have been incorporated:

- A. Paging public address and page answer lines;
- B. Conference lines; and,
- C. "Meet-me" conference line.

The in-plant 4-channel intercommunication system is composed of local amplifier-loudspeaker-handset combinations. The entire system is solid-state.

The commercial telephone system is supplied by GTE.

ARKANSAS NUCLEAR ONE UNIT 2

Industrial two-way radios are mobile transceivers. Vehicle mounted and hand-held units, along with the base station, operate on FCC approved frequencies. The hand-held two-way units are available for use by the fire brigade. Fixed repeaters have been installed to assure adequate communication between all plant areas using the hand held two-way radios.

The Dispatcher's Network contains a direct line between ANO and the Dispatchers Center in Pine Bluff, Arkansas.

The Plant Evacuation Warning System is composed of electronic sirens and beacons (for areas with high background noise) manually controlled from the control room. The Plant Evacuation Warning System is further discussed in the Arkansas Nuclear One Emergency Plan.

Intrusion and entry alarms, as well as closed circuit television usage, are discussed in the Arkansas Nuclear One Security Plan.

9.5.2.3 Inspection and Testing

Most systems with the exception of the Plant Evacuation Warning System are in daily operation. This allows for testing to ensure that each system is operable. An administrative procedure provides for periodic testing of the Plant Evacuation Warning System in addition to procedures which require testing of the emergency communication equipment.

9.5.3 LIGHTING SYSTEMS

Lighting is provided to furnish illumination levels adequate for the safe performance of operating and maintenance duties. Emergency DC lighting is provided in all operating areas for the safety of personnel in case of the failure of AC power. Figure 8.3-17 shows the single line diagram of the lighting distribution system.

Lighting systems are not required for the safe shutdown of the reactor.

Alternate shutdown lighting is provided to facilitate access and egress to areas that require manual operator action in the event of a control room/cable spreading room fire.

9.5.3.1 Design Bases

Design of the lighting systems for the various buildings and areas of the plant is based on illumination levels that equal or exceed those recommended by the Illuminating Engineering Society for central stations.

Because of restrictions on the use of mercury or its compounds in certain areas, interior lighting of the containment and of the fuel handling area is incandescent except for high pressure sodium vapor lighting in areas which have been specifically evaluated and approved (such as the Spent Fuel Pool). Non-mercury based Light Emitting Diode (LED) lighting has also been evaluated for overhead use in the Spent Fuel Pool area.

ARKANSAS NUCLEAR ONE
UNIT 2

9.5.3.2 System Description

Plant lighting is divided into four main systems which are defined as follows:

- A. Normal: Lighting supplied by the normal plant AC source.
- B. Essential: Lighting which is supplied by the normal plant AC source, but upon failure of this source, it is supplied from a diesel-generator.
- C. Emergency: Lighting supplied by the station batteries following loss of both normal and essential AC lighting.
- D. Alternate Shutdown: Lighting supplied by independent 8 hour battery packs following a loss of normal and essential AC lighting for the control rooms and other essential locations.

Normal and essential lights are mercury vapor, high pressure sodium, fluorescent, light emitting diodes (LEDs), or incandescent and operate at either 480/277-volt AC or 208/120-volt AC. Emergency lights are incandescent and operate at 125-volt DC. Alternate shutdown lighting fixtures are powered by self-contained batteries rated for eight hours of operation.

All lighting raceways are run in separate conduits. Emergency lighting raceway is run separately from the normal lighting raceway.

The emergency lighting supplied by the station batteries is brought into operation by an automatic transfer switch, actuated by the loss of essential AC lighting power. When power becomes available, essential lighting is restored and emergency lighting is discontinued.

Individual 8-hour battery powered emergency lighting units are provided in the control room and other strategic plant locations needed for operation of safe shutdown equipment and access and egress routes thereto. Upon loss of normal and/or essential area lighting power, these DC lighting units will be automatically switched on.

9.5.3.3 Tests and Inspection

AC lighting circuits are normally energized and require no periodic testing. The emergency DC and alternate shutdown lighting system will be inspected and tested periodically to prove the operability of the automatic transfer switch and other components in the system.

9.5.4 DIESEL GENERATOR FUEL OIL STORAGE AND TRANSFER SYSTEM

Figure 9.5-8 shows a schematic diagram of the diesel generator fuel oil storage and transfer system. This system provides adequate storage of diesel fuel and supplies it to the two emergency diesel generators.

9.5.4.1 Design Bases

The diesel generator fuel oil storage and transfer system is designed to provide independent sources of fuel oil for each emergency diesel generator.

ARKANSAS NUCLEAR ONE
UNIT 2

The capacity of the above ground bulk storage tank was based on the quantity of fuel oil required for a Unit 1 startup. The startup boiler will use about 50,000 gallons of fuel oil per day for a period lasting from one to four days during startup of Unit 1 following a planned shutdown. The capacity of the bulk storage tank (185,000 gallons) plus the capacity of the Unit 1 startup boiler day tank (15,200 gallons) provides enough fuel oil for four days operation of the startup boiler. Fuel delivery to the plant site will be scheduled to replenish fuel consumed during this operation.

A fuel capacity of at least 22,500 gallons for one underground Emergency Storage Tank plus a fuel capacity of at least 520 gallons for one diesel day tank will be sufficient for not less than three and one half days of operation of one Emergency Diesel Generator loaded to its maximum continuous rating. Thus, in accordance with ANSI 59.51 and NRC Regulatory Guide 1.137, at least a seven day total diesel fuel inventory will be available onsite in the emergency storage tanks for operation of one Emergency Diesel Generator loaded to its maximum continuous rating during loss of electric power conditions. Each diesel generator day tank has a low level alarm capacity sufficient to power an Emergency Diesel Generator at 110% of its maximum continuous load for a period in excess of 60 minutes.

Under maximum flood conditions (no nuclear accident), the plant will be shut down and one diesel generator loaded to about 50 percent of its rating. Therefore, the emergency fuel oil capacity is expected to last for at least 7 days of operation, even if one emergency storage tank is considered unavailable. Because station power during a flood event can be supplied by either an EDG or the Startup #2 Transformer, any single failure assumed would not prevent the unit from meeting post-flood safe shutdown requirements. Emphasis has been placed on rigging emergency off-site power prior to the flood reaching the site as described in Section 8.2.1.4. After the Design Basis Earthquake (DBE) and a simultaneous nuclear accident, three and one-half days emergency supply of diesel oil is assumed to be available even in the unlikely event one emergency storage tank has failed. Within this period, additional fuel could be delivered to the plant site by any one of three methods: truck delivery, rail car delivery or delivery by barge from the river. In the highly unlikely event that all three of these normal supply routes are unavailable because of the earthquake, fuel could be airlifted to the plant site via helicopter. Based on conservative estimates from the Corps of Engineers it is expected that the probable maximum flood could be above plant grade (Elevation 353 feet) for two to five days.

9.5.4.2 System Description

The system consists of the following components:

- A. two 22,500-gallon underground storage tanks (2T57A & B);
- B. four fuel oil transfer pumps (P16A & B and 2P16A & B);
- C. two 550-gallon fuel oil day tanks (2T30A & B);
- D. one 185,000-gallon bulk storage tank (T25);
- E. associated piping, valves and instrumentation; and,
- F. hose cross connection (2-inch) and valves.

All of the above components except the bulk storage tank and piping from the bulk storage tank to the underground storage tanks meet Seismic Category 1 requirements.

ARKANSAS NUCLEAR ONE
UNIT 2

The two storage tanks are located in underground vaults in the plant yard and the two smaller "day tanks" are located adjacent to the diesel generators in the auxiliary building. The emergency storage tank inventory is replenished from the conventional above-ground fuel oil bulk storage tank by gravity feed through a buried pipeline.

All other systems requiring fuel oil such as the plant heating boilers and the Unit 1 startup boiler take oil directly from the common fuel oil bulk storage tank. Thus, the inventory of diesel fuel oil in the emergency diesel fuel tanks is unaffected by other demands on the fuel oil bulk storage tank.

Because the bulk storage tank is not an essential fuel supply to the diesels, it is not designed to tornado, flood or single failure criteria.

The emergency storage tank vaults are of Seismic Category 1 design and, in addition, have been specifically designed to resist the loadings imposed by the probable maximum flood. This includes anchoring the vault to rock and providing ventilation openings above flood elevation. The outside door is of watertight construction.

The emergency storage tank vaults are equipped with a water spray fire protection system which is described in Section 9.5.1. In addition, each storage tank vault is separated from the other vault by 3-hour fire rated walls and doors. The volume of the vault below the door elevation is sufficient to contain the full inventory of oil in the unlikely event of a ruptured fuel tank. Each emergency storage tank vault has a sump which in turn is connected to a main sump equipped with a sump pump. The two Unit 2 sumps are kept isolated from the main sump by normally closed valves. Level switches in the sumps annunciate a high level alarm in the control room.

Each emergency storage tank is gravity connected to a transfer pump located in the underground vault. Strainers are provided at the pump inlet to prevent particulate matter from entering the pump. The transfer pumps discharge to the diesel "day tanks" through buried pipelines. The diesel fuel oil transfer piping from the emergency storage tanks to the day tanks is designed to ANSI B31.1.0 and is in accordance with the additional requirements of Seismic Category 1 and the Quality Assurance Program Manual (QAPM). The transfer pumps, 2P16A and 2P16B, are cross-connected at their suctions and discharges with two normally closed valves and are each capable of drawing diesel oil from either emergency storage tank and supplying it to either diesel engine. An additional modification was made based upon the Appendix R review. In performing the Appendix R analysis and review of July 1982, it was revealed that "red" and "green" power cables for the unit pumps are routed together in a manner which was not in compliance with Appendix R separation requirements. Therefore, a cross connection of the Unit 1 and Unit 2 transfer pumps was made in order that pumps from either unit may supply fuel oil to the diesel generator of the other unit. The system is depicted in FSAR Figure 9.5-8. Each emergency storage tank is vented by a Seismic Category 1 vent pipe with a flame arrester which penetrates that portion of the roof which is above the maximum flood elevation. To prevent oil from flowing over the emergency tank vents before the bulk storage tank T25 is completely filled, the vents on emergency tanks 2T57A and B were raised three feet in elevation (from Elevation 380 to 383 feet). This places them above the T25 overflow line. A high level alarm is provided on bulk storage tank T25.

The two emergency diesel generator fuel oil day tanks are located in the auxiliary building at Elevation 369 feet. Each day tank and its associated diesel generator unit are located in Seismic Category 1 enclosures and are isolated from the other diesel generator unit and

ARKANSAS NUCLEAR ONE
UNIT 2

associated equipment by a fire wall. Each day tank is also isolated from all other associated equipment by a fireproof enclosure and is equipped with water spray fire protection and fire and smoke detection systems as described in Section 9.5.1. The atmospheric vents on the day tanks are fitted with flame arresters to prevent ignition of the fuel oil from an outside spark. The rotary fuel pump transfers the fuel from the day tank, through a duplex filter to further eliminate particulates, to the fuel metering injection pumps.

The day tanks can be supplied with diesel oil from the storage tanks by either manual or automatic operation of the transfer pumps. For the EDG 2K4A fuel transfer system, in the automatic mode of operation, level switches 2LS-2801-1 and 2LS-2804-1 will start fuel oil transfer pump 2P16A. Level switch 2LS-2804-1 will also open the fuel oil supply valve, 2SV-2802-1, on low level in fuel oil day tank 2T30A. Level switch 2LIS-2801-1 will close and activate an alarm on low level if the day tank level fails to rise. As an additional safeguard, an alarm will be activated if either of the two transfer pump discharge valves are closed while the pump is running. Level switch 2LS-2801-1 will stop the transfer pump and level switch 2LS-2804-1 will close the supply valve on high level in the day tank thus preventing a day tank overflow due to a single failure of a level switch. Level switch 2LS-2804-1 is wired in series with level switch 2LS-2801-1 in the automatic operation mode circuitry to provide a means to stop the transfer pump in the event that 2LS-2801-1 fails to operate. This provides backup protection against the transfer pump's operating with high day tank level. Similar controls are provided on the fuel oil transfer system for EDG 2K4B.

Further pertaining to EDG 2K4A, should pump 2P16A still fail to stop, a high-high level signal from 2LIS-2801-1 will activate a high-high level alarm. Level switch 2LIS-2800 closes and activates a low level alarm on low fuel oil level in underground storage tank 2T57A. Similar controls are provided on the fuel oil storage and transfer systems for EDG 2K4B.

All components of the electrical system provided for the diesel fuel oil system are Class 1E electric systems as described in Section 8.3. Electric power to the diesel fuel oil transfer pump (2P16A) and solenoid valve (2SV-2802-1) associated with the underground storage tank serving the 2K4A diesel generator is supplied from ESF Channel 1. Similarly, electric power to pump 2P16B and solenoid valve 2SV-2822-2 associated with the tank serving the 2K4B diesel generator is supplied from ESF Channel 2. ESF Channels 1 and 2 power supplies are accessible to their corresponding diesel generator.

The diesel fuel oil system is required to supply acceptable quality diesel oil to the emergency diesel generators in an emergency condition for safe shutdown of the plant.

Procedures have been developed to address the use of the Unit 1 transfer pumps, the materials required for the cross-connection, the method of performing the cross connection, including the alignment of valves, operation of the system to supply fuel to the diesel day tanks of either unit.

9.5.4.3 Design Evaluation

The diesel generator fuel oil storage and transfer system provides two independent sources of fuel oil supply. The pumps, tanks, and piping are so arranged that malfunction or failure of either an active or passive component in one source of supply will not impair the ability of the other source to supply fuel oil. Electrical power is supplied through two separate ESF channels, so that a single failure will not result in loss of both independent sources of fuel oil. The system therefore meets the requirements of the single failure criteria.

ARKANSAS NUCLEAR ONE
UNIT 2

The system is designed to withstand environmental design conditions. The underground storage tanks are designed for outdoor, underground installation with a temperature range of 30 to 100 °F. The diesel generator day tanks are designed for indoor, above-ground installation with an ambient temperature range of 60 to 105 °F. The diesel oil transfer pumps are designed to handle oil in the temperature range 40 to 100 °F. The exterior surfaces of the underground storage tanks are commercially sand blasted, primed and finish painted to prevent corrosion. The interior surfaces of the tank up to 18 inches from the bottom are solvent cleaned, sand blasted and coated with two coats of polyamide cured coaltar epoxy at eight mils minimum dry film thickness per coat. The exterior surface of the underground fuel oil piping is cleaned by wire brushing, coated with a primer, and wrapped with coal tar tape in the field.

9.5.4.4 Tests and Inspection

Historical data removed - To review the exact wording, please refer to Section 9.5.4.4 of the FSAR.

The underground storage tanks are stamped in accordance with ASME Code, Section VIII. During periodic testing of the diesel generators proper operation of the fuel system is monitored as required by the Technical Specifications. Switches will also be exercised to confirm annunciation features.

9.5.5 DIESEL GENERATOR COOLING WATER SYSTEM

The diesel generator cooling water systems are shown in Figure 9.5-8.

9.5.5.1 Design Bases

The diesel generator jacket cooling water system is a closed loop system designed to supply clean water to the diesel engines in order to maintain proper operating temperatures of the cylinders and pistons. The diesel generator service water cooling system is designed to carry away waste heat from the jacket cooling water, lubricating oil, and the scavenging air.

9.5.5.2 System Description

The diesel generator jacket cooling water system consists of the following Seismic Category 1 equipment:

- A. jacket cooling water expansion tank;
- B. jacket cooling water circulating pump;
- C. jacket cooling water heat exchanger;
- D. electric standby heater;
- E. standby circulating pump; and,
- F. piping, valves, and instrumentation.

The jacket cooling water circulating pump is an engine driven centrifugal type water pump designed to provide cooling water flow at all engine loadings. The pump discharge flow is directed into the engine cooling passages. Each cylinder liner is fitted with a forged steel water jacket surrounding a symmetrical liner, and the liner adjacent to the jacket is machined to

ARKANSAS NUCLEAR ONE
UNIT 2

provide circumferential and axial passages through which the cooling water flows. After passage through the engine, the cooling water is collected in a cooling water header and is then directed to a thermostatic bypass valve where a portion of the flow is diverted through the shell side of the jacket cooling water heat exchanger in order to maintain the required jacket water operating temperature. The bypass valve is of fail-safe type and will close on a malfunction, thereby providing full cooling capacity. The two flow paths again join at the heat exchanger outlet and flow back to the pump suction.

A connection to the cooling water circuit between the jacket water heat exchanger outlet and the pump suction leads to an expansion tank. The expansion tank compensates for changes in jacket cooling water volume as the engine heats up and cools down. The expansion tank has provisions for filling and corrosion inhibitor addition. Makeup water to the expansion tank is provided by the condensate transfer pumps (2P9A/B) which take suction from the condensate storage tanks (2T41A/B). The makeup water system is designed as Seismic Category 2 up to the expansion tank isolation valve. The makeup water pipe, including the isolation valve, to the expansion tank is designed as Seismic Category 1. The expansion tank is vented to atmosphere and is provided with local level indication and a low level alarm which annunciates at the diesel generator control panel and initiates a common alarm in the control room. The expansion tank is filled as required during routine testing of diesel.

The diesel engine Cooling Water (CW) system is designed as a leak tight system. The engine CW pump is provided with spring loaded carbon seals which are designed not to leak. Shop tests at full rated load continuous of similar model diesels as those provided at Unit 2 indicate no makeup water to the expansion tank is required due to leakage. Calculations indicate the evaporation loss from the CW expansion tank will be approximately seven gallons in seven days with the diesel operating at full rated load continuously. Therefore, the diesel can be operated for seven days without makeup to the CW expansion tank.

During periods of standby, the jacket cooling water and water passages are maintained at a warm "ready" condition by the electric standby heater and the motor driven standby circulating pump. Operation of the heater and standby circulating pump are not required under emergency start conditions.

The diesel generator service water cooling system consists of the following Seismic Category 1 equipment:

- A. jacket cooling water heat exchanger;
- B. lubricating oil heat exchanger; and,
- C. air cooler heat exchanger.

The above three heat exchangers are mounted on the diesel generator skid and are piped with the tube sides (service water) in series. Service water enters the air cooler heat exchanger first, then flows through the lube oil cooler and finally through the jacket cooling water heat exchanger, carrying away the waste heat from the three respective engine systems. The SWS is described in Section 9.2.1.

ARKANSAS NUCLEAR ONE
UNIT 2

9.5.5.3 Design Evaluation

The diesel generator cooling water systems have adequate capability to carry away the waste heat from the diesel generator units under all combinations of engine loadings and ambient conditions.

The jacket cooling water system has a sufficient volume of water to allow the engine to run at full load for three minutes without raw water cooling available, thus assuring that no engine damage will occur during the time interval between receipt of the Safety Injection Actuation Signal (SIAS) and the start of the service water pumps which supply the diesel generator cooling water.

Corrosion of the jacket cooling water system is reduced by using demineralized water from the PMU and by the addition of an inhibitor. The coolant space in each cylinder liner is coated after assembly at the factory with a Heresite coating to further prevent corrosion and to extend the life of the liner assembly. The engine is designed such that no water is in contact with the fabricated cylinder block, thus eliminating block damage from corrosion or freezing. All parts in the engine system in contact with the jacket coolant are readily renewable to facilitate maintenance and repair.

Corrosion of the service water cooling system is precluded by using Admiralty B-111 tubes in the three diesel generator skid mounted service water cooled heat exchangers. The service water is passed through traveling screens and 3/16-inch mesh basket strainers before reaching the heat exchangers, thus reducing the possibility of tube plugging by debris in the water.

If a failure occurs in the cooling water system of one diesel generator, the other diesel generator is available and is capable of bringing the plant to a safe shutdown in an emergency condition. There are no interconnections between the cooling water systems of the two diesel generators.

9.5.5.4 Tests and Inspection

The lube oil heat exchanger, air cooler heat exchanger, and the jacket cooling water heat exchanger are all built, tested, and stamped in accordance with ASME Section VIII. All skid mounted cooling water piping is fabricated in accordance with the manufacturer's standard procedures, conforming generally with American Welding Society (AWS) requirements. In addition, the entire skid mounted cooling water system meets Seismic Category 1 requirements and is functionally tested in the manufacturer's factory prior to shipment. During periodic testing of the diesel generator, temperature and pressure readings are available to monitor proper operation of the cooling water system.

9.5.5.5 Instrumentation Applications

The following local alarm points are provided in the cooling water systems of each diesel generator:

- A. jacket water low temperature;
- B. jacket water level low;
- C. jacket water high temperature;
- D. jacket water low pressure; and
- E. service water low pressure.

ARKANSAS NUCLEAR ONE
UNIT 2

Operation of any one of the above A., B., or D. local alarms activates an "Engine/Gen Trouble" alarm in the control room. Operation of either the C. or E. local alarm activates a "Potential Engine Failure" alarm in the control room. In addition, pressure and temperature indicating devices are provided for local indication. Local flow indicating devices are provided for periodic surveillance testing and service water flow balancing.

9.5.6 DIESEL GENERATOR STARTING SYSTEM

The diesel generator air starting system is shown in Figure 9.5-8.

9.5.6.1 Design Bases

The diesel generator starting system is designed to store and supply an adequate source of compressed air to the diesel engine cylinders for fast, reliable cranking and starting under planned or emergency start conditions.

9.5.6.2 System Description

The starting system for each diesel generator consists of the following Seismic Category 1 components:

- A. Two electric motor driven starting air compressors;
- B. Two starting air receivers;
- C. Two starting air strainers;
- D. Two solenoid air admission valves;
- E. Pilot air distributor valve;
- F. Twelve cylinder air start valves; and,
- G. Associated piping, valves, and instrumentation.

The starting air compressors, receivers, and associated accessories are located in the auxiliary building at Elevation 369 feet. Each starting system and its associated diesel generator unit are located in a Seismic Category 1 enclosure and are isolated from the other diesel generator unit and associated equipment by a fire and missile proof wall.

The starting air compressors take suction from the room air through compressor mounted air filters and each compressor discharges to its respective air receiver through a Seismic Category 1 pipe line. The air receivers are maintained at a pressure above 225 psig by automatic starting of the compressor at 225 psig receiver pressure and maintained below the receiver's relief setpoint of 250 psig. The compressor air inlet valves are held open on compressor motor starting by compressed air from the receivers until the motor is up to rated speed. Unloaded motor starting assures fast attainment of rated speed and prolongs compressor motor life.

Each air receiver is equipped with a safety valve, pressure indicator, drain valve, low pressure alarm, and shutoff valves. Either air receiver or compressor can be removed from service, repaired, or replaced without affecting the other, parallel, air supply system.

ARKANSAS NUCLEAR ONE
UNIT 2

The air receivers are connected to each engine system via two parallel, Seismic Category 1 pipe lines fitted with a flexible hose for vibration isolation, stop valve, check valve, strainer, and air start solenoid valve. On receipt of a starting signal, both solenoid valves open simultaneously, delivering air to the timed pilot air distributor valve and the individual air start valves located in each cylinder. Pilot air delivered by the timed distributor valve opens the air start valves in proper sequence, admitting starting air directly into the engine cylinders for cranking. This air-over-piston starting system eliminates the need for starting air motors. Adequate cranking effort is obtained with only six air valves in the 12-cylinder engine operating; the additional six valves provide increased starting reliability.

Provisions for manual and automatic starting are provided. Manual operation from the control room (remote) or the diesel generator control panel (local) is possible, with the choice of operating location controlled by a "Local-Remote" selector switch located on the generator control panel. Placing the selector switch in the "Local" mode will permit manual starting of the unit from the local position only, and this mode is annunciated in the control room. With the selector switch in the "Remote" mode, manual starting can be accomplished from the control room only. Both diesel generators will start automatically on receipt of an Engineered Safety Features Actuation Signal (ESFAS) or by an undervoltage relay on the respective 4160-volt ESF bus, regardless of the position of the "Local-Remote" selector switch. In addition to the "Local-Remote" selector switch, there is a local, key operated, 3-position "Start-Auto-Lockout" control switch located on the diesel generator control panel. The key is removable in the "Auto" position only and turning the switch to the "Lockout" position is not possible unless the key is inserted. When in the "Lockout" mode, neither manual nor automatic starting of the diesel generator is possible. This mode is used only during engine or generator maintenance operations. Placing the selector switch in the "Lockout" position initiates an alarm in the control room to indicate that the diesel generator is not available. Additional information on this onsite power system is contained in Section 8.3.

9.5.6.3 Design Evaluation

Each diesel generator is equipped with two air compressors, air receivers, and solenoid air admission valves, either set of which is capable of starting the engine. Each of the two air receivers is sized to store enough air to crank and start the engine five times for the normal cranking duration without the use of the air compressors. All operations necessary to maintain the starting systems in a ready condition are entirely automatic and self-initiated. Sufficient instrumentation is provided to monitor the operation and status of each starting system. A means for local and remote starting and stopping are provided, with automatic starting capability provided regardless of previous status except when in "Lockout" position. When a SIAS signal is present, a running diesel generator can only be shut down locally. The system is designed to start the engine in such a time that the diesel generator unit can reach rated speed and voltage in a maximum of 15 seconds.

The starting system of each individual diesel generator is not required to meet the single failure criterion, as the two emergency diesel generators are redundant. If a failure occurs in the starting system of one diesel generator, the other diesel generator is available and is capable of bringing the plant to a safe shutdown in an emergency condition. There are no interconnections between the starting systems of the two diesel generators.

ARKANSAS NUCLEAR ONE
UNIT 2

The diesel is designed to be accelerated to 150-180 rpm by the Air Starting System in less than two to five seconds at which time diesel ignition will commence. If the diesel is not up to a speed of 250 rpm in 10 seconds, the diesel will be shut down by the start failure relay (if both crank limit timers time out) and start failure will alarm in the control room.

The start failure setting is based on previous tests performed on similar diesels wherein it has been determined that if the diesel has not reached a speed of 250 rpm in 10 seconds then the diesel will not start with further cranking by the air start system.

It has been determined that sufficient reserve starting air capacity for cranking and starting the diesel two additional times will be available if the diesel is shutdown after 10 seconds of cranking. This will allow an operator to correct any malfunction, such as resetting the overspeed trip mechanism, and allow two additional attempts at starting the diesel.

The overspeed mechanism is mechanically linked with the fuel cut-out lever. An overspeed trip condition as a result of actual overspeeding of the engine will engage the overspeed trip mechanism which will close the fuel racks and stop the engine. This condition will annunciate and light the "Overspeed Trip" window on the generator local control panel and at the same time annunciate and light the control room "Engine/Exciter Shutdown" window.

The alarm horn will sound and the alarm window will flash until acknowledged. Then the alarm horn will silence and the alarm window will be lit steady. The alarm window will remain lit until the alarms are reset at the local EDG panel.

Low lube oil pressure will shut down the diesel through the shutdown relay if two out of three of the low lube oil pressure switches are actuated.

9.5.6.4 Tests and Inspection

All components in the emergency diesel generator starting systems meet Seismic Category 1 requirements. The air receivers are fabricated, tested, and stamped in accordance with Section VIII of the ASME Boiler and Pressure Vessel Code, and all piping is fabricated and tested in accordance with the manufacturer's standards, conforming to American Welding Society (AWS) requirements.

The diesel generator starting system is required to operate in an emergency condition for safe shutdown of the plant.

9.5.6.5 Instrumentation Applications

In addition to the instruments and controls discussed in Section 9.5.6.2, the following items are provided in the starting systems.

- A. Starting air low pressure alarms for each air receiver and compressor inoperable alarms located in the local annunciator panel. Operation of any one initiates a "Start Air Trouble" alarm in the control room.
- B. Diesel Engine "Start Failure" alarm in the control room which operates on any starting malfunction.
- C. Diesel Generator "Auto Start Command" alarm in the control room.

9.5.7 DIESEL GENERATOR LUBRICATION SYSTEM

The lubricating oil system for the diesel generators is shown in Figure 9.5-8.

9.5.7.1 Design Bases

The diesel generator lubrication system is designed to supply lubricating oil to the diesel generator main bearings, thrust bearings, wrist pins, engine accessories, and the underside of the piston crown for piston cooling.

9.5.7.2 System Description

The diesel generator lubrication system consists of the following Seismic Category 1 equipment:

- A. lube oil strainer;
- B. lube oil cooler;
- C. lube oil filter;
- D. circulating oil pump;
- E. pre-lube pump;
- F. standby lube oil circulation pump;
- G. electric standby heater; and,
- H. piping, valves, and instrumentation.

The main circulating oil pump is an engine driven rotary gear type pump which maintains the required oil flow while the engine is running. The pump takes suction from the engine sump through a suction strainer and discharges through the full flow oil filter to the thermostatic bypass valve, where a portion of the oil flow is directed through the shell side of the lube oil cooler to maintain the required oil operating temperature. After the two flow paths again join at the cooler outlet, the lube oil passes through the lube oil strainer and into the engine main oil headers for distribution to the various engine components. A portion of the lube oil is circulated to the underside of the piston crown through drilled passages in the connecting rods to assist in cooling of the pistons.

During periods of standby, the lubricating oil is maintained at a constant elevated temperature by the electric standby heater and is circulated by the motor driven standby circulating pump to assure optimum viscosity and lubricating properties.

The diesel engines are periodically tested in accordance with Technical Specification requirements. To reduce wear on moving parts which would occur during engine startup before oil pressure is established, a motor-driven pre-lube pump is provided. Before a planned engine startup, the pump is manually switched on for the manufacturer recommended time to establish oil flow and pressure prior to engine cranking. Occasional EDG starts without pre-lube (i.e., actual demand tests) can be tolerated only on a limited basis. Pre-lube pump operation is not required under emergency start conditions.

ARKANSAS NUCLEAR ONE
UNIT 2

9.5.7.3 Design Evaluation

The diesel generator lubrication systems have sufficient capacity to store, purify, and supply lubricating oil for the emergency diesel generators. Standby heaters and preoperational lube oil pumps are provided to ensure optimum startup conditions and reduce wearing of moving parts during engine exercising startups. The lubrication system of each individual diesel generator is not required to meet the single failure criterion as the two emergency diesel generators are redundant. If a failure occurs in the lubrication system of one diesel generator, the other diesel generator is available and is capable of bringing the plant to a safe shutdown in an emergency condition. There are no interconnections between the lubrication systems of the two diesel generators.

9.5.7.4 Tests and Inspection

The lubricating oil cooler, lubricating oil filter, lubricating oil strainer, and lubricating oil electric standby heater are built, tested, and stamped in accordance with ASME Section VIII. The lube oil piping is fabricated in accordance with the manufacturer's standard procedures. In addition, the entire lubricating oil system meets Seismic Category 1 requirements and is functionally tested in the manufacturer's factory prior to shipment.

9.5.7.5 Instrumentation Applications

The lubrication system is equipped with three low lube oil pressure switches; operation of any one sounds local and control room alarms; and, operation of any two shuts the engine down. Additional local alarms include high temperature, low temperature, and high crankcase pressure. Operation of the high temperature or high crankcase pressure alarm activates a "Potential Engine Failure" alarm in the control room. Operation of the low temperature alarm activates an "Engine/Gen Trouble" alarm in the control room.

Pressure and temperature indicating devices are provided for local indication, and may be used to confirm proper operation of the lube oil system during periodic testing of the diesel generator.

9.5.8 SEISMIC CATEGORY 1 VALVES

Information concerning all Seismic Category 1 valves is maintained current in the ANO Component Data Base.

9.5.9 DIESEL GENERATOR COMBUSTION AIR INTAKE AND EXHAUST SYSTEM

9.5.9.1 Design Bases

The diesel generator combustion air intake and exhaust system is designed to supply adequate combustion air to the diesel generator and exhaust the combustion products to the atmosphere.

9.5.9.2 System Description

Each diesel generator takes suction from the diesel generator room for its combustion air. The air is filtered at the engine before entering the combustion chambers. Intake air is drawn into the room through a louvered opening at the top of the room. The combustion products are exhausted by a muffler system and exhaust piping to the atmosphere at Elevation 425 feet.

ARKANSAS NUCLEAR ONE
UNIT 2

9.5.9.3 Design Evaluation

The combustion air intake into the room is designed to Seismic Category 1 requirements, protected from tornado generated missiles, and shielded from direct wind, rain or snow.

The Combustion Products Exhaust System is also designed to Seismic Category 1 requirements. Failure of any of the exhaust system fans and the diesel generator room high temperature will actuate a "2DG1 RM TEMP HI/FAN TROUBLE" alarm in the control room. The flue gases are exhausted at an elevation 30 feet above the air intake at a sufficiently high velocity (116 feet per second) to avoid introduction of exhaust gases into the air intake. The sodium bromide/sodium hypochlorite, hydrogen, and carbon dioxide storage buildings are more than 300 feet away from the air intake. The nearest location where gaseous fire extinguishing media may be used is the cable spreading room, which is more than 100 feet away. Under any accident or meteorological conditions, the possibilities of diluting the oxygen content of the combustion air to the extent as to prevent the diesel generators from developing full rated power or causing the engines to shut down is minimal.

9.5.9.4 Test and Inspections

The diesel generators will be tested periodically per the Technical Specifications which will test the air intake and exhaust system.

ARKANSAS NUCLEAR ONE
Unit 2

9.6 REFERENCES

1. "Design of Structures for Missile Impact," BC-TOP-9A, Revision 2, Bechtel Corporation, San Francisco, California, September, 1974.
2. "First Monthly Operational Report for The LaCrosse Boiling Water Reactor," ACNP-67529, July 1967.
3. "MRI/Stardyne User Manual," Computer Methods Department, Mechanic Research, Inc., Los Angeles, California, January 1, 1970.
4. "Specification for Design, Fabrication and Erection of Structural Steel for Buildings," America Institute of Steel Construction, 1970.
5. Criticality Safety Evaluations CALC-06-E-0014-03, Criticality Safety Evaluation of The ANO Unit 2 Spent Fuel Pool, and CALC-06-E-0014-04, Criticality Safety Evaluation of The ANO Unit 2 New Fuel Storage Vault.
6. "CASMO: A Fuel Assembly Burnup Program," Studsvik of America.
7. "SIMULATE: Advanced Three-Dimensional Two-Group Reactor Analysis Code," Studsvik of America.
8. (REFERENCE DELETED FROM SECTION 9.1.1.3)
9. Edinger, J. E., Buchak, E. M., Kaplan, E., and Socrates, G., "Generic Emergency Cooling Pond Analysis," University of Pennsylvania, U.S.A.E.C. Contract No. AT(11-1)-2224, May 1972 - October 1972.
10. Gabrielson, V. K., "SHOCK-A - Computer Code for Solving Lumped-Mass Dynamic Systems," SCL-DR-65-34, January 1966.
11. (REFERENCE DELETED FROM SECTION 9.1.2.3)
12. (REFERENCE DELETED FROM SECTION 9.1.2.3)
13. (REFERENCE DELETED FROM SECTION 9.1.2.3)
14. (REFERENCE DELETED FROM SECTION 9.1.2.3)
15. Ryan, P. J. and Harleman, D. R. F., "An Analytical and Experimental Study of Transient Cooling Pond Behavior," Ralph M. Parsons Laboratory for Water Resources and Hydrodynamics, Report No. 161, January 1973.
16. (REFERENCE DELETED FROM SECTION 9.1.1.3)
17. SCALE-4: A modular Code System for Performing Standardized Computer Analysis for Licensing Evaluation, Oak Ridge National Laboratory, ODC. Number CCC-545, NUREG/CR-0200 Rev. 4.
18. Calculation No. 91-E-0099-10, ECP Peak Temperature and Inventory Loss Analysis Summary.

ARKANSAS NUCLEAR ONE
Unit 2

19. US Department of the Interior, Bureau of Reclamation, "Design of Small Dams," First Edition 1960 and Third Edition 1987.
20. [Calculation No. 91-E-0099-14, ECP Peak Temperature and Inventory Loss Analysis.](#)

ARKANSAS NUCLEAR ONE
UNIT 2

Table 9.1-1

FUEL POOL SYSTEM PROCESS FLOW DATA

The values given are nominal; actual operating flows, pressures, and temperatures will vary. The pressure drop across the filters, strainers, and ion exchangers will vary with loading. The pressure losses are typical.

1. Normal Fuel Pool Cooling

<u>FPS Location*</u>	1	2	3
Flow, gpm	2000	2000	2000
Pressure, psig	5	30	28
Temperature, °F	120	120	110

2. Maximum Fuel Pool Cooling

<u>FPS Location*</u>	1	2	3
Flow, gpm	3770	3770	3770
Pressure, psig	5	43	35
Temperature, °F	150	150	133

3. Purification

<u>FPS Location*</u>	4a	4b	5	6	7
Flow, gpm	150	-	150	150	150
Pressure, psig	5	-	50	45	30
Temperature, °F	120	-	120	120	120

4. Skimming Operations

<u>FPS Location*</u>	4a	4b	5	6	7
Flow, gpm	125-150	0-25	150	150	150
Pressure, psig	5	5	50	45	30
Temperature, °F	120	120	120	120	120

***Location**

- | | |
|---|--|
| 1. Fuel pool pump suction | 4b. Fuel pool skimmer discharge |
| 2. Fuel pool pump discharge | 5. Fuel pool purification pump discharge |
| 3. Fuel pool heat exchanger outlet | 6. Fuel pool filter outlet |
| 4a. Fuel pool purification pump suction | 7. Fuel pool ion exchanger outlet |

ARKANSAS NUCLEAR ONE
UNIT 2

Table 9.1-2

FUEL POOL WATER CHEMISTRY

pH (77 °F)	4.5 to 10.6
Boron, ppm	> 2000
Chloride, Maximum, ppm	0.15
Fluoride, Maximum, ppm	0.15

ARKANSAS NUCLEAR ONE
UNIT 2

Table 9.1-3

ORIGINAL DESIGN DATA FOR FUEL POOL SYSTEM COMPONENTS

1. Heat Exchangers

Quantity	1
Type	Shell and Tube, Horizontal
Tube Side	
Fluid	Fuel Pool Water
Design Temperature, °F	250
Design Pressure, psig	75
Normal Operating Conditions	
Flow, gpm	2000
Inlet Temperature, °F	120
Outlet Temperature, °F	109.9
Materials	ASTM-SA-240, Type 304
Code	ASME VIII, DIV. 1
Shell Side	
Fluid	Service Water
Design Temperature, °F	250
Design Pressure, psig	150
Normal Operating Conditions	
Flow, gpm	1570
Inlet Temperature, °F	85
Outlet Temperature, °F	89
Materials	Carbon Steel
Code	ASME VIII, DIV. 1

2. Ion Exchangers

Quantity	1
Type	Mixed Bed, Disposable
Design Pressure, psig	200
Design Temperature, °F	250
Normal Operating Temperature, °F	120
Vessel Volume, ft ³	55
Resin Volume, ft ³ (useful)	32
Code	ASME III, Class C
Normal Flow Rate, gpm	150
Materials	ASTM-SA-240, Type 304

ARKANSAS NUCLEAR ONE
UNIT 2

Table 9.1-3 (continued)

3. <u>Pumps</u>	<u>Fuel Pool Cooling</u>	<u>Fuel Pool Purification</u>
Quantity	2	1
Type	Centrifugal	Centrifugal
Design Pressure, psig	75	150
Design Temperature, °F	250	200
Normal Operating Conditions		
Flow, each, gpm	2000	150
Head, ft	80	165
Fluid Temperature, °F	120	120
Seal Type	Mechanical	Mechanical
Horsepower	60	15
Material	ASTM A-351	ASTM A-351
Gr CF-8M	Gr CF-8M	
4. <u>Filters</u>		
Quantity		2
Type of Elements		Replaceable Cartridge
Design Pressure, psig		150
Design Temperature, °F		200
Design Flow, gpm		150
Material		ASTM-SA-240, Type 304
Code		ASME VIII
5. <u>Strainers</u>	<u>Fuel Pool Purification Pump Suction</u>	<u>Fuel Pool Ion Exchanger</u>
Quantity	1	1
Type	Basket	Wye
Design Flow, gpm	150	150
Design Pressure, psig	50	100
Design Temperature, °F	200	200
Screen Size	1/8" perforated	100 U.S. Mesh
Body Material	SA-312	ASTM A-351
6. <u>Fuel Transfer Valve</u>		
Type		Gate
Size, in.		36
Design Pressure, psig		75
Normal Operating Differential Pressure		34'-6" H ₂ O
Design Temperature, °F		150
Normal Operating Temperature, °F		140
Materials		ASTM-A-351 CF-8M
Design Integrated Dose, Rads		1 x 10 ⁷
Allowable Seat Leakage, cc/hr		72

ARKANSAS NUCLEAR ONE
UNIT 2

Table 9.1-4

FUEL POOL SYSTEM INSTRUMENTATION

<u>System Parameter and Location</u>	<u>Indication</u>		<u>Alarm¹</u>		<u>Control Function</u>	<u>Inst. Range</u>	<u>Normal Operating Range</u>
	<u>Local</u>	<u>Control Room</u>	<u>High</u>	<u>Low</u>			
Heat Exchanger inlet temperature	*					0-200 °F	60-120 °F
Heat Exchanger outlet temperature	*					0-200 °F	50-120 °F
Fuel pool temperature	*		*			50-300 °F	60-130 °F
Fuel pool pump discharge pressure	*					0-100 psig	50 psig
Purification pump suction pressure	*					0-30 psig	5-18 psig
Purification pump discharge pressure	*					0-100 psig	80-95 psig
Ion exchanger differential pressure	*					0-30 psi	10-20 psi
Filter differential pressure	*					0-30 psi	5-20 psi
Fuel pool water level switch			*	*			

¹ All alarms and recorders are in the control room unless otherwise indicated.

ARKANSAS NUCLEAR ONE
UNIT 2

Table 9.1-5

SINGLE FAILURE MODE ANALYSIS OF THE FUEL HANDLING EQUIPMENT

<u>Component Identification</u>	<u>Failure Mode</u>	<u>Detrimental Effect On System</u>	<u>Corrective Action</u>	<u>Remarks</u>
Refueling machine fuel hoist weight system	Electrical overload trip fails	None	Continue refueling, repair on non-interfering basis	Use visual presentation of load meter
	Complete system fails	None	As above	Maximum stall torque of motor will not damage bundle
Fuel carrier	Wheels lock in transfer tube	Transfer change not completed	Switch to 5 hp mode	Load sufficient to move fuel carrier with all wheels locked
Hydraulic power supply for upender	Line to cylinder on upender ruptures	None	Valve off defective line	Upender has two cylinders each of which is capable of raising upender
	Loss of hydraulic power	Process can continue on slower basis	Upend manually	Use tool provided
Brake on refueling machine fuel hoist	Does not provide required brake load	None	Continue, repair on non-interfering basis	Redundant brake system provided
Fuel carrier cable	Cable parts	Delays refueling	Move fuel carrier to safe position with manual tool	Remove fuel prior to repair

ARKANSAS NUCLEAR ONE
UNIT 2

Table 9.1-5 (continued)

<u>Component Identification</u>	<u>Failure Mode</u>	<u>Detrimental Effect On System</u>	<u>Corrective Action</u>	<u>Remarks</u>
Refueling machine hoist motor	Power failure	Operation must be completed manually	Repair	Hoist using manual handwheel
Bridge drive motor	Power failure	Operation must be completed manually	Repair	Drive using manual handwheel
Electronic position indication	Power failure	None	Repair on non-interfering basis	Indexing can be accomplished by backup scale and pointer
Fuel carrier position sensing	Electrical failure	None	Repair on non-interfering basis	Winch motor stalls on overload
Refueling machine pressure	Loss of air	None	Repair	Continue using manual mode
Refueling machine TV camera	Electrical failure	None	Repair on non-interfering basis	Not mandatory for fuel handling
Refueling machine electronic hoist position indication	Electrical failure	None	Repair on non-interfering basis	Redundant mechanical counter
Fuel transfer tube isolation valve	Fails to close	None	Repair	

ARKANSAS NUCLEAR ONE
UNIT 2

Table 9.1-6 – DELETED

TABLE 9.1-7

FUEL ASSEMBLY PARAMETERS USED IN SFP AND NFV CRITICALITY ANALYSES

Parameter	16 x 16 Standard	16 x 16 NGF
Fuel enrichment (wt. % U-235)	4.95	4.95
Number of fuel rods (per assembly)	236	236
Fuel Rod OD (inch)	0.382	0.374
Fuel Rod ID (inch)	0.332	0.329
Cladding thickness (inch)	0.025	0.225
Cladding material	Zircaloy-4	Optimized ZIRLO
Fuel pellet OD (inch)	0.325	0.3225
Stack density (g/cc)	10.412	10.522
Annular pellet inner diameter (inch)	0.16275	0.155
Fuel Rod pitch (inch)	0.506	0.506
ZrB ₂ Coating Loading (mg ¹⁰ B/inch)	3.14 (Cycle 18) 2.95 (Cycle 19)	3.14
ZrB ₂ Coating Thickness (inch)	.0004170 (Cycle 18) .0003920 (Cycle 19)	.0004170
Coating Length (inch)	134 (Cycle 18) 136 (Cycle 19)	138
Number of tubes (4 guide / 1 instrument per assembly)	5	5
Guide tube OD (inch)	0.98	0.98
Guide tube thickness (inch)	0.04	0.04
Active fuel height (inch)	149.61 – 150.0	150.0

NOTE: This table provides the values assumed in the criticality analyses documented in Reference 5. Variations in the pellet radius, fuel enrichment, stack density, and active fuel height occur for different reload batches.

Table 9.1-8 – DELETED

Table 9.1-9 – DELETED

ARKANSAS NUCLEAR ONE
UNIT 2

Table 9.1-10

**Appendix B Supplement to Generic Licensing Topical Report EDR-1 for
Spent Fuel Handling Crane L-3 Summary of Plant Specific Crane Data**

Reg. Guide 1.104 Position	EDR-1 Topical Report Section	Information to be Provided	Specific Crane Data
C.1.a	III.C(C.1.a)	<ol style="list-style-type: none"> The actual crane duty classification of the crane specified by the applicant. 	<ol style="list-style-type: none"> The trolley has a Class “C” crane duty classification in accordance with CMAA Specification #70. The bridge has a Class A crane duty classification.
C.1.b	III.C(C.1.b)	<ol style="list-style-type: none"> The minimum operating temperature of the crane specified by the applicant. 	<ol style="list-style-type: none"> The trolley was designed and fabricated for a minimum operating temperature of 30 °F.
C.2.b	III.C(C.2.b) III.E.4	<ol style="list-style-type: none"> The maximum extent of load motion and the peak kinetic energy of the load following a drive train failure. Provisions for actuating the emergency drum brake prior to traversing with the load, when required to accommodate the load motion following a drive train failure. 	<ol style="list-style-type: none"> The Main Hoist was designed such that the maximum vertical load motion following a drive train failure does not exceed 1.5 feet and the maximum kinetic energy of the load is less than that resulting from one inch of free fall of the maximum critical load. Provisions for automatically actuating the emergency drum brake prior to traversing with the load are not required since the maximum amount of load motion and kinetic energy has been factored into the facility design of the spent fuel pool floor (Elevation 404’-0”). This elevation can accommodate the load motion and the load will be administratively controlled by Procedure 1402.133 to maintain greater than or equal to 1.5 feet when traversing the Elevation 404’-0” floor.
C.3.e	III.C(C.3.e)	<ol style="list-style-type: none"> The maximum cable loading following a wire rope failure in terms of the acceptance criteria established in Section III.C(C.3.e). 	<ol style="list-style-type: none"> The maximum cable loading following a wire rope failure in the Main Hoist meets the maximum allowed by the acceptance criteria established in Section III.C(C.3.e).

ARKANSAS NUCLEAR ONE
UNIT 2

Table 9.1-10 (continued)

Reg. Guide 1.104 Position	EDR-1 Topical Report Section	Information to be Provided	Specific Crane Data
C.3.f	III.C(C.3.f)	<ol style="list-style-type: none"> 1. Maximum fleet angle 2. Number of reverse bends 3. Sheave diameter 	<ol style="list-style-type: none"> 1. 3.5 degrees, Main Hoist. 2. None, other than the one between the wire rope drum and the first sheave in the load block. 3. 18 x wire rope diameter, Main Hoist.
C.3.h	III.C(C.3.h) III.E.11	<ol style="list-style-type: none"> 1. The maximum extent of motion and peak kinetic energy of the load following a single wire rope failure. 	<ol style="list-style-type: none"> 1. The Main Hoist was designed such that the maximum load motion following a single wire rope failure is less than 1.5 feet and the maximum kinetic energy of the load does not exceed that resulting from one inch of free fall of the maximum critical load.
C.3.i	III.C(C.3.i)	<ol style="list-style-type: none"> 1. The type of load control system specified by the applicant. 2. Whether interlocks are recommended by Regulatory Guide 1.13 to prevent trolley and bridge movements while fuel elements are being lifted and whether they are provided for this application. 	<ol style="list-style-type: none"> 1. <ol style="list-style-type: none"> A. Ederer AC flux vector, Main Hoist. B. Shepard Niles mechanical load brake, Aux Hoist. 2. The crane will not be used to lift fuel elements from the spent fuel racks. Therefore, interlocks to prevent trolley and bridge movements while hoisting have not been provided.
C.3.j	III.C(C.3.j)	<ol style="list-style-type: none"> 1. The maximum cable and machinery loading that would result in the event of a high speed two blocking, assuming a control system malfunction that would allow the full breakdown torque of the motor to be applied to the drive motor shaft. 	<ol style="list-style-type: none"> 1. The energy absorbing torque limiter (EATL) was designed such that the maximum machinery load, which would result in the event a two-blocking occurs while lifting the rated load at the rated speed. This allows the full breakdown torque of the motor to be applied to the drive shaft and it will not exceed 3 times the design rated loading. In addition, the EATL design does not allow the maximum cable loading to exceed the acceptance criteria established in Section III.C(C.3.e) during the above described two-blockings.

ARKANSAS NUCLEAR ONE
UNIT 2

Table 9.1-10 (continued)

Reg. Guide 1.104 Position	EDR-1 Topical Report Section	Information to be Provided	Specific Crane Data
	III.C(C.3.j) (continued)	2. Means of preventing two blocking of auxiliary hoist, if provided.	2. The 15 Ton Auxiliary Hoist has a geared upper limit switch and an arm actuated up over-travel switch.
C.3.k	III.C(C.3.k)	1. Type of drum safety support provided.	1. The alternate design drum safety restraint shown in Figure III.D.4 of EDR-1 is arranged to counter gear and brake forces as well as downward loads. These brackets act on the diameter of the ends of the drum on the Main Hoist.
C.3.o	NA	1. Type of hoist drive to provide incremental motion.	1. AC flux vector.
C.3.p	NA	1. Maximum trolley speed. 2. Maximum bridge speed. 3. Type of overspeed protection for the trolley and bridge drives.	1. 28 fpm. 2. 25 fpm. 3. Overspeed switches which actuate the brakes are provided for the trolley and bridge drives.
C.3.q	NA	1. Control station location.	1. The complete operating control system, including an emergency stop button, is located on the remote radio control station. An additional emergency stop button is located on the pendant station, permitting de-energization of the crane independent of the control station.
NA	III.D.1	1. The type of emergency drum brake used, including type of release mechanism. 2. The relative location of the emergency drum brake. 3. Emergency drum brake capacity.	1. A pneumatically released band brake is used for the Main Hoist. 2. The emergency drum brake engages the wire rope drum of the Main Hoist. 3. The Main Hoist emergency drum brake has a minimum capacity of 125% of that required to hold the design rated load.

ARKANSAS NUCLEAR ONE
UNIT 2

Table 9.1-10 (continued)

Reg. Guide 1.104 Position	EDR-1 Topical Report Section	Information to be Provided	Specific Crane Data
NA	III.D.2	<ol style="list-style-type: none"> 1. Number of friction surfaces in EATL. 2. EATL torque setting. 	<ol style="list-style-type: none"> 1. The main surface of the EATL has 21 friction surfaces. 2. The specified EATL torque setting is approximately 130% of the Main Hoist design rated load.
NA	III.D.3	<ol style="list-style-type: none"> 1. Type of failure detection system. 	<ol style="list-style-type: none"> 1. A totally mechanical drive train continuity detector and emergency drum brake actuator have been provided in accordance with Appendix G of Revision 3 of EDR 1 for the Main Hoist.
NA	III.D.5	<ol style="list-style-type: none"> 1. Type of hydraulic load equalization system. 	<ol style="list-style-type: none"> 1. The Main Hoist hydraulic load equalization system includes both features described in Section III.D.5.
NA	III.D.6	<ol style="list-style-type: none"> 1. Type of hook. 2. Hook design load. 3. Hook load test. 	<ol style="list-style-type: none"> 1. Both the Main and Auxiliary Hooks have a single load path. 2. <ol style="list-style-type: none"> A. The Main Hook design critical lift load is 130 tons with a 10:1 factor of safety on ultimate. B. The Auxiliary Hook design lift load is 15 tons with a 5:1 factor of safety on ultimate. 3. The test load for each load path of the Main Hook is 260 tons.
NA	III.F.1	<ol style="list-style-type: none"> 1. Design rated load. 2. Maximum Critical Load (MCL) rating. 3. Trolley weight (net). 4. Trolley weight (with load). 	<ol style="list-style-type: none"> 1. Main Hoist – 130 Ton Auxiliary Hoist – 15 Ton 2. Main Hoist – 130 Ton Auxiliary Hoist – NA 3. 74,000 lb (incl. Hooks) 4. 334,000 lb

ARKANSAS NUCLEAR ONE
UNIT 2

Table 9.1-10 (continued)

Reg. Guide 1.104 Position	EDR-1 Topical Report Section	Information to be Provided	Specific Crane Data
	III.F.1 (continued)	<p>5. Hook lift.</p> <p>6. Number of wire rope drums.</p> <p>7. Number of parts of wire.</p> <p>8. Drum size (pitch diameter).</p> <p>9. Wire rope diameter.</p> <p>10. Wire rope type.</p> <p>11. Wire rope material.</p> <p>12. Wire rope breaking strength.</p> <p>13. Wire rope yield strength.</p> <p>14. Wire rope reserve strength.</p> <p>15. Number of wire ropes.</p>	<p>5. Main Hook – 80 feet, 0 inches Auxiliary Hook – 80 feet, 0 inches</p> <p>6. The Main and Auxiliary Hoist each have one wire rope drum.</p> <p>7. Main Hoist – 4 parts per wire rope, 2 ropes, with (2) ropes off drum.</p> <p>8. Main Hoist – 33 inches Auxiliary Hoist – 16 inches</p> <p>9. Main Hoist – 1-3/8 inches Auxiliary Hoist – 5/8 inch</p> <p>10. Main Hoist – Spelter Socket Williamsport Wire Ropes Works Royal Purple Plus Triple PAC</p> <p style="padding-left: 40px;">Auxiliary Hoist – 6 x 37 EIPS/IWRC</p> <p>11. Carbon steel Main and Auxiliary Hoist.</p> <p>12. Main Hoist – 259,200 lb</p> <p style="padding-left: 40px;">Auxiliary Hoist – 41,200 lb</p> <p>13. Main Hoist – 207,360 lb</p> <p style="padding-left: 40px;">Auxiliary Hoist – NA</p> <p>14. Main Hoist – 0.5777</p> <p style="padding-left: 40px;">Auxiliary Hoist – NA</p> <p>15. The Main Hoist has 2 ropes. The Auxiliary Hoist has one rope.</p>

ARKANSAS NUCLEAR ONE
UNIT 2

Table 9.1-10 (continued)

Reg. Guide 1.104 Position	EDR-1 Topical Report Section	Information to be Provided	Specific Crane Data
	III.C(C.1.b(1))	1. The extent of venting of closed box sections.	1. Closed box sections are not vented since the auxiliary building that houses the crane will not be pressurized.
C.1.b(3) C.1.b(4) C.4.d	III.C(C.1.b(3)) III.C(C.1.b(4)) III.C.(C.4.d)	1. The nondestructive and cold proof testing to be performed on existing structural members for which satisfactory impact test data is not available.	1. The procurement documents for the modified bridge structure did not invoke 10 CFR 50 Appendix B. An installation plan, to capture all of the critical characteristics of the structural members, is being used to ensure the structural members meet the requirements for the crane's intended function. Cold proof testing has been performed on the modified bridge, followed by a visual inspection of all accessible welds whose failure would result in the drop of a load. Visual inspections of structural degradation of the modified bridge were performed and no degradation was identified. Additional NDE of the critical welds on the bridge girder was performed. The ambient temperature when the 125% (+0%, -5%) static load test is performed is the minimum operating temperature for the crane. The minimum crane operating temperature has been established at 65 °F. In the event that the crane must be operated at a lower temperature, another 125% (+0%, -5%) static proof test will be performed at the lower temperature.

ARKANSAS NUCLEAR ONE
UNIT 2

Table 9.1-10 (continued)

Reg. Guide 1.104 Position	EDR-1 Topical Report Section	Information to be Provided	Specific Crane Data
C.1.c	III.C.(C.1.c)	<ol style="list-style-type: none"> The extent the crane's structures which are not being replaced are capable of meeting the seismic requirements of Regulatory Guide 1.29. 	<ol style="list-style-type: none"> The modified bridge structure and new trolley have been analyzed. Existing steel and concrete support structures have been analyzed for the design basis earthquake while supporting the maximum critical loads. This is documented in Entergy Calculation 61, Bechtel Book 21. Analysis methods and acceptance criteria are consistent with the ANO design basis for the support structure and runway girder, and meet the intent of Regulatory Guide 1.29, C.2.
C.1.d	III.C(C.1.d)	<ol style="list-style-type: none"> The extent welds joints in the crane's structures, which are not being replaced, were nondestructively examined The extent the base material, at joints susceptible to lamellar tearing, was nondestructively examined. 	<ol style="list-style-type: none"> Nondestructive examinations of the existing bridge structure were not required by existing regulations at the time of construction. However, the X-SAM® system provides additional overload protection, and the inspections of the existing structure described in C.1.b(3) above are adequate to ensure the structural integrity of the existing bridge. The weld geometries used in (a) the existing bridge structure and (b) the replacement trolley structure are not considered to be susceptible to lamellar tearing.
C.1.e	III.C(C.1.e)	<ol style="list-style-type: none"> The extent the crane's structures, which are not being replaced are capable of withstanding the fatigue effects of cyclic loading from previous and projected usage, including any construction usage. 	<ol style="list-style-type: none"> All past and projected uses of the modified structural components were assessed to ensure the crane is within the cyclic loading capability of the modified bridge structure and welds at 130 Tons for CMAA Class "A" service.

ARKANSAS NUCLEAR ONE
UNIT 2

Table 9.1-10 (continued)

Reg. Guide 1.104 Position	EDR-1 Topical Report Section	Information to be Provided	Specific Crane Data
C.1.f	III.C(C.1.f)	<ol style="list-style-type: none"> The extent the crane's structures which are not being replaced, were post-weld heat treated in accordance with Sub article 3.9 of AWS D1.1, "structural welding code". 	<ol style="list-style-type: none"> The material thickness of the modified bridge components are such that paragraph III.C(C.1.f) of EDR-1 does not require post weld heat treatment.
C.2.b	III.C(C.2.b) III.E.4	<ol style="list-style-type: none"> Provisions for accommodating the load motion and kinetic energy following a drive train failure when the load is being traversed and when it is being raised or lowered. 	<ol style="list-style-type: none"> Administrative procedures will be used to assure that a minimum of 1.5 feet of clearance is maintained between the load and surfaces that cannot withstand the kinetic energy associated with one inch free fall of the load involved. The spent fuel pool floor laydown area (Elevation 404'-0") can withstand the kinetic energy associated with one inch free fall of the MCL, documented in Calculation 92-D-2001-62.
C.2.c	III.C(C.2.c)	<ol style="list-style-type: none"> Location of safe laydown areas for use in the event repairs to the crane are required that cannot be made with the load suspended. 	<ol style="list-style-type: none"> The laydown areas that can be used in the event that repairs to the crane are required that cannot be made with the load suspended are the spent fuel pool floor and Elevation 404'-0" laydown area, documented in Procedure 1402.133.
C.2.d	III.C(C.2.d)	<ol style="list-style-type: none"> Size of modified components that can be brought into the building for repair of the crane without having to break the building integrity. Location of area where repair work can be accomplished on the crane without affecting the safe shut-down capability. Any limitations on operations that would result from crane repairs. 	<ol style="list-style-type: none"> The X-SAM® trolley and modified bridge components can be brought in through the auxiliary building floor opening. The opening is 12'-0" x 24'-0". Area is identified in Procedures 1402.133 and 1402.135. No limitations for normal operations.

ARKANSAS NUCLEAR ONE
UNIT 2

Table 9.1-10 (continued)

Reg. Guide 1.104 Position	EDR-1 Topical Report Section	Information to be Provided	Specific Crane Data
C.3.b	III.C(C.3.b)	<ol style="list-style-type: none"> The design margin and type of lifting devices that are attached to the hook to carry critical loads. 	<ol style="list-style-type: none"> As an alternative to a dual load path system, the normal stress design factors have been doubled. The maximum critical load lifting device attached to the hook to carry critical loads will support a load six times the static plus dynamic load being handled without permanent deformation. The safety factor is 10:1 when compared to ultimate. This is in accordance with NUREG-0612, Section 5.1.6, Paragraph 1(a) and ANSI N14.6, Section 7.2.1.
C.3.t	III.C(C.3.t)	<ol style="list-style-type: none"> The extent construction requirements for the crane's structures, which will not be replaced, are more severe than those for permanent plant service. The modifications and inspections to be accomplished on the crane following construction use, which was more severe than those for permanent plant service. 	<ol style="list-style-type: none"> Prior use and load histories have been documented and reviewed for the modified bridge components as part of the final closeout information documented in Entergy MAI's and ER-ANO-2000-2688-02 associated with the spent fuel crane modifications. Nondestructive examination of the accessible load bearing weld seams, and justification that the fatigue life of the modified components has not been compromised, were completed prior to the 125% design load test.
C.3.u	NA	<ol style="list-style-type: none"> The extent of installation and operating instructions. 	<ol style="list-style-type: none"> The installation and operating instructions will be updated to fully comply with the requirements of Section C.3.u of Regulatory Guide 1.104 and Sections 7.1 and 9 of NUREG-0554.

ARKANSAS NUCLEAR ONE
UNIT 2

Table 9.1-10 (continued)

Reg. Guide 1.104 Position	EDR-1 Topical Report Section	Information to be Provided	Specific Crane Data
C.4.a C.4.b C.4.c C.4.d	NA	1. The extent of assembly checkout, test procedures, load testing and rated load marking of the crane.	1. Prior to handling critical loads, the crane was given a complete assembly checkout, and then given a no-load test of all motions in accordance with updated procedures provided by Ederer. A 125% static load test and 100% performance test were also performed at this time in accordance with updated test procedures provided by Ederer. A no-load test of all motions and a two blocking test were performed by Ederer prior to delivery of the crane per Topical Report EDR 1. The maximum critical load is plainly marked on each side of the crane.
C.5.a	III.C(C.5.a)	1. The extent the procurement documents for the crane's structure's, which will not be replaced, required the crane manufacturer to provide a quality assurance program consistent with the pertinent provisions of Regulatory Guide 1.28.	1. The procurement documents for the components of the modified bridge structure did not invoke 10 CFR 50 Appendix B. However, these components were built to the manufacturer's quality control processes. Quality assurance provisions denoted in the procurement documents covered such items as design control, material selection and inspection and testing. The installation of the trolley and any structural modifications to the existing bridge is controlled by the Arkansas Nuclear One quality assurance plan and design change package ER-ANO-2000-2688.

ARKANSAS NUCLEAR ONE
UNIT 2

Table 9.2-1

DELETED

Table 9.2-2

**SERVICE WATER SYSTEM
TRAVELING WATER SCREEN DATA**

CHARACTERISTICS	DATA
Equipment Numbers	2F7A,B
Quantity	2
Type	Manual*
Fluid	Water
Maximum Design Flow rating, gpm	33,000/each
Normal Flow, gpm	11,000/each

* A periodic screenwash is scheduled and can also be performed if required by increased differential pressure.

ARKANSAS NUCLEAR ONE
UNIT 2

Table 9.2-3

SERVICE WATER PUMP DATA

CHARACTERISTICS	DATA
Equipment numbers	2P4A, B and C
Quantity	3
Type	Vertical Turbine
Pump Fluid	Water
Design flow rating, gpm	12,000
Rated differential pressure, feet	205
Submergence required at design flow rate, ft.	8' - 0"
Pump maximum operating flow rate, gpm	14,000
Pump runout flow rate, gpm	20,000
Differential pressure at maximum operating flow rate, feet	195
Submergence required at maximum operating flow rate, feet	8
Shutoff head, feet	330
Materials of construction:	
Bowls	Carbon Steel or Alternate Stainless Steel
Impeller	Stainless Steel
Lineshaft	Stainless Steel
Column	Carbon Steel
	SA351 Gr. CF3M ASTM A743 CA-6NM SA479 Type 410 SA 53 Gr B & SA283 Gr. D
Driver:	
Type	Electric Motor
Service Factor, %	100
Nameplate Rating, hp	800
Voltage, volts	4000
RPM	900

ARKANSAS NUCLEAR ONE
UNIT 2

Table 9.2-4

SERVICE WATER BASKET STRAINER DATA

CHARACTERISTICS	DATA
Equipment number	2F6A,B,C
Quantity	3
Type	Single Basket
Design pressure, psig	150
Maximum flow rate, gpm	13,200
Normal flow rate, gpm	11,000
Size of perforations in strainer element, inches	3/16
Total free hole area, inches ²	814.4
Pressure drop psig, clean*	1.1
Maximum allowable pressure drop psig, clogged	10.0**
Materials of construction	
Body	Carbon steel SA 516 Gr 70
Screen	Stainless steel SA 240 Type 304

* Actual pressure drop varies according to flow rate

** 10 psid is the strainer basket ΔP design limit, but operability at higher ΔP limits may be established.

ARKANSAS NUCLEAR ONE
Unit 2

Table 9.2-5
SERVICE WATER SYSTEM SINGLE FAILURE ANALYSIS

COMPONENT	FAILURE	COMMENTS & CONSEQUENCES
Intake Structure	Blockage of water flow to service water pumps or loss of Dardanelle Reservoir inventory due to dam rupture	Water is supplied to the system from the Emergency Cooling Pond by opening of 2CV-1471-1, 2CV-1473-5 and 2CV-1475-2, and closing of 2CV-1470-1, 2CV-1472-5 and 2CV-1474-2.
Service Water Pumps	One pump malfunctions	The other train will supply 100% of minimum requirements under all operating conditions, and the standby pump may be brought into service to supply an additional 100% of minimum requirements under all operating conditions.
Service Water Strainer	Blockage of water flow in one strainer	The other train will supply 100% of minimum requirements under all operating conditions, and the standby pump and strainer may be brought into service to provide an additional 100% of minimum requirements under all operating conditions.
System Pressure Boundary	Failure in Seismic Category 1 pressure boundary	The two trains are normally isolated from each other so that a failure in one train will not affect the other train. The trains can be isolated by operator action during other plant operating conditions.
Service water compartment sluice gates: 2CV-1471-1, 2CV-1473-5, 2CV-1475-2, 2CV-1470-1, 2CV-1472-5, or 2CV-1474-2	Valve fails to close or open with the hand switch	The other train will provide 100% of system requirements.

ARKANSAS NUCLEAR ONE
Unit 2

Table 9.2-5 (continued)

COMPONENT	FAILURE	COMMENTS & CONSEQUENCES
Auxiliary cooling system isolation valve: 2CV-1425-1 or 2CV-1427-2	Valve fails to close after SIAS or MSIS or RAS	The other valve 2CV-1427-2 or 2CV-1425-1 will close & isolate the auxiliary system.
Isolation valve serving "A" train ESF equipment in Aux. Bldg. pump rooms: 2CV-1400-1	Valve fails to open after SIAS	The other train will provide 100% of of system requirements.
Isolation valve serving "B" train ESF equipment in Aux. Bldg. pump rooms: 2CV-1406-2	Valve fails to open after SIAS	The other train will provide 100% of system requirements.
Inlet valves to Aux. Bldg. HPSI pump room unit coolers: 2CV-1407-1 or 2CV-1408-2	Inadvertent Valve Closure	The other train provides 100% of system requirements.
Inlet valve to shutdown cooling heat exchanger 2E35A: 2CV-1453-1	Valve fails to open after RAS	The other train will provide 100% of system requirements.
Inlet valve to shutdown cooling heat exchanger 2E35B: 2CV-1456-2	Valve fails to open after RAS	The other train will provide 100% of system requirements.
Inlet valves to switch gear rooms unit coolers: 2CV-1486-2, 2CV-1487-2, 2CV-1488-1, or 2CV-1489-1	Valve fails to open with associated fan start	The remaining unit cooler within the same train provides 100% of normal cooling requirements.
SWS discharge to Dardanelle Reservoir isolation valves: 2CV-1481-1 or 2CV-1480-2	Valve fails to close with hand switch	The other train will provide 100% of system requirements.
SW outlet valve from diesel generator "A": 2CV-1503-1	Valve fails to open with diesel generator start	The other train will provide 100% of system requirements.

ARKANSAS NUCLEAR ONE
Unit 2

Table 9.2-5 (continued)

COMPONENT	FAILURE	COMMENTS & CONSEQUENCES
SW outlet valve from diesel generator "B": 2CV-1504-2	Valve fails to open with generator start	The other train will provide 100% of system requirements.
SW inlet valves to Aux. Bldg charging pump room coolers: 2CV-1500-1, 2CV-1501-5, or 2CV-1502-2	Valve fails to open with associated fan start	The cooling capacity will be decreased about 35%. No credit is given to these coolers for safe shutdown of the plant under accident conditions.
SW outlet from "B" train containment Service Water Cooling Coils: 2CV-1513-2	Valve fails to open after CCAS	The other train will provide 100% of system requirements.
SW outlet from "A" train containment Service Water Cooling Coils: 2CV-1519-1	Valve fails to open after CCAS	The other train will provide 100% of system requirements.
SW inlet valves to the "B" train Aux. Bldg. electric equip. unit coolers: 2CV-1562-2 or 2CV-1564-2	Valve fails to open with associated fan start	The remaining unit cooler within the same train will provide additional 100% of system requirements.
SW inlet valves to the Aux. Bldg. emergency F.W. pump room unit coolers 2CV-1529-2 or 2CV-1532-1	Valve fails to open with associated fan start	The other train will provide 100% of system requirements.
SW inlet valves to the "A" train Aux. Bldg. electric equipment unit coolers: 2CV-1561-1 or 2CV-1563-1	Valve fails to open with associated fan start	The remaining unit cooler within the same train will provide additional 100% of normal system requirements. No credit is given to these coolers for safe shutdown of the plant under accident conditions.
SWS isolation valves supplying the CCW heat exchangers and main chillers: 2CV-1530-1 or 2CV-1531-2	Valve fails to close with SIAS or MSIS or RAS	The other train will provide 100% of system requirements.

ARKANSAS NUCLEAR ONE
Unit 2

Table 9.2-5 (continued)

COMPONENT	FAILURE	COMMENTS & CONSEQUENCES
SWS isolation valves supplying the Fuel Pool Heat Exchangers: 2CV-1525-1 or 2CV-1526-2	Valve fails to close with SIAS	The other train will provide 100% of system requirements.
SWS discharge line isolation valve in "A" loop: 2CV-1543-1	Valve fails to close with SIAS or MSIS or RAS	The other train will provide 100% of system requirements.
SWS discharge line isolation valve in "B" loop: 2CV-1542-2	Valve fails to close with SIAS or MSIS or RAS	The other train will provide 100% of system requirements.
SWS discharge to the Emergency Cooling Pond: 2CV-1560-2 or 2CV-1541-1	Valve fails to open with hand switch	The other train will provide 100% of system requirements.
Power Supplies	Failure of normal power source	The power supply automatically transfers to the preferred source.
	Failures of both normal and preferred power sources	The power supply automatically transfers to the diesel generators.
	Failure of power supply bus to one train	Other train is supplied from an independent and physically separate bus.
SW discharge control valves from control room emergency condensing unit (2VE1A or 2VE1B) 2CV-1509 or 2CV-1506	Valve fails to function	The other train will provide 100% of cooling requirements.

ARKANSAS NUCLEAR ONE
Unit 2

Table 9.2-6

SERVICE WATER SYSTEM INDICATION AND ALARMS

1. Low water level alarm intake structure
2. SW pump high discharge pressure alarm
3. SW basket strainer high differential pressure alarm
4. SW pump motor stator windings high temperature alarm
5. Auxiliary cooling header low pressure alarm
6. SW loop low pressure alarm
7. SW and auxiliary loop pressure
8. Containment cooling coils low flow alarm
9. Containment cooling coils high radiation alarm
10. Fuel pool heat exchanger high/low flow alarm
11. Fuel pool heat exchanger high radiation alarm
12. Shutdown heat exchanger high/low flow alarm
13. Shutdown heat exchanger high radiation alarm
14. SW pump failure alarm (on SIAS)
15. SW pump tripped alarm
16. SW pump control switch locked out alarm
17. SW screen ΔP HI alarm
18. SW inlet/outlet MOVs to CCW Hx and main chillers overridden
19. SW isolation MOVs for ACW system overridden

ARKANSAS NUCLEAR ONE
Unit 2

Table 9.2-7

**COMPONENT COOLING WATER
PUMP DATA**

CHARACTERISTICS	DATA
Equipment numbers	2P33A,B,C
Quantity	3
Type	Horizontal, Centrifugal
Pump Fluid	Water
Design flow rate, gpm	2900
Design head, feet	190
NPSH required at design flow rate, feet	14
Maximum operating flow rate, gpm	2849
NPSH required at maximum operating flow rate, feet	14
Minimum available NPSH, feet	60
Shutoff head, feet	245
Materials of construction:	
Casing	Cast Iron
Impeller	Bronze
Shaft	Steel
Driver:	
Type	Electric Motor
Nameplate rating, hp	200
Voltage	460
RPM	1750

ARKANSAS NUCLEAR ONE
Unit 2

Table 9.2-8

**COMPONENT COOLING WATER SYSTEM
HEAT EXCHANGER DATA**

CHARACTERISTICS	DATA
Equipment numbers	2E28A,B,C
Quantity	3
Type	Shell and tube
Design heat duty, Btu/hr (2E-28A/C)	26(+6)
Design heat duty, Btu/hr (2E-28B)	27(+6)
Shell side:	
Fluid	Water(CCW)
Design Temperature, °F	200
Design operating temperature inlet, °F	115
Design operating temperature outlet, °F	95
Design pressure, psig	150
Design operating flow, gpm	2700
Pressure loss at design flow, psi	12
Design fouling factor, hr-ft ² - °F/Btu	0.0005
Tube side:	
Fluid	Service Water
Design temperature, °F	150
Design operating temperature inlet, °F	85
Design operating temperature outlet (2E-28A/C), °F	96.3
Design operating temperature outlet (2E-28B), °F	96.8
Design pressure, psig	150
Design operating flow, gpm	4600
Pressure loss at design flow, psi	13
Design fouling factor (2E-28A), hr-ft ² - °F/Btu	0.0015
Design fouling factor (2E-28B/C), hr-ft ² - °F/Btu	0.0010
Materials of construction:	
<u>2E-28A</u>	
Shell	Carbon steel
Tubes	Admiralty
Tubesheets	Carbon steel
<u>2E-28B/C</u>	
Shell	Carbon steel
Tubes	Titanium
Tubesheets	Carbon steel with Titanium overlay

ARKANSAS NUCLEAR ONE
Unit 2

Table 9.2-9

**COMPONENT COOLING WATER SYSTEM
SURGE TANK DATA**

CHARACTERISTICS	DATA
Equipment number	2T37A,B
Quantity	Two
Type	Vertical
Stored material	Condensate
Design pressure, psig	Atmospheric
Normal operating pressure, psig	Atmospheric
Design temperature, °F	100
Normal operating temperature, °F	85
Capacity, gallons	1000
Material of construction	Carbon steel

ARKANSAS NUCLEAR ONE
Unit 2

Table 9.2-10

COMPONENT COOLING WATER SYSTEM INDICATION AND ALARMS

1. CCW pump discharge pressure
2. CCW pump discharge high and low pressure alarm
3. Low flow alarm from RCP motor coolers
4. Total CCW loop flow
5. Low CCW loop flow alarm
6. CCW fluid radiation level
7. CCW high radiation alarm
8. CCW heat exchanger outlet temperature
9. CCW heat exchanger high/low outlet temperature alarm
10. CCW surge tank high/low level alarm
11. Low flow alarm for iso-phase bus coolers
12. Automatic start alarm for 2P33B or C
13. CCW flow to letdown heat exchanger
14. High CCW flow alarm for letdown heat exchanger

ARKANSAS NUCLEAR ONE
Unit 2

Table 9.2-11

RAW WATER HOLDUP TANK DATA

Equipment number	T61
Quantity	One
Type	Vertical
Stored Material	Water
Design Pressure, psig	Atmospheric
Capacity, gallons	150,000
Material of construction	Carbon steel

Table 9.2-12

DOMESTIC WATER PUMPS DATA

Equipment Number	2P10A,B
Quantity	Two
Type	Horizontal, Centrifugal
Pump Fluid	Water
Design Pressure, psig	60 psi
Design flow rate, gpm	80 gpm
Design head, feet	139
NPSH required at design flow, feet	11
Shutoff head, feet	167

Materials of Construction:

Casing	Cast Iron
Impeller	Bronze
Shaft	316 stainless steel

Driver:

Type	Electric Motor
Service factor	1.15
Nameplate rating, hp	5
Voltage	460
RPM	3500

ARKANSAS NUCLEAR ONE
Unit 2

Table 9.2-13

DOMESTIC WATER PRESSURE TANK DATA

Equipment number	2T44
Quantity	One
Type	Horizontal
Stored Material	Water
Design Pressure, psig	100
Design Temperature, °F	90
Normal operating pressure, psig	40 - 60
Normal operating temperature, °F	60
Capacity, gallons	1300 (nominal)
Material of construction	Carbon steel

Table 9.2-14

DOMESTIC WATER STORAGE HEATER DATA

Equipment Number	2E43
Type	Vertical
Stored Material	Water
Design Pressure, psig	150
Normal operating pressure, psig	40 - 60
Design temperature, °F	210
Normal operating temperature, °F	140
Capacity, gallons	1300
Heater, type	Electric
Rating	200,000 Btu/hr
Tank material	Copper lined, steel jacket with fiberglass insulation

ARKANSAS NUCLEAR ONE
Unit 2

Table 9.2-15

DOMESTIC HOT WATER CIRCULATING PUMP DATA

Equipment Number	2P30
Quantity	One
Type	Centrifugal, in line
Pump Fluid	Water
Design Pressure, psig	3.19
Design flow rate, gpm	5
Design head, feet	7.5
Materials of construction:	
Casing	Bronze
Impeller	Bronze
Shaft	316 stainless steel
Driver:	
Type	Electric
Nameplate rating, hp	1/6
Voltage, volts	120
RPM	1750

Table 9.2-16

CONDENSATE STORAGE TANK DATA

Equipment Number	2T41A,B
Quantity	Two
Type	Vertical
Stored Material	Demineralized Water
Design pressure	Atmospheric
Normal operating pressure	Atmospheric
Design Temperature, °F	100
Normal operating temperature, °F	80
Capacity, gallons	200,000
Material of construction	Stainless Steel(304)
Code	API-650

ARKANSAS NUCLEAR ONE
Unit 2

Table 9.2-17

LITTLE ROCK METEOROLOGY - TEMPERATURE ANALYSIS
(Historical – not used in updated analysis)

Worst Case 1 day Meteorology - June 17, 1934
Worst Case 30 day Meteorology - June 26 - July 25, 1934

Date	Wind Speed (MPH)	Dry Bulb Temp. (°F)	Relative Hum. (%)	Cloud Cover (Frac.)	Solar Radiation (Langleys/Day)
June 17, 1934	1.4	87	64	.25	691
June 26 – July 5, 1934	4.4	84	65	.25	685

Table 9.2-18

LITTLE ROCK METEOROLOGY - EVAPORATION ANALYSIS
(Historical – not used in updated analysis)

Highest 30-day Dew Point Depression - July 16 - August 14, 1930
Highest Daily Average Windspeed - July 16 - August 14, 1930

Date	Wind Speed (MPH)	Dry Bulb Temp. (°F)	Relative Hum. (%)	Cloud Cover (Frac.)	Solar Radiation (Langleys/Day)
July 16 - Aug 14, 1930	10.0	87	41	.25	653

Table 9.2-19

DELETED

Table 9.2-20

DELETED

ARKANSAS NUCLEAR ONE
Unit 2

Table 9.3-1

**PRIMARY SAMPLING SYSTEM
SAMPLE POINT DESIGN DATA**

<u>Sample Name</u>	<u>Sample Conditions</u>			
	<u>Pressure (psig)</u>		<u>Temperature (°F)</u>	
	<u>Normal</u>	<u>Maximum</u>	<u>Normal</u>	<u>Maximum</u>
Reactor Coolant Hot Leg	2200	2350	600	650
Pressurizer Surge Line	2200	2350	600	650
Pressurizer Steam Space	2200	2350	649	658
Purification Filter Inlet	70	200	120	150
Purification Filter Outlet	70	200	120	150
Letdown Strainer Outlet	70	200	120	150
Safety Injection Tanks (4)	600	700	100	200
HPSI Pump Minimum Flow Line	20	20	140	140
Shutdown Cooling Heat Exchanger Outlet	175-185*	480	90-120	300
Shutdown Cooling System Suction Line	~20*	300	90-120	300
Steam Generator Water (2)	815	1085	520	556

* Reactor Vessel Head removed.

ARKANSAS NUCLEAR ONE
Unit 2

Table 9.3-2

**SECONDARY SAMPLING SYSTEM
SAMPLE POINT DESIGN DATA**

<u>Sample Name</u>	<u>Sample Conditions</u>	
	<u>Normal/Max. Pressure (psig)</u>	<u>Normal/Max. Temp (°F)</u>
1. Makeup water mixed bed demineralizer tank outlet	15/100	60/100
2. Makeup water anion demineralizer tanks outlets	27/100	60/100
3. Makeup water cation demineralizer tanks outlets	40/100	60/100
4. Condensate storage tanks	10/60	100/140
5. Main steam headers	885/1085	529/556
6. 2E1A&B feedwater heater outlets	1085/1560	455/460
7. Feedwater into steam generators (grab sample only)	1085/1560	455/460
8. Emergency feedwater lines (grab sample only)	1200/1400	85/150
9. Heater drain pumps discharges (grab sample only)	630/835	386/390
10. Condensate pumps discharges	635/835	190/192
11. Condenser tube sheet leak detection trays	0/30	110/133
12. Cooling tower basin	5/10	97/110
13. Circulating water pumps discharge	45/85	97/110
14. Condenser hotwell	0/100	110/133

Note: The values listed represent historical operating conditions. The latest pressure-temperature analyses shall be utilized for determination of pressure-temperature design inputs.

ARKANSAS NUCLEAR ONE
Unit 2

Table 9.3-3

**WASTE GAS ANALYZER SYSTEM SAMPLE
POINT DESIGN DATA**

<u>Sample Name</u>	<u>Sample Conditions</u>	
	<u>Normal/Max. Pressure (psig)</u>	<u>Normal/Max. Temp (°F)</u>
Volume Control Tank	15/50	120/150
Vacuum Degasifier	15/50	120/150
Waste Gas Decay Tanks (3)	250/380	120/150
Quench Tank	10/40	120/250
Reactor Drain Tank	10/40	120/250

ARKANSAS NUCLEAR ONE
Unit 2

Table 9.3-4

REACTOR COOLANT AND REACTOR MAKEUP WATER CHEMISTRY

<u>Variable</u>	<u>Reactor Coolant</u>		<u>Reactor Makeup</u>
	<u>During Passivation</u>	<u>Operational</u>	
Suspended solids ppm, max	0.5	0.35 (7)	---
pH at 77 °F	9.0-10.4	---	---
Chloride, ppm C1, max	0.15	0.15	0.15
Fluoride, ppm F, max	0.10	0.15	0.10
Hydrogen as H ₂ , cc/kg H ₂ O, (STP)	0 (1)	25-50 (7)	---
Dissolved O ₂ , ppm, max (2)	0.1	0.1	0.10 (5)
Lithium as Li-7, ppm	1.0-2.0	Consistent with Station Lithium Program	---
Boron as boric acid, ppm	0 (3)	(6)	---
Hydrazine, ppm	30-50		---
Ammonia (NH ₃), ppm	50		---
Conductivity, μmhos/cm	(4)		
Silica, ppm, max	---	---	0.10
Zinc, ppb, max	---	≤ 40	
Zinc, ppb, excursions	---	≤ 80	

NOTES:

- (1) Nitrogen overpressure is used in the CVCS volume control tank during passivation operations to exclude oxygen.
- (2) At temperatures ≤ 250 °F, no upper limit on dissolved oxygen is specified.
- (3) Boric acid should be added to the RCS as close as possible to fuel loading. Following the boric acid addition, hydrazine and ammonia concentrations should be reduced to maintain a primary coolant conductivity of less than 20 μmhos/cm.
- (4) Depends on the concentrations of additives in the coolant.
- (5) When degas tower is available.
- (6) As required for reactivity control.
- (7) Above cold shutdown conditions.

ARKANSAS NUCLEAR ONE
Unit 2

Table 9.3-5

CHEMICAL AND VOLUME CONTROL SYSTEM PARAMETERS

Normal letdown and purification flow, gpm	40
Normal charging flow, gpm	44
Reactor coolant pump controlled bleedoff, 4 pumps, gpm	4
Normal letdown temperature from reactor coolant system, °F	551
Normal charging temperature of reactor coolant system loop, °F	479
Ion exchanger operating temperature, °F	120
Soluble boron addition rate capability at end of cycle, one charging pump operating, (ppm/hr.)	277.8

Table 9.3-6

SCHEDULE OF WASTE GENERATION

(original design assumptions based on 12-month refueling cycle)

<u>Source</u>	<u>Quantity, gal/yr</u>
Refueling Shutdown and Startup	205,000
Cold Shutdowns and Startups	404,000
Hot Shutdowns and Startups	116,000
Boron Dilution	242,000
Average Daily Leakage to Reactor Drain Tank and Equipment Drain Tank	250 gal/day

ARKANSAS NUCLEAR ONE
Unit 2

Table 9.3-7

CHEMICAL AND VOLUME CONTROL SYSTEM PROCESS FLOW DATA

Values given are nominal based on Tcold at 550 °F; actual operating values may vary. The pressure drop across the purification prefilter, afterfilter, and ion exchanger varies with loading. The pressure drops shown are typical. The pressure in the volume control tank varies and affects the pressures at locations 5 through 11 and 14a through 14g proportionally.

CVCS Normal Purification Operation (One Charging Pump in Operation)

CVCS Location*	1	2	3	4	5	6	7	8	9	10
Flow, gpm	40	40	40	40	40	39	1	40	40	40
Pressure, psig	2195	2192	356	350	25	22	25	21	20	19
Temperature, °F	550	218	218	120	120	120	120	120	120	120
CVCS Location*	10a	10b	10c	11	12	13	14a-d	14e	14f	14g
Flow, gpm	40	40	44	44	44	44	1	0	4	4
Pressure, psig	18	15	15	15	2297	2287	100	100	100	16
Temperature, °F	120	120	120	120	120	410	120	120	120	120

CVCS Intermediate Purification Operation (Two Charging Pumps in Operation)

CVCS Location*	1	2	3	4	5	6	7	8	9	10
Flow, gpm	84	84	84	84	84	83	1	84	84	84
Pressure, psig	2150	2138	374	350	43	40	43	38	35	33
Temperature, °F	550	327	327	120	120	120	120	120	120	120
CVCS Location*	10a	10b	10c	11	12	13	14a-d	14e	14f	14g
Flow, gpm	84	84	88	88	88	88	1	0	4	4
Pressure, psig	30	15	15	15	2331	2291	100	100	100	16
Temperature, °F	120	120	120	120	120	363	120	120	120	120

CVCS Maximum Purification Operation (Three Charging Pumps in Operation)

CVCS Location*	1	2	3	4	5	6	7	8	9	10
Flow, gpm	128	128	128	128	128	127	1	128	128	128
Pressure, psig	2100	2015	400	350	75	68	75	64	57	54
Temperature, °F	550	366	366	120	120	120	120	120	120	120
CVCS Location*	10a	10b	10c	11	12	13	14a-d	14e	14f	14g
Flow, gpm	128	128	132	132	132	132	1	0	4	4
Pressure, psig	47	15	15	15	2390	2310	100	100	100	16
Temperature, °F	120	120	120	120	120	324	120	120	120	120

ARKANSAS NUCLEAR ONE
Unit 2

Table 9.3-7 (continued)

**CVCS Makeup System Operation - Automatic Mode:
Blended Boric Acid Concentration at 925 ppm**

(This mode is currently not used)

CVCS Location*	15	16	17	18	19	20	21	22	23
Flow, gpm	174	174	10	10	0	10	140	140	150
Pressure, psig	7	91	91	86	15	20	140	20	20
Temperature, °F	140	140	140	140	160	140	60	60	65
CVCS Location*	24	25	26	27	28	29	30	31	32
Flow, gpm	0	0	0	164	154	10	10	0	0
Pressure, psig	12	91	15	91	91	91	20	7	7
Temperature, °F	70	160	160	140	140	140	140	160	160

CVCS Makeup System Operation - Borate Mode: Three Charging Pumps Operating

CVCS Location*	15	16	17	18	19	20	21	22	23
Flow, gpm	180	180	16	16	0	16	0	0	16
Pressure, psig	7	90	90	76	15	20	165	20	20
Temperature, °F	140	140	140	140	160	140	60	60	140
CVCS Location*	24	25	26	27	28	29	30	31	32
Flow, gpm	0	0	0	164	154	10	10	0	0
Pressure, psig	12	90	15	90	90	90	20	7	7
Temperature, °F	70	140	160	140	140	140	140	160	160

CVCS Makeup System Operation - Dilute Mode: Three Charging Pumps Operating

CVCS Location*	15	16	17	18	19	20	21	22	23
Flow, gpm	160	160	0	0	0	0	128	128	128
Pressure, psig	7	88	88	88	15	20	142	20	20
Temperature, °F	140	140	160	160	160	160	60	60	60
CVCS Location*	24	25	26	27	28	29	30	31	32
Flow, gpm	0	0	0	160	150	10	10	0	0
Pressure, psig	12	88	15	88	88	88	20	7	7
Temperature, °F	70	160	160	140	140	140	140	160	160

ARKANSAS NUCLEAR ONE
Unit 2

Table 9.3-7 (continued)

The data shown for the various modes of CVCS Makeup System Operation is typical. The pressure in the isolated piping of the CVCS makeup system will normally be 0 psig but may range as high as 140 psig before the relief valve lifts.

**CVCS Makeup System Operation - Manual Mode:
Blended Boric Acid Concentration at 2300 ppm**

CVCS Location*	15	16	17	18	19	20	21	22	23
Flow, gpm	174	174	10	10	0	10	50	50	60
Pressure, psig	7	91	90	86	15	20	155	20	20
Temperature, °F	140	140	140	140	160	140	60	60	75
CVCS Location*	24	25	26	27	28	29	30	31	32
Flow, gpm	0	0	0	164	154	10	10	0	0
Pressure, psig	12	91	15	91	91	91	20	7	7
Temperature, °F	70	160	160	140	140	140	140	160	160

**CVCS Makeup System Operation - Emergency Boration (SIAS) via boric acid makeup
pump and one pump is operating; three charging pumps operating;
Two boric acid makeup pumps operating**

CVCS Location*	15	16	17	18	19	20	21	22	23
Flow, gpm	142	142	132	0	0	0	0	0	0
Pressure, psig	7	97	97	97	97	15	165	15	15
Temperature, °F	140	140	140	160	160	160	60	60	160
CVCS Location*	24	25	26	27	28	29	30	31	32
Flow, gpm	0	132	132	10	0	10	10	0	0
Pressure, psig	12	97	92	97	97	97	20	7	7
Temperature, °F	70	140	140	140	160	140	140	160	160

CVCS Makeup System Operation - Emergency Boration (SIAS) via gravity feed

CVCS Location*	15	16	17	18	19	20	21	22	23
Flow, gpm	0	0	0	0	0	0	0	0	0
Pressure, psig	7	7	7	7	5	15	165	15	15
Temperature, °F	160	160	160	160	160	160	60	60	160
CVCS Location*	24	25	26	27	28	29	30	31	32
Flow, gpm	0	0	0	0	0	0	0	66	66
Pressure, psig	12	7	5	7	7	7	7	7	7
Temperature, °F	70	160	160	160	160	160	160	140	140

ARKANSAS NUCLEAR ONE
Unit 2

Table 9.3-7 (continued)

CVCS Makeup System Operation - Shutdown Boration

CVCS Location*	15	16	17	18	19	20	21	22	23
Flow, gpm	180	180	16	0	0	0	0	0	0
Pressure, psig	7	91	90	90	90	15	165	15	15
Temperature, °F	140	140	140	160	160	160	60	60	160
CVCS Location*	24	25	26	27	28	29	30	31	32
Flow, gpm	0	16	16	164	154	10	10	0	0
Pressure, psig	125	90	89	90	90	90	90	7	7
Temperature, °F	70	140	140	140	140	140	140	160	160

*** LOCATIONS**

(For original process data point locations indicated on the P&ID, refer to M-2231)

1.	Regenerative heat exchanger tube side inlet	14g.	Controlled bleedoff inlet to VCT
2.	Regenerative heat exchanger tube side outlet	15.	Boric acid makeup tanks outlet (per tank)
3.	Letdown heat exchanger inlet	16	Boric acid makeup pumps discharge (per pump)
4.	Letdown heat exchanger outlet	17.	Boric acid makeup pump minus recirc flow
5.	Letdown purification filter inlet	18.	Inlet to boric acid flow control valve
6.	Purification filter outlet	19.	Boric acid bypass flow to charging pumps
7.	Letdown to rad monitor	20.	Boric acid inlet to mixing tee
8.	Purification ion exchangers inlet	21.	Reactor makeup water inlet to flow control valve
9.	Purification ion exchangers outlet	22.	Reactor makeup water inlet to mixing tee
10.	Inlet to letdown strainer	23.	Outlet of mixing tee
10a.	Volume control tank inlet	24.	RWT supply to suction of charging pumps
10b.	Spray into volume control tank	25.	Inlet to Emergency Boration valve
10c.	Volume control tank outlet	26.	Outlet of Emergency Boration valve
11.	Charging pump inlet	27.	Boric acid pump recirc flow (per pump)
12.	Regenerative heat exchanger shell side inlet	28.	Inlet to boric acid pump recirc valve
13.	Regenerative heat exchanger shell side outlet	29.	Inlet to boric acid pump recirc bypass valve
14a-d:	Reactor coolant pump controlled bleedoff	30.	Outlet of boric acid pump recirc bypass valve
14e.	Controlled bleedoff to quench tank	31.	2T-6B gravity feed valve outlet
14f.	Controlled bleedoff combined header	32	2T-6A gravity feed valve outlet

ARKANSAS NUCLEAR ONE
Unit 2

Table 9.3-8

**DESIGN TRANSIENTS
REGENERATIVE AND LETDOWN HEAT EXCHANGERS**

<u>Transient</u>	<u>Cycles</u>	<u>Variation Level</u>		<u>Rate</u>	<u>Letdown Flow</u>		<u>Charging Flow</u> (GPM)
		<u>Initial</u>	<u>Final</u>		<u>Initial</u>	<u>Final</u>	
Plant Startup	500	70 °F Atmos.	532 °F 2250 psia	75 °F/hr	56 150	150 40	44
			RCS		(GPM)		
					in 8.6 hrs		
					in 3 hrs		
Step Power Change		90%	100%		40	90	44
or	3120 (total)				90	40	
					in 40 min		
Ramp Power Change		15%	100%	5%/min	40	128	44
					in 17 min		
					128	40	
					in 17 min		
Step Power Change		100%	90%		40	73	44
or	3120 (total)				73	40	(88 briefly)
					in 20 min		
Ramp Power Change		100%	15%	-5%/min	40	30	44 88 132
					30	40	132 88 44
					in 27 min		in 27 min
Turbine Trip	400	100%	0%		40	30	44 88 132
					30	40	132 88 44
					in 35 min		in 15 min
Loss of Load	40	100%	0%		40	30	44 88 132
					30	40	132 88 44
					in 35 min		in 15 min

ARKANSAS NUCLEAR ONE
Unit 2

Table 9.3-8 (continued)

<u>Transient</u>	<u>Cycles</u>	<u>Variation Level</u>		<u>Rate</u>	<u>Letdown Flow</u>			<u>Charging Flow</u>		
		<u>Initial</u>	<u>Final</u>		<u>Initial</u>	<u>Final</u>	<u>(GPM)</u>			
Loss of Flow	40	100%	0%		40	30		44	88	132
					30	40		132	88	44
					in 35 min			in 15 min		
Loss of Secondary Pressure	5				40	30	0	44		132
					in 12 sec					
Maximum Purification	1000				40	84	128	44	88	132
					128	84	40	132	88	44
Low-Low Volume Control Tank Response	80	Charging Flow Temp. 120 °F 40 °F			40					44
					in 10 sec					
Loss of Charging (with restoration in ≥ 4 hrs.)					40		0	44		0
					in 13 sec					
or	1390				0		40	0		44
(total)										
Loss of Letdown					40		0			44
					0	128	40			
					25 min after restart					
Loss of Charging (with restoration in < 4 hrs.)	1500				40		0	44		0
					in 13 sec					
					0		40	0		44
Plant Cooldown	500				30		100			132
		532 °F	70 °F		in 11 hrs					
		2250 psia			100		30	132		44
					(rapidly)					

ARKANSAS NUCLEAR ONE
Unit 2

Table 9.3-9

REGENERATIVE HEAT EXCHANGER DESIGN DATA

1) Design Parameters

Quantity	1
Type	Shell and Tube, Vertical
Code	ASME Section III, Class 2
Tube Side – Letdown:	
Fluid	Reactor coolant, 1.5 w/o boric acid maximum
Design pressure, psig	2485
Design temperature, °F	650
Materials	Stainless Steel, Type 304
Pressure loss at 128 gpm, psi	100
Normal flow, gpm	40
Design flow, gpm	128
Shell Side – Charging:	
Fluid	Reactor coolant, 12 w/o boric acid maximum
Design pressure, psig	3025
Design temperature, °F	650
Materials:	
Shell	ASME SA-304, TP 304
Tubes	ASME SA-213, TP 304
Baffles	ASME SA-240, TP 304
Tube Sheet	ASME SA-182, F 304
Channel	ASME SA-312, TP 304
Pressure loss at 132 gpm, psi	70
Normal flow, gpm	44
Design flow, gpm	132

2) Operating Parameters

	Normal	Minimum Letdown/ Maximum Charging	Maximum Letdown/ Maximum Charging	Maximum Letdown/ Minimum Charging
Tube Side – Letdown				
Flow - gpm @ 120 °F	40	30	128	128
Inlet Temp. - °F	550	550	550	550
Outlet Temp.* - °F	218	152	366	442
* May vary with 551 °F inlet temperature.				
Shell Side – Charging				
Flow - gpm @ 120 °F	44	132	132	44
Inlet Temp. - °F	120	120	120	120
Outlet Temp. - °F	410	223	324	479

ARKANSAS NUCLEAR ONE
Unit 2

Table 9.3-10

LETDOWN HEAT EXCHANGER DESIGN DATA

1) Design Parameters

Quantity	1
Type	Shell and Tube, Horizontal
Tube Side – Letdown:	
Code	ASME Section III, Class 2
Fluid	Reactor coolant, 1.5 w/o boric acid maximum
Design pressure, psig	650
Design temperature, °F	550
Pressure loss at 128 gpm, psi	50
Normal flow, gpm	40
Design flow, gpm	128
Materials:	
Shell	ASME SA-106 Gr.B
Tubes	ASME SA-213, Type 304
Cover	ASME SA-285, Gr. C F.B.Q.
Tubesheet	ASME SA-182, F 304
Channel	ASME SA-240, Type 304
Shell Side – cooling water:	
Code	ASME Section III, Class 3
Fluid	Component Cooling Water
Design pressure, psig	150
Design temperature, °F	250
Materials	Carbon Steel
Normal flow, gpm	180
Design flow, gpm	1200

2) Operating Parameters

	Normal	Minimum Letdown/ Maximum Charging	Maximum Letdown/ Maximum Charging	Maximum Letdown/ Minimum Charging
Tube Side – Letdown				
Flow - gpm @ 120 °F	40	30	128	128
Inlet Temp.* - °F	218	152	366	442
Outlet Temp. - °F	120	120	123	130

* Based on letdown temperature of 550°F, may vary with letdown temperature of 551 °F.

Shell Side – Charging				
Flow - gpm @ 120 °F	121	35	1200	1200
Inlet Temp. - °F	100	100	100	100
Outlet Temp. - °F	133	129	127	134

ARKANSAS NUCLEAR ONE
Unit 2

Table 9.3-11

PURIFICATION FILTER DESIGN DATA

Quantity	2
Type Elements	Cartridges
Normal operating temperature, °F	120
Design pressure, psig	200
Maximum allowable pressure loss clean, psi @ 128 gpm	5
Maximum allowable pressure loss, loaded psi at 128 gpm	60
Design temperature, °F	250
Design flow, gpm	128
Normal flow, gpm	40
Code	ASME III, Class 3
Materials, wetted	SA-240 Type 304 Stainless Steel
Fluid, w/o boric acid, maximum	1.5

Table 9.3-12

PURIFICATION AND DEBORATING ION EXCHANGERS DESIGN DATA

Quantity	2 purification 1 deborating
Type	Flushable
Design pressure, psig	200
Design temperature, °F	250
Normal operating temperature, °F	120
Resin volume, cu. ft. each (total)	36.2
Resin volume, cu.ft. each (useful)	32.0
Normal flow, gpm	40
Maximum flow, gpm	1280
Code for vessel	ASME III, Class C
Retention screen size	80 U.S. Mesh
Material	Stainless Steel, SA-240, Type 304
Fluid, w/o boric acid, maximum	1.5
Resin type	Cation/anion mixed bed for purification and deborating

ARKANSAS NUCLEAR ONE
Unit 2

Table 9.3-13

VOLUME CONTROL TANK DESIGN DATA

Quantity	1
Type	Vertical, Cylindrical
Internal volume, gallons	4200
Design pressure, internal, psig	75
Design pressure, external, psig	15
Design Temperature, °F	250
Normal operating pressure, psig	15
Normal operating temperature, °F	120
Normal spray flow, gpm	40
Blanket gas - during plant operation	Hydrogen
Code	ASME III, Class C
Fluid, w/o boric acid, maximum	12
Material	ASME SA-240, Type 304

Table 9.3-14

CHARGING PUMPS DESIGN DATA

Quantity	3
Type	Horizontal, Positive Displacement, Triplex
Design pressure, psig	2735
Design Temperature, °F	250
Capacity, gpm	44
Normal discharge pressure, psig	2300
Normal suction pressure, psig	15 to 20
Normal temperature of pumped fluid, °F	120
NPSH required, psia (most limiting)	3.8
Driver rating, hp	100
Code	ASME P&V Code Class 2
Materials in contact with pumped fluid	SA-182, F 316, F 304 or F 304L; SA-479 TY-304; SA-705 TY-630 H1100
Fluid, w/o boric acid, maximum	12

ARKANSAS NUCLEAR ONE
Unit 2

Table 9.3-15

BORIC ACID MAKEUP TANKS DESIGN DATA

Quantity	2
Volume, gal each	11,700
Design pressure, psig	15
Design temperature, °F	200
Normal operating temperature, °F	70 – 80
Type heater*	6 electrical strap-on heaters, 2.25kW total each (2 banks of 3 each)
Fluid, w/o boric acid, maximum*	12
Material	ASME SA-240 Type 304
Code	ASME III, Class C

* Starting with Cycle 7, the maximum boric acid concentration in an operable tank is limited to 3.5 w/o to eliminate precipitation of boron at the ambient temperatures of the auxiliary building, thereby eliminating the need for tank heaters.

Table 9.3-16

BORIC ACID BATCHING TANK DESIGN DATA

Quantity	1
Internal volume, gal	630
Design pressure	Atmospheric
Design temperature, °F	200
Normal operating temperature, °F	110 – 160
Type heater*	Electrical Immersion
Number of heaters	3
Heater capacity, kw each	15
Fluid, w/o boric acid, maximum**	12
Material	ASME SA-240 Type 304
Code	None

** The control setpoint for the heat trace on the discharge piping is selected for a maximum boric acid concentration of 8.1 w/o.

ARKANSAS NUCLEAR ONE
Unit 2

Table 9.3-17

BORIC ACID MAKEUP PUMPS DESIGN DATA

Quantity	2
Type	Centrifugal, Horizontal
Design pressure, psig	150
Design Temperature, °F	250
Design head, ft	231
Design flow, gpm	143
Normal operating temperature, °F	70
NPSH required, ft	6
Motor horsepower	25
Motor voltage/phase/Hz	440/3/60
Fluid, wt % boric acid, maximum	12*
Material in contact with liquid	Austenitic Stainless Steel
Code	ASME III, Class 2

* Starting with Cycle 7, the maximum boric acid concentration in an operable flow path from the BAMT is limited to 3.5 wt % due to the elimination of heat tracing for this piping. This prevents boron precipitation at the ambient temperatures of the auxiliary building.

Table 9.3-18

CHEMICAL ADDITION TANK DESIGN DATA

Quantity	1
Internal volume, gals	8
Design pressure, psig	150
Design temperature, °F	150
Normal operating temperature, °F	Ambient
Materials	Austenitic Stainless Steel
Code	None

Table 9.3-19

CVCS PROCESS RADIATION MONITOR DESIGN DATA

Quantity	1
Type	Gamma scintillation
Design pressure, psig	200
Design temperature, °F	250
Normal operating temperature, °F	120
Normal flow rate, gpm	1.2
Measurement range, µCi/cc, I-135	10^{-4} to 10^{+2}
Code	ASME III, Class C

Table 9.3-20

Deleted

ARKANSAS NUCLEAR ONE
Unit 2

Table 9.3-21

SINGLE FAILURE ANALYSIS - CHEMICAL AND VOLUME CONTROL SYSTEM

<u>Component</u>	<u>Failure Mode</u>	<u>Cause</u>	<u>Symptoms and Local Effects</u>	<u>Method of Detection</u>	<u>Inherent Compensating Provision(s)</u>
Regenerative Heat Exchanger (RHX)	Decrease in ability to transfer heat	Excessive fouling or crud deposition	High temperature in letdown line	High temperature alarm from 2TAH-4820	Hot flow will automatically bypass IXs and PRM (2) 2TS-4820 will shut valve 2CV-4820-2 and stop letdown flow
Regenerative Heat Exchanger (RHX)	Shell to tube leakage	Corrosion and/or manufacturing defect	Eventual out of spec. boron concentration; heat exchanger temperature disparities	Isolate letdown and measure flow on 2FIS-4863 while charging. Perform only during shutdown	Safe plant shutdown not affected. Charging via SIS filling pressurizer, letdown via reactor coolant pumps
Letdown Heat Exchanger (LHX)	Decrease in ability to transfer heat	Excessive fouling or crud deposition	High temperature in letdown line or abnormally high cooling water flow rate	High temperature alarm from 2TAH-3805 and high temperature reading from 2TIC-4815	Hot flow will automatically bypass IXs
Letdown Heat Exchanger (LHX)	Cross Leakage	Corrosion and/or manufacturing defect	Radioactivity will be transferred to CCW	Activity monitor in CCW will sound alarm	Safe plant shutdown not affected

ARKANSAS NUCLEAR ONE
Unit 2

Table 9.3-21 (continued)

<u>Component</u>	<u>Failure Mode</u>	<u>Cause</u>	<u>Symptoms and Local Effects</u>	<u>Method of Detection</u>	<u>Inherent Compensating Provision(s)</u>
Line, between 2TE-4820 and 2CV-4811 (outside Containment)	Rupture	Faulty weld	High temperature in letdown line	High temperature alarm from 2TAH-4820 and low pressure alarm from 2PAHL-4812	2TS-4820 will shut valve 2CV-4820-2 and stop letdown flow
Line, between LHX and 2TE-4805	Rupture	Faulty weld	Loss of pressure in letdown line	Low pressure alarm from 2PAHL-4812 and high temp. alarm 2TAH-4820	2TS-4820 will close letdown stop valve 2CV-4820-2
Purification Filter	Clogs	Contamination	High differential pressure across filter	Sensor, 2PDIS-4802 will actuate alarm	Bypass Line will facilitate cartridge replacement
Purification Filter	Cartridge rupture	Excessive differential pressure	Contamination of IXs and PRM	None for small breaks, for larger breaks the reading of 2PDIS-4802 will be lower than normal also periodic sampling for activity buildup	Bypass line will facilitate cartridge replacement
Radiation Monitor	Fails to detect high levels radiation	Electrical malfunction	May allow a buildup of contamination	Laboratory analysis of coolant sample	Backup by sampling system and local samples
Radiation Monitor	False indication of high level of radiation	Electrical malfunction	Alarm	Laboratory analysis of coolant sample	Backup by sampling system and local samples

ARKANSAS NUCLEAR ONE
Unit 2

Table 9.3-21 (continued)

<u>Component</u>	<u>Failure Mode</u>	<u>Cause</u>	<u>Symptoms and Local Effects</u>	<u>Method of Detection</u>	<u>Inherent Compensating Provision(s)</u>
Letdown Ion Exchanger	Fails to remove contamination	Resin exhaustion	Buildup in RCS activity	Alarm from PRM and laboratory sample analysis	Bypass ion exchangers during replacement of resin
Letdown Ion Exchanger	Fails to remove boron from coolant	Resin exhaustion	Unable to maintain power at end of core cycle	Coolant sample and decreasing power	Bypass and replace during replacement of changer
Charging pumps	Fails to provide sufficient flow to RCS	Seal failure, electrical malfunction, or low NPSH	High letdown temp at 2TI-4820, and low charging flow rate at 2FIS-4863, and low pressurizer liquid level	Low level in pressurizer, low flow alarm at pump outlet (2FAL-4863)	Low level in pressurizer will start second and third pump
Line, Makeup to Volume Control Tank (VCT)	Rupture	Faulty weld	Possible loss of makeup, activity release from VCT, VCT low pressure	Low VCT level alarm, possible annunciation of area radiation monitors, VCT low pressure alarm	VCT level controller 2LS 4861-A will close VCT discharge valve 2CV-48731 and open valve to refueling water tank
Boric Acid Batching Tank Heater and Controller	Fails off	Electrical malfunction	Precipitation, inability to mix boric acid	2TIC-4901 will indicate low temperature	Sufficient reserve in makeup tanks is available until malfunction is corrected
Boric Acid Batching Tank Heater and Controller	Fails on	Electrical malfunction	Overheating of boric acid in batching tank	2TIC-4901 will indicate high temperature	Isolate and repair, sufficient reserve in makeup tanks

ARKANSAS NUCLEAR ONE
Unit 2

Table 9.3-21 (continued)

<u>Component</u>	<u>Failure Mode</u>	<u>Cause</u>	<u>Symptoms and Local Effects</u>	<u>Method of Detection</u>	<u>Inherent Compensating Provision(s)</u>
Boric Acid Batching Tank Mixer	Fails to start	Electrical malfunction	Unable to batch boric acid solution	Visual	Isolate and repair, sufficient reserve in makeup tanks
Boric Acid Makeup tank	Leak	Faulty weld or connection	Loss of boric acid	Level indication and alarm	Redundant standby tank
Line, Discharge Boric Acid Makeup Tank	Leak	Faulty weld or connection	Loss of boric acid	Level indication alarm	Redundant standby tank
Boric Acid Makeup Pump	Fails to start	Electrical malfunction or shaft break	Loss of Flow	Pump discharge pressure low alarm	Redundant standby pump, gravity feed or use refueling water tank
Line, Boric Acid Pump Discharge	Rupture	Faulty weld	Loss of boric acid	Pump discharge pressure low alarm	Redundant standby pump, and boric acid from refueling water tank
Line, Gravity feed to charging	Rupture	Faulty weld	Loss of boric acid	Boric acid makeup tank level indication	Alternate flow path of boric acid available from refueling water tank
Heat Tracing	Fails off	Electrical malfunction	No adverse impact on system or system operation		

ARKANSAS NUCLEAR ONE
Unit 2

Table 9.3-21 (continued)

<u>Component</u>	<u>Failure Mode</u>	<u>Cause</u>	<u>Symptoms and Local Effects</u>	<u>Method of Detection</u>	<u>Inherent Compensating Provision(s)</u>
Volume Control Tank (VCT)	Rupture	Faulty weld	Loss of liquid and radioactive gases	Pressure and level indication and alarms on VCT, and radiation alarm in auxiliary building	Charging pump suction will automatically be supplied by refueling water tank on low level in VCT
Line, Discharge of VCT	Rupture	Faulty weld	Loss of coolant, radioactive gases and liquids released and low VCT pressure	Pressure and level indications and alarms in VCT	VCT discharge valve will close on low VCT level and charging pump suction will switch to refueling water tank
Line, Refueling Water Tank to CVCS	Rupture	Faulty weld	Loss of RWT contents	Level alarm in RWT	Ability to borate the RCS with contents of makeup tanks not affected. Isolation valve at tank
Line, Charging Pump Discharge	Rupture	Faulty weld	Loss of pressure, Loss of coolant	Low pressure alarm 2PAL-4870 and low flow alarm 2FAL-4863	Isolate and charge through HPSI header

ABBREVIATIONS

RHX - Regenerative heat exchanger
LHX - Letdown heat exchanger
IX - Ion exchanger
PRM - Process radiation monitor
SIS - Safety injection system

RCS - Reactor Coolant System
VCT - Volume control tank
RWT - Refueling water tank
CCW - Component cooling water (system)

ARKANSAS NUCLEAR ONE
Unit 2

Table 9.3-22

CHEMICAL AND VOLUME CONTROL SYSTEM INSTRUMENT APPLICATION

<u>System Parameter and Location</u>	<u>Indication</u>		<u>Alarm⁽¹⁾</u>		<u>Rec.⁽¹⁾</u>	<u>Control Function</u>	<u>Instrument Range</u>	<u>Normal Operating Range</u>
	<u>Local</u>	<u>Control Room</u>	<u>High</u>	<u>Low</u>				
Boric Acid Makeup Tank Temperature	*		*	*		Heaters	50-200 °F	70-80 °F
Boric Acid Batching Tank Temperature	*					Heaters	50-200 °F	110-160 °F
Letdown Temperature after Regenerative Heat Exchanger	*	*				Letdown Flow	100-500 °F	215 °F
Letdown Temperature after Letdown Heat Exchanger	*	*				Component Cooling Water	50-200 °F	120 °F
Letdown Temperature	*	*				Process Radiation Isolation Valve, Ion Exchanger Bypass Valve	50-200 °F	120 °F
Volume Control Tank Temperature	*	*					0-200 °F	120 °F
Regenerative Heat Exchanger Shell Temperature	*						0-600 °F	410 °F
Letdown Pressure	*	*	*	*		Backpressure Control Valves	0-600 psig	350 psig ⁽²⁾
Letdown Pressure	*						0-300 psig	0-150 psig

ARKANSAS NUCLEAR ONE
Unit 2

Table 9.3-22 (continued)

<u>System Parameter and Location</u>	<u>Indication</u>		<u>Alarm⁽¹⁾</u>			<u>Control Function</u>	<u>Instrument Range</u>	<u>Normal Operating Range</u>
	<u>Local</u>	<u>Control Room</u>	<u>High</u>	<u>Low</u>	<u>Rec.⁽¹⁾</u>			
Purification Filter Δp	*		*				0-40 psid	1-5 psid
Ion Exchanger Δp	*						0-40 psid	1-5 psid
Letdown Strainer Δp	*		*				0-30 psid	1-10 psid
Boric Acid Pump Discharge Pressure	*			*			0-120 psig	50-110 psig
Charging Pump Header Pressure		*		*			0-3000 psig	2300 psig
RCP Bleedoff Header Pressure		*	*				0-300 psig	25-175 psig
Charging Pump Suction Pressure						Charging Pump Permissive	30 in. Hg V.-100 psig 30 in. Hg V.-0.5 psig	15-115 psig 15-115 psig (2PS-4852 only)
Volume Control Tank Pressure	*	*	*	*			0-75 psig 0-100 psig (local)	15-50 psig
Charging Pump Seal Lube Pressure	*		*	*			0-30 psig	5.5-6.0 psig
Boric Acid Makeup Tank Level	*	*	*	*			0-100%	88-94%

ARKANSAS NUCLEAR ONE
Unit 2

Table 9.3-22 (continued)

System Parameter and Location	Indication		Alarm ⁽¹⁾			Control Function	Instrument Range	Normal Operating Range
	Local	Control Room	High	Low	Rec. ⁽¹⁾			
Volume Control Tank Level		*	*	*		Level Replenishment Bypass to BMS, Tank Isolation	0-100%	60-75%
Letdown Flow		*					0-150 gpm	40 gpm
Process Radiation Monitor Flow	*			*			0.2-2 gpm	1.0 gpm
Boron Flow		*	*	*	*	VCT Level; Boron Concentration Maintenance	0-30 gpm 0-999,999 gal	0-30 gpm
Demineralized Makeup Water Flow		*	*	*	*	B.A. Flow Control Valve, Totalizer, Batchswitch; Boron Concentration Maintenance	0-150 gpm 0-999,999 gal	0-150 gpm
Charging Flow		*		*			0-150 gpm	44 gpm
Process Radiation		*	*		*		10 ⁻⁴ -10 ⁻² µCi/cc	

(1) All alarms and recorders are in the control room unless otherwise indicated.

(2) The letdown backpressure setpoint may be adjusted in the range of 350 – 460 psig for process control.

ARKANSAS NUCLEAR ONE
Unit 2

Table 9.3-23

SHUTDOWN COOLING MODE DESIGN PARAMETERS

Tube Side:	
Flow, million lb/hr	1.5
Inlet temperature, °F	144
Outlet temperature, °F	124.8
Shell Side:	
Flow, million lb/hr	2.41
Inlet temperature, °F	100
Outlet temperature, °F	111.9
Heat load, million Btu/hr	28.7
Service transfer rate, Btu/hr-°F-sq.ft.	187
Total fouling factor	.0026

TABLE 9.3-24

SHUTDOWN COOLING HEAT EXCHANGER DATA

Quantity	2
Type	Shell and tube, horizontal U-tube
Code:	
Tube side	ASME III, Class 2 (2007 with 2008 Addenda)
Shell side	ASME Section VIII (2015)
Tube Side:	
Fluid	Reactor coolant
Design pressure, psig	650
Design temperature, °F	400
Materials	Superaustenitic stainless steel SB-676 (N08367)
Shell Side:	
Fluid	Service water
Design pressure, psig	150
Design temperature, °F	250
Materials	Superaustenitic stainless steel SB-688 (N08367)

ARKANSAS NUCLEAR ONE
Unit 2

Table 9.3-25

SHUTDOWN COOLING SYSTEM INSTRUMENT APPLICATION

System Parameter and Location	Indication		Alarm ⁽¹⁾			Control Function	Instrument Range	Normal Operating Range
	Local	Control Room	High	Low	Recorder ⁽¹⁾			
Heat Exchanger Inlet Temperature, 2TI-5617, 2TI-5619	*						0-400 °F	90-120 °F
Heat Exchanger Outlet Temperature, 2TI-5618, 2TI-5620		*					0-400 °F	90-120 °F
Shutdown Cooling Return Temperature and Mixed Outlet and Bypass of Heat Exchanger, 2TR-5097					*		0-400 °F	90-120 °F
Heat Exchanger Inlet Pressure, 2PI-5622, 2PI-5625		*					0-600 psig	175-185 psig ⁽²⁾
Shutdown Cooling Return Flow, 2FIC-5091		*	*	*		Heat Exchanger Bypass Valve	0-8000 gpm	Variable
Low Pressure Safety Injection Discharge Header 2PI-5092		*	*	*			0-600 psig	Variable
LPSI Pump Suction Pressure, 2PI-5039A		*	*	*			0-50 psig	~20 psig ⁽²⁾
LPSI Pump ΔP, 2PI-5039A							0-300 psid	~130-140 psid ⁽³⁾

ARKANSAS NUCLEAR ONE
Unit 2

Table 9.3-25 (Continued)

<u>System Parameter and Location</u>	<u>Indication</u>		<u>Alarm⁽¹⁾</u>			<u>Control Function</u>	<u>Instrument Range</u>	<u>Normal Operating Range</u>
	<u>Local</u>	<u>Control Room</u>	<u>High</u>	<u>Low</u>	<u>Recorder⁽¹⁾</u>			
LPSI Pump Motor Current, 2II-5018A	*						0-100 Amps	Variable
RCS Refueling Level, 2LI-4791, 2LI-4792							0-420"	Variable
RCS Refueling Level, Tygon Tubing							369'-1½" to 401'-5½"	Variable
CET Temperature, 2TI-4793							0-2300 °F	Variable

(1) All alarms and recorders are in the control room unless otherwise indicated.

(2) Reactor Vessel Head removed.

(3) LPSI Pump indicated ΔP includes pressure drop across 2FO-5090.

ARKANSAS NUCLEAR ONE
Unit 2

Table 9.4-1

SINGLE FAILURE ANALYSIS - CONTROL ROOM EMERGENCY AIR CONDITIONING SYSTEM

Component	Failure	Comments & Consequences
Off-site power	Not available	Emergency diesels start and supply electrical load to system.
Emergency diesels	One not available	The operative diesel supplies necessary power to one of the redundant system flow paths.
Control room emergency air conditioning system	One not available	The standby, full-capacity, control room emergency air conditioning system is available to provide suitable environmental conditions in the control room for operating personnel and safety-related control equipment.
Control room emergency air conditioning system	Rupture of equipment casings	The system is designed as a Seismic Category 1 System. The equipment and components are also inspectable and protected against credible missiles.
Control room emergency air conditioning system	Rupture of one loop of the service water piping system	The standby, full-capacity, control room emergency air conditioning system is supplied by the second loop of the service water piping system.

ARKANSAS NUCLEAR ONE
Unit 2

Table 9.4-2

SINGLE FAILURE ANALYSIS-EMERGENCY DIESEL GENERATOR ROOM VENTILATION SYSTEMS

Component	Failure	Comments & Consequences
Off-site power	Not available	Emergency diesels start and supply electrical load to systems.
Emergency Diesels	One not available	The operative diesel supplies necessary power to ventilation system serving the emergency diesel generator room in use.
Emergency Diesel Generator	One not available	The standby, full capacity, ventilation system is Room Ventilation Systems available to maintain a suitable environment for essential equipment to the second emergency diesel generator room.
Emergency Diesel Generator Room Ventilation Fans	One not available	The second fan will maintain the room at 115 °F DB with an outside air temperature of 95 °F or at 120 °F with an outside air temperature of 100 °F.
Emergency Diesel Generator Room Ventilation Systems	Rupture of equipment casings and/or ducts	The systems are designed as Seismic Category 1. The equipment and components are also inspectable and protected against credible missiles.

ARKANSAS NUCLEAR ONE
Unit 2

Table 9.4-3

**CONFORMANCE OF ATMOSPHERE CLEANUP SYSTEMS (ACS) WITH RESPECT TO
EACH POSITION OF U.S. NRC REGULATORY GUIDE 1.52 DATED JUNE 1973⁽¹⁾**

<u>REGULATORY GUIDE POSITION 1: ENVIRONMENTAL DESIGN CRITERIA</u>	<u>Control Room Ventilation System⁽²⁾</u>	<u>Containment Purge System</u>	<u>Penetration Room Ventilation System</u>	<u>Auxiliary Bldg and Fuel Handling Floor Ventilation Systems</u>
A) Each ESF atmosphere cleanup system is based on conditions resulting from DBA	Designed to maintain radiological dosage within limits of 10 CRF 50 Appendix A, Criterion 19	Originally designed to lower containment atmosphere activity below 10 CFR 20 limits for personnel access to the containment building (see Section 6.2.5.1)	Designed to collect and process potential containment penetration leakage after DBA	Non-ESF. Design based on assumptions in Regulatory Guide 1.25
B) System design based on 30 days integrated radiation dose	Yes	Yes	Yes	Yes, design based on assumptions in Regulatory Guide 1.25
C) Design of adsorber based on concentration and relative abundance of iodine species	Yes	Yes	Yes	Yes, design based on assumptions in Regulatory Guide 1.25
D) Compatibility of ACS with other ESF systems in containment	N/A	N/A	N/A	N/A
E) Components designed to lowest and highest outdoor temperature	N/A, Recirculation System	Yes	Yes	N/A

ARKANSAS NUCLEAR ONE
Unit 2

Table 9.4-3 (continued)

<u>REGULATORY GUIDE POSITION 2: ENVIRONMENTAL DESIGN CRITERIA</u>	<u>Control Room Ventilation System⁽²⁾</u>	<u>Containment Purge System</u>	<u>Penetration Room Ventilation System</u>	<u>Auxiliary Bldg and Fuel Handling Floor Ventilation Systems</u>
A) (i) ACS components consist of demister, prefilter, HEPA, iodine adsorber, HEPA filter after the adsorber, ducts and valves, fans and related instruments	No demister, no HEPA filter after the adsorber (no entrained moisture)	No demister, no HEPA filter after the adsorber (no entrained moisture)	No demister, no HEPA filter after the adsorber (no entrained moisture)	No demister, no HEPA filter after the adsorber (no entrained moisture)
(ii) Redundancy of ACS if required for mitigation of accident doses	Yes	No, single filter train	Yes	Single filter train, redundant fans
B) Physical separation and missile protection of redundant ACSs	Yes	N/A	Yes	No
C) Seismic Category 1 designation of ACSs	Yes	Yes	Yes	Yes
D) ACS pressure surge protection	N/A	N/A	N/A	N/A
E) Effect of radiation on ACS construction materials to perform intended function	Yes	Yes	Yes	Yes
F) Air flow rate of ACSs	2,000 cfm	40,000 cfm	2,000 cfm	See P&ID M-2262
G) Instrumentation provided in control room	Alarm for low flow and high pressure drop	Alarm for low flow and high pressure drop and high radiation in discharge air	Alarm for low flow and high pressure drop	Alarm for high pressure drop and high radiation in discharge air. Alarm for low flow on Fuel Handling Floor Ventilation

ARKANSAS NUCLEAR ONE
Unit 2

Table 9.4-3 (continued)

<u>REGULATORY GUIDE POSITION 2: ENVIRONMENTAL DESIGN CRITERIA</u>	<u>Control Room Ventilation System⁽²⁾</u>	<u>Containment Purge System</u>	<u>Penetration Room Ventilation System</u>	<u>Auxiliary Bldg and Fuel Handling Floor Ventilation Systems</u>
H) Electrical power supply and distribution in accordance with IEEE Standards	Yes	Yes	Yes	Yes
I) Design avoids bypassing of unfiltered air (except temporarily for tests)	All recirculating air flow through filter train	No bypass	No bypass	No bypass
J) Protection of workers from radiation during maintenance	Standard CVI design	Standard CVI design	Standard CVI design	Standard CVI design
K) Minimization of meteorological effects on outdoor air intakes		N/A	N/A	N/A
L) Maximum leakage rate of ACS housing and ductwork	Welded seam ductwork and housing, Seismic Category 1 design, zero-leakage	Seismic Category 1 design, zero-leakage	Piping constructed to ASME Section VIII requirement, Seismic Category 1, zero-leakage	2% leakage in exhaust ductwork
M) Performance of ACS not ESF classified	N/A	N/A	N/A	N/A
<u>REGULATORY GUIDE POSITION 3: ENVIRONMENTAL DESIGN CRITERIA</u>	<u>Control Room Ventilation System⁽²⁾</u>	<u>Containment Purge System</u>	<u>Penetration Room Ventilation System</u>	<u>Auxiliary Bldg and Fuel Handling Floor Ventilation Systems</u>
A) Demister performance and qualification requirement	No demister required	No demister required	No demister required	No demister required
B) Humidity control for adsorption units	None required	None required	None required	Exhaust air from conditioned space, no humidity control

ARKANSAS NUCLEAR ONE
Unit 2

Table 9.4-3 (continued)

<u>REGULATORY GUIDE POSITION 3: ENVIRONMENTAL DESIGN CRITERIA</u>	<u>Control Room Ventilation System⁽²⁾</u>	<u>Containment Purge System</u>	<u>Penetration Room Ventilation System</u>	<u>Auxiliary Bldg and Fuel Handling Floor Ventilation Systems</u>
C) Prefilter construction and efficiency	UL Class 1, 80% efficient by ASHRAE STD. 52-68 Test Method	UL Class 1, 80% efficient by ASHRAE STD. 52-68 Test Method original, current revision for replacements	UL Class 1, 80% efficient by ASHRAE STD. 52-68 Test Method original, current revision for replacements	UL Class 1, 80% efficient by ASHRAE STD. 52-68 Test Method original, current revision for replacements
D) HEPA filter construction and efficiency	Meets MIL-F-51068D, MIL-F-51079A and UL-586. Tested at 100% and 20% rated flow	Original meets MIL-F-51068D, MIL-F-51079A and UL-586. Replacements meet ASME AG-1 and UL586 and tested at 1000 cfm and 300 cfm flow rate	Meets MIL-F-51068D, MIL-F-51079A and UL-586. Tested at 100% and 20% rated flow.	Original meets MIL-F-51068D, MIL-F-51079A and UL-586. Original tested at 1000 cfm and 20% rated flow. Replacements meet ASME AG-1 and UL-586 and tested at 1000 cfm and 300 cfm flow rate
E) Filter and adsorber mounting frame design and construction	Designed to ORNL-NSIC-65	Designed to ORNL-NSIC-65	Designed to ORNL-NSIC-65	Vertical bed, designed to ORNL-NSIC-65
F) System filter housing design and construction	Designed to ORNL-NSIC-65	Designed to ORNL-NSIC-65	Designed to ORNL-NSIC-65	Designed to ORNL-NSIC-65
G) Water drains design	Designed to ORNL-NSIC-65	Designed to ORNL-NSIC-65	Designed to ORNL-NSIC-65	Designed to ORNL-NSIC-65
H) Consideration of radiation effect on material	Yes	Yes	Yes	Yes

ARKANSAS NUCLEAR ONE
Unit 2

Table 9.4-3 (continued)

<u>REGULATORY GUIDE POSITION 3: ENVIRONMENTAL DESIGN CRITERIA</u>	<u>Control Room Ventilation System⁽²⁾</u>	<u>Containment Purge System</u>	<u>Penetration Room Ventilation System</u>	<u>Auxiliary Bldg and Fuel Handling Floor Ventilation Systems</u>
I) Removal of iodine by adsorber material	CVI 4" deep tray type	CVI 2" vertical bed	CVI 2" deep tray type	CVI 2" vertical bed
J) Prevention of fire in adsorber resulting from decay heat	Auto ignition temp above 340 °C. Filter train is isolated. Fire detector provided	Auto ignition temp above 340 °C	Auto ignition temp not exceeded even with no convective or conductive heat removal for 30 days post LOCA	None
K) System fans provided with sufficient capacity and pressure	Yes	Yes	Yes	Yes
L) System fans capable of operation in post DBA environmental condition	Yes	Yes	Yes	No
M) Ductwork design	Designed to ORNL-NSIC-65 and industry standards	Designed to ORNL-NSIC-65 and industry standards	All steel piping	Designed to SMACNA, medium pressure high velocity
N) Ductwork and housing laid out with minimum of ledges, protrusions, crevices, etc., which impede personnel or create a hazard	Yes, all components are readily accessible	Yes, all components are readily accessible	Yes, all components are readily accessible	Yes, all components are readily accessible

ARKANSAS NUCLEAR ONE
Unit 2

Table 9.4-3 (continued)

<u>REGULATORY GUIDE POSITION 4: ENVIRONMENTAL DESIGN CRITERIA</u>	<u>Control Room Ventilation System⁽²⁾</u>	<u>Containment Purge System</u>	<u>Penetration Room Ventilation System</u>	<u>Auxiliary Bldg and Fuel Handling Floor Ventilation Systems</u>
A) Minimum radiation exposure to personnel during filter removal	Yes, standard CVI design	Yes, standard CVI design	Yes, standard CVI design	Yes, standard CVI design
B) Accessibility to components	All components are readily accessible without temporary ladder or scaffolding	Temporary platform required for access to prefilter and HEPA filter cells	All components are readily accessible without temporary ladder or scaffolding	Temporary platform required for access to prefilter and HEPA filter cells
C) Filter housing provided with adequately sized door with hinges	Filter housing provided with adequately sized door with hinges	Yes, at least one for each compartment	Yes, at least one for each compartment	Yes, at least one for each compartment
D) Adequate spacing between filter banks	Yes	Yes	Yes	Yes
E) Provision for alignment and support of elements during filter change	Standard CVI design	Standard CVI design	Standard CVI design	Standard CVI design
F) Adequate spacing between filter elements	Yes	Yes	Yes	Yes
G) Use of material handling facilities	Yes	Yes	Yes	Yes
H) Provision for permanent test probe with external connection	Yes	Yes	Yes	Yes
I) Periodic operation of ACS train	Yes	No, containment isolation valves must remain closed during power operation	Yes	Yes

ARKANSAS NUCLEAR ONE
Unit 2

Table 9.4-3 (continued)

<u>REGULATORY GUIDE POSITION 4: ENVIRONMENTAL DESIGN CRITERIA</u>	<u>Control Room Ventilation System⁽²⁾</u>	<u>Containment Purge System</u>	<u>Penetration Room Ventilation System</u>	<u>Auxiliary Bldg and Fuel Handling Floor Ventilation Systems</u>
J) Filter elements installed after active construction	Yes	Yes	Yes	Yes
K) Adequate vapor-tight lighting in filter housing	At least one in each compartment	At least one in each compartment	At least one in each compartment	At least one in each compartment
L) Electrical, water and compressed air services nearby but not inside housing	Yes	Yes	Yes	Yes
M) Ledges and sharp edges should be avoided	Yes	Yes	Yes	Yes
<u>REGULATORY GUIDE POSITION 5: ENVIRONMENTAL DESIGN CRITERIA</u>	<u>Control Room Ventilation System⁽²⁾</u>	<u>Containment Purge System</u>	<u>Penetration Room Ventilation System</u>	<u>Auxiliary Bldg and Fuel Handling Floor Ventilation Systems</u>
A) Even air flow distribution to filters	Yes	No, volumetric flowrate obtained per Section 8 of ANSI-N510-1980	Yes	Yes
B) In-place test of HEPA filter in conformance to ANSI Standard	Conform to ANSI-N101.1-1972	Conform to Section 10 of ANSI-N510-1980	Conform to ANSI-N101.1-1972	Conform to ANSI-N101.1-1972
C) In-place test of adsorber in accordance with USAEC Report	Conform to USAEC Report DP-1082 ORNL-NSIC-65	Conform to Section 12 of ANSI-N510-1980	Conform to USAEC Report DP-1082 ORNL-NSIC-65	Conform to USAEC Report DP-1082 ORNL-NSIC-65

ARKANSAS NUCLEAR ONE
Unit 2

Table 9.4-3 (continued)

<u>REGULATORY GUIDE POSITION 6: ENVIRONMENTAL DESIGN CRITERIA</u>	<u>Control Room Ventilation System⁽²⁾</u>	<u>Containment Purge System</u>	<u>Penetration Room Ventilation System</u>	<u>Auxiliary Bldg and Fuel Handling Floor Ventilation Systems</u>
A) If the activated carbon adsorber meets the regulatory requirement, the adsorber section should be assigned the decontamination efficiencies. If not, the carbon should not be used in ESF adsorbers	Carbon meets regulatory requirements as tested by manufacturer	Carbon meets regulatory requirements as tested by manufacturer	Carbon meets regulatory requirements as tested by manufacturer	Carbon meets regulatory requirements as tested by manufacturer
B) The efficiency of the adsorber should be determined by laboratory testing of representative samples of the activated carbon exposed simultaneously to the same service conditions as the adsorber section	Three test cannisters are provided in adsorber bank for periodic testing by supplier in laboratory	Three test cannisters are provided in adsorber bank for periodic testing	Three test cannisters are provided in adsorber bank for periodic testing by supplier in laboratory	Three test cannisters are provided in adsorber bank for periodic testing by supplier in laboratory
C) The user should prepare detailed procedures for each required field and laboratory test suggested by the regulatory guide	Yes	Yes	Yes	Yes

Note:

1. All of Table 9.4-3 is in response to NRC questions.
2. This column is applicable to 2VSF-9 and associated filters. Redundant unit is VSF-9 and is part of Unit 1. See Docket No. 50-313 for details of Unit 1 design.

ARKANSAS NUCLEAR ONE
Unit 2

Table 9.5-1

FIRE WATER PUMP DATA

<u>Characteristics</u>	<u>Electric</u>	<u>Diesel</u>	<u>Jockey</u>
Equipment Numbers	P6A	P6B	P11
Type	3 Stage, Vertical Centrifugal	3 Stage, Vertical Centrifugal	7 Stage, Vertical Centrifugal
Pumped Fluid	Water	Water	Water
Design Pressure	125 psi	125 psi	125 psi
Design Flow Rate	2500 gpm	2500 gpm	90 gpm
Materials of Construction			
Casing	Cast Iron	Cast Iron	Cast Iron
Impeller	Bronze	Bronze	Bronze
Shaft	Steel	Steel	Steel
Sleeves	Stainless Steel	Stainless Steel	Stainless Steel
Driver			
Type	Induction	Diesel	Induction
Service Factor	1.00	-	1.15
Nameplate Rating, HP	300	340	10
Voltage	4000	-	460
RPM	1774	2300	3475

Table 9.5-2

DELETED

Table 9.5-3

FIRE HOSE STATIONS

Fire hose station locations in safety-related areas are identified in the SAR, Appendix 9D.

Table 9.5-4

FIRE AND SMOKE MONITORING, DETECTION AND ALARM SYSTEM DEVICES

Fire and smoke monitoring, detection, and alarm system devices located in safety-related areas are identified in the SAR, Appendix 9D.

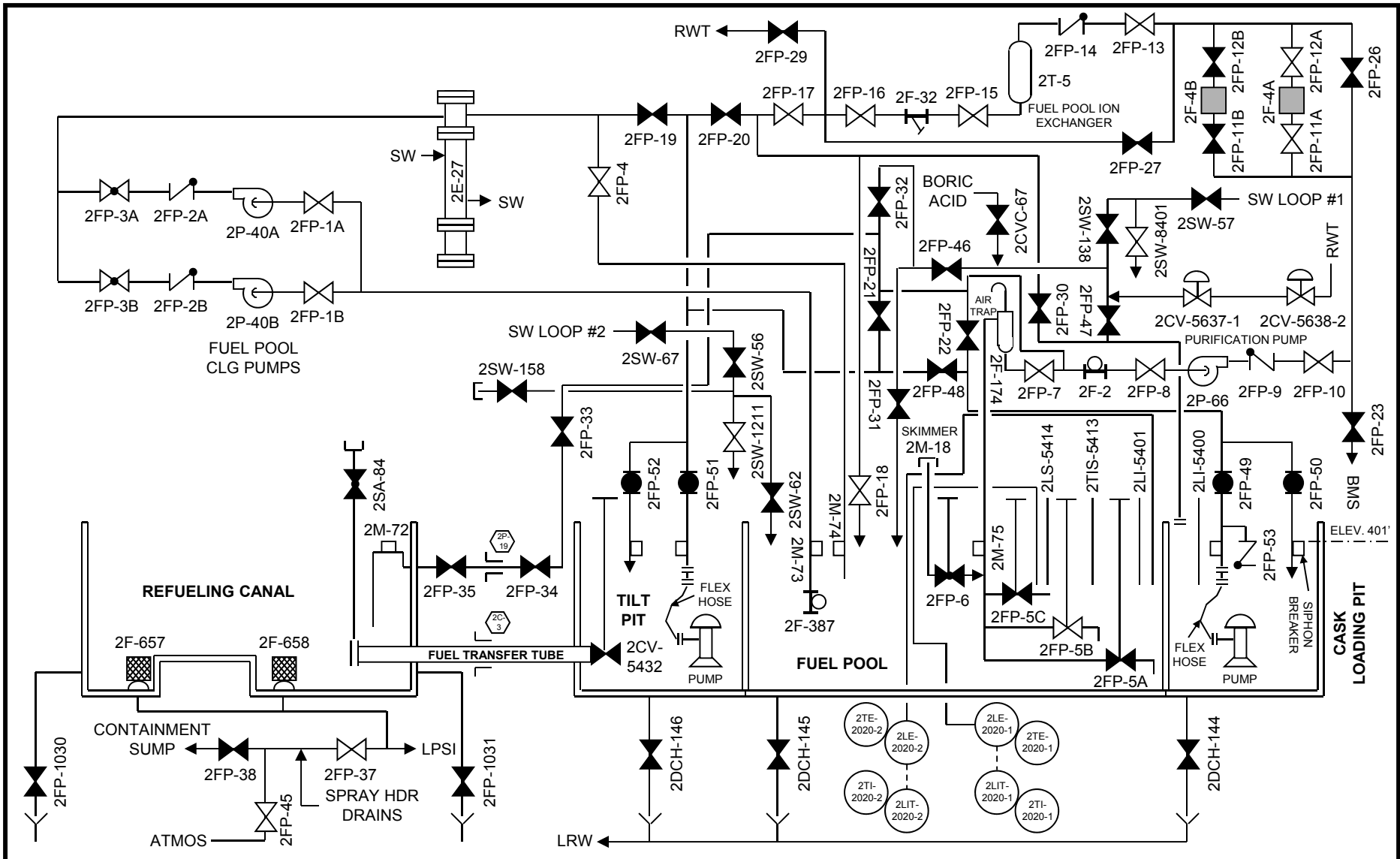

FUEL POOL SYSTEM

SAR FIGURE NO. 9.1-1

ARKANSAS NUCLEAR ONE
 UNIT 2
 RUSSELLVILLE, ARKANSAS



SCALE: NONE
 DRAWN: ENTERGY
 DESIGN: ENTERGY
 CAD NO:

AMENDMENT 26

BASED ON DRAWING NO	SHEET	REV.
---------------------	-------	------

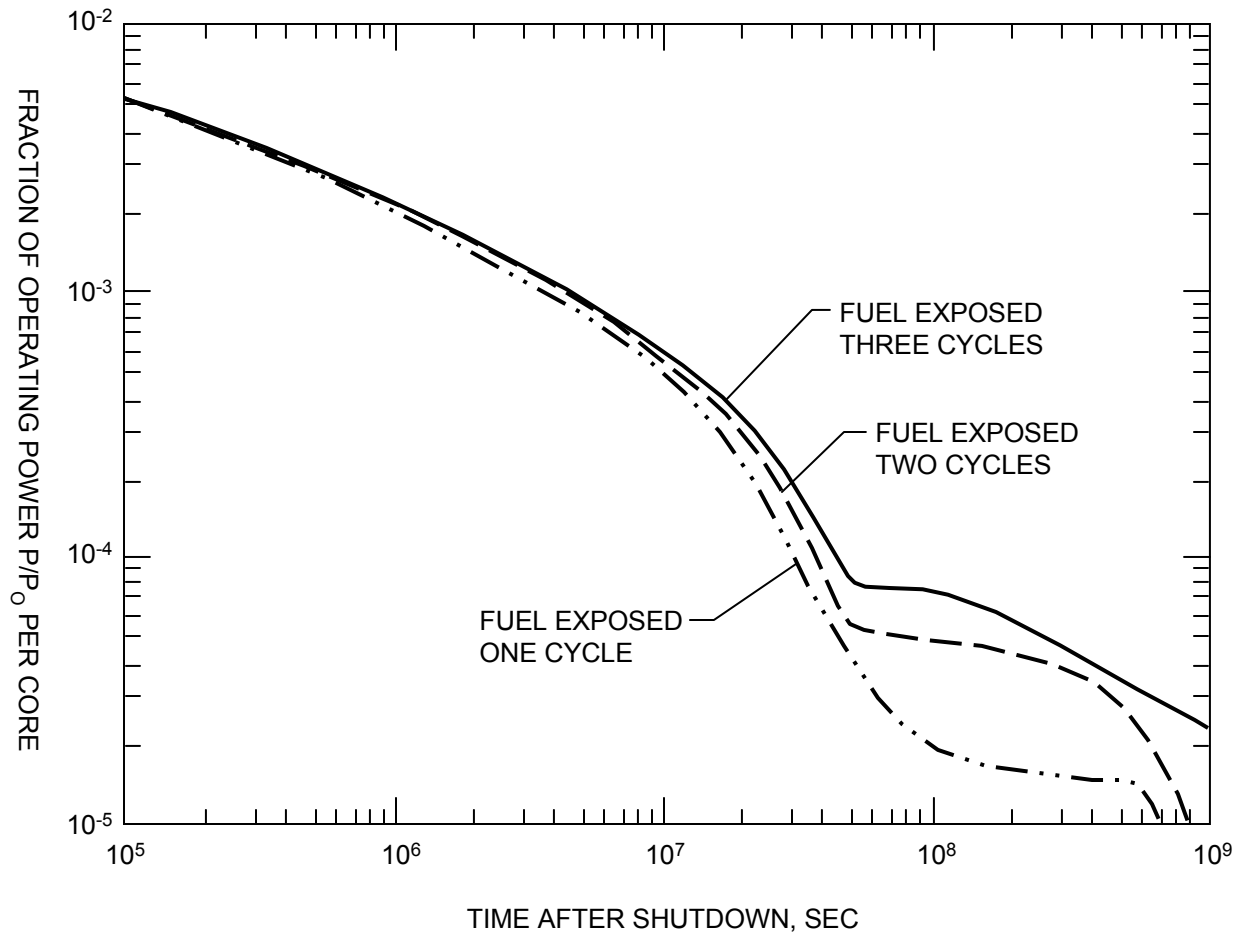

SAR FIGURE NO. 9.1-2

AMENDMENT 20

ARKANSAS NUCLEAR ONE
UNIT 2
RUSSELLVILLE, ARKANSAS



SCALE:	NONE
DRAWN:	
DESIGN:	ENERGY
CAD NO:	

FISSION PRODUCT DECAY HEAT CURVE

BASED ON DRAWING NO

SHEET

REV.

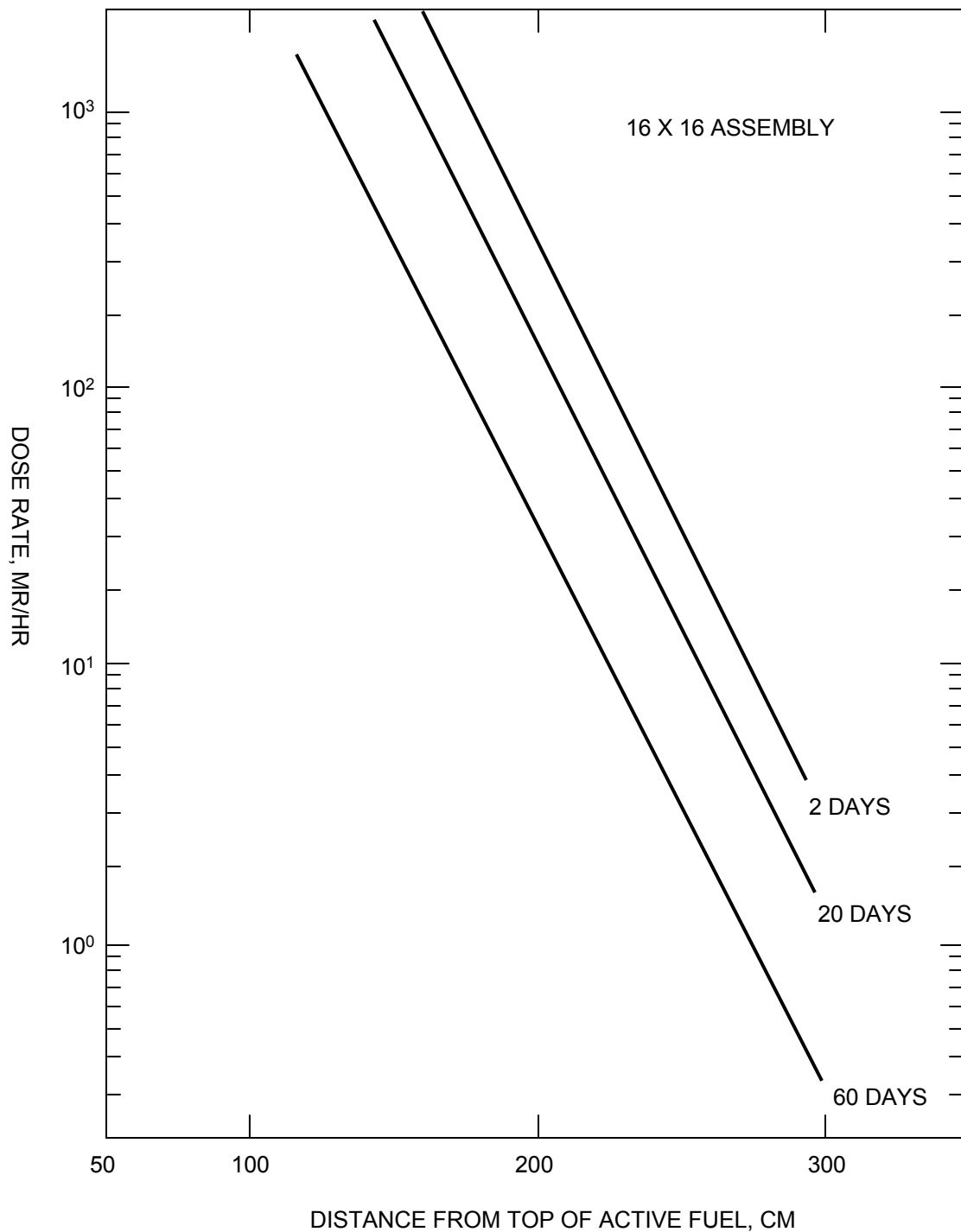

SAR FIGURE NO. 9.1-3

AMENDMENT 20

ARKANSAS NUCLEAR ONE
UNIT 2
RUSSELLVILLE, ARKANSAS



SCALE:	NONE
DRAWN:	
DESIGN:	ENERGY
CAD NO:	

DOSE RATE AXIALLY FROM TOP OF SPENT
FUEL ASSEMBLY IN WATER 2825 MWT PLANT

BASED ON DRAWING NO

SHEET

REV.

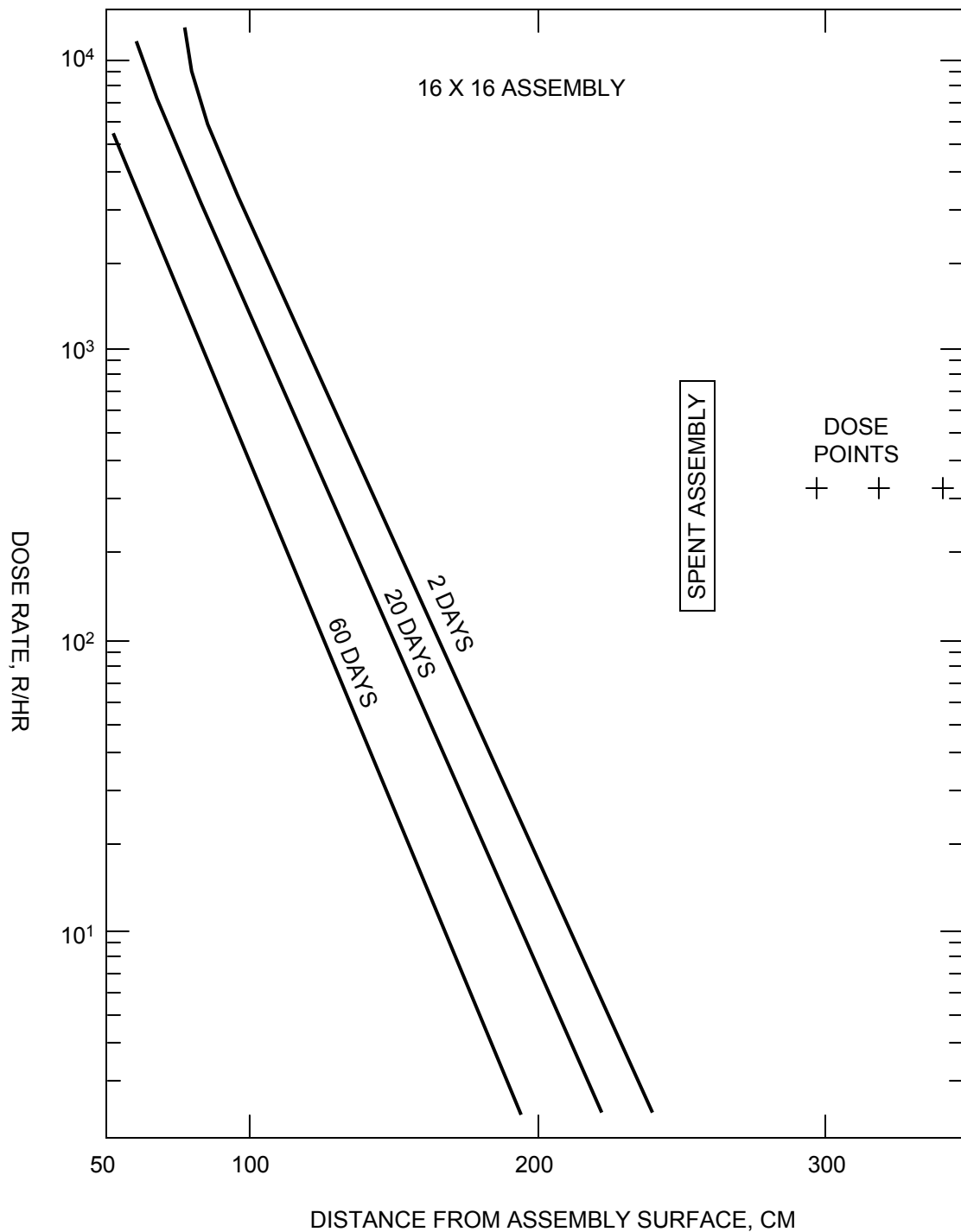

SAR FIGURE NO. 9.1-4

AMENDMENT 20

ARKANSAS NUCLEAR ONE
UNIT 2
RUSSELLVILLE, ARKANSAS



SCALE: NONE
DRAWN:
DESIGN: ENTERGY
CAD NO:

DOSE RATE FROM SIDE OF SPENT FUEL
ASSEMBLY IN WATER 2825 MWT PLANT

BASED ON DRAWING NO

SHEET

REV.

DELETED

SAR FIGURE NO. 9.1-5

AMENDMENT 20

ARKANSAS NUCLEAR ONE
UNIT 2
RUSSELLVILLE, ARKANSAS



SCALE: NONE

DRAWN:

DESIGN: ENTERGY

CAD NO:

BASED ON DRAWING NO

SHEET

REV.

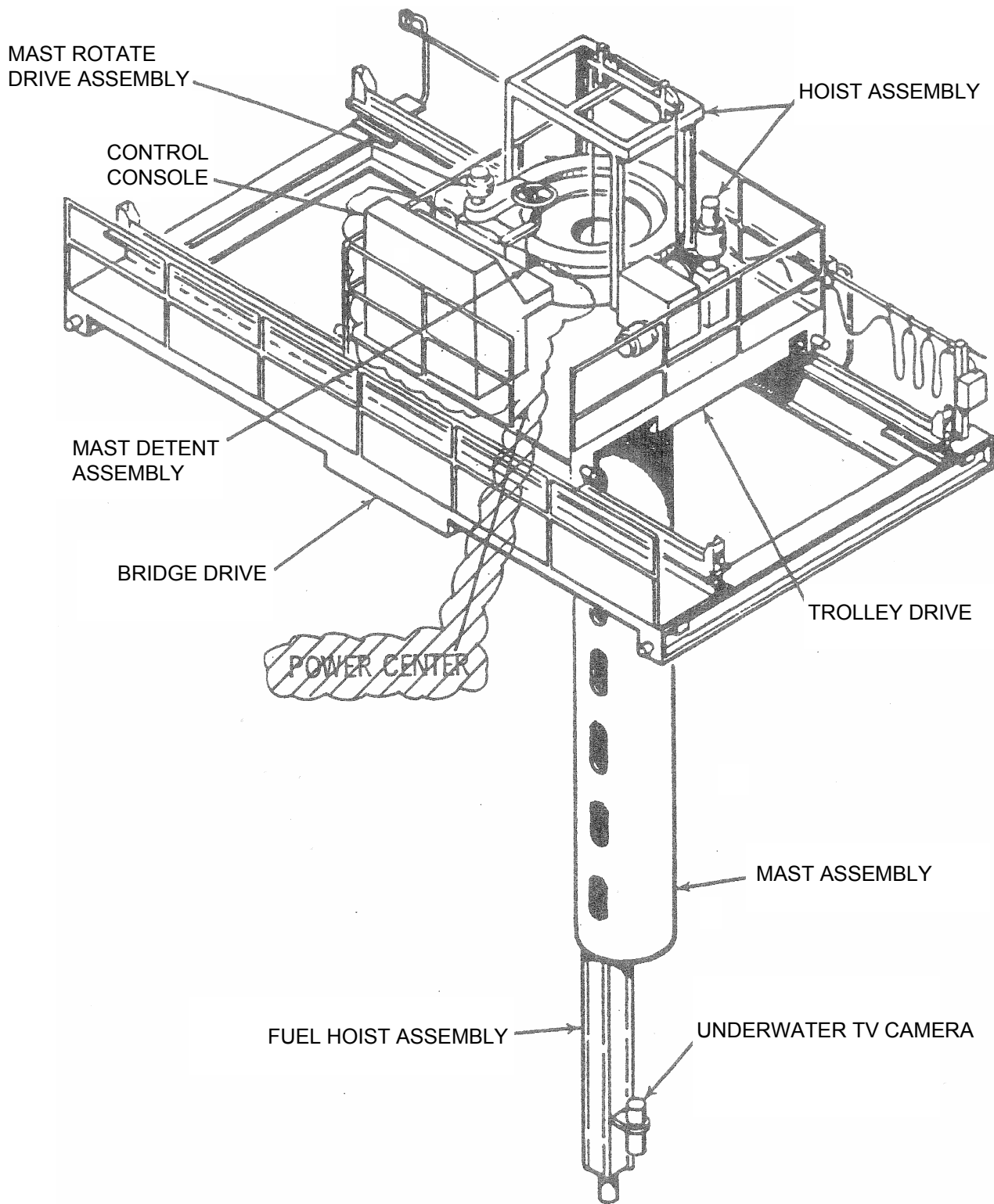

SAR FIGURE NO. 9.1-6

AMENDMENT 20

ARKANSAS NUCLEAR ONE
UNIT 2
RUSSELLVILLE, ARKANSAS



SCALE:	NONE
DRAWN:	
DESIGN:	ENTERGY
CAD NO:	

REFUELING MACHINE

BASED ON DRAWING NO

SHEET

REV.

DELETED

SAR FIGURE NO. 9.1-7

AMENDMENT 20

ARKANSAS NUCLEAR ONE
UNIT 2
RUSSELLVILLE, ARKANSAS



SCALE: NONE

DRAWN:

DESIGN: ENTERGY

CAD NO:

BASED ON DRAWING NO

SHEET

REV.

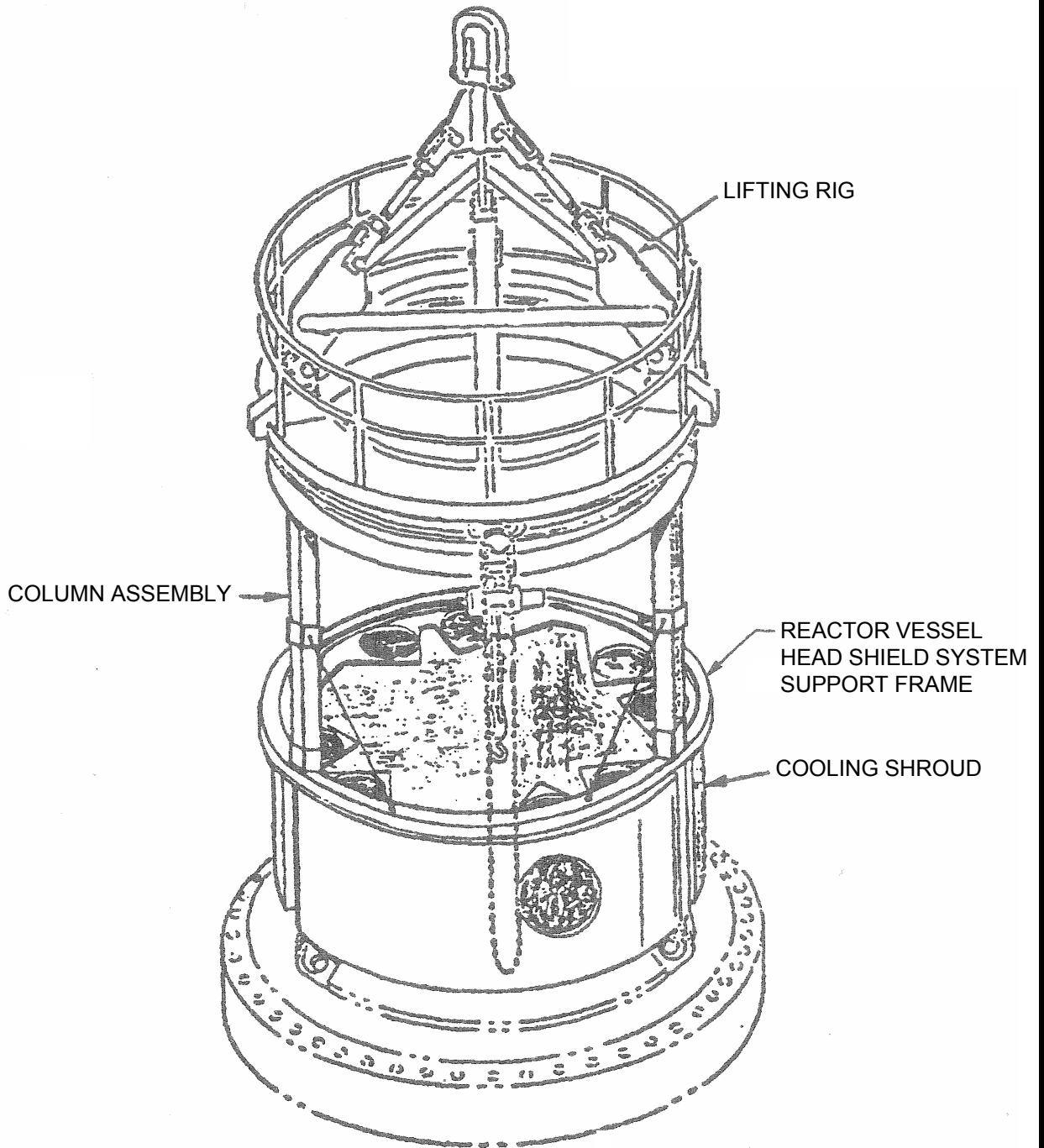

SAR FIGURE NO. 9.1-8

AMENDMENT 20

ARKANSAS NUCLEAR ONE
UNIT 2
RUSSELLVILLE, ARKANSAS



SCALE: NONE

DRAWN:

DESIGN: ENTERGY

CAD NO:

REACTOR VESSEL HEAD LIFTING RIG

BASED ON DRAWING NO

SHEET

REV.

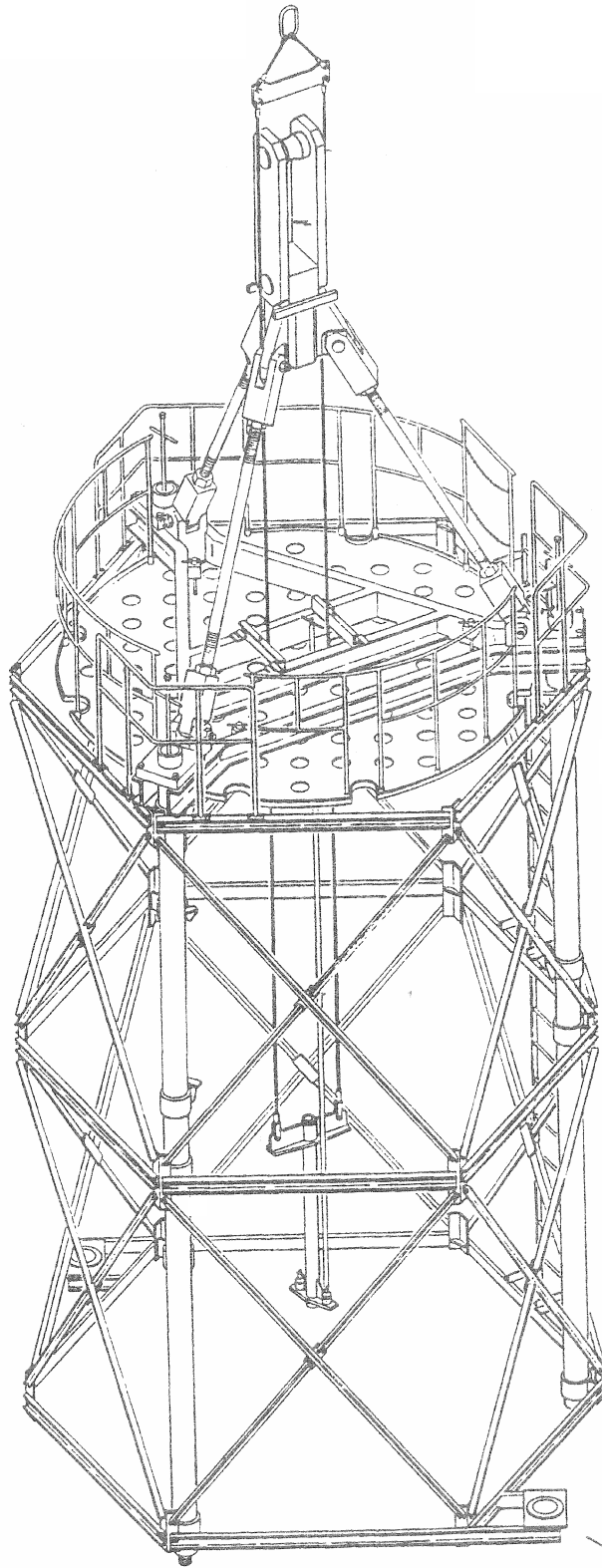

SAR FIGURE NO. 9.1-9

AMENDMENT 20

ARKANSAS NUCLEAR ONE
 UNIT 2
 RUSSELLVILLE, ARKANSAS



SCALE: NONE

DRAWN:

DESIGN: ENTERGY

CAD NO:

UPPER GUIDE STRUCTURE LIFT RIG

BASED ON DRAWING NO

SHEET

REV.

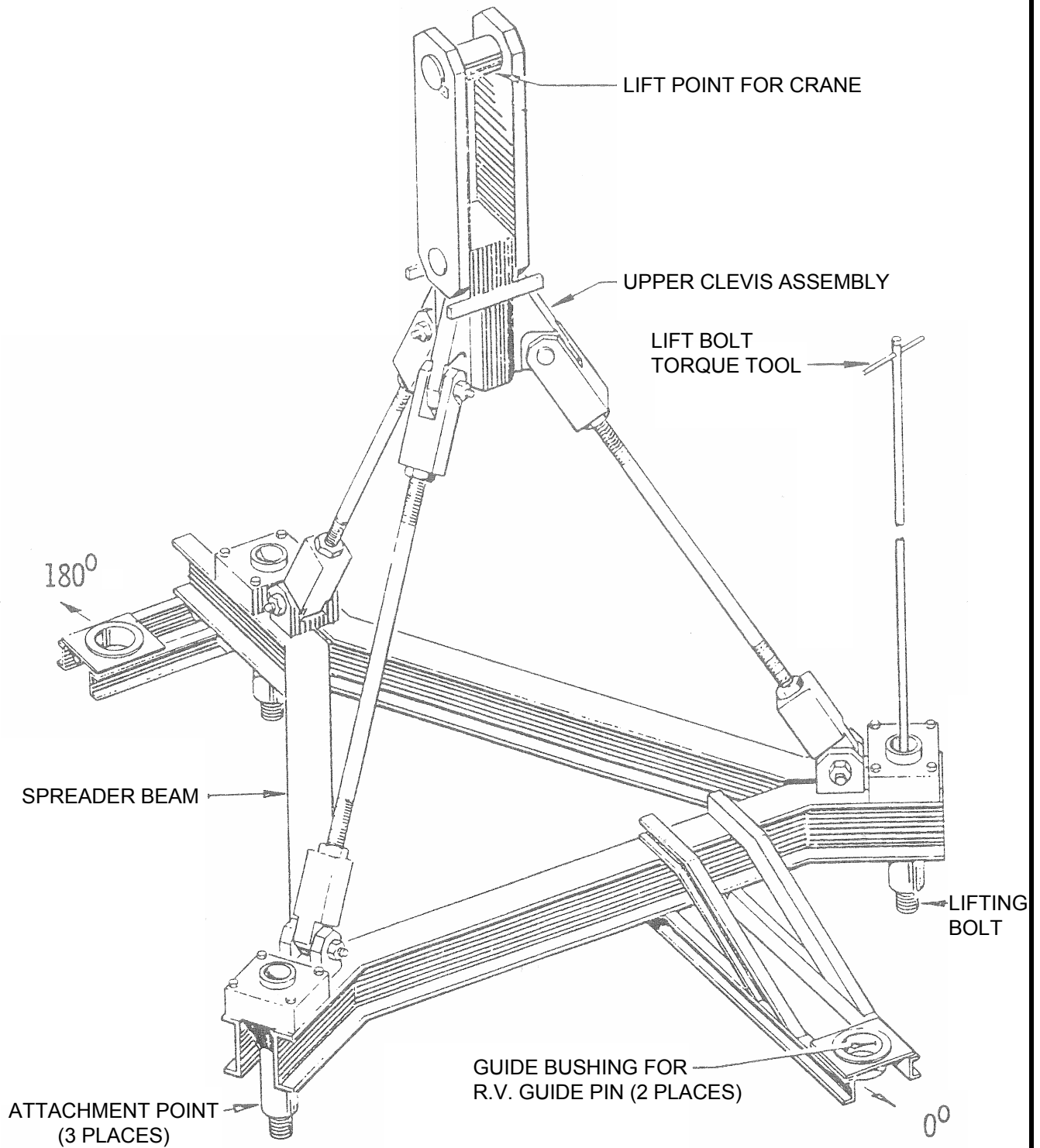

SAR FIGURE NO. 9.1-10

AMENDMENT 20

ARKANSAS NUCLEAR ONE
 UNIT 2
 RUSSELLVILLE, ARKANSAS



SCALE: NONE
 DRAWN:
 DESIGN: ENTERGY
 CAD NO:

CORE SUPPORT BARREL LIFT RIG
 ASSEMBLY

BASED ON DRAWING NO

SHEET

REV.

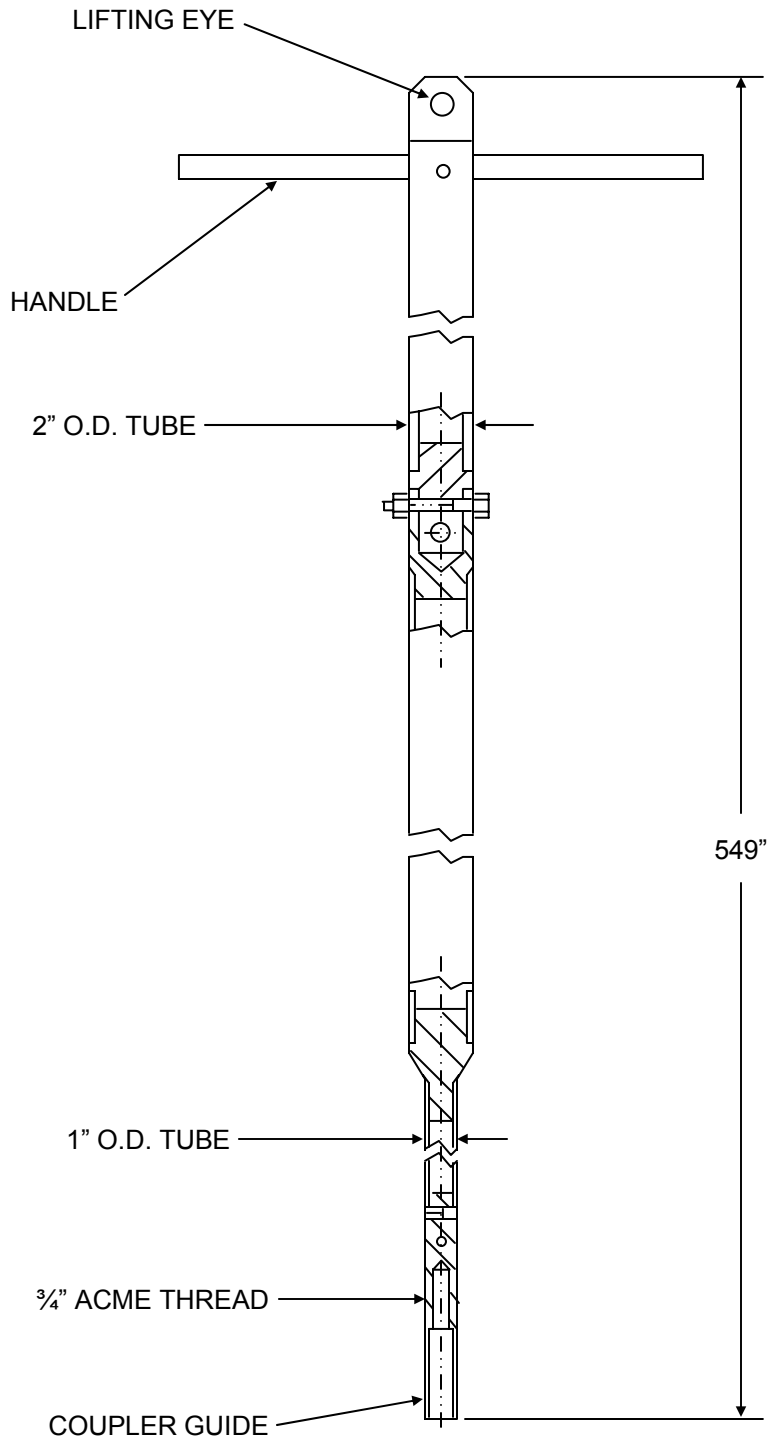

SAR FIGURE NO. 9.1-11

AMENDMENT 20

ARKANSAS NUCLEAR ONE
UNIT 2
RUSSELLVILLE, ARKANSAS



SCALE: NONE
DRAWN:
DESIGN: ENTERGY
CAD NO:

SURVEILLANCE CAPSULE RETRIEVAL
TOOL

BASED ON DRAWING NO

SHEET

REV.

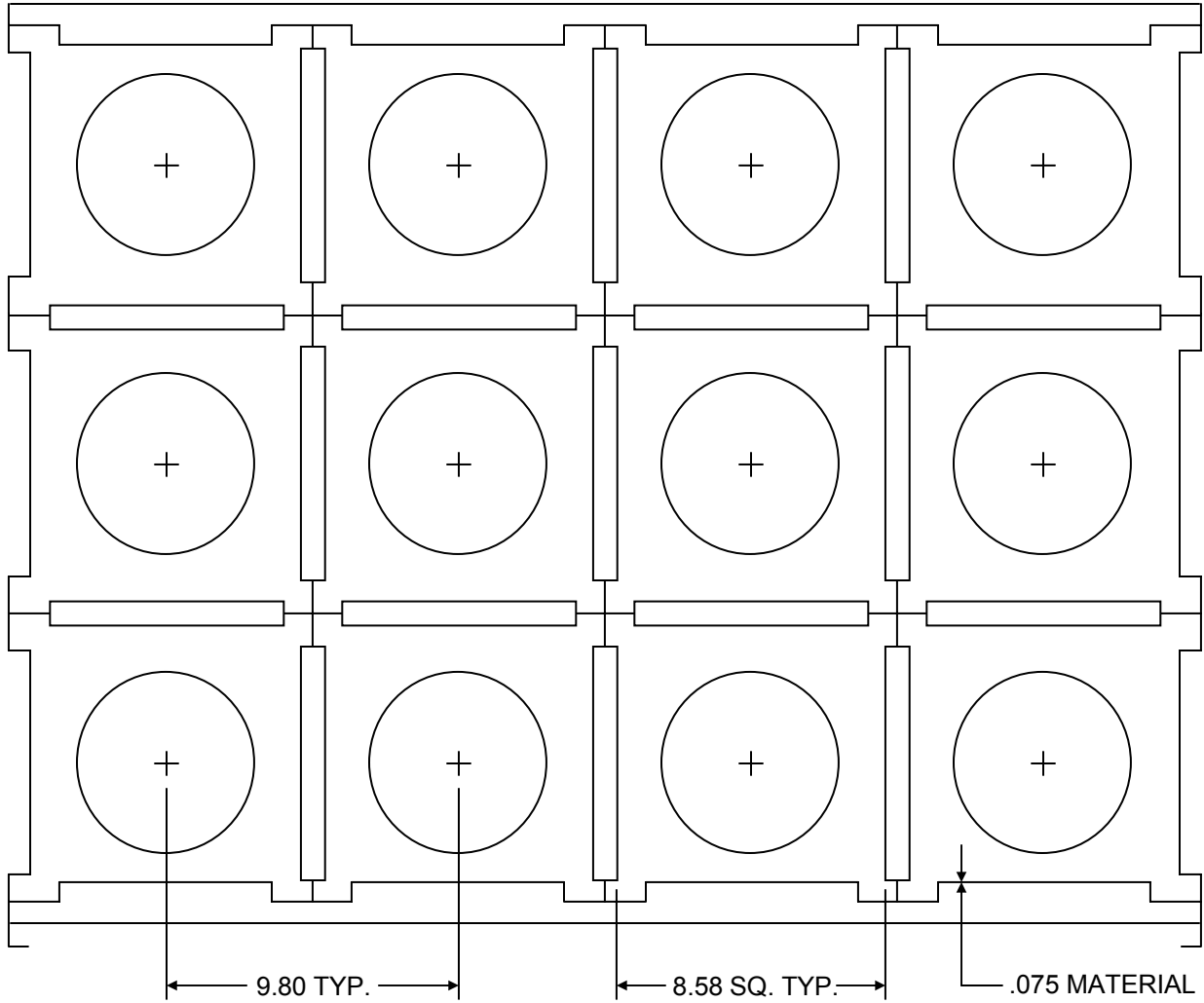

SAR FIGURE NO. 9.1-12

AMENDMENT 21

ARKANSAS NUCLEAR ONE
 UNIT 2
 RUSSELLVILLE, ARKANSAS



SCALE:	NONE
DRAWN:	
DESIGN:	ENERGY
CAD NO:	

SPENT FUEL POOL REGION 2 STORAGE RACK
 "SPACER POCKET" DESIGN PLAN VIEW

BASED ON DRAWING NO

SHEET

REV.

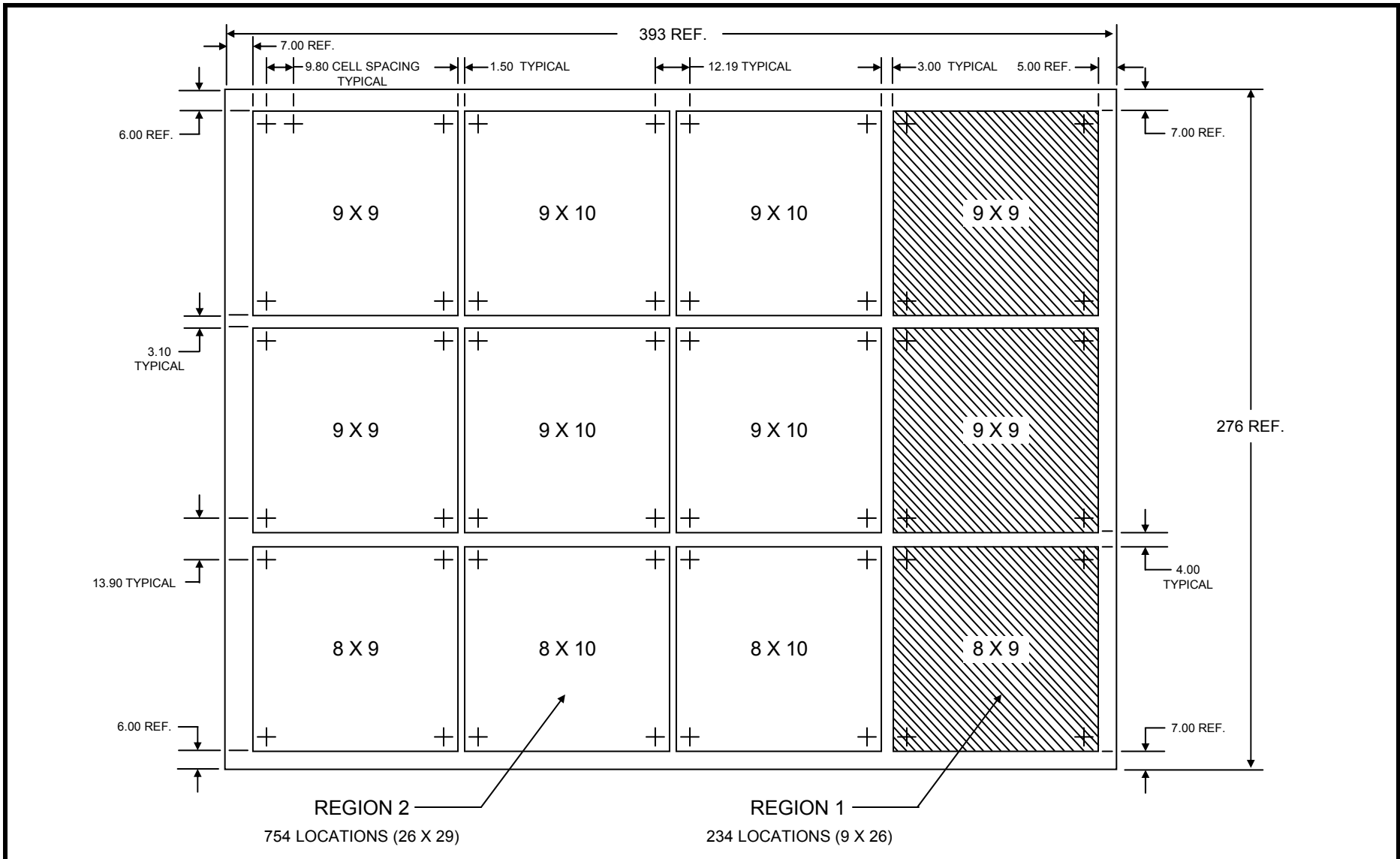

SPENT FUEL POOL ARRANGEMENT UNIT 2

SAR FIGURE NO. 9.1-13

ARKANSAS NUCLEAR ONE
 UNIT 2
 RUSSELLVILLE, ARKANSAS



SCALE:	NONE
DRAWN:	ENERGY
DESIGN:	ENERGY
CAD NO:	

AMENDMENT 21

BASED ON DRAWING NO	SHEET	REV.

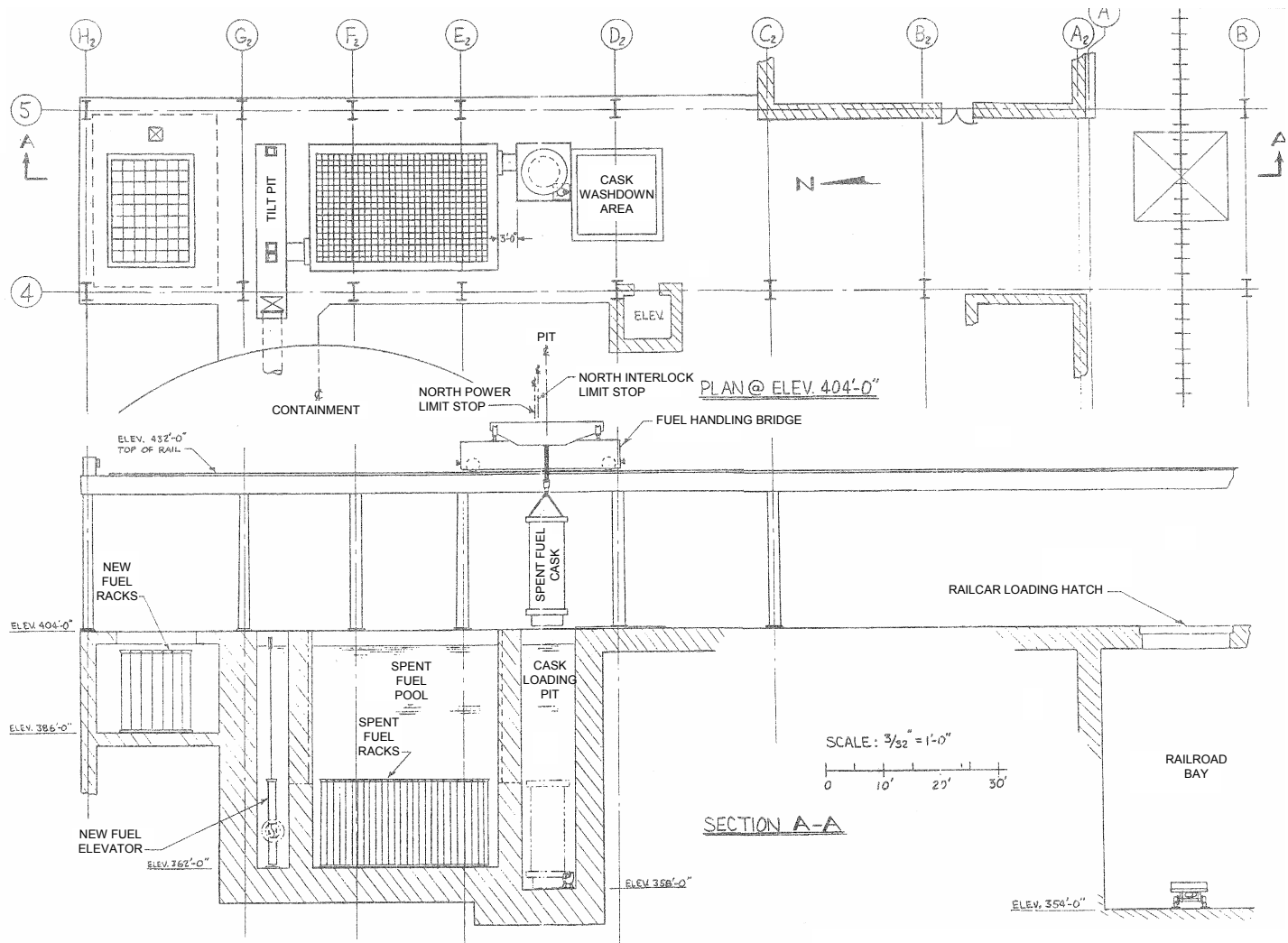

AUXILIARY BUILDING FUEL HANDLING ARRANGEMENT

SAR FIGURE NO. 9.1-14

ARKANSAS NUCLEAR ONE
 UNIT 2
 RUSSELLVILLE, ARKANSAS



SCALE: NONE
 DRAWN: ENTERGY
 DESIGN: ENTERGY
 CAD NO:

AMENDMENT 20

BASED ON DRAWING NO

SHEET

REV.

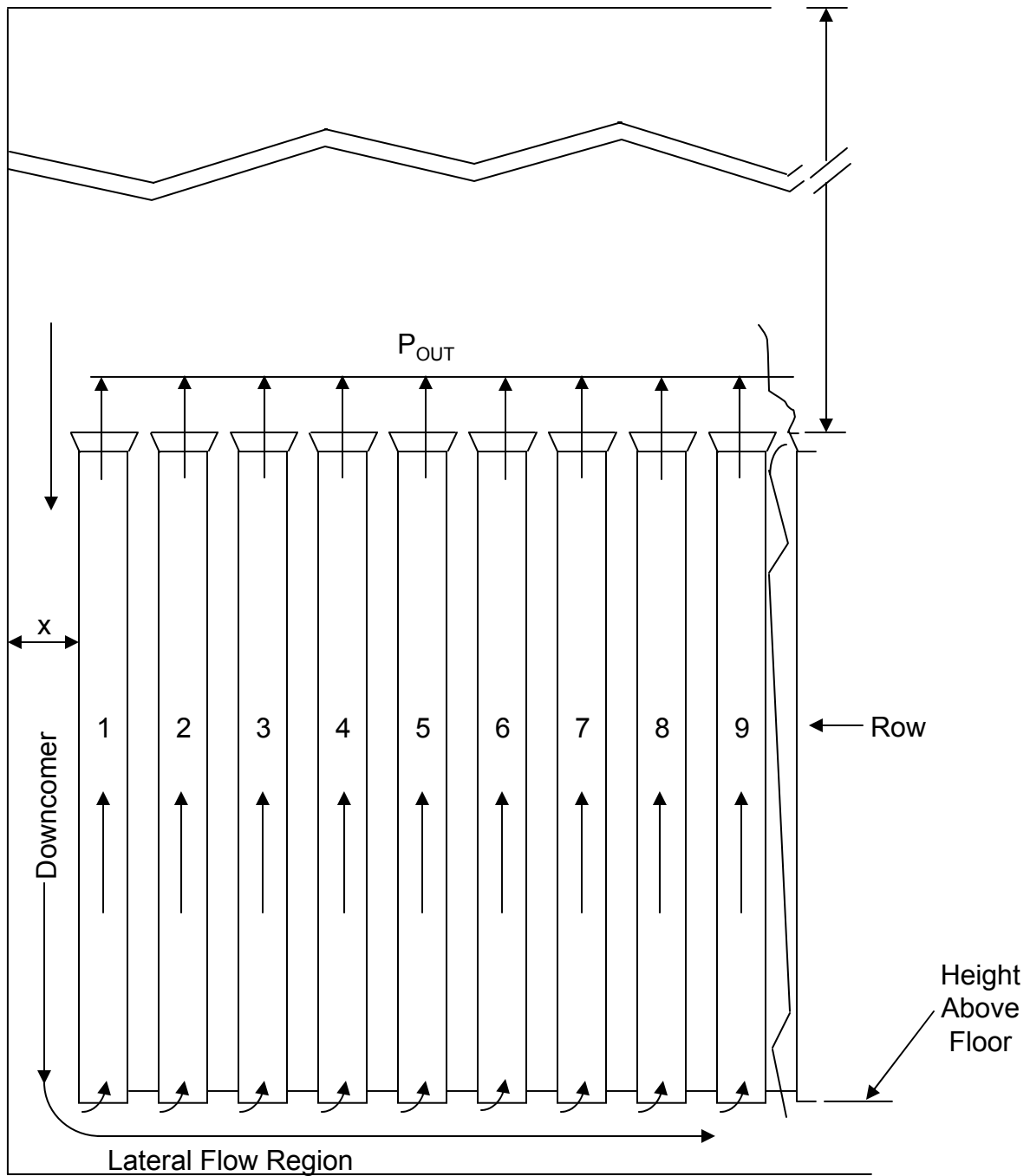

SAR FIGURE NO. 9.1-15

AMENDMENT 20

ARKANSAS NUCLEAR ONE
UNIT 2
RUSSELLVILLE, ARKANSAS



SCALE:	NONE
DRAWN:	
DESIGN:	ENERGY
CAD NO:	

SPENT FUEL POOL WATER SURFACE PATH

BASED ON DRAWING NO

SHEET

REV.

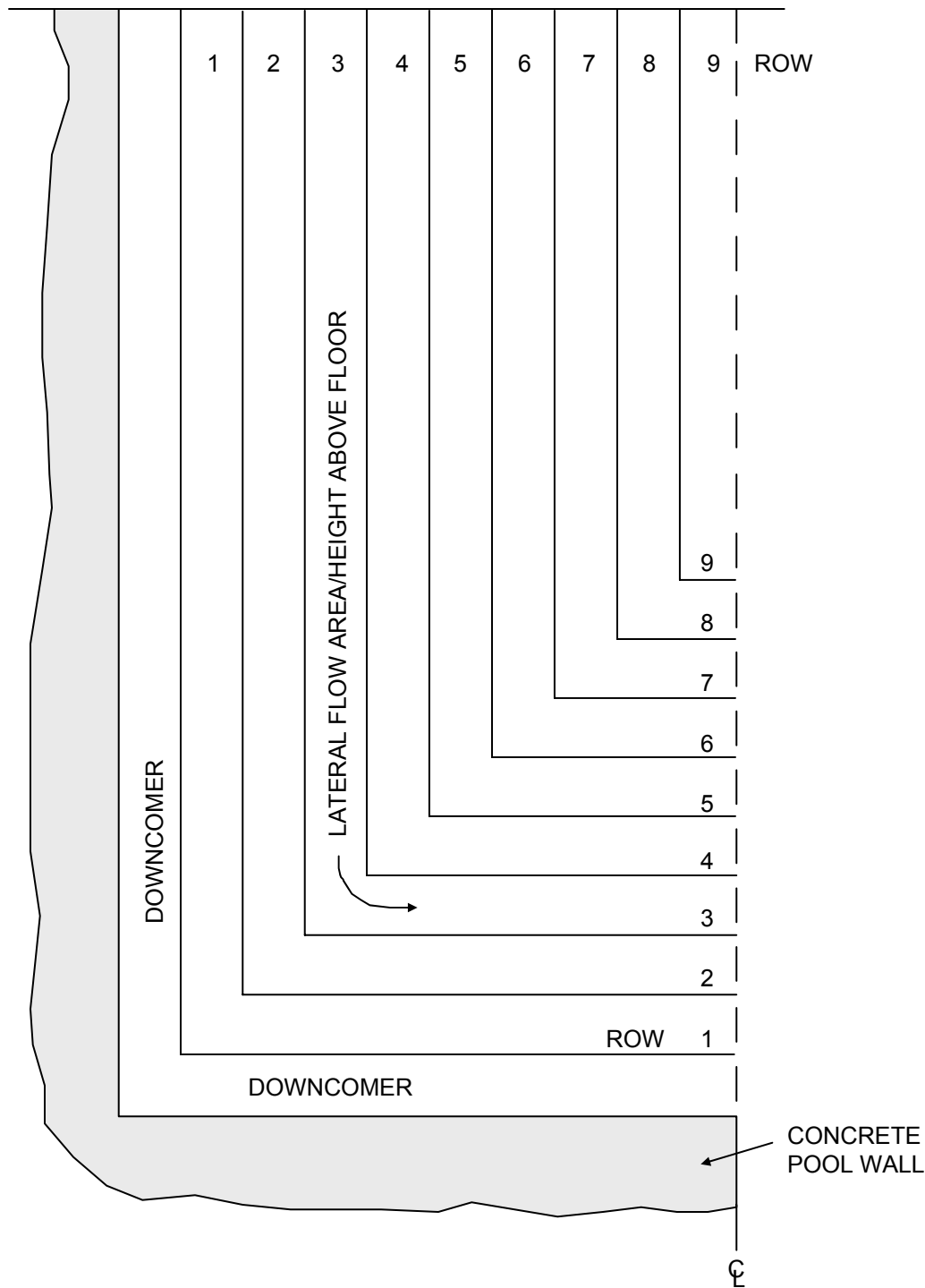

SAR FIGURE NO. 9.1-15A

AMENDMENT 20

ARKANSAS NUCLEAR ONE
UNIT 2
RUSSELLVILLE, ARKANSAS



SCALE:	NONE
DRAWN:	
DESIGN:	ENERGY
CAD NO:	

SPENT FUEL POOL WATER SURFACE PATH
(PLAN VIEW)

BASED ON DRAWING NO

SHEET

REV.

DELETED

SAR FIGURE NO. 9.1-16

AMENDMENT 20

ARKANSAS NUCLEAR ONE
UNIT 2
RUSSELLVILLE, ARKANSAS



SCALE:	NONE
DRAWN:	ENERGY
DESIGN:	ENERGY
CAD NO:	N/A

BASED ON DRAWING NO

SHEET

REV.

DELETED

SAR FIGURE NO. 9.1-17

AMENDMENT 20

ARKANSAS NUCLEAR ONE
UNIT 2
RUSSELLVILLE, ARKANSAS



SCALE:	NONE
DRAWN:	ENERGY
DESIGN:	ENERGY
CAD NO:	N/A

BASED ON DRAWING NO

SHEET

REV.

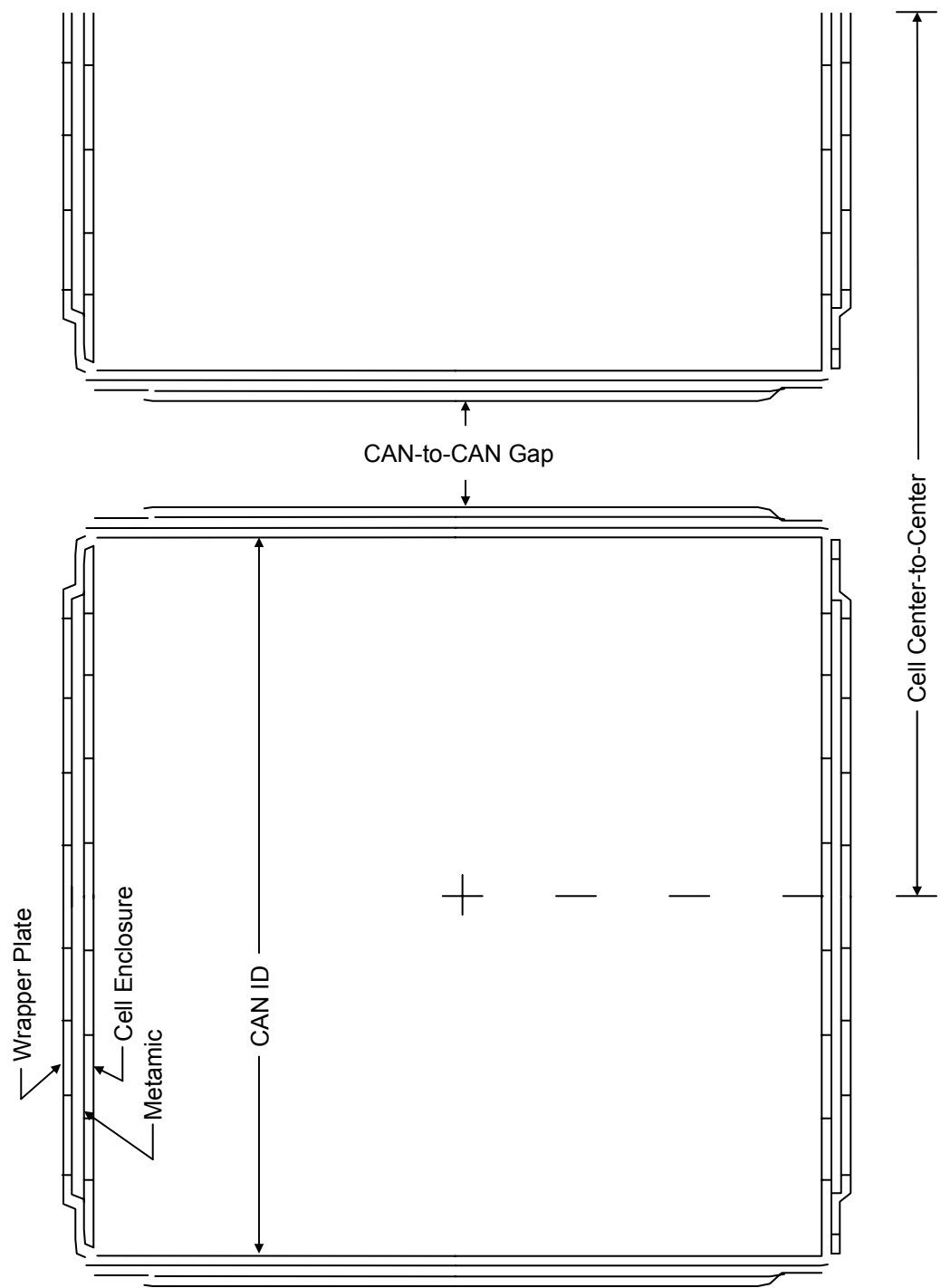

SAR FIGURE NO. 9.1-18

AMENDMENT 21

ARKANSAS NUCLEAR ONE
UNIT 2
RUSSELLVILLE, ARKANSAS



SCALE: NONE

DRAWN:

DESIGN: ENTERGY

CAD NO:

SPENT FUEL POOL REGION 1 STORAGE
RACK CELL LAYOUT

BASED ON DRAWING NO

SHEET

REV.

Figure 9.1-19
 Fuel Pool Cooling System Heat Removal Capacity
 with Pool Temperature = 120 °F

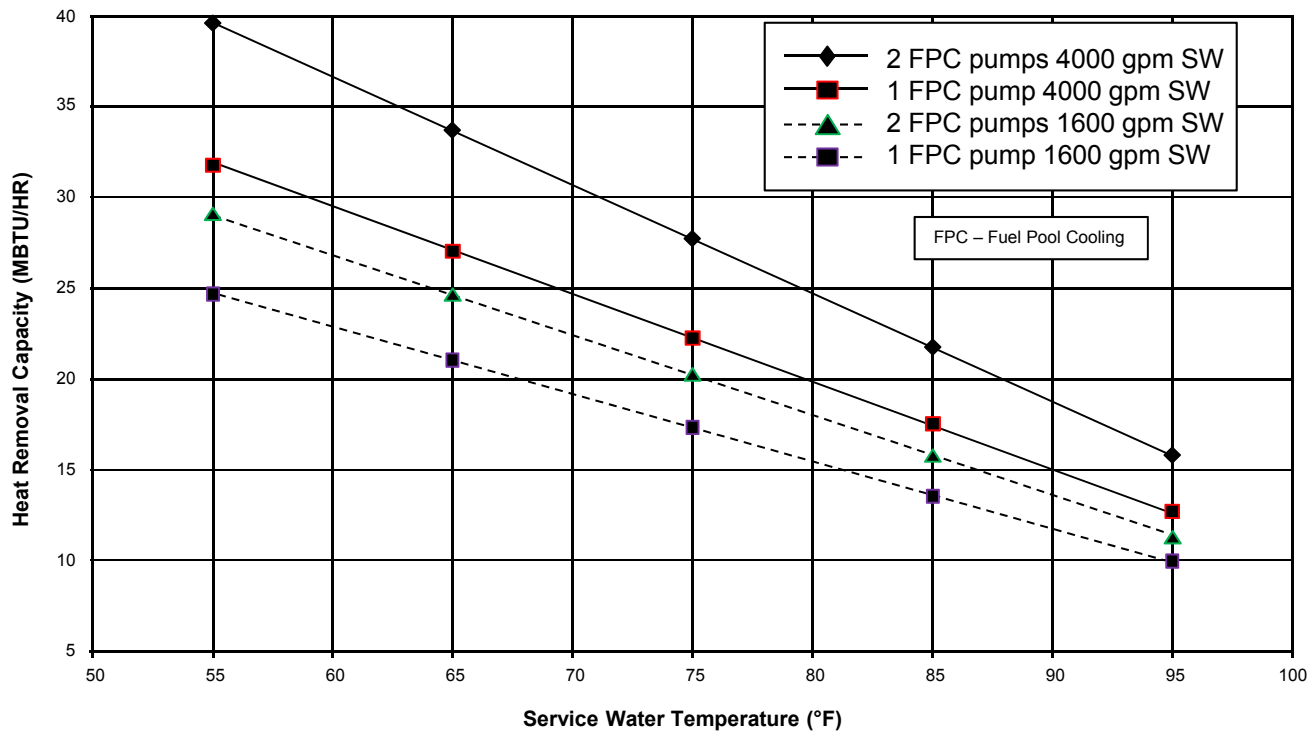

FUEL POOL COOLING SYSTEM HEAT REMOVAL CAPACITY

SAR FIGURE NO. 9.1-19

ARKANSAS NUCLEAR ONE
 UNIT 2
 RUSSELLVILLE, ARKANSAS



SCALE: NONE
 DRAWN: ENTERGY
 DESIGN: ENTERGY
 CAD NO:

AMENDMENT 27

BASED ON DRAWING NO

SHEET

REV.

Figure 9.1-20
 Fuel Pool Cooling System Heat Removal Capacity
 with Pool Temperature = 150 °F

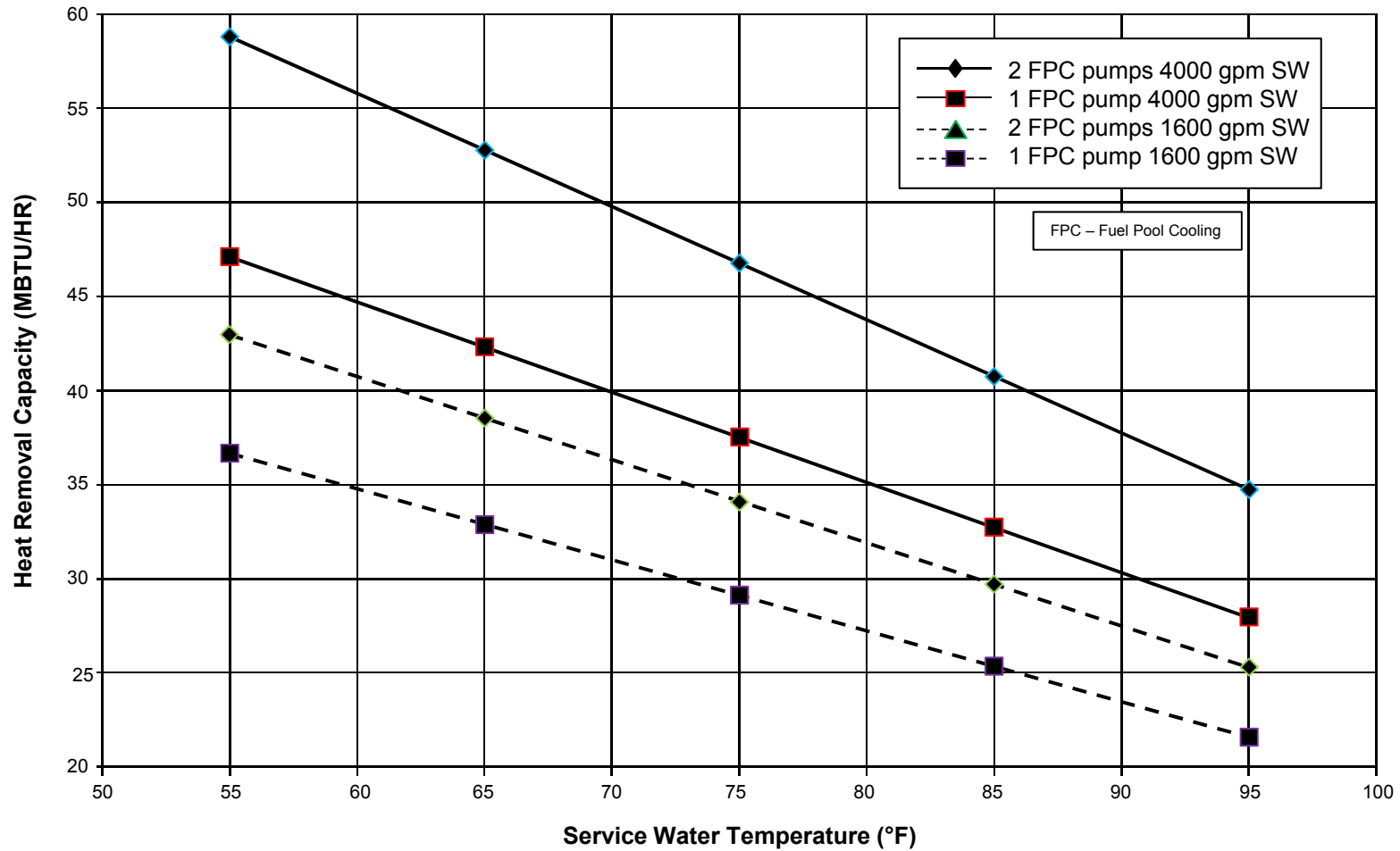

FUEL POOL COOLING SYSTEM HEAT REMOVAL CAPACITY

SAR FIGURE NO. 9.1-20

ARKANSAS NUCLEAR ONE
 UNIT 2
 RUSSELLVILLE, ARKANSAS



SCALE: NONE
 DRAWN: ENTERGY
 DESIGN: ENTERGY
 CAD NO:

AMENDMENT 27

BASED ON DRAWING NO

SHEET

REV.

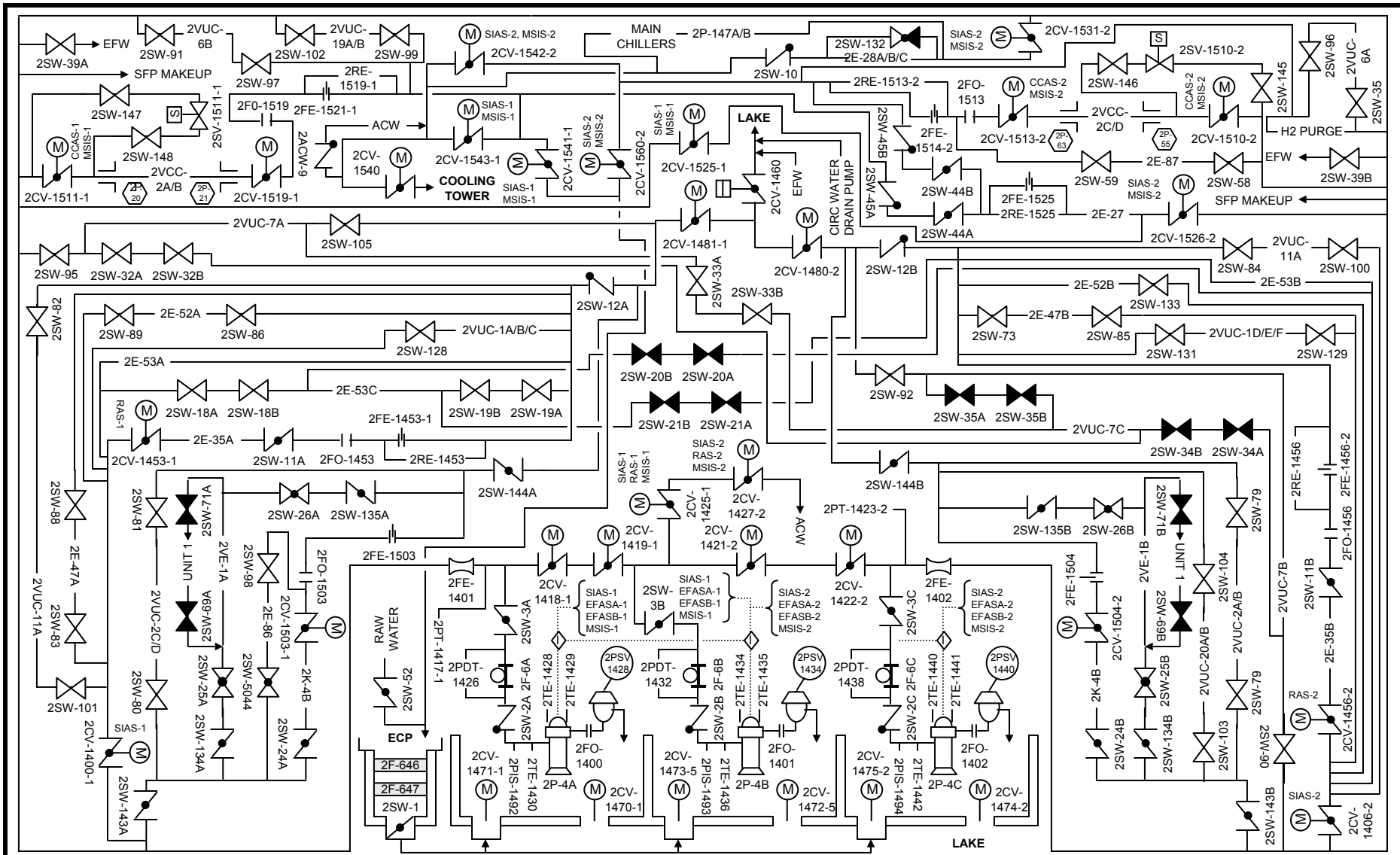

SERVICE WATER

SAR FIGURE NO. 9.2-1A

ARKANSAS NUCLEAR ONE
UNIT 2
RUSSELLVILLE, ARKANSAS



SCALE: NONE
DRAWN: ENTERGY
DESIGN: ENTERGY
CAD NO:

AMENDMENT 20

BASED ON DRAWING NO

SHEET

REV.

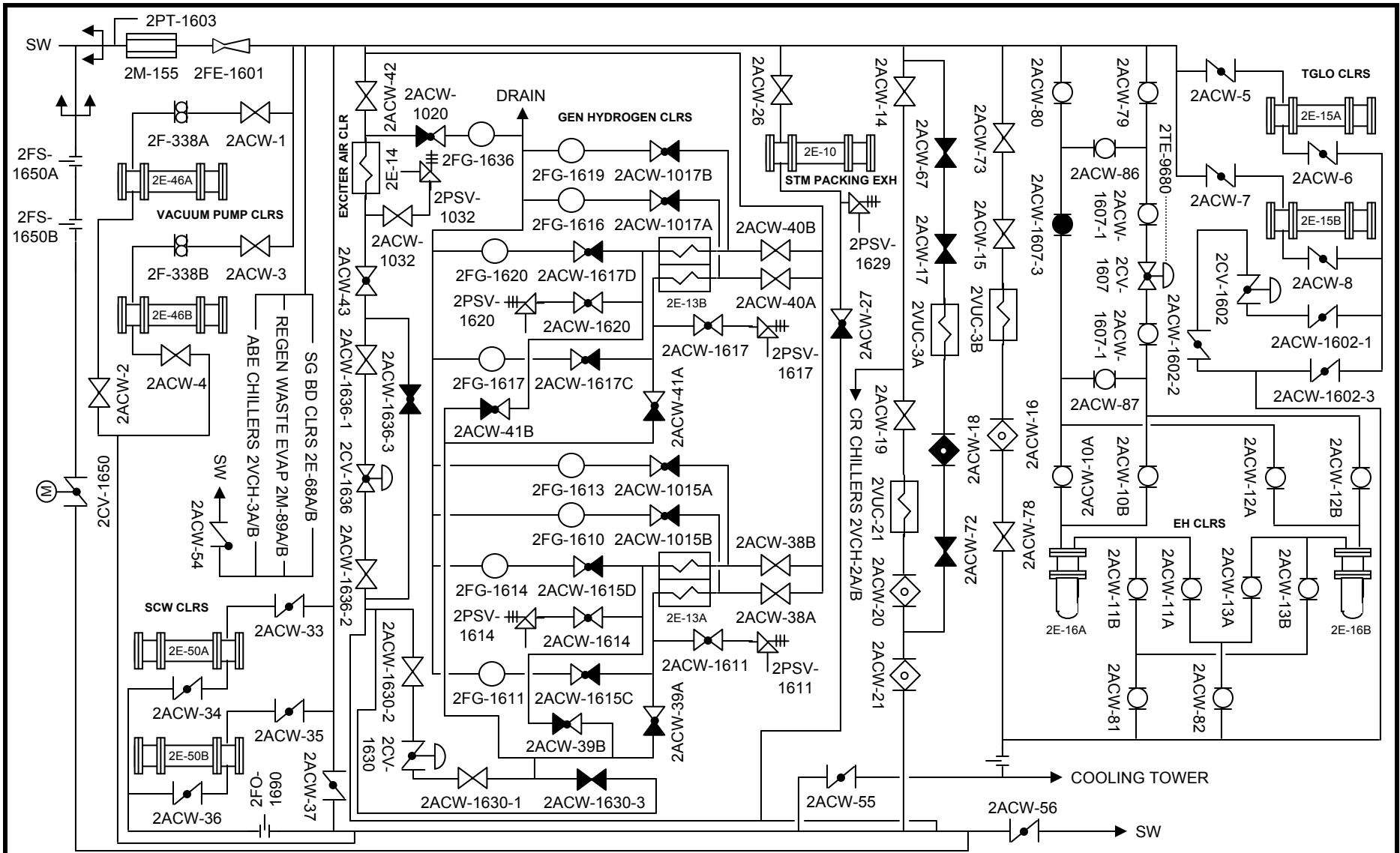

AUXILIARY COOLING WATER

SAR FIGURE NO. 9.2-1B

ARKANSAS NUCLEAR ONE
UNIT 2
RUSSELLVILLE, ARKANSAS



SCALE:	NONE
DRAWN:	ENERGY
DESIGN:	ENERGY
CAD NO:	

AMENDMENT 22		
BASED ON DRAWING NO	SHEET	REV.

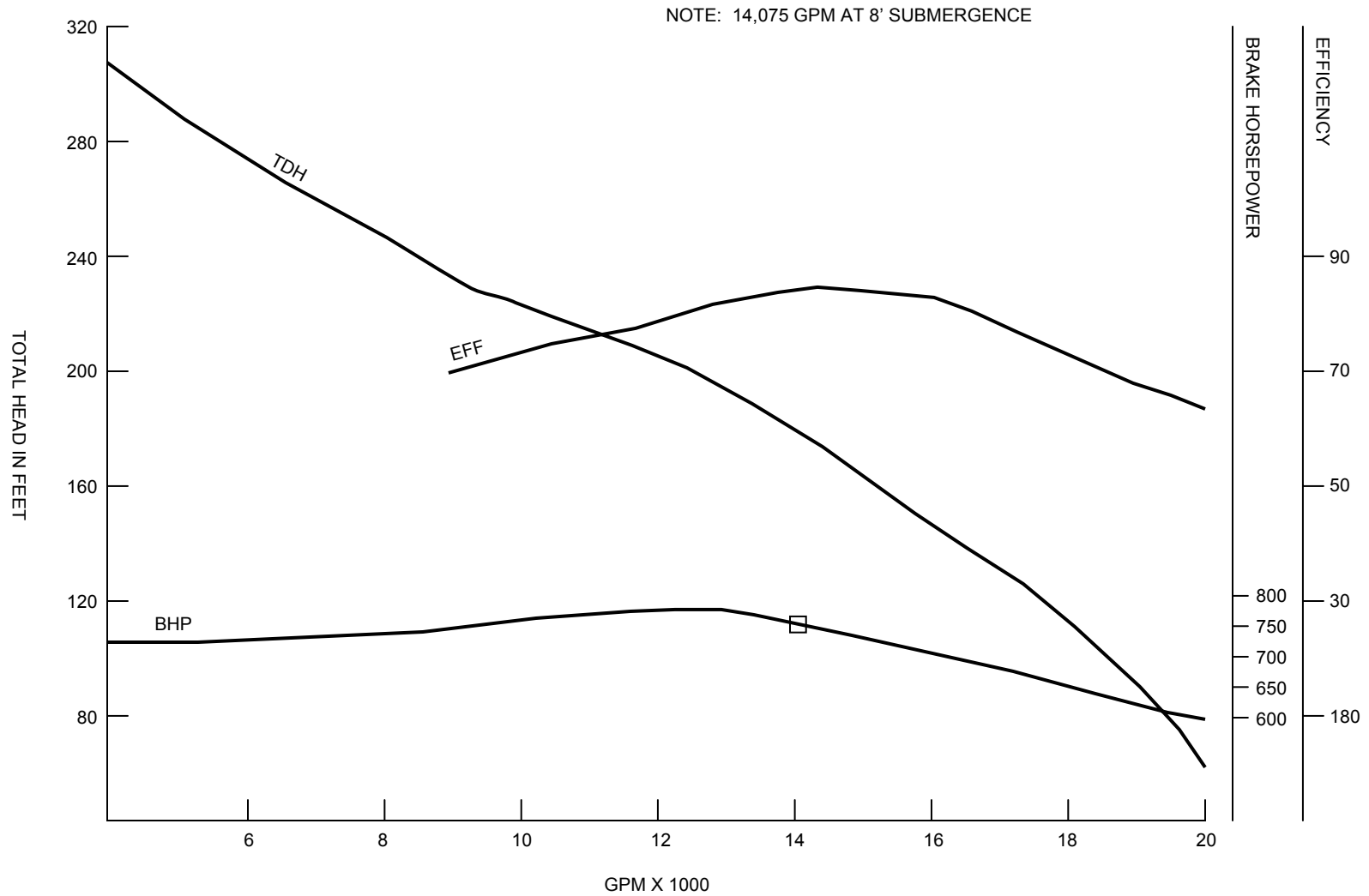

TYPICAL SERVICE WATER PUMP PERFORMANCE CURVE

SAR FIGURE NO. 9.2-2

ARKANSAS NUCLEAR ONE
 UNIT 2
 RUSSELLVILLE, ARKANSAS



SCALE: NONE
 DRAWN: ENTERGY
 DESIGN: ENTERGY
 CAD NO:

AMENDMENT 20

BASED ON DRAWING NO

SHEET

REV.

DELETED

SAR FIGURE NO. 9.2-3

AMENDMENT 20

ARKANSAS NUCLEAR ONE
UNIT 2
RUSSELLVILLE, ARKANSAS



SCALE: NONE

DRAWN:

DESIGN: ENTERGY

CAD NO:

BASED ON DRAWING NO

SHEET

REV.

DELETED

SAR FIGURE NO. 9.2-4

AMENDMENT 20

ARKANSAS NUCLEAR ONE
UNIT 2
RUSSELLVILLE, ARKANSAS



SCALE: NONE

DRAWN:

DESIGN: ENTERGY

CAD NO:

BASED ON DRAWING NO

SHEET

REV.

DELETED

SAR FIGURE NO. 9.2-5

AMENDMENT 20

ARKANSAS NUCLEAR ONE
UNIT 2
RUSSELLVILLE, ARKANSAS



SCALE: NONE

DRAWN:

DESIGN: ENTERGY

CAD NO:

BASED ON DRAWING NO

SHEET

REV.

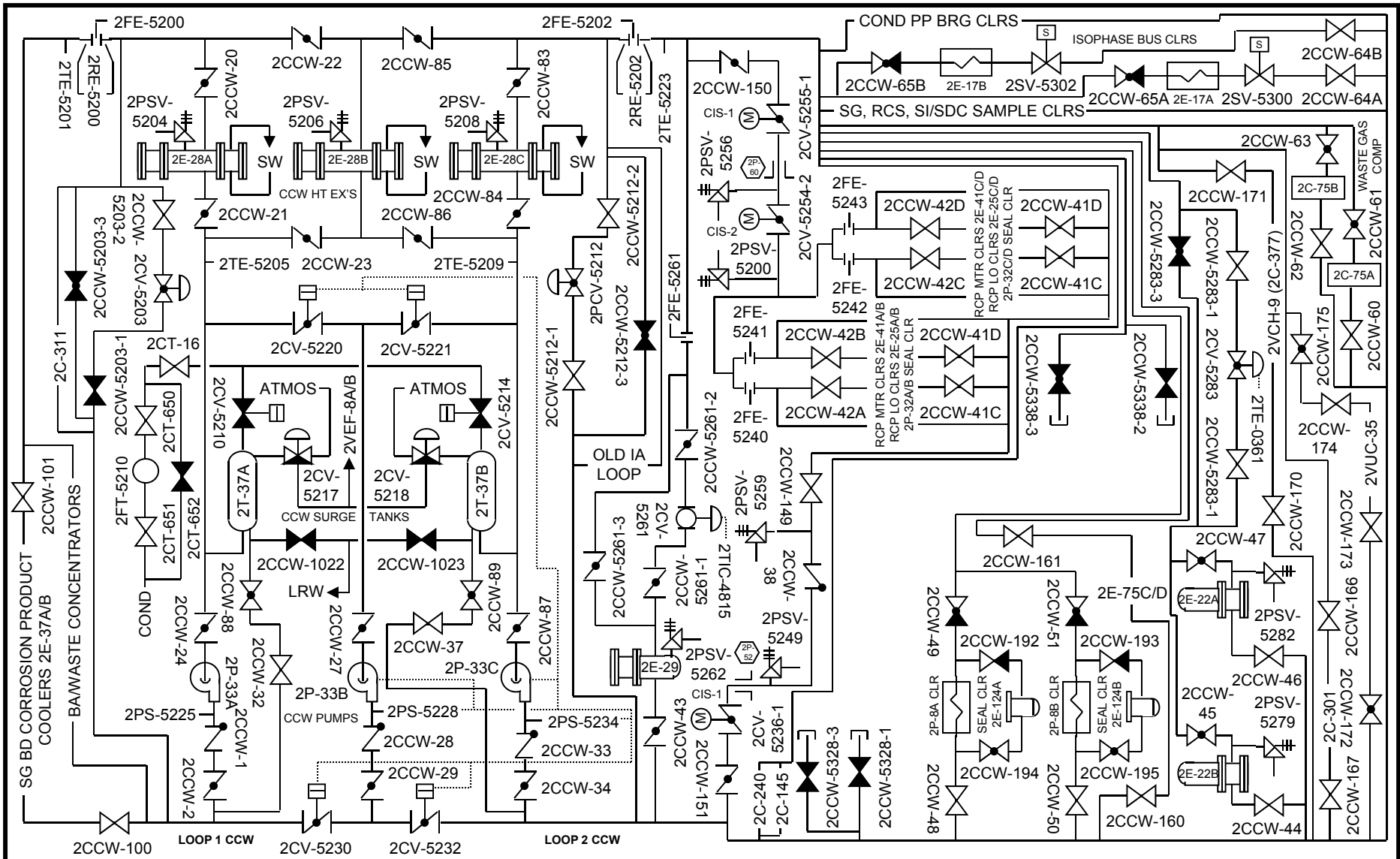

COMPONENT COOLING WATER

SAR FIGURE NO. 9.2-6

ARKANSAS NUCLEAR ONE
UNIT 2
RUSSELLVILLE, ARKANSAS



SCALE:	NONE
DRAWN:	ENERGY
DESIGN:	ENERGY
CAD NO:	

AMENDMENT 28

BASED ON DRAWING NO

SHEET

REV.

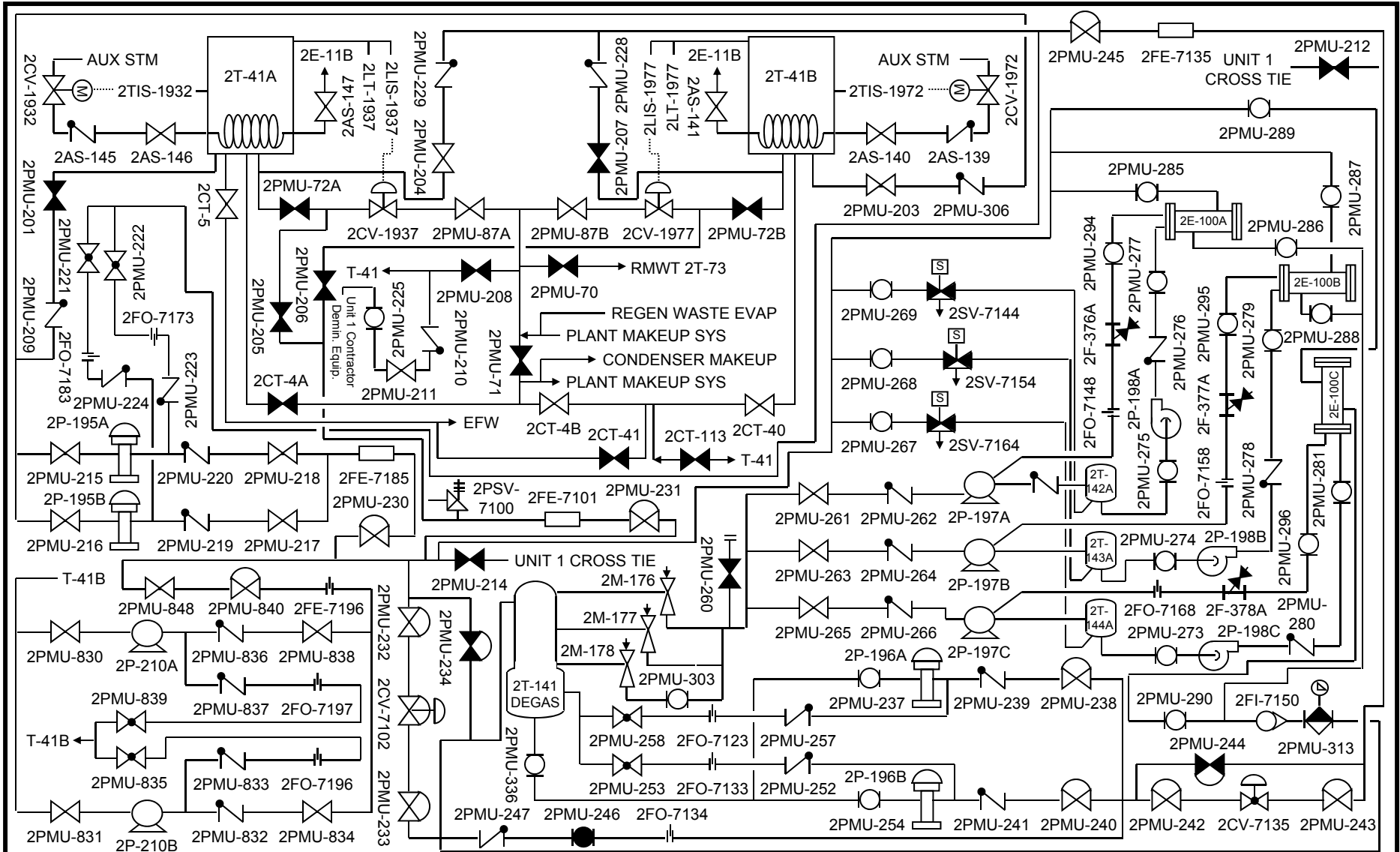

CONDENSATE STORAGE

SAR FIGURE NO. 9.2-7A

ARKANSAS NUCLEAR ONE
UNIT 2
RUSSELLVILLE, ARKANSAS



SCALE:	NONE
DRAWN:	ENERGY
DESIGN:	ENERGY
CAD NO:	

AMENDMENT 26

BASED ON DRAWING NO

SHEET

REV.

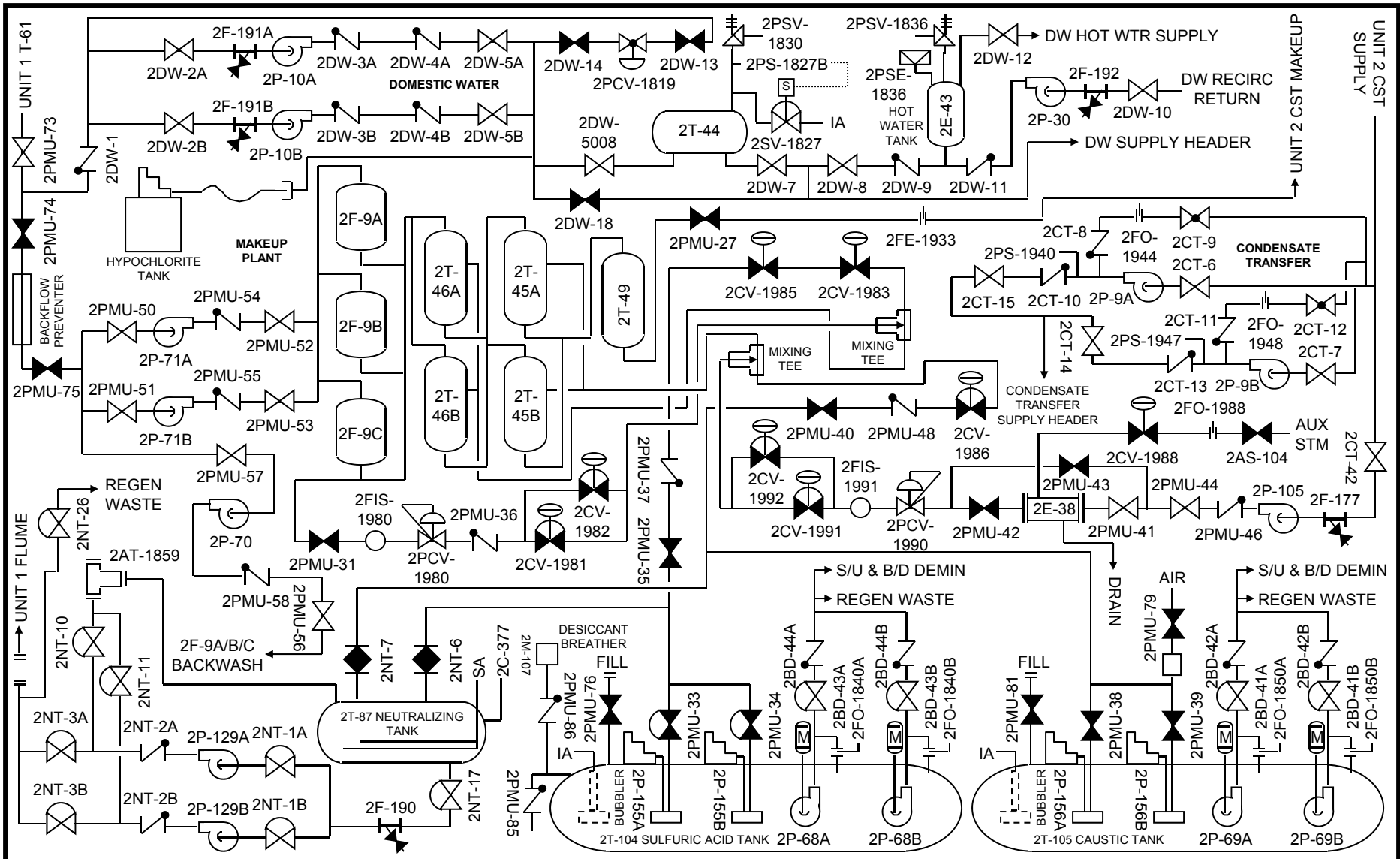

PLANT MAKEUP, CONDENSATE TRANSFER, AND DOMESTIC WATER

SAR FIGURE NO. 9.2-7B

ARKANSAS NUCLEAR ONE
 UNIT 2
 RUSSELLVILLE, ARKANSAS



SCALE:	NONE
DRAWN:	ENERGY
DESIGN:	ENERGY
CAD NO:	

AMENDMENT 20		
BASED ON DRAWING NO	SHEET	REV.

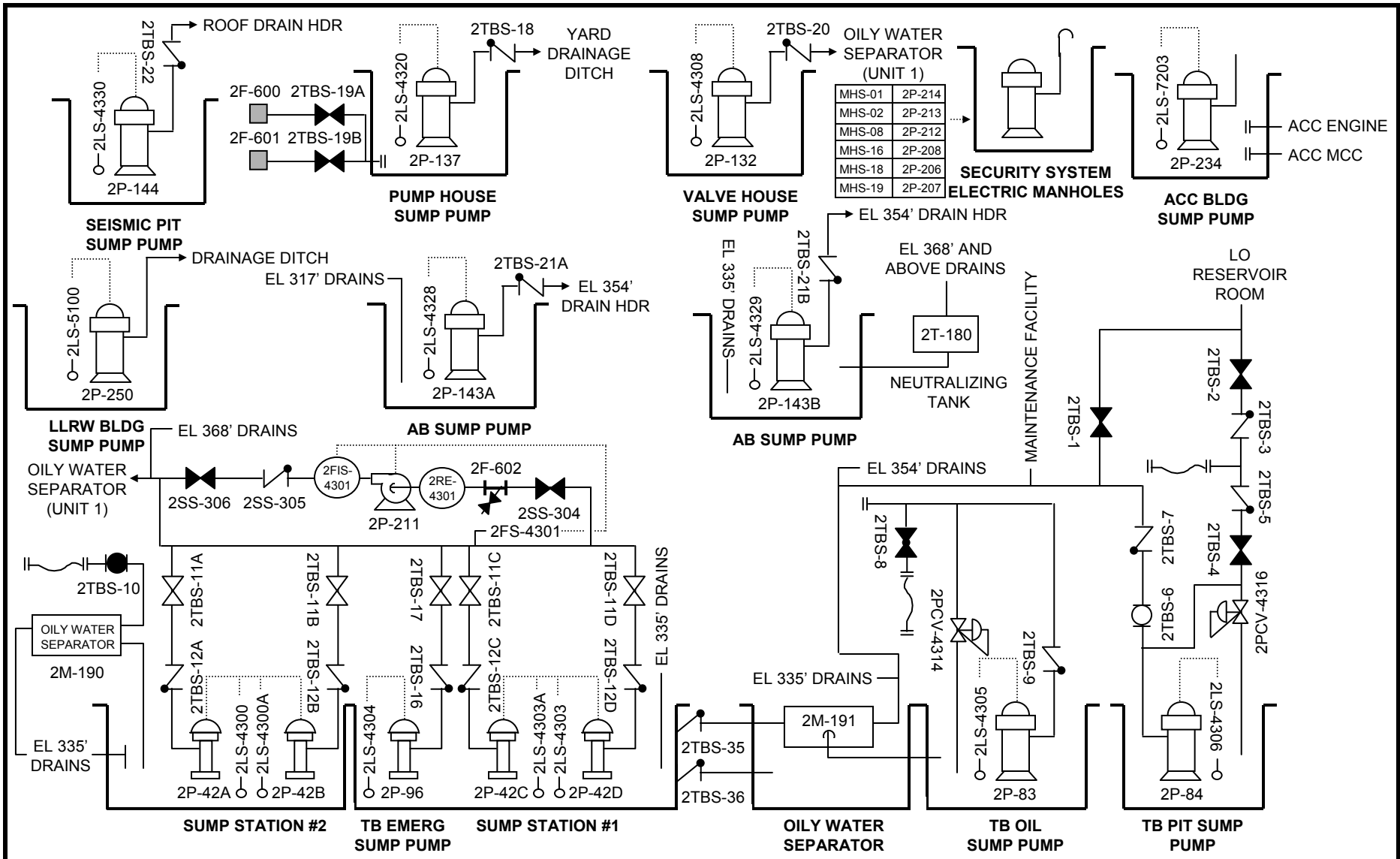

SUMP PUMPS

SAR FIGURE NO. 9.2-7C

ARKANSAS NUCLEAR ONE
UNIT 2
RUSSELLVILLE, ARKANSAS



SCALE:	NONE
DRAWN:	ENERGY
DESIGN:	ENERGY
CAD NO:	

AMENDMENT 23		
BASED ON DRAWING NO	SHEET	REV.

DELETED

SAR FIGURE NO. 9.2-8

AMENDMENT 20

ARKANSAS NUCLEAR ONE
UNIT 2
RUSSELLVILLE, ARKANSAS



SCALE: NONE

DRAWN:

DESIGN: ENTERGY

CAD NO:

BASED ON DRAWING NO

SHEET

REV.

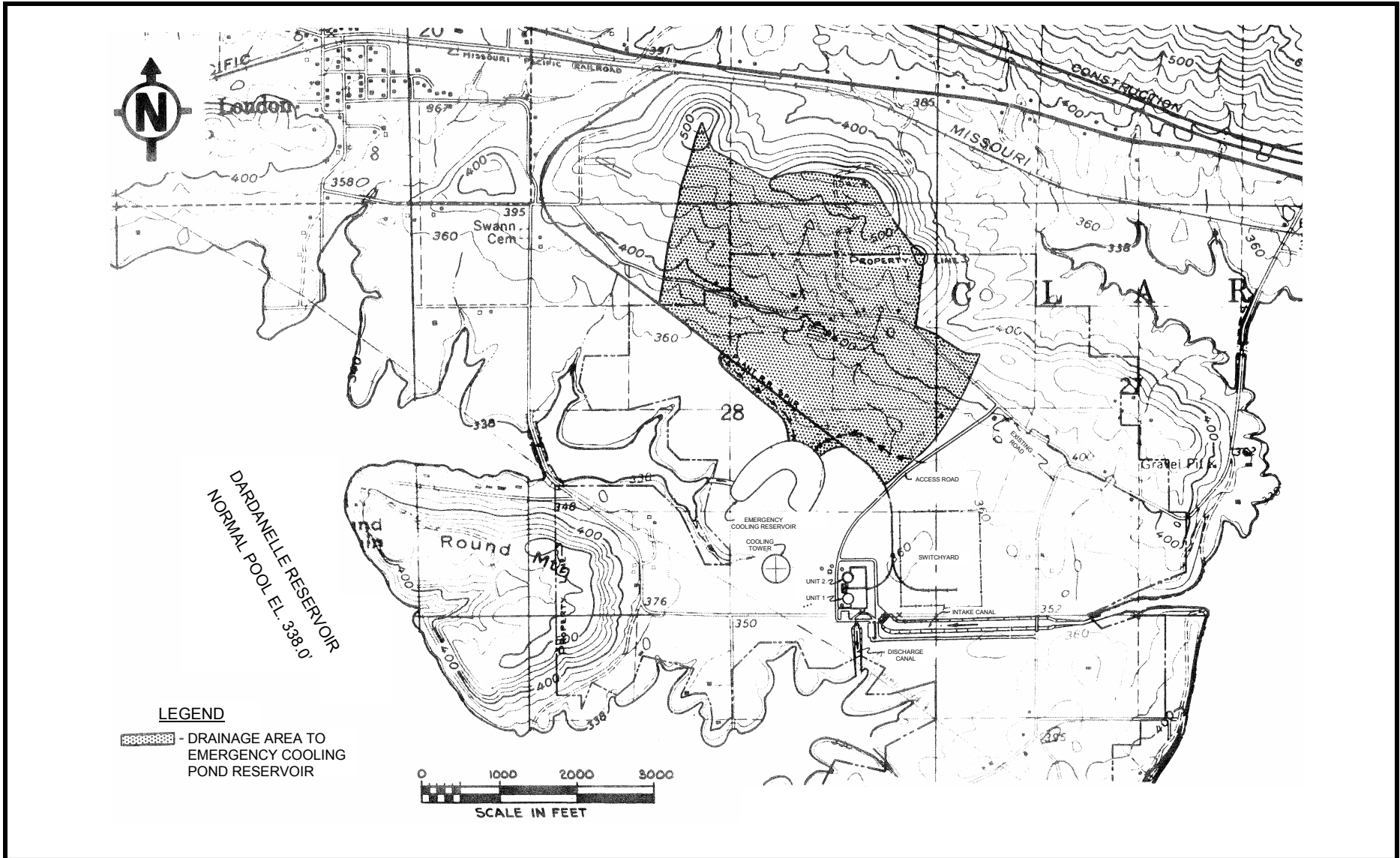

COOLING POND SURROUNDING AREA TOPICAL MAP

SAR FIGURE NO. 9.2-9

ARKANSAS NUCLEAR ONE
 UNIT 2
 RUSSELLVILLE, ARKANSAS



SCALE: NONE
 DRAWN: ENTERGY
 DESIGN: ENTERGY
 CAD NO:

AMENDMENT 20

BASED ON DRAWING NO

SHEET

REV.

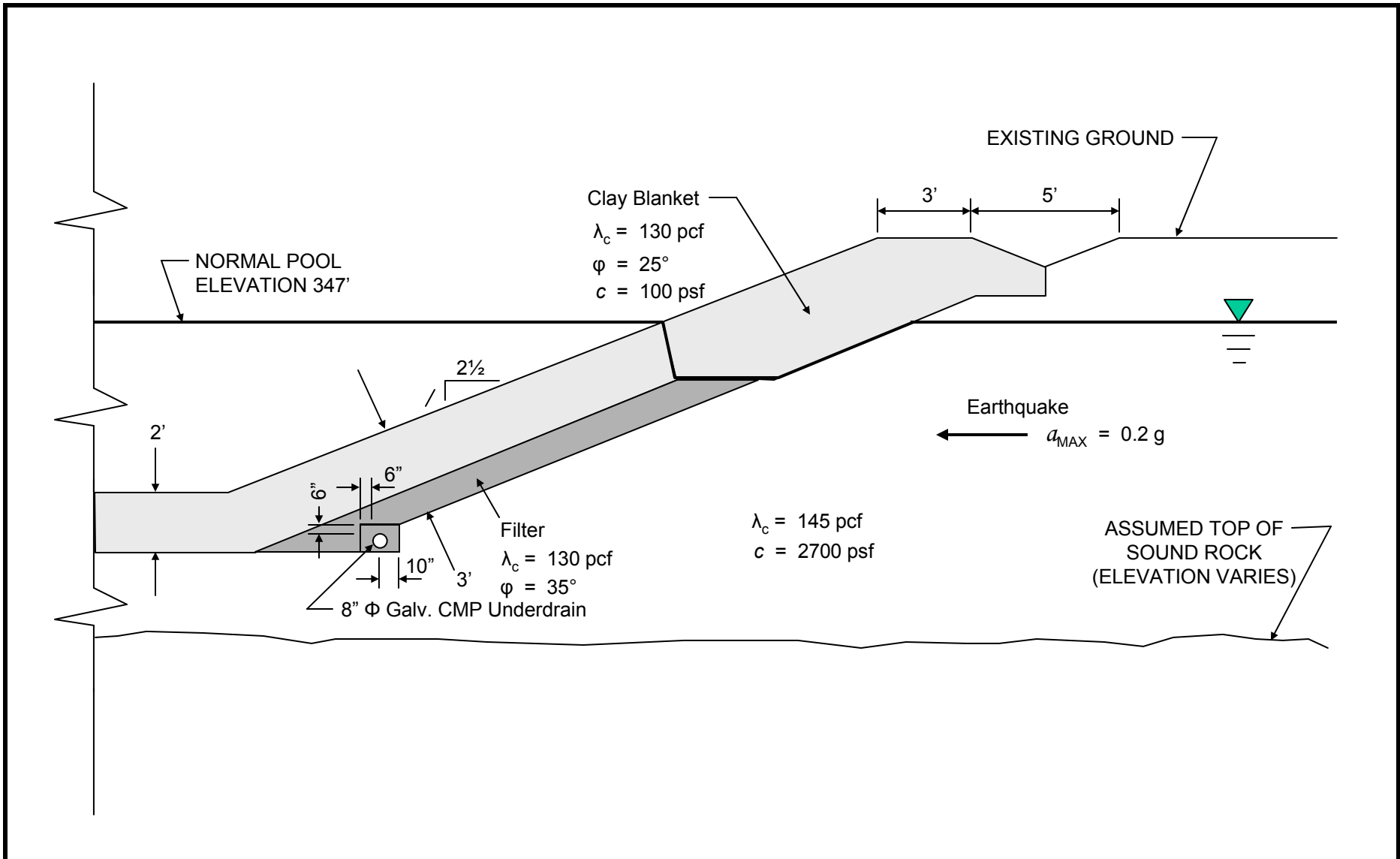

EMERGENCY COOLING POND TYPICAL SECTION

SAR FIGURE NO. 9.2-10

ARKANSAS NUCLEAR ONE
 UNIT 2
 RUSSELLVILLE, ARKANSAS



SCALE:	NONE
DRAWN:	ENERGY
DESIGN:	ENERGY
CAD NO:	

AMENDMENT 22		
BASED ON DRAWING NO	SHEET	REV.

SEE ANO-1 SAR
FIGURE 9-33

SAR FIGURE NO. 9.2-11

AMENDMENT 21

ARKANSAS NUCLEAR ONE
UNIT 2
RUSSELLVILLE, ARKANSAS



SCALE: NONE

DRAWN:

DESIGN: ENTERGY

CAD NO:

BASED ON DRAWING NO

SHEET

REV.

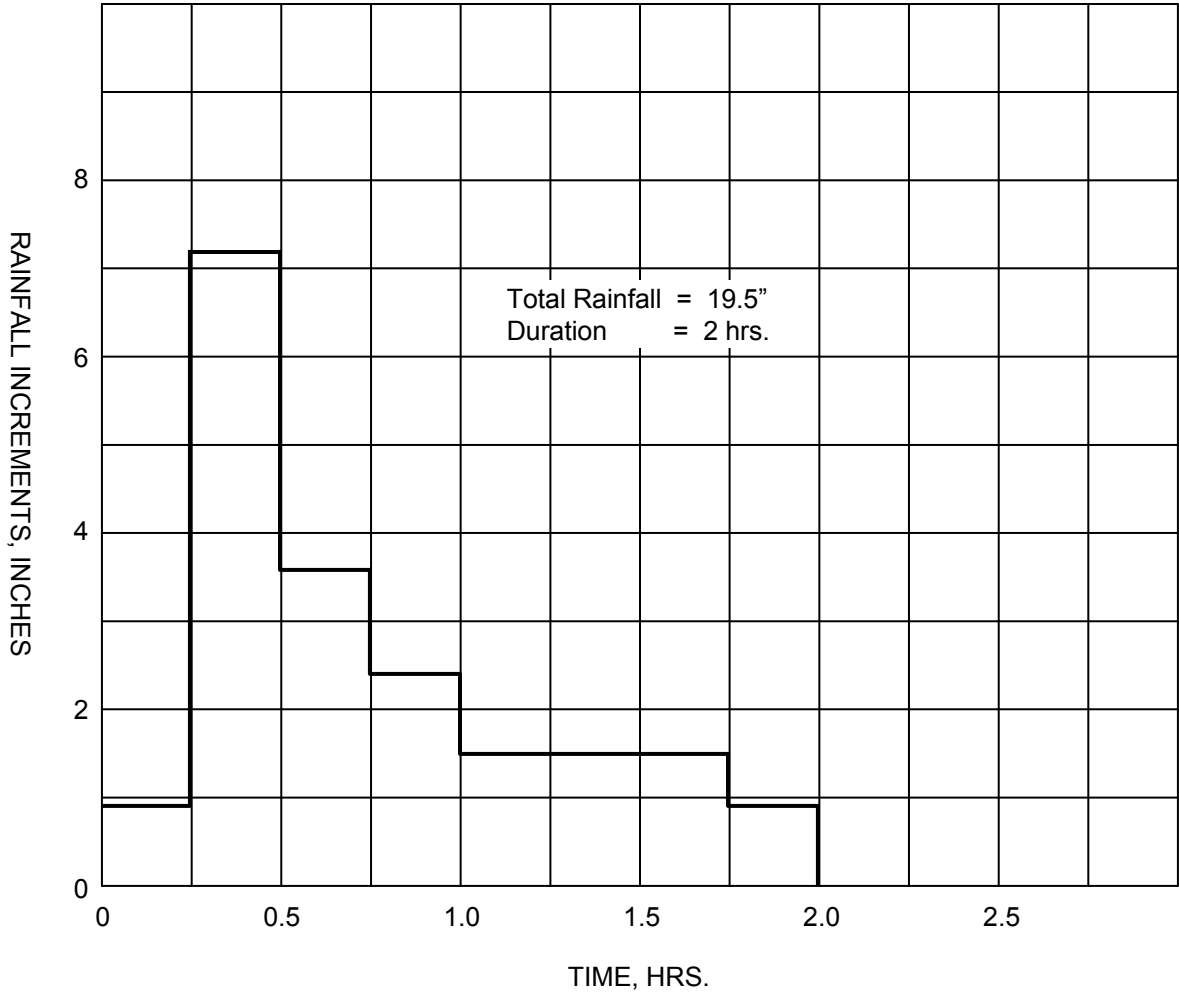

SAR FIGURE NO. 9.2-12

AMENDMENT 22

ARKANSAS NUCLEAR ONE
 UNIT 2
 RUSSELLVILLE, ARKANSAS



SCALE:	NONE
DRAWN:	
DESIGN:	ENERGY
CAD NO:	

HISTOGRAM OF PROBABLE MAXIMUM
 PRECIPITATION

BASED ON DRAWING NO

SHEET

REV.

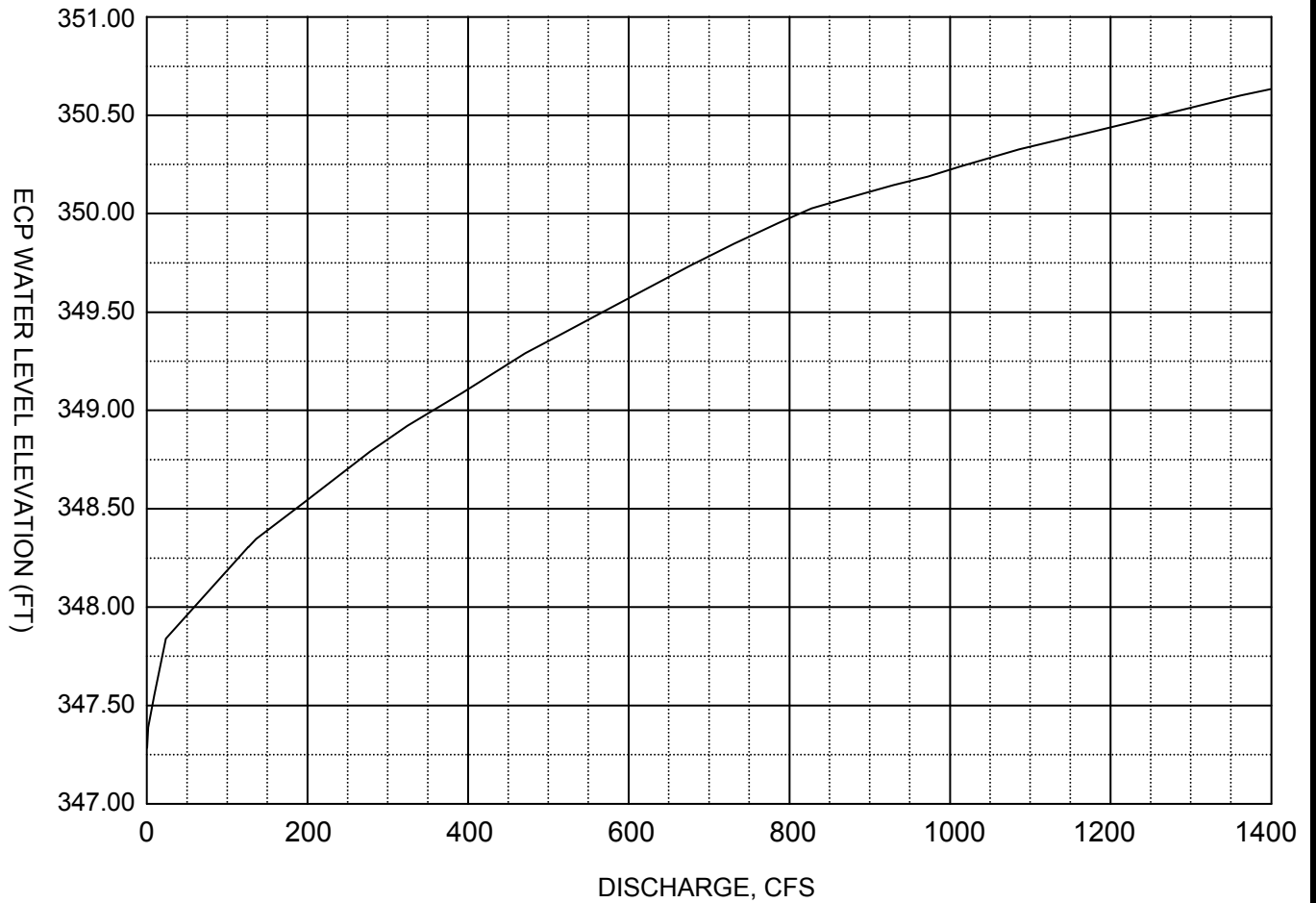

SAR FIGURE NO. 9.2-13

AMENDMENT 22

ARKANSAS NUCLEAR ONE
 UNIT 2
 RUSSELLVILLE, ARKANSAS



SCALE:	NONE
DRAWN:	
DESIGN:	ENERGY
CAD NO:	

ECP OGEE SPILLWAY RATING CURVE

BASED ON DRAWING NO

SHEET

REV.

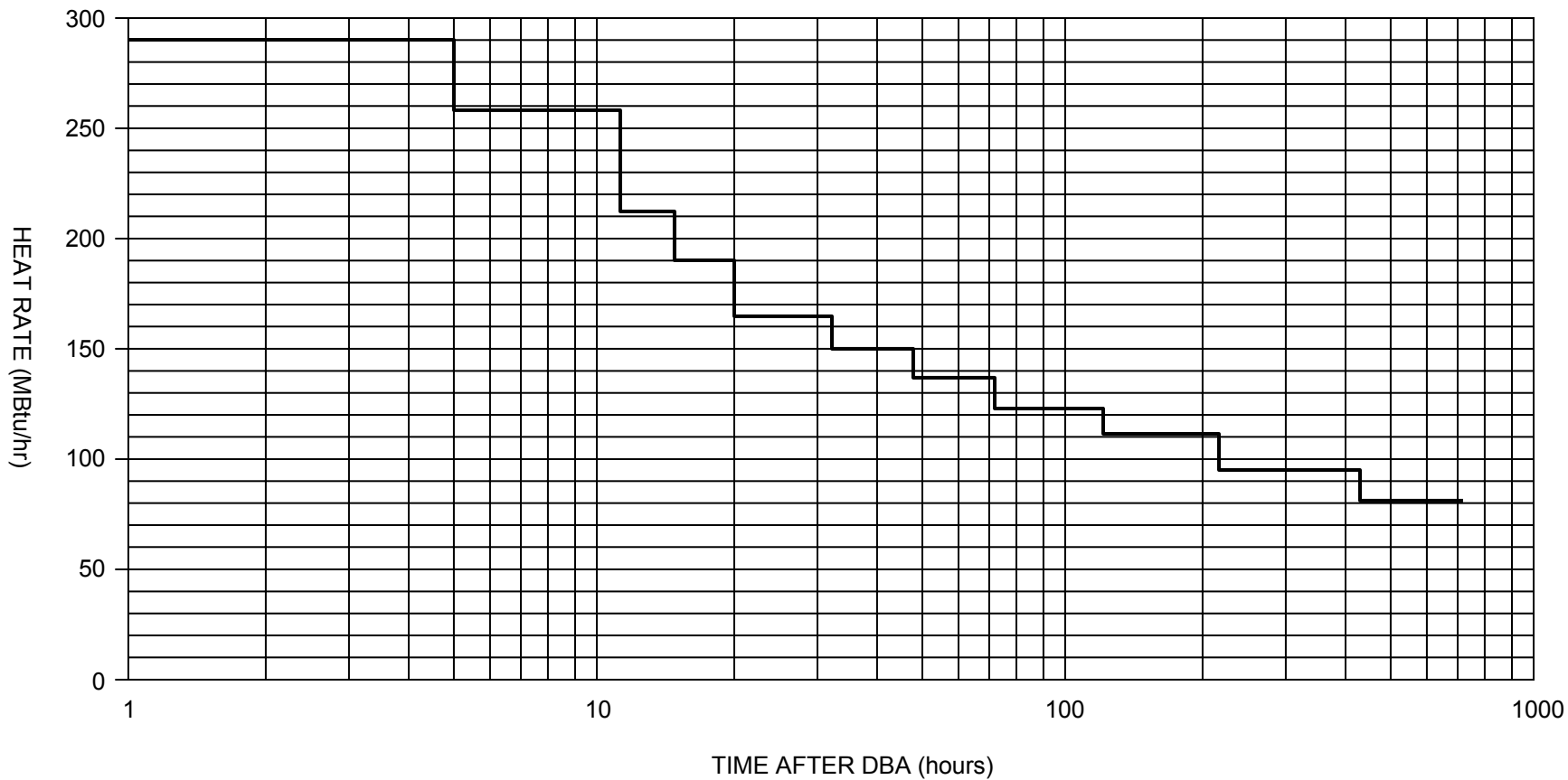

DESIGN BASIS HEAT REJECTION TO THE COOLING POND

SAR FIGURE NO. 9.2-14

ARKANSAS NUCLEAR ONE
 UNIT 2
 RUSSELLVILLE, ARKANSAS



SCALE: NONE
 DRAWN: ENTERGY
 DESIGN: ENTERGY
 CAD NO:

AMENDMENT 20

BASED ON DRAWING NO

SHEET

REV.

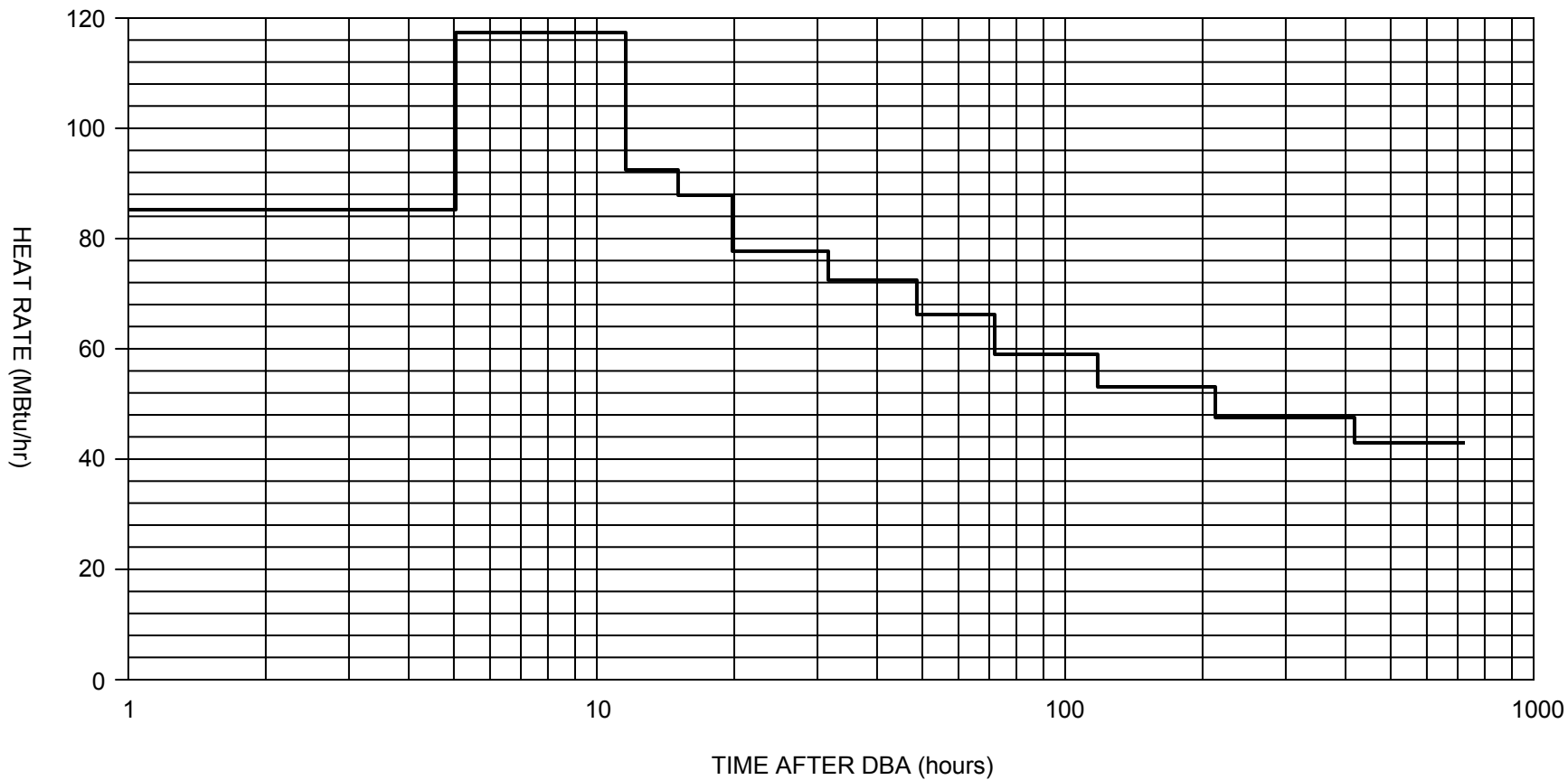

HEAT LOAD – UNIT 1 SAFE SHUTDOWN

SAR FIGURE NO. 9.2-15

ARKANSAS NUCLEAR ONE
 UNIT 2
 RUSSELLVILLE, ARKANSAS



SCALE: NONE
 DRAWN: ENTERGY
 DESIGN: ENTERGY
 CAD NO:

AMENDMENT 20

BASED ON DRAWING NO

SHEET

REV.

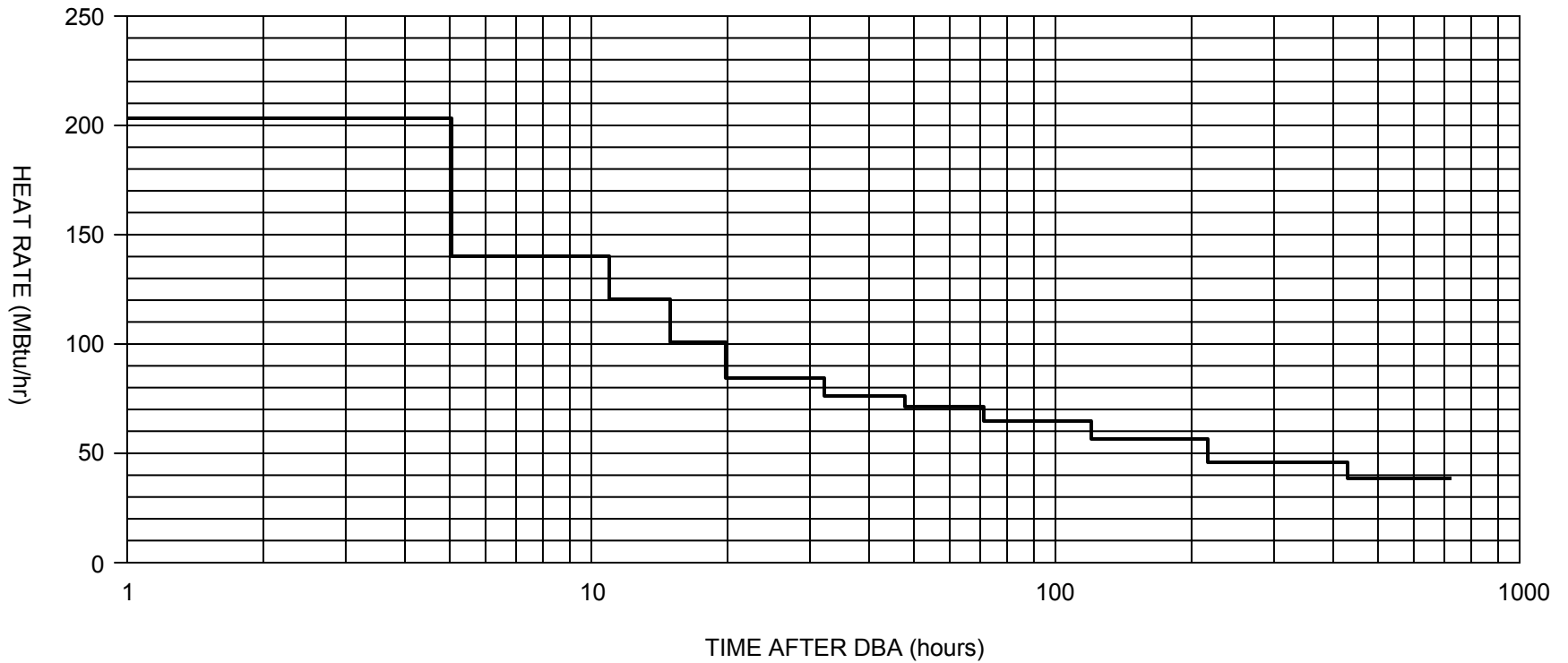

HEAT LOAD – UNIT 2 DBA

SAR FIGURE NO. 9.2-16

ARKANSAS NUCLEAR ONE
 UNIT 2
 RUSSELLVILLE, ARKANSAS



SCALE: NONE
 DRAWN: ENERGY
 DESIGN: ENERGY
 CAD NO:

AMENDMENT 20

BASED ON DRAWING NO

SHEET

REV.

DELETED

SAR FIGURE NO. 9.2-17

AMENDMENT 20

ARKANSAS NUCLEAR ONE
UNIT 2
RUSSELLVILLE, ARKANSAS



SCALE: NONE

DRAWN:

DESIGN: ENTERGY

CAD NO:

BASED ON DRAWING NO

SHEET

REV.

DELETED

SAR FIGURE NO. 9.2-18

AMENDMENT 20

ARKANSAS NUCLEAR ONE
UNIT 2
RUSSELLVILLE, ARKANSAS



SCALE: NONE

DRAWN:

DESIGN: ENTERGY

CAD NO:

BASED ON DRAWING NO

SHEET

REV.

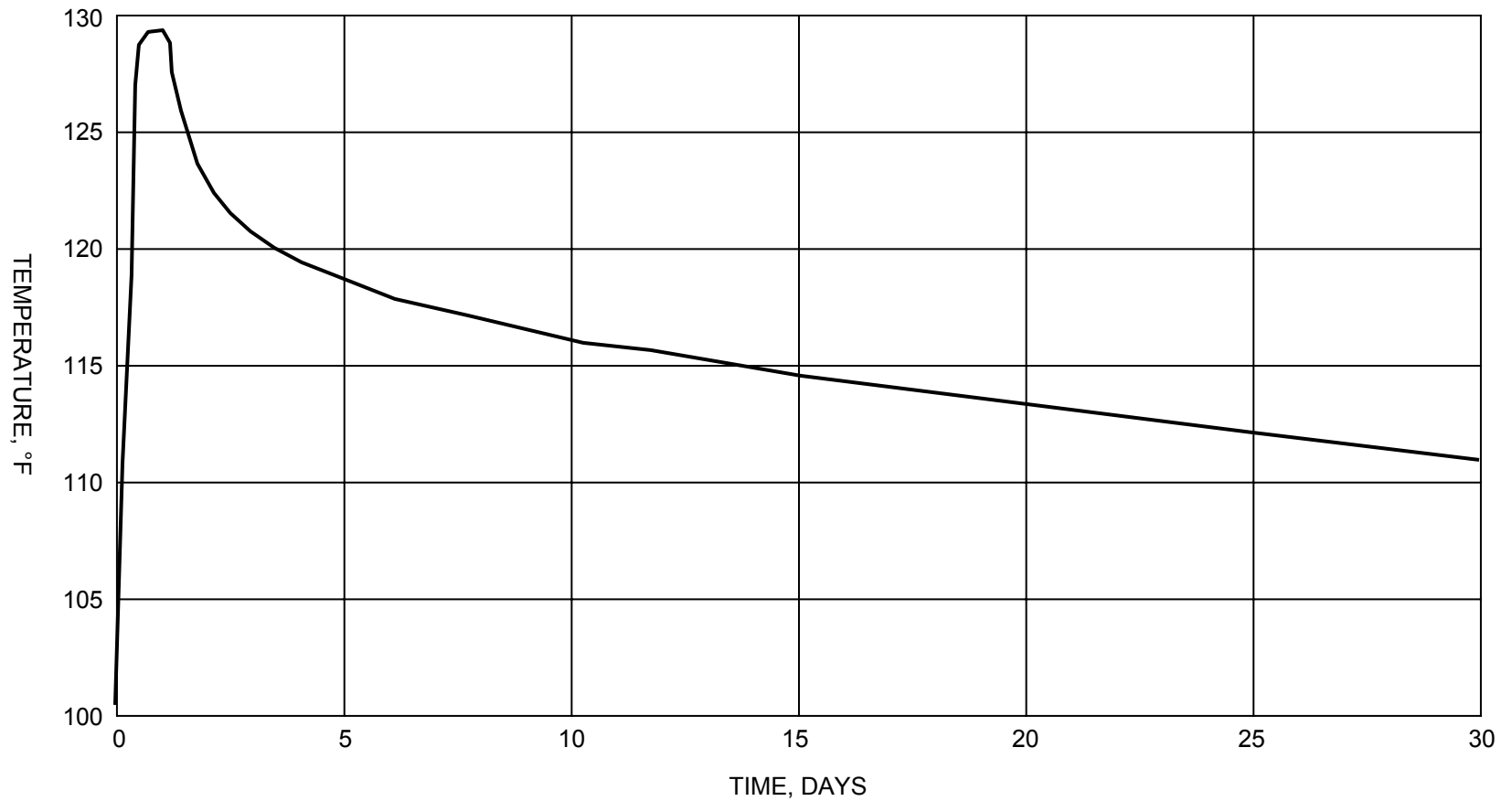

ORIGINAL DBA ECP OUTLET TEMPERATURE

SAR FIGURE NO. 9.2-19

ARKANSAS NUCLEAR ONE
 UNIT 2
 RUSSELLVILLE, ARKANSAS



SCALE: NONE
 DRAWN: ENTERGY
 DESIGN: ENTERGY
 CAD NO:

AMENDMENT 20

BASED ON DRAWING NO

SHEET

REV.

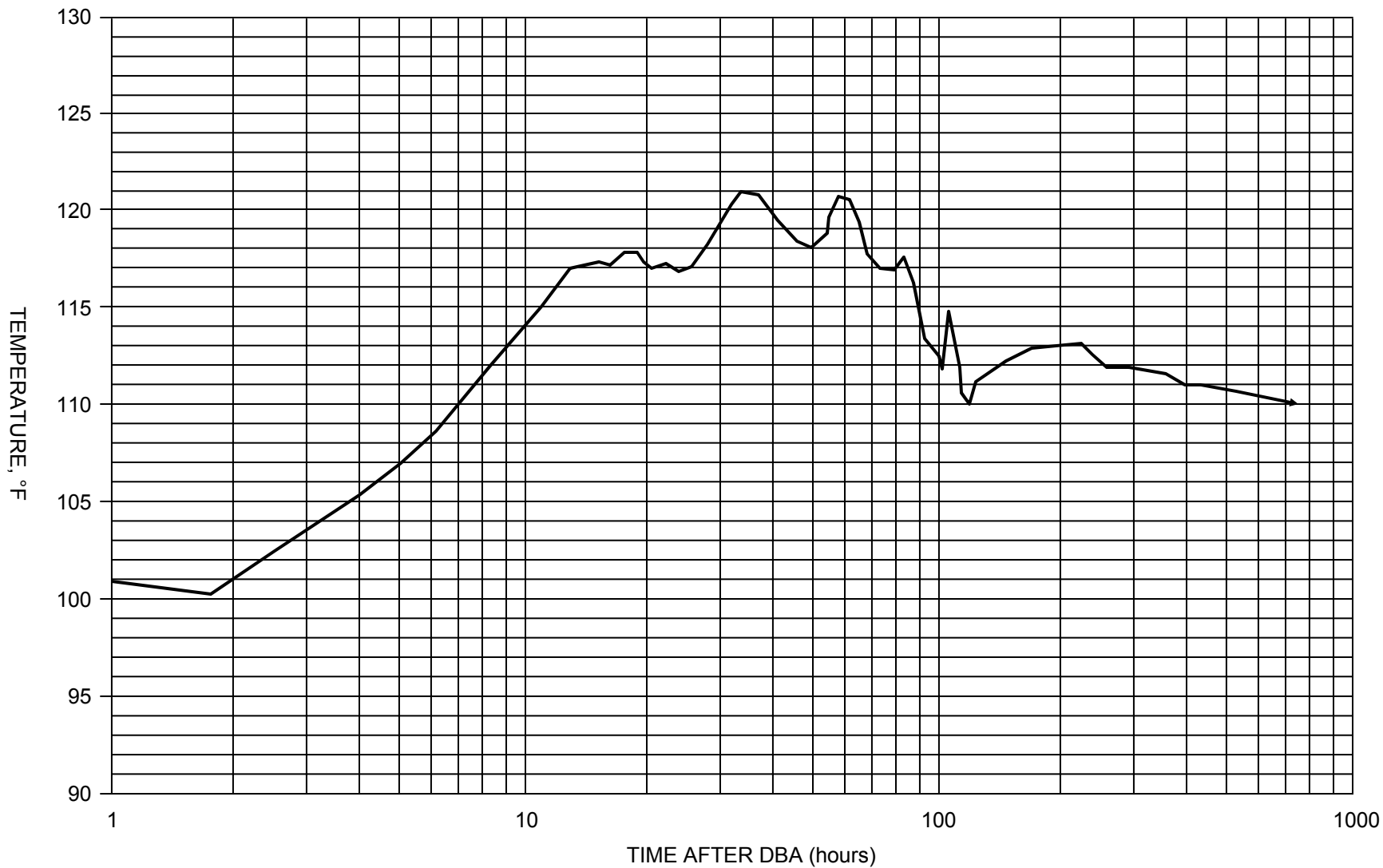

ECP TEMPERATURE – UNIT 2 DBA AND UNIT 1 SHUTDOWN

SAR FIGURE NO. 9.2-20

ARKANSAS NUCLEAR ONE
 UNIT 2
 RUSSELLVILLE, ARKANSAS



SCALE: NONE
 DRAWN: ENTERGY
 DESIGN: ENTERGY
 CAD NO:

AMENDMENT 20

BASED ON DRAWING NO

SHEET

REV.

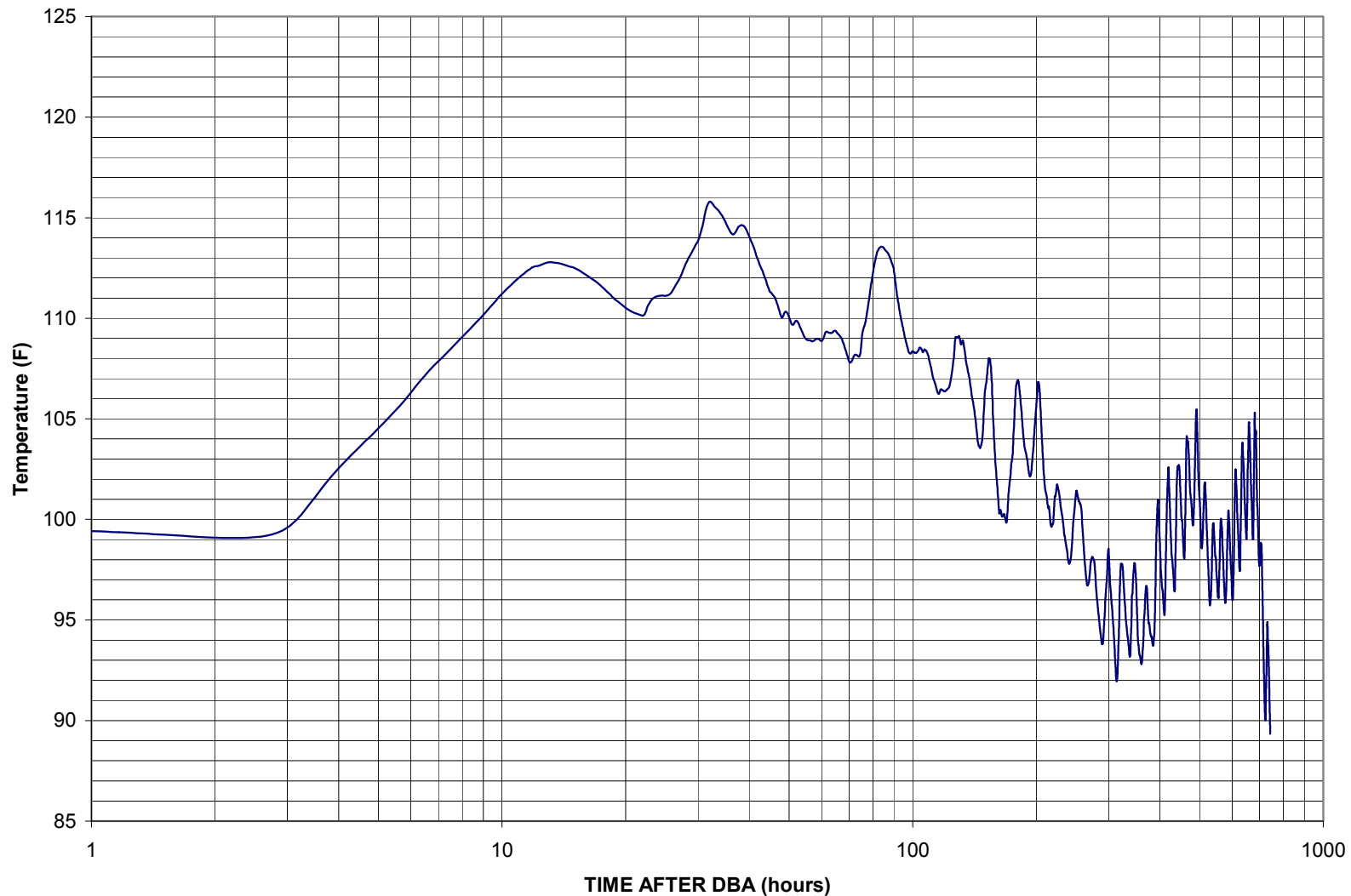

EMERGENCY COOLING POND TEMPERATURE – UPDATED ANALYSIS

SAR FIGURE NO. 9.2-21

ARKANSAS NUCLEAR ONE
 UNIT 2
 RUSSELLVILLE, ARKANSAS



SCALE: NONE
 DRAWN: ENERGY
 DESIGN: ENERGY
 CAD NO:

AMENDMENT 24

BASED ON DRAWING NO

SHEET

REV.

DELETED

SAR FIGURE NO. 9.2-22

AMENDMENT 20

ARKANSAS NUCLEAR ONE
UNIT 2
RUSSELLVILLE, ARKANSAS



SCALE: NONE

DRAWN:

DESIGN: ENTERGY

CAD NO:

BASED ON DRAWING NO

SHEET

REV.

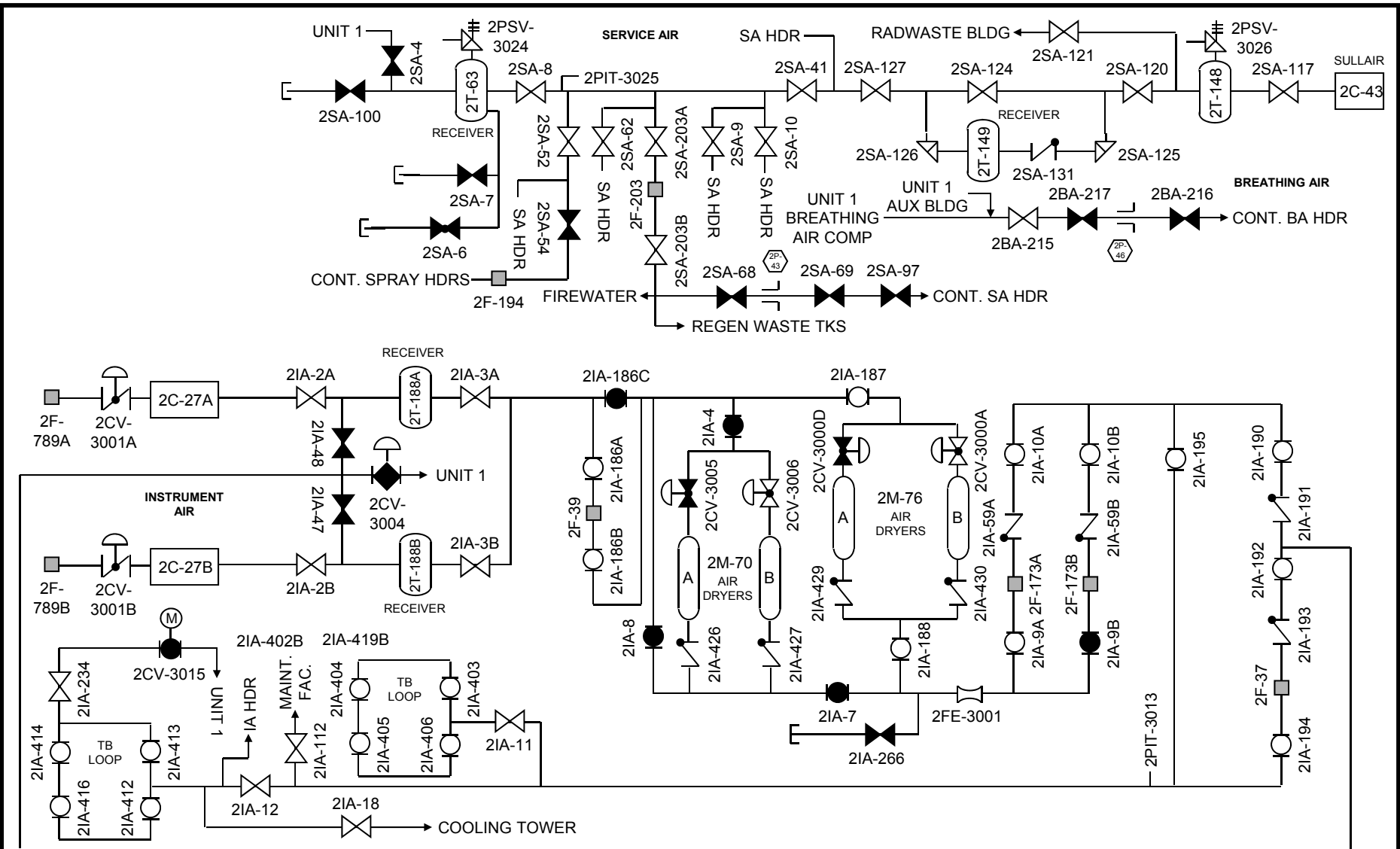

SERVICE, BREATHING, AND INSTRUMENT AIR

SAR FIGURE NO. 9.3-1

ARKANSAS NUCLEAR ONE
 UNIT 2
 RUSSELLVILLE, ARKANSAS



SCALE: NONE
 DRAWN: ENTERGY
 DESIGN: ENTERGY
 CAD NO:

AMENDMENT 28

BASED ON DRAWING NO	SHEET	REV.
---------------------	-------	------

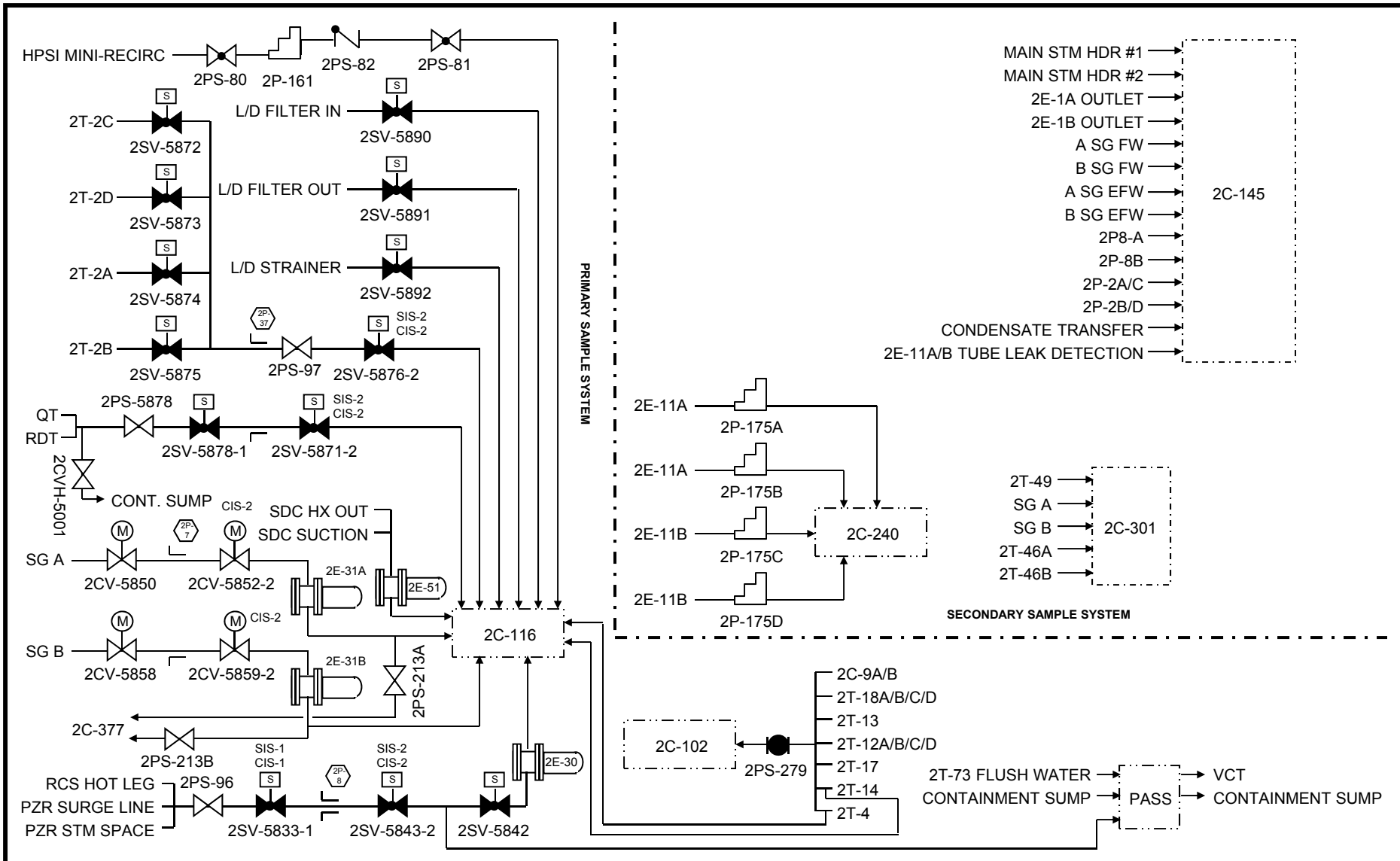

PRIMARY AND SECONDARY SAMPLING SYSTEM

SAR FIGURE NO. 9.3-2

ARKANSAS NUCLEAR ONE
UNIT 2
RUSSELLVILLE, ARKANSAS



SCALE: NONE
DRAWN: ENTERGY
DESIGN: ENTERGY
CAD NO:

AMENDMENT 28

BASED ON DRAWING NO

SHEET

REV.

DELETED

SAR FIGURE NO. 9.3-3

AMENDMENT 20

ARKANSAS NUCLEAR ONE
UNIT 2
RUSSELLVILLE, ARKANSAS



SCALE: NONE

DRAWN:

DESIGN: ENTERGY

CAD NO:

BASED ON DRAWING NO

SHEET

REV.

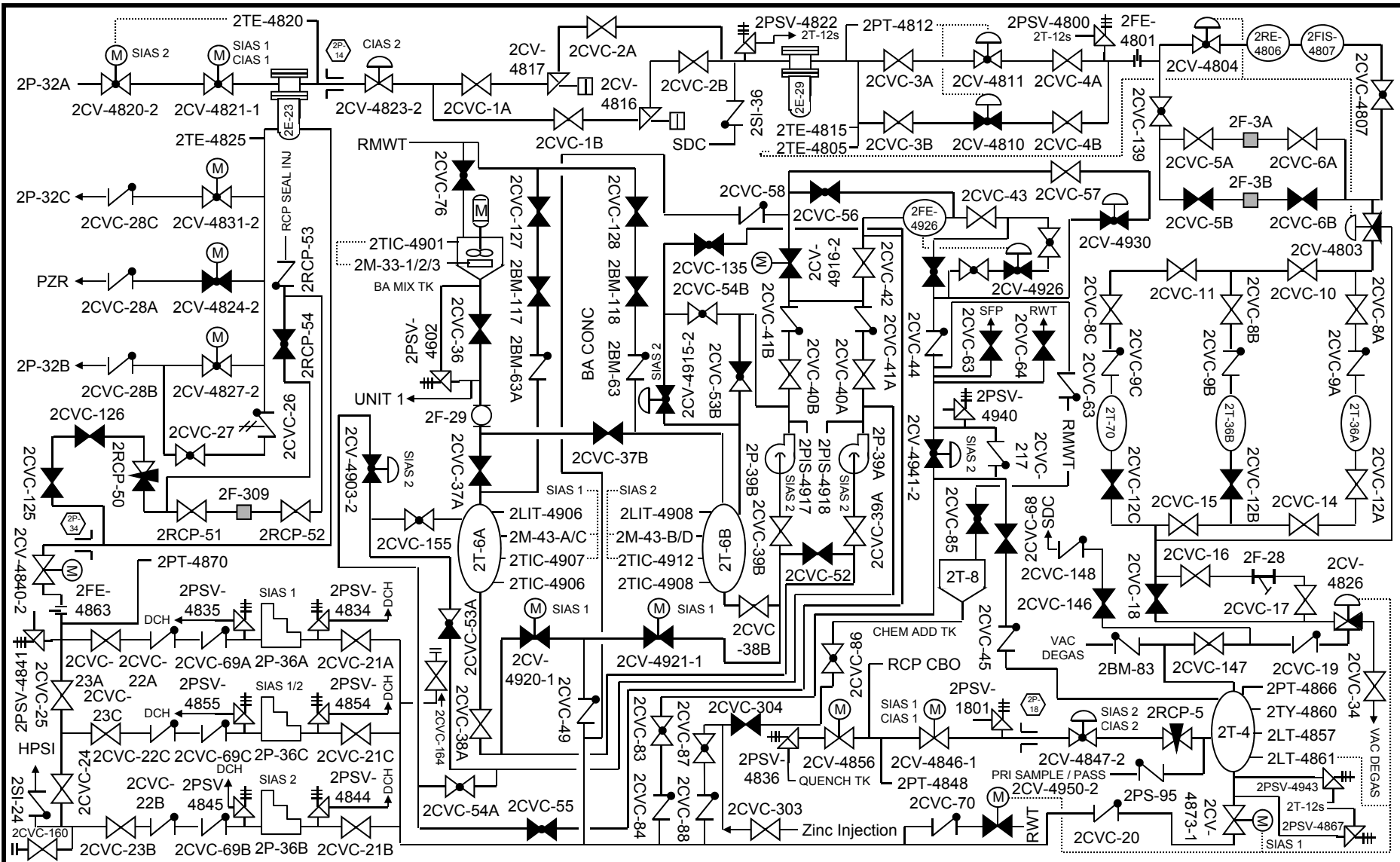

CHEMICAL AND VOLUME CONTROL SYSTEM

SAR FIGURE NO. 9.3-4

ARKANSAS NUCLEAR ONE
UNIT 2
RUSSELLVILLE, ARKANSAS



SCALE:	NONE
DRAWN:	ENERGY
DESIGN:	ENERGY
CAD NO:	

AMENDMENT 26

BASED ON DRAWING NO	SHEET	REV.

DELETED

SAR FIGURE NO. 9.3-5

AMENDMENT 20

ARKANSAS NUCLEAR ONE
UNIT 2
RUSSELLVILLE, ARKANSAS



SCALE: NONE

DRAWN:

DESIGN: ENTERGY

CAD NO:

BASED ON DRAWING NO

SHEET

REV.

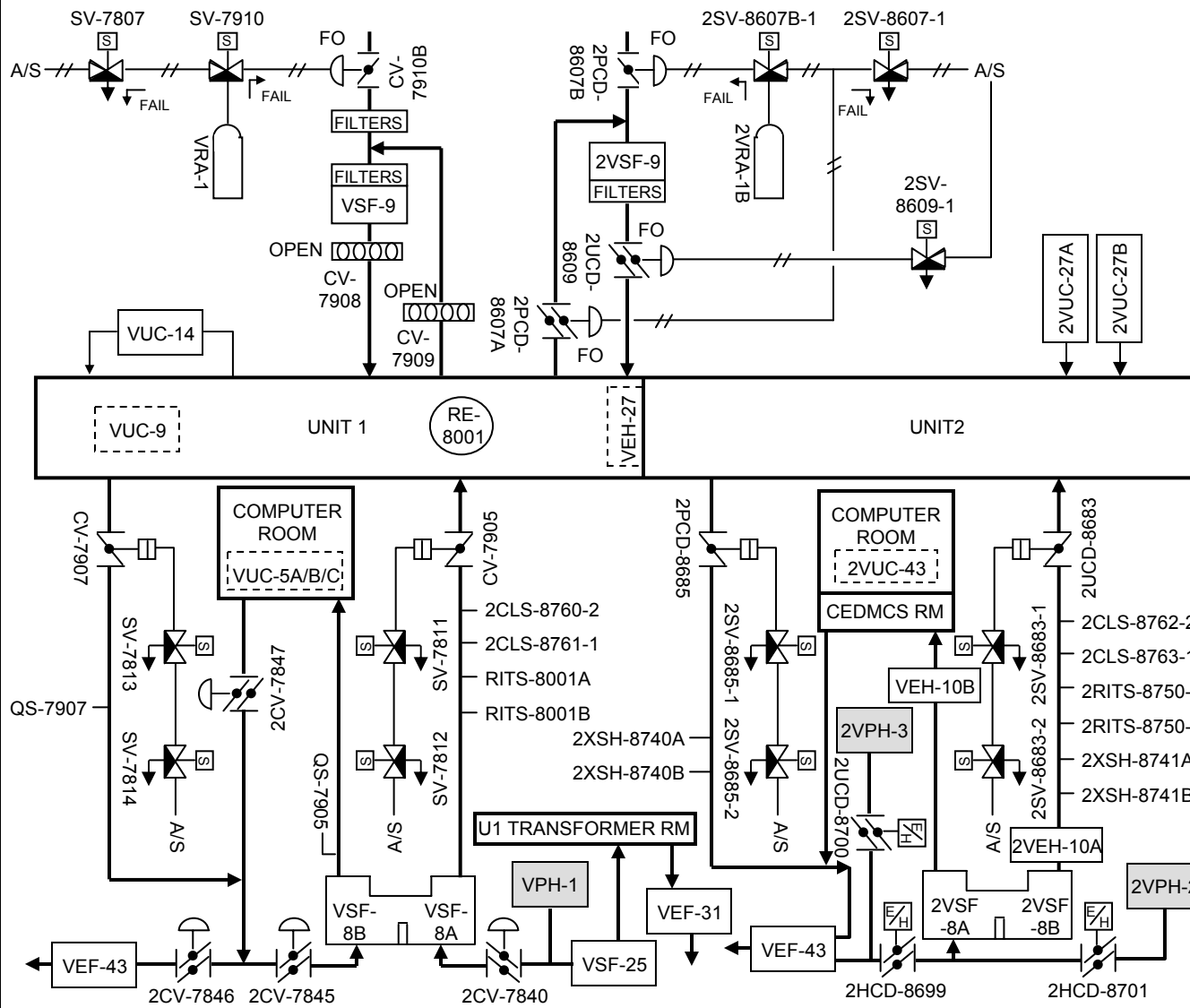

MISCELLANEOUS AUX BLDG VENTILATION	
AREA	VENTILATION UNIT
SWITCHGEAR RM	2VEF-56A/B, 2VUC-2A/B/C/D
MET LAB	2VUC-23, 2VEH-9
ELEC EQUIP RM 2108	2VUC-21
CABLE SPREADING RM	2VEF-62
ELEC EQUIP RM 2091	2VEF-63/64, 2VUC-19A/B
ELEC EQUIP RM 2076	2VUC-17A/B
VENTILATION EQUIP RM	2VSF-24, 2VEF-30, 2VUH-32/33
MN STM LINE ENCLOSURE	2VEF-36
BATTERY ROOMS	2VEF-49, 2VEF-61, 2VEF-65
ELEVATOR MACH RM	2VSF-28
EDG RM	2VEF-24A/B/C/D, 2VUE-32 2VUE-33, 2VUE-34, 2VUE-35
COMPUTER RM	2VSF-44, 2VEF-71
SAMPLE RMS	2VSF-46, 2VSF-45, 2VEF-73
CPC RM	2VUC-37A/B
CA-2 / RP AREA	2VS-10/36/51, 2VEF-4
AUX BLDG	2VSF-7A/B, 2VEF-8A/B
ELEC EQUIP RM 2096	2VUC-20A/B
LSEP RM	2VUE-24, 2VUE-25
USEP RM	2VUE-26, 2VUE-27, 2VUE-28
UNEP RM	2VUE-29
RAD MON ENCLOSURES	2VEF-59, 2VEF-60
AB FUEL HANDLING FLR	2VSF-4, 2VEF-14A/B, 2VUH-34
ELEC EQUIP RM 2150	2VUC-25A/B, 2VUC-28
USPP RM	2VUE-22, 2VUE-23
HOT LAB	2VEF-55, 2VEH-4, 2VEH-7
LSPP RM	2VUE-19, 2VUE-20
LNPP RM	2VUE-21
EFW RMS	2VUC-6A/B
HOT MACH / DRUMMING	2VSF-38
CHARGING PUMPS	2VUC-7A/B/C
HOLDUP TK AREAS	2VUE-10 THRU -18
"A" ECCS RM	2VUC-1A/B/C, 2VUE-2/3/6
"B" ECCS RM	2VUC-1D/E/F, 2VUE-3/4/7/8
"C" HPSI RM	2VUC-11A/B
TENDON GALLERY	2VEF-23A THRU -23E
VENTILATION EQUIP RM	2VUH-54

CONTROL ROOM VENTILATION AND MISCELLANEOUS AUXILIARY BUILDING VENTILATION

SAR FIGURE NO. 9.4-1

ARKANSAS NUCLEAR ONE
UNIT 2
RUSSELLVILLE, ARKANSAS



SCALE: NONE
DRAWN: ENTERGY
DESIGN: ENTERGY
CAD NO:

AMENDMENT 20

BASED ON DRAWING NO	SHEET	REV.
---------------------	-------	------

DELETED

SAR FIGURE NO. 9.4-2

AMENDMENT 20

ARKANSAS NUCLEAR ONE
UNIT 2
RUSSELLVILLE, ARKANSAS



SCALE: NONE

DRAWN:

DESIGN: ENTERGY

CAD NO:

BASED ON DRAWING NO

SHEET

REV.

DELETED

SAR FIGURE NO. 9.4-3

AMENDMENT 20

ARKANSAS NUCLEAR ONE
UNIT 2
RUSSELLVILLE, ARKANSAS



SCALE: NONE

DRAWN:

DESIGN: ENTERGY

CAD NO:

BASED ON DRAWING NO

SHEET

REV.

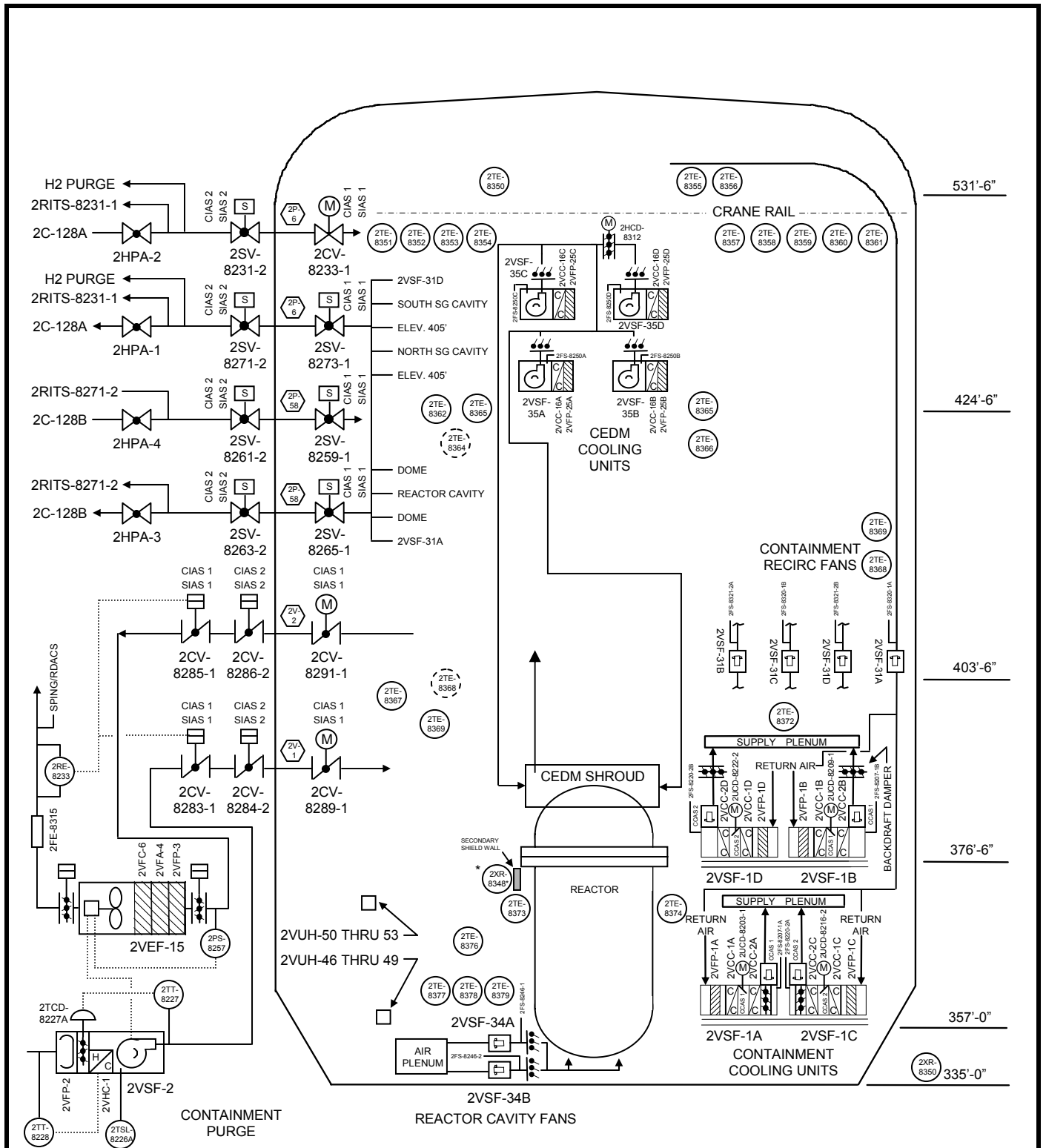

*2XR-8348 is Abandoned in Place

SAR FIGURE NO. 9.4-4

AMENDMENT 25

ARKANSAS NUCLEAR ONE
 UNIT 2
 RUSSELLVILLE, ARKANSAS



SCALE: NONE
 DRAWN:
 DESIGN: ENTERGY
 CAD NO:

CONTAINMENT BUILDING

BASED ON DRAWING NO

SHEET

REV.

1

DELETED

SAR FIGURE NO. 9.4-5

AMENDMENT 20

ARKANSAS NUCLEAR ONE
UNIT 2
RUSSELLVILLE, ARKANSAS



SCALE: NONE

DRAWN:

DESIGN: ENTERGY

CAD NO:

BASED ON DRAWING NO

SHEET

REV.

DELETED

SAR FIGURE NO. 9.4-6

AMENDMENT 20

ARKANSAS NUCLEAR ONE
UNIT 2
RUSSELLVILLE, ARKANSAS



SCALE: NONE

DRAWN:

DESIGN: ENTERGY

CAD NO:

BASED ON DRAWING NO

SHEET

REV.

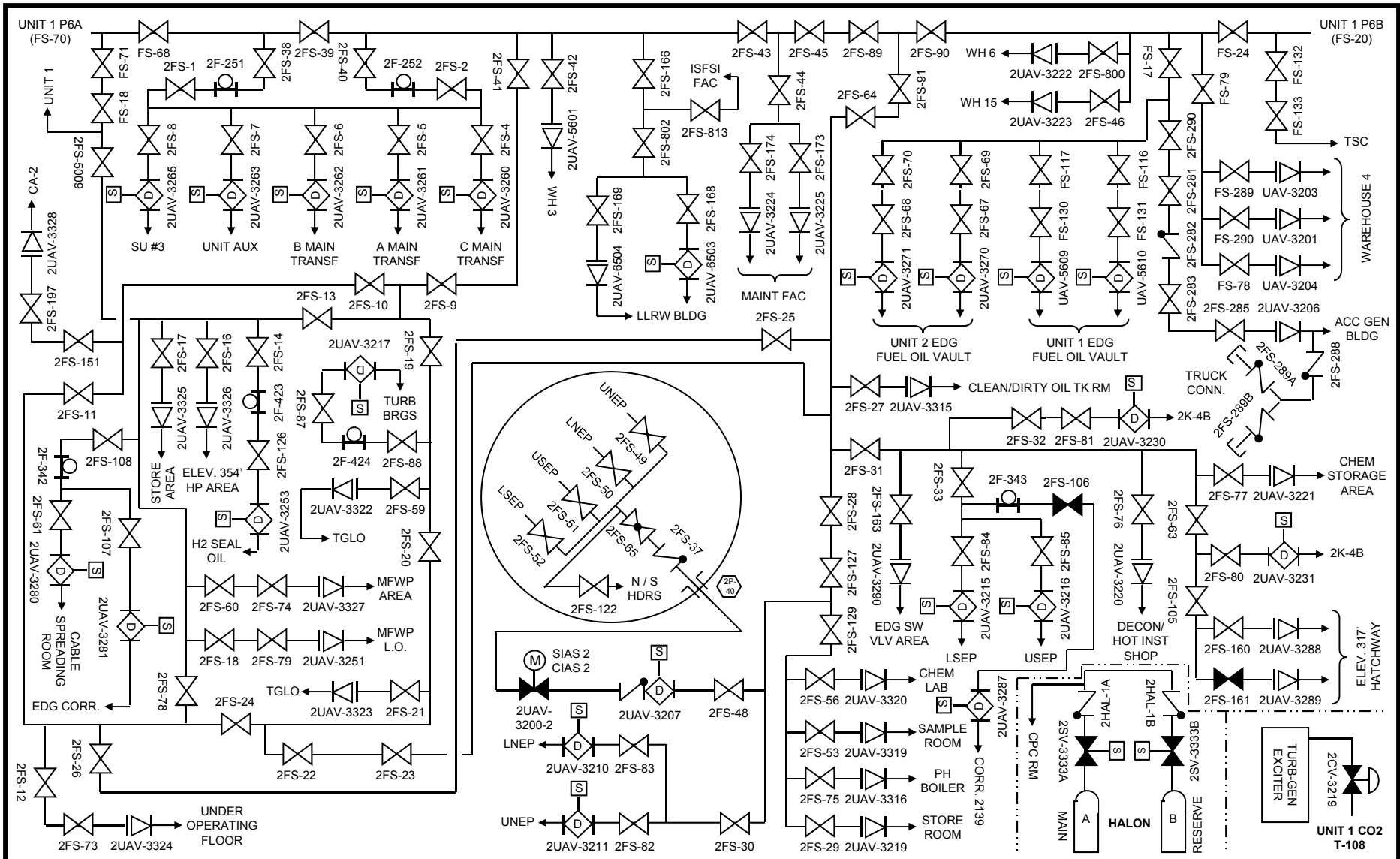

FIRE WATER

SAR FIGURE NO. 9.5-1

ARKANSAS NUCLEAR ONE
UNIT 2
RUSSELLVILLE, ARKANSAS



SCALE: NONE
DRAWN: ENTERGY
DESIGN: ENTERGY
CAD NO:

AMENDMENT 26

BASED ON DRAWING NO	SHEET	REV.
---------------------	-------	------

Figures 9.5-2 through 9.5-7
DELETED

SAR FIGURE NOS. 9.5-2 – 9.5-7

AMENDMENT 20

ARKANSAS NUCLEAR ONE
UNIT 2
RUSSELLVILLE, ARKANSAS



SCALE: NONE

DRAWN:

DESIGN: ENTERGY

CAD NO:

BASED ON DRAWING NO

SHEET

REV.

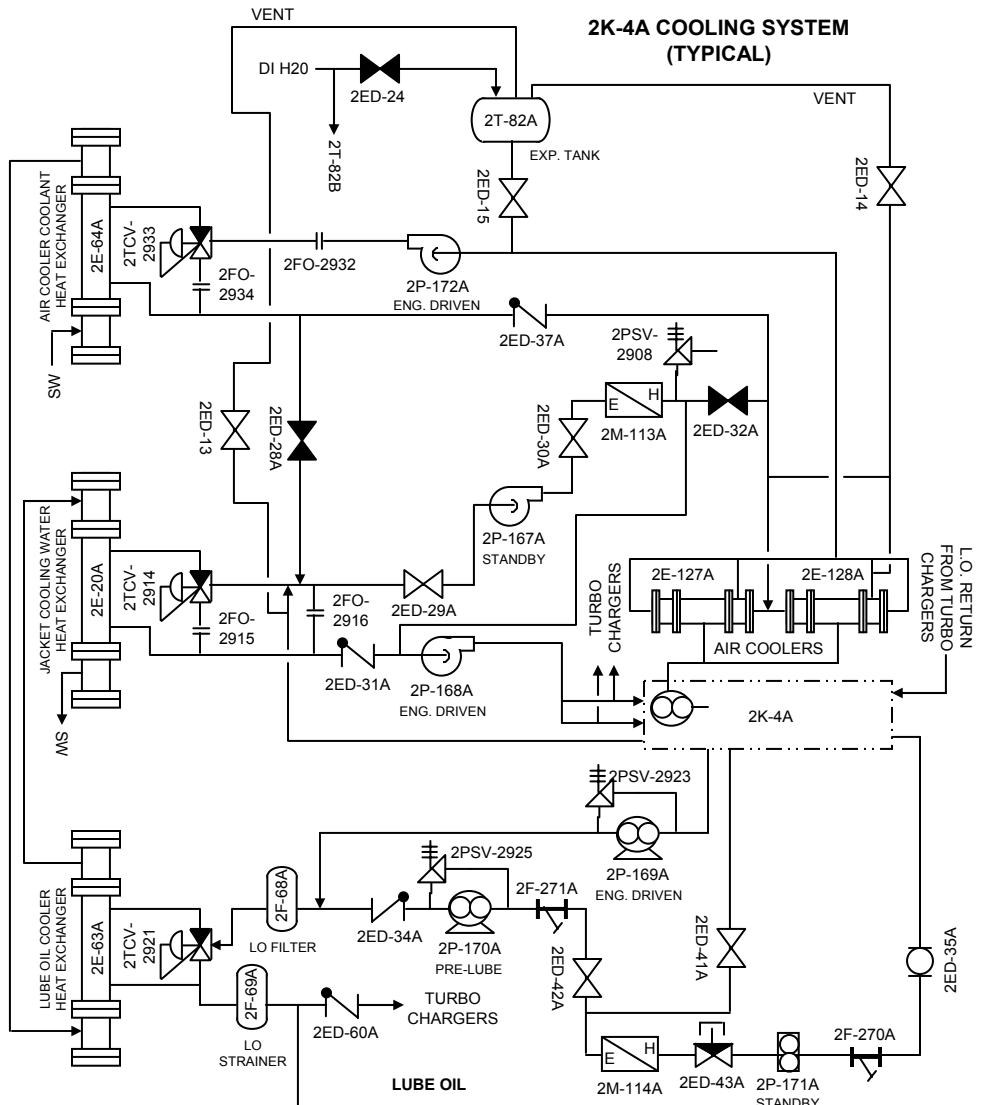
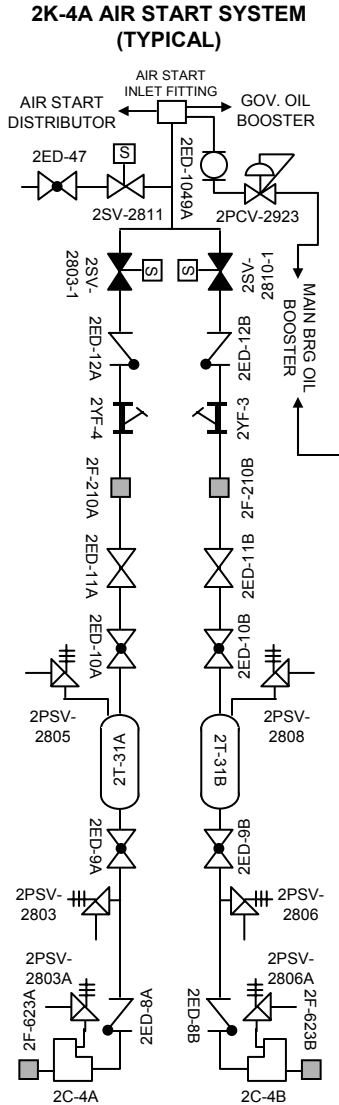
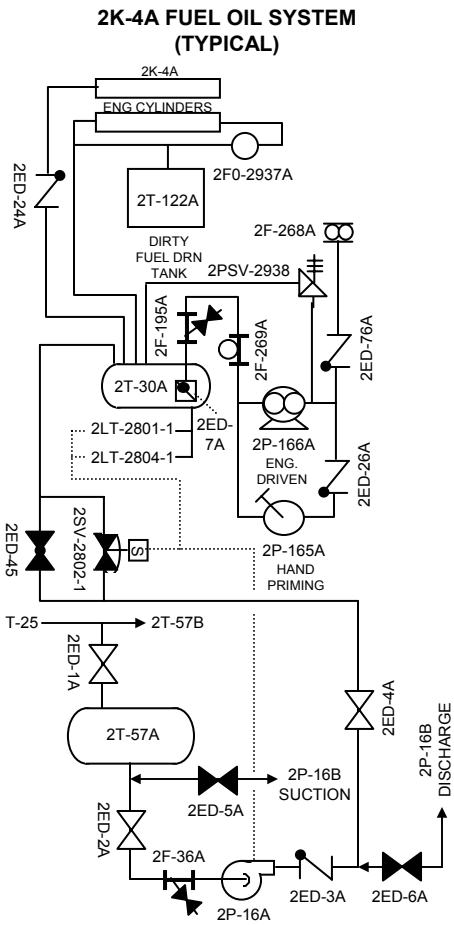

EMERGENCY DIESEL GENERATOR AUXILIARIES

SAR FIGURE NO. 9.5-8

ARKANSAS NUCLEAR ONE
UNIT 2
RUSSELLVILLE, ARKANSAS



SCALE:	NONE
DRAWN:	ENERGY
DESIGN:	ENERGY
CAD NO:	

AMENDMENT 20		
BASED ON DRAWING NO	SHEET	REV.

DELETED

SAR FIGURE NO. 9.5-9

AMENDMENT 20

ARKANSAS NUCLEAR ONE
UNIT 2
RUSSELLVILLE, ARKANSAS



SCALE: NONE

DRAWN:

DESIGN: ENTERGY

CAD NO:

BASED ON DRAWING NO

SHEET

REV.

DELETED

SAR FIGURE NO. 9.5-10

AMENDMENT 20

ARKANSAS NUCLEAR ONE
UNIT 2
RUSSELLVILLE, ARKANSAS



SCALE: NONE

DRAWN:

DESIGN: ENTERGY

CAD NO:

BASED ON DRAWING NO

SHEET

REV.

APPENDIX 9A

FIRE PROTECTION PROGRAM

9A.1 PROGRAM DESCRIPTION

The Arkansas Nuclear One Fire Protection Program is defined as the following documents:

- section 9.5 of the Safety Analysis Report (SAR),
- the Operability, Surveillance, and Administrative Requirements (located in the SAR Appendix 9D),
- the 2012, 2013, and 2014 NFPA 805 submittals, and
- the 2015 NFPA 805 Safety Evaluation Report.

9A.2 SCOPE AND APPLICABILITY

The ANO Fire Protection Program has been incorporated into the SAR per Generic Letters 86-10 and 88-12. The Program is described in Section 9.5 and Appendices 9A through 9D.

The purpose of the Fire Protection Program is to extend the concept of defense-in-depth to fire protection in fire areas important to safety with the following objectives:

- To prevent fire from starting,
- To detect rapidly, control, and extinguish promptly those fires that do occur,
- To provide protection for structures, systems, and components important to safety so that a fire that is not promptly extinguished by fire suppression activities will not compromise the ability to achieve the safe shutdown of the plant.

The Fire Protection Program also delineates the responsibilities and the methods to be used to accomplish the objectives stated above. The Fire Protection Program will interface with other ANO manuals, plans and procedures to provide an effective and coordinated Fire Protection Program that encompasses all phases of operation, administration, and maintenance.

9A.3 ORGANIZATION AND RESPONSIBILITY

The personnel and organizations responsible for the oversight, implementation and maintenance for the ANO Fire Protection Program are described in SAR Section 13.1.1.

9A.4 ADMINISTRATIVE CONTROLS AND PROCEDURES

The ANO Fire Protection Program is controlled and maintained by various plant procedures that includes but not limited to implementing procedures, operational procedures, maintenance procedures, surveillance procedures, etc.

9A.5 FIRE HAZARDS ANALYSIS

The ANO Fire Hazards Analysis (FHA) is described in the SAR Appendix 9B.

ARKANSAS NUCLEAR ONE
Unit 2

9A.6 SAFETY EVALUATION REPORTS

ANO received a Safety Evaluation Report for the Fire Protection Program in 1978 and another one for Appendix R exemptions in 1988. These documents are numbered 2CNA087801 (2N-78-126) for 1978 and 2CNA108802 for 1988.

In 2012, ANO-2 submitted a request to revise the licensing basis from Appendix R to NFPA 805 as allowed by 10 CFR 50.48(c) (letter number 2CAN121202). ANO-2 received a Safety Evaluation Report for the revised Fire Protection Program in 2015 (letter number 2CNA021502)

9A.7 SAFE SHUTDOWN SYSTEMS

A listing of safe shutdown systems and the methodology used to ensure that modifications do not affect the ability to achieve a safe and stable condition following a fire are included in the FHA (SAR Appendix 9B).

9A.8 FIRE PROTECTION SYSTEMS

The ANO fire protection systems consists of fire pumps and distribution header, sprinkler systems, detection systems, hose reels, portable extinguishers, barriers, etc. A description of the fire protection systems may be found in the SAR Section 9.5.

9A.9 QUALITY ASSURANCE

Appropriate QA program controls ensure that the Fire Protection Program is maintained in accordance with the overall ANO QA Program.

9A.10 FIRE BRIGADE

Fire Brigade staffing, training, etc. may be found in the SAR Section 9.5.

ARKANSAS NUCLEAR ONE
Unit 2

APPENDIX 9B

FIRE HAZARDS ANALYSIS REPORT

The ANO Fire Hazards Analysis (FHA), maintained under separate cover, is considered part of the Fire Protection Program described in Appendix 9A of the SAR and as such is subject to the provisions of ANO Operating Licensing Condition 2.C.(3)(b).

ARKANSAS NUCLEAR ONE
Unit 2

APPENDIX 9C
SAFE SHUTDOWN CAPABILITY ASSESSMENT

DELETED

ARKANSAS NUCLEAR ONE
UNIT 2

APPENDIX 9D

FIRE PROTECTION SYSTEM ADMINISTRATIVE REQUIREMENTS

Appendix 9D contains the Administrative Requirements related to Fire Protection Systems. These requirements were relocated from the ANO-2 Technical Specifications in accordance with Generic Letter 88-12. Other Fire Protection System requirements have been relocated to the ANO-2 Technical Requirements Manual.

9D.1 ADMINISTRATIVE REQUIREMENTS

9D.1.1 FIRE BRIGADE

A site Fire Brigade of at least 5 members shall be maintained onsite at all times. The Fire Brigade shall not include 3 members of the minimum shift crew necessary for safe shutdown of the unit and any personnel required for other essential functions during a fire emergency.

9D.1.2 TRAINING

A training program for the Fire Brigade shall be maintained and shall meet or exceed the requirements of Section 3.4.3 of NFPA 805, [as approved in the NRC Safety Evaluation Report associated with the transition to NFPA 805](#).

ARKANSAS NUCLEAR ONE
Unit 2

CHAPTER 10

TABLE OF CONTENTS

<u>Section</u>	<u>Title</u>	<u>Page</u>
10	<u>STEAM AND POWER CONVERSION SYSTEM</u>	10.1-1
10.1	<u>SUMMARY DESCRIPTION</u>	10.1-1
10.2	<u>TURBINE GENERATOR</u>	10.2-1
10.2.1	DESIGN BASES.....	10.2-1
10.2.2	SYSTEM DESCRIPTION	10.2-1
10.2.2.1	<u>Turbine Generator Auxiliary Systems</u>	10.2-2
10.2.2.2	<u>Electrohydraulic Control System</u>	10.2-3
10.2.2.3	<u>Turbine Generator Overspeed Protection</u>	10.2-4
10.2.2.4	<u>Turbine Generator Trips</u>	10.2-6
10.2.3	TURBINE MISSILES	10.2-7
10.2.4	EVALUATION.....	10.2-7
10.3	<u>MAIN STEAM SUPPLY SYSTEM</u>	10.3-1
10.3.1	DESIGN BASES.....	10.3-1
10.3.2	SYSTEM DESCRIPTION	10.3-1
10.3.2.1	<u>General Description</u>	10.3-1
10.3.2.2	<u>System Operation</u>	10.3-3
10.3.3	SAFETY EVALUATION.....	10.3-3
10.3.4	TESTS AND INSPECTIONS	10.3-5
10.3.4.1	<u>Shop Tests</u>	10.3-5
10.3.5	WATER CHEMISTRY	10.3-5
10.4	<u>OTHER FEATURES OF STEAM AND POWER CONVERSION SYSTEM</u> ..	10.4-1
10.4.1	MAIN CONDENSER	10.4-1
10.4.1.1	<u>Design Bases</u>	10.4-1

ARKANSAS NUCLEAR ONE
Unit 2

TABLE OF CONTENTS (continued)

<u>Section</u>	<u>Title</u>	<u>Page</u>
10.4.1.2	<u>System Description</u>	10.4-2
10.4.1.3	<u>Safety Evaluation</u>	10.4-3
10.4.1.4	<u>Tests and Inspections</u>	10.4-3
10.4.1.5	<u>Instrumentation Applications</u>	10.4-4
10.4.2	MAIN CONDENSER EVACUATION SYSTEM	10.4-4
10.4.2.1	<u>Design Bases</u>	10.4-4
10.4.2.2	<u>System Description</u>	10.4-4
10.4.2.3	<u>Safety Evaluation</u>	10.4-5
10.4.2.4	<u>Tests and Inspections</u>	10.4-5
10.4.2.5	<u>Instrumentation Applications</u>	10.4-5
10.4.3	TURBINE GLAND SEALING SYSTEM	10.4-6
10.4.3.1	<u>Design Bases</u>	10.4-6
10.4.3.2	<u>System Description</u>	10.4-6
10.4.3.3	<u>Safety Evaluation</u>	10.4-7
10.4.3.4	<u>Tests and Inspections</u>	10.4-7
10.4.3.5	<u>Instrumentation Applications</u>	10.4-8
10.4.4	STEAM DUMP AND BYPASS SYSTEM.....	10.4-8
10.4.4.1	<u>Design Bases</u>	10.4-9
10.4.4.2	<u>System Description</u>	10.4-9
10.4.4.3	<u>Safety Evaluation</u>	10.4-10
10.4.4.4	<u>Tests and Inspections</u>	10.4-10
10.4.5	CIRCULATING WATER SYSTEM	10.4-11
10.4.5.1	<u>Design Bases</u>	10.4-11
10.4.5.2	<u>System Description</u>	10.4-12

ARKANSAS NUCLEAR ONE
Unit 2

TABLE OF CONTENTS (continued)

<u>Section</u>	<u>Title</u>	<u>Page</u>
10.4.5.3	<u>Safety Evaluation</u>	10.4-14
10.4.5.4	<u>Tests and Inspection</u>	10.4-14
10.4.5.5	<u>Instrumentation Application</u>	10.4-15
10.4.6	CONDENSATE CLEANUP SYSTEM.....	10.4-16
10.4.7	CONDENSATE AND FEEDWATER SYSTEMS	10.4-16
10.4.7.1	<u>Design Bases</u>	10.4-16
10.4.7.2	<u>System Description</u>	10.4-17
10.4.7.3	<u>Design Evaluation</u>	10.4-20
10.4.7.4	<u>Tests and Inspection</u>	10.4-21
10.4.7.5	<u>Instrumentation Applications</u>	10.4-21
10.4.8	STEAM GENERATOR BLOWDOWN SYSTEM.....	10.4-22
10.4.8.1	<u>Design Bases</u>	10.4-22
10.4.8.2	<u>System Design</u>	10.4-23
10.4.8.3	<u>Design Evaluation</u>	10.4-24
10.4.8.4	<u>Test and Inspection</u>	10.4-25
10.4.8.5	<u>Instrumentation Applications</u>	10.4-25
10.4.9	EMERGENCY FEEDWATER SYSTEM.....	10.4-25
10.4.9.1	<u>Design Bases</u>	10.4-25
10.4.9.2	<u>System Description</u>	10.4-26
10.4.9.3	<u>Safety Evaluation</u>	10.4-30
10.4.9.4	<u>Tests and Inspections</u>	10.4-33
10.4.9.5	<u>Instrumentation Applications</u>	10.4-33
10.4.10	STARTUP AND BLOWDOWN DEMINERALIZER SYSTEM	10.4-34
10.4.10.1	<u>Design Bases</u>	10.4-34

ARKANSAS NUCLEAR ONE
Unit 2

TABLE OF CONTENTS (continued)

<u>Section</u>	<u>Title</u>	<u>Page</u>
10.4.10.2	<u>System Design and Operation</u>	10.4-34
10.4.10.3	<u>Design Evaluation</u>	10.4-35
10.4.10.4	<u>Testing and Instrumentation Applications</u>	10.4-35
10.4.11	COMMON FEEDWATER SYSTEM	10.4-36
10.4.11.1	<u>Design Basis</u>	10.4-36
10.4.11.2	<u>System Description</u>	10.4-36
10.4.11.3	<u>Safety Evaluation</u>	10.4-36
10.4.11.4	<u>Tests and Inspections</u>	10.4-36
10.4.11.5	<u>Instrumentation Application</u>	10.4-37
10.5	<u>TABLES</u>	10.5-1

ARKANSAS NUCLEAR ONE
Unit 2

LIST OF TABLES

<u>Table No.</u>	<u>Title</u>	<u>Page</u>
10.3-1	MAIN STEAM SUPPLY SYSTEM, MAIN STEAM LINE SAFETY VALVES..	10.5-1
10.3-2	DELETED	10.5-1
10.3-3	DELETED	10.5-1
10.3-4	MAIN STEAM ISOLATION SYSTEM SINGLE FAILURE ANALYSIS	10.5-2
10.4-1	MAIN CONDENSER DESIGN PERFORMANCE AND DATA.....	10.5-4
10.4-2	CIRCULATING WATER PUMPS PERFORMANCE AND DATA	10.5-5
10.4-3	COOLING TOWER PERFORMANCE AND DATA	10.5-6
10.4-4	CONDENSATE PUMP DATA.....	10.5-8
10.4-5	HEATER DRAIN PUMP DATA.....	10.5-9
10.4-6	MAIN FEEDWATER PUMP DATA.....	10.5-10
10.4-7	DELETED	10.5-11
10.4-8	STEAM GENERATOR BLOWDOWN TANK DATA	10.5-11
10.4-9	STEAM GENERATOR BLOWDOWN PUMP DATA	10.5-12
10.4-10	EMERGENCY FEEDWATER PUMP DATA.....	10.5-13
10.4-10A	AUXILIARY FEEDWATER PUMP DATA	10.5-14
10.4-11	EMERGENCY FEEDWATER SYSTEM SINGLE FAILURE ANALYSIS	10.5-15
10.4-12	STARTUP AND BLOWDOWN DEMINERALIZER SYSTEM COMPONENT DATA.....	10.5-16
10.4-13	COMMON FEEDWATER PUMP DATA	10.5-18

ARKANSAS NUCLEAR ONE
Unit 2

LIST OF FIGURES

<u>Figure No.</u>	<u>Title</u>
10.2-1	DESIGN STEAM PRESSURE VARIATION WITH POWER
10.2-2	DELETED
10.2-3	MAIN STEAM, AUXILIARY STEAM, GLAND SEAL STEAM, AMMONIUM HYDROXIDE, AND STEAM GENERATOR BLOWDOWN
10.2-4	EMERGENCY AND AUXILIARY FEEDWATER, STARTUP & BLOWDOWN DEMINERALIZERS
10.2-5	DELETED
10.2-6	ELECTRO-HYDRAULIC CONTROL SYSTEM
10.3-1	MAIN STEAM ISOLATION VALVES AIR CONTROL SYSTEM
10.4-1	CIRCULATING WATER AND 'A' CONDENSER VACUUM (TYPICAL)
10.4-2	CONDENSATE AND EXTRACTION STEAM
10.4-3	HEATER DRAINS, MAIN FEEDWATER, AND REHEAT STEAM
10.4-4	COMMON FEEDWATER SYSTEM

ARKANSAS NUCLEAR ONE
Unit 2

UPDATE REFERENCE LIST

Sections and references listed below denote documents that contain additional cross reference information used to update the SAR.

<u>Section</u>	<u>Cross References</u>
10.4.7.2	Correspondence from Williams, AP&L, to Stolz, NRC, dated January 31, 1978. (2CAN017827).
10.4.1.2	Correspondence from Williams, AP&L, to Stolz, NRC, dated April 28, 1978. (2CAN047832).
10.4.8.2.1	Correspondence from Trimble, AP&L, to Seyfrit, NRC, dated March 21, 1979. (0CAN037915).
10.4.4.2	Correspondence from Cavanaugh, AP&L, to Seyfrit, NRC, dated February 5, 1980. (2CAN028001).
10.4.9.2.1	Correspondence from Trimble, AP&L, to Seyfrit, NRC, dated May 5, 1980. (2CAN058003).
	Correspondence from Trimble, AP&L, to Seyfrit, NRC, dated July 14, 1980. (2CAN078019)
10.4.9.2.1	Correspondence from Trimble, AP&L, to Seyfrit, NRC, dated November 7, 1980. (2CAN118011).
10.4.7.2	Correspondence from Trimble, AP&L, to Seyfrit, NRC, dated March 31, 1981. (0CAN048102).
10.4.9.2.1	Correspondence from Trimble, AP&L to Clark, NRC, dated May 8, 1981. (2CAN058103).
10.4.8.5	Correspondence from Trimble, AP&L, to Clark, NRC, dated July 1, 1981. (2CAN078101).
10.4.9.2.1	Correspondence from Trimble, AP&L, to Eisenhut, NRC, dated August 7, 1981. (0CAN088106).
10.4.1.2	Design Change Package 327, (Title not available), 1975. (0DCP750327).
10.4.2.2	Design Change Package 238 "2C5A&B Main Condenser Vacuum Pump Seal Water," 1978. (2DCP780238).
10.2.2.1	Design Change Package 327, (Title not available), 1978. (2DCP780327).
10.4.3.2	Design Change Package 623, (Title not available), 1978. (2DCP780623).
10.4.9.2.1	Design Change Package 635, (Title not available), 1978. (2DCP780635).

ARKANSAS NUCLEAR ONE
Unit 2

UPDATE REFERENCE LIST (continued)

<u>Section</u>	<u>Cross References</u>
10.4.7.2	Design Change Package 701, (Title not available), 1978. (2DCP780701).
10.4.7.3	Design Change Package 707, (Title not available), 1978. (2DCP780707).
10.4.8.2.1	Design Change Package 711, (Title not available), 1978. (2DCP780711).
10.4.1.2	Design Change Package 721, "Platforms," 1978. (2DCP780721).
10.4.8.2.1	Design Change Package 723, (Title not available), 1978. (2DCP780723).
10.4.9.2.1	Design Change Package 738, (Title not available), 1978. (2DCP780738).
10.4.9.5	Design Change Package 752, "EFW Channel 2 Alarm," 1978. (2DCP780752).
10.4.2.3	Design Change Package 768, "Tubing Addition Cond. Leak Detection," 1978. (2DCP780768).
10.4.9.5	Design Change Package 802, "Added 'Inoperable' Alarms for EFW Valves, DC MCC's, Panels 2RA1 & 2RA2 and Inverters," 1978. (2DCP780802).
10.4.7.2	Design Change Package 843, "Heater Drain Pump Seal Leakoff Modification," 1979. (2DCP790843).
10.4.8.2.2	Design Change Package 846, "Pump Valve Interlock SV/BD
10.4.8.5	Systems," 1979. (2DCP790846).
10.4.1.2	Design Change Package 847, "Condenser Modification, Cross Over & Drains," 1979. (2DCP790847).
10.4.4.2	Design Change Package 851, "Steam Dump & Bypass System," 1979. (2DCP790851).
10.4.2.5	Design Change Package 2091, (Title not available), 1979. (2DCP792091).
10.4.7.5	Design Change Package 2049, "Startup FW Flow Control," 1980. (2DCP802049).
10.3.2.1	Design Change Package 2085, "Interim Radiation Monitoring on the Main Steam Lines," 1980. (2DCP802085).
10.4.9.2.1	Design Change Package 2144, "Temperature IDCR# 2-79-68," 1980 (2DCP802144).
10.4.7.2	Design Change Package 2077, "Install Local Condensate Fill Connection," 1981. (2DCP812077).
10.4.7.5	Design Change Package 2091, (Title not available), 1981. (2DCP812091).

ARKANSAS NUCLEAR ONE
Unit 2

UPDATE REFERENCE LIST (continued)

<u>Section</u>	<u>Cross References</u>
10.4.9.2.1	Correspondence from Marshall, AP&L, to NRC, dated July 16, 1984. (2CAN078402)
10.4.9.2.1 Figure 10.4-2	Design Change Package 82-2077, "Install Bypass Startup System on 2K-3," 1982.
10.5	Design Change Package 79-2105, "Redundant Main Feedwater Isolation Valves."
10.4.10.4	Design Change Package 82-2033, "Panel 2K11 Annunciator Upgrade."
10.2	Design Change Package 82-2149, "EOF Alarms."
10.4.7.2 10.4.7.5 Figure 10.2-4 Figure 10.4-2	Design Change Package 83-2032, "MFW Pump High Discharge Pressure Trip."
10.4.9.2.1 Figure 10.4-2 Figure 10.4-6	Design Change Package 83-2196, "Replace Limitorque Motor Operator (2CV-0706) with Manual Operator (2EFW-0706)."
10.4.9	Design Change Package 82-2086B, "Q-Condensate Storage Tank."
10.4.7.3 10.2.2.4	Design Change Package 82-2149, "Remove Digital Outputs from Computer to Turbine Generator Electrohydraulic Control Cabinet 2C31."
10.3.5	Design Change Package 82-2058A, "Install Steam Generator Secondary System Sample Panel 2C377."
10.4.7.2	Design Change Package 81-2044, "Hangers for Redundant Main Feedwater Isolation Valves."
10.4.10.2	Design Change Package 86-2114, "Annunciator Upgrade of 2K03, 2K10, 2K11."
Figure 10.2-3	Design Change Package 80-2085A, "Main Steam Radiation Monitoring."
Figure 10.2-3	Design Change Package 80-2123M, "SPDS Additional Computer Figure 10.4-2 Inputs."
Figure 10.2-3	Design Change Package 80-2127, "Atmospheric Dump Valve Drain."
Figure 10.2-3	Design Change Package 82-2050, "Install 2FT-1029A and 2FT-1129A to the Main Feedwater Lines."

ARKANSAS NUCLEAR ONE
Unit 2

UPDATE REFERENCE LIST (continued)

<u>Section</u>	<u>Cross References</u>
Figure 10.2-3 Figure 10.2-5 Figure 10.4-2 Figure 10.4-3	Design Change Package 83-2001, "Mass Transport-Corrosion Monitoring Sample Points."
Figure 10.2-3	Design Change Package 83-2001A, "Feed Train Sample Point Relocation."
Figure 10.2-3	Design Change Package 83-2042, "Steam Generator and Hotwell Level Alarm Changes."
Figure 10.2-3	Design Change Package 83-2080, "Remote Shutdown Appendix R."
Figure 10.2-3	Design Change Package 83-2217, "Reg. Guide 1.97 Steam Generator Level Upgrade."
Figure 10.2-5	Design Change Package 82-2104, "Moisture Separator Reheater Drain Tanks Modification."
Figure 10.4-1	Design Change Package 79-2137, "Cooling Tower Water Treatment Facility."
Figure 10.4-1	Design Change Package 80-2206, "Install Fiberglass Piping on Amertap Condenser Cleaning System."
Figure 10.4-1	Design Change Package 82-2166, "Chlorine Leak Visible Alarm."
Figure 10.4-1	Design Change Package 83-2007, "Cooling Tower Blowdown Flow Measurement Loop Modifications."
Figure 10.4-1	Design Change Package 83-2121, "Cyclone Separators for 2P3 System."
Figure 10.4-2 Figure 10.4-3	Design Change Package 81-2081, "Remove 2PD15-0722 and 2PD15-0728."
Figure 10.4-2	Design Change Package 81-2082, "Condenser Offgas Radiation Monitor Modification."
Figure 10.4-2	Design Change Package 82-2039, "Condensate Pump Seal Water System Modification."
Figure 10.4-2	Design Change Package 82-2142, "Permanent Pressure Gauges for Pump Operational Surveillances."
Figure 10.4-2	Design Change Package 83-2033, "Condensate Pump High Seal Pressure Alarm Deletion."
Figure 10.4-2	Design Change Package 83-2206, "Relabel Feedwater Pump (2P1A) Permissive Start Panel as 2C385."

ARKANSAS NUCLEAR ONE
Unit 2

UPDATE REFERENCE LIST (continued)

<u>Section</u>	<u>Cross References</u>
Figure 10.4-3	Design Change Package 83-2141, "Heater Drain Tank Level Control."
Figure 10.4-5	Design Change Package 82-2081, "Installation of New Ammonia Pumps 2P5BA, B and C."
Figure 10.4-7	Design Change Package 79-2208, "Install Mixed Resin Sample Point on Demineralizer System."
<u>Amendment 6</u>	
10.3.2.1	Design Change Package 2079, "Replace Mainsteam Safeties," 1979. (2DCP792079).
<u>Amendment 8</u>	
Figure 10.2-3	DCP 89-2018A, "Removable Spool Pieces at 2EBB-3-1 and 2EBB-4-1."
Figure 10.2-5	DCP 87-2060, "Deletion of 2HS-0401 and 2HS-0461."
Figure 10.4-7	PC 89-8045, "Reroute Recirculation Line for 2PB8."
Table 10.4-4	Tech Manual, "Pump Data Sheet, Page 1 and Equipment Description, Page 3."
<u>Amendment 9</u>	
Table 10.3-2 Table 10.3-3 10.3.5	Procedure 1000.043, Rev. 12, "Steam Generator Water Chemistry Monitoring Unit II."
10.4.4.2	Procedure 2102.004, Rev. 14, "Power Operation."
Figure 10.4-1	Plant Change 89-0486, "Check Valve Addition to 2PDIS-1265."
<u>Amendment 10</u>	
10.3.5 10.4.7.2 Table 10.3-2	Procedure 1000.043, Rev. 13, "Steam Generator Water Chemistry Monitoring Unit II."
10.3.5	Design Change Package 85-2084, "Removal of Silica Analyzers from 2C145II and 2C301."
10.4.9.1 10.4.9.2.1 10.4.9.2.2 10.4.9.3 Table 10.4-10A Figure 10.4-2	Design Change Package 89-2043, "ANO-2 Auxiliary Feedwater Pump Installation."

ARKANSAS NUCLEAR ONE
Unit 2

UPDATE REFERENCE LIST (continued)

<u>Section</u>	<u>Cross References</u>
10.4.10.2	Plant Change 88-3087, "Startup and Blowdown Demineralizer Inlet Temperature Alarm Setpoint Change."
Figure 10.2-3	Plant Change 85-3630, "Unused Pressure Switch Removal."
Figure 10.2-3	Design Change Package 89-2053, "ATWS Diverse Emergency Feedwater Actuation System."
Figure 10.2-3	Design Change Package 90-2004, "Redesign of the Nitrogen Supply Lines."
Figure 10.2-4 Figure 10.4-2	Procedure 2106.016, Rev. 28, "Feedwater and Steam Systems."
Figure 10.2-4	Design Change Package 83-1167, "ANO-1 Startup Boiler - Overall Piping."
Figure 10.2-4 Figure 10.2-5 Figure 10.4-1 Figure 10.4-3	Design Change Package 88-2110, "ANO-2 Alarm Upgrade, Phase II."
Figure 10.2-4 Figure 10.2-5 Figure 10.4-2	Design Change Package 89-2024, "Recorder Upgrade."
Figure 10.2-4	Plant Change 91-8041, "Add EFW Turbine Speed Signal to SPDS."
Figure 10.4-1	Procedure 2628.007, Rev. 3, "Unloading and Transferring PCL-1096 at Cooling Tower."
Figure 10.4-2	Plant Change 87-0682, "Heater Drain Pump Seal Water Injection Piping."
Figure 10.4-2	Plant Change 87-3253, "Provide Seal Water to the Packing on 2C-5A&B."
Figure 10.4-2	Plant Change 90-8041, "2T-79 Discharge Line Sample Point Additions."
Figure 10.4-2	Plant Change 90-8086, "Replacement of Condenser Vacuum Pump Pressure Switches."
Figure 10.4-3	Limited Change Package 90-6011, "Feedwater Heater Condensate Return Pipe Replacement."
Figure 10.4-5	Procedure 2618.029, Rev. 0, "Sampling the Secondary Boric Acid Mix Tank (2T-142) - Unit 2."

ARKANSAS NUCLEAR ONE
Unit 2

UPDATE REFERENCE LIST (continued)

<u>Section</u>	<u>Cross References</u>
<u>Amendment 11</u>	
10.2.1 10.4.1.1 10.4.1.3 10.4.4.1	ANO Procedure 2105.008, Rev. 10, "Steam Dump and Bypass Control System Operations."
10.3.5 Table 10.3-2	ANO Procedure 1000.043, Rev. 13, "Steam Generator Water Chemistry Monitoring Unit II."
10.3.5 10.4.6 Table 10.3-2 Figure 10.2-3 Figure 10.4-2 Figure 10.4-3 Figure 10.4-5	Design Change Package 92-2014, "ANO-2 Morpholine Addition System."
10.4.5.1 10.4.5.2 10.4.5.5 Figure 10.4-1	Plant Change 92-8010, "Circulating Water Bromination."
10.4.5.2	Plant Change 90-8037, "Upgrade of Domestic Water Piping to Figure 10.4-1 the Circulating Water Pumps."
10.4.5.2 Figure 10.4-1	Design Change Package 90-2023, "Sodium Bromide/Sodium Hypochlorite System Addition."
10.4.5.2 Figure 10.4-1	Design Change Package 82-2135, "Cooling Tower Acid Feed System."
10.4.7.3	Design Change Package 91-2009, "ANO-2 Steam Generator "A" Thermal Sleeve Replacement."
Figure 10.2-3	Plant Change 91-8015, "Corrosion Product Samplers on the Feedwater System."
Figure 10.2-3 Figure 10.2-4 Figure 10.2-5 Figure 10.4-1 Figure 10.4-2 Figure 10.4-3	Design Change Package 90-2036, "Unit 2 Plant Computer Replacement."
Figure 10.2-3	Plant Engineering Action Request 91-7425, "Correct Line Class and Valve Types For 2MS-95 & 2MS-98."

ARKANSAS NUCLEAR ONE
Unit 2

UPDATE REFERENCE LIST (continued)

<u>Section</u>	<u>Cross References</u>
Figure 10.2-4	Design Change Package 80-2144, "Addition of Steam Trap."
Figure 10.2-4 Figure 10.4-1 Figure 10.4-2 Figure 10.4-4 Figure 10.4-7	Design Change Package 88-2111, "ANO-2 Annunciator Upgrade Phase III."
Figure 10.2-4	Design Change Package 92-2019, "Addition of N16 Monitors on Main Steam Lines."
Figure 10.2-4	Design Change Package 91-2017, "EFW Turbine Modification."
Figure 10.4-1	Plant Change 91-8052, "Circulating Water Pump Casing Sump Pumps."
Figure 10.4-1	Plant Change 91-8008, "Relocation of Circulating Water Corrosion Coupon Rack 2M-180."
Figure 10.4-1	Plant Engineering Action Request 91-7097, "Unidentified Valve in 2P-3A Pit."
Figure 10.4-2	Plant Change 92-8049, "Condensate Make-Up Flow Indication."
Figure 10.4-2	Limited Change Package 90-6003, "Removal of Temporary Supports on Abandoned Feedwater Piping."
Figure 10.4-2	Plant Change 86-0684, "EFW Pumps Mini-Recirculation Flow Indication."
Figure 10.4-5	Plant Change 91-8046, "Delete Heat Trace For 2T103 and Spare Associated Controllers."
Figure 10.4-5	Design Change Package 92-1009, "Feedwater Chemical Addition."
Figure 10.4-5	Plant Change 91-8036, "Hydrazine Bulk Tank Addition."
Figure 10.4-7	Plant Engineering Action Request 88-1125, "2C-311 Component Tagging."
Figure 10.4-7	Design Change Package 92-2012, "Ion Chromatograph."
<u>Amendment 12</u>	
10.2.2.4 Figure 10.2-5 Figure 10.4-2	Limited Change Package 93-6020, "Turbine/Generator Instrumentation Upgrade"
10.3.5 10.4.6 10.4.7.2 Table 10.3-2	Procedure 1000.043, Revision 14, "Steam Generator Chemistry Monitoring Unit 2"

ARKANSAS NUCLEAR ONE
Unit 2

UPDATE REFERENCE LIST (continued)

<u>Section</u>	<u>Cross References</u>
Figure 10.2-3 Figure 10.4-2 Figure 10.4-3 Figure 10.4-5	
10.4.5.2 Figure 10.4-1	Design Change Package 92-2013, "Cooling Tower Chemical Addition"
10.4.5.2 Figure 10.4-1	Procedure 2628.007, Revision 4, "Operation of Circulating Water Chemical Injection System"
10.4.8	Plant Change 92-8008, "Valve Operator Replacement on Steam Generator Figure 10.2-3 Blowdown Control Valves"
Figure 10.2-3	Design Change Package 92-2023, "Unit 2 Plant Computer Replacement"
Figure 10.2-3 Figure 10.3-1	Design Change Package 91-2001, "Main Steam Isolation Valve (MSIV) Solenoid Operated Valve Logic Upgrade"
Figure 10.2-4	Limited Change Package 92-6001, "Emergency Feedwater Pump Room Accessibility"
Figure 10.2-4 Figure 10.2-5	Plant Change 94-8010, "Moisture Separator Reheater (MSR) Performance Monitoring Taps"
Figure 10.4-1	Plant Engineering Action Request 93-0423, "Circulating Water Valve 2CW-32"
Figure 10.4-2	Limited Change Package 94-6004, "Main Feedwater Regulating Valves (MFRVs) Modification"
Figure 10.4-2	Plant Change 92-8047, "Vacuum Pump Separator Drain Tank"
Figure 10.4-2	Procedure 2106.016 Revision 30, PC-4 and PC-5. Valve Position Changes.
Figure 10.4-3	Plant Change 93-8056, "Upgrade of Valve Parts for Unit 2 Turbine Bleeder Trip Valves (BTVs)"
Figure 10.4-5	Plant Change 93-3037, "Heat Trace Upgrade"
Figure 10.4-7	Design Change Package 92-2015, "Chemistry Point Addition to Plant Computer"
Figure 10.4-7	Plant Change 89-8045, "Reroute Recirculation Line Around 2P138"
Figure 10.4-7	Procedure 2106.024 Revision 11, "Start-up and Blowdown Demineralizer Operations"

ARKANSAS NUCLEAR ONE
Unit 2

UPDATE REFERENCE LIST (continued)

<u>Section</u>	<u>Cross References</u>
<u>Amendment 13</u>	
10.4.5.2 Figure 10.4-1	Design Change Package 82-2135, "Cooling Tower Acid Feed System"
10.4.5.2 Figure 10.4-1	Plant Change 94-8025, "Circulating Water Sulfuric Acid Gravity Drain"
10.4.5.3 Table 10.4-1 Table 10.4-2 Table 10.4-3 Figure 10.4-4	Limited Change Package 93-6021, "Upgrade of Unit 2 Circulating Water Pump Impellers"
10.4.7.2 10.4.7.5 Figure 10.2-3 Figure 10.2-4 Figure 10.4-2	Limited Change Package 94-6027, "Main Feedwater Pumps Trip Hardening"
10.4.9.2.1 Figure 10.2-4	Design Change Package 94-2013, "Replace SOV 2SV-0205 with MOV 2CV-0205-2"
Figure 10.2-3	Plant Change 93-8002, "Corrosion Product Samplers for the Steam Generator Blowdown System"
Figure 10.2-3 Figure 10.4-2	Plant Change 93-8023, "Electrochemical Potential Monitoring"
Figure 10.2-4 Figure 10.4-1 Figure 10.4-2 Figure 10.4-7	Design Change Package 93-2007, "ANO-2 New Points to Plant Monitoring System"
Figure 10.2-4	Limited Change Package 94-6007A, "Piping Code Compliance - Auxiliary Building"
Figure 10.2-4	Plant Change 95-8022, "Gauge Panel for 2P-7A"
Figure 10.2-5 Figure 10.4-2	Plant Change 95-8025, "Replacement Level Indicators for the MSR Drain Tanks and the Condenser Hotwell Levels"
Figure 10.4-2	Plant Change 90-8009, "Install Pressure Gauge in 2PC-0787 Reference Line"
Figure 10.4-2	Plant Change 92-8079, "2RITS-8750-1 Recorder Output Change"
Figure 10.4-2	Plant Change 93-8024, "Molar Ratio Control"

ARKANSAS NUCLEAR ONE
Unit 2

UPDATE REFERENCE LIST (continued)

<u>Section</u>	<u>Cross References</u>
Figure 10.4-2	Limited Change Package 95-6008, "MSIS Relays Single Failure Modifications"
Figure 10.4-2 Figure 10.4-3 Figure 10.4-7	Plant Change 95-8013, "Condensate Pump Piping Enhancements"
Figure 10.4-3	Plant Change 95-8034, "The Changeout of Components on Line 2HBD, 2EBD, and 2VTS to 2 1/4% Cr Moly Material, FW Heater Vent Pipe 2E-5A, 2E-5B, 2E-6A, 2E-6B, 2E-7A, and 2E-7B"
Figure 10.4-4	Limited Change Package 95-6002, "Circulating Pump Bay Improvements"
Figure 10.4-4	Limited Change Package 95-6004, "Circulating Water Pumps and Discharge Valves Logic Change"
Figure 10.4-7	Plant Change 95-8023, "Steam Generator Blowdown to the Regenerative Waste Management System"
<u>Amendment 14</u>	
10.3.2.1 Table 10.2-1 Table 10.4-1 Figure 10.2-2 Figure 10.2-4	Limited Change Package 96-3355, "High Pressure Turbine First Stage Nozzle and Bucket Modification"
10.4.5.2 10.4.5.5 Figure 10.4-1 Figure 10.4-4	Limited Change Package 94-6036, "Cooling Tower Automatic pH Control System Modification"
10.4.7.2 10.4.7.5 Figure 10.2-3 Figure 10.2-4 Figure 10.4-2 Figure 10.4-5	Design Change Package 94-2008, "Feedwater Control System Upgrade"
10.4.9.2.1	Design Change Package 89-2043, "Third Emergency Feedwater Pump"
Figure 10.2-3	Plant Change 962051P201, "Setpoint Calibration on 2RR-1057 & 2RE-0645"
Figure 10.2-4	Design Change Package 88-2110, "2R8 Annunciator Upgrade"
Figure 10.2-4	Plant Change 95-8024, "2P7 Alarm Replacement"

ARKANSAS NUCLEAR ONE
Unit 2

UPDATE REFERENCE LIST (continued)

<u>Section</u>	<u>Cross References</u>
Figure 10.2-4	Limited Change Package 962032L201, "Relocation of Heater Drain Pump Stop Check Valves 2CS-11A&B"
Figure 10.2-5	Design Change Package 94-6033, "Moisture Separator Reheater Chevron Upgrade"
Figure 10.2-5	Plant Change 95-8025, "Replacement of Level Indicators on MSR Drain Tanks 2T55A&B, 2T58A&B, and 2T77A&B"
Figure 10.4-1	Design Change Package 93-2007, "Plant Computer Point Addition"
Figure 10.4-1 Figure 10.4-4	Plant Change 95-8058, "DW Booster Pump Installation for CW Pump Gland Flow"
Figure 10.4-1	Plant Change 95-8107, "Circulating Water Piping Upgrade"
Figure 10.4-1 Figure 10.4-2 Figure 10.4-4	Limited Change Package 963501L201, "2P3A Motor Replacement"
Figure 10.4-2	Plant Change 95-8103, "2CV-0711-2 & 2CV-0716-1 for Pressure Locking/Thermal Binding"
Figure 10.4-2	Plant Change 963108P201, "Feed Pump Delta T Interlock"
Figure 10.4-2	Plant Change 96-8037, "Installation of Dual Indicator for 2P7A & 2P7B"
Figure 10.4-3	Plant Change 958091P201, "Water Hammer on FWH-2E-6A Dump Line"
Figure 10.4-5	Plant Change 95-8033, "Hydrazine Pump VTS Installation/Auto Modification"
Figure 10.4-7	Plant Change 95-8043, "2T94A & 2T94B Inlet Sample Line Test Equipment Rack"
Figure 10.4-7	Plant Change 963055P201, "Installation of Sample Taps in Regen Vessel Sight Glasses"
<u>Amendment 15</u>	
10.2.1	Engineering Request 981059E201, "Quarterly Valve Stroke Test Deferral"
10.2.1	Procedure 2102.004, "Current Operating Temperatures"
10.4.1.2 10.4.1.4	Design Change Package 963230D201, "Condenser Tube Bundle Replacement"
Table 10.4-1	
Table 10.4-2	
Table 10.4-3	
Figure 10.4-4	

ARKANSAS NUCLEAR ONE
Unit 2

UPDATE REFERENCE LIST (continued)

<u>Section</u>	<u>Cross References</u>
10.4.9.2.1 10.4.9.3	Condition Report 2-94-0374, "Emergency Feedwater Flow Requirements"
10.4.5.2	Procedure 2628.012, "Operation of Copper Corrosion Inhibitor System at Cooling Tower"
10.4.10.2	Plant Change 980704N201, "Partial Flow Condensate Filtration Modification"
Figure 10.2-3	Design Change Package 94-2008, "Feedwater Control System Upgrade"
Figure 10.2-3	Limited Change Package 974379L201, "Vent Drain and Misc. Code Compliance"
Figure 10.2-4	Plant Change 94-8026, "Nitrogen Supply to Condensers"
Figure 10.2-5	Plant Change 973786N201, "MSR Tube Bundle Replacement"
Figure 10.4-1	Design Change Package 973806N301, "Intake Structure Trash Troughs & Baskets"
Figure 10.4-2	Plant Change 962029P201, "Feedwater Recirc Valve Upgrade"
Figure 10.4-2	Plant Change 980184P201, "Amine Feed to EFW/AFW Suction"
Figure 10.4-7	Plant Change 974991N202, "SGBD Filtration System"
<u>Amendment 16</u>	
10.2.1 10.2.2 Figure 10.2-2 Figure 10.2-5	Nuclear Change Package 974372N201, "High Pressure Turbine Steam Path Replacement"
10.3.2.1 10.3.5 10.4.7.3 Figure 10.2-1	Engineering Request 980642I243, "Mechanical Support for RSG Project"
10.3.2.1	Design Change Package 980642D210, "Replacement Steam Generator Design/Qualification"
10.3.3 10.4.7.2 10.4.7.3 Table 10.3-4	Nuclear Change Package 975122N201, "High-High Containment Pressure Isolation of Main Feedwater"

ARKANSAS NUCLEAR ONE
Unit 2

UPDATE REFERENCE LIST (continued)

<u>Section</u>	<u>Cross References</u>
10.3.3	Nuclear Change Package 980547N204, "Replacement Steam Generator SDBCS Setpoint Modification"
10.4.9.2.2	Engineering Request 991710E203, "Evaluation to Justify Use of the ACW System via the FWCS"
10.4.10 Figure 10.4-7	Nuclear Change Package 974991N203, "Demineralizer Modification and Steam Generator Blowdown Filter Installation"
10.4.10.2 Table 10.4-12 Figure 10.4-7	Nuclear Change Package 974991N202, "Steam Generator Blowdown Filtration System"
Table 10.4-7	Engineering Request 992050E201, Evaluation of CS, FW, FWCS Systems for RSG and Power Uprate"
Table 10.4-12 Figure 10.4-7	Nuclear Change Package 981243N201, "Replacement of Steam Generator Blowdown Heat Exchangers"
Figure 10.2-3	Design Change Package 980642D209, "Disconnect and Reconnect of Small Bore Piping and Tubing to Support the RSG Project"
Figure 10.2-3	Nuclear Change Package 991642N201, "Emergency Feedwater Steam Supply Check Valve Replacement"
Figure 10.2-5	Nuclear Change Package 003185N201, "MSR 1st Stage Inlet Relief Valve Replacement"
Figure 10.4-1 Figure 10.4-4	Plant Change 974119P201, "Deletion of Multiple Control Station 2N-130"
Figure 10.4-1	Plant Change 974196P201, "Chlorination Booster Pump Removal"
Figure 10.4-1	Plant Change 980066P201, "Traveling Screen Upgrades"
Figure 10.4-2 Figure 10.4-5	Nuclear Change Package 974991N204, "Installation of Injection Lines from Molar Skid to 2E1A/B Outlet"
Figure 10.4-2	Nuclear Change Package 975122N202, "Additional AFW Trip"
Figure 10.4-7	Nuclear Change Package 963197N202, "Sodium Analyzer Replacement"
Figure 10.4-7	Nuclear Change Package 973954N201, "Startup Boiler DI Outlet Sample to Online IC"
Figure 10.4-7	Plant Change 963056P201, "2T97 Resin Outlet Modification"

ARKANSAS NUCLEAR ONE
Unit 2

UPDATE REFERENCE LIST (continued)

<u>Section</u>	<u>Cross References</u>
<u>Amendment 17</u>	
10.2.1	Engineering Request ANO-2000-2344-026, "Power Uprate Evaluation"
10.2.2	
10.3.2.1	
10.3.3	
10.4.1.3	
10.4.3.1	
10.4.4	
10.4.4.1	
10.4.4.2	
10.4.4.3	
10.4.4.4	
10.4.7.1	
10.4.7.2	
10.4.8.1	
10.4.8.2.2	
10.4.9.2.1	
10.4.9.3	
Table 10.3-1	
Table 10.4-1	
Table 10.4-3	
Table 10.4-4	
Table 10.4-5	
Table 10.4-6	
Table 10.4-9	
Figure 10.2-2	
10.3.5	PWR Water Chemistry Guidelines Revision
10.4.5.2	Engineering Request ANO-1997-5009-001, "Acid Tank Replacement"
Figure 10.4-1	
Figure 10.4-4	
10.4.5.5	Engineering Request ANO-2002-0053, "Alarm Circuit Modification"
Figure 10.4-1	
Figure 10.4-4	
10.4.7.5	Engineering Request ANO-2001-0212-001, "Condensate Recirculation Valve and Controller Upgrade"
Figure 10.4-2	
10.4.9.2.1	Engineering Request ANO-2001-0377-002, "Emergency Feedwater Test/Flush Line Valve Installation"
Figure 10.4-2	
10.4.9.3.1	Unit 2 Technical Specification Amendment 232
Table 10.4-5	Engineering Request ANO-1998-0405-012, "Heater Drain Pump Power Uprate Impacts"
Figure 10.4-2	
Figure 10.4-5	

ARKANSAS NUCLEAR ONE
Unit 2

UPDATE REFERENCE LIST (continued)

<u>Section</u>	<u>Cross References</u>
Figure 10.2-3 Figure 10.2-4 Figure 10.2-5	Engineering Request ANO-1998-0489-001, "MS, FW, and CA system piping Modifications"
Figure 10.2-3 Figure 10.2-4 Figure 10.2-5	Engineering Request ANO-1998-0489-001, "Installation of Pipe Vibration Restraints"
Figure 10.2-4	Engineering Request ANO-2002-0054-000, "Valve Status Changes"
Figure 10.2-5	Condition Report ANO-2-2001-1930, "Computer Point Designation Discrepancy"
Figure 10.4-1	Condition Report ANO-2-2002-0161, "Drawing Discrepancy"
Figure 10.4-2	Engineering Request ANO-2000-2803-001, Addition of Three Branch Connections"
<u>Amendment 18</u>	
10.1 10.3 10.3.1	Engineering Request ANO-2003-0920-000, "ANO-2 Main Steam Cross Over to ANO-1 Aux Steam Supply Header"
Figure 10.2-3	Condition Report ANO-2-2002-1928, "Seismic Break Downstream of 2CV-1002 and 2CV-1052"
Figure 10.2-3	Engineering Request ANO-2000-2867-001, "Correct Valve Label for 2MS-72B and Install Flexible Stainless Steel Hose"
Figure 10.2-3	Condition Report ANO-2-2003-0266, "Show Drain Path Connection for Steam Trap 2F-339"
Figure 10.2-4	Engineering Request ANO-2002-0068-000, "Recorder 2UR-0242 Removed From Control Room Panel 2C11"
Table 10.4-3	Engineering Request ANO-2003-0728-001, "New Fill Type for Cooling Tower"
Figure 10.4-4	SAR Discrepancy 2-98-0259, "Remove Reference to Chlorination System"
10.4.5.2	Licensed Based Document Change 2-10.4-0160, "Delete Unnecessary Information Regarding Circulating Water Pump Operation"
Figure 10.4-7	Condition Report ANO-2-2002-2034, "Correct Valve Configuration for 2PI-4524A"

ARKANSAS NUCLEAR ONE
Unit 2

UPDATE REFERENCE LIST (continued)

<u>Section</u>	<u>Cross References</u>
10.4.9.2.1	Engineering Request ANO-2002-0539-000, "Reset 2EFW-25 for Continuous Flow Operation"
10.4.9.2.1	Engineering Request ANO-2003-0532-004, "Replace EFW Flow Orifices 2FO-0714A and 2FO-0798A"
10.4.9.2.2	SAR Discrepancy 2-97-0235, "Shutdown Cooling Initiation Temperature"
Table 10.4-5	License Basis Document Change 2-7.3-0036, "Revision of Secondary Heater Drain Pump Design Criteria"
Figure 10.4-1	Engineering Request ER-ANO-1995-8071-001, "Removal of Level Indicators from 2T-145 and 2T-146"
Figure 10.2-4	Engineering Request ER-ANO-2002-0826-000, "Symbol Change and Use Revision to 2MS-2052A Cap"
Figure 10.2-3 Figure 10.4-2	Engineering Request ER-ANO-2003-0476-000, "Removal of Feedwater Drain Valves"
Figure 10.4-2	Engineering Request ER-ANO-2000-2803, "Installation of Three Additional Condenser Airflow Monitors"
Figure 10.4-7	License Basis Document Change 2-10.4-0156, "Revise Representation of 2AS-1039 to a Normally Closed Configuration"
10.4.5.5 Figure 10.4-1	License Basis Document Change 2-10.4-0159, "Removal of 2FIS-1216 from Alarm Circuit"
Figure 10.4-2	Engineering Request ER-ANO-2002-0622-000, "Replacement of Vacuum System Valve 2VS-1014"
Figure 10.4-2	Engineering Request ER-ANO-2003-0964-000, "Addition of Vacuum Pump Holding/Hogging Mode Handswitches"
Figure 10.4-2	Condition Report CR-ANO-2-2003-1748, "Correction of Valve Types Depicted on Condenser Vacuum Pump Drawing"
Figure 10.4-2	Engineering Request ER-ANO-2003-0394-001, "Revision of Setpoint for Condenser Vacuum Pressure Switch 2PS-0686"
Figure 10.2-3	Condition Report CR-ANO-2-2003-0352, "Valve Label Correction"
Figure 10.4-7	License Document Change 2-10.4-0157, "Configuration Correction to Match Actual Operational Configuration"

ARKANSAS NUCLEAR ONE
Unit 2

UPDATE REFERENCE LIST (continued)

<u>Section</u>	<u>Cross References</u>
<u>Amendment 19</u>	
Figure 10.2-4	Engineering Request ER-ANO-2002-0898-000, "Modification of Turbine EHC System Throttle Pressure Compensator"
Table 10.4-6 Figure 10.4-2 Sh2	Engineering Request ER-ANO-2005-0248-000, "Main Feedwater Pump NPSH Revision"
Figure 10.4-1 Sh1	Engineering Request ER-ANO-2005-0281-000, "Circulating Water System Piping Upgrade"
10.4.7.3	License Document Change Request 2-1.2-0048, "Deletion/replacement of Excessive Detailed Drawings from SAR"
Figure 10.2-3 Sh1	Condition Report CR-ANO-C-2005-0800, "MFW Valve Location Drawing Discrepancy"
10.4.5.2 Figure 10.4-1 Sh1	Engineering Request ER-ANO-2005-0427-001, "Circulating Water System Acid Piping Upgrade"
Figure 10.4-2 Sh4	Engineering Request ER-ANO-2005-0229-000, "Auxiliary Feedwater Pump Suction Strainer Installation"
Figure 10.4-4 Sh1	Condition Report CR-ANO-C-2004-2204, "Handswitch Labeling Drawing Discrepancy"

Amendment 20

10.2	License Document Change Request 05-058, "Deletion/simplification of Excessive Detailed Drawings from SAR"
10.2.1	
10.2.2.2	
10.2.2.3	
10.3.2.1	
10.3.3	
10.3.5	
10.4.2	
10.4.3	
10.4.4.2	
10.4.5.1	
10.4.5.3	
10.4.7	
10.4.7.2	
10.4.9.2.1	
10.4.9.2.2	
10.4.10.1	
10.4.10.2	
Figures – ALL	

ARKANSAS NUCLEAR ONE
Unit 2

UPDATE REFERENCE LIST (continued)

<u>Section</u>	<u>Cross References</u>
10.4.9.2.1 10.4.9.3	Engineering Request ER-ANO-2006-0389-000, "Use of QCST as Emergency Feedwater Suction Source"
Table 10.4-2	Engineering Request ER-ANO-2005-0554-000, "Circulating Water Pump 2P-3A Motor Replacement"
<u>Amendment 21</u>	
Figure 10.2-3	Engineering Change EC-1922 (with ECN-7298), "CCW Heat Exchanger Modification"
<u>Amendment 22</u>	
Figure 10.2-3	Engineering Change EC-9504, "Revise Normal Position of 2FW-2006A/B"
10.4.5.2	Engineering Change EC-16881, "Circulating Water Pipe Modification"
<u>Amendment 23</u>	
10.4.3.1 10.4.3.5 Figure 10.2-3	Engineering Change EC-16238, "Addition of New Main Turbine Generator Gland Seal System Pressure Control Valve"
<u>Amendment 24</u>	
Figure 10.4-1	Engineering Change EC-17680, "Addition of Discharge Check Valves to Circulating Water Pump Sump Pumps"
Table 10.4-10	Performance Evaluation Request PER-2-83-06, "Revise SAR Steam-Driven EFW Pump Speed Consistent with 1983 Evaluation"
<u>Amendment 25</u>	
Figure 10.2-3	Condition Report CR-ANO-2-2014-0063 "ID Number Correction"
Table 10.4-2	Engineering Change EC-43048, "Circulating Water Pump Motor Replacement"
<u>Amendment 26</u>	
Figure 10.2-4	Engineering Change EC-48343, "Installation of FLEX Connections"
<u>Amendment 27</u>	
10.4.5.3	Engineering Change EC-63132, "Updated Turbine Building Flood Evaluation"
10.2.2.4	Engineering Change EC-58918, "Disable MTG Supervisory Instrumentation High Vibration Trip"

ARKANSAS NUCLEAR ONE
Unit 2

UPDATE REFERENCE LIST (continued)

<u>Section</u>	<u>Cross References</u>
Table 10.4-2	Engineering Change EC-69455, "Circulating Water Pump Motor Replacement"
10.4.11	Engineering Change EC-58247, "Installation of Common Feedwater System"
10.4.11.1	
10.4.11.2	
10.4.11.3	
10.4.11.4	
10.4.11.5	
Table 10.4-13	
Figure 10.4-4	
<u>Amendment 28</u>	
Figure 10.2-3	Condition Report CR-ANO-2-2018-2515, "Correct of Valve Label on Figure 10.2-3"

ARKANSAS NUCLEAR ONE
Unit 2

RECORD OF REVISIONS

<u>PAGE #</u>	<u>AMENDMENT #</u>	<u>PAGE #</u>	<u>AMENDMENT #</u>	<u>PAGE #</u>	<u>AMENDMENT #</u>
TABLE OF CONTENTS		CHAPTER 10 (continued)		CHAPTER 10 (continued)	
10-i	28	10.3-5	20	10.5-5	27
10-ii	28	10.3-6	20	10.5-6	27
10-iii	28			10.5-7	27
10-iv	28	10.4-1	27	10.5-8	27
10-v	28	10.4-2	27	10.5-9	27
10-vi	28	10.4-3	27	10.5-10	27
10-vii	28	10.4-4	27	10.5-11	27
10-viii	28	10.4-5	27	10.5-12	27
10-ix	28	10.4-6	27	10.5-13	27
10-x	28	10.4-7	27	10.5-14	27
10-xi	28	10.4-8	27	10.5-15	27
10-xii	28	10.4-9	27	10.5-16	27
10-xiii	28	10.4-10	27	10.5-17	27
10-xiv	28	10.4-11	27	10.5-18	27
10-xv	28	10.4-12	27		
10-xvi	28	10.4-13	27	F 10.2-1	20
10-xvii	28	10.4-14	27	F 10.2-2	20
10-xviii	28	10.4-15	27	F 10.2-3	28
10-xix	28	10.4-16	27	F 10.2-4	26
10-xx	28	10.4-17	27	F 10.2-5	20
10-xxi	28	10.4-18	27	F 10.2-6	20
10-xxii	28	10.4-19	27		
10-xxiii	28	10.4-20	27	F 10.3-1	20
10-xxiv	28	10.4-21	27		
10-xxv	28	10.4-22	27	F 10.4-1	24
10-xxvi	28	10.4-23	27	F 10.4-2	20
		10.4-24	27	F 10.4-3	20
		10.4-25	27	F 10.4-4	27
		10.4-26	27		
CHAPTER 10		10.4-27	27		
10.1-1	18	10.4-28	27		
		10.4-29	27		
10.2-1	27	10.4-30	27		
10.2-2	27	10.4-31	27		
10.2-3	27	10.4-32	27		
10.2-4	27	10.4-33	27		
10.2-5	27	10.4-34	27		
10.2-6	27	10.4-35	27		
10.2-7	27	10.4-36	27		
10.2-8	27	10.4-37	27		
10.3-1	20	10.5-1	27		
10.3-2	20	10.5-2	27		
10.3-3	20	10.5-3	27		
10.3-4	20	10.5-4	27		

10 STEAM AND POWER CONVERSION SYSTEM

This chapter provides information concerning the Steam and Power Conversion System (SPCS). The SPCS includes the steam system, turbine generator, main condenser and other auxiliary subsystems.

This description is provided to allow an understanding of the SPCS with an emphasis on those aspects of the design and operation of the system that affect the reactor and its safety features. Information is provided to show the capability of the system to function without compromising the nuclear safety of the plant under both normal operating or transient conditions. The radiological aspects of the normal operation of the system are summarized in this chapter, and are presented in detail in Chapter 11.

10.1 SUMMARY DESCRIPTION

The SPCS converts a portion of the thermal energy of the steam produced in the two steam generators into electrical energy. The steam is subsequently condensed and returned to the steam generators as heated feedwater.

The system also removes decay heat from the reactor core by bypassing steam to the main condenser or dumping to atmosphere prior to initiation of shutdown cooling.

The steam generated in the two generators is supplied to the high pressure turbine and to the second stage of the moisture separator reheaters. Upon leaving the high pressure turbine, it passes through the moisture separator-reheaters and then is admitted to the two low pressure turbines. A portion of the steam is extracted from the turbines for feedwater heating, first stage moisture separator reheaters, the main feedwater pump turbines, and the auxiliary steam system heating steam header. Main steam is also available to the emergency feedwater pump turbine, gland sealing steam, main feedwater pump turbine during startup, auxiliary steam system and the ANO Unit 1 auxiliary steam system via the boric acid concentrator (2M39) and the waste concentrator (2M41) supply header.

Exhaust steam from the low pressure turbines is condensed and deaerated in the main condenser. The heat rejected to the main condenser is removed by the closed loop circulating water system utilizing a natural draft cooling tower. The condensate pumps take suction from the condenser hotwell and deliver the condensate through two low pressure feedwater heater trains of five stages each to the suction of the main feedwater pumps. The main feedwater pumps discharge the feedwater through two high pressure feedwater heater trains of two stages each to the two steam generators. Drains from the moisture separator-reheaters and the two high pressure and one low pressure feedwater heater stages are collected in the heater drain tank and returned to the suction of the main feedwater pumps by the heater drain pumps. Drains from the remaining four low pressure feedwater heater stages are cascaded and ultimately returned to the condenser.

The flow diagrams, design performance characteristics, and safety-related design features of the SPCS are described in the remaining sections of Chapter 10.

ARKANSAS NUCLEAR ONE
Unit 2

10.2 TURBINE GENERATOR

The turbine generator receives steam from the two steam generators and converts a portion of the available enthalpy into electrical energy. Figures 10.2-1, 10.2-3, 10.2-4, and 10.2-6 show the turbine generator design features and the related flow diagrams.

10.2.1 DESIGN BASES

The turbine generator is designed for variation in steam pressure as shown in Figure 10.2-1, and also for steam pressure and temperature transients which will occur following a sudden loss of electrical load.

"Base-load" operation is intended for the turbine generator unit. Turbine generator gross electrical output corresponding to nominal full reactor coolant system power output (3,044 MWt) and lowest anticipated condenser cooling water temperature (65 °F) was originally 958 MWe. During 2R14, the original steam generators were replaced with larger replacement steam generators (RSG) to accommodate the anticipated 107.5% power uprate to 3044 Mwt during 2R15. Concurrent with the RSG installation during 2R14, the high pressure (HP) and low pressure (LP) turbines were redesigned to optimize plant operation from Operating Cycle 15 forward.

Because the Nuclear Steam Supply System (NSSS) was designed with the capability of automatically accepting a step load change of 10 percent and ramp load change of five percent per minute over the load range of 15 to 100 percent, the rate of load change of the turbine generator is restricted to these values, although it has a capability of accepting load change at faster rates. In the current configuration which has the atmospheric dump valves (ADV) located upstream of the main steam isolation valves (MSIVs) blocked closed, automatic operation of the SDBS can accept a load rejection of up to 49% power without a reactor trip.

The turbine generator and accessories are classified as Seismic Category 2 and are designed in accordance with industry standards and, where applicable, in accordance with the requirements of ANSI Code for Pressure Piping, TEMA Standards for Heat Exchangers, NEMA Standards, IEEE Standards, Hydraulic Institute Standards, and regulations of the National Board of Fire Underwriters.

To ensure continued conformance with these design bases, an inspection program has been established for the turbine. The turbines and valves will be disassembled for inspection, overhaul, and cleaning on a scheduled basis. The frequency of the inservice inspection of any piece of equipment depends on its operating history at Arkansas Nuclear One - Unit 2 as well as in other similar nuclear units.

10.2.2 SYSTEM DESCRIPTION

The turbine is a General Electric impulse-reaction, 1,800 rpm, tandem-component, 4-flow, 2-stage reheat unit with 43-inch last stage buckets. It is an indoor unit with a design throttle flow (valves wide open) of approximately 13.6×10^6 lb/hr at approximately 1.18"/2.05" Hga backpressure and zero makeup with initial steam conditions of approximately 896.0 psia at 1194.9 Btu/lb. The design flow is 103 percent of rated flow at 900 psia to insure turbine Maximum Guaranteed Rating (MGR) is met. The turbine supplies extraction steam to seven stages of feedwater heaters, two main feedwater pump turbine drivers, and the auxiliary steam system heating steam header.

ARKANSAS NUCLEAR ONE
Unit 2

Steam leaving the high pressure turbine is dried and superheated by passing through two moisture separator-reheater units in parallel and then to two low pressure turbines. A portion of the main steam and the first stage extraction steam is bypassed to the 2-stage reheaters as the heat source.

The generator is a direct driven, 3-phase, 60-cycle, 22 kV, conductor cooled synchronous unit rated at 1,133,334 KVA at 60 psig hydrogen pressure, 0.95 power factor and 0.58 short circuit ratio. The exciter is direct-driven and is of the silicon diode rectifier type rated at 465 volts and 2,555 kW.

10.2.2.1 Turbine Generator Auxiliary Systems

The generator accessories include the following:

- A. A seal oil system with shaft glands to prevent hydrogen leakage,
- B. A closed loop hydrogen system to cool the generator field windings,
- C. A closed loop demineralized water system to cool the stator windings,
- D. An exciter air cooler,
- E. A rectifier section,
- F. An exciter field breaker, and
- G. An automatic voltage adjuster and a manual voltage adjuster.

During degassing or hydrogen filling operations, the generator casing is purged using an inert gas (CO₂) to prevent fires or explosions. The purging operation is monitored utilizing a gas analyzer to insure the casing contains greater than 95 percent CO₂ when purging H₂ out of the generator and greater than or equal to 70 percent CO₂ when purging air out of the generator. During operation, H₂ purity is indicated in the Control Room and alarmed at 90 percent.

Accessories for the turbine include combination moisture separator-reheaters, steam seal system, bearing lubricating oil system, electrohydraulic control system and supervisory instruments.

The turbine has one double-flow, high pressure element in tandem with two double-flow, low pressure elements. Moisture separation and 2-stage reheating of the steam are provided between the high pressure and low pressure elements, with two horizontal-axis, cylindrical-shell, combined moisture separator reheater assemblies. One assembly is located on each side of the high pressure turbine element.

Steam from the two steam generators is supplied to the turbine generator unit. The steam enters the high pressure turbine through four stop valves and four control valves. The eight valves comprise the valve steam chest assembly with an equalizer line between the stop and control valves. After expanding through the high pressure turbine, steam flows through the combined moisture separators and 2-stage reheaters, and then through combined intermediate valves to two low pressure turbines.

The two moisture separators drain to separate drain tanks, which in turn discharge to the two high pressure heater drain tanks. The drains from these tanks are then pumped to the suction of the feedwater pumps. Extraction steam from the high pressure turbine is supplied to the first

ARKANSAS NUCLEAR ONE
Unit 2

reheater stage tube bundle in each reheater. Each bundle drains to its drain tank and subsequently to the shell side of Feedwater Heater 2 in the appropriate heater train. Main steam is supplied to the second reheater stage tube bundle in each reheater. Each second stage bundle also drains to its drain tank and subsequently to the shell side of Feedwater Heater 1 in the appropriate heater train.

To prevent reheater tube bundle flooding and consequent reheater drain instabilities, a scavenging steam system has been added to the moisture separator reheaters. This system has the effect of increasing steam flow through the tube bundle.

A turbine gland sealing system, using steam to seal the annular space where the shaft penetrates the casings, prevents steam outleakage or air inleakage along the shaft. A description of the turbine gland sealing system is given in Section 10.4.3.

The turbine generator bearings are lubricated by a pressurized lube oil system. During normal operation, bearing oil is provided from the discharge of one end of a double-ended oil turbine. The oil turbine is driven by high pressure (about 200 psig) oil supplied by a centrifugal pump mounted on the extension of the turbine generator shaft. During normal operation the other end of the oil turbine provides pressure to satisfy Net Positive Suction Head (NPSH) requirements of the shaft pump. During startup and shutdown (low shaft speed), an AC motor-driven turning gear oil pump and an AC motor suction pump supply bearing oil to the turbine generator and shaft oil pump, respectively. A DC motor-driven emergency bearing oil pump is provided to supply bearing oil in case of loss of AC power.

10.2.2.2 Electrohydraulic Control System

The turbine generator unit is equipped with an electrohydraulic control system to control the steam flow through the turbine. The control system consists of three major subsystems: a speed control unit, a load control unit, and a valve flow control unit.

The speed control unit compares actual turbine speed with a speed reference or actual acceleration with an acceleration reference and provides a speed error signal for the load control unit. The load control unit provides the proper bias and determines desired steam flow signals for the flow control units of the main stop valves, control valves, and intercept valves. The valve flow control units in turn position all the steam admission valves to obtain required steam flow through the turbine.

The flow control of the main steam entering the high pressure turbine is accomplished by the use of four parallel systems each of which consists of a stop valve and a governing control valve in series. Each stop valve is controlled by an electrohydraulic servoactuator so that it is either fully open or fully closed. The function of the stop valves is to shut off the flow of steam to the turbine when required. They close within three to five seconds by actuation of an emergency trip system which is independent of the electronic flow control units.

The turbine control valves are positioned by an electrohydraulic servoactuator in response to a signal from the flow control unit. The flow control unit signal positions the control valves for speed control during startup of the turbine and for load control after the turbine generator unit is synchronized.

ARKANSAS NUCLEAR ONE
Unit 2

The valves located in the crossover lines are combination reheat stop and intercept valves in one casing and control steam flow to the low pressure turbines. During normal operation of the turbine, the intermediate stop and intercept valves will be wide open. The intercept valve flow control unit positions the valve during startup and normal operations and closes the valves rapidly on turbine overspeed due to loss of load. The reheat stop valves close completely on any turbine trip.

The rate sensitive power-load unbalance relay in the load control unit acts to prevent a turbine generator overspeed trip following a sudden loss of electrical load. If a power load unbalance of 40 percent or greater exists, the power load unbalance relay will close the control valves until the power and load signals are back in balance. As the turbine accelerates, the control and intercept valves will be closed at the maximum rate by means of fast-acting solenoid valves, actuated by the power load unbalance relay, to prevent the unit from reaching the overspeed trip setting. Closure of the main and reheat stop valves on an overspeed trip is the second line of turbine protection.

10.2.2.3 Turbine Generator Overspeed Protection

Figures 10.2-3, 10.2-4, and 10.4-3 illustrate the steam path between the steam generators and the turbine. As shown, main and secondary steam inlets have two valves in series to control the flow of steam into the turbine. The operation of these valves to prevent excessive turbine overspeed is as follows.

A. Speed Sensing

1. The operating speed signal is obtained from two magnetic pickups on a toothed wheel at the high pressure turbine shaft. Increase of any one of the speed signals tends to close control and intercept valves.
 - a. Loss of one of the speed signals will transfer control to the other speed signals.
 - b. Loss of both speed signals will actuate the emergency trip system through two (redundant) trip signals. The operation of both speed signals is continuously monitored by the alarm system.
2. The mechanical overspeed trip will actuate the emergency trip system directly upon reaching its set speed (approximately 110 percent of rated speed).

The overspeed trip mechanism consists of an eccentric weight mounted on the turbine shaft, which is held concentric with the shaft by a spring until the speed reaches approximately 110 percent of rated speed. Centrifugal force then overcomes the spring force and the weight flies out, striking a trigger which actuates the overspeed trip valve and releases the emergency trip system fluid to drain. The resulting decrease in emergency trip system fluid pressure causes the emergency trip valve to dump the hydraulic fluid pressure to drain, thereby closing the main stop and control valves and the combined intermediate stop and intercept valves. The operation of the overspeed trip mechanism and the mechanical trip valve can be tested during normal operation.

ARKANSAS NUCLEAR ONE
Unit 2

3. The electrical backup overspeed trip will trip the emergency trip fluid system through two (redundant) trip signals upon reaching its set speed (approximately 112 percent of rated speed). The speed signal is obtained from the third magnetic pickup on the toothed wheel at the high pressure turbine shaft.

The operation of the backup overspeed trip and the electrically operated master trip solenoid valves can be tested during normal operation. Therefore, there are three independent levels of speed sensing normally in operation and two levels as a minimum during the short period used to test either one of the two overspeed trip devices.

B. Steam Flow Controlling Valves

1. For the main and secondary steam inlets, two valves are used in series.
 - a. Control valves are normally controlled by the speed control unit and closed rapidly when pressure in the emergency trip fluid system is removed by any of the redundant trip valves.
 - b. The main stop valves are held open by pressure in the emergency trip fluid system and tripped closed rapidly upon removal of the pressure in this system.
2. Combined stop and intercept valves - Such valves are required where the energy storage in reheaters or moisture separators is sufficient to accelerate the turbine generator to excessive overspeed on loss of load. Two independently operated valves are arranged in series in one valve body.
 - a. The intercept valves are normally wide open but are closed by the speed control unit upon a moderate speed increase and are tripped closed rapidly upon removal of the pressure in the emergency trip fluid system.
 - b. Reheat (or intermediate) stop valves are normally open but are closed rapidly upon removal of the pressure in the emergency trip fluid system.
3. Uncontrolled extraction lines to feedwater heaters - If the energy stored in an uncontrolled extraction line is sufficient to cause a dangerous overspeed, two positive closing non-return valves are required in series. These valves are actuated upon low hydraulic trip fluid pressure caused by operation of either the mechanical or electrical backup overspeed trip. These valves are designed for remote manual periodic tests to ensure proper operation. The extraction lines to the feedwater heaters and check valve systems were reviewed during the design stages to verify that the entrained steam between the turbine, feedwater heaters, and the non-return valves cannot overspeed the unit beyond safe limits.

Both the number and type of non-return valves were reviewed to confirm that the turbine designer's recommendations have been followed. Reviews are also made of proper techniques of inspection and maintenance of governor and protective valves with the purchaser prior to initial startup and at subsequent inspections.

Special tests are made of new components to confirm proper operation. Such special tests include the capability of controls to prevent excessive speed.

ARKANSAS NUCLEAR ONE
Unit 2

All steam control valves are periodically exercised to insure that they are free to operate in the event of a turbine trip.

10.2.2.4 Turbine Generator Trips

In order to protect the turbine generator, various supervisory instruments and the following protective trips independent of the speed control subsystem are provided. Any of the following trips will cause tripping of all turbine steam admission valves:

- A. overspeed trip (mechanical)
- B. backup overspeed trip (electrical)
- C. low vacuum trip
- D. excessive thrust bearing wear trip
- E. reactor trip
- F. generator electrical trips (see Chapter 8)
- G. manual trip from control room
- H. manual located at the turbine
- I. moisture separator drain system high level trip
- J. prolonged loss of stator coolant
- K. low hydraulic fluid pressure trip
- L. loss of both speed signals
- M. loss of bearing oil pressure
- N. shaft pump discharge low pressure
- O. loss of 125-volt DC to EH controller
- P. 500 kV breaker 5130/5134 failure.

In addition to the devices listed above, the turbine and steam systems are equipped with the following protective devices:

- A. automatic load runback to less than 27 (approximately 25) percent of full load in the event of loss of cooling water to generator stator or high stator coolant outlet temperature;
- B. safety valves on the shell side of the moisture separator-reheater to protect the high pressure turbine cylinder from overpressure in the event of a turbine trip;
- C. extraction line non-return valves to protect the turbine from overspeed due to reverse flow in the event of a turbine trip and,
- D. exhaust casing rupture diaphragms to protect the low pressure turbine cylinders from overpressure in the event of loss of condenser vacuum.

Various parameters for the turbine generator auxiliary systems are recorded and alarmed in the control room and logged on the plant computer. A full compliment of controls and instruments are provided in order that the turbine generator may be started, operated, tested, and shut down from the control room.

ARKANSAS NUCLEAR ONE
Unit 2

10.2.3 TURBINE MISSILES

Because of the redundancy and reliability of the turbine control and protection system, the close control of oil purity, the periodic check of steam admission valve freedom, and the high value of the bursting overspeed, any missile resulting from a turbine generator overspeed incident is hypothetical only and not considered credible.

An analysis of the probability of a hypothetical turbine failure missile is provided in Section 3.5. Previous analyses concentrating on the consequences of a hypothetical turbine missile are provided in Reference 75 of that section, and particularly the references listed in the General Electric Company Memo Report dated March 14, 1973, "Hypothetical Turbine Missiles - Probability of Occurrence," by J. E. Downs (Reference 53 of Section 3). As the discussion in Section 3.5 shows, damage to critical plant components is so improbable as not to require specific protective shielding against hypothetical turbine failure missiles. The discussion below summarizes the major point provided in the references of Section 3.5.

A study of all turbine generator rotating elements' failures known to the Turbine Division of General Electric has indicated that the failures are of two general types:

- A. failure of rotating components operating at or near normal speed; and,
- B. failure of components that control steam admission to the turbine resulting in excessive shaft rotation speed.

The present advanced state-of-the-art of rotor forgings and inspection techniques, plus the experience gained from past documented incidents guarantees, for all practical purposes, defect free turbine rotors. Therefore, the generation of missiles as a result of turbine failure at or near normal speed is not considered credible.

The turbine generator speed control and overspeed protection system is discussed in Section 10.2.2 above. As the discussion shows, it takes the simultaneous failure of three independent control systems which operate two steam admission valves in series before the turbine generator can exceed the design speed (120 percent of rated speed). Therefore, overspeed beyond 120 percent of rated speed is highly improbable. Also significant is that above 150 percent of rated speed turbine component failures which do not produce missiles would cause braking of the turbine. However, the low pressure turbine last stage bucket vanes, which constitute the most severe hypothetical turbine missile, are not postulated to fail until overspeed reaches 177 percent of rated speed. Therefore, turbine failure missiles of the second type, as a result of excessive overspeed, are even less probable than failure of the three independent overspeed trip systems.

10.2.4 EVALUATION

The steam generated in the two steam generators is not normally radioactive. Only in the event of primary-to-secondary system leakage (due to a steam generator tube leak) is it possible for the SPCS to become radioactively contaminated. In this event, monitoring of condenser air discharge will detect any contamination. A full discussion of the radiological aspects of primary-to-secondary leakage, including anticipated operating concentrations of radioactive contaminants, means of detection of radioactive contamination, anticipated releases to the environment, and limiting conditions for operation, is included in Chapter 11.

ARKANSAS NUCLEAR ONE
Unit 2

A description of the protection provided by bypassing and dumping main steam to the condenser and atmosphere in case of sudden load rejection by the turbine generator is included in Section 10.4.4. A description of the protection provided by exhausting steam to the atmosphere through the safety valves in the event of a turbine generator trip and coincident failure of the SDBS is given in Section 10.3.

The protection of the plant against hypothetical missiles generated due to failure of turbine generator rotating parts is discussed in Sections 3.5 and 10.2.3.

ARKANSAS NUCLEAR ONE
UNIT 2

10.3 MAIN STEAM SUPPLY SYSTEM

The Main Steam System (MS) carries the steam generated in the two steam generators through the containment wall to the following major components:

- A. turbine generator
- B. moisture separator reheaters
- C. turbine shaft gland seals
- D. main feedwater pump turbines
- E. turbine-driven emergency feedwater pump
- F. Steam Dump and Bypass System (SDBS) valves.
- G. Boric acid concentrator and waste concentrator

10.3.1 DESIGN BASES

The MS is designed to convey steam generated by the steam generators to the turbine generator and to other auxiliary equipment for power generation. It supplies steam to the high pressure turbine and to the moisture separator reheaters during normal plant operation, to the turbine gland seals during low load, and to the main feedwater pumps steam turbine drivers during low loads or whenever low pressure steam is not sufficient. It may also supply steam to ANO Unit 1 via the boric acid concentrator (2M39) and waste concentrator (2M41) supply header.

The MS is designed to remove the heat generated in the Nuclear Steam Supply System (NSSS) during normal load, plant startup, hot standby, hot shutdown and normal cooldown, and to permit load reductions of up to full load. This function is accomplished by means of the SDBS in conjunction with the main condenser, Emergency Feedwater (EFW) System and/or main steam safety valves. The SDBS is discussed in Section 10.4.4 and the EFW System in Section 10.4.9.

The MS is designed to provide isolation of the steam generators from other components of the system by means of the main steam isolation valves following a hypothetical main steam line break.

The MS is designed to provide an assured source of steam to operate the emergency feedwater pump turbine driver.

10.3.2 SYSTEM DESCRIPTION

10.3.2.1 General Description

The MS is shown schematically in Figure 10.2-3. The major components are: two 38-inch main steam lines, one coming from each of the two steam generators and each provided with a venturi flow element; main steam safety valves (five in each line); main steam isolation valves (MSIVs); steam supply lines to the EFW pump steam turbine driver and to the atmospheric dump valves. The main steam piping up to and including the main steam isolation valves outside of the containment is safety-related and designed to meet Seismic Category 1 and ASME Code, Section III, Class 2 requirements. Certain sections of main steam piping are classified as Critical Pipe. Critical Pipe lines are designed to meet the requirements of ANSI B31.1.0, and additionally, to meet the requirements of ASME Code Section III Class III

ARKANSAS NUCLEAR ONE
UNIT 2

requirements with respect to repair of defect, material traceability, and nondestructive tests.” The quality group classifications for the main steam piping and Seismic Category 1 components of the MS are listed in Section 3.2.2. The MS piping inside containment is environmental Category 1-B (see Section 3.11). All other components of the system are located outside containment and are environmental Category 1-E (see Section 3.11).

The main steam lines carry the total steam flow from the steam generators. The main steam penetration design is discussed in Section 3.8.1.4.2 and is shown in Figure 3.8-9. Each line is anchored to the containment wall and is routed to provide sufficient flexibility for movement of the steam generators and piping due to thermal expansion.

Each main steam line is furnished with a venturi flow element installed at the steam generator outlet inside the containment. The venturi flow element is used to measure steam flow derived from differential pressure measurement during normal plant operation. The venturi flow element can also function to limit the blowdown rate following a postulated pipe rupture in the main steam line; however, the main steam flow restrictors installed in the steam generator outlet nozzles are credited with performing this function (see Section 5.5.4).

Each main steam line has a radiation monitor attached between the containment penetration and the main steam safety valves. The purpose of these monitors is to provide indications of primary-to-secondary reactor coolant leakage as early as possible.

Each main steam line has an unattached radiation monitor between the main steam stop valves and the turbine stop valves. The purpose of these monitors is to detect N-16 gamma radiation, which will provide very rapid indication of the affected steam generator and the rate of primary-to-secondary reactor coolant leakage.

The main steam safety valves are provided to limit steam generator pressure to 1,210 psia as allowed by the ASME Code.

The main steam safety valves provided in the MS are designed in accordance with ASME Code, Section III, Class 2. The design capacities of the safety valves are as shown in Table 10.3-1. The total capacity of the safety valves is sufficient to pass greater than 100 percent of the steam flow generated at rated load. The setpoint of one safety valve on the main steam line from each steam generator is equal to or less than the steam line design pressure. The other valves are set to open at higher pressures, as shown in Table 10.3-1. Pressure will not exceed 1,210 psia which is 110 percent of steam generator line pressure, in accordance with ASME Code, Section III, Class 2.

The spring loaded, dual outlet main steam safety valves are installed on the main steam lines upstream of the main steam isolation valves. The arrangement is such that the valves with lower setpoints are installed ahead of the higher setpoint valves, in numerical order, in the direction of flow.

The main steam isolation valves are provided to isolate the steam generators from the rest of the secondary system in the event of a postulated MS failure as discussed in Section 15.1.14. The valves are designed in accordance with ASME Code, Section III, Class 2. Each valve is a spring loaded, Y-pattern globe designed to function both as an isolation valve and a non-return valve. As an isolation valve, it is designed for tight shut off and fast closing. The MSIV closure time is controlled by a hydraulic speed control, regardless of pressure differential across the valve which may be caused by varying loads on the disk. As a result, the seating velocity is not sufficient to cause significant impact loading of the disk. As a non-return valve, downstream

ARKANSAS NUCLEAR ONE
UNIT 2

pressure is internally ported to the top side of the main valve disk, maintaining the valve in the closed position. The valve is designed such that in the closed position, steam leakage in either direction past the valve seats shall not exceed 5 cfs. The valves can not be tested during normal operation without causing severe system transients. Therefore, they are provided with an exercise mode which allows the valves to be cycled from full open to 90 percent open and back to full open during power operation. This ensures that the valve stems are free to move in the event a rapid closure is required.

Full stroke testing of the actuation system can be accomplished during scheduled plant shutdown periods and is performed in accordance with Technical Specification requirements. The valves are furnished with a common accumulator which provides backup motive air to the valves. These are the only valves of this type in any safety-related system. In case of a line break in the non-Seismic Category 1 portion of the air supply line, the accumulator delivers required air to replenish leakage and prevent an undesired fast closing of the valves. This feature is intended to prevent interruption of power generation and is not required for plant safety. During normal plant operation the main steam isolation valves are open and may be controlled (closed) either remote manually or automatically. Redundant Main Steam Isolation System (MSIS) signals are provided to the solenoid air supply valves of each MSIV (see Figure 10.3-1) from independent ESF power supplies. Either signal is adequate to cause a rapid closure of the MSIV.

The branch piping leading to the emergency feedwater turbine and to the upstream atmospheric dump valves is installed upstream of the main steam isolation valves. This arrangement insures that steam to these systems is available with the main steam isolation valves closed.

10.3.2.2 System Operation

Plant startup is effected by means of the Auxiliary Feedwater Pump operating in conjunction with the SDBS. When sufficient heat is generated in the NSSS, feedwater supply operation is shifted over to the Condensate and Feedwater System (CFWS). At low power levels, main steam is supplied to the main feedwater pump turbine drivers and the turbine gland sealing system. At higher power levels, the steam supply to the feed pump drivers is transferred from main steam to the output of the moisture separator reheaters.

If a large, rapid reduction in power demand occurs, the SDBS exhausts steam to the condenser and/or atmosphere to prevent tripping of the reactor. In case the condenser is not available as a heat sink, e.g., high condenser back pressure caused by loss of circulating water, the turbine bypass valves are blocked closed. Steam is then exhausted to the atmosphere through the atmospheric dump valves or main steam safety valves for decay heat removal.

10.3.3 SAFETY EVALUATION

Heat dissipation requirements during plant startup, hot shutdown, and cooldown are normally met by bypassing steam to the condenser via the turbine bypass system described in Section 10.4.4. If the bypass system is not available, the atmospheric dump valves are adequately sized to remove decay heat in the event of plant shutdowns. In the current configuration which has the atmospheric dump valves (ADVs) located upstream of the main steam isolation valves (MSIVs) blocked closed, automatic operation of the SDBS can accept a turbine generator load rejection of up to 49% without a reactor trip and without lifting any main steam safety valves. Failure of the SDBS to function during turbine reactor power mismatch will result in a reactor trip and main steam pressure will rise. However, the main steam safety valves, which are adequately sized to permit load rejection from full power, will open and prevent pressure rise above 110 percent of the maximum allowable pressure for the steam generators.

ARKANSAS NUCLEAR ONE UNIT 2

In the unlikely event of a main steam line rupture, a Main Steam Isolation Signal (MSIS) or Containment Spray Actuation Signal (CSAS) terminates feedwater flow to the affected steam generator and provides for timely isolation of the intact steam generator (see Section 7.3.1.1.11.4).

The main steam isolation valves (MSIVs) will receive a CSAS or an MSIS close signal and the valves will close in 3.0 ± 0.3 seconds. The air operators for these valves are furnished with redundant solenoid supply and vent valves to insure that no single electrical failure will prevent MSIV closure. If the break occurs upstream of the valve, the valve will be maintained in the closed position due to downstream line pressure being internally ported to the topside of the main valve disk. The leakage through the valve in the direction towards the break (reverse flow) will not exceed 5 cfs. This is less than the maximum allowable leak inward to the containment (15 cfs). If the failure occurs downstream of the MSIV, the pressure acting on the disc will maintain the valve tightly closed and will show no discernable leakage. CSAS and MSIS are provided to close the main feedwater isolation valves, the backup isolation valves, and the main feedwater pump turbine steam supply valves. The condensate pumps in both condensate/feedwater trains and the heater drain pumps are also tripped by CSAS and MSIS. This prevents the addition of feedwater to the affected steam generator. A MSIS is also provided to each motor operated atmospheric dump isolation valve as additional conservatism and to ensure closure. Table 10.3-4 contains a single failure analysis which demonstrates the adequacy of CSAS or MSIS to perform the above described design function. Either train of CSAS or MSIS will actuate isolation of main feedwater and main steam. The flow restrictors in the main steam lines limit the rate of blowdown of steam from the steam generators following a postulated steam line break.

Following a main steam line break, the water level in the intact steam generator is maintained by the emergency feedwater (EFW) system, which is described in Section 10.4.9. Emergency feedwater system actuation and control are described in Section 7.3.1.1.11.8. The main steam system is arranged such that steam is always available to the emergency feedwater pump turbine driver from either or both steam generators, even when the MSIVs are closed. The steam line to the turbine driver is routed from a header which connects to the two main steam lines upstream of the MSIVs. The motor operated isolation valves installed in the header are normally open. Although the inlet block valve to the turbine is normally closed, during turbine startup a small bypass line is used to pre-heat the turbine before the inlet block valve opens. This arrangement prevents thermal and steam shock to the turbine and the EFW system steam piping system. Flow between the steam generators is prevented by check valves in the lines from each main steam header.

Two sets of SDBS atmospheric dump and isolation valves are provided in the main steam lines upstream of the MSIVs, one set in each main steam line. This arrangement permits controlled release of steam for Reactor Coolant System (RCS) cooling when the MSIVs are closed. This can be accomplished by manual operation either from the control room or MCC handswitches or by using local handwheels.

All safety-related components in the main steam system are designed to perform their intended function in the normal and accident temperature, pressure, humidity, chemical, and radiation environment to which they will be subjected. Environmental design bases and qualifications are discussed in Section 3.11, Environmental Design of Mechanical and Electrical Equipment.

The MS is Seismic Category 1 up to and including the main steam isolation valves, the emergency feedwater pump turbine driver, and the main steam safety valve outlets. Main steam isolation valve air actuation piping is Seismic Category 1 from upstream of the solenoid isolation valves to and including the MSIV actuator. The control and power circuits for the

ARKANSAS NUCLEAR ONE
UNIT 2

redundant equipment have been designed in accordance with the separation criteria as described in Section 8.3.1.4, "Independence of Redundant Systems." The MSIS is a part of the Engineered Safety Features Actuation System (ESFAS) and is described in Section 7.3.1.1. The ESFAS/MSIS conformance to safety criteria is described in Section 7.1.2 and the design bases in Section 7.3.1.2. Note the safety related main feedwater valves are not designed to close against the maximum possible header pressure. The valves function to isolate feedwater after forced flow has been terminated. Termination of forced flow is accomplished by stopping of the non-Q main feedwater pumps, condensate pumps, and heater drain pumps.

The analysis of the effects of main steam line breaks and the criteria employed in postulating the break locations are provided in Section 3.6. Isometrics and cutaway views of the main steam headers necessary for the study of pipe break consequences are also provided in Section 3.6.

10.3.4 TESTS AND INSPECTIONS

Historical data removed, to review the exact wording, please refer to Section 10.3.4 of the FSAR.

The MS is hydrostatically tested in accordance with applicable codes. The components are given preoperational and functional tests to insure that they will perform in accordance with design. The closure times of the main steam isolation valves are determined during the preoperational tests of the main steam system. This is accomplished by measuring the elapsed time from the generation of a main steam isolation signal until the valve is closed, as summarized in Section 14.1. The test is repeated during the life of the unit as required by the Technical Specifications.

The MS piping from the steam generators up to and including the main steam isolation valves is equipped with removable insulation for inservice inspection of welds. Likewise, the steam supply piping to the turbine driver is furnished with removable insulation to allow inspection of the welds.

10.3.4.1 Shop Tests

Historical data removed; see Section 10.3.4.1 of the FSAR.

10.3.5 WATER CHEMISTRY

Secondary system chemistry control is accomplished through the implementation of "Steam Generator Water Chemistry Monitoring Unit II" Procedure No. 1000.043 and by:

- A. Close control of feedwater, steam generator water and steam quality by sampling and analyzing to limit the amount of impurities which can be introduced into the secondary system.
- B. Chemical injection to neutralize the effect of the trace impurities which do enter the condensate and feedwater system, and maintain a pH level to protect the system from corrosion.
- C. Blowdown is employed to reduce the total concentration of impurities and additives which accumulate due to the concentrating effect within the recirculating type steam generators. When blowdown recovery is undesirable, blowdown may be diverted to holdup tanks for treatment or discharged directly to the circulating water flume if water chemistry and radioactivity levels permit.

ARKANSAS NUCLEAR ONE UNIT 2

During normal plant operations, a continuous blowdown from each steam generator is maintained. Under abnormal operating conditions this rate may be increased. The actual blowdown rate is determined by steam generator operating water chemistry requirements. The blowdown is normally processed in the startup and blowdown demineralizer system and returned to the condenser.

In general, the feedwater and steam generator water chemistry is based on the volatile chemistry control method. This is accomplished by the use of volatile chemicals for pH control which do not concentrate in the steam generator, by careful control of feedwater impurities, and by maintaining a proper pH and hydrazine residual. The basis of volatile pH control is the exclusion of solids, both insoluble and soluble, from the steam generator. This method employs the injection of a volatile additive for pH control into the secondary water to maintain alkalinity within the feedwater and the steam generator. This reduces the release of corrosion products from metal surfaces. Exclusion of solids limits the accumulation of scale and deposits on steam generator heat transfer surfaces and internals. Scale and deposit formation can alter the thermal hydraulic performance in local regions and, if allowed to concentrate to high levels, may cause corrosion. Ammonium hydroxide, an amine, and/or hydrazine is added to establish the desired pH range (See Procedure 1000.043, "Steam Generator Water Chemistry Monitoring Unit II), but will not concentrate in the steam generator due to their volatility.

The removal of oxygen (O_2) from the feedwater and steam generator water is essential to prevent corrosion of wet steel surfaces. If oxygen corrosion is allowed to proceed without correction, then this can significantly affect the operating lifetime of the secondary system. Oxygen is removed from the feedwater by the use of the deaerating section of the main condensers and by the addition of hydrazine to the feedwater.

Hydrazine is added to the feedwater at the outlet of the condensate pumps to scavenge traces of oxygen. Hydrazine reacts with oxygen to form nitrogen and water, which are volatile and do not add to the steam generator solids concentration.

Additives to the secondary side water, ammonia and/or an amine and hydrazine, are monitored continually by indicating controllers. Quantities and rates of addition of chemicals are controlled by adjusting the hydrazine and ammonia or amine pump strokes as the system requires chemical addition.

The specific conductivity, cation conductivity, pH, and sodium (Na) concentration of the steam generator water are continually monitored by conductivity sensing elements, pH sensing elements, and sodium sensing elements on each steam generator sample cooler discharge line. On the feedwater system, the cation and specific conductivity and pH as well as hydrazine and oxygen monitoring is done by the sensing elements in the sample lines from the last stage feedwater heater outlets (see Figure 9.3-3).

Free hydroxide concentration in the steam generator water is not measured. At power operation ($> 5\%$ reactor power), certain impurities (e.g., chloride) in the steam generator water are measured daily when the feedwater sample analysis is done. Ammonia, hydrazine, and amine in the feedwater sample are also analyzed at this time and recorded by the chemistry lab.

The electrical conductivity as well as Na and O_2 content are monitored continually by the use of sensing elements in the sample lines from the discharge of the condensate pumps. Na is also monitored in the sample lines from condenser water boxes to detect condenser leaks (see Figure 9.3-2).

The chemistry limits for steam generator water and feedwater during normal and action level conditions are presented in Procedure 1000.043, "Steam Generator Water Chemistry Monitoring Unit II".

10.4 OTHER FEATURES OF STEAM AND POWER CONVERSION SYSTEM

10.4.1 MAIN CONDENSER

The two-shell, three-pressure main condenser provides a continuous heat sink for the exhaust from the two tandem low pressure turbines and for miscellaneous flows, drains and vents during normal plant operation.

The main condenser also provides a heat sink for steam bypassed directly to the condenser by the steam dump and bypass system (SDBS) during other operating configurations.

10.4.1.1 Design Bases

The main condenser is designed to function as the steam cycle heat sink and collection point for the following flows:

- A. main low pressure turbines exhaust
- B. main low pressure turbines last-stage moisture removal drains
- C. feedwater heaters drain and vent
- D. steam seal regulator leakoff
- E. steam packing exhauster drain
- F. main feedwater pumps turbine exhaust
- G. turbine bypass
- H. main feedwater pumps recirculation
- I. condensate pumps recirculation
- J. demineralized water makeup
- K. steam generator blowdown tank vent
- L. startup and blowdown demineralizer returns
- M. miscellaneous equipment dumps, drains and vents.

Design data of the main condenser at normal full load operation of the plant is shown in Table 10.4-1.

The main condenser is also designed to:

- A. Condense main steam bypassed directly to the condenser by the turbine bypass system. This condition could occur in case of a sudden load rejection by the turbine generator, a turbine trip, or during startup and shutdown, as described in Section 10.4.4.
- B. Provide for removal of noncondensable gases from the condensing steam through the condenser evacuation system, as described in Section 10.4.2.
- C. Deaerate the condensate before it leaves the condenser hotwell.

The main condenser is constructed in accordance with the Heat Exchanger Institute Standards for steam surface condensers and is designed to provide for a seismic load of 0.05 g.

ARKANSAS NUCLEAR ONE
Unit 2

10.4.1.2 System Description

The main condenser is a two-pass, two-shell, three-pressure type with divided waterboxes. Each shell is located below its respective low pressure turbine. The tubes in both the low pressure shell and the high pressure shell are oriented transverse to the turbine generator longitudinal axis. The hotwell storage, which is the third pressure zone, is located under both shells.

The condensate flows by gravity from the low pressure shell to the high pressure shell, where it is heated to the saturation pressure of the high pressure shell. The condensate is then heated by the incoming feed pump turbine exhaust steam as it flows by gravity from the high pressure shell to the 75,000 gallon hotwell live storage section. The live storage is the available condensate volume to meet the condensate and feedwater system requirements. One condensate outlet per shell is provided.

An automatic makeup and reject system was originally provided for the condenser to maintain a normal level in the hotwell. On low water level in the hotwell, a control valve opened to admit condensate from the condensate storage tank (CST) into the hotwell through a gravity (vacuum drag) line. On high water level in the hotwell, another control valve opened to reject condensate from the condensate pump discharge to the condensate storage tank. This system is currently not in use; the hotwell level is controlled manually.

During startup, condensate is recirculated from the condensate pumps discharge to the hotwell. To provide cooling, additional high level recirculation lines may be used which enter the hotwell at levels above the tube bundles. This contact with the tube bundles provides sufficient cooling to prevent damage to the startup and blowdown demineralizer resin. It also limits locally high temperatures at the hotwell recirculation penetrations.

Each condenser shell has two tube bundles, each of which is connected to a separate circulation water line through a waterbox. The waterboxes of the two shells are connected in series so that the circulating water passes through the low pressure shell and then through the high pressure shell as shown on Figure 10.4-1.

The condenser tubes are Titanium, B338 GR2. This material was chosen for its excellent resistance to corrosion.

The removal of noncondensable gases from the main condenser is described in Section 10.4.2.

A number of design modifications have been added to the main condenser and condensate and feedwater system to reduce the time required to locate, isolate and repair a condenser leak. These modifications are as follows:

- A 4-point condenser hotwell quadrant sampling system for the purpose of locating a leak is installed.
- A pumping system is installed to allow for quicker draining of the condenser circulating water boxes.
- Climbing rungs are added inside the condenser circulating water boxes for the purpose of reducing the time required to plug a leaking tube.

ARKANSAS NUCLEAR ONE
Unit 2

- A sample cooler is included to improve the quality of the oxygen analysis.
- Two sodium analyzers are installed in the secondary sample system which can sample both feedwater trains. Multiple sample points allow detection of contaminants from the heater drain pumps and detection of leakage between circulating water and secondary side coolant.
- Permanent connections are provided to slug feed the condenser with hydrazine.

10.4.1.3 Safety Evaluation

The main condenser is used to remove residual heat from the Reactor Coolant System (RCS) during the initial cooling period after plant shutdown when the main steam is bypassed to the condenser by the turbine bypass system. The condenser is also used to condense the main steam bypassed to the condenser in the event of sudden load rejection by the turbine generator or a turbine trip.

In the event of a load rejection, the condenser will condense the steam bypassed to it by the SDBS, which is up to 27 percent of full load main steam flow, as well as any steam used by the turbine to maintain house loads. The atmospheric steam dump valves or spring-loaded safety valves will discharge the remaining main steam flow to atmosphere to permit continued reactor operation or to effect safe reactor shutdown and to protect the MS from overpressure.

If the main condenser becomes unavailable during normal plant shutdown, sudden load rejection or turbine generator trip, the atmospheric steam dump valves and the spring-loaded safety valves can discharge full main steam flow to the atmosphere and effect a safe shutdown condition. Non-availability of the main condenser considered here includes failure of circulating water pumps to supply cooling water, failure of condenser evacuation system to remove noncondensable gases, excessive leakage of air through turbine gland packings due to failure of the turbine gland seal system, or failure of the condenser due to any other reason.

Section 10.4.5 discusses the prevention of flooding of the Engineered Safety Features (ESF) equipment located in the auxiliary building due to failure of waterboxes or circulating water piping.

During normal operation and shutdown, the main condenser will have no significant radioactive contaminants inventory. Radioactive contaminants can only be obtained through primary-to-secondary system leakage due to a steam generator tube leak. A full discussion of the radiological aspects of primary-to-secondary leakage, including anticipated operating concentrations of radioactive contaminants, is included in Chapter 11. No hydrogen buildup in the main condenser is anticipated.

10.4.1.4 Tests and Inspections

The main condenser waterboxes were hydrostatically tested in accordance with Section S-27 of the HEI standards for steam surface condensers.

Condenser shells were completely filled with water and tested in accordance with the ASME Power Test Code before being placed in initial operation.

10.4.1.5 Instrumentation Applications

The main condenser hotwell is equipped with level control devices which were originally designed for automatic control of system water makeup and reject, as described in Section 10.4.1.2 (currently the level is controlled manually). A low-low hotwell water level alarm is provided in the control room. The sampling system takes suction from troughs in condenser shells and measures the sodium content of the condensate to provide an indication of a condenser tube leak. The sampling system can indicate the sodium content of the condensate before it rises to a level where excessive blowdown and, potentially, steam generator shutdown would be required. Local and remote indicating devices are provided for monitoring pressures and water levels in the condenser shells.

10.4.2 MAIN CONDENSER EVACUATION SYSTEMS

The Main Condenser Evacuation System (MCES), shown in Figure 10.4-1, removes noncondensable gases and air from the main condenser during plant startup, cooldown, and normal operation. The system has no safety-related function.

10.4.2.1 Design Bases

The MCES is designed to remove noncondensable gases and inleaking air from the steam space of the two condenser shells. Each exhaustor assembly is designed to continuously remove 25 scfm of free dry air at 71.5 °F and 1-inch Hga. The MCES is also designed to rapidly remove air from the two shells to create a vacuum in the condenser during plant startup. Each exhaustor assemble has a "hogging" capacity rating of 750 scfm of free dry air at 70 °F and 10 inches Hga.

The system is designed and constructed in accordance with standards of the Heat Exchange Institute's "Standards of Surface Condensers" and to provide for a seismic load of 0.05g.

Each exhaustor assembly is designed to draw air from the two condenser shells operating at two different pressures.

10.4.2.2 System Description

The system consists of two 100 percent capacity exhaustor assemblies. Each assembly consists of one motor driven rotary type vacuum pump with one seal system including one centrifugal circulating pump and one heat exchanger, two atmospheric air ejectors, two integral jet heaters, one separator and all necessary piping, valves, instruments and electric devices for automatic operation of the system.

In normal operation one exhaustor assembly is in use with the second assembly in standby. The noncondensable gases are released to the atmosphere through the auxiliary building ventilation system.

Energizing the exhaustor starter for system startup opens the exhaustor inlet valves and allows the air to flow directly to the vacuum pump outlet. This operation, called hogging, allows full use of vacuum pump capacity by bypassing the air jets. When the pressure in the condenser reaches approximately 5 inches Hga, the bypass valves close and the motive air valves open, allowing atmospheric air to flow to the jet nozzles. The system air leakage is then drawn through the jets to the vacuum pump. This operation is called holding. Should condenser

ARKANSAS NUCLEAR ONE
Unit 2

vacuum decay, the standby exhauster will automatically start, and will remain running to hold condenser vacuum at normal operating level. Should vacuum continue to decay to approximately 5 inches Hga, both exhausters will automatically go into hogging operation.

Energizing the exhauster starter also automatically starts the seal water system associated with the exhauster assembly. Seal water is used as the liquid compressant with the vacuum pump, serves as cooling water for the vacuum pump, and seals clearances within the vacuum pump. The seal water pump takes suction from the bottom of the separator tank and delivers the flow through the seal water to the vacuum pump casing. The seal water return line from each end of the vacuum pump is routed back to the discharge of the vacuum pump. From there, the seal water is returned to the separator tank along with the air and gases drawn from the condenser.

10.4.2.3 Safety Evaluation

The MCES is used during reactor cooldown following a turbine generator or reactor trip when steam is bypassed to the condenser.

If the MCES is not operable, it is possible that the bypassed steam is not condensed after accumulation of noncondensable gases and inleaking air in the condenser. This is considered a main condenser failure and safe shutdown of the reactor in such an event is discussed in Section 10.4.1.

The noncondensable gases and vapor mixture discharged to atmosphere from the MCES is not normally radioactive. However, in the event of primary to secondary system leakage due to a steam generator tube leak, it is possible for the mixture discharged to become radioactively contaminated. A discussion of radiological aspects of primary to secondary leakage and limiting conditions for operation is included in Chapter 11. The anticipated radioactive releases to the environment during normal operation of the system are shown in Table 11.3-5.

A radiation detector is located in the common discharge header which runs from the two MCES moisture separators' discharge to the auxiliary building vent discharge system. The radioactivity level is continuously recorded in the control room. The high radiation switch actuates an alarm in the control room.

10.4.2.4 Tests and Inspections

Testing of the MCES during normal operation is minimal since the system is in use. Pre-startup testing ensures proper operation of valves and verifies pressure switch setpoints. The system can be shut down for short periods of time during plant operation, for inspection, without adversely affecting condenser performance.

10.4.2.5 Instrumentation Applications

A radiation detector is provided in the MCES with the remote indicating switch and alarm located in the control room. To prevent moisture buildup and consequent erroneous readings, radiation detector 2RE-0645 is located in the common discharge header which runs from the two MCES moisture separators' discharge to the auxiliary building vent discharge system.

ARKANSAS NUCLEAR ONE
Unit 2

Radioactivity is monitored by a chart recorder in the control room and can also be monitored on the Safety Parameter Display System (SPDS) or the plant computer. Local indicating devices such as pressure, temperature, and flow indicators are provided as required for monitoring the system operation. There are no control functions of the system which could influence operation of the RCS.

10.4.3 TURBINE GLAND SEALING SYSTEM

The Turbine Gland Sealing System (TGSS) provides sealing of the turbine generator shaft and the main feedwater pump turbine shafts against leakage of air into the turbine casings and escape of steam into the turbine building. The system is shown in Figure 10.2-3. The system has no safety-related function.

10.4.3.1 Design Bases

The TGSS is designed to prevent atmospheric air leakage into the turbine casing and main condenser and steam leakage out of the casings of the turbine generator and main feedwater pump turbines. This system performs these functions from startup to full load.

During normal operation both steam and air are transported along the turbine shafts to the steam packing exhauster. Net excess steam is bypassed to the main condenser. The system is designed to handle greater flows resulting from startup and no load operation, low auxiliary steam source pressure, and twice the normal packing clearances. The Unit 1 startup boiler and the Unit 2 main steam system are the only sources of gland steam that have the capacity to provide the flow required for twice the normal packing clearances. The system is classified Seismic Category 2.

10.4.3.2 System Description

Steam flow to the shaft seals is controlled by the TGSS steam feed control valves and unloading valves. A small quantity of steam leaks into the turbines while the remainder is exhausted through an exhauster system. The packing low pressure side vent annuli are maintained at a slight vacuum by the steam packing exhauster condenser. The exhauster condenser is a shell and tube heat exchanger with two blowers, either of which maintains the necessary vacuum. The Auxiliary Cooling Water System supplies cooling water to the tube side of the exhauster condenser. Drains from the shell side of the exhauster condenser are returned to the main condenser, while non-condensibles and some vapor are discharged to atmosphere above the turbine building roof by the blowers. Excess steam from the steam seal feed header is bypassed to the main condenser by the unloading valves. Condensate is removed from the steam seal header through a floating type steam trap.

At startup, the sealing steam source may be either main steam or auxiliary steam (both from Unit 1). When sufficient pressure has been established in the steam generator, the auxiliary steam source valve is closed and Unit 2 main steam provides sealing. As the turbine is brought up to load, steam leakage past the high pressure turbine high pressure seals enters the steam seal header. When this leakage is sufficient to maintain required steam seal header pressure, the main steam feed control valve is closed, and all sealing steam is supplied from the high pressure turbine.

ARKANSAS NUCLEAR ONE
Unit 2

During normal operation of the turbine generator, the steam from the high pressure turbine casing passes along the turbine shaft through the clearances of the labyrinth-type gland seals. The gland leakage from the high pressure casing is then passed to the gland seals on the low pressure turbine and the main feedwater pump turbines. The exhaust from the turbine seals and the main feedwater pump turbine seals is routed to the steam packing exhauster condenser where the steam is condensed and returned to the main condenser. The air and noncondensable gases from the exhauster condenser are discharged to the atmosphere above the turbine building roof by one of the blowers.

10.4.3.3 Safety Evaluation

The TGSS has the capacity to handle steam and air flows resulting from twice the normal packing clearances.

During the normal operation of the turbine generator, the sealing steam pressure is automatically maintained by opening the steam packing unloading valves which pass excess steam to the main condenser. In the event of a malfunction of one or both of the automatic unloading valves, a motor operated unloading valve bypass valve may be operated to manually control steam seal header pressure. In addition, three relief valves are provided to prevent excessive steam seal header pressure. The relief valves discharge to the main condenser.

The system can be used during reactor cooldown following a turbine generator and reactor trip when steam is bypassed to the condenser. The turbine gland seals can be supplied with the low pressure steam generated in the steam generators during reactor cooldown.

Exhauster vacuum on the low pressure side of the seals can be maintained with either blower, or both, in operation. Failure of one blower (low vacuum) automatically starts the second blower. Loss of both blowers can cause steam leakage into the turbine building and is alarmed. However, a failed steam packing exhauster condenser tube can be plugged during turbine operation by isolating the exhauster condenser tube side. The blowers will continue to operate during this time. In addition, provisions have been made to supply condensate to the shell side to promote direct contact condensation of exhaust steam during maintenance.

The non-condensable gases and vapor mixture discharged to the atmosphere by the steam packing exhauster blower is not normally radioactive. Only in the event of primary-to-secondary system leakage (due to a steam generator tube leak) is it possible for the mixture discharged to be radioactively contaminated. Radiation monitoring of steam generator blowdown and main condenser vacuum pump discharge will detect this condition. A discussion of the radiological aspects of primary-to-secondary system leakage including anticipated releases from the TGSS is included in Chapter 11. The anticipated contamination discharge rates listed in Chapter 11 are based on twice the normal steam and air leakage through the seals to cover wear of labyrinth seals and malfunction of any component of the system. Failure of the TGSS is discussed in Section 15.1.35.

10.4.3.4 Tests and Inspections

The system was tested in accordance with written procedures during the initial testing and operation program, and is readily available for inspection. The system is normally in operation when the plant is operating and thus special tests are not required to ensure operability.

10.4.3.5 Instrumentation Applications

A pressure controller is provided to automatically maintain the gland seal steam supply pressure. In case of high pressure, the steam packing unloading valves bypass excess steam to the main condenser.

During startup or in case of low gland seal steam pressure, the pressure controller signal opens a pressure reducing valve to supply steam from the main steam line. Motor operated valves are provided to permit manual operation of the TGSS in the event the automatic pressure controlled valves malfunction.

Local and remote indicating and alarm devices are provided, as required, for monitoring the system, including the following:

- A. steam seal supply header pressure indication
- B. steam seal supply header pressure high/low alarm
- C. steam packing exhauster vacuum indication
- D. steam packing exhauster vacuum low alarm and automatic starting of second exhauster blower
- E. loss of both exhauster blowers alarm

10.4.4 STEAM DUMP AND BYPASS SYSTEM

The Steam Dump and Bypass System (SDBS) and the Steam Dump and Bypass Control System (SDBCS) (Section 7.7.1.1.5) are non-safety related systems. The principle operational objectives of these two systems are to maintain plant availability, prevent unnecessary opening of the Main Steam Safety Valves (MSSVs) during power operation, and to provide a means of removing excess Nuclear Steam Supply System (NSSS) energy during start-up, hot zero power and cooldown evolutions. These objectives are achieved by the controlled release of steam. Other systems such as the Feed Water Control System (FWCS), Pressurizer Level Control System (PLCS), and the Pressurizer Pressure Control System (PPCS) also contribute to achieving the objectives.

During load reduction transients and other conditions causing an increase in steady-state steam pressure, the SDBS valves are modulated to maintain steam pressure below a programmed value. The modulation speed of the valves is relatively slow (15 to 20 seconds full stroke time) which limits the maximum load changes that can be accommodated by modulation control only. For load reductions of large magnitude or rate, the energy accumulated in the NSSS while the valves are opening may be large enough to cause a reactor trip or the MSSVs to open. To increase system capability, a quick open design feature fully opens the SDBS valves at a faster speed (less than 1 second stroke time) based on the magnitude and rate of change of system load.

Protection against spurious valve opening is provided by incorporating redundant channels for each valve control mode and requiring a demand from both channels for the valves to open. The SDBS has seven valves: 4 atmospheric dump valves (ADVs) and 3 turbine bypass valves (TBVs) that dump to the condenser. The system was originally designed for a capacity of 85 percent. Six valves consisting of the ADVs and two TBVs were originally designed to have a capacity of 13.3% each. As a result of initial startup testing, these valves were determined to have a capacity of 11.5% each. The remaining TBV is described as having a 5% capacity. The change from 13.3% to 11.5% reduced system capacity to 74%.

ARKANSAS NUCLEAR ONE
Unit 2

A design change in the late 1980s resulted in the upstream ADV isolation valves being kept normally closed and deenergized (blocked closed). This reduced the SDBS capacity in the normal configuration by an additional 23% to 51%.

Power uprate did not reduce the capacity of the SDBS system in terms of cubic feet per minute. However, uprate reduces system capacity as a percent of full power from 51% to 49% since it increases the number of electrical megawatts generated.

The analysis of record indicates that at power uprate conditions, the capacity of the ADVs and TBVs varies over a reasonably narrow range since each valve capacity is a function of the upstream pressure at its location. However, the total capacity of the downstream ADVs and the TBVs at power uprate conditions is 49%.

10.4.4.1 Design Bases

Other operational objectives of the SDBS include:

- A. The principle operational objectives of these two systems are to maintain plant availability, prevent unnecessary opening of the Main Steam Safety Valves (MSSVs) during power operation, and provide a means of removing excess Nuclear Steam Supply System (NSSS) energy during startup, hot zero power, and cooldown evolutions.
- B. In the normal configuration with the two upstream ADVs blocked closed (i.e., upstream of the main steam isolation valves), to permit small turbine load rejections of up to 49 percent power without tripping the reactor or opening the MSSVs.
- C. To provide a means of manually controlling reactor coolant temperature during plant normal heatup and cooldown when the condenser is available.
- D. To provide automatic removal of the RCS energy following a unit trip and effect a smooth transition to hot standby conditions.
- E. To automatically control main steam pressure during hot standby. Since the ASME Code main steam safety valves provide the required overpressure protection for the steam generators, that portion of the turbine bypass system located downstream of the main steam isolation valves is designed in accordance with ANSI B31.1.0 Code requirements. Two of the valves in the system are located upstream of the main steam isolation valves and are therefore designed in accordance with the ASME Code, Section III, Class 2.

10.4.4.2 System Description

The SDBS is shown in Figures 10.2-3. The SDBS consists of seven parallel air operated globe valves and associated instruments and controls. Three of these valves bypass directly to the condenser (the turbine bypass valves) and the remaining four dump to the atmosphere. The SDBS control system is described in Section 7.7.1.

Two of the four ADVs are located upstream of the main steam isolation valves. During normal operation, these two ADVs are placed in the "OFF" (closed) position, and the three turbine bypass valves and two downstream atmospheric dump valves are under automatic control of the SDBS. In this configuration, the SDBS has a load rejection capacity of up to 49% power at normal operating steam pressure.

ARKANSAS NUCLEAR ONE
Unit 2

During plant cooldown with off-site power available, one bypass valve is remote manually positioned to remove reactor decay heat, pump heat, and RCS sensible heat to reduce the reactor coolant temperature. Since steam pressure decreases as the system temperature is reduced, bypass valve flow capacity becomes limited at low pressures and additional bypass valves are opened to finish the cooldown at the design rate while shutdown cooling is initiated.

In the absence of off-site power, the two atmospheric dump valves located upstream of the main steam isolation valves may be used to remove reactor decay and sensible heat. The isolation valves for these two upstream ADVs are provided with modulating capability and have motor operators that are controlled from the control room and the MCC. In addition, the valve operators have handwheels that will permit local operation. During normal operations, these ADV isolation valves are administratively kept closed.

The SDBS valves are equipped with handwheels to permit manual operation at the valve location. In addition, the SDBS emergency off/condenser vacuum interlock can be actuated and reset from the remote shutdown panel 2C80. This capability enables the operators to prevent excessive cooldown under certain conditions coincident with control room uninhabitability.

Drains are installed on all 10-inch SDBS valve bodies which are horizontally mounted in the system piping. The remaining 10-inch SDBS valves, which are the two non-safety-grade atmospheric reliefs 2CV-0301 and 2CV-0305, are vertically mounted in the piping system such that they do not require valve body drains.

The valves and piping for the system (except the atmospheric dump valves and their isolation valves) are located in the turbine building to facilitate access to the main condenser.

10.4.4.3 Safety Evaluation

The steam dump and bypass control system is designed so that no single component failure or operator error will result in the opening of more than one valve. The effect of such an event on the RCS has been analyzed; this excess load accident is discussed in Chapter 15. The atmospheric dump valves located upstream of the main steam isolation valves fail open on loss of air and are therefore normally kept isolated. The normally closed isolation valves receive Class 1E power and a back-up MSIS to prevent spurious opening following a main steam line break.

The turbine bypass valves in the SDBS are designed to fail closed to prevent uncontrolled bypass of steam to the condenser. Should the bypass valves fail to open on command, the main steam safety valves provide overpressure protection, and the atmospheric dump valves can provide a means for controlled cooldown of the reactor. The main steam safety valves are described in Section 10.3.2.

Should the condenser not be available as a heat sink, a condenser high pressure signal will prevent the opening of, or will close, the valves which discharge to the condenser; the remaining valves (and the main steam safety valves, if required) control the load transient.

10.4.4.4 Tests and Inspections

Preoperational testing was performed to demonstrate that the system operates to control reactor coolant temperature during turbine load transients.

ARKANSAS NUCLEAR ONE
Unit 2

10.4.5 CIRCULATING WATER SYSTEM

The Circulating Water System (CWS) provides cooling water for removal of heat from the main condenser. The system is schematically shown in Figure 10.4-1. In addition, the system serves as the preferred heat sink for normal reactor cooldown until shutdown cooling is available. However, the system has no safety function.

10.4.5.1 Design Bases

The CWS is designed to supply the cooling water required to remove the heat loads developed in the main condenser and the main circulating water pump motor coolers when the plant is operated at maximum rated load.

The CWS design includes the following subsystems:

- A. cooling tower makeup
- B. cooling tower blowdown
- C. cooling tower de-icing
- D. cooling tower bypass
- E. cooling tower chemical addition
- F. circulating water biocide addition
- G. condenser tube cleaning
- H. circulating water drainage

The CWS components are designed and built in accordance with the following applicable regulations and codes:

- A. The State of Arkansas
- B. American Concrete Institute (ACI)
- C. American Institute of Steel Construction (AISC)
- D. American National Standards Institute (ANSI)
- E. American Society for Testing and Materials (ASTM)
- F. American Society of Civil Engineers (ASCE)
- G. American Society of Mechanical Engineers (ASME)
- H. American Water Works Association (AWWA)
- I. American Welding Society (AWS)
- J. Anti-Friction Bearings Manufacturers Association (AFBMA)
- K. Cooling Tower Institute (CTI)
- L. Expansion Joints Manufacturers Association (EJMA)
- M. Federal Aviation Administration (FAA) Regulations
- N. Department of Labor, Occupational Safety and Health Administration (OSHA)
- O. Hydraulic Institute (HI)
- P. Institute of Electrical & Electronics Engineers (IEEE)
- Q. International Electro-Chemical Commission (IEC)
- R. Manufacturers Standardization Society of Valves & Fittings Industry

ARKANSAS NUCLEAR ONE
Unit 2

- S. National Electrical Manufacturers Association (NEMA)
- T. National Fire Protection Association (NFPA)
- U. Nuclear Energy Property Insurance Association (NEPIA)
- V. Underwriters Laboratories "Master Labeled" Lightning Protection System.

All CWS components are designed to withstand transient conditions and to prevent excessive corrosion due to the concentrated brackish type circulating water.

The structural design of all CWS components allows seismic load of 0.05g.

10.4.5.2 System Description

The CWS consists of the following:

- A. two 50 percent capacity, vertical mixed flow type, circulating pumps (2P3A & B)
- B. one hyperbolic, natural draft cooling tower (2M30)
- C. two 100 percent capacity cooling tower acid pumps (2P54A & B)
- D. one cooling tower acid tank (2T-24)
- E. one condenser tube cleaning system including strainer with motor operated screens, recirculation and reinjection pumps, collectors, and distributors (2M-50)
- F. piping, valves, expansion joints, and instrumentation.

The CWS is a closed loop system with provisions for continuous makeup for water losses and continuous blowdown for chemistry control.

The circulating water pumps are installed in a wet pit type pump structure as part of the closed loop CWS which utilizes a cooling tower installation for heat dissipation. Cooled water from the cooling tower collecting basin is conveyed to the adjacent wet pit of the circulating water pumps through stationary screens. The pumps discharge the circulating water through individual 96-inch pressure pipes. The two 96-inch discharge lines join into one 132-inch line leading to the turbine building. Just before entering the main condenser water boxes, the 132-inch line splits into two 96-inch lines. Warm water discharge through two 96-inch lines from the condenser is conveyed through a single 132-inch pipeline to the natural draft cooling tower and recirculated by the pumps.

In addition, the circulating water pumps supply cooling water to the circulating water motors and dilution water to the sulfuric acid addition mixing tee. The data for the circulating water pumps are given in Table 10.4-2.

The Domestic Water System supplies lubricating water to the circulating water pump bearings and packing glands. On loss of domestic water, a solenoid valve at each pump will open automatically and allow the pump discharge lubricating water to provide the required flow. Renewal of domestic water flow will automatically close the solenoid valves. Each circulating water pump is provided with dual cyclone separators to clean the water injected into the packing gland. Dual sump pumps remove shaft packing gland leakoff water from the circulating water pump casing.

ARKANSAS NUCLEAR ONE
Unit 2

The counterflow type, hyperbolic natural draft cooling tower cools the heated circulating water returning from the main condenser. Design data for the cooling tower are given in Table 10.4-3. Performance data showing the cooling water outlet temperature at various dry bulb air temperatures and relative humidities are also shown in Table 10.4-3.

The cooling tower makeup system provides the water necessary to replace losses due to evaporation, drift and blowdown. The cooling tower makeup is supplied from the Service Water System discharge as described in Section 9.2.1.

The cooling tower blowdown system that discharges to the discharge canal through the existing Unit 1 discharge flume maintains the concentration of the circulating water below the solubility limit of calcium sulfate, thus preventing scale precipitation on the condenser tubes. The cooling tower de-icing system shuts off the water flow to the center portion of the tower during freezing weather operation. The isolation of this portion of the tower reduces the working fill surface while the normal water flow to the tower is maintained. The increased specific water flow over the remaining portion of the tower raises the water temperature, reduces the total air flow and, consequently, prevents ice accumulation over the peripheral sections.

The cooling tower bypass system, which is used during startup and low heat load to the tower in winter, prevents ice formation in the fill by increasing the circulating water temperature.

The cooling tower sulfuric acid addition system maintains an acceptable circulating water pH to prevent formation of calcium carbonate and magnesium hydroxide scales on the condenser tubes. The concentrated acid can be pumped from the acid tank to a mixing tee where it is diluted by water supplied directly from the circulating water pumps discharge or it can be gravity fed to the circulating water pump suction bays.

To assist in system corrosion protection and prevention of calcium carbonate scale, a Calgon additive system may be used. This system consists of bulk tanks, day tanks, electric pumps, and interconnecting piping. The Calgon additive is a mixture which inhibits calcium carbonate deposition by keeping these solids in suspension. The additive mixture is injected as needed to maintain a set concentration. A metal coupons testing program is in progress to monitor effectiveness and to determine the optimal additive concentration in the CWS.

The circulating water biocide addition system controls algae and slime in the CWS. Biocide is supplied by chemical addition equipment at the cooling tower.

The condenser tube cleaning system is a closed loop system. Elastic sponge or abrasive rubber balls are injected into the circulating water flow upstream of the condenser and are forced through the condenser tubes by the natural differential pressure existing between the inlet and the outlet of the condenser. A strainer section with motor operated screens installed in the circulating water pipe downstream of the condenser routes the balls together with a small quantity of water through the recirculation unit back to the condenser inlet pipe.

The circulating water drainage system dewateres the condenser boxes and part of the circulating water pipe through an inline type centrifugal pump.

Isolation valves are provided upstream and downstream of specific equipment to enable maintenance. Metallic bellows type expansion joints are provided upstream and downstream of each condenser waterbox. The 96- and 132-inch diameter steel piping is epoxy lined. Diluted sulfuric acid piping is constructed of carbon steel lined with a suitable polymer. Concentrated sulfuric acid piping is for the most part, constructed of carbon steel; however, some carbon steel plastic-lined pipe or acid resistant metal alloy pipe is also used.

ARKANSAS NUCLEAR ONE
Unit 2

During all modes of power generation, the cooling tower blowdown, makeup, and acid addition systems are operated continuously. The cooling tower blowdown flushing, condenser tube cleaning, and biocide addition systems are operated intermittently as necessary.

10.4.5.3 Safety Evaluation

The CWS is used to supply cooling water to the main condenser to remove residual heat from the reactor coolant during the initial cooling period of plant shutdown when the main steam is bypassed to the condenser. However, if the CWS fails to supply cooling water due to failure of the circulating water pumps, the cooling tower or the circulating water piping, the bypassed main steam cannot be condensed in the main condenser. This is considered a condenser failure and safe shutdown of the reactor in such an event is discussed in Section 10.4.1.

All CWS components including the steel expansion joints are designed for a pressure of 85 psig, the shutoff head of the CWS pumps, and are hydrotested to 128 psig.

The CWS pump discharge valves are motor operated butterfly valves and are programmed to open and close to preclude the possibility of exceeding the CWS design pressure. An abnormal event which will cause a CWS pressure transient is a simultaneous trip of both CWS pumps and a failure of the discharge valve interlock such that both valves are inadvertently closed. In such an event the initial momentum of the circulating water in the forward direction will cause a vacuum to be drawn in the CWS pipe downstream of the discharge valves. The vacuum will be broken by the air vacuum release valves installed in the CWS piping. As the circulating water slows down, stops and starts flowing backwards, the air drawn in when the circulating water was moving forward will be released through the air vacuum release valve, and the controlled release of air will act as a shock absorber to prevent large pressure transients.

In the event a failure occurs to a CWS component inside the turbine building, there is a potential of discharging circulating water into the turbine building basement at a maximum rate of 498,000 gpm (both CWS pumps at runout). [However, in the event of a postulated pipe break or rupture of an expansion joint on the Unit 2 CWS inside the Unit 2 turbine building, sufficient time exists to allow for Operations to respond to the pipe break and trip the Unit 2 CWS pumps 2P-3A/B, thereby preventing the consequential internal flood water level inside the Unit 2 turbine building from reaching El. 354'.](#)

[There are no paths below El. 354' by which this water could enter any safety-related structure. Furthermore, the turbine building sump level indicator and the condenser tubes cleaning system pit level controller have high level alarms which, in conjunction with the circulating water pumps low discharge pressure alarm, will alert the operators to possible CWS leakage.](#)

To prevent degradation of the ESF due to a break in the circulating water pipe, condenser expansion joints or condenser water boxes, all ESF equipment is located in watertight portions of the auxiliary building.

The potential for damage to other plant structures in the event of collapse of the cooling tower is evaluated in Section 2.2.2.

10.4.5.4 Tests and Inspection

Historical data removed, to review the exact wording, please refer to Section 10.4.5.4 of the FSAR.

ARKANSAS NUCLEAR ONE
Unit 2

Operational testing included testing of acid feed components, blowdown system instrumentation and tube cleaning system instrumentation. Operation of the circulating pump lube water and sump level system was tested.

10.4.5.5 Instrumentation Application

The CWS is provided with all necessary instruments and controls to operate the plant safely.

Motor operated butterfly valves are provided at the discharge of each circulating water pump. Each circulating water pump motor starter is interlocked with its respective discharge valve to prevent overloading of the pump motor during startup. Opening and closing of the discharge valves are programmed to protect all CWS components during all modes of operation and hydraulic transients. The circulating water pump discharge valves and condenser inlet and outlet valves are provided with position switches. Indicating lights showing open and closed position of these valves are provided on a control panel.

Circulating water pump sump pumps are operated on level switches. An alarm sounds on high water level.

The bearings and stator of each circulating water pump motor are provided with thermocouple and resistance thermal detectors. Temperature is recorded at each point and an alarm sounds on high temperature.

The discharge pressure of each circulating water pump is logged periodically. An alarm sounds on low and high pressure signals from the pressure switch.

Local pressure and temperature indicators are provided on the discharge of each circulating water pump and the inlet and outlet of each condenser waterbox.

Circulating water temperature is recorded at the inlet and outlet of the condenser waterboxes. Circulating water differential pressure between inlet and outlet condenser waterboxes is recorded.

A level indicating controller is provided in the cooling tower basin. An alarm sounds on high and low level signals from the level switch.

The differential pressure across the stationary screens is measured by a differential level sensor. An alarm sounds on a high pressure signal from a differential pressure switch.

The cooling tower blowdown is controlled by the conductivity level in the circulating water. The control valve opens as conductivity rises. An alarm sounds on a high or low conductivity level signal from the conductivity switch.

Sulfuric acid addition is controlled by the pH of the circulating water. The pH is recorded at either the common discharge of the circulating water pumps or the circulating water return to the cooling tower. The sulfuric acid pumps are interlocked with the acid storage tank level control and dilution water flow. An alarm sounds on a high or low pH from either pH controller and on high and low level signals from the acid tank level switch.

The biocide addition system is either timer actuated or manually controlled.

ARKANSAS NUCLEAR ONE
Unit 2

The cooling tower bypass valve and de-icing gates are manually controlled. Each valve and gate is provided with a position switch. Open and closed indicating lights for these valves and gates are provided in the control room.

The condenser tubes cleaning system is manually operated.

10.4.6 CONDENSATE CLEANUP SYSTEM

Condensate cleanup is accomplished by operation of the Steam Generator Blowdown System (SGBS) in conjunction with the Process Sampling System (PSS) to keep water chemistry within the limits specified in Section 10.3.5. The PSS, described in Section 9.3.2, injects hydrazine, ammonia, and/or an amine for oxygen and pH control via the condensate and feedwater chemical feed system. These chemicals are injected in both condensate streams downstream of the condensate pumps. The SGBS operates as described in Section 10.4.8 to maintain low concentrations of silica (SiO_2), sodium (Na), sulfates (SO_4), and chlorides (Cl) and to minimize the corrosion products of iron and copper. The startup and blowdown demineralizer system, described in Section 10.4.10, processes the blowdown and assists in establishing condensate chemistry values prior to plant startup.

10.4.7 CONDENSATE AND FEEDWATER SYSTEMS

The Condensate and Feedwater System (CFWS), shown in Figures 10.4-2 and 10.4-3, draws water from the condenser hotwells and high pressure feedwater heater drains and pumps it to the steam generators.

10.4.7.1 Design Bases

The CFWS is designed to provide continuous feedwater supply to the two steam generators at the required pressures and temperatures under all anticipated steady state and transient conditions. It has also been designed with the capability to maintain unit operation when the system has to operate under abnormal conditions due to a feed pump, a condensate pump, a heater drain pump, or a heater or string of heaters, being out of service. It can continuously operate at a reduced output with just one train of pumps and low pressure feedwater heaters.

The Emergency Feedwater System (EFWS) supplies feedwater to the steam generators during plant startup, shutdown, hot standby and emergency conditions as described in Section 10.4.9.

The CFWS design includes provisions for automatic isolation of the system from the steam generators when required to mitigate the consequences of a steam line break or certain malfunctions in the CFWS as described in Section 10.4.7.2.

The portion of the feedwater piping from the condenser hotwell suction up to the main feedwater pumps suction is designed and fabricated in accordance with ANSI B31.1.0, and all components are classified Seismic Category 2. The main header piping from the high pressure feed pump discharge nozzles up to the outboard containment isolation valves (main isolation valves) is designed to meet ANSI B31.1.0 and Critical Pipe requirements." Critical piping requirements are discussed in Section 10.3.2. The portion from the main isolation valves (including the valves) up to the steam generators is designed and fabricated in accordance with ASME Code, Section III, Class 2, and meets seismic Category 1 requirements. The feed pumps, condensate pumps, and heater drain pumps are all designed and built in accordance with the Standards of the Hydraulics Institute, ASME Code, and ASTM Standards. All the feedwater heaters are designed and built in accordance with the requirements of the Heat Exchanger Institute Standards for Closed Feedwater Heaters, ASME Code Section VIII, and ASTM Standards.

ARKANSAS NUCLEAR ONE
Unit 2

10.4.7.2 System Description

The CFWS is made up of two interconnected trains, Train A and Train B, consisting of condensate pumps, heater drain pumps, main feedwater pumps and feedwater heaters. The two trains are interconnected at the main suction lines from the condenser hotwells, at the condensate pumps discharge, and at the suction and discharge sides of the main feedwater pumps. The CFWS has the following components:

- A. Four vertical condensate pumps: 2P2A, B, C, and D.
- B. Five stages of low pressure feedwater heaters: 2E7A & B, 2E6A & B, 2E5A & B, 2E4A & B, and 2E3A & B.
- C. Two heater drain pumps: 2P8A & B. Each pump takes suction from its own heater drain tank and discharges into its own stream at the feedwater pump suction.
- D. Two feedwater pumps: 2P1A & B.
- E. Two stages of high pressure feedwater heaters: 2E2A & B, and 2E1A & B.
- F. Piping, control and isolation valves, and instrumentation.

The condensate pumps take suction from the condenser hotwells and discharge the condensate into the two strings of low pressure feedwater heaters to supply the feedwater pumps suction. Condensate pump recirculation valves 2CV-0662 and 2CV-0663 are designed to fail closed.

The heater drain pumps take suction from the heater drain tanks, which are supplied by high pressure feedwater heater drains from heaters 2E1A & B through 2E3A & B and drains from the moisture separator reheater units, and discharge to combine with the main condensate streams at the main feedwater pumps suction.

Heater drain pump recirculation valves 2CV-0719 and 2CV-0725 are pneumatically rather than electrically operated to reduce susceptibility to vibration damage.

The drains from the low pressure feedwater heaters from 2E4A & B through 2E7A & B are cascaded down to the condenser hotwell. To accurately measure the vacuum during low power operation, feedwater heaters 2E5, 6 & 7 are equipped with absolute pressure transmitters for the shell and extraction measurements. The feedwater pumps discharge the heated condensate, via a common header and feedwater control valves, into two independent strings of high pressure feedwater heaters before discharging into the steam generators.

The two trains of feedwater and condensate systems have been furnished with several cross connections to have flexibility and to permit the maximum and most efficient combination of operating pumps and feedwater heaters at all times, including the remote case of single train operation.

During full power operation, three condensate pumps are in operation and the fourth condensate pump is available as a standby. Also, there are two heater drain pumps in operation which take suction from their respective heater drain tanks and feed the heater drain flow into the feedwater lines. There are two feedwater pumps, which take suction from the

ARKANSAS NUCLEAR ONE
Unit 2

common condensate and heater drain pump discharge header and feed the steam generators. The feedwater control system (FWCS) regulates flow to the steam generators (see Section 7.7.1.1.4).

The condensate pumps and the heater drain pumps are vertical, multistage, can-type, constant speed, motor driven centrifugal pumps. The main feedwater pumps are vertically split, single stage, double suction, steam turbine-driven, horizontal centrifugal pumps. Data for the condensate pumps, heater drain pumps, and the main feedwater pumps are shown in Tables 10.4-4, 10.4-5, and 10.4-6, respectively.

The main feedwater pumps are driven by a dual admission type steam turbine with a connection to both the main steam and crossover steam piping. Under normal conditions the turbine drivers are powered by low pressure crossover steam. High pressure main steam is used during startup, low load, or transient conditions when crossover steam is either not available or of insufficient pressure.

The feedwater heaters are U-tube type with integral drain coolers except the 2E3A and 2E3B feedwater heaters which have no drain cooling sections. The 2E6A, 2E6B, 2E7A and 2E7B feedwater heaters are installed in the condenser necks.

The main feedwater lines just before the containment building penetrations and the crossover piping between the feedwater pumps' suction are furnished with motor operated control valves. Manually operated valves are provided at the suction and discharge side of each pump and at appropriate points in the feedwater trains as required for isolation of a feedwater heater or string of feedwater heaters. Air operated feedwater control valves (2CV-0748 and 2CV-0740) with their corresponding bypass valves (2CV-0753 and 2CV-0744, respectively) are provided downstream of the main feedwater pumps just after the discharge cross-tie piping, and just upstream of the high pressure heaters. At a location outside the containment between the feedwater control valves and the main feedwater isolation valves, a backup main feedwater isolation valve was added in each train. The two motor-operated main feedwater isolation valves, 2CV-1024-1 and 2CV-1074-1, the two motor-operated main feedwater isolation valves, 2CV-1023-2 and 2CV-1073-2, and the two check valves downstream of the containment penetrations are Seismic Category 1 valves. The emergency feedwater line for each steam generator joins the main feedwater lines to the steam generators inside the containment, just downstream of the main feedwater line check valves. The emergency feedwater lines are similarly furnished with Seismic Category 1 motor operated control valves located just outside of the containment and two Seismic Category 1 check valves located inside the containment. The motor operated control valves are further described in Section 10.4.9.2.1.

During normal plant operation, when the plant load output is less than 50 percent of rated load, and with maximum availability of pumps and feedwater heaters, there may be two condensate pumps, two main feedwater pumps, and one heater drain pump running in the two feedwater trains. At over 50 percent load output, two or three condensate pumps, two main feedwater pumps and two heater drain pumps may be running in the two trains. When more than one heater drain pump is out of service, approximately 80 percent feedwater flow can be supplied by the system, but plant power will be less than 80 percent due to reduced feedwater temperature supplied in the steam generators. With one heater drain pump out of service, 100 percent feedwater flow may be supplied by the system, but the heater drain pump in service may be subject to cavitation.

ARKANSAS NUCLEAR ONE
Unit 2

The main feedwater pumps are tripped automatically on any of the following trip signals:

- A. Channel One or Two Main Steam Isolation Signal (MSIS)
- B. Channel One or Two Containment Spray Actuation Signal (CSAS)
- C. high pressure feedwater heaters outlet pressure high and main feedwater pump discharge pressure high
- D. low pump suction pressure
- E. low pump flow (may be bypassed)
- F. low lube oil pressure
- G. pump turbine driver overspeed
- H. turbine driver exhaust pressure high
- I. thrust bearing wear.

The main feedwater pump for which the preferred trip selector switch is positioned will trip when the main turbine trips. The active feedwater pump which remains running after a turbine trip will be accelerated to match the demand of the steam generators to prevent a reactor trip. After a reactor trip without an MSIS or CSAS, the feedwater pump will be run at minimum speed to provide inventory for steam generator level control.

The two steam generators are operated in parallel with each generator's Feedwater Control System (FWCS) maintaining its downcomer water level within acceptable limits. The FWCS for each steam generator consists of a low power mode and a high power mode. In the low power mode, the FWCS operates as a single element control system based on steam generator level. In the high power mode, the FWCS operates as a three-element control system based on steam generator level, feedwater flow, and main steam flow. The FWCS program logic develops a flow demand which controls the main and bypass control valves and feedwater pump speed to maintain steam generator levels at the desired setpoint.

After termination of forced flow, the CFWS is isolated from the steam generators by closing the main feedwater valves, 2CV-1024-1 and 2CV-1074-1, and the redundant main feedwater isolation valves, 2CV-1023-2 and 2CV-1073-2, upon an MSIS or CSAS from either channel. The signal to close the isolation valves will also trip the feedwater pump turbine drivers to prevent shutoff head pressure operation on the high pressure feedwater heaters.

The Feedwater Control System (FWCS) is described in Section 7.7.1.1.4. The Emergency Feedwater Actuation Signal (EFAS) and feedwater isolation by the Main Steam Isolation System (MSIS) are described in Section 7.3. Section 7.7.1.7 contains a description of the Diverse Emergency Feedwater Actuation System (DEFAS).

An automatic system was originally provided to maintain the total water volume in the CFWS through makeup and return of condensate to the condensate storage tank by means of control valves 2CV-0634 (the makeup valve) and 2CV-0633 and 2CV-0632 (the reject valves). This method was unsatisfactory and is no longer used. The hotwell level is now controlled manually.

ARKANSAS NUCLEAR ONE
Unit 2

The system water quality is maintained through the injection of hydrazine and ammonia and/or amine into the condensate. Ammonia and/or amine and hydrazine injection is controlled by pH and dissolved oxygen controllers which continually monitor a sample flow from the system. The condensate and feedwater chemical feed system is shown in Figure 10.2-3.

A condensate system fill connection is provided in the existing cross connect line between condensate storage tanks 2T-41A & B and T-41. The three-inch fill connection line consists of a manual gate valve and a check valve to prevent drainage of the condensate storage tanks in the event of a line break in vendor equipment providing demineralized makeup.

10.4.7.3 Design Evaluation

The CFWS has been designed with ample margin to ensure that the loss of a single component, such as when one feedwater pump is out of service, or when one of the two trains of low pressure feedwater heaters has been isolated, the system can still safely operate at a reduced unit output. The loss of one of the four condensate pumps does not reduce the system capability to maintain feedwater supply for 100 percent load. The loss of one or both heater drain pumps still permits safe and continuous operation at reduced unit output.

The Seismic Category 2 portion of the CFWS, including the condensate pumps, low pressure and high pressure feedwater heaters, the main feedwater pumps and the main feedwater piping up to the motor-operated isolation valves, is not essential for safe shutdown of the plant. In the event of failure of both main feedwater pumps, the emergency feedwater pumps will be started and will supply water for safe shutdown of the plant. If there is a break in the Seismic Category piping of the condensate and feedwater piping, the steam generator level will fall. Low level in the steam generator will trip the reactor which will also trip the main turbine generator unit and cause one main feedwater pump to trip.

Feedwater line isolation limits the blowdown energy release and the magnitude of RCS cooldown in case of a main steam line break. To assure isolation of the steam generators from CFWS after an MSIS or CSAS, two separate control channels are provided. A signal from either channel will cause closure of the isolation or backup valves as described previously.

System transients initiated by or resulting in a reactor trip can cause uncovering of the feedwater feeding in the steam generator or the steam generator feedwater inlet nozzles. This potentially allows steam to enter portions of the feedwater piping and can result in transmission of pressure waves through the piping. Operating experience at similar plants, particularly the water hammer event at Indian Point 2 on November 13, 1973, shows that such pressure waves can damage the feedwater piping. To reduce the possibility of steam bubble formation in the feeding and feedwater piping during normal operating transients, the following design provisions are incorporated in Unit 2:

- A. The routing of the main feedwater piping external to the steam generator minimizes the horizontal piping volume at the inlet to the steam generator that could pocket steam, thereby minimizing the potential for water hammer in the feedwater piping and steam generator feeding;
- B. The steam generator feeding design incorporates provisions that minimize the potential for water hammer. The steam generator feeding is elevated above the feedwater inlet nozzle to minimize the horizontal volume at the feedwater nozzle. The feeding incorporates top discharge inverted J-nozzles that terminate above the

ARKANSAS NUCLEAR ONE
Unit 2

feeding but remain open to the downcomer annulus at that elevation. The feeding design also incorporates a thermal liner that is welded to the feedwater nozzle forging to form a positive seal. If water falls below the feeding due to a system transient, these design features eliminate potential leak paths within the steam generator through which water can drain from the feeding unless it drains back into the feedwater system. They also prevent the formation of a steam pocket in the feeding. Tests performed on steam generators with similar feeding designs have indicated that this feeding design is effective in preventing water hammer.

Samples of the condensate and feedwater are taken from the condenser hotwells, condensate pump discharge, feedwater line to the steam generators and steam generator blowdown lines. The heater drains are also sampled at a point immediately downstream of the pump discharge flanges and upstream of the minimum flow recirculation lines. As described in Section 9.3.2, process sampling system, the samples are analyzed to control the quality of the condensate and feedwater. Samples from the steam generator blowdown lines are also analyzed to detect radioactivity.

During normal operation, condensate and feedwater contain no significant radioactive contaminants. However, in the event of primary-to-secondary system leakage due to a steam generator tube leak, it is possible for the CFWS to become radioactively contaminated. A full discussion of the radiological aspects of primary-to-secondary leakage, including anticipated operating concentrations of radioactive contaminants, means of detection of radioactive contamination, anticipated releases to the environment and limiting conditions for operation, is included in Section 11.4.

10.4.7.4 Tests and Inspection

Historical data removed, to review the exact wording, please refer to Section 10.4.7.4 of the FSAR.

All of the components of the system will be continually monitored during operation to ensure satisfactory operation.

10.4.7.5 Instrumentation Applications

A flow element with a flow transmitter is installed at the suction of each main feedwater pump. Flow signals are transmitted to 1) a flow switch which sounds an alarm at low flow and trips the feedwater pump turbine driver on low-low flow (this trip may be bypassed), 2) a flow indicating controller which activates and modulates the feedwater recirculation valve to ensure minimum safe flow through the feedwater pump, 3) a condensate recirculation flow controller, which sums feedwater pump suction flow with condensate recirculation flow minus heater drain pump discharge flow (measured to indicate condensate pump flow), and 4) a flow summer which combines both feedwater pump flows. This summer determines the operation of the heater drain pumps and the third running condensate pump. On low-low condensate recirculation flow, the flow controller actuates the condensate pump recirculation valves.

Pressure switches are furnished at the suction and discharge of each feedwater pump. The pressure switch for pump suction pressure starts a standby condensate pump on low suction pressure. Other pressure switches trip the turbine driver on low-low suction pressure to the feedwater pump (2-out-of-3). Pressure switches on the discharge side open the feedwater recirculation valve on high pressure (2-out-of-3). Pressure transmitters, located downstream of

ARKANSAS NUCLEAR ONE
Unit 2

the high pressure feedwater heaters 2E1A and 2E1B, provide trip signals to the main feedwater pumps on high pressure to protect the high pressure heater trains from overpressure. These trip signals are combined with signals from the pressure switches that open the feedwater recirculation valves on high discharge pressure to trip the turbine drivers. Control room indication is also provided by signals from these pressure transmitters. Other pressure transmitters are installed at the feedwater pump discharge to provide control room indication. Flow elements, furnished with flow transmitters, provide flow signals to their respective 3-element feedwater control system.

In order to protect the low pressure feedwater heaters, pressure switches are installed at the discharge of each condensate pump to trip the pump on high condensate pump discharge pressure. Also each condensate pump start switch is interlocked with the suction butterfly valve position indicator to avoid starting of a condensate pump with a closed suction valve.

The heater drain pumps can be started only when there is sufficient water in the heater drain tanks. The pumps trip on low suction level or high differential pressure across the pump. In order to ensure sufficient NPSH, the water level in the heater drain tank is maintained at a minimum level by heater drain pump recirculation valves.

The CFWS is furnished with necessary instrumentation at appropriate locations for monitoring flow, pressures and temperatures.

10.4.8 STEAM GENERATOR BLOWDOWN SYSTEM

The Steam Generator Blowdown System (SGBS), shown in Figure 10.2-3, is used in conjunction with the chemical feed system and the process sampling system to control the chemical composition of water in the steam generator shell within the specified limits.

The SGBS, with the exception of the blowdown piping from the steam generators to the containment isolation valves, has no safety-related function.

10.4.8.1 Design Bases

The SGBS is designed to fulfill the following requirements:

- A. to maintain the steam generator shell side water chemistry within the conditions shown in Procedure 1000.043, "Steam Generator Water Chemistry Monitoring Unit II".
- B. to provide a continuous blowdown for each steam generator under normal plant operating conditions to maintain steam generator water chemistry.
- C. to permit a maximum blowdown rate for each steam generator under abnormal plant operating conditions.
- D. to direct the blowdown to the startup and blowdown demineralizers for treatment and/or discharge.

The part of the SGBS from the steam generators to and including the air-operated containment isolation valves comprises an extension of the steam generator boundary. This portion of the system has been designed in accordance with Seismic Category requirements. The remainder of the system is Seismic Category 2, and has been designed in accordance with ANSI B31.1.0.

ARKANSAS NUCLEAR ONE
Unit 2

On the basis of existing data and anticipated operating conditions, an analysis has been performed on the steam generator blowdown activity levels and chemical concentrations for a failed fuel fraction of 0.25 and 1.0 percent and steam generator primary-to-secondary leak rate of 13 and 100 gpd, respectively.

The steam generator blowdown tank has been designed in accordance with ASME Code Section VIII requirements. The steam generator blowdown pumps and motors have been designed and constructed in accordance with the requirements of ASME, ANSI, ASTM, Hydraulic Institute, NEMA and IEEE standards. The SGBS is designed for adequate capacity. The tank is normally vented to the high pressure condenser and the blowdown is directed to the startup and blowdown demineralizer system. When processing and recovery of steam generator blowdown via the startup and blowdown demineralizer system is not desired, blowdown may be diverted directly to the regenerative waste tanks or discharged directly to the circulating water flume if water chemistry and radioactivity levels permit. The components of the SGBS are located outside the containment; the blowdown tank and the tank drain pumps are located in the controlled area of the auxiliary building.

10.4.8.2 System Design

10.4.8.2.1 General Description

The SGBS consists of the following components:

- A. one steam generator blowdown tank (2T67)
- B. two steam generator blowdown pumps (2P139A, B)
- C. two steam generator blowdown control valves 2CV-1017 and 2CV-1067
- D. piping, flow elements, control isolation valves, and instrumentation.

Table 10.4-8 shows the physical data for the SGBS tank, Table 10.4-9 shows the data for the pumps.

There are two blowdown lines, one coming from the bottom of the shell side of each steam generator. Each blowdown line has a connection which leads to the sampling systems, one motor operated steam generator isolation valve located inside the containment, one pneumatically operated steam generator isolation valve located just outside the containment, one flow element, and a blowdown control valve. Each blowdown line leaves the containment through its own penetration and discharges into the steam generator blowdown tank. The motor operated and the air operated containment isolation valves are both normally open and can be manually operated from the control room. The air operated valve automatically closes upon receipt of a Main Steam Isolation Signal (MSIS).

The flow element is furnished with a flow transmitter and transmits blowdown flow rate to the control room.

The blowdown control valve, directly installed on the blowdown tank, drops the pressure from steam generator pressure to approximately condenser pressure. It is furnished with a pneumatic operator and can be operated by a hand indicating controller in the control room to regulate blowdown rate.

ARKANSAS NUCLEAR ONE
Unit 2

The steam generator blowdown tank (2T67) is normally vented to the high pressure condenser by means of a 12-inch diameter vent line. This vent causes the blowdown to flash into condenser low pressure, resulting in a low effluent temperature, and permitting continuous processing of the blowdown by the startup and blowdown demineralizer system. Replaceable stainless steel mesh entrainment separators installed inside the tank prevent solid particulates and liquid carry over in the flash steam. Water level sensors monitor the level in the tank and generate signals to automatically start, or stop, operation of the blowdown tank drain pumps and modulate the level control valve.

The two steam generator blowdown tank drain pumps, 2P139A & B, are located in the controlled area and are installed 20 feet below the drain tank to ensure adequate NPSH. These pumps are furnished with mechanical seals to provide zero leakage of the blowdown liquid into the surroundings. The pumps are manually controlled from the control room. In addition, they are furnished with automatic switches, working from preset blowdown tank water levels, to start one pump on high level, and the other pump on high-high level. Both pumps stop on low level. The pumps are set to operate alternately by an alternating controller.

10.4.8.2.2 System Operation

The steam generator blowdown rate is determined by the results of the steam generator shell water sample analyses. During normal plant operation with zero condenser and steam generator primary-to-secondary leakage, the steam generator will require very little blowdown. A nominal blowdown rate is required to maintain steam generator water chemistry.

Should water sample analysis indicate abnormal secondary system chemistry due to condenser and/or primary-to-secondary steam generator tube leakage, the blowdown can be increased as necessary to control the chemistry.

During normal operation, all liquid not flashed to steam in the blowdown tank is pumped to the startup and blowdown demineralizer system regardless of the radioactivity levels in the fluid. If blowdown water quality makes recovery undesirable, blowdown may be diverted to the regenerative waste tanks for holdup and treatment, or discharged directly to the circulating water flume if water chemistry and radioactivity levels permit. To prevent flashing in the blowdown pump suction piping during system operation, condensate is injected into the steam generator blowdown drain line.

The flashed steam effluent that is vented into the condenser is practically clear vapor because of the filtering effect of the entrainment separators in the tank. Any gaseous radioactivity in the tank will be detected by the radiation monitors installed in the discharge lines of the condenser vacuum pumps. The gases carried through the condenser vacuum system to the auxiliary building vent system are processed through HEPA and charcoal filters before being discharged to the atmosphere. Of the total blowdown, at full power, about 35 percent by weight is flash steam.

10.4.8.3 Design Evaluation

Although the SGBS is designed to process potentially radioactive fluids, no release path to the environment for any such radioactivity is available in this system. The monitoring and controlling of radioactive fluids originating in the SGBS is described in Sections 10.4.2.3, 10.4.10 and 11.2.2.3.

ARKANSAS NUCLEAR ONE
Unit 2

The SGBS has no safety-related function, with the exception of the piping from the steam generators to and including the containment isolation valves. These valves and piping constitute an integral part of the steam generator boundary and are discussed in Section 6.2.4. Failure of any component in the system would compromise the system operation but would not affect the safe shutdown of the plant.

The blowdown and sample lines and valves inside the containment are protected from missiles generated by the RCS to avoid any intereffect between a postulated LOCA and blowdown sample line integrity.

The containment isolation valves located outside containment in each blowdown line receive redundant MSIS from separate channels to ensure that the single failure criterion is met.

10.4.8.4 Test and Inspection

Historical data removed; see Section 10.4.8.4 of the FSAR.

10.4.8.5 Instrumentation Applications

Rate of blowdown, steam generator blowdown tank pressure and level are monitored and transmitted to the control room.

10.4.9 EMERGENCY FEEDWATER SYSTEM

10.4.9.1 Design Bases

- A. The EFWS is designed to provide means of supplying water to the intact steam generator(s) following a postulated main steam line rupture or loss of main feedwater to remove reactor decay heat and provide for cooldown of the RCS to within the temperature and pressure at which the shutdown cooling (SDC) system can be placed in operation (see Section 9.3.6 for the SDC System description). Redundancy of components is provided to guarantee operation in the event of a single failure of a mechanical or electrical component within the system. The EFW System meets the redundant parallel flow path (piping and valves) requirements of recommendation GL-2 in NUREG-0635, pages X-51. Redundancy of power supplies is also provided to meet the diversity requirement of NRC branch technical position APCSB 10-1. All electrically operated components associated with the turbine driven pump train receive Channel 2 DC power except the isolation valves 2CV-1037 and 2CV-1039, which receive Channel 1 DC power. Channel 1 AC power is provided to all active components in the motor driven pump train except the isolation valves 2CV-1036 and 2CV-1038, which receive channel 2 AC power.
- B. The auxiliary feedwater pump in the EFW System is designed to supply condensate to the steam generators during plant startup, hot standby, hot shutdown, and normal cooldown and operates in conjunction with the main steam system to maintain steam generator level.
- C. The EFW System is designed to remain functional after a DBE. The components of the EFW System are designed to meet Seismic Category 1 requirements and ASME Code Section III, Class 3 requirements except for the suction lines from the

ARKANSAS NUCLEAR ONE
Unit 2

condensate storage tanks (2T41A and B) and the startup and blowdown demineralizer, the EFW pump turbine exhaust, and the flush and recirculation lines downstream of the first isolation valves, and auxiliary feedwater pump, suction, and discharge piping (up to the first check valve). The isolation valves 2CV-1036, 1037, 1038 and 1039 and piping downstream are designed to meet ASME Section III, Class 2 and Seismic Category 1 requirements. The EFW pump turbine exhaust piping is ANSI B31.1.0 class and has been analyzed to withstand DBE seismic loads.

- D. The suction piping of the auxiliary feedwater pump and the discharge piping from the AFW pump discharge nozzle to the main feedwater line and to the first check valve on the two 4" branch lines connected to the EFW pumps' discharge lines are designed and fabricated in accordance with ANSI B31.1.

10.4.9.2 System Description

10.4.9.2.1 General Description

The EFWS is shown in Figure 10.2-4. The system employs two safety related pumps (turbine driven and motor driven) with two independent feedwater trains, each capable of supplying either of the two steam generators, and a non-safety related pump whose discharge line is interconnected to each of the safety-related EFW pump's discharge line and to the main feedwater discharge line. Data for the pumps and their drivers are given in Table 10.4-10 and 10.4-10A.

The EFWS piping and valving arrangement, shown in Figure 10.2-4, is designed to ensure the capability of supplying cooling water to the Steam Generators during emergency conditions, as well as other applicable normal operating modes.

The EFWS is designed so the non-safety auxiliary feedwater pump (2P75) may be used to supply water to the steam generators during non-emergency conditions to avoid challenging the safety related EFW pumps. The auxiliary feedwater pump is capable of supplying sufficient water to the steam generators for heat load of approximately 4% of full NSSS power at maximum steam generator pressure.

During an emergency condition, the safety-related EFW pumps (2P7A and 2P7B) are designed to automatically supply water to the steam generators upon the actuation of an EFAS signal or a DEFAS signal. In addition, in the unlikely failure of both safety related EFW pumps during an emergency condition, the auxiliary feedwater pump can be manually actuated to supply water to the steam generators.

The safety-related EFW pumps are identical. Each pump is capable of providing sufficient water to the steam generators to mitigate the consequences of design bases accident conditions. The pumps are horizontal, multi-stage pumps with horizontally split cases, using double volutes at each stage and impellers arranged in opposed groups for hydraulic balancing.

The steam turbine driver (for 2P7A) is a single stage, solid wheel, non-condensing, horizontal, split case unit. It is designed for variable speed operation and is equipped with an electrohydraulic actuator for speed control, an overspeed trip mechanism, and an integral trip throttle valve. It is designed for rapid starting and will operate with steam generator pressures ranging from 1,100 psia to 60 psia. Steam can be supplied to the turbine driver from either or both steam headers. The turbine exhausts to the atmosphere. Cooling water for the turbine oil

ARKANSAS NUCLEAR ONE
Unit 2

cooler is piped from the pump suction line rather than from the pump recirculation line. This is because the pressure available at the suction provides adequate cooling water flow through the cooler.

The electric motor driver for 2P7B is designed to NEMA Class B standards for normal starting torque and low starting current at full voltage. It is capable of accelerating the pump within 4.5 seconds with 80 percent voltage and within 2.4 seconds at full voltage. The motor can be powered from normal, preferred, or emergency power sources.

The electric motor driver for non-safety auxiliary feedwater pump 2P75 is designed to NEMA Class B Standards. It is rated at 1,000HP, 4,000V, and 3,600rpm with a service factor of 1.0. The motor is designed to be powered from the Non-ESF Bus 2A1.

During shutdown and startup with power below ten percent, the AFW pump will be aligned to the startup and blowdown demineralizer effluent for feeding the Steam Generators. Above ten percent power, the AFW suction is shifted to the condensate storage tanks and the startup and blowdown demineralizer source is isolated by closing valve 2EFW-0706, which is then verified to be closed once per shift (2CAN058003), 2CAN078019, 2CAN088506). Valve 2EFW-0706 is normally locked closed under normal conditions at greater than or equal to ten percent power.

The two redundant and independent 6-inch SWS lines provide an assured source of water in the case of failure of the Seismic Category 2 condensate supply line. The condensate supply line is furnished with two motor operated isolation valves, 2CV-0795 and 2CV-0789, and two pressure switches, 2PIS-0795 and 2PIS-0789. The service water lines are each provided with a non-return check valve and motor operated isolation valves, 2CV-0711 and 2CV-0716. The normal pressure in the condensate line is about 20 psig. If the pressure drops to 7 psig, a control room alarm will be actuated. If the pressure drops to 5 psig when an emergency feedwater actuation signal is present, the pressure switches will automatically close the condensate line isolation valves 2CV-0795 and 2CV-0789 and will simultaneously open the SWS valves 2CV-0711 and 2CV-0716.

The preferred method of feeding the steam generators during non-emergency conditions is by means of the auxiliary feedwater pump. The discharge line of the auxiliary feedwater pump is connected to each of the safety-related EFW pump's discharge lines and to the main feedwater discharge line to provide alternate flow paths to the steam generators.

Each branch line to the EFW pump's discharge lines is furnished with a control valve to modulate the pump flow and two series check valves to isolate the safety-related EFW train from the non-safety auxiliary feedwater train.

The branch line to the main feedwater line is provided with a flow control valve for modulation and a check valve to protect the EFW piping from the main feedwater backflow of high operating temperatures.

Each discharge stream of the motor driven EFW pump discharge piping system is furnished with a flushing line which connects to a common header that discharges to the startup and blowdown demineralizer system. Means are also provided by cross-connecting pipe and normally closed block valves for flushing the turbine driven pump discharge piping system. These flushing lines are provided in order to meet feedwater quality requirements. An air operated valve is furnished for each flush line which is automatically closed if emergency operation of the EFWS is initiated.

ARKANSAS NUCLEAR ONE
Unit 2

Manual valves 2EFW-11B and 2EFW-11C are installed between the EFW discharge and 2CV-0798-1. These manual valves are used to provide EFW system isolation from the test/flush line. Although 2CV-0798-1 closes automatically on EFAS, 2EFW-11B and 2EFW-11C are credited with providing isolation for this line.

A pump minimum flow recirculation line is provided from each EFW pump discharge bypassing the air operated flush valves. Each minimum flow line is provided with an orifice and a globe valve for limiting and regulating the flow while providing a normally open flow path to ensure that each pump has a minimum flow of 45 gpm. The auxiliary feedwater pump discharge line includes the automatic recirculation control valve (2EFW-25) that will provide the minimum recirculation flow of approximately 125 gpm during the low load pump operation. This valve (2EFW-25) is essentially a check valve with built in pressure reducing and flow sensing devices that actuate the pilot for the bypass control valves, which permits the passage of limited flows during AFW pump low flow operation. ER 2002-0359-000 adjusted the pilot valve to permit a continuous recirculation flow to prevent water hammer.

The safety related EFW pumps, EFWS discharge piping and valving arrangement is designed to allow either pump to supply water to either or both steam generators. Each supply line to each steam generator is provided with redundant series connected valves, in accordance with the single failure criterion, to ensure isolation of the steam generators and feeding of the remaining intact steam generator(s) as required during an EFAS operation of the emergency feedwater system following a postulated main steam or feedwater line break. The steam supply line feeding the steam turbine driver, shown in Figure 10.2-3, provides an assured source of steam to the turbine, from both or either steam generator, even when the main steam isolation valves are closed. To minimize thermal and steam shock on the turbine and piping, the isolation valves 2CV-1000 and 2CV-1050 are normally open. When an EFAS signal is received, the motor-operated bypass valve and the turbine cooling water solenoid valve will open, and the turbine will reach idle speed allowing the turbine governor hydraulic system to pressurize. Fifteen seconds later, the main steam valve 2CV-0340-2 will open, the motor-operated bypass valve will close, and the turbine will come up to normal speed.

In 1983 a commitment was made in response to 10CFR50.49 which required replacement of the EFWS isolation valves 2CV-1036, 1037, 1038 and 1039. Suitable environmentally qualified ball valves with fail closed actuators similar to the existing valves could not be acquired. Therefore motor operated gate valves were installed with operating times and flow performance specified to be at least as good as the original units. Since the MOVs are fail-as-is components the single failure analysis (Table 10.4-11) was modified. Resulting requirements of the modified analysis were: 1) the turbine driven pump train isolation valves, 2CV-1037 and 2CV-1039, would receive channel 1 DC power and safety initiation circuits, and the motor driven pump train isolation valves, 2CV-1036 and 2CV-1038, would receive channel 2 AC power and safety initiation circuits; and 2) all of the isolation valves would be kept normally open during non-ESF operation when the EFWS is required to be operable. Human factors concerns dictated that the control switches for these valves be kept in their existing locations in ESF control panels 2C16 and 2C17 near the controls and indication for their associated equipment trains. This use of redundant channel power and devices in each panel required special barrier enclosures for these control switches, and the routing of their cables in metal flex conduit from the point of entry into the panel to the switch enclosures, in order to comply with the separation criteria in effect for ANO-2.

ARKANSAS NUCLEAR ONE
Unit 2

A description of Class 1E systems provided for the plant and the criterion with regard to redundancy and separation for these systems are given in Chapter 8. Electrical power to valves 2CV-1025-1 and 2CV-1075-1 is supplied (via transformer) from ESF Bus 2A3, to valves 2CV-1026-2 and 2CV-1076-2 from DC ESF Bus 2D02, to Valves 2CV-1036-2 and 2CV-1038-2 by ESF Bus 2B6, and to Valves 2CV-1037-1 and 2CV-1039-1 by 125V DC ESF Bus 2D01.

The electrical power to control MOVs 2CV-0760, 2CV-0761, and 2CV-0762 for the non-safety auxiliary feedwater pump discharge flow is supplied from non-ESF Bus 2B1.

The EFWS is provided with necessary control for automatic or manual operation of the system. The controls are in the main control room. All controls and control signals for the steam turbine driven pump and the electric motor driven pump are channelized. Physical separation between the electrical components of this system is provided in accordance with IEEE 279-1971, "Standard Criteria for Protection Systems for Nuclear Power Generating Stations."

10.4.9.2.2 System Operation

The EFWS operations discussed below include normal plant operation, emergency operation, and operation of the EFWS during plant startup, hot standby, hot shutdown, and normal plant cooldown.

During normal plant operation, the EFWS is not required to operate. However, the EFWS will automatically start and operate upon an EFAS or a DEFAS. The situations causing automatic operation of the EFWS are indicated in Section 7.3.1.1.11.8; DEFAS is discussed in Section 7.7.1.7.

When an EFAS is received by the EFWS, both pumps 2P7A and 2P7B will start and provide water to the steam generators as required by level control. Simultaneously, all valves in the discharge lines will open. However, if a steam generator isolation is required, as in the case of a postulated main steam line break, the EFAS will open only the valves leading to the intact steam generator and close the valves leading to the isolated steam generator. A combination of measured variables (level and pressure) for each steam generator are used to determine which generator(s) are intact (see Section 7.3.1.1.11.8). The system logic will then open only the emergency feedwater valves to the intact generator(s) with an EFAS. The valves to a generator that is not intact will not receive an EFAS and will therefore be closed. Should one of these valves receive a spurious signal to open to a generator which is not intact, the other valve in series will be closed precluding feeding of the generator.

If condensate supply pressure falls to 7 psig, an alarm will sound. If pressure falls to 5 psig, with an emergency feedwater actuation signal present, the pressure switches in the condensate supply line will close the condensate line isolation valves and will simultaneously open the SWS supply valves.

The above events will occur without any operator action. The operator can subsequently secure one of the EFW pumps since one pump alone has sufficient capacity to provide the required flow.

ARKANSAS NUCLEAR ONE
Unit 2

The preferred water source for emergency feedwater is condensate; therefore, the system is normally aligned to supply condensate from the condensate storage tanks. In the event of a complete loss of AC power, valve 2CV-0711-2 would not be required to open from its normally closed position because: 1) condensate is preferred and available, and 2) service water would not be available even if 2CV-0711-2 were opened as no AC power would be available to the service water pumps.

If emergency feedwater suction were pulled from service water and a loss of AC power occurred, service water would be lost, necessitating a change to condensate feed. If valve 2CV-0711-2 were AC, it could not close to complete the interlock logic with valve 2CV-0795-2 and allow that valve to open. However, since condensate is the preferred emergency feedwater source, the fact that service water was being used would indicate that no condensate was available. Therefore, operation of the valves would not supply a source of emergency feedwater.

The above discussion shows that valve 2CV-0711-2 could be AC powered and still meet the power supply diversity requirement of NRC Branch Technical Position APCSB 10-1. However, to simplify the connection of interlocks between 2CV-0711-2 and 2CV-0795-2, both valves are equipped with DC operators.

During plant startup, hot standby, hot shutdown, and normal plant cooldown, the auxiliary feedwater pump is the preferred source of feedwater. The AFW pump is manually started and is under operator control. The operator maintains the proper flow to the steam generators by means of control valves 2CV-0760, 2CV-0761, 2CV-1075-1 and 2CV-1025-1 when the flow path is through the interconnected safety related EFW pumps discharge lines or the feedwater control valves 2CV-0744 and 2CV-0753 when the flow path is through the interconnected main feedwater lines. When the AFW system is automatically controlled by the FWCS, the proper flow for steam generator level control is by way of 2CV-0744 and 2CV-0753 through the feedwater lines.

During plant startup, the auxiliary feedwater pump is normally used until sufficient steam is available to run the main feedwater pump turbine drivers and the condensate and feedwater system is placed in operation.

During hot standby and hot shutdown, the auxiliary feedwater pump is normally used to maintain steam generator level. The average feedwater flow requirement in this case is about 320 gpm, which is within the rated capacity of the auxiliary feedwater pump (1000 gpm).

During cooldown, the auxiliary feedwater pump is normally used to maintain steam generator level during decay heat removal operation until the RCS temperature is brought down to about < 275 °F, at which point decay heat removal is switched over to the Shutdown Cooling (SDC) System. The operation of the EFWS in this mode lasts about 3.4 hours at an average flow of 510 gpm.

10.4.9.3 Safety Evaluation

The EFWS provides a means of supplying emergency makeup to the steam generators for reactor decay heat removal. Redundancy of components is provided to ensure proper functioning, even in the event of a single component failure within the system. Fail-as-is motor operated gate valves with appropriately diverse power sources and redundant safety channelization are provided to ensure positive isolation when required. Each component is designed to provide 100 percent feedwater capacity for safe cooldown of the RCS.

ARKANSAS NUCLEAR ONE
Unit 2

The design basis minimum flow requirement for the emergency feedwater pumps is that each pump must be capable of delivering sufficient emergency feedwater to the steam generators to preserve their function as a secondary heat sink for normal shutdowns. The pump must also provide sufficient feedwater in combination with pressurizer sprays or the RCS safety valves to preclude over pressurization of the RCS for feedwater line break accidents. For normal operating conditions, the emergency feedwater pump capacity will ensure adequate flow to maintain steam generator water level and primary to secondary heat transfer. For normal operating conditions the evaluation of pump capacity is based on the pump rated flow data rather than the design basis minimum flow used in the accident analyses. Based on the manufacturer's head curves, and assuming nominal hot standby steam generator pressure control at 985 psig, and an allowance of 100 psi for line losses, each pump will provide about 615 gpm to the steam generators. This is sufficient flow to remove decay heat equivalent to 2.74% full power, and the heat from four reactor coolant pumps. Based on the ANS/ANSI 5.1-1979 decay heat curve, the decay energy generation rate falls below 2.74% within approximately 320 seconds and is approximately 2.4% 10 minutes following a reactor trip from full power. While this evaluation does not consider uncertainties such as pump degradation, it does demonstrate that for normal operations, the design capacity of the EFW pumps will easily maintain secondary cooling.

For the main feedwater line break, the cases presented in Section 15.1.14 demonstrate that the emergency feedwater pump capacity in combination with either the pressurizer sprays, if AC power is available, or the RCS safety valves, if AC power is lost, is sufficient to prevent overpressurization of the RCS. The assumptions for EFW capacity used in the main feedwater line break analyses are the design basis minimum flow requirements. The assumptions for EFW flow to the steam generators as a function of steam generator pressure, used in both the loss of feedwater and the main feedwater line break analyses, establish the design basis minimum flow requirements for the EFW pumps.

The MSLB event also requires EFW flow. The EFW system is configured to supply feedwater to the intact steam generator which allows long term secondary cooling following the event. However, the MSLB is an overcooling event that does not challenge the minimum capacity of the EFW pumps. Given that a significant amount of energy will be extracted from the primary during the event, the post event demand on the EFW system will be less than that from either the loss of feedwater or the main feedwater line break.

In a main steam line break from full power with a concurrent loss of AC electrical power and no return to power, there is an immediate trip and the decay heat generation rate is the same as for a loss of AC electrical power transient. Isolation of the intact steam generator on a MSIS due to low steam generator pressure ensures that the steam generator heat removal capacity is initially unaffected. Automatic startup of emergency feedwater to the steam generator connected to the intact steam line is subsequently initiated on a low steam generator water level or can be actuated by operator action. The combination of the steam generator water inventory and emergency feedwater pump capacity is adequate to maintain the secondary heat sink.

For the steam line break cases with a return to power, the intact steam generator water inventory and emergency feedwater pump capacity are also adequate to maintain a level in the steam generator during the transient, thus preserving the secondary heat sink.

The pumps take suction from either of two sources: one of the condensate storage tanks or the redundant and independent SWS lines. The supply lines are designed to ensure isolation of the Seismic Category II condensate water supply line and permit transfer of suction to the Seismic

ARKANSAS NUCLEAR ONE
Unit 2

Category I SWS if condensate water from the condensate storage tanks is unavailable. Check valves in the SWS lines prevent loss of suction pressure in the event a SWS line fails or is not pressurized. This suction piping arrangement ensures a positive supply of water to the pumps. The safety-grade condensate storage tank, T41B, is connected to the Unit 2 EFW system as an available source of EFW. This tank is a shared source of EFW with Unit 1.

The uses of an electric motor driver for one Emergency Feedwater pump and a steam turbine driver for the other pump provides maximum pumping availability. The electric motor driver can draw power from normal, preferred, or emergency power sources. The automatic transfer of power supply is discussed in Section 8.3. In the remote case of simultaneous failure of normal, preferred, and emergency electrical power, steam is available from either or both steam generators to drive the turbine driven pump.

The EFWS is required to mitigate the consequences of a rupture in the main steam line or a loss of main feedwater accident as discussed in Sections 10.3.3 and 10.4.7.3, respectively. Table 10.4-11 demonstrates the adequacy of the EFWS to perform its design function in the event of a single active failure within the system. In addition, a single failure of the non-safety related portion of the EFWS has no effects on the safety function of the EFWS. Analyses of the effects of the main steam line and main feedwater line ruptures have been performed, in accordance with the criteria set forth in Section 3.6, to ensure that none of these postulated ruptures would result in a loss of redundancy within the system. The results of these analyses are contained in Chapter 3.

The EFWS supply from one of the condensate storage tanks provides a means of pumping condensate quality water to the steam generators during all modes of operation. The condensate storage tank has sufficient volume to sustain the operation of the EFWS during these conditions. Water level is transmitted to the control room and is alarmed at low level in the selected tank.

The EFWS is designed to remain functional after a DBE. The pumps, valves, SWS supply lines, and the discharge piping are all designed, fabricated, and hydrostatically tested to meet the applicable requirements for ASME Code Section III, Class 3 and Seismic Category 1 components with the exception of the isolation valves (2CV-1036, 1037, 1038 and 1039) and downstream piping, which are designed, fabricated and tested to meet the applicable requirements for ASME Section III, Class 2 and Seismic Category 1 components. The condensate water supply line and the flush and recirculation lines downstream of the first isolation valves are designed to ANSI B31.1.0 requirements. The pumps and the components of the EFWS are all Seismic Category 1 and are installed within the Seismic Category 1 auxiliary building.

The auxiliary feedwater pump is non-seismic and is installed within the Turbine Building. The discharge piping for the auxiliary feedwater pump is designed in accordance with ASME Code, Section III, Class 3 criteria from the first isolation check valve (2EFW-28, 2EFW-30) to its tie-in with the EFW pump discharge piping.

In the event of a break in the common steam supply line to the turbine driven emergency feedwater pump, the steam flow through the break will not exceed 4.7 percent of the main steam flow. Should a pump discharge valve, e.g., 2CV-1075, stick open in the line to the low pressure generator, i.e., 2E24B, the other valve in series, i.e., 2CV-1036, will remain closed as it is actuated by a different EFWS bus. This redundancy will protect both feedwater pumps from a runout flow condition under the postulated single failure (valve sticks open).

ARKANSAS NUCLEAR ONE
Unit 2

The common suction piping for the safety related emergency feedwater pumps 2P7A and 2P7B includes the pressure safety relief valve 2PSV-0706 with a set pressure of 150 psig to prevent the overpressurization of the piping due to the possible leakage of the EFW pumps discharge stop check valves during the auxiliary feedwater pump operation.

10.4.9.4 Tests and Inspections

Historical data removed Section 10.4.9.4 of the FSAR.

Each EFWS pump is designed, fabricated and hydrostatically tested to the requirements of ASME Code Section III, Class 3. The piping and valves are designed, fabricated, and hydrostatically tested to ASME Code Section III, Class 3 requirements.

The portion of the EFWS piping inside the containment is furnished with removable insulation for inservice inspection.

The EFWS is normally in use during plant startup and shutdown and proper operation of all components will be observed at these times. The emergency start capability will be functionally tested as required by the Technical Specifications.

10.4.9.5 Instrumentation Applications

DISPLAY INFORMATION - Display instrumentation related to the EFWS is discussed in Section 7.5. Information indicative of the readiness of the EFWS prior to operation and the status of active components during system operation is displayed for the operator in the control room.

Indicating lights are provided to monitor equipment status. Each motor-driven component has "on" and "off" indicating lights; each remotely controlled open-shut service valve has corresponding open-shut light indication; and each breaker control switch has an associated open-shut indicating light. A red light is used to indicate an operating status, i.e., motor running, valve not fully closed, or breaker closed. A green light indicates that the equipment is not in an operating status, i.e., motor off, valve not fully open, or breaker open.

Equipment availability and bypass status indication/annunciation are provided as described in Section 8.3 and Chapter 7.

Sensing and indicating instruments are provided for emergency feedwater pump discharge pressure, feedwater flow rate, feedwater pump turbine speed, and turbine supply steam pressure. Condensate water supply pressure and SWS supply pressure are indicated and low pressure is alarmed. Indication and alarm are also provided for condensate storage tank level.

EFWS component inoperable alarm circuits monitor the status of associated electrical equipment and the EFWS suction and discharge valves. The EFWS component alarm circuits alarm in the control room. In addition, an EFWS turbine pump train inoperable alarm will annunciate in the control room whenever steam supply valves 2CV-1000-1 and 2CV-1050-2 are not fully open.

SYSTEM INITIATION - Initiating circuits and logic are discussed in Chapter 7.

10.4.10 STARTUP AND BLOWDOWN DEMINERALIZER SYSTEM

10.4.10.1 Design Bases

The startup and blowdown demineralizer system, shown in Figure 10.2-4, is designed to fulfill the following requirements:

- A. to achieve and maintain the chemistry requirements of the water inventory in the condensate and feedwater system prior to introduction of feedwater into the steam generators during plant startup operations; and,
- B. to process the liquid discharged by the steam generator blowdown system.

This system is designed to demineralize quantities of water originating in the secondary systems during plant startup operations and during normal plant operations. The bases for sizing the system were the temperatures, pressures, quantities and chemistry of fluids to be processed.

The pressure vessels in the system have been designed in accordance with ASME Code, Section VIII requirements. The appropriate requirements of ANSI, ASTM, ASME, Hydraulics Institute, IEEE, and NEMA have been included in the design and fabrication standards for components in the system. The components of the system are located outside the containment.

10.4.10.2 System Design and Operation

The startup and blowdown demineralizer system consists of the following components:

- A. steam generator blowdown heat exchangers (2E68A, B)
- B. one startup and blowdown demineralizer (2T94A) and one steam generator blowdown demineralizer (2T94B)
- C. three resin regeneration system pressure vessels (2T95, 96, 97)
- D. one regeneration heater (2E69)
- E. one demineralizer regeneration pump (2P138)
- F. two resin traps (2F212A,B)
- G. piping, valves, and instrumentation
- H. one startup blowdown condensate filter (2F-807)
- I. one steam generator blowdown filter (2F-808)

Demineralizer Regeneration Equipment - The active Demineralizer Regeneration Equipment consists of a 17,000 gallon acid storage tank, a 17,000 gallon caustic storage tank, and a caustic heating system. The acid tank and caustic tank (as well as the adjacent ammonia storage tank) are surrounded by a concrete wall to protect nearby equipment in the event of a tank rupture. In addition, the caustic tank vents are heat traced to prevent the vent pipes from freezing during cold weather.

ARKANSAS NUCLEAR ONE
Unit 2

Following the initial stages of cleaning the condensate and feedwater system prior to the plant startup, a recirculation flow from the discharge of feedwater heaters 2E1A & B back to the condenser passes through the startup and blowdown demineralizer. The recirculation cleanup flow rate is 3,200 gpm and will be maintained below 140°F to prevent damage to the mixed bed resin.

During normal plant operation, the effluent from the steam generator blowdown tank is processed in this system. The startup and blowdown demineralizer (2T94A) must process a minimum flow of 624 gpm to prevent resin bed channeling. The blowdown flow is supplemented by flow from the condensate pumps to meet the 624 gpm requirement during normal plant operation. The steam generator blowdown demineralizer (2T94B) is designed to operate at flows from 60 to 500 gpm. The steam generator blowdown heat exchanger is used to cool the blowdown, if required, before it passes through the demineralizer or is discharged to the circulating water flume via the regenerative waste transfer system. Auxiliary cooling water is the cooling fluid in the heat exchanger. The demineralizer blowdown is returned to the condenser for water conservation.

Adequate instrumentation and sampling of fluids is provided to ensure that proper operation of the system and to indicate when cleaning and/or regeneration of the demineralizer mixed bed resin is required.

When regeneration or cleaning of the resin is needed, the resin is transferred to the regeneration vessels. All waste water from the cleaning regeneration sequences including backwashes, regenerant chemicals, sluice water, etc. is discharged to the regenerative waste processing system shown in Figure 11.1-1. The startup and blowdown demineralizer system is designed to process radioactive steam generator blowdown. During the regeneration sequence, the radioactive constituents are removed from the resin and discharged with the regenerant waste water to the regenerative waste processing system. The regenerant waste water volumes generated are summarized in Table 11.2-24.

10.4.10.3 Design Evaluation

The startup and blowdown demineralizer system has no potential radioactivity release path to the environment except to the circulating water flume via the Emergency Feedwater System. In the event that the fluid being processed in the system is radioactive, the system has the effect of concentrating the activity on the resin which is then discharged to the regenerative waste processing system during a regeneration. The system has no safety-related function. Failure of any component in the system would compromise the system operation but would not affect safe shutdown of the plant.

10.4.10.4 Testing and Instrumentation Applications

The startup and blowdown demineralizer system is functionally tested to ensure satisfactory operation for all operating modes.

A local control panel is provided for system monitoring and control. Chemistry monitoring instrumentation is provided on the process lines to ensure efficient demineralizer operation. Trouble alarms are provided in the control room to indicate "train exhausted" and "service trouble".

10.4.11 COMMON FEEDWATER SYSTEM

10.4.11.1 Design Basis

The Common Feed Water (CFW) system provides a non-safety related backup source of water to either or both Steam Generators (SGs) on either Unit 1 or Unit 2 in the event that the Emergency Feed Water (EFW) system is not available during certain fire scenarios. The CFW system is an NFPA 805 based fire protection program system shared by ANO Units 1 and 2.

10.4.11.2 System Description

The CFW system has two motor driven pumps (P-805A and P-805B) equipped with minimum and full flow recirculation orifices to provide protection from overheating and to allow for pump testing. The pumps discharge into a common header with branch lines that connect into the EFW piping. Each branch line has a motor operated valve (MOV) and check valve that are extensions of the EFW system. MOVs 2CV-1070A and 2CV-1070B control the injection rate to each SG from the CFW pumps. In addition to the CFW function, 2CV-1070A and 2CV-1070B provide the containment (Reactor Building) isolation function. The valves are maintained locked closed and de-energized unless the CFW system is needed to feed the SGs. The system is designed to allow the valves to be energized from the Control Room through the use of disconnect switches. The CFW piping system in the Auxiliary Building is Seismic Class 1.

The preferred pump suction alignment is from the Unit 1 CST (T-41). Alternately, the suction may be aligned from Unit 2 CSTs (2T-41A and 2T-41B).

Power to each CFW pump motor is supplied normally from 4.16 kV Switchgear A15 (P-805A) and A19 (P-805B). The power sources that are available to supply both A15 and A19 include Unit 1 4.16 kV AC Bus A1 and the "London Line" through 13.8 kV/4.16 KV Transformer X-150. A15 and A19 feed 4160 V/480 VAC transformers X-155 and X-195 respectively. The output of these transformers supply two automatic transfer switches which allow either transformer to supply either 480 V AC Panel PP51 or PP91. PP51 supplies power to one CFW MOV on Unit 1 and one CFW MOV on Unit 2. Likewise PP91 feeds the opposite CFW MOV on both units.

The CFW control system consists of two main Programmable Logic Cabinets (PLC) cabinets and a termination cabinet located in the Startup Boiler Control Room and a remote Input/Output (I/O) cabinet in the Safety Parameter Display System (SPDS) computer room. The CFW control system monitors and controls CFW parameters and equipment including CFW pumps, MOVs, flow and pressure transmitters, switchgear breakers, and associated system status inputs. Three Human Machine Interface (HMI) terminals are utilized by the CFW control system; one located in the Unit 1 Control Room, one in the Unit 2 Control Room, and one in the Startup Boiler Control Room. The CFW control system provides a common alarm output to each unit via the SPDS programmable alarms.

10.4.11.3 Safety Evaluation

The CFW system is non-safety related augmented quality and is not credited to mitigate any accident identified in the UFSAR.

10.4.11.4 Tests and Inspections

The CFW system is tested and inspected at a regular frequency to ensure system availability.

ARKANSAS NUCLEAR ONE
Unit 2

10.4.11.5 Instrumentation Application

Instrumentation is installed to allow monitoring of the pumps, motors, switchgear, and control system. Indication of system status and alarms are displayed on the HMI terminals in the Control Room and in the Start-up Boiler Control Room. Flow elements are installed to provide indication of pump total flow and flow to each SG.

A flow diagram of the CFW System is provided in Figure 10.4-4.

ARKANSAS NUCLEAR ONE
UNIT 2

Table 10.3-1

MAIN STEAM SUPPLY SYSTEM
MAIN STEAM LINE SAFETY VALVES

Number of main steam lines	2
Number of valves per main steam line	5
Total number of safety valves	10

Design Data for Valves in Each Main Steam Line

<u>Line #1</u>	<u>Valve No.</u> <u>Line #2</u>	<u>Set Pressure</u> <u>(psig)</u>	<u>Stamped Capacity</u> <u>(lbs/hr./valve)</u>
2PSV 1002	2PSV 1052	1078	1,437,505
2PSV 1003	2PSV 1053	1105	1,473,039
2PSV 1004	2PSV 1054	1105	1,473,039
2PSV 1005	2PSV 1055	1132	1,508,573
2PSV 1006	2PSV 1056	1132	1,508,573

Total Rated Flow (per line with each valve at 1132 psig) 7,542,865

* Per ASME Section III, the stamped capacity is approximately 90% of actual flow as defined in Subsection NC-7800.

See also Table 5.5-11.

Table 10.3-2 DELETED

Table 10.3-3 DELETED

ARKANSAS NUCLEAR ONE
UNIT 2

TABLE 10.3-4

**MAIN STEAM ISOLATION SYSTEM
SINGLE FAILURE ANALYSIS**

<u>COMPONENT</u>	<u>FAILURE</u>	<u>COMMENTS AND CONSEQUENCES</u>
Main Steam Isolation Valves (MSIV) (2CV-1060-2, 2CV-1010-1)	Electrical failure of MSIS or CSAS actuation circuitry to MSIV.	Redundant solenoid valves are provided on the air supply and exhaust lines to the air cylinders on each of the MSIVs. Redundant power supplies, CSAS, and MSIS signals to these solenoid valves preclude the possibility of a single electrical failure resulting in the failure of the MSIV to close.
	Mechanical failure resulting in failure of MSIV of either steam generator to close on MSIS.	The MSIVs are designed such that they will close upon loss of air with the springs only. A mechanical failure resulting in the failure of the MSIV to close is not considered credible.
Main Feedwater Isolation Valves (2CV-1024-1, 2CV-1074-1, 2CV-1023-2, 2CV-1073-2)	Affected steam generator feedwater isolation valve fails to close on MSIS or CSAS.	MSIS or CSAS trips the main feedwater pump turbine drivers, trips the condensate pumps and the heater drain pumps. Redundant MFWIV closes. See Note 1.
	Unaffected steam generator feedwater isolation valve fails to close on MSIS or CSAS.	MSIS or CSAS trips the main feedwater pump turbine drivers, trips the condensate pumps and the heater drain pumps. See Note 1.
Main Feedwater Pumps (2P1A,B)	MSIS or CSAS fails to trip a main feedwater pump turbine driver.	MSIS or CSAS closes main feedwater isolation valves. Closure of MSIV's results in loss of steam supply to main feedwater pump turbine driver. All other CFWS pumps trip on MSIS or CSAS. Note 2.
Condensate Pumps (2P2A,B,C,D)	MSIS or CSAS fails to trip one condensate pump.	MSIS or CSAS closes main feedwater isolation valves and trips other CFWS pumps. Both channels of MSIS and CSAS are applied to each pump. Note 2.

ARKANSAS NUCLEAR ONE
UNIT 2

Table 10.3-4 (continued)

<u>COMPONENT</u>	<u>FAILURE</u>	<u>COMMENTS AND CONSEQUENCES</u>
Heater Drain Pumps (2P8A,B)	MSIS or CSAS fails to trip one heater drain pump.	MSIS or CSAS closes main feedwater isolation valves and trips all other CFWS pumps. Both channels of MSIS and CSAS are applied to each pump. Note 2.
Atmospheric Steam Dump Isolation Valves (2CV-1002, 2CV-1052)	Spurious "OPEN" signal.	Valves are normally closed. MSIS provides backup "CLOSE" command and prevent spurious "OPEN" signal.
Steam Generator Blowdown Tank Isolation Valves (2CV-1016-1, 2CV-1066-1)	Spurious "OPEN" signal or failure of one MSIS to provide "CLOSE" signal.	Valves fail closed on loss of air. Redundant and independent MSIS signals are provided to separate air supply solenoid valves to ensure that the blowdown tank isolation valves close even if one solenoid valve fails.

NOTES:

- (1) The main feedwater turbine driver steam supply valves and the condensate pumps are non-Class 1E equipment and are powered from non-vital power supplies. Both channels of MSIS and CSAS will trip the heater drain, condensate, and main feedwater pumps. During a loss of off-site power, these are de-energized which is the safe condition. Section 6.2.1 presents an analysis of the most limiting single failure and its effect on containment pressure.
- (2) The main feedwater isolation and backup valves are redundant only for retention of upstream condensate. The valves are not credited for closing with more than one condensate, heater drain, or feedwater pump running.

ARKANSAS NUCLEAR ONE
UNIT 2

Table 10.4-1

MAIN CONDENSER DESIGN PERFORMANCE AND DATA

<u>Characteristics</u>	<u>LP Shell</u>	<u>HP Shell</u>
Equipment no.	2E11B	2E11A
Total heat load, btu/hr	3364x10 ⁶	3375x10 ⁶
Effective surface area, ft ²	346,637	493,153
Cleanliness factor, %	85	85
Steam flow rate, lbs/hr	3,595,899	3,595,899
Circulating water flow rate, gpm	420,000	420,000
Circulating water temp. in, °F	97.3	113.43
Circulating water temp. out, °F	113.43	129.66
Oper. pressure at turb. flange, in. Hga	3.75	5.10
Average velocity in tubes, ft/sec	6.63	6.63
Tube outside diameter, in.	7/8	7/8
Tube BWG	24&20	24&20
Tube overall length, ft-in	40-7¼	57-8¼
Number of 24 BWG tubes	34,480	34,480
Number of 20 BWG tubes	2956	2956
Tube material	Titanium B338 GR 2	Titanium B338 GR 2
Shell material	A-36 carbon steel	A-36 carbon steel
Waterbox material	A-36 carbon steel	A-36 carbon steel
Tube sheet material	Titanium B265 G2	Titanium B265 G2
Hotwell material	A-36 carbon steel	A-36 carbon steel

ARKANSAS NUCLEAR ONE
UNIT 2

Table 10.4-2

CIRCULATING WATER PUMPS PERFORMANCE AND DATA

<u>Characteristics</u>	<u>Data</u>
Equipment number	2P3A,B
Quantity	2
Type	Vertical-mixed flow
Liquid pumped	Treated water
Flow design/operating, gpm	210,000/216,000
Maximum operating flow, gpm	249,000
Head design/operating, feet	97.21/95.21
Shut-off head, feet	180
Submergence available/required, feet	28/20
Brake horsepower design/operating, bhp	5765/5910
Brake horsepower at shut-off, bhp	7250
Pump speed, rpm	356
Material of construction:	
Bowl	Meehanite GM 60
Casing & discharge head	Carbon steel A-285 grade C
Upper Shaft	Stainless steel-type 416
Lower Shaft	ASTM A276 Type 410 S.S. or ASTM A582 Type 416 S.S.
Impeller	ASTM A351 MOD CF3M
Driver:	
Type	Induction electric motor
Rating/speed	6,000 hp / 356 rpm
Service factor	1.0
Voltage	6600
Thrust bearing type	Kingsbury

ARKANSAS NUCLEAR ONE
UNIT 2

Table 10.4-3

COOLING TOWER PERFORMANCE AND DATA

<u>Characteristics</u>	<u>Data</u>
Equipment Number	2M30
Quantity	1
Type	Hyperbolic, natural draft
Flow Pattern	Counter flow
Design flow, gpm	404,000
Nominal Flow, gpm	420,000
Heat load, btu/hr	6740 x 10 ⁶
Design atmosphere conditions, °F WB @ %Humidity	81 @ 37
Approach, °F	15.3
Range, °F	32.36
Water loss due to evaporation at design conditions, gpm	11,589
Water loss due to drift at design conditions, gpm	40.5 (0.01%)
Water temperature to tower @ design conditions, °F	129.66
Water temperature from tower @ design conditions, °F	96.3
Cooling tower basin inside diameter, ft	396
Overall height of tower above basin curb, ft.	447
Holding capacity of tower basin, cu. ft.	615,000
Fill material	Type V asbestos cement or suitable substitute
Typical exit temperature of plume, °F	
Winter	80
Summer	115
Typical exit velocity of plume, ft/sec.	
Winter	20
Summer	15

ARKANSAS NUCLEAR ONE
UNIT 2

Table 10.4-3 (continued)

<u>NO.</u>	<u>°F WB</u>	<u>RH</u>	<u>BASIN WATER TEMPERATURE, °F</u>
1	81	37	96.3
2	80	55	93.95
3	78	55	92.65
4	76	70	90.3
5	74	85	88.4
6	72	91	86.8
7	70	83	86.15
8	68	90	54.55
9	66	85	83.6
10	64	90	82.4
11	62	90	81.2
12	60	90	80.0
13	58	89	78.85
14	56	79	78.2
15	54	88	76.75
16	52	88	75.55
17	50	77	74.85
18	48	77	73.65
19	46	75	72.65
20	44	88	71.1
21	42	60	71.0
22	40	70	69.4
23	38	70	68.3
24	36	68	67.3
25	34	67	66.3
26	32	81	64.7

ARKANSAS NUCLEAR ONE
UNIT 2

Table 10.4-4

CONDENSATE PUMP DATA

<u>Characteristics</u>	<u>Data</u>
Equipment Numbers	2P2A,B,C,D
Type	Vertical, 12 stage/centrifugal
Size of Connections:	
Suction	30-inch flanged
Discharge	18-inch butt weld
Pumped fluid	Condensate
Design Pressure, psig	833
Design Temperature, °F	100/150
Design Flowrate, gpm	7,200
Design Head, ft.	1,580
NPSH required at design flow rate, ft.	14
Maximum operating flow rate, gpm	9,000
NPSH required at maximum operating flow rate, ft	22
Minimum available NPSH, ft.	24
Shut off head, ft.	1860
Materials of Construction	
Casing	ASTM A217
Impeller	
First stage	ASTM A296 CA-15
Subsequent stages	ASTM B143-1970
Shaft	AISI 416 SS
Driver	
Type	Induction motor
Service factor	1.0
Nameplate rating, hp	4,000
Voltage	4,000
RPM	1,180

ARKANSAS NUCLEAR ONE
UNIT 2

Table 10.4-5

HEATER DRAIN PUMP DATA

<u>Characteristics</u>	<u>Data</u>
Equipment Numbers	2P8A,B
Type	Vertical, 10 stage/centrifugal
Pumped fluid	Condensate
Design pressure, psig	
Suction side	280
Discharge side	800
Size of Connections	
Suction	18-inch flanged
Discharge	16-inch flanged
Design flow rate, gpm ⁽¹⁾	5,025
Design head, ft. ⁽¹⁾	1,000
NPSH required at design flow rate, ft.	14.5
Maximum operating flow rate, gpm	5,200
Head at maximum operating flow rate, ft.	900
NPSH required at maximum operating flow rate, ft.	18
Minimum available NPSH, ft. ⁽²⁾	24.7
Minimum NPSH margin, ft. ⁽²⁾	6.7
Shut off head, ft.	2,280
Material of Construction	
Casing	ASTM A-296 Gr CA-6NM
Impeller	ASTM A-296 Gr CA-6NM
Shaft	A 276 Type 410 HT
Driver	
Type	Induction motor
Service factor	1.0
Nameplate rating, hp.	1,750
Voltage	4,000
RPM	1,780

⁽¹⁾ for pump recirculating to Heater Drain Tanks

⁽²⁾ at Heater Drain Tank minimum level

ARKANSAS NUCLEAR ONE
UNIT 2

Table 10.4-6

MAIN FEEDWATER PUMP DATA

<u>Characteristics</u>	<u>Data</u>
Equipment numbers	2P1A,B
Type	Horizontal, Centrifugal, 1-stage
Pumped fluid	Condensate
Design pressure, psig	2,565
Design temperature, °F	410
Design flow rate, gpm	15,700
Size of Connections	
Suction	24-inch flanged
Discharge	24-inch buttweld
Design head, ft.	1,240 @ 3,775 RPM
NPSH required at design flow rate, ft.	130
Maximum operating flow rate, gpm	24,000 @ 5,050 RPM
Head at maximum operating flow rate, ft.	1,900 @ 5,050 RPM
NPSH required at maximum operating flow rate, ft.	250
Minimum available NPSH, ft.	901
Shut off head, ft.	2,775 @ 5,050 RPM
Materials of construction	
Casing	ASTM A217 C5
Impeller	17-4 PH
Shaft	Type 410 SS
Driver	
Type	Variable speed steam turbine
bhp	11,250 @ max. flow rate

ARKANSAS NUCLEAR ONE
UNIT 2

Table 10.4-7

DELETED

Table 10.4-8

**STEAM GENERATOR BLOWDOWN
TANK DATA**

<u>Characteristics</u>	<u>Data</u>
Equipment number	2T67
Quantity	1
Type	Horizontal
Stored material	Condensate
Design pressure, psig	200
Normal operating temperature, °F	200
Tank dimensions: ft.	
Outside diameter	6
Overall length	10
Capacity, gal.	---
Material of construction:	ASTM SA-515-70
Tank internals separator	4" thick SS entrainment

ARKANSAS NUCLEAR ONE
UNIT 2

Table 10.4-9

STEAM GENERATOR BLOWDOWN PUMP DATA

<u>Characteristics</u>	<u>Data</u>
Equipment numbers	2P139A,B
Quantity	2
Type	Horizontal, end-suction, 1-stage
Pumped liquid	Blowdown condensate
Design pressure, psig	180
Design temperature, °F	250
Design flow rate, gpm	180
Design head, ft.	180
NPSH required at design flow rate, ft.	7.5
Maximum operating flow rate, gpm	270
Head at maximum operating flow rate, ft.	120
NPSH required at maximum operating flow rate, ft.	11.0
Minimum available NPSH, ft.	17
Materials of construction	
Casing	A 395
Impeller	A 48 C1.25
Shaft	A 322 Gr. 4140
Driver	
Type	Induction motor
Service factor	1.15
Nameplate horsepower rating	20
Voltage	460
RPM	3450

ARKANSAS NUCLEAR ONE
UNIT 2

Table 10.4-10

EMERGENCY FEEDWATER PUMP DATA

<u>Characteristics</u>	<u>Data</u>
Equipment	2P7A,B
Quantity	2
Type	Centrifugal-horizontal-multistage
Pumped fluid	Water
Design pressure, psig	1600
Design temperature, °F	100
Design flow rate, gpm	575
Design head, ft.	2800
NPSH required at design flow rate, ft.	16
Minimum available NPSH, ft.	32
Discharge pressure at shutoff, psig	1390
Rated speed, rpm	3575 ¹
Materials of construction:	
Casing	ASME SA 216 Gr. WCB
Impeller	ASME SA 351 Gr. CA-15
Shaft	ASME SA 479 Type 410 H.T.
Turbine driver:	
Type	Solid wheel, variable speed, horizontal
Steam inlet pressure: psia	
Operating	Function of steam generator pressure
Minimum	60
Maximum	1100
Steam condition, 0/0 moisture	1/2
Back pressure, psig	10
Rated bhp	575
Rated speed	3575 ¹
Electric motor driver:	
Voltage	4000
Rated rpm	3600
Rated bhp	600

¹ 2K-3 turbine and 2P-7A pump speed of 3790 rpm is authorized by Byron Jackson and Terry Turbine. 2K-3 turbine and 2P-7A pump speed of 3790 rpm has been accepted by Operations in accordance with PER 2-83-06 dated July 7, 1983.

ARKANSAS NUCLEAR ONE
UNIT 2

Table 10.4-10A

AUXILIARY FEEDWATER PUMP DATA

<u>Characteristics</u>	<u>Data</u>
Equipment	2P75
Quantity	1
Type	Centrifugal-Horizontal-Multistage
Pumped fluid	Water
Design pressure, psig	1600
Design temperature, °F	160
Design flow rate, gpm	1000
Design head, ft.	2694
NPSH required at design flow rate, ft.	17
Minimum available NPSH, ft.	23
Discharge pressure at shutoff, psig	1460
Rated speed, rpm	3550
Materials of construction:	
Casing	Carbon Steel
Impeller	13-4 Chrome/Nickel
Shaft	410 HT-Steel
Electric motor driver:	
Voltage	4000
Nameplate rpm	3600
Rated bhp	1000

ARKANSAS NUCLEAR ONE
UNIT 2

Table 10.4-11

**EMERGENCY FEEDWATER SYSTEM
SINGLE FAILURE ANALYSIS**

<u>Component</u>	<u>Failure</u>	<u>Comments & Consequences</u>
Condensate Water Supply	Failure of normal supply from condensate storage tank.	Condensate water supply line will be isolated and SWS isolation valves will automatically open
Service Water Line	Failure of a line supplying service water to pumps.	Service water will be supplied by other line.
EFW Pumps	Failure of electric motor driven pump to operate.	Steam driven pump will operate and supply 100% required flow.
	Failure of steam driven pump to operate.	Motor driven pump will operate and supply 100% required flow.
EFW Discharge Piping System	One of two series valves in the supply lines fails to close during steam generator isolation (EFAS).	Other valve will close. (Valve uses a power supply from a redundant power supply to the first series valve.)
	One of two series valves fails to open (EFAS).	Affected steam generator will be supplied by the other supply line.
Turbine driver	Loss of steam supply from one steam generator due to low steam generator pressure.	100% required steam will be supplied by intact steam generator.
	EFAS and Failure of ESF bus 2D01	2P7B cannot start. However since 2CV-1037 and 2CV-1039 are normally open, turbine train can supply either generator.

ARKANSAS NUCLEAR ONE
UNIT 2

Table 10.4-12

STARTUP AND BLOWDOWN DEMINERALIZER SYSTEM COMPONENT DATA

	Steam Generator Blowdown Heat Exchangers	Startup & Blowdown Demineralizers	Cation Regeneration Vessel	Anion Regeneration Vessel	Steam Generator Blowdown Filter
Equipment Numbers	2E68A, B	2T94A, B	2T95	2T96	2F-808
Quantity	2	2	1	1	1
Type	Horizontal Shell & Tube	Vertical Tank	Vertical Tank	Vertical Tank	Horizontal Tank
Size	14" diam. x 24' long	9' diam. x 6' shell	7' diam x 12' shell	4'-6" diam. x 10' shell	18" diam. 8'-1 1/2" long
Design Pressure/ Temperature, psig/°F	150/300 shell 150/150 tubes	150/150	85/150	85/150	240/250
Design Code	ASME VIII	ASME VIII	ASME VIII	ASME VIII	TEMA R
Materials of Construction	SA-106 Gr B Shell AL6XN Tubes	Rubber-lined C.S.	Rubber-lined C.S.	Rubber-lined C.S.	SA-106 GR B Shell

ARKANSAS NUCLEAR ONE
UNIT 2

Table 10.4-12 (continued)

	<u>Resin Storage Tank</u>	<u>Regeneration Heater</u>	<u>Ammoniation Cation Demineralizer</u>	<u>Demineralizer Regeneration Pump</u>	<u>Resin Traps</u>	<u>Condensate Filter</u>
Equipment Numbers	2T97	2E69	-	2P138	2F212A,B	2F-807
Quantity	1	1	1	1	2	1
Type	Vertical Tank	Horizontal Shell & Tube	Vertical Tank	Horizontal Centifugal	Basket	Horizontal Tank
Size	7' diam. x 10'-6" Shell	9-3/4" diam x 39-1/4" long	5' diam x 10'-6" Shell	-	-	30" diam. x 9' -5" long
Design Pressure/ Temperature, psig/°F	85/150	150/350 Shell 150/350 Tubes	85/150	70/120	150/150	707/150
Design Code	ASME VIII	ASME VIII	ASME VIII	-	ASME VIII	ASME VIII
Materials of Construction	Rubber-lined C.S.	C.S. Shell S.S. Tubes	Rubber-lined C.S.	S.S.	C.S. Body S.S. Basket	C.S. Body

ARKANSAS NUCLEAR ONE
UNIT 2

Table 10.4-13

COMMON FEEDWATER PUMP DATA

<u>Characteristics</u>	<u>Data</u>
Equipment	2P-805A/B
Quantity	2
Type	Centrifugal-Horizontal-Multistage
Pumped Fluid	Water
Design Pressure, psig	1543.5
Design Temperature, °F	110
Design Flow Rate, gpm	600
Total Developed Head, ft.	2950
NPSH Absolute Required at Design Flow Rate, ft.	20.0 (< 1 atmosphere)
Maximum Head at Shutoff, ft.	3408.5
Rated Speed, rpm	3560
Materials of Construction:	
Casing	ASTM A216 Gr WCB
Impeller	12% Chrome
Impeller Wear Ring	420 SS
Case Wear Ring	420 SS
Shaft	410 SS
Electric Motor Driver:	
Voltage / Phase / Hz	4000 V / 3 / 60
Nameplate rpm	3585
Rated bhp	600
Insulation	Class F
Frame Size	5810A

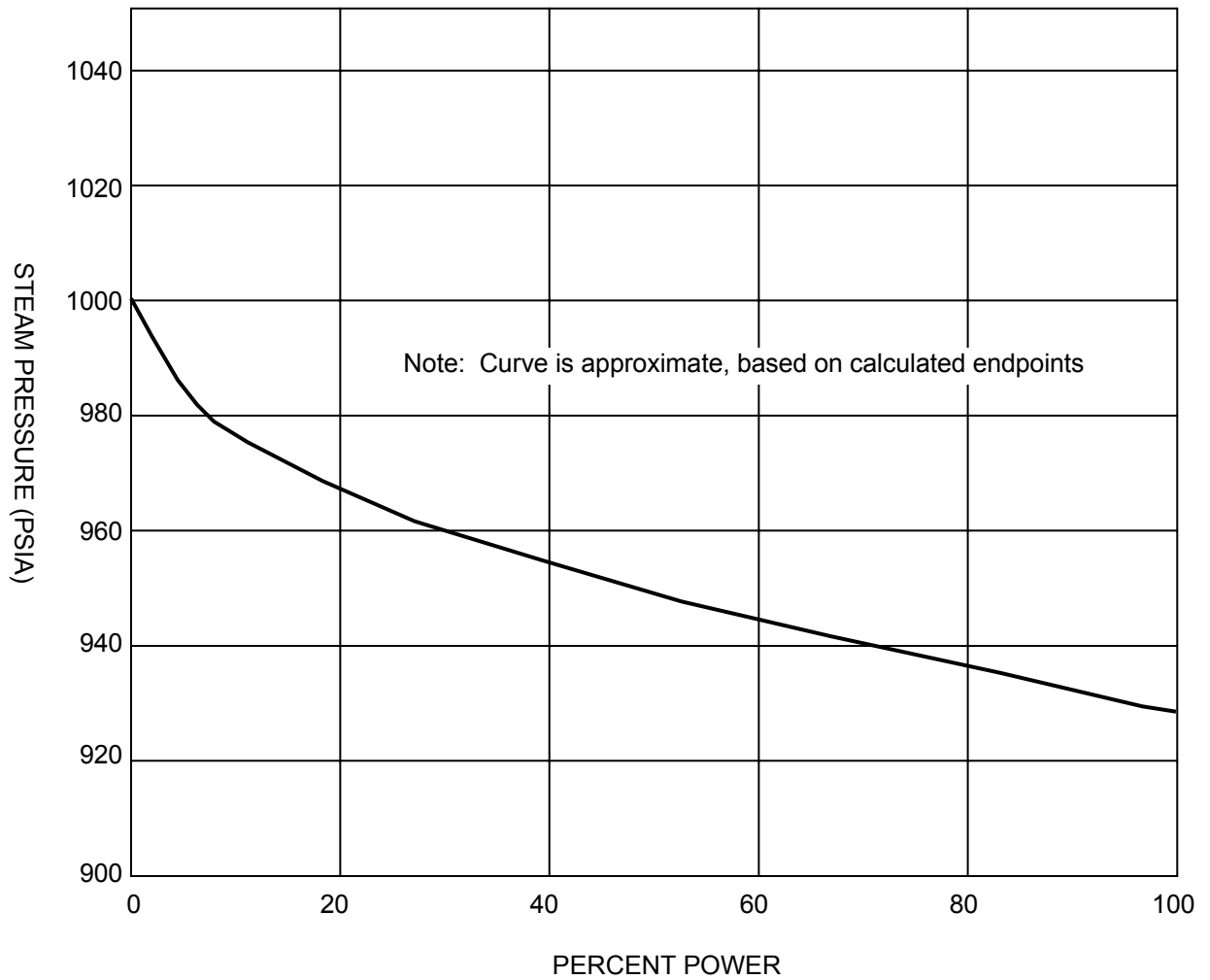

SAR FIGURE NO. 10.2-1

AMENDMENT 20

ARKANSAS NUCLEAR ONE
UNIT 2
RUSSELLVILLE, ARKANSAS



SCALE:	NONE
DRAWN:	
DESIGN:	ENERGY
CAD NO:	

DESIGN STEAM PRESSURE VARIATION
WITH POWER

BASED ON DRAWING NO

SHEET

REV.

DELETED

SAR FIGURE NO. 10.2-2

AMENDMENT 20

ARKANSAS NUCLEAR ONE
UNIT 2
RUSSELLVILLE, ARKANSAS



SCALE: NONE

DRAWN:

DESIGN: ENTERGY

CAD NO:

BASED ON DRAWING NO

SHEET

REV.

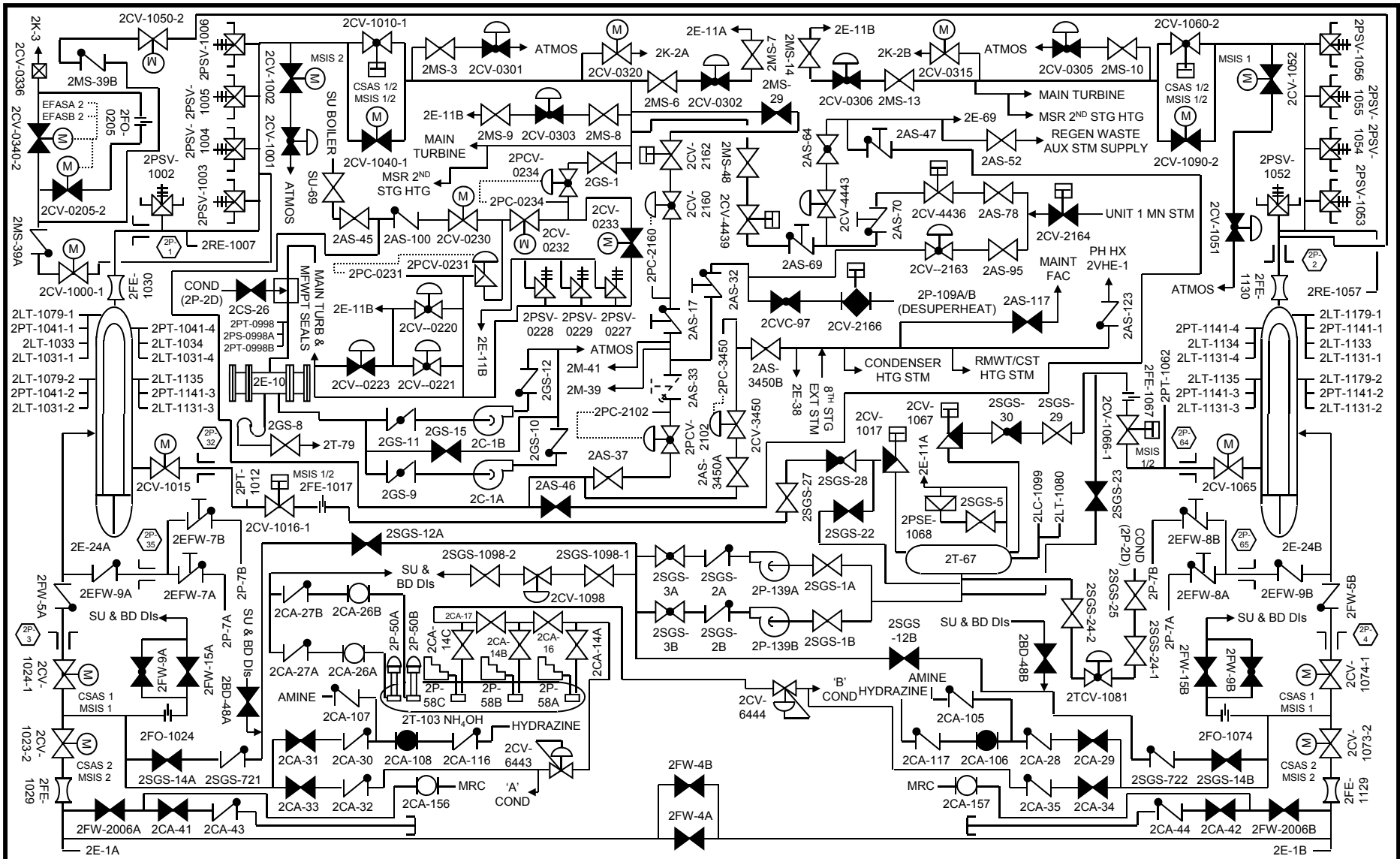

MAIN STEAM, AUXILIARY STEAM, GLAND SEAL STEAM, AMMONIUM HYDROXIDE, AND STEAM GENERATOR BLOWDOWN

SAR FIGURE NO. 10.2-3

ARKANSAS NUCLEAR ONE
UNIT 2
RUSSELLVILLE, ARKANSAS



SCALE:	NONE
DRAWN:	ENERGY
DESIGN:	ENERGY
CAD NO:	

AMENDMENT 28

BASED ON DRAWING NO	SHEET	REV.

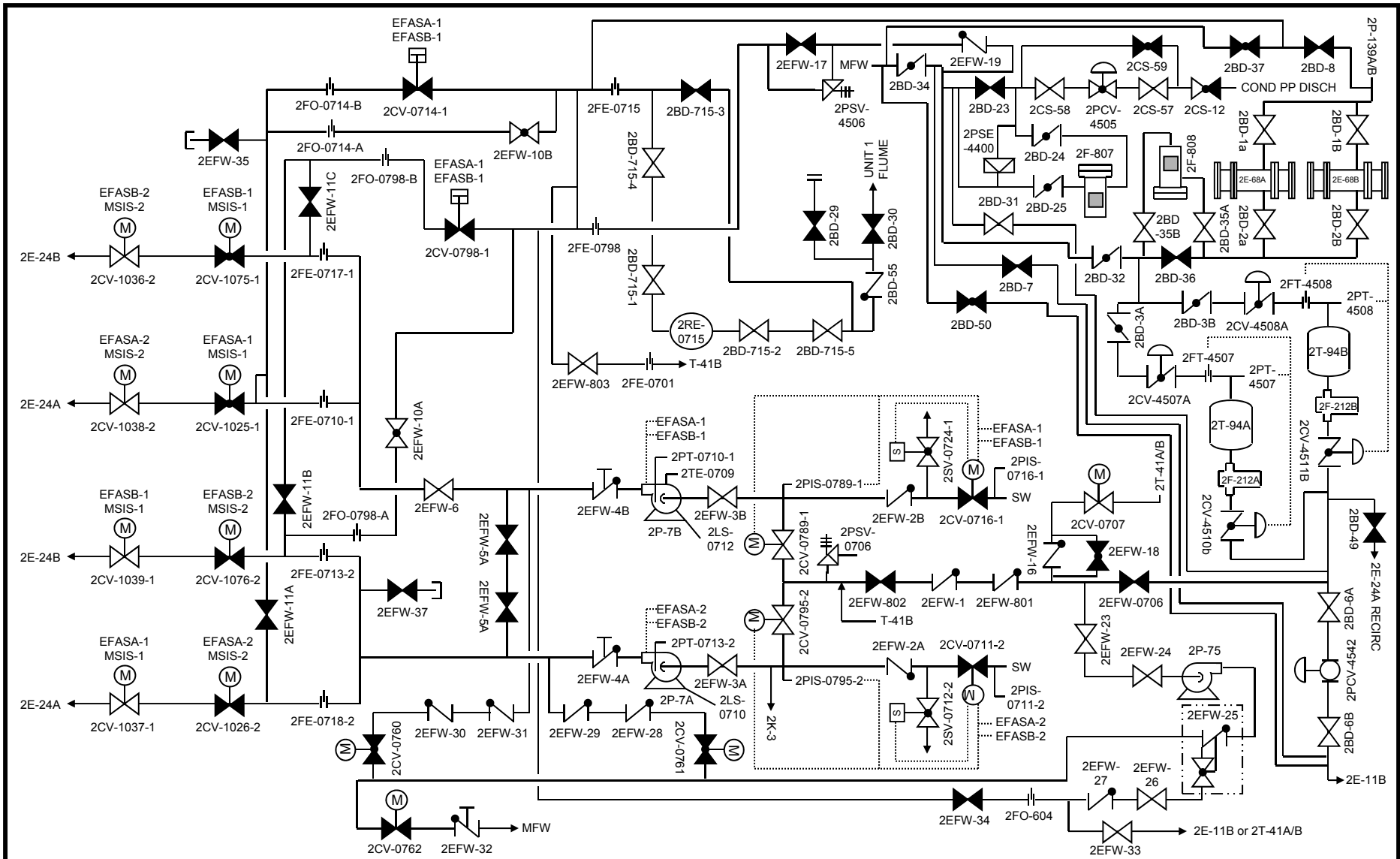

EMERGENCY AND AUXILIARY FEEDWATER,
STARTUP & BLOWDOWN DEMINERALIZERS

SAR FIGURE NO. 10.2-4

ARKANSAS NUCLEAR ONE
UNIT 2
RUSSELLVILLE, ARKANSAS



SCALE:	NONE
DRAWN:	ENERGY
DESIGN:	ENERGY
CAD NO:	

AMENDMENT 26

BASED ON DRAWING NO	SHEET	REV.
---------------------	-------	------

DELETED

SAR FIGURE NO. 10.2-5

AMENDMENT 20

ARKANSAS NUCLEAR ONE
UNIT 2
RUSSELLVILLE, ARKANSAS



SCALE: NONE

DRAWN:

DESIGN: ENTERGY

CAD NO:

BASED ON DRAWING NO

SHEET

REV.

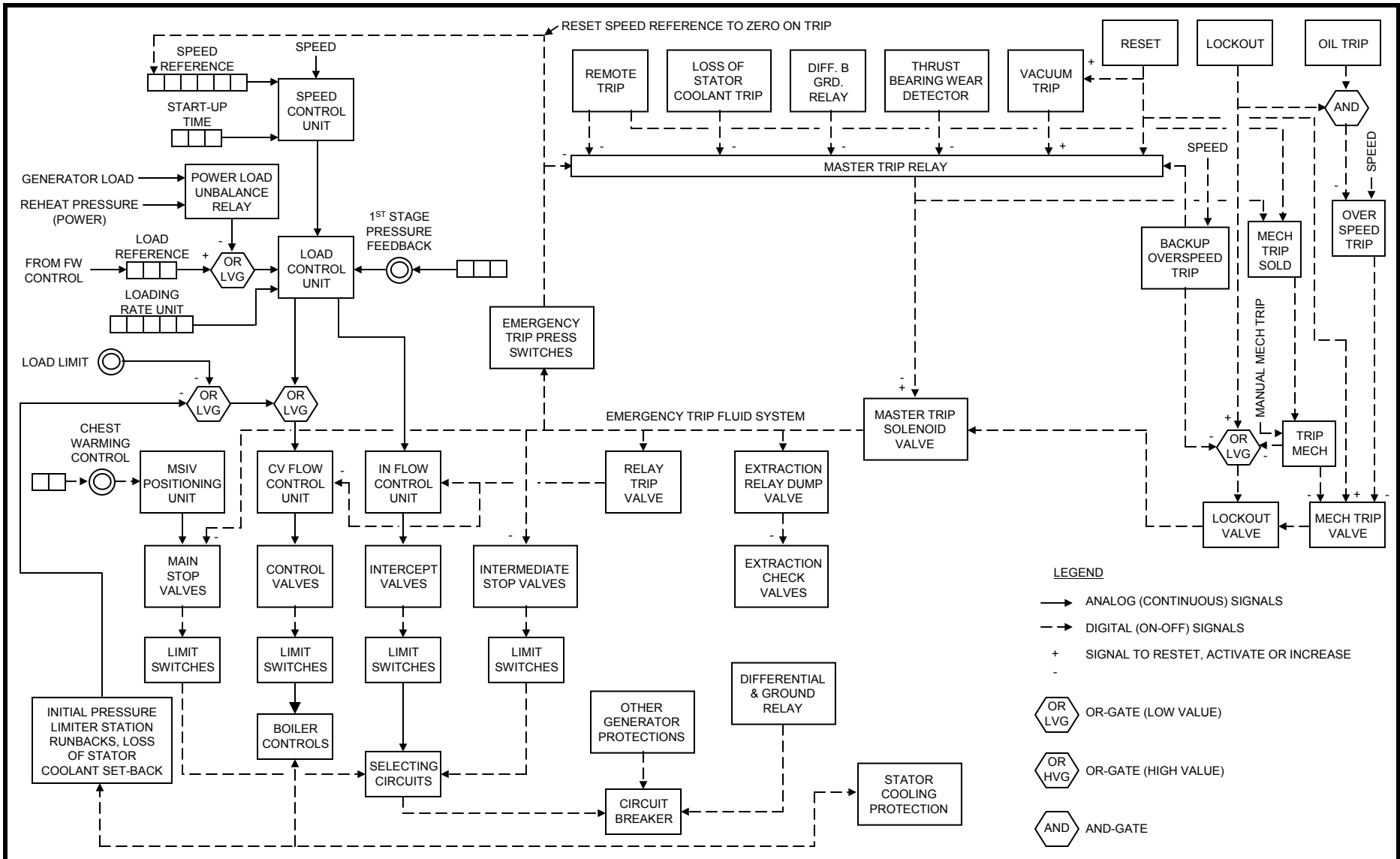

ELECTRO-HYDRAULIC CONTROL SYSTEM

SAR FIGURE NO. 10.2-6

ARKANSAS NUCLEAR ONE
 UNIT 2
 RUSSELLVILLE, ARKANSAS



SCALE: NONE
 DRAWN: ENTERGY
 DESIGN: ENTERGY
 CAD NO:

AMENDMENT 20

BASED ON DRAWING NO	SHEET	REV.
---------------------	-------	------

SYSTEM SHOW DE-ENERGIZED WITH
MAIN STEAM BLOCK VALVE CLOSED

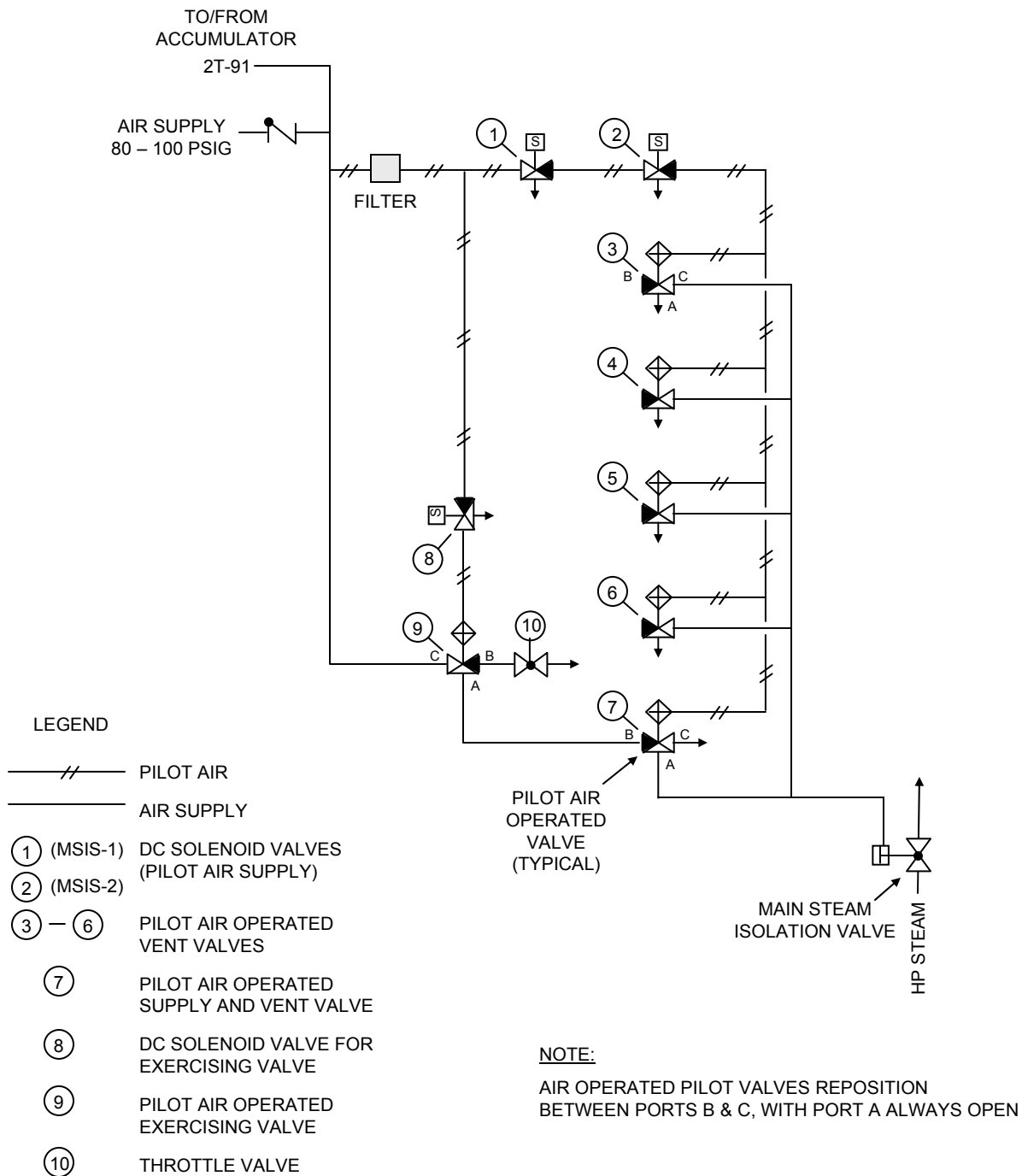

SAR FIGURE NO. 10.3-1

AMENDMENT 20

ARKANSAS NUCLEAR ONE
UNIT 2
RUSSELLVILLE, ARKANSAS



SCALE: NONE
DRAWN:
DESIGN: ENTERGY
CAD NO:

MAIN STEAM ISOLATION VALVES AIR
CONTROL SYSTEM

BASED ON DRAWING NO

SHEET

REV.

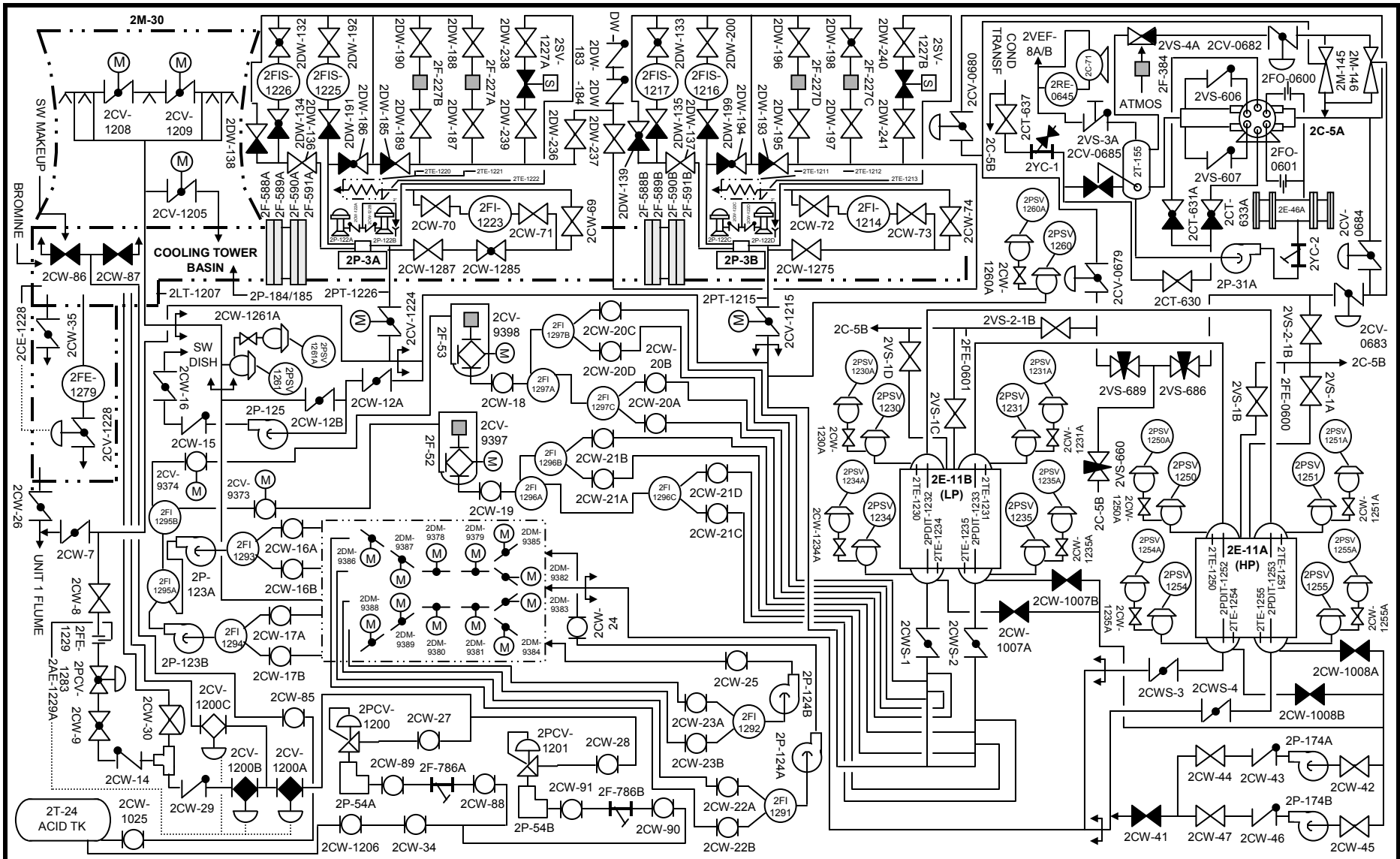

CIRCULATING WATER AND 'A' CONDENSER VACUUM (TYPICAL)

SAR FIGURE NO. 10.4-1

ARKANSAS NUCLEAR ONE
 UNIT 2
 RUSSELLVILLE, ARKANSAS



SCALE: NONE
 DRAWN: ENTERGY
 DESIGN: ENTERGY
 CAD NO:

AMENDMENT 24

BASED ON DRAWING NO SHEET REV.

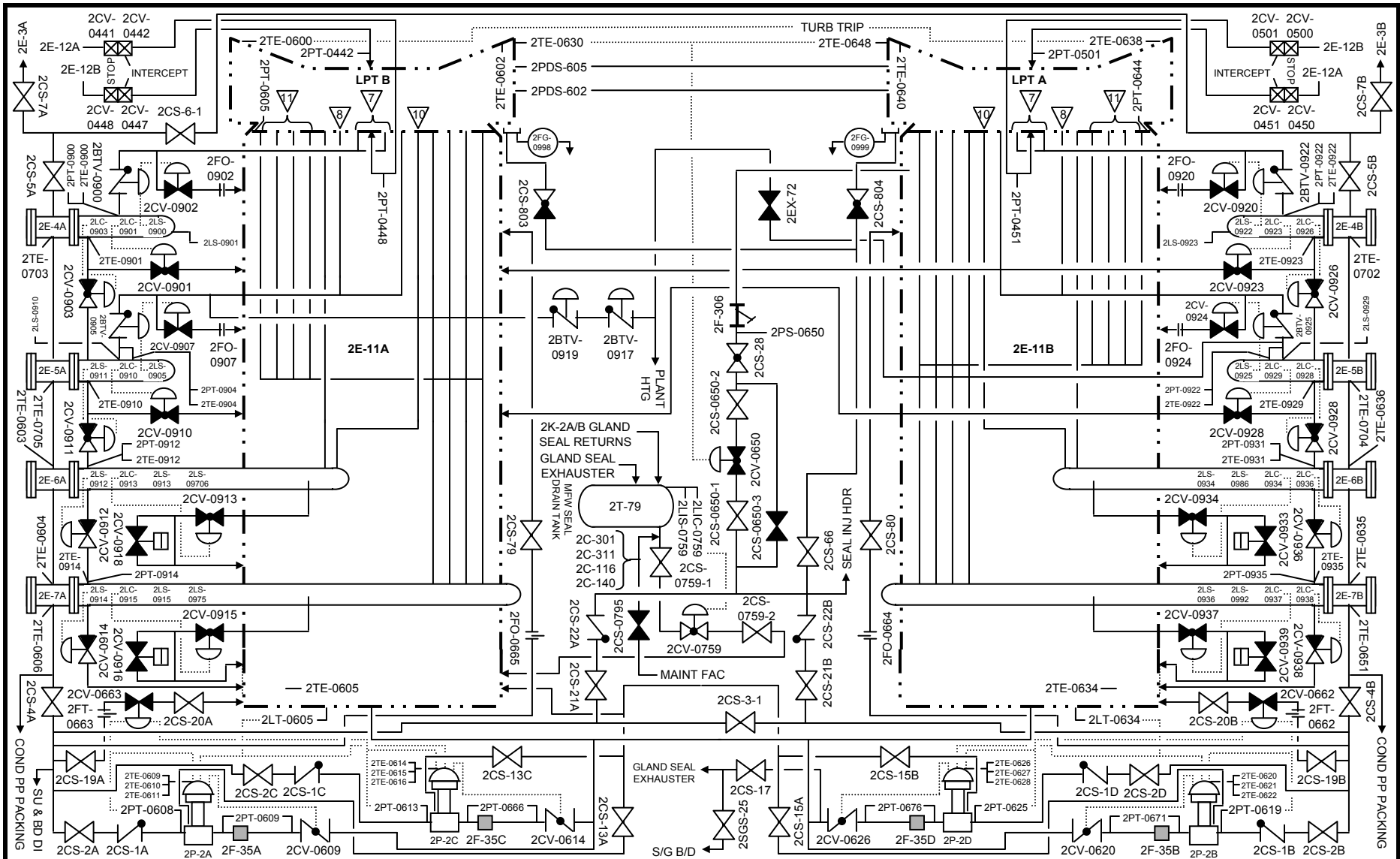

CONDENSATE AND EXTRACTION STEAM

SAR FIGURE NO. 10.4-2

ARKANSAS NUCLEAR ONE
 UNIT 2
 RUSSELLVILLE, ARKANSAS



SCALE:	NONE
DRAWN:	ENERGY
DESIGN:	ENERGY
CAD NO:	

AMENDMENT 20

BASED ON DRAWING NO	SHEET	REV.
---------------------	-------	------

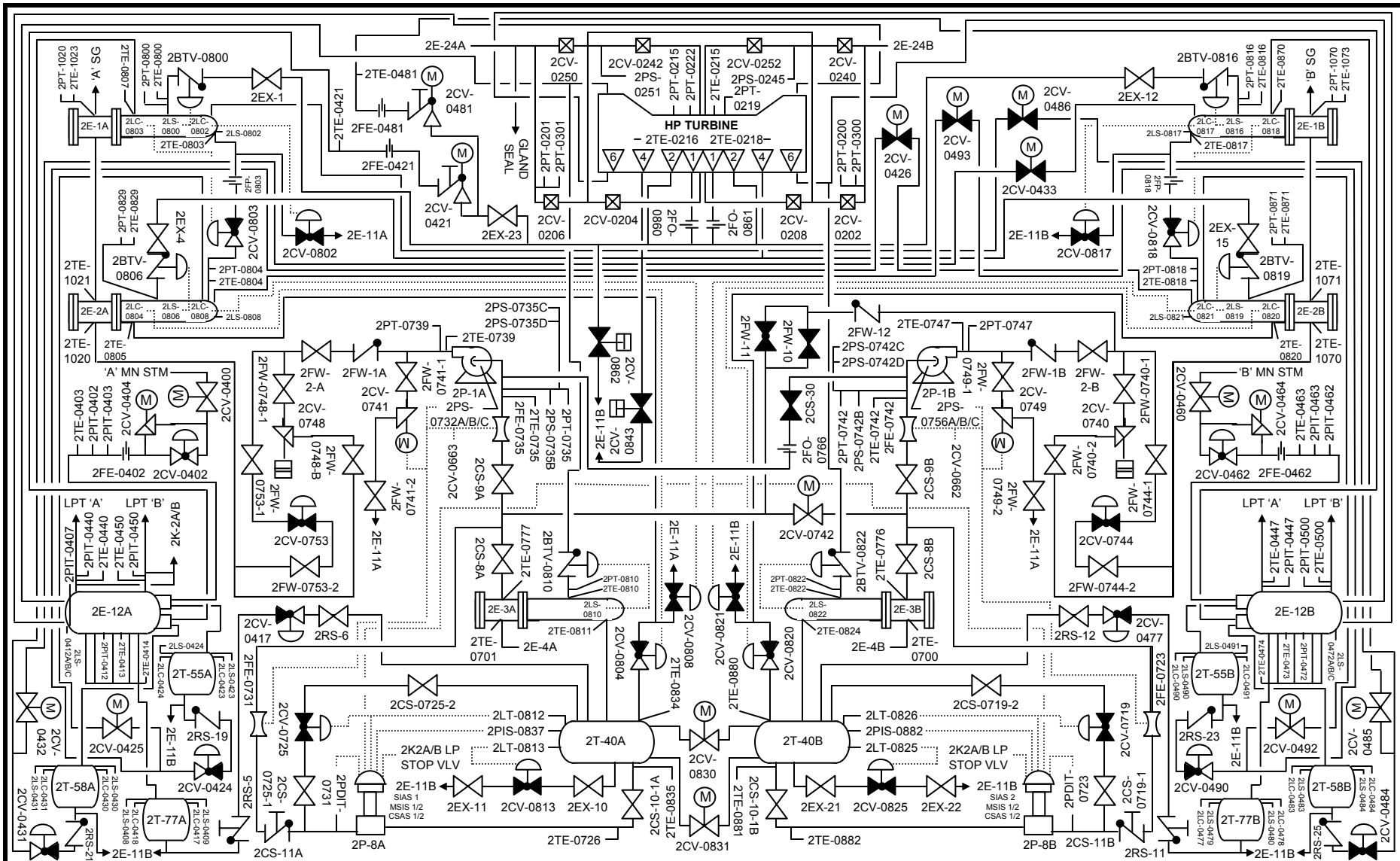

HEATER DRAINS, MAIN FEEDWATER, AND REHEAT STEAM

SAR FIGURE NO. 10.4-3

ARKANSAS NUCLEAR ONE
 UNIT 2
 RUSSELLVILLE, ARKANSAS



SCALE:	NONE
DRAWN:	ENERGY
DESIGN:	ENERGY
CAD NO:	

AMENDMENT 20		
BASED ON DRAWING NO	SHEET	REV.

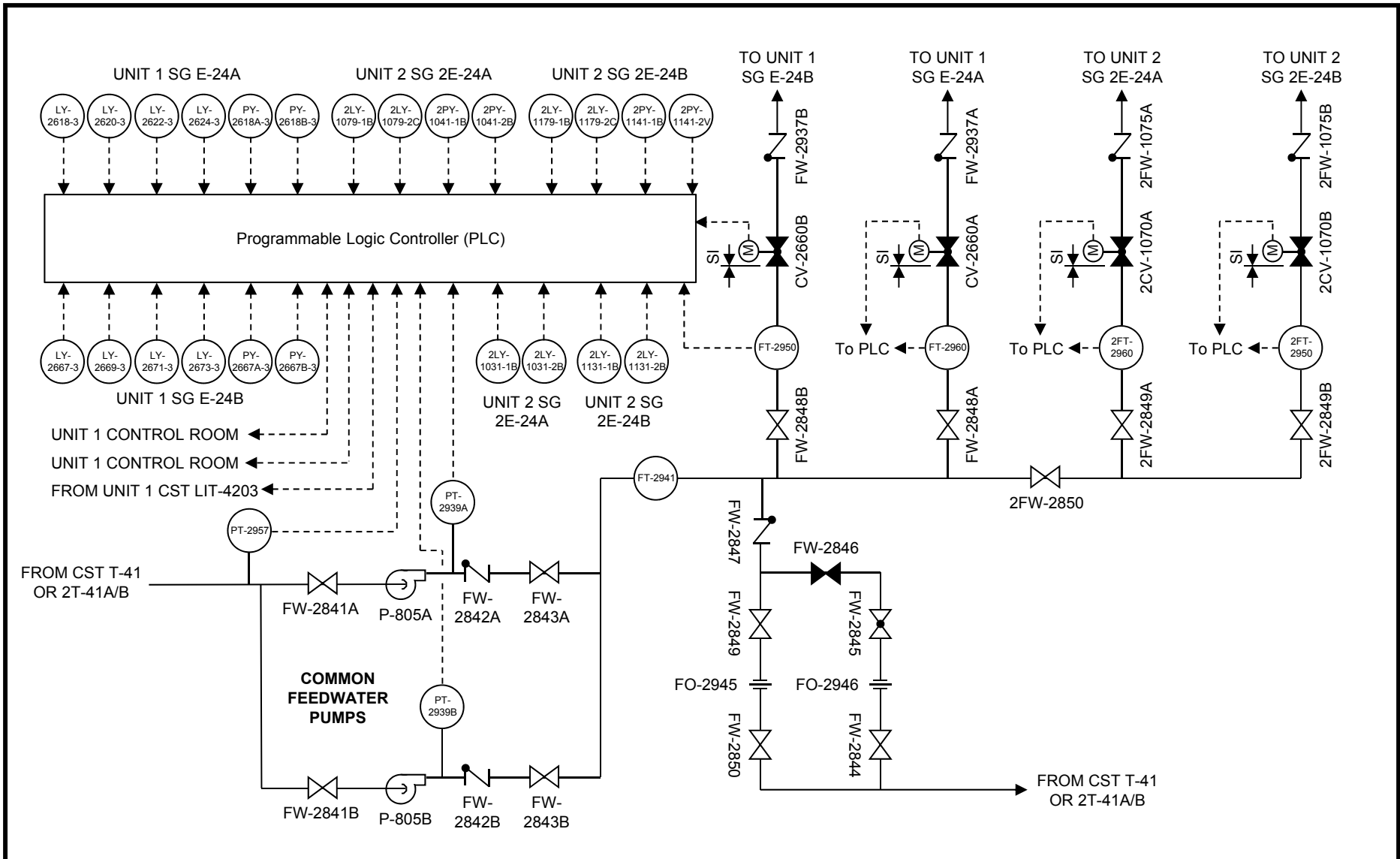

COMMON FEEDWATER SYSTEM

SAR FIGURE NO. 10.4-4

ARKANSAS NUCLEAR ONE
 UNIT 2
 RUSSELLVILLE, ARKANSAS



SCALE:	NONE
DRAWN:	ENERGY
DESIGN:	ENERGY
CAD NO:	

AMENDMENT 27

BASED ON DRAWING NO	SHEET	REV.

ARKANSAS NUCLEAR ONE
Unit 2

CHAPTER 11

TABLE OF CONTENTS

<u>Section</u>	<u>Title</u>	<u>Page</u>
11	<u>RADIOACTIVE WASTE MANAGEMENT</u>	11.1-1
11.1	<u>SOURCE TERMS</u>	11.1-1
11.1.1	FISSION PRODUCTS	11.1-1
11.1.2	CORROSION PRODUCTS	11.1-3
11.1.3	TRITIUM PRODUCTION.....	11.1-5
11.1.4	NITROGEN-16 ACTIVITY	11.1-6
11.1.5	FUEL EXPERIENCE	11.1-7
11.1.6	REACTOR COOLANT LEAKAGE.....	11.1-7
11.1.7	STEAM GENERATOR ACTIVITY	11.1-7
11.1.8	DERIVATION OF CORE RESIDENCE TIME (EQUATION 11.1.3)	11.1-8
11.2	<u>LIQUID WASTE SYSTEMS</u>	11.2-1
11.2.1	DESIGN OBJECTIVES	11.2-1
11.2.2	SYSTEM DESCRIPTION	11.2-2
11.2.2.1	<u>Boron Management System</u>	11.2-2
11.2.2.2	<u>Waste Management System</u>	11.2-3
11.2.2.3	<u>Regenerative Waste Processing System</u>	11.2-5
11.2.3	SYSTEM DESIGN.....	11.2-5
11.2.4	OPERATING PROCEDURES	11.2-7
11.2.4.1	<u>Boron Management System</u>	11.2-7
11.2.4.2	<u>Waste Management System</u>	11.2-8
11.2.5	PERFORMANCE TESTS.....	11.2-9
11.2.6	ESTIMATED RELEASES.....	11.2-9
11.2.6.1	<u>Liquid Waste Systems</u>	11.2-9

ARKANSAS NUCLEAR ONE
Unit 2

TABLE OF CONTENTS (continued)

<u>Section</u>	<u>Title</u>	<u>Page</u>
11.2.6.2	<u>Steam Generator Blowdown Releases</u>	11.2-10
11.2.6.3	<u>Tritium Releases</u>	11.2-10
11.2.6.4	<u>Unit 1 Liquid Releases</u>	11.2-11
11.2.7	RELEASE POINTS	11.2-13
11.2.8	DILUTION FACTORS.....	11.2-14
11.2.9	ESTIMATED DOSES	11.2-14
11.3	<u>GASEOUS WASTE SYSTEM</u>	11.3-1
11.3.1	DESIGN OBJECTIVES	11.3-1
11.3.2	SYSTEM DESCRIPTION	11.3-1
11.3.3	SYSTEM DESIGN	11.3-2
11.3.4	OPERATING PROCEDURE	11.3-3
11.3.4.1	<u>Tank Purging</u>	11.3-3
11.3.4.2	<u>Compressor Lineup</u>	11.3-3
11.3.4.3	<u>Gas Decay Tank Isolation</u>	11.3-4
11.3.4.4	<u>Discharge Monitoring</u>	11.3-4
11.3.4.5	<u>Water Draining From Gas Surge Tank</u>	11.3-4
11.3.4.6	<u>Gas Analyzer Control and Gas Sampling</u>	11.3-4
11.3.5	PERFORMANCE TESTS	11.3-4
11.3.6	ESTIMATED RELEASES	11.3-4
11.3.6.1	<u>Gaseous Waste System</u>	11.3-5
11.3.6.2	<u>Containment Purge Exhaust</u>	11.3-5
11.3.6.3	<u>Auxiliary Building Ventilation System</u>	11.3-6
11.3.6.4	<u>Steam Generator Blowdown Tank Vent</u>	11.3-7
11.3.6.5	<u>Condenser Vacuum Pump Exhaust</u>	11.3-7

ARKANSAS NUCLEAR ONE
Unit 2

TABLE OF CONTENTS (continued)

<u>Section</u>	<u>Title</u>	<u>Page</u>
11.3.6.6	<u>Turbine Gland Seal Exhaust</u>	11.3-8
11.3.6.7	<u>Steam Dump Valve and Relief Valve Discharge</u>	11.3-9
11.3.6.8	<u>Turbine Building Vent Exhaust</u>	11.3-9
11.3.6.9	<u>LLRWSB Vent Exhaust</u>	11.3-10
11.3.6.10	<u>PASS Discharges</u>	11.3-10
11.3.6.11	<u>Unit 1 Gaseous Releases</u>	11.3-10
11.3.7	RELEASE POINTS	11.3-13
11.3.8	DILUTION FACTORS.....	11.3-14
11.3.9	ESTIMATED DOSES	11.3-16
11.4	<u>PROCESS AND EFFLUENT RADIOLOGICAL MONITORING SYSTEMS</u> ..	11.4-1
11.4.1	DESIGN OBJECTIVES	11.4-1
11.4.2	CONTINUOUS MONITORING	11.4-2
11.4.2.1	<u>Process Liquid Monitors</u>	11.4-3
11.4.2.2	<u>Gas Monitoring Systems</u>	11.4-8
11.4.3	SAMPLING	11.4-11
11.4.4	INSPECTION, CALIBRATION, AND MAINTENANCE.....	11.4-11
11.4.4.1	<u>Continuous Monitoring Systems</u>	11.4-11
11.4.4.2	<u>Laboratory Radiation Detectors</u>	11.4-11
11.5	<u>SOLID RADIOACTIVE WASTE PROGRAM</u>	11.5-1
11.5.1	PROGRAM OBJECTIVES.....	11.5-1
11.5.2	RADIOACTIVE WASTE INPUTS	11.5-1
11.5.2.1	<u>Spent Resins</u>	11.5-1
11.5.2.2	<u>Expended Filter Cartridges</u>	11.5-2
11.5.2.3	<u>Dry Active Waste</u>	11.5-2

ARKANSAS NUCLEAR ONE
Unit 2

TABLE OF CONTENTS (continued)

<u>Section</u>	<u>Title</u>	<u>Page</u>
11.5.3	EQUIPMENT DESCRIPTION.....	11.5-2
11.5.4	EXPECTED SOLID WASTE QUANTITIES.....	11.5-2
11.5.5	PACKAGING AND SHIPPING.....	11.5-2
11.5.6	STORAGE FACILITIES.....	11.5-2
11.5.6.1	<u>Low Level Radioactive Waste Storage Building</u>	11.5-2
11.5.6.2	<u>Original Steam Generator Storage Facilities</u>	11.5-4
11.5.6.3	<u>Old Radwaste Storage Building</u>	11.5-5
11.5.6.4	<u>Pole Barn</u>	11.5-5
11.6	<u>OFF-SITE RADIOLOGICAL MONITORING PROGRAM</u>	11.6-1
11.6.1	EXPECTED BACKGROUND.....	11.6-1
11.6.2	CRITICAL PATHWAYS.....	11.6-1
11.6.3	SAMPLING MEDIA, LOCATIONS AND FREQUENCY.....	11.6-2
11.6.3.1	<u>Atmospheric Discharges</u>	11.6-2
11.6.3.2	<u>Liquid Discharges</u>	11.6-2
11.6.3.3	<u>Sampling Frequency</u>	11.6-2
11.6.4	ANALYTICAL SENSITIVITY.....	11.6-3
11.6.5	DATA ANALYSIS AND PRESENTATION.....	11.6-3
11.6.6	IN-PLANT EFFLUENT MONITORING.....	11.6-3
11.7	<u>REFERENCES</u>	11.7-1
11.8	<u>TABLES</u>	11.8-1

ARKANSAS NUCLEAR ONE
Unit 2

LIST OF TABLES

<u>Table No.</u>	<u>Title</u>	<u>Page</u>
11.1-1	BASIS FOR REACTOR COOLANT FISSION PRODUCT ACTIVITIES.....	11.8-1
11.1-2	MAXIMUM FISSION PRODUCT ACTIVITY IN THE REACTOR COOLANT DUE TO CONTINUOUS OPERATION AT 2900 MWt WITH ONE PERCENT FAILED FUEL.....	11.8-2
11.1-3	AVERAGE FISSION PRODUCT ACTIVITIES DUE TO CONTINUOUS OPERATION AT 2900 MWt WITH ONE PERCENT FAILED FUEL	11.8-3
11.1-4	AVERAGE FISSION PRODUCT ACTIVITIES DUE TO CONTINUOUS OPERATION AT 2900 MWt BASED ON NORMAL CONDITIONS, 0.25 PERCENT FAILED FUEL.....	11.8-4
11.1-5	LONG-LIVED ISOTOPES IN CRUD	11.8-4
11.1-6	MEASURED RADIOACTIVE CRUD ACTIVITY	11.8-5
11.1-7	AVERAGE AND MAXIMUM RESIDENCE TIMES	11.8-6
11.1-8	LONG-LIVED CRUD ACTIVITY	11.8-7
11.1-9	EQUILIBRIUM CRUD FILM THICKNESS	11.8-7
11.1-10	TRITIUM DATA	11.8-8
11.1-11	PARAMETERS USED IN THE CALCULATION OF STEAM GENERATOR WATER ACTIVITIES	11.8-9
11.1-12	EQUILIBRIUM STEAM GENERATOR WATER ACTIVITY	11.8-10
11.1-13	EQUILIBRIUM STEAM GENERATOR STEAM ACTIVITY	11.8-11
11.2-1	SOURCE AND VOLUME OF LIQUID WASTE.....	11.8-12
11.2-2	DESIGN DATA FOR BORON MANAGEMENT SYSTEM COMPONENTS ..	11.8-13
11.2-3	BORON MANAGEMENT SYSTEM PROCESS FLOW DATA	11.8-15
11.2-4	BMS MAX. NUCLIDE CONCENTRATIONS (70 °F) DURING NORMAL OPERATIONS.....	11.8-17
11.2-5	BMS MAX. NUCLIDE CONCENTRATIONS DURING ANTICIPATED OPERATIONAL OCCURRENCES	11.8-19
11.2-6	EXPECTED FILTER AND ION EXCHANGER PERFORMANCE	11.8-21
11.2-7	BORON MANAGEMENT SYSTEM PERFORMANCE DATA	11.8-22

ARKANSAS NUCLEAR ONE
Unit 2

LIST OF TABLES (continued)

<u>Table No.</u>	<u>Title</u>	<u>Page</u>
11.2-8	DESIGN DATA FOR WASTE MANAGEMENT SYSTEM COMPONENTS ..	11.8-23
11.2-9	WASTE MANAGEMENT SYSTEM FLOW DATA	11.8-25
11.2-10	WASTE MANAGEMENT SYSTEM EXPECTED PERFORMANCE	11.8-26
11.2-11	WMS NUCLIDE CONCENTRATIONS DURING NORMAL OPERATION	11.8-27
11.2-12	WMS NUCLIDE CONCENTRATIONS DURING ANTICIPATED OPERATIONS	11.8-28
11.2-13	ASSUMPTIONS USED IN CALCULATING ESTIMATED NORMAL AND ANTICIPATED OPERATIONAL OCCURRENCE RELEASES	11.8-29
11.2-14	BORON AND RADIOACTIVE WASTE MANAGEMENT SYSTEM INSTRUMENTATION APPLICATION	11.8-30
11.2-15A	EXPECTED LIQUID RELEASES FROM THE LIQUID WASTE SYSTEMS, NORMAL OPERATION	11.8-33
11.2-15B	EXPECTED LIQUID RELEASES FROM THE LIQUID WASTE SYSTEMS, ANTICIPATED OPERATIONAL OCCURRENCES	11.8-35
11.2-16A	COMPARISON OF LIQUID RELEASES TO 10 CFR 20 GUIDELINES, NORMAL OPERATION	11.8-37
11.2-16B	COMPARISON OF LIQUID RELEASES TO 10 CFR 20 GUIDELINES, ANTICIPATED OPERATIONAL OCCURRENCES	11.8-39
11.2-17	BIOLOGICAL CONCENTRATION FACTORS	11.8-41
11.2-18	DOSE CONVERSION CONSTANTS FOR DEPOSITED SEDIMENTS	11.8-42
11.2-19	CONSUMPTION RATES OF WATER AND BIOTA BY MAN	11.8-42
11.2-20	ANNUAL DOSES TO AVERAGE INDIVIDUAL	11.8-43
11.2-21	ANNUAL DOSES TO MAXIMUM INDIVIDUAL	11.8-44
11.2-22	ANNUAL POPULATION DOSE FROM LIQUID EFFLUENTS	11.8-44
11.2-23	DESIGN DATA FOR REGENERATIVE WASTE PROCESSING SYSTEM COMPONENTS	11.8-45
11.2-24	REGENERATIVE WASTE EVAPORATOR SYSTEM PROCESS FLOWS ..	11.8-46
11.3-1	GASEOUS WASTE SYSTEM FLOW DATA POINTS - NORMAL OPERATION	11.8-47

ARKANSAS NUCLEAR ONE
Unit 2

LIST OF TABLES (continued)

<u>Table No.</u>	<u>Title</u>	<u>Page</u>
11.3-2	GASEOUS WASTE SYSTEM FLOW DATA POINTS - ANTICIPATED OPERATIONAL OCCURRENCES	11.8-49
11.3-3	COMPONENT DATA FOR GASEOUS WASTE SYSTEM.....	11.8-50
11.3-4	GAS COLLECTION HEADER SOURCE POINTS	11.8-51
11.3-5A	ESTIMATED ANNUAL GASEOUS RELEASES, NORMAL OPERATION	11.8-52
11.3-5B	ESTIMATED ANNUAL GASEOUS RELEASES, ANTICIPATED OPERATIONAL OCCURRENCE	11.8-56
11.3-6	TOTAL AIR FLOW FROM EACH GASEOUS WASTE DISCHARGE POINT	11.8-60
11.3-7A	SITE BOUNDARY AIR CONCENTRATIONS RESULTING FROM ESTIMATED GASEOUS RELEASES, NORMAL OPERATIONS	11.8-60
11.3-7B	SITE BOUNDARY AIR CONCENTRATIONS RESULTING FROM ESTIMATED GASEOUS RELEASES, ANTICIPATED OPERATIONAL OCCURRENCE	11.8-61
11.3-8	PHYSICAL DATA FOR ISOTOPES	11.8-62
11.3-9	PARAMETERS USED IN INGESTION DOSE ANALYSIS.....	11.8-63
11.3-10A	SUMMARY OF DOSES FROM GASEOUS EFFLUENTS DUE TO NORMAL OPERATIONS	11.8-64
11.3-10B	SUMMARY OF DOSES FROM GASEOUS EFFLUENTS DUE TO ANTICIPATED OPERATIONAL OCCURRENCE.....	11.8-65
11.3-11	EXPOSURE PER PERSON DURING NORMAL OPERATIONS.....	11.8-65
11.3-12	TOTAL POPULATION EXPOSURE DURING NORMAL OPERATION USING 1980 and 2010 POPULATION DISTRIBUTION.....	11.8-66
11.3-13	EXPOSURE PER PERSON DURING ANTICIPATED OPERATIONAL OCCURRENCES.....	11.8-66
11.3-14	TOTAL POPULATION EXPOSURE DURING ANTICIPATED OPERATIONAL OCCURRENCES USING 1980 AND 2010 POPULATION DISTRIBUTION	11.8-66
11.4-1	PROCESS RADIATION MONITORS.....	11.8-67

ARKANSAS NUCLEAR ONE
Unit 2

LIST OF TABLES (continued)

<u>Table No.</u>	<u>Title</u>	<u>Page</u>
11.5-1	LOW LEVEL RADIOACTIVE WASTE STORAGE BUILDING (LLRWSB) TOTAL RADIOACTIVE ISOTOPE INVENTORY BASED ON CAPACITY	11.8-71
11.5.2	OLD RADWASTE STORAGE BUILDING (ORWSB) TOTAL RADIOACTIVE ISOTOPE INVENTORY BASED ON CAPACITY	11.8-74
11.5-3	ORIGINAL STEAM GENERATOR STORAGE FACILITY (OSGSF) TOTAL RADIOACTIVE ISOTOPE INVENTORY OF STEAM GENERATORS	11.8-75
11.5-4	SOLID RADIOACTIVE WASTE EQUIPMENT DATA.....	11.8-76
11.5-5	POLE BARN TOTAL RADIOACTIVE ISOTOPE INVENTORY	11.8-77
	BASED ON CAPACITY	
11.6-1	AIR	11.8-78
11.6-2	WATER	11.8-79
11.6-3	TERRESTRIAL.....	11.8-80
11.6-4	DELETED.....	11.8-80
11.6-5	DELETED.....	11.8-80
11.6-6	DELETED.....	11.8-80
11.6-7	DELETED.....	11.8-80

ARKANSAS NUCLEAR ONE
Unit 2

LIST OF FIGURES

<u>Figure No.</u>	<u>Title</u>
11.1-1	ESCAPE RATE COEFFICIENTS
11.2-1	LIQUID RADWASTE, BORON MANAGEMENT SYSTEM, REGENERATIVE WASTE
11.2-2	DELETED
11.2-3	DELETED
11.3-1	GASEOUS RADWASTE AND SOLID RADWASTE
11.3-2	DELETED
11.3-3	DELETED
11.5-1	UNIT 2 ORIGINAL STEAM GENERATOR STORAGE FACILITY
11.5-2	LOW LEVEL RADWASTE BUILDING STORAGE
11.6-1	EXPOSURE PATHWAYS FOR MAN

ARKANSAS NUCLEAR ONE
Unit 2

UPDATE REFERENCE LIST

Sections and references listed below denote documents that contain additional cross reference information used to update the SAR.

<u>Section</u>	<u>Cross References</u>
11.3.8 11.7	Correspondence from Rueter, AP&L, to Youngblood, NRC, dated September 22, 1976. (2CAN097613).
11.3.2	Correspondence from Trimble AP&L, to Clark, NRC, dated October 8, 1980. (2CAN108007)
11.5.1	Correspondence from Griffin, AP&L, to ES Department Heads, AP&L, dated December 16, 1985. (EDS-85-10)
11.5.4 Table 11.5-1	Arkansas Nuclear One - Effluent and Waste Disposal Report (Regulatory Guide 1.21) for the period January 1, 1985 to December 31, 1985.
11.5.6	Arkansas Nuclear One - Unit 1&2 - Low Level Radioactive Waste Storage Building Design and Licensing Reports - prepared by Nutech Engineers, San Jose, California.
11.3.2 11.3.3 11.3.4.6 Table 11.2-14 Table 11.3-4 Figure 11.2-2 Figure 11.3-1 Figure 11.5-1	Design Change Package 82-2004, "ANO-2 New Waste Gas Panels."
11.3.6.9	Design Change Package 84-1069, "Hydrogen Recombiners."
Figure 11.2-1	Design Change Package 80-2043F, "Construction of Post Accident Sampling System."
Figure 11.2-1	Design Change Package 82-2010, "Add Sample Sink Drain Line and Loop Seals."
Figure 11.2-1 Figure 11.2-2	Design Change Package 82-2168, "Valves 2CV-2061-2 and 2CV-2201-2 Modification."
Figure 11.2-3	Design Change Package 79-2197, "Drain Lines from Showers and Floor Drains in SU/BD Demineralizer and Decon Room."
Figure 11.2-3	Design Change Package 82-2051, "Tie-In Line from Neutralizing Tank (2T-87) to Regen Waste Tank (2T-92)."
Figure 11.2-3	Design Change Package 82-2172, "Regenerative Waste System Alarm Modifications."

ARKANSAS NUCLEAR ONE
Unit 2

UPDATE REFERENCE LIST (continued)

<u>Section</u>	<u>Cross References</u>
Figure 11.3-1	Design Change Package 84-2065A, "EPG Ball Valve Actuator Replacement."
Figure 11.5-1	Design Change Package 81-2098A, "Installation of Spent Resin Bypass for 2T-13."
<u>Amendment 9</u>	
Figure 11.2-2	Design Change Package 86-2011, "LPSI Pump Section Line Evaluation."
Figure 11.2-3	Procedure 2106.015, Rev. 10, "Condensate Transfer System."
Figure 11.3-2	Design Change Package 79-2025, "Maintenance Facility and Turbine Deck Expansion."
11.3.6.11 11.4.2.2.3 Table 11.4-1	ANO Calculation 89-E-0105-01, "Use of Hydrogen Purge System."
11.4.4.1	ANO Technical Specifications 4.3.3.1 and Table 4.3-3
<u>Amendment 10</u>	
11.2.2.3	Procedure 2104.021, Rev. 11, "Regenerative Waste Systems."
11.2.6.2	Procedure 2106.008, Rev. 14, "S/G Secondary Fill, Drain, and Wet Layup."
11.2.7 11.6.3.3	Procedure 2104.023, Rev. 2, "Turbine Building and Auxiliary Building Extension Drain Sumps."
Table 11.2-14 Figure 11.2-1 Figure 11.5-1	Design Change Package 83-2052, "2K11-B8 Modifications - Panel 2C113."
Table 11.2-14 Figure 11.2-2	Design Change Package 83-2054, "2K11-E8 Modifications - Panel 2C112."
11.4.2 Table 11.4-1	Design Change Package 85-2070, "Turbine Building Drain Line Radiation Monitor."
Table 11.4-1	Procedure 2105.016, Rev. 13, Permanent Change 2, "Radiation Monitoring and Evacuation Alarm System."
Table 11.4-1	Procedure 2105.016, Rev. 13, Permanent Change 4, "Radiation Monitoring and Evacuation Alarm System."
Figure 11.2-1	Plant Change 88-1963, "Vacuum Breaker Installation on 2T-20 A & B."
Figure 11.2-2	Design Change Package 88-2004, "LPSI System Overpressurization."

ARKANSAS NUCLEAR ONE
Unit 2

UPDATE REFERENCE LIST (continued)

<u>Section</u>	<u>Cross References</u>
Figure 11.2-2	Design Change Package 89-2024, "Recorder Upgrade."
Figure 11.3-1	Plant Change 88-2516, "Removal of Extra Discharge Check Valve From 2C-9B."
Figure 11.3-1	Plant Change 90-8025, "Gas Collection Header Isolation/Flush Valves."
<u>Amendment 11</u>	
11.2.2.3 11.4.2.1.5 Table 11.4-1 Figure 11.2-3	Plant Change 92-8026, "Removal of Regenerate Waste Radiation Detector & Monitor."
11.4.2	ANO Procedure 2104.023, Rev. 2, "Turbine Building and Auxiliary Building Extension Drain Sumps."
Table 11.2-2 Table 11.2-8	Condition Report 2-89-0053, "Pall-Trinity Filter Data."
Figure 11.2-1	ANO Procedure 2104.014, Rev. 23, "LRW and BMS Operations."
Figure 11.2-1	Design Change Package 88-2111, "ANO-2 Annunciator Upgrade Phase III."
Figure 11.2-2	Plant Engineering Action Request 91-7345, "Boron Management System."
Figure 11.2-2	ANO Procedure 2104.018, Rev. 3, "B.A. & Waste Concentrators Operations."
Figure 11.3-1	Plant Change 88-1962, "Vacuum Breaker Installation on 2T-6A & B."
Figure 11.3-1	Limited Change Package 92-6014, "Spectacle Flange Addition on 2HBB-1-2".
Figure 11.3-1	ANO Procedure 2104.022, Rev. 25, "Gaseous Radwaste System."
<u>Amendment 12</u>	
11.2.1 Figure 11.2-1 Figure 11.2-2 Figure 11.5-1	Design Change Package 93-2003, "Permanent Piping Installation for Vendor Supplied Liquid Radioactive Waste System"
11.2.2.1 11.2.2.2 11.2.3	Plant Change 93-8022, "Removal of the BMS to CVCS Supply Line"

ARKANSAS NUCLEAR ONE
Unit 2

UPDATE REFERENCE LIST (continued)

<u>Section</u>	<u>Cross References</u>
11.2.9 11.5.1 11.5.6 11.6.2 11.7	Evaluation of Health Physics Changes Required for Revised 10 CFR 20 Implementation
Figure 11.2-1	Limited Change Package 93-6027, "Permanent Modification to Ensure ANO-2 Reactor Building Sump Integrity"
Figure 11.2-2	Plant Change 92-2027, "Install Additional Handswitch for 2CV-2330A & B"
Figure 11.2-3	Plant Change 93-8037, "Heat Trace Upgrade"
Figure 11.3-1	Plant Change 93-8009, "Replacement of Pneumatic Waste Gas Compressor Discharge Isolation Valves 2CV-2447 and 2CV-2457 with Manual Valves"
<u>Amendment 13</u>	
Figure 11.2-1	Plant Change 92-8016, "Removal of Decon Sink and Exhaust Hood from Hot Tool Room"
Figure 11.2-1 Figure 11.2-2	Design Change Package 93-2007, "ANO-2 New Points to Plant Monitoring System"
Figure 11.2-1	Limited Change Package 93-6025, "ANO-2 HPSI Pump Room 'C' Floor Drain Modification"
Figure 11.2-1	Limited Change Package 93-6027, "Permanent Modifications to Ensure ANO-2 Reactor Building Sump Integrity"
Figure 11.2-1	Design Change Package 94-1001, "E-1A & E-1B Feedwater Heater Replacement"
Figure 11.2-1 Figure 11.2-2 Figure 11.3-1	Limited Change Package 94-6028, "ANO-2 Gaseous Waste System Modification"
Figure 11.2-1	Plant Change 94-8044, "Installation of Clean-out Access on Line 2HCD-47-2"
Figure 11.2-2	Plant Change 92-8079, "2RITS-8750-1 Recorder Output Change"
Figure 11.2-2	Plant Change 95-8012, "Deletion of 2F68 RDT Low Pressure Alarm"
Figure 11.2-3	Plant Change 95-8023, "Steam Generator Blowdown to the Regenerative Waste Management System"

ARKANSAS NUCLEAR ONE
Unit 2

UPDATE REFERENCE LIST (continued)

<u>Section</u>	<u>Cross References</u>
<u>Amendment 14</u>	
Figure 11.2-1	Plant Change 92-8063, "Connection of LRW Vent Line to Duct Work"
Figure 11.2-2	Plant Change 96-8030, "Modification to RX Drain Tank Line to Assist Refueling Canal"
Figure 11.3-1	Plant Change 95-8052, "Containment Depressurization System"
<u>Amendment 15</u>	
11.2.2.1	Procedure 2102.002, "Plant Heatup"
11.2.6.4.1.1 11.2.6.4.2.E 11.2.8 Table 11.2.15A Table 11.2-15B	Design Change Package 951018D101, "Condenser Tube Bundle & Water Box Replacement"
11.3.2 11.3.3 11.3.4.2 11.3.5 11.3.6.11.1 Table 11.2-14 Table 11.3-3 Figure 11.2-1 Figure 11.2-2 Figure 11.3-1	Design Change Package 946012D201, "Containment Vent Header/Waste Gas System Modification"
11.3.6.11.1	Procedure 1604.051, "Eberline Radiation Monitoring System"
11.4.2 11.4.2.2.5 Table 11.4-1 Figure 11.2-2	Design Change Package 942021D201, "Replacement of Control Room Radiation Monitor"
11.5.1 11.5.2.1 11.5.2.2 11.5.2.3 11.5.4 11.5.6 Table 11.5-1	Procedure 1000.141, "Solid Radioactive Management Process Control Program"
Figure 11.2-3	Plant Change 95-8066, "Steam Generator Blowdown to the Flume via the Regen Waste"

ARKANSAS NUCLEAR ONE
Unit 2

UPDATE REFERENCE LIST (continued)

<u>Section</u>	<u>Cross References</u>
Figure 11.3-1	Procedure 2304.165, "Removal of Radioactive Radwaste System Instrumentation"
<u>Amendment 16</u>	
11.4.2.2.2	Nuclear Change Package 002239N201, "Reactor Building Pressure and Oxygen Control"
11.5.6	Design Change Package 980642D201, "Steam Generator Replacement Facilities"
Figure 11.2-1 Figure 11.2-2	Design Change Package 974814D201, "Installation of Thermal Relief Valves on Containment Penetrations"
Figure 11.2-1	Nuclear Change Package 991522N201, "Containment Cooler Chilled Water Coil Replacement and Fan Pitch"
Figure 11.2-3	Plant Change 963212P201, "Regen Waste System Upgrade"
Figure 11.3-1	Nuclear Change Package 980781N201, "Waste Gas Vent Valve for Line Purge"
<u>Amendment 17</u>	
Figure 11.2-1	Condition Report ANO-2002-0402, "Drawing Discrepancy"
<u>Amendment 18</u>	
Figure 11.2-1	Engineering Request ER-ANO-2003-0221-000, "Isolation of Post Accident Sampling System"
Figure 11.3-1	Engineering Request ER-ANO-2002-0325-000, "2PCV-2427 Valve Operator Replacement"
Figure 11.5-1	Condition Report CR-ANO-2-2002-1763, "2SZ-11 Revised to Closed Configuration"
Figure 11.5-1	License Basis Document Change 2-11.5-0012, "Correction of Interconnecting Piping Illustration"
Figure 11.2-1	Engineering Request ER-ANO-2002-0968, "Alternate Configuration for Electrically Disabling 2P-133"
11.2.3 Figure 11.5-1	Engineering Request ER-ANO-2000-2400-001, "Addition of Spent Resin Tank Pressure Gauge and Associated Valves"
Figure 11.2-1	Engineering Request ER-ANO-1994-6012, "Modification of Waste Gas and Containment Vent Header"

ARKANSAS NUCLEAR ONE
Unit 2

UPDATE REFERENCE LIST (continued)

<u>Section</u>	<u>Cross References</u>
11.5 11.5.2.1 11.5.2.2	License Document Change 2-11.5-0013, "Deleted Reference to 'ANO' in Program Title"
<u>Amendment 19</u>	
11.2.3	License Document Change Request 2-1.2-0048, "Deletion/replacement of Excessive Detailed Drawings from SAR"
Figure 11.2-1	Sh5 Condition Report CR-ANO-2-2003-0707, "Removal of Non-Existent Valve From Drawing"
Figure 11.2-2	Sh1 Condition Report CR-ANO-2-2003-1180, "Modification of the Gaseous Radwaste System"
Figure 11.3-1	
Figure 11.3-2	Condition Report CR-ANO-2-2004-1839, "Drawing Label Correction"
Table 11.2-23	Engineering Request ER-ANO-2005-0391-000, "Evaluation of Design Temperature/Pressure of Regenerative Waste System Pumps"
Table 11.3-3	Engineering Request ER-ANO-1994-6012-201, "Removal of Vacuum Degasifier Vacuum Pumps"
<u>Amendment 20</u>	
11.2.2.1	License Document Change Request 05-058, "Deletion/simplification of Excessive Detailed Drawings from SAR"
11.2.2.3	
11.2.3	
11.2.7	
11.3.3	
11.3.6.11	
11.4.2.1.4	
11.4.2.1.5	
11.4.2.2.1	
11.4.2.2.4	
Table 11.2-3	
Table 11.2-9	
Table 11.3-1	
Table 11.3-6	
Figures – ALL	
<u>Amendment 21</u>	
11.4.4.1	Engineering Request EC 383, "Calibration of Continuous Air Monitors"

ARKANSAS NUCLEAR ONE
Unit 2

UPDATE REFERENCE LIST (continued)

<u>Section</u>	<u>Cross References</u>
<u>Amendment 22</u>	
11.5.6	Engineering Change ER-ANO-2002-1078-006, "Replacement Steam Generators"
<u>Amendment 23</u>	
11.2.2.1 11.2.3 Table 11.5-4	Engineering Report ER-ANO-2002-0052-000, "Solid Waste System Abandonment"
<u>Amendment 24</u>	
11.3.7 Figure 11.2-2	Condition Report CR-ANO-C-2012-0749, "Comprehensive Listing of SPING Monitored Release Points"
<u>Amendment 25</u>	
Figure 11.2-1	Engineering Change EC-48544, "Administrative Changes to Drawings"
11.5.6.1 11.5.6.2 11.5.6.3 Table 11.5-3 Figure 11.5-1 Figure 11.5-2	Licensing Basis Document Change LBDC 14-031, "Add Detail to OSFSFs and LLRW Building"
<u>Amendment 26</u>	
11.5.6.1 11.5.6.2 11.5.6.3 Table 11.5-1 Table 11.5-2	Condition Report CR-ANO-C-2014-1356, "Add Detail of Outside Radioactive Storage Facilities"
11.5.6.4 Table 11.5-5	Condition Report CR-ANO-C-2014-1356, "Add Detail of Outside Radioactive Storage Facilities"
11.5.6.4	Engineering Change EC-46199, "New Cask Transfer Facility"
<u>Amendment 27</u>	
Table 11.3-2	Licensing Basis Document Change LBDC 17-044, "Table 11.3-2 Editorial Correction"

ARKANSAS NUCLEAR ONE
Unit 2

UPDATE REFERENCE LIST (continued)

Section

Cross References

Amendment 29

11.4.2.2.4	Engineering Change EC-71778, "SPING Replacements"
11.5.6.1	
Figure 11.2-2	

ARKANSAS NUCLEAR ONE
Unit 2

RECORD OF REVISIONS

<u>PAGE #</u>	<u>AMENDMENT #</u>	<u>PAGE #</u>	<u>AMENDMENT #</u>	<u>PAGE #</u>	<u>AMENDMENT #</u>
TABLE OF CONTENTS		CHAPTER 11 (CONT.)		CHAPTER 11 (CONT.)	
11-i	28	11.2-10	23	11.5-4	26
11-ii	28	11.2-11	23	11.5-5	26
11-iii	28	11.2-12	23	11.5-6	26
11-iv	28	11.2-13	23		
11-v	28	11.2-14	23	11.6-1	16
11-vi	28	11.2-15	23	11.6-2	16
11-vii	28	11.2-16	23	11.6-3	16
11-viii	28	11.2-17	23	11.6-4	16
11-ix	28				
11-x	28	11.3-1	24	11.7-1	12
11-xi	28	11.3-2	24	11.7-2	12
11-xii	28	11.3-3	24		
11-xiii	28	11.3-4	24	11.8-1	27
11-xiv	28	11.3-5	24	11.8-2	27
11-xv	28	11.3-6	24	11.8-3	27
11-xvi	28	11.3-7	24	11.8-4	27
11-xvii	28	11.3-8	24	11.8-5	27
11-xviii	28	11.3-9	24	11.8-6	27
11-xix	28	11.3-10	24	11.8-7	27
		11.3-11	24	11.8-8	27
		11.3-12	24	11.8-9	27
CHAPTER 11		11.3-13	24	11.8-10	27
		11.3-14	24	11.8-11	27
11.1-1	16	11.3-15	24	11.8-12	27
11.1-2	16	11.3-16	24	11.8-13	27
11.1-3	16	11.3-17	24	11.8-14	27
11.1-4	16	11.3-18	24	11.8-15	27
11.1-5	16	11.3-19	24	11.8-16	27
11.1-6	16			11.8-17	27
11.1-7	16	11.4-1	28	11.8-18	27
11.1-8	16	11.4-2	28	11.8-19	27
11.1-9	16	11.4-3	28	11.8-20	27
11.1-10	16	11.4-4	28	11.8-21	27
11.1-11	16	11.4-5	28	11.8-22	27
		11.4-6	28	11.8-23	27
11.2-1	22	11.4-7	28	11.8-24	27
11.2-2	22	11.4-8	28	11.8-25	27
11.2-3	22	11.4-9	28	11.8-26	27
11.2-4	22	11.4-10	28	11.8-27	27
11.2-5	22	11.4-11	28	11.8-28	27
11.2-6	22	11.4-12	28	11.8-29	27
11.2-7	22			11.8-30	27
11.2-8	22	11.5-1	28	11.8-31	27
11.2-9	22	11.5-2	28	11.8-32	27
		11.5-3	28	11.8-33	27
				11.8-34	27

ARKANSAS NUCLEAR ONE
Unit 2

RECORD OF REVISIONS (continued)

<u>PAGE #</u>	<u>AMENDMENT #</u>	<u>PAGE #</u>	<u>AMENDMENT #</u>	<u>PAGE #</u>	<u>AMENDMENT #</u>
CHAPTER 11 (CONT.)		CHAPTER 11 (CONT.)		CHAPTER 11 (CONT.)	
11.8-35	27	11.8-78	27		
11.8-36	27	11.8-79	27		
11.8-37	27	11.8-80	27		
11.8-38	27				
11.8-39	27				
11.8-40	27	F 11.1-1	20		
11.8-41	27				
11.8-42	27	F 11.2-1	25		
11.8-43	27	F 11.2-2	28		
11.8-44	27	F 11.2-3	20		
11.8-45	27				
11.8-46	27	F 11.3-1	20		
11.8-47	27	F 11.3-2	20		
11.8-48	27	F 11.3-3	20		
11.8-49	27				
11.8-50	27	F 11.5-1	25		
11.8-51	27	F 11.5-2	25		
11.8-52	27				
11.8-53	27	F 11.6-1	20		
11.8-54	27				
11.8-55	27				
11.8-56	27				
11.8-57	27				
11.8-58	27				
11.8-59	27				
11.8-60	27				
11.8-61	27				
11.8-62	27				
11.8-63	27				
11.8-64	27				
11.8-65	27				
11.8-66	27				
11.8-67	27				
11.8-68	27				
11.8-69	27				
11.8-70	27				
11.8-71	27				
11.8-72	27				
11.8-73	27				
11.8-74	27				
11.8-75	27				
11.8-76	27				
11.8-77	27				

11 RADIOACTIVE WASTE MANAGEMENT

The purpose of this section is to provide assurance that the plant has sufficient installed capacity and treatment equipment in the radioactive waste (radwaste) systems to reduce the radioactivity to levels which will not be in excess of the appropriate limits for the general public or plant personnel and are as low as practicable.

Actual operating experience may differ from the assumptions used in this chapter.

Note: In descriptions of detectors, monitors, and samplers, "in-line" or "on-line" means that the instrument is in the process flow. "Off-line" instruments require a venturi or sample pump to provide a representative sample.

11.1 SOURCE TERMS

This section defines the sources of radioactivity which serve as input into the various radwaste systems. These are original design basis assumptions and analyses which were used to verify the adequacy of the radwaste systems as designed.

11.1.1 FISSION PRODUCTS

[This section consists of historical information.]

The mathematical model used for determining the specific concentration of nuclides in the reactor coolant involves a group of time dependent simultaneous equations. The fuel pellet region and the reactor coolant region are analyzed by applying a mass balance of production and removal for each nuclide thereby establishing a set of first order, differential equations. In the fuel pellet region, the mass balance includes the fission product production by direct fission yield, by parent fission product decay and by neutron activation, and removal by decay, by neutron activation, and by escape to the reactor coolant. In the coolant region, the analysis includes the fission product production by escape from the fuel through defective fuel rod cladding, parent decay in the coolant, and neutron activation of coolant fission products. Removal is by decay, by coolant purification by feed (makeup) and bleed (letdown to Boron Management System (BMS), and by leakage or other feed and bleed due to such operations as cold or hot startups and shutdowns or load follow operations.

The expression derived to determine the fission product inventory in the fuel pellet region is:

$$\frac{dN_{pi}}{dt} = FY_i P + (f_{i-1} \lambda_{i-1} + \sigma_{i-1} \phi) N_{pi-1} - (\lambda_i + \nu_i + \sigma_i \phi) N_{pi} \quad \text{Eq. 11.1.1}$$

and in the reactor coolant region is:

$$\frac{dN_{ci}}{dt} = D \nu_i N_{pi} + (f_{i-1} \lambda_{i-1} + \sigma_{i-1} \phi \text{ FCS}) N_{ci-1} - \left[\lambda_i + \frac{R_p}{W_c} \eta_i + \frac{(1 - \eta_i)}{C_o - \dot{C}t_i} \dot{C} + \lambda_c \right] N_{ci} \quad \text{Eq. 11.1.2}$$

ARKANSAS NUCLEAR ONE
Unit 2

where

- N = Population (atoms)
- F = Average fission rate (fission/MWt-sec)
- Y = U-235 fission yield of nuclide (fraction) (Reference 31)
- P = Core power (MWt)
- λ = Decay constant (sec^{-1}) - Half lives taken from the "Chart of Nuclides" (Reference 3)
- σ = Microscopic capture cross section (cm^2) (Reference 11)
- ϕ = Thermal neutron flux (neutrons/ cm^2 -sec)
- ν = Escape rate coefficient (sec^{-1})
- f = Branching fraction
- t = Time (sec)
- D = Defective fuel rod cladding (fraction)
- FCS = Core coolant volume-to-reactor coolant volume ratio
- R = Purification flow rate during power cycle (lbm/sec)
- W = Reactor coolant mass during power cycle (lbm)
- η = Resin efficiency of Chemical and Volume Control System (CVCS) ion exchanger for a given nuclide
- C_o = Beginning of Cycle (BOC) boron concentration (ppm)
- \dot{C} = Boron reduction rate by feed and bleed (ppm/sec) compensating for fuel burnup

Subscripts

- P = pellet region
- C = coolant region
- I = Designates the nuclide parameters (i.e., XE^{133})
- i-1 = Designates the parent nuclide parameters (i.e., I^{133})

This model does not involve the fuel plenum and gap region. Instead escape rate coefficients are used to represent the overall release for the fuel pellets to the reactor coolant. Plenum and gap region activities are presented in Section 15.1.23.

ARKANSAS NUCLEAR ONE
Unit 2

The primary factor in determining the fission product inventories is the escape rate coefficient. This is an empirical coefficient which was derived from experiments initiated by Bettis and run in the NRX and MTR reactors (Reference 27). The present escape rate coefficient derived from these data are shown in Table 11.1-1. The escape rate coefficients were obtained from test rods which were operated at high linear heat rates. The linear heat rates were uniform over the test sections which were only 1.25 inches in length. The exact linear heat rates were not precisely known but post-irradiation inspection showed that some test rods had experienced centerline melting. Later tests were done in Canada to determine the effect of rod length on the release of fission gases and iodines from defective fuel (Reference 18). A byproduct of these experiments was the effect of linear heat rate on the escape rate coefficient. Escape rate coefficients for several nuclides as a function of the linear heat rate are shown in Figure 11.1-1. Also shown in Figure 11.1-1 are the escape rate coefficients used for noble gases and halogens. Since the average heat rate for a fuel rod (approximately 7 kilowatts per foot) is well below the crossover point in Figure 11.1-1 which is above 17 kilowatts power foot in each case, the presently used escape rate coefficients are conservative.

The fission product activity concentration used as basic source terms are given in Tables 11.1-2 through 11.1-4. The data used for these calculations are given in Table 11.1-1.

11.1.2 CORROSION PRODUCTS

[This section consists of historical information.]

The activity of radioactive crud and its thickness on primary system surfaces have been evaluated using measured data from various operating Pressurized Water Reactors (PWR's). (References 4, 5, 8, 9, 10, 15, 16, 17, 37 and 38).

Even though these reactors have different water chemistries and different materials in contact with the primary coolant, their crud activity (dpm/mg-crud), crud film thicknesses and dose rates due to this crud are markedly similar. The half-lives, reactions and gamma weighted average decay energy for each of the long-lived isotopes in the radioactive crud are as shown in Table 11.1-5. The long-lived isotopes are those significant isotopes remaining after a 48-hour delay.

The radioactive crud originates on in-core and out-of-core surfaces. The crud plates out on the in-core surfaces and re-erodes after a short irradiation period. This irradiation period or core residence time is determined by the following expressions.

Circulating Crud:

$$t_{\text{res}} = \frac{1}{\lambda} \ln \left[1 - \frac{A S (16.67)}{\Sigma_c \phi C} \right] \text{sec} \quad \text{Eq. 11.1.3}$$

where

A is the crud activity (dpm/mg-crud)

S is the total primary system area (cm²)

$\Sigma_c \phi$ is the activation rate (d/g-sec)

C is the core surface area (cm²)

λ is the decay constant (sec⁻⁵).

ARKANSAS NUCLEAR ONE
Unit 2

See Section 11.1.8 for the derivation of Equation 11.1.3.

Deposited Crud:

$$t_{\text{res}} = -\frac{1}{\lambda} \ln \left(1 - \frac{A(16.67)}{\Sigma_c \phi} \right), \text{ secs.}$$

The average and maximum crud activities (dpm/mg-crud) for those reactors considered in the determination of the core residence times are as shown in Table 11.1-6. The average and maximum core residence times as determined by the above expressions and the activities in Table 11.1-6 are as shown in Table 11.1-7. As all the Fe-59 residence times are long, its activity is assumed saturated. The average values of the maximum residence times for each isotope are also given.

Utilizing these average values of the maximum core residence times, the calculated crud activities (dpm/mg-crud) are determined by the following expression:

$$A = \Sigma_c \phi (1 - e^{-\lambda t_{\text{res}}}) 0.06 \frac{C}{S}, \text{ dpm/mg} \quad \text{Eq. 11.1.4}$$

As the average values of the maximum residence times are used, the calculated crud activities will be conservative. The resulting calculated crud activities of the long-lived isotopes considered are as shown in Table 11.1-8.

Using the average crud level in the primary coolant (75 ppb) of those operating reactors shown in Table 11.1-6 and the calculated crud activities (dpm/mg crud), the average isotopic activities in the primary coolant are determined by the following expression:

$$\bar{A} = \frac{A}{60} (75 \times 10^{-6}) \rho (2.7 \times 10^{-5}), \mu\text{ci/cm}^3 \quad \text{Eq. 11.1.5}$$

where

ρ is crud density (g/cm³)

The average calculated activities of the primary coolant using the above expression are also shown in Table 11.1-8. The maximum coolant activities can be higher due to "crud bursts" during shutdowns or changes in power. However, these "bursts" occur over a short period of time; therefore, the average values are more reasonable to use for long-term operation.

The equilibrium thickness of radioactive crud film (mg crud/cm²) has been determined by two methods:

- A. The direct measurement of the film during maintenance and or tests in operating reactors.
- B. Calculating crud film thickness from measured dose rates and specific activities (dpm/mg crud) of deposited crud.

The equilibrium crud film thicknesses for various primary system areas are as shown in Table 11.1-9.

ARKANSAS NUCLEAR ONE
Unit 2

11.1.3 TRITIUM PRODUCTION

[This section consists of historical information.]

Tritium may be produced in the coolant or enter the coolant from a number of sources. One source is from fissioning of uranium within the fuel yielding tritium as a ternary fission product. Since zircaloy fuel cladding reacts with tritium to form zirconium hydride, no tritium diffuses through the cladding (References 33 and 36). Therefore, the tritium released to the coolant from the fuel is only from defective fuel rod cladding.

Tritium is also produced by the reaction of neutrons with boron in the Control Element Assemblies (CEA's). Data from operating plants using B₄C control rods indicates that no tritium is released from the control rods. The tritium may combine with carbon to form hydrocarbons and or with lithium to form lithium hydride thereby preventing diffusion through the NiCrFe cladding. Another possibility is the low internal temperature of the B₄C control rods (relative to stainless clad fuel rods from which about 45 percent escape can be expected) may prohibit tritium diffusion. To account for possible control rod cladding defects it is assumed that one percent of the tritium produced in the CEA is released to the coolant.

Other sources of tritium are the activation of boron, lithium, deuterium, and nitrogen within the reactor coolant. Boron in the form of boric acid is used in the coolant for reactivity control. Lithium is produced in the coolant as a result of neutron-boron reaction and may also be added as a pH control agent. Deuterium is a naturally occurring constituent of water. Nitrogen may be present due to aeration of the coolant during shutdown and due to aerated makeup water.

The expression used to determine the Reactor Coolant System (RCS) tritium inventory is:

$$\frac{dN}{dt} = A(t) - B(t)N$$

where N is the tritium population in atoms, A(t) is the generalized production rate in atoms/sec and B(t) is the removal rate in sec⁻¹. The expressions for A(t) and B(t) are:

$$A(t) = PFYD(C_o - \dot{C}_t)(L_o - \dot{L}t)(FCS)E$$

$$B(t) = \lambda + \left(\frac{\dot{C}}{C_o \dot{C}t} \right) + \lambda_c$$

where

- P = Core power (MWt)
- F = Average fission rate (fissions/MWt-sec)
- Y = Yield (see Table 11.1-10)
- D = Defective fuel rod cladding (fraction)
- C_o = initial boron concentration (ppm Boron)

ARKANSAS NUCLEAR ONE
Unit 2

- \dot{C} = Boron concentration reduction rate (ppm B/sec)
- L_o = Initial lithium concentration (ppm Lithium)
- \dot{L} = Core coolant volume to reactor coolant volume ratio
- FCS = Core coolant volume to reactor coolant volume ratio
- E = Equivalent full power CEAs in the core
- λ = Tritium decay constant (sec⁻¹)
- λ_c = Leakage constant (sec⁻¹)

As indicated in Table 11.1-10, when one or more factors of A(t) do not apply to a given source, they reduce to unity, leaving A(t) unaffected. Hence, only one expression is needed to calculate tritium production from all sources.

Tables 11.1-2, 11.1-3 and 11.1-4 list the appropriate tritium concentrations obtained using this model.

11.1.4 NITROGEN-16 ACTIVITY

[This section consists of historical information.]

Nitrogen-16 is produced by the ¹⁶O(n,p)¹⁶N reaction when beta decays, emitting high energy gammas 82 percent of the time. The gamma energies are 6.13 and 7.10 mev in a ratio of 12.5 to 1.0. The N-16 half-life is 7.13 seconds. The threshold for the reaction is 10.2 mev.

The N-16 activity at the reactor vessel outlet nozzle is 4.08 x 10⁶ disintegrations/cm³-sec. This activity is based on the following expression and reactor parameters:

$$\text{Activity (d/cm}^3\text{-sec)} = \frac{\Sigma\phi(1 - e^{-\lambda t_c})e^{-\lambda t_R}}{(1 - e^{-\lambda t_T})}$$

where

- $\Sigma\phi$ = reaction rate (4.23 x 10⁷ d/cm³-sec),
- t_c = core transit time (0.80 sec),
- t_T = total primary loop transit time (11.59 sec),
- t_R = time from the core outlet to the point of interest (1.42 sec. to outlet nozzle).
- λ = N-16 decay constant (0.0943 sec⁻¹)

11.1.5 FUEL EXPERIENCE

[This section consists of historical information.]

Zircaloy-clad UO_2 fuel in the Obrigheim reactor in Germany sustained a fuel failure rate just over 0.1 percent in its first cycle; this has fallen in the second cycle to essentially zero (< 0.00 percent). The fuel failure rate in the Dresden 1 reactor over a 9-year period has averaged < 0.1 percent with the rate more recently being even lower. Fuel in the Mihama reactor in Japan and the Point Beach reactor has exceeded the burnup at which failures in fuel of similar design were observed in Ginna, without exhibiting increases in coolant activity (indicative of fuel defects).

The fact that widespread defects in some reactors, associated with fuel clad contamination, have now been recognized, and corrective measures taken, provides further assurance that failures at this frequency from this cause will not occur in the future. Nevertheless, there is always the possibility, despite careful testing and manufacture, that other defects will become apparent in new fuel designs in the future which, because of statistical considerations or unrecognized or uncontrollable environmental differences, could not be foreseen. The design refinements continually introduced to nuclear power reactors and their fuel as a natural outcome of a dynamic industry will, on rare occasions, introduce such defects. Existing licensing regulations limit coolant activity to that associated with one percent failed fuel, even during those transitory and infrequent periods. Over the lifetime of an operating reactor, it is expected that reactor coolant activity levels corresponding to 0.1 percent failed fuel will predominate.

11.1.6 REACTOR COOLANT LEAKAGE

[This section consists of historical information.]

Systems containing radioactive coolant are potential sources of leakage that can contribute to the total release to the environment. If leakage occurs from systems containing reactor coolant, gaseous radioactivity could be released via several pathways.

Leakage from the RCS exposed to the containment atmosphere is expected to be 40 gallons per day or less. Concentrations of the nuclides up to those defined in Table 11.1-2 with one percent failed fuel could enter the containment. Under equilibrium conditions, 10 percent or less of the iodine and particulates leaking into the containment remains in the atmosphere and is available for release. The other 90 percent of the iodine and particulates is either plated out in the containment or remains in the liquid and is collected in the containment sump. The annual average exposed leakage into the auxiliary building is expected to be 20 gallons per day or less. The maximum specific activity of the leakage with one percent failed fuel is indicated in Table 11.1-2.

Means of detecting leakage are discussed in Section 5.2.7.

11.1.7 STEAM GENERATOR ACTIVITY

[This section consists of historical information.]

Radionuclides will be released in effluents from the secondary system during periods of primary-to-secondary leakage through defective steam generator tubes. Annual releases in liquid and gaseous effluents are given in Sections 11.2 and 11.3, respectively. These releases have been derived from equilibrium radionuclide concentrations in steam generator water during assumed conditions of reactor coolant activity, primary-to-secondary leak rate and steam generator blowdown rate.

ARKANSAS NUCLEAR ONE
Unit 2

Assuming that radionuclides are removed from the secondary system only by exhausting through the main condenser vacuum pumps, by steam generator blowdown, or by radioactive decay during steam generator residency, the activities of radionuclides in steam generator water are described by the equation:

$$\frac{dN_{Si}}{dt} = \frac{R_L N_{Ci}}{V_s} - \left[\frac{R_s \eta_{Si} (1 - \eta_{Ci})}{V_s} + \lambda_i + \frac{R_B}{V_s} \right] N_{Si}$$

where

- N_s = nuclide concentration in steam generator water ($\mu\text{Ci/cc}$)
- N_c = nuclide concentration in reactor coolant ($\mu\text{Ci/cc}$)
- R_L = primary to secondary leakage rate (cc/sec)
- R_s = main steam flow rate (cc/sec)
- R_B = steam generator blowdown flow rate (cc/sec)
- V_s = steam generator liquid volume (cc)
- λ = radioactive decay constant (sec^{-1})
- η_s = nuclide concentration in steam/nuclide concentration in steam generator water
- η_c = $1 - 1/\text{main condenser partition factor}$
- i = nuclide index.

Under the assumption of constant reactor coolant activities, the concentrations of nuclides in steam generator water at equilibrium are given by:

$$N_{Si} = \frac{R_L N_{Ci}}{R_s \eta_{Si} (1 - \eta_{Ci}) + \lambda_i V_s + R_B}$$

An additional source term is employed in the above equations to determine activities of daughter nuclides in steam generator water resulting from decay of precursor nuclides within the secondary system.

The parameters appearing in the above formulation which have been used to calculate equilibrium steam generator water activities are given in Table 11.1-11. Equilibrium steam generator steam and water activities upon which normal and anticipated operational occurrence secondary system effluents have been determined are given in Tables 11.1-12 and 11.1-13.

11.1.8 DERIVATION OF CORE RESIDENCE TIME (EQUATION 11.1.3)

[This section consists of historical information.]

ARKANSAS NUCLEAR ONE
Unit 2

For Circulating Crud

A. The number of radioactive atoms in the film on in-core surface is:

$$\frac{dN_f}{dt} = \Sigma_c \phi - \lambda N_f$$

where

N_f = Number of radioactive atoms in film

λ = Decay constant

$\Sigma_c \phi$ = Reaction rate

Integrating the above equation:

$$N_f e^{\lambda t} = \frac{\Sigma_c \phi e^{\lambda t}}{\lambda} + C$$

where

C = Constant of Integration

Evaluating C:

At $t=0$, $N_f=0$

Therefore:

$$C = \frac{-\Sigma_c \phi}{\lambda}$$

Substituting C into the Equation for N_f

$$N_f = \frac{-\Sigma_c \phi}{\lambda} (1 - e^{-\lambda t}) \text{ atoms/gm}$$

Since t is the in-core residence time, the above equation becomes:

$$N_f = \frac{-\Sigma_c \phi}{\lambda} (1 - e^{-\lambda t \text{ res}})$$

B. Now determining an expression for the net number of radioactive atoms released to the coolant:

$$\frac{dN_R}{dt} = N_f RC - (\alpha + \beta + \lambda) N_R$$

ARKANSAS NUCLEAR ONE
Unit 2

where

N_R = Number of atoms released

R = Erosion rate

C = Core surface area

α = Plateout rate

β = Purification cleanup rate

Integrating the above equation:

$$N_R e^{(\alpha+\beta+\lambda)t} = \frac{N_f RC e^{(\alpha+\beta+\lambda)t}}{\alpha + \beta + \lambda} + D$$

where

D = Constant of Integration

Evaluating D :

At $t=0$, $N=0$

Therefore:

$$D = \frac{-N_f RC}{\alpha + \beta + \lambda}$$

Substituting D into the equation for N_R :

$$N_R = \frac{N_f RC}{\alpha + \beta + \lambda} \left[1 - e^{-(\alpha+\beta+\lambda)t} \right] \text{ atoms}$$

- C. Determining the total net amount of crud released to the coolant from all primary system surfaces assuming that the contribution of radioactive crud is negligible,

$$\frac{dM_R}{dt} = RS - (\alpha + \beta)M_R$$

where

M_R = Total crud released from system surfaces

S = Total RCS surface area

Now integrating and solving for the constant of integration similar to the method used for determining N_R :

$$M_R = \frac{RS}{\alpha + \beta} \left(1 - e^{-(\alpha+\beta)t} \right) \text{ gm - crud}$$

ARKANSAS NUCLEAR ONE
Unit 2

D. Then the activity of crud released to the system is:

$$A = \lambda \frac{N_R}{M_R} \quad \text{dps / gm - crud}$$

Substituting for N_R and M_R , and since λ is small as compared to ∞ and β , the activity becomes:

$$A = \frac{\sum_c \phi C}{S} (1 - e^{-\lambda t_{res}})$$

Rearranging and solving for t_{res}

$$t_{res} = \frac{-1}{\lambda} \ln \left(1 - \frac{AS}{C \sum_c \phi} \right)$$

With the units of A in dpm/mg-crud and the units of $\sum_c \phi$ in dps/gm the above equation becomes:

$$t_{res} = \frac{-1}{\lambda} \ln \left(1 - \frac{16.67 AS}{C \sum_c \phi} \right)$$

For Deposited Crud:

A. The activity deposited on in-core surfaces is:

$$A = \lambda N_f \quad \text{dps/gm}$$

Substituting for N_f :

$$A = \sum_c \phi (1 - e^{-\lambda t_{res}})$$

or

$$t_{res} = \frac{-1}{\lambda} \ln \left(1 - \frac{A}{\sum_c \phi} \right)$$

With the units of A in dpm/mg-crud and the units of $\sum_c \phi$ in dps/gm the above equation becomes:

$$t_{res} = \frac{-1}{\lambda} \ln \left(1 - \frac{16.67 A}{\sum_c \phi} \right)$$

11.2 LIQUID WASTE SYSTEMS

11.2.1 DESIGN OBJECTIVES

The Boron Management System (BMS), the Waste Management System (WMS), and the Regenerative Waste Processing System (RWPS) are designed to provide controlled collection, handling, treatment, and disposal of radioactive wastes from plant operation. Due to technological changes in waste monitoring and processing, alternative, vendor-supplied, specifically authorized methods may be used. The principle original design criteria to ensure protection of the general public from hazardous radiation exposure by maintaining activity release levels as low as practicable and to provide a reliable, functional, processing system were as follows:

- A. Process the various potentially radioactive liquid wastes such that the radioactivity release to the environment during normal plant operation will be in accordance with the Appendix I limits to 10 CFR 50. The numerical design objectives for releases during normal operation were to limit the average annual liquid activity release quantity to five Ci and the average annual liquid activity release concentration to 2×10^{-8} uCi/cc (excluding tritium and dissolved fission product gases).
- B. Limit the annual average tritium discharge concentration to 5×10^{-6} uCi/cc in accordance with the Appendix I limits to 10 CFR 50.
- C. Limit releases due to anticipated operational occurrences with 10 CFR 20 limits.
- D. Provide sufficient flexibility to allow the plant operator to select the desired balance between holdup and radioactive decay, evaporation, ion exchange, filtration, and dilution. This capability permits removal of radioactivity as soon as feasible in the process in order to concentrate activities into areas where adequate shielding can be provided, thus preventing the buildup of excessive activity in the remainder of the system.
- E. Provide the capability to process wastes with activities resulting from continuous operations within the criterion of one percent fuel rod cladding failures. In addition, the system shall have the capacity to accommodate all liquid wastes generated during the following operations:
 1. Base loaded operation at warranted output up to approximately 97 percent of equilibrium cycle core life.
 2. Back-to-back cold shutdowns to five percent subcritical and startups to approximately 82 percent of equilibrium cycle core life assuming that the boric acid concentrator is available for use during the shutdown period.

Table 11.2-1 gives the source and expected volume of liquid waste based on estimates made before Unit 2 began operating. This information is historical. Normal operation is defined as operating with 0.25 percent failed fuel and anticipated operational occurrences are evaluated assuming operation with 1.0 percent failed fuel.

ARKANSAS NUCLEAR ONE
Unit 2

11.2.2 SYSTEM DESCRIPTION

Liquid waste influents to the liquid waste treatment systems are segregated by chemistry and/or probable source activity for more efficient processing. Tritiated, hydrogenated, borated reactor coolant quality wastes of potentially high activity are mainly processed in the BMS. Aerated, chemically contaminated, and low activity liquid wastes are received and processed separately in the WMS. Low activity waste resulting from startup and blowdown ion exchanger regeneration is processed in the RWPS. If necessary, similar waste from Unit 1 condensate demineralizer regeneration could be transferred to the Unit 2 RWPS for processing.

11.2.2.1 Boron Management System

The major influent to the BMS is reactor coolant from the Chemical and Volume Control System (CVCS) letdown due to feed and bleed operations for shutdown, startups, and boron dilution over core life. Reactor coolant quality water from valve and equipment leakoffs, drains, and relief valves within the containment are collected in the reactor drain tank and subsequently processed by this system. During plant heatup and cooldown, controlled bleed-off flow from the reactor coolant pump seals may also be collected by the reactor drain tank. Reactor coolant from leakoffs and drains in the reactor auxiliary building are collected in a waste tank of the WMS.

The BMS simplified diagram is shown on Figure 11.2-1. The borated and hydrogenated water discharged by the reactor drain pumps or diverted by the CVCS volume control tank diversion valve is sent to the vacuum degasifier for dissolved gas removal or transferred directly to one of the holdup tanks for further processing or holdup if dissolved gas levels are sufficiently low. If necessary, hydrogen is stripped from the water so that an explosive gas mixture does not occur in subsequent process equipment. Borated and hydrogenated water that has been transferred to the holdup tanks may be recirculated back to the degasifier if sample results indicate further gas stripping is necessary. The degassed liquid is pumped from the degasifier to the holdup tanks or back to the CVCS when preparing for a plant shutdown. The holdup tanks provide sufficient storage capacity to accumulate discharges until a sufficient volume is available for further processing on a batch basis. The radioactivity of the liquid is significantly reduced during storage by natural decay of the short half-lived radionuclides. During this period, any degasification and radioactive decay can be monitored by liquid sample analysis or periodic grab samples of the tank gas space. The holdup tanks have high and low pressure alarms that annunciate locally on the Boron Management System Control Panel and high level alarms that annunciate on the control panel and input to a common system trouble alarm in the Control Room. The holdup recirculation pump was originally intended to supply flushing water to the preconcentrator ion exchangers and spent resin tank during resin sluice operations. ANO-2 resin is transferred using one of the Reactor Makeup Water Pumps (2P-109A/B) and the holdup recirculation pump has not been used for this purpose.

The contents of the holdup tanks are normally processed through either the vendor processing skid or the installed preconcentrator filter and preconcentrator ion exchanger to the waste condensate tanks or the boric acid condensate tank. If necessary, a holdup tank may be recirculated for processing prior to transfer. The holdup pumps (or holdup recirculation pump, if being used to transfer) are (is) stopped manually when the desired holdup tank level is reached. The water may be recirculated for further processing or discharged to the circulating water flume. The BMS was originally designed with a boric acid concentrator that is currently not in use. Fluid from the holdup tanks could be transferred to the boric acid concentrator through the preconcentrator filter and preconcentrator ion exchanger. If necessary, the contents of one holdup tank could be recirculated through a preconcentrator filter and ion exchanger prior to

ARKANSAS NUCLEAR ONE
Unit 2

discharge to the boric acid concentrator. The holdup pumps and holdup recirculation pump can be stopped manually on low holdup tank level. The boric acid concentrator has local grab sample provisions that can ensure control of the effluent chemistry. The boric acid concentrator provides a level signal that, after the initial manual pump start, can automatically start and stop the holdup or holdup recirculation pump aligned to the boric acid concentrator. Concentrate (recovery boric acid) from the boric acid concentrator can pass through a discharge strainer and be collected in the boric acid makeup tanks. These bottoms could also be pumped to the Solid Radioactive Waste System (SRWS) for ultimate off-site disposal. The [solidification portion of the SRWS has been abandoned](#). The distillate from the boric acid concentrator, after flowing through one of the boric acid concentrate ion exchangers, could be collected in the boric acid condensate tanks. The water could then be recirculated to the holdup tanks or the boric acid concentrator condensate ion exchanger for further processing or discharged to the circulating water discharge.

Prior to a controlled discharge of the treated liquid waste, the fluid must be analyzed and its activity verified as acceptably low. Controlled discharge is accomplished through an effluent radiation monitor which records the release activity level and automatically terminates discharge on high radiation.

Design data for the major components are given in Table 11.2-2. Flow, temperature, and pressure are given in Table 11.2-3. In addition, process flow Mode 1 indicates the system parameters during processing of the reactor drain tank contents through the vacuum degasifier. Modes 2, 3, and 4 indicate the system parameters during three possible conditions of processing the CVCS letdown flow which has been diverted from the volume control tank. Mode 5 was based on processing a full holdup tank through the boric acid concentrator (currently not in use) after nine days of decay. In the event that the holdup tank contents require additional processing, recirculation Mode 6 can be employed to cycle the tanks' contents through the preconcentrator filter and ion exchanger.

The nuclide concentrations for normal operation and for anticipated operational occurrences have been determined using the component design data shown in Table 11.2-2 and the process flow data shown in Table 11.2-3. The resulting concentrations, adjusted to 70 °F, are indicated for selected system locations in Tables 11.2-4 and 11.2-5, respectively. Normal operation is defined as operating with 0.25 percent failed fuel and anticipated operational occurrences are evaluated assuming operation with 1.0 percent failed fuel.

Analysis is made assuming that the activities in Tables 11.1-3 and 11.1-4 exist in the coolant upstream of the purification equipment in conjunction with the expected equipment performance given in Tables 11.2-6 and 11.2-7.

Systems similar in function and design to the BMS described herein have been used successfully at plants such as Connecticut Yankee and Ginna. Even with significant coolant radioactivity at Ginna, releases have been controlled well within the 10 CFR 20 limits.

All process components have been used extensively in the nuclear industry to remove radioactive contaminants from liquids. The performance of process units used in the analysis is in agreement with general industry experience.

11.2.2.2 Waste Management System

The WMS is shown in Figure 11.2-1. Liquid waste influents to this system include those from chemical laboratory drains, decontamination area drains, sampling drains, equipment drains, and building sumps.

ARKANSAS NUCLEAR ONE
Unit 2

Low activity equipment drains are collected by the drain collection and LRW drain headers and directed to either of two Waste Collection Tanks (2T-20A/B). If contamination levels in steam generator blowdown preclude processing in the RWPS, the blowdown can be aligned to the LRW drain collection header if necessary. Low activity, aerated and potentially dirty liquid drains, building sumps, chemical drains from the sampling system, decontamination drains, and contaminated shower drains are collected in the Auxiliary Building Sump. The contents of the Auxiliary Building Sump are then automatically pumped to either of the two Waste Collection Tanks when an established level setpoint is reached, or are manually pumped to one of the tanks when desired. When sufficient volume in the on-line waste tank is collected, the contents are transferred to a BMS Holdup Tank (2T-12A/B/C/D) for subsequent processing with collected BMS waste or processed directly via the Vendor Processing Skid to a Waste Condensate Tank (2T-20A/B) or a Boric Acid Condensate Tank (2T-69A/B). If desired, the waste collection tank can be recirculated for sampling prior to transfer or processing.

The WMS was originally designed with a waste concentrator that is currently not in use. Currently, the LRW system effluent collected in a BMS Holdup tank is then processed via the Vendor Processing Skid (or the BMS filters/demineralizers if desired) to a Boric Acid Condensate Tank (2T-69A/B). A BMS Holdup Tank may also be processed via the VPS to a Waste Condensate Tank (2T-21A/B). LRW system effluent that has been processed directly to a Boric Acid Condensate Tank or a Waste Condensate Tank is then sampled for release purposes. If activity and pH levels permit, the Boric Acid or Waste Condensate Tank contents are pumped out at a controlled rate to the Circulating water discharge. If discharge limitations can not be met, tank contents are recirculated through the VPS for further treatment. The activity of the discharge line effluent is monitored and recorded. Should the activity exceed the high setpoint value, the discharge is automatically terminated.

All tanks are equipped with water level instrumentation alarms and their respective pumps are tripped on low level signals.

There is no field run piping in this system.

Design data for the major components is given in Table 11.2-8. Flow, temperature, and pressure are given in Table 11.2-9.

In addition, process flow Mode 1 indicates the system parameters during the purification of waste tank 2T20A contents via the waste concentrator (currently not in use) and waste condensate tanks. Mode 2 indicates a similar procedure for the processing of waste tank 2T20B.

The nuclide concentrations adjusted to 70 °F for the original design normal operation and anticipated operational occurrences are given in Tables 11.2-11 and 11.2-12, respectively. The selected locations are indicated by the process data points described on Table 11.2-9. The original design equipment performance characteristics utilized by these tables are defined in Table 11.2-10.

The activity of the aerated liquid wastes collected in the waste tanks is approximately one percent of the reactor coolant activity, owing to dilution from washdown and decontamination procedures.

ARKANSAS NUCLEAR ONE
Unit 2

As the system was originally designed, major radioactivity removal, if necessary, could have been accomplished by the concentrators. Experience indicated that a concentrator DF (bottoms to distillate) of 10^4 could have been obtained. The concentrators were specified at this rating and testing by the vendor confirmed the performance.

Section 11.2.6 defines the leakage sources and the assumptions used in calculating estimated normal and anticipated operational occurrence releases due to leakage sources. This information is historical.

11.2.2.3 Regenerative Waste Processing System

Aqueous waste from chemical regeneration of spent startup/blowdown demineralizer resins in Unit 2 (or spent condensate demineralizer resins in Unit 1, if necessary) is drained into regenerative waste holdup tanks. Normally, a block flange is installed to prevent inadvertent cross contamination between units. Unprocessed steam generator blowdown water may be directed into the regenerative waste tanks after being cooled in the blowdown heat exchangers. The system is shown in Figure 11.2-1. Waste samples are taken prior to release of each batch to verify monitor accuracy and isotopic composition peculiar to regenerative waste. If holdup tank activity is below a calculated release activity limit, the waste batch is neutralized to a 6.0 - 9.0 pH and discharged to the circulating water flume. While the release is in progress, pH and radioactivity levels are monitored either by installed instrumentation or by grab sample analyzed by chemists. If at any time during the release the pH level is found to be outside the 6.0 to 9.0 band or activity is found to be above the predetermined limit, the release is terminated. Additionally, a discharge isolation valve can automatically terminate the waste discharge if pH and/or radioactivity limits are exceeded.

As the RWPS was originally designed, a radioactive circulating batch could be processed through the Regenerative Waste Evaporator System. The evaporator is currently not in use. This system could concentrate the total solids and radioactivity from the wastes into a bottoms slurry which could be immobilized in drums or shielded casks for transport to off-site radwaste burial. Over 95 percent of the water in the regenerative waste could be removed as very low activity level distillate. The distillate could then be recycled to the Condensate System through the startup/blowdown demineralizers. It could also be monitored for radiation and, if sufficiently nonradioactive, discharged to the circulating water flume. Flow and radioactivity of the distillate discharge could be monitored and recorded.

Design data for the major components of this system are given in Table 11.2-23. A tabulation of flows to be processed by the RWPS is given in Table 11.2-24.

11.2.3 SYSTEM DESIGN

The liquid waste systems are designed on batch mode basis for flexibility of operation. These batching operations proceed intermittently at faster flow rates than the annual average process rates and therefore, the system components are sized per this criterion. Tables 11.2-2 and 11.2-8 list the design parameters for the major components of the liquid waste systems. The designation as "non-nuclear safety" of components listed in Tables 11.2-2 and 11.2-8, and Section 3.2.2 is based on the hypothetical failure of the component not resulting in calculated potential exposures in excess of 170 mRem (whole body). For example, failure of the holdup tanks filled with letdown concentrations of radionuclides from the vacuum degasifier would release 784 equivalent curies of Xe-133 and results in a dose ≤ 170 mRem. Noble gases would be the limiting criteria for whole body dose, and the largest inventory of noble gases in all the non-nuclear safety components would be in the holdup tanks.

ARKANSAS NUCLEAR ONE
Unit 2

Similarly, the Seismic Category (described in Section 3.2.1) was determined from the total site boundary dose received after a simultaneous failure of all nonseismic components. The two major nonseismic components containing noble gases, the holdup and waste condensate tanks, could only release 833 equivalent curies of Xe-133 and would result in a whole body dose ≤ 2.5 rem.

Process and radiation instrumentation are depicted in Figure 11.2-1 and are described in Table 11.2-14.

On all tanks containing radioactive liquid, provisions have been made to contain and collect overflow in the event that any of these tanks are inadvertently overfilled. In addition, high level alarms are provided on the majority of these tanks to minimize the possibility of inadvertent overfilling. Level indication and alarm instrumentation for the tanks are located inside the auxiliary building. The four boron management holdup tanks (2T12A-D) are interconnected via the common gas vent/gas analyzer header and the common vent relief header so that the overflow from any one of these tanks will be collected in the other three. The waste tanks (2T20A, B) and the boric acid condensate tanks (2T69A, B) overflow to the auxiliary building sump. The spent resin storage tank (2T13) and the waste condensate tanks (2T21A, B) overflow to the waste tanks via the drain collection header. The concentrator bottoms tank (2T78) was originally designed to overflow via the drain collection header, but it has been abandoned in place and isolated.

In addition to the above, the following tanks were originally designed to contain potentially radioactive liquid:

- A. Refueling Water Tank (RWT) (2T3);
- B. Reactor Makeup Water Tank (RMWT) (2T73);
- C. Regenerative Waste Tanks (2T-92A, B, C);
- D. Boric Acid Makeup Tanks (2T6A, B); and,
- E. Volume Control Tank (VCT) (2T4)

The operating modes of the WMS and BMS processes have resulted in 2T73, 2T6A, and 2T6B not having contained radioactive liquid.

With the exception of the RWT and the RMWT, all of the above tanks are located inside the auxiliary building. The RWT is located just southwest of the containment, on the top slab of Area 26 of the auxiliary building. The inherent system design for the enclosure of this tank and the associated piping makes it highly improbable that the radioactive liquid will spill to the ground. If the tank were inadvertently overfilled, a 4-inch overflow line would route the liquid to the holdup tank vault which drains to the auxiliary building sump. This line will adequately accommodate the maximum makeup rate to the tank. There are no obstructions to flow in this line. System valves and components associated with the RWT are located inside the Seismic Category 1 auxiliary building. This tank is shown on the Containment Spray System Diagram (Figure 6.2-17).

The RMWT is located on the ground northwest of the containment. Makeup to the RMWT is normally from the vendor's Mobile Water Treatment Facility. Tank level indication is provided in the control room with a high level alarm to preclude inadvertent tank overfill.

ARKANSAS NUCLEAR ONE
Unit 2

Level indication and level alarms for the regenerative waste tanks are provided on the Regenerative Waste System control panel. Overflow from each of these tanks is directed to a sump located in one corner of the tank room. Sump level is maintained automatically by pumping the liquid to the off-service tank.

Level indication and level alarms for the boric acid makeup tanks and the volume control tank are provided in the control room. Overflow from the boric acid makeup tanks is routed to the waste tanks via the tank room floor drain. The volume control tank is not a vented tank. In the event of increasing tank level beyond the alarm set point, the reactor coolant letdown flow to this tank is automatically diverted to the BMS.

11.2.4 OPERATING PROCEDURES

Procedures are available and used when their associated equipment or process is used. All of the equipment and processes listed below are available, but not necessarily used.

11.2.4.1 Boron Management System

Liquid waste enters the BMS for processing by the method described in Section 11.2.2.1. The operating procedures necessary to process this fluid are identified below to logically reflect the various monitoring and operating functions required of plant operators.

11.2.4.1.1 Chemical Volume Control Letdown to Holdup Tank (Automatic Operation)

CVCS letdown that is diverted to the BMS normally bypasses the vacuum degasifier as specified by procedure. Monitoring requirements of the vacuum degasifier controls and vacuum degasifier pumps are also specified and procedures for valve lineup to the holdup tanks are specified.

11.2.4.1.2 Chemical and Volume Control System Letdown Degassing in Preparation for Plant Shutdown

Procedures and valve lineups for degassing the reactor coolant in the vacuum degasifier and returning it to the CVCS prior to plant shutdown are specified.

11.2.4.1.3 Reactor Drain Tank Operations

Monitoring requirements of reactor drain conditions are specified and procedures for processing the tank contents via the vacuum degasifier to a holdup tank are specified.

11.2.4.1.4 Vacuum Degasifier Bypass

Monitoring and possible actions to be taken to limit hydrogen and air mixtures in the holdup tanks are specified for normal operation when the vacuum degasifier is bypassed.

11.2.4.1.5 Holdup Tank Operations

Monitoring requirements for the conditions of the four holdup tanks are specified. Further processing requirements are based on the chemical and radioactivity sample analysis.

11.2.4.1.6 Holdup Tank Processing Recirculation

Procedures and valve lineups for processing the contents of a holdup tank through the vendor processing skid or through a preconcentrator filter and ion exchanger back to the same or different tanks are specified. Process sampling requirements are specified.

11.2.4.1.7 Holdup Tank Processing to Boric Acid Concentrator

The Boric Acid Concentrator is currently not in use. If placed in service, the procedure and valve lineups for processing the contents of a holdup tank through a preconcentrator filter and ion exchanger to the boric acid concentrator will be developed. Operation of pump and concentrator interlocks will be specified. Process sampling requirements will be specified.

11.2.4.1.8 Boric Acid Concentrator Operating Procedure

The Boric Acid Concentrator is currently not in use. If placed in service, the procedures for startup, steady state, shutdown and layup operations will be developed. Sampling requirements to confirm low carryover and proper operation of boron concentration controls will be specified. Automatic and manual batch bottoms discharge control procedures and heat tracing system operating procedures will be specified.

11.2.4.1.9 Boric Acid Condensate Tank Operations

Monitoring requirements for the condensate tanks conditions and procedures for valve lineups are specified. Sampling and reprocessing procedures are specified.

11.2.4.1.10 Environmental Discharge Procedures

Operating procedures for the discharge instrumentation and valves are specified. The method for determining whether to process or reprocess the liquid or discharge is specified. The method for determining the discharge flow rate in terms of radioactivity discharge limits is specified.

11.2.4.2 Waste Management System

Liquid waste enters the liquid waste system for processing by the methods described in Section 11.2.2.2. The operating procedures necessary to process this fluid are briefly described below to logically reflect the various monitoring and operating functions required of plant operators.

11.2.4.2.1 Waste Tank Operation

Procedures for waste tank influent valve lineups, monitoring tank conditions, sampling, and valve line-up are specified.

11.2.4.2.2 Waste Concentrator Operation

The Waste Concentrator is currently not in use. If placed in service, the procedures for waste concentrator startup, steady state, shutdown and lay-up operations will be developed. Sampling procedures to assure low carryover and to monitor bottoms concentration will be provided. Heat tracing system operating procedures will also be specified.

ARKANSAS NUCLEAR ONE
Unit 2

11.2.4.2.3 Waste Condensate Tank Operation

Monitoring requirements for waste condensate tank conditions, valve lineups, sampling and reprocessing are specified. Discharge is done under the same procedure used for the BMS.

11.2.5 PERFORMANCE TESTS

The BMS and WMS were tested prior to initial power plant startup to verify satisfactory flow characteristics through the equipment, to demonstrate satisfactory performance of pumps and instruments, to check the integrity of piping and equipment, and to verify proper operation controls. All piping and components were checked to ensure that they are properly installed. All manual and automatic valves were operated and checked for ability to function. All alarms were checked for operability and verification of locations. The concentrators were tested for operation before installation at the site and after installation to assure proper integration with the system. The boric acid and waste concentrators were shop tested prior to shipment to demonstrate compliance with performance objectives. During hot functional testing, the BMS operation was integrated with the CVCS. The purpose of this test was to check the procedures and system components used for receiving and processing waste water. Boric acid transfer operations and liquid waste disposal procedures were tested.

During normal plant operation, periodic testing verifies that the system components are operating as designed. Filter performance is determined by the observation of filter differential pressure. Filters are monitored for differential pressure and radiation level on a regular basis. Ion exchanger performance is determined by comparing the level of radioactivity from inlet and outlet samples. Ion exchangers are monitored for differential pressure and radiation level on a regular basis. To ensure that the vacuum degasifier is performing adequately, a liquid sample from the influent and effluent can be obtained to verify the hydrogen stripping function of the unit. Although the boric acid concentrator is currently not in use, if it were placed in service its performance could be determined by comparing the concentration of boric acid from inlet, bottoms and condensate samples. All liquid discharges to the environment are sampled for radioactivity before discharge. The discharge radiation monitor is calibrated on a regular basis to assure accuracy.

11.2.6 ESTIMATED RELEASES

[Information on expected releases is historical as are some of the system descriptions. Because releases were estimated before the unit began operating, actual operating experience may differ from the assumptions used in this section.]

The release of radioactive liquid from the plant discharge header will vary with plant operating conditions. The quantities of liquids generated by the systems discharging to the plant discharge header during various operating conditions and the radioactive content of these waste effluents are discussed below. Section 11.2.6.4 describes liquid releases from Unit 1.

11.2.6.1 Liquid Waste Systems

[This section contains historical information.]

The expected liquid releases from the plant are summarized by nuclide in Table 11.2-15A. The reactor coolant concentrations utilized for this evaluation are indicated in Tables 11.1-3 and 11.1-4. The curies released from the BMS and WMS are determined by multiplying the nuclide concentrations in the boric acid and waste condensate tanks as shown in Tables 11.2-4,

ARKANSAS NUCLEAR ONE
Unit 2

11.2-5, 11.2-11 and 11.2-12 by the waste processed through each system. The assumptions used in calculating the estimated normal and anticipated operational occurrence releases are summarized in Table 11.2-13. Expected performance data for the filters and ion exchangers is given in Table 11.2-6 and component performance data for the BMS is given in Table 11.2-7. The waste schedule is shown in Table 11.2-1.

Tables 11.2-16A and B provide a comparison of the liquid releases to 10CFR20 limits. As indicated by the data presented in this table the activity released to the circulating water discharge canal is within the design objectives stated in Section 11.2.1.

11.2.6.2 Steam Generator Blowdown Releases

[This section contains historical information.]

Although Unit 2 steam generator blowdown is normally recycled via the Startup and Blowdown Demineralizer System described in Section 10.4.10, it may be released to the circulating water flume if it meets the applicable chemistry limits (i.e., pH, radioactivity, suspended solids).

The following assumptions were made in determining the activity released as steam generator blowdown during normal operation:

- A. Reactor coolant activity is based on fuel cladding defects in 0.25 percent of the fuel rods.
- B. Primary-to-secondary leakage amounts to 13 gal/day.
- C. A continuous blowdown of 15 gpm is discharged to the WMS for 313 days a year. The liquid released is at equilibrium steam generator activity levels for the assumed conditions as listed in Table 11.1-12.

The following assumptions were made in determining the activity released by the Steam Generator Blowdown System for anticipated operational occurrences:

- A. Reactor coolant activity is based on fuel cladding defects in 1.0 percent of the fuel rods.
- B. Primary-to-secondary leakage amounts of 100 gal/day.
- C. A continuous blowdown of 15 gpm is discharged to the WMS for 313 days a year. The liquid released is at equilibrium steam generator activity levels for the assumed conditions as listed in Table 11.1-12.

A detailed description of the analysis of secondary system activities is presented in Section 11.1.7. The estimated annual activity released by the Steam Generator Blowdown System is summarized in Table 11.2-15 for normal and anticipated operational occurrences.

11.2.6.3 Tritium Releases

[This section contains historical information.]

Tritium, in the form of tritiated water, is treated separately because, at this time, there is no feasible way of removing it from the waste through processing. It is assumed that all tritium leaking into or produced in, the reactor coolant is released to the environment. For an equilibrium fuel cycle with 0.25 percent failed fuel, this will amount to about 204 Ci per year (see Section 11.1.3). For a one percent failed fuel condition, estimated tritium releases increase to 290 Ci per year.

ARKANSAS NUCLEAR ONE
Unit 2

11.2.6.4 Unit 1 Liquid Releases

[This section contains historical information.]

In order to meet the plant design objectives outlined in Section 11.2.1, Unit 1 liquid releases can be processed through Unit 2 liquid waste systems. Discharges from the Clean Liquid Radioactive Waste System (CZ) and Dirty Liquid Radioactive Waste System (DZ) can be processed by the Unit 2 BMS and WMS, respectively. Condensate demineralizer regenerative wastes can be processed through the RWPS. Operation of the Laundry Radioactive Waste System has been discontinued. The Unit 1 SAR presents a complete description of the Unit 1 radioactive waste systems.

Table 11.2-15 summarizes the releases from the Clean and Dirty Liquid Radwaste Systems.

11.2.6.4.1 Clean Liquid Radioactive Waste System Releases

[This section contains historical information.]

The Unit 1 CZ processes the same type of waste as the Unit 2 BMS, i.e. hydrogenated, borated reactor coolant quality wastes of potentially high activity.

After processing by the CZ, effluent from the treated waste monitor tanks can be routed through the Unit 2 boric acid concentrator (currently not in use), boric acid condensate ion exchanger and collected in the boric condensate tanks. As with Unit 2 wastes, sampling prior to discharge and continuous monitoring during discharge is required.

The following assumptions were made in determining the activity released by the CZ during expected (normal) operation.

- A. 513,000 gallons of clean wastes were generated in the cycle as a result of bleed wastes from base loaded operation at 2,568 MWt for 310 days, two cold startups and refueling concentration, and one drain for refueling.
- B. Reactor coolant concentration based on 0.25 percent failed fuel.
- C. DF = 100 in Purification Demineralizer for all isotopes in bleed wastes except the noble gases (DF = 1), Cs, Mo, and Y (DF = 1).
- D. DF = 400 for degasification of bleed wastes in the vacuum degasifier.
- E. 20-day decay of all isotopes in the clean waste receiver tanks.
- F. DF = 10,000 for corrosion activity in the purification filter, clean wastes filter and ion exchangers for bleed wastes.
- G. DF = 1000 for all soluble activity in the bleed wastes for two radwaste demineralizers in series (except Mo and Y DF = 10).
- H. DF = 200 for Unit 2 boric concentrator.

ARKANSAS NUCLEAR ONE
Unit 2

- I. All wastes discharged into a circulating water flow of 383,000 gpm. The ANO-1 Condenser Replacement (ER 951018D101) resulted in a 2.4% increase in circulating water flow rate. This increase in flow rate provides more dilution water for radiological releases. Therefore, the flow rate stated above is bounding and conservative.

Maximum expected release activity levels (anticipated operational occurrence) are based on one percent failed fuel and the above assumptions.

11.2.6.4.2 Dirty Liquid Radioactive Waste System Releases

[This section contains historical information.]

The Unit 1 DZ processes the same type of waste as the Unit 2 WMS, i.e., low activity aerated and potential dirty chemical drains, decontamination drains and building sumps.

After processing by the DZ, effluent can be routed to the Unit 2 waste concentrator, the Unit 2 waste condensate ion exchanger, and collected in the Unit 2 waste condensate tanks. The resulting effluent is sampled prior to discharge and continuously monitored during discharge.

The following assumptions were made in determining the activity released by the DZ during normal operation.

- A. 142,000 gallons of miscellaneous or dirty wastes generated from equipment drains, decontamination operations, contaminated showers, etc. at average concentrations equal to one percent of the average reactor coolant concentrations with a 0.25 percent failed fuel.
- B. DF = 100 for corrosion activity in the dirty waste filters for miscellaneous wastes.
- C. One-day decay of all miscellaneous wastes.
- D. DF = 500 for Unit 2 waste concentrator
- E. All wastes discharged into circulating water flow of 383,000 gpm. The ANO-1 Condenser Replacement (ER 951018D101) resulted in a 2.4% increase in circulating water flow rate. This increase in flow rate provides more dilution water for radiological releases. Therefore, the flow rate stated above is bounding and conservative.

Maximum expected (anticipated operational occurrence) releases are based on the above assumptions and time averaged reactor coolant concentrations with one percent failed fuel.

11.2.6.4.3 Condensate Demineralizer Regenerative Waste Releases

[This section contains historical information.]

Unit 1 has once-through steam generators. Water chemistry is maintained by treating 70 percent of the feedwater flow with deep-bed demineralizers. The demineralizers are regenerated periodically and the regenerant solutions can be processed through the Regenerative Waste Processing System described in Section 11.2.2.3, if necessary. Currently a blank flange is installed to prevent the transfer of water from Unit 1.

ARKANSAS NUCLEAR ONE
Unit 2

Expected releases from the condensate demineralizer regenerative waste evaporator are based on the following assumptions:

- A. Reactor coolant activity is due to 0.25 percent failed fuel;
- B. Steam generator tube leak amounts to 20 gpd for 310 days;
- C. All soluble activity leaking into the secondary system is removed by the demineralizers;
- D. Demineralizers normally operate on a hydrogen cycle. Each of the five demineralizers will be regenerated as necessary;
- E. In regeneration all activity accumulated will be removed from the resin and pumped via the neutralizing tank to holdup tanks where a five day holdup is assumed; and,
- F. The regenerative waste is processed through the Regenerative Waste Evaporative System (currently not in use). DF = 10 (+3) for iodine and 10 (+4) for all other isotopes.

Maximum expected releases are based on one percent failed fuel, steam generator tube leakage of 100 gpd, and the remainder of the above assumptions. Table 11.2-15 summarizes the estimated releases.

11.2.6.4.4 Laundry Radioactive Waste Releases

Operation of the Laundry Radioactive Waste System has been discontinued and replaced by use of an off-site vendor's service at an approved facility. The Unit 1 FSAR presents a description of this process which was designed to accommodate Unit 1 and Unit 2.

11.2.7 RELEASE POINTS

The planned release of liquid radioactivity effluents to unrestricted areas at Unit 2 occurs through the Unit 1 circulating water discharge canal. The canal receives liquid waste from Unit 1 and Unit 2 systems that may contain radioactive nuclides and discharges them to the Dardanelle Reservoir by way of a discharge embayment. Unit 2 systems discharging wastes to the canal include the BMS, the WMS and the RWPS discharge. Water from steam generators may also be discharged to the canal via the Startup and Blowdown System and Emergency Feedwater System (see Figure 10.2-4). A site plot plan for liquid and gaseous releases is shown in Figure 11.3-2.

All flow of radioactive effluents is regulated by valves which may be throttled as necessary to establish a desired release rate of radioactive liquids. These valves may be positioned, dependent upon the actual levels of activity to be released and available dilution, such that the radioactive concentration after dilution in the discharge canal will not exceed Unit 2 Technical Specification limits for effluents to unrestricted areas. The flow of effluents is monitored by an in-line radiation monitor that will stop discharge flow if unacceptable activity levels are detected, by automatically shutting an air-operated isolation valve. The system response and the isolation valve location in the discharge piping are such that high activity liquid will not be released before the valve closes.

Section 11.4.2 discusses the monitoring system and the basis for the detector setpoints.

ARKANSAS NUCLEAR ONE
Unit 2

The turbine building sump may be considered a release point in the event of tube leakage in one or both of the steam generators. Primary to secondary leakage is monitored by both the Steam Generator Monitoring System (see Section 11.4.2.1.4) and the Condenser Air Discharge Monitoring System (see Section 11.4.2.2.1). Should a valid alarm on either monitor occur, the Turbine Building Sump pumps will be secured and subsequent discharges will be sampled in accordance with radioactive release procedures prior to release.

11.2.8 DILUTION FACTORS

The waste systems direct system effluents to the Unit 1 discharge canal where they are diluted by discharge flow to the reservoir from the Unit 1 Circulating Water System.

The amount of flow available for diluting the waste is a function of the number of Unit 1 circulating water pumps in operation.

During normal operations, the maximum dilution flow rate will be approximately 766,000 gpm with four circulating water pumps in operation and the minimum dilution flow will be approximately 383,000 gpm with two circulating water pumps in operation. On limited occasions when less than two circulating water pumps are in operation, release of radioactive liquid is allowed under strict administrative controls. The ANO-1 Condenser Replacement (ER 951018D101) resulted in a 2.4% increase in circulating water flow rate. This increase in flow rate provides more dilution water for radiological releases. Therefore, the flow rate stated above is bounding and conservative.

Tables 11.2-15A and B give the annual average concentration in the circulating water canal prior to dilution in the reservoir.

11.2.9 ESTIMATED DOSES

Three principal pathways exist through the environment for exposure due to the release of liquid effluents. An internal dose can result from the ingestion of water and foods that contain radioactive material. An external dose can result either from swimming in the river or by being exposed to sediment that has accumulated radioactive material.

Radionuclide concentrations in the circulating water discharge canal have been estimated using the dilution factors discussed in Section 11.2.8 and the release rates of Tables 11.2-15A and B. Table 11.2-15A and B gives these concentrations for both normal operation and during anticipated operational occurrences.

Radionuclide concentrations in aquatic biota (fish, invertebrates, and vegetation) have been estimated by multiplying the radionuclide concentrations in water by appropriate freshwater biological concentration factor for each nuclide. The concentration factors employed are given in Table 11.2-17 (References 6, 20, 24, 28, 29 and 32). The average freshwater concentration factors given in Reference 29 were employed where available, supplemented by the average freshwater values given in Reference 24. Concentration factors given in References 6, 20, 28 and 32 confirm that the values employed here are conservative values.

The deposition of radionuclides in bottom sediment has been estimated by assuming that the fraction of each nuclide associated with suspended sediment will be completely retained and uniformly distributed over the river bottom and shoreline downstream from Unit 2 with subsequent removal only by radioactive decay.

ARKANSAS NUCLEAR ONE
Unit 2

Nuclides for which suspended fractions were not available were assumed to be completely retained in the downstream bottom sediment. By this method, the deposition of the nuclide per unit area of bottom sediment is given by:

$$S = \frac{1000Rf}{A} (1 - e^{-\lambda t})$$

where:

- S = cumulative deposition of nuclide in bottom sediment, mCi/km²
- R = rate of discharge of nuclide, Ci/year
- F = fraction of nuclide retained in bottom sediment
- A = downstream area of the river, km²
- λ = radioactive decay constant, yr⁻¹
- t = time after the discharge begins, yr

The annual dose to man from drinking water and from consumption of fish and invertebrates has been determined from recommended Maximum Permissible Concentrations (MPCs) in water and Maximum Permissible Doses (MPDs) of the ICRP (Reference 12) according to the following relationship:

$$D = \left(\frac{C}{MPC} \right) \left(\frac{r}{2200} \right) MPD$$

where:

- D = dose to man, mrem/yr
- C = concentration of nuclide in water or biota, μCi/cc
- MPC = maximum permissible concentration in water, μCi/cc
- r = consumption rate of water or biota, cc/day
- MPD = maximum permissible dose, mrem/year.

For the radioactive isotopes of iodine and strontium, the recommendations of the Federal Radiation Council (Reference 2) were used to determine the dose to the thyroid and bone.

Two external exposure pathways were considered: swimming in the river downstream of the plant, and exposure to contaminated sediment on the bank of the river. The dose from swimming in the river is given by the relationship:

$$D = 1.87 \times 10^7 C \left(\frac{T}{8760} \right)^{(0.5E_{\beta} + E_{\gamma})}$$

ARKANSAS NUCLEAR ONE
Unit 2

where:

D = dose to man, mrem/yr

C = radionuclide concentration in the river water ($\mu\text{Ci/cc}$)

T = time spent swimming (hr/yr)

E_{β} = average beta energy per disintegration (Reference 30), MeV

E_{γ} = average gamma energy per disintegration (Reference 30), MeV

The external gamma dose from exposure to contaminated sediments is given by the relationship:

$$D = \frac{K}{G} C \left(\frac{T}{8760} \right)$$

where:

D = dose to man, mrem/yr

C = radionuclide concentration on the surface of the river bank, mCi/km^2

T = time of exposure, hr/yr

G = geometry factor to account for the depth distribution of the radionuclides (Reference 19), 2.5

K = dose conversion constant, $(\text{mrem/yr})/(\text{mCi/km}^2)$.

The values of the constant K for each radionuclide are listed in Table 11.2-18 (Reference 25).

Two types of individuals were considered in the dose estimates:

- A. The maximum exposed individual - a person whose dietary, recreational, or commercial activities result in higher-than-normal internal or external dose. This individual would be an avid sports fisherman or a commercial fisherman. Doses to this individual are summarized in Table 11.2-21.
- B. The average exposed individual - a person whose dietary and recreational habits are representative of the general population from this particular geographic region. The doses to this individual are summarized in Table 11.2-20.

Consumption rates of water and biota, and annual exposure times in water and along the shoreline are given in Table 11.2-19 for both the maximum exposed individual and the average exposed individual (Reference 7).

In addition to the annual dose to individuals, the total dose to various population groups in the vicinity of the plant has been estimated. For this purpose, it has been assumed that:

- A. The entire commercial fish catch from the Arkansas River (2.7 million pounds per year) is uniformly contaminated using the concentration factors presented in Table 11.2-17 and is entirely consumed.

ARKANSAS NUCLEAR ONE
Unit 2

- B. 3,200,000 man-hr of occupancy on the shoreline is expended annually. This corresponds to 400,000 fisherman per year at an average occupancy time of eight hours (Reference 1).
- C. 36,000 boaters and 42,000 swimmers are assumed to use the river each year at an average duration of eight hour per boater and eight hours per swimmer (Reference 1).

Population exposures resulting from radionuclides in liquid effluents are summarized in Table 11.2-22 for normal operation and for operation during anticipated operational occurrences.

ARKANSAS NUCLEAR ONE
UNIT 2

11.3 GASEOUS WASTE SYSTEM

11.3.1 DESIGN OBJECTIVES

The Gaseous Waste System (GWS) processes the vent gases from equipment located in the Chemical and Volume Control System (CVCS), Waste Management System (WMS), Boron Management System (BMS) and Fuel Pool System such that the radioactive gaseous release to the environment will be as low as practicable in accordance with Appendix I to 10 CFR 50. The numerical design objective for releases during normal operation is to limit the site boundary noble gas dose to less than 10 mrem/year and Iodine-131 and particulate concentrations at the nearest pasture to 10^{-5} times 10 CFR 20 limits. Releases due to anticipated operational occurrences will be within 10 CFR 20 limits.

11.3.2 SYSTEM DESCRIPTION

The principal flow paths of the GWS are shown on Figure 11.3-1. Process flow and activity data for the original system design are given in Tables 11.3-1 and 11.3-2. Component data is provided in Table 11.3-3.

Plant gaseous releases come from the steam generator blowdown, reactor auxiliary building ventilation, turbine system leakage, containment purges, waste gas decay tank discharges, and the gas collection header.

Waste gas is collected from the various source components by two headers: containment vent header and the gas collection header. The containment vent header receives hydrogenated, potentially radioactive gas mixtures vented from the reactor drain tank, quench tank, and the regenerative heat exchanger and directs the gases to the suction of the waste gas compressors. Hydrogenated and potentially radioactive gases are also collected directly from the volume control tank and vacuum degasifier tank gas spaces to the suction of the waste gas compressors. The waste gas surge tank and the gas surge header are not used to collect waste gases for processing with the waste gas compressors. The waste gas surge tank is available as a relief volume in the event of a waste gas decay tank or compressor suction, interstage, or discharge relief valve lifting. The gas surge header is isolated and unused.

Waste gases flow from the containment vent header, volume control tank, and the vacuum degasifier tank at positive pressures to a waste gas compressor where they are compressed to 350 psig and cooled by an aftercooler prior to entering the waste gas decay tanks where the gases are held up for radioactive decay. Two compressors are available for transferring the gas to the gas decay tanks.

Aftercoolers supplied with each gas compressor cool the compressed gas prior to entering the gas decay tanks. There are three gas decay tanks (each provided with a pressure indicator including local alarm and temperature indicator) which receive the compressed gas from the waste gas compressors. The decay tanks have sufficient storage capacity for an average 30-day holdup. After radioactivity has decayed to an acceptable level which is consistent with the design objective and has been verified by laboratory sample analysis, the gas is released to the environment via the plant vent at a controlled rate.

The fill procedure for the decay tanks is to have only one tank lined up to the compressor discharge. When the pressure in the tank increases to about 250 psig, the tank is isolated and the compressor discharge is manually switched over to an empty tank. The gaseous radioactivity in the filled tank is allowed to decay for approximately 30 days. During this decay period the gas is periodically sampled and activity level determined. The Process Sampling System is described in Section 9.3.2.

ARKANSAS NUCLEAR ONE
UNIT 2

Prior to release, the required flow rate is determined, and the setpoint on the radiation monitor is established. Initially, the discharge valve from the gas decay tank, needle valve and pneumatic operated valve are closed. The on-off pneumatic operated valve is opened and placed in automatic, and the discharge valve on the desired gas decay tank is opened. The needle valve is then opened as required to establish the desired flow rate to the plant vent, and the pressure reducing valve will maintain constant downstream pressure of 30 psig. The on-off pneumatic operated valve automatically closes on high radioactivity level thus terminating discharge flow. An alarm will annunciate this event in the control room. When discharge flow decreases and the decay tank pressure decreases to approximately 30 psig, as noted by observing the gas flow meter and pressure indicator on the gas decay tank, the pressure reducing valve setpoint must be reduced to vent the tank down to atmospheric pressure.

The system flow paths and release points of the gases from the gas decay tanks and gas collection header are indicated on Figure 11.3-1.

The gas collection header collects the gases from primarily aerated vents of process equipment in the CCW System, BMS, SRS, WMS, CVCS, and FPS. Also the high point pipe vents and concentrator vents will be aerated during initial plant startup, when nitrogen is purged from the process equipment or during maintenance and released through the gas collection header. During these periods essentially no activity will be present in the gas.

Table 11.3-4 identifies each of the inputs to the gas collection header. Because of the large volume of gas and the low activity level from the sources, the gases are routed directly to the plant vent. The gases and expected activities to the plant vent from the gas collection header based on the original system design are given in Tables 11.3-1 and 11.3-2 at process data point No. 12. As a further check on activity from this source, the plant vent contains radioactivity monitors with alarms to indicate unexpected activity release.

There is no field run piping in the GWS.

11.3.3 SYSTEM DESIGN

Each piece of equipment in the GWS is described in Table 11.3-3. Within the GWS the waste gas surge tank and waste gas decay tanks are Seismic Category 1, and the waste gas compressors are Quality Class D components. The GWS is housed within the auxiliary building which is also Seismic Category 1.

The process instrumentation (including hydrogen analyzers) and radiation instrumentation are shown on Figure 11.3-1 and are described specifically in Table 11.2-14.

The Waste Gas Analyzer System (WGAS) provides the capability to monitor hydrogen and oxygen concentrations in the tanks and equipment listed in Table 9.3-3 and indicated in the Sample P&ID (M-2237). The gas sample is analyzed for free oxygen and hydrogen. When concentrations exceed a predetermined set point, an alarm is annunciated. Ranges are identified in Section 9.3.2.2.3.

If the analyzer panel is out of service, grab samples are taken.

The gas analyzer represents an appropriate safeguard against an explosion hazard in the GWS when compared with the risks involved. An explosion in the GWS would have to involve the simultaneous occurrence of three unlikely events:

ARKANSAS NUCLEAR ONE
UNIT 2

- A. There would have to be an operator error or equipment failure to admit oxygen to the GWS such as not purging a tank after maintenance.
- B. The gas analyzer would have to malfunction at the time oxygen was present in the system so as not to cause an alarm.
- C. There would have to be a spark to initiate detonation. The low probability of occurrence of each of these events is examined below.

Potential sources of oxygen to the waste gas system are the degasifier, volume control tank, quench tank, reactor drain tank, and regenerative heat exchanger. Hydrogen, nitrogen and fission gases stripped from letdown are sent to the waste gas tanks for storage and decay. The volume control, quench and reactor drain tanks are operated at a positive pressure with either hydrogen or nitrogen as the cover gas so O₂ will not enter. The only feasible time for O₂ to be in these tanks would be during maintenance periods. There are procedures for purging tanks, piping and components with nitrogen after maintenance to reduce the possibility of O₂ entering GWS.

Assuming that O₂ does inadvertently enter the GWS, the gas analyzer will automatically alarm to warn operators of a potentially dangerous situation. Since the only feasible time of O₂ entering the system is during shutdown, many of the components will not have to be analyzed. The gas analyzer would have to malfunction during this time for the O₂ to go undetected.

All active components in the GWS are explosion-proof; they will not create a spark within the piping.

If in the worst conditions air was added to a gas decay tank by two compressors, it would take 1.5 to seven hours to reach an explosive mixture, depending on the initial hydrogen content and gas volume in the tank. Under the more probable and realistic circumstances of trace oxygen, the time to reach an explosive mixture would be substantially greater.

In view of the low probability of significant oxygen being present in the GWS and the substantial time periods required for explosive mixture buildup, manual sampling with portable or laboratory analysis provides adequate backup for the gas analyzer.

11.3.4 OPERATING PROCEDURE

Operating procedures are available within the GWS to perform each of the following functions.

11.3.4.1 Tank Purging

Tank purging and venting procedures for all tanks venting to the WGS and for the tanks in the GWS are specified.

11.3.4.2 Compressor Lineup

Gas decay tank valve and compressor lineup procedures, requirements for monitoring proper operation of the gas compressors, procedures for servicing the compressors, filters, and after coolers are all specified.

ARKANSAS NUCLEAR ONE
UNIT 2

11.3.4.3 Gas Decay Tank Isolation

Procedures for isolating a gas decay tank after filling and for monitoring the contents during the decay period are specified.

11.3.4.4 Discharge Monitoring

Procedures have been established for setting the high trip setpoint on the discharge radiation monitor, for lining up the valves for discharge, and for determining the discharge flow rate and establishing it. Monitoring requirements during the discharge period and procedures to reduce gas decay tank pressure to atmospheric at the end of the discharge period are also specified.

11.3.4.5 Water Draining From Gas Surge Tank

Procedures for draining water from the gas surge tank and the gas decay tanks are specified.

11.3.4.6 Gas Analyzer Control and Gas Sampling

Procedures for gas analyzer control of sample point selection, procedures for obtaining a gas sample in a sampling cylinder for laboratory analysis and procedures for calibrating the gas analyzers to assure representative automatic sampling are specified.

11.3.5 PERFORMANCE TESTS

The gas compressors were shop tested to assure proper operation. The gas analyzer system was shop tested.

The GWS preoperational tests are described in Table 14.1-1.

During plant operation, periodic testing is done as follows:

- A. The discharge radiation monitor is periodically calibrated with standard radiation source;
- B. The hydrogen and oxygen gas analyzer is periodically calibrated with zero and upscale gas concentrations; and,
- C. Process instrumentation is periodically calibrated.

11.3.6 ESTIMATED RELEASES

[Information on expected releases is historical as are some of the system descriptions. Because releases were estimated before the unit began operating, actual operating experience may differ from the assumptions used in this section.]

The release of radioactive noble gases, airborne halogens, and air particulates from Unit 1 and Unit 2 GWSs and other potential release points will vary with plant operating conditions. The basis for estimating the annual release of gaseous activity, by isotope, includes assumptions about each of the systems involved. In each case, analysis is made of the normal activity levels of wastes expected during plant operations as well as the maximum levels of activity for anticipated operational occurrences during the life of the plant. The number of curies of each isotope estimated to be released annually from each of these systems and potential release points for normal and anticipated operational occurrences are summarized in Tables 11.3-5A and 11.3-5B.

ARKANSAS NUCLEAR ONE
UNIT 2

The general assumptions made in estimating the annual release of gaseous wastes are:

- A. Normal operational reactor coolant activity levels are determined on the basis of fission product diffusion through cladding defects in 0.25 percent of the fuel rods. Reactor coolant activity levels for this condition are listed in Table 11.1-4;
- B. The reactor coolant activity levels for anticipated operational occurrences are based on fission product diffusion through cladding defects in 1.0 percent of the fuel rods. Reactor coolant activity levels for this condition are listed in Table 11.1-3;
- C. High Efficiency Particulate Air (HEPA) filters have a particulate removal efficiency of 99.9 percent and do not retain iodine or noble gases. No credit is taken for the particulate retentions by prefilters; and,
- D. Charcoal filters have an iodine removal efficiency of 90 percent and do not retain noble gases or particulates.

11.3.6.1 Gaseous Waste System

[This section contains historical information.]

The estimated releases from the GWS in curies per year are listed in Tables 11.3-5A and B. The source terms and assumptions used to determine these releases are given in Section 11.3.2 (see Section 11.3.2 of the FSAR). During normal operation the expected activity releases from the plant are based on 0.25 percent failed fuel, while the anticipated operational occurrences are assumed at 1.0 percent failed fuel. The radioactivity that is released from the failed fuel is reduced in concentration by the process equipment in the CVCS, WMS and BMS. For iodine, the purification and preconcentrator ion exchanger Decontamination Factor (DF) is 1,000, and a liquid to gas partition factor of 10,000 is used for the reactor drain tank, vacuum degasifier, holdup tank, waste tanks, and boric acid concentrator. Noble gases are stripped by a factor of approximately 120 in the vacuum degasifier and five in the boric acid concentrator. (The boric acid concentrator is currently not in use.) Activity will be reduced by natural decay due to residence time in the reactor drain tank, and gas decay tanks. The noble gas releases from the gas collection header and gas surge header are based on diffusion estimates from all the components.

Table 11.3-5 shows the calculated releases of radioactive material in the gaseous effluents. As indicated by the data presented in this table, the activity released to the site boundary falls within the design objectives stated in Section 11.3.1.

11.3.6.2 Containment Purge Exhaust

[This section contains historical information.]

The gaseous wastes released annually from containment purging under normal operating conditions are based on the following assumptions:

- A. Containment air activity is based on RCS leakage of 20 gpd with reactor coolant at equilibrium fission product activity levels for diffusion through cladding defects in 0.25 percent of the fuel rods;

ARKANSAS NUCLEAR ONE
UNIT 2

- B. A partition coefficient of 10 is assumed for halogens and particulates at the leakage point. A partition coefficient of one is assumed for noble gases;
- C. Ninety days of activity accumulation is assumed. There is no particulate plateout, containment leakage, or other activity removal except natural decay; and,
- D. Containment purge rate is 40,000 cfm, and the purge is filtered through HEPA and charcoal filters.

The gaseous wastes released annually from containment purging under anticipated operational occurrences are based on the following assumptions:

- A. Containment air activity is based on RCS leakage of 40 gpd, with reactor coolant at equilibrium fission product activity levels for diffusion through cladding defects in 1.0 percent of the fuel rods;
- B. A partition coefficient of 10 is assumed for halogens and particulates at the leakage point. A partition coefficient of one is assumed for noble gases;
- C. Ninety days of activity accumulation is assumed. There is no particulate plateout, containment leakage, or other activity removal except natural decay; and,
- D. Containment purge rate is 40,000 cfm, and the purge is filtered through HEPA and charcoal filters.

11.3.6.3 Auxiliary Building Ventilation System

[This section contains historical information.]

The estimated annual release of gaseous activity from the auxiliary building ventilation exhaust will result from two general input sources.

- A. The fuel handling floor area is exhausted by two 40,000 cfm fans, one of which is normally in operation. The exhaust flow passes through a HEPA filter and a charcoal filter and is discharged to the exhaust duct. The spent fuel pool contains reactor coolant grade water that is normally maintained at low activity levels by the Spent Fuel Pool Purification System described in Section 9.1.3. The pool will contain activity levels due to partial mixing with the Reactor Coolant System (RCS) once each year during refueling. Coolant degassing and pool purification reduce gaseous, air particulate, and iodine releases. The release of gaseous waste from the spent fuel pool area is based on evaporation and diffusion from the spent fuel pool.
- B. The remainder of the auxiliary building and the radwaste area is exhausted by two 53,250 cfm exhaust fans, one of which is normally in operation. This exhaust path will carry with it any gaseous activity generated by valve stem leakage, equipment vents, and other radioactive sources not served by the vent collection or gas collection headers. The air flow passes through one HEPA filter and one charcoal filter before being exhausted to the main ventilation exhaust path. Proper equipment operation, adequate preventative and corrective maintenance practices, and other good engineering practices will minimize gaseous activity in this exhaust path.

ARKANSAS NUCLEAR ONE
UNIT 2

The gaseous waste release from this source is assumed to generate from reactor coolant leakage of 20 gpd downstream of the letdown heat exchanger. The partition coefficient for halogens and particulates is assumed to be 1,000 at the 20 gpd leakage point. The partition coefficient for noble gases is uniformly assumed to be one. The coolant activity during normal operation is assumed to be at equilibrium levels for fission product diffusion through cladding defects in 0.25 percent of the fuel rods. Anticipated operational occurrence coolant activity is assumed to be at equilibrium levels for fission product diffusion through cladding defects in 1.0 percent of the fuel rods.

11.3.6.4 Steam Generator Blowdown Tank Vent

[This section contains historical information.]

The estimated annual release of gaseous waste from the steam generator blowdown tank vent under normal operating conditions is based on the following assumptions.

- A. Steam generator activity is at equilibrium levels for 13-gpd primary-to-secondary leakage and 15-gpm continuous blowdown flow. Reactor coolant activity is assumed to result from fission product diffusion through cladding defects in 0.25 percent of the fuel rods. Primary coolant activity reduction due to leakage into the secondary system is negligible;
- B. Steam flashing in the blowdown tank is assumed to account for a partition coefficient of 1,000 for particulates, 20 for iodine, and one for noble gases;
- C. The blowdown tank vent exhausts to the main condenser which provides a partition coefficient of 2,000 for particulates and halogens; and,
- D. All noble gas in the blowdown flow is assumed to be released through the tank vent to the main condenser and ultimately to the environment via the condenser vacuum pumps and Auxiliary Building Ventilation System (ABVS).

The estimated release of gaseous waste from the steam generator blowdown tank vent during anticipated operational occurrences is based on the following assumptions:

- A. Steam generator activity is at equilibrium levels for 100-gpd primary-to-secondary leakage and 15-gpm continuous blowdown flow. Reactor coolant activity is assumed to result from fission product diffusion through cladding defects in 1.0 percent of the fuel rods. Coolant activity reduction due to leakage into the secondary system is negligible; and,
- B. The assumed partition coefficients are the same as for normal operation.

A description of the analysis of steam generator activity levels for normal and anticipated operational occurrences is presented in Section 11.1.7, and Tables 11.1-12 and 11.1-13 summarize the resulting concentrations by isotope.

11.3.6.5 Condenser Vacuum Pump Exhaust

[This section contains historical information.]

ARKANSAS NUCLEAR ONE
UNIT 2

The estimated annual release of gaseous waste from the condenser vacuum pump exhaust during normal operation is based on the following assumptions.

- A. Steam generator activity is at equilibrium levels for 13-gpm primary-to-secondary leakage and 15-gpm continuous blowdown flow. Reactor coolant activity is assumed to result from fission product diffusion through cladding defects in 0.25 percent of the fuel rods. Primary coolant activity reduction due to leakage into the secondary system is negligible.
- B. Activity carryover in the steam flow is assumed to be 0.25 percent for halogens, 0.1 percent for particulates, and 100 percent for noble gases. Steam flow is assumed to be 12,660,000 lb/hr.
- C. The main condenser is assumed to provide a partition coefficient of 2,000 for particulates and halogens and one for noble gases.
- D. The vacuum pump exhaust is assumed to release all gaseous waste partitioned in the condenser from a total steam flow of 12,660,000 lb/hr for 313 days a year. Exhaust is filtered through a HEPA and charcoal filters in the ABVS.

The estimated release of gaseous waste from the condenser vacuum pump exhaust for anticipated operational occurrences is based on the following assumptions.

- A. Steam generator activity is at equilibrium levels for 100-gpd primary-to-secondary leakage and 15-gpm continuous blowdown flow. Reactor coolant activity is assumed to result from fission product diffusion through cladding defects in 1.0 percent of the fuel rods.
- B. The assumed carryover fractions, partition coefficients, and total steam flow values are the same as for normal operation.

A description of the analysis of steam generator activity levels for normal and anticipated operational occurrences is presented in Section 11.1.7, and Tables 11.1-12 and 11.1-13 summarize the resulting concentrations by isotope.

11.3.6.6 Turbine Gland Seal Exhaust

[This section contains historical information.]

The estimated annual release of gaseous waste from the Turbine Gland Sealing System (TGSS) during normal operation is based on the following assumptions.

- A. The activity of the steam system is as defined by the assumptions in Section 11.3.6.5 for normal operation.
- B. Total turbine gland exhaust flow amounts to 6,040 lb/hr of steam for 313 days a year.
- C. The turbine gland seal condenser exhaust is assumed to provide a partition coefficient of 100 for halogens and particulates, and one for noble gases.
- D. The turbine gland seal condenser exhaust releases all gaseous waste partitioned in the exhauster.

ARKANSAS NUCLEAR ONE
UNIT 2

The estimated release of gaseous waste from the TGSS for anticipated operational occurrences is based on the following assumptions.

- A. The activity of the steam system is as defined by the assumptions in Section 11.3.6.5 for anticipated operational occurrences.
- B. Total turbine gland seal exhaust flow, based on twice normal packing clearances, will be 12,080 lb/hr of steam for 313 days a year.
- C. The assumed partition coefficients are the same as for normal operation.

11.3.6.7 Steam Dump Valve and Relief Valve Discharge

[This section contains historical information.]

The estimated annual release of gaseous and air particulate activity from the steam dump valves and relief valves are normally expected to be nil.

The estimated release for anticipated operational occurrences is based on action of one valve for 300 seconds, assuming an average valve discharge rate of 720,000 lb/hr saturated steam. This amounts to 60,000 lb of steam which is assumed to be at equilibrium activity levels determined on the basis of the assumptions in Section 11.3.6.5 for anticipated operational occurrences.

11.3.6.8 Turbine Building Vent Exhaust

[This section contains historical information.]

The estimated annual release of gaseous waste from the turbine building vent exhaust during normal operation is based on the following assumptions.

- A. The activity released is assumed to generate from steam leaks in the turbine building totaling 1,700 lb/hr for 313 days a year.
- B. The activity of the steam system is as defined by the assumptions in Section 11.3.6.5 for normal operation.
- C. No partitioning of activity is assumed to occur at the leakage point.

The estimated annual release of gaseous waste from the turbine building vent exhaust during anticipated operational occurrences is based on the following assumptions.

- A. The activity released is assumed to generate from steam leaks in the turbine building totaling 1,700 lb/hr for 313 days a year.
- B. The activity of the steam system is as defined by the assumptions in Section 11.3.6.5 for anticipated operational occurrences.
- C. No partitioning of activity is assumed to occur at the leakage point.

ARKANSAS NUCLEAR ONE
UNIT 2

11.3.6.9 LLRWSB Vent Exhaust

The only activity releases from this path are assumed to be those from high specific activity waste prepared for shipment, and those associated with compaction and storage of dry active waste. The LLRWSB is equipped with a HVAC system which maintains a negative pressure within the building when in service. HEPA filters are installed to reduce the release of airborne particulates to the atmosphere. Storage capacities are presented in Section 11.5, Solid Radioactive Waste Program. These insignificant releases are not included in the tables dealing with effluent releases.

11.3.6.10 PASS Discharges

During normal operation these discharges are through other systems for both Unit 1 and Unit 2 and the discharges pass through HEPA and charcoal filters. During accident conditions all discharges are returned to the containment building.

Normal operation discharges are due to testing, emergency procedure training, and possible use during emergency drills. These releases are not included in the Tables dealing with effluent releases because these releases are insignificant.

11.3.6.11 Unit 1 Gaseous Releases

[This section contains historical information.]

As with Unit 2, the releases of noble gases, airborne halogens, and air particulates vary with plant operations.

Unit 1 release points and potential release points are as follows:

- A. Gaseous Radioactive Waste System (GRWS);
- B. Reactor Building Purge Exhaust;
- C. Auxiliary Building Ventilation;
- D. Condenser Vacuum Pump Exhaust;
- E. Turbine Gland Seal Exhaust;
- F. Steam Dump and Relief Valves;
- G. Turbine Building Exhaust; and,
- H. Penetration Room Vents.

The general assumptions made in estimating the annual release of gaseous wastes are:

- A. Expected reactor coolant activity levels are determined on the basis of fission product diffusion through cladding defects in 0.25 percent of the fuel rods. Reactor coolant concentrations for 0.1 percent failed fuel are presented in the ANO-1 Unit 1 SAR. These values have been linearly extrapolated to obtain 0.25 percent failed fuel;
- B. The reactor coolant activity levels for maximum expected occurrences are based on fission product diffusion through cladding defects in 1.0 percent of the fuel rods. Reactor coolant activity levels for these conditions are also presented in the ANO-1 Unit 1 SAR;

ARKANSAS NUCLEAR ONE
UNIT 2

- C. HEPA filters have a particulate removal efficiency of 99.9 percent and do not retain iodine or noble gases. No credit is taken for the particulate retentions by prefilters; and,
- D. Charcoal filters have an iodine removal efficiency of 90 percent and do not retain noble gases or particulates.

11.3.6.11.1 Gaseous Radioactive Waste System

[This section contains historical information.]

The purpose of this Unit 1 system is to collect and discharge, under monitored conditions, radioactive gases vented from auxiliary system equipment and tanks and collect, compress, store, and discharge under controlled conditions radioactive gases released from RCS equipment and other primary systems. The Unit 1 SAR gives a complete description of the GRWS.

Aerated low activity gases are collected in the gas collection header, and are vented directly to the station vent plenum through HEPA and charcoal filters. The sources of these gases are the various equipment vents in the auxiliary building which may contain air. These gases are therefore separated from all the gases associated with primary system water (which contains hydrogen gas) to prevent the formation of an explosive mixture anywhere in the GRWS.

Primary system vents and the discharge of the vacuum degasifier contribute the largest quantity of gaseous radwaste of all the components processed through the system. These gases are normally filtered, monitored, and discharged to the environment. Should the activity in the discharge header be too high, the gaseous waste discharge valve will close and the gas flow will be diverted to an empty waste gas tank. The gas is compressed and stored in the waste gas decay tanks until the radioactivity level drops sufficiently to be discharged through the discharge header to the environment. The decay tanks are conservatively sized to provide a 30-day holdup time for decay. Compressors are alternately started by a mechanical sequencer.

The following assumptions were used in determining gases expected to be released during normal operations.

- A. All radioactive gases in bleed wastes that were generated in the core and leaked into the coolant during the base loaded cycle were removed in the vacuum degasifier. Reactor coolant concentration due to 0.25 percent failed fuel.
- B. All gases held up 30 days (45 equivalent days) for decay.
- C. Annual average exclusion distance $X/Q = 2.8E-6 \text{ sec/m}^3$ used for evaluating exclusion distance concentrations.

Tables 11.3-5A and B summarize the releases from the GRWS during expected (normal) and maximum expected (anticipated operational occurrences).

11.3.6.11.2 Reactor Building Purge Exhaust

[This section contains historical information.]

ARKANSAS NUCLEAR ONE
UNIT 2

Expected and maximum expected releases due to Unit 1 reactor building purge are based on the same assumptions used for Unit 2 containment purge during normal and anticipated operational occurrence (see Section 11.3.6.2).

11.3.6.11.3 Auxiliary Building Ventilation

[This section contains historical information.]

Expected releases from the Unit 1 Auxiliary Building Ventilation System are based on the following assumptions:

- A. A 20-gpd reactor coolant leak occurs downstream of the letdown heat exchanger and releases activity for 313 days;
- B. A partition coefficient of 1,000 is assumed for halogens and particulates at the leak point;
- C. A partition coefficient of one is assumed for noble gases; and,
- D. Ventilation exhaust is through HEPA and charcoal filters.

Maximum expected releases are based on the above assumptions with fission product activities based on 1.0 percent failed fuel.

11.3.6.11.4 Condenser Vacuum Pump Exhaust

[This section contains historical information.]

Expected releases from the Unit 1 condenser vacuum pump are based on the following assumptions:

- A. Steam generator activity is at equilibrium levels for 13-gpd primary-to-secondary leakage. Reactor coolant activity is assumed to result from fission product diffusion through cladding defects in 0.25 percent of the fuel rods. Primary coolant activity reduction due to leakage into the secondary system is negligible;
- B. Activity carryover in the steam flow is assumed to be 100 percent for halogens, particulates, and noble gases. Steam flow is assumed to be 10,600,000 lb/hr;
- C. The main condenser is assumed to provide a partition coefficient of 2,000 for particulates and halogens and one for noble gases;
- D. Condensate demineralizers are uniformly assumed to provide a DF of 10 for halogens and particulates;
- E. The vacuum pump exhaust is assumed to release all gaseous waste partitioned in the condenser for a total steam flow of 10,600,000 lb/hr for 310 days a year. Exhaust is filtered through HEPA and charcoal filters.

Maximum expected releases are based on a 100 gpd primary to secondary leak with reactor coolant activity due to 1.0 percent failed fuel.

ARKANSAS NUCLEAR ONE
UNIT 2

11.3.6.11.5 Turbine Gland Seal Exhaust

[This section contains historical information.]

Expected and maximum expected releases due to Unit 1 turbine gland seal exhaust are based on the same assumptions used for Unit 2 normal and anticipated operations except expected gland seal flow is 5,870 lb/hr for 310 days a year and maximum expected flow is 11,740 lb/hr for 310 days a year.

11.3.6.11.6 Steam Dump Valve and Relief Valve Discharges

[This section contains historical information.]

The estimated annual release of gaseous and air particulate activity from the Unit 1 steam dump valves and relief valves are normally expected to be nil.

The estimated release for maximum expected occurrences is based on actuation of one valve for 300 seconds assuming an average valve discharge rate of 335,000 lb/hr saturated steam. This amounts to 28,000 pounds of steam which is assumed to be at equilibrium activity levels determined on the basis of the assumptions in Section 11.3.6.11.4 for anticipated operational occurrences.

11.3.6.11.7 Turbine Building Vent Exhaust

[This section contains historical information.]

Expected and maximum expected releases from Unit 1 turbine building ventilation exhaust are based on the same assumptions used for Unit 2 turbine building vent exhaust for normal and anticipated operational occurrences.

11.3.7 RELEASE POINTS

Releases from the Unit 2 gas collection header, Gaseous Waste System, containment purge, [fuel handling floor](#), [auxiliary building extension](#), and the auxiliary building ventilation exhaust all discharge from release points at the top of the containment at Elevation 533 feet (180 feet above grade). Figure 11.2-2, an elevation view of the containment, shows the rectangular duct which directs the effluents from these systems along one of the buttresses of the containment to the release point.

The turbine gland seal exhaust is located between the turbine building and auxiliary building. Releases are directed to the atmosphere through a line that exhausts at Elevation 461 feet (108 feet above grade).

The main steam dump and relief valves are located between the containment and the auxiliary building. Releases from the valve discharges are directed through individual pipes extending upwards to release points at Elevation 455 feet (102 feet above grade).

Releases from the Penetration Room Ventilation System discharge through a 12 inch line ([see Figure 11.2-2](#)) that exhausts at the top of the containment at Elevation 536.5 feet (183.5 feet above grade).

Discharges from potential release points within the turbine building are directed through penetrations in the turbine building roof. The turbine building ventilation exhaust is released through roof vents at Elevation 448 feet (95 feet above grade). Grade elevation is 353 feet.

ARKANSAS NUCLEAR ONE
UNIT 2

Discharges from the PASS Building and Low Level Radwaste Storage Building are released through exhaust lines at each location (see Figure 11.2-2).

11.3.8 DILUTION FACTORS

The discharge of gaseous wastes to plant effluent paths will account for some inplant dilution prior to exhausting to the environment. Table 11.3-6 summarizes the total air flow from each gaseous waste discharge point which will provide this dilution.

Once the discharge is released from the plant, dispersion of the plume occurs. The annual average X/Q value used in calculating the radionuclide concentrations at the site boundary is 2.8(-6) sec/m³. Its derivation is discussed in Section 2.3. The annual average meteorological data used to determine the total radiation exposure to the population was that observed for the period from February 7, 1972 to February 7, 1973 using wind speeds recorded at the 40-foot elevation.

The models used in the analyses of relative concentrations, plume depletion, radioactive decay and deposition are described as follows:

Straight Line Trajectory Air Flow Model Relative Concentrations

The computer program used for this analysis is based on the specifications in Regulatory Guide 1.111 (Reference 14).

For calculations, the plume is assumed to be a ground release because the stack vents fail, by a small margin, to exceed the height of closest solid adjacent structures. For ground level releases, the relative dispersion factor is determined from:

$$X / Q (i,D) = \frac{2.032}{nD} \sum_{j=1}^n \sum_{i=1}^n \frac{K}{\bar{u}(j) \left[\sigma_z(j,D)^2 + \frac{CV^2}{\pi} \right]^{1/2}} \quad (1)$$

where

- X/Q (i,D) = relative ground level dispersion factor (seconds/meter³) in sector i at distance D.
- $\sigma_z(j,D)$ = vertical dispersion coefficient for hour j (dependent on Pasquill stability class), at distance D (meters)
- $\bar{u}(j)$ = average wind speed (meters/second) for hour j at the 10 meter height
- D = distance from reactor containment structure to point of interest (meters)
- V = height of reactor containment structure (meters)
- C = building wake shape factor
- n = number of valid observations during the period of interest
- K = wind direction dependent variable (1 if wind blowing to sector i, 0 if wind not blowing to sector i)

ARKANSAS NUCLEAR ONE
UNIT 2

$$\frac{CV^2}{\pi}$$

The effect on X/Q of the wake factor is limited to a factor π of 3 or less, i.e., (X/Q) wake $\geq \frac{1}{3}$ (X/Q) no wake. Calm wind conditions are included in the calculation by assigning a wind speed of one-half threshold of the anemometer and distributing them around the 16 direction sectors in proportion to the directional frequencies of the lowest speed class interval for the appropriate Pasquill stability class. The above equation reflects the annual average (longer averaging periods) dilution factor which are applicable to routine venting or other routine gaseous effluent release. This equation uses the sector spread technique which accounts for variations of wind direction from the sector center lines during each hour's release.

Radioactive Decay

Relative concentrations of radionuclides were adjusted to account for radioactive decay in accordance with procedures given in Meteorology and Atomic Energy (Reference 35) using the following equation:

$$X / Q_{(\text{decay})} = X / Q \exp \left[-\frac{0.693}{T_{1/2}} t \right] \quad (2)$$

where

$X/Q_{(\text{decay})}$ = the relative concentration decreased by the decay of the radionuclides

X/Q = undecayed relative concentration

t = transit times for radionuclides; distance to receptor divided by wind speed

$T_{1/2}$ = half life of radionuclide

A half life of 2.26 days was used for all noble gases and of eight days for iodines.

Deposition

Deposition was calculated in accordance with the procedures recommended in Regulatory Guide 1.111. The values of relative deposition rate from Figure 7 of this guide are a function of distance only for ground level releases. The values are determined from the distance of the sources to the receptor divided by the arc length of the 22.50 wind sector at that distance:

$$D = \frac{\Gamma_D}{\text{WDTH}}$$

where

D = relative deposition

Γ_D = relative deposition rate of distance d from the source (obtained from curve in Figure 7 of Regulatory Guide 1.111)

WDTH = width of 22.5° sector at distance d ($2 d \sin (11.25)$)

ARKANSAS NUCLEAR ONE
UNIT 2

The above are determined for each observation of a given wind direction and distance.

Plume Depletion

Plume depletion effects were accounted for in accordance with procedures recommended in Regulatory Guide 1.111. Proportion of plume remaining after travel to distance, D, was taken from Figure 3 of this Guide. Annual relative concentrations, decayed and depleted, are derived by multiplying all values of decayed plumes, at distance D, by the depletion value at Distance D.

11.3.9 ESTIMATED DOSES

The dose to man resulting from radionuclides in gaseous effluents has been evaluated for the following principal exposure pathways.

- A. Immersion in a semi-infinite cloud containing radioactive material.
- B. Inhalation of radioactive halogens and airborne particulate material.
- C. Exposure to direct radiation from radionuclides that have deposited on ground around the site.
- D. Ingestion of food containing radionuclides deposited from gaseous effluents in the atmosphere.

Maximum radionuclide concentrations in air at the site boundary have been estimated using an annual average X/Q value of 2.8(-6) sec/m³ and the annual radionuclide releases given in Section 11.3.6.

Tables 11.3-7A and B give the maximum site boundary radionuclide concentrations under normal operation and operation during anticipated operational occurrences.

Radionuclide concentrations on the ground were found by assuming a deposition velocity of 0.5 cm/sec for halogens and particulates (1). The equation describing the radionuclide concentrations on the ground is:

$$C_G = \frac{1 \times 10^7 C_A V}{\lambda} (1 - e^{-\lambda t})$$

where

- C_G = radionuclide concentration on ground, (mCi/km²)
- C_A = radionuclide concentration in air, (μCi/cc)
- V = deposition velocity, (cm/sec)
- λ = radioactive decay constant, (sec⁻¹)
- t = reactor lifetime, (sec) assumed to be 40 yr

ARKANSAS NUCLEAR ONE
UNIT 2

The whole body dose to man from gamma radiation emitted by radionuclides deposited on the ground is given by:

$$D_g = \frac{KC_G}{g}$$

where

- D_g = annual whole body dose, mrem/yr
- K = dose conversion constant, mrem/yr/mCi/km² (Reference 25)
- g = self-absorption factor.

The dose conversion constants, K , apply to the dose from both uncollided and collided photons three feet above an infinite plane source containing uniform radionuclide deposition. A value of 2.5 was employed for the self-absorption factor, g , to account for radionuclide penetration into the soil. This value can be arrived from measurements by Beck (Reference 19). It has also been assumed that an individual spends eight hr/day and 365 days/yr exposed to radionuclides deposited on the ground.

The external dose to the surface of the body from immersion in a semi-infinite cloud of radioactive material is given by:

$$D_C = 250 (E_\beta + E_\gamma) R X/Q$$

where

- E_β = average beta energy per disintegration, Mev
- E_γ = average gamma energy per disintegration, Mev
- R = radionuclide release rate, Ci/yr
- D_C = annual dose, mrem/yr

The decay energies employed in the immersion dose calculation are given in Table 11.3-8.

Estimated site boundary whole body doses are summarized in Tables 11.3-10A and B for normal operation and anticipated operational occurrences.

In evaluating the dose from inhaled radioactive materials, continuous exposure to maximum site boundary airborne concentrations is assumed.

The dose from inhalation is given by:

$$D = \frac{C_A}{MPC} MPD$$

where

- D = annual dose to a given organ, mrem/yr
- C_A = airborne radionuclide concentration at the site boundary, μ Ci/cc
- MPC = maximum permissible radionuclide concentration in air, μ Ci/cc (References 2 and 13)
- MPD = maximum permissible organ dose resulting from continuous exposure at MPC, mrem/yr (References 2 and 13).

ARKANSAS NUCLEAR ONE
UNIT 2

For purposes of estimating the lung dose, it was assumed that the insoluble form of the radionuclide was present.

Estimated site boundary inhalation doses are summarized in Tables 11.3-10A and B for normal operation and for anticipated operational occurrences.

The dose from the consumption of food was evaluated for the following pathways.

- A. Adult consumption of green and tuberous vegetables containing deposited radionuclides.
- B. Adult consumption of meat from animals that have grazed continuously on pasture land containing deposited radionuclides.
- C. Infant and adult consumption of milk from cows at the nearest dairy herd 4.8 mi to the northwest of the plant.

The principal isotopes of significance in food chains leading to man are Sr-89, Sr-90, Cs-134, Cs-137 and I-131. Only these nuclides have therefore been included in the estimated doses from food consumption.

Two mechanisms for transfer into vegetation have been considered. These are uptake from the soil via the roots of the plant, and foliar deposition. For Sr-89 and I-131, only foliar deposition was considered. In general, radionuclide concentrations in food material are given by an empirical equation of the form (see References 22 and 34):

$$C_F = P_r F_r + P_d F_d$$

where

- C_F = radionuclide concentration in food, $\mu\text{Ci/g}$
- P_r = ate proportionality constant, $\mu\text{Ci/g/mCi/km}^2$
- F_r = annual rate of radionuclide deposition, mCi/km^2
- P_d = soil proportionality constant, $\mu\text{Ci/g/mCi/km}^2$
- F_d = cumulative radionuclide deposit, mCi/km^2

The empirical constants, P_r and P_d , employed in the analysis for strontium and cesium isotopes are given in Table 11.3-9.

Concentrations of radioiodine isotopes in milk were determined assuming a deposition velocity of 1 cm/sec, a pasture half-life of 14 days, and an empirical rate constant of 9(-8) ($\mu\text{Ci/cc}$) milk/(mCi/km^2) pasture. This set of assumptions corresponds to the factor of 700 reduction in the MPC_a for I-131 which is commonly employed to account for the milk-infant exposure pathway (Reference 23).

The annual average concentration of radioiodine isotopes in milk has been based on the assumption that cows are grazed for nine months each year.

ARKANSAS NUCLEAR ONE
UNIT 2

The doses from food consumption were computed using the equation:

$$D = \frac{C_F}{MPC} \frac{R}{2200} \text{MPD}$$

where

- D = organ or whole body dose, mrem/yr
- R = rate of food intake, g/day
- C_F = radionuclide concentration in food, μCi/g
- MPD = maximum permissible organ dose, mrem/yr (References 2 and 13)
- MPC = the maximum permissible radionuclide concentration corresponding to the MPD, μCi/cc (References 2 and 13)

The dose to adults and infants from food ingestion are summarized in Table 11.3-10A and B.

The dose to individuals and populations within a 50-mile radius of ANO have been evaluated as a function of distance and direction from the containment. For simplification, only the immersion dose was included in the evaluation. The exposure per person in each 22.5 degree sector as a function of distance is given by:

$$D_S = D_B \frac{(X/Q)_S}{(X/Q)_B}$$

where

- D_S = immersion dose in a given sector at a given distance, mrem/yr
- D_B = immersion dose at the north site boundary, mrem/yr
- X/Q_B = annual average X/Q value at the north site boundary, sec/m³
- X/Q_S = annual average X/Q value in a given sector at a given distance, sec/m³.

The x/Q values employed in the analysis are given in Section 2.3, and are annual average values based on 40-foot level wind data.

Population immersion doses, i.e. man-rem, were determined by multiplying the doses determined above by the number of people in each sector and distance interval. The population distribution data given in Section 2.1 were employed.

The resulting doses to individuals and population groups are presented in Tables 11.3-11 and 11.3-12 for normal operational gaseous release, and in Tables 11.3-13 and 11.3-14 for releases during anticipated operational occurrences.

For information on site characteristics, including population distribution, agricultural usage, and fish and wildlife usage, see Chapter 2.

ARKANSAS NUCLEAR ONE
UNIT 2

11.4 PROCESS AND EFFLUENT RADIOLOGICAL MONITORING SYSTEMS

The process and effluent radiological monitoring systems provide the means for monitoring the containment atmosphere and the ventilation exhaust from spaces containing components used for the recirculation of hypothetical Loss of Coolant Accident (LOCA) fluids. These systems also monitor all other gaseous and liquid effluent paths by which radionuclides may be released to the environment except the turbine building sumps. The turbine building sumps are monitored as described in 11.6.3.3. The system consists of permanently installed continuous monitoring devices together with a program of and provisions for specific sample collections and laboratory analyses. The overall system is designed to function and provide information of use in evaluating the radiological consequences of normal plant operation, anticipated operational occurrences, and hypothetical accidents.

This section describes the instrumentation and the program of sample collection and analysis at Unit 2. The design of the overall system is evaluated for radioactivity releases during normal plant operation, as described in Sections 11.2 and 11.3, and for release during hypothetical accidents, as described in Chapter 15.

11.4.1 DESIGN OBJECTIVES

The principal objectives of the monitoring systems are:

- A. To provide for evaluation of the performance of all plant systems that function to minimize the release of radioactivity to accessible areas of the plant and to the environment;
- B. to estimate quantities of radioactivity in effluents or potential effluents before and/or during their release to unrestricted areas; and,
- C. to quantify releases of individual nuclides and radionuclides in effluents to unrestricted areas during and after release.

The accomplishment of these general objectives will provide assurance that doses to individuals in restricted and unrestricted areas are as low as practicable during normal plant operation and during anticipated operational occurrences as defined in 10 CFR 20, Appendix I of 10 CFR 50, and the Technical Specification limits for releases. In addition, these monitoring systems will allow plant personnel to evaluate the radiological consequences of hypothetical accidents.

Specific design objectives include the following:

- A. To collect representative samples of planned air and water effluents prior to discharge to unrestricted areas during normal reactor operation and during anticipated operational occurrences in order to allow measuring and recording of the quantity of each of the principal radionuclides present in these discharges as required by Section 50.36A of 10 CFR 50 and Regulatory Guide 1.21 (12/29/71).
- B. To collect representative samples of air and water effluents that are discharged continuously to unrestricted areas during normal reactor operation and during anticipated operational occurrences in order to allow measuring and recording of the quantity of each of the principal radionuclides present in the discharges as specified in 10 CFR 50 and Regulatory Guide 1.21.

ARKANSAS NUCLEAR ONE
UNIT 2

- C. To provide sample facilities that allow monitoring of the containment atmosphere, spaces containing components for recirculation of LOCA fluids, effluent discharge paths, and the plant environment for radioactivity that may be released from postulated accidents.
- D. To continuously monitor radioactivity in both intermittent and continuous discharges of potentially radioactive plant air and water effluents to unrestricted areas during normal plant operations, including anticipated operational occurrences. The turbine building sumps monitoring is discussed in Section 11.6.3.3. This pathway is not continuously monitored. The monitors verify that such releases are at concentrations and radiation levels that are within the limits specified in Table II of Appendix B to 10 CFR 20, as well as the guidelines of Sections I, IIc, III, and IV, of Appendix I to 10 CFR 50.
- E. To provide alarm and automatic termination of the release of effluents when radionuclide concentrations and/or radiation levels exceed the limits specified in "D" above. Where the termination of releases is not feasible, the monitors provide continuous indication of the magnitude of the activity releases.
- F. To provide an indication of the existence of and, to the extent possible, the magnitude of Reactor Coolant System (RCS) and Reactor Auxiliary System leakage to the containment atmosphere, the CCW, the Service Water system, or the secondary plant side of the steam generators.

11.4.2 CONTINUOUS MONITORING

The continuous Liquid and Gas Radiation Monitoring Systems are presented and described in the following sections. For each location subject to continuous monitoring, the basis for location selection, the expected concentrations or radiation levels, and the parameters to be measured are presented. The detectors used are described by type, sensitivity and range. The recording and indicating devices and annunciators and alarms are also discussed. The bases for the selection of monitor setpoints and the actions initiated upon exceeding the setpoints are discussed. Indicators and controls for continuous Liquid and Gas Process and Effluent Monitoring Systems are provided in the control room at the radiation monitoring panels.

The radiation monitoring control panel is a Seismic Category 1 enclosure and houses the remote readouts and associated controls for the monitoring systems. They are the liquid radiation monitoring system control panel, the gaseous waste monitoring system control panel and the area radiation monitoring control panel. The monitor outputs are recorded on multi-point recorders. Monitor detector outputs provide indication at the monitoring panels on a logarithmic ratemeter having two ranges (wide range-five decades and expanded range-three decades) or on a ratemeter with an auto ranging digital display).

The liquid monitoring and gaseous monitoring system control panels are provided with dual level alarms. Selected channels are provided with triple level alarms. The low level alarm is set below the background counting rate to act as a circuit failure alarm. The high level alarm is set at a high level trip point corresponding to the maximum permissible radiation level for the particular system. The third setpoint is adjustable over the full range between circuit failure and maximum permissible level.

ARKANSAS NUCLEAR ONE UNIT 2

The alarm circuits are operative when the ratemeters are in the power-on condition. When ratemeters are in a voltage checking mode, the alarm circuits are not bypassed. In a calibration mode the alarm circuits are used to set and check bistable trip points. Failure of power causes an alarm of all circuits. The low alarm circuits are automatically reset when the cause of the alarm condition is corrected and the high alarm is manually reset.

Most monitors in the continuous gaseous and liquid monitoring system are provided with a solenoid or motor operated check source that will simulate a radioactive sample in the detector sample chamber and is used for operational and gross calibration checks of the detector and readout equipment. All check sources have half-lives greater than 10 years. The control room inlet air monitor system is provided with a pulsed LED which provides an identical detector response as an isotopic check source and is used for the functional check of the detector, preamplifier, and readout equipment.

Most monitors in the continuous gaseous and liquid monitor systems are provided with an in-line or off-line sample chamber, a radiation detector, a check source, associated process filters and other applicable equipment. The sample chamber is sized and shielded as required to achieve the specified minimum system sensitivities. Each sampler is constructed of 304 stainless steel in accordance with the fabrication codes of the associated system and is located as close as practical to the process stream, such that sample line interference or losses will be insignificant. Table 11.4-1 lists the process radiation monitors. The control room inlet air monitor system is provided with a radiation detector (which incorporates a pulsed LED for functional verification), preamplifier, and ratemeter.

Figure 9.2-7 (Sheet 4) shows the turbine building sump and associated pumps and piping. The system collects turbine building liquid waste, normal (nonradioactive) and oily waste from the auxiliary building, component leakage, and chemical waste from the chemistry laboratory and battery rooms. Chemical wastes are neutralized prior to processing in an oil/water separator. Waste oil is collected in 55-gallon drums for off-site disposal. Water from the oil/water separators is routed to the turbine building sump. The turbine building sump level is controlled automatically by pumps which are started on high sump level. Effluent from the sump is pumped to the outside oil/water separator where the water is discharged to the intake canal.

The volume and activity of potentially contaminated liquid waste discharged from the turbine building drains is expected to be negligible. During periods of primary to secondary leakage, this could be slightly radioactive. Provisions have been made to allow local sampling for laboratory analysis to ensure that Technical Specifications are not exceeded.

11.4.2.1 Process Liquid Monitors

The process liquid monitors are provided to detect failed fuel and leakage between process systems, and to continuously monitor the activity of liquids discharged to the environment. The isotopic concentrations that are expected for each of the liquid streams are presented in Section 11.2 for normal plant operations including anticipated operational occurrences. The concentrations of releases resulting from postulated accidents are presented in Chapter 15.

ARKANSAS NUCLEAR ONE
UNIT 2

11.4.2.1.1 Chemical and Volume Control System Process Radiation Monitor (Failed Fuel Detector)

The primary purpose of the Chemical and Volume Control System (CVCS) process radiation monitor is to alert plant operators to an increase in coolant radioactivity as quickly as possible. Such an increase in radioactivity would usually be caused by crud released in the RCS or CVCS letdown line. However, an increase in specific fission product nuclide activity along with an increase in gross gamma activity would indicate failed fuel cladding.

The monitor is located in the CVCS letdown line in parallel with the purification filter but upstream of the ion exchangers. This location was selected because a continuous sample at relatively low temperature and pressure can be conveniently obtained and the sample effluent can be returned to the purification system without difficulty. This location also provides an optimum compromise between a minimum sample lag time and the required delay time for sample background radioactivity decay. The time lag from the RCS to the monitor is sufficient to permit N-16 to decay to a low level that will not interfere with monitor readings for all operating conditions.

Gross gamma activity concentration and the activity concentration of a specific nuclide are monitored simultaneously. Iodine-131 is the specific nuclide chosen for activity monitoring for several reasons.

First, Iodine-131 is a fission product that is found in relative abundance in the reactor coolant in the event of fuel cladding failure. Second, it is released from defective fuel with relative ease and does not plate out on the system surfaces. Finally, Iodine-131 is chosen because its 0.364 Mev gamma can be readily monitored using discrimination techniques, and its 8.04 day half-life is long relative to sample lag time but short enough to provide indication of current fission product escape from the fuel. Some fission products that would contribute to gross gamma level plate out on the walls of the piping. The gross gamma activity after minimum lag time is dominated by gaseous fission product and is representative of coolant activity.

The reactor coolant specific activity sensitivity as measured at a coolant temperature of 70 °F by the CVCS process radiation monitor is listed in Table 11.4-1. Design data for the process monitor is listed in Table 9.3-19.

The monitor consists of shielding, sampler, detector holder, gamma scintillation detector preamplifier, logarithmic ratemeter, and single-channel linear ratemeter/analyzer. The gamma scintillation detector is a sodium iodide crystal, one and one-half inches diameter by one inch long, with photomultiplier tube and integral preamplifier which monitors gamma radiation in the energy range of 100 Kev to 3 Mev. The minimum and maximum detectable coolant activities are 1(-4) and 1(-2) in $\mu\text{Ci/cc}$ of I-131, respectively. A remotely operated Cs-137 check source is used to test the overall operation of the system.

The sampler is of the in-line type with a sample volume two and one-half inches in diameter and 1-3/4 inches deep. The sampler and tubing are fabricated from stainless steel designed for 200 psig at 250 °F. The detector assembly is completely shielded in 4π geometry by approximately four and one-half inches of lead to reduce the background signal contribution. The shielding assembly also includes a removable collimating plug that must be placed between the detector and sample cell to increase the operating range of the monitor above 1 (-1) $\mu\text{Ci/cc}$ of I-131.

ARKANSAS NUCLEAR ONE
UNIT 2

After amplification, the detector output signal is fed to a linear ratemeter/analyzer and a logarithmic ratemeter located in the control room. The linear ratemeter/analyzer can monitor a specific fission product gamma activity (I-131) with a total range of 0 to 1.0 (+6) cpm. The logarithmic rate meter measures gross gamma activity with a range of 10 to 1.0 (+6) cpm. Alarms are provided on both the linear ratemeter/analyzer and the logarithmic ratemeter with adjustable set points over the complete range.

The CVCS process radiation monitor is a trend monitor and its primary purpose is to indicate the possibility of fuel clad failure. See Table 11.4-1 for information concerning alarm setpoints. It is expected that gross activity and perhaps Iodine-131 activity will periodically increase above the alarm setpoints due to normal plant transients. Consequently, the alarm will periodically activate and the operator must determine the cause of the alarm. If an alarm is received and the Iodine-131 activity has increased and remains significantly above the prior steady state level, additional fuel failure can be assumed to have occurred. However, if an alarm is received due to an increase in gross activity and a plant load increase, crud burst release can be suspected. In time, the coolant activity should return to the prior, lower, steady state value.

11.4.2.1.2 Component Cooling Water Monitoring System

The Component Cooling Water Monitoring System is provided to continuously monitor the activity level of components that may contain radioactivity. Each of the two component cooling water loops is provided with an off-line sampler that takes a continuous sample and returns it to the component cooling water heat exchanger inlet. Section 9.2.2 presents a detailed discussion of the Component Cooling Water System and Figure 9.2-6 shows the monitor locations in the process stream.

The normal monitor readings will result from the detector background radiation levels, since contaminated leakage to the system is not expected. The monitor provides a high alarm when concentration levels reach a preset limit, which constitutes positive indication of contaminated leakage to the system. The receipt of this alarm will alert the operator to the presence of leakage so that additional radiation surveys, sampling, and equipment isolation can be effected in order to locate and repair the leakage source.

The detector is a one and one-half inches in diameter by one inch thick NaI (TI) crystal optically coupled to a photomultiplier tube which is housed in a mu-metal shield. The detector has a fixed position with respect to the waste liquid monitor, and is shielded by 7.5 inches of lead in all directions. An electronic matching network applies a DC voltage to the photomultiplier tube, and couples the radiation response signal into the interconnecting cable. Only passive components are located at the detector.

The system is capable of detecting 5(-6) $\mu\text{Ci/cc}$ of Cs-137 in a 2.5 mr/hr background. Readout is provided in the control room by two log count ratemeters.

11.4.2.1.3 Service Water Monitoring System

The Service Water Monitoring System is provided to continuously monitor the Service Water System (SWS) to detect leakage in any of the heat exchangers. The SWS continuously circulates water through the plant for cooling purposes and leakage in any of the heat exchangers handling a radioactive liquid could potentially release radioactive material to the Dardanelle Reservoir.

ARKANSAS NUCLEAR ONE
UNIT 2

The Service Water Monitoring System consists of one channel downstream of each pair of containment cooling coils, one channel downstream of each shutdown heat exchanger and one channel downstream of the fuel pool heat exchanger. Section 9.2.1 presents a detailed discussion of the SWS and Figure 9.2-1 shows the monitor locations in the process stream.

The normal monitor readings will result from the detector background radiation levels and any associated electronics since contaminated leakage to the system is not expected. A high alarm from the monitor downstream of each pair of containment cooling coils initiates a signal which annunciates an alarm in the control room. The operator will then activate the service water isolation valves as required.

Each channel consists of a continuous off-line sampler and scintillation detector as described in Section 11.4.2.1.2. The two channels downstream of the containment cooling coils are designed to detect 5(-6) uCi/cc of Cs-137 in a 2.5 mr/hr background and readout is provided in the control room by two log count ratemeters. The channel downstream of each shutdown heat exchanger is sensitive enough to detect 5(-6) µCi/cc of Cs-137 in a 2.5 mr/hr background and readout is provided in the control room by two log count ratemeters. The channel downstream of the fuel pool heat exchanger is sensitive to 5(-6) µCi/cc of Cs-137 in a 2.5 mr/hr background and readout is provided by a log count ratemeter in the control room.

11.4.2.1.4 Steam Generator Monitoring System

The Steam Generator Monitoring System is provided to continuously monitor the activity level of the secondary side of the steam generators during normal plant operations. These monitors provide positive indication of primary-to-secondary leakage and a means of determining which steam generator is leaking.

The Steam Generator Monitoring System consists of three separate monitoring systems described below:

- A. The Process Sampling System monitors consist of one channel downstream of each steam generator sample cooler.

Section 9.3.2 presents a detailed description of the Process Sampling System.

Each monitor channel consists of a sampler and scintillation detector as described in Section 11.4.2.1.2. The monitors downstream of each steam generator sample cooler have a sensitivity of 5(-6) µCi/cc of Cs-137 in a 2.5 mr/hr background. Readout is provided in the control room by three log count ratemeters and by a chart recorder in the control room on panel 2C14. Normal monitor readings will result from detector background radiation.

- B. The Main Steam Line Area Monitors consist of one detector attached to each main steam line located in the upper elevation of the Main Steam Isolation Valve Room in the Auxiliary Extension Building.

Each monitor channel consists of a Geiger-Mueller type detector with a range of 0.1 mR/h to 10,000 mR/h. Readout is provided in the control room on the control modules, chart recorder on 2C14, and the SPDS and PMS computers.

ARKANSAS NUCLEAR ONE
UNIT 2

- C. The Steam Generator N-16 Monitoring System consists of one detector in close proximity to each main steam line located on elevation 354 of the Turbine Building in the southwest corner of the CCW room.

Each monitor channel consists of a scintillation type detector and computer control system located in the Startup and Blowdown Demineralizer Control Room on the 374 elevation of the Auxiliary Extension Building.

The N-16 gamma is a result of the neutron activation of oxygen and subsequent unique seven second half life gamma decay. The energy range of the N-16 gamma is above the energy range of gammas produced by other reactor interactions or naturally produced gammas. The N-16 gamma concentration is directly proportional to power level. These factors make the N-16 gamma an ideal isotope to detect and quantify primary-to-secondary leakage.

The computer control system has been programmed to provide indication of primary-to-secondary leakage in gallons per day whenever plant power is above 20%. The designed minimum detectable leakage is 5.25 GPD. The calculated leakrate is provided to the Plant Monitoring System where it is displayed in Leak Rate (GPD), Leak Rate (GPM), and Leak Rate Rate of Change. The Plant Monitoring System also provides three system related alarms on 2K11.

11.4.2.1.5 Liquid Radioactive Waste Discharge Monitoring System

The Liquid Radioactive Waste Discharge Monitoring System continuously monitors the activity of liquids discharged to the plant discharge header. The header receives liquid wastes from plant systems that potentially contain radioactive nuclides and constitutes a path by which planned releases of radioactive liquid effluents can be discharged to the environment from the Waste Management System (WMS) and Boron Management System (BMS). The monitor is located in the WMS discharge line to the circulating water canal. Monitoring before dilution with circulating water allows greater accuracy of measurement. Section 11.2 presents a detailed discussion of the WMS and BMS and Figure 11.2-1 show the monitor locations in the effluent streams.

The Liquid Waste Monitoring System consists of a single channel, in-line sampler and a scintillation detector as described in Section 11.4.2.1.2 with a sensitivity of 5(-6) $\mu\text{Ci}/\text{cc}$ of Cs-137 in a 2.5 mr/hr background. If the activity reaches the alarm setpoint, an alarm is activated in the control room, and valves 2CV-2330A and 2CV-2330B, shown on Figure 11.2-2, are tripped closed to stop the discharge flow. The operator must then determine the cause of the alarm. Operator actions would be the same as those described for the gaseous discharge monitor.

The Regenerative Waste Processing Monitoring System consists of two monitors. The monitor of the RWP discharge from the neutralizing tank, 2RE-4425, is currently not in use. The monitor located in the line from the regenerative waste transfer pump to the discharge flume, 2RE-4423, consists of a sampler and a scintillation detector as described in Section 11.4.2.1.2. The sensitivity of this detector is 5(-6) $\mu\text{Ci}/\text{cc}$ of Cs-137 in a 2.5 mr/hr field. If the activity reaches the alarm setpoint, an alarm is activated on the local control panel and in the Control Room and the discharge valve, 2CV-4424, is automatically closed.

ARKANSAS NUCLEAR ONE
UNIT 2

11.4.2.2 Gas Monitoring Systems

The Continuous Gas Monitoring Systems are provided to monitor and quantitatively analyze discharges from plant gaseous effluent paths which potentially contain radioactive noble gases, halogens and particulates. The isotopic concentrations expected for each of the gaseous discharge paths monitored are presented in Section 11.3 for normal plant operation, including anticipated operational occurrences. The concentrations of releases resulting from postulated accidents are presented in Chapter 15.

Each of the Gas Monitoring Systems consists of one or more of the following, depending upon the intended service of the monitoring system:

- A. Airborne particulate and iodine channel-removable filter; or
- B. low level gas channel.

The airborne particulate channels are removable paper filters for particulate collection and activated charcoal for iodine collection with a 99.9 percent collection efficiency for 0.3 micron particles. These filters are removed and counted by laboratory analysis.

11.4.2.2.1 Main Condenser Air Discharge Radiation Monitoring System

The Condenser Air Discharge Monitoring System is provided to continuously monitor the gaseous activity levels released to the plant vent by the condenser vacuum pump. In the event of a steam generator tube leak, the vacuum pump exhaust will contain airborne activity entrained in the air evacuated from the condenser during normal plant operations. The Condenser Air Discharge Monitoring System is provided to detect the presence and, to the extent possible, the magnitude of primary-to-secondary system leakage as well as to quantitatively analyze the resulting discharge of radioactivity to the plant vent. Section 10.4.2 presents a detailed discussion of the condenser evacuation system, and Figure 10.4-1 shows the location of the monitor in the effluent stream.

The monitor consists of an off-line sampler and a G-M tube for gross beta-gamma analysis and the system has a sensitivity of 1(-5) $\mu\text{Ci/cc}$ of Xe-133 in a 2.5 mr/hr background. The readout is provided in the control room by the secondary system trend recorder on panel 2C14 and by a log count ratemeter.

11.4.2.2.2 Waste Gas Monitoring System

The Gaseous Radioactive Waste Monitoring System is provided to continuously monitor the gaseous activity levels released to the vent from the waste gas decay tanks. The tanks potentially contain high levels of radioactive noble gases which are periodically released to the plant vent on a controlled basis. Section 11.3 presents a detailed description of the GWS and Figure 11.3-1 shows the location of the monitor.

The monitor consists of an in-line sampler and the detector is a gross beta-gamma G-M tube. The system is capable of detecting 1(-5) $\mu\text{Ci/cc}$ of Xe-133 in a 2.5 mr/hr background. The monitor has an alarm and trip system that is operated by a logarithmic ratemeter. The setpoint of the alarm and trip is adjustable over the full range of the ratemeter. Prior to the release of gaseous activity, a sample is taken for radioactive analysis. The Process Sampling System is described in Section 9.3.2. Both gross and isotopic radioactivity analyses are performed to

ARKANSAS NUCLEAR ONE
UNIT 2

verify that the activity in the tank can be released to the environment without exceeding the applicable limits. The alarm setpoint of the monitor is set slightly greater than the level determined by the gross gamma radioactivity analysis but below the applicable release limits.

If the activity should increase above the set point, an alarm is activated in the control room and valve 2CV-2428 (see Figure 11.3-1) is tripped closed to stop discharge flow. The operator must then determine the cause of the alarm. Another sample would be taken for radioactivity analysis to determine if the alarm and trip were due to high activity or instrument miscalibration or malfunction. If high activity is the source of alarm, discharging from that particular gas decay tank must either be justified at a higher activity level or the contents must be allowed to decay for an additional time period.

11.4.2.2.3 Containment Atmosphere Monitoring System

The Containment Atmosphere Monitoring System is a redundant system provided to continuously monitor the gaseous and particulate activity levels in the containment in order to determine if there is leakage from the reactor coolant pressure boundary. The Containment Atmosphere Monitoring System (CAMS) also provides a means of controlling reactor building pressure and maintaining the oxygen concentrations at levels acceptable for human occupancy. Section 5.2.7 gives a complete system description and Figure 9.4-4 shows the monitor locations in the process stream.

11.4.2.2.4 Vent Radiation Monitoring System

The original Westinghouse Vent Radiation Monitoring System provides the capability of continuously monitoring the gaseous activity released to the environment and provides the capability of determining the particulate and iodine releases by laboratory analysis. With the addition of the SPING (Super Particulate Iodine Noble Gas) monitors, the capability of directly reading the particulate and iodine releases was provided. The SPING Monitor has on-line monitoring of particulates, iodines, and noble gases in the effluent.

Removable filters are provided along with sample ports upstream of the filters permitting plant personnel to obtain representative grab samples of the effluent being released. Sample stream concentrations of up to 10^{-4} $\mu\text{Ci}/\text{cc}$ of gaseous radioiodine and particulate can be monitored by use of filters and grab samples.

The SPING Monitor has the capability to remotely purge the monitor assembly as well as remotely actuating a check source. Readouts of each detector channel and the status of each monitor are available in both control rooms.

Radiological releases or potential releases occur through three plant vents which handle the ventilation exhaust from the fuel handling area, radwaste area, and containment purge. The SPING monitors provide backup monitoring for the three areas listed above and additional monitoring for the Penetration Room Exhaust and the Auxiliary Building Extension Ventilation that input into these vents.

A SPING Monitor is provided for the Low Level Radwaste Building ventilation exhaust.

- A. The fuel handling area ventilation monitor is provided to continuously monitor the gaseous activity levels released to the environment by the ventilation fans exhausting the new fuel area and the spent fuel pool area of the auxiliary building. The spent fuel pool will contain gaseous activity levels due to partial mixing with the RCS during each

ARKANSAS NUCLEAR ONE
UNIT 2

refueling. Diffusion of this activity from the pool will generate airborne activity which the fuel handling area vent monitoring system quantitatively analyzes prior to release to the environment. The monitor will also provide an indication of gaseous activity released incident to a fuel handling accident. Section 9.4.3 presents a detailed description of the fuel handling area ventilation system. The system consists of an offline sampler incorporating a sliding vane pump which draws a gas stream through particulate and charcoal filters where radioiodines and solid isotopes are extracted for laboratory analysis. The gas is then monitored for radioactivity by the gas monitor. Sample flow is continuously drawn from and returned to the vent exhaust duct by an isokinetic sampling probe.

The detector consists of a gross beta-gamma G-M tube and the system is capable of measuring 1(-5) $\mu\text{Ci}/\text{cc}$ of Xe-133 in a 2.5 mr/hr background. Readout is provided in the control room by a log count ratemeter.

The expected monitor readings for the detector channel during normal plant operation will result from the combined activity levels contributed by the various releases directed into the fuel handling area ventilation exhaust. These expected activities are described in Tables 11.3-5A and B.

Information concerning process radiation monitor alarms is contained in Table 11.4-1.

Additional monitoring of this area is provided by a SPING Monitor.

- B. The radwaste area ventilation monitor continuously monitors the gaseous activity levels released to the environment in the combined ventilation exhaust flow from the auxiliary buildings and provides the capability of determining particulate and iodine releases by lab analysis of the fixed particulate and charcoal filters. This flow path provides ventilation exhaust for all building structures housing reactor coolant and reactor auxiliary system components outside the containment. These components represent potential sources for release of gaseous and air particulate activities in addition to the drainage sumps, tanks, and equipment purged by the vent collection and gas collection headers. The system will additionally monitor releases from the vacuum pump exhaust, the gas collection header, and the waste gas decay tanks after they are diluted in the radwaste area ventilation exhaust flow. Section 9.4.3 presents a detailed description of the radwaste area ventilation system. The monitoring equipment and its function is identical to that used in the fuel handling area ventilation monitoring system.

Additional monitoring of this area is provided by a SPING Monitor.

- C. The containment purge monitor is provided to continuously monitor the gaseous activity levels released to the environment during normal purge operations and provides the capability of determining particulate and iodine releases by analysis of the fixed particulate and charcoal filters. Section 9.4.5 describes the containment purge system and the location of the monitor is shown in Figure 9.4-4.

The monitoring equipment is identical to that used in the fuel handling ventilation monitoring system. On high radiation alarm, containment purge is automatically terminated.

Additional monitoring of this area is provided by a SPING Monitor.

ARKANSAS NUCLEAR ONE
UNIT 2

11.4.2.2.5 Control Room Inlet Air Monitoring System

The Control Room inlet air monitor continuously monitors the activity level in the inlet air. Section 9.4.1.2.2 presents a detailed description of the Control Room Ventilation System and the location of the detector in the inlet air duct is shown in Fig. 9.4-1.

The detector is a beta-gamma scintillation type detector and is capable of measuring 1(-5) $\mu\text{Ci/cc}$ of Cs-137. Readout is provided in the control room by an auto ranging digital display rate meter. A high radiation level in the inlet air to Unit 2 will automatically isolate both Units 1 and 2 from unfiltered outside air.

11.4.3 SAMPLING

The Process Sampling System is described in Section 9.3.2.

11.4.4 INSPECTION, CALIBRATION, AND MAINTENANCE

11.4.4.1 Continuous Monitoring Systems

The continuous radiation monitors have been calibrated by the manufacturer for at least the principal radionuclides listed in Table 11.4-1. The manufacturer's calibration is traceable to certified NIST or commercial radionuclide standards, and is accurate to at least five percent. The source-detector geometry during this primary calibration was identical to the sample-detector geometry in actual use. Secondary standards which were counted in reproducible geometry during the primary calibration are supplied with each continuous monitor for calibration after installation. Each continuous monitor is calibrated during plant operation using the secondary radionuclide standard or dedicated sources traceable to the certified NIST or commercial radionuclide standard.

The count rate response of each continuous monitor to remotely positionable check sources supplied with each monitor was recorded by the manufacturer after the primary calibration, and again after installation.

Following repairs or modifications the monitors will be recalibrated at the plant with the secondary radionuclide standards or dedicated sources traceable to the certified NIST or commercial radionuclide standard.

All detectors monitoring the activity of WMS, BMS and Gaseous Waste System (GWS) waste being discharged to the environment, i.e. to the circulating water flume or the atmosphere, are in-line detectors. Valves are provided to isolate the process flow stream from the detector and the environment in the event detector replacement is necessary. To ensure that all radioactive discharge to the environment is monitored, no bypass lines have been provided around these detectors. If it becomes necessary to replace the associated detector or place the associated monitor out of service, grab samples must be obtained and analyzed per appropriate procedures prior to discharging any given process system to the environment.

11.4.4.2 Laboratory Radiation Detectors

Counting efficiencies of all laboratory radiation detectors have been determined with certified radionuclide standards having accuracy better than five percent. Gross beta analyses are standardized against a selected beta source and gross alpha analyses are standardized against

ARKANSAS NUCLEAR ONE
UNIT 2

a selected alpha source. The high purity germanium gamma spectrometers have been calibrated in terms of photopeak efficiency versus gamma energy, and counting efficiencies for individual gamma emitters are based on nuclear decay schemes as given in the Table of Isotopes.

The response of each laboratory detector to alpha, beta or gamma check sources was recorded during the primary calibration with the certified radionuclide standards. These check sources are ruggedized to maintain their integrity during repeated handling. The response of each beta and gamma counter to the appropriate check source and the background count rate of each detector is determined at least weekly, and in most cases daily. The response of each alpha counter to the appropriate check source and the background count rate of each detector is determined at least monthly and/or prior to use. A control chart showing check source response and counter background is maintained for each laboratory counter. Instrument responses falling outside of statistical limits imposed by counting statistics are investigated and the instrument serviced as required.

11.5 SOLID RADIOACTIVE WASTE PROGRAM

The installed Radioactive Waste Concentration and Solidification Systems which were designed to process boric acid and other highly radioactive liquid wastes are obsolete due to technological advances. Therefore use of these systems has been suspended. Any system used to process radioactive wastes is controlled by the Process Control Program and appropriate operating procedures. Boric acid and other highly radioactive liquid wastes are presently processed similarly to lower level liquid radioactive wastes. The description of the previous program has been replaced with a description of the current Solid Radioactive Waste Program.

11.5.1 PROGRAM OBJECTIVES

The purpose of the Solid Radioactive Waste Program is to solidify, stabilize, or encapsulate solid radioactive waste materials for storage, off-site shipment and disposal in accordance with applicable regulations. Solid radioactive waste processing is controlled under a single program at ANO which serves Units 1 and 2. Processed wastes typically include spent ion exchanger resins, used filter elements, and miscellaneous refuse classified as radioactive waste.

Considerations for keeping personnel dose As Low As Reasonably Achievable (ALARA) are factored into the management of solid radioactive wastes at ANO. These considerations include items such as shielding of waste packages to reduce dose rates, remote operations, use of quick connect fittings, and use of temporary shielding when required.

Another objective of the Solid Radioactive Waste Program is to reduce the volume of radioactive waste generated at ANO. This objective is met by incorporating practices which:

- A. Recommend, review and evaluate radioactive waste operations and volume reduction techniques to minimize further radioactive waste volumes,
- B. Implement policies and procedures which eliminate or minimize the number of contaminated areas within the ANO facility and which also control the amount of material and equipment introduced into contaminated areas,
- C. Implement waste segregation and sorting procedures,
- D. Incorporate volume reduction requirements, techniques and practices into the ANO General Employee Training Program.

11.5.2 RADIOACTIVE WASTE INPUTS

11.5.2.1 Spent Resins

Spent ion exchanger resins are disposed of after being collected and held for decay in spent resin storage tanks. Disposal is normally accomplished by shipping the resins to an authorized off-site processing facility or disposal facility in approved containers. Typically shipment occurs after the resins have been solidified or dewatered. The capability to solidify spent resins is available as an alternate method of disposal processing. Vendor services may be employed either to dewater or solidify spent resins. All vendor services are performed in accordance with the Radioactive Waste Process Control Program, as specified in the Offsite Dose Calculation Manual.

ARKANSAS NUCLEAR ONE
Unit 2

11.5.2.2 Expended Filter Cartridges

Spent radioactive filters may be removed and transported to the work area by means of a remotely operated shielded cask or by other approved means. The filters are placed in approved shipping containers and shipped to an off-site processing facility or disposal facility in accordance with the Radioactive Waste Process Control Program.

11.5.2.3 Dry Active Waste

Low level, or potentially contaminated, wastes are processed in a low level waste work area. Solid wastes such as anti-contamination clothing, rags, paper, gloves, shoe coverings, glove bags and other items are packaged in approved containers. Filled containers are monitored for radiation and may be temporarily stored prior to shipment to an off-site processing facility or disposal facility.

11.5.3 EQUIPMENT DESCRIPTION

Solid radioactive waste processing is not vital to plant protection and has no accident prevention functions. The drumming station, waste storage tanks, and permanent waste handling equipment are all located in Seismic Category 1 structures.

11.5.4 EXPECTED SOLID WASTE QUANTITIES

The quantity of solid waste generated and processed at ANO will vary with plant conditions. Operating conditions, maintenance activities, outages, repairs, and installation of new equipment influence the volume of waste generated.

11.5.5 PACKAGING AND SHIPPING

Radioactive wastes shipped from the ANO site are packaged and transported in accordance with applicable regulations.

11.5.6 STORAGE FACILITIES

11.5.6.1 Low Level Radioactive Waste Storage Building

A Low Level Radioactive Waste Storage Building (LLRWSB) is provided consistent with the guidance of Generic Letter (GL) 81-38, "Storage of Low-Level Radioactive Wastes at Reactor Power Sites" and is located northeast of Unit 2, adjacent to the switchyard. The facility is designed to provide a controlled environment for receiving and shipping, inspection, equipment sorting, compaction, and decontamination activities associated with on-site storage and off-site shipment of LLRW (see Figure 11.5-2). In addition to the GL 81-38 recommendations, area gamma detectors are provided as an additional personnel protective feature. The LLRWSB is a reinforced concrete structure containing separate storage areas for Dry Active Waste (DAW) and other low activity waste, and High Specific Activity Waste (HSAW). Reusable radioactive material may also be stored in the LLRWSB. A truck bay, a waste segregation and compaction area, and an office area are also included in the building design. The LLRWSB is used to temporarily store packaged waste prior to shipment to an off-site processing facility or disposal facility and other (non-waste) low level radioactive material. The building design includes storage capacity for five years of waste generation.

ARKANSAS NUCLEAR ONE
Unit 2

The DAW and other waste are generally characterized by relatively low activities and the ability to handle by direct contact using appropriate radiological controls. Typically, DAW consists of general contaminated trash items such as protective clothing, laboratory equipment, small tools, mops, brooms, rags, HEPA filters, and other miscellaneous items including various wood, metal, plastic, and rubber objects. Other waste typically consists of absorbed or solidified oil and sludge, damp trash and scintillation vials. HSAW, consisting primarily of filters and resins, is considered LLRW, but is characterized by higher activities than DAW and the necessity of remote handling and are maintained in a locked high radiation area within the LLRWSB, which is surrounded on all sides by concrete shield walls. The HSAW containers are transported to the LLRWSB in shielded transportation casks and remotely moved to a dedicated storage area. The total annual generation of LLRW for ANO is estimated to be approximately 24,000 ft³.

The overall building design incorporates systems for remote handling of HSAW containers via overhead crane and camera system, handling of DAW and other waste, drainage collection and sampling, fire detection/protection, HVAC, electrical power supply and lighting, radiation detection and decontamination, and building utilities such as water and sewer. A remotely operated overhead crane, equipped with closed circuit television cameras, is used to handle HSAW containers within the LLRWSB. DAW containers are typically handled by use of an electric forklift.

The LLRWSB is designed to permit unrestricted access to the outside of the building at any time (except near the truck bay entrances during handling of resin or filter liners). Dose rates around the LLRWSB should not exceed 2.0 mrem/hr (reference 10 CFR 20.1302(b)(2)(ii)) at the vertical plane of the inner security fence forming the protected area boundary. Dose rates beyond the site boundary should not exceed 0.9 mrem/year. The LLRWSB office area is designed to keep dose rates less than 0.5 mrem/hr. Administrative controls associated with the stacking of waste containers near the office area boundary wall may be required to maintain this design objective.

Calculated dose rates and radioactive energies conservatively assumed the HSAW full of resin containers. The Curie content was calculated using the isotopic content (reference Calc 83-0-2228-01) in order to determine expected dose rates. An estimation of facility dose rates is provided in Figure 12.1-13 for informational purposes. The total estimated Curie content in the facility is 1.96E3 Ci. The dose rate at the Exclusion Area Boundary (EAB) per Curie of stored material is estimated at 8.8E-10 mR/hr per Curie. See Table 11.5-1 for radioactive isotope inventory.

The only potential release of radioactivity would occur during compacting operations; however, this process is not currently used. The LLRWSB is equipped with an HVAC system which maintains a negative pressure within the building. HEPA filters are installed to reduce the release of airborne particulates to the atmosphere. The HVAC system is normally in operation. Radiation Protection personnel perform air sampling based on work activities and the potential for the generation of airborne radioactive contamination.

The radiation monitoring system in the LLRWSB consists of area radiation detectors with local and control room monitors and alarms. The effluent release path is monitored by 2RX-9850 (SPING-11), which is a SPING-type monitor. The SPING has on-line monitoring of particulates, iodines and noble gases in the effluent.

Removable filters are provided along with sample ports upstream of the filters permitting plant personnel to obtain representative grab samples of the effluent being released. Sample stream concentrations of up to 10⁻⁴ µCi/cc of gaseous radioiodine and particulate can be monitored by use of filters and grab samples.

ARKANSAS NUCLEAR ONE
Unit 2

The SPING has the capability to remotely purge the monitor assembly as well as remotely actuating a check source. Readouts of each detector channel and the status of each monitor are available in both control rooms.

Fire protection systems within the LLRWSB include an automatic deluge system for the HSAW area and a portion of the DAW storage area, automatic wet pipe sprinkler systems for the office area, truck bay and remaining DAW storage areas. Other fire protection equipment includes portable fire extinguishers, smoke/heat detectors and alarms, a fire hose station and a nearby fire hydrant.

11.5.6.2 Original Steam Generator Storage Facilities

The Original Steam Generator Storage Facilities (OSGSFs) are located north of Unit 2 within the Security Owner Controlled Area (SOCA), outside the protected area, and adjacent to the north access road. They are reinforced concrete structures designed for long-term storage of contaminated equipment. The Unit 2 OSGSF contains both original steam generators (OSGs). The Unit 1 OSGSF contains the two Unit 1 OSGs, the Unit 1 RCS hot leg elbows, and the original Unit 1 reactor vessel closure head (RVCH) with service structure and Control Rod Drive Mechanisms (CRDMs). Based on a response to a Commissioner's comment in SECY-80-511 and NRC memorandum from L. Cunningham/Po Lohaus to directors of the regional headquarters, these components are not treated as radwaste, but contaminated equipment to be retained on site until the plant is decommissioned (reference EC 4372). The facilities are not intended for onsite storage of radwaste materials such as resins, solid radwaste shipping casks, contaminated clothing, or other waste products. Further detail of the Unit 2 OSGSF is included below. For further information related to the Unit 1 OSGSF, refer to Section 11.1.3.3.8.2 of the ANO-1 SAR.

The Unit 2 OSGSF is a permanent reinforced concrete and steel structure of approximately 4000 ft² with 30-inch thick walls and an 18-inch thick roof slab, designed to the Uniform Building Code (UBC). No ventilation is provided. The south side of the building originally contained a construction opening to allow access for placement of the OSGs. After the OSGs were placed inside the OSGSF, the opening was closed by a wall composed of 30-inch thick, pre-cast, tongue-and-groove configuration, reinforced concrete blocks. With the opening sealed, the OSGSF has no normally open penetrations. The two OSGs were placed end-to-end with the channel head ends of the OSGs facing the northern side of the OSGSF.

A labyrinth-type vestibule is provided at the personnel entrance to the OSGSF. A water collection sump is provided in the OSGSF floor slab. The sump access/monitoring port is located within the vestibule and designed to accommodate checking the collection sump without entry into the facility (only entry into the vestibule is required) and to allow access for radiological survey of the facility sump. As the OSGs were drained and the nozzle openings sealed prior to storage in the OSGSF, the normal source of water collected in the sumps, if any, will be condensation. In the unlikely event the sump fills with water and requires draining, the sump can be pumped by inserting a hose through the access port from the vestibule. The OSGSF walls are sealed to a minimum of 361 ft (probably maximum flood). In addition, the entrance into the OSGSF from the vestibule is sealed to a minimum of 361 ft by a removable vertical steel plate.

ARKANSAS NUCLEAR ONE
Unit 2

The OSGSF is a non-safety-related structure. The facility is designed for dead, live, wind, seismic, and flood loads which meet or exceed the Unit 2 SAR requirements for Seismic Category II structures. The applicable recommendations of RG 1.69, Concrete Radiation Shields for Nuclear Power Plants, were used in the design and construction of the OSGSF. The OSGSF is a stand-alone facility, having no interface with other permanent plant SSCs, onsite or offsite power supplies, and is not equipped with lighting or electrical convenience outlets. The OSGSF design is illustrated in Figure 11.5-1 and location illustrated in Figure 2.5-39.

The shielding provided by the concrete walls and roofs is sufficient to keep cumulative external doses external to both the Unit 1 and Unit 2 OSGSFs below the requirements of 10 CFR 20 and 40 CFR 190. The exterior dose rate of the OSGSF has been shown to be less than the design dose rate of 1.0 mR/hr. Cumulative dose has been calculated based on an occupancy factor of 5% at the EAB and a 100% occupancy factor at the nearest occupied building and nearest permanent residence. The shielding (building) was designed to ensure ≤ 1 mR/year at the EAB. The calculated dose rate for the OSGSF exterior classifies it as a radiation Zone I area, although the roof is designated as a Zone II area, since the roof will not be accessed by non-plant personnel or visitors to the site and will be accessed infrequently by plant personnel. For radiological considerations, the OSGSF is assumed to fail during a seismic event. A design basis event (fire, tornado, seismic event, flood) which causes the simultaneous collapse of the Unit 1 and Unit 2 OSGSF and the subsequent release of contamination from each OSGSF will not result in doses that exceed a small fraction of 10 CFR 100 dose limits for accidental releases, or the maximum predicted dose that a member of the public at the EAB could receive as the result of a waste gas tank rupture as evaluated in the SAR.

Total estimated Curie content for both Unit 2 OSGs in the mausoleum at the time of internment (October, 2000) is $(2680 \text{ Ci})(2) = 5360 \text{ Ci}$. The dose rate at EAB per Curie of stored material is estimated at $1.65 \text{ E-}11 \text{ mR/hr per Curie}$. Table 11.5-3 contains the total Curie content with respect to each nuclide for the OSGs. Note that Curie concentrations decrease over time as a result of radioisotope decay. Radiation zoning is illustrated in Figure 12.1-15.

11.5.6.3 Old Radwaste Storage Building

A second storage facility is located east of the Unit 1 turbine building and will be used for storage of reusable, contaminated tools. The standard storage container used is a B-25 box. The building is a metal and concrete structure with 6' high 0.64' thick concrete shield walls provided along the inside of the north and south walls as necessary to comply with applicable regulations. Building drains are collected in a trench that is directed to a sump located in its north-west region. Based on dimensions, the facility could house up to 1799 B-25 boxes (reference CR-ANO-C-2014-1356 and SAR Figure 12.1-12). The total estimated Curie content in the facility is 150 Ci. The dose rate at EAB per Curie of stored material is estimated at $1.0\text{E-}6 \text{ mR/hr per Curie}$. See Table 11.5-2 for radioactive isotope inventory.

11.5.6.4 Pole Barn

The pole barn is a metal building with approximate dimensions of 100' x 200' x 50' which contains a posted radioactive material storage area. The area contains low activity level material that is logistically challenging (size, origin, plan for storage and disposal) to the site. Based on dimensions, the facility could house material such that the total estimated Curie content would be 0.218 Ci (reference CR-ANO-C-2014-1356 and SAR Figure 12.1-11). The dose rate at EAB per Curie of stored material is estimated at $1.2\text{E-}6 \text{ mR/hr per Curie}$. See Table 11.5-5 for radioactive isotope inventory.

ARKANSAS NUCLEAR ONE
Unit 2

11.5.6.5 Cask Transfer Facility

A Cask Transfer Facility (CTF) commercial building has been constructed to enclose the CTF structure (where dry fuel storage activities will transfer canister of spent fuel assemblies from a metal transfer storage cask to a concrete storage cask) located on the northeastern part of the plant protected area just northeast of the Low Level Radwaste Storage facility. Radioactive / contaminated dry fuel transfer equipment and tools will be kept and stored in the CTF building. No radwaste will be permanently stored in the CTF building. Storage of the radioactive / contaminated dry fuel equipment and tools will be controlled per ANO site and Entergy Radiological Protection (RP) procedures and ANO dry fuel procedures.

ARKANSAS NUCLEAR ONE
Unit 2

11.6 OFF-SITE RADIOLOGICAL MONITORING PROGRAM

The radiological monitoring program consists of the measurements of environmental radionuclide concentrations and radioactivity levels of important pathway media at off-site and onsite locations of the ANO plant. The objectives of this program are:

- A. To provide an estimate of the dose to man and biota from direct radiation and releases of radionuclides from ANO.
- B. To verify conformance with governmental regulations pertaining to radionuclide release rates and resultant environmental concentrations and doses.
- C. To document radiological conditions and report this information for examination by the NRC, local health agencies, and the general public.

The preoperational monitoring program for Unit 2 was a smooth continuation of the current off-site radiological monitoring program established for Unit 1.

11.6.1 EXPECTED BACKGROUND

Whole body dose to individuals living in the site region from existing natural radiation sources is expected to average about 135 mrem/year. The major portion of this radiation dose (approximately 100 mrem/year) is due to external exposure from cosmic-induced radiation and radiation from naturally occurring radionuclides in the soil and air. An additional average dose of approximately 7 mrem/year is from buildings where people live and work. A dose of approximately 25 mrem/year is due to internal exposure from naturally occurring radionuclides such as K^{40} that become incorporated in body tissues. A dose associated with tritium and radioactive fallout by all pathways to man should be less than 4 mrem/year.

The average dose to members of the population within 50 miles of the station resulting from gaseous effluents will be less than 0.01 mrem/year. All liquid effluents leaving ANO enter the Arkansas River. The Arkansas River is used by the city of Russellville as a supplementary source of drinking water during periods of extremely low flow of the Illinois Bayou. An estimated average dose of 0.01 mrem/year would be obtained from drinking two liters per day of the river water three miles downstream of the plant. An average dose of less than 0.01 mrem/year will result from all other uses of the water.

Analytical data on background levels of radioactivity in air, water, and terrestrial media are given in Tables 11.6-1, 11.6-2 and 11.6-3.

11.6.2 CRITICAL PATHWAYS

The possible pathways of human exposure from plant operation are shown in Figure 11.6-1. These pathways are dependent upon the type of release (gaseous or liquid) and the nature of the dispersing media. The estimated doses resulting from the various pathways and the models and assumptions used are presented in Sections 11.2.9 and 11.3.9.

The critical pathways are those pathways which contribute the maximum dose to man. Consideration must be given to those pathways in which individual doses as well as population dose is possible. The critical pathways from gaseous releases will be whole body dose from noble gases and the passage of radioiodine from the air to grass to cow to milk to infant. The critical pathways for liquid releases will be exposure to shoreline sediments containing long-term accumulations of Cs-134 and Cs-137, and the consumption of fish that have accumulated released radionuclides.

ARKANSAS NUCLEAR ONE
Unit 2

11.6.3 SAMPLING MEDIA, LOCATIONS AND FREQUENCY

To ensure that Arkansas Nuclear One presents no real hazard to man or his environment, an environmental monitoring program has been implemented. Part of this program includes radiological surveillance. The surveillance network is designed to document levels of direct radiation and concentrations of radionuclides that exist in the environment both before and during the operation of the plant. The parameters being measured are direct radiation and radionuclide concentrations in airborne particulate and radioiodine, water, milk, vegetation, fish, and bottom sediment.

The type, location, and frequency of sampling of each of the above media were determined by studying the most probable pathway to man for all important radiological emissions from the plant. For sample locations and schedules see Table 4.1 of the ODCM.

11.6.3.1 Atmospheric Discharges

Airborne releases from the plant may contain low level radionuclide concentrations. This type of discharge can affect man in the following ways: (1) whole body external exposure, (2) inhalation exposure, (3) deposition on grass → cattle → milk → man, (4) deposition on grass → cattle → beef → man, (5) deposition of leafy vegetables → man, and (6) deposition on soil → plants → man.

Environmental contamination due to atmospheric discharge of radionuclides is monitored per guideline listed in Table 11.6-4 for airborne and ingestion exposure pathways.

11.6.3.2 Liquid Discharges

Aqueous discharges containing radioactive materials are released into the Arkansas River. This type of discharge has the following possible pathways to man: (1) waterway → external exposure, (2) waterway → sediment → external exposure, (3) waterway → drinking water supply → man, (4) waterway → fish → man, and (5) waterway → aquatic plants → animals → man.

Environmental contamination due to the release of radionuclides in liquid discharges is monitored per guidelines listed in Table 11.6-4 for surveillance of waterborne and ingestion exposure pathway.

11.6.3.3 Sampling Frequency

In developing the frequency of sampling for the various media of the radiological monitoring program, the major consideration was the acquisition of the maximum amount of relevant and practical data of the critical pathways to meet the requirements of the NRC.

All effluents containing radionuclides, except the turbine building sumps, at ANO are monitored by continuous instrumentation which record, alarm, and terminate discharge. Frequent sampling is also performed with subsequent and immediate in-plant laboratory analysis; therefore, it is highly improbable that a significant release of radioactivity at ANO would occur. Periodic samples are taken of the contents of the Turbine Building Sump. If the contents are identified as contaminated, the liquid is accounted for in the offsite liquid release totals. If a valid high alarm exists on any Secondary System radiation monitor, [the Turbine Building Sump](#)

ARKANSAS NUCLEAR ONE
Unit 2

pumps will be secured. A sample of the sump contents will be obtained prior to release and, if contaminated, will be accounted for in the offsite liquid release totals. Section 11.2.7 provides additional information on the turbine building sump. For this reason, the off-site radiological monitoring program is not specifically designed to give an instantaneous alert of increased levels of environmental radioactivity. The frequency of sampling reflects the expected variability in environmental radioactivity levels, the radioactive half-lives of the nuclides expected in ANO effluent that contribute most significantly to dose, and the reporting requirements of the NRC and is consistent with guidelines promulgated by NUREG 0472, "Radiological Effluent Technical Specifications."

11.6.4 ANALYTICAL SENSITIVITY

Analytical lower limits of detection (LLD) and reportable levels for radionuclide in the various sample matrices addressed by the radiological environmental program are in accordance with guidelines promulgated by the ODCM. The accuracy of the analytical data is ascertained through the Interlaboratory Comparison Program specified in the ODCM.

11.6.5 DATA ANALYSIS AND PRESENTATION

The analytical data generated in the radiological environmental monitoring program is reported each year in accordance with the ODCM.

11.6.6 IN-PLANT EFFLUENT MONITORING

During operation, off-site radiation doses can also be evaluated from in-plant measurements of nuclides in gaseous and liquid effluents in the same fashion as done earlier in Sections 11.2 and 11.3. While these doses may be less accurate and less realistic than doses that are calculated from actual measurements of environmental media, they provide a more detailed definition of the dose increment due to plant effluents than will the environmental measurements. An indication of the sensitivity of the in-plant effluent monitoring systems for the assessment of off-site dose is given here by determining the annual average concentrations of the most important nuclides in the effluent stream of highest flow which would result in off-site doses of 5 mrem/year.

For radioiodine in gaseous effluents, the effluent stream of highest average flow, and thus, lowest average radionuclide concentration for a given release rate of a nuclide (Ci/year) is the turbine building vent exhaust having an air flow of approximately 1(+6) cfm. The release rate of I-131 resulting in a 5 mrem/year infant thyroid dose at the nearest dairy farm is 2.3 Ci per year. Assuming continuous release at a constant rate, the corresponding concentration in the turbine building vent exhaust is 1.5 (-4) pCi/cc. The turbine building air will be periodically monitored for radioactive material with portable sampling instruments. In reality, releases of radioiodine are expected to be of a more periodic nature in addition to being monitored in other effluent streams of lower flow. Releases of radioiodine resulting in conservatively calculated thyroid doses of several orders of magnitude less than 5 mrem/year are therefore readily determined by the in-plant monitoring system.

The principal effluent streams through which noble gas nuclides may be released are the auxiliary building vent exhaust, the containment purge exhaust, the condenser vacuum pump exhaust. Of these, the auxiliary building vent exhaust has the highest flow, 110(+6) cfm and hence, the lowest average radionuclide concentration for a given release rate. The annual average concentrations of Kr-85 and Xe-133 in the auxiliary building vent exhaust which would result in 5 mrem/year submersion doses at the site boundary are 3.0(-6) and 3.4(-6) μ Ci/cc,

ARKANSAS NUCLEAR ONE
Unit 2

respectively. In reality releases such as from the venting of waste gas decay tanks and the purging of containment will be intermittent in nature, rather than continuous, resulting in higher concentrations in effluents over short periods of time. The detection limit of the off-line noble gas detectors on each of the three effluent streams above is $1(-7)$ $\mu\text{Ci/cc}$ for Kr-85 and Xe-133. The inplant measurements of noble gases will, therefore, provide sufficient sensitivity for determining site boundary doses of less than 5 mrem/year.

The critical nuclides in liquid releases will probably be Cs-134 and Cs-137, and the critical pathway will probably prove to be the consumption of fish. From the analysis in Section 11.2.8 and 11.2.9, the annual release of Cs-137, which would result in a 5 mrem/year dose (GI tract) by the fish consumption pathway, is found to be 60 Ci/yr. Assuming that the entire release occurs through the liquid radioactive waste monitor tanks, the in-plant concentrations of Cs-137 prior to dilution are $1(+5)$ pCi/ml for liquid radwaste. These concentrations are many orders of magnitude higher than the laboratory detection limits of 0.01 to 0.1 pCi/ml. The diluted concentration of Cs-137 in the discharge would be 4 pCi/ml.

In summary, the in-plant process and effluent monitoring system and the off-site radiological monitoring program provide adequate sensitivity, independently, to enable estimation of the dose to man at present NRC guidelines of 5 mrem/year (10 mrem/year for noble gas).

ARKANSAS NUCLEAR ONE
Unit 2

11.7 REFERENCES

1. "Arkansas Nuclear One - Unit 2 Environmental Report," Arkansas Power and Light Co.
2. "Background Material for the Development of Radiation Protection Standards," Federal Radiation Council, FRC Report No. 2, U.S. Government Printing Office, Washington, D.C., 1961, p. 19.
3. "Chart of Nuclides," USAEC, Modified by Battelle-Northwest, May 1969 and May 1970.
4. Connecticut Yankee Monthly Operating Reports, 1968-1972.
5. "Corrosion Product Behavior in Stainless-Steel-Clad Water Reactor Systems," Nuclear Applications, Vol. I, October 1965.
6. Disposal of Radioactive Wastes into Rivers, Lakes and Estuaries, IAEA, Vienna (1971).
7. "Food Consumption of Households in the United States, Spring 1965, A Preliminary Report," ARS 62-16, USDA, August 1967.
8. Indian Point 1 Semi-Annual Operation Reports, September 1966 - March 1968.
9. "Large Closed-Cycle Water Reactor Research and Development Program, Progress Report, January 1, 1965 - March 31, 1965," WCAP-3620-12.
10. "Large Closed-Cycle Water Reactor Research and Development Program, Progress Report April 1, 1965 - June 30, 1965," WCAP-3269-13.
11. "Neutron Cross Sections," BNL-325, Supplement 2, May 1964.
12. "Permissible Dose for Internal Radiation," Recommendations of the International Commission on Radiological Protection, ICRP Publication 2, Pergamon Press (1959).
13. "Report of Committee II on Permissible Dose for Internal Radiation," Internal Commission on Radiological Protection, ICRP Publication No. 2, Pergamon Press, N.Y., 1959, p. 233.
14. Regulatory Guide 1.111, "Methods For Estimating Atmospheric Transport and Dispersion of Gaseous Effluents in Routing Releases From Light- Water-Cooled Reactors," U. S. Nuclear Regulatory Commission, March 1976.
15. San Onofre Monthly Operating Reports, 1971.
16. Yankee Rowe Monthly Operating Reports, 1969-1972.
17. Abrams, C. S., Salterelli, E. A., Decontamination of the Shippingport Atomic Power Station, WAPD-299, January 1966.
18. Allison, G. M., and H. K. Rae, "The Release of Fission Gases and Iodines from Defected UO₂ Fuel Elements of Different Lengths," AECL-2206, June 1965.
19. Beck, H. L., "Environmental Gamma Radiation from Deposited Fission Products, 1960-1964," Health Physics, 12 (1966) pp. 313-322.

ARKANSAS NUCLEAR ONE
Unit 2

20. Beninson, D., et al, "Biological Aspects in the Disposal of Fission Products in Surface Waters," Disposal of Radioactive Wastes into Seas, Oceans and Surface Waters, IAEA, Vienna (1966) pp. 337-354.
21. Bryant, P. M., "Data for Assessments Concerning Controlled and Accidental Releases of I-131 and Cs-137 to Atmosphere," Health Physics, 17 (1969) pp. 51-57.
22. Bryant, P. M., "Derivation of Working Limits for Continuous Release Rates of Sr-90 and Cs-137 to Atmosphere in a Milk Producing Area," Health Physics, 12 (1966), pp. 1393-1405.
23. Burnett, T. J., "A Derivation of the 'Factor of 700' for I-131," Health Physics, 18 (1970), pp. 73-75.
24. Chapman, W. H., H. L. Fisher and M. W. Pratt, "Concentration Factors of Chemical Elements in Edible Aquatic Organisms," UCRL-50564, 1968.
25. Crocker, G. R., M. A. Conners, and D. T. Wong, "Gamma-Emission Data for the Calculation of Exposure Rates from Nuclear Debris," Vol. I and II, USNRDL-TR-876 and -888 (1965) pp. 73 & 81.
26. DiNunno, J. J., et al, "Calculation of Distance Factors for Power and Test Reactor Sites," TID-14844, U.S. Atomic Energy Commission, March 1962.
27. Eichenberg, J. D., "Effects of Irradiation on Bulk UO₂," WAPD-183, October 1957.
28. Fletcher, J. F., and W. L. Dotson, "HERMES - A Digital Computer Code for Estimating Regional Radiological Effects from the Nuclear Power Industry," HEDL-TME-71-168, 1971.
29. Jinks, S. M., and M. Eisenbud, "Concentration Factors in the Aquatic Environment," Radiation Data and Reports, 13 (1972) pp. 243-7.
30. Lederer, C. M., et al, Table of Isotopes, 6th ed., John Wiley and Sons, N.Y. (1967).
31. Meek, M. E., B. F. Rider, "Summary of Fission Product Yields U-235, U-238, Pu-239 and Pu-241 at Thermal Fission Spectrum and 14 Mev Neutron Energies," APED-5938, March 1, 1968.
32. Merlini, M., et al, "Activation Analysis in Studies of an Aquatic Ecosystem," Nuclear Activation Techniques in the Life Sciences, IAEA, Vienna (1967) pp. 615-629.
33. Ray, Joseph W., et al, "Investigation of Tritium Generation and Release in PM Nuclear Power Plants," BMI-1787, October 31, 1966.
34. Russell, R. S., (ed.), Radioactivity and Human Diet, Pergamon Press, N.Y. (1961).
35. Slade, David H. (Editor), Meteorology and Atomic Energy, Air Resources Laboratories, U. S. Atomic Energy Commission, July 1968.
36. Smith, James M. Jr., "The Significance of Tritium in Water Reactors," GE, APED, September 19, 1967.
37. Weingart E., "Radiation Buildup on Mechanisms and Thermal Barriers," WAPD-PWR-TE-145, June 1963.
38. Weisman, J., Bartnoff, S., "The Saxton Chemical Shim Experiment," WCAP-3269-24, July 1965.
39. "Limits For Intakes of Radionuclides by Workers," International Commission on Radiological Protection, ICRP Publication No. 30, Vol. 2, Pergamon Press, N.Y. 1979.

ARKANSAS NUCLEAR ONE
Unit 2

Table 11.1-1

BASIS FOR REACTOR COOLANT FISSION PRODUCT ACTIVITIES
[This table consists of historical information]

Duration of Reactor Operation at 2900 MWt	5 core cycles
Equilibrium Fuel Cycle, Full Power Days	313
Average Thermal Fission Rate (fissions/MW-sec)	3.12×10^{16}
Thermal Neutron Flux - Average (n/cm ² -sec)	4.62×10^{13}
Reactor Coolant Mass, 1bm	4.619×10^5
Core Coolant Volume to Reactor Coolant Volume Ratio	0.0713
Purification Flow, gpm	40
Beginning of Cycle Coolant Boron Concentration, ppm	1140
Boron Concentration Reduction Rate, ppm/sec	4.215×10^{-5}

<u>Ion Exchanger Removal Effectiveness</u>	<u>DF*</u>	<u>%EFF</u>
All Nuclides Except Xe, Kr, Y, Mo, Cs, H-3	10	90
Xe, Kr and H-3	1	0
Y, Mo and Cs	10**	90

<u>Fission Product Escape Rate Coefficients, sec⁻¹</u>	
Noble Gases	6.5×10^{-8}
Cs	2.3×10^{-8}
Halogens	1.3×10^{-8}
Te, Mo	1.4×10^{-9}
All others	1.4×10^{-11}

	<u>Normal</u>	<u>Abnormal</u>
Percent Failed Fuel	0.25	1.0
Cold Shutdowns***	50% Core Life	30%, 60%, 90% Core Life
Hot Shutdowns	None	55%, 65% Core Life

* Ion Exchanger decontamination factors (DF) were estimated from the following: Simon, Abrams and Lindsey, "The Performance of Base Form Ion Exchangers For pH Control and Removal of Radioisotopes From a Pressurized Water Reactor," Reactor," WAPD-TM-215, 1960.

** These nuclides are removed from the process fluid via the purification ion exchanger used to control the lithium concentration within the reactor coolant. This ion exchanger is used approximately 20 percent of a core cycle.

*** For shutdown waste volumes see Table 9.3-6.

ARKANSAS NUCLEAR ONE
Unit 2

Table 11.1-2

**MAXIMUM FISSION PRODUCT ACTIVITY IN THE REACTOR COOLANT DUE TO
CONTINUOUS OPERATION AT 2900 MWt WITH ONE PERCENT FAILED FUEL**

<u>Nuclide</u>	<u>Activity at 70 °F (μCi/cc)</u>	<u>Nuclide</u>	<u>Activity at 70 °F (μCi/cc)</u>
H-3	6.10 (-1)	I-131	3.73
Br-84	3.78 (-2)	Xe-131m	2.26
Kr-85m	2.25	Te-132	5.30 (-1)
Kr-85	4.91	I-132	1.16
Kr-87	1.21	I-133	5.08
Kr-88	3.91	Xe-133	3.21 (+2)
Rb-88	3.85	Te-134	3.93 (-2)
Rb-89	9.52 (-2)	I-134	5.44 (-1)
Sr-89	8.28 (-3)	Cs-134	3.68 (-1)
Sr-90	4.48 (-4)	I-135	2.35
Y-90	1.16 (-3)	Xe-135	8.75
Sr-91	5.52 (-3)	Cs-136	5.44 (-2)
Y-91	3.81 (-2)	Cs-137	1.48
Zr-95	8.90 (-3)	Xe-138	5.36 (-1)
Nb-95	9.13 (-3)	Cs-138	1.02
Mo-99	1.98	Ba-140	1.01 (-2)
Ru-103	7.21 (-3)	La-140	9.72 (-3)
Ru-106	3.96 (-4)	Pr-143	8.73 (-3)
Te-129	4.02 (-2)	Ce-144	6.05 (-3)
I-129	9.39 (-8)		

ARKANSAS NUCLEAR ONE
Unit 2

Table 11.1-3

**AVERAGE FISSION PRODUCT ACTIVITIES DUE TO CONTINUOUS OPERATION AT 2900
MWt WITH ONE PERCENT FAILED FUEL**

<u>Nuclide</u>	<u>Time Average RCS Activity (μCi/cc)</u>	<u>Volume Average Activity to BMS (μCi/cc)</u>	<u>Nuclide</u>	<u>Time Average RCS Activity (μCi/cc)</u>	<u>Volume Average Activity to BMS (μCi/cc)</u>
H- 3	-	0.13	I-131	3.46	1.28 (-3)
Br-84	3.70 (-2)	1.65 (-3)	Xe-131m	1.49	1.07
Kr-85m	2.17	1.46	Te-132	5.01 (-1)	1.86 (-2)
Kr-85	1.35	1.12	I-132	1.10	4.04 (-2)
Kr-87	1.18	7.94 (-1)	I-133	4.89	1.78 (-1)
Kr-88	3.80	2.55	Xe-133	2.55 (+2)	1.75 (+2)
Rb-88	3.73	1.36 (-1)	Te-134	3.85 (-2)	1.70 (-3)
Rb-89	9.35 (-2)	3.71 (-3)	I-134	5.31 (-1)	1.96 (-2)
Sr-89	7.32 (-3)	5.83 (-4)	Cs-134	2.94 (-1)	1.14 (-1)
Sr-90	3.53 (-4)	3.17 (-4)	I-135	2.28	8.33 (-2)
Y-90	8.97 (-4)	3.38 (-4)	Xe-135	8.36	5.61
Sr-91	5.37 (-3)	4.98 (-4)	Cs-136	4.69 (-2)	1.97 (-2)
Y-91	3.17 (-2)	1.47 (-2)	Cs-137	1.23	4.59 (-1)
Zr-95	7.62 (-3)	6.01 (-4)	Xe-138	5.25 (-1)	3.55 (-1)
Nb-95	7.49 (-3)	6.02 (-4)	Cs-138	1.00	3.68 (-1)
Mo-99	1.81	6.44 (-1)	Ba-140	9.27 (-3)	6.47 (-3)
Ru-103	6.06 (-3)	5.31 (-4)	La-140	8.84 (-3)	6.33 (-3)
Ru-106	3.22 (-4)	3.16 (-4)	Pr-143	7.54 (-3)	5.98 (-3)
Te-129	3.63 (-2)	1.68 (-3)	Ce-144	4.94 (-3)	4.99 (-3)
I-129	7.60 (-8)	3.03 (-4)			

ARKANSAS NUCLEAR ONE
Unit 2

Table 11.1-4

**AVERAGE FISSION PRODUCT ACTIVITIES DUE TO CONTINUOUS OPERATION
AT 2900 MWt BASED ON NORMAL CONDITIONS: 0.25 PERCENT FAILED FUEL**

<u>Nuclide</u>	Time Average RCS Activity (<u>μCi/cc</u>)	Volume Average Activity to BMS (<u>μCi/cc</u>)	<u>Nuclide</u>	Time Average RCS Activity (<u>μCi/cc</u>)	Volume Average Activity to BMS (<u>μCi/cc</u>)
H-3	-	0.192 (-4)	I-131	8.90 (-1)	6.98 (-2)
Br-84	9.41 (-3)	8.36 (-4)	Xe-131m	4.40 (-1)	4.43 (-1)
Kr-85m	5.55 (-1)	5.40 (-1)	Te-132	1.29 (-1)	1.01 (-2)
Kr-85	5.40 (-1)	6.37 (-1)	I-132	2.81 (-1)	2.19 (-2)
Kr-87	3.00 (-1)	2.93 (-1)	I-133	1.25	9.60 (-2)
Kr-88	9.68 (-1)	9.41 (-1)	Xe-133	7.01 (1)	6.78 (1)
Rb-88	9.52 (-1)	7.26 (-2)	Xe-133	7.01 (1)	6.78 (1)
Rb-89	2.37 (-2)	1.92 (-3)	Te-134	9.77 (-3)	8.64 (-4)
Sr-89	1.88 (-3)	2.70 (-4)	I-134	1.35 (-1)	1.04 (-2)
Sr-90	9.09 (-5)	1.25 (-4)	Cs-134	7.84 (-2)	6.46 (-2)
Y-90	2.34 (-4)	1.37 (-3)	I-135	5.83 (-1)	4.47 (-2)
Sr-91	1.37 (-3)	2.22 (-4)	Xe-135	2.14	2.07
Y-91	8.44 (-3)	7.85 (-3)	Cs-136	1.24 (-2)	1.06 (-2)
Zr-95	1.96 (-3)	2.80 (-4)	Cs-137	3.25 (-1)	2.59 (-1)
Nb-95	1.93 (-3)	2.80 (-4)	Xe-138	1.33 (-1)	1.31 (-1)
Mo-99	4.71 (-1)	3.56 (-1)	Cs-138	2.55 (-1)	1.95 (-1)
Ru-103	1.56 (-3)	2.41 (-4)	Ba-140	2.38 (-3)	3.05 (-4)
Ru-106	8.28 (-5)	1.25 (-4)	La-140	2.28 (-3)	2.98 (-4)
Te-129	9.31 (-3)	8.64 (-4)	Pr-143	1.94 (-3)	2.78 (-4)
I-129	1.95 (-8)	1.18 (-4)	Ce-144	1.27 (-3)	2.24 (-4)

Table 11.1-5

LONG-LIVED ISOTOPES IN CRUD

<u>Isotope</u>	<u>T_{1/2}</u>	<u>Parent</u>	<u>Reaction</u>	<u>γ/dis</u>	<u>E(mev)</u>
Co-60	5.26y	Co-59	N/γ	2.00	1.25
Co-58	71.4d	Ni-58	N,P	1.00	0.81
Mn-54	313d	Fe-54	N,P	1.00	0.84
Cr-51	27.8d	Cr-50	N,γ	0.10	0.32
Fe-59	45d	Fe-58	N,γ	1.00	1.18
Hf-181	45d	Hf-180	N,γ	0.25	0.50
Zr-95	65.5d	Zr-94	N,γ	2.00	0.75
Cu-64	12.9h	Cu-63	N,γ	1.24	0.51

ARKANSAS NUCLEAR ONE
Unit 2

Table 11.1-6

MEASURED RADIOACTIVE CRUD ACTIVITY (DPM/MG-CRUD)

<u>Reactor</u>	<u>Co-60</u>	<u>Co-58</u>	<u>Mn-54</u>	<u>Cr-51</u>	<u>Fe-59</u>	<u>Hf-181</u>	<u>Zr-95</u>	<u>Cu-64</u>	<u>Crud, ppb</u>	<u>Ref.</u>
Conn. Yankee										1
Ave.	1.4(+7)	1.2(+8)	2.4(+6)	2.7(+7)	4.2(+6)	----	--	--	85	
Max.	3.5(+7)	4.0(+8)	1.2(+7)	1.4(+8)	1.5(+7)	----	----	----	4000	
San Onofre										2
Ave.	2.0(+6)	2.2(+7)	1.4(+6)	3.1(+6)	6.7(+5)	----	----	----	90	
Max.	2.0(+7)	1.2(+8)	4.2(+6)	6.7(+5)	3.8(+6)	----	----	----	400	
Yankee Rowe										3,7
Ave	6.7(+6)	3.3(+7)	4.5(+6)	1.7(+7)	5.5(+6)	----	6.6(+5)	----	70	
Max.	2.1(+7)	1.2(+8)	1.9(+7)	1.4(+8)	1.8(+7)	----	1.8(+6)	----	----	
Saxton										4,5,6,7
Ave.	5.5(+6)	4.6(+7)	7.7(+6)	9.0(+7)	2.7(+6)	----	----	----	55	
Max.	2.2(+7)	1.5(+8)	1.4(+7)	1.1(+8)	6.0(+6)	----	----	----	250	
Shippingport										8,9
Ave.	2.3(+7)	2.8(+6)	1.3(+6)	2.2(+6)	1.8(+6)	5.2(+5)	7.0(+5)	----	75	
Max.	4.8(+7)	3.2(+6)	1.7(+6)	2.2(+6)	1.8(+6)	7.6(+5)	9.7(+5)	----	----	
Indian Point 1										10
Ave.	1.4(+6)	5.1(+6)	6.6(+5)	6.1(+6)	1.3(+6)	1.5(+5)	3.0(+5)	3.1(+9)	72	
Max.	2.0(+6)	9.1(+6)	2.0(+6)	8.2(+6)	3.3(+6)	----	4.2(+5)	1.2(+10)	----	
Average Crud (ppb)									75	

ARKANSAS NUCLEAR ONE
Unit 2

Table 11.1-7

**AVERAGE AND MAXIMUM RESIDENCE TIMES
(SEC)**

<u>Reactor</u>	<u>Co-60</u>	<u>Co-58</u>	<u>Mn-54</u>	<u>Cr-51</u>	<u>Fe-59</u>	<u>Zr-95</u>
Conn. Yankee						
Ave.	151	15	99	4	Sat.*	----
Max.	395	63	125	26	Sat.	----
San Onofre						
Ave	21	3	55	1	Sat.	----
Max.	219	15	191	3	Sat.	----
Yankee Rowe						
Ave.	32	10	25	2	121	6
Max.	102	40	116	18	Sat.	17
Saxton						
Ave.	99	9	40	34	Sat.	----
Max.	418	35	73	48	Sat.	----
Shippingport						
Ave.	133	1	10	1	10	2
Max.	296	1	13	1	10	3
Indian Point 1						
Ave.	19	4	6	2	46	10
Max.	27	7	18	3	Sat.	15
Ave. of Max.	243	27	89	17	Sat.	12

* Fe-59 isotope reaches saturation before erosion from core surfaces.

ARKANSAS NUCLEAR ONE
Unit 2

Table 11.1-8

LONG-LIVED CRUD ACTIVITY

<u>Isotope</u>	<u>T_{res}(d)</u>	<u>Half Life</u>	<u>Crud Activity (dpm/mg)</u>	<u>Coolant Activity (μCi/cc)</u>
Co-60	243	5.26Y	2.8(+7)	9.4(-4)*
Co-58	27	71.4d	2.5(+8)	8.4(-3)
Mn-54	89	313d	2.8(+6)	9.4(-5)
Cr-51	17	27.8d	1.3(+8)	4.4(-3)
Fe-59	Sat.	45d	1.5(+6)	5.1(-5)
Zr-95	12	65.5d	1.3(+6)	4.4(-5)

Parentheses denotes powers of ten.

* Specific Activity (μCi/cc) at 70 °F.

Table 11.1-9

EQUILIBRIUM CRUD FILM THICKNESS

<u>Location</u>	<u>Thickness (mg/cm²)</u>
Vessel Internals, piping, SG Inlet Plenum	1.0
Pressurizer	0.4
CEDM, Vessel Head ICI Tops	0.3
SG Tubing	0.1

ARKANSAS NUCLEAR ONE
Unit 2

Table 11.1-10

TRITIUM DATA

<u>Source</u>	<u>λ^{-1}, sec</u>	<u>Y, atoms/fission</u>	<u>D</u>	<u>C₀, ppm B</u>	<u>Ċ, ppm, B/sec</u>	<u>L₀, ppm, Li</u>	<u>L̇, ppm, Li/sec</u>	<u>FCS</u>	<u>E</u>
Fission	1.79(-9)	8.8E-5	.01	1.0	0.0	1.0	0.0	1.0	1.0
CEA	1.79(-9)	3.96E-9 per CEA	1.0	1.0	0.0	1.0	0.0	1.0	14
Boron	1.79(-9)	3.69E-8 per ppm B	1.0	C ₀ *	C	1.0	0.0	.06	1.0
Lithium	1.79(-9)	1.45E-7 per ppm Li	1.0	1.0	0.0	L ₀	L	.06	1.0
Deuterium	1.79(-9)	2.78E-7**	1.0	1.0	0.0	1.0	0.0	.06	1.0
Nitrogen	1.79(-9)	8.14E-9	1.0	1.0	0.0	1.0	0.0	.06	1.0
Ammonia	1.79(-9)	5.34E-9	1.0	1.0	0.0	1.0	0.0	.06	1.0

* Denotes actual value (i.e. input value)

** Based on 150 ppm naturally present in water

ARKANSAS NUCLEAR ONE
Unit 2

Table 11.1-11

**PARAMETERS USED IN THE CALCULATION OF
STEAM GENERATOR WATER ACTIVITIES^(a)**

[The information in this table is historical]

<u>Parameters</u>	<u>Value</u>
Reactor coolant activities, percent failed fuel ^(b)	
Normal operation	0.25
Anticipated operational occurrence	1.0
Primary to secondary leak rate, gal/day	
Normal operation	13
Anticipated operational occurrence	100
Main steam temperature, °F	532
Main steam flow rate, lb/hr	1.27(+7)
Steam generator water volume, ft ³	4976
Steam generator average water temperature, °F	492
Steam generator blowdown temperature, °F	452
Steam generator blowdown rate, gal/min, Annual average	15
Steam generator partition factors	
Noble gases	1
Halogens	400
All other nuclides	1000
Main condenser partition factors	
Noble gases	1
Halogens	2000
All other nuclides	2000

^(a) Flow rates and volumes are totals for both steam generators at a reactor power of 2900 MWt.

^(b) Average reactor coolant activities corresponding to one percent and 0.25 percent failed fuel are given in Table 11.1-3 and 11.1-4.

ARKANSAS NUCLEAR ONE
Unit 2

Table 11.1-12

EQUILIBRIUM STEAM GENERATOR WATER ACTIVITY ($\mu\text{Ci/cc}$)

[The information in this table is historical]

<u>Isotope</u>	<u>Normal Operation</u>	<u>Anticipated Operational Occurrence</u>	<u>Isotope</u>	<u>Normal Operation</u>	<u>Anticipated Operational Occurrence</u>
Br-84	1.03 (-07)	3.13 (-06)	Fe-59	2.99 (-08)	2.99 (-08)
Rb-88	6.22 (-06)	2.65 (-05)	Zr-95	2.60 (-08)	2.60 (-08)
Rb-89	1.23 (-07)	3.74 (-06)	I-129	1.23 (-11)	3.69 (-10)
Sr-89	1.11 (-06)	3.32 (-05)	I-131	4.87 (-04)	1.45 (-02)
Sr-90	5.47 (-08)	1.63 (-06)	I-132	6.53 (-05)	1.95 (-03)
Sr-91	2.08 (-07)	6.28 (-06)	I-133	3.24 (-04)	1.45 (-02)
Y-90	1.14 (-07)	3.37 (-06)	I-134	2.57 (-06)	7.77 (-05)
Y-91	4.98 (-06)	1.44 (-04)	I-135	6.70 (-05)	2.02 (-03)
Zr-95	2.60 (-08)	3.46 (-05)	Kr-85m	1.67 (-07)	5.01 (-06)
Nb-95	1.12 (-06)	3.47 (-05)	Kr-85	1.63 (-07)	3.13 (-06)
Mo-99	1.99 (-04)	5.88 (-03)	Kr-87	8.94 (-08)	2.70 (-06)
Ru-103	9.12 (-07)	2.72 (-05)	Kr-88	2.90 (-07)	8.76 (-06)
Ru-106	4.97 (-08)	1.49 (-06)	Xe-131m	1.33 (-07)	3.46 (-06)
Te-129	2.10 (-07)	6.30 (-06)	Xe-133	2.11 (-05)	5.91 (-04)
Te-132	5.63 (-05)	1.70 (-03)	Xe-135	7.21 (-07)	2.17 (-05)
Te-134	1.40 (-07)	4.25 (-06)	Xe-138	3.81 (-08)	1.16 (-06)
Cs-134	4.71 (-05)	1.36 (-03)	Cs-135	1.18 (-15)	3.55 (-14)
Cs-136	6.83 (-06)	1.99 (-04)	Rb-87	5.65 (-21)	1.71 (-19)
Cs-137	1.96 (-04)	5.69 (-03)	Xe-135m	9.25 (-07)	2.78 (-05)
Cs-138	2.86 (-06)	8.62 (-05)	Nb-95m	2.51 (-10)	1.67 (-07)
Ba-140	1.31 (-06)	3.92 (-05)	Pr-144	7.54 (-07)	2.25 (-05)
La-140	1.35 (-06)	4.02 (-05)	Nd-144	1.17 (-24)	3.51 (-23)
Pr-143	1.07 (-06)	3.21 (-05)	Ba-137m	1.86 (-04)	5.40 (-03)
Ce-144	7.61 (-07)	2.28 (-05)	Rh-106	4.97 (-08)	1.49 (-06)
Cr-51	2.54 (-06)	2.54 (-06)	Rh-103m	8.78 (-07)	2.62 (-05)
Mn-54	5.64 (-08)	2.64 (-08)	Tc-99m	1.48 (-04)	4.38 (-03)
Co-58	4.99 (-06)	4.99 (-06)	Tc-99	2.62 (-12)	7.74 (-11)
Co-60	5.68 (-07)	5.68 (-07)	Y-91m	1.19 (-07)	3.60 (-06)

ARKANSAS NUCLEAR ONE
Unit 2

Table 11.1-13

EQUILIBRIUM STEAM GENERATOR STEAM ACTIVITY ($\mu\text{Ci/cc}$)

[The information in this table is historical]

<u>Isotope</u>	<u>Normal Operation</u>	<u>Anticipated Operational Occurrence</u>	<u>Isotope</u>	<u>Normal Operation</u>	<u>Anticipated Operational Occurrence</u>
Br-84	1.03 (-09)	3.13 (-08)	Fe-59	2.99 (-11)	2.99 (-11)
Rb-88	6.21 (-09)	2.65 (-08)	Zr-95	2.60 (-11)	2.60 (-11)
Rb-89	1.23 (-10)	3.74 (-09)	I-129	3.08 (-14)	9.23 (-13)
Sr-89	1.11 (-09)	3.32 (-08)	I-131	1.22 (-06)	3.64 (-05)
Sr-90	5.47 (-11)	1.63 (-09)	I-132	1.63 (-07)	4.89 (-06)
Sr-91	2.08 (-10)	6.28 (-09)	I-133	8.11 (-07)	3.64 (-05)
Y-90	1.14 (-10)	3.37 (-09)	I-134	6.42 (-09)	1.94 (-07)
Y-91	4.98 (-09)	1.44 (-07)	I-135	1.68 (-07)	5.04 (-06)
Zr-95	2.60 (-11)	3.46 (-08)	Kr-85m	1.67 (-07)	5.01 (-06)
Nb-95	1.12 (-09)	3.47 (-08)	Kr-85	1.63 (-07)	5.13 (-06)
Mo-99	1.99 (-07)	5.88 (-06)	Kr-87	8.94 (-08)	2.70 (-06)
Ru-103	9.12 (-10)	2.72 (-08)	Kr-88	2.90 (-07)	8.76 (-06)
Ru-106	4.97 (-11)	1.49 (-09)	Xe-131m	1.33 (-07)	3.46 (-06)
Te-129	2.10 (-10)	6.30 (-09)	Xe-133	2.11 (-05)	5.91 (-04)
Te-132	5.68 (-08)	1.70 (-06)	Xe-135	7.21 (-07)	2.17 (-05)
Te-134	1.40 (-10)	4.25 (-09)	Xe-138	3.81 (-08)	1.16 (-06)
Cs-134	4.71 (-08)	1.36 (-06)	Cs-135	1.18 (-18)	3.55 (-17)
Cs-136	6.83 (-09)	1.99 (-07)	Rb-87	5.65 (-24)	1.71 (-22)
Cs-137	1.96 (-07)	5.69 (-06)	Xe-135m	9.25 (-07)	2.78 (-05)
Cs-138	2.86 (-09)	8.62 (-08)	Nb-95m	2.51 (-13)	1.67 (-10)
Ba-140	1.31 (-09)	3.92 (-08)	Pr-144	7.54 (-10)	2.25 (-08)
La-140	1.35 (-09)	4.02 (-08)	Nd-144	1.17 (-27)	3.51 (-26)
Pr-143	1.07 (-09)	3.21 (-08)	Ba-137m	1.86 (-07)	5.40 (-06)
Ce-144	7.61 (-10)	2.28 (-08)	Rh-106	4.97 (-11)	1.49 (-09)
Cr-51	2.54 (-09)	2.54 (-09)	Rh-103m	8.78 (-10)	2.62 (-08)
Mn-54	5.64 (-11)	5.64 (-11)	Tc-99m	1.48 (-07)	4.38 (-06)
Co-58	4.99 (-09)	4.99 (-09)	Tc-99	2.62 (-15)	7.74 (-14)
Co-60	5.68 (-10)	5.68 (-10)	Y-91m	1.19 (-10)	3.60 (-09)

ARKANSAS NUCLEAR ONE
Unit 2

Table 11.2-1

SOURCE AND VOLUME OF LIQUID WASTE
[The information in this table is historical]

1. <u>Boron Management System</u>	<u>Amount (Gal.)</u>	
<u>Source</u>	<u>Anticipated Operations</u>	<u>Normal Operations</u>
Refueling Shutdown	12,500	
Refueling Startup	<u>59,000</u>	
Total Refueling Waste	71,500	71,500
Leakage to Reactor Drain Tank @ 220gpd	68,860	68,860
 Cold Shutdowns & Startups		
30% Core Life	54,600	
50% Core Life		66,200
60% Core Life	74,600	
90% Core Life	<u>138,800</u>	
Total	268,000	66,200
 Hot Shutdowns & Startups		
55% Core Life	37,000	
65% Core Life	<u>47,600</u>	
Total	84,600	<u>0</u>
 Boron Dilution (Fuel Burnup Waste)	201,600	201,600
 Total Liquid Waste Volume	694,560	408,160
 2. <u>Waste Management System</u>		<u>Amount (Gal.)</u>
Equipment drains and leakage		28,000
Sample and laboratory sink drains		7,000
Equipment Decontamination		73,000
Floor Drains		18,000
Fuel Cask Washdown		<u>30,000</u>
Total Estimated Normal Operation or Anticipated Occurrence		156,000

ARKANSAS NUCLEAR ONE
Unit 2

Table 11.2-2

DESIGN DATA FOR BORON MANAGEMENT SYSTEM COMPONENTS

1. <u>Ion Exchangers</u>	<u>Preconcentrator</u>		<u>Boric Acid Condensate</u>		
	Quantity	2	2		
	Type	H-OH Mixed-Bed	OH		
	Design Pressure, psig	150	150		
	Design Temperature, °F,	240	240		
	Normal Operating Pressure, psig	60	60		
	Normal Operating Temperature, °F	120	140		
	Normal Operating Flow, gpm	20	20		
	Resin Volume, ft ³ , useful	32	32		
	Materials	ss	ss		
2. <u>Tanks</u>	<u>Reactor Drain</u>		<u>Holdup</u>	<u>Boric Acid Condensate</u>	
	Quantity	1	4	2	
	Internal Volume, gal	1600 min.	51,270	30,267	
	Design Pressure, psig	25 Int.; 15 Ext.	10 Int.; 2 Ext.	Atmosphere	
	Design Temperature, °F	250	240	250	
	Normal Operating Pressure, psig	0.5	1.0	Atmosphere	
	Normal Operating Temperature, °F	120	120	120	
	Blanket Gas	Nitrogen	Atmosphere		
	Material	s.s.	s.s.	s.s.	
	ASME Code	VIII			
3. <u>Pumps</u>	<u>Reactor Drain</u>	<u>Holdup Drain Holdup Recir.</u>	<u>Boric Acid Condensate</u>	<u>Degasifier Effluent</u>	
	Quantity-Full Capacity	2	3	2	2
	Type	Centrifugal	Centrifugal	Centrifugal	Centrifugal
	Design Pressure, psig	150	150	150	75
	Design Temperature, °F	200	200	200	140
	Design Conditions				
	Flow, gpm	50	50	50	140
	Head, ft	145	145	145	107
	Wetted Materials	s.s.	s.s.	s.s.	s.s.
	Seal type	Mechanical	Mechanical	Mechanical	Mechanical
	Motor Horsepower	7.5	7.5	7.5	10
	Motor Voltage, volt	460	460	460	460
	ASME Code	III	None	None	None

ARKANSAS NUCLEAR ONE
Unit 2

Table 11.2-2 (Continued)

4. Preconcentrator Filters

Quantity	2
Type of Elements	Surface
Design Pressure, psig	150
Design Temperature, °F	240
Design Flow, gpm	100
Material	s.s.
ASME Code	VIII

5. Boric Acid Concentrators (currently not in use)

Quantity	1
Design Pressure, psig	60
Design Temperature, °F	200
Design Flow, gpm	20
Cooling Water Flow Rate, gpm	1104
Steam required at 15 psig, lb/hr	13,000
ASME Code	VIII

6. Vacuum Degasifier

Quantity	1
Design Pressure, psig	75 Int; 15 Ext.
Design Temperature, °F	250
DF	120
ASME Code (Class)	VIII

ARKANSAS NUCLEAR ONE
Unit 2

**Table 11.2-3
BORON MANAGEMENT SYSTEM PROCESS FLOW DATA**

Mode #1: Processing RDT Contents

<u>Location:*</u>	<u>1</u>	<u>2</u>	<u>3</u>	<u>4</u>	<u>5</u>	<u>6</u>	<u>7</u>	<u>8</u>
Flow, gpm	200 gpd	50	50	50	50	60	50	50
Pressure, psig	1	4	12	7.5	6.5	4	45	2
Temperature, °F	120	120	120	120	120	120	120	120

Mode #2: CVCS Normal Purification VCT Diversion Processing

<u>Location:*</u>	<u>1</u>	<u>2</u>	<u>3</u>	<u>4</u>	<u>5</u>	<u>6</u>	<u>7</u>	<u>8</u>
Flow, gpm	200 gpd	-	-	40	40	50	40	40
Pressure, psig	1	-	-	5	4.5	4	44	2
Temperature, °F	120	-	-	120	120	120	120	120

Mode #3: CVCS Intermediate Purification VCT Diversion Processing

<u>Location:*</u>	<u>1</u>	<u>2</u>	<u>3</u>	<u>4</u>	<u>5</u>	<u>6</u>	<u>7</u>	<u>8</u>
Flow, gpm	200 gpd	-	-	84	84	94	84	84
Pressure, psig	1	-	-	21	18.5	4	34	2
Temperature, °F	120	-	-	120	120	120	120	120

Mode #4: CVCS Maximum Purification VCT Diversion Processing

<u>Location:*</u>	<u>1</u>	<u>2</u>	<u>3</u>	<u>4</u>	<u>5</u>	<u>6</u>	<u>7</u>	<u>8</u>
Flow, gpm	200 gpd	-	-	128	128	138	128	128
Pressure, psig	1	-	-	51	45.5	4	18	2
Temperature, °F	120	-	-	120	120	120	120	120

Mode #5: Processing Holdup Tank Contents Via the Boric Acid Concentrator (Note 3)

<u>Location:*</u>	<u>12</u>	<u>13</u>	<u>14</u>	<u>15</u>	<u>16</u>	<u>17</u>	<u>18</u>	<u>19</u>	<u>20</u>	<u>21</u>
Flow, gpm	20	20	20	20	20	16-19	16-19	75	75	75
Pressure, psig	3	65	62	60	59	2	4	4	60	10
Temperature, °F	120	120	120	120	120	120	120	120	120	120

Mode #6: Holdup Tank Contents Recirculation Through Preconcentrator Filter and Preconcentrator Ion Exchanger

<u>Location:*</u>	<u>9</u>	<u>10</u>	<u>11</u>
Flow, gpm	50	50	50
Pressure, psig	4	32	27
Temperature, °F	120	120	120

ARKANSAS NUCLEAR ONE
Unit 2

Table 11.2-3(continued)

***Locations**

- | | |
|--|--|
| 1. Reactor Drain Tank inlet | 12. Holdup Tank Drain Pumps suction |
| 2. Reactor Drain Pumps suction | 13. 2F15B inlet |
| 3. Reactor Drain Pumps discharge | 14. 2F15B outlet |
| 4. Letdown inlet to Vacuum Degasifier | 15. 2T15s to U-1/U-2 Liquid RW/BMS manifold |
| 5. Vacuum Degasifier inlet | 16. Waste influent from manifold |
| 6. Vacuum Degasifier outlet | 17. Concentrator outlet to ion exchanger |
| 7. Degasifier Effluent Pumps discharge | 17a. Concentrator outlet to Boric Acid Makeup Tank |
| 8. Downstream of 2CV2222 | 18. Boric Acid Condensate Tanks inlet |
| 9. Holdup Tank Recirc Pump suction | 19. Boric Acid Condensate Tanks outlet |
| 10. 2F15A inlet | 20. Boric Acid Condensate Pumps discharge |
| 11. 2F15A outlet | 21. Discharge to the flume |

Notes:

1. Values given are nominal; actual operating flows, pressures, and temperatures may vary.
2. Location 17a is referenced in other SAR tables.
3. Boric Acid Concentrator is currently not in use.

ARKANSAS NUCLEAR ONE
Unit 2

Table 11.2-4

BMS MAX. NUCLIDE CONCENTRATIONS (70°F) DURING NORMAL OPERATIONS

(System numbers refer to process data points.*)

<u>NUCLIDE</u>	<u>CVCS 5</u>	<u>CVCS 6</u>	<u>CVCS 3</u>	<u>BMS 2</u>	<u>BMS 5</u>	<u>BMS 6</u>	<u>BMS 12</u>	<u>BMS 15</u>	<u>BMS 17a</u>	<u>BMS 17</u>	<u>BMS 18</u>	<u>BMS 21</u>
H-3	0.13	0.13	0.13	0.13	0.13	0.13	0.13	0.13	0.13	0.13	0.13	0.13
BR-84	9.4(-3)	9.4(-3)	9.4(-6)	1.0(-4)	2.1(-5)	2.1(-5)	0.0(0)	0.0(0)	0.0(0)	0.0(0)	0.0(0)	0.0(0)
KR-85M	5.5(-1)	5.5(-1)	5.5(-1)	2.3(-2)	4.9(-1)	4.1(-3)	6.8(-18)	6.8(-18)	0.0(0)	1.4(-18)	1.4(-18)	1.3(-18)
KR-85	5.4(-1)	5.4(-1)	5.4(-1)	2.5(-1)	5.0(-1)	4.2(-3)	4.2(-3)	4.2(-3)	0.0(0)	8.4(-4)	8.4(-4)	8.3(-4)
KR-87	3.0(-1)	3.0(-1)	3.0(-1)	3.6(-3)	2.6(-1)	2.2(-3)	0.0(0)	0.0(0)	0.0(0)	0.0(0)	0.0(0)	0.0(0)
KR-88	9.7(-1)	9.7(-1)	9.7(-1)	2.5(-2)	8.5(-1)	7.1(-3)	0.0(0)	0.0(0)	0.0(0)	0.0(0)	0.0(0)	0.0(0)
RB-88	9.5(-1)	9.5(-1)	9.5(-1)	5.7(-3)	8.4(-1)	8.4(-1)	0.0(0)	0.0(0)	0.0(0)	0.0(0)	0.0(0)	0.0(0)
RB-89	2.4(-2)	2.4(-2)	2.4(-2)	1.3(-4)	2.1(-2)	2.1(-2)	0.0(0)	0.0(0)	0.0(0)	0.0(0)	0.0(0)	0.0(0)
SR-89	1.9(-3)	1.9(-3)	1.9(-5)	1.8(-3)	2.4(-4)	2.4(-4)	2.1(-4)	2.1(-5)	1.1(-3)	1.1(-7)	1.1(-7)	1.1(-7)
SR-90	9.1(-5)	9.1(-5)	9.1(-7)	9.0(-5)	1.2(-5)	1.2(-5)	1.2(-5)	1.2(-6)	6.0(-5)	6.0(-9)	6.0(-9)	6.0(-9)
Y-90	2.3(-4)	2.3(-4)	2.3(-4)	1.6(-4)	2.3(-4)	2.3(-4)	2.2(-5)	2.2(-6)	1.1(-4)	1.1(-8)	1.1(-8)	1.1(-8)
SR-91	1.4(-3)	1.4(-3)	1.4(-5)	2.6(-4)	4.4(-5)	4.4(-5)	8.8(-12)	8.8(-13)	4.4(-11)	4.4(-15)	4.4(-15)	4.4(-15)
Y-91	8.4(-3)	8.4(-3)	8.4(-3)	8.2(-3)	8.4(-3)	8.4(-3)	7.6(-3)	7.6(-4)	3.8(-2)	3.8(-6)	3.8(-6)	3.8(-6)
MD-99	4.7(-1)	4.7(-1)	4.7(-1)	3.3(-1)	4.5(-1)	4.5(-1)	4.9(-2)	4.9(-3)	2.4(-1)	2.4(-5)	2.4(-5)	2.4(-5)
RU-103	1.6(-3)	1.6(-3)	1.6(-4)	1.5(-3)	3.2(-4)	3.2(-4)	2.8(-4)	2.8(-5)	4.1(-3)	1.4(-7)	1.4(-7)	1.4(-7)
RU-106	8.3(-5)	8.3(-5)	8.3(-6)	8.2(-5)	1.7(-5)	1.7(-5)	1.7(-5)	1.7(-6)	8.5(-5)	8.5(-9)	8.5(-9)	8.5(-9)
TE-129	9.3(-3)	9.3(-3)	9.3(-4)	2.1(-4)	8.4(-4)	8.4(-4)	0.0(0)	0.0(0)	0.0(0)	0.0(0)	0.0(0)	0.0(0)
I-129	1.9(-8)	1.9(-8)	1.9(-11)	1.9(-8)	2.4(-9)	2.4(-9)	2.4(-9)	2.4(-12)	1.2(-10)	1.2(-14)	1.2(-14)	1.2(-14)
I-131	8.9(-1)	8.9(-1)	8.9(-4)	7.8(-1)	9.7(-2)	9.7(-2)	4.5(-2)	4.5(-5)	2.2(-3)	2.2(-7)	2.2(-7)	2.2(-7)
XE-131M	4.4(-1)	4.4(-1)	4.4(-1)	1.9(-1)	4.1(-1)	3.4(-3)	2.0(-3)	2.0(-3)	0.0(0)	4.1(-4)	4.1(-4)	4.0(-4)
TE-132	1.3(-1)	1.3(-1)	1.3(-2)	9.5(-2)	2.3(-2)	2.3(-2)	3.5(-3)	3.5(-4)	1.8(-2)	1.8(-6)	1.8(-6)	1.8(-6)
I-132	2.8(-1)	2.8(-1)	2.8(-4)	1.3(-2)	1.8(-3)	1.8(-3)	0.0(0)	0.0(0)	0.0(0)	0.0(0)	0.0(0)	0.0(0)
I-133	1.3(0)	1.3(0)	1.2(-3)	4.7(-1)	5.9(-2)	5.9(-2)	4.8(-5)	4.8(-8)	2.4(-6)	2.4(-10)	2.4(-10)	2.4(-10)
XE-133	7.0(1)	7.0(1)	7.0(1)	2.7(1)	6.5(1)	5.4(-1)	1.7(-1)	1.7(-1)	0.0(0)	3.3(-2)	3.3(-2)	3.2(-2)

ARKANSAS NUCLEAR ONE
Unit 2

Table 11.2-4 (continued)

<u>NUCLIDE</u>	<u>CVCS 5</u>	<u>CVCS 6</u>	<u>CVCS 3</u>	<u>BMS 2</u>	<u>BMS 5</u>	<u>BMS 6</u>	<u>BMS 12</u>	<u>BMS 15</u>	<u>BMS 17a</u>	<u>BMS 17</u>	<u>BMS 18</u>	<u>BMS 21</u>
TE-134	9.8(-3)	9.8(-3)	9.8(-4)	1.4(-4)	8.7(-4)	8.7(-4)	0.0(0)	0.0(0)	0.0(0)	0.0(0)	0.0(0)	0.0(0)
I-134	1.3(-1)	1.3(-1)	1.3(-4)	2.4(-3)	4.1(-4)	4.1(-4)	0.0(0)	0.0(0)	0.0(0)	0.0(0)	0.0(0)	0.0(0)
CS-134	7.8(-2)	7.8(-2)	7.8(-2)	7.8(-2)	7.8(-2)	7.8(-2)	7.8(-2)	7.8(-4)	3.9(-2)	3.9(-6)	3.9(-6)	3.9(-6)
I-135	5.8(-1)	5.8(-1)	5.8(-4)	7.8(-2)	1.0(-2)	1.0(-2)	2.0(-12)	2.0(-15)	9.9(-14)	9.9(-18)	9.9(-18)	9.9(-18)
XE-135	2.1(0)	2.1(0)	2.1(0)	1.3(-1)	1.9(0)	1.6(-2)	2.5(-12)	2.5(-12)	0.0(0)	5.0(-13)	5.0(-13)	4.9(-13)
CS-136	1.2(-2)	1.2(-2)	1.2(-2)	1.1(-2)	1.2(-2)	1.2(-2)	7.6(-3)	7.6(-5)	3.8(-3)	3.8(-7)	3.8(-7)	3.8(-7)
CS-137	3.2(-1)	3.2(-1)	3.2(-1)	3.2(-1)	3.2(-1)	3.2(-1)	3.2(-1)	3.2(-3)	1.6(-1)	1.6(-5)	1.6(-5)	1.6(-5)
XE-138	1.3(-1)	1.3(-1)	1.3(-1)	3.5(-4)	1.2(-1)	5.8(-2)	0.0(0)	0.0(0)	0.0(0)	0.0(0)	0.0(0)	0.0(0)
H-3	0.13	0.13	0.13	0.13	0.13	0.13	0.13	0.13	0.13	0.13	0.13	0.13
CS-138	2.5(-1)	2.5(-1)	2.5(-1)	2.7(-3)	2.2(-1)	2.2(-1)	0.0(0)	0.0(0)	0.0(0)	0.0(0)	0.0(0)	0.0(0)
BA-140	2.4(-3)	2.4(-3)	2.4(-5)	2.2(-3)	2.9(-4)	2.9(-4)	1.8(-4)	1.8(-5)	8.9(-4)	8.9(-8)	8.9(-8)	8.9(-8)
LA-140	2.3(-3)	2.3(-3)	2.3(-4)	1.3(-3)	3.6(-4)	3.6(-4)	8.7(-6)	8.7(-7)	4.3(-5)	4.3(-9)	4.3(-9)	4.3(-9)
PR-143	1.9(-3)	1.9(-3)	1.9(-4)	1.8(-3)	3.9(-4)	3.9(-4)	2.5(-4)	2.5(-5)	1.2(-3)	1.2(-7)	1.2(-7)	1.2(-7)
CE-144	1.3(-3)	1.3(-3)	1.3(-4)	1.3(-3)	2.7(-4)	2.7(-4)	2.6(-4)	2.6(-5)	1.3(-3)	1.3(-7)	1.3(-7)	1.3(-7)
CO-60	9.4(-4)	9.4(-5)	9.4(-5)	9.3(-4)	2.0(-4)	2.0(-4)	2.0(-4)	2.0(-4)	9.8(-3)	9.8(-7)	9.8(-7)	9.8(-7)
FE-59	5.1(-5)	5.1(-6)	5.1(-6)	5.0(-5)	1.1(-5)	1.1(-5)	9.2(-6)	9.2(-6)	4.6(-4)	4.6(-8)	4.6(-8)	4.6(-8)
CO-58	8.4(-3)	8.4(-4)	8.4(-4)	8.2(-3)	1.7(-3)	1.7(-3)	1.6(-3)	1.6(-3)	8.0(-2)	8.0(-6)	8.0(-6)	8.0(-6)
MN-54	9.4(-5)	9.4(-6)	9.4(-6)	9.3(-5)	2.0(-5)	2.0(-5)	1.9(-5)	1.9(-5)	9.7(-4)	9.7(-8)	9.7(-8)	9.7(-8)
CR-51	4.4(-3)	4.4(-4)	4.4(-4)	4.2(-3)	9.0(-4)	9.0(-4)	7.2(-4)	7.2(-4)	3.6(-2)	3.6(-6)	3.6(-6)	3.6(-6)
ZR-95	4.4(-5)	4.4(-6)	4.4(-6)	4.3(-5)	9.2(-6)	9.2(-6)	8.3(-6)	8.3(-6)	4.2(-4)	4.2(-8)	4.2(-8)	4.2(-8)

* BMS Data Points are shown on Table 11.2-3.

* CVCS Data Points are shown on Table 9.3-7.

ARKANSAS NUCLEAR ONE
Unit 2

Table 11.2-5

BMS MAX. NUCLIDE CONCENTRATIONS DURING ANTICIPATED OPERATIONAL OCCURRENCES

(System numbers refer to process data points.*)

<u>NUCLIDE</u>	<u>CVCS 5</u>	<u>CVCS 6</u>	<u>CVCS 3</u>	<u>BMS 2</u>	<u>BMS 5</u>	<u>BMS 6</u>	<u>BMS 12</u>	<u>BMS 15</u>	<u>BMS 17a</u>	<u>BMS 17</u>	<u>BMS 18</u>	<u>BMS 21</u>
H-3	0.192	0.192	0.192	0.192	0.192	0.192	0.192	0.192	0.192	0.192	0.192	0.192
BR-84	3.7(-2)	3.7(-2)	3.7(-5)	4.0(-4)	6.7(-5)	6.7(-5)	0.0(0)	0.0(0)	0.0(0)	0.0(0)	0.0(0)	0.0(0)
KR-85M	2.2(0)	2.2(0)	2.2(0)	8.9(-2)	2.0(0)	1.7(-2)	2.8(-17)	2.8(-17)	0.0(0)	5.6(-18)	5.6(-18)	5.5(-18)
KR-85	1.4(0)	1.4(0)	1.4(0)	6.3(-1)	1.3(0)	1.1(-2)	1.1(-2)	1.1(-2)	0.0(0)	2.1(-3)	2.1(-3)	2.1(-3)
KR-87	1.2(0)	1.2(0)	1.2(0)	1.4(-2)	1.1(0)	9.0(-3)	0.0(0)	0.0(0)	0.0(0)	0.0(0)	0.0(0)	0.0(0)
KR-88	3.8(0)	3.8(0)	3.8(0)	10.0(-2)	3.5(0)	2.9(-2)	0.0(0)	0.0(0)	0.0(0)	0.0(0)	0.0(0)	0.0(0)
RB-88	3.7(0)	3.7(0)	3.7(0)	2.2(-2)	3.4(0)	3.4(0)	0.0(0)	0.0(0)	0.0(0)	0.0(0)	0.0(0)	0.0(0)
RB-89	9.3(-2)	9.3(-2)	9.3(-2)	5.1(-4)	8.6(-2)	8.6(-2)	0.0(0)	0.0(0)	0.0(0)	0.0(0)	0.0(0)	0.0(0)
SR-89	7.3(-3)	7.3(-3)	7.3(-5)	7.1(-3)	6.6(-4)	6.6(-4)	5.8(-4)	5.8(-5)	2.9(-3)	2.9(-7)	2.9(-7)	2.9(-7)
SR-90	3.5(-4)	3.5(-4)	3.5(-6)	3.5(-4)	3.2(-5)	3.2(-5)	3.2(-5)	3.2(-6)	1.6(-4)	1.6(-8)	1.6(-8)	1.6(-8)
Y-90	9.0(-4)	9.0(-4)	9.0(-4)	6.2(-4)	8.7(-4)	8.7(-4)	8.5(-5)	8.5(-6)	4.2(-4)	4.2(-8)	4.2(-8)	4.2(-8)
SR-91	5.4(-3)	5.4(-3)	5.4(-5)	1.0(-3)	1.3(-4)	1.3(-4)	2.7(-11)	2.7(-12)	1.3(-10)	1.3(-14)	1.3(-14)	1.3(-14)
Y-91	3.2(-2)	3.2(-2)	3.2(-2)	3.1(-2)	3.2(-2)	3.2(-2)	2.8(-2)	2.8(-3)	1.4(-1)	1.4(-5)	1.4(-5)	1.4(-5)
MO-99	1.8(0)	1.8(0)	1.8(0)	1.3(0)	1.8(0)	1.8(0)	1.9(-1)	1.9(-2)	9.4(-1)	9.4(-5)	9.4(-5)	9.4(-5)
RU-103	6.1(-3)	6.1(-3)	6.1(-4)	5.9(-3)	1.0(-3)	1.0(-3)	8.9(-4)	8.9(-5)	1.3(-2)	4.5(-7)	4.5(-7)	4.5(-7)
RU-106	3.2(-4)	3.2(-4)	3.2(-5)	3.2(-4)	5.6(-5)	5.6(-5)	5.5(-5)	5.5(-6)	2.8(-4)	2.8(-8)	2.8(-8)	2.8(-8)
TE-129	3.6(-2)	3.6(-2)	3.6(-3)	8.1(-4)	3.4(-3)	3.4(-3)	0.0(0)	0.0(0)	0.0(0)	0.0(0)	0.0(0)	0.0(0)
I-129	7.6(-8)	7.6(-8)	7.6(-11)	7.6(-8)	6.3(-9)	6.3(-9)	6.3(-9)	6.3(-12)	3.2(-10)	3.2(-14)	3.2(-14)	3.2(-14)
I-131	3.5(0)	3.5(0)	3.5(-3)	3.0(0)	2.5(-1)	2.5(-1)	1.2(-1)	1.2(-4)	5.9(-3)	5.9(-7)	5.9(-7)	5.9(-7)
XE-131M	1.5(0)	1.5(0)	1.5(0)	6.4(-1)	1.4(0)	1.2(-2)	7.0(-3)	7.0(-3)	0.0(0)	1.4(-3)	1.4(-3)	1.4(-3)
TE-132	5.0(-1)	5.0(-1)	5.0(-2)	3.7(-1)	7.7(-2)	7.7(-2)	1.2(-2)	1.2(-3)	5.6(-2)	5.8(-6)	5.8(-6)	5.8(-6)
I-132	1.1(0)	1.1(0)	1.1(-3)	5.0(-2)	5.2(-3)	5.2(-3)	0.0(0)	0.0(0)	0.0(0)	0.0(0)	0.0(0)	0.0(0)
I-133	4.9(0)	4.9(0)	4.9(-3)	1.9(0)	1.6(-1)	1.6(-1)	1.3(-4)	1.3(-7)	6.4(-6)	6.4(-10)	6.4(-10)	6.4(-10)
XE-133	2.5(2)	2.5(2)	2.5(2)	9.8(1)	2.4(2)	2.0(0)	6.2(-1)	6.2(-1)	0.0(0)	1.2(-1)	1.2(-1)	1.2(-1)
TE-134	3.8(-2)	3.8(-2)	3.8(-3)	5.4(-4)	3.6(-3)	3.6(-3)	0.0(0)	0.0(0)	0.0(0)	0.0(0)	0.0(0)	0.0(0)

ARKANSAS NUCLEAR ONE
Unit 2

Table 11.2-5 (continued)

<u>NUCLIDE</u>	<u>CVCS 5</u>	<u>CVCS 6</u>	<u>CVCS 3</u>	<u>BMS 2</u>	<u>BMS 5</u>	<u>BMS 6</u>	<u>BMS 12</u>	<u>BMS 15</u>	<u>BMS 17a</u>	<u>BMS 17</u>	<u>BMS 18</u>	<u>BMS 21</u>
I-134	5.3(-1)	5.3(-1)	5.3(-4)	9.3(-3)	1.3(-3)	1.3(-3)	0.0(0)	0.0(0)	0.0(0)	0.0(0)	0.0(0)	0.0(0)
CS-134	2.9(-1)	2.9(-1)	2.9(-1)	2.9(-1)	2.9(-1)	2.9(-1)	2.9(-1)	2.9(-3)	1.5(-1)	1.5(-5)	1.5(-5)	1.5(-5)
I-135	2.3(0)	2.3(0)	2.3(-3)	3.0(-1)	2.7(-2)	2.7(-2)	5.4(-12)	5.4(-15)	2.7(-13)	2.7(-17)	2.7(-17)	2.7(-17)
XE-135	8.4(0)	8.4(0)	8.4(0)	5.2(-1)	7.7(0)	6.4(-2)	1.0(-11)	1.0(-11)	0.0(0)	2.0(-12)	2.0(-12)	2.9(-12)
CS-136	4.7(-2)	4.7(-2)	4.7(-2)	4.3(-2)	4.7(-2)	4.7(-2)	2.9(-2)	2.9(-4)	1.4(-2)	1.4(-6)	1.4(-6)	1.4(-6)
CS-137	1.2(0)	1.2(0)	1.2(0)	1.2(0)	1.2(0)	1.2(0)	1.2(0)	1.2(-2)	6.1(-1)	6.1(-5)	6.1(-5)	6.1(-5)
XE-138	5.2(-1)	5.2(-1)	5.2(-1)	1.4(-3)	4.8(-1)	2.4(-1)	0.0(0)	0.0(0)	0.0(0)	0.0(0)	0.0(0)	0.0(0)
H-3	0.192	0.192	0.192	0.192	0.192	0.192	0.192	0.192	0.192	0.192	0.192	0.192
CS-138	1.0(0)	1.0(0)	1.0(0)	1.1(-2)	9.2(-1)	9.2(-1)	0.0(0)	0.0(0)	0.0(0)	0.0(0)	0.0(0)	0.0(0)
BA-140	9.3(-3)	9.3(-3)	9.3(-5)	8.5(-3)	7.9(-4)	7.9(-4)	4.9(-4)	4.9(-5)	2.4(-3)	2.4(-7)	2.4(-7)	2.4(-7)
LA-140	8.8(-3)	8.8(-3)	8.8(-4)	5.0(-3)	1.2(-3)	1.2(-3)	3.0(-5)	3.0(-6)	1.5(-4)	1.5(-8)	1.5(-8)	1.5(-8)
PR-143	7.5(-3)	7.5(-3)	7.5(-4)	7.0(-3)	1.3(-3)	1.3(-3)	8.0(-4)	8.0(-5)	4.0(-3)	4.0(-7)	4.0(-7)	4.0(-7)
CE-144	4.9(-3)	4.9(-3)	4.9(-4)	4.9(-3)	8.6(-4)	8.6(-4)	8.4(-4)	8.4(-5)	4.2(-3)	4.2(-7)	4.2(-7)	4.2(-7)
CO-60	9.4(-4)	9.4(-5)	9.4(-5)	9.3(-4)	1.6(-4)	1.6(-4)	1.6(-4)	1.6(-4)	8.2(-3)	8.2(-7)	8.2(-7)	8.2(-7)
FE-59	5.1(-5)	5.1(-6)	5.1(-6)	5.0(-5)	8.8(-6)	8.8(-6)	7.7(-6)	7.7(-6)	3.8(-4)	3.8(-8)	3.8(-8)	3.8(-8)
CO-58	8.4(-3)	8.4(-4)	8.4(-4)	8.2(-3)	1.5(-3)	1.5(-3)	1.3(-3)	1.3(-3)	6.7(-2)	6.7(-6)	6.7(-6)	6.7(-6)
MN-54	9.4(-5)	9.4(-6)	9.4(-6)	9.3(-5)	1.6(-5)	1.6(-5)	1.6(-5)	1.6(-5)	8.0(-4)	8.0(-8)	8.0(-8)	8.0(-8)
CR-51	4.4(-3)	4.4(-4)	4.4(-4)	4.2(-3)	7.5(-4)	7.5(-4)	6.0(-4)	6.0(-4)	3.0(-2)	3.0(-6)	3.0(-6)	3.0(-6)
ZR-95	4.4(-5)	4.4(-6)	4.4(-6)	4.3(-5)	7.6(-6)	7.6(-6)	6.9(-6)	6.9(-6)	3.5(-4)	3.5(-8)	3.5(-8)	3.5(-8)

* BMS Data Points are shown on Table 11.2-3

* CVCS Data Points are shown on Table 9.3-7

ARKANSAS NUCLEAR ONE
Unit 2

Table 11.2-6

EXPECTED FILTER AND ION EXCHANGER PERFORMANCE

Nuclide	<u>Chemical and Volume Control System</u>		<u>Boron Management Waste Processing System</u>	
	<u>Filter DF</u>	<u>Ion Exchanger DF</u>	<u>Filter DF</u>	<u>Ion Exchanger DF</u>
Br-84	1	1000	1	100
Rb-88	1	1	1	100
Rb-89	1	1	1	100
Sr-89	1	100	1	10
Sr-90	1	100	1	10
Y-90	1	1	1	10
Sr-91	1	100	1	10
Y-91	1	1	1	10
Mo-99	1	1	1	10
Ru-103	1	10	1	10
Ru-106	1	10	1	10
Te-129	1	10	1	10
I-129	1	1000	1	1000
I-131	1	1000	1	1000
Te-132	1	10	1	10
I-132	1	1000	1	1000
I-133	1	1000	1	1000
Te-134	1	10	1	10
I-134	1	1000	1	1000
Cs-134	1	1	1	100
I-135	1	1000	1	1000
Cs-136	1	1	1	100
Cs-137	1	1	1	100
Cs-138	1	1	1	100
Ba-140	1	100	1	10
La-140	1	10	1	10
Pr-140	1	10	1	10
Ce-144	1	10	1	10
Co-60	10	1	1	1
Fe-59	10	1	1	1
Co-58	10	1	1	1
Mn-54	10	1	1	1
Cr-51	10	1	1	1
Zr-95	10	1	1	1

ARKANSAS NUCLEAR ONE
Unit 2

Table 11.2-7

BORON MANAGEMENT SYSTEM PERFORMANCE DATA

Vacuum Degasifier DF for Fission Gases	120
Boric Acid Concentrator (currently not in use)	
DF for Liquid (Influent to Distillate)	200
Bottoms to Distillate DF	10,000
DF for Fission Gases	5
Holdup Tank Delay Factor, Days	9
Average Concentration Factor	50

ARKANSAS NUCLEAR ONE
Unit 2

Table 11.2-8

DESIGN DATA FOR WASTE MANAGEMENT SYSTEM COMPONENTS

1.	<u>Ion Exchanger</u>	<u>Waste Condensate</u>
	Quantity	2
	Type	H-OH Mixed Bed
	Design Pressure, psig	150
	Design Temperature, °F	240
	Normal Operating Pressure, psig	60
	Normal Operating Temperature, °F	140
	Normal Operating Flow, gpm	20
	Resin Volume, ft ³	32
	Materials	ss
2.	<u>Tanks</u>	<u>Waste Tanks 2T20A and 2T20B</u>
	Quantity	2
	Internal Volume, gal.	6000 min.
	Design Pressure, psig	Atmospheric
	Design Temperature, °F	250
	Normal Operating Pressure, psig	Atmospheric
	Normal Operating Temperature, °F	120
	Material	ss
	<u>Tanks</u>	<u>Waste Condensate</u>
	Quantity	2
	Internal Volume, gal	15,200
	Design Pressure, psig	Atmospheric
	Design Temperature, °F	250
	Normal Operating Pressure, psig	Atmospheric
	Normal Operating Temperature, °F	120
	Material	ss

ARKANSAS NUCLEAR ONE
Unit 2

Table 11.2-8 (continued)

3.	<u>Pumps</u>	<u>Waste: Waste Condensate</u>
	Quantity	4
	Type	Centrifugal
	Design Pressure, psig	150
	Design Temperature, °F	200
	Design Conditions	
	Flow, gpm	50
	Head, ft	135
	Wetted Materials	ss
	Seal Type	Mechanical
	Motor Horsepower	7.5
	Motor Voltage	460
4.	<u>Filters</u>	<u>Waste</u>
	Quantity	1
	Type of Elements	Replaceable cartridge
	Design Pressure, psig	150
	Design Temperature, °F	200
	Design Flow, gpm	50
	Material	ss
5.	<u>Concentrator</u> (currently not in use)	<u>Waste</u>
	Quantity	1
	Design Pressure, psig	80
	Design Temperature, °F	250
	Design Flow, gpm	20
	Cooling Water Flow Rate, gpm	1184
	Steam required at 100 psig, lb/hr	13,150

ARKANSAS NUCLEAR ONE
Unit 2

Table 11.2-9

WASTE MANAGEMENT SYSTEM FLOW DATA

**Mode #1: Processing Waste Tank 2T20A Contents Via The Waste Concentrator (Note 3):
Discharging a Waste Condensate Tank**

<u>Location*</u>	<u>1</u>	<u>1a</u>	<u>2</u>	<u>2a</u>	<u>3</u>	<u>4</u>	<u>5</u>	<u>6</u>
Flow gpm	0.825	0	0.912	7	2	2	2	50
Pressure, psig	0.5	2.0	0.5	2.0	67	5	4	62
Temperature °F	120	120	120	120	120	120	120	120

**Mode #2: Processing Waste Tank 2T20B Contents Via The Waste Concentrator (Note 3):
Discharging a Waste Condensate Tank**

<u>Location*</u>	<u>1</u>	<u>1a</u>	<u>2</u>	<u>2a</u>	<u>3</u>	<u>4</u>	<u>5</u>	<u>6</u>
Flow gpm	0.825	7.0	0.912	0	2	2	2	50
Pressure, psig	0.5	2.0	0.5	2.0	67	5	4	62
Temperature °F	120	120	120	120	120	120	120	120

***Location**

1. Waste Tank 2T20B inlet
- 1a. Waste Tank 2T20B outlet
2. Waste Tank 2T20A inlet
- 2a. Waste Tank 2T20A outlet
3. Waste Filter 2F11s inlet
4. Waste Condensate Ion Exchanger inlet
5. Waste Condensate Tanks inlet
6. Waste Condensate Pumps discharge
7. Waste Concentrator discharge to Concentrator Bottoms Tank

Notes:

1. Values given are nominal; actual operating flows, pressures, and temperatures may vary.
2. Location 7 is referenced in other SAR tables.
3. The Waste Concentrator is currently not in use.

ARKANSAS NUCLEAR ONE
Unit 2

Table 11.2-10

WASTE MANAGEMENT SYSTEM EXPECTED PERFORMANCE

Ion Exchanger Decontamination Factor

Tritium Corrosion Products	1
All Others	10

Filter Decontamination Factor

All Nuclides	1
--------------	---

Waste Concentrator DF

(Bottoms/Distillate)	10 ⁴
(Influent/Distillate)	500

Waste Concentrator Concentration Factor	20
---	----

Note: The Waste Concentrator is currently not in use.

ARKANSAS NUCLEAR ONE
Unit 2

Table 11.2-11
WMS NUCLIDE CONCENTRATIONS DURING NORMAL OPERATION (70 °F μCi/cc)
(System numbers refer to process data points shown on Table 11.2-9)

<u>NUCLIDE</u>	<u>WMS 1</u>	<u>WMS 2</u>	<u>WMS 3</u>	<u>WMS 4</u>	<u>WMS 5</u>	<u>WMS 6</u>	<u>WMS 7</u>
H-3	8.0(-5)	4.1(-1)	8.1(-3)	8.1(-3)	8.1(-3)	8.1(-3)	8.1(-3)
BR-84	1.2(-7)	9.4(-5)	2.0(-6)	4.0(-9)	4.0(-10)	4.0(-10)	4.0(-5)
KR-85M	0.0(0)	0.0(0)	0.0(0)	0.0(0)	0.0(0)	0.0(0)	0.0(0)
KR-85	0.0(0)	0.0(0)	0.0(0)	0.0(0)	0.0(0)	0.0(0)	0.0(0)
KR-87	0.0(0)	0.0(0)	0.0(0)	0.0(0)	0.0(0)	0.0(0)	0.0(0)
KR-88	0.0(0)	0.0(0)	0.0(0)	0.0(0)	0.0(0)	0.0(0)	0.0(0)
RB-88	7.0(-6)	9.5(-3)	2.0(-4)	3.9(-7)	3.9(-8)	3.9(-8)	3.9(-3)
RB-89	1.6(-7)	2.4(-4)	4.9(-6)	9.8(-9)	9.8(-10)	9.8(-10)	9.8(-5)
SR-89	1.1(-6)	1.9(-5)	1.5(-6)	2.9(-9)	2.9(-10)	2.9(-10)	2.9(-5)
SR-90	5.5(-8)	9.1(-7)	7.2(-8)	1.4(-10)	1.4(-11)	1.4(-11)	1.4(-6)
Y-90	1.0(-7)	2.3(-6)	1.5(-7)	2.9(-10)	2.9(-11)	2.9(-11)	2.9(-6)
SR-91	2.4(-7)	1.4(-5)	5.1(-7)	1.0(-9)	1.0(-10)	1.0(-10)	1.0(-5)
Y-91	5.0(-6)	8.4(-5)	6.6(-6)	1.3(-8)	1.3(-9)	1.3(-9)	1.3(-4)
MO-99	2.1(-4)	4.7(-3)	3.0(-4)	6.0(-7)	6.0(-8)	6.0(-8)	6.0(-3)
RU-103	2.7(-6)	4.7(-5)	3.6(-5)	7.3(-9)	7.3(-10)	7.3(-10)	7.3(-5)
RU-106	5.0(-8)	8.3(-7)	6.5(-8)	1.3(-10)	1.3(-11)	1.3(-11)	1.3(-6)
TE-129	2.5(-7)	9.3(-5)	2.1(-6)	4.2(-9)	4.2(-10)	4.2(-10)	4.2(-5)
I-129	1.2(-11)	1.9(-10)	1.5(-11)	3.1(-14)	3.1(-15)	3.1(-15)	3.1(-10)
I-131	4.8(-4)	8.9(-3)	6.4(-4)	1.3(-6)	1.3(-7)	1.3(-7)	1.3(-2)
Xe-131M	0.0(0)	0.0(0)	0.0(0)	0.0(0)	0.0(0)	0.0(0)	0.0(0)
TE-132	6.0(-5)	1.3(-3)	8.4(-5)	1.7(-7)	1.7(-8)	1.7(-8)	1.7(-3)
I-132	1.5(-5)	2.8(-3)	7.1(-5)	1.4(-7)	1.4(-8)	1.4(-8)	1.4(-3)
I-133	3.5(-4)	1.3(-2)	5.9(-4)	1.2(-6)	1.2(-7)	1.2(-7)	1.2(-2)
XE-133	0.0(0)	0.0(0)	0.0(0)	0.0(0)	0.0(0)	0.0(0)	0.0(0)
TE-134	1.7(-7)	9.8(-5)	2.1(-6)	4.2(-9)	4.2(-10)	4.2(-10)	4.2(-5)
I-134	2.9(-6)	1.3(-3)	3.0(-5)	6.0(-8)	6.0(-9)	6.0(-9)	6.0(-4)
CS-134	4.7(-5)	7.8(-4)	6.2(-5)	1.2(-7)	1.2(-8)	1.2(-8)	1.2(-3)
I-135	7.6(-5)	5.8(-3)	1.9(-4)	3.8(-7)	3.8(-8)	3.8(-8)	3.8(-3)
XE-135	0.0(0)	0.0(0)	0.0(0)	0.0(0)	0.0(0)	0.0(0)	0.0(0)
CS-136	6.9(-6)	1.2(-4)	9.3(-6)	1.9(-8)	1.9(-9)	1.9(-9)	1.9(-4)
CS-137	2.0(-4)	3.2(-3)	2.6(-4)	5.1(-7)	5.1(-8)	5.1(-8)	5.1(-3)
XE-138	0.0(0)	0.0(0)	0.0(0)	0.0(0)	0.0(0)	0.0(0)	0.0(0)
CS-138	3.3(-6)	2.5(-3)	5.4(-5)	1.1(-7)	1.1(-8)	1.1(-8)	1.1(-3)
BA-140	1.3(-6)	2.4(-5)	1.8(-6)	3.6(-9)	3.6(-10)	3.6(-10)	3.6(-5)
LA-140	8.6(-7)	2.3(-5)	1.3(-6)	2.6(-9)	2.6(-10)	2.6(-10)	2.6(-5)
PR-143	1.1(-6)	1.9(-5)	1.5(-6)	2.9(-9)	2.9(-10)	2.9(-10)	2.9(-5)
CE-144	7.6(-7)	1.3(-5)	1.0(-6)	2.0(-9)	2.0(-10)	2.0(-10)	2.0(-5)
CO-60	5.7(-7)	9.4(-6)	7.4(-7)	1.5(-9)	1.5(-9)	1.5(-9)	1.5(-5)
FE-59	3.0(-8)	5.1(-7)	4.0(-8)	7.9(-11)	7.9(-11)	7.9(-11)	7.9(-7)
CO-58	5.0(-6)	8.4(-5)	6.6(-6)	1.3(-8)	1.3(-8)	1.3(-8)	1.3(-4)
MN-54	5.6(-8)	9.4(-7)	7.4(-8)	1.5(-10)	1.5(-10)	1.5(-10)	1.5(-6)
CR-51	2.6(-6)	4.4(-5)	3.4(-6)	6.8(-9)	6.8(-9)	6.8(-9)	6.8(-5)
ZR-95	2.6(-8)	4.4(-7)	3.4(-8)	6.9(-11)	6.9(-11)	6.9(-11)	6.9(-7)

ARKANSAS NUCLEAR ONE
Unit 2

Table 11.2-12
WMS NUCLIDE CONCENTRATIONS DURING ANTICIPATED OPERATIONS (70 °F μCi/cc)
(System numbers refer to process data points shown on Table 11.2-9)

<u>NUCLIDE</u>	<u>WMS 1</u>	<u>WMS 2</u>	<u>WMS 3</u>	<u>WMS 4</u>	<u>WMS 5</u>	<u>WMS 6</u>	<u>WMS 7</u>
H-3	9.2(-4)	6.1(-1)	1.3(-3)	1.3(-3)	1.3(-3)	1.3(-3)	1.3(-3)
BR-84	3.7(-6)	3.7(-4)	1.1(-5)	2.2(-8)	2.2(-9)	2.2(-9)	2.2(-4)
KR-85M	0.0(0)	0.0(0)	0.0(0)	0.0(0)	0.0(0)	0.0(0)	0.0(0)
KR-85	0.0(0)	0.0(0)	0.0(0)	0.0(0)	0.0(0)	0.0(0)	0.0(0)
KR-87	0.0(0)	0.0(0)	0.0(0)	0.0(0)	0.0(0)	0.0(0)	0.0(0)
KR-88	0.0(0)	0.0(0)	0.0(0)	0.0(0)	0.0(0)	0.0(0)	0.0(0)
RB-88	2.1(-4)	3.7(-2)	9.5(-4)	1.9(-6)	1.9(-7)	1.9(-7)	1.9(-2)
RB-89	4.8(-6)	9.3(-4)	2.3(-5)	4.7(-8)	4.7(-9)	4.7(-9)	4.7(-4)
SR-89	3.3(-5)	7.3(-5)	3.4(-5)	6.8(-8)	6.8(-9)	6.8(-9)	6.8(-4)
SR-90	1.6(-6)	3.5(-6)	1.7(-6)	3.3(-9)	3.3(-10)	3.3(-10)	3.3(-5)
Y-90	3.0(-6)	9.0(-6)	3.1(-6)	6.3(-9)	6.3(-10)	6.3(-10)	6.3(-5)
SR-91	7.1(-6)	5.4(-5)	8.0(-6)	1.6(-8)	1.6(-9)	1.6(-9)	1.6(-4)
Y-91	1.4(-4)	3.2(-4)	1.5(-4)	3.0(-7)	3.0(-8)	3.0(-8)	3.0(-3)
MO-99	6.2(-3)	1.8(-2)	6.4(-3)	1.3(-5)	1.3(-6)	1.3(-6)	1.3(-1)
RU-103	8.2(-5)	1.8(-4)	8.4(-5)	1.7(-7)	1.7(-8)	1.7(-8)	1.7(-3)
RU-106	1.5(-6)	3.2(-6)	1.5(-6)	3.0(-9)	3.0(-10)	3.0(-10)	3.0(-5)
TE-129	7.4(-6)	3.6(-4)	1.4(-5)	2.9(-8)	2.9(-9)	2.9(-9)	2.9(-4)
I-129	3.5(-10)	7.6(-10)	3.6(-10)	7.2(-13)	7.2(-14)	7.2(-14)	7.2(-9)
I-131	1.4(-2)	3.5(-2)	1.5(-2)	2.9(-5)	2.9(-6)	2.9(-6)	2.9(-1)
Xe-131M	0.0(0)	0.0(0)	0.0(0)	0.0(0)	0.0(0)	0.0(0)	0.0(0)
TE-132	1.8(-3)	5.0(-3)	1.8(-3)	3.7(-6)	3.7(-7)	3.7(-7)	3.7(-2)
I-132	4.4(-4)	1.1(-2)	6.5(-4)	1.3(-6)	1.3(-7)	1.3(-7)	1.3(-2)
I-133	1.1(-2)	4.9(-2)	1.1(-2)	2.3(-5)	2.3(-6)	2.3(-6)	2.3(-1)
XE-133	0.0(0)	0.0(0)	0.0(0)	0.0(0)	0.0(0)	0.0(0)	0.0(0)
TE-134	5.0(-6)	3.8(-4)	1.3(-5)	2.5(-8)	2.5(-9)	2.5(-9)	2.5(-4)
I-134	8.6(-5)	5.3(-3)	1.9(-4)	3.8(-7)	3.8(-8)	3.8(-8)	3.8(-3)
CS-134	1.4(-3)	2.9(-3)	1.4(-3)	2.8(-6)	2.8(-7)	2.8(-7)	2.8(-2)
I-135	2.3(-3)	2.3(-2)	2.7(-3)	5.4(-6)	5.4(-7)	5.4(-7)	5.4(-2)
XE-135	0.0(0)	0.0(0)	0.0(0)	0.0(0)	0.0(0)	0.0(0)	0.0(0)
CS-136	2.0(-4)	4.7(-4)	2.1(-4)	4.1(-7)	4.1(-8)	4.1(-8)	4.1(-3)
CS-137	5.7(-3)	1.2(-2)	5.8(-3)	1.2(-5)	1.2(-6)	1.2(-6)	1.2(-1)
XE-138	0.0(0)	0.0(0)	0.0(0)	0.0(0)	0.0(0)	0.0(0)	0.0(0)
CS-138	1.0(-4)	1.0(-2)	3.0(-4)	6.0(-7)	6.0(-8)	6.0(-8)	6.0(-3)
BA-140	4.0(-5)	9.3(-5)	4.1(-5)	8.2(-8)	8.2(-9)	8.2(-9)	8.2(-4)
LA-140	2.6(-5)	8.8(-5)	2.7(-5)	5.4(-8)	5.4(-9)	5.4(-9)	5.4(-4)
PR-143	3.3(-5)	7.5(-5)	3.3(-5)	6.7(-8)	6.7(-9)	6.7(-9)	6.7(-4)
CE-144	2.3(-5)	4.9(-5)	2.3(-5)	4.7(-8)	4.7(-9)	4.7(-9)	4.7(-4)
CO-60	4.3(-6)	9.4(-6)	4.5(-6)	8.9(-9)	8.9(-9)	8.9(-9)	8.9(-5)
FE-59	2.3(-7)	5.1(-7)	2.4(-7)	4.7(-10)	4.7(-10)	4.7(-10)	4.7(-6)
CO-58	3.8(-5)	8.4(-5)	3.9(-5)	7.9(-8)	7.9(-8)	7.9(-8)	7.9(-4)
MN-54	4.3(-7)	9.4(-7)	4.4(-7)	8.9(-10)	8.9(-10)	8.9(-10)	8.9(-6)
CR-51	2.0(-5)	4.4(-5)	2.0(-5)	4.0(-8)	4.0(-8)	4.0(-8)	4.0(-4)
ZR-95	2.0(-7)	4.4(-7)	2.1(-7)	4.1(-10)	4.1(-10)	4.1(-10)	4.1(-6)

ARKANSAS NUCLEAR ONE
Unit 2

Table 11.2-13

**ASSUMPTIONS USED IN CALCULATING ESTIMATED NORMAL
AND ANTICIPATED OPERATIONAL OCCURRENCE RELEASES**
[The information in this table is historical]

	<u>Estimated Normal Releases</u>	<u>Anticipated Operational Occurrence</u>
1. <u>Steam Generator (SG) Blowdown Releases</u>		
Main Stream Flow Rate, lb/hr	12,660,000	12,660,000
SG Liquid Inventory Per SG, lb.	131,000	131,000
Blowdown Rate Gal/Min @ 70 °F	15	15
2. <u>Failed Fuel Percent</u>	0.25	1.0
3. <u>Miscellaneous Liquid Waste from the BMS gal/yr</u>	156,000	156,000
4. <u>Holdup Time</u>	<u>Time (days)</u>	
Reactor Drain Tank (Average fill and drain time)	3	
Holdup Tank (Average decay time in BMS)	9	
WMS	0	
5. <u>Fuel Power Days or Cycle</u>	313	

ARKANSAS NUCLEAR ONE
Unit 2

Table 11.2-14

BORON AND RADIOACTIVE WASTE MANAGEMENT SYSTEM INSTRUMENTATION APPLICATION

<u>System Parameter & Location</u>	<u>Local</u>	<u>Control Room</u>	<u>Indication</u>		<u>Rec</u>	<u>Control Function</u>	<u>Inst. Range</u>	<u>Normal Operating Range</u>
			<u>Alarm⁽¹⁾ High</u>	<u>Low</u>				
Gas Decay Tanks Temperature	x						0 - 250 °F	70 - 150 °F
Gas Surge Tank Temperature	x						0 - 200 °F	70 - 150 °F
Reactor Drain Tank Pressure	x		x				0 - 25 psig	2 - 4 psig
Vacuum Degasifier Pressure	x		x				0 - 100 psig	20 - 30 psig
Holdup Tanks 2T12A, 2T12B, 2T12C, & 2T12D Pressure	x		(2)	(2)			0 - 10 psig	2 - 3 psig
Spent Resin Tank Pressure	x		(2)				0 - 50 psig	0 - 15 psig
Gas Decay Tanks Pressure	x		(2)				0 - 400 psig	0 - 250 psig
Gas Surge Tank Pressure	x		(2)				0 - 30 psig	1 - 5 psig
Reactor Drain Pump Discharge Pressure	x						0 - 100 psig	1 - 4 psig
Holdup Drain Pumps Discharge Pressure	x						0 - 100 psig	0 - 60 psig
Boric Acid Condensate Pumps Discharge Press.	x						0 - 100 psig	0 - 60 psig
Waste Tank 2T20A & 2T20B Pump Discharge Pressure	x						0 - 100 psig	0 - 60 psig

ARKANSAS NUCLEAR ONE
Unit 2

Table 11.2-14 (continued)

System Parameter & Location	Local	Control Room	Indication		Rec	Control Function	Inst. Range	Normal Operating Range
			Alarm ⁽¹⁾ High	Low				
Waste Condensate Pumps Discharge Pressure	x						0 - 100 psig	0 - 60 psig
Waste Gas Compressors Discharge Pressure	x						0 - 400 psig	0 - 250 psig
Waste Ion Exchanger ΔP's	x		(2)				0 - 50 psid	1 - 15 psid
Pre-Concentrator Filters ΔP's	x		(2)				0 - 50 psid	1 - 25 psid
Pre-Concentrator Ion Exchangers ΔP's	x		(2)				0 - 50 psid	1 - 15 psid
Boric Acid Condensate Exchangers ΔP's	x		(2)				0 - 50 psid	1 - 15 psid
Waste Filter ΔP	x		(2)				0 - 50 psid	0 - 1 psid
Reactor Drain Tank Level	x	x	x	x		Reactor Drain Pumps	0 - 48"	7" - 44"
Holdup Tanks Levels	x	x	x				0 - 159	1" - 142"
Boric Acid Cond. Tanks Level	x		x			Boric Acid Condensate Pumps	0 - 234"	1 - 227"
Waste Cond. Tanks Levels	x		(4)			Waste Condensate Pumps	0 - 144"	15" - 140"
Waste Tanks 2T20A, 2T20B	x		(3)				0 - 84"	3" - 81"
Conc. Bottoms Tank Level ⁽⁵⁾	(3)		(3)				0 - 7'	1' - 6'
Gas Surge Tank Level			x				-	

ARKANSAS NUCLEAR ONE
Unit 2

Table 11.2-14 (continued)

<u>System Parameter & Location</u>	<u>Local</u>	<u>Control Room</u>	<u>Indication</u>		<u>Rec</u>	<u>Control Function</u>	<u>Inst. Range</u>	<u>Normal Operating Range</u>
			<u>Alarm⁽¹⁾ High</u>	<u>Low</u>				
Degasifier Vessel Level	x		x	x		Degasifier Bypass Valve Degasifier Effluent Pumps	0 - 100%	10 - 50%
Liquid Waste Discharge Flow	x	x			(6)	Liquid Waste Discharge Isolation Valves	0 - 75 gpm	10 - 75 gpm
Liquid Waste Disch. Radiation	x	x	x	(6)		Liquid Waste Discharge Isolation Valves	10 ⁻⁶ to 10 ⁻¹ μCi/cc	10 ⁻³ μCi/cc
Waste Gas Discharge	x	x	x	(6)		Waste Gas Discharge Isolation Valve	10 ⁻⁵ to 1 μCi/cc	10 ⁻³ μCi/cc
Boric Acid Conc. Instr. ⁽⁷⁾	x		x	x		Various	Various	Various
Radioactive Waste Conc. ⁽⁷⁾	x		x	x		Various	Various	Various
Boron Management System Annunciator Panel Trouble		x				Various	Various	Various
Waste Management System Annunciator Panel Trouble		x				Various	Various	Various
Waste Gas Monitoring System Panel Trouble		x				Various	Various	Various

- (1) All alarms are in the control room and on local panel unless otherwise indicated.
(2) On local system panel only.
(3) Level indications and high level alarms on both the Liquid Radwaste System Control Panel and the Solid Radwaste Control Panel.
(4) Level indication and high alarm only provided locally.
(5) Tank currently not in use.
(6) In control room only.
(7) Currently not in use.

ARKANSAS NUCLEAR ONE

Unit 2

Table 11.2-15A
EXPECTED LIQUID RELEASES FROM THE LIQUID WASTE SYSTEMS
NORMAL OPERATION
(Curies/Year)

Isotope	Unit 2				Unit 1			
	<u>LWS**</u>	<u>SG Blowdown</u>	<u>Total Unit 2</u>	<u>Circulating Water Activity***</u>	<u>LWS</u>	<u>Regenerative Waste</u>	<u>Total Unit 1</u>	<u>Circulating Water Activity***</u>
H-3	203.6	-	203.6	2.67(-7)	560	0	560	7.34(-7)
Br-84	1.1(-5)	*	1.1(-5)	1.44(-14)	-	-	-	-
Kr-85m	2.5(-15)	0	2.5(-15)	3.28(-24)	-	-	-	-
Kr-85	1.5	0	1.5	1.97(-9)	-	-	-	-
Kr-87	*	0	*	*	-	-	-	-
Kr-88	*	0	*	*	-	-	-	-
Rb-88	1.0(-3)	*	1.0(-3)	1.31(-12)	0	0	0	0
Rb-89	2.6(-5)	*	2.6(-5)	3.41(-14)	-	-	-	-
Sr-89	2.1(-4)	7.48(-06)	2.1(-4)	2.75(-13)	1.09(-4)	1.71(-4)	2.80(-4)	3.67(-13)
Sr-90	1.1(-5)	4.20(-07)	1.1(-5)	1.44(-14)	9.33(-6)	1.86(-6)	1.62(-5)	1.47(-14)
Y-90	2.1(-5)	4.61(-07)	2.1(-5)	2.75(-14)	1.49(-3)	9.86(-6)	1.49(-3)	1.95(-12)
Sr-91	2.7(-6)	*	2.7(-6)	3.54(-15)	2.24(-5)	1.02(-5)	3.26(-5)	4.27(-14)
Y-91	7.1(-3)	3.43(-05)	7.1(-3)	9.31(-12)	1.77(-2)	7.95(-6)	1.77(-2)	2.32(-11)
Mo-99	4.7(-2)	1.49(-04)	4.7(-2)	6.16(-11)	1.66(-2)	1.03(-4)	1.66(-2)	2.18(-11)
Ru-103	2.8(-4)	5.94(-06)	2.8(-4)	3.67(-13)	-	-	-	-
Ru-106	1.6(-5)	3.74(-07)	1.6(-5)	2.10(-14)	-	-	-	-
Te-129	1.1(-5)	*	1.1(-5)	1.44(-14)	-	-	-	-
I-129	1.0(-10)	8.99(-11)	1.9(-10)	2.49(-19)	-	-	-	-
I-131	3.8(-3)	1.59(-03)	5.4(-3)	7.08(-12)	8.03(-3)	4.35(-3)	1.25(-2)	1.63(-11)
Xe-131m	7.4(-1)	6.86(-06)	7.4(-1)	9.70(-10)	-	-	-	-
Te-132	3.7(-3)	5.94(-05)	3.7(-3)	4.85(-12)	-	-	-	-
I-132	3.1(-4)	6.12(-05)	4.3(-4)	5.64(-13)	8.35(-6)	0	8.35(-6)	1.09(-14)
I-133	3.1(-3)	1.45(-06)	3.1(-3)	4.06(-12)	4.60 (-3)	1.76 (-4)	4.60(-3)	6.03(-12)
Xe-133	6.1(1)	0	6.1(1)	7.99 (-08)	-	-	-	-
Te-134	1.1(-5)	*	1.1(-5)	1.44(-14)	-	-	-	-

ARKANSAS NUCLEAR ONE
Unit 2

Table 11.2-15A (continued)

Isotope	Unit 2				Unit 1			
	LWS**	SG Blowdown	Total Unit 2	Circulating Water Activity***	LWS	Regenerative Waste	Total Unit 1	Circulating Water Activity***
I-134	1.6(-4)	8.70(-21)	1.6(-4)	2.10(-13)	0	0	0	0
Cs-134	7.6(-3)	3.58(-04)	8.0(-3)	1.05(-11)	8.13(-3)	1.02(-3)	9.15(-3)	1.20(-11)
I-135	1.0(-3)	4.56(-14)	1.0(-3)	1.31(-12)	1.72(-3)	2.74(-7)	1.72(-3)	2.25(-12)
Xe-135	9.1(-10)	6.37(-11)	9.7(-10)	1.27(-18)	-	-	-	-
Cs-136	7.6(-4)	3.17(-05)	7.9(-4)	1.04(-12)	1.73(-3)	1.20(-4)	2.93(-3)	3.84(-12)
Cs-137	3.2(-2)	1.50(-03)	3.4(-2)	4.46(-11)	9.15(-2)	1.18(-2)	4.56(-1)	5.98(-10)
Xe-138	*	0	*	*	-	-	-	-
Cs-138	2.9(-4)	9.73(-21)	2.9(-4)	3.80(-13)	0	0	0	0
Ba-140	1.8(-4)	6.07(-06)	1.8(-4)	2.36(-13)	1.62(-4)	1.37(-5)	1.62(-4)	2.12(-13)
La-140	1.5(-5)	6.94(-06)	2.2(-5)	2.88(-14)	3.73(-4)	1.27(-7)	3.73(-4)	4.89(-13)
Pr-143	2.4(-4)	5.12(-06)	2.4(-4)	3.15(-13)	-	-	-	-
Ce-144	2.5(-4)	5.71(-06)	2.5(-4)	3.28(-13)	7.85(-6)	1.35(-6)	9.20(-6)	1.21(-14)
Co-60	1.9(-3)	4.33(-06)	1.9(-3)	2.49(-12)	9.51(-4)	1.14(-5)	1.07(-3)	1.40(-12)
Fe-59	8.8(-5)	1.99(-07)	8.8(-5)	1.15(-13)	2.68(-5)	2.95(-7)	2.68(-5)	3.51(-14)
Co-58	1.5(-2)	3.48(-05)	1.5(-2)	1.97(-11)	1.54(-3)	1.76(-5)	1.54(-3)	2.02(-12)
Mn-54	1.8(-4)	4.22(-07)	1.8(-4)	2.36(-13)	3.18(-5)	4.00(-7)	3.18(-5)	4.17(-14)
Cr-51	6.9(-3)	1.54(-05)	6.9(-3)	9.04(-12)	2.09(-4)	2.18(-6)	2.09(-4)	2.74(-13)
Zr-95	7.9(-5)	3.61(-07)	7.9(-5)	1.04(-13)	2.01(-3)	2.28(-5)	2.03(-3)	2.66(-12)

TOTAL Curies Per Year Released:

H-3:	203.6	-			560	-		
Noble Gases:	63.0	-			-	-		
All Others:	0.26	-			.16	.018		

* Denotes Releases less than 10 (-10) curies.

** Discharge from BMS and WMS.

*** In $\mu\text{Ci/cc}$, based on flow rate of 383,000 gpm for 1 year.

The ANO-1 Condenser Replacement (ER 951018D101) resulted in a 2.4% increase in circulating water flow rate. This increase in flow rate provides more dilution water for radiological releases. Therefore, the flow rate stated above is bounding and conservative.

ARKANSAS NUCLEAR ONE

Unit 2

Table 11.2-15B
EXPECTED LIQUID RELEASES FROM THE LIQUID WASTE SYSTEMS
ANTICIPATED OPERATIONAL OCCURENCES
(Curies/Year)

Isotope	Unit 2				Unit 1			
	<u>LWS**</u>	<u>SG Blowdown</u>	<u>Total Unit 2</u>	<u>Circulating Water Activity***</u>	<u>LWS</u>	<u>Regenerative Waste</u>	<u>Total Unit 1</u>	<u>Circulating Water Activity***</u>
H-3	290****	-	290****	3.80(-7)	560	0	560	7.34(-7)
Br-84	5.9(-5)	*	5.9(-5)	7.73(-14)	-	-	-	-
Kr-85m	1.6(-14)	0	1.6(-14)	2.10(-23)	-	-	-	-
Kr-85	6.1	0	6.1	7.99(-9)	-	-	-	-
Kr-87	*	0	*	*	-	-	-	-
Kr-88	*	0	*	*	-	-	-	-
Rb-88	5.1(-3)	*	5.1(-3)	6.68(-12)	0	0	0	0
Rb-89	1.2(-4)	*	1.2(-4)	1.57(-13)	-	-	-	-
Sr-89	1.0(-3)	2.24(-04)	1.2(-3)	1.57(-12)	4.35(-4)	3.42(-3)	3.96(-3)	4.53(-12)
Sr-90	5.5(-5)	1.25(-05)	6.8(-5)	8.91(-14)	3.73(-5)	3.72(-5)	7.45(-5)	9.76(-14)
Y-90	1.4(-4)	1.37(-05)	1.5(-4)	1.97(-13)	5.95(-3)	1.97(-4)	5.97(-3)	7.82(-12)
Sr-91	4.3(-5)	*	4.3 (-5)	5.64(-14)	8.94(-5)	2.04(-4)	2.13(-4)	2.79(-13)
Y-91	4.2(-2)	9.88(-04)	4.2(-2)	5.50(-11)	7.07(-2)	1.59(-4)	7.07(-2)	9.27(-11)
Mo-99	3.1(-1)	4.40(-03)	3.1(-1)	4.06(-10)	6.63(-2)	2.06(-3)	6.63(-2)	8.69(-11)
Ru-103	1.7(-3)	1.78(-04)	1.9(-3)	2.49(-12)	-	-	-	-
Ru-106	8.7(-5)	1.12(-05)	9.8(-5)	1.28(-13)	-	-	-	-
Te-129	7.7 (-5)	*	7.7(-5)	1.01(-13)	-	-	-	-
I-129	2.0(-9)	2.69(-09)	4.7(-9)	6.16(-18)	-	-	-	-
I-131	7.9(-2)	9.50(-02)	1.9(-2)	2.49(-11)	3.21(-2)	8.7(-2)	1.19(-1)	1.56(-10)
Xe-131m	4.0(0)	4.10(-04)	4.0(0)	5.24(-9)	-	-	-	-
Te-132	2.7(-2)	1.77(-03)	2.9(-2)	3.80(-11)	-	-	-	-
I-132	3.5(-3)	1.83(-03)	3.5(-3)	4.59(-12)	3.34(-5)	0	3.34(-5)	4.38(-14)
I-133	6.0(-2)	-	6.0(-2)	7.86(-11)	1.84(-2)	3.52(-3)	1.87(-2)	2.45(-11)
Xe-133	3.5(2)	0	3.5(2)	4.59(-7)	-	-	-	-
Te-134	6.7(-5)	*	6.7(-5)	8.78(-14)	-	-	-	-
I-134	1.0(-3)	2.64(-19)	1.0(-3)	1.31(-12)	0	0	0	0

ARKANSAS NUCLEAR ONE
Unit 2

Table 11.2-15B (continued)

Isotope	Unit 2				Unit 1			
	<u>LWS**</u>	<u>SG Blowdown</u>	<u>Total Unit 2</u>	<u>Circulating Water Activity***</u>	<u>LWS</u>	<u>Regenerative Waste</u>	<u>Total Unit 1</u>	<u>Circulating Water Activity***</u>
Cs-134	4.9(-2)	1.03(-02)	5.9(-2)	7.73(-11)	3.25(-2)	2.04(-2)	5.29(-2)	6.93(-11)
I-135	1.4(-2)	1.37(-12)	1.4(-2)	1.83(-11)	6.88(-3)	5.48(-6)	6.88(-3)	9.02(-12)
Xe-135	5.7(-9)	0	5.7(-9)	7.47(-18)	-	-	-	-
Cs-136	5.2(-3)	9.27(-04)	6.1(-3)	7.99(-12)	6.91(-3)	2.40(-3)	9.31(-3)	1.22(-11)
Cs-137	2.1(-1)	4.35(-02)	2.5(-1)	3.28(-10)	3.66(-1)	2.36(-1)	6.02(-1)	7.89(-10)
Xe-138	*	0	*	*	-	-	-	-
Cs-138	1.6(-3)	2.94(-19)	1.6(-3)	2.10(-12)	0	0	0	0
Ba-140	9.2(-4)	1.82(-04)	1.1(-3)	1.44(-12)	6.48(-4)	2.74(-4)	9.22(-4)	1.21(-12)
La-140	1.8(-4)	2.08(-04)	3.9(-4)	5.11(-13)	1.49(-4)	2.54(-6)	1.49(-4)	1.95(-13)
Pr-143	1.3(-3)	1.53(-04)	1.4(-3)	1.83(-12)	-	-	-	-
Ce-144	1.3(-3)	1.71(-04)	1.5(-3)	1.97(-12)	3.14(-5)	2.70(-5)	5.84(-5)	7.65(-14)
Co-60	2.6(-3)	3.33(-05)	2.6(-3)	3.41(-12)	9.51(-4)	2.28(-4)	1.18(-3)	1.55(-12)
Fe-59	1.2(-4)	1.53(-06)	1.2(-4)	1.57(-13)	2.68(-5)	5.90(-6)	2.74(-5)	2.59(-14)
Co-58	2.1(-2)	2.69(-04)	2.1(-2)	2.75(-11)	1.54(-3)	3.52(-4)	1.57(-3)	2.06(-12)
Mn-54	2.5(-4)	3.25(-06)	2.5(-4)	3.28(-13)	3.18(-5)	8.00(-6)	3.26(-5)	4.27(-14)
Cr-51	9.7(-3)	1.19(-04)	9.8(-3)	1.28(-11)	2.09(-4)	4.36(-5)	2.13(-4)	2.79(-13)
Zr-95	1.1(-4)	2.76(-06)	1.1(-4)	1.44(-13)	2.01(-3)	4.56(-4)	3.07(-3)	2.71(-12)

TOTAL Curies Per Year Released:

H-3:	290.0	-	560	-
Noble Gases:	360.0	-	-	-
All Others:	.84	-	.61	.36

* Denotes Releases less than 10 (-10) curies.

** Discharge from BMS and WMS.

*** In $\mu\text{Ci/cc}$, based on flow rate of 383,000 gpm for 1 year.

**** Based on Li at 99.98 percent Li-7

The ANO-1 Condenser Replacement (ER 951018D101) resulted in a 2.4% increase in circulating water flow rate. This increase in flow rate provides more dilution water for radiological releases. Therefore, the flow rate stated above is bounding and conservative.

ARKANSAS NUCLEAR ONE
Unit 2

Table 11.2-16A

COMPARISON OF LIQUID RELEASES TO 10CFR20 GUIDELINES
NORMAL OPERATION

<u>Isotope</u>	<u>Circulating Water</u> <u>Concentration Unit 2 (μCi/cc)</u>	<u>Circulating Water</u> <u>Concentration Unit 1 & 2 (μCi/cc)</u>	<u>10 CFR 20 Limits</u>	<u>Fraction of</u> <u>10 CFR 20 Limits</u>
H-3	2.67(-07)	1.00(-06)	3.0(-03)	3.33(-4)
Br-84	1.44(-14)	1.44(-14)	*	**
Kr-85m	3.28(-24)	3.28(-24)	**	**
Kr-85	1.97(-09)	1.97(-09)	**	**
Kr-87	*	*	**	**
Kr-88	*	*	**	**
Rb-88	1.31(-12)	1.31(-12)	**	**
Rb-89	3.47(-14)	3.47(-14)	**	**
Sr-89	2.75(-13)	6.42(-13)	3.0(-06)	2.14(-7)
Sr-90	1.44(-14)	2.91(-14)	3.0(-07)	9.70(-8)
Y-90	2.75(-14)	1.98(-12)	2.0(-05)	9.90(-8)
Sr-91	3.54(-15)	4.62(-14)	7.0(-05)	6.60(-10)
Y-91	9.31(-12)	3.25(-11)	3.0(-05)	1.08(-6)
Mo-99	6.16(-11)	8.34(-11)	2.0(-04)	4.17(-7)
Ru-103	3.67(-13)	3.67(-13)	8.0(-05)	4.59(-9)
Ru-106	2.10(-14)	2.10(-14)	1.0(-06)	2.10(-8)
Te-129	1.44(-14)	1.44(-14)	8.0(-04)	1.80(-11)
I-129	2.49(-19)	2.49(-19)	6.0(-08)	4.15(-12)
I-131	7.08(-12)	2.34(-11)	3.0(-07)	7.80(-5)
Xe-131m	9.70(-10)	9.70(-10)	**	**
Te-132	4.85(-12)	4.85(-12)	3.0(-05)	1.62(-7)
I-132	5.64(-13)	5.75(-13)	8.0(-06)	7.19(-8)
I-133	4.06(-12)	1.01(-11)	1.0(-06)	1.01(-5)
Xe-133	7.99(-08)	7.99(-08)	**	**

ARKANSAS NUCLEAR ONE
Unit 2

Table 11.2-16A (continued)

<u>Isotope</u>	<u>Circulating Water. Concentration Unit 2 (μCi/cc)</u>	<u>Circulating Water Concentration Unit 1 & 2 (μCi/cc)</u>	<u>10 CFR 20 Limits</u>	<u>Fraction of 10 CFR 20 Limits</u>
Te-134	1.44(-14)	1.44(-14)	**	**
I-134	2.10(-13)	2.10(-13)	2.0(-05)	1.05(-8)
Cs-134	1.05(-11)	2.25(-11)	9.0(-06)	2.50(-6)
I-135	1.31(-12)	3.56(-12)	4.0(-06)	8.90(-7)
Xe-135	1.27(-18)	1.27(-18)	**	**
Cs-136	1.04(-12)	3.88(-12)	9.0(-05)	4.31(-8)
Cs-137	4.46(-11)	6.34(-10)	2.0(-05)	3.17(-5)
Xe-138	*	*	**	**
Cs-138	3.80(-13)	3.80(-13)	**	**
Ba-140	2.36(-13)	4.48(-13)	3.0(-05)	1.49(-8)
La-140	2.88(-14)	5.18(-13)	2.0(-05)	2.59(-8)
Pr-143	3.15(-13)	3.27(-13)	5.0(-05)	6.40(-9)
Ce-144	3.28(-13)	1.73(-12)	1.0(-05)	1.73(-7)
Co-60	2.49(-12)	3.89(-12)	3.0(-05)	1.30(-7)
Fe-59	1.15(-13)	1.50(-13)	5.0(-05)	3.00(-9)
Co-58	1.97(-11)	2.95(-11)	9.0(-05)	3.28(-7)
Mn-54	2.36(-13)	3.70(-13)	1.0(-04)	3.70(-9)
Cr-51	9.04(-12)	1.31(-11)	2.0(-03)	6.55(-9)
Zr-95	1.04(-13)	2.80(-12)	3.0(-05)	9.33(-8)

* Denotes concentration less than 10(-20) (μCi/cc).

** Not addressed in 10 CFR 20.

ARKANSAS NUCLEAR ONE
Unit 2

Table 11.2-16B
COMPARISON OF LIQUID RELEASES TO 10CFR20 GUIDELINES
ANTICIPATED OPERATIONAL OCCURRENCES

<u>Isotope</u>	<u>Circulating Water</u> <u>Concentration Unit 2 (μCi/cc)</u>	<u>Circulating Water</u> <u>Concentration Unit 1 & 2 (μCi/cc)</u>	<u>10 CFR 20 Limits</u>	<u>Fraction of</u> <u>10 CFR 20 Limits</u>
H-3	3.80(-7)	1.11(-6)	3.0(-03)	3.67(-4)
Br-84	7.73(-14)	7.73(-14)	**	**
Kr-85m	2.10(-23)	2.10(-23)	**	**
Kr-85	7.99(-9)	7.99(-9)	**	**
Kr-87	*	*	**	**
Kr-88	*	*	**	**
Rb-88	6.68(-12)	6.68(-12)	**	**
Rb-89	1.57(-13)	1.57(-13)	**	**
Sr-89	1.57(-12)	6.10(-12)	3.0(-06)	2.03(-6)
Sr-90	8.91(-14)	1.87(-13)	3.0(-07)	6.23(-7)
Y-90	1.97(-13)	8.02(-12)	2.0(-05)	4.01(-7)
Sr-91	5.64(-14)	3.35(-13)	7.0(-05)	4.79(-9)
Y-91	5.50(-11)	1.48(-10)	3.0(-05)	4.93(-6)
M0-99	4.06(-10)	4.93(-10)	2.0(-04)	2.47(-6)
Ru-103	2.49(-12)	2.49(-12)	8.0(-05)	3.11(-8)
Ru-106	1.28(-13)	1.28(-13)	1.0(-06)	1.28(-7)
Te-129	1.01(-13)	1.01(-13)	8.0(-04)	1.26(-10)
I-129	6.16(-18)	6.16(-18)	6.0(-08)	1.03(-10)
I-131	2.49(-11)	1.81(-10)	3.0(-07)	6.03(-4)
Xe-131m	5.24(-9)	5.24(-9)	**	**
Te-132	3.80(-11)	3.80(-11)	3.0(-05)	1.27(-6)
I-132	4.59(-12)	4.63(-12)	8.0(-06)	5.89(-7)
I-133	7.86(-11)	1.03(-10)	1.0(-06)	1.03(-4)
Xe-133	4.59(-7)	4.59(-7)	**	**
Te-134	8.78(-14)	8.78(-14)	**	**

ARKANSAS NUCLEAR ONE
Unit 2

Table 11.2-16B (continued)

<u>Isotope</u>	<u>Circulating Water. Concentration Unit 2 (μCi/cc)</u>	<u>Circulating Water Concentration Unit 1 & 2 (μCi/cc)</u>	<u>10 CFR 20 Limits</u>	<u>Fraction of 10 CFR 20 Limits</u>
I-134	1.31(-12)	1.31(-12)	2.0(-05)	6.55(-8)
Cs-134	7.73(-11)	1.15(-10)	9.0(-06)	1.28(-5)
I-135	1.83(-11)	2.73(-11)	4.0(-06)	6.83(-6)
Xe-135	7.47(-18)	7.47(-18)	**	**
Cs-136	7.99(-12)	2.02(-11)	9.0(-05)	2.24(-7)
Cs-137	3.28(-10)	1.12(-09)	2.0(-05)	5.60(-5)
Xe-138	*	*	**	**
Cs-138	2.10(-12)	2.10(-12)	**	**
Ba-140	1.44(-12)	2.65(-12)	3.0(-05)	8.83(-8)
La-140	5.11(-13)	7.06(-13)	2.0(-05)	3.53(-8)
Pr-143	1.83(-12)	1.91(-12)	5.0(-05)	3.82(-8)
Ce-144	1.97(-12)	3.52(-12)	1.0(-05)	3.52(-7)
Co-60	3.41(-12)	4.96(-12)	3.0(-05)	1.65(-7)
Fe-59	1.57(-13)	1.76(-13)	5.0(-05)	3.52(-9)
Co-58	2.75(-11)	3.16(-11)	9.0(-05)	3.51(-7)
Mn-54	3.28(-13)	4.13(-13)	1.0(-04)	4.13(-9)
Cr-51	1.28(-11)	1.34(-11)	2.0(-03)	6.70(-9)
Zr-95	1.44(-13)	6.82(-12)	3.0(-05)	2.27(-7)

* Denotes concentration less than 10(-20) (μCi/cc).

** Not addressed in 10 CFR 20.

ARKANSAS NUCLEAR ONE
Unit 2

Table 11.2-17
BIOLOGICAL CONCENTRATION FACTORS^(a)

<u>ISOTOPE</u>	<u>FISH</u>	<u>INVERTEBRATES</u>	<u>AQUATIC PLANTS</u>
H-3	1.00 (+00)	1.00 (+00)	1.00 (+00)
Cr-51	2.00 (+02)	2.00 (+03)	4.00 (+03)
Mn-54	8.10 (+01)	3.00 (+05)	1.50 (+05)
Mn-56	8.10 (+01)	3.00 (+05)	1.50 (+05)
Fe-59	1.90 (+02)	2.50 (+04)	6.70 (+03)
Co-58	1.60 (+03)	3.20 (+04)	6.80 (+03)
Co-60	1.60 (+03)	3.20 (+04)	6.80 (+03)
Zn-65	1.70 (+03)	3.40 (+04)	3.20 (+03)
Br-84	1.30 (+02)	1.00 (+02)	8.00 (+02)
Sr-89	1.40 (+01)	5.00 (+02)	2.00 (+02)
Sr-90	1.40 (+01)	5.00 (+02)	2.00 (+02)
Sr-91	1.40 (+01)	5.00 (+02)	2.00 (+02)
Y-90	1.00 (+02)	1.00 (+03)	1.00 (+04)
Y-91m	1.00 (+02)	1.00 (+03)	1.00 (+04)
Y-91	1.00 (+02)	1.00 (+03)	1.00 (+04)
Y-92	1.00 (+02)	1.00 (+03)	1.00 (+04)
Zr-95	1.00 (+02)	1.00 (+03)	1.00 (+04)
Nb-95	3.00 (+04)	1.00 (+02)	1.00 (+03)
Mo-99	1.00 (+02)	1.00 (+02)	1.00 (+02)
Tc-99m	1.00 (+00)	3.00 (+01)	1.00 (+02)
Tc-99	1.00 (+00)	3.00 (+01)	1.00 (+02)
Ru-103	1.00 (+02)	2.00 (+03)	2.00 (+03)
Ru-106	1.00 (+02)	2.00 (+03)	2.00 (+03)
Rh-103m	1.00 (+02)	2.00 (+03)	2.00 (+03)
Ag-110m	3.00 (+03)	3.00 (+03)	2.00 (+02)
Ag-110	3.00 (+03)	3.00 (+03)	2.00 (+02)
Te-132	1.00 (+00)	2.00 (+02)	2.00 (+02)
I-131	9.00 (+00)	3.20 (+02)	6.90 (+01)
I-132	9.00 (+00)	3.20 (+02)	6.90 (+01)
I-133	9.00 (+00)	3.20 (+02)	6.90 (+01)
I-134	9.00 (+00)	3.20 (+02)	6.90 (+01)
I-135	9.00 (+00)	3.20 (+02)	6.90 (+01)
Cs-134	5.00 (+03)	1.00 (+03)	9.10 (+02)
Cs-136	5.00 (+03)	1.00 (+03)	9.10 (+02)
Cs-137	5.00 (+03)	1.00 (+03)	9.10 (+02)
Cs-138	5.00 (+03)	1.00 (+03)	9.10 (+02)
Ba-140	1.00 (+01)	2.00 (+02)	5.00 (+02)
La-140	1.00 (+02)	1.00 (+03)	1.00 (+04)
Ce-141	8.10 (+01)	1.10 (+03)	3.20 (+03)
Ce-144	8.10 (+01)	1.10 (+03)	3.20 (+03)
Nd-144	1.00 (+02)	1.00 (+03)	1.00 (+04)

(a) References 6, 20, 24, 28, 29 and 32.

ARKANSAS NUCLEAR ONE
Unit 2

Table 11.2-18

DOSE CONVERSION CONSTANTS FOR DEPOSITED SEDIMENTS^(a)

<u>ISOTOPE</u>	<u>mrem/yr</u> <u>mCi/km²</u>	<u>ISOTOPE</u>	<u>mrem/yr</u> <u>mCi/k m²</u>
H-3	0.0	Ru-103	7.40 (-02)
Cr-51	4.60 (-03)	Ru-106	4.20 (-02)
Mn-54	1.20 (-01)	Rh-103m	3.95 (-03)
Mn-56	2.50 (-01)	Ag-110m	3.90 (-01)
Fe-59	1.60 (-01)	Ag-110	0.0
Co-58	1.20 (-01)	Te-132	4.10 (-02)
Co-60	3.40 (-01)	I-131	6.30 (-02)
Zn-65	7.60 (-02)	I-132	3.20 (-01)
Br-84	2.97 (-01)	I-133	8.90 (-02)
Sr-89	0.0	I-134	3.95 (-01)
Sr-90	0.0	I-135	4.40 (-01)
Sr-91	1.35 (-01)	Cs-134	2.30 (-01)
Y-90	0.0	Cs-136	3.30 (-01)
Y-91m	9.12 (-02)	Cs-137	8.40 (-02)
Y-91	0.0	Cs-138	3.16 (-01)
Y-92	3.95 (-02)	Ba-140	4.01 (-01)
Zr-95	3.50 (-01)	La-140	3.70 (-01)
Nb-95	1.27 (-01)	Ce-141	1.30 (-02)
Mo-99	1.90 (-02)	Ce-144	7.50 (-03)
Tc-99m	2.41 (-02)	Nd-144	0.0
Tc-99	2.41 (-02)		

(a) Reference 25.

Table 11.2-19

CONSUMPTION RATES OF WATER AND BIOTA BY MAN

	<u>Maximum Individual</u>	<u>Average Individual</u>
Consumption of water*, gm/day	~2200	~1000
Consumption of fish, gm/day	100	25
Consumption of aquatic plants, gm/day	0	0
Consumption of invertebrates, gm/day	0	0
Exposure time on shore, hr/yr	500	50
Exposure time swimming, hr/yr	240	30

* Only for dose calculations. No water is consumed from the Arkansas River between and including the Dardanelle Reservoir down to the Mississippi River.

ARKANSAS NUCLEAR ONE
Unit 2

Table 11.2-20

ANNUAL DOSES TO AVERAGE INDIVIDUAL
mrem/yr

<u>Exposure Pathway</u>	Unit 2					Unit 1 & 2				
	<u>Whole Body</u>	<u>Bone</u>	<u>Internal Organs</u>	<u>Infant Thyroid</u>	<u>Adult Thyroid</u>	<u>Whole Body</u>	<u>Bone</u>	<u>Internal Organs</u>	<u>Infant Thyroid</u>	<u>Adult Thyroid</u>
<u>Normal Releases</u>										
Drinking Water	5.0(-4)	3.5(-5)	5.5(-4)	4.5(-4)	1.5(-4)	2.0(-3)	4.2(-4)	2.4(-3)	1.5(-3)	5.0(-4)
Fish Consumption	2.4(-3)	4.1(-3)	7.0(-3)	1.0(-4)	3.4(-5)	2.4(-2)	5.0(-2)	7.0(-2)	3.3(-4)	1.1(-4)
Exposure to Contaminated Sediment	1.3(-2)	1.3(-2)	1.3(-2)	1.3(-2)	1.3(-2)	1.7(-1)	1.7(-1)	1.7(-1)	1.7(-1)	1.7(-1)
Submersion in Water	4.9(-6)	5.1(-7)	5.1(-7)	5.1(-7)	5.1(-7)	1.9(-5)	2.6(-6)	2.6(-6)	2.6(-6)	2.6(-6)
TOTAL	1.6(-2)	1.7(-2)	2.1(-2)	1.4(-2)	1.3(-2)	2.0(-1)	1.7(-1)	2.4(-1)	1.7(-1)	1.7(-1)
<u>Anticipated Operational Occurrence</u>										
Drinking Water	8.2(-4)	2.6(-4)	1.1(-3)	2.7(-3)	9.1(-4)	2.4(-3)	8.2(-4)	3.3(-3)	1.1(-2)	3.9(-3)
Fish Consumption	1.7(-2)	3.0(-2)	5.0(-2)	6.0(-4)	2.1(-4)	4.9(-2)	1.0(-1)	1.5(-1)	2.6(-3)	8.5(-4)
Exposure to Contaminated Sediment	9.1(-2)	9.1(-2)	9.1(-2)	9.1(-2)	9.1(-2)	3.0(-1)	3.0(-1)	3.0(-1)	3.0(-1)	3.0(-1)
Submersion in Water	9.8(-6)	3.0(-6)	3.0(-6)	3.0(-6)	3.0(-6)	2.6(-5)	6.7(-6)	6.7(-6)	6.7(-6)	6.7(-6)
TOTAL	1.1(-1)	1.2(-1)	1.4(-1)	9.4(-2)	9.2(-2)	3.5(-1)	4.0(-1)	4.5(-1)	3.1(-1)	3.0(-1)

ARKANSAS NUCLEAR ONE
Unit 2

Table 11.2-21
ANNUAL DOSES TO MAXIMUM INDIVIDUAL
mrem/yr

<u>Exposure Pathway</u>	<u>Unit 2</u>					<u>Unit 1 & 2</u>				
	<u>Whole Body</u>	<u>Bone</u>	<u>Internal Organs</u>	<u>Infant Thyroid</u>	<u>Adult Thyroid</u>	<u>Whole Body</u>	<u>Bone</u>	<u>Internal Organs</u>	<u>Infant Thyroid</u>	<u>Adult Thyroid</u>
<u>Normal Releases</u>										
Drinking Water	1.1(-3)	7.8(-5)	1.2(-3)	1.0(-3)	3.3(-4)	4.4(-3)	9.2(-4)	5.3(-3)	3.2(-3)	1.1(-3)
Fish Consumption	4.7(-3)	8.2(-3)	1.4(-2)	2.0(-4)	6.8(-5)	4.7(-2)	1.0(-1)	1.4(-1)	6.5(-4)	2.2(-4)
Exposure to Contaminated Sediment	5.6(-2)	5.6(-2)	5.6(-2)	5.6(-2)	5.6(-2)	7.1(-1)	7.1(-1)	7.1(-1)	7.1(-1)	7.1(-1)
Submersion in Water	2.1(-5)	2.2(-6)	2.2(-6)	2.2(-6)	2.2(-6)	8.1(-5)	1.1(-5)	1.1(-5)	1.1(-5)	1.1(-5)
TOTAL	6.3(-2)	6.6(-2)	8.1(-2)	6.4(-2)	5.8(-2)	7.7(-1)	8.4(-1)	8.9(-1)	7.4(-1)	7.2(-1)
<u>Anticipated Operational Occurrence</u>										
Drinking Water	1.8(-3)	5.7(-4)	2.5(-3)	6.0(-3)	2.0(-3)	5.3(-3)	1.8(-3)	7.3(-3)	2.5(-2)	8.5(-3)
Fish Consumption	3.4(-2)	6.0(-2)	9.9(-2)	1.2(-3)	4.1(-3)	9.8(-2)	1.9(-1)	2.9(-1)	5.2(-3)	1.7(-3)
Exposure to Contaminated Sediment	3.9(-1)	3.9(-1)	3.9(-1)	3.9(-1)	3.9(-1)	1.3(0)	1.3(0)	1.3(0)	1.3(0)	1.3(0)
Submersion in Water	4.2(-5)	1.3(-5)	1.3(-5)	1.3(-5)	1.3(-5)	1.1(-4)	2.9(-5)	2.9(-5)	2.9(-5)	2.9(-5)
TOTAL	4.3(-1)	4.6(-1)	5.2(-1)	4.4(-1)	4.0(-1)	1.4(0)	1.5(0)	1.6(0)	1.5(0)	1.3(0)

Table 11.2-22
ANNUAL POPULATION DOSE FROM LIQUID EFFLUENTS
(mrem/yr)

<u>Pathway</u>	<u>Normal Operation</u>		<u>Anticipated Operational Occurrences</u>	
	<u>Unit 2</u>	<u>Unit 1 & 2</u>	<u>Unit 2</u>	<u>Unit 1 & 2</u>
Drinking water	1.2 (-2)	4.8 (-2)	2.0 (-2)	5.8 (-2)
Fish Consumption	3.2 (-1)	3.2	2.3	5.3
Exposure to Contaminated Sediment	1.7	2.3 (+1)	1.2 (+1)	4.0 (+1)
Submersion in Water	<u>3.8 (-5)</u>	<u>1.5 (-4)</u>	<u>7.6 (-5)</u>	<u>2.0 (-3)</u>
TOTAL	2.0	2.6 (+1)	1.4 (+1)	4.5 (+1)

ARKANSAS NUCLEAR ONE
Unit 2

Table 11.2-23

DESIGN DATA FOR REGENERATIVE WASTE PROCESSING SYSTEM COMPONENTS

<u>Component</u>	<u>Regenerative Waste Tanks</u>	<u>Regenerative Waste Transfer Pumps</u>	<u>Regenerative Waste Discharge Pumps</u>	<u>RWPS Evaporator Feed Pumps*</u>
Equipment No.	2T92A, B & C	2P-134A & B	2P-135A & B	2P-146A & B
Quantity	3	2	2	2
Type	Vertical/Atmospheric	Centrifugal	Centrifugal	Centrifugal
Capacity	30,000 gal.	100 gpm	100 gpm	40 gpm
Materials of Construction	Type 316 S.S.	Type 316 S.S.	Type 316 S.S.	Type 316 S.S.
Design Code	API Std. 650	None	None	None
<u>Component</u>	<u>RWPS Evaporator*</u>	<u>RWPS Evaporator Heater*</u>	<u>RWPS Evaporator Condenser Sub-Cooler*</u>	
Equipment No.	2M89A & B	2E81A & B	2E82A & B	
Quantity	2	2	2	
Type	Vertical Force Circulation	Vertical Shell & Tube Hx	Vertical Shell & Tube HX	
Design Pressure/Temp	30 psig to F.V./270 °F	Tube- 30 psig to F.V./300 °F Shell- 75 psig to F.V./300 °F	Tube – 150 psig/150 °F Shell- 30 psig/270 °F	
Capacity	10 gpm	5,850,000 Btu/hr	5,850,000 Btu/hr	
Materials of Construction	Type 316L S.S.	Heads-Type 316L S.S. Tube - Incoly 825 Shell - C.S.	Heads - C.S. Tubes - Type 304L S.S. Shell - Type 304L S.S.	
Design Code	ASME VIII	ASME VIII TEMA R	ASME VIII TEMA R	
<u>Component</u>	<u>RWPS Evaporator Recirculation Pump*</u>	<u>RWPS Evaporator Distillate Pump*</u>	<u>RWPS Evaporator Condensate Pump*</u>	
Equipment No.	2P-152A & B	2P-153A & B	2P-154A & B	
Quantity	2	2	2	
Type	Centrifugal	Centrifugal	Centrifugal	
Design Pressure/Temp	9 psig/250 °F	150 ft/180 °F	150 ft/260 °F	
Capacity	3000 gpm	40 gpm	26 gpm	
Materials of Construction	Type 316 S.S.	Type 316 S.S.	Ductile Iron	
Design Code	None	None	None	

* Currently not in use.

ARKANSAS NUCLEAR ONE
Unit 2

Table 11.2-24

REGENERATIVE WASTE EVAPORATOR SYSTEM PROCESS FLOWS

<u>Normal Operation</u>	<u>Unit 1*</u>	<u>Unit 2**</u>
High TDS waste	3170 gpd	760 gpd
Low TDS waste	3170 gpd	2270 gpd
<u>Anticipated Operational Occurrences</u> (Design Basis)***		
High TDS waste	3170 gpd	1220 gpd
Low TDS waste	3170 gpd	2440 gpd

- * Unit 1 Normal Operation and Anticipated Operational Occurrences as defined in Section 11.2.6.4.3 with no condenser tube leakage.
- ** Unit 2 Normal Operation and Anticipated Operational Occurrences as defined in Section 11.2.6.2 with no condenser tube leakage.
- *** Anticipated Operational Occurrences used as design basis with 35 percent duty factor for both evaporators.

ARKANSAS NUCLEAR ONE
Unit 2

Table 11.3-1

GASEOUS WASTE SYSTEM FLOW DATA POINTS - NORMAL OPERATION
Normal Operational Nuclide Concentration for 0.25 Percent Failed Fuel ($\mu\text{Ci/cc}$)

Location numbers described below. Numbers in parentheses denote powers of 10.

<u>Location No.</u>	<u>1</u>	<u>2</u>	<u>3</u>	<u>4</u>	<u>5</u>	<u>6</u>
Flow, scf/yr	1.26 (4)	2.8 (3)	1.05 (3)	120.4	3.16 (3)	80-420
Pressure, psig	.5-7	.5-7	.5-7	.5-7	.5-7	.5-7
Temperature, °F	70-120	70-120	70-120	70-120	70-120	70-120
Kr-85m	2.1 (-1)	1.1 (1)	*	*	1.6 (-1)	1.8
Kr-85**	2.1 (-1)	1.1 (1)	2.4(-1)	*	1.9(-1)	1.8
Kr-87**	1.2 (-1)	6.0	*	*	5.9 (-2)	9.3 (-1)
Kr-88**	3.7 (-1)	2.0 (1)	*	*	2.5 (-1)	3.0
Xe-131m**	1.7(-1)	9.6	1.2 (-1)	*	1.4 (-1)	1.5
Xe-133**	2.7 (1)	1.5 (3)	9.7	*	2.2 (1)	2.3 (2)
Xe-135**	2.3 (-1)	4.4 (1)	1.4 (-10)	*	5.9 (-1)	6.4
Xe-138**	5.2 (-2)	2.8	*	*	9.6 (-3)	4.5 (-1)
I-129**	1.4 (-12)	5.7 (-12)	1.7 (-14)	2.4 (-11)	7.4 (-16)	1.7 (-12)
I-131**	6.4 (-5)	2.3 (-4)	3.2 (-7)	1.0 (-3)	3.4 (-8)	7.3 (-5)
I-132**	2.0 (-5)	4.3 (-6)	*	1.1 (-4)	7.5 (-9)	1.4 (-5)
I-133**	9.2 (-5)	1.4 (-4)	3.4 (-10)	9.2 (-4)	4.5 (-8)	7.7 (-5)
I-134**	9.8 (-6)	9.6 (-7)	*	4.7 (-5)	2.5 (-9)	6.4 (-6)
I-135**	4.2 (-5)	2.4 (-5)	*	3.0 (-4)	1.9 (-8)	3.0 (-5)
<u>Location No.</u>	<u>7</u>	<u>8</u>	<u>9</u>	<u>10</u>	<u>11</u>	<u>12</u>
Flow, scf/yr	1.97 (04)	1.97 (04)	1.97 (04)	1.97 (04)	1.97 (04)	1.54 (07)
Pressure, psig	0.5-7	10-345	10-345	10	<0.1	<0.1
Temperature, °F	70-120	70-110	80	80	80	70-120
Kr-85m**	1.8	1.8	1.8	*	*	1.7 (-5)
Kr-85**	1.8	1.8	1.8	1.8	1.8	3.1 (-5)
Kr-87**	9.3 (-1)	9.3 (-1)	9.3 (-1)	*	*	2.8 (-6)
Kr-88**	3.0	3.0	3.0	*	*	1.7(-5)
Xe-131m**	1.5	1.5	1.5	2.5 (-1)	2.5 (-1)	3.0 (-5)
Xe-135**	6.4	6.4	6.4	*	*	7.4 (-5)
Xe-138**	4.5 (-1)	4.5 (-1)	4.5 (-1)	*	*	3.0 (-7)
I-129**	1.7 (-12)	1.7 (-12)	1.7 (-12)	1.7 (-12)	1.7 (-12)	1.0 (-15)
I-131**	7.3 (-5)	7.3 (-5)	7.3 (-5)	5.5 (-6)	5.5 (-6)	2.0 (-8)
I-132**	1.4 (-5)	1.4 (-5)	1.4 (-5)	*	*	1.9 (-12)
I-133**	7.7 (-5)	7.7 (-5)	7.7 (-5)	3.8 (-15)	3.8 (-15)	2.3 (-11)
I-134**	6.4 (-6)	6.4 (-6)	6.4 (-6)	*	*	3.7 (-14)
I-135**	3.0 (-5)	3.0 (-5)	3.0 (-5)	*	*	9.3 (-13)

* Denotes concentrations of less than 10^{-20} $\mu\text{Ci/cc}$

** Activity values $\mu\text{Ci/cc}$ calculated at standard temperature and pressure

ARKANSAS NUCLEAR ONE
Unit 2

Table 11.3-1 (continued)

Gaseous Waste System Process Data Point Locations

- | | |
|---------------------------------|---------------------------------|
| 1. Reactor Drain Tank vent | 7. Waste Gas Surge Tank inlet |
| 2. Vacuum Degasifier pump | 8. Waste Gas Surge Tank outlet |
| 3. Boric Acid Concentrator vent | 9. Waste Gas Decay Tank inlet |
| 4. Waste Concentrator vent | 10. Waste Gas Decay Tank outlet |
| 5. Volume Control Tank vent | 11. Waste Gas System discharge |
| 6. Gas Analyzer | 12. Gas Collection Header |

Note: Information in this table represents the original system design and has not been updated to reflect operating experience.

ARKANSAS NUCLEAR ONE
Unit 2

Table 11.3-2

GASEOUS WASTE SYSTEM FLOW DATA POINTS - ANTICIPATED OPERATIONAL OCCURRENCES

Anticipated Operational Nuclide Concentrations for One Percent Failed Fuel (μCi/cc)

Process data point location numbers are described in Table 11.3-1. Numbers in parentheses denote powers of 10.

<u>Location No.</u>	<u>1</u>	<u>2</u>	<u>3</u>	<u>4</u>	<u>5</u>	<u>6</u>
Flow, scf/yr	1.26 (04)	4.05 (03)	1.61 (03)	1.20 (02)	5.31 (03)	80-430
Pressure, psig	0.5-7	0.5-7	0.5-7	0.5-7	0.5-7	0.5-7
Temperature, °F	70-120	70-120	70-120	70-120	70-120	70-120
Kr-85m**	8.4 (-1)	5.0 (-1)	*	*	7.3 (-1)	9.1
Kr-85**	5.3 (-1)	3.2 (1)	6.5 (1)	*	5.5 (-1)	6.0
Kr-87**	4.5 (-1)	2.7 (1)	*	*	2.7 (-1)	4.9
Kr-88**	1.5	8.7 (1)	*	*	1.2	1.6 (1)
Xe-131m**	5.9	3.5 (1)	4.0 (-1)	*	5.5 (-1)	6.4
Xe-133**	9.8 (1)	5.9 (3)	3.1 (1)	*	9.4 (1)	1.1 (3)
Xe-135**	8.7 (-1)	1.9 (2)	*	*	2.7	3.1 (1)
Xe-138**	2.0 (-1)	1.2 (1)	*	*	4.5 (-2)	2.2
I-129**	5.6 (-12)	1.6 (-11)	4.5 (-14)	5.6 (-10)	3.4 (-15)	7.0 (-12)
I-131**	2.5 (-4)	6.3 (-4)	8.8 (-2)	2.3 (-2)	1.6 (-4)	3.0 (-4)
I-132**	8.1 (-5)	1.3 (-5)	*	1.0 (-3)	3.5 (-7)	4.8 (-5)
I-133**	3.6 (-4)	4.0 (-4)	9.3 (-10)	1.8 (-2)	2.1 (-7)	3.1 (-4)
I-134**	3.9 (-5)	3.2 (-6)	*	3.0 (-4)	1.2 (-8)	2.2 (-5)
I-135**	1.7 (-4)	6.8 (-5)	*	4.2 (-3)	9.0 (-8)	1.1 (-4)
<u>Location No.</u>	<u>7</u>	<u>8</u>	<u>9</u>	<u>10</u>	<u>11</u>	<u>12</u>
Flow, scf/yr.	2.37(04)	2.37 (04)	2.37 (04)	2.37 (04)	2.37 (04)	1.54 (07)
Pressure, psig	0.5-7	10-345	10-345	10	< 0.1	< 0.1
Temperature, °F	70-120	70-110	80	80	80	70-120
Kr-85m**	9.1	9.1	9.1	*	*	5.0 (-5)
Kr-85**	6.0	6.0	6.0	6.0	6.0	9.5 (-5)
Kr-87**	4.9	4.9	4.9	*	*	1.1 (-5)
Kr-88**	1.6 (1)	1.6 (1)	1.6 (1)	*	*	6.5 (-7)
Xe-131m**	6.4	6.4	6.4	1.1	1.1	8.4 (-5)
Xe-133**	1.1 (3)	1.1 (3)	1.1 (3)	2.1 (1)	2.1 (1)	1.5 (-2)
Xe-135**	3.1 (1)	3.1 (1)	3.1 (1)	*	*	2.8 (-4)
Xe-138**	2.2	2.2	2.2	*	*	1.2 (-6)
I-129**	7.0 (-12)	7.0 (-12)	7.0 (-12)	7.0 (-12)	7.0 (-12)	4.2 (-15)
I-131**	3.0 (-4)	3.0 (-4)	3.0 (-4)	2.2 (-5)	2.2 (-5)	7.9 (-8)
I-132**	4.8 (-5)	4.8 (-5)	4.8 (-5)	*	*	7.4 (-12)
I-133**	3.1 (-4)	3.1 (-4)	3.1 (-4)	1.5 (-14)	1.5 (-14)	1.0 (-10)
I-134**	2.2 (-5)	2.2 (-5)	2.2 (-5)	*	*	1.5 (-13)
I-135**	1.1 (-4)	1.1 (-4)	1.1 (-4)	*	*	3.7 (-12)

* Denotes concentrations less than 10⁻²⁰ μCi/cc

** Activity values μCi/cc calculated at standard temperature and pressure

Note: Information in this table represents the original system design and has not been updated to reflect operating experience.

ARKANSAS NUCLEAR ONE
Unit 2

Table 11.3-3

COMPONENT DATA FOR GASEOUS WASTE SYSTEM

1.	<u>Waste Gas Compressor</u>	
	Type	Positive Displacement
	Quantity	2
	Capacity, scfm	10
	Discharge pressure, psig	350
	Codes	Manufacturer Standard
	Materials	Ductile Iron
	Design Temperature, °F	175 - Inlet; 350 – Outlet
	Design Pressure, psig	400
2.	<u>Compressor Aftercooler</u>	
	Type	Shell and Tube
	Quantity	2
	Codes: gas side	ASME VIII
	shell side	ASME VIII
	Materials	Stainless Steel
	Discharge Temperature, °F	120 maximum
3.	<u>Gas Surge Tank</u>	
	Type	Vertical
	Quantity	1
	Volume, ft ³	10
	Design Pressure, psig	40
	Design Temperature, °F	200
	Codes	ASME VII, Div. 1
	Material	Carbon Steel
4.	<u>Gas Decay Tank</u>	
	Type	Vertical
	Quantity	3
	Volume, each, ft ³	300
	Design Pressure, psig	380
	Design Temperature, °F	250
	Codes	ASME VIII, Div. 1
	Materials	Carbon Steel

ARKANSAS NUCLEAR ONE
Unit 2

Table 11.3-4

GAS COLLECTION HEADER SOURCE POINTS

1. Waste Condensate Ion Exchangers Vent *
2. Boric Acid Condensate Tanks Vent
3. Boric Acid Condensate Ion Exchangers Vent
4. Preconcentrator Ion Exchangers Vent
5. Holdup Tanks Vent
6. Fuel Pool Ion Exchanger Vent
7. ABS Vent
8. Boric Acid Concentrator *
9. Charging Pump Stuffing Box Vent
10. Purification Filter Vent
11. CVCS Ion Exchangers Vent
12. Boric Acid Makeup Tank Vents (2)
13. Volume Control Tank Gas Relief
14. Waste Concentrator Vent *
15. Waste Tank Vents (2)
16. Waste Condensate Tanks Vent
17. Spent Resin Tank Vent
18. Concentrator Bottoms Storage Tank Vent *
19. Vacuum Degasifier
20. Waste Gas Monitoring System
21. Waste Gas Tanks

* Currently not in use.

ARKANSAS NUCLEAR ONE

Unit 2

Table 11.3-5A

ESTIMATED ANNUAL GASEOUS RELEASES, NORMAL OPERATION (Ci/Yr)

<u>Isotope</u>	<u>Unit 2</u>							<u>UNIT 2 TOTAL</u>
	<u>Gas Surge Header**</u>	<u>Gas Collection Header</u>	<u>Containment Purge</u>	<u>Auxiliary Building Vent</u>	<u>Vacuum Pump Exhaust</u>	<u>Turbine Gland Seal Exhaust</u>	<u>Turbine Building Exhaust</u>	
Kr-85m	*	7.5	4.43 (-02)	1.31 (+01)	8.52	3.48 (-03)	1.28 (-03)	2.92 (01)
Kr-85	1.0 (+03)	1.32 (+01)	1.46 (+01)	1.28 (+01)	8.32	3.40 (-03)	1.24 (-03)	1.05 (03)
Kr-87	*	1.2	6.90 (-03)	7.12	4.57	1.87 (-03)	6.84 (-04)	1.29 (01)
Kr-88	*	7.1	4.92 (-02)	2.30 (+01)	1.48 (+01)	6.07 (-03)	2.22 (-03)	4.50 (01)
Xe-131m	1.4 (+02)	1.3 (+01)	2.27	1.05 (+01)	6.79	2.77 (-03)	1.02 (-03)	1.73 (02)
Xe-133	2.5 (+03)	1.81 (+03)	1.61 (+02)	1.66 (+03)	1.08 (+03)	4.42 (-01)	1.62 (-01)	7.21 (03)
Xe-135	*	3.2 (+01)	4.26 (-01)	5.09 (+01)	3.69 (+01)	1.51 (-02)	5.52 (-03)	1.20 (02)
Xe-138	*	1.3 (-01)	7.04 (-04)	3.14	1.95	7.98 (-04)	2.92 (-04)	5.22 (00)
I-129	9.6 (-11)	4.5 (-11)	5.30 (-09)	4.63 (-11)	7.95 (-12)	6.44 (-12)	2.36 (-10)	5.74 (-09)
I-131	3.1 (-04)	8.4 (-04)	3.12 (-02)	2.11 (-03)	3.14 (-04)	2.55 (-04)	9.35 (-03)	4.44 (-02)
I-132	*	8.2 (-08)	1.94 (-03)	6.65 (-04)	4.22 (-05)	3.41 (-05)	1.25 (-03)	3.93 (-03)
I-133	2.1 (-13)	1.0 (-06)	4.61 (-03)	2.98 (-03)	2.09 (-04)	1.70 (-04)	6.23 (-03)	1.42 (-02)
I-134	*	1.6 (-09)	2.25 (-05)	3.19 (-04)	1.66 (-06)	1.34 (-06)	4.92 (-05)	3.94 (-04)
I-135	*	4.0 (-08)	7.07 (-04)	1.38 (-03)	4.32 (-05)	3.51 (-05)	1.29 (-03)	3.46 (-03)
Br-84			9.05 (-07)	2.23 (-05)	2.65 (-07)	2.16 (-07)	7.93 (-06)	3.16 (-05)
Rb-88			5.43 (-05)	2.25 (-05)	1.59 (-07)	1.30 (-06)	4.76 (-05)	1.26 (-05)
Rb-89			1.10 (-07)	5.60 (-07)	3.16 (-09)	2.58 (-08)	9.40 (-07)	1.64 (-06)
Sr-89			3.00 (-05)	4.43 (-08)	2.83 (-08)	2.32 (-07)	8.50 (-06)	3.88 (-05)
Sr-90			2.46 (-06)	2.15 (-09)	1.40 (-09)	1.14 (-08)	4.19(-07)	2.83 (-06)
Sr-91			2.41 (-07)	3.25 (-08)	5.33 (-09)	4.36 (-08)	1.56 (-06)	1.88 (-06)
Y-90			2.62 (-06)	5.55 (-09)	2.92 (-09)	2.39 (-08)	8.75 (-08)	3.53 (-06)
Y-91			1.42 (-04)	2.00 (-07)	1.27 (-07)	1.04 (-06)	3.82 (-05)	1.82 (-04)
Nb-95			4.53 (-05)	4.57 (-08)	2.88 (-08)	2.35 (-07)	8.66 (-06)	5.43 (-05)
Mo-99			5.70 (-04)	1.11 (-05)	5.10 (-06)	4.17 (-05)	1.53 (-03)	2.16 (-03)
Ru-103			2.13 (-05)	3.68 (-08)	2.33 (-08)	1.90 (-07)	6.98 (-06)	2.85 (-05)

ARKANSAS NUCLEAR ONE
Unit 2

Table 11.3-5A (continued)

<u>Isotope</u>	<u>Gas Surge Header**</u>	<u>Gas Collection Header</u>	<u>Containment Purge</u>	<u>Auxiliary Building Vent</u>	<u>Vacuum Pump Exhaust</u>	<u>Turbine Gland Seal Exhaust</u>	<u>Turbine Building Exhaust</u>	<u>UNIT 2 TOTAL</u>
Ru-106			2.07 (-06)	1.96 (-09)	1.37 (-09)	1.04 (-08)	3.82 (-06)	5.90 (-06)
Te-129			1.94 (-07)	2.20 (-07)	5.37 (-09)	4.38 (-08)	1.61 (-06)	2.07 (-06)
Te-132			1.82 (-04)	3.06 (-06)	1.45 (-06)	1.19 (-05)	4.36 (-04)	6.34 (-04)
Te-134			1.24 (-07)	2.31 (-07)	3.58 (-09)	2.92 (-08)	1.07 (-06)	1.46 (-06)
Cs-134			2.04 (-03)	1.86 (-06)	1.20 (-06)	9.86 (-06)	3.60 (-04)	2.41 (-03)
Cs-136			7.32 (-05)	2.92 (-07)	1.74 (-07)	1.43 (-06)	5.25 (-05)	1.28 (-04)
Cs-137			8.81 (-03)	7.69 (-06)	5.00 (-06)	4.09 (-05)	1.50 (-03)	1.04 (-02)
Cs-138			3.19 (-06)	6.03 (-06)	7.30 (-08)	3.98 (-07)	2.19 (-05)	3.18 (-05)
Ba-140			1.32 (-05)	5.63 (-08)	3.34 (-08)	2.74 (-07)	1.00 (-05)	2.36 (-05)
La-140			1.48 (-05)	5.39 (-08)	3.44 (-08)	2.81 (-07)	1.03 (-05)	2.55 (-05)
Pr-143			1.14 (-05)	4.60 (-08)	2.74 (-08)	2.25 (-07)	8.22 (-06)	1.75 (-05)
Ce-144			3.10 (-05)	3.00 (-08)	1.94 (-08)	1.60 (-07)	5.85 (-06)	5.07 (-05)
Cr-51			4.76 (-05)	1.04 (-07)	6.49 (-08)	5.31 (-07)	1.95 (-05)	6.78 (-05)
Mn-54			2.31 (-06)	2.22 (-09)	1.44 (-09)	1.18 (-08)	4.33 (-07)	2.76 (-06)
Co-58			1.52 (-04)	1.99 (-07)	1.28 (-07)	1.05 (-06)	3.82 (-05)	1.82 (-04)
Co-60			2.51 (-05)	2.22 (-08)	1.45 (-08)	1.19 (-07)	4.36 (-06)	2.96 (-05)
Fe-59			7.55 (-07)	1.21 (-09)	7.65 (-10)	6.25 (-09)	2.29 (-07)	9.92 (-07)
Zr-95			3.51 (-05)	4.63 (-08)	6.65 (-10)	1.09 (-08)	3.98 (-07)	3.56 (-05)
TOTAL								
Noble Gases	3,640	1,884	178	1,784	1,162	.476	.173	8,645
Iodine	3.10 (-04)	8.41 (-04)	3.78 (-02)	7.45 (-03)	6.08 (-04)	4.95 (-04)	1.86 (-02)	.0664

* Denotes Releases less than 10^{-20} $\mu\text{Ci/cc}$.

** Historical information representing original system design. The gas surge header is currently isolated and unused.

ARKANSAS NUCLEAR ONE
Unit 2

Table 11.3-5A (continued)

Unit 1

<u>Isotope</u>	<u>Gaseous Radwaste System</u>	<u>Reactor Building Purge</u>	<u>Auxiliary Building Vent</u>	<u>Vacuum Pump Exhaust</u>	<u>Turbine Gland Seal Exhaust</u>	<u>Turbine Building Exhaust</u>	<u>UNIT 1 TOTAL</u>
Kr-85m	*	3.00 (-02)	8.90	5.74	3.60 (-03)	1.36 (-03)	1.47 (01)
Kr-85	1.71 (+03)	3.31 (+01)	2.92 (+01)	1.88 (+01)	1.18 (-02)	4.44 (-03)	1.79 (03)
Kr-87	*	4.83 (-03)	4.98	3.21	2.01 (-03)	7.58 (-03)	8.20 (00)
Kr-88	*	3.43 (-02)	1.60 (+01)	1.03 (+01)	6.47 (-03)	2.44 (-03)	2.63 (01)
Xe-131m	8.48 (+01)	1.81	8.31	5.36	3.36 (-03)	1.26 (-03)	9.85 (01)
Xe-133	1.27 (+03)	1.11 (+02)	1.13 (+03)	7.31 (+02)	4.57 (-01)	1.72 (-01)	3.24 (03)
Xe-135	*	3.05 (-01)	3.17 (+01)	2.05 (+01)	1.28 (-02)	4.84 (-03)	5.25 (01)
Xe-138	*	6.78 (-04)	3.03 (+01)	1.96	1.22 (-03)	4.63 (-04)	3.23 (01)
I-129	*	-	-	-	-	-	-
I-131	*	2.80 (-02)	1.90 (-03)	6.12 (-04)	7.66 (-06)	2.90 (-04)	3.08 (-02)
I-132	*	4.35 (-04)	2.51 (-03)	8.11 (-04)	1.01 (-04)	3.82 (-03)	7.68 (-03)
I-133	8.40 (-07)	3.50 (-03)	2.25 (-03)	7.27 (-04)	9.09 (-05)	3.44 (-03)	1.00 (-02)
I-134	*	1.97 (-05)	2.98 (-04)	9.96 (-05)	1.20 (-05)	4.52 (-04)	8.81 (-04)
I-135	*	8.19 (-04)	1.60 (-03)	5.16 (-04)	5.71 (-04)	2.44 (-03)	5.95 (-04)
Br-84		-	-	-	-	-	-
Rb-88		3.79 (-05)	1.60 (-05)	5.16 (-06)	6.47 (-05)	2.44 (-03)	2.56 (-03)
Rb-89		-	-	-	-	-	-
Sr-89		1.53 (-03)	2.27 (-06)	7.33 (-07)	9.17 (-06)	3.46 (-04)	1.89 (-03)
Sr-90		2.15 (-05)	1.88 (-08)	6.08 (-09)	7.60 (-08)	2.87 (-06)	2.45 (-05)
Sr-91		2.02 (-06)	2.73 (-07)	8.80 (-07)	1.10 (-06)	4.17 (-05)	4.60 (-05)
Y-90		1.93 (-04)	3.73 (-06)	1.21 (-06)	1.51 (-05)	5.71 (-04)	7.84 (-04)
Y-91		4.79 (-04)	6.14 (-07)	2.18 (-07)	2.73 (-06)	1.03 (-04)	6.10 (-04)
Nb-95		-	-	-	-	-	-
Mo-99		1.39 (-03)	2.73 (-05)	8.80 (-06)	9.93 (-05)	3.76 (-03)	5.29 (-03)
Ru-103		-	-	-	-	-	-
Ru-106		-	-	-	-	-	-

ARKANSAS NUCLEAR ONE
Unit 2

Table 11.3-5A (continued)

<u>Isotope</u>	<u>Gaseous Radwaste System</u>	<u>Reactor Building Purge</u>	<u>Auxiliary Building Vent</u>	<u>Vacuum Pump Exhaust</u>	<u>Turbine Gland Seal Exhaust</u>	<u>Turbine Building Exhaust</u>	<u>UNIT 1 TOTAL</u>
Te-129		-	-	-	-	-	-
Te-132		-	-	-	-	-	-
Te-134		-	-	-	-	-	-
Cs-134		1.15 (-02)	1.04 (-05)	3.37 (-06)	4.22 (-05)	1.59 (-03)	1.31 (-02)
Cs-136		7.86 (-04)	3.14 (-06)	1.02 (-06)	1.27 (-05)	4.79 (-04)	1.28 (-03)
Cs-137		1.35 (-01)	1.18 (-04)	3.83 (-05)	4.79 (-04)	1.81 (-02)	1.54 (-01)
Cs-138		2.48 (-06)	4.38 (-05)	1.42 (-06)	1.77 (-05)	6.68 (-04)	7.33 (-04)
Ba-140		8.58 (-06)	3.68 (-08)	1.19 (-07)	1.48 (-06)	7.31 (-05)	8.33 (-05)
La-140		1.24 (-05)	1.24 (-07)	4.02 (-08)	5.03 (-07)	1.81 (-05)	3.07 (-05)
Pr-143		-	-	-	-	-	-
Ce-144		1.65 (-05)	1.60 (-08)	5.16 (-09)	6.47 (-08)	2.44 (-06)	1.91 (-05)
Cr-51		1.62 (-05)	3.55 (-08)	1.15 (-08)	1.44 (-07)	5.41 (-06)	2.21 (-05)
Mn-54		4.18 (-06)	4.03 (-09)	1.30 (-09)	1.63 (-08)	6.14 (-07)	4.81 (-06)
Co-58		1.65 (-04)	2.15 (-07)	6.96 (-08)	8.71 (-07)	3.30 (-05)	1.99 (-04)
Co-60		1.31 (-04)	1.16 (-07)	3.75 (-08)	4.71 (-08)	1.77 (-06)	1.33 (-04)
Fe-59		2.52 (-06)	4.03 (-09)	1.30 (-09)	1.63 (-08)	6.14 (-07)	3.19 (-06)
Zr-95		4.79 (-04)	2.84 (-07)	9.18 (-08)	1.15 (-06)	4.33 (-05)	5.24 (-04)
TOTAL							
Noble Gases	3,065	146	1,259	797	.498	.194	5,262
Iodine	8.40 (-07)	3.15 (-02)	8.56 (-03)	2.77 (-03)	7.75 (-04)	1.04 (-02)	.0551

* Denotes Releases less than 10^{-20} $\mu\text{Ci/cc}$.

ARKANSAS NUCLEAR ONE

Unit 2

Table 11.3-5B

ESTIMATED ANNUAL GASEOUS RELEASES, ANTICIPATED OPERATIONAL OCCURRENCE (Ci/Yr)

Unit 2

Isotope	Gas Surge Header	Gas Collection Header	Containment Purge	Auxiliary Building Vent	Vacuum Pump Exhaust	Turbine Gland Seal Exhaust	Steam Dump		UNIT 2 TOTAL
							and Relief Valve Discharge	Turbine Building Exhaust	
Kr-85m	*	2.17 (+01)	3.47 (-01)	5.14 (+01)	2.56 (+02)	2.09 (-01)	3.19 (-02)	3.84 (-02)	3.30 (02)
Kr-85	4.0 (+03)	4.07 (+01)	7.28 (+01)	3.19 (+01)	1.60 (+02)	1.30 (-01)	1.99 (-02)	2.40 (-02)	4.31 (03)
Kr-87	*	4.57	5.43 (-02)	2.79 (+01)	1.38 (+02)	1.13 (-01)	1.72 (-02)	2.07 (-02)	1.71 (02)
Kr-88	*	2.75 (+01)	3.86 (-01)	9.01 (+01)	4.48 (+02)	3.65	5.58 (-02)	6.71 (-02)	5.70 (02)
Xe-131m	7.60 (+02)	3.60 (+01)	1.55 (+01)	3.55 (+01)	1.77 (+02)	1.45 (-01)	2.20 (-02)	2.65 (-02)	1.02 (03)
Xe-133	1.4 (+04)	6.5 (+03)	1.17 (+03)	6.03 (+03)	3.02 (+04)	2.47 (+01)	3.76 (-02)	4.52	5.79 (04)
Xe-135	*	1.23 (+02)	3.33	1.98 (+02)	1.11 (+03)	9.09 (-01)	1.38 (-01)	1.66 (-01)	1.43 (03)
Xe-138	*	5.10 (-01)	5.56 (-03)	1.24 (+01)	5.92 (+01)	4.85 (-01)	7.39 (-02)	8.88 (-03)	7.72 (01)
I-129	4.7 (-09)	1.8 (-09)	4.13 (-08)	1.80 (-10)	2.38 (-10)	3.87 (-10)	5.88 (-09)	7.09 (-09)	5.71 (-08)
I-131	1.5 (-02)	3.4 (-02)	4.85 (-01)	1.64 (-02)	9.39 (-03)	3.03 (-02)	2.32 (-01)	5.57 (-01)	1.33 (00)
I-132	*	3/2 (-06)	1.50 (-02)	2.61 (-03)	1.26 (-03)	2.04 (-03)	3.14 (-02)	3.73 (-02)	8.96 (-02)
I-133	1.0 (-11)	4.4 (-05)	-	-	9.39 (-03)	-	2.32 (-01)	-	2.41 (-01)
I-134	*	6.3 (-08)	1.77 (-04)	1.26 (-03)	5.01 (-05)	8.12 (-05)	1.24 (-03)	1.49 (-03)	4.30 (-03)
I-135	*	1.6 (-06)	5.53 (-03)	5.41 (-03)	1.30 (-03)	2.11 (-03)	3.21 (-02)	3.87 (-02)	8.52 (-02)
Br-84			7.12 (-06)	8.77 (-05)	8.02 (-06)	1.31 (-05)	1.99 (-04)	2.40 (-04)	3.15 (-04)
Rb-88			3.98 (-04)	8.82 (-06)	6.80 (-07)	1.11 (-05)	1.69 (-04)	2.04 (-04)	5.80 (-04)
Rb-89			8.71 (-07)	2.21 (-06)	9.58 (-08)	1.29 (-06)	2.38 (-05)	2.87 (-05)	2.83 (-05)
Sr-89			2.34 (-04)	1.73 (-07)	8.49 (-07)	1.39 (-05)	1.99 (-04)	2.54 (-04)	4.48 (-04)
Sr-90			1.91 (-05)	8.36 (-09)	4.18 (-08)	6.84 (-07)	1.04 (-05)	1.25 (-05)	3.02 (-05)
Sr-91			1.89 (-06)	1.27 (-07)	1.61 (-07)	2.57 (-06)	4.00 (-05)	4.82 (-05)	4.47 (-05)
Y-90			2.03 (-05)	2.12 (-08)	8.63 (-08)	1.41 (-06)	2.15 (-05)	2.59 (-05)	4.33 (-05)
Y-91			1.06 (-03)	7.50 (-07)	3.68 (-06)	6.01 (-05)	9.17 (-04)	1.10 (-03)	2.04 (-03)
Nb-95			3.48 (-04)	1.77 (-07)	8.86 (-07)	1.40 (-05)	2.13 (-04)	2.57 (-04)	5.76 (-04)
Mo-99			4.38 (-03)	4.28 (-05)	1.51 (-04)	2.46 (-03)	3.75 (-02)	4.52 (-02)	4.45 (-02)
Ru-103			1.66 (-04)	1.43 (-07)	6.96 (-07)	1.14 (-05)	1.73 (-04)	2.09 (-04)	3.51 (-04)

ARKANSAS NUCLEAR ONE
Unit 2

Table 11.3-5B (continued)

<u>Isotope</u>	<u>Gas Surge Header</u>	<u>Gas Collection Header</u>	<u>Containment Purge</u>	<u>Auxiliary Building Vent</u>	<u>Vacuum Pump Exhaust</u>	<u>Turbine Gland Seal Exhaust</u>	<u>Steam Dump and Relief Valve Discharge</u>	<u>Turbine Building Exhaust</u>	<u>UNIT 2 TOTAL</u>
Ru-106			1.61 (-05)	7.63 (-09)	3.80 (-08)	6.22 (-07)	9.49 (-06)	1.14 (-05)	2.63 (-05)
Te-129			1.51 (-06)	8.61 (-07)	1.61 (-07)	2.63 (-06)	4.01 (-05)	4.82 (-05)	4.53 (-05)
Te-132			1.41 (-03)	1.19 (-05)	4.34 (-05)	7.09 (-04)	1.08 (-02)	1.29 (-02)	1.30 (-02)
Te-134			3.79 (-07)	9.12 (-07)	1.09 (-07)	1.78 (-06)	2.71 (-05)	3.25 (-05)	3.01 (-05)
Cs-134			1.53 (-02)	6.95 (-06)	3.47 (-05)	5.69 (-04)	8.66 (-03)	1.04 (-02)	2.46 (-02)
Cs-136			5.54 (-04)	1.11 (-06)	5.08 (-06)	8.31 (-05)	1.27 (-04)	1.53 (-03)	7.70 (-04)
Cs-137			6.67 (-02)	2.92 (-05)	1.46 (-04)	2.38 (-03)	3.62 (-02)	4.36 (-02)	1.05 (-01)
Cs-138			2.50 (-05)	2.37 (-05)	2.20 (-06)	3.60 (-05)	5.49 (-04)	6.60 (-04)	6.36 (-04)
Ba-140			1.03 (-04)	2.19 (-07)	1.00 (-06)	1.65 (-05)	2.50 (-04)	3.00 (-04)	3.70 (-04)
La-140			1.15 (-04)	2.09 (-07)	1.03 (-06)	1.68 (-05)	2.56 (-04)	3.08 (-04)	3.89 (-04)
Pr-143			8.84 (-05)	1.79 (-07)	8.21 (-07)	1.35 (-05)	2.04 (-05)	2.46 (-04)	1.23 (-04)
Ce-144			2.41 (-04)	1.20 (-07)	5.82 (-07)	9.52 (-06)	1.45 (-04)	1.75 (-04)	3.96 (-04)
Cr-51			9.52 (-05)	4.16 (-07)	1.30 (-07)	8.17 (-06)	1.24 (-04)	1.50 (-04)	2.28 (-04)
Mn-54			4.62 (-06)	8.88 (-09)	2.88 (-09)	1.81 (-07)	2.76 (-06)	3.33 (-06)	7.57 (-06)
Co-58			3.04 (-04)	7.96 (-07)	2.56 (-07)	1.60 (-05)	2.45 (-04)	2.95 (-04)	5.66 (-04)
Co-60			5.02 (-05)	8.88 (-08)	2.90 (-08)	1.83 (-06)	2.78 (-05)	3.36 (-05)	7.99 (-05)
Fe-59			1.51 (-06)	4.84 (-09)	1.53 (-09)	9.60 (-08)	1.47 (-06)	1.76 (-06)	3.09 (-06)
Zr-95			2.67 (-04)	1.85 (-07)	8.86 (-07)	1.67 (-07)	1.27 (-06)	3.06 (-06)	2.70 (-04)
TOTALS									
Noble Gases	18,760	6,754	1,262	6,477	32,548	30.4	396	5.21	65,837
Iodines	1.5 (-03)	3.4 (-03)	.506	.026	.021	.035	.528	.634	1.75

* Denotes Releases less than 10^{-20} $\mu\text{Ci/cc}$.

ARKANSAS NUCLEAR ONE

Unit 2

Table 11.3-5B (continued)

Isotope	<u>Unit 1</u>							UNIT 1 TOTAL
	Gaseous Radwaste System	Reactor Building Purge	Auxiliary Building Vent	Vacuum Pump Exhaust	Turbine Gland Seal Exhaust	Steam Dump and Relief Valve Discharge	Turbine Building Exhaust	
Kr-85m	*	2.40 (-01)	3.55 (+01)	1.77 (+02)	2.21 (-01)	2.38 (-03)	4.17 (-02)	2.13 (02)
Kr-85	2.30 (+04)	2.65 (+02)	1.16 (+02)	1.16 (+03)	7.23 (-01)	7.78 (-03)	1.36 (-01)	2.45 (04)
Kr-87	*	3.86 (-02)	1.99 (+01)	9.91 (+01)	1.24		2.34 (-01)	1.21 (02)
Kr-88	*	2.75 (-01)	6.41 (+01)	3.19 (+02)	3.98 (-01)	1.33 (-03)	7.50 (-02)	3.84 (02)
Xe-131m	8.35 (+02)	1.45 (+01)	3.33 (+01)	2.36 (+02)	2.06 (-01)	2.22 (-03)	3.90 (-02)	1.12 (03)
Xe-133	1.09 (+04)	8.85 (+02)	4.52 (+03)	2.87 (+04)	2.81 (+01)	3.03 (-01)	5.30	4.50 (04)
Xe-135	*	2.44	1.27 (+02)	6.61 (+02)	7.90 (-01)	8.48 (-03)	1.49 (-01)	7.91 (02)
Xe-138	*	5.40 (-03)	1.21 (+01)	6.02 (+01)	7.55 (-02)	8.13 (-04)	1.43 (-02)	7.24 (01)
I-129	*	-	-	-	-	-	-	-
I-131	*	2.24 (-01)	7.58 (-03)	1.89 (-02)	4.71 (-03)	5.07 (-03)	8.90 (-02)	3.49 (-01)
I-132	*	3.49 (-03)	1.01 (-02)	2.48 (-02)	6.25 (-03)	6.73 (-03)	1.18 (-01)	1.69 (-01)
I-133	3.36 (-06)	2.80 (-02)	9.01 (-03)	2.24 (-02)	5.60 (-03)	6.03 (-03)	1.06 (-01)	1.79 (-01)
I-134	*	1.57 (-04)	1.19 (-03)	2.95 (-03)	7.36 (-04)	7.91 (-04)	1.39 (-02)	1.97 (-02)
Br-84		-	-	-	-	-	-	-
Rb-88		3.04 (-04)	6.39 (-05)	1.59 (-04)	3.98 (-03)	4.27 (-03)	7.67 (-02)	8.55 (-02)
Rb-89		-	-	-	-	-	-	-
Sr-89		1.72 (-04)	9.07 (-07)	2.26 (-05)	5.66 (-04)	6.07 (-04)	1.07 (-02)	9.70 (-02)
Sr-90		1.61 (-05)	7.52 (-08)	2.87 (-07)	4.68 (-05)	5.03 (-06)	8.82 (-05)	1.57 (-04)
Sr-91		1.67 (-06)	1.09 (-06)	2.71 (-05)	6.79 (-05)	7.30 (-05)	1.28 (-03)	1.45 (-03)
Y-90		1.54 (-03)	1.49 (-05)	3.72 (-05)	9.31 (-04)	1.00 (-03)	1.75 (-02)	2.10 (-02)
Y-91		3.83 (-03)	2.70 (-06)	6.71 (-06)	1.68 (-04)	1.80 (-04)	3.17 (-03)	7.36 (-03)
Nb-95		-	-	-	-	-	-	-
Mo-99		1.11 (-02)	1.09 (-04)	2.71 (-04)	6.79 (-03)	7.30 (-03)	1.29 (-01)	1.54 (-01)
Ru-103		-	-	-	-	-	-	-
Ru-106		-	-	-	-	-	-	-
Te-129		-	-	-	-	-	-	-

ARKANSAS NUCLEAR ONE
Unit 2

Table 11.3-5B (continued)

<u>Isotope</u>	<u>Gaseous Radwaste System</u>	<u>Reactor Building Purge</u>	<u>Auxiliary Building Vent</u>	<u>Vacuum Pump Exhaust</u>	<u>Turbine Gland Seal Exhaust</u>	<u>Steam Dump and Relief Valve Discharge</u>	<u>Turbine Building Exhaust</u>	<u>UNIT 1 TOTAL</u>
Te-132		-	-	-	-	-	-	-
Te-134		-	-	-	-	-	-	-
Cs-134		9.17 (-02)	4.17 (-05)	1.04 (-04)	2.60 (-03)	2.79 (-03)	4.90 (-02)	1.46 (-01)
Cs-136		6.25 (-03)	1.26 (-05)	3.14 (-05)	7.85 (-04)	8.43 (-04)	1.48 (-02)	2.27 (-02)
Cs-137		1.08 (00)	4.74 (-04)	1.18 (-03)	2.95 (-02)	3.17 (-02)	5.55 (-01)	1.70 (00)
Cs-138		1.98 (-05)	1.75 (-05)	4.37 (-05)	1.09 (-03)	1.17 (-03)	2.05 (-02)	2.28 (-02)
Ba-140		6.84 (-04)	1.92 (-06)	3.66 (-06)	1.20 (-04)	9.83 (-05)	1.72 (-03)	2.01 (-03)
La-140		7.14 (-04)	4.98 (-07)	1.24 (-06)	3.08 (-05)	3.3 (-05)	5.85 (-04)	8.38 (-04)
Pr-143		-	-	-	-	-	-	-
Ce-144		1.32 (-04)	6.39 (-08)	1.59 (-07)	3.98 (-06)	4.28 (-06)	7.50 (-05)	2.15 (-04)
Cr-51		3.24 (-05)	1.42 (-07)	3.54 (-07)	8.88 (-06)	9.53 (-05)	1.67 (-04)	3.04 (-04)
Mn-54		8.36 (-06)	1.61 (-08)	4.00 (-08)	1.00 (-06)	1.08 (-06)	1.89 (-05)	2.94 (-05)
Co-58		3.30 (-04)	8.62 (-07)	2.14 (-06)	5.36 (-05)	5.77 (-04)	1.01 (-03)	1.79 (-03)
Co-60		2.60 (-04)	4.64 (-07)	1.15 (-06)	2.90 (-05)	3.11 (-05)	5.44 (-03)	5.76 (-03)
Fe-59		5.04 (-06)	1.61 (-08)	4.00 (-08)	1.00 (-06)	1.08 (-06)	1.89 (-05)	5.79 (-03)
Zr-95		4.20 (-04)	1.14 (-06)	2.83 (-06)	7.06 (-05)	7.60 (-05)	1.33 (-03)	1.90 (-03)
TOTALS								
Noble Gas	34,735	1,167	4,928	31,382	30.9	.325	5.99	72,249
Iodines	3.36 (-06)	.259	.034	.0882	.021	.023	.402	.829

* Denotes Releases less than 10^{-20} $\mu\text{Ci/cc}$.

ARKANSAS NUCLEAR ONE
Unit 2

Table 11.3-6

TOTAL AIR FLOW FROM EACH GASEOUS WASTE DISCHARGE POINT

<u>Release Point</u>	<u>Flow (scfm)</u>
Gas collection header	30
Auxiliary Building exhaust consisting of:	93,400
Fuel handling area exhaust (2VEF-14A or 2VEF-14B)	See P&ID M-2262
Radwaste area exhaust (2VEF-8A or 2VEF-8B)	See P&ID M-2262
Condenser vacuum pump exhaust	25
Containment purge exhaust	40,000
Turbine Building vent exhaust	686,000
Turbine gland seal exhaust	485

Table 11.3-7A

**SITE BOUNDARY AIR CONCENTRATIONS RESULTING FROM ESTIMATED GASEOUS RELEASES
NORMAL OPERATIONS**

(μCi/cc)

<u>Isotope</u>	<u>Unit 2</u>	<u>Unit 1 & 2</u>	<u>Isotope</u>	<u>Unit 2</u>	<u>Unit 1 & 2</u>
Kr-85M	2.6 (-12)	3.9 (-12)	Nb-95	4.8 (-18)	4.8 (-18)
Kr-85	9.3 (-11)	2.5 (-10)	Mo-99	1.9 (-16)	6.6 (-16)
Kr-87	1.1 (-12)	1.9 (-12)	Ru-103	2.5 (-18)	2.5 (-18)
Kr-88	4.0 (-12)	6.3 (-12)	Ru-106	5.2 (-19)	5.2 (-19)
Xe-131M	1.5 (-11)	2.4 (-11)	Te-129	1.8 (-19)	1.8 (-19)
Xe-133	6.4 (-10)	9.3 (-10)	Te-132	5.6 (-17)	5.6 (-17)
Xe-135	1.1 (-11)	1.5 (-11)	Te-134	1.3 (-19)	1.3 (-19)
Xe-138	4.6 (-13)	3.3 (-12)	Cs-134	2.1 (-16)	1.4 (-15)
I-129	5.1 (-22)	5.1 (-22)	Cs-136	1.1 (-17)	1.3 (-16)
I-131	3.9 (-15)	6.7 (-15)	Cs-137	9.2 (-16)	1.5 (-14)
I-132	3.5 (-16)	1.0 (-15)	Cs-138	2.8 (-18)	6.8 (-17)
I-133	1.3 (-15)	2.1 (-15)	Ba-140	2.1 (-18)	9.5 (-18)
I-134	3.5 (-17)	1.1 (-16)	La-140	2.3 (-18)	5.0 (-18)
I-135	3.1 (-16)	3.6 (-16)	Pr-143	1.6 (-18)	1.6 (-18)
Br-84	2.8 (-18)	2.8 (-18)	Ce-144	4.5 (-18)	6.2 (-18)
Rb-88	1.1 (-18)	2.3 (-16)	Cr-51	6.0 (-18)	8.0 (-18)
Rb-89	1.5 (-19)	1.5 (-19)	Mn-54	2.5 (-19)	6.7 (-19)
Sr-89	3.4 (-18)	1.7 (-16)	Co-58	1.6 (-17)	3.4 (-17)
Sr-90	2.5 (-19)	2.4 (-18)	Co-60	2.6 (-18)	1.4 (-17)
Sr-91	1.7 (-19)	4.3 (-18)	Fe-59	8.8 (-20)	3.7 (-19)
Y-90	3.1 (-19)	7.0 (-17)	Zr-95	3.2 (-18)	5.0 (-17)
Y-91	1.6 (-17)	7.0 (-17)			

ARKANSAS NUCLEAR ONE
Unit 2

Table 11.3-7B

**SITE BOUNDARY AIR CONCENTRATIONS RESULTING FROM ESTIMATED GASEOUS RELEASES
ANTICIPATED OPERATIONAL OCCURRENCE**

(μCi/cc)

<u>Isotope</u>	<u>Unit 2</u>	<u>Unit 1 & 2</u>	<u>Isotope</u>	<u>Unit 2</u>	<u>Unit 1 & 2</u>
Kr-85M	2.9 (-11)	4.8 (-11)	Nb-95	5.1 (-17)	5.1 (-17)
Kr-85	3.8 (-10)	2.6 (- 9)	Mo-99	4.0 (-15)	1.8 (-14)
Kr-87	1.5 (-11)	2.6 (-11)	Ru-103	3.1 (-17)	3.1 (-17)
Kr-88	5.1 (-11)	8.5 (-11)	Ru-106	2.3 (-18)	2.3 (-18)
Xe-131M	9.1 (-11)	1.9 (-10)	Te-129	4.0 (-18)	4.0 (-18)
Xe-133	5.1 (- 9)	9.1 (- 9)	Te-132	1.2 (-15)	1.2 (-15)
Xe-135	1.3 (-10)	2.0 (-10)	Te-134	2.7 (-18)	2.7 (-18)
Xe-138	6.5 (-12)	1.3 (-11)	Cs-134	2.2 (-15)	1.5 (-14)
I-129	5.1 (-21)	5.1 (-21)	Cs-136	6.8 (-17)	2.1 (-15)
I-131	1.2 (-13)	1.5 (-13)	Cs-137	9.3 (-15)	1.6 (-13)
I-132	8.0 (-15)	2.3 (-14)	Cs-138	5.6 (-17)	2.1 (-15)
I-133	2.1 (-14)	3.7 (-14)	Ba-140	3.3 (-17)	2.1 (-16)
I-134	3.8 (-16)	2.1 (-15)	La-140	3.5 (-17)	1.1 (-16)
I-135	7.6 (-15)	1.8 (-14)	Pr-143	1.1 (-17)	1.1 (-17)
Br-84	2.8 (-17)	2.8 (-17)	Ce-144	3.5 (-17)	5.4 (-17)
Rb-88	5.1 (-17)	7.6 (-15)	Cr-51	2.0 (-17)	4.7 (-17)
Rb-89	2.5 (-18)	2.5 (-18)	Mn-54	6.7 (-19)	3.3 (-18)
Sr-89	4.0 (-17)	8.7 (-15)	Co-58	5.0 (-17)	2.1 (-16)
Sr-90	2.7 (-18)	1.7 (-17)	Co-60	7.1 (-18)	5.2 (-16)
Sr-91	4.0 (-18)	1.3 (-16)	Fe-59	2.7 (-19)	5.1 (-16)
Y-90	3.8 (-18)	1.9 (-15)	Zr-95	2.4 (-17)	1.9 (-16)
Y-91	1.8 (-16)	8.3 (-16)			

ARKANSAS NUCLEAR ONE
Unit 2

Table 11.3-8

PHYSICAL DATA FOR ISOTOPES

<u>Isotope</u>	<u>Decay Constant^(a), (hr⁻¹)</u>	<u>Gamma Energy^(a), (MeV/Dis)</u>	<u>Beta Energy^(a), (MeV/Dis)</u>	<u>Dose Conversion Factor^(b), (rem/Ci)</u>
I-131	3.59 X 10 ⁻³	0.375	0.207	1.48 X 10 ⁶
I-132	3.01 X 10 ⁻¹	2.30	0.420	5.35 X 10 ⁴
I-133	3.30 X 10 ⁻²	0.513	0.430	4.00 X 10 ⁵
I-134	8.00 X 10 ⁻¹	2.53	0.603	2.50 X 10 ⁴
I-135	1.03 X 10 ⁻¹	1.89	0.302	1.24 X 10 ⁵
Xe-131m	2.45 X 10 ⁻³	0.0291	0.135	
Xe-133	5.48 X 10 ⁻³	0.0486	1.147	
Xe-133m	1.28 X 10 ⁻²	0.0594	0.173	
Xe-135	7.53 X 10 ⁻²	0.249	0.313	
Xe-135m	2.67 X 10 ⁻⁰	0.429	0.0977	
Xe-138	2.45 X 10 ⁻⁰	1.39	0.470	
Kr-85	1.35 X 10 ⁻⁶	0.00211	0.223	
Kr-85m	1.58 X 10 ⁻¹	0.160	0.238	
Kr-87	5.47 X 10 ⁻¹	1.48	0.804	
Kr-88	2.48 X 10 ⁻¹	1.74	0.297	

(a) Reference 30.

(b) Reference 26.

ARKANSAS NUCLEAR ONE
Unit 2

Table 11.3-9

PARAMETERS USED IN INGESTION DOSE ANALYSIS

Consumption rate of milk by adults and infants	1000 cc/day
Consumption rate of green vegetables	1500 g/day
Consumption rate of tuberous or root vegetables	1000 g/day
Consumption rate of meat	200 g/day
Calcium content in vegetables	200 mg Ca/100 g
Calcium content in milk	1.40 g/l

Rate Factors for Milk

Sr-90	$P_r = 0.8 \text{ pCi/gram Ca per mCi/km}^2 \text{ per year}$
	$P_d = 0.3 \text{ pCi/gram Ca per mCi/km}^2 \text{ cumulative deposit}$
Cs-134, Cs-137	$P_r = 3.6 \text{ pCi/1 per mCi/km}^2 \text{ per year}$
	$P_d = 0.65 \text{ pCi/1 per mCi/km}^2 \text{ for the previous 2 yr}$

Rate Factors for Tuberous or Root Vegetables

Sr-90	$P_r = 0$
	$P_d = 1.0 \text{ pCi/gram Ca per mCi/km}^2 \text{ cumulative deposit}$

Rate Factors for Green Vegetables

Sr-90	$P_r = 1.0 \text{ pCi/gram Ca per mCi/km}^2 \text{ per year}$
	$P_d = 1.0 \text{ pCi/gram Ca per mCi/km}^2 \text{ cumulative deposit}$

Rate Factors for Meat

Cs-137	$P_r = 15 \text{ pCi/kg meat per mCi/km}^2 \text{ per year}$
	$P_d = 2.5 \text{ pCi/kg meat per mCi/km}^2 \text{ deposited in the previous 2 yr}$

ARKANSAS NUCLEAR ONE
Unit 2

Table 11.3-10A

**SUMMARY OF DOSES FROM GASEOUS EFFLUENTS
DUE TO NORMAL OPERATIONS**
(mrem/yr)

Unit 2

	<u>Whole Body</u>	<u>Skin</u>	<u>Lung</u>	<u>Bone</u>	<u>Infant Thyroid</u>	<u>Adult Thyroid</u>
Immersion	2.5(-1)	1.00(0)	2.5(-1)	2.5(-1)	-	2.5(-1)
Inhalation	-	-	4.3(-3)	-	-	4.7(-2)
Surface Contamination	8.3(-2)	8.3(-2)	8.3(-2)	8.3(-2)	-	8.3(-2)
Food Ingestion						
Milk	7.0(-3)	-	-	1.6(-2)	1.4(+1)	-
Vegetables	1.7(-2)	-	-	3.1(-2)	-	4.6(-1)
Meat	3.9(-3)	-	-	9.1(-3)	-	-

Unit 1 & 2

	<u>Whole Body</u>	<u>Skin</u>	<u>Lung</u>	<u>Bone</u>	<u>Infant Thyroid</u>	<u>Adult Thyroid</u>
Immersion	4.4(-1)	1.7	4.4(-1)	4.4(-1)	-	4.4(-1)
Inhalation	-	-	5.0(-2)	-	-	8.0(-2)
Surface Contamination	1.3	1.3	1.3	1.3	-	1.3
Food Ingestion						
Milk	9.1(-2)	-	-	2.3(-1)	2.3(+1)	-
Vegetables	2.0(-1)	-	-	4.5(-1)	-	7.8(-1)
Meat	6.2(-2)	-	-	1.4(-1)	-	-

ARKANSAS NUCLEAR ONE
Unit 2

Table 11.3-10B

**SUMMARY OF DOSES FROM GASEOUS EFFLUENTS
DUE TO ANTICIPATED OPERATIONAL OCCURRENCE**
(mrem/yr)

Unit 2

	<u>Whole Body</u>	<u>Skin</u>	<u>Lung</u>	<u>Bone</u>	<u>Infant Thyroid</u>	<u>Adult Thyroid</u>
Immersion	2.5	8.3	2.5	2.5	-	2.5
Inhalation	-	-	5.5(-2)	-	-	-
Surface Contamination	8.4(-1)	8.4(-1)	8.4(-1)	8.4(-1)	-	8.4(-1)
Food Ingestion						
Milk	7.1(-2)	-	-	1.7(-1)	4.1(+2)	-
Vegetables	2.0(-1)	-	-	3.2(-1)	-	-
Meat	4.0(-2)	-	-	9.2(-2)	-	-

Unit 1 & 2

	<u>Whole Body</u>	<u>Skin</u>	<u>Lung</u>	<u>Bone</u>	<u>Infant Thyroid</u>	<u>Adult Thyroid</u>
Immersion	4.4	1.7(+1)	4.4	4.4	-	4.4
Inhalation	-	-	5.9(-1)	-	-	1.8
Surface Contamination	1.4(+1)	1.4(+1)	1.4(+1)	1.4(+1)	-	1.4(+1)
Food Ingestion						
Milk	9.1(-1)	-	-	2.3	5.2(+2)	-
Vegetables	2.2	-	-	5.3	-	1.8(+1)
Meat	6.8(-1)	-	-	1.6	-	-

Table 11.3-11

EXPOSURE PER PERSON DURING NORMAL OPERATIONS

(Rem/Yr.)

<u>Year</u>	<u>Unit 2</u>	<u>Unit 1 & 2</u>
1980	4.8 (-6)	2.8 (-5)
2010	5.2 (-6)	3.0 (-5)

ARKANSAS NUCLEAR ONE
Unit 2

Table 11.3-12

**TOTAL POPULATION EXPOSURE DURING NORMAL OPERATION
USING 1980 AND 2010 POPULATION DISTRIBUTION**

(Man - Rem/Yr.)

<u>Year</u>	<u>Unit 2</u>	<u>Unit 1 & 2</u>
1980	8.5 (-1)	4.9
2010	1.24	7.2

Table 11.3-13

EXPOSURE PER PERSON DURING ANTICIPATED OPERATIONAL OCCURRENCES

(Rem/Yr.)

<u>Year</u>	<u>Unit 2</u>	<u>Unit 1 & 2</u>
1980	4.8 (-5)	2.9 (-4)
2010	5.3 (-5)	3.2 (-4)

Table 11.3-14

**TOTAL POPULATION EXPOSURE DURING ANTICIPATED OPERATIONAL OCCURRENCES
USING 1980 AND 2010 POPULATION DISTRIBUTION**

(Man - Rem/Yr.)

<u>Year</u>	<u>Unit 2</u>	<u>Unit 1 & 2</u>
1980	8.5	5.2 (+1)
2010	1.3 (+1)	7.7 (+1)

ARKANSAS NUCLEAR ONE
Unit 2

**Table 11.4-1
PROCESS RADIATION MONITORS**

<u>Channel</u>	<u>Monitor</u>	<u>Type-Detector</u>	<u>Readout</u>	<u>MDL*</u>	<u>Setpoint¹</u>	<u>Alarm & Control</u>
2RE-4806	CVCS Process Radiation monitor (Failed Fuel)	Gamma Scintillation Crystal, with photomultiplier tube and integral preamplifier	Linear Ratemeter and logarithmic ratemeter	1(-4) $\mu\text{Ci/cc}$ of I-131		Alarm on high radiation
2RE-5200 2RE-5202	Component Cooling water monitors	Gamma Scintillation crystal with photomultiplier tube and integral preamplifier	Logarithmic ratemeters	5(-6) $\mu\text{Ci/cc}$ of Cs-137 in 2.5 mr/hr background		Alarm on high radiation and circuit failure
2RE-1513-2 2RE-1519-1	Service Water, Containment Cooling Coils	"	Logarithmic ratemeters	5(-6) $\mu\text{Ci/cc}$ of Cs-137 in 2.5 mr/hr background		Alarm on high radiation and circuit failure
2RE-1453 2RE-1456	Service Water, Shutdown Cooling Heat Exchangers	"	Logarithmic ratemeters	5(-6) $\mu\text{Ci/cc}$ of Cs-137 in 2.5 mr/hr background		Alarm on high radiation and circuit failure
2RE-1525	Service Water, Fuel Pool Heat Exchanger	"	Logarithmic ratemeter	5(-6) $\mu\text{Ci/cc}$ of Cs-137 in 2.5 mr/hr background		"
2RE-4423 2RE-4425**	Regenerative Waste Process Monitors	"	Logarithmic ratemeter	5(-6) $\mu\text{Ci/cc}$ of Cs-137 in 2.5 mr/hr background		Alarm on high radiation and circuit failure. High alarm terminates discharge

ARKANSAS NUCLEAR ONE
Unit 2

Table 11.4-1 (continued)

<u>Channel</u>	<u>Monitor</u>	<u>Type-Detector</u>	<u>Readout</u>	<u>MDL*</u>	<u>Setpoint¹</u>	<u>Alarm & Control</u>
2RE-5854 2RE-5864	Steam Generator sample coolers	"	Logarithmic ratemeters	5(-6) $\mu\text{Ci/cc}$ of Cs-137 in 2.5 mr/hr background		Alarm on high radiation and circuit failure
2RE-0715	Startup/Blowdown Demin. monitor	"	"	3(-7) $\mu\text{Ci/cc}$		"
2RE-2330	Waste Management System	"	Logarithmic ratemeter	5(-6) $\mu\text{Ci/cc}$ of Cs-137 in 2.5 mr/hr background		Alarm on high radiation and circuit failure. High alarm terminates discharge
2RE-0645	Main Condenser air discharge monitor	Beta-Gamma sensitive GM tube	Log Count ratemeters	1(-5) $\mu\text{Ci/cc}$ of Xe-133 in 2.5 mr/hr background		Alarm on high radiation and circuit failure
2RE-2429	Waste gas Monitoring system	"	Log Count ratemeter	1(-5) $\mu\text{Ci/cc}$ of Xe-133 in 2.5 mr/hr background		Alarm on high radiation and circuit failure terminates discharge

ARKANSAS NUCLEAR ONE
Unit 2

Table 11.4-1 (continued)

<u>Channel</u>	<u>Monitor</u>	<u>Type-Detector</u>	<u>Readout</u>	<u>MDL*</u>	<u>Setpoint¹</u>	<u>Alarm & Control</u>
2RE-8845 2RE-8846	Penetration rooms monitoring system	"	Log Count ratemeters	1(-5) $\mu\text{Ci/cc}$ of Xe-133 in 2.5 mr/hr background		Alarm on high radiation and circuit failure
2RE-8271-2 2RE-8231-1	Containment atmosphere monitor	Particulate: Gamma Scintillation crystal, Gas: Beta-Gamma sensitive GM tube	Log Count ratemeters	Particulate: 1.5 (-10) $\mu\text{Ci/cc}$ of Cs-137, Gas: 1(-5) $\mu\text{Ci/cc}$ of Xe-133 in 2.5 mr/hr background		Alarm on high radiation and circuit failure
<u>Ventilation Monitoring System</u>						
2RE-8540	Fuel Handling area ventilation monitor	Beta-Gamma sensitive GM tube	Log Count ratemeters	1(-5) $\mu\text{Ci/cc}$ of Xe-133, 2.5 mr/hr background		Alarm on high radiation and circuit failure
2RE-8542	Radwaste area ventilation monitor	"	"	"		"
2RE-8233	Containment purge monitor	"	Log Count ratemeter	1(-5) $\mu\text{Ci/cc}$ of Xe-133, 2.5 mr/hr background		Alarm on high radiation and circuit failure terminates containment purge

ARKANSAS NUCLEAR ONE
Unit 2

Table 11.4-1 (continued)

<u>Channel</u>	<u>Monitor</u>	<u>Type-Detector</u>	<u>Readout</u>	<u>MDL*</u>	<u>Setpoint¹</u>	<u>Alarm & Control</u>
2RE-7828	Aux. Bldg. extension ventilation monitor	"	"	"		Alarm on high radiation and circuit failure
2RE-8750-1A 2RE-8750-1B	Control Room inlet air monitor	Beta-Gamma sensitive scintillation	Auto Ranging digital ratemeter	1(-5) $\mu\text{Ci/cc}$ of Cs-137 with no lead shield		Alarm on high radiation and circuit failure High alarm isolates control room.
2RE-4301	Turbine Bldg. drain line monitor	Off-line liquid sampler assembly with NaI (TI) detector	Logarithmic ratemeter	3.7(-7) $\mu\text{Ci/cc}$ of Cs-137 with .02 mr/hr Co-60 background		Alarm on high radiation and rad monitor flow trouble.

* MDL = Minimum Detectable Level

** Currently not in use.

Note 1: Low alarm setpoints are set below the normal background level to act as a circuit failure alarm. The Control Room ventilation inlet setpoint is determined in accordance with Technical Specifications Table 3.3-6. Other setpoints are approximately two times normal background. See ANO Procedure 2105.016 for specific requirements.

ARKANSAS NUCLEAR ONE
Unit 2

Table 11.5-1

**LOW LEVEL RADIOACTIVE WASTE STORAGE BUILDING (LLRWSB)
TOTAL RADIOACTIVE ISOTOPE INVENTORY BASED ON CAPACITY**

(Reference CR-ANO-C-2014-1356)

B-25 Boxes

Nuclide	mCi per B-25 Box	Total Ci
Cs-137	36.8	23.552
Co-58	7.66	4.9024
Co-60	17.4	11.136
Mn-54	2.32	1.4848
Cs-134	2.78	1.7792
Sb-125	16.4	10.496
Total		29.7984

Maximum B-25 box storage capacity estimated at 640 boxes.

55 Gallon Drums

Nuclide	mCi per Drum	Total Ci
C-14	40.6	31.1808
Co-58	0.221	0.169728
Co-60	0.719	0.552192
Cs-137	5.55	4.2624
H-3	61.4	47.1552
I-129	15.6	11.9808
Mn-54	986	757.248
Nb-95	0.00188	0.001444
Sb-125	0.00687	0.005276
Tc-99	38.4	29.4912
Total		882.047

Maximum 55 Gallon Drum storage capacity estimated at 768 drums.

ARKANSAS NUCLEAR ONE
Unit 2

Table 11.5-1 (continued)

Filter Liners

Nuclide	mCi per Filter Liner	Total Ci
Be-7	4.14E-03	0.00019
C-14	112	5.152
Cr-51	1.07E-09	4.92E-11
Co-57	1.92E+00	8.83E-02
Co-58	0.127	0.005842
Co-60	653	30.038
Cs-134	16.3	0.7498
Cs-137	39.3	1.8078
Fe-55	1.13E+03	51.98
Fe-59	3.89E-06	1.79E-07
H-3	61.4	2.8244
Hf-181	3.19E-07	1.47E-08
Mn-54	138	6.348
Nb-95	1.41E-06	6.49E-08
Ni-63	322	14.812
Sb-124	4.60E-05	2.12E-06
Sb-125	63.2	2.9072
Sn-113	0.424	0.019504
Sr-89	1.23E-05	5.66E-07
Sr-90	3.36	0.15456
Tc-99	0.816	0.037536
Zn-65	2.15	0.0989
Zr-95	2.79E-02	0.001283
Total		117.0253

Maximum Filter Liner storage capacity estimated at 46 liners.

ARKANSAS NUCLEAR ONE
Unit 2

Table 11.5-1 (continued)

Resin Liners

Nuclide	mCi per Resin Liner	Total Ci
Am-241	5.64E-02	2.54E-03
C-14	1.09E+03	49.05
Ce-144	9.24E+01	4.16E+00
Co-57	1.22E+01	5.50E-01
Co-58	38.6	1.737
Co-60	6000	270
Cs-134	78.8	3.546
Cs-137	749	33.705
Fe-55	4.68E+03	210.6
H-3	13.9	0.6255
I-129	0.0969	0.004361
Mn-54	476	21.42
Ni-59	39.2	1.764
Ni-63	6390	287.55
Sb-125	798	35.91
Sr-90	6.26	0.2817
Tc-99	2.58	0.1161
Zn-65	89.4	4.023
Total		925.04

Maximum Resin Liner storage capacity estimated at 45 liners.

Sea Land (One – Located in Truck Bay)

Nuclide	mCi per Sea Land	Total Ci
C-14	4.94E+01	0.0494
Co-58	26.8	0.0268
Co-60	60.9	0.0609
Cs-134	9.74	0.00974
Cs-137	129	0.129
H-3	298	0.298
I-129	12.4	0.0124
Mn-54	8.12	0.00812
Tc-99	67.2	0.0672
Sb-125	57.4	0.0574
Total		0.71896

ARKANSAS NUCLEAR ONE
Unit 2

Table 11.5-2

OLD RADWASTE STORAGE BUILDING

TOTAL RADIOACTIVE ISOTOPE INVENTORY BASED ON CAPACITY

Nuclide	mCi / B-25 Box	Total Ci at ORWSB Capacity
Co-58	7.66	13.78
Cs-137	36.8	66.21
Co-60	17.4	31.31
Mn-54	2.32	4.17
Cs-134	2.78	5.00
Sb-125	16.4	29.51
Total		149.99

Maximum B-25 box storage capacity stacked 4 high is estimated at 1799 boxes assuming a total storage volume of 202444 ft³.

ARKANSAS NUCLEAR ONE
Unit 2

Table 11.5-3

**ORIGINAL STEAM GENERATOR STORAGE FACILITY (OSGSF)
TOTAL RADIOACTIVE ISOTOPE INVENTORY OF STEAM GENERATORS**

Nuclide	Curies	μCi/cc
Cr-51	1.244E+03	1.057E+01
Co-60	5.560E+02	4.724E+00
Co-58	1.536E+03	1.305E+01
Co-57	7.928E+00	6.736E-02
Cm-244	1.094E-01	9.298E-04
Cm-243	1.094E-01	9.298E-04
Cm-242	1.510E-01	1.283E-03
Am-241	5.752E-02	4.888E-04
Pu-241	3.842E+00	3.264E-02
Pu-240	2.196E-02	1.866E-04
Pu-239	2.196E-02	1.866E-04
Pu-238	7.110E-02	6.040E-04
Sr-90	3.100E-01	2.634E-03
Ni-63	3.428E+02	2.912E+00
Fe-55	1.046E+03	8.890E+00
La-140	1.514E+00	1.286E-02
Sn-117m	7.336E+00	6.232E-02
Sn-113	1.184E+01	1.006E-01
Ag-110m	1.623E+01	1.379E-01
Ru-103	1.480E+01	1.258E-01
Zr-95	1.608E+02	1.366E+00
Nb-95	2.472E+02	2.100E+00
Mn-54	1.224E+02	1.040E+00
Sb-125	3.970E+01	3.374E-01
Totals:	5.360E+03	4.554E+01

- Modeling of the SG to assess curie content utilized WMG Megashield, Version 3.0.
- Isotopic proportions based on previous samples.
- The composite curie content mixture was derived from gamma spectrum analyses performed at the general time of SG removal, and from waste stream analyses performed by Duke Engineering and Services Environmental Laboratory (DE&S) in support of 10 CFR 61 waste characterization requirements.
- The estimate is conservative to arrive at a value that bounds component storage. Reference ANO-2014-0034.

ARKANSAS NUCLEAR ONE
Unit 2

Table 11.5-4

SOLID RADIOACTIVE WASTE EQUIPMENT DATA

<u>Tank Data</u>	Concentrator Bottoms <u>Storage Tank¹</u>	Spent Resin <u>Storage Tank</u>	Solidifier <u>Storage Tank¹</u>	Catalyst <u>Storage Tank¹</u>
Equipment No.	2T-78	2T-13	2T-80	2T-81
Quantity	1	1	1	1
Design Pressure	Atmospheric	50 psig	Atmospheric	Atmospheric
Design Temp.	200 °F	200 °F	200 °F	200 °F
Capacity	1600 gallon	3200 gallon	2985 gallon	150 gallon
Material	Stainless Steel	Stainless Steel	Lined Carbon Steel	Polyethylene

Radwaste disposable liners: 50 ft³ capacity, carbon steel

<u>Pump and Motor Data</u>	Radwaste <u>Pump¹</u>	Solidifier <u>Pump¹</u>	Catalyst <u>Pump¹</u>	Dewater <u>Pump¹</u>
Equipment No.	2P-117	2P-118	2P-119	2P-120
Quantity	1	1	1	1
Type	PDPC ⁴	PDPC ⁴	PDPC ⁴	PDPC ⁴
Design Flow (gpm)	10	10	10	10
NPSH required at design flow (ft)	-	-	-	-
Driver Rating (HP)	1.5	1.5	1.0	1.5
Mat'l: Casing	316 SS	Cast Iron	316 SS	316 SS
Impeller	316 SS	Tool Steel	316 SS	316 SS
Stator	Butyl Rubber	Hard Rubber	Biton	Butyl Rubber

<u>Pump and Motor Data</u>	Bottoms <u>Recirc Pump¹</u>	Resin <u>Recirc Pump²</u>	Liner <u>Mixer Motor¹</u>
Equipment No.	2P-116	2P-115A, B ³	2MM-99
Quantity	1	2	1
Type	Centrifugal	Centrifugal	Gear-head
Design Flow (gpm)	50	60	-
NPSH required at design flow (ft)	5.0	4.0	-
Driver Rating (HP)	1.0	2.0	5.0
Casing, Impeller Material	316 SS	316 SS	-

Notes:

- ¹ This equipment is no longer used and has been abandoned in place.
- ² The motors for 2P-115A/B have been abandoned in place. The pumps are intact and are passive components in the flow path for certain evolutions.
- ³ 2P-115B is provided for the recirculation of Unit 1 spent resin from storage tank T-13.
- ⁴ Positive-displacement, precessing-cavity.

ARKANSAS NUCLEAR ONE
Unit 2

Table 11.5-5

POLE BARN

TOTAL RADIOACTIVE ISOTOPE INVENTORY BASED ON CAPACITY

Nuclide	mCi*
C-14	2.44
Co-57	0.68
Co-58	1.06
Co-60	52.35
Cr-51	0.62
Cs-134	0.20
Cs-137	21.24
Fe-55	70.15
Mn-54	2.49
Nb-95	1.96
Ni-63	63.39
Sb-125	0.61
Zr-95	1.10
Total	218.3

* Activity estimate based on material that could be stored given building dimensions.

ARKANSAS NUCLEAR ONE
Unit 2

Table 11.6-1

AIR

	<u>Average</u>	<u>Range</u>
Particulate Gross Beta (pCi/m ³)	0.17 ^(a)	0.01-1.08
Precipitation Gross Beta	22.6 ^(b)	2.9-120.0
Direct Radiation (LiF TLD)	25 mR ^(c)	

(a) Average of 175 samples from 7 points.

(b) Average of 56 samples from 2 points.

(c) Average results from 7 sample points.

ARKANSAS NUCLEAR ONE
Unit 2

Table 11.6-2

WATER

	<u>1 (pCi/l)</u>	<u>2 (pCi/l)</u>	<u>3 (pCi/l)</u>	<u>4 (pCi/g)</u>		<u>5 (pCi/g)</u>		<u>6 (pCi/l)</u>
				<u>Average</u>	<u>Range</u>	<u>Average</u>	<u>Range</u>	
Gross Alpha	< 0.2	< 0.2	< 0.2	6.8	5.3 - 9.1			< 3.0
Gross Beta	5.5 ± 3.0	2.6 ± 2.0	3.1 ± 2.0	39.1	34.0 - 47.6	< 53	<53	76.0 ± 17.5
Tritium	0.2 ± 0.2	< 0.2	± 0.2					
Ce ¹⁴⁴	< 8.1			3.0	2.8 - 3.7	13882	9314 - 20539	< 0.17
I ¹³¹	< 2.0			0.24	0.2 - 0.4	< 1259	< 1259	< 0.03
Ru ¹⁰⁶	< 7.0			0.12	0.1 - 0.2	< 7545	< 7545	< 0.15
Cs ¹³⁷	< 2.0			0.34	0.09 - 0.6	< 1630	< 1630	< 0.03
Zr ⁹⁵	< 2.0			0.24	0.09 - 0.4	< 1676	< 1676	< 0.03
Mn ⁵⁴	< 1.1			< 0.09	< 0.09	1416	1377 - 1570	< 0.02
Th ²³²				0.56	0.2 - 08			
Zn ⁶⁵	< 3.0			< 0.09	< 0.09	< 3075	< 3075	< 0.06
Ba ¹⁴⁰	< 1.4			0.44	0.3 - 0.7	< 1638	< 1638	< 0.029
Bi ²¹⁴				0.66	0.5 - 0.8			
K(stable)g	< 0.09			< 0.09	< 0.09	< 18.9	< 18.9	< 0.0003

Notes:

1. Dardanelle Reservoir
2. Ground water
3. Russellville city water
4. Dardanelle Reservoir bottom sediments
5. Darandelle Reservoir aquatic biota
6. Dardanelle Reservoir fish

ARKANSAS NUCLEAR ONE
Unit 2

Table 11.6-3

TERRESTRIAL

	<u>Milk* (pCi/l)</u>	<u>Vegetation, (pCi/l)</u>		<u>Soil, (pCi/l)</u>	
		<u>Average</u>	<u>Range</u>	<u>Average</u>	<u>Range</u>
Gross Alpha		9.3	8.0 - 10.4	25.2	15.1 - 30.9
Gross Beta		56.5	21.5 - 82.4	28.3	< 10 - 39.5
Ce ¹⁴⁴		1.3	0.6 - 3.8	3.5	3.1 - 3.9
I ¹³¹	< 11.0	< 0.3	< 0.3	0.2	< 0.2 - 0.3
Ru ¹⁰⁶		2.0	1.0 - 3.1	0.3	< 0.1 - 0.4
Cs ¹³⁷	15 ± 8.0	0.4	< 0.2 - 0.8	0.43	< 0.09 - 1.0
Zr ⁹⁵		4.2	1.3 - 10.3	0.23	< 0.09 - 0.3
Mn ⁵⁴		< 0.1	< 0.1	< 0.09	< 0.09
Th ²³²				0.57	0.5 - 0.8
Zn ⁶⁵		< 0.2	< 0.2	< 0.09	< 0.09
Ba ¹⁴⁰	< 15	0.18	< 0.1 - 0.3	< 0.1	< 0.1
Bi ²¹⁴				0.94	0.9 - 1.0
K(stable)	1.3 ± 0.1 g/l	< 0.09	< 0.09	< 0.09	< 0.09
Sr ⁸⁹	< 13.0				
Sr ⁹⁰	< 10.0				

*Ark. Polytechnic College Herd

Table 11.6-4

**DELETED
(See ODCM)**

Table 11.6-5

DETECTION LIMITS FOR GAMMA EMITTERS

This table has been intentionally deleted.

Table 11.6-6

DIETARY ASSUMPTION

This table has been intentionally deleted.

Table 11.6-7

**MAXIMUM DOSES AT MINIMUM DETECTABLE LEVELS
OF ENVIRONMENTAL RADIOACTIVITY**

This table has been intentionally deleted.

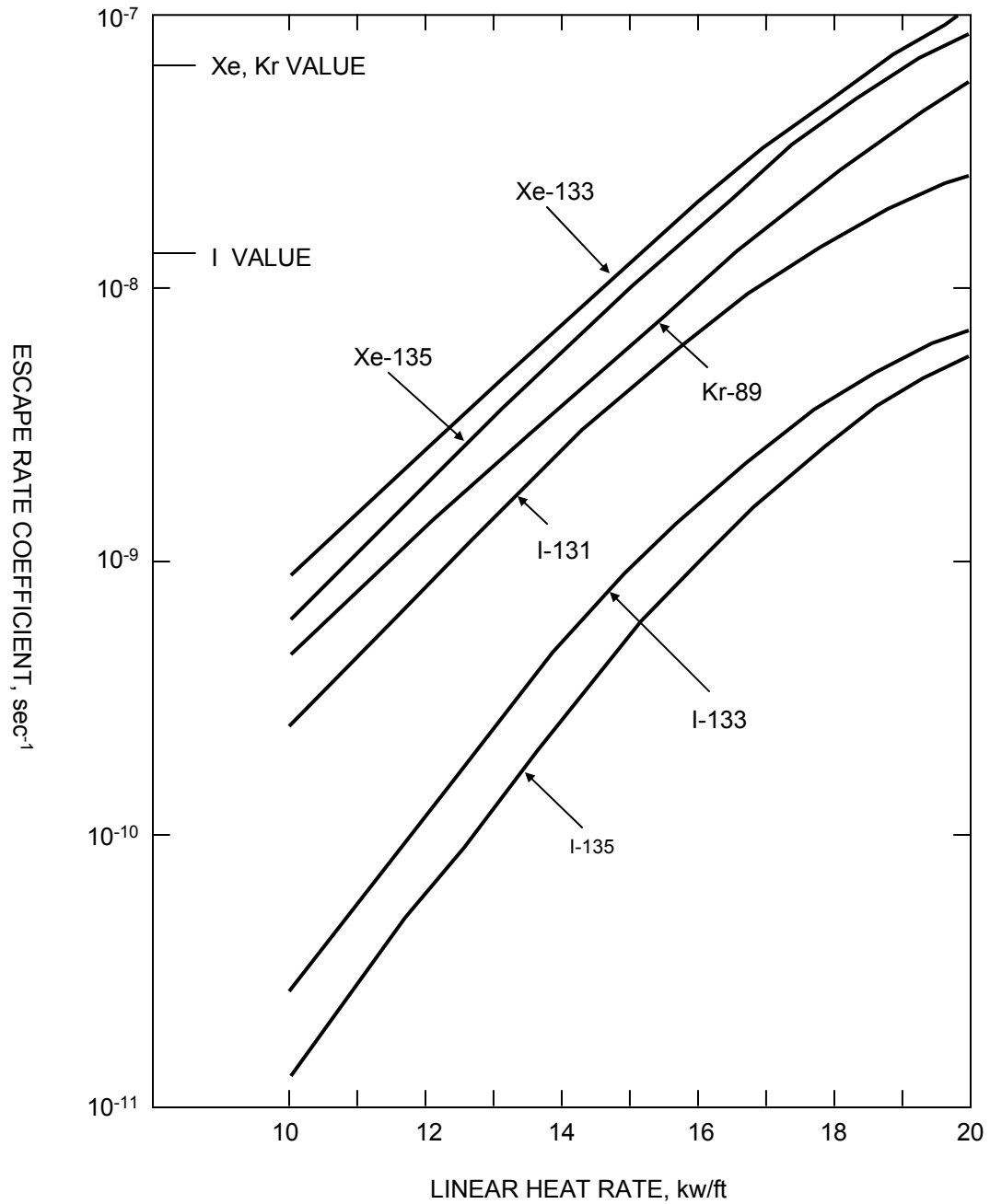

SAR FIGURE NO. 11.1-1

AMENDMENT 20

ARKANSAS NUCLEAR ONE
UNIT 2
RUSSELLVILLE, ARKANSAS



SCALE: NONE
DRAWN:
DESIGN: ENTERGY
CAD NO:

ESCAPE RATE COEFFICIENTS

BASED ON DRAWING NO

SHEET

REV.

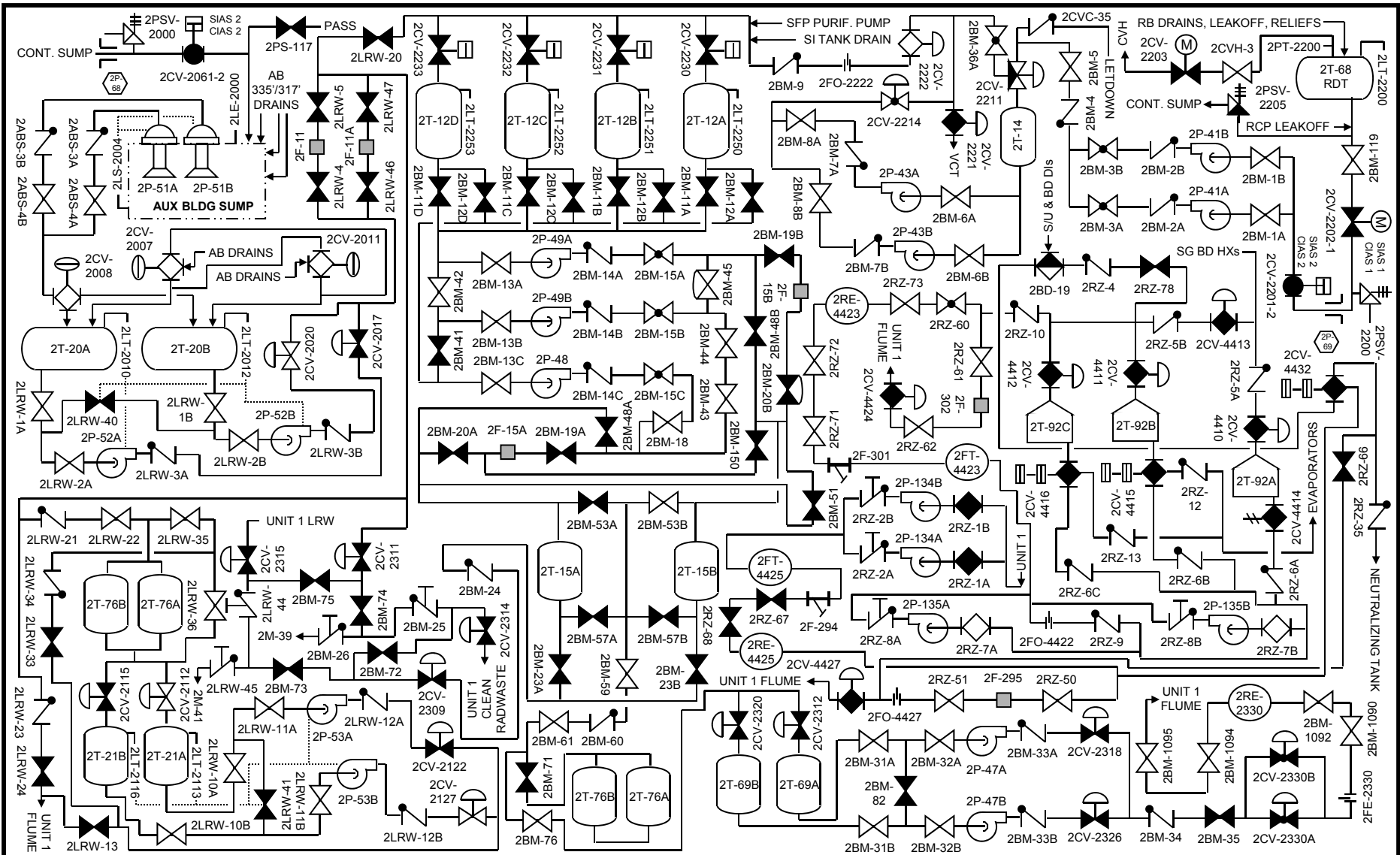

LIQUID RADWASTE, BORON MANAGEMENT SYSTEM, AND REGENERATIVE WASTE

SAR FIGURE NO. 11.2-1

ARKANSAS NUCLEAR ONE
UNIT 2
RUSSELLVILLE, ARKANSAS



SCALE:	NONE
DRAWN:	ENERGY
DESIGN:	ENERGY
CAD NO:	

AMENDMENT 25

BASED ON DRAWING NO	SHEET	REV.

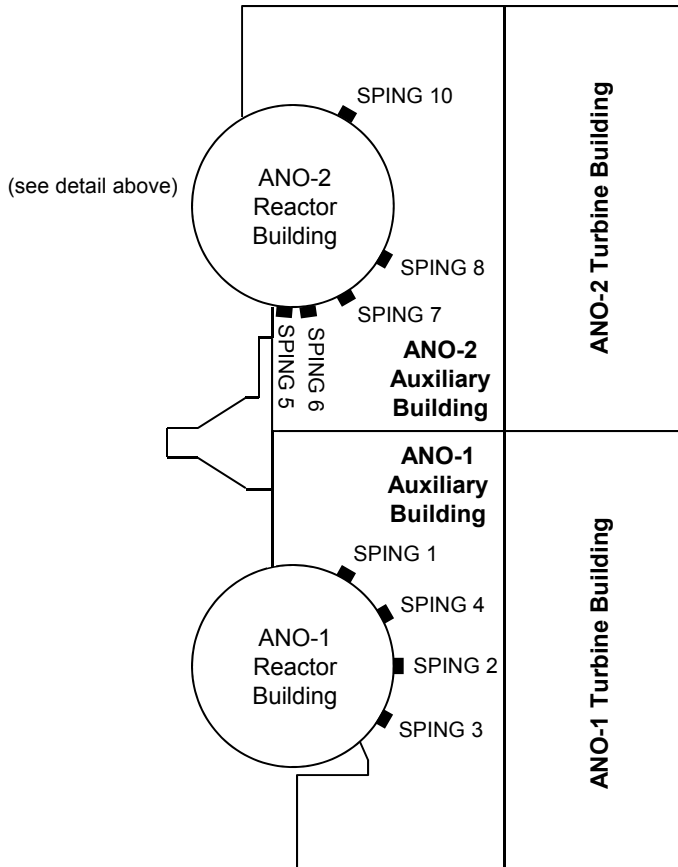
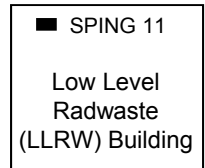
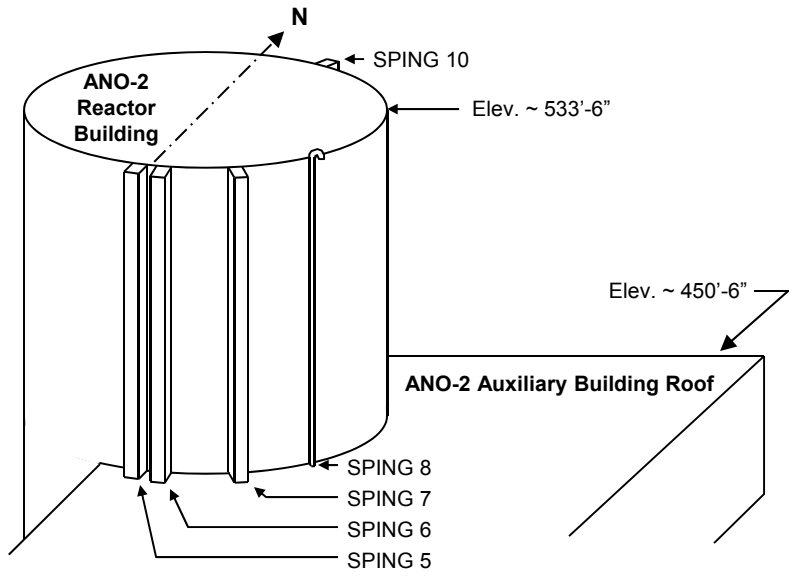

NOTES:

1. PASS release point at approximate Elev. 404'
2. LLRW release point at approximate Elev. 392'
3. Ground level approximate Elev. 354'
4. SPING monitors are as follows:

SPING 1	RX-9820	U1 Reactor Building Purge
SPING 2	RX-9825	U1 Radwaste Area
SPING 3	RX-9830	U1 Fuel Handling Area
SPING 4	RX-9835	U1 Penetration Rooms
SPING 5	2RX-9820	U2 Containment Purge
SPING 6	2RX-9825	U2 Radwaste Area
SPING 7	2RX-9830	U2 Fuel Handling Area
SPING 8	2RX-9835	U2 Penetration Rooms
SPING 10	2RX-9845	U2 Aux Building Extension
SPING 11	2RX-9850	LLRW Building
5. Gaseous Radwaste System vents and Condenser Vacuum off-gas discharge into the respective unit's Radwaste Area exhaust ducting upstream of the installed HEPA/Charcoal filter units
6. Other potential release points are included in ANO-2 SAR Tables 11.3-5A and 11.3-5B
7. SPING sample points are downstream of each exhaust fan and HEPA/Charcoal filter unit

SAR FIGURE NO. 11.2-2

AMENDMENT 28

ARKANSAS NUCLEAR ONE
 UNIT 2
 RUSSELLVILLE, ARKANSAS



SCALE:	NONE
DRAWN:	
DESIGN:	ENTERGY
CAD NO:	

**MONITORED VENTILATION EXHAUST
 RELEASE POINTS**

BASED ON DRAWING NO

SHEET

REV.

DELETED

SAR FIGURE NO. 11.2-3

AMENDMENT 20

ARKANSAS NUCLEAR ONE
UNIT 2
RUSSELLVILLE, ARKANSAS



SCALE: NONE

DRAWN:

DESIGN: ENTERGY

CAD NO:

BASED ON DRAWING NO

SHEET

REV.

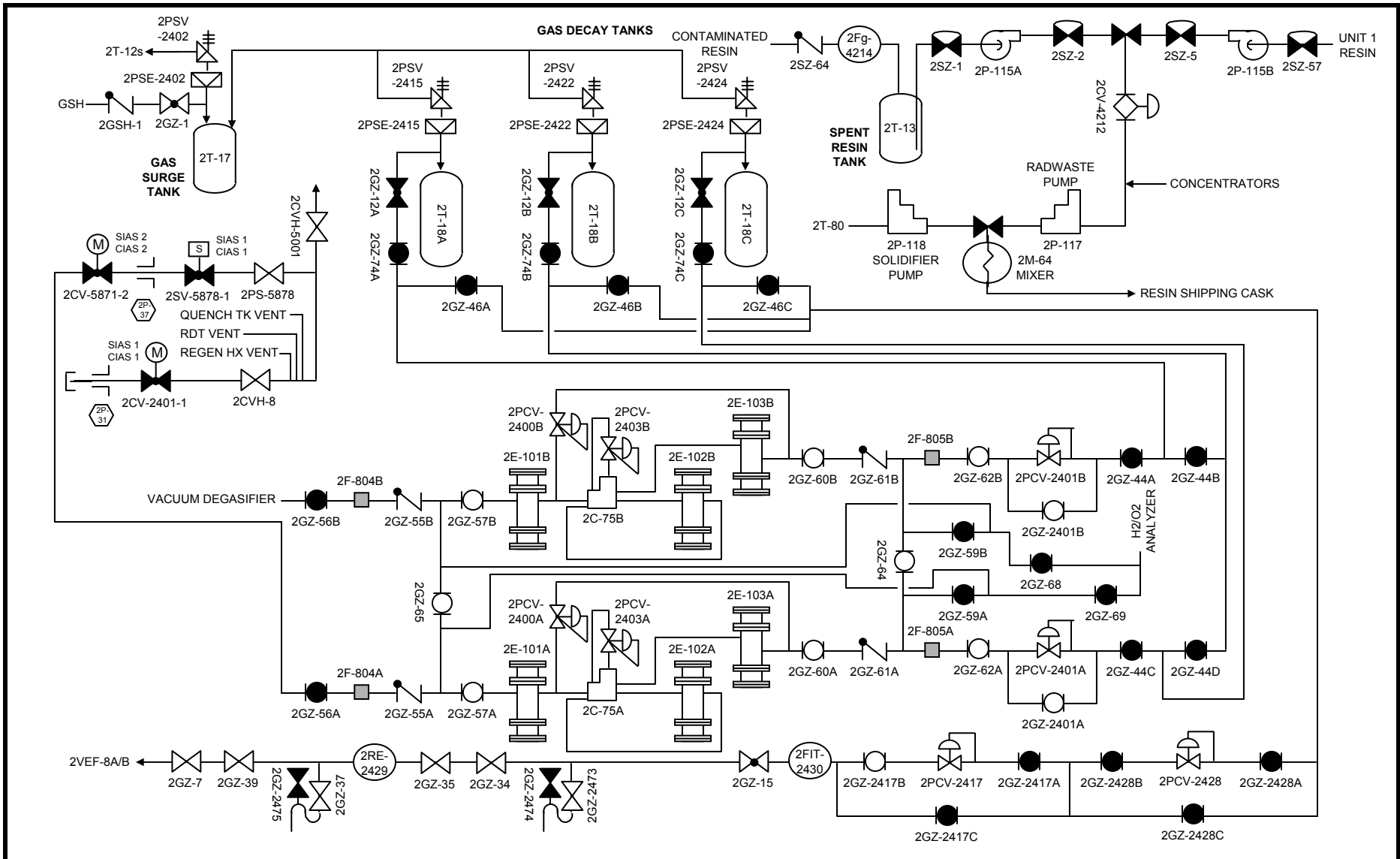

GASEOUS RADWASTE AND SOLID RADWASTE

SAR FIGURE NO. 11.3-1

ARKANSAS NUCLEAR ONE
UNIT 2
RUSSELLVILLE, ARKANSAS



SCALE: NONE
DRAWN: ENTERGY
DESIGN: ENTERGY
CAD NO:

AMENDMENT 20

BASED ON DRAWING NO

SHEET

REV.

DELETED

SAR FIGURE NO. 11.3-2

AMENDMENT 20

ARKANSAS NUCLEAR ONE
UNIT 2
RUSSELLVILLE, ARKANSAS



SCALE: NONE

DRAWN:

DESIGN: ENTERGY

CAD NO:

BASED ON DRAWING NO

SHEET

REV.

DELETED

SAR FIGURE NO. 11.3-3

AMENDMENT 20

ARKANSAS NUCLEAR ONE
UNIT 2
RUSSELLVILLE, ARKANSAS



SCALE: NONE

DRAWN:

DESIGN: ENTERGY

CAD NO:

BASED ON DRAWING NO

SHEET

REV.

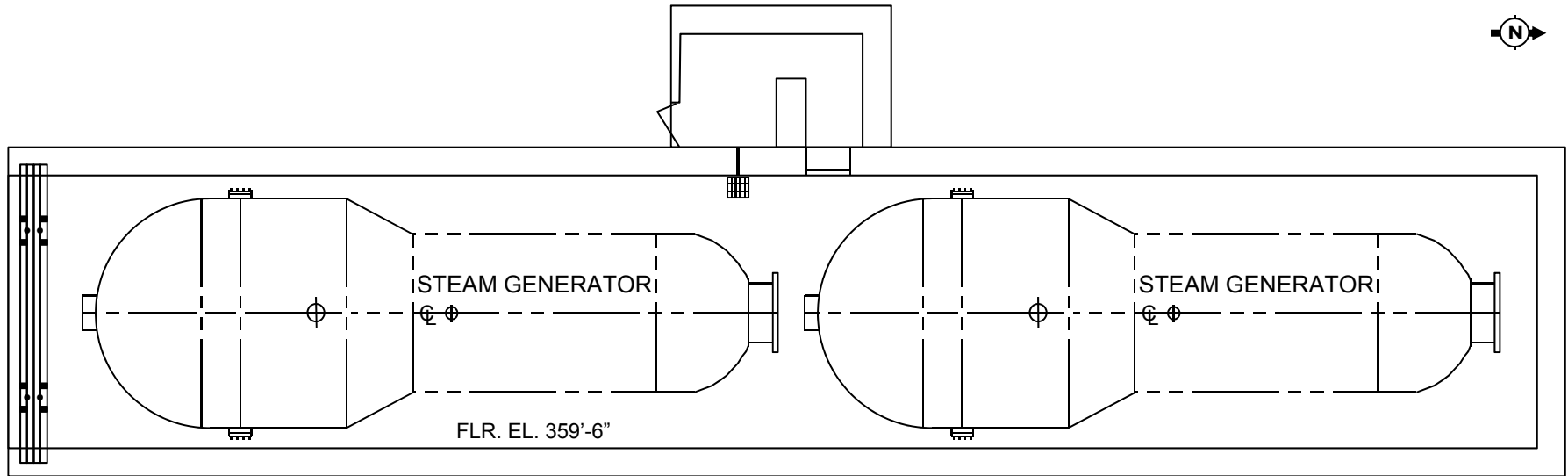

UNIT 2 ORIGINAL STEAM GENERATOR STORAGE FACILITY

SAR FIGURE NO. 11.5-1

ARKANSAS NUCLEAR ONE
 UNIT 2
 RUSSELLVILLE, ARKANSAS



SCALE: NONE
 DRAWN: ENTERGY
 DESIGN: ENTERGY
 CAD NO:

AMENDMENT 25

BASED ON DRAWING NO

SHEET

REV.

High Specific Activity Waste ¹

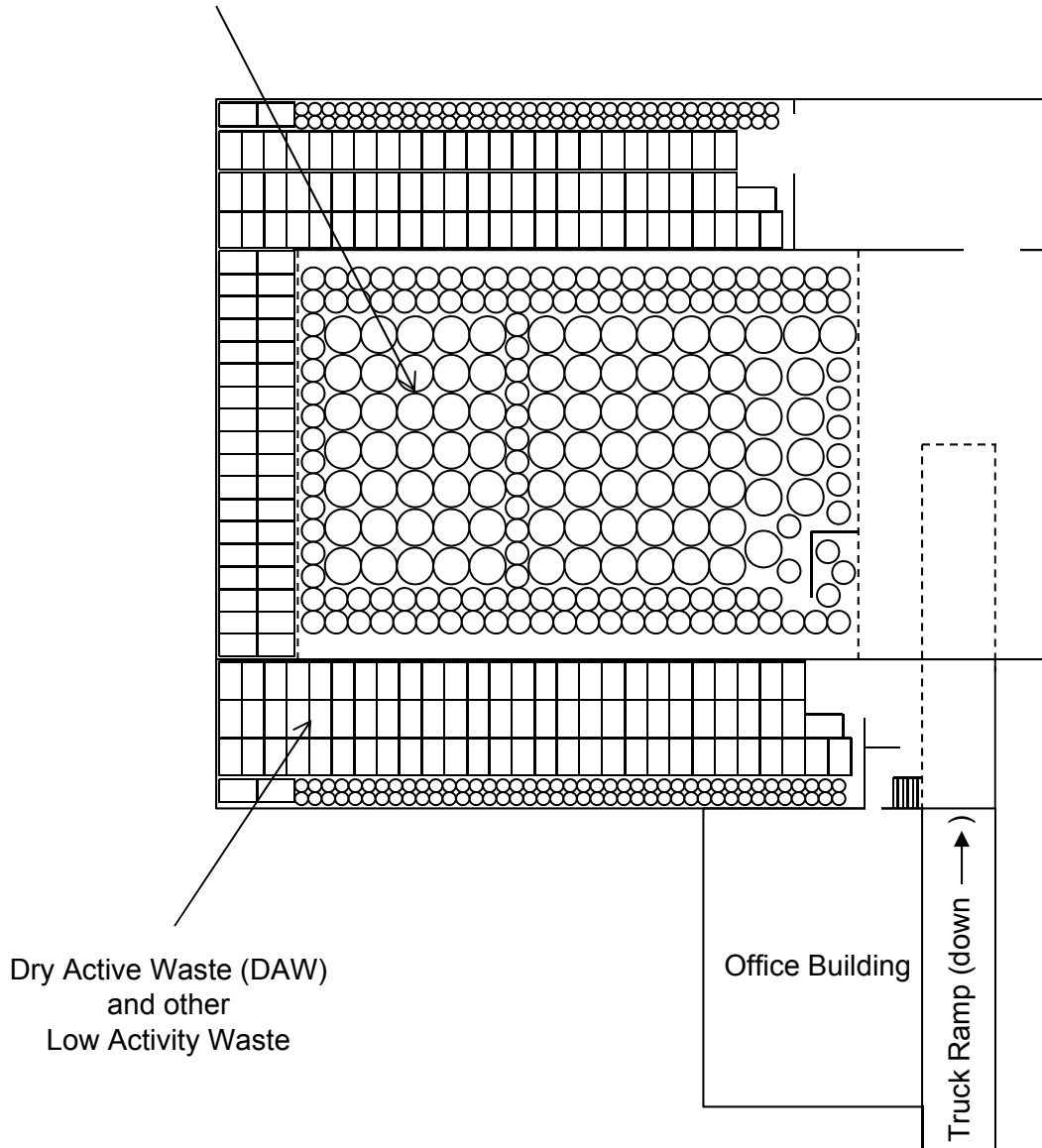

Dry Active Waste (DAW)
and other
Low Activity Waste

Office Building

Truck Ramp (down ↑)

¹ High Specific Activity Waste (HSAW) consists of primarily filters and resins, and is considered Low Level Radwaste (LLRW), but is characterized by higher activities than DAW and the necessity of remote handling.

SAR FIGURE NO. 11.5-2

AMENDMENT 25

ARKANSAS NUCLEAR ONE
UNIT 2
RUSSELLVILLE, ARKANSAS



SCALE:	NONE
DRAWN:	
DESIGN:	ENTERGY
CAD NO:	

LOW LEVEL RADWASTE BUILDING STORAGE

BASED ON DRAWING NO

SHEET

REV.

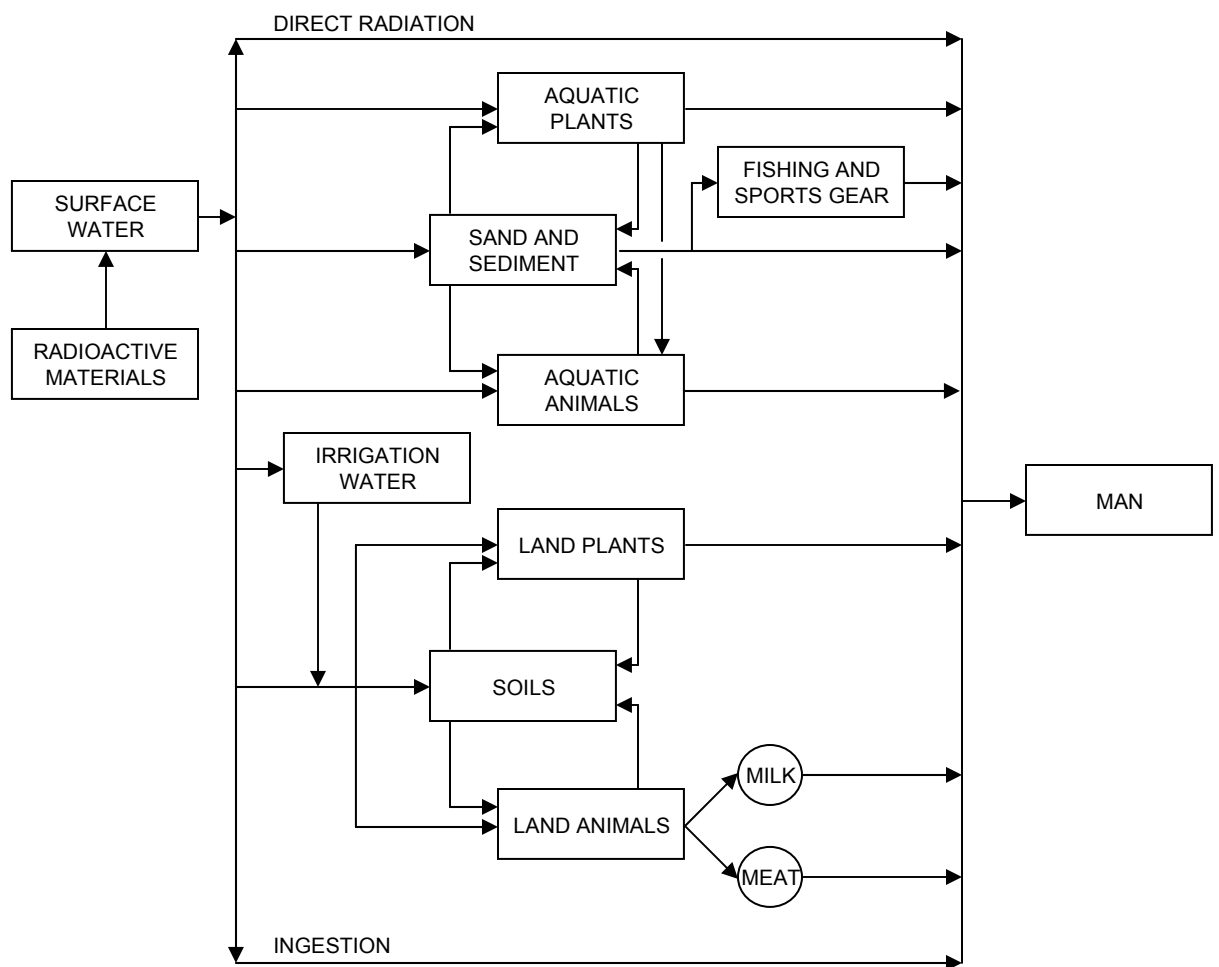
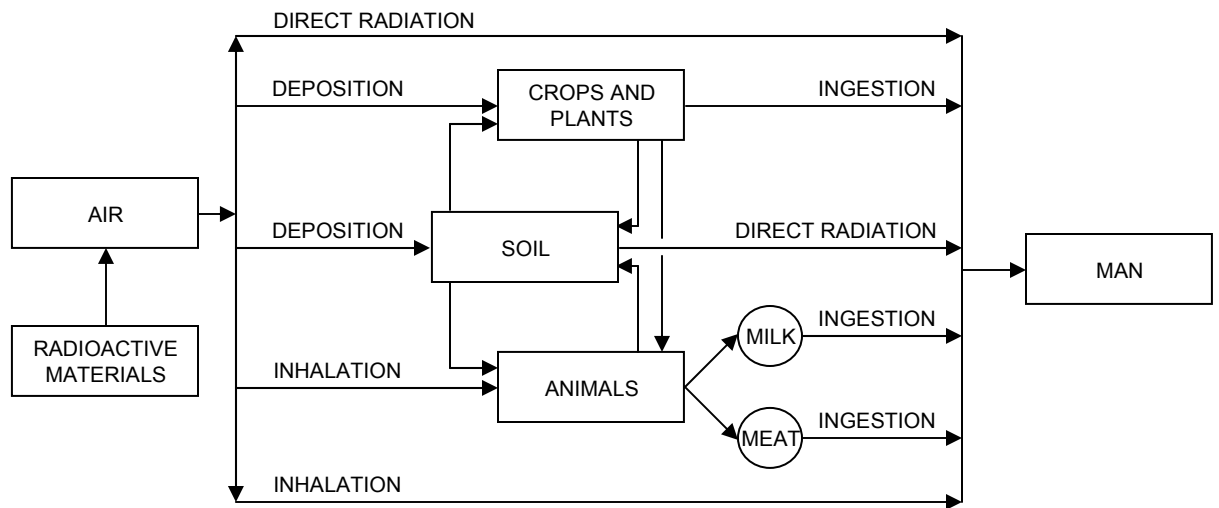

SAR FIGURE NO. 11.6-1

AMENDMENT 20

ARKANSAS NUCLEAR ONE
 UNIT 2
 RUSSELLVILLE, ARKANSAS



SCALE:	NONE
DRAWN:	
DESIGN:	ENTERGY
CAD NO:	

EXPOSURE PATHWAYS FOR MAN

BASED ON DRAWING NO

SHEET

REV.

ARKANSAS NUCLEAR ONE
Unit 2

CHAPTER 12

TABLE OF CONTENTS

<u>Section</u>	<u>Title</u>	<u>Page</u>
12	<u>RADIATION PROTECTION</u>	12.1-1
12.1	<u>SHIELDING</u>	12.1-1
12.1.1	DESIGN OBJECTIVES	12.1-1
12.1.1.1	<u>Shielding for Normal Full Power Operation</u>	12.1-1
12.1.1.2	<u>Shielding for Plant Shutdown</u>	12.1-2
12.1.1.3	<u>Shielding for Design Basis Events</u>	12.1-2
12.1.2	DESIGN DESCRIPTION	12.1-2
12.1.2.1	<u>General Shielding Design Description</u>	12.1-2
12.1.2.2	<u>Radiation Zoning and Access Control</u>	12.1-3
12.1.2.3	<u>Penetrations</u>	12.1-4
12.1.2.4	<u>Justification for Shield Design Thickness</u>	12.1-4
12.1.2.5	<u>Containment Shielding Design Description</u>	12.1-5
12.1.2.6	<u>Containment Interior Shielding Design Description</u>	12.1-5
12.1.2.7	<u>Control Room Shielding</u>	12.1-6
12.1.2.8	<u>Spent Fuel Handling Area Shielding</u>	12.1-7
12.1.2.9	<u>Auxiliary Building Shielding</u>	12.1-7
12.1.2.10	<u>Radwaste and Source Area Shielding</u>	12.1-7
12.1.2.11	<u>Miscellaneous Plant and Plant Yard Areas</u>	12.1-8
12.1.2.12	<u>OSGSF Shielding</u>	12.1-8
12.1.2.13	<u>LLRWSB</u>	12.1-8
12.1.2.14	<u>ORWSB</u>	12.1-8
12.1.2.15	<u>Pole Barn</u>	12.1-9
12.1.3	SOURCE TERMS	12.1-9

ARKANSAS NUCLEAR ONE
Unit 2

TABLE OF CONTENTS (continued)

<u>Section</u>	<u>Title</u>	<u>Page</u>
12.1.3.1	<u>Sources for Normal Power Operation</u>	12.1-9
12.1.3.2	<u>Sources for Shutdown Conditions</u>	12.1-10
12.1.3.3	<u>Sources for Design Basis Events</u>	12.1-10
12.1.3.4	<u>Stored Radioactivity</u>	12.1-10
12.1.3.5	<u>Field Run Process Piping</u>	12.1-11
12.1.4	AREA RADIATION MONITORING SYSTEM.....	12.1-11
12.1.4.1	<u>Design Bases</u>	12.1-11
12.1.4.2	<u>System Description</u>	12.1-12
12.1.4.3	<u>Design Evaluation</u>	12.1-13
12.1.4.4	<u>Inspection and Tests</u>	12.1-13
12.1.5	OPERATING PROCEDURES.....	12.1-14
12.1.6	ESTIMATES OF EXPOSURE	12.1-16
12.1.7	EQUIPMENT AND AREA DECONTAMINATION PROVISIONS	12.1-16
12.2	<u>VENTILATION</u>	12.2-1
12.2.1	DESIGN OBJECTIVES	12.2-1
12.2.2	DESIGN DESCRIPTION	12.2-2
12.2.2.1	<u>Containment Ventilation System</u>	12.2-2
12.2.2.2	<u>Fuel Handling Floor Radwaste Area and Auxiliary Building Radwaste Area Ventilation Systems</u>	12.2-3
12.2.2.3	<u>Control Room Ventilation System</u>	12.2-4
12.2.2.4	<u>Turbine Building Ventilation System</u>	12.2-5
12.2.3	SOURCE TERMS	12.2-5
12.2.4	AIRBORNE RADIOACTIVITY MONITORING.....	12.2-5
12.2.5	OPERATING PROCEDURES.....	12.2-6
12.2.6	ESTIMATES OF INHALATION DOSES.....	12.2-6

ARKANSAS NUCLEAR ONE
Unit 2

TABLE OF CONTENTS (continued)

<u>Section</u>	<u>Title</u>	<u>Page</u>
12.3	<u>HEALTH PHYSICS PROGRAM</u>	12.3-1
12.3.1	<u>PROGRAM OBJECTIVES</u>	12.3-1
12.3.2	<u>FACILITIES AND EQUIPMENT</u>	12.3-2
12.3.2.1	<u>Controlled Access Facilities</u>	12.3-2
12.3.2.2	<u>Nuclear Chemistry Laboratory Facilities</u>	12.3-2
12.3.2.3	<u>Decontamination Facilities</u>	12.3-2
12.3.2.4	<u>Medical Facilities</u>	12.3-2
12.3.2.5	<u>Portable Health Physics Instruments and Equipment</u>	12.3-2
12.3.2.6	<u>Air Monitoring Equipment</u>	12.3-3
12.3.2.7	<u>Personnel Protective Equipment</u>	12.3-3
12.3.2.8	<u>Special Equipment and Devices</u>	12.3-3
12.3.3	<u>PERSONNEL DOSIMETRY</u>	12.3-3
12.3.3.1	<u>External Dosimetry</u>	12.3-3
12.3.3.2	<u>Internal Dosimetry</u>	12.3-4
12.3.4	<u>PROCEDURES</u>	12.3-4
12.4	<u>RADIOACTIVE MATERIALS SAFETY</u>	12.4-1
12.4.1	<u>RADIOACTIVE MATERIALS SAFETY PROGRAM</u>	12.4-1
12.4.1.1	<u>Special Nuclear Material</u>	12.4-1
12.4.1.2	<u>Other Sealed Sources</u>	12.4-1
12.4.2	<u>RADIOACTIVE MATERIALS CONTROL</u>	12.4-1
12.4.3	<u>RADIOACTIVE MATERIALS</u>	12.4-2
12.5	<u>REFERENCES</u>	12.5-1
12.6	<u>TABLES</u>	12.6-1

ARKANSAS NUCLEAR ONE
Unit 2

LIST OF TABLES

<u>Section</u>	<u>Title</u>	<u>Page</u>
12.1-1	RADIATION ZONES.....	12.6-1
12.1-2	LIST OF COMPUTER CODES USED IN SHIELDING DESIGN CALCULATIONS	12.6-1
12.1-3	SHIELDING DESIGN SOURCE TERMS FOR REACTOR COOLANT SYSTEM N-16 SOURCES.....	12.6-2
12.1-4	SHIELDING DESIGN SOURCE TERMS FOR REFUELING WATER TANK ACTIVITY	12.6-2
12.1-4A	SHIELDING DESIGN RADIONUCLIDE SOURCE TERMS	12.6-3
12.1-5	SHIELDING DESIGN SOURCE TERMS FOR SPENT FUEL POOL ACTIVITY	12.6-7
12.1-5A	ESTIMATES OF EXPOSURE	12.6-8
12.1-6	REACTOR CAVITY NEUTRON SHIELD MATERIAL PROPERTIES	12.6-8
12.2-1	SOURCE TERM SUMMARY.....	12.6-9
12.2-2	DESIGN SOURCE TERMS FOR RADIONUCLIDE CONCENTRATIONS IN BUILDING EXHAUST	12.6-9
12.2-3	DELETED	12.6-10
12.2-4	DOSE SUMMARY	12.6-10
12.2-5	ASSUMPTIONS FOR INHALATION THYROID DOSE CALCULATION.....	12.6-10

ARKANSAS NUCLEAR ONE
Unit 2

LIST OF FIGURES

<u>Section</u>	<u>Title</u>
12.1-1 – 12.1-12	DELETED
12.1-13	LOW LEVEL RADWASTE BUILDING ROOF ESTIMATED DOSE RATES
12.1-14	GENERAL ARRANGEMENT MAIN CONTROL ROOM
12.1-15	RADIATION ZONING & ACCESS CONTROL PLAN AT OSGSF
12.1-16	REACTOR CAVITY NEUTRON SHIELD

ARKANSAS NUCLEAR ONE
Unit 2

UPDATE REFERENCE LIST

Sections and references listed below denote documents that contain additional cross reference information used to update the SAR.

<u>Section</u>	<u>Cross References</u>
Table 12.2-3	Correspondence from Williams, AP&L, to Seyfrit, NRC, dated July 24, 1978. (2CAN077823)
<u>Amendment 9</u>	
Figure 12.1.2 Figure 12.1-8	Design Change Package 88-2022, "Opening Between "A" and "C" Charging Pump Rooms."
Figure 12.1-13	Design Change Package 79-2025, "Maintenance Facility and Turbine Deck Expansion."
Figure 12.1-5	Design Change Package 86-2131, "Operations Support Facility."
Figure 12.1-3 Figure 12.1-5 Figure 12.1-9 Figure 12.1-11	Design Change Packages 86-2090, "Controlled Access Entry/Exit Modifications," and 86-2090A, "H.P. Renovation Work."
12.2.2.1	ANO Calculation 89-E-0105-01, "Use of Hydrogen Purge System."
<u>Amendment 10</u>	
12.3.1	ANO-2 Technical Specifications Amendment 119, dated June 19, 1991. (0CNA069115)
12.3.1 12.3.2.5 12.4.2	ANO-2 Technical Specifications Amendment 98, dated June 21, 1989. (0CNA068917).
<u>Amendment 11</u>	
Figure 12.1-5 Figure 12.1-11	Plant Change 89-8002, "Modification to H.P. Instrument Room."
<u>Amendment 12</u>	
12.1 12.1.1 12.1.1.3 12.1.2.2 12.1.2.4 12.1.2.9 12.1.5 12.1.6 12.2.6 12.3.3.1 12.5	"Evaluation of Health Physics Changes Required for Revised 10 CFR 20 Implementation"

ARKANSAS NUCLEAR ONE
Unit 2

UPDATE REFERENCE LIST (continued)

<u>Section</u>	<u>Cross References</u>
<u>Amendment 13</u>	
Figure 12.1-5	Design Change Package 90-2053, "Control Room Expansion Facility Addition"
Figure 12.1-5 Figure 12.1-9 Figure 12.1-11	Design Change Package 93-2020, "CA-1/CA-2 Remodel"
<u>Amendment 14</u>	
12.1.2.8 12.4.1.1	Design Change Package 92-2001, "High Level Waste Storage"
Figure 12.1-14	Design Change Package 94-2008, "Feedwater Control System Upgrade"
<u>Amendment 15</u>	
12.1.2.9 12.3.1 12.3.2.5 12.4.2	Procedure 1000.141, "Solid Radioactive Management Process Control Program"
<u>Amendment 16</u>	
12.1.1.1 12.1.2.1 12.1.2.2 12.1.2.12 12.1.3.4 12.5 Figure 12.1-13	Design Change Package 980642D201, "Steam Generator Replacement Facilities"
12.2.2.2	Engineering Request 002864E201, "Evaluation of Filter Specification Change"
<u>Amendment 17</u>	
12.1.2.7	Engineering Request ANO-2000-2344-026, "Power Uprate Evaluation"
12.2.2.3	Engineering Request ANO-2000-2864-001, "Replacement Filter Evaluation" and Condition Report ANO-C-1998-0177
<u>Amendment 18</u>	
12.1.2.8	Engineering Request ER-ANO-2000-3333-010, "Use of Dry Fuel Storage Casks of Holtec Design"

ARKANSAS NUCLEAR ONE
Unit 2

UPDATE REFERENCE LIST (continued)

<u>Section</u>	<u>Cross References</u>
Figure 12.1-1 Figure 12.1-3 Figure 12.1-4 Figure 12.1-5 Figure 12.1-6	SAR Discrepancy 2-98-0314, "Corrections to Radiation Zoning Figures"
12.2.2.2	Condition Report CR-ANO-2-2004-0605, "Typographical Error Associated with Spent Fuel Supply Fans"
Figure 12.1-2 Figure 12.1-8	Engineering Request ER-ANO-1988-2022, "Modification of Opening Between A and C Charging Pump Rooms"
Figure 12.1-14	Engineering Request ER-ANO-1994-2021, "Control Room Radiation Monitor Replacement"
<u>Amendment 19</u>	
12.4.2	License Document Change Request 2-12.4-0002, "Clarification of Fuel Handling Personnel Qualification"
12.3.1	License Document Change Request 2-1.3-0009, "Revisions Resulting from Implementation of ANO-2 Technical Specification Amendment 255"
12.1.2.1 12.1.2.11 Figure 12.1-13	License Document Change Request 2-1.2-0048, "Deletion/replacement of Excessive Detailed Drawings from SAR"
<u>Amendment 20</u>	
12.1.1.1 12.1.2.1 12.1.2.2 12.1.2.5 12.1.2.6 12.1.2.7 12.1.2.8 12.1.2.9 12.1.2.12 12.1.4.2 12.2.2.2 Table 12.1-5A Figures – ALL	License Document Change Request 05-058, "Deletion/simplification of Excessive Detailed Drawings from SAR"
12.3.3.1 12.3.4	License Document Change Request 07-035, "Use of New Type Dosimeter"

ARKANSAS NUCLEAR ONE
Unit 2

UPDATE REFERENCE LIST (continued)

<u>Section</u>	<u>Cross References</u>
<u>Amendment 21</u>	
12.3.2.6	License Document Change Request 07-061, "Replacement of Obsolete Continuous Air Monitors (PINGs)"
12.3.1 12.3.2.5 12.4.2	Condition Report CR-HNQ-2007-0151, "Employee Alignment-Related Organizational Changes"
12.2.2.1.B.1.b 12.2.2.1.B.1.c	Engineering Change EC-592, "Reactor Vessel Closure Head Upgrade"
<u>Amendment 22</u>	
Figure 12.1-14	Engineering Change EC-2711, "Safety Parameter Display System (SPDS)
12.1.2.12 12.1.3.4 12.5	Engineering Change ER-ANO-2002-1078-006, "Replacement Steam Generators"
<u>Amendment 23</u>	
12.1.1.3 12.1.2.5 12.1.2.7 12.2.1	Engineering Change EC-10746, "Adoption of Alternate Source Terms"
<u>Amendment 24</u>	
12.1.4.2	Condition Reports CR-ANO-1-2012-0066 and CR-ANO-2-2012-0098, "High Range Containment Radiation Monitor Type Correction"
<u>Amendment 25</u>	
12.4.2	License Document Change Request 13-029, "Update to Reflect New Organizational Structure"
12.1.2.11 12.1.2.12 12.1.2.13 Figure 12.1-1 Figure 12.1-13 Figure 12.1-15	Licensing Basis Document Change LBDC 14-031, "Add Detail to OSFSFs and LLRW Building"

ARKANSAS NUCLEAR ONE
Unit 2

UPDATE REFERENCE LIST (continued)

Section

Cross References

Amendment 26

12.1.2.10	Condition Report CR-ANO-C-2014-1356, "Add Detail of Outside Radioactive Storage Facilities"
12.1.2.11	
12.1.2.13	
12.1.2.14	
Figure 12.1-12	
12.1.2.15	"Condition Report CR-ANO-C-2014-1356, "Add Detail of Outside Radioactive Storage Facilities"
Figure 12.1-1	
Figure 12.1-11	
Figure 12.1-14	Engineering Change EC-48348, ""Installation of SFP FLEX Instrumentation"

ARKANSAS NUCLEAR ONE
Unit 2

RECORD OF REVISIONS

<u>PAGE #</u>	<u>AMENDMENT #</u>	<u>PAGE #</u>	<u>AMENDMENT #</u>	<u>PAGE #</u>	<u>AMENDMENT #</u>
TABLE OF CONTENTS		CHAPTER 12 (CONT.)		CHAPTER 12 (CONT.)	
12-i	26	12.3-4	21		
12-ii	26	12.3-5	21		
12-iii	26				
12-iv	26	12.4-1	25		
12-v	26	12.4-2	25		
12-vi	26				
12-vii	26	12.5-1	22		
12-viii	26	12.5-2	22		
12-ix	26				
12-x	26	12.6-1	20		
12-xi	26	12.6-2	20		
		12.6-3	20		
		12.6-4	20		
CHAPTER 12		12.6-5	20		
		12.6-6	20		
12.1-1	26	12.6-7	20		
12.1-2	26	12.6-8	20		
12.1-3	26	12.6-9	20		
12.1-4	26	12.6-10	20		
12.1-5	26				
12.1-6	26	F 12.1-1	26		
12.1-7	26	F 12.1-11	26		
12.1-8	26	F 12.1-12	26		
12.1-9	26	F 12.1-13	25		
12.1-10	26	F 12.1-14	26		
12.1-11	26	F 12.1-15	25		
12.1-12	26	F 12.1-16	20		
12.1-13	26				
12.1-14	26				
12.1-15	26				
12.1-15	26				
12.1-16	26				
12.2-1	23				
12.2-2	23				
12.2-3	23				
12.2-4	23				
12.2-5	23				
12.2-6	23				
12.2-7	23				
12.3-1	21				
12.3-2	21				
12.3-3	21				

12 RADIATION PROTECTION

12.1 SHIELDING

This section describes the bases for the radiation shielding design, discusses the shielding configurations, identifies source terms, and gives estimates of exposure to personnel involved in plant operation and to persons proximate to the site boundary. Design methods for maintaining personnel doses as low as practicable are discussed.

12.1.1 DESIGN OBJECTIVES

The primary objective of the plant radiation shielding is to reduce external doses to plant personnel, in conjunction with a program of controlled personnel access and occupancy in radiation areas, to levels which are both as low as practicable, and which are within the dose regulations of 10 CFR 20 and 10 CFR 50. Regulatory Guide 8.8 will be employed as a shielding and equipment design guide document to ensure that doses are maintained as low as reasonably achievable during all anticipated personnel activities in all areas of the plant containing radioactive materials.

The radiation shielding design considers three plant conditions:

- A. Normal full power operation;
- B. Plant shutdown; and
- C. Design basis events.

12.1.1.1 Shielding for Normal Full Power Operation

Design objectives of plant radiation shielding during normal operation, including anticipated operational occurrences are:

- A. To protect plant personnel, administrators, construction workers, visitors, and proximate site boundary occupants from potential direct radiation and maintain whole body doses within the requirements of 10 CFR 20 and 10 CFR 50 and in conformance with the guidelines of Regulatory Guide 8.8.
- B. To ensure, in the unlikely event of an operational occurrence, adequate protection for plant personnel to permit the safe termination of accident conditions within the guidelines of 10 CFR 20 and 10 CFR 50. (Section 13.3)
- C. To assure sufficient access and occupancy time to allow normal maintenance or safety-related operations required for each plant equipment area and instrumentation area.
- D. To reduce potential equipment activation and mitigate the possibility of radiation damage to materials.

The shielding design is based on assumed plant operating parameters which produce conservative, yet reasonable, radiation activities for each piece of piping and plant equipment (Section 12.1.3). It is expected that the average doses will be much lower than the upper dose levels for each of the accessible zone plant areas.

12.1.1.2 Shielding for Plant Shutdown

The shielding design for the shutdown plant condition considers mainly radiation from the subcritical reactor core, radiation from spent fuel assemblies during onsite transfer, residual activity in the reactor coolant, radiation from neutron-activated materials, and radiation from deposited crud on system internal surfaces.

12.1.1.3 Shielding for Design Basis Events

For the design basis events, the shielding design considered the waste gas decay tank rupture, the fuel handling accident, and the Loss of Coolant Accident (LOCA). For all accident cases, sufficient shielding is provided such that the safety of the personnel remaining on the premises and the general populace is maintained. Doses remain within limits delineated in 10 CFR 50.

12.1.2 DESIGN DESCRIPTION

This section outlines the criteria used in the shielding design and describes the major shielding structures.

12.1.2.1 General Shielding Design Description

Shielding is designed to attenuate radiation through walls and penetrations to less than the upper limit of the radiation zone for each plant area.

Sufficient shielding is provided to reduce the dose rate in each indicated area to the rate for which the area is zoned. In the shielding calculations, the highest anticipated content of radioactive materials in the equipment contributing to the dose is assumed and the dose rate is evaluated at the point in the areas having the highest dose from the aggregate of all contributing sources. Specifically, doses are evaluated for anticipated operational occurrence equipment activity levels corresponding to one percent defective fuel, with conservative credit being taken for decay, dilution and purification losses upstream of the equipment being shielded. Normally, the point within each area at which the dose is evaluated is at the surface of either the shield wall or the surface of the equipment within the area. During normal reactor operation, less than 0.2 percent of the fuel is expected to be defective. In addition, the normal fluid activity contained in each piece of equipment will be substantially lower than assumed in the shielding evaluation due to decay and purification processes for which reduced credit has been taken during shielding design.

Because shielding design is based on conservative plant operating source terms which are much larger than any potential crud source terms, the dose contribution from crud during full power operation is negligible.

A site plot plan is shown in Figure 2.1-3 and a site boundary plan with locations for estimated exposure is given in Figure 2.5-17. A scaled isometric view and a layout drawing of the control room are presented in Figure 12.1-14.

Most plant shielding material is ordinary concrete with an average bulk density of 147 pounds per cubic foot. Variation of concrete density does not exceed minus four percent. Wherever poured-in-place concrete has been replaced by concrete blocks, design assures protection on an equivalent shielding basis. Water and concrete are used for shielding during spent fuel handling and storage. Steel and lead are occasionally used for shielding where space is limited.

ARKANSAS NUCLEAR ONE
Unit 2

12.1.2.2 Radiation Zoning and Access Control

The amount of shielding required was dictated by radiation source strengths and radiation zone dose limits of adjacent areas. Access to areas inside the plant structures and plant yards is regulated by radiation zoning and access control (Sections 12.3.2 and 13.7). Each radiation zone defines the radiation level to which the aggregate of all contributing radiation sources must be attenuated by shielding.

Zoning was determined by required access and occupancy periods in conformance with 10 CFR 20 and 10 CFR 50. Each room, corridor, and pipeway of every plant building was evaluated for potential radiation sources during normal operation, shutdown, and emergency operations; for maintenance occupancy requirements; for general access requirements; and for material exposure limits to determine appropriate zoning. Radiation zones employed and their descriptions are given in Table 12.1-1. All frequently accessed areas such as corridors are shielded for Zone II or Zone I access. The Zone II maximum of 2.5 mrem/hr is based on a restricted occupancy of 40 hours per week. An individual receiving the maximum Zone I dose rate (1.0 mrem/hr) could spend up to 100 hours/wk in Zone I areas and remain within the 10 CFR 20 limits.

It would be of marginal benefit to lower the Zone II maximum allowable dose rate since plant radiation workers generally receive most of their dose from maintenance work in higher zoned areas. The cost of additional shielding, of structural design and engineering, and of architectural rearrangement would outweigh the possible slight benefits from reduced radiation levels.

Zoning and acceptable radiation levels at valve stations were determined by a weighted combination of anticipated radiation level at the valves resulting from crud buildup and/or process fluid in lines and valves, radiation from adjacent shielded or unshielded equipment, and the anticipated frequency of required valve operations.

In areas where the product of the dose rate times the access time required for valve operation yields an expected dose of 100 mrem/wk or greater to plant personnel, the valves are equipped with reach rods which pass through or over the shield wall, or with remote manual operators, or with motor operators. All valves located in Zone V areas which must be operated manually will be provided with reach rods or remote manual operators or motor operators.

When equipment located in Zone V is operated intermittently, only those valves associated with safe operation, shutdown, and draining of the equipment have remote-manual operators, or reach rods. All other operations may be performed with the equipment in the shutdown mode.

Instrumentation which required periodic visual inspection is located in corridors or on local or central control boards. Most pieces of equipment are located in individually shielded compartments for maintenance or repair to limit radiation exposure from adjacent sources.

Removable shadow shields of concrete, steel, or lead will be utilized to facilitate maintenance and repair operations which must be performed in the presence of radiation fields.

Pipes carrying radioactive materials have been routed through controlled access areas properly zoned for that level of activity. Each piping run has been individually analyzed to determine potential radioactivity level and surface dose rate. Where it is necessary that radioactive piping be routed through corridors or other low zoned areas, shielded pipeways are provided. Care

ARKANSAS NUCLEAR ONE
Unit 2

was exercised to separate radioactive piping from non-radioactive piping to minimize personnel dose. Should maintenance be required, provision is made to drain piping and associated equipment. Potentially radioactive pipes are always located in appropriately zoned and restricted areas. Health physicists will monitor process piping to ensure that access is controlled to limit personnel dose (see Section 12.3.1).

Plant personnel ingress and egress to controlled areas are supervised from the access control station at Elevation 386 feet of the auxiliary building. Access will be permitted only after an area has been adequately surveyed to establish that dose rates and allowable working time are within 10 CFR 20 limits.

Any area, accessible to personnel, having a radiation level which could produce a whole body dose in excess of 5.0 mrem in any hour, will be posted as a "Radiation Area." Any area having a radiation level which could produce, in any one hour, a dose equal to or greater than 100 mrem will be posted as a "High Radiation Area."

Restrictions are enforced by locked doors and other barriers, removable concrete shielding, and administrative control. Radiation areas are provided with barriers and postings.

Personnel have been given instruction in the use of escape routes which involve the minimum exit time in case of emergencies. Wherever practical, the measured radiation level and location of the source will be posted at the entrance into any radiation areas.

12.1.2.3 Penetrations

Penetrations or other discontinuities in shield walls required for piping, ventilation, electrical cables, or access to any equipment are arranged carefully to avoid a direct line of sight with the radiation source to prevent streaming into a lower zoned area. Grouting material is used to fill the voids between the penetration and the wall where necessary. Bends and offsets are also used where necessary to reduce streaming through the penetrations.

Shield discontinuities include concrete hatch covers, shielding doors and access labyrinths. To reduce radiation streaming through the gap between the main shield and the removable section, offsets were used. Access labyrinths into rooms containing radiation sources were designed to eliminate direct shine through the offset passage to the accessible areas.

12.1.2.4 Justification for Shield Design Thickness

The shielding thicknesses provided to ensure compliance with plant radiation zoning and to minimize plant personnel exposure were based upon maximum equipment activities under the plant operating conditions as described in Section 12.1.3. The thickness of each shield wall surrounding radioactive equipment was determined by approximating as closely as possible the actual geometry and physical condition of the source or sources. In general, the volumetric sources were assumed to be homogeneous and static. The isotopic concentrations were converted to energy group sources using data from Reference 13.

The geometric model assumed for shielding evaluation of tanks, heat exchangers, filters, demineralizers, evaporators, and the containment was a finite cylindrical volume source. For shielding evaluation of piping, the geometric model was an infinite shielded cylinder. In cases where corrosion products are deposited on surfaces such as a pipe, the latter was treated as a cylindrical surface source. The shielding thicknesses were selected to maintain the aggregate

ARKANSAS NUCLEAR ONE
Unit 2

computed dose rate from all sources of radiation at less than the maximum allowable dose rate for each particular radiation zone. Dose rates were evaluated at the point of maximum radiation dose through any wall. Therefore, the actual anticipated radiation levels in the greater area of each radiation zone are less than the upper radiation zone limit.

The computer programs that were used in shielding calculations are briefly described in Table 12.1-2. A bibliography of shielding references and data references is given in Section 12.5.

12.1.2.5 Containment Shielding Design Description

The containment is a reinforced, prestressed, post-tensioned, steel-lined concrete structure. During operation the containment and containment internal structures protect personnel in adjacent plant structures and yard areas from radiation emanating from the reactor vessel and primary loop components. The reactor vessel shield and steam generator shield walls, together with the 3-foot, 9-inch thick concrete containment wall, reduce radiation levels outside the containment to less than 1 mrem/hr (see Section 12.1.2.7).

For the design basis accident, the containment shell would reduce the plant and off-site radiation intensities from fission products inside the containment to acceptable emergency levels as defined by 10 CFR 50, Appendix A, Criterion 19 for the control room (see Section 12.1.2.7) and 10 CFR 50.67 for off-site and exclusion locations (see Section 15.1.13).

Where personnel and equipment hatches or other penetrations pass through the containment wall, additional shielding is provided to attenuate radiation to the required level defined by the outside radiation zone.

12.1.2.6 Containment Interior Shielding Design Description

During reactor operation, access to most areas inside the containment will be prohibited due to high radiation levels. However, shielding is provided to reduce dose rates to as low as practicable to allow access into areas of the containment during reactor operation. These areas are designated Zone IV or lower.

The main radiation sources are the reactor vessel and primary loop components consisting of the steam generators, pressurizer, reactor coolant pumps, and associated piping. The reactor vessel is shielded by the primary shield wall (5 feet, 6 inches of reinforced concrete) and the reactor cavity neutron shield. The reactor cavity neutron shield consists of a 1-foot thick ring of a silicone elastomer between the reactor vessel and primary shield wall, with the top of the shield just below the reactor vessel nozzles. (See Figure 12.1-16.) Table 12.1-6 lists the chemical and physical data of the shield material. One inch of insulation is provided between the reactor vessel and the reactor cavity neutron shield and its supports to prevent direct contact of the shield material with the reactor vessel. Ventilation flow paths are provided through the shield by the use of double-elbow ventilation ducts distributed throughout the shield. These ducts prevent overheating, dehydration, and degradation of the shielding and structural properties of the primary shield. The primary shield and reactor cavity neutron shield, in conjunction with the secondary shield, attenuate radiation from the vessel and reduce neutron activation of components and structures over the life of the plant.

ARKANSAS NUCLEAR ONE
Unit 2

The secondary shield consists of four feet of reinforced concrete. It surrounds the steam generators, reactor coolant pumps, pressurizer and all associated piping. The secondary shield supplements the primary shield by further attenuating neutrons escaping the primary shield. It also attenuates high energy gamma radiation from the Reactor Coolant System (RCS) allowing limited local access in containment during full power operation.

After shutdown, most of the containment is accessible for limited time periods; all access is controlled. Areas are surveyed to establish allowable working periods. Dose rates are expected to range from one to 1,000 mrem/hr depending on the location inside the containment (excluding the reactor cavity). These dose rates result from residual fission products, neutron-activated materials, and corrosion products in the RCS.

Spent fuel is the primary source of radiation during refueling operations (see Section 9.1.2). Because of the extremely high activity of the fission products contained in the spent fuel elements, massive shielding has been provided for areas surrounding the fuel pool and the fuel transfer canal. All removal and transfer operations of spent fuel assemblies are performed under borated water. During fuel handling, a dose rate of 2.5 mrem/hr or less in working areas is maintained.

12.1.2.7 Control Room Shielding

Layout and isometric drawings of the control room, given in Figure 12.1-14, show its relationship to the containment.

The design basis LOCA dictates the shielding requirements for the control room. Shielding is provided to permit access and occupancy of the control room under LOCA conditions with radiation exposures limited to 5 rem TEDE for the duration of the accident in accordance with 10 CFR 50.67.

The design basis LOCA is described in Section 15.1.13 and is based on Regulatory Guide 1.183. Protection of the control room personnel from the fission product release in the containment is provided by the concrete walls between the control room and the containment. Direct radiation from the airborne fission products inside the containment would contribute less than 0.1 rem TEDE to personnel inside the control room for the 30-day period following the LOCA (see Section 15.1.13).

The parameters used in the demonstration of the control room habitability, in addition to Regulatory Guide 1.183, are listed below.

- A. No credit is taken for shielding by the internal structures in the containment. Credit is taken for the 3-foot, 9-inch containment wall.
- B. Credit is taken for the 1-foot, 6-inch thick control room walls.
- C. Credit is taken for radiological decay.
- D. Credit is taken for iodine species distribution as listed in Section 15.1.13.
- E. Credit is taken for spray removal of iodine as listed in Section 15.1.13.

Emergency air conditioning and filtration systems are provided for post-LOCA conditions (see Section 9.4.1). Ventilation system parameters are listed in Section 12.2.

12.1.2.8 Spent Fuel Handling Area Shielding

Fuel handling area shielding is designed to protect personnel during spent fuel removal, spent fuel transfer to the spent fuel pool, spent fuel pool storage, and subsequent handling and loading into shipping casks. All spent fuel storage and handling operations take place under borated water until placed into a dry fuel storage system cask.

In the fuel handling area, massive shielding is provided around the transfer tube, the tilt pit, spent fuel storage pool, and the cask pit. Other equipment in the fuel handling area that requires shielding includes the fuel pool heat exchangers, fuel pool cooling pumps and associated piping.

12.1.2.9 Auxiliary Building Shielding

Each piece of equipment in the auxiliary building is shielded in accordance with its postulated maximum activity and with the specified zoning and access requirements of adjacent areas.

During normal operation the main equipment in the auxiliary building with potentially high radioactivity is that in the Chemical and Volume Control System (CVCS), described in Section 9.3.4. The auxiliary building shielding includes all concrete walls, floors, ceilings, covers, and removable blocks that protect personnel working near various system components of the CVCS, primary sampling system, and Shutdown Cooling (SDC) System. This includes the letdown lines, letdown heat exchanger, purification filters and demineralizers, volume control tank, and charging pumps. Sufficient transit time exists in fluid lines from the reactor pressure vessel exit to the outside of containment to decay virtually all the Nitrogen-16 activity (see Section 12.1.3). The design of the letdown line ensures a delay of at least 52 seconds.

Specific activities of the reactor coolant in each of these components are given in Section 12.1.3.

The filters and demineralizers could accumulate large amounts of radioactivity during letdown system operation and are located in individually shielded compartments accessible through removable hatches. Contaminated filter elements may be remotely removed and raised into a shielded filter handling device depending on radiation levels. After being transported to the low level radwaste building, the elements are transferred to a shielded shipping cask for off-site disposal or processing.

Spent resins are flushed from the demineralizers to the spent resin storage tank. This operation does not involve dose to the operators. The entire route of the backwashed resins is provided with extensive shielding in conformance with area zoning and access requirements.

Components of the Gaseous Waste System (GWS) are shielded for the maximum accumulated activity discussed in Section 12.1.3 and given in Table 11.3-2.

12.1.2.10 Radwaste and Source Area Shielding

The shielding of the radwaste area includes exterior and interior shield walls. The radwaste area exterior shield walls surround all equipment in the area. The interior shield walls provide shielding for each piece of equipment consistent with its postulated maximum radiation level and with the access requirements of the area and adjacent areas. The sources of radiation in the radwaste area are gases and liquids from the RCS, leakages from other systems, and solids from the spent resins, filters, liquid waste solidification, and shipping container storage area. See Chapter 11 for a discussion of the radwaste systems.

ARKANSAS NUCLEAR ONE
Unit 2

The ANO-2 Auxiliary Building Extension Elev. 335' (east and west concrete racket ball courts) are locked by a chain-link gate and are used for dosimeter irradiations and historically contain a 3 Ci (original activity) Cs-137 source and a 1.2 Ci (original activity) Cs-137 source, respectively. In addition, the ANO-1 Turbine Building Elev. 335' (Pu-Be storage room) is accessed via a locked door and is used to response check neutron instrumentation. This area historically contains a 4.71 Ci (original activity) PuBe source, a 0.72 Ci (original activity) AmBe source, and a 0.120 Ci (original activity) Cs-137 source. The aforementioned areas are posted and controlled in accordance with procedure at all times.

12.1.2.11 Miscellaneous Plant and Plant Yard Areas

The radiation fields at all areas outside the auxiliary building and the containment are much the same during both operation and shutdown. For each of these cases, the dose rate at the building outside surface is normally less than 1 mrem/hr. One exception is the Old Radwaste Storage Building if assumed to be loaded to full capacity; however, normal radioactive material stored is of less curie content than that assumed in calculations and area loading is minimal in comparison to that which the facility is capable of storing. Refer to SAR Section 11.5.6.3 for further radiological information.

The turbine building and plant yard areas are fully accessible during normal operation and shutdown. Shielded solid waste shipping casks and low level solid wastes such as used gloves, anti-C clothing and plastic bags are typically stored in the Low Level Radioactive Waste Storage Building at the east end of the complex. Radwaste storage is further discussed in SAR Section 11.5.6.3. Figure 2.5-17 shows the site plan with locations for estimated exposure.

12.1.2.12 OSGSF Shielding

The shielding for the Original Steam Generator Storage Facilities (OSGSFs) is designed to keep the dose rate outside the OSGSFs less than 1 mrem/hr. The OSGSFs are further discussed in SAR Section 11.5.6.2 and Section 11.1.3.3.8.2 of the ANO-1 SAR. Radiation zoning is illustrated in SAR Figure 12.1-15 (ANO-1 SAR Figure 11-5).

12.1.2.13 LLRWSB

A Low Level Radioactive Waste Storage Building (LLRWSB) provides a controlled environment for receiving and shipping, inspection, equipment sorting, compaction, and decontamination activities associated with on-site storage and off-site shipment of LLRW (see Figures 11.5-2 and 12.1-13). HSAW, consisting primarily of filters and resins, is considered LLRW, but is characterized by higher activities than DAW and the necessity of remote handling and are maintained in a locked high radiation area within the LLRWSB, which is surrounded on all sides by concrete shield walls. The LLRWSB is further discussed in SAR Section 11.5.6.1.

12.1.2.14 ORWSB

The Old Radwaste Storage Building is primarily used to store reusable radioactive material. The standard storage container used is a B-25 box. The building is a metal and concrete structure with 6' high 0.64' thick concrete shield walls extending along north and south sides (see Figure 12.1-12). The ORWSB is further discussed in SAR Section 11.5.6.3.

ARKANSAS NUCLEAR ONE
Unit 2

12.1.2.15 Pole Barn

The pole barn is a metal building with approximate dimensions of 100' x 200' x 50' which contains a posted radioactive material storage area. The area contains low activity level material that is logistically challenging (size, origin, plan for storage and disposal) to the site (see Figure 12.1-11). The Pole Barn is further discussed in SAR Section 11.5.6.4.

12.1.3 SOURCE TERMS

[Information on estimated activities is historical. Because activities were estimated before the unit began operating, actual operating experience may differ from the assumptions used in this section.]

Shielding design source terms are based upon the three general plant conditions: normal full power operation, shutdown, and design basis accidents.

12.1.3.1 Sources for Normal Power Operation

At normal full power operation the core produces 2,815 MWt. For conservatism, the shielding design is based on a reactor power of 2,900 MWt. The main sources of activity are Nitrogen-16 from coolant activation processes, fission products from fuel leaks, and corrosion and activation products. The estimated activity level of Nitrogen-16 at various locations in the RCS is shown in Table 12.1-3. The isotopic inventory of fission, corrosion, and activation products in the reactor coolant is given in Tables 11.1-2 and 11.1-8 for operation at one percent failed fuel. Most shielding was based on the maximum case of one percent failed fuel. It is expected that no greater than 0.2 percent failed fuel will be experienced.

Each plant system was shielded according to the amount of activity present and adjacent zoning and access criteria. These systems include the following:

- Reactor Coolant System
- Chemical and Volume Control System
- Waste Management System
- Gaseous Waste System
- Spent Fuel Pool Cooling and Purification System
- Safety Injection System
- Containment Spray System
- Steam Generator Blowdown System
- Shutdown Cooling System

The main source of radiation in the RCS is Nitrogen-16. Sources of radiation in the Safety Injection System (SIS) and Containment Spray System (CSS) arise from operation with coolant flow from the Refueling Water Tank (RWT). The RWT activity was assumed to be the 313-day concentration of the maximum fission and corrosion product activity in the reactor coolant at 70 °F, excluding tritium, xenon, and krypton, decayed for 30 days and diluted by the volume of the RWT. An ion exchanger purification factor was applied to all isotopes. The assumed maximum RWT activity is given in Table 12.1-4.

ARKANSAS NUCLEAR ONE
Unit 2

In most cases shielding for each component of the radioactive waste systems was based on operation under the maximum activity conditions as outlined in Sections 11.2 and 11.3 for the liquid and gaseous Radioactive Waste Systems (RWS). Tabulation of maximum activities is shown in Tables 12.1-4 and 12.1-4A.

The steam generator blowdown system sources result from carryover of reactor coolant activity through possible steam generator tube leaks into the secondary system. The shielding of the blowdown system was designed for a 1,500 gal/day steam generator tube leak.

The spent fuel pool cooling and purification system has two major sources of activity, reactor coolant activity dispersed to the pool following reactor vessel head removal after shutdown and possible leakage of fission products from spent fuel elements. The maximum spent fuel pool water activity is given in Table 12.1-5.

The CVCS (see Section 9.3.4) source activity is the reactor coolant inventory assuming one percent failed fuel, Table 11.1-2. The Nitrogen-16 coolant activity decays to a very low level before the letdown line exits the containment. It is, therefore, not significant in determining shielding of the CVCS equipment outside the containment. The design activities of the CVCS demineralizer, filters and piping are given in Tables 11.5-1 and 11.1-2.

12.1.3.2 Sources for Shutdown Conditions

In the reactor shutdown condition, the only sources of radiation requiring shielding are the SDC equipment and the spent fuel elements during transfer and storage operation.

The maximum specific activity in the SDC System and the design basis source for SDC shielding is the reactor coolant activity assuming one percent failed fuel decayed three and one-half hours (Table 11.1-2).

For all shielding associated with spent fuel handling, the gamma spectra data are taken from Figures 8-1 and 8-2 of "Reactor Physics Constants," ANL-5800.

12.1.3.3 Sources for Design Basis Events

The accidents evaluated for shielding design are the fuel handling accident and LOCA. Accident parameters for these design basis events are discussed and evaluated in Chapter 15.

12.1.3.4 Stored Radioactivity

Shielded solid waste storage casks are typically stored in a special area of the plant yard as discussed in Section 11.5. Design source terms for outside plant water storage tanks and shielded solid waste shipping casks contribute approximately 0.327 mrem/yr at the site boundary.

The case of two liners (containers) filled with CVCS ion exchanger resins with a holdup time of one year was assumed. The surface dose rate of the 2-inch thick lead casks containing the liners was assumed to be 200 mrem/hr, and the casks were positioned as closely as possible to the radwaste storage building wall. It was assumed that the two casks were placed in the building such that they were closest to the dose point chosen on the site boundary. The building wall thickness was 1/8-inch steel. Source geometry was a right circular cylinder of height 127 cm and radius 60.96 cm. Concentric shielding was assumed. The computer code GRACE II, described in Table 12.1-2, was used to compute the dose rate.

ARKANSAS NUCLEAR ONE
Unit 2

The Original Steam Generator Storage Facilities (OSGSFs) are located north of Unit 2, outside the protected area and adjacent to the north access road. They are reinforced concrete structures designed for long-term storage of contaminated equipment (i.e., the steam generators originally stored in Units 1 and 2, the Unit 1 RCS hot leg elbows, and the reactor vessel closure head originally installed in Unit 1). The shielding provided by the concrete walls and roofs is sufficient to keep doses external to the OSGSFs below the requirements of 10 CFR 20 and 40 CFR 190.

12.1.3.5 Field Run Process Piping

There is no field run process piping which contains radioactive material.

12.1.4 AREA RADIATION MONITORING SYSTEM

12.1.4.1 Design Bases

The Area Radiation Monitoring System (ARMS) is provided to supplement the personnel and area radiation monitoring provisions of the plant health physics program described in Section 12.3. Included in this system are 23 permanently located radiation detectors which provide continuous local and remote indication and alarm of direct radiation dose rate. Also included are the two containment high range monitors for post-accident monitoring and two of the area radiation monitors installed in the Post Accident Sampling System (PASS) building. (A third area radiation monitor in the PASS building is designated as a Unit 1 instrument).

The primary objectives of the ARMS are:

- A. To immediately alert plant personnel prior to entering or working in areas of increasing or abnormally high radiation levels, which, if unnoticed, might possibly result in inadvertent overexposures;
- B. To inform the control room operators of the occurrence and approximate location of abnormal events resulting in the release of radioactive materials or the degradation of shielding structures;
- C. To provide, in the event of many types of hypothetical accidents leading to the contamination of the plant, a means of remotely determining external dose rates in those areas most likely to be contaminated, prior to entry by personnel; and,
- D. To provide a continuous record of external dose rates at selected locations, thereby ensuring detection of transient increases in dose which are attributable to rapid changes in the radioactivity content of equipment and process streams.

The ARMS has no function related to the safe shutdown of the plant, or to the quantitative monitoring of releases of radioactive material to the environment. Only in unusual circumstances where spurious personnel dosimeter readings are suspected would the area monitor readings be utilized to estimate radiation exposures of plant personnel.

ARKANSAS NUCLEAR ONE
Unit 2

12.1.4.2 System Description

The ARMS consists of 20 low range area monitors, three containment area monitors for normal operations, two high-range containment monitors for post-accident monitoring, and two PASS building monitors. Each monitor channel consists of a detector, remote and local alarms, remote and local indicators and a remote power supply.

The low range detectors are wall mounted gamma sensitive Geiger-Mueller tubes with a dynamic range of 1.0E-4 R/hr to 10 R/hr. Their energy dependence is typically flat within ± 20 percent from 80 KeV to three MeV and each detector is provided with an integral 1.0 μ Ci Sr-90 check source operated from the ratemeter processing electronics in the control room.

The three containment radiation detectors are gamma sensitive Geiger-Muller tubes with a dynamic range of 1.0(E-2) R/hr to 1.0(E+3) R/hr and a typically flat response within ± 20 percent from 80 KeV to three MeV. An integral check source is not provided with the three containment radiation detectors.

Periodic checks are performed on the containment radiation detectors. An electronically simulated signal is used during normal plant operating conditions. Portable calibration sources are used for radiation monitor checks during plant shutdown. Handling of check sources is described in Section 12.4, Radioactive Materials Safety.

Each monitor channel is provided with a dual alarm that does not impair indicator movement. One level is set below the background radiation level to act as a circuit failure alarm. The second alarm level is set high enough above the normal measured radiation levels in the area to prevent spurious alarms yet low enough to indicate transient radiation level increases. On occasion other alarm points may be selected depending upon work in progress in the area or operations that will vary the normal measured radiation levels in the area. Some monitors are expected to have different alarm points when the reactor is critical than they will have when the reactor is shut down. Setpoints for high and low alarms are established in accordance with a plant procedure. Both alarms initiate continuous audible and visual alarms at the detector. The local visual alarm is a 75-W incandescent light with a red protective glass cover mounted on a NEMA III enclosure and protected by a cage. The control room annunciator provides a single window which alarms for any channel detecting high radiation levels. Visual verification of the channel that has alarmed is done at the area radiation monitoring control panel in the control room.

Each radiation monitor channel is recorded on a multi-point recorder to provide the operator with a continuous indication and a permanent record of radiation levels in each area.

The two containment high-range radiation monitors are gamma sensitive ion chamber with a range of 1 R/hr to 10E8 R/hr. The monitors are qualified for post-accident use and the detector for each monitor is encased in stainless steel to protect it from harsh post accident conditions. The maximum design temperature for these detectors is 350 °F. Both detectors have an internal Uranium-234 source that is used as an instrument check. The U-234 source should provide a reading of 1 R/hr during normal conditions. The monitors have indication in the control room and one channel is also recorded. They have control room alarms separate from the other area radiation monitors. Ambient temperatures greater than 150 °F in the containment can cause indication errors due to thermally induced "noise" in the detector cabling. The error is greatest at low detector current and will become negligible during post-accident conditions. When the temperature falls below 150 °F, the indication will again be accurate.

ARKANSAS NUCLEAR ONE
Unit 2

The PASS Building monitors are gamma sensitive Geiger-Mueller tubes with a range of 1E-4 R/hr to 10 R/hr. These monitors are similar to the low range area monitors in range. The PASS monitors provide indication in the control room, but no remote indication or alarm. The control modules have a green NORMAL light that is normally illuminated. Upon loss of input pulses from the detector, the NORMAL light will extinguish indicating a failure. The ALERT and HIGH alarm lights on the control module are not used. The monitor has a check source that is activated by depressing the NORMAL light. The check source will cause an upscale reading on the control module meter.

In the auxiliary building, the criterion for selecting these particular locations is to provide a minimum of one radiation monitor on each elevation where equipment handling normally radioactive material is located. On each such building elevation, the monitors are placed in those areas having 40-hr/week occupancy (Radiation Zone II) so as to be seen and/or heard, upon alarming, from both ingress points and points of highest expected occupancy. Readings from the monitors inside containment will permit estimation of personnel occupancy times prior to entry. Three monitors located at elevation 404 feet in the spent fuel area of the auxiliary building are available to indicate abnormal gamma radiation levels in the new fuel and spent fuel handling and storage areas. The three monitors do not meet (and are not required to meet) the criteria specified in Regulatory Guide 8.12 and ANSI/ANS-8.3-1979 for the Criticality Monitoring Instruments described in 10 CFR 70.24.

12.1.4.3 Design Evaluation

The original 23 units of the ARMS are designed to operate unattended for extended periods of time, measuring and recording ambient gamma radiation. Ambient radiation dose rate at the detector is indicated locally at the detector and remotely in the control room. Audible and visual alarms are given at both locations if radiation levels exceed preset limits. The components are solid-state and the system is designed for maximum reliability. The Containment High Range monitors provide alarms in the control room only, and only Channel 1 is recorded. The PASS monitors provide indication only in the control room.

The original 23 units of the ARMS are not essential for safe shutdown and serves no active emergency function during operation. The system warns of increasing radiation levels in various plant areas. All monitor channels are independent and failure of one channel will have no effect on the others. The locally mounted detector and alarm units are housed in NEMA III enclosures. The remote readout modules in the control room are general purpose for panel mounting. All monitors and alarms are fabricated to Seismic Category 2 requirements. The control panel is fabricated to Seismic Category 1 requirements. The Containment High Range monitors are class 1E, and Seismic Category 1 detectors. They provide indication to the operators during accident conditions and are classified as EOP significant. The PASS monitors are not safety related. The indicators are mounted in Control Room Seismic Category 1 cabinets.

12.1.4.4 Inspection and Tests

Each of the monitors was calibrated by the instrument manufacturer prior to shipment using secondary long half-life isotope standards traceable to the National Bureau of Standards. Subsequent monitor calibrations use either on-site calibration standards supplied by the manufacturer or known adjustable radiation fields provided by fixed sources, similar to the Shepherd Source, located on-site. Each of the low range area radiation detectors, including the

ARKANSAS NUCLEAR ONE
Unit 2

PASS building detectors, is supplied with a solenoid operated check source. The low range containment monitors have no check source at all while the containment high range monitors have an internal U-234 source. This source is continually exposed to the detector and provides approximately 1R/hr indication to show that the monitoring circuit has not failed. All monitors are calibrated at the frequency and with the calibration source(s) specified in station procedures.

12.1.5 OPERATING PROCEDURES

Radiological health and safety procedures (see Section 13.5) provide for the protection of plant personnel and visitors against exposure to radiation and radioactive materials during all phases of plant operation and maintenance, as well as during any abnormal plant occurrence. The health physics program is described in Section 12.3.

Visual inspections of plant shielding were made during construction. Due to the massive structure of the shielding, these inspections are limited to inspecting for major defects. Once the reactor is operating, radiation surveys are made to ensure that:

- A. There are no defects or inadequacies in the shielding that might affect personnel doses during normal operation and maintenance of the plant; and,
- B. Areas of the plant are correctly posted and barricaded as radiation and high radiation areas.

These surveys will consist of both gamma and neutron monitoring where appropriate. Continued routine radiation surveys of all plant areas will assure integrity of the shielding (see Section 12.3).

While it is impossible to completely eliminate the production of crud and its subsequent activation, transport, and redeposition throughout the RCS, various means are available to reduce their formation rate and to minimize their concentration in areas of low flow ("crud traps"). These means include system design, material selection, and chemistry control.

System Design

The coolant system is designed to minimize crud buildup problems by the elimination of "crud traps" to the maximum extent possible. Piping runs are kept as short and as unrestrictive as possible to reduce the possibility of low flow areas which could become crud traps and, unless necessary for their operation, all penetrations of the reactor coolant piping originate at the side or top of the pipe to prevent the formation of areas where crud could easily settle.

Material Selection

To avoid the formation of excessive amounts of corrosion products, all piping and components in contact with reactor coolant are constructed of corrosion resistant material. Zircaloy, stainless steel, and Inconel are the major alloys used and all three exhibit superior corrosion resistance at the temperatures and pressures of the RCS. The use of alloys high in Cobalt is minimized in the system unless their superior hardness and wear properties necessitate their use.

ARKANSAS NUCLEAR ONE
Unit 2

Chemistry Control

Effective control over long-term corrosion (the primary source of crud) starts with careful chemistry control during the commissioning period. Chemistry control during the early stage of plant operation is aimed at:

- A. Protection from corrosion due to the presence of construction residues or inadvertent chemical contamination.
- B. Development of a passive oxide film on the system surfaces prior to critical operation.
- C. Protection of the system from localized corrosion induced by oxygen.

Excluding the core, which is not installed initially, the major surfaces are either Inconel-600 or 300 series stainless steel. These materials, although extremely resistant to general corrosion are susceptible to localized attack by contaminants, primarily halide ions, especially before a protective film has been built up. By minimizing the presence of the contaminants by high velocity flushing, by avoiding sensitized materials through close quality control during manufacture, by controlling the concentration of impurities in flush and layup water, and by the use of inhibitors (hydrazine/carbohydrazide), the possibility of attack is substantially reduced. Hydrazine/carbohydrazide also serves the purpose of removing oxygen.

The development of a passive oxide film on primary system surfaces (preconditioning) is extremely important in minimizing corrosion and corrosion product release following critical operation. As the general corrosion of Inconel and stainless steels proceeds, part of the metal oxide forms an adherent layer on the metal surface. As the layer develops, it becomes increasingly passive and slows the corrosion rate to the low, steady state values. To ensure adequate formation of this layer, a special preconditioning period is specified during which reactor coolant chemistry is adjusted to assist in the rapid development of the passive film.

During operation, reactor coolant chemistry is controlled to minimize general corrosion and protect the passive layer developed during pre-core operation. This is accomplished by limiting the impurities present in makeup water and limiting the impurities in the reactor coolant water itself.

Makeup water can contain only limited amounts of dissolved impurities if it is to be used in the RCS. Certain ions known to be harmful (chloride and fluoride) are specifically limited in the makeup water and the presence of other impurities is determined by monitoring and trending conductivity. Thus, the introduction of potential corrodents into the RCS is minimized.

Reactor coolant is maintained in a chemistry condition which is conducive to protecting the passive layer and minimizing corrosion. Oxygen is limited through the use of hydrogen normally, or hydrazine/carbohydrazide when the coolant temperature is below 150 °F. pH is maintained in a band consistent with low corrosion rates by the combined action of lithium (which is produced in the coolant by the neutron activation of B10) and boric acid. Chloride and fluoride, already limited in the makeup water, are also limited in the RCS. By this limitation of corrodents, the corrosion rate is maintained at a low level.

ARKANSAS NUCLEAR ONE
Unit 2

12.1.6 ESTIMATES OF EXPOSURE

Doses to individuals in the plant and at locations in the vicinity of the plant are estimated for normal plant operating conditions, including anticipated operational occurrences. Doses in the plant proper are determined by the occupancy times in the specific radiation zones.

Plant vicinity doses consider direct and scatter radiation associated with equipment inside plant structures as well as radiation source contributions from all outside plant water storage tanks and shielded solid waste shipping casks.

Estimated annual doses and peak dose rates under normal operation with anticipated operational occurrences were calculated for the site boundary, administration building, intake structure, control room, health physics office and hot machine shop. Results are given in Table 12.1-5A.

12.1.7 EQUIPMENT AND AREA DECONTAMINATION PROVISIONS

The design of certain equipment, piping and plant area facilitates decontamination to minimize radiation exposure, in compliance with Regulatory Guide 8.8.

Piping is designed to minimize low points with dead legs. Drains are provided on piping where low points cannot be eliminated. In radioactive systems, the use of backing rings in the piping joint is prohibited to avoid faulting the results of ultrasonic tests of joints and to reduce the potential of crud trap formation for radioactive materials.

Those systems which will become highly radioactive, such as the reactor coolant purification and radwaste slurry transport system, are provided with flush and drain connections to facilitate decontamination.

Access control and traffic patterns are considered in the basic plant layout to minimize the spread of contamination. In addition, to minimize the spread of contamination, (a) equipment vents and drains are piped directly to a collection device connected to the collection system instead of allowing any contaminated fluid to flow across the floor to the floor drain; (b) all-welded piping systems are employed on contaminated systems to the maximum extent practicable to reduce system leakage; and, (c) the valves in some systems are provided with leak-off connections piped directly to the collection system. Decontamination of potentially contaminated areas within the plant is facilitated by hose washdown stations and the use of suitable coatings applied to the concrete floors and walls. Floor drains are provided in all areas of the plant which are potentially contaminated.

ARKANSAS NUCLEAR ONE
UNIT 2

12.2 VENTILATION

The plant ventilation systems are designed to provide a suitable environment for both personnel and equipment during normal plant operation, including anticipated operational occurrences. Certain parts of the plant ventilation system also perform safety-related functions.

12.2.1 DESIGN OBJECTIVES

The plant ventilation system for normal plant operation, including anticipated operational occurrences, is designed to meet the requirements of 10 CFR 20, "Standards for Protection Against Radiation," 10 CFR 50, "Licensing of Production and Utilization Facilities" and 10 CFR 100, "Reactor Site Criteria."

Design criteria for the plant ventilation systems include the following:

- A. During normal operation and anticipated operational occurrences, the maximum airborne radioactive material concentrations in air breathed by personnel in restricted areas of the plant must be as low as reasonably achievable and within the limits specified in Appendix B, Table 1 of 10 CFR 20.

The maximum airborne radioactive material concentrations in unrestricted areas of the plant must be within the limits specified in Appendix B, Table II of 10 CFR 20.

- B. During normal operation and anticipated operational occurrences the dose from concentrations of airborne radioactive material in unrestricted areas beyond the site boundary are As Low As Reasonably Achievable (ALARA) and within the limits specified in 10 CFR 20 and 10 CFR 50.
- C. The dose guidelines of 10 CFR 50.67 must be satisfied following hypothetical accidents.
- D. The dose of control room personnel shall not exceed the limits specified in General Design Criterion 19 of Appendix A to 10 CFR 50 and 10 CFR 50.67.
- E. Airborne radioactivity monitoring is provided in compliance with General Design Criteria 63 and 64 of Appendix A to 10 CFR 50.

In the design of all ventilation systems, the following guidelines are followed wherever practicable:

- A. The airflow is directed from areas of lesser potential contamination to areas of greater potential contamination.
- B. In building compartments with a potential for contamination, a greater volumetric flow is exhausted from the area than is supplied to the area to minimize the amount of exfiltration from the area.
- C. Airborne radioactivity indication is provided by a recorder and alarms in the control room. Local alarms are provided in potentially contaminated areas in which personnel normally have access.

ARKANSAS NUCLEAR ONE
UNIT 2

- D. Consideration is given to the disruption of normal airflow patterns by maintenance operations. Ventilation systems are provided with backdraft dampers and manually adjustable volume dampers to re-establish airflow patterns.
- E. Ventilation fans and filters are provided with adequate space around the units to allow servicing.
- F. Generally, ducts which have a potential high radiation source are routed in low access zones. If a duct with a higher radiation level is routed through a low radiation zone, shielding is provided in the form of a ductway.
- G. Access control and traffic patterns are considered in the basic plant layout to minimize the spread of contamination. In addition, to minimize the spread of contamination, (a) equipment vents and drains are piped directly to a collection device connected to the collection system instead of allowing any contaminated fluid to flow across the floor to the floor drain; (b) all-welded piping systems are employed on contaminated systems to the maximum extent practicable to reduce system leakage; and (c) the valves in some systems are provided with leak-off connections piped directly to the collection system. Decontamination of potentially contaminated areas within the plant is facilitated by hose washdown stations and the use of suitable coatings applied to the concrete floors and walls. Floor drains are provided in all areas of the plant which are potentially contaminated.
- H. In order to minimize the amount of airborne contamination, as a result of valve leakage, a double set of packing with lantern ring is provided for most larger valves (three inches and larger) in lines carrying radioactive fluids. A packing gland is also provided with a leak-off connection which may be piped to a drain header. Metal diaphragm valves are utilized on those systems where essentially zero leakage is required.
- I. Contaminated equipment have design features which will minimize the potential for airborne contamination during maintenance operations. These include flushing connections on pump casings for draining and flushing the pump prior to maintenance, smaller pumps have flanged connections, for ease of removal and flush and drain connections on those piping systems which could become highly radioactive.

12.2.2 DESIGN DESCRIPTION

The following sections describe the ventilation systems for each building expected to contain radioactive material. The descriptions include the design criteria, building volumes, expected flow rates and filter characteristics for the containment ventilation systems, the fuel handling floor radwaste area and the auxiliary building radwaste area ventilation systems, the control room ventilation system, and the turbine building ventilation system.

12.2.2.1 Containment Ventilation System

The systems provided for ventilation of the atmosphere inside the containment and their design criteria (Sections 6.2.2, 6.2.3, 9.4.5) include the following:

- A. Containment Purge System (CPS);
- B. Containment Cooling System (CCS); and
- C. Containment Air Recirculation System.

ARKANSAS NUCLEAR ONE
UNIT 2

The following data pertain to the containment ventilation systems design.

A. Containment volume, cu.ft.	1,800,000
B. Flow rates, cfm	
1. Containment	153,000
a. Containment cooling units (3 of 4)	90,000
b. Control Element Drive Mechanism (CEDM) shroud cooling units	66,000
c. Control Element Drive Mechanism (CEDM) shroud coolings units minimum required flow	32,450
2. Containment Purge System	40,000
3. Containment Air Recirculation System	10,000

A roughing filter, a HEPA filter, and a charcoal adsorber are provided in the CPS. See Section 9.4.5 for a description of the filters and adsorbers.

The condensate from the unit coolers is drained to the Waste Management System (WMS).

A discussion of the estimated environmental releases from containment purge operations is presented in Section 11.3 for normal and anticipated operational occurrences. Section 5.2.7 presents a discussion of the containment monitoring system provided to allow remote indication and alarm of airborne activity within the containment. A tabulation of equilibrium airborne activity levels for expected reactor coolant leak rates and activity levels is presented in Tables 2.2-1 and 12.2-2 and is based on the source term assumptions presented in Section 11.1.

12.2.2.2 Fuel Handling Floor Radwaste Area and Auxiliary Building Radwaste Area Ventilation Systems

The fuel handling floor radwaste area and the auxiliary building radwaste area ventilation systems are described in detail in Section 9.4.3. The fuel handling floor radwaste area ventilation system consists of a single air handling unit equipped with a centrifugal type supply fan, a heating coil and a roll type filter. The auxiliary building radwaste area ventilation system consists of two air handling units each equipped with a centrifugal type supply fan, a heating coil, a cooling coil, and a roll type filter. The incoming air of both systems is directed to all parts of the radwaste area through two independent ductwork systems.

Two independent exhaust systems serve the fuel handling floor radwaste area and the auxiliary building radwaste area. Each system consists of a roughing filter, a HEPA filter, a charcoal adsorber, and two vaneaxial type exhaust fans (one standby). See Section 6.5.2 for a detailed description of the filters and adsorbers, with the following exceptions. Replacement medium efficiency roughing filters are 80% efficient with initial resistance not to exceed 0.56 inch W. G. clean and a face area of 23-3/8" x 23-3/8". Replacement HEPA filters are in compliance with and meet the basic design criteria of ASME AG-1 in lieu of AEC-HSB-306, MIL-F-51079A, and MIL-F-51068D and are not evaluated for dust holding capacity.

ARKANSAS NUCLEAR ONE
UNIT 2

The air for each system is exhausted through a containment flute (vent). Automatic continuous radiation monitoring is provided for the exhaust ducts as described in Section 11.4.2.

The following data pertain to the fuel handling floor radwaste area and the auxiliary building radwaste ventilation system.

A. Fuel handling floor radwaste area volume, cu.ft.	390,000
B. Auxiliary building radwaste area volume, cu.ft.	438,000
C. Flow rates, cfm	
1. Fuel handling floor radwaste area supply system (2VSF-4)	See P&ID M-2262
2. Fuel handling floor radwaste area exhaust system (2VEF-14A <u>or</u> 2VEF-14B)	See P&ID M-2262
3. Auxiliary building radwaste area supply system (2VSF-7A <u>and</u> 2VSF-7B)	See P&ID M-2262
4. Auxiliary building radwaste area exhaust system (2VEF-8A <u>or</u> 2VEF-8B)	See P&ID M-2262

The exhaust systems are designed to maintain the preferred direction of air flow from spaces with low potential radioactivity into spaces of higher potential radioactivity, thus preventing exfiltration of any airborne radioactivity from the radioactive areas.

12.2.2.3 Control Room Ventilation System

The control room is served by both a normal and an emergency air conditioning system. These systems are described in detail in Section 9.4.1.

The following data pertain to the control room air conditioning and filtering systems:

A. Control room volume, ft ³	28,500
combined control room volume, ft ³	~ 40,000
B. Flow rates, cfm	
1. Normal system (air conditioning and filtering)	21,300
2. Emergency system	
a. Air conditioning	9,900
b. Filtering	2,000

Evaluation of the capability of the control room ventilation system to meet General Design Criterion 19 is discussed in Section 12.1 for shielding and radiation monitoring and in Section 9.5.1 for fire protection. The air conditioning portion is discussed in Section 9.4.1 and in the following paragraph.

ARKANSAS NUCLEAR ONE
UNIT 2

The control room is designed to sustain a simultaneous Design Basis Accident (DBA) and Design Basis Earthquake (DBE) without loss of function or habitability. It has been extensively analyzed to ensure that it remains habitable for the 30-day period following a DBA. The results of these analyses are presented in Chapter 15.

The air filter banks are sized for maximum efficiency. See Section 6.5.2 for a detailed description of the filters and adsorbers, except that replacement HEPA filters are not evaluated for dust holding capacity and contain $\leq 7\%$ combustible material by weight.

12.2.2.4 Turbine Building Ventilation System

No consideration was given to potential sources of radioactivity during establishment of air flow paths in the turbine building. Upon indication of steam generator tube leakage, the turbine building air will be periodically monitored for radioactive material with portable sampling instruments. Steam generator tube leakage will be detected by the N-16 monitors, the radiation monitor on the condenser air ejector lines, main steam line radiation monitors, or the steam generator sample monitors. Ventilation air for the areas in the turbine building is supplied by 34 supply fans equipped with roll type filters. Air is exhausted through 10 roof mounted and three wall mounted exhaust fans.

The following data pertain to the turbine building ventilation system design:

A. Turbine Building volume, ft ³	1,660,000
B. Flow rates, cfm	
1. Supply	990,000
2. Exhaust	686,000

12.2.3 SOURCE TERMS

The leakage of steam or liquids containing radioactive material can introduce radionuclides into plant building ventilation air. In the case of steam leakage, essentially all of the noble gases as well as most of the entrained halogens and radioactive particulates will become airborne. For leaking liquids all of the noble gases as well as some of the radioiodines and particulates will become airborne. A complete discussion of the source terms in each plant building is given in Section 11.3. A summary of this material is presented in Table 12.2-2.

12.2.4 AIRBORNE RADIOACTIVITY MONITORING

All fixed airborne radioactivity monitoring instruments within the plant are designed for service as process and effluent monitors. Section 11.4, Process and Effluent Radiological Monitoring System, has a complete discussion of these monitors, including criteria used to determine:

- A. Necessity for and location of instruments.
- B. Sampler and detector operational characteristics;
- C. Detector type, sensitivity, and range;

ARKANSAS NUCLEAR ONE
UNIT 2

- D. Type and location of power sources, indicating and recording devices;
- E. Setpoint and their bases;
- F. Type and location of annunciators and alarms, and the system or operator actions they initiate; and,
- G. The maintenance and calibration programs to be followed.

A discussion of portable airborne monitor instruments used to check the fixed systems is also included.

12.2.5 OPERATING PROCEDURES

Plant operating procedures assure that onsite inhalation exposures will be kept ALARA during plant operation and maintenance. Health physics procedures and methods for controlling radiation exposures are described in Section 12.3.

12.2.6 ESTIMATES OF INHALATION DOSES

The inhalation doses received by plant personnel are dependent on many factors. Some of the more important of those factors are:

- A. Fluid leaking into various building compartments.
- B. The time spent in each compartment.
- C. The activity level of the leaking fluid.
- D. The ventilation flow rate in the building compartment.
- E. The activity level of the ventilating air.
- F. Type of leaking fluid (steam or water).
- G. The use of administrative procedures such as masks or supplemental air supply.

In the design of the plant various measures are taken to prevent the spread of airborne contamination to normally accessible areas of the plant. Wherever practicable, the mechanical equipment will be designed to prevent the release of radioactive material to the building atmosphere. During periods of plant maintenance, the inhalation doses are expected to be low due to the design features of the plant that minimize the potential for airborne contaminants.

ARKANSAS NUCLEAR ONE
UNIT 2

The thyroid inhalation doses given in Table 12.2-4 were evaluated for radioiodine nuclides using the equation:

$$D = \frac{B}{P} \left(\frac{t}{8760} \right) \sum_j C_j DCF_j$$

where

- D = dose rate, rem/yr
- B = breathing rate, cc/yr
- t = annual hours of exposure
- 8760 = total hours per year
- C = airborne radionuclide concentration, $\mu\text{Ci/cc}$
- DCF = dose conversion factor, rem/ μCi inhaled
- P = respirator protection factor
- j = subscript denoting radioiodine nuclide.

The noble gas and radioiodine concentrations employed in the calculation are given in Table 12.2-2. A conservative upper limit to the inhalation dose that could be received by an operator can be estimated by assuming that an operator breathes the plant ventilation exhaust air for 40 hours per week, 50 weeks per year. The occupancy factor for the radwaste area of the auxiliary building was also assumed to be 40 hours per week, 50 weeks per year.

The noble gas decay energies and radioiodine dose conversion factors which were employed are given in Table 15.1.0-2. The breathing rate of plant personnel during the exposure periods was assumed to be 1.1 (+10) cc/yr (10 m³/8 hr). Other assumptions are given in Table 12.2-5.

Surveys to determine concentrations of airborne radioactive materials will be performed routinely at fixed frequencies in predetermined plant areas, and immediately prior to and during personnel entry into areas where the potential for airborne contamination exists. The results of these surveys will determine personnel occupancy factors, respirator requirement, or the need for purging of equipment contents constituting the source of airborne radioactivity, which will limit the weekly intake of radioactive materials by inhalation and skin absorption to the intake derived from 10 CFR 20, Table 1, Column 1, concentrations assuming 40 hr/wk exposure. The exposure of personnel above these levels will require prior authorization from the NRC.

ARKANSAS NUCLEAR ONE
UNIT 2

12.3 HEALTH PHYSICS PROGRAM

12.3.1 PROGRAM OBJECTIVES

Rules and procedures have been established for protection against radiation and contamination. All personnel assigned to the plant and all visitors are required to follow these rules and procedures.

A program is in place which will ensure the capability to accurately determine the airborne iodine concentration in vital areas under accident conditions. This program includes the following:

1. Training of personnel,
2. Procedures for monitoring, and
3. Provisions for maintenance of sampling and analysis equipment.

The ANO Radiation Protection Manual and Health Physics procedures specify administrative controls designed to provide protection of personnel from exposure to radiation in excess of the limits specified in 10 CFR 20 and further to maintain personnel radiation exposure [As Low As Reasonably Achievable \(ALARA\)](#).

The procedures concerning radiation exposure are subject to the same review and approval process as all other plant procedures. All work in controlled access, or other radiation or contamination areas, requires an appropriate Radiological Work Permit (RWP). An RWP must be approved by Health Physics. The radiological hazards associated with the jobs will typically be determined and evaluated prior to approval of the RWPs. The RWP identifies the precautions to be taken, the protective clothing to be worn, and any other radiological safety precautions that are required. In order to control access to radiological areas, warning signs, audible and visual indicators, barricades, and locked doors are used as appropriate.

It is the policy of Entergy Operations, Inc. to keep personnel radiation exposure within the limits set forth in applicable regulations. In addition, Entergy Operations, Inc. is dedicated to the philosophy of ALARA and has established an ALARA program at the Arkansas Nuclear One Facility. The ALARA program is designed to ensure that each person will keep their radiation exposure as low as is reasonably achievable, consistent with performing assigned work. Each individual is responsible for observing rules adopted for the individual's safety and the safety of others.

Procedures, work plans, Radiological Work Permits, and other documents required for jobs involving substantial radiation hazards are reviewed by the ALARA Committee. Items considered in this review may include the use of remote or special tools, temporary shielding, preliminary job-site decontamination, special ventilation containment areas, respiratory protection, special anti-contamination clothing, continuous air monitoring, or any other procedures or devices that will serve to reduce the dose received during the job performance.

ARKANSAS NUCLEAR ONE
UNIT 2

12.3.2 FACILITIES AND EQUIPMENT

12.3.2.1 Controlled Access Facilities

Most of the ANO radiologically controlled areas exist inside the Unit 1 and Unit 2 Reactor and Auxiliary Buildings. (Notable exceptions are the Radioactive Waste Storage Building and the Contaminated Materials Storage Building.) Normal ingress to the Unit 1 and Unit 2 Reactor and Auxiliary Buildings is through a single controlled access portal located on the 386 foot elevation of the Unit 2 side of the plant. Normal egress from these areas is through a similar controlled access portal located on the 386 foot elevation of the Unit 1 side of the plant. The Unit 2 controlled access point contains offices for Health Physics personnel and the ingress control point. The Unit 1 controlled egress point contains a frisking station, personnel decontamination station and the egress control point.

12.3.2.2 Nuclear Chemistry Laboratory Facilities

Nuclear chemistry facilities consist of two conventional chemistry laboratories, a nuclear chemistry laboratory, nuclear chemistry counting room, sample rooms, and sample preparation room.

The nuclear chemistry laboratory has been constructed for ease of decontamination. The lab is designed for the preparation and chemical analysis of reactor coolant. There is a stainless steel lined fume hood in the nuclear chemistry laboratory with a designed exhaust flow of 800 cfm. Two exhaust fans are capable of drawing air from the fume hood, nuclear chemistry laboratory, and other areas in the Auxiliary Building. One fan will start automatically if the other fan stops. If both fans fail, an alarm will sound in the Control Room. Drains from the nuclear chemistry laboratory including the fume hood, floor drains and sinks are connected to the radioactive liquid collection system.

The counting room contains laboratory equipment needed to implement the Nuclear Chemistry Program.

12.3.2.3 Decontamination Facilities

The personnel decontamination station is equipped with a shower, sink, hampers for contaminated clothing, and monitoring equipment for personnel decontamination. Detergents and other cleaning agents along with brushes and towels are also available for this purpose.

Large pieces of equipment can be decontaminated in the cask washdown area on the fuel handling floor, if necessary.

12.3.2.4 Medical Facilities

Medical observation and treatment are available in case of overexposure and contamination. Local physicians and hospital facilities are used in the initial care and treatment of injuries received at ANO.

12.3.2.5 Portable Health Physics Instruments and Equipment

Available [portable](#) instruments are of sufficient variety and function to measure all types of radiation of concern and in all ranges expected during normal and emergency operations. Health Physics instrument procedures are available and training is conducted to assist qualified personnel in the proper selection and use of instrumentation.

ARKANSAS NUCLEAR ONE
UNIT 2

Typical types of portable health physics survey and monitoring instruments available at ANO include:

- A. Battery powered GM count rate meters,
- B. High range GM survey meters,
- C. AC powered GM count rate meters,
- D. Scintillation detectors,
- E. High and low range ionization chamber survey meters,
- F. Neutron REM Meters.

Calibration and maintenance of portable health physics instrumentation is performed in accordance with applicable procedures, using National Institute of Standards and Technology traceable sources and equipment.

12.3.2.6 Air Monitoring Equipment

Continuous air monitors consist of air samplers capable of continuously sampling and monitoring airborne particulate and iodine radioactivity. The monitors can be set to identify airborne activity levels, alarm locally, and transmit data to a remote station for display and recording. When continuous air monitors indicate airborne activity, portable air samplers equipped with collection media for particulate, radioiodine, and noble gas are used to obtain air samples for analysis.

12.3.2.7 Personnel Protective Equipment

Anti-contamination clothing, such as shoe covers, gloves, coveralls, and head covers, is available for use. The protective clothing, respiratory protective equipment and other equipment required for use in contaminated areas is determined by Health Physics and is typically specified on the required Radiological Work Permit.

Respiratory protection equipment used at Arkansas Nuclear One for radiological protection consists of full face respirators, air-line breathing units, and self contained breathing apparatus. Procedures governing the use and maintenance of this equipment comply with the requirements of 10 CFR 20 and rules of good practice such as those published by the American Industrial Hygiene Association, "Respiratory Protective Devices Manual".

12.3.2.8 Special Equipment and Devices

Temporary shielding, remote and special tools, and mock-ups are used as applicable to reduce personnel radiation exposures. Temporary shielding in various forms, such as bricks, blankets and sheets, is available at ANO. Standard types of remote handling tools are also available. Other remote or special handling tools may be purchased or fabricated as the need arises.

12.3.3 PERSONNEL DOSIMETRY

12.3.3.1 External Dosimetry

Personnel monitoring devices such as electronic alarming dosimeters (EADs) and primary dosimeters of legal record (DLRs) are used for measuring personnel dose equivalent due to beta-gamma and neutron radiation from external sources. External dosimetry measurements, records, and reporting systems comply with the requirements set forth in 10 CFR 19 and 10 CFR 20.

ARKANSAS NUCLEAR ONE
UNIT 2

Dose of legal record from external radiation exposure is based upon primary dosimeter results. Primary dosimeters are processed by a laboratory certified by the National Voluntary Laboratory Accreditation Program (NVLAP) as required by NRC regulations. If valid primary dosimeter results are not available, external dose of record will be assigned in accordance with applicable procedures.

12.3.3.2 Internal Dosimetry

Arkansas Nuclear One has the capability to assess the presence of radionuclides and perform in-vivo isotopic analysis. The presence of internally deposited radionuclides is assessed periodically. The reasons for monitoring include initiation of dose monitoring, assessment of the effectiveness of the respiratory protection program, evaluation of suspected intakes of radioactive material, and termination of dose monitoring. This monitoring is performed by personnel monitoring equipment. In-vivo isotopic analyses are normally performed when the assessment indicates internally deposited radionuclides in quantities that exceed the monitor setpoint.

Certain isotopes, such as tritium (H^3), which are difficult to assess in-vivo are assessed by in-vitro analyses. These measurements may be made using Entergy facilities or contracted to vendor services. The need for in-vitro bioassay measurements is evaluated by Health Physics. Any calculated doses, due to internal exposure, are assigned in accordance with the requirements of 10 CFR 20.

12.3.4 PROCEDURES

Procedures are an integral portion of any program. Our Radiological Waste Management and Health Physics Programs are no exception. The procedures which are part of these programs deal with many topics. As a minimum procedures are maintained to address the following areas:

- A. Solid Radioactive Waste Program
 - 1. Minimize the number of contaminated areas and reduce the introduction of materials into contaminated areas.
 - 2. Waste segregation methods and procedures.
- B. Health Physics Program
 - 1. Protection against radiation and contamination.
 - 2. Use of survey and monitoring instruments.
 - 3. Calibration of survey and monitoring instruments.
 - 4. Use and care of respiratory protective equipment.
 - 5. Assignment of dose received if dosimeter of legal record (DLR) results are not available.

ARKANSAS NUCLEAR ONE
UNIT 2

C. Radioactive Material Safety

1. Control, use and storage of Special Nuclear Material.
2. Fuel handling.
3. Sealed source inventory.

ARKANSAS NUCLEAR ONE
UNIT 2

12.4 RADIOACTIVE MATERIALS SAFETY

12.4.1 RADIOACTIVE MATERIALS SAFETY PROGRAM

The Radioactive Materials Safety Program is administered at ANO as a single program for both Unit 1 and Unit 2.

12.4.1.1 Special Nuclear Material

Entergy Operations, Inc. has implemented a program to control the Special Nuclear Material under title to or in possession of the company. The use, storage and control of Special Nuclear Material is accomplished as specified in the operating license and as specifically implemented in applicable procedures. These procedures are part of the company's fuel accountability program and are used in receiving, handling and storing all Special Nuclear Material.

Special Nuclear Material contained in unirradiated fuel assemblies is stored in noncritical arrays in either the new fuel pit or spent fuel pool, both of which are Seismic Class I structures as described in Section 9.1, "Fuel Storage and Handling." Fuel assemblies are inserted into and removed from the reactor according to approved fuel handling procedures using fuel handling equipment as described in Section 9.1. Irradiated fuel assemblies are handled and stored underwater, as described in Section 9.1.2, "Spent Fuel Storage." Licensed storage or shipping casks will be used to move spent fuel from the spent fuel pool.

12.4.1.2 Other Sealed Sources

Other sealed sources of radioactive material, including specific quantities of Special Nuclear Material are controlled through the Health Physics Program described in Section 12.3. Sealed sources containing a sufficient quantity of radioactive material to create a High Radiation Area are locked in a shield or stored in the shielded position when not in use. The rooms in which these sources are used are posted and locked when the sources are in an unshielded position and left unattended.

12.4.2 RADIOACTIVE MATERIALS CONTROL

Reactor Engineering is responsible for the physical accountability of special nuclear material at ANO. Reactor Engineering is also responsible for providing the storage, movement and loading sequences to minimize the handling of fuel assemblies. Operations is responsible for the safe movement and handling of fuel assemblies according to written plant procedures. Personnel trained and qualified in the use of fuel handling equipment perform material movement operations. Onsite shift Operations management is responsible for fuel handling operations on the respective shift.

Other sealed sources of radioactive material are controlled through the Health Physics Program. These sealed sources are used primarily for instrument and out-of-core detector calibrations and may typically include materials, such as radiocesium, radiocobalt, or plutonium-beryllium of various activities. Sealed sources are accounted for through inventories performed as specified by procedure. Leak testing of sealed sources is performed in accordance with Plant Technical Specifications.

ARKANSAS NUCLEAR ONE
UNIT 2

12.4.3 RADIOACTIVE MATERIALS

A complete inventory of licensable quantities of sealed radioactive sources is maintained. At present there are no plans to have any radioactive materials onsite that exceed the limits specified below:

<u>Material</u>	<u>Form and Use</u>	<u>Possession Limit</u>
A. Any Byproduct, Source and Special Nuclear Material	As reactor fuel; as sealed sources for reactor start up; as sealed sources for reactor instrument and radiation monitoring equipment calibration; and as fission detectors	As required for reactor operation
B. Any Byproduct, Source or Special Nuclear Material Krypton-85	Any form for sample analysis or instrument calibration excluding	100 millicuries each isotope; any by-product material 100 milligrams each isotope; any source or special nuclear material *2 curies Krypton-85 as instrument calibration source

* A maximum of 2 curies of Krypton-85 will be onsite for use as an instrument calibration source for both plant process and area radiation monitors. The isotope is kept in pressurized bottles. The maximum total activity for any single bottle is not expected to exceed 950 millicuries.

ARKANSAS NUCLEAR ONE
Unit 2

12.5 REFERENCES

1. Code of Federal Regulations, Titles 10-11 (as of January 1, 1970).
2. "Reactor Physics Constants," ANL-5800, Argonne National Laboratory, July 1963.
3. "Recommendations of the International Commission on Radiological Protection," ICRP Publication 2, Report of Committee II on Permissible Dose for Internal Radiation, 1959.
4. Regulatory Guide 8.8, U. S. Atomic Energy Commission, July, 1973.
5. Baller, D. C., The FAIM Code, A Multigroup, One-Dimensional Diffusion Equation Code, Atomics International, AMTD-118 (1961).
6. Blizzard, E. P., and L. S. Abbott, Reactor Handbook, Vol. III Part B, Shielding, Second Edition (1962).
7. Duncan, D. S., and A. B. Spear, Grace I - An IBM 704-709 Program Design for Computing Gamma Ray Attenuation and Heating in Reactor Shields, Atomics International (June 1959).
8. Duncan, D. S., and A. B. Spear, Grace II - An IBM 709 Program for Computing Gamma Ray Attenuation and Spherical Geometries, Atomics International (June 1959).
9. Engle, Ward W., Jr., "A User's Manual for ANISN: A One-Dimensional Discrete Ordinates Transport Code with Anisotropic Scattering," Union Carbide Corporation, Report No. K-1693 (1968).
10. Grodstein, G. W., "X-ray Attenuation Coefficients from 10 keV to 100 meV," National Bureau of Standards Circular 583, issued April 30, 1957.
11. Jaeger, R. G., et al., "Engineering Compendium on Radiation Shielding," Shielding Fundamentals and Methods, I (1968).
12. Kircher, J. F., and R. E. Poowman, Effects of Radiation on Materials and Components (March 1964).
13. Lederer, C. M., et. al., Table of Isotopes, Lawrence Radiation Laboratory, University of California (March 1968).
14. Marr, D. R., "A User's Manual for 2DBS, A Diffusion Theory Shielding Code," Battelle Memorial Institute, BNWL-1291 February, 1970.
15. Rockwell, T., Reactor Shielding Design Manual, D. Van Nostrand Co., New York (1956).
16. Soodak, H., Reactor Handbook, Vol. III, Part A, Physics, Second Edition (1962).
17. Tipton, C. R., Jr., Reactor Handbook, Vol. I, Materials, Second Edition (1962).
18. Walker, R. L., and M. Grotenhuis, "A Summary of Shielding for Concrete," ANL-6443, November 1961.
19. "Limits For Intakes of Radionuclides by Workers," International Commission on Radiological Protection, ICRP Publication No. 30, Vol. 2, Pergamon Press, N.Y., 1979.

ARKANSAS NUCLEAR ONE
Unit 2

20. SHIELD-SG, Bechtel Standard Computer Program NE650, Version D2-11 [Program Package Release No is D2-11, Executable version is D2-10].
21. SHIELDLIB, Bechtel Standard Computer Program NE660, Version 5 [ALBEDO Executable version is C1-3].
22. ORNL/RSICC, "MCNP4C and MCNPDATAT," C00700ALLCP01 and D00200ALLCP01, dated 7/11/00 to 7/19/00. MCNP4C is a generalized geometry, time-dependent, Monte Carlo transport code that can be used to model complex radiological shielding models.

ARKANSAS NUCLEAR ONE
Unit 2

Table 12.1-1

RADIATION ZONES

<u>Zone</u>	<u>Dose Rate (mrem/hr)</u>	<u>Description</u>
I	≤ 1.0	Controlled access, unlimited occupancy
II	$> 1.0 \leq 2.5$	Controlled access, limited occupancy 40 hr/wk
III	$> 2.5 \leq 15$	Controlled access, limited occupancy between 6-40 hr/wk
IV	$> 15 \leq 100$	Controlled access, limited occupancy for short periods; 1-6 hr/wk
V	> 100	Normally inaccessible. Controlled access, limited occupancy for short periods during emergencies.

Controlled Access Areas - where higher radiation levels and/or radioactive contamination, which have a greater probability of radiation health hazard to individuals, can be expected. Only individuals directly involved in the operation of the plant will, in general, be allowed to enter these areas. Ingress and egress are under the direct supervision and authorization by the plant health physics staff.

Occupancy - the time spent by an individual in a particular area. For Zones III-V, occupancy is to be determined on an area-by-area basis and individual-by-individual basis by the plant health physics staff.

Table 12.1-2

LIST OF COMPUTER CODES USED IN ORIGINAL SHIELDING DESIGN CALCULATIONS

GRACE I	Multigroup, multiregion, gamma ray attenuation code used to computed gamma heating and gamma dose rates in slab geometry (Reference 7).
GRACE II	Multigroup, multiregion, gamma ray attenuation code used to compute the dose rate or heat generation rate for a spherical or a cylindrical source with slab or concentric shields (Reference 8).
ANISN	Multigroup, multiregion code solving the Boltzman transport equation for neutrons or gamma rays in one dimensional slab, cylindrical, or spherical geometry using discrete ordinate, Sn, techniques (Reference 9).
FAIM	Multigroup, multiregion neutron diffusion code used to compute neutron dose rates and neutron heating in one dimensional slab, cylindrical, or spherical geometry (Reference 5).
2DBS	Multigroup, multiregion neutron diffusion code used to compute neutron dose rates and neutron heating in two-dimensional geometry (Reference 14).

ARKANSAS NUCLEAR ONE
Unit 2

Table 12.1-3

**SHIELDING DESIGN SOURCE TERMS FOR
REACTOR COOLANT SYSTEM N-16 SOURCES**

<u>Location</u>	<u>μCi/gm</u>
Exiting Core	173.7
Exiting Reactor Vessel	152.2
Entering Steam Generator	146.8
Exiting Steam Generator	97.0
Entering Reactor Coolant Pump	91.2
Entering Reactor Vessel	82.2
Entering Core	66.2
Exiting Containment in Letdown Line	0.19

Table 12.1-4

**SHIELDING DESIGN SOURCE TERMS FOR
REFUELING WATER TANK ACTIVITY**

<u>Isotope</u>	<u>Activity (μCi/cc)</u>	<u>Total Activity (Ci)</u>	<u>Isotope</u>	<u>Total Activity (μCi/cc)</u>	<u>Activity (Ci)</u>
Sr-89	8.54(-5)	1.62(-1)	Cs-134	4.36(-5)	1.8(-3)
Sr-90	5.77(-6)	2.38(-4)	Cs-136	2.71(-4)	5.13(-1)
Y-90	5.77(-6)	2.38(-4)	Cs-137	1.49(-1)	6.16
Sr-91	3.19(-27)	6.04(-24)	Ba-140	2.99(-5)	1.24(-3)
Y-91	1.52(-3)	6.28(-2)	La-140	3.44(-5)	1.42(-3)
Mo-99	1.03(-5)	4.26(-4)	Pr-143	2.9(-5)	1.2(-3)
Ru-103	6.12(-6)	2.53(-4)	Ce-144	8.44(-5)	3.49(-3)
Ru-106	5.53(-6)	2.29(-4)	Co-60	1.07(-4)	4.42(-3)
I-129	1.71(-9)	3.24(-6)	Fe-59	2.81(-6)	1.16(-4)
I-131	7.48(-3)	3.09(-1)	Co-60	1.07(-4)	4.42(-3)
Te-132	1.3(-5)	5.38(-4)	Mn-54	5.35(-6)	2.21(-4)
I-132	1.34(-5)	5.54(-4)	Cr-51	3.75(-4)	1.55(-2)
I-133	2.83(-12)	5.36(-9)	Zr-95	1.42(-7)	2.69(-4)

Total Ci = 7.27

ARKANSAS NUCLEAR ONE
Unit 2

Table 12.1-4A

SHIELDING DESIGN RADIONUCLIDE SOURCE TERMS (Ci)

<u>Isotope</u>	<u>Reactor Vessel</u>	<u>Steam Generator</u>	<u>Pressurizer</u>	<u>Purification Ion Exchanger</u>	<u>Purification Filter</u>
Br-84	4.32	1.7	6.42(-1)	2.6(-1)	0
Kr-85m	2.58(+2)	1.01(+2)	3.82(+1)	0	0
Kr-85	5.62(+2)	2.21(+2)	8.34(+1)	0	0
Kr-87	1.39(+2)	5.44(+1)	2.06(+1)	0	0
Kr-88	4.48(+2)	1.76(+2)	6.64(+1)	0	0
Rb-88	4.41(+2)	1.73(+2)	6.54(+1)	0	0
Rb-89	1.09(+1)	4.28	1.62	0	0
Sr-89	9.48(-1)	3.72(-1)	1.41(-1)	1.1(+2)	0
Sr-90	5.13(-2)	2.01(-2)	7.61(-3)	2.4(+1)	0
Y-90	1.33(-1)	5.22(-2)	1.97(-2)	0	0
Sr-91	6.32(-1)	2.48(-1)	9.38(-2)	6.8(-1)	0
Y-91	4.36	1.71	6.47(-1)	0	0
Zr-95	1.02	4.0(-1)	1.52(-1)	0	7.8(-1)
Nb-95	1.05	4.11(-1)	1.55(-1)	0	0
Mo-99	2.27(+2)	8.9(+1)	3.36(+1)	0	0
Ru-103	8.26(-1)	3.24(-1)	1.23(-1)	6.8(+1)	0
Ru-106	4.53(-2)	1.78(-2)	6.73(-3)	1.5(+1)	0
Te-129	4.60	1.81	6.83(-1)	4.8(-1)	0
I-129	1.08(-5)	4.22(-6)	1.6(-6)	0	0
I-131	4.27(+2)	1.68(+2)	6.34(+1)	8.8(+3)	0
Xe-131m	2.59(+2)	1.02(+2)	3.84(+1)	0	0
Te-132	6.07(+1)	2.38(+1)	9.01	4.7(+2)	0
I-132	1.33(+2)	5.22(+1)	1.97(+1)	3.3(+1)	0
I-133	5.82(+2)	2.28(+2)	8.63(+1)	1.3(+3)	0
Xe-133	3.68(+4)	1.44(+4)	5.45(+3)	0	0
Te-134	4.50	1.77	6.68(-1)	3.2(-1)	0
I-134	6.23(+1)	2.45(+1)	9.24	6.1	0
Cs-134	4.21(+1)	1.65(+1)	6.25	0	0
I-135	2.69(+2)	1.06(+2)	3.99(+1)	2.0(+2)	0
Xe-135	1.00(+3)	3.94(+2)	1.49(+2)	0	0
Cs-136	6.23	2.45	9.24(-1)	0	0
Cs-137	1.69(+2)	6.66(+1)	2.51(+1)	0	0
Xe-138	6.14(+1)	2.41(+1)	9.11	0	0
Cs-138	1.17(+2)	4.59(+1)	1.73(+1)	0	0
Ba-140	1.16	4.54(-1)	1.72(-1)	3.7(+1)	0
La-140	4.37(-1)	4.37(-1)	1.65(-1)	4.2	0
Pr-143	1.00	3.93(-1)	1.48(-1)	2.9(+1)	0
Ce-144	6.93(-1)	2.72(-1)	1.03(-1)	2.1(+2)	0
Co-60	1.08(-1)	4.32(-2)	1.6(-1)	0	5.5(+1)
Co-58	9.62(-1)	3.78(-1)	1.43(-1)	0	1.6(+2)
Mn-54	1.08(-2)	4.23(-3)	1.6(-2)	0	4.2
Cr-51	5.04(-1)	1.98(-1)	7.48(-2)	0	3.5(+1)
<u>Fe-59</u>	<u>5.84(-3)</u>	<u>2.29(-3)</u>	<u>8.67(-4)</u>	<u>0</u>	<u>6.4(-1)</u>
TOTAL Ci	4.21(+4)	1.65(+4)	6.24(+3)	1.13(+4)	2.56(+2)

ARKANSAS NUCLEAR ONE
Unit 2

Table 12.1-4A (continued)

<u>Isotope</u>	<u>Volume Control Tank</u>	<u>Boric Acid Makeup Tank*</u>	<u>Reactor Drain Tank</u>	<u>Vacuum Degasifier</u>	<u>Boric Acid Holdup Tank</u>
Br-84	1.9(-4)	0	9.9(-4)	2.5(-4)	1.5(-3)
Kr-85m	3.0(+1)	0	4.8(-1)	7.6	2.0
Kr-85	2.4(+1)	0	4.1	4.9	2.1
Kr-87	1.0(+1)	0	7.5(-2)	4.1	4.7(-1)
Kr-88	4.6(+1)	0	5.3(-1)	1.3(+1)	2.8
Rb-88	1.2(+1)	0	5.6(-2)	1.3(+1)	4.3(+1)
Rb-89	2.8(-1)	0	1.3(-3)	3.2(-1)	9.8(-1)
Sr-89	1.3(-3)	1.3(-1)	2.2(-2)	2.5(-3)	1.3(-1)
Sr-90	6.4(-5)	7.2(-3)	1.1(-3)	1.2(-4)	6.3(-3)
Y-90	1.6(-2)	1.3(-2)	1.8(-3)	3.3(-3)	1.6(-1)
Sr-91	8.5(-4)	0	2.6(-3)	5.1(-4)	2.1(-2)
Y-91	5.7(-1)	6.2	9.4(-2)	1.2(-1)	6.1
Mo-99	3.2(+1)	2.9(-1)	3.6	6.7	3.3(+2)
Ru-103	1.1(-2)	5.8(-1)	1.8(-2)	3.9(-3)	2.0(-1)
Ru-106	5.8(-4)	1.2(-2)	9.7(-4)	2.1(-4)	1.1(-2)
Te-129	2.9(-2)	0	2.0(-3)	1.3(-2)	1.6(-1)
I-131	6.2(-2)	2.3(-1)	9.0	9.6(-1)	4.9(+1)
Xe-131m	2.7(+1)	0	4.1	5.4	2.3
Te-132	8.9(-1)	1.9	1.1	2.9(-1)	1.4(+1)
I-132	1.2(-2)	0	1.3(-1)	2.0(-2)	4.3(-1)
I-133	8.3(-2)	1.0(-4)	4.8	6.0(-1)	2.8(+1)
Xe-133	4.6(+3)	0	6.1(+2)	9.2(+2)	3.8(+2)
Te-134	2.3(-2)	0	1.3(-3)	1.4(-2)	1.0(-1)
I-134	3.7(-3)	0	2.3(-2)	4.8(-3)	4.6(-2)
Cs-134	5.3	6.4	8.9(-1)	1.1	5.7(+1)
I-135	3.4(-2)	0	7.6(-1)	1.0(-1)	3.8
Xe-135	1.3(+2)	0	2.8	2.9(+1)	9.0
Cs-136	8.4(-1)	5.9(-1)	1.3(-1)	1.8(-1)	9.0
Cs-137	2.2(+1)	2.7(+1)	3.7	4.7	2.4(+2)
Xe-138	1.6	0	7.4(-3)	1.8	2.9
Cs-138	5.1	0	2.7(-2)	3.5	2.1(+1)
Ba-140	1.7(-3)	9.9(-2)	2.5(-2)	3.0(-3)	1.5(-1)
La-140	1.5(-2)	3.7(-3)	1.4(-2)	4.7(-3)	2.2(-1)
Pr-143	1.4(-2)	1.6(-1)	2.1(-2)	4.8(-3)	2.4(-1)
Ce-144	8.9(-3)	1.9(-1)	1.5(-2)	3.3(-3)	1.7(-1)
Co-60	1.7(-3)	3.8(-1)	2.8(-3)	6.2(-4)	3.2(-2)
Fe-59	9.2(-5)	1.7(-2)	1.5(-4)	3.3(-5)	1.7(-3)
Co-58	1.5(-2)	2.9	2.5(-2)	5.5(-3)	2.8(-1)
Mn-54	1.7(-4)	3.5(-2)	2.8(-4)	6.2(-5)	3.2(-3)
Cr-51	7.9(-3)	1.3	1.3(-2)	2.9(-3)	1.5(-1)
<u>Zr-95</u>	<u>8.0(-5)</u>	<u>1.5(-2)</u>	<u>1.3(-4)</u>	<u>2.9(-5)</u>	<u>1.5(-3)</u>
TOTAL Ci	4.95(+3)	4.85(+1)	6.47(+2)	1.02(+3)	1.21(+3)

* Historical information. Recycling of boric acid concentrate has not been used and tanks have not contained radioactive material.

ARKANSAS NUCLEAR ONE
Unit 2

Table 12.1-4A (continued)

<u>Isotope</u>	<u>Waste Condensate Tank</u>	<u>Preconcen- trator Filter*</u>	<u>Preconcentrator Exchanger*</u>	<u>Boric Acid Concentrator*</u>	<u>Boric Acid Condensate Ion Exch.*</u>
Kr-85	2.4(-1)	0	0	2.4	0
Sr-89	2.8(-5)	0	3.5(-1)	9.7(-3)	1.7(-4)
Sr-90	1.8(-6)	0	8.3(-2)	7.1(-4)	4.1(-5)
Y-90	1.0(-6)	0	2.7(-3)	2.6(-4)	1.4(-6)
Y-91	1.4(-3)	0	2.0(+1)	4.8(-1)	9.8(-3)
Mo-99	2.3(-3)	0	6.3	8.8(-1)	3.1(-3)
Ru-103	4.1(-5)	0	4.2(-1)	1.4(-2)	2.1(-4)
Ru-106	3.1(-6)	0	1.1(-1)	1.2(-3)	5.4(-5)
I-131	3.0(-5)	0	1.3(+1)	8.4(-3)	6.3(-5)
Xe-131m	8.7(-2)	0	0	8.5(-1)	0
Te-132	1.6(-4)	0	4.6(-1)	4.3(-2)	2.3(-4)
Xe-133	4.9	0	0	3.3(+1)	0
I-133	0	0	1.8(-3)	1.4(-6)	0
Cs-134	1.6(-3)	0	7.2(+2)	6.3(-1)	3.6(-2)
Cs-136	9.3(-5)	0	4.9	2.8(-2)	2.5(-4)
Cs-137	7.0(-3)	0	3.5(+3)	2.7	1.7(-1)
Ba-140	1.6(-5)	0	7.4(-2)	4.7(-3)	3.7(-5)
La-140	2.4(-7)	0	5.9(-4)	6.0(-5)	3.0(-7)
Pr-143	2.7(-5)	0	1.3(-1)	8.0(-3)	6.6(-5)
Ce-144	4.6(-5)	0	1.5	1.7(-2)	7.6(-4)
Co-60	9.3(-5)	4.0(-1)	0	3.6(-2)	0
Fe-59	3.6(-6)	4.1(-3)	0	1.2(-3)	0
Co-58	6.7(-4)	1.1	0	2.4(-1)	0
Mn-54	8.9(-6)	3.0(-2)	0	3.3(-3)	0
Cr-51	2.5(-4)	2.0(-1)	0	8.3(-2)	0
<u>Zr-95</u>	<u>3.4(-6)</u>	<u>5.2(-3)</u>	<u>0</u>	<u>1.2(-3)</u>	<u>0</u>
TOTAL Ci	6.02	1.74	4.27(+3)	4.14(+1)	2.2(-1)

* Historical information. The boric acid concentrator has not been operational and system filters/demineralizers have been replaced with superior vendor-installed equipment.

ARKANSAS NUCLEAR ONE
Unit 2

Table 12.1-4A (continued)

<u>Isotope</u>	<u>Waste Tank</u>	<u>Waste Filter*</u>	<u>Waste Concentrator*</u>	<u>Waste Condensate Ion Exch.*</u>	<u>Waste Condensate Tank</u>
Br-84	2.7(-5)	0	2.9(-5)	5.3(-9)	5.9(-9)
Rb-88	1.3(-3)	0	1.4(-3)	2.8(-7)	2.9(-7)
Rb-89	3.0(-5)	0	3.1(-5)	5.8(-9)	6.4(-9)
Sr-89	7.7(-4)	0	2.5(-3)	3.7(-5)	3.7(-6)
Sr-90	3.8(-5)	0	1.3(-4)	7.8(-6)	1.9(-7)
Y-90	6.7(-5)	0	1.9(-4)	1.8(-7)	1.7(-7)
Sr-91	1.2(-4)	0	2.4(-4)	7.0(-8)	7.8(-8)
Y-91	3.3(-3)	0	1.1(-2)	1.8(-4)	1.6(-5)
Mo-99	1.4(-1)	0	4.0(-1)	3.9(-4)	3.5(-4)
Ru-103	1.9(-3)	0	6.3(-3)	7.3(-5)	9.0(-6)
Ru-106	3.5(-5)	0	1.2(-4)	5.4(-6)	1.7(-7)
Te-129	8.5(-5)	0	7.6(-5)	1.5(-8)	1.6(-8)
I-131	3.3(-1)	0	1.0	2.6(-3)	1.3(-3)
Te-132	4.0(-2)	0	1.2(-1)	1.3(-4)	1.1(-4)
I-132	5.0(-3)	0	6.5(-3)	1.4(-6)	1.5(-6)
I-133	2.1(-1)	0	5.0(-1)	2.1(-4)	2.4(-4)
Te-134	3.6(-5)	0	4.2(-5)	8.0(-9)	8.9(-9)
I-134	7.1(-4)	0	8.0(-4)	1.5(-7)	1.7(-7)
Cs-134	3.2(-2)	0	1.1(-1)	5.7(-3)	1.6(-4)
I-135	3.7(-2)	0	6.3(-2)	1.6(-5)	1.8(-5)
Cs-136	4.6(-3)	0	1.5(-2)	5.8(-5)	2.0(-5)
Cs-137	1.3(-1)	0	4.4(-1)	2.7(-2)	6.6(-4)
Cs-138	7.2(-4)	0	7.8(-4)	1.4(-7)	1.6(-7)
Ba-140	9.2(-4)	0	3.0(-3)	1.1(-5)	3.9(-6)
La-140	5.5(-4)	0	1.5(-3)	9.7(-7)	1.0(-6)
Pr-143	7.5(-4)	0	2.4(-3)	9.9(-6)	3.2(-6)
Ce-144	5.3(-4)	0	1.8(-3)	7.7(-5)	2.6(-6)
Co-60	1.0(-4)	9.9(-2)	3.4(-4)	0	5.1(-6)
Fe-59	5.4(-6)	1.1(-3)	1.8(-5)	0	2.6(-7)
Co-58	8.9(-4)	2.9(-1)	3.0(-3)	0	4.3(-5)
Mn-54	1.0(-5)	7.5(-3)	3.4(-5)	0	5.0(-7)
Cr-51	4.6(-4)	6.1(-2)	1.5(-3)	0	2.1(-5)
<u>Zr-95</u>	<u>4.7(-6)</u>	<u>1.4(-3)</u>	<u>1.5(-5)</u>	<u>0</u>	<u>2.3(-7)</u>
TOTAL Ci	9.42(-1)	4.6(-1)	2.69	3.65(-2)	2.96(-3)

* Historical information. The waste concentrator has not been operational and filters/demineralizers have been replaced with superior vendor installed equipment.

ARKANSAS NUCLEAR ONE
Unit 2

Table 12.1-5

**SHIELDING DESIGN SOURCE TERMS FOR
SPENT FUEL POOL ACTIVITY**

<u>Isotope</u>	<u>Activity (uCi/cc)</u>
Sr-89	5.29(-9)
Sr-90	2.51(-10)
Y-90	5.59(-10)
Sr-91	2.04(-11)
Y-91	2.45(-7)
Mo-99	1.02(-6)
Ru-103	4.28(-9)
Ru-106	2.53(-10)
I-129	7.45(-14)
Te-129	3.17(-27)
I-131	3.33(-6)
Te-132	1.83(-7)
I-132	1.88(-7)
I-133	4.98(-7)
Te-134	2.77(-39)
I-134	6.93(-32)
Cs-134	5.27(-6)
I-135	1.52(-9)
Cs-136	1.24(-7)
Cs-137	1.76(-5)
Ba-140	5.62(-9)
La-140	6.12(-9)
Pr-143	5.0(-9)
Ce-144	3.93(-9)
Co-60	4.69(-10)
Fe-59	1.85(-11)
Co-58	4.1(-9)
Mn-54	2.48(-11)
Cr-51	3.2(-9)
Zr-95	8.2(-13)

ARKANSAS NUCLEAR ONE
Unit 2

Table 12.1-5A

ESTIMATES OF EXPOSURE

<u>Location</u>	<u>Peak Dose Rate (mrem/hr)</u>	<u>Annual Dose (mrem/yr)</u>
Site Boundary	4.34×10^{-5}	.375 (note 2)
Administration Bldg.	6.75×10^{-4}	5.83 (note 2)
Intake structure	8.15×10^{-4}	7.04 (note 2)
Control room (El.386')	8.6×10^{-4}	7.43 (note 2)
Health physics off. (El. 386')	7.44×10^{-4}	6.42 (note 2)
Hot machine shop (El. 354')	2.37 (note 1)	4.74 (+3) (note 3)

Notes:

1. Worst case with adjacent sources of volume control tank and spent resin tank having maximum radioactivity.
2. Continuous occupancy, 365 days.
3. 40 hr/wk for 50 wk/yr occupancy (2000 hr/yr)

Table 12.1-6

REACTOR CAVITY NEUTRON SHIELD MATERIAL PROPERTIES

Base	Silicone Elastomer
Temp. Range	0 °F to +550 °F (Min)
Specific Gravity	1.08 (67.3 pcf) at 25 °C (77 °F) (Min)
Gamma Radiation Resistance	1×10^{10} rads (Min)
Heat Aging - Weight Loss	Max 4% - 30,000 hrs. at 400 °F in air
Hydrogen Loss	Max 0.2% - 30,000 hrs. at 400 °F in air
Fire Resistance	
Limiting Oxygen Index	Min 40% oxygen atmosphere to sustain combustion
Heat Conductivity	4×10^{-4} to 8×10^{-4} Cal/sec/cm/c ² /c°
Toxicity	No toxic effects
Hydrogen Density	.065 gm/cc

ARKANSAS NUCLEAR ONE
Unit 2

Table 12.2-1

SOURCE TERM SUMMARY

[This table consists of historical information]

	<u>Leak Rate</u>	<u>Failed Fuel Fraction</u>	<u>Halogen Partition Factor</u>
Containment			
Normal Operation	20 gpd	0.25%	10
Anticipated Operation Occurrence	40 gpd	1.0%	10
Auxiliary Building			
Normal Operation	20 gpd	0.25%	1000
Anticipated Operation Occurrence	20 gpd	1.0%	1000
Turbine Building			
Normal Operation	1700 lb/hr ⁽¹⁾	0.25%	1
Anticipated Operation Occurrence	1700 lb/hr ⁽²⁾	1.0%	1

(1) 13 gpd Steam generator tube leakage, 15 gpm blowdown

(2) 100 gpd Steam generator tube leakage, 15 gpm blowdown

Table 12.2-2

**DESIGN SOURCE TERMS FOR
RADIONUCLIDE CONCENTRATIONS IN BUILDING EXHAUST, $\mu\text{Ci/cc}$**

<u>Isotopes</u>	<u>Auxiliary Bldg.</u>		<u>Turbine Bldg.</u>	
	<u>Normal Operation</u>	<u>Anticipated Operational Occurrence</u>	<u>Normal Operation</u>	<u>Anticipated Operational Occurrence</u>
I-130	0	0	0	0
I-131	2.66(-12)	2.07(-11)	9.42(-13)	5.61(-11)
I-132	8.39(-13)	3.29(-12)	1.26(-13)	3.76(-12)
I-133	3.76(-12)	0	6.28(-13)	0
I-134	4.03(-13)	1.59(-12)	4.96(-15)	1.50(-13)
I-135	1.74(-12)	6.83(-12)	1.30(-13)	3.90(-12)
Kr-83m	0	0	0	0
Kr-85m	1.65(-8)	6.49(-8)	4.29(-13)	3.87(-12)
Kr-85	1.62(-8)	4.03(-8)	1.25(-13)	2.42(-12)
Kr-87	8.99(-9)	3.52(-8)	6.89(-14)	2.09(-12)
Kr-88	2.90(-8)	1.14(-7)	2.24(-13)	6.76(-12)
Xe-131m	1.33(-8)	4.48(-8)	1.03(-13)	2.67(-12)
Xe-133m	0	0	0	0
Xe-133	2.09(-6)	7.61(-6)	1.63(-11)	4.56(-10)
Xe-135	6.42(-8)	2.50(-7)	5.56(-13)	1.67(-11)
Xe-135m	0	0	0	0
Xe-137	0	0	0	0
Xe-138	3.96(-9)	1.56(-8)	2.94(-14)	8.95(-13)

ARKANSAS NUCLEAR ONE
Unit 2

Table 12.2-3

THIS PAGE INTENTIONALLY BLANK
REFER TO AMENDMENT NO. 6

Table 12.2-4

DOSE SUMMARY (REM/YR)

	<u>Auxiliary Building Vent</u>	<u>Turbine Building Vent</u>
Whole Body		
Normal Operation	2.13(-02)	5.26(-07)
Anticipated Operational Occurrences	8.01(-02)	1.59(-05)
Skin		
Normal Operation	5.14(-01)	5.04(-06)
Anticipated Operational Occurrences	1.89	1.40(-04)
Inhalation Thyroid		
Normal Operation	1.43(-02)	4.17(-03)
Anticipated Operational Occurrences	7.92(-02)	2.09(-01)
	<u>Auxiliary Building Radwaste Area</u>	<u>Containment*</u>
Inhalation Thyroid		
Normal Operation	1.43(-02)	5.91(-01)
Anticipated Operational Occurrences	7.92(-02)	8.81(-03)

* Assumptions are given in Table 12.2-5.

Table 12.2-5

ASSUMPTIONS FOR INHALATION THYROID DOSE CALCULATION

CONTAINMENT

- A. Four purges per year
- B. Semi-infinite cloud model for inhalation thyroid dose calculation.
- C. DF = 1000 for wearing respirator
- D. Assume one two hour containment entry per year at anticipated operational occurrence activity level.
- E. Occupancy factor of 40 hrs per week, 50 weeks per year for normal operation.

AUXILIARY BUILDING

- A. Building vent exhaust rate of 5.32×10^4 CFM
- B. Semi-infinite cloud model for inhalation thyroid dose calculation
- C. Occupancy factor of 40 hrs per week, 50 week per year.

FIGURES 12.1-1
THROUGH 12.1-10
DELETED

SAR FIGURE NO. 12.1-1

AMENDMENT 26

ARKANSAS NUCLEAR ONE
UNIT 2
RUSSELLVILLE, ARKANSAS



SCALE: NONE

DRAWN:

DESIGN: ENTERGY

CAD NO:

BASED ON DRAWING NO

SHEET

REV.

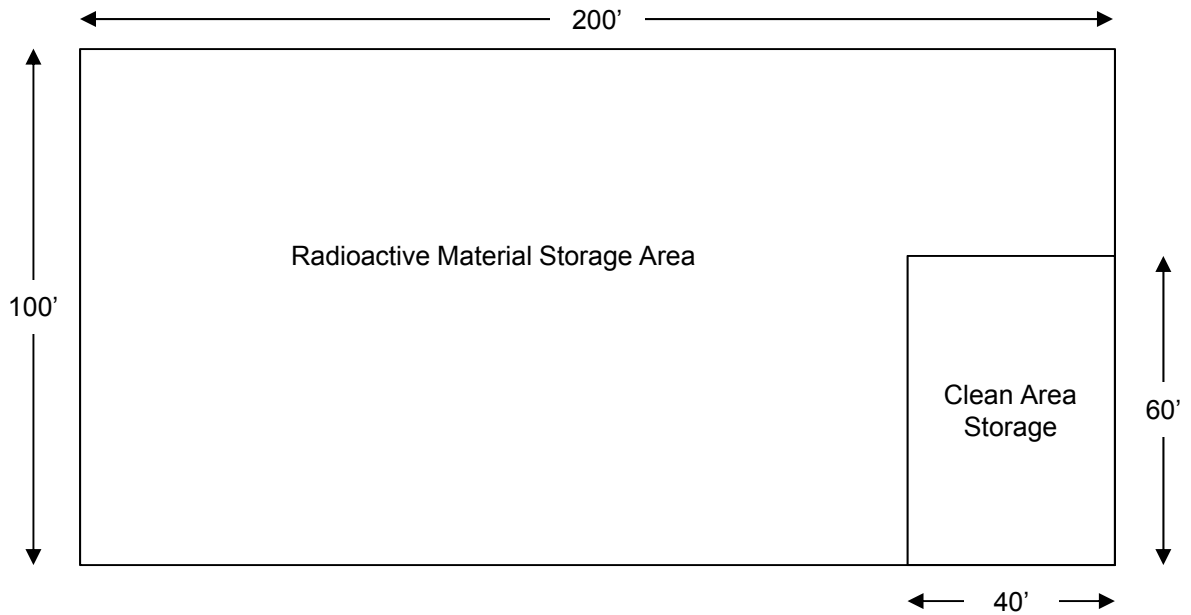

Building height ~ 50'

NOTE: Hypothetical source term geometry estimated to be a right circular cylinder of 50' radius and 30' height with total content of 0.218 Curies.

SAR FIGURE NO. 12.1-11

AMENDMENT 26

ARKANSAS NUCLEAR ONE
UNIT 2
RUSSELLVILLE, ARKANSAS



SCALE:	NONE
DRAWN:	
DESIGN:	ENTERGY
CAD NO:	

POLE BARN

BASED ON DRAWING NO

SHEET

REV.

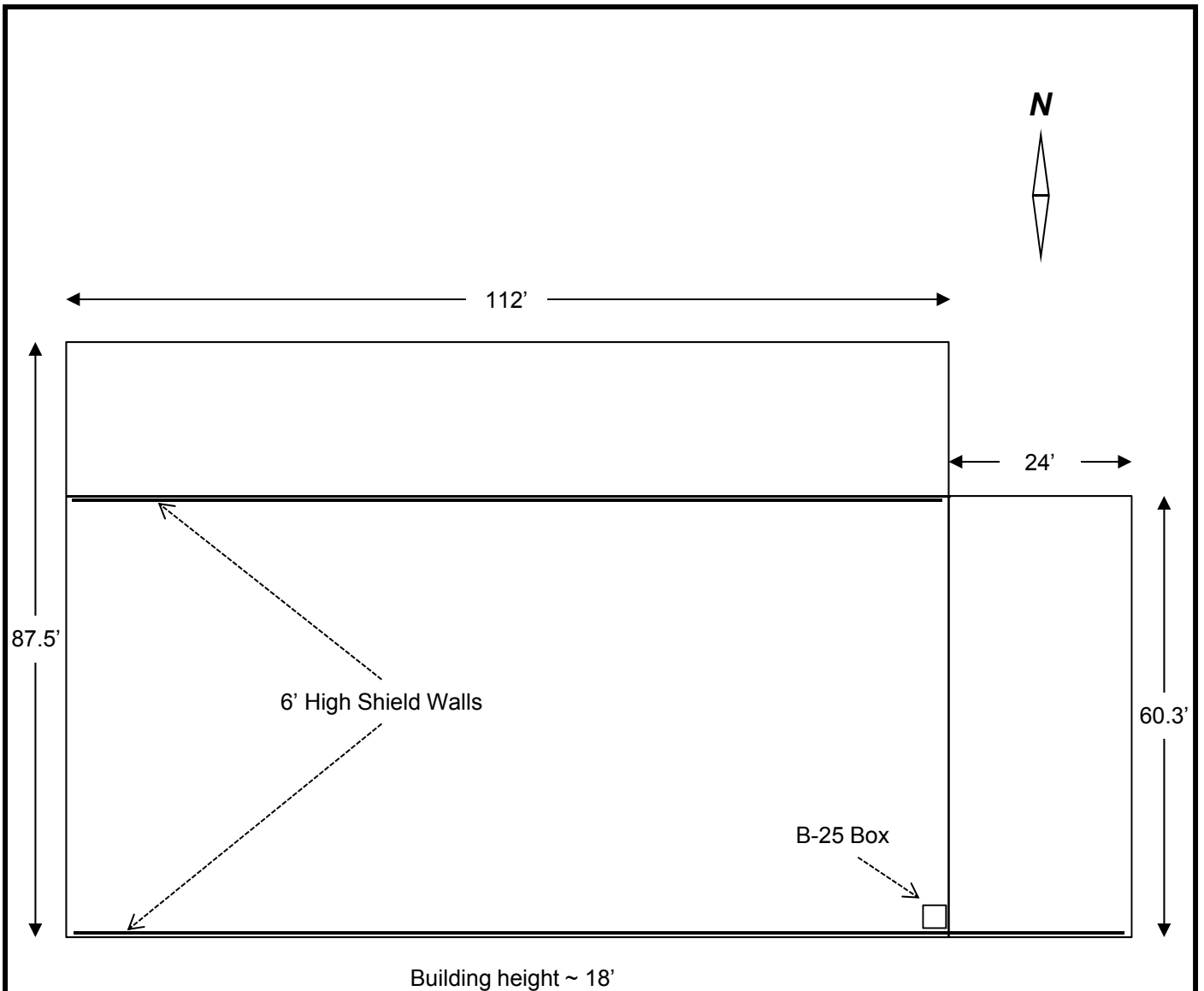

NOTES:

1. Based on estimated volumetric footprint, a total of 1799 B-25 boxes can be stored if stacked 4 high.
2. Conservative estimated dose rate per B-25 box ~ 80 mR/hr.

SAR FIGURE NO. 12.1-12

AMENDMENT 26

ARKANSAS NUCLEAR ONE
UNIT 2
RUSSELLVILLE, ARKANSAS



SCALE:	NONE
DRAWN:	
DESIGN:	ENTERGY
CAD NO:	

OLD RADWASTE STORAGE FACILITY

BASED ON DRAWING NO

SHEET

REV.

High Specific Activity Waste ¹



(dose rates based on maximum storage (mrem/hr))

¹ High Specific Activity Waste (HSAW) consists of primarily filters and resins, and is considered Low Level Radwaste (LLRW), but is characterized by higher activities than DAW and the necessity of remote handling.

SAR FIGURE NO. 12.1-13

AMENDMENT 25

ARKANSAS NUCLEAR ONE
UNIT 2
RUSSELLVILLE, ARKANSAS



SCALE: NONE
DRAWN:
DESIGN: ENTERGY
CAD NO:

LOW LEVEL RADWASTE BUILDING ROOF
ESTIMATED DOSE RATES

BASED ON DRAWING NO

SHEET

REV.

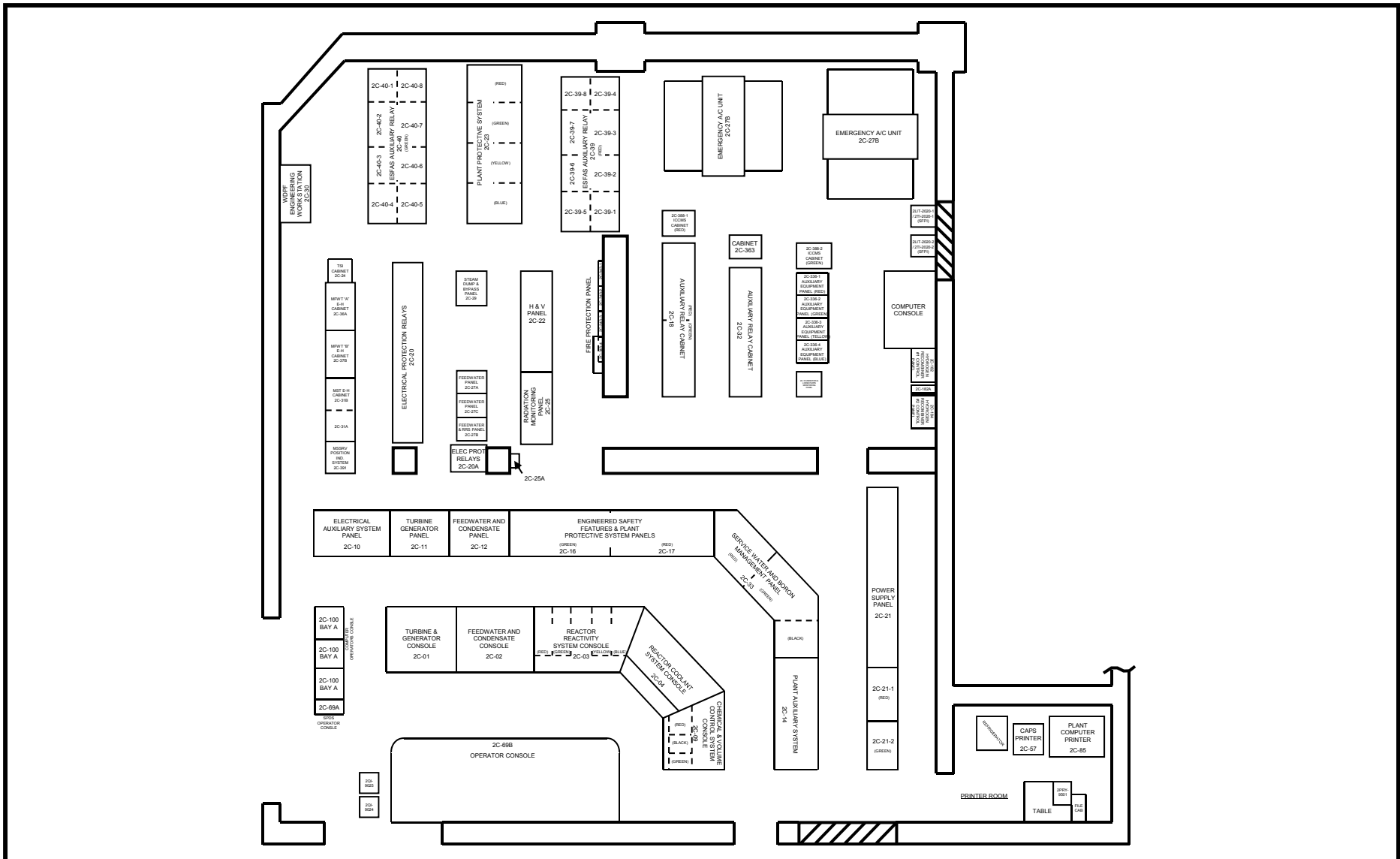

MAIN CONTROL ROOM

SAR FIGURE NO. 12.1-14

ARKANSAS NUCLEAR ONE
 UNIT 2
 RUSSELLVILLE, ARKANSAS



SCALE:	NONE
DRAWN:	ENERGY
DESIGN:	ENERGY
CAD NO:	

AMENDMENT 26		
BASED ON DRAWING NO	SHEET	REV.

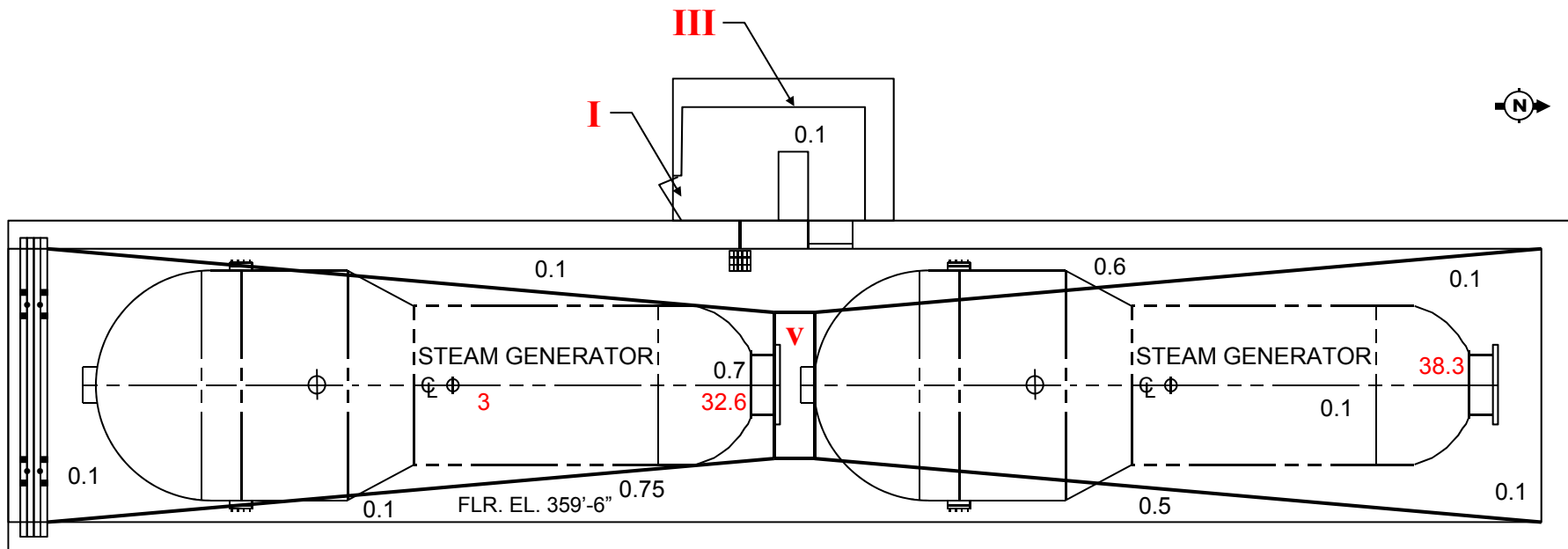

Notes

1. Radiation Zones I – V are defined in SAR Table 12.1-1
2. The OSGSF roof is a Zone I area, but treated as a Zone II area
3. General area dose rates (mR/hr) in black
4. Contact dose rates (mR/hr) in red
5. Dose rates based on 2014 survey

RADIATION ZONING & ACCESS CONTROL PLAN AT OSGSF

SAR FIGURE NO. 12.1-15

ARKANSAS NUCLEAR ONE
 UNIT 2
 RUSSELLVILLE, ARKANSAS



SCALE: NONE
 DRAWN: ENTERGY
 DESIGN: ENTERGY
 CAD NO:

AMENDMENT 25

BASED ON DRAWING NO

SHEET

REV.

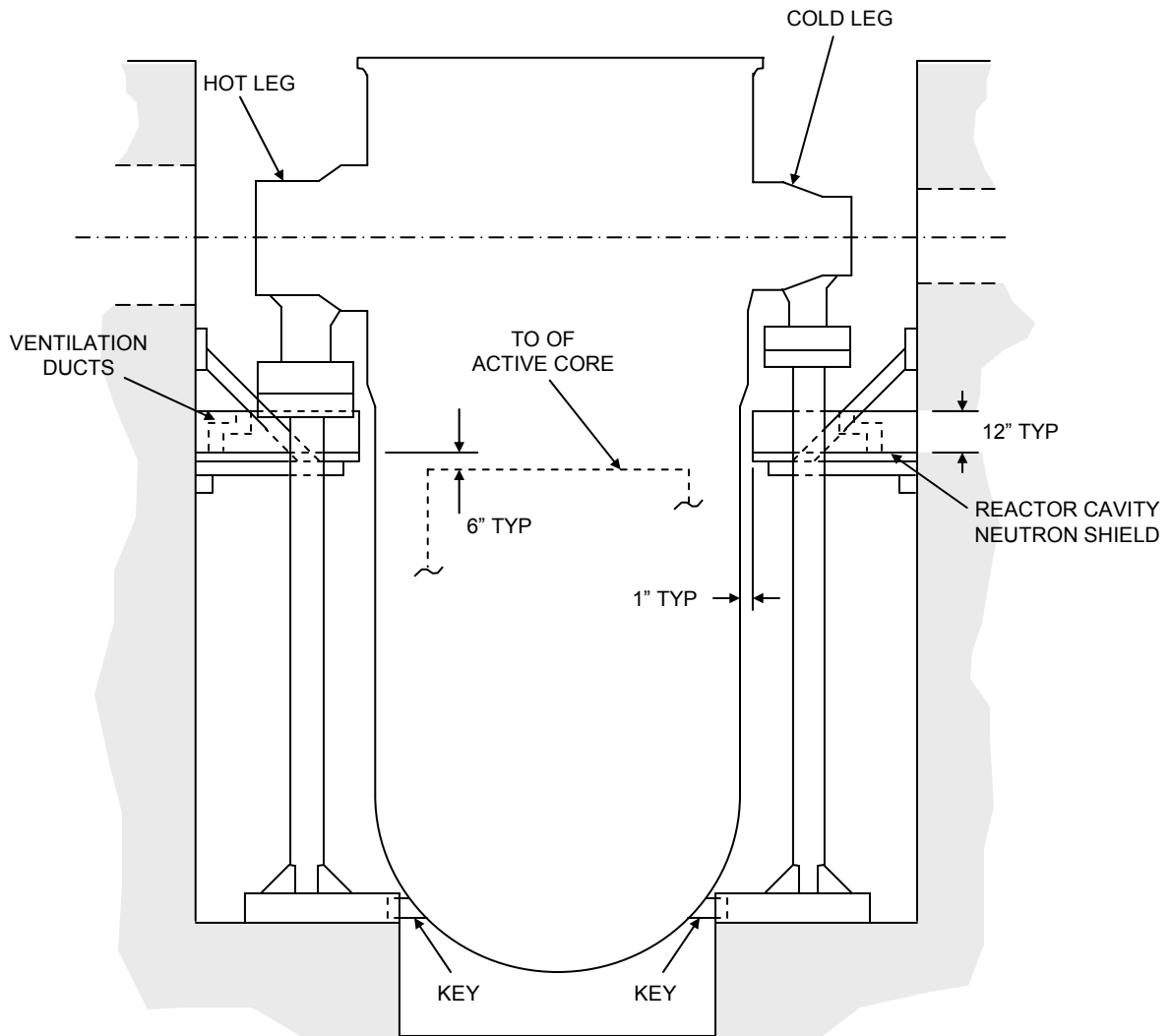

SAR FIGURE NO. 12.1-16

AMENDMENT 20

ARKANSAS NUCLEAR ONE
 UNIT 2
 RUSSELLVILLE, ARKANSAS



SCALE:	NONE
DRAWN:	
DESIGN:	ENTERGY
CAD NO:	

REACTOR CAVITY NEUTRON SHIELD

BASED ON DRAWING NO

SHEET

REV.

ARKANSAS NUCLEAR ONE
Unit 2

CHAPTER 13

TABLE OF CONTENTS

<u>Section</u>	<u>Title</u>	<u>Page</u>
13	<u>CONDUCT OF OPERATIONS</u>	13.1-1
13.1	<u>ORGANIZATIONAL STRUCTURES OF APPLICANT</u>	13.1-1
13.1.1	MANAGEMENT AND TECHNICAL SUPPORT ORGANIZATIONS.....	13.1-1
13.1.2	ORGANIZATION INTERFACES AND RESPONSIBILITIES.....	13.1-1
13.1.3	QUALIFICATIONS OF NUCLEAR OPERATIONS PERSONNEL.....	13.1-1
13.1.4	TECHNICAL CONSULTANTS	13.1-1
13.2	<u>TRAINING PROGRAM</u>	13.2-1
13.2.1	PLANT STAFF INITIAL TRAINING PROGRAM.....	13.2-1
13.2.2	REPLACEMENT TRAINING	13.2-1
13.2.2.1	<u>Replacement Training - Licensed Personnel</u>	13.2-1
13.2.2.2	<u>Replacement Training - Non-Licensed Personnel</u>	13.2-1
13.2.3	RETRAINING PROGRAM.....	13.2-2
13.2.3.1	<u>Licensed Operator Continuing Training Program</u>	13.2-2
13.2.4	RECORDS	13.2-2
13.3	<u>EMERGENCY PLANNING</u>	13.3-1
13.4	<u>REVIEW AND AUDIT</u>	13.4-1
13.5	<u>PLANT PROCEDURES</u>	13.5-1
13.5.1	ADMINISTRATIVE PROCEDURES	13.5-1
13.5.2	OPERATING AND MAINTENANCE PROCEDURES	13.5-1
13.5.2.1	<u>Operations Procedures</u>	13.5-1
13.5.2.2	<u>Other Procedures</u>	13.5-3
13.5.3	PROCEDURE CONTROL	13.5-3
13.6	<u>INDUSTRIAL SECURITY</u>	13.6-1

ARKANSAS NUCLEAR ONE
Unit 2

TABLE OF CONTENTS (continued)

<u>Section</u>	<u>Title</u>	<u>Page</u>
13.7	<u>FIRE PROTECTION PLAN (See Section 9.5.1.5)</u>	13.7-1
13.8	<u>TECHNICAL REQUIREMENTS MANUAL</u>	13.8-1
13.8.1	REGULATORY STATUS/REQUIREMENTS.....	13.8-1
13.8.2	CHANGES TO THE TRM.....	13.8-1

ARKANSAS NUCLEAR ONE
Unit 2

LIST OF TABLES

<u>Section</u>	<u>Title</u>	<u>Page</u>
13.1-1	DELETED	

ARKANSAS NUCLEAR ONE
Unit 2

LIST OF FIGURES

<u>Figure No.</u>	<u>Title</u>
13.1-1	PLANT SPECIFIC TITLES FOR GENERIC TITLES LOCATED IN THE TECHNICAL SPECIFICATIONS
13.1-2	DELETED
13.1-3	DELETED
13.1-4	DELETED
13.1-5	DELETED
13.2-1	DELETED
13.8-1	DELETED

ARKANSAS NUCLEAR ONE
Unit 2

UPDATE REFERENCE LIST

Sections and references listed below denote documents that contain additional cross reference information used to update the SAR.

<u>Section</u>	<u>Cross Reference</u>
13.1.2.1	Correspondence from Williams, AP&L, to Heltemes, NRC, dated April 17, 1978. (0CAN047801).
13.1.2.2	Correspondence from Cavanaugh, AP&L to Reid and Clark, NRC, dated October 20, 1980. (0CAN108017).
13.1.2.1 13.1.2.3 Table 13.1-1 13.2.1 13.2.3.2	Correspondence from Trimble, AP&L, to Eisenhut, NRC, dated December 31, 1980. (0CAN128017).
13.1.1.2	Correspondence from Cavanaugh, AP&L, to Clark, NRC, dated May 27, 1981. (0CAN058116).
13.1.2.2	Correspondence from Cavanaugh, AP&L, to Clark and Stolz, NRC, dated October 8, 1981. (0CAN108104).
13.8.6	Correspondence from Williams, AP&L, to Stolz/Reid, NRC, dated July 7, 1978. (2CAN077806).
<u>Amendment 10</u>	
13.1.1	ANO-2 Technical Specifications Amendment 114, dated February 4, 1991. (0CNA029101).
13.2.2.1 13.2.3.1	Generic Letter No. 87-07.
13.2.2.2.C	Procedure 1063.024, Rev. 9, "Shift Engineer/Shift Technical Advisor Training Program."
<u>Amendment 14</u>	
13.4	Technical Specification 6.5, Amendment 160, "Quality Assurance, Security Plan, and Emergency Plan Requirements"
<u>Amendment 16</u>	
13.1.1.3	ANO-2 Technical Specification 209, "Consolidated Quality Assurance Program"
<u>Amendment 17</u>	
13.1 Figure 13.1-5	Nuclear Management Manual OM-119, "On-Site Safety Review Committee"

ARKANSAS NUCLEAR ONE
Unit 2

UPDATE REFERENCE LIST (continued)

<u>Section</u>	<u>Cross Reference</u>	
<u>Amendment 18</u>		
13.1.1.3.1.1.4	License Basis Document Change 2-13.1-0015, "Organization Changes"	
13.1.1.3.1	License Basis Document Change 2-13.1-0016, "Changes in Organization and Responsibilities"	
13.1.1.3.1.1		
13.1.1.3.1.1.5		
13.1.1.3.1.2		
13.1.1.3.1.3		
13.1.1.3.1.2.1		
13.1.1.3.1.3.1		
13.1.1.3.1.3.2		
13.1.1.3.1.3		
13.1.1.3.1.4		
13.1.1.4.1		License Basis Document Change 2-13.1-0017, "Deletion of Redundant Information Relating to On-Site and Off-Site Safety Review Committees"
13.1.1.4.1.1		
13.1.1.4.1.2		
13.1.1.4.2		
13.1.1.4.2.1		
13.1.1.4.2.2		
13.1.1.3.2.1	License Basis Document Change 2-13.1-0018 "Change in Authority"	
13.1.1.3.2.1.1		
13.1.1.3.2.1	License Basis Document Change 2-13.1-0019 "Deletion of Redundant Information Relating to QA Approval Authority"	
13.2.2.1	License Basis Document Change 2-13.2-0003, "10 CFR Reference Correction"	
13.2.3.1		
13.1.1.3.2.1 Figure 13.1-5	License Basis Document Change 2-13.1-0020, "Organizational Changes"	
<u>Amendment 19</u>		
13.1.1.5.2.1.1	Nuclear Management Manual QV-103, "Corporate Assessment Process"	
13.1.1.3.2.1	License Document Change Request 1-12.1-0022, "Site Organizational Changes"	
13.1.1.3.2.1.2		
13.1.1.5.2.1.1		
13.5.3	Condition Report CR-ANO-C-2005-0014, "Deletion of Incorrect Procedural Reference"	
13.2.2.2	License Document Change Request 2-13.2-0004, "Clarification of Shift Engineer Training Requirements"	

ARKANSAS NUCLEAR ONE
Unit 2

UPDATE REFERENCE LIST (continued)

<u>Section</u>	<u>Cross Reference</u>
13.1.1.3	License Document Change Request 2-13.1-0023, "Plant Organization and Title Changes"
13.1.1.3.1	
13.1.1.3.1.1.2	
13.1.1.3.1.1.3	
13.1.1.3.1.1.4	
13.1.1.3.1.1.5	
13.1.1.3.1.2	
13.1.1.3.1.2.1	
13.1.1.3.1.3	
<u>Amendment 20</u>	
Figures - ALL	License Document Change Request 05-058, "Deletion/simplification of Excessive Detailed Drawings from SAR"
13.1.1.3.1.1.3	Licensing Document Change Request 06-048, "Inspection Program Revision"
13.1.1.3.2.1	
13.1.1.3.2.1.1	
13.1.1.3.2.1.2	
13.1.1.3.2.1	Licensing Document Change Request 06-047, "Revision to QAPM"
<u>Amendment 21</u>	
13.1.1.3.4	License Document Change Request 07-070, "Employee Alignment-Related Organizational Changes"
13.1.1	Condition Report CR-HNQ-2007-0151, "Employee Alignment-Related Organizational Changes"
13.1.1.1	
13.1.1.2	
13.1.1.3	
13.1.1.3.1	
13.1.1.3.1.1	
13.1.1.3.1.1.1	
13.1.1.3.1.1.1.1	
13.1.1.3.1.1.2	
13.1.1.3.1.1.3	
13.1.1.3.1.1.4	
13.1.1.3.1.1.5	
13.1.1.3.1.2	
13.1.1.3.1.3	
13.1.1.3.2	
13.1.1.3.2.1	
13.1.1.3.2.1.1	
13.1.1.3.3	
13.1.1.3.3.1	
13.1.1.3.3.2	
13.1.1.3.4	

ARKANSAS NUCLEAR ONE
Unit 2

UPDATE REFERENCE LIST (continued)

<u>Section</u>	<u>Cross Reference</u>
13.1.1.3.5	
13.1.1.4	
13.1.1.4.1	
13.1.1.4.2	
13.1.1.5	
13.1.1.5.1	
13.1.1.5.2	
13.1.1.5.2.1	
13.1.1.5.2.1.1	
13.1.1.5.2.1.2	
13.1.1.5.2.2	
13.1.1.5.2.3	
13.1.1.5.2.4	
13.1.1.5.2.4.1	
Figure 13.1-1	
Figure 13.1-5	
<u>Amendment 25</u>	
13.1.1	License Document Change Request 13-024, "Remove Specific Corporate Management Titles"
Figure 13.1-1 Figure 13.1-5	License Document Change Request 13-029, "Update to Reflect New Organizational Structure"
<u>Amendment 27</u>	
13.2.2.2	Licensing Basis Document Change LBDC 16-046, "General Employee Refresher Training Frequency"
13.1.1 Figure 13.1-5	Licensing Basis Document Change LBDC 17-013, "Removal of Obsolete or Redundant SAR Figures"

ARKANSAS NUCLEAR ONE
Unit 2

RECORD OF REVISIONS

PAGE # AMENDMENT # PAGE # AMENDMENT #

TABLE OF CONTENTS

13-i	27
13-ii	27
13-iii	27
13-iv	27
13-v	27
13-vi	27
13-vii	27
13-viii	27
13-ix	27

CHAPTER 13 (CONT.)

CHAPTER 13

13.1-1	27
13.2-1	27
13.2-2	27
13.3-1	12
13.4-1	15
13.5-1	19
13.5-2	19
13.5-3	19
13.6-1	15
13.7-1	12
13.8-1	15
F 13.1-1	25
F 13.1-2	20
F 13.1-3	20
F 13.1-4	20
F 13.1-5	27
F 13.2-1	20
F 13.8-1	20

13 CONDUCT OF OPERATIONS

13.1 ORGANIZATIONAL STRUCTURES OF APPLICANT

13.1.1 MANAGEMENT AND TECHNICAL SUPPORT ORGANIZATIONS

The Entergy organization is described in the Quality Assurance Program Manual (QAPM). The role of the corporate organization is to monitor, assess and provide support to the Entergy Operations' nuclear sites and help minimize the activity of the nuclear sites staffs that are not directly related to day-to-day site management.

Plant specific titles for generic titles in the Technical Specifications are located in Figure 13.1-1.

13.1.2 ORGANIZATIONAL INTERFACES AND RESPONSIBILITIES

Entergy Arkansas, Inc. and Entergy Operations, Inc. are joint licensees under the facility operating license condition, each responsible for specific areas and jointly responsible for regulatory compliance and response. Entergy Arkansas, Inc. is licensed to possess the facility and Entergy Operations, Inc. is licensed to possess, use, and operate the facility.

Each supplier of equipment, material, or services and each maintenance or modification contractor is responsible for administering the applicable quality assurance/quality control functions as required by ANO. The Quality Organization is responsible for assuring by surveillance, inspection, audit, or review of objective evidence that onsite functions are accomplished for systems, structures, and services that affect the safety and integrity of the plant.

13.1.3 QUALIFICATIONS OF NUCLEAR OPERATIONS PERSONNEL

The education and experience of the plant operation, technical, and maintenance support personnel meet the requirements set forth in ANSI/ANS 3.1 (1978).

Qualification requirements for Quality Control Personnel that are not specifically addressed in ANSI/ANS 3.1 (1978) have been adopted from and meet the intent of Regulatory Guide 1.8.

Qualification and educational backgrounds of Arkansas Nuclear One management and supervisory personnel are maintained on file at Arkansas Nuclear One.

13.1.4 TECHNICAL CONSULTANTS

Historical data removed; see Section 13.1 of the FSAR.

ARKANSAS NUCLEAR ONE
Unit 2

13.2 TRAINING PROGRAM

Section 13.2.1 describes the initial training developed and conducted for personnel at ANO-2 during the time up to and including initial licensing. Current training is described in Sections 13.2.2 and 13.2.3.

13.2.1 PLANT STAFF INITIAL TRAINING PROGRAM

Historical data removed - To review the exact wording please refer to Section 13.2.1 of the FSAR.

13.2.2 REPLACEMENT TRAINING

13.2.2.1 Replacement Training – Licensed Personnel

The replacement training program for Licensed personnel is based on a Systems approach to training and is accredited by the National Academy of Nuclear Training. The initial accreditation of the training program took place in January, 1984. The new training program, which incorporated revisions required by changes to 10 CFR 55, was audited by the National Academy of Nuclear Training in January, 1988. The current program supercedes the previously existing NRC approved training program (certified to the Commission in accordance with Generic Letter No. 87-07 and the guidance given in NUREG-1262 in May, 1988).

13.2.2.2 Replacement Training - Non-Licensed Personnel

Training for personnel not requiring NRC licenses is provided based upon the individual's background experience and duties and responsibilities of his or her position.

A. General Employee Training

All employees who enter the protected area at ANO are required to attend the General Employee Training program or be accompanied by someone who has completed the training. The program provides a general plant physical and safety orientation to ensure safe execution of their duties. Refresher training is provided to personnel [on a periodic basis](#).

B. Non-Licensed Operator Training

Non-Licensed Operator Training consists of two separate programs. The first program is the auxiliary operator training program which includes on-the-job training and classroom instruction in the categories shift administration, plant design and plant auxiliary systems.

The second program is the waste control operator program which includes classroom presentation and on-the-job training in shift administration, plant systems and design, and advanced radiation worker training.

ARKANSAS NUCLEAR ONE
Unit 2

C. Shift Engineer/Shift Technical Advisor Training

The Shift Engineer/Shift Technical Advisor (SE/STA) Training Program is a comprehensive program of study based on NUREG 0737 designed to provide a SE/STA candidate with a Bachelor's Degree or equivalent in a scientific or engineering discipline with the necessary knowledge and training to perform the duties of an SE/STA. The program is divided into classroom presentations and on-the-job training in the following courses: general employee training, plant systems/instrumentation and controls, plant response and analysis, operating procedures, shift administration, and simulator training.

Continuing training for shift engineers/shift technical advisors consists of attending the licensed operator continuing training program on the unit involved. A minimum of 40 hours of simulator training per year is provided. This 40 hours will include 20 hours of classroom training and 20 hours of training on the simulator.

D. Other Non-Licensed Training

Other areas of training are provided for non-licensed personnel as needed and include such areas as maintenance training (electrical, mechanical and I&C) Health Physics training, Radioactive Waste training, Chemistry training and Radiochemistry training.

13.2.3 RETRAINING PROGRAM

13.2.3.1 Licensed Operator Continuing Training Program

This program was established for the purpose of maintaining Licensed Operators at a level of knowledge and proficiency which is necessary for continued safe operation of the plant.

The Licensed Operator Continuing Training program for Licensed personnel is based on a Systems approach to training and is accredited by the National Academy of Nuclear Training. The initial accreditation of the training program took place in January, 1984. The new training program, which incorporated revisions required by changes to 10 CFR 55, was audited by the National Academy of Nuclear Training in January, 1988. The current program supercedes the previously existing NRC approved training program (certified to the Commission in accordance with Generic Letter No. 87-07 and the guidance given in NUREG-1262 in May, 1988).

13.2.4 RECORDS

Records of qualifications, experience, training, and retraining are maintained at the plant site for each member of the plant organization. These records include grades for individual courses as well as details of experience obtained during observation and on-the-job training periods at operating nuclear power plants. Results of these tests are also maintained in the plant records.

ARKANSAS NUCLEAR ONE
Unit 2

13.3 EMERGENCY PLANNING

The Arkansas Nuclear One Emergency Plan was developed to accommodate emergencies involving Unit 1 and/or Unit 2. For further information, see the Emergency Plan.

This Plan:

- A. Establishes an Emergency Organization to cope with emergency conditions of radiological incidents;
- B. Identifies personnel and delineates their duties and responsibilities in the Emergency Organization;
- C. Establishes criteria for determining the magnitude of the release of radioactive material and the appropriate response;
- D. Establishes a system for reporting radiological incidents to local, state and federal agencies in compliance with the criteria for notification;
- E. Establishes a system for requesting radiological assistance;
- F. Establishes a system of communication for use during emergencies; and,
- G. Identifies possible emergency conditions and the equipment and facilities available to combat them.

ARKANSAS NUCLEAR ONE
Unit 2

13.4 REVIEW AND AUDIT

A program for reviews, including in-plant and independent corporate reviews and audits is established to provide for independent and objective evaluation of matters affecting the Safe Operation of ANO.

A complete description of this program is discussed within the [Quality Assurance Program Manual](#).

ANO facility review and audit procedures are consistent with the requirements of Regulatory Guide 1.33.

13.5 PLANT PROCEDURES

13.5.1 ADMINISTRATIVE PROCEDURES

For the administrative control of safety-related activities, the plant staff will adhere to detailed written procedures covering administrative areas listed below:

- A. Administrative procedures describing operator authority and responsibilities and definition of "Control Room."
- B. Quality Control procedures including, but not limited to, design equipment and material control.
- C. Surveillance and testing requirements.

ANO administrative procedures are consistent with the requirements of Regulatory Guide 1.33.

EOI Headquarters administrative and section procedures provide guidance to the site to ensure consistent management direction on programs and processes. They also convey information to the site for specific requirements based on multi-site development of standardized programs and processes. The site maintains alignment with these procedures through direct implementation or implementation through site administrative and section procedures. All procedures issued from corporate headquarters that are implemented directly at the site and provide instructions in the areas of significant safety or management administrative controls are prepared and reviewed as delineated in Section 13.5.3, PROCEDURE CONTROL.

13.5.2 OPERATING AND MAINTENANCE PROCEDURES

For the operation and maintenance of all systems and components involving nuclear safety, the plant staff will adhere to detailed written procedures covering the activities listed below:

13.5.2.1 Operations Procedures

- A. Plant Operating Procedures, including, but not limited, to the following activities:
 - 1. Plant Preheat and Precritical Check
 - 2. Plant Startup
 - 3. Power Operation
 - 4. Plant Shutdown and Cooldown
 - 5. Refueling Operations (various procedures)
- B. Reactor Coolant System Operating Procedures, including, but not limited to, the following activities:
 - 1. Filling and Venting Reactor Coolant System
 - 2. Soluble Poison Control
 - 3. Pressurizer Operation
 - 4. Reactor Coolant Pump Operation
 - 5. Quench Tank Operation
 - 6. Draining and Blanketing Reactor Coolant System
 - 7. Reactor Coolant Leak Detection
 - 8. Reactivity and Heat Balance Calculation

ARKANSAS NUCLEAR ONE
Unit 2

- C. Auxiliary System Operating Procedures, including, but not limited to, the following activities:
 - 1. Chemical and Volume Control System Operation
 - 2. Shutdown Cooling System Operation
 - 3. Safety Injection Tank Operation
 - 4. Containment Spray Operation
 - 5. Spent Fuel Cooling Operation
 - 6. Circulating Water System Operation
 - 7. Waste Control (various procedures)
 - 8. Instrument and Service Air System Operation
 - 9. Cooling Water System Operation (various procedures)
 - 10. Diesel Generator Operations
 - 11. Building Atmosphere Control (various procedures)

- D. Instrumentation and Control Systems, including, but not limited to, the following activities:
 - 1. CPC/CEAC Operations
 - 2. Vibration and Loose Parts Monitor Operation
 - 3. ESF Electrical System Operation
 - 4. COLSS Operations
 - 5. Control Element Drive Mechanism Control System
 - 6. Computer Operation

- E. Steam System Operating Procedures, including, but not limited to, the following activities:
 - 1. Turbine Startup
 - 2. Condenser and Vacuum System Operation
 - 3. Condensate, Feedwater and Steam System Operation
 - 4. Startup and Blowdown Demineralizer System
 - 5. Main Feedwater Pump and FWCS Operation

- F. Abnormal Operating Procedures, including, but not limited to, the following conditions:
 - 1. Loss of Turbine Load
 - 2. Loss of Instrument Air
 - 3. Loss of Service Water
 - 4. Reactor Coolant Pump and Motor Emergencies
 - 5. Remote Shutdown
 - 6. Primary to Secondary Leakage
 - 7. Alternate Shutdown
 - 8. Natural Emergencies
 - 9. CEA Malfunction
 - 10. Loss of Containment Integrity
 - 11. Annunciator Corrective Actions

ARKANSAS NUCLEAR ONE
Unit 2

- G. Emergency Operating Procedures, including, but not limited to, the following conditions:
 - 1. Reactor Trip Recovery
 - 2. Loss of Reactor Coolant
 - 3. Loss of Feedwater

13.5.2.2 Other Procedures

- A. Radiation Protection Procedures.
- B. Plant Instrumentation Calibration and Test Procedures.
- C. Plant Maintenance Procedures, including, but not limited to:
 - 1. Pressurizer Maintenance
 - 2. Reactor Coolant Pump Maintenance
 - 3. Steam Generator Maintenance
 - 4. Reactor, Internals, Head and Control Element Maintenance
 - 5. Auxiliary Systems Maintenance
 - 6. Refueling Maintenance Procedures
- D. Security Procedures
- E. Emergency Plan Implementing Procedures, including, but not limited to:
 - 1. Offsite Dose Assessments (various procedures)
 - 2. Evacuation
 - 3. Communications System Operation

13.5.3 PROCEDURE CONTROL

Procedure 1000.006, "Procedure Control" provides the administrative controls and requirements for 1) all ANO administrative procedures [and](#) 2) all ANO implementing procedures.

ARKANSAS NUCLEAR ONE
Unit 2

13.6 INDUSTRIAL SECURITY

The Arkansas Nuclear One Industrial Security Plan was developed to accommodate the security of both Unit 1 and Unit 2. This plan is designed to provide the information described in Regulatory Guide 1.17 and covers basically three objectives:

- A. To describe the physical security protection of Arkansas Nuclear One;
- B. To define actions taken by individuals to prevent a security hazard; and,
- C. To describe the preventive measures beyond physical barriers taken to minimize hazards.

Further details are given in the Arkansas Nuclear One Industrial Security Plan (Docket No. 50-313).

ARKANSAS NUCLEAR ONE
Unit 2

13.7 **FIRE PROTECTION PLAN** (See Section 9.5.1.5)

13.8 TECHNICAL REQUIREMENTS MANUAL

The NRC's Final Policy Statement on Technical Specification Improvements for nuclear power plants and 10 CFR 50.36 allow certain requirements to be relocated from the Technical Specifications (TS) to other licensee controlled documents such as the SAR, ODCM, or administrative procedures. To provide an alternative central location for the requirements relocated from the TS and ensure that the necessary administrative controls are applied to these requirements, ANO developed a Technical Requirements Manual (TRM).

The TRM is an operator aid that provides a central location for relocated items. In addition to using the TS numbering and format for relocated items, the TRM provides a reference to the TS, when appropriate, to connect the relocated information to the applicable TS.

13.8.1 REGULATORY STATUS/REQUIREMENTS

The requirements contained in the TRM are part of the licensing basis. Failure to comply with a requirement of the TRM will be evaluated in accordance with the ANO corrective action program. This evaluation will consider effects upon equipment operability and applicable reporting requirements.

13.8.2 CHANGES TO THE TRM

The TRM is administered as part of the SAR. Changes to the TRM are subject to the criteria of 10 CFR 50.59. Administrative controls for processing TRM changes are included in the site procedures.

Technical Specification Generic Title	Corresponding Plant Specific Title
Shift Manager -----	Manager, Shift Ops
Plant Manager Operations -----	Sr. Manager, Operations
Operations Manager -----	Sr. Manager, Operations
Assistant Operations Manager -----	Manager, Ops - Support
	Manager, Ops - Shift
Radiation Protection Manager -----	Manager, Radiation Protection
General Manager -----	General Manager, Plant Operations

SAR FIGURE NO. 13.1-1

AMENDMENT 25

ARKANSAS NUCLEAR ONE
UNIT 2
RUSSELLVILLE, ARKANSAS



SCALE:	NONE
DRAWN:	
DESIGN:	ENTERGY
CAD NO:	

Plant Specific Titles for Generic Titles Located
in the Technical Specifications

BASED ON DRAWING NO

SHEET

REV.

ARKANSAS NUCLEAR ONE
Unit 2

CHAPTER 14

TABLE OF CONTENTS

<u>Section</u>	<u>Title</u>	<u>Page</u>
14	<u>INITIAL TESTS AND OPERATION</u>	14.1-1
14.1	<u>TEST PROGRAM</u>	14.1-1
14.1.1	ADMINISTRATIVE PROCEDURES (TESTING)	14.1-2
14.1.1.1	<u>Organization</u>	14.1-2
14.1.1.2	<u>Test Procedure Development</u>	14.1-3
14.1.1.3	<u>Test Execution</u>	14.1-4
14.1.1.4	<u>Test Results</u>	14.1-4
14.1.1.5	<u>Utilization of Plant Operating and Testing Experience at Other Reactor Facilities</u>	14.1-5
14.1.2	ADMINISTRATIVE PROCEDURES (MODIFICATIONS)	14.1-6
14.1.3	TEST OBJECTIVES AND PROCEDURES	14.1-6
14.1.3.1	<u>Preheatup and Test Phase</u>	14.1-7
14.1.3.2	<u>Hot Functional Test Phase</u>	14.1-8
14.1.4	FUEL LOADING AND INITIAL OPERATION	14.1-8
14.1.4.1	<u>Preparation for Initial Criticality</u>	14.1-9
14.1.4.2	<u>Initial Criticality</u>	14.1-10
14.1.4.3	<u>Post-Criticality Test Program</u>	14.1-11
14.1.4.4	<u>Operating Restrictions</u>	14.1-11
14.1.5	ADMINISTRATIVE PROCEDURES (SYSTEM OPERATION).....	14.1-11
14.1.6	STEAM GENERATOR REPLACEMENT AND POWER UPRATE	14.1-12
14.1.6.1	<u>Cycle 15 Post Steam Generator Replacement Test Program</u>	14.1-12
14.1.6.2	<u>Cycle 16 Post Power Uprate Test Program</u>	14.1-12

ARKANSAS NUCLEAR ONE
Unit 2

TABLE OF CONTENTS (continued)

<u>Section</u>	<u>Title</u>	<u>Page</u>
14.2	<u>AUGMENTATION OF APPLICANT'S STAFF FOR INITIAL TESTS AND OPERATION</u>	14.2-1
14.2.1	ORGANIZATIONAL FUNCTIONS, RESPONSIBILITIES AND AUTHORITIES	14.2-1
14.2.2	INTERRELATIONSHIPS AND INTERFACES	14.2-1
14.2.3	PERSONNEL FUNCTIONS, RESPONSIBILITIES AND AUTHORITIES	14.2-2
14.2.4	PERSONNEL QUALIFICATIONS.....	14.2-2
14.3	<u>TABLES</u>	14.3-1

ARKANSAS NUCLEAR ONE
Unit 2

LIST OF TABLES

<u>Table No.</u>	<u>Title</u>	<u>Page</u>
14.1-1	INITIAL TEST PROGRAM SUMMARIES	14.3-1
14.1-2	POST CORE HOT FUNCTIONAL TEST SUMMARIES	14.3-85
14.1-3	LOW POWER PHYSICS TEST SUMMARIES	14.3-94
14.1-4	POWER RANGE TEST SUMMARIES	14.3-102
14.1-5	REPLACEMENT STEAM GENERATOR TESTS	14.3-121
14.1-6	POWER UPRATE TESTS	14.3-122

ARKANSAS NUCLEAR ONE
Unit 2

LIST OF FIGURES

<u>Figure No.</u>	<u>Title</u>
14.1-1	AP&L ORGANIZATION CHART FOR UNIT 2 STARTUP
14.1-2	FLOW CHART FOR TEST PROCEDURE REVIEW
14.1-3	TEST PROGRAM SEQUENCE

ARKANSAS NUCLEAR ONE
Unit 2

UPDATE REFERENCE LIST

Sections and references listed below denote documents that contain additional cross reference information used to update the SAR.

<u>Section</u>	<u>Cross References</u>
Table 14.1-1	Correspondence from Trimble, AP&L, to Reid, NRC, dated March 6, 1980. (2CAN038004).
Table 14.1-1	Correspondence from Trimble, AP&L, to Seyfrit, NRC, dated June 9, 1980. (2CAN068005).
<u>Amendment 8</u>	
14.1.1.5	Correspondence from Williams, AP&L, to Stolz, NRC, dated January 25, 1978 (2CAN017821).
14.1.1.5	Design Change Package 85-2111, "Reactor Coolant Pump Vibration Monitoring", 1985. (2DCP852111)."
<u>Amendment 9</u>	
Table 14.1-1	ANO Calculation 89-E-0105-01, "Use of Hydrogen Purge System."
<u>Amendment 12</u>	
Table 14.1-4	Design Change Package 92-2023, "Critical Applications Programs Systems (CAPS) Migration to the Plant Computer"
<u>Amendment 15</u>	
Table 14.1-1	Design Change Package 973950D201, "NaOH Replacement with TSP"
<u>Amendment 17</u>	
14.1.6	Engineering Request ANO-2000-2344-026, "Power Uprate Evaluation"
14.1.6.1	
14.1.6.2	
Table 14.1-5	
Table 14.1-6	
<u>Amendment 20</u>	
Figures - ALL	License Document Change Request 05-058, "Deletion/simplification of Excessive Detailed Drawings from SAR"
<u>Amendment 23</u>	
ALL	License Document Change Request 11-026, "Page Number Corrections"

ARKANSAS NUCLEAR ONE
Unit 2

RECORD OF REVISIONS

<u>PAGE #</u>	<u>AMENDMENT #</u>	<u>PAGE #</u>	<u>AMENDMENT #</u>	<u>PAGE #</u>	<u>AMENDMENT #</u>
TABLE OF CONTENTS		CHAPTER 14 (CONT.)		CHAPTER 14 (CONT.)	
14-i	23	14.3-19	23	14.3-64	23
14-ii	23	14.3-20	23	14.3-65	23
14-iii	23	14.3-21	23	14.3-66	23
14-iv	23	14.3-22	23	14.3-67	23
14-v	23	14.3-23	23	14.3-68	23
14-vi	23	14.3-24	23	14.3-69	23
14-vii	23	14.3-25	23	14.3-70	23
		14.3-26	23	14.3-71	23
CHAPTER 14		14.3-27	23	14.3-72	23
		14.3-28	23	14.3-73	23
14.1-1	17	14.3-29	23	14.3-74	23
14.1-2	17	14.3-30	23	14.3-75	23
14.1-3	17	14.3-31	23	14.3-76	23
14.1-4	17	14.3-32	23	14.3-77	23
14.1-5	17	14.3-33	23	14.3-78	23
14.1-6	17	14.3-34	23	14.3-79	23
14.1-7	17	14.3-35	23	14.3-80	23
14.1-8	17	14.3-36	23	14.3-81	23
14.1-9	17	14.3-37	23	14.3-82	23
14.1-10	17	14.3-38	23	14.3-83	23
14.1-11	17	14.3-39	23	14.3-84	23
14.1-12	17	14.3-40	23	14.3-85	23
		14.3-41	23	14.3-86	23
14.2-1	15	14.3-42	23	14.3-87	23
14.2-2	15	14.3-43	23	14.3-88	23
14.2-3	15	14.3-44	23	14.3-89	23
		14.3-45	23	14.3-90	23
14.3-1	23	14.3-46	23	14.3-91	23
14.3-2	23	14.3-47	23	14.3-92	23
14.3-3	23	14.3-48	23	14.3-93	23
14.3-4	23	14.3-49	23	14.3-94	23
14.3-5	23	14.3-50	23	14.3-95	23
14.3-6	23	14.3-51	23	14.3-96	23
14.3-7	23	14.3-52	23	14.3-97	23
14.3-8	23	14.3-53	23	14.3-98	23
14.3-9	23	14.3-54	23	14.3-99	23
14.3-10	23	14.3-55	23	14.3-100	23
14.3-11	23	14.3-56	23	14.3-101	23
14.3-12	23	14.3-57	23	14.3-102	23
14.3-13	23	14.3-58	23	14.3-103	23
14.3-14	23	14.3-59	23	14.3-104	23
14.3-15	23	14.3-60	23	14.3-105	23
14.3-16	23	14.3-61	23	14.3-106	23
14.3-17	23	14.3-62	23	14.3-107	23
14.3-18	23	14.3-63	23	14.3-108	23

ARKANSAS NUCLEAR ONE
Unit 2

RECORD OF REVISIONS (continued)

<u>PAGE #</u>	<u>AMENDMENT #</u>	<u>PAGE #</u>	<u>AMENDMENT #</u>	<u>PAGE #</u>	<u>AMENDMENT #</u>
CHAPTER 14 (CONT.)		CHAPTER 14 (CONT.)		CHAPTER 14 (CONT.)	
14.3-109	23				
14.3-110	23				
14.3-111	23				
14.3-112	23				
14.3-113	23				
14.3-114	23				
14.3-115	23				
14.3-116	23				
14.3-117	23				
14.3-118	23				
14.3-119	23				
14.3-120	23				
14.3-121	23				
14.3-122	23				
F 14.1-1	20				
F 14.1-2	20				
F 14.1-3	20				

ARKANSAS NUCLEAR ONE
Unit 2

14 INITIAL TESTS AND OPERATION

14.1 TEST PROGRAM

A comprehensive preoperational and operational program was conducted on Unit 2 similar to that performed on Unit 1. The purpose of this program is: (1) to assure that the equipment and systems perform in accordance with design criteria, (2) to effect initial fuel loading in a safe, efficient manner, (3) to determine the nuclear parameters, and (4) to bring the unit to rated capacity.

The test program began as installation of individual components and systems was completed. The individual components and systems were tested and evaluated according to written test procedures. An analysis of the test results verified that each component and system performed satisfactorily.

The startup organization, under the supervision of the Production Startup Supervisor, maintained a technical file of all test records. These records consisted of system release packages, completed component test data sheets, technical procedures, and completed test procedures. At the conclusion of the test program, these records were transmitted to the ANO General Manager for permanent retention in accordance with plant administrative procedures for retention of test records.

The written procedures for the preoperational and operational tests included the purpose, initial conditions, limits and precautions, prerequisites, and acceptance criteria.

Testing of the applicable, individual systems was conducted in accordance with Regulatory Guides 1.41, dated March 16, 1973, and 1.52, dated June 1973, through the test methods described in the Test Abstracts of Table 14.1.1.

The scope of the test program was as defined in Regulatory Guide 1.68, "Preoperational and Initial Startup Test Programs for Water-Cooled Power Reactors," dated November 1973. However, the neutron count rate deviated somewhat from that proposed in Regulatory Guide 1.68, Section C (startup to critical procedures). The test method used for this test is described in Section 14.1.4.2. Additionally, Regulatory Guide 1.80 was followed, with the exception of Sections C.8, C.9 and C.10. These sections suggested a method for acquiring loss of air data. It was planned to conform with the intent of these sections within each individual system test by simulation of a loss of air condition with all combinations of component status.

In general, the Emergency Core Cooling System (ECCS) was tested as suggested by Regulatory Guide 1.79, Revision 1. However, the preoperational test program deviates from Section C.1.b(2). This section suggests that the capability to recirculate coolant from the containment sump into the Reactor Coolant System (RCS) be verified. Because of small sump capacity and inability to test screen pressure drop in the as-built configuration, this test was not conducted.

Containment sump design is discussed in Section 6.2.2.2.1.B.7. Since the design provides for two flow paths into the sump, the probability of excessive screen pressure drop in an accident condition is reduced. Tests were conducted to demonstrate the realignment of valves and pumps for recirculation from the containment sump. In addition, adequate Net Positive Suction Head (NPSH) was verified by pumping from the refueling water storage tank. The measured NPSH was corrected to account for friction losses and the height differences between tank level and sump level and the result compared to the minimum acceptable NPSH.

ARKANSAS NUCLEAR ONE
Unit 2

Figure 14.1-3 shows the interrelationships and sequence for performing the preoperational, fuel load, low power and power escalation tests. The duration and relationship to the fuel load date is also depicted.

Final revision of the draft test procedures was scheduled to begin at least three months prior to the projected test date. The objective was for this revision and subsequent review and approval to be completed in a manner such that the approved test procedure was available for onsite NRC review at least 30 days prior to the scheduled test date.

14.1.1 ADMINISTRATIVE PROCEDURES (TESTING)

14.1.1.1 Organization

The AP&L organization as it existed during preoperational testing is illustrated in Figure 14.1-1. The Production Startup Supervisor had overall responsibility for the test program and administered the preoperational testing program. Two Assistant Production Startup Supervisors assisted the Production Startup Supervisor in administering all aspects of the test program and acted for him in his absence.

Resumes for the Production Startup Supervisor and an Assistant Production Startup Supervisor are presented in Section 13.1.1.2.5.1 of the FSAR.

The Plant Safety Committee's (PSC) function in the preoperational testing program was to review the fuel load and all post-fuel load test procedures to assure the safe operation of all affected equipment. The General Office Safety Review Committee's (SRC) function in the preoperational testing program was to review all Unit 2 test procedures which may constitute an unreviewed safety question as defined by 10 CFR 50.59(a).

Additional information on the ANO organization during startup and on the duties of the PSC and SRC at that time is provided in Chapters 13 and 17 of the FSAR.

A Test Working Group (TWG) was formed and met at regular intervals during the most active phases of the test program. This group was composed of experienced people from the AP&L staff and from startup (S/U) consultants (as required).

The membership of the TWG was as follows:

<u>DUTY</u>	<u>POSITION</u>	<u>ORGANIZATION</u>
Chairman	Assistant Production Project S/U Supervisor (Testing)	AP&L Startup
Member	Combustion Engineering Lead S/U Engineer	Combustion Engineering
Member	Performance Engineer	AP&L ANO Plant Staff
Member	Combustion Engineering Site Manager	Combustion Engineering
Member	Bechtel Project S/U Engineer	Bechtel S/U

ARKANSAS NUCLEAR ONE
Unit 2

A quorum consisted of the chairman, or alternate, and three members, or alternates. Regular members who could not attend a scheduled meeting were to designate a responsible alternate from their own organization.

The TWG evaluated the test program and test procedures periodically and recommended to the Production Startup Supervisor any changes they felt should be made in order to fulfill requirements. The TWG reviewed all test procedures before testing. After testing, the TWG reviewed test results and recommended to the Production Startup Supervisor the action the TWG felt should be taken: (1) in resolving discrepancies or deficiencies that had been found to exist, (2) in determining if acceptance criteria had been met, and (3) when, for any reason, the test was found to be unacceptable.

AP&L engaged the services of special S/U consultants, as required, to supplement the AP&L staff during startup activities.

14.1.1.2 Test Procedure Development

Test procedures were written in advance for all plant systems. All test procedures were submitted initially to the Production Startup Supervisor who, with the aid of the appropriate Assistant Production Startup Supervisor, coordinated the review process in a timely fashion so as to accomplish approved procedures before the test was scheduled to be conducted.

The review and approval process for all test procedures is shown in Figure 14.1-2. During initial procedure development, administrative controls existed which required the procedures writer to utilize all existing approved project documents in the development of a test procedure. These documents included the project FSAR, design specification, design drawings, regulatory guides, vendor manuals, and all applicable codes and regulations.

These test procedures were written by procedures writers within the various organizations (the Architect/Engineer, the Nuclear Steam Supply System (NSSS) vendor or Arkansas Power and Light Company). To ensure a review by the responsible design organization, the procedure writers submitted the test procedures to their respective organization for review prior to transmittal of the procedure to the Production Startup Supervisor. Administrative controls existed to ensure this review.

Prior to review by the TWG, the procedure was updated to the latest revision of all project documents by the Systems Engineer. The Systems Engineer is a member of the startup group who was assigned primary responsibility for testing a specific portion of the total plant. The Systems Engineer was a graduate of a 4-year accredited engineering or science college or university and had two years of experience in startup testing activities on test facilities, nuclear or fossil power plants or equivalent installations, or he was a high school graduate and had four years of experience.

Through TWG participation, the NSSS vendor and the plant staff had an opportunity to provide inputs to the test procedures. Review of all fuel load and post-fuel load test procedures by the PSC and approval by the General Manager assured proper inputs on matters involving safe plant operation. The Safety Review Committee further reviewed those test procedures to which the PSC might refer.

Development of the test procedure was complete upon review by the appropriate committees and the Production Startup Supervisor's approval.

ARKANSAS NUCLEAR ONE
Unit 2

14.1.1.3 Test Execution

A Test Director (TD) was assigned by the Production Startup Supervisor for each test. His responsibility was to coordinate the preparation for and performance of the test, maintain a chronological test log of significant events and unusual conditions occurring during the test, identify discrepancies between test results and acceptance criteria, and have test results analyzed. The minimum qualifications for the Test Director were that he must be a high school graduate and have one year of experience in testing or inspection of construction and installation activities. In most cases, the Systems Engineer also served as the Test Director.

A "clearance to proceed" was required prior to actual testing. This "clearance to proceed" consisted of verification by the Production Startup Supervisor or an Assistant Startup Supervisor that prerequisites were completed, including required inspections, checks, and associated records, that support systems were available, as required, and that the system was ready to be tested.

The test was conducted in accordance with the official copy of the procedure, except as provided in Section 14.1.2 below. Administrative procedures were implemented which will assure that a retest was performed, where applicable, on systems or components which were repaired, replaced, or modified. Modifications proposed as a result of testing were reviewed and approved by the appropriate design organization.

The Systems Engineer reviewed all new and/or revised project documents to determine if a change required retesting. The technical files which contained data sheets and test records were then updated and any affected test procedure was modified and re-executed, as applicable.

After system release from construction, all work performed by construction on a system was authorized by the Production Startup Supervisor's approval of a Startup Work Request. This special form required the Systems Engineer to indicate in writing if a retest was required.

All retesting was reviewed and approved in the same manner as original testing.

14.1.1.4 Test Results

The TWG reviewed all test results and specified any action necessary to meet all acceptance criteria. A successful and completed test was acknowledged by the TWG when the chairman signed the test endorsement record which was attached to the official copy of the test procedure.

Any discrepancies or deficiencies found to exist during testing or upon review of test data after testing was completed were documented on a special form and attached to the official copy of the test procedure. The TWG reviewed the form and recommended to the Production Startup Supervisor the action they felt should be taken in resolving the deficiency. Retests were performed on systems and components, as necessary, to verify the adequacy of the corrective action.

Final approval of a test was given by the Production Startup Supervisor when he reviewed the test results and signed in the space provided on the test endorsement record.

ARKANSAS NUCLEAR ONE
Unit 2

Administrative controls were established to ensure that safety-related preoperational test results were reviewed and approved prior to fuel loading. In some cases, certain aspects of the test results, while not meeting the acceptance criteria, have met the safety requirements, and an interim endorsement of the test results may have been obtained. During the post-fuel load phase startup test results were reviewed and given at least interim endorsement at each major power test plateau prior to raising power to the next plateau. Any limitation or restriction required as a result of the interim endorsement (if any) was to be clearly denoted within the test procedure by any of the groups or individuals responsible for approving the test results. Final approval was required before the limitation or restriction was excluded, or by the end of the test program, if no limit or restriction exists.

14.1.1.5 Utilization of Plant Operating and Testing Experience at Other Reactor Facilities

Several mechanisms existed for utilizing operating and testing experience from other nuclear power plants to assure an effective, complete test program. All TWG members actively participated in at least one previous nuclear power plant startup. Published information on other plant operating and testing experience was available to the startup organization. Although no formal programs existed, all persons involved in the startup effort were made aware of other nuclear plant operating and testing experience through review of applicable periodicals, applicable NRC bulletins and internal AP&L, CE and Bechtel correspondence.

In addition, the Nuclear Services Organization was on distribution for "EEI Nuclear Power Subcommittee Abnormal Occurrence Reports" transmittals. These were reviewed by a Nuclear Services staff member who distributed copies of appropriate documents to applicable Nuclear Services supervisors. The EEI material was then sent to the plant staff accompanied by a note specifying particularly applicable pages to be noted by particular plant staff supervisors. Particular attention was paid to reports from similar CE-supplied reactor systems. When necessary, alterations in design or test methods were made based on this review.

Operating and testing experience at other facilities was also used as the basis for excluding the Reactor Coolant Piping from the more rigorous shock and vibration testing needed on other piping systems. The following provides discussion justifying this exclusion, and describes the alternate means used to demonstrate compliance with the ASME Code (NB-3622.3) and the intent of Regulatory Guide 1.68:

Examination of results of rigorous vibration testing programs at similar operating plants indicates the following:

- A. Experience in monitoring similarly constructed reactor coolant piping on other units indicates that vibration is not a problem;
- B. At Calvert Cliffs (a CE unit constructed by Bechtel) the smallest vibration amplitude limit (based on one-half the material endurance limit) was determined to be 0.010 inch single amplitude;
- C. Any effects causing vibration of the reactor coolant piping other than reactor coolant pump vibration will only be secondary due to the piping size, routing, length and supports; and,
- D. The Unit 2 reactor coolant pump vibration monitors will alarm between 0.002 and 0.003 inch single amplitude vibration.

ARKANSAS NUCLEAR ONE
Unit 2

Although the Unit 2 reactor coolant piping was instrumented for rigorous vibration testing, procedures were in place to ensure compliance with the acceptance criteria of 0.005 inch single amplitude vibration. In the event of an alarm of reactor coolant pump vibration monitors during steady state conditions, the actual vibration condition was to be verified with more reliable and accurate hand held monitors. If the piping vibration were confirmed to be greater than 0.005 inch single amplitude, steps would then be taken to determine the actual amplitude limit at the location of the vibration (based on one-half the material endurance limit) and compare the measured vibration against the rigorous acceptance criteria.

It should be noted that the above acceptance criteria was based on the Reactor Coolant Pump vibration monitors which were in use during the Initial testing and Start-up. The values given above are not comparable with the setpoints selected for the upgraded Reactor Coolant Pump Monitoring System installed by DCP 85-2111.

14.1.2 ADMINISTRATIVE PROCEDURES (MODIFICATIONS)

After a test procedure was approved, the test was conducted according to the procedure. However, the test procedure may have been modified, as necessary, to complete the test. All modifications made prior to issuance of an operating license must have been approved by the Production Startup Supervisor, or by one of the Assistant Production Startup Supervisors, in the absence of the Production Startup Supervisor.

Changes to test procedures made after issuance of an operating license were made in accordance with the Technical Specifications.

All modifications were documented on a special form which was to be included within the Test Procedure Package. During review of test results, all changes were reviewed to ensure applicability and proper administration of the change.

14.1.3 TEST OBJECTIVES AND PROCEDURES

The tests prior to reactor fuel loading assured that the systems were complete and operated in accordance with design. These tests were classified as hydro/leak, operational, electrical, and functional, with the following definitions for each classification.

- A. Hydro/Leak Test - Structural integrity leak test of the various systems and components at the appropriate pressure.
- B. Operational Test - Operation of systems and equipment under operating conditions.
- C. Electrical Test - Consisted of grounding, meggar, continuity, and phasing checks; circuit breaker operation and control checks; potential measurement and energizing of buses and equipment to ensure continuity, circuit integrity, and proper functioning of electrical apparatus.
- D. Functional Test - Tests to verify that systems and equipment will function as intended.

Instruments and controls of each system or component were also subjected to a preoperational instrumentation and controls calibration test prior to the initial operation of that system or component to assure proper operation.

ARKANSAS NUCLEAR ONE
Unit 2

An Engineered Safety Features (ESF) system test was performed to assure proper actuation and operation for the ESF and to evaluate the test method and frequency for future testing. The operating times of ESF valves were measured as part of the ESF Response Time Test. The term "critical valves" used in several test summaries in connection with valve operating times refers to those valves in Table 6.2-26 and elsewhere in the original FSAR for which opening and/or closure times are specified.

The test program was divided into two phases: Preheatup Test Phase and Hot Functional Test Phase. In many instances, systems were tested during both the Preheatup Test Phase and the Hot Functional Test Phase.

A summary of the test program prior to fuel loading is provided in Table 14.1-1.

Note that testing of the High Pressure Safety Injection (HPSI) system was not performed at hot operating conditions, as the guidance of Regulatory Guide 1.68 suggests. The reasons are given below:

Injecting ambient temperature water into a hot thick-walled system produces a significant thermally induced stress transient. This significance is likewise born out in the low number (5) of allowable cycles for this transient. To use one of the allowable cycles for testing unreasonably jeopardizes the warranted service life.

Full consideration must also be given to the more likely event that a less severe (than a Loss of Coolant Accident (LOCA)) transient may cause initiation of ECCS, while the NSSS is at elevated temperatures. This may occur due to operator or equipment maloperation at any unexpected time in the serviceable life of the plant. Such unexpected injections would also claim one of the allowable transients. Using one of these allowable transients for an initial test may, in the future, cause unnecessary administrative restrictions on operations.

As with any significant stress producing transient, recovery from an injection of ambient temperature water into the RCS at elevated temperatures requires significant post-test inspections such as ultrasonic, radiographic, and visual inspections followed by another high pressure hydrostatic pressure test to ensure that the integrity of the RCS has not been jeopardized and is satisfactory for warranted life. Such a test represents a major effort and will prolong the startup significantly.

In lieu of injecting ambient temperature water into a hot system, the capability of the HPSI system to deliver water as required under accident conditions was verified by analysis based on as-built HPSI pump and system head capacity curves. The operability of the check valves for both the HPSI headers and the safety injection tank lines were, however, verified under hot operating conditions, as described in Section 6.3.4.2.

14.1.3.1 Preheatup Test Phase

The objective of the Preheatup Test Phase is to assure that the equipment and systems perform as required during hot functional testing. This phase of the testing included certain preoperational calibration and hydro/leak, operational, electrical, and functional tests, as required. The containment system underwent a structural integrity and integrated leakage rate test to verify the containment design and to ensure that leakage is within the design limit.

ARKANSAS NUCLEAR ONE
Unit 2

14.1.3.2 Hot Functional Test Phase

The Hot Functional Test Phase was a period of hot operation of the RCS and the associated auxiliary systems prior to the initial fueling of the reactor. The RCS was heated to no-load operating pressure and temperature during this phase.

The Hot Functional Test Phase continued the preparation toward the initial fuel loading. The objectives of this phase of the test program are:

- A. Operational tests of systems, components, and non-nuclear instrumentation and controls at no load operating pressure and temperature.
- B. Operator training.
- C. Verification of normal and emergency operating procedures, where practical.

The following capabilities were demonstrated as part of the pre-core load hot functional tests:

- A. The steam dump and bypass system can control RCS temperature satisfactorily.
- B. The emergency feedwater system can supply feedwater to the steam generators at operating conditions.
- C. The main steam isolation valves can be shut under hot, low steam flow conditions.
- D. The plant can be cooled utilizing the emergency cooling pond.
- E. The soluble poison concentration in the RCS can be changed at a rate consistent with accident analysis assumptions.

14.1.4 FUEL LOADING AND INITIAL OPERATION

Fuel was loaded into the reactor in accordance with a step-by-step written procedure. This procedure contained a number of safety precautions and operating limitations.

Upon completion of fuel loading operations, the final core loading was verified by visually surveying the core and recording the fuel assembly number versus core location on a core grid map. After completing the survey, the person surveying the core then signed the completed core map. A second individual then compared the core survey to the approved core loading plan. If the survey agreed with the loading plan, the individual comparing these documents signed the core survey to verify that the core loading was correct. The use of two independent persons verified that the location and orientation of the fuel was in agreement with prescribed core loading plan.

The fuel loading procedure included:

- A. A sequence of loading temporary detectors, sources, Control Element Assemblies (CEAs), and fuel assemblies in order to assure shutdown margin requirements are maintained;
- B. The conditions under which fuel loading may continue after any step;

ARKANSAS NUCLEAR ONE
Unit 2

- C. An identification of responsibility and authority;
- D. After insertion of the source, a minimum of two detectors operating and indicating neutron level whenever core geometry is being changed, or at least one detector indicating neutron level at all other times;
- E. Checks of reactivity effects for each fuel assembly addition prior to the release of the fuel assembly by the fuel handling grapple;
- F. Maintenance of two completely independent plots of reciprocal neutron multiplication as a function of the parameter causing reactivity change (used to estimate the reactivity effect of inserting additional fuel assemblies prior to their insertion);
- G. Maintenance of the boron concentration in the reactor vessel, spent fuel pool, and RCS at a value to assure the required subcritical margin at all times;
- H. Periodic check of the valve alignment of the auxiliary systems connected to the RCS to prevent dilution of the reactor coolant boron concentration;
- I. Chemical analysis and water level monitoring to assure that inadvertent dilution of the reactor coolant boron concentration had not occurred;
- J. Direct communication between control room and fuel handling areas;
- K. Operation of the plant radiation monitoring systems, or if not, use of portable monitoring equipment with appropriate sensitivities and ranges in the area where radiation monitors are inoperable; and
- L. Health physics and chemistry monitoring and services.

14.1.4.1 Preparation for Initial Criticality

Upon completion of the initial fuel loading, normal maintenance and operating procedures were used to take the plant from refueling condition to cold shutdown. These procedures detailed the installation of the remainder of the vessel internals including couplings of the CEAs, installation and tensioning of the head, installation of in-core instruments and other installations and checkouts necessary to bring the plant to the cold shutdown condition.

Following the completion of the above evolutions, the post-core hot functional testing was completed prior to the approach to initial criticality. This testing in conjunction with normal operating procedures, took the plant from cold shutdown to hot zero power conditions and back to hot shutdown in preparation for initial criticality. Testing was conducted under both hot shutdown (approximately 260 °F) and hot zero power conditions (approximately 545 °F). The testing included measurements of the RCS heat loss, RCS flow under various pump combinations, RCS flow coastdown, Control Element Drive Mechanism (CEDM) functioning and drop time testing, monitoring of RCS and steam generator water chemistry, and initial verification of COLSS and Core Protection Calculator (CPC) flow-related algorithms. RCS leakrate tests were covered by normal operating procedures and surveillance requirements. Table 14.1-2 and its test summaries provide a more complete picture of the testing to be performed.

ARKANSAS NUCLEAR ONE
Unit 2

The checkout of reactor protection trip circuits referred to in Appendix A, Section B.1.b of Regulatory Guide 1.68 was accomplished in conjunction with preoperational testing.

The checkout of source range monitors referred to in Appendix A, Section B.1.f of Regulatory Guide 1.68 was accomplished in conjunction with initial fuel loading.

Measurements of CEA drop time was done at cold shutdown with no reactor coolant pumps operating and at hot zero power conditions with four reactor coolant pumps operating. Five additional measurements of CEA drop time for both cold and hot flow conditions were performed on each of the fastest and slowest CEAs. Testing at hot zero power full flow conditions provided a conservative measure of the CEA drop time expected during power operation.

The vibration monitoring program referred to in Appendix A, Sections B.1.j and D.1.p of Regulatory Guide 1.68 was discussed in detail in the FSAR on pages Q110.28 through Q110.28c in the "AEC Questions" section.

14.1.4.2 Initial Criticality

A written procedure was followed during the approach to initial criticality. This procedure specified in detail the sequence to be followed, the limits and precautions, the required plant status, and the prerequisite system conditions. This procedure also specified the alignment of fluid systems to assure controlled boron dilution and core conditions under which the approach to initial criticality may proceed.

Initial criticality was achieved by the following method:

- A. Begin with boron concentration sufficient for shutdown with all CEAs out.
- B. Withdraw all CEAs to approximately six inches withdrawal and perform a manual trip to demonstrate trip capability.
- C. Withdraw CEA groups to normal operating configuration.
- D. Deborate until criticality is achieved.

Permissible group withdrawal and deboration was based on calculated reactivity effects. Two independent inverse neutron multiplication curves were maintained during group withdrawal and deboration. A predicted boron concentration for criticality was determined before group withdrawal or deboration is started.

The startup channels were verified to discriminate noise and gamma pulses such that the signal to noise ratio is at least two by a calibration with neutron and gamma calibration sources prior to the approach to initial criticality.

During the deboration to initial criticality, the neutron count rate was verified to be greater than one-half count per second above background when the RCS boron concentration was approximately 75 ppm from the estimated critical boron concentration.

During the approach to initial criticality, an overlap of one decade between the startup channels and the logarithmic range of the safety channels was demonstrated.

ARKANSAS NUCLEAR ONE
Unit 2

14.1.4.3 Post-Criticality Test Program

The post-criticality test program was performed to provide assurance that the plant is operating in a safe manner. Systems and components which could not be operationally tested prior to initial criticality were tested during the post-criticality test program to verify reactor parameters and to obtain information required for plant operation. The post-criticality tests are listed in Tables 14.1-3 and 14.1-4 and described in the test summaries.

14.1.4.3.1 Low Power Physics Tests

Following initial criticality, a program of reactor physics measurement was undertaken to verify the calculated parameters. Measurements were carried out at hot shutdown (~260 °F), heatup (260 – 545 °F) and hot zero power (~545 °F) conditions. Measurements were made of CEA group and individual worths, isothermal temperature coefficients, boron worths, and critical borons. The measurements carried out in the hot zero power condition were more extensive than those measurements at hot shutdown. Measurements during heatup were limited to critical borons, pressure coefficients, and isothermal temperature coefficients. Measurements to be carried out are listed in Table 14.1-3 and described in the associated summaries.

Detailed written procedures were used to specify the sequence of tests, parameters to be measured, and conditions under which each test was to be performed. These tests involved a series of prescribed CEA configurations and boron concentrations with intervening measurements of reactivity changes during boron concentration changes, moderator temperature changes, and CEA position changes.

14.1.4.3.2 Power Escalation Test Program

Following determination of the operating characteristics and physics parameters of the reactor at zero power, a power escalation test program was conducted. This program consisted of specified incremental increases in power levels up to full power, with appropriate testing conducted at each (20, 50, 80, and 100 percent) power level. An analysis of the significant parameters at each step was made prior to initiating an additional power escalation. The tests listed in Table 14.1-4 and described in the test summaries were carried out at either one or more of the four power level plateaus mentioned above or after completion of the 100 percent plateau.

14.1.4.4 Operating Restrictions

During initial operations and associated testing, the normal plant safety procedures and Technical Specifications were in effect. In addition, special safety precautions and limitations were included in the test procedure.

14.1.5 ADMINISTRATIVE PROCEDURES (SYSTEM OPERATION)

Operational and emergency procedures were referenced in test procedures, where applicable, throughout the preoperational testing and initial operating period.

ARKANSAS NUCLEAR ONE
Unit 2

14.1.6 STEAM GENERATOR REPLACEMENT AND POWER UPRATE

A comprehensive test program was conducted on Unit 2 following Steam Generator Replacement and again after Power Uprate. The purpose of these test programs were to assure that all modified systems/components of the BOP and NSSS were performing in compliance with the design and licensing bases, and to establish the new operating margins of the plant systems. The test program for NSSS and BOP systems was developed based upon a review of the ANO-2 Safety Analysis Report (SAR), new design specifications and contract warranty requirements, the scope of the modifications performed during each implementation outage, and industry experience for the other steam generator replacements, power uprate projects, and startup testing.

A Startup Test Group made up of qualified and trained test engineers was assembled to determine testing requirements, develop test procedures, perform tests, and review test results for compliance with design predictions, test requirements, and acceptance criteria. Written procedures were developed and approved by the Onsite Safety Review Committee. The test requirements and results for selected tests were reviewed and approved by the Test Working Group. This group was reestablished similar to the initial test program to provide experienced test personnel and management oversight to the test program. The Test Working Group controlled the Power Uprate power ascension by approving the test results and any deficiencies for each test plateau before recommending increases in plant power from approximately 90, 92.5, 95, 97.5 to 100% of the new licensed power level.

14.1.6.1 Cycle 15 Post Steam Generator Replacement Test Program

A summary of the testing performed following Steam Generator Replacement is provided in Table 14.1-5. The tests were performed to meet the requirements and acceptance criteria supplied in the 2R14 design change packages or similar to the Initial Test Program specified in this chapter.

14.1.6.2 Cycle 16 Post Power Uprate Test Program

A summary of the testing performed following Power Uprate is provided in Table 14.1-6. The tests were performed to meet the requirements and acceptance criteria supplied in the 2R15 design change packages or similar to the Initial Test Program specified in this chapter.

14.2 AUGMENTATION OF APPLICANT'S STAFF FOR INITIAL TESTS AND OPERATION

The normal operating organization was utilized throughout the startup program. During this period, the permanent staff was augmented by additional AP&L personnel plus additional engineers and technical consultants from Bechtel Corporation, Combustion Engineering and EDS Nuclear, Inc., as required. These consultants, reporting to the AP&L Manager, Nuclear Operations were personnel with extensive experience in mechanical, electrical, instrument and control, and physics testing activities who were assigned to the project to assist in specific phases of the startup.

14.2.1 ORGANIZATIONAL FUNCTIONS, RESPONSIBILITIES AND AUTHORITIES

The Arkansas Power & Light Startup Group provided the overall direction of the startup program. Consequently, the Production Project Startup Supervisor had overall responsibility for the startup program. He coordinated this effort with all of the involved parties. All of the consultants hired by the company for startup assistance reported to the Production Project Startup Supervisor.

Specific engineers from among the plant staff and/or the various consultants were assigned the responsibility of conducting the individual tests.

The plant staff provided all of the necessary mechanics, electricians and instrument technicians to repair, maintain, and properly calibrate the various pieces of equipment during the test program. In addition, the plant staff provided the necessary operating personnel, as required by the test program.

Participation by the plant staff was coordinated by the Production Project Startup Supervisor and the General Manager, Operating and Maintenance Manager, Plant Administrative Manager, and the Engineering and Technical Support Manager.

The project startup schedule was developed and maintained by the Production Startup Supervisor and consultants reporting to him.

The Production Project Startup Supervisor had the ultimate authority and responsibility for conducting the test program to meet the testing requirements. The General Manager had the ultimate responsibility for the safe operation of the plant.

14.2.2 INTERRELATIONSHIPS AND INTERFACES

During the cold and hot functional test programs, the augmenting groups involved, including various plant groups, company groups, Combustion Engineering consultants, Bechtel consultants and other outside consultants, worked under the supervision of the Production Project Startup Supervisor. During fuel loading and the post-fuel loading test program, the Production Project Startup Supervisor directed the program and provided technical support to the General Manager, who had the responsibility for the safe operation of the plant.

The Production Project Startup Supervisor could have assigned another supervisor to coordinate activities of the various groups for individual tests.

ARKANSAS NUCLEAR ONE
Unit 2

14.2.3 PERSONNEL FUNCTIONS, RESPONSIBILITIES AND AUTHORITIES

The Production Project Startup Supervisor was responsible for all startup and test programs. He had the authority to stop or discontinue any test he deemed unsafe or not in the best interests of the company. He functioned to schedule and coordinate all groups involved in a particular evolution. He could have assigned responsibility to other supervisors under him.

The General Manager was responsible for coordinating the operational and maintenance support required by the startup program and, as requested, by the Production Project Startup Supervisor. He had the authority to stop or discontinue any test he deemed unsafe or not in the best interest of the company.

The Operations and Maintenance Manager was responsible for the conduct and coordination of all operations during the startup and test programs. He had the authority to stop or discontinue any test he deemed unsafe or not in the best interest of the company.

The Plant Analysis Superintendent was responsible for directing reactor physics tests and neutron monitoring during initial core loading and zero and low power physics testing.

Other department supervisors were responsible for technical support for the test programs. They assigned staff members to various phases of the test program, as necessary.

14.2.4 PERSONNEL QUALIFICATIONS

Mr. Michael L. Alexander (EDS Nuclear), Supervising Engineer, is a Nuclear Engineer, having graduated from the University of Tennessee with a Bachelor of Science degree and a Master of Science degree in Nuclear Engineering. He has had extensive experience in the construction, startup and operation of commercial nuclear power plants, including: program planning, scheduling, and sequencing; procedure preparation review and approval; and performance and supervision of testing. Most recently, as Senior Operations Engineer for Burns and Roe, Inc., Mr. Alexander directed the startup activities at an 850 MWe BWR. Previously, as Lead Test Engineer for Virginia Electric Power Company, he was responsible for the direction and guidance of engineers and technicians in the development and performance of preoperational and startup test programs at an 800 MWe PWR. He joined EDS Nuclear in September 1974. Mr. Alexander is a registered professional Engineer in the State of California and is a member of the American Nuclear Society.

Mr. Alexander B. McGregor (Combustion Engineering), Lead Startup Engineer, is a graduate of Dartmouth College with a Bachelor of Arts in Biology. From 1968 to 1972, he served with the United States Navy. He attended USN Officer Submarine School, Nuclear Power School, and prototype training. He served as Reactor Controls Officer, Auxiliary Division Officer, and Refueling Officer on an operating nuclear submarine. During this time, he participated in the refueling and startup testing of the ship's reactor plant. He qualified as Engineering Officer of the Watch. Since 1974, he has been employed by Combustion Engineering as a Startup Engineer, with assignments including: Ft. Calhoun plant - procedure preparation and supervision of outage work plus assistance during refueling and subsequent startup; St. Lucie, Unit 1 - procedure review, assistance with system startup through power ascension testing, and procedure preparation plus assistance during onsite fuel reconstitution; Arkansas Nuclear One, Unit 2 - procedure review and assistance with system startup. Since June 1978, he has been assigned as Test Director for the Unit 2 Post-Fuel Load Test Program.

ARKANSAS NUCLEAR ONE
Unit 2

Mr. David L. Harris (Bechtel Corporation), Project Startup Engineer, is a graduate of the University of California with a Bachelor of Science Degree in Mechanical Engineering. Mr. Harris worked as a Control System Engineer from 1956 to 1960 for Standard Oil Company of California. In 1960, he joined the Los Alamos Scientific Laboratory Testing Division, responsible for design of testing equipment for nuclear weapons and nuclear rockets. From 1962 to 1972, he was located at the Nevada Test Site as Manager of the Equipment Testing Laboratory and later as Section Leader for Testing Services, supporting the Nuclear Rocket Test Program. In 1972, he joined Bechtel Power Corporation as a Senior Startup Engineer. He has been associated with the Arkansas Nuclear One Project since June 1972. He is experienced in the performance and supervision of testing, procedure preparation and review, and scoping and planning. He has been a Group Leader since May 1977, supervising engineers and technicians for the startup program. Mr. Harris is a registered Nuclear and Control Systems Engineer in the State of California and registered Mechanical Engineer in the State of Nevada. He is a member of the Instrument Society of America.

Mr. Joseph F. Weinman (Bechtel Corporation), Senior Startup Engineer, served in the United States Navy from 1961 to 1968, during which time he attended Navy Nuclear Power School and Prototype Training. Following this training, he was assigned to a nuclear submarine for new construction. During new construction, he qualified as reactor operator and participated in much of the initial startup testing. The remaining years of naval experience were spent on an operational nuclear submarine, during which time he continued to upgrade and qualify, achieving Engineering Officer of the Watch. Following honorable discharge, Mr. Weinman joined the Mining and Metals Division of Bechtel Corporation. His assignments consisted of Instrument Engineer on a fuel pelletizing plant and a uranium oxide conversion plant. In 1970, Mr. Weinman transferred to the Power Division of Bechtel Corporation. Since that time, he has participated in the startup of five conventional power plants and three nuclear plants.

ARKANSAS NUCLEAR ONE
Unit 2

Table 14.1-1

INITIAL TEST PROGRAM SUMMARIES

SAR sections referenced by this table are in the FSAR.
Components or systems described may have been modified since initial testing.
Refer to the appropriate section of the SAR for current system descriptions.

	<u>Test Title</u>	<u>Page No.</u>
1	125-V DC POWER SYSTEM	14.3-4
2	VITAL AC POWER SYSTEMS	14.3-5
3	EMERGENCY DC LIGHTING SYSTEM	14.3-5
4	COMMUNICATION SYSTEMS	14.3-6
5	INTAKE SCREENS AND SCREEN WASH SYSTEM	14.3-7
6	SERVICE WATER SYSTEM	14.3-8
7	EMERGENCY COOLING WATER POND	14.3-8
8	FIRE PROTECTION SYSTEMS	14.3-9
9	COMPONENT COOLING WATER SYSTEM	14.3-10
10	INSTRUMENT AIR SYSTEM	14.3-10
11*	DRAINS AND SUMPS	14.3-11
12	CONDENSATE STORAGE AND TRANSFER SYSTEM	14.3-12
13	EMERGENCY DIESEL GENERATOR SYSTEMS	14.3-13
14	CONTROL AND COMPUTER ROOM HVAC SYSTEM	14.3-13
15	PLANT COMPUTER SYSTEM	14.3-14
16	AUXILIARY BUILDING HVAC SYSTEMS	14.3-15
17	AUXILIARY BUILDING RADWASTE AREAS HVAC SYSTEMS	14.3-15
18	CONTAINMENT PURGE SYSTEM	14.3-16
19	EMERGENCY FEEDWATER SYSTEM	14.3-17
20	CONTAINMENT HVAC SYSTEM	14.3-18
21	SAMPLING SYSTEMS	14.3-18
22	AUTOMATIC GAS ANALYZER	14.3-19
23	PENETRATION ROOM VENTILATION SYSTEM	14.3-20
24*	CIRCULATING WATER SYSTEM	14.3-20
25	MAIN CONDENSER AND AIR REMOVAL SYSTEM	14.3-21
26*	CONDENSATE SYSTEM	14.3-22
27*	FEEDWATER SYSTEM	14.3-22
28	FEEDWATER CONTROL SYSTEM	14.3-23
29*	EXTRACTION STEAM SYSTEM	14.3-24
30	SAFETY INJECTION ACTUATION SYSTEM	14.3-24
31	CONTAINMENT ISOLATION ACTUATION SYSTEM	14.3-25
32	CONTAINMENT SPRAY ACTUATION SYSTEM	14.3-26
33	CONTAINMENT COOLING ACTUATION SYSTEM	14.3-27
34	RECIRCULATION ACTUATION SYSTEM	14.3-27

ARKANSAS NUCLEAR ONE
Unit 2

Table 14.1-1 (continued)

	<u>Test Title</u>	<u>Page No.</u>
35	MAIN STEAM ISOLATION ACTUATION SYSTEM	14.3-28
36	EMERGENCY FEEDWATER ACTUATION SYSTEM	14.3-29
37	INTEGRATED ENGINEERED SAFETY FEATURES ACTUATION	14.3-30
38	SHUTDOWN COOLING SYSTEM	14.3-31
39	HIGH PRESSURE SAFETY INJECTION SYSTEM	14.3-31
40	SAFETY INJECTION TANKS	14.3-32
41	LOW PRESSURE SAFETY INJECTION SYSTEM	14.3-33
42	REED SWITCH ACTUATION SYSTEM	14.3-34
43	CEDM CONTROL SYSTEM	14.3-34
44	REACTOR TRIP CIRCUIT BREAKERS	14.3-35
45	PLANT PROTECTION SYSTEM	14.3-36
46	CORE PROTECTION CALCULATOR SYSTEM	14.3-37
47*	CORE OPERATING LIMIT SUPERVISORY SYSTEM	14.3-37
48	CEA CALCULATOR SYSTEM	14.3-38
49	CONTAINMENT POLAR CRANE	14.3-39
50	CONTAINMENT INTEGRATED LEAK RATE TEST	14.3-39
51	CONTAINMENT STRUCTURAL INTEGRITY TEST	14.3-40
52	CONTAINMENT SPRAY SYSTEM	14.3-41
53	VIBRATION AND LOOSE PARTS MONITORING SYSTEM	14.3-42
54	STEAM GENERATOR BLOWDOWN SYSTEM	14.3-43
55	REACTOR COOLANT LETDOWN SYSTEM	14.3-43
56	REACTOR COOLANT CHARGING SYSTEM	14.3-44
57	VOLUME CONTROL TANK	14.3-45
58	REACTOR COOLANT PURIFICATION SYSTEM	14.3-46
59	BORIC ACID ADDITION SYSTEM	14.3-46
60	BORIC ACID BATCHING SYSTEM	14.3-47
61	CHEMICAL ADDITION SYSTEM	14.3-48
62	REACTOR MAKEUP WATER STORAGE AND TRANSFER SYSTEM	14.3-48
63	Deleted	
64	PROCESS RADIATION MONITORS	14.3-49
65	PRESSURIZER PRESSURE CONTROL SYSTEM	14.3-50
66	PRESSURIZER RELIEF AND QUENCH TANK SYSTEM	14.3-51
67	PRESSURIZER SAFETY VALVE BENCH TEST	14.3-51
68	REACTOR REGULATING SYSTEM	14.3-52
69*	SPENT FUEL COOLING SYSTEM	14.3-52
70	HOLDUP TANK SYSTEM	14.3-53
71	REACTOR DRAIN TANK SYSTEM	14.3-54
72*	BORIC ACID CONCENTRATOR FEED SYSTEM	14.3-55
73*	BORIC ACID CONCENTRATOR SYSTEM	14.3-55

ARKANSAS NUCLEAR ONE
Unit 2

Table 14.1-1 (continued)

<u>Test Title</u>	<u>Page No.</u>
74* BORIC ACID CONDENSATE STORAGE AND TRANSFER SYSTEM	14.3-56
75 RADWASTE/BMS MANIFOLD	14.3-57
76 WASTE COLLECTION SYSTEM	14.3-58
77 PIPING SHOCK AND VIBRATION TEST	14.3-58
78 RESIN SLUICE SYSTEM	14.3-59
79 GASEOUS WASTE DECAY SYSTEM	14.3-60
80 GASEOUS WASTE COLLECTION SYSTEM	14.3-60
81 GASEOUS WASTE DISCHARGE SYSTEM	14.3-61
82 GASEOUS RADIATION MONITORING SYSTEM	14.3-62
83 EXCORE MONITORING SYSTEM	14.3-63
84 INCORE MONITORING SYSTEM	14.3-63
85 MOVABLE INCORE DETECTOR DRIVE SYSTEM	14.3-64
86 AREA RADIATION MONITORS	14.3-65
87 REACTOR CAVITY FUEL HANDLING SYSTEM	14.3-66
88 SPENT FUEL PIT HANDLING AND TRANSPORT SYSTEM	14.3-67
89 FUEL TRANSFER CANAL HANDLING AND TRANSPORT SYSTEM	14.3-67
90 FUEL HANDLING CRANE	14.3-68
91 CEA CHANGE MECHANISM	14.3-69
92 MAIN STEAM SYSTEM	14.3-70
93 STEAM DUMP AND BYPASS CONTROL SYSTEM	14.3-70
94* MAIN TURBINE SYSTEMS	14.3-71
95* AUTOMATIC DISPATCH SYSTEM	14.3-72
96 SEISMIC MONITOR	14.3-73
97 STEAM GENERATOR HYDROSTATIC TEST	14.3-73
98 RCS HYDROSTATIC TEST	14.3-74
99 FILTER TESTS	14.3-74
100* PIPE/COMPONENT HOT DEFLECTION TEST	14.3-75
101* PIPING SHOCK AND VIBRATION TEST	14.3-76
102 REMOTE SHUTDOWN EQUIPMENT	14.3-77
103 RCS LEAKAGE MEASUREMENT	14.3-77
104 HYDROGEN ANALYZERS	14.3-78
105 HYDROGEN RECOMBINER	14.3-79
106 HYDROGEN PURGE SYSTEM	14.3-79
108 THERMAL EXPANSION (HOT DEFLECTION) TEST	14.3-80
109 STEADY STATE VIBRATION TEST	14.3-82
110 DYNAMIC TRANSIENT TEST	14.3-83

* May be completed post-fuel load.

ARKANSAS NUCLEAR ONE
Unit 2

Table 14.1-1 (continued)

125-V DC POWER SYSTEM

1.0 OBJECTIVE

To demonstrate that the 125-V DC power system provides a reliable source of power for startup, operation, and shutdown under normal and emergency conditions, and to verify that the three separate power sources and their respective loads are independent of each other. The 125-V DC power system will be tested in accordance with IEEE-450-1972.0

2.0 PREREQUISITES

- 2.1 Construction activities completed on components to be tested.
- 2.2 Meters and relays calibrated.
- 2.3 Batteries fully charged with normal height of electrolyte.
- 2.4 Load resistor bank available for battery capacity test.
- 2.5 Construction activities completed on safety-related equipment supplied by the battery system for the integrated system test.

3.0 TEST METHOD

- 3.1 Battery capacity and charger performance verified.
- 3.2 Bus transfer devices tested.
- 3.3 Alarms and tripping devices tested.
- 3.4 The ground detector checked.
- 3.5 The load capacity of the battery measured by discharging the battery with a resistive load without the battery charger.
- 3.6 The operation of safety-related DC loads verified in a separate integral test procedure by disconnecting the battery and adjusting the battery charger voltage to the level obtained at the end of the discharge test.

4.0 DATA REQUIRED

- 4.1 Battery voltage & load current without charger.
- 4.2 Charger float voltage & current.
- 4.3 Charger voltage & current as battery eliminator.
- 4.4 Test discharge readings of voltage, current, temperature, & capacity in ampere hours. Individual cell voltage readings.
- 4.5 Bus voltage at maximum load current.
- 4.6 During the separate integrated test, the total load current of safety-related equipment will be recorded.

5.0 ACCEPTANCE CRITERIA

The 125-V DC power system will perform all of the functions described in Section 8.3.2.

ARKANSAS NUCLEAR ONE
Unit 2

Table 14.1-1 (continued)

VITAL AC POWER SYSTEMS

1.0 OBJECTIVE

To demonstrate that an uninterrupted 120-V AC power supply has been provided with an independent power source to each redundant protective channel.

2.0 PREREQUISITES

- 2.1 Construction activities complete on components to be tested.
- 2.2 Meters and relays calibrated.
- 2.3 One battery bank must be operational with charger.
- 2.4 A normal 480-V supply and an emergency 480-V supply must be available.
- 2.5 Four distribution panels must be available.

3.0 TEST METHOD

- 3.1 Control logic verified for each inverter.
- 3.2 Alarms and tripping devices verified.
- 3.3 The transfer devices checked.
- 3.4 Checks for DC grounds made.

4.0 DATA REQUIRED

- 4.1 Direct current and voltage of each inverter from each power source.
- 4.2 Alternating current voltage and frequency of each inverter from each power source.
- 4.3 Verify the alternating current voltage at each of the four distribution panels while the inverters are being fed from each of the three power sources.

5.0 ACCEPTANCE CRITERIA

The vital AC power systems will perform all of the functions outlined in Section 8.3.1.

EMERGENCY DC LIGHTING SYSTEM

1.0 OBJECTIVE

To demonstrate the adequacy of the emergency DC lighting system.

2.0 PREREQUISITES

- 2.1 Construction activities completed on the items to be tested.
- 2.2 Containment lighting system operational.
- 2.3 Auxiliary building lighting system operational.

ARKANSAS NUCLEAR ONE
Unit 2

Table 14.1-1 (continued)

3.0 TEST METHOD

- 3.1 Verify that when the normal AC power supply for the containment lighting system is interrupted, the emergency containment lighting system is automatically energized.
- 3.2 Verify that when the normal AC power supply for the auxiliary building lighting system is interrupted, the emergency auxiliary building lighting system is automatically energized.

4.0 DATA REQUIRED

- 4.1 Control logic verification.
- 4.2 Automatic transfer switch transfer time (loss of AC to DC initiation).
- 4.3 Verify that the lighting systems cannot be energized from two sources simultaneously.

5.0 ACCEPTANCE CRITERIA

The emergency DC lighting system is capable of supplying lighting to the auxiliary building and the containment building upon loss of normal AC.

COMMUNICATION SYSTEMS

1.0 OBJECTIVE

To demonstrate the adequacy of the inplant communications systems to provide communications between vital plant areas and to test the operability of the emergency evacuation alarms.

2.0 PREREQUISITES

- 2.1 All possible plant equipment that contributes to the ambient noise level should be in operation.
- 2.2 Construction activities complete on the items to be tested.

3.0 TEST METHOD

- 3.1 Check the continuity and audibility of the Gai-Tronics phones.
- 3.2 Check the continuity and audibility of the Pax phones.
- 3.3 Check the audibility of the sound powered phones.
- 3.4 Check the audibility of the evacuation alarms in all plant locations.
- 3.5 Check the audibility of the page from the control room in all plant locations.
- 3.6 Check the audibility from all plant locations in the control room.

ARKANSAS NUCLEAR ONE
Unit 2

Table 14.1-1 (continued)

4.0 DATA REQUIRED

- 4.1 Operability of the Gai-Tronics at all locations.
- 4.2 Audibility of the page in all plant locations.
- 4.3 Operability of the Pax at all plant locations.
- 4.4 Operability of the sound powered phones.
- 4.5 Audibility of reactor building evacuation alarm.
- 4.6 Audibility of physical plant evacuation alarm.

5.0 ACCEPTANCE CRITERIA

The communications systems will perform the functions of Section 9.5.2.

INTAKE SCREENS AND SCREEN WASH SYSTEM

1.0 OBJECTIVE

To demonstrate the capability of the intake screens and screen wash system to perform the design function of removing debris from the reservoir water prior to use by the service water system.

2.0 PREREQUISITES

- 2.1 Unit 1 traveling water screens are operational.
- 2.2 Unit 1 screen wash system is available.
- 2.3 All associated instrumentation has been calibrated.
- 2.4 Construction activities are complete on the components to be tested.

3.0 TEST METHOD

- 3.1 Traveling screen performance will be checked.
- 3.2 Alarms and interlocks will be verified.
- 3.3 With the traveling screens in automatic, the screen wash cycle times will be verified.

4.0 DATA REQUIRED

- 4.1 Conditions under which alarms and interlocks operate.
- 4.2 Verification of adequate water supply through the screens to the service water pumps.

5.0 ACCEPTANCE CRITERIA

The intake screens and screen wash system operates to provide water to the service water system per Section 9.2.1.

ARKANSAS NUCLEAR ONE
Unit 2

Table 14.1-1 (continued)

SERVICE WATER SYSTEM

1.0 OBJECTIVE

To demonstrate the ability of the service water system to supply cooling water, as designed, under normal and emergency conditions.

2.0 PREREQUISITES

- 2.1 Instruments calibrated and operational.
- 2.2 Construction activities complete on items to be tested.
- 2.3 Emergency pond at normal level.

3.0 TEST METHOD

- 3.1 Pump performance will be checked.
- 3.2 Alarms and interlocks will be checked.
- 3.3 Pump suction will be taken from both the reservoir and the emergency pond.
- 3.4 Flow verifications will be performed.
- 3.5 ESF actuation is simulated.

4.0 DATA REQUIRED

- 4.1 Verification of adequate flow to the components served by the service water system.
- 4.2 Conditions under which alarms and interlocks actuate.
- 4.3 Restart of service water pumps following loss of AC power.
- 4.4 Performance of system during ESF actuation.

5.0 ACCEPTANCE CRITERIA

The service water system will meet the requirements of Section 9.2.1.

EMERGENCY COOLING WATER POND

1.0 OBJECTIVE

To verify the operation of the emergency cooling water pond sluice gates.

2.0 PREREQUISITES

- 2.1 Construction activities are complete on the sluice gates and emergency cooling water pond.
- 2.2 Emergency cooling water pond is at normal level.

ARKANSAS NUCLEAR ONE
Unit 2

Table 14.1-1 (continued)

3.0 TEST METHOD

- 3.1 Functionally check the operation of the sluice gates both electrically and manually.
- 3.2 Interlocks will be verified with associated equipment.

4.0 DATA REQUIRED

- 4.1 Sluice gate performance.
- 4.2 Conditions under which interlocks actuate.

5.0 ACCEPTANCE CRITERIA

The emergency cooling water pond performs in accordance with Section 9.2.1.

FIRE PROTECTION SYSTEMS

1.0 OBJECTIVE

To demonstrate the ability of the fire protection systems to provide an adequate extinguishing agent to prevent the spread of fire.

2.0 PREREQUISITES

- 2.1 All associated instrumentation has been calibrated.
- 2.2 Construction activities are complete on the components to be tested.
- 2.3 Unit 1 fire pumps are available.

3.0 TEST METHOD

- 3.1 Alarms and interlocks checked.
- 3.2 Temperature and smoke sensors actuated where possible.
- 3.3 Sprinkler and deluge spray patterns verified where possible.
- 3.4 Fire alarm verified.

4.0 DATA REQUIRED

- 4.1 Conditions under which alarms and interlocks actuate.
- 4.2 Sprinkler and deluge spray patterns.
- 4.3 Fire alarm operability.
- 4.4 Temperature and smoke sensors operability.

5.0 ACCEPTANCE CRITERIA

The fire protection systems operate as described in Section 9.5.1.

ARKANSAS NUCLEAR ONE
Unit 2

Table 14.1-1 (continued)

COMPONENT COOLING WATER SYSTEM

1.0 OBJECTIVE

Demonstrate the capability of the component cooling water system to supply cooling water through two closed cycle, interconnected loops at a positive pressure to various reactor auxiliary components.

2.0 PREREQUISITES

- 2.1 Service water system is operational (at least one pump operating).
- 2.2 Instrumentation has been calibrated.
- 2.3 Construction activities are complete on items to be tested.

3.0 TEST METHOD

- 3.1 All manual modes of operation demonstrated, including proper pump/loop verifications.
- 3.2 All automatic and standby modes verified.
- 3.3 All alarms and interlocks checked.
- 3.4 Flow verifications made.

4.0 DATA REQUIRED

- 4.1 Differential pressure on the CCW heat exchangers (CCW side).
- 4.2 Pressure and flow measurements in each loop.
- 4.3 Actuation points of all alarms and interlocks.

5.0 ACCEPTANCE CRITERIA

The component cooling water system operates in accordance with Section 9.2.2.

INSTRUMENT AIR SYSTEM

1.0 OBJECTIVE

To demonstrate the ability of the instrument air system to supply clean, dry instrument air under all postulated conditions.

2.0 PREREQUISITES

- 2.1 Construction activities complete on items to be tested.
- 2.2 Instruments calibrated.
- 2.3 Component cooling water available.

ARKANSAS NUCLEAR ONE
Unit 2

Table 14.1-1 (continued)

3.0 TEST METHOD

- 3.1 Check the capacity of the compressors.
- 3.2 System header pressure will be reduced to demonstrate start of the standby compressor.
- 3.3 With instrument air dryers in automatic operation, the cycle times and regeneration temperatures will be verified.
- 3.4 Alarms and interlock setpoints will be checked.
- 3.5 Air dryer dew point temperatures will be measured.
- 3.6 Air samples for cleanliness will be made.

4.0 DATA REQUIRED

- 4.1 Capacity data on compressors.
- 4.2 Conditions under which alarms and interlocks operate.
- 4.3 Cycle times and regeneration temperatures of air dryers.
- 4.4 Air dryer dew point temperatures.
- 4.5 Air sample results.

5.0 ACCEPTANCE CRITERIA

The instrument air system operates as described in Section 9.3.1.

DRAINS AND SUMPS

1.0 OBJECTIVE

To demonstrate that each drain line is correctly routed to its sump, that the sump pumps operate per design, and all alarms and interlocks actuate properly.

2.0 PREREQUISITE

- 2.1 Construction activities complete on items to be tested.
- 2.2 Water available for drain flow path checks.
- 2.3 Instruments calibrated.

3.0 TEST METHOD

- 3.1 Alarms and interlocks will be checked.
- 3.2 Sump water levels will be varied to determine sump pump operating setpoints.
- 3.3 Water is hosed into drain openings to verify that drains discharge to their designated design points.

ARKANSAS NUCLEAR ONE
Unit 2

Table 14.1-1 (continued)

4.0 DATA REQUIRED

- 4.1 Sump pump operating data.
- 4.2 Conditions under which alarms and interlocks operate.
- 4.3 Discharge point of drains.

5.0 ACCEPTANCE CRITERIA

- 5.1 Drains discharge at their designed discharge points.
- 5.2 All alarms and interlocks will function per design.
- 5.3 Sump pumps operating setpoints are as designed.

CONDENSATE STORAGE AND TRANSFER SYSTEM

1.0 OBJECTIVE

To demonstrate the ability of the condensate storage and transfer system to supply plant makeup water requirements while retaining the necessary volume required to bring the reactor to cold shutdown.

2.0 PREREQUISITES

- 2.1 Construction activities complete on items to be tested.
- 2.2 Makeup water plant in service.
- 2.3 Condensate system in service.
- 2.4 All associated instrumentation calibrated.

3.0 TEST METHOD

- 3.1 All manual modes of operation and water storage capabilities will be demonstrated.
- 3.2 All automatic modes of operation will be functionally verified.
- 3.3 All alarms and protective devices will be verified.

4.0 DATA REQUIRED

- 4.1 Automatic level control setpoints.
- 4.2 Level alarm setpoint initiations.
- 4.3 Transfer pump operating data.

5.0 ACCEPTANCE CRITERIA

The condensate storage and transfer system will meet the requirements of Section 9.2.6.

ARKANSAS NUCLEAR ONE
Unit 2

Table 14.1-1 (continued)

EMERGENCY DIESEL GENERATOR SYSTEMS

1.0 OBJECTIVE

To demonstrate the capability of the emergency diesel generators and their support equipment to provide emergency power to safely shut down the reactor, remove residual heat, and maintain safe shutdown conditions upon loss of preferred power.

2.0 PREREQUISITES

- 2.1 All construction activities are complete on items to be tested.
- 2.2 Provisions for loading the diesel generator are available.
- 2.3 All associated instrumentation has been calibrated.

3.0 TEST METHOD

- 3.1 All local/remote, manual/automatic mode combinations will be verified for all support equipment, including the fuel systems starting air and switchgear.
- 3.2 Manual control and starting of the diesel will be demonstrated and operating parameters monitored.
- 3.3 Emergency starting conditions will be demonstrated and recorded.
- 3.4 Load tests will be conducted to verify performance of the units.
- 3.5 Repetitive starting capability tests will be performed.

4.0 DATA REQUIRED

- 4.1 Shop test data verification where possible.
- 4.2 Actual test data traces.
- 4.3 Running data for all auxiliary equipment.
- 4.4 Starting and loading sequence timing.

5.0 ACCEPTANCE CRITERIA

Each diesel generator set will perform in accordance with the criteria of Section 8.3.1.1.7.

CONTROL AND COMPUTER ROOM HVAC SYSTEM

1.0 OBJECTIVE

To demonstrate the functional performance of the computer and control room HVAC units to ensure habitability for personnel and equipment under all postulated conditions.

2.0 PREREQUISITES

- 2.1 Construction activities are complete on all items to be tested.
- 2.2 All affiliated instrumentation has been calibrated.

ARKANSAS NUCLEAR ONE
Unit 2

Table 14.1-1 (continued)

3.0 TEST METHOD

- 3.1 In the manual operating mode, all equipment will be checked, air flows verified, and adequate performance demonstrated.
- 3.2 In the automatic operating mode, all interlocks will be checked, including operation in the emergency modes resulting from 1) smoke detection or 2) radiation detection or 3) chlorine detection.

4.0 DATA REQUIRED

- 4.1 Air balancing verification.
- 4.2 Automatic operation at proper set-points.

5.0 ACCEPTANCE CRITERIA

Provide a suitable environment for personnel and equipment, per Section 9.4.

PLANT COMPUTER SYSTEM

1.0 OBJECTIVES

To verify that all system hardware is installed and operating properly and that all system software responds correctly to external inputs and provides proper outputs to the computer peripheral equipment.

2.0 PREREQUISITES

- 2.1 All construction and installation activities are completed on the items to be checked.
- 2.2 Applicable manufacturer's and owner's systems manuals are available.
- 2.3 Inherent and external test instrumentation is calibrated and available.

3.0 TEST METHOD

- 3.1 Test programs are to be run and sequenced as specified by the manufacturer to ascertain the reliability of computer systems to perform all required hardware functions.
- 3.2 External inputs to the system shall be simulated and the outputs measured using the external test instrumentation.
- 3.3 Computer functional programs shall be verified using proper software and/or control panel inputs, as applicable.
- 3.4 Alarm and indication functions shall be verified by the computer system instrumentation and/or the external test measurements, as applicable.

ARKANSAS NUCLEAR ONE
Unit 2

Table 14.1-1 (continued)

4.0 DATA REQUIRED

- 4.1 Hardware operating data.
- 4.2 Software performance verifications.

5.0 ACCEPTANCE CRITERIA

Plant computer system performance shall be in accordance with Chapter 7.

AUXILIARY BUILDING HVAC SYSTEMS

1.0 OBJECTIVE

To verify the functional performance of the auxiliary building HVAC systems for the non-contaminated areas of the auxiliary building.

2.0 PREREQUISITES

- 2.1 Construction has been completed on each component system to be tested.
- 2.2 All associated instrumentation has been calibrated.

3.0 TEST METHOD

- 3.1 All equipment will be operated in the manual operating modes.
- 3.2 All standby modes of operation will be demonstrated.
- 3.3 Air flow balancing data will be verified.

4.0 DATA REQUIRED

- 4.1 Air flow verification.
- 4.2 Standby operation at proper setpoints.

5.0 ACCEPTANCE CRITERIA

The auxiliary building HVAC systems perform in accordance with Section 9.4.2.

AUXILIARY BUILDING RADWASTE AREAS HVAC SYSTEMS

1.0 OBJECTIVE

To demonstrate the functional performance of the auxiliary building radwaste area HVAC systems.

ARKANSAS NUCLEAR ONE
Unit 2

Table 14.1-1 (continued)

2.0 PREREQUISITES

- 2.1 Construction activities are completed on the items to be tested.
- 2.2 All associated instrumentation has been calibrated.

3.0 TEST METHOD

- 3.1 In the normal mode, all equipment will be manually run, flows verified, and adequate performance demonstrated.
- 3.2 All interlocks with ESF equipment will be verified and documented.
- 3.3 All standby modes of operation will be tested.

4.0 DATA REQUIRED

- 4.1 Air flow balancing verifications.
- 4.2 Automatic actuation at the proper setpoints.

5.0 ACCEPTANCE CRITERIA

All equipment performs in accordance with Section 9.4.3.

CONTAINMENT PURGE SYSTEM

1.0 OBJECTIVE

To demonstrate the proper operation of the containment purge system for accessibility to the containment.

2.0 PREREQUISITES

- 2.1 Construction activities completed on the items to be tested.
- 2.2 All associated instrumentation has been calibrated.

3.0 TEST METHOD

- 3.1 All manual modes of operation will be demonstrated, including air flow verifications and adequate operation.
- 3.2 All automatic modes of operation, including interlocks with radiation monitoring equipment, will be verified.

4.0 DATA REQUIRED

- 4.1 Operation of all interlocks at proper setpoints.
- 4.2 Air balancing verification.

ARKANSAS NUCLEAR ONE
Unit 2

Table 14.1-1 (continued)

5.0 ACCEPTANCE CRITERIA

Equipment performs in accordance with Section 9.4.5 to provide accessibility to the containment.

EMERGENCY FEEDWATER SYSTEM

1.0 OBJECTIVE

To demonstrate the ability of the emergency feedwater system to:

- 1.1 Supply water to the intact steam generator(s) following a main steam line rupture.
- 1.2 Maintain steam generator water level during periods of reactor power less than 3.5 percent for startup, shutdown, or standby operation.

2.0 PREREQUISITES

- 2.1 Construction activities are completed on the items to be tested.
- 2.2 All associated instrumentation is calibrated.
- 2.3 Plant conditions are such that functional testing is possible.

3.0 TEST METHOD

- 3.1 All manual modes of operation will be verified on all equipment, including running data on drivers, pumps, and valves.
- 3.2 All normal, automatic modes of operation will be demonstrated.
- 3.3 All emergency, automatic modes of operation will be verified through trial operation with minimal simulation.

4.0 DATA REQUIRED

- 4.1 All initiating setpoint data.
- 4.2 Complete flow data on both pumps.
- 4.3 Complete pump driver data during operation.
- 4.4 Automatic valve operation data.

5.0 ACCEPTANCE CRITERIA

All equipment shall be capable of performing per Section 10.4.9.

ARKANSAS NUCLEAR ONE
Unit 2

Table 14.1-1 (continued)

CONTAINMENT HVAC SYSTEM

1.0 OBJECTIVE

To demonstrate the proper operation of the HVAC portions of the containment cooling system.

2.0 PREREQUISITES

- 2.1 Construction activities completed on the items to be tested.
- 2.2 All instrumentation associated with the containment HVAC system has been calibrated.
- 2.3 Containment at maximum design pressure (for selected portions of test).
- 2.4 Reactor coolant system at rated design temperature (for selected portions of test).

3.0 TEST METHOD

- 3.1 All normal modes of operation will be demonstrated, including manual and standby interlocks.
- 3.2 All automatic modes will be demonstrated including ESF actuations, and operation at maximum designed containment pressure.
- 3.3 Air flow verifications and system adequacy will be demonstrated at rated RCS temperature.

4.0 DATA REQUIRED

- 4.1 Air flow and thermal performance verification.
- 4.2 Interlock setpoint verifications.
- 4.3 ESF initiation and operation data.

5.0 ACCEPTANCE CRITERIA

The containment HVAC system performs in accordance with Section 9.4.5.

SAMPLING SYSTEMS

1.0 OBJECTIVE

To demonstrate that a specified quantity of representative fluid can be obtained safely at each sample point, as required to provide accurate laboratory chemical and radiochemical analysis.

2.0 PREREQUISITES

- 2.1 Construction activities complete on the items to be tested.
- 2.2 Fluid and pressure is available for withdrawing the required liquid samples.
- 2.3 Instruments associated with the sampling systems are calibrated.

ARKANSAS NUCLEAR ONE
Unit 2

Table 14.1-1 (continued)

3.0 TEST METHOD

- 3.1 Fluid is withdrawn from each sample point into the appropriate vessel and/or sample sink.
- 3.2 Adequate flow is demonstrated from appropriate sample points.
- 3.3 Alarms and interlocks are checked.
- 3.4 Sample points will be verified as correct.

4.0 DATA REQUIRED

- 4.1 Conditions under which alarms and interlocks operate.
- 4.2 Capability of sampling with adequate flow.
- 4.3 Sample point verification.

5.0 ACCEPTANCE CRITERIA

- 5.1 Flow paths are as designed.
- 5.2 All alarms and interlocks function per design.
- 5.3 Representative samples can be collected from all sample points.

AUTOMATIC GAS ANALYZER

1.0 OBJECTIVE

To verify the gas analyzer package will automatically monitor hydrogen and oxygen concentrations.

2.0 PREREQUISITES

Sample points are hooked up to the gas analyzer package.

3.0 TEST METHOD

- 3.1 Check proper operation of the sequence selector for automatic monitoring of inputs.
- 3.2 Check ability to correctly measure and record known oxygen and hydrogen concentrations.
- 3.3 Check alarm setpoints.

4.0 DATA REQUIRED

- 4.1 Oxygen and hydrogen concentrations.
- 4.2 Alarm setpoints.

5.0 ACCEPTANCE CRITERIA

The automatic gas analyzer shall perform as described in Section 9.3.2.2.3.

ARKANSAS NUCLEAR ONE
Unit 2

Table 14.1-1 (continued)

PENETRATION ROOM VENTILATION SYSTEM

1.0 OBJECTIVE

To demonstrate the ability of the penetration room ventilation system to collect and process containment penetration leakage.

2.0 PREREQUISITES

- 2.1 Construction activities on the system are completed.
- 2.2 Construction activities on the associated room are completed.
- 2.3 All instrumentation has been calibrated.

3.0 TEST METHOD

- 3.1 All normal modes of operation will be demonstrated, including air flow verifications and interlocks.
- 3.2 All automatic and standby modes of operation will be demonstrated, including containment isolation system actuation of the system.
- 3.3 The ability of the system to maintain a slightly negative pressure in the penetration room will be ensured.

4.0 DATA REQUIRED

- 4.1 Air flow verification.
- 4.2 Operation of interlocks at the proper setpoints.
- 4.3 CIS actuation data.
- 4.4 Room air leakage data.

5.0 ACCEPTANCE CRITERIA

The penetration room ventilation system meets the criteria of Section 6.5.

CIRCULATING WATER SYSTEM

1.0 OBJECTIVE

To demonstrate the ability of the circulating water system to provide a continuous supply of cooling water to the main condensers and return the water to the cooling tower for heat dissipation.

2.0 PREREQUISITES

- 2.1 Construction activities are complete on the items to be tested.
- 2.2 Construction activities are complete on the main condenser tube side.
- 2.3 All associated instrumentation has been calibrated.

ARKANSAS NUCLEAR ONE
Unit 2

Table 14.1-1 (continued)

3.0 TEST METHOD

- 3.1 Verify pump flow by measuring motor current and pump head.
- 3.2 Verify all required alarms and the corresponding actions.
- 3.3 Simulate high conductivity and verify automatic operation of the blowdown system.

4.0 DATA REQUIRED

- 4.1 Verification of all trips and alarms.
- 4.2 Pump operating parameters.

5.0 ACCEPTANCE CRITERIA

The circulating water system performance shall be as described in Section 10.4.5.

MAIN CONDENSER AND AIR REMOVAL SYSTEM

1.0 OBJECTIVE

To demonstrate the ability of the main condenser and air removal system to provide a continuous heat sink for normal operation as well as a sink for the steam dump and bypass system under certain conditions.

2.0 PREREQUISITES

- 2.1 Construction activities are completed on the items to be tested.
- 2.2 All associated instrumentation has been calibrated.
- 2.3 Plant conditions are suitable for condenser vacuum.

3.0 TEST METHOD

- 3.1 The main condenser will be functionally tested in conjunction with the operation of other systems, including automatic hotwell control.
- 3.2 The air removal system will be tested in both modes of operation: manual and standby.

4.0 DATA REQUIRED

- 4.1 Operating data for the condenser exhausters.
- 4.2 Instrument setpoint data.

5.0 ACCEPTANCE CRITERIA

The main condenser and air removal system shall perform in accordance with Sections 10.4.1 and 10.4.2.

ARKANSAS NUCLEAR ONE
Unit 2

Table 14.1-1 (continued)

CONDENSATE SYSTEM

1.0 OBJECTIVE

To demonstrate the ability of the condensate system to supply water at the required pressure to the main feedwater pumps under all anticipated steady state or transient conditions.

2.0 PREREQUISITES

- 2.1 All construction activities are completed on the items to be tested.
- 2.2 All associated instrumentation is calibrated.
- 2.3 Plant conditions provide for a flow path.

3.0 TEST METHOD

- 3.1 All normal modes of operations will be verified.
- 3.2 All standby modes of operation and other interlocks will be demonstrated with minimal simulation.

4.0 DATA REQUIRED

All interlock setpoint initiations.

5.0 ACCEPTANCE CRITERIA

The condensate system shall operate in accordance with the criteria of Section 10.4.7.

FEEDWATER SYSTEM

1.0 OBJECTIVE

To demonstrate the design intent of 2K2A and 2K2B main feedwater pump turbines.

2.0 PREREQUISITES

- 2.1 Construction complete on the feedwater and condensate system.
- 2.2 Construction complete on the condenser shell side.
- 2.3 Construction complete on all required support systems.
- 2.4 All system instrumentation is calibrated.
- 2.5 Steam is available to the pump drivers.

ARKANSAS NUCLEAR ONE
Unit 2

Table 14.1-1 (continued)

3.0 TEST METHOD

- 3.1 Verify proper operation of the lube oil system.
- 3.2 Verify proper operation of the feedwater pump turbine turning gear.
- 3.3 Verify proper valve operation and lineup.
- 3.4 The feedwater pumps and turbine drivers will be operated as practical.

4.0 DATA REQUIRED

- 4.1 Gland seal steam pressure.
- 4.2 Lube oil pressure.
- 4.3 Feedwater flow and pressure, as obtainable.
- 4.4 Turbine operating data.

5.0 ACCEPTANCE CRITERIA

The feedwater system operates as described in Section 10.4.7.

FEEDWATER CONTROL SYSTEM

1.0 OBJECTIVE

To verify proper performance of the feedwater control system.

2.0 PREREQUISITES

- 2.1 Construction activities are complete on the items to be tested.
- 2.2 Instrumentation has been calibrated.

3.0 TEST METHOD

- 3.1 Using external test instrumentation, simulate and vary all input signals to the system.
- 3.2 In automatic control above 15 percent power, verify that the output signals to main and bypass feedwater control valves and also to the feed pump speed setpoints are functionally related to the system's input signals, such as feedwater flow, steam flow and steam generator downcomer water level.
- 3.3 Verify that at a present value of the steam generator downcomer level, the feedwater control valve is closed automatically.
- 3.4 Verify that in manual control from the master control panel, feedwater control valve positions and pump speed setpoints are adjusted simultaneously.

ARKANSAS NUCLEAR ONE
Unit 2

Table 14.1-1 (continued)

4.0 DATA REQUIRED

Record the values of signals simulating 15% power and steam generator's downcomer level required to close the feedwater control valve.

5.0 ACCEPTANCE CRITERIA

Feedwater control system shall perform as described in Section 7.7.

EXTRACTION STEAM SYSTEM

1.0 OBJECTIVE

To demonstrate the capability of the bleeder trip valves, the bleeder trip valve bypass drain valves, and the feedwater heater drain valves to operate per design intent.

2.0 PREREQUISITES

- 2.1 Construction checks complete on those items to be tested.
- 2.2 Associated instrumentation has been calibrated.

3.0 TEST METHOD

- 3.1 Alarms and interlocks will be checked.
- 3.2 Feedwater heater level controls will be verified.

4.0 DATA REQUIRED

- 4.1 Conditions under which alarms and interlocks operate.
- 4.2 Performance data on all valves will be taken.

5.0 ACCEPTANCE CRITERIA

The extraction steam system operates in conjunction with other systems in accordance with Section 10.3.

SAFETY INJECTION ACTUATION SYSTEM

1.0 OBJECTIVE

To verify the proper functional performance of the safety injection actuation system.

2.0 PREREQUISITES

- 2.1 Construction is complete on the items to be tested.
- 2.2 Instrumentation has been calibrated.

ARKANSAS NUCLEAR ONE
Unit 2

Table 14.1-1 (continued)

3.0 TEST METHOD

- 3.1 Using external test instrumentation, monitor the status of all input signals and verify proper operation of the two-out-of-four redundancy circuits generating the Safety Injection Actuation Signal (SIAS).
- 3.2 Verify generation of SIAS by de-energizing any two circuits within the two-out-of-four matrix.
- 3.3 Manually block the safety injection actuation system.
- 3.4 Simulate a variable RCS pressure signal and determine the blocking limits of the system.

4.0 DATA REQUIRED

- 4.1 Values of all input signals.
- 4.2 Status of two-out-of-four redundancy circuits as a function of all possible configurations of input signals.
- 4.3 Status of two-out-of-four redundancy circuits as a function of power loss of any two circuits.
- 4.4 Value of the SIAS at all possible configurations of the input signals.
- 4.5 Value of the SIAS blocking removal signal.

5.0 ACCEPTANCE CRITERIA

Safety injection actuation system performance shall be as described in Sections 6.3 and 7.3.

CONTAINMENT ISOLATION ACTUATION SYSTEM

1.0 OBJECTIVE

To verify the proper functional performance of the containment isolation actuation system.

2.0 PREREQUISITES

- 2.1 Construction is complete on the items to be tested.
- 2.2 Associated instrumentation is calibrated.

3.0 TEST METHOD

- 3.1 Using external test instrumentation, monitor the status of all input signals and verify proper operation of the two-out-of-four redundancy circuits generating the containment isolation actuation signal (CIAS).
- 3.2 Verify generation of CIAS by disconnecting power to any two circuits within the two-out-of-four matrix.

ARKANSAS NUCLEAR ONE
Unit 2

Table 14.1-1 (continued)

4.0 DATA REQUIRED

- 4.1 Values of all input signals.
- 4.2 Status of two-out-of-four redundancy circuits as a function of all possible configurations of input signals.
- 4.3 Status of two-out-of-four redundancy circuits as a function of power loss of any two circuits.

5.0 ACCEPTANCE CRITERIA

Containment isolation actuation system performance shall be as described in Sections 6.2 and 7.3.

CONTAINMENT SPRAY ACTUATION SYSTEM

1.0 OBJECTIVE

To verify the proper functional performance of the containment spray actuation system.

2.0 PREREQUISITES

- 2.1 Construction activities are complete on the items to be tested.
- 2.2 Associated instrumentation is calibrated.

3.0 TEST METHOD

- 3.1 Simulate the SIAS using external test instrumentation, monitor the status of all input signals and verify proper operation of the two-out-of-four redundancy circuits generating the Containment Spray Actuation Signal (CSAS).
- 3.2 Verify generation of CSAS by disconnecting power to any two circuits within the two-out-of-four matrix.

4.0 DATA REQUIRED

- 4.1 Values of all input signals.
- 4.2 Status of two-out-of-four redundancy circuits as a function of all possible configurations of input signals.
- 4.3 Status of two-out-of-four redundancy circuits as a function of power loss to any two circuits.

5.0 ACCEPTANCE CRITERIA

Containment spray actuation system performance shall be as described in Sections 6.2 and 7.3.

ARKANSAS NUCLEAR ONE
Unit 2

Table 14.1-1 (continued)

CONTAINMENT COOLING ACTUATION SYSTEM

1.0 OBJECTIVE

Verify proper functional performance of the containment cooling actuation system.

2.0 PREREQUISITES

- 2.1 Construction activities are complete on the items to be tested.
- 2.2 Associated instrumentation is calibrated.

3.0 TEST METHOD

- 3.1 Using external test instrumentation, monitor the status of all input signals and verify operation of the two-out-of-four redundancy circuits generating the Containment Cooling Actuation Signal (CCAS).
- 3.2 Verify generation of CCAS by disconnecting power to any two circuits.

4.0 DATA REQUIRED

- 4.1 Values of all input signals.
- 4.2 Status of two-out-of-four redundancy circuits as a function of all possible configurations of input signals.
- 4.3 Status of two-out-of-four redundancy circuits as a function of power loss of any two circuits.

5.0 ACCEPTANCE CRITERIA

Containment cooling actuation system performance shall be as described in Sections 6.2 and 7.3.

RECIRCULATION ACTUATION SYSTEM

1.0 OBJECTIVE

To verify the proper functional performance of the recirculation actuation system.

2.0 PREREQUISITES

- 2.1 Construction activities are complete on the items to be tested.
- 2.2 Associated instrumentation is calibrated.

ARKANSAS NUCLEAR ONE
Unit 2

Table 14.1-1 (continued)

3.0 TEST METHOD

- 3.1 Using external test instrumentation monitor the status of all input signals and verify proper operation of the two-out-of-four redundancy circuits generating the Recirculation Actuation Signal (RAS).
- 3.2 Verify generation of RAS by disconnecting power to any two circuits within the two-out-of-four matrix.

4.0 DATA REQUIRED

- 4.1 Values of all input signals.
- 4.2 Status of two-out-of-four redundancy circuits as a function of all possible configurations of input signals.
- 4.3 Status of two-out-of-four redundancy circuits as a function of power loss to any two circuits.

5.0 ACCEPTANCE CRITERIA

Recirculation actuation system performance shall be as described in Sections 6.2 and 7.3.

MAIN STEAM ISOLATION ACTUATION SYSTEM

1.0 OBJECTIVE

Verify functional performance of the main steam isolation actuation system.

2.0 PREREQUISITES

- 2.1 Construction activities are complete on the items to be tested.
- 2.2 Associated instrumentation is calibrated.

3.0 TEST METHOD

- 3.1 Using external test instrumentation, vary and monitor the status of all input signals and verify proper operation of the two-out-of-four redundancy circuits generating the main steam isolation signal (MSIS).
- 3.2 Verify generation of MSIS by disconnecting power to any two circuits within the two-out-of-four matrix.
- 3.3 Verify that MSIS (generated by the logic or by actuation of the remote manual control switch) produces signals to close both main steam isolation valves and both main feedwater isolation valves, stops both main feedwater pumps and stops all four condensate pumps.
- 3.4 Simulate steam generator pressure and verify that:
 - a. The pressure setpoint varies as a function of the steam pressure.
 - b. An automatic MSIS is initiated at a predetermined pressure setpoint.

ARKANSAS NUCLEAR ONE
Unit 2

Table 14.1-1 (continued)

4.0 DATA REQUIRED

- 4.1 Values of all input signals.
- 4.2 Status of two-out-of-four redundancy circuits as a function of all possible configurations of input signals and power losses.
- 4.3 Steam pressure generating automatic MSIS.

5.0 ACCEPTANCE CRITERIA

Main steam isolation actuation system performance shall be as described in Sections 7.3 and 10.3.

EMERGENCY FEEDWATER ACTUATION SYSTEM

1.0 OBJECTIVE

To verify proper functional performance of the emergency feedwater actuation system.

2.0 PREREQUISITES

- 2.1 Construction activities are complete on the items to be tested.
- 2.2 Associated instrumentation is calibrated.

3.0 TEST METHOD

- 3.1 Using external test instrumentation, vary and monitor the status of all input signals and verify proper operation of the two-out-of-four redundancy circuits generating the Emergency Feedwater Actuation Signal (EFAS).
- 3.2 Verify generation of EFAS by disconnecting power to any two circuits within the two-out-of-four matrix.

4.0 DATA REQUIRED

- 4.1 Values of all input signals.
- 4.2 Status of two-out-of-four redundancy circuits as a function of all possible configurations of input signals and power losses.

5.0 ACCEPTANCE CRITERIA

Emergency feedwater actuation system performance shall be as described in Sections 7.3 and 10.4.

Table 14.1-1 (continued)

INTEGRATED ENGINEERED SAFETY FEATURES ACTUATION

1.0 OBJECTIVE

To demonstrate the full operational sequence of the engineered safety features actuation system including the capability of each individual emergency diesel generator and its support equipment, to provide the required safeguards equipment during a simulated accident condition coupled with a loss of offsite power and subsequent transfer to alternate power sources.

2.0 PREREQUISITES

- 2.1 All construction activities are completed on items to be tested.
- 2.2 Provisions for loading the diesel generators are available.
- 2.3 All systems actuated by the engineered safety features actuation system should have their individual functional tests completed.
- 2.4 Individual engineered safety features preoperational and calibration tests completed.

3.0 TEST METHOD

- 3.1 One diesel generator will be disabled from automatic start.
- 3.2 The AC and DC systems for the associated diesel generator will be placed out of service.
- 3.3 The onsite distribution system will be divorced from the switchyard by opening breakers as required.
- 3.4 A simulated accident signal will be inserted into the plant protective circuitry.
- 3.5 Actuate all combinations of the engineered safety feature channels on emergency power sources.
- 3.6 Steps 3.1 through 3.5 will be repeated using the other diesel generator.
- 3.7 Actuate all combinations of the emergency safety feature channels on the normal engineered safety feature power sources.

4.0 DATA REQUIRED

- 4.1 Actual test data traces.
- 4.2 Starting and loading sequence timing.
- 4.3 Monitoring of all load groups.
- 4.4 Engineered safety features flows.
- 4.5 Diesel generator output.

ARKANSAS NUCLEAR ONE
Unit 2

Table 14.1-1 (continued)

5.0 ACCEPTANCE CRITERIA

- 5.1 The Engineered Safety Features System (ESFS) in conjunction with the normal and emergency electrical power systems, responds as described in Chapter 6 and Sections 7.3, 8.3.1.1.7 and 10.4.9.
- 5.2 Each diesel generator set energizes only its required load groups.

SHUTDOWN COOLING SYSTEM

1.0 OBJECTIVE

To functionally test the operation of the components within the shutdown cooling system.

2.0 PREREQUISITES

- 2.1 Refueling water tank is available for use.
- 2.2 Reactor vessel head is removed.
- 2.3 Reactor vessel is at a level above the hot leg nozzles.

3.0 TEST METHOD

- 3.1 LPSI pumps will be operated in the shutdown cooling mode.
- 3.2 Interlocks will be tested for proper operation.
- 3.3 Flow control valve functions will be demonstrated.

4.0 DATA REQUIRED

- 4.1 Reactor vessel water level shutdown cooling flow, and LPSI pump discharge pressure and suction pressures.
- 4.2 Interlock actuation setpoints.

5.0 ACCEPTANCE CRITERIA

The shutdown cooling system operates as described in Section 9.3.6.

HIGH PRESSURE SAFETY INJECTION SYSTEM

1.0 OBJECTIVE

To demonstrate proper functional performance of the high pressure safety injection system to the RCS.

2.0 PREREQUISITES

- 2.1 Construction activities are completed on those items to be tested.
- 2.2 HPSI ESF valves are lined up in normal operating position.
- 2.3 Reactor vessel head removed.

ARKANSAS NUCLEAR ONE
Unit 2

Table 14.1-1 (continued)

3.0 TEST METHOD

- 3.1 Test each HPSI pump individually.
- 3.2 Simulate an ESF signal to the HPSI system.
- 3.3 Verify proper valve operation and pump performance.
- 3.4 Check all pump flow paths.

4.0 DATA REQUIRED

- 4.1 Record HPSI pump flow through loop A and loop B.
- 4.2 Record HPSI pump response time.
- 4.3 Record HPSI valve response time.

5.0 ACCEPTANCE CRITERIA

The high pressure safety injection system operates as described in Section 6.1.2.

SAFETY INJECTION TANKS

1.0 OBJECTIVE

To demonstrate that the flow path from the safety injection tanks to the reactor vessel is free from obstruction by discharging water from the tanks to the reactor vessel, and to functionally test the safety injection tank level and pressure instrumentation.

2.0 PREREQUISITES

- 2.1 Construction activities are completed on the items to be tested.
- 2.2 All associated instrumentation calibrations are completed.
- 2.3 Reactor vessel to pool seal is installed.
- 2.4 Reactor vessel filled above the hot leg nozzles.

3.0 TEST METHOD

- 3.1 Discharge the tanks into the open reactor vessel to verify valve operability.
- 3.2 Check level and pressure alarm actuation.
- 3.3 Record operating data on electrically operated valves.
- 3.4 Check tank isolation valve/pressurizer pressure interlock.

ARKANSAS NUCLEAR ONE
Unit 2

Table 14.1-1 (continued)

4.0 DATA REQUIRED

- 4.1 Safety injection tank level and pressure.
- 4.2 Valve operating data.
- 4.3 Time required for safety injection tanks to empty, as a function of safety injection tank level.
- 4.4 Setpoint data.

5.0 ACCEPTANCE CRITERIA

The safety injection tanks operate as described in Section 6.1.2.

LOW PRESSURE SAFETY INJECTION SYSTEM

1.0 OBJECTIVE

To demonstrate that the low pressure safety injection system operates per design.

2.0 PREREQUISITES

- 2.1 Construction activities completed on items to be tested.
- 2.2 Reactor pressure head removed.
- 2.3 ESF valves lined up in normal operating position.

3.0 TEST METHOD

- 3.1 Test each LPSI pump individually.
- 3.2 Simulate an ESF signal to the LPSI system.
- 3.3 Verify proper valve operation.
- 3.4 Check all pump flow paths.

4.0 DATA REQUIRED

- 4.1 Record LPSI pump flows and response times.
- 4.2 Record ESF valve response time.
- 4.3 Record all instrument setpoint data.

5.0 ACCEPTANCE CRITERIA

The low pressure safety injection system operates in accordance with Section 6.1.2.

ARKANSAS NUCLEAR ONE
Unit 2

Table 14.1-1 (continued)

REED SWITCH ACTUATION SYSTEM

1.0 OBJECTIVE

To verify proper operation of the reed switch actuation system CEA position-indicating system.

2.0 PREREQUISITES

- 2.1 Construction activities are completed on the items to be tested.
- 2.2 External test instrumentation calibrated.
- 2.3 CRT and CEA position indication is installed and calibration checks complete.

3.0 TEST METHOD

- 3.1 Using external test instrumentation, simulate the CEA position as determined by the Reed Switch string.
- 3.2 Monitor the CRT for proper indication.
- 3.3 Monitor the input signal to the CEA calculators.

4.0 DATA REQUIRED

Record CRT indication and CEA calculator inputs for various simulated signals.

5.0 ACCEPTANCE CRITERIA

The reed switch (CEA position-indicating system) actuation system shall perform as described in Sections 7.2 and 7.5.

CEDM CONTROL SYSTEM

1.0 OBJECTIVE

To verify proper operation of the Control Element Drive Mechanism Control System (CEDM) for all operating modes.

2.0 PREREQUISITES

- 2.1 Construction activities are complete on items to be tested.
- 2.2 Test instrumentation is calibrated.
- 2.3 Special CEDM test box is available.

ARKANSAS NUCLEAR ONE
Unit 2

Table 14.1-1 (continued)

3.0 TEST METHOD

- 3.1 Connect cables for CEDM control circuits to be tested to test box.
- 3.2 Operate CEDS in various modes. Simulate necessary signals using external test instrumentation.
- 3.3 Check proper operation of digital CEA position indication.

4.0 DATA REQUIRED

- 4.1 Digital position and operating time.
- 4.2 Verification of proper operation for each CEDM control circuit in all modes.

5.0 ACCEPTANCE CRITERIA

The CEDM control system shall operate as described in Section 7.7.

REACTOR TRIP CIRCUIT BREAKERS

1.0 OBJECTIVE

To verify proper reactor trip circuit breaker performance upon initiation of manual or automatic trip signals.

2.0 PREREQUISITES

- 2.1 Construction activities are complete on all items to be tested.
- 2.2 Installed instrumentation is calibrated.

3.0 TEST METHOD

- 3.1 Simulate automatic trip signals from the plant protection system.
- 3.2 Manually actuate the reactor trip circuit breakers by the remote manual trips.
- 3.3 Actuate the reactor trip circuit breakers by the local emergency trips.

4.0 DATA REQUIRED

Record circuit breaker operation for the various initiating sources.

5.0 ACCEPTANCE CRITERIA

Reactor trip circuit breakers shall perform as described in Section 7.2.

ARKANSAS NUCLEAR ONE
Unit 2

Table 14.1-1 (continued)

PLANT PROTECTION SYSTEM

1.0 OBJECTIVE

To verify that the plant protection system is properly installed, calibrated, and ready for operation.

2.0 PREREQUISITES

- 2.1 All construction activities are completed.
- 2.2 Necessary technical manuals are available.
- 2.3 External test instrumentation is calibrated and available.

3.0 TEST METHOD

- 3.1 Verify that the operation of each trip unit is at the correct setpoint.
- 3.2 Check the operation of trip bypass features.
- 3.3 Verify that the trip bypasses are cancelled automatically at the proper setpoint, where applicable.
- 3.4 Check that high power and low steam generator pressure trip setpoints track the process variable in the conservative direction and can be manually reset to the proper margin above the process variable.
- 3.5 Verify that the installed testing devices operate properly.
- 3.6 Verify that the various combinations of 2 of 4 logic will trip the reactor trip circuit breakers.
- 3.7 Verify that response time of the reactor trip system is acceptable.
- 3.8 Verify proper operation of interlock features.
- 3.9 Check the proper alarm actuation.
- 3.10 Verify the proper actuation of ESF signals upon actuation of appropriate trip units.

4.0 DATA REQUIRED

- 4.1 Point of actuation of trip units.
- 4.2 Reset margin of variable setpoints.
- 4.3 Maximum and minimum values of variable setpoints.
- 4.4 Response time of reactor trip system.

5.0 ACCEPTANCE CRITERIA

The plant protection system shall operate as described in Sections 7.1, 7.2, 7.3, and 7.4.

ARKANSAS NUCLEAR ONE
Unit 2

Table 14.1-1 (continued)

CORE PROTECTION CALCULATOR SYSTEM

1.0 OBJECTIVE

To verify proper functional performance of the Core Protection Calculator (CPC) system.

2.0 PREREQUISITES

- 2.1 Construction activities are complete on the items to be tested.
- 2.2 CPC test panel is operable.
- 2.3 Associated instrumentation has been calibrated.

3.0 TEST METHOD

- 3.1 Using external test instrumentation, simulate all signals required to generate high local power density (HLPD) and low departure from nucleate boiling ratio (LDNBR) trips.
- 3.2 Verify that audible and visual pre-trip alarms are obtained when trip conditions are approached in both (HLPD and LDNBR) cases.
- 3.3 Using the CPC test panel, repeat the above test 3.2.
- 3.4 Verify that in case of loss of power, the CPC system will assume a fail-safe state.

4.0 DATA REQUIRED

- 4.1 Values of input signals generating pre-trip indications and trip actions.
- 4.2 Values of output signals representing pre-trip and trip conditions.
- 4.3 Status of the system in case of a power failure.

5.0 ACCEPTANCE CRITERIA

Core protection calculator system performance shall be described in Section 7.2, CEN-57(A), CEN-58(A), CEN-67(A), CEN-44(A), CEN-45(A), CEN-63(A) and the CPC Technical Manual.

CORE OPERATING LIMIT SUPERVISORY SYSTEM

1.0 OBJECTIVE

To verify the proper operation of the Core Operating Limit Supervisory System (COLSS).

2.0 PREREQUISITES

- 2.1 Construction activities are complete on the items to be tested.
- 2.2 Associated instrumentation has been calibrated.

ARKANSAS NUCLEAR ONE
Unit 2

Table 14.1-1 (continued)

3.0 TEST METHOD

- 3.1 Using simulated test signals, vary the inputs of all parameters required for the monitoring of peak-linear heat rate, margin to DNB, total core power and axial flux tilts.
- 3.2 Varying simulated inputs, verify the following:
 - a. Reactor core power indication and its operating limits indication.
 - b. Margin indications between reactor core power and the nearest reactor core power operating limit.
 - c. Alarms initiated by the reactor core power operating limits or excessive azimuthal flux tilts.

4.0 DATA REQUIRED

Record values of all simulated input signals providing operating limits, alarms and reactor trips.

5.0 ACCEPTANCE CRITERIA

The core operating limit supervisory system shall perform as described in Section 7.7.

CEA CALCULATOR SYSTEM

1.0 OBJECTIVE

To verify proper functional performance of the CEA calculator system.

2.0 PREREQUISITES

- 2.1 Construction activities are complete on the items to be tested.
- 2.2 Associated instrumentation has been calibrated.

3.0 TEST METHOD

- 3.1 Test hardware functions by input signal simulation and performance of hardware diagnostic tests which verify protected memory integrity and CPU, ALU and I/O system operability.
- 3.2 Test software functions by performance of system test cases which calculate deviation data, CEA sensor failures and penalty factors.
- 3.3 Verify system annunciators by software input of data simulating alarm conditions.
- 3.4 Verify system redundancy and CEAC-CPC data link operability by outputting penalty factors to each CPC.

4.0 DATA REQUIRED

Values of the inputs in 3.3 above generating alarm conditions.

ARKANSAS NUCLEAR ONE
Unit 2

Table 14.1-1 (continued)

5.0 ACCEPTANCE CRITERIA

The CEA calculator system shall perform as described in Section 7.2.

CONTAINMENT POLAR CRANE

1.0 OBJECTIVE

Verify the functional performance of the containment polar crane.

2.0 PREREQUISITES

- 2.1 Electric power available.
- 2.2 Instrumentation available and calibrated.
- 2.3 Construction activities are complete on the crane and associated equipment.

3.0 TEST METHOD

- 3.1 Verify operability of trolley, bridge, and hoist.
- 3.2 Check hoist and trolley speeds.
- 3.3 Check capability of crane to position over all required containment building equipment.

4.0 DATA REQUIRED

- 4.1 Hoist and trolley speeds.
- 4.2 Verification of proper operation of interlocks.

5.0 ACCEPTANCE CRITERIA

- 5.1 All interlocks operate as required.
- 5.2 Hoist and trolley speeds are within specification limits.
- 5.3 Crane can position over all required equipment.

CONTAINMENT INTEGRATED LEAK RATE TEST

1.0 OBJECTIVE

To verify that the potential leakage from the containment is within acceptable values as stated in the Technical Specifications.

2.0 PREREQUISITES

- 2.1 Containment penetrations are installed.
- 2.2 Containment ventilation system, personnel lock, and isolation valves are operable.
- 2.3 Structural integrity test is complete.

ARKANSAS NUCLEAR ONE
Unit 2

Table 14.1-1 (continued)

3.0 TEST METHOD

- 3.1 Penetration tests shall be performed at peak design pressure using one of the following accepted methods: halogen gas detection, soap bubbles, pressure decay, hydrostatic flow or equivalent. Quantitative measurements will also be made.
- 3.2 The containment leak rate will be determined at calculated peak accident pressure and at one-half calculated peak accident pressure. Leakage will be verified by reference vessel method and/or absolute pressure method. Test accuracy shall be verified by supplementary means, such as measuring the quantity of air required to return to the starting point (pump back) or by imposing a known leak (known leak) rate to demonstrate the validity of measurement.

4.0 DATA REQUIRED

- 4.1 Individual penetration leak data.
- 4.2 Integrated leak rate data: pressure and humidity
- 4.3 Reference vessel temperature and pressure
- 4.4 Atmospheric pressure and temperature
- 4.5 "Known leakage" and/or "pump back" air flow

5.0 ACCEPTANCE CRITERIA

The leak rates must not exceed the allowable limits given in the Technical Specifications.

CONTAINMENT STRUCTURAL INTEGRITY TEST

1.0 OBJECTIVE

To demonstrate and verify the structural integrity of the containment building at 115% of design pressure.

2.0 PREREQUISITES

- 2.1 Construction activities are completed on the containment.
- 2.2 The equipment hatch, personnel hatch and escape hatch have been installed and are sealed.

3.0 TEST METHOD

- 3.1 The internal pressure in the containment building will be increased from atmospheric pressure to 1.15 times the postulated maximum loss-of-coolant accident pressure in at least four approximately equal increments and depressurized in the same increments.
- 3.2 At each pressure level, during pressurization and depressurization, data will be recorded to ascertain the radial and vertical displacement of the reactor building.

ARKANSAS NUCLEAR ONE
Unit 2

Table 14.1-1 (continued)

- 3.3 Crack patterns and crack widths shall be observed on its exterior surface at prescribed locations of high stress.
 - 3.4 A visual inspection of the containment hatches, penetrations and gaskets will be made.
- 4.0 DATA REQUIRED
- 4.1 The readings of strain gauges, load cells and deflection rods will be recorded at selected pressure levels.
 - 4.2 Selected areas of the exterior concrete surface shall be visually examined for cracking due to pressurization.
 - 4.3 The displacement of the linear plate between anchor points shall be monitored at selected locations.
- 5.0 ACCEPTANCE CRITERIA
- 5.1 The structure is capable of withstanding an internal pressure of 1.15 times the design pressure.
 - 5.2 The radial and vertical displacement of the structure is within the limits predicted by analyses.
 - 5.3 Crack patterns and widths exhibit no unexpected response to the test.
 - 5.4 The structure responds as described in Section 3.8.1.5.

CONTAINMENT SPRAY SYSTEM

1.0 OBJECTIVE

To functionally check the operation of the reactor building spray system, including the performance of the containment spray pumps, and to verify that the spray nozzles are free from obstructions.

2.0 PREREQUISITES

- 2.1 Construction activities are complete on the items to be tested.
- 2.2 Refueling water tank available.
- 2.3 Flow indicating sensors available for all spray nozzles.
- 2.4 Instruments are calibrated.

3.0 TEST METHOD

- 3.1 Flow will be established with each spray pump by recirculating water from the refueling water tank.
- 3.2 Pump performance will be checked.
- 3.3 Alarms will be checked.
- 3.4 Service air will be used to establish air flow in each spray header and flow will be verified from each nozzle.

ARKANSAS NUCLEAR ONE
Unit 2

Table 14.1-1 (continued)

4.0 DATA REQUIRED

- 4.1 Pump suction and discharge pressures versus flow rate.
- 4.2 Observation of flow through each spray nozzle.
- 4.3 Conditions under which alarms actuate.

5.0 ACCEPTANCE CRITERIA

The containment spray system will perform in accordance with Section 6.2.2.

VIBRATION AND LOOSE PARTS MONITORING SYSTEM

1.0 OBJECTIVE

To demonstrate that the vibration and loose parts monitoring system is properly installed, calibrated and ready for operation.

2.0 PREREQUISITES

- 2.1 Vibration and loose parts monitor panel is installed and construction activities are complete.
- 2.2 Sensors and preamplifiers are installed and operable.
- 2.3 X-Y plotter and chart recorder have been calibrated.
- 2.4 Spectrum analyzer has been checked for proper operation in accordance with technical manual.
- 2.5 Tape recorder is operable.
- 2.6 External test instrumentation is available and calibrated.

3.0 TEST METHOD

- 3.1 Measure and record all power supply voltages.
- 3.2 Utilizing external test instrumentation apply a known input signal and measure the resulting output signal. Vary the input signal until an alarm occurs.
- 3.3 Using the installed tape recorder, record and play back various frequencies.
- 3.4 Utilizing a known weight and pendulum, simulate a loose part at the sensor. Record resulting signal.
- 3.5 Verify automatic tape recorder start on alarm condition.

4.0 DATA REQUIRED

- 4.1 Power supply voltages.
- 4.2 Output versus input signal in all channels. Value of input signal that causes an alarm.
- 4.3 Chart recording of simulated loose part.

ARKANSAS NUCLEAR ONE
Unit 2

Table 14.1-1 (continued)

5.0 ACCEPTANCE CRITERIA

The vibration and loose parts monitoring system shall operate in accordance with design.

STEAM GENERATOR BLOWDOWN SYSTEM

1.0 OBJECTIVE

To demonstrate that the steam generator blowdown system is ready for operation.

2.0 PREREQUISITES

- 2.1 All associated instrumentation has been calibrated.
- 2.2 Construction activities on the components are complete.
- 2.3 Electrical power and instrument air are available.

3.0 TEST METHOD

- 3.1 Check the response of remotely operated valves.
- 3.2 Collect operating data on the blowdown tank drain pumps, condensate recycle pumps, and demineralizer regeneration pumps.
- 3.3 Verify open flow paths for steam generator blowdowns and subsequent condensate recycle.
- 3.4 Check the flow paths for regenerating resin.
- 3.5 Check the proper operation of pump, valve controls, and system instrumentation.

4.0 DATA REQUIRED

- 4.1 Pump operating data.
- 4.2 Valve position indication and opening and/or closing times on critical valve.

5.0 ACCEPTANCE CRITERIA

The steam generator blowdown system operates as described in sections 10.4.8 and 10.4.10.

REACTOR COOLANT LETDOWN SYSTEM

1.0 OBJECTIVE

To demonstrate that components in the reactor coolant letdown system are operable and meet design requirements.

ARKANSAS NUCLEAR ONE
Unit 2

Table 14.1-1 (continued)

2.0 PREREQUISITES

- 2.1 Construction activities on associated items are complete.
- 2.2 Associated instrumentation has been calibrated.

3.0 TEST METHOD

- 3.1 Check the response of both letdown control valves to a simulated automatic pressurizer level error signal and to a manual signal.
- 3.2 Check the response of both letdown backpressure valves to a simulated automatic pressure error signal and to a manual signal.
- 3.3 Check the proper operation of other remotely operated letdown valves.

4.0 DATA REQUIRED

- 4.1 Valve position indication and opening and/or closing on critical valves.
- 4.2 Valve responses versus simulated signal for letdown control valves and letdown backpressure valves.

5.0 ACCEPTANCE CRITERIA

- 5.1 Valve opening and closing times in agreement with specifications.
- 5.2 Valve indication working correctly.
- 5.3 Letdown control and backpressure valves give correct responses to simulated signals.

REACTOR COOLANT CHARGING SYSTEM

1.0 OBJECTIVE

To demonstrate the operation of the components in the reactor coolant charging system.

2.0 PREREQUISITES

- 2.1 Construction activities are complete on the items to be tested.
- 2.2 Associated instrumentation has been calibrated.
- 2.3 Charging pumps are operational.
- 2.4 Volume control tank system is available.

3.0 TEST METHOD

- 3.1 Check the proper operation of remotely operated valves.
- 3.2 Check the charging pump controls response to a simulated pressurizer level error signal.
- 3.3 Verify charging pump operation.
- 3.4 Demonstrate the charging pump seal lubrication system.

ARKANSAS NUCLEAR ONE
Unit 2

Table 14.1-1 (continued)

4.0 DATA REQUIRED

- 4.1 Valve position indication and opening and/or closing times on critical valves.
- 4.2 Charging pump running data.
- 4.3 Charging pump seal lubrication data.

5.0 ACCEPTANCE CRITERIA

The reactor coolant charging system performs in accordance with Section 9.3.4.

VOLUME CONTROL TANK

1.0 OBJECTIVE

To demonstrate that the volume control tank and associated components operate as designed.

2.0 PREREQUISITES

- 2.1 Construction activities are complete on the items to be tested.
- 2.2 All associated instrumentation has been calibrated.
- 2.3 Reactor coolant charging system is operational.

3.0 TEST METHOD

- 3.1 Check the proper operation of remotely operated valves.
- 3.2 Fill and drain the volume control tank and check the operation of alarms, nitrogen pressurization, letdown dump valve, auto makeup, and transfer of charging pump suction to refueling water tank.
- 3.3 Check the operation ESF components to simulated ESF signal.

4.0 DATA REQUIRED

- 4.1 Valve opening and closing times and proper indication.
- 4.2 Valve and alarm response versus volume control tank level.
- 4.3 Nitrogen pressure versus volume control tank level.

5.0 ACCEPTANCE CRITERIA

The volume control tank and associated equipment perform in accordance with Section 9.3.4.

ARKANSAS NUCLEAR ONE
Unit 2

Table 14.1-1 (continued)

REACTOR COOLANT PURIFICATION SYSTEM

1.0 OBJECTIVE

To demonstrate that components in the reactor coolant purification system operate as designed.

2.0 PREREQUISITES

- 2.1 Construction activities complete on the items to be tested.
- 2.2 All associated instrumentation has been calibrated.

3.0 TEST METHOD

- 3.1 Check the response of remotely operated valves.
- 3.2 Check the ability to change out the filter elements remotely.
- 3.3 Check the paths open to replace resin.

4.0 DATA REQUIRED

- 4.1 Valve position indication and opening and/or closing times on critical valves.
- 4.2 Quantitative purification data.

5.0 ACCEPTANCE CRITERIA

The reactor coolant purification system meets the requirements of Section 9.3.4.

BORIC ACID ADDITION SYSTEM

1.0 OBJECTIVE

To test the components and design functions of the boric acid addition system.

2.0 PREREQUISITES

- 2.1 Associated instrumentation has been calibrated.
- 2.2 Construction activities complete on items to be tested.
- 2.3 Volume control tank is operational.

3.0 TEST METHOD

- 3.1 Check the proper operation of all remotely operated valves and level alarms in the boric acid addition system.
- 3.2 Collect operating data during initial boric acid makeup pump runs.

ARKANSAS NUCLEAR ONE
Unit 2

Table 14.1-1 (continued)

3.3 Check the ability of the boric acid makeup pumps to provide water to the volume control tank and the charging pump suction header, to recirculate makeup tank contents, to pump from one makeup tank to the other, and to supply makeup to the refueling water tank.

4.0 DATA REQUIRED

4.1 Valve position indication and opening and/or closing times on critical valves.

4.2 Tank level versus alarm initiation.

4.3 Boric acid makeup pumps initial run data.

4.4 Valve and pump response to various positions of the makeup mode selector switch.

5.0 ACCEPTANCE CRITERIA

The boric acid addition systems meets the requirements of Section 9.3.4.

BORIC ACID BATCHING SYSTEM

1.0 OBJECTIVE

To demonstrate that the boric acid batching system meets the design requirements.

2.0 PREREQUISITES

2.1 Construction activities are complete on items to be tested.

2.2 Associated instrumentation has been calibrated.

2.3 Boric acid makeup tanks are operational.

2.4 Heaters are operational.

3.0 TEST METHOD

3.1 Fill the batching tank and check capacity of the heaters and operability of the temperature controller and mixer.

3.2 Drain the tank to each boric acid makeup tank.

4.0 DATA REQUIRED

4.1 Heatup rates.

4.2 Setpoint of temperature controller.

5.0 ACCEPTANCE CRITERIA

The boric acid batching system meets the requirements of Section 9.3.4.

ARKANSAS NUCLEAR ONE
Unit 2

Table 14.1-1 (continued)

CHEMICAL ADDITION SYSTEM

1.0 OBJECTIVE

To demonstrate that the chemical addition system operates per design.

2.0 PREREQUISITES

- 2.1 Construction activities are complete on items to be tested.
- 2.2 Associated instrumentation has been calibrated.
- 2.3 Charging system is operable.

3.0 TEST METHOD

- 3.1 All manual modes of chemical addition will be verified.
- 3.2 All automated modes of chemical addition will be demonstrated including verification of proper flows to charging pump suction.

4.0 DATA REQUIRED

- 4.1 All instrument setpoint verifications.
- 4.2 Flow data to charging pump suction.

5.0 ACCEPTANCE CRITERIA

The chemical addition system operates in accordance with the specifications of Section 9.3.4.

REACTOR MAKEUP WATER STORAGE AND TRANSFER SYSTEM

1.0 OBJECTIVE

To demonstrate that the reactor makeup waste storage and transfer system is operational.

2.0 PREREQUISITES

- 2.1 Construction activities complete on items to be tested.
- 2.2 Demineralized water is available.
- 2.3 Associated instrumentation has been calibrated.

3.0 TEST METHOD

- 3.1 Check the proper operation of makeup water tank level alarms and demineralized water inlet valve.
- 3.2 Collect operating data during initial reactor makeup water pump runs.
- 3.3 Check for unobstructed flow through all pump discharge paths.

ARKANSAS NUCLEAR ONE
Unit 2

Table 14.1-1 (continued)

4.0 DATA REQUIRED

- 4.1 Valve position indication and opening and/or closing times on critical valves.
- 4.2 Tank level versus alarm initiation.
- 4.3 Reactor makeup water pumps initial run data.

5.0 ACCEPTANCE CRITERIA

The reactor makeup water storage and transfer system operates in accordance with Section 9.3.4.

PROCESS RADIATION MONITORS

1.0 OBJECTIVE

To verify that the process radiation monitors installed in the reactor coolant letdown system, component cooling water system, service water system, steam generator blowdown system, and liquid radwaste system are ready for operation.

2.0 PREREQUISITES

- 2.1 The radiation monitor to be tested has been installed and construction activities are complete.
- 2.2 The radiation monitor has been calibrated.
- 2.3 Check source(s) are available.
- 2.4 External test instrumentation is available and calibrated.

3.0 TEST METHOD

- 3.1 Utilizing the check source and external test equipment, verify calibration and operation of the monitor.
- 3.2 Check the self-testing feature of the monitor.
- 3.3 Where applicable, verify proper control actuation by the monitor and record the response time.
- 3.4 Verify proper alarm actuation in the control room.

4.0 DATA REQUIRED

- 4.1 The monitor response to check source.
- 4.2 Technical data associated with the source.
- 4.3 The monitor response to test signals.
- 4.4 Signals necessary to cause alarm actuation.
- 4.5 Response time of the monitor to perform control functions.

ARKANSAS NUCLEAR ONE
Unit 2

Table 14.1-1 (continued)

5.0 ACCEPTANCE CRITERIA

The various process radiation monitors will perform as described in Section 11.4.2.1.

PRESSURIZER PRESSURE CONTROL SYSTEM

1.0 OBJECTIVE

To verify proper functional performance of the pressurizer pressure control system.

2.0 PREREQUISITES

2.1 Construction activities are complete on items to be tested.

2.2 Associated instrumentation has been calibrated.

3.0 TEST METHOD

3.1 Using external test instrumentation, simulate variations in pressurizer pressure and verify the following control functions for each channel:

- a. Below low-pressure setpoint, signal will energize all heaters.
- b. Above low-pressure setpoint, small group of heaters will be proportionally controlled as a function of pressure variations.
- c. Above high-pressure setpoint, the spray valve position is proportionally controlled as a function of pressure variation signal.

4.0 DATA REQUIRED

4.1 Setpoint value for all heaters-energized condition.

4.2 Proportionality values signal to proportional heaters versus pressure function.

4.3 Setpoint value for high pressure condition.

4.4 Proportionality values signal to spray valves versus pressure function.

5.0 ACCEPTANCE CRITERIA

Pressurizer pressure control system performance shall be as described in Section 5.6.

ARKANSAS NUCLEAR ONE
Unit 2

Table 14.1-1 (continued)

PRESSURIZER RELIEF AND QUENCH TANK SYSTEM

1.0 OBJECTIVE

To demonstrate the functional performance of the pressurizer relief and quench tank system.

2.0 PREREQUISITES

- 2.1 Construction activities are complete on items to be tested.
- 2.2 Associated instrumentation has been calibrated.
- 2.3 Reactor makeup water is available.

3.0 TEST METHOD

- 3.1 Check the proper operation of all remotely operated valves.
- 3.2 Raise and lower the quench tank level and verify the level alarm.

4.0 DATA REQUIRED

- 4.1 Valve position indication and opening and/or closing times on critical valves.
- 4.2 Quench tank level alarms versus level.
- 4.3 Instrument setpoint verifications.

5.0 ACCEPTANCE CRITERIA

The pressurizer relief and quench tank system operates in accordance with Section 5.5.11.

PRESSURIZER SAFETY VALVE BENCH TEST

1.0 OBJECTIVE

To verify the setpoints of the pressurizer safety valves.

2.0 PREREQUISITES

- 2.1 A lifting device and associated support equipment is available.
- 2.2 The plant is in hot functional testing with the RCS at normal operating pressure and temperature.

3.0 TEST METHOD

- 3.1 With the pressurizer at normal operating pressure, increase the hydroset pressure until the safety valve starts to simmer.
- 3.2 With the safety valve simmering, reduce the hydroset pressure until the safety valve seats.

ARKANSAS NUCLEAR ONE
Unit 2

Table 14.1-1 (continued)

4.0 DATA REQUIRED

Pressure at which the safety valves start to open and close.

5.0 ACCEPTANCE CRITERIA

Safety valve lifting setpoints are 2485 psig \pm 25 psig, as described in Section 5.5.13.

REACTOR REGULATING SYSTEM

1.0 OBJECTIVE

To demonstrate functional performance of the reactor regulating system.

2.0 PREREQUISITES

2.1 Construction activities are complete on items to be tested.

2.2 Associated instrumentation has been calibrated.

3.0 TEST METHOD

Utilizing installed test equipment, vary each input parameter to verify proper outputs of specified control programs, which provide power reference signals to the reactor coolant average temperature programmer and the direction and rate signals to the CEA drives.

4.0 DATA REQUIRED

Values of programmed outputs as a function of input parameter variations.

5.0 ACCEPTANCE CRITERIA

Reactor regulating system performance is as described in Section 7.7.

SPENT FUEL COOLING SYSTEM

1.0 OBJECTIVE

To verify the functional operation of the spent fuel cooling system.

2.0 PREREQUISITES

2.1 Construction activities completed on all items to be tested.

2.2 Associated instrumentation has been calibrated.

2.3 Fuel pool filled with water.

ARKANSAS NUCLEAR ONE
Unit 2

Table 14.1-1 (continued)

3.0 TEST METHOD

- 3.1 Check flow path and pump capacity.
- 3.2 Collect operating data on the pumps.
- 3.3 Check operability of pump low pressure alarms.

4.0 DATA REQUIRED

- 4.1 Fuel pool pumps operating data.
- 4.2 Low pressure alarm setpoint.

5.0 ACCEPTANCE CRITERIA

The spent fuel cooling system operates as described in Section 9.1.3.

HOLDUP TANK SYSTEM

1.0 OBJECTIVE

To demonstrate that the holdup tank system operates as designed.

2.0 PREREQUISITES

- 2.1 Construction activities are complete on items to be tested.
- 2.2 Associated instrumentation has been calibrated.
- 2.3 Gaseous waste system is available.

3.0 TEST METHOD

- 3.1 Check the proper operation of remotely operated valves.
- 3.2 Verify the operability of the holdup tank level alarms.
- 3.3 Verify the operability of the holdup tank pressure alarms.
- 3.4 Collect operating data during initial run of holdup tank recirculation and drain pumps.
- 3.5 Demonstrate pump start and stop interlocks.
- 3.6 Verify pump and tank flow paths.
- 3.7 Check operability of pressure regulators.

4.0 DATA REQUIRED

- 4.1 Valve position indication and opening and/or closing times on critical valves.
- 4.2 Holdup tank level alarms setpoint.
- 4.3 Holdup tank pressure versus pressure alarms setpoint.
- 4.4 Holdup tank recirculation and drain pumps initial run data.

ARKANSAS NUCLEAR ONE
Unit 2

Table 14.1-1 (continued)

5.0 ACCEPTANCE CRITERIA

The holdup tank system operates in accordance with Section 11.2.

REACTOR DRAIN TANK SYSTEM

1.0 OBJECTIVE

To demonstrate the functional performance of the reactor drain tank system.

2.0 PREREQUISITES

- 2.1 Construction activities are complete on items to be tested.
- 2.2 Associated instrumentation has been calibrated.
- 2.3 Holdup tank system is available.
- 2.4 Gaseous waste system is available.

3.0 TEST METHOD

- 3.1 Check the proper operation of remotely operated valves.
- 3.2 Raise and lower the reactor drain tank level and verify the level alarms.
- 3.3 Collect operating data during initial reactor drain pump runs.
- 3.4 Check the reactor drain pump interlocks on reactor drain tank level and suction valve position.

4.0 DATA REQUIRED

- 4.1 Valve position indication and opening and/or closing times on critical valves.
- 4.2 Reactor drain tank level versus level alarms and reactor drain pump interlocks.
- 4.3 Reactor drain pumps initial run data.

5.0 ACCEPTANCE CRITERIA

The reactor drain tank system operates as described in Section 9.3.4.

ARKANSAS NUCLEAR ONE
Unit 2

Table 14.1-1 (continued)

BORIC ACID CONCENTRATOR FEED SYSTEM

1.0 **OBJECTIVE**

To demonstrate that the boric acid concentrator feed system operates as designed.

2.0 **PREREQUISITES**

- 2.1 Construction activities are complete on items to be tested.
- 2.2 Associated instrumentation has been calibrated.
- 2.3 Holdup tank system available.

3.0 **TEST METHOD**

- 3.1 Check the ability to recirculate water from the holdup tanks through the preconcentrator ion exchangers.
- 3.2 Verify the operability of the high differential pressure alarms across the preconcentrator filters, ion exchangers, and strainers.
- 3.3 Demonstrate the ability to change out filter elements remotely and replace resin.
- 3.4 Verify the operability of remotely operated valves.

4.0 **DATA REQUIRED**

- 4.1 Valve position indication and opening and/or closing times on critical valves.
- 4.2 Preconcentrator filters, ion exchanger, and strainer differential pressure indication and alarms.

5.0 **ACCEPTANCE CRITERIA**

The boric acid concentrator feed system operates as described in Section 9.3.4 and Section 11.2.

BORIC ACID CONCENTRATOR SYSTEM

1.0 **OBJECTIVE**

To demonstrate that the boric acid concentrator system operates as designed.

2.0 **PREREQUISITES**

- 2.1 Construction activities are complete on items to be tested.
- 2.2 Associated instrumentation has been calibrated.

ARKANSAS NUCLEAR ONE
Unit 2

Table 14.1-1 (continued)

3.0 TEST METHOD

- 3.1 Check the ability to process liquid from the boron management holdup tanks to the boric acid concentrator.
- 3.2 Verify unobstructed flows through the liquid radwaste/BMS manifold.
- 3.3 Demonstrate proper operation of remotely operated valves.
- 3.4 Verify pump start and stop interlocks.
- 3.5 Check all pump flow paths.

4.0 DATA REQUIRED

- 4.1 Valve position indication and opening and/or closing times on critical valves.
- 4.2 Boric acid concentrator initial operating data.
- 4.3 Interlock setpoints.

5.0 ACCEPTANCE CRITERIA

The boric acid concentrator system operates in accordance with Section 9.3.4 and Section 11.2.

BORIC ACID CONDENSATE STORAGE AND TRANSFER SYSTEM

1.0 OBJECTIVE

To demonstrate the functional performance of the boric acid condensate storage and transfer system.

2.0 PREREQUISITES

- 2.1 Construction activities are complete on items to be tested.
- 2.2 Associated instrumentation has been calibrated.

3.0 TEST METHOD

- 3.1 Check the proper operation of remotely operated valves.
- 3.2 Verify remote valve indication.
- 3.3 Verify the flow path from the boric acid holdup tanks to the condensate tanks and vice versa.
- 3.4 Raise and lower the boric acid condensate tank level and check the level alarms and boric acid condensate pumps.
- 3.5 Demonstrate the operability of the high differential pressure alarms across the boric acid condensate ion exchangers and strainer.
- 3.6 Demonstrate the ability to replace resin.

ARKANSAS NUCLEAR ONE
Unit 2

Table 14.1-1 (continued)

4.0 DATA REQUIRED

- 4.1 Valve position indication and opening and/or closing times on critical valves.
- 4.2 Ion exchanger and strainer differential pressure indication and alarms.
- 4.3 Boric acid condensate tank level versus alarms.
- 4.4 Boric acid condensate pumps initial run data.

5.0 ACCEPTANCE CRITERIA

The boric acid condensate storage and transfer system operates in accordance with Section 9.3.4 and Section 11.2.

RADWASTE/BMS MANIFOLD

1.0 OBJECTIVE

To demonstrate that the radwaste/BMS manifold is operable.

2.0 PREREQUISITES

- 2.1 Associated instrumentation has been calibrated.
- 2.2 Construction activities are complete on items to be tested.

3.0 TEST METHOD

- 3.1 Check the operation and indication of all remotely operated and manual valves.
- 3.2 Verify valve and pump interlocks.

4.0 DATA REQUIRED

- 4.1 Valve position indication and opening and/or closing times on critical valves.
- 4.2 Valve and pump interlock operation.

5.0 ACCEPTANCE CRITERIA

- 5.1 Valve indication working correctly.
- 5.2 Valve and pump interlocks work as designed.

ARKANSAS NUCLEAR ONE
Unit 2

Table 14.1-1 (continued)

WASTE COLLECTION SYSTEM

1.0 OBJECTIVE

To demonstrate the functional performance of the waste collection system.

2.0 PREREQUISITES

- 2.1 Associated instrumentation has been calibrated.
- 2.2 Construction activities are complete on items to be tested.

3.0 TEST METHOD

- 3.1 Check the proper operation of the remotely operated valves.
- 3.2 Raise and lower waste tank level and verify the level alarms.
- 3.3 Collect operating data during the initial run of waste pumps.
- 3.4 Check the waste pumps start and stop interlocks and all pump flow paths.
- 3.5 Demonstrate the ability to change out the filter element remotely.
- 3.6 Verify the high differential pressure alarm across filter.

4.0 DATA REQUIRED

- 4.1 Valve position indication and opening and/or closing times on critical valves.
- 4.2 Waste tank level versus level alarms.
- 4.3 Waste pumps initial run data.
- 4.4 Waste filter differential pressure versus alarms.

5.0 ACCEPTANCE CRITERIA

The waste collection system operates in accordance with Section 11.2.

PIPING SHOCK AND VIBRATION TEST

1.0 OBJECTIVE

To determine the steady state vibration of the charging system and the transient response of the main steam line piping.

2.0 PREREQUISITES

- 2.1 Steady state vibration of the charging system is observed during initial hot functional testing.
- 2.2 Transient response of the main steam line between the steam generators and turbine stop valves is conducted during the power escalation test program. Test instrumentation is installed and calibrated.

ARKANSAS NUCLEAR ONE
Unit 2

Table 14.1-1 (continued)

3.0 TEST METHOD

3.1 Pipe movement within the charging system during steady state operation is observed during initial hot functional testing. If unusual movement is noted, additional measurements will be made.

3.2 Pipe response data will be taken on the mainsteam line, as required.

4.0 DATA REQUIRED

4.1 Pipe response data.

4.2 Initial plant conditions.

5.0 ACCEPTANCE CRITERIA

Test results shall be within the calculated acceptable range.

RESIN SLUICE SYSTEM

1.0 OBJECTIVE

To demonstrate the functional performance of the resin sludge system.

2.0 PREREQUISITES

2.1 Construction activities are complete on all components to be tested.

2.2 All associated instrumentation has been calibrated.

3.0 TEST METHOD

3.1 Collect initial run data on the resin addition pump.

3.2 Verify the flow paths for new resin addition and resin sludge.

4.0 DATA REQUIRED

Resin addition pump initial run data.

5.0 ACCEPTANCE CRITERIA

The resin sludge system operates in accordance with Section 11.2.

ARKANSAS NUCLEAR ONE
Unit 2

Table 14.1-1 (continued)

GASEOUS WASTE DECAY SYSTEM

1.0 OBJECTIVE

To demonstrate the functional performance of the waste gas compressors and discharge valves.

2.0 PREREQUISITES

- 2.1 Construction activities are complete on all components to be tested.
- 2.2 All associated instrumentation has been calibrated.
- 2.3 Gaseous waste collection system available.

3.0 TEST METHOD

- 3.1 Check the control valves for proper operation.
- 3.2 Collect operating data during the initial run of waste gas compressors.
- 3.3 Check the waste gas compressor common alarms and start and stop interlocks.

4.0 DATA REQUIRED

- 4.1 Waste gas compressor initial run data.
- 4.2 Waste gas compressor alarm and interlock setpoints.

5.0 ACCEPTANCE CRITERIA

The gaseous waste decay system operates in accordance with Section 11.3.

GASEOUS WASTE COLLECTION SYSTEM

1.0 OBJECTIVE

To demonstrate that the waste gas surge tank and associated alarms and control valves function as designed.

2.0 PREREQUISITES

- 2.1 Construction activities are complete on all components to be tested.
- 2.2 All associated instrumentation has been calibrated.
- 2.3 Nitrogen system is available.
- 2.4 Radwaste/BMS manifold is operational.

ARKANSAS NUCLEAR ONE
Unit 2

Table 14.1-1 (continued)

3.0 TEST METHOD

- 3.1 Check the remotely operated valves for proper operation.
- 3.2 Pressurize the waste gas surge tank.
- 3.3 Check the setpoints of the alarms and pressure regulation valves.

4.0 DATA REQUIRED

- 4.1 Valve position indication and opening and/or closing time on critical valves.
- 4.2 Setpoints of pressure regulation valves.
- 4.3 Setpoints of pressure alarms for the waste gas surge tank.

5.0 ACCEPTANCE CRITERIA

The gaseous waste collection system operates in accordance with Section 11.3.

GASEOUS WASTE DISCHARGE SYSTEM

1.0 OBJECTIVE

To demonstrate that the waste gas decay tanks and control valves to the plant vent plenum function as designed.

2.0 PREREQUISITES

- 2.1 Construction activities are complete on all components to be tested.
- 2.2 Associated instrumentation has been calibrated.
- 2.3 Nitrogen system is available.

3.0 TEST METHOD

- 3.1 Check the remotely operated valves for proper operation.
- 3.2 Pressurize the waste gas decay tanks.
- 3.3 Verify the setpoints of the alarms and pressure regulation valves.
- 3.4 Verify the flow paths to the waste gas analyzer.

4.0 DATA REQUIRED

- 4.1 Valve position indication and opening and/or closing times on critical valves.
- 4.2 Setpoint of pressure regulation valves.
- 4.3 Setpoints of pressure alarms.

5.0 ACCEPTANCE CRITERIA

The gaseous waste discharge system operates in accordance with Section 11.3.

ARKANSAS NUCLEAR ONE
Unit 2

Table 14.1-1 (continued)

GASEOUS RADIATION MONITORING SYSTEM

1.0 OBJECTIVE

The objective is to verify the proper operation of the gaseous radiation monitors installed in the main condenser, waste gas system, hydrogen purge system, fuel handling area ventilation system, radwaste area ventilation system, containment purge system, and control room air inlet.

2.0 PREREQUISITES

- 2.1 Monitors are installed and construction activities are complete.
- 2.2 Monitors have been calibrated.
- 2.3 External test instrumentation is available and has been calibrated.
- 2.4 The required check sources are available.

3.0 TEST METHOD

- 3.1 Utilizing a check source and external test equipment, verify the calibration and operation of the monitor.
- 3.2 Check the self-testing feature of the monitor.
- 3.3 Where applicable, verify the proper control actuation by the monitor, and record the response time.
- 3.4 Verify the proper alarm actuation in the control room.
- 3.5 Where applicable, check for the proper operation of the monitor failure alarms.

4.0 DATA REQUIRED

- 4.1 Monitor response to the check source.
- 4.2 Technical data associated with the source.
- 4.3 Monitor response (local and remote) to test signals.
- 4.4 Signals necessary to cause alarm actuation.
- 4.5 Response time of the monitor to perform control functions.

5.0 ACCEPTANCE CRITERIA

The gaseous radiation monitoring system performs as described in Section 11.4.2.2.

ARKANSAS NUCLEAR ONE
Unit 2

Table 14.1-1 (continued)

EXCORE MONITORING SYSTEM

1.0 OBJECTIVE

To verify the proper functional performance of the excore (neutron flux) monitoring system.

2.0 PREREQUISITES

2.1 Construction activities on the excore monitoring system are complete. (Detectors do not need to be installed.)

2.2 Associated instrumentation has been calibrated.

3.0 TEST METHOD

3.1 Using simulated test signals, vary all input signals to the startup, safety, and control channels of the excore monitoring system.

3.2 Monitor and record all output signals as a function of variable inputs provided by external test instrumentation.

3.3 Verify the proper performance of audio and visual indicators in response to changing input signals.

3.4 Verify the independent performance of channels by testing each channel separately.

3.5 Verify the fail-safe status of the system in case of power failure.

4.0 DATA REQUIRED

4.1 Values of input and output signals for correlation purposes, as required.

4.2 Values of all output signals triggering audio and visual alarms.

4.3 Status of the system when power is lost.

5.0 ACCEPTANCE CRITERIA

The excore monitoring system shall perform as described in Section 7.2.

INCORE MONITORING SYSTEM

1.0 OBJECTIVE

To verify the proper functional performance of the incore (neutron flux) monitoring system.

2.0 PREREQUISITES

2.1 Construction activities on the incore monitoring system are complete. (Detectors do not need to be installed.)

2.2 Associated instrumentation has been calibrated.

ARKANSAS NUCLEAR ONE
Unit 2

Table 14.1-1 (continued)

3.0 TEST METHOD

- 3.1 Using external test instrumentation, simulate incore detector signals into the signal conditioning (amplifier) circuits.
- 3.2 Using internal test circuits, test each amplifier for proper operation in accordance with manufacturer's instruction manual.
- 3.3 Vary the simulated inputs to the amplifier and record its outputs to the plant computer.

4.0 DATA REQUIRED

- 4.1 Status and performance of the internal test circuits.
- 4.2 Values of simulated input and derived output signals for correlation purposes.

5.0 ACCEPTANCE CRITERIA

The incore monitoring system shall perform as described in Section 7.7.

MOVABLE INCORE DETECTOR DRIVE SYSTEM

1.0 OBJECTIVE

To verify the proper functional performance of the movable incore detector drive system.

2.0 PREREQUISITES

- 2.1 Construction activities on the movable incore detector drive system and its portable control box are complete. (Detectors do not need to be installed.)
- 2.2 Associated instrumentation has been calibrated.

3.0 TEST METHOD

- 3.1 Operate one set of drive and transfer machines at a time, and record all pertinent outputs, including encoder signals.
- 3.2 Using external instrumentation, simulate the plant computer command signals to drive the detectors and to change inlet to outlet instrument tube alignments. Monitor all feedback signals, as required for verification of simulated commands.
- 3.3 Operate the system from the main control room board and verify proper operation by monitoring the feedback signals.
- 3.4 Operate the system from a local position with the portable control box, and verify proper operation by monitoring the feedback signals.

ARKANSAS NUCLEAR ONE
Unit 2

Table 14.1-1 (continued)

4.0 DATA REQUIRED

- 4.1 Record simulated command signals and all output signals to the computer system for correlation purposes.
- 4.2 Record all commands initiated at the main control room board and corresponding feedback signals.
- 4.3 Record all commands initiated on the portable control box and corresponding feedback signals.

5.0 ACCEPTANCE CRITERIA

The movable incore detector drive system shall perform as described in Section 7.7.

AREA RADIATION MONITORS

1.0 OBJECTIVE

The objective is to verify the functional performance of the area radiation monitors.

2.0 PREREQUISITES

- 2.1 The area radiation monitor(s) to be tested is installed and construction activities are completed.
- 2.2 The radiation monitor(s) to be tested has been calibrated.
- 2.3 Check source is available.
- 2.4 External test instrumentation is available and calibrated.

3.0 TEST METHOD

- 3.1 Utilizing a check source and external test equipment, verify the calibration and operation of the monitor.
- 3.2 Check the self-testing feature of the monitor.
- 3.3 Compare the local and remote indications for several values.
- 3.4 Verify proper local and remote alarm actuations.

4.0 DATA REQUIRED

- 4.1 Monitor response to a check source.
- 4.2 Technical data associated with the source.
- 4.3 Local and remote responses to test signals.
- 4.4 Signals necessary to cause alarm actuation.

5.0 ACCEPTANCE CRITERIA

The various area radiation monitors will perform as described in Section 12.1.4.

ARKANSAS NUCLEAR ONE
Unit 2

Table 14.1-1 (continued)

REACTOR CAVITY FUEL HANDLING SYSTEM

1.0 OBJECTIVE

To demonstrate the proper functional performance of the reactor cavity fuel handling system.

2.0 PREREQUISITES

- 2.1 Construction activities are complete on all components to be tested.
- 2.2 Associated instrumentation has been calibrated.
- 2.3 Reactor vessel head removed.
- 2.4 Core support barrel installed and aligned.

3.0 TEST METHOD

- 3.1 Record the X-Y coordinates of each core position.
- 3.2 Check the bridge, trolley, and hoist speeds.
- 3.3 Verify the operability of all bridge, trolley, and hoist interlocks.
- 3.4 Check the overload and hoist cable slack limit switches.
- 3.5 Verify the interlocks between the upender, CEA change mechanism, and refueling machine.
- 3.6 Check the camera tilt operation.
- 3.7 Position the underwater lights and move a dummy fuel assembly between the upender and reactor vessel.

4.0 DATA REQUIRED

- 4.1 X-Y coordinates of each core position.
- 4.2 Bridge, trolley, and hoist speeds.
- 4.3 Conditions under which interlocks and limit switches operate.
- 4.4 CEA change mechanism and transfer position.

5.0 ACCEPTANCE CRITERIA

- 5.1 Refueling machine can be positioned over each core position within design tolerances.
- 5.2 All interlocks and limit switches operate as designed.
- 5.3 Bridge, trolley, and hoist speeds are within tolerances.

ARKANSAS NUCLEAR ONE
Unit 2

Table 14.1-1 (continued)

SPENT FUEL PIT HANDLING AND TRANSPORT SYSTEM

1.0 OBJECTIVE

To demonstrate the functional performance of the spent fuel handling and transport system including the new fuel elevator.

2.0 PREREQUISITES

- 2.1 Construction activities are completed on the items to be tested.
- 2.2 All associated instrumentation has been calibrated.

3.0 TEST METHOD

- 3.1 Check the bridge, trolley, and hoist speeds, position indication, and travel limit switches.
- 3.2 Verify the interlocks between the upender and spent fuel handling machine.
- 3.3 Check the spent fuel handling machine hoist overload and foot switch control of hoist.
- 3.4 Check the cable slack switch on the new fuel elevator.
- 3.5 Lower a dummy fuel assembly with the new fuel elevator, and transfer it to a spent fuel rack with the spent fuel handling machine.

4.0 DATA REQUIRED

- 4.1 Bridge, trolley, and hoist speeds.
- 4.2 Conditions under which limit switches and interlocks operate.

5.0 ACCEPTANCE CRITERIA

- 5.1 All interlocks and limit switches operate as designed.
- 5.2 Bridge, trolley, and hoist speeds are within tolerances.
- 5.3 Movement and transfer of a dummy fuel assembly with the new fuel elevator and spent fuel handling machine is verified.

FUEL TRANSFER CANAL HANDLING AND TRANSPORT SYSTEM

1.0 OBJECTIVE

To demonstrate the functional performance of the fuel transfer canal handling and transport system.

2.0 PREREQUISITES

- 2.1 Construction activities are complete on the items to be tested.
- 2.2 Associated instrumentation calibrations are complete.

ARKANSAS NUCLEAR ONE
Unit 2

Table 14.1-1 (continued)

3.0 TEST METHOD

- 3.1 Raise and lower both upenders and check the interlocks with the transfer carriage, refueling machine, and spent fuel handling machine.
- 3.2 Operate the transfer carriage from both consoles, and check the overload limit.
- 3.3 Use the special tools provided to check the ability to remove the equipment remotely and to operate the upenders manually.
- 3.4 Transfer a dummy fuel assembly through the transfer canal.

4.0 DATA REQUIRED

- 4.1 Conditions under which interlocks operate.
- 4.2 Overload setting on transfer carriage.
- 4.3 Check all instrumentation indications, and verify proper instrumentation operation.

5.0 ACCEPTANCE CRITERIA

- 5.1 All interlocks and overloads operate as designed.
- 5.2 Upenders can be operated remotely and manually.
- 5.3 Upenders can be removed and replaced from the operating floor of the spent fuel pit area.

FUEL HANDLING CRANE

1.0 OBJECTIVE

To demonstrate the functional performance of the overhead crane in the Unit 2 spent fuel area.

2.0 PREREQUISITES

Construction activities are completed on the overhead crane.

3.0 TEST METHOD

- 3.1 Verify the operability of all bridge, trolley, and hoist interlocks.
- 3.2 Check the hoist and trolley speeds for the hoist.
- 3.3 Check the capability of the 4-ton hoist to position over all new fuel storage positions.

4.0 DATA REQUIRED

- 4.1 Overhead crane trolley and hoist speeds.
- 4.2 Conditions under which interlocks and limit switches operate.

ARKANSAS NUCLEAR ONE
Unit 2

Table 14.1-1 (continued)

5.0 ACCEPTANCE CRITERIA

- 5.1 All interlocks and limit switches operate as required.
- 5.2 Four-ton hoist - trolley and hoist speeds are within tolerances.
- 5.3 Four-ton hoist can position over all new fuel storage positions.

CEA CHANGE MECHANISM

1.0 OBJECTIVE

To demonstrate the functional performance of the CEA change mechanism.

2.0 PREREQUISITES

- 2.1 Construction activities are completed on all components to be tested.
- 2.2 Associated instrumentation has been calibrated.

3.0 TEST METHOD

- 3.1 Check the hoist speed, traverse speed, and position indication.
- 3.2 Check the hoist, fuel aligner, and traverse interlocks.
- 3.3 Remove and re-insert a dummy CEA in a dummy fuel assembly.
- 3.4 Check the hoist overload and no-load limits.
- 3.5 Traverse the CEA change mechanism, and check the interlocks with the upender and refueling machine.

4.0 DATA REQUIRED

- 4.1 Hoist and traverse positions and speeds.
- 4.2 Conditions under which interlocks operate.
- 4.3 Hoist load settings.

5.0 ACCEPTANCE CRITERIA

- 5.1 Interlocks and overloads operate as designed.
- 5.2 Hoist and traverse speeds are within tolerances.
- 5.3 Removal and re-insertion of a CEA is verified.

ARKANSAS NUCLEAR ONE
Unit 2

Table 14.1-1 (continued)

MAIN STEAM SYSTEM

1.0 OBJECTIVE

To demonstrate the functional performance of the main steam system, including the closing times of the main steam isolation valves, the adjustment of the main steam safety relief valves, and the operability of main steam system control valves.

2.0 PREREQUISITES

- 2.1 Construction activities are complete on the items to be tested.
- 2.2 Associated instruments have been calibrated.
- 2.3 Test equipment for testing main steam system safety relief valves installed.
- 2.4 Plant conditions are as necessary for testing.

3.0 TEST METHOD

- 3.1 Determine the lift pressure of the main steam safety relief valves by hydraulic assist.
- 3.2 Verify all interlocks.
- 3.3 Determine the closing times of the main steam isolation valves.
- 3.4 Determine the operability of main steam system control valves.

4.0 DATA REQUIRED

- 4.1 Conditions under which interlocks operate.
- 4.2 Closing times of main steam isolation valves.
- 4.3 Lift pressures of main steam safety relief valves.

5.0 ACCEPTANCE CRITERIA

The main steam system operates in accordance with Section 10.3.

STEAM DUMP AND BYPASS CONTROL SYSTEM

1.0 OBJECTIVE

To verify proper performance of the steam dump and bypass control system.

2.0 PREREQUISITES

- 2.1 Construction activities on the steam dump and bypass control system are complete.
- 2.2 Associated instrumentation has been calibrated.

ARKANSAS NUCLEAR ONE
Unit 2

Table 14.1-1 (continued)

3.0 TEST METHOD

- 3.1 Using external test instrumentation, simulate and vary the actual steam pressure and steam pressure setpoint input signals to system controller, and observe modulation of valve groups.
- 3.2 De-energize the dump/bypass demand signals one at a time to verify that redundancy arrangement is intact and that no more than one valve will open.
- 3.3 In the automatic mode, simulate the valve quick-opening demand signal, check the redundant circuits, and verify that no more than one valve will open as a result of simulated signals.
- 3.4 Verify that an automatic withdrawal prohibit signal is generated whenever an automatic bypass valve opening demand signal exists.
- 3.5 Manually select the automatic-motion-inhibit threshold and verify that for load rejections, including turbine trip, to levels below 15 percent, the reactor regulatory system (RRS) will be prevented from withdrawing or inserting CEAs (by CEA motion inhibit signal when the reactor power output falls below the threshold).

4.0 DATA REQUIRED

- 4.1 Valve quick-opening demand signal.
- 4.2 Automatic Withdrawal Prohibit (AWP) signal amplitude.
- 4.3 CEA Motion Inhibit (CMI) signal amplitude.

5.0 ACCEPTANCE CRITERIA

Steam dump and bypass control system shall perform as described in Section 7.7.

MAIN TURBINE SYSTEMS

1.0 OBJECTIVE

Verify the functional performance of the main turbine systems.

2.0 PREREQUISITES

- 2.1 All construction activities are completed on the items to be tested.
- 2.2 Associated instrumentation has been calibrated.
- 2.3 The auxiliary support systems are functional and are in service.

3.0 TEST METHODS

- 3.1 All manual modes of operation of the turbine and auxiliary support systems will be demonstrated by operation or simulated.
- 3.2 All automatic modes of operation of the turbine and auxiliary support systems will be demonstrated by operation or simulated.
- 3.3 All alarms and protective devices will be verified.

ARKANSAS NUCLEAR ONE
Unit 2

Table 14.1-1 (continued)

4.0 DATA REQUIRED

- 4.1 Conditions under which alarms and interlocks operate.
- 4.2 Verification of all control logic combinations.
- 4.3 Valve stroke data and logic verification of electrohydraulic control system.

5.0 ACCEPTANCE CRITERIA

The main turbine system performance shall be as described in Section 10.2.

AUTOMATIC DISPATCH SYSTEM

1.0 OBJECTIVE

To demonstrate the functional performance of the automatic dispatch system.

2.0 PREREQUISITES

- 2.1 All construction activities are complete on the items to be tested.
- 2.2 All instrumentation associated with the automatic dispatch system has been calibrated.
- 2.3 Megawatt demand setter system and electrohydraulic control system are operational.
- 2.4 Conitel (control, indication and telemetry) system is operational.
- 2.5 Bulk Power Management System (BPMS) computer is available for testing with the system.

3.0 TEST METHOD

- 3.1 Check the capability of the Conitel system to be controlled by the BPMS computer at Pine Bluff.
- 3.2 Simulate signals or contacts to all inputs of the Conitel system to verify operability.
- 3.3 Check for proper output from all transducers, contact devices, and other telemetry sources external to the Conitel unit.
- 3.4 Check the ability to change the load demand within the limits set by the MDS from Pine Bluff.
- 3.5 All alarms and interlocks will be verified.

4.0 DATA REQUIRED

- 4.1 Alarm and interlock set point verification.
- 4.2 Response to load change commands.
- 4.3 System output signals for given test signals.

5.0 ACCEPTANCE CRITERIA

The automatic dispatch system shall perform as described in Section 7.7.

ARKANSAS NUCLEAR ONE
Unit 2

Table 14.1-1 (continued)

SEISMIC MONITOR

1.0 OBJECTIVE

To illustrate functional performance and calibrate the peak recording accelerographs provided in the Unit 2 reactor building.

2.0 PREREQUISITES

2.1 Accelerographs are properly installed.

2.2 Construction activities are complete.

3.0 TEST METHOD

Using techniques similar to those used for the strong motion accelerographs, calibrate the peak-recording accelerographs.

4.0 DATA REQUIRED

Accelerographs calibration data.

5.0 ACCEPTANCE CRITERIA

The seismic monitors are calibrated and function to provide data for a seismic event in accordance with Section 3.7.4.

STEAM GENERATOR HYDROSTATIC TEST

1.0 OBJECTIVE

To hydrostatically test the non-isolable feed and steam lines connected to the secondary side of the steam generator.

2.0 PREREQUISITES

2.1 Steam generator secondary side filled and vented.

2.2 RCS filled and vented above design transition temperature.

3.0 TEST METHOD

3.1 Using hydropumps, raise the system pressure to code requirements.

3.2 Check the system for leakage.

3.3 Depressurize the system.

4.0 DATA REQUIRED

Pressure, temperature, and results of visual inspection.

ARKANSAS NUCLEAR ONE
Unit 2

Table 14.1-1 (continued)

5.0 ACCEPTANCE CRITERIA

Conformance to the applicable code requirements.

RCS HYDROSTATIC TEST

1.0 OBJECTIVE

To hydrostatically test the RCS and connected 2,485 psig design piping and components, in accordance with code requirements.

2.0 PREREQUISITES

- 2.1 RCS filled and vented.
- 2.2 Steam generator secondary side filled and vented.
- 2.3 Fill water within chemistry specifications.
- 2.4 System temperatures maintained above NDTT.

3.0 TEST METHOD

- 3.1 Using hydropumps, raise the system pressure to code requirements.
- 3.2 Check the system for leakage.
- 3.3 Depressurize the system.

4.0 DATA REQUIRED

Pressure, temperature, and results of visual inspection.

5.0 ACCEPTANCE CRITERIA

Conformance to the applicable code requirements.

FILTER TESTS

1.0 OBJECTIVE

The objective of these tests is to insure that the as-installed air filtration systems perform as designed.

2.0 PREREQUISITES

- 2.1 Filters are installed per design, and construction is complete on the filters to be tested.
- 2.2 Fans and blowers are installed and are capable of supplying design flow rates to the filters.

ARKANSAS NUCLEAR ONE
Unit 2

Table 14.1-1 (continued)

3.0 TEST METHOD

Filter pressure differential and efficiency measurements will be conducted in accordance with Regulatory Guide 1.52, dated June 1973.

4.0 DATA REQUIRED

- 4.1 Air flow distribution to HEPA filters and absorbers.
- 4.2 Efficiency data on HEPA filters and iodine absorbers.

5.0 ACCEPTANCE CRITERIA

Acceptance limits on filter efficiency, leakage and air flow distribution will be per Regulatory Guide 1.52, dated June 1973.

PIPE/COMPONENT HOT DEFLECTION TEST

1.0 OBJECTIVE

To demonstrate that the piping system is free to expand thermally, as designed, and return to its baseline cold position after cooldown to ambient conditions.

2.0 PREREQUISITES

- 2.1 This test is carried out in conjunction with the initial RCS heatup, and all the conditions for initial heatup must be established.
- 2.2 Construction activities are complete on the pipes to be measured.
- 2.3 Adjustment, setting, and marking of initial positions of spring hangers, hydraulic restraints, and special devices of the systems has been completed.
- 2.4 Temporary scaffolding and ladders are installed, as required, to make observations and record data.

3.0 TEST METHOD

- 3.1 Prior to the start of hot functional testing, a complete set of position measurements will be made for the steam generators and reactor coolant pumps. In addition, the RCS shutdown cooling system, main steam system, and feedwater system both inside and outside containment, will be observed during testing to verify proper expansion.
- 3.2 During heatup, a complete set of position versus temperature measurements will be made.
- 3.3 On completion of plant cooldown, a complete set of position measurements is again taken at ambient temperature.

ARKANSAS NUCLEAR ONE
Unit 2

Table 14.1-1 (continued)

4.0 DATA REQUIRED

Position measurements versus temperature.

5.0 ACCEPTANCE CRITERIA

5.1 Unrestricted expansion for selected points on components and piping.

5.2 Verification that the components and piping return to their approximate baseline cold position.

PIPING SHOCK AND VIBRATION TEST

1.0 OBJECTIVE

To determine the steady state vibration of the charging system and the transient response of the main steam line piping.

2.0 PREREQUISITES

2.1 Steady state vibration of the charging system is observed during low power functional testing.

2.2 Transient response of the main steam line between the steam generators and turbine stop valves is conducted during the power escalation test program. Test instrumentation is installed and calibrated.

3.0 TEST METHOD

3.1 Pipe movement within the charging system during steady state operation is observed. If unusual movement is noted additional measurements will be made.

3.2 Pipe response data will be taken on the main steam line, as required.

4.0 DATA REQUIRED

4.1 Pipe response data.

4.2 Initial plant conditions.

5.0 ACCEPTANCE CRITERIA

Test results shall be within the calculated acceptable range.

ARKANSAS NUCLEAR ONE
Unit 2

Table 14.1-1 (continued)

REMOTE SHUTDOWN EQUIPMENT

1.0 OBJECTIVE

To demonstrate the functional control of all equipment associated with the remote shutdown panel prior to fuel loading.

2.0 PREREQUISITE

- 2.1 All construction activities are completed on the components to be tested.
- 2.2 Preoperational testing of systems with components on the remote shutdown panel is completed.
- 2.3 Plant status is such that all equipment on the panel may be operated.

3.0 TEST METHOD

- 3.1 Each display and indicating device (instruments, lights, etc.) on the remote shutdown panel will be verified to be in agreement with those devices in all other indicating locations.
- 3.2 All control devices will be tested in a manner to demonstrate their overriding control of the proper equipment regardless of the control positions in other locations.
- 3.3 Communications between the remote shutdown panel and all local control stations used in remote shutdown will be verified as adequate.

4.0 DATA REQUIRED

- 4.1 Verification of all control logic combinations.
- 4.2 Instrumentation readout cross references.
- 4.3 Indicating light cross references.

5.0 ACCEPTANCE CRITERIA

All equipment associated with the remote shutdown panel shall operate per design intent to ensure a safe, orderly shutdown from outside the control room.

RCS LEAKAGE MEASUREMENT

1.0 OBJECTIVE

To demonstrate that reactor coolant leakage at hot pressurized system conditions is within the limits set in the Technical Specifications.

2.0 PREREQUISITES

- 2.1 Hydrostatic tests of systems which form the RCS boundaries.
- 2.2 The chemical and volume control system and the RCS are operating as a closed system.
- 2.3 The RCS is hot and pressurized.

ARKANSAS NUCLEAR ONE
Unit 2

Table 14.1-1 (continued)

3.0 TEST METHOD

Calculate the reactor coolant inventory change by measuring changes in pressurizer and volume control tank levels during a specified time interval, with correction for reactor coolant temperature changes.

4.0 DATA REQUIRED

Record RCS average temperature, pressurizer level, and volume control tank level at the beginning and end of the time interval.

5.0 ACCEPTANCE CRITERIA

Reactor coolant leakage does not exceed limits set by the Technical Specifications.

HYDROGEN ANALYZERS

1.0 OBJECTIVE

To demonstrate the ability of the two hydrogen analyzers to accurately measure hydrogen concentrations inside the containment.

2.0 PREREQUISITES

- 2.1 All construction activities are complete on the items to be tested.
- 2.2 All initial analyzer calibrations have been made.
- 2.3 External test instrumentation is calibrated and available.

3.0 TEST METHOD

- 3.1 Using a known source and external test instrumentation, various hydrogen concentrations will be simulated.
- 3.2 The analyzer will be monitored for proper response.

4.0 DATA REQUIRED

- 4.1 Known source values and test instrument values.
- 4.2 Hydrogen analyzer responses.

5.0 ACCEPTANCE CRITERIA

The hydrogen analyzers perform per Section 6.2.5.

ARKANSAS NUCLEAR ONE
Unit 2

Table 14.1-1 (continued)

HYDROGEN RECOMBINER

1.0 OBJECTIVE

To demonstrate the ability of the hydrogen recombiners to control combustible hydrogen gas concentrations within the containment.

2.0 PREREQUISITES

- 2.1 Construction activities are completed on the items to be tested.
- 2.2 All associated instrumentation has been calibrated.
- 2.3 External test instrumentation is calibrated and available.

3.0 TEST METHOD

- 3.1 The manual mode of initiation will be verified.
- 3.2 The design convective air flow capacity will be verified.
- 3.3 The design thermal capacity will be demonstrated.

4.0 DATA REQUIRED

- 4.1 Convective air flow rates.
- 4.2 Thermal performance data.

5.0 ACCEPTANCE CRITERIA

Each hydrogen recombiner will be capable of performing per Section 6.2.5.

HYDROGEN PURGE SYSTEM

1.0 OBJECTIVE

To demonstrate the ability of the hydrogen purge system to act as a backup to the hydrogen recombiners to limit hydrogen gas concentrations by a controlled purge of the containment atmosphere.

2.0 PREREQUISITES

- 2.1 All construction activities are complete on the equipment to be tested.
- 2.2 All associated instrumentation has been calibrated and is operable.

ARKANSAS NUCLEAR ONE
Unit 2

Table 14.1-1 (continued)

3.0 TEST METHOD

- 3.1 All manual modes of operation will be demonstrated, including air flow verifications from the various purge headers.
- 3.2 All automatic modes of operation will be verified including Containment Isolation System (CIS) actuation.
- 3.3 All alarms and process trips will be checked.

4.0 DATA REQUIRED

- 4.1 Air flow verification.
- 4.2 Operation of alarms and interlocks at the proper set points.
- 4.3 CIS actuation data.

5.0 ACCEPTANCE CRITERIA

The hydrogen purge system functions per the criteria of Section 6.2.5.

THERMAL EXPANSION (HOT DEFLECTION) TEST

1.0 OBJECTIVE

To verify that the piping system expands in a manner consistent with design determinations.

2.0 PREREQUISITES

- 2.1 All construction activities are complete on the system to be tested.
- 2.2 All associated instrumentation has been calibrated.

3.0 TEST METHOD

- 3.1 Thermal Expansion (Hot Deflection) Test was conducted for the following piping systems:
 - Main Steam
 - Steam Supply to Emergency Feedwater Pump Turbine
 - Main Feedwater
 - Emergency Feedwater
 - Pressurizer Relief Line (line cold with pressurizer hot)
 - Shutdown Cooling
 - Steam Generator Blowdown
 - Reactor Coolant System (including the pressurizer surge and spray lines)
 - Letdown line up to the letdown heat exchanger
 - Changing line from the Regen H.X. to the RCS

ARKANSAS NUCLEAR ONE
Unit 2

Table 14.1-1 (continued)

- 3.2 During the thermal expansion test, pipe deflections were measured or observed at locations based on the following criteria:
- a. at every spring hanger,
 - b. at every snubber, and
 - c. at points where large displacement of the pipe is expected, based on analysis.
- 3.3 One complete thermal cycle, i.e., cold position to hot position to cold position, was monitored. If hot shimming was required for piping restraints, an additional thermal cycle was monitored.
- 3.4 For most systems, the thermal expansion was monitored at cold conditions and at normal operating temperature. Significant locations were observed during the transient. Intermediate temperatures are generally not practical due to the short time during which the normal operating temperature is reached. For the RCS and the main steam system, measurements were made at cold, 290°F, 450°F, and maximum temperature conditions.
- 3.5 Measurement or observation was made during either preoperational testing or power escalation.

4.0 DATA REQUIRED

- 4.1 Initial normal configurations of piping systems.
- 4.2 All piping hangers and restraints were adjusted and verified for the as-designed configuration by a piping stress analyst.

5.0 ACCEPTANCE CRITERIA

The acceptance of the thermal expansion test results are determined based on the following criteria:

- a. The piping system is free to expand thermally, as intended, i.e., does not lock at the snubbers and spring hangers and there is no interference with structures or other pipes.
- b. The measured global displacement shall be within ± 0.38 inch of the expected global displacement when the expected global displacement is less than 0.75 inches.
- c. The measured global displacement shall be within 50 percent of the expected global displacement when the expected global displacement is greater than 0.75 inches but less than 2.0 inches.
- d. The measured global displacement were within ± 1.0 inch of the expected global displacement when the expected global displacement is greater than 2.0 inches.

Exceptions to the above criteria were approved by a qualified design engineer familiar with the system and stress analysis.

ARKANSAS NUCLEAR ONE
Unit 2

Table 14.1-1 (continued)

STEADY STATE VIBRATION TEST

1.0 OBJECTIVE

To monitor pipe vibrations of specific systems during all significant plant operating modes that are likely to cause vibration in the subject system and are postulated to have a moderate to high probability of occurrence during the plant's lifetime.

2.0 PREREQUISITES

- 2.1 All construction activities are complete on the system to be tested.
- 2.2 All associated instrumentation has been calibrated.
- 2.3 As much system operation as possible has occurred within the constraints of the plant startup schedule.

3.0 TEST METHOD

- 3.1 Testing was conducted on the following:
 - a. Main feedwater system
 - b. Emergency feedwater system
 - c. Main steam system
 - d. Reheat steam system
 - e. Condensate system
 - f. Extraction steam system
 - g. Service water system
 - h. Gaseous waste (2T17 to CV-2428)
 - i. Spent fuel pool cooling and purification
 - j. Penetration room ventilation
- 3.2 Vibration monitoring was limited to a qualitative examination of each system at the specified test mode.
- 3.3 The test was performed at various power plateaus during ascension from 50 percent to 100 percent full power. Each particular section was performed as dictated by the procedure.
- 3.4 The spent fuel pool cooling and purification system was not inspected at this time. The steady state vibration inspection of this system is to be performed at the first refueling outage when the pool is to be filled and all associated systems will be in operation.

ARKANSAS NUCLEAR ONE
Unit 2

Table 14.1-1 (continued)

4.0 DATA REQUIRED

- 4.1 Initial normal configurations of piping systems.
- 4.2 All piping hangers and restraints will be adjusted and verified for the as-designed configuration by a piping stress analyst.
- 4.3 Endurance limit for piping material.

5.0 ACCEPTANCE CRITERIA

There were a number of items that indicated higher than expected steady state vibrations. They were:

- a. Train "B" main feed regulating valve bypass piping (2CV-0744, 3FW-0744-A, and 2FW-0744-1).
- b. Main steam atmospheric dump valves 2CV-0305 and 2CV-0301.
- c. Main steam dump to condenser, specifically 2CV-0306.
- d. The No. 1 main steam header, snubbers of hanger 2EBD-1H13.

The above noted items were referred to Bechtel (S.F.) for engineering evaluation. Based upon this analysis and resulting calculation, the steady state vibration of the noted piping and systems was found to be acceptable and complies with the acceptance criteria for steady state vibration in the Unit 2 FSAR.

DYNAMIC TRANSIENT TEST

1.0 OBJECTIVE

To verify the adequacy of the piping restraint configuration for specific piping systems during a main steam stop valve trip at 80 and 100 percent reactor power.

2.0 PREREQUISITES

- 2.1 All construction activities are complete on the systems to be tested.
- 2.2 All associated instrumentation has been calibrated.
- 2.3 Dynamic transient analysis of subject lines has been performed to determine piping system response.

3.0 TEST METHOD

- 3.1 Testing was conducted on the following:
 - a. Main steam lines
 - b. Main steam dump line to the condenser
 - c. Main steam branch lines to the main feedwater pump turbine driver
 - d. Second stage reheat steam supply lines

ARKANSAS NUCLEAR ONE
Unit 2

Table 14.1-1 (continued)

- 3.2 The reactor was at the nominal power level (80 percent, 100 percent).
- 3.3 The instrumentation utilized to measure pipe displacement (measured as maximum pipe displacement in inches), restraint loads (measured in kilopounds), pipe pressure rise (measured as peak difference pressure of first pressure pulse in pounds per square inch), and valve displacement (measured as time required for valve to reach approximately 90 percent of full travel in seconds) verified to be connected to the test recorders with proper gain settings.
- 3.4 The recorders were started at a speed of ≥ 10 inches per second just prior to a turbine trip, from which a main stop valve closure resulted.
- 3.5 Data recording continued for a minimum of 10 seconds following main stop valve closure.
- 3.6 Recorder charts were removed, and required data points were analyzed.

4.0 DATA REQUIRED

- 4.1 Initial normal configurations of piping systems.
- 4.2 All piping hangers and restraints will be adjusted and verified for the as-designed configuration by a piping stress analyst.
- 4.3 Design values of snubbers and restraints.

5.0 ACCEPTANCE CRITERIA

The measured loads in the snubbers and restraint shall be below the design values of the snubbers and restraints.

ARKANSAS NUCLEAR ONE
Unit 2

TABLE 14.1-2

POST CORE HOT FUNCTIONAL TEST SUMMARIES

Components or systems described may have been modified since initial testing.
Refer to the appropriate section of the SAR for current system descriptions.

	<u>Test Title</u>	<u>Page No.</u>
1	REACTOR COOLANT SYSTEM HEAT LOSS	14.3-86
2	REACTOR COOLANT SYSTEM FLOW AND COASTDOWN MEASUREMENT	14.3-86
3	CONTROL ELEMENT DRIVE MECHANISM (CEDM) PERFORMANCE	14.3-87
4	REACTOR COOLANT SYSTEM CHEMISTRY	14.3-89
5	STEAM GENERATOR CHEMISTRY	14.3-90
6	INCORE INSTRUMENTATION MEASUREMENTS	14.3-90
7	COMPARISON OF PPS, CPCs, AND PROCESS COMPUTER INPUT	14.3-92
8	PRESSURIZER SPRAY EFFECTIVENESS	14.3-92

ARKANSAS NUCLEAR ONE
Unit 2

Table 14.1-2 (continued)

REACTOR COOLANT SYSTEM HEAT LOSS

1.0 OBJECTIVE

To measure the RCS heat loss under hot, zero power conditions.

2.0 PREREQUISITES

RCS conditions are approximately 545 °F and 2,250 psia with four reactor coolant pumps in operation.

3.0 TEST METHOD

Heat loss determination by steam flow

Secure feed to steam generators and maintain steady state RCS conditions solely by steam flow from the steam generators to remove excess RCS heat.

4.0 DATA REQUIRED

- 4.1 RCS temperatures
- 4.2 Pressurizer pressure
- 4.3 Steam generator levels
- 4.4 Steam generator pressures
- 4.5 General plant conditions

5.0 ACCEPTANCE CRITERIA

The RCS heat loss as is in satisfactory agreement with anticipated heat losses.

REACTOR COOLANT SYSTEM FLOW AND COASTDOWN MEASUREMENT

1.0 OBJECTIVES

- 1.1 To determine the as-built RCS flow.
- 1.2 To demonstrate that the RCS flow coastdown is consistent or conservative with respect to the safety analysis.
- 1.3 To demonstrate the validity of the flow-related algorithms and constants in the COLSS and the CPCs.

2.0 PREREQUISITES

- 2.1 RCS operating at nominal hot, zero power conditions (approximately 545 °F, 2,250 psia).
- 2.2 Desired reactor coolant pumps operating.
- 2.3 COLSS and CPCs in operation.

ARKANSAS NUCLEAR ONE
Unit 2

Table 14.1-2 (continued)

3.0 TEST METHOD

3.1 RCS flow determination

Operate the specified reactor coolant pump combinations and collect necessary data.

3.2 RCS flow coastdown measurements

With the specified reactor coolant pumps operating, trip the appropriate reactor coolant pump(s) for collection of coastdown data.

4.0 DATA REQUIRED

4.1 Conditions of the measurement

- a. RCS temperatures
- b. Pressurizer pressure
- c. Reactor coolant pump rotational speeds
- d. Reactor coolant pump differential pressures
- e. Steam generator pressures
- f. Flow-related inputs to the COLSS and to the CPCs.

4.2 Time dependent information

- a. Reactor coolant pump differential pressures
- b. Reactor coolant pump rotational speeds

5.0 ACCEPTANCE CRITERIA

- 5.1 RCS flow has been measured and is consistent or conservative with respect to flow rates used in safety analysis.
- 5.2 RCS flow coastdown has been measured and is consistent or conservative with respect to the coastdown used in the safety analysis.
- 5.3 Flow-related algorithms and constants in the COLSS and the CPCs have been verified, and appropriate modifications made for on-line flow determination, if necessary.

CONTROL ELEMENT DRIVE MECHANISM (CEDM) PERFORMANCE

1.0 OBJECTIVES

- 1.1 To demonstrate proper operation of CEDM under cold and hot shutdown conditions and hot, zero power conditions.
- 1.2 To verify the proper operation of the position indication systems and CEA alarms.
- 1.3 To measure CEA drop times.

ARKANSAS NUCLEAR ONE
Unit 2

Table 14.1-2 (continued)

2.0 PREREQUISITES

- 2.1 RCS conditions are being maintained in steady state at the desired temperature and pressure for the CEDM measurements.
- 2.2 Support systems required for operation of CEDMs are operational.
- 2.3 CEDM coil resistances have been measured for the RCS conditions of the test.

3.0 TEST METHOD

- 3.1 Cold shutdown conditions with no reactor coolant flow
 - a. Each CEA is withdrawn and inserted while appropriate position indications and alarm operation are recorded.
 - b. The drop time of each CEA is measured.
 - c. Five additional measurements of drop time are made for each of the fastest and slowest CEAs.
- 3.2 Hot shutdown conditions (approximately 260°F with two or three reactor coolant pumps)
 - a. The drop time of each CEA is measured.
 - b. Three additional measurements of drop time are made for each of the two fastest and two slowest CEAs.
 - c. Five additional measurements of drop time are made for each of the fastest and slowest CEAs.
- 3.3 Hot, zero power conditions (approximately 545°F with four reactor coolant pumps)
 - a. Each CEA is withdrawn and inserted while appropriate position indications and alarm operation are recorded.
 - b. The drop time of each CEA is measured.
 - c. Three additional measurements of drop time are made for each of the two fastest and two slowest CEAs.

4.0 DATA REQUIRED

- 4.1 RCS temperature
- 4.2 Pressurizer pressure
- 4.3 CEDM/CEA identifications
- 4.4 Position indications
- 4.5 Alarm operations
- 4.6 CEA drop times

ARKANSAS NUCLEAR ONE
Unit 2

Table 14.1-2 (continued)

5.0 ACCEPTANCE CRITERIA

- 5.1 The CEDM/CEAs and their associated position indication operate as designed.
- 5.2 CEA drop times are consistent or conservative with respect to the values assumed in the safety analysis and as specified by the Technical Specifications.

REACTOR COOLANT SYSTEM CHEMISTRY

1.0 OBJECTIVES

- 1.1 To maintain proper water chemistry for the RCS.
- 1.2 To establish the necessary sampling frequency to comply with Technical Specifications, and to provide assurance that chemistry limits are not exceeded.

2.0 PREREQUISITES

Sampling systems for the RCS and CVCS are operable.

3.0 TEST METHOD

The RCS will be sampled at specified intervals throughout the hot functional testing.

4.0 DATA REQUIRED

4.1 Conditions of the measurement

- a. RCS temperatures
- b. Pressurizer pressure
- c. General plant conditions

4.2 Test data

Sample point locations and times of samples.

5.0 ACCEPTANCE CRITERIA

- 5.1 Water chemistry of the RCS is maintained within specifications.
- 5.2 Appropriateness of established sampling frequencies is demonstrated.
- 5.3 Baseline data for RCS chemistry is established.

ARKANSAS NUCLEAR ONE
Unit 2

Table 14.1-2 (continued)

STEAM GENERATOR CHEMISTRY

1.0 OBJECTIVES

- 1.1 To maintain proper water chemistry for the steam generators.
- 1.2 To establish the necessary sampling frequency to comply with Technical Specifications, and to provide assurance that chemistry limits are not exceeded.

2.0 PREREQUISITES

Sampling systems for the steam generators are operable.

3.0 TEST METHOD

The steam generators will be sampled at specified intervals throughout the hot functional testing.

4.0 DATA REQUIRED

4.1 Conditions of the measurement

- a. RCS temperature
- b. Pressurizer pressure
- c. Steam generator levels
- d. Feedwater temperatures
- e. General plant conditions

4.2 Test data

Sample point locations and time of samples

5.0 ACCEPTANCE CRITERIA

- 5.1 Steam generator chemistry is maintained within specifications.
- 5.2 Appropriateness of established sampling frequencies is demonstrated.
- 5.3 Baseline data for steam generator chemistry is established.

INCORE INSTRUMENTATION MEASUREMENTS

1.0 OBJECTIVE

- 1.1 To provide in-place calibration data for the incore thermocouples.
- 1.2 To measure the leakage resistance of the fixed incore detectors.
- 1.3 To demonstrate operation of the movable incore detector system.

ARKANSAS NUCLEAR ONE
Unit 2

Table 14.1-2 (continued)

2.0 PREREQUISITES

- 2.1 RCS is being operated at the specified conditions.
- 2.2 Installation and preoperational checkout of incore instrumentation is complete.

3.0 TEST METHOD

3.1 Incore thermocouple readings

Record incore thermocouple readings in conjunction with the readings from the installed RCS RTDs during heatup and steady state operation of the RCS.

3.2 Incore detector leakage

Measure the leakage resistance of each incore detector at the nominal hot, zero power conditions.

3.3 Movable incore detector movement

Proper operation of the movable incore detector system will be demonstrated at the nominal hot, zero power conditions. This demonstration will include indexing and movement to all accessible locations.

4.0 DATA REQUIRED

4.1 Conditions of the measurement

- a. RCS temperature
- b. Pressurizer pressure
- c. Reactor coolant pumps operating

4.2 Test data

- a. Incore thermocouple readings
- b. Incore detector leakage resistances
- c. Movable incore detector positions

5.0 ACCEPTANCE CRITERIA

- 5.1 Leakage resistance of the incore detectors is satisfactory.
- 5.2 The movable incore detector system is demonstrated capable of properly accessing the various locations within the core.

ARKANSAS NUCLEAR ONE
Unit 2

Table 14.1-2 (continued)

COMPARISON OF PPS, CPCs AND PROCESS COMPUTER INPUT

1.0 OBJECTIVES

To demonstrate that the inputs and appropriate outputs of the PPS, the CPCs, and the process computer are consistent and correct.

2.0 PREREQUISITES

The plant operating at the desired conditions.

3.0 TEST METHOD

Simultaneous readings of related inputs and appropriate outputs of the PPS, the CPCs and the process computer are made.

4.0 DATA REQUIRED

Test data

- a. RCS temperatures
- b. Pressurizer pressures
- c. Steam generator levels
- d. Steam generator pressures
- e. Reactor coolant pump rotational speeds
- f. RCS flow

5.0 ACCEPTANCE CRITERIA

The input and appropriate outputs of the PPS, CPCs and the process computer are consistent and in agreement with the actual plant conditions.

PRESSURIZER SPRAY EFFECTIVENESS

1.0 OBJECTIVES

- 1.1 To establish the proper settings for the continuous spray valves.
- 1.2 To measure the rate at which pressurizer pressure can be reduced using pressurizer spray.

2.0 PREREQUISITES

The RCS is being operated at the nominal hot, zero power conditions with four reactor coolant pumps operating.

ARKANSAS NUCLEAR ONE
Unit 2

Table 14.1-2 (continued)

3.0 TEST METHOD

- 3.1 The continuous spray valves are adjusted to provide the desired amount of continuous spray.
- 3.2 RCS pressure is reduced using the three possible combinations of pressurizer spray valves.

4.0 DATA REQUIRED

- 4.1 Conditions of the measurement
 - a. RCS temperature
 - b. Pressurizer pressure
 - c. Spray line temperatures
 - d. Continuous spray valve positions
 - e. Spray valve operating status

- 4.2 Time dependent data
 - Pressurizer pressure

5.0 ACCEPTANCE CRITERIA

- 5.1 The continuous spray valves are adjusted to produce the desired continuous spray.
- 5.2 The ability of pressurizer spray to reduce pressurizer pressure consistent with the design rate is demonstrated.

ARKANSAS NUCLEAR ONE
Unit 2

Table 14.1-3

LOW POWER PHYSICS TEST SUMMARIES

Components or systems described may have been modified since initial testing.
Refer to the appropriate section of the SAR for current system descriptions.

	<u>Test Title</u>	<u>Page No.</u>
1	BIOLOGICAL SHIELDING SURVEY	14.3-95
2	CONTROL ELEMENT ASSEMBLY SYMMETRY	14.3-95
3	ISOTHERMAL TEMPERATURE COEFFICIENT	14.3-96
4	REGULATING & SHUTDOWN CEA GROUP WORTH	14.3-97
5	BORON WORTH	14.3-98
6	CRITICAL CONFIGURATION BORON CONCENTRATIONS	14.3-99
7	PSEUDO DROPPED & EJECTED CEA WORTH	14.3-100

ARKANSAS NUCLEAR ONE
Unit 2

Table 14.1-3 (continued)

BIOLOGICAL SHIELD SURVEY

1.0 OBJECTIVE

- 1.1 To measure radiation in accessible locations of the plant outside the biological shield.
- 1.2 To obtain baseline levels for comparison with future measurements of level buildup with operation.

2.0 PREREQUISITES

- 2.1 Radiation survey instruments calibrated.
- 2.2 Background radiation levels measured in designated locations prior to initial criticality.

3.0 TEST METHOD

Measure gamma and neutron dose rates during low power physics tests.

4.0 DATA REQUIRED

- 4.1 Power level
- 4.2 Gamma and neutron dose rates at each specified location.

5.0 ACCEPTANCE CRITERIA

Radiation levels have been demonstrated acceptable.

CONTROL ELEMENT ASSEMBLY SYMMETRY

1.0 OBJECTIVE

- 1.1 To demonstrate that no loading or fabrication errors that result in measurable CEA worth asymmetries have occurred.
- 1.2 To demonstrate proper coupling of each CEA and its drive mechanism.

2.0 PREREQUISITES

- 2.1 The reactivity computer is in operation.
- 2.2 The reactor is critical at approximately 545 °F and 2,250 psia with CEA Group 6 partially inserted in manual control.

ARKANSAS NUCLEAR ONE
Unit 2

Table 14.1-3 (continued)

3.0 TEST METHOD

- 3.1 The first CEA of each group is fully inserted while compensating with motion of the last CEA of the previous group and Group 6.
- a. The reactivity is adjusted to zero, as observed on the reactivity computer, and variations in the group's CEA worths are determined from the change in reactivity which occurs due to swapping CEAs.
 - b. The CEAs within a group are sequentially swapped until the relative worth of each CEA in the group has been determined.
- 3.2 The swapping process is then extended to the next group.

4.0 DATA REQUIRED

- 4.1 Conditions of the measurement
- a. RCS temperature
 - b. Pressurizer pressure
 - c. Boron concentration
- 4.2 Data for individual CEA
- a. CEA number
 - b. Position of Group 6
 - c. Net reactivity

5.0 ACCEPTANCE CRITERIA

- 5.1 The relative worths of symmetric CEAs are within measurement limitations.
- 5.2 All CEAs are demonstrated to be coupled.

ISOTHERMAL TEMPERATURE COEFFICIENT

1.0 OBJECTIVE

To measure the isothermal temperature coefficients (ITCs) for various CEA configurations at approximately 260 °F, 545 °F, and intermediate temperatures.

2.0 PREREQUISITES

- 2.1 The reactor is critical, with a stable boron concentration, at the desired CEA configuration and RCS temperature and pressure.
- 2.2 The reactivity computer is in operation.

ARKANSAS NUCLEAR ONE
Unit 2

Table 14.1-3 (continued)

3.0 TEST METHODS

- 3.1 Changes in reactor coolant temperature are introduced and the resultant changes in reactivity measured.
- 3.2 Reactivity and power swings are limited, when necessary, by compensation with CEA motion.

4.0 DATA REQUIRED

- 4.1 Conditions of the measurement
 - a. RCS temperature
 - b. Pressurizer pressure
 - c. CEA configuration
 - d. Boron concentration
- 4.2 Time dependent information
 - a. Reactivity variation (strip chart)
 - b. Changes in CEA positions
 - c. Temperature variations

5.0 ACCEPTANCE CRITERIA

- 5.1 The measured ITCs are in satisfactory agreement with the predicted values.
- 5.2 The moderator temperature coefficients (MTCs) derived from the measured ITCs are consistent with the Technical Specifications.

REGULATING AND SHUTDOWN CONTROL ELEMENT ASSEMBLY GROUP WORTH

1.0 OBJECTIVE

- 1.1 To determine regulating (including PLCEAs) and shutdown CEA group worth.
- 1.2 To verify that the CEA insertion limits are adequate to assure the shutdown margin.

2.0 PREREQUISITES

- 2.1 The reactor is critical.
- 2.2 The reactivity computer is operating.

ARKANSAS NUCLEAR ONE
Unit 2

Table 14.1-3 (continued)

3.0 TEST METHOD

3.1 Hot shutdown measurement of selected CEA groups

The CEA group worths will be measured by boron dilution/boration.

3.2 Hot, zero power measurement of CEA Groups 6 thru A

- a. The CEA group worths will be measured by boron dilution/boration.
- b. Where boron dilution is not feasible, worths will be determined by CEA drop and/or by use of alternate CEA configurations.

4.0 DATA REQUIRED

4.1 Conditions of the measurement

- a. RCS temperature
- b. Pressurizer pressure
- c. CEA configuration
- d. Boron concentration

4.2 Time dependent information

- a. Reactivity variation (strip chart)
- b. Changes in CEA positions
- c. Temperature variation

5.0 ACCEPTANCE CRITERIA

5.1 Evaluation of the measurements verifies that the CEA insertion limits are adequate to assure shutdown margin.

5.2 The measured CEA group worths are in satisfactory agreement with predictions.

BORON WORTH

1.0 OBJECTIVE

To measure the boron reactivity worth for various CEA configurations at approximately 260 °F and 545 °F.

2.0 PREREQUISITES

- 2.1 Regulating and shutdown CEA group worth tests are completed.
- 2.2 Critical configuration boron concentration tests are completed.

ARKANSAS NUCLEAR ONE
Unit 2

Table 14.1-3 (continued)

3.0 TEST METHOD

The boron worths are determined by analyzing the measured boron concentrations associated with state points measured during the CEA group worth tests.

4.0 DATA REQUIRED

4.1 Conditions of the measurement for state points

- a. RCS temperature
- b. Pressurizer pressure
- c. CEA configuration
- d. Boron concentration

4.2 Integral reactivity changes between state points

5.0 ACCEPTANCE CRITERIA

The measured boron worths are in satisfactory agreement with predicted values.

CRITICAL CONFIGURATION BORON CONCENTRATIONS

1.0 OBJECTIVE

To measure critical boron concentrations for various CEA configurations at approximately 260°F, 545°F and intermediate temperatures and associated pressures.

2.0 PREREQUISITES

- 2.1 The reactor critical at the desired conditions.
- 2.2 The appropriate portion of the regulating and shutdown CEA group worth tests have been completed.

3.0 TEST METHOD

- 3.1 The reactor is critical with the desired CEA configuration (arrived at as endpoints of selected plateaus in the regulating and shutdown CEA group worth tests).
- 3.2 Circulation through the pressurizer and the volume control tank is maximized to bring their boron concentrations to equilibrium with the RCS.
- 3.3 Coolant samples are taken and chemically analyzed for boron content until it is established that an equilibrium state has been achieved.

ARKANSAS NUCLEAR ONE
Unit 2

Table 14.1-3 (continued)

4.0 DATA REQUIRED

Critical conditions:

- a. Boron concentration
- b. CEA positions
- c. RCS temperature
- d. Pressurizer pressure

5.0 ACCEPTANCE CRITERIA

The measured critical boron concentrations are in satisfactory agreement with the predictions.

PSEUDO DROPPED AND EJECTED CONTROL ELEMENT ASSEMBLY WORTH

1.0 OBJECTIVE

- 1.1 To measure the worth of the pseudo "dropped" CEA.
- 1.2 To measure the worth of the pseudo "ejected" CEA from the ZPDIL.

2.0 PREREQUISITES

- 2.1 Reactor critical at approximately 545 °F and 2250 psia, with the appropriate CEA configurations.
- 2.2 The reactivity computer is in operation.

3.0 TEST METHOD

3.1 Pseudo worst "dropped" CEA measurement

- a. The pseudo worst "dropped" CEA worth is established on the basis of predictions and verified during the symmetry check.
- b. The worst and next worst are then measured by boron dilution.

3.2 Pseudo worst "dropped" PLCEA and "dropped" PLCEA subgroup measurement

- a. The pseudo worst "dropped" PLCEA and "dropped" PLCEA subgroups are established by prediction.
- b. The worst single PLCEA and subgroup of PLCEAs are measured by boron dilution/boration and/or CEA compensation.

3.3 Pseudo worst "ejected" CEA measurement

- a. The worth of the worst pseudo "ejected" CEA is established by means of a prediction.
- b. The worst and next worst are measured by boration for the ZPDIL CEA configurations.

ARKANSAS NUCLEAR ONE
Unit 2

Table 14.1-3 (continued)

4.0 DATA REQUIRED

4.1 Conditions of the measurement

- a. RCS temperature
- b. Pressurizer pressure
- c. CEA configuration
- d. Boron concentration

4.2 Time dependent information

- a. Reactivity variation (strip chart)
- b. Changes in CEA positions

5.0 ACCEPTANCE CRITERIA

The measured worths are in satisfactory agreement with the predicted worths.

ARKANSAS NUCLEAR ONE
Unit 2

Table 14.1-4

POWER RANGE TEST SUMMARIES

Components or systems described may have been modified since initial testing.
Refer to the appropriate section of the SAR for current system descriptions.

	<u>Test Title</u>	<u>Page No.</u>
1	NATURAL CIRCULATION	14.3-103
2	VARIABLE TAVG (ITC & POWER COEFFICIENT)	14.3-104
3	UNIT LOAD TRANSIENT	14.3-105
4	CONTROL SYSTEMS CHECKOUT	14.3-106
5	REACTOR COOLANT SYSTEM CHEMISTRY AND RADIOCHEMISTRY (PROCESS MONITOR)	14.3-107
6	STEADY STATE CORE PERFORMANCE	14.3-108
7	TURBINE TRIP	14.3-109
8	LOAD REJECTION	14.3-110
9	SHUTDOWN FROM OUTSIDE THE CONTROL ROOM	14.3-110
10	LOSS OF OFFSITE POWER	14.3-111
11	BIOLOGICAL SHIELD SURVEY	14.3-112
12	XENON OSCILLATION CONTROL (PLCEA)	14.3-113
13	DROPPED CONTROL ELEMENT ASSEMBLY	14.3-114
14	PSEUDO ROD EJECTION	14.3-115
15	COMPARISON OF PPS, CPCs, & PROCESS COMPUTER INPUTS	14.3-116
16	VERIFICATION OF CPC POWER DISTRIBUTION RELATED CONSTANTS	14.3-117
17	STEAM GENERATOR CHEMISTRY	14.3-118
18	STEAM DUMP VALVE AND BYPASS SYSTEMS	14.3-118
19	MAIN AND EMERGENCY FEEDWATER SYSTEMS	14.3-120

ARKANSAS NUCLEAR ONE
Unit 2

Table 14.1-4 (continued)

NATURAL CIRCULATION

1.0 OBJECTIVE

To evaluate natural circulation flow conditions.

2.0 PREREQUISITES

The reactor has operated in a manner to ensure that it will be a satisfactory heat source after the trip.

3.0 TEST METHOD

- 3.1 All reactor coolant pumps are secured.
- 3.2 The plant is tripped.
- 3.3 The RCS temperatures and pressurizer pressure are recorded.
- 3.4 The steam generator levels and pressures are recorded.

4.0 DATA REQUIRED

- 4.1 Conditions of the measurement
 - a. Power
 - b. Power history
 - c. RCS temperatures
- 4.2 Time dependent information
 - a. RCS temperatures and pressurizer pressure
 - b. Steam generator level and pressure

5.0 ACCEPTANCE CRITERIA

The natural circulation power to flow ratio is less than 1.0.

ARKANSAS NUCLEAR ONE
Unit 2

Table 14.1-4 (continued)

VARIABLE T_{AVG} (ITC & POWER COEFFICIENT)

1.0 OBJECTIVE

To measure the power and isothermal temperature coefficients of reactivity at selected power levels.

2.0 PREREQUISITES

- 2.1 Measurement of the central CEA worth at zero power.
- 2.2 Calculated values for the zero power and at power conditions for the worth of the central CEA.
- 2.3 Equilibrium Xe and boron conditions at the desired power and CEA configurations.

3.0 TEST METHOD

3.1 ITC Measurement

- a. The ITC is measured by changing the core average temperature while maintaining the power essentially constant.
- b. Changes in reactivity are compensated for by means of movement of the central CEA.

3.2 Power coefficient measurement

- a. The power coefficient is measured by changing the core power while maintaining the core average temperature essentially constant.
- b. Changes in reactivity are compensated for by means of movement of the central CEA.

4.0 DATA REQUIRED

4.1 Conditions of the measurement

- a. Power
- b. RCS temperature
- c. CEA configuration
- d. Boron concentration
- e. Burnup

4.2 Data required for the ITC measurement

- a. Power level before and after temperature changes
- b. RCS temperatures before and after temperature changes
- c. Control CEA positions before and after temperature changes
 1. Group 6
 2. CEA 6-1

ARKANSAS NUCLEAR ONE
Unit 2

Table 14.1-4 (continued)

- 4.3 Data required for power coefficient measurement
- a. Power level before and after power changes
 - b. RCS temperatures before and after power changes
 - c. Control CEA positions before and after power changes
 - 1. Group 6
 - 2. CEA 6-1

5.0 ACCEPTANCE CRITERIA

- 5.1 Satisfactory agreement with predicted values.
- 5.2 Conformance with the Technical Specifications.

UNIT LOAD TRANSIENT

1.0 OBJECTIVE

To demonstrate that load changes can be made at the desired rates.

2.0 PREREQUISITES

- 2.1 Unit operating at the desired power.
- 2.2 The RRS, FWCS, MDS, SDBCS, and the pressurizer level and pressure controls are in the mode of operation used during normal operation under the conditions existing for the test.

3.0 TEST METHOD

Perform load reductions and load increases at selected power levels between 15 percent and 100 percent power.

4.0 DATA REQUIRED

Time dependent data

- a. Pressurizer level and pressure
- b. RCS temperatures
- c. CEA motion
- d. Power level and demand
- e. Steam generator levels and pressure

ARKANSAS NUCLEAR ONE
Unit 2

Table 14.1-4 (continued)

5.0 ACCEPTANCE CRITERIA

- 5.1 The reactor power, RCS temperatures, and pressurizer pressure and level are maintained within acceptable ranges during transient operation.
- 5.2 The steam generator levels and pressures are maintained within acceptable ranges during transient operation.

CONTROL SYSTEMS CHECKOUT

1.0 OBJECTIVE

To demonstrate that the automatic control systems operate satisfactorily during steady state and transient conditions.

2.0 PREREQUISITES

The RRS, FWCS, MDS, SDBCS, and the pressurizer level and pressure controls are in the mode of operation used during normal operation under the conditions existing for the test.

3.0 TEST METHOD

The performance of the control systems during normal operations, transients and trips will be monitored to demonstrate that the systems are operating satisfactorily.

4.0 DATA REQUIRED

Time dependent data

- a. Pressurizer level and pressure
- b. RCS temperatures
- c. CEA motion
- d. Power level and demand
- e. Steam generator levels and pressure

5.0 ACCEPTANCE CRITERIA

- 5.1 The control systems maintain the reactor power, RCS temperature, and pressurizer pressure and level within acceptable ranges during both steady state and transient operation.
- 5.2 The control systems maintain the steam generator levels and pressures within acceptable ranges during both steady state and transient operation.

ARKANSAS NUCLEAR ONE
Unit 2

Table 14.1-4 (continued)

REACTOR COOLANT SYSTEM CHEMISTRY AND RADIOCHEMISTRY (PROCESS MONITOR)

1.0 OBJECTIVE

- 1.1 To verify the calibration of the process radiation monitor against an acceptable standard.
- 1.2 To monitor any activity buildup in the reactor coolant following fuel loading and power escalation, and to establish base activity levels.

2.0 PREREQUISITES

- 2.1 Plant stable at the desired power levels.
- 2.2 Sampling system for the RCS and CVCS are operable.

3.0 TEST METHOD

- 3.1 Samples will be collected from the process radiation monitor at various power levels during the initial escalation to full power.

The samples will be analyzed with lab instruments and compared with the radiation monitor results.

- 3.2 Sampling techniques will be verified and background activity levels will be established.

Sampling will start following fuel loading and continue through power operation to follow any buildup of activity.

4.0 DATA REQUIRED

- 4.1 Conditions of the measurement
 - a. Power
 - b. RCS temperature
 - c. Boron concentration
- 4.2 Samples for measurement of gross activities and isotopics

5.0 ACCEPTANCE CRITERIA

- 5.1 Procedures for sample collection and analysis are verified.
- 5.2 Base activities are established.
- 5.3 Laboratory analyses agree satisfactorily with radiation monitor.

ARKANSAS NUCLEAR ONE
Unit 2

Table 14.1-4 (continued)

STEADY STATE CORE PERFORMANCE

1.0 OBJECTIVE

- 1.1 To document the RCS and steam generator steady state parameters as a function of reactor power.
- 1.2 To determine core power distributions using incore instrumentation.

2.0 PREREQUISITES

- 2.1 Desired power level and CEA configuration.
- 2.2 Equilibrium Xe and boron conditions.
- 2.3 Steady state conditions at the desired power level.
- 2.4 Incore instrument system in operation.

3.0 TEST METHOD

- 3.1 Determine power by heat balance.
- 3.2 Determine the core power distribution using the incore detectors.

4.0 DATA REQUIRED

- 4.1 Conditions of the measurement
 - a. Power
 - b. RCS temperature
 - c. CEA configuration
 - d. Boron concentration
 - e. Core average burnup
- 4.2 Test data
 - a. RCS temperatures and flow
 - b. Pressurizer pressure and level
 - c. Steam generator pressures, levels, and steam flow
 - d. Turbine header pressure
 - e. Feedwater temperature and flow
 - f. Valve positions in feedwater system
 - g. Generator megawatts
 - h. Incore detector maps

ARKANSAS NUCLEAR ONE
Unit 2

Table 14.1-4 (continued)

5.0 ACCEPTANCE CRITERIA

- 5.1 Results of measurements at each power level indicate acceptable performance at the next power level.
- 5.2 Parameters do not exceed equipment or safety limits.
- 5.3 The agreement between predicted and measured power distributions is satisfactory.
- 5.4 Measured radial peaking factors are no higher than the corresponding values used in the CPCs.

TURBINE TRIP

1.0 OBJECTIVE

To demonstrate that the plant responds and is controlled as designed, following a 100 percent turbine trip.

2.0 PREREQUISITES

- 2.1 Reactor operating at or near 100 percent power.
- 2.2 The SDBCS, FWCS, RRS, and pressurizer pressure and level controls are in the mode of operation used during normal operation under the conditions existing for the test.

3.0 TEST METHOD

- 3.1 The turbine is tripped.
- 3.2 Plant behavior, is monitored to assure that the RRS, FWCS, and pressurizer pressure and level controls properly control the turbine trip.

4.0 DATA REQUIRED

- 4.1 Plant condition prior to trip

Power

- 4.2 Time dependent data

- a. Pressurizer level and pressure
- b. Steam generator levels and pressure
- c. RCS temperatures
- d. CEA positions

5.0 ACCEPTANCE CRITERIA

The plant control systems and operator actions satisfactorily control a 100 percent turbine trip.

ARKANSAS NUCLEAR ONE
Unit 2

Table 14.1-4 (continued)

LOAD REJECTION

1.0 OBJECTIVE

To demonstrate that the NSSS can sustain a 100 percent load rejection.

2.0 PREREQUISITES

2.1 Reactor operating at or near 100 percent power.

2.2 The SDBCS, FWCS, RRS, and pressurizer pressure and level control are in the mode of operation used during normal operation under the conditions existing for the test.

3.0 TEST METHOD

3.1 The generator main breaker is tripped.

3.2 Monitor the plant behavior to assure that the RRS, SDBCS, and FWCS and pressurizer pressure and level controls properly control the load rejection transient.

4.0 DATA REQUIRED

4.1 Plant condition prior to trip

Power

4.2 Time dependent data

- a. Pressurizer level and pressure
- b. Steam generator levels and pressure
- c. RCS temperatures
- d. CEA positions

5.0 ACCEPTANCE CRITERIA

The plant control systems and operator actions satisfactorily control a 100 percent load rejection.

SHUTDOWN FROM OUTSIDE THE CONTROL ROOM

1.0 OBJECTIVE

To demonstrate that the plant can be maintained in hot standby from outside the control room following a reactor trip.

2.0 PREREQUISITES

Plant operating at ≥ 10 percent generator output.

ARKANSAS NUCLEAR ONE
Unit 2

Table 14.1-4 (continued)

3.0 TEST METHOD

- 3.1 The operating crew evacuates the control room; standby crew remains in the control room.
- 3.2 Reactor is tripped.
- 3.3 The reactor is brought to hot standby by the operating crew from outside the control room.

4.0 DATA REQUIRED

Time dependent data

- a. Pressurizer level and pressure
- b. RCS temperature
- c. Steam generator pressure and level

5.0 ACCEPTANCE CRITERIA

The ability to achieve and control the reactor at hot standby from outside the control room is demonstrated.

- a. RCS temperatures are maintained in the desired range.
- b. The pressurizer pressure and level are maintained in the desired range.
- c. The steam generator levels are maintained at desired levels.

LOSS OF OFFSITE POWER*

1.0 OBJECTIVE

To verify that the unit can safely sustain a loss of offsite power without exceeding any safety limits, while maintaining the main turbine generator on line supplying auxiliary house load, but isolated from the power grid.

2.0 PREREQUISITES

- 2.1 Generator output \geq 10 percent.
- 2.2 Unit supplying it's own auxiliary load.
- 2.3 Both diesel generators operable and prepared to supply emergency power.

3.0 TEST METHOD

- 3.1 The unit is isolated from all offsite power by isolating the startup transformers from the unit and then separating the unit from the grid.
- 3.2 The unit will continue to supply it's own auxiliary load through the auxiliary transformer.

ARKANSAS NUCLEAR ONE
Unit 2

Table 14.1-4 (continued)

4.0 DATA REQUIRED

Time dependent data

- a. Steam generator pressure and levels
- b. Pressurizer pressure and level
- c. RCS temperatures

5.0 ACCEPTANCE CRITERIA

5.1 The unit is isolated from all sources of offsite power without a loss of house loads, or if the auxiliary transformer is lost, the unit is shutdown and maintained in hot standby with emergency power sources.

5.2 No safety limits are exceeded.

* This test method was subsequently modified. See letter 2CAN047809.

BIOLOGICAL SHIELD SURVEY

1.0 OBJECTIVE

- 1.1 To measure radiation in accessible locations of the plant outside of the biological shield.
- 1.2 To obtain baseline levels for comparison with future measurements of level buildup with operation.

2.0 PREREQUISITES

- 2.1 Radiation survey instruments calibrated.
- 2.2 Background radiation levels measured in designated locations prior to initial criticality.

3.0 TEST METHOD

Measure gamma and neutron dose rates.

- a. 50 percent power
- b. 100 percent power

4.0 DATA REQUIRED

- 4.1 Power level
- 4.2 Gamma and neutron dose rates at each specified location

5.0 ACCEPTANCE CRITERIA

5.1 Radiation levels are demonstrated acceptable for full power operation.

5.2 Accessible areas and occupancy times during power operation are defined.

ARKANSAS NUCLEAR ONE
Unit 2

Table 14.1-4 (continued)

XENON OSCILLATION CONTROL (PLCEA)

1.0 OBJECTIVE

To demonstrate a satisfactory technique for damping xenon oscillations using the PLCEAs.

2.0 PREREQUISITES

- 2.1 Reactor critical at approximately 65 percent power; PLCEAs inserted with xenon equilibrium.
- 2.2 Free xenon oscillations measured as part of proceeding power escalation testing.
- 2.3 The COLSS and the incore system are in operation.

3.0 TEST METHOD

- 3.1 A free oscillation is established.
- 3.2 Control schemes are implemented utilizing the PLCEAs.

4.0 DATA REQUIRED

- 4.1 Reactor conditions
 - a. Power level
 - b. Boron concentration
 - c. RCS temperatures
 - d. Burnup
- 4.2 Time dependent data
 - a. Incore detector maps
 - b. Excore readings
 - c. CEA positions
 - d. PLCEA positions

5.0 ACCEPTANCE CRITERIA

The ability to dampen xenon oscillations using the PLCEAs is demonstrated.

ARKANSAS NUCLEAR ONE
Unit 2

Table 14.1-4 (continued)

DROPPED CONTROL ELEMENT ASSEMBLY

1.0 OBJECTIVE

To determine the flux distribution resulting from a "dropped" CEA.

2.0 PREREQUISITES

2.1 The reactor is critical at approximately 50 percent power, with equilibrium conditions for the desired CEA configuration.

2.2 The incore detector system is in operation.

3.0 TEST METHOD

3.1 Full length CEA

- a. The selected CEA is rapidly inserted to the full "in" position.
- b. The CEA remains inserted for a preselected time.
- c. Excore and incore instrument signals are recorded before, during and after the CEA insertion.

3.2 PLCEA

- a. The selected PLCEA is rapidly inserted to the specified insertion.
- b. The PLCEA remains inserted for a preselected time.
- c. Excore and incore instrument signals are recorded before, during and after the CEA insertion.

4.0 DATA REQUIRED

4.1 Conditions of the measurement

- a. Power
- b. RCS temperatures
- c. CEA configuration
- d. Boron concentration
- e. Burnup

4.2 Time dependent data

- a. Incore and excore detector readings
- b. RCS temperatures
- c. CEA positions
- d. Power

5.0 ACCEPTANCE CRITERIA

The measured incore maps are in satisfactory agreement with the predictions.

ARKANSAS NUCLEAR ONE
Unit 2

Table 14.1-4 (continued)

PSEUDO ROD EJECTION

1.0 OBJECTIVE

To determine that the power distribution associated with the pseudo CEA ejection from the FPDIL CEA configuration is adequately represented in the safety analysis.

2.0 PREREQUISITES

2.1 The reactor critical at approximately 50 percent power.

- a. CEAs at the FPDIL
- b. Equilibrium xenon

2.2 The incore detector system is in operation.

3.0 TEST METHOD

3.1 The pseudo CEA ejection test is performed at approximately 50 percent power by withdrawing the "worst" (selected by calculation) CEA from the FPDIL.

3.2 Incore detector maps are taken before and after withdrawal of the static "ejected" CEA.

3.3 The next worst "ejected" CEA is withdrawn while inserting the previous CEA.

3.4 An incore detector map is taken.

3.5 The CEAs are returned to a normal configuration.

4.0 DATA REQUIRED

4.1 Conditions of the measurement

- a. Power
- b. RCS temperature
- c. CEA configuration
- d. Boron concentration
- e. Burnup

4.2 Time dependent data

- a. Power
- b. Incore and excore detector readings
- c. RCS temperatures
- d. CEA positions

5.0 ACCEPTANCE CRITERIA

Analyses of the incore maps indicate satisfactory agreement with predictions.

ARKANSAS NUCLEAR ONE
Unit 2

Table 14.1-4 (continued)

COMPARISON OF PPS, CPCs AND PROCESS COMPUTER INPUTS

1.0 OBJECTIVE

To demonstrate that the inputs and appropriate outputs of the PPS, the CPCs and the process computer are consistent and correct.

2.0 PREREQUISITES

The plant operating at desired conditions.

3.0 TEST METHOD

Simultaneous reading of related inputs and appropriate outputs of the PPS, the CPCs and the process computer are made.

4.0 DATA REQUIRED

4.1 Conditions of the measurement

- a. Power
- b. Boron concentration
- c. Burnup

4.2 Test data

- a. RCS temperatures and flows
- b. Excore detector readings
- c. Incore detector readings
- d. CEA positions
- e. Pressurizer pressure
- f. Steam generator levels and pressure

5.0 ACCEPTANCE CRITERIA

The inputs to the PPS, the CPCs and the process computer are consistent and in satisfactory agreement.

ARKANSAS NUCLEAR ONE
Unit 2

Table 14.1-4 (continued)

VERIFICATION OF CPC POWER DISTRIBUTION-RELATED CONSTANTS

1.0 OBJECTIVE

- 1.1 To verify the planar radial peaking, shape annealing and boundary point correlation, and rod shadowing factors.
- 1.2 To verify the algorithms used in the CPCs to relate excore signals to incore power distribution.

2.0 PREREQUISITES

- 2.1 The incore detector systems has been demonstrated to operate satisfactorily.
- 2.2 The safety channels have been demonstrated to be operating satisfactorily.
- 2.3 The reactor is critical and at required power levels.

3.0 TEST METHOD

- 3.1 Planar radial peaking factors are verified at selected power levels for ARO and various CEA configurations (including misaligned CEAs) by comparison of the CPC values with values measured with the incore detector system.
- 3.2 The rod shadowing factors are verified in conjunction with peaking factor measurements by comparing the rodded and unrodded excore detector responses.
- 3.3 The shape annealing matrix and boundary point correlation will be determined from a series of Xe oscillations carried out during the 50 percent testing.

4.0 DATA REQUIRED

4.1 Conditions of the measurement

- a. Power
- b. RCS temperatures
- c. Pressurizer pressure
- d. CEA configuration
- e. Boron concentration
- f. Burnup

4.2 Time dependent data

- a. Incore detector readings and corresponding excore detector readings.
- b. Corresponding CEA configuration.

5.0 ACCEPTANCE CRITERIA

- 5.1 Measured radial peaking factors determined from incore flux maps are no higher than the corresponding values used in the CPCs.
- 5.2 Other CPC power distribution constants, used in the axial power distribution synthesis, are in satisfactory agreement with predictions.

ARKANSAS NUCLEAR ONE
Unit 2

Table 14.1-4 (continued)

STEAM GENERATOR CHEMISTRY

1.0 OBJECTIVE

- 1.1 To maintain proper water chemistry for the steam generators and the feedwater system.
- 1.2 To establish the necessary sampling frequency to provide assurance that chemistry limits are not exceeded.

2.0 PREREQUISITES

Sampling systems for the steam generators and the feedwater system are operable.

3.0 TEST METHOD

During power escalation, the steam generators and the feedwater system will be sampled to verify that chemistry specifications are maintained.

4.0 DATA REQUIRED

4.1 Conditions of the measurement

- a. Power level
- b. Power history

4.2 Test data

- a. Sample point locations
- b. Time of sample

5.0 ACCEPTANCE CRITERIA

Chemistry of the steam generators and the feedwater system are maintained within specifications.

STEAM DUMP VALVE AND BYPASS SYSTEMS

1.0 OBJECTIVE

- 1.1 To demonstrate that the maximum steam flow capacity of atmospheric steam dump valves upstream of the main steam isolation valves (MSIVs) is less than that assumed for the most severe excess heat removal incident.
- 1.2 To demonstrate that the operation of the Steam Dump and Bypass Control System (SDBCS) during operational transients and plant trips is satisfactory.

ARKANSAS NUCLEAR ONE
Unit 2

Table 14.1-4 (continued)

2.0 PREREQUISITES

- 2.1 The reactor is critical at approximately 15 percent power using the SDBCS to dump steam to the condenser.
- 2.2 The SDBCS is in automatic operation.
- 2.3 Control systems are in automatic, where applicable.

3.0 TEST METHOD

- 3.1 The individual steam flows through each of the steam dump valves upstream of the MSIVS are measured.
- 3.2 The operation of the SDBCS is observed during planned and unplanned operational transients and trips.

4.0 DATA REQUIRED

4.1 Atmospheric dump valve test

- a. Reactor power
- b. RCS temperatures and pressurizer pressure
- c. Steam generator levels and pressure
- d. Steam dump and bypass valve positions

4.2 Demonstration of SDBCS

- a. Reactor power
- b. RCS temperature and pressurizer pressure
- c. Steam generator flows, pressures, and levels

5.0 ACCEPTANCE CRITERIA

5.1 Atmospheric steam dump valve capacity

The individual steam dump valve capacities are less than the values used in the safety analysis.

5.2 SDBCS operation

The SDBCS functioned satisfactorily during operational transients and plant trips.

ARKANSAS NUCLEAR ONE
Unit 2

Table 14.1-4 (continued)

MAIN AND EMERGENCY FEEDWATER SYSTEMS

1.0 OBJECTIVE

To demonstrate that the operation of the main feedwater and emergency feedwater systems during normal operation, operational transients, and plant trips is satisfactory.

2.0 PREREQUISITES

The SDBCS, FWCS, RRS, and pressurizer pressure and level controls are in operation.

3.0 TEST METHODS

Performance of the feedwater systems will be monitored during normal operation, operational transients, and trips.

The resulting observations and/or data will be used to evaluate the performance of the feedwater systems.

4.0 DATA REQUIRED

Observations and/or data taken during normal operation, operational transients, and trips.

- a. Reactor power
 - b. RCS temperatures and pressurizer pressure
 - c. Steam generator levels and pressures
 - d. Steam and feedwater flows

5.0 ACCEPTANCE CRITERIA

- 5.1 The main feedwater system operates consistent with design.
- 5.2 The emergency feedwater system operates consistent with design.

ARKANSAS NUCLEAR ONE
Unit 2

Table 14.1-5

REPLACEMENT STEAM GENERATOR TESTS

Test Title

1. 2R14 Startup Requirements
2. Unit 2 Containment Structural Integrity Test and Code Pressure Test
3. Spillover, Shutdown Cooling Vortexing Test
4. Service Water/Auxiliary Cooling Water Flow Balancing and Testing
5. Nuclear Steam Supply System Heat Loss Test
6. Reactor Coolant System Chemistry
7. Steam Generator Chemistry
8. Reactor Building Ventilation Testing
9. Inside Reactor Building Thermal Expansion Measurements/Walkdowns
10. Steam Generator Blowdown Testing
11. Pressurizer Spray Valve Bypass Valve Setting
12. Chemical and Volume Control System Integrated Testing Vibration and Loose Parts Monitoring System Test
13. Pressurizer Spray Effectiveness Test
14. Pressurizer Heat Loss Test
15. Control Element Drive Mechanism Cooling Performance Test
16. Vibration and Loose Parts Monitoring System Test
17. Hot Functional Steady State RCS Flow Determination
18. Unit Load Transients And LTC (Long Term Cooling) Validation
19. Replacement Steam Generator Moisture Carryover Test
20. Vibration/Temperature Data Collection and Walkdowns Inside Containment
21. Vibration/Thermal Expansion Measurements And Walkdowns Outside Containment
22. Secondary Performance Testing
23. Isophase Cooling Testing
25. Steam Dump and Bypass Control System Valve Capacity Testing
26. Steam Dump and Bypass Control System Testing
27. Biological Shield Surveys
28. Feedwater Control System/Reactor Regulating System Power Ascension Testing
29. Cycle 15 Replacement Steam Generator Performance Testing
30. Reactor Coolant System Flowrate Determination

ARKANSAS NUCLEAR ONE
Unit 2

Table 14.1-6

POWER UPRATE TESTS

Test Title

1. Replacement Steam Generator Thermal Expansion Test
2. Control Room Inleakage Tracer Gas Test
3. Hot Functional Steady State RCS Flow Determination
4. Control Element Drive Mechanism Performance
5. Reactor Coolant System Chemistry
6. Steam Generator Chemistry
7. Incore Instrumentation Measurements
8. Comparison Of Plant Protection System, Core Protection Calculators and Process Computer Input
9. Isothermal Temperature Coefficient
10. Control Element Assembly Group Worth
11. Boron Worth
12. Critical Configuration Boron Concentrations
13. 2r15 Startup Requirements
14. Power Uprate Data Collection/Design Prediction Test
15. Variable Tav_g (Isothermal Temperature Coefficient And Power Coefficient)
16. Steady State Core Performance
17. Verification of Core Protection Calculator Power Distribution Related Constants
18. Biological Shield Surveys
19. Vibration/Data Collection Inside and Outside Containment
20. Unit Load Transients And LTC (Long Term Cooling) Validation
21. Replacement Steam Generator Moisture Carryover Test
22. Cycle 16 Replacement Steam Generator Performance Testing
23. Unit 2 Maximum Dependable Capability Test
24. Reactor Coolant System Flowrate Determination

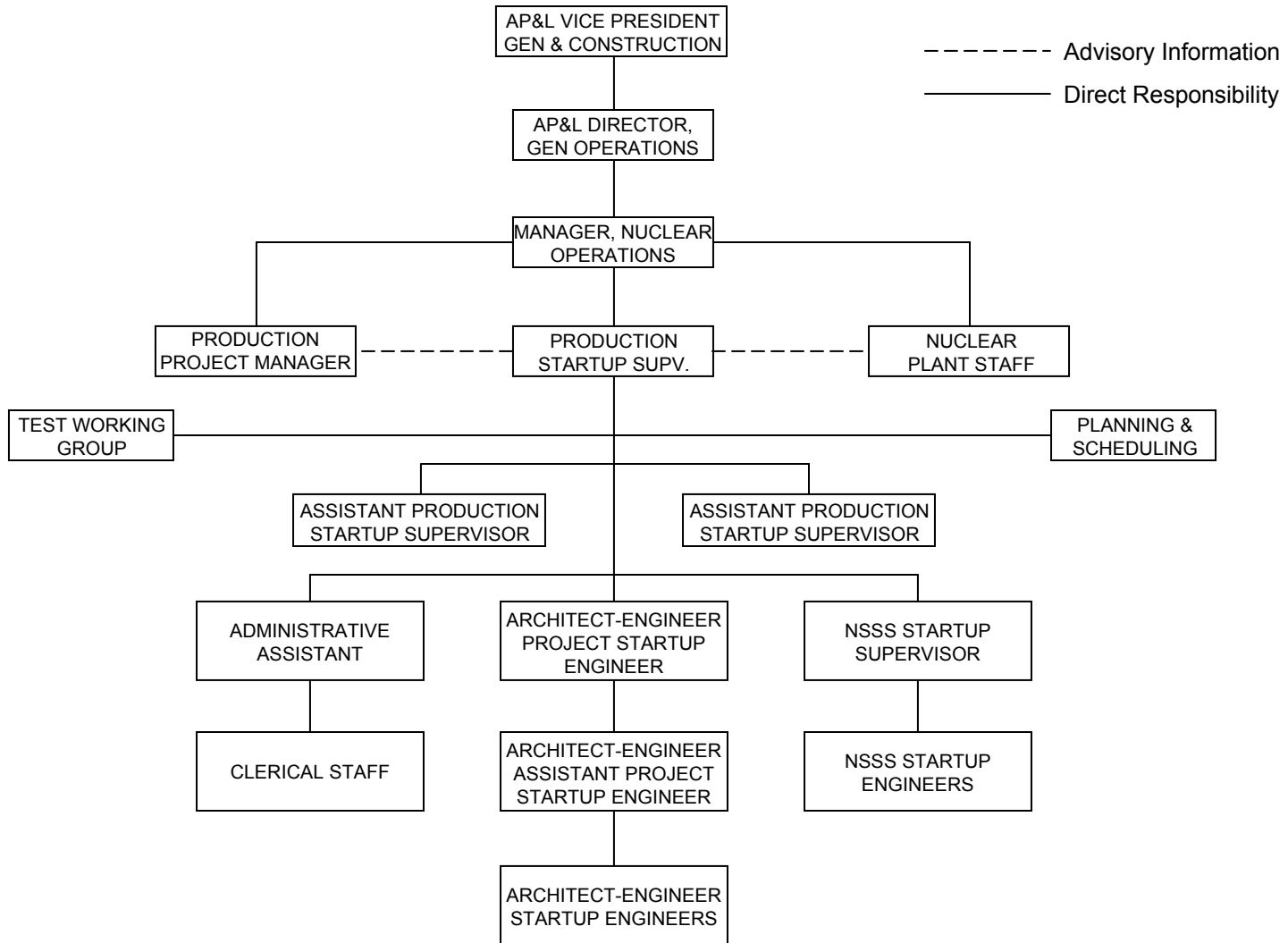

AP&L ORGANIZATION CHART FOR UNIT 2 STARTUP

SAR FIGURE NO. 14.1-1

ARKANSAS NUCLEAR ONE
UNIT 2
RUSSELLVILLE, ARKANSAS



SCALE: NONE
DRAWN: ENERGY
DESIGN: ENERGY
CAD NO:

AMENDMENT 20

BASED ON DRAWING NO

SHEET

REV.

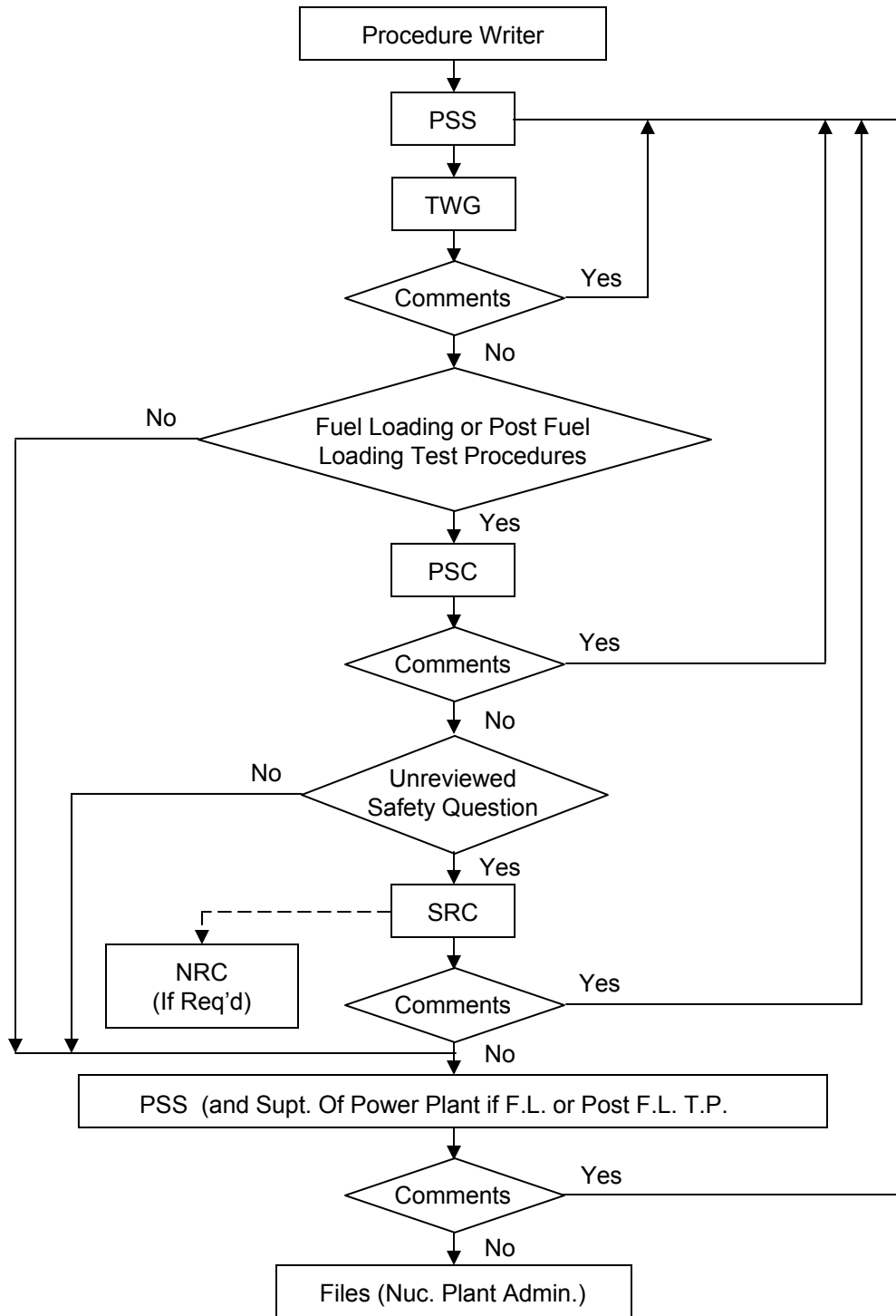

July 11, 1975

SAR FIGURE NO. 14.1-2

AMENDMENT 20

ARKANSAS NUCLEAR ONE
UNIT 2
RUSSELLVILLE, ARKANSAS



SCALE:	NONE
DRAWN:	
DESIGN:	ENERGY
CAD NO:	

FLOW CHART FOR TEST PROCEDURE
REVIEW

BASED ON DRAWING NO

SHEET

REV.

MONTHS TO FUEL LOAD

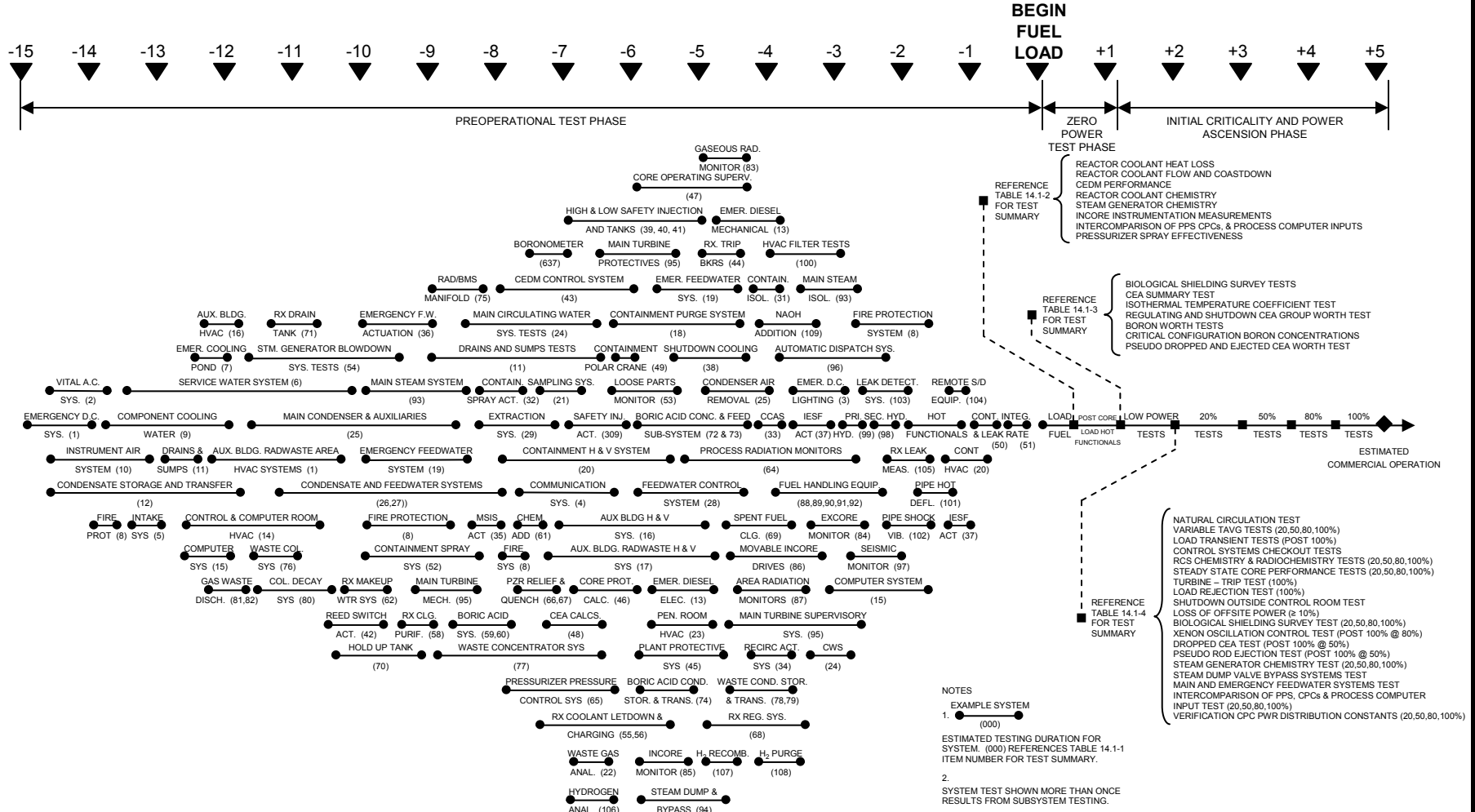

TEST PROGRAM SEQUENCE

SAR FIGURE NO. 14.1-3

ARKANSAS NUCLEAR ONE
UNIT 2
RUSSELLVILLE, ARKANSAS



SCALE:	NONE
DRAWN:	ENTERGY
DESIGN:	ENTERGY
CAD NO:	

AMENDMENT 20

BASED ON DRAWING NO	SHEET	REV.

ARKANSAS NUCLEAR ONE
Unit 2

CHAPTER 15

TABLE OF CONTENTS

<u>Section</u>	<u>Title</u>	<u>Page</u>
15	<u>ACCIDENT ANALYSIS</u>	15.1-1
15.1	<u>GENERAL</u>	15.1-1
15.1.0	INTRODUCTION.....	15.1-1
15.1.0.1	<u>Initial Conditions</u>	15.1-1
15.1.0.2	<u>Reactivity Coefficients</u>	15.1-3
15.1.0.3	<u>Effective Delayed Neutron Fraction</u>	15.1-5
15.1.0.4	<u>Reactor Protective System Trips and Engineered Safety Features Response Times</u>	15.1-6
15.1.0.5	<u>Radiological Parameters</u>	15.1-7
15.1.0.6	<u>Computer Programs</u>	15.1-10
15.1.1	UNCONTROLLED CONTROL ELEMENT ASSEMBLY WITHDRAWAL FROM A SUBCRITICAL CONDITION	15.1-14
15.1.1.1	<u>Identification of Causes</u>	15.1-14
15.1.1.2	<u>Analysis of Effects and Consequences</u>	15.1-14
15.1.1.3	<u>Conclusion</u>	15.1-15
15.1.1.4	<u>Subsequent Analyses</u>	15.1-15
15.1.2	UNCONTROLLED CEA WITHDRAWAL FROM CRITICAL CONDITIONS ..	15.1-19
15.1.2.1	<u>Identification of Causes</u>	15.1-19
15.1.2.2	<u>Analysis of Effects and Consequences</u>	15.1-20
15.1.2.3	<u>Conclusion</u>	15.1-20
15.1.2.4	<u>Subsequent Analyses</u>	15.1-21
15.1.3	CEA MISOPERATION.....	15.1-27
15.1.3.1	<u>Identification of Causes</u>	15.1-27
15.1.3.2	<u>Analysis of Effects and Consequences (Prior to Cycle 16)</u>	15.1-28

ARKANSAS NUCLEAR ONE
Unit 2

TABLE OF CONTENTS (continued)

<u>Section</u>	<u>Title</u>	<u>Page</u>
15.1.3.3	<u>Conclusion (Prior to Cycle 16)</u>	15.1-30
15.1.3.4	<u>Subsequent Analysis</u>	15.1-30
15.1.4	UNCONTROLLED BORON DILUTION INCIDENT	15.1-31
15.1.4.1	<u>Identification of Causes</u>	15.1-31
15.1.4.2	<u>Analysis of Effects and Consequences</u>	15.1-32
15.1.4.3	<u>Conclusion</u>	15.1-39
15.1.4.4	<u>Cycle 17/18 Uncontrolled Boron Dilution Incident</u>	15.1-40
15.1.5	TOTAL AND PARTIAL LOSS OF REACTOR COOLANT FORCED FLOW .	15.1-41
15.1.5.1	<u>Identification of Causes</u>	15.1-41
15.1.5.2	<u>Analysis of Effects and Consequences</u>	15.1-42
15.1.5.3	<u>Conclusion</u>	15.1-56
15.1.6	IDLE LOOP STARTUP	15.1-57
15.1.6.1	<u>Identification of Causes</u>	15.1-57
15.1.6.2	<u>Analysis of Effects and Consequences</u>	15.1-57
15.1.6.3	<u>Conclusion</u>	15.1-57
15.1.7	LOSS OF EXTERNAL LOAD AND/OR TURBINE TRIP	15.1-57
15.1.7.1	<u>Identification of Causes</u>	15.1-57
15.1.7.2	<u>Analysis of Effects and Consequences</u>	15.1-58
15.1.7.3	<u>Conclusion</u>	15.1-59
15.1.7.4	<u>Loss of External Load and/or Turbine Trip Subsequent Analyses</u>	15.1-59
15.1.8	LOSS OF NORMAL FEEDWATER FLOW.....	15.1-61
15.1.8.1	<u>Identification of Cause</u>	15.1-61
15.1.8.2	<u>Analysis of Effects and Consequences</u>	15.1-61
15.1.8.3	<u>Conclusion</u>	15.1-62
15.1.8.4	<u>Loss of Normal Feedwater Subsequent Analyses</u>	15-1-62

ARKANSAS NUCLEAR ONE
Unit 2

TABLE OF CONTENTS (continued)

<u>Section</u>	<u>Title</u>	<u>Page</u>
15.1.9	LOSS OF ALL NORMAL AND PREFERRED AC POWER TO THE STATION AUXILIARIES.....	15.1-64
15.1.9.1	<u>Identification of Causes</u>	15.1-64
15.1.9.2	<u>Analysis of Effects and Consequences</u>	15.1-64
15.1.9.3	<u>Conclusion</u>	15.1-65
15.1.9.4	<u>Subsequent Analysis</u>	15.1-65
15.1.10	EXCESS HEAT REMOVAL DUE TO SECONDARY SYSTEM MALFUNCTION.....	15.1-66
15.1.10.1	<u>Identification of Causes</u>	15.1-66
15.1.10.2	<u>Analysis of Effects and Consequences</u>	15.1-67
15.1.10.3	<u>Conclusion</u>	15.1-68
15.1.10.4	<u>Subsequent Analyses</u>	15.1-68
15.1.11	FAILURE OF THE REGULATING INSTRUMENTATION	15.1-74
15.1.11.1	<u>Identification of Causes</u>	15.1-74
15.1.12	INTERNAL AND EXTERNAL EVENTS INCLUDING MAJOR AND MINOR FIRES, FLOODS, STORMS, AND EARTHQUAKES.....	15.1-74
15.1.12.1	<u>Fires</u>	15.1-74
15.1.12.2	<u>Floods</u>	15.1-75
15.1.12.3	<u>Storms</u>	15.1-75
15.1.12.4	<u>Earthquakes</u>	15.1-75
15.1.13	MAJOR RUPTURE OF PIPES CONTAINING REACTOR COOLANT UP TO AND INCLUDING DOUBLE-ENDED RUPTURE OF LARGEST PIPE IN THE REACTOR COOLANT SYSTEM (LOSS OF COOLANT ACCIDENT).....	15.1-76
15.1.13.1	<u>Identification of Causes</u>	15.1-76
15.1.13.2	<u>Analysis of Events and Consequences</u>	15.1-77
15.1.13.3	<u>Results</u>	15.1-77

ARKANSAS NUCLEAR ONE
Unit 2

TABLE OF CONTENTS (continued)

<u>Section</u>	<u>Title</u>	<u>Page</u>
15.1.13.4	<u>Post-Accident Leakage</u>	15.1-77
15.1.14	MAJOR SECONDARY SYSTEM PIPE BREAKS WITH OR WITHOUT A CONCURRENT LOSS OF AC POWER.....	15.1-78
15.1.14.1	<u>Steam Line Break Accident</u>	15.1-78
15.1.14.2	Feedwater Line Break Accident	15.1-97
15.1.14.3	<u>Additional Main Steam Line/Feedwater Line Break Information and Analyses</u>	15.1-108
15.1.15	INADVERTENT LOADING OF A FUEL ASSEMBLY INTO THE IMPROPER POSITION	15.1-108
15.1.15.1	<u>Identification of Causes</u>	15.1-108
15.1.15.2	<u>Analysis of Effects and Consequences</u>	15.1-110
15.1.16	WASTE GAS DECAY TANK LEAKAGE OR RUPTURE.....	15.1-111
15.1.16.1	<u>Identification of Causes</u>	15.1-111
15.1.16.2	<u>Analysis of Events and Consequences</u>	15.1-111
15.1.17	FAILURE OF AIR EJECTOR LINES (BWR)	15.1-111
15.1.18	STEAM GENERATOR TUBE RUPTURE WITH OR WITHOUT A CONCURRENT LOSS OF AC POWER	15.1-112
15.1.18.1	<u>Identification of Causes</u>	15.1-112
15.1.18.2	<u>Removed – Historical Data</u>	
15.1.18.3	<u>Removed – Historical Data</u>	
15.1.18.4	<u>SGTR Subsequent Analyses</u>	15.1-113
15.1.19	FAILURE OF CHARCOAL OF CYROGENIC SYSTEM (BWR)	15.1-116
15.1.20	CONTROL ELEMENT ASSEMBLY EJECTION	15.1-116
15.1.20.1	<u>Identification of Causes</u>	15.1-116
15.1.20.2	<u>Analysis of Effects and Consequences</u>	15.1-117
15.1.20.3	<u>Conclusion</u>	15.1-120

ARKANSAS NUCLEAR ONE
Unit 2

TABLE OF CONTENTS (continued)

<u>Section</u>	<u>Title</u>	<u>Page</u>
15.1.20.4	<u>CEA Ejection Subsequent Analyses</u>	15.1-120
15.1.21	THE SPECTRUM OF ROD DROP ACCIDENTS (BWR)	15.1-127
15.1.22	BREAK IN INSTRUMENT LINE OR OTHER LINES FROM REACTOR COOLANT PRESSURE BOUNDARY THAT PENETRATE CONTAINMENT.....	15.1-127
15.1.22.1	<u>Identification of Causes</u>	15.1-127
15.1.23	FUEL HANDLING ACCIDENT	15.1-127
15.1.23.1	<u>Identification of Causes</u>	15.1-127
15.1.23.2	<u>Analysis of Effects and Consequences</u>	15.1-128
15.1.23.3	<u>Results</u>	15.1-131
15.1.24	SMALL SPILLS OR LEAKS OF RADIOACTIVE MATERIAL OUTSIDE CONTAINMENT	15.1-131
15.1.24.1	<u>Identification of Causes</u>	15.1-131
15.1.24.2	<u>Analysis of Effects and Consequences</u>	15.1-132
15.1.24.3	<u>Conclusion</u>	15.1-132
15.1.25	FUEL CLADDING FAILURE COMBINED WITH STEAM GENERATOR LEAK.....	15.1-132
15.1.26	CONTROL ROOM UNINHABITABILITY	15.1-133
15.1.26.1	<u>Identification of Causes</u>	15.1-133
15.1.26.2	<u>Analysis of Effects and Consequences</u>	15.1-134
15.1.27	FAILURE OR OVERPRESSURIZATION OF LOW PRESSURE RESIDUAL HEAT REMOVAL SYSTEM.....	15.1-134
15.1.28	LOSS OF CONDENSER VACUUM	15.1-134
15.1.28.1	<u>Identification of Causes</u>	15.1-134
15.1.28.2	<u>Analysis of Effects and Consequences</u>	15.1-134
15.1.28.3	<u>Conclusion</u>	15.1-135
15.1.29	TURBINE TRIP WITH COINCIDENT FAILURE OF TURBINE BYPASS VALVES TO OPEN	15.1-135

ARKANSAS NUCLEAR ONE
Unit 2

TABLE OF CONTENTS (continued)

<u>Section</u>	<u>Title</u>	<u>Page</u>
15.1.30	LOSS OF SERVICE WATER SYSTEM	15.1-135
15.1.30.1	<u>Identification of Causes</u>	15.1-135
15.1.30.2	<u>Analysis of Effects and Consequences</u>	15.1-136
15.1.31	LOSS OF ONE DC SYSTEM	15.1-136
15.1.31.1	<u>Identification of Cause</u>	15.1-136
15.1.31.2	<u>Analysis of Effects and Consequences</u>	15.1-136
15.1.32	INADVERTENT OPERATION OF ECCS DURING POWER OPERATION	15.1-137
15.1.33	TURBINE TRIP WITH FAILURE OF GENERATOR BREAKER TO OPEN	15.1-137
15.1.33.1	<u>Identification of Causes</u>	15.1-137
15.1.33.2	<u>Analysis of Effects and Consequences</u>	15.1-137
15.1.34	LOSS OF INSTRUMENT AIR SYSTEM.....	15.1-138
15.1.34.1	<u>Identification of Causes</u>	15.1-138
15.1.34.2	Analysis of Effects and Consequences	15.1-138
15.1.34.3	<u>Conclusion</u>	15.1-138
15.1.35	MALFUNCTION OF TURBINE GLAND SEALING SYSTEM	15.1-138
15.1.35.1	<u>Identification of Causes and Accident Description</u>	15.1-138
15.1.35.2	<u>Analysis of Effects and Consequences</u>	15.1-138
15.1.36	TRANSIENTS RESULTING FROM THE INSTANTANEOUS CLOSURE OF A SINGLE MSIV	15.1-139
15.1.36.1	<u>Identification of Causes and Accident Description</u>	15.1-139
15.1.36.2	<u>Analysis of Effects and Consequences</u>	15.1-139
15.1.36.3	<u>Transients Resulting From the Instantaneous Closure of a Single MSIV Subsequent Analyses</u>	15.1-140
15.2	<u>REFERENCES</u>	15.2-1
15.3	<u>TABLES</u>	15.3-1

ARKANSAS NUCLEAR ONE
Unit 2

LIST OF TABLES

<u>Table No.</u>	<u>Title</u>	<u>Page</u>
15.1.0-1	REACTOR PROTECTIVE SYSTEM TRIPS USED IN THE SAFETY ANALYSES.....	15.3-1
15.1.0-2A	PRIMARY COOLANT SOURCE TERM FOR NON-FUEL FAILURE EVENTS and SECONDARY COOLANT SOURCE TERM FOR MAIN STEAM LINE BREAK ANALYSIS	15.3-4
15.1.0-2B	CORE ISOTOPIC INVENTORY FOR FUEL FAILURE EVENTS.....	15.3-5
15.1.0-3	FGR DATA FOR ISOTOPES	15.3-6
15.1.0-4	BREATHING RATES.....	15.3-6
15.1.0-5	ACCIDENT ATMOSPHERIC DILUTION FACTORS	15.3-6
15.1.0-6	INITIAL CONDITIONS.....	15.3-7
15.1.0-7	ENGINEERED SAFETY FEATURES RESPONSE TIMES.....	15.3-8
15.1.1-1	ASSUMPTIONS FOR THE UNCONTROLLED CEA WITHDRAWAL FROM A SUBCRITICAL CONDITION	15.3-10
15.1.1-2	SEQUENCE OF EVENTS FOR THE UNCONTROLLED CEA WITHDRAWAL FROM A SUBCRITICAL CONDITION	15.3-11
15.1.1-3	ASSUMPTIONS FOR THE CYCLE 12 UNCONTROLLED CEA WITHDRAWAL FROM A SUBCRITICAL CONDITION	15.3-12
15.1.1-4	ASSUMPTIONS FOR THE CYCLE 13 UNCONTROLLED CEA WITHDRAWAL FROM A SUBCRITICAL CONDITION	15.3-13
15.1.1-5	SEQUENCE OF EVENTS FOR THE CYCLE 13 UNCONTROLLED CEA WITHDRAWAL FROM SUBCRITICAL CONDITIONS CASE 1	15.3-14
15.1.1-6	SEQUENCE OF EVENTS FOR THE CYCLE 13 UNCONTROLLED CEA WITHDRAWAL FROM SUBCRITICAL CONDITIONS CASE 2	15.3-14
15.1.1-7	ASSUMPTIONS FOR THE CYCLE 16 UNCONTROLLED CEA WITHDRAWAL FROM A SUBCRITICAL CONDITION.....	15.3-15
15.1.1-8	SEQUENCE OF EVENTS FOR THE CYCLE 16 UNCONTROLLED CEA WITHDRAWAL FROM A SUBCRITICAL CONDITION WITH A RIR OF $2.5 \times 10^{-4} \Delta p/\text{SEC}$	15.3-16
15.1.1-9	SEQUENCE OF EVENTS FOR THE CYCLE 16 UNCONTROLLED CEA WITHDRAWAL FROM A SUBCRITICAL CONDITION WITH A RIR OF $2.0 \times 10^{-4} \Delta p/\text{SEC}$	15.3-16

ARKANSAS NUCLEAR ONE
Unit 2

LIST OF TABLES (continued)

<u>Table No.</u>	<u>Title</u>	<u>Page</u>
15.1.2-1	ASSUMPTIONS FOR THE UNCONTROLLED CEA WITHDRAWAL FROM ONE PERCENT POWER	15.3-17
15.1.2-2	ASSUMPTIONS FOR THE UNCONTROLLED CEA WITHDRAWAL FROM FULL POWER	15.3-18
15.1.2-3	SEQUENCES OF EVENTS FOR THE UNCONTROLLED CEA WITHDRAWAL FROM ONE PERCENT POWER, BOC CONDITIONS.....	15.3-19
15.1.2-4	SEQUENCE OF EVENTS FOR THE UNCONTROLLED CEA WITHDRAWAL FROM FULL POWER	15.3-19
15.1.2-5	ASSUMPTIONS FOR THE CYCLE 13 UNCONTROLLED CEA WITHDRAWAL FROM ONE PERCENT POWER	15.3-20
15.1.2-6	ASSUMPTIONS FOR THE CYCLE 12 UNCONTROLLED CEA WITHDRAWAL FROM FULL POWER.....	15.3-21
15.1.2-7	SEQUENCE OF EVENTS FOR THE CYCLE 13 UNCONTROLLED CEA WITHDRAWAL FROM ONE PERCENT POWER.....	15.3-22
15.1.2-8	ASSUMPTIONS FOR THE CYCLE 16 UNCONTROLLED CEA WITHDRAWAL FROM HOT ZERO POWER	15.3-23
15.1.2-9	SEQUENCE OF EVENTS FOR THE CYCLE 16 UNCONTROLLED CEA WITHDRAWAL FROM HOT ZERO POWER.....	15.3-24
15.1.2-10	ASSUMPTIONS FOR THE CYCLE 16 UNCONTROLLED CEA WITHDRAWAL AT HOT FULL POWER	15.3-24
15.1.2-11	SEQUENCE OF EVENTS FOR THE CYCLE 16 UNCONTROLLED CEA WITHDRAWAL AT HOT FULL POWER	15.3-25
15.1.3-1	ASSUMPTIONS FOR THE FULL LENGTH CEA DROP.....	15.3-26
15.1.3-2	RESULTS OF FULL LENGTH CEA DROP	15.3-27
15.1.3-3	INITIAL HOT CHANNEL AXIAL POWER DISTRIBUTIONS FOR CEA MISOPERATION ANALYSIS	15.3-28
15.1.3-4	SEQUENCE OF EVENTS FOR FULL LENGTH CEA DROP	15.3-30
15.1.3-5	ASSUMPTIONS FOR THE CYCLE 16 CEA MISOPERATION AT POWER.....	15.3-31
15.1.4-1	ASSUMPTIONS FOR UNCONTROLLED BORON DILUTION	15.3-32
15.1.5-1	ASSUMPTIONS FOR THE LOSS OF COOLANT FLOW	15.3-34

ARKANSAS NUCLEAR ONE
Unit 2

LIST OF TABLES (continued)

<u>Table No.</u>	<u>Title</u>	<u>Page</u>
15.1.5-2	ASSUMPTIONS FOR THE LOSS OF COOLANT FLOW RESULTING FROM A SHAFT SEIZURE.....	15.3-35
15.1.5-3	SEQUENCE OF EVENTS FOR THE 4-PUMP LOSS OF COOLANT FLOW FOR CYCLE 2	15.3-36
15.1.5-4	SEQUENCE OF EVENTS FOR THE 2-PUMP LOSS OF COOLANT FLOW FROM 4-PUMP OPERATION FOR CYCLE 1	15.3-36
15.1.5-5	SEQUENCE OF EVENTS FOR THE SINGLE REACTOR COOLANT PUMP SHAFT SEIZURE	15.3-37
15.1.5-6	FLOW COASTDOWN FOR A 6.47 HERTZ GRID FREQUENCY TRANSIENT.....	15.3-38
15.1.5-7	INITIAL NSSS PLANT PARAMETER FOR CENTRAN SIMULATION.....	15.3-38
15.1.5-8	ASSUMPTIONS FOR THE LOSS OF COOLANT FLOW ANALYSIS ASSUMING 30% STEAM GENERATOR TUBE PLUGGING.....	15.3-39
15.1.5-9	SEQUENCE OF EVENTS FOR THE 4-PUMP LOSS OF COOLANT FLOW ANALYSIS	15.3-39
15.1.5-10	AST RADIOLOGICAL DOSE RESULTS FOR REACTOR COOLANT PUMP SHAFT SEIZURE ASSUMING 14% FUEL FAILURE	15.3-40
15.1.5-11	CYCLE 15 FOUR REACTOR COOLANT PUMP FLOW COASTDOWN RESULTING FROM AN ELECTRICAL FAILURE	15.3-40
15.1.5-12	FOUR REACTOR COOLANT PUMP FLOW COASTDOWN RESULTING FROM AN ELECTRICAL FAILURE	15.3-41
15.1.5-13	ASSUMPTIONS FOR THE CYCLE 16 LOSS OF COOLANT FLOW ANALYSIS.....	15.3-41
15.1.5-14	SEQUENCE OF EVENTS FOR THE CYCLE 16 FOUR PUMP LOSS OF COOLANT FLOW ANALYSIS.....	15.3-42
15.1.5-15	ASSUMPTIONS FOR THE CYCLE 16 LOSS OF COOLANT FLOW RESULTING FROM PUMP SHAFT SEIZURE	15.3-43
15.1.5-16	SEQUENCE OF EVENTS FOR THE CYCLE 16 (TYPICAL CASE) LOSS OF COOLANT FLOW PUMP SHAFT SEIZURE ANALYSIS	15.3-44
15.1.6-1	ASSUMPTIONS FOR THE IDLE LOOP STARTUP	15.3-45
15.1.6-2	INITIAL CONDITIONS FOR IDLE LOOP STARTUP.....	15.3-45

ARKANSAS NUCLEAR ONE
Unit 2

LIST OF TABLES (continued)

<u>Table No.</u>	<u>Title</u>	<u>Page</u>
15.1.6-3	SEQUENCE OF EVENTS FOR THE IDLE LOOP STARTUP.....	15.3-46
15.1.7-1	ASSUMPTIONS FOR THE LOSS OF EXTERNAL LOAD/LOSS OF CONDENSER VACUUM.....	15.3-47
15.1.7-2	SEQUENCE OF EVENTS FOR THE LOSS OF EXTERNAL LOAD/LOSS OF CONDENSER VACUUM.....	15.3-48
15.1.7-3	REMOVED – HISTORICAL DATA.....	15.3-48
15.1.7-4	ASSUMPTIONS FOR THE CYCLE 13 LOSS OF EXTERNAL LOAD/LOSS OF CONDENSER VACUUM.....	15.3-49
15.1.7-5	SEQUENCE OF EVENTS FOR THE CYCLE 13 LOSS OF EXTERNAL LOAD/LOSS OF CONDENSER VACUUM.....	15.3-50
15.1.7-6	ASSUMPTIONS FOR CYCLE 15 AT 3026 MWT LOSS OF EXTERNAL LOAD/LOSS OF CONDENSER VACUUM.....	15.3-51
15.1.7-7	SEQUENCE OF EVENTS FOR CYCLE 15 AT 3026 MWT LOSS OF EXTERNAL LOAD/LOSS OF CONDENSER VACUUM.....	15.3-52
15.1.8-1	ASSUMPTIONS FOR THE LOSS OF NORMAL FEEDWATER FLOW.....	15.3-52
15.1.8-2	PRINCIPAL RESULTS FOR THE LOSS OF NORMAL FEEDWATER FLOW.....	15.3-53
15.1.8-3	ASSUMPTIONS FOR THE CYCLE 13 LOSS OF NORMAL FEEDWATER FLOW.....	15.3-53
15.1.8-4	PRINCIPAL RESULTS FOR THE CYCLE 13 LOSS OF NORMAL FEEDWATER FLOW.....	15.3-54
15.1.8-5	ASSUMPTIONS FOR CYCLE 15 AT 3026 MWT LOSS OF NORMAL FEEDWATER FLOW.....	15.3-55
15.1.8-6	SEQUENCE OF EVENTS FOR CYCLE 15 AT 3026 MWT LOSS OF NORMAL FEEDWATER FLOW.....	15.3-56
15.1.9-1	ASSUMPTIONS FOR THE LOSS OF ALL NORMAL AC POWER TO THE STATION AUXILIARIES.....	15.3-57
15.1.9-2	SEQUENCE OF EVENTS FOR THE LOSS OF NORMAL AND PREFERRED AC POWER TO THE STATION AUXILIARIES.....	15.3-58
15.1.10-1	ASSUMPTIONS FOR THE FEEDWATER SYSTEM MALFUNCTION.....	15.3-59
15.1.10-2	ASSUMPTIONS FOR THE STEAM BYPASS SYSTEM MALFUNCTION....	15.3-60

ARKANSAS NUCLEAR ONE
Unit 2

LIST OF TABLES (continued)

<u>Table No.</u>	<u>Title</u>	<u>Page</u>
15.1.10-3A	SEQUENCE OF EVENTS FOR FEEDWATER SYSTEM MALFUNCTION INVOLVING 160% FEEDWATER FLOW TO BOTH STEAM GENERATORS	15.3-61
15.1.10-3B	SEQUENCE OF EVENTS FOR FEEDWATER SYSTEM MALFUNCTION INVOLVING 160% FEEDWATER FLOW TO ONE STEAM GENERATOR.....	15.3-61
15.1.10-4	SEQUENCE OF EVENTS FOR THE STEAM BYPASS SYSTEM MALFUNCTION ACCIDENT	15.3-62
15.1.10-5	ASSUMPTIONS FOR CYCLE 15 AT 3026 MWT FEEDWATER SYSTEM MALFUNCTION.....	15.3-63
15.1.10-6	SEQUENCE OF EVENTS FOR CYCLE 15 AT 3026 MWT FEEDWATER SYSTEM MALFUNCTION	15.3-64
15.1.10-7	ASSUMPTIONS OF CYCLE 15 AT 3026 MWT STEAM BYPASS SYSTEM MALFUNCTION	15.3-64
15.1.10-8	SEQUENCE OF EVENTS FOR CYCLE 15 AT 3026 MWT STEAM BYPASS SYSTEM MALFUNCTION	15.3-65
15.1.13-1	ASSUMPTIONS FOR DESIGN BASIS LOSS OF COOLANT ACCIDENT ...	15.3-66
15.1.13-2	LOSS OF COOLANT ACCIDENT DOSES.....	15.3-67
15.1.13-3	RELEASE FRACTIONS AND TIMING	15.3-67
15.1.14-1	AVERAGE MOISTURE CARRYOVER FOR VARIOUS STEAM GENERATOR CONDITIONS.....	15.3-68
15.1.14-2	ASSUMPTIONS FOR STEAM LINE BREAK ANALYSIS.....	15.3-68
15.1.14-3 – 15.1.14-10	REMOVED - HISTORICAL DATA	15.3-69
15.1.14-11	SEQUENCE OF EVENTS FOR THE STEAM LINE BREAK ACCIDENT (NO LOAD, ONE-LOOP CONDITION, RUPTURE OUTSIDE CONTAINMENT).....	15.3-69
15.1.14-12	SEQUENCE OF EVENTS FOR THE STEAM LINE BREAK ACCIDENT WITH LOSS OF AC POWER (FULL LOAD, TWO-LOOP INITIAL CONDITION, SMALL BREAK).....	15.3-70
15.1.14-13	SEQUENCE OF EVENTS FOR THE STEAM LINE BREAK ACCIDENT WITH LOSS OF AC POWER (NO LOAD, ONE-LOOP INITIAL CONDITION, SMALL BREAK)	15.3-71

ARKANSAS NUCLEAR ONE
Unit 2

LIST OF TABLES (continued)

<u>Table No.</u>	<u>Title</u>	<u>Page</u>
15.1.14-14	SEQUENCE OF EVENTS FOR THE STEAM LINE BREAK ACCIDENT WITH AC POWER (FULL LOAD, TWO-LOOP INITIAL CONDITION, NOZZLE BREAK, WITHOUT MOISTURE CARRYOVER).....	15.3-72
15.1.14-15	SEQUENCE OF EVENTS FOR THE STEAM LINE BREAK ACCIDENT WITHOUT AC POWER (FULL LOAD, TWO-LOOP INITIAL CONDITION, NOZZLE BREAK, WITHOUT MOISTURE CARRYOVER).....	15.3-73
15.1.14-16	SEQUENCE OF EVENTS FOR THE STEAM LINE BREAK ACCIDENT WITH AC POWER (NO LOAD, TWO-LOOP INITIAL CONDITION, NOZZLE BREAK, WITHOUT MOISTURE CARRYOVER).....	15.3-74
15.1.14-17	SEQUENCE OF EVENTS FOR THE STEAM LINE BREAK ACCIDENT WITHOUT AC POWER (NO LOAD, TWO-LOOP INITIAL CONDITION, NOZZLE BREAK, WITHOUT MOISTURE CARRYOVER).....	15.3-75
15.1.14-18	ASSUMPTION FOR FEEDWATER LINE BREAK ANALYSIS	15.3-76
15.1.14-19	SEQUENCE OF EVENTS FOR THE FEEDWATER LINE BREAK ACCIDENT WITH AC AVAILABLE	15.3-77
15.1.14-20	SEQUENCE OF EVENTS FOR THE FEEDWATER LINE BREAK ACCIDENT WITH LOSS OF AC	15.3-78
15.1.14-21	STEAM GENERATOR LIQUID INVENTORIES FOR FEEDWATER LINE BREAK ACCIDENT WITH AC POWER AVAILABLE	15.3-79
15.1.14-22	STEAM GENERATOR LIQUID INVENTORIES FOR FEEDWATER LINE BREAK ACCIDENT WITH LOSS OF AC POWER	15.3-79
15.1.14-23	ASSUMPTIONS FOR THE CYCLE 3 FEEDWATER LINE BREAK ANALYSIS.....	15.3-80
15.1.14-24	ASSUMPTIONS FOR THE CYCLE 13 FEEDWATER LINE BREAK ANALYSIS.....	15.3-81
15.1.14-25	SEQUENCE OF EVENTS FOR THE CYCLE 13 FEEDWATER LINE BREAK ACCIDENT WITH LOSS OF AC	15.3-82
15.1.14-26	ASSUMPTIONS FOR CYCLE 12 STEAM LINE BREAK ANALYSIS FULL LOAD	15.3-83
15.1.14-27	ASSUMPTIONS FOR CYCLE 12 STEAM LINE BREAK ANALYSIS NO LOAD.....	15.3-83

ARKANSAS NUCLEAR ONE
Unit 2

LIST OF TABLES (continued)

<u>Table No.</u>	<u>Title</u>	<u>Page</u>
15.1.14-28	SEQUENCE OF EVENTS FOR THE CYCLE 12 STEAM LINE BREAK EVENT WITH LOSS OF AC, 1 HPSI PUMP, HFP	15.3-84
15.1.14-29	SEQUENCE OF EVENTS FOR THE CYCLE 12 STEAM LINE BREAK EVENT WITH AC AVAILABLE, 2 HPSI PUMPS, HFP.....	15.3-85
15.1.14-30	SEQUENCE OF EVENTS FOR THE CYCLE 12 STEAM LINE BREAK EVENT WITH LOSS OF AC, 1 HPSI PUMP, HZP.....	15.3-86
15.1.14-31	SEQUENCE OF EVENTS FOR THE CYCLE 12 STEAM LINE BREAK EVENT WITH AC AVAILABLE, 1 HPSI PUMP, HZP	15.3-87
15.1.14-32	ASSUMPTIONS FOR THE CYCLE 14 STEAM LINE BREAK ANALYSIS FROM HOT FULL POWER AND HOT ZERO POWER.....	15.3-88
15.1.14-33	SEQUENCE OF EVENTS FOR THE CYCLE 14 STEAM LINE BREAK HOT FULL POWER WITH LOSS OF AC.....	15.3-89
15.1.14-34	SEQUENCE OF EVENTS FOR THE CYCLE 14 STEAM LINE BREAK HOT FULL POWER WITH AC AVAILABLE.....	15.3-90
15.1.14-35	SEQUENCE OF EVENTS FOR THE CYCLE 14 STEAM LINE BREAK HOT ZERO POWER WITH LOSS OF AC.....	15.3-91
15.1.14-36	SEQUENCE OF EVENTS FOR THE CYCLE 14 STEAM LINE BREAK HOT ZERO POWER WITH AC AVAILABLE.....	15.3-92
15.1.14-37	REMOVED – HISTORICAL DATA	15.3-93
15.1.14-38	EVENT GENERATED IODINE SPIKE RADIOLOGICAL DOSE RESULTS FOR AST MAIN STEAM LINE BREAK EVENT	15.3-93
15.1.14-39	PRE-EXISTING IODINE SPIKE RADIOLOGICAL DOSE RESULTS FOR AST MAIN STEAM LINE BREAK EVENT	15.3-93
15.1.14-40	REMOVED – HISTORICAL DATA	15.3-93
15.1.14-41	ASSUMPTIONS FOR CYCLE 15 AT 3026 MWT STEAM LINE BREAK ANALYSIS FROM HOT FULL POWER TO HOT ZERO POWER	15.3-94
15.1.14-42	SEQUENCE OF EVENTS FOR CYCLE 15 AT 3026 MWT STEAM LINE BREAK HOT FULL POWER WITH LOSS OF AC	15.3-95
15.1.14-43	SEQUENCE OF EVENTS FOR CYCLE 15 AT 3026 MWT STEAM LINE BREAK HOT FULL POWER WITH AC AVAILABLE INSIDE CONTAINMENT	15.3-96

ARKANSAS NUCLEAR ONE
Unit 2

LIST OF TABLES (continued)

<u>Table No.</u>	<u>Title</u>	<u>Page</u>
15.1.14-44	SEQUENCE OF EVENTS FOR CYCLE 15 AT 3026 MWT STEAM LINE BREAK HOT ZERO POWER WITH LOSS OF AC	15.3-97
15.1.14-45	SEQUENCE OF EVENTS FOR CYCLE 15 AT 3026 MWT STEAM LINE BREAK HOT ZERO POWER WITH AC AVAILABLE OUTSIDE CONTAINMENT	15.3-98
15.1.14-46	ASSUMPTIONS FOR CYCLE 15 FEEDWATER LINE BREAK	15.3-99
15.1.14-47	PRINCIPAL RESULTS FOR CYCLE 15 FEEDWATER LINE BREAK.....	15.3-100
15.1.14-48	ASSUMPTIONS FOR CYCLE 16 FEEDWATER LINE BREAK	15.3-101
15.1.14-49	SEQUENCE OF EVENTS FOR THE CYCLE 16 FEEDWATER LINE BREAK	15.3-102
15.1.15-1	DELETED	15.3-103
15.1.16-1 – 15.1.16-2	DELETED	15.3-103
15.1.18-1 – 15.1.18-4	REMOVED – HISTORICAL DATA	15.3-103
15.1.18-5	ASSUMPTIONS FOR CYCLE 16 STEAM GENERATOR TUBE RUPTURE WITH A CONCURRENT LOSS OF AC POWER	15.3-104
15.1.18-6	SEQUENCE OF EVENTS FOR THE CYCLE 16 STEAM GENERATOR TUBE RUPTURE WITH A CONCURRENT LOSS OF AC POWER	15.3-105
15.1.18-7	STEAM GENERATOR TUBE RUPTURE WITH A CONCURRENT LOSS OF AC POWER DOSE RESULTS FOR EVENT GENERATED IODINE SPIKE	15.3-105
15.1.18-8	STEAM GENERATOR TUBE RUPTURE WITH A CONCURRENT LOSS OF AC POWER PRE-EXISTING IODINE SPIKE RADIOLOGICAL DOSE RESULTS	15.3-106
15.1.20-1	FULL POWER CEA EJECTION ACCIDENT VARIABLES.....	15.3-106
15.1.20-2	ZERO POWER CEA EJECTION ACCIDENT VARIABLES.....	15.3-107
15.1.20-3	FULL POWER CEA EJECTION ACCIDENT RESULTS	15.3-108
15.1.20-4	ZERO POWER CEA EJECTION ACCIDENT RESULTS	15.3-108
15.1.20-5	CEA EJECTION CASES AT HOT FULL POWER.....	15.3-109

ARKANSAS NUCLEAR ONE
Unit 2

LIST OF TABLES (continued)

<u>Table No.</u>	<u>Title</u>	<u>Page</u>
15.1.20-6	CEA EJECTION CASES AT HOT ZERO POWER.....	15.3-110
15.1.20-7	AXIAL POWER DISTRIBUTION USED FOR CEA EJECTION ACCIDENT ANALYSIS.....	15.3-111
15.1.20-8	KEY PARAMETERS ASSUMED IN THE CYCLE 2 CEA EJECTION ANALYSIS	15.3-112
15.1.20-9	CYCLE 2 CEA EJECTION EVENT RESULTS	15.3-113
15.1.20-10	ASSUMPTIONS FOR THE CYCLE 10 CEA EJECTION ACCIDENT ANALYSIS.....	15.3-114
15.1.20-11	RESULTS FOR THE CYCLE 10 CEA EJECTION ACCIDENT ANALYSIS ..	15.3-114
15.1.20-12	AXIAL POWER DISTRIBUTION USED FOR CYCLE 10 AND 12 CEA EJECTION ACCIDENT ANALYSES	15.3-115
15.1.20-13	ASSUMPTIONS FOR THE CYCLE 12 CEA EJECTION ACCIDENT ANALYSIS.....	15.3-116
15.1.20-14	RESULTS FOR THE CYCLE 12 CEA EJECTION ACCIDENT ANALYSIS.....	15.3-116
15.1.20-15	ASSUMPTIONS FOR THE CYCLE 13 CEA EJECTION ACCIDENT ANALYSIS.....	15.3-117
15.1.20-16	AXIAL POWER DISTRIBUTION USED FOR CYCLE 13 CEA EJECTION ACCIDENT ANALYSIS	15.3-118
15.1.20-17	RESULTS FOR THE CYCLE 13 CEA EJECTION ACCIDENT ANALYSIS.....	15.3-118
15.1.20-18	RESULTS FOR THE CYCLE 14 CEA EJECTION ACCIDENT ANALYSIS ..	15.3-119
15.1.20-19	ASSUMPTIONS FOR THE CYCLE 16 CEA EJECTION ANALYSIS	15.3-119
15.1.20-20	CYCLE 16 CEA EJECTION ANALYSIS RESULTS	15.3-120
15.1.20-21	AST CEA EJECTION RADIOLOGICAL DOSE RESULTS.....	15.3-120
15.1.20-22	RESULTS FOR THE CYCLE 18 CEA EJECTION ANALYSIS.....	15.3-121
15.1.20-23	RESULTS FOR THE CYCLE 20 CEA EJECTION ANALYSIS.....	15.3-121
15.1.23-1	REMOVED – HISTORICAL DATA.....	15.3-121

ARKANSAS NUCLEAR ONE
Unit 2

LIST OF TABLES (continued)

<u>Table No.</u>	<u>Title</u>	<u>Page</u>
15.1.23-2	FUEL HANDLING ACCIDENT DOSES CALCULATED WITH REGULATORY GUIDE 1.83 ASSUMPTIONS FOR 3086.52 MWt AND ASSUMING FAILURE OF TWO COMPLETE FUEL ASSEMBLIES.....	15.3-121
15.1.34-1	IDENTIFICATION OF SAFETY-RELATED AIR OPERATED VALVES AND THEIR FAILURE MODES.....	15.3-122
15.1.36-1	KEY PARAMETERS ASSUMED IN THE ANALYSIS OF LOSS OF LOAD TO ONE STEAM GENERATOR.....	15.3-126
15.1.36-2	SEQUENCE OF EVENTS FOR LOSS OF LOAD TO ONE STEAM GENERATOR	15.3-126
15.1.36-3	ASSUMPTIONS FOR THE CYCLE 13 ANALYSIS OF LOSS OF LOAD TO ONE STEAM GENERATOR.....	15.3-127
15.1.36-4	SEQUENCE OF EVENTS FOR THE CYCLE 13 ANALYSIS OF LOSS OF LOAD TO ONE STEAM GENERATOR	15.3-127
15.1.36-5	ASSUMPTIONS FOR CYCLE 15 AT 3026 MWT ASYMMETRIC STEAM GENERATOR TRANSIENT EVENT	15.3-128
15.1.36-6	SEQUENCE OF EVENTS FOR CYCLE 15 AT 3026 MWT ASYMMETRIC STEAM GENERATOR TRANSIENT EVENT	15.3-128

ARKANSAS NUCLEAR ONE
Unit 2

LIST OF FIGURES

<u>Figure No.</u>	<u>Title</u>
15.1.0-1	REACTIVITY VS FRACTION OF SHUTDOWN CEAs INSERTED
15.1.0-1A	REACTIVITY VS FRACTION OF SHUTDOWN CEAs INSERTED, CYCLE 1
15.1.0-1B	REACTIVITY VS FRACTION OF SHUTDOWN CEAs INSERTED, CYCLE 7
15.1.0-1C	NORMALIZED REACTIVITY INSERTION
15.1.0-1D	REACTIVITY INSERTION VS CEA INSERTION
15.1.0-1E	CEA INSERTION VS TIME
15.1.0-2	TRANSIENT PARAMETERS DURING FOUR PUMP LOSS-OF-FLOW
15.1.0-3	DOPPLER REACTIVITY VS FUEL TEMPERATURE
15.1.0-4	DOPPLER REACTIVITY VS FUEL TEMPERATURE
15.1.0-5	DELETED
15.1.1-1	CEA WITHDRAWAL FROM SUBCRITICAL CONDITIONS - CORE POWER VS TIME
15.1.1-2	CEA WITHDRAWAL EVENT FROM SUBCRITICAL CONDITIONS - CORE AVERAGE HEAT FLUX VS TIME
15.1.1-3	CEA WITHDRAWAL EVENT FROM SUBCRITICAL CONDITIONS -RCS PRESSURE VS TIME
15.1.1-4	CEA WITHDRAWAL EVENT FROM SUBCRITICAL CONDITIONS -RCS TEMPERATURES VS TIME
15.1.1-5	CYCLE 16 UNCONTROLLED CEA BANK WITHDRAWAL FROM SUBCRITICAL CONDITIONS WITH AN RIR OF $2.5 \times 10^{-4} \Delta p/\text{sec}$ - CORE POWER VS TIME
15.1.1-6	CYCLE 16 UNCONTROLLED CEA BANK WITHDRAWAL FROM SUBCRITICAL CONDITIONS WITH AN RIR OF $2.5 \times 10^{-4} \Delta p/\text{sec}$ - CORE AVERAGE HEAT FLUX VS TIME
15.1.1-7	CYCLE 16 UNCONTROLLED CEA BANK WITHDRAWAL FROM SUBCRITICAL CONDITIONS WITH AN RIR OF $2.5 \times 10^{-4} \Delta p/\text{sec}$ - REACTOR COOLANT SYSTEM PRESSURE VS TIME
15.1.1-8	CYCLE 16 UNCONTROLLED CEA BANK WITHDRAWAL FROM SUBCRITICAL CONDITIONS WITH AN RIR OF $2.5 \times 10^{-4} \Delta p/\text{sec}$ - REACTOR COOLANT SYSTEM TEMPERATURE VS TIME
15.1.2-1	CEA WITHDRAWAL AT 1% POWER - CORE POWER VS TIME

ARKANSAS NUCLEAR ONE
Unit 2

LIST OF FIGURES (continued)

<u>Figure No.</u>	<u>Title</u>
15.1.2-2	CEA WITHDRAWAL AT 1% POWER - CORE HEAT FLUX VS TIME
15.1.2-3	CEA WITHDRAWAL AT 1% POWER - RCS PRESSURE VS TIME
15.1.2-4	CEA WITHDRAWAL AT 1% POWER - RCS TEMPERATURE VS TIME
15.1.2-5	CEA WITHDRAWAL AT FULL POWER - CORE POWER VS TIME
15.1.2-6	CEA WITHDRAWAL AT FULL POWER - CORE HEAT FLUX VS TIME
15.1.2-7	CEA WITHDRAWAL AT FULL POWER - RCS PRESSURE VS TIME
15.1.2-8	CEA WITHDRAWAL AT FULL POWER - STEAM GENERATOR PRESSURES VS TIME
15.1.2-9	CEA WITHDRAWAL AT FULL POWER - RCS TEMPERATURES VS TIME
15.1.2-10	DELETED
15.1.2-11	CYCLE 16 UNCONTROLLED CEA BANK WITHDRAWAL FROM HOT ZERO POWER - CORE POWER VS TIME
15.1.2-12	CYCLE 16 UNCONTROLLED CEA BANK WITHDRAWAL FROM HOT ZERO POWER - CORE AVERAGE HEAT FLUX VS TIME
15.1.2-13	CYCLE 16 UNCONTROLLED CEA BANK WITHDRAWAL FROM HOT ZERO POWER – REACTOR COOLANT SYSTEM PRESSURE VS TIME
15.1.2-14	CYCLE 16 UNCONTROLLED CEA BANK WITHDRAWAL FROM HOT ZERO POWER – REACTOR COOLANT SYSTEM TEMPERATURE VS TIME
15.1.2-15	CYCLE 16 UNCONTROLLED CEA BANK WITHDRAWAL FROM HOT FULL POWER – CORE POWER VS TIME
15.1.2-16	CYCLE 16 UNCONTROLLED CEA BANK WITHDRAWAL FROM HOT FULL POWER – CORE AVERAGE HEAT FLUX VS TIME
15.1.2-17	CYCLE 16 UNCONTROLLED CEA BANK WITHDRAWAL FROM HOT FULL POWER – RCS PRESSURE VS TIME
15.1.2-18	CYCLE 16 UNCONTROLLED CEA BANK WITHDRAWAL FROM HOT FULL POWER – STEAM GENERATOR PRESSURE VS TIME
15.1.2-19	CYCLE 16 UNCONTROLLED CEA BANK WITHDRAWAL FROM HOT FULL POWER – RCS TEMPERATURES VS TIME
15.1.3-1	CEA MISOPERATION - FULL LENGTH CEA DROP - CORE POWER VS TIME

ARKANSAS NUCLEAR ONE
Unit 2

LIST OF FIGURES (continued)

<u>Figure No.</u>	<u>Title</u>
15.1.3-2	CEA MISOPERATION - FULL LENGTH CEA DROP - RCS PRESSURE VS TIME
15.1.3-3	CEA MISOPERATION - FULL LENGTH CEA DROP - RCS TEMPERATURE VS TIME
15.1.3-4	CEA MISOPERATION - FULL LENGTH CEA DROP - MINIMUM DNB RATIO VS TIME
15.1.3-5	CEA MISOPERATION - FULL LENGTH CEA DROP - CORE POWER VS TIME
15.1.3-6	CEA MISOPERATION - FULL LENGTH CEA DROP - CORE AVERAGE HEAT FLUX VS TIME
15.1.3-7	CEA MISOPERATION - FULL LENGTH CEA DROP - HOT CHANNEL HEAT FLUX VS TIME
15.1.3-8	CEA MISOPERATION - FULL LENGTH CEA DROP - RCS PRESSURE VS TIME
15.1.3-9	CEA MISOPERATION - FULL LENGTH CEA DROP - RCS TEMPERATURE VS TIME
15.1.3-10	CEA MISOPERATION - FULL LENGTH CEA DROP - MINIMUM DNB RATIO VS TIME
15.1.3-11 – 15.1.3-22	DELETED
15.1.3-23	CEA MISOPERATION - CORE OPERATING LIMIT ON DNBR VS AXIAL SHAPE INDEX
15.1.4-1	MODE 6 BORON DILUTION
15.1.4-2	MODE 5 DRAINED BORON DILUTION (ALARMS OPERABLE)
15.1.4-3	MODE 5 FILLED BORON DILUTION (ALARMS INOPERABLE)
15.1.4-4	MODE 5 FILLED BORON DILUTION (ALARMS OPERABLE)
15.1.4-5	MODE 4 BORON DILUTION (ALARMS INOPERABLE)
15.1.4-6	MODE 4 BORON DILUTION (ALARMS OPERABLE)
15.1.4-7	MODE 3 BORON DILUTION (ALARMS INOPERABLE)
15.1.4-8	MODE 3 BORON DILUTION (ALARMS OPERABLE)
15.1.4-9	CRITICAL OPERATION BORON DILUTION

ARKANSAS NUCLEAR ONE
Unit 2

LIST OF FIGURES (continued)

<u>Figure No.</u>	<u>Title</u>
15.1.5-1	LOSS OF COOLANT FLOW EVENT - CORE FLOW VS TIME
15.1.5-2	LOSS OF COOLANT FLOW EVENT - CORE POWER VS TIME
15.1.5-3	LOSS OF COOLANT FLOW EVENT - CORE AVERAGE HEAT FLUX VS TIME
15.1.5-4	LOSS OF COOLANT FLOW EVENT - RCS PRESSURE VS TIME
15.1.5-5	LOSS OF COOLANT FLOW EVENT - RCS TEMPERATURES VS TIME
15.1.5-6	LOSS OF COOLANT FLOW EVENT - MINIMUM HOT CHANNEL CE-1 DNBR VS TIME
15.1.5-7	LOSS OF COOLANT FLOW - TWO PUMP LOSS OF COOLANT FLOW - CORE FLOW RATE VS TIME
15.1.5-8	LOSS OF COOLANT FLOW - SEIZED SHAFT-CORE FLOW VS TIME
15.1.5-9	LOSS OF COOLANT FLOW - SEIZED SHAFT - CORE POWER VS TIME
15.1.5-10	LOSS OF COOLANT FLOW - SEIZED SHAFT - CORE HEAT FLUX VS TIME
15.1.5-11	LOSS OF COOLANT FLOW - SEIZED SHAFT - REACTOR COOLANT SYSTEM PRESSURE VS TIME
15.1.5-12	LOSS OF COOLANT FLOW - SEIZED SHAFT - REACTOR COOLANT TEMPERATURE VS TIME
15.1.5-13	LOSS OF COOLANT FLOW - SEIZED SHAFT - CUMULATIVE DISTRIBUTION OF THE FRACTION OF RODS VS NUCLEAR RADIAL PEAKING FACTOR
15.1.5-14	MAXIMUM INITIAL RATE OF FREQUENCY DECAY VS UNIT LOAD BEFORE DISTURBANCE
15.1.5-15	DNBR VS TIME FOR 6.47 Hz/SECOND GRID FREQUENCY TRANSIENT AT 30% RATED POWER
15.1.5-16	RCP FLOW COAST DOWN WITH 30% STEAM GENERATOR TUBE PLUGGING
15.1.5-17	DNBR VS TIME
15.1.5-18	CYCLE 16 4-PUMP LOSS OF COOLANT FLOW EVENT - CORE FLOW VS TIME
15.1.5-19	CYCLE 21 4-PUMP LOSS OF COOLANT FLOW EVENT – DNBR VS TIME – MAXIMUM SUBCOOLING

ARKANSAS NUCLEAR ONE
Unit 2

LIST OF FIGURES (continued)

<u>Figure No.</u>	<u>Title</u>
15.1.5-20	CYCLE 21 4-PUMP LOSS OF COOLANT FLOW EVENT – DNBR VS TIME – MINIMUM SUBCOOLING
15.1.5-21	CYCLE 21 4-PUMP LOSS OF COOLANT FLOW EVENT PUMP SHAFT SEIZURE - FR VS DNBR
15.1.5-22	CYCLE 16 4-PUMP LOSS OF COOLANT FLOW EVENT PUMP SHAFT SEIZURE – CORE FLOW RATE VS TIME
15.1.5-23	CYCLE 16 LOSS OF COOLANT FLOW PUMP SHAFT SEIZURE – CORE POWER VS TIME
15.1.5-24	CYCLE 16 LOSS OF COOLANT FLOW PUMP SHAFT SEIZURE – CORE AVERAGE HEAT FLUX VS TIME
15.1.5-25	CYCLE 16 LOSS OF COOLANT FLOW PUMP SHAFT SEIZURE – REACTOR COOLANT SYSTEM PRESSURE VS TIME
15.1.5-26	CYCLE 16 LOSS OF COOLANT FLOW PUMP SHAFT SEIZURE – RCS TEMPERATURE VS TIME
15.1.5-27	DELETED
15.1.6-1	IDLE LOOP STARTUP - CORE POWER VS TIME
15.1.6-2	IDLE LOOP STARTUP - CORE HEAT FLUX VS TIME
15.1.6-3	IDLE LOOP STARTUP - REACTOR COOLANT SYSTEM PRESSURE VS TIME
15.1.6-4	IDLE LOOP STARTUP - STEAM GENERATOR PRESSURE VS TIME
15.1.6-5	IDLE LOOP STARTUP - REACTOR COOLANT TEMPERATURE VS TIME
15.1.6-6	IDLE LOOP STARTUP - FLOW FRACTION VS TIME
15.1.7-1	LOSS OF LOAD/LOSS OF CONDENSER VACUUM – CORE POWER VS TIME
15.1.7-2	LOSS OF LOAD/LOSS OF CONDENSER VACUUM - CORE AVERAGE HEAT FLUX VS TIME
15.1.7-3	LOSS OF LOAD/LOSS OF CONDENSER VACUUM - RCS PRESSURE VS TIME
15.1.7-4	LOSS OF LOAD/LOSS OF CONDENSER VACUUM - STEAM GENERATOR PRESSURES VS TIME
15.1.7-5	LOSS OF LOAD/LOSS OF CONDENSER VACUUM - RCS TEMPERATURES VS TIME

ARKANSAS NUCLEAR ONE
Unit 2

LIST OF FIGURES (continued)

<u>Figure No.</u>	<u>Title</u>
15.1.7-6	CYCLE 15 AT 3026 MWT LOSS OF LOAD/LOSS OF CONDENSER VACUUM – CORE POWER VS TIME
15.1.7-7	CYCLE 15 AT 3026 MWT LOSS OF LOAD/LOSS OF CONDENSER VACUUM – CORE AVERAGE HEAT FLUX VS TIME
15.1.7-8	CYCLE 15 AT 3026 MWT LOSS OF LOAD/LOSS OF CONDENSER VACUUM – REACTOR COOLANT SYSTEM PRESSURE VS TIME
15.1.7-9	CYCLE 15 AT 3026 MWT LOSS OF LOAD/LOSS OF CONDENSER VACUUM – REACTOR COOLANT SYSTEM TEMPERATURE VS TIME
15.1.7-10	CYCLE 15 AT 3026 MWT LOSS OF LOAD/LOSS OF CONDENSER VACUUM – STEAM GENERATOR PRESSURE VS TIME
15.1.8-1	LOSS OF FEEDWATER FLOW - CORE POWER VS TIME
15.1.8-2	LOSS OF FEEDWATER FLOW - REACTOR COOLANT SYSTEM PRESSURE VS TIME
15.1.8-3	LOSS OF FEEDWATER FLOW - STEAM GENERATOR PRESSURE VS TIME
15.1.8-4	LOSS OF FEEDWATER FLOW - REACTOR COOLANT TEMPERATURE VS TIME
15.1.8-5	CYCLE 15 AT 3026 MWT LOSS OF NORMAL FEEDWATER FLOW – CORE POWER VS TIME
15.1.8-6	CYCLE 15 AT 3026 MWT LOSS OF NORMAL FEEDWATER FLOW – CORE AVERAGE HEAT FLUX VS TIME
15.1.8-7	CYCLE 15 AT 3026 MWT LOSS OF NORMAL FEEDWATER FLOW – REACTOR COOLANT SYSTEM PRESSURE VS TIME
15.1.8-8	CYCLE 15 AT 3026 MWT LOSS OF NORMAL FEEDWATER FLOW – REACTOR COOLANT SYSTEM TEMPERATURE VS TIME
15.1.8-9	CYCLE 15 AT 3026 MWT LOSS OF NORMAL FEEDWATER FLOW – STEAM GENERATOR PRESSURE VS TIME
15.1.9-1	LOSS OF NORMAL ONSITE, OFF-SITE ELECTRICAL POWER - CORE POWER VS TIME
15.1.9-2	LOSS OF NORMAL ONSITE, OFF-SITE ELECTRICAL POWER - REACTOR COOLANT SYSTEM PRESSURE VS TIME
15.1.9-3	LOSS OF NORMAL ONSITE, OFF-SITE ELECTRICAL POWER - STEAM GENERATOR PRESSURE VS TIME

ARKANSAS NUCLEAR ONE
Unit 2

LIST OF FIGURES (continued)

<u>Figure No.</u>	<u>Title</u>
15.1.9-4	LOSS OF NORMAL ONSITE, OFF-SITE ELECTRICAL POWER - REACTOR COOLANT TEMPERATURE VS TIME
15.1.10-1A	EXCESS LOAD - EXCESS FEEDWATER FLOW/BOTH STEAM GENERATORS - CORE POWER VS TIME
15.1.10-1B	EXCESS LOAD - EXCESS FEEDWATER FLOW/ONE STEAM GENERATOR - CORE POWER VS TIME
15.1.10-2A	EXCESS LOAD - EXCESS FEEDWATER FLOW/BOTH STEAM GENERATORS - REACTOR COOLANT SYSTEM PRESSURE VS TIME
15.1.10-2B	EXCESS LOAD - EXCESS FEEDWATER FLOW/ONE STEAM GENERATOR - REACTOR COOLANT SYSTEM PRESSURE VS TIME
15.1.10-3A	EXCESS LOAD - EXCESS FEEDWATER FLOW/BOTH STEAM GENERATORS - STEAM GENERATOR PRESSURE VS TIME
15.1.10-3B	EXCESS LOAD - EXCESS FEEDWATER FLOW/ONE STEAM GENERATOR - STEAM GENERATOR PRESSURE VS TIME
15.1.10-4A	EXCESS LOAD - EXCESS FEEDWATER FLOW/BOTH STEAM GENERATORS - REACTOR COOLANT TEMPERATURE VS TIME
15.1.10-4B	EXCESS LOAD - EXCESS FEEDWATER FLOW/ONE STEAM GENERATOR - REACTOR COOLANT TEMPERATURE VS TIME
15.1.10-5	EXCESS HEAT REMOVAL-STEAM BYPASS SYSTEM MALFUNCTION - CORE POWER VS TIME
15.1.10-6	EXCESS HEAT REMOVAL - STEAM BYPASS SYSTEM MALFUNCTION - REACTOR COOLANT SYSTEM PRESSURE VS TIME
15.1.10-7	EXCESS HEAT REMOVAL - STEAM BYPASS SYSTEM MALFUNCTION - STEAM GENERATOR PRESSURE VS TIME
15.1.10-8	EXCESS HEAT REMOVAL - STEAM BYPASS SYSTEM MALFUNCTION - REACTOR COOLANT SYSTEM TEMPERATURE VS TIME
15.1.10-9	CYCLE 15 AT 3026 MWT FEEDWATER SYSTEM MALFUNCTION – CORE POWER VS TIME
15.1.10-10	CYCLE 15 AT 3026 MWT FEEDWATER SYSTEM MALFUNCTION – CORE AVERAGE HEAT FLUX VS TIME
15.1.10-11	CYCLE 15 AT 3026 MWT FEEDWATER SYSTEM MALFUNCTION – REACTOR COOLANT SYSTEM PRESSURE VS TIME

ARKANSAS NUCLEAR ONE
Unit 2

LIST OF FIGURES (continued)

<u>Figure No.</u>	<u>Title</u>
15.1.10-12	CYCLE 15 AT 3026 MWT FEEDWATER SYSTEM MALFUNCTION – REACTOR COOLANT SYSTEM TEMPERATURE VS TIME
15.1.10-13	CYCLE 15 AT 3026 MWT FEEDWATER SYSTEM MALFUNCTION – STEAM GENERATOR PRESSURE VS TIME
15.1.10-14	CYCLE 15 AT 3026 MWT STEAM BYPASS SYSTEM MALFUNCTION – CORE POWER VS TIME
15.1.10-15	CYCLE 15 AT 3026 MWT STEAM BYPASS SYSTEM MALFUNCTION –CORE AVERAGE HEAT FLUX VS TIME
15.1.10-16	CYCLE 15 AT 3026 MWT STEAM BYPASS SYSTEM MALFUNCTION – REACTOR COOLANT SYSTEM PRESSURE VS TIME
15.1.10-17	CYCLE 15 AT 3026 MWT STEAM BYPASS SYSTEM MALFUNCTION – REACTOR COOLANT SYSTEM TEMPERATURE VS TIME
15.1.10-18	CYCLE 15 AT 3026 MWT STEAM BYPASS SYSTEM MALFUNCTION – STEAM GENERATOR PRESSURE VS TIME
15.1.13-1 – 15.1.14-28	DELETED
15.1.14-29	STEAM LINE RUPTURE INCIDENT - ONE-LOOP NO LOAD INITIAL CONDITION - RUPTURE OUTSIDE CONTAINMENT
15.1.14-30	STEAM LINE RUPTURE INCIDENT - REACTIVITY VS MODERATOR DENSITY
15.1.14-31	STEAM LINE RUPTURE INCIDENT WITH LOSS OF AC POWER – TWO LOOP FULL LOAD INITIAL CONDITION - SMALL BREAK
15.1.14-32	STEAM LINE RUPTURE INCIDENT WITH LOSS OF AC POWER - ONE LOOP NO LOAD INITIAL CONDITION - SMALL BREAK
15.1.14-33	STEAM LINE RUPTURE INCIDENT WITH LOSS OF AC POWER - ONE LOOP NO LOAD INITIAL CONDITION - SMALL BREAK
15.1.14-34	STEAM LINE RUPTURE INCIDENT WITH LOSS OF AC POWER - ONE LOOP NO LOAD INITIAL CONDITION - SMALL BREAK
15.1.14-35	STEAM LINE RUPTURE INCIDENT WITH LOSS OF AC POWER - ONE LOOP NO LOAD INITIAL CONDITION - SMALL BREAK
15.1.14-36	STEAM LINE RUPTURE INCIDENT WITH LOSS OF AC POWER - ONE LOOP NO LOAD INITIAL CONDITION - SMALL BREAK

ARKANSAS NUCLEAR ONE
Unit 2

LIST OF FIGURES (continued)

<u>Figure No.</u>	<u>Title</u>
15.1.14-37	STEAM LINE RUPTURE INCIDENT WITH LOSS OF AC POWER - ONE LOOP NO LOAD INITIAL CONDITION - SMALL BREAK
15.1.14-38	DELETED
15.1.14-39	STEAM LINE RUPTURE INCIDENT WITHOUT LOSS OF AC POWER - TWO-LOOP FULL POWER INITIAL CONDITION - NOZZLE BREAK WITHOUT MOISTURE CARRYOVER
15.1.14-40	STEAM LINE RUPTURE INCIDENT WITHOUT LOSS OF AC POWER - TWO-LOOP FULL POWER INITIAL CONDITION - NOZZLE BREAK WITHOUT MOISTURE CARRYOVER
15.1.14-41	STEAM LINE RUPTURE INCIDENT WITHOUT LOSS OF AC POWER - TWO-LOOP FULL POWER INITIAL CONDITION - NOZZLE BREAK WITHOUT MOISTURE CARRYOVER
15.1.14-42	STEAM LINE RUPTURE INCIDENT WITHOUT LOSS OF AC POWER - TWO-LOOP FULL POWER INITIAL CONDITION - NOZZLE BREAK WITHOUT MOISTURE CARRYOVER
15.1.14-43	STEAM LINE RUPTURE INCIDENT WITHOUT LOSS OF AC POWER - TWO-LOOP FULL POWER INITIAL CONDITION - NOZZLE BREAK WITHOUT MOISTURE CARRYOVER
15.1.14-44	STEAM LINE RUPTURE INCIDENT WITHOUT LOSS OF AC POWER - TWO-LOOP FULL POWER INITIAL CONDITION - NOZZLE BREAK WITHOUT MOISTURE CARRYOVER
15.1.14-45	STEAM LINE RUPTURE INCIDENT WITH LOSS OF AC POWER - TWO-LOOP FULL POWER INITIAL CONDITION - NOZZLE BREAK WITHOUT MOISTURE CARRYOVER
15.1.14-46	STEAM LINE RUPTURE INCIDENT WITH LOSS OF AC POWER - TWO-LOOP FULL POWER INITIAL CONDITION - NOZZLE BREAK WITHOUT MOISTURE CARRYOVER
15.1.14-47	STEAM LINE RUPTURE INCIDENT WITH LOSS OF AC POWER - TWO-LOOP FULL POWER INITIAL CONDITION - NOZZLE BREAK WITHOUT MOISTURE CARRYOVER
15.1.14-48	STEAM LINE RUPTURE INCIDENT WITH LOSS OF AC POWER - TWO-LOOP FULL POWER INITIAL CONDITION - NOZZLE BREAK WITHOUT MOISTURE CARRYOVER
15.1.14-49	STEAM LINE RUPTURE INCIDENT WITH LOSS OF AC POWER - TWO-LOOP FULL POWER INITIAL CONDITION - NOZZLE BREAK WITHOUT MOISTURE CARRYOVER

ARKANSAS NUCLEAR ONE
Unit 2

LIST OF FIGURES (continued)

<u>Figure No.</u>	<u>Title</u>
15.1.14-50	STEAM LINE RUPTURE INCIDENT WITH LOSS OF AC POWER - TWO-LOOP FULL POWER INITIAL CONDITION - NOZZLE BREAK WITHOUT MOISTURE CARRYOVER
15.1.14-51	STEAM LINE RUPTURE INCIDENT WITHOUT LOSS OF AC POWER - TWO-LOOP NO LOAD INITIAL CONDITION - NOZZLE BREAK WITHOUT MOISTURE CARRYOVER
15.1.14-52	STEAM LINE RUPTURE INCIDENT WITHOUT LOSS OF AC POWER - TWO-LOOP NO LOAD INITIAL CONDITION - NOZZLE BREAK WITHOUT MOISTURE CARRYOVER
15.1.14-53	STEAM LINE RUPTURE INCIDENT WITHOUT LOSS OF AC POWER - TWO-LOOP NO LOAD INITIAL CONDITION - NOZZLE BREAK WITHOUT MOISTURE CARRYOVER
15.1.14-54	STEAM LINE RUPTURE INCIDENT WITHOUT LOSS OF AC POWER - TWO-LOOP NO LOAD INITIAL CONDITION - NOZZLE BREAK WITHOUT MOISTURE CARRYOVER
15.1.14-55	STEAM LINE RUPTURE INCIDENT WITHOUT LOSS OF AC POWER - TWO-LOOP NO LOAD INITIAL CONDITION - NOZZLE BREAK WITHOUT MOISTURE CARRYOVER
15.1.14-56	STEAM LINE RUPTURE INCIDENT WITHOUT LOSS OF AC POWER - TWO-LOOP NO LOAD INITIAL CONDITION - NOZZLE BREAK WITHOUT MOISTURE CARRYOVER
15.1.14-57	STEAM LINE RUPTURE INCIDENT WITH LOSS OF AC POWER - TWO-LOOP NO LOAD INITIAL CONDITION - NOZZLE BREAK WITHOUT MOISTURE CARRYOVER
15.1.14-58	STEAM LINE RUPTURE INCIDENT WITH LOSS OF AC POWER - TWO-LOOP NO LOAD INITIAL CONDITION - NOZZLE BREAK WITHOUT MOISTURE CARRYOVER
15.1.14-59	STEAM LINE RUPTURE INCIDENT WITH LOSS OF AC POWER - TWO-LOOP NO LOAD INITIAL CONDITION - NOZZLE BREAK WITHOUT MOISTURE CARRYOVER
15.1.14-60	STEAM LINE RUPTURE INCIDENT WITH LOSS OF AC POWER - TWO-LOOP NO LOAD INITIAL CONDITION - NOZZLE BREAK WITHOUT MOISTURE CARRYOVER
15.1.14-61	STEAM LINE RUPTURE INCIDENT WITH LOSS OF AC POWER - TWO-LOOP NO LOAD INITIAL CONDITION - NOZZLE BREAK WITHOUT MOISTURE CARRYOVER

ARKANSAS NUCLEAR ONE
Unit 2

LIST OF FIGURES (continued)

<u>Figure No.</u>	<u>Title</u>
15.1.14-62	STEAM LINE RUPTURE INCIDENT WITH LOSS OF AC POWER - TWO- LOOP NO LOAD INITIAL CONDITION - NOZZLE BREAK WITHOUT MOISTURE CARRYOVER
15.1.14-63	FEEDWATER LINE RUPTURE WITH AC POWER - CORE POWER VS TIME
15.1.14-64	FEEDWATER LINE RUPTURE WITH AC POWER - CORE HEAT FLUX VS TIME
15.1.14-65	FEEDWATER LINE RUPTURE WITH AC POWER - REACTOR COOLANT SYSTEM PRESSURE VS TIME
15.1.14-66	FEEDWATER LINE RUPTURE WITH AC POWER - REACTOR COOLANT SYSTEM TEMPERATURES VS TIME
15.1.14-67	FEEDWATER LINE RUPTURE WITH AC POWER - STEAM GENERATOR PRESSURE VS TIME
15.1.14-68	FEEDWATER LINE RUPTURE WITH LOSS OF AC POWER - CORE POWER VS TIME
15.1.14-69	FEEDWATER LINE RUPTURE WITH LOSS OF AC POWER - CORE HEAT FLUX VS TIME
15.1.14-70	FEEDWATER LINE RUPTURE WITH LOSS OF AC POWER - RCS PRESSURE VS TIME
15.1.14-71	FEEDWATER LINE RUPTURE WITH LOSS OF AC POWER - RCS TEMPERATURE VS TIME
15.1.14-72	FEEDWATER LINE RUPTURE WITH LOSS OF AC POWER - STEAM GENERATOR PRESSURE VS TIME
15.1.14-73 – 15.1.14-79	DELETED
15.1.14-80	CYCLE 13 FEEDWATER LINE RUPTURE WITH LOSS OF AC POWER CORE POWER VS TIME
15.1.14-81	CYCLE 13 FEEDWATER LINE RUPTURE WITH LOSS OF AC POWER CORE HEAT FLUX VS TIME
15.1.14-82	CYCLE 13 FEEDWATER LINE RUPTURE WITH LOSS OF AC POWER REACTOR COOLANT SYSTEM PRESSURE VS TIME
15.1.14-83	CYCLE 13 FEEDWATER LINE RUPTURE WITH LOSS OF AC POWER REACTOR COOLANT SYSTEM TEMPERATURE VS TIME

ARKANSAS NUCLEAR ONE
Unit 2

LIST OF FIGURES (continued)

<u>Figure No.</u>	<u>Title</u>
15.1.14-84	CYCLE 13 FEEDWATER LINE RUPTURE WITH LOSS OF AC POWER STEAM GENERATOR PRESSURE VS TIME
15.1.14-85	CYCLE 12 MSLB ANALYSIS HOT FULL POWER WITH LOSS OF AC CORE POWER VS TIME
15.1.14-86	CYCLE 12 MSLB ANALYSIS HOT FULL POWER WITH LOSS OF AC CORE AVERAGE HEAT FLUX VS TIME
15.1.14-87	CYCLE 12 MSLB ANALYSIS HOT FULL POWER WITH LOSS OF AC RCS PRESSURE VS TIME
15.1.14-88	CYCLE 12 MSLB ANALYSIS HOT FULL POWER WITH LOSS OF AC RCS TEMPERATURES VS TIME
15.1.14-89	CYCLE 12 MSLB ANALYSIS HOT FULL POWER WITH LOSS OF AC STEAM GENERATOR PRESSURES VS TIME
15.1.14-90	CYCLE 12 MSLB ANALYSIS HOT FULL POWER WITH LOSS OF AC REACTIVITIES VS TIME
15.1.14-91	CYCLE 12 MSLB ANALYSIS HOT FULL POWER WITH AC AVAILABLE - CORE POWER VS TIME
15.1.14-92	CYCLE 12 MSLB ANALYSIS HOT FULL POWER WITH AC AVAILABLE - CORE AVERAGE HEAT FLUX VS TIME
15.1.14-93	CYCLE 12 MSLB ANALYSIS HOT FULL POWER WITH AC AVAILABLE - RCS PRESSURE VS TIME
15.1.14-94	CYCLE 12 MSLB ANALYSIS HOT FULL POWER WITH AC AVAILABLE - RCS TEMPERATURES VS TIME
15.1.14-95	CYCLE 12 MSLB ANALYSIS HOT FULL POWER WITH AC AVAILABLE - STEAM GENERATOR PRESSURES VS TIME
15.1.14-96	CYCLE 12 MSLB ANALYSIS HOT FULL POWER WITH AC AVAILABLE - REACTIVITIES VS TIME
15.1.14-97	CYCLE 12 MSLB ANALYSIS HOT ZERO POWER WITH LOSS OF AC-CORE POWER VS TIME
15.1.14-98	CYCLE 12 MSLB ANALYSIS HOT ZERO POWER WITH LOSS OF AC CORE AVERAGE HEAT FLUX VS TIME
15.1.14-99	CYCLE 12 MSLB ANALYSIS HOT ZERO POWER WITH LOSS OF AC RCS PRESSURE VS TIME

ARKANSAS NUCLEAR ONE
Unit 2

LIST OF FIGURES (continued)

<u>Figure No.</u>	<u>Title</u>
15.1.14-100	CYCLE 12 MSLB ANALYSIS HOT ZERO POWER WITH LOSS OF AC RCS TEMPERATURES VS TIME
15.1.14-101	CYCLE 12 MSLB ANALYSIS HOT ZERO POWER WITH LOSS OF AC STEAM GENERATOR PRESSURES VS TIME
15.1.14-102	CYCLE 12 MSLB ANALYSIS HOT ZERO POWER WITH LOSS OF AC REACTIVITIES VS TIME
15.1.14-103	CYCLE 12 MSLB ANALYSIS HOT ZERO POWER WITH AC AVAILABLE - CORE POWER VS TIME
15.1.14-104	CYCLE 12 MSLB ANALYSIS HOT ZERO POWER WITH AC AVAILABLE - CORE AVERAGE HEAT FLUX VS TIME
15.1.14-105	CYCLE 12 MSLB ANALYSIS HOT ZERO POWER WITH AC AVAILABLE - RCS PRESSURE VS TIME
15.1.14-106	CYCLE 12 MSLB ANALYSIS HOT ZERO POWER WITH AC AVAILABLE - RCS TEMPERATURES VS TIME
15.1.14-107	CYCLE 12 MSLB ANALYSIS HOT ZERO POWER WITH AC AVAILABLE - STEAM GENERATOR PRESSURES VS TIME
15.1.14-108	CYCLE 12 MSLB ANALYSIS HOT ZERO POWER WITH AC AVAILABLE - REACTIVITIES VS TIME
15.1.14-109	ANO UNIT 2 COOLDOWN USED IN THE CYCLE 12 MSLB ANALYSIS
15.1.14-110	DOPPLER REACTIVITY VS FUEL TEMPERATURE FOR THE CYCLE 12 MSLB ANALYSIS
15.1.14-111	COOLDOWN DATA FOR THE CYCLE 13 MSLB ANALYSIS
15.1.14-112	DOPPLER REACTIVITY VS FUEL TEMPERATURE FOR THE CYCLE 13 MSLB ANALYSIS
15.1.14-113	CYCLE 15 AT 3026 MWT MODERATOR COOLDOWN CURVES – MODERATOR REACTIVITY VS MODERATOR TEMPERATURE
15.1.14-114	CYCLE 15 AT 3026 MWT HOT FULL POWER MAIN STEAM LINE BREAK WITH LOSS OF AC INSIDE CONTAINMENT BREAK – CORE POWER VS TIME
15.1.14-115	CYCLE 15 AT 3026 MWT HOT FULL POWER MAIN STEAM LINE BREAK WITH LOSS OF AC INSIDE CONTAINMENT BREAK – CORE AVERAGE HEAT FLUX VS TIME

ARKANSAS NUCLEAR ONE
Unit 2

LIST OF FIGURES (continued)

<u>Figure No.</u>	<u>Title</u>
15.1.14-116	CYCLE 15 AT 3026 MWT HOT FULL POWER MAIN STEAM LINE BREAK WITH LOSS OF AC INSIDE CONTAINMENT BREAK – REACTOR COOLANT SYSTEM PRESSURE VS TIME
15.1.14-117	CYCLE 15 AT 3026 MWT HOT FULL POWER MAIN STEAM LINE BREAK WITH LOSS OF AC INSIDE CONTAINMENT BREAK – REACTOR COOLANT SYSTEM TEMPERATURE VS TIME
15.1.14-118	CYCLE 15 AT 3026 MWT HOT FULL POWER MAIN STEAM LINE BREAK WITH LOSS OF AC INSIDE CONTAINMENT BREAK – STEAM GENERATOR PRESSURE VS TIME
15.1.14-119	CYCLE 15 AT 3026 MWT HOT FULL POWER MAIN STEAM LINE BREAK WITH LOSS OF AC INSIDE CONTAINMENT BREAK – REACTIVITIES VS TIME
15.1.14-120	CYCLE 15 AT 3026 MWT HOT FULL POWER MAIN STEAM LINE BREAK WITH AC AVAILABLE INSIDE CONTAINMENT BREAK – CORE POWER VS TIME
15.1.14-121	CYCLE 15 AT 3026 MWT HOT FULL POWER MAIN STEAM LINE BREAK WITH AC AVAILABLE INSIDE CONTAINMENT BREAK – CORE AVERAGE HEAT FLUX VS TIME
15.1.14-122	CYCLE 15 AT 3026 MWT HOT FULL POWER MAIN STEAM LINE BREAK WITH AC AVAILABLE INSIDE CONTAINMENT BREAK – REACTOR COOLANT SYSTEM PRESSURE VS TIME
15.1.14-123	CYCLE 15 AT 3026 MWT HOT FULL POWER MAIN STEAM LINE BREAK WITH AC AVAILABLE INSIDE CONTAINMENT BREAK – REACTOR COOLANT SYSTEM TEMPERATURE VS TIME
15.1.14-124	CYCLE 15 AT 3026 MWT HOT FULL POWER MAIN STEAM LINE BREAK WITH AC AVAILABLE INSIDE CONTAINMENT BREAK – STEAM GENERATOR PRESSURE VS TIME
15.1.14-125	CYCLE 15 AT 3026 MWT HOT FULL POWER MAIN STEAM LINE BREAK WITH AC AVAILABLE INSIDE CONTAINMENT BREAK – REACTIVITIES VS TIME
15.1.14-126	CYCLE 15 AT 3026 MWT HOT ZERO POWER MAIN STEAM LINE BREAK WITH LOSS OF AC INSIDE CONTAINMENT BREAK – CORE POWER VS TIME
15.1.14-127	CYCLE 15 AT 3026 MWT HOT ZERO POWER MAIN STEAM LINE BREAK WITH LOSS OF AC INSIDE CONTAINMENT BREAK – CORE AVERAGE HEAT FLUX VS TIME
15.1.14-128	CYCLE 15 AT 3026 MWT HOT ZERO POWER MAIN STEAM LINE BREAK WITH LOSS OF AC INSIDE CONTAINMENT BREAK – REACTOR COOLANT SYSTEM PRESSURE VS TIME

ARKANSAS NUCLEAR ONE
Unit 2

LIST OF FIGURES (continued)

<u>Figure No.</u>	<u>Title</u>
15.1.14-129	CYCLE 15 AT 3026 MWT HOT ZERO POWER MAIN STEAM LINE BREAK WITH LOSS OF AC INSIDE CONTAINMENT BREAK – REACTOR COOLANT SYSTEM TEMPERATURE VS TIME
15.1.14-130	CYCLE 15 AT 3026 MWT HOT ZERO POWER MAIN STEAM LINE BREAK WITH LOSS OF AC INSIDE CONTAINMENT BREAK – STEAM GENERATOR PRESSURE VS TIME
15.1.14-131	CYCLE 15 AT 3026 MWT HOT ZERO POWER MAIN STEAM LINE BREAK WITH LOSS OF AC INSIDE CONTAINMENT BREAK – REACTIVITIES VS TIME
15.1.14-132	CYCLE 15 AT 3026 MWT HOT ZERO POWER MAIN STEAM LINE BREAK WITH AC AVAILABLE OUTSIDE CONTAINMENT BREAK – CORE POWER VS TIME
15.1.14-133	CYCLE 15 AT 3026 MWT HOT ZERO POWER MAIN STEAM LINE BREAK WITH AC AVAILABLE OUTSIDE CONTAINMENT BREAK – CORE AVERAGE HEAT FLUX VS TIME
15.1.14-134	CYCLE 15 AT 3026 MWT HOT ZERO POWER MAIN STEAM LINE BREAK WITH AC AVAILABLE OUTSIDE CONTAINMENT BREAK – REACTOR COOLANT SYSTEM PRESSURE VS TIME
15.1.14-135	CYCLE 15 AT 3026 MWT HOT ZERO POWER MAIN STEAM LINE BREAK WITH AC AVAILABLE OUTSIDE CONTAINMENT BREAK – REACTOR COOLANT SYSTEM TEMPERATURE VS TIME
15.1.14-136	CYCLE 15 AT 3026 MWT HOT ZERO POWER MAIN STEAM LINE BREAK WITH AC AVAILABLE OUTSIDE CONTAINMENT BREAK – STEAM GENERATOR PRESSURE VS TIME
15.1.14-137	CYCLE 15 AT 3026 MWT HOT ZERO POWER MAIN STEAM LINE BREAK WITH AC AVAILABLE OUTSIDE CONTAINMENT BREAK – REACTIVITIES VS TIME
15.1.14-138	CYCLE 15 AT 2815 MWT FEEDWATER LINE BREAK – CORE POWER VS TIME
15.1.14-139	CYCLE 15 AT 2815 MWT FEEDWATER LINE BREAK – CORE AVERAGE HEAT FLUX VS TIME
15.1.14-140	CYCLE 15 AT 2815 MWT FEEDWATER LINE BREAK – REACTOR COOLANT SYSTEM PRESSURE VS TIME
15.1.14-141	CYCLE 15 AT 2815 MWT FEEDWATER LINE BREAK – REACTOR COOLANT SYSTEM TEMPERATURE VS TIME
15.1.14-142	CYCLE 15 AT 2815 MWT FEEDWATER LINE BREAK – STEAM GENERATOR PRESSURE VS TIME
15.1.14-143	CYCLE 16 FEEDWATER LINE BREAK – CORE POWER VS TIME

ARKANSAS NUCLEAR ONE
Unit 2

LIST OF FIGURES (continued)

<u>Figure No.</u>	<u>Title</u>
15.1.14-144	CYCLE 16 FEEDWATER LINE BREAK – CORE AVERAGE HEAT FLUX VS TIME
15.1.14-145	CYCLE 16 FEEDWATER LINE BREAK – RCS PRESSURE VS TIME
15.1.14-146	CYCLE 16 FEEDWATER LINE BREAK – RCS TEMPERATURE VS TIME
15.1.14-147	CYCLE 16 FEEDWATER LINE BREAK – STEAM GENERATOR PRESSURE VS TIME
15.1.15-1 – 15.1.15-6	DELETED
15.1.18-1 – 15.1.18-16	DELETED
15.1.18-17	CYCLE 16 STEAM GENERATOR TUBE RUPTURE ANALYSIS WITH LOSS OF AC POWER – CORE POWER VS TIME
15.1.18-18	CYCLE 16 STEAM GENERATOR TUBE RUPTURE ANALYSIS WITH LOSS OF AC POWER – RCS PRESSURE VS TIME
15.1.18-19	CYCLE 16 STEAM GENERATOR TUBE RUPTURE ANALYSIS WITH LOSS OF AC POWER – RCS TEMPERATURE VS TIME
15.1.18-20	CYCLE 16 STEAM GENERATOR TUBE RUPTURE ANALYSIS WITH LOSS OF AC POWER – STEAM GENERATOR PRESSURE VS TIME
15.1.18-21	CYCLE 16 STEAM GENERATOR TUBE RUPTURE ANALYSIS WITH LOSS OF AC POWER – RUPTURED TUBE LEAK RATE VS TIME
15.1.18-22	CYCLE 16 STEAM GENERATOR TUBE RUPTURE ANALYSIS WITH LOSS OF AC POWER – PRESSURIZER LEVEL VS TIME
15.1.18-23	CYCLE 16 STEAM GENERATOR TUBE RUPTURE ANALYSIS WITH LOSS OF AC POWER – STEAM GENERATOR LIQUID MASS VS TIME
15.1.18-24	CYCLE 16 STEAM GENERATOR TUBE RUPTURE ANALYSIS WITH LOSS OF AC POWER – SECONDARY SAFETY VALVE FLOW RATE VS TIME
15.1.20-1	CEA EJECTION INCIDENT - CORE POWER VS TIME (FULL POWER INITIAL CONDITION)
15.1.20-2	CEA EJECTION INCIDENT - CORE POWER VS TIME (HOT STANDBY INITIAL CONDITION)

ARKANSAS NUCLEAR ONE
Unit 2

LIST OF FIGURES (continued)

<u>Figure No.</u>	<u>Title</u>
15.1.20-3	CEA EJECTION INCIDENT - FULL POWER, BOC INITIAL CONDITIONS - REACTIVITY COMPONENTS VS TIME
15.1.20-4	CEA EJECTION INCIDENT - FULL POWER EOC INITIAL CONDITIONS - REACTIVITY COMPONENTS VS TIME
15.1.20-5	CEA EJECTION INCIDENT - ZERO POWER EOC INITIAL CONDITIONS - REACTIVITY COMPONENTS VS TIME
15.1.20-6	CEA EJECTION INCIDENT - ZERO POWER BOC INITIAL CONDITIONS - REACTIVITY COMPONENTS VS TIME
15.1.20-7	IDENTIFICATION OF EJECTED CEA LOCATIONS
15.1.20-8	CEA EJECTION EVENT FROM FULL POWER - CORE POWER VS TIME
15.1.20-9	CEA EJECTION EVENT FROM ZERO POWER - CORE POWER VS TIME
15.1.36-1	LOSS OF LOAD/1 STEAM GENERATOR EVENT - CORE POWER VS TIME
15.1.36-2	LOSS OF LOAD/1 STEAM GENERATOR EVENT - CORE HEAT FLUX VS TIME
15.1.36-3	LOSS OF LOAD/1 STEAM GENERATOR EVENT - RCS PRESSURE VS TIME
15.1.36-4	LOSS OF LOAD/1 STEAM GENERATOR EVENT - RCS TEMPERATURES VS TIME
15.1.36-5	LOSS OF LOAD/1 STEAM GENERATOR EVENT - STEAM GENERATOR PRESSURES VS TIME
15.1.36-6	CYCLE 15 AT 3026 MWT ASSYMETRIC STEAM GENERATOR TRANSIENT - CORE POWER VS TIME
15.1.36-7	CYCLE 15 AT 3026 MWT ASSYMETRIC STEAM GENERATOR TRANSIENT - CORE AVERAGE HEAT FLUX VS TIME
15.1.36-8	CYCLE 15 AT 3026 MWT ASSYMETRIC STEAM GENERATOR TRANSIENT - REACTOR COOLANT SYSTEM PRESSURE VS TIME
15.1.36-9	CYCLE 15 AT 3026 MWT ASSYMETRIC STEAM GENERATOR TRANSIENT - REACTOR COOLANT SYSTEM TEMPERATURES VS TIME
15.1.36-10	CYCLE 15 AT 3026 MWT ASSYMETRIC STEAM GENERATOR TRANSIENT - STEAM GENERATOR PRESSURE VS TIME

ARKANSAS NUCLEAR ONE
Unit 2

UPDATE REFERENCE LIST

Sections and references listed below denote documents that contain additional cross reference information used to update the SAR.

<u>Section</u>	<u>Cross References</u>
15.1.14.2.14	Correspondence from Rueter, AP&L, to Stolz, NRC, dated February 10, 1977. (2CAN027706).
15.1.14.2.1.2, 15.1.14.2.14, Table 15.1.14-23	Correspondence from Rueter, AP&L, to Stolz, NRC, dated March 30, 1977. (2CAN037717).
15.1.14.2.14, Table 15.1.14-27 Table 15.1.14-28 Table 15.1.14-29 Table 15.1.14-30	Correspondence from Rueter, AP&L, to Stolz, NRC, dated June 17, 1977. (2CAN067707).
15.1.14.2.14, Table 15.1.14-24 Table 15.1.14-25	Correspondence from Rueter, AP&L, to Stolz, NRC, dated July 19, 1977. (2CAN077709).
15.1.14.2.14, Table 15.1.14-26	Correspondence from Rueter, AP&L, to Stolz, NRC, dated January 27, 1978. (2CAN017824).
15.1.14.2.14, Tables 15.1.14-31 thru 15.1.14-38	Correspondence from Williams, AP&L, to Stolz, NRC, dated January 31, 1978. (2CAN017827).
15.1.14.2.14	Correspondence from Williams, AP&L, to Stolz, NRC, dated March 24, 1978. (2CAN037821).
15.1.13.4.3	Correspondence from Williams, AP&L, to Stolz, NRC, dated June 20, 1978. (2CAN067823).
15.1.13.4.3	Correspondence from Williams, AP&L, to Stolz, NRC, dated July 7, 1978. (2CAN077804).
15.1.36	Correspondence from Cavanaugh, AP&L, to Denton, NRC, dated October 5, 1979. (2CAN107905).
15.1.14.2.14	Correspondence from Trimble, AP&L, to Seyfrit, NRC, dated May 27, 1980. (0CAN058018).
15.1.36	Correspondence from Trimble, AP&L, to Clark, NRC, dated February 20, 1981. (2CAN028107).

ARKANSAS NUCLEAR ONE
Unit 2

UPDATE REFERENCE LIST (continued)

<u>Section</u>	<u>Cross References</u>
15.1.15.2.3 15.1.36 Table 15.1.15-2 Table 15.1.15-3	Correspondence from Trimble, AP&L, to Clark, NRC, dated May 27, 1981. (2CAN058112).
<u>Amendment 9</u>	
Table 15.1.0-1	Design Change Package 88-2026, "Pressurizer Pressure Transmitter Replacement."
15.1.13.1	ANO Calculation 89-E-0105-01, "Use of Hydrogen Purge System."
<u>Amendment 10</u>	
15.1.8.1	Design Change Package 89-2043, "Auxiliary Feedwater Pump Installation."
<u>Amendment 11</u>	
15.1.10.1.2.D 15.1.10.2.1 15.1.10.2.2	ANO Procedure 2105.008, Rev. 10, "Steam Dump and Bypass Control System Operations."
15.1.26.1	Design Change Package 90-2023, "Sodium Bromide/Sodium Hypochlorite System Addition."
15.1.3.4.2	Design Change Package 90-1064, "Control Room Isolation Dampers CV-7905/CV-7907 Replacement."
<u>Amendment 12</u>	
15.1.0.6 Table 15.1.13-2	Condition Report 2-91-0557, "ANO-2 Safety Analysis Report," Subject - Control Room Habitability
15.1.13.4	"Evaluation of Health Physics Changes Required for Revised 10 CFR 20 Implementation"
15.1.13.4.2 15.1.4.1	Design Change Package 89-2017, "Alternate AC Power Source"
Table 15.1.13-5	Design Change Package 93-2012, "High Pressure Safety Injection (HPSI) System Injection Valve Replacement"
<u>Amendment 13</u>	
15.1.13.4.2	Limited Change Package 93-6025, "ANO-2 HPSI Pump Room 'C' Floor Drain Modification"

ARKANSAS NUCLEAR ONE
Unit 2

UPDATE REFERENCE LIST (continued)

<u>Section</u>	<u>Cross References</u>
15.1	Design Change Package 94-2017, "Replacement of the Part Length Control Element Assemblies"
Table 15.1.3-2	
Table 15.1.3-3	
Table 15.1.3-5	
Table 15.1.3-6	
Table 15.1.3-9	
Table 15.1.3-10	
Figure 15.1.3-11	
Figure 15.1.3-12	
Figure 15.1.3-13	
Figure 15.1.3-14	
Figure 15.1.3-15	
Figure 15.1.3-16	
Figure 15.1.3-17	
Figure 15.1.3-18	
Figure 15.1.3-19	
Figure 15.1.3-20	
Figure 15.1.3-21	
Figure 15.1.3-22	
Figure 15.1.3-23	
15.1.33	Design Change Package 94-2024, "Generator Sequential Tripping/Trip Hardening"
15.1.16.1	Limited Change Package 94-6028, "ANO-2 Gaseous Waste System Modification"
Table 15.1.13-5	Design Change Package 94-2002, "HPSI Injection Valve Replacement"
Table 15.1.13-5	Limited Change Package 95-6011, "Modification to Prevent Pressure Locking of 2CV-5649-1 and 2CV-5650-2"
<u>Amendment 14</u>	
15.1.3.2.1.1	Design Change Package 94-2008, "Feedwater Control System Upgrade"
15.1.4.1	
15.1.4.2.2.5	
Table 15.1.2-1	
Table 15.1.3-1	
Table 15.1.3-2	
Table 15.1.3-3	
Table 15.1.4-1	
Table 15.1.10-2	

ARKANSAS NUCLEAR ONE
Unit 2

UPDATE REFERENCE LIST (continued)

<u>Section</u>	<u>Cross References</u>	
15.1.10.1.1	Limited Change Package 96-3355, "High Pressure Turbine First Stage Nozzle and Bucket Modification"	
Table 15.1.3-1		
Table 15.1.4-1		
Table 15.1.5-1		
Table 15.1.5-2		
Table 15.1.6-1		
Table 15.1.8-1		
Table 15.1.9-1		
Table 15.1.10-1		
Table 15.1.18-1		
15.1.23.1	Design Change Package 92-2001, "High Level Waste Storage"	
15.1.23.2.2		
15.1.23.1	Plant Change 963036P101, "Dry Cask/High Level Waste Storage Pad Phase II Construction"	
<u>Amendment 15</u>		
15.1.0.5.2	Design Change Package 973950D201, "NaOH Replacement with TSP"	
15.1.13.2		
15.1.13.3		
15.1.13.4.1		
15.1.13.4.3		
Table 15.1.0-3		
Table 15.1.0-4		
Table 15.1.13-1		
Table 15.1.13-2		
Table 15.1.13-3		
Table 15.1.13-5		
15.1.1.4.1		Engineering Request 981159N201, "High Log Power and CPC Trips Operating Bypass Bistable Setpoint Change"
15.1.2.4.2.2		Engineering Request 975015D201, "MSIS Setpoint Reduction"
15.1.4.4		
15.1.4.4.1		
15.1.5.2.3		
15.1.5.2.3.2		
15.1.5.2.3.3		
15.1.10.4.1		
15.1.14.4.4		
15.1.18.4.1		
15.1.18.4.1		
Table 15.1.0-1		
Table 15.1.0-6		
Table 15.1.5-8		
Table 15.1.14-37		

ARKANSAS NUCLEAR ONE
Unit 2

UPDATE REFERENCE LIST (continued)

<u>Section</u>	<u>Cross References</u>
Table 15.1.5-9 Figure 15.1.5-16 Figure 15.1.5-17	
15.1.4 15.1.14.1.4.3 15.1.14.1.4.4 15.1.20.4.5 Table 15.1.20-18	Calculation 97R201802, "Cycle 14 Reload Analysis Report"
15.1.16.1 Table 15.1.34-1	Design Change Package 946012D201, "Containment Vent Header/Waste Gas System Modification"
15.1.31	Design Change Package 963242D201, "Vital AC System Upgrade"
<u>Amendment 16</u>	
15.1.0.1 15.1.0.2.1 15.1.0.2.2 15.1.0.2.3 15.1.0.3 15.1.0.5.3 15.1.0.5.4 15.1.0.5.5 15.1.2.4.2 15.1.5.2.3 15.1.7.4.2 15.1.8.4.2 15.1.9.4 15.1.9.4.1 15.2 15.1.10.4.3 15.1.10.4.4 15.1.14.1.4 15.1.14.2.4 15.1.18.4.2 15.1.36.3.2 Table 15.1.0-1 Table 15.1.0-3A Table 15.1.0-3B Table 15.1.0-3C Table 15.1.0-6 Table 15.1.0-7 Table 15.1.5-9 Table 15.1.5-10 Table 15.1.5-11 Table 15.1.7-6	Engineering Request 980564E203, "Non-LOCA Accident Analyses Supporting Replacement Steam Generators"

ARKANSAS NUCLEAR ONE
Unit 2

UPDATE REFERENCE LIST (continued)

Section Cross References

Table 15.1.8-5
Table 15.1.8-6
Table 15.1.10-5
Table 15.1.10-6
Table 15.1.10-7
Table 15.1.10-8
Table 15.1.14-38
Table 15.1.14-39
Table 15.1.14-40
Table 15.1.14-41
Table 15.1.14-42
Table 15.1.14-43
Table 15.1.14-44
Table 15.1.14-45
Table 15.1.14-46
Table 15.1.14-47
Figure 15.1.0-1E
Figure 15.1.7-6
Figure 15.1.7-7
Figure 15.1.7-8
Figure 15.1.7-9
Figure 15.1.7-10
Figure 15.1.8-5
Figure 15.1.8-6
Figure 15.1.8-7
Figure 15.1.8-8
Figure 15.1.8-9
Figure 15.1.10-9
Figure 15.1.10-10
Figure 15.1.10-11
Figure 15.1.10-12
Figure 15.1.10-13
Figure 15.1.10-14
Figure 15.1.10-15
Figure 15.1.10-16
Figure 15.1.10-17
Figure 15.1.10-18
Figure 15.1.14-113
Figure 15.1.14-114
Figure 15.1.14-115
Figure 15.1.14-116
Figure 15.1.14-117
Figure 15.1.14-118
Figure 15.1.14-119
Figure 15.1.14-120
Figure 15.1.14-121
Figure 15.1.14-122
Figure 15.1.14-123

ARKANSAS NUCLEAR ONE
Unit 2

UPDATE REFERENCE LIST (continued)

<u>Section</u>	<u>Cross References</u>
Figure 15.1.14-124	
Figure 15.1.14-125	
Figure 15.1.14-126	
Figure 15.1.14-127	
Figure 15.1.14-128	
Figure 15.1.14-129	
Figure 15.1.14-130	
Figure 15.1.14-131	
Figure 15.1.14-132	
Figure 15.1.14-133	
Figure 15.1.14-134	
Figure 15.1.14-135	
Figure 15.1.14-136	
Figure 15.1.14-137	
Figure 15.1.14-138	
Figure 15.1.14-139	
Figure 15.1.14-140	
Figure 15.1.14-141	
Figure 15.1.14-142	
Figure 15.1.36-6	
Figure 15.1.36-7	
Figure 15.1.36-8	
Figure 15.1.36-9	
Figure 15.1.36-10	
15.1.4.4.1	Design Change Package 980642D210, "Replacement Steam Generator Design/Qualification"
15.1.5.2.3	
15.1.13.4.1	
15.1.13.4.3	
15.1.20.4.5	
15.1.36.3.2	
Figure 13.1.13-1	
15.1.13.4.1	ANO Calculation 97-E-0117-01, "Revised Containment Cooling System Fan Flow and 10% Steam Generator Plugging Limits for Replacement Steam Generators"
15.1.13.4.3	
Table 15.1.13-1	
Table 15.1.13-2	
Table 15.1.13-3	
15.1.13.4.1	Condition Report 2-2000-0938, "Revised Inputs to the Loss of Coolant Dose Analysis"
15.1.13.4.3	
Table 15.1.13-1	
Table 15.1.13-2	
Table 15.1.13-3	
15.1.14.1.4	ANO Calculation 98-E-2005-03, "Cycle 15 Core Design"
15.1.20	
Table 15.1.14-42	

ARKANSAS NUCLEAR ONE
Unit 2

UPDATE REFERENCE LIST (continued)

<u>Section</u>	<u>Cross References</u>
Table 15.1.14-43	
Table 15.1.14-44	
Table 15.1.14-46	
15.1.14.2.1	Nuclear Change Package 985122N201, "High-High Containment Pressure Isolation of Main Feedwater"
15.1.31.2	Nuclear Change Package 973608N201, "PPS Indefinite Bypass"
15.1.23.1	Technical Specification Amendment 203, "Equipment Hatch Open During Fuel Handling"

Amendment 17

15.1.0.4.1	Engineering Request ANO-2000-2344-026, "Power Uprate Evaluation"
15.1.0.5.1	
15.1.0.5.2	
15.1.0.5.5	
15.1.0.6.11	
15.1.0.6.12	
15.1.1.4.3	
15.1.13.1	
15.1.13.4.1	
15.1.14.1.4.7	
15.1.14.2.4.4	
15.1.15.2.2	
15.1.15.2.3	
15.1.18.4.3	
15.1.18.4.3.1	
15.1.18.4.3.2	
15.1.18.4.3.3	
15.1.2.4.1.2	
15.1.2.4.2.4	
15.1.20.4.7	
15.1.23.2.2	
15.1.3.1	
15.1.3.2	
15.1.3.2.1	
15.1.3.2.2	
15.1.3.2.3	
15.1.3.2.4	
15.1.3.3	
15.1.3.4	
15.1.3.4.1	
15.1.3.4.2	
15.1.4.2.1	
15.1.4.2.2	
15.1.4.2.3.1	

ARKANSAS NUCLEAR ONE
Unit 2

UPDATE REFERENCE LIST (continued)

Section Cross References

15.1.4.2.3.2
15.1.4.2.4
15.1.4.2.5
15.1.4.2.6
15.1.4.4
15.1.4.4.1
15.1.5.2.3.7
15.1.5.2.3.8
15.2
Table 15.1.0-1
Table 15.1.0-2
Table 15.1.1-7
Table 15.1.1-8
Table 15.1.1-9
Table 15.1.13-1
Table 15.1.13-2
Table 15.1.13-3
Table 15.1.13-5
Table 15.1.14-48
Table 15.1.14-49
Table 15.1.18-5
Table 15.1.18-6
Table 15.1.18-7
Table 15.1.18-8
Table 15.1.2-8
Table 15.1.2-9
Table 15.1.2-10
Table 15.1.2-11
Table 15.1.3-2
Table 15.1.3-3
Table 15.1.3-4
Table 15.1.3-5
Table 15.1.4-1
Table 15.1.5-12
Table 15.1.5-13
Table 15.1.5-14
Table 15.1.5-15
Table 15.1.5-16
Table 15.1.20-19
Table 15.1.20-20
Table 15.1.20-21
Table 15.1.23-1
Table 15.1.23-2
Figure 15.1.0-5
Figure 15.1.1-5
Figure 15.1.1-6
Figure 15.1.1-7
Figure 15.1.1-8

ARKANSAS NUCLEAR ONE
Unit 2

UPDATE REFERENCE LIST (continued)

<u>Section</u>	<u>Cross References</u>
Figure 15.1.2-11	
Figure 15.1.2-12	
Figure 15.1.2-13	
Figure 15.1.2-14	
Figure 15.1.2-15	
Figure 15.1.2-16	
Figure 15.1.2-17	
Figure 15.1.2-18	
Figure 15.1.2-19	
Figure 15.1.4-1	
Figure 15.1.4-2	
Figure 15.1.4-3	
Figure 15.1.4-4	
Figure 15.1.4-5	
Figure 15.1.4-6	
Figure 15.1.4-7	
Figure 15.1.4-8	
Figure 15.1.4-9	
Figure 15.1.5-18	
Figure 15.1.5-19	
Figure 15.1.5-20	
Figure 15.1.5-21	
Figure 15.1.5-22	
Figure 15.1.5-23	
Figure 15.1.5-24	
Figure 15.1.5-25	
Figure 15.1.5-26	
Figure 15.14-143	
Figure 15.14-144	
Figure 15.14-145	
Figure 15.14-146	
Figure 15.14-147	
Figure 15.18-17	
Figure 15.18-18	
Figure 15.18-19	
Figure 15.18-20	
Figure 15.18-21	
Figure 15.18-22	
Figure 15.18-23	
Figure 15.18-24	
15.1.15.1.1	ANO Engineering Report 01-R-2008-03, ANO-2 Cycle 16 Reload Analysis Report”
15.1.2.1	Unit 2 Technical Specification Amendment 238
Table 15.1.34-1	Engineering Report ANO-2001-0377-002, “Addition of EFW Manual Valve”

ARKANSAS NUCLEAR ONE
Unit 2

UPDATE REFERENCE LIST (continued)

<u>Section</u>	<u>Cross References</u>
<u>Amendment 18</u>	
15.1.23.1	Engineering Request ER-ANO-2000-2688, "Fuel Handling Crane 2L3 Upgrade"
Figure 15.1.14-39	Condition Report ANO-C-1997-0282, "Revision of SAR Figure Titles"
15.1.4.2.2.D	Calculation CALC-A2-NE-2003-001-00, "ANO-2 Cycle 17 Reload Analysis"
Table 15.1.13-1	Condition Report CR-ANO-1-2003-0623-004, "Clarification of Control Room Makeup Air Flow for Fans VSF-9 and 2VSF-9"
15.1.23.3	Engineering Request ER-ANO-2000-3333-010, "Use of Dry Fuel Storage Casks of Holtec Design"
15.1.13.4.2	SAR Discrepancy 2-98-0038, "Leakage in ESF Rooms"
15.1.10.2.1	SAR Discrepancy 2-98-0084, "CPC Penalty Factor Constants"
Table 15.1.13-2	License Document Change Request 2-15.1-0061, "Addition of Note to Table 15.1.13-2 Inadvertently Omitted in Previous Amendment"
<u>Amendment 19</u>	
15.1.18.4.3.2	Engineering Request ER-ANO-2000-2804-017, "Modification of High Pressure Safety Injection Pump 2P-89C"
15.1.4.2.1	Engineering Request ER-ANO-2003-0012-029, "Methodology for Boron Dilution Alarm Setpoint"
15.1.2.4.2.5	Calculation A2-NE-2004-000, "ANO-2 Cycle 18 Reload Analysis Report"
15.1.4.4	
15.1.10.4.5	
15.1.10.4.6	
15.1.14.1.4.8	
15.1.20.4.8	
15.1.36.3.3	
15.2	
Table 15.1.20-22	
Figure 15.1.4-1	
Figure 15.1.4-2	
Figure 15.1.4-4	
Figure 15.1.4-6	
Figure 15.1.4-8	

ARKANSAS NUCLEAR ONE
Unit 2

UPDATE REFERENCE LIST (continued)

<u>Section</u>	<u>Cross References</u>
<u>Amendment 20</u>	
Table 15.1.34-1 Figures – ALL ¹	License Document Change Request 05-058, "Deletion/simplification of Excessive Detailed Drawings from SAR"
	¹ Except Figures 15.1.4-1, 15.1.4-2, 15.1.4-4, 15.1.4-6, and 15.1.4-8
<u>Amendment 21</u>	
15.1.1.4.4 15.1.2.4.1.3 15.1.20.4.9 15.2 Table 15.1.1-8 Table 15.1.1-9 Table 15.1.20-23	Calculation CALC-ANO2-NE-08-00001, "ANO-2 Cycle 20 Reload Analysis Report"
15.1.0.2.3	TS Amendment 275, "CEA Drop Time"
<u>Amendment 22</u>	
15.1.1.1 15.1.1.2.2 15.1.2.1 15.1.2.3 15.1.8.3 Table 15.1.2-3 Table 15.1.2-4 Table 15.1.36-2	TS Amendment 287, "DNBR Safety Limit"
15.1.0.1 15.1.1.4.5 15.1.2.4.1.4 15.1.2.4.2.6 15.1.5.2.3.9 15.1.5.2.3.10 15.1.10.4.7 15.1.10.4.8 15.1.14.1.4.9 15.1.36.3.4 15.2 Table 15.1.0-1 Table 15.1.1-8 Table 15.1.1-9 Table 15.1.2-9 Table 15.1.2-11 Table 15.1.5-14 Table 15.1.5-16	Calculation CALC-ANO2-NE-09-00001, "ANO-2 Cycle 21 Reload Report"

ARKANSAS NUCLEAR ONE
Unit 2

UPDATE REFERENCE LIST (continued)

<u>Section</u>	<u>Cross References</u>
Table 15.1.10-6	
Table 15.1.10-8	
Table 15.1.14-42	
Table 15.1.36-6	
Figure 15.1.5-19	
Figure 15.1.5-20	
Figure 15.1.5-21	
<u>Amendment 23</u>	
15.1.5.2.3.11	Calculation CALC-ANO2-NE-10-00002, "ANO-2 Cycle 22 Reload
Figure 15.1.5-27	Analysis Report"
15.1.0.5.1	Engineering Change EC-10746, "Adoption of Alternate Source Terms"
15.1.0.5.2	
15.1.0.5.3	
15.1.0.5.4	
15.1.0.5.5	
15.1.0.5.6	
15.1.0.6.5	
15.1.0.6.6	
15.1.0.6.12	
15.1.5.2.3.4	
15.1.5.2.3.11	
15.1.5.2.3.12	
15.1.5.3.2	
15.1.7.2.1	
15.1.7.2.2	
15.1.7.4.2	
15.1.9.2.1	
15.1.9.2.2	
15.1.9.3	
15.1.9.4.1	
15.1.10.4.2	
15.1.10.4.4	
15.1.13.1	
15.1.13.2	
15.1.13.3	
15.1.13.4.1	
15.1.13.4.3	
15.1.14.1.2.1	
15.1.14.1.2.2.1	
15.1.14.1.2.2.2	
15.1.14.1.2.2.3	
15.1.14.1.4.3	
15.1.14.1.4.4	
15.1.14.1.4.5	
15.1.14.1.4.6	

ARKANSAS NUCLEAR ONE
Unit 2

UPDATE REFERENCE LIST (continued)

Section Cross References

15.1.14.1.4.7
15.1.14.1.4.8
15.1.14.1.4.9
15.1.14.2.4.3
15.1.14.2.4.4
15.1.18.1
15.1.18.2
15.1.18.2.1
15.1.18.2.2
15.1.18.2.2.1
15.1.18.2.2.2
15.1.18.3
15.1.18.4.1
15.1.18.4.3.1
15.1.18.4.3.2
15.1.18.4.3.3
15.1.18.4.4
15.1.20.4.7
15.1.20.4.8
15.1.20.4.9
15.1.20.4.10
15.1.23.2
15.1.23.2.1
15.1.23.2.2
15.1.23.3
15.2
Table 15.1.0-2
Table 15.1.0-2A
Table 15.1.0-2B
Table 15.1.0-3
Table 15.1.0-3A
Table 15.1.0-3B
Table 15.1.0-3C
Table 15.1.0-4
Table 15.1.5-10
Table 15.1.7-3
Table 15.1.13-1
Table 15.1.13-2
Table 15.1.13-3
Table 15.1.14-37
Table 15.1.14-38
Table 15.1.14-39
Table 15.1.14-40
Table 15.1.18-1
Table 15.1.18-2
Table 15.1.18-3
Table 15.1.18-4
Table 15.1.18-7

ARKANSAS NUCLEAR ONE
Unit 2

UPDATE REFERENCE LIST (continued)

<u>Section</u>	<u>Cross References</u>
Table 15.1.18-8	
Table 15.1.20-21	
Table 15.1.23-1	
Table 15.1.23-2	
Figure 15.1.18-1	
Figure 15.1.18-2	
Figure 15.1.18-3	
Figure 15.1.18-4	
Figure 15.1.18-5	
Figure 15.1.18-6	
Figure 15.1.18-7	
Figure 15.1.18-8	
Figure 15.1.18-9	
Figure 15.1.18-10	
Figure 15.1.18-11	
Figure 15.1.18-12	
Figure 15.1.18-13	
Figure 15.1.18-14	
Figure 15.1.18-15	
Figure 15.1.18-16	
<u>Amendment 24</u>	
15.1.0.5.2	Licensing Document Change Request 12-012, "Correct Reference Tie in Section 15.1.0.5.2"
Table 15.1.13-1	License Document Change Request 12-021, "Correction of editorial errors in accordance with EN-LI-113 Steps 3.0[3](a) and 3.0[3](d)(1)"
Table 15.1.13-1	
Figure 15.1.5-27	Engineering Change EC-32194, "ANO-2 Cycle 23 Reload Report"
<u>Amendment 25</u>	
Table 15.1.13-2	Engineering Change EC-37543, "LOCA Dose Analysis Revision"
Figure 15.1.5-27	Engineering Change EC-42844, "ANO-2 Cycle 24 Reload Report"
15.1.4.2.2	License Document Change Request 14-014, "Correction of Editorial Errors"
15.1.4.4	
<u>Amendment 26</u>	
15.1.5.2.3.11	Engineering Change EC-53837, "ANO-2 Cycle 25 Reload Report"
Figure 15.1.5-27	
<u>Amendment 27</u>	
Table 15.1.13-2	Engineering Change EC-68304, "Revise LOCA Dose Results for Control Rooms"

ARKANSAS NUCLEAR ONE
Unit 2

UPDATE REFERENCE LIST (continued)

<u>Section</u>	<u>Cross References</u>
15.1.15.2.3	Engineering Change EC-62439, "Cycle 26 Reload Report"

ARKANSAS NUCLEAR ONE
Unit 2

RECORD OF REVISIONS

<u>PAGE #</u>	<u>AMENDMENT #</u>	<u>PAGE #</u>	<u>AMENDMENT #</u>	<u>PAGE #</u>	<u>AMENDMENT #</u>
TABLE OF CONTENTS		TABLE OF CONTENTS		CHAPTER 15 (CONT.)	
15-i	27	15-xlvi	27	15.1-33	27
15-ii	27	15-xlvii	27	15.1-34	27
15-iii	27	15-xlviii	27	15.1-35	27
15-iv	27	15-xlix	27	15.1-36	27
15-v	27	15-l	27	15.1-37	27
15-vi	27	15-li	27	15.1-38	27
15-vii	27	15-lii	27	15.1-39	27
15-viii	27	15-liii	27	15.1-40	27
15-ix	27	15-liv	27	15.1-41	27
15-x	27			15.1-42	27
15-xi	27			15.1-43	27
15-xii	27	CHAPTER 15		15.1-44	27
15-xiii	27			15.1-45	27
15-xiv	27	15.1-1	27	15.1-46	27
15-xv	27	15.1-2	27	15.1-47	27
15-xvi	27	15.1-3	27	15.1-48	27
15-xvii	27	15.1-4	27	15.1-49	27
15-xviii	27	15.1-5	27	15.1-50	27
15-xix	27	15.1-6	27	15.1-51	27
15-xx	27	15.1-7	27	15.1-52	27
15-xxi	27	15.1-8	27	15.1-53	27
15-xxii	27	15.1-9	27	15.1-54	27
15-xxiii	27	15.1-10	27	15.1-55	27
15-xxiv	27	15.1-11	27	15.1-56	27
15-xxv	27	15.1-12	27	15.1-57	27
15-xxvi	27	15.1-13	27	15.1-58	27
15-xxvii	27	15.1-14	27	15.1-59	27
15-xxviii	27	15.1-15	27	15.1-60	27
15-xxix	27	15.1-16	27	15.1-61	27
15-xxx	27	15.1-17	27	15.1-62	27
15-xxxi	27	15.1-18	27	15.1-63	27
15-xxxii	27	15.1-19	27	15.1-64	27
15-xxxiii	27	15.1-20	27	15.1-65	27
15-xxxiv	27	15.1-21	27	15.1-66	27
15-xxxv	27	15.1-22	27	15.1-67	27
15-xxxvi	27	15.1-23	27	15.1-68	27
15-xxxvii	27	15.1-24	27	15.1-69	27
15-xxxviii	27	15.1-25	27	15.1-70	27
15-xxxix	27	15.1-26	27	15.1-71	27
15-xl	27	15.1-27	27	15.1-72	27
15-xli	27	15.1-28	27	15.1-73	27
15-xlii	27	15.1-29	27	15.1-74	27
15-xliii	27	15.1-30	27	15.1-75	27
15-xliv	27	15.1-31	27	15.1-76	27
15-xlv	27	15.1-32	27	15.1-77	27

ARKANSAS NUCLEAR ONE
Unit 2

RECORD OF REVISIONS (continued)

<u>PAGE #</u>	<u>AMENDMENT #</u>	<u>PAGE #</u>	<u>AMENDMENT #</u>	<u>PAGE #</u>	<u>AMENDMENT #</u>
CHAPTER 15 (CONT.)		CHAPTER 15 (CONT.)		CHAPTER 15 (CONT.)	
15.1-78	27	15.1-119	27	15.3-14	27
15.1-79	27	15.1-120	27	15.3-15	27
15.1-80	27	15.1-121	27	15.3-16	27
15.1-81	27	15.1-122	27	15.3-17	27
15.1-82	27	15.1-123	27	15.3-18	27
15.1-83	27	15.1-124	27	15.3-20	27
15.1-84	27	15.1-125	27	15.3-20	27
15.1-85	27	15.1-126	27	15.3-21	27
15.1-86	27	15.1-127	27	15.3-22	27
15.1-87	27	15.1-128	27	15.3-23	27
15.1-88	27	15.1-129	27	15.3-24	27
15.1-89	27	15.1-130	27	15.3-25	27
15.1-90	27	15.1-131	27	15.3-26	27
15.1-91	27	15.1-132	27	15.3-27	27
15.1-92	27	15.1-133	27	15.3-28	27
15.1-93	27	15.1-134	27	15.3-29	27
15.1-94	27	15.1-135	27	15.3-30	27
15.1-95	27	15.1-136	27	15.3-31	27
15.1-96	27	15.1-137	27	15.3-32	27
15.1-97	27	15.1-138	27	15.3-33	27
15.1-98	27	15.1-139	27	15.3-34	27
15.1-99	27	15.1-140	27	15.3-35	27
15.1-100	27	15.1-141	27	15.3-36	27
15.1-101	27	15.1-142	27	15.3-37	27
15.1-102	27			15.3-38	27
15.1-103	27	15.2-1	23	15.3-39	27
15.1-104	27	15.2-2	23	15.3-40	27
15.1-105	27	15.2-3	23	15.3-41	27
15.1-106	27	15.2-4	23	15.3-42	27
15.1-107	27			15.3-43	27
15.1-108	27	15.3-1	27	15.3-44	27
15.1-109	27	15.3-2	27	15.3-45	27
15.1-110	27	15.3-3	27	15.3-46	27
15.1-111	27	15.3-4	27	15.3-47	27
15.1-112	27	15.3-5	27	15.3-48	27
15.1-113	27	15.3-6	27	15.3-49	27
15.1-114	27	15.3-7	27	15.3-50	27
15.1-115	27	15.3-8	27	15.3-51	27
15.1-116	27	15.3-9	27	15.3-52	27
15.1-117	27	15.3-10	27	15.3-53	27
15.1-118	27	15.3-11	27	15.3-54	27
		15.3-12	27	15.3-55	27
		15.3-13	27	15.3-56	27
				15.3-57	27
				15.3-58	27

ARKANSAS NUCLEAR ONE
Unit 2

RECORD OF REVISIONS (continued)

<u>PAGE #</u>	<u>AMENDMENT #</u>	<u>PAGE #</u>	<u>AMENDMENT #</u>	<u>PAGE #</u>	<u>AMENDMENT #</u>
CHAPTER 15 (CONT.)		CHAPTER 15 (CONT.)		CHAPTER 15 (CONT.)	
15.3-59	27	15.3-104	27	F15.1.2-1	20
15.3-60	27	15.3-105	27	F15.1.2-2	20
15.3-61	27	15.3-106	27	F15.1.2-3	20
15.3-62	27	15.3-107	27	F15.1.2-4	20
15.3-63	27	15.3-108	27	F15.1.2-5	20
15.3-64	27	15.3-109	27	F15.1.2-6	20
15.3-65	27	15.3-110	27	F15.1.2-7	20
15.3-66	27	15.3-111	27	F15.1.2-8	20
15.3-67	27	15.3-112	27	F15.1.2-9	20
15.3-68	27	15.3-113	27	F15.1.2-10	20
15.3-69	27	15.3-114	27	F15.1.2-11	20
15.3-70	27	15.3-115	27	F15.1.2-12	20
15.3-71	27	15.3-116	27	F15.1.2-13	20
15.3-72	27	15.3-117	27	F15.1.2-14	20
15.3-73	27	15.3-118	27	F15.1.2-15	20
15.3-74	27	15.3-120	27	F15.1.2-16	20
15.3-75	27	15.3-120	27	F15.1.2-17	20
15.3-76	27	15.3-121	27	F15.1.2-18	20
15.3-77	27	15.3-122	27	F15.1.2-20	20
15.3-78	27	15.3-123	27		
15.3-79	27	15.3-124	27	F15.1.3-1	20
15.3-80	27	15.3-125	27	F15.1.3-2	20
15.3-81	27	15.3-126	27	F15.1.3-3	20
15.3-82	27	15.3-127	27	F15.1.3-4	20
15.3-83	27	15.3-128	27	F15.1.3-5	20
15.3-84	27			F15.1.3-6	20
15.3-85	27	F15.1.0-1	20	F15.1.3-7	20
15.3-86	27	F15.1.0-1A	20	F15.1.3-8	20
15.3-87	27	F15.1.0-1B	20	F15.1.3-9	20
15.3-88	27	F15.1.0-1C	20	F15.1.3-10	20
15.3-89	27	F15.1.0-1D	20	F15.1.3-11	20
15.3-90	27	F15.1.0-1E	20	F15.1.3-23	20
15.3-91	27	F15.1.0-2	20		
15.3-92	27	F15.1.0-3	20	F15.1.4-1	20
15.3-93	27	F15.1.0-4	20	F15.1.4-2	20
15.3-94	27	F15.1.0-5	20	F15.1.4-3	20
15.3-95	27			F15.1.4-4	20
15.3-96	27	F15.1.1-1	20	F15.1.4-5	20
15.3-97	27	F15.1.1-2	20	F15.1.4-6	20
15.3-98	27	F15.1.1-3	20	F15.1.4-7	20
15.3-99	27	F15.1.1-4	20	F15.1.4-8	20
15.3-100	27	F15.1.1-5	20	F15.1.4-9	20
15.3-101	27	F15.1.1-6	20		
15.3-102	27	F15.1.1-7	20		
15.3-103	27	F15.1.1-8	20		

ARKANSAS NUCLEAR ONE
Unit 2

RECORD OF REVISIONS (continued)

<u>PAGE #</u>	<u>AMENDMENT #</u>	<u>PAGE #</u>	<u>AMENDMENT #</u>	<u>PAGE #</u>	<u>AMENDMENT #</u>
CHAPTER 15 (CONT.)		CHAPTER 15 (CONT.)		CHAPTER 15 (CONT.)	
F15.1.5-1	20	F15.1.8-1	20	F15.1.14-34	20
F15.1.5-2	20	F15.1.8-2	20	F15.1.14-35	20
F15.1.5-3	20	F15.1.8-3	20	F15.1.14-36	20
F15.1.5-4	20	F15.1.8-4	20	F15.1.14-37	20
F15.1.5-5	20	F15.1.8-5	20	F15.1.14-38	20
F15.1.5-6	20	F15.1.8-6	20		
F15.1.5-7	20	F15.1.8-7	20	F15.1.14-39	20
F15.1.5-8	20	F15.1.8-8	20	F15.1.14-40	20
F15.1.5-9	20	F15.1.8-9	20	F15.1.14-41	20
F15.1.5-10	20			F15.1.14-42	20
F15.1.5-11	20	F15.1.9-1	20	F15.1.14-43	20
F15.1.5-12	20	F15.1.9-2	20	F15.1.14-44	20
F15.1.5-13	20	F15.1.9-3	20	F15.1.14-45	20
F15.1.5-14	20	F15.1.9-4	20	F15.1.14-46	20
F15.1.5-15	20			F15.1.14-47	20
F15.1.5-16	20	F15.1.10-1A	20	F15.1.14-48	20
F15.1.5-17	20	F15.1.10-1B	20	F15.1.14-49	20
F15.1.5-18	20	F15.1.10-2A	20	F15.1.14-50	20
F15.1.5-19	22	F15.1.10-2B	20	F15.1.14-51	20
F15.1.5-20	22	F15.1.10-3A	20	F15.1.14-52	20
F15.1.5-21	22	F15.1.10-3B	20	F15.1.14-53	20
F15.1.5-22	20	F15.1.10-4A	20	F15.1.14-54	20
F15.1.5-23	20	F15.1.10-4B	20	F15.1.14-55	20
F15.1.5-24	20	F15.1.10-5	20	F15.1.14-56	20
F15.1.5-25	20	F15.1.10-6	20	F15.1.14-57	20
F15.1.5-26	20	F15.1.10-7	20	F15.1.14-58	20
F15.1.5-27	26	F15.1.10-8	20	F15.1.14-59	20
		F15.1.10-9	20	F15.1.14-60	20
F15.1.6-1	20	F15.1.10-10	20	F15.1.14-61	20
F15.1.6-2	20	F15.1.10-11	20	F15.1.14-62	20
F15.1.6-3	20	F15.1.10-12	20	F15.1.14-63	20
F15.1.6-4	20	F15.1.10-13	20	F15.1.14-64	20
F15.1.6-5	20	F15.1.10-14	20	F15.1.14-65	20
F15.1.6-6	20	F15.1.10-15	20	F15.1.14-66	20
		F15.1.10-16	20	F15.1.14-67	20
F15.1.7-1	20	F15.1.10-17	20	F15.1.14-68	20
F15.1.7-2	20	F15.1.10-18	20	F15.1.14-69	20
F15.1.7-3	20	F15.1.13-1	20	F15.1.14-70	20
F15.1.7-4	20			F15.1.14-71	20
F15.1.7-5	20	F15.1.14-29	20	F15.1.14-72	20
F15.1.7-6	20	F15.1.14-30	20	F15.1.14-73	20
F15.1.7-7	20	F15.1.14-31	20	F15.1.14-80	20
F15.1.7-8	20	F15.1.14-32	20	F15.1.14-81	20
F15.1.7-9	20	F15.1.14-33	20	F15.1.14-82	20
F15.1.7-10	20				

ARKANSAS NUCLEAR ONE
Unit 2

RECORD OF REVISIONS (continued)

<u>PAGE #</u>	<u>AMENDMENT #</u>	<u>PAGE #</u>	<u>AMENDMENT #</u>	<u>PAGE #</u>	<u>AMENDMENT #</u>
CHAPTER 15 (CONT.)		CHAPTER 15 (CONT.)		CHAPTER 15 (CONT.)	
F15.1.14-83	20	F15.1.14-126	20	F15.1.36-1	20
F15.1.14-84	20	F15.1.14-127	20	F15.1.36-2	20
F15.1.14-85	20	F15.1.14-128	20	F15.1.36-3	20
F15.1.14-86	20	F15.1.14-129	20	F15.1.36-4	20
F15.1.14-87	20	F15.1.14-130	20	F15.1.36-5	20
F15.1.14-88	20	F15.1.14-131	20	F15.1.36-6	20
F15.1.14-89	20	F15.1.14-132	20	F15.1.36-7	20
F15.1.14-90	20	F15.1.14-133	20	F15.1.36-8	20
F15.1.14-91	20	F15.1.14-134	20	F15.1.36-9	20
F15.1.14-92	20	F15.1.14-135	20	F15.1.36-10	20
F15.1.14-93	20	F15.1.14-136	20		
F15.1.14-94	20	F15.1.14-137	20		
F15.1.14-95	20	F15.1.14-138	20		
F15.1.14-96	20	F15.1.14-139	20		
F15.1.14-97	20	F15.1.14-140	20		
F15.1.14-98	20	F15.1.14-141	20		
F15.1.14-99	20	F15.1.14-142	20		
F15.1.14-100	20	F15.1.14-143	20		
F15.1.14-101	20	F15.1.14-144	20		
F15.1.14-102	20	F15.1.14-145	20		
F15.1.14-103	20	F15.1.14-146	20		
F15.1.14-104	20	F15.1.14-147	20		
F15.1.14-105	20				
F15.1.14-106	20	F15.1.15-1	20		
F15.1.14-107	20				
F15.1.14-108	20	F15.1.18-1	23		
F15.1.14-109	20	F15.1.18-17	20		
F15.1.14-110	20	F15.1.18-18	20		
F15.1.14-111	20	F15.1.18-20	20		
F15.1.14-112	20	F15.1.18-20	20		
F15.1.14-113	20	F15.1.18-21	20		
F15.1.14-114	20	F15.1.18-22	20		
F15.1.14-115	20	F15.1.18-23	20		
F15.1.14-116	20	F15.1.18-24	20		
F15.1.14-117	20				
F15.1.14-118	20	F15.1.20-1	20		
F15.1.14-120	20	F15.1.20-2	20		
F15.1.14-120	20	F15.1.20-3	20		
F15.1.14-121	20	F15.1.20-4	20		
F15.1.14-122	20	F15.1.20-5	20		
F15.1.14-123	20	F15.1.20-6	20		
F15.1.14-124	20	F15.1.20-7	20		
F15.1.14-125	20	F15.1.20-8	20		
		F15.1.20-9	20		

15 ACCIDENT ANALYSIS

15.1 GENERAL

Previous chapters describe the major systems and components of the plant and evaluate their reliability from a safety standpoint. In this section, the occurrence of certain accidents is postulated despite the precautions taken to prevent their happening. The potential consequences of such occurrences are then examined to determine their effect on the plant, to determine whether plant design is adequate to minimize the consequences of such occurrences, and to assure that the health and safety of the public and plant personnel are protected from the consequences. The events analyzed in this section are listed in Table 15-1 in the "Standard Format and Content of Safety Analysis Reports for Nuclear Power Plants," Revision 1, issued October 1972.

The sections of this chapter generally represent the most limiting analyses performed for the operation of all fuel cycles.

15.1.0 INTRODUCTION

15.1.0.1 Initial Conditions

The parameters used in the analyses are consistent with those listed in preceding sections and are primarily based on those generated in the design of a specific fuel cycle. Based on experience, it is not anticipated that a significant number of these parameters will change from cycle to cycle. Nonetheless, for each core reload, the calculated parameters for the proposed core will be compared with the values used for the analysis of record. The impact of any parameter changes on the safety analysis will be evaluated. Then, any reanalysis required will be performed and evaluated per 10 CFR 50.59 for determination of acceptable results. The ultimate core power level of 2,900 MWt is assumed in all analyses prior to Cycle 15. Starting with Cycle 15, most analyses were performed at a rated power level of 3026 MWt plus 2% uncertainty. For Cycle 16 and beyond, all analyses will be performed at a rated power level of 3026 MWt plus a 2% uncertainty.

The initial conditions, i.e., reactor power, pressurizer pressure, reactor coolant temperature at the core inlet, core power distribution, etc., are selected for the analysis to be consistent with the core operating limits allowed by the Limiting Conditions for Operation (LCOs) as maintained by the operators using the Core Operating Limit Supervisory System (COLSS) or CPCs, when COLSS is out of service. The core operating limits are defined as a set of initial conditions for which the specified acceptable fuel design limits are not violated as a result of the most rapid decrease in thermal margin caused by an anticipated operational occurrence. The set of initial conditions used in the analyses in this section forms a representative case which has been determined to require the largest initial margin to Departure from Nucleate Boiling (DNB), e.g., CE-1 Departure from Nucleate Boiling Ratio (DNBR) of 2.25, using a conservative value for the trip delay time and an axial power distribution that has the most adverse effect on the required initial margin. These are not the only initial conditions which represent core operating limits allowed by the LCOs, in that operation is allowed with less margin to DNB, i.e., a CE-1 DNBR as low as 1.50, for more favorable axial power distributions (see the Technical Specifications). In addition, a reduction in the initial margin to DNB would be allowed by changes such as the use of a more realistic trip delay time, the use of improved calculational techniques, or the use of more favorable data based on measured plant parameters.

ARKANSAS NUCLEAR ONE
Unit 2

The margin to DNB incorporated in the core operating limits is typically established by the 4-pump loss of coolant flow event, the asymmetric steam generator transient (ASGT), full length Control Element Assembly (CEA) drop, and CEA withdrawal. The margin to fuel centerline melting is typically established by the initial linear heat rate used in the Loss of Coolant Accident (LOCA) analysis.

The range of core inlet temperatures and pressures permitted by the LCOs is determined by parametric analyses performed to determine the margin to DNB required by the loss of coolant flow events. As indicated in Section 15.1.3.2.2, the CEA misoperation events are not sensitive to variation in initial Reactor Coolant System (RCS) temperatures and pressures. The required margin is determined by the combinations of permitted inlet temperature and pressure which require the largest margin to DNB. This procedure ensures adequate margin to the DNB for all Anticipated Operational Occurrences (AOOs) since the LCO limit on DNB is based on the combined requirements of each of the limiting AOOs.

The range of values of each of the principal process variables that were considered in analyses of all events discussed in this chapter are listed in Table 15.1.0-6.

No credit is taken in the analysis for any automatic action, e.g., load demand reduction as safety limits are approached, which could normally mitigate the consequences of the transient.

The plant safety analysis is performed on the basis that the plant is operated within all limiting conditions for operation at the initiation of all events. One of these limiting conditions for operation is the specified required DNB margin.

The theoretical basis for a core operating limit on DNBR, i.e., the margin required to a DNBR representative of DNB, which varies as a function of axial shape index as given in Technical Specification 3.2.4 is explained by considering the principal parameters which determine the reduction in minimum DNBR during the design basis event which is the limiting AOO. The limiting AOO is the AOO producing the most rapid reduction of margin to DNB and is the 4-pump Loss of Reactor Coolant Flow (LOF) for Arkansas Nuclear One - Unit 2.

The rate of reduction of DNBR during a LOF and the time at which the minimum DNBR is reached are determined by the competing effects of a reduction of reactor coolant mass flow rate and a reduction of heat flux in the hot channel. The reduction of mass flow rate produces a reduction of DNBR. The rate of flow reduction is determined by the Reactor Coolant Pump (RCP) design and the RCS hydraulic parameters and is relatively insensitive to core power distribution. The reduction of heat flux produces retardation and eventual reversal of the reduction of DNBR. The rate of heat flux reduction is primarily determined by the rate of negative reactivity insertion into the core following a Reactor Trip (RT). The rate of negative reactivity insertion is determined by the CEA insertion rate and the core axial power distribution.

The more power there is in the upper half of the core, the faster is the rate of negative reactivity insertion. Thus, the rate of heat flux reduction is determined by the axial shape index which is defined as the ratio of the amount of power produced in the lower half of the core minus the amount of power produced in the upper half of the core divided by the total core power.

The effect of these opposing influences on reduction of DNBR during a LOF is illustrated schematically in Figure 15.1.0-2. The mass flow rate as a function of time is shown in Figure 15.1.0-2a. The heat flux as a function of time is shown in Figure 15.1.0-2b for two axial shapes illustrated in Figure 15.1.0-2c. The time of RT is assumed to be the same for both

ARKANSAS NUCLEAR ONE
Unit 2

shapes. The axial shape peaked in the upper half of the core, labeled U, produces a faster rate of heat flux reduction following trip than the shape peaked in the lower half of the core, labeled L. The minimum DNBR as a function of time is shown in Figure 15.1.0-2d for the two axial shapes illustrated in Figure 15.1.0-2c. The initial DNBR is assumed to be the same for both shapes for convenience of illustration. Beginning a LOF transient with the axial shape peaked in the upper half of the core results in less reduction of DNBR and an earlier minimum DNBR than with the shape peaked in the lower half of the core. This is because (1) the more rapid heat flux reduction after RT with shape U lessens the rate of reduction of DNBR and (2) the flow rate at any particular heat flux is greater with shape U. Hence, with shape U the minimum DNBR occurs sooner with a correspondingly higher reactor coolant flow rate and, thus, it has a greater value.

The core operating limit on DNBR is defined as the minimum DNBR which must be maintained to ensure that the reduction in DNBR during a 4-pump LOF will not produce a DNBR which is less than the Specified Acceptable Fuel Design Limit (SAFDL). Thus, referring to Figure 15.1.0-2, if the minimum DNBR during the LOF with shape L is the SAFDL, the initial DNBR is a core operating limit with shape L. Similarly, since the minimum DNBR during the LOF with shape U is greater than the SAFDL, the initial DNBR is not a core operating limit. Assuming for illustration that the reduction of DNBR during the LOF for a given axial power shape is independent of initial DNBR, the core operating limit with shape U equals the initial DNBR shown in Figure 15.1.0-2d minus the difference between the minimum DNBR shown for shape U and the SAFDL. The DNBR transient for shape U from its associated core operating limit, defined in this way, is shown by the curve labeled U' in Figure 15.1.0-2d.

The preceding discussion illustrates conceptually that the core operation limit on DNBR depends on axial power shape. Thus, using the axial shape index to characterize the axial power shape, the core operating limit on DNBR can be defined.

The method used to develop the correlation of the core operating limit on DNBR with axial shape index, as presented in Technical Specification 3.2.4, is discussed in this section.

The CE-1 Critical Heat Flux (CHF) correlation has been replaced with the WSSV-T and ABB-NV CHF correlations (Reference 58) due to the implementation of a full core of Next Generation Fuel (NGF). Cycle 21 is the first time application of a full core of NGF (Reference 57) and Optimized ZIRLO™ cladding (Reference 56).

15.1.0.2 Reactivity Coefficients

15.1.0.2.1 Doppler Coefficient

The Cycle 1 core average fuel temperature coefficient of reactivity (Doppler Coefficient) is shown in Figure 4.3-24 and is multiplied by a weighting factor to conservatively account for higher feedback effects in the higher power density portions of the core. The Doppler weighting factor, which is specified for each analysis, is 0.85 for cases where less Doppler feedback produces more adverse results and 1.15 or greater for cases where more Doppler feedback produces more adverse results. A similar set of data with uncertainty factors is generated for each core reload and evaluated with respect to the following analyses of record assumptions. Due to the changes in the Doppler coefficient over the years, various Doppler coefficient curves may be used in some of the following analyses. Figure 15.1.0-3 is a curve of more bounding Doppler data that is used in some of the following analyses (as noted in the specific analysis).

ARKANSAS NUCLEAR ONE
Unit 2

New Doppler coefficient curves were generated for Cycle 13 and subsequent cycles. Figure 15.1.0-4 represents the fuel temperature reactivity curves for BOC and EOC. These curves already include a 0.85 multiplier for uncertainty on BOC reactivity and a 1.4 multiplier for uncertainty on EOC reactivity. This curve has been used in some of the following analyses as specified in the specific analysis.

15.1.0.2.2 Moderator Temperature Coefficient

The range of moderator temperature coefficient of reactivity at Beginning of Cycle (BOC) operating conditions is $+0.5 \times 10^{-4} \Delta\rho/^\circ\text{F}$ to $-2.0 \times 10^{-4} \Delta\rho/^\circ\text{F}$ and the corresponding End of Cycle (EOC) conditions of $-3.4 \times 10^{-4} \Delta\rho/^\circ\text{F}$ for a power rating of 2815 MWt and $-3.8 \times 10^{-4} \Delta\rho/^\circ\text{F}$ for uprated power rating of 3026 MWt. Allowances are included in the preceding to account for: (1) changes from cycle to cycle; (2) changes in coefficient that might occur due to design changes; (3) changes in coefficient that might occur due to difference between design parameters and as-built parameters (such as shim loadings, enrichments, etc.); (4) any changes in parameters that might occur during a cycle; and, (5) calculational uncertainties or biases. In addition, the moderator coefficient varies with changes in coolant temperature and the inserted CEA worth. The most unfavorable value of the moderator coefficient is assumed for a particular analysis. A less limiting moderator temperature coefficient within the ranges defined above may be assumed in some of the following analyses. Such an assumption would be based on the cycle specific predictions and limits defined in the COLR.

15.1.0.2.3 Shutdown CEA Reactivity

The shutdown reactivity is dependent on the CEA worth available on Reactor Trip (RT), the axial power distribution, the position of the CEA Groups 1-6 and Group P, and the time in cycle life. The minimum total negative reactivity worth of the CEAs available for a RT at full power and zero power is assumed to be -5.4 percent $\Delta\rho$ and -2.4 percent $\Delta\rho$, respectively, for the Cycle 1 safety analyses. These values include the most reactive CEA stuck in the fully withdrawn position and the effects of cooldown to hot zero power temperature conditions. The full power value consists of -2.4 percent $\Delta\rho$ for shutdown and accident analysis allowance of -1.4 $\Delta\rho$ for fuel temperature variation from full power to hot standby. The actual cycle specific CEA worth may vary from cycle to cycle. Credit for greater worth on a cycle specific basis may be taken, as noted in some of the following analyses.

The shutdown worth versus position is calculated by assuming that the axial power distribution is peaked in the bottom half of the core and that the core is initially unrodded, i.e., all CEAs fully withdrawn. These assumptions are made (1) since the unrodded core allows the highest permissible axial peak to be used for the transient calculation; (2) since dropping CEAs into an initially unrodded core is more conservative in terms of the initial negative reactivity insertion during the transient; and, (3) since the higher the axial peak and the lower in the core it occurs, the lower the initial shutdown reactivity as the shutdown CEAs are inserted.

The shutdown reactivity worth versus position curve employed in the Section 15 Safety Analyses for Cycle 1 is shown in Figure 15.1.0-1A. This shutdown worth versus position curve was calculated assuming a more highly bottom peaked axial shape than is expected to occur during operation, including power maneuvering. Accordingly, it is a conservative representation of shutdown reactivity insertion rates for RTs which occur as a result of anticipated transients or accidents.

ARKANSAS NUCLEAR ONE
Unit 2

The shutdown reactivity versus position curves in Figure 15.1.0-1A were calculated using the static neutronic methods for the Cycle 1 safety analyses. In order to support the Technical Specification requirement of an increased CEA drop time (from 3.0 to 3.2 seconds) for Cycle 7, new shutdown reactivity versus position curves were calculated based on space time neutronic methods. These space time shutdown reactivity versus position curves remove some of the excess conservatism inherent in static neutronic methods. The HERMITE computer code was used for the space-time neutronic calculations.

The Cycle 7 space-time shutdown reactivity versus position curves for the minimum total negative reactivity of -5.4 and -2.4% $\Delta\rho$ are shown in Figure 15.0.1-1B for full power and zero power, respectively. Comparing to the Cycle 1 shutdown reactivity insertion in Figure 15.1.0-1A, Figure 15.1.0-1B shows more realistic but still conservative shutdown reactivity insertion.

Figure 15.1.0-1C presents normalized reactivity inserted with CEA position consistent with more recent cycle specific data used in some of the following analyses, as noted in the analysis. This curve is based on a +0.3 ASI. The CEA insertion curve assumed with Figure 15.1.0-1C utilizes a 0.6 second holding coil delay time and a 3.2 second arithmetic average drop time to 90% inserted. A maximum CEA drop time of up to 3.5 seconds to the 90% insertion limit with an arithmetic average drop time of 3.2 seconds has been justified using HERMITE space-time methods.

A new reactivity insertion curve was developed for the Cycle 13 and subsequent analyses. This new curve is presented in Figure 15.1.0-1D. The scram curve is based on an ASI of + 0.3. A CEA insertion curve consistent with Figure 15.1.0-1E utilizing a 0.6 second holding coil delay time and a 3.2 second arithmetic average drop time to 90% inserted was assumed. A shutdown worth of 5% $\Delta\rho$ is incorporated into Figure 15.1.0-1D. Figure 15.1.0-1D and 15.1.0-1E have been used in the following analyses as specified in the analysis.

The individual CEA drop time limit was increased to a maximum of 3.7 seconds for Cycle 20 when the Next Generation Fuel design was implemented. The limit for the average for all the CEA drop times did not change. Engineering evaluations illustrate that increasing the drop time limit for individual CEAs, while maintaining the average drop time limit, will not result in actual "fission power versus time during a scram" being non-conservative with respect to what is currently assumed in the safety analyses.

15.1.0.3 Effective Delayed Neutron Fraction

The effective neutron lifetime and delayed neutron fraction are functions of fuel burnup. For each analysis, one of the following values of the neutron lifetime and the delayed neutron fraction is selected, depending upon the time in life analyzed. The first set of data was used in the Cycle 1 analyses. Subsequent analyses have used the second set of data unless indicated differently in the analysis.

	<u>Neutron Lifetime (10^{-6} sec.)</u>	<u>Delayed Neutron Fraction</u>
Beginning of Cycle	30.5	0.00713
End of Cycle	31.1	0.00497
Beginning of Cycle	15.0	0.00725
End of Cycle	33.7	0.00443

ARKANSAS NUCLEAR ONE
Unit 2

A new set of data was developed for the Cycle 13 and subsequent analyses. All of the Cycle 13 and subsequent analyses use the following data unless indicated differently in the analysis.

	<u>Neutron Lifetime (10^{-6} sec.)</u>	<u>Delayed Neutron Fraction</u>
Beginning of Cycle	13	0.007252
End of Cycle	36	0.004341

15.1.0.4 Reactor Protective System Trips and Engineered Safety Features Response Times

15.1.0.4.1 Reactor Protective System Trips

Table 15.1.0-1 lists the assumed Reactor Protective System (RPS) trip setpoints and the trip delay time associated with each trip utilized in the analyses. Some of the following analyses may use more conservative analysis setpoints and trip delay times than those noted in Table 15.1.0-1. No credit was taken in the analyses for those channels with response times indicated as not applicable.

The analyses of the accidents take into consideration the response times of actuated devices after the trip setting is reached. The elapsed time between the time when the setpoint condition exists at the sensor and the time when the trip breakers are open is defined as the trip delay time, as shown in Table 15.1.0-1. The following CEA drop time was assumed up to Cycle 7 analysis efforts. The interval between trip breaker opening and the time at which the magnetic flux of the CEA holding coils has decayed enough to allow CEA motion is conservatively assumed to be 0.3 seconds. Finally, a conservative value of 2.7 seconds is assumed for CEA insertion, defined as the elapsed time from the beginning of CEA motion to the time of 90 percent insertion of the CEAs in the reactor core. As indicated above in Section 15.1.0.2.3, this quicker drop time than that used in more recent analysis efforts was evaluated to be acceptable.

An arithmetic average of the CEA drop times of all CEAs of 3.2 seconds to 90% insertion is the current analysis limit. Of the 3.2 seconds, 0.6 seconds is attributed to the holding coils. For example, the total time from the occurrence of a high linear power level condition at the sensor until the CEAs reach the 90 percent insertion position is 3.6 seconds, i.e., 0.4 second for trip delay, plus 0.6 second for CEA holding coil flux decay, plus 2.6 seconds for CEAs to reach 90 percent insertion position.

The trip delay times shown in Table 15.1.0-1 are divided, for test purposes, into sensor delay time and Plant Protection System (PPS) delay time. Sensor delay time is defined as the elapsed time between the time the condition exists at the sensor until the sensor output signal reaches the trip setpoint. This time is determined by manufacturer's tests on typical sensor models. The PPS delay time is defined as the elapsed time between the input signal reaching the trip setpoint until the trip circuit breakers open. This time is determined during the preoperational test of the PPS. For the Reactor Protective System Trips listed in Table 15.1.0-1, the delay time can also be defined as the time interval from when the monitored parameter exceeds its trip setpoint at the channel sensor until electrical power is interrupted to the CEA drive mechanism. The sum of the sensor delay time and the PPS delay time must be less than or equal to the appropriate value listed in Table 15.1.0-1.

ARKANSAS NUCLEAR ONE
Unit 2

RTD response time is defined as the time interval required for the RTD output to achieve 63.2% of its total change when subjected to a step change in RTD temperature. The RTD response time for the Core Protection Calculator System (CPCS) is expressed as an effective time constant. For hot leg temperatures, the effective time constant for a given CPC channel is defined as the mean time constant for averaged pairs of hot leg RTD inputs to the channel. This is done because the CPCS utilizes the mean hot leg temperature in its calculations. The maximum hot leg effective time constant allowable for use in the CPCS is 13.0 seconds. For cold leg temperatures, the effective time constant is the maximum time constant of the two cold leg RTD inputs for a given channel. The CPCS utilizes the more conservative cold leg temperature in the various DNBR and LPD calculations. The maximum cold leg effective time constant allowable for use in the CPCS is 8.0 seconds.

15.1.0.4.2 Engineered Safety Features Response Times

The minimum response times of Engineered Safety Features functions assumed in the safety analyses are listed in Table 15.1.0-7. (More conservative response time assumptions may be used in some analyses.) The response times for the functions are given for each initiating signal that actuates the function. No credit was taken in the analyses for those channels with response times indicated as not applicable.

The Engineered Safety Features Response Times are defined as the time interval from when the monitored parameter exceeds its ESF actuation setpoint at the channel sensor until the ESF equipment is capable of performing its safety function (i.e., the valves travel to their required positions, pump discharge pressures reach their required values, etc.). Times include diesel generator starting and sequence loading delays where applicable.

15.1.0.5 Radiological Parameters

15.1.0.5.1 Secondary Side Activity

Several of the accidents discussed are accompanied by atmospheric release of steam. However, the radioactivity due to primary-to-secondary leakage is much greater than the radioactivity pre-existing in the main steam system, such that only the dose results of a main steam line break (MSLB) may be significantly affected by secondary side activity.

To assess the radiological consequences of a MSLB, the pre-existing fission product inventory in the main steam system is determined based on the maximum allowable concentration specified in the plant Technical Specifications (TSs). Table 15.1.0-2A provides the secondary side activity (i.e. secondary coolant source term) used in the MSLB radiological analyses.

15.1.0.5.2 Dose Model Assumptions

In order to determine the doses resulting from plant accidents, a five percentile criterion is used to determine atmospheric dispersion characteristics. The criterion is selected as being conservative on the basis that it represents unusually severe conditions. The actual conditions may be more severe only five percent of the time and less severe the remaining 95 percent of the time.

The following assumptions are basic to the radioactivity dose models.

ARKANSAS NUCLEAR ONE
Unit 2

- A. Direct radiation from the source point is negligible compared to whole body radiation due to submersion in the radioactive materials cloud.
- B. All radioactivity releases are treated as ground level releases regardless of the point of discharge.
- C. The dose receptor is a standard man and dose conversion factors (DCFs) are from Federal Guidance Reports (FGR) Nos. 11 and 12.
- D. Radioactive decay from the point of release to the dose receptor is neglected.

The DCF and breathing rate data are given in Tables 15.1.0-3 and 15.1.0-4. The atmospheric dilution factors used in the analysis of the environmental consequences of accidents are given in Table 15.1.0-5 for all offsite doses and in Table 15.1.13-1 for LOCA control room doses. The atmospheric dilution factors for control room dose analyses of other events are provided in Reference 25.

15.1.0.5.3 REMOVED – HISTORICAL INFORMATION

15.1.0.5.4 TEDE Dose

The total effective dose equivalent (TEDE) dose delivered to a dose receptor is obtained by considering the dose receptor to be immersed in a cloud containing radioactive material that is infinite in all directions above the ground plant, i.e., semi-infinite cloud. The concentration of radioactive material within this cloud is uniform and equal to the maximum centerline ground level concentration that would exist in the cloud at the approximate distance from the point of release.

15.1.0.5.5 Analysis to Support Replacement Steam Generator and Power Uprate

A radiological analysis was performed to support replacement steam generators and power uprate. The following inputs and assumptions used in this analysis differed from those of previous analyses. These differences were merely more conservative analysis assumptions.

- A. A constant secondary side activity equal to 0.1 $\mu\text{Ci/g}$ DEQ I-131;
- B. A constant primary side activity equal to 1.0 $\mu\text{Ci/g}$ DEQ I-131;
- C. A constant primary side noble gas activity of $100/E_{\text{bar}}$ $\mu\text{Ci/g}$ for non-fuel failure analyses, where E_{bar} is defined as the average of the sum of the average beta and gamma energies per disintegration (in MeV) for isotopes other than iodines;
- D. RCS activity for fuel failure analyses was based on ORIGEN2 generated pin activities;
- E. A continuous primary to secondary leak rate of 150 gallons per day per steam generator, except for events which result in a significant primary to secondary pressure differential (main steam line breaks and main feedwater line breaks) which use 0.5 gallons per minute;
- F. An activity discharged through steaming determined by a time dependent mathematical model;
- G. Isotopic data given by Tables 15.1.0-3A and B;

ARKANSAS NUCLEAR ONE
Unit 2

H. Whole Body dose consequences defined by:

$$D_{wb} = (X/Q) \times \sum_j A_j \times DCF_j$$

where

D_{wb} = Whole body dose (rem)

A_j = Activity release of isotope j (Ci), for all isotopes

DCF_j = Whole Body Dose Conversion Factor isotope j (rem-m³/s-Ci)

(X/Q) = Atmospheric dilution (s/m³) from Table 15.1.0-5

ICRP-2 values for the DCF were used for events without fuel failure. These values are given in Table 15.1.0-3B. For these events, the DCF_j were calculated by:

$$DCF_j = DCF_{\gamma j} + DCF_{\beta j}$$

ICRP-30 values for the DCF_j were used for events with fuel failure. These values are given in Table 15.1.0-3A.

I. Thyroid dose consequences defined by:

$$D_{Thyroid} = (X/Q) \times B \times \sum_i A_{I,i} \times DCF_{I,i}$$

where

$D_{Thyroid}$ = Thyroid dose (rem)

$A_{I,i}$ = Activity release of Iodine isotope i (Ci)

$DCF_{I,i}$ = Thyroid Dose Conversion Factor for Iodine Isotope i (rem-m³/s-Ci)

B = Breathing Rate (m³/s) from Table 15.1.0-4

(X/Q) = Atmospheric dilution (s/m³) from Table 15.1.0-5

ICRP-2 values for the DCF_{I,i} were used for events without fuel failure.

ICRP-30 values for the DCF_{I,i} were used for events with fuel failure.

J. Iodine Release from the Steam Generators was determined by:

For events that result in steam generator dryout, all of the iodine activity of the dry steam generator is released.

For the Steam Generator Tube Rupture (SGTR) event, all of the iodine contained in the fraction of the primary coolant that flashes to steam is released.

For all other events, an iodine partition factor of 100 is assumed.

ARKANSAS NUCLEAR ONE
Unit 2

- K. For iodine spiking considerations in the MSLB event and SGTR event, a pre-existing spike of 60 times the normal, and an event generated spike with a spiking factor of 500 assuming normal operation with one charging pump running;
- L. A core power of 3087 MWt;
- M. The Exclusion Area Boundary (EAB) doses are based on a 2 hour release (approximately 670,000 lbm). The Low Population Zone (LPZ) doses are based on an 8 hour cooldown to shutdown cooling entry conditions (approximately 1,770,000 lbm). Offsite releases are assumed to cease upon initiation of shutdown cooling.

15.1.0.5.6 Adoption of Alternate Source Term Methodology

A complete set of radiological analyses that use the alternate source term methodology of NRC Regulatory Guide 1.183 were performed to support an increase in allowed control room unfiltered air inleakage and to remove the previous ECCS pump seal passive failure assumption. The following is a partial list of inputs and assumptions used in the new analyses that differ from those listed in Section 15.1.0.5.5. The differences are typically the result of differences in the methodology.

- A. The TEDE acceptance criterion of 10 CFR 50.67(b)(2) replaced the previous whole body and thyroid dose guidelines of 10 CFR 100.11.
- B. ICRP-2 and ICRP-30 DCF values are no longer used. DCFs for inhalation and submersion were taken from Federal Guidance Reports (FGR) Nos. 11 and 12, respectively.
- C. The primary side noble gas activity of $100/E_{\text{bar}}$ $\mu\text{Ci/g}$ for non-fuel failure analyses was replaced by assumed concentrations of each noble gas isotope possibly present during normal operation. Note: The assumed concentrations were then converted into a dose equivalent Xe-133, which then replaced $100/E_{\text{bar}}$ $\mu\text{Ci/g}$ in the plant TSs. These activities are now shown in Table 15.1.0-2A.
- D. The ORIGEN-generated pin activities were revised to accommodate potential future variations in reload fuel designs. These activities are now shown in Table 15.1.0-2B.
- E. Main feedwater line break (MFLB) dose consequences are no longer calculated, since the MSLB dose consequences would be bounding.
- F. For iodine spiking considerations in the SGTR event, an event-generated iodine spike of 335 times the maximum TS allowed RCS iodine activity was assumed.
- G. Releases following a MSLB event were assumed to terminate when the RCS temperature reached 212 °F.

15.1.0.6 Computer Programs

The computer programs for the analyses in this chapter are described below. The input data used in the execution of these programs is consistent with the plant design and the plant operating limits described previously.

ARKANSAS NUCLEAR ONE
Unit 2

15.1.0.6.1 CESEC

The CESEC computer program is used to simulate the NSSS. This program is described in References 7 and 13.

CESEC computes key system parameters during a transient including core heat flux, pressures, temperatures, and valve actions. Symmetric and asymmetric plant responses over a wide range of operating conditions can be determined by CESEC. The following is a partial list of the dynamic functions included in this NSSS simulation:

- point kinetics
- doppler and moderator reactivity feedback
- boron and CEA reactivity effects
- multi-node average and hot channel reactor core thermal hydraulics
- reactor coolant pressurization and mass transport
- Reactor Coolant System safety valve behavior
- steam generation
- steam generator water level
- main steam bypass
- secondary safety and turbine valve behavior (and alarms)
- control system functions
- protective system functions
- engineered safety feature system functions

The turbine and its associated controls are not included in the simulation. Steam generator feedwater enthalpy and flowrate are provided as input to CESEC.

During execution, CESEC obtains steady-state and transient solutions to the set of equations that mathematically models the NSSS dynamic functions mentioned above. Simultaneous numerical integration of a set of nonlinear, first-order ordinary differential equations with time-varying coefficients is carried out by means of a predictor corrector Runge-Kutta scheme. As the time variable evolves, edits of the principle system parameters are printed at specified intervals. An extensive library of the thermodynamic properties of uranium dioxide, water and zircaloy is incorporated into this program.

15.1.0.6.2 CHIC-KIN

The CHIC-KIN code is described in WAPD-TM-479, J. A. Redfield, "CHIC-KIN - A Fortran Program for Intermediate and Fast Transients in a Water Moderated Reactor," January 1965. The use of this code is described in Section 15.1.20.

15.1.0.6.3 TWIGL

The TWIGL Program is described in WAPD-TM-743, J. B. Yasinsky, M. Natelson and L. A. Hageman, "TWIGL - A Program to Solve the Two-Dimensional Two Group, Space-Time Neutron Diffusion Equations with Temperature Feedback," February 1968. Use of the code is described in Section 15.1.20.

ARKANSAS NUCLEAR ONE
Unit 2

15.1.0.6.4 COAST

The COAST code analyzes reactor coolant flow under any combination of active and inactive pumps in a 2-loop, 4-pump plant. The equation of conservation of momentum is written for each of the seven flow segments of the model assuming unsteady one-dimensional flow of an incompressible fluid. The equation of conservation of mass is written for the appropriate nodal points. Pressure losses due to friction, bend and shock losses are assumed proportional to the flow velocity squared. Pump dynamics are modeled with the aid of the head-flow curve for fully operational pumps and by four quadrant curves, which are parametric diagrams of pump head and torque on coordinates of speed versus flow.

Calculations using this code have been made for the Palisades plant (Docket No. 50-255). Subsequently, the flows have been measured during the test program at Palisades. The comparison of predicted and test data has demonstrated the accuracy of the CE calculational model. The model, input parameters, and the experimental basis for parameter selection for the COAST computer program have been described in CENPD-98 (Reference 1).

15.1.0.6.5 REMOVED – HISTORICAL INFORMATION

15.1.0.6.6 RADTRAD

RADTRAD estimates the radiological doses at offsite locations and in the control room of nuclear power plants as consequences of postulated accidents. The code considers the timing, physical form (i.e., vapor or aerosol) and chemical species of the radioactive material released into the environment.

15.1.0.6.7 STRIKIN-II

The STRIKIN-II computer program is used to simulate the heat conduction within a reactor fuel rod and its associated surface heat transfer. The STRIKIN-II program is described in Reference 20.

The STRIKIN-II computer program provides a single, or dual, closed channel model of a core flow channel to calculate the clad and fuel temperatures for an average or hot cylindrical fuel rod, and the extent of the zirconium water reaction for that fuel rod. STRIKIN-II includes.

- A. Incorporation of all major reactivity feedback mechanisms
- B. A maximum of six delayed neutron groups
- C. Both axial (maximum of 20) and radial (maximum of 20) segmentation of the fuel element
- D. CEA trip initiation on high neutron power

15.1.0.6.8 TORC AND CETOP

The TORC and CETOP computer programs are used to simulate the fluid conditions within the reactor core and to predict the existence of DNB on the fuel rods. The TORC program is described in Section 4.4. The CETOP computer program is also described in Section 4.4 and in Reference 21.

ARKANSAS NUCLEAR ONE
Unit 2

15.1.0.6.9 HERMITE

The HERMITE space-time kinetics computer code is used for the analysis of transients by means of numerical solution to the multi-dimensional, few-group, time-dependent neutron diffusion equation including feedback effects of fuel temperature, coolant temperature, coolant density and control rod motion. The time-dependent neutron diffusion equation is solved by a finite element method. The heat conduction equation in the pellet, gap and clad is solved by a finite difference method. Continuity and energy conservation equations are solved for the coolant enthalpy and density. Further information on HERMITE is found in Reference 23.

15.1.0.6.10 CENTS

CENTS is an interactive, high fidelity computer code for simulation of the Nuclear Steam Supply System (NSSS) components. It calculates the transient behavior of a PWR for normal and abnormal conditions including accidents. CENTS determines the core power and heat transfer throughout the NSSS. It also computes the thermal and hydraulic behavior of the reactor coolant in the primary and secondary systems. Primary and secondary thermal-hydraulic behavior is calculated with detailed multi-node and flowpath models. It includes the primary and secondary control systems and the balance-of-plant fluid systems.

CENTS incorporates a number of features that enhance its usefulness. First-principle models provide a high degree of fidelity and flexibility. Use of nonequilibrium, nonhomogeneous models allows a full range of fluid conditions to be represented, including forced circulation, natural circulation, and coolant voiding. The code simulates a wide range of variations in plant state from steady state conditions to severe accidents. It provides a full range of interactions between the analyst, the reactor control systems and the NSSS. Further information on CENTS can be found in Reference 24.

15.1.0.6.11 ARCON96

ARCON96 is an atmospheric dispersion code intended for use in control room habitability assessments. The code uses hourly meteorological data and refined methods for estimating dispersion in the vicinity of buildings to calculate relative concentrations at control room air intakes that would be exceeded no more than 5% of the time. These calculations are calculated for averaging periods ranging from one hour to 30 days in duration. The ARCON96 program is described in Reference 51.

15.1.0.6.12 ORIGEN-S

ORIGEN-S is a computer code system for calculating buildup, decay, and processing of radioactive materials. ORIGEN-S is a revised version of ORIGEN and incorporates updates of the reactor models, cross sections, fission product yields, decay data, and decay photon data as well as the source code. The ORIGEN-S program is described in Reference 52.

15.1.1 UNCONTROLLED CONTROL ELEMENT ASSEMBLY WITHDRAWAL FROM A SUBCRITICAL CONDITION

15.1.1.1 Identification of Causes

The withdrawal of CEAs from subcritical conditions (less than 10^{-4} percent power) adds reactivity to the reactor core, causing both the core power level and the core heat flux to increase. Since the transient is initiated at low power levels, the normal reactor feedback mechanisms, moderator feedback, and Doppler feedback do not occur until power generation in the core is large enough to cause changes in the fuel and moderator temperatures. The RPS is designed to prevent such a transient from resulting in a minimum DNBR less than 1.25 (CE-1 Correlation) or 1.23 (WSSV-T /ABB NV Correlations) by a high logarithmic power level reactor trip. The high linear power level trip, the CPC variable overpower trip (VOPT), the high local power density trip, and the low DNBR trip provide backup protection while the high pressurizer pressure trip provides protection for the Reactor Coolant Pressure Boundary (RCPB).

A continuous withdrawal of CEAs could result from a malfunction in the Control Element Drive Mechanism Control System (CEDMCS) or by operator error.

Startup of the reactor involves a planned sequence of events during which certain CEA groups are withdrawn, at a controlled rate and in a prescribed order, to increase the core reactivity gradually from subcritical to critical. To ensure that rapid shutdown by CEAs is always possible when the reactor is critical or near critical, Technical Specifications require that specified groups of CEAs be withdrawn before reaching criticality. These groups of assemblies combined with soluble boron concentration will have a total negative reactivity worth that is sufficient to provide at least the Technical Specification required shutdown margin at the hot standby condition, with the most reactive CEA of the groups assumed to remain in the fully withdrawn position. Once criticality has been achieved, the control groups are withdrawn in a programmed sequence as discussed in Section 7.7.

In order to ensure the SAFDLs and the RCS pressure boundary limits are not exceeded, the following criteria was ensured for this event:

- RCS pressure less than 2750 psia (i.e., 110% of the 2500 psia design pressure),
- Minimum DNBR greater than or equal to 1.25 (CE-1 Correlation) or 1.23 (WSSV-T /ABB NV Correlations), and
- Fuel centerline temperatures are below those corresponding to fuel centerline melting.

15.1.1.2 Analysis of Effects and Consequences

15.1.1.2.1 Method of Analysis

The subcritical CEA withdrawal is analyzed as a CEA withdrawal initiated at the source power level. In addition to the parameters described in Section 15.1.0, Table 15.1.1-1 lists the conservative assumptions made for this analysis. The key parameters for the transient analysis are the reactivity addition rate due to rod motion, moderator temperature feedback effects, and initial axial power distribution. The input values selected maximize the power increase and thus the margin degradation.

ARKANSAS NUCLEAR ONE
Unit 2

15.1.1.2.2 Results

Table 15.1.1-2 list the reactivity control and RPS responses for the case analyzed. Figures 15.1.1-1 through 15.1.1-4 present the corresponding transient behavior of core power, core average heat flux, RCS pressure, and the RCS coolant temperatures. This transient results in a minimum DNBR greater than 1.25 (CE-1 Correlation) or 1.23 (WSSV-T /ABB NV Correlations). Also, the analysis shows that the fuel centerline temperatures are well below those corresponding to the fuel centerline melt limit.

15.1.1.3 Conclusion

As shown by the analysis, the high logarithmic power level trip affords the required protection such that specified acceptable fuel design limits are not exceeded.

15.1.1.4 Subsequent Analyses

15.1.1.4.1 Cycle 12 CEA Withdrawal From Subcritical Conditions

Two separate bank subcritical CEA withdrawal events were analyzed for Cycle 12 using CESEC-III. CETOP was used to perform the DNB calculations. The first case is the withdrawal of Bank B with Bank A already withdrawn. The second case is the withdrawal of Bank P with Banks A and B already withdrawn. These analyses were performed essentially consistent with the analysis described above using the inputs from Table 15.1.1-3 and Section 15.1.0 with the following assumptions:

- A. A high logarithmic power trip setpoint of 4% of full power was assumed.
- B. A steam generator tube plugging limit of 15% was modeled.
- C. CEA scram worth was not credited on trip, rather, a CEA coil decay time of 0.6 seconds was assumed followed by negative reactivity proportionate to the CEA position post trip. (A 0.6 second delay after the trip breakers open is assumed prior to the CEAs beginning to drop into the core.) Reactivity is held constant for the 0.6 second delay time. After the 0.6 second delay, negative reactivity is reinserted at the same rate of the positive insertion relative to the rod position, up to the total positive reactivity added. The CEA position versus time post trip is consistent with Figure 15.1.0-1C.
- D. The BOC Doppler curve in Figure 15.1.0-3 with a 0.85 multiplier is conservatively used.
- E. The amount of initial subcriticality assumed is large enough to compensate for the worth of the withdrawn CEAs.

The high logarithmic power trip function is only credited at low power levels; however, the logarithmic channel instrument calibration is routinely performed at 100% power. To account for the total decalibration under these conditions, including drift, processing uncertainties and an allowance for power distribution changes during the cycle, an analytical trip setpoint of 4% rated power is assumed.

ARKANSAS NUCLEAR ONE
Unit 2

At power levels below 10^{-4} % power, the CPCs are bypassed prior to the trip matrix relays. With this bypass in place, the trip matrix is presented with a no-trip condition for the CPCs even if the CPCs are tripped or are unpowered (or otherwise inoperable). This bypass permits the CEDMs to be powered even if the CPCs are in a 'tripped' condition. The CPC operating bypass is present at highly subcritical conditions and is automatically removed at 10^{-4} % rated power during power escalation. This removal of the CPC operating bypass is performed via a bistable from the Logarithmic Power channels.

The power level, as indicated by the Logarithmic Power Level channels, is increasing as criticality is approached during a CEAW event. Actual criticality occurs at a power level of $\sim 10^{-5}$ % of rated. The postulated CEAW continues the power increase until, at a power level of 10^{-4} % of rated power, the CPC operating bypass is automatically removed.

Protective action will result by either the removal of the CPC operating bypass or by action of the High Logarithmic Power Trip. Since two equipment trip functions effectively exist for this event, the most conservative (0.75% power) is used to determine the consequences and the lower (10^{-4} % power) is used to define the set of conditions for which equipment decalibration must be assessed. The initial conditions for the evaluation of the decalibration of the High Logarithmic Power Trip function are limited as follows:

- A. RCS inlet temperature > 495 °F
- B. CEA shadowing of shutdown banks excluded
- C. Only four pump operation considered

These conditions satisfy the CPC range checks and would result in a no-trip condition when, at 10^{-4} % power, the CPC operating bypass is removed. Such conditions would require the High Logarithmic Power trip function to terminate this event.

Amendment 196 to Facility Operating License revised the requirements for the CPC operating bypass. Automatic bypass removal occurs prior to exceeding 10^{-2} % power and manual initiation of the operating bypass is permitted below 10^{-2} % Power. The revised operating range does not impact the conditions for decalibration or the decalibration factor used in the analysis described above.

The results from this analysis are bounded by those given above. A peak power level of 24% and 87% of full power, a peak heat flux of 7% and 26% full power, a minimum DNBR of 8.1 and 2.1, a peak linear heat rate of 13.2 kW/ft and centerline melt temperature of 1670 °F, and a peak RCS pressure of 2022 psia and 2062 psia for the Bank B and Bank P withdrawal respectively have been calculated for this analysis.

15.1.1.4.2 Cycle 13 CEA Withdrawal From Subcritical Conditions

The CEA withdrawal from subcritical conditions was analyzed for Cycle 13 using CENTS and CETOP computer codes. CENTS is described in Section 15.1.0.6.10. Two reactivity addition rates were considered for Cycle 13, $0.00025 \Delta\rho/\text{sec}$ and $0.0002 \Delta\rho/\text{sec}$. These reactivity addition rates are consistent with the maximum addition rates expected for bank withdrawals near critical conditions. Only bank withdrawals which will result in critical conditions are considered for this event. The inputs used in these analyses are provided in Table 15.1.1-4 and Section 15.1.0 with the following assumptions:

ARKANSAS NUCLEAR ONE
Unit 2

- A. A steam generator tube plugging limit of 30% was modeled.
- B. CEA scram worth was not credited on trip, rather a CEA coil decay time of 0.6 seconds was assumed followed by negative reactivity proportionate to the CEA position post trip. Reactivity is held constant for the 0.6 second delay time. After the 0.6 second delay, negative reactivity is reinserted at the same rate of the positive insertion relative to the rod position, up to the total positive reactivity added. The CEA position versus time post trip is consistent with Figure 15.1.0-1C.
- C. The BOC Doppler curve of Figure 15.1.0-4, which includes a 0.85 multiplier, is conservatively used.
- D. The Cycle 13 EOC delayed neutron fraction and effective neutron lifetime consistent with Section 15.1.0.3 was assumed.

The sequence of events for these transients is provided in Tables 15.1.1-5 and 15.1.1-6. The maximum fuel centerline temperature is less than 2800 °F. The results from these analyses are bounded by those given above. The conclusions of Section 15.1.1.3 remain the same: the SAFDLs and the RCS pressure boundary limits are not violated.

15.1.1.4.3 Cycle 16 CEA Withdrawal from Subcritical Conditions

The CEA Withdrawal from Subcritical conditions was analyzed for Cycle 16 using CENTS computer code for the transient analysis simulation and CETOP computer code for the minimum DNBR evaluation.

Two reactivity addition rates were considered for Cycle 16, 0.00025 $\Delta\rho/\text{sec}$ and 0.0002 $\Delta\rho/\text{sec}$. These reactivity addition rates are consistent with the maximum addition rates expected for bank withdrawals near critical conditions. Only bank withdrawals which will result in critical conditions are considered for this event. Operating procedures are credited to ensure greater than critical boron concentration is maintained whenever the CEDMCS are energized. Procedural controls on rod withdrawal sequences limit the potential inadvertent bank withdrawal which could result in critical core condition.

Input parameters from Table 15.1.1-7 and the core physics data from Section 15.1.0 have been incorporated in this analysis with the following clarifications:

- A. The BOC Doppler curve of Figure 15.1.0-4 is conservatively used.
- B. An EOC delayed neutron fraction and effective neutron lifetime consistent with Section 15.1.0.3 was assumed.
- C. CEA scram worth was not credited on trip, rather a CEA coil decay time of 0.6 seconds was assumed followed by negative reactivity proportionate to the CEA position post trip. Reactivity is held constant for the 0.6 second delay time. After the 0.6 second delay, negative reactivity is reinserted at the same rate of the positive insertion relative to the rod position, up to the total positive reactivity added. The CEA position versus time post trip is consistent with Figure 15.1.0-1E.
- D. A high logarithmic power level trip setpoint of 4% and a response time of 0.4 seconds were assumed.

ARKANSAS NUCLEAR ONE
Unit 2

- E. An initial power of 9.63×10^{-7} MWt was assumed.
- F. Installation of the Replacement Steam Generators (RSGs) was assumed.
- G. Parametric analyses were performed on the number of plugged U-tubes per steam generator. It was determined that 10% plugged U-tubes per steam generator was slightly more limiting.

The sequence of events for these transients is provided in Tables 15.1.1-8 and 15.1.1-9. Figures 15.1.1-5 through 15.1.1-8 present the transient response of key parameters for the 0.00025 $\Delta\rho$ /sec case. The maximum fuel centerline temperature is well below centerline melt. The conclusions of Section 15.1.1.3 that the SAFDLs and the RCS pressure boundary limits are not violated, remain the same.

15.1.1.4.4 Cycle 20 CEA Withdrawal from Subcritical Conditions

The CEA Withdrawal from Subcritical conditions was analyzed for Cycle 20 using the CETOP computer code for the minimum DNBR evaluation.

The implementation of a half core of Next Generation Fuel (NGF) resulted in an increase in core flow area and a decrease in fuel mass. The increase in core flow area resulted in a decrease in core mass flux. No CENTS cases were repeated as all other current input parameters in Table 15.1.1-7 remained unchanged. Both the 0.00025 $\Delta\rho$ /second and 0.0002 $\Delta\rho$ /second cases' minimum DNBRs and centerline melt values were re-evaluated.

The half core of NGF resulted in a very small decrease in core mass flux compared to Cycle 16. This decrease was offset by crediting margin between the cycle-specific hot full power heat flux and the bounding hot full power heat flux used for Cycle 16. Consequently, the mDNBR values remain above the CE-1 DNB SAFDL of 1.25 as delineated in Tables 15.1.1-8 and 15.1.1-9.

The Cycle 16 centerline melt analysis used a Total Nuclear Heat flux Factor of 9.5 to bound the values reported in Table 15.1.1-7. The decrease in core fuel mass was offset by reducing the Total Nuclear Heat Flux Factor down to the Table 15.1.1-7 values. Hence, the maximum fuel centerline temperature is well below centerline melt.

Based on the evaluation above, the SAFDLs are not violated. As no CENTS cases were repeated the RCS pressure boundary limits are not violated. Consequently, the conclusions in SAR Section 15.1.1.3 for the SAFDLs and the RCS pressure boundary limits remain the same.

15.1.1.4.5 Cycle 21 CEA Withdrawal from Subcritical Conditions

The CEA Withdrawal from Subcritical conditions was analyzed for Cycle 21 using the CETOP computer code and the WSSV-T and ABB-NV critical heat flux correlations for the minimum DNBR evaluation.

The implementation of a full core of Next Generation Fuel (NGF) resulted in an increase in core flow area and a decrease in fuel mass. The increase in core flow area resulted in a decrease in core mass flux. No CENTS cases were repeated, as all other current input parameters in Table 15.1.1-7 remained unchanged. Both the 0.00025 $\Delta\rho$ /second and 0.0002 $\Delta\rho$ /sec cases minimum DNBRs and centerline melt values were evaluated.

ARKANSAS NUCLEAR ONE
Unit 2

The full core of NGF resulted in a very small decrease in core mass flux from Cycle 20. The mDNBRs for these two reactivity insertion rate (RIR) events were re-evaluated using the WSSV-T and ABB-NV critical heat flux correlations, the CENTS input from Cycle 16, and the lower core mass flux. The mDNBR values were larger than the WSSV-T / ABB-NV SAFDL of 1.23. Tables 15.1.1-8 and 15.1.1-9 have been revised for NGF to include the WSSV-T / ABB-NV CHF correlations and a 1.23 DNB SAFDL.

The Cycle 16 centerline melt analysis used a Total Nuclear Heat Flux Factor of 9.5 to bound the values reported in Table 15.1.1-7. The decrease in core fuel mass was offset by reducing the Total Nuclear Heat Flux Factor down to the Table 15.1.1-7 values. Hence, the maximum fuel centerline temperature is well below centerline melt.

Based on the evaluation above, the SAFDLs are not violated. As no CENTS cases were repeated, the RCS pressure boundary limits are not violated. Consequently, the conclusions in SAR Section 15.1.1.3 for the SAFDLs and the RCS pressure boundary limits remain the same.

15.1.2 UNCONTROLLED CEA WITHDRAWAL FROM CRITICAL CONDITIONS

15.1.2.1 Identification of Causes

The withdrawal of CEAs from a critical condition (greater than 10^{-4} percent power) adds reactivity to the reactor core, causing the core power level to increase. A continuous withdrawal of CEAs could result from a malfunction in the CEDMCS or by operator error.

No failure which can cause CEA withdrawal or insertion can prevent the insertion of CEAs upon receipt of any protective system reactor trip signal.

In the event of inadvertent CEA withdrawal, the RPS and pressurizer safety valves assure applicable safety limits are not exceeded as follows:

- A. The low DNBR trip assures a minimum DNBR of 1.25 (CE-1 Correlation) or 1.23 (WSSV-T / ABB NV Correlations) is not violated.
- B. The high local power density trip assures that the kW/ft value corresponding to fuel centerline melting safety limit is not exceeded.
- C. The high pressurizer pressure trip, in conjunction with the pressurizer safety valves, assures the 110 percent of 2,500 psia reactor coolant pressure safety limit is not violated.
- D. The low steam generator water level trip and automatic emergency feedwater initiation assure against the loss of steam generator heat removal capability.

The CPC DNBR trip based on the Variable Overpower Trip (VOPT) setpoints in CPCs also provides protection to ensure the SAFDLs are not exceeded.

15.1.2.2 Analysis of Effects and Consequences

15.1.2.2.1 Method of Analysis

The uncontrolled CEA withdrawal was analyzed with the CESEC computer program described in Section 15.1.0. In addition to the parameters described in Section 15.1.0, Tables 15.1.2-1 and 15.1.2-2 list the conservative assumptions made for this analysis.

The regulating CEA groups (Groups 1 through 5) are programmed for withdrawal in a specified sequence having a predetermined group overlap. Reactivity addition by withdrawal of CEA groups is dependent on the initial position of the groups prior to the withdrawal and on the integral worth of the groups.

Analyses have shown that the most adverse results for the CEA withdrawal events occur with the maximum reactivity addition rates. The analysis of the CEA withdrawal from critical conditions therefore utilizes the maximum reactivity addition rate with the CEA withdrawal speed (30 in/minute).

15.1.2.2.2 Results

15.1.2.2.2.1 Results of the Uncontrolled Sequential Withdrawal of CEAs From One Percent Power

The sequence of events for the CEA withdrawal from one percent power is shown in Table 15.1.2-3. Figures 15.1.2-1 through 15.1.2-4 show the transient response of the Nuclear Steam Supply System (NSSS). For this limiting case, the transient is terminated by a high pressurizer pressure trip and results in a maximum RCS pressure of 2662 psia. Since the high pressurizer pressure trip occurs before the time at which a high LPD or low DNBR trip would be required, DNBR and centerline melt (CTM) temperature limits are not exceeded.

15.1.2.2.2.2 Results of the Uncontrolled Sequential Withdrawal of CEAs From Full Power

Protection against exceeding the DNB and CTM limits for a CEA withdrawal at full power is provided by the CPCs which provide an automatic reactor trip on low DNB or high LPD. When initiated from the extremes of the LCOs, the CPC low DNBR trip will be initiated prior to 14.6 seconds for the most severe full power case. Key parameters for the full power case are detailed in Table 15.1.2-2. The sequence of events is given in Table 15.1.2-4 and NSSS parameter responses are shown in Figures 15.1.2-5 through 15.1.2-9.

15.1.2.3 Conclusion

As shown by the analysis, the uncontrolled CEA withdrawal from critical conditions does not lead to the violation of specified acceptable fuel design limits or the RCS pressure boundary safety limits. For the initial power levels and withdrawal rates analyzed, the high pressurizer pressure trip, low DNBR trip, high local power density trip, and low steam generator water level trip function to assure that the minimum transient DNBR does not fall below 1.25 (CE-1 Correlation) or 1.23 (WSSV-T /ABB NV Correlations), that the maximum local power density is below the value that would cause centerline fuel melting, and that the RCPB safety limit is not exceeded.

ARKANSAS NUCLEAR ONE
Unit 2

15.1.2.4 Subsequent Analyses

15.1.2.4.1 CEA Withdrawal From One Percent Power Subsequent Analyses

15.1.2.4.1.1 Cycle 13 CEA Withdrawal From One Percent Power

A CEA withdrawal from HZP conditions was analyzed for Cycle 13 using CENTS and CETOP computer codes. CENTS is described in Section 15.1.0.6.10. The inputs used in this analysis are provided in Table 15.1.2-5 and Section 15.1.0 with the following assumptions:

- A. A steam generator tube plugging limit of 30% was modeled.
- B. The worth of the CEAs at trip was assumed to be 2%. The CEA drop time is consistent with Figure 15.1.0-1C with the 0.6 second holding coil delay time; however, a more conservative normalized reactivity insertion versus CEA position for a +0.6 ASI curve was assumed.
- C. The BOC Doppler curve of Figure 15.1.0-4, which includes a 0.85 multiplier, is conservatively used.
- D. The Cycle 13 delayed neutron fraction and effective neutron lifetime consistent with Section 15.1.0.3 was assumed.

The sequence of events for this transient is provided in Table 15.1.2-7. The maximum fuel centerline temperature is less than 3330 °F. The conclusions of Section 15.1.2.3 remain the same: the SAFDLs and the RCS pressure boundary limits are not violated.

15.1.2.4.1.2 Cycle 16 CEA Withdrawal From Hot Zero Power

The CEA withdrawal from HZP conditions was analyzed for Cycle 16 using CENTS computer code for the transient analysis simulation and CETOP computer code for the minimum DNBR evaluation.

Input parameters from Table 15.1.2-8 and the bounding physics data from Section 15.1.0 have been incorporated in this analysis with the following clarifications:

- A. The BOC Doppler curve of Figure 15.1.0-4 is conservatively used.
- B. A delayed neutron fraction and effective neutron lifetime consistent with Section 15.1.0.3 was assumed.
- C. The CEA insertion curve (scram curve) is based on an ASI of +0.6. A CEA insertion curve consistent with Figure 15.1.0-1E was assumed utilizing a 0.6 second holding coil decay time. A CEA worth of 2.0% $\Delta\rho$ was conservatively assumed.
- D. A positive MTC of $0.5 \times 10^{-4} \Delta\rho/^\circ\text{F}$ was assumed.
- E. A conservative VOPT setpoint of 36% of rated power and a response time of 0.6 seconds were assumed. The response time for the neutron flux power from the neutron excore detectors was increased to 0.40 seconds and is included in the 0.6 seconds.

ARKANSAS NUCLEAR ONE
Unit 2

- F. An initial core power of 0.0003026 MWt (10⁻⁵ % initial power) was assumed. This is conservative to the high log power trip bypass permissive setpoint of 10⁻⁴ % initial power. The use of a lower initial power results in the largest power spike.
- G. Installation of the RSGs was assumed with 10% plugged U-tubes per steam generator.
- H. A minimum initial RCS flow rate of 315,560 gpm was assumed.
- I. A Reactivity Insertion Rate (RIR) of 1.8 x 10⁻⁴ Δρ/sec was assumed.
- J. A nuclear heat flux factor of 7.7 was assumed.

The sequence of events for this transient is provided in Table 15.1.2-9. Figures 15.1.2-11 through 15.1.2-14 present the transient response of key parameters for the 1 x 10⁻⁵% initial power analysis. The maximum fuel centerline temperature is well below centerline melt. The conclusions of Section 15.1.2.3, namely the SAFDLs and the RCS pressure boundary limits are not violated, remain the same.

15.1.2.4.1.3 Cycle 20 CEA Withdrawal from Hot Zero Power

The CEA Withdrawal from HZP conditions was analyzed for Cycle 20 using the CETOP computer code for the minimum DNBR evaluation.

The implementation of a half core of Next Generation Fuel (NGF) resulted in an increase in core flow area and a decrease in fuel mass. The increase in core flow area resulted in a decrease in core mass flux. No CENTS cases were repeated as all other current input parameters in Table 15.1.2-8 remained unchanged.

The half core of NGF resulted in a very small decrease in core mass flux compared to Cycle 16. This decrease was offset by crediting margin between the cycle-specific hot full power heat flux and the bounding hot full power heat flux used for Cycle 16. Consequently, the mDNBR values remain above the CE-1 DNB SAFDL of 1.25 as delineated in Tables 15.1.2-9.

The Cycle 16 centerline melt analysis used a Total Nuclear Heat flux Factor of 9.5 to bound the values reported in Table 15.1.2-8. The decrease in core fuel mass was offset by reducing the Total Nuclear Heat Flux Factor down to the Table 15.1.2-8 value. Hence, the maximum fuel centerline temperature is well below centerline melt.

Based on the evaluation above, neither the SAFDLs nor the RCS pressure boundary limits are violated. Consequently, the conclusions in SAR Section 15.1.2.3 for the SAFDLs and the RCS pressure boundary limits remain the same.

15.1.2.4.1.4 Cycle 21 CEA Withdrawal From Hot Zero Power

The CEA Withdrawal from HZP was analyzed for Cycle 21 using the CETOP computer code and the WSSV-T and ABB-NV critical heat flux correlations for the minimum DNBR evaluation. The implementation of full core of Next Generation Fuel (NGF) resulted in an increase in core flow area and a decrease in fuel mass. The increase in core flow area resulted in a decrease in core mass flux. No CENTS cases were repeated, as all other current input parameters in Table 15.1.2-8 remained unchanged.

ARKANSAS NUCLEAR ONE
Unit 2

The full core of NGF resulted in a very small decrease in core mass flux from Cycle 20. The mDNBR for this event was re-evaluated using the WSSV-T and ABB-NV critical heat flux correlations, the CENTS input from Cycle 16, and the lower core mass flux. The mDNBR value was larger than the WSSV-T / ABB-NV SAFDL of 1.23. Table 15.1.2-9 has been revised for NGF to include the WSSV-T / ABB-NV CHF correlations and a 1.23 DNB SAFDL.

The Cycle 16 centerline melt analysis used a Total Nuclear Heat Flux Factor of 9.5 to bound the value reported in Table 15.1.2-8. The decrease in core fuel mass was offset by reducing the Total Nuclear Heat Flux Factor down to the Table 15.1.2-8 value. Consequently, the maximum fuel centerline temperature is well below centerline melt.

Based on the evaluation above, the SAFDLs are not violated. As no CENTS cases were repeated, the RCS pressure boundary limits are not violated. Consequently, the conclusions in SAR Section 15.1.2.3 for the SAFDLs (mDNBR remains above the DNB SAFDL) and the RCS pressure boundary limits remain the same.

15.1.2.4.2 CEA Withdrawal From Full Power Subsequent Analyses

15.1.2.4.2.1 Cycle 12 CEA Withdrawal From Full Power

The full power CEA withdrawal event was reanalyzed for Cycle 12 using CESEC-III. CETOP was used to perform the DNB calculations. This analysis was performed consistent with the analysis described above using the inputs from Table 15.1.2-6 and Section 15.1.0 with the following assumptions:

- A. The CPC DNBR VOPT ceiling was not credited. The CPC DNBR VOPT follow trip (DELSPV) of 15.4% was assumed resulting in a power trip at 118.4% of full power.
- B. A steam generator tube plugging limit of 15% was modeled.
- C. The CPC DNBR trip (based on VOPT) response time was assumed to be 0.39 seconds.
- D. The CEA coil decay time of 0.3 seconds was increased to 0.6 seconds. (A 0.6 second delay after the trip breakers open is assumed prior to the CEAs beginning to drop into the core.) Reactivity is held constant for the 0.6 second delay time. After the 0.6 second delay, negative reactivity is reinserted at the same rate of the positive insertion relative to the rod position, up to the total positive reactivity added. The CEA position versus time post trip is consistent with Figure 15.1.0-1C.
- E. The BOC Doppler curve in Figure 15.1.0-3 with a 0.85 multiplier is conservatively used.

The objective of this analysis was to perform a CPC filter verification that is to ensure that the CPCs and COLSS will protect the DNB SAFDL. Input parameters are selected to maximize the margin degradation. Results from this analysis indicate that the CPC DNBR trip (based on the VOPT follow setpoint) is reached before 11.3 seconds. COLSS and CPCs are verified to ensure enough margin exists to prevent a minimum DNB of less than 1.25.

ARKANSAS NUCLEAR ONE
Unit 2

15.1.2.4.2.2 Cycle 13 CEA Withdrawal From Full Power

The effect of up to 30% steam generator tube plugging and a 10% reduction in RCS flow was assessed with respect to the impact on the CEA withdrawal event from full power. The CEA bank withdrawal event is examined as the fastest rate of increasing power with respect to the anticipated operational occurrences (AOOs) for which the CPCs ensure that the SAFDLs would not be violated. An evaluation was performed to validate that the response to the CPC compensated neutron flux power for a CEA withdrawal event is conservative with respect to the actual rates for both the core power and core heat flux increase given this event. By ensuring the CPC protective calculations are conservative, the SAFDLs would not be violated.

This event is simulated with the CENTS code. The time dependent plant parameters calculated using CENTS are then input into the CPC simulation code (referred to as "CPC FORTRAN"). The output for the CPC FORTRAN code is then compared to CENTS to judge the conservatism of the CPC filtering process.

Cycle 13 physics data consistent with that defined in Section 15.1.0 was assumed for this assessment. An initial power level of 90%, Tcold of 540 °F, RCS flow of 135.3E6 lbm/hr, MTC of 0.0E-4 $\Delta\rho/^\circ\text{F}$, 30% steam generator tube plugging, and a reactivity insertion rate of 1.0E-4 $\Delta\rho/\text{sec}$ were assumed. Based on the results of this analysis, the CPC power exceeds CENTS power and heat flux illustrating acceptable functioning of the CPC filters.

15.1.2.4.2.3 Cycle 15 CEA Withdrawal from Full Power

The full power CEA Withdrawal event was evaluated to determine the impact of the replacement steam generators (RSGs) and the increase in RCS flow for Cycle 15. One key parameter that changed for the CEA Withdrawal from HFP event is the maximum RCS flow range, which has increased to account for the RSGs. A CPC Dynamic Filter analysis was performed for Cycle 15 with RSG at an uprate power of 3026 MWt to assure that the CPCs can accurately sense the power increase associated with the CEA withdrawal event.

The CPC Dynamic Filter analysis used the CENTS computer code for the transient analysis simulation. The time dependent plant parameters calculated using CENTS are then input into the CPC Simulation code (CPC FORTRAN).

Previously defined input parameters and the bounding physics data from Section 15.1.0 have been incorporated in this analysis with the following clarifications:

1. The BOC Doppler curve in Figure 15.1.0-4 was assumed.
2. The Cycle 13 delayed neutron fractions and neutron lifetimes consistent with those defined in Section 15.1.0.3 were assumed.
3. The CEA reactivity insertion curve in Figure 15.1.0-1D was assumed. This curve accounts for a 0.6 second holding coil delay. CEA worths dependent on initial core power were conservatively assumed.
4. RCS flow of 147.3×10^6 lbm/hr was assumed.
5. An MTC of $0.0 \times 10^{-4} \Delta\rho/^\circ\text{F}$ was assumed.

ARKANSAS NUCLEAR ONE
Unit 2

6. Installation of the RSGs was assumed.
7. An initial temperature of 540 °F was assumed.
8. Steam Generator tube plugging of 10% was assumed.
9. Reactivity insertion rate of $1.0 \times 10^{-4} \Delta\rho/\text{sec}$ was assumed.

The CPC transient filters analysis was performed to assure that the CPCs could conservatively respond to a power increase associated with CEA bank withdrawal with the changes due to the RSGs, an increase in rated power, and an increase in RCS flow.

The CPC transient filter analysis verifies that the CPC adjusted process parameters are conservative with respect to the expected values for a CEA bank withdrawal event. The CPC coefficients are adjusted as necessary to assure the CPCs action prevents SAFDL violation during the transient.

The effects of the RSGs, the increase in rated power, and the increase in RCS flow have been evaluated. This evaluation ensures that the CPCs and RPS will provide the necessary trip functions to protect the SAFDLs.

15.1.2.4.2.4 Cycle 16 CEA Withdrawal From Full Power

A CEA Bank Withdrawal from HFP conditions was reanalyzed for Cycle 16 using the CENTS and CETOP computer codes. The CEA Bank Withdrawal at power is protected by the Core Protection Calculator System (CPCS). Specifically, the CPCS has dynamic compensation lead-lag filters that project increases in core heat flux and core power. These dynamic compensation filters in conjunction with static power correction factors ensure that the CEA withdrawal transients are terminated before the SAFDLs are violated.

Input parameters provided in Table 15.1.2-10 and the bounding physics data from Section 15.1.0 have been incorporated in this analysis with the following clarifications:

- A. The BOC Doppler curve of Figure 15.1.0-4 is conservatively used.
- B. A delayed neutron fraction and effective neutron lifetime consistent with Section 15.1.0.3 was assumed.
- C. The CEA insertion curve in Figure 15.1.0-1E was assumed. A 0.6 second CEA holding coil delay after the trip breakers open is assumed prior to the CEA Bank beginning to drop into the core. After the 0.6 second delay, negative reactivity is reinserted at the same rate of positive insertion caused by the CEA Bank withdrawal. A CEA worth of $-5\% \Delta\rho$ was assumed.
- D. An initial core power of 3087 MWt was assumed based on a rated power of 3026 MWt and a 2% measurement uncertainty.
- E. A Moderator Temperature Coefficient (MTC) of $0.0 \times 10^{-4} \Delta\rho/^\circ\text{F}$ is assumed.
- F. The response time for the neutron flux power from the ex-core neutron detectors was increased to 0.40 seconds.

ARKANSAS NUCLEAR ONE
Unit 2

- G. A Reactivity Insertion Rate (RIR) of $1 \times 10^{-4} \Delta\rho/\text{sec}$ was modeled.
- H. The Core Protection Calculator System (CPCS) Variable Overpower Trip (VOPT) ceiling was not credited. The CPCS VOPT follow trip of 10.2% was assumed resulting in a power trip at 112.4% of full power.
- I. Installation of the RSGs was assumed with a tube plugging limit of 10%.

The sequence of events is listed in Table 15.1.2-11. Figures 15.1.2-15 through 15.1.2-19 present transient response of key parameters for full power plus uncertainty (3087 MWt). The peak heat flux results in a minimum DNBR greater than 1.25. The peak core power results in a peak linear heat rate of less than 21 kW/ft. This is not a limiting peak RCS pressure event. Thus, there is no violation of SAFDLs.

15.1.2.4.2.5 Cycle 18 CEA Withdrawal from Full Power

The CEA Bank Withdrawal event from HFP conditions was evaluated at a higher LOCA Limit of 14.4 KW/ft. Only the peak LHR margin was affected. There was no impact on DNB margin.

The methodology was the same as that used in the current analysis presented in Section 15.1.2.4.2.4. The LOCA Limit value of 14.4 KW/ft was used in place of the previous value of 13.7 KW/ft. No new computer cases were required.

The CEA Bank Withdrawal at power is protected by the Core Protection Calculator System (CPCS). Specifically, the CPCS increasing power filters provide conservative neutron and thermal power input into the CPCS Low DNBR and High Local Power Density (LPD) trips. Thus, sufficient SAFDL protection is provided for a power increase due to a positive reactivity insertion from a full power CEA bank withdrawal in conjunction with the higher LOCA Limit value of 14.4 KW/ft.

15.1.2.4.2.6 Cycle 21 CEA Withdrawal From Full Power

The CEA Withdrawal from HFP was evaluated for Cycle 21 for Next Generation Fuel (NGF). Only the DNB margin was affected. There was no impact on the LHR margin.

The methodology was the same as that used in the current analysis presented in Section 15.1.2.4.2.4. The CEA Withdrawal from full power was evaluated for Cycle 21 using the WSSV-T and ABB-NV critical heat flux correlations and the lower DNB SAFDL of 1.23 for the minimum DNBR evaluation. No CENTS cases were repeated, as all other current input parameters in Table 15.1.2-10 remained unchanged.

The CEA Bank Withdrawal at power is protected by the Core Protection Calculator System (CPCS). Specifically, the CPCS increasing power filters provide conservative neutron and thermal power input into the CPCS Low DNBR and High Local Power Density (LPD) trips. Thus, sufficient SAFDL protection is provided for a power increase due to a positive reactivity insertion from a full power CEA bank withdrawal in conjunction with the new CHF correlations and the lower DNB SAFDL value.

ARKANSAS NUCLEAR ONE
Unit 2

Based on the evaluation above, the SAFDLs are not violated. As no CENTS cases were repeated, the RCS pressure boundary limits are not violated. Table 15.1.2-11 has been revised for NGF to include the WSSV-T / ABB-NV CHF correlations and 1.23 DNB SAFDL. Consequently, the conclusions in SAR Section 15.1.2.4.2.4 for the SAFDLs and the RCS pressure boundary limits remain the same.

15.1.3 CEA MISOPERATION

15.1.3.1 Identification of Causes

A CEA misoperation is defined as any event which could result from a single malfunction in the reactivity control system, with the exception of sequential group withdrawals which are considered in Sections 15.1.1 and 15.1.2. A list of the events which could be caused by a single malfunction in the reactivity control system is included in Chapter 7. CEA misalignment may be caused by a malfunction of the Control Element Drive Mechanism (CEDM), CEDMCS or by operator error.

A stuck CEA may be caused by mechanical jamming of the CEA fingers or grippers or by failure of a gripper coil. A dropped CEA may be caused by electrical failure in the CEDMCS or by opening an individual CEA breaker. A dropped CEA subgroup could be caused by an electrical fault in the CEDMCS, opening a subgroup breaker, or by failure of the hold bus during maintenance activities.

The core protection calculator (CPC) and control element assembly calculator (CEAC) algorithms detect and compensate for the effect of CEA misoperation on the core power distribution by providing heat flux and radial peaking factor penalties to the on-line DNBR and linear heat rate calculations. For the first 5 cycles, a single CEA inward deviation (drop) incident resulted in penalties which quickly tripped the plant. The penalties associated with a single inward CEA deviation have since been removed and operator action is credited to mitigate these events.

Protection for CEA misoperation events is provided either by a Core Protection Calculator System (CPCS) trip or, for events which do not require a trip, by providing adequate initial DNBR and local power density margin to preclude violation of the SAFDLs prior to the reactor operator taking action to restore plant conditions and CEA alignment.

The results of a CEA drop are presented below. Section 15.1.3.2 and 15.1.3.3 present results consistent with the original design considerations. See Section 15.1.3.4 for the latest analysis considerations.

Prior to Cycle 12, ANO-2 had 8 part-length CEAs. Because these CEAs were replaced with full length CEAs, the PLCEA drop analyses have been deleted.

A full length CEA drop can result from a single failure which causes power to be interrupted to a single CEDM. In order to provide a rapid shutdown function upon a reactor trip signal, the CEDMs are designed to release the CEAs when power to the CEA holding coils is interrupted. Power to the CEA holding coils is provided through the trip breakers which are operated by the output signal from the RPS.

15.1.3.2 Analysis of Effects and Consequences (Prior to Cycle 16)

15.1.3.2.1 Method of Analysis (Prior to Cycle 16)

The transient following a dropped CEA was analyzed with the CESEC computer program, described in Section 15.1.0.6.1, which simulates the NSSS. The heat flux in the hot channel, following the CEA drop, was analyzed with the STRIKIN computer program, described in Section 6.3. In addition to the parameters described in Section 15.1.0, the conservative assumptions shown in Table 15.1.3-1 were used in the analysis. The most negative Doppler and moderator temperature coefficients were chosen for the full length CEA drop. These negative values result in the largest power overshoot in response to the drop in core average temperature.

The worst full length CEA drop incident is the case in which the maximum increase in radial peaking factor is produced by the dropped CEA. Basis for this choice lies in the results of studies of the CEA drop event which indicate that the results of the analysis are much more sensitive to the radial peaking factor input than to the associated reactivity worths. The largest calculated increase in radial peaking factor for any dropped CEA is 24 percent. A +10 percent uncertainty is applied to this nominal value prior to use in the analysis. The nominal calculated reactivity worth for this is -0.10 percent.

An uncertainty factor is not applied to this value since application in the same direction as that for changes in radial peak has been shown to produce more favorable results, i.e., 10 percent increase in worth, and application in a direction opposite, i.e., 10 percent decrease in worth, to that for changes in radial peak is considered to be physically inconsistent.

Even though the RRS automatic mode has been physically removed from operation, the most adverse reactor control condition for the full length CEA drop results from postulating that control is in the automatic mode and that a CEA withdrawal prohibit signal does not initiate upon detection of core conditions caused by the dropped CEA. With control in this mode, reduction in average reactor coolant temperature and a mismatch of reactor turbine power will initiate a withdrawal of regulating CEAs causing positive reactivity to be inserted. The effect of this action is simulated in a conservative manner by assuming that regulating CEAs begin to withdraw at the maximum speed of 30 in/min immediately after the dropped CEA becomes fully inserted and that they produce a positive reactivity addition at the maximum rate of $0.7 \times 10^{-4} \Delta\rho/\text{sec}$.

15.1.3.2.2 Results (Prior to Cycle 16)

The results of the CEA drop cases are summarized in Table 15.1.3-2. The detailed sequence of events for the CEA drop transients from initial DNBRs of 1.39 and 2.25 are presented in Table 15.1.3-4 and the transient is shown in Figures 15.1.3-1 through 15.1.3-10. A rapid decrease in reactivity occurs which causes a corresponding decrease in power. Reactivity contributions from moderator and Doppler feedback and regulating CEA motion then override the negative reactivity effects of the dropped CEA causing the power to rise.

The power rises to 90 percent of full power at 1.7 seconds at which time a low DNBR trip condition exists and the CEA drop transient is subsequently terminated with a minimum DNBR of 1.3. The DNBR, as shown in Figure 15.1.3-4 is calculated to initially decrease due only to the conservative combination of the average density and the radial peaking factor following the full length CEA drop. The initial rate of decrease in the average core power as predicted by the point kinetics is less than the assumed rate of increase in the radial peak, resulting in an initial increase in the hot channel heat flux and a corresponding decrease in DNBR.

ARKANSAS NUCLEAR ONE
Unit 2

The peak linear heat rate during the transient is below the value of linear heat rate which would result in fuel centerline melting.

15.1.3.2.3 Effect of Varying Initial Conditions (Prior to Cycle 16)

The basis for the selection of initial conditions for the CEA misoperation incident is discussed in Section 15.1.0.1; parameter values used in the analyses are provided for the CEA drop incident in Table 15.1.3-1. The effect of varying initial conditions for RCS pressure, reactor inlet temperature, reactor coolant flow and core power distribution while maintaining a fixed margin to a 1.3 DNBR, i.e., same initial DNBR, is discussed below.

For the CEA drop incident, no impact will be made on the results when the transients are initiated from different initial reactor inlet temperatures, RCS pressures and RCS flows with the initial DNBR remaining in accordance with Technical Specification 3.2.4. Under the constraint of a constant initial DNBR, the time and value of the minimum transient DNBR is solely dependent on the rate of change of DNBR which for these transients is governed by changes in local heat flux and, therefore, is essentially independent of initial inlet temperature, RCS pressure, and reactor coolant flow.

Varying the core average axial power distribution while maintaining a constant initial DNBR has an effect on the results of the incidents which is due to the dependence of scram reactivity insertion rate on axial flux distribution. The rate at which shutdown reactivity is inserted will affect both the value and time of the minimum transient DNBR. The scram reactivity functions which were used in the CEA drop analysis describe scram reactivity insertion in a conservative manner and were chosen based on power distributions permitted to occur during both normal operating and accident situations as a function of axial shape index. Further discussion of the scram reactivity input to the analyses is provided in Section 15.1.0.2.3.

The reactivity worths and changes in peaking factors produced by a dropped CEA directly affect the results of the transients and are dependent on the initial axial power distribution. The analysis of this event has, therefore, been carried out as a function of axial shape index.

As stated in Section 15.1.0, the COLSS monitors conditions which affect the margin to DNBR including the reactor coolant mass flow rate. The flow measurement techniques and instrumentation are described in Section 7.7.1.3. In addition, the Technical Specifications (TS 3.2.4) define the bases for DNBR and state the requirements that depend on the availability status of COLSS and operability of CEACs. In summary, since the margin to DNB is monitored directly in the Unit 2 plant, it is not necessary to provide a Technical Specification on flow in order to assure the required margin to DNB.

15.1.3.2.4 Assumptions Concerning Pressurizer, Steam Bypass & Feedwater Regulating Systems (Prior to Cycle 16)

For the CEA drop analysis, steam release via the steam bypass system does not occur prior to the time of reactor trip and, therefore, the assumptions concerning mode of operation of this system have no effect on the results of these incidents. The assumption that this system is operating in the automatic mode is consistent with normal plant operating conditions.

The assumption that the feedwater regulating system is in the automatic mode is also based on assuming normal plant operating conditions. For the CEA misoperation analysis, a variation in feedwater flow rate of less than one percent of the full power value occurs prior to the time of

ARKANSAS NUCLEAR ONE
Unit 2

reactor trip. The slight steam generator mass flow imbalance that would result if the feedwater regulating system were operating in the manual mode has been investigated with regard to the results of the CEA misoperation event and determined to have negligible impact.

The pressurizer is assumed to be in the normal automatic operating mode as described in Section 5.5.10. The CESEC code, which is described in Section 15.1.0.6.1, was used to simulate pressurizer operation during the CEA misoperation incident. For the CEA misoperation analysis, the time interval between initiation of the event and reactor trip is sufficiently small such that the assumption concerning mode of pressurizer control has negligible impact on the results.

15.1.3.3 Conclusion (Prior to Cycle 16)

Based on the analysis presented in this section, operation of Cycle 1 within the limits on allowable initial DNBR as a function of axial shape index assures that no CEA misoperation event will result in violation of specified acceptable fuel design limits. This information is presented in Figure 15.1.3-23.

15.1.3.4 Subsequent Analysis

15.1.3.4.1 Cycle 16 CEA Misoperation Analysis Approach (Normal Operation)

The Core Protection Calculator (CPC) and Control Element Assembly Calculator (CEAC) algorithms detect and compensate for the effect of CEA misoperations on the core power distribution by providing appropriate peaking factors and power penalties to the on-line DNBR and linear heat rate calculations. The single CEA drop event will not generate and does not require a reactor trip. Adequate initial DNBR and local power density margin provides protection against this CEA misoperation event.

A single CEA drop is defined as the inadvertent release of a CEA causing it to drop into the core. After the drop of a single CEA, a rapid decrease in power follows. This is accompanied by a decrease in reactor coolant temperatures and pressure. In the presence of a negative moderator temperature coefficient (MTC), positive reactivity is added. Since the turbine is in manual and there is a power mismatch between the secondary side and the primary side, the primary side responds and attempts to restore itself to the initial power level.

The purpose of the analysis is to review the CEA misoperation DNB thermal margin requirements that must be reserved in the technical specification Limiting Conditions for Operation (LCOs). This assures that the minimum DNBR for these events does not exceed the DNB SAFDL.

The methodology employed for the single CEA drop event is to “back-calculate” the maximum radial distortion factor (Fr) allowed assuming the minimum required thermal margin reserved by the LCOs. This maximum sensitivity of DNBR to Fr is calculated based on the range of initial conditions possible for the event. For Cycle 16 and beyond, the reload analysis process will confirm that these radial distortion factors are not exceeded for the as-built core. The increase in rated power, the range of initial conditions (temperature, pressure and RCS flow), and the “Required Power Reduction After Inward CEA Deviation” figure increase from 1 hour to 2 hours have been accounted for in the DNBR to Fr sensitivity.

ARKANSAS NUCLEAR ONE
Unit 2

In the analysis of the CEA drop event, power is assumed to return to the original power level driven by turbine demand, with negligible change in temperature, pressure, or RCS flow. This is the most adverse possible outcome of a CEA drop that changes the power distribution without any accompanying power or temperature reduction. This conservative modeling assumption eliminates the need for explicit transient analysis with CENTS. The change in margin to DNB is evaluated using the maximum sensitivity of DNBR to Fr for the range of conditions of the event.

DNBR margin degradation for the single CEA drop event is determined crediting the operator response requirements of Technical Specification 3.1.3.1, "CEA Position," and COLR Figure 2, "Required Power Reduction After Inward CEA Deviation." This technical specification requires that the operator initiate a power reduction as specified in the COLR figure shortly after the occurrence of a CEA drop.

For the single CEA drop event, the change in margin to the linear heat rate limit is smaller than the change in margin to the DNBR limit. The margin requirements for CEA drop events (which do not result in a reactor trip) clearly bound the margin requirements for CEA misoperation events that result in reactor trip.

The change in sensitivity of DNBR to Fr is based on the input parameter ranges from Table 15.1.3-5.

15.1.3.4.2 Results

The single CEA drop event is a subset of the anticipated operational occurrences (AOOs) that are analyzed to determine the minimum required thermal margin that must be maintained by the Technical Specification Limiting Conditions for Operation (LCOs) such that, in conjunction with the Reactor Protection System (RPS), the DNB and centerline-to-melt SAFDLs are not violated. The required thermal margin is monitored by COLSS when it is in service and by the operators using the CPCS and COLR specified limits when COLSS is out of service.

Single CEA drop event radial power peaking distortion factor limits have been determined to assure that the DNBR and LHR SAFDLs are not exceeded. For Cycle 16 and beyond, the reload analysis process will confirm that these radial distortion factor limits are not exceeded for the as-built core based on the CEA Positions" (TS 3.1.3.1), "Required Power Reduction After Inward CEA Deviation" figure (COLR Figure 2).

15.1.4 UNCONTROLLED BORON DILUTION INCIDENT

15.1.4.1 Identification of Causes

The Chemical and Volume Control System (CVCS) regulates both the chemistry and the quantity of coolant in the RCS. Changing the boron concentration in the RCS is a part of normal plant operation, compensating for long-term reactivity effects, such as fuel burnup, xenon buildup and decay, and plant cooldown. For refueling operations, borated water is supplied from the Refueling Water Tank (RWT).

Boron dilution is a manual operation conducted under strict procedural controls, which specify permissible limits on the rate and magnitude of any required change in boron concentration. Boron concentration in the RCS can be decreased either by controlled addition of unborated makeup water, with a corresponding removal of reactor coolant (feed and bleed), or by using one of the letdown ion exchangers. The letdown ion exchangers are used for boron removal

ARKANSAS NUCLEAR ONE
Unit 2

when the boron concentration is low (< 30 ppm), since the feed-and-bleed method becomes inefficient at low concentrations. A discussion of normal reactor coolant boron concentration control is presented in Section 9.3.4.

To effect boron dilution, the makeup controller mode selector switch must be set to "Dilute" and the demineralized water batch quantity selector set to the desired quantity. When the specified amount has been injected, the demineralizer water control valve shuts automatically. A charging pump must be running in addition to a reactor makeup water pump for boron dilution to take place.

Dilution of the reactor coolant can be terminated by isolating the reactor makeup water system; by stopping either the reactor makeup water pumps or the charging pumps; or by closing the charging system isolation valve 2CV-4840-2.

The CVCS is equipped with the following indications and alarm functions which will inform the reactor operator when a change in boron concentration in the RCS may be occurring:

- A. VCT level indication and high and low alarms;
- B. Makeup controller flow indication and alarms;
- C. Letdown diverter valve position indication.

Depending upon the mode of plant operation at the initiation of a dilution event, other alarms and indications are available to the operator to detect the event.

Because of the procedures involved and the numerous alarms and indications available to the operator, the probability of a sustained or erroneous dilution is very low.

15.1.4.2 Analysis of Effects and Consequences

15.1.4.2.1 General

The time required to achieve criticality from a subcritical condition due to boron dilution is based on the initial and critical boron concentrations, the boron reactivity worth, and the rate of dilution. Reactivity increase rates due to boron dilution are based on the boron worth and the dilution rate.

Six different general operational modes were analyzed for the boron dilution incident: dilution during refueling, cold shutdown, hot shutdown, hot standby, and during low and full power operation. During normal plant operation, operation of more than one charging pump is not the normal mode. However, operation of more than one charging pump may result from a system transient or direct operator control. Nevertheless, in each case it is assumed that the boron dilution results from pumping unborated demineralized water into the RCS at the maximum possible rate of 138 gpm (the combined capacity of three charging pumps). The boron concentration within the minimum volume considered in each analyzed mode is uniform at all times since sufficient circulation exists to maintain a uniform mixture. During refueling, cold shutdown, and occasionally during hot shutdown conditions this circulation is provided by the operation of the shutdown cooling system. Operation of the shutdown cooling system does not assure complete mixing of the RCS under all conditions. Consequently, a reduced RCS volume is assumed in these conditions. During hot shutdown, hot standby, and power conditions, the

ARKANSAS NUCLEAR ONE
Unit 2

reactor coolant pumps are normally operating. If both pumps are off in one loop, there is sufficient reverse flow through the idle loop to ensure a uniform concentration throughout the system.

The method of analysis used to determine the rate of change in core reactivity due to uncontrolled boron dilution is dependent on the boron reactivity and the dilution time constant τ , which is defined by the ratio of the "reactor coolant mass inventory" to the "maximum charging rate". The reactivity held down by soluble boron is determined by the time in core life and the degree of subcriticality at shutdown. For any shutdown condition, the maximum negative reactivity contributed by soluble boron and, therefore, the maximum boron concentration, occurs at the BOC. Therefore, BOC conditions are assumed in these analyses. This assumption results in minimum calculated times to loss of shutdown.

For Cycle 14 and subsequent cycles, a different approach was taken in that the dilution equations were rearranged to solve for relationships between inverse boron worth (IBW) and critical boron concentration (CBC). That is, for a given dilution time constant (τ_{BD}), subcriticality at time of alarm ($\% \Delta \rho$), and time from alarm to criticality (Δt_{crit}), various values of CBC were input into the equations and the corresponding IBWs were calculated. The resulting CBC/IBW "limit lines" are used to determine the acceptability of a cycle's core design with respect to Uncontrolled Boron Dilution Incident (UBDI) by verifying that the cycle specific CBC and IBW values fall within the "acceptable" region.

In February 2004, (Cycle 17), Westinghouse issued a Nuclear Safety Advisory Letter (NSAL-04-2) concerning some non-conservative boron dilution analyses.

The boron dilution alarm monitors the neutron flux from the excore detectors using the startup channels. When the count rate increased by a fixed factor (i.e., the boron dilution alarm setpoint (BDAS)), an alarm is activated. For ANO-2 boron dilution event analysis of record, BDAS was used to determine the amount of shutdown margin (SDM) remaining at the time of the alarm using the linear $1/\rho$ approach in Modes 3, 4, and 5. The SDM is used to determine the boron concentration at the time of the boron dilution alarm. From this concentration, the IBW versus CBC limit lines for physics is generated, such that sufficient time for operator action is preserved.

For those Westinghouse fleet plants that Westinghouse prepares the boron dilution calculations for, the Inverse Count Rate Ratio (ICRR) method is used. The ICRR method uses the measured detector count rate versus boron concentration at a fixed rod position and temperature. As the RCS boron concentration decreases to the critical concentration, the detector response for large differences between the initial and critical boron concentrations begins as a linear function. However, as the boron concentration approaches the critical boron concentration (~150 ppm from the critical boron concentration), the detector count rate increases at a faster non-linear rate. Westinghouse has collected measured data from numerous Westinghouse fleet plant startups and generated a generic, conservative ICRR curve. Westinghouse fleet plants use this generic ICRR curve or have alternately used a plant-specific ICRR curve in the boron dilution analyses for subcritical modes of operation.

CE fleet plants use a detector signal that is proportional to the subcritical multiplication factor (M). CE reviewed similar startup data for the CE fleet plants and concluded that the subcritical multiplication was inversely proportional to the reactivity and was an acceptable approximation. In a direct comparison between the two methods, the non-linear method resulted in a longer time to reach the BDAS from the start of the event and thus a shorter time to criticality after the BDAS is reached.

ARKANSAS NUCLEAR ONE
Unit 2

During the aforementioned CE fleet boron dilution analysis, plant-specific startup data was reviewed and was found to be non-linear and consistent with the generic Westinghouse ICRR data. Upon a second review of the CE-fleet startup data, it was concluded that the CE fleet methodology for the BDAS using the linear approximation had introduced some degree of non-conservatism into the calculation involving the BDAS.

The only impact of the non-conservative linear approximation is in the calculation of the time that the BDAS is reached and the calculation of the time from the alarm to the time of criticality. The overall time of criticality from the start of the event is not affected. There is no impact on the analyses that do not use the boron dilution alarm.

Based on the above, the alarm operable limit lines for IBW versus CBC for Modes 3, 4, and 5 (filled and drained) are non-conservative and have been evaluated. The Mode 3, 4, and 5 (filled and drained) alarms inoperable limit lines for IBW versus CBC are not impacted by this error and remain valid.

This concern does not impact the limit lines for Modes 1, 2, and 6 since the boron dilution alarm is not used in these modes.

This analysis of the change in the detector response characteristic is for Cycle 17 only.

The criterion for the modes of operation in question is that the operators have at least 15 minutes from the time the alarm comes in to respond to the event.

Cycle 17 specific physics data for IBW and CBC were used to determine the Modes 3, 4, and 5 (filled and drained) times from alarm to criticality assuming non-linear excore response for the conditions when the boron dilution alarm is operable. The shortest time from time of alarm to time of criticality is 27.8 minutes for Mode 5 drained. All other times from time of alarm to time of criticality for the modes of concern are greater than 27.8 minutes (e.g., Mode 3 – 39.7 minutes; Mode 4 – 45.1 minutes; Mode 5 filled – 44.5 minutes). Since all the times are greater than the 15 minute acceptance criteria, the current alarm setpoint of 1.5 in conjunction with calculation Cycle 17 specific data does not result in an unsafe or unanalyzed condition.

To evaluate the results of the analyzed events, the time between the beginning of the event and the loss of shutdown margin is determined for events initiated from critical conditions. The consequences of a UBDI event initiating from Mode 1 conditions are demonstrated to be bounded by the CEA Bank Withdrawal event as described in Section 15.1.4.2.6. For events initiated in other modes of operation, the time from a control room alarm or other indication of the event to the loss of shutdown margin is determined. For those events initiated from non-critical conditions, the time from an alarm until the loss of shutdown margin must exceed 15 minutes or 30 minutes for events during refueling.

15.1.4.2.2 Dilution During Refueling

The limiting case for boron dilution during refueling occurs for the cold clean initial cycle fuel loading. In addition to Table 15.1.4-1, the following assumptions are made to determine the most rapid boron dilution that could occur during refueling:

ARKANSAS NUCLEAR ONE
Unit 2

- A. The initial shutdown reactivity is determined by the difference between the minimum refueling water boron concentration allowed by Technical Specifications and a bounding beginning of cycle critical boron concentration for refueling conditions. The initial boron concentration was chosen to be consistent with a $K_{eff} = 0.95$, with a 1% $\Delta k/k$ uncertainty being accounted for in the physics calculations. That is, the physics calculated refueling boron concentration is based on $K_{eff} = 0.94$.
- B. All fuel assemblies are installed in the core.
- C. During refueling, the uniformity of boron concentration is assured by operation of one Low Pressure Safety Injection (LPSI) pump or Containment Spray pump at $\geq 2,000$ gpm. Under refueling conditions, the LPSI pump takes suction from and provides discharge to the RCS.
- D. A combination of inserted CEAs and soluble boron is used to maintain the core at the required subcriticality state, including uncertainty.
- E. In order to cause inadvertent boron dilution, the reactor operator would have to carry out the following sequence of misoperations:
 - 1. Open valve to divert letdown purification flow to the Boron Management System;
 - 2. Open valve to connect makeup water supply to the charging pump suction;
 - 3. Set makeup flow controller at 138 gpm;
 - 4. Start reactor makeup water pumps and charging pumps.

The sequence will permit 138 gpm charging of unborated water and a letdown flow of 138 gpm of water contained in reactor vessel.

The positive reactivity addition due to dilution of the boron concentration would cause the neutron flux to increase above the source level value. The operator is made aware of this increase by startup channel indicators registered on a recorder in the control room, by audible count rate, and by redundant startup channel alarms. In addition, the logarithmic ex-core safety channels will detect the increase in neutron flux level. Recorded indications of these channels are also provided in the control room. Finally, the following alarms/indicators would alert the control room operator to the fact that systems necessary for the uncontrolled boron dilution during refueling were operating:

- A. "Charging Pump Header Flow Low" annunciator would clear (annunciators slow-flash when clear and are extinguished when subsequently cleared by the Operator).
- B. "Reactor Makeup Water Pump to Blender Flow HIGH/LOW" annunciator would be actuated.
- C. Other indications available are: a) charging pump header pressure, b) charging pump discharge flow, c) charging pump operating, and d) makeup water flow.

These alarms and indications would alert the operator to the starting of the first charging pump coincident with the start of the dilution event.

ARKANSAS NUCLEAR ONE
Unit 2

For conservatism, the initial boron concentration was chosen to be consistent with the Technical Specification limit of $k_{\text{eff}} = 0.95$. The CBC/IBW limit lines as presented in Figure 15.1.4-1 were based on 31 minutes from alarms to loss of shutdown margin.

15.1.4.2.3 Dilution During Cold Shutdown

The allowable RCS configuration during cold shutdown conditions leads to two separate analyses of the uncontrolled dilution event. The RCS may be partially drained to support maintenance. In this condition, the charging pumps are not operating and the analysis is similar to the refueling event. The RCS may also be filled and a charging pump may be in operation, which precludes reliance on the charging pump alarm to notify the operator of the onset of the event. These two conditions are treated separately.

15.1.4.2.3.1 Dilution During Cold Shutdown with the RCS Filled

In addition to the assumptions for Cold Shutdown presented in Table 15.1.4-1, the following conditions were assumed:

- A. The minimum shutdown margin required by Technical Specifications is available prior to the start of the event.
- B. Although the RCS is filled, the operation of the Shutdown Cooling System does not always assure complete mixing of the RCS volume. Only part of the RCS volume is considered in the analysis. Since at least one loop of shutdown cooling will be in operation, the volume of one shutdown cooling loop is also included.
- C. A charging pump may or may not be operating before the dilution flow of 138 gpm from the operation of all three pumps is assumed to start. If a charging pump is in operation, the alarm available on initial operation of a pump will not notify the operator of the beginning of the event. The analysis conservatively assumes that a charging pump is running.
- D. To provide indication of the event, one of the following two conditions is assumed:
 1. An operable boron dilution count rate monitor is available to provide an alarm when the startup range excore neutron detectors indicate an increasing count rate. The monitors are set to provide the alarm when the count rate reaches 1.5 times the background count rate.
 2. If the monitors are not operable, Control Element Assemblies (CEA) have been withdrawn to provide trippable reactivity. In this condition, a boron dilution event would eventually cause reactor power to increase to the high logarithmic power trip setpoint which would result in the insertion of the CEAs and numerous alarms to notify the operator of the event.

If the boron dilution count rate monitors are operable and no CEAs are withdrawn, the operator will receive an alarm from the count rate monitors more than 15 minutes before the loss of all shutdown margin. If the count rate monitors are not operating and assuming the withdrawn CEAs are worth a minimum of 2.0% $\Delta k/k$, the high logarithmic power trip will alert the operator more than 15 minutes before the loss of all shutdown margin. In both of these conditions, the

ARKANSAS NUCLEAR ONE
Unit 2

operator will be alerted to the event with more than the minimum 15 minutes of response time available. The CBC / IBW limit lines presented in Figures 15.1.4-3 and 15.1.4-4, for alarms inoperable and operable, respectively were based on 16 minutes from alarms to loss of shutdown margin.

15.1.4.2.3.2 Dilution During Cold Shutdown with the RCS Partially Drained

In addition to the assumptions for Cold Shutdown presented in Table 15.1.4-1, the following conditions are assumed:

- A. The minimum shutdown margin required by Technical Specifications is available prior to the start of the event.
- B. The RCS is filled only to the bottom of the hot leg nozzles. The volume of one Shutdown Cooling System loop is included in the analysis.
- C. As in the RCS filled case of the cold shutdown analysis, (see 15.1.4.2.3.1) a charging pump is assumed to be operating such that the charging pump alarm will not alert the operator to the start of the remaining pumps.
- D. To provide indication of the UBDI, an alarm on initial operation of a charging pump or an alarm when the startup range excore neutron detectors indicate an increasing count rate is available. The monitors are set to provide the alarm when the count rate reaches 1.5 times the background count rate.

For the partially drained condition, the operator will receive an alarm from the count rate monitors or charging pump start more than 15 minutes before the loss of all shutdown margin. The operator will be alerted to the event with more than the minimum 15 minutes response time available. The CBC / IBW limit line presented in Figure 15.1.4-2 was based on 16 minutes from alarms to loss of shutdown margin.

15.1.4.2.4 Dilution During Hot Shutdown

In addition to the assumptions for Hot Shutdown presented in Table 15.1.4-1, the following conditions are assumed:

- A. The minimum shutdown margin required by Technical Specifications is available prior to the start of the event. A 0.5% $\Delta k/k$ reactivity conservatism is accounted for in the plant operating procedures.
- B. In some cases, shutdown cooling may be in operation rather than the reactor coolant pumps. Consequently, a reduced RCS volume is assumed. The volume of one shutdown cooling loop is included in the analysis.
- C. As in the RCS filled case of the cold shutdown analysis, (see 15.1.4.2.3.1) a charging pump is assumed to be operating such that the charging pump alarm is not assumed to alert the operator to the start of the remaining pumps.

ARKANSAS NUCLEAR ONE
Unit 2

- D. As in the RCS filled case of the cold shutdown analysis, one of the following two conditions exists to alert the operator of a dilution event:
1. An operable dilution count rate monitor is available, set at 1.5 times the background count rate.
 2. If the monitors are not operable, CEAs have been withdrawn to provide trippable reactivity.

If the boron dilution count rate monitors are operable and no CEAs are withdrawn, the operator will receive an alarm more than 15 minutes before the loss of all shutdown margin. If the monitors are not operating and assuming the withdrawn CEAs are worth a minimum of 2.0% $\Delta k/k$, the high logarithmic power trip will alert the operator more than 15 minutes before the loss of all shutdown margin. In both of these conditions, the operator will be alerted to the event with more than the minimum 15 minutes response time available. The CBC / IBW limit lines for Hot Shutdown are presented in Figures 15.1.4-5 and 15.1.4-6, for alarms inoperable and operable, respectively. The limit lines associated with Hot Shutdown were based on 16 minutes from alarms to loss of shutdown margin.

15.1.4.2.5 Dilution During Hot Standby

In addition to the assumptions for Hot Standby presented in Table 15.1.4-1, the following conditions are assumed:

- A. The minimum shutdown margin required by Technical Specifications is available prior to the start of the event. A 0.5% $\Delta k/k$ reactivity conservatism is accounted for in the plant operating procedures.
- B. In some cases, shutdown cooling may be in operation rather than the reactor coolant pumps. Consequently, a reduced RCS volume is assumed. The volume of one shutdown cooling loop is included in the analysis.
- C. As in the RCS filled case of the cold shutdown analysis, (see 15.1.4.2.3.1) a charging pump is assumed to be operating such that the charging pump alarm is not assumed to alert the operator to the start of the remaining pumps.
- D. As in the RCS filled case of the cold shutdown analysis, one of the following two conditions exists to alert the operator of a dilution event:
 1. An operable dilution count rate monitor is available, set at 1.5 times the background count rate.
 2. If the monitors are not operable, CEAs have been withdrawn to provide trippable reactivity.

If the boron dilution count rate monitors are operable and no CEAs are withdrawn, the operator will receive an alarm more than 15 minutes before the loss of all shutdown margin. If the monitors are not operating and assuming the withdrawn CEAs are worth a minimum of 2.0% $\Delta k/k$, the high logarithmic power trip will alert the operator more than 15 minutes prior to the loss of all shutdown margin. In both of these conditions, the operator will be alerted to the event with more than the minimum 15 minutes response time available. The CBC / IBW limit

ARKANSAS NUCLEAR ONE
Unit 2

lines for Hot Standby are presented in Figures 15.1.4-7 and 15.1.4-8, for alarms inoperable and operable, respectively. The limit lines associated with Hot Standby were based on 16 minutes from alarms to loss of shutdown margin.

15.1.4.2.6 Dilution During Critical Operation

For a boron dilution transient with the reactor critical, reactor power would increase due to the positive reactivity addition and reactor coolant temperature and pressure would increase.

For an unplanned boron dilution with the reactor critical, the following RPS responses will prevent violation of the associated limits:

- A. Low DNBR trip;
- B. High local power density trip;
- C. High pressurizer pressure trip;
- D. Variable overpower trip.

The addition of positive reactivity may cause system parameters to change in such a manner that the margin to specified acceptable fuel design limits is reduced. These parameters are sensed and supplied to the CPCs where the DNBR and local power density (LPD) are continually calculated. If the variation in parameters were to result in either the DNBR or LPD fuel design limits being approached, a reactor trip would occur to prevent the limits from being violated. A reactor trip on high pressurizer pressure would prevent reaching the safety limit on RCS pressure.

When considering an UBDI event in Modes 1 and 2 care needs to be taken to ensure that the DNBR and centerline melt (CTM) limits are not exceeded. The concern is the rate of power increase. For example, inadvertent charging of unborated water into the RCS, while the reactor is at full power could result in a maximum rate of reactivity addition of $\sim 1.5 \times 10^{-5} \Delta\rho/\text{sec}$. If boron dilution occurs at this rate, and the operator fails to take corrective action, reactor power, coolant temperature, and coolant pressure would increase. These changes are such that a low minimum DNBR or variable overpower trip would occur. During a CEA Bank Withdrawal event, the reactivity insertion rate at full power is $\sim 1.0 \times 10^{-4} \Delta\rho/\text{sec}$ (0% power is $\sim 1.8 \times 10^{-4} \Delta\rho/\text{sec}$). Hence, the rate of reactivity addition (and corresponding power increase) during an UBDI event as compared to that of a full power CEA Bank Withdrawal event would result in a less limiting event. Therefore, the concern of violating the peak LHR and DNBR criteria, which would be present for Modes 1 and 2 are bounded by the CEA bank withdrawal event.

15.1.4.3 Conclusion

A sustained uncontrolled boron dilution event is unlikely in view of the administrative procedures and system design and in view of numerous indications available to the operator. However, should the postulated events discussed above occur, the maximum reactivity addition due to the dilution is slow enough to allow the operator to determine the cause of the dilution and take corrective action before significant shutdown margin is lost.

ARKANSAS NUCLEAR ONE
Unit 2

15.1.4.4 Cycle 17/18 Uncontrolled Boron Dilution Incident

For Cycle 17 / 18 the modeling of the excore/dilution alarm response for the subcritical operational modes was changed from a linear response to a non-linear response based on generic plant startup data for the uncontrolled boron dilution event (UBDE).

The boron dilution alarm monitors the neutron flux from the excore detectors using the startup channels. When the count rate increases by a fixed factor [i.e., boron dilution alarm setpoint (BDAS)], an alarm is activated. During the boron dilution event, the BDAS is used to determine the amount of shutdown margin (SDM) remaining at the time of the alarm using the non-linear response approach in Modes 3, 4, and 5. As described in Section 15.1.4.2.1, the SDM was then used to determine the boron concentration at the time of the boron dilution alarm. From this boron concentration, the inverse boron worth (IBW) versus critical boron concentration (CBC) "limit lines" were generated such that sufficient time for operator action is preserved. Hence, the Alarms-Operable IBW versus CBC "limit lines" for Modes 3, 4, and 5 (filled and drained) were revised using a non-linear response based on generic plant start-up data to determine boron concentration (or SDM in this case). The Mode 3, 4, and 5 (filled and drained) Alarms-Inoperable IBW vs. CBC "limit lines" were not impacted since they do not rely on the boron dilution alarm and thus remain valid.

The change in excore response did not impact Modes 1, 2, and 6 since the boron dilution alarm was not used. In Modes 1 and 2, protection is provided by the reactor protection system on the variable high power trip or thermal margin trip. In Mode 6, there are a number of alarms/indications other than the boron dilution alarm that alert the operator that an uncontrolled dilution is in progress as discussed in Section 15.1.4.2.2. Thus, in Mode 6 the operator is alerted at the start of the UBDE and does not rely on the boron dilution alarm to alert him that an UBDE is occurring, and Mode 6 was not impacted by the response of the boron dilution alarm. Since Modes 2 and 6 did not rely on the boron dilution alarm to alert the operator of an ongoing UBDE, the Mode 2 and 6 EPAC limit lines for IBW versus CBC were not impacted by the BDAS and remained valid.

Only Modes 3, 4, and 5 (filled and drained) with the boron dilution alarm-operable were impacted. Figures 15.1.4-2 [Mode 5 Drained Boron Dilution (Alarms Operable)], 15.1.4-4 [Mode 5 Filled Boron Dilution (Alarms Operable)], 15.1.4-6 [Mode 4 Boron Dilution (Alarms Operable)], and 15.1.4-8 [Mode 3 Boron Dilution (Alarms Operable)] were updated to include the non-linear response of the excore detectors.

The Mode 6 (refueling operation) IBW versus CBC "limit line" was revised to credit the Technical Specification 3/4.9 requirement that the refueling boron concentration is greater than or equal to 2500 ppm. By limiting initial boron concentration to values greater than or equal to 2500 ppm, the "Unacceptable Region" for Mode 6 IBW versus CBC "limit line" was reduced. The method utilized was the same as described in Section 15.1.4.2.1 in conjunction with finding the limiting CBC/IBW pair. The Mode 6 "limit line" was restricted from showing points with CBC values associated with initial boron concentration values below 2500 ppm. Hence, Figure 15.1.4-1 produced a "limit line" that satisfies the Mode 6 requirements.

15.1.5 TOTAL AND PARTIAL LOSS OF REACTOR COOLANT FORCED FLOW

15.1.5.1 Identification of Causes

A loss of reactor coolant forced flow can result from the occurrence of a mechanical or electrical failure. A partial loss of flow can occur as the result of a mechanical or electrical failure in a reactor coolant pump or from a loss of power to the pump bus. A complete loss of coolant flow results from a simultaneous loss of electrical power to all operating reactor coolant pumps.

During power operation, electrical power to the reactor coolant pumps is supplied through buses from the unit AC power source, i.e., main generator. An alternate supply to the pump buses is also provided from the preferred (off-site) AC power source. Automatic fast transfer is provided to restore the preferred AC power source to the auxiliary power distribution system in the event that the unit AC power source is lost for any reason. If the main generator trips, the pump buses are transferred and there is no significant effect on coolant flow through the core. See Chapter 8 for further discussion of the electrical system.

15.1.5.1.1 Loss of Coolant Flow Resulting From an Electrical Failure

Loss of flow during power operation causes an increase in reactor coolant temperature and results in a reduction in the margin to DNB. The low DNBR trip will prevent the minimum DNBR from falling below allowable limits at any time during the transient.

In the event that this does occur, the flow coastdown energy of the pump motor assembly determines the rate at which the core flow rate drops. The decrease in the reactor coolant flow rate during a free-wheeling coastdown is primarily governed by the rotational inertia of the reactor coolant pump and motor, including a flywheel. However, if the coolant pumps remain connected to their power supply buses, a sufficiently rapid transient frequency reduction could force the coolant pump induction motors to develop negative torque and act as generators. This would cause a coolant flow reduction more rapid than that caused by a loss of power, since some of the kinetic energy of the coolant and flywheel would be converted to electrical energy through the pump and motor.

An analysis demonstrating that an underfrequency condition will not prevent the pumps from performing their coastdown function is contained in Section 15.1.5.2.2.1.

In the event that this does occur, the flow coastdown energy of the pump-motor assembly determines the rate at which the core flow rate drops.

The 4-pump loss of flow is presented because it is the most severe loss of flow resulting from an electrical failure. Although the loss of power to one of the 2-pump buses results in loss of power to one pump in each loop the loss of power to two pumps in the same loop is presented as a limiting case for a 2-pump loss of flow.

15.1.5.1.2 Loss of Coolant Flow Resulting From a Pump Shaft Seizure

The single reactor coolant pump shaft seizure is not an anticipated operational occurrence. This accident is postulated to occur as a consequence of an instantaneous seizure of the pump shaft due to a mechanical failure. The reactor coolant flow is rapidly reduced to the 3-pump value. Since a rapid reduction in coolant flow results in a rapid reduction in the margin to DNB, a low DNBR trip will occur.

15.1.5.2 Analysis of Effects and Consequences

15.1.5.2.1 Method of Analysis

15.1.5.2.1.1 Loss of Coolant Flow Resulting from an Electrical Failure

Two loss of coolant flow incidents resulting from an electrical failure were analyzed: the loss of power to all four reactor coolant pumps; and the loss of power to two reactor coolant pumps in one loop during 4-pump operation. The conservative assumptions used for the analysis, listed in Table 15.1.5-1, are used in addition to the parameters described in Section 15.1.0. The analysis was carried out in the following steps:

- A. The time-dependent core and individual loop flow rates and steam generator pressure drops are determined using the COAST program (Section 15.1.0) which solves the conservation equations for mass flow rate and momentum. The general forcing functions for the fluid momentum equations consist of the pump torque values from the manufacturer's four quadrant curves, wherein the torque is related to the pump angular velocity and discharge rate.
- B. The resultant flow rates are used as input to CESEC, a digital computer code, described in Section 15.1.0, which simulates the NSSS.
- C. The transient heat flux generated by CESEC and average channel mass velocity are used as input to the CETOP computer program which determines the DNBR for the hot channel.

15.1.5.2.1.2 Loss of Coolant Flow Resulting from a Shaft Seizure

In addition to the assumptions stated in Section 15.1.0, the conservative initial conditions in Table 15.1.5-2 are used for this analysis.

The analysis encompassed the following steps:

- A. Upon initiation of this transient, the core flow rate reduces rapidly to the asymptotic 3-pump core flow rate of 89.8×10^6 lbm/hr. The coastdown curve is obtained from the COAST code (Section 15.1.0).
- B. The resultant flow rates are used as input to CESEC, a digital computer code, described in Section 15.1.0, which simulates the NSSS. The transient results in a minimum DNBR that is below 1.3; however, this condition exists for only a short period of time.
- C. The analysis is repeated with the above assumptions, using the COSMO computer code to determine the minimum DNBR for fuel pins of various radial peaks. An integral fuel damage calculation is then performed by combining the results from the COSMO code with the number of fuel rods having a given radial peaking factor. The number of fuel rods versus radial peaking factor is taken from the "cumulative distribution of the fraction of fuel rods versus nuclear radial peaking factor" (Figure 15.1.5-13).

ARKANSAS NUCLEAR ONE
Unit 2

The radiological consequences of the loss of coolant flow resulting from a shaft seizure was analyzed, using the information presented in Section 15.1.0.5. The effects of gas transport in the condenser hotwell are also included in the determination of the radiological consequences. The amount of iodine that leaves the condenser hotwell via the condenser vacuum pump discharge is assumed to be 0.1 percent of all the iodine that passes through the condenser during the entire course of the incident. After discharge from the vacuum pump, the gases are filtered by the Auxiliary Building Ventilation System (ABVS). All the noble gas leaked into the main steam system is continuously released with the steam to the main condenser evacuation system.

15.1.5.2.2 Results

15.1.5.2.2.1 Loss of Coolant Flow Resulting From an Electrical Failure

The 4-pump loss of coolant flow produces an approach to the DNBR limit due to the decrease in the core coolant flow. Protection against exceeding the DNBR limit for this transient is provided by the initial steady state thermal margin which is maintained by adhering to the Technical Specifications LCOs on DNBR margin and by the response of the RPS which provides an automatic reactor trip on low DNBR as calculated by the CPCs.

The loss of coolant flow transient is characterized by the flow coastdown curve given in Figure 15.1.5-1. Table 15.1.5-1 lists the key transient parameters used in the analysis for Cycle 2. The integrated radial peaking Factor (F_r) was chosen so that the transient is initiated from conditions which would correspond to a POL.

Table 15.1.5-3 presents the NSSS and RPS responses during a four pump loss of flow initiated from an axial shape with a negative shape index of -0.18 performed for Cycle 2. The COLSS and CPC data bases are established parametrically as a function of axial shape index. The representative case shown is one of the limiting cases. The CPCs initiate the low DNBR trip at 0.6 seconds and the scram rods start dropping into the core 0.45 seconds later. A minimum CE-1 DNBR of 1.24 is reached at 2.90 seconds. Figures 15.1.5-2 to 15.1.5-5 present the core power, heat flux, RCS pressure, and core coolant temperatures as a function of time. Figure 15.1.5-6 presents a trace of hot channel DNBR vs. time for the limiting case presented.

Subsequent cycle analyses have been performed with more restrictive values for scram worth. These analyses have shown that Technical Specification LCOs maintain sufficient margin to DNBR limits applicable to the respective cycle.

A study was also conducted for Unit 2 to establish the maximum probable frequency decay rates following a system disturbance resulting in an overload on the available generation and the effects of such decay rates on reactor coolant flow. The engineering analysis used to determine these decay rates is based on the maximum electrical load which a generator-transformer combination will accept. The maximum overload is a function of the impedance characteristics of the generator overload and its connected system, and the initial operating conditions of the plant.

The rates of system frequency decay during grid disturbances are not monitored. However, this is not uncommon since very little recorded data exists on an industry-wide basis on the subject. Those decay rates which are recorded are, in general, considerably lower than those calculated in the following analysis.

ARKANSAS NUCLEAR ONE
Unit 2

Analysis

When the electrical power output of a generator exceeds the mechanical power input, there will be a tendency for the unit to change speed. The rate at which the speed of a rotating mass can change is shown by Newton's second law of motion applied to rotation.

$$T = J \frac{dw}{dt}$$

By neglecting losses in the unit and by use in a 60 hertz system, we have the equation

$$\frac{df}{dt} = \frac{30}{H} (P_T - P_G)$$

where

P_T = turbine power in per unit on the generator MVA base.

P_G = electrical power of the generator in per unit on the generator rated MVA base.

H = inertia constant in Kw-secs per KVA of generator rating.

It is seen that the maximum decay rate must occur when the greatest power mismatch exists.

When a generator becomes overloaded without changing load power factor, the current must increase with a resulting voltage decrease. However, because of the relationship of load voltage and load current, load power does not increase linearly as load current increases. The maximum overload that can be imposed on a generator can therefore be found analytically.

The system and its phasor diagram shown below has its load power shown by the equation

$$P_L = [PF_L] \left[I_L \sqrt{V_g^2 - I_L^2 X^2 (PF_L)^2} - I_L^2 X \sqrt{1 - PF_L^2} \right]$$

ARKANSAS NUCLEAR ONE
Unit 2

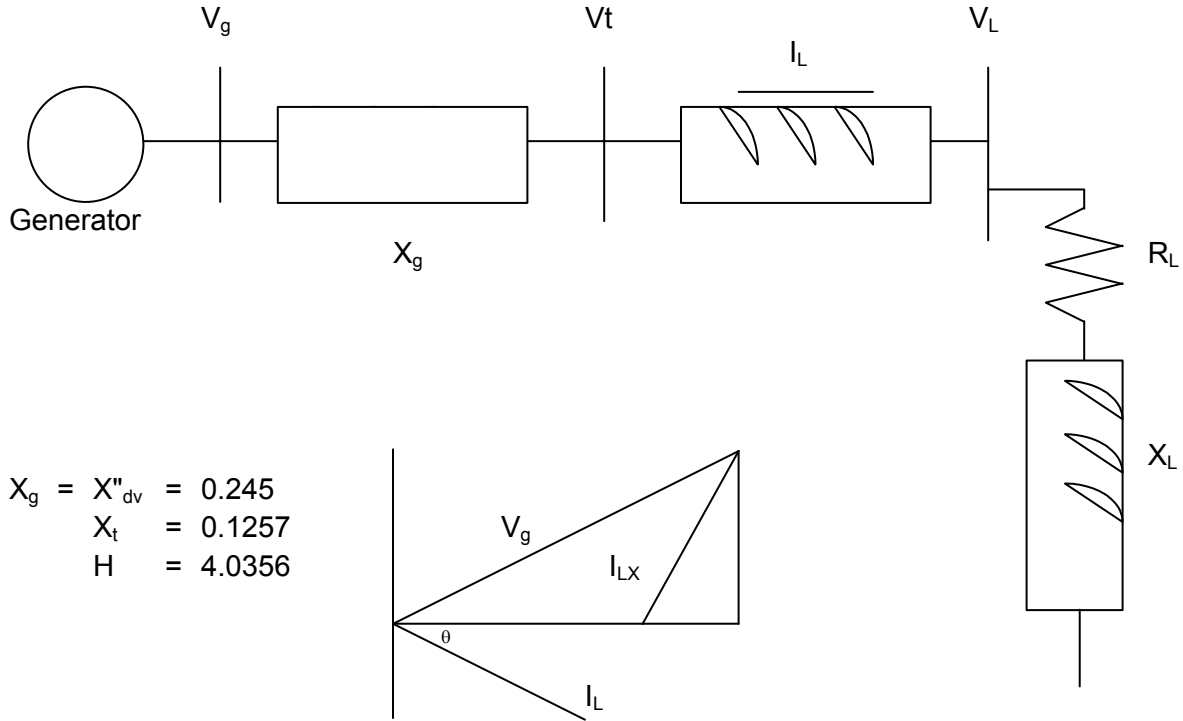

The maximum power (P_{Lmax}) is therefore found by differentiating this equation with respect to load current, the result being

$$P_{Lmax} = \left[\frac{V_g^2}{2X} \right] \left[PF_L - \frac{RF_L}{PF_L} (1 - RF_L) \right]$$

where

PF_L = power factor of the load

RF_L = the load reactive factor

It follows that the greatest power mismatch is $P_{Lmax} - P_T$

With regard to curves and the associated discussion of Reference 1, it is shown that the initial decay rate immediately following the disturbance will be the maximum occurring for a single disturbance. It is also shown that the maximum mismatch occurs at high load power factor and turbine power.

ANO-2 is normally base loaded at or very near 100 percent power. Therefore, the possibility of encountering accelerated frequency decay rates due to low turbine power are minimized.

An analysis of the frequency decay rate for ANO-2 under typical conditions has been performed. Figure 15.1.5-14 shows the decay rates for various initial conditions.

ARKANSAS NUCLEAR ONE
Unit 2

Conservatively assuming that these calculated frequency transients are characterized by a sustained linear decay rate, a review of the final LOFA DBE indicates that the maximum decay rate with the unit at 100 percent power is acceptably considered by the 4-pump loss of flow analysis because of the similarity of the pump coastdown rate with the frequency decay rate.

The higher frequency decay rate from 30 percent initial plant load was analyzed with the CENTRAN Code which provides simulation data of the CPCs as well as CESEC simulation data for the response of the NSSS. A reactor scram was initiated upon a trip signal generated by the CPC system. The flow coastdown was generated by the CPC flow algorithm using the pump speed as input. The pump speed was assumed to decrease at a rate of 10.7 percent per second. Table 15.1.5-6 summarizes the resultant normalized core flow rate as a function of time which was also used in the CESEC simulation. Table 15.1.5-7 summarized the initial NSSS parameters which are important relative to DNBR.

The simulation results of the CPC system verifies that a CPC low DNBR trip would occur at 0.656 seconds. The CESEC simulation data verifies that the minimum DNBR occurs at 3.2 seconds and is greater than 1.3, the acceptable fuel design limit.

Graphical results of the CESEC DNBR data are provided in Figure 15.1.5-15 for one of the cases analyzed.

15.1.5.2.2 Loss of Coolant Flow Resulting From a Shaft Seizure

The reduction of the coolant rate to the asymptotic 3-pump value is shown in Figure 15.1.5-8. In Table 15.1.5-5 and Figures 15.1.5-9 through 15.1.5-12, the NSSS and RPS responses for the single reactor coolant pump seized shaft are shown. For this transient, it was conservatively determined that less than two percent of the fuel is expected to experience DNB for a short period of time.

In the course of the 3-hour cooldown period following the seized shaft accident, which presumably results from dumping steam to the main condenser with the aid of the steam bypass valves, approximately 820,000 lbs. of steam is required to cool the plant to 350 °F. At 350 °F, the main condenser is shut down and vacuum pump discharge to the ABVS is terminated.

The resulting quantities of activity released via the vacuum pump to the atmosphere over this period of time is 7×10^{-4} dose equivalent curies of I^{131} and 100 dose equivalent curies of Xe^{133} . This results in a 3-hour inhalation dose value at the site boundary less than 2.34×10^{-5} rem and a 3-hour whole body dose value at the site boundary less than 2.97×10^{-3} rem.

15.1.5.2.3 Subsequent Evaluation

15.1.5.2.3.1 Cycle 12 Seized Rotor

The Seized Rotor event was reanalyzed for Cycle 12 to evaluate the impact of a more adverse Cycle 12 seized rotor pin census.

There has been a change in the methodology for analysis of the Seized Rotor event. The current methodology includes determining POL with CETOP and conservatively reducing the mass flow rate to 3-pump asymptotic flow maintaining 100% heat flux. Therefore, no transient response was performed and the only physics data required is the pin census.

ARKANSAS NUCLEAR ONE
Unit 2

Employing the current methodology demonstrates that the calculated fuel failure for Cycle 12 is less than the value determined in the previous analysis of record (Cycle 3). The offsite dose remains well within 10 CFR 100 limits.

15.1.5.2.3.2 Loss of Flow Analysis to Support RCS Flow Reduction and 30% Steam Generator Tube Plugging

To determine the impacts of a 10 percent reduction in RCS design flow and 30 percent steam generator tube plugging on the Four Pump Loss of Flow analysis, the following evaluation was performed. This evaluation has employed the HERMITE computer code instead of the CESEC code used previously for this event. The CENTS computer code has replaced the COAST program for calculating the RCS flow coastdown.

For a loss of flow at any power operating condition, a reactor trip will be initiated when any one of four Reactor Coolant Pump (RCP) shaft speeds drops to 95 percent of its nominal speed. In this method, the partial loss of flow resulting from a loss of electrical power to three or less RCPs is less limiting than a four pump loss of flow. This is because the reactor will trip at the same time for both cases but the partial loss of flow has a slower flow coastdown. Therefore, only the four pump loss of flow event is presented herein.

The analysis was carried out in the following steps:

- A. The RCP coastdown data for the loss of flow event was generated using the CENTS code. The use of the CENTS code is a change from the original coastdown analysis which used the COAST code.

Coastdown data to account for 30% steam generator tube plugging was determined by first benchmarking the CENTS coastdown results against the original coastdown data from the COAST code and plant specific coastdown data. The CENTS basedeck was then adjusted to account for the 30% steam generator tube plugging. The CENTS coastdown analysis considered the affects of both symmetric and asymmetric steam generator tube plugging (up to 1000 tube asymmetry). The coastdown analysis also considered the effects of initial RCS pressure, temperature, and flow. The resulting coastdown data generated from CENTS was used as input to the HERMITE code.

- B. The HERMITE code is used to determine the reactor core response during the postulated loss of flow event. The HERMITE code solves the few-group, space and time dependent neutron diffusion equation including the feedback effects of fuel temperature, coolant temperature, coolant density, and control rod motion for a one-dimensional average fuel bundle.
- C. The time dependent thermal hydraulic information generated from the HERMITE code is transferred directly to the CETOP computer code for thermal margin and DNBR evaluation. The CETOP method was used to calculate both the time of occurrence and value of the minimum DNBR during the transient.

The four pump loss of flow event used the conservative assumptions provided in Table 15.1.5-8 including the Cycle 13 physics data and the following assumptions:

ARKANSAS NUCLEAR ONE
Unit 2

- A. A CEA insertion curve consistent with the CEA position versus time used to develop Figure 15.1.0-1D was assumed. This curve accounts for a 0.6 second holding coil delay and a 3.2 second arithmetic average drop time to 90% inserted.
- B. A BOC delayed neutron fraction of 0.0072546 was assumed.
- C. A BOC fuel temperature coefficient of $-0.0013 \Delta\rho/\sqrt{^\circ}\text{K}$ was assumed.
- D. For this analysis, a trip on low RCP speed is the primary trip for the loss of flow event, replacing the trip on low flow-projected DNBR. A CPC trip is initiated when the RCP shaft speed drops to 95 percent of its normal speed.

The four pump loss of coolant flow produces an approach to the DNBR limit due to the decrease in the core coolant flow. Protection against the DNBR limit for this transient is provided by the initial steady state thermal margin which is maintained by adhering to the Technical Specification LCOs on DNBR margin and by the response of the RPS which provides an automatic reactor trip as calculated by the CPCs.

The principal process variables that determine thermal margin to DNB in the core are monitored by the COLSS. The COLSS computes a power operating limit which ensures that the thermal margin available in the core is equal to or greater than that needed to cause the minimum DNBR to remain greater than the DNBR limit. The minimum thermal margin required (reserved) in COLSS for the loss of flow event is set equal to the maximum thermal margin degradation observed during a loss of flow event.

The initial conditions are selected such that the system is at a very subcooled state. Initiating the event from such a state results in the least amount of negative reactivity inserted due to generation of voids in the RCS. In this manner the system undergoes the greatest amount of thermal margin degradation due to the RCP coastdown.

To demonstrate explicitly that the DNBR SAFDL is not violated during a loss of flow event, a sample case is provided in which the initial conditions are chosen such that at the onset of the event the minimum thermal margin required by the COLSS power operating limit is preserved. This analysis has used an RCS flow of 108.36 Mlbm/hr which is 90 percent of the minimum design flow corresponding to 30 percent tube-plugging. Figure 15.1.5-16 provides a graph of the RCS flow coastdown used for the loss of flow event with 30% steam generator tube plugging. The consequences following a total loss of forced reactor coolant flow, with respect to approaching the DNBR SAFDL, initiated from any set of initial conditions which preserve the minimum COLSS margin would be no more adverse than those presented herein.

The results of this analysis is the calculation of minimum thermal margin required to be reserved in COLSS to prevent the violation of the DNBR SAFDL during a loss of flow event. With a minimum thermal margin reserved in COLSS, the minimum DNBR observed during this event is 1.29 at 2.8 seconds. The sequence of events for the four pump loss of flow assuming 30% steam generator tube plugging is provided in Table 15.1.5-9. Figure 15.1.5-17 provides a graph of DNBR versus time for the event.

For the loss of flow event, the CPC trip on pump low speed in conjunction with the initial margin reserved in COLSS is sufficient to prevent the violation of the DNBR SAFDL from any set of initial conditions.

15.1.5.2.3.3 Seized Rotor Event Analysis for RCS Flow Reduction and 30% Tube Plugging

When analyzing the seized rotor event, the event is initiated from a power operating limit with the minimal acceptable thermal margin to the DNBR limit. Based on this consideration, the initial RCS flow does not have a significant impact on the analysis results. Rather, the change in flow rate from the initial value to the final flow rate is a critical parameter. Due to the potential that increased tube plugging may affect the change in flow rate, an evaluation was performed to determine the effective change in flow rate due to 30% steam generator tube plugging.

This analysis concluded that the final "steady state" flow fraction for the 30% steam generator tube plugging case is essentially equal to the "steady state" flow fraction used in the analysis of record. The coastdown data for the seized rotor event was generated using the CENTS code. The use of the CENTS code is a change from the original coastdown analysis which used the COAST code.

The analysis of record seized rotor event assumes an instantaneous drop from the initial flow rate to the reduced "steady state" flow fraction. Based on the above, this assumption remains valid; therefore, a reanalysis of the seized rotor event was not required.

**15.1.5.2.3.4 Cycle 15 Loss of Coolant Flow Resulting From a Pump Shaft Seizure-
Radiological Assessment**

A subsequent radiological analysis was performed to support steam generator replacement and power uprate. Radiological consequences were calculated for a loss of AC power. These results will bound an AC power available case due to the unavailability of the condenser for steam release.

The analysis input and assumptions used in the calculation of the radiological dose releases for the seized shaft event are discussed in Section 15.1.0.5.5 and have been incorporated in this analysis with the following clarifications:

1. The condenser is assumed unavailable for cooldown (this is a conservative assumption with respect to the method defined in Section 15.1.5.2.2.2). Thus, the entire cooldown was performed by dumping steam to the atmosphere from the steam generators.
2. The radiological doses were conservatively calculated at a higher rated power of 3026 MWt (3087 MWt including uncertainties) and parametric in 0.5% fuel failure intervals.
3. An RCS primary to secondary leakage rate of 150 gpd per steam generator was assumed.

The effect of the increase in RCS and steam generator inventories, due to steam generator replacement, was combined with the 3026 MWt (3087 MWt including uncertainties) rated power physics radiological dose data to calculate the doses in fuel failure increments of 0.5%. The results of the analysis demonstrated that the EAB and LPZ radiological doses remained a small fraction (10%) of 10 CFR 100 limits up to 14% fuel failure.

ARKANSAS NUCLEAR ONE
Unit 2

15.1.5.2.3.5 Cycle 15 Loss of Reactor Coolant Flow Resulting from an Electrical Failure

The previous LOF event analysis was analyzed using the HERMITE code. The HERMITE code described in Reference 23 does not employ a steam generator model, but does use as an input the four RCP flow coastdown data. The effect of the replacement steam generators (RSGs) was modeled by supplying the core flow rate as a function of time as input data to model the four-RCP flow coastdown.

The method used in this evaluation performed a comparison of key plant and physics input parameters between those used in the previous analysis and that of the new input data due to the RSGs and other plant changes.

The evaluation was carried out in the following steps to determine the impact of key plant and physics input data changes:

1. The RCP coastdown data for the loss of flow event were generated using the CENTS code (Reference 24).
2. The impact of a 0.15% decrease in four-pump RCS flow for the first four seconds was assessed. Table 15.1.5-11 documents the flow coastdown for the first ten seconds.
3. The increase in initial maximum RCS flow assumption from 355,200 gpm to 386,400 gpm was assessed.
4. An increase in CPC response time from 0.3 seconds to 0.4 seconds was assessed.
5. The least negative Doppler coefficient becoming less negative, changing from $0.00131 \Delta\rho/K$ to $-0.00128 \Delta\rho/K$ was assessed.

The HERMITE code was not used. Instead, an engineering evaluation of changes in key input data was employed to assess the impact on the LOF event. Based on previous sensitivity studies, the required thermal margin increase was conservatively calculated based on the above input data changes.

The overall impact on the required thermal margin increase is less than 1%. Thus, the minimum DNBR in the previous analysis was decreased from 1.29 to no less than 1.277, but remains above the DNB SAFDL value of 1.25. Table 15.1.5-9 provides a modified sequence of events for Cycle 15.

The four pump loss of coolant flow produces an approach to the DNBR limit due to the decrease in the core coolant flow. Protection against the DNBR limit for this transient is provided by the initial steady state thermal margin which is maintained by adhering to the Technical Specification LCOs on DNBR margin and by the response of the RPS which provides an automatic reactor trip as calculated by the CPCs.

The principal process variables that determine thermal margin to DNB in the core are monitored by the COLSS. The COLSS computes a power operating limit which ensures that the thermal margin available in the core is equal to or greater than that needed to cause the minimum DNBR to remain greater than the DNBR limit. The minimum thermal margin required (reserved) in COLSS for the loss of flow event is set equal to the maximum thermal margin degradation observed during a loss of flow event.

ARKANSAS NUCLEAR ONE
Unit 2

For the loss of flow event, the CPC trip on pump low speed in conjunction with the initial margin reserved in COLSS is sufficient to prevent the violation of the DNBR SAFDL from any set of initial conditions.

15.1.5.2.3.6 Cycle 15 Loss of Coolant Flow Resulting from a Pump Shaft Seizure

The Loss of Flow from a Pump Shaft Seizure was evaluated to determine the impact of the replacement steam generators (RSGs) for Cycle 15.

The method of the previous analysis for the seized rotor assumes an instantaneous drop from the initial flow rate to the reduced three-pump steady-state flow fraction. Only the final asymptotic three-pump flow fraction is important and not the actual RCS flow coastdown. The evaluation was carried out in the following steps to determine the impact of key plant and physics input data changes:

1. The RCS flow coastdown data for the seized rotor flow event was generated using the CENTS code. A slightly lower final asymptotic three-pump RCS flow value of 0.6% was assessed.
2. The increase in initial maximum RCS flow limit from 355,200 gpm to 386,400 gpm was assessed.
3. The increase in RCS and steam generator inventories was assessed using the new radiological dose method (see Section 15.1.5.2.3.4).

No explicit cases were analyzed. An engineering evaluation of changes in key input data has been employed to assess the impact on the seized shaft event.

The difference in the three-pump asymptotic percentage flow value was lower by 0.6%. This difference has a small impact on the calculated fuel failure for the seized rotor event.

The increase in maximum initial RCS flow was determined to be bounded by the results of the minimum initial RCS flow results; hence increasing the maximum initial RCS flow has no impact on the analysis results.

15.1.5.2.3.7 Cycle 16 Loss of Coolant Flow Resulting from an Electrical Failure

The following analysis was performed to address Power Uprate. The implementation of Power Uprate resulted in a slightly faster four reactor coolant pump flow coastdown, which can be found in Table 15.1.5-12 and Figure 15.1.5-18.

For a loss of flow at any power operating condition, a reactor trip will be initiated when any one of four Reactor Coolant Pump (RCP) shaft speeds drops to 95 percent of its nominal speed. Crediting this trip, the partial loss of flow resulting from a loss of electrical power to three or fewer RCPs is less limiting than a four pump loss of flow. This is because the reactor will trip at the same time for both cases but the partial loss of flow has a slower flow coastdown. Therefore, only the four pump loss of flow event is presented herein.

ARKANSAS NUCLEAR ONE
Unit 2

The analysis was carried out in the following steps:

- A. The RCP coastdown data for the loss of flow event was generated using the CENTS code. Coastdown data to account for up to 10% steam generator tube plugging was determined. The CENTS coastdown analysis considered the affects of both symmetric and asymmetric steam generator tube plugging (up to 10% tube asymmetry). The coastdown analysis also considered the affects of initial RCS pressure, temperature, and flow. The resulting coastdown data generated from CENTS was used as input to the HERMITE code.
- B. The HERMITE code is used to determine the reactor core response during the postulated loss of flow event. The HERMITE code solves the few-group, space and time dependent neutron diffusion equation including the feedback effects of fuel temperature, coolant temperature, coolant density, and control rod motion for a one-dimensional average fuel bundle.
- C. The time dependent thermal hydraulic information generated from the HERMITE code is transferred directly to the CETOP computer code for thermal margin and DNBR evaluation. The CETOP method was used to calculate both the time of occurrence and value of the minimum DNBR during the transient.

Input parameters from Tables 15.1.5-12 and 15.1.5-13 including bounding physics data from Section 15.1.0 have been incorporated in this analysis with the following clarifications:

- A. The CEA insertion curve in Figure 15.1.0-1D was assumed. This curve accounts for a 0.6 second holding coil delay. A CEA worth of $-5.0\% \Delta\rho$ was conservatively assumed.
- B. A BOC delayed neutron fraction consistent with those defined in Section 15.1.0.3 was assumed.
- C. A least negative Doppler coefficient of $-0.00128 \Delta\rho/\sqrt{^\circ\text{K}}$ was assumed.
- D. A CPCS trip is initiated when the RCP shaft speed drops to 95 percent of its normal speed with a response time of 0.4 seconds.
- E. An initial core power of 3087 MWt was assumed, based on a rated power of 3026 MWt and a 2% uncertainty.
- F. A MTC of $0.0 \times 10^{-4} \Delta\rho/^\circ\text{F}$ was assumed.
- G. The following RCS flow, temperature, and pressure ranges in conjunction with a radial peaking factor range are assumed as a basis for input into the maximum and minimum subcooled cases.
 - $118.0 \times 10^6 \text{ lbm/hr} \leq \text{RCS flow} \leq 142.1 \times 10^6 \text{ lbm/hr}$
 - $540 \text{ }^\circ\text{F} \leq \text{core inlet temperature} \leq 556.7 \text{ }^\circ\text{F}$
 - $2000 \text{ psia} \leq \text{RCS pressure} \leq 2300 \text{ psia}$
 - $1.28 \leq \text{radial peak factor} \leq 1.71$

ARKANSAS NUCLEAR ONE
Unit 2

The four pump loss of coolant flow produces an approach to the DNB limit due to the decrease in the core coolant flow. Protection against the DNB limit for this transient is provided by the initial steady state thermal margin which is maintained by adhering to the Technical Specification LCOs on DNBR margin and by the response of the RPS, which provides an automatic reactor trip as calculated by the CPCs.

The COLSS monitors the principal process variables that determine thermal margin to DNB in the core. The COLSS computes a power operating limit, which ensures that the thermal margin available in the core is equal to or greater than that needed to cause the minimum DNBR to remain greater than the DNB limit.

The initial conditions are typically selected such that the system is at a very subcooled state. Initiating the event from such a state results in the least amount of negative reactivity inserted due to generation of voids in the core. In this manner, the system undergoes the greatest amount of thermal margin degradation due to the RCP coastdown.

To demonstrate explicitly that the DNB SAFDL is not violated during a loss of flow event, two sample cases are provided in which the initial conditions are chosen such that at the onset of the event the minimum thermal margin required by the COLSS power operating limit is preserved.

The results of these analyses are the calculation of minimum thermal margin required to be reserved in COLSS to prevent the violation of the DNB SAFDL during a loss of flow event. With a minimum thermal margin reserved in COLSS, the minimum DNBR observed during this event is greater than 1.25 for the maximum subcooled case. The sequence of events for the four pump loss of flow is provided in Table 15.1.5-14. Figures 15.1.5-19 & 15.1.5-20 provide graphs of DNBR versus time for the maximum and minimum subcooled cases, respectively.

Two cases are presented in this section to demonstrate the conservatism in starting at a maximum subcooled state. One case is based on the conservative assumptions used in the Loss of Flow analysis to maintain the core as subcooled as possible to prevent bulk boiling and negative reactivity feedbacks. The second case analyzed uses assumptions, which minimize subcooling and were selected to be within the LCOs. As can be seen by comparing the DNBR traces for these two cases, the DNBR trace using the maximum subcooling assumptions (Figure 15.1.5-19) is more adverse than the DNBR trace using minimal subcooling assumptions (Figure 15.1.5-20).

For the loss of flow event, the CPC trip on low pump speed in conjunction with the initial margin reserved in COLSS is sufficient to prevent the violation of the DNBR SAFDL from any set of initial conditions.

15.1.5.2.3.8 Cycle 16 Loss of Coolant Flow Resulting from a Seized Rotor

The Seized Rotor event was reanalyzed for Cycle 16 to evaluate the impact of increasing the core power to 3026 MWt. The analytical bases for the seized rotor simulation are discussed below.

- A. Upon initiation of this transient, the core flow rate reduces rapidly to the asymptotic (steady state) 3-pump flow fraction. The RCP coastdown data for the seized rotor event was generated using the CENTS code.

ARKANSAS NUCLEAR ONE
Unit 2

- B. The method of the analysis for the seized rotor conservatively assumes an instantaneous drop from the initial flow rate to the reduced 3-pump “steady state” flow fraction calculated previously. Only the final asymptotic 3-pump flow fraction is important to calculation of potential fuel failure and not the actual RCS flow coastdown.
- C. A minimum thermal margin power operating limit is modeled using the CETOP code. Then the mass flow is conservatively reduced to the 3-pump asymptotic flow fraction value while maintaining all the other initial conditions. Therefore, no transient response is required and the only physics data is the pin census.
- D. The analysis is repeated with the above assumptions, using the TORC computer code to determine the minimum DNBR for fuel pins of various radial peaks. An integral fuel damage calculation is then performed by combining the results from the TORC code with the number of fuel rods having a given radial peaking factor. The number of fuel rods versus radial peaking factor is taken from the “cumulative distribution of the fraction of fuel rods versus nuclear radial peaking factor.” Figure 15.1.5-21 presents the results of the TORC computer code determined minimum DNBR for fuel pins of various radial peaks. The total number of calculated fuel failures is compared to the 14% fuel failure limit that assures dose limits are met.

Although no transient response is required, a representative pump shaft seizure was performed from the limiting thermal margin conditions to provide the NSSS response to the event and determine the time of minimum DNBR. The results from the typical NSSS response have no impact on the calculated fuel failure due to the conservative methods discussed above. The CENTS digital computer code is used to simulate the NSSS response and calculate the time of minimum DNBR assuming a CPCS low reactor coolant pump shaft speed trip and response time to mitigate the event. The minimum DNBR condition exists for only a short period of time below the DNB SAFDL. The parameters from Table 15.1.5-15 and the bounding physics data from Section 15.1.0 have been incorporated into the NSSS system response with the following clarifications:

- A. The BOC Doppler curve in Figure 15.1.0-4 was assumed.
- B. A BOC delayed neutron fraction consistent with that defined in Section 15.1.0.3 was assumed.
- C. The CEA insertion curve in Figure 15.1.0-1D was assumed. This curve accounts for a 0.6 second holding coil delay. A CEA worth of $-5.0\% \Delta\rho$ was conservatively assumed.
- D. An initial core power of 3087 MWt was assumed, based on a rated power of 3026 MWt and a 2% uncertainty.
- E. A MTC of $-0.2 \times 10^{-4} \Delta\rho/^\circ\text{F}$ was assumed.
- F. A maximum RCS flow of 386,400 gpm was assumed.
- G. A maximum RCS pressure of 2300 psia was assumed.

ARKANSAS NUCLEAR ONE
Unit 2

- H. A CPCS low reactor coolant pump shaft speed trip setpoint of 95% and a conservative total delay time of 0.5 seconds were assumed. CPCS initiates a reactor trip when the reactor coolant pump shaft speed drops below 95% of its nominal speed.
- I. The asymptotic flow for the one-pump reactor coolant pump flow coastdown was assumed to be 73%. A representative one-pump flow coastdown can be found in Figure 15.1.5-22.

Table 15.1.5-16 and Figures 15.1.5-23 through 15.1.5-26 show the NSSS and RPS responses for a typical loss of reactor coolant flow from a pump shaft seizure event. Employing the current methodology demonstrates a calculated fuel failure of less than 14% for Cycle 16, thus the radiological assessment of the seized rotor event found in Section 15.1.5.2.3.4 remains valid.

15.1.5.2.3.9 Cycle 21 Loss of Coolant Flow Resulting from an Electrical Failure

The Loss of Flow event was evaluated for Cycle 21 for Next Generation Fuel (NGF). Only the DNB margin was affected. The mDNBR for this event was re-evaluated using the WSSV-T and ABB-NV critical heat flux correlations, the input from Cycle 16, and the lower DNB SAFDL of 1.23.

There are no changes to the input, results, and conclusions other than the DNB SAFDL and the time of mDNBR for the maximum subcooled case. The Cycle 16 NSSS analysis remains valid for NGF. The initial assumptions shown in Table 15.1.5-13 remain unchanged for the Cycle 21 analysis. Thus the Cycle 16 thermal hydraulic data was re-evaluated using the current method from Section 15.1.5.2.3.7 with the NGF WSSV-T and ABB-NV CHF correlations. Figures 15.1.5-19 and 15.1.5-20 document the new DNBR versus Time Figures of maximum and minimum subcooled conditions for the WSSV-T and ABB-NV CHF correlations and a DNB SAFDL of 1.23. Table 15.1.5-14 provides the revised Sequence of Events for the full core implementation of NGF.

The minimum DNBR values for the maximum and minimum subcooled condition cases remain above the DNB SAFDL value of 1.23. Consequently, the conclusions in SAR Section 15.1.5.3.1 remain the same.

15.1.5.2.3.10 Cycle 21 Loss of Coolant Flow Resulting from a Seized Rotor

The Seized Rotor event was evaluated for Cycle 21 for Next Generation Fuel (NGF). Only the DNB margin was affected. The mDNBR for this event was re-evaluated using the WSSV-T and ABB-NV critical heat flux correlations, the input from Cycle 16, and the lower DNB SAFDL of 1.23.

There are no changes to the input, results, or conclusions other than the Fr versus DNBR data required to calculate the level of fuel failure. The Cycle 16 NSSS analysis remains valid for NGF. The initial assumptions shown in Table 15.1.5-15 remain unchanged for the Cycle 21 analysis. Thus, the Cycle 16 thermal hydraulic data was re-evaluated using the current method from Section 15.1.5.2.3.8 with the NGF WSSV-T and ABB-NV CHF correlations. The CETOP and TORC code results, described by SAR Section 15.1.5.2.3.8, Items C and D, are impacted. Figure 15.1.5-21 documents the new DNBR versus integrated radial peak factor (Fr) responses. Table 15.1.5-16 provides the revised Sequence of Events for the full core implementation of NGF.

ARKANSAS NUCLEAR ONE
Unit 2

The calculated fuel failures remain below the maximum value used for the radiological dose evaluation. Consequently, the conclusions in SAR Section 15.1.5.3.2 for the radiological releases remain the same.

15.1.5.2.3.11 Cycle 22 Loss of Coolant Flow Resulting from a Seized Rotor

The Seized Rotor event was evaluated for Cycle 22 to reduce the calculated fuel failure to below the radiological dose input limit. Only the DNB margin was affected. The mDNBR for the event was re-evaluated using the input from Cycle 21.

There are no changes to the input, results, or conclusions other than the Fr versus DNBR data required to calculate the level of fuel failure. The Cycle 16 NSSS analysis remains valid for Cycle 22. The initial assumptions shown in Table 15.1.5-15 remain unchanged for the Cycle 22 analysis. The sequence of events in Table 15.1.5-16 remains valid for Cycle 22.

The calculated fuel failures remain below the maximum value used for the radiological dose evaluation. Consequently, the conclusion in SAR Section 15.1.5.3.2 for the radiological releases remained the same.

15.1.5.2.3.12 AST Seized Rotor Analysis

The analysis input and assumptions used in the AST calculation of the radiological dose releases due to a seized rotor event are discussed in Section 15.1.0.5 with the following clarifications:

1. Fission product gap fractions of 0.08 for I-131, 0.10 for Kr-85, 0.05 for other noble gases and iodines and 0.12 for alkali metals, consistent with RG 1.183, Table 3, were used;
2. Secondary release iodine species distribution of 0% particulate, 97% elemental and 3% organic, consistent with RG 1.183, was assumed;
3. A minimum SG secondary mass of 1.253×10^8 gm was used to maximize activity concentration.

The calculated results for 14% fuel failure are presented in Table 15.1.5-10.

15.1.5.3 Conclusion

15.1.5.3.1 Loss of Coolant Flow Resulting From an Electrical Failure

For the cases of the loss of coolant flow arising from the simultaneous loss of power to four reactor coolant pumps or from loss of power to two reactor coolant pumps, the low DNBR trip assures that the minimum DNBR is maintained above its limits. Also, the study conducted to establish the maximum probable frequency decay rates has shown that the rates established are acceptable in their effect on DNBR due to reactor coolant pump speed effects.

15.1.5.3.2 Loss of Coolant Flow Resulting From a Shaft Seizure

For the loss of reactor coolant flow resulting from a seized shaft, the low DNBR trip assures that the radiological releases are less than 10 CFR 50.67 limits.

ARKANSAS NUCLEAR ONE
Unit 2

15.1.6 IDLE LOOP STARTUP

15.1.6.1 Identification of Causes

Idle loop startup is defined as the startup of a reactor coolant pump, without observance of prescribed operating procedures, assuming that both reactor coolant pumps in that loop were idle. The RCS consists of two loops connected parallel to the reactor vessel. Each loop includes two single suction, centrifugal pumps located between the steam generator outlet and the reactor vessel inlet nozzles. The pump motors have non-reversing mechanisms to prevent reverse rotation and also to limit backflow through the pump while the pump is out of service.

The Unit 2 plant was originally designed to permit continued operation with one or two reactor coolant pumps idle. The final Technical Specifications for Unit 2, however, precluded critical operation with any inoperative pumps. An analysis of the idle loop startup was completed prior to the initial issuance of the ANO-2 Technical Specifications, and is presented here for completeness.

15.1.6.2 Analysis of Effects and Consequences

15.1.6.2.1 Method of Analysis

Analysis of the idle loop startup incident was performed with the CESEC computer program, described in Section 15.1.0, for Cycle 1 operation.

The most adverse case involving startup of an idle reactor coolant pump results from EOC initial conditions with two reactor coolant pumps operating in one loop (both reactor coolant pumps idle in the other loop), and with reactor power at nominal conditions for 2-pump operation. At time zero, one of the pumps is started.

In addition to the parameters described in Section 15.1.0, the conservative assumptions given in Table 15.1.6-1 are used for this analysis.

The time zero conditions are summarized in Table 15.1.6-2.

15.1.6.2.2 Results

The RPS and the NSSS responses are shown in Table 15.1.6-3 and in Figures 15.1.6-1 through 15.1.6-6.

15.1.6.3 Conclusion

For the idle reactor coolant pump startup, the minimum DNBR is significantly greater than 1.3.

15.1.7 LOSS OF EXTERNAL LOAD AND/OR TURBINE TRIP

15.1.7.1 Identification of Causes

Loss of external load and/or turbine trip results in a reduction of steam flow from the steam generators to the turbine generator. Cessation of steam flow to the turbine generator occurs because of closure of the turbine stop valves or turbine control valves. The cause of loss of load may be abnormal events in the electrical distribution network or turbine trip. In either of these situations, off-site power is available to provide AC power to the auxiliaries. The loss of all off-site AC power is discussed in Section 15.1.9.

ARKANSAS NUCLEAR ONE
Unit 2

For a turbine generator trip, Reactor Trip (RT) depends on the initial reactor power and the number of turbine bypass valves in the automatic mode. If a sufficient number of turbine bypass valves are in the automatic mode to release steam, then the reactor will not trip. Otherwise, RT will follow turbine trip. In this analysis, all turbine bypass valves are assumed to be in the manual mode.

In the event that the turbine admission valves closed and the steam bypass system valves did not open, and if no credit is taken for RT on turbine trip, RT would occur as a result of high pressurizer pressure. The main steam system pressure and the RCS pressure will be limited to within 110 percent of their design values by action of the pressurizer and steam generator safety valves and the RT on high pressurizer pressure.

The bounding event considered is a Loss of Load (LOL) event initiated by a turbine trip without a simultaneous reactor trip and assuming the Steam Dump and Bypass system is inoperable. If the turbine trip were caused by a Loss of Condenser Vacuum (discussed in Section 15.1.28), the main feedwater pump steam turbines would trip at the same time. Therefore, a LOL concurrent with loss of feed was analyzed to cover these events. The loss of load causes steam generator pressure to increase to the opening pressure of the main steam safety valves. The reduced secondary heat sink leads to a heatup of the RCS. The transient is terminated by a reactor trip on high pressurizer pressure.

15.1.7.2 Analysis of Effects and Consequences

15.1.7.2.1 Method of Analysis

The analysis of a complete loss of load incident was performed with the CESEC-III computer program, described in Section 15.1.0.

In addition to the parameters described in Section 15.1.0 for subsequent analyses, this event was initiated at the conditions shown in Table 15.1.7-1. The combination of parameters shown in Table 15.1.7-1 maximizes the calculated peak RCS pressure. The key parameters for this event are the initial primary and secondary pressures and the moderator and fuel temperature coefficients of reactivity.

The initial core average axial power distribution for this analysis was assumed to be a bottom peaked shape. This distribution is assumed because it minimizes the negative reactivity inserted during the initial portion of the scram following a reactor trip and maximizes the time required to mitigate the pressure and heat flux increases. The CEA position versus time of Figure 15.1.0-1C and a 0.6 second holding coil delay time are assumed in this analysis. A Moderator Temperature Coefficient (MTC) of $0.0 \times 10^{-4} \Delta\rho/^\circ\text{F}$ was assumed in this analysis. This MTC, in conjunction with the increasing coolant temperatures, enhances the rate of change of heat flux and the pressure at the time of reactor trip. A Fuel Temperature Coefficient (FTC) (Doppler Coefficient) corresponding to beginning of cycle conditions was used in the analysis consistent with Figure 15.1.0-3. This FTC causes the least amount of negative reactivity feedback to mitigate the transient increases in both the core heat flux and the pressure. The Doppler Coefficient multiplier used in the analysis for uncertainty is shown in Table 15.1.7-1. The lower initial RCS pressure is used to maximize the rate of change of pressure and thus peak pressure following trip. The lower coolant inlet temperature and lower steam generator pressure combination made the secondary transient more severe by delaying opening of the main steam safety valves.

ARKANSAS NUCLEAR ONE
Unit 2

15.1.7.2.2 Results

In Table 15.1.7-2, the RPS and the NSSS responses are listed for the case analyzed. In Figures 15.1.7-1 through 15.1.7-5, the core power, core average heat flux, reactor system pressure, steam generator pressure and coolant temperatures are shown as a function of time.

The Loss of Load event, initiated at the conditions given in Table 15.1.7-1, results in a high pressurizer pressure trip condition at 7.4 seconds. At 10.6 seconds, the primary pressure reaches its maximum value of 2747 psia. The increase in secondary pressure is limited by the opening of the main steam safety valves, which open at 9.6 seconds. The secondary pressure reaches its maximum value of less than 1169 psia at 15.1 seconds after initiation of the event.

The steam generator safety valves continue to relieve to the atmosphere until the steam dump and bypass system is returned to operation or until the atmospheric dump valves are opened. If operation of the steam dump and bypass system is assumed (1) within 30 minutes, no more than 130,000 pounds of steam will have been discharged and (2) within 60 minutes, no more than 260,000 pounds will be discharged. If, however, the steam bypass system continues to be unavailable and it becomes necessary to cool the plant to 350°F by dumping steam to the atmosphere, approximately 700,000 pounds would be discharged during the 3-hour cooldown, at which point shutdown cooling is initiated.

15.1.7.3 Conclusion

In the case of a complete loss of load which occurs without an immediate reactor trip, the protection provided by the high pressurizer pressure trip, pressurizer safety valves and the steam generator safety valves is sufficient to ensure that the RCS and main steam system pressure is maintained within 110 percent of design values and specified acceptable fuel design limits are not exceeded.

15.1.7.4 Loss of External Load and /or Turbine Trip Subsequent Analyses

15.1.7.4.1 Cycle 13 Loss of External Load and/or Turbine Trip

This subsequent analysis to the loss of external load and/or turbine trip was undertaken to account for Cycle 13 input parameter variations. This analysis was performed essentially consistent with the analysis described above. For the analysis presented herein, the CENTS computer code described in Section 15.1.0.6.10 was utilized.

Input parameters from Table 15.1.7-4 and Section 15.1.0 have been incorporated in this subsequent analysis with these following clarifications:

- A. The BOC Doppler curve in Figure 15.1.0-4, which includes a 0.85 multiplier, is conservatively used.
- B. The Cycle 13 delayed neutron fraction and effective neutron lifetime consistent with Section 15.1.0.3 was assumed.
- C. The Cycle 13 CEA insertion curve in Figure 15.1.0-1D was utilized. This curve accounts for a 0.6 second holding coil delay.

ARKANSAS NUCLEAR ONE
Unit 2

A summary of the principal results for the loss of external load/loss of condenser vacuum are given in Table 15.1.7-5. These results indicate that the peak primary pressure is 2683 psia and the peak secondary pressure is 1162 psia. A separate analysis was performed to determine a conservative peak secondary pressure, as the input assumptions described above and denoted in Table 15.1.7-4 are established to ensure a peak primary pressure. This second analysis is effectively the same as the peak primary analysis except the input assumptions delineated above are adjusted to ensure a conservative peak secondary pressure. The results of this second effort indicate a peak secondary pressure of 1195 psia.

The results of these subsequent analyses shows that the peak RCS and secondary side pressures are maintained less than 110% of design values.

15.1.7.4.2 Cycle 15 at 3026 MWt Loss of External Load and/or Turbine Trip

Subsequent evaluation to the previously described Loss of Load concurrent with a Loss of Condenser Vacuum analysis has been performed to address the installation of the Replacement Steam Generators and a Power Uprate to 3026 MWt at hot full power. The methodology used in this analysis was the same as that used for the previous analysis. This analysis has utilized the CENTS computer code for the transient analysis simulation.

Input parameters from Table 15.1.7-6 and the bounding physics data from Section 15.1.0 have been incorporated in this analysis with the following clarifications:

1. The BOC Doppler curve in Figure 15.1.0-4 was assumed.
2. A BOC delayed neutron fraction and neutron lifetime consistent with those defined in Section 15.1.0.3 was assumed.
3. The CEA reactivity insertion curve in Figure 15.1.0-1D was assumed. This curve accounts for a 0.6 second holding coil delay. CEA worth of $-5.0\% \Delta\rho$ was conservatively assumed.
4. A High Pressurizer Pressure Trip setpoint of 2392 psia and a response time of 0.65 seconds were assumed.
5. An MSSV tolerance of +3% was conservatively assumed.
6. An initial core power of 3087 MWt, based on a rated power of 3026 MWt and a 2% uncertainty, was assumed.
7. An MTC of $0.0 \times 10^{-4} \Delta\rho/^\circ\text{F}$ at HFP was assumed.
8. The minimum HFP core inlet temperature of 540 °F was assumed.
9. A PSV tolerance of 3.2% was conservatively assumed.
10. Parametric analyses were performed on the number of plugged U-tubes per steam generator. It was determined that zero plugged U-tubes per steam generator was limiting.
11. Installation of the RSGs was assumed.
12. A maximum RCS flow of 386,400 gpm was assumed.
13. The PSV flow was adjusted by the Napier correction.

ARKANSAS NUCLEAR ONE
Unit 2

A similar analysis was performed to determine a conservative peak secondary pressure, as the input assumptions described above and denoted in Table 15.1.7-6 are established to ensure a peak primary pressure. This second analysis is effectively the same as the peak primary analysis except the input assumptions delineated above are adjusted to ensure a conservative peak secondary pressure.

The peak RCS and steam generator pressures (2688 psia and 1180 psia, respectively) remained well below the RCS criterion of 2750 psia and the main steam system criterion of 1210 psia. The NSSS and RPS responses for the LOCV event are shown in Table 15.1.7-7 and in Figures 15.1.7-6 through 15.1.7-10. The results of the second analysis to determine peak secondary pressure resulted in a steam generator dome pressure of 1209 psia, which remained below the 1210 psia main steam system criterion.

A subsequent radiological analysis was performed to support steam generator replacement and power uprate. No radiological doses were explicitly calculated for this event due to the bounding nature of the MSLB doses.

15.1.8 LOSS OF NORMAL FEEDWATER FLOW

15.1.8.1 Identification of Cause

The loss of normal feedwater flow is defined as a reduction in feedwater flow to the steam generators when operating at power, without a corresponding reduction in steam flow from the steam generators. The result of this mismatch is a reduction in the water inventory in the steam generators.

The condensate and feedwater system is described in Section 10.4.7 and the emergency feedwater system in Section 10.4.9. The emergency feedwater system is available to automatically provide sufficient feedwater flow to remove residual heat generation from the RCS following RT from rated power. This system consists of one motor-driven and one turbine-driven emergency feedwater pump, and a non-safety Auxiliary Feedwater pump.

A complete loss of both main feedwater pumps or a complete loss of all four condensate pumps results in the loss of all normal feedwater. Closure of the Main Feedwater Block valves or all feedwater regulating or and regulating bypass valves also results in loss of normal feed flow.

The PPS provides protection against loss of the secondary heat sink by the steam generator low water level trip and automatic initiation of the emergency feedwater system. The high pressurizer pressure trip provides protection in the event that the RCS pressure limit is approached.

15.1.8.2 Analysis of Effects and Consequences

15.1.8.2.1 Methods of Analysis

For the loss of feedwater flow analysis, a complete loss of feedwater flow is assumed, since this condition requires the most rapid response from the PPS.

The analysis of a complete loss of feedwater was performed with the CESEC computer program, described in Section 15.1.0.6. Table 15.1.8-1 lists the conservative assumptions made for this analysis.

15.1.8.2.2 Results

The loss of normal feedwater flow is analyzed by assuming an instantaneous complete stoppage of feedwater flow to both steam generators. The emergency feedwater system is automatically actuated following the low steam generator water level trip at 36.4 seconds. To be conservative, it was assumed in the analysis that emergency feedwater would not reach the steam generators for an additional 65 seconds. The principal results for the transients are shown in Table 15.1.8-2. Figures 15.1.8-1 through 15.1.8-4 show the dynamic behavior of the parameters of interest during the transient.

15.1.8.3 Conclusion

For the loss of normal feedwater, the plant protective system assures that the DNB ratio is not less than 1.25 (CE-1 Correlation) or 1.23 (WSSV-T /ABB NV Correlations) and that the steam generator heat removal capability is maintained.

15.1.8.4 Loss of Normal Feedwater Subsequent Analyses

15.1.8.4.1 Cycle 13 Loss of Feedwater Analysis

This subsequent evaluation to the previously described Loss of Feedwater analysis has been performed using essentially the same inputs except those described in this subsection. In addition to the input modifications, the evaluation has utilized the CENTS computer code described in Section 15.1.0.6.10.

This analysis was performed using the inputs from Table 15.1.8-3, Section 15.1.0, and the following assumptions:

- A. An EFW response time of 97.4 seconds was assumed. EFW flow was determined based on steam generator pressure. Prior analysis efforts assumed a constant flow rate regardless of steam generator pressure.
- B. The EOC Doppler curve in Figure 15.1.0-4 which includes a 1.4 multiplier is conservatively used.
- C. The Cycle 13 delayed neutron fraction and neutron lifetime consistent with Section 15.1.0.3 was assumed.
- D. The Cycle 13 CEA insertion curve in Figure 15.1.0-1D was utilized. This curve accounts for a 0.6 second holding coil delay.
- E. An MSSV tolerance of -3% is conservatively assumed.

A summary of the principal results for the loss of normal feedwater flow is given in Table 15.1.8-4. The conclusions of Section 15.1.8.3, that the steam generator heat removal capability is maintained, is unchanged.

ARKANSAS NUCLEAR ONE
Unit 2

15.1.8.4.2 Cycle 15 at 3026 MWt – Loss of Feedwater Analysis

Subsequent analysis of the previously described Loss of Feedwater analysis has been performed to address the installation of the Replacement Steam Generators and a Power Uprate to 3026 MWt at hot full power. The methodology used in this analysis is the same as that used for the previous analysis. This analysis utilized the CENTS computer code for the transient analysis simulation.

Input parameters from Table 15.1.8-5 and the bounding physics data from Section 15.1.0 have been incorporated in this analysis with the following clarifications:

1. The EOC Doppler curve in Figure 15.1.0-4 was assumed.
2. A BOC delayed neutron fraction and neutron lifetime consistent with those defined in Section 15.1.0.3 were assumed.
3. The CEA reactivity insertion curve in Figure 15.1.0-1D was assumed. This curve accounts for a 0.6 second holding coil delay. CEA worth of $-5.0\% \Delta\rho$ was conservatively assumed.
4. An EFW analytical response time of 97.4 seconds was assumed. EFW flow was determined based on steam generator pressure.
5. An MSSV tolerance of -3.5% was conservatively assumed.
6. An initial core power of 3087 MWt, based on a rated power of 3026 MWt and a 2% uncertainty, was assumed.
7. The most negative MTC of $-3.8 \times 10^{-4} \Delta\rho/^\circ\text{F}$ was assumed.
8. Low Steam Generator Level Trip and EFAS analytical setpoints of 9% of narrow range indication were assumed.
9. Installation of the RSGs was assumed.
10. An RCS flow of 315,560 gpm was assumed.
11. The PSV flow was adjusted by the Napier correction.

The minimum steam generator inventory occurred at 212 seconds for steam generator A (RCS loop with pressurizer) and 288 seconds for steam generator B.

The NSSS, RPS, and EFW system responses for the LOFW event are shown in Table 15.1.8-6 and in Figures 15.1.8-5 through 15.1.8-9.

The combination of the replacement steam generators, an increase in rated power, and the change in Low Steam Generator Level Trip and EFAS setpoints did not result in steam generator dryout. Since a minimum steam generator liquid inventory was maintained, there was no loss of secondary heat sink.

15.1.9 LOSS OF ALL NORMAL AND PREFERRED AC POWER TO THE STATION AUXILIARIES

15.1.9.1 Identification of Causes

The loss of AC power is defined as a complete loss of preferred (off-site) AC electrical power and a concurrent turbine generator trip. As a result, electrical power would be unavailable for the station auxiliaries such as the reactor coolant pumps, the steam generator main feedwater pumps and the main circulating water pumps. Under such circumstances, the plant would experience a simultaneous loss of load, feedwater flow, and forced reactor coolant flow.

The loss of all station power is followed by automatic startup of the emergency diesel generators, the power output of which is sufficient to supply electrical power to all engineered safety features and to provide the capability of maintaining the plant in a safe shutdown condition.

Subsequent to reactor trip, stored heat and fission product decay heat must be dissipated. In the absence of forced reactor coolant flow, convective heat transfer throughout the core is maintained by natural circulation. Initially, the residual water inventory in the steam generators is used and steam is released to atmosphere via the steam generator safety valves. With the availability of standby power, emergency feedwater is automatically initiated on a low steam generator water level signal. Plant cooldown is controlled via the path provided by the upstream ADVs which fail open on loss of instrument air, and the remotely controlled motor operated isolation valves or the downstream ADVs.

The low DNBR trip will prevent the DNB safety limit from being violated as a result of this transient. In addition, the pressurizer and secondary safety valves, will prevent the RCS pressure and secondary system pressure from exceeding 110 percent of their design values.

15.1.9.2 Analysis of Effects and Consequences

15.1.9.2.1 Method of Analysis

The analysis of the loss of all normal and preferred AC power was performed using the digital computer simulation of the NSSS, CESEC (see Section 15.1.0). The transient heat flux generated by CESEC and average channel mass velocity are used as input to the COSMO computer program, described in Section 4.4.3, which determines the DNBR for the hot channel as a function of time and axial position. The RCS pressure is held constant at 2,250 psia for all the DNBR calculations; this is conservative since pressure will increase. In addition to the parameters described in Section 15.1, the conservative assumptions given in Table 15.1.9-1 are used for the analysis.

During the transient the following actions are assumed.

- A. At time zero, when all electrical power is lost to the station auxiliaries, the following assumptions are made:
 1. The turbine stop valves close, and the area of the turbine admission valves is instantaneously reduced to zero;
 2. The steam generator feedwater flow to both steam generators is instantaneously reduced to zero;

ARKANSAS NUCLEAR ONE
Unit 2

3. The reactor coolant pumps begin to coast down. Following coastdown, the coolant flow necessary to remove decay heat is maintained by natural circulation. Reactor coolant pump coastdown and natural circulation flow is calculated by the digital computer code, COAST (Section 15.1.0).
- B. Emergency diesel generators start automatically after the loss of AC power. The motor driven emergency feedwater pump and the turbine driven emergency feedwater pump are started automatically on low steam generator water level.
- C. Manual action may be taken to:
1. Actuate the steam generator atmospheric dump and isolation valves 15 minutes subsequent to initiation of the incident;
 2. Cool the plant by means of the atmospheric dump and isolation valves, to hot standby temperature of 547.6 °F in less than 30 minutes subsequent to initiation of the incident.

15.1.9.2.2 Results

The RPS and the NSSS responses are shown in Table 15.1.9-2 and in Figures 15.1.9-1 through 15.1.9-4.

15.1.9.3 Conclusion

Analysis shows that for the loss of normal and preferred AC power the minimum hot channel DNBR during the transient is not less than 1.3.

15.1.9.4 Subsequent Analysis

15.1.9.4.1 Cycle 15 at 3026 MWt Loss of All Normal and Preferred AC Power to the Station Auxiliaries

The LOAC event was evaluated to determine the impact of the replacement steam generators (RSGs) for Cycle 15 up to 3026 MWt rated power. The method for evaluation was to identify other DBEs that have behavior similar to the LOAC event, with the same acceptance criteria, and result in more adverse consequences.

An evaluation of the LOAC has verified that:

1. The LOAC event's minimum DNB SAFDL is bounded by the Loss of Forced Reactor Coolant Flow event (Section 15.1.5).
2. The LOAC event's peak RCS and steam generator pressures are bounded by the Loss of External Load/Turbine Trip event (Section 15.1.7).
3. The LOAC event's radiological doses for the EAB and LPZ are acceptable due to the bounding nature of the MSLB doses.

ARKANSAS NUCLEAR ONE
Unit 2

Based on this evaluation, no subsequent LOAC analyses have been performed and none need be performed for Cycle 15 and for power uprate as well, since the results of the three bounding events listed meet the acceptance criteria for the respective event.

15.1.10 EXCESS HEAT REMOVAL DUE TO SECONDARY SYSTEM MALFUNCTION

15.1.10.1 Identification of Causes

Excess heat removal due to secondary system malfunction can occur as a result of feedwater system or main steam system valve malfunction.

Excess heat removal causes a decrease in the temperature of the reactor coolant, an increase in reactor power due to the negative moderator temperature coefficient and a decrease in the RCS and steam generator pressures. Detection of these conditions is accomplished by the RCS and steam generator pressure alarms and the high reactor power alarm.

Protection against the violation of specified acceptable fuel design limits as a consequence of an excessive heat removal accident is provided by the low DNBR and high local power density trips.

15.1.10.1.1 Excess Heat Removal Due to Feedwater System Malfunction

Excess heat removal due to feedwater system malfunction may be caused by:

- A. Loss of one of several feedwater heaters. The loss could be due to interruption of steam extraction flow. The high pressure heaters are conservatively assumed to increase the feedwater enthalpy by 54 Btu/lb at full load. In order to lose this heating, four valves (one per extraction line) would need to be operated. The loss of any of the low pressure heaters before the feedwater pumps will produce a lesser effect due to the compensating effect of the high pressure heater in that cycle.
- B. Startup of emergency feedwater. The emergency feedwater system supplies 950 gpm of relatively cold water from the condensate storage tank to the steam generators; starting of this system would decrease feedwater temperature and increase feedwater flow.
- C. An increase in feedwater flow may be caused by further opening of a feedwater control valve or an increase in feedwater pump speed. The maximum flow increase at full power is approximately 60 percent above normal.

15.1.10.1.2 Excess Heat Removal Due to Main Steam System Valve Malfunction

Excess heat removal due to main steam system valve malfunctions may be caused by:

- A. Rapid opening of the turbine admission valves. The maximum increase in steam flow due to opening of the turbine admission valves is limited by the turbine load limit control.
- B. Opening of one of the steam dump and bypass system valves at power due to a control system failure. One of the valves in the steam dump and bypass system may be opened as a result of a single failure in the steam dump and bypass control system.

ARKANSAS NUCLEAR ONE
Unit 2

- C. Opening of one of the steam dump and bypass system valves at hot standby conditions due to a control system failure. One of the secondary valves in the system can be opened as a result of a single failure in the steam dump and bypass control system.
- D. Inadvertent opening of an atmospheric dump valve. This valve has a flow capacity of 11.5 percent of full power steam flow rate. The analysis is conservatively based upon the original design capacity of 13 percent.

15.1.10.2 Analysis of Effects and Consequences

15.1.10.2.1 Methods of Analysis

The analysis was performed with the CESEC computer program described in Section 15.1.0.

For the feedwater system malfunction cases, the increase in feedwater flow causes the largest decrease in the feedwater enthalpy and is therefore the most severe incident. The conservative initial conditions, shown in Table 15.1.10-1, are used in addition to the parameters described in Section 15.1.0.

A parametric study was performed to determine the most adverse case considering initial power level and opening of either the turbine admission valves (from their steady state position to full open with no credit taken for the turbine load limit control) or one of the valves in the steam dump and bypass system (total original design capacity 13 percent of full power steam flow at rated conditions).

The excess heat removal incident due to the opening of one of the steam dump and bypass system valves which vent to the atmosphere has been determined to be the most severe incident. The conservative initial conditions, shown in Table 15.1.10-2, are used in addition to the parameters described in Section 15.1.0.

15.1.10.2.2 Results

The NSSS and RPS responses for excess heat removal due to feedwater system malfunction are shown in Tables 15.1.10-3A and B, and in Figures 15.1.10-1A through 15.1.10-4A and Figures 15.1.10-1B through 15.1.10-4B.

The NSSS and RPS responses for steam dump and bypass system malfunction are shown in Table 15.1.10-4 and in Figures 15.1.10-5 through 15.1.10-8.

As stated above, a remotely operated atmospheric steam dump valve is assumed to have the original design flow capacity of 13 percent of the full power steam flow rate. Under full power conditions this valve can release 470 lb/sec of steam. If this steam release were to continue, a low steam generator water level trip would occur. The associated decrease in steam generator pressure would eventually lead to the closure of the main steam isolation valves. For the case presented here, the atmospheric dump valve opened is assumed to be positioned upstream of the main steam isolation valve and therefore steam release through this valve must be terminated by the operator. It is assumed that in 30 minutes the operator will close this valve and assume control of the plant.

ARKANSAS NUCLEAR ONE
Unit 2

The transient results in a total steam discharge to atmosphere of 400,000 lbs of steam. Associated with this steam release is the release of less than 0.0208 dose equivalent curies of I^{131} and 3.03 dose equivalent curies of Xe^{133} . For this situation, the inhalation dose at the site boundary is conservatively evaluated to be 3.34×10^{-3} rem and the whole body dose at the site boundary is conservatively evaluated to be 9.01×10^{-5} rem.

15.1.10.3 Conclusion

As shown by the analysis, a feedwater system malfunction will attain a new steady state with sufficient margin to DNB and maximum local power density below the value that would result in centerline melting.

A steam dump and bypass system malfunction may cause a reactor trip but no core damage results since the minimum DNBR for the most severe case is greater than 1.3 and the maximum local power density remains below a value that would result in centerline melting. The radioactivity release resulting from the opening of one of the steam dump and bypass system valves will be below the limits set forth in 10 CFR 20.

15.1.10.4 Subsequent Analyses

15.1.10.4.1 Cycle 13 Excess Heat Removal Assessment (Excess Heat Removal Due to Secondary System Malfunction)

To assure that the CPCs can accurately sense the cooldown associated with an excess heat removal event, even with the change in transient dynamics due to tube plugging and RCS flow reduction, a CPC transient filters analysis was performed for Cycle 13. The CPC transient filters analysis verifies the CPC adjusted process parameters are conservative with respect to the expected values for a given transient event. The CPC coefficients are adjusted as necessary to assure the CPC action prevents SAFDL violation during the transient. A spectrum of potential turbine admission valve driven increases in steam flow was analyzed to ensure that the filters are conservative in the decreasing temperature direction over the spectrum of possible power to load imbalances.

Cycle 13 physics data consistent with that defined in Section 15.1.0 was assumed for this assessment. A T_{cold} of 556.7°F, initial RCS pressure of 2000 psia, a low steam generator trip setpoint of 620 psia, Cycle 13 BOC Doppler curve, and an MTC of $-1.5E-4 \Delta\rho/^\circ F$ were also assumed for this analysis.

This analysis included parametric studies on RCS flow and tube plugging to determine the limiting values of these inputs. The design minimum RCS flow reduced by 10% and 0% tube plugging were limiting assumptions to a CENTS analysis of an excess heat removal event. The results of the analysis verifies proper detection of significant overcooling transient and conservative CPC actions. Consequently, the effects of tube plugging and reduced flow on the significant excess heat removal events have been evaluated. This evaluation ensures that the CPCs and RPS will provide the necessary trip function to prevent the SAFDLs from being violated.

15.1.10.4.2 Lower Low Steam Generator Pressure Setpoint Assessment

The inadvertent opening of an ADV has been determined to be the most severe excess heat removal incident due to a main steam valve malfunction. Lowering the MSIS low steam generator pressure setpoint from 678 psia to 620 psia will not affect this event with respect to the time of plant trip. Plant trip is initiated in this event based on a low steam generator level condition. Lowering the low steam generator pressure trip setpoint will delay the time at which an MSIS signal is generated. An MSIS signal is credited as isolating the unaffected steam generator. For this event it was assumed that one of the ADVs upstream of the MSIVs inadvertently opened and operator action was required to isolate the affected steam generator. A longer delay in isolating the unaffected steam generator will result in a slightly larger steam generator mass release than that presented above. Less than a 10% increase in the amount of mass release indicated above for this event is conservatively estimated. As a result, the total mass released under these conditions are well within those considered for the MSLB (Section 15.1.14.1.4.4). Based on the bounding nature of the MSLB release, the results of the MSLB event can be used to bound this event.

A lower low steam generator pressure setpoint does not affect the results of this event with respect to the timing of reactor trip and thereby does not affect the conclusion with respect to the minimum DNBR, maximum local power density, and peak primary and secondary system pressures. A steam dump and bypass system malfunction may cause a reactor trip but no core damage results since the minimum DNBR and maximum local power density remain within acceptance criteria. The radioactivity release for this event is bounded by the results of the MSLB event.

15.1.10.4.3 Cycle 15 at 3026 MWt Excess Heat Removal Due to Feedwater System Malfunction

The Excess Heat Removal due to Feedwater System Malfunction event analysis was performed to assess the impact of the replacement steam generators at a rated power of 3026 MWt. The methodology used in this analysis is similar to the methodology used in the previous analysis, except that the CENTS code is used instead of the CESEC code. The minimum DNBR evaluation was determined using the CETOP code.

Two different types of feedwater malfunction events were reviewed:

1. An instantaneous increase in main feedwater to 160% of initial flow to both steam generators with a decrease in feedwater enthalpy of 152 Btu/lbm.
2. A loss of two feedwater heaters in both main feedwater trains that resulted in a decrease in feedwater enthalpy of 86 Btu/lbm.

Of the two feedwater malfunction events, the instantaneous increase in main feedwater to 160% of initial main feedwater flow with a decrease in feedwater enthalpy of 152 Btu/lbm was determined to be the more adverse event of the two.

Input parameters from Table 15.1.10-5 and the bounding physics data from Section 15.1.0 have been incorporated in this analysis with the following clarifications:

ARKANSAS NUCLEAR ONE
Unit 2

1. The BOC Doppler curve in Figure 15.1.0-4 was assumed.
2. A delayed neutron fraction and neutron lifetime consistent with those defined in Section 15.1.0.3 were assumed.
3. The CEA reactivity insertion curve in Figure 15.1.0-1D was assumed. This curve accounts for a 0.6 second holding coil delay. A CEA worth of $-5.0\% \Delta\rho$ was assumed.
4. The CPC VOPT was employed in the analysis. A cold leg RTD response time of 8 seconds was accounted for along with a CPC trip delay time of 0.60 seconds.
5. An initial core power of 3087 MWt, based on a rated power of 3026 MWt and a 2% uncertainty, was assumed.
6. The most negative MTC of $-3.8 \times 10^{-4} \Delta\rho/^\circ\text{F}$ was assumed.
7. Initial RCS pressure was assumed to be 2300 psia.
8. Initial RCS flow was assumed at the minimum value of 315,560 gpm.
9. It was assumed that the main feedwater flow to both steam generators increased from 102% to 160% of the flow at 3026 MWt instantaneously (0.5 seconds) with a decrease in feedwater enthalpy of 152 Btu/lbm.
10. Installation of the RSGs was assumed.
11. An initial steam generator pressure of 1003 psia was assumed.

An increase in main feedwater can cause an overcooling of the RCS as a result of the decreasing cold leg inlet temperature. Core power also increases due to the reactivity feedback interaction caused by the lower cold leg inlet temperature. The CPC VOPT terminates the transient.

The NSSS and RPS responses for excess heat removal due to feedwater system malfunction are shown in Table 15.1.10-6 and in Figures 15.1.10-9 through 15.1.10-13.

For the limiting feedwater malfunction event, the increase in feedwater flow to 160% with a 152 Btu/lbm decrease in feedwater enthalpy, the minimum DNBR is greater than 1.25 and the peak linear heat rate is less than 21 KW/ft. Thus, the SAFDLs are protected.

15.1.10.4.4 Cycle 15 at 3026 MWt Excess Heat Removal Due to Main Steam System Valve Malfunction

The Excess Heat Removal due to Main Steam System Valve Malfunction event analysis was performed to assess the impact of replacement steam generators (RSGs) at a rated power of 3026 MWt. The methodology used in this analysis was similar to the methodology used in the previous analysis, except that the CENTS code was used instead of the CESEC code. The minimum DNBR evaluation was determined using the CETOP code.

The CPCs will terminate this transient on either a VOPT or low DNBR trip to protect the SAFDLs.

ARKANSAS NUCLEAR ONE
Unit 2

Of the main steam system valve malfunctions listed above that can initiate excess steam flow, inadvertent opening of an ADV is the most adverse. The increase in steam flow caused by rapid opening of the turbine admission valves from their steady state 100% power position to full open position is typically less than the design flow capacity of a fully open atmospheric dump valve. The high pressure turbine was modified for Cycle 15 to accommodate the RSG pressures and anticipated power uprate efforts. The excess capacity of the turbine admission valves will be less than that of the ADV event analyzed below, assuming the plant is operating at normal 100% power conditions with a steam generator pressure of approximately 940 psia. The turbine admission valve capacity under high steam generator pressure conditions (1000 psia) will slightly exceed the ADV capacity by approximately 2%. This excess capacity is only available in an off normal operating regime (plant operation at the high end of the TS Tcold operating range). This analysis assumes the inadvertent opening of one ADV upstream of the MSIV associated with steam generator A. At the full open position, this analysis conservatively assumed 13% flow capacity for the dump valve at power uprate conditions.

Input parameters from Table 15.1.10-7 and the bounding physics data from Section 15.1.0 have been incorporated in the excess heat removal analysis with the following clarifications:

1. The BOC Doppler curve in Figure 15.1.0-4 was assumed.
2. A delayed neutron fraction and neutron lifetime consistent with those defined in Section 15.1.0.3 were assumed.
3. The CEA reactivity insertion curve in Figure 15.1.0-1D was assumed. This curve accounts for a 0.6 second holding coil delay. A CEA worth of $-5.0\% \Delta\rho$ was assumed.
4. The analysis was conservatively based on an inadvertent opening of an ADV with a flow capacity of approximately 13% full power flow. By maintaining this conservative assumption, the impact of increasing the rated power was very small.
5. The CPC VOPT was employed in the analysis. A cold leg RTD response time of 8 seconds was included along with a CPC trip delay time of 0.60 seconds.
6. An initial core power of 3087 MWt, based on a rated power of 3026 MWt and a 2% uncertainty, was assumed.
7. The most negative MTC of $-3.8 \times 10^{-4} \Delta\rho/^\circ\text{F}$ was assumed. This results in the largest radial power distortion in the core due to the core temperature asymmetry.
8. The analytical MSIS setpoint was 693 psia. The MSIVs, MFIVs, and Back-up MFIVs all receive an MSIS signal to close. An analytical response time of 4.9 seconds (which includes a 1.4 second MSIS response time) was assumed for the MSIVs. The MFIVs were assumed to close in 26.4 seconds (including the 1.4 second MSIS response time) which is longer than the time to close the Back-up MFIVs.
9. Installation of the RSGs was assumed.
10. An initial RCS pressure of 2300 psia was assumed.
11. An initial RCS flow of 315,560 gpm was assumed.

ARKANSAS NUCLEAR ONE
Unit 2

12. An initial steam generator pressure of 1003 psia was assumed.
13. An analytical SIAS setpoint of 1400 psia was assumed. A response time of 40 seconds for the HPSI pumps to reach full speed was also assumed.
14. The MSSVs are assumed to lift early at -3.5%.

The impact of the ADV malfunction is an overcooling of the RCS. Core power also increases due to the reactivity feedback interaction caused by the lower cold leg inlet temperature. The CPC VOPT terminates the transient. The NSSS and RPS responses for excess heat removal due to opening of an ADV are shown in Table 15.1.10-8 and in Figures 15.1.10-14 through 15.1.10-18.

For the opening of an atmospheric dump valve event, the minimum DNBR is greater than 1.25 and the peak LHR is less than 21 KW/ft. Thus, the SAFDLs are protected.

Additionally, the excess load event is analyzed from different initial power levels, MTC values, and load demands as part of the CPC filter verification analysis. The object of this is to verify that the CPC T_{cmax} and T_{cmin} algorithms provide conservative input into the CPC VOPT and CPC Low DNBR calculations. If the CPC filter coefficients/algorithms are non-conservative, then a penalty factor is provided for inclusion in the CPC constants calculation. The fastest events present the most challenge to the CPCs, since input is changing rapidly. If the CPC provides adequate protection for the faster events, then the slower events are also protected.

The initial conditions assumed in the CPC transient filter analysis are different than those assumed in the excess load transient discussed above. The initial conditions are selected to provide the greatest challenge to the CPCs (temperature decreasing filters).

The CPC transient filter analysis verifies that the CPC adjusted process parameters are conservative with respect to the expected values for the excess heat removal event. The CPC coefficients are adjusted as necessary to assure the CPCs action prevents SAFDL violation during the transient.

No dose calculation was performed for this excess heat removal event because doses for this and other AOOs are deemed to be acceptable due to the bounding nature of the MSLB doses.

15.1.10.4.5 Cycle 18 Excess Heat Removal Due to Feedwater System Malfunction

The Excess Heat Removal Due to Feedwater System Malfunction event was evaluated at a higher LOCA Limit of 14.4 KW/ft. Only the peak LHR margin was affected. There was no impact on DNB margin.

The methodology was the same as that used in the current analysis in Section 15.1.10.4.3. The LOCA Limit value of 14.4 KW/ft was used in place of the previous value of 13.7 KW/ft. No new computer cases were required.

The combination of the radial power distortion and core power results from the current analysis were combined with the higher LOCA Limit value of 14.4 KW/ft to determine the new peak LHR value. The calculated value remained less than the 21 KW/ft SAFDL value.

15.1.10.4.6 Cycle 18 Excess Heat Removal Due to Main Steam System Valve Malfunction

The excess heat removal due to main steam system valve malfunction event was evaluated at a higher LOCA Limit of 14.4 KW/ft.

The methodology was the same as that used in the current analysis in Section 15.1.10.4.4. The LOCA Limit value of 14.4 KW/ft was used in place of the previous value of 13.7 KW/ft. No new computer cases were required.

The CPCS transient filters analysis verified that the CPCS adjusted process parameters were conservative with respect to the expected values for a given transient event. The CPCS coefficients were adjusted as necessary to assure the CPCS action prevents SAFDL violation during the transient. The results of the analysis verified proper detection of significant overcooling transients and conservative CPCS actions. Consequently, the effects of the increase in the LOCA Limit to 14.4 KW/ft had been evaluated for the excess load events. The current CPCS coefficients ensured that the CPCS DNBR / LPD calculations are sufficiently conservative to generate a reactor trip in sufficient time to prevent violation of the SAFDLs. This change in LOCA Limit does not impact the radiological dose results.

15.1.10.4.7 Cycle 21 Excess Heat Removal Due to Feedwater System Malfunction

The Excess Heat Removal Due to Feedwater System Malfunction event was evaluated for Cycle 21 for Next Generation Fuel (NGF). Only the DNB margin was affected. There was no impact on the LHR margin.

The methodology was the same as that used in the current analysis presented in Section 15.1.10.4.3. The Excess Heat Removal Due to Feedwater System Malfunction event was evaluated for Cycle 21 using the WSSV-T and ABB-NV critical heat flux correlations and the lower DNB SAFDL of 1.23 for the minimum DNBR evaluation. No CENTS cases were repeated as all other current input parameters in Table 15.1.10-5 remained unchanged.

The Excess Heat Removal Due to Feedwater System Malfunction event is less adverse than the Excess Heat Removal Due to Main Steam System Valve Malfunction event and is protected by the Core Protection Calculator System (CPCS). The current CPCS coefficients and setpoints ensure that the calculations are sufficiently conservative to generate a reactor trip in sufficient time to prevent violation of the SAFDLs.

Table 15.1.10-6 provides the revised Sequence of Events for the full core implementation of NGF. The minimum DNBR value remains above the DNB SAFDL value of 1.23. Consequently, the conclusions in SAR Sections 15.1.1.10.4.3 (mDNBR remains above the DNB SAFDL) and 15.1.10.4.5 (peak LHR remains below the LHR SAFDL) remain the same.

15.1.10.4.8 Cycle 21 Excess Heat Removal Due to Main Steam System Valve Malfunction

The Excess Heat Removal Due to Main Steam System Valve Malfunction event was evaluated for Cycle 21 for Next Generation Fuel (NGF). Only the DNB margin was affected. There was no impact on the LHR margin.

ARKANSAS NUCLEAR ONE
Unit 2

The methodology was the same as that used in the current analysis presented in Section 15.1.10.4.4. The Excess Heat Removal Due to Main Steam System Valve Malfunction event was evaluated for Cycle 21 using the WSSV-T and ABB-NV critical heat flux correlations and the lower DNB SAFDL of 1.23 for the minimum DNBR evaluation. No CENTS cases were repeated, as all other current input parameters in Table 15.1.10-7 remained unchanged.

The CPCS transient filters analysis verified that the CPCS adjusted process parameters were conservative with respect to the expected values for a given transient event. The CPCS coefficients were adjusted as necessary, to assure the CPCS action prevents SAFDL violation during the transient. The results of the analysis verified proper detection of significant overcooling transients and conservative CPCS actions. The current CPCS coefficients ensure that the CPCS DNBR / LPD calculations are sufficiently conservative to generate a reactor trip in sufficient time to prevent violation of the SAFDLs.

Table 15.1.10-8 provides the revised Sequence of Events for the full core implementation of NGF. Consequently, the conclusions in SAR Sections 15.1.1.10.4.4 (mDNBR remains above the DNB SAFDL) and 15.1.10.4.6 (peak LHR remains below the LHR SAFDL) remain the same.

15.1.11 FAILURE OF THE REGULATING INSTRUMENTATION

15.1.11.1 Identification of Causes

A reactor coolant flow controlled malfunction is not possible. Unit 2 does not include coolant flow controllers.

Malfunction or failure of other regulating systems (control systems described in Section 7.7) could result in deviation of plant process parameters from prescribed values. Such deviations would initiate a reactor trip in the event a core safety limit were approached.

15.1.12 INTERNAL AND EXTERNAL EVENTS INCLUDING MAJOR AND MINOR FIRES, FLOODS, STORMS, AND EARTHQUAKES

Improbable naturally occurring events and events caused by mechanical or electrical failure of plant components are discussed in this section. Internal events include major and minor fires. External events include storms, flooding, and earthquakes, caused by atmospheric or geological disturbances.

15.1.12.1 Fires

15.1.12.1.1 Identification of Causes

Sources of both major and minor fires are assumed to be equipment malfunctions, personnel negligence, or natural phenomena.

15.1.12.1.2 Analysis of Effects and Consequences

Fire prevention methods, operational procedures of the Fire Protection System (FPS) and incident fire analyses are presented and discussed in Section 9.5.1. Physical separation of redundant safety-related equipment precludes the possibility that one fire could damage more than one train or channel.

ARKANSAS NUCLEAR ONE
Unit 2

15.1.12.2 Floods

Unit 2 has been designed to withstand the probable maximum flood. Under these conditions, the plant will be able to attain and sustain a safe shutdown condition with no loss of integrity to safety-related systems or Seismic Category 1 structures, systems and components.

15.1.12.2.1 Identification of Causes

The origins of a possible flood are assumed to be excessive precipitation, spring snow runoff and/or the failure of an upstream dam. The Arkansas river navigation project provides 17 locks and dams and is expected to eliminate flood hazards based on maximum probable flood flows computed by the Corps of Engineers as described in Section 2.4.

15.1.12.2.2 Analysis of Effects and Consequences

Flood design criteria are presented in Section 3.4, Flood Protection Methods. Operational procedures and analyses are given in Section 2.4.

15.1.12.3 Storms

15.1.12.3.1 Identification of Causes

Considering its inland location, a tornado was analyzed to be the most destructive type of storm that could possibly affect the plant. Unit 2 has been designed to withstand wind loadings, pressure differentials and missiles generated by tornadoes. The Probable Maximum Precipitation (PMP) has been determined according to methods presented in Section 2.4.

15.1.12.3.2 Analysis of Effects and Consequences

Tornado loadings and missile analyses are presented and discussed in Sections 3.3.2 and 3.5, respectively. The effects of the PMP are discussed in Section 2.4. Neither of these natural phenomena will prevent the safe shutdown of the plant.

15.1.12.4 Earthquakes

15.1.12.4.1 Identification of Causes

Unit 2 is located in an area of relative geologic stability. However, safety-related structures, systems, and components have been designed to withstand a Design Basis Earthquake (DBE). Unit 2 seismology is discussed in Section 2.5.

15.1.12.4.2 Analysis of Effects and Consequences

Sections 3.7, 3.8, 3.9 and 3.10 describe the seismic design methods and results. Vibratory ground motion up to and including the DBE will not prevent the safe shutdown of the plant.

15.1.13 MAJOR RUPTURE OF PIPES CONTAINING REACTOR COOLANT UP TO AND INCLUDING DOUBLE-ENDED RUPTURE OF LARGEST PIPE IN THE REACTOR COOLANT SYSTEM (LOSS OF COOLANT ACCIDENT)

15.1.13.1 Identification of Causes

Regulatory Guide 1.4 describes a design basis LOCA as one of the hypothetical accidents used to evaluate the adequacy of various plant structures, systems, and components used to protect the public health and safety. Such an evaluation is required in Section 50.34 of 10 CFR 50 and is the subject of this analysis. LOCA analyses for the purpose of demonstrating the satisfactory performance of the safety injection system are given in Section 6.3.3 for a full spectrum of pipe break sizes.

The design basis LOCA is postulated as a break in the RCPB piping. A release of the core's radioactive inventory to the containment in two phases over 1.8 hours is assumed. The fractions of the core's radioactive inventory assumed to be airborne within the containment and available for release by leakage to the environment is shown in Table 15.1.13-3.

For halogens, of the 40 percent which becomes available, it is assumed that 4.85 percent is elemental iodine, 95 percent is particulate iodine and 0.15 percent are organic iodides.

Because of the extreme care taken in design and construction of the plant, and because of the periodic testing and inspection required, the probability of a LOCA is considered to be extremely low. Nevertheless, because of the potential consequences, several important systems, identified as engineered safety feature systems have been provided to prevent clad and fuel melting, to limit chemical reactions, and to protect the health and safety of the public.

These systems, described in Chapter 6, are the Safety Injection System (SIS) (Emergency Core Cooling System (ECCS)); the containment heat removal systems (Containment Spray System (CSS) and Containment Cooling System (CCS)); the Containment Isolation System (CIS); the Penetration Rooms Ventilation System (PRVS); and the combustible gas control system (hydrogen recombiners). Containment air purification (iodine removal) is accomplished by the CSS as described in Section 6.2.3.

The radioactive source terms for this analysis are based on ORIGEN-S (Reference 52) and exceed that which would result from Section 6.3.3. Section 6.3.3 effects can be summarized as follows:

- A. A small amount of zirconium clad oxidation (Zr - steam reaction; < 1.0 percent);
- B. No significant fuel or clad melting; and,
- C. Some clad perforation.

Damage to the reactor core would be limited to clad swelling and perforation, and to a negligible amount by clad oxidation. Thus, the activity released to the containment by a LOCA would be limited to the gases and volatile fission products present in the gas gap (plenum) of those fuel rods which perforate.

15.1.13.2 Analysis of Events and Consequences

For a conservative analysis of the accident, the containment is assumed to reach and remain at its design pressure for the first 24 hours, yielding a maximum containment leak rate during this period.

TEDE doses which result from the design basis LOCA have been calculated.

The RADTRAD code was used to calculate off site and control room doses using dose conversion factors from FGR-11 and FGR-12. Table 15.1.13-1 indicates the basic assumptions used in the analysis. The dose models used are described in Section 15.1.0.5.

15.1.13.3 Results

Table 15.1.13-2 summarizes the calculated doses at the exclusion area boundary (1,046 meters), at the low population zone boundary (4,184 meters), and for the control room operator resulting from the design basis LOCA, including doses due to the containment release and due to post accident leakage.

15.1.13.4 Post-Accident Leakage

15.1.13.4.1 Recirculation Leakage

Subsequent to the injection phase of Engineered Safety Features (ESF) system operation during which the ESF pumps discharge the contents of the RWT to the containment spray header and the RCS, the water in the containment sump is recirculated by the High Pressure Safety Injection (HPSI) and containment spray pumps. The transfer of the pump suction from the RWT to the containment sump is accomplished automatically by the Recirculation Actuation Signal (RAS) (see Section 7.3.1.1.11.6). The Low Pressure Safety Injection (LPSI) pumps are also secured by the RAS. Because the LOCA will cause the sump water to contain much of the radioiodine, the potential off-site dose due to operation of this external recirculation path with leakage has been evaluated.

The dose calculations of ESF leakage are conservatively based on 100 percent of the released core iodine being homogeneously mixed in the sump at the beginning of recirculation.

The total assumed leakage from the ECCS is 4120 cc/hr, i.e. double the total allowed leakage during normal plant operation. This leakage rate assumes two containment spray and three HPSI pumps are in operation. Both ESF trains were assumed to operate at 100 percent capacity for the 30 days following the accident.

The off-site and control room doses resulting from this leakage were obtained using the dilution factors of Table 15.1.0-5 and Table 15.1.13-1 respectively. The control room dilution factors were recalculated using ARCON96 (see Section 15.1.0.6.11) and meteorological data from 1995 through 1999. An iodine-water partition factor of 0.1 was used to calculate the amount of iodine which is available for release from the pump rooms (Reference 39). Activity was assumed to be dispersed instantaneously from the pump rooms to the atmosphere with no further nuclide holdup or decay. No credit was taken from adsorption and filtration of exhaust air from the auxiliary building.

The total doses due to ESF leakage are included in Table 15.1.13-2.

ARKANSAS NUCLEAR ONE
Unit 2

The doses resulting from this source are small compared to those resulting from the activity released due to containment leakage.

The results of this analysis are believed to be extremely conservative for the following reasons:

- A. It is expected that only the gap radioiodine activity would be present in the sump water and this would be only about one percent of the radioiodine activity assumed in the analysis.
- B. Release of radioiodine to the atmosphere is not instantaneous as assumed, since the majority of the components within the ESF pump rooms are isolated from the remainder of the auxiliary building atmosphere.
- C. No consideration or credit was included in the analysis for any plate out of iodine on metal surfaces.

15.1.13.4.2 Other Leakage

Gross leakage from any piping system in an ESF pump room would be detected by a level detector located in each room. Each level switch actuates an alarm in the control room.

Operator action is initiated when the liquid level in the floor drain piping or room has reached the high level alarm point. Equipment and floor drainage systems for the auxiliary building are discussed in Section 9.3.3. This action would consist of determining the source of leakage, manually draining the room floor drain piping or in the case of gross leakage, isolation of all piping systems that could conceivably drain to the room that has alarmed high level. For the limiting configuration, the quantity of leakage prior to an alarm that would initiate operator action is approximately 35 gallons based upon the volume of pipe or floor area below the lowest alarm level switch.

Operator action for isolation of piping systems is to close the isolation valves and secure the pumps for the piping systems involved. The time required for operator action and valve closure is estimated to be five minutes.

ESF pump rooms in the auxiliary building are equipped with watertight doors. Separation is maintained between redundant trains of ESF equipment by isolating separate trains in separate rooms. Independent drainage systems are provided for each train to preclude flooding via a drainage system.

15.1.14 MAJOR SECONDARY SYSTEM PIPE BREAKS WITH OR WITHOUT A CONCURRENT LOSS OF AC POWER

15.1.14.1 Steam Line Break Accident

15.1.14.1.1 Identification of Causes

Major secondary system pipe breaks are those ruptures in the main steam system which result in action of the plant protection system. Inadvertent opening of valves in the main steam system is discussed in Section 15.1.10. A rupture in the main steam system reduces the steam generator pressure, increases steam flow rate, and causes cooldown of the RCS. Depending

ARKANSAS NUCLEAR ONE
Unit 2

on initial conditions, break size, and break location, any of several plant protection system actions may occur. A severe decrease in main steam pressure will initiate a reactor trip signal on low steam generator pressure and a Main Steam Isolation Signal (MSIS) and will cause the main steam isolation valves to trip closed. Increased flow rate from the steam generator reduces the steam generator inventory and may result in a low steam generator water level trip. Additional protection against loss of the secondary heat sink is provided by automatic initiation of emergency feedwater to the intact steam generator. Emergency Feedwater Actuation Signal logic prevents EFW flow to the faulted steam generator. Cooldown of the RCS coupled with a negative moderator coefficient of reactivity, results in a positive reactivity addition and causes reactor power to increase. This increase in reactor power can result in the following:

- A. High linear power level trip signal;
- B. Low DNBR trip signal;
- C. High local power density trip signal.

In addition, cooldown of the RCS reduces the reactor coolant volume and pressurizer pressure. These reductions may result in:

- A. Emptying of the pressurizer;
- B. A low pressurizer pressure trip signal;
- C. A Safety Injection Actuation Signal (SIAS).

A major secondary system pipe break with a concurrent loss of AC power is defined as a rupture in the main steam system with a simultaneous complete loss of AC electrical power and a concurrent turbine-generator trip. As a result, electrical power would be unavailable for the station auxiliaries such as the reactor coolant pumps, the steam generator feedwater pumps and the main circulating water pumps. Under such circumstances, the plant would experience a simultaneous loss of load, feedwater flow, forced reactor coolant flow, cooldown of the RCS and depressurization of the main steam system which in turn may result in:

- A. High linear power level trip signal;
- B. DNBR trip (based on low RCP speed) signal;
- C. Low steam generator pressure trip signal;
- D. Low pressurizer pressure trip signal;
- E. SIAS; and,
- F. Emptying pressurizer or steam generator depending on the initial condition and break size.

The loss of all station power is followed by automatic startup of the standby diesel generators, the power output of which is sufficient to supply electrical power to all necessary ESF systems and to provide the capability of maintaining the plant in a safe shutdown condition.

Subsequent to reactor trip, stored and fission product decay energy must be dissipated by the RCS and main steam system. In the absence of forced reactor coolant flow, convective heat transfer into and out of the reactor core is supported by natural circulation reactor coolant flow. Initially, the residual water inventory in the steam generators is used and the resultant steam is released to atmosphere by the spring-loaded secondary safety valves. With the availability of

ARKANSAS NUCLEAR ONE
Unit 2

standby power, emergency feedwater is assumed to be automatically initiated on a low steam generator water level signal. Plant cooldown may be operator controlled via the remotely operated atmospheric steam dump valves.

Each steam generator has one 34-inch ID main steam nozzle (6.3 ft²). A flow measuring venturi with an area of 2.49 ft² is located in each steam line.

In the case of ruptures inside containment, the maximum effective break area assumed is 6.3 ft². For ruptures outside containment maximum effective break area assumed is 2.49 ft². If the steam line rupture occurs between the steam generator and isolation valve, blowdown of the affected steam generator continues. However, flow from the intact steam generator terminates with closure of the main steam block valve.

15.1.14.1.2 Analysis of Effects and Consequences

15.1.14.1.2.1 Discussion of Cases and Parameters

The analysis of the steam line rupture is performed using CESEC, a digital simulation of the NSSS described in Section 15.1.0.

The major factor affecting the results of the steam line break analysis relates to the moisture carryover which occurs during the blowdown of the steam generator. An analysis similar to the one presented in Reference 26 was performed for this steam generator. The results of this analysis give conservatively low estimates of the average moisture carryover versus break size for both full load and no load initial conditions. Table 15.1.14-1 gives the conservative average moisture carryover fraction used for this analysis for both the complete blowdown of the steam generator connected to the ruptured steam line and for the intact steam generator blowdown which occurs through 560 feet of main steam piping and is terminated by the closure of the main steam block valves.

An extensive parametric analysis of the transients associated with the various combinations of steam line break size and average moisture carryover fraction indicates that the most severe pressure transients occur for full nozzle and/or pipe breaks. The most severe NSSS power transients occur for the largest of the steam line break sizes which do not result in moisture carryover, conservatively assumed to be one-half of the total effective turbine admission valve area (1.0 square foot) for no load initial conditions, and the total effective turbine admission valve area (2.0 square feet) for full load initial conditions.

Therefore, a total of 11 cases including the two most severe steam line break cases with a concurrent loss of AC power, i.e., no load, 1-loop and full load, 2-loop case both with outside small breaks, were originally presented covering the most severe pressure and power transients for the following initial conditions:

- A. Full load and no load initial conditions;
- B. Two-loop and 1-loop operation; and,
- C. Inside and outside containment breaks.
- D. With or without AC power.

ARKANSAS NUCLEAR ONE
Unit 2

At the time the original 11 cases were performed the moisture carryover methods had not been approved; hence, the NRC requested that additional analyses be performed assuming no moisture carryover. Four no moisture carryover analyses are presented in Section 15.1.14.1.4.1. The results from the no moisture carryover analyses were determined to be limiting with respect to the shutdown margin required to assure conditions no worse than those presented in the original 11 cases were bounding. As a result of the more limiting nature of these events and the moisture carryover methods not being approved, the original shutdown margin cases have been removed and can be found in the FSAR. Of the original 11 cases, 3 cases were used for radioactivity release purposes. These 3 cases are presented in this section.

Table 15.1.14-2 lists some of the conservative assumptions used in each analysis with the following explanation:

- A. The variation of reactivity with fuel temperature is included. For conservatism, the slope of the reactivity versus fuel temperature function is decreased 15 percent for the no load case to account for calculational uncertainty. For full load initial conditions, the slope of the reactivity versus fuel temperature function has been increased by 15 percent; this assures that the calculation of the reactivity increase due to the cooldown of the fuel from its nominal temperature is conservative.
- B. For the cases analyzed, the most reactive CEA is stuck in the fully withdrawn position. The minimum CEA worth available for shutdown when the reactor is tripped is -5.8 percent $\Delta\rho$ for the full load conditions, and -2.4 percent $\Delta\rho$ for the no load conditions. If all CEAs insert, there is no return to criticality and no power transient following trip. Analyses are performed, however, including the effects of the most reactive CEA being stuck in the out position.

The -5.8 percent $\Delta\rho$ full power CEA worth is 0.4 percent $\Delta\rho$ higher than the worth assumed for other Cycle 1 accidents starting from full power. This 0.4 percent $\Delta\rho$ is due to the effect of changing the core power distribution during the cooldown from full power to zero power temperature with CEAs in the core. This effect is accounted for in the moderator reactivity density function described below and, therefore, credit is taken for this effect in the reactivity insertion on trip. The effect is not directly accounted for in the moderator coefficients assumed for the other accidents, i.e., the +0.5 to $-3.5 \times 10^{-4} \Delta\rho/^\circ\text{F}$ range of moderator coefficients are for cases without insertion of the shutdown CEAs, therefore, credit is not taken for this effect in other analyses in Chapter 15.

- C. For the steam line break cases analyzed without a concurrent loss of AC power, the total reactor coolant volumetric flow rate is assumed constant during the transient. The design values, 322,000 gpm for 2-loop operation and 153,915 gpm for 1-loop operation, are used. The total steam generator heat transfer area is assumed to be active during the transient. The overall steam generator heat transfer coefficient used in the analysis is a dynamic function of reactor coolant flow rate and steam generator heat flux.
- D. Feedwater flow at the start of the transient corresponds to initial steady state operation. For the full load initial condition without loss of AC power, it is automatically reduced from 100 percent to zero percent in 20 seconds following reactor trip. For the no load initial condition without loss of AC power, feedwater flow is assumed to match energy input by the reactor coolant pumps and the 1 MWt core power.

ARKANSAS NUCLEAR ONE
Unit 2

- E. For the analysis at time zero, when all electrical power is lost to the station auxiliaries, the following events are assumed to occur:
1. The turbine stop valves close and it is assumed that the area of the turbine admission is instantaneously reduced to zero;
 2. The feedwater flow to both steam generators is instantaneously assumed to go to zero; and,
 3. The reactor coolant pumps begin to coastdown.

Following coastdown, the coolant flow necessary to remove residual heat and to cool the reactor core is maintained by natural circulation. Reactor coolant pump coastdown and natural circulation flow is calculated by the digital computer code, COAST (See Section 15.1.0).

As the transient progressed, the emergency diesel generators, which start automatically after the loss of AC power, provide power to the emergency feedwater pumps which start automatically on low steam generator water level.

Manual action may be taken to actuate the atmospheric steam dump and isolation valves 30 minutes subsequent to initiation of the accident.

The following three steam generator levels may be important:

- A. Downcomer liquid level;
- B. Tube bundle 2-phase level; and,
- C. Steam dome 2-phase level.

The downcomer liquid level is important for those transients which require a steam generator low water level trip to terminate the transients. This downcomer level and associated steam generator inventory are established by steady state design codes and then input into the transients analysis code.

The tube bundle 2-phase level is important in determining the heat transfer between the RCS and the Main Steam System (MSS). For conservatism, the full heat transfer surface area is assumed to be available, i.e., the tubes are assumed to always be covered by the 2-phase level, until a steam generator becomes empty.

The steam dome 2-phase level is important in determining the moisture carryover which occurs during the steam line break transient. This level is conservatively determined using the methodology presented in Reference 26.

The following assumptions are made for the steam line break analyses:

- A. The cooldown due to a steam line rupture results in the greatest reactivity increase when the moderator temperature coefficient is most negative. The conditions selected for the analyses, i.e., materials inventories in the core and the power distributions, are those expected for later fuel cycles.

ARKANSAS NUCLEAR ONE
Unit 2

The moderator temperature coefficient of reactivity varies significantly over the range of moderator temperatures covered in the analysis; therefore, a reactivity versus moderator density function is employed rather than a single value coefficient. The most adverse moderator function is calculated assuming all CEAs except the most reactive are inserted. This function (shown in Figure 15.1.14-30) is increased by 10 percent to account for calculational uncertainties.

In addition, the effect of uneven temperature distribution on the moderator reactivity is accounted for conservatively, by assuming that the moderator reactivity is a function of the lowest cold leg temperature.

- B. Following CEA insertion, the power distribution is distorted by the stuck CEA; however, the power produced by the decay of the initial condition delayed neutron precursors and by nominal decay power is distributed according to the nominal power distribution. The coincident high radial peaking and low reactor coolant pressure can lead to local boiling at moderate power levels. The power flattening effect of the voids and of the locally high fuel temperature is included in the analysis, but no credit is taken for the corresponding reactivity feedback. The computed maximum average core power after trip is thus conservative.

The power flattening effect during a Steam Line Break (SLB) transient has been verified as conservative by a series of two-dimensional PDQ analyses which assume one stuck CEA. An input function of moderator density versus radial peak was determined from a separate analysis using a 2-channel version of the STRIKIN thermohydraulic code which models the core average channel and a hot channel as two parallel closed channels. For this STRIKIN analysis average core conditions (inlet flow, inlet temperature, core power, RCS pressure, etc.) were taken from a typical SLB transient to determine the average core pressure drop. This pressure drop, along with a variable radial peak and other parameters, i.e., geometry, inlet temperature, etc, are used as input for the hot channel to obtain functions of the hot channel flow rate, moderator density at the core midplane and minimum hot channel DNBR versus radial peak. The moderator density versus radial peak functions are used in the 2-D PDQ calculations to determine the maximum expected peak for the chosen SLB conditions. The STRIKIN analysis then gives the DNBR for this radial peak. Parametric analyses show that as average core power increases the maximum expected radial peak decreases from values as high as 30 (for zero power) to values less than 2.0 while DNBR associated with the expected peak decreases from a value near infinity (for zero power) to a value near 1.0 as the expected peak drops below 2.0. For conservatism, it is assumed that the expected radial peak does not decrease below a value of 3.0, thus, DNBR values are conservatively predicted for SLB power transients.

- C. The fast cooldown following a steam line rupture results in rapid contraction of the reactor coolant. After the pressurizer is emptied, the reactor coolant pressure is assumed to be equal to the saturation pressure corresponding to the highest temperature in the RCS.
- D. Determination of the critical heat flux for the fuel elements is based on a method utilizing a correlation developed by R. V. MacBeth (Reference 19).
- E. The SIAS is generated when the pressurizer pressure falls below 1,600 psia.

ARKANSAS NUCLEAR ONE
Unit 2

- F. Critical flow is assumed through the steam line break for the moisture carryover fractions given by Table 15.1.14-1. The flow rate is determined from the same functional relationship used in the moisture carryover study (Reference 26).

15.1.14.1.2.2 Results

15.1.14.1.2.2.1 No Load, One-Loop Initial Condition Nozzle Break Outside Containment Without Loss of AC Power

The RPS and NSSS responses are summarized in Table 15.1.14-11, while the reactivity transient is shown in Figure 15.1.14-29.

15.1.14.1.2.2.2 Full Load, Two-Loop, Initial Condition, Small Break Outside Containment With Loss of AC Power

For this case, the RPS and NSSS responses are summarized in Table 15.1.14-12 while the reactivity transient is shown in Figure 15.1.14-31.

After complete CEA insertion, the steam generator blowdown results in a maximum 145 °F cooldown of the reactor coolant which increases the total reactivity to -0.15 percent $\Delta\rho$. This negative reactivity is large enough to prevent any return to power even with the delayed neutron precursors as a source.

15.1.14.1.2.2.3 No Load, One-Loop, Initial Condition, Small Break Outside Containment With Loss of AC Power

For this case, the RPS and NSSS responses are summarized in Table 15.1.14-13 while various NSSS transient parameters are shown in Figures 15.1.14-32 through 15.1.14-37.

Prior to complete insertion of CEAs on reactor trip at 32.0 seconds, a peak transient heat flux of 7.0 percent occurs. Due to high RCS pressure, reduced reactor coolant temperature, and normal power distribution, i.e., stuck CEA distribution does not apply until after shutdown CEAs are inserted, the minimum DNBR for this peak heat flux is greater than 2.0. After the complete CEA insertion, the steam generator blowdown results in a maximum 139.6 °F cooldown of the reactor coolant which increases the total reactivity to a positive value. As a result of this, a peak transient heat flux after complete CEA insertion of 5.0 percent $\Delta\rho$ occurs at 495.0 seconds. At this time, the Macbeth DNBR is greater than 2.0.

15.1.14.1.3 Conclusion

For all of the cases analyzed, sufficient margin to the critical heat flux exists to assure that no fuel damage will occur as a result of the steam line break transient.

15.1.14.1.4 Steam Line Break Accident Subsequent Analyses

15.1.14.1.4.1 Steam Line Rupture Analyses Performed Without Moisture Carryover

The following analyses were performed at the request of the NRC, to determine the most limiting transients assuming no moisture carryover regardless of the break size. The results of these analyses show that the following four transients are limiting with respect to the shutdown margin required.

ARKANSAS NUCLEAR ONE
Unit 2

- A. Full Power, 2-loop, nozzle break with AC available
- B. Full Power, 2-loop, nozzle break without AC available
- C. Zero Power, 2-loop, nozzle break with AC available
- D. Zero Power, 2-loop, nozzle break without AC available

The nozzle size break results in the most severe NSSS transient (peak return-to-power) when moisture carryover is not considered.

For both full power and zero power cases parametric analyses were performed to determine the required shutdown margin such that the consequences of the transient were no more severe than the analyses presented in the FSAR with moisture carryover assumed. The full power cases include failures in the main feedwater system for the worst single failure of an active system component. The failure of one condensate pump to trip on MSIS produced the worst consequences for the case with AC power available. The failure of a single main feedwater isolation valve to close on MSIS produced the worst consequences for the case with concurrent loss of AC power. The single failures in the main feedwater system have the effect of (1) increasing the amount of feedwater flow to the steam generator until the main feedwater isolation valves close for the case with failure of one condensate pump to trip, and (2) continuing feedwater flow even after the main feedwater pumps have stopped due to the driving force provided by residual pressure in the heater drain tanks in case of a failure of a main feedwater isolation valve to close. Consequently, each of these failures results in an increased duration of steam generator blowdown.

For the full power, 2-loop, nozzle break cases, the required shutdown CEA worth is -8.6 percent $\Delta\rho$, while for the no load, 2-loop, nozzle break cases, the required shutdown CEA worth is -5.0 percent $\Delta\rho$.

The following analyses were analyzed with these shutdown CEA worths.

- A. Full Load, Two-Loop Initial Condition, Nozzle Break, Without Moisture Carryover, Without Loss of AC Power.
- B. Full Load, Two-Loop, Initial Condition, Nozzle Break, Without Moisture Carryover, With Loss of AC Power.
- C. No Load, Two-Loop, Initial Condition, Nozzle Break, Without Moisture Carryover, Without Loss of AC Power.
- D. No Load, Two-Loop, Initial Condition, Nozzle Break, Without Moisture Carryover, With Loss of AC Power.

The NSSS and RPS responses for Case A are presented in Table 15.1.14-14 and Figures 15.1.14-39 through 15.1.14-44. The rapid decrease in secondary pressure resulting from the blowdown through the rupture results in a reactor trip signal due to low steam generator pressure and a MSIS being generated 1.4 seconds into the transient. Flow is terminated from the steam generator connected to the intact steam line at 5.3 seconds into the transient when the Main Steam Isolation Valves (MSIVs) are fully closed.

ARKANSAS NUCLEAR ONE
Unit 2

The core power level decays rapidly with CEA insertion and approaches decay heat levels. However, the continued cooldown of the RCS due to the blowdown through the rupture results in a peak post-trip reactivity of -0.073 percent $\Delta\rho$ occurring at 59.7 seconds and subsequently a peak return to power of 18.3 percent occurring at 60.4 seconds into the transient. The return-to-power transient is terminated when the steam generator connected to the ruptured line empties at 57.0 seconds (this terminates cooldown of the RCS). As a result of the peak return-to-power heat flux of 17.4 percent, which occurs 61.6 seconds into the transient, the minimum Macbeth DNBR for Case A is greater than 2.9.

The NSSS and RPS responses for Case B are presented in Table 15.1.14-15 and Figures 15.1.14-45 through 15.1.14-50. As a result of the loss of AC power, reactor trip occurs on a low DNBR signal at 0.6 seconds into the transient. The rapid decrease in the secondary pressure resulting from the blowdown through the rupture results in an MSIS occurring at 1.5 seconds into the transient thus terminating flow from the steam generator connected to the intact steam line at 5.4 seconds into the transient.

The continued cooldown of the RCS due to the blowdown through the rupture results in a peak post-trip reactivity of +0.023 percent $\Delta\rho$ occurring at 74.0 seconds into the transient and subsequently a peak return-to-power after CEA insertion of 30.8 percent occurring 96.2 seconds into the transient. The return-to-power transient is terminated by the emptying of the steam generator connected to the ruptured steam line which terminates the cooldown of the RCS. For Case B, the peak return-to-power heat flux + 29.9 percent and the resulting minimum Macbeth DNBR of 1.4 occur 99.0 seconds into the transient.

The NSSS and RPS responses for Case C are presented in Table 15.1.14-16 and Figures 15.1.14-51 through 15.1.14-56. As a result of the rapid decrease in secondary pressure resulting from the blowdown through the rupture, a reactor trip signal on low steam generator pressure occurs at 1.9 seconds into the transient. This signal results in the MSIVs being fully closed 5.8 seconds into the transient thus terminated blowdown from the steam generator connected to the intact steam line.

Cooldown of the RCS continues due to the blowdown through the rupture resulting in a peak reactivity of 0.34 percent $\Delta\rho$ occurring at 85 seconds into the transient with a subsequent peak return to power, after CEA insertion, of 21.3 percent occurring at 92.1 seconds into the transient. The resulting peak post trip heat flux of 16.9 percent and resultant minimum Macbeth DNBR of 2.3 occur at 94.2 seconds into the transient in Case C. The return-to-power is terminated by the emptying of the steam generator connected to the ruptured steam line which terminates the cooldown of the RCS, and injection of boron via the HPSI system (one-pump injection assumed).

The NSSS and RPS responses for Case D are presented in Table 15.1.14-17 and Figures 15.1.14-57 through 15.1.14-62. As a result of the rapid decrease in secondary pressure resulting from the blowdown through the rupture, a reactor trip signal on low steam generator pressure occurs at 1.9 seconds into the transient. This signal results in CEA insertion and closure of the MSIVs. The MSIVs are fully closed 5.8 seconds into the transient thus terminating blowdown from the steam generator connected to the intact steam line.

Cooldown of the RCS continues due to blowdown through the rupture resulting in a peak reactivity of 0.43 percent occurring at 66.6 seconds into the transient with a subsequent peak return-to-power, after CEA insertion, of 43.2 percent occurring at 68.3 seconds into the transient. For Case D, the peak post-CEA insertion heat flux of 25.3 percent results in a minimum Macbeth DNBR of 1.4 occurring 105.2 seconds into the transient. The post-CEA

ARKANSAS NUCLEAR ONE
Unit 2

insertion return-to-power is terminated by the emptying of the ruptured steam generator, which terminated cooldown of the RCS, and injection of boron via the HPSI system (one-pump injection assumed).

Although neither an electrical nor a mechanical failure of the main steam isolation valves to close is considered credible, a steam line break analysis was performed for the limiting case with loss of AC power. The results of this analysis were less severe than the results for the main feedwater isolation valve failure. Failure of the main steam isolation valve (MSIV) on the unaffected steam generator to close can result in continued blowdown of steam from that steam generator due to the presence of a steam flow path that is not automatically isolated. The unisolated flow path is the steam line to the tube side of the moisture separators between the high and low pressure turbines. Nominal full power flow for this steam line is 3.5 percent of total full power steam flow from the steam generators. Peak power and peak core heat flux during the post-trip return-to-power were lower for failure of the main steam isolation valve to close than for the main feedwater isolation valve failure. In addition, the return-to-power is of shorter duration than for the main feedwater isolation valve failure.

15.1.14.1.4.2 Cycle 12 Steam Line Break Analysis

The no moisture carryover steam line break post-trip return to power events were reanalyzed for a lower MSIS setpoint, and to bound various plant parameter changes and physics input changes. CESEC-III was used to model the NSSS response, RCP coastdown and natural circulation, and RELAP5 was used to model the feedwater system response for the hot full power (HFP or full load) cases. Prior analysis efforts had utilized CESEC, COAST, and the HFP feedwater system was modeled with simplifying assumptions or the HSTA code. For the hot zero power (HZA or not load) cases, feedwater flow is modeled by matching the energy input by the core at the start of the event.

The analytical basis for the HFP and HZA simulations are discussed below.

- A. A double-ended guillotine break (6.14 ft²) causes the greatest cooldown of the RCS and the most severe degradation of shutdown margin.
- B. A break inside the containment building, upstream of the MSIVs and flow measuring venturis causes a non-isolable condition in the affected steam generator. This results in an approach to criticality which is terminated by the dryout of the affected steam generator.
- C. A SIAS is actuated when the pressurizer pressure drops below 1400 psia. Time delays associated with the safety injection pump acceleration and valve opening are taken into account. A 40 second HPSI response time was assumed to account for these delays. Additionally, the event was initiated from the highest pressure allowed by the technical specification to delay the effect of the safety injection boron.
- D. The cooldown of the RCS is terminated when the affected steam generator blows dry. As the coolant temperature begins increasing, positive reactivity insertion from moderator reactivity feedback decreases. The decrease in moderator reactivity combined with negative reactivity inserted via boron injection cause the total reactivity to become more negative.

ARKANSAS NUCLEAR ONE
Unit 2

- E. CESEC-III is used to model the RCP pump coast down on a loss of offsite power. The CPC low DNBR (based on pump speed) trip is credited in this analysis following a loss of offsite power. A CPC low DNBR trip setpoint based on 95% of RCP speed with a 1.0 second response time are assumed.
- F. A low steam generator reactor trip setpoint of 620 psia was assumed with a 1.2 second response time.
- G. MSIS is actuated on a low steam generator setpoint of 620 psia. The MSIVs, MFIVs and Backup MFIVs all receive an MSIS signal to close. A response time of 4.3 seconds was assumed for the MSIVs. The MFIVs and Back-up MFIVs were assumed to close in 36.4 seconds and 31.8 seconds with a loss of offsite power, and 21.4 seconds and 16.8 seconds with offsite power available, respectively.

The conservative assumptions included in the HZP and HFP simulations are discussed below.

The MTC assumed in the analysis corresponds to the most negative value. This negative MTC results in the greatest positive reactivity addition during the RCS cooldown caused by the steam line break. Since the coefficient of reactivity associated with moderator feedback varies significantly over the range of moderator density covered in the analysis, a curve of reactivity insertion versus moderator density rather than a single value of MTC is assumed in the analysis. The moderator cooldown curve used in the analysis (Figure 15.1.14-109) was conservatively calculated assuming that on reactor trip, the highest worth control element assembly is stuck in the fully withdrawn position. The effect of uneven temperature distribution on the moderator reactivity is accounted for by assuming that the moderator reactivity is a function of the lowest cold leg temperature.

For conservatism, the full steam generator heat transfer surface area is assumed to always be covered by the 2-phase level until a steam generator becomes essentially empty.

The reactivity defect associated with fuel temperature decrease is also based on the most negative Fuel Temperature Coefficient (FTC). Figure 15.1.14-110 represents the FTC curve used in the analysis. This FTC, in conjunction with the decreasing fuel temperatures, causes the greatest positive reactivity insertion during the steam line break event. The delayed neutron fraction assumed is the maximum value including uncertainties for end-of-cycle conditions (total delayed neutron fraction, β , 0.005994). This too maximizes subcritical multiplication and thus increases the potential for return to power.

The minimum CEA worth assumed to be available for shutdown at the time of reactor trip at the maximum allowed power level is $-8.25\% \Delta\rho$ with a loss of AC and $-8.0\% \Delta\rho$ with AC available. For the HZP cases a shutdown CEA worth of $-6.0\% \Delta\rho$ was used. The scram worths used are consistent with the moderator cooldown curve and stuck rod assumed in the analysis. The CEA position versus time of Figure 15.1.0-1C and a 0.6 second holding coil delay time are consistent with the analysis assumption; however, a more conservative normalized reactivity insertion versus CEA position for a +0.3 ASI curve was used.

The EFW system is conservatively modeled to initiate early with both EFW pumps available, this maximizes the potential cooling that could occur. System response times, flows and setpoints are assumed based on increasing the cooling potential of the EFW system.

ARKANSAS NUCLEAR ONE
Unit 2

The analysis assumed that, for the loss of AC power cases one EDG failed to start. The failure of an EDG results in the failure of one HPSI pump and one of the main feedwater isolation valves to close (the faster closing back-up MFIVs were assumed to remain open). For the HFP case with AC available, the failure of the main feedwater pump to trip is the most limiting single failure, therefore, in this case both HPSI pumps are functioning. The single failure of a main feedwater pump was determined to be more limiting than that of a condensate pump utilized in the prior analysis. This was confirmed with the RELAP model. A single failure of a HPSI pump to start was assumed for the HZP case with AC available. The boration from the Safety Injection Tanks was not credited in this analysis.

The key parameters used for the post-trip steam line break analyses are listed in Table 15.1.14-26 for HFP cases and Table 15.1.14-27 for HZP cases. Table 15.1.14-28 through 15.1.14-31 present the sequence of events for the HFP and HZP steam line break cases with and without a concurrent loss of AC. The key transient parameters (core power, core heat flux, RCS pressure, RCS temperatures, steam generator pressure and reactivities) are shown in Figures 15.1.14-85 through 15.1.14-108. The maximum post-trip peak fission powers were negligible and bounded by the analyses presented above.

15.1.14.1.4.3 Cycle 13 Steam Line Break Analysis

The no moisture carryover steam line break post-trip return to power events were reanalyzed to account for a 10 % reduction in the RCS design flow, a small increase in feedwater flow, and address Cycle 13 physics data. CENTS was used to model the NSSS response, RCP coastdown and natural circulation, RELAP5 was used to model the feedwater system response for the hot full power (HFP or full load) cases, HRISE was used to calculate thermal margin on DNBR, and ROCS/HERMITE were used to assess reactivity feedback and peaking.

The analytical basis for the HFP and hot zero power (HZP) simulations are discussed below.

- A. A double-ended guillotine break (6.357 ft²) causes the greatest cooldown of the RCS and the most severe degradation of shutdown margin.
- B. A break inside the containment building, upstream of the MSIVs and flow measuring venturis causes a non-isolable condition in the affected steam generator.
- C. A SIAS is actuated when the pressurizer pressure drops below 1400 psia. Time delays associated with the safety injection pump acceleration and valve opening are taken into account. A 40-second HPSI response time was assumed to account for these delays. Additionally, the event was initiated from the highest pressure allowed by the technical specifications to delay the effect of the safety injection boron.
- D. The cooldown of the RCS is terminated when the affected steam generator blows dry. As the coolant temperatures begin increasing, positive reactivity insertion from moderator reactivity feedback decreases. The decrease in moderator reactivity combined with the negative reactivity inserted via boron injection cause the total reactivity to become more negative.
- E. CENTS is used to model the RCP pump coast down on a loss of offsite power. The CPC low DNBR (based on pump speed) trip is credited in this analysis following a loss of offsite power. A CPC low DNBR trip setpoint based on 96.5% of RCP speed with a 1.0 second response time are assumed.

ARKANSAS NUCLEAR ONE
Unit 2

- F. A low steam generator pressure reactor trip setpoint of 620 psia was assumed with a 1.3 second response time.
- G. MSIS is actuated on a low steam generator pressure setpoint of 620 psia. The MSIVs, MFIVs and Back-up MFIVs all receive an MSIS signal to close. A response time of 4.3 seconds was assumed for the MSIVs. The MFIVs and Back-up MFIVs were assumed to close in 36.4 seconds and 31.8 seconds with a loss of offsite power, and 21.4 seconds and 16.8 seconds with offsite power available, respectively.
- H. The HERMITE code was used to calculate the reactivity for the post-trip return to power portion of the analysis. This was done since the HERMITE code, which is a three-dimensional coupled neutronics-open channel thermal hydraulics code can more accurately model the effects of moderator temperature feedback on the power distribution and reactivity for the critical configuration existing during the return to power. The HERMITE results used in the ANO-2 analysis were actually obtained from a parametric study performed for Calvert Cliffs Unit 1 Cycle 7. ANO-2 specific ROCS calculations were used to confirm the applicability of these parametric results to ANO-2.
- I. Three-dimensional power distribution peaks (Fq) were determined with the above mentioned ROCS and HERMITE evaluations. Axial profiles consistent with these conservative power distribution peaks were utilized in the analysis.
- J. The power produced by the decay of the initial condition delayed neutron precursors and by nominal decay power is distributed according to the nominal power distribution.
- K. The thermal margin on DNBR in the reactor core was simulated using the HRISE computer program. The HRISE code is based on the MacBeth CHF correlation described in Reference 48. RCS conditions from CENTS (RCS temperature, pressure, flow, and power) are used in the HRISE thermal margin calculations.

The conservative assumptions included in the HZP and HFP simulations are discussed below.

The MTC assumed in the analysis corresponds to the most negative value. This negative MTC results in the greatest positive reactivity addition during the RCS cooldown caused by the steam line break. Since the coefficient of reactivity associated with moderator feedback varies significantly over the range of moderator density covered in the analysis, a curve of reactivity insertion versus moderator density rather than a single value of MTC is assumed in the analysis. The moderator cooldown curve used in the analysis (Figure 15.1.14-111) was conservatively calculated assuming that on reactor trip, the highest worth control element assembly is stuck in the fully withdrawn position. The effect of uneven temperature distribution on the moderator reactivity is accounted for by assuming that the moderator reactivity is a function of the lowest cold leg temperature.

For conservatism, the full steam generator heat transfer surface area is assumed to always be covered by the 2-phase level until a steam generator becomes essentially empty.

The reactivity defect associated with fuel temperature decrease is also based on the most negative Fuel Temperature Coefficient (FTC). Figure 15.1.14-112 represents the FTC curve used in the analysis. This FTC, in conjunction with the decreasing fuel temperatures, causes

ARKANSAS NUCLEAR ONE
Unit 2

the greatest positive reactivity insertion during the steam line break event. The delayed neutron fraction assumed is the maximum value including uncertainties for end-of-cycle conditions (total delayed neutron fraction, β , 0.005994). This too maximizes subcritical multiplication and thus increases the potential for return to power.

The minimum CEA worth assumed to be available for shutdown at the time of reactor trip at the maximum allowed power level is -7.5144% $\Delta\rho$. For the HZP cases a shutdown CEA worth of -5.0% $\Delta\rho$ was used. The scram worths used are consistent with the moderator cooldown curve and stuck rod assumed in the analysis. The CEA reactivity addition curve of Figure 15.1.0-1D adjusted to a worth of 7.5144 was used in the HFP cases. The HZP cases assumed a CEA drop time consistent with Figure 15.1.0-1C with the 0.6 second holding coil delay time; however, a more conservative normalized reactivity insertion versus CEA position for a +0.6 ASI curve was used.

The EFW system is conservatively modeled to initiate early with both EFW pumps available, this maximizes the potential cooling that could occur. System response times, flows and setpoints are assumed based on increasing the cooling potential of the EFW system.

The analysis assumed that, for the loss of AC power cases one EDG failed to start. The failure of an EDG results in the failure of one HPSI pump and one of the main feedwater isolation valves to close (the faster closing back-up MFIVs were assumed to remain open). For the HFP case with AC available, a bus fast transfer failure is the most limiting single failure as this failure is modeled as the failure of the back-up MFIVs and a HPSI pump. A fast transfer failure would only result in the delayed actuation of the back-up MFIV and HPSI pump. These components would be actuated once the EDG has started. Therefore, the modeling of the fast transfer failure is conservative. This conservative modeling of a fast transfer failure is slightly more limiting than the single failure of a main feedwater pump, which was determined to be more limiting in the prior analysis. A single failure of a HPSI pump to start was assumed for the HZP case with AC available. The boration from the Safety Injection Tanks was not credited in this analysis.

The HFP feedwater addition to the steam generator assumed in this analysis is taken from the Cycle 12 analysis which used a RELAP5 model of the feedwater system. The steam generator pressure profiles and time of MSIS were verified to be consistent with respect to this analysis, thereby allowing the application of the feedwater data generated for Cycle 12. The HFP feedwater data for Cycle 12 was increased by 1% to account for a small expected increase in feedwater flow due to modifications to the high pressure turbine. For the hot zero power (HZP or no load) cases, feedwater flow is modeled by matching the energy input by the core at the start of the event.

The results of the post-trip steam line break analyses demonstrated that there was no calculated fuel failure. Thus the coolable geometry is maintained and the conclusions of Section 15.1.14.1.3 are valid.

15.1.14.1.4.4 Cycle 14 Steam Line Break Analysis

The no moisture carryover steam line break post-trip return to power events were reanalyzed for Cycle 14 because the individual reactivity components were not all bounded by those used in the prior (Cycle 13) analysis. The methodology used was identical to that used for Cycle 13, with the exception that physics uncertainties in the reactivity components are accounted for by a single adjustment to the shutdown worth, rather than the traditional method of adjusting each activity component individually.

ARKANSAS NUCLEAR ONE
Unit 2

The conservative assumptions included in the HZP and HFP simulations that are different from the Cycle 13 assessment are discussed below.

The delayed neutron fraction assumed is the maximum value including uncertainties for end-of-life conditions (total delayed neutron fraction, β , 0.0051594). The minimum CEA worth assumed to be available for shutdown at the time of reactor trip at the maximum allowed power level is -7.1049% $\Delta\rho$. For the HZP cases a shutdown CEA worth of -4.8400% $\Delta\rho$ was used. The CEA reactivity addition curve was adjusted to a worth of 7.1049% $\Delta\rho$.

The key parameters used for the post-trip steam line break Cycle 14 analyses are listed in Table 15.1.14-32. Tables 15.1.14-33 through 15.1.14-36 present the sequence of events for the HFP and HZP steam line break cases with and without a concurrent loss of AC power. Minor changes from the Cycle 13 assessment are caused by more realistic modeling adjustments and the cycle specific physics data.

The results of the post-trip steam line break analyses demonstrated that there was no calculated fuel failure. Thus, the coolable geometry is maintained and the conclusions of Section 15.1.14.1.3 are valid.

15.1.14.1.4.5 Cycle 15 at 3026 MWt Main Steam Line Break Analysis

The no moisture carryover steam line break events were reanalyzed to account for replacement steam generators (RSGs) and Power Uprate to a rated power of 3026 MWt. CENTS was used to model the NSSS response, RCP coastdown, and natural circulation. RELAP5/MOD3.1 was used to model the feedwater system response for the HFP (or full load) cases. HRISE was used to calculate the thermal margin on DNBR, which employed the MacBeth correlation. ROCS/HERMITE were used to assess reactivity feedback and peaking.

Input parameters for HFP and HZP from Table 15.1.14-41 and the bounding physics data from Section 15.1.0 have been incorporated in this analysis with the following clarifications:

1. A double-ended guillotine break (6.357 ft²) causes the greatest cooldown of the RCS and the most severe degradation of SDM. Due to integral flow restrictors, this results in an equivalent break area of less than 2.0 ft².
2. A break inside or outside the containment building, upstream of the MSIVs causes a non-isolatable condition in the affected steam generator.
3. An SIAS is actuated when the pressurizer pressure drops below 1400 psia. Time delays associated with the safety injection pump acceleration and valve opening are taken into account. A 40-second HPSI response time was assumed to account for these delays. Additionally, the event was initiated from the highest pressure allowed by the Technical Specifications to delay the effect of the safety injection boron.
4. The cooldown of the RCS is terminated when the affected steam generator blows dry. As the coolant temperatures begin increasing, positive reactivity insertion from moderator reactivity feedback decreases. The decrease in moderator reactivity combined with the negative reactivity inserted via boron injection cause the total reactivity to become more negative.

ARKANSAS NUCLEAR ONE
Unit 2

5. CENTS is used to model the RCP coast down on a loss of offsite power. The CPC low DNBR (based on pump speed) trip is credited in this analysis following a loss of offsite power. The analysis assumed a CPC low DNBR trip setpoint based on 95% of RCP speed with a 1.0-second response time.
6. Due to the reduction of the effective break area, a combination of RPS trips was employed to generate a reactor trip for the offsite power available cases.

A Low Steam Generator Pressure Trip setpoint of 693 psia for outside containment breaks (normal environment) was assumed with a 1.3-second response time.

A High Containment Pressure Trip setpoint of 20.7 psia for inside containment breaks (harsh environment) was assumed with a 1.59-second response time.

For HFP outside containment breaks (normal environment), the CPCs are also available to generate a reactor trip. A CPCs Variable Overpower Trip (VOPT) was assumed with a conservative 1.2-second response time.

7. MSIS is actuated on a low steam generator pressure setpoint of 658 psia for inside containment breaks (harsh environment) and 693 psia for outside containment breaks (normal environment). The MSIVs, MFIVs, and back-up MFIVs all receive an MSIS signal to close. A response time of 4.9 seconds (which includes a 1.4-second MSIS response time) was assumed for the MSIVs. The MFIVs and Back-up MFIVs were assumed to close in 41.4 seconds and 34.9 seconds with a loss of offsite power, and 26.4 seconds and 19.9 seconds with offsite power available, respectively.
8. The HERMITE code (Reference 23) was used to calculate the reactivity for the post-trip return to power portion of the analysis. This was done since the HERMITE code, which is a three-dimensional, coupled neutronics, open channel thermal hydraulics code, can more accurately model the effects of moderator temperature feedback on the power distribution and reactivity for the critical configuration existing during the return to power. The HERMITE results used in the ANO-2 analysis were actually obtained from a parametric study performed for Calvert Cliffs Unit 1 Cycle 7. ANO-2 specific ROCS calculations were used to confirm the applicability of these parametric results to ANO-2.
9. Three-dimensional power distribution peaks (F_q) were determined with the ROCS and HERMITE evaluations mentioned above. Axial profiles consistent with these conservative power distribution peaks were utilized in the analysis.
10. The power produced by the decay of the initial condition delayed neutron precursors and by nominal decay power is distributed according to the nominal power distribution.
11. The thermal margin on DNBR in the reactor core was simulated using the HRISE computer program, which employed the MacBeth CHF correlation and a 1.3 DNBR limit described in Reference 48. RCS conditions from CENTS (RCS temperature, pressure, flow, and power) are used in the HRISE thermal margin calculations.
12. The EOC Doppler curve in Figure 15.1.0-4 was assumed. This was based on the most negative FTC. This FTC, in conjunction with the decreasing fuel temperatures, causes the greatest positive reactivity insertion during the steam line break event.

ARKANSAS NUCLEAR ONE
Unit 2

13. The delayed neutron fraction assumed is the maximum value including uncertainties for end-of-cycle conditions (total delayed neutron fraction, β , 0.005994). This too minimizes neutron generation time and thus increases the potential for return to power.
14. EFW is conservatively modeled to actuate early.
15. The SITs were credited in this analysis only for the AC power available cases. The SITs were configured to have the minimum allowed pressure with the maximum volume of water and minimum water temperature. The boron concentration was at the minimum allowed value.
16. A minimum initial RCS flow of 315,560 gpm was assumed for HFP, and a minimum initial RCS flow of 314,682 gpm was assumed for HZP.
17. An initial steam generator pressure of 1001 psia was assumed for HFP, and an initial steam generator pressure of 1065 psia was assumed for HZP.

The conservative assumptions included in the HZP and HFP simulations are discussed below.

The MTC assumed in the analysis corresponds to the most negative value. This negative MTC results in the greatest positive reactivity addition during the RCS cooldown caused by the steam line break. Since the coefficient of reactivity associated with the moderator feedback varies significantly over the range of moderator density covered in the analysis, a curve of reactivity insertion versus moderator density rather than a single value of MTC is assumed in the analysis. The moderator cooldown curve used in the analysis (Figure 15.1.14-113) was conservatively calculated assuming that on reactor trip, the highest worth control element assembly is stuck in the fully withdrawn position. The effect of uneven temperature distribution on the moderator reactivity is accounted for by assuming that the moderator reactivity is a function of the lowest cold leg temperature.

For conservatism, the full steam generator heat transfer surface area is assumed to always be covered by the 2-phase level until a steam generator becomes essentially empty.

The minimum CEA worth assumed to be available for shutdown at the time of reactor trip at the maximum allowed power level is $-6.84\% \Delta\rho$. For the HZP cases a shutdown CEA worth of $-4.84\% \Delta\rho$ was used. The scram worths used are consistent with the moderator cooldown curve and stuck rod assumed in the analysis. The CEA reactivity addition curve of Figure 15.1.0-1D adjusted to a worth of $-6.84\% \Delta\rho$ was used in the HFP cases. The HZP cases assumed a CEA drop time consistent with Figure 15.1.0-1C with the 0.6 second holding coil delay time and a scram worth of $-4.84\% \Delta\rho$; however, a more conservative normalized reactivity insertion versus CEA position for a $+0.6$ ASI curve was used.

The EFW system is conservatively modeled to initiate early with both EFW pumps available, maximizing the potential cooling that could occur. System response times, flows, and setpoints are assumed based on increasing the cooling potential of the EFW system.

These analyses have considered the worst single failure of an active component. The analysis assumed that, for the loss of AC power cases, one EDG failed to start. The failure of an EDG resulted in the failure of one HPSI pump and one of the MFIVs to close. The faster closing Back-up MFIVs were assumed to remain open. For the HFP case with AC available, a bus fast

ARKANSAS NUCLEAR ONE
Unit 2

transfer failure is the most limiting single failure. This failure was modeled as the failure of the Back-up MFIV and a HPSI pump. A fast transfer failure would only result in the delayed actuation of the Back-up MFIV and HPSI pump. These components would be actuated once the EDG has started. Therefore, the modeling of the fast transfer failure was conservative. This conservative modeling of a fast transfer failure was slightly more limiting than the single failure of a main feedwater pump to trip, which is consistent with the current analysis. A single failure of a HPSI pump to start was assumed for the HZP case with AC available.

The HFP feedwater addition to the steam generators assumed in this analysis was re-generated due to the installation of the RSGs and increase in rated power. The analysis used a RELAP5/MOD3.1 model (Reference 50) to generate the feedwater system response. The steam generator pressure profiles and time of MSIS were verified to be consistent between the CENTS and RELAP5/MOD3.1 results. For the HZP (or no load) cases, feedwater flow is modeled by matching the energy input by the core at the start of the event. An increase in feedwater flow is assumed based on the capacity of the auxiliary feedwater (AFW) pump.

The key parameters used for the post-trip steam line break analyses are listed in Table 15.1.14-41. For the HFP cases, an RCS flow of 315,560 gpm was assumed. For the HZP cases a lower RCS flow of 314,682 gpm was assumed.

Tables 15.1.14-42 through 15.1.14-45 present the sequence of events for the HFP and HZP steam line break cases with and without a concurrent loss of AC power. Only the limiting inside or outside containment case was presented for the HFP and HZP conditions with AC available. Figures 15.1.14-114 through 15.1.14-137 show the transient response for key parameters.

The HFP results of this analysis indicate that a slight return to criticality occurs for the case with loss of AC power. The new maximum post trip reactivity values are 0.0173 % $\Delta\rho$ and -0.0218% $\Delta\rho$ considering a loss of AC and offsite power available, respectively. The peak return to power and minimum DNBR values are 2.76% and 1.70, and 4.26% and 2.72 considering a loss of AC and offsite power available, respectively.

The HERMITE 3-D feedback and 3-D peaking factors are power dependent. The Cycle 15 – 2815 MWt values were more limiting than the Cycle 16 – 3026 MWt values. This input in conjunction with the RSG resulted in a slightly more adverse post-trip return to criticality for the HFP with and without loss of offsite power events (see the sequence of events in Table 15.1.14-42 and Table 15.1.14-43). (The HFP with loss of offsite power event maximum post trip reactivity is 0.0211% $\Delta\rho$, peak return to power is 3.39% of 2815 MWt, and minimum DNBR is 1.38. The HFP with offsite power available event maximum post trip reactivity is -0.02314% $\Delta\rho$, peak return to power is 4.392% of 2815 MWt, and minimum DNBR is 2.48). The times for the sequence of events were within two seconds of the Cycle 16 sequence of events. Since the results for Cycle 15 are valid for only one cycle, they are provided as footnotes to the Cycle 16 sequence of events.

The HZP results of this analysis indicate that a slight return to critical occurs for the case with loss of AC power. The new maximum post trip reactivity values are +0.206% $\Delta\rho$ and -0.545% $\Delta\rho$ considering a loss of AC and offsite power available, respectively. The peak return-to-power and minimum DNBR values are 0.15% and > 10, and zero and > 10 considering a loss of AC and offsite power available, respectively. The Cycle 15 (2815 MWt) results are valid only for one cycle.

ARKANSAS NUCLEAR ONE
Unit 2

As these results indicate acceptable DNBR values, no fuel failure is predicted. The results of the steam line break analyses demonstrated that there were no calculated fuel failures, thus the coolable geometry has been maintained.

A sensitivity study was completed on CEA worth at trip to determine the lowest CEA worth value that would produce either a DNBR of 1.30 (MacBeth) or a peak Linear Heat Rate of 21 KW/ft. The method used was to hold all input parameters, both physics input and plant values, constant and lower the CEA worth at trip until one of the above limits was reached.

The purpose of this sensitivity study was to determine the amount of CEA worth at trip that could be utilized in future reload efforts to offset other physics parameters. Thus, the incremental CEA worth at trip of 0.09 % $\Delta\rho$ can be credited in future reload efforts. Similarly, an incremental shutdown margin of 1.29 % $\Delta\rho$ can be credited in future HZP analysis.

15.1.14.1.4.6 Cycle 18 Main Steam Line Break Analysis

The Main Steam Line Break event was evaluated at a higher LOCA Limit of 14.4 KW/ft. The LOCA Limit was used to determine the decay heat 3-D peak.

The methodology was the same as that used in the current analysis in Section 15.1.14.1.4.5. The LOCA Limit value of 14.4 KW/ft was used in place of the previous value of 13.7 KW/ft. No new computer cases were required.

The combination of the radial power distortion and core power that resulted from the current analysis are combined with the higher LOCA Limit value of 14.4 KW/ft to determine the new decay heat 3-D peak for minimum DNBR (mDNBR). The mDNBR was assessed with the new decay heat 3-D peak plus the current fission 3-D peak from the current analysis. Since the fission power 3-D peak was dominant, the increase in decay heat 3-D peak had a negligible impact on the current mDNBR value, which remained above the SAFDL. There was no impact on the current calculated peak LHR value as the current analysis 3-D decay heat radial peak was bounding with respect to the 14.4 KW/ft value. As there were no calculated fuel failures, the radiological dose results are unchanged.

15.1.14.1.4.7 Cycle 21 Main Steam Line Break Analysis

The post-trip Main Steam Line Break (MSLB) event analyses were evaluated to determine the impact of a full core of Next Generation Fuel (NGF). The major impact was the implementation of the NGF pin dimensions and its affect on the calculated MacBeth critical heat flux correlation mDNBR.

The methodology is the same as that used in the current analysis presented in Section 15.1.14.1.4.5. No CENTS computer code cases were run, since input changes due to NGF are small enough such that impact on the results are insignificant and all current input parameters in Table 15.1.14-41 remained unchanged. Of the four post-trip MSLB events analyzed, only the HFP with Loss of AC power (LOAC) was re-evaluated. The remaining three MSLB events, HFP with AC power available, HZP with LOAC, and HZP with AC power available were not reevaluated; as all three of these MSLB events had a minimum MacBeth DNBR value greater than 2.0 and had sufficient margin to the 1.3 MacBeth DNBR limit.

ARKANSAS NUCLEAR ONE
Unit 2

Only the HFP with Loss of AC power (LOAC) case's DNB margin analysis was affected. With the implementation of NGF, the minimum MacBeth DNBR decreased from 1.70 to 1.68. The minimum MacBeth DNBR still remains above the SAFDL of 1.30. Table 15.1.14-42 provides a revised SAR Sequence of Events that includes the new DNBR value. There are no impacts on the MSLB sensitivity study analyses that determine the CEA worth at trip that can be utilized in future reload efforts to offset other physics parameters. Consequently, the conclusions in SAR Section 15.1.14.1.4.5 remain the same.

15.1.14.2 Feedwater Line Break Accident

15.1.14.2.1 Identification of Causes

A feedwater line rupture accident is defined as the failure of a main feedwater system pipe during plant operation. The main feedwater and condensate system on which these analyses are based, are described in Section 10.4.7. A rupture in the main feedwater system rapidly reduces the steam generator inventory causing a partial loss of the main steam heat sink, thereby allowing heatup of the RCS. Depending on initial conditions, break size, break location and steam generator inventory, any of several plant protective system actions may occur. A decrease in the steam generator water level will initiate a reactor trip signal on low steam generator water level. In addition, the decrease in the steam generator pressure may result in a low steam generator pressure trip signal and cause the main steam isolation valves and the main feedwater isolation valves to close. Additional protection against loss of the main steam heat sink is provided by automatic initiation of emergency feedwater to the intact steam generator. The RCS is protected from overpressurization by the high RCS pressurizer pressure trip and the pressurizer safety valves.

If the feedwater line breaks outside of containment or inside containment but upstream of the feedwater line check valves, steam generator blowdown is prevented by the closure of the check valves. The consequences of these feedwater line breaks are the same as the consequences of the loss of normal feedwater flow incidents (Section 15.1.8).

If the feedwater line rupture occurs between the steam generator and the feedwater line check valves, blowdown of the affected steam generator continues until the steam generator pressure equals the containment back pressure. However, termination of the feedwater flow from the intact steam generator as well as the intact lines on the damaged steam generator occurs with closure of the check valves. In addition, the main feedwater isolation valves close on a main steam isolation signal or containment spray actuation signal.

The steam generators are designed to withstand RCS operating pressure on the tube side with atmospheric pressure on the shell side; therefore, the integrity of the RCPB is assured.

15.1.14.2.2 Analysis of Effects and Consequences

15.1.14.2.2.1 Discussion of Cases and Parameters

The analysis of the feedwater line rupture is performed using CESEC, which is a digital simulation of the NSSS, described in Section 15.1.0.6.

Parametric studies were performed to determine the limiting transient with respect to the feedwater line break size. For conservatism the initial steam generator mass and break size were varied in order to obtain the following limiting conditions at the time of trip:

ARKANSAS NUCLEAR ONE
Unit 2

- A. Downcomer level, of the steam generator connected to the intact feedwater line, at the low steam generator water level setpoint;
- B. Steam generator connected to the ruptured feedwater line empties;
- C. Greatest energy content of the RCS without initiating a trip, i.e., RCS pressure 2422 psia; and,

The RCS energy content was maximized through the following set of assumptions:

1. The initial core power was increased to 2,900 MWt (103 percent of design full power).
 2. The initial core inlet temperature was increased from 553.7 °F (design) to 556.7 °F.
 3. The initial core flow was decreased from 120.8 (design flow) to 116.2 million lbm/hr, which increased the core outlet and hot leg temperatures.
 4. The minimum value (BOC, zero burnup) for the fuel gap heat transfer coefficient maximized the stored energy of the fuel.
 5. A moderator temperature coefficient of $+0.5 \times 10^{-4} \Delta\rho/^\circ\text{F}$ and a 15 percent reduction of the Doppler reactivity feedback maximized the increase of core power prior to trip.
 6. Decay heat was maximized by assuming equilibrium core conditions.
 7. RCS heatup prior to reactor trip was prolonged by maximizing time to trip. This was accomplished by reducing the initial RCS pressure from 2,250 psia to 2,200 psia and by choosing the combination of a small break with unrealistically high initial steam generator inventories (190,000 lbm).
 8. The fluid discharged through the break was assumed to be saturated liquid, although physically the discharge quality must increase as the steam generator liquid is depleted.
 9. For the loss of offsite power case, at the time of trip all non-emergency electrical power was assumed to be lost. This minimized heat transfer out of the RCS due to a loss of coolant flow and closure of the turbine and turbine bypass valves.
 10. Reactor trip was delayed by not taking credit for a low level trip in the ruptured steam generator.
 11. For conservatism, the full heat transfer surface area is available, i.e., the tubes are assumed to always be covered by the 2-phase level, until a steam generator becomes empty.
- D. Greatest RCS pressure change with respect to time at the time of trip.

ARKANSAS NUCLEAR ONE
Unit 2

The combination of all of the above conditions existing at the time of trip assures that; 1) the most limiting RCS transient prior to trip has occurred and that 2) a minimum secondary heat sink exists for the subsequent cooldown of the RCS.

As indicated in items "A" through "C" the analyses results in the simultaneous occurrence of the following three trip signals:

- A. Steam generator low water level trip signal (steam generator connected to the intact feedwater line);
- B. Steam generator low pressure trip signal (steam generator connected to ruptured feedwater line); and,
- C. High pressurizer pressure trip signal.

No credit is taken for a low steam generator water level trip in the steam generator connected to the ruptured feedwater line.

Table 15.1.14-18 lists some of the conservative initial assumptions used in the analyses. For the cases analyzed:

- A. The variation of reactivity with fuel temperature is included. For conservatism, the absolute value of the slope of the reactivity versus fuel temperature function is decreased 15 percent for both cases.
- B. The most reactive CEA is assumed stuck in the fully withdrawn position. The minimum CEA worth available for shutdown when the reactor is tripped is -5.4 percent $\Delta\rho$ for the full load conditions.
- C. The emergency feedwater is automatically initiated to the steam generator with the intact feedwater line on a low steam generator water level signal. There is a 65-second delay before this flow reaches the steam generator, if AC power is available, otherwise there is a 112-second delay from the time AC power is lost due to the loading sequence of the diesel generators.
- D. The quality of fluid discharged out of the ruptured feedwater line is assumed to be saturated water at the pressure calculated by using the CESEC code. For the limiting transients, a flow rate of 1,300 lbm/sec and an initial steam generator fluid inventory of 190,000 lbm was used. This initial steam generator inventory and break size results in the limiting conditions as discussed above. The initial steam generator inventories assumed are significantly different from the nominal inventories at full power conditions and were used to obtain the most limiting conditions as discussed above. For lower initial steam generator inventories a reactor trip on a low steam generator water level signal in the steam generator connected to the intact feedwater line would occur at an earlier time and subsequently a lower RCS energy content would exist at the time of trip. The combination of the larger initial steam generator inventories and the small blowdown rate through the break allows the pressurizer control systems in the RCS, i.e., pressurizer sprays, etc., to limit the pressure transient to a value below the high pressurizer pressure trip while increasing the energy of the RCS. Increasing the break size will result in either a low steam generator pressure trip in the steam generator connected to the ruptured feedwater line or a high pressurizer pressure trip prior to the occurrence of the limiting conditions listed above.

ARKANSAS NUCLEAR ONE
Unit 2

- E. Credit is taken for the closure of the feedwater line swing check valve. Closure of the swing check valve assures isolation of the steam generator connected to the intact feedwater line. Additional isolation of the intact steam generator is provided by closure of the feedwater isolation valves on a MSIS.
- F. A conservatively small value of the fuel gap heat transfer coefficient was assumed in the analysis, corresponding to BOC, zero burnup. Doubling the value of the coefficient decreased the peak RCS pressure by 40 psi due to the reduction of fuel temperatures which reduced the Doppler effect and the stored fuel energy.

15.1.14.2.2.2 Results

The NSSS and RPS responses for the feedwater line break cases are presented in Tables 15.1.14-19 through 15.1.14-22 and in Figures 15.1.14-63 through 15.1.14-72.

A. Full Power With AC Available

Tables 15.1.14-19 and 15.1.14-21, and Figures 15.1.14-63 through 15.1.14-67 present the transient for this case.

Concurrently, at 57.6 seconds into the transient the following occur:

1. Affected steam generator empties and low steam generator pressure trip signal is generated;
2. High pressurizer pressure trip signal occurs; and,
3. Low steam generator water level signal occurs in the steam generator connected to the intact feedwater line.

The reduction in the secondary heat sink due to the emptying of the affected steam generator and subsequent closure of the MSIVs results in a peak RCS pressure of 2,576 psia occurring at 62.2 seconds into the transient. Subsequently, the decay in core power level and action of the pressurizer sprays reduce the RCS system pressure until 96.3 seconds into the transient at which time the steam generator connected to the intact feedwater lines empties. As a result of the emptying of this steam generator, the RCS pressure increases to 2,281 psia at 157 seconds into the transient. At this time the effect of the pressurizer sprays and emergency feedwater are sufficient to terminate the RCS pressure rise.

B. Full Power With Loss of AC at Time of Trip.

Tables 15.1.14-20 and 15.1.14-22, and Figures 15.1.14-68 through 15.1.14-72 present the transient for this case.

Prior to trip this case is identical to Case A. At the time of trip, however, the following events are assumed to occur in response to the loss of AC power.

1. Turbine stop valves close instantaneously;
2. Reactor coolant pumps begin to coastdown; and,
3. Pressurizer control systems are lost.

ARKANSAS NUCLEAR ONE
Unit 2

The result of the loss of AC power in addition to the system response in Case A is to cause a higher peak RCS pressure (2,635 psia) to occur at 62.6 seconds into the transient. Subsequently decay in the core power level and the action of the secondary safety valves result in a reduction in the RCS pressure until 91.4 seconds into the transient when the steam generator connected to the intact feedwater line empties. As a result of the emptying of this steam generator, the RCS pressure increases to a peak pressure of 2,508 psia and is maintained below this pressure by the action of the RCS safety valves.

Filling of the pressurizer is prevented by the action of the emergency feedwater, which enters the intact steam generator 175.7 seconds into the transient. At 990 seconds into the transient the effect of the emergency feedwater flow is sufficient to result in a contraction of the RCS and subsequently a decay in the RCS pressures and temperatures, and closure of the pressurizer safety valves.

15.1.14.2.3 Conclusions

As shown by the results of the feedwater line break analysis, no unacceptable consequences occur. The RCS pressure does not exceed 110 percent of the design value and the pressurizer does not fill. Radiological consequences for the feedwater line break transients are no more severe than those presented for the loss of AC power (Section 15.1.9) because the fluid from the steam generator blowdown remains inside the containment.

15.1.14.2.4 Feedwater Line Break Accident Subsequent Analyses

15.1.14.2.4.1 Cycle 3 Feedwater Line Break Analysis

The feedwater line break accident analysis with a loss of AC power was reanalyzed for Cycle 3 using CESEC-III, which is a later version of the method identified above. This analysis was performed essentially consistent with the analysis described above assuming a loss of AC using the inputs from Table 15.1.14-23. The following are some differences from the above identified analysis:

- A. The affected steam generator empties, the high pressurizer pressure trip condition occurs, and a low steam generator level trip on the intact steam generator all occur within 2 seconds of each other.
- B. A low steam generator pressure trip condition does not occur until minutes after the high pressurizer pressure trip and low steam generator level trip conditions occur.
- C. A reactor coolant system pressure of 2300 psia was assumed.
- D. Steam generator initial pressure was 949 psia.
- E. A moderator temperature coefficient of $0.0 \times 10^{-4} \Delta\rho/^{\circ}\text{F}$ was assumed.
- F. A CEA worth at trip of $-6.8 \times 10^{-2} \Delta\rho$ was assumed.
- G. A tolerance limit of +1% on the primary side safety valves was accounted for.
- H. A core mass flow rate of 115.5×10^6 lbm/hr was conservatively assumed.

ARKANSAS NUCLEAR ONE
Unit 2

The results indicate that the reduction of the secondary heat sink due to the discharging of saturated water through the feedwater line break and the subsequent emptying of the affected steam generator cause the RCS pressure to increase to 2742 psia. Following reactor trip on high pressurizer pressure, the decay in core power and the action of the primary and secondary safety valves result in a reduction of the RCS pressure.

15.1.14.2.4.2 Cycle 13 Feedwater Line Break Analysis

The feedwater line break accident analysis with a loss of AC power was reanalyzed using CENTS to account for Cycle 13 physics data. This analysis was performed essentially consistent with the analyses described above assuming a loss of AC and using the inputs from Table 15.1.14-24. The analytical bases are discussed below.

- A. The feedwater line break analyzed was assumed to occur during full power operation (2900 MWt) with a loss of offsite power at the time trip breakers open. With a loss of offsite power the turbine stop valves are assumed to close, the reactor coolant pumps begin to coast down, and the pressurizer control systems are lost.
- B. A CEA insertion curve consistent with the CEA position versus time (including a 0.6 second holding coil delay time) of Figure 15.1.0-1D is used in this analysis; however, a more conservative normalized reactivity insertion versus CEA position for a +0.6 ASI curve was used. The minimum CEA worth assumed available for shutdown, with the most reactive CEA remaining in the fully withdrawn position, when the reactor is tripped is -5.0% $\Delta\rho$.
- C. The Doppler curve assumed is consistent with the BOC curve in Figure 15.1.0-4 which already includes a 0.85 multiplier.
- D. The initial intact steam generator liquid inventory was assumed to be 168,700 lbm and 93,060 lbm was assumed for the affected unit. These masses were used to ensure the coincidence trip conditions described below.
- E. A low steam generator pressure trip does not occur until minutes after the high pressurizer pressure trip and low steam generator level trip conditions occur. This is similar to the Cycle 3 analysis.
- F. Only flow from one EFW pump was credited to the steam generator with the intact feedwater line. Flow to this generator is based on a 36.3 second delay after a low steam generator pressure condition exists, which is 225 seconds after a low steam generator level condition occurs. This allows time for the EFW pumps to accelerate and flow to the affected steam generator to be isolated prior to crediting EFW flow to the intact steam generator.
- G. A MSIS low steam generator pressure setpoint of 620 psia was assumed with a 1.3 second response time. A 3 second MSIV stroke time (4.3 second response time) and 35 second EFW isolation valve stroke time (36.3 second response time) were also assumed.
- H. A conservatively small value for the fuel gap heat transfer coefficient was assumed corresponding to BOC.

ARKANSAS NUCLEAR ONE
Unit 2

- I. The lift tolerance for the primary safety valves and secondary safety valves was assumed to be +3% of setpoint.
- J. Decay heat was maximized by assuming equilibrium core conditions.
- K. The Cycle 13 BOC delayed neutron fraction and EOC neutron lifetime consistent with Section 15.1.0.3 was assumed.

The conservative assumptions included in the feedwater line break simulation are discussed below.

The feedwater line break was assumed to occur during full power operation with concurrent loss of non-emergency AC power at the time of trip. This is limiting from the standpoint of potential RCS pressure increase, since this results in the maximum initial stored energy and minimum steam generator inventory.

A new limiting break size was established by a parametric study as part of this effort. Break size was revisited due to the use of CENTS versus CESEC. The new limiting break size has become that which is sized to pass all feedwater flow but not large enough to cause back flow from the ruptured steam generator. No back flow is modeled until after trip when the feedwater goes away. Feedwater is assumed to go to zero at the start of the event. The break area necessary to pass all feedwater is assumed to be 0.24 ft².

The steam generator heat transfer area is conservatively assumed to be fully available down to 19,000 lbm of liquid in the steam generator at which point the area is ramped down to zero at 2000 lbm.

It is conservatively assumed that the blowdown of the affected steam generator is saturated water, when in reality the blowdown would change to "two phase discharge" after the water level dropped below the feedwater ring.

The initial RCS pressure and initial steam generator inventories are selected such that the Low Steam Generator Water Level Trip on the intact steam generator and the High Pressurizer Pressure Trip occur simultaneously with the dryout of the affect steam generator. This results in the maximum peak RCS pressure after trip. A 1.3 second response time has been associated with the low steam generator level trip and a 0.9 second response time with the high pressurizer pressure trip. This difference in response time is reflected in the sequence of event.

The feedwater line break event was initiated at the conditions shown in Table 15.1.14-24. Table 15.1.14-25 presents the sequence of events for this transient. Figures 15.1.14-80 through 15.1.14-84 show the transient response of the key parameters. The results indicate that the reduction of the secondary heat sink and subsequent emptying of the affected steam generator cause the RCS pressure to increase to a maximum of 2730.1 psia. Following reactor trip on high pressurizer pressure/low steam generator (intact) water level, the decay in core power and the action of the PSVs and MSSVs results in a reduction of the RCS and steam generator pressures. The RCS pressure continues to decrease until low steam generator pressure initiates the closure of the MSIVs and MFIVs. The MSIV closure terminates the blowdown of steam from the intact steam generator through the break thus causing the RCS to heat up once more. This heatup is terminated by the opening of the MSSVs and initiation of emergency feedwater to the intact steam generator.

ARKANSAS NUCLEAR ONE
Unit 2

15.1.14.2.4.3 Cycle 15 Feedwater Line Break Analysis

The Feedwater Line Break (FWLB) with a loss of normal AC power event analysis was performed to determine the impact of the Cycle 15 changes including installation of the replacement steam generators.

The methodology used in this analysis has changed slightly from that used in the previous analysis. The previous method determined the limiting FWLB area by combining a simultaneous High Pressurizer Pressure Trip and Low Steam Generator Level Trip on the intact steam generator with a concurrent emptying of the affected steam generator. This required an overly conservative large initial mass difference between the two steam generators. The new method assumes both steam generators are at the same initial mass level. The limiting FWLB area is calculated based on a simultaneous High Pressurizer Pressure Trip and Low Steam Generator Level Trip on the intact steam generator. This is still considered a very conservative approach as no credit is taken for the low level trip in the affected steam generator and the fluid discharge through the break was assumed to be saturated liquid until the affected generator empties.

This analysis has utilized the CENTS computer code for the transient analysis simulation.

Input parameters from Table 15.1.14-46 and the bounding physics data from Section 15.1.0 have been incorporated in this analysis with the following clarifications:

1. The BOC Doppler curve in Figure 15.1.0-4 was assumed.
2. A BOC delayed neutron fraction and neutron lifetime consistent with those defined in Section 15.1.0.3 were assumed.
3. The CEA reactivity insertion curve in Figure 15.1.0-1D was assumed. This curve accounts for a 0.6 second holding coil delay. The curve is consistent with that used in most analyses versus a curve associated with a +0.6 ASI as was used for the Cycle 13 analysis. A CEA worth of -5.0% $\Delta\rho$ was conservatively assumed.
4. The feedwater line break analyzed was assumed to occur during hot full power operation with a loss of offsite power at the time that the trip breakers opened. With a loss of offsite power the turbine stop valves are assumed to close, RCPs begin to coast down, and the pressurizer control systems are lost.
5. The initial steam generator liquid inventory for both steam generators was assumed to be 178,500 lbm.
6. A parametric analysis was performed to determine the FWLB area (0.1798 ft²) such that a simultaneous trip occurred on High Pressurizer Pressure and Low Steam Generator Level of the intact steam generator. A High Pressurizer Pressure Trip analytical setpoint of 2415 psia with a delay time of 0.65 seconds was assumed. A Low Steam Generator Level Trip analytical setpoint of 6% of narrow range indication with a 1.3 second response time was assumed. This is different than the previous analysis, which assumed a concurrent emptying of the affected steam generator. The analytical trip setpoints for the High Pressurizer Pressure Trip conservatively assumes a harsh environment uncertainty and the Low Steam Generator Level Trip assumes an abnormal environment uncertainty.

ARKANSAS NUCLEAR ONE
Unit 2

7. Only EFW flow from one EFW pump was credited to the steam generator with the intact feedwater line. A conservative EFW flow analytical actuation setpoint of 0% of narrow range indication was assumed with a delay time of 112.4 seconds. The uncertainty associated with the setpoint for EFW flow actuation is based on a harsh environment uncertainty. The time of EFW flow delivery to this generator was based on the maximum of:
- a) the time to receive an EFAS with a delay period that allows the EFW pump to accelerate, or
 - b) the time to receive an MSIS with a delay period that allows EFW flow to the affected steam generator to be isolated, or
 - c) the time the steam generator ΔP setpoint is reached with a delay period that allows EFW flow to the intact steam generator to be re-initiated.

Isolation of EFW to the affected steam generator is based on the EFW valve isolation time of 36.4 seconds. EFW flow rate to the intact steam generator is dependent on steam generator pressure.

8. An MSIS analytical setpoint of 658 psia was assumed with a 1.4 second response time, a 3.5 second MSIV closure time, and a 35 second EFW isolation valve stroke time. A high ΔP analytical setpoint of 220 psid was assumed with a 1.4-second response time and a 35-second EFW isolation valve stroke time.
9. A conservatively small value for the fuel gap heat transfer coefficient was assumed corresponding to BOC.
10. An MSSV lift tolerance of +3% and PSV lift tolerance of +3.2% were assumed.
11. An initial core power of 2900 MWt, based on a rated power of 2815 MWt and a 3% uncertainty, was assumed.
12. The BOC MTC of $-0.2 \times 10^{-4} \Delta\rho/^\circ\text{F}$ was assumed.
13. Assuming equilibrium core conditions maximized decay heat.
14. The analysis considered plugged U-tubes between zero and 10% plugged range per steam generator, with zero percent being conservative.
15. Installation of the RSGs was assumed.
16. A minimum RCS flow of 315,560 gpm was assumed
17. An initial steam generator pressure of 1000 psia was assumed.
18. The PSV flow was adjusted by the Napier correction.
19. Steam generator full heat transfer area is conservatively assumed down to 19,000 lbm (liquid mass). At 19,000 lbm, the steam generator heat transfer is assumed to ramp linearly to zero at 2000 lbm.

ARKANSAS NUCLEAR ONE
Unit 2

The peak RCS and steam generator pressures remained below the respective criteria of 2750 psia and 1210 psia, and the pressurizer did not fill solid with liquid.

The NSSS, RPS, and EFW system responses for the FWLB with loss of AC power on turbine trip event are shown in Table 15.1.14-47 and in Figures 15.1.14-138 through 15.1.14-142.

The combination of the replacement steam generators, an increase in minimum RCS flow, the change in the analytical Low Steam Generator Level Trip and EFAS setpoints, and the change in the analytical MSIS setpoint did not result in the RCS and steam generator pressures exceeding criteria and a pressurizer over-fill did not occur.

15.1.14.2.4.4 Cycle 16 Feedwater Line Break Analysis

The Feedwater Line Break (FWLB) with a loss of normal AC power event analysis was performed to determine the impact of the Cycle 16 changes including a power uprate to a nominal full power of 3026 Mwt.

The methodology used in this analysis has changed slightly from that used in the previous analysis. The previous method determined the limiting FWLB area by combining a simultaneous High Pressurizer Pressure Trip and Low Steam Generator Level Trip on the intact steam generator. The new method assumes that a Low Steam Generator Level Trip on the affected steam generator will occur with 40,000 lbm liquid inventory remaining in the steam generator. The limiting FWLB area is calculated based on a simultaneous High Pressurizer Pressure Trip and Low Steam Generator Level Trip on the affected steam generator at 40,000 lbm. This is still considered a very conservative approach as the fluid discharge through the break was assumed to be saturated liquid until the affected generator empties.

The initial pressurizer pressure which allows simultaneous trips with ruptured steam generator low level, as discussed above, is 2300 psia. This is different from previous analyses where the lowest allowable initial pressurizer pressure, 2000 psia, provided the limiting transient RCS pressure.

This analysis has utilized the CENTS computer code for the transient analysis simulation and NOTRUMP for determining the liquid inventory in the faulted steam generator at the low-level trip setpoint.

Input parameters from Table 15.1.14-48 and the bounding physics data from Section 15.1.0 have been incorporated in this analysis with the following clarifications:

1. The BOC Doppler curve in Figure 15.1.0-4 was assumed.
2. A BOC delayed neutron fraction and neutron lifetime consistent with those defined in Section 15.1.0.3 was assumed.
3. The CEA insertion curve in Figure 15.1.0-1D was assumed. This curve accounts for a 0.6 second holding coil delay. A CEA worth of -5.0% $\Delta\rho$ was conservatively assumed.
4. The feedwater line break analysis was assumed to occur during hot full power operation with a loss of offsite power at the time that the trip breakers opened. With a loss of offsite power the turbine stop valves are assumed to close, RCPs begin to coast down, and the pressurizer control systems are lost.

ARKANSAS NUCLEAR ONE
Unit 2

5. The initial steam generator liquid inventory for both steam generators was assumed to be 164,400 lbm.
6. A parametric analysis was performed to determine the FWLB area (0.1492 ft²) such that a simultaneous trip occurred on High Pressurizer Pressure and Low Steam Generator Level of the affected steam generator at 40,000 lbm liquid inventory. A High Pressurizer Pressure Trip analytical setpoint of 2415 psia with a delay time of 0.90 seconds was assumed. A Low Steam Generator Level Trip response time of 1.3 seconds was assumed. This is different than the previous analysis, which assumed a Low Steam Generator Level Trip at 6% narrow range level on the intact steam generator. The analytical trip setpoints for the High Pressurizer Pressure Trip conservatively assumes a harsh environment uncertainty.
7. Only EFW flow from one EFW pump was credited to the steam generator with the intact feedwater line. A conservative EFW flow actuation setpoint of 0% of narrow range was assumed with a delay time of 112.4 seconds. The uncertainty assumed on the EFW flow actuation setpoint is based on a harsh environment uncertainty. The time of EFW flow delivery to this generator was based on the maximum of:
 - a) the time to receive an EFAS with a delay period that allows the EFW pump to accelerate, or
 - b) the time to receive a MSIS with a delay period that allows EFW flow to the affected steam generator to be isolated, or
 - c) the time the steam generator Δp setpoint is reached with a delay period that allows EFW flow to the intact steam generator to be re-initiated. Isolation of EFW to the affected steam generator is based on the EFW valve isolation time of 36.4 seconds. EFW flow rate to the intact steam generator is dependent on steam generator pressure.
8. A MSIS analytical setpoint of 905 psia was assumed with no delay in response time, instantaneous MSIV closure time, and a 35 second EFW isolation valve stroke time. A high Δp analytical setpoint of 220 psid was assumed with a 1.4-second response time and a 35-second EFW isolation valve stroke time. This is a modification to the previous analysis which assumed a minimum MSIS analytical setpoint pressure of 658 psia and a maximum response time delay and MSIV valve closure time. For the current analysis, a maximum MSIS setpoint minimizes the cooldown of the RCS. In the previous analysis, a minimum setpoint was used to provide maximum depletion of the intact steam generator inventory. For this analysis, intact steam generator inventory depletion is mitigated by the affected steam generator low level trip.
9. A conservatively small value for the fuel gap heat transfer coefficient was assumed corresponding to BOC.
10. A MSSV lift tolerance of +3.5% and PSV lift tolerance of +3.2% were assumed.
11. An initial core power of 3087 MWt was assumed, based on a rated power of 3026 MWt and a 2% uncertainty.

ARKANSAS NUCLEAR ONE
Unit 2

12. The BOC MTC of $-0.2 \times 10^{-4} \Delta\rho/^\circ\text{F}$ was assumed.
13. Assuming equilibrium core conditions maximized decay heat.
14. The analysis considered plugged U-tubes between zero and 10% plugged range per steam generator, with zero percent being conservative.
15. Installation of the RSGs was assumed.
16. A minimum RCS flow of 315,560 gpm was assumed.
17. An initial steam generator pressure of 999 psia was assumed.
18. The PSV flow was adjusted by the Napier correction.
19. Steam generator full heat transfer area is conservatively assumed down to 19,000 lbm (liquid mass). At 19,000 lbm, the steam generator heat transfer is assumed to ramp linearly to zero at 2000 lbm.
20. An initial pressurizer pressure of 2300 psia was assumed.

The peak RCS and secondary system pressures remained below the respective criteria of 2750 psia and 1210 psia, and the pressurizer did not fill solid with liquid. The NSSS, RPS, and EFW system responses for the FWLB with loss of AC power on turbine trip event are shown in Table 15.1.14-49 and in Figures 15.1.14-143 through 15.1.14-147.

The combination of the increased core power, the change in the analytical Low Steam Generator Level Trip methodology, and the change in the analytical MSIS setpoint and response did not result in the RCS and secondary system pressures exceeding criteria and a pressurizer overflow did not occur.

15.1.14.3 Additional Main Steam Line/Feedwater Line Break Information and Analyses

Additional analyses and information are contained in correspondence to the NRC. These are included in the reference section at the end of this chapter.

15.1.15 INADVERTENT LOADING OF A FUEL ASSEMBLY INTO THE IMPROPER POSITION

15.1.15.1 Identification of Causes

Two accidents are considered in this section: 1) the erroneous loading of fuel pellets or fuel rods of different enrichment in a fuel assembly; and, 2) the erroneous placement or orientation of fuel assemblies.

The likelihood of an error in assembly, fabrication, or core loading is considered to be extremely remote because of the extensive quality control and quality surveillance programs employed during the fabrication process as well as the strict procedural control used during core loading. However, even if the core were to have incorrectly placed fuel rods or assemblies, these would either be detectable from the results of the startup or would lead to a minimal number of rods with excessive power during full power operation.

15.1.15.1.1 Erroneous Loading of Fuel Pellets or Fuel Pins of Different Enrichment in a Fuel Assembly

The probability of manufacturing a fuel assembly with an incorrect enrichment is considered an unlikely event. The extensive quality control and quality surveillance programs in effect during the manufacture of the fuel pellets, in the loading of the fuel rods and in the assembly of the fuel bundles preclude the possibility of manufacturing a fuel bundle with an incorrect enrichment(s).

During the manufacture and assembly of the fuel rods, numerous check points and assay tests ensure that the enrichment is as specified and that the fuel rods and fuel assemblies are properly loaded and assembled. An assay is made of each lot of UO_2 powder to ensure that the enrichment is as required by the fuel specification. During the manufacture of the pellets, each powder lot is isolated during processing. After sintering, an additional enrichment check of the fabricated pellets is made by random sampling. Assembly of the fuel rods is performed by loading the fuel pellets into cladding onto which one end cap has been welded. With the exception of some Batch U fuel rods, the end cap is marked prior to welding, thereby identifying the enrichment to be loaded into the fuel rod. Beginning with Batch U, individual fuel rods will be marked with laser etched bar codes, providing additional means of identifying and tracking each rod.

During assembly of the fuel bundle, the quality control procedures require verification of each fuel rod in the assembly. Each fuel assembly is identified by a serial number which is engraved on the upper assembly plate in a prominent location.

A record of all operations performed on each fuel rod up to and including final assembly into the fuel bundle is recorded by computer. This procedure permits a rapid check at completion of fabrication to ensure that each rod within the fuel assembly has completed all of the required steps within the fabrication process. The computerized recordkeeping system also has the advantage of providing a mechanism by which an accurate record of all fuel rods within a fuel assembly can be defined as well as the enrichment, weight of U^{235} and UO_2 , and lot number of the fuel within each fuel rod.

If, however, it is assumed that an assembly is fabricated with some fuel rods made up entirely of the wrong enrichment pellets, then assumptions must be made as to the location and enrichments of these pins.

15.1.15.1.2 Erroneous Placement or Orientation of Fuel Assemblies

The fuel enrichment(s) within a fuel assembly is identified by a coded serial number marked on the exposed surface of the top end plate of the fuel assembly. This serial number is used as a means of positive identification for each assembly in the plant. During the period of core loading, a tag board or computer monitoring system is provided in the control room showing a schematic representation of the reactor core, spent fuel pool and new fuel storage area. The location of each CEA, fuel assembly, and source will be shown on this tag board or computer monitoring system. The tag board or computer monitoring system will be updated in the control room whenever a fuel assembly is moved. The tag board or computer monitoring system operator will be in constant communication with the area where this occurs. Also, a licensed senior reactor operator or senior reactor operator limited to fuel handling will be present in the area to supervise core alterations and ensure that the assemblies are moved to the correct locations. Fuel assemblies will not be moved unless these lines of communication are available. In addition to these precautions, independent inventories of components in the

ARKANSAS NUCLEAR ONE
Unit 2

reactor core and spent fuel storage areas will be made when fuel movement is complete to ensure that the tag board or computer monitoring system is correct. At the completion of core loading, the exposed surfaces of the top end plates are inspected to verify that all assemblies are correctly located. These precautions are included in the core loading procedures which are to be reviewed by appropriate plant personnel.

If, however, in spite of these precautions it is assumed that an assembly is placed in the wrong core position, then many possibilities exist. Probably the worst situation would be the interchange of two assemblies of different reactivities.

15.1.15.2 Analysis of Effects and Consequences

15.1.15.2.1 Erroneous Loading of Fuel Pellets or Fuel Pins of Different Enrichment in a Fuel Assembly

If the enrichment loaded into an assembly is lower than expected or if the misloaded rod or pellet is in an assembly that is not near the peak power density, then the core performance would not be adversely affected.

If the enrichment loaded into an assembly is higher than expected, the magnitude of the local peaking factor increase would depend on several conditions that must be postulated arbitrarily, such as the number of rods replaced by higher enrichment rods and the location of these rods with respect to water holes. At one end of the scale of postulated situations, the increased local peaking would be too small to adversely affect core performance during conditions of normal operation or under accident conditions. These errors may go undetected. Fuel loading errors that cause local power peaking increases large enough to adversely affect core performance under normal or accident conditions will be detectable through the use of in-core instrumentation during startup testing.

15.1.15.2.2 Erroneous Placement or Orientation of Fuel Assemblies

If, in spite of the extreme precautions described above, it is postulated that a fuel assembly is misloaded, several situations may be postulated. The misloading of a fuel assembly may affect the core power distribution only slightly, for example, if assemblies of similar enrichments and reactivities are misloaded. Alternatively, the core power distribution may be affected enough so that core performance would be affected if assemblies having different enrichments or reactivities are misloaded.

In the unlikely event that two assemblies of different enrichments would be interchanged, the misloading would be detected using core power distribution data from the fixed in-core detectors. See Section 4.5 for description of the Core Power Distribution Testing.

The fuel misloading event was considered for power uprate conditions to 3026 MWt. The analysis showed that the ability to detect core misloadings using incore detectors is not degraded due to the power uprate.

The minimum required over-power margin (ROPM) set aside in the setpoint analysis to protect the linear heat generation rate (LHGR) and DNB SAFDLs for the non-LOCA safety analysis AOs (rod drop, loss of flow, CEAW, etc.) is available to offset the increase in peaking associated with assembly misloadings. Since the maximum increase in peaking associated with the representative assembly misloading (a detectable assembly misloading) is bounded by the minimum ROPM, the LHGR and DNB SAFDLs will not be violated.

ARKANSAS NUCLEAR ONE
Unit 2

15.1.15.2.3 Additional Fuel Misloading Analyses for Reload Cycles

The fuel misloading accident was analyzed for the first cycle and for Power Uprate to 3026 MWt. However, the fuel misloading event is not reanalyzed for reload cycles or reported in the reload licensing submittal. For additional information on fuel misloading, see letter of May 1981 (2CAN058112) regarding analyses done at other CE plants and CE Report CE NPSD-366, "Verification of Control Rod Integrity and Fuel Symmetry."

The fuel misloading accident was reanalyzed (first application for Cycle 26) to explicitly consider operation with NGF fuel. This analysis determined the impact of the worst undetectable fuel assembly misload. ROPM values were determined for 15% and 25% failed incore detector conditions that ensure the DNB SAFDL will not be violated. The minimum ROPM set aside in the setpoint analysis is sufficient to ensure the DNB SAFDL will not be violated with less than or equal to 15% of the incore detectors (randomly) inoperable. If greater than 15% of the incore detectors are failed, the ROPM required exceeds the minimum amount set aside in the setpoints process. Should greater than 15% of the incore detectors become inoperable, additional ROPM will be reserved through setpoint changes to preclude the possibility of fuel failure due to an undetected fuel assembly misload. With respect to the LHGR SAFDL, the analysis demonstrated that no undetectable fuel assembly misload would violate this limit.

15.1.16 WASTE GAS DECAY TANK LEAKAGE OR RUPTURE

15.1.16.1 Identification of Causes

The most limiting waste gas accident is an unexpected and uncontrolled release to the atmosphere of the radioactive xenon and krypton fission gases that are stored in one waste gas decay tank. The Gaseous Waste System (GWS) is described in Section 11.3.

Since the waste gas decay tanks are Seismic Category I and Quality Group D, and since they are normally not subjected to pressures greater than 250 psig (design pressure 380 psig), a failure is unlikely. However, a rupture of a waste gas decay tank is analyzed to determine the limiting result from any malfunction in the GWS.

15.1.16.2 Analysis of Events and Consequences

Assumptions and methods used in this analysis are consistent with those of Branch Technical Position ETSB 11-5. The quantity of radioactivity contained in a single tank has been limited to a curie value which will prevent a member of the public at the exclusion area boundary from receiving a total body exposure exceeding 0.5 Rem in a 2-hour period. This is consistent with NUREG-0800, BTP ETSB 11-5, July 1981.

15.1.17 FAILURE OF AIR EJECTOR LINES (BWR)

Unit 2 is a Pressurized Water Reactor (PWR), and this event is not applicable.

15.1.18 STEAM GENERATOR TUBE RUPTURE WITH OR WITHOUT A CONCURRENT LOSS OF AC POWER

15.1.18.1 Identification of Causes

The steam generator tube rupture accident with or without a loss of AC power is a penetration of the barrier between the RCS and the main steam system. Integrity of this barrier is significant from a radiological standpoint, since a leaking steam generator tube would allow transport of reactor coolant into the main steam system. Radioactivity contained in the reactor coolant would mix with shellside water in the affected steam generator. This radioactivity would be transported through the turbine to the condenser, where the noncondensable radioactive materials would be released to the auxiliary building ventilation system via the condenser vacuum pumps.

CE's experience with nuclear steam generators indicates the probability of complete severance of the Inconel vertical U-tubes is remote. No such double-ended rupture has ever occurred in a CE steam generator of this design. The more probable modes of failure result in considerably smaller penetrations of the pressure barrier. They involve the formation of etch pits or small cracks in the U-tubes or cracks in the welds joining the tubes to the tubesheet.

Diagnosis of the accident is facilitated by radiation monitors in the condenser vacuum pump outlet lines and in the steam generator continuous sample lines. These monitors initiate alarms in the control room to inform the operator of abnormal activity levels.

Behavior of the systems varies depending upon the size of the rupture. For leak rates up to the capacity of the charging pumps, reactor coolant inventory can be maintained and an automatic reactor trip would not occur. The gaseous fission products would be released to the station stack (containment building flutes) through filter units from the secondary system at the condenser vacuum pump discharge.

The amount of radioactivity released increases with the size of the tube failure. For radiological analyses, a leakage area equivalent to a double-ended break of one steam generator tube is assumed. At normal operating conditions the leak rate through the double-ended rupture of one tube would have a maximum flow rate of 52 lb/sec. This exceeds the maximum flow rate available from the charging pumps (18 lb/sec). Therefore, the RCS pressure decreases until a low DNBR trip occurs. Following the reactor trip, the reactor coolant temperature is normally reduced by exhausting steam through the dump and bypass system. The radioactivity exhausted through this system flows to the condenser, where the noncondensable gaseous products are removed via the condenser vacuum pump.

The bypass valves in the dump and bypass system modulate closed to regulate the secondary pressure to the programmed value following the reactor trip. At zero power, the steam bypass controller functions to maintain secondary pressure of 1,000 psia and, in order to cooldown the RCS, the valve must be manually controlled for pressure below 1,000 psia. When the reactor coolant temperature is below 300 °F, the operator can place the shutdown cooling system into operation and terminate RCS heat removal via the steam generators.

For the case with concurrent loss of AC power, the RCS pressure also decreases after the initial pressure transient associated with the loss of AC power. As a result of the loss of AC electrical power would not be available for the station auxiliaries such as the reactor coolant pumps, the steam generator feedwater pumps, and the main circulating water pumps. Under such circumstances, the plant would experience a simultaneous loss of load, feedwater flow, and forced reactor coolant flow.

ARKANSAS NUCLEAR ONE
Unit 2

The loss of all station power is followed by automatic startup of the standby diesel generators, the power output of which is sufficient to supply electrical power to all engineered safety features and to provide the capability of maintaining the plant in a safe shutdown condition.

Subsequent to reactor trip, stored and fission product decay energy must be dissipated by the reactor coolant and steam generator systems. In the absence of forced reactor coolant flow, convective heat transfer into and out of the reactor core is supported by natural circulation reactor coolant flow. Initially, the residual water inventory in the steam generators is used and the resultant steam is released to atmosphere via the self-actuated steam generator safety valves. With the availability of standby power, emergency feedwater is automatically initiated on a low steam generator water level signal and plant cooldown is operator controlled via remotely operated atmosphere dump valves.

The low DNBR trip will prevent the DNB safety limit from being exceeded as a result of this transient. In addition, the pressurizer and secondary safety valves will prevent the RCS pressure and secondary system pressure from exceeding 110 percent of their design values.

15.1.18.2 – 15.1.18.3 REMOVED – HISTORICAL DATA

15.1.18.4 SGTR Subsequent Analyses

15.1.18.4.1 REMOVED – HISTORICAL DATA

15.1.18.4.2 Cycle 15 Steam Generator Tube Rupture With or Without a Concurrent Loss of AC Power

A Steam Generator Tube Rupture with and without a LOAC event evaluation was performed for Cycle 15 to determine the impact of the RSGs. The method used for the evaluation was a comparison of changes in key input parameters between those of the previous analysis versus the new data due to the RSGs.

The major change is the actual steam generator. The RSG consists of the following:

1. A larger secondary side volume of 8172 ft³ versus 7957 ft³
2. A larger number of U-tubes per steam generator of 10,637 versus 8411
3. A smaller U-tube inside diameter of 0.608 inches versus 0.654 inches
4. Different U-tube loss coefficients (longer active and inactive U-tube lengths)
5. Higher steam generator operating pressure

An engineering evaluation of changes in key input data was employed to assess the impact on the SGTR events. No computer codes were used. The comparison of key input parameters demonstrated that all values were either the same or conservative for Cycle 15, except for some RSG data. The major driving force is the leak rate from the broken U-tube. The leak rate for the RSG would be lower than for the original steam generator due to the following:

1. The smaller U-tube diameter results in a smaller flow that is directly proportional to the square of the diameter. This alone results in reduction in U-tube leak rates of 13%.

ARKANSAS NUCLEAR ONE
Unit 2

2. The higher secondary side pressure results in a lower pre-trip delta-pressure from primary to secondary system.
3. A comparison of the U-tube flow resistances resulted in a reduction of the U-tube leak rate of at least 5% due to a larger U-tube flow resistance.

Since the U-tube leak rate is less, the primary mass released to the affected steam generator would be less than that documented hence no increase in radiological doses. Due to the bounding nature of the previous analysis, this event was not reanalyzed.

15.1.18.4.3 Power Uprate (Rated Power 3026 MWt) Steam Generator Tube Rupture with a Concurrent Loss of AC Power

15.1.18.4.3.1 Assumptions and Conditions

Subsequent evaluation of a steam generator tube rupture with a concurrent loss of AC power analysis was performed to address Power Uprate to 3026 MWt at Hot Full Power. The CENTS code was used to perform the analysis.

The SGTR with concurrent LOAC event was analyzed to determine the radiological doses for the 2-hour exclusion area boundary (EAB) and the 8-hour low population zone (LPZ) doses. Since the steam releases for this event are directly to the atmosphere via the MSSVs and the intact steam generator atmospheric dump valve, it bounds the radiological doses for the SGTR event with AC power available. Hence, only the SGTR event with concurrent LOAC was analyzed.

Input parameters from Table 15.1.18-5 and the bounding physics data from Section 15.1.0 were incorporated in this analysis with these following clarifications:

- A. Installation of the replacement steam generators was assumed.
- B. An initial RCS flow of 315,560 gpm was assumed.
- C. Core power of 3087 MWt. [3026 MWt plus 2% uncertainty]
- D. Emergency Feedwater Actuation Signal setpoint is assumed at 41% narrow range.
- E. An initial steam generator pressure of 960 psia was assumed.
- F. A SIAS is actuated when the pressurizer pressure drops below 1800 psia. Time delays associated with the safety injection pump acceleration and valve opening are taken into account. A 10 second HPSI response time was assumed to account for these delays.
- G. For the analysis, at time zero, when all electrical power is lost to the station auxiliaries, the following is assumed to occur:
 1. The turbine stop valves close and it is assumed that the area of the turbine admission valves is reduced to zero at the minimum closing rate

ARKANSAS NUCLEAR ONE
Unit 2

2. The steam generator feedwater flow to both steam generators is assumed to go to zero within 10 seconds.
 3. The reactor coolant pumps begin to coastdown and following coastdown the coolant flow necessary to remove residual heat and to cool the reactor core is maintained by natural circulation.
 4. Charging and letdown flow is reduced to zero. Upon initiation of SIAS, the charging flow instantaneously resumes at maximum capacity.
 5. The steam dump and bypass control system is unavailable for post-trip steam releases.
- H. A CPCS low reactor coolant pump shaft speed trip setpoint of 95% and a total delay time of 1.0 second were conservatively assumed. CPCS initiates a reactor trip when the reactor coolant pump shaft speed drops below 95% of its nominal speed.
- I. The most negative MTC of $-3.8 \times 10^{-4} \Delta\rho/^\circ\text{F}$ was assumed.
- J. The EOC Doppler curve in Figure 15.1.0-4, was assumed.
- K. The BOC delayed neutron fraction consistent with those defined in Section 15.1.0.3 was assumed.
- L. The CEA insertion curve of Figure 15.1.0-1D was assumed. This curve accounts for a 0.6 second holding coil delay. A CEA worth of $-5.0\% \Delta\rho$ was conservatively assumed.
- M. An initial maximum core inlet temperature of 556.7 °F was assumed.
- N. An initial pressurizer pressure of 2300 psia was assumed.
- O. A loss of AC power concurrent with a guillotine rupture of a single U-tube was assumed.
- P. Sixty minutes after the tube rupture, the operator has determined which steam generator contains the ruptured tube and isolates the affected steam generator from the main steam system by closing the MSIV.

15.1.18.4.3.2 Results

Figures 15.1.18-17 through 15.1.18-24, and Table 15.1.18-6 presents the transient resulting from a steam generator tube rupture with a concurrent loss of AC power. The steam generator liquid inventory versus time is presented in Figure 15.1.18-23. Figure 15.1.18-24 provides the discharge rate out through the secondary safety valves. During the first 60 minutes following the initiation transient, < 122,500 lbs. of reactor coolant was transported to the main steam system. For this case, radioactivity can only be transported to the surrounding environment by the steam released through the secondary safety valves or atmospheric dump valves. During the first 60 minutes of the transient, 362,000 lbs. of steam were released out the secondary safety valves. The total secondary release within the first 2 hours for the EAB considerations was approximately 635,000 lbm and for the first 8 hours for the LPZ considerations was approximately 1,772,000 lbm.

ARKANSAS NUCLEAR ONE
Unit 2

15.1.18.4.4 AST SGTR Analysis

The analysis input and assumptions used in the calculation of the radiological dose releases for the SGTR event are discussed in Sections 15.1.0.5.5 and 15.1.0.5.6 with the following clarifications:

1. The condenser is assumed unavailable for cooldown. Thus, the entire cooldown was performed by dumping steam to the atmosphere from the intact steam generator.
2. An RCS primary to secondary leakage rate of 150 gpd for the intact steam generator was assumed.
3. Since the SGTR with concurrent loss of AC power event does not result in fuel failure, only the maximum initial RCS activity plus iodine spiking was analyzed.
4. A SG flashing fraction of 0.05 was assumed based on primary fluid and steam generator conditions. No credit for steam generator level recovery and tubes re-submergence, which will occur in approximately 1 hour, has been taken.
5. RCS liquid masses of 454,000 lbm (maximum, to produce largest equilibrium appearance rate) and 432,000 lbm (minimum, to maximize concentrations) are assumed.

Event-generated iodine and preexisting iodine spiking cases were performed for this analysis.

Tables 15.1.18-7 and 15.1.18-8 presents the radiological doses associated with this event for the exclusion area (EAB), and the low population zone (LPZ). For these locations the TEDE doses received are shown for the event-generated iodine spiking (GIS) and pre-existing iodine spiking (PIS) conditions.

The radiological releases for a steam generator tube rupture with or without a concurrent loss of AC power are less than the 10 CFR 50.67 guidelines.

15.1.19 FAILURE OF CHARCOAL OR CRYOGENIC SYSTEM (BWR)

Unit 2 utilizes a PWR. This event is not applicable.

15.1.20 CONTROL ELEMENT ASSEMBLY EJECTION

15.1.20.1 Identification of Causes

Rapid ejection of a CEA from the core would require a complete circumferential rupture of the CEDM housing or the CEDM nozzle. The CEDM housing and nozzle are part of the RCPB and are designed and manufactured in compliance with the ASME Code, Section III. Hence, the occurrence of such a failure is considered highly unlikely.

A typical CEA ejection transient behaves in the following manner. After ejection of a CEA from the full power or zero power (critical) initial conditions, the core power rises rapidly for a brief period. The rise is terminated by the Doppler effect. Reactor shutdown is initiated by the high linear power level trip or CPC DNBR trip (based on VOPT), which limit the maximum enthalpy in the fuel during the transient to an acceptable value.

ARKANSAS NUCLEAR ONE
Unit 2

The consequences of the loss of coolant resulting from the RCS rupture are similar to those for small breaks as discussed in Section 6.3.3.

15.1.20.2 Analysis of Effects and Consequences

15.1.20.2.1 Method of Analysis

In the analysis performed to support the operation of Cycle 1, the reactivity forced power transient was simulated by a digital computer program (CHIC-KIN) which simultaneously solves the one velocity neutron point kinetics equations together with the time and space dependent thermal and hydraulics equations for heat generation and transport within a single channel (Reference 27). The kinetics model incorporates the standard 6-delay group representation along with explicit reactivity contributions from CEA motion, Doppler effect, and moderator density variations. By simulating the core average channel, the CHIC-KIN code computes the total core power generated during the course of the transient.

In the CEA ejection transient, the principal reactivity feedback mechanism affecting the nuclear transient is the Doppler effect. In the point kinetics approach utilized in CHIC-KIN, a spatial Doppler weighting factor accounts for the fact that the Doppler feedback effect is a function of the spatial flux distribution. Although the axial shape does not change significantly during the course of a CEA ejection accident, the radial peak undergoes marked changes. In order to represent the radial Doppler effect, an analysis was performed in which point kinetics calculations were compared with space-time diffusion theory results, for various radial slices, obtained with a CE modified version of the TWIGL code (Reference 45). The radial Doppler weighting factor, W_R , was thus obtained as a function of the ejected CEA worth such that CHIC-KIN and TWIGL results gave the same total core energy release. The values of the radial Doppler weighting factors used in the analysis were obtained from a straight line relationship of Doppler weighting as a function of ejected CEA worth. For conservatism, the straight line was drawn such that the weighting factor was unity for zero ejected CEA worth and was at least 20 percent below all data points.

The results of the space-time analysis have demonstrated that the use of the static, non-Doppler flattened radial fuel rod peaking factors, as obtained from two-dimensional diffusion theory results, in conjunction with the average core energy release as obtained from the point kinetics results, yields hot spot energy releases which are conservative. This results from the lack of consideration of the fact that the Doppler effect during a transient is strongest at the radial peak location, limiting the radial peak to a value below that obtained from the static ejected CEA configuration for the major portion of the transient. The effective transient radial peaking factor is defined as the ratio of the energy rise in the hot fuel rod to the core average energy rise. The ratio of this effective radial peaking factor to the static peaking factor was determined as a function of the ejected CEA worth, and a straight line is used in the analysis to obtain a reduction factor (K) which is used in conjunction with the static radial fuel rod peaking factor and the average core energy release.

The average energy rise in the hottest fuel pellet is obtained from the following relationship:

$$\Delta E_H = [(P/A)_H \times \Delta E_{Ave} \times K] - E_{HT} \quad \text{Equation 15.1.20-1}$$

where ΔE_{Ave} is the average core energy rise obtained from CHIC-KIN; $(P/A)_H$ (the three-dimensional fuel rod peaking factor) is the ratio of the hot spot power to the average core power obtained from static, non-Doppler flattened diffusion theory calculations; K is the reduction

ARKANSAS NUCLEAR ONE
Unit 2

factor defined above; and E_{HT} accounts for heat that is transferred out of the fuel rod during the transient. A conservative calculation of E_{HT} is made by assuming that a post-DNB surface coefficient exists throughout the transient (Reference 10).

The average energy in the hottest fuel pellet at the beginning of the transient is added to the net average energy rise in the hottest fuel pellet as obtained from Equation 15.1.20-1 to determine the total average enthalpy in the hottest fuel spot in the core. A similar procedure is used to compute the total centerline enthalpy in the hottest fuel spot. The initial energy is obtained from the initial local fuel temperature along with an empirical temperature-enthalpy relationship (Reference 11).

The variation of the core local-to-average power ratio with core volume results from the convolution of the axial and radial power distributions for the post-ejection condition, which are based on static core physics calculations. Combining these results with the total average and centerline enthalpies in the hottest fuel spot yields the fractions of fuel with specific total average and centerline enthalpies. The calculated enthalpy values are compared to threshold enthalpy values to determine the amount of fuel experiencing the various degrees of fuel damage. These threshold enthalpy values are as follows (See References 2, 3 and 11):

Clad Damage Threshold:

Total Average Enthalpy = 200 cal/gm

Incipient Centerline Melting Threshold:

Total Centerline Enthalpy = 250 cal/gm

Fully Molten Centerline Threshold:

Total Centerline Enthalpy = 310 cal/gm

The criterion for determining the radioactive fission product release during a CEA ejection is that any fuel rod that exceeds a total average enthalpy of 200 cal/gm releases all of its gap activity.

The CEA ejection is assumed to occur at steady state initial conditions. Four analyses were performed; at BOC and EOC for ultimate full power (2,900 MWt) and zero power (1 MWt.).

These cases represent boundary conditions with respect to reactor operation; the consequences of a CEA ejection incident under other circumstances will be within the range determined from these cases.

For each of the above boundary cases, input parameters for power peaking and ejected CEA worth were selected on the basis of a calculational survey which determined the worst cases. In all cases analyzed, the highest three-dimensional power peak resulted when the maximum reactivity worth CEA was ejected. All calculated ejected CEA worths and three-dimensional peaking factors were increased by 10 percent to account for calculational uncertainties.

The significant independent variables for the full power CEA ejection accident are given in Table 15.1.20-1 and the significant independent variables for the zero power CEA ejection accident are given in Table 15.1.20-2.

ARKANSAS NUCLEAR ONE
Unit 2

Ejected CEA worths and peaking factors for several representative cases at full power are shown in Table 15.1.20-5. Table 15.1.20-6 shows representative cases at zero power. The rod locations corresponding to the lettering scheme used in these tables is shown in Figure 15.1.20-7.

It has been noted that the zero power ejected CEA worth at EOC is less than the worth at BOC. The difference in the worths of the ejected CEA shown in Table 15.1.20-2 between BOC and EOC is accounted for by differences in the reference radial power distributions at hot zero power in combination with the location of the worst ejected CEA. The worst ejected CEA at BOC is in a more important region of the core relative to its location at EOC; hence, it has a greater worth.

The axial power distribution used in this analysis for the fuel enthalpy and DNBR calculations is given in Table 15.1.20-7.

15.1.20.2.2 Results

The transients power generation for the full power BOC and EOC CEA ejection accidents are shown in Figure 15.1.20-1. Significant results for the full power CEA ejection accident are given in Table 15.1.20-3.

The reactivity contributions due to the ejected CEA, insertion of the shutdown CEAs and the feedback effects of fuel and moderator temperature changes for the full power BOC and EOC cases are shown in Figures 15.1.20-3 and 15.1.20-4, respectively. Any changes in the reactivity due to the effects of voids and pressure changes are small compared to the other contributing mechanisms and, therefore, are not included in the analysis.

The transient power generation for zero power BOC and EOC CEA ejection accidents are shown in Figure 15.1.20-2. Significant results for the zero power CEA ejection accident are given in Table 15.1.20-4.

The reactivity contributions due to the CEA ejection, insertion of the shutdown CEAs and the feedback effects of fuel and moderator temperature changes for the zero power EOC and BOC cases are shown in Figures 15.1.20-5 and 15.1.20-6, respectively.

Clad damage may occur during a CEA ejection at zero power for BOC and EOC. The conservative analysis indicates that 2.5 and 4.1 percent of the total number of rods suffer clad damage at zero power for BOC and EOC, respectively. This conservative estimate of clad damage has been made in accordance with the methods described in Section 15.1.20.2.1 and References 2, 3 and 11. The method relies upon comparison of calculate peak rod enthalpy values to the clad damage threshold value of 200 cal/gm. The calculated peak rod enthalpy values are contained in Tables 15.1.20-3 and 15.1.20-4. It is assumed that any rod which exceeds a total average enthalpy of 200 cal/gm experiences cladding damage and releases all of its gap activity. In addition to the above, Regulatory Guide 1.77 recommends that a minimum DNBR of 1.3 be used as the basis for predicting clad failure. CE does not equate a DNBR of 1.3 with the onset of cladding damage. Nevertheless, the fraction of rods below a DNBR of 1.3 is given below:

A. Full Power CEA Ejection Accident Results

	<u>BOC</u>	<u>EOC</u>
Fraction of Rods that Experience DNBR < 1.3	0.0546	0.0568

ARKANSAS NUCLEAR ONE
Unit 2

B. Zero Power CEA Ejection Accident Results

	<u>BOC</u>	<u>EOC</u>
Fraction of Rods that Experience DNBR < 1.3	0.0814	0.1126

The STRIKIN-II code was used to calculate the number of pins that would experience a DNBR < 1.3. For each of the four cases above, parametric hot channel calculations were made using the time dependent average channel power (from CHIC-KIN) multiplied by various radial peaks until a radial peaking factor was determined such that the minimum calculated DNBR during the transient was 1.3. A radial peaking factor versus pin census edit was then used to determine the number of pins with radial peaking factors greater than the above value. This is the value above as the number of fuel pins calculated to experience a DNBR less than 1.3.

In addition to the methods and results explained above, the maximum pressure during the worst zero power CEA ejection accident was conservatively estimated to be less than 2,500 psia. The initial pressurizer level was conservatively chosen to be consistent with full power steady state operating conditions. No credit was taken for heat transfer from the primary to the secondary side of the steam generator. The initial pressurizer and steam generator water level and pressure, as controlled within the operating limit, have an insignificant effect on the number of clad failures.

15.1.20.3 Conclusion

Both full power and zero power CEA ejection accidents have been analyzed and both have been shown to be acceptable at BOC and EOC. No clad damage is predicted for full power at BOC and EOC. Minimal clad damage is predicted for zero power at both BOC and EOC using the initial cycle analysis methodology, but no damage was predicted using the reload cycle methodology. No fully molten centerline condition is indicated for any CEA ejection accident.

15.1.20.4 CEA Ejection Subsequent Analyses

15.1.20.4.1 Cycle 2 CEA Ejection Analysis

The CEA Ejection event was reanalyzed for Cycle 2 to determine the fraction of fuel pins that exceed the criteria for clad damage. The analytical method employed in the reanalysis of this event was the NRC approved Combustion Engineering CEA Ejection method which is described in CENPD-190-A (Reference 49). These methods are similar to those described above with STRIKIN-II being used rather than CHIC-KIN.

The procedure outlined in CENPD-190-A was used to determine the radial average and centerline enthalpies in the hottest axial region of the rod. The calculated enthalpy values were compared to threshold enthalpy values to determine the amount of fuel exceeding these thresholds. These threshold enthalpy values were the same as those used for Cycle 1.

Table 15.1.20-8 lists all the key parameters used in the zero power and full power analyses.

To bound the most adverse conditions during the cycle, the most limiting of either the Beginning of Cycle (BOC) or End of Cycle (EOC) parameter values were used in the analysis. A BOC Doppler defect was used since it produces the least amount of negative reactivity feedback to mitigate the transient. A BOC moderator temperature coefficient of $+0.5 \times 10^{-4} \Delta k/k/^\circ F$ was used because a positive MTC results in positive reactivity feedback and thus increases both coolant temperatures and stored energy. An EOC delayed neutron fraction was used in the analysis to produce the highest power rise during the event.

ARKANSAS NUCLEAR ONE
Unit 2

The power transient produced by a CEA ejection initiated at the maximum allowed power is shown in Figure 15.1.20-8 for the Cycle 2 analysis. Similar results for the zero power case are shown in Figure 15.1.20-9. Both full power and zero power cases are terminated by the high linear power level trip.

The results of the two CEA ejection cases analyzed (Table 15.1.20-9) show that the maximum total energy deposited during the event is less than the criterion for clad damage (i.e., 200 cal/gm). Only a small fraction (≤ 0.005) of the fuel reaches the incipient centerline melting threshold.

15.1.20.4.2 Cycle 10 CEA Ejection Analysis

To address a reduction in the minimum allowable reactor coolant system initial pressure for Cycle 10, the CEA ejection events at HFP and HZP conditions were assessed. Methods consistent with those identified above for the Cycle 2 analysis were employed in this analysis. These analyses were performed based on the parameters in Table 15.1.20-10 and the following input assumptions:

- A. A Doppler curve consistent with Figure 15.1.0-3 (BOC) was assumed in both the HFP and HZP analyses.
- B. A CEA insertion curve consistent with Figure 15.1.0-1C with a 0.6 second holding coil delay time was assumed for the HFP case. For the HZP case, the CEA position versus time of Figure 15.1.0-1C is consistent with the analysis assumption; however, a more conservative normalized reactivity insertion versus CEA position for a +0.6 ASI curve was used.
- C. A high linear power trip setpoint of 128.1 % (of 2815 MWt) with a response time of 0.4 seconds was used in the HFP analysis. The high linear power trip setpoint is increased in this analysis to a value greater than that in Table 15.1.0-1 to include an excor penalty and instrument uncertainty (which accounts for geometry effects of the location of the excor detector in relation to the ejected CEA). A CPC DNBR trip (based on VOPT) setpoint of 54 % (of 2815 MWt) with a response time of 0.59 seconds was assumed in the HZP analysis.
- D. The axial power distribution provided in Table 15.1.20-12 was assumed in both cases.
- E. A minimum BOC delayed neutron fraction (0.00536) was used in this analysis rather than an EOC value, which is smaller. The EOC value would be overly conservative due to most of the other parameters being based on BOC conditions.

Table 15.1.20-11 presents the average fuel pin and centerline enthalpies that were calculated.

Based on the results, the acceptance criteria are met with no fuel pins calculated to experience cladding damage or a fully molten centerline. Additionally, for the HZP case no pins were predicted to even reach incipient centerline melting and only 0.33 % of the total number of pins reached this limit for the HFP case.

15.1.20.4.3 Cycle 12 CEA Ejection Analysis

For Cycle 12, the CEA ejection events at HFP and HZP conditions were assessed with regards to developing curves of acceptable ejected 3D peak F_q 's versus ejected worths. Methods consistent with those identified above for the Cycle 2 analysis were employed in this analysis. These analyses were performed based on the parameters in Table 15.1.20-13 and the following input assumptions:

- A. A Doppler curve consistent with Figure 15.1.0-3 (BOC) was assumed in both the HFP and HZP analyses.
- B. A CEA insertion curve consistent with Figure 15.1.0-1C with a 0.6 second holding coil delay time was assumed for the HFP case. For the HZP case, the CEA position versus time of Figure 15.1.0-1C is consistent with the analysis assumption; however, a more conservative normalized reactivity insertion versus CEA position for a +0.6 ASI curve was used.
- C. A CPC DNBR trip (based on VOPT) setpoint of 55% and 125.5% (of 2815 MWt) with a response time of 0.59 seconds was assumed in the HZP and HFP analyses, respectively.
- D. The axial power distribution provided in Table 15.1.20-12 was assumed in both cases.

The objective of this analysis was to ensure the cycle specific physics data was acceptable; hence, a 100 % power case was run rather than the limiting 103 % power limit. Table 15.1.20-14 lists acceptable ejected 3D peak F_q 's versus ejected worths that was generated based on the above parameters and the following acceptance criteria:

Total Average Enthalpy \leq 200 cal/gm

Total Centerline Enthalpy \leq 250 cal/gm.

The cycle specific physics data is reviewed to ensure these limits are not exceeded.

Based on the above results, no fuel failure is predicted as the acceptance criteria of the total average enthalpy of 200 cal/gm and a total centerline enthalpy of 250 cal/gm were used to determine the allowable ejected 3D peak F_q 's versus ejected CEA worth. Ensuring these limits are met also ensures that the results of the prior analyses remain bounding.

15.1.20.4.4 Cycle 13 CEA Ejection Analysis

The CEA Ejection Event at both HFP and HZP conditions were reanalyzed in Cycle 13 to assess a 10% reduction in the RCS design flow. RCS flow reduction has an adverse effect on the deposited energy during the event. Methods consistent with those identified above for the Cycle 2 analysis were employed in this analysis. These analyses were performed based on the parameters in Table 15.1.20-15 and the following input assumptions.

- A. A Doppler curve consistent with Figure 15.1.0-4 (BOC) was assumed in both the HFP and HZP analyses.

ARKANSAS NUCLEAR ONE
Unit 2

- B. A CEA insertion curve consistent with Figure 15.1.0-1D with a 0.6 holding coil delay time was assumed for the HFP case. For the HZP case, the CEA position versus time of Figure 15.1.0-1C is consistent with the analysis assumption; however, a more conservative normalized reactivity insertion versus CEA position for a +0.6 ASI curve was used.
- C. The axial power distribution provided in Table 15.1.20-16 was assumed in both cases.
- D. A CPC DNBR trip (based on VOPT) setpoint of 47% and 134% (of 2815 MWt) with a response time of 0.59 seconds was assumed in the HZP and HFP analyses, respectively.
- E. A minimum EOC delayed neutron fraction was assumed.

Table 15.1.20-17 lists the acceptable 3D peak F_q 's versus ejected CEA worth that was generated based on the above parameters and the following acceptance criteria.

Total Average Enthalpy \leq 200 cal/gm

Total Centerline Enthalpy \leq 310 cal/gm

Cycle specific calculation of the maximum ejected F_q and ejected worth are performed and verified to fall within the limits calculated above.

Based on the above, no fuel failure due to either clad damage or fully molten centerline temperature was predicted. The results of this analysis is bounded by the prior analyses.

15.1.20.4.5 Cycle 14 CEA Ejection Analysis

To address changes in the MTC limits at the 20% and 50% power levels, the CEA Ejection event was reassessed at these power levels. Methods consistent with those identified above for the Cycle 2 analysis were employed to this analysis. The inputs, other than the MTC limit at these power levels, were the same as was used in the Cycle 13 analysis.

Table 15.1.20-18 lists the acceptable 3D peak F_q s versus ejected CEA worth that was generated based on the parameters and acceptance criteria listed in the previous section.

Cycle specific calculation of the maximum ejected F_q s and ejected worth will be performed as part of the cycle specific reload analysis and verified to fall within the limits.

Based on the above, no fuel failure due to either clad damage or fully molten centerline temperature was predicted. The results of this analysis are bounded by the prior analyses.

15.1.20.4.6 Cycle 15 CEA Ejection Analysis

Cycle specific calculation of the maximum ejected F_q 's and ejected worth were performed and verified to fall within the limits.

Based on the above, no fuel failure due to either clad damage or fully molten centerline temperature was predicted.

ARKANSAS NUCLEAR ONE
Unit 2

In Cycle 15, the bounding excore decalibration values documented in Table 15.1.20-18 were not verified. The results of the fast-trip CEA ejection cases are not highly sensitive to excore decalibration since the power prompt-jumps above the credible trip setpoint. Due to the limited impact of these parameters on the CEA ejection Fq limits and the significant margin available to those limits in Cycle 15, these parameters were judged to be acceptable for Cycle 15.

The results of the Cycle 15 analysis are bounded by the prior analyses.

15.1.20.4.7 Cycle 16 CEA Ejection Analysis

The CEA Ejection Event at both HZP and HFP conditions were reanalyzed in Cycle 16 to assess the impact of uprating the plant power level from 2815 MWt to 3026 MWt. An increase in power level has an adverse effect on the deposited energy during the event. Consistent with the Cycle 12 analysis, the CEA Ejection Event for Cycle 16 was analyzed with regards to developing curves of acceptable ejected 3D peak Fqs versus ejected worths. Methods consistent with those identified above for the Cycle 2 analyses were employed in this analysis. These analyses were performed based on the parameters in Table 15.1.20-19 and the bounding physics data from Section 15.1.0 with the following clarifications:

- A. The BOC Doppler curve in Figure 15.1.0-4 was assumed.
- B. An EOC delayed neutron fraction consistent with that defined in Section 15.1.0.3 was assumed.
- C. For HFP the CEA insertion curve in Figure 15.1.0-1D was assumed. This curve accounts for a 0.6 second holding coil delay. A CEA worth of $-5.0\% \Delta\rho$ was conservatively assumed for HFP.

For HZP the CEA insertion curve (scram curve) is based on an AS1 of $+0.6$. A CEA insertion curve consistent with Figure 15.1.0-1E utilizing a 0.6 second holding coil delay was assumed. A CEA worth of $-2.0\% \Delta\rho$ was conservatively assumed.

- D. For MTC, zero and $+0.5 \times 10^{-4} \Delta\rho/^\circ\text{F}$ were assumed for HFP and HZP conditions, respectively.
- E. The variable overpower trip (VOPT) of the core protection calculator system (CPCS) was employed in the analysis. A CPCS trip delay time of 0.60 seconds was assumed. The VOPT assumed an excore uncertainty of 40% from Table 15.1.20-20. For HFP and HZP, conservative VOPT setpoints of 153% and 98% were assumed.
- F. For HFP an initial core power of 3087 MWt was assumed based on a rated power of 3026 MWt and a 2% uncertainty. For HZP an initial core power of 30.3 MWt was assumed based on one percent of the rated power value of 3026 MWt.
- G. An axial power distribution in Table 15.1.20-16 was assumed.
- H. The HFP core inlet temperature of 556.7 was conservatively assumed for HZP.
- I. A RCS flow of 315,560 gpm was assumed for HFP and HZP conditions.

ARKANSAS NUCLEAR ONE
Unit 2

Table 15.1.20-20 lists the acceptable 3D peak F_q s versus ejected CEA worth that was generated based on the above-parameters and the following acceptance criteria:

Total Average Enthalpy \leq 200 cal/gm

Total Centerline Enthalpy \leq 250 cal/gm

Cycle specific calculation of the maximum ejected F_q and ejected worth are performed and verified to fall within the limits calculated above.

Based on the above, no fuel failure due to either clad damage or incipient melt temperature was predicted to occur. However, to accommodate anticipated predicted fuel failure, radiological dose for up to 14% fuel failure due to clad damage has been considered.

15.1.20.4.8 Cycle 18 CEA Ejection Analysis

The CEA Ejection Event at HFP and HZP power were reanalyzed for Cycle 18 to address the impact of the implementation of ZIRLO™ cladding, Zirconium diboride (ZrB_2) Integrated Fuel Burnable Absorber (IFBA) fuel, and an increase in LOCA linear heat rate (LHR) Limit from 13.7 kW/ft to 14.4 kW/ft.

An increase in the LOCA LHR limit had a small adverse effect on the deposited energy during the event, and then only at the higher initial power levels. The impact of ZrB_2 IFBA fuel and ZIRLO™ cladding had a small effect on the deposited energy and it varied with initial power level. References 54 and 55 discuss the impact of the fuel changes.

Consistent with the Cycle 16 analysis, the CEA Ejection Event for Cycle 18 was analyzed with regards to developing curves of acceptable ejected 3D peaks (F_q 's) versus ejected worths. Methods consistent with those identified above for the Cycle 16 analysis were employed in this analysis. These analyses were performed based on the same parameters and same input assumptions used in Cycle 16. The only changes were to the STRIKIN-II code's FATES files that were modified to include the IFBA ZrB_2 fuel and ZIRLO™ fuel cladding, and an increase in the LOCA LHR limit. Table 15.1.20-22 lists the acceptable 3D peaks versus ejected CEA worths that were generated based on the Cycle 18 parameters and the following acceptance criteria:

Total Average Enthalpy $<$ 200 cal/gm

Total Centerline Enthalpy $<$ 250 cal/gm

Cycle specific calculation of the maximum ejected F_q and ejected worth were performed and verified to fall within the limits calculated above.

Based on the above, no fuel failure due to either clad damage or incipient melt temperature was predicted to occur.

15.1.20.4.9 Cycle 20 CEA Ejection Analysis

The CEA Ejection Events at HZP power were reanalyzed for Cycle 20 to address the impact of the implementation of Optimized ZIRLO™ cladding and Next Generation Fuel. The CEA Ejection Events at HFP remained bounded by Cycle 18 analyses.

ARKANSAS NUCLEAR ONE
Unit 2

Implementation of Optimized ZIRLO™ cladding and NGF has a small effect on deposited energy that varies with initial power level. References 56 and 57 discuss the impact of the fuel changes.

Consistent with the Cycle 18 analysis, the CEA Ejection Event for Cycle 20 was analyzed with regards to developing curves of acceptable ejected 3D peaks (Fq's) versus ejected worths. Methods consistent with those identified above for the Cycle 18 analysis were employed in this analysis. These analyses were performed based on the same parameters and same input assumptions used in Cycle 18. The only changes were to the STRIKIN-II code's FATES files that were modified to include the NGF and Optimized ZIRLO™ fuel cladding. Table 15.1.20-23 lists the acceptable 3D peaks versus ejected CEA worths that were generated based on the Cycle 18 parameters and the following acceptance criteria:

Total Average Enthalpy < 200 cal/gm

Total Centerline Enthalpy < 250 cal/gm

Cycle specific calculation of the maximum ejected Fq and ejected worth were performed and verified to fall within the limits calculated above.

Based on the above, no fuel failure due to either clad damage or incipient melt temperature was predicted to occur.

15.1.20.4.10 AST CEA Ejection Analysis

The analysis input and assumptions used in the AST calculation of the radiological dose releases for the CEA ejection event are discussed in Section 15.1.0.5 with the following clarifications:

1. The CEA radiological analyses assume two cases: one in which 100% of the activity released from the fuel is instantaneously and homogeneously mixed in the containment atmosphere and a separate case in which 100% of the activity released from the damaged fuel is completely dissolved in the primary coolant and available for release to the secondary system.
2. The calculations assume 14% failed fuel with fission product gap fractions of 0.10 for noble gases and iodines and 0.12 for alkali metals. A peaking factor of 1.65 is included.
3. The iodine species distribution for the containment release case is 95% particulate, 4.85% elemental and 0.15% organic. For the secondary release case, the distribution is 97% elemental and 3% organic.
4. The primary-secondary release rate is 300 gpd (150 gpd per SG).
5. A flashing fraction of 0.05 is applied to the primary-secondary leakage for the 8-hour duration of the cooldown to entry into shutdown cooling. No credit has been taken for recovery of SG level and re-submergence of the SG tubes, which is expected to occur in approximately one hour following event initiation.

ARKANSAS NUCLEAR ONE
Unit 2

6. No credit has been taken for containment spray or the penetration room ventilation system.
7. A sedimentation coefficient of 0.1/hr, until DF=1000, is assumed. After DF=1000, this coefficient is assumed to be 0.

Table 15.1.20-21 provides the radiological dose results for both CEA ejection cases.

15.1.21 THE SPECTRUM OF ROD DROP ACCIDENTS (BWR)

Unit 2 is a PWR, and this event is not applicable.

15.1.22 BREAK IN INSTRUMENT LINE OR OTHER LINES FROM REACTOR COOLANT PRESSURE BOUNDARY THAT PENETRATE CONTAINMENT

15.1.22.1 Identification of Causes

There are no instrument lines from the RCS which penetrate the containment. Sampling lines are discussed in Section 9.3.2 and containment isolation in Section 6.2.4.

15.1.23 FUEL HANDLING ACCIDENT

15.1.23.1 Identification of Causes

The likelihood of a fuel handling accident is minimized by administrative controls and physical limitations imposed on fuel handling operations. All refueling operations are conducted in accordance with prescribed procedures under direct surveillance of a qualified supervisor. Also, before any refueling operations begin, verification of complete CEA insertion is obtained by tripping each CEA individually to obtain indication of assembly drop and disengagement from the drive shaft. Boron concentration in the coolant is raised to the refueling concentration and is verified by chemical analysis. At the refueling boron concentration, the core would be subcritical, even with all CEAs withdrawn.

After the vessel head is removed, the CEA drive shafts are disconnected from the CEAs. A load cell is used to indicate that the drive shaft is free of the CEA as the lifting force is applied.

The maximum elevation to which the fuel assemblies can be raised is limited by the design of the fuel handling hoists and manipulators to assure that the minimum depth of water above the top of a fuel assembly required for shielding is always present (see Section 9.1.4). This constraint is applied in fuel handling areas inside containment and in the spent fuel pool area.

Supplementing the physical limits on fuel withdrawal, area radiation monitors located at the fuel handling areas would provide both audible and visual warning of high radiation levels in the event of a low water level in the refueling cavity and fuel pool.

The design of the spent fuel storage racks and handling facilities in both the containment and fuel storage area is such that fuel will always be in a subcritical geometrical array, assuming zero boron concentration in the fuel pool water. The spent fuel pool and refueling pool water contains boron at the refueling water boron concentration. Natural convection of the surrounding water provides adequate cooling of fuel during handling and storage. Adequate cooling of the water is provided by forced circulation in the fuel pool system.

ARKANSAS NUCLEAR ONE
Unit 2

Fuel failure during refueling as a result of inadvertent criticality or overheating is not credible. The possibility of damage to a fuel assembly as a consequence of mishandling is minimized by thorough training, detailed procedures, and equipment design. The design of the auxiliary building crane (L3) precludes the handling of heavy objects such as shipping casks over the spent fuel storage racks (See Section 9.1.4.2.10). Movement of heavy loads over the spent fuel storage racks by the new fuel handling crane (2L35) is prevented by administrative controls. Inadvertent disengagement of a fuel assembly from the fuel handling machine is prevented by mechanical interlocks; consequently, the possibility of dropping and damaging a fuel assembly is remote.

Should a fuel assembly be dropped or otherwise damaged during handling, radioactive release could occur in either the containment or the auxiliary building. The ventilation exhaust air from both of these areas is monitored and filtered before release to the atmosphere. The radiation monitors immediately indicate the increased activity level and alarm. The affected area would then be evacuated.

Release of activity through the containment purge system would be prevented by automatic closure of the containment isolation dampers. The containment equipment hatch and the containment personnel hatches would be shut, following personnel evacuation, upon a fuel handling accident inside containment, which would substantially, if not completely reduce the radiological release. Since the auxiliary building cannot be completely isolated, this results in a more limiting activity release to the environment. The ventilation system draws air across the spent fuel pool area; this air is filtered and discharged to the atmosphere through the plant vent.

Since all exterior doors are closed during fuel handling operations, this is the only route for the release of activity to the environment.

Handling of the spent fuel cask is discussed in Section 9.1.4.2.10. The final movement of the spent fuel to storage or in shipping it off-site involves lowering the spent fuel cask through a vertical equipment handling shaft in Unit 1 from the 404-foot level to a railroad car on the 354-foot level. Operational procedures based on safe handling practices and periodic inspections of the fuel handling crane make the possibility of a free-fall drop of the cask occurring in this vertical shaft not credible. Because the crane is designed in accordance with NUREG-0554 and therefore is single failure proof, a postulated cask drop is not a credible event and the structural integrity of the spent fuel pool cask will not be impaired and no safety related components will be impacted. Table 9.1-10 provides site specific information regarding compliance with Ederer's Generic Topical Report for single failure proof cranes. For consideration of ANO-1 systems, structures, and components, see Unit 1 SAR.

15.1.23.2 Analysis of Effects and Consequences

15.1.23.2.1 Method of Analysis

The analysis assumes that a fuel assembly is dropped during fuel handling. Interlocks and procedural and administrative controls make such an event highly unlikely; however, if an assembly were damaged to the extent that one or more fuel rods were broken, the accumulated fission gases and iodines in the fuel rod gaps would be released to the surrounding water. Release of the solid fission products in the fuel would be negligible because of the low fuel temperature during refueling.

ARKANSAS NUCLEAR ONE
Unit 2

The fuel assemblies are stored within the spent fuel rack at the bottom of the spent fuel pool. The top of the rack extends 10 inches above the tops of the stored fuel assemblies. A dropped fuel assembly could not strike more than one fuel assembly in the storage rack (see Figure 9.1-15). Impact could occur only between the ends of the involved fuel assemblies, the bottom end fitting of the dropped fuel assembly impacting against the top end fitting of the stored fuel assembly. The maximum drop distance for this event is 26 inches from the bottom of a fuel assembly residing in the spent fuel handling machine to the top of a fuel assembly in the spent fuel storage racks. For the 26-inch drop the fuel assembly impact velocity is 131 inches per second and the impact stress in the fuel rod cladding is 12,300 psi.

The maximum possible drop distance for a fuel assembly in the spent fuel pool is 202 inches. This is the distance from the bottom of a fuel assembly in the spent fuel handling machine to the spent fuel pool floor. For this worst case drop, the velocity of the fuel assembly at impact with the fuel pool floor is 331 inches per second, and the impact stress in the fuel rod cladding is 31,000 psi.

The analyses of the fuel assembly vertical drops were performed assuming possibly attached appurtenances (CEA, fuel grapple, etc.) were attached and fell with the assembly, consistent with RG 1.183 assumptions. The result of these conservative analyses indicates possible complete failure of both the dropped fuel assembly and the dropped-on fuel assembly. Therefore, the AST dose analyses assume failure of two entire fuel assemblies (472 fuel rods).

The methods used to calculate site boundary doses are described in Section 15.1.0. The RADTRAD code was used to calculate site boundary doses using dose conversion factors from FGR-11 and FGR-12 for the fuel handling accidents in the fuel handling building and in containment.

15.1.23.2.2 Source Term Assumptions

The assumptions related to the release of radioactive material from the fuel and fuel storage facility as a result of a fuel handling accident are given in Regulatory Guide 1.83. Below is a listing of assumptions for the AST analysis.

- A. Technical Specifications restrict fuel handling operations until 100 hours after shutdown.
- B. The maximum fuel rod pressure 100 hours after a refueling shutdown will be less than 1,500 psig.
- C. The spent fuel pool is normally of sufficient depth that the water depth between the top of the damaged fuel rods and the fuel pool surface is no less than 23 feet. A dropped fuel assembly impacting a line load near completion of rotation to a horizontal position will be covered by more than 23 feet of water.
- D. All of the gap activity in the damaged rods is released and consists of approximately five percent of the total noble gases other than Kr^{85} , ten percent of the Kr^{85} , five percent of the total radioactive iodine other than I^{131} , and eight percent of the I^{131} in the rods at the time of the accident. This analysis uses ORIGEN-S code to generate the source terms.
- E. Rated power for Cycle 16 and beyond is 3026 MWt. The FHA source terms are based on 102% of rated (i.e., 3087 MWt) and a radial peaking factor of 1.70. Each term is then increased by 4% to account for potential future variations in reload core designs.

ARKANSAS NUCLEAR ONE
Unit 2

- F. The analysis assumes that the gap inventory is composed of 99.85% inorganic iodine and 0.15% organic iodine.
- G. The pool decontamination factors for the inorganic and organic species are 286 and 1, respectively, giving an overall effective decontamination factor of 200. This difference in decontamination factors for inorganic and organic iodine species results in the iodine above the fuel pool being composed of 70 percent inorganic and 30 percent organic species."
- H. The analysis assumes a noble gas pool decontamination factor of 1 for noble gases.
- I. All releases of fission products to the environment are assumed to occur over a two hour time period.
- J. All releases are assumed to be unfiltered and thus, the iodine removal efficiency is 0%.
- K. No credit was taken for mixing in the building atmosphere and no credit was taken for an elevated release in this analysis.
- L. A site boundary χ/Q of 6.5×10^{-4} seconds / cubic meter was assumed. A control room χ/Q of 1.2×10^{-3} seconds / cubic meter was used. The control room dispersion factor was calculated using ARCON96 except the spent fuel building exhaust fan location was used. The spent fuel building location dispersion factor was more limiting than the containment, hence was used in this assessment.
- M. A breathing rate of 3.5×10^{-4} cubic meter / sec was assumed.

The source term assumptions for the shipping cask drop of 50 feet would be as follows:

Fifteen fuel assemblies
Three years operating time
At design power on all assemblies
Cask movement occurs not sooner than 100 days after shutdown
Twenty-five percent of the noble gases are released*
Ten percent of the iodine is released*
Fifty percent of the iodine released plates out**
None of the solid fission products are released from the fuel.

$$\frac{X}{Q} = 6.5 \times 10^{-4} \text{ sec/m}^3 \text{ at site boundary Q}$$

* Based on AEC Division of Reactor Licensing (DRL) staff evaluation of fuel handling accidents.

** Fifty percent plate out of the iodine is a conservative value and is based on the fact that the door at the rail spur access to the plant is shut when the spent fuel cask is lowered. Iodine which escapes the cask resting area after the postulated drop would be plated out on the walls, floors, and ventilation piping.

ARKANSAS NUCLEAR ONE
Unit 2

No credit would be taken for filtration from the auxiliary building ventilation system, since a portion of the ventilation flow path goes through the unfiltered turbine building. Further conservatism would be an assumption of an instantaneous release of the activity vice a "release-rate" approach.

15.1.23.3 Results

Currently, neither unit ships spent fuel offsite and there are no plans to do so. As such, no dropped spent fuel shipping cask accident doses are presented. Dry fuel storage casks are used on site. See the vendor's FSAR for the VSC-24 or the Holtec HI-STORM 100 for further information.

An FHA is assumed to result in failure of two entire fuel assemblies (472 fuel rods) and make their gas gap activities available for release. These activities represent ten percent of total Kr^{85} in the fuel rods, eight percent of total I^{131} in the fuel rods, and five percent of all other noble gases and iodines in the fuel rods. Values of the individual fission product inventories are evaluated assuming operation at 3087 MWt and a maximum radial peaking factor of 1.70. In addition, a 4% margin has been added to accommodate potential reload fuel design variations. FGR-11 and FGR-12 dose conversion factors were used. While certain design features of the plant make the fuel handling accident assumptions listed in Regulatory Guide 1.183 overly conservative for Unit 2, the analysis has been performed using these assumptions.

For bounding FHA, the radionuclides released during the fuel handling accident are assumed to enter the atmosphere directly without filtration. A decay time of 100 hours after shutdown is assumed and 472 fuel rods are assumed to fail with the release modeled as a puff release. Since the release is assumed to be instantaneous without filtration, the analysis is applicable to a fuel handling accident in either the containment or in the spent fuel building (without filtration).

The doses for a fuel handling accident in the auxiliary building with no ventilation or in containment with the personnel airlock open during fuel handling are given in Table 15.1.23-2. These doses are below the acceptable limits of 10 CFR 50.67. In the case of a fuel handling accident in containment, these doses would be further reduced by promptly shutting the personnel airlock, following containment evacuation, in the event of a refueling accident.

15.1.24 SMALL SPILLS OR LEAKS OF RADIOACTIVE MATERIAL OUTSIDE CONTAINMENT

15.1.24.1 Identification of Causes

During normal conditions, all radioactive material is contained within the RCS, the auxiliary systems, or other containers or vessels which are designed to prevent the uncontrolled release of radioactivity to the environment.

Spills, leaks and pipe breaks can occur, however, in a variety of components outside the containment over the lifetime of the plant. Components of greatest concern are those containing fluids with potentially significant radioactive concentrations. The CVCS components contain reactor coolant and are representative of such potentially significant sources. These sources represent a low level of continuous leakage unless repaired.

ARKANSAS NUCLEAR ONE
Unit 2

Any liquid leakage or spills in the auxiliary building have been assumed to reach the site groundwater. Noble gases and iodine releases will be removed by the Auxiliary Building Fuel Handling Floor and Radwaste Area Ventilation Systems. The Auxiliary Building Fuel Handling Floor and Radwaste Area Ventilation Systems are equipped with HEPA and charcoal filters and are continuously monitored for gaseous activity.

15.1.24.2 Analysis of Effects and Consequences

The potential pathway for exposure subsequent to a failure of components outside the containment containing radioactive liquids is assumed to be a release into the groundwater and subsequent transport to a potential receptor.

The site is underlaid by clay and silty clay deposits which overlie shale. Tests performed at the site indicate that these materials exhibit very low permeability. Test results are presented in Chapter 2 of this report. Since both the clay material near the surface and the underlying slate are of such low permeability, radioactive material releases to the groundwater due to an accidental spill would be confined to the immediate vicinity of the site.

The velocity of the groundwater can be calculated by D'Arcy's Law.

$$V(\text{water}) = (P) \times (i)/(\theta)$$

where

$V(\text{water})$ = the velocity of the groundwater

P = permeability of the material = 4.2×10^{-6} cm/sec

i = hydraulic gradient = 7/2600 ft/ft (assumes maximum groundwater level at the site and minimum power pool - 336 feet - in the reservoir)

θ = porosity of the material = 20 percent

15.1.24.3 Conclusion

The nearest potential receptor is conservatively assumed to be at the Dardanelle Reservoir, 2,600 feet from the plant. Using these parameters a transit time of 4.6×10^4 years to the nearest receptor was calculated, sufficient to allow for radioactive decay to reduce the radionuclides released to negligible levels. The effects of ion exchange and mechanical dispersion in transit were not considered in the analysis, however both effects would reduce radionuclide concentrations further.

15.1.25 FUEL CLADDING FAILURE COMBINED WITH STEAM GENERATOR LEAK

In analyzing the consequences of transients which result in the release of steam from the secondary system, the specific activity of the released steam is determined from the following assumptions:

- A. Continuous operation with a one gpm primary-to-secondary steam generator tube leak;
- B. Specific activity of reactor coolant based on continuous operation with one percent failed fuel.

ARKANSAS NUCLEAR ONE
Unit 2

Normal releases resulting from operation with leaking steam generator tubes and defective cladding are discussed in Chapter 11.

15.1.26 CONTROL ROOM UNINHABITABILITY

In order to conform to the requirements of General Design Criterion 19, provisions have been made outside the control room to allow operating personnel, following control room evacuation, to verify that the plant is in a safe hot shutdown condition and to maintain the plant in this condition until such time as the control room is again accessible or additional personnel are available to affect a cold shutdown (see Section 7.4.1.5). Initial conditions and limitations are as follows:

- A. The plant is in a normal operating condition (Condition I as defined by ANSI N18.2); concurrent or subsequent accident conditions are not postulated.
- B. Concurrent or subsequent natural disasters are not postulated since the probability of such events is small for the time considered.
- C. The reactor is tripped by operating personnel prior to evacuation of the control room. The operators inside have 10 minutes in which to reach the remote shutdown panel. The expected maximum time is four minutes.
- D. The control room remains intact and all automatic control systems continue to function as designed.
- E. Off-site power is not lost. Grid stability studies show that off-site power will not be lost even if Units 1 and 2 are tripped simultaneously.

15.1.26.1 Identification of Causes

Section 9.5.1 describes the fireproof provisions of the control room. Any fire that might start would be limited in size and could be quickly extinguished by one of the control room operators who are always present when the plant is operating. The control room has separate, redundant, self-contained ventilation and air conditioning systems to protect the operators in the event of smoke, noxious gases, or radioactivity in the surrounding areas of the plant. These features are detailed in Sections 9.4 and 12.2. The control room is shielded from both radioactivity and missiles as described in Sections 12.1 and 3.5, respectively.

Since the control room is the only structure other than the containment that can be completely isolated from outside air, it is not credible to postulate control room evacuation due to noxious gases outside the plant. In the event of noxious gas, a small amount of filtered outside air will be used for pressurization of the control room to minimize unfiltered air inleakage. Self-contained air breathing equipment is available inside the control room to allow continued operation in the event of noxious gases. From the above discussion, it is clear that no reasonable basis exists for evacuating the control room. However, such an event is postulated to occur and the effects have been analyzed.

15.1.26.2 Analysis of Effects and Consequences

During a control room evacuation, the operator would trip the reactor. This action results in a turbine trip which is a less severe transient than a loss of load or turbine trip without a RT (see Section 15.1.7 for an analysis of the loss of load accident). Excess steam will be bypassed to the main condenser. No radioactivity will be released to the environment due to control room evacuation.

If control room accessibility is not restored, adequate instrumentation and controls have been provided to maintain the reactor in a safe hot shutdown condition and to bring the reactor to a cold shutdown condition from outside the control room as described in Section 7.4.1.5.

15.1.27 FAILURE OR OVERPRESSURIZATION OF LOW PRESSURE RESIDUAL HEAT REMOVAL SYSTEM

The failure of the shutdown cooling system is discussed in Section 6.3.

15.1.28 LOSS OF CONDENSER VACUUM

15.1.28.1 Identification of Causes

A loss of condenser vacuum due to failure of the circulating water system to supply cooling water, failure of the main condenser evacuation system to remove non-condensable gases, excessive leakage of air through turbine gland packing or any other reasons, results in a turbine generator trip which in turn trips the reactor (unless below approximately 15 percent power). The excess steam generated is dumped into the atmosphere either by the steam dump and bypass system or the main steam safety valves.

15.1.28.2 Analysis of Effects and Consequences

Loss of condenser vacuum is sensed by the turbine emergency trip system, and results in a turbine-generator trip. An analysis of the effects and consequences of a turbine-generator trip is provided in Section 15.1.7. The following analysis describes the functioning of the turbine emergency trip system as condenser vacuum decreases.

Each of the two condenser shells are provided with four pressure switches (total of eight). One switch is used to initiate an alarm should condenser vacuum decrease to approximately 25 inches Hg. The alarm will permit the plant operator to take appropriate corrective actions. Such actions might include starting standby condenser cooling water pump, and/or reducing turbine load to reduce the heat load imposed on the condenser. Should condenser vacuum continue to decrease, two other pressure switches will initiate a turbine trip signal when vacuum decreases to approximately 22 inches Hg. The two switches from each shell are electrically configured to prevent an erroneous turbine trip due to failure of either pressure switch.

The trip signal from the vacuum trip switches de-energizes the two solenoids of the turbine master trip solenoid valve. Two solenoids are provided to prevent a turbine trip upon failure of either solenoid. When de-energized, this valve ports the emergency trip system hydraulic fluid pressure to drain which trips all turbine valves closed. Decrease in the emergency trip system fluid pressure is sensed by two other pressure switches which lock the master trip solenoid in the tripped position until reset by the operator. The latter two pressure switches are provided downstream of a flow orifice to prevent tripping the turbine during short duration pressure

ARKANSAS NUCLEAR ONE
Unit 2

changes. The fourth pressure switch provides an interlock with the steam dump and bypass system at approximately 25 inches Hg to prevent or terminate the dumping of steam to the condenser when sufficient vacuum is not available.

15.1.28.3 Conclusion

The turbine protective system incorporates redundant instrumentation which guarantees detection of loss of condenser vacuum. Loss of condenser vacuum will result in a turbine-generator trip. A turbine-generator trip presents no hazard to the integrity of the RCS or the main steam system, as analyzed in Section 15.1.7.

15.1.29 TURBINE TRIP WITH COINCIDENT FAILURE OF TURBINE BYPASS VALVES TO OPEN

This event is described and analyzed in Section 15.1.7.

15.1.30 LOSS OF SERVICE WATER SYSTEM

15.1.30.1 Identification of Causes

The essential portions of the Service Water System (SWS) required to be operated to achieve a safe shutdown of the plant under the postulated accident conditions are designed to meet the requirements of the ASME Code, Section III, Class 3 and Seismic Category 1, including protection from tornado and postulated tornado missiles. Containment penetration piping and the associated isolation valves are designed to meet the requirements of ASME Code, Section III, Class 2 and Seismic Category 1. A program of periodic testing and service rotation of standby equipment is incorporated into the station operating procedures to maintain capability and integrity of the SWS. Starting conditions and assumptions include (1) operational tests, hydrotests and/or visual inspections of the SWS were performed prior to initial startup of the plant to assure system capability and integrity, (2) the emergency cooling pond must contain a sufficient volume of water required for safe shutdown of the plant under the postulated accident conditions, and (3) two loops of the SWS must be in operation prior to plant power generation.

Partial loss of the SWS however, is postulated and can be caused by any one of the following:

A. Electrical power failure:

The active components of the SWS are powered from the engineered safety features electrical system for two redundant loops. A complete loss of one loop, however, is considered when one of two emergency diesel generators fails.

B. Active failure of components:

This includes the mechanical failure of sluice gates, service water pumps, and the motor operated valves serving ESF equipment or isolating Seismic Category 1 portions of the SWS.

C. Passive failure of components:

This includes the failure of equipment and piping in Seismic Category 1 portions.

ARKANSAS NUCLEAR ONE
Unit 2

Operator action is necessary for the following operations:

- A. The transfer of service water source from Dardanelle Reservoir to the emergency pond requires operator action from the control room to close the sluice gates at Dardanelle Reservoir and open the ones at the emergency pond. At the same time, SWS discharge must be switched to the pond in order to form a closed loop between the pond, pump compartments and the essential portions of the SWS.

Valve position failure alarms are provided for the sluice gates, and the service water discharge header valves whose malfunction can lead to a loss of the pond water to the reservoir. Upon actuation of alarm, the associated component and/or the service water loop will be isolated and secured by operator action in the control room.

- B. Operator action is also required to isolate and secure the component and/or the service water loop associated with a leak. The components in the SWS can be isolated on an individual basis.

15.1.30.2 Analysis of Effects and Consequences

Based on the single failure analysis presented in Table 9.2-5, no single failure of an active or a passive component of the SWS can lead to a LOCA. The other loop has redundant components and will effect a safe shutdown of the plant. Fluid loss in the essential portions of SWS can be detected as described in Section 9.2.1.3. While the service water pump is running, the actuation of a low pressure alarm energized by a pressure indicating switch located on each main service water supply header can be an indication of a major pipe rupture which could endanger the plant by flooding. In this event, the associated service water pump will be stopped by operator action upon confirmation of the leak.

15.1.31 LOSS OF ONE DC SYSTEM

The DC system has been designed to maintain maximum flexibility for design basis events. Each redundant DC bus has two sources of power: a battery charger (designed as a battery eliminator) and a battery. Additionally, each DC bus has a standby backup charger.

During the transition period between the transfer from off-site power (preferred source) to emergency standby power, control and instrumentation power is provided from the batteries. The battery chargers will be reenergized during the loading sequence of the diesel generator.

15.1.31.1 Identification of Cause

Two abnormal occurrences will cause the loss of a single DC system:

- A. bus fault on the 125-volt DC control center; or
- B. cable fault between the 125-volt DC control center and the ESF distribution panel.

15.1.31.2 Analysis of Effects and Consequences

The effects of either a bus fault or a cable fault will immediately render that DC system and its associated power train/division inoperable. The bus fault is assumed to cause a secondary plant trip that results in loss of 480 VAC to the faulted train due to loss of control voltage to the

ARKANSAS NUCLEAR ONE
Unit 2

offsite switchgear, onsite switchgear, and EDG. Thus, both vital AC inverters on the faulted train de-energize. In the event of the loss of one DC bus, the redundant power train/division will allow a safe shutdown of the plant during emergency conditions.

Monitoring devices and administrative controls ensure that the loss of one DC system during normal operating conditions initiates immediate corrective action.

15.1.32 INADVERTENT OPERATION OF ECCS DURING POWER OPERATION

During power operation, the pressure of the RCS, 2,200 psia, exceeds the shutoff head of the HPSI pumps or the opening pressure of the safety injection tanks. Therefore, a spurious SIAS during power operation will not cause injection of water at refueling boron concentration into the RCS.

15.1.33 TURBINE TRIP WITH FAILURE OF GENERATOR BREAKER TO OPEN

The unit protection system is designed to ensure reliable opening of the 500 kV generator breakers upon a turbine trip. The redundant trip functions are provided by:

- A. Sequential trip scheme which trips the generator breakers through position switches on the main stop and intercept valves in series with an anti-motoring relay with a 3 second delay;
- B. Electrical anti-motoring relay with a 30 second delay which senses the condition of the machine operating as a motor when the steam supply is lost.

Schemes (A) and (B) use DC power sources derived from redundant batteries. They also act on separate trip coils provided on each 500 kV generator breaker.

15.1.33.1 Identification of Causes

Failure of the generator breakers to isolate the unit on a turbine trip can occur if the 500 kV generator breakers fail to open on a trip command due to a mechanical failure.

15.1.33.2 Analysis of Effects and Consequences

Failure of the 500 kV generator breakers to open against a trip signal will initiate the 500 kV breaker failure relaying scheme provided as part of the switchyard protection scheme. After a preset time delay (approximately 10 cycles), it will trip out all other 500 kV breakers associated with the failed generator breaker.

There are two cases to be considered:

- A. Both the 500 kV generator breakers were in service before the turbine trip. Assuming a single failure, one of the generator breakers will open correctly while the second one may fail.
- B. Only one of the two generator breakers was in service before the turbine trip. This one breaker fails to open.

ARKANSAS NUCLEAR ONE
Unit 2

In either case, one of two 500 kV bus sections will be completely de-energized. One or both of the two startup transformer (preferred) sources will continue to be available. No system disturbances are anticipated.

15.1.34 LOSS OF INSTRUMENT AIR SYSTEM

15.1.34.1 Identification of Causes

The instrument air system is a non-Seismic Category 1 system, except for the containment penetration piping and associated isolation valves. It is not essential for safe shutdown of the plant. The containment isolation function is discussed in Section 6.2.4.

Failure of the air compressors or their power supplies or the rupture of a component of the system could result in demand exceeding supply with resultant loss of pressure and failure of air operated components to function.

15.1.34.2 Analysis of Effects and Consequences

Pneumatically operated safety-related devices are designed to assume a safe position upon loss of the instrument air supply. Air operated valves which are safety-related are identified in Table 15.1.34-1. Failure modes are also specified in this table.

15.1.34.3 Conclusion

Failure of the instrument air system will not prevent the safe shutdown of the plant and will not allow uncontrolled release of radioactivity to the environment.

15.1.35 MALFUNCTION OF TURBINE GLAND SEALING SYSTEM

15.1.35.1 Identification of Causes and Accident Description

The Turbine Gland Sealing System (TGSS) is discussed in Section 10.4.3. As the discussion shows, in order to guarantee operation of the turbine shaft seals, at least two components, one automatic and one manual, are provided to accomplish major system functions. Therefore, should the automatic component fail to regulate supply steam, unload excess pressure, or maintain necessary vent annuli vacuum, the operator can manually achieve the function. Low steam seal header pressure, high header pressure and low exhauster vacuum conditions are alarmed to alert the operator that the automatic component has failed.

Upon failure of automatic components in the absence of manual control by the operator, steam can escape from the turbine shaft seals into the turbine building, and air may leak into the condenser. The latter condition is considered a loss of condenser vacuum accident, and safe shutdown of the reactor is discussed in Section 15.1.28. The following discussion considers the effects of steam leakage from the shaft seals to the turbine building.

15.1.35.2 Analysis of Effects and Consequences

Failure of the TGSS alone presents no hazard to the safe operation and shutdown of the plant. In the event of primary-to-secondary system leakage from a steam generator tube failure, it is possible for the turbine seal steam to become radioactively contaminated. Radiation monitoring of steam generator blowdown and main condenser vacuum pump discharge will detect this

ARKANSAS NUCLEAR ONE
Unit 2

condition. A discussion of the radiological aspects of primary-to-secondary system leakage, including anticipated releases from the TGSS and limiting conditions for operation, are included in Chapter 11. The maximum rate at which steam could be lost through the TGSS is 32,000 lbm/hr. Assuming the uncontrolled release of steam to the turbine building at this rate for one hour and neglecting iodine plate out within the turbine building, off-site doses would be less than one-fourth of the dose due to a turbine trip with steam dumped for one-half hour (see Section 15.1.7).

15.1.36 TRANSIENTS RESULTING FROM THE INSTANTANEOUS CLOSURE OF A SINGLE MSIV

15.1.36.1 Identification of Causes and Accident Description

The transients resulting from the instantaneous closure of a single Main Steam Isolation Valve (MSIV) are analyzed to determine the CPC Asymmetric Steam Generator Transient Protection (ASGTP) trip setpoint such that in conjunction with the initial margins maintained by the LCOs the DNBR and fuel centerline melt (CTM) design limits are not exceeded.

The event is initiated by the inadvertent closure of a single Main Steam Isolation Valve causing a loss of load to one steam generator. Upon loss of load, pressure and temperature in the affected steam generator increase to the opening pressure of the main steam safety valves. The intact steam generator "picks up" the lost load which causes its temperature and pressure to decrease. The cold leg temperature asymmetry leads to a reactor inlet temperature tilt which produces an azimuthal core power tilt. The most negative moderator temperature coefficient is assumed since this maximizes the power tilt and hot channel radial peaking factor increase. With this assumed sequence of events, the transient results in the greatest asymmetry in core inlet temperature distribution, the greatest increase in hot channel radial peaking factors, and the most limiting DNBR.

15.1.36.2 Analysis of Effects and Consequences

The transient was initiated at the conditions given in Table 15.1.36-1. Table 15.1.36-2 presents the sequence of events for the loss of load to one steam generator. The transient behavior of key NSSS parameters is presented in Figures 15.1.36-1 to 15.1.36-5. A reactor trip is generated by the CPCs low DNBR trip at 2.5 seconds based on high differential temperature between the cold legs associated with the two steam generators. The ASGTP trip setpoint within the CPCs ensures that the acceptable DNBR limit will not be exceeded during the event.

A maximum allowable initial linear heat generation rate of 16.5 kW/ft could exist as an initial condition without exceeding the acceptable fuel to centerline melt of 21.0 kW/ft during this transient. This amount of margin is assured by setting the Linear Heat Rate LCO based on the more limiting of the allowable linear heat rate for LOCA and other transients.

The event initiated from the extremes of the LCO in conjunction with the CPC (ASGT protective) trip will prevent DNBR or centerline fuel temperature from exceeding the design limits.

15.1.36.3 Transients Resulting From the Instantaneous Closure of a Single MSIV Subsequent Analyses

15.1.36.3.1 Cycle 13 Instantaneous Closure of a Single MSIV

The Cycle 13 evaluation of the previously described Asymmetric Steam Generator Transient (ASGT) event has been performed utilizing the same inputs except those described below. In addition to the input modifications, this evaluation has utilized the CENTS computer code described in Section 15.1.0.6.10.

Input parameters from Table 15.1.36-3 and Section 15.1.0 have been incorporated in this subsequent analysis with these following clarifications:

- A. The BOC Doppler curve in Figure 15.1.0-4 which includes a 0.85 multiplier is conservatively used.
- B. The Cycle 13 delayed neutron fraction and neutron lifetime consistent with Section 15.1.0.3 was assumed.
- C. The Cycle 13 CEA insertion curve in Figure 15.1.0-1D was utilized. This curve accounts for a 0.6 second holding coil delay and a CEA worth of 5%.
- D. A CPC asymmetric steam generator trip setpoint of 11 °F was assumed. Cold and Hot leg RTD response times of 8 seconds and 13 seconds, respectively, were accounted for along with a CPC trip delay time of 0.59 seconds.
- E. The Cycle 13 analysis was performed at 90% power and assumed a nominal RCS pressure of 2250 psia.

A summary of the principal results for the ASGT are given in Table 15.1.36-4. The combined effects of the input modifications and the improved models utilized in the CENTS codes have shown that there are no adverse impacts due to the input modifications. Thus the ASGT trip setpoint incorporated in the CPCs ensures that acceptable DNBR limits will not be exceeded during an ASGT event.

15.1.36.3.2 Cycle 15 at 3026 MWt Instantaneous Closure of a Single MSIV

The Instantaneous Closure of a Single Main Steam Isolation Valve event analysis, previously described as Asymmetric Steam Generator Transient (ASGT) event, was performed to document the impact of the replacement steam generators and a Power Uprate to 3026 MWt at hot full power.

The methodology used in this analysis is the same as that used in the current analysis. This analysis has utilized the CENTS computer code for the transient analysis simulation. The minimum DNBR evaluation was determined using the CETOP code.

Input parameters from Table 15.1.36-5 and the bounding physics data from Section 15.1.0 have been incorporated in this analysis with the following clarifications:

- 1. The BOC Doppler curve in Figure 15.1.0-4 was assumed.

ARKANSAS NUCLEAR ONE
Unit 2

2. A BOC delayed neutron fraction and neutron lifetime consistent with those defined in Section 15.1.0.3 were assumed.
3. The CEA reactivity insertion curve in Figure 15.1.0-1D was assumed. This curve accounts for a 0.6 second holding coil delay. A CEA worth of $-4.5\% \Delta \rho$ was conservatively assumed.
4. A CPC ASGT Trip setpoint of 11 °F was assumed. Cold and hot leg RTD response times of 8 seconds and 13 seconds, respectively, were accounted for along with a CPC trip delay time of 0.60 seconds.
5. The analysis was performed at 90% of rated power and assumed a nominal RCS pressure 2200 psia.
6. An increase in core rated power to 3026 MWt rated was assumed.
7. The most negative MTC of $-3.8 \times 10^{-4} \Delta \rho / ^\circ \text{F}$ was assumed with 10% plugging assumed in the affected steam generator. This results in the largest radial power distortion in the core due to the core temperature asymmetry.
8. Installation of the RSGs was assumed.
9. An RCS flow of 315,560 gpm was assumed.

For the limiting ASGT event, the minimum DNBR is greater than 1.25 and the peak power never increases above its initial value. Although the radial power distortion is large, this in combination with the core power results in a peak LHR that is less than 21 KW/ft. Thus, the SAFDLs are protected.

The NSSS and RPS responses for the ASGT event are shown in Table 15.1.36-6 and in Figures 15.1.36-6 through 15.1.36-10. The combined effects of the input modifications have shown that there are no adverse impacts due to the RSGs, an increase in rated power to 3026 MWT, an increase in RCS flow, and the increase in the most negative MTC (more negative) to $-3.8 \times 10^{-4} \Delta \rho / ^\circ \text{F}$.

The ASGT Trip setpoint that is incorporated in the CPCs ensures that the acceptable DNB and CTM limits will not be exceeded during an ASGT event. The minimum thermal margin required (reserved) in COLSS for the ASGT event is set equal to or greater than the maximum thermal margin degradation observed during an ASGT event.

15.1.36.3.3 Cycle 18 Instantaneous Closure of a Single MSIV

The instantaneous Closure of a Single Main Isolation Valve event was evaluated at a higher LOCA Limit of 14.4 KW/ft. Only the peak LHR margin was affected. There was no impact on DNB margin.

The methodology was the same as that used in the current analysis presented in Section 15.1.36.3.2. The LOCA Limit value of 14.4 KW/ft was used in place of the previous value of 13.7 KW/ft. No new computer cases were required.

ARKANSAS NUCLEAR ONE
Unit 2

The combination of the radial power distortion and core power results from the current analysis were combined with the higher value of 14.4 KW/ft to determine the new peak LHR value. The newly calculated value remained less than the 21 KW/ft SAFDL.

15.1.36.3.4 Cycle 21 Instantaneous Closure of a Single MSIV

The Instantaneous Closure of a Single Main Steam Isolation Valve (MSIV) event was evaluated for Cycle 21 for Next Generation Fuel (NGF). Only the DNB margin was affected. There was no impact on the LHR margin.

The methodology was the same as that used in the current analysis presented in Section 15.1.36.3.2. The Instantaneous Closure of a Single MSIV event was evaluated for Cycle 21 using the WSSV-T and ABB-NV critical heat flux correlations and the lower DNB SAFDL of 1.23 for the minimum DNBR evaluation. No CENTS cases were repeated, as all other current input parameters in Table 15.1.36-5 remained unchanged.

The Asymmetric Steam Generator Transient Trip setpoint that is incorporated in the CPCs ensures that the acceptable DNB and CTM limits will not be exceeded during an Instantaneous Closure of a Single MSIV event. The minimum thermal margin required (reserved) in COLSS for the Instantaneous Closure of a Single MSIV event is set equal to or greater than the maximum thermal margin degradation observed during the event.

Table 15.1.36-6 provides the revised Sequence of Events for the full core implementation of NGF. The minimum DNBR value remains above the DNB SAFDL value of 1.23. Consequently, the conclusions in SAR Section 15.1.36.3.2 remain the same.

ARKANSAS NUCLEAR ONE
Unit 2

15.2 REFERENCES

1. "COAST Code Description," CENPD-98, April, 1973.
2. "Idaho Nuclear Corporation Monthly Report," NY-123-69, October, 1969.
3. "Idaho Nuclear Corporation Monthly Report," Hai-127-70, March, 1970.
4. Not used.
5. "Moisture Carryover During NSSS Steam Line Break Accident," CENPD-80, Combustion Engineering, January 1973.
6. "System 80 PSAR," CESSAR, Docket No. STN-50-470.
7. "CESEC Digital Simulation of a Combustion Engineering Nuclear Steam Supply System," CENPD-107, April 1974.
8. Baldwin, M. S., and H. S. Schenkel, "Determination of Frequency Decay Rates During Periods of Generation Deficiency," Westinghouse Electric Corp.
9. Baltzer, R. A., "A Study of Column Separation Accompanying Transient Flow of Liquids in Pipes," PhD Thesis, University of Michigan, Ann Arbor, 1967.
10. Bishop, A. A., et al, "Forced Convection Heat Transfer at High Pressure After the Critical Heat Flux," ASME Paper G5-HT-31, May, 1965.
11. Brassfield, H. C., et al, "Recommended Property and Reaction Kinetics Data for Use in Evaluating a Light Water-Cooled Reactor Loss-of-Coolant Incident Involving Zircaloy-4 or 304-SS Clad UO₂," GEMP-482, April, 1968.
12. Not used.
13. LD-82-001 (dated 1/6/82), "CESEC Digital Simulation of a Combustion Engineering Nuclear Steam Supply System," Enclosure 1-P to letter from A. E. Scherer to D. G. Eisenhut, December, 1981.
14. Not used.
15. DiNunno, J. J., et al, "Calculation of Distance Factors for Power and Test Reactor Sites," TID-14844, USAEC, 1962.
16. Not used.
17. Kalkwijk, J. P. Th. and Kranenburg, C., "Cavitation in Horizontal Pipelines Due to Water Hammer," Journal of the Hydraulics Division, ASCE, Vol. 97, No. HY 10, 1971, pp. 1585 - 1605.
18. Not used.
19. MacBeth, R. V., "Burnout Analysis Part 4: Application of a Local Conditions Hypothesis to World Data for Uniformly Heated Round Tube and Rectangular Channels," AEEW-R-267, August 1963.

ARKANSAS NUCLEAR ONE
Unit 2

20. "STRIKIN-II, A Cylindrical Geometry Fuel Rod Heat Transfer Program," CENPD-135P, August 1974.

"STRIKIN-II, A Cylindrical Geometry Fuel Rod Heat Transfer Program (Modification)," CENPD-135P, Supplement 2, February 1975.

"STRIKIN-II, A Cylindrical Geometry Fuel Rod Heat Transfer Program," CENPD-135, Supplement 4-P, August 1976.
21. "CETOP-D Code Structures and Modeling Methods for Arkansas Nuclear One - Unit 2," CEN-214(A)-P, July 1982.
22. Martinelli, R. C. and Nelson, D. B., "Prediction of Pressure Drop During Forced Circulation Boiling of Water," ASME Transactions, 78, 1948, p. 695.
23. "A Multi-Dimensional Space-Time Kinetics Code for PWR Transients", CENPD-188-A, July 1976.
24. "Technical Manual for the CENTS Code," CENPD 282-P-A, Rev. 2 / WCAP-15996-P-A, Rev. 1, March 2005 (effective September 27, 2005).
25. [Correspondence from Walsh, Entergy Operations, to NRC, dated March 31, 2010.](#)
26. Peeler, G. B., C. L. Kling, "Moisture Carryover During a NSSS Steam Line Break Accident," Combustion Engineering Proprietary Information Version, CENPD-80, January 1973.
27. Redfield, J. A., "CHIC-KIN - A FORTRAN Program for Intermediate and Fast Transients in a Water Moderated Reactor," WAPD-TM-479, January, 1965.
28. Correspondence from Rueter, AP&L, to Stolz, NRC, dated February 10, 1977.
29. Correspondence from Rueter, AP&L, to Stolz, NRC, dated March 30, 1977.
30. Correspondence from Rueter, AP&L, to Stolz, NRC, dated June 17, 1977.
31. Correspondence from Rueter, AP&L, to Stolz, NRC, dated July 19, 1977.
32. Correspondence from Rueter, AP&L, to Stolz, NRC, dated January 27, 1978.
33. Safwat, H. H., "Transients in Cooling Water Systems of Thermal Power Plants," D.Sc. Dissertation, Delft University of Technology, Delft, 1972.
34. Safwat, H. H., "Water Column Separation and Cavitation in Short Pipelines," ASME Paper 75-FE-33, May 1975.
35. Safwat, H. H. and Kluyver, J. D., "Digital Computations for Water Hammer - Column Separation," First International Conference on Pressure Surges, University of Kent, Canterbury, Paper C 4, September 6-8, 1972.
36. Safwat, H. H. and Polder, J. V. D., "Experimental and Analytic Data Correlation Study of Water Column Separation," Journal of Fluids Engineering, TRANS ASME, Vol. 95, Series I, No. 1 (1973), pp. 91 - 97.

ARKANSAS NUCLEAR ONE
Unit 2

37. Siemons, J., "The Phenomenon of Cavitation in a Horizontal Pipe Line Due to Sudden Pump Failure," *Journal of Hydraulic Research, IAHR*, Vol. 5, No. 2 (1967) pp. 135 - 152.
38. Streeter, V. L. and Wylie, E. B., *Hydraulic Transients*, McGraw Hill, New York, 1967.
39. Syrikovich, M. A. and O.I. Martynova, "Transfer of Iodine from Aqueous Solutions to Saturated Vapor," *Atomnaya Energiya*, 17(1), July 1964, pp. 45-49.
40. Thomas, G. O., "Determination of Pump Characteristics for Computerized Pump Transient Analysis," Paper A-3, International Conference on Pressure Surges, organized by BHRA, Canterbury, England, September 1972.
41. Vreugdenhil, C. B., Vries, A. H. D., Kalkwijk, J. P. Th. and Kranenburg, C., "Investigation Into Cavitation in Long Horizontal Pipelines Caused by Water Hammer," *Proceedings 6th Symposium of the IAHR*, Rome, 1972.
42. Weyler, M. E., "An Investigation of the Effect of Cavitation Bubbles on Momentum Loss in Transient Pipe Flow," PhD Thesis, University of Michigan, Ann Arbor, 1969.
43. Correspondence from Williams, AP&L, to Stolz, NRC, dated January 31, 1978.
44. Correspondence from Williams, AP&L, to Stolz, NRC, dated March 24, 1978.
45. Yasinsky, J. B., M. Natelson, and L. A. Hageman, "TWIGL - A Program to Solve the Two-Dimensional, Two-Group, Space-Time Neutron Diffusion Equations With Temperature Feedback," WAPD-TM-743, February, 1968.
46. Entergy Calculation 92-E-0001-04, Rev. 0, "ABB-CE Analysis Results to Support a Reduced Pressurizer Pressure."
47. [Not used.](#)
48. MacBeth, R. V., "An Appraisal of Forced Convection Burnout Data," *Proc. Inst. Mech. Engrs.*, Vol. 180, Pt. 3C, 1965 - 1966.
49. "CEA Ejection, C-E Method for Control Element Assembly Ejection Analysis", CENPD-190-A, July 1976.
50. "RELAP5MOD3.1/MOD3 Code Manual Volumes I, II, III, and IV", NUREG/CR-5535.
51. J. V. Ramadell and C. A. Simon, "Atmospheric Relative Concentrations in Building Wakes," NUREG-6331, Revision 1, U. S. Nuclear Regulatory Commission, May 1997.
52. [ORNL/TM-2005/39. Version 5, Vol. II, Book 1, Sect. F7, ORIGEN-S: "SCALE System Module to Calculate Fuel Depletion, Actinide Transmutation, Fission Product Buildup and Decay, and Associated Radiation Source Terms," I.C. Gauld et al, April 2005.](#)
53. [Not used.](#)
54. WCAP-16072-P, Rev. 00, "Implementation of Zirconium Diboride Burnable Absorber Coatings in CE Nuclear Power Fuel Assembly Designs," April 2003.

ARKANSAS NUCLEAR ONE
Unit 2

55. CENPD-404-P-A, "Implementation of ZIRLO™ Cladding Material in CE Nuclear Power Fuel Assembly Designs," November 2001.
56. "Addendum 1 to WCAP-12610-P-A and CENPD-404-P-A Optimized ZIRLO™," WCAP-12610-P-A and CENPD-404-P-A, February 2003.
57. "CE 16 x 16 Next Generation Fuel Core Reference Report," WCAP-16500-P-A, Rev. 0, August 2007.
58. "Westinghouse Correlations WSSV and WSSV-T for Predicting Critical Heat Flux in Rod Bundles with Side-Supported Mixing Vanes," WCAP-16523-P-A, August 2007.

ARKANSAS NUCLEAR ONE
Unit 2

Table 15.1.0-1

**REACTOR PROTECTIVE SYSTEM TRIPS
USED IN THE SAFETY ANALYSES**

	<u>Analysis Setpoint⁽¹⁾</u>	<u>Trip Delay Time (Sec)</u>
High Logarithmic Power Level ⁽⁵⁾	4%	0.4 ⁽⁸⁾
High Linear Power Level ⁽⁵⁾	115.1% ⁽⁷⁾⁽¹⁰⁾	0.4 ⁽⁸⁾
Low DNBR ⁽⁵⁾	1.25 ⁽⁶⁾	0.15 ⁽⁹⁾
High Local Power Density ⁽⁵⁾	21 kw/ft ⁽²⁾	0.15 ⁽⁹⁾
High Pressurizer Pressure ⁽⁵⁾	2415 psia ⁽¹¹⁾	0.65 ⁽¹⁴⁾
Low Pressurizer Pressure ⁽⁵⁾	1400 psia ⁽⁴⁾	1.2
Low Steam Generator Water Level ⁽⁵⁾	6% ⁽³⁾	1.3
Low Steam Generator Pressure ⁽⁵⁾	693 psia ⁽¹²⁾	1.3
High Containment Pressure ⁽⁵⁾	20.7 psia	1.2 ⁽¹³⁾
Manual Reactor Trip	Not Applicable	Not Applicable
High Steam Generator Water Level	Not Applicable	Not Applicable

-
- (1) The analysis setpoints represent the parameter values at which a reactor protective trip is assumed. The actual instrumentation setpoints are set to assure trip at or before the assumed analysis setpoint is reached, taking into account all sensor process delays and uncertainties. Further discussions of the instrumentation setpoints and uncertainties are given in Section 7.2.
- (2) Setpoint value is set below the value at which fuel centerline melting would occur, see Section 4.4. This trip may be actuated on several conditions including high local power density Asymmetric Steam Generator Trip (ASGT) and variable over power as discussed in Section 7.2.
- (3) Percent of distance between the level nozzles. Upon this trip, the emergency feedwater pumps are automatically started and the emergency feedwater valves are automatically opened. A 9% reactor trip setpoint and Emergency Feedwater analytical actuation is assumed for a Loss of Normal Feedwater. The 6% trip setpoint is assumed in the FWLB analysis. Also in the FWLB analysis, an Emergency Feedwater (EFW) flow analytical actuation setpoint of 0% was assumed.

ARKANSAS NUCLEAR ONE
Unit 2

Table 15.1.0-1 (Continued)

- (4) See Section 7.2. An RPS setpoint value of 1400 psia is assumed for the Loss of Coolant Accident (LOCA) analysis. An SIAS setpoint value of 1800 psia is used for the Steam Generator Tube Rupture (SGTR). All other analyses, except SGTR, (Major Secondary System Pipe Break Accident and Excess Heat Removal due to Main Steam System Valve Malfunction) assume an SIAS setpoint of 1400 psia.
- (5) The response time testing of these protective system trips is required by Technical Specifications.
- (6) The Low DNBR trip is actuated based on the DNBR calculation in the Core Protection Calculator System (CPCS). The CPCS retains the CE-1 CHF correlation and, therefore, the trip setpoint is 1.25. However, the safety analysis uses the TORC and CETOP-D codes, which implement the WSSV-T and ABB-NV CHF correlations for NGF. The DNBR limit for the WSSV-T and ABB-NV CHF correlations is 1.23, which is used in the safety analysis as the SAFDL. The CPCS trip setpoint of 1.25 assures that the DNBR limit or SAFDL of 1.23 for the WSSV-T and ABB-NV CHF correlations will not be violated during normal operation and anticipated operational occurrences to at least a 95/95 probability/confidence level. This trip may be actuated on several conditions including low DNBR, low RCP shaft speed, ASGT, and variable overpower as discussed in Section 7.2.
- (7) Additional uncertainties are accounted for in the CEA ejection event, which requires a higher analysis value to account for geometry effects.
- (8) The response time of the neutron flux signal portion of the channels is measured from the detector output or the input of the first electronic component in the channel. The neutron detectors themselves are exempt from response time testing.
- (9) This is the time from CPC trip generation until trip breaker open. Other delays in generating a CPC trip are discussed in Section 7.2 and individual event descriptions.

The total CPC trip delay, based on changes to the input parameters for the respective trips are:

Low DNBR

- | | |
|---|--------------------|
| a. Neutron Flux Power from Excore Neutron Detectors | ≤ 0.39 seconds* |
| b. CEA Positions | ≤ 1.09 seconds** |
| c. Cold Leg Temperature | ≤ 3.79 seconds### |
| d. Hot Leg Temperature | ≤ 1.54 seconds#### |
| e. Primary Coolant Pump Shaft Speed | ≤ 0.80 seconds# |
| f. Reactor Coolant Pressure from Pressurizer | ≤ 3.19 seconds |

High Local Power Density

- | | |
|---|------------------|
| a. Neutron Flux Power from Excore Neutron Detectors | ≤ 2.58 seconds* |
| b. CEA Positions | ≤ 1.58 seconds** |

* The response time of the neutron flux signal portion of the channel is measured from detector output or input of first electronic component in channel. The neutron detectors are exempt from response time testing.

ARKANSAS NUCLEAR ONE
Unit 2

Table 15.1.0-1 (Continued)

- ** Response time is measured from the onset of a single CEA drop.
- # Response time is measured from the onset of a 2 out of 4 Reactor Coolant Pump coastdown.
- ## Based on an effective resistance temperature detector (RTD) response time of ≤ 8.0 seconds.
- ### Based on an effective RTD response time of ≤ 13.0 seconds.

(10) This value is lower when 1 or more Main Steam Safety Valves (MSSVs) are inoperable.

(11) A setpoint value of 2392 psia is assumed for the Loss of External Load and/or Turbine Trip event and Loss of Condenser Vacuum (LOCV) event.

(12) An RPS trip setpoint of 693 psia is assumed for the Main Steam Line Break (MSLB) outside containment event. A Main Steam Isolation Signal (MSIS) setpoint of 693 psia is assumed for the MSLB outside containment event and the Excess Heat Removal due to Main Steam System Malfunction. An MSIS setpoint of 658 psia is assumed for the MSLB inside containment event. For the Feedwater Line Break (FWLB), a MSIS analytical setpoint of 905 psia was assumed with no delay in response time.

The MSLB assumes a Trip Delay Time of 1.59 seconds. A reduced response time of 1.2 seconds, used for a High Containment Pressure trip, is credited as a back-up to High Pressurizer Pressure, Low Steam Generator Level, and low pressurizer pressure to maintain the containment environment.

(14) The FWLB assumes a Trip Delay of 0.9 seconds.

ARKANSAS NUCLEAR ONE
Unit 2

Table 15.1.0-2A

PRIMARY COOLANT SOURCE TERM FOR NON-FUEL FAILURE EVENTS

<u>Nuclide</u>	<u>Activity (Ci)</u>	<u>Nuclide</u>	<u>Activity (Ci)</u>
Kr-85m	1.88E+03	I-130	7.65E+02
Kr-85	9.23E+02	I-131	1.19E+02
Kr-87	2.26E+03	I-132	3.12E+02
Kr-88	3.80E+03	I-133	4.14E+02
Xe-131m	4.80E+02	I-134	4.81E+02
Xe-133m	1.31E+03	I-135	4.93E+02
Xe-133	6.10E+04	Cs-134	4.96E+02
Xe-135m	1.18E+03	Cs-136	5.56E+01
Xe-135	1.35E+04	Cs-137	4.84E+02
Xe-138	3.82E+03	Cs-138	7.06E+03
		Rb-86	1.75E+02

SECONDARY COOLANT SOURCE TERM FOR MAIN STEAM LINE BREAK ANALYSIS

<u>Nuclide</u>	<u>Activity (Ci)</u>	<u>Nuclide</u>	<u>Activity (Ci)</u>
I-130	5.60E+01	Cs-134	3.63E+01
I-131	8.72E+00	Cs-136	4.07E+00
I-132	2.28E+01	Cs-137	3.54E+01
I-133	3.03E+01	Cs-138	5.17E+02
I-134	3.52E+01	Rb-86	1.28E+01
I-135	3.61E+01		

ARKANSAS NUCLEAR ONE
Unit 2

Table 15.1.0-2B

CORE ISOTOPIC INVENTORY FOR FUEL FAILURE EVENTS⁽¹⁾

Isotope	Core Inventory (Curies)	Isotope	Core Inventory (Curies)	Isotope	Core Inventory (Curies)
Kr-83m	1.032E+07	Sb-129	2.347E+07	Ce-141	1.429E+08
Kr-85	8.801E+05	Sb-131	6.632E+07	Ce-143	1.315E+08
Kr-85m	2.234E+07	Te-127	7.511E+06	Ce-144	1.093E+08
Kr-87	4.401E+07	Te-127m	1.250E+06	Np-239	1.621E+09
Kr-88	5.912E+07	Te-129	2.199E+07	Pu-238	1.451E+05
Xe-131m	9.144E+05	Te-129m	4.237E+06	Pu-239	2.411E+04
Xe-133	1.715E+08	Te-131	7.140E+07	Pu-240	3.669E+04
Xe-133m	5.381E+06	Te-131m	1.642E+07	Pu-241	8.901E+06
Xe-135	3.544E+07	Te-132	1.201E+08	Am-241	8.025E+03
Xe-135m	3.617E+07	Te-133	9.225E+07	Cm-242	2.157E+06
Xe-138	1.480E+08	Te-133m	8.217E+07	Cm-244	1.255E+05
I-130	1.459E+06	Sr-89	8.498E+07	La-140	1.552E+08
I-131	8.430E+07	Sr-90	6.786E+06	La-142	1.353E+08
I-132	1.229E+08	Sr-91	1.034E+08	Nb-95	1.500E+08
I-133	1.735E+08	Sr-92	1.106E+08	Nd-147	5.463E+07
I-134	1.950E+08	Ba-139	1.543E+08	Pr-143	1.300E+08
I-135	1.649E+08	Ba-140	1.500E+08	Y-90	7.079E+06
Cs-134	1.217E+07	Mo-99	1.575E+08	Y-91	1.108E+08
Cs-136	3.045E+06	Rh-105	8.327E+07	Y-92	1.120E+08
Cs-137	8.819E+06	Ru-103	1.304E+08	Y-93	1.261E+08
Cs-138	1.619E+08	Ru-105	8.854E+07	Zr-95	1.477E+08
Rb-86	1.389E+05	Ru-106	3.914E+07	Zr-97	1.442E+08
Sb-127	7.667E+06	Tc-99m	1.386E+08		

⁽¹⁾ Dose analyses of the various fuel failure events may not use all of the isotopes listed, because the isotope may have an insignificant impact on the analysis results (e.g. due to radioactive decay).

ARKANSAS NUCLEAR ONE
Unit 2

Table 15.1.0-3

FGR DATA FOR ISOTOPES

<u>Nuclide</u>	<u>FGR 11 CEDE (Sv/Bq)</u>	<u>FGR 12 EDE (Sv-m³/Bq-sec)</u>	<u>Nuclide</u>	<u>FGR 11 CEDE (Sv/Bq)</u>	<u>FGR 12 EDE (Sv-m³/Bq-sec)</u>
Kr-85m	NA	7.48E-15	I-130	7.14E-10	1.04E-13
Kr-85	NA	1.19E-16	I-131	8.89E-9	1.82E-14
Kr-87	NA	4.12E-14	I-132	1.03E-10	1.12E-13
Kr-88	NA	1.02E-13	I-133	1.58E-9	2.94E-14
Xe-131m	NA	3.89E-16	I-134	3.55E-11	1.30E-13
Xe-133m	NA	1.37E-15	I-135	3.32E-10	7.98E-14
Xe-133	NA	1.56E-15	Cs-134	1.25E-8	7.57E-14
Xe-135m	NA	2.04E-14	Cs-136	1.98E-9	1.06E-13
Xe-135	NA	1.19E-14	Cs-137	8.63E-9	2.88E-14
Xe-138	NA	5.77E-14	Cs-138	2.74E-11	1.21E-13
			Rb-86	1.79E-9	4.81E-15

Table 15.1.0-4

BREATHING RATES

<u>Time Period</u>	<u>Breathing Rate</u>
0 - 8 hr	3.5 x 10 ⁻⁴
8 - 24 hr	1.8 x 10 ⁻⁴
1 - 30 day	2.3 x 10 ⁻⁴

Table 15.1.0-5

ACCIDENT ATMOSPHERIC DILUTION FACTORS

<u>Time Period</u>	<u>(sec./m³)</u>	
	<u>Site Boundary</u>	<u>Low Population Zone</u>
0 - 2 Hr.	6.5 x 10 ⁻⁴	-
0 - 8 Hr.	-	3.1 x 10 ⁻⁵
8 - 24 Hr.	-	3.6 x 10 ⁻⁶
1 - 4 Days	-	2.3 x 10 ⁻⁶
4 - 30 Days	-	1.4 x 10 ⁻⁶

ARKANSAS NUCLEAR ONE
Unit 2

Table 15.1.0-6
INITIAL CONDITIONS

<u>Parameter</u>	<u>Units</u>	<u>Range</u>
Core Power, B		
Rated	% of 2815 MWt	$B \leq 103$
Up-rated	% of 3026 MWt	$B \leq 102$
Axial shape index, ASI ^(a)	--	$-0.3 \leq ASI \leq +0.3$
RCS Flow, G	% of 322,000 gpm	$98^{(b)} \leq G \leq 120$
Core inlet coolant temperature, T	°F	$540 \leq T \leq 556.7$
System Pressure, P	psia	$2000 \leq P \leq 2300$

(a) $ASI = (P_L - P_U) / (P_L + P_U)$

where:

P_L = relative power in lower half of core.

P_U = relative power in upper half of core.

(b) The lesser of 98% of 322,000 gpm or 118×10^6 lbm/hr.

ARKANSAS NUCLEAR ONE
Unit 2

Table 15.1.0-7

ENGINEERED SAFETY FEATURES RESPONSE TIMES

<u>INITIATING SIGNAL AND FUNCTION</u>	<u>RESPONSE TIME IN SECONDS</u>
1. <u>Manual</u>	
a. SIAS Safety Injection	Not Applicable
b. CSAS Containment Spray	Not Applicable
c. CIAS Containment Isolation	Not Applicable
d. MSIS Main Steam Isolation	Not Applicable
e. CCAS Containment Cooling	Not Applicable
f. RAS Containment Sump Recirculation	Not Applicable
g. EFAS	
Train A	Not Applicable
Train B	Not Applicable
2. <u>Pressurizer Pressure-Low</u>	
a. Safety Injection	
1) High Pressure Safety Injection ⁽¹⁾	30*
2) Low Pressure Safety Injection ⁽¹⁾	35*
3. <u>Containment Pressure-High</u>	
a. Safety Injection	
1) High Pressure Safety Injection ⁽¹⁾	31.6*
2) Low Pressure Safety Injection ⁽¹⁾	51.6*
b. Containment Isolation ⁽¹⁾	52.1*/37.1**
c. Containment Cooling ⁽¹⁾	51***/28.1**

ARKANSAS NUCLEAR ONE
Unit 2

Table 15.1.0-7 (Continued)

<u>INITIATING SIGNAL AND FUNCTION</u>	<u>RESPONSE TIME IN SECONDS</u>
4. <u>Containment Pressure-High-High</u>	
a. Containment Spray ⁽¹⁾	42.1*/27.1**
b. Main Steam Isolation ⁽¹⁾	5.1*
c. Feedwater Isolation ⁽¹⁾	41.6*/26.6**
d. Feedwater Isolation-Backup Feedwater Isolation Valves ⁽¹⁾	35.1*/20.1**
5. <u>Steam Generator Pressure-Low</u>	
a. Main Steam Isolation ⁽¹⁾	3.9
b. Feedwater Isolation ⁽¹⁾	36.4*/21.4**
c. Feedwater Isolation-Backup Feedwater Isolation Valves ⁽¹⁾	31.8*/16.8**
6. <u>Refueling Water Tank-Low</u>	
a. Containment Sump Valve Open ⁽¹⁾	145.0
7. <u>Steam Generator Level-Low</u>	
a. Emergency Feedwater - Train A ⁽¹⁾	97.4
b. Emergency Feedwater - Train B ⁽¹⁾	112.4*/97.4**
8. <u>Steam Generator ΔP-High Coincident With Steam Generator Level-Low</u>	
a. Emergency Feedwater - Train A ⁽¹⁾	97.4
b. Emergency Feedwater - Train B ⁽¹⁾	112.4*/97.4**

TABLE NOTATION

* Diesel generator starting and sequence loading delays included.

** Diesel generator starting delays not included, sequence loading delays included. Offsite power available.

*** Diesel generator starting and sequence loading delays, and time delay for water hammer concerns included.

⁽¹⁾ The response time testing of these Engineered Safety Features functions is required by Technical Specifications.

ARKANSAS NUCLEAR ONE
Unit 2

Table 15.1.1-1

**ASSUMPTIONS FOR THE
UNCONTROLLED CEA WITHDRAWAL
FROM A SUBCRITICAL CONDITION**

<u>Parameter</u>	<u>Units</u>	<u>Assumptions</u>
Initial Core Power Level	(MWt)	2900 x 10 ⁻¹⁰
Initial Inlet Coolant Temperature	(°F)	544.6
Core Mass Flow Rate	(10 ⁶ lb _m /hr)	116.2
Reactor Coolant System Pressure	(psia)	2200
Steam Generator Pressure	(psia)	990
Total Nuclear Heat Flux Factor	----	4.2
Moderator Temperature Coefficient	(10 ⁻⁴ Δρ/°F)	+0.5
Fuel Temperature Coefficient Multiplier	----	0.85
CEA Maximum Reactivity Addition Rate	(10 ⁻⁴ Δρ/sec)	2.5
CEA Worth on Trip	(10 ⁻² Δρ)	-5.0
Steam Bypass System	----	Manual
Feedwater Regulating System	----	Manual

ARKANSAS NUCLEAR ONE
Unit 2

Table 15.1.1-2

**SEQUENCE OF EVENTS FOR THE UNCONTROLLED
CEA WITHDRAWAL FROM A SUBCRITICAL CONDITION**

<u>Time (sec)</u>	<u>Event</u>	<u>Set Point Or Value</u>
0.0	Initiation of withdrawal	----
40.0	Reactor reaches criticality	----
58.8	High Logarithmic power level trip condition	+2 percent of full power
59.2	Trip breakers open	----
59.5	Shutdown CEAs begin to drop into core	----
59.6	Peak transient neutron flux	129 percent of 2815 MWt
61.4	Peak transient core average heat flux	75 percent of full power value
61.4	Minimum transient DNBR	1.28
62.0	Peak fuel centerline temperature	3800 °F
63.7	Maximum pressurizer pressure	2498 psia

ARKANSAS NUCLEAR ONE
Unit 2

Table 15.1.1-3

**ASSUMPTIONS FOR THE
CYCLE 12 UNCONTROLLED CEA WITHDRAWAL
FROM A SUBCRITICAL CONDITION**

<u>Parameter</u>	<u>Units</u>	<u>Assumptions Bank B</u>	<u>Assumptions Bank P</u>
Initial Core Power	(MWt)	3.947×10^{-8}	8.25×10^{-7}
Core Inlet Temperature	(°F)	545	545
Reactor Coolant System Pressure	(psia)	2000	2000
Steam Generator Pressure	(psia)	1004	1004
Reactor Coolant System Flow	(gpm)	315,560	315,560
Total Nuclear Heat Flux Factor	-	10	8
Moderator Temperature Coefficient	$(10^{-4} \Delta\rho/^\circ\text{F})$	+0.5	+0.5
Doppler Multiplier	-	0.85	0.85
CEA Maximum Reactivity Addition Rate	$(10^{-4} \Delta\rho/\text{sec})$	4.0	2.2
Steam Bypass System	-	Manual	Manual
Feedwater Regulating System	-	Manual	Manual

ARKANSAS NUCLEAR ONE
Unit 2

Table 15.1.1-4

**ASSUMPTIONS FOR THE
CYCLE 13 UNCONTROLLED CEA WITHDRAWAL
FROM A SUBCRITICAL CONDITION**

<u>Parameter</u>	<u>Units</u>	<u>Assumptions Case 1</u>	<u>Assumptions Case 2</u>
Initial Core Power	(MWt)	896. x 10 ⁻⁹	896. x 10 ⁻⁹
RCP Heat	(MWt)	18	18
Core Inlet Temperature	(°F)	552	552
Reactor Coolant System Pressure	(psia)	2000	2000
Steam Generator Pressure	(psia)	1055	1055
Reactor Coolant System Flow	(lbm/hr)	108.36 x 10 ⁶	108.36 x 10 ⁶
Total Nuclear Heat Flux Factor	-	6.8	9
Moderator Temperature Coefficient	(10 ⁻⁴ Δρ/°F)	+0.5	+0.5
Doppler Multiplier	-	0.85	0.85
CEA Maximum Reactivity Addition Rate	(10 ⁻⁴ Δρ/sec)	2.5	2.0
Steam Bypass System	-	Manual	Manual
Feedwater Regulating System	-	Manual	Manual

ARKANSAS NUCLEAR ONE
Unit 2

Table 15.1.1-5

**SEQUENCE OF EVENTS FOR THE CYCLE 13 UNCONTROLLED
CEA WITHDRAWAL FROM SUBCRITICAL CONDITIONS
CASE 1**

<u>Time (sec)</u>	<u>Event</u>	<u>Setpoint or Value</u>
0.0	Initiation of withdrawal	-
256.6	High Logarithmic power level trip condition	4% of full power
257.0	Trip breakers open, and Rod withdrawal stops	-
257.4	Maximum Power occurs	97.4% of full power
257.6	CEAs begin to drop	-
257.7	Maximum heat flux, and Minimum DNBR	34.5% of full power 1.27
261.2	Maximum RCS Pressure	2119.6 psia
300	End of transient	-

Table 15.1.1-6

**SEQUENCE OF EVENTS FOR THE CYCLE 13 UNCONTROLLED
CEA WITHDRAWAL FROM SUBCRITICAL CONDITIONS
CASE 2**

<u>Time (sec)</u>	<u>Event</u>	<u>Setpoint or Value</u>
0.0	Initiation of withdrawal	-
320.2	High Logarithmic power level trip condition	4% of full power
320.6	Trip breakers open, and Rod withdrawal stops	-
321.2	CEAs begin to drop, and Maximum Power occurs	- 77.7% of full power
321.3	Maximum heat flux, and Minimum DNBR	24.84% of full power 1.42
324.7	Maximum RCS Pressure	2099.4 psia
350	End of transient	-

ARKANSAS NUCLEAR ONE
Unit 2

Table 15.1.1-7

**ASSUMPTIONS FOR THE
CYCLE 16 UNCONTROLLED CEA WITHDRAWAL
FROM A SUBCRITICAL CONDITION**

<u>Parameter</u>	<u>Units</u>	<u>Conservative Assumptions Case 1</u>	<u>Conservative Assumptions Case 2</u>
Initial Core Power Level	MWt	9.63×10^{-7}	9.63×10^{-7}
RCP Heat	MWt	18	18
Core Inlet Temperature	°F	552	552
Pressurizer Pressure ⁽¹⁾	psia	2000	2000
Steam Generator Pressure	psia	1058	1058
Reactor Coolant System Flow	10^6 lbm/hr	117.78	117.78
Total Nuclear Heat Flux Factor	--	6.8	9
Moderator Temperature Coefficient	$10^{-4} \Delta\rho/^\circ\text{F}$	+0.5	+0.5
Fuel Temperature Coefficient	--	BOC	BOC
CEA Reactivity Addition Rate	$10^{-4} \Delta\rho/\text{sec}$	2.5	2.0
Steam Bypass System	--	Manual	Manual
Feedwater Regulating System	--	Manual	Manual

(1) Initial pressures are input as pressurizer pressure. Figures are of RCS pressure. Therefore, the initial values in the Figures are slightly higher by 20 to 30 psi than the value quoted here.

ARKANSAS NUCLEAR ONE
Unit 2

Table 15.1.1-8

**SEQUENCE OF EVENTS FOR THE CYCLE 16 UNCONTROLLED
CEA WITHDRAWAL FROM A SUBCRITICAL CONDITION
WITH A RIR OF $2.5 \times 10^{-4} \Delta\rho/\text{sec}$**

<u>Time, Seconds</u>	<u>Event</u>	<u>Setpoint or Value</u>
0.0	Initiation of withdrawal	--
256.5	High logarithmic power level trip condition	4% of full power
256.9	Trip breakers open, and Rod withdrawal stops	--
257.3	Maximum power occurs	93.3% of full power
257.5	CEAs begin to drop	--
257.6	Maximum heat flux, and Minimum WSSV-T / ABB-NV DNBR*	33.2% of full power > 1.23
261.1	Maximum RCS pressure	< 2750 psia
300	End of transient	--

* For Cycle 21, the WSSV-T / ABB-NV CHF correlations and a DNB SAFDL of 1.23 were applied due to the implementation of a full core of NGF.

Table 15.1.1-9

**SEQUENCE OF EVENTS FOR THE CYCLE 16 UNCONTROLLED
CEA WITHDRAWAL FROM A SUBCRITICAL CONDITION
WITH A RIR OF $2.0 \times 10^{-4} \Delta\rho/\text{sec}$**

<u>Time, Seconds</u>	<u>Event</u>	<u>Setpoint or Value</u>
0.0	Initiation of withdrawal	--
320.1	High logarithmic power level trip condition	4% of full power
320.5	Trip breakers open, and Rod withdrawal stops	--
321.1	CEAs begin to drop, and Maximum power occurs	73.8% of full power
321.2	Maximum heat flux, and Minimum WSSV-T / ABB-NV DNBR*	23.4% of full power > 1.23
324.7	Maximum RCS pressure	< 2750 psia
400	End of transient	--

* For Cycle 21, the WSSV-T / ABB-NV CHF correlations and a DNB SAFDL of 1.23 were applied due to the implementation of a full core of NGF.

ARKANSAS NUCLEAR ONE
Unit 2

Table 15.1.2-1

**ASSUMPTIONS FOR THE
UNCONTROLLED CEA WITHDRAWAL
FROM ONE PERCENT POWER**

<u>Parameter</u>	<u>Units</u>	<u>Assumptions</u>
Initial Core Power Level	(MWt)	29.0
Core Inlet Coolant Temperature	(°F)	544.6
Core Mass Flow Rate	(10 ⁶ lb _m /hr)	116.2
Reactor Coolant System Pressure	(psia)	2200
Steam Generator Pressure	(psia)	978
Total Nuclear Heat Flux Factor	-----	4.2
Moderator Temperature Coefficient	(10 ⁻⁴ Δρ/°F)	+0.5
Doppler Coefficient Multiplier	-----	0.85
CEA Worth on Trip	(10 ⁻² Δρ)	-5.0
Steam Bypass System	-----	Manual
Feedwater Regulating System	-----	Manual
Reactivity Addition Rate	(10 ⁻⁴ Δρ/sec)	1.5
Automatic Withdrawal Prohibit ⁽¹⁾	-----	Inoperative

(1) This function of the RRS has been physically removed.

ARKANSAS NUCLEAR ONE
Unit 2

Table 15.1.2-2

**ASSUMPTIONS FOR THE
UNCONTROLLED CEA WITHDRAWAL
FROM FULL POWER**

<u>Parameter</u>	<u>Units</u>	<u>Assumptions</u>
Initial Core Power Level	(MWt)	2900
Core Inlet Coolant Temperature	(°F)	556.7
Core Mass Flow Rate	(10 ⁶ lb _m /hr)	116.2
Reactor Coolant System Pressure	(psia)	2200
Steam Generator Pressure	(psia)	939
Moderator Temperature Coefficient	(10 ⁻⁴ Δρ/°F)	+0.5
Doppler Coefficient Multiplier	-----	0.85
CEA Worth on Trip	(10 ⁻² Δρ)	-5.4
Steam Bypass System	-----	Manual
Feedwater Regulating System	-----	Automatic
Reactivity Addition Rate	(10 ⁻⁴ Δρ/sec)	0.5

ARKANSAS NUCLEAR ONE
Unit 2

Table 15.1.2-3

**SEQUENCES OF EVENTS
FOR THE UNCONTROLLED CEA WITHDRAWAL
FROM ONE PERCENT POWER, BOC CONDITIONS**

<u>Time (Sec)</u>	<u>Event</u>	<u>Setpoint or Value</u>
0.0	Initiation of Uncontrolled Sequential CEA Withdrawal	----
25.1	High pressurizer pressure trip condition	2422 psia
26.0	Trip Breakers Open	----
26.2	Pressurizer Safety Valves Begin to Open	2500 psia
26.3	Shutdown CEAs begin to drop into core	----
27.6	Peak Core Power Occurs	91% (of 2815 MWt)
28.2	Peak Core Average Heat Flux Occurs	76% (of full power heat flux)
28.2	Minimum DNBR Occurs	≥ 1.25*
28.5	Peak RCS Pressure Occurs	2662 psia

* Based on the CE-1 Correlation, which was used at the time this analysis was performed.

Table 15.1.2-4

**SEQUENCE OF EVENTS FOR THE
UNCONTROLLED CEA WITHDRAWAL FROM FULL POWER**

<u>Time (sec)</u>	<u>Event</u>	<u>Setpoint or Value</u>
0.0	Initiation of Uncontrolled Sequential CEA Withdrawal	-----
14.6	Low DNBR Trip Condition	1.25 (CPC projected)
14.75	Trip Breakers Open	-----
15.05	Shutdown CEAs begin to drop into core	-----
15.15	Peak Core Power Occurs	124% (of 2815 MWt)
15.65	Peak Core Average Heat Flux occurs	120% (of full power)
15.65	Minimum DNBR Occurs	≥ 1.25*
17.6	Peak RCS Pressure Occurs	2425 psia

* Based on the CE-1 Correlation, which was used at the time this analysis was performed.

ARKANSAS NUCLEAR ONE
Unit 2

Table 15.1.2-5

**ASSUMPTIONS FOR THE CYCLE 13
UNCONTROLLED CEA WITHDRAWAL
FROM ONE PERCENT POWER**

<u>Parameter</u>	<u>Units</u>	<u>Assumptions</u>
Initial Core Power	(MWt)	0.002815
RCP Heat	(MWt)	18
Core Inlet Temperature	(°F)	552
Reactor Coolant System Pressure	(psia)	2000
Steam Generator Pressure	(psia)	1055
Reactor Coolant System Flow	(lbm/hr)	108.36 x 10 ⁶
Total Nuclear Heat Flux Factor	---	7.5
Moderator Temperature Coefficient	(10 ⁻⁴ Δρ/°F)	+0.5
Doppler Multiplier	---	0.85
CEA Worth on Trip	(10 ⁻² Δρ)	-2
CEA Maximum Reactivity Addition Rate	(10 ⁻⁴ Δρ/sec)	1.8
Steam Bypass System	---	Manual
Feedwater Regulating System	---	Manual
Automatic Withdrawal Prohibit	---	Inoperative

ARKANSAS NUCLEAR ONE
Unit 2

Table 15.1.2-6

**ASSUMPTIONS FOR THE CYCLE 12
UNCONTROLLED CEA WITHDRAWAL
FROM FULL POWER**

<u>Parameter</u>	<u>Units</u>	<u>Assumptions</u>
Initial Core Power	(MWt)	2900
Core Inlet Temperature	(°F)	556.7
Reactor Coolant System Pressure	(psia)	2000
Steam Generator Pressure	(psia)	874.3
Reactor Coolant System Flow	(gpm)	315,560
Moderator Temperature Coefficient	($10^{-4} \Delta\rho/^\circ\text{F}$)	-0.1
Doppler Multiplier	-	0.85
CEA Reactivity Addition Rate	($10^{-4} \Delta\rho/\text{sec}$)	0.8
Steam Bypass System	-	Manual
Feedwater Regulating System	-	Manual

ARKANSAS NUCLEAR ONE
Unit 2

Table 15.1.2-7

**SEQUENCE OF EVENTS FOR THE CYCLE 13 UNCONTROLLED
CEA WITHDRAWAL FROM ONE PERCENT POWER**

<u>Time (sec)</u>	<u>Event</u>	<u>Setpoint or Value</u>
0.0	Initiation of withdrawal	-
22.2	VOPT trip conditions occurs	41% of full power
22.8	Trip breakers open, and Rod withdrawal stops	-
23.1	Maximum Power occurs	71.3% of full power
23.4	CEAs begin to drop	-
23.5	Maximum heat flux, and Minimum DNBR	38% of full power see values below
27.2	Maximum RCS Pressure	2174.2 psia

Minimum DNBR Results for Various Power Shapes

<u>ASI</u>	<u>Fr</u>	<u>DNBR</u>
0	3.95	1.31
-0.3	3.52	1.33
-0.6	3.26	1.34
-0.75	2.97	1.34
-0.9	2.90	1.33

ARKANSAS NUCLEAR ONE
Unit 2

Table 15.1.2-8

**ASSUMPTIONS FOR THE CYCLE 16
UNCONTROLLED CEA WITHDRAWAL
FROM HOT ZERO POWER**

<u>Parameter</u>	<u>Units</u>	<u>Conservative Assumptions</u>
Initial Core Power	MWt	0.0003026
RCP Heat	MWt	18
Core Inlet Temperature	°F	552
Pressurizer Pressure ⁽¹⁾	psia	2000
Steam Generator Pressure	psia	1058
Reactor Coolant System Flow	gpm	315,560
Total Nuclear Heat Flux Factor	---	7.7
Moderator Temperature Coefficient	$10^{-4} \Delta\rho/^\circ\text{F}$	+0.5
Fuel Temperature Coefficient	---	BOC
CEA Worth on Trip	$10^{-2} \Delta\rho$	-2
CEA Reactivity Addition Rate	$10^{-4} \Delta\rho/\text{sec}$	1.8
Steam Bypass System	---	Manual
Feedwater Regulating System	---	Manual
Automatic Withdrawal Prohibit	---	Inoperative

Initial pressures are input as pressurizer pressure. Figures are of RCS pressure. Therefore, the initial values in the Figures are slightly higher by 20 to 30 psi than the value quoted here.

ARKANSAS NUCLEAR ONE
Unit 2

Table 15.1.2-9

**SEQUENCE OF EVENTS FOR THE CYCLE 16 UNCONTROLLED
CEA WITHDRAWAL FROM HOT ZERO POWER**

<u>Time, seconds</u>	<u>Event</u>	<u>Setpoint or Value</u>
0.0	Initiation of CEA bank withdrawal	--
22.4	CPCS VOPT trip conditions occurs	36% of full power
23.0	Trip breakers open, and Rod withdrawal stops	--
23.2	Maximum power occurs	75.5% of full power
23.6	CEAs begin to drop	--
23.7	Maximum heat flux occurs, and Minimum WSSV-T / ABB-NV DNBR*	38% of full power > 1.23
27.4	Maximum RCS pressure occurs (includes pump head)	< 2750 psia

* For Cycle 21, the WSSV-T / ABB-NV CHF correlations and a DNB SAFDL of 1.23 were applied due to the implementation of a full core of NGF.

Table 15.1.2-10

**ASSUMPTIONS FOR THE CYCLE 16
UNCONTROLLED CEA WITHDRAWAL AT HOT FULL POWER**

<u>Parameter</u>	<u>Units</u>	<u>Conservative Assumptions</u>
Initial Core Power Level	MWt	3087
RCP Heat	MWt	18
Core Inlet Temperature	°F	556.7
Pressurizer Pressure ⁽¹⁾	psai	2000
Steam Generator Pressure	psia	1044
Reactor Coolant System Flow	gpm	315,560
Moderator Temperature Coefficient	$10^{-4} \Delta\rho/^\circ\text{F}$	0.0
Fuel Temperature Coefficient	---	BOC
CEA Reactivity Addition Rate	$10^{-4} \Delta\rho/\text{sec}$	1.0
CEA Worth on Trip	$10^{-2} \Delta\rho$	-5.0
Steam Bypass System	---	Manual

(1) Initial pressures are input as pressurizer pressure. Figures are of RCS pressure. Therefore, the initial values in the Figures are slightly higher by 20 to 30 psi than the value quoted here.

ARKANSAS NUCLEAR ONE
Unit 2

Table 15.1.2-11

**SEQUENCE OF EVENTS FOR THE CYCLE 16 UNCONTROLLED
CEA WITHDRAWAL AT HOT FULL POWER**

<u>Time, seconds</u>	<u>Event</u>	<u>Setpoint or Value</u>
0.0	Initiation of CEA bank withdrawal	--
6.5	CPCS VOPT trip conditions occurs	112.4% of full power
7.1	Trip breakers open	--
7.7	Maximum power occurs, and CEAs begin to drop	114% of full power
8.1	Maximum heat flux occurs, and Minimum WSSV-T / ABB-NV DNBR*	111% of full power > 1.23
9.7	Maximum RCS pressure occurs (includes RCP pump head)	< 2750 psia

* For Cycle 21, the WSSV-T / ABB-NV CHF correlations and a DNB SAFDL of 1.23 were applied due to the implementation of a full core of NGF.

ARKANSAS NUCLEAR ONE
Unit 2

Table 15.1.3-1

ASSUMPTIONS FOR THE FULL LENGTH CEA DROP

<u>Parameter</u>	<u>Units</u>	<u>Conservative Assumptions</u>
Initial Core Power Level	MWt	2900
Core Inlet Coolant Temperature	(°F)	556.7
Core Mass Flow Rate	(10 ⁶ lbm/hr)	116.2
Reactor Coolant System Pressure	(psia)	2250
Steam Generator Pressure	(psia)	923
Axial Shape Index ⁽¹⁾	(asiu)	(2)
Initial Total Nuclear Heat Flux Factor	--	2.35
Dropped CEA Reactivity Worth	(10 ⁻² Δρ)	(2)
Ratio of After-Drop to Before-Drop Rod Radial Peak	--	(2)
Time for Dropped CEA to be fully inserted	(sec)	1.0
Moderator Temperature Coefficient	(10 ⁻² Δρ/°F)	-3.5
Doppler Coefficient Multiplier	--	1.15
CEA Worth on Trip	(10 ⁻² Δρ)	-5.3
Reactor Regulating System	--	Automatic ⁽³⁾
Steam Bypass System	--	Automatic
Feedwater Regulating System	--	Automatic

- (1) Axial Shape Index = $\frac{\text{Power in Lower Half of Core} - \text{Power in Upper Half of Core}}{\text{Total Core Power}}$
- (2) See Table 15.1.3 for cases at two initial axial shape indices
- (3) The RRS automatic mode has been physically removed; however, this assumption is retained in the analyses for the purpose of conservatism.

ARKANSAS NUCLEAR ONE
Unit 2

Table 15.1.3-2

RESULTS OF FULL LENGTH CEA DROP

Axial Shape Index	Reactivity Insertion	Initial DNBR	Final 3-D Peak	Initial ⁽¹⁾ 3-D Peak	Time ⁽²⁾ of Trip	Peak Hot Channel Heat Flux Value/Time	Min. DNBR Value/Time
+0.19	-0.10% $\Delta\rho$	1.68		1.27	0.6 sec	103.6/2 sec	1.3/2.0 sec
+0.19	-0.10% $\Delta\rho$	2.25		1.27	2.3 sec	110.1/3 sec	1.3/3.5 sec
-0.27	-0.10% $\Delta\rho$	1.39		1.27	0.6 sec	101.8/1.3 sec	1.3/1.3 sec
-0.27	-0.10% $\Delta\rho$	1.55		1.27	1.7 sec	105.6/2.2 sec	1.3/2.2 sec

- (1) The 27 percent increase in radial peaking factor during the transient is 10 percent greater than the calculated increase in peaking factor which is 24 percent. This uncertainty is in addition to the 10 percent uncertainty applied to the initial radial peak.
- (2) Time of trip refers to the time a low DNBR Trip Signal is generated. The scram rods begin to fall into the core 0.45 seconds later.

ARKANSAS NUCLEAR ONE
Unit 2

Table 15.1.3-3

INITIAL HOT CHANNEL AXIAL POWER DISTRIBUTIONS FOR
CEA MISOPERATION ANALYSIS

Axial Node	-0.270 ASI <u>Power</u>	-0.267 ASI <u>Power</u>	-0.131 ASI <u>Power</u>	-0.091 ASI <u>Power</u>	+0.077 ASI <u>Power</u>	+0.0162 ASI <u>Power</u>	+0.104 ASI <u>Power</u>	+0.188 ASI <u>Power</u>	+0.274 ASI <u>Power</u>	+0.315 ASI <u>Power</u>
	(Normalized)									
1(Bottom)	0.351	0.293	0.454	0.533	0.721	0.532	0.675	0.850	0.891	1.022
2	0.503	0.462	0.706	0.754	1.021	0.715	1.037	1.210	1.358	1.420
3	0.586	0.550	0.811	0.858	1.132	1.004	1.181	1.310	1.507	1.560
4	0.640	0.612	0.853	0.903	1.161	1.124	1.213	1.340	1.500	1.552
5	0.691	0.679	0.882	0.930	1.157	1.153	1.205	1.320	1.439	1.486
6	0.753	0.762	0.916	0.958	1.145	1.149	1.189	1.280	1.366	1.402
7	0.825	0.856	0.957	0.991	1.133	1.138	1.172	1.230	1.291	1.314
8	0.906	0.953	1.000	1.026	1.121	1.128	1.153	1.180	1.214	1.225
9	0.988	1.043	1.041	1.057	1.103	1.117	1.127	1.130	1.132	1.133
10	1.062	1.120	1.074	1.080	1.077	1.102	1.092	1.060	1.046	1.037
11	1.124	1.182	1.101	1.089	1.040	1.077	1.052	1.000	0.959	0.938
12	1.192	1.234	1.126	1.105	1.012	1.041	1.014	0.950	0.883	0.855
13	1.264	1.281	1.152	1.128	0.994	1.015	0.985	0.900	0.821	0.789

ARKANSAS NUCLEAR ONE
Unit 2

Table 15.1.3-3 (continued)

<u>Axial Node</u>	<u>-0.270 ASI Power</u>	<u>-0.267 ASI Power</u>	<u>-0.131 ASI Power</u>	<u>-0.091 ASI Power</u>	<u>+0.077 ASI Power</u>	<u>+0.0162 ASI Power</u>	<u>+0.104 ASI Power</u>	<u>+0.188 ASI Power</u>	<u>+0.274 ASI Power</u>	<u>+0.315 ASI Power</u>
	(Normalized)									
14	1.336	1.328	1.182	1.157	0.987	1.000	0.967	0.870	0.776	0.740
15	1.406	1.376	1.218	1.188	0.987	0.993	0.958	0.830	0.747	0.705
16	1.461	1.421	1.255	1.214	0.990	0.995	0.952	0.800	0.730	0.681
17	1.481	1.445	1.275	1.217	0.980	0.998	0.935	0.770	0.715	0.658
18	1.418	1.406	1.239	1.160	0.929	0.989	0.879	0.720	0.678	0.614
19	1.208	1.215	1.070	0.990	0.790	0.936	0.739	0.670	0.579	0.520
20(Top)	0.805	0.782	0.688	0.662	0.520	0.794	0.475	0.610	0.368	0.349

ARKANSAS NUCLEAR ONE
Unit 2

Table 15.1.3-4

**SEQUENCE OF EVENTS FOR FULL LENGTH CEA DROP
FOR BOTTOM PEAKED AXIAL POWER DISTRIBUTION**

<u>Time (Sec.)</u>	<u>Event</u>	<u>Setpoint or Value</u>
0.0	Full Length CEA Drop Initiated	--
1.0	Full Length CEA Reaches Bottom of Core	--
1.0	Regulating CEAs Begin to Withdraw	$0.7 \times 10^{-4} \Delta \rho / \text{sec}$
1.7	Low DNBR Trip Condition	See Section 15.1.0
2.45	Trip Breakers Open	--
2.75	Shutdown CEAs Begin to Drop Into Core	--
2.85	Core Power Returns to its Maximum Value After the CEA Drop	93.3% of 2900 Mwt
3.5	Minimum DNBR for Transient is Reached	1.3

FOR TOP PEAKED AXIAL POWER DISTRIBUTION

<u>Time (Sec.)</u>	<u>Event</u>	<u>Setpoint or Value</u>
0.0	Full Length CEA Drop Initiated	--
0.6	Flow DNBR Trip Condition Exists	--
0.75	Trip Breakers Open	--
1.0	Full Length CEA Reaches Bottom of Core	--
1.05	Shutdown CEAs Begin to Drop Into Core	--
1.3	Minimum DNBR for Transient is Reached	1.3

ARKANSAS NUCLEAR ONE
Unit 2

Table 15.1.3-5

**ASSUMPTIONS FOR THE CYCLE 16
CEA MISOPERATION
AT POWER**

<u>Parameter</u>	<u>Units</u>	<u>Conservative Assumptions</u>
Core Inlet Coolant Temperature	°F	540 to 556.7
Reactor Coolant System Flow	gpm	315,560 to 386,400
Pressurizer Pressure	psia	2000 to 2300
Steady State Axial Shape	ASI	-0.3 to +0.3

ARKANSAS NUCLEAR ONE
Unit 2

Table 15.1.4-1

ASSUMPTIONS FOR UNCONTROLLED BORON DILUTION

<u>Parameter</u>	<u>Units</u>	<u>Conservative Assumptions</u>
<u>Refueling Condition – Mode 6</u>		
Reactor Vessel Volume to the Nozzles	ft ³	2457
Charging Rate	gpm	138
Initial Boron Concentration	Keff	0.95
Critical Boron Concentration	Ppm	Figure 15.1.4-1
<u>Cold Shutdown Condition – Mode 5 – Alarms Operable</u>		
RCS Volume - Partially Drained Reactor Vessel to Nozzles Plus One Shutdown Cooling System Loop	ft ³	2901
Charging Rate	gpm	138
Critical Boron Concentration	ppm	Figure 15.1.4-2
Initial Shutdown Reactivity*	10 ⁻² Δρ	-5.0
<u>Cold Shutdown Condition – Mode 5 – Alarms Inoperable</u>		
RCS Volume - Filled Reactor Vessel to Nozzles Plus One Shutdown Cooling System Loop	ft ³	4647
Charging Rate	gpm	138
Critical Boron Concentration	ppm	Figure 15.1.4-3
Initial Shutdown Reactivity	10 ⁻² Δρ	-2.0
<u>Cold Shutdown Condition – Mode 5 – Alarms Operable</u>		
RCS Volume - Filled Reactor Vessel to Nozzles Plus One Shutdown Cooling System Loop	ft ³	4647
Charging Rate	gpm	138
Critical Boron Concentration	ppm	Figure 15.1.4-4
Initial Shutdown Reactivity*	10 ⁻² Δρ	-5.0

ARKANSAS NUCLEAR ONE
Unit 2

Table 15.1.4-1 (continued)

<u>Parameter</u>	<u>Units</u>	<u>Conservative Assumptions</u>
<u>Hot Shutdown Condition – Mode 4 – Alarms Inoperable</u>		
RCS Volume - Filled Reactor Vessel to Nozzles Plus One Shutdown Cooling System Loop	ft ³	4647
Charging Rate	gpm	138
Critical Boron Concentration	ppm	Figure 15.1.4-5
Initial Shutdown Reactivity	10 ⁻² Δρ	-2.0
<u>Hot Shutdown Condition – Mode 4 – Alarms Operable</u>		
RCS Volume - Filled Reactor Vessel to Nozzles Plus One Shutdown Cooling System Loop	ft ³	4647
Charging Rate	gpm	138
Critical Boron Concentration	ppm	Figure 15.1.4-6
Initial Shutdown Reactivity*	10 ⁻² Δρ	-5.0
<u>Hot Standby Condition – Mode 3 – Alarms Inoperable</u>		
RCS Volume - Filled Reactor Vessel to Nozzles Plus One Shutdown Cooling System Loop	ft ³	4647
Charging Rate	gpm	138
Critical Boron Concentration	ppm	Figure 15.1.4-7
Initial Shutdown Reactivity	10 ⁻² Δρ	-2.0
<u>Hot Standby Condition – Mode 3 – Alarms Operable</u>		
RCS Volume - Filled Reactor Vessel to Nozzles Plus One Shutdown Cooling System Loop	ft ³	4647
Charging Rate	gpm	138
Critical Boron Concentration	ppm	Figure 15.1.4-8
Initial Shutdown Reactivity*	10 ⁻² Δρ	-5.0

ARKANSAS NUCLEAR ONE
Unit 2

Table 15.1.4-1 (continued)

<u>Parameter</u>	<u>Units</u>	<u>Conservative Assumptions</u>
<u>Startup Condition – Mode 2</u>		
RCS Volume	ft ³	9040
Charging Rate	gpm	138
Critical Boron Concentration	ppm	Figure 15.1.4-9
Initial Shutdown Reactivity	10 ⁻² Δρ	-5.0

* Note that a value of $-3.3 \times 10^{-2} \Delta\rho$ was actually used in the analysis. This is due to the boron dilution count rate monitor providing an alarm when the count rate reaches 1.5 times the background rate.

Table 15.1.5-1

ASSUMPTIONS FOR THE LOSS OF COOLANT FLOW

<u>Parameter</u>	<u>Units</u>	<u>Conservative Assumptions</u>
Initial Core Power Level	(Mwt)	2900
Core Inlet Coolant Temperature	(°F)	556.7
Core Mass Flow Rate	(10 ⁶ lbm/hr)	116.2
RCS Pressure	(psia)	2200
Steam Generator Pressure	(psia)	923
Total Nuclear Heat Flux Factor	-----	2.35
Moderator Temperature Coefficient	(10 ⁻⁴ Δρ/°F)	+0.5
Doppler Coefficient Multiplier	-----	0.85
CEA Worth on Trip	(10 ⁻² Δρ)	-8.0*
Steam Bypass System	-----	Automatic
Feedwater Regulating System	-----	Automatic

* Reduced CEA trip worth has been assumed for subsequent cycle reload analysis and shown to have acceptable results requiring no changes to COLSS/CPC or Technical Specifications.

ARKANSAS NUCLEAR ONE
Unit 2

Table 15.1.5-2

**ASSUMPTIONS FOR THE
LOSS OF COOLANT FLOW RESULTING
FROM A SHAFT SEIZURE**

<u>Parameter</u>	<u>Units</u>	<u>Conservative Assumptions</u>
Initial Core Power Level	(Mwt)	2900
Core Inlet Coolant Temperature	(°F)	556.7
Core Mass Flow Rate	(10 ⁶ lb _m /hr)	116.2
RCS Pressure	(psia)	2250
Steam Generator Pressure	(psia)	923
Total Nuclear Heat Flux Factor	-----	2.35
Moderator Temperature Coefficient	(10 ⁻⁴ Δρ/°F)	+0.5
Doppler Coefficient Multiplier	-----	0.85
CEA Worth on Trip	(10 ⁻² Δρ)	-5.4
Steam Bypass System	-----	Automatic
Feedwater Regulating System	-----	Automatic

ARKANSAS NUCLEAR ONE
Unit 2

Table 15.1.5-3

**SEQUENCE OF EVENTS
FOR THE 4-PUMP LOSS OF COOLANT FLOW
FOR CYCLE 2**

<u>Time (sec)</u>	<u>Event</u>	<u>Setpoint or Value</u>
0.0	Loss of power to all four reactor coolant pumps	-----
0.60	CPC Low DNBR trip Signal Generated	1.24 (CPC Projected)
0.75	Trip breakers open	-----
1.05	Shutdown CEAs begin to drop into core	-----
2.90	Minimum CE-1 DNBR	≥ 1.24

Table 15.1.5-4

**SEQUENCE OF EVENTS
FOR THE 2-PUMP LOSS OF COOLANT FLOW
FROM 4-PUMP OPERATON
FOR CYCLE 1**

<u>Time (sec)</u>	<u>Event</u>	<u>Setpoint or Value</u>
0.0	Loss of power to two of the reactor coolant pumps	-----
4.05	Low DNBR trip condition	See Section 15.1.0
4.20	Trip Breakers Open	-----
4.50	Shutdown CEAs begin to drop into core	-----
5.73	Minimum DNBR occurs	1.3

ARKANSAS NUCLEAR ONE
Unit 2

Table 15.1.5-5

**SEQUENCE OF EVENTS
FOR THE SINGLE REACTOR COOLANT PUMP SHAFT SEIZURE**

<u>Time (sec)</u>	<u>Event</u>	<u>Setpoint or Value</u>
0.0	Shaft seizure on one reactor coolant pump	-----
0.60	Low DNBR trip condition	See Section 15.1.0
0.75	Trip breakers open	-----
0.80	Minimum DNBR falls below 1.3	-----
1.05	Shutdown CEAs begin to drop into core	
2.00	Minimum DNBR for the transient occurs	0.5
3.00	Core flow reaches asymptotic three-pump value	$89.8 \times 10^6 \text{ lb}_m/\text{hr}$
4.10	Maximum RCS pressure	2336

ARKANSAS NUCLEAR ONE
Unit 2

Table 15.1.5-6

**FLOW COASTDOWN FOR A 6.47 HERTZ GRID
FREQUENCY TRANSIENT**

<u>Time (Seconds)</u>	<u>Core Flow Rate* Normalized</u>
0	1.0030
0.5	0.9796
1.0	0.9308
2.0	0.8235
3.0	0.7191
4.0	0.6158
5.0	0.5184
6.0	0.4254
7.0	0.3387
8.0	0.2610
9.0	0.1961
10.0	0.1604

* Core Mass Velocity = Core Flow Rate x 2.597E+6 (LBM/hr-ft²)

Table 15.1.5-7

INITIAL NSSS PLANT PARAMETER FOR CENTRAN SIMULATION

<u>NSSS Parameter</u>	<u>Unit</u>	<u>Simulation Value</u>	<u>Acceptable Range</u>
Core Coolant Inlet Temperature	°F	560.0	≤ 560
Primary Coolant Pressure	PSIA	2100.0	≥ 2100.0
Average Core Heat Flux (30% Power)	BTU/hr-ft ²	56638.5	≤ 56638.5
One Pin Peak	-	2.15	≥ 2.15
Axial Shape Index	-	-0.4 to +0.4	-0.4 to +0.4
Initial Core Mass Velocity	LBM/hr-ft ²	2.6E+6	≥ 2.6E+6

ARKANSAS NUCLEAR ONE
Unit 2

Table 15.1.5-8

**ASSUMPTIONS FOR THE LOSS OF COOLANT FLOW ANALYSIS ASSUMING 30%
STEAM GENERATOR TUBE PLUGGING**

<u>Parameter</u>	<u>Units</u>	<u>Conservative Assumptions</u>
Initial Core Power Level	(MWt)	2900
Core Inlet Coolant Temperature	(°F)	556.7
Core Mass Flow Rate	(10 ⁶ lbm/hr)	104.57
RCS Pressure	(psia)	2200
Radial Peaking Factor, Fr	----	1.71
Axial Shape Index	----	0.3
Moderator Temperature Coefficient	(10 ⁻⁴ Δρ/°F)	0.0
Scram Worth	(%Δρ)	-5.0

Table 15.1.5-9

**SEQUENCE OF EVENTS
FOR THE 4-PUMP LOSS OF COOLANT FLOW ANALYSIS**

<u>Time (sec)</u>	<u>Event</u>	<u>Setpoint or Value</u>
0.0	Loss of power to all four reactor coolant pumps	-----
0.8	CPC Low RCP Speed Trip (95%)	95% nominal speed
1.1*	Trip breakers open	-----
1.7*	Shutdown CEAs begin to drop into core	-----
2.8*	Minimum CE-1 DNBR	1.29**

* For Cycle 15, the CPC Low RCP Speed Trip response time was increased to 0.4 seconds. Hence, all values have increased by 0.1 seconds.

** For Cycle 15 adjustments this value decreased to 1.277.

ARKANSAS NUCLEAR ONE
Unit 2

Table 15.1.5-10

**AST RADIOLOGICAL DOSE RESULTS FOR
REACTOR COOLANT PUMP SHAFT SEIZURE
ASSUMING 14% FUEL FAILURE**

<u>Radiological Dose</u>	<u>Rem TEDE</u>
EAB	1.01
LPZ	0.16
CR	0.27

Table 15.1.5-11

**CYCLE 15
FOUR REACTOR COOLANT PUMP FLOW COASTDOWN
RESULTING FROM AN ELECTRICAL FAILURE**

<u>Time (Seconds)</u>	<u>Core Flow Rate (Normalized)</u>
0.0	1.000
0.5	0.9715
1.0	0.9323
1.5	0.8953
2.0	0.8607
2.5	0.8293
3.0	0.7996
3.5	0.7721
4.0	0.7465
4.5	0.7225
5.0	0.7000
10.0	0.5349

ARKANSAS NUCLEAR ONE
Unit 2

Table 15.1.5-12

**FOUR REACTOR COOLANT PUMP FLOW COASTDOWN
RESULTING FROM AN ELECTRICAL FAILURE**

<u>Time (Seconds)</u>	<u>Core Flow Rate (Normalized)</u>
0.0	1.000
0.5	0.970
1.0	0.931
1.5	0.894
2.0	0.859
2.5	0.827
3.0	0.798
3.5	0.771
4.0	0.745
4.5	0.721
5.0	0.698

Table 15.1.5-13

ASSUMPTIONS FOR THE CYCLE 16 LOSS OF COOLANT FLOW ANALYSIS

<u>Parameter</u>	<u>Units</u>	<u>Minimum Subcooling Assumptions</u>	<u>Maximum Subcooling Assumptions</u>
Initial Core Power Level	MWt	3087	3087
Core Inlet Coolant Temperature	°F	556.7	540.0
Reactor Core Mass Flow	10 ⁶ lbm/hr	118.0	142.1
Pressurizer Pressure	psia	2000	2300
Radial Peaking Factor, Fr	--	1.71	1.28
Axial Shape Index	--	0.3	0.3
Moderator Temperature Coefficient	10 ⁻⁴ Δρ/°F	0.0	0.0
CEA Worth on Trip	10 ⁻² Δρ	-5.0	-5.0

ARKANSAS NUCLEAR ONE
Unit 2

Table 15.1.5-14

**SEQUENCE OF EVENTS
FOR THE CYCLE 16 FOUR PUMP LOSS OF COOLANT FLOW ANALYSIS**

<u>Time (sec)</u>		<u>Event</u>	<u>Setpoint or Value</u>	
<u>Maximum Subcooled</u>	<u>Minimum Subcooled</u>		<u>Maximum Subcooled</u>	<u>Minimum Subcooled</u>
0.0	0.0	Loss of all four reactor coolant pumps	--	--
0.8	0.8	CPC low RCP speed trip	95% nominal speed	95% nominal speed
1.2	1.2	Trip breakers open	--	--
1.8	1.8	Shutdown CEAs begin to drop into core	--	--
3.15	3.05	Minimum WSSV-T / ABB-NV DNBR*	≥ 1.23	≥ 1.23

* For Cycle 21, the WSSV-T / ABB-NV CHF correlations and a DNB SAFDL of 1.23 were applied due to the implementation of a full core of NGF.

ARKANSAS NUCLEAR ONE
Unit 2

Table 15.1.5-15

**ASSUMPTIONS FOR THE CYCLE 16
LOSS OF COOLANT FLOW RESULTING
FROM A PUMP SHAFT SEIZURE**

<u>Parameter</u>	<u>Units</u>	<u>Conservative Assumptions</u>
Initial Core Power Level	MWt	3087
RCP Heat	MWt	18
Core Inlet Coolant Temperature	°F	556.7
Reactor Coolant System Flow	gpm	386,400
Pressurizer Pressure ⁽¹⁾	psia	2300
Steam Generator Pressure	psia	967
Moderator Temperature Coefficient	$10^{-4} \Delta\rho/^\circ\text{F}$	-0.2
Fuel Temperature Coefficient	--	BOC
CEA Worth on Trip	$10^{-2} \Delta\rho$	-5.0
Steam Bypass System	--	Manual
Feedwater Regulating System	--	Automatic

(1) Initial pressures are input as pressurizer pressure. Figures are of RCS pressure. Therefore, the initial values in Figures are slightly higher by 20 to 30 psi than the value quoted here.

ARKANSAS NUCLEAR ONE
Unit 2

Table 15.1.5-16

**SEQUENCE OF EVENTS
FOR THE CYCLE 16 (TYPICAL CASE)
LOSS OF COOLANT FLOW PUMP SHAFT SEIZURE ANALYSIS**

<u>Time (sec)</u>	<u>Event</u>	<u>Setpoint or Value</u>
0.0	Shaft seizure of one reactor coolant pump	--
0.30	CPC low RCP speed trip occurs	0.95 of nominal
0.80	Reactor trip breakers open	--
1.30	WSSV-T / ABB-NV DNBR falls below SAFDL*	< 1.23
1.40	Shutdown CEAs begin to drop into core	--
1.90	Minimum DNBR occurs	--
2.10	Core flow reaches asymptotic three-pump value	73% of initial flow
4.10	Maximum RCS pressure occurs	< 2750 psia

* For Cycle 21, the WSSV-T / ABB-NV CHF correlations and a DNB SAFDL of 1.23 were applied due to the implementation of a full core of NGF.

ARKANSAS NUCLEAR ONE
Unit 2

Table 15.1.6-1

ASSUMPTIONS FOR THE IDLE LOOP STARTUP

<u>Parameter</u>	<u>Units</u>	<u>Conservative Assumptions</u>
Initial Core Power Level	(MWt)	1271
Core Inlet Coolant Temperature	(°F)	559.4
Core Mass Flow Rate	(10 ⁶ lb _m /hr)	53.7
Reactor Coolant System Pressure	(psia)	2250
Total Nuclear Heat Flux Factor	-----	2.11
Moderator Temperature Coefficient	(10 ⁻⁴ Δρ/°F)	-3.5
Doppler Coefficient Multiplier	-----	0.85
CEA Worth on Trip	(10 ⁻² Δρ)	-5.4
Steam Bypass System	-----	Automatic
Feedwater Regulating System	-----	Automatic

Table 15.1.6-2

INITIAL CONDITIONS FOR IDLE LOOP STARTUP

	<u>Temperature, °F</u>			<u>Steam Pressure psia</u>	<u>Load⁽¹⁾ %</u>	<u>Reactor⁽²⁾ Coolant System Flow</u>
	<u>Hot Leg</u>	<u>Cold Leg</u>	<u>Steam</u>			
Active Loop	603.5	559.4	540.0	962.7	93.3	0.573
Inactive Loop	538.7	559.4	538.6	951.5	6.7	0.095

NOTES: (1) Percent of 1271 Mwt (NSSS power, includes + 2 percent uncertainty).

(2) Flow is given is fraction of full four-pump reactor vessel flow and a negative flow fraction indicates reverse flow.

ARKANSAS NUCLEAR ONE
Unit 2

Table 15.1.6-3

SEQUENCE OF EVENTS FOR THE IDLE LOOP STARTUP

<u>Time (sec)</u>	<u>Event</u>	<u>Setpoint Or Value</u>
0.0	Idle loop start up	-----
16.0	Vessel flow rate stabilizes at 3-pump flow rate	77.4%
21.1	High RCS pressure alarm	2350 psia
23.8	Peak reactor power occurs	68.4%
30.0	Peak heat flux occurs	66.5%
30.0	Minimum DNBR occurs	5.2
35.0	Maximum RCS pressure occurs	2408 psia
85.0	Attains new steady-state reactor power level	62%

ARKANSAS NUCLEAR ONE
Unit 2

Table 15.1.7-1

**ASSUMPTIONS FOR THE LOSS OF EXTERNAL
LOAD/LOSS OF CONDENSER VACUUM**

<u>Parameter</u>	<u>Units</u>	<u>Conservative Assumption</u>
Core Power	MWt	2910
Core Inlet Temperature	°F	540
RCS Pressure	psia	2000
RCS Flow	gpm	355,200
Steam Generator Pressure	psia	796
CEA Worth at Trip	% $\Delta\rho$	-5.4
Moderator Temperature Coefficient	$10^{-4} \Delta\rho/^\circ\text{F}$	0.0
Number U-tubes assumed plugged per Steam Generator	----	841
Doppler Coefficient Multiplier	----	0.85
Steam Bypass System	----	Inoperative
Feedwater Regulating System	----	Manual
Tolerance on MSSV Setpoint	%	1
Tolerance on PSV Setpoint	%	1

ARKANSAS NUCLEAR ONE
Unit 2

Table 15.1.7-2

**SEQUENCE OF EVENTS FOR THE LOSS OF
EXTERNAL LOAD/LOSS OF CONDENSER VACUUM**

<u>Time, sec</u>	<u>Event</u>	<u>Setpoint or Value</u>
0	Loss of Condenser Vacuum, Turbine Stop Valves Close, and Main Feedwater Valves Close	-----
7.4	High Pressurizer Pressure Trip Condition Occurs	2422 psia
8.3	Trip Breakers Open	-----
8.4	Pressurizer Safety Valves Open	2525 psia
8.9	CEAs Begin to Drop	-----
9.6	Main Steam Safety Valves Open	1104 psia
10.6	Maximum RCS Pressure Occurs	< 2750 psia
15.1	Peak Secondary Pressure Occurs	< 1210 psia
18.9	Pressurizer Safety Valves Close	2424 psia

Table 15.1.7-3

REMOVED – HISTORICAL DATA

ARKANSAS NUCLEAR ONE
Unit 2

Table 15.1.7-4

**ASSUMPTIONS FOR THE
CYCLE 13 LOSS OF EXTERNAL LOAD/LOSS OF CONDENSER VACUUM**

<u>Parameter</u>	<u>Units</u>	<u>Conservative Assumptions</u>
Initial Core Power Level	(MWt)	2900
RCP Heat	(MWt)	18
Core Inlet Coolant Temperature	(°F)	540
Reactor Coolant System Flow	(10 ⁶ lb _m /hr)	135.3
Reactor Coolant System Pressure	(psia)	2000
Steam Generator Pressure	(psia)	795
Moderator Temperature Coefficient	(10 ⁻⁴ Δρ/°F)	0
Doppler Multiplier	-	0.85
CEA Worth on Trip	(10 ⁻² Δρ)	-5.0
Steam Generator tube Plugging	%	0
Tolerance on MSSV Setpoint	%	3
Tolerance on PSV Setpoint	%	3
Steam Bypass System	-	Inoperative
Feedwater Regulating System	-	Manual

ARKANSAS NUCLEAR ONE
Unit 2

Table 15.1.7-5

**SEQUENCE OF EVENTS FOR THE
CYCLE 13 LOSS OF EXTERNAL LOAD/LOSS OF CONDENSER VACUUM**

<u>Time (sec)</u>	<u>Event</u>	<u>Setpoint or Value</u>
0.0	Loss of Condenser Vacuum, Turbine Stop Valves Close, and Main Feedwater Valves Close	-
8.1	High Pressurizer Pressure Trip Condition Occurs	2422 psia
9.0	Trip Breakers Open	-
9.6	CEAs Begin to Drop	-
9.9	Pressurizer Safety Valves Open	2575 psia
10.5	Maximum RCS Pressure Occurs	2683 psia
11.4	Main Steam Safety Valves Open	1125.5 psia
13.6	Peak Secondary Pressure Occurs	1162 psia
13.9	Pressurizer Safety Valves Close	2472 psia

ARKANSAS NUCLEAR ONE
Unit 2

Table 15.1.7-6

**ASSUMPTIONS FOR CYCLE 15 AT 3026 MWt
LOSS OF EXTERNAL LOAD/LOSS OF CONDENSER VACUUM**

<u>Parameter</u>	<u>Units</u>	<u>Conservative Assumptions</u>
Initial Core Power Level	MWt	3087
RCP Heat	MWt	18
Core Inlet Coolant Temperature	°F	540.0
Reactor Coolant System Flow	gpm	386,400
Pressurizer Pressure*	psia	2000
Steam Generator Pressure	psia	848
Moderator Temperature Coefficient	$10^{-4} \Delta\rho/^\circ\text{F}$	0.0
Fuel Temperature Coefficient	-	BOC
CEA Worth on Trip	$10^{-2} \Delta\rho$	-5.0
Steam Generator Tube Plugging	%	0
Tolerance on MSSV Setpoint	%	3
Tolerance on PSV Setpoint	%	+3.2
Steam Bypass System	-	Inoperative
Feedwater Regulating System	-	Manual

* Does not include RCP head.

ARKANSAS NUCLEAR ONE
Unit 2

Table 15.1.7-7

**SEQUENCE OF EVENTS FOR CYCLE 15 AT 3026 MWt
LOSS OF EXTERNAL LOAD/LOSS OF CONDENSER VACUUM**

<u>Time (seconds)</u>	<u>Event</u>	<u>Setpoint or Value</u>
0.0	Loss of Condenser Vacuum, Turbine Stop Valves Close, Main Feedwater Valves Close	---
7.63	High Pressurizer Pressure Trip Condition Occurs	2392 psia
8.28	Trip Breakers Open	---
8.88	CEAs Begin to Drop	---
9.05	Main Steam Safety Valves Open	1125.48 psia
10.10	Pressurizer Safety Valves Open	2580 psia
10.53	Maximum RCS Pressure Occurs	2688 psia ⁽¹⁾
12.10	Pressurizer Safety Valves Close	2503 psia
17.10	Peak Secondary Side Pressure (Steam Dome)	1180 psia

(1) Includes reactor coolant pump head.

TABLE 15.1.8-1

ASSUMPTIONS FOR THE LOSS OF NORMAL FEEDWATER FLOW

<u>Parameter</u>	<u>Units</u>	<u>Conservative Assumptions</u>
Initial Core Power Level	(MWt)	2900
Core Inlet Coolant Temperature	(°F)	556.7
Core Mass Flow Rate	(10 ⁶ lb _m /hr)	116.2
RCS Pressure	(psia)	2250
Steam Generator Pressure	(psia)	923
Total Nuclear Heat Flux Factor	--	2.35
Moderate Temperature Coefficient	(10 ⁻⁴ Δρ/°F)	+0.5
Doppler Coefficient Multiplier	--	0.85
CEA Worth On Trip	(10 ⁻² Δρ)	-5.4
Steam Bypass System	--	Automatic
Feedwater Regulating System	--	Malfunction

ARKANSAS NUCLEAR ONE
Unit 2

Table 15.1.8-2

PRINCIPAL RESULTS FOR THE LOSS OF NORMAL FEEDWATER FLOW

<u>Time (Sec)</u>	<u>Event</u>	<u>Setpoint or Value</u>
0.0	Termination of Feedwater Flow	-----
13.4	Steam Dump and Bypass System Actuated	959 psia
36.4	Low Steam Generator Water Level Trip Condition	5%
36.4	RCS Pressure Attains Maximum Value	2354 psia
44.8	Steam Generator Pressure Attains Maximum Value	1102 psia
101.4	Emergency Feedwater Reaches Steam Generator	
140.0	RCS Pressure Attains Minimum Value	-----

Table 15.1.8-3

**ASSUMPTIONS FOR THE
CYCLE 13 LOSS OF NORMAL FEEDWATER FLOW**

<u>Parameter</u>	<u>Units</u>	<u>Conservative Assumptions</u>
Initial Core Power Level	(MWt)	2900
RCP Heat	(MWt)	18
Core Inlet Coolant Temperature	(°F)	556.7
Reactor Coolant System Flow	(10 ⁶ lb _m /hr)	108.4
Reactor Coolant System Pressure	(psia)	2000
Steam Generator Pressure	(psia)	922
Moderator Temperature Coefficient	(10 ⁻⁴ Δρ/°F)	-3.5
Doppler Multiplier	-	1.4
CEA Worth On Trip	(10 ⁻² Δρ)	-5.0
Steam Bypass System	-	Automatic
Feedwater Regulating System	-	Malfunction

ARKANSAS NUCLEAR ONE
Unit 2

Table 15.1.8-4

**PRINCIPAL RESULTS FOR THE
CYCLE 13 LOSS OF NORMAL FEEDWATER FLOW**

<u>Time</u>	<u>Event</u>	<u>Setpoint or Value</u>
0.0	Loss of Feedwater Flow	-
18.5	Steam Dump and Bypass Begins to Open	Variable
47.2	Low Steam Generator Water Level Trip Condition	5%
48.5	Trip Breakers Open	-
49.1	CEAs Begin to Drop	-
51.9	Peak RCS Pressure Occurs	2229 psia
53.0	MSSVs Open	1059.9 psia
57.1	Peak Steam Generator Pressure Occurs	1084.5 psia
68.5	MSSVs Close	1006.9 psia
144.6	EFW Begins to Inject	-
203	Minimum Liquid Inventory in Steam Generator A	-
260.5	Minimum Liquid Inventory in Steam Generator B	-

ARKANSAS NUCLEAR ONE
Unit 2

Table 15.1.8-5

**ASSUMPTIONS FOR CYCLE 15 AT 3026 MWt
LOSS OF NORMAL FEEDWATER FLOW**

<u>Parameter</u>	<u>Units</u>	<u>Conservative Assumptions</u>
Initial Core Power Level	MWt	3087
RCP Heat	MWt	18
Core Inlet Coolant Temperature	°F	556.7
Reactor Coolant System Flow	gpm	315,560
Pressurizer Pressure*	psia	2000
Steam Generator Pressure	psia	1000
Moderator Temperature Coefficient	$10^{-4} \Delta\rho/^\circ\text{F}$	-3.8
Fuel Temperature Coefficient	-	EOC
CEA Worth on Trip	$10^{-2}\Delta\rho$	-5.0
Steam Bypass System	-	Automatic
Feedwater Regulating System	-	Malfunction

* Does not include RCP head.

ARKANSAS NUCLEAR ONE
Unit 2

TABLE 15.1.8-6

**SEQUENCE OF EVENTS FOR CYCLE 15 AT 3026 MWt
LOSS OF NORMAL FEEDWATER FLOW**

<u>Time (seconds)</u>	<u>Event</u>	<u>Setpoint or Value</u>
0.0	LOFW occurs	-
27.4	Steam Dump and Bypass Begins to Open	-
49.2	Low Steam Generator Level Trip Condition Occurs	9% of NR
50.5	Trip Breakers Open	-
51.1	CEAs Begin to Drop, MSSVs Open	- 1054.45 psia
53.5	Peak RCS Pressure Occurs	2153 psia
54.5	Peak Steam Generator Pressure Occurs	1091 psia
89.3	MSSVs Close	1002
146.6	EFW Begins to Inject	-
212.0	Minimum Liquid Inventory in Steam Generator A	-
288.0	Minimum Liquid Inventory in Steam Generator B	-

ARKANSAS NUCLEAR ONE
Unit 2

Table 15.1.9-1

**ASSUMPTIONS FOR THE LOSS OF ALL NORMAL AC
POWER TO THE STATION AUXILIARIES**

<u>Parameter</u>	<u>Units</u>	<u>Conservative Assumptions</u>
Initial Core Power Level	(MWT)	2900
Core Inlet Coolant Temperature	(°F)	556.7
Core Mass Flow Rate	(106lbm/hr)	116.2
RCS Pressure	(psia)	2250
Steam Generator Pressure	(psia)	923
Total Nuclear Heat Flux Factor	--	2.35
Moderate Temperature Coefficient	($10^{-4}\Delta\rho/^\circ\text{F}$)	+0.5
Doppler Coefficient Multiplier	--	0.85
CEA Worth On Trip	($10^{-2}\Delta\rho$)	-5.4
Steam Bypass System	--	Inoperative
Feedwater Regulating System	--	Inoperative

ARKANSAS NUCLEAR ONE
Unit 2

Table 15.1.9-2

**SEQUENCE OF EVENTS FOR THE LOSS OF NORMAL AND
PREFERRED AC POWER TO THE STATION AUXILIARIES**

<u>Time (sec)</u>	<u>Event</u>	<u>Setpoint or Valve</u>
0.0	Loss of power to station auxiliaries	---
0.60	Low DNBR trip condition	See Section 15.1.0
0.75	Trip breakers open	---
1.05	Shutdown CEAs begin to drop into core	---
2.72	Minimum DNBR occurs	1.3
3.7	Steam generator safety valves start to open	1078.0 psia
5.7	Maximum RCS pressure occurs	2354 psia
35.0	Automatic emergency feedwater initiated	---
400.0	Reactor reaches approximate steady state condition with main steam safety valves dissipating decay heat	---
900.0	Operator activates the remotely-operated atmospheric dump valves	---
~2700.0	Operator regulates steam generator pressure to 1000 psia	---

ARKANSAS NUCLEAR ONE
Unit 2

Table 15.1.10-1

ASSUMPTIONS FOR THE FEEDWATER SYSTEM MALFUNCTION

<u>Parameter</u>	<u>Units</u>	<u>Conservative Assumptions</u>
Initial Core Power Level	(Mwt)	2900
Core Inlet Coolant Temperature	(°F)	556.7
Core Mass Flow Rate	(10 ⁶ lbm/hr)	119.9
RCS Pressure	(psia)	2250
Steam Generator Pressure	(psia)	917
Total Nuclear Heat Flux Factor	----	2.35
Moderator Temperature Coefficient	(10 ⁻⁴ Δρ/°F)	-3.5
Doppler Coefficient Multiplier	----	0.85
CEA Worth on Trip	(10 ⁻² Δρ)	-5.4
Steam Bypass System	----	Automatic
Feedwater Regulation System	----	Malfunction
Feedwater Energy Reduction	(Btu/lb)	96.6

ARKANSAS NUCLEAR ONE
Unit 2

Table 15.1.10-2

ASSUMPTIONS FOR THE STEAM BYPASS SYSTEM MALFUNCTION

<u>Parameter</u>	<u>Units</u>	<u>Conservative Assumptions</u>
Initial Core Power Level	(MWt)	2900
Core Inlet Coolant Temperature	(°F)	556.7
Core Mass Flow Rate	(10 ⁶ lbm/hr)	116.2
RCS Pressure	(psia)	2250
Steam Generator Pressure	(psia)	923
Total Nuclear Heat Flux Factor	----	2.35
Moderator Temperature Coefficient	(10 ⁻⁴ Δρ/°F)	-3.5
Doppler Coefficient Multiplier	----	0.85
CEA Worth on Trip	(10 ⁻² Δρ)	-5.4
Steam Bypass System	----	Malfunction
Feedwater Regulating System	----	Manual

ARKANSAS NUCLEAR ONE
Unit 2

Table 15.1.10-3A

**SEQUENCE OF EVENTS FOR FEEDWATER SYSTEM MALFUNCTION
INVOLVING 160% FEEDWATER FLOW TO BOTH STEAM GENERATORS**

<u>Time (sec)</u>	<u>Event</u>	<u>Setpoint or Value</u>
0.0	Failure occurs in the Feedwater Control System	----
0.001	Feedwater Flow to One Steam Generator Increases Generator Increases to 160%. Enthalpy of Feedwater to Affected Steam Generator Drops From 433 BTU/lbm to 336.5 BTU/lbm	----
10.8	High Power Level Trip	116%
10.9	Dump Valves Open	----
11.1	CEAs Begin to Fall	----
11.3	Maximum Core Power	117%
--	Minimum DNBR	1.405
30.5	Dump Valves Close	----

Table 15.1.10-3B

**SEQUENCE OF EVENTS FOR FEEDWATER SYSTEM MALFUNCTION
INVOLVING 160% FEEDWATER FLOW TO ONE STEAM GENERATOR**

<u>Time (sec)</u>	<u>Event</u>	<u>Setpoint or Value</u>
0.0	Failure occurs in the Feedwater Control System	----
0.001	Feedwater Flow to One Steam Generator Increases to 160%. Enthalpy of Feedwater to Affected Steam Generator Drops From 433 BTU/lbm to 336.5 BTU/lbm	----
20.0	Reactor Trip on High Steam Generator Level should occur (not credited in analysis)	93.7%
20.8	Minimum RCS Pressure	2223 Psia
34.8	Minimum RCS Inlet Temperature	551°F
37.6	Maximum Core Power	115.8%
--	Minimum DNBR	1.447

ARKANSAS NUCLEAR ONE
Unit 2

Table 15.1.10-4

SEQUENCE OF EVENTS FOR THE STEAM BYPASS SYSTEM MALFUNCTION ACCIDENT

<u>Time (sec)</u>	<u>Event</u>	<u>Setpoint or Value</u>
0.0	One atmospheric dump valve opens	
43.1	Maximum power	111 percent of 2900 Mwt
53.6	Maximum heat flux	111 percent of full power
329.6	Low steam generator water level trip condition between high and low water level taps	Five percent distance
330.5	Trip breakers open	
330.8	Shutdown CEAs begin to drop into core	
331.7	Maximum RCS pressure	2246.2 psia
335.1	Steam generator safety valves open	1030 psia
380.0	Steam generator safety valves close	980 psia
406.5	Pressurizer emptied, safety injection pumps started	1600 psia
480.0	Boron reaches midplane °F	----
495.7	Low steam generator pressure signal, MSIS initiated	678 psia
498.8	MSIVs fully closed	----
1313.7	Minimum RCS Pressure	542 psia
1800.0	Operator assumes control of plant	----

ARKANSAS NUCLEAR ONE
Unit 2

Table 15.1.10-5

**ASSUMPTIONS FOR CYCLE 15 AT 3026 MWt
FEEDWATER SYSTEM MALFUNCTION**

<u>Parameter</u>	<u>Units</u>	<u>Conservative Assumptions</u>
Initial Core Power Level	MWt	3087
RCP Heat	MWt	10
Core Inlet Coolant Temperature	°F	556.7
Reactor Coolant System Flow	gpm	315,560
Pressurizer Pressure*	psia	2300
Steam Generator Pressure	psia	1003
Moderator Temperature Coefficient	$10^{-4} \Delta\rho/^\circ\text{F}$	-3.8
Fuel Temperature Coefficient	-	BOC
CEA Worth on Trip	$10^{-2} \Delta\rho$	-5.0
Steam Bypass System	-	Automatic
Feedwater Regulating System	-	Malfunction
Feedwater Energy Reduction	BTU/lbm	152

* Does not include RCP head.

ARKANSAS NUCLEAR ONE
Unit 2

TABLE 15.1.10-6
SEQUENCE OF EVENTS FOR CYCLE 15 AT 3026 MWt
FEEDWATER SYSTEM MALFUNCTION

<u>Time (seconds)</u>	<u>Event</u>	<u>Setpoint or Value</u>
0.0	Failure Occurs in Feedwater Control System	-
0.5	Symmetric Feedwater Flow to Both SGs Increases to Approximately 160%	-
18.2	CPC VOPT Condition Occurs	112%
18.8	Trip Breakers Open	-
19.4	CEAs Begin to Drop	-
19.5	Maximum Core Power Occurs, Minimum WSSV-T / ABB-NV DNBR*	114% >1.23
19.9	Dump Valves Fully Open	-
28.3	Dump Valves Begin to Close	-

* For Cycle 21, the WSSV-T / ABB-NV CHF correlations and a DNB SAFDL of 1.23 were applied due to the implementation of a full core of NGF.

TABLE 15.1.10-7
ASSUMPTIONS FOR CYCLE 15 AT 3026 MWt
STEAM BYPASS SYSTEM MALFUNCTION

<u>Parameter</u>	<u>Units</u>	<u>Conservative Assumptions</u>
Initial Core Power Level	MWt	3087
RCP Heat	MWt	10
Core Inlet Coolant Temperature	°F	556.7
Reactor Coolant System Flow	gpm	315,560
Pressurizer Pressure*	psia	2300
Steam Generator Pressure	psia	1003
Moderator Temperature Coefficient	$10^{-4} \Delta\rho/^\circ\text{F}$	-3.8
Fuel Temperature Coefficient	-	BOC
CEA Worth on Trip	$10^{-2} \Delta\rho$	-5.0
Steam Bypass System	-	Malfunction
Feedwater Regulating System	-	Manual

* Does not include RCP head.

ARKANSAS NUCLEAR ONE
Unit 2

Table 15.1.10-8

**SEQUENCE OF EVENTS FOR CYCLE 15 AT 3026 MWt
STEAM BYPASS SYSTEM MALFUNCTION**

<u>Time (seconds)</u>	<u>Event</u>	<u>Setpoint or Value</u>
0.0	One Atmospheric Dump Valve Opens	-
17.9	CPC VOPT Condition Occurs	112%
18.5	Trip Breakers Open	-
19.1	CEAs Begin to Drop	-
19.3	Maximum Core Power Occurs, Minimum WSSV-T / ABB-NV DNBR*	112% of rated >1.23
21.5	Peak RCS Pressure Occurs	2247 psia
23.5	Steam Generator Safety Valves Open	1054 psia
24.9	Peak Steam Generator Pressure Occurs	1086 psia
40.2	Steam Generator Safety Valves Close	1002 psia
55.1	Pressurizer Emptied, SIAS Setpoint Achieved	1400 psia
119.1	Boron Reaches Injection Nozzle	-
188.3	Low Steam Generator Pressure, MSIS Initiated	693 psia
193.2	Main Steam Isolation Valves Fully Closed	-
209.5	Minimum RCS Pressure	887 psia
214.7	Main Feedwater Isolation Valves Fully Closed	-
1800	Operator Assumes Control of Plant	-

* For Cycle 21, the WSSV-T / ABB-NV CHF correlations and a DNB SAFDL of 1.23 were applied due to the implementation of a full core of NGF.

ARKANSAS NUCLEAR ONE
Unit 2

Table 15.1.13-1

ASSUMPTIONS FOR DESIGN BASIS LOSS OF COOLANT-ACCIDENT

<u>Parameter/Assumption</u>	<u>Assumed Value</u>
Reactor Power	3086.52 MWt (102% Rated Power)
Percent of Core Noble Gases Released	100%
Percent of Core Iodine Released	40%
Iodine Species Distribution	4.85% Elemental 95% Particulate 0.15% Organic
Containment Free Volume	1.78 E6 ft ³
Sump Water Volume	62898 ft ³
Sprayed Volume	1.388 E6 ft ³
Unsprayed Volume	3.92 E5 ft ³
Mixing Rates Between Sprayed and Unsprayed Regions	11880 CFM
Spray Removal Rates	
Elemental Iodine	20/hour prior to recirculation 0/hour during first 11 min of recirculation 10/hour up to Decontamination Factor (DF) of 200 0/hour after DF = 200
Particulate Iodine	3.97/hour prior to recirculation 4.24/hour during recirculation up to DF of 50 0.424/hour until DF=1000 DF = 1000 0/hour after DF = 1000
Organic Iodine	No Removal
Containment Leak Rate	0.1%/day from 0 to 24 hours 0.05%/day after 24 hours
Release Point	Ground Level
Dose Conversion Factors	From FGR 11 & 12
Percent of Released Iodine in Sump During Recirculation (for ESF leakage calculation)	100%

ADDITIONAL CONTROL ROOM DOSE ASSUMPTIONS

Dispersion Coefficients, χ/Q	
0 to 2 hours	9.77 E-4 sec/m ³
2 to 8 hours	5.76 E-4 sec/m ³
8 to 24 hours	2.56 E-4 sec/m ³
1 to 4 days	1.69 E-4 sec/m ³
4 to 30 days	1.28 E-4 sec/m ³
Control Room Volume	40,000 ft ³
Control Room Unfiltered Inleakage	250 CFM
Control Room Filtered Inflow	333 CFM*
Control Room Recirculation Flow	1667 CFM*
Intake Filter Efficiency	99%
Recirculation Filter Efficiency	
Elemental & Organic	95%
Particulate	99%
Occupancy Factors	
0 to 24 hours	1.0
1 to 4 days	0.6
4 to 30 days	0.4
Breathing Rate	3.5 E-4 m ³ /sec

* Limiting case is VSF-9 in operation with 333 cfm outside air.

ARKANSAS NUCLEAR ONE
Unit 2

Table 15.1.13-2

LOSS OF COOLANT ACCIDENT DOSES

<u>Location/Dose Component</u>	<u>Dose (Rem TEDE)</u>
<u>2 Hour Exclusion Area Boundary Doses</u>	
Containment Release	9.350
ESF Leakage	0.174
Total	9.524
<u>30 Day Low Population Zone Doses</u>	
Containment Release	0.654
ESF Leakage	0.055
Total	0.709
<u>Control Room Doses</u>	
Containment Release	1.708
ESF Leakage	0.274
Cloud Shine	0.008
Containment Shine	0.106
Total	2.096

Table 15.1.13-3

RELEASE FRACTIONS AND TIMING

<u>Phase</u>	<u>Timing</u>	<u>Fraction</u>
Gap Release	30 sec – 0.5 hrs	0.05 for noble gases
		0.05 for halogens
		0.05 for alkali metals
Early In-Vessel Release	0.5 – 1.8 hrs	0.95 noble gases
		0.35 halogens
		0.25 alkali metals
		0.05 tellurium metals
		0.02 strontium and barium
		0.0025 noble metals
		0.0005 cerium group
0.0002 lanthanides		

ARKANSAS NUCLEAR ONE
Unit 2

Table 15.1.14-1

**AVERAGE MOISTURE CARRYOVER FOR
VARIOUS STEAM GENERATOR CONDITIONS**

<u>Initial Condition</u>	<u>Effective Break Area</u>	<u>Average Moisture Carryover Fraction Ruptured Steam Generator</u>	<u>Average Moisture Carryover Fraction Intact Steam Generator</u>
Full Load	6.3 ft ²	0.65	0.41
	2.0 ft ²	0.0	0.0
No Load	6.3 ft ²	0.77	0.41
	1.0 ft ²	0.0	0.0
No Load (Outside Containment)	2.49 ft ²	0.64	0.41

Table 15.1.14-2

ASSUMPTIONS FOR STEAM LINE BREAK ANALYSIS

<u>Parameter</u>	<u>Conservative Assumptions</u>	
	<u>Full Load 2-Loop/1-Loop</u>	<u>No Load 2-Loop/1-Loop</u>
Initial Core Power Level, Mwt	2900/1277	1.0
Core Inlet Coolant Temperature, °F	556.7/559.4	547.6
Core Flow Rate 10 ⁶ lbm/hr	116.2/53.7	116.2/53.7
SG Pressure, psia	932/963 (AL), 952 (IL)*	1025
RCS Pressure, psia	2250	2250
Total Nuclear Heat Flux Factor	2.35/2.11	4.60
Moderator Temperature Coefficient Multiplier	1.1	1.1
Doppler Coefficient Multiplier	1.15	0.85
CEA Worth at Trip, 10 ⁻² Δρ	-5.8	-2.4
Feedwater Regulating System	Automatic	Manual

* AL = Active Loop, IL = Inactive Loop

ARKANSAS NUCLEAR ONE
Unit 2

Tables 15.1.14-3 through 15.1.14-10

REMOVED - HISTORICAL DATA - SEE FSAR

Table 15.1.14-11

SEQUENCE OF EVENTS FOR THE STEAM LINE BREAK ACCIDENT (NO LOAD,
ONE-LOOP CONDITION, RUPTURE OUTSIDE CONTAINMENT)

<u>Time (sec)</u>	<u>Event</u>	<u>Setpoint Or Value</u>
0.0	Initiation of break	--
5.5	Low steam generator pressure trip and MSIS initiated	678 psia
6.4	Trip breakers open and main steam isolation valves begin to close	--
6.7	Shutdown CEAs begin to drop into core	--
11.4	Complete closure of main steam isolation valves terminating blowdown from the steam generator connected to the intact steam line	--
20.4	Pressurizer empties and SIAS initiated	1600 psia
35.4	Affected steam generator empties	--
41.0	Peak total transient reactivity	-0.2% $\Delta\rho$
124.0	Minimum RCS pressure	633 psia

ARKANSAS NUCLEAR ONE
Unit 2

Table 15.1.14-12

**SEQUENCE OF EVENTS FOR THE
STEAM LINE BREAK ACCIDENT WITH LOSS OF AC POWER
(FULL LOAD, TWO-LOOP INITIAL CONDITION, SMALL BREAK)**

<u>Time (sec)</u>	<u>Event</u>	<u>Setpoint or Value</u>
0.0	Initiation of break	--
0.6	Low DNBR trip signal	--
0.75	Trip breakers open	--
1.05	Shutdown CEAs begin to drop into core	--
2.72	Minimum DNBR occurs	1.3
13.0	MSIS initiated on low steam generator pressure signal	678 psia
13.9	Main steam isolation valves begin to close	--
18.9	Complete closure of main steam isolation valves terminating blowdown from the steam generator connected to the intact steam line	--
21.0	Pressurizer empties and SIAS initiated	1600 psia
237.0	Peak total transient reactivity	-0.15% $\Delta\rho$
291.0	Affected steam generator empties	--
535.0	Minimum RCS pressure	660 psia

ARKANSAS NUCLEAR ONE
Unit 2

Table 15.1.14-13

**SEQUENCE OF EVENTS FOR THE
STEAM LINE BREAK ACCIDENT WITH LOSS OF AC POWER
(NO LOAD, ONE-LOOP INITIAL CONDITION, SMALL BREAK)**

<u>Time (sec)</u>	<u>Event</u>	<u>Setpoint or Value</u>
0.0	Initiation of break	--
28.0	Peak total transient reactivity before trip	0.37% $\Delta\rho$
28.5	Low steam generator pressure trip and MSIS initiated	678 psia
29.4	Trip breakers open and main steam isolation valves begin to close	--
29.7	Shutdown CEAs begin to drop into core	--
32.0	Peak transient heat flux prior to complete insertion of CEAs	7.0% of heat flux at 2900 MWt
34.4	Complete closure of main steam isolation valves terminating blowdown from the steam generator connected to the intact steam line	--
62.0	Pressurizer empties and SIAS initiated	1600 psia
138.0	Peak total transient reactivity	0.24% $\Delta\rho$
180.0	Minimum RCS pressure	735 psia
495.0	Peak transient heat flux after trip	5% of heat flux at 2900 MWt
495.0	RCS pressure	787 psia
495.0	Macbeth DNBR	> 2.0
595.0	Affected steam generator empties	--

ARKANSAS NUCLEAR ONE
Unit 2

Table 15.1.14-14

**SEQUENCE OF EVENTS FOR THE STEAM LINE BREAK ACCIDENT WITH AC POWER
(FULL LOAD, TWO-LOOP INITIAL CONDITION, NOZZLE BREAK,
WITHOUT MOISTURE CARRYOVER)**

<u>Time (sec)</u>	<u>Event</u>	<u>Setpoint or Value</u>
0.0	Initiation of break	--
1.4	Steam generator low pressure trip and MSIS initiated	678 psia
2.3	Trip breakers open and main steam isolation valves begin to close	--
2.6	Shutdown CEAs begin to drop into core	--
5.3	Complete closure of main steam isolation valves terminating blowdown from the intact steam generator	--
6.5	Feedwater flow to the intact steam generator terminates	--
13.2	Pressurizer empties and SIAS initiated	1600 psia
26.5	Feedwater flow to the affected steam generator terminates	--
57.0	Affected steam generator empties	--
59.7	Peak reactivity occurs	-0.073% $\Delta\rho$
60.4	Peak return-to-power occurs	18.3%
61.6	Peak return-to-power heat flux occurs	17.4%
61.6	RCS pressure	659 psia
61.6	Macbeth DNBR	> 2.9

ARKANSAS NUCLEAR ONE
Unit 2

Table 15.1.14-15

**SEQUENCE OF EVENTS FOR THE STEAM LINE BREAK ACCIDENT
WITHOUT AC POWER (FULL LOAD, TWO-LOOP INITIAL CONDITION,
NOZZLE BREAK, WITHOUT MOISTURE CARRYOVER)**

<u>Time (sec)</u>	<u>Event</u>	<u>Setpoint or Value</u>
0.0	Initiation of break	--
0.6	Low DNBR trip signal occurs	--
0.75	Trip breakers open	--
1.05	Shutdown CEAs being to drop into core	--
1.5	MSIS initiated on steam generator low pressure signal	678 psia
2.4	Main steam isolation valves begin to close	--
5.4	Complete closure of main steam isolation valves terminating blowdown from the intact steam generator	--
15.0	Pressurizer empties and SIAS initiated	1600 psia
74.0	Peak reactivity occurs	+0.023% $\Delta\rho$
88.6	Affected steam generator liquid inventory depleted and beginning of blowdown of feedwater only	--
96.2	Peak return-to-power occurs	30.8%
99.0	Peak return-to-power flux occurs	29.9%
99.0	RCS pressure	1094 psia
99.0	Macbeth DNBR	1.4
152.0	Feedwater flow to affected steam generator terminates	--

ARKANSAS NUCLEAR ONE
Unit 2

Table 15.1.14-16

**SEQUENCE OF EVENTS FOR THE STEAM LINE BREAK ACCIDENT
WITH AC POWER (NO LOAD, TWO-LOOP INITIAL CONDITION, NOZZLE BREAK,
WITHOUT MOISTURE CARRYOVER)**

<u>Time (sec)</u>	<u>Event</u>	<u>Setpoint or Value</u>
0.0	Initiation of break	--
1.9	Steam generator low pressure trip and MSIS initiated	678 psia
2.8	Trip breakers open and main steam isolation valves begin to close	--
3.1	Shutdown CEAs being to drop into core	--
5.8	Complete closure of main steam isolation valves terminating blowdown from the intact steam generator	--
12.0	Pressurizer empties and SIAS initiated	1600 psia
85.0	Peak reactivity occurs	0.34% $\Delta\rho$
88.0	Affected steam generator empties	--
92.1	Peak return-to-power occurs	21.3%
94.2	Peak return-to-power heat flux occurs	16.9%
94.2	RCS pressure	332 psia
94.2	Macbeth DNBR	> 2.0

ARKANSAS NUCLEAR ONE
Unit 2

Table 15.1.14-17

**SEQUENCE OF EVENTS FOR THE STEAM LINE BREAK ACCIDENT WITHOUT AC POWER
(NO LOAD, TWO-LOOP INITIAL CONDITION, NOZZLE BREAK,
WITHOUT MOISTURE CARRYOVER)**

<u>Time (sec)</u>	<u>Event</u>	<u>Setpoint or Value</u>
0.0	Initiation of break	--
1.9	Steam generator low pressure trip and MSIS initiated	678 psia
2.8	Trip breakers open and main steam isolation valves begin to close	--
3.1	Shutdown CEAs begin to drop into core	--
5.8	Complete closure of main steam isolation valves terminating blowdown from the intact steam generator	--
14.0	Pressurizer empties and SIAS initiated	1600 psia
66.6	Peak reactivity occurs	0.43% $\Delta\rho$
68.3	Peak return-to-power occurs	43.2%
105.2	Peak return-to-power heat flux occurs	25.3%
105.2	RCS pressure	788 psia
105.2	Macbeth DNBR	> 1.4
169.7	Affected steam generator empties	--

ARKANSAS NUCLEAR ONE
Unit 2

Table 15.1.14-18

ASSUMPTION FOR FEEDWATER LINE BREAK ANALYSIS

<u>Parameter</u>	<u>Conservative Assumptions</u>
Initial Core Power Level, MWt	2900
Core Inlet Coolant Temperature, °F	556.7
Core Flow Rate, 10 ⁶ lbm/hr	116.2
Steam Generator Pressure, psia	923
RCS Pressure, psia	2200
Total Nuclear Heat Flux Factor	2.35
Moderator Temperature Coefficient (10 ⁻⁴ Δρ/°F)	0.5
Doppler Coefficient Multiplier	0.85
CEA Worth at Trip, 10 ⁻² Δρ	-5.4
Pressurizer Code Safety Valve Setpoint, psia	2500

ARKANSAS NUCLEAR ONE
Unit 2

Table 15.1.14-19

**SEQUENCE OF EVENTS FOR THE FEEDWATER LINE BREAK
ACCIDENT WITH AC AVAILABLE**

<u>Time (sec)</u>	<u>Event</u>	<u>Setpoint or Value</u>
0.0	Initiation of rupture	--
28.0	Turbine bypass valves open	--
57.6	Affected steam generator empties and steam generator low pressure trip signal occurs	678 psia
57.6	High pressurizer pressure trip signal occurs	2422 psia
57.6	Low steam generator water level signal occurs in intact steam generator	5% of lower instrument range
58.5	Trip breakers open	--
58.8	Shutdown CEAs begin to drop into core	--
62.2	Peak RCS pressure occurs	2576 psia
96.3	Intact steam generator empties	--
123.5	Emergency feedwater enters intact steam generator	--
157	RCS Pressure	2281 psia

ARKANSAS NUCLEAR ONE
Unit 2

Table 15.1.14-20

**SEQUENCE OF EVENTS FOR THE FEEDWATER LINE BREAK
ACCIDENT WITH LOSS OF AC**

<u>Time (Sec)</u>	<u>Event</u>	<u>Setpoint or Value</u>
0.0	Initiation of Rupture	----
28.0	Turbine Bypass Valves Open	----
57.6	Affected Steam Generator Empties	----
57.6	High Pressurizer Pressure Trip Signal Occurs	2422 psia
57.6	Low Steam Generator Water Level Signal Occurs in Intact Steam Generator	5% of lower instrument range
57.6	AC Power Is Lost	----
58.5	Trip Breakers Open	----
58.8	Shutdown CEAS Begin To Drop Into Core	----
62.6	Peak RCS Pressure Occurs	2635 psia
91.4	Intact Steam Generator Empties	----
175.7	Emergency Feedwater Enters Intact Steam Generator	-----

ARKANSAS NUCLEAR ONE
Unit 2

Table 15.1.14-21

**STEAM GENERATOR LIQUID INVENTORIES
FOR FEEDWATER LINE BREAK ACCIDENT WITH AC POWER AVAILABLE**

STEAM GENERATOR LIQUID INVENTORY (LBM)

<u>TIME (Sec)</u>	<u>RUPTURED STEAM GENERATOR</u>	<u>INTACT STEAM GENERATOR</u>
0.0	181610	181610
5.0	167410	170490
10.0	151840	160350
20.0	120620	140020
28.0	95500	123650
40.0	57019	98217
45.0	40186	86977
52.0	17867	72088
57.6	0	58000
62.0	0	48357
72.0	0	32516
82.0	0	17732
96.3	0	0

Table 15.1.14-22

**STEAM GENERATOR LIQUID INVENTORIES FOR
FEEDWATER LINE BREAK ACCIDENT WITH LOSS OF AC POWER**

STEAM GENERATOR LIQUID INVENTORY (LBM)

<u>TIME (Sec)</u>	<u>RUPTURED STEAM GENERATOR</u>	<u>INTACT STEAM GENERATOR</u>
0.0	181610	181610
5.0	167410	170490
10.0	151840	160350
20.0	120620	140020
28.0	95500	123650
40.0	57019	98217
52.0	17867	72088
57.6	0	58000
62.0	0	47771
72.0	0	28345
82.0	0	12275
91.4	0	0

ARKANSAS NUCLEAR ONE
Unit 2

Table 15.1.14-23

ASSUMPTIONS FOR THE CYCLE 3 FEEDWATER LINE BREAK ANALYSIS

<u>Parameter</u>	<u>Conservative Assumption</u>
Initial Core Power Level, MWt	2900
Core Inlet Coolant Temperature, °F	556.7
Core Flow Rate, 10 ⁶ lbm/hr	115.5
Steam Generator Pressure, psia	949
RCS Pressure, psia	2300
Total Nuclear Heat Flux Factor	2.35
Moderator Temperature Coefficient, 10 ⁻⁴ Δρ/°F	0.0
Doppler Coefficient Multiplier	0.85
CEA Worth at Trip, 10 ⁻² Δρ	-6.8
Pressurizer Safety Valve Setpoint, psia	2525

ARKANSAS NUCLEAR ONE
Unit 2

Table 15.1.14-24

**ASSUMPTIONS FOR THE
CYCLE 13 FEEDWATER LINE BREAK ANALYSIS**

<u>Parameter</u>	<u>Units</u>	<u>Conservative Assumptions</u>
Initial Core Power Level	(MWt)	2900
RCP Heat	(MWt)	18
Core Inlet Coolant Temperature	(°F)	556.7
Reactor Coolant System Flow	(10 ⁶ lb _m /hr)	120.4
Reactor Coolant System Pressure	(psia)	2005
Steam Generator Pressure	(psia)	910
Moderator Temperature Coefficient	(10 ⁻⁴ Δρ/°F)	0
Doppler Multiplier	-	0.85
CEA Worth on Trip	(10 ⁻² Δρ)	-5.0
Steam Generator Tube Plugging	%	0
Tolerance on MSSV Setpoint	%	3
Tolerance on PSV Setpoint	%	3

ARKANSAS NUCLEAR ONE
Unit 2

Table 15.1.14-25

**SEQUENCE OF EVENTS FOR THE CYCLE 13 FEEDWATER LINE BREAK ACCIDENT
WITH LOSS OF AC**

<u>Time, sec</u>	<u>Event</u>	<u>Setpoint or Value</u>
0.0	Rupture of the Main Feedwater Line	----
44.3	Low Steam Generator Water Level Trip Condition on Intact Steam Generator Occur	5%
	Actuation of the Emergency Feedwater Signal	----
	Downcomer Empties on Ruptured Steam Generator	----
44.7	High Pressurizer Pressure Trip Condition	2422 psia
45.6	Trip Breakers Open, Loss of AC Power Occurs, RCPs Begin Coasting Down	----
46.2	CEAs Begin to Drop	----
46.5	Pressurizer Safety Valves Start to Open	2575 psia
48.8	Main Steam Safety Valves Open on the Intact Steam Generator	1125.5 psia
49.2	Main Steam Safety Valves Open on the Affected Steam Generator	1125.5 psia
49.2	Maximum RCS Pressure Occurs	2730.1 psia
53.0	Pressurizer Safety Valves Close	2472 psia
58.0	Affected SG Goes Dry	----
61.0	Main Steam Safety Valves Close on the Affected Steam Generator	1069 psia
76.0	Main Steam Safety Valves Close on the Intact Steam Generator	1069 psia
233.1	Steam Generator Low Pressure Trip Condition and MSIS Initiated	620 psia
234.4	Main Steam Isolation Valves Begin to Close	----
237.4	Complete Closure of Main Steam Isolation Valves Terminating Blowdown from the Intact Steam Generator	----
269.4	Emergency Feedwater Enters Intact Steam Generator	----
270.0	Minimum Liquid Mass in the Steam Generator Connected to Intact Feedline	9197 lbm
448.0	Main Steam Safety Valves Open on the Intact Steam Generator (Begin Cycling, Long Term)	1125.5 psia
600.0	Case Terminated	----

ARKANSAS NUCLEAR ONE
Unit 2

Table 15.1.14-26

ASSUMPTIONS FOR CYCLE 12 STEAM LINE BREAK ANALYSIS FULL LOAD

<u>Parameter</u>	<u>Units</u>	<u>Assumed Value</u>
Initial Core Power Level	MWt	2918
Initial Core Coolant Inlet Temperature	°F	556.7
Initial Reactor Coolant Flow	GPM	322,000
Initial Reactor Coolant System Pressure	psia	2300
CEA Worth at Trip	% $\Delta\rho$	-8.25/-8.0*
Initial Steam Generator Pressure	psia	948
Doppler Coefficient	--	1.29
MTC	$10^{-4}\Delta\rho/^\circ\text{F}$	-3.4
Feedwater Regulating System	--	Automatic

* The value -8.25 is for the HFP case with the loss of AC, whereas the value -8.0 is for the HFP case with AC available.

Table 15.1.14-27

ASSUMPTIONS FOR CYCLE 12 STEAM LINE BREAK ANALYSIS NO LOAD

<u>Parameter</u>	<u>Units</u>	<u>Assumed Value</u>
Initial Core Power Level	MWt	29
Initial Core Coolant Inlet Temperature	°F	552
Initial Reactor Coolant Flow	GPM	322,000
Initial Reactor Coolant System Pressure	psia	2300
CEA Worth at Trip	% $\Delta\rho$	-6.0
Initial Steam Generator Pressure	psia	1053
Doppler Coefficient	--	1.29
MTC	$10^{-4}\times\Delta\rho/^\circ\text{F}$	-3.4
Feedwater Regulating System	--	Manual

ARKANSAS NUCLEAR ONE
Unit 2

Table 15.1.14-28

**SEQUENCE OF EVENTS FOR THE CYCLE 12 STEAM LINE BREAK EVENT
WITH LOSS OF AC, 1 HPSI PUMP, HFP**

<u>Time, sec</u>	<u>Event</u>	<u>Setpoint or Value</u>
0.0	Steam Line Break Occurs, Loss of AC Power Occurs, RCPs Begin Coasting Down	----
0.75	CPC Low RCP Pump Speed Trip Signal generated, fraction	0.95
1.75	Trip Breaker Open	----
2.16	MSIS Initiation Setpoint has been reached, psia	620
3.46	MSIV's Begin to Close	----
3.56	MFIV Begin to Close	----
5.8	The Intact SG Level Reaches EFW Actuation Analysis Setpoint, % of Narrow Range	35.0
6.46	Complete Closure of MSIV	----
30.8	EFW Enters Intact SG Via Steam Driven Pump	----
34.4	Pressurizer Empties	----
38.56	Complete Closure of MFIV	----
60.6	SIAS Analysis Setpoint is Reached, psia	1400
93.8	EFW to Intact SG Is Increased Via Motor Driven Pump	----
100.6	SIAS Pumps Reach Full Speed	----
165.0	Boron Enters RCS	----
191.2	Ruptured Steam Generator Empties, Liquid Inventory, lbm	< 2500
207.5	Maximum Post-trip Reactivity, % $\Delta\rho$	-0.044
209.0	Max Post-trip fission power, % of 2815 MWt	1.9
1800.0	Operator Initiates Cooldown	----

ARKANSAS NUCLEAR ONE
Unit 2

Table 15.1.14-29

**SEQUENCE OF EVENTS FOR THE CYCLE 12 STEAM LINE BREAK EVENT
WITH AC AVAILABLE, 2 HPSI PUMPS, HFP**

<u>Time, sec</u>	<u>Event</u>	<u>Setpoint or Value</u>
0.0	Steam Line Break Occurs	----
2.16	Steam Generator Low Pressure Trip Condition and MSIS Initiation setpoint, psia	620
3.36	Trip Breaker Open	----
3.47	MSIV's Begin to Close, Backup MFIV Begin to Close	----
5.7	The Intact SG Level Reaches EFW Actuation Analysis Setpoint, % of Narrow Range	35.0
6.47	Complete Closure of MSIVs	----
18.96	Complete Closure of Backup MFIV	----
30.7	EFW Enters Intact SG Via Steam Driven Pump	----
33.6	Pressurizer Empties	----
52.1	SIAS Analysis Setpoint is Reached, psia	1400
81.45	Maximum Post-Trip Reactivity, $\% \Delta \rho$	-0.693
88.7	EFW to Intact SG Is Increased Via Motor Driven Pump	----
92.1	SIAS Pumps Reach Full Speed	----
102.2	Ruptured Steam Generator Empties, Liquid Inventory, lbm	< 2500
121.0	Boron Enters RCS	----
1800.0	Operator Initiates Cooldown	----

ARKANSAS NUCLEAR ONE
Unit 2

Table 15.1.14-30

**SEQUENCE OF EVENTS FOR THE CYCLE 12 STEAM LINE BREAK EVENT
WITH LOSS OF AC, 1 HPSI PUMP, HZP**

<u>Time, sec</u>	<u>Event</u>	<u>Setpoint or Value</u>
0.0	Steam Line Break Occurs, Loss of AC Power, RCPs Begin Coasting Down	----
0.85	CPC Low RCP Pump Speed Trip Signal generated, fraction	0.95
1.85	Trip Breaker Open	----
2.84	MSIS Initiation Setpoint has been reached, psia	620
4.14	MSIV's Begin to Close	----
7.14	Complete Closure of MSIVs	----
25.2	Pressurizer Empties	----
26.3	Pressurizer Pressure Reached SIAS Analysis Setpoint, psia	1400
66.3	SIAS Pumps Reach Full Speed	----
110.5	Boron Enters RCS	----
357.3	Maximum Post-trip Reactivity, $\% \Delta \rho$	-0.1688
1800.0	Operator Initiates Cooldown	----

ARKANSAS NUCLEAR ONE
Unit 2

Table 15.1.14-31

**SEQUENCE OF EVENTS FOR THE CYCLE 12 STEAM LINE BREAK EVENT
WITH AC AVAILABLE, 1 HPSI PUMP, HZP**

<u>Time, sec</u>	<u>Event</u>	<u>Setpoint or Value</u>
0.0	Steam Line Break Occurs	----
2.85	Steam Generator Low Pressure Trip Condition and MSIS Initiation setpoint, psia	620
4.05	Trip Breaker Open	----
4.15	MSIV's Begin to Close	----
7.15	Complete Closure of MSIVs	----
22.1	Pressurizer Empties	----
22.9	Pressurizer Pressure Reaches SIAS Analysis Setpoint, psia	1400
62.9	SIAS Pumps Reach Full Speed	----
102.9	Boron Enters RCS	----
128.9	Maximum Post-trip Reactivity, $\% \Delta \rho$	-0.8399
1800.0	Operator Initiates Cooldown	----

ARKANSAS NUCLEAR ONE
Unit 2

Table 15.1.14-32

**ASSUMPTIONS FOR THE CYCLE 14 STEAM LINE BREAK ANALYSIS
FROM HOT FULL POWER AND HOT ZERO POWER**

<u>Parameter</u>	<u>Units</u>	<u>Assumptions</u>	
		<u>Hot Full Power</u>	<u>Hot Zero Power</u>
Initial Incore Power Level	Mwt	2900	1
RCP Heat	Mwt	10	10
Initial Core Inlet Temperature	°F	556.7	552
Initial Reactor Coolant Flow	10 ⁶ lbm/hr	108.36	108.36
Initial Reactor Coolant System Pressure	psia	2300	2300
CEA Worth at Trip	%Δρ	-7.1049	-4.84
Initial Steam Generator Pressure	psia	922	1059
Doppler Coefficient		1.22	1.22
Moderator Temperature Coefficient	10 ⁻⁴ Δρ/°F	-3.4	-3.4
Feedwater Regulating System	----	Automatic	Manual

ARKANSAS NUCLEAR ONE
Unit 2

Table 15.1.14-33

**SEQUENCE OF EVENTS FOR THE CYCLE 14 STEAM
LINE BREAK HOT FULL POWER WITH LOSS OF AC**

<u>Time Seconds</u>	<u>Event</u>	<u>Setpoint or Value</u>
0	Steam line break occurs Loss of AC power occurs RCPs begin coasting down	----
0.31	CPC Low pump speed trip signal, fraction	0.965
1.31	Trip breakers open	----
1.8	SG delta pressure isolation reached, psid	220
1.91	CEAs begin to drop	----
2	MSIS setpoint has been reached, psia	620
3.31	MSIV begin to close	----
6.31	Complete Closure of the MSIV	----
13.66	Intact SG level reaches EFW actuation setpoint, % of narrow range	35.0
25	Pressurizer empties	----
35.57	SIAS setpoint is reached, psia	1400
38.66	EFW enters intact SG (steam pump)	----
39.71	Complete closure of the MFIV	----
75.61	SIAS pumps reach full speed and begin injecting	----
100.4	EFW to intact SG is increased (electric pump)	----
133.8	Boron reaches RCS	----
185.6	Maximum post-trip fission power, % of 2815 Mwt	2.987
185.6	Minimum DNBR	1.59
275.4	Maximum post trip reactivity, % $\Delta\rho$	-0.020
375	End of calculation	----
1800	Operator initiates cooldown (not simulated)	----

ARKANSAS NUCLEAR ONE
Unit 2

Table 15.1.14-34

**SEQUENCE OF EVENTS FOR THE CYCLE 14 STEAM
LINE BREAK HOT FULL POWER WITH AC AVAILABLE**

<u>Time Seconds</u>	<u>Event</u>	<u>Setpoint or Value</u>
0	Steam line break occurs	---
1.8	SG delta pressure isolation reached, psid	220
2.07	SG low pressure trip condition and MSIS setpoint has been reached, psia	620
3.34	MSIVs begin to close	----
3.37	Trip breakers open	----
3.47	MFIV begin to close	----
3.97	CEAs begin to drop	----
6.34	Complete Closure of the MSIVs	----
13.93	Intact SG level reaches EFW actuation setpoint, % of narrow range	35.0
20.7	Pressurizer empties	----
23.36	SIAS setpoint is reached, psia	1400
23.47	Complete closure of the MFIV	----
38.93	EFW enters intact SG (steam pump)	----
63.37	SIAS pumps reach full speed and begin injecting	----
62.36	Maximum post-trip fission power, % of 2815 Mwt	5.516
53.61	Minimum DNBR	2.30
77.81	Maximum post trip reactivity, % $\Delta\rho$	-0.359
93.1	Boron reaches RCS	----
96.5	EFW to intact SG is increased (electric pump)	----
350	End of calculation	----
1800	Operator initiates cooldown (not simulated)	----

ARKANSAS NUCLEAR ONE
Unit 2

Table 15.1.14-35

**SEQUENCE OF EVENTS FOR THE CYCLE 14 STEAM
LINE BREAK HOT ZERO POWER WITH LOSS OF AC**

<u>Time Seconds</u>	<u>Event</u>	<u>Setpoint or Value</u>
0	Steam line break occurs Loss of AC power occurs RCPs begin coasting down	----
0.32	CPC Low flow trip signal, Fraction of pump speed	0.965
1.32	Trip breakers open	----
1.9	SG delta pressure isolation reached, psid	220
1.92	CEAs begin to drop	----
3.2	MSIS initiation setpoint has been reached, psia	620
4.47	MSIV's begin to close	----
7.47	Complete Closure of the MSIV	----
41	Pressurizer empties	----
42.93	SIAS setpoint is reached, psia	1400
55.77	Emergency Feed valves close	----
83.01	SIAS pumps reach full speed and begin injecting	----
122.3	Boron enters RCS	----
178.1	Maximum post trip reactivity (first peak), $\% \Delta \rho$	0.255
318	Maximum post-trip fission power, % of 2815 Mwt	0.272
324	Minimum DNBR	20.2
650	End of calculation	----
1800	Operator initiates cooldown (not simulated)	----

ARKANSAS NUCLEAR ONE
Unit 2

Table 15.1.14-36

**SEQUENCE OF EVENTS FOR THE CYCLE 14 STEAM LINE BREAK
HOT ZERO POWER WITH AC AVAILABLE**

<u>Time Seconds</u>	<u>Event</u>	<u>Setpoint or Value</u>
0	Steam line break occurs	---
1.90	SG Delta pressure isolation reached, psid	220
3.22	SG low pressure trip condition and MSIS initiation setpoint has been reached, psia	620
4.49	MSIVs begin to close	----
4.49	Trip breakers open	----
5.09	CEAs begin to drop	----
7.49	Complete Closure of the MSIV	----
27.5	Pressurizer empties	----
28.6	SIAS setpoint is reached, psia	1400
68.7	SIAS pumps reach full speed and begin injecting	----
95.1	Boron enters RCS	----
133.7	Maximum post trip reactivity, $\% \Delta \rho$	0.126
136.5	Maximum post-trip fission power, % of 2815 Mwt	0.025
136.4	Minimum DNBR	607
250	End of calculation	----
1800	Operator initiates cooldown (not simulated)	----

ARKANSAS NUCLEAR ONE
Unit 2

Table 15.1.14-37

REMOVED – HISTORICAL DATA

Table 15.1.14-38

EVENT GENERATED IODINE SPIKE RADIOLOGICAL DOSE RESULTS
FOR AST MAIN STEAM LINE BREAK EVENT

<u>Radiological Dose</u>	<u>Event Generated Iodine Spike, Rem TEDE</u>
EAB	2.252
LPZ	0.225
CR	1.143

Table 15.1.14-39

PRE-EXISTING IODINE SPIKE RADIOLOGICAL DOSE RESULTS
FOR AST MAIN STEAM LINE BREAK EVENT

<u>Radiological Dose</u>	<u>Pre-existing Iodine Spike, Rem TEDE</u>
EAB	0.815
LPZ	0.064
CR	1.008

Table 15.1.14-40

REMOVED – HISTORICAL DATA

ARKANSAS NUCLEAR ONE
Unit 2

Table 15.1.14-41

**ASSUMPTIONS FOR CYCLE 15 AT 3026 MWt STEAM LINE BREAK ANALYSIS FROM
HOT FULL POWER TO HOT ZERO POWER**

<u>Parameter</u>	<u>Units</u>	<u>Assumptions</u>	
		<u>Hot Full Power</u>	<u>Hot Zero Power</u>
Initial Core Power Level	MWt	3087	1
RCP Heat	MWt	10	10
Core Inlet Coolant Temperature	°F	556.7	552
Reactor Coolant System Flow	gpm	315,560	314,682
Pressurizer Pressure ⁽²⁾	psia	2300	2300
Steam Generator Pressure	psia	1001	1065
Moderator Temperature Coefficient	$10^{-4} \Delta\rho/^\circ\text{F}$	-3.8 ⁽¹⁾	-3.8 ⁽¹⁾
Fuel Temperature Coefficient	-	EOC	EOC
CEA Worth on Trip	$10^{-2} \Delta\rho$	-6.84	-4.84
MTC Multiplier	-	1.0	1.0
Feedwater Regulating System	-	Automatic	Automatic

(1) See Figure 15.1.14-113

(2) Does not include RCP head

ARKANSAS NUCLEAR ONE
Unit 2

Table 15.1.14-42

**SEQUENCE OF EVENTS FOR CYCLE 15 AT 3026 MWt STEAM LINE BREAK
HOT FULL POWER WITH LOSS OF AC**

<u>Time, (seconds)</u>	<u>Event</u>	<u>Setpoint or Value</u>
0.0	Steam Line Break Occurs Loss of AC Power Occurs RCPs Begin Coastdown	-
0.51	CPC Low RCP Speed Trip Signal	95% of Rated Speed
1.51	Trip Breakers Open	-
2.11	CEAs Begin to Drop	-
14.16	MSIS Setpoint Achieved	658 psia
15.58	MSIVs Begin to Close	-
19.08	Complete Closure of the MSIVs	-
25.21	EFW System Actuated	41% of NR
26.98	Pressurizer Empties	< 0.5 ft
27.80	SG Delta Pressure Achieved	220 psid
37.45	SIAS Setpoint Achieved	1400 psia
50.21	Turbine-Driven EFW Pump Feeding Intact SG	-
77.45	SIAS Pumps Begin Injection	-
113.21	Motor-Driven EFW Pump Begins to Feed Intact SG	-
133.45	Boron Reaches RCS	-
281.60	Maximum Post-Trip Reactivity	0.0173 %Δρ
286.56	Time of Minimum DNBR, (MacBeth) ⁽¹⁾	1.68*
288.04	Maximum Post-Trip Fission Power	2.76% of 3026 MWt
491.12	Affected SG Empties, (liquid mass in evaporator)	< 1000 lbm
600	End of Calculation	-
1800	Operator Initiates Cooldown (not simulated)	-

* For Cycle 21, the DNBR was revised due to the implementation of a full core of NGF.

ARKANSAS NUCLEAR ONE
Unit 2

Table 15.1.14-43

**SEQUENCE OF EVENTS FOR CYCLE 15 AT 3026 MWt STEAM LINE BREAK
HOT FULL POWER WITH AC AVAILABLE INSIDE CONTAINMENT**

<u>Time, (seconds)</u>	<u>Event</u>	<u>Setpoint or Value</u>
0.0	Steam Line Break Occurs	-
2.01	Containment High Pressure Trip Signal	20.7 psia
3.59	Trip Breakers Open	-
4.19	CEAs Begin to Drop	-
16.59	MSIS Setpoint Achieved	658 psia
17.99	MSIVs Begin to Close	-
21.49	Complete Closure of the MSIVs	-
22.16	Pressurizer Empties	< 0.5 ft
24.46	SIAS Setpoint Achieved	1400 psia
30.76	EFW System Actuated	41.0% of NR
32.59	SG Delta Pressure Achieved	220 psid
55.78	Turbine-Driven EFW Pump Feeding Intact SG	-
64.46	SIAS Pumps Begin Injection	-
95.30	Boron Reaches RCS	-
113.78	Motor-Driven EFW Pump Feeding Intact SG	-
116.46	Time of Minimum DNBR, (MacBeth) ⁽²⁾	2.72
118.58	Maximum Post-Trip Fission Power ⁽²⁾	4.26% of 3026 MWt
120.54	SIT Activation Pressure Reached	550 psia
267.08	Maximum Post-Trip Reactivity ⁽²⁾	-0.0218% Δρ
302.53	Affected SG Empties, (liquid mass in evaporator)	< 1000 lbm
400	End of Calculation	-
1800	Operator Initiates Cooldown (not simulated)	-

⁽²⁾ For Cycle 15, the HFP with offsite power available sequence of events is the same with the exact timing of the event being within 2 seconds of the times shown above.

The Cycle 15 maximum post-trip fission power is 4.392% of 2815 MWt, the minimum MacBeth DNBR is 2.48, and the maximum post-trip reactivity is -0.02314.

ARKANSAS NUCLEAR ONE
Unit 2

Table 15.1.14-44

**SEQUENCE OF EVENTS FOR CYCLE 15 AT 3026 MWt STEAM LINE BREAK
HOT ZERO POWER WITH LOSS OF AC**

<u>Time, (seconds)</u>	<u>Event</u>	<u>Setpoint or Value</u>
0.0	Steam Line Break Occurs Loss of AC Power Occurs RCPs Begin Coastdown Maximum Start-Up Feed Pump Flow to Affected SG	-
0.51	CPC Low RCP Speed Trip Signal	95% of Rated Speed
1.51	Trip Breakers Open	-
2.11	CEAs Begin to Drop	-
11.66	MSIS Setpoint Achieved	658 psia
13.06	MSIVs Begin to Close	-
16.56	Complete Closure of the MSIVs	-
28.20	SG Delta Pressure Achieved	220 psid
55.90	Pressurizer Empties	< 0.5 ft
61.06	SIAS Setpoint Achieved	1400 psia
63.30	EFIV Closed	-
101.06	SIAS Pumps Begin Injection	-
141.34	Boron Reaches RCS	-
400.51	Maximum Post-Trip Reactivity	+0.206% $\Delta\rho$
684.00	Time of Minimum DNBR, (MacBeth)	22.8
684.12	Time of Maximum Post-Trip Fission Power	0.15% of 3026 MWt
900	End of Calculation	-
1800	Operator Initiates Cooldown (not simulated)	-

ARKANSAS NUCLEAR ONE
Unit 2

Table 15.1.14-45

**SEQUENCE OF EVENTS FOR CYCLE 15 AT 3026 MWt STEAM LINE BREAK
HOT ZERO POWER WITH AC AVAILABLE OUTSIDE CONTAINMENT**

<u>Time, (seconds)</u>	<u>Event</u>	<u>Setpoint or Value</u>
0.0	Steam Line Break Occurs Maximum Start-Up Feed Pump Flow to Affected SG	-
11.06	Low SG Pressure Trip, MSIS Setpoint Achieved	693 psia
12.37	Trip Breakers Open	-
12.46	MSIVs Begin to Close	-
12.97	CEAs Begin to Drop	-
15.96	Complete Closure of MSIVs	-
26.60	SG Delta Pressure Achieved	220 psid
46.30	Pressurizer Empties	< 0.5 ft
47.47	EFIV Closed	-
49.42	SIAS Setpoint Achieved	1400 psia
59.82	Time of Minimum DNBR, (MacBeth)	78.9
89.42	SIAS Pumps Begin Injection	-
116.42	Boron Reaches RCS	-
125.82	SIT Activation Pressure Achieved	550 psia
233.64	Maximum Post-Trip Reactivity	-0.545% $\Delta\rho$
404.46	Affected SG Empties, (liquid mass in evaporator)	< 1000
500	End of Calculation	-
1800	Operator Initiates Cooldown (not simulated)	-

ARKANSAS NUCLEAR ONE
Unit 2

Table 15.1.14-46

**ASSUMPTIONS FOR CYCLE 15
FEEDWATER LINE BREAK**

<u>Parameter</u>	<u>Units</u>	<u>Conservative Assumptions</u>
Initial Core Power Level	MWt	2900
RCP Heat	MWt	18
Core Inlet Coolant Temperature	°F	556.7
Reactor Coolant System Flow	gpm	315,560
Pressurizer Pressure*	psia	2000
Steam Generator Pressure	psia	1000
Moderator Temperature Coefficient	$10^{-4} \Delta\rho/^\circ\text{F}$	-0.2
Fuel Temperature Coefficient	-	BOC
CEA Worth on Trip	$10^{-2} \Delta\rho$	-5.0
Steam Generator Tube Plugging	%	0
Tolerance on MSSV Setpoint	%	+3
Tolerance on PSV Setpoint	%	+3.2

* Does not include RCP head.

ARKANSAS NUCLEAR ONE
Unit 2

Table 15.1.14-47

**PRINCIPAL RESULTS FOR CYCLE 15
FEEDWATER LINE BREAK**

<u>Time, (seconds)</u>	<u>Event</u>	<u>Setpoint or Value</u>
0.0	Feedwater Line Break Occurs	-
44.9	Low SG Level Trip Occurs on Intact SG	6% of NR
45.4	Affected Steam Generator Empties	-
45.5	High Pressurizer Pressure Trip Condition Occurs	2415 psia
46.2	Trip Circuit Breakers Open, Loss of AC Power Occurs, RCPs Begin Coastdown	-
46.8	CEAs Begin to Drop	-
47.9	Pressurizer Safety Valves Open	2580 psia
48.1	EFAS, EFW Pumps Start	0% of NR
49.2	Peak RCS Pressure Occurs	2694 psia ⁽¹⁾
53.9	Pressurizer Safety Valves Close	2502.5 psia
128.2	SG Low Pressure Trip and MSIS Initiated	658 psia
129.6	Main Steam Isolation Valves Begin to Close	-
133.1	Main Steam Isolation Valve Closed	-
139.4	Pressure Difference Between Steam Generators, EFAS Signal Opens EFW Valves to Feed Intact SG	220 psid
175.8	Emergency Feedwater Enters Intact SG	-
176.1	Minimum Liquid Mass in the Intact SG	13,140 lbm
303.7	MSSVs Open on Intact SG (long term cycling start)	1125.5 psia
2000	Case Terminated	-

(1) Includes reactor coolant pump head

ARKANSAS NUCLEAR ONE
Unit 2

Table 15.1.14-48

**ASSUMPTIONS FOR CYCLE 16
FEEDWATER LINE BREAK**

<u>Parameter</u>	<u>Units</u>	<u>Conservative Assumptions</u>
Initial Core Power Level	MWt	3087
RCP Heat	MWt	18
Core Inlet Coolant Temperature	°F	556.7
Reactor Coolant System Flow	gpm	315,560
Pressurizer Pressure ⁽¹⁾	psia	2300
Steam Generator Pressure	psia	999
Moderator Temperature Coefficient	$10^{-4} \Delta\rho/^\circ\text{F}$	-0.2
Fuel Temperature Coefficient	--	BOC
CEA Worth on Trip	$10^{-2} \Delta\rho$	-5.0
Tolerance on PSV Setpoint	%	+3.2
Tolerance on MSSV Setpoint	%	+3.5
Number of U-tubes assumed to be plugged per Steam Generator	%	0

(1) Initial pressures are input as pressurizer pressure. Figures are of RCS pressure. Therefore, the initial values in the Figures are slightly higher by 20 to 30 psi than the value quoted here.

ARKANSAS NUCLEAR ONE
Unit 2

Table 15.1.14-49

**SEQUENCE OF EVENTS FOR THE CYCLE 16
FEEDWATER LINE BREAK**

<u>Time, (seconds)</u>	<u>Event</u>	<u>Setpoint or Value</u>
0.0	Feedwater line break occurs	--
33.3	Low steam generator level trip occurs on ruptured steam generator	40,000 lbm liquid inventory
33.7	High pressurizer pressure trip condition occurs	2415 psia
34.6	Trip breakers open, loss of AC power occurs, RCPs begin coasting down	--
35.2	CEAs begin to drop	--
36.9	Pressurizer safety valves start to open	2580 psia
37.2	Maximum RCS pressure occurs	2647 psia ⁽¹⁾
38.9	Pressurizer safety valves close	2502.5 psia
40.7	EFAS occurs, EFW pumps start	0% Narrow Range
55.3	Ruptured steam generator empties	--
90.3	Steam generator low pressure trip condition and MSIS initiated	905 psia
90.3	Main steam isolation valves begin to close	--
90.3	Complete closure of main steam isolation valves terminating blowdown from intact steam generator	--
96.0	Pressure difference reached between steam generators, EFAS signal to opens EFW valves to feed intact SG	220 psid
153.1	Emergency feedwater enters the intact steam generator	--
190.3	Main steam safety valves open on the intact steam generator (begin cycling long term)	1130.94 psia
222.1	Minimum liquid mass in the intact steam generator	117,100 lbm
3000.0	Case Terminated	--

(1) Includes reactor coolant pump head

ARKANSAS NUCLEAR ONE
Unit 2

Table 15.1.15-1

DELETED

Table 15.1.16-1

DELETED

Table 15.1.16-2

DELETED

Tables 15.1.18-1 through 15.1.18-4

REMOVED - HISTORICAL DATA

ARKANSAS NUCLEAR ONE
Unit 2

Table 15.1.18-5

**ASSUMPTIONS FOR CYCLE 16 STEAM GENERATOR
TUBE RUPTURE WITH A CONCURRENT LOSS OF AC POWER**

<u>Parameter</u>	<u>Units</u>	<u>Conservative Assumptions</u>
Initial Core Power Level	MWt	3087
Core Inlet Coolant Temperature	°F	556.7
Reactor Coolant System Flow	10 ⁶ lbm/hr	117.6
Pressurizer Pressure ⁽¹⁾	psia	2300
Steam Generator Pressure	psia	960
Moderator Temperature Coefficient	10 ⁻⁴ Δρ/°F	-3.8
Fuel Temperature Coefficient	--	BOC
CEA Worth on Trip	10 ⁻² Δρ	-5.0
Steam Bypass System	--	Inoperative
Feedwater Regulating System	--	Inoperative
Steam Generator Blowdown System	--	Inoperative
Steam Condenser	--	Inoperative

(1) Initial pressures are input as pressurizer pressure. Figures are of RCS pressure. Therefore, the initial values in the Figures are slightly higher by 20 to 30 psi than the value quoted here.

ARKANSAS NUCLEAR ONE
Unit 2

Table 15.1.18-6

**SEQUENCE OF EVENTS FOR THE CYCLE 16
STEAM GENERATOR TUBE RUPTURE
WITH A CONCURRENT LOSS OF AC POWER**

<u>Time, (seconds)</u>	<u>Event</u>	<u>Setpoint or Value</u>
0.0	Double-ended ruptured steam generator and concurrent loss of AC power	--
0.6	CPC low RCP speed trip occurs	95% of nominal speed
1.6	Trip breakers open	--
2.2	CEAs begin to drop	--
4.8	Maximum RCS pressure occurs	2412 psia
5.5	Main steam safety valves open	1054.45 psia
7.4	Maximum secondary pressure occurs	1079 psia
10.4	Emergency feedwater is initiated to intact steam generator	41% of NR
61.3	Main steam safety valves close	1002.0 psia
251.0	SIAS generated	1800 psia
	Charging flow initiated to primary	--
521.5	SIAS pumps reach full speed and begin injecting	--
3600.0	Operator isolates steam generator with ruptured U-tube. Controlled cooldown of NSSS is initiated.	--

Table 15.1.18-7

**STEAM GENERATOR TUBE RUPTURE WITH A
CONCURRENT LOSS OF AC POWER DOSE RESULTS
FOR EVENT GENERATED IODINE SPIKE**

<u>Radiological Dose</u>	<u>Event Generated Iodine Spike, Rem TEDE</u>
EAB	2.07
LPZ	0.11
CR	0.22

ARKANSAS NUCLEAR ONE
Unit 2

Table 15.1.18-8

**STEAM GENERATOR TUBE RUPTURE WITH A
CONCURRENT LOSS OF AC POWER PRE-EXISTING
IODINE SPIKE RADIOLOGICAL DOSE RESULTS**

<u>Radiological Dose</u>	<u>Pre-existing Iodine Spike, Rem TEDE</u>
EAB	2.80
LPZ	0.14
CR	0.59

Table 15.1.20-1

FULL POWER CEA EJECTION ACCIDENT VARIABLES

	<u>Beginning-of-Cycle</u>		<u>End of Cycle</u>	
	<u>Conservative Assumptions</u>	<u>Realistic Assumptions</u>	<u>Conservative Assumptions</u>	<u>Realistic Assumptions</u>
Initial Core Power (MWT)	2900	2815	2900	2815
Delayed Neutron Fraction (β)	0.007135	0.007135	0.004972	0.004972
Moderate Temperature Coefficient ($\Delta\rho/^\circ\text{F}$)	$+ 0.5 \times 10^{-4}$	$- 0.5 \times 10^{-4}$	$- 1.5 \times 10^{-4}$	$- 2.5 \times 10^{-4}$
K Factor	0.925	0.925	0.925	0.925
Ejected CEA Worth ($10^{-2}\Delta\rho$)	0.24	0.22	0.24	0.22
Radial Doppler Weighting Factor; W_R	1.23	1.87	1.35	1.95
Three-dimensional Fuel Rod Power Peak At Hot Spot; $(P/A)_H$	3.87	3.48	3.50	3.15
Total CEA Worth Available for Insertion on Reactor Trip ($10^{-2}\Delta\rho$)	- 5.4	- 11.3	- 5.4	- 11.3
CEA Ejection Time (Sec)	0.05	0.14	0.05	0.14

ARKANSAS NUCLEAR ONE
Unit 2

Table 15.1.20-2

ZERO POWER CEA EJECTION ACCIDENT VARIABLES

	<u>Beginning-of-Cycle</u>		<u>End of Cycle</u>	
	<u>Conservative Assumptions</u>	<u>Realistic Assumptions</u>	<u>Conservative Assumptions</u>	<u>Realistic Assumptions</u>
Initial Core Power (MWT)	1	1	1	1
Delayed Neutron Fraction (β)	0.007135	0.007135	0.004972	0.004972
Moderate Temperature Coefficient ($\Delta\rho/^\circ\text{F}$)	0.0	-0.8×10^{-4}	-1.3×10^{-4}	-2.1×10^{-4}
K Factor	0.808	0.808	0.845	0.845
Ejected CEA Worth ($10^{-2}\Delta\rho$)	1.1	0.99	0.98	0.88
Radial Doppler Weighting Factor; W_R	2.13	2.63	2.44	2.92
Three-dimensional Fuel Rod Power Peak At Hot Spot; $(P/A)_H$	14.72	13.25	20.95	18.85
Total CEA Worth Available for Insertion on Reactor Trip ($10^{-2}\Delta\rho$)	- 2.4	- 8.3	- 2.4	- 8.3
CEA Ejection Time (Sec)	0.05	0.14	0.05	0.14

ARKANSAS NUCLEAR ONE
Unit 2

Table 15.1.20-3

FULL POWER CEA EJECTION ACCIDENT RESULTS

	<u>Beginning of Cycle (BOC)</u>	<u>End of Cycle (EOC)</u>
Total Average Enthalpy of Hottest Fuel Pellet (cal/gm)	177.9	158.0
Total Centerline Enthalpy of Hottest Fuel Pellet (cal/gm)	242.9	223.0
Fraction of Rods that Suffer Clad Damage (Average Enthalpy \geq 200 cal/gm)	0.0	0.0
Fraction of Fuel Having at Least Incipient Centerline Melting (Centerline Enthalpy \geq 250 cal/gm)	0.0	0.0
Fraction of Fuel Having a Fully Molten Centerline Condition (Centerline Enthalpy \geq 310 cal/gm)	0.0	0.0

Table 15.1.20-4

ZERO POWER CEA EJECTION ACCIDENT RESULTS

	<u>BOC</u>	<u>EOC</u>
Total Average Enthalpy of Hottest Fuel Pellet (cal/gm)	275	275
Total Centerline Enthalpy of Hottest Fuel Pellet (cal/gm)	280	280
Fraction of Rods that Suffer Clad Damage (Average Enthalpy \geq 200 cal/gm)	0.02465	0.04123
Fraction of Fuel Having at Least Incipient Centerline Melting (Centerline Enthalpy \geq 50 cal/gm)	0.00505	0.01805
Fraction of Fuel Having a Fully Molten Centerline Condition (Centerline Enthalpy \geq 310 cal/gm)	0.0	0.0

ARKANSAS NUCLEAR ONE
Unit 2

Table 15.1.20-5

CEA EJECTION CASES AT HOT FULL POWER

Beginning of Cycle

Ejected Rod Location (Figure 15.1.20-7)	<u>Ejected Worth (%$\Delta\rho$)</u>		With PLR <u>Inserted</u>	$\frac{F_g^N}{\text{Without PLR}}$ <u>Inserted</u>
	With PLR <u>Inserted</u>	Without PLR <u>Inserted</u>		
G	0.20	0.17	2.2	2.1
F	0.22	0.15	3.5	2.8

End of Cycle

Ejected Rod Location (Figure 15.1.20-7)	<u>Ejected Worth (%$\Delta\rho$)</u>		With PLR <u>Inserted</u>	$\frac{F_g^N}{\text{Without PLR}}$ <u>Inserted</u>
	With PLR <u>Inserted</u>	Without PLR <u>Inserted</u>		
G	0.16	0.15	2.0	1.8
F	0.22	0.17	3.2	2.5

ARKANSAS NUCLEAR ONE
Unit 2

Table 15.1.20-6

CEA EJECTION CASES AT HOT ZERO POWER

Beginning of Cycle

Ejected Rod Location (Figure 15.1.20-7)	<u>Ejected Worth (%$\Delta\rho$)</u>		With PLR <u>Inserted</u>	$\frac{F_g^N}{\text{Without PLR}}$ <u>Inserted</u>
	With PLR <u>Inserted</u>	Without PLR <u>Inserted</u>		
A	0.24	0.23	5.7	4.3
B	0.27	0.27	3.7	3.7
C	0.46	0.26	10.4	5.9
D	0.40	0.40	4.8	5.1
E	0.25	0.15	7.0	3.8
F	0.99	0.78	13.2	10.3
G	0.22	0.17	3.3	2.5

End of Cycle

Ejected Rod Location (Figure 15.1.20-7)	<u>Ejected Worth (%$\Delta\rho$)</u>		With PLR <u>Inserted</u>	$\frac{F_g^N}{\text{Without PLR}}$ <u>Inserted</u>
	With PLR <u>Inserted</u>	Without PLR <u>Inserted</u>		
A	0.24	0.24	9.4	7.4
C	0.48	0.26	17.5	9.8
D	0.37	0.37	7.9	8.5
F	0.88	0.67	18.9	14.3

ARKANSAS NUCLEAR ONE
Unit 2

Table 15.1.20-7

**AXIAL POWER DISTRIBUTION USED FOR CEA EJECTION
ACCIDENT ANALYSIS**

<u>Fractional Distance from Bottom of Reactor Core</u>	<u>Power Fraction</u>
0.025	0.3976
0.075	1.2922
0.125	1.5712
0.175	1.5935
0.225	1.497
0.275	1.3671
0.325	1.2399
0.375	1.1268
0.425	1.0299
0.475	0.94865
0.525	0.88209
0.575	0.83005
0.625	0.79305
0.675	0.77196
0.725	0.76714
0.775	0.77663
0.825	0.79266
0.875	0.79566
0.925	0.74645
0.975	0.59113
1.0	0.18938

ARKANSAS NUCLEAR ONE
Unit 2

Table 15.1.20-8

KEY PARAMETERS ASSUMED IN THE CYCLE 2 CEA EJECTION ANALYSES

<u>Parameter</u>		
<u>Full Power</u>	<u>Units</u>	<u>Cycle 2</u>
Core Power Level	MWt	2900
Core Average Linear Heat Generation Rate at 2815 MWt	KW/ft	5.54
Moderator Temperature Coefficient	$10^{-4} \Delta\rho/^\circ\text{F}$	+0.5
Ejected CEA Worth	$\%\Delta\rho$	0.30
Delayed Neutron Fraction, β	--	0.00482
Maximum Post-Ejected Radial Power Peak	--	2.94
Axial Power Peak	--	1.75
CEA Bank Worth at Trip	$\%\Delta\rho$	-5.4
Fuel Temperature Coefficient	--	0.85
CEA Ejection Time	sec	0.05
 <u>Zero Power</u>		
Core Power Level	MWt	1.0
Ejected CEA Worth	$\%\Delta\rho$	0.82
Post-Ejected Radial Power Peak	--	8.23
Axial Power Peak	--	2.50
CEA Bank Worth at Trip	$\%\Delta\rho$	-2.4
Fuel Temperature Coefficient Multiplier	--	0.85
CEA Ejection Time	sec	0.05

ARKANSAS NUCLEAR ONE
Unit 2

Table 15.1.20-9

CYCLE 2 CEA EJECTION EVENT RESULTS

<u>Full Power</u>	<u>Cycle 2</u>
Total Average Enthalpy of Hottest Fuel Pellet (cal/gm)	156
Total Centerline Enthalpy of Hottest Fuel Pellet (cal/gm)	267
Fraction of Rods that Suffer Clad Damage (average Enthalpy \geq 200 cal/gm)	0
Fraction of Fuel Having at Least Incipient Centerline Melting (Centerline Enthalpy \geq 250 cal/gm)	\leq 0.005
Fraction of Fuel Having a Fully Molten Centerline Condition (Centerline Enthalpy \geq 310 cal/gm)	0
 <u>Zero Power</u>	 <u>Cycle 2</u>
Total Average Enthalpy of Hottest Fuel Pellet (cal/gm)	164
Total Centerline Enthalpy of Hottest Fuel Pellet (cal/gm)	296
Fraction of Rods that Suffer Clad Damage (Average Enthalpy \geq 200 cal/gm)	0
Fraction of Fuel Having at Least Incipient Centerline Melting (Centerline Enthalpy \geq 250 cal/gm)	\leq 0.005
Fraction of Fuel Having a Fully Molten Centerline Condition (Centerline Enthalpy \geq 310 cal/gm)	0

ARKANSAS NUCLEAR ONE
Unit 2

Table 15.1.20-10

**ASSUMPTIONS FOR THE CYCLE 10
CEA EJECTION ACCIDENT ANALYSIS**

<u>Parameter</u>	<u>Units</u>	<u>HZP</u>	<u>HFP</u>
Initial Core Power	(MWt)	1	2910
Core Inlet Temperature	(°F)	545	556.7
Reactor Coolant System Pressure	(psia)	2000	2000
Reactor Coolant System Flow	(gpm)	322,000	322,000
Total Delayed Neutron Fraction (β)	-	0.00536	0.00536
Moderator Temperature Coefficient	($10^{-4} \Delta\rho/^\circ\text{F}$)	+0.5	0.0
CEA Ejection Time	(sec)	0.05	0.05
Doppler Multiplier	-	0.85	0.85
CEA Worth at Trip	($10^{-2} \Delta\rho$)	-2.4	-5.4
Ejected CEA Worth	($\%\Delta\rho$)	0.82	0.28
Ejected 3D Peak, F_q	-	12.710	5.208

Table 15.1.20-11

**RESULTS FOR THE CYCLE 10
CEA EJECTION ACCIDENT ANALYSIS**

HFP

Total Average Enthalpy (cal/gm)	157.2
Total Centerline Enthalpy (cal/gm)	264.1

HZP

Total Average Enthalpy (cal/gm)	94.5
Total Centerline Enthalpy (cal/gm)	141.9

ARKANSAS NUCLEAR ONE
Unit 2

Table 15.1.20-12

**AXIAL POWER DISTRIBUTION USED FOR CYCLE 10 AND 12
CEA EJECTION ACCIDENT ANALYSES**

<u>Fractional Distance from Bottom of Reactor Core</u>	<u>Power Fraction, Fz HFP</u>	<u>Power Fraction, Fz H2P</u>
0.025	0.1801	1.0948
0.075	0.2716	1.5333
0.125	0.3359	2.5000
0.175	0.3376	1.6222
0.225	0.4881	1.6461
0.275	0.5623	1.5128
0.325	0.6473	1.3865
0.375	0.7469	1.2697
0.425	0.8608	1.1541
0.475	0.9869	1.0346
0.525	1.0792	0.9461
0.575	1.2038	0.8253
0.625	1.3244	0.7161
0.675	1.4462	0.6205
0.725	1.5780	0.5391
0.775	1.7170	0.4680
0.825	1.6921	0.3715
0.875	1.7460	0.3220
0.925	1.5993	0.2647
0.975	1.1419	0.1726

ARKANSAS NUCLEAR ONE
Unit 2

Table 15.1.20-13

**ASSUMPTIONS FOR THE CYCLE 12
CEA EJECTION ACCIDENT ANALYSIS**

<u>Parameter</u>	<u>Units</u>	<u>HZP</u>	<u>HFP</u>
Initial Core Power	(MWt)	1	2815
Core Inlet Temperature	(°F)	552	556.7
Reactor Coolant System Pressure	(psia)	2000	2000
Reactor Coolant System Flow	(gpm)	315,560	315,560
Total Delayed Neutron Fraction (β)	-	0.00443	0.00443
Moderator Temperature Coefficient	($10^{-4} \Delta\rho/^\circ\text{F}$)	+0.5	0.0
CEA Ejection Time	(sec)	0.05	0.05
Doppler Multiplier	-	0.85	0.85
CEA Worth at Trip	($10^{-2} \Delta\rho$)	-2.4	-5.4

Table 15.1.20-14

**RESULTS FOR THE CYCLE 12
CEA EJECTION ACCIDENT ANALYSIS**

<u>Initial Power % of 2815 MWt</u>	<u>Ejected CEA Worth ($10^{-2} \Delta\rho$)</u>	<u>Acceptable Ejected 3D Peak, F_g</u>
100	0.30	4.0
	0.20	4.8
	0.11	5.6
0	0.85	16.5
	0.70	17.4
	0.56	21.0

ARKANSAS NUCLEAR ONE
Unit 2

Table 15.1.20-15

**ASSUMPTIONS FOR THE CYCLE 13
CEA EJECTION ACCIDENT ANALYSIS**

<u>Parameter</u>	<u>Units</u>	<u>HZP</u>	<u>HFP</u>
Initial Core Power	(MWt)	29	2900
Core Inlet Temperature	(°F)	552	556.7
Reactor Coolant System Pressure	(psia)	2000	2000
Reactor Coolant System Flow	(10 ⁶ lbm/hr)	108.36	108.36
Total Delayed Neutron Fraction (β)	-	0.0043414	0.0043414
Moderator Temperature Coefficient	(10 ⁻⁴ $\Delta\rho/^\circ\text{F}$)	+0.5	0.0
CEA Ejection Time	(sec)	0.05	0.05
Doppler Multiplier	-	0.85	0.85
CEA Worth at Trip	% $\Delta\rho$	- 2	- 5

ARKANSAS NUCLEAR ONE
Unit 2

Table 15.1.20-16

**AXIAL POWER DISTRIBUTION USED FOR CYCLE 13
CEA EJECTION ACCIDENT ANALYSES**

<u>Fractional Distance from the Bottom of the Reactor Core</u>	<u>Power Fraction, Fz</u>
0.025	0.5
0.075	0.8
0.125	1.0
0.175	1.1
0.225	1.1
0.275	1.1
0.325	1.1
0.375	1.1
0.425	1.1
0.475	1.1
0.525	1.1
0.575	1.1
0.625	1.1
0.675	1.1
0.725	1.1
0.775	1.1
0.825	1.1
0.875	1.0
0.925	0.8
0.975	0.5

Table 15.1.20-17

**RESULTS FOR THE CYCLE 13
CEA EJECTION ACCIDENT ANALYSIS**

<u>Initial Power % of 2815 MWt</u>	<u>Ejected CEA Worth ($10^{-2} \Delta\rho$)</u>	<u>Acceptable Ejected 3D Peak, F_g</u>	<u>Excure Detector Uncertainty, %</u>
100	0.30	4.98	20
	0.20	5.94	
	0.17	6.27	
0	0.85	14.7	10
	0.70	15.6	

ARKANSAS NUCLEAR ONE
Unit 2

Table 15.1.20-18

**RESULTS FOR THE CYCLE 14
CEA EJECTION ACCIDENT ANALYSIS**

<u>Initial Power % of 2815 MWt</u>	<u>Ejected CEA Worth ($10^{-2} \Delta\rho$)</u>	<u>Acceptable Ejected 3D Peak, F_g</u>	<u>Excure Detector Uncertainty, %</u>
100	0.30	4.98	20
	0.20	5.94	
	0.17	6.7	
80	0.35	5.33	20
	0.25	6.49	
	0.22	6.93	
50	0.40	6.87	20
	0.30	8.30	
20	0.55	9.46	10
	0.45	10.34	
	0.24	17.6	
0	0.85	14.7	10
	0.70	15.6	

Table 15.1.20-19

**ASSUMPTIONS FOR THE CYCLE 16
CEA EJECTION ANALYSIS**

<u>Parameter</u>	<u>Units</u>	<u>Conservative Assumptions H_{ZP}</u>	<u>Conservative Assumptions H_{FP}</u>
Initial Core Power Level	MWt	30.3	3087
Core Inlet Coolant Temperature	°F	556.7	556.7
Pressurizer Pressure	psia	2000	2000
Reactor Coolant System Flow	gpm	315,560	315,560
Total Delayed Neutron Fraction (β)	--	0.0043414	0.0043414
Moderator Temperature Coefficient	$10^{-4} \Delta\rho/^\circ\text{F}$	+0.5	0.0
CEA Ejection Time	Seconds	0.05	0.05
Fuel Temperature Coefficient	--	BOC	BOC
CEA Worth at Trip	$10^{-2} \Delta\rho$	-2.0	-5.0

ARKANSAS NUCLEAR ONE
Unit 2

Table 15.1.20-20

**CYCLE 16 CEA EJECTION
ANALYSIS RESULTS**

<u>Initial Power % of 3026 MWt</u>	<u>Ejected CEA Worth, 10⁻² Δρ</u>	<u>Acceptable Ejected 3D Peak, Fq</u>	<u>Excure Detector Uncertainty, %</u>
100	0.45	3.2	40
	0.25	3.8	
	0.15	4.6	
0	0.80	14.4	40
	0.60	16.5	
	0.45	22.0	

Table 15.1.20-21

**AST CEA EJECTION
RADIOLOGICAL DOSE RESULTS**

<u>Radiological Dose</u>	<u>Rem TEDE</u>
<i>Containment Release</i>	
EAB	2.265
LPZ	0.327
CR	0.95
<i>Secondary Release</i>	
EAB	1.422
LPZ	0.217
CR	0.321

ARKANSAS NUCLEAR ONE
Unit 2

Table 15.1.20-22

RESULTS FOR THE CYCLE 18 CEA EJECTION ANALYSIS

Initial Power, % of 3026 MWt	Ejected CEA Worth ($10^{-2} \Delta\rho$)	Acceptable Ejected 3D Peak, Fq	Excure Detector Uncertainty, %
100	0.45	3.1	40
	0.25	3.7	
	0.15	4.5	
0	0.80	13.4	40
	0.60	15.4	
	0.45	20.5	

Table 15.1.20-23

RESULTS FOR THE CYCLE 20 CEA EJECTION ANALYSIS

Initial Power, % of 3026 MWt	Ejected CEA Worth ($10^{-2} \Delta\rho$)	Acceptable Ejected 3D Peak, fq	Excure Detector Uncertainty, %
100	0.45	3.1	40
	0.25	3.7	
	0.15	4.5	
0	0.80	13.3	40
	0.60	15.2	
	0.45	20.3	

Table 15.1.23-1

REMOVED - HISTORICAL DATA

Table 15.1.23-2

**FUEL HANDLING ACCIDENT DOSES CALCULATED
WITH REGULATORY GUIDE 1.83 ASSUMPTIONS FOR 3086.52 MWt
AND ASSUMING FAILURE OF TWO COMPLETE FUEL ASSEMBLIES**

	<u>EAB</u> (Rem TEDE)	<u>LPZ</u> (Rem TEDE)	<u>CR</u> (Rem TEDE)
Auxiliary building with no ventilation or containment with open personnel airlock	4.01	0.19	1.19

ARKANSAS NUCLEAR ONE
Unit 2

Table 15.1.34-1

IDENTIFICATION OF SAFETY-RELATED AIR OPERATED VALVES AND THEIR FAILURE MODES

<u>Valve No.</u>	<u>Valve Description</u>	<u>SAR Figure No.</u>	<u>Failure Mode</u>	<u>Comments and Consequences</u>
2CV-6207-2	Nitrogen Supply to Safety Injection Tanks Isolation Valve	3.2-5	Fail Closed	Valves close on CIAS or SIAS. Nitrogen supply is not required for shutdown.
2CV-6213-2	Nitrogen Supply to Containment Isolation Valve	3.2-5	Fail Closed	
2CV-4823-2	CVCS Letdown Flow Valve	9.3-4	Fail Closed	Valve closes on CIAS. Letdown flow is not required for safe shutdown.
2CV-4847-2	Reactor Coolant Pump Bleed-off Valve	9.3-4	Fail Closed	Valve closes on CIAS or SIAS. Bleed-off is not required following containment isolation.
2CV-2061-2	Containment Sump to Auxiliary Building Sump Isolation Valve	11.2-1	Fail Closed	Valves close on CIAS or SIAS. Closed position isolates Containment.
2CV-2201-2	Reactor Drain Pump Suction Isolation Valve	11.2-1	Fail Closed	

ARKANSAS NUCLEAR ONE
Unit 2

Table 15.1.34-1 (continued)

<u>Valve No.</u>	<u>Valve Description</u>	<u>SAR Figure No.</u>	<u>Failure Mode</u>	<u>Comments and Consequences</u>
2CV-1016-1 2CV-1066-1	Steam Generator Blowdown Tank Valves	10.2-3	Fail Closed	Valves close on MSIS. Closed position prevents blowdown of steam generator via this path.
2CV-1010-1 2CV-1060-2	Main Steam Isolation Valves	10.2-3	Fail Closed	Valves close on loss of air supply. Pressure in secondary system will build up but overpressure is prevented by main steam safety valves. Accumulator T-091 provides air supply to prevent fast closing of valves if normal air supply air line break occurs.
2CV-8283-1 2CV-8284-2 2CV-8285-1 2CV-8286-2	Containment Purge System Isolation Valves	9.4-4	Fail Closed	Valves close on CIAS or SIAS. Valve closing isolates containment.
2CV-8471-1 2CV-8472-1 2CV-8474-2 2CV-8475-2 2CV-8497-2 2CV-8498-2	ESF Pump Room Ventilation Isolation Valves	N.A. (M-2262)	Fail Closed	Valves close on SIAS. Closed position isolates the ESF pump rooms. Emergency cooling is provided in each room.

ARKANSAS NUCLEAR ONE
Unit 2

Table 15.1.34-1 (continued)

<u>Valve No.</u>	<u>Valve Description</u>	<u>SAR Figure No.</u>	<u>Failure Mode</u>	<u>Comments and Consequences</u>
2UCD-8683	Control Room Isolation Damper	9.4-1	Fail Closed	Failure of air supply or electric power isolates the control room.
2PCD-8685	Control Room Isolation Damper	9.4-1	Fail Closed	
2UCD-8609	2VSF-9 Shutoff Damper	9.4-1	Fail Open	Open position ensures availability of flow path to control room emergency filters.
2PCD-8607-A	2VSF-9 Return Air Damper	9.4-1	Fail Open	
2PCD-8607-B	2VSF-9 Outside Air Damper	9.4-1	Fail Open	
2CV-3852-1 2CV-3851-1	Chilled Water Containment Isolation Valves	3.2-4	Fail Closed	Valves close on CIAS. Chilled water is not required for plant safety.
2CV-0714-1	EFW 2P-7A/B Flushing Control Valve	10.2-4	Fail Closed	Verified closed by EFAS.
2CV-0798-1	EFW 2P-7A/B Recirc. Flush Line Control Valve	10.2-4	Fail Closed	Closed by EFAS, but not credited for isolation. 2EFW-11B & C are credited for isolation.
2CV-5091	Shutdown Cooling Bypass Valve	6.3-2	Fail Open	Open during power operation with key removed from handswitch.

ARKANSAS NUCLEAR ONE
Unit 2

Table 15.1.34-1 (continued)

<u>Valve No.</u>	<u>Valve Description</u>	<u>SAR Figure No.</u>	<u>Failure Mode</u>	<u>Comments and Consequences</u>
2CV-5093	Shutdown Cooling Modulating Valve	6.3-2	Fail Closed	Closed during power operation.
2CV-5637-1	RWT to SFP Purification Isolation Valve	9.1-1	Fail Closed	Closed by SIAS.
2CV-5638-2	RWT to SFP Purification Isolation Valve	9.1-1	Fail Closed	Closed by SIAS

ARKANSAS NUCLEAR ONE
Unit 2

Table 15.1.36-1

**KEY PARAMETERS ASSUMED IN
THE ANALYSIS OF LOSS OF LOAD TO ONE STEAM GENERATOR**

<u>Parameters</u>	<u>Units</u>	<u>Assumed Value</u>
Initial Core Power	MWt	2900
Initial Core Inlet Temperature	°F	556.7
Initial Reactor Coolant System Pressure	psia	2200
Moderator Temperature Coefficient	$10^{-4}\Delta\rho/^\circ\text{F}$	-3.5
Fuel Temperature Coefficient Multiplier		1.15
Axial Shape Index	asiu	-0.30

Table 15.1.36-2

**SEQUENCE OF EVENTS FOR
LOSS OF LOAD TO ONE STEAM GENERATOR**

<u>Time (sec)</u>	<u>Event</u>	<u>Setpoint or Value</u>
0.0	Spurious closure of a single main steam isolation valve	---
0.0	Steam flow from unaffected steam generator increases to maintain turbine power	---
3.4	Safety valves open on isolated steam generator	1093 psia
3.6	ASGTP* Analysis setpoint reached(differential temperature)	14°F
3.75	Trip Breakers open	---
4.05	CEAs begin to drop into core	---
6.10	Minimum DNBR occurs	$\geq 1.25^{**}$
8.2	Maximum steam generator pressure	1137 psia

* ASGTP - Asymmetric Steam Generator Transient Protection

** Based on the CE-1 Correlation, which was used at the time this analysis was performed.

ARKANSAS NUCLEAR ONE
Unit 2

Table 15.1.36-3

**ASSUMPTIONS FOR THE
CYCLE 13 ANALYSIS OF LOSS OF LOAD TO ONE STEAM GENERATOR**

<u>Parameter</u>	<u>Units</u>	<u>Conservative Assumptions</u>
Initial Core Power Level	(MWt)	2534
Core Inlet Coolant Temperature	(°F)	556.7
Reactor Coolant System Flow	(10 ⁶ lbm/hr)	108.36
Reactor Coolant System Pressure	(psia)	2250
Moderator Temperature Coefficient	(10 ⁻⁴ Δρ/°F)	-3.5
Doppler Multiplier	-	0.85
CEA Worth on Trip	(10 ⁻² Δρ)	-5.0
Steam Generator tube Plugging	%	30
Tolerance on MSSV lift Setpoint	%	3
Axial Shape Index	asiu	-0.3

Table 15.1.36-4

**SEQUENCE OF EVENTS FOR THE
CYCLE 13 ANALYSIS OF LOSS OF LOAD TO ONE STEAM GENERATOR**

<u>Time (sec)</u>	<u>Event</u>	<u>Setpoint or Value</u>
0.0	Spurious closure of a single MSIV	-
5.72	ASGT trip setpoint reached	11 °F
6.0	Main steam safety valves open on affected steam generator	1125.5 psia
6.31	Trip breakers open	-
6.91	CEAs begin to drop into core	-
7.90	Time of minimum DNBR	≥ 1.25
9.8	Maximum steam generator pressure	1160 psia

ARKANSAS NUCLEAR ONE
Unit 2

Table 15.1.36-5

**ASSUMPTIONS FOR CYCLE 15 AT 3026 MWt
ASYMMETRIC STEAM GENERATOR TRANSIENT EVENT**

<u>Parameter</u>	<u>Units</u>	<u>Conservative Assumptions</u>
Initial Core Power Level	MWt	90% of 3026
Core Inlet Coolant Temperature	°F	556.7
Reactor Coolant System Flow	gpm	315,560
Pressurizer Pressure*	psia	2000
Steam Generator Pressure	psia	978
Moderator Temperature Coefficient	10 ⁻⁴ Δρ/°F	-3.8
Fuel Temperature Coefficient	-	BOC
CEA Worth on Trip	10 ⁻² Δρ	-4.5
Steam Generator Tube Plugging	%	10 (Affected SG Only)
Tolerance on MSSV Setpoint	%	+3.5
Axial Shape Index	asiu	-0.3

* Does not include RCP head

Table 15.1.36-6

**SEQUENCE OF EVENTS FOR CYCLE 15 AT 3026 MWt
ASYMMETRIC STEAM GENERATOR TRANSIENT EVENT**

<u>Time (seconds)</u>	<u>Event</u>	<u>Setpoint or Value</u>
0.0	Spurious Closure of a Single MSIV	-
4.2	MSSVs Open on Affected Steam Generator	1131 psia
5.6	ASGT Trip Setpoint Achieved	11°F
6.2	Trip Breakers Open	-
6.8	CEAs Begin to Drop	-
9.2	Time of Minimum WSSV-T / ABB-NV DNBR*	> 1.23
12.9	Maximum Steam Generator Pressure Occurs	1192 psia

* For Cycle 21, the WSSV-T / ABB-NV CHF correlations and a DNB SAFDL of 1.23 were applied due to the implementation of a full core of NGF.

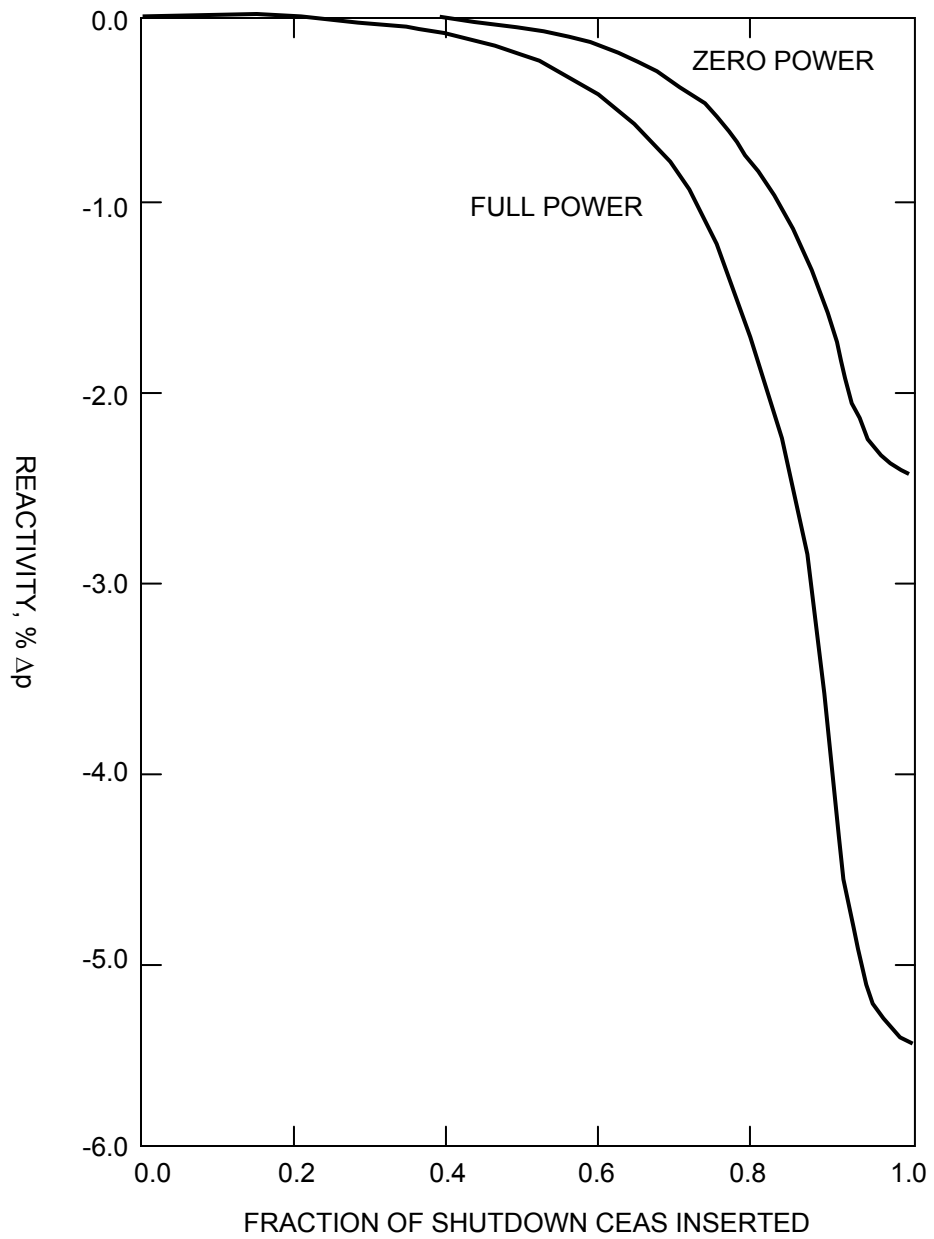

SAR FIGURE NO. 15.1.0-1

AMENDMENT 20

ARKANSAS NUCLEAR ONE
UNIT 2
RUSSELLVILLE, ARKANSAS



SCALE:	NONE
DRAWN:	
DESIGN:	ENERGY
CAD NO:	

REACTIVITY VERSUS FRACTION OF SHUTDOWN CEAS INSERTED

BASED ON DRAWING NO

SHEET

REV.

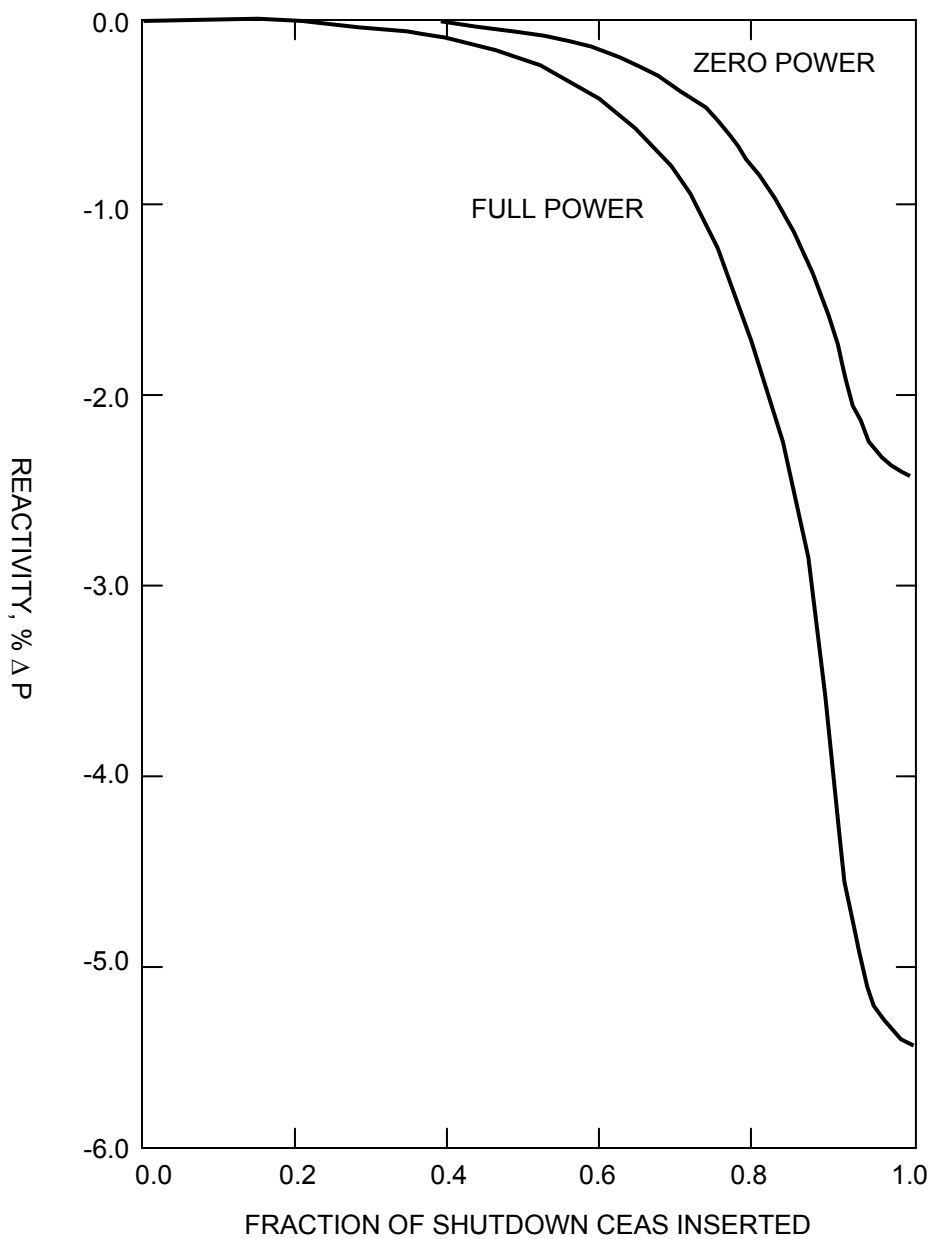

SAR FIGURE NO. 15.1.0-1A

AMENDMENT 20

ARKANSAS NUCLEAR ONE
UNIT 2
RUSSELLVILLE, ARKANSAS



SCALE:	NONE
DRAWN:	
DESIGN:	ENERGY
CAD NO:	

REACTIVITY VERSUS FRACTION OF SHUTDOWN CEAS INSERTED, CYCLE 1

BASED ON DRAWING NO

SHEET

REV.

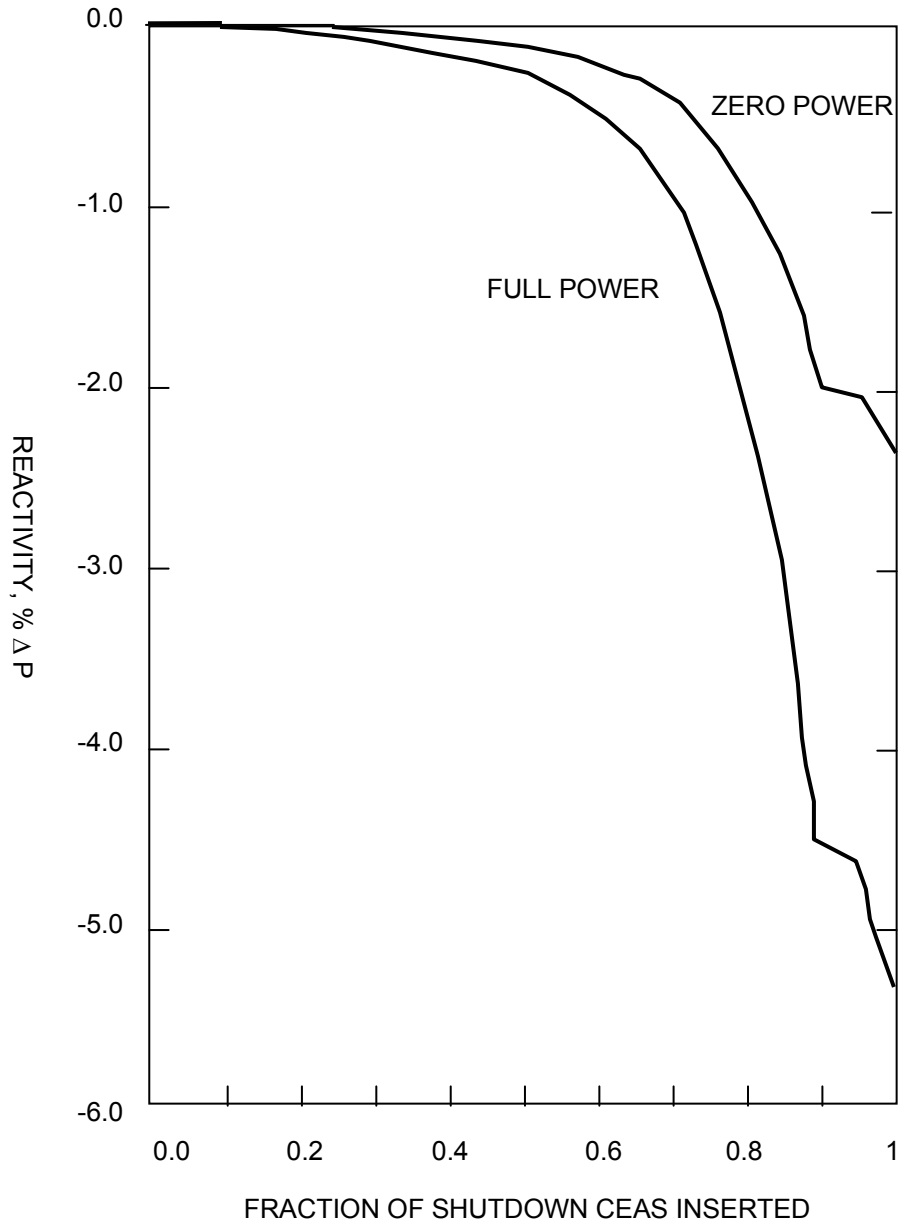

SAR FIGURE NO. 15.1.0-1B

AMENDMENT 20

ARKANSAS NUCLEAR ONE
UNIT 2
RUSSELLVILLE, ARKANSAS



SCALE:	NONE
DRAWN:	
DESIGN:	ENERGY
CAD NO:	

REACTIVITY VERSUS FRACTION OF SHUTDOWN CEAS INSERTED, CYCLE 7

BASED ON DRAWING NO

SHEET

REV.

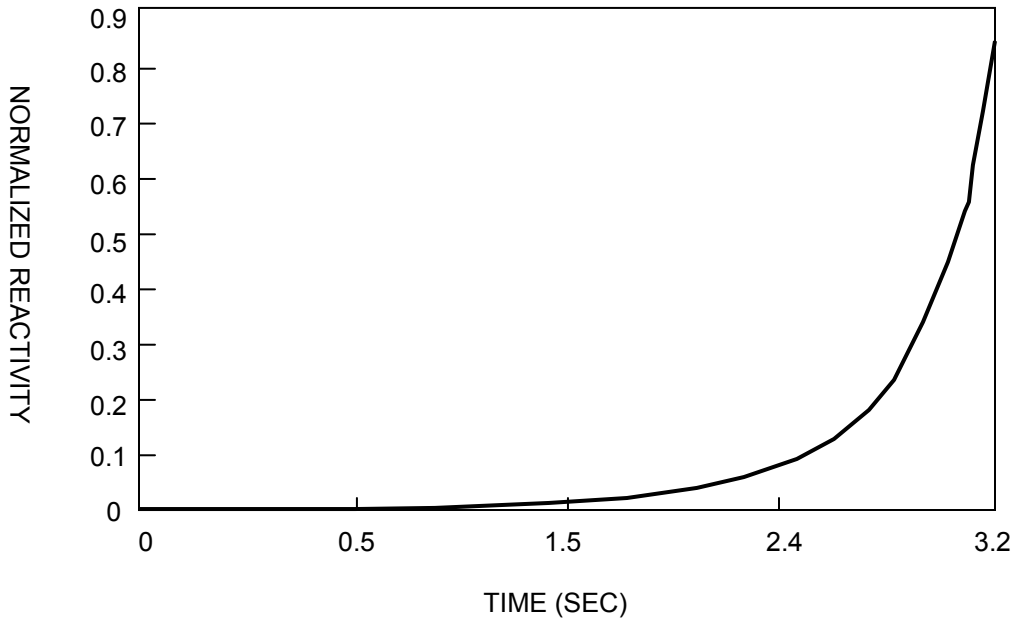
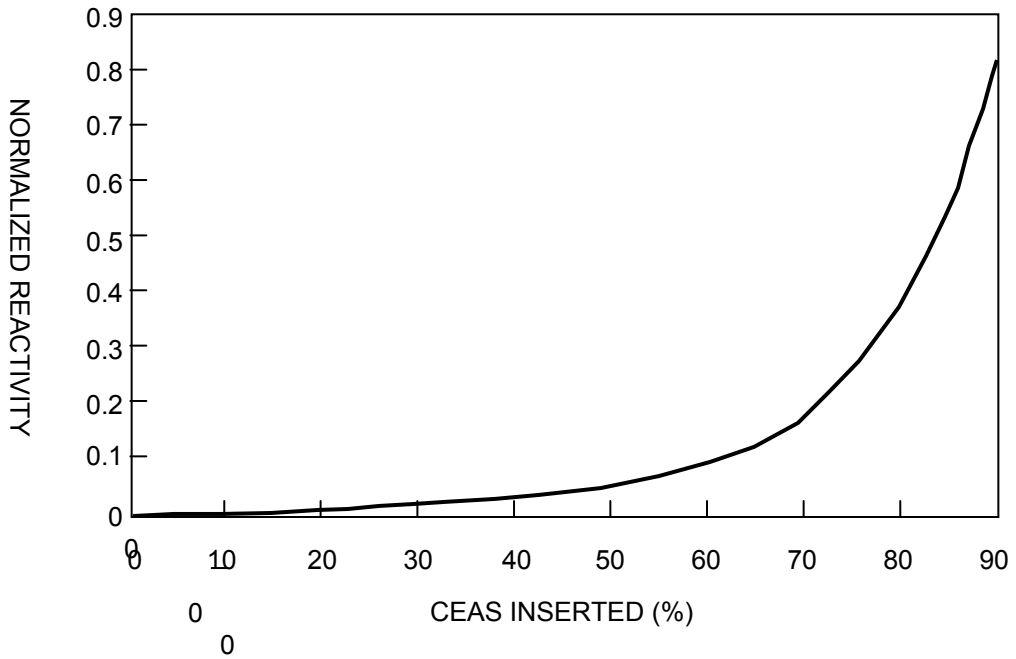

SAR FIGURE NO. 15.1.0-1C

AMENDMENT 20

ARKANSAS NUCLEAR ONE
UNIT 2
RUSSELLVILLE, ARKANSAS



SCALE:	NONE
DRAWN:	
DESIGN:	ENERGY
CAD NO:	

NORMALIZED
REACTIVITY INSERTION

BASED ON DRAWING NO

SHEET

REV.

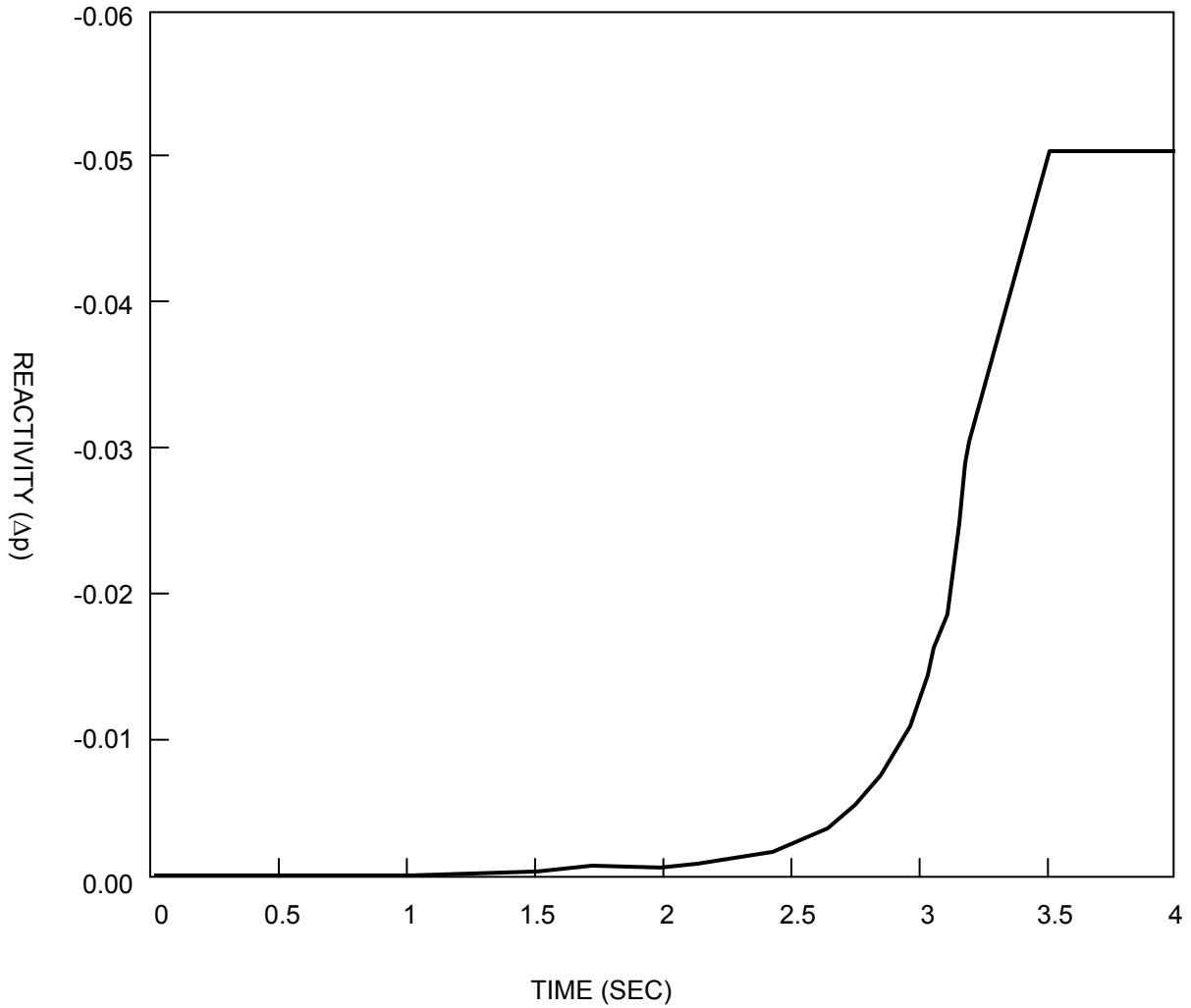

SAR FIGURE NO. 15.1.0-1D

AMENDMENT 20

ARKANSAS NUCLEAR ONE
 UNIT 2
 RUSSELLVILLE, ARKANSAS



SCALE:	NONE
DRAWN:	
DESIGN:	ENERGY
CAD NO:	

REACTIVITY INSERTION
 VERSUS CEA INSERTION

BASED ON DRAWING NO

SHEET

REV.

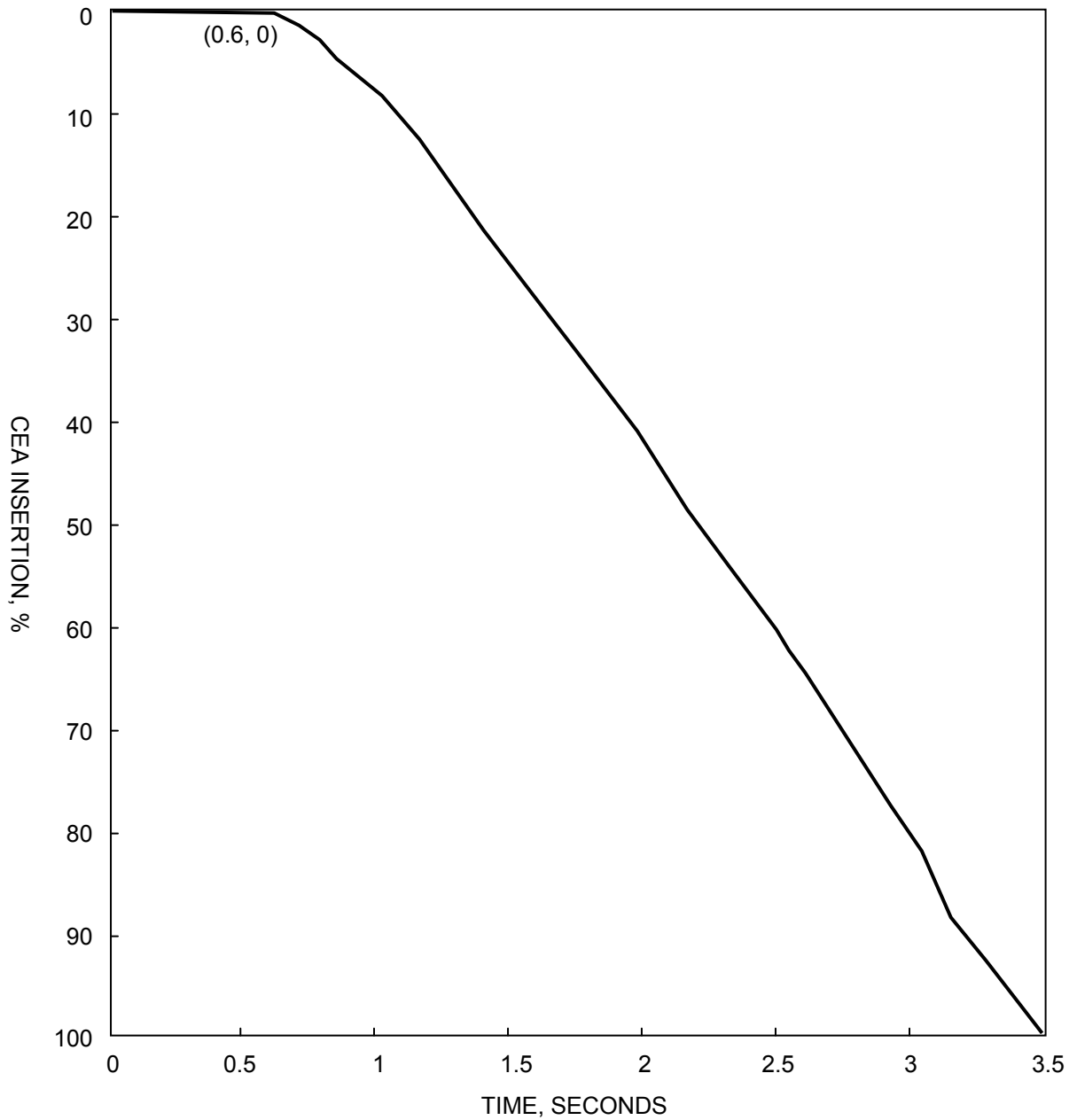

SAR FIGURE NO. 15.1.0-1E

AMENDMENT 20

ARKANSAS NUCLEAR ONE
 UNIT 2
 RUSSELLVILLE, ARKANSAS



SCALE:	NONE
DRAWN:	
DESIGN:	ENERGY
CAD NO:	

CEA INSERTION
 VERSUS TIME

BASED ON DRAWING NO

SHEET

REV.

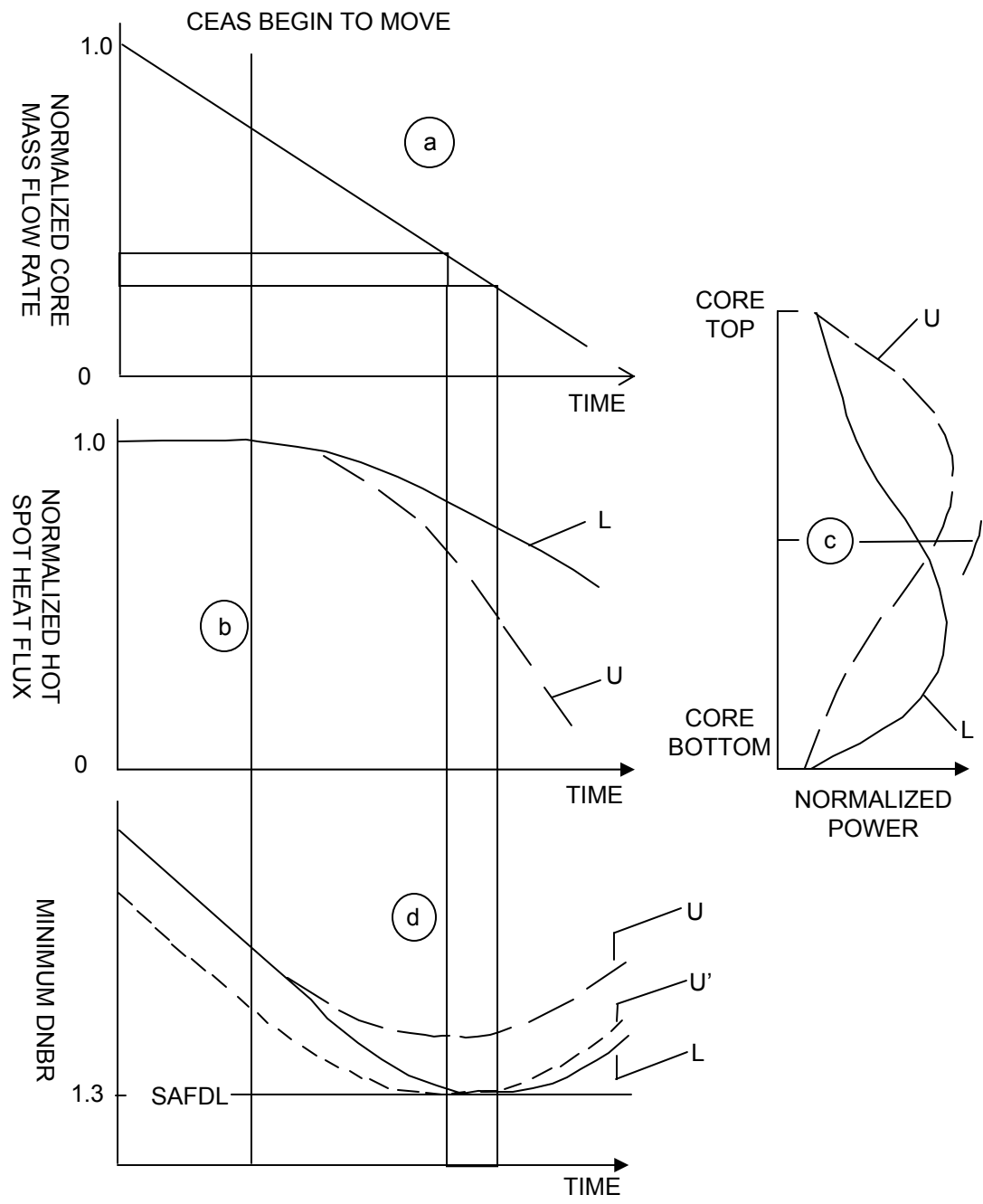

SAR FIGURE NO. 15.1.0-2

AMENDMENT 20

ARKANSAS NUCLEAR ONE
UNIT 2
RUSSELLVILLE, ARKANSAS



SCALE:	NONE
DRAWN:	
DESIGN:	ENTERGY
CAD NO:	

TRANSIENT PARAMETERS DURING
FOUR PUMP LOSS OF FLOW

BASED ON DRAWING NO

SHEET

REV.

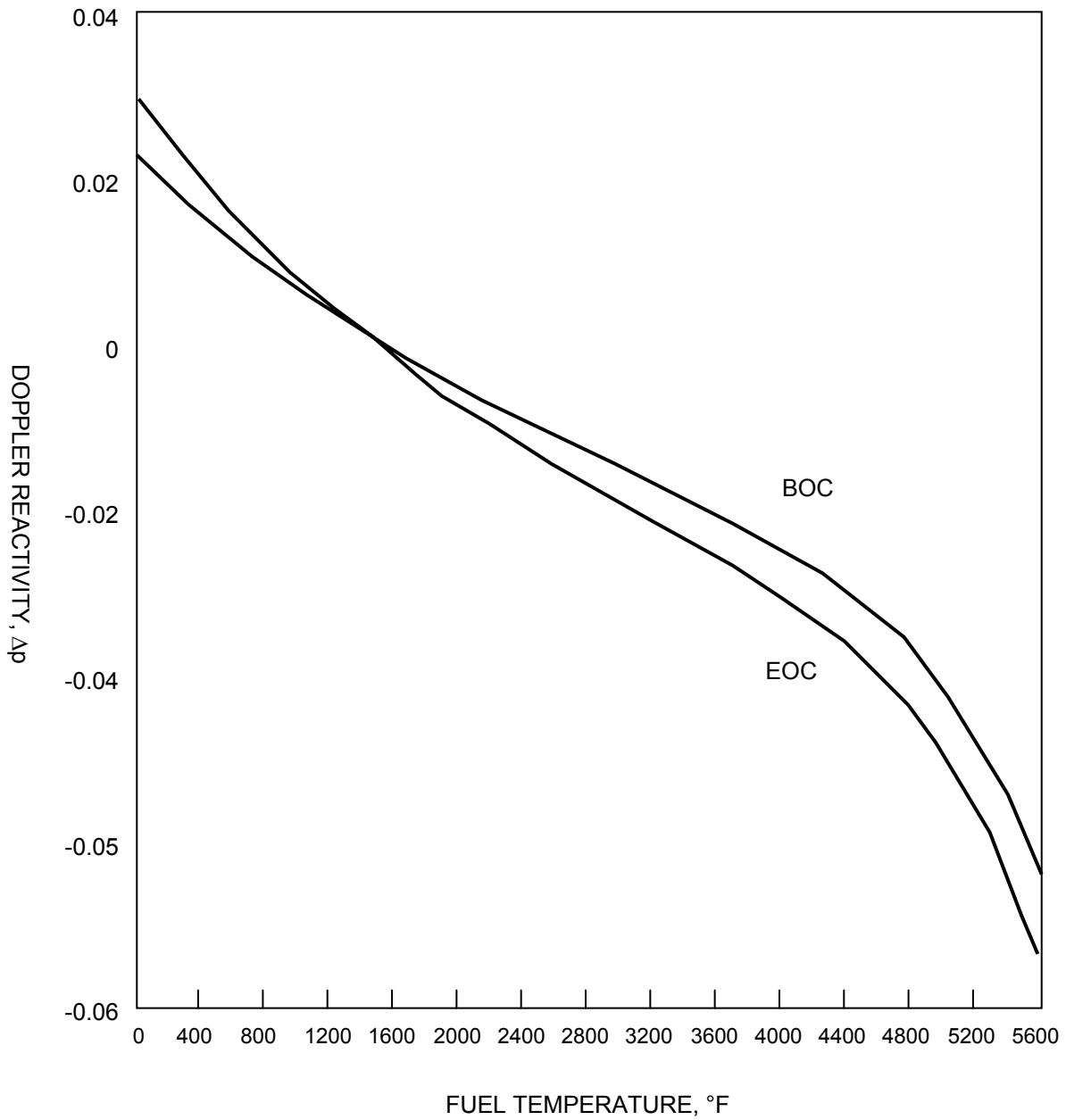

SAR FIGURE NO. 15.1.0-3

AMENDMENT 20

ARKANSAS NUCLEAR ONE
UNIT 2
RUSSELLVILLE, ARKANSAS



SCALE:	NONE
DRAWN:	
DESIGN:	ENERGY
CAD NO:	

DOPPLER REACTIVITY VERSUS
FUEL TEMPERATURE

BASED ON DRAWING NO

SHEET

REV.

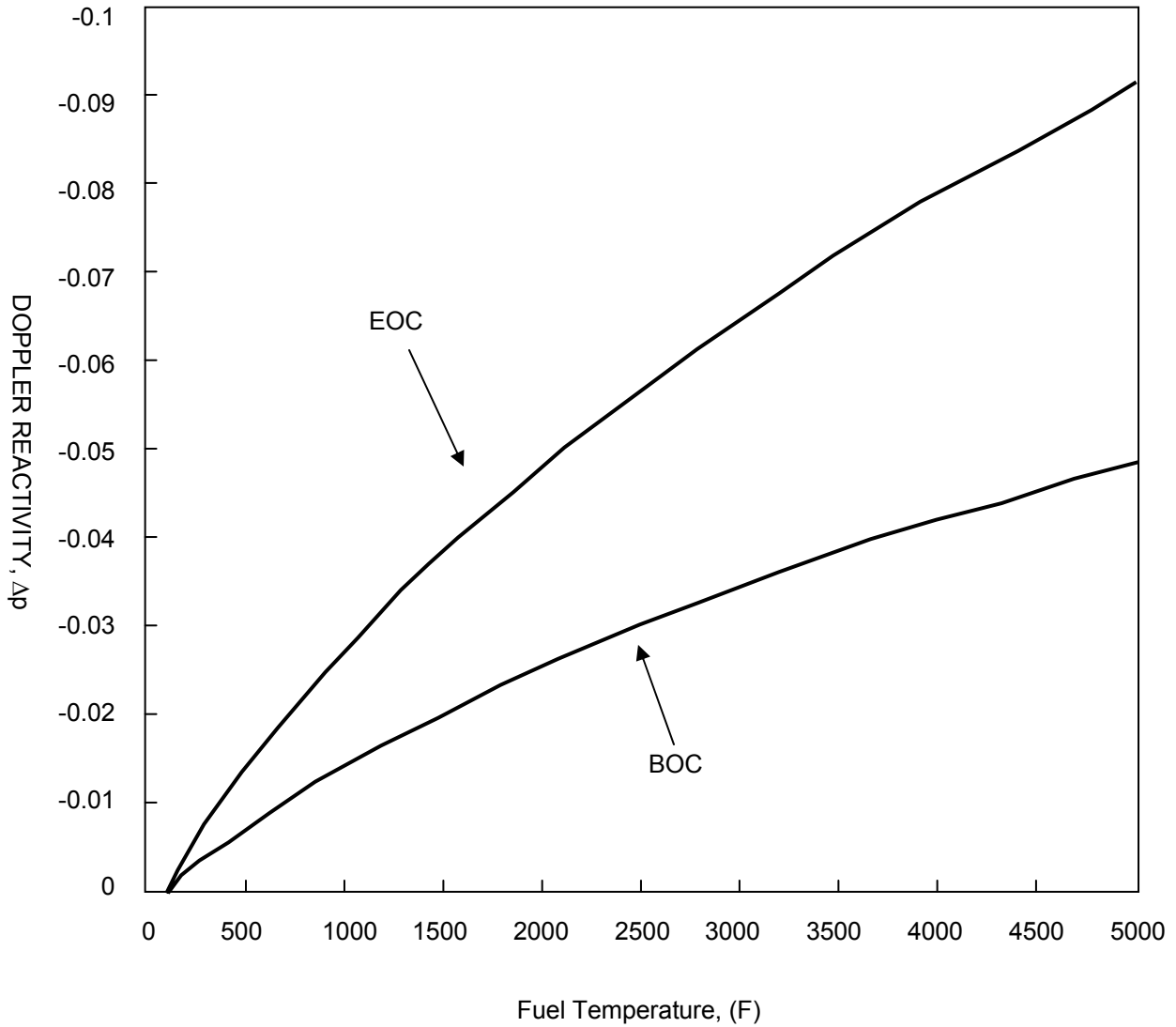

SAR FIGURE NO. 15.1.0-4

AMENDMENT 20

ARKANSAS NUCLEAR ONE
UNIT 2
RUSSELLVILLE, ARKANSAS



SCALE:	NONE
DRAWN:	
DESIGN:	ENERGY
CAD NO:	

DOPPLER REACTIVITY VERSUS
FUEL TEMPERATURE

BASED ON DRAWING NO

SHEET

REV.

DELETED

SAR FIGURE NO. 15.1.0-5

AMENDMENT 20

ARKANSAS NUCLEAR ONE
UNIT 2
RUSSELLVILLE, ARKANSAS



SCALE: NONE

DRAWN:

DESIGN: ENTERGY

CAD NO:

BASED ON DRAWING NO

SHEET

REV.

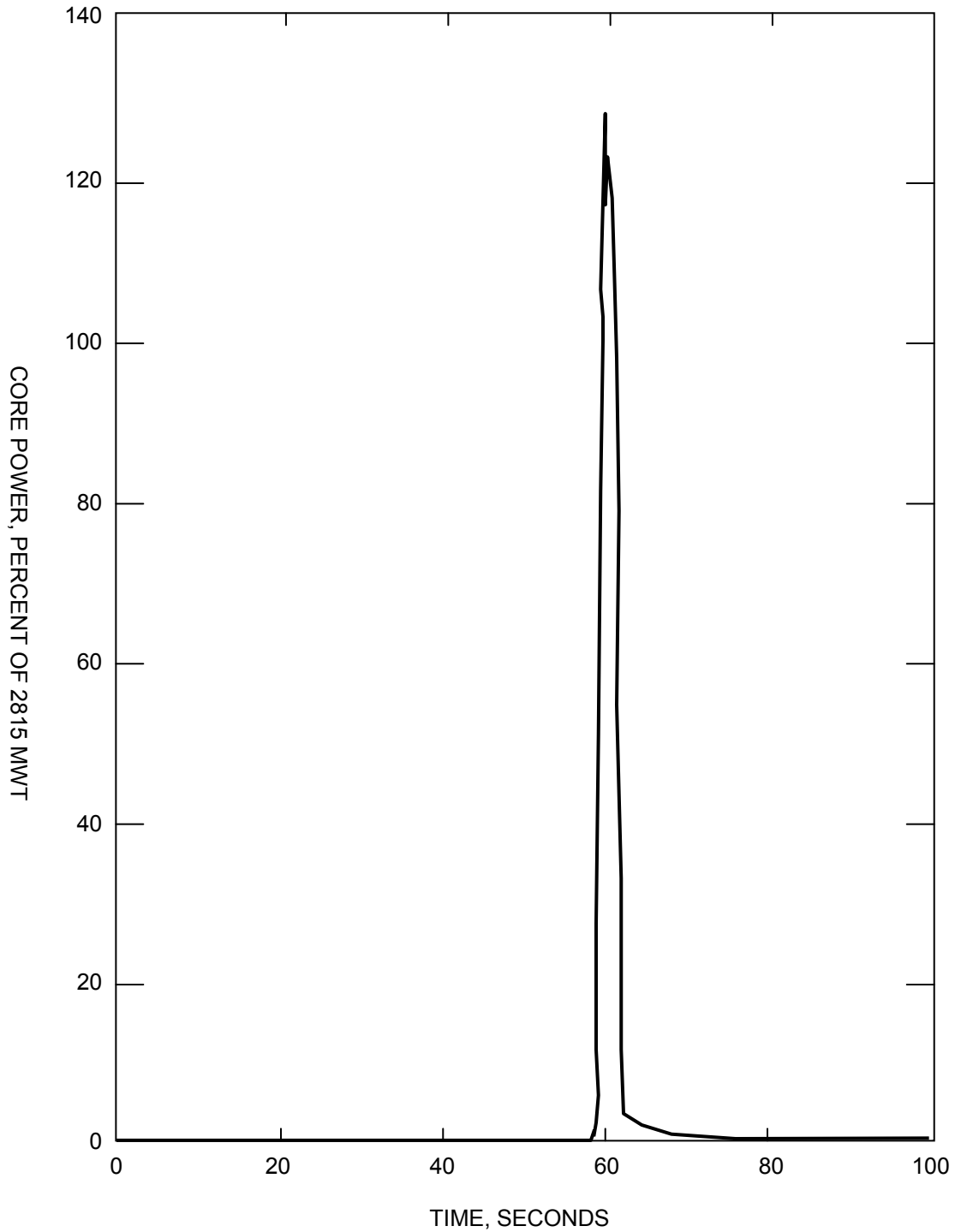

SAR FIGURE NO. 15.1.1-1

AMENDMENT 20

ARKANSAS NUCLEAR ONE
UNIT 2
RUSSELLVILLE, ARKANSAS



SCALE:	NONE
DRAWN:	
DESIGN:	ENTERGY
CAD NO:	

CEA WITHDRAWAL FROM SUBCRITICAL
CONDITIONS, CORE POWER VERSUS TIME

BASED ON DRAWING NO

SHEET

REV.

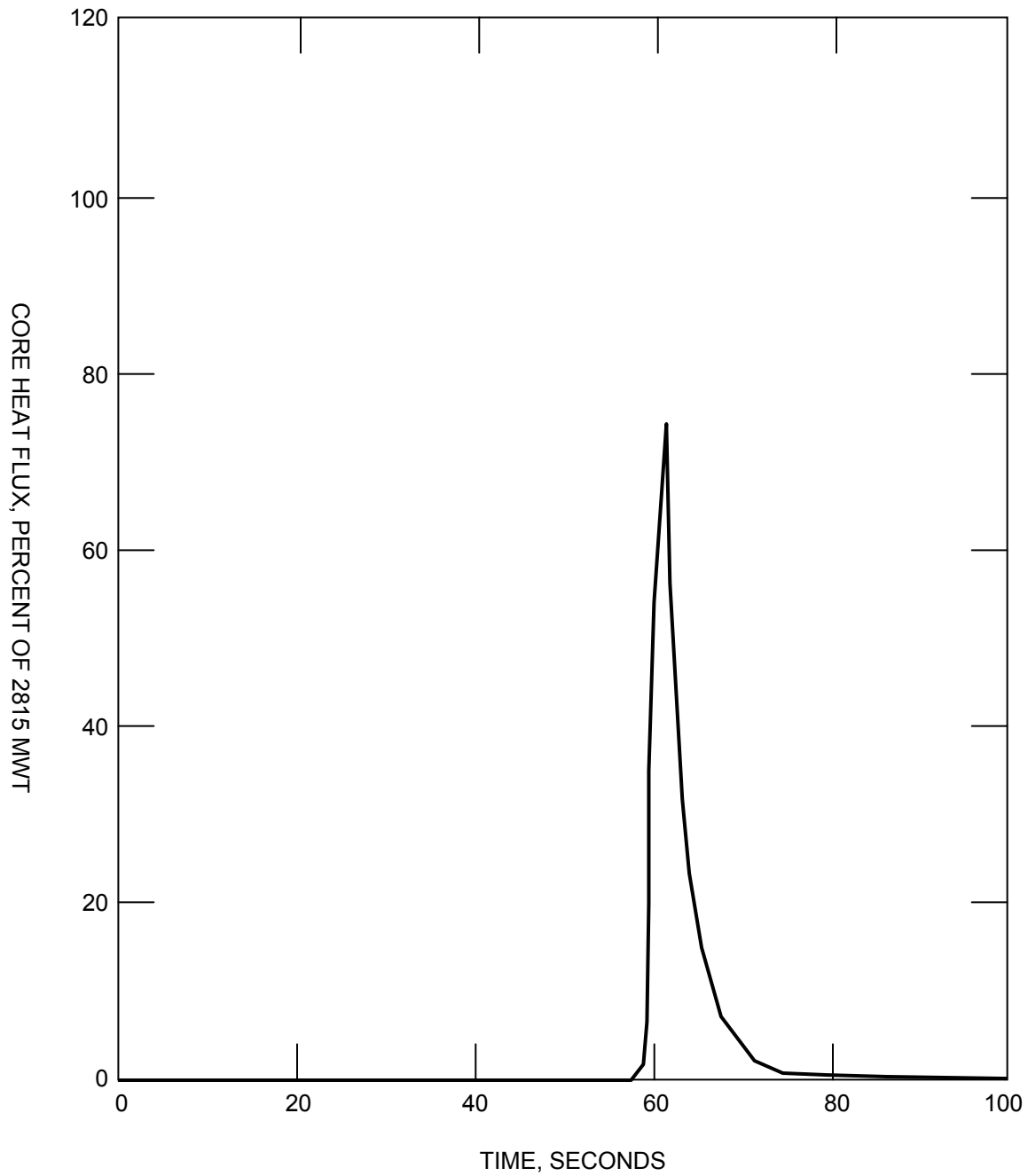

SAR FIGURE NO. 15.1.1-2

AMENDMENT 20

ARKANSAS NUCLEAR ONE
 UNIT 2
 RUSSELLVILLE, ARKANSAS



SCALE:	NONE
DRAWN:	
DESIGN:	ENTERGY
CAD NO:	

CEA WITHDRAWAL EVENT FROM SUBCRITICAL
 CONDITIONS, CORE AVERAGE HEAT FLUX VERSUS
 TIME

BASED ON DRAWING NO

SHEET

REV.

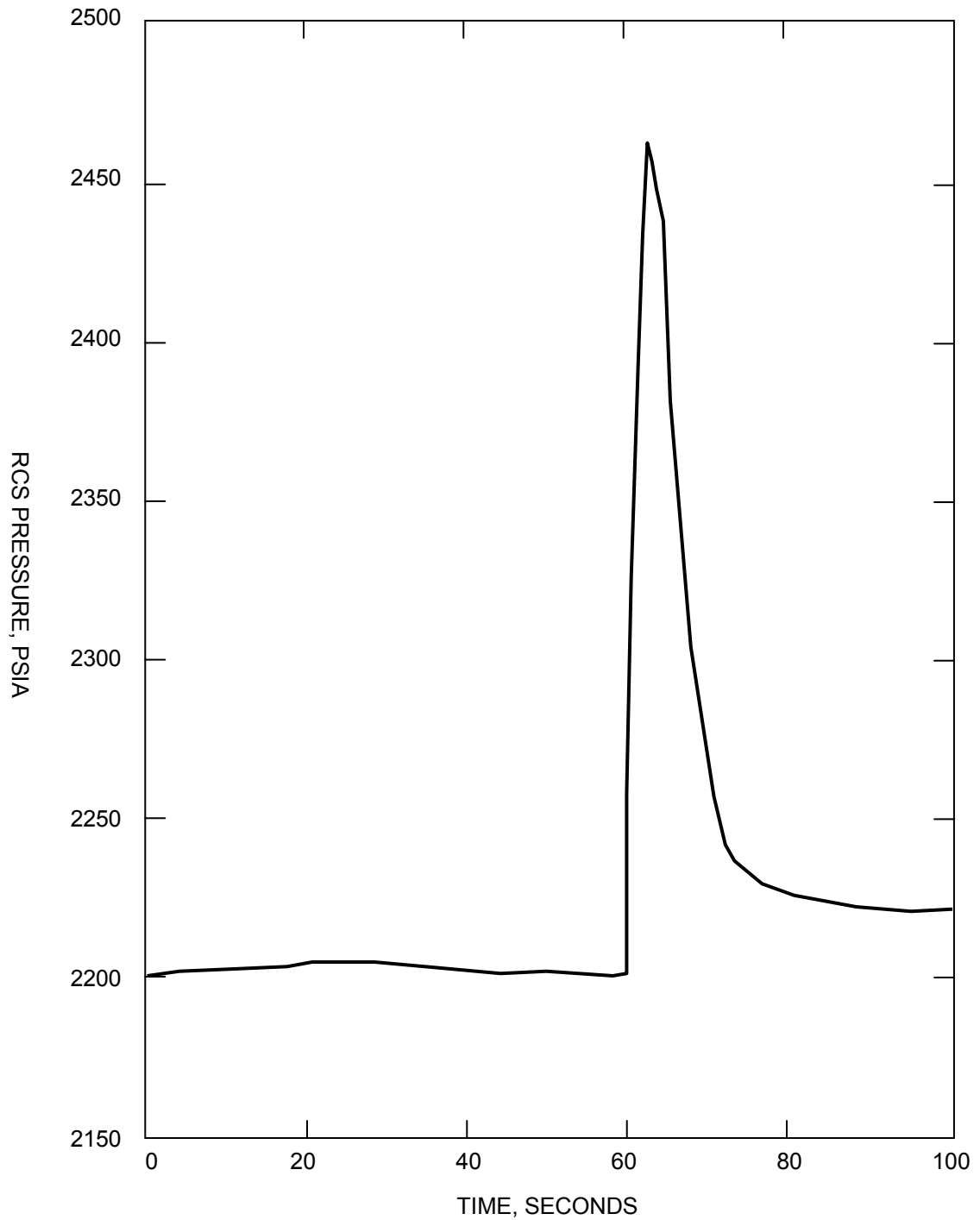

SAR FIGURE NO. 15.1.1-3

AMENDMENT 20

ARKANSAS NUCLEAR ONE
UNIT 2
RUSSELLVILLE, ARKANSAS



SCALE:	NONE
DRAWN:	
DESIGN:	ENTERGY
CAD NO:	

CEA WITHDRAWAL EVENT FROM SUBCRITICAL
CONDITIONS, REACTOR COOLANT SYSTEM
PRESSURE VS. TIME

BASED ON DRAWING NO

SHEET

REV.

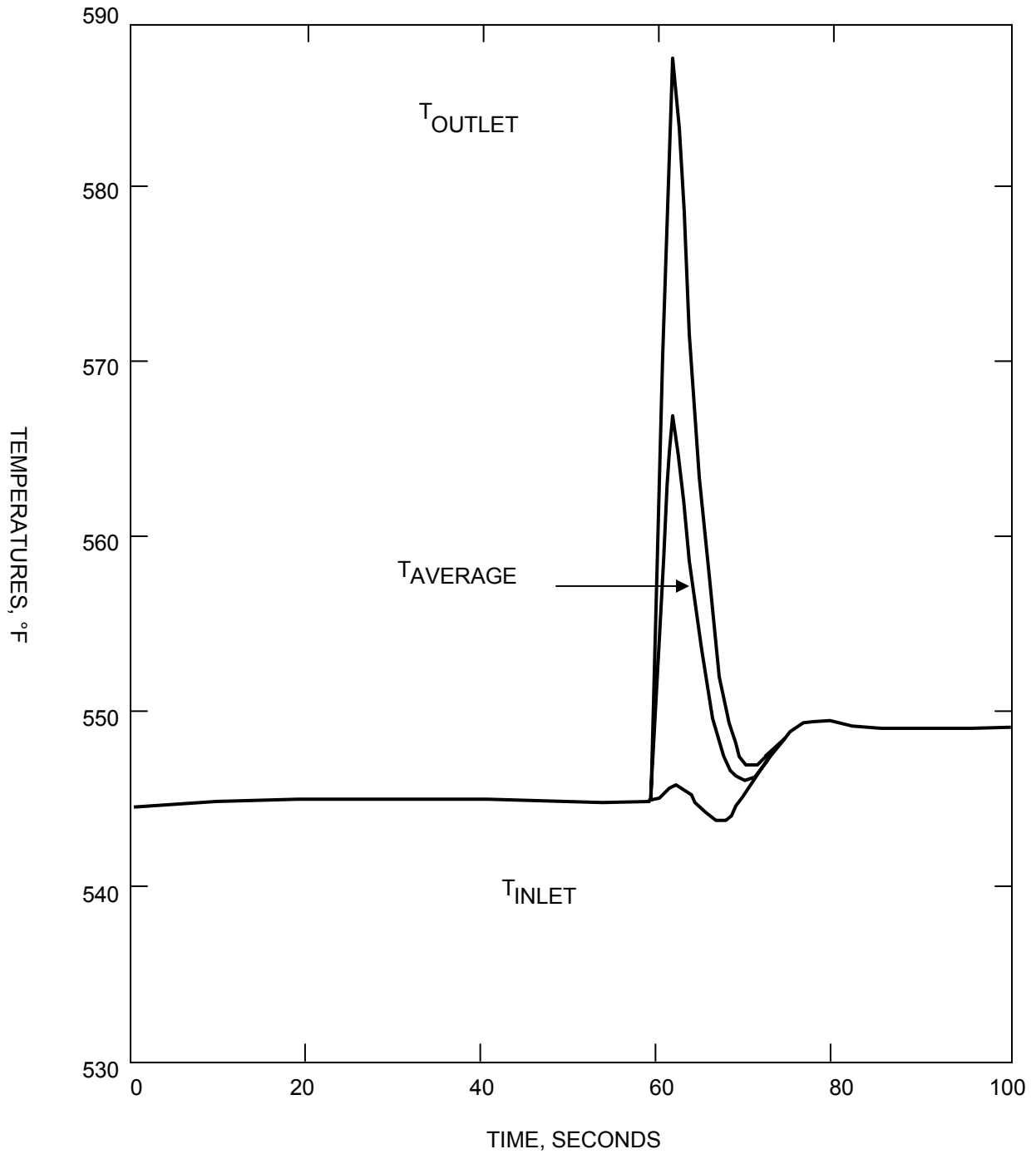

SAR FIGURE NO. 15.1.1-4

AMENDMENT 20

ARKANSAS NUCLEAR ONE
UNIT 2
RUSSELLVILLE, ARKANSAS



SCALE:	NONE
DRAWN:	
DESIGN:	ENERGY
CAD NO:	

CEA WITHDRAWAL EVENT FROM SUBCRITICAL
CONDITIONS, REACTOR COOLANT SYSTEM
TEMPERATURES VS. TIME

BASED ON DRAWING NO

SHEET

REV.

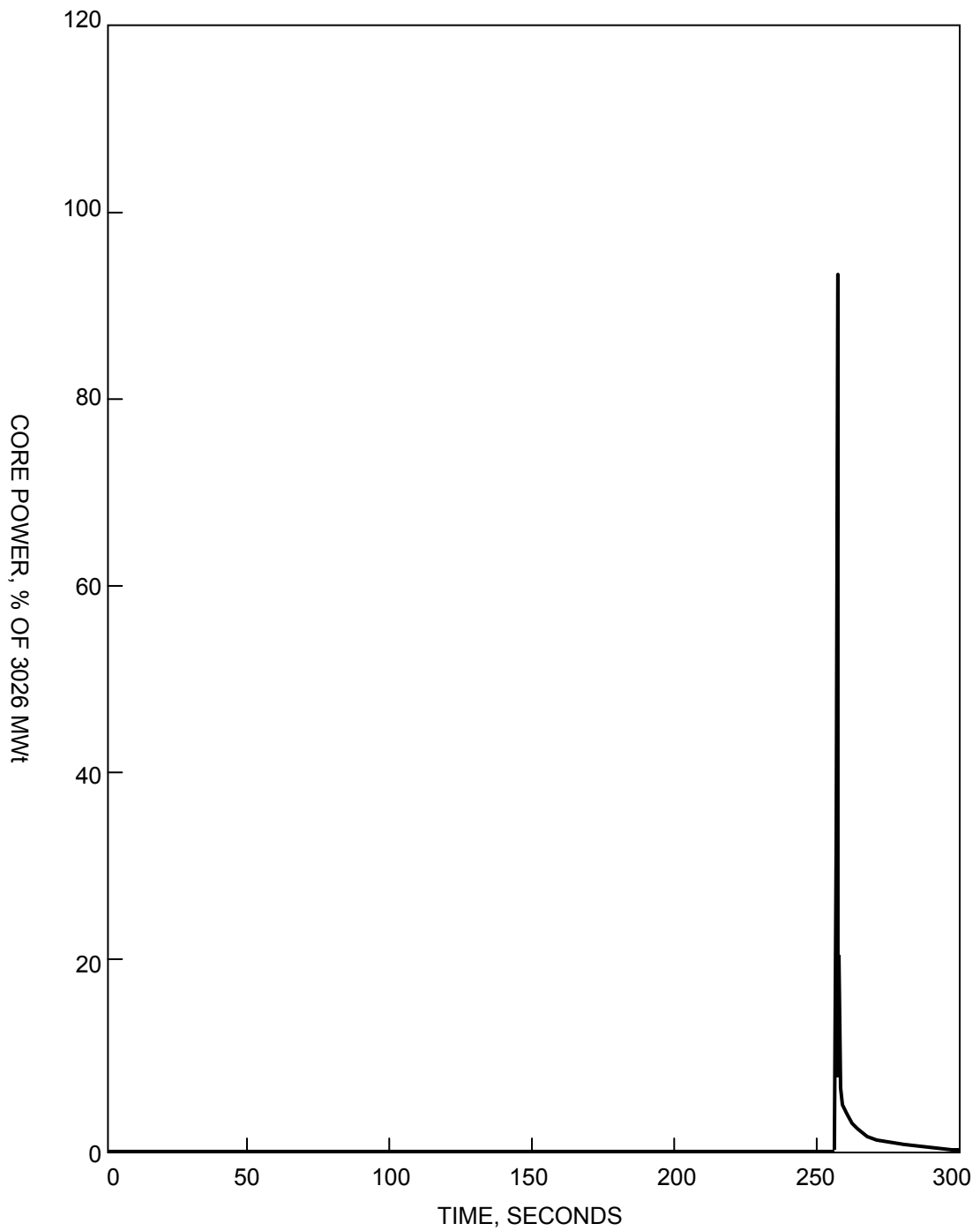

SAR FIGURE NO. 15.1.1-5

AMENDMENT 20

ARKANSAS NUCLEAR ONE
 UNIT 2
 RUSSELLVILLE, ARKANSAS



SCALE:	NONE
DRAWN:	
DESIGN:	ENTERGY
CAD NO:	

CYCLE 16 UNCONTROLLED CEA BANK WITHDRAWAL FROM SUBCRITICAL CONDITIONS WITH AN RIR OF $2.5 \times 10^{-4} \Delta\rho/\text{sec}$, CORE POWER VERSUS TIME

BASED ON DRAWING NO	SHEET	REV.

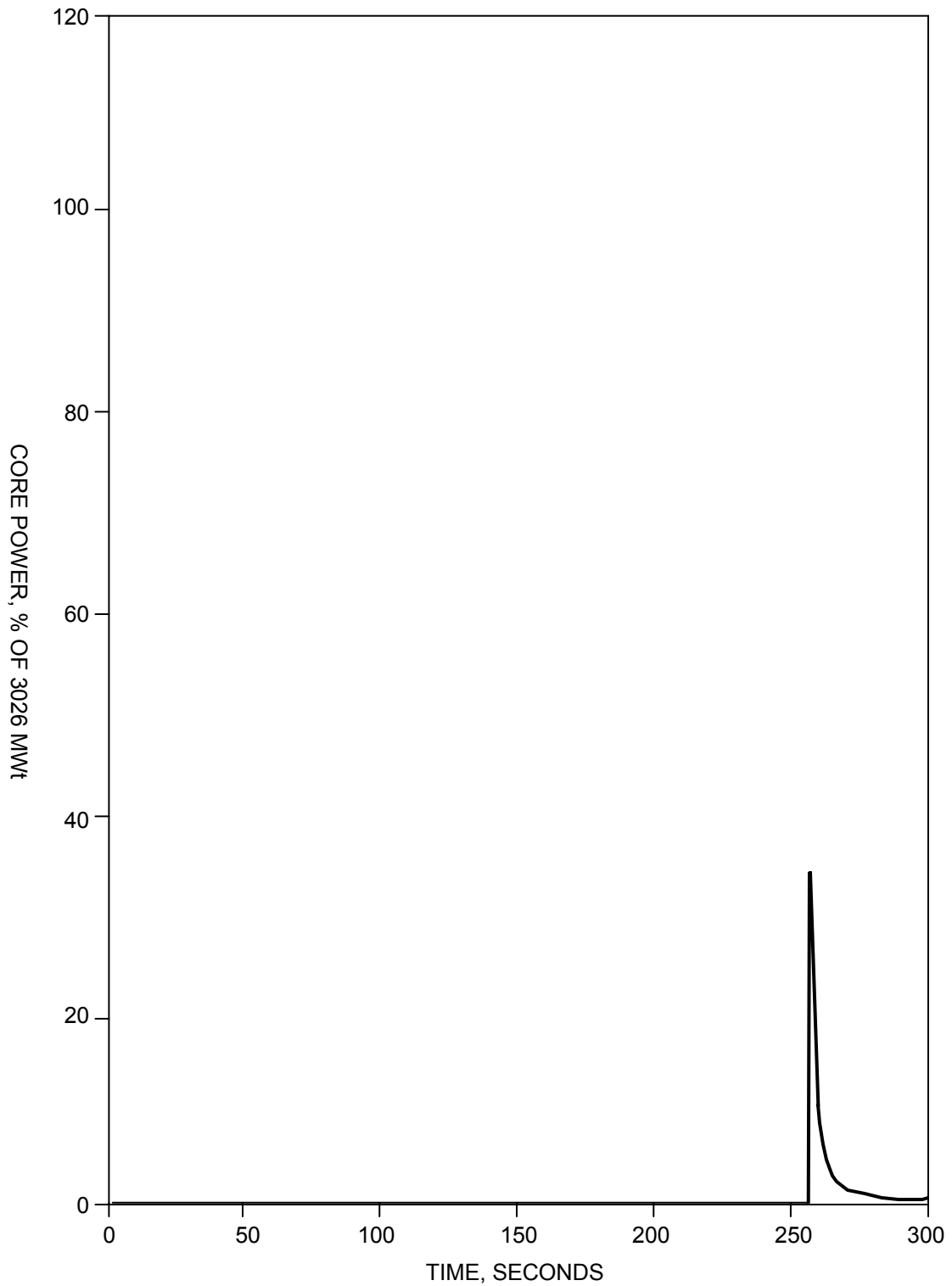

SAR FIGURE NO. 15.1.1-6

AMENDMENT 20

ARKANSAS NUCLEAR ONE
UNIT 2
RUSSELLVILLE, ARKANSAS



SCALE:	NONE
DRAWN:	
DESIGN:	ENTERGY
CAD NO:	

CYCLE 16 UNCONTROLLED CEA BANK WITHDRAWAL
FROM SUBCRITICAL CONDITIONS WITH AN RIR OF
 $2.5 \times 10^{-4} \Delta p/\text{sec}$, CORE AVERAGE HEAT FLUX VS. TIME

BASED ON DRAWING NO

SHEET

REV.

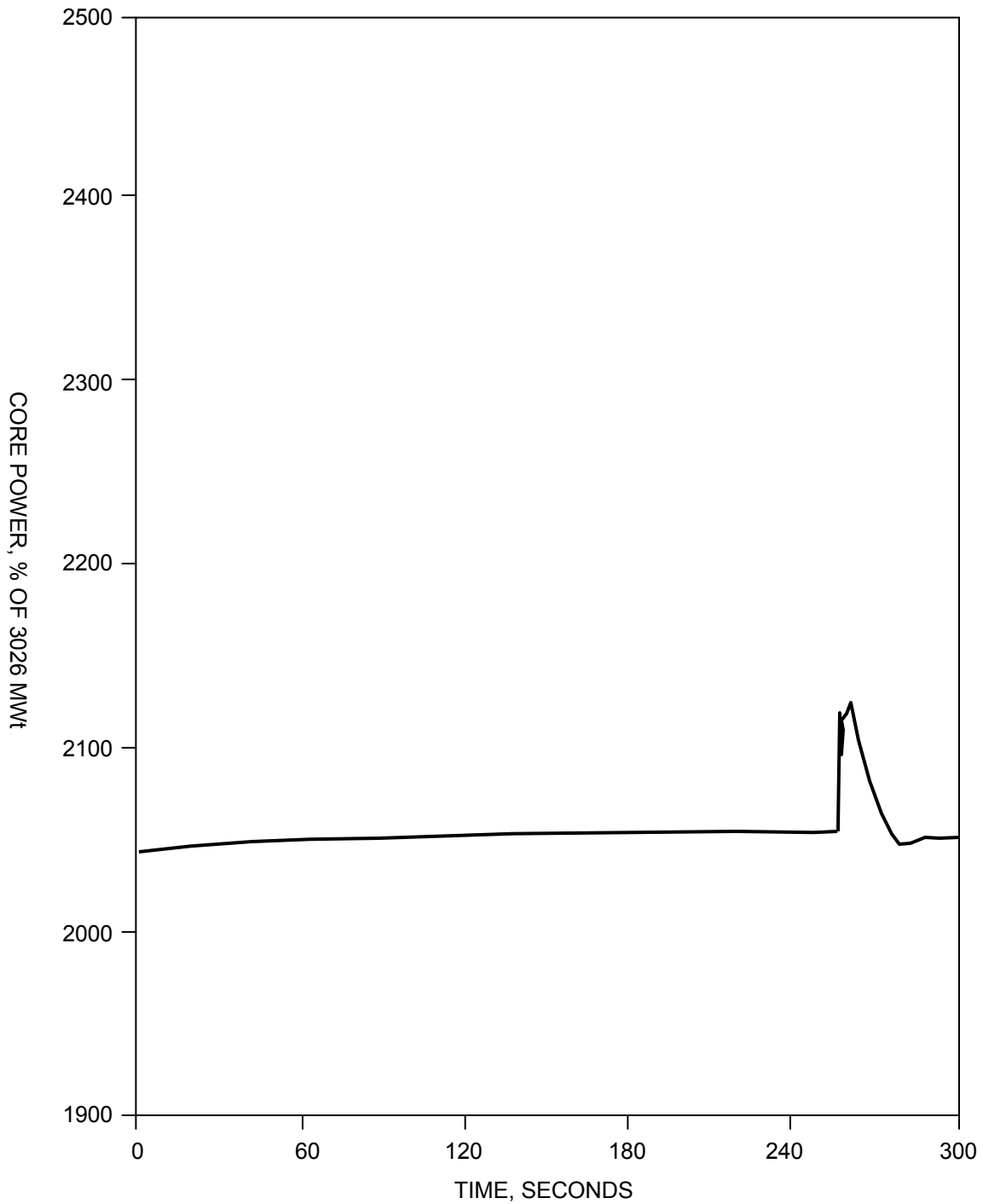

SAR FIGURE NO. 15.1.1-7

AMENDMENT 20

ARKANSAS NUCLEAR ONE
UNIT 2
RUSSELLVILLE, ARKANSAS



SCALE:	NONE
DRAWN:	
DESIGN:	ENTERGY
CAD NO:	

CYCLE 16 UNCONTROLLED CEA BANK WITHDRAWAL
FROM SUBCRITICAL CONDITIONS WITH AN RIR OF
 $2.5 \times 10^{-4} \Delta p/\text{sec}$, RCS PRESSURE VS. TIME

BASED ON DRAWING NO

SHEET

REV.

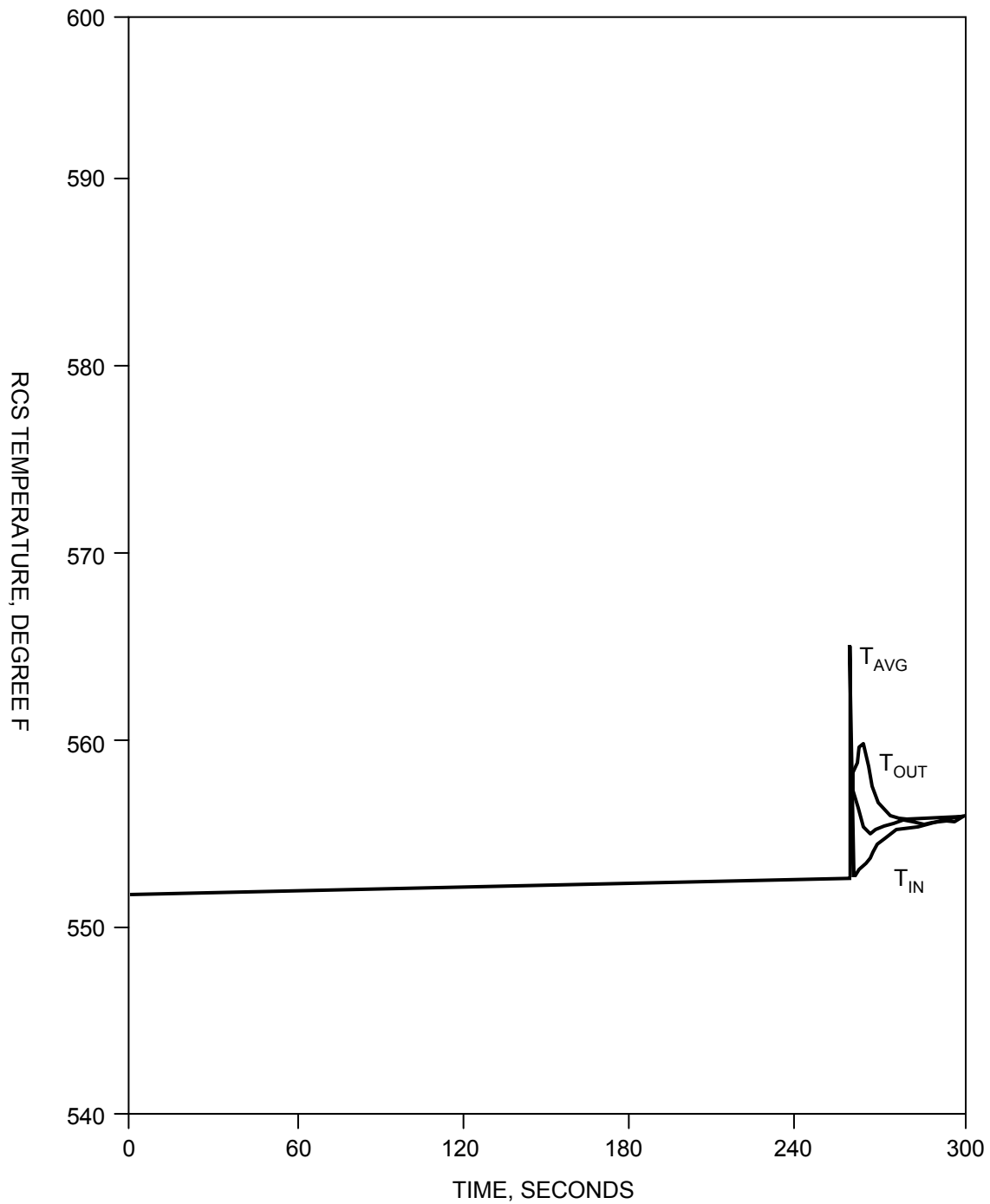

SAR FIGURE NO. 15.1.1-8

AMENDMENT 20

ARKANSAS NUCLEAR ONE
UNIT 2
RUSSELLVILLE, ARKANSAS



SCALE:	NONE
DRAWN:	
DESIGN:	ENERGY
CAD NO:	

CYCLE 16 UNCONTROLLED CEA BANK WITHDRAWAL
FROM SUBCRITICAL CONDITIONS WITH AN RIR OF
 $2.5 \times 10^{-4} \Delta p/\text{sec}$, RCS TEMPERATURE VS. TIME

BASED ON DRAWING NO

SHEET

REV.

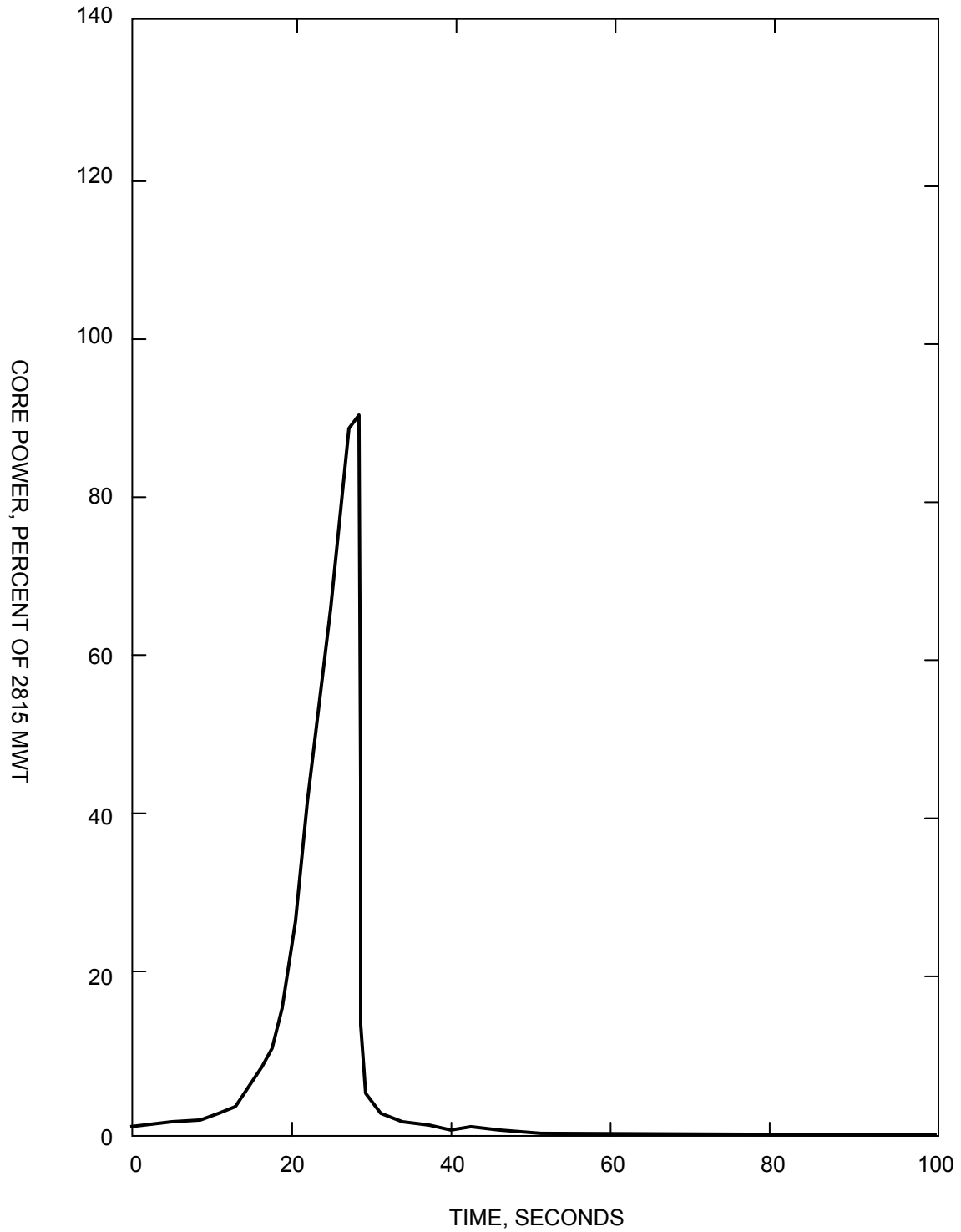

SAR FIGURE NO. 15.1.2-1

AMENDMENT 20

ARKANSAS NUCLEAR ONE
UNIT 2
RUSSELLVILLE, ARKANSAS



SCALE: NONE

DRAWN:

DESIGN: ENTERGY

CAD NO:

CEA WITHDRAWAL AT 1% POWER
CORE POWER VERSUS TIME

BASED ON DRAWING NO

SHEET

REV.

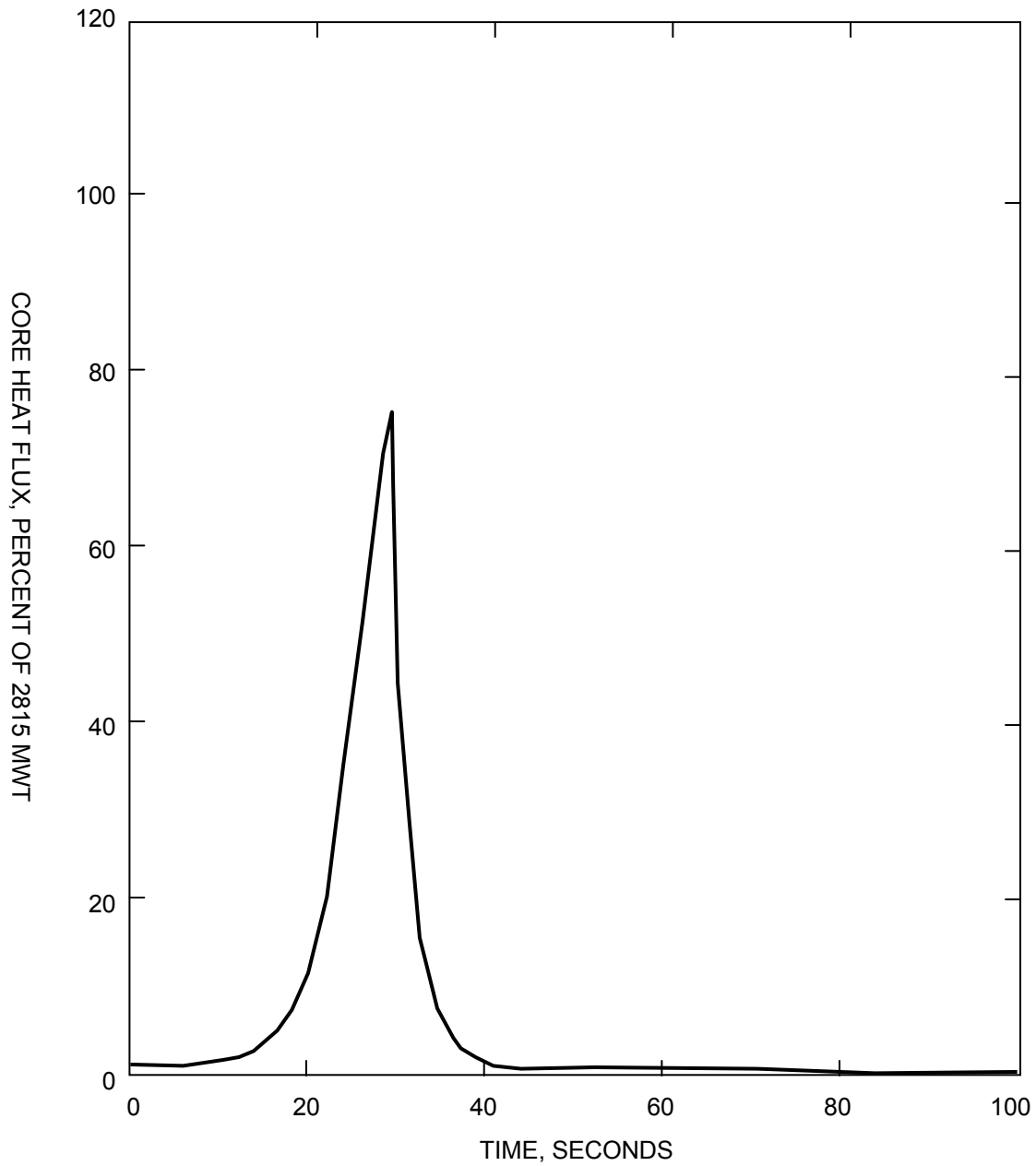

SAR FIGURE NO. 15.1.2-2

AMENDMENT 20

ARKANSAS NUCLEAR ONE
UNIT 2
RUSSELLVILLE, ARKANSAS



SCALE:	NONE
DRAWN:	
DESIGN:	ENTERGY
CAD NO:	

CEA WITHDRAWAL AT 1% POWER
CORE HEAT FLUX VERSUS TIME

BASED ON DRAWING NO

SHEET

REV.

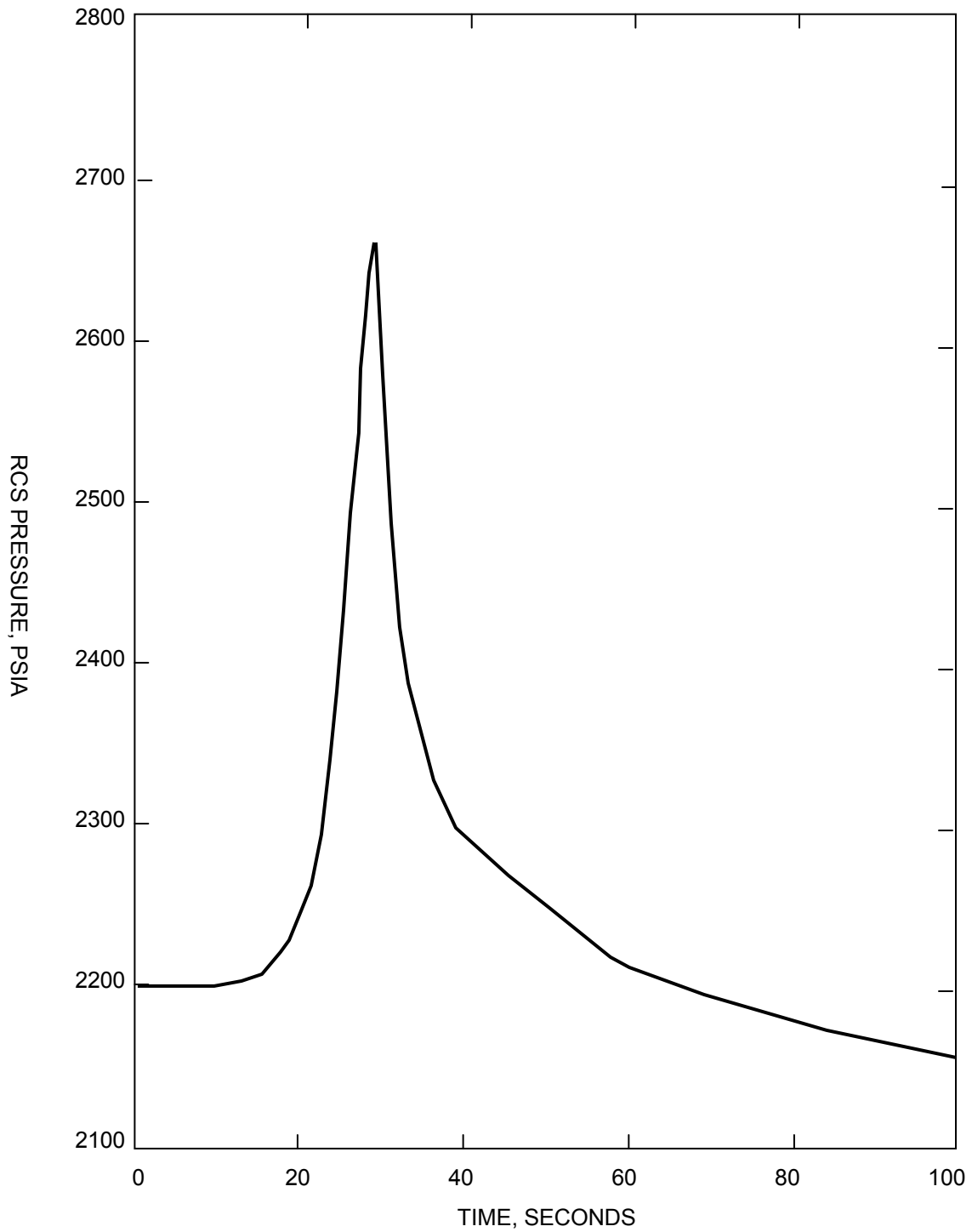

SAR FIGURE NO. 15.1.2-3

AMENDMENT 20

ARKANSAS NUCLEAR ONE
 UNIT 2
 RUSSELLVILLE, ARKANSAS



SCALE:	NONE
DRAWN:	
DESIGN:	ENTERGY
CAD NO:	

CEA WITHDRAWAL AT 1% POWER
 RCS PRESSURE VERSUS TIME

BASED ON DRAWING NO

SHEET

REV.

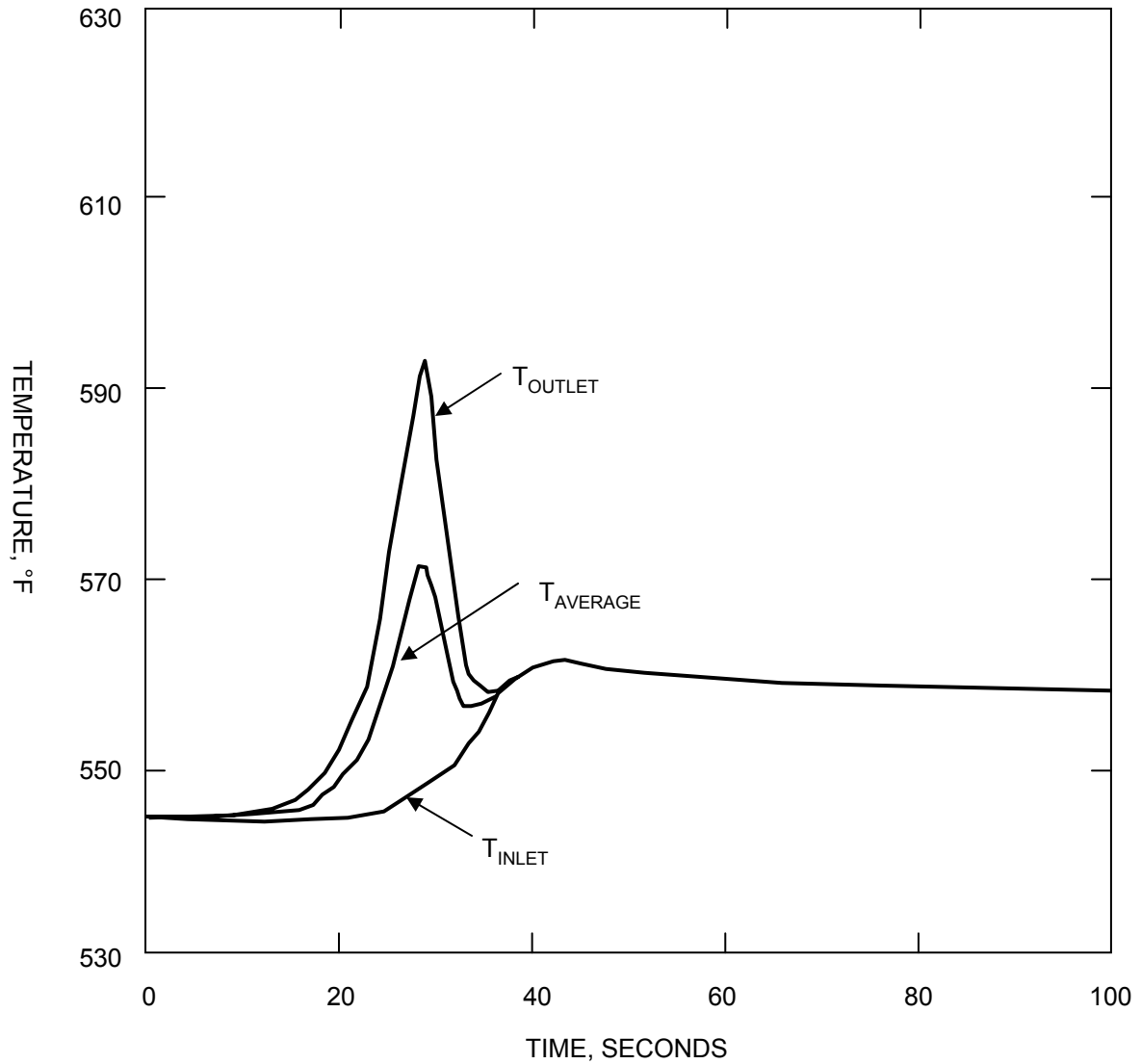

SAR FIGURE NO. 15.1.2-4

AMENDMENT 20

ARKANSAS NUCLEAR ONE
UNIT 2
RUSSELLVILLE, ARKANSAS



SCALE:	NONE
DRAWN:	
DESIGN:	ENERGY
CAD NO:	

CEA WITHDRAWAL AT 1% POWER
RCS TEMPERATURE VERSUS TIME

BASED ON DRAWING NO

SHEET

REV.

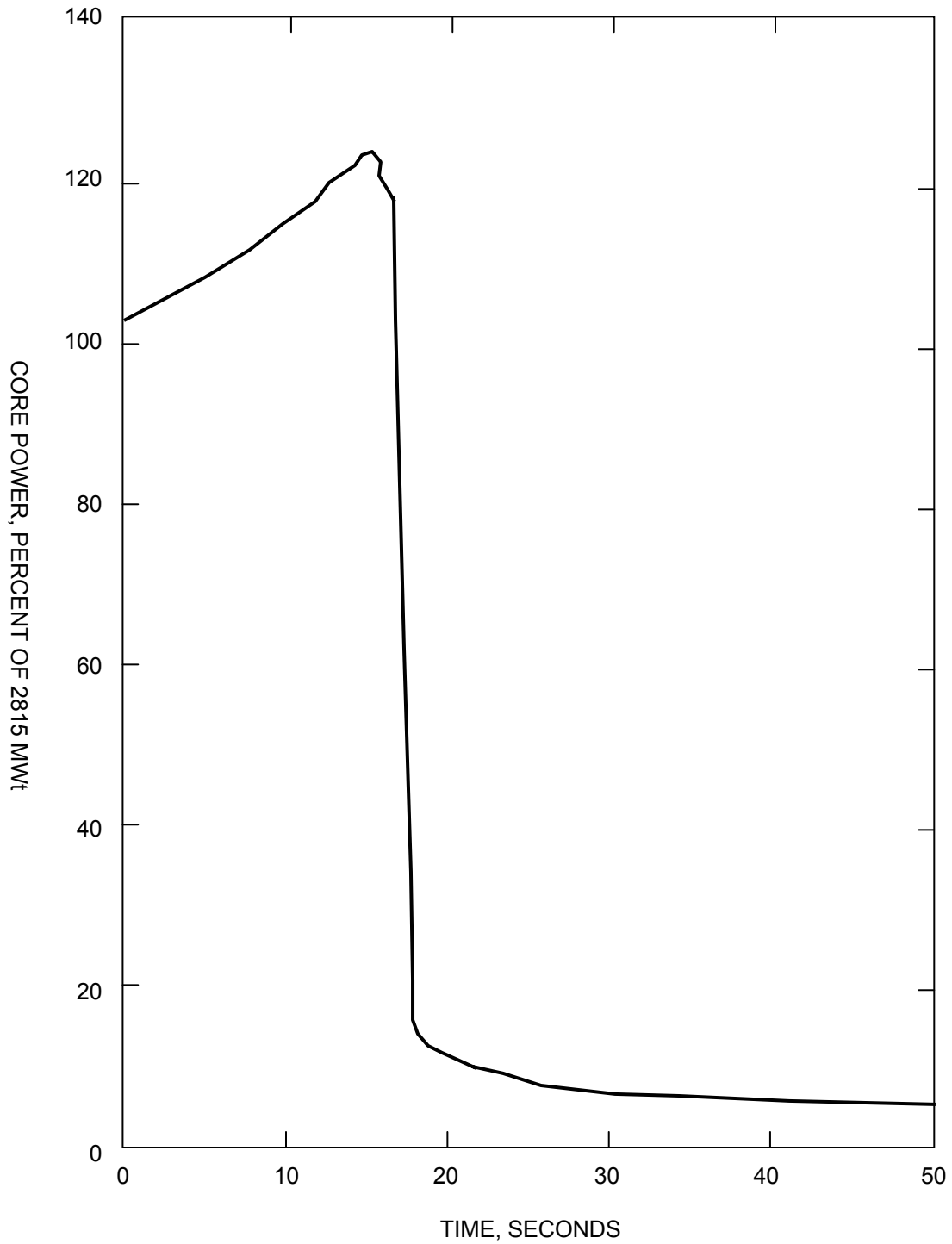

SAR FIGURE NO. 15.1.2-5

AMENDMENT 20

ARKANSAS NUCLEAR ONE
UNIT 2
RUSSELLVILLE, ARKANSAS



SCALE:	NONE
DRAWN:	
DESIGN:	ENTERGY
CAD NO:	

CEA WITHDRAWAL AT FULL POWER
CORE POWER VERSUS TIME

BASED ON DRAWING NO

SHEET

REV.

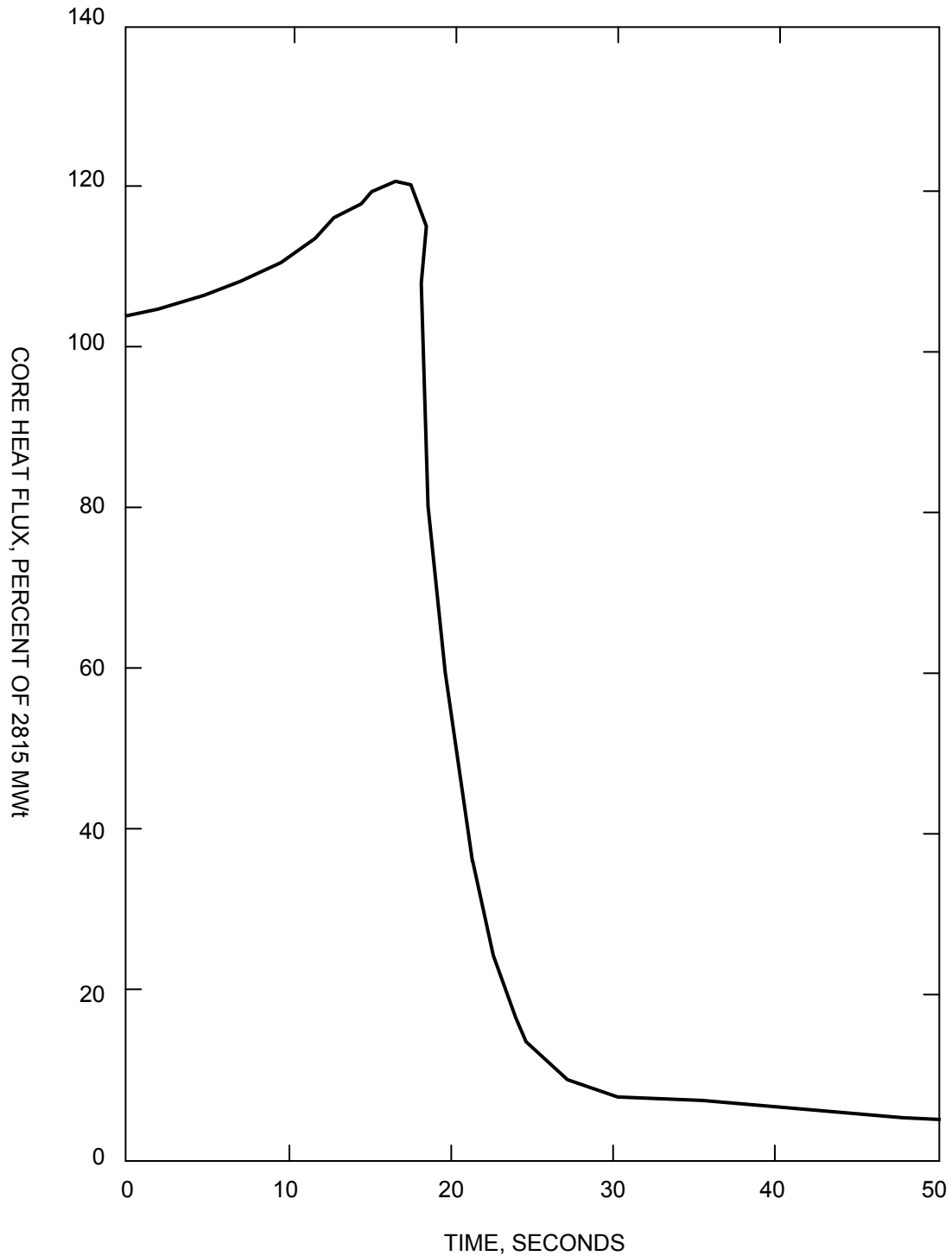

SAR FIGURE NO. 15.1.2-6

AMENDMENT 20

ARKANSAS NUCLEAR ONE
UNIT 2
RUSSELLVILLE, ARKANSAS



SCALE:	NONE
DRAWN:	
DESIGN:	ENTERGY
CAD NO:	

CEA WITHDRAWAL AT FULL POWER
CORE HEAT FLUX VERSUS TIME

BASED ON DRAWING NO

SHEET

REV.

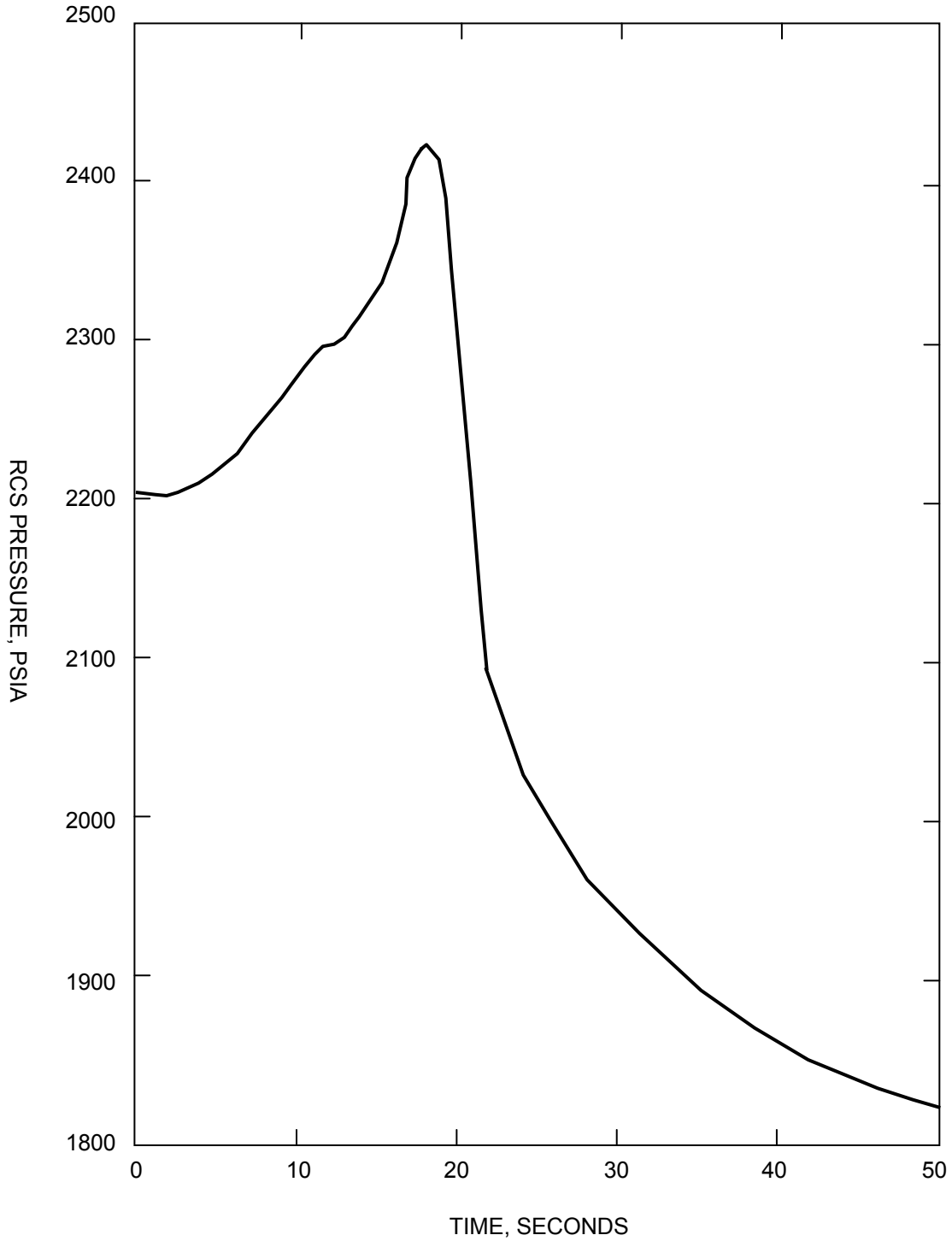

SAR FIGURE NO. 15.1.2-7

AMENDMENT 20

ARKANSAS NUCLEAR ONE
UNIT 2
RUSSELLVILLE, ARKANSAS



SCALE:	NONE
DRAWN:	
DESIGN:	ENTERGY
CAD NO:	

CEA WITHDRAWAL AT FULL POWER
RCS PRESSURE VERSUS TIME

BASED ON DRAWING NO

SHEET

REV.

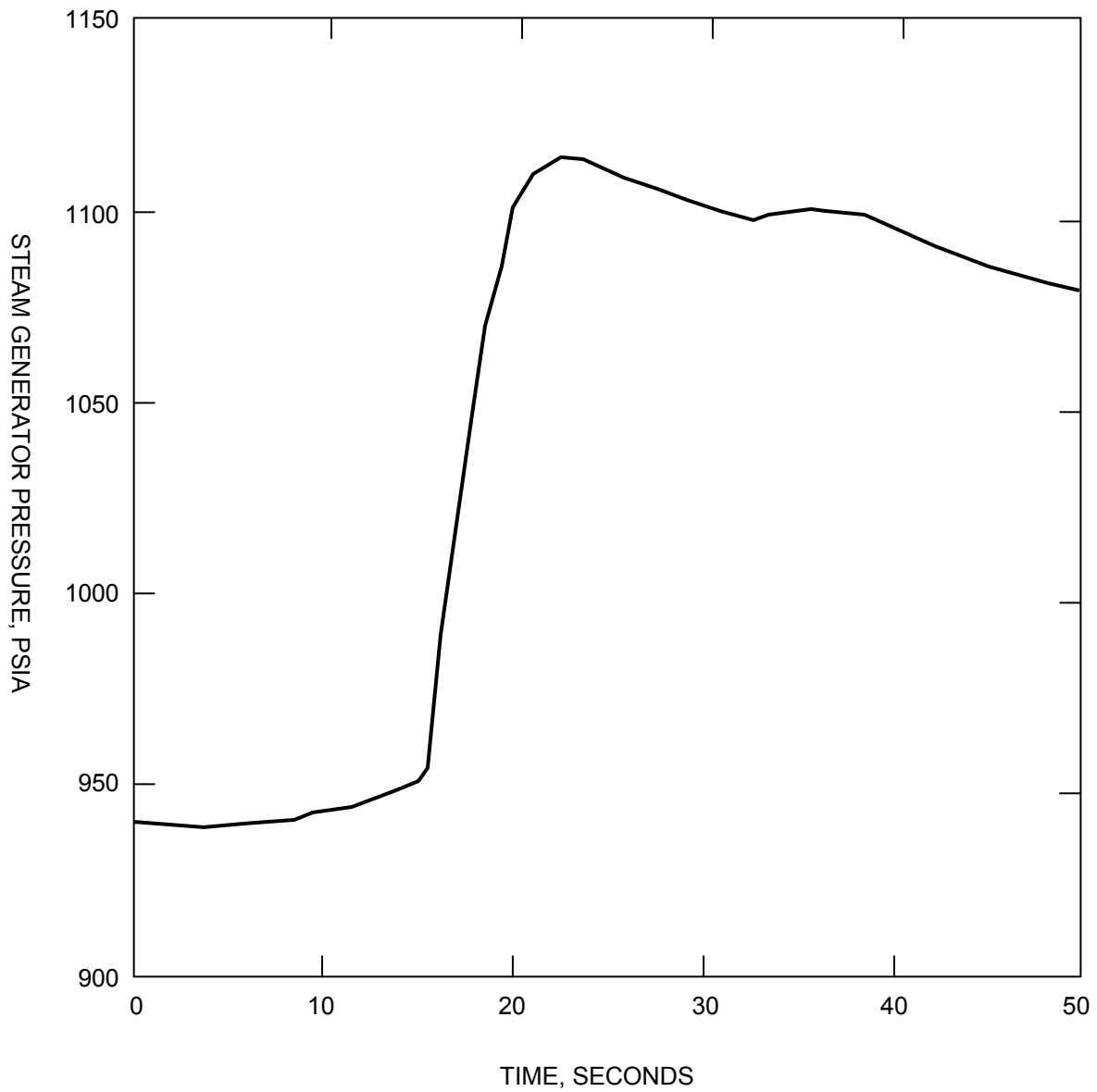

SAR FIGURE NO. 15.1.2-8

AMENDMENT 20

ARKANSAS NUCLEAR ONE
UNIT 2
RUSSELLVILLE, ARKANSAS



SCALE:	NONE
DRAWN:	
DESIGN:	ENERGY
CAD NO:	

CEA WITHDRAWAL AT FULL POWER
STEAM GENERATOR PRESSURES VERSUS TIME

BASED ON DRAWING NO

SHEET

REV.

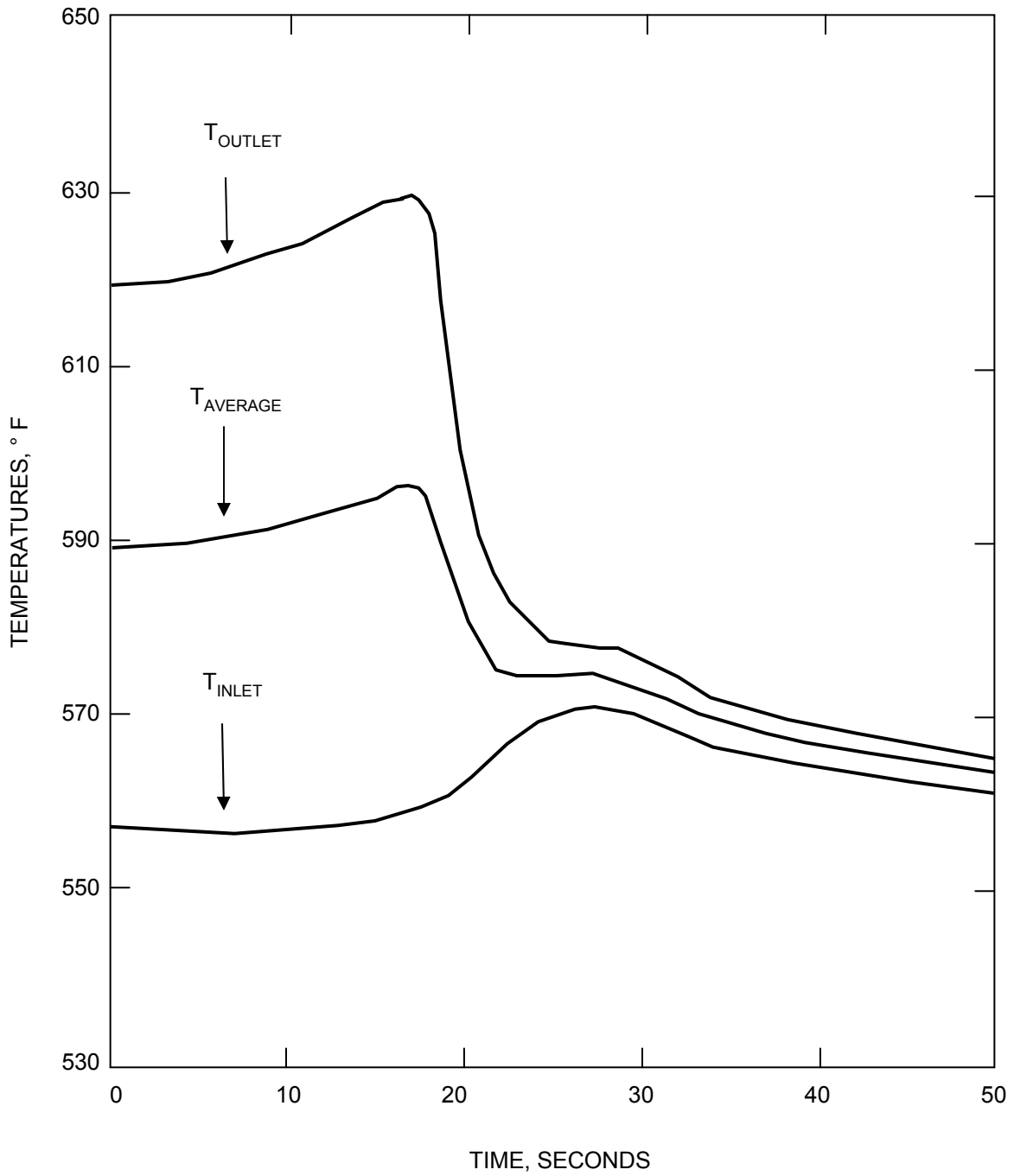

SAR FIGURE NO. 15.1.2-9

AMENDMENT 20

ARKANSAS NUCLEAR ONE
UNIT 2
RUSSELLVILLE, ARKANSAS



SCALE:	NONE
DRAWN:	
DESIGN:	ENERGY
CAD NO:	

CEA WITHDRAWAL AT FULL POWER
RCS TEMPERATURES VERSUS TIME

BASED ON DRAWING NO

SHEET

REV.

DELETED

SAR FIGURE NO. 15.1.2-10

AMENDMENT 20

ARKANSAS NUCLEAR ONE
UNIT 2
RUSSELLVILLE, ARKANSAS



SCALE: NONE

DRAWN:

DESIGN: ENTERGY

CAD NO:

BASED ON DRAWING NO

SHEET

REV.

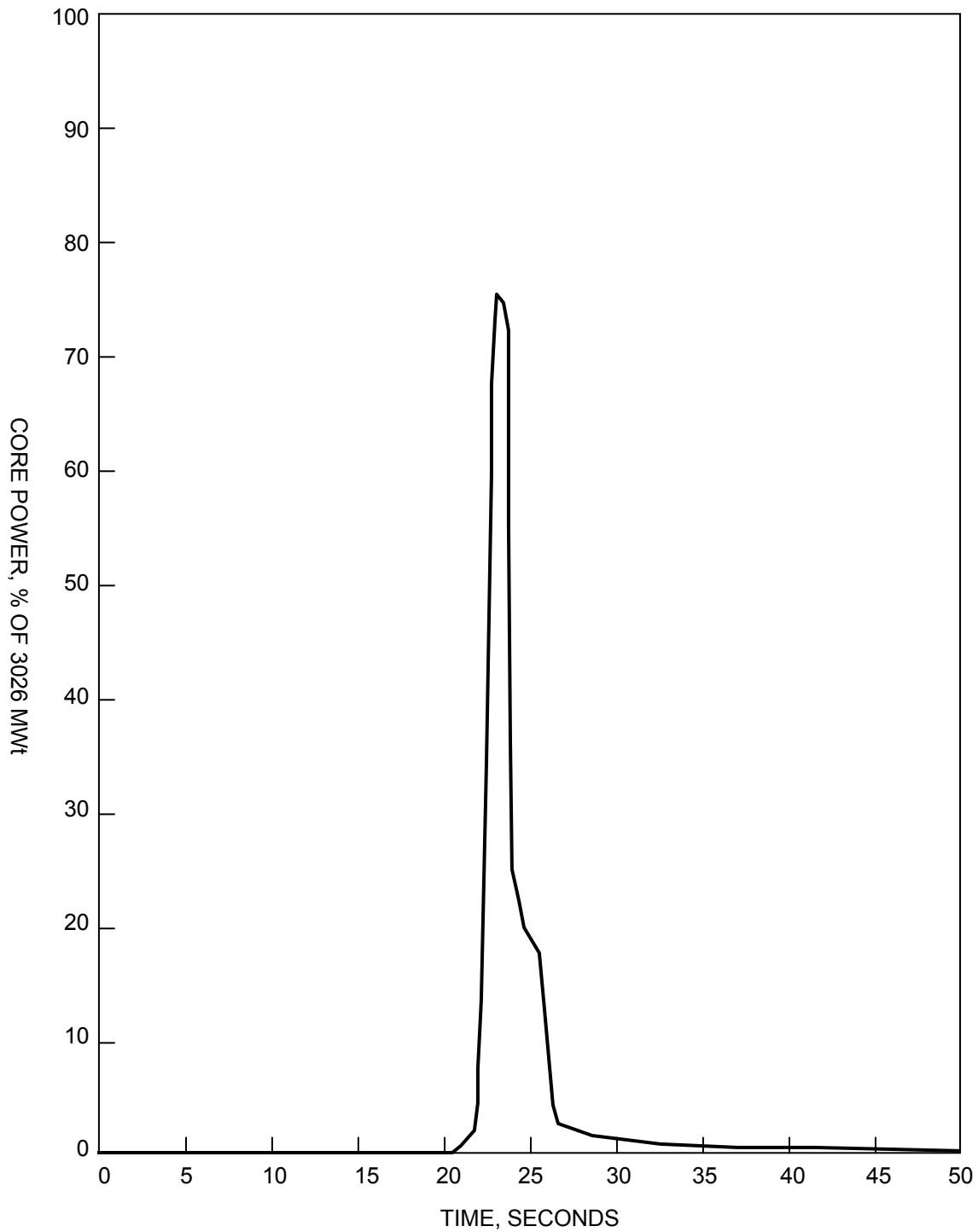

SAR FIGURE NO. 15.1.2-11

AMENDMENT 20

ARKANSAS NUCLEAR ONE
UNIT 2
RUSSELLVILLE, ARKANSAS



SCALE:	NONE
DRAWN:	
DESIGN:	ENTERGY
CAD NO:	

CYCLE 16 UNCONTROLLED CEA BANK
WITHDRAWAL FROM HOT ZERO POWER
CORE POWER VERSUS TIME

BASED ON DRAWING NO

SHEET

REV.

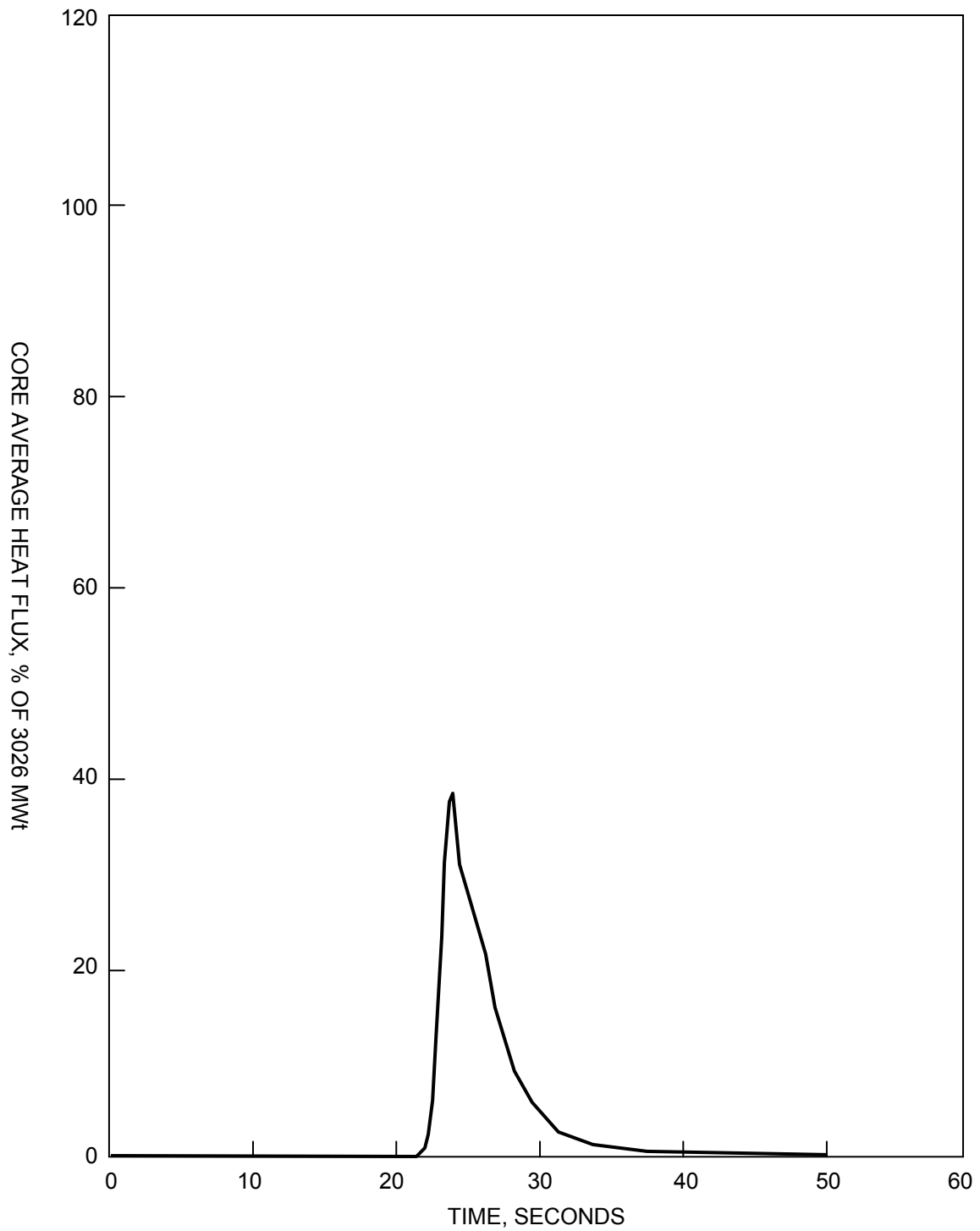

SAR FIGURE NO. 15.1.2-12

AMENDMENT 20

ARKANSAS NUCLEAR ONE
UNIT 2
RUSSELLVILLE, ARKANSAS



SCALE:	NONE
DRAWN:	
DESIGN:	ENTERGY
CAD NO:	

CYCLE 16 UNCONTROLLED CEA BANK
WITHDRAWAL FROM HOT ZERO POWER
CORE AVERAGE HEAT FLUX VERSUS TIME

BASED ON DRAWING NO

SHEET

REV.

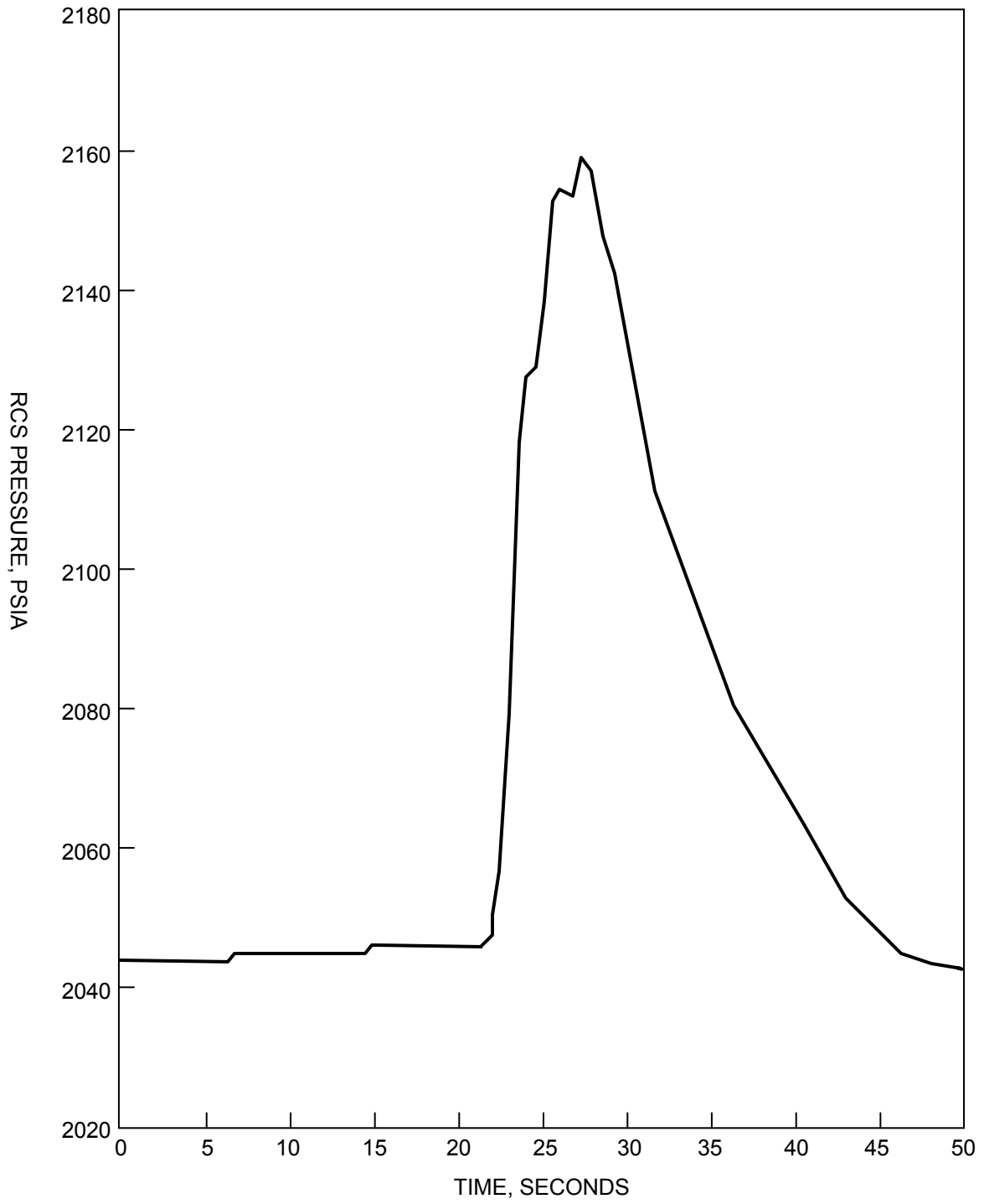

SAR FIGURE NO. 15.1.2-13

AMENDMENT 20

ARKANSAS NUCLEAR ONE
 UNIT 2
 RUSSELLVILLE, ARKANSAS



SCALE:	NONE
DRAWN:	
DESIGN:	ENTERGY
CAD NO:	

CYCLE 16 UNCONTROLLED CEA BANK WITHDRAWAL
 FROM HOT ZERO POWER, REACTOR COOLANT
 SYSTEM PRESSURE VERSUS TIME

BASED ON DRAWING NO

SHEET

REV.

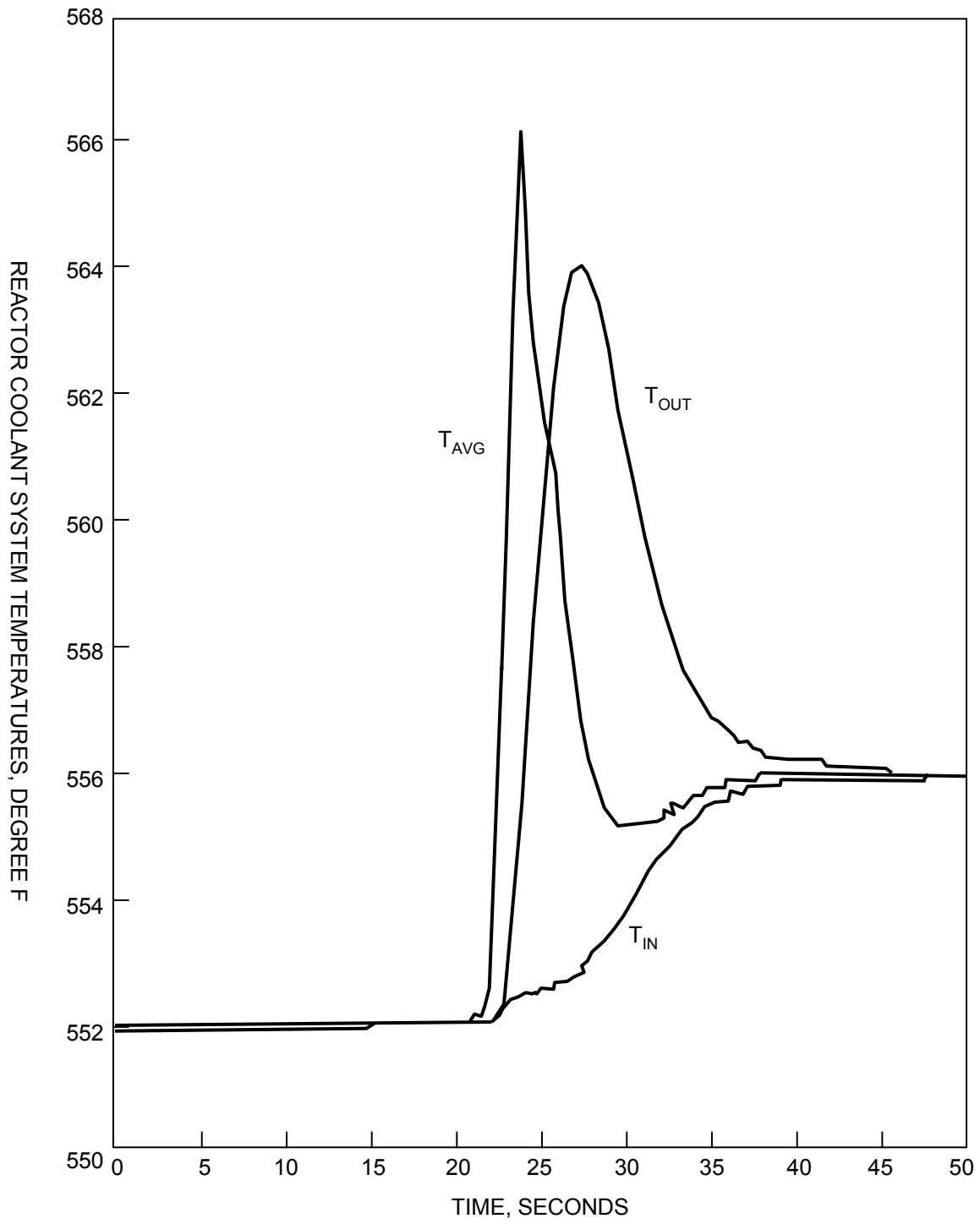

SAR FIGURE NO. 15.1.2-14

AMENDMENT 20

ARKANSAS NUCLEAR ONE
UNIT 2
RUSSELLVILLE, ARKANSAS



SCALE:	NONE
DRAWN:	
DESIGN:	ENERGY
CAD NO:	

CYCLE 16 UNCONTROLLED CEA BANK WITHDRAWAL
FROM HOT ZERO POWER, REACTOR COOLANT
SYSTEM TEMPERATURE VERSUS TIME

BASED ON DRAWING NO

SHEET

REV.

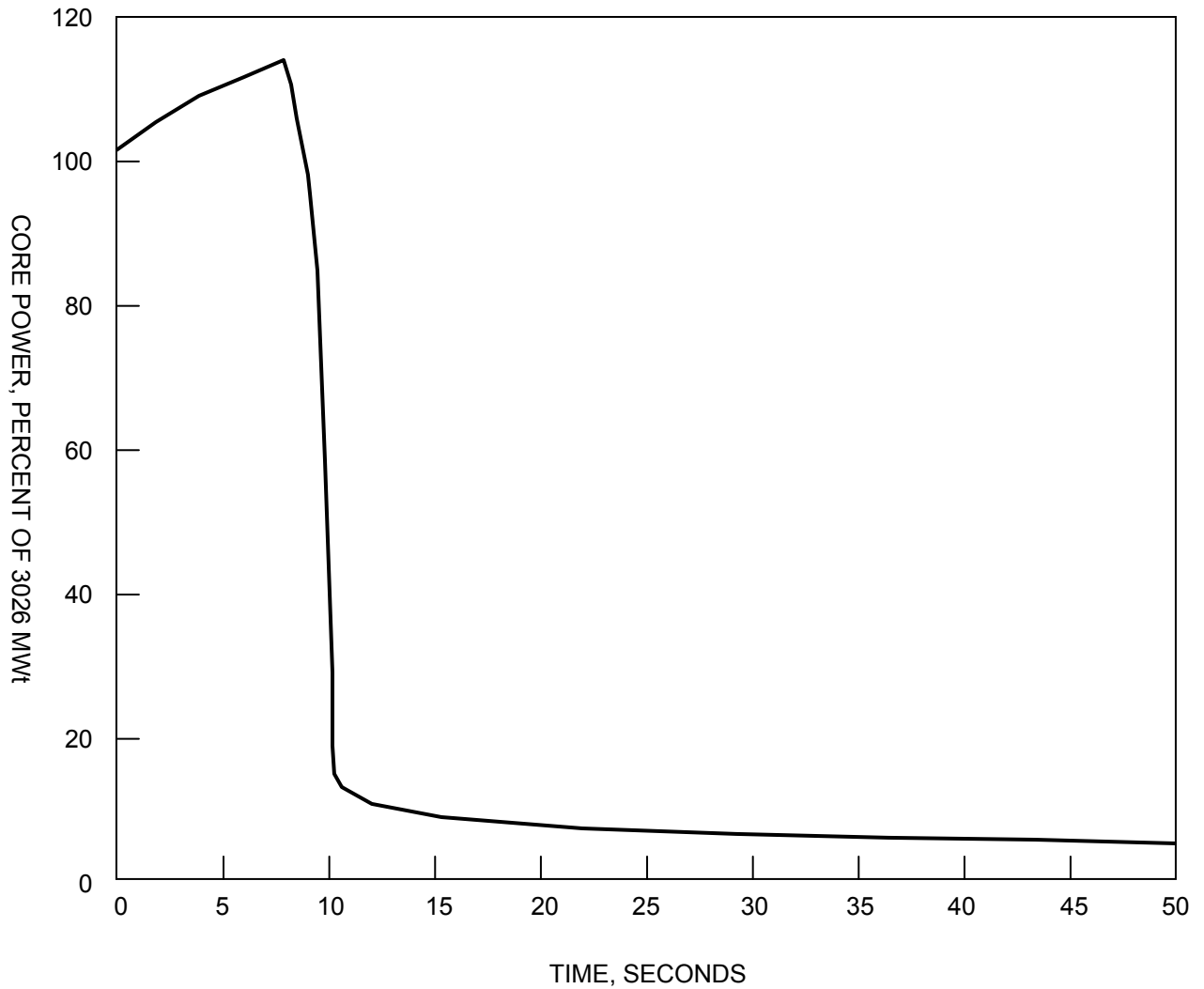

SAR FIGURE NO. 15.1.2-15

AMENDMENT 20

ARKANSAS NUCLEAR ONE
 UNIT 2
 RUSSELLVILLE, ARKANSAS



SCALE: NONE

DRAWN:

DESIGN: ENTERGY

CAD NO:

CYCLE 16 UNCONTROLLED CEA BANK
 WITHDRAWAL FROM HOT FULL POWER
 CORE POWER VERSUS TIME

BASED ON DRAWING NO

SHEET

REV.

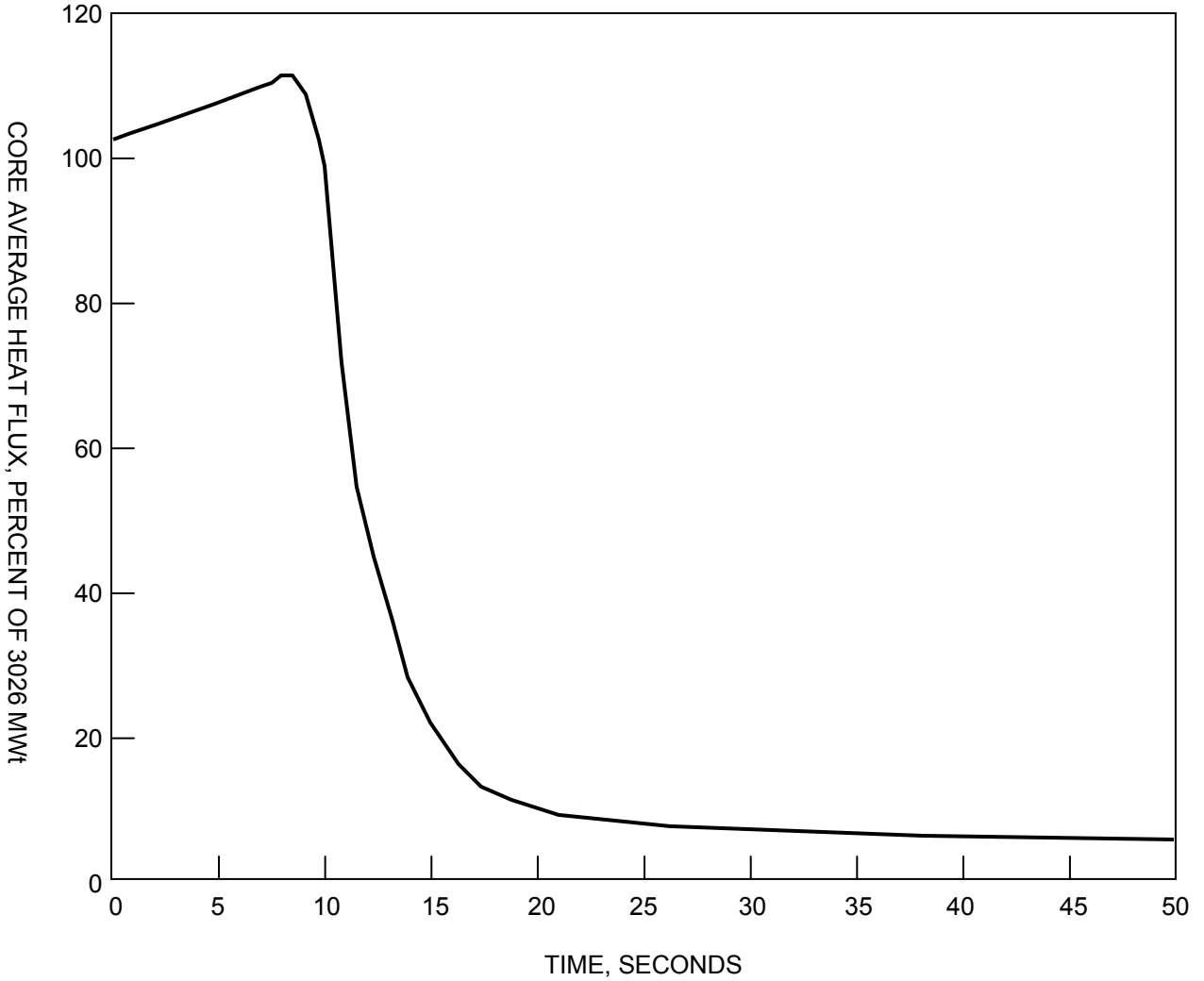

SAR FIGURE NO. 15.1.2-16

AMENDMENT 20

ARKANSAS NUCLEAR ONE
 UNIT 2
 RUSSELLVILLE, ARKANSAS



SCALE: NONE

DRAWN:

DESIGN: ENTERGY

CAD NO:

CYCLE 16 UNCONTROLLED CEA BANK
 WITHDRAWAL FROM HOT FULL POWER
 CORE AVERAGE HEAT FLUX VERSUS TIME

BASED ON DRAWING NO

SHEET

REV.

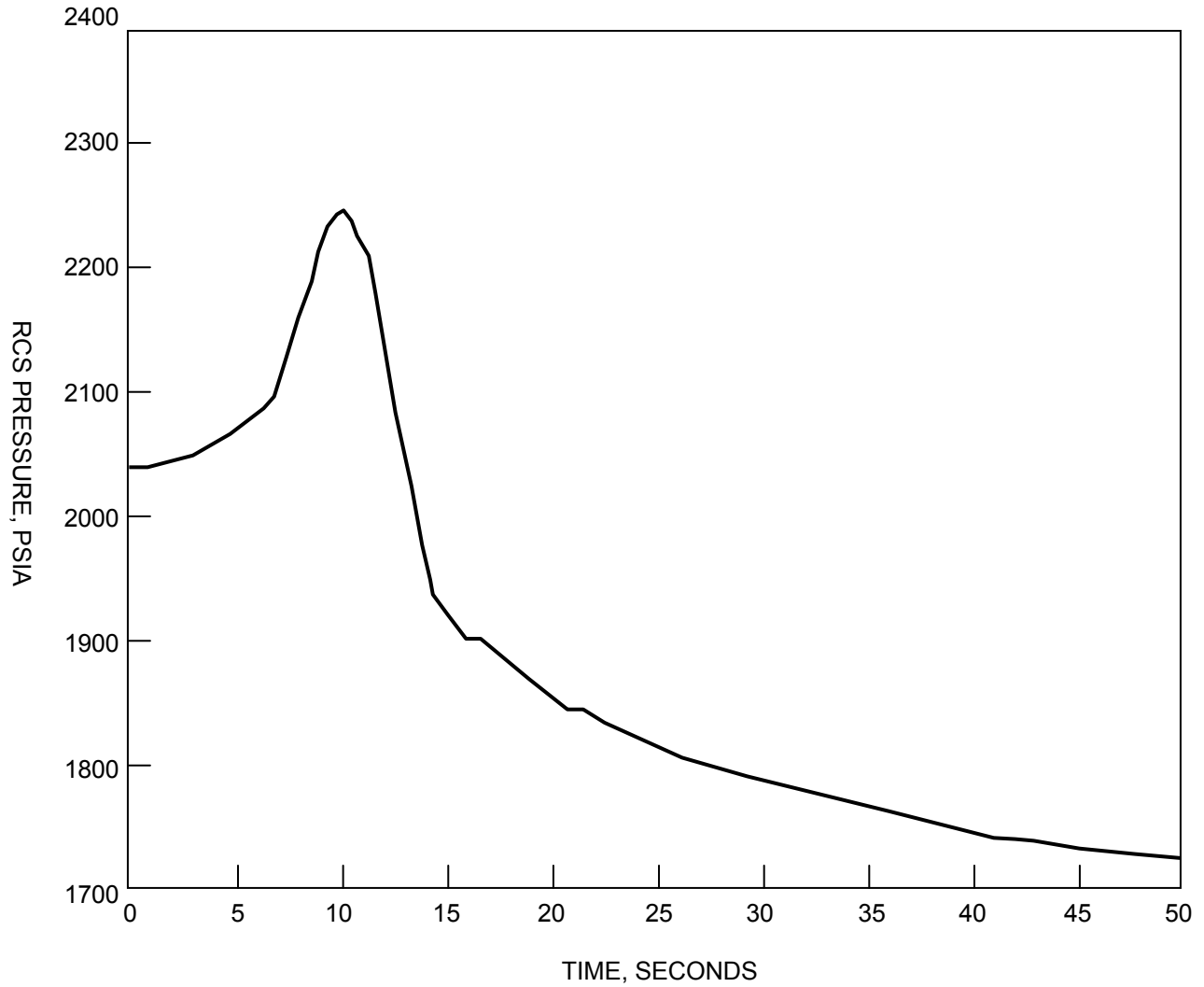

SAR FIGURE NO. 15.1.2-17

AMENDMENT 20

ARKANSAS NUCLEAR ONE
 UNIT 2
 RUSSELLVILLE, ARKANSAS



SCALE:	NONE
DRAWN:	
DESIGN:	ENERGY
CAD NO:	

CYCLE 16 UNCONTROLLED CEA BANK
 WITHDRAWAL FROM HOT FULL POWER
 RCS PRESSURE VERSUS TIME

BASED ON DRAWING NO

SHEET

REV.

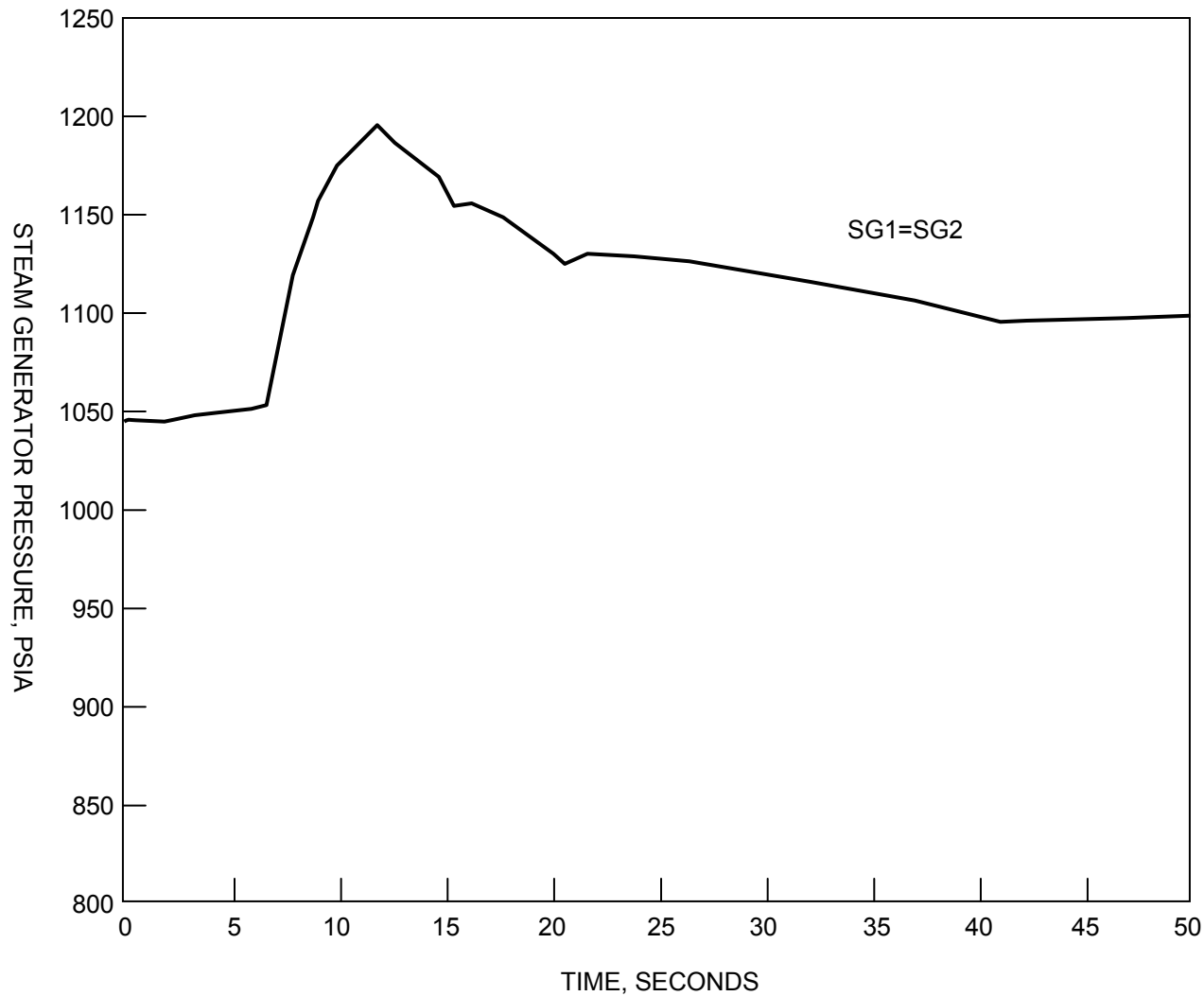

SAR FIGURE NO. 15.1.2-18

AMENDMENT 20

ARKANSAS NUCLEAR ONE
 UNIT 2
 RUSSELLVILLE, ARKANSAS



SCALE:	NONE
DRAWN:	
DESIGN:	ENERGY
CAD NO:	

CYCLE 16 UNCONTROLLED CEA BANK
 WITHDRAWAL FROM HOT FULL POWER
 STEAM GENERATOR PRESSURE VERSUS TIME

BASED ON DRAWING NO

SHEET

REV.

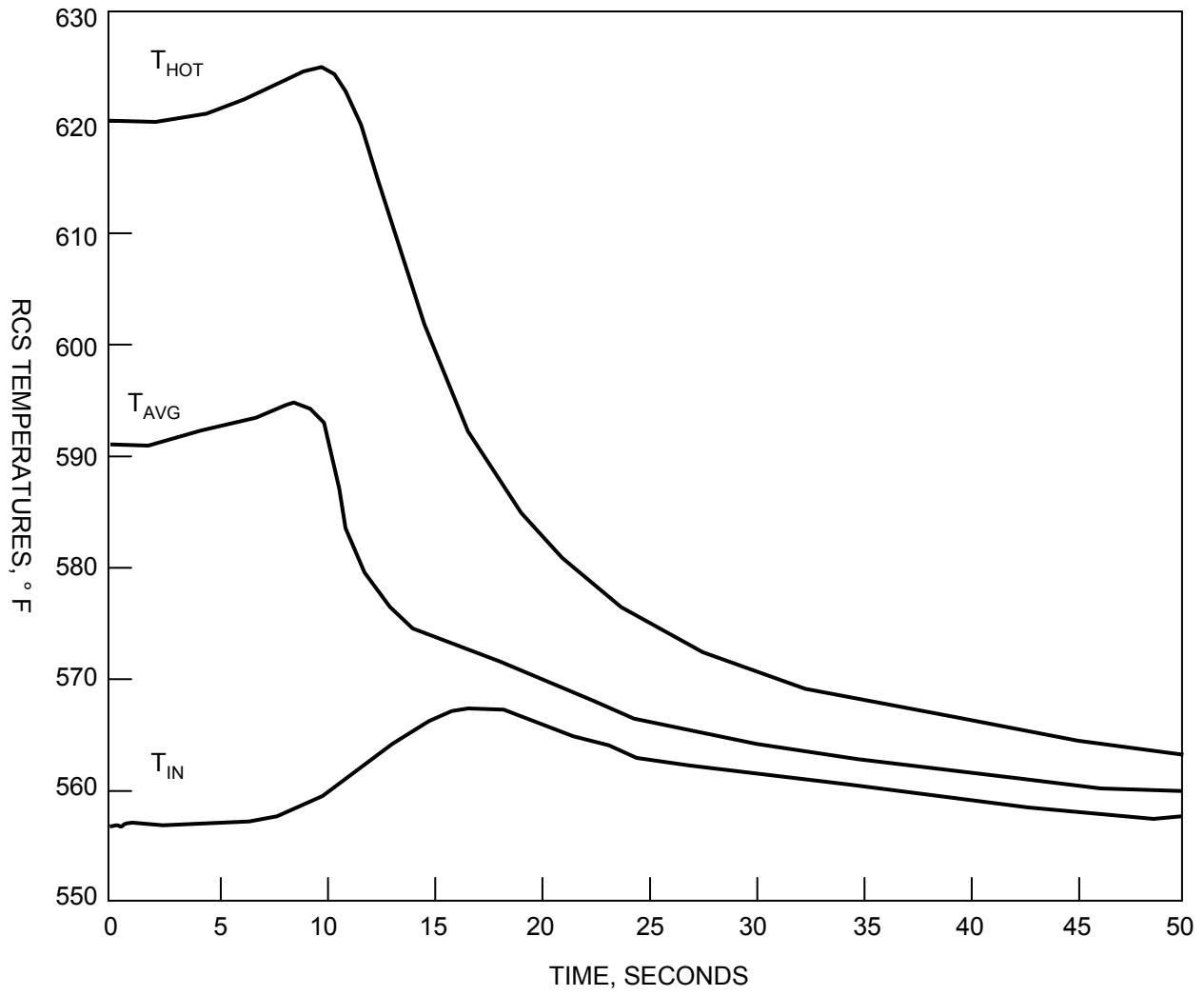

SAR FIGURE NO. 15.1.2-19

AMENDMENT 20

ARKANSAS NUCLEAR ONE
 UNIT 2
 RUSSELLVILLE, ARKANSAS



SCALE:	NONE
DRAWN:	
DESIGN:	ENERGY
CAD NO:	

CYCLE 16 UNCONTROLLED CEA BANK
 WITHDRAWAL FROM HOT FULL POWER
 RCS TEMPERATURE VERSUS TIME

BASED ON DRAWING NO

SHEET

REV.

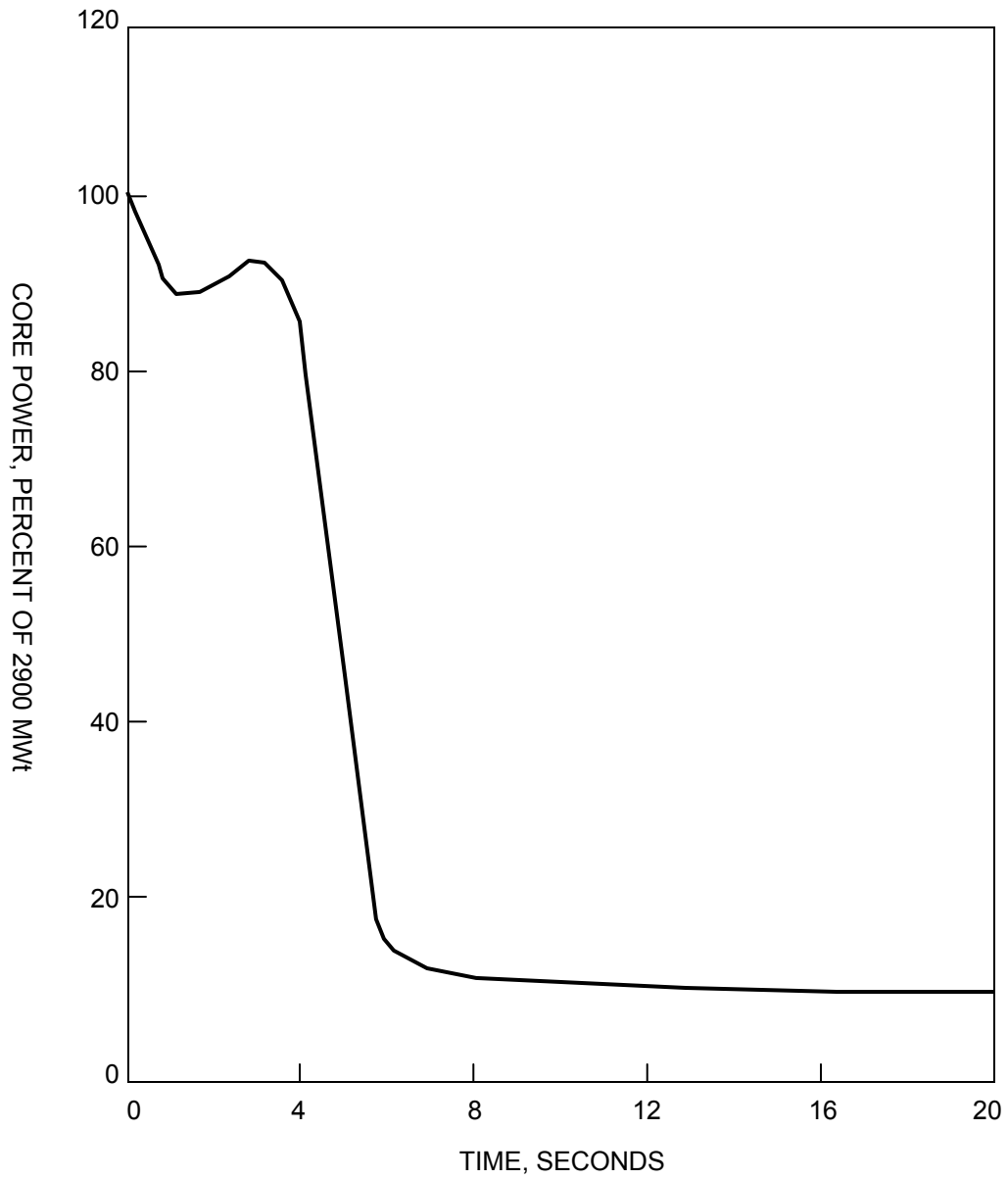

SAR FIGURE NO. 15.1.3-1

AMENDMENT 20

ARKANSAS NUCLEAR ONE
UNIT 2
RUSSELLVILLE, ARKANSAS



SCALE:	NONE
DRAWN:	
DESIGN:	ENERGY
CAD NO:	

CEA MISOPERATION FULL LENGTH CEA
DROP CORE POWER VERSUS TIME

BASED ON DRAWING NO

SHEET

REV.

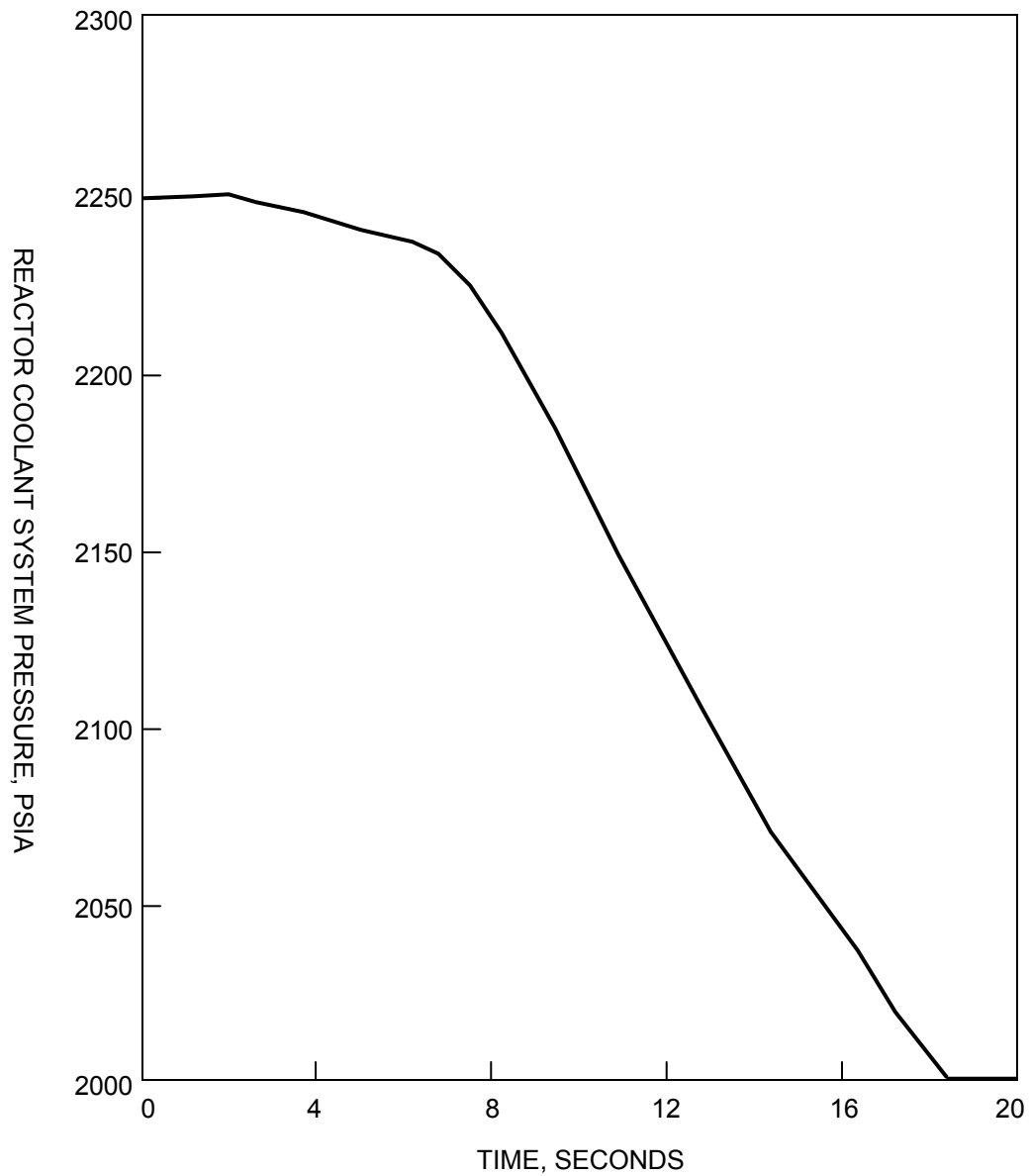

SAR FIGURE NO. 15.1.3-2

AMENDMENT 20

ARKANSAS NUCLEAR ONE
 UNIT 2
 RUSSELLVILLE, ARKANSAS



SCALE:	NONE
DRAWN:	
DESIGN:	ENERGY
CAD NO:	

CEA MISOPERATION FULL LENGTH CEA
 DROP RCS PRESSURE VERSUS TIME

BASED ON DRAWING NO

SHEET

REV.

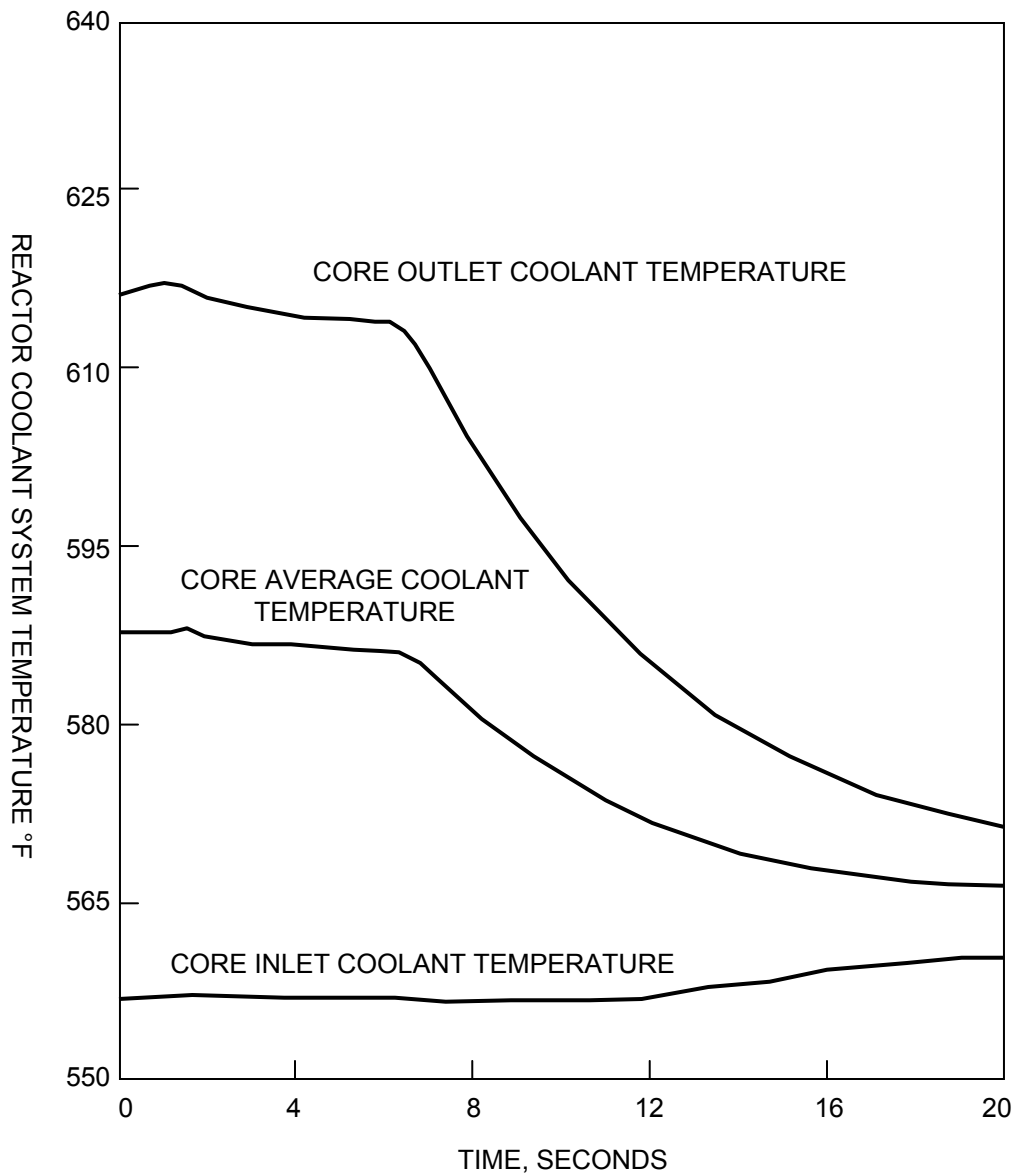

SAR FIGURE NO. 15.1.3-3

AMENDMENT 20

ARKANSAS NUCLEAR ONE
 UNIT 2
 RUSSELLVILLE, ARKANSAS



SCALE:	NONE
DRAWN:	
DESIGN:	ENTERGY
CAD NO:	

CEA MISOPERATION FULL LENGTH CEA
 DROP RCS TEMPERATURE VERSUS TIME

BASED ON DRAWING NO

SHEET

REV.

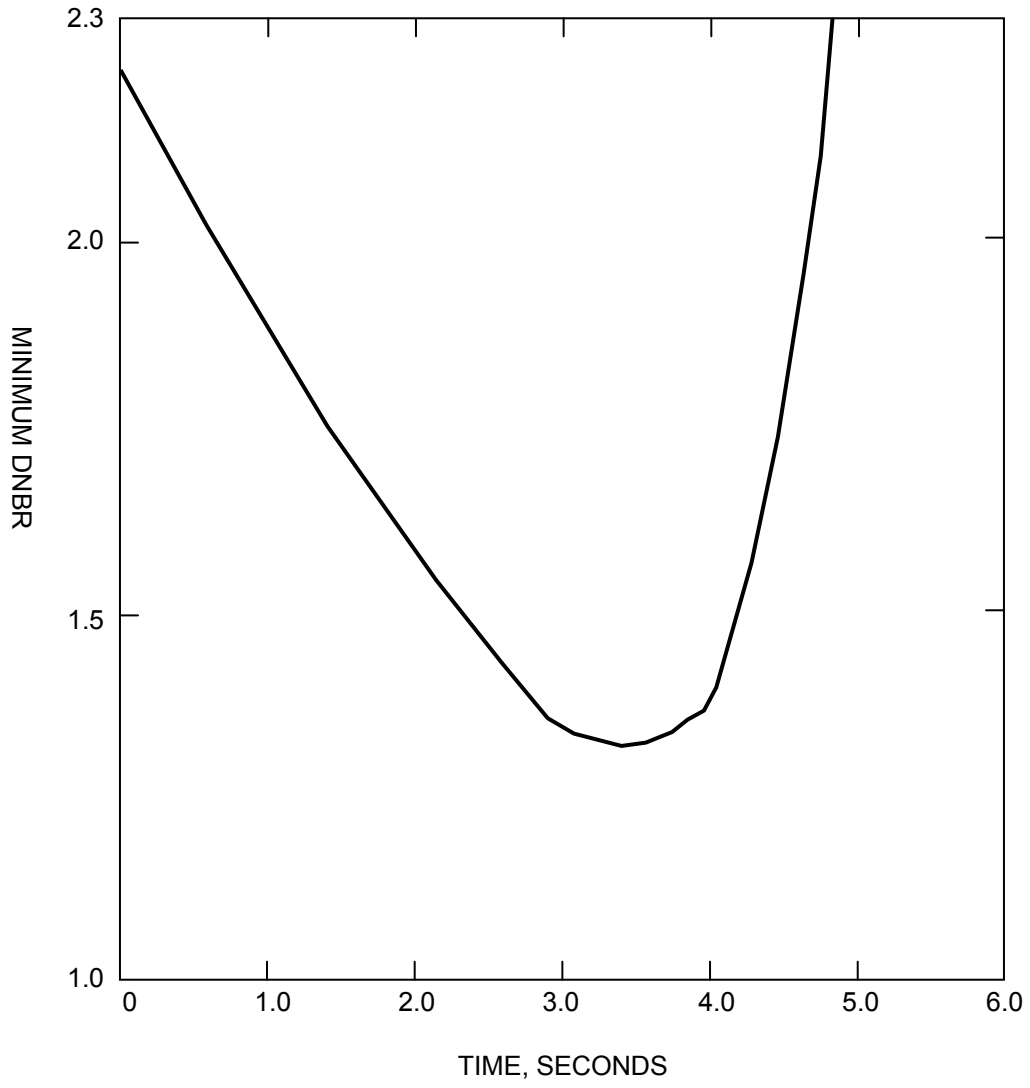

SAR FIGURE NO. 15.1.3-4

AMENDMENT 20

ARKANSAS NUCLEAR ONE
 UNIT 2
 RUSSELLVILLE, ARKANSAS



SCALE:	NONE
DRAWN:	
DESIGN:	ENTERGY
CAD NO:	

CEA MISOPERATION FULL LENGTH CEA
 DROP MINIMUM DNB RATION VERSUS TIME

BASED ON DRAWING NO

SHEET

REV.

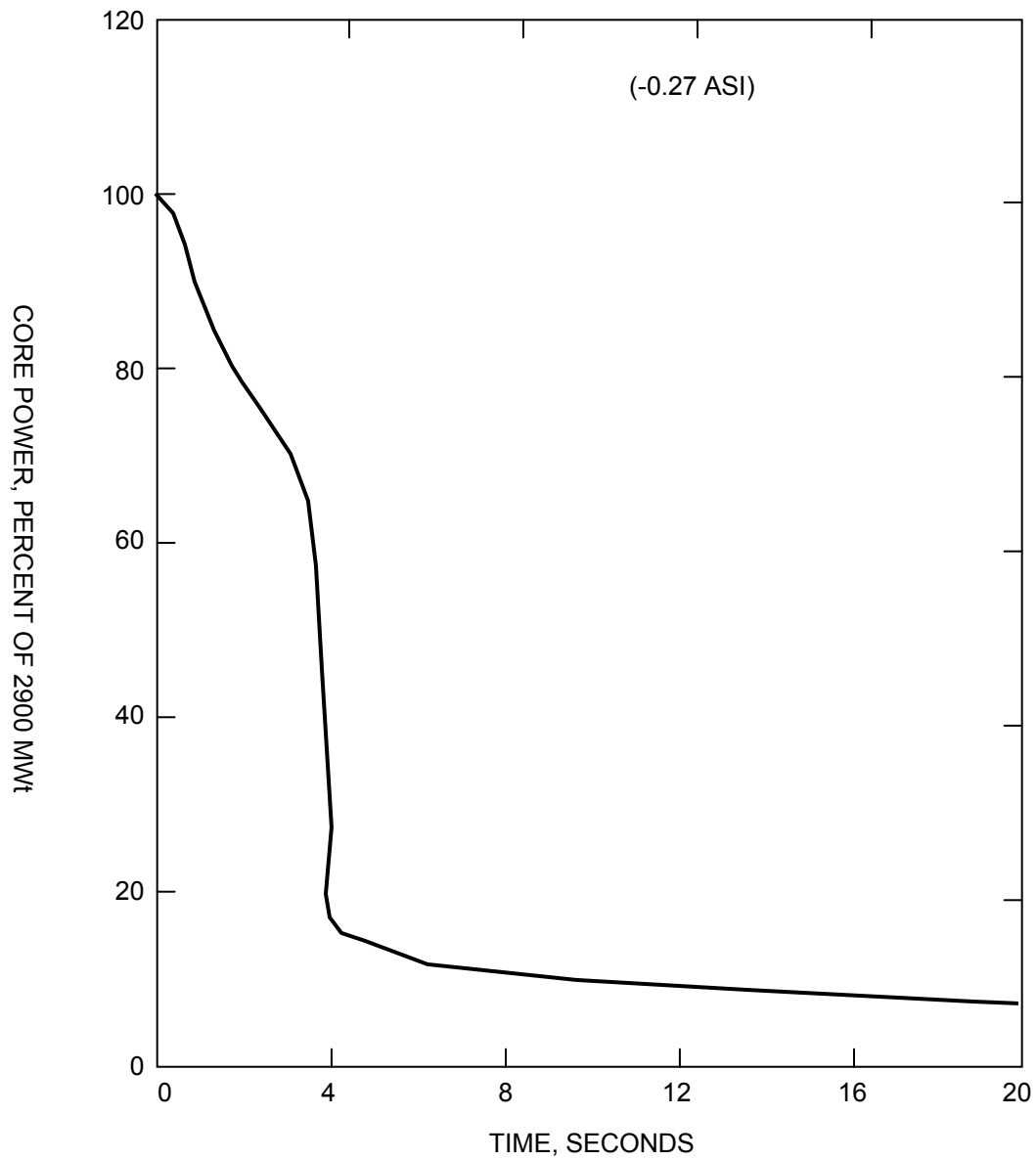

SAR FIGURE NO. 15.1.3-5

AMENDMENT 20

ARKANSAS NUCLEAR ONE
UNIT 2
RUSSELLVILLE, ARKANSAS



SCALE:	NONE
DRAWN:	
DESIGN:	ENTERGY
CAD NO:	

CEA MISOPERATION FULL LENGTH CEA
DROP CORE POWER VERSUS TIME

BASED ON DRAWING NO

SHEET

REV.

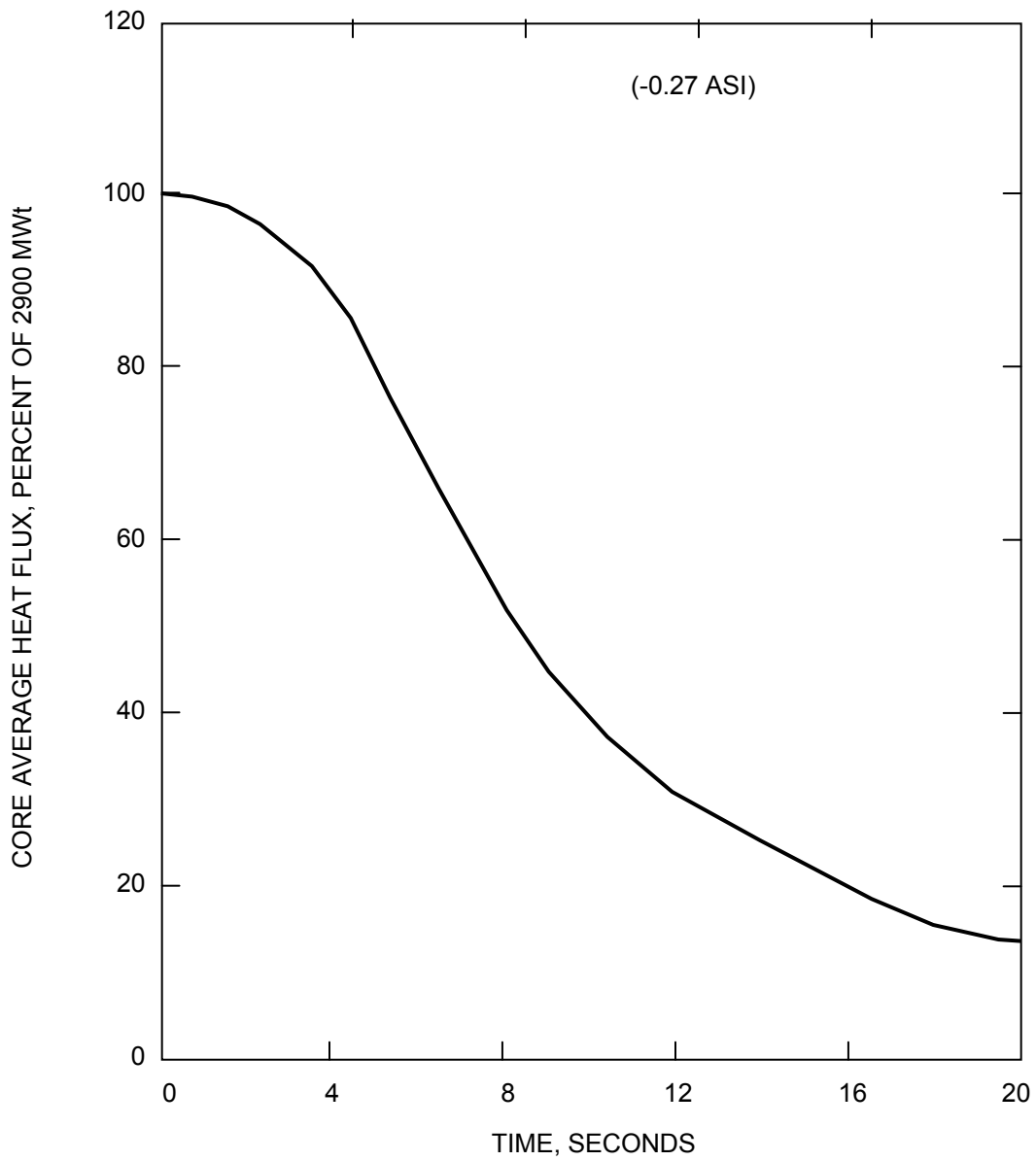

SAR FIGURE NO. 15.1.3-6

AMENDMENT 20

ARKANSAS NUCLEAR ONE
UNIT 2
RUSSELLVILLE, ARKANSAS



SCALE:	NONE
DRAWN:	
DESIGN:	ENTERGY
CAD NO:	

CEA MISOPERATION FULL LENGTH CEA DROP
CORE AVERAGE HEAT FLUX VERSUS TIME

BASED ON DRAWING NO

SHEET

REV.

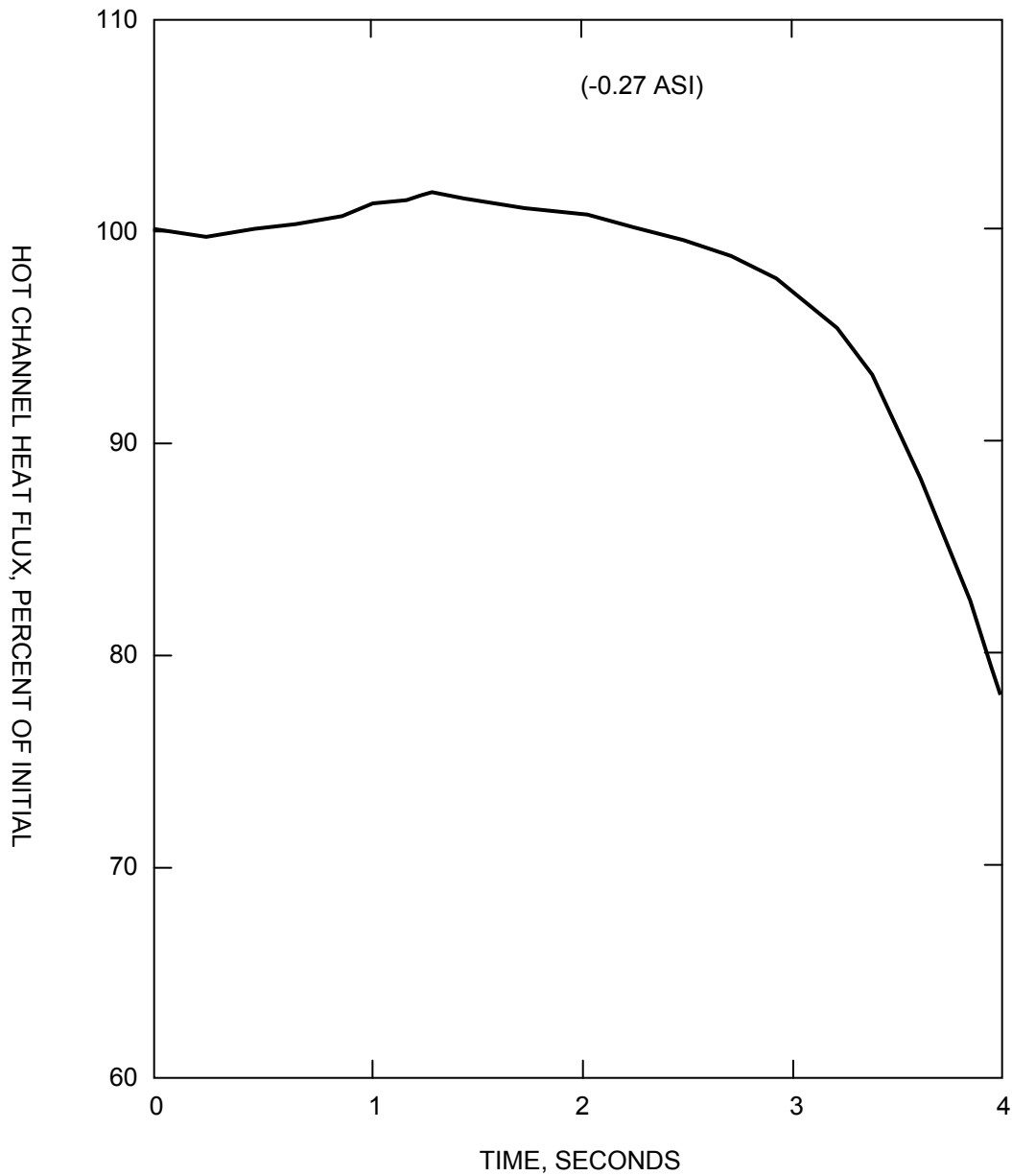

SAR FIGURE NO. 15.1.3-7

AMENDMENT 20

ARKANSAS NUCLEAR ONE
UNIT 2
RUSSELLVILLE, ARKANSAS



SCALE:	NONE
DRAWN:	
DESIGN:	ENERGY
CAD NO:	

CEA MISOPERATION FULL LENGTH CEA DROP
HOT CHANNEL HEAT FLUX VERSUS TIME

BASED ON DRAWING NO

SHEET

REV.

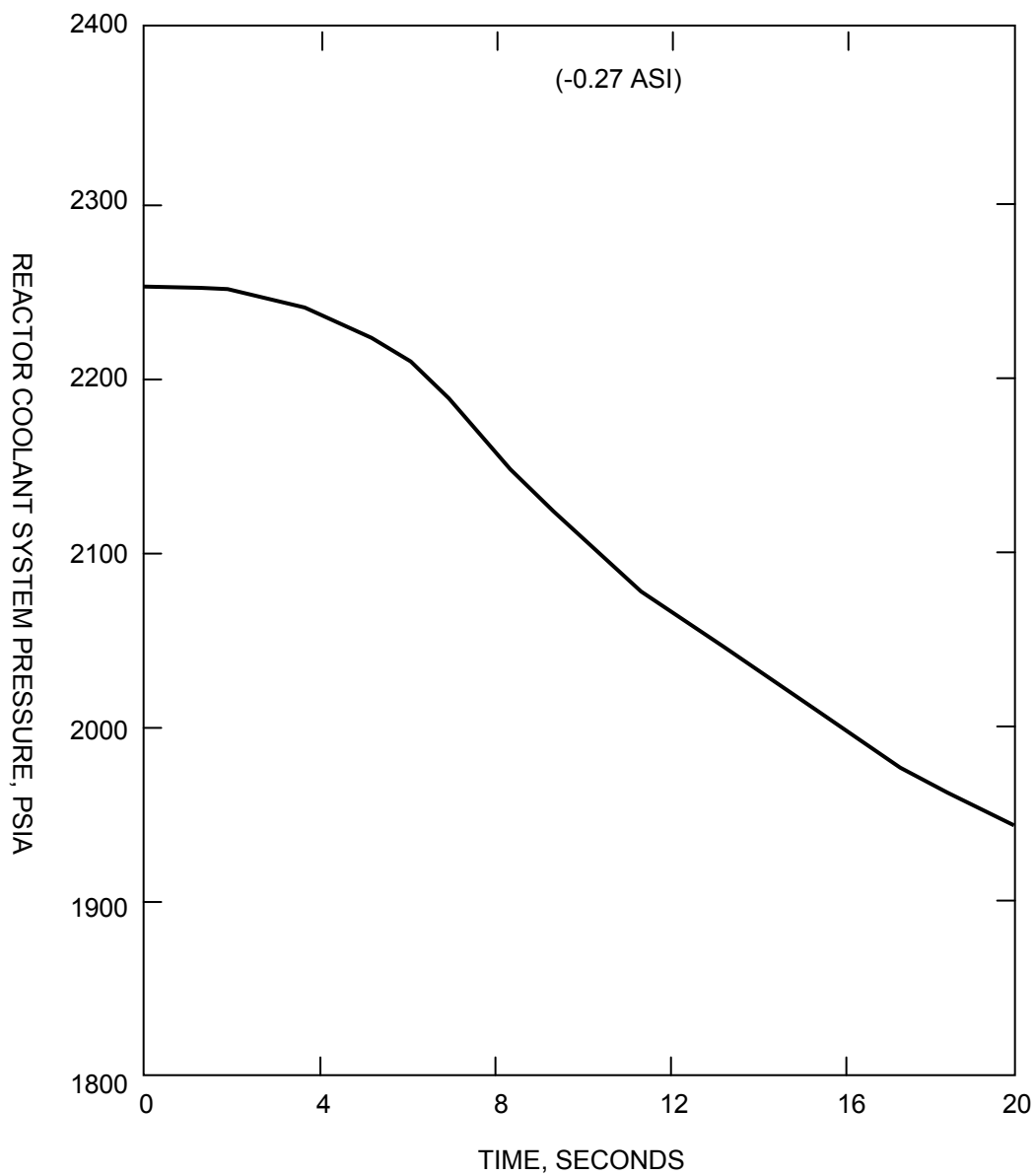

SAR FIGURE NO. 15.1.3-8

AMENDMENT 20

ARKANSAS NUCLEAR ONE
UNIT 2
RUSSELLVILLE, ARKANSAS



SCALE:	NONE
DRAWN:	
DESIGN:	ENERGY
CAD NO:	

CEA MISOPERATION FULL LENGTH CEA
DROP RCS PRESSURE VERSUS TIME

BASED ON DRAWING NO

SHEET

REV.

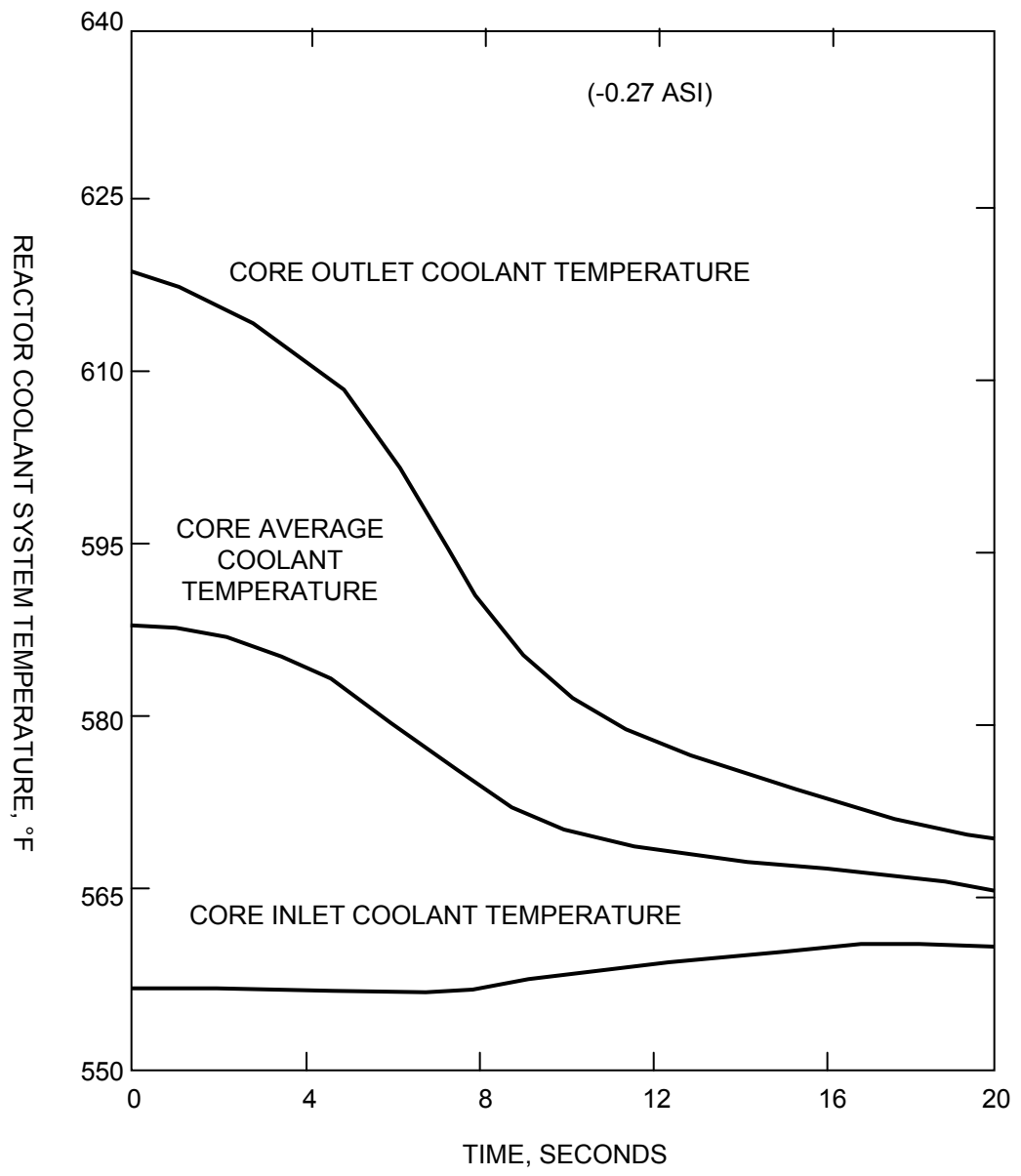

SAR FIGURE NO. 15.1.3-9

AMENDMENT 20

ARKANSAS NUCLEAR ONE
 UNIT 2
 RUSSELLVILLE, ARKANSAS



SCALE:	NONE
DRAWN:	
DESIGN:	ENTERGY
CAD NO:	

CEA MISOPERATION FULL LENGTH CEA
 DROP RCS TEMPERATURE VERSUS TIME

BASED ON DRAWING NO

SHEET

REV.

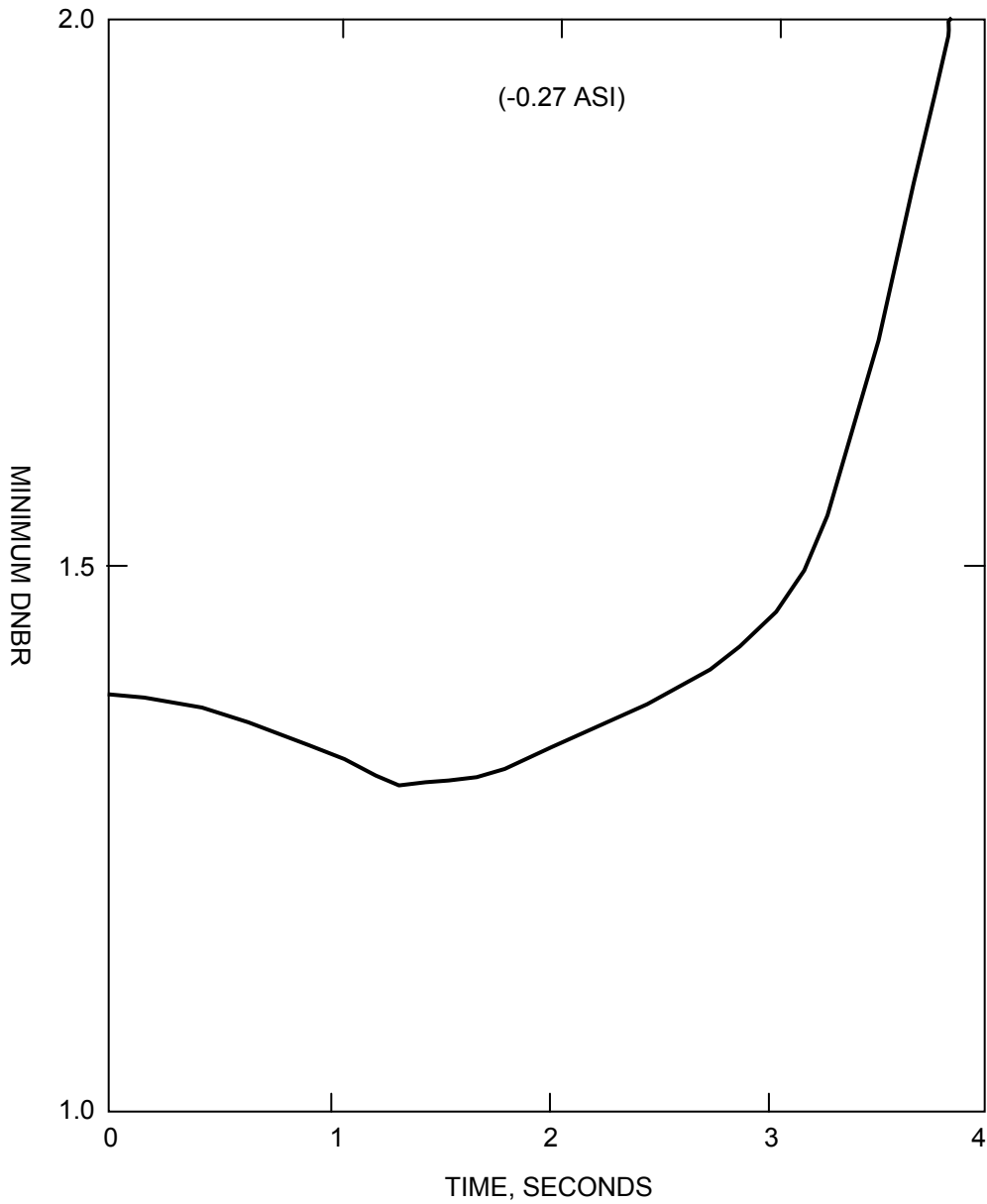

SAR FIGURE NO. 15.1.3-10

AMENDMENT 20

ARKANSAS NUCLEAR ONE
UNIT 2
RUSSELLVILLE, ARKANSAS



SCALE:	NONE
DRAWN:	
DESIGN:	ENERGY
CAD NO:	

CEA MISOPERATION FULL LENGTH CEA
DROP MINIMUM DNB RATION VERSUS TIME

BASED ON DRAWING NO

SHEET

REV.

FIGURES 15.1.3-11
THROUGH 15.1.3-22
DELETED

SAR FIGURE NO. 15.1.3-11

AMENDMENT 20

ARKANSAS NUCLEAR ONE
UNIT 2
RUSSELLVILLE, ARKANSAS



SCALE: NONE

DRAWN:

DESIGN: ENTERGY

CAD NO:

BASED ON DRAWING NO

SHEET

REV.

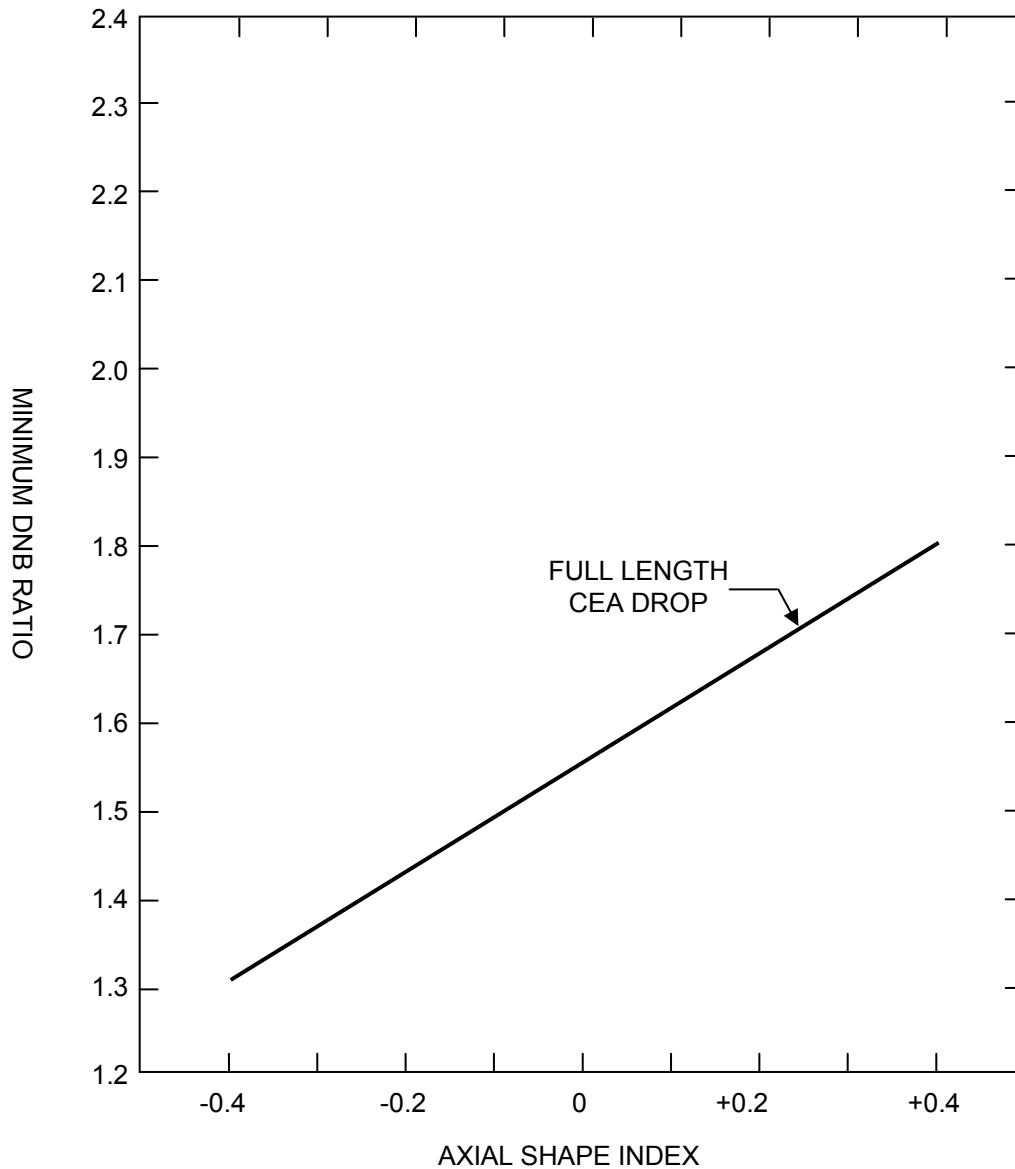

SAR FIGURE NO. 15.1.3-23

AMENDMENT 20

ARKANSAS NUCLEAR ONE
UNIT 2
RUSSELLVILLE, ARKANSAS



SCALE:	NONE
DRAWN:	
DESIGN:	ENERGY
CAD NO:	

CEA MISOPERATION CORE OPERTING LIMIT
ON DNBR VERSUS AXIAL SHAPE INDEX

BASED ON DRAWING NO

SHEET

REV.

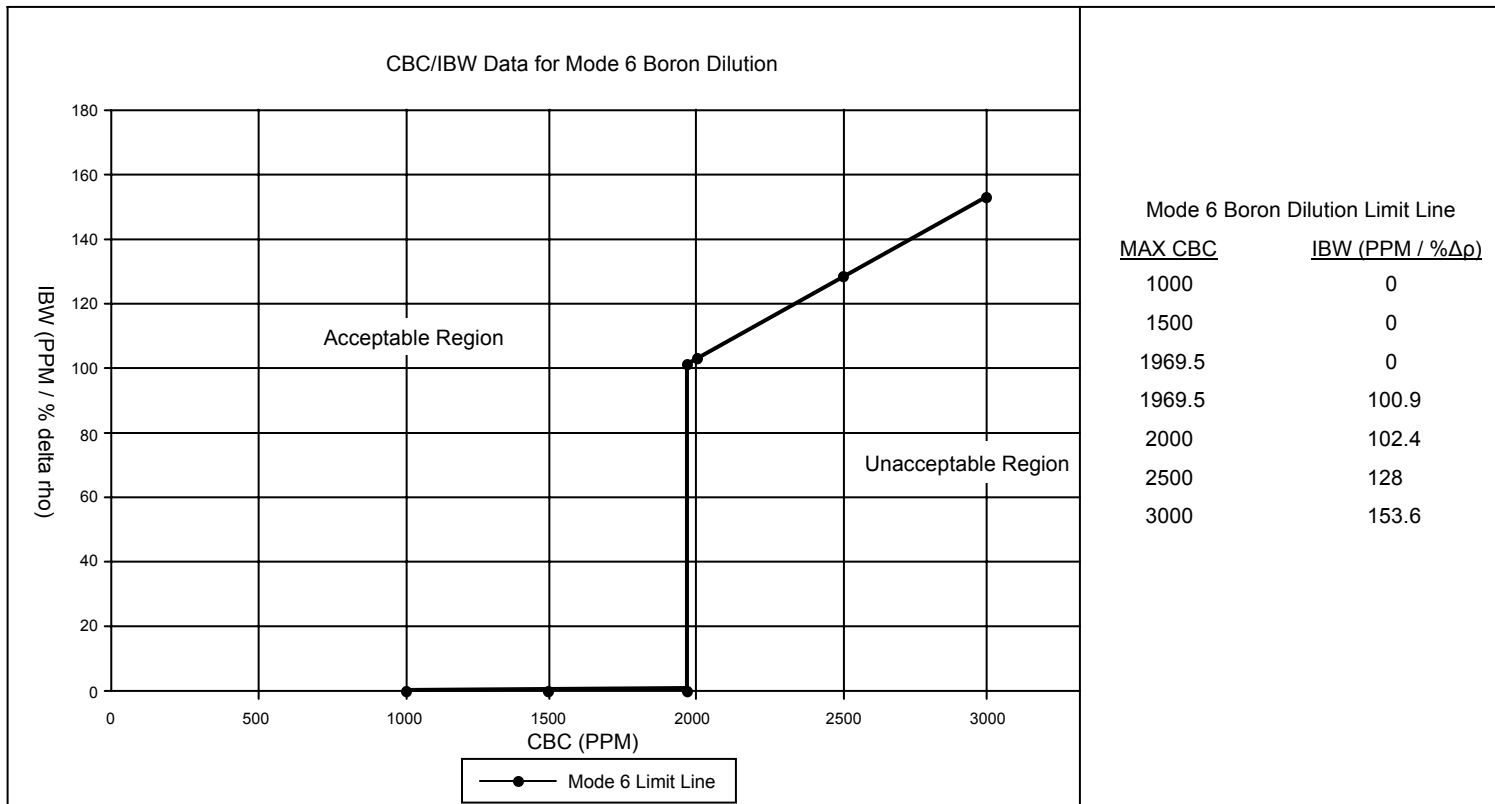

MODE 6 BORON DILUTION

SAR FIGURE NO. 15.1.4-1

ARKANSAS NUCLEAR ONE
 UNIT 2
 RUSSELLVILLE, ARKANSAS



SCALE: NONE
 DRAWN: ENTERGY
 DESIGN: ENTERGY
 CAD NO:

AMENDMENT 19

BASED ON DRAWING NO	SHEET	REV.

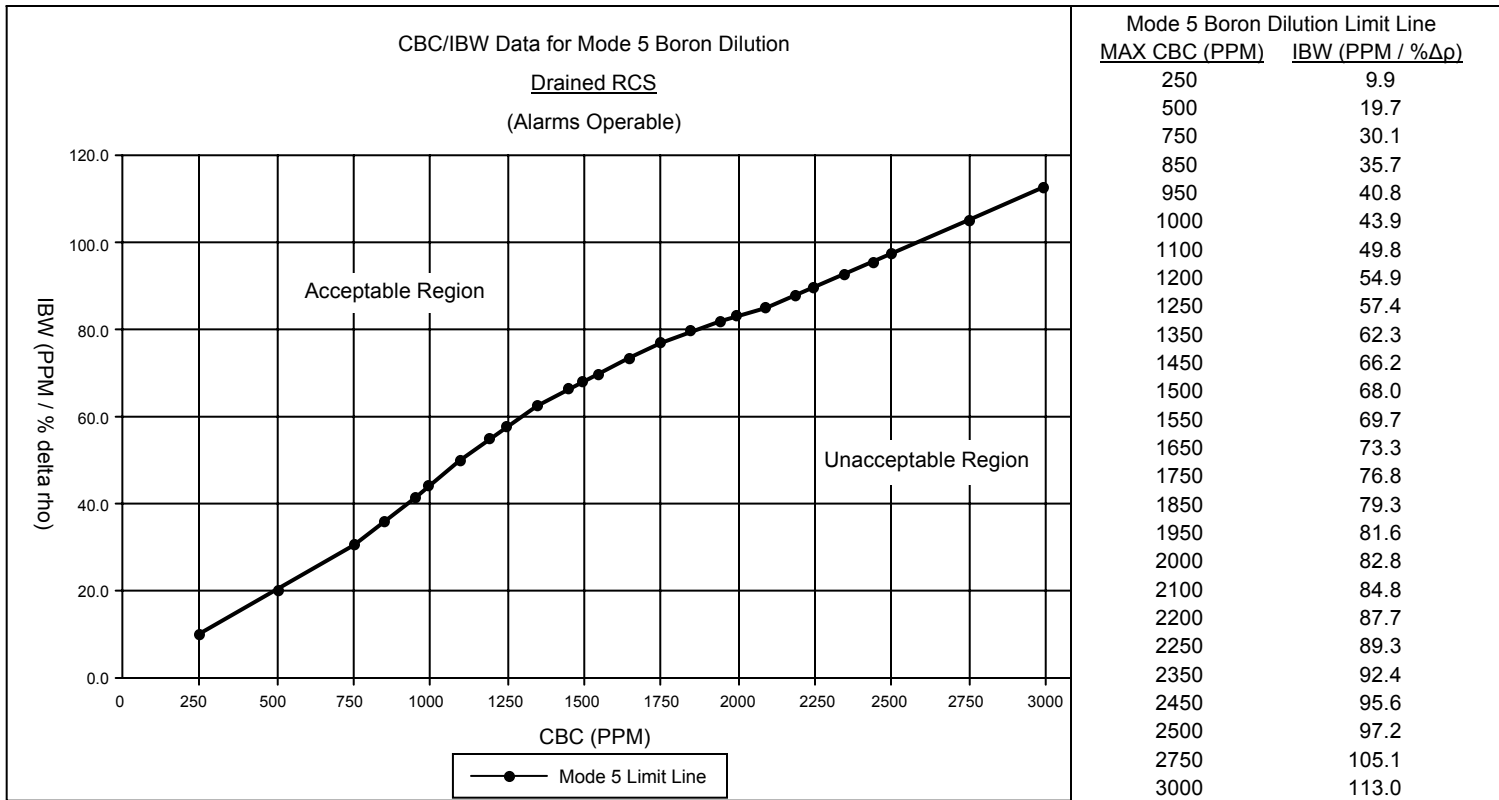

MODE 5 DRAINED BORON DILUTION (ALARMS OPERABLE)

SAR FIGURE NO. 15.1.4-2

ARKANSAS NUCLEAR ONE
 UNIT 2
 RUSSELLVILLE, ARKANSAS



SCALE: NONE
 DRAWN: ENTERGY
 DESIGN: ENTERGY
 CAD NO:

AMENDMENT 19

BASED ON DRAWING NO

SHEET

REV.

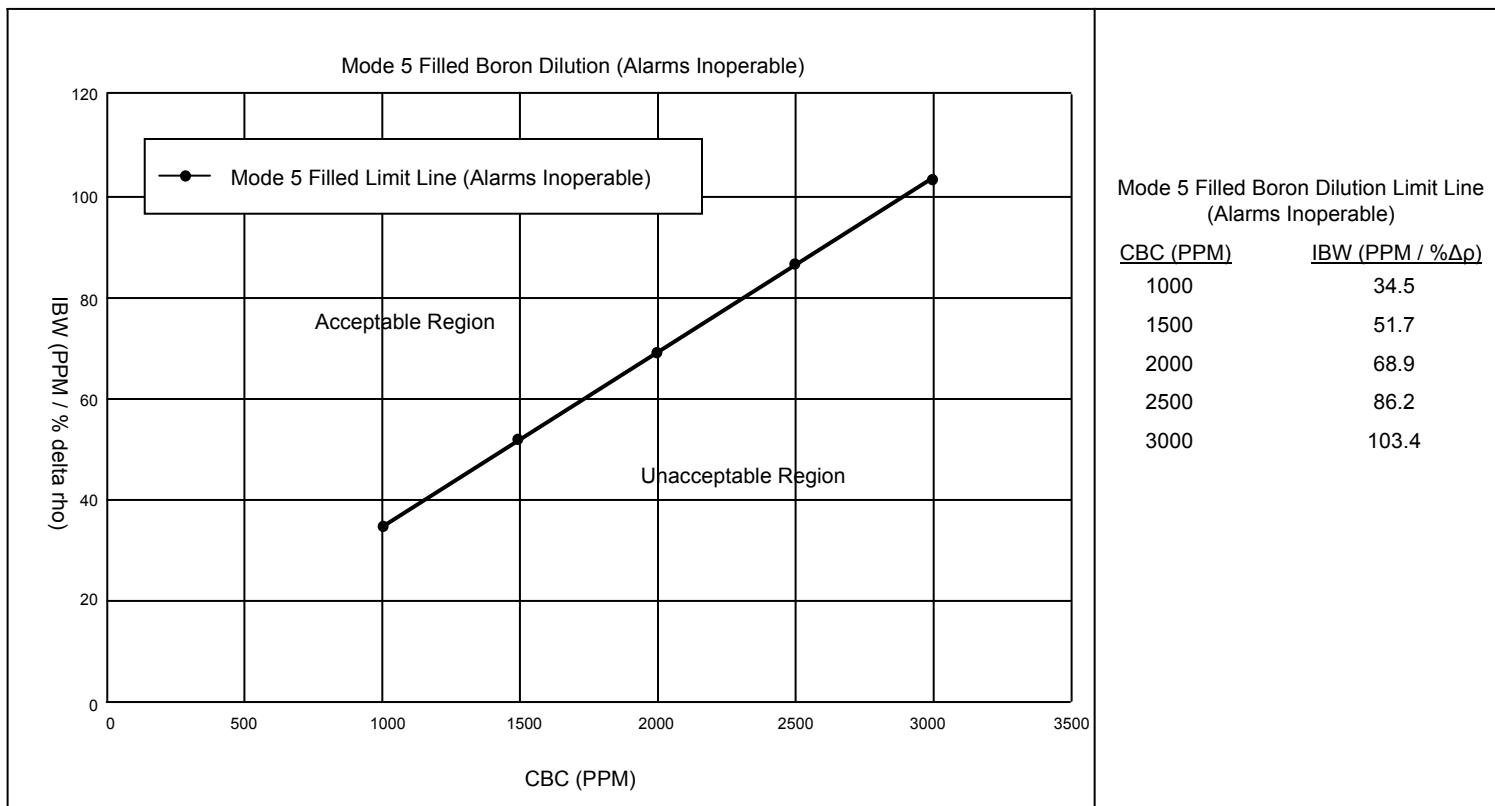

MODE 5 FILLED BORON DILUTION (ALARMS INOPERABLE)

SAR FIGURE NO. 15.1.4-3

ARKANSAS NUCLEAR ONE
 UNIT 2
 RUSSELLVILLE, ARKANSAS



SCALE: NONE
 DRAWN: ENTERGY
 DESIGN: ENTERGY
 CAD NO:

AMENDMENT 20

BASED ON DRAWING NO

SHEET

REV.

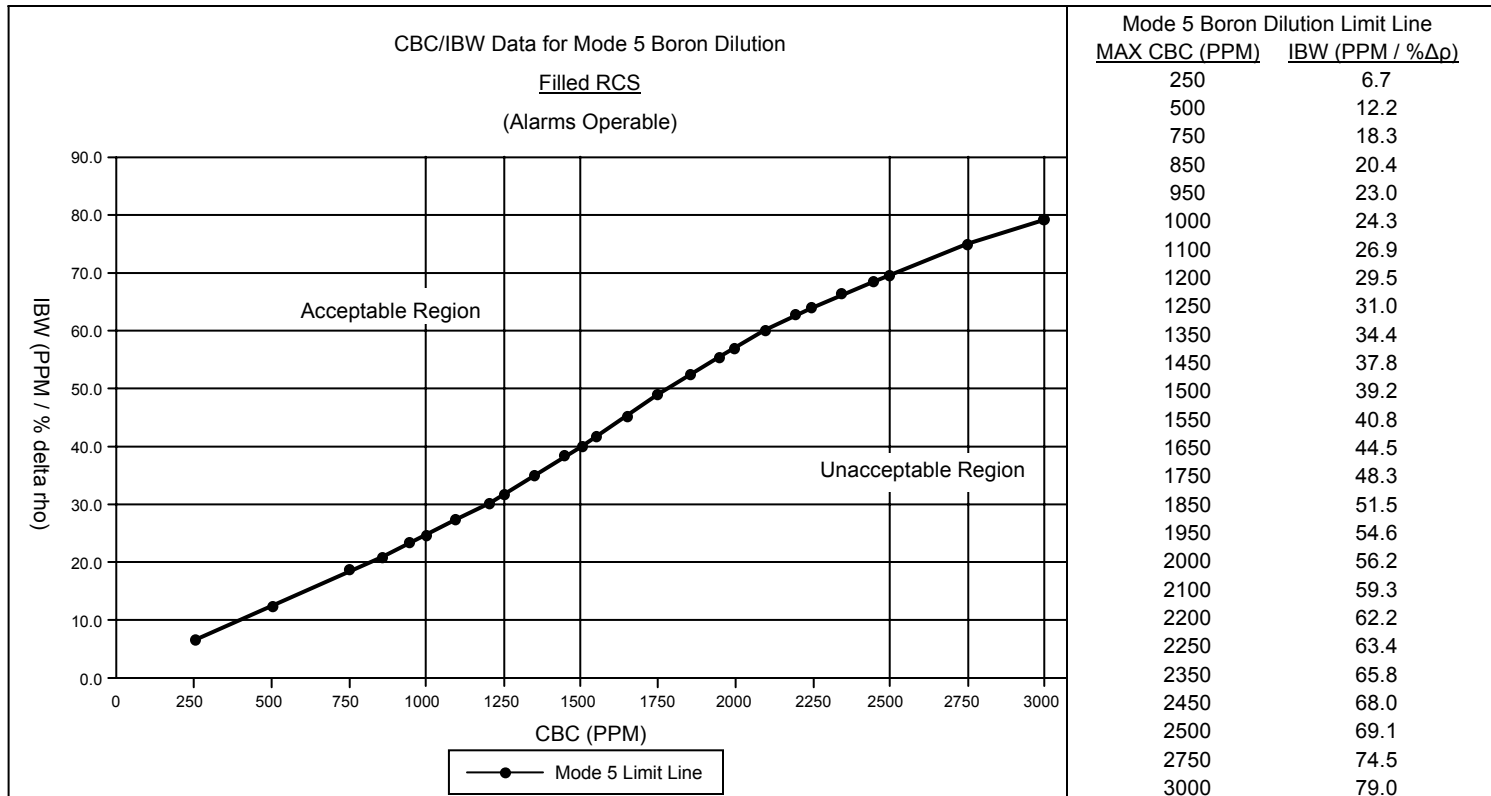

MODE 5 FILLED BORON DILUTION (ALARMS OPERABLE)

SAR FIGURE NO. 15.1.4-4

ARKANSAS NUCLEAR ONE
UNIT 2
RUSSELLVILLE, ARKANSAS



SCALE: NONE
DRAWN: ENTERGY
DESIGN: ENTERGY
CAD NO:

AMENDMENT 19

BASED ON DRAWING NO

SHEET

REV.

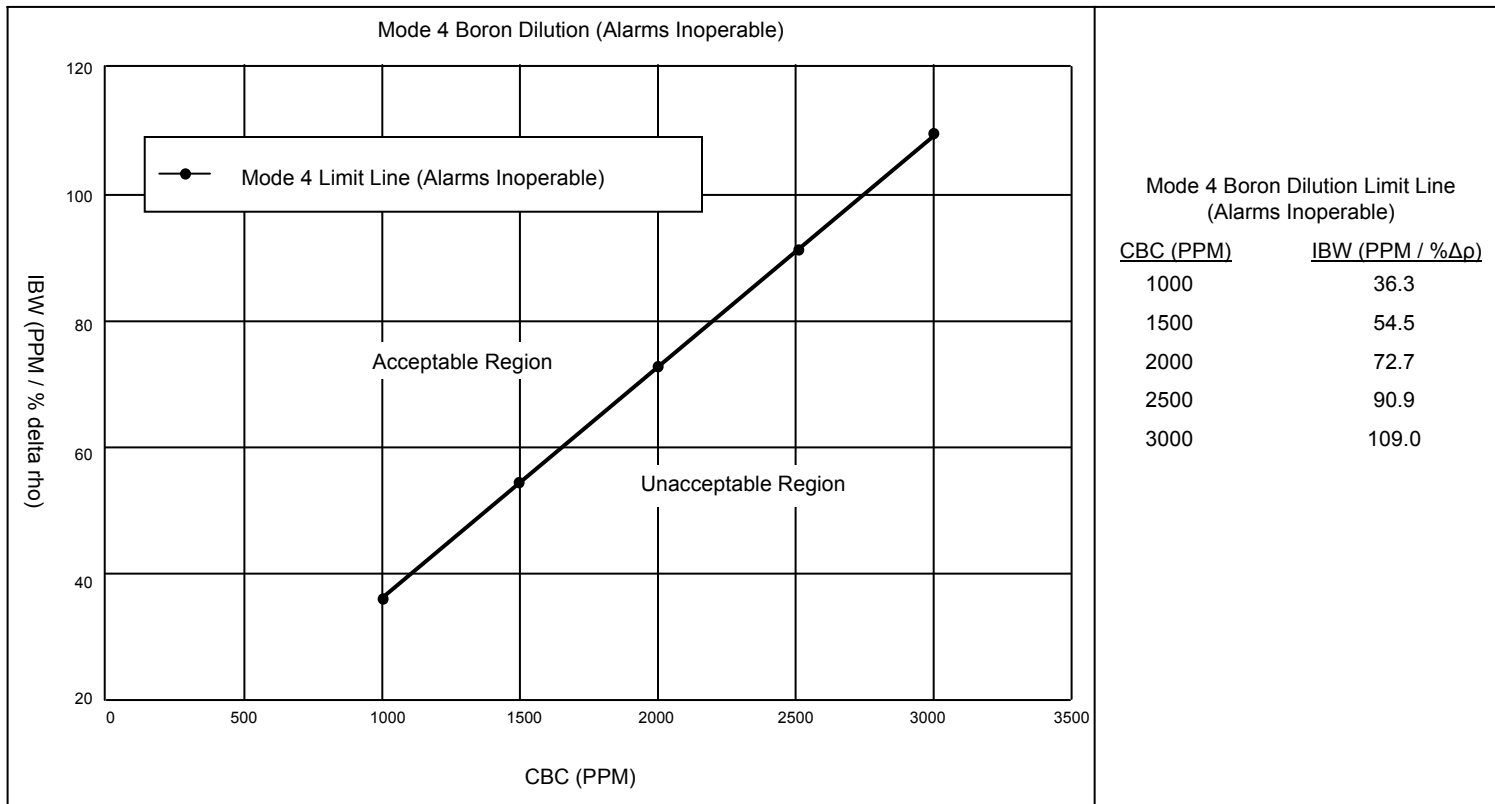

MODE 4 BORON DILUTION (ALARMS INOPERABLE)

SAR FIGURE NO. 15.1.4-5

ARKANSAS NUCLEAR ONE
 UNIT 2
 RUSSELLVILLE, ARKANSAS



SCALE: NONE
 DRAWN: ENTERGY
 DESIGN: ENTERGY
 CAD NO:

AMENDMENT 20

BASED ON DRAWING NO

SHEET

REV.

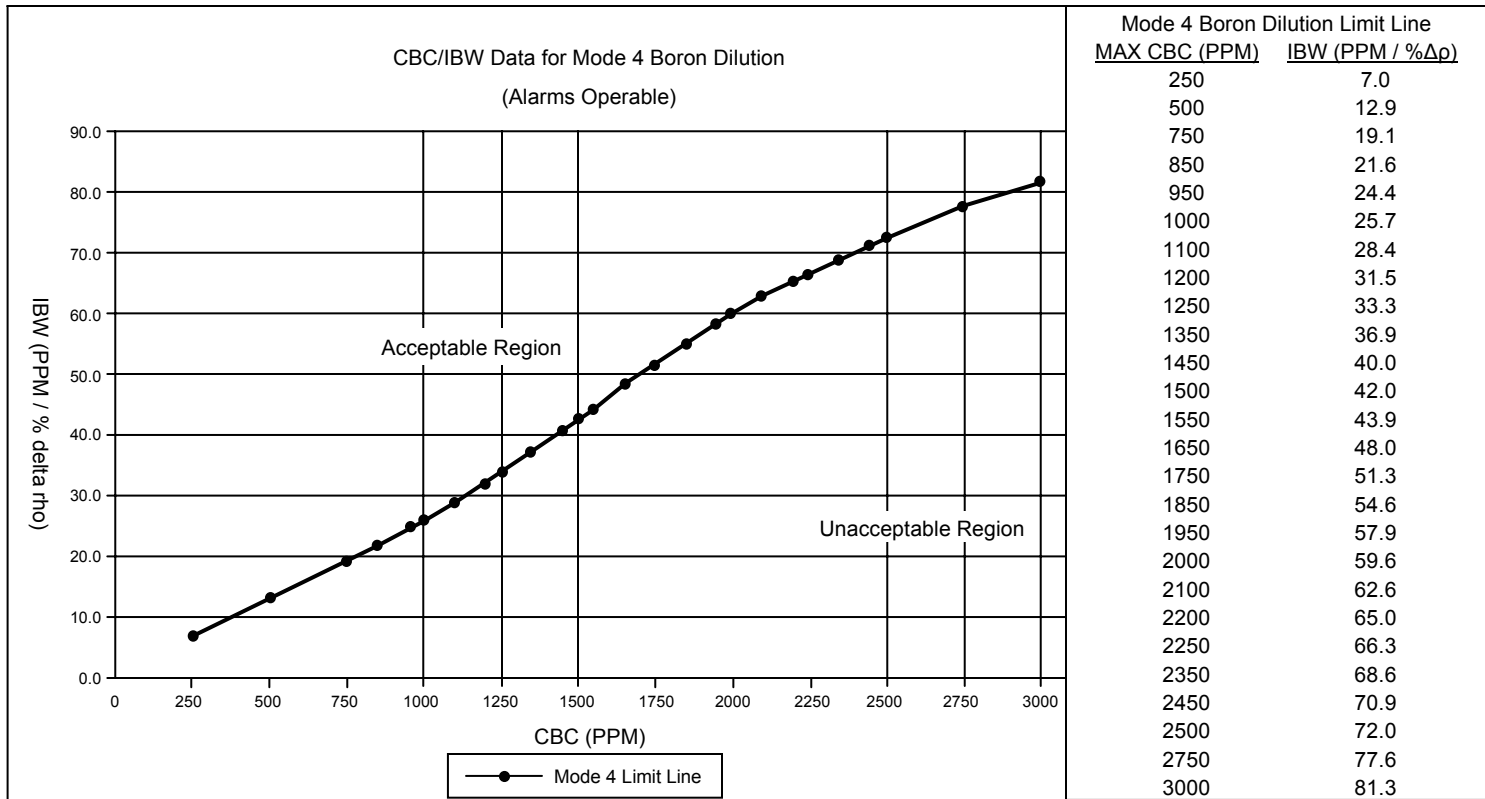

MODE 4 BORON DILUTION (ALARMS OPERABLE)

SAR FIGURE NO. 15.1.4-6

ARKANSAS NUCLEAR ONE
UNIT 2
RUSSELLVILLE, ARKANSAS



SCALE: NONE
DRAWN: ENERGY
DESIGN: ENERGY
CAD NO:

AMENDMENT 19

BASED ON DRAWING NO	SHEET	REV.

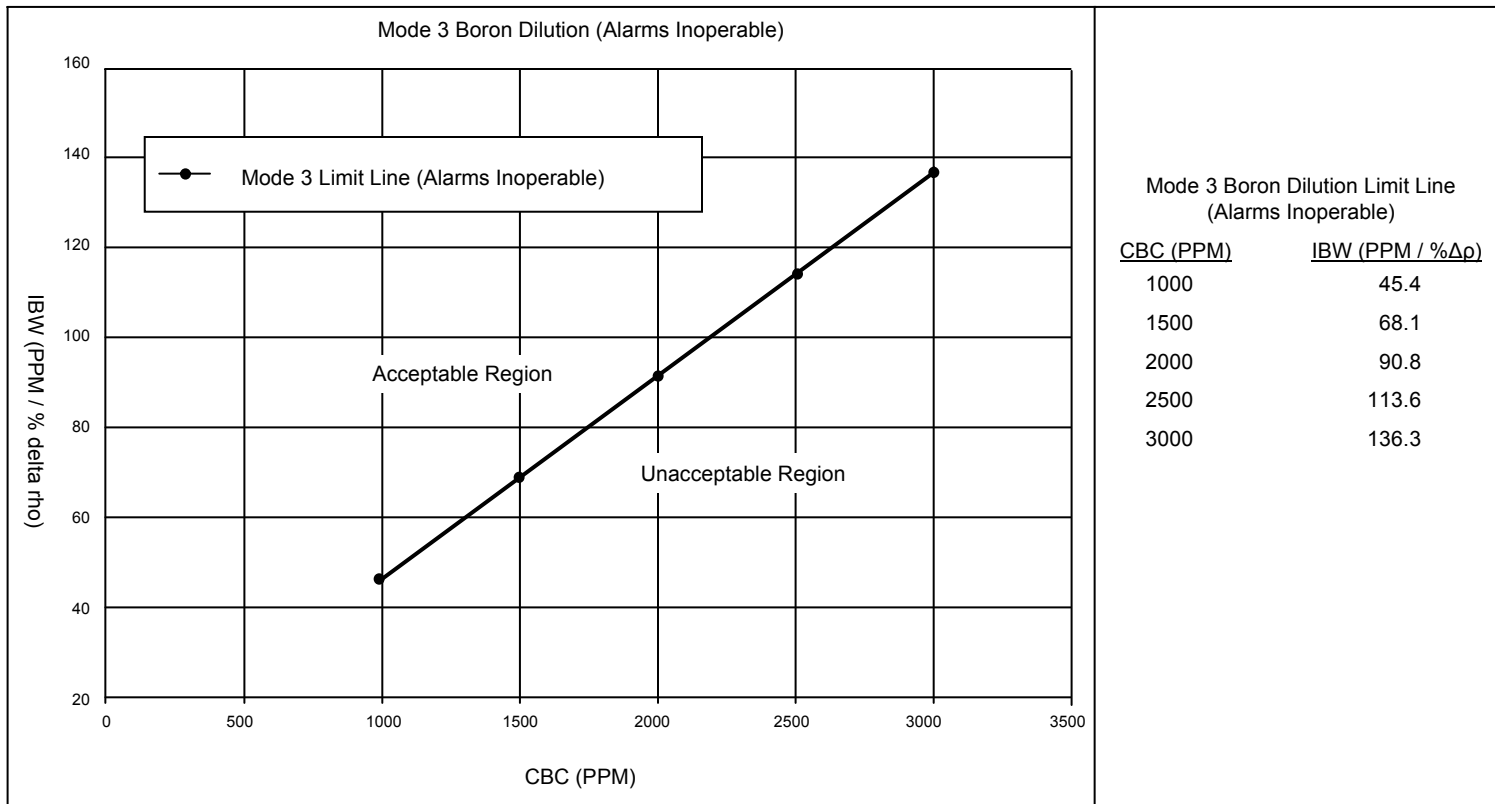

MODE 3 BORON DILUTION (ALARMS INOPERABLE)

SAR FIGURE NO. 15.1.4-7

ARKANSAS NUCLEAR ONE
UNIT 2
RUSSELLVILLE, ARKANSAS



SCALE: NONE
DRAWN: ENTERGY
DESIGN: ENTERGY
CAD NO:

AMENDMENT 20

BASED ON DRAWING NO

SHEET

REV.

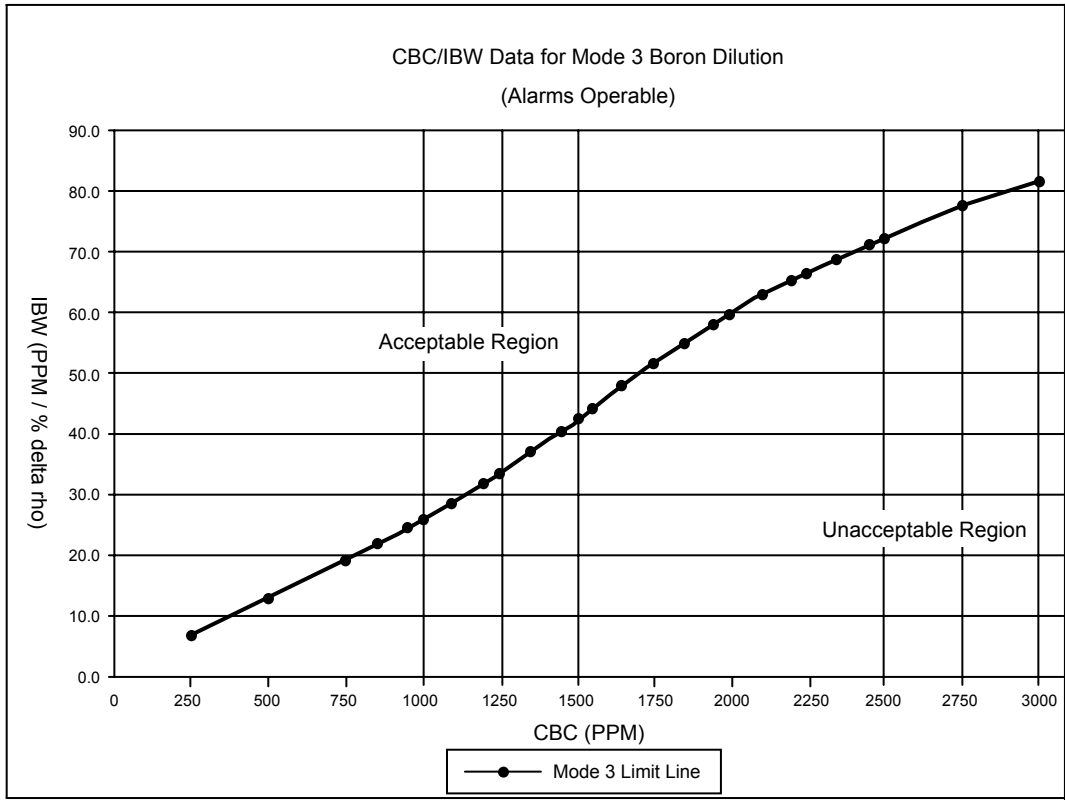

Mode 3 Boron Dilution Limit Line	
MAX CBC (PPM)	IBW (PPM / % $\Delta\rho$)
250	8.3
500	16.1
750	24.0
850	27.4
950	31.1
1000	33.3
1100	37.8
1200	42.0
1250	44.4
1350	49.2
1450	53.4
1500	55.4
1550	57.5
1650	61.6
1750	64.7
1850	67.7
1950	70.6
2000	72.0
2100	74.9
2200	77.6
2250	78.5
2350	80.4
2450	82.3
2500	83.2
2750	88.3
3000	94.7

MODE 3 BORON DILUTION (ALARMS OPERABLE)

SAR FIGURE NO. 15.1.4-8

ARKANSAS NUCLEAR ONE
UNIT 2
RUSSELLVILLE, ARKANSAS



SCALE:	NONE
DRAWN:	ENERGY
DESIGN:	ENERGY
CAD NO:	

AMENDMENT 19

BASED ON DRAWING NO	SHEET	REV.

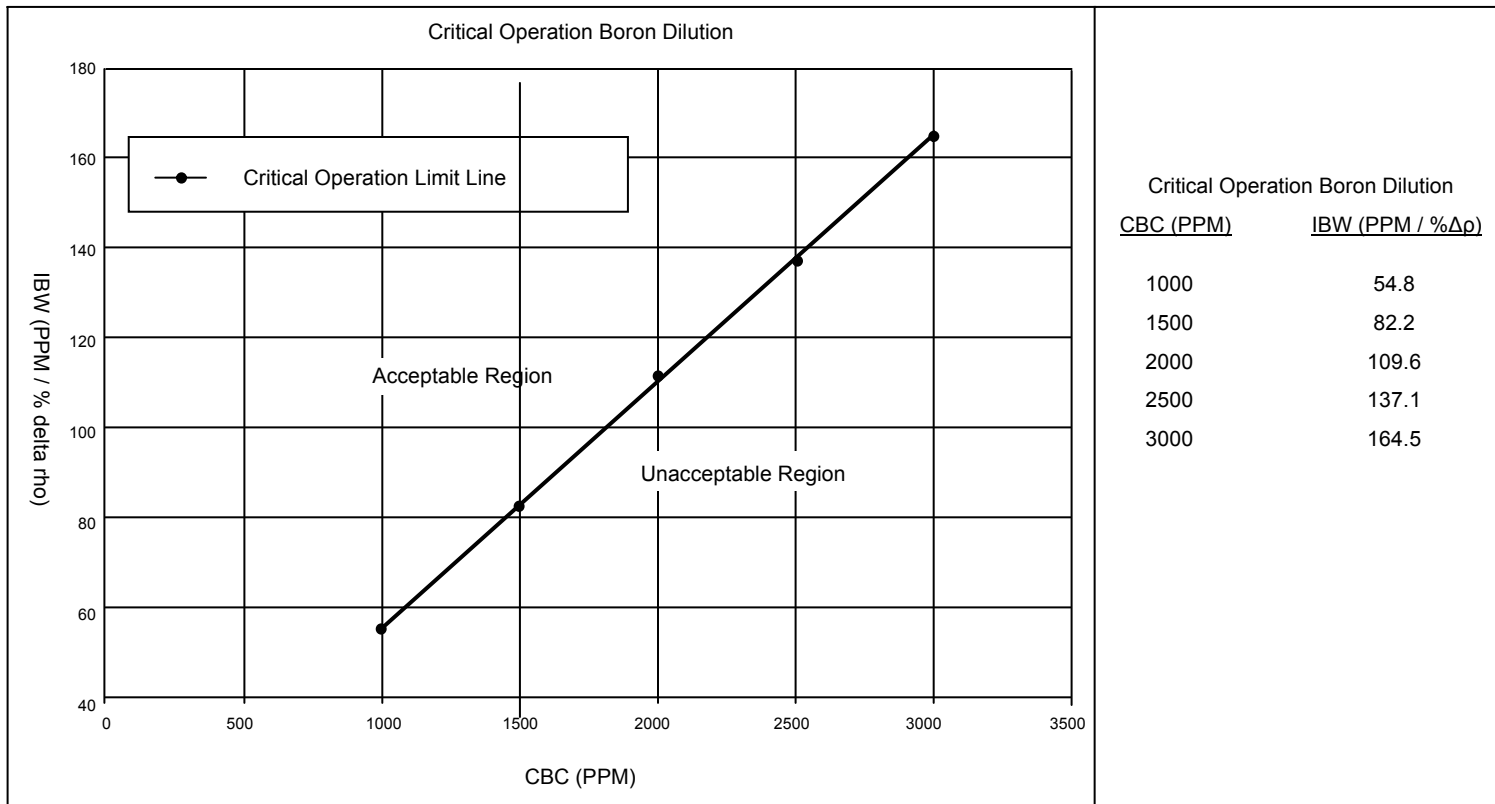

CRITICAL OPERATION BORON DILUTION

SAR FIGURE NO. 15.1.4-9

ARKANSAS NUCLEAR ONE
UNIT 2
RUSSELLVILLE, ARKANSAS



SCALE: NONE
DRAWN: ENTERGY
DESIGN: ENTERGY
CAD NO:

AMENDMENT 20

BASED ON DRAWING NO	SHEET	REV.

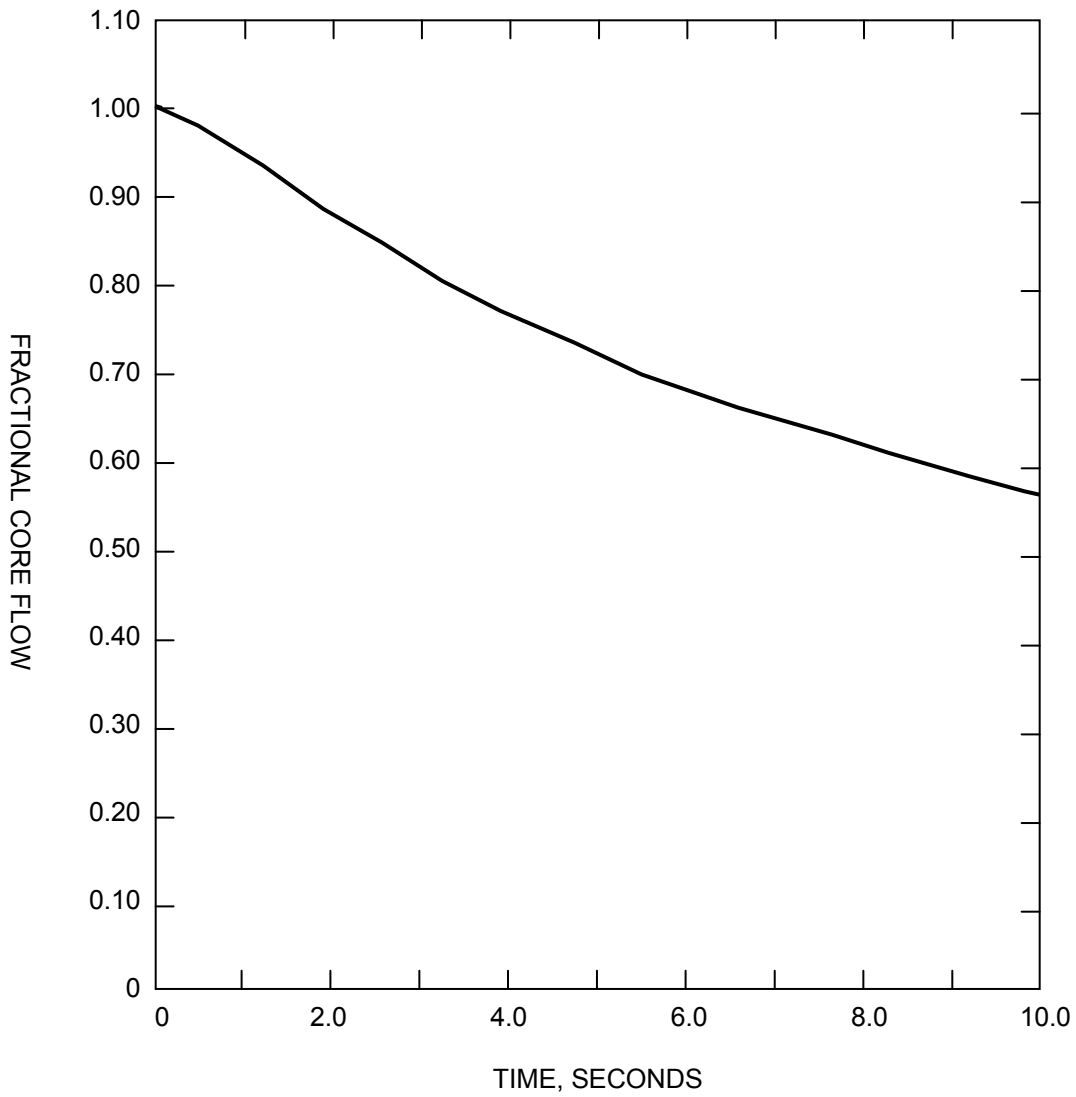

SAR FIGURE NO. 15.1.5-1

AMENDMENT 20

ARKANSAS NUCLEAR ONE
 UNIT 2
 RUSSELLVILLE, ARKANSAS



SCALE:	NONE
DRAWN:	
DESIGN:	ENERGY
CAD NO:	

LOSS OF COOLANT FLOW EVENT
 CORE FLOW VERSUS TIME

BASED ON DRAWING NO

SHEET

REV.

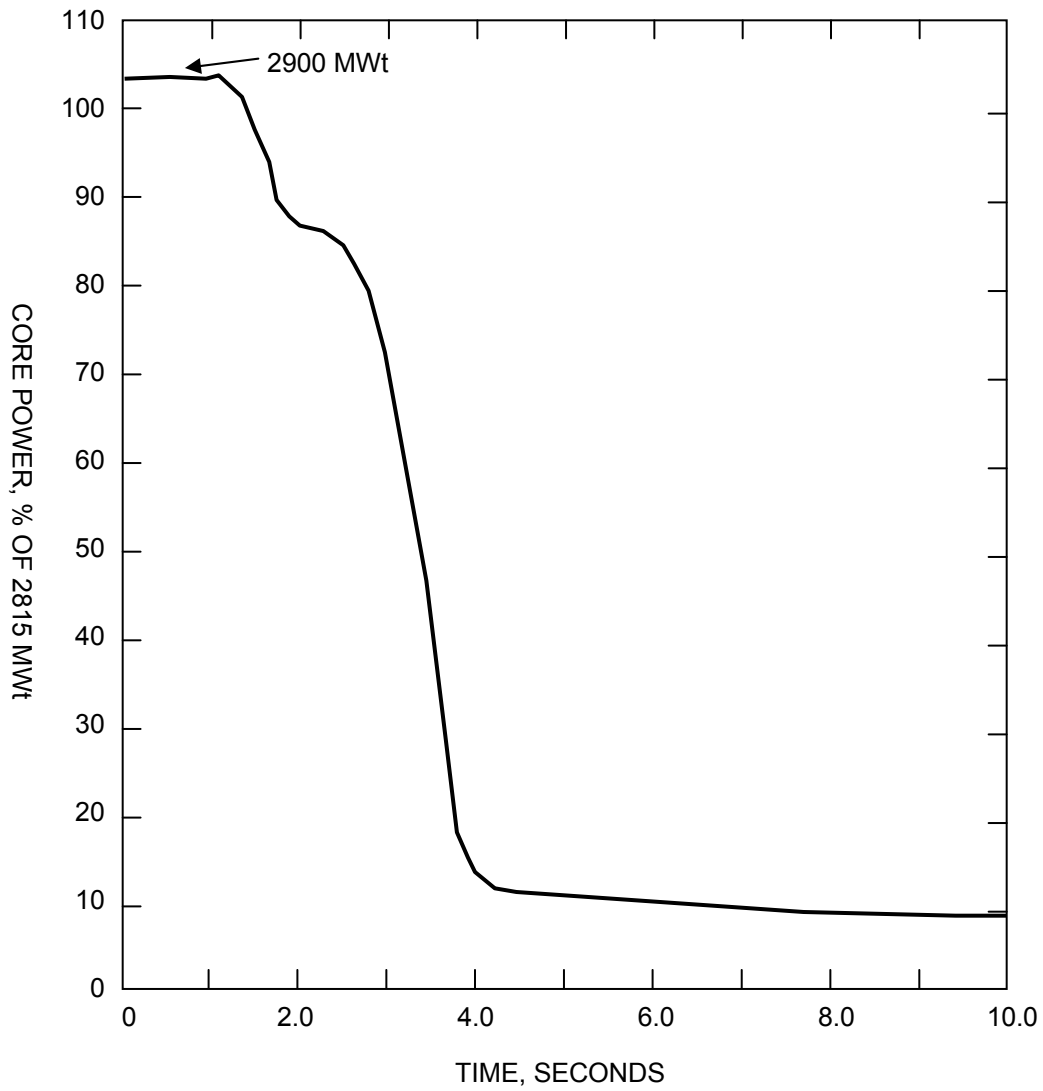

SAR FIGURE NO. 15.1.5-2

AMENDMENT 20

ARKANSAS NUCLEAR ONE
UNIT 2
RUSSELLVILLE, ARKANSAS



SCALE:	NONE
DRAWN:	
DESIGN:	ENERGY
CAD NO:	

LOSS OF COOLANT FLOW EVENT
CORE POWER VERSUS TIME

BASED ON DRAWING NO

SHEET

REV.

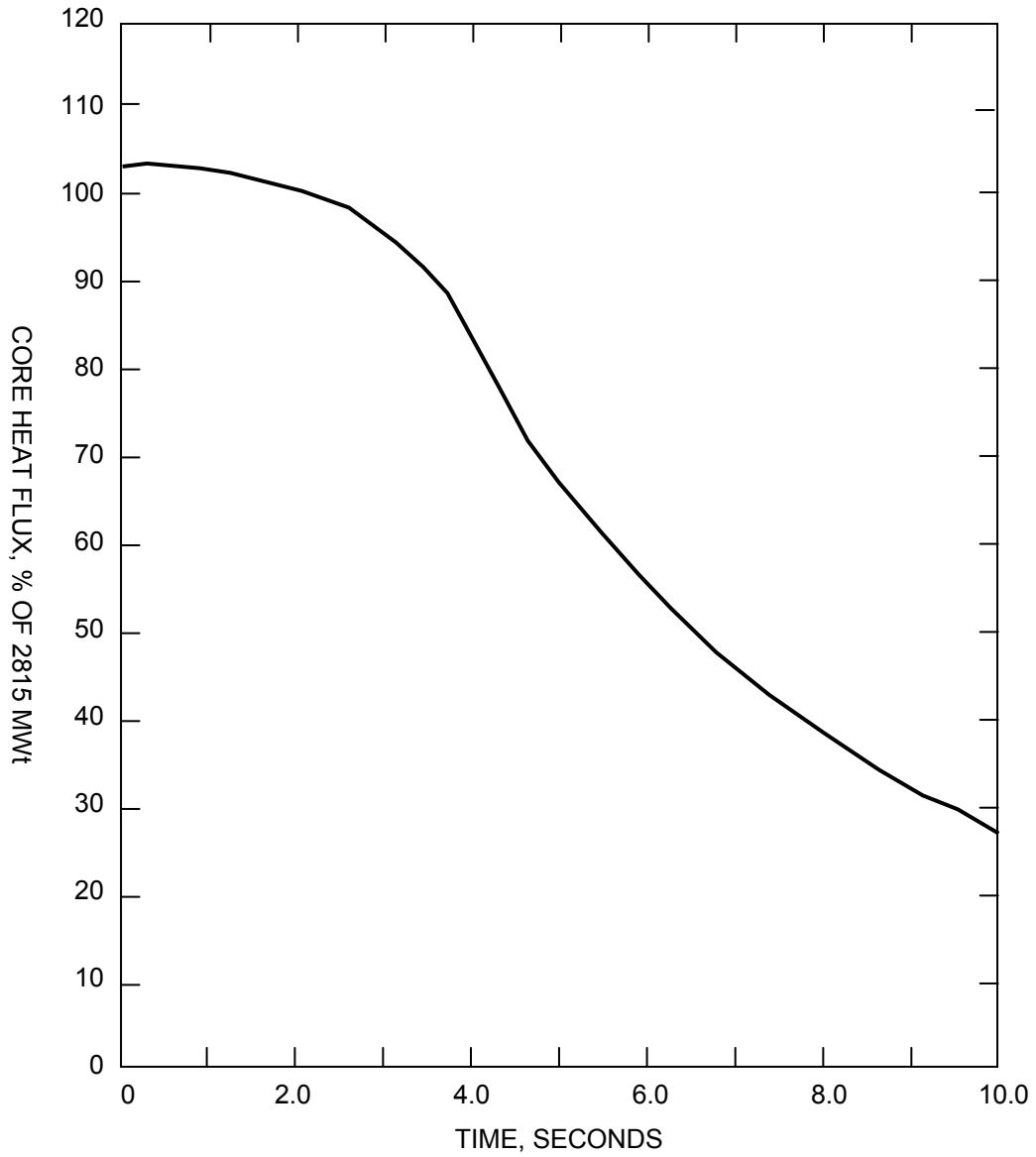

SAR FIGURE NO. 15.1.5-3

AMENDMENT 20

ARKANSAS NUCLEAR ONE
UNIT 2
RUSSELLVILLE, ARKANSAS



SCALE:	NONE
DRAWN:	
DESIGN:	ENTERGY
CAD NO:	

LOSS OF COOLANT FLOW EVENT
CORE AVERAGE HEAT FLUX VERSUS TIME

BASED ON DRAWING NO

SHEET

REV.

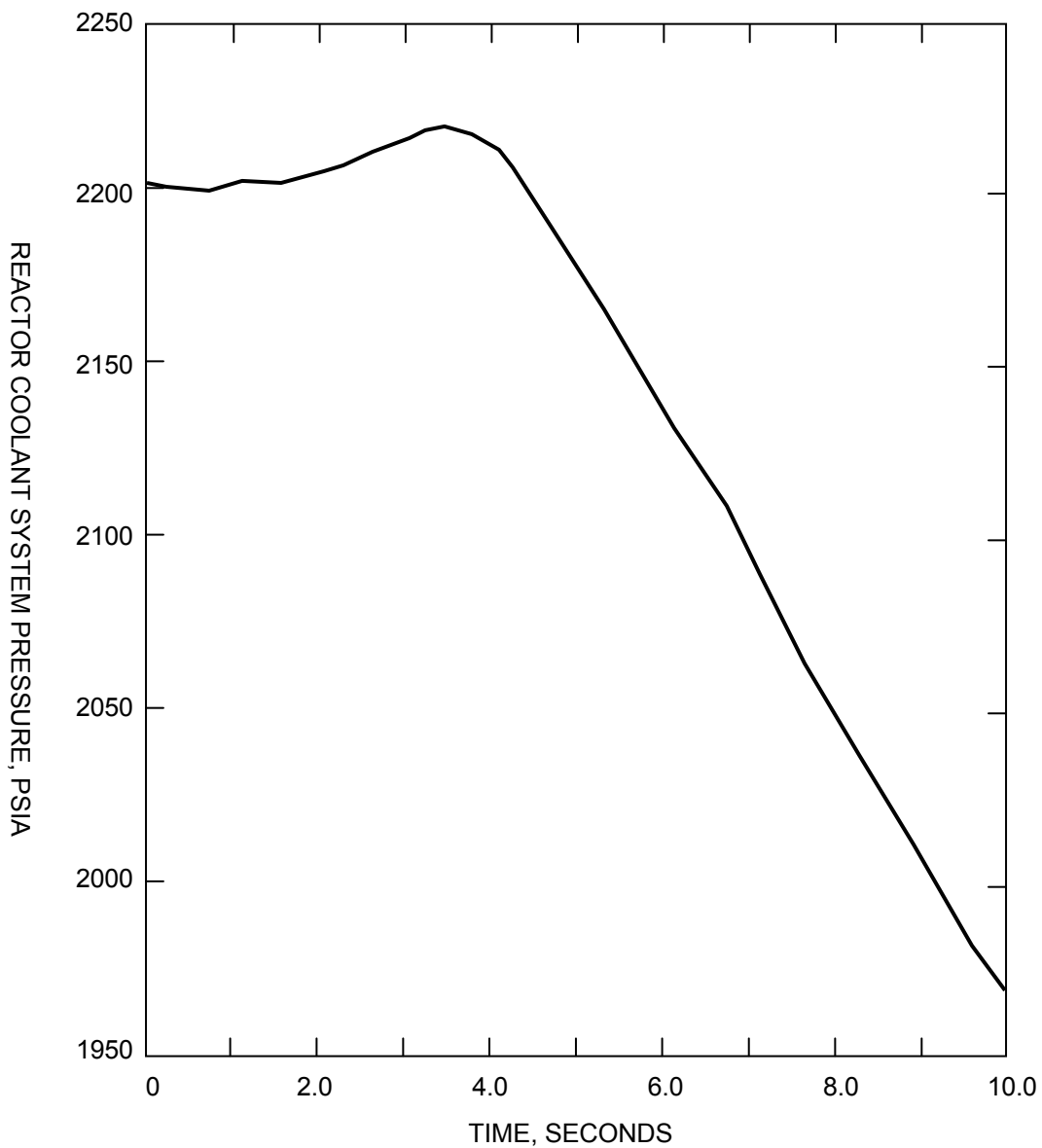

SAR FIGURE NO. 15.1.5-4

AMENDMENT 20

ARKANSAS NUCLEAR ONE
UNIT 2
RUSSELLVILLE, ARKANSAS



SCALE:	NONE
DRAWN:	
DESIGN:	ENERGY
CAD NO:	

LOSS OF COOLANT FLOW EVENT
RCS PRESSURE VERSUS TIME

BASED ON DRAWING NO

SHEET

REV.

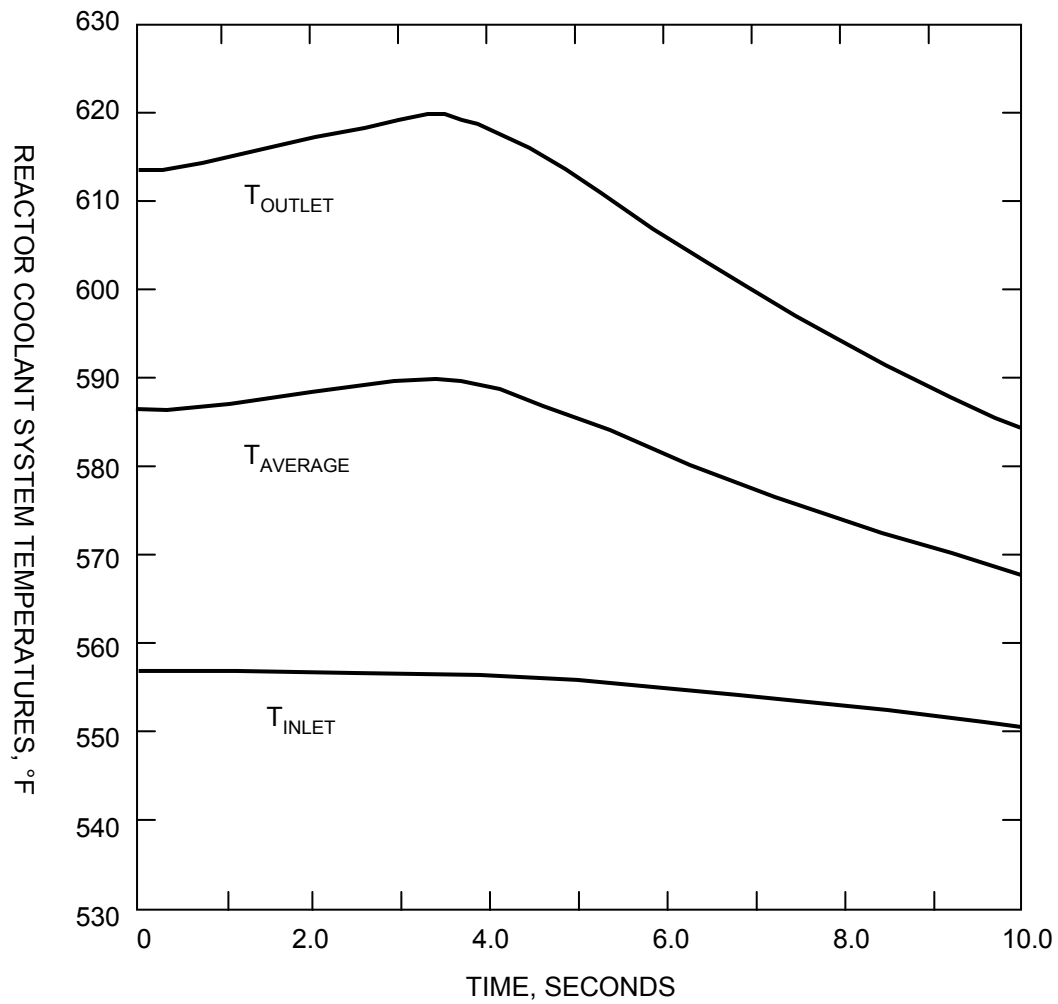

SAR FIGURE NO. 15.1.5-5

AMENDMENT 20

ARKANSAS NUCLEAR ONE
UNIT 2
RUSSELLVILLE, ARKANSAS



SCALE:	NONE
DRAWN:	
DESIGN:	ENERGY
CAD NO:	

LOSS OF COOLANT FLOW EVENT
RCS TEMPERATURES VERSUS TIME

BASED ON DRAWING NO

SHEET

REV.

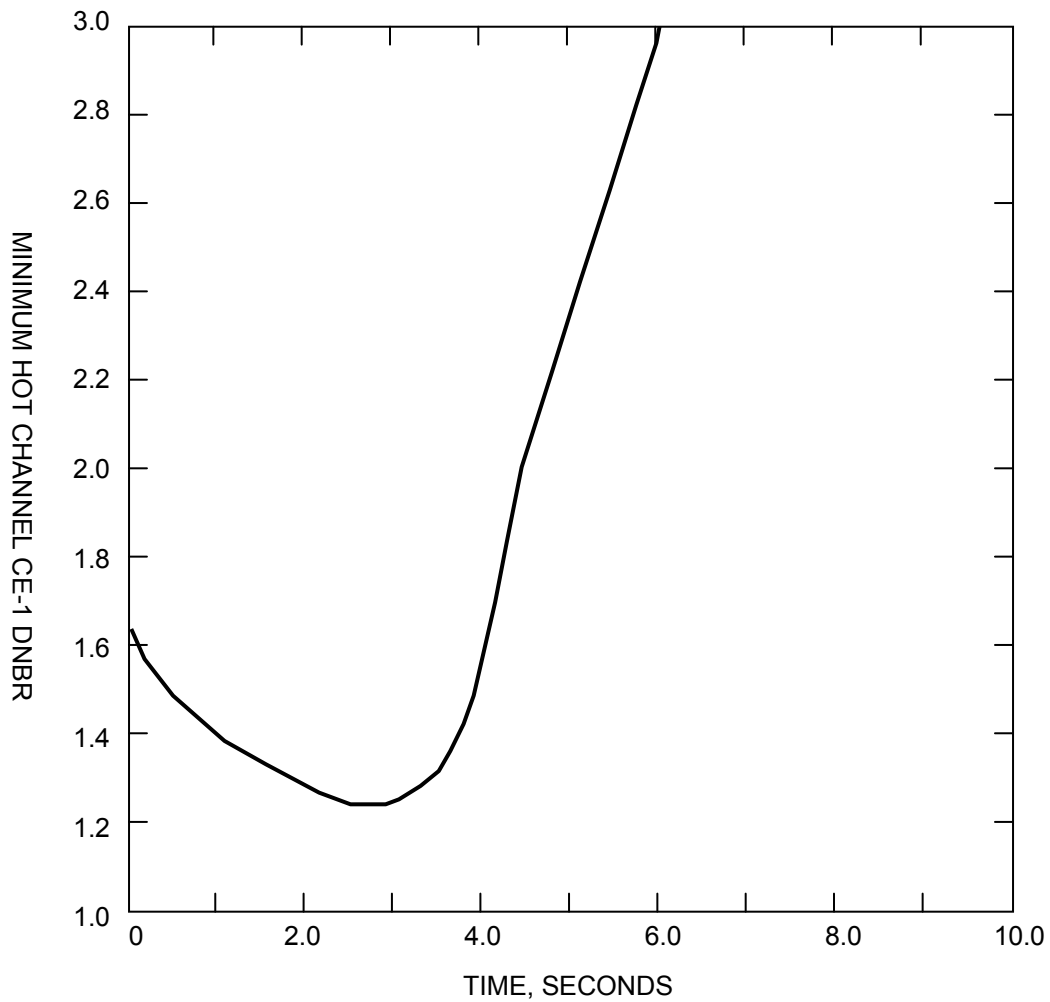

SAR FIGURE NO. 15.1.5-6

AMENDMENT 20

ARKANSAS NUCLEAR ONE
UNIT 2
RUSSELLVILLE, ARKANSAS



SCALE:	NONE
DRAWN:	
DESIGN:	ENERGY
CAD NO:	

LOSS OF COOLANT FLOW EVENT, MINIMUM
HOT CHANNEL CE-1 DNBR VERSUS TIME

BASED ON DRAWING NO

SHEET

REV.

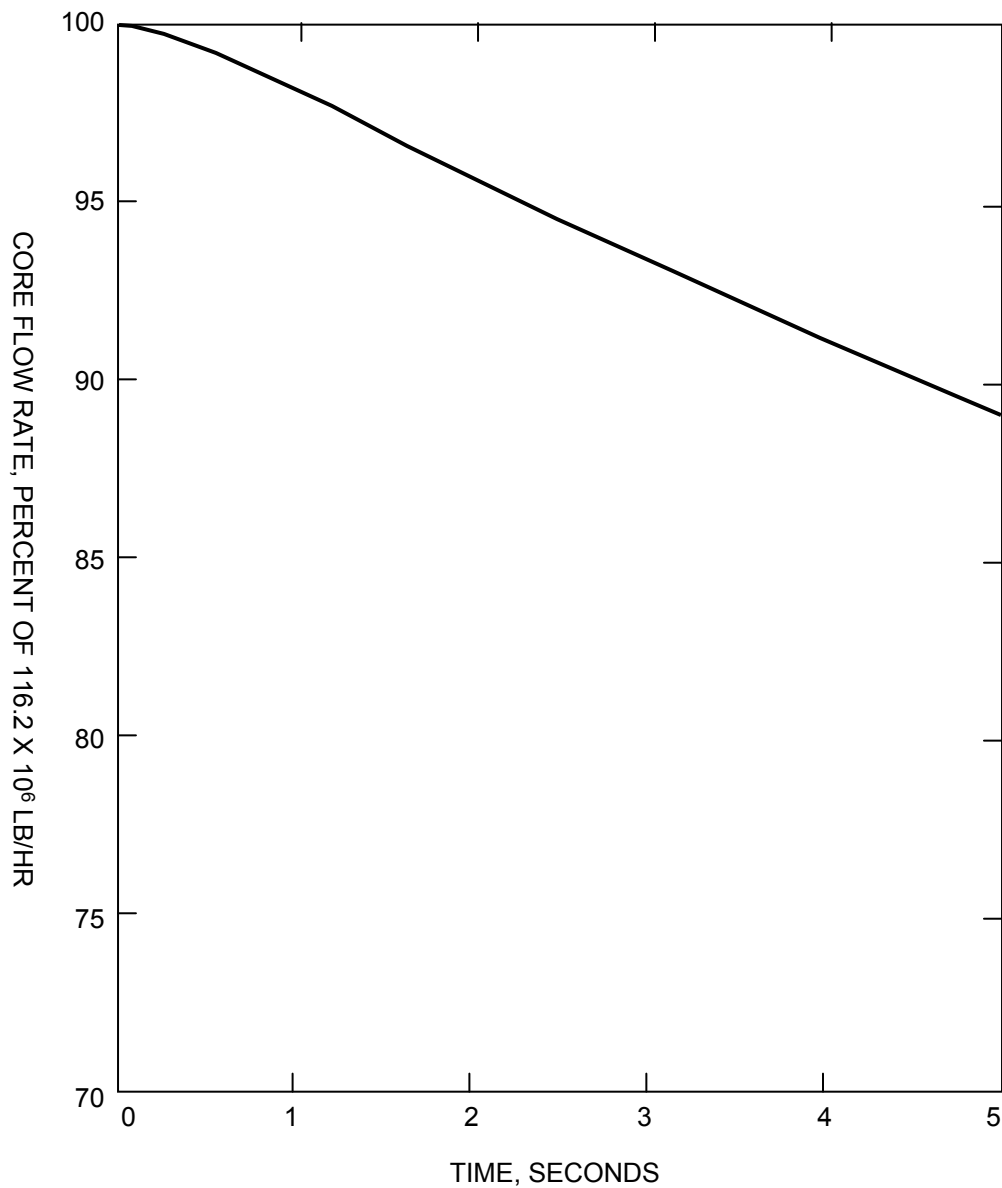

SAR FIGURE NO. 15.1.5-7

AMENDMENT 20

ARKANSAS NUCLEAR ONE
UNIT 2
RUSSELLVILLE, ARKANSAS



SCALE:	NONE
DRAWN:	
DESIGN:	ENERGY
CAD NO:	

LOSS OF COOLANT FLOW 2 PUMP LOSS OF COOLANT
FLOW CORE FLOW RATE VERSUS TIME

BASED ON DRAWING NO

SHEET

REV.

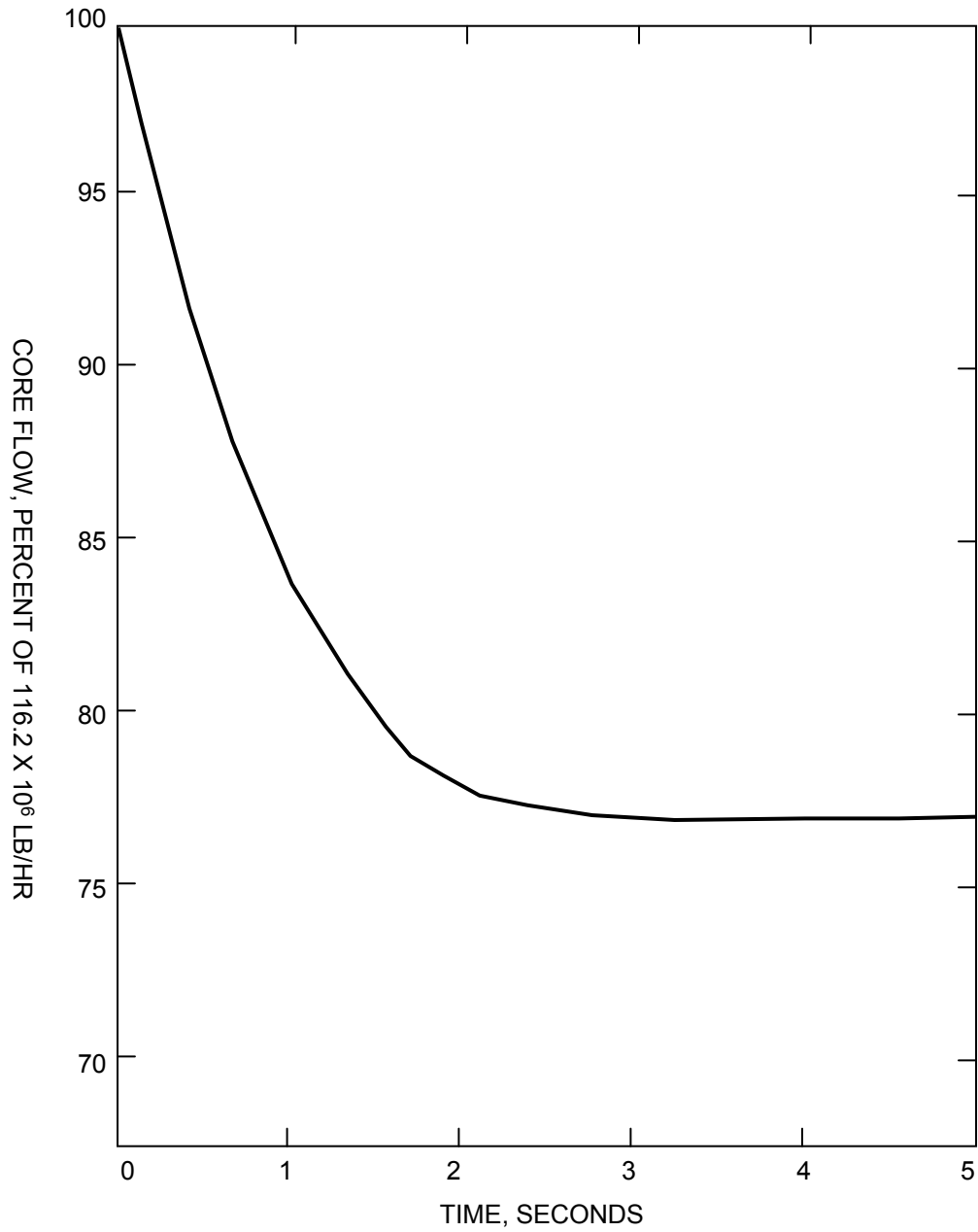

SAR FIGURE NO. 15.1.5-8

AMENDMENT 20

ARKANSAS NUCLEAR ONE
UNIT 2
RUSSELLVILLE, ARKANSAS



SCALE:	NONE
DRAWN:	
DESIGN:	ENERGY
CAD NO:	

LOSS OF COOLANT FLOW SEIZED SHAFT
CORE FLOW VERSUS TIME

BASED ON DRAWING NO

SHEET

REV.

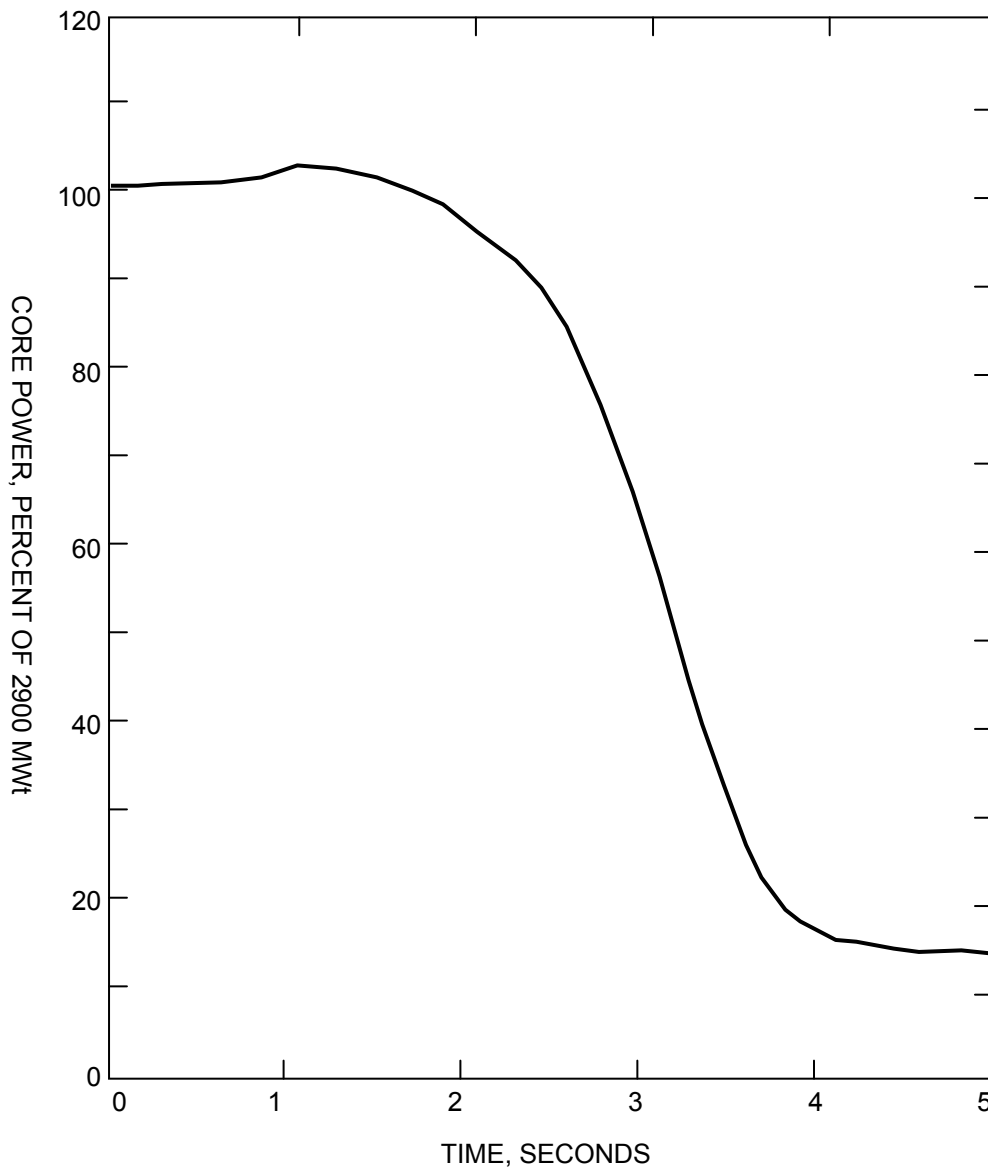

SAR FIGURE NO. 15.1.5-9

AMENDMENT 20

ARKANSAS NUCLEAR ONE
UNIT 2
RUSSELLVILLE, ARKANSAS



SCALE:	NONE
DRAWN:	
DESIGN:	ENERGY
CAD NO:	

LOSS OF COOLANT FLOW SEIZED SHAFT
CORE POWER VERSUS TIME

BASED ON DRAWING NO

SHEET

REV.

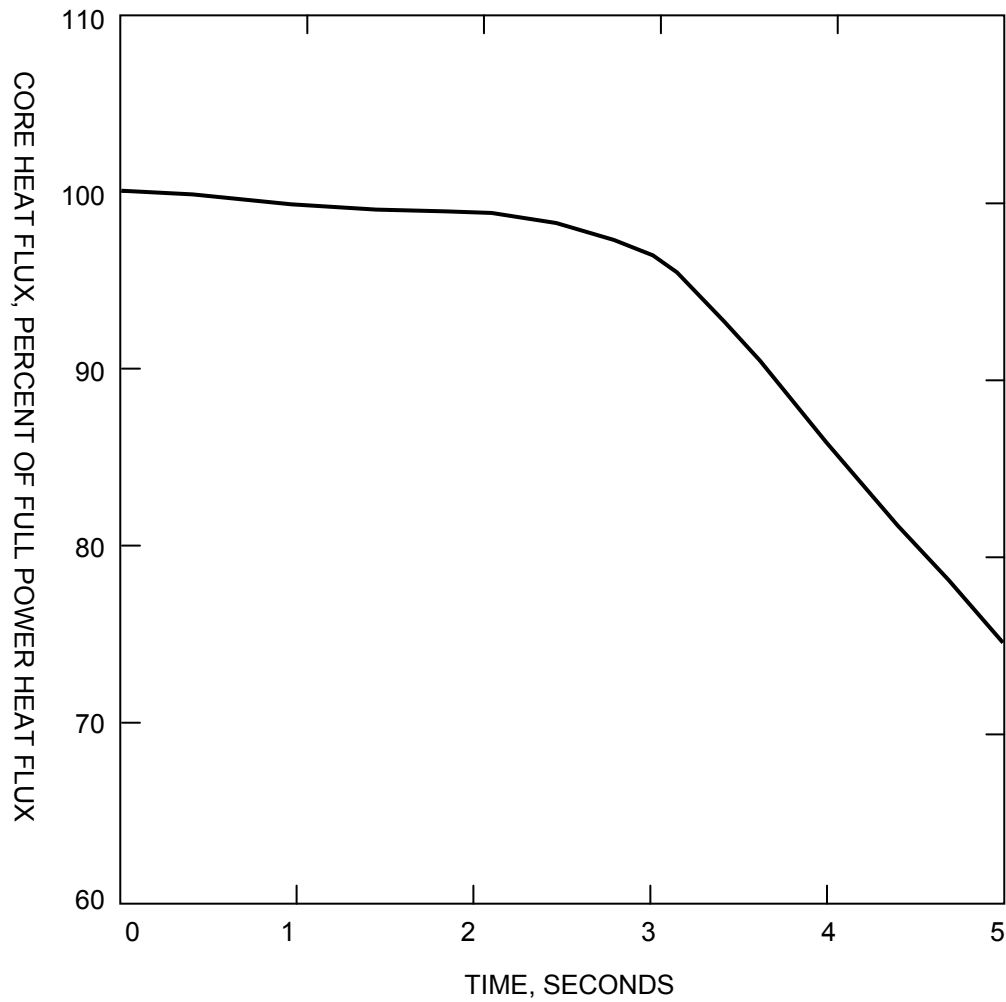

SAR FIGURE NO. 15.1.5-10

AMENDMENT 20

ARKANSAS NUCLEAR ONE
 UNIT 2
 RUSSELLVILLE, ARKANSAS



SCALE: NONE

DRAWN:

DESIGN: ENTERGY

CAD NO:

LOSS OF COOLANT FLOW SEIZED SHAFT
 CORE HEAT FLUX VERSUS TIME

BASED ON DRAWING NO

SHEET

REV.

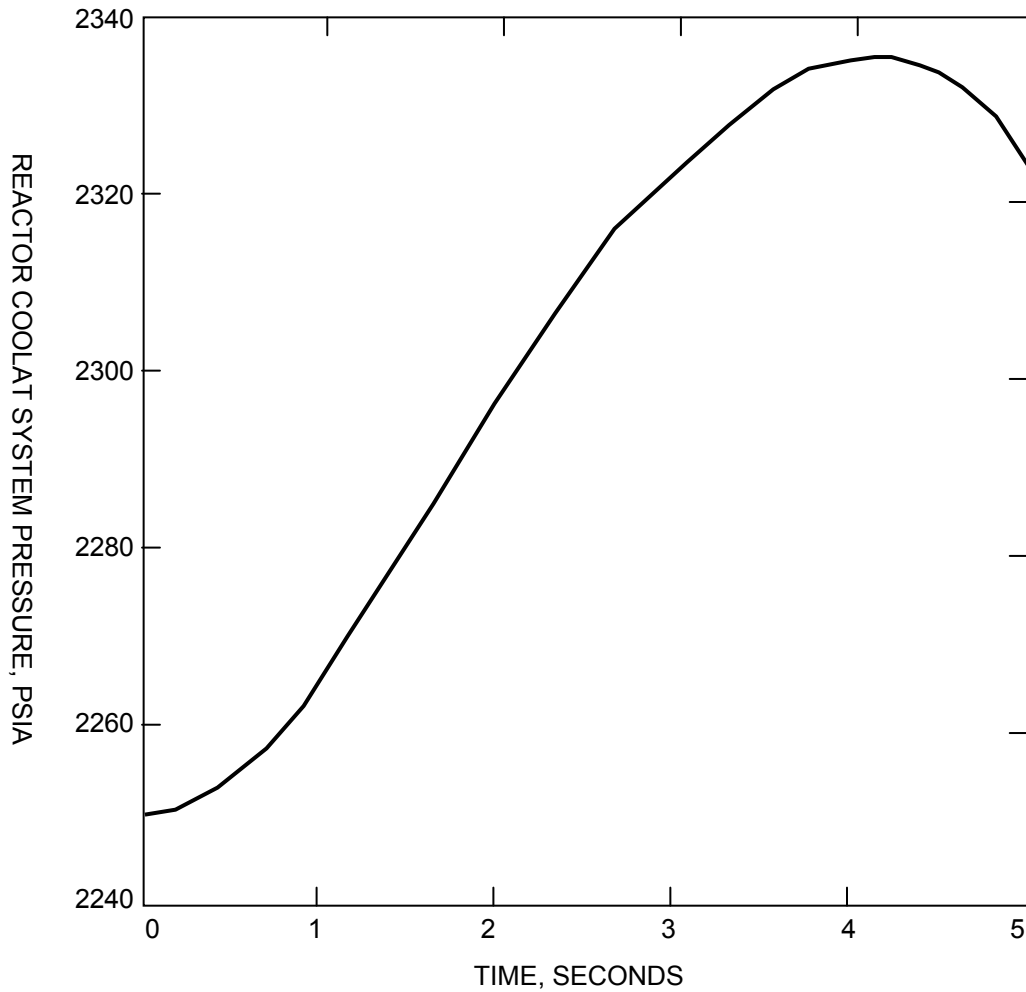

SAR FIGURE NO. 15.1.5-11

AMENDMENT 20

ARKANSAS NUCLEAR ONE
UNIT 2
RUSSELLVILLE, ARKANSAS



SCALE:	NONE
DRAWN:	
DESIGN:	ENERGY
CAD NO:	

LOSS OF COOLANT FLOW SEIZED SHAFT
RCS PRESSURE VERSUS TIME

BASED ON DRAWING NO

SHEET

REV.

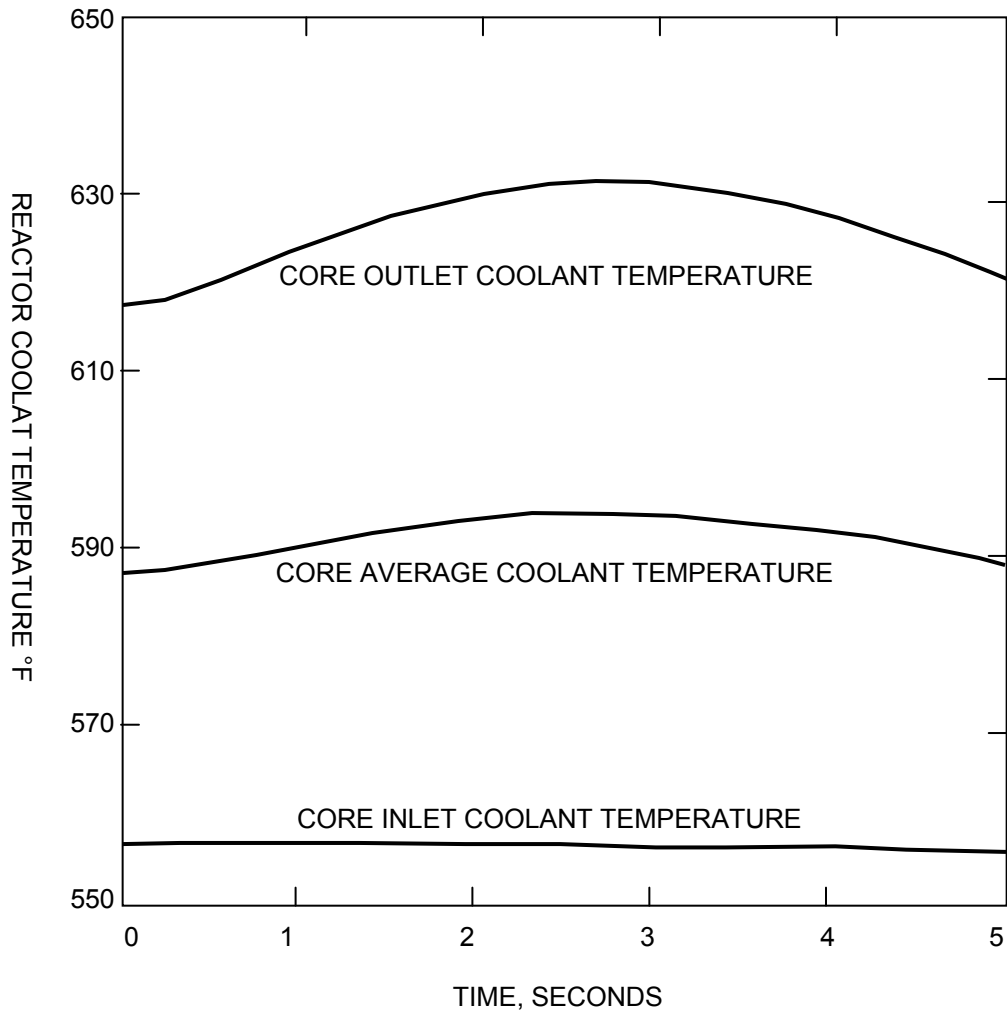

SAR FIGURE NO. 15.1.5-12

AMENDMENT 20

ARKANSAS NUCLEAR ONE
UNIT 2
RUSSELLVILLE, ARKANSAS



SCALE:	NONE
DRAWN:	
DESIGN:	ENERGY
CAD NO:	

LOSS OF COOLANT FLOW SEIZED SHAFT
RCS TEMPERATURE VERSUS TIME

BASED ON DRAWING NO

SHEET

REV.

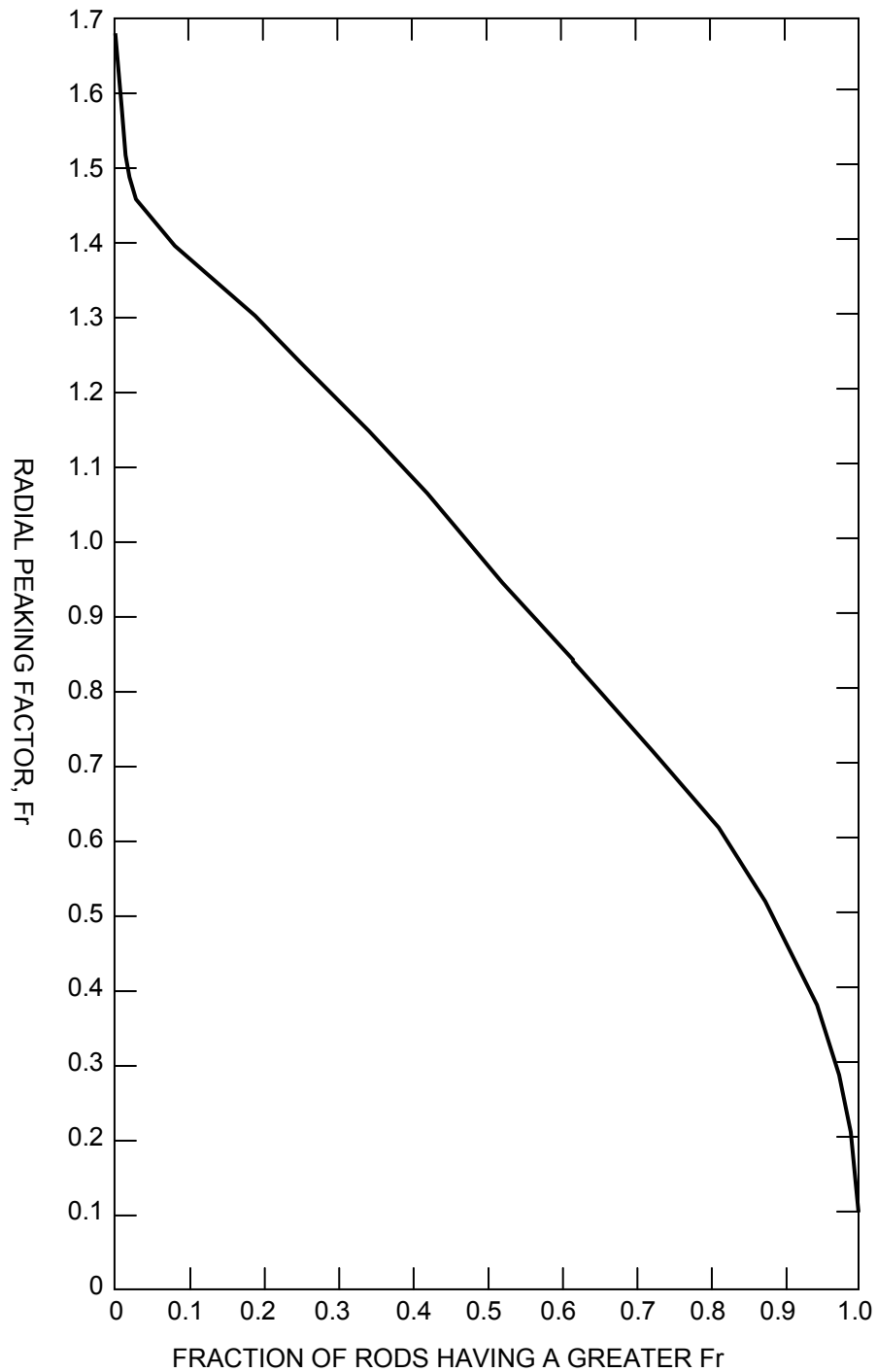

SAR FIGURE NO. 15.1.5-13

AMENDMENT 20

ARKANSAS NUCLEAR ONE
UNIT 2
RUSSELLVILLE, ARKANSAS



SCALE:	NONE
DRAWN:	
DESIGN:	ENERGY
CAD NO:	

LOSS OF COOLANT FLOW SEIZED SHAFT
CUMMULATIVE DISPOSITION OF THE FRACTION OF
RODS VERSUS NUCLEAR RADIAL PEAKING FACTOR

BASED ON DRAWING NO

SHEET

REV.

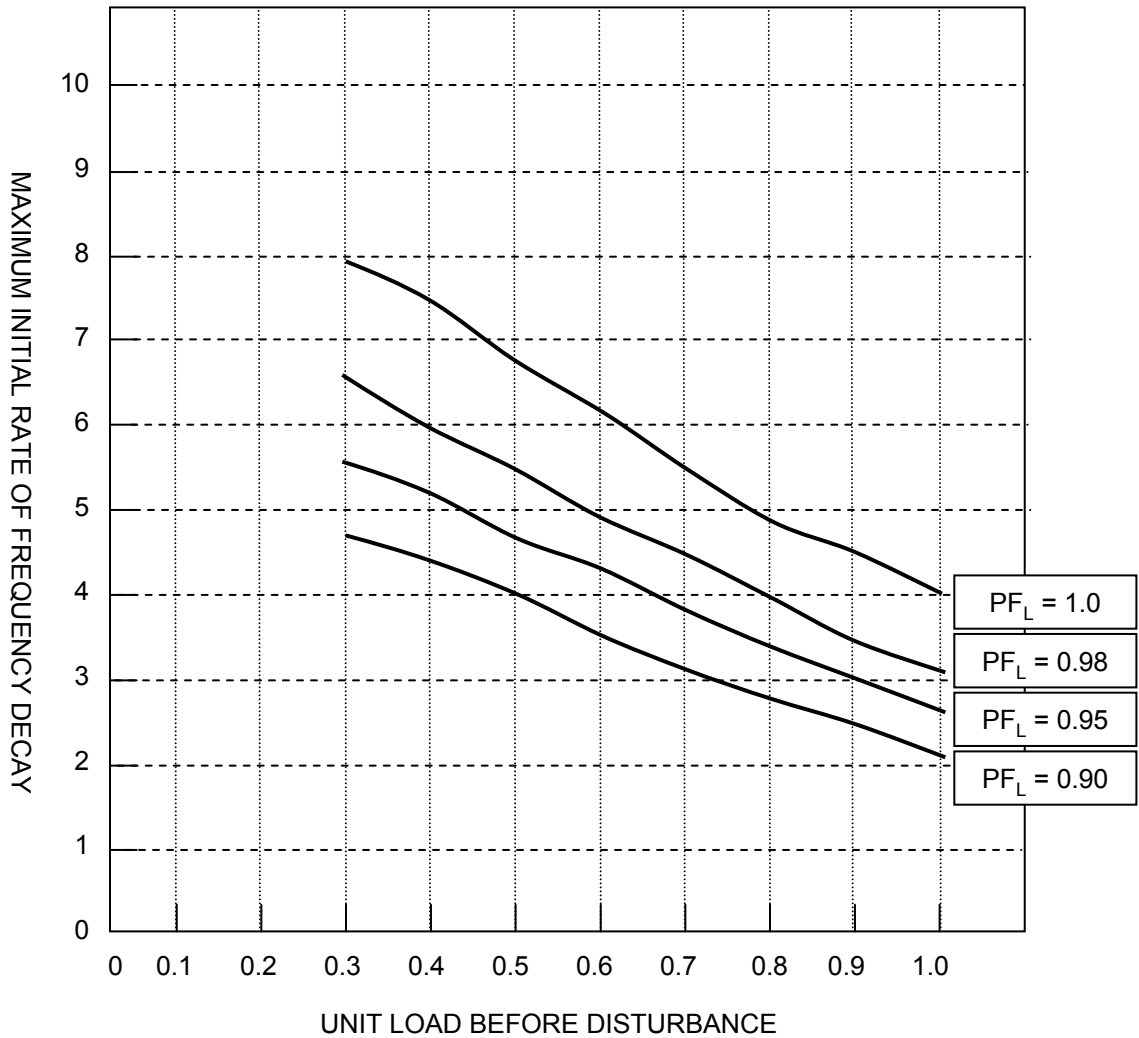

SAR FIGURE NO. 15.1.5-14

AMENDMENT 20

ARKANSAS NUCLEAR ONE
UNIT 2
RUSSELLVILLE, ARKANSAS



SCALE:	NONE
DRAWN:	
DESIGN:	ENTERGY
CAD NO:	

MAXIMUM INITIAL RATE OF FREQUENCY DECAY
VERSUS UNIT LOAD BEFORE DISTURBANCE

BASED ON DRAWING NO

SHEET

REV.

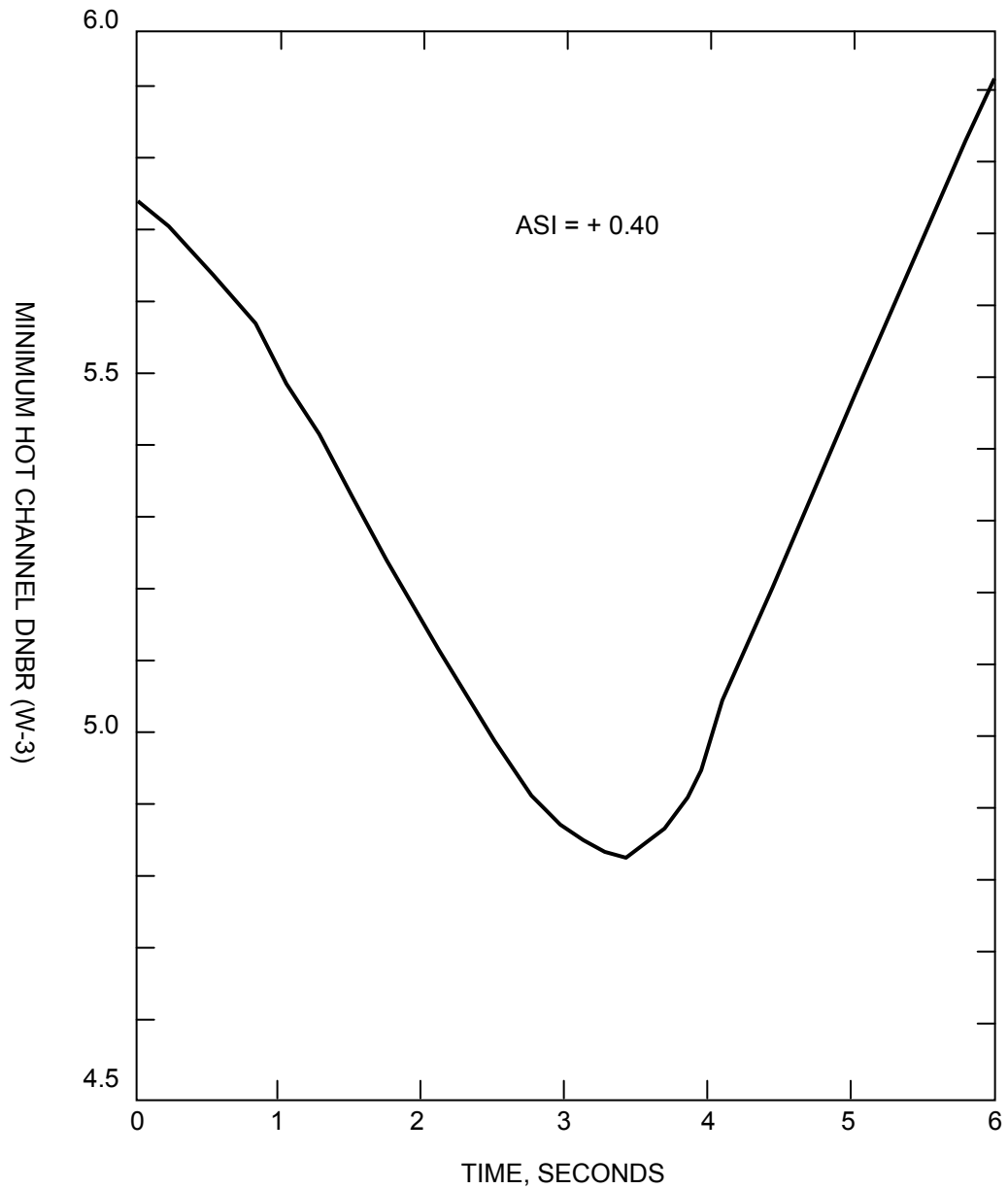

SAR FIGURE NO. 15.1.5-15

AMENDMENT 20

ARKANSAS NUCLEAR ONE
 UNIT 2
 RUSSELLVILLE, ARKANSAS



SCALE:	NONE
DRAWN:	
DESIGN:	ENTERGY
CAD NO:	

DNBR VERSUS TIME FOR 6.47 HZ/SEC GRID
 FREQUENCY TRANSIENT AT 30% RATED POWER

BASED ON DRAWING NO

SHEET

REV.

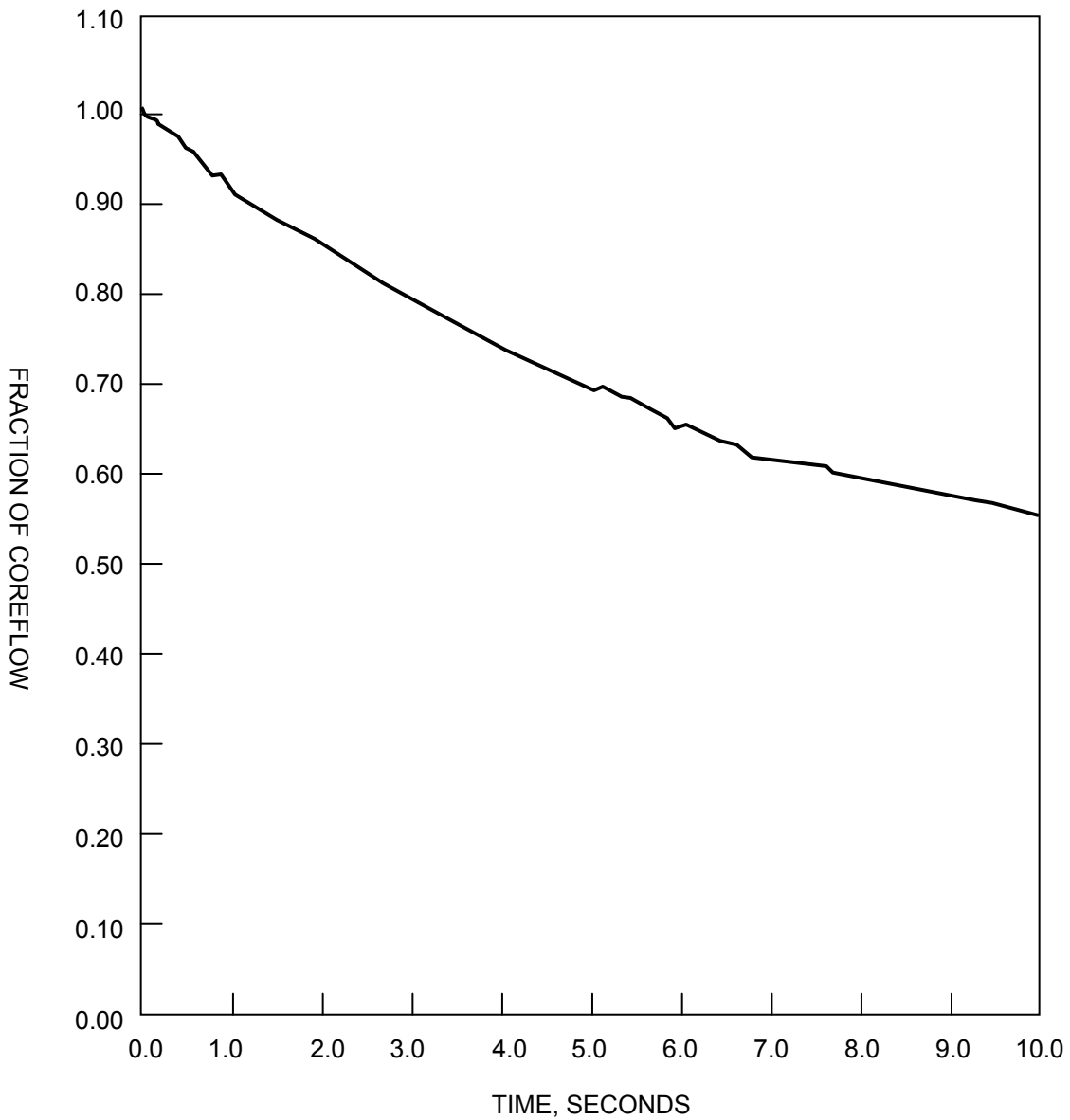

SAR FIGURE NO. 15.1.5-16

AMENDMENT 20

ARKANSAS NUCLEAR ONE
 UNIT 2
 RUSSELLVILLE, ARKANSAS



SCALE:	NONE
DRAWN:	
DESIGN:	ENERGY
CAD NO:	

RCP FLOW COAST DOWN WITH 30% STEAM
 GENERATOR TUBE PLUGGING

BASED ON DRAWING NO

SHEET

REV.

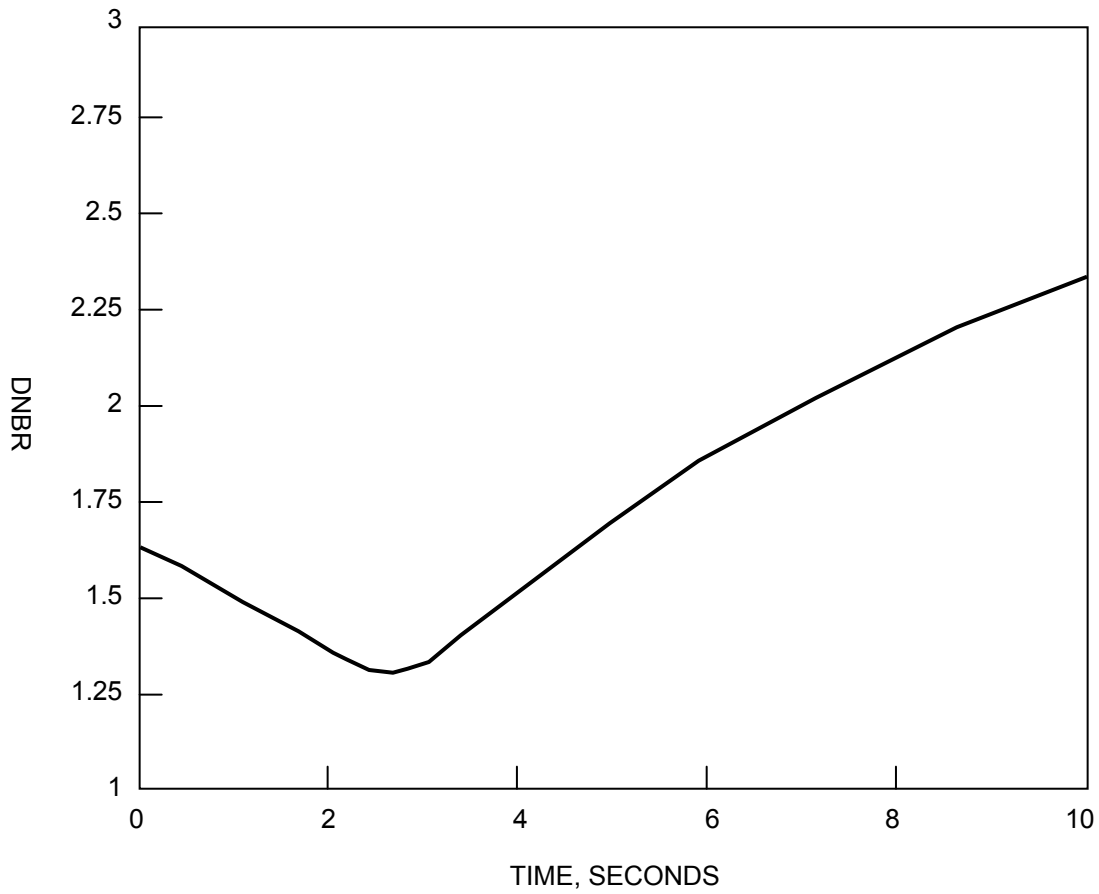

SAR FIGURE NO. 15.1.5-17

AMENDMENT 20

ARKANSAS NUCLEAR ONE
 UNIT 2
 RUSSELLVILLE, ARKANSAS



SCALE:	NONE
DRAWN:	
DESIGN:	ENTERGY
CAD NO:	

DNBR VERSUS TIME

BASED ON DRAWING NO

SHEET

REV.

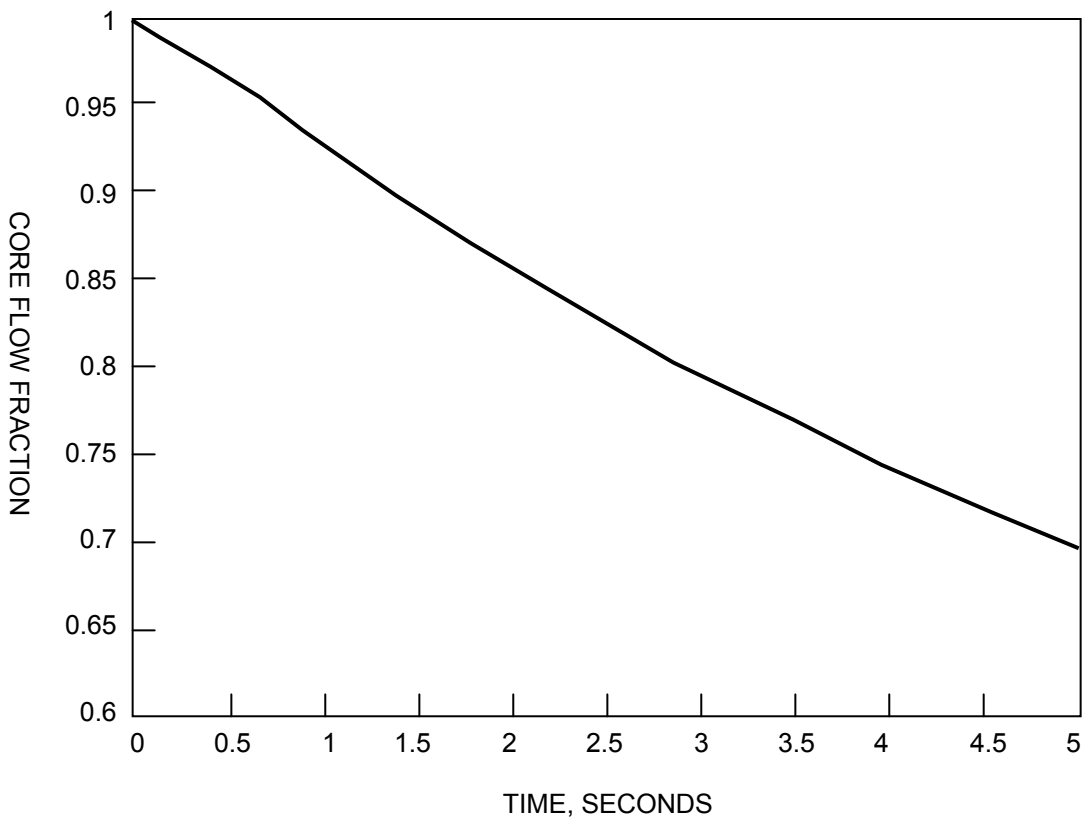

SAR FIGURE NO. 15.1.5-18

AMENDMENT 20

ARKANSAS NUCLEAR ONE
 UNIT 2
 RUSSELLVILLE, ARKANSAS



SCALE:	NONE
DRAWN:	
DESIGN:	ENERGY
CAD NO:	

CYCLE 16 FOUR PUMP LOSS OF COOLANT
 FLOW EVENT, CORE FLOW VERSUS TIME

BASED ON DRAWING NO

SHEET

REV.

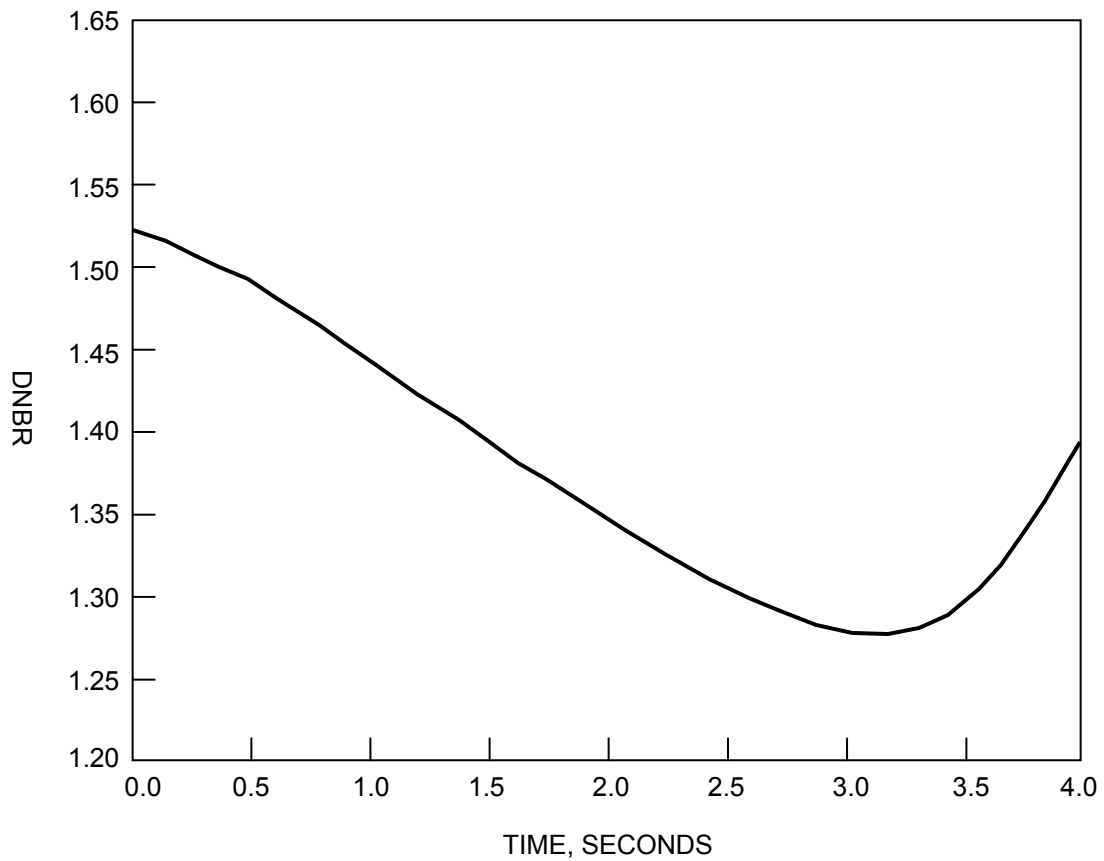

SAR FIGURE NO. 15.1.5-19

AMENDMENT 22

ARKANSAS NUCLEAR ONE
 UNIT 2
 RUSSELLVILLE, ARKANSAS



SCALE: NONE

DRAWN:

DESIGN: ENTERGY

CAD NO:

NGF CYCLE 21 FOUR PUMP LOSS OF COOLANT FLOW
 EVENT, DNBR VERSUS TIME – MAXIMUM SUBCOOLING
 ASSUMPTIONS

BASED ON DRAWING NO

SHEET

REV.

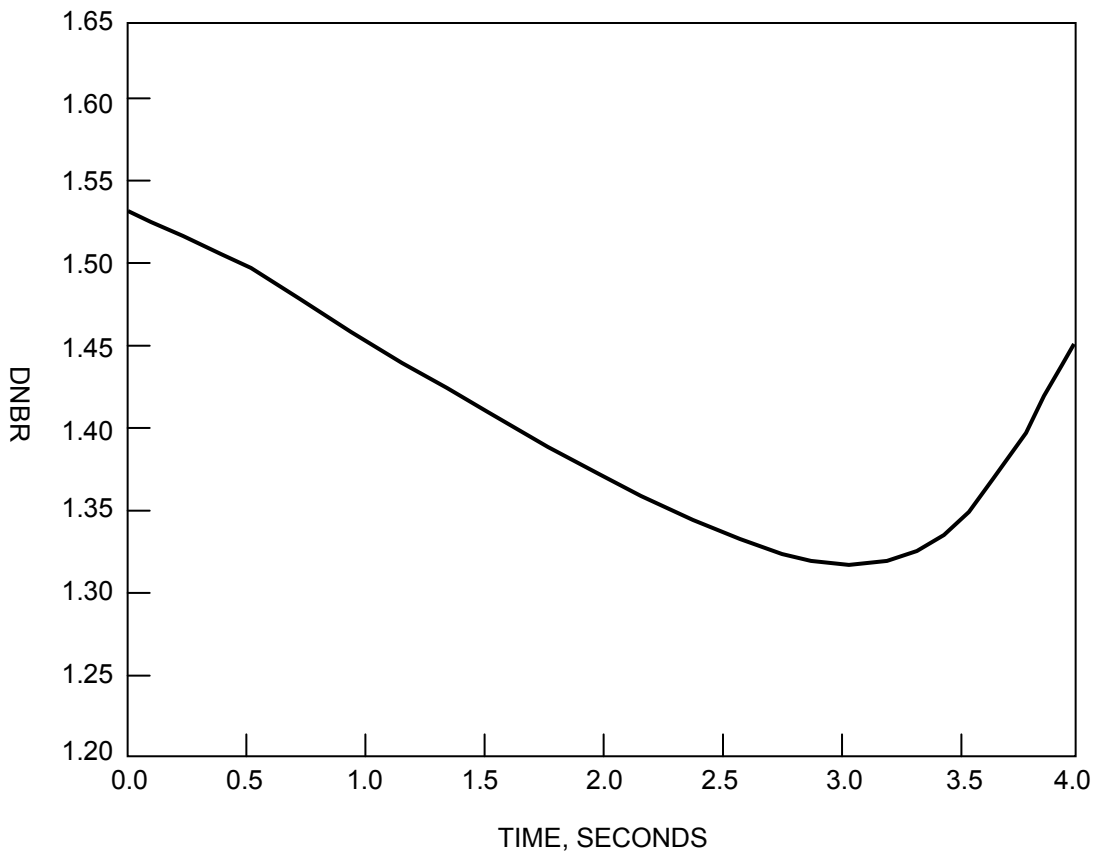

SAR FIGURE NO. 15.1.5-20

AMENDMENT 22

ARKANSAS NUCLEAR ONE
 UNIT 2
 RUSSELLVILLE, ARKANSAS



SCALE: NONE

DRAWN:

DESIGN: ENTERGY

CAD NO:

NGF CYCLE 21 FOUR PUMP LOSS OF COOLANT FLOW
 EVENT, DNBR VERSUS TIME - MINIMUM SUBCOOLING
 ASSUMPTION

BASED ON DRAWING NO

SHEET

REV.

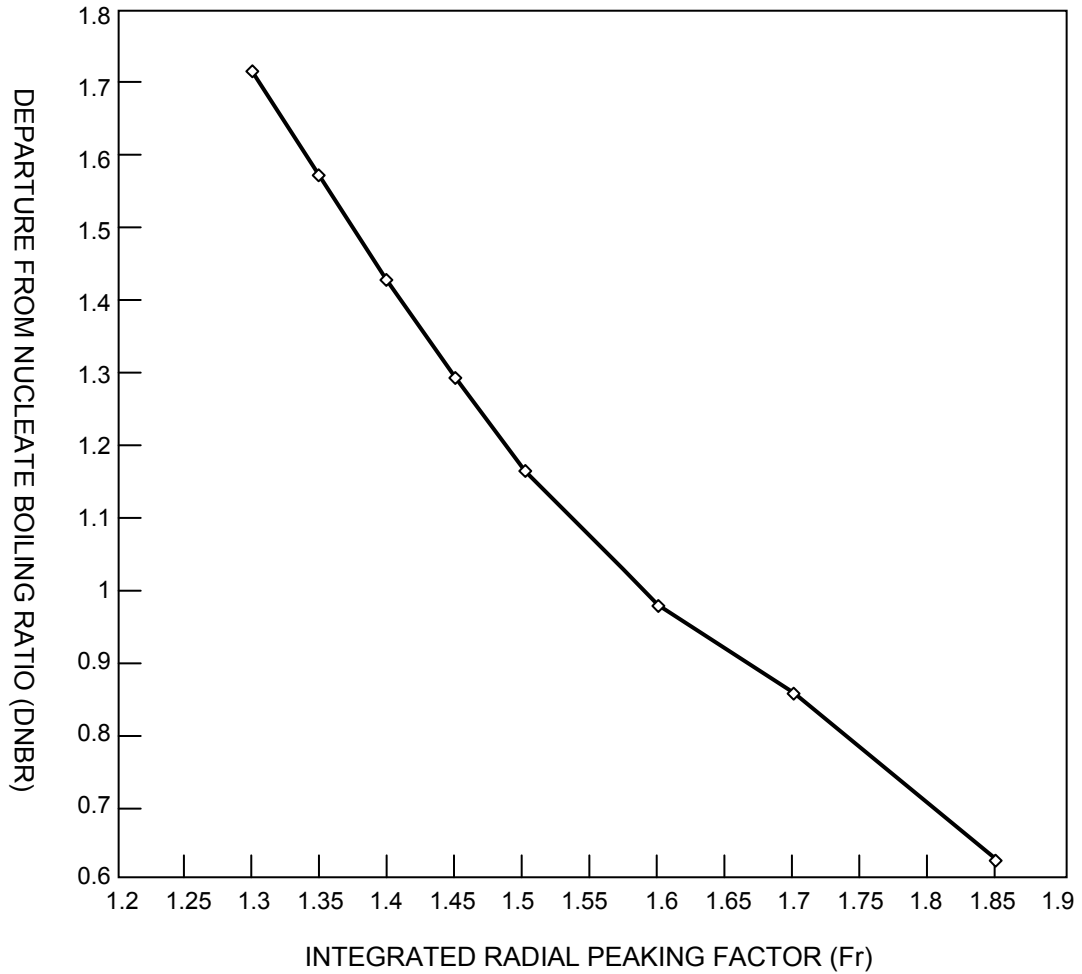

SAR FIGURE NO. 15.1.5-21

AMENDMENT 22

ARKANSAS NUCLEAR ONE
 UNIT 2
 RUSSELLVILLE, ARKANSAS



SCALE:	NONE
DRAWN:	
DESIGN:	ENERGY
CAD NO:	

NGF CYCLE 21 FOUR PUMP LOSS OF COOLANT FLOW
 EVENT, PUMP SHAFT SEIZURE – FR VERSUS DNBR

BASED ON DRAWING NO

SHEET

REV.

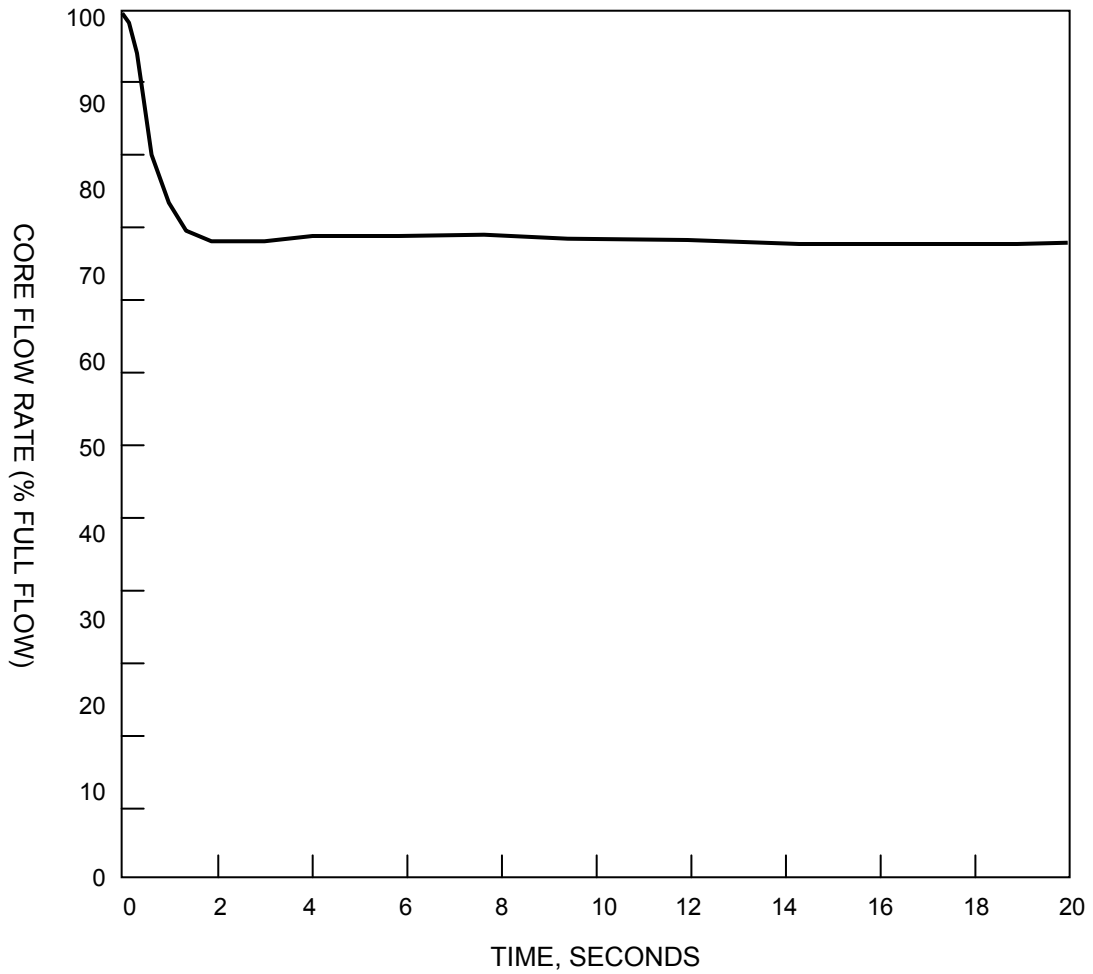

SAR FIGURE NO. 15.1.5-22

AMENDMENT 20

ARKANSAS NUCLEAR ONE
 UNIT 2
 RUSSELLVILLE, ARKANSAS



SCALE: NONE

DRAWN:

DESIGN: ENTERGY

CAD NO:

CYCLE 16 FOUR PUMP LOSS OF COOLANT FLOW
 EVENT, PUMP SHAFT SEIZURE – CORE FLOW RATE
 VERSUS TIME

BASED ON DRAWING NO

SHEET

REV.

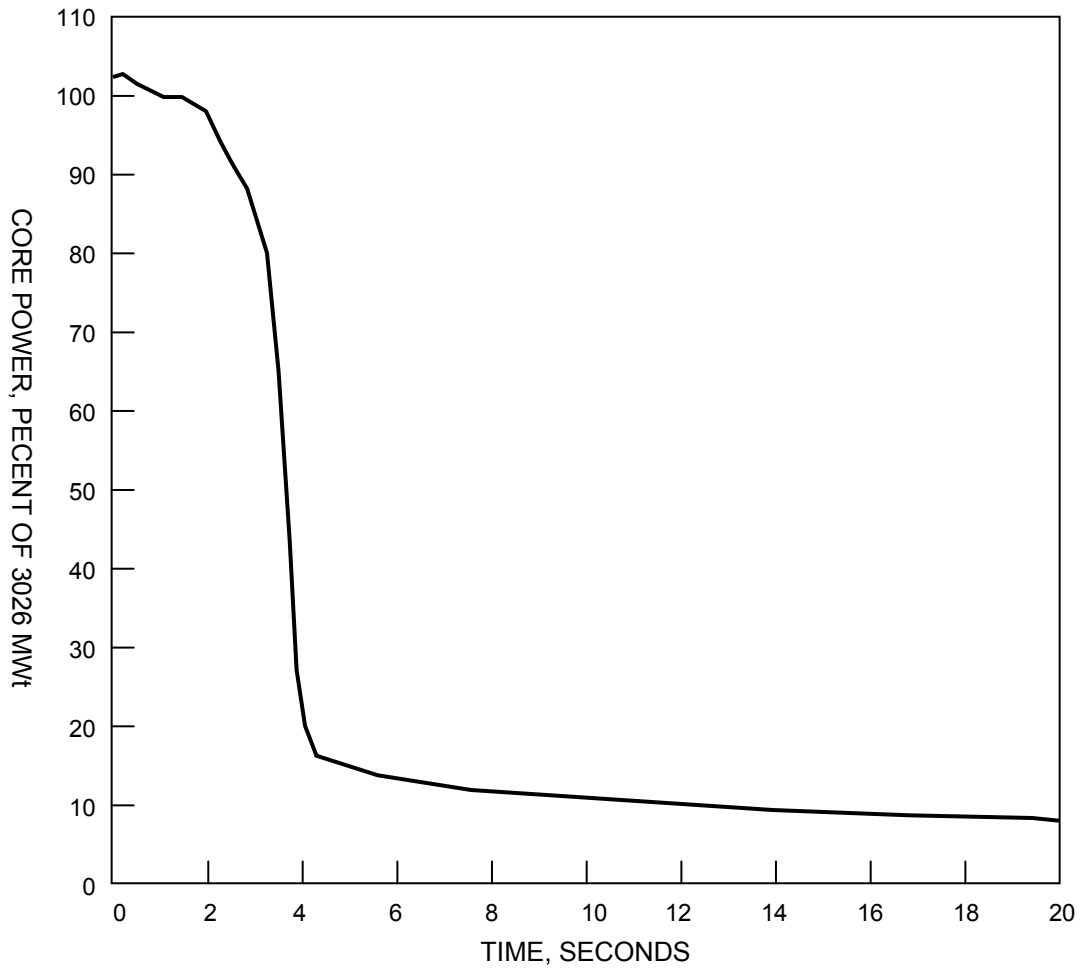

SAR FIGURE NO. 15.1.5-23

AMENDMENT 20

ARKANSAS NUCLEAR ONE
UNIT 2
RUSSELLVILLE, ARKANSAS



SCALE: NONE

DRAWN:

DESIGN: ENTERGY

CAD NO:

CYCLE 16 FOUR PUMP LOSS OF COOLANT FLOW PUMP
SHAFT SEIZURE – CORE POWER VERSUS TIME

BASED ON DRAWING NO

SHEET

REV.

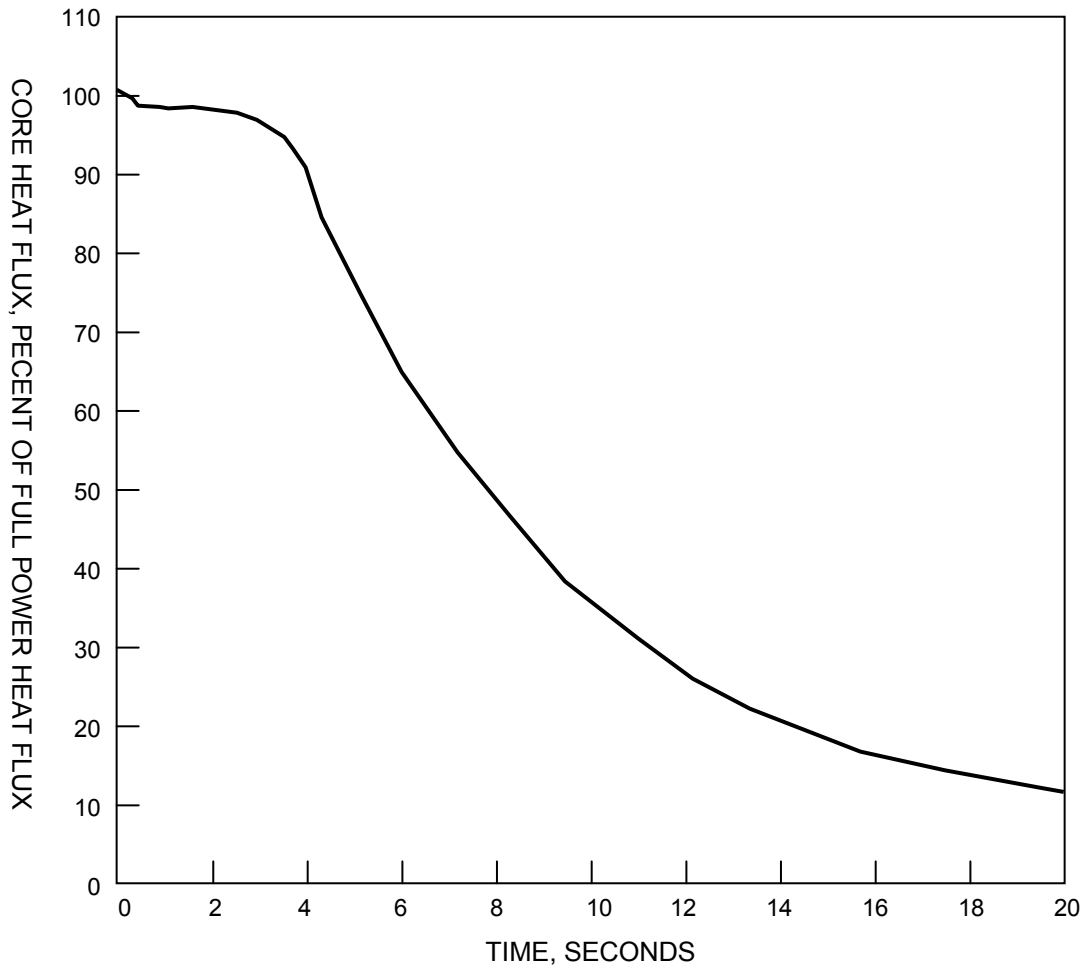

SAR FIGURE NO. 15.1.5-24

AMENDMENT 20

ARKANSAS NUCLEAR ONE
 UNIT 2
 RUSSELLVILLE, ARKANSAS



SCALE: NONE

DRAWN:

DESIGN: ENTERGY

CAD NO:

CYCLE 16 4-PUMP LOSS OF COOLANT FLOW PUMP
 SHAFT SEIZURE – CORE AVERAGE HEAT FLUX VERSUS
 TIME

BASED ON DRAWING NO

SHEET

REV.

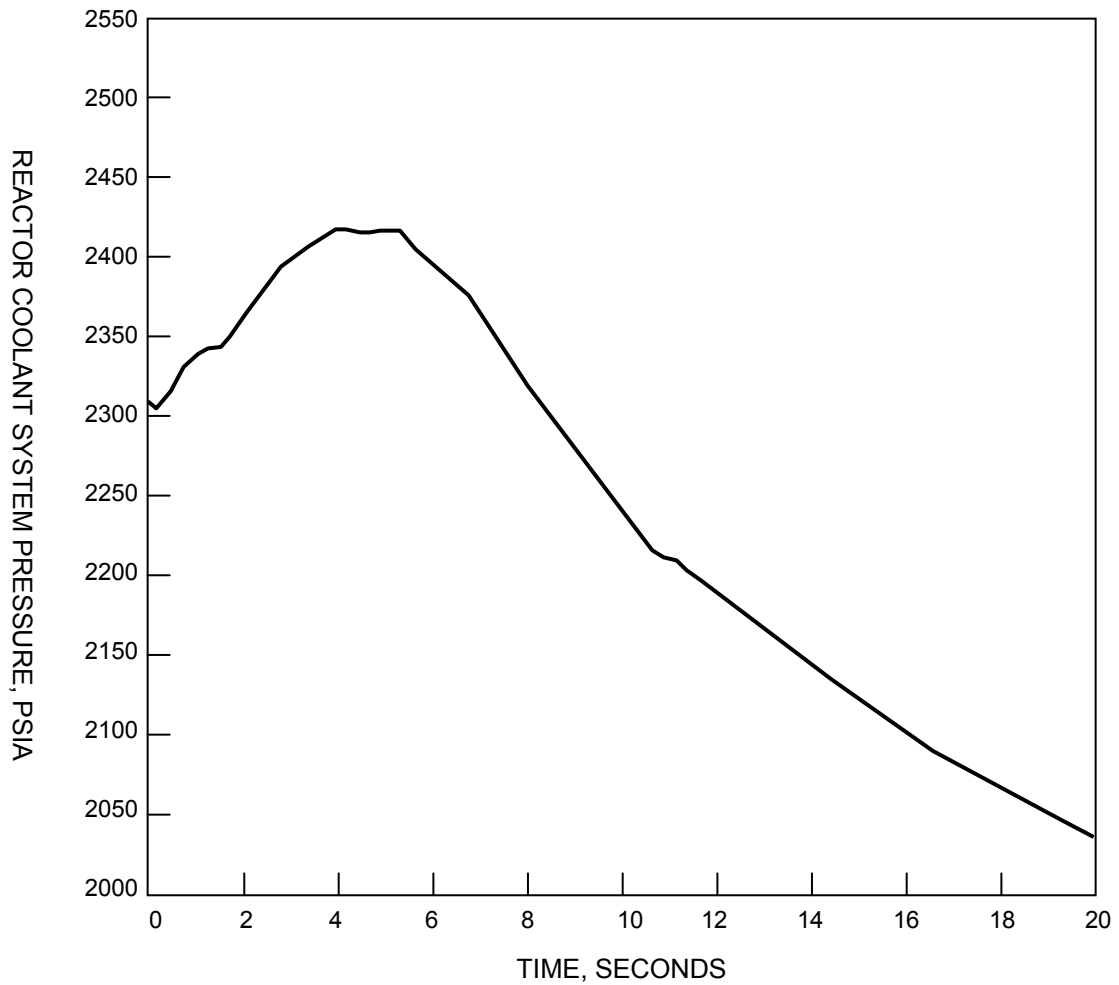

SAR FIGURE NO. 15.1.5-25

AMENDMENT 20

ARKANSAS NUCLEAR ONE
UNIT 2
RUSSELLVILLE, ARKANSAS



SCALE:	NONE
DRAWN:	
DESIGN:	ENERGY
CAD NO:	

CYCLE 16 LOSS OF COOLANT FLOW PUMP SHAFT SEIZURE – RCS PRESSURE VERSUS TIME

BASED ON DRAWING NO

SHEET

REV.

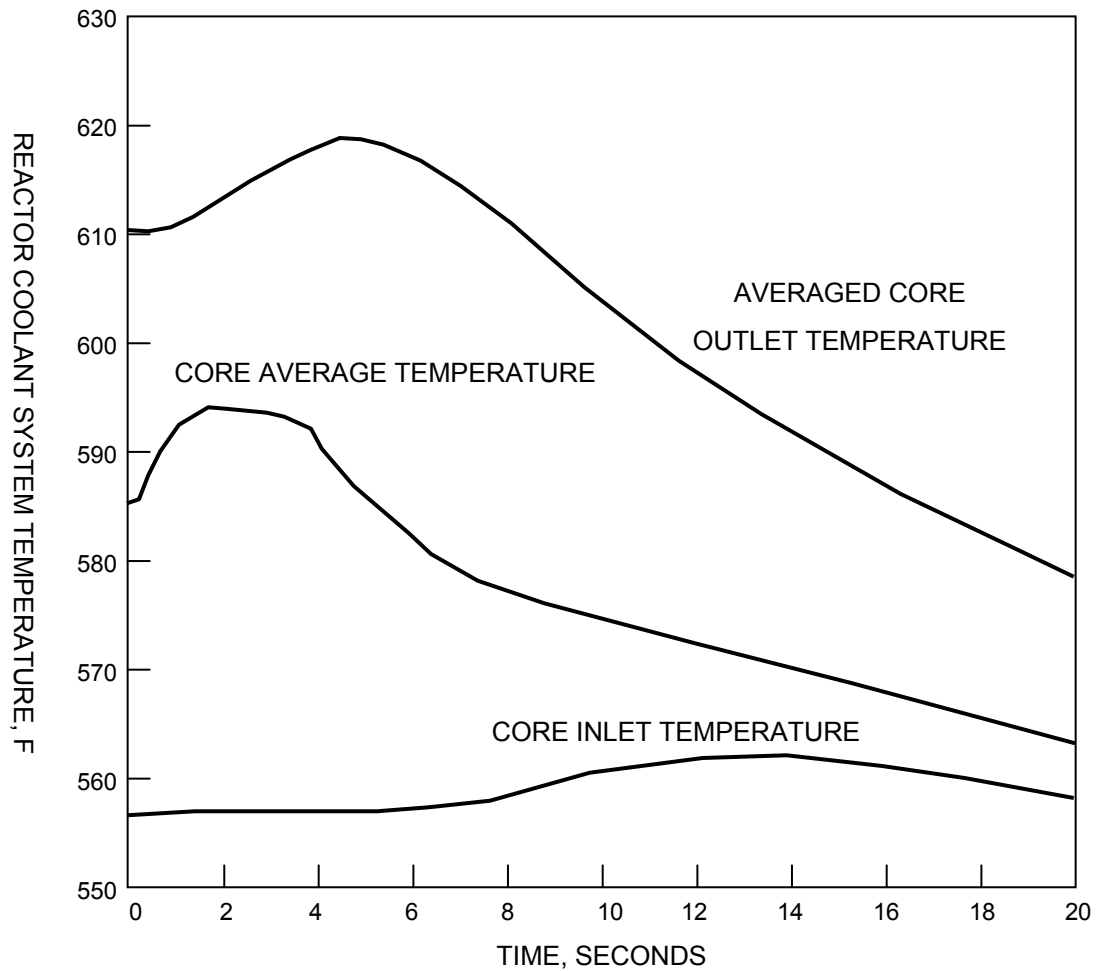

SAR FIGURE NO. 15.1.5-26

AMENDMENT 20

ARKANSAS NUCLEAR ONE
UNIT 2
RUSSELLVILLE, ARKANSAS



SCALE:	NONE
DRAWN:	
DESIGN:	ENTERGY
CAD NO:	

CYCLE 16 LOSS OF COOLANT FLOW PUMP SHAFT SEIZURE - RCS TEMPERATURE VERSUS TIME

BASED ON DRAWING NO

SHEET

REV.

DELETED

SAR FIGURE NO. 15.1.5-27

AMENDMENT 26

ARKANSAS NUCLEAR ONE
UNIT 2
RUSSELLVILLE, ARKANSAS



SCALE: NONE

DRAWN:

DESIGN: ENTERGY

CAD NO:

BASED ON DRAWING NO

SHEET

REV.

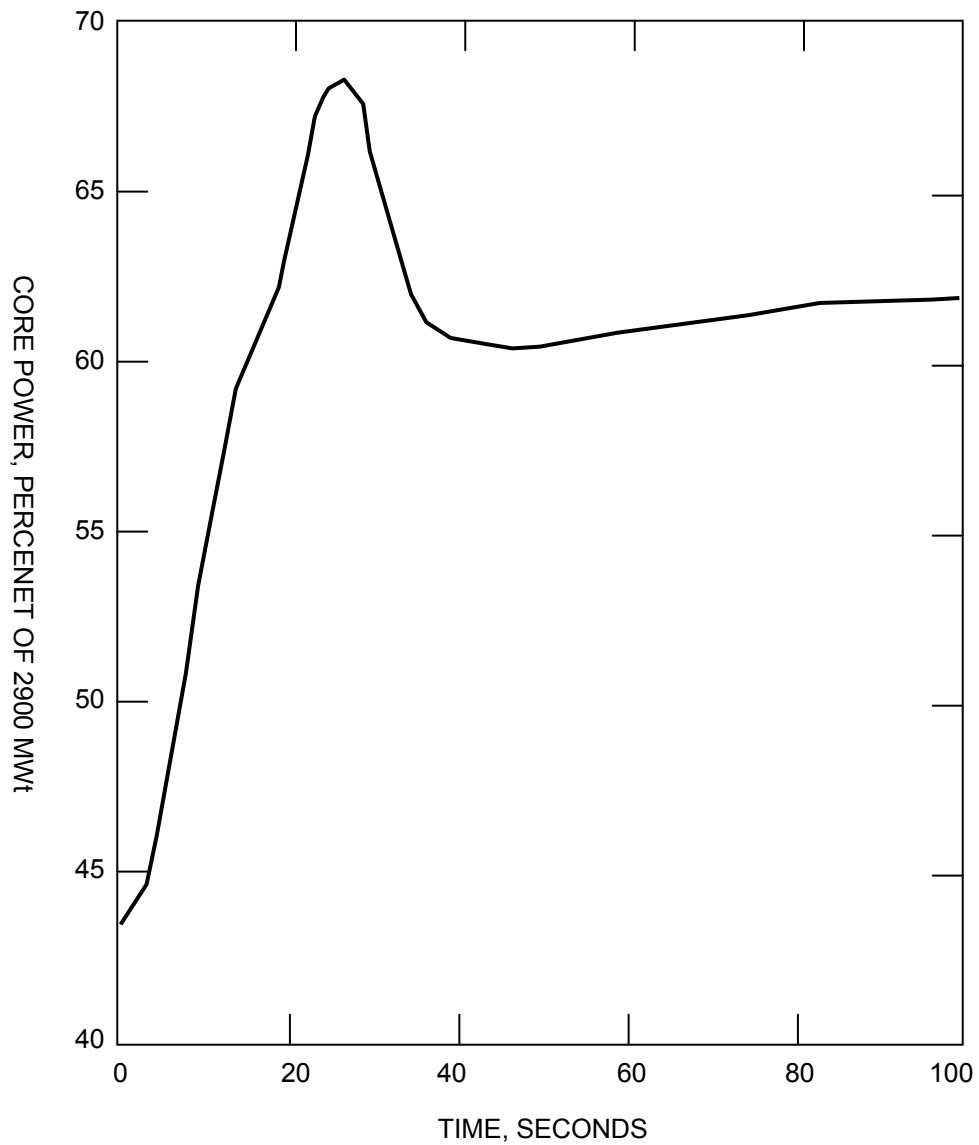

SAR FIGURE NO. 15.1.6-1

AMENDMENT 20

ARKANSAS NUCLEAR ONE
UNIT 2
RUSSELLVILLE, ARKANSAS



SCALE:	NONE
DRAWN:	
DESIGN:	ENERGY
CAD NO:	

IDLE LOOP STARTUP
CORE POWER VERSUS TIME

BASED ON DRAWING NO

SHEET

REV.

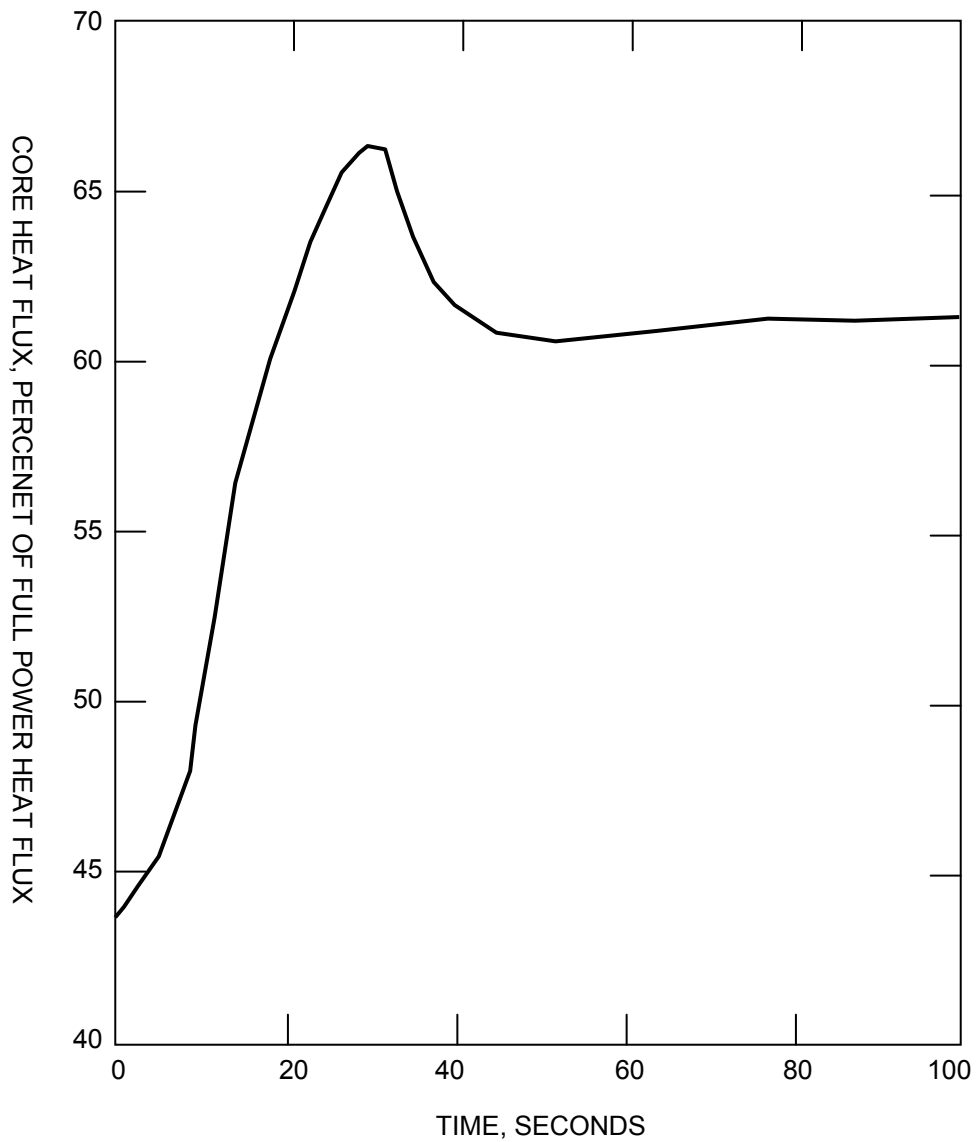

SAR FIGURE NO. 15.1.6-2

AMENDMENT 20

ARKANSAS NUCLEAR ONE
UNIT 2
RUSSELLVILLE, ARKANSAS



SCALE:	NONE
DRAWN:	
DESIGN:	ENERGY
CAD NO:	

IDLE LOOP STARTUP
CORE HEAT FLUX VERSUS TIME

BASED ON DRAWING NO

SHEET

REV.

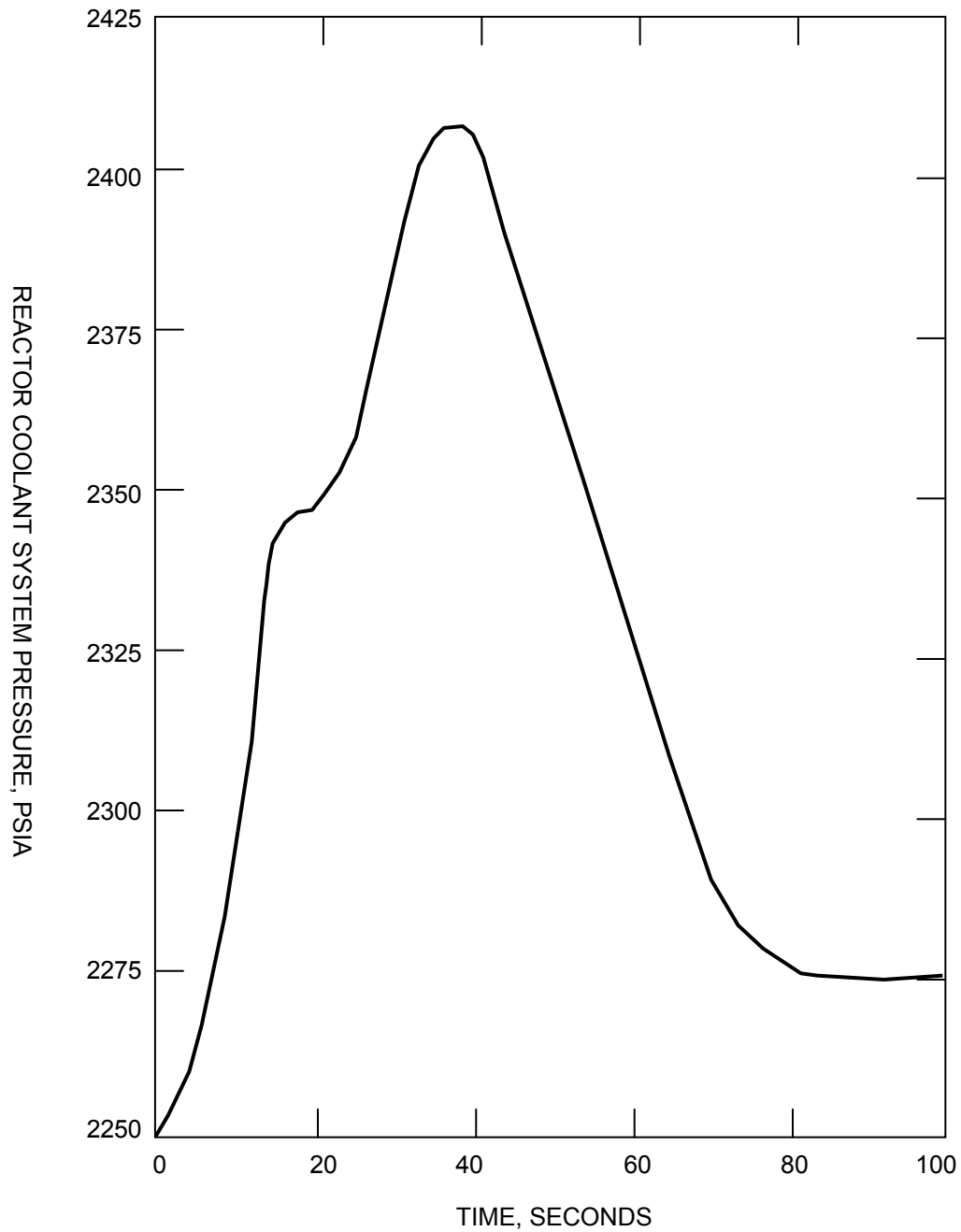

SAR FIGURE NO. 15.1.6-3

AMENDMENT 20

ARKANSAS NUCLEAR ONE
UNIT 2
RUSSELLVILLE, ARKANSAS



SCALE:	NONE
DRAWN:	
DESIGN:	ENERGY
CAD NO:	

IDLE LOOP STARTUP, REACTOR COOLANT
SYSTEM PRESSURE VERSUS TIME

BASED ON DRAWING NO

SHEET

REV.

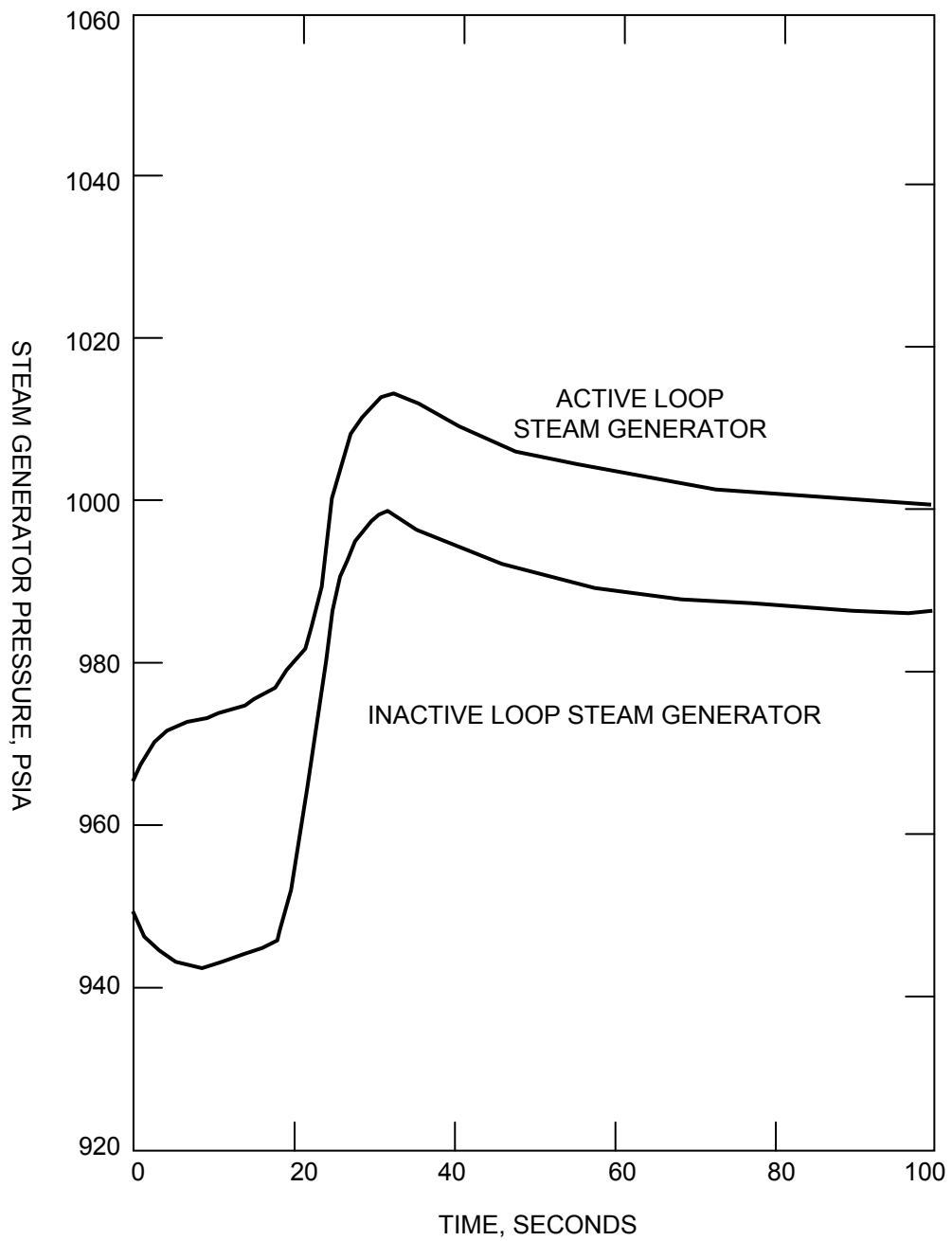

SAR FIGURE NO. 15.1.6-4

AMENDMENT 20

ARKANSAS NUCLEAR ONE
UNIT 2
RUSSELLVILLE, ARKANSAS



SCALE:	NONE
DRAWN:	
DESIGN:	ENERGY
CAD NO:	

IDLE LOOP STARTUP, STEAM GENERATOR PRESSURE VERSUS TIME

BASED ON DRAWING NO

SHEET

REV.

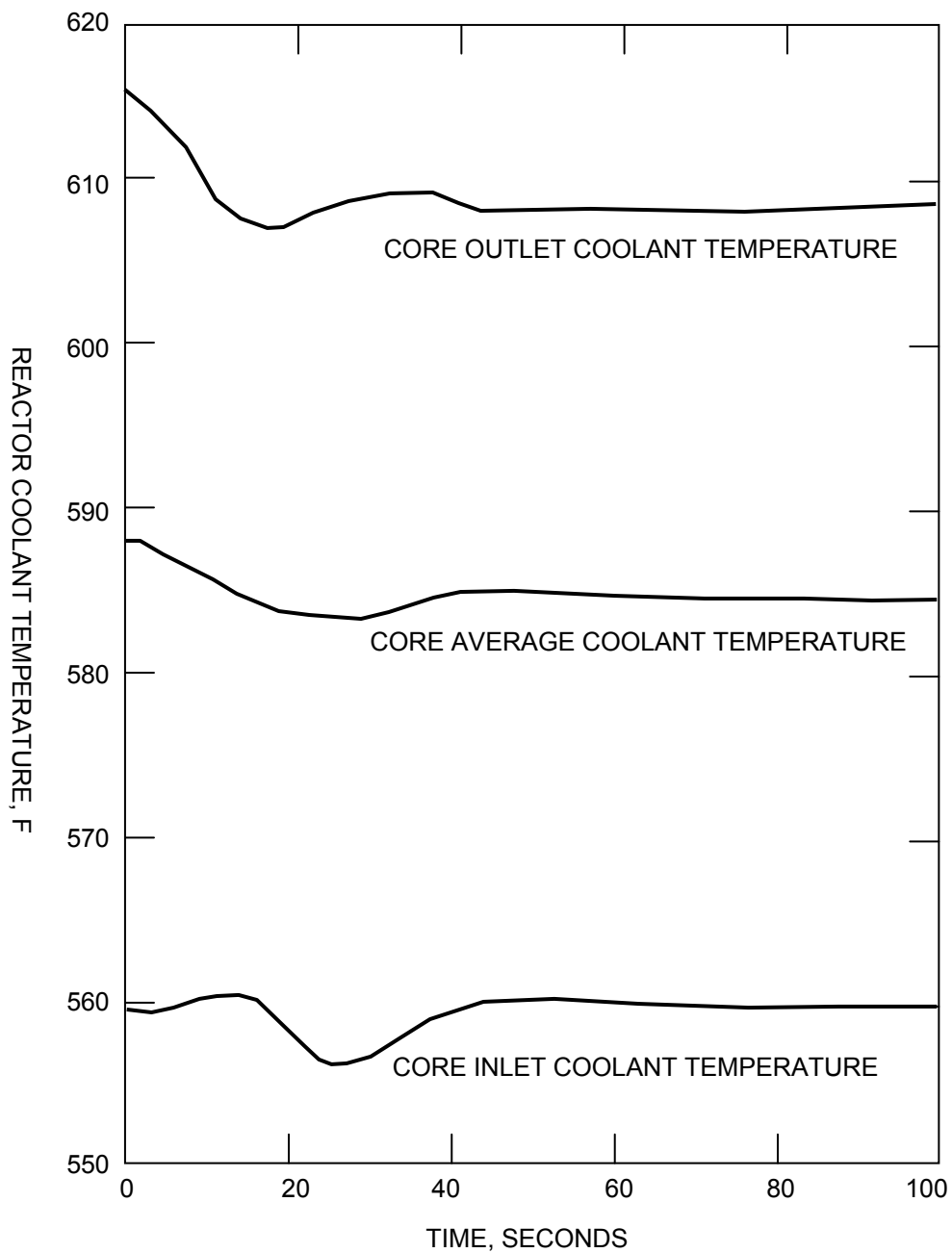

SAR FIGURE NO. 15.1.6-5

AMENDMENT 20

ARKANSAS NUCLEAR ONE
UNIT 2
RUSSELLVILLE, ARKANSAS



SCALE:	NONE
DRAWN:	
DESIGN:	ENERGY
CAD NO:	

IDLE LOOP STARTUP, REACTOR COOLANT
TEMPERATURE VERSUS TIME

BASED ON DRAWING NO

SHEET

REV.

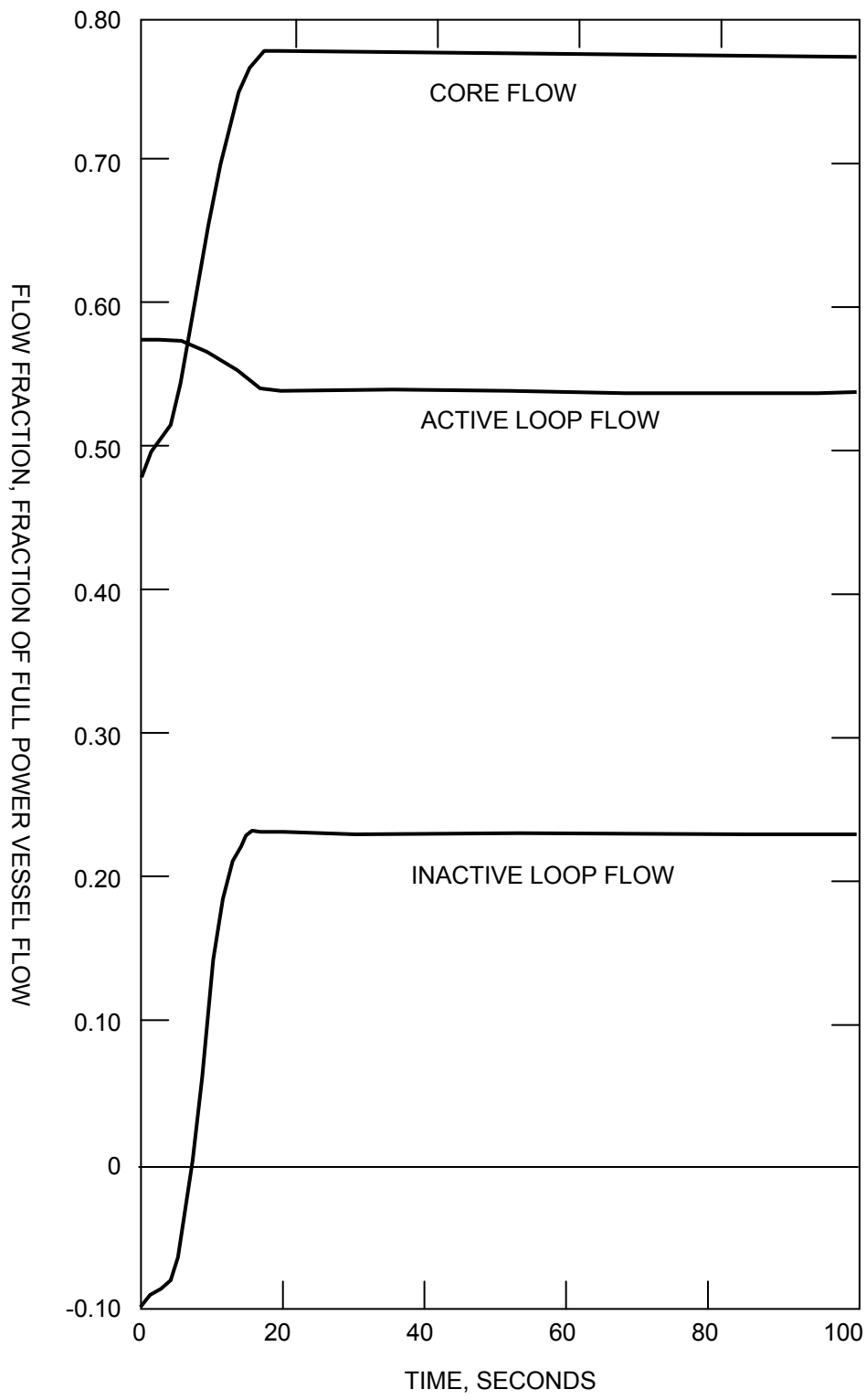

SAR FIGURE NO. 15.1.6-6

AMENDMENT 20

ARKANSAS NUCLEAR ONE
 UNIT 2
 RUSSELLVILLE, ARKANSAS



SCALE:	NONE
DRAWN:	
DESIGN:	ENTERGY
CAD NO:	

IDLE LOOP STARTUP
 FLOW FRACTION VERSUS TIME

BASED ON DRAWING NO

SHEET

REV.

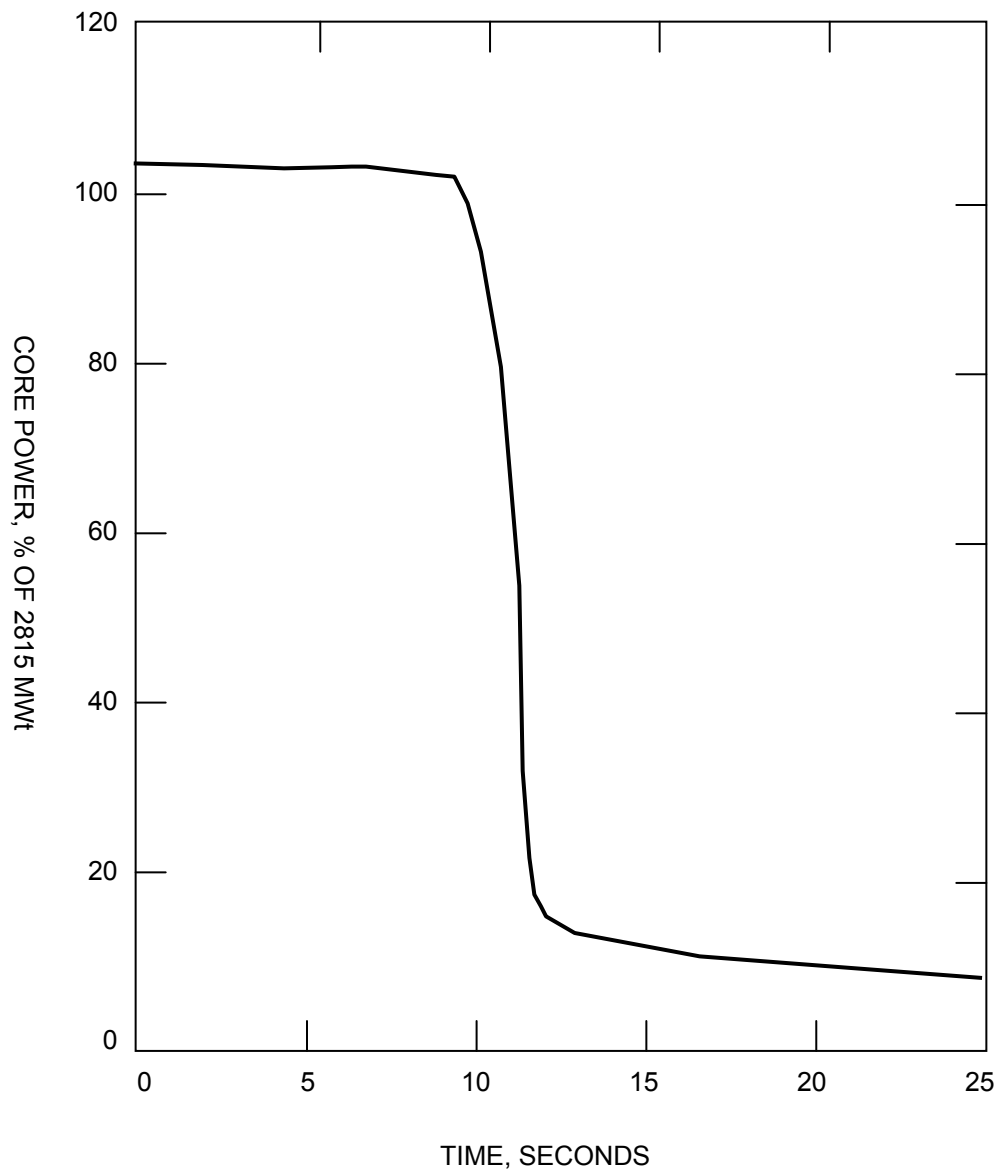

SAR FIGURE NO. 15.1.7-1

AMENDMENT 20

ARKANSAS NUCLEAR ONE
 UNIT 2
 RUSSELLVILLE, ARKANSAS



SCALE:	NONE
DRAWN:	
DESIGN:	ENERGY
CAD NO:	

LOSS OF LOAD / LOSS OF CONDENSER
 VACUUM, CORE POWER VERSUS TIME

BASED ON DRAWING NO

SHEET

REV.

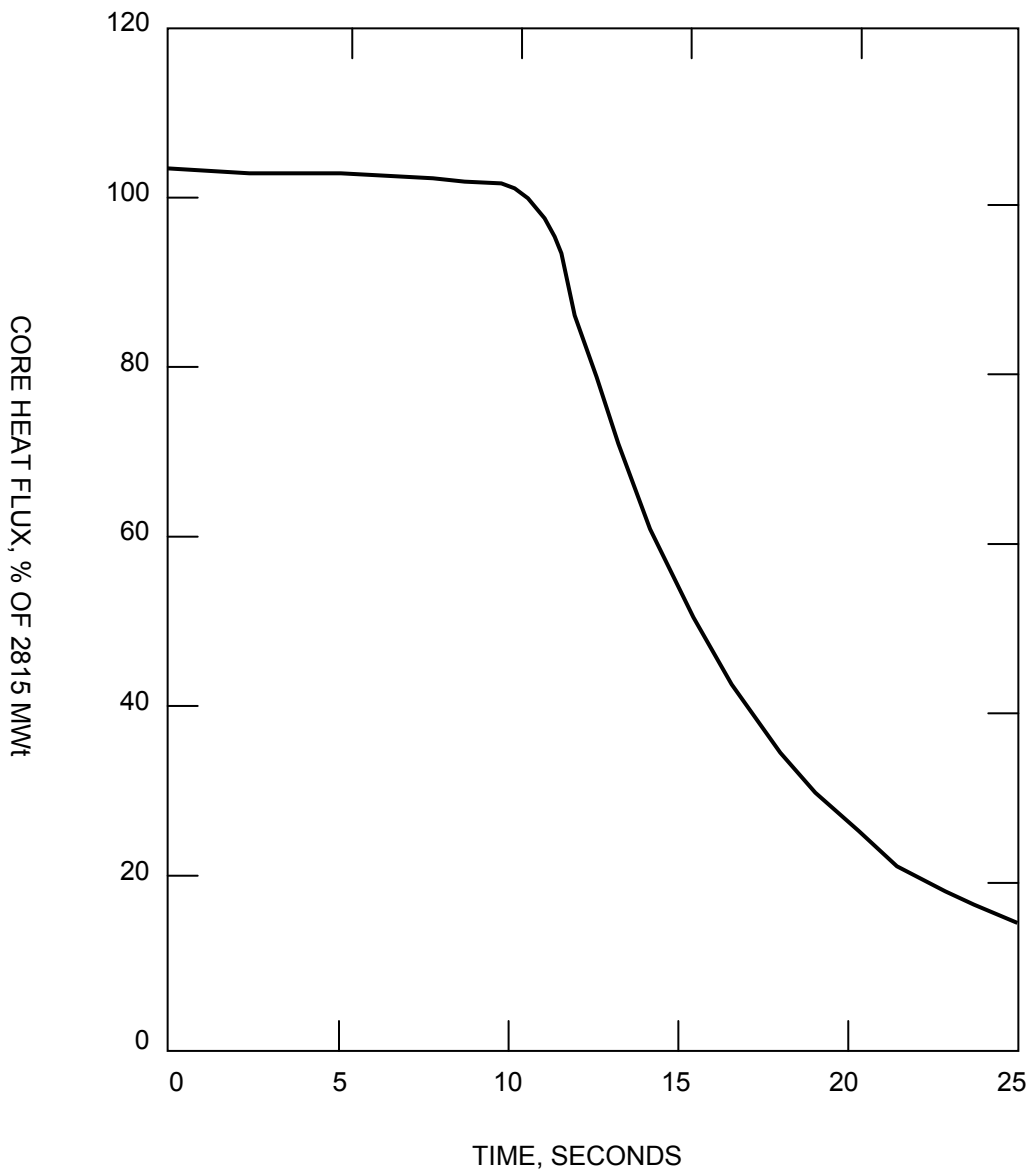

SAR FIGURE NO. 15.1.7-2

AMENDMENT 20

ARKANSAS NUCLEAR ONE
UNIT 2
RUSSELLVILLE, ARKANSAS



SCALE:	NONE
DRAWN:	
DESIGN:	ENERGY
CAD NO:	

LOSS OF LOAD / LOSS OF CONDENSER VACUUM,
CORE AVERAGE HEAT FLUX VERSUS TIME

BASED ON DRAWING NO

SHEET

REV.

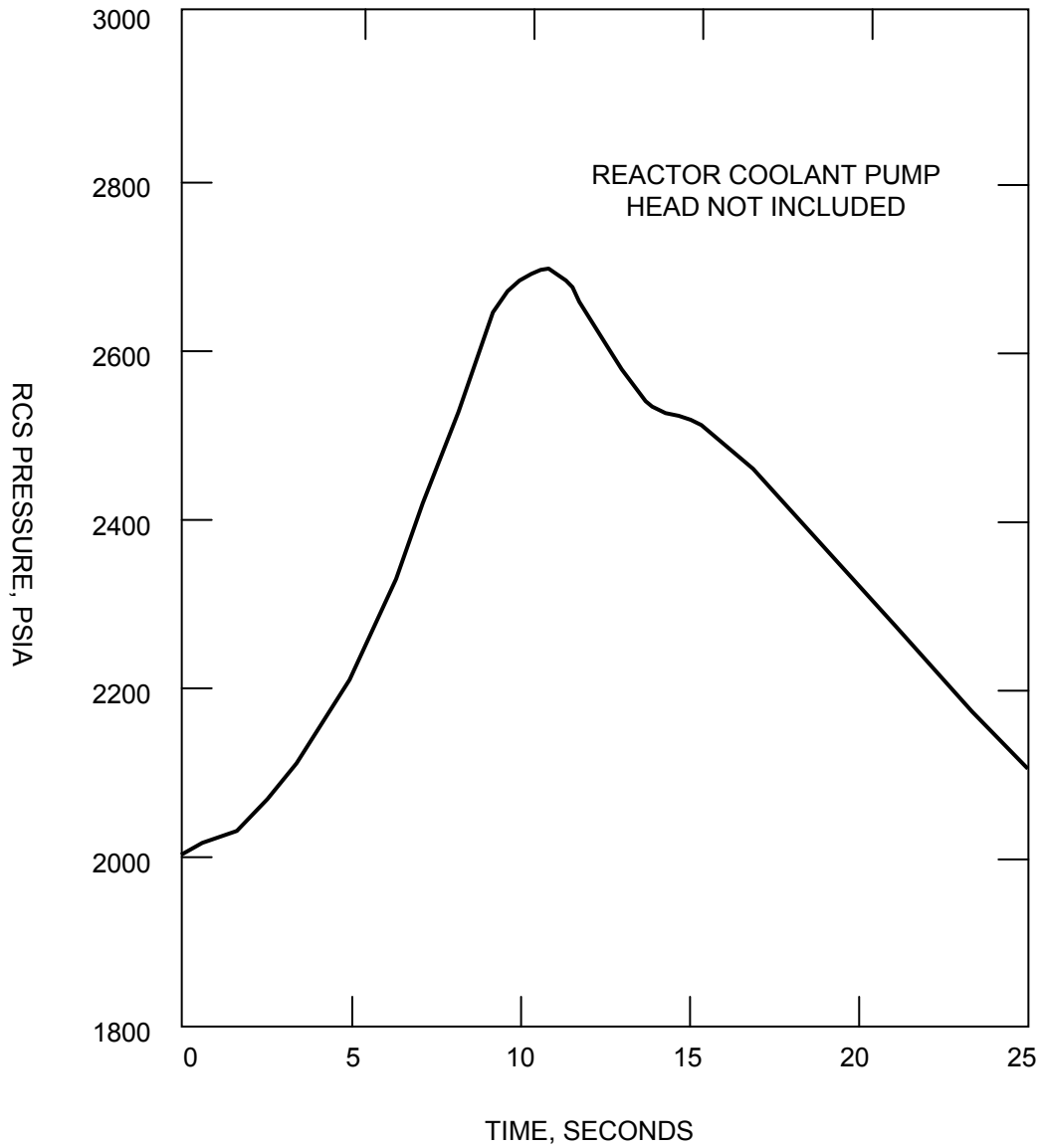

SAR FIGURE NO. 15.1.7-3

AMENDMENT 20

ARKANSAS NUCLEAR ONE
UNIT 2
RUSSELLVILLE, ARKANSAS



SCALE:	NONE
DRAWN:	
DESIGN:	ENERGY
CAD NO:	

LOSS OF LOAD / LOSS OF CONDENSER
VACUUM, RCS PRESSURE VERSUS TIME

BASED ON DRAWING NO

SHEET

REV.

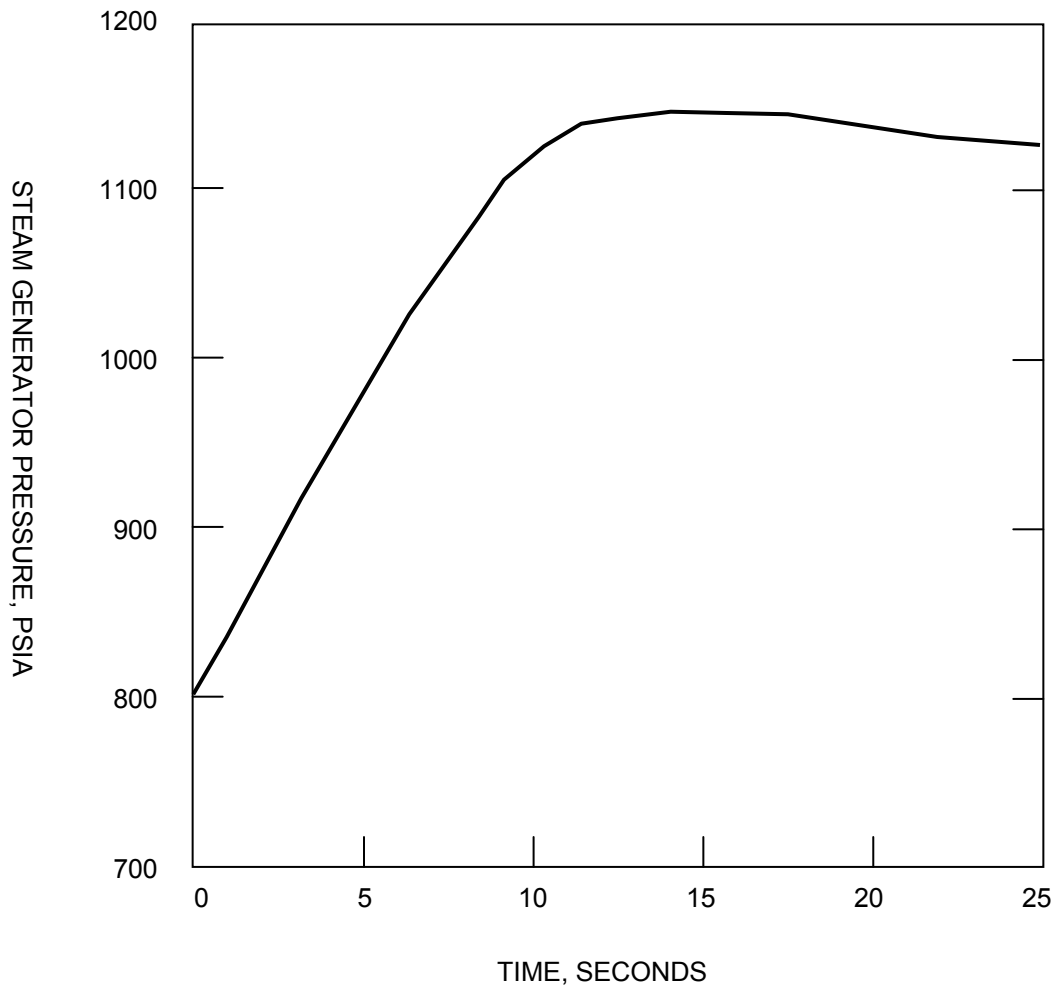

SAR FIGURE NO. 15.1.7-4

AMENDMENT 20

ARKANSAS NUCLEAR ONE
UNIT 2
RUSSELLVILLE, ARKANSAS



SCALE:	NONE
DRAWN:	
DESIGN:	ENERGY
CAD NO:	

LOSS OF LOAD / LOSS OF CONDENSER VACUUM,
STEAM GENERATOR PRESSURES VERSUS TIME

BASED ON DRAWING NO

SHEET

REV.

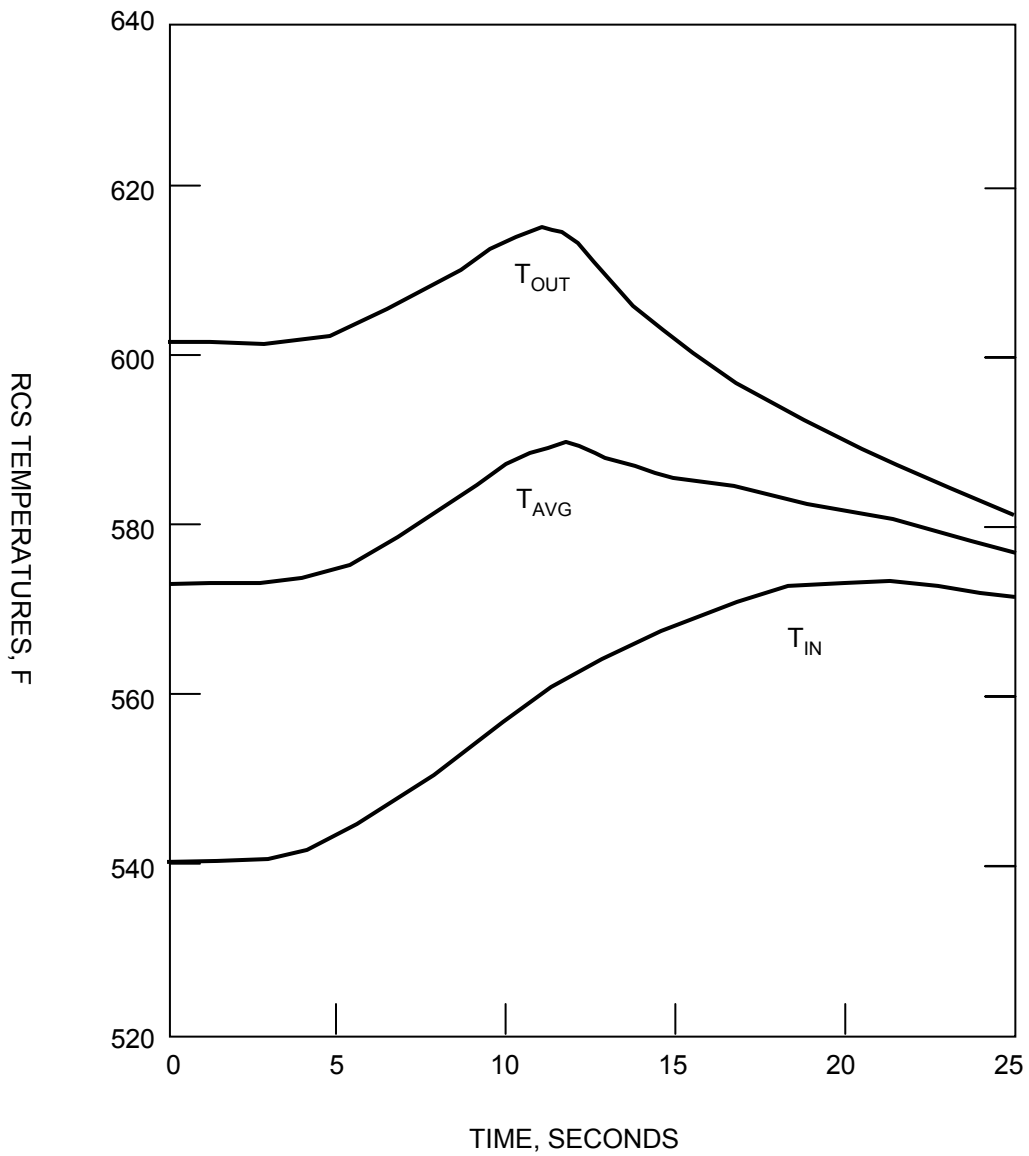

SAR FIGURE NO. 15.1.7-5

AMENDMENT 20

ARKANSAS NUCLEAR ONE
UNIT 2
RUSSELLVILLE, ARKANSAS



SCALE:	NONE
DRAWN:	
DESIGN:	ENERGY
CAD NO:	

LOSS OF LOAD / LOSS OF CONDENSER
VACUUM, RCS TEMPERATURES VERSUS TIME

BASED ON DRAWING NO

SHEET

REV.

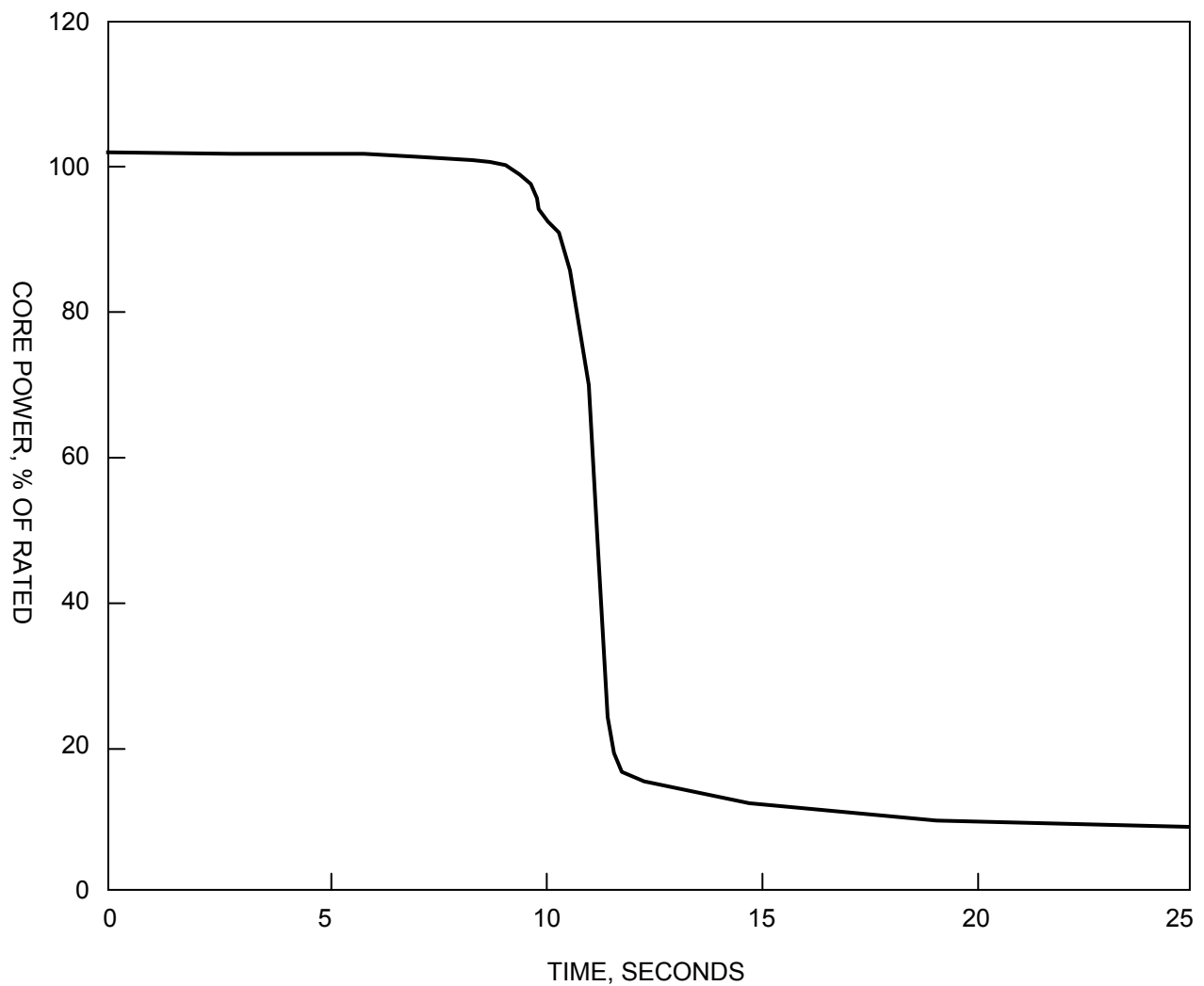

SAR FIGURE NO. 15.1.7-6

AMENDMENT 20

ARKANSAS NUCLEAR ONE
UNIT 2
RUSSELLVILLE, ARKANSAS



SCALE:	NONE
DRAWN:	
DESIGN:	ENERGY
CAD NO:	

CYCLE 15 AT 3026 MWt LOSS OF LOAD / LOSS OF CONDENSER VACUUM, CORE POWER VERSUS TIME

BASED ON DRAWING NO

SHEET

REV.

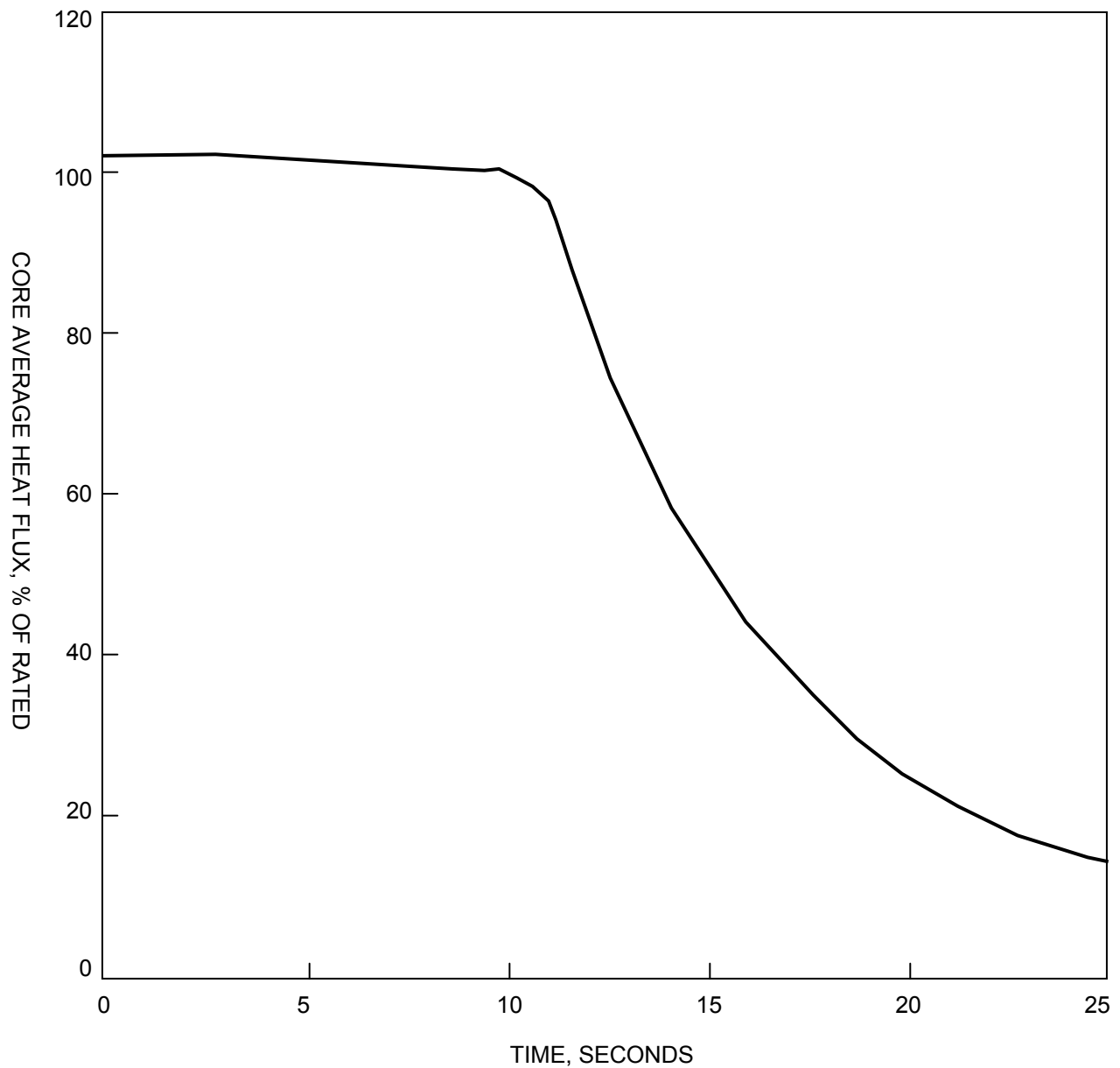

SAR FIGURE NO. 15.1.7-7

AMENDMENT 20

ARKANSAS NUCLEAR ONE
 UNIT 2
 RUSSELLVILLE, ARKANSAS



SCALE:	NONE
DRAWN:	
DESIGN:	ENERGY
CAD NO:	

CYCLE 15 AT 3026 MWt LOSS OF LOAD / LOSS OF
 CONDENSER VACUUM, CORE AVERAGE HEAT FLUX
 VERSUS TIME

BASED ON DRAWING NO

SHEET

REV.

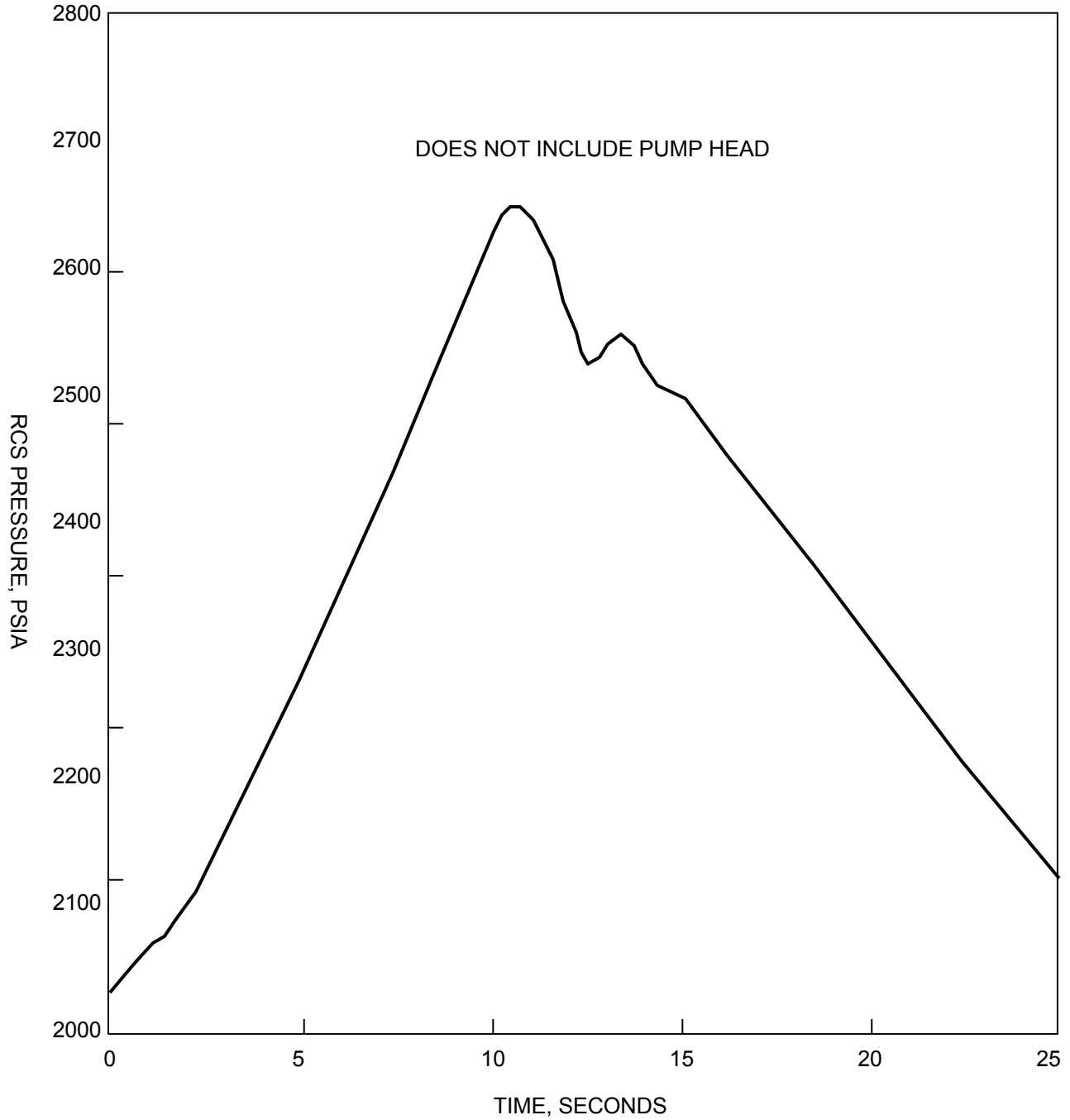

SAR FIGURE NO. 15.1.7-8

AMENDMENT 20

ARKANSAS NUCLEAR ONE
 UNIT 2
 RUSSELLVILLE, ARKANSAS



SCALE:	NONE
DRAWN:	
DESIGN:	ENERGY
CAD NO:	

CYCLE 15 AT 3026 MWt LOSS OF LOAD / LOSS OF
 CONDENSER VACUUM, REACTOR COOLANT SYSTEM
 PRESSURE VERSUS TIME

BASED ON DRAWING NO

SHEET

REV.

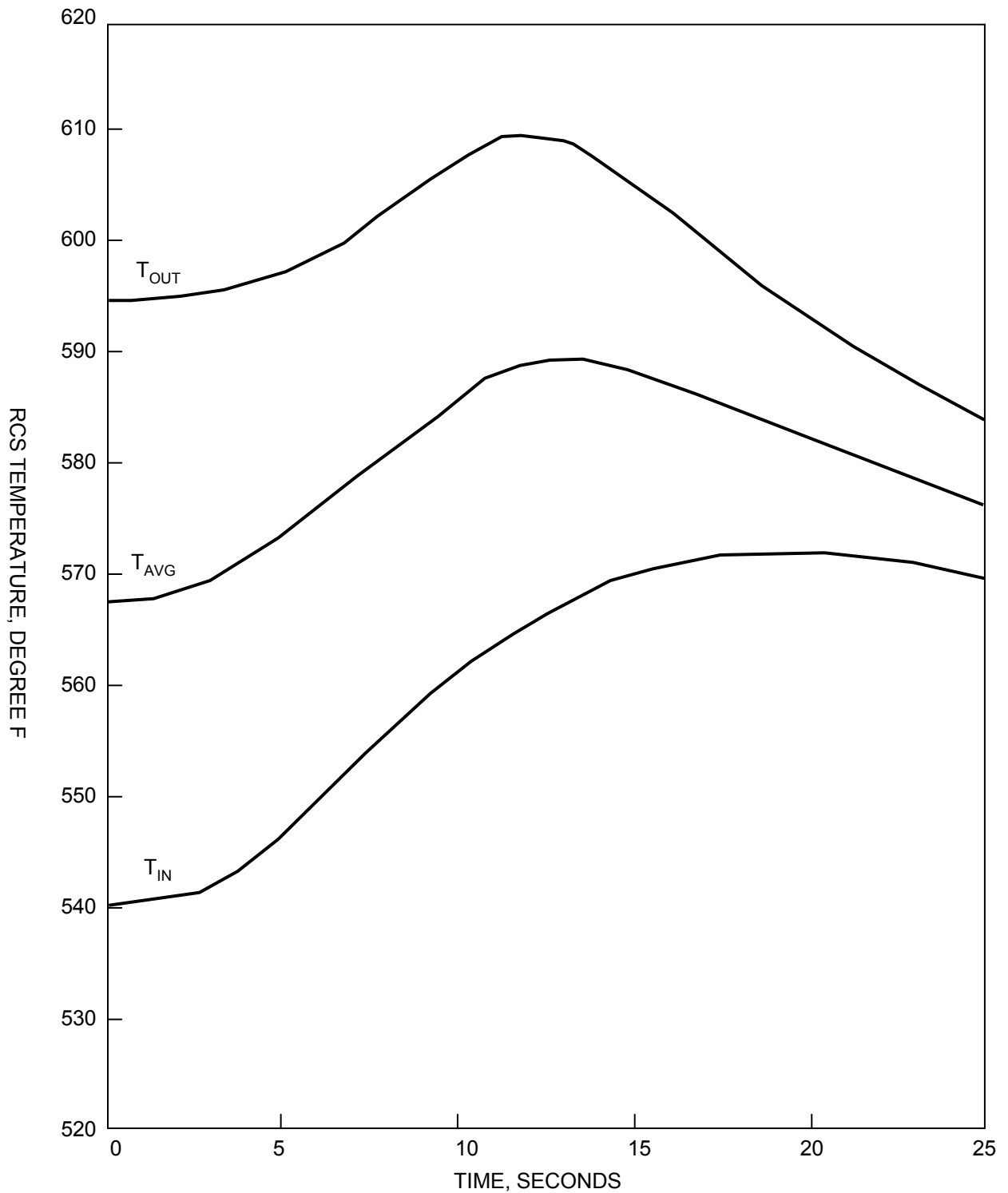

SAR FIGURE NO. 15.1.7-9

AMENDMENT 20

ARKANSAS NUCLEAR ONE
UNIT 2
RUSSELLVILLE, ARKANSAS



SCALE:	NONE
DRAWN:	
DESIGN:	ENERGY
CAD NO:	

CYCLE 15 AT 3026 MWt LOSS OF LOAD / LOSS OF
CONDENSER VACUUM, RCS TEMPERATURE VERSUS
TIME

BASED ON DRAWING NO

SHEET

REV.

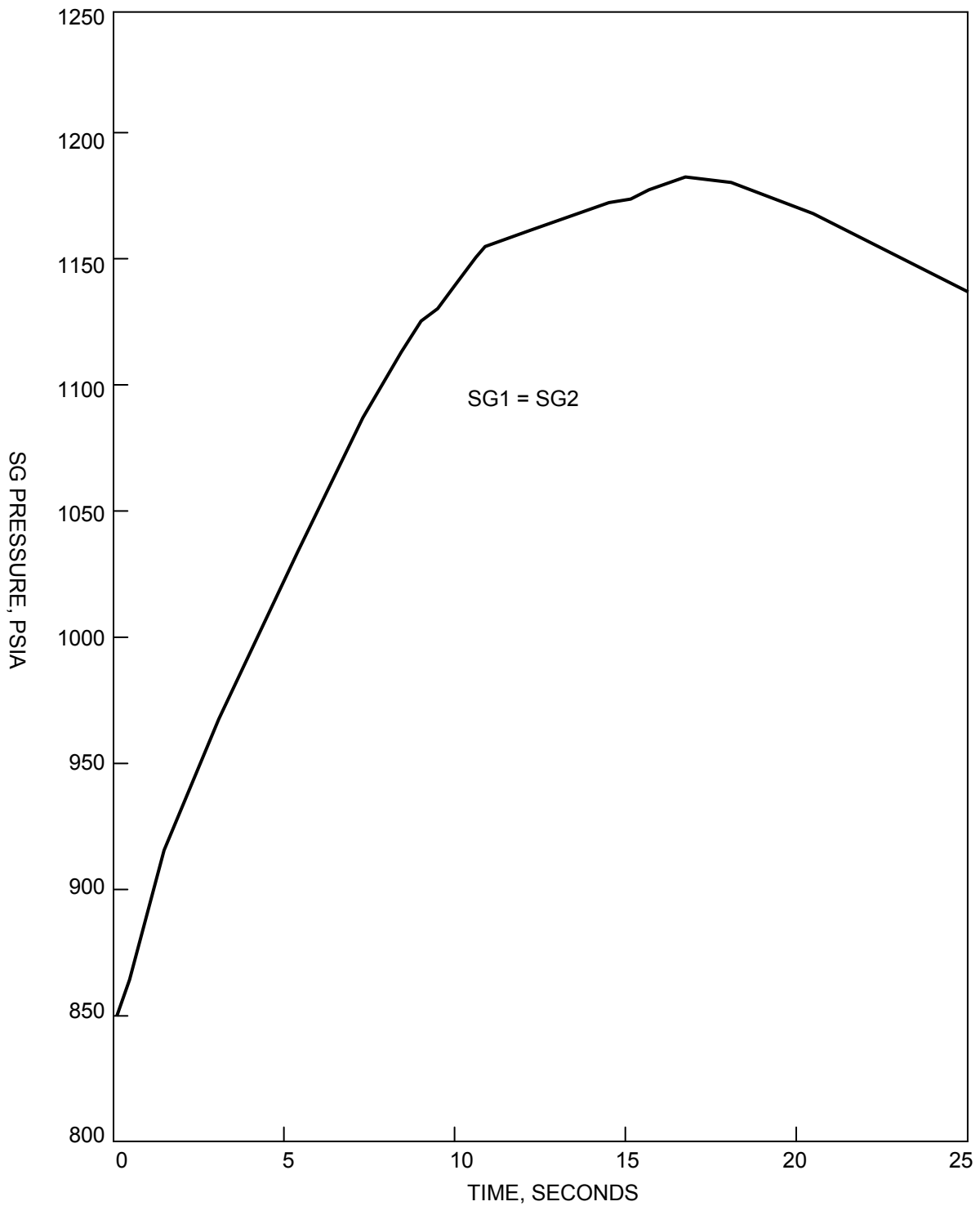

SAR FIGURE NO. 15.1.7-10

AMENDMENT 20

ARKANSAS NUCLEAR ONE
UNIT 2
RUSSELLVILLE, ARKANSAS



SCALE:	NONE
DRAWN:	
DESIGN:	ENTERGY
CAD NO:	

CYCLE 15 AT 3026 MWt LOSS OF LOAD / LOSS OF
CONDENSER VACUUM, STEAM GENERATOR PRESSURE
VERSUS TIME

BASED ON DRAWING NO

SHEET

REV.

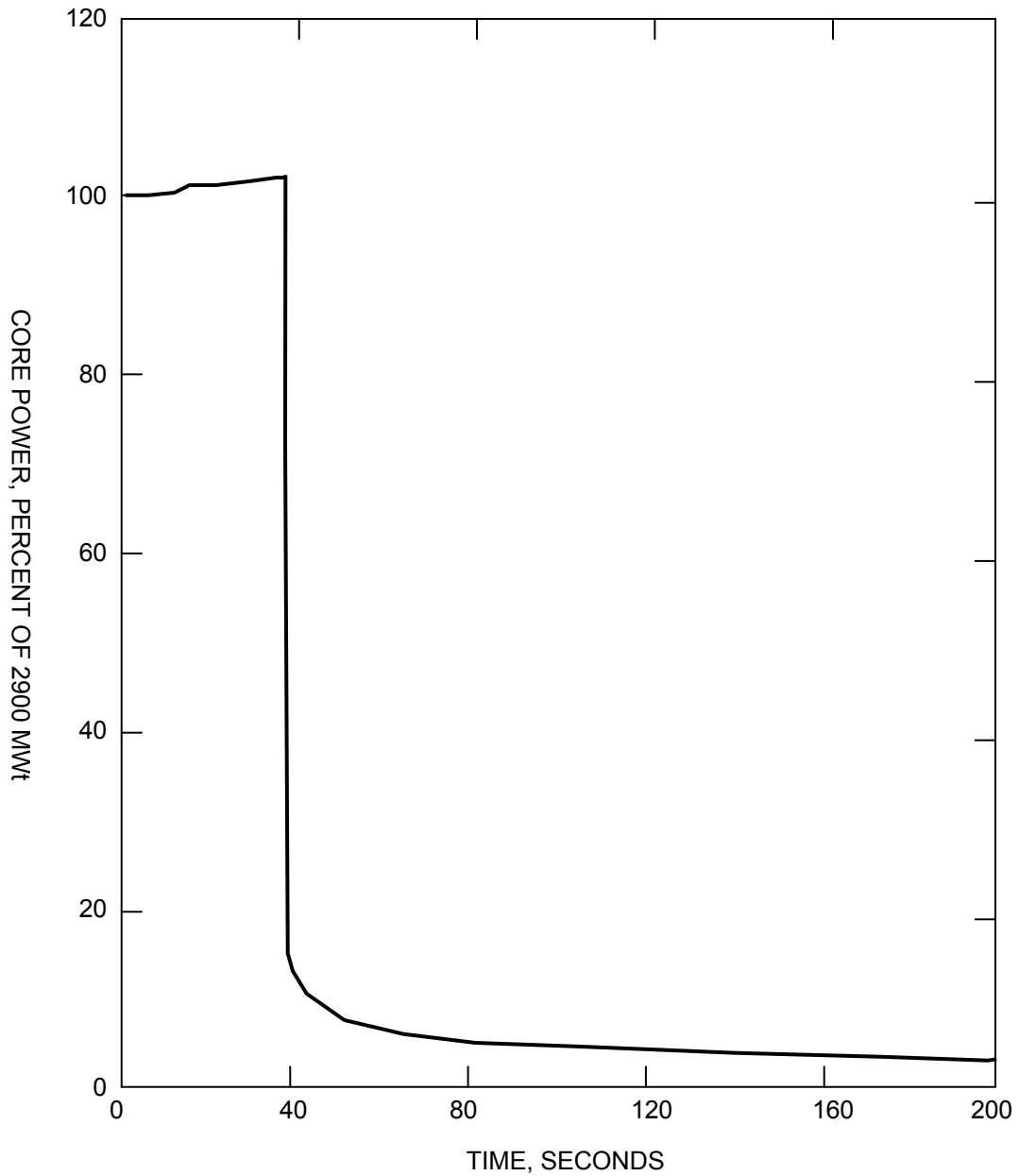

SAR FIGURE NO. 15.1.8-1

AMENDMENT 20

ARKANSAS NUCLEAR ONE
UNIT 2
RUSSELLVILLE, ARKANSAS



SCALE:	NONE
DRAWN:	
DESIGN:	ENTERGY
CAD NO:	

LOSS OF FEEDWATER FLOW
CORE POWER VERSUS TIME

BASED ON DRAWING NO

SHEET

REV.

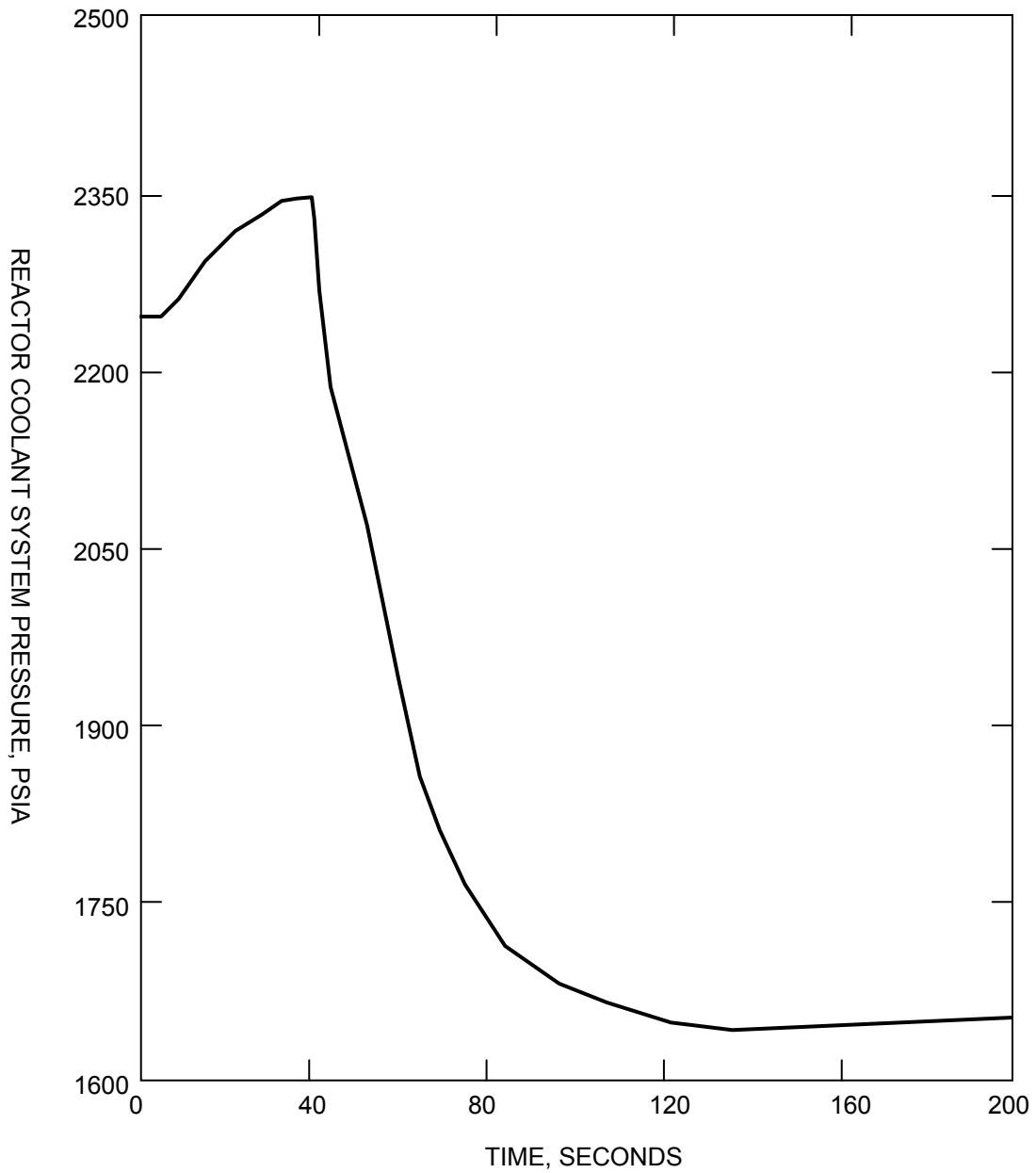

SAR FIGURE NO. 15.1.8-2

AMENDMENT 20

ARKANSAS NUCLEAR ONE
UNIT 2
RUSSELLVILLE, ARKANSAS



SCALE:	NONE
DRAWN:	
DESIGN:	ENERGY
CAD NO:	

LOSS OF FEEDWATER FLOW, REACTOR
COOLANT SYSTEM PRESSURE VERSUS TIME

BASED ON DRAWING NO

SHEET

REV.

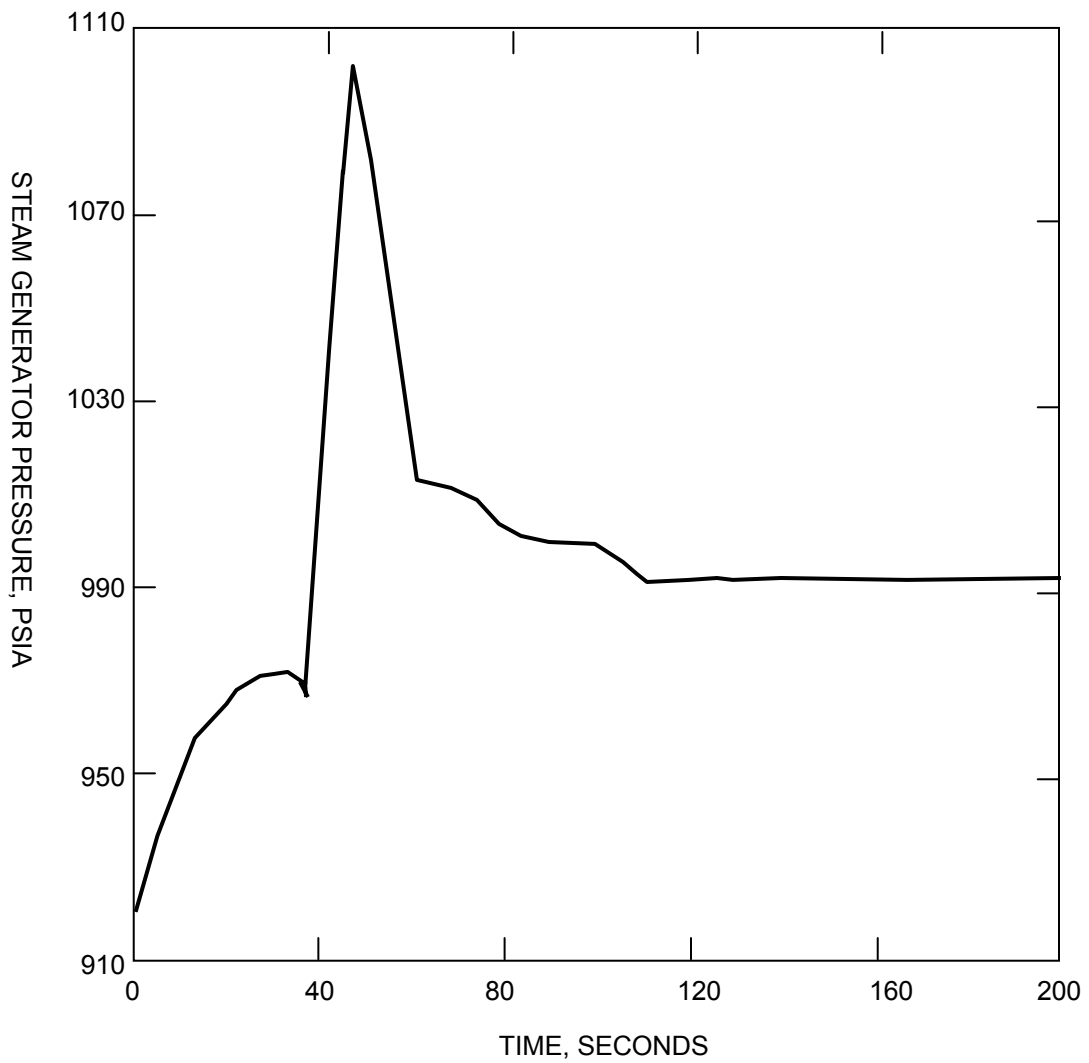

SAR FIGURE NO. 15.1.8-3

AMENDMENT 20

ARKANSAS NUCLEAR ONE
 UNIT 2
 RUSSELLVILLE, ARKANSAS



SCALE:	NONE
DRAWN:	
DESIGN:	ENERGY
CAD NO:	

LOSS OF FEEDWATER FLOW, STEAM
 GENERATOR PRESSURE VERSUS TIME

BASED ON DRAWING NO

SHEET

REV.

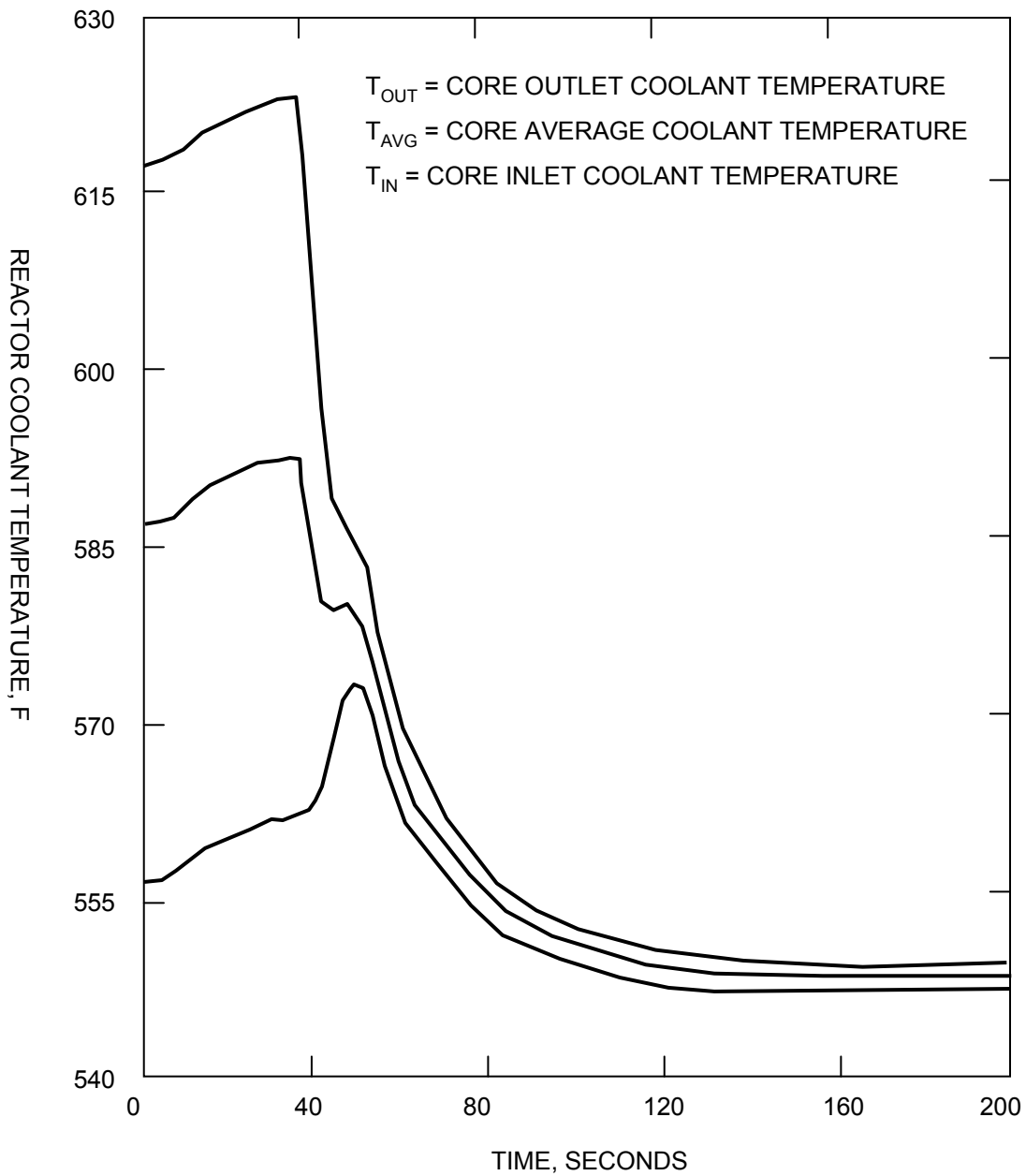

SAR FIGURE NO. 15.1.8-4

AMENDMENT 20

ARKANSAS NUCLEAR ONE
 UNIT 2
 RUSSELLVILLE, ARKANSAS



SCALE:	NONE
DRAWN:	
DESIGN:	ENERGY
CAD NO:	

LOSS OF FEEDWATER FLOW, REACTOR COOLANT TEMPERATURE VERSUS TIME

BASED ON DRAWING NO

SHEET

REV.

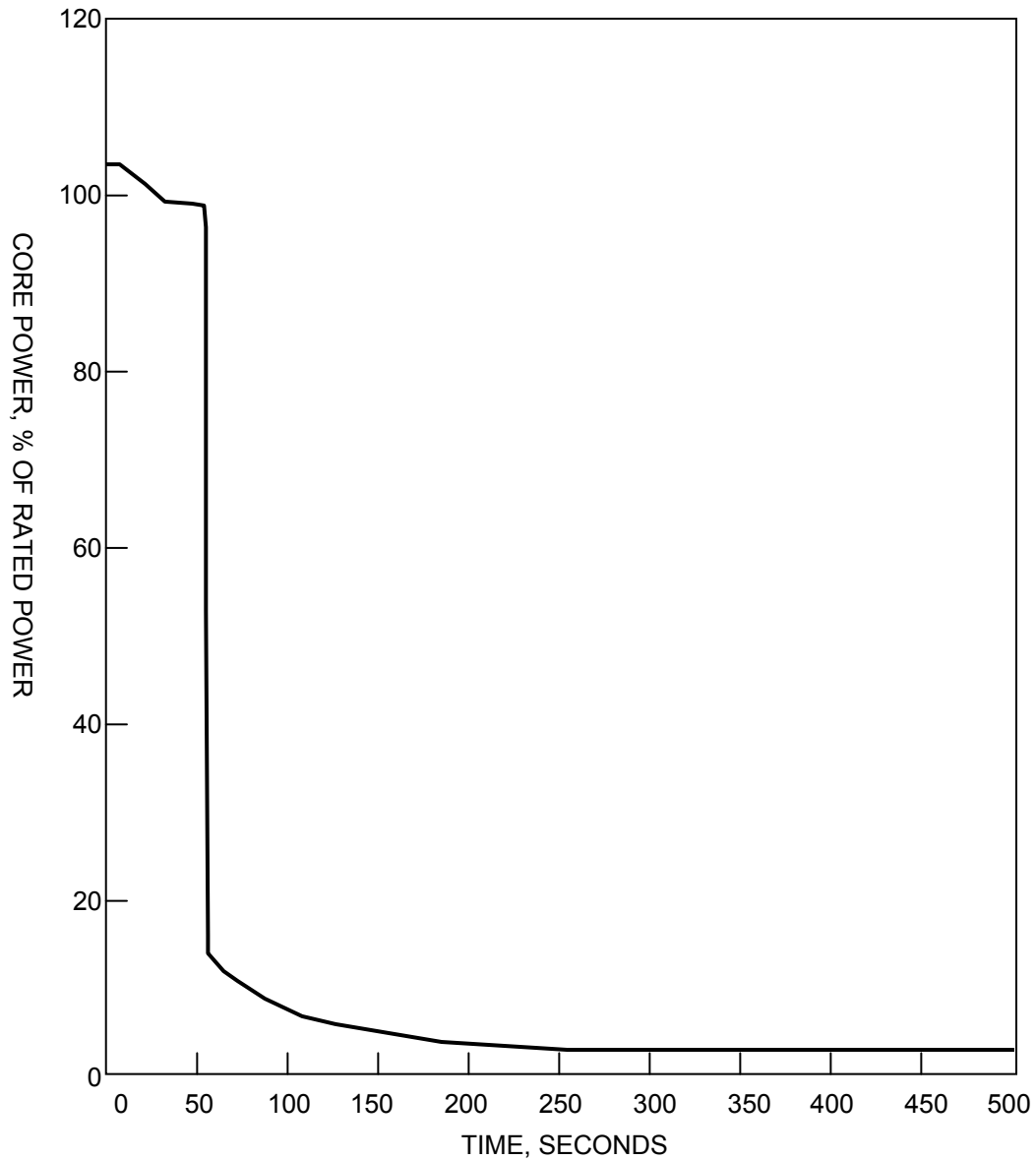

SAR FIGURE NO. 15.1.8-5

AMENDMENT 20

ARKANSAS NUCLEAR ONE
UNIT 2
RUSSELLVILLE, ARKANSAS



SCALE:	NONE
DRAWN:	
DESIGN:	ENERGY
CAD NO:	

CYCLE 15 AT 3026 MWt LOSS OF NORMAL
FEEDWATER FLOW CORE POWER VERSUS TIME

BASED ON DRAWING NO

SHEET

REV.

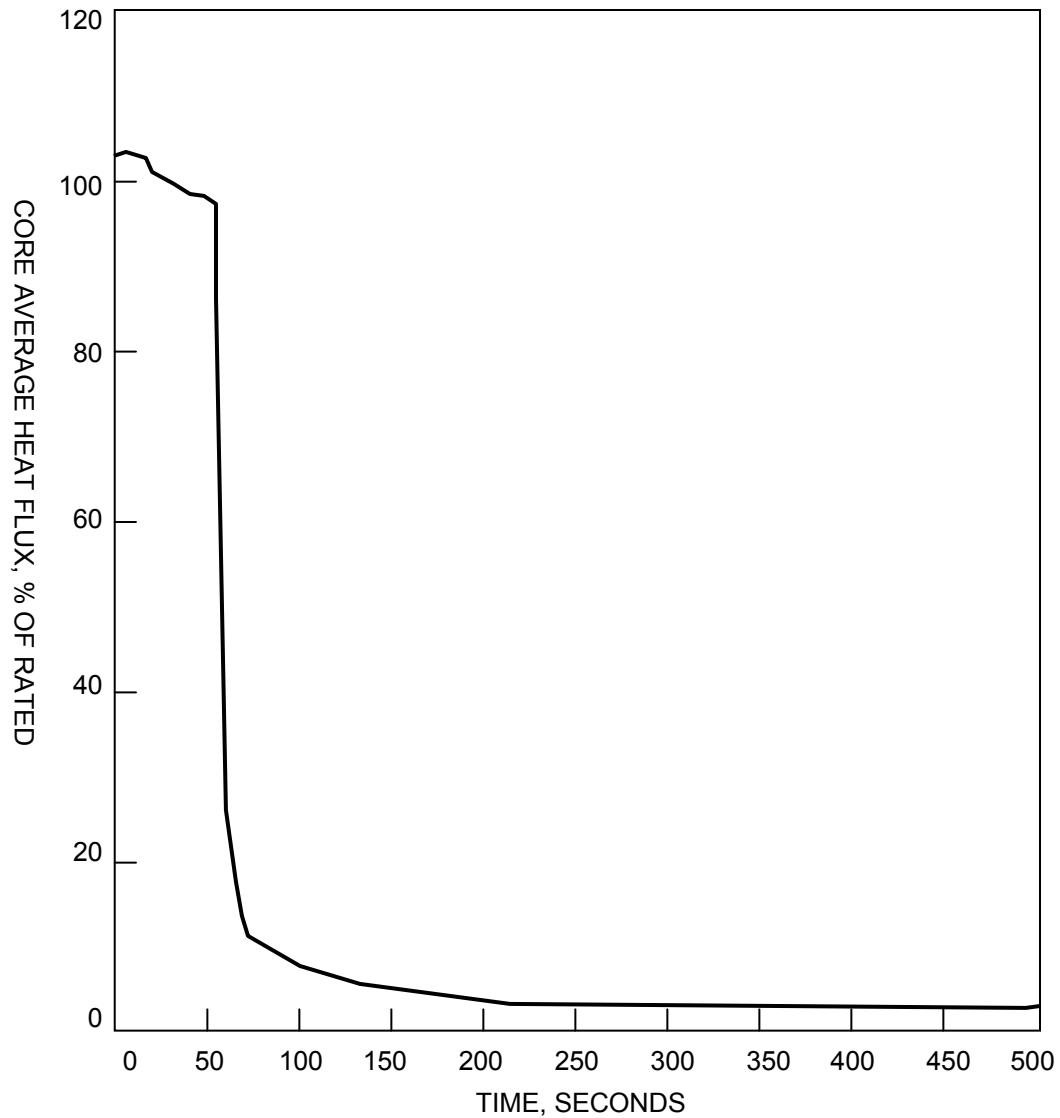

SAR FIGURE NO. 15.1.8-6

AMENDMENT 20

ARKANSAS NUCLEAR ONE
UNIT 2
RUSSELLVILLE, ARKANSAS



SCALE:	NONE
DRAWN:	
DESIGN:	ENTERGY
CAD NO:	

CYCLE 15 AT 3026 MWt LOSS OF NORMAL FEEDWATER
FLOW CORE AVERAGE HEAT FLUX VERSUS TIME

BASED ON DRAWING NO

SHEET

REV.

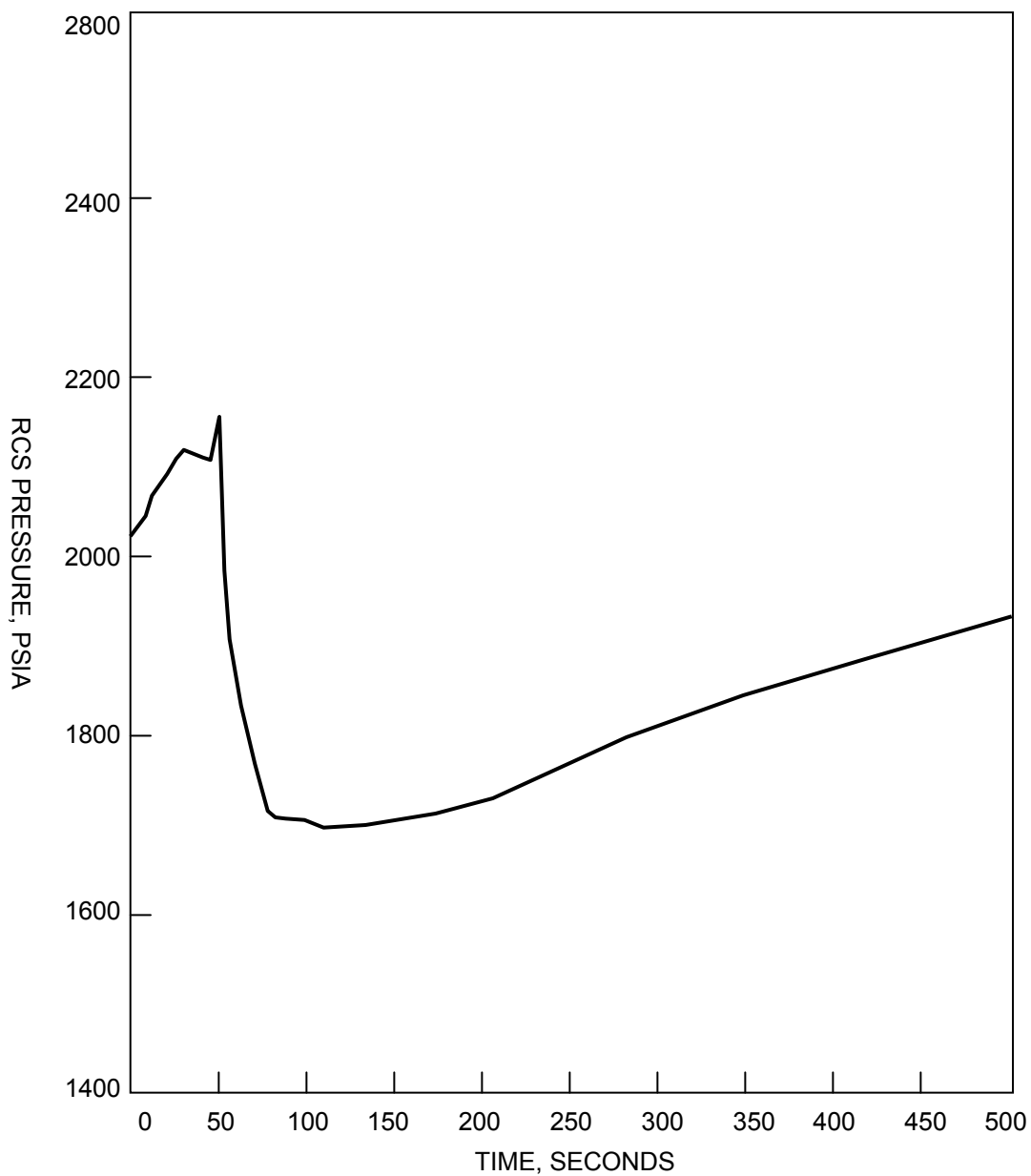

SAR FIGURE NO. 15.1.8-7

AMENDMENT 20

ARKANSAS NUCLEAR ONE
 UNIT 2
 RUSSELLVILLE, ARKANSAS



SCALE:	NONE
DRAWN:	
DESIGN:	ENERGY
CAD NO:	

CYCLE 15 AT 3026 MWt LOSS OF NORMAL
 FEEDWATER FLOW RCS PRESSURE VERSUS TIME

BASED ON DRAWING NO

SHEET

REV.

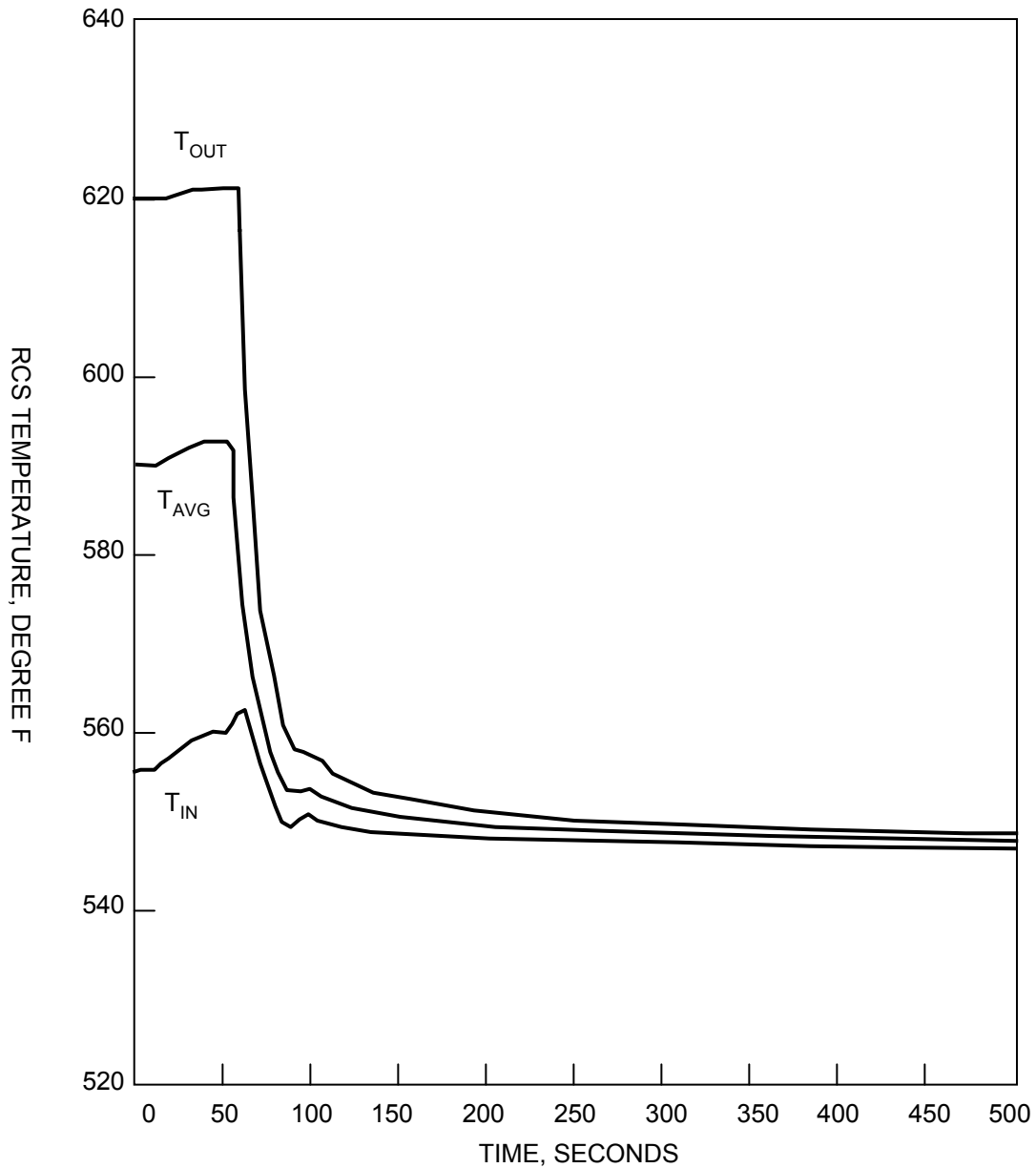

SAR FIGURE NO. 15.1.8-8

AMENDMENT 20

ARKANSAS NUCLEAR ONE
UNIT 2
RUSSELLVILLE, ARKANSAS



SCALE:	NONE
DRAWN:	
DESIGN:	ENERGY
CAD NO:	

CYCLE 15 AT 3026 MWt LOSS OF NORMAL FEEDWATER
FLOW RCS TEMPERATURE VERSUS TIME

BASED ON DRAWING NO

SHEET

REV.

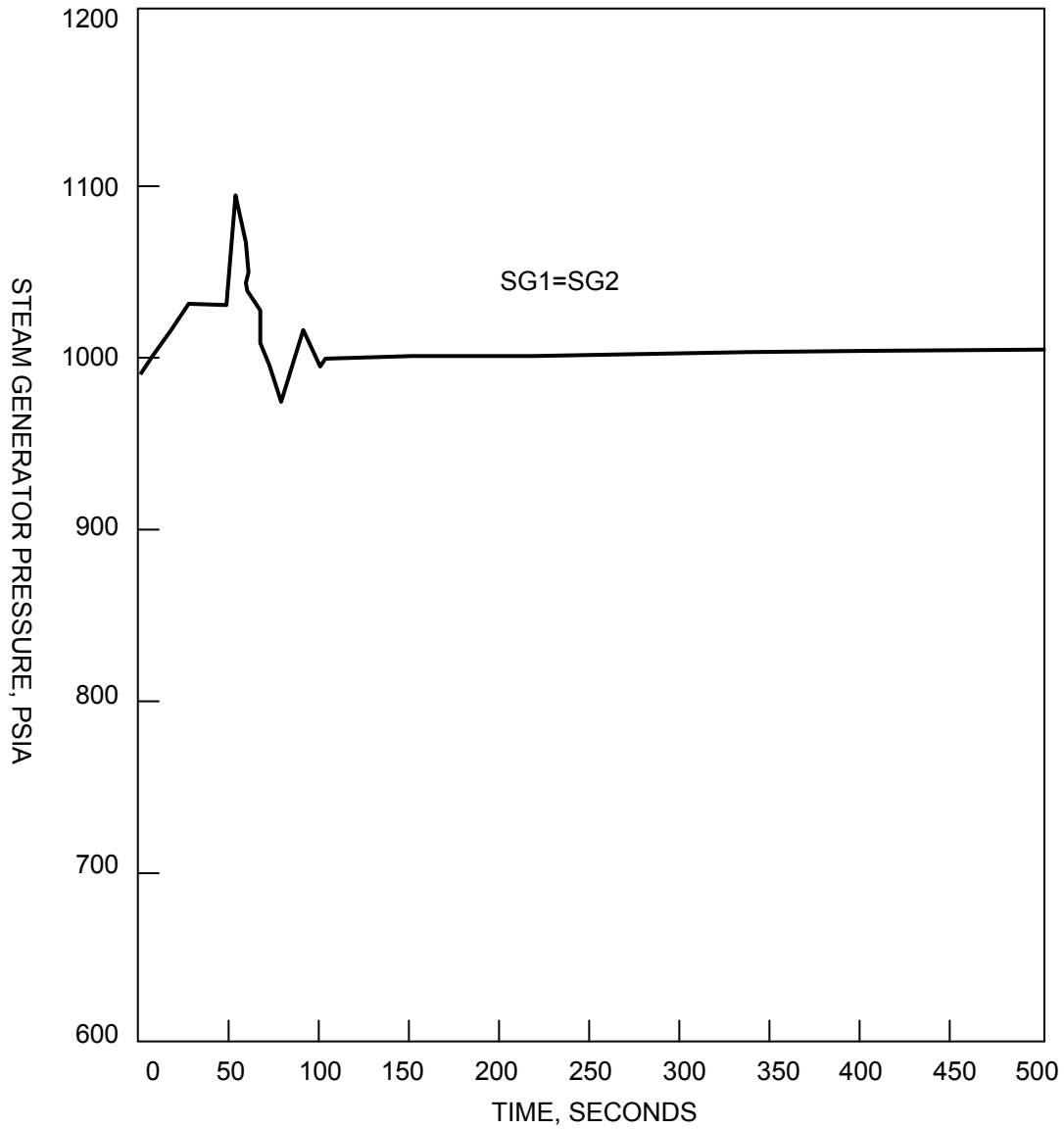

SAR FIGURE NO. 15.1.8-9

AMENDMENT 20

ARKANSAS NUCLEAR ONE
UNIT 2
RUSSELLVILLE, ARKANSAS



SCALE:	NONE
DRAWN:	
DESIGN:	ENERGY
CAD NO:	

CYCLE 15 AT 3026 MWt LOSS OF NORMAL FEEDWATER
FLOW STEAM GENERATOR PRESSURE VERSUS TIME

BASED ON DRAWING NO

SHEET

REV.

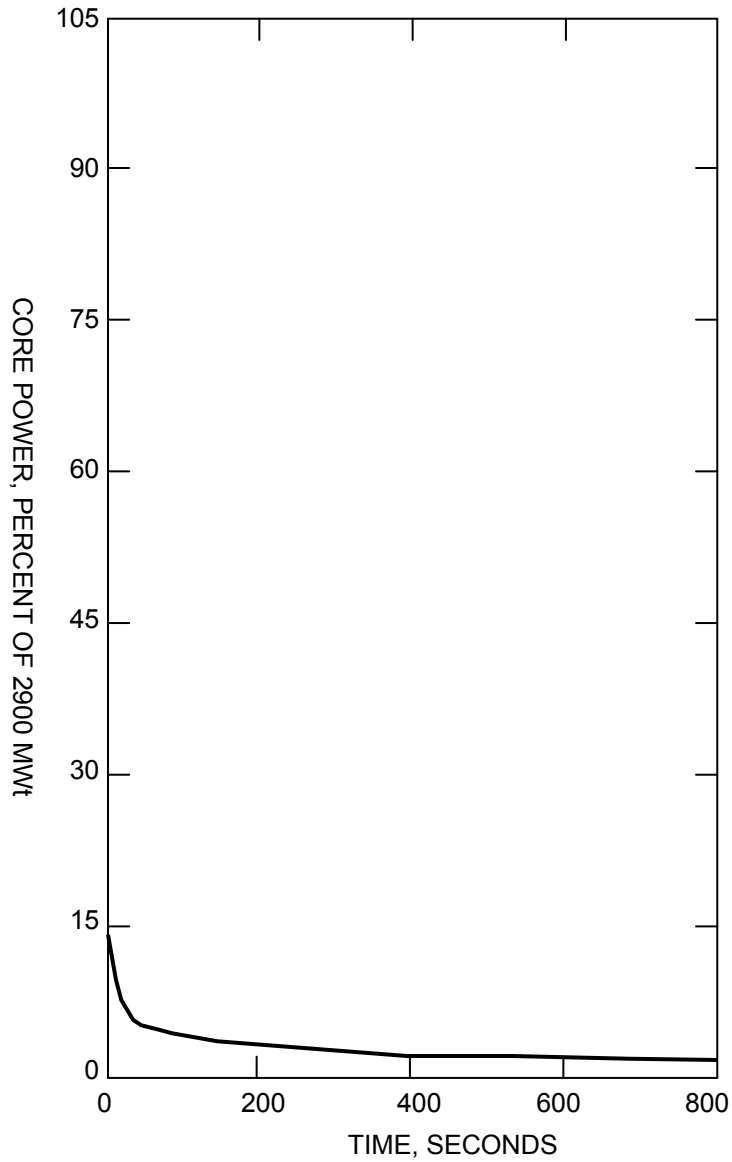

SAR FIGURE NO. 15.1.9-1

AMENDMENT 20

ARKANSAS NUCLEAR ONE
UNIT 2
RUSSELLVILLE, ARKANSAS



SCALE:	NONE
DRAWN:	
DESIGN:	ENTERGY
CAD NO:	

LOSS OF NORMAL ONSITE, OFFSITE ELECTRICAL
POWER CORE POWER VERSUS TIME

BASED ON DRAWING NO

SHEET

REV.

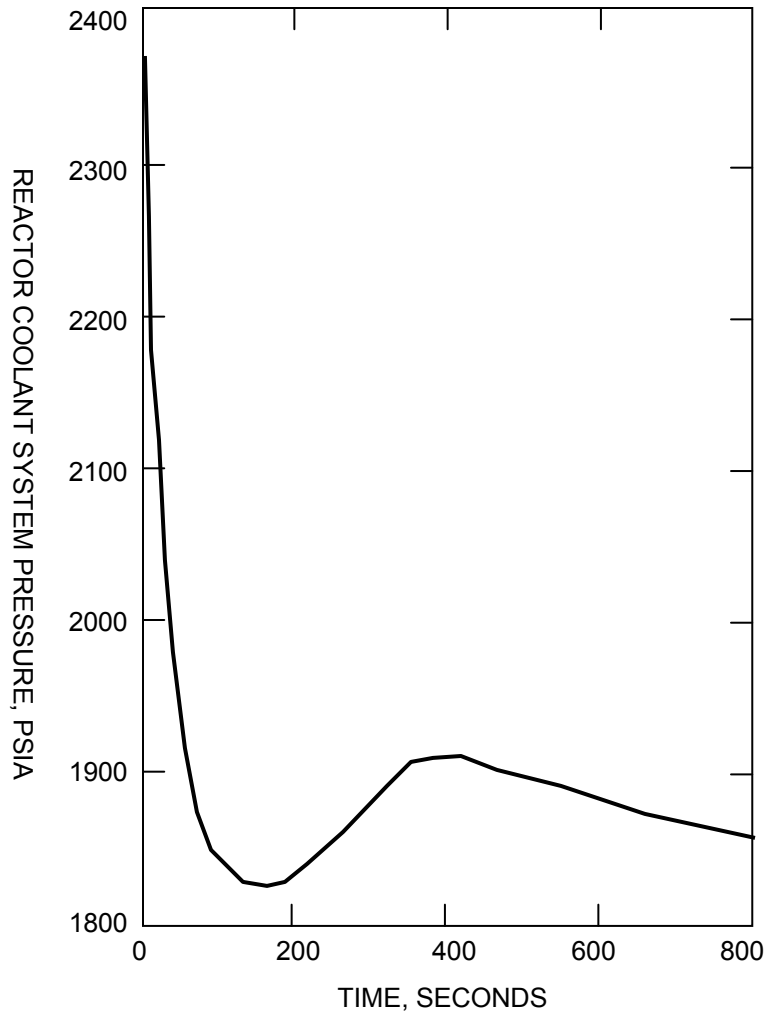

SAR FIGURE NO. 15.1.9-2

AMENDMENT 20

ARKANSAS NUCLEAR ONE
UNIT 2
RUSSELLVILLE, ARKANSAS



SCALE:	NONE
DRAWN:	
DESIGN:	ENTERGY
CAD NO:	

LOSS OF NORMAL ONSITE, OFFSITE ELECTRICAL
POWER RCS PRESSURE VERSUS TIME

BASED ON DRAWING NO

SHEET

REV.

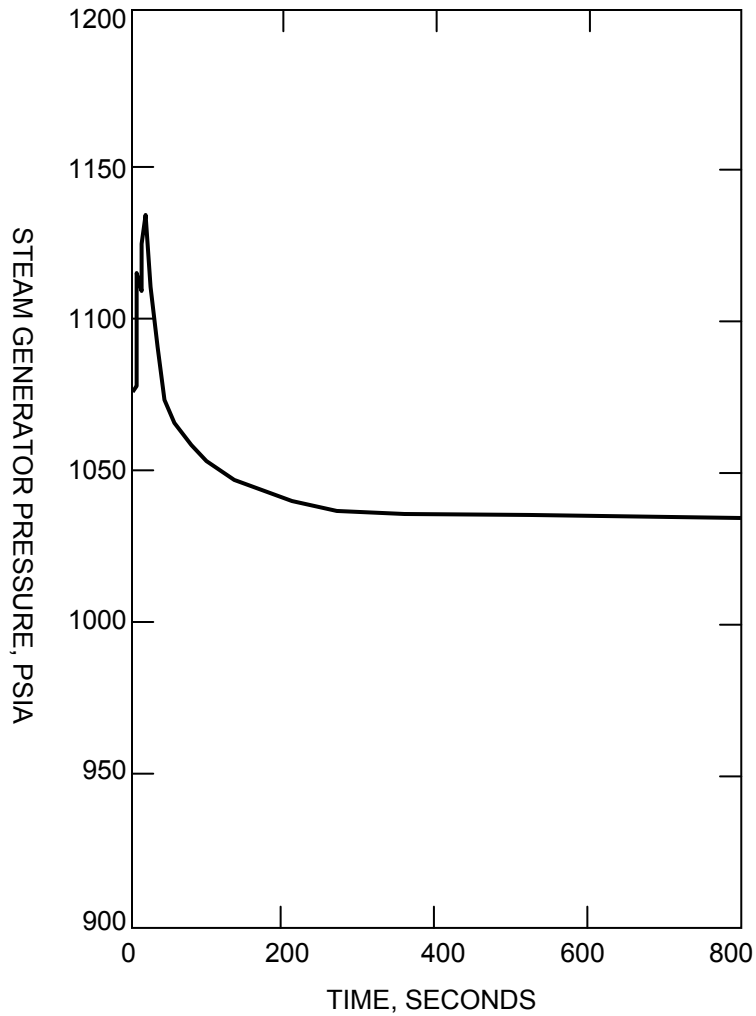

SAR FIGURE NO. 15.1.9-3

AMENDMENT 20

ARKANSAS NUCLEAR ONE
UNIT 2
RUSSELLVILLE, ARKANSAS



SCALE:	NONE
DRAWN:	
DESIGN:	ENERGY
CAD NO:	

LOSS OF NORMAL ONSITE, OFFSITE ELECTRICAL POWER
STEAM GENERATOR PRESSURE VERSUS TIME

BASED ON DRAWING NO

SHEET

REV.

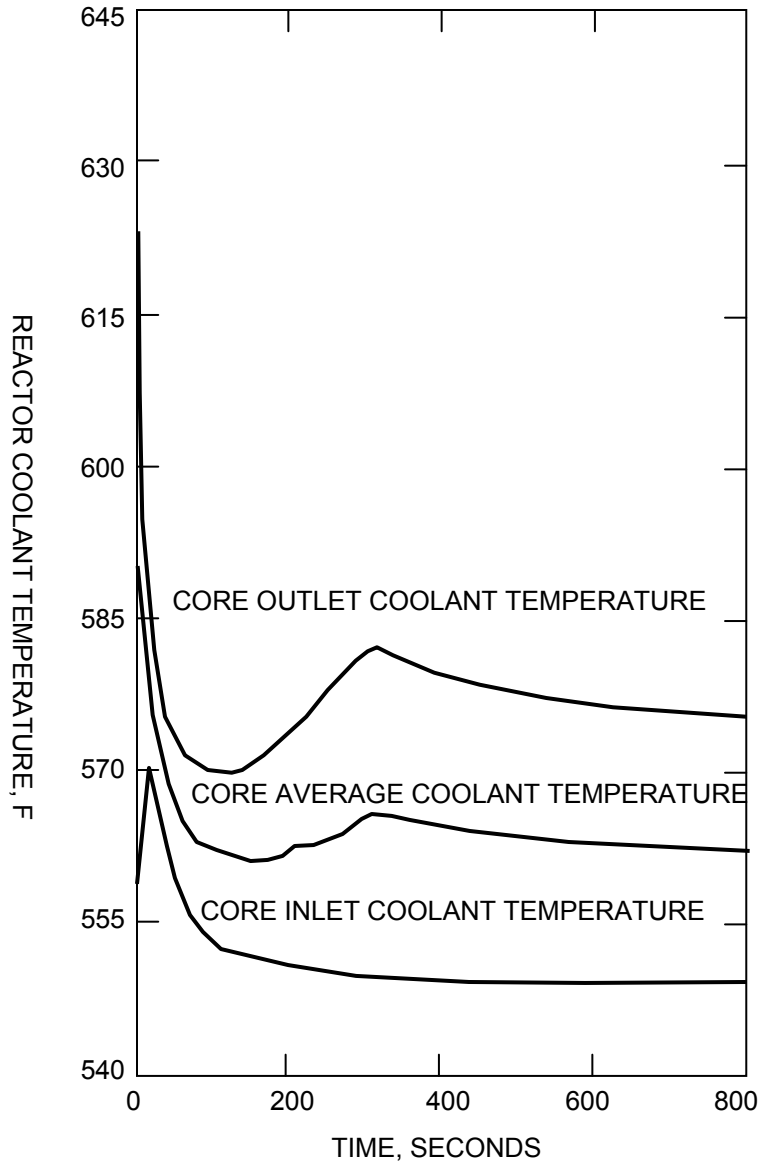

SAR FIGURE NO. 15.1.9-4

AMENDMENT 20

ARKANSAS NUCLEAR ONE
UNIT 2
RUSSELLVILLE, ARKANSAS



SCALE:	NONE
DRAWN:	
DESIGN:	ENTERGY
CAD NO:	

LOSS OF NORMAL ONSITE, OFFSITE ELECTRICAL
POWER RCS TEMPERATURE VERSUS TIME

BASED ON DRAWING NO

SHEET

REV.

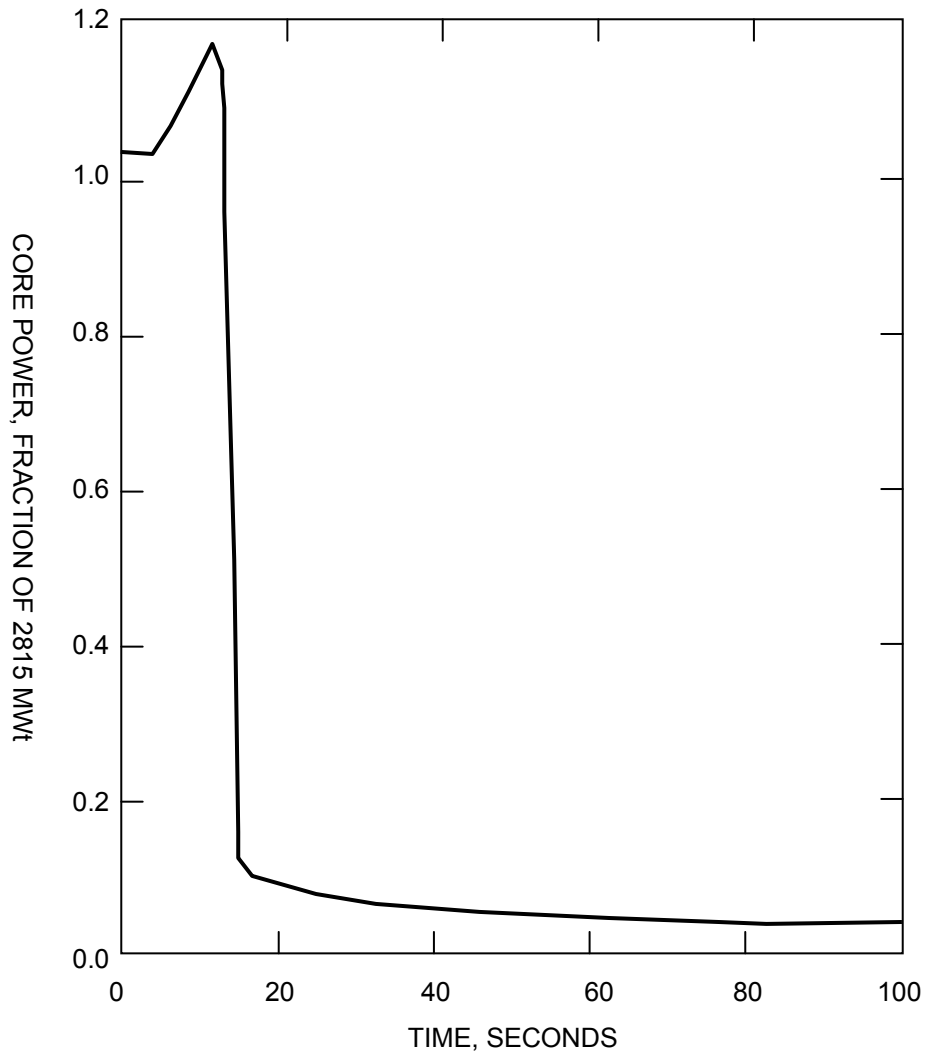

SAR FIGURE NO. 15.1.10-1A

AMENDMENT 20

ARKANSAS NUCLEAR ONE
 UNIT 2
 RUSSELLVILLE, ARKANSAS



SCALE:	NONE
DRAWN:	
DESIGN:	ENERGY
CAD NO:	

EXCESS LOAD EXCESS FEEDWATER FLOW / BOTH
 STEAM GENERATORS CORE POWER VERSUS TIME

BASED ON DRAWING NO

SHEET

REV.

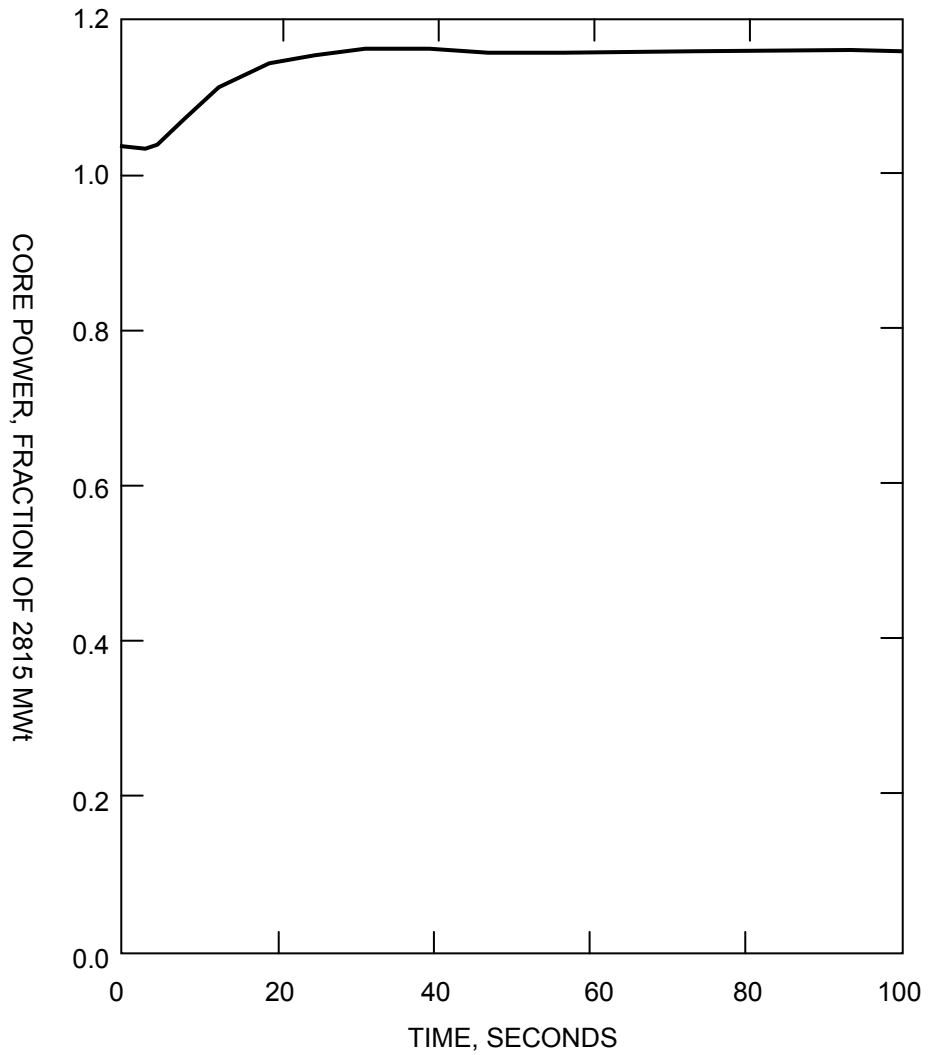

SAR FIGURE NO. 15.1.10-1B

AMENDMENT 20

ARKANSAS NUCLEAR ONE
 UNIT 2
 RUSSELLVILLE, ARKANSAS



SCALE:	NONE
DRAWN:	
DESIGN:	ENERGY
CAD NO:	

EXCESS LOAD EXCESS FEEDWATER FLOW / ONE
 STEAM GENERATOR CORE POWER VERSUS TIME

BASED ON DRAWING NO

SHEET

REV.

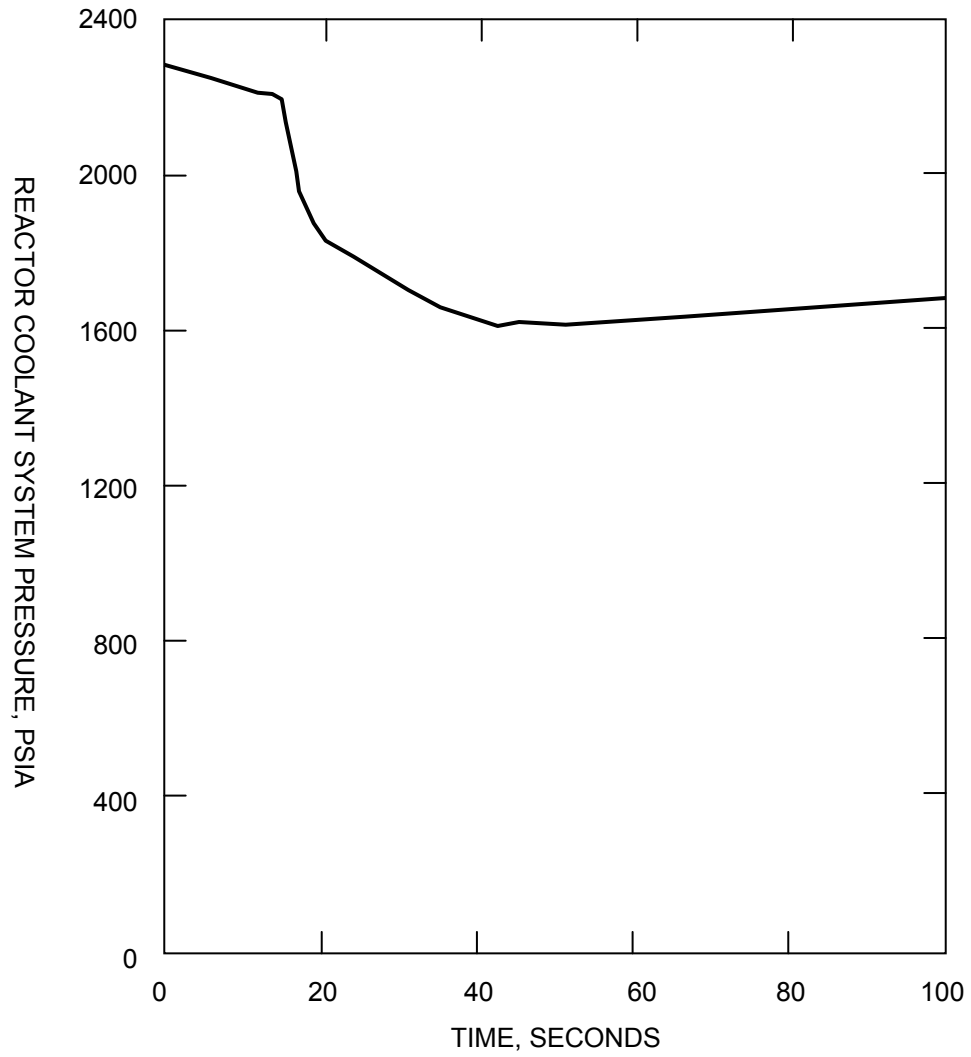

SAR FIGURE NO. 15.1.10-2A

AMENDMENT 20

ARKANSAS NUCLEAR ONE
 UNIT 2
 RUSSELLVILLE, ARKANSAS



SCALE:	NONE
DRAWN:	
DESIGN:	ENERGY
CAD NO:	

EXCESS LOAD EXCESS FEEDWATER FLOW / BOTH
 STEAM GENERATORS RCS PRESSURE VERSUS TIME

BASED ON DRAWING NO

SHEET

REV.

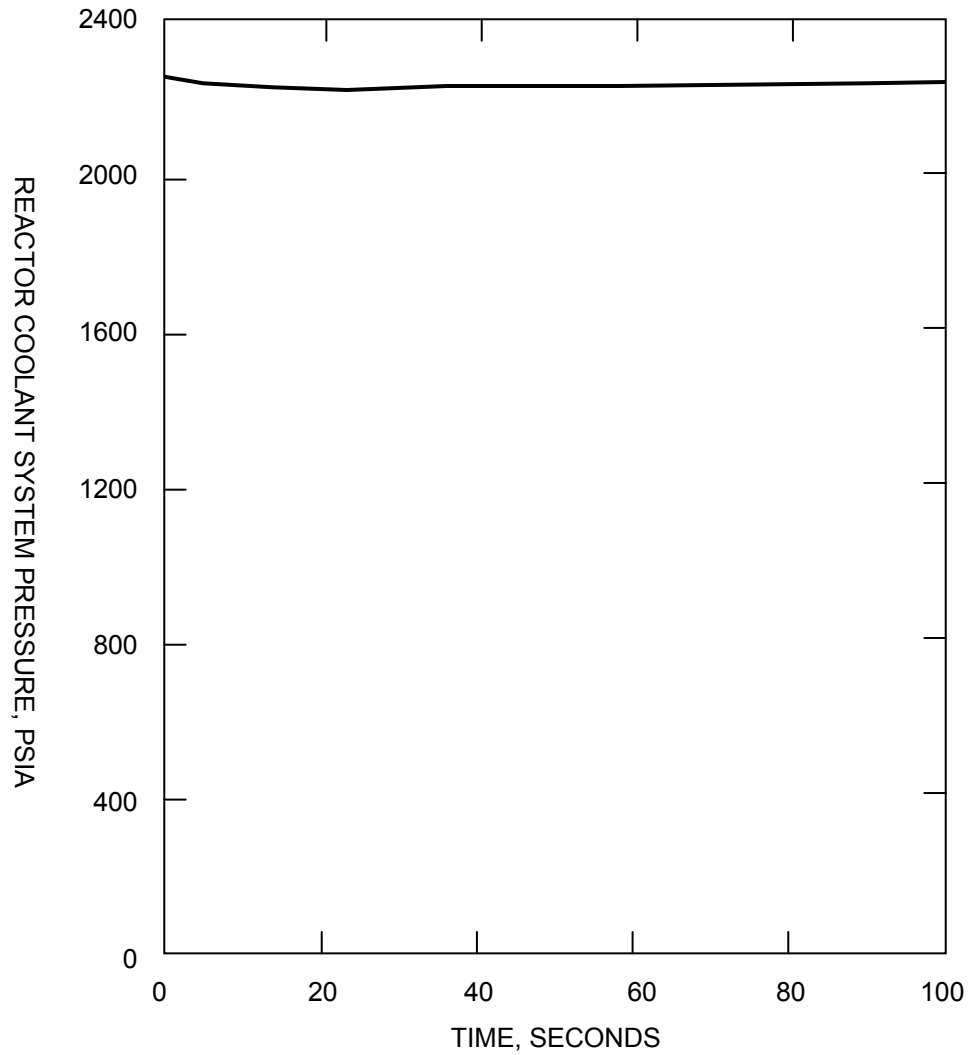

SAR FIGURE NO. 15.1.10-2B

AMENDMENT 20

ARKANSAS NUCLEAR ONE
UNIT 2
RUSSELLVILLE, ARKANSAS



SCALE:	NONE
DRAWN:	
DESIGN:	ENERGY
CAD NO:	

EXCESS LOAD EXCESS FEEDWATER FLOW / ONE STEAM
GENERATOR RCS PRESSURE VERSUS TIME

BASED ON DRAWING NO

SHEET

REV.

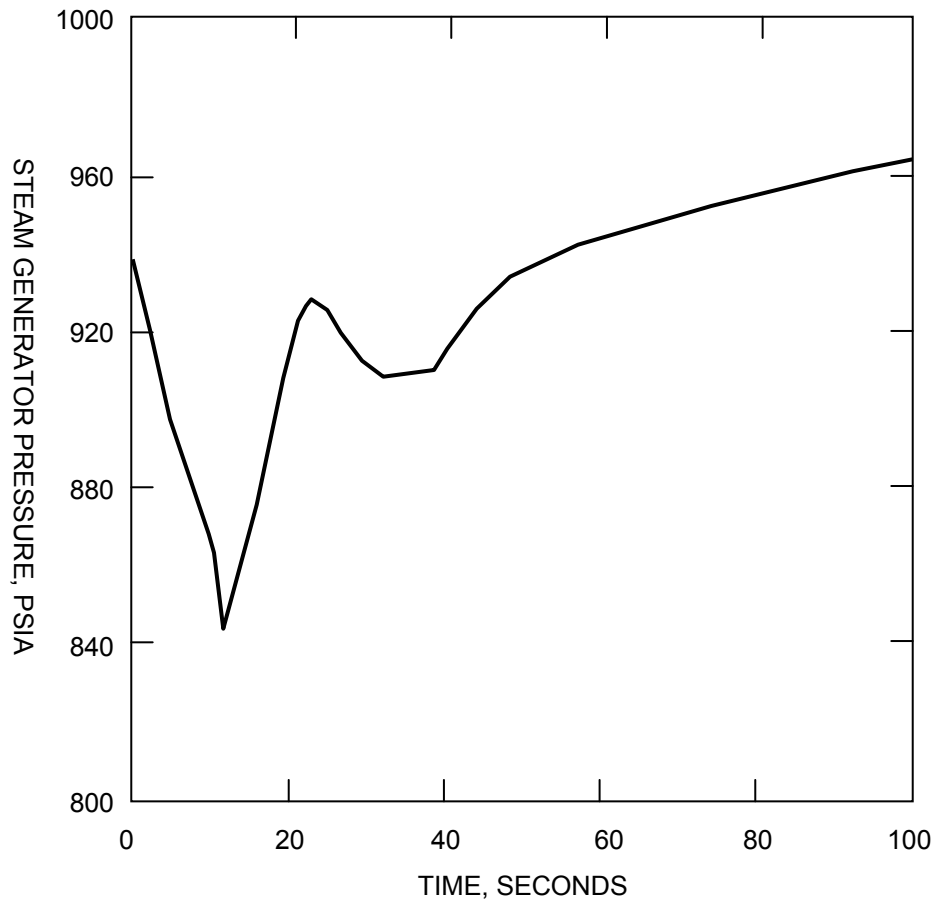

SAR FIGURE NO. 15.1.10-3A

AMENDMENT 20

ARKANSAS NUCLEAR ONE
 UNIT 2
 RUSSELLVILLE, ARKANSAS



SCALE:	NONE
DRAWN:	
DESIGN:	ENERGY
CAD NO:	

EXCESS LOAD EXCESS FEEDWATER FLOW / BOTH
 STEAM GENERATORS STEAM GENERATOR PRESSURE
 VERSUS TIME

BASED ON DRAWING NO

SHEET

REV.

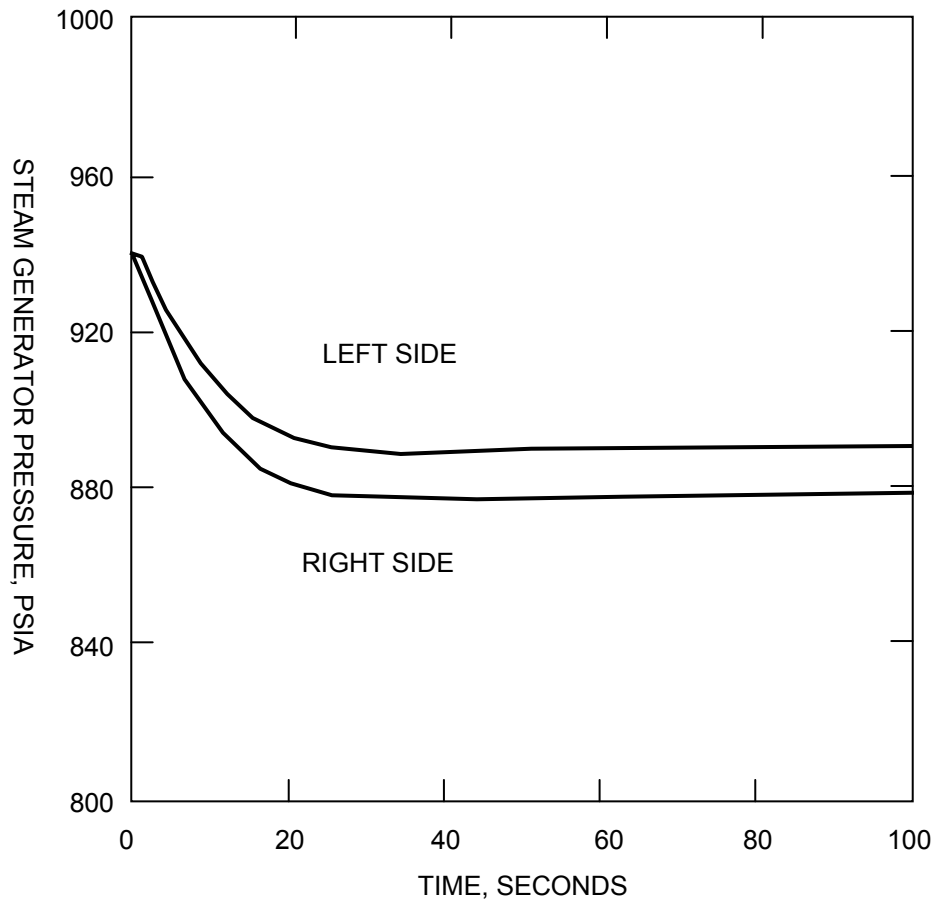

SAR FIGURE NO. 15.1.10-3B

AMENDMENT 20

ARKANSAS NUCLEAR ONE
UNIT 2
RUSSELLVILLE, ARKANSAS



SCALE:	NONE
DRAWN:	
DESIGN:	ENERGY
CAD NO:	

EXCESS LOAD EXCESS FEEDWATER FLOW / ONE STEAM
GENERATOR STEAM GENERATOR PRESSURE VERSUS
TIME

BASED ON DRAWING NO

SHEET

REV.

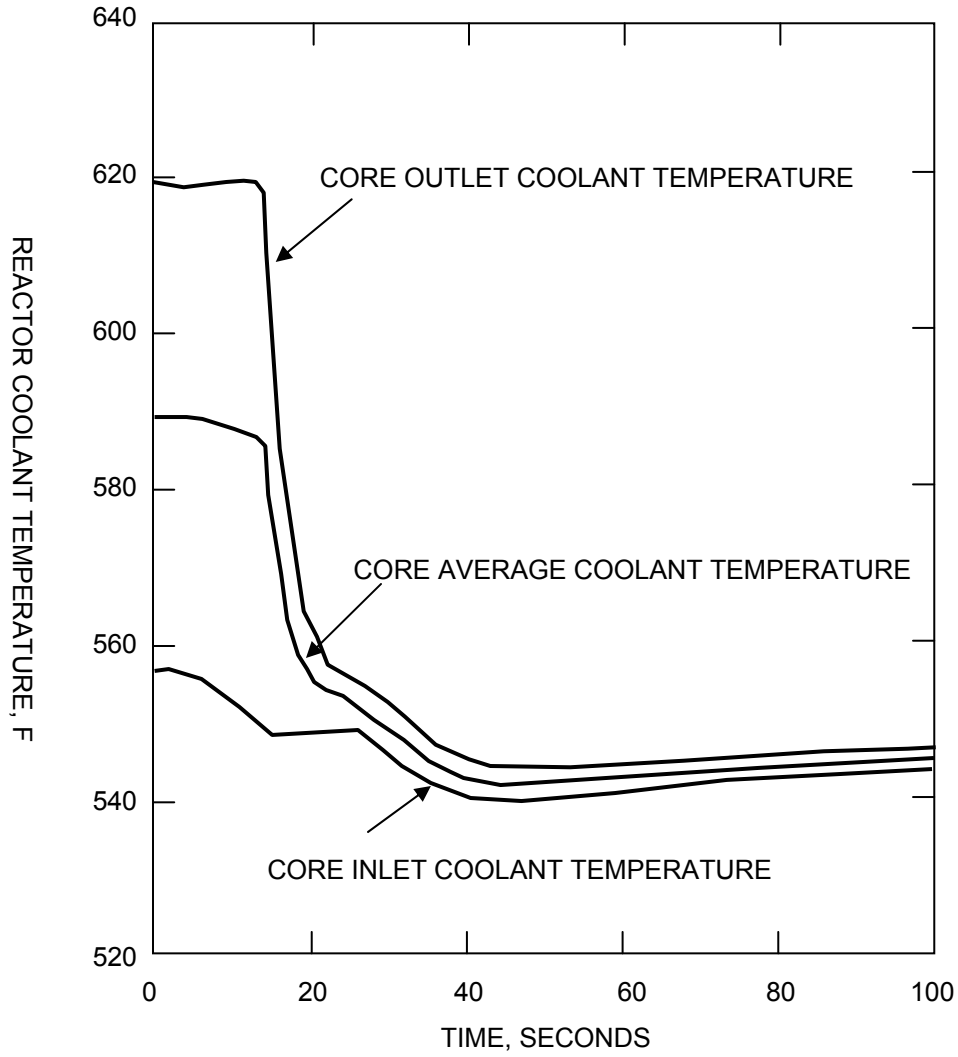

SAR FIGURE NO. 15.1.10-4A

AMENDMENT 20

ARKANSAS NUCLEAR ONE
UNIT 2
RUSSELLVILLE, ARKANSAS



SCALE:	NONE
DRAWN:	
DESIGN:	ENERGY
CAD NO:	

EXCESS LOAD EXCESS FEEDWATER FLOW / BOTH
STEAM GENERATORS STEAM RCS TEMPERATURE
VERSUS TIME

BASED ON DRAWING NO

SHEET

REV.

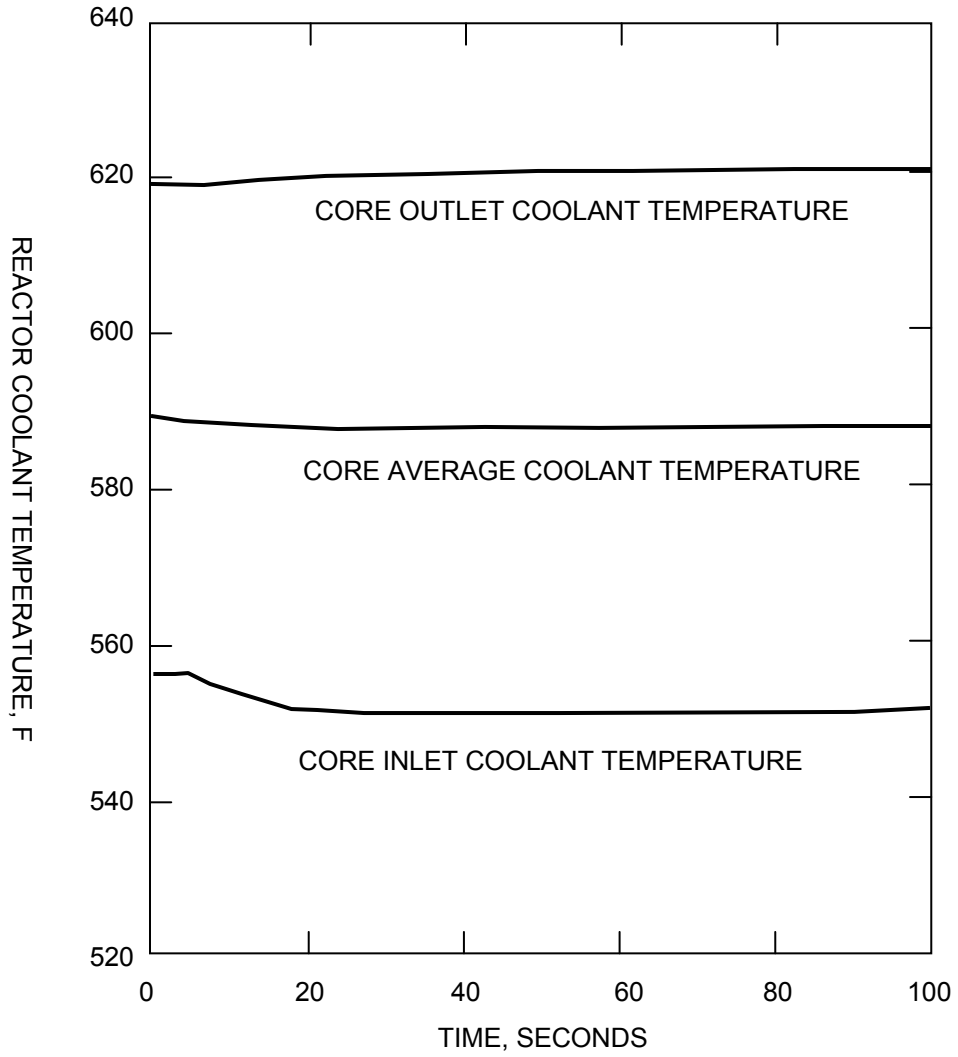

SAR FIGURE NO. 15.1.10-4B

AMENDMENT 20

ARKANSAS NUCLEAR ONE
UNIT 2
RUSSELLVILLE, ARKANSAS



SCALE:	NONE
DRAWN:	
DESIGN:	ENERGY
CAD NO:	

EXCESS LOAD EXCESS FEEDWATER FLOW / ONE STEAM GENERATOR STEAM RCS TEMPERATURE VERSUS TIME

BASED ON DRAWING NO

SHEET

REV.

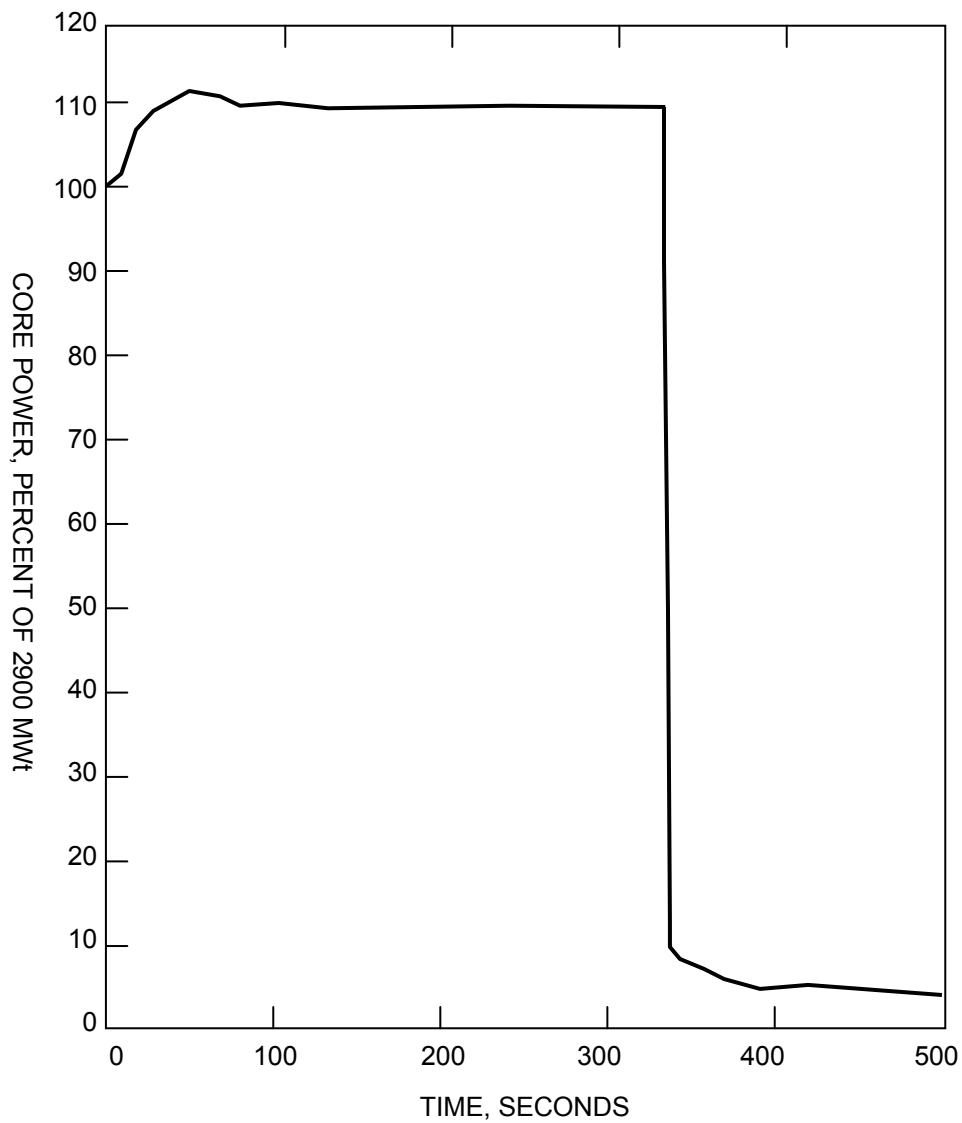

SAR FIGURE NO. 15.1.10-5

AMENDMENT 20

ARKANSAS NUCLEAR ONE
UNIT 2
RUSSELLVILLE, ARKANSAS



SCALE:	NONE
DRAWN:	
DESIGN:	ENERGY
CAD NO:	

EXCESS HEAT REMOVAL STEAM BYPASS SYSTEM
MALFUNCTION CORE POWER VERSUS TIME

BASED ON DRAWING NO

SHEET

REV.

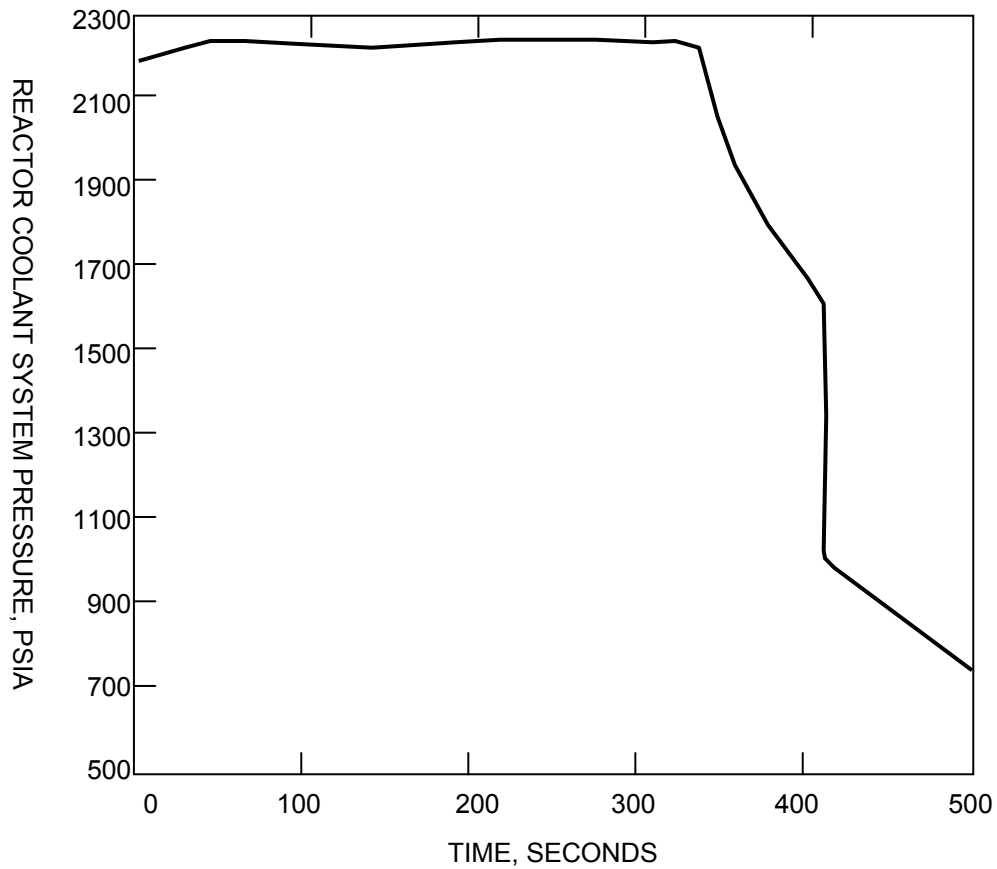

SAR FIGURE NO. 15.1.10-6

AMENDMENT 20

ARKANSAS NUCLEAR ONE
UNIT 2
RUSSELLVILLE, ARKANSAS



SCALE:	NONE
DRAWN:	
DESIGN:	ENERGY
CAD NO:	

EXCESS HEAT REMOVAL STEAM BYPASS SYSTEM
MALFUNCTION RCS PRESSURE VERSUS TIME

BASED ON DRAWING NO

SHEET

REV.

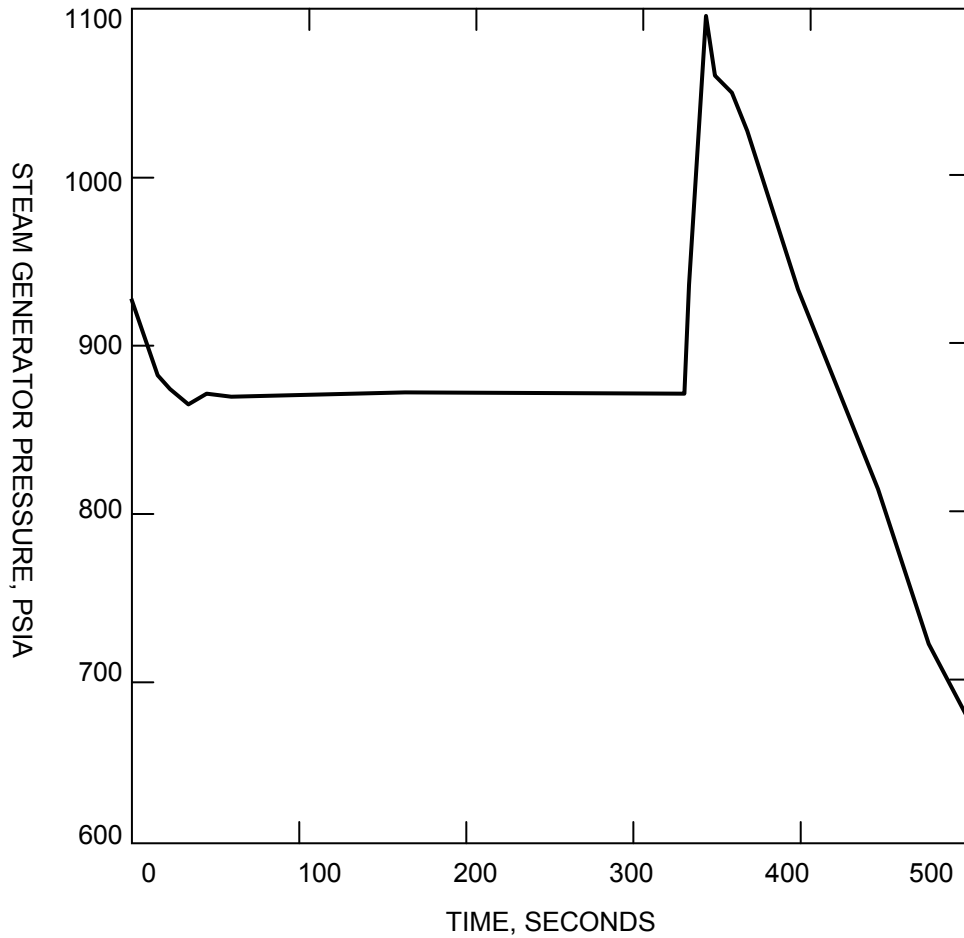

SAR FIGURE NO. 15.1.10-7

AMENDMENT 20

ARKANSAS NUCLEAR ONE
 UNIT 2
 RUSSELLVILLE, ARKANSAS



SCALE:	NONE
DRAWN:	
DESIGN:	ENERGY
CAD NO:	

EXCESS HEAT REMOVAL STEAM BYPASS SYSTEM
 MALFUNCTION STEAM GENERATOR PRESSURE VERSUS
 TIME

BASED ON DRAWING NO

SHEET

REV.

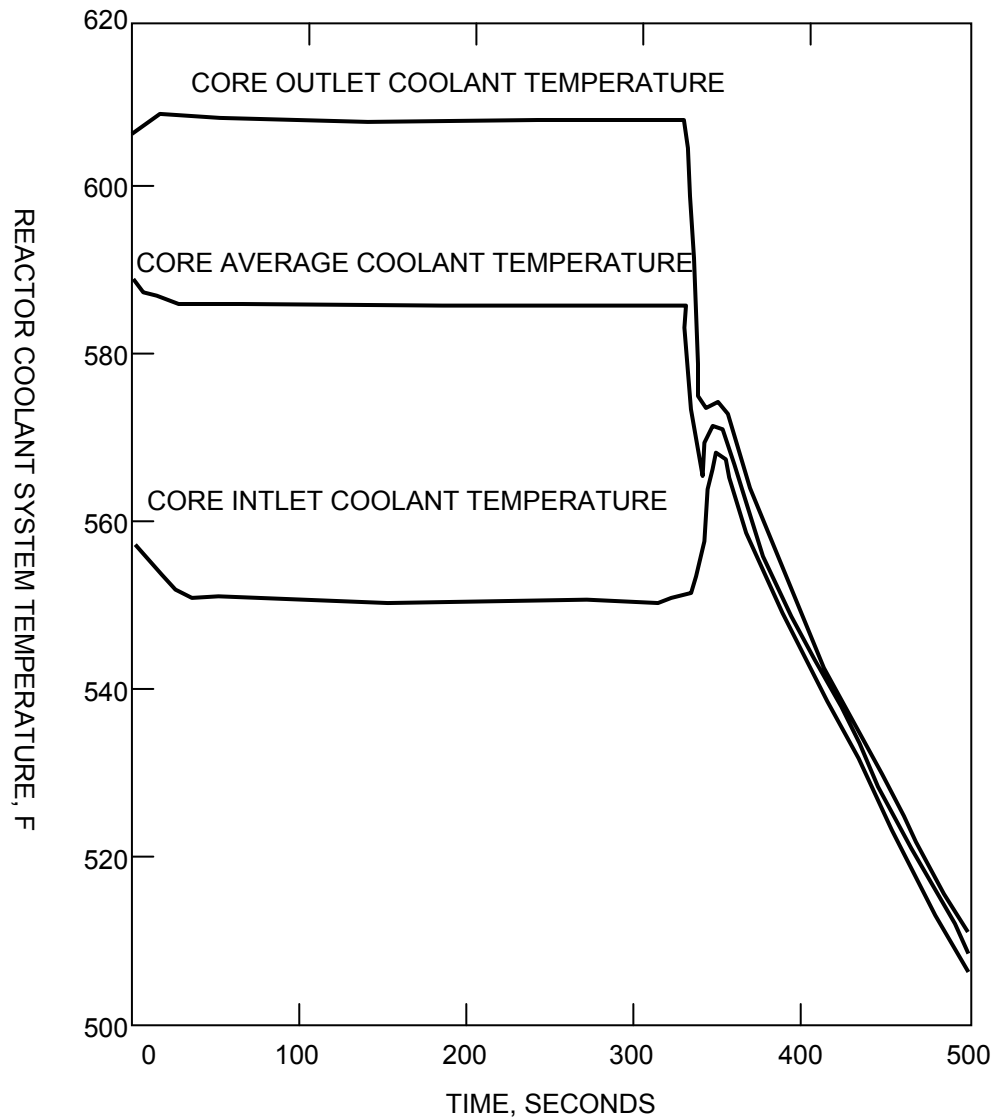

SAR FIGURE NO. 15.1.10-8

AMENDMENT 20

ARKANSAS NUCLEAR ONE
UNIT 2
RUSSELLVILLE, ARKANSAS



SCALE:	NONE
DRAWN:	
DESIGN:	ENERGY
CAD NO:	

EXCESS HEAT REMOVAL STEAM BYPASS SYSTEM
MALFUNCTION RCS TEMPERATURE VERSUS TIME

BASED ON DRAWING NO

SHEET

REV.

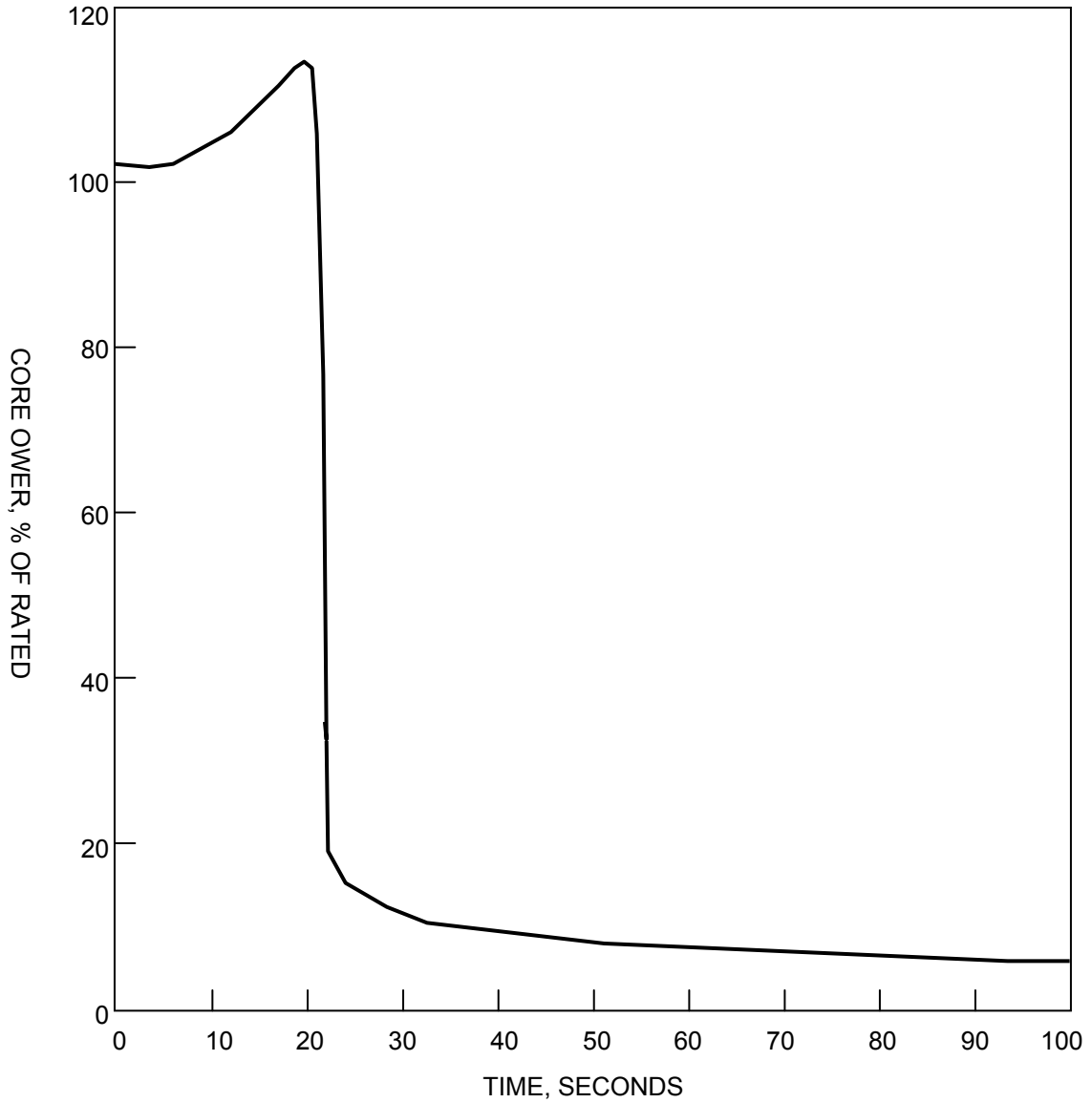

SAR FIGURE NO. 15.1.10-9

AMENDMENT 20

ARKANSAS NUCLEAR ONE
 UNIT 2
 RUSSELLVILLE, ARKANSAS



SCALE: NONE

DRAWN:

DESIGN: ENTERGY

CAD NO:

CYCLE 15 AT 3026 MWt FEEDWATER SYSTEM
 MALFUNCTION CORE POWER VERSUS TIME

BASED ON DRAWING NO

SHEET

REV.

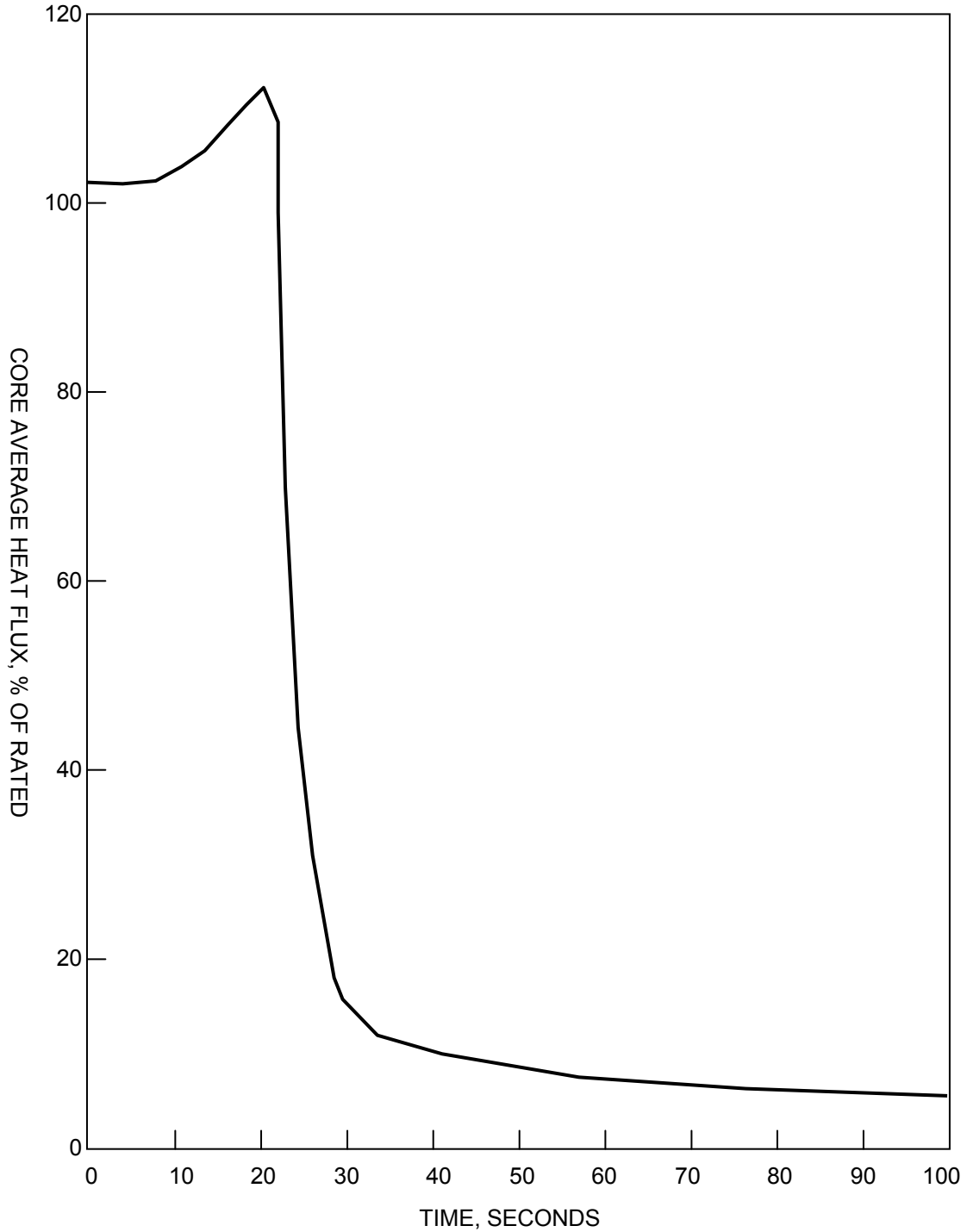

SAR FIGURE NO. 15.1.10-10

AMENDMENT 20

ARKANSAS NUCLEAR ONE
UNIT 2
RUSSELLVILLE, ARKANSAS



SCALE:	NONE
DRAWN:	
DESIGN:	ENTERGY
CAD NO:	

CYCLE 15 AT 3026 MWt FEEDWATER SYSTEM
MALFUNCTION CORE AVERAGE HEAT FLUX VERSUS
TIME

BASED ON DRAWING NO

SHEET

REV.

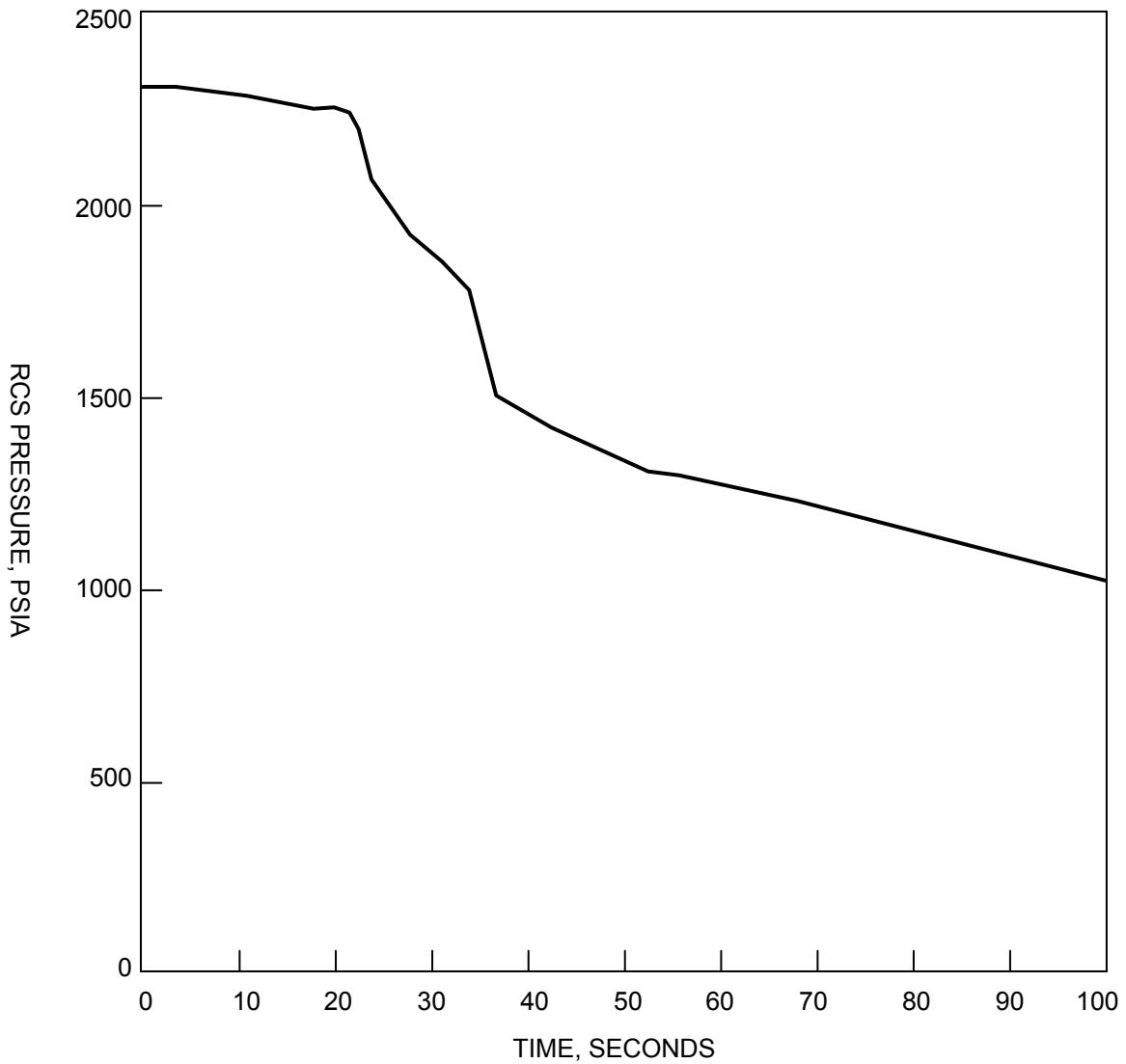

SAR FIGURE NO. 15.1.10-11

AMENDMENT 20

ARKANSAS NUCLEAR ONE
UNIT 2
RUSSELLVILLE, ARKANSAS



SCALE:	NONE
DRAWN:	
DESIGN:	ENERGY
CAD NO:	

CYCLE 15 AT 3026 MWt FEEDWATER SYSTEM
MALFUNCTION RCS PRESSURE VERSUS TIME

BASED ON DRAWING NO

SHEET

REV.

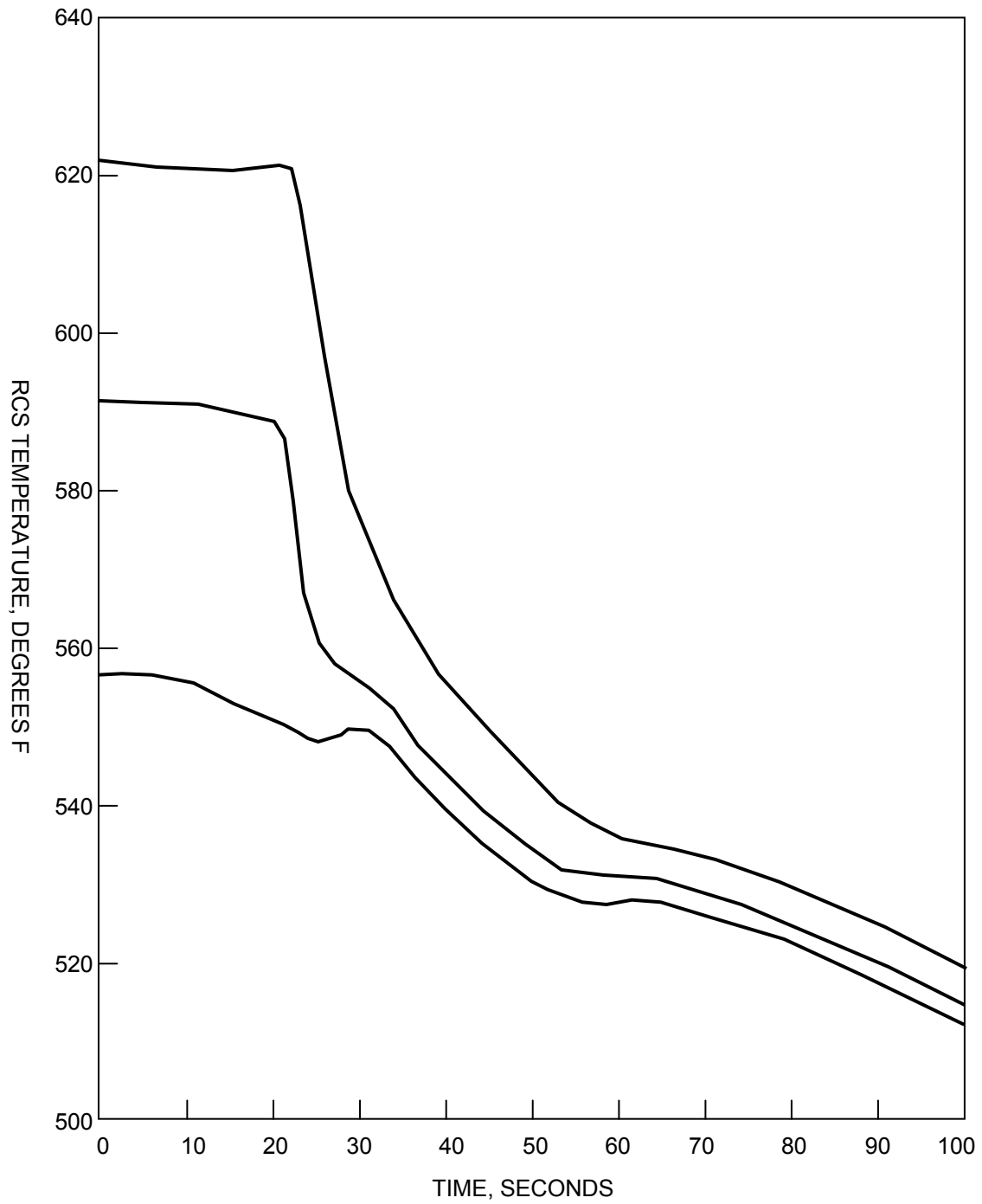

SAR FIGURE NO. 15.1.10-12

AMENDMENT 20

ARKANSAS NUCLEAR ONE
 UNIT 2
 RUSSELLVILLE, ARKANSAS



SCALE:	NONE
DRAWN:	
DESIGN:	ENTERGY
CAD NO:	

CYCLE 15 AT 3026 MWt FEEDWATER SYSTEM
 MALFUNCTION RCS TEMPERATURE VERSUS TIME

BASED ON DRAWING NO

SHEET

REV.

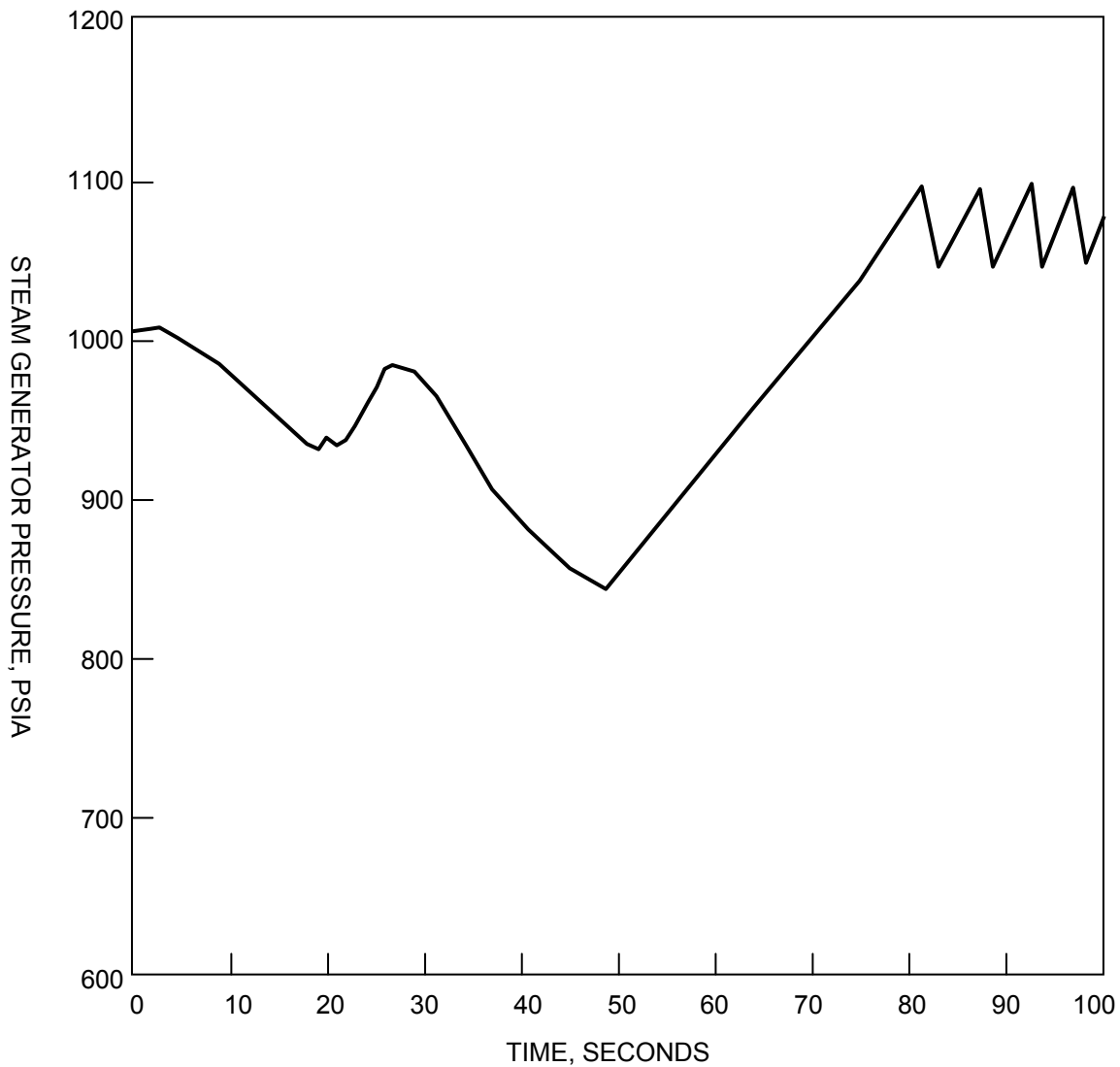

SAR FIGURE NO. 15.1.10-13

AMENDMENT 20

ARKANSAS NUCLEAR ONE
UNIT 2
RUSSELLVILLE, ARKANSAS



SCALE: NONE

DRAWN:

DESIGN: ENTERGY

CAD NO:

CYCLE 15 AT 3026 MWt FEEDWATER SYSTEM
MALFUNCTION STEAM GENERATOR PRESSURE VERSUS
TIME

BASED ON DRAWING NO

SHEET

REV.

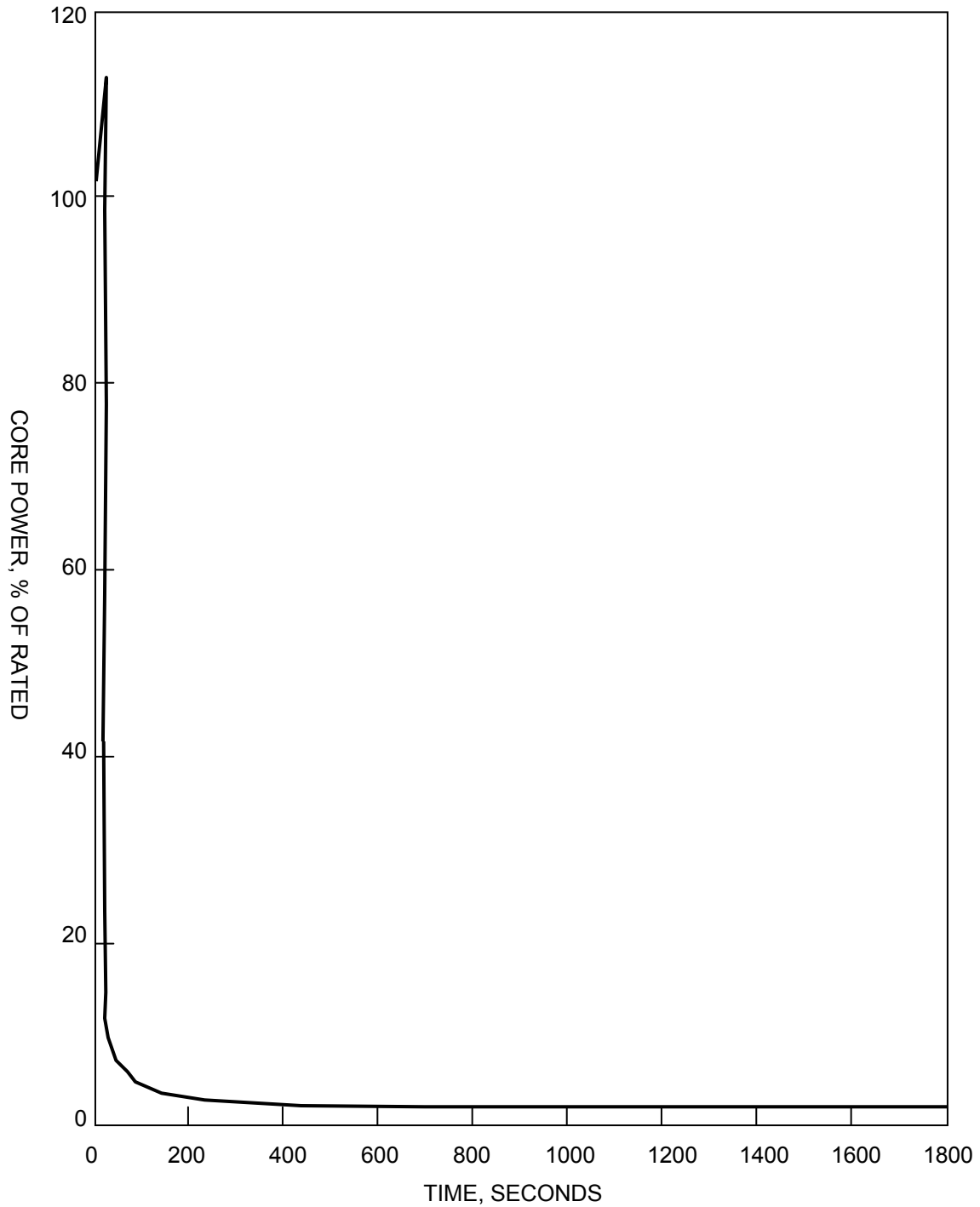

SAR FIGURE NO. 15.1.10-14

AMENDMENT 20

ARKANSAS NUCLEAR ONE
UNIT 2
RUSSELLVILLE, ARKANSAS



SCALE:	NONE
DRAWN:	
DESIGN:	ENTERGY
CAD NO:	

CYCLE 15 AT 3026 MWt STEAM BYPASS SYSTEM
MALFUNCTION CORE POWER VERSUS TIME

BASED ON DRAWING NO

SHEET

REV.

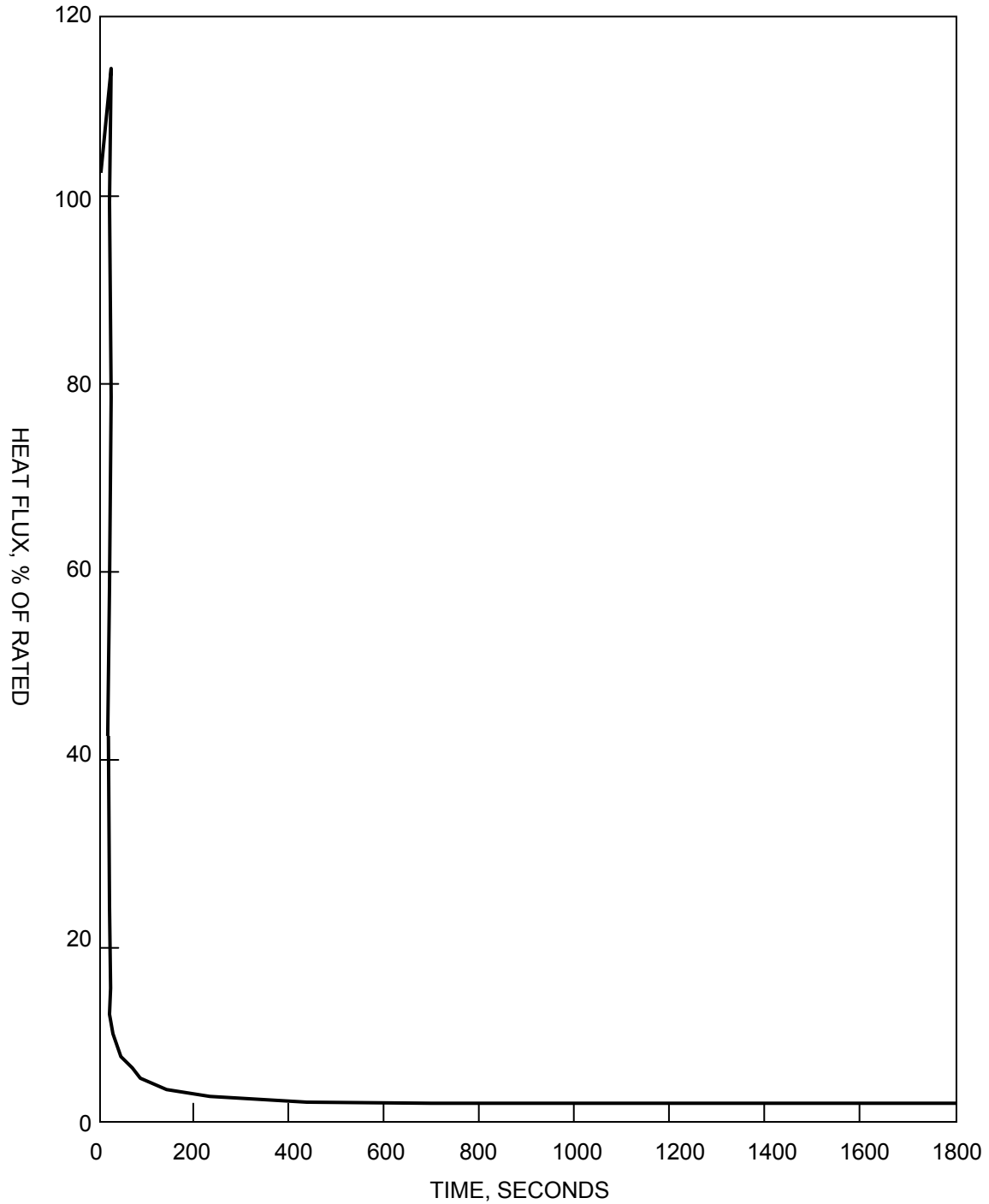

SAR FIGURE NO. 15.1.10-15

AMENDMENT 20

ARKANSAS NUCLEAR ONE
UNIT 2
RUSSELLVILLE, ARKANSAS



SCALE:	NONE
DRAWN:	
DESIGN:	ENTERGY
CAD NO:	

CYCLE 15 AT 3026 MWt STEAM BYPASS SYSTEM
MALFUNCTION CORE AVERAGE HEAT FLUX VERSUS
TIME

BASED ON DRAWING NO

SHEET

REV.

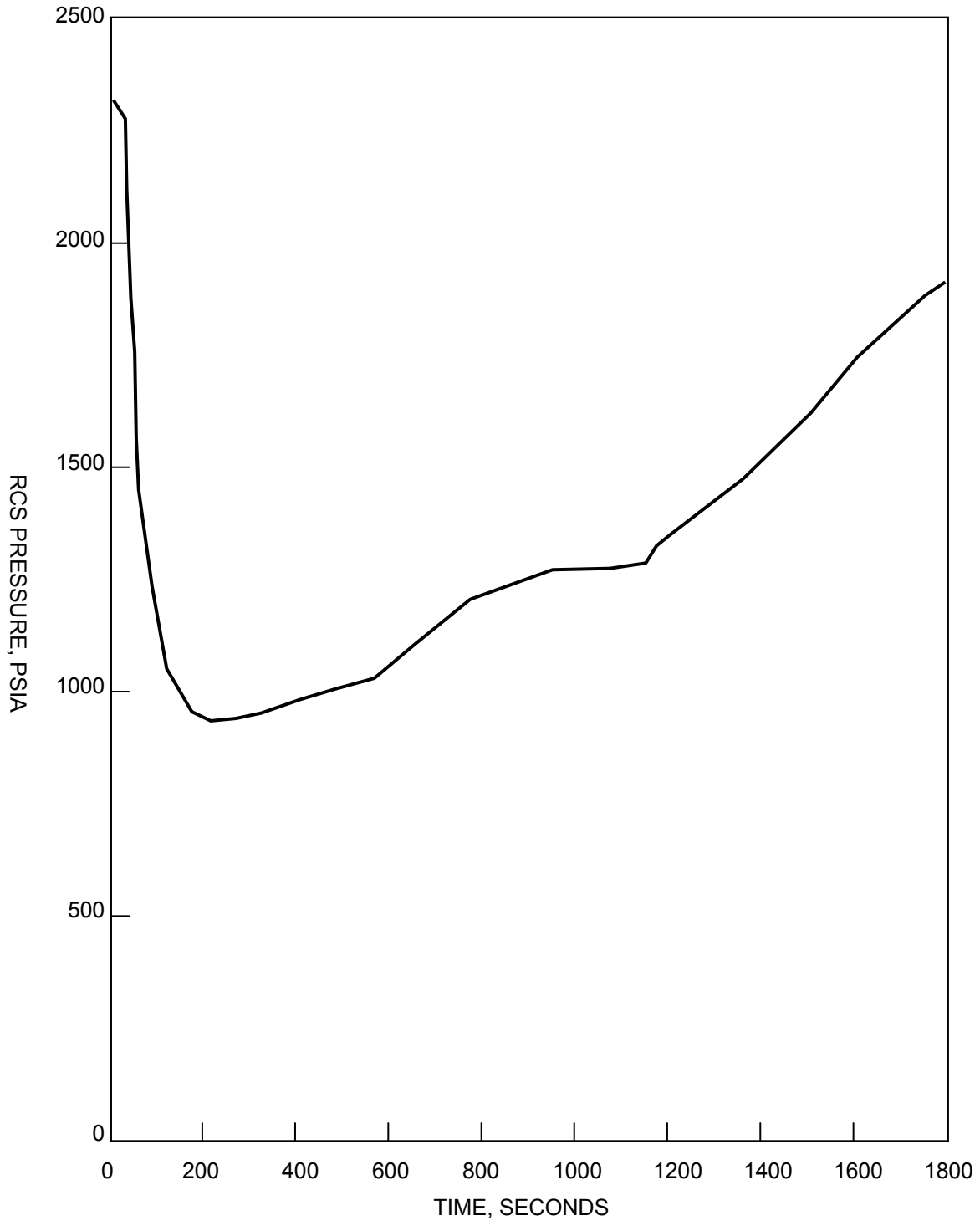

SAR FIGURE NO. 15.1.10-16

AMENDMENT 20

ARKANSAS NUCLEAR ONE
UNIT 2
RUSSELLVILLE, ARKANSAS



SCALE:	NONE
DRAWN:	
DESIGN:	ENTERGY
CAD NO:	

CYCLE 15 AT 3026 MWt STEAM BYPASS SYSTEM
MALFUNCTION RCS PRESSURE VERSUS TIME

BASED ON DRAWING NO

SHEET

REV.

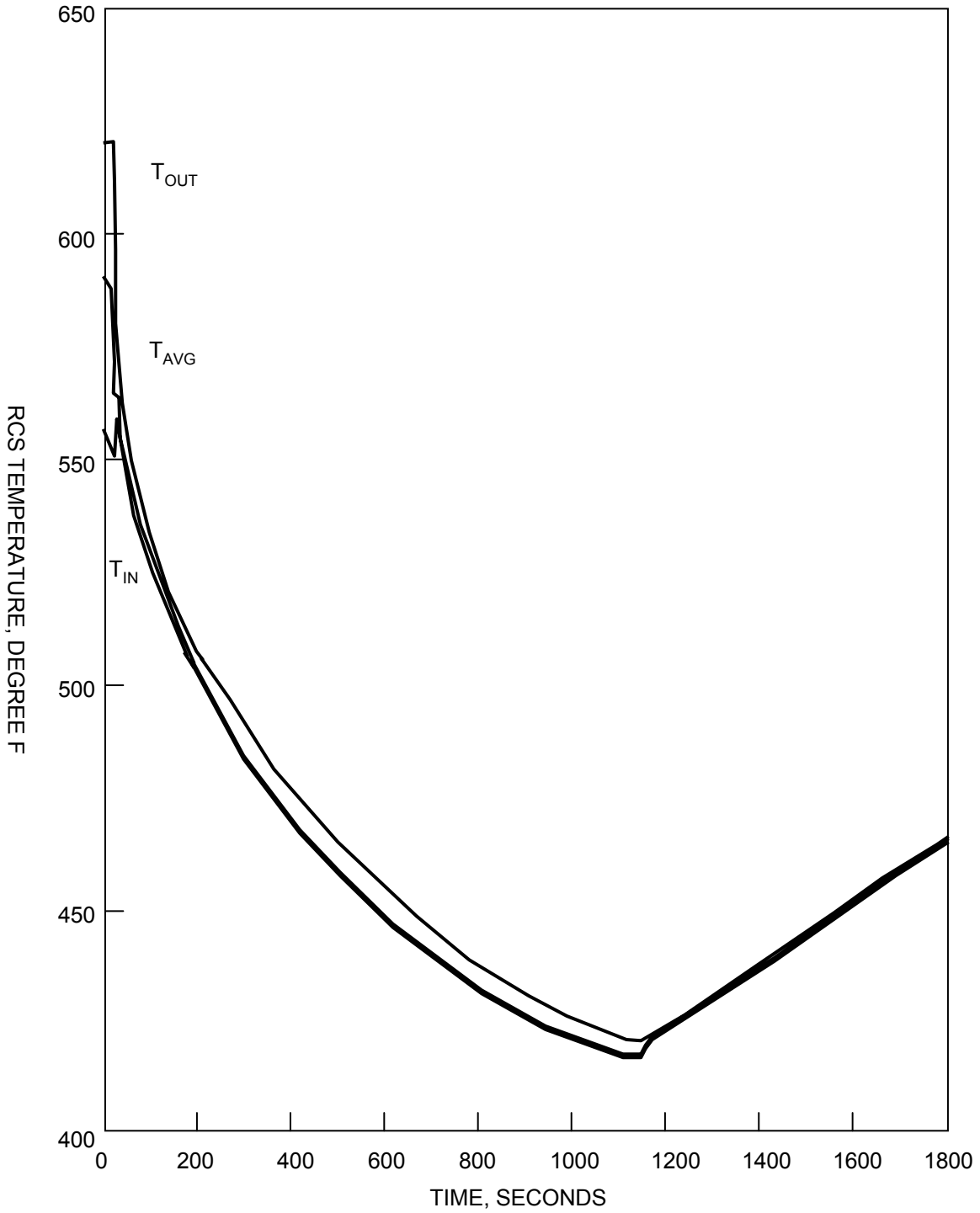

SAR FIGURE NO. 15.1.10-17

AMENDMENT 20

ARKANSAS NUCLEAR ONE
UNIT 2
RUSSELLVILLE, ARKANSAS



SCALE:	NONE
DRAWN:	
DESIGN:	ENTERGY
CAD NO:	

CYCLE 15 AT 3026 MWt STEAM BYPASS SYSTEM
MALFUNCTION RCS TEMPERATURE VERSUS TIME

BASED ON DRAWING NO

SHEET

REV.

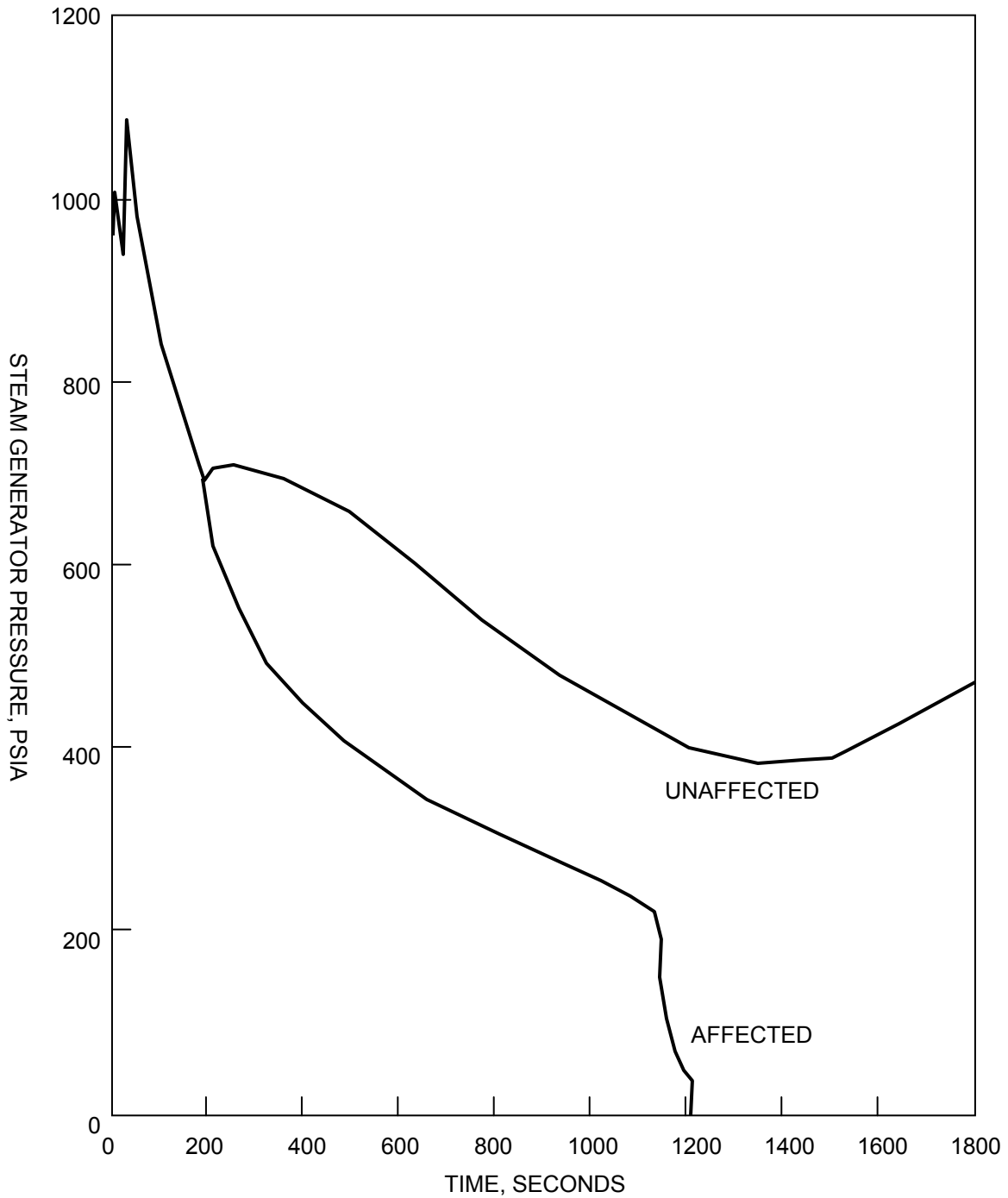

SAR FIGURE NO. 15.1.10-18

AMENDMENT 20

ARKANSAS NUCLEAR ONE
UNIT 2
RUSSELLVILLE, ARKANSAS



SCALE:	NONE
DRAWN:	
DESIGN:	ENTERGY
CAD NO:	

CYCLE 15 AT 3026 MWt STEAM BYPASS SYSTEM
MALFUNCTION STEAM GENERATOR PRESSURE VERSUS
TIME

BASED ON DRAWING NO

SHEET

REV.

FIGURES 15.1.13-1
THROUGH 15.1.14-28
DELETED

SAR FIGURE NO. 15.1.13-1

AMENDMENT 20

ARKANSAS NUCLEAR ONE
UNIT 2
RUSSELLVILLE, ARKANSAS



SCALE:	NONE
DRAWN:	ENERGY
DESIGN:	ENERGY
CAD NO:	N/A

BASED ON DRAWING NO

SHEET

REV.

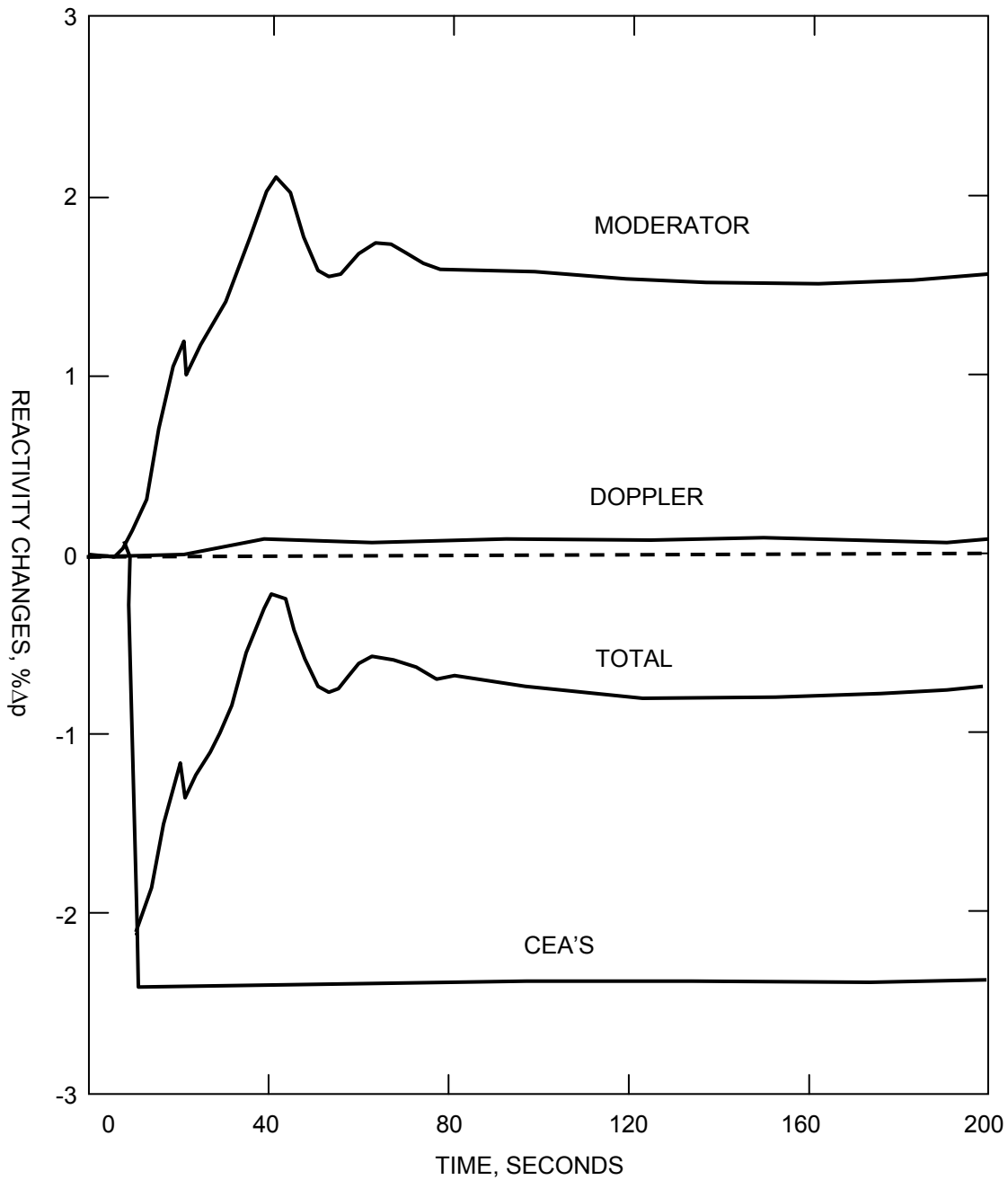

SAR FIGURE NO. 15.1.14-29

AMENDMENT 20

ARKANSAS NUCLEAR ONE
UNIT 2
RUSSELLVILLE, ARKANSAS



SCALE:	NONE
DRAWN:	
DESIGN:	ENERGY
CAD NO:	

STEAM LINE RUPTURE INCIDENT ONE LOOP NO LOAD
INITIAL CONDITION RUPTURE OUTSIDE CONTAINMENT

BASED ON DRAWING NO

SHEET

REV.

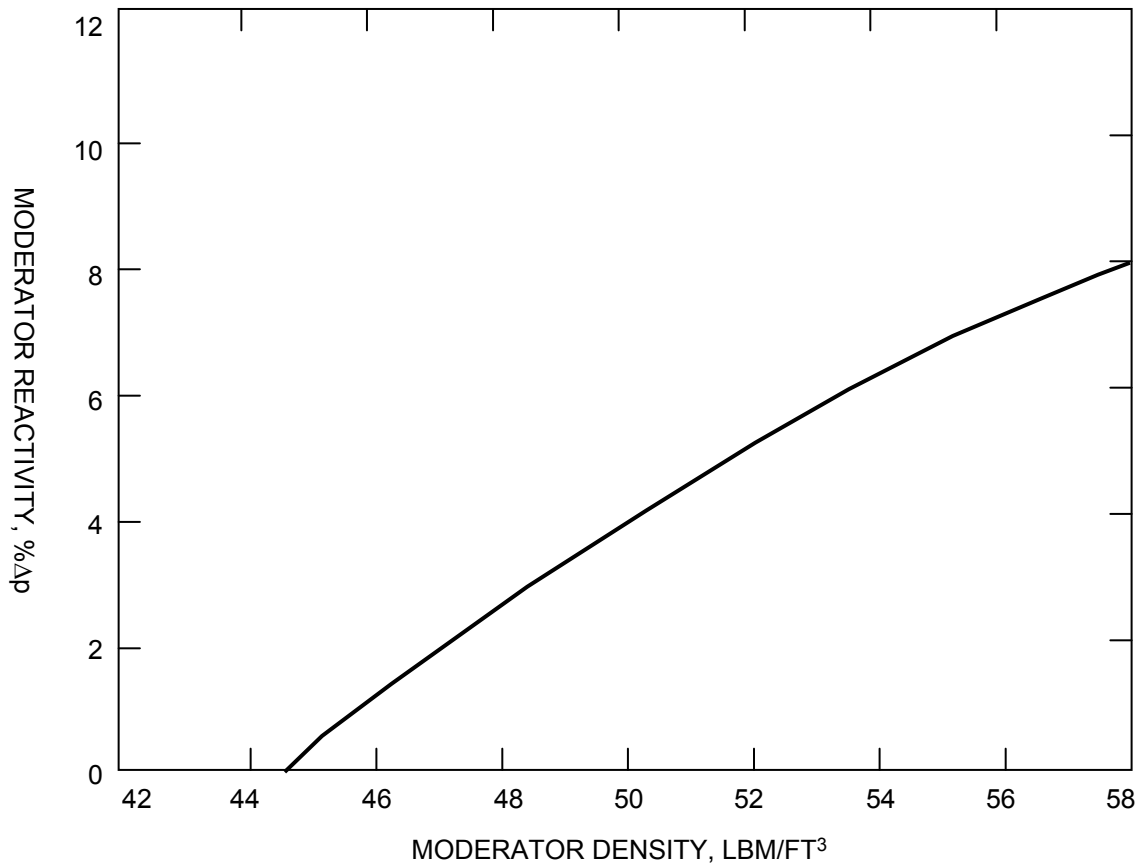

SAR FIGURE NO. 15.1.14-30

AMENDMENT 20

ARKANSAS NUCLEAR ONE
UNIT 2
RUSSELLVILLE, ARKANSAS



SCALE:	NONE
DRAWN:	
DESIGN:	ENTERGY
CAD NO:	

STEAM LINE RUPTURE INCIDENT
REACTIVITY VERSUS MODERATOR DENSITY

BASED ON DRAWING NO

SHEET

REV.

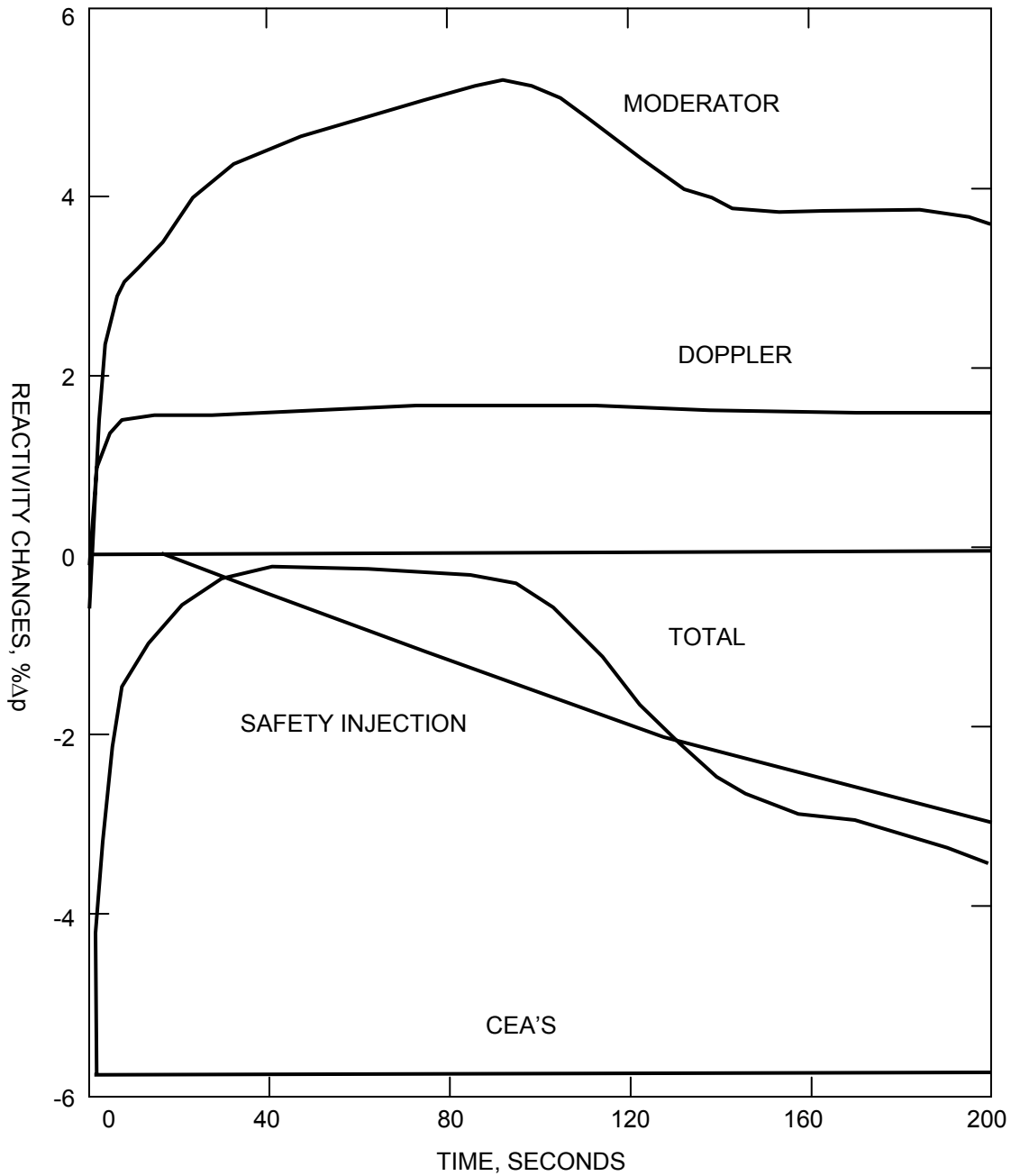

SAR FIGURE NO. 15.1.14-31

AMENDMENT 20

ARKANSAS NUCLEAR ONE
UNIT 2
RUSSELLVILLE, ARKANSAS



SCALE:	NONE
DRAWN:	
DESIGN:	ENTERGY
CAD NO:	

STEAM LINE RUPTURE INCIDENT WITH LOSS OF AC
POWER TWO LOOP FULL LOAD INITIAL CONDITON SMALL
BREAK

BASED ON DRAWING NO

SHEET

REV.

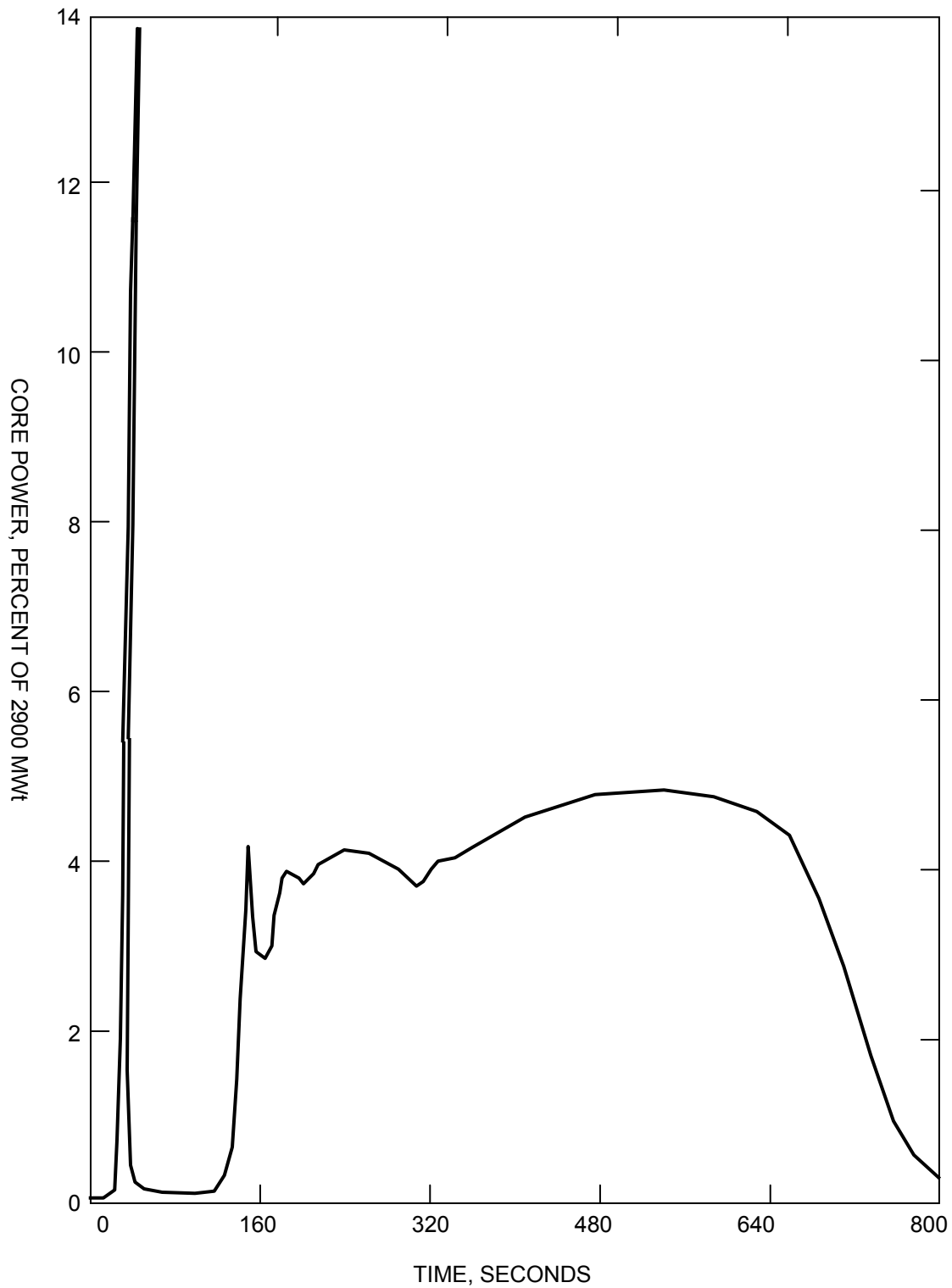

SAR FIGURE NO. 15.1.14-32

AMENDMENT 20

ARKANSAS NUCLEAR ONE
UNIT 2
RUSSELLVILLE, ARKANSAS



SCALE:	NONE
DRAWN:	
DESIGN:	ENTERGY
CAD NO:	

STEAM LINE RUPTURE INCIDENT WITH LOSS OF AC
POWER ONE LOOP NO LOAD INITIAL CONDITON SMALL
BREAK

BASED ON DRAWING NO

SHEET

REV.

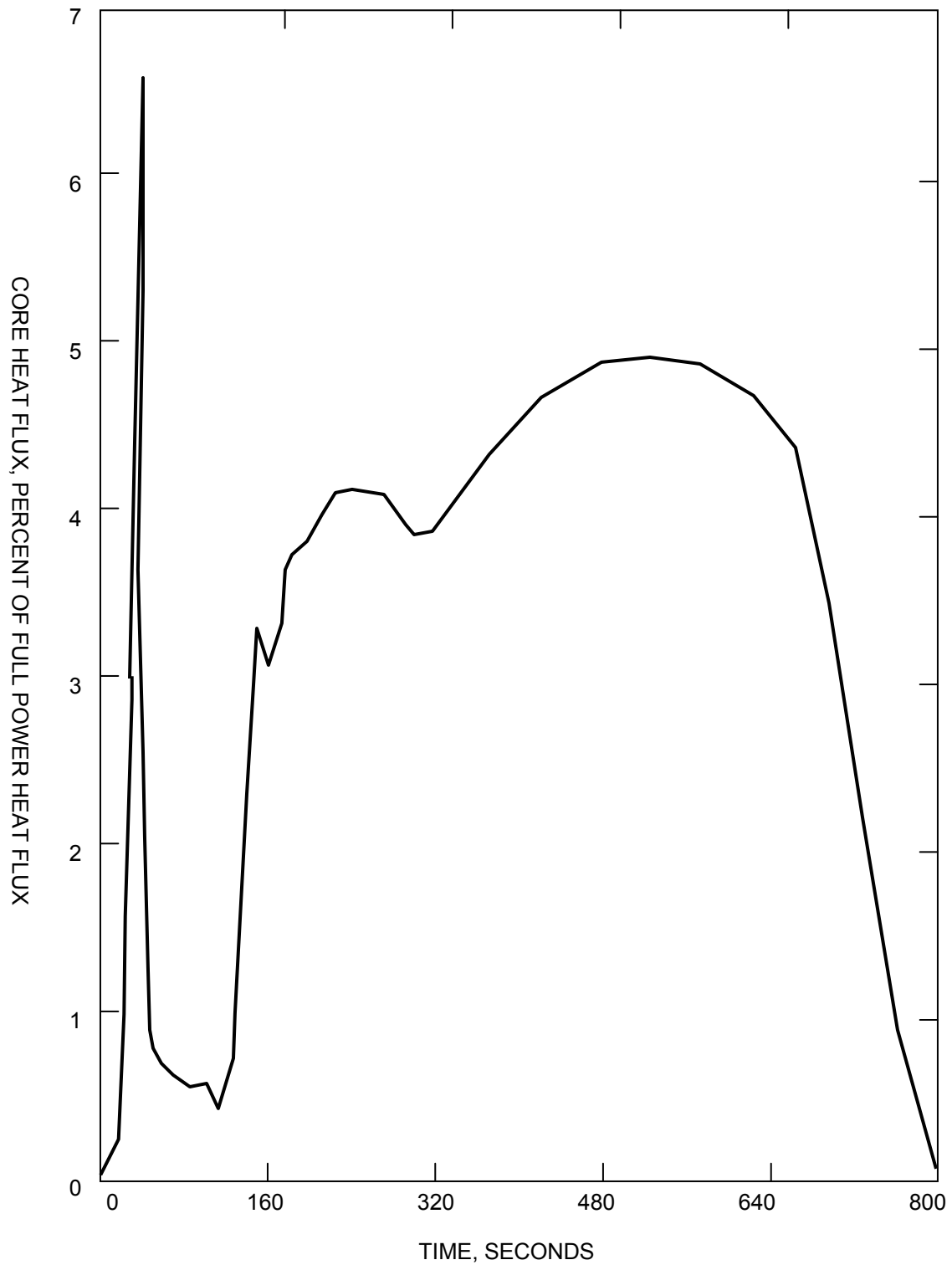

SAR FIGURE NO. 15.1.14-33

AMENDMENT 20

ARKANSAS NUCLEAR ONE
UNIT 2
RUSSELLVILLE, ARKANSAS



SCALE: NONE

DRAWN:

DESIGN: ENTERGY

CAD NO:

STEAM LINE RUPTURE INCIDENT WITH LOSS OF AC
POWER ONE LOOP NO LOAD INITIAL CONDITON SMALL
BREAK

BASED ON DRAWING NO

SHEET

REV.

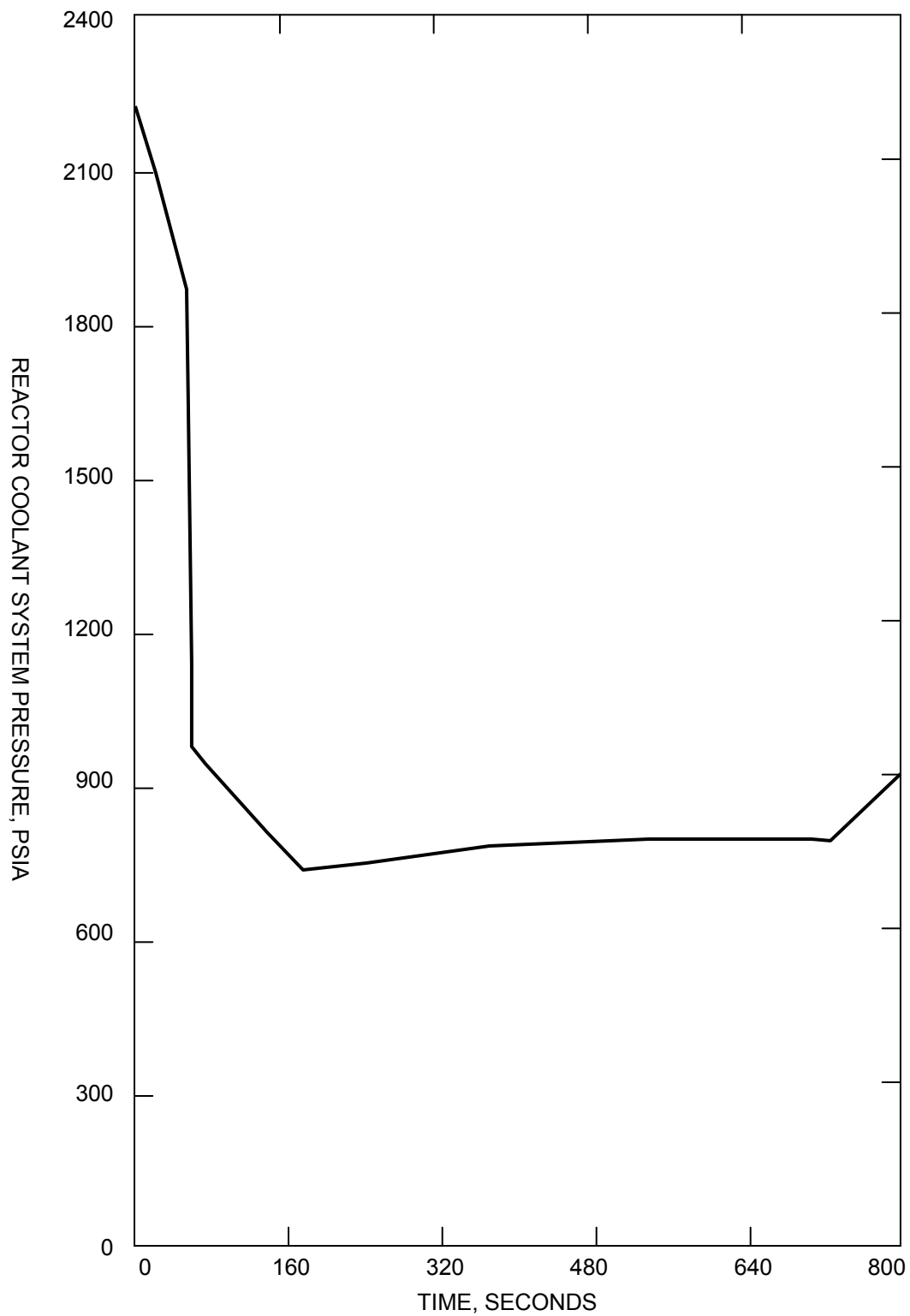

SAR FIGURE NO. 15.1.14-34

AMENDMENT 20

ARKANSAS NUCLEAR ONE
 UNIT 2
 RUSSELLVILLE, ARKANSAS



SCALE:	NONE
DRAWN:	
DESIGN:	ENERGY
CAD NO:	

STEAM LINE RUPTURE INCIDENT WITH LOSS OF AC
 POWER ONE LOOP NO LOAD INITIAL CONDITON SMALL
 BREAK

BASED ON DRAWING NO

SHEET

REV.

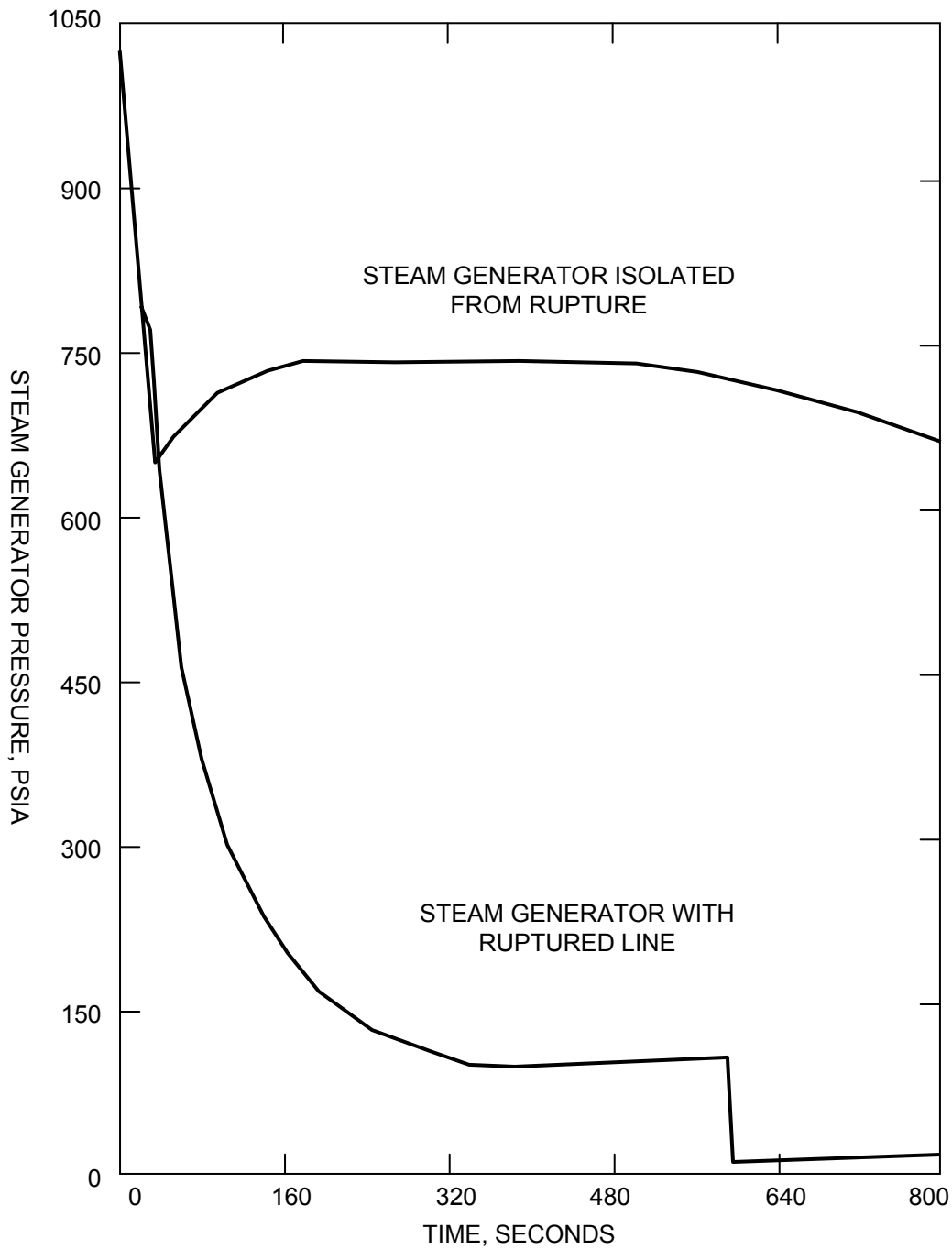

SAR FIGURE NO. 15.1.14-35

AMENDMENT 20

ARKANSAS NUCLEAR ONE
 UNIT 2
 RUSSELLVILLE, ARKANSAS



SCALE:	NONE
DRAWN:	
DESIGN:	ENERGY
CAD NO:	

STEAM LINE RUPTURE INCIDENT WITH LOSS OF AC
 POWER ONE LOOP NO LOAD INITIAL CONDITON SMALL
 BREAK

BASED ON DRAWING NO

SHEET

REV.

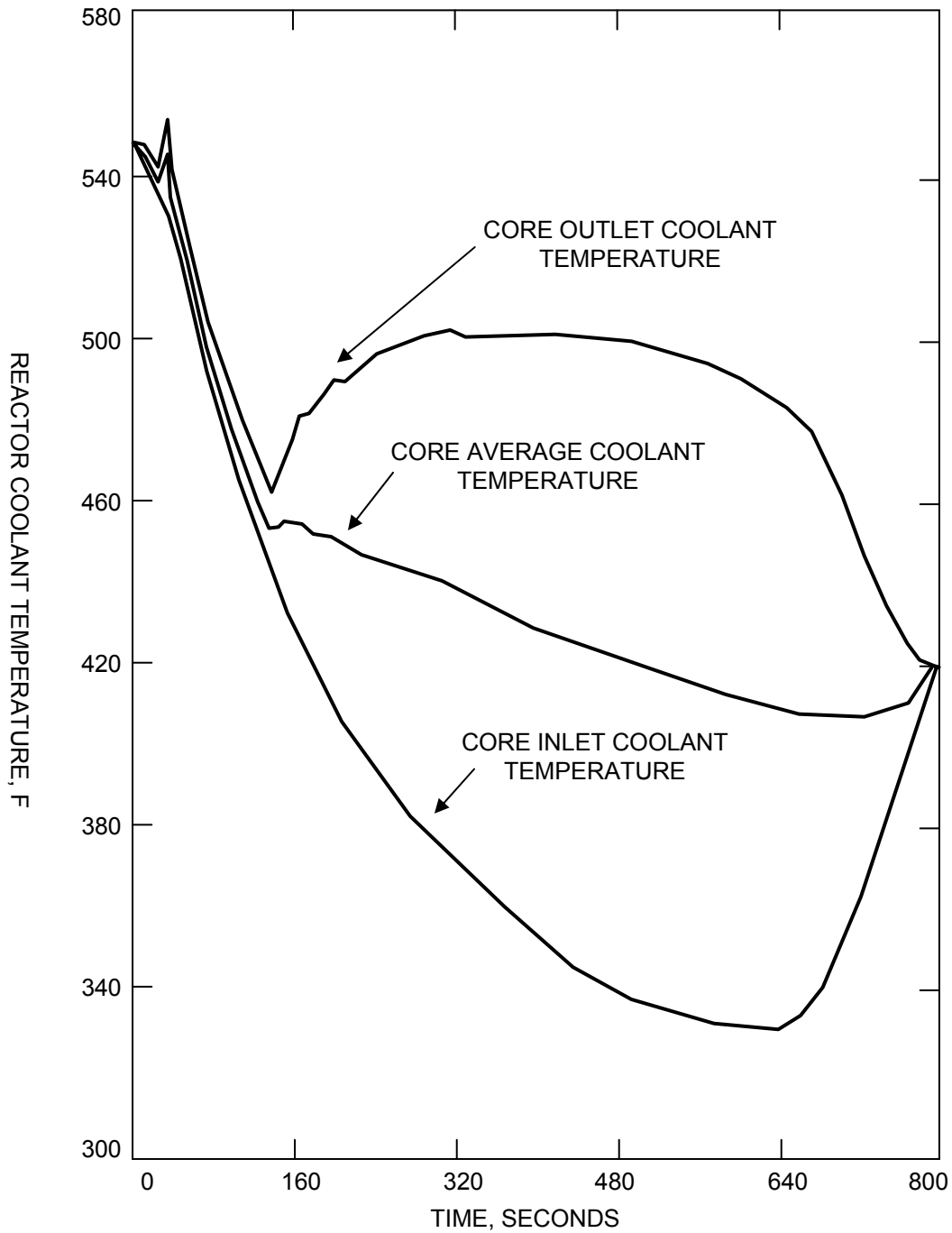

SAR FIGURE NO. 15.1.14-36

AMENDMENT 20

ARKANSAS NUCLEAR ONE
 UNIT 2
 RUSSELLVILLE, ARKANSAS



SCALE:	NONE
DRAWN:	
DESIGN:	ENERGY
CAD NO:	

STEAM LINE RUPTURE INCIDENT WITH LOSS OF AC
 POWER ONE LOOP NO LOAD INITIAL CONDITON SMALL
 BREAK

BASED ON DRAWING NO

SHEET

REV.

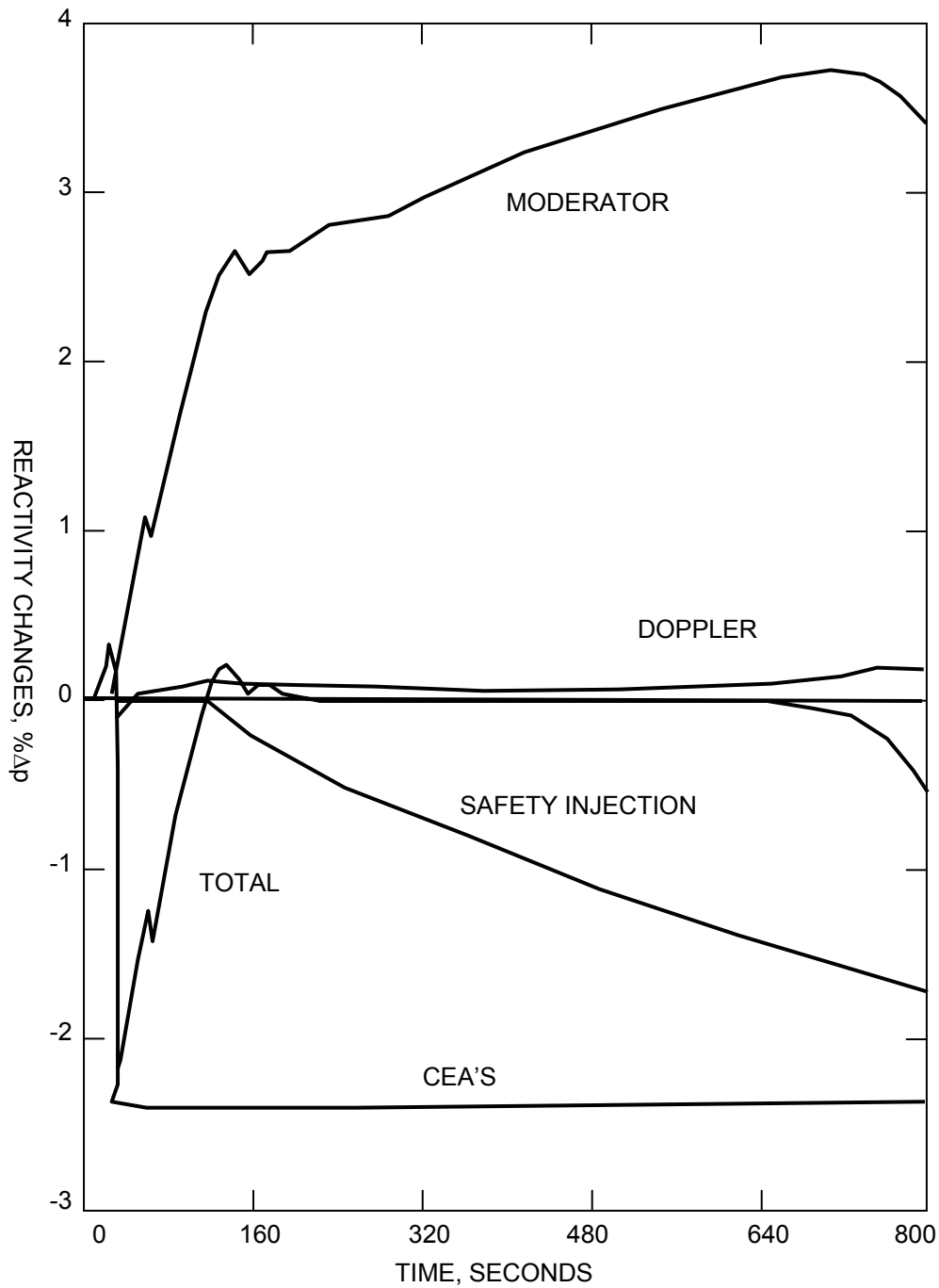

SAR FIGURE NO. 15.1.14-37

AMENDMENT 20

ARKANSAS NUCLEAR ONE
UNIT 2
RUSSELLVILLE, ARKANSAS



SCALE:	NONE
DRAWN:	
DESIGN:	ENERGY
CAD NO:	

STEAM LINE RUPTURE INCIDENT WITH LOSS OF AC
POWER ONE LOOP NO LOAD INITIAL CONDITON SMALL
BREAK

BASED ON DRAWING NO

SHEET

REV.

DELETED

SAR FIGURE NO. 15.1.14-38

AMENDMENT 20

ARKANSAS NUCLEAR ONE
UNIT 2
RUSSELLVILLE, ARKANSAS



SCALE: NONE

DRAWN:

DESIGN: ENTERGY

CAD NO:

BASED ON DRAWING NO

SHEET

REV.

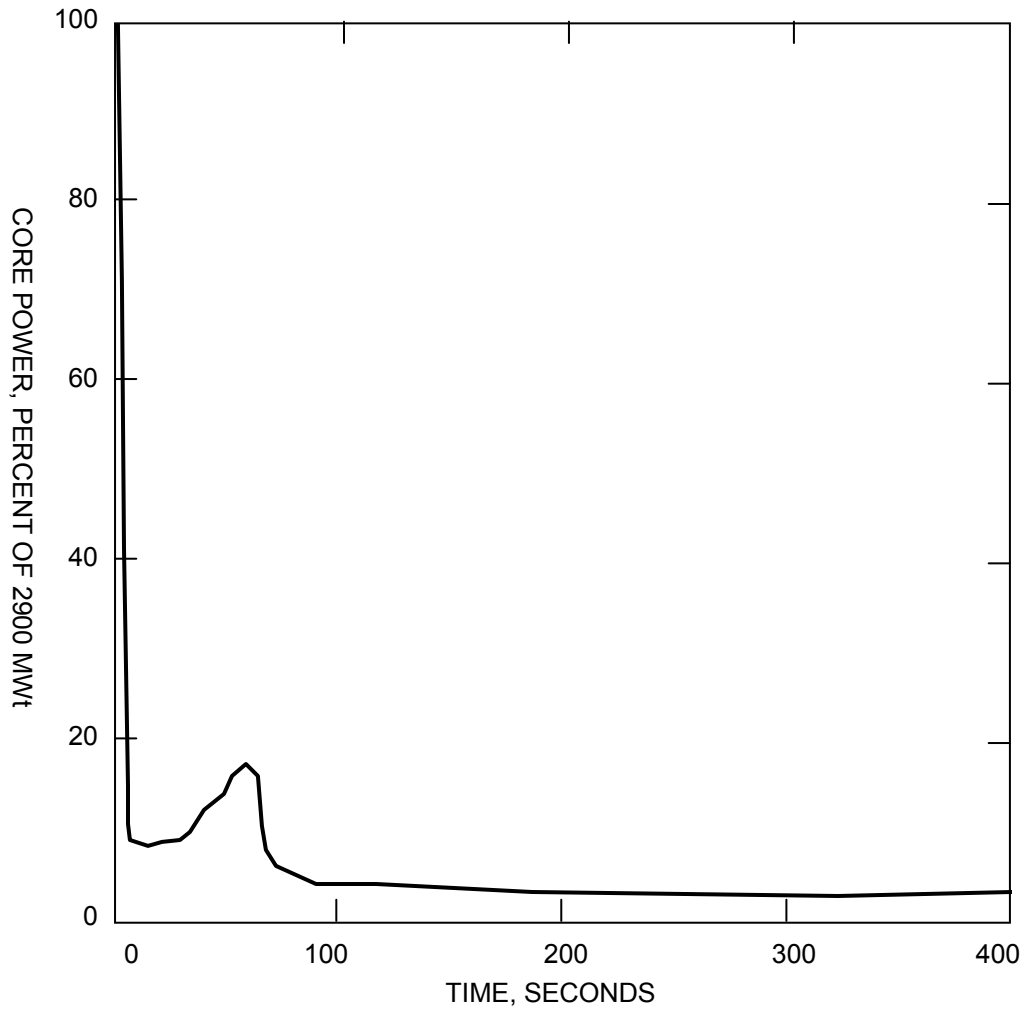

SAR FIGURE NO. 15.1.14-39

AMENDMENT 20

ARKANSAS NUCLEAR ONE
 UNIT 2
 RUSSELLVILLE, ARKANSAS



SCALE:	NONE
DRAWN:	
DESIGN:	ENERGY
CAD NO:	

STEAM LINE RUPTURE INCIDENT WITHOUT LOSS OF AC
 POWER TWO LOOP FULL POWER INITIAL CONDITON
 NOZZLE BREAK WITHOUT MOISTURE CARRYOVER

BASED ON DRAWING NO

SHEET

REV.

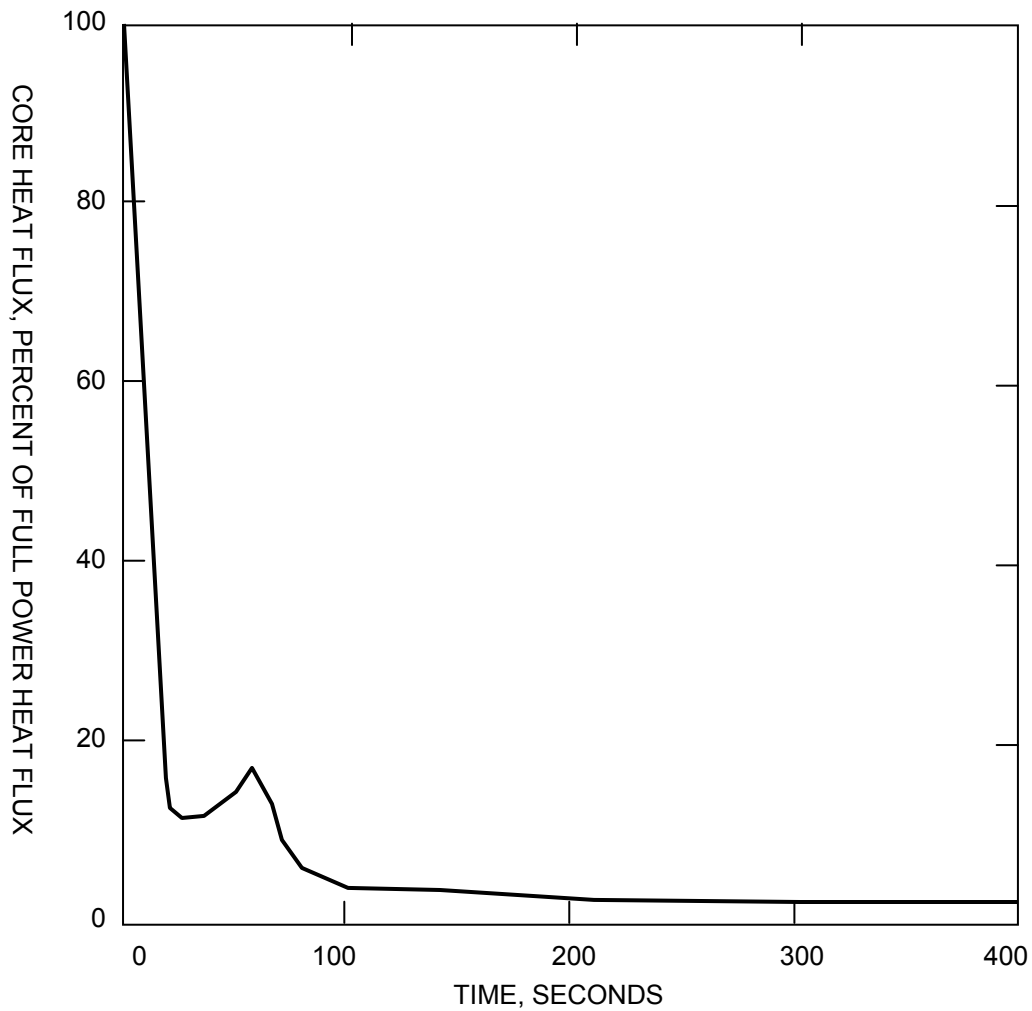

SAR FIGURE NO. 15.1.14-40

AMENDMENT 20

ARKANSAS NUCLEAR ONE
 UNIT 2
 RUSSELLVILLE, ARKANSAS



SCALE:	NONE
DRAWN:	
DESIGN:	ENERGY
CAD NO:	

STEAM LINE RUPTURE INCIDENT WITHOUT LOSS OF AC
 POWER TWO LOOP FULL POWER INITIAL CONDITON
 NOZZLE BREAK WITHOUT MOISTURE CARRYOVER

BASED ON DRAWING NO

SHEET

REV.

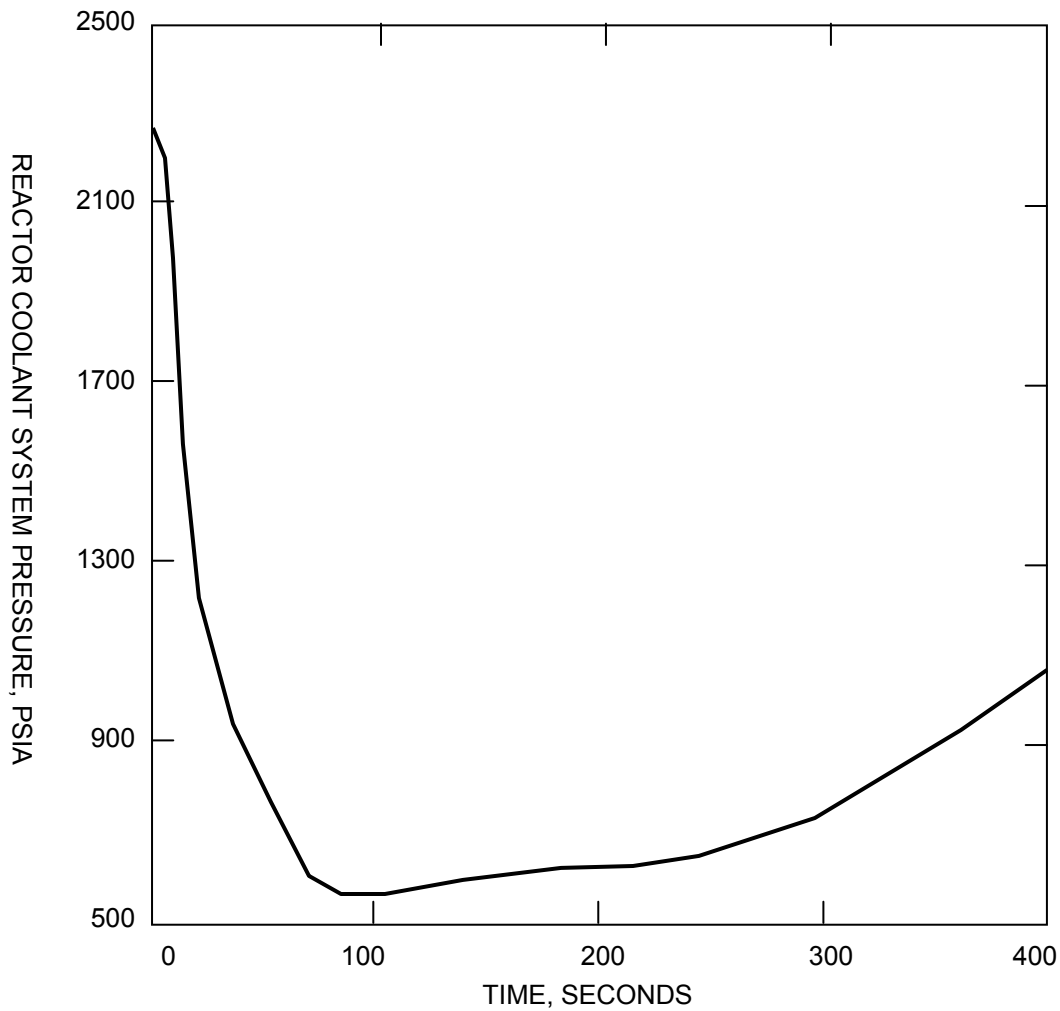

SAR FIGURE NO. 15.1.14-41

AMENDMENT 20

ARKANSAS NUCLEAR ONE
 UNIT 2
 RUSSELLVILLE, ARKANSAS



SCALE:	NONE
DRAWN:	
DESIGN:	ENERGY
CAD NO:	

STEAM LINE RUPTURE INCIDENT WITHOUT LOSS OF AC
 POWER TWO LOOP FULL POWER INITIAL CONDITON
 NOZZLE BREAK WITHOUT MOISTURE CARRYOVER

BASED ON DRAWING NO

SHEET

REV.

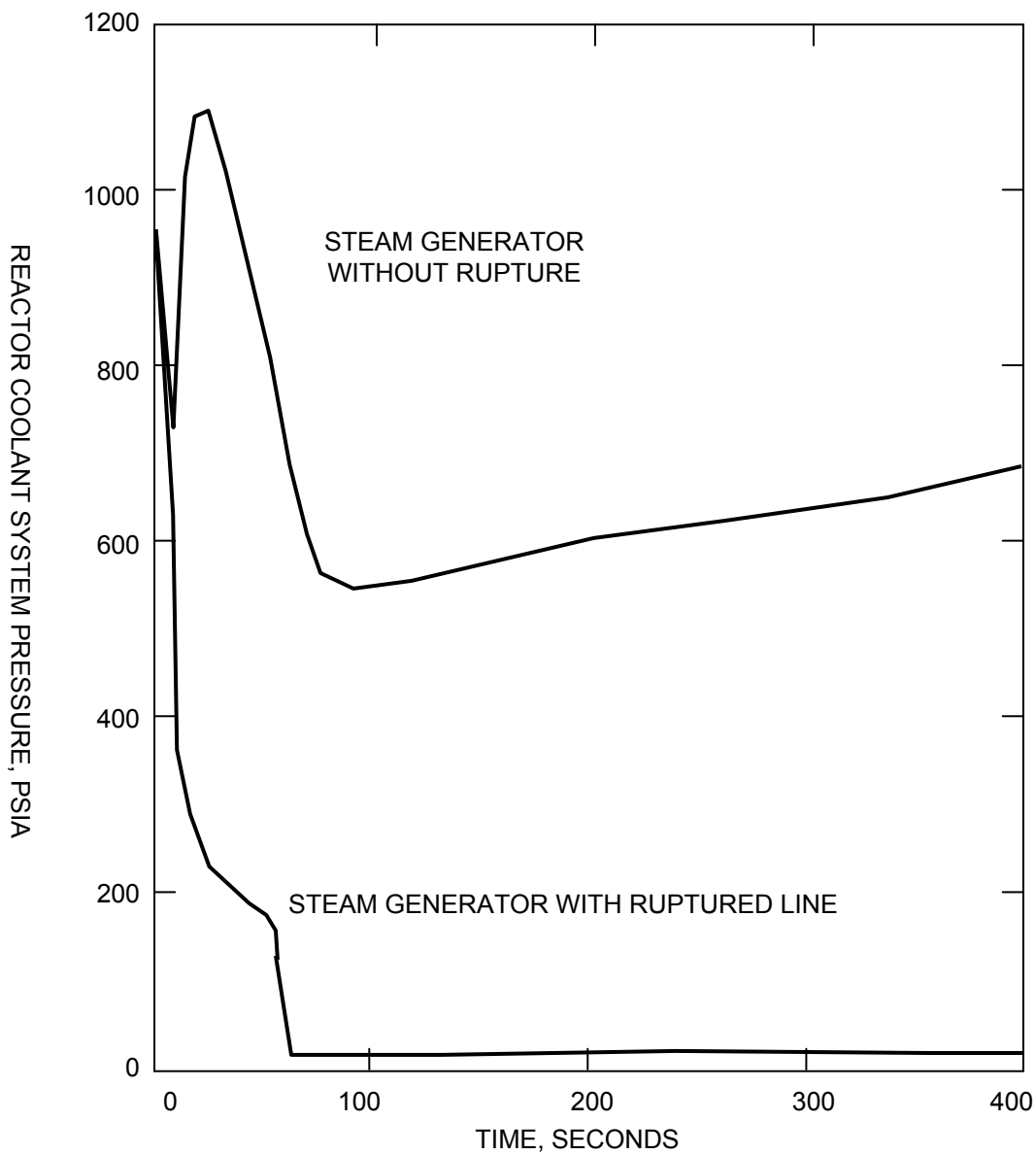

SAR FIGURE NO. 15.1.14-42

AMENDMENT 20

ARKANSAS NUCLEAR ONE
 UNIT 2
 RUSSELLVILLE, ARKANSAS



SCALE:	NONE
DRAWN:	
DESIGN:	ENERGY
CAD NO:	

STEAM LINE RUPTURE INCIDENT WITHOUT LOSS OF AC
 POWER TWO LOOP FULL POWER INITIAL CONDITON
 NOZZLE BREAK WITHOUT MOISTURE CARRYOVER

BASED ON DRAWING NO

SHEET

REV.

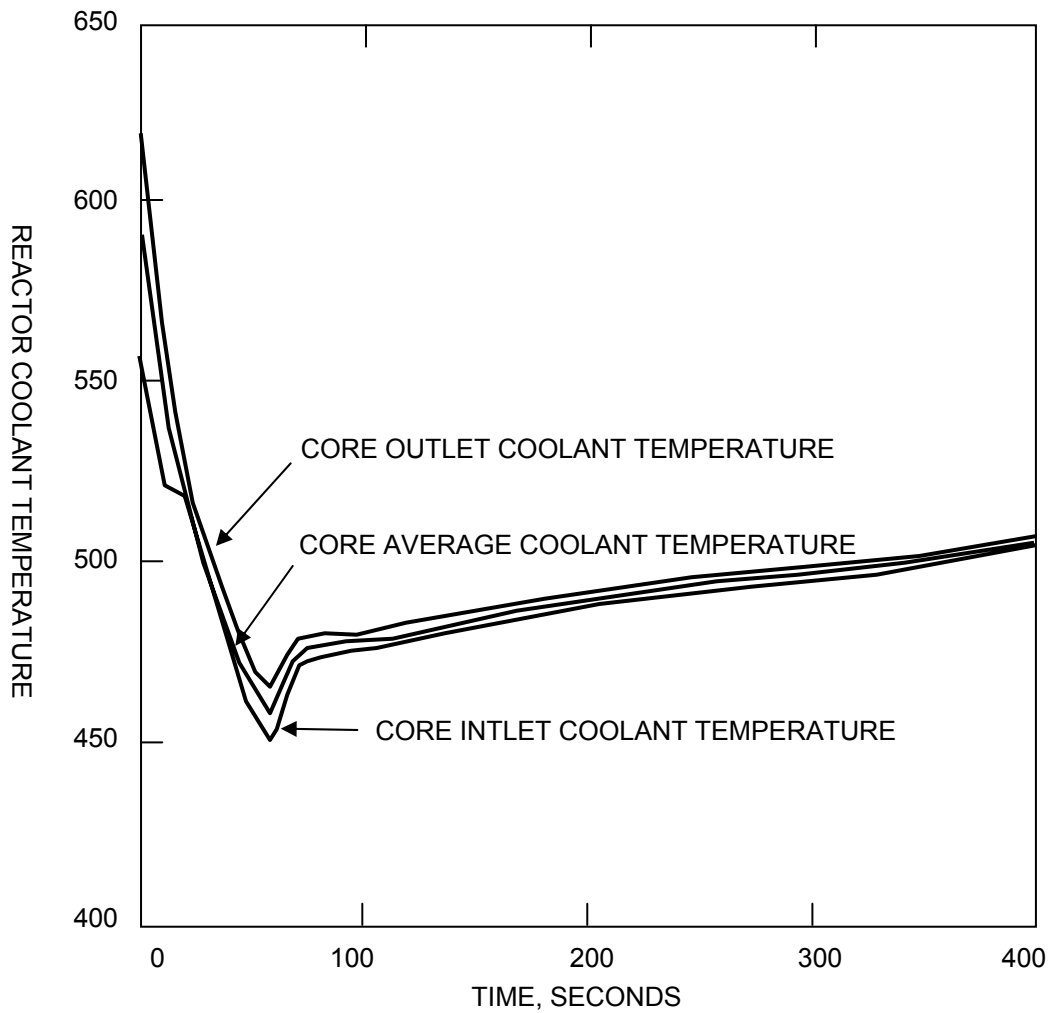

SAR FIGURE NO. 15.1.14-43

AMENDMENT 20

ARKANSAS NUCLEAR ONE
UNIT 2
RUSSELLVILLE, ARKANSAS



SCALE:	NONE
DRAWN:	
DESIGN:	ENERGY
CAD NO:	

STEAM LINE RUPTURE INCIDENT WITHOUT LOSS OF AC
POWER TWO LOOP FULL POWER INITIAL CONDITON
NOZZLE BREAK WITHOUT MOISTURE CARRYOVER

BASED ON DRAWING NO

SHEET

REV.

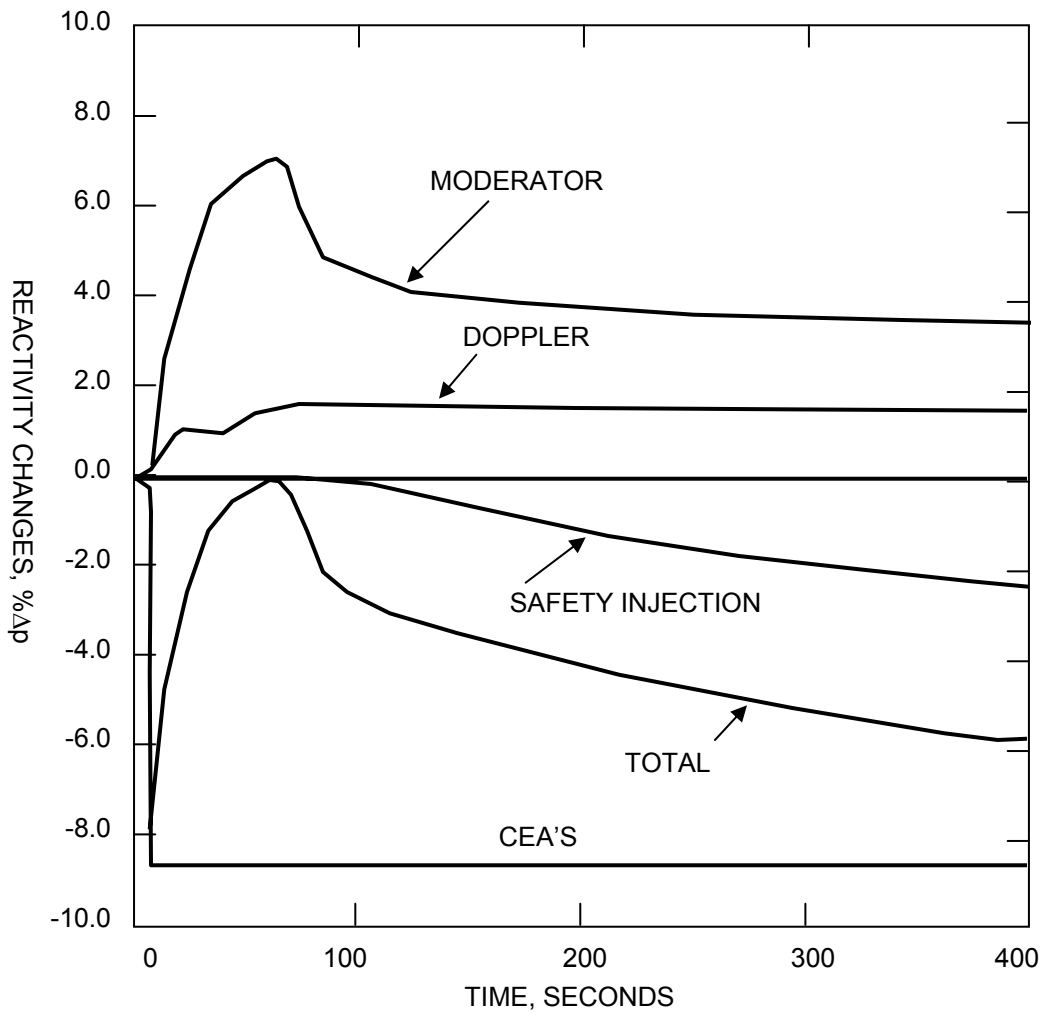

SAR FIGURE NO. 15.1.14-44

AMENDMENT 20

ARKANSAS NUCLEAR ONE
UNIT 2
RUSSELLVILLE, ARKANSAS



SCALE:	NONE
DRAWN:	
DESIGN:	ENERGY
CAD NO:	

STEAM LINE RUPTURE INCIDENT WITHOUT LOSS OF AC
POWER TWO LOOP FULL POWER INITIAL CONDITON
NOZZLE BREAK WITHOUT MOISTURE CARRYOVER

BASED ON DRAWING NO

SHEET

REV.

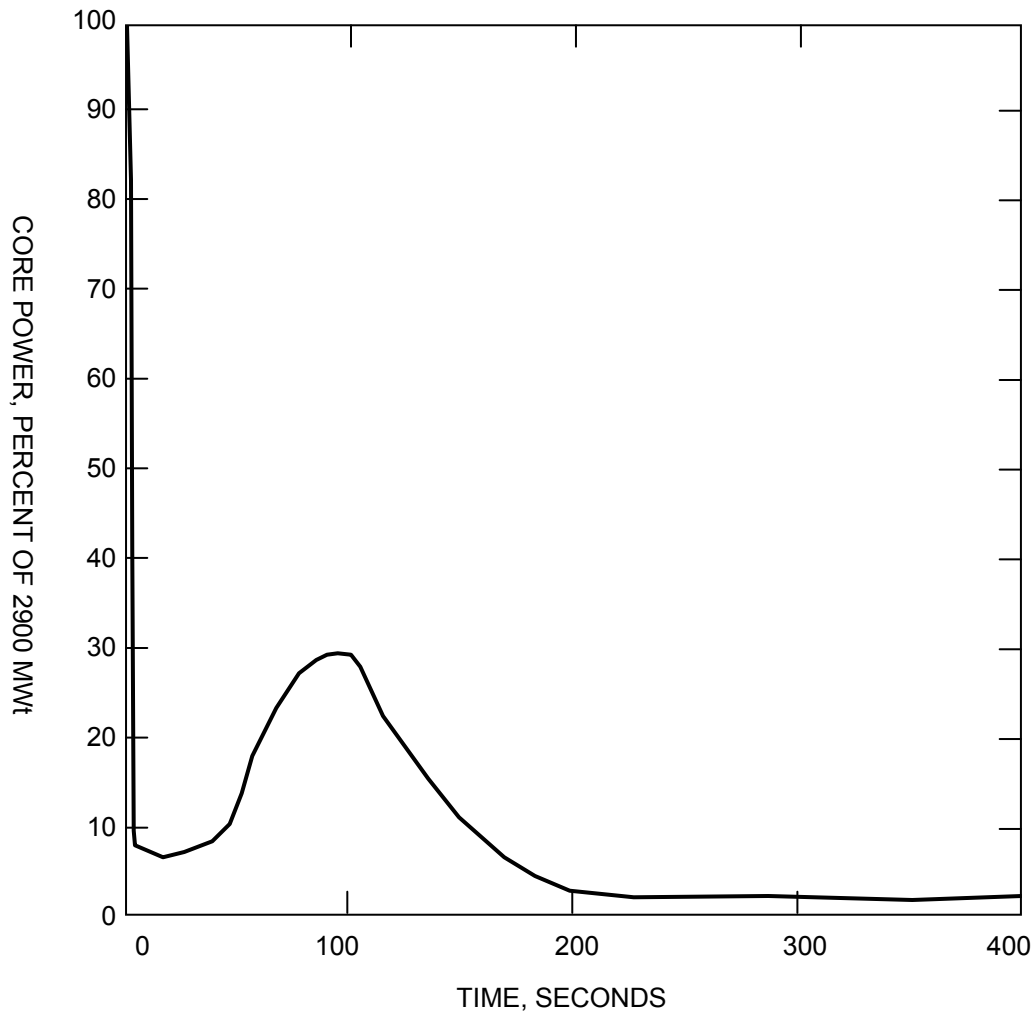

SAR FIGURE NO. 15.1.14-45

AMENDMENT 20

ARKANSAS NUCLEAR ONE
 UNIT 2
 RUSSELLVILLE, ARKANSAS



SCALE:	NONE
DRAWN:	
DESIGN:	ENERGY
CAD NO:	

STEAM LINE RUPTURE INCIDENT WITHOUT LOSS OF AC
 POWER TWO LOOP FULL POWER INITIAL CONDITON
 NOZZLE BREAK WITHOUT MOISTURE CARRYOVER

BASED ON DRAWING NO

SHEET

REV.

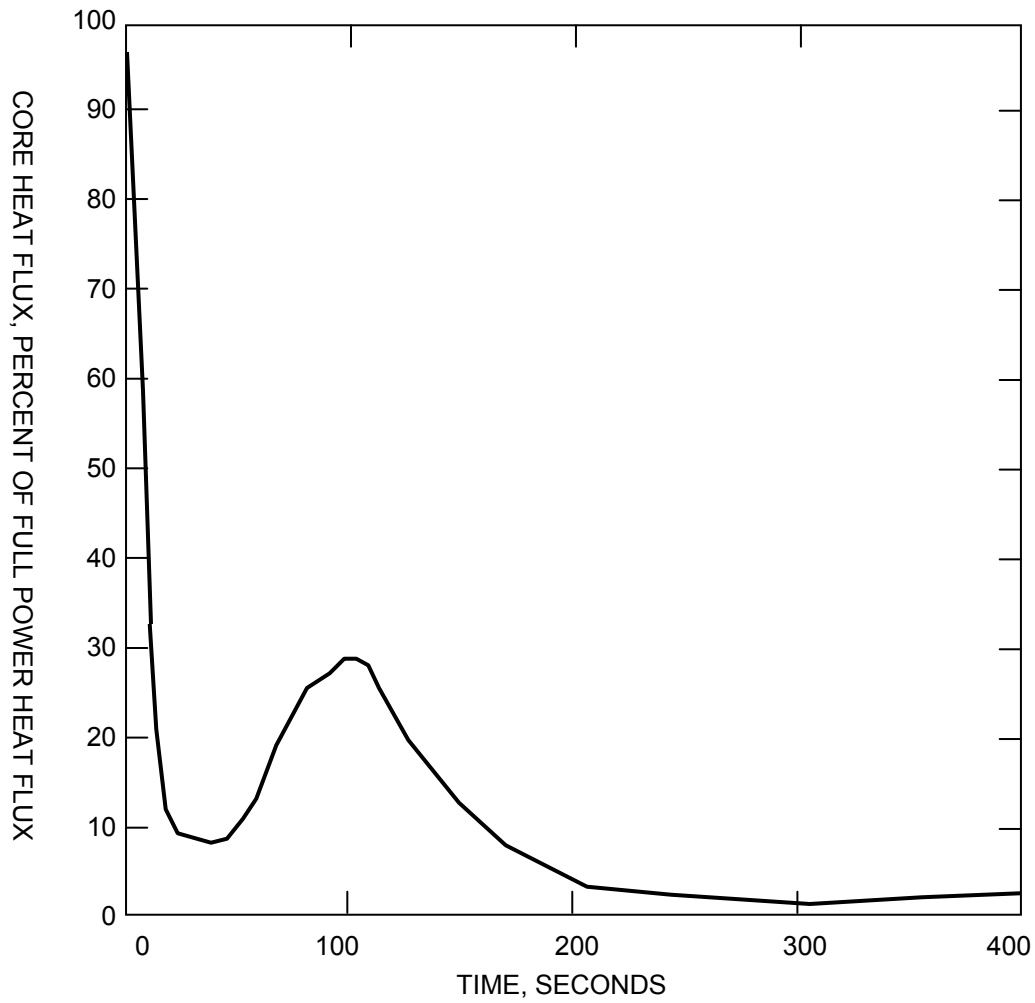

SAR FIGURE NO. 15.1.14-46

AMENDMENT 20

ARKANSAS NUCLEAR ONE
 UNIT 2
 RUSSELLVILLE, ARKANSAS



SCALE:	NONE
DRAWN:	
DESIGN:	ENERGY
CAD NO:	

STEAM LINE RUPTURE INCIDENT WITHOUT LOSS OF AC
 POWER TWO LOOP FULL POWER INITIAL CONDITON
 NOZZLE BREAK WITHOUT MOISTURE CARRYOVER

BASED ON DRAWING NO

SHEET

REV.

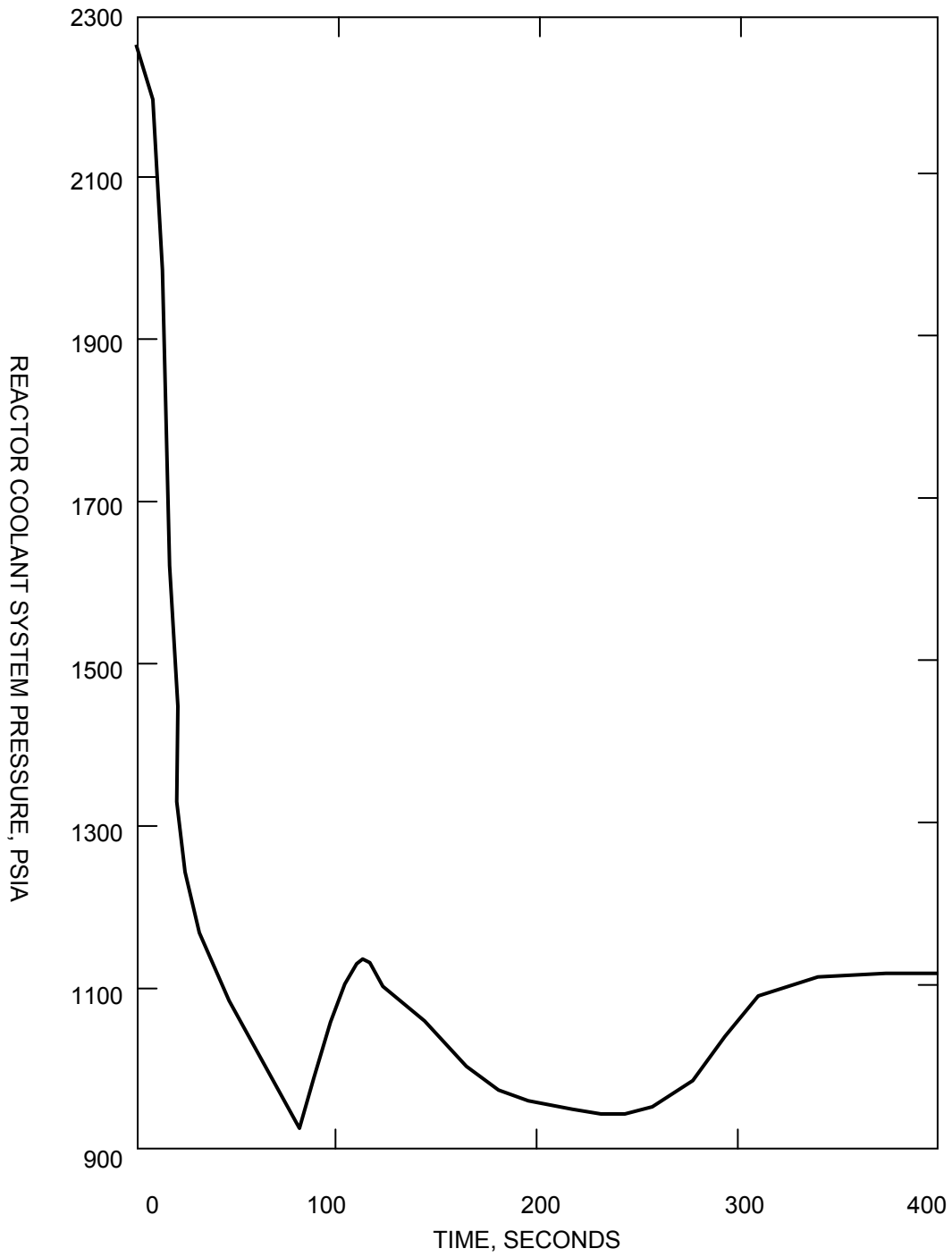

SAR FIGURE NO. 15.1.14-47

AMENDMENT 20

ARKANSAS NUCLEAR ONE
 UNIT 2
 RUSSELLVILLE, ARKANSAS



SCALE:	NONE
DRAWN:	
DESIGN:	ENERGY
CAD NO:	

STEAM LINE RUPTURE INCIDENT WITHOUT LOSS OF AC
 POWER TWO LOOP FULL POWER INITIAL CONDITON
 NOZZLE BREAK WITHOUT MOISTURE CARRYOVER

BASED ON DRAWING NO

SHEET

REV.

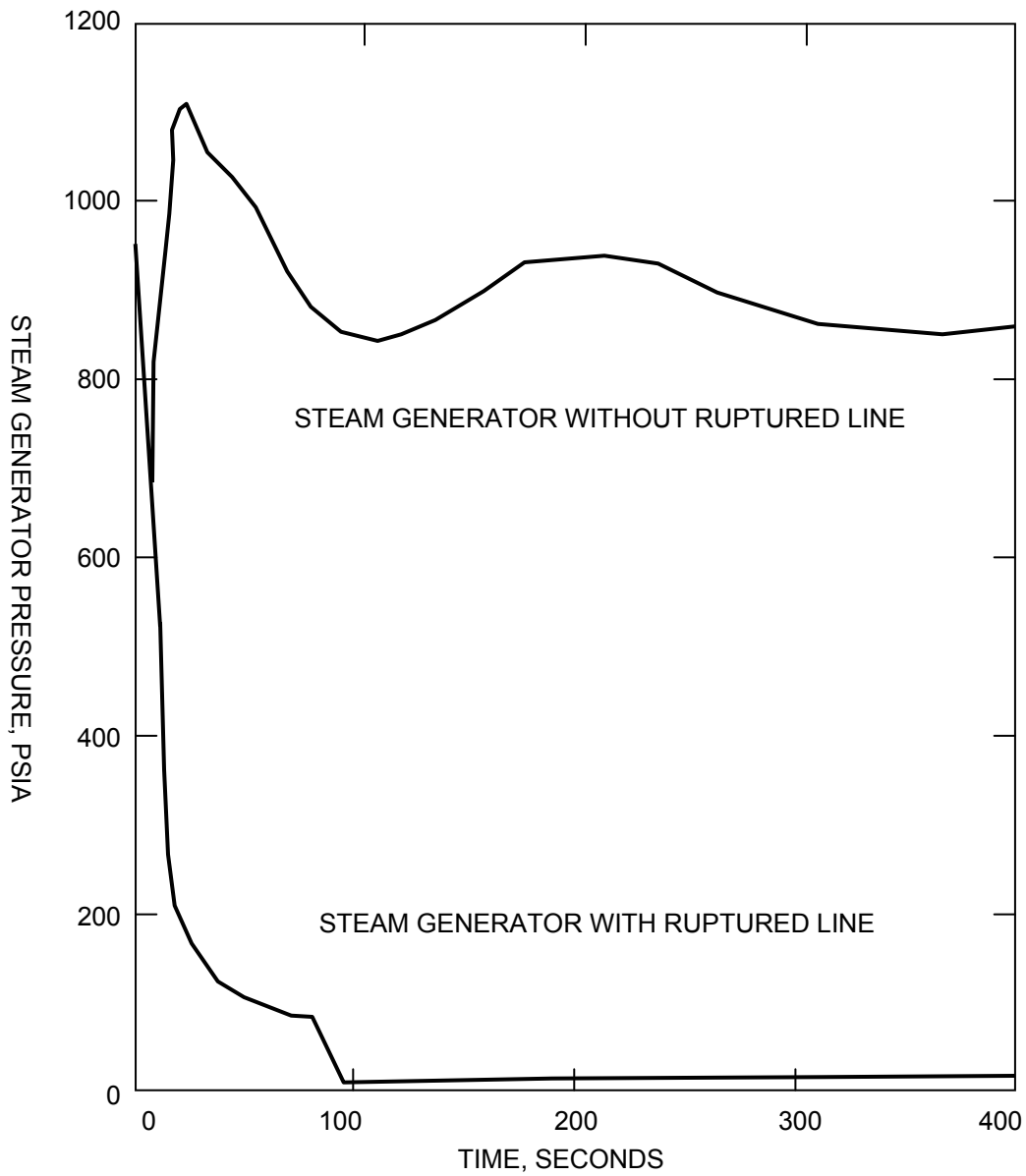

SAR FIGURE NO. 15.1.14-48

AMENDMENT 20

ARKANSAS NUCLEAR ONE
 UNIT 2
 RUSSELLVILLE, ARKANSAS



SCALE:	NONE
DRAWN:	
DESIGN:	ENERGY
CAD NO:	

STEAM LINE RUPTURE INCIDENT WITHOUT LOSS OF AC
 POWER TWO LOOP FULL POWER INITIAL CONDITON
 NOZZLE BREAK WITHOUT MOISTURE CARRYOVER

BASED ON DRAWING NO

SHEET

REV.

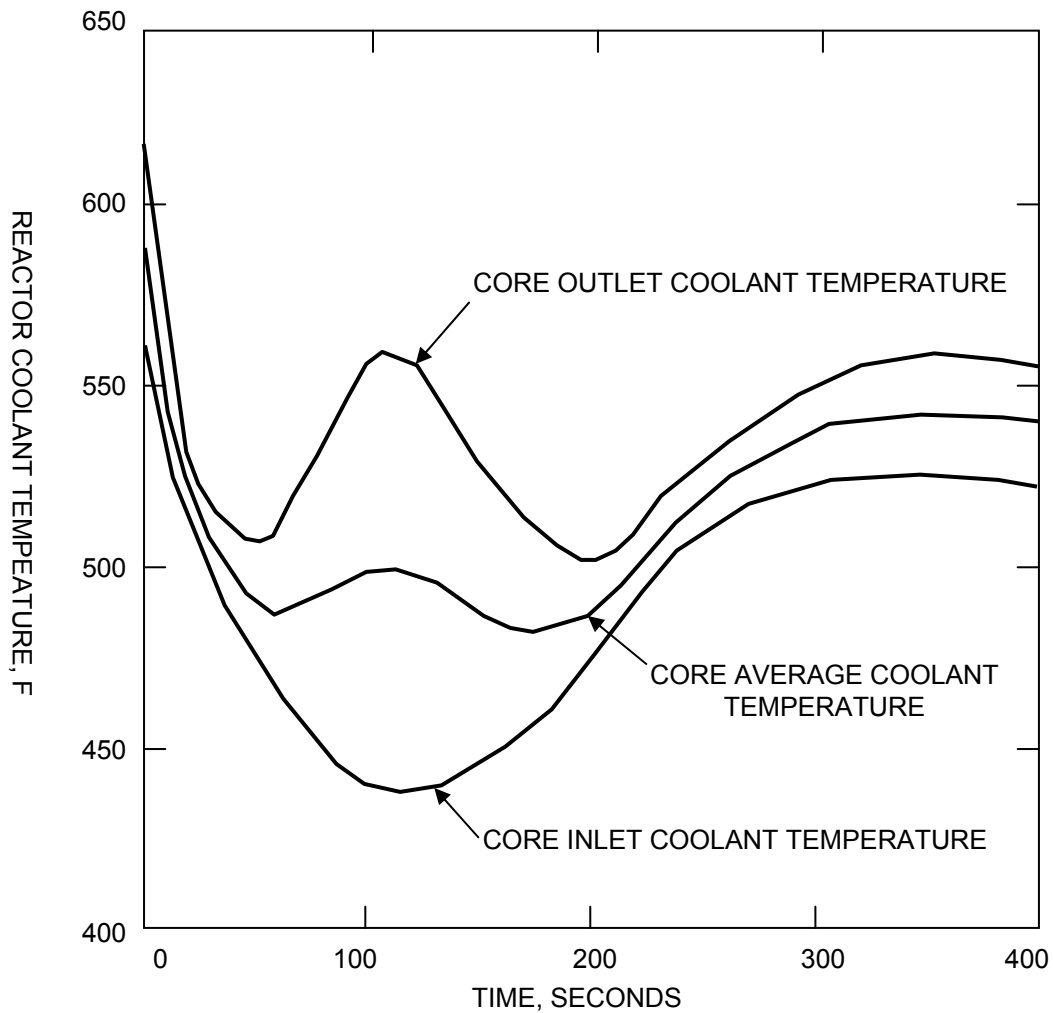

SAR FIGURE NO. 15.1.14-49

AMENDMENT 20

ARKANSAS NUCLEAR ONE
 UNIT 2
 RUSSELLVILLE, ARKANSAS



SCALE:	NONE
DRAWN:	
DESIGN:	ENERGY
CAD NO:	

STEAM LINE RUPTURE INCIDENT WITHOUT LOSS OF AC
 POWER TWO LOOP FULL POWER INITIAL CONDITON
 NOZZLE BREAK WITHOUT MOISTURE CARRYOVER

BASED ON DRAWING NO

SHEET

REV.

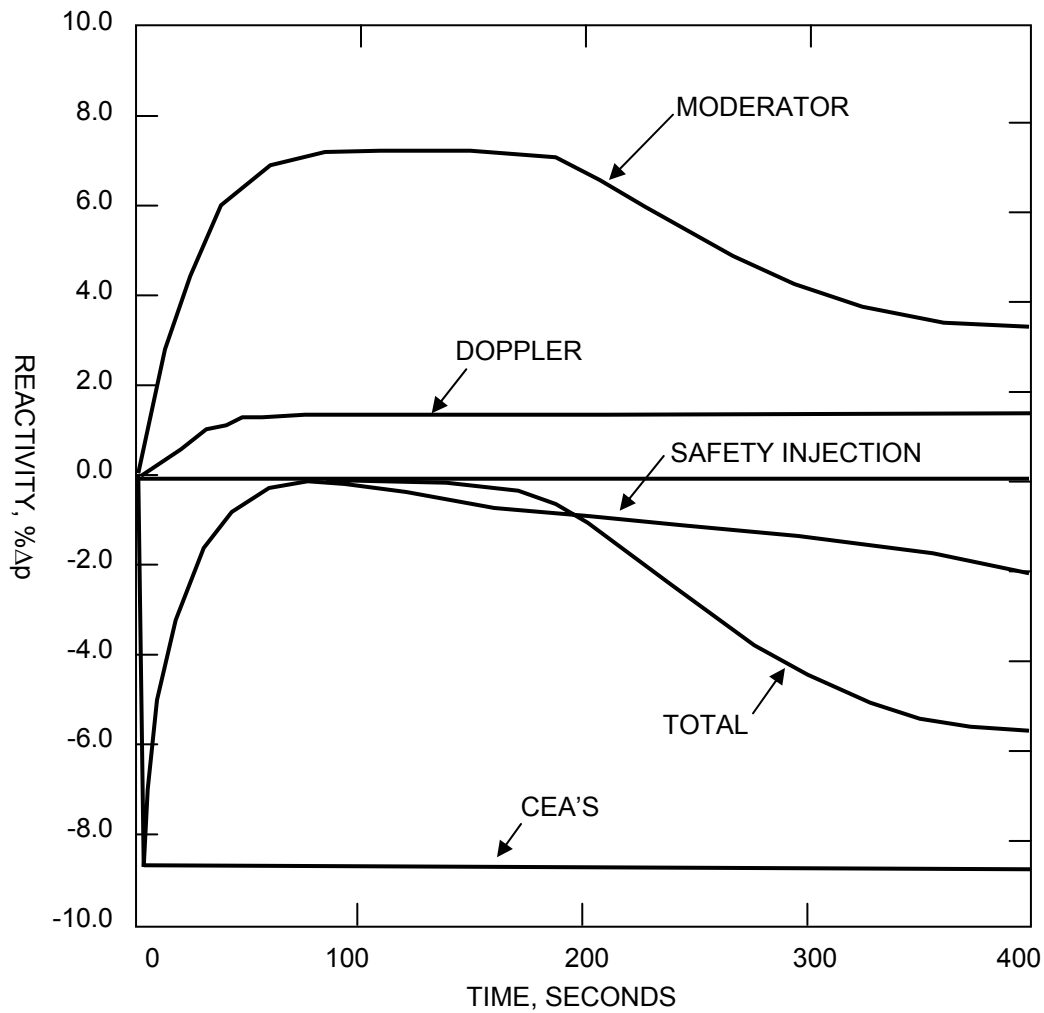

SAR FIGURE NO. 15.1.14-50

AMENDMENT 20

ARKANSAS NUCLEAR ONE
UNIT 2
RUSSELLVILLE, ARKANSAS



SCALE:	NONE
DRAWN:	
DESIGN:	ENERGY
CAD NO:	

STEAM LINE RUPTURE INCIDENT WITHOUT LOSS OF AC
POWER TWO LOOP FULL POWER INITIAL CONDITON
NOZZLE BREAK WITHOUT MOISTURE CARRYOVER

BASED ON DRAWING NO

SHEET

REV.

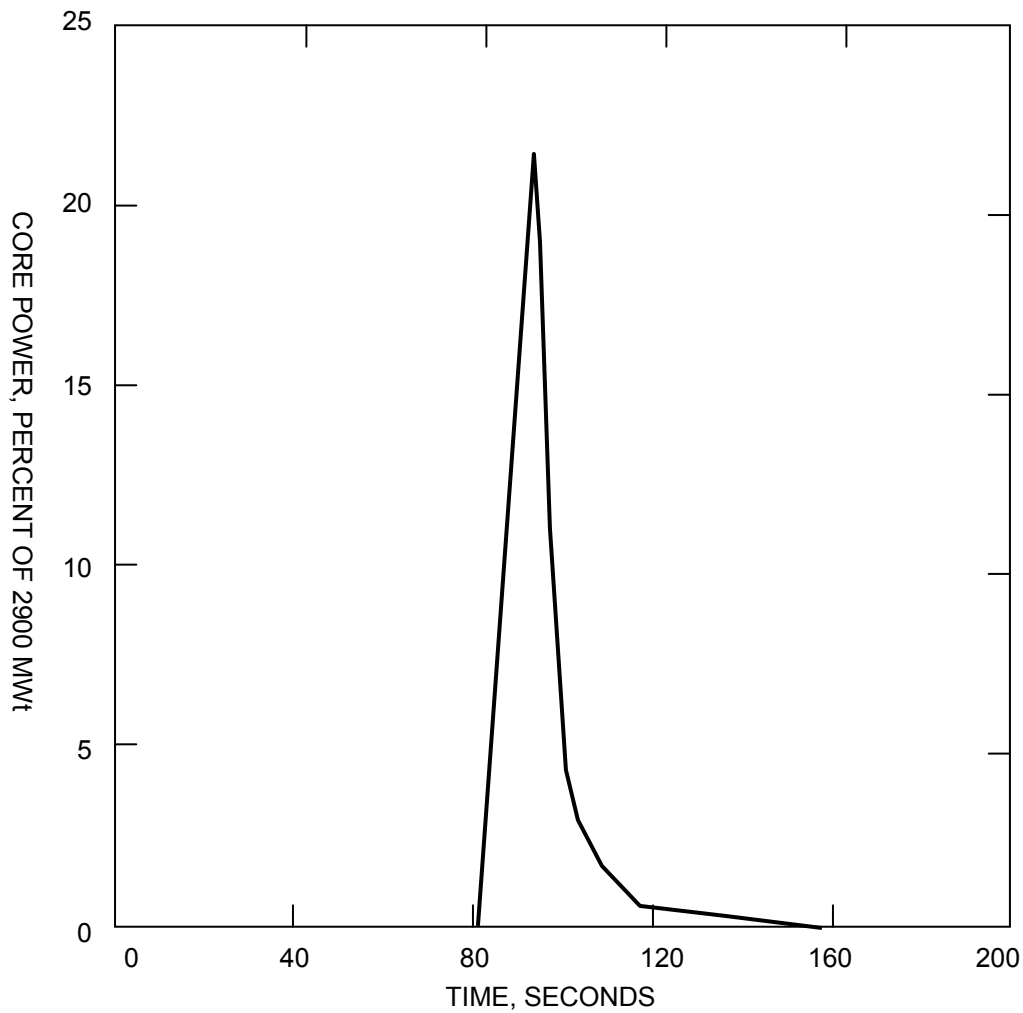

SAR FIGURE NO. 15.1.14-51

AMENDMENT 20

ARKANSAS NUCLEAR ONE
 UNIT 2
 RUSSELLVILLE, ARKANSAS



SCALE:	NONE
DRAWN:	
DESIGN:	ENERGY
CAD NO:	

STEAM LINE RUPTURE INCIDENT WITHOUT LOSS OF AC
 POWER TWO LOOP NO LOAD INITIAL CONDITON NOZZLE
 BREAK WITHOUT MOISTURE CARRYOVER

BASED ON DRAWING NO

SHEET

REV.

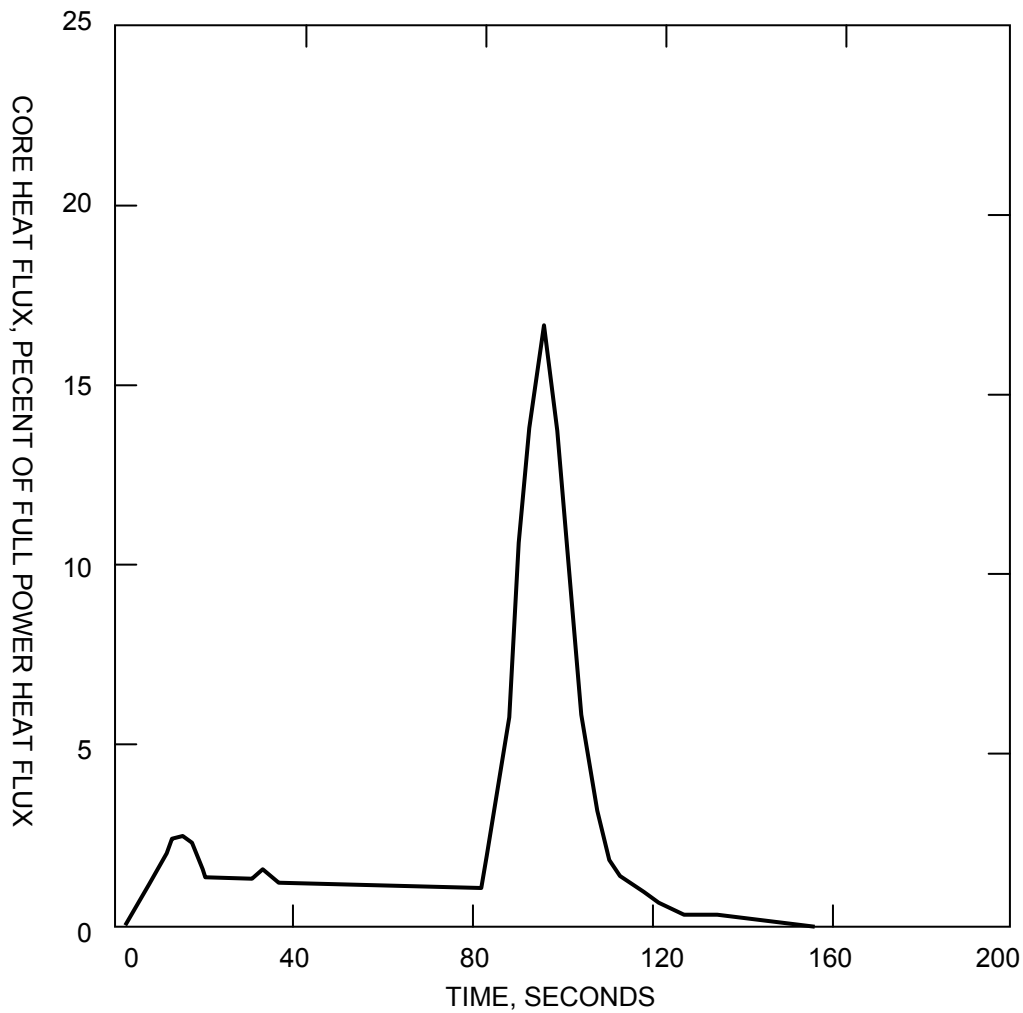

SAR FIGURE NO. 15.1.14-52

AMENDMENT 20

ARKANSAS NUCLEAR ONE
 UNIT 2
 RUSSELLVILLE, ARKANSAS



SCALE:	NONE
DRAWN:	
DESIGN:	ENERGY
CAD NO:	

STEAM LINE RUPTURE INCIDENT WITHOUT LOSS OF AC
 POWER TWO LOOP NO LOAD INITIAL CONDITON NOZZLE
 BREAK WITHOUT MOISTURE CARRYOVER

BASED ON DRAWING NO

SHEET

REV.

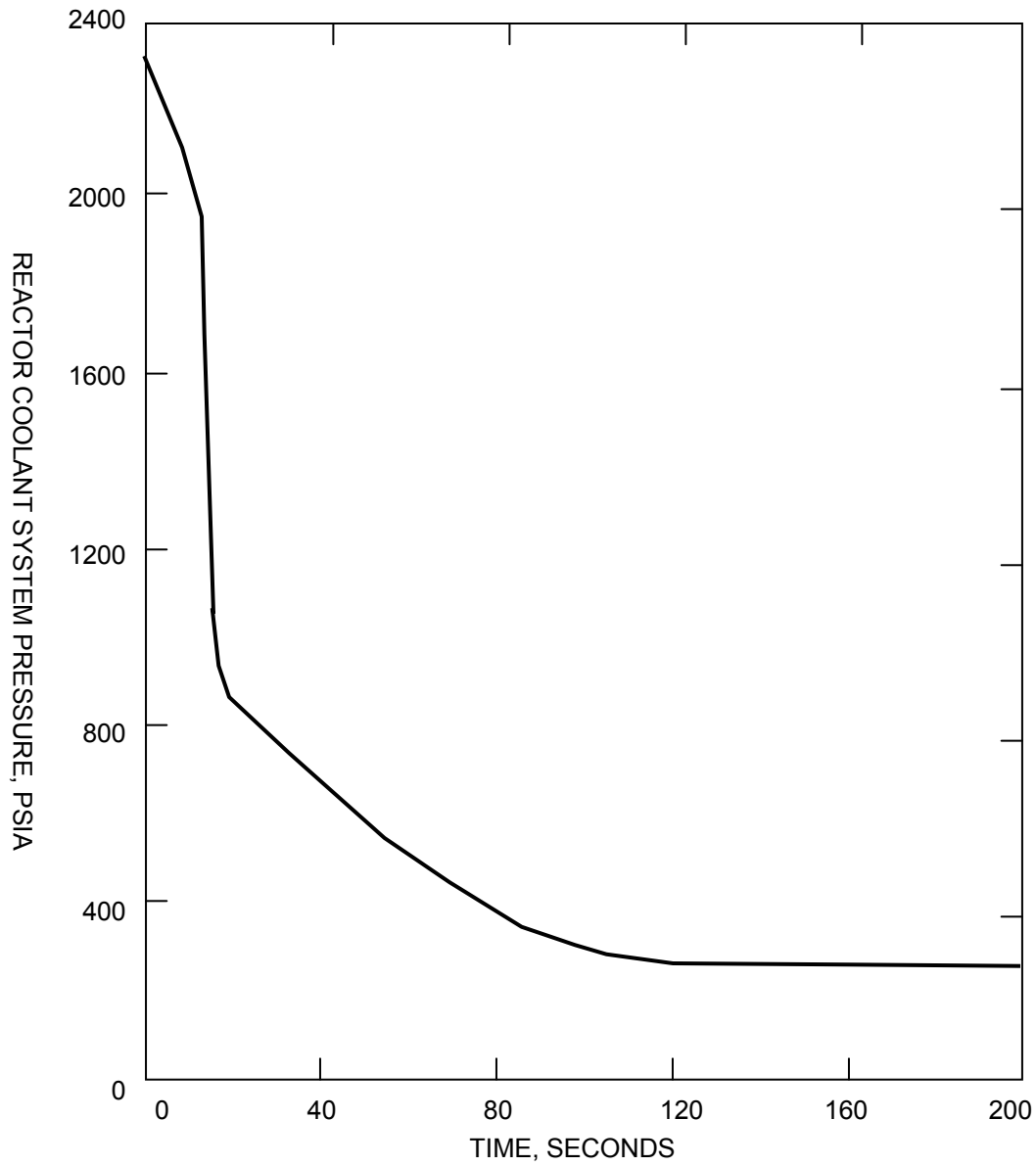

SAR FIGURE NO. 15.1.14-53

AMENDMENT 20

ARKANSAS NUCLEAR ONE
 UNIT 2
 RUSSELLVILLE, ARKANSAS



SCALE:	NONE
DRAWN:	
DESIGN:	ENERGY
CAD NO:	

STEAM LINE RUPTURE INCIDENT WITHOUT LOSS OF AC
 POWER TWO LOOP NO LOAD INITIAL CONDITON NOZZLE
 BREAK WITHOUT MOISTURE CARRYOVER

BASED ON DRAWING NO

SHEET

REV.

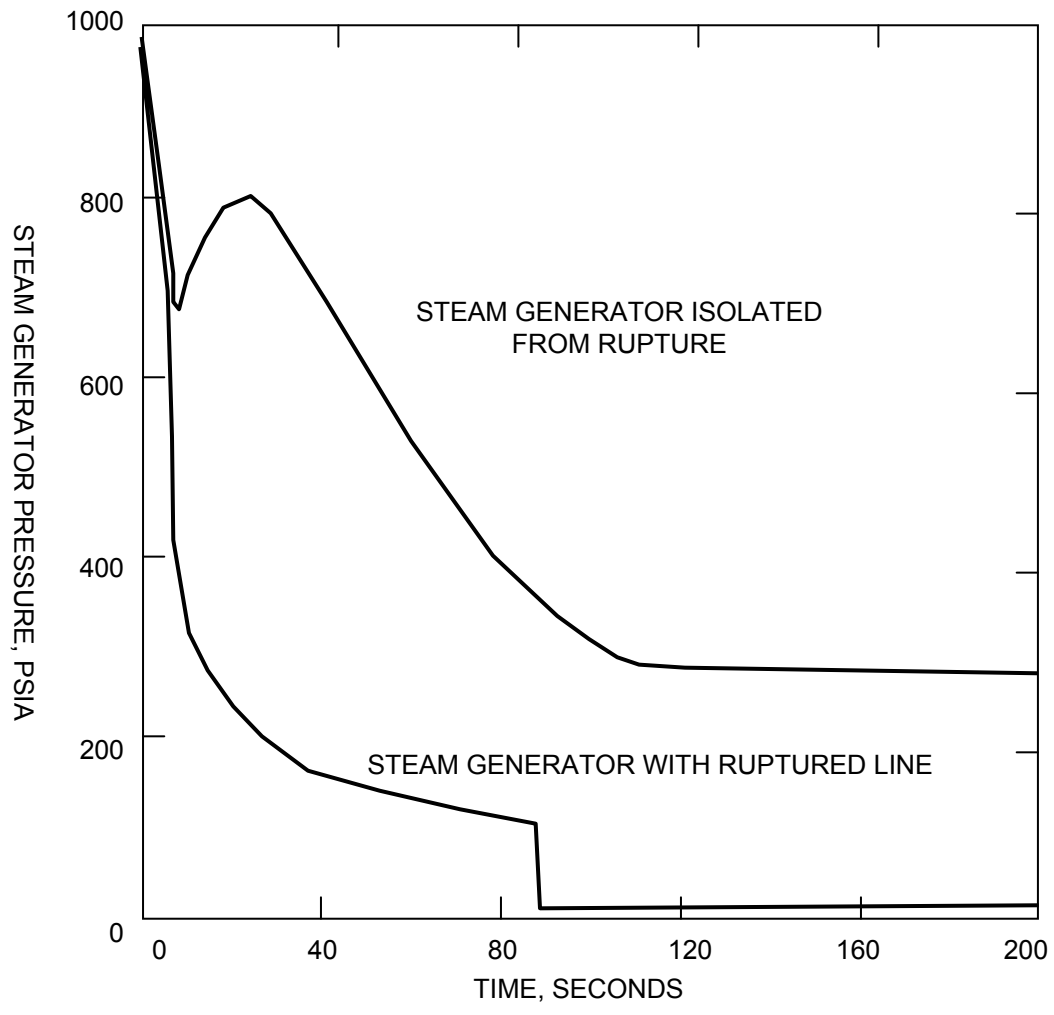

SAR FIGURE NO. 15.1.14-54

AMENDMENT 20

ARKANSAS NUCLEAR ONE
 UNIT 2
 RUSSELLVILLE, ARKANSAS



SCALE:	NONE
DRAWN:	
DESIGN:	ENERGY
CAD NO:	

STEAM LINE RUPTURE INCIDENT WITHOUT LOSS OF AC
 POWER TWO LOOP NO LOAD INITIAL CONDITON NOZZLE
 BREAK WITHOUT MOISTURE CARRYOVER

BASED ON DRAWING NO	SHEET	REV.

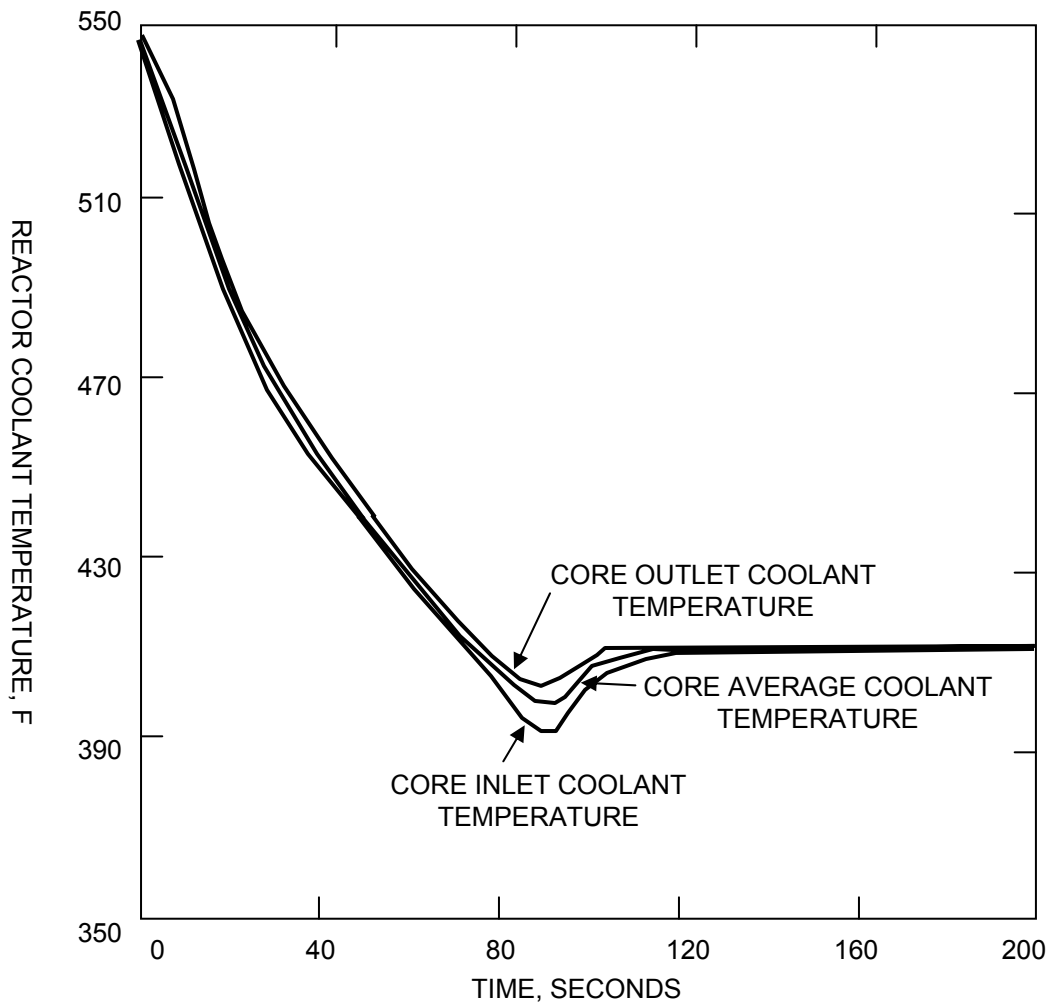

SAR FIGURE NO. 15.1.14-55

AMENDMENT 20

ARKANSAS NUCLEAR ONE
 UNIT 2
 RUSSELLVILLE, ARKANSAS



SCALE:	NONE
DRAWN:	
DESIGN:	ENERGY
CAD NO:	

STEAM LINE RUPTURE INCIDENT WITHOUT LOSS OF AC
 POWER TWO LOOP NO LOAD INITIAL CONDITON NOZZLE
 BREAK WITHOUT MOISTURE CARRYOVER

BASED ON DRAWING NO

SHEET

REV.

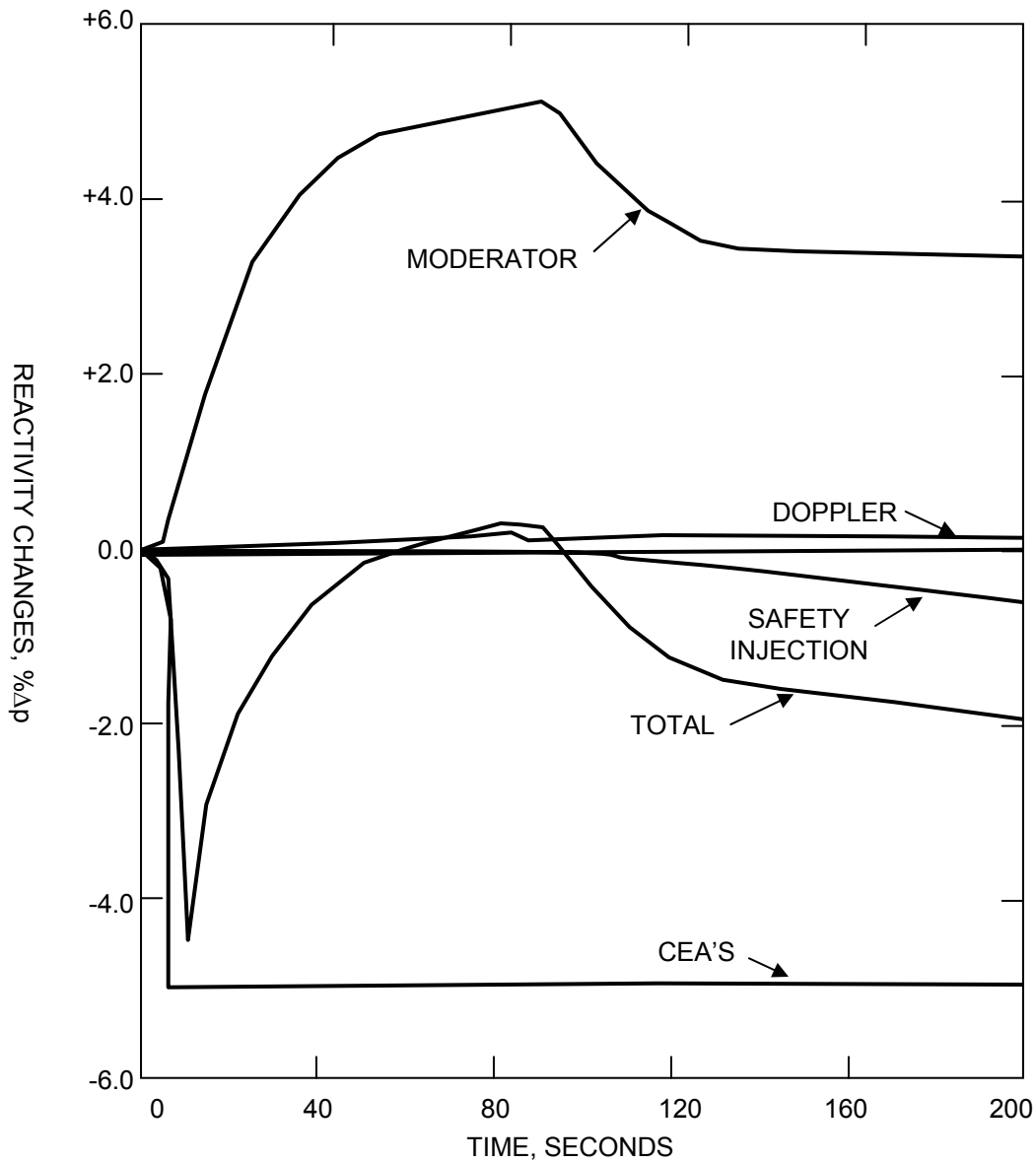

SAR FIGURE NO. 15.1.14-56

AMENDMENT 20

ARKANSAS NUCLEAR ONE
UNIT 2
RUSSELLVILLE, ARKANSAS



SCALE:	NONE
DRAWN:	
DESIGN:	ENERGY
CAD NO:	

STEAM LINE RUPTURE INCIDENT WITHOUT LOSS OF AC
POWER TWO LOOP NO LOAD INITIAL CONDITON NOZZLE
BREAK WITHOUT MOISTURE CARRYOVER

BASED ON DRAWING NO

SHEET

REV.

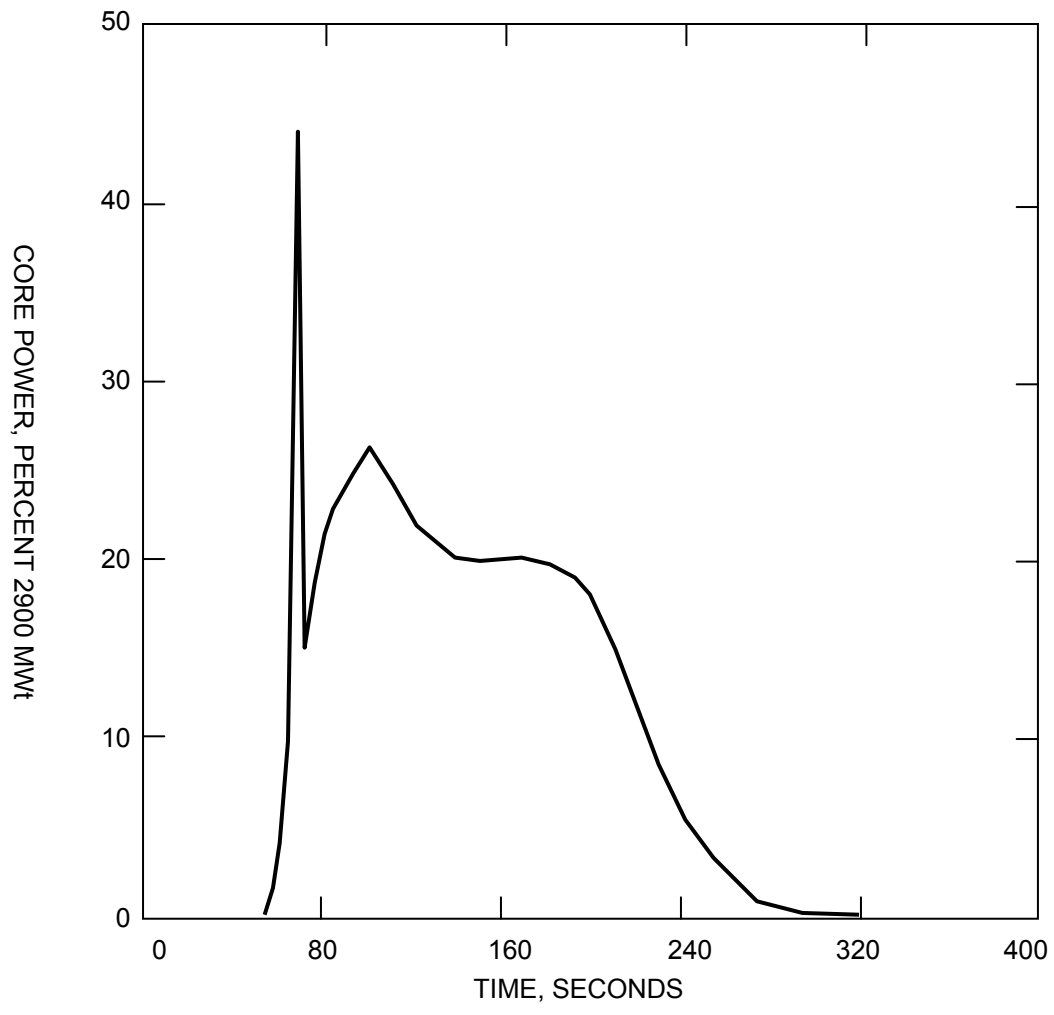

SAR FIGURE NO. 15.1.14-57

AMENDMENT 20

ARKANSAS NUCLEAR ONE
 UNIT 2
 RUSSELLVILLE, ARKANSAS



SCALE:	NONE
DRAWN:	
DESIGN:	ENERGY
CAD NO:	

STEAM LINE RUPTURE INCIDENT WITHOUT LOSS OF AC
 POWER TWO LOOP NO LOAD INITIAL CONDITON NOZZLE
 BREAK WITHOUT MOISTURE CARRYOVER

BASED ON DRAWING NO	SHEET	REV.

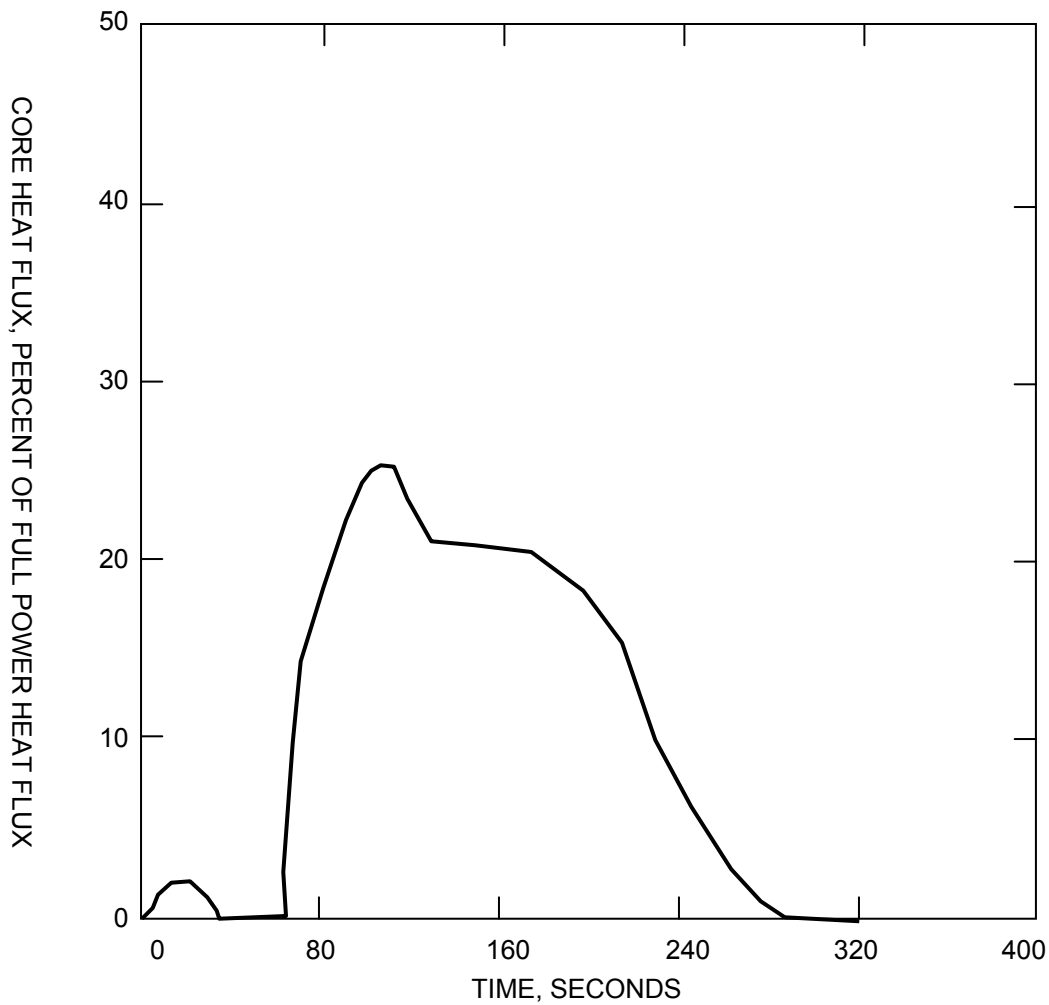

SAR FIGURE NO. 15.1.14-58

AMENDMENT 20

ARKANSAS NUCLEAR ONE
 UNIT 2
 RUSSELLVILLE, ARKANSAS



SCALE:	NONE
DRAWN:	
DESIGN:	ENERGY
CAD NO:	

STEAM LINE RUPTURE INCIDENT WITHOUT LOSS OF AC
 POWER TWO LOOP NO LOAD INITIAL CONDITON NOZZLE
 BREAK WITHOUT MOISTURE CARRYOVER

BASED ON DRAWING NO

SHEET

REV.

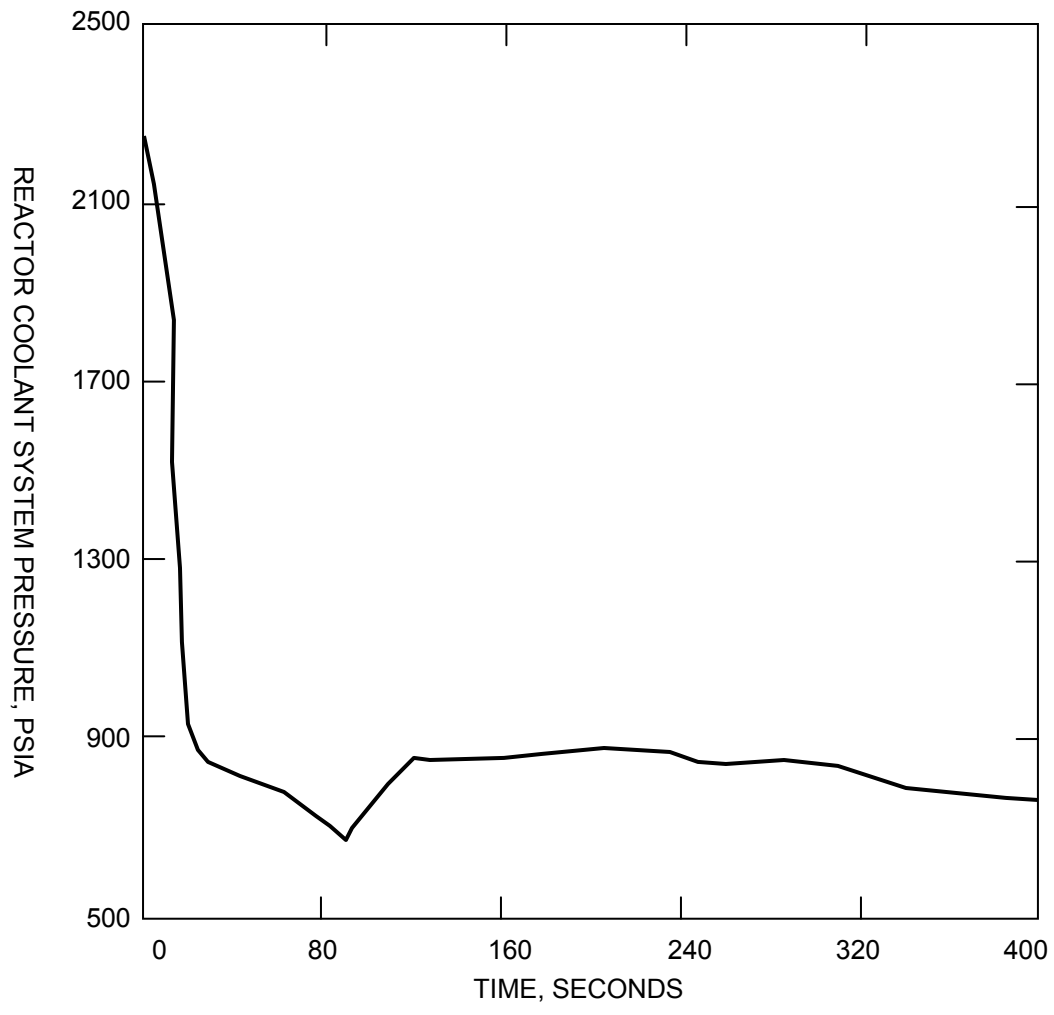

SAR FIGURE NO. 15.1.14-59

AMENDMENT 20

ARKANSAS NUCLEAR ONE
 UNIT 2
 RUSSELLVILLE, ARKANSAS



SCALE: NONE

DRAWN:

DESIGN: ENTERGY

CAD NO:

STEAM LINE RUPTURE INCIDENT WITHOUT LOSS OF AC
 POWER TWO LOOP NO LOAD INITIAL CONDITON NOZZLE
 BREAK WITHOUT MOISTURE CARRYOVER

BASED ON DRAWING NO

SHEET

REV.

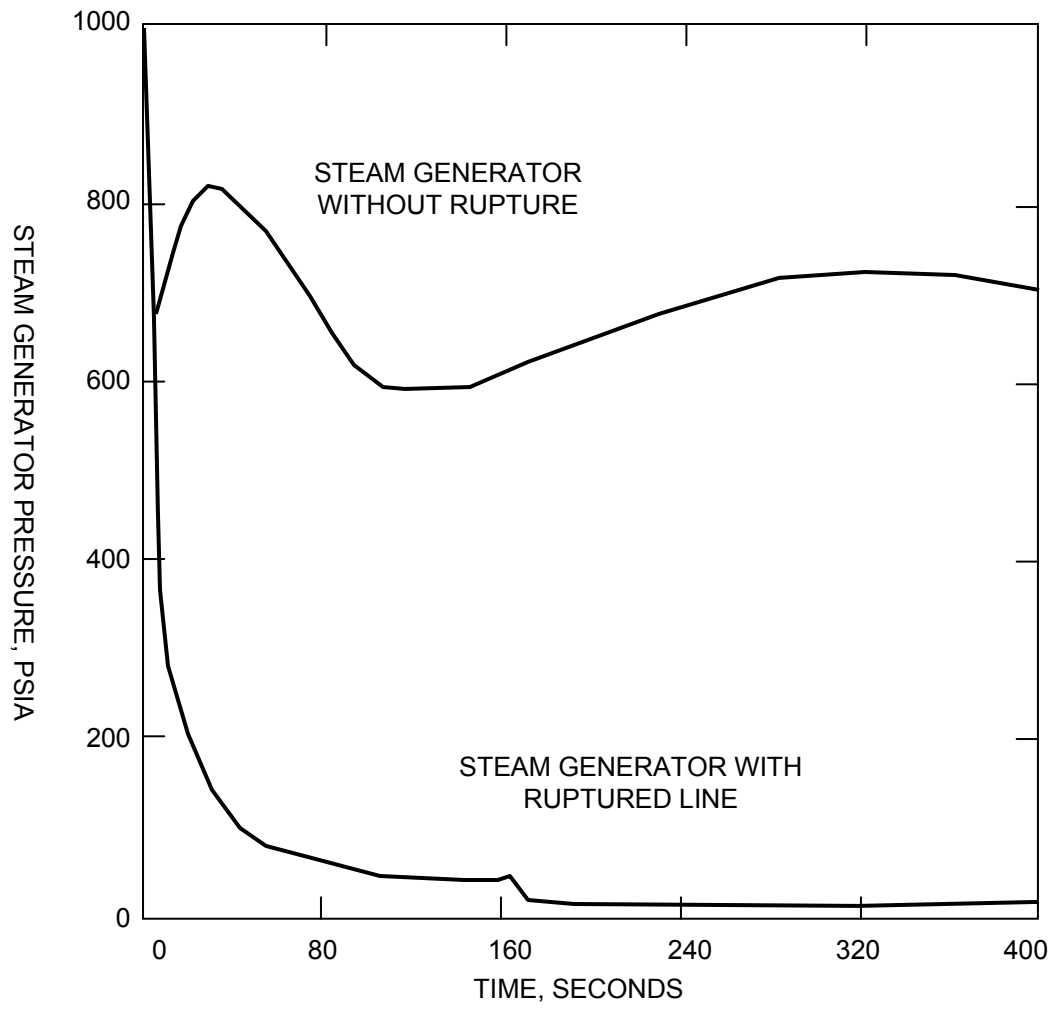

SAR FIGURE NO. 15.1.14-60

AMENDMENT 20

ARKANSAS NUCLEAR ONE
 UNIT 2
 RUSSELLVILLE, ARKANSAS



SCALE:	NONE
DRAWN:	
DESIGN:	ENERGY
CAD NO:	

STEAM LINE RUPTURE INCIDENT WITHOUT LOSS OF AC
 POWER TWO LOOP NO LOAD INITIAL CONDITON NOZZLE
 BREAK WITHOUT MOISTURE CARRYOVER

BASED ON DRAWING NO	SHEET	REV.

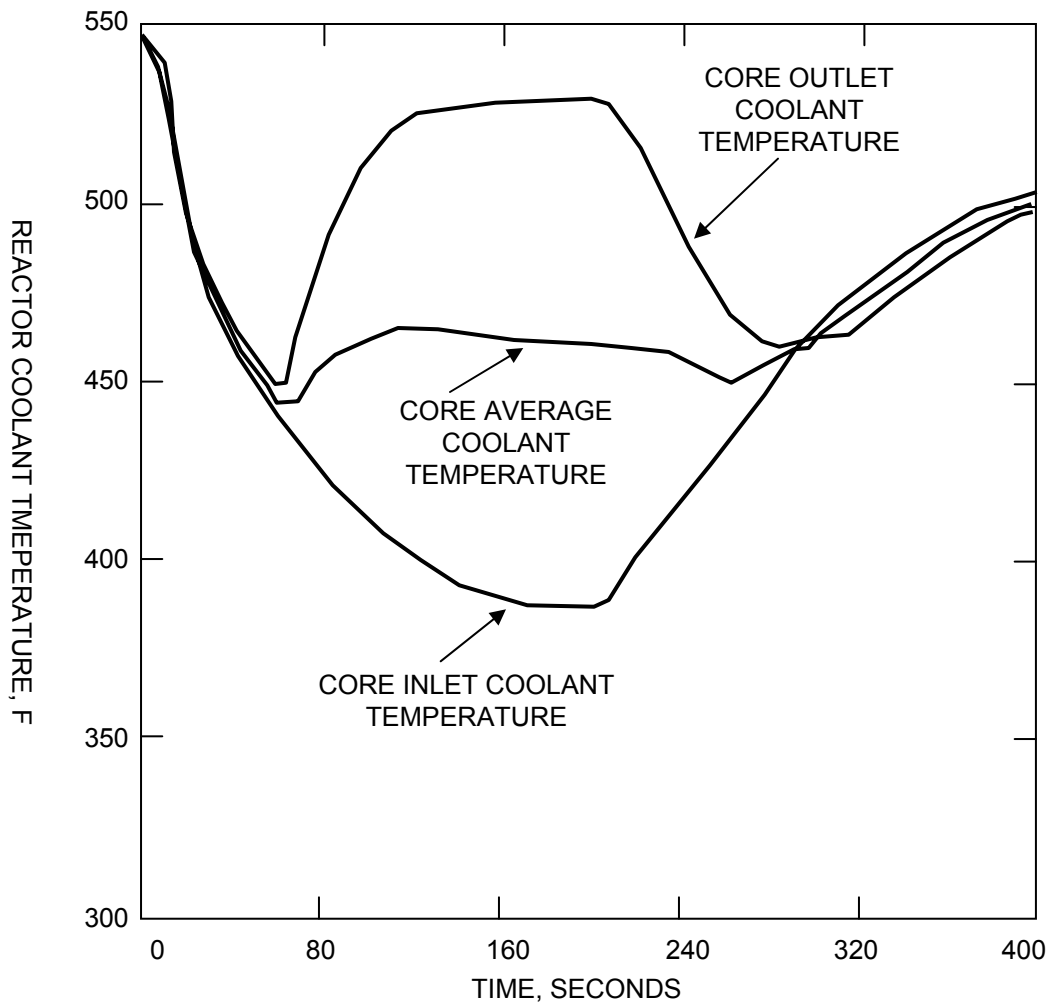

SAR FIGURE NO. 15.1.14-61

AMENDMENT 20

ARKANSAS NUCLEAR ONE
 UNIT 2
 RUSSELLVILLE, ARKANSAS



SCALE:	NONE
DRAWN:	
DESIGN:	ENERGY
CAD NO:	

STEAM LINE RUPTURE INCIDENT WITHOUT LOSS OF AC
 POWER TWO LOOP NO LOAD INITIAL CONDITON NOZZLE
 BREAK WITHOUT MOISTURE CARRYOVER

BASED ON DRAWING NO

SHEET

REV.

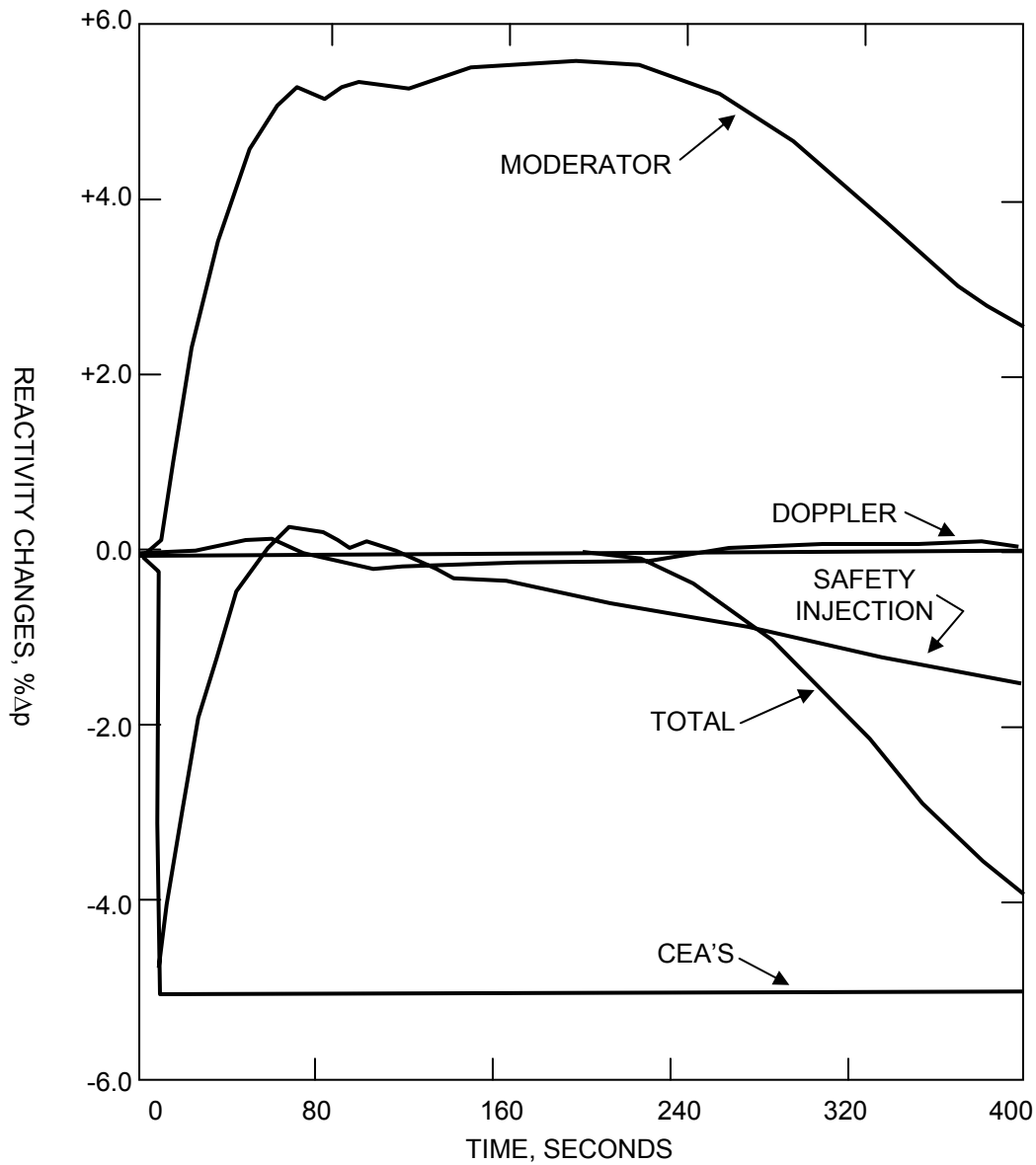

SAR FIGURE NO. 15.1.14-62

AMENDMENT 20

ARKANSAS NUCLEAR ONE
UNIT 2
RUSSELLVILLE, ARKANSAS



SCALE:	NONE
DRAWN:	
DESIGN:	ENERGY
CAD NO:	

STEAM LINE RUPTURE INCIDENT WITHOUT LOSS OF AC
POWER TWO LOOP NO LOAD INITIAL CONDITON NOZZLE
BREAK WITHOUT MOISTURE CARRYOVER

BASED ON DRAWING NO

SHEET

REV.

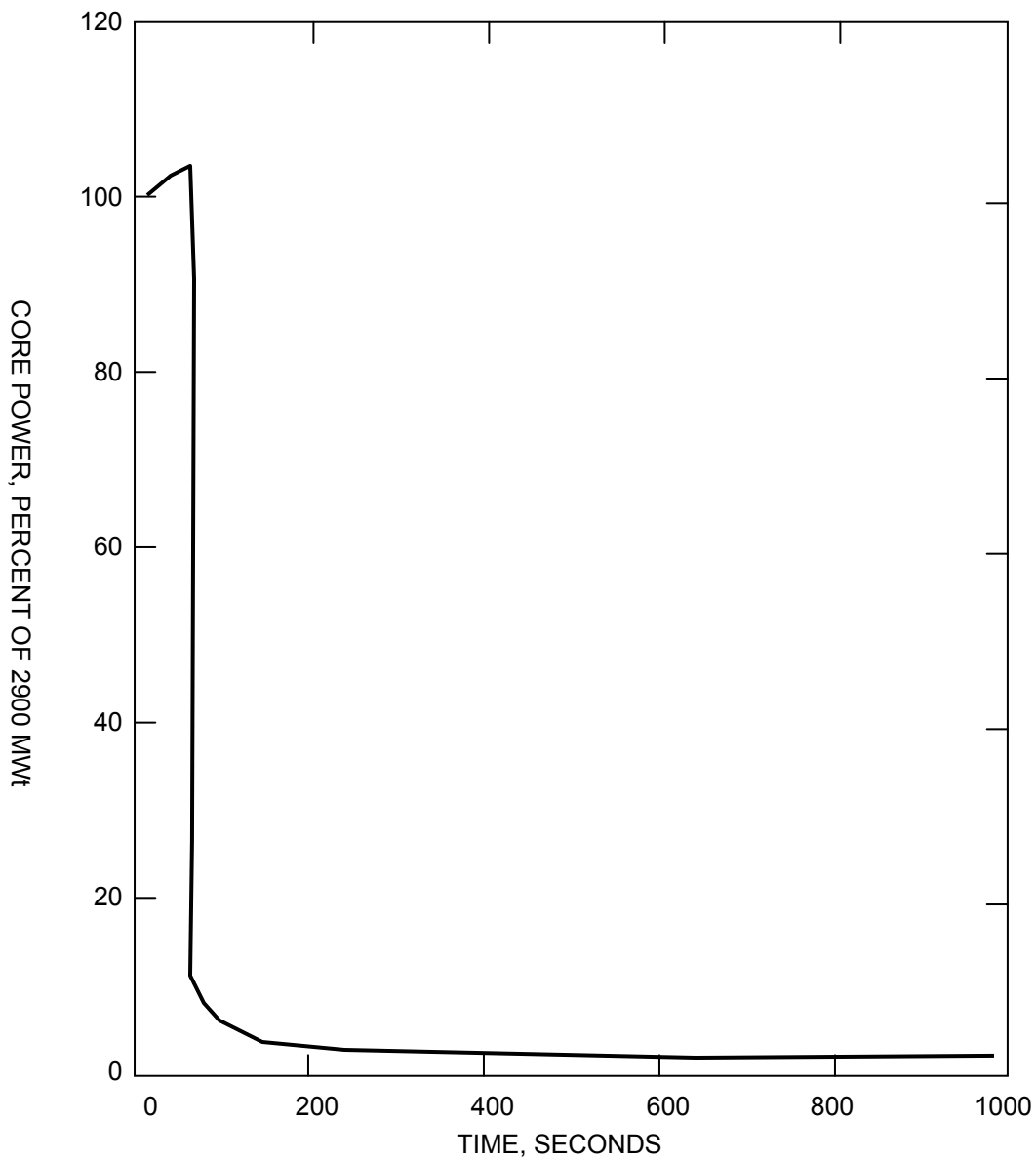

SAR FIGURE NO. 15.1.14-63

AMENDMENT 20

ARKANSAS NUCLEAR ONE
UNIT 2
RUSSELLVILLE, ARKANSAS



SCALE:	NONE
DRAWN:	
DESIGN:	ENERGY
CAD NO:	

FEEDWATER LINE RUPTURE WITH AC
POWER, CORE POWER VERSUS TIME

BASED ON DRAWING NO

SHEET

REV.

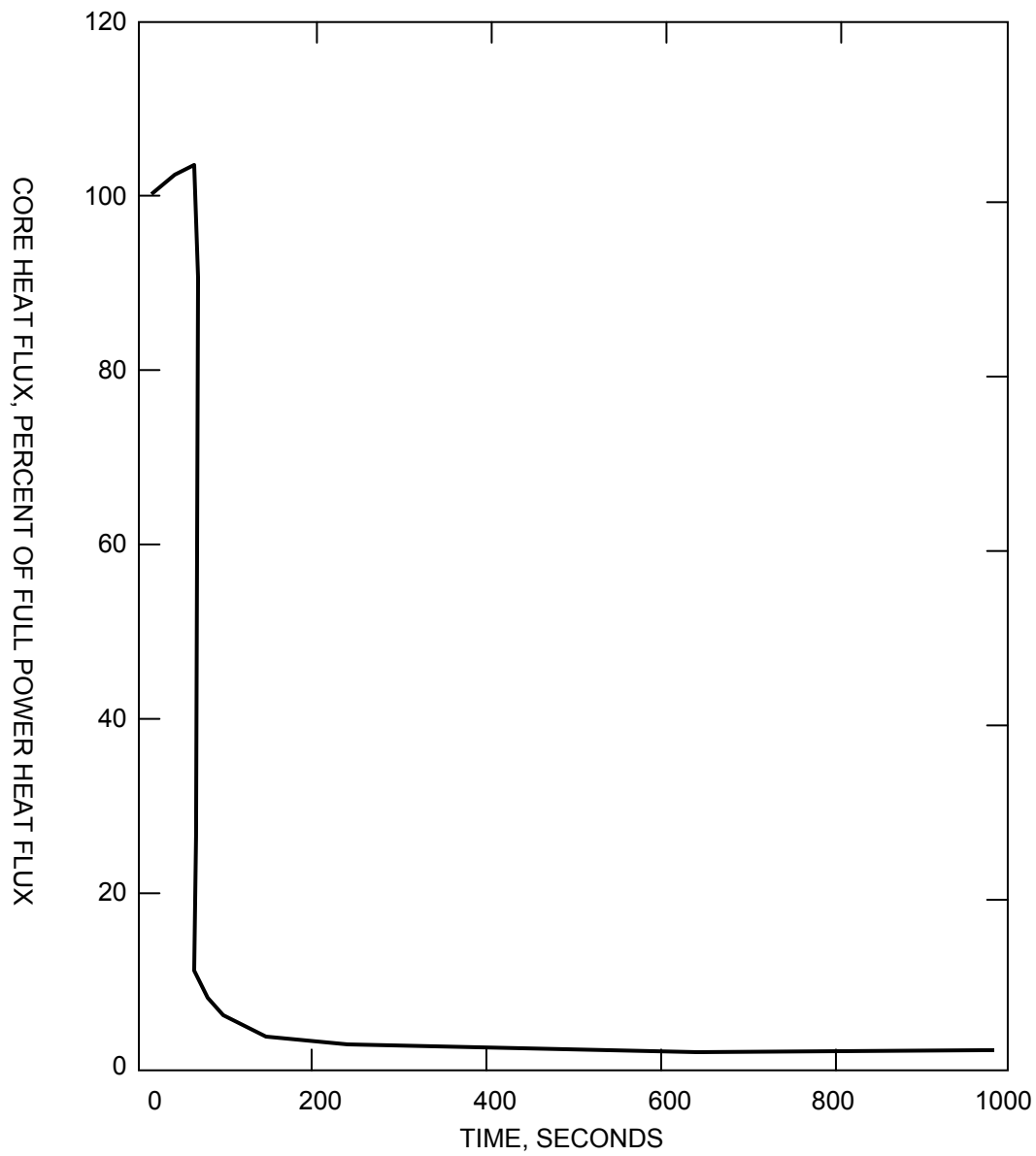

SAR FIGURE NO. 15.1.14-64

AMENDMENT 20

ARKANSAS NUCLEAR ONE
UNIT 2
RUSSELLVILLE, ARKANSAS



SCALE:	NONE
DRAWN:	
DESIGN:	ENERGY
CAD NO:	

FEEDWATER LINE RUPTURE WITH AC
POWER, CORE HEAT FLUX VERSUS TIME

BASED ON DRAWING NO

SHEET

REV.

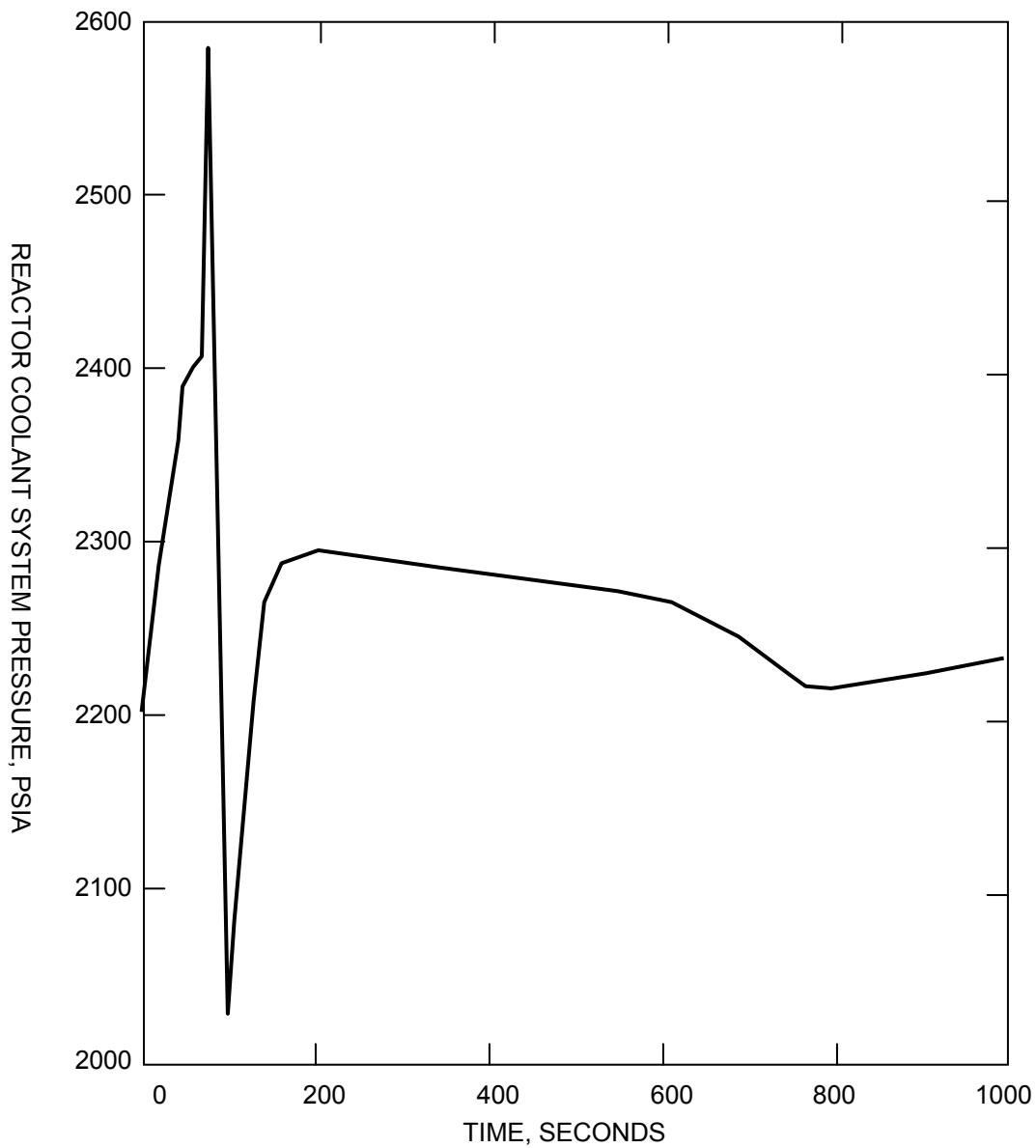

SAR FIGURE NO. 15.1.14-65

AMENDMENT 20

ARKANSAS NUCLEAR ONE
UNIT 2
RUSSELLVILLE, ARKANSAS



SCALE:	NONE
DRAWN:	
DESIGN:	ENTERGY
CAD NO:	

FEEDWATER LINE RUPTURE WITH AC POWER, REACTOR COOLANT SYSTEM PRESSURE VERSUS TIME

BASED ON DRAWING NO

SHEET

REV.

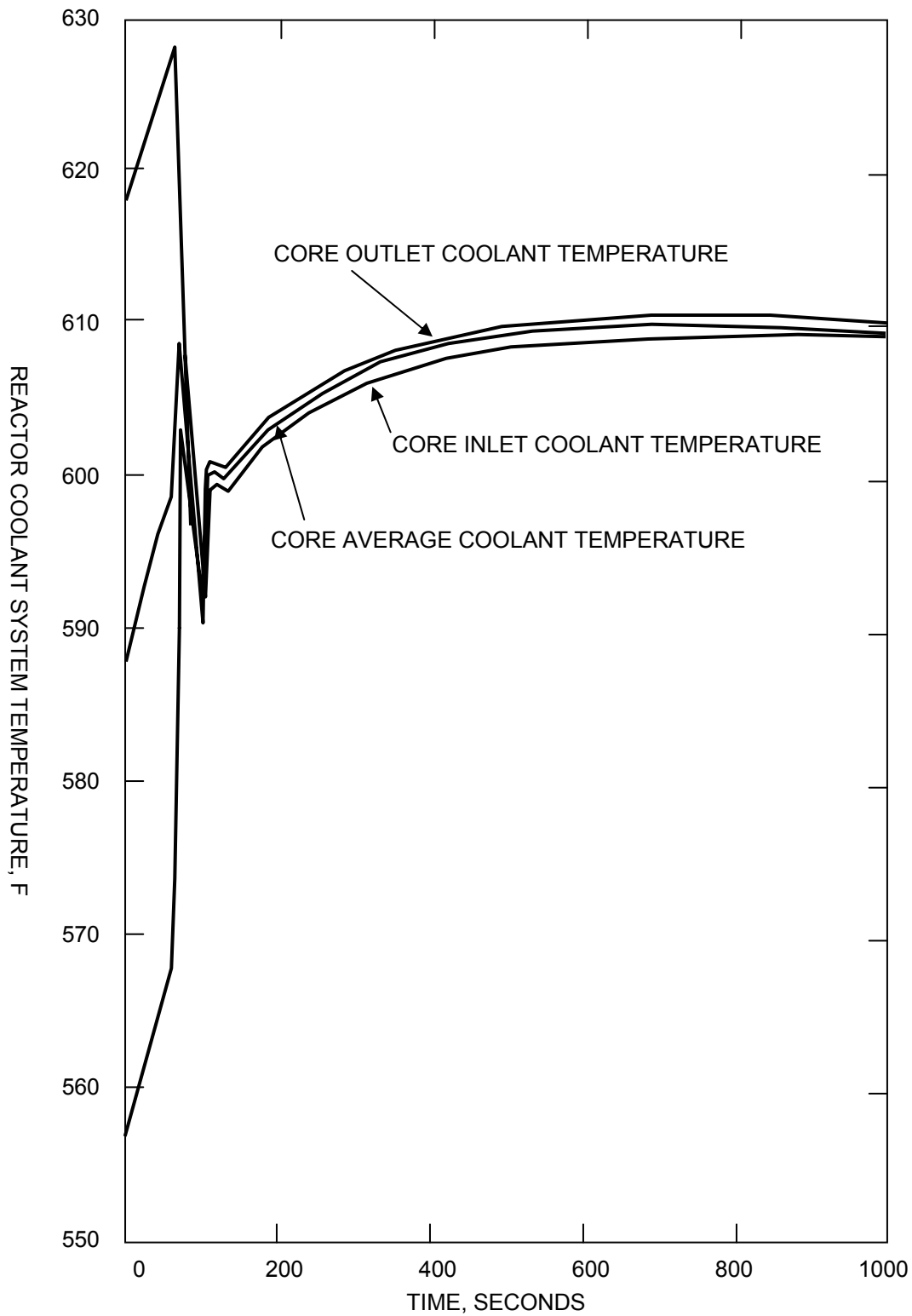

SAR FIGURE NO. 15.1.14-66

AMENDMENT 20

ARKANSAS NUCLEAR ONE
UNIT 2
RUSSELLVILLE, ARKANSAS



SCALE:	NONE
DRAWN:	
DESIGN:	ENTERGY
CAD NO:	

FEEDWATER LINE RUPTURE WITH AC POWER, REACTOR COOLANT SYSTEM TEMPERATURES VERSUS TIME

BASED ON DRAWING NO

SHEET

REV.

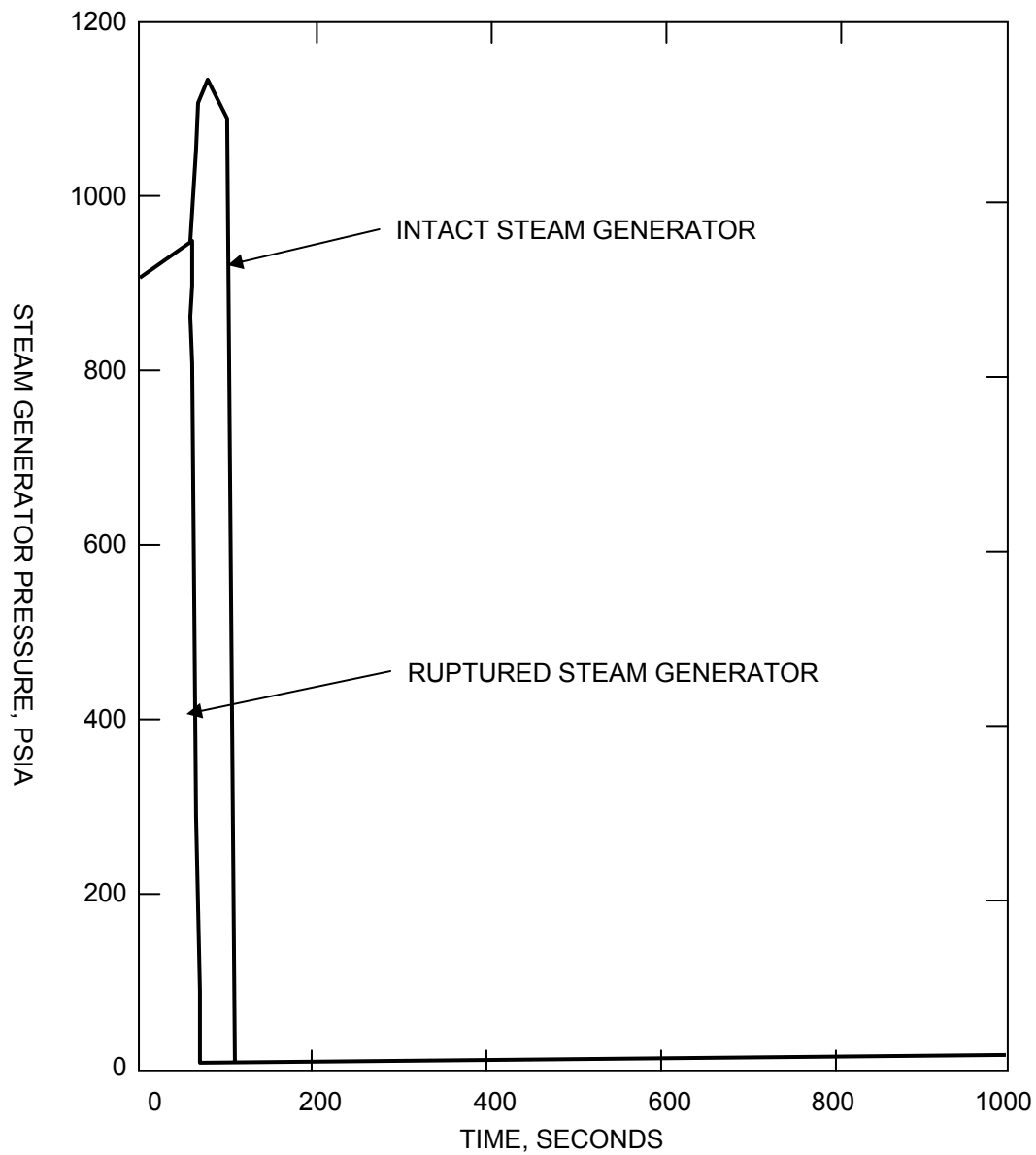

SAR FIGURE NO. 15.1.14-67

AMENDMENT 20

ARKANSAS NUCLEAR ONE
UNIT 2
RUSSELLVILLE, ARKANSAS



SCALE:	NONE
DRAWN:	
DESIGN:	ENTERGY
CAD NO:	

FEEDWATER LINE RUPTURE WITH AC POWER, STEAM GENERATOR PRESSURE VERSUS TIME

BASED ON DRAWING NO

SHEET

REV.

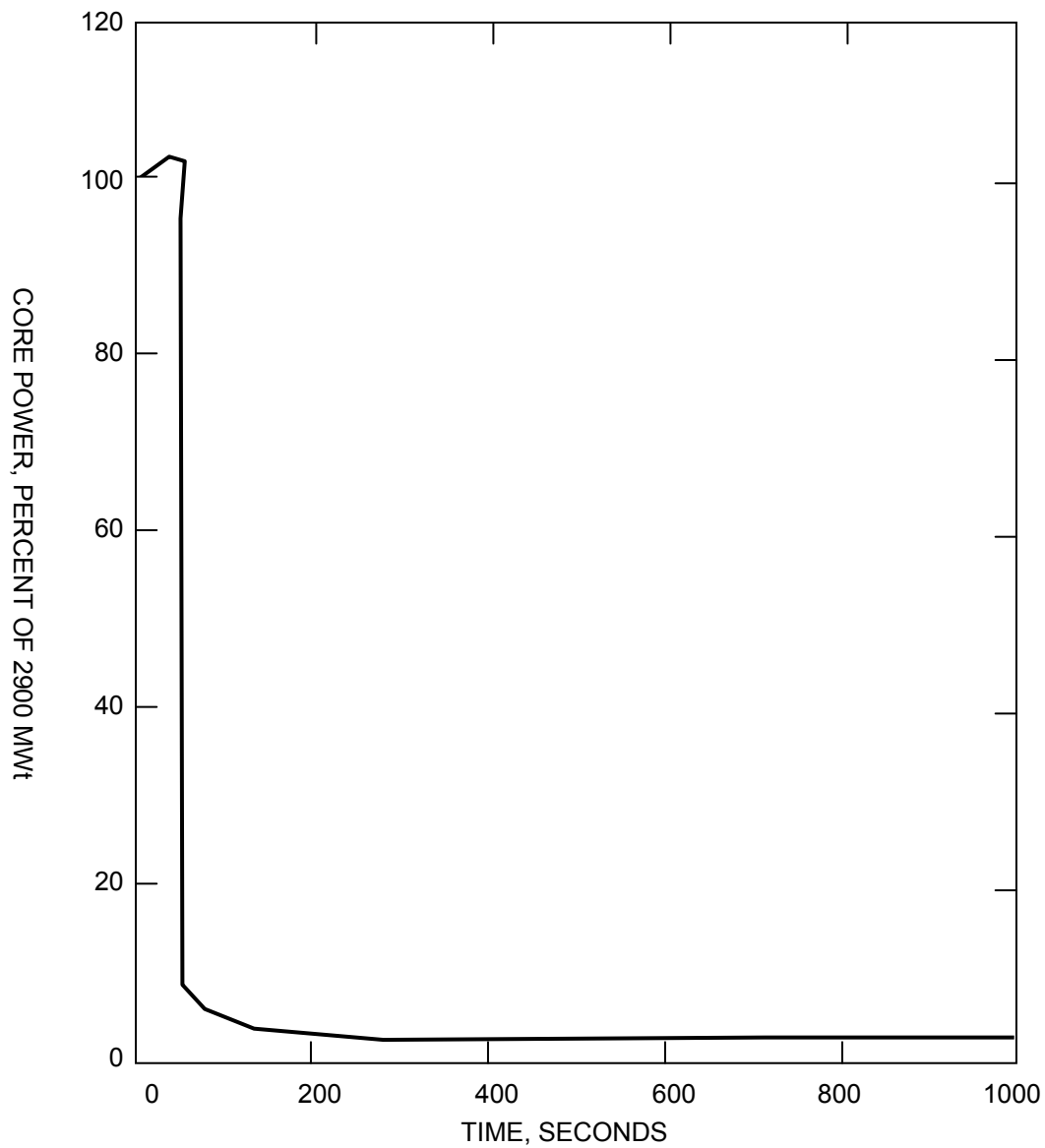

SAR FIGURE NO. 15.1.14-68

AMENDMENT 20

ARKANSAS NUCLEAR ONE
UNIT 2
RUSSELLVILLE, ARKANSAS



SCALE:	NONE
DRAWN:	
DESIGN:	ENTERGY
CAD NO:	

FEEDWATER LINE RUPTURE WITH LOSS OF AC
POWER, CORE POWER VERSUS TIME

BASED ON DRAWING NO

SHEET

REV.

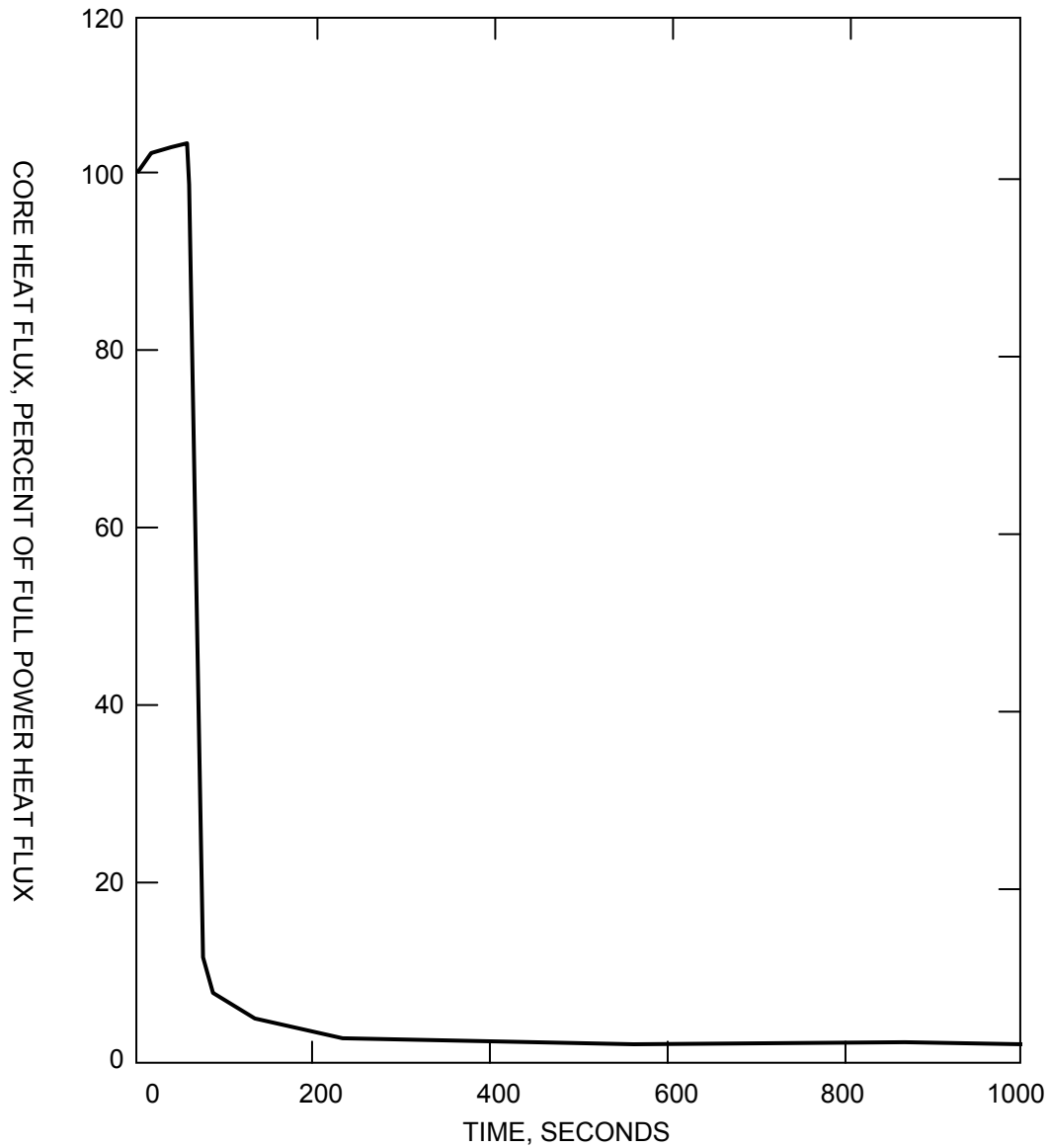

SAR FIGURE NO. 15.1.14-69

AMENDMENT 20

ARKANSAS NUCLEAR ONE
UNIT 2
RUSSELLVILLE, ARKANSAS



SCALE:	NONE
DRAWN:	
DESIGN:	ENTERGY
CAD NO:	

FEEDWATER LINE RUPTURE WITH LOSS OF AC
POWER, CORE HEAT FLUX VERSUS TIME

BASED ON DRAWING NO

SHEET

REV.

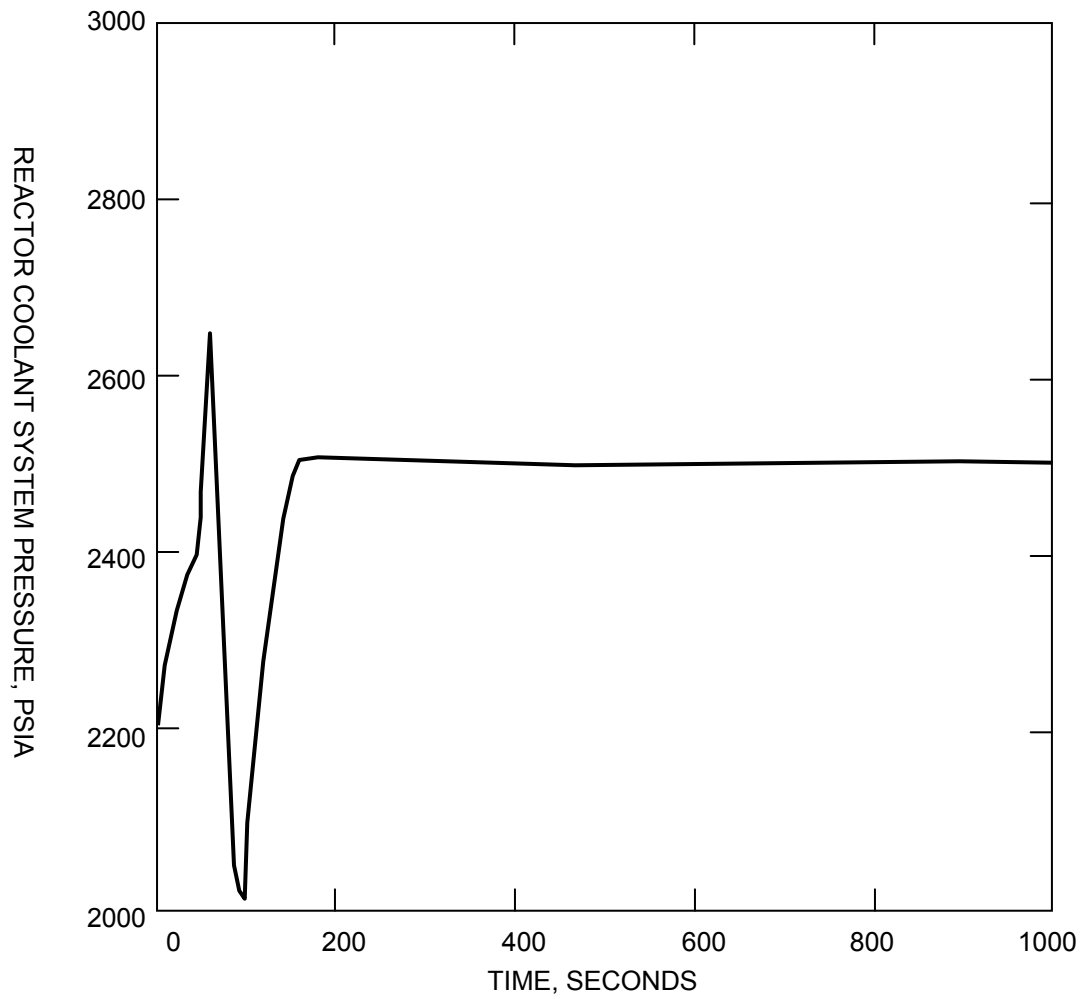

SAR FIGURE NO. 15.1.14-70

AMENDMENT 20

ARKANSAS NUCLEAR ONE
UNIT 2
RUSSELLVILLE, ARKANSAS



SCALE:	NONE
DRAWN:	
DESIGN:	ENERGY
CAD NO:	

FEEDWATER LINE RUPTURE WITH LOSS OF AC POWER,
REACTOR COOLANT SYSTEM PRESSURE VERSUS TIME

BASED ON DRAWING NO

SHEET

REV.

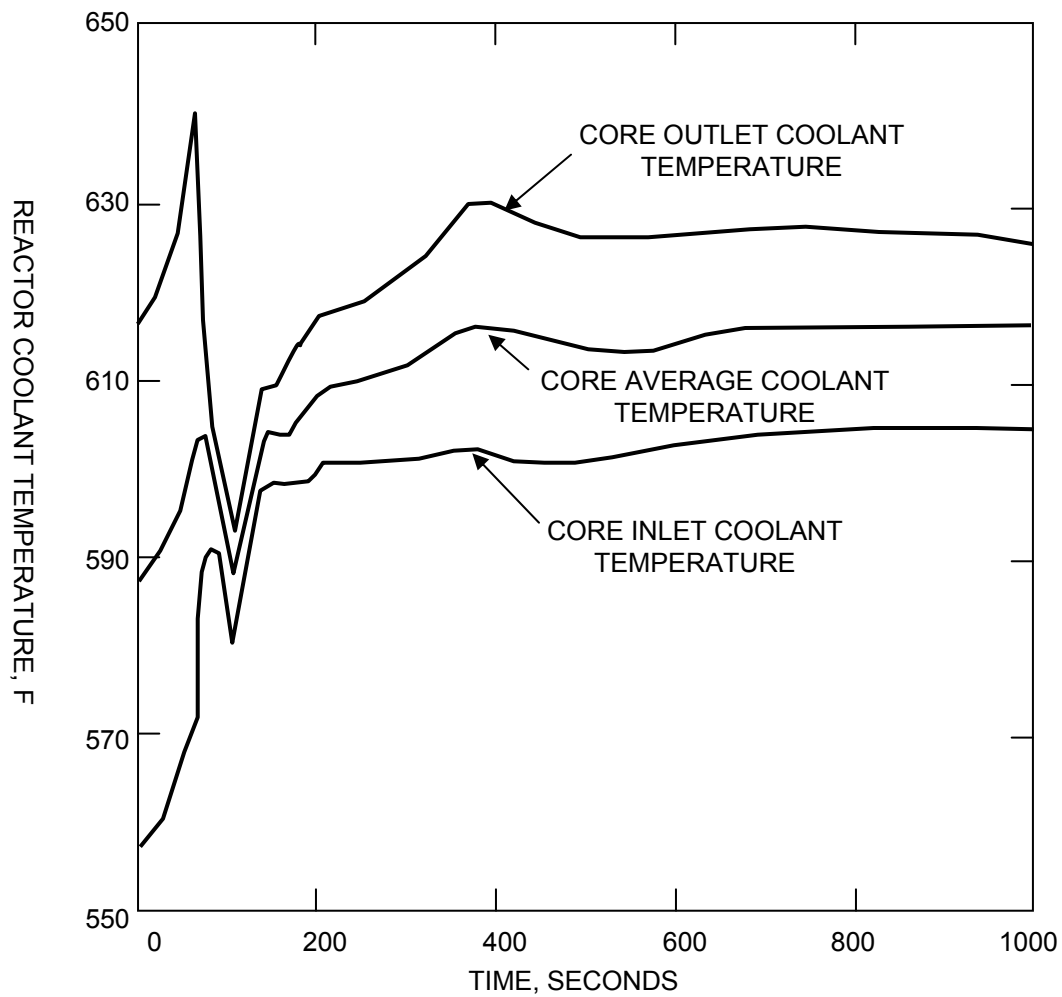

SAR FIGURE NO. 15.1.14-71

AMENDMENT 20

ARKANSAS NUCLEAR ONE
UNIT 2
RUSSELLVILLE, ARKANSAS



SCALE: NONE
DRAWN:
DESIGN: ENTERGY
CAD NO:

FEEDWATER LINE RUPTURE WITH LOSS OF AC POWER,
REACTOR COOLANT SYSTEM TEMPERATURE VERSUS
TIME

BASED ON DRAWING NO

SHEET

REV.

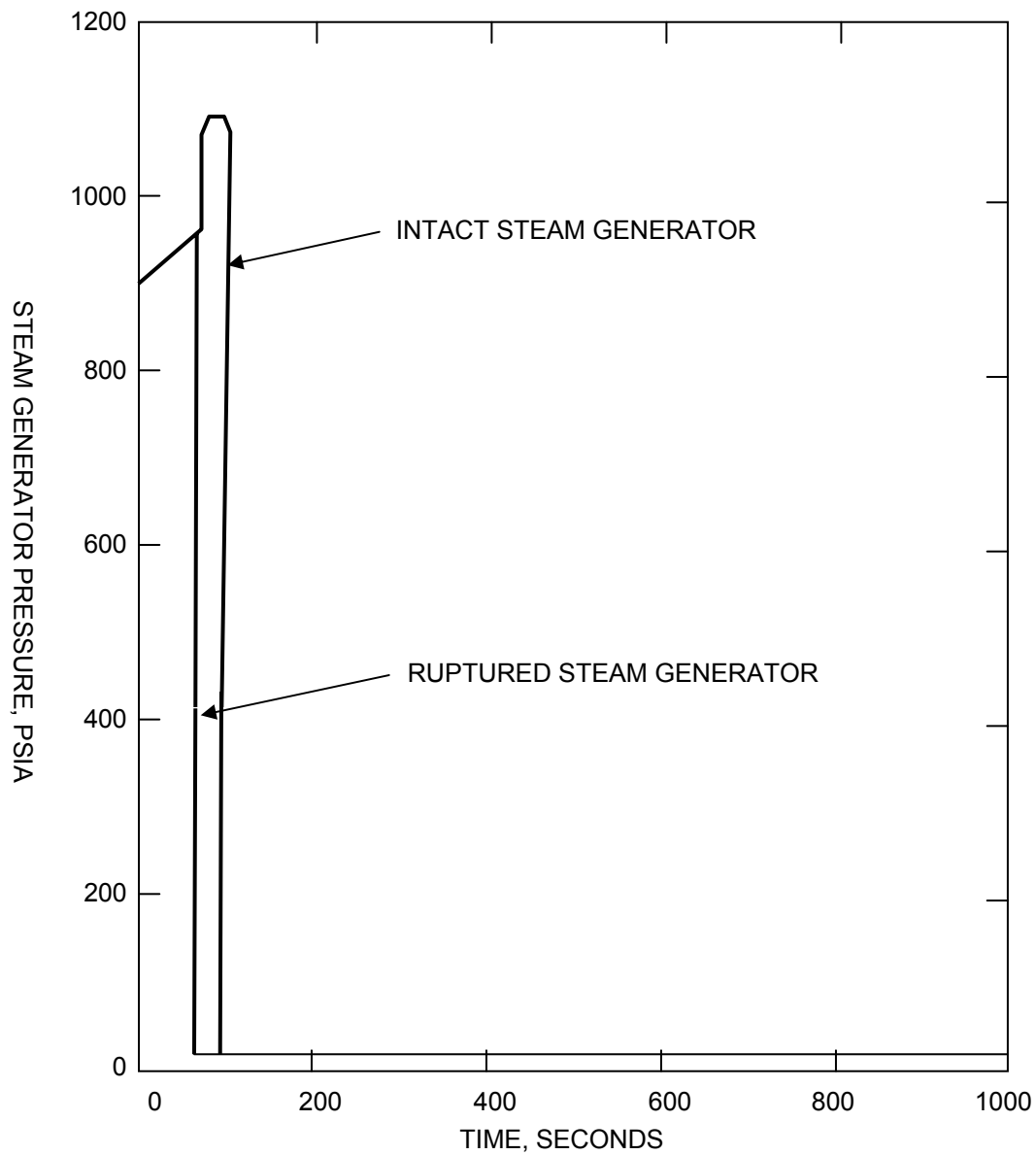

SAR FIGURE NO. 15.1.14-72

AMENDMENT 20

ARKANSAS NUCLEAR ONE
UNIT 2
RUSSELLVILLE, ARKANSAS



SCALE:	NONE
DRAWN:	
DESIGN:	ENERGY
CAD NO:	

FEEDWATER LINE RUPTURE WITH LOSS OF AC POWER,
STEAM GENERATOR PRESSURE VERSUS TIME

BASED ON DRAWING NO

SHEET

REV.

FIGURES 15.1.14-73
THROUGH 15.1.14-79
DELETED

SAR FIGURE NO. 15.1.14-73

AMENDMENT 20

ARKANSAS NUCLEAR ONE
UNIT 2
RUSSELLVILLE, ARKANSAS



SCALE:	NONE
DRAWN:	ENERGY
DESIGN:	ENERGY
CAD NO:	N/A

BASED ON DRAWING NO

SHEET

REV.

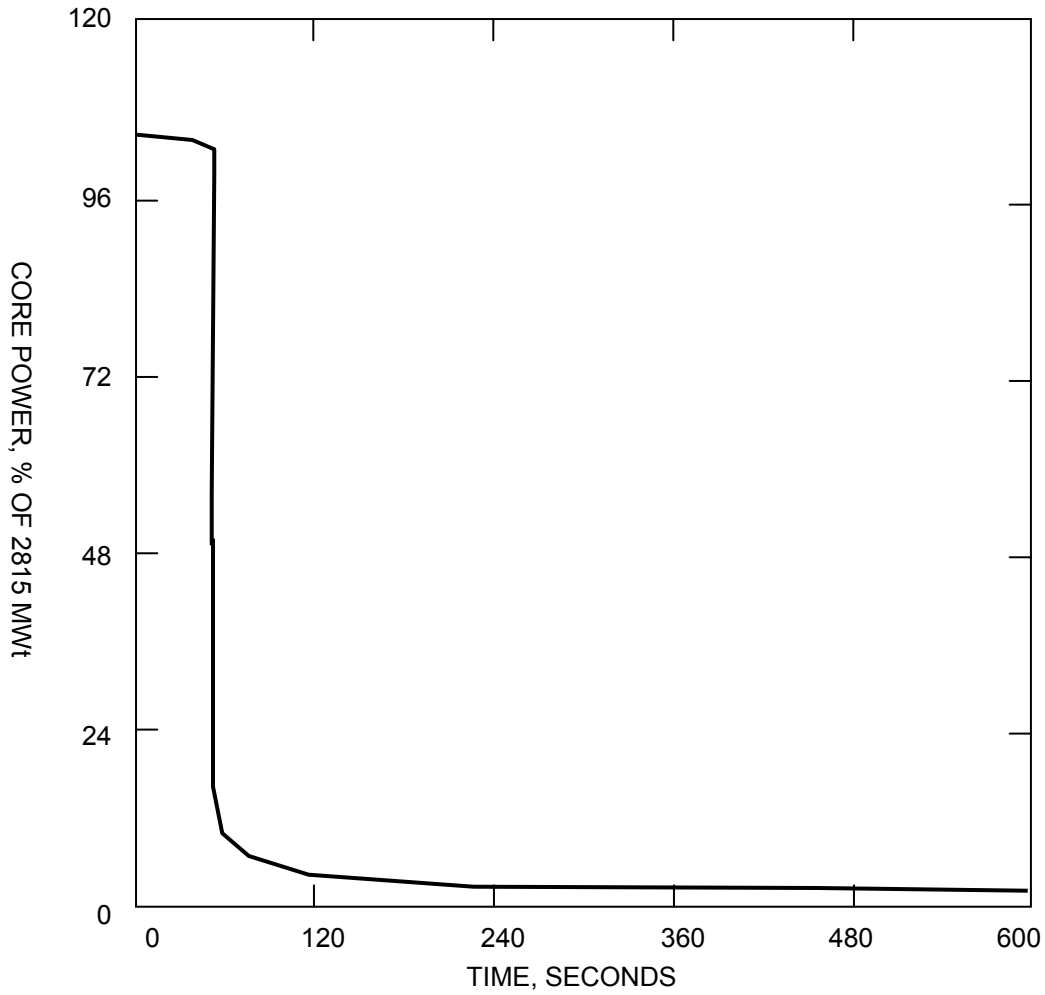

SAR FIGURE NO. 15.1.14-80

AMENDMENT 20

ARKANSAS NUCLEAR ONE
UNIT 2
RUSSELLVILLE, ARKANSAS



SCALE:	NONE
DRAWN:	
DESIGN:	ENERGY
CAD NO:	

CYCLE 13 FEEDWATER LINE RUPTURE WITH LOSS OF AC POWER, CORE POWER VERSUS TIME

BASED ON DRAWING NO

SHEET

REV.

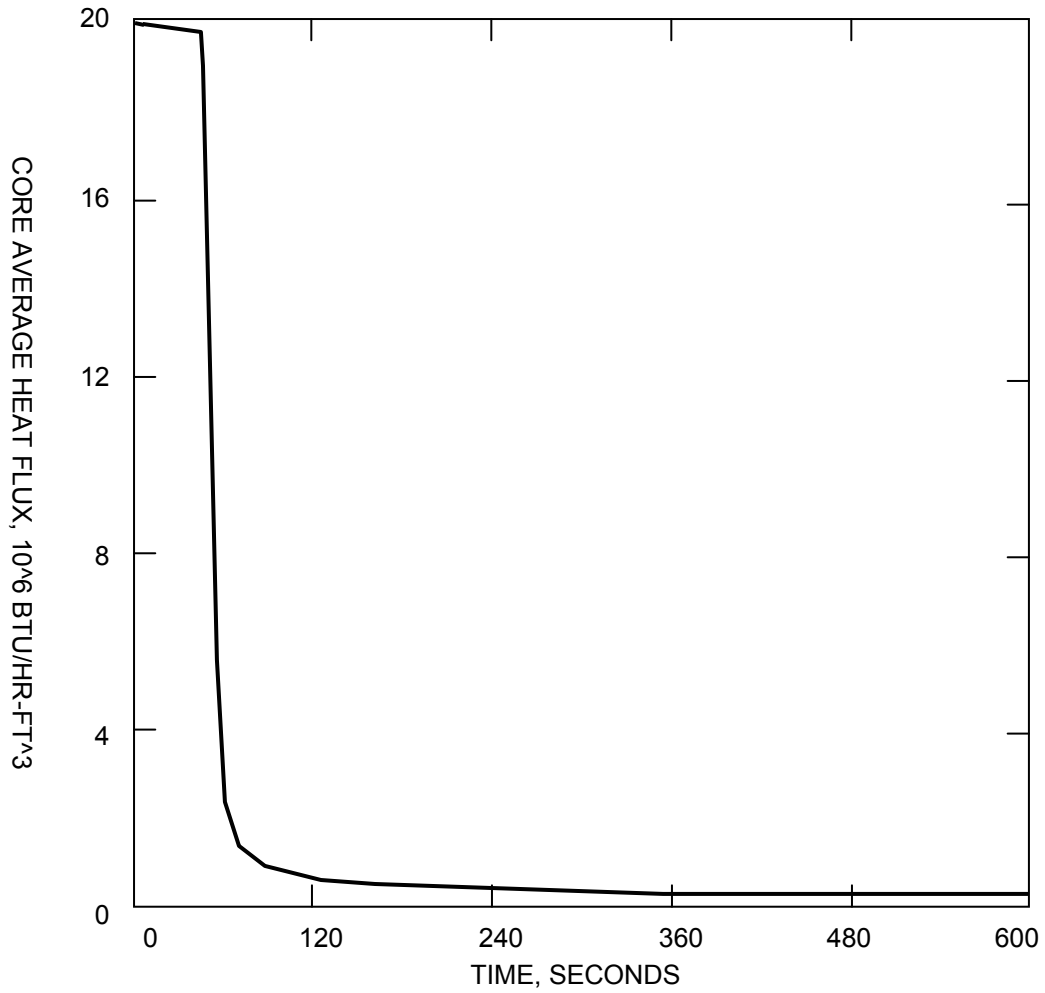

SAR FIGURE NO. 15.1.14-81

AMENDMENT 20

ARKANSAS NUCLEAR ONE
UNIT 2
RUSSELLVILLE, ARKANSAS



SCALE: NONE

DRAWN:

DESIGN: ENTERGY

CAD NO:

CYCLE 13 FEEDWATER LINE RUPTURE WITH LOSS OF AC POWER, CORE HEAT FLUX VERSUS TIME

BASED ON DRAWING NO

SHEET

REV.

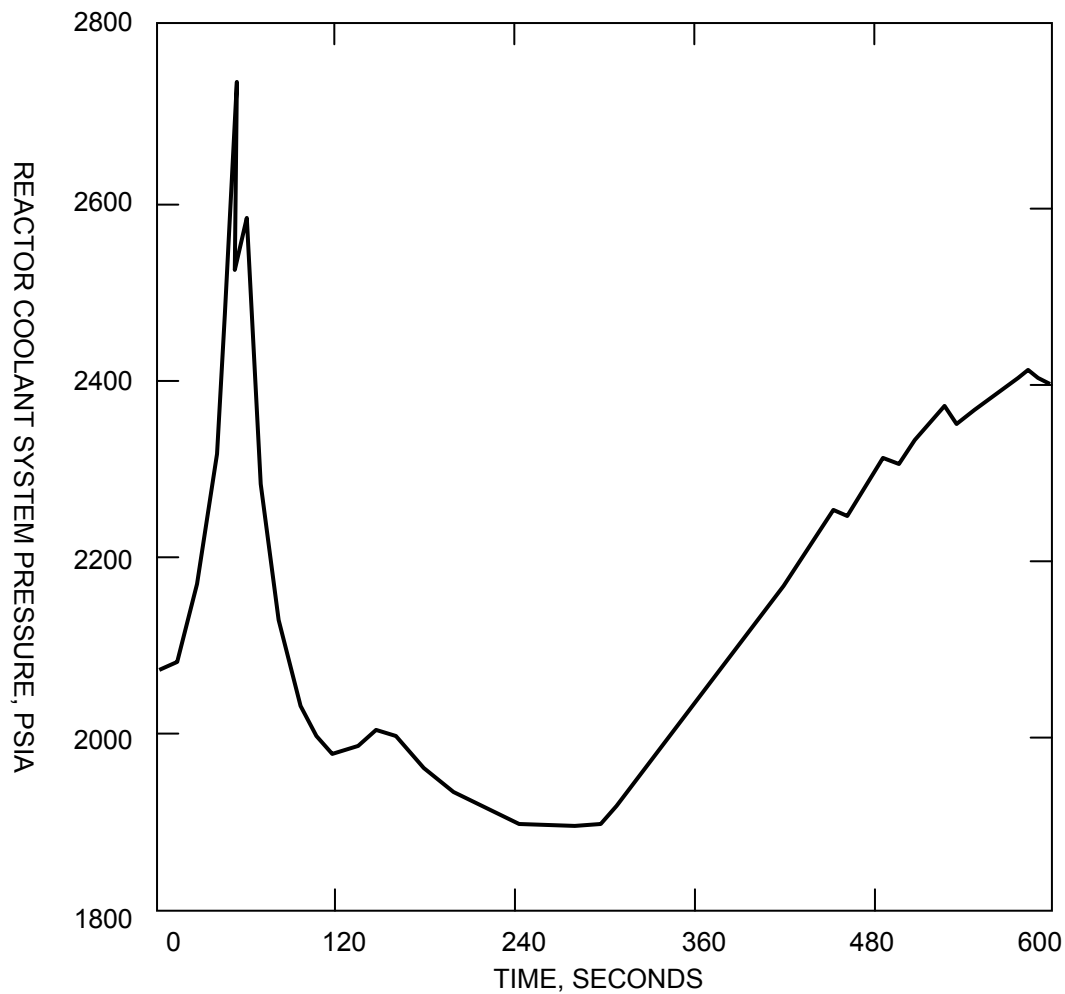

SAR FIGURE NO. 15.1.14-82

AMENDMENT 20

ARKANSAS NUCLEAR ONE
UNIT 2
RUSSELLVILLE, ARKANSAS



SCALE:	NONE
DRAWN:	
DESIGN:	ENERGY
CAD NO:	

CYCLE 13 FEEDWATER LINE RUPTURE WITH LOSS OF AC
POWER, REACTOR COOLANT SYSTEM PRESSURE
VERSUS TIME

BASED ON DRAWING NO

SHEET

REV.

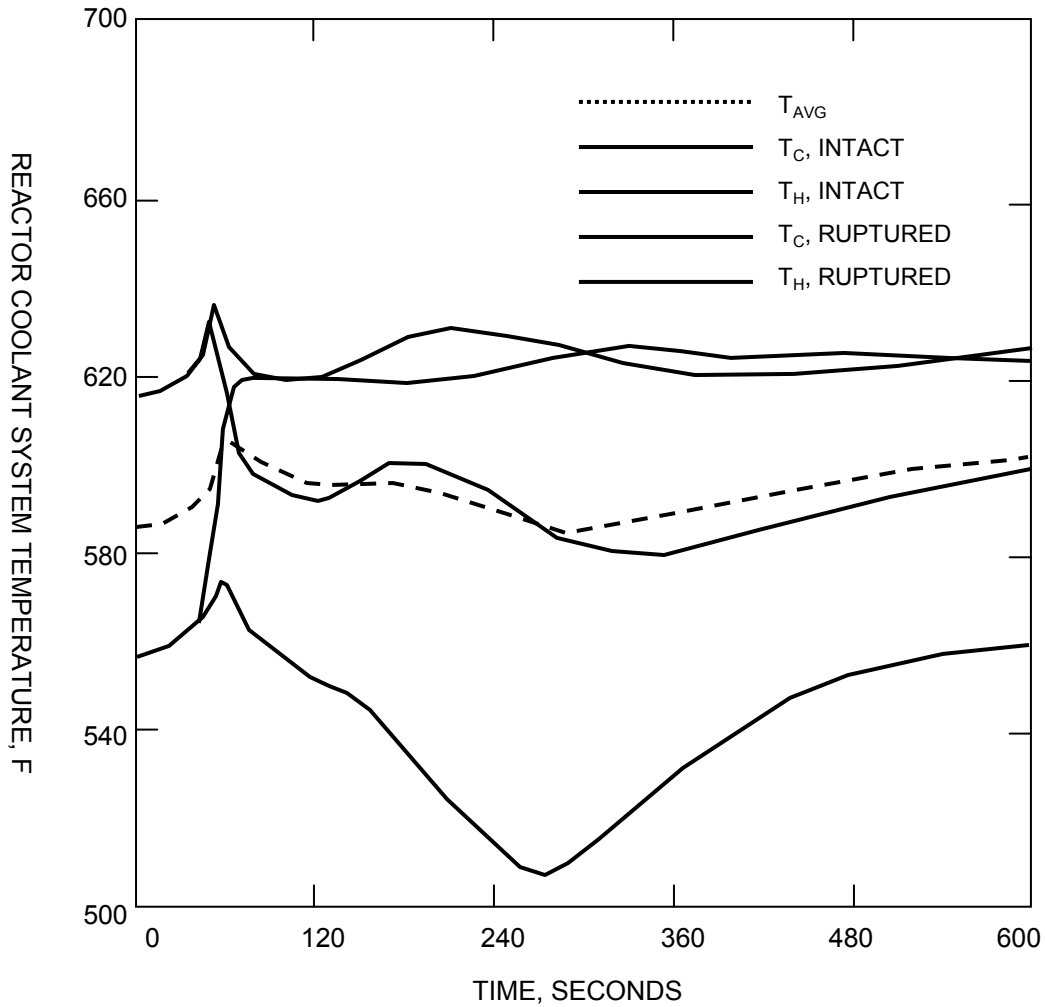

SAR FIGURE NO. 15.1.14-83

AMENDMENT 20

ARKANSAS NUCLEAR ONE
UNIT 2
RUSSELLVILLE, ARKANSAS



SCALE: NONE
DRAWN:
DESIGN: ENTERGY
CAD NO:

CYCLE 13 FEEDWATER LINE RUPTURE WITH LOSS OF AC
POWER, REACTOR COOLANT SYSTEM TEMPERATURE
VERSUS TIME

BASED ON DRAWING NO

SHEET

REV.

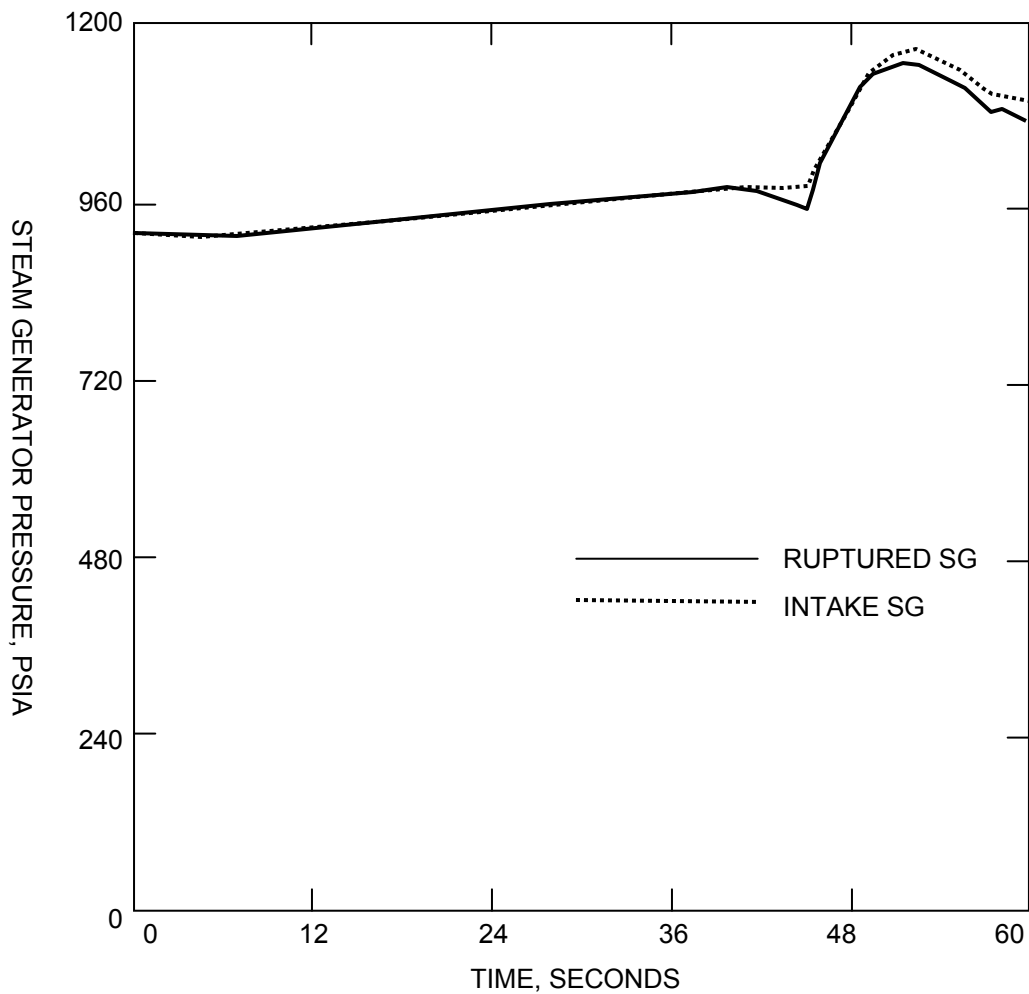

SAR FIGURE NO. 15.1.14-84

AMENDMENT 20

ARKANSAS NUCLEAR ONE
UNIT 2
RUSSELLVILLE, ARKANSAS



SCALE:	NONE
DRAWN:	
DESIGN:	ENERGY
CAD NO:	

CYCLE 13 FEEDWATER LINE RUPTURE WITH LOSS OF AC POWER, STEAM GENERATOR PRESSURE VERSUS TIME

BASED ON DRAWING NO

SHEET

REV.

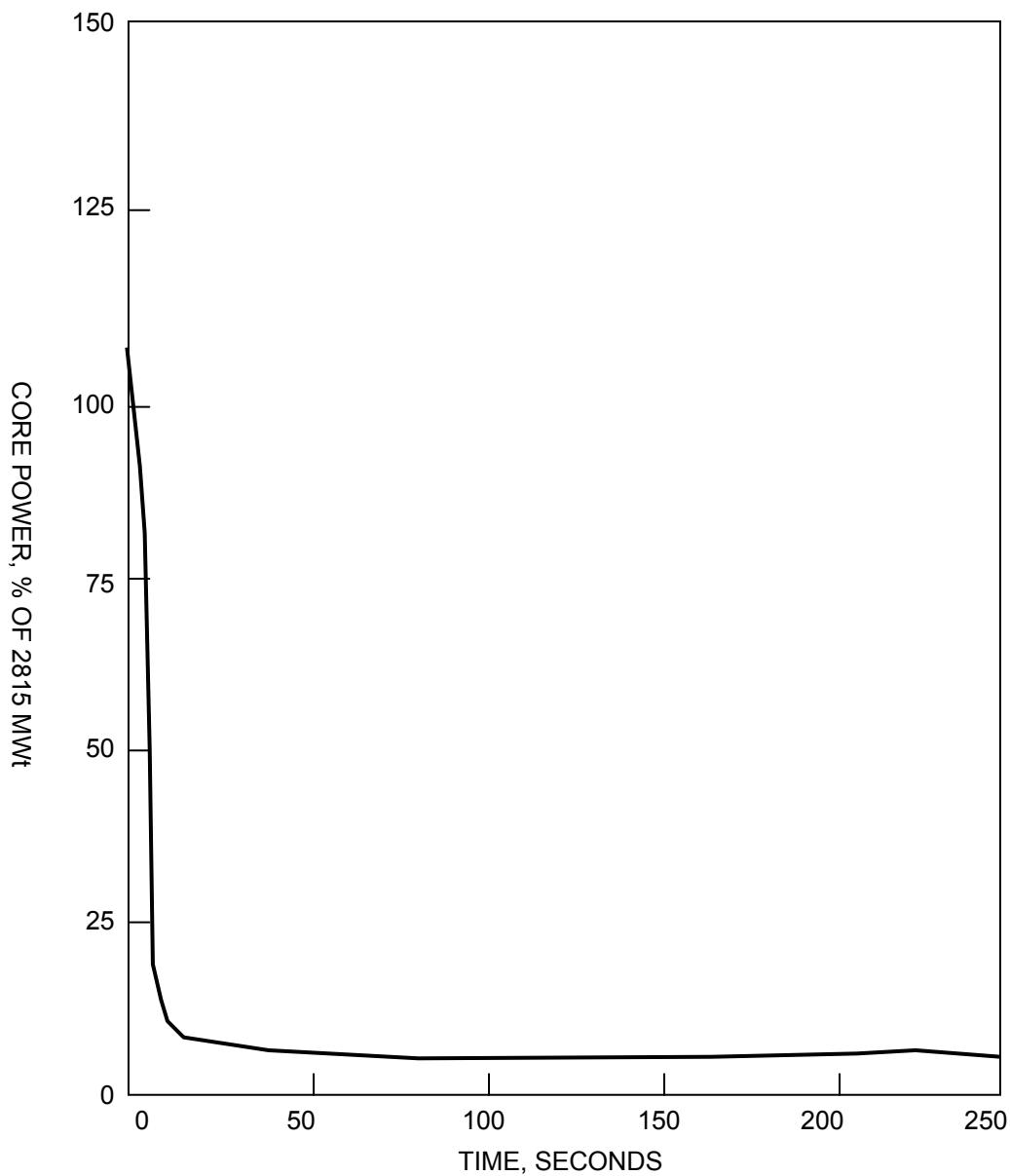

SAR FIGURE NO. 15.1.14-85

AMENDMENT 20

ARKANSAS NUCLEAR ONE
UNIT 2
RUSSELLVILLE, ARKANSAS



SCALE:	NONE
DRAWN:	
DESIGN:	ENTERGY
CAD NO:	

CYCLE 12 MSLB ANALYSIS HOT FULL POWER WITH
LOSS OF AC CORE POWER VERSUS TIME

BASED ON DRAWING NO

SHEET

REV.

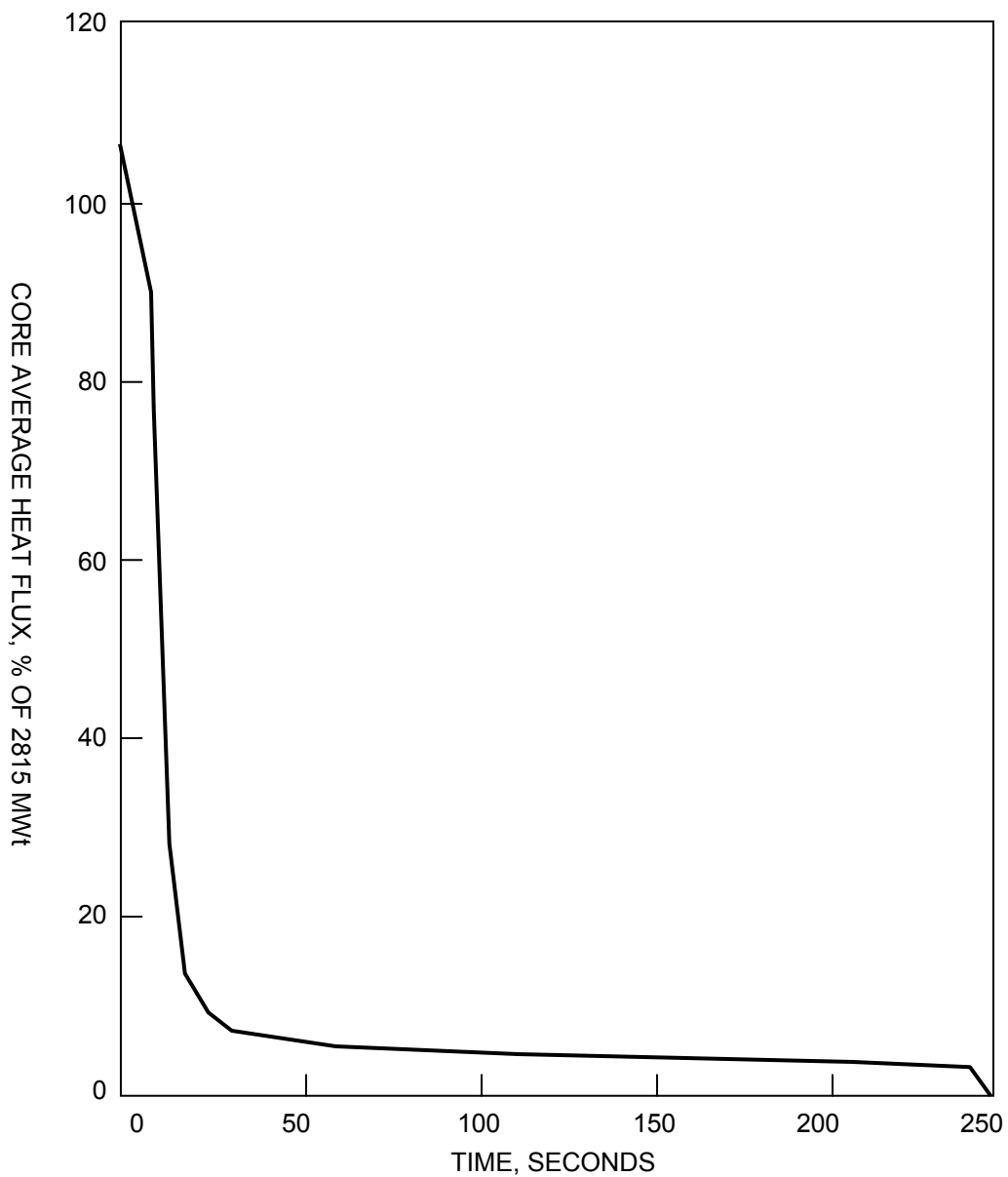

SAR FIGURE NO. 15.1.14-86

AMENDMENT 20

ARKANSAS NUCLEAR ONE
UNIT 2
RUSSELLVILLE, ARKANSAS



SCALE:	NONE
DRAWN:	
DESIGN:	ENERGY
CAD NO:	

CYCLE 12 MSLB ANALYSIS HOT FULL POWER WITH LOSS OF AC CORE AVERAGE HEAT FLUX VERSUS TIME

BASED ON DRAWING NO

SHEET

REV.

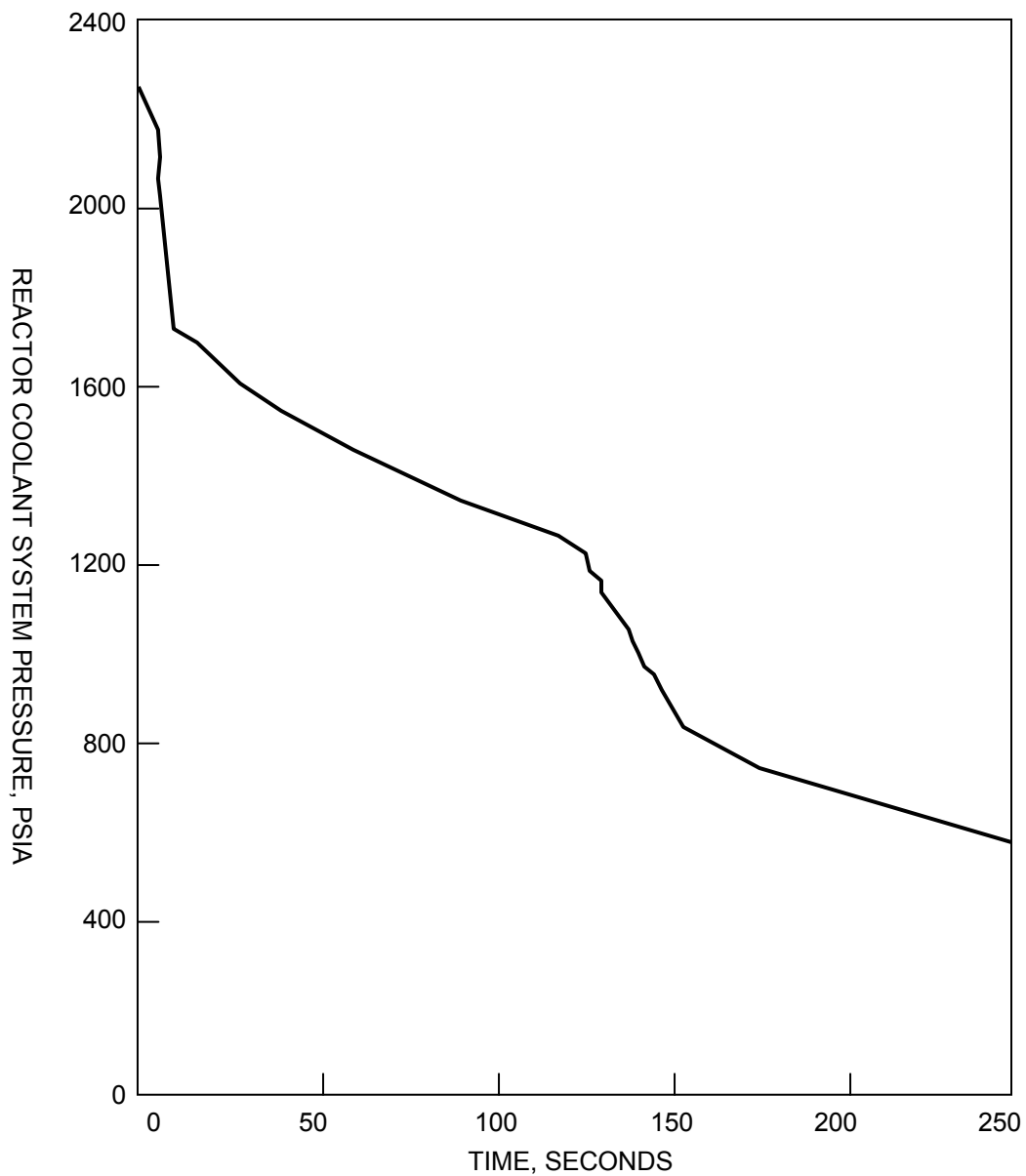

SAR FIGURE NO. 15.1.14-87

AMENDMENT 20

ARKANSAS NUCLEAR ONE
UNIT 2
RUSSELLVILLE, ARKANSAS



SCALE:	NONE
DRAWN:	
DESIGN:	ENERGY
CAD NO:	

CYCLE 12 MSLB ANALYSIS HOT FULL POWER WITH LOSS
OF AC RCS PRESSURE VERSUS TIME

BASED ON DRAWING NO

SHEET

REV.

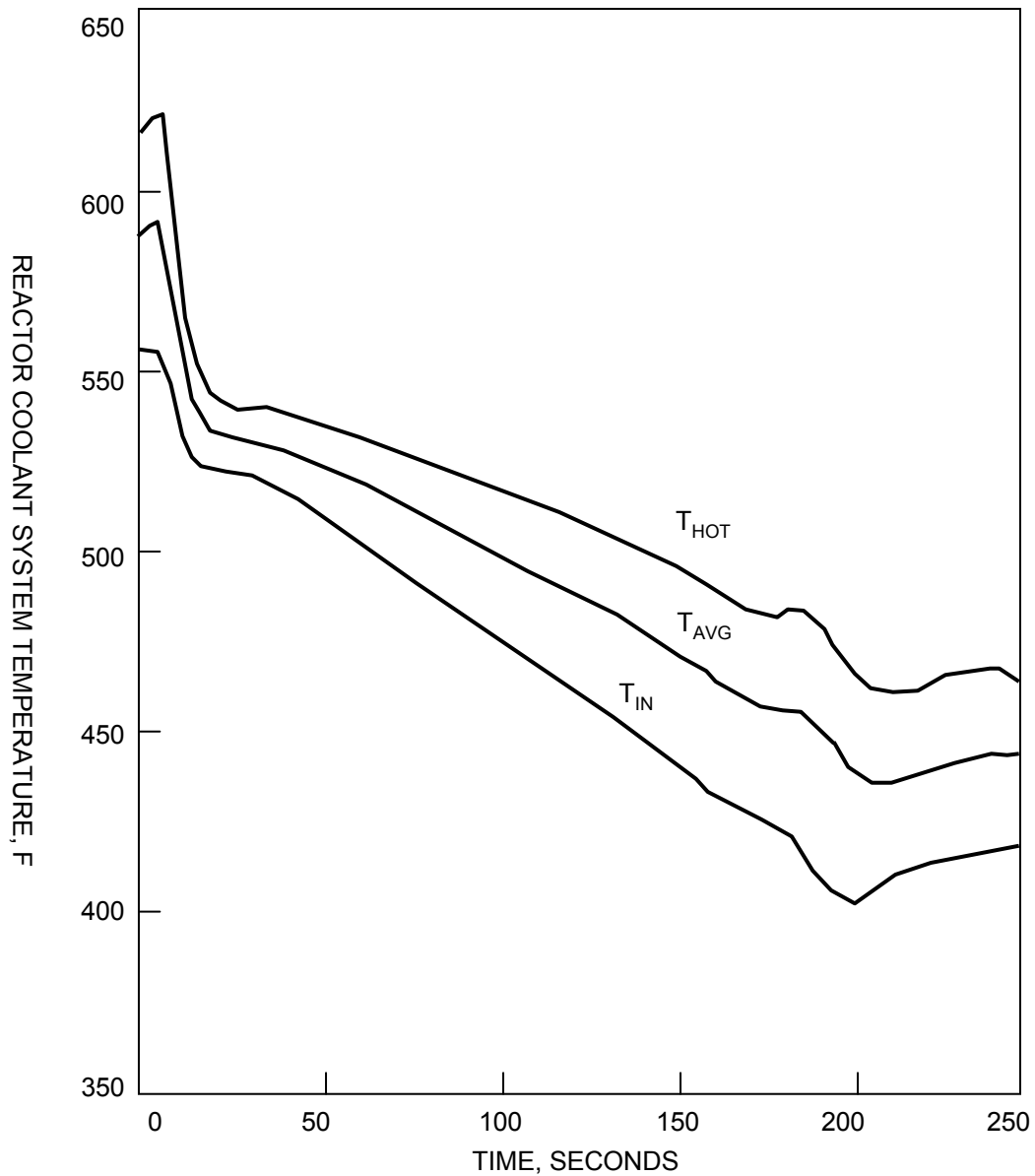

SAR FIGURE NO. 15.1.14-88

AMENDMENT 20

ARKANSAS NUCLEAR ONE
UNIT 2
RUSSELLVILLE, ARKANSAS



SCALE:	NONE
DRAWN:	
DESIGN:	ENERGY
CAD NO:	

CYCLE 12 MSLB ANALYSIS HOT FULL POWER WITH LOSS OF AC RCS TEMPERATURES VERSUS TIME

BASED ON DRAWING NO

SHEET

REV.

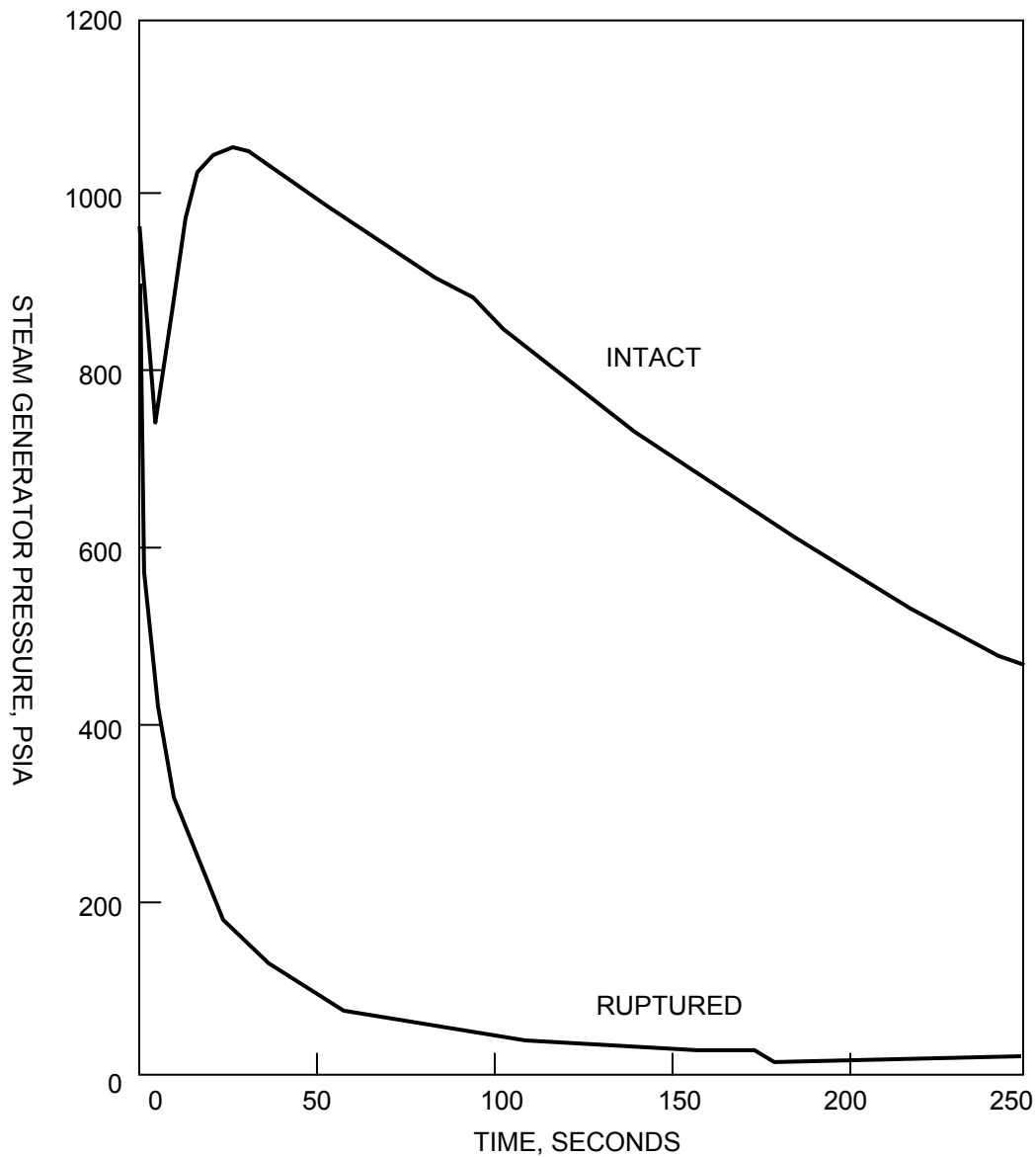

SAR FIGURE NO. 15.1.14-89

AMENDMENT 20

ARKANSAS NUCLEAR ONE
UNIT 2
RUSSELLVILLE, ARKANSAS



SCALE:	NONE
DRAWN:	
DESIGN:	ENERGY
CAD NO:	

CYCLE 12 MSLB ANALYSIS HOT FULL POWER WITH LOSS OF AC STEAM GENERATOR PRESSURE VERSUS TIME

BASED ON DRAWING NO

SHEET

REV.

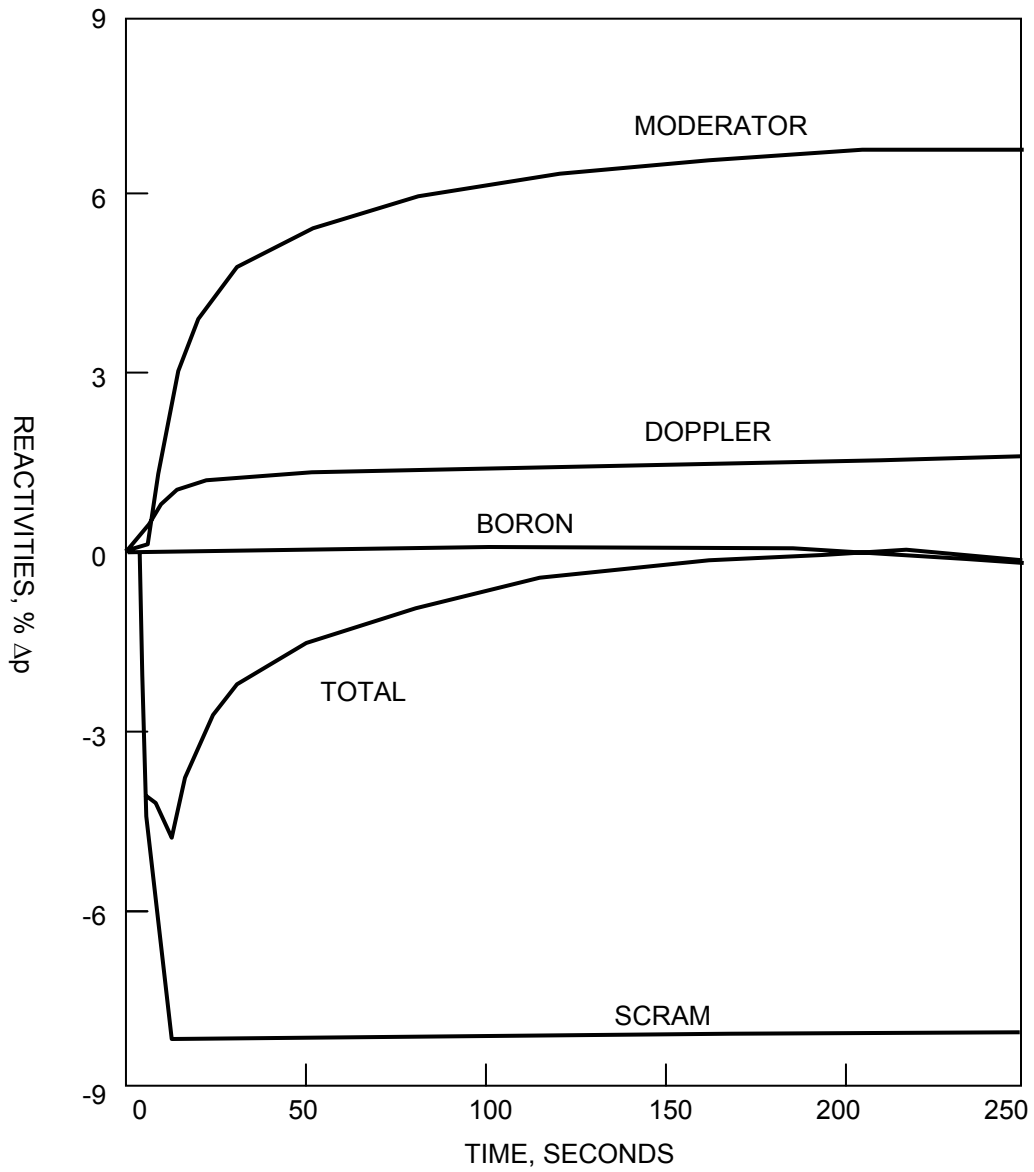

SAR FIGURE NO. 15.1.14-90

AMENDMENT 20

ARKANSAS NUCLEAR ONE
UNIT 2
RUSSELLVILLE, ARKANSAS



SCALE:	NONE
DRAWN:	
DESIGN:	ENERGY
CAD NO:	

CYCLE 12 MSLB ANALYSIS HOT FULL POWER WITH
LOSS OF AC REACTIVITIES VERSUS TIME

BASED ON DRAWING NO

SHEET

REV.

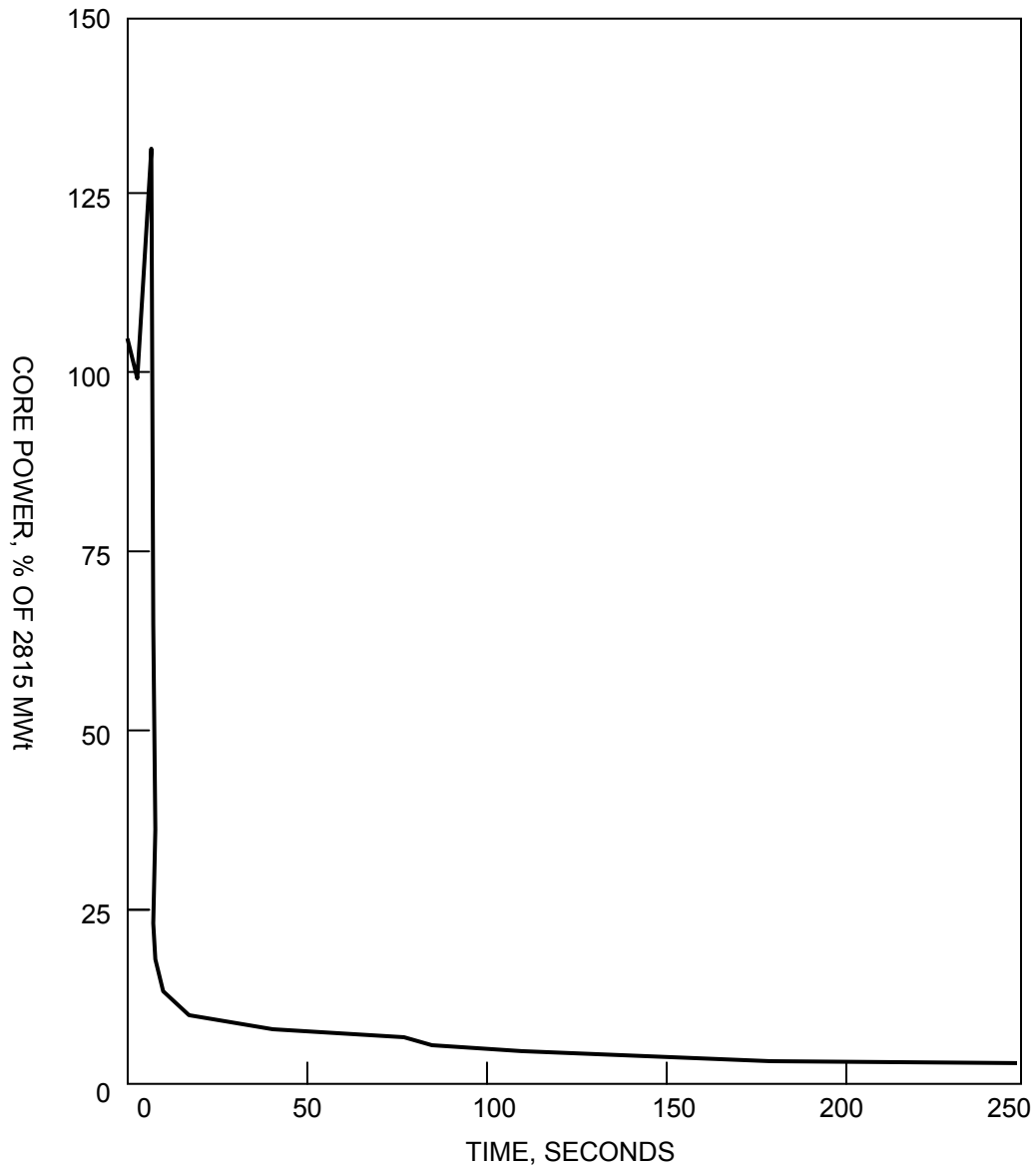

SAR FIGURE NO. 15.1.14-91

AMENDMENT 20

ARKANSAS NUCLEAR ONE
UNIT 2
RUSSELLVILLE, ARKANSAS



SCALE:	NONE
DRAWN:	
DESIGN:	ENTERGY
CAD NO:	

CYCLE 12 MSLB ANALYSIS HOT FULL POWER WITH
AC AVAILABLE CORE POWER VERSUS TIME

BASED ON DRAWING NO

SHEET

REV.

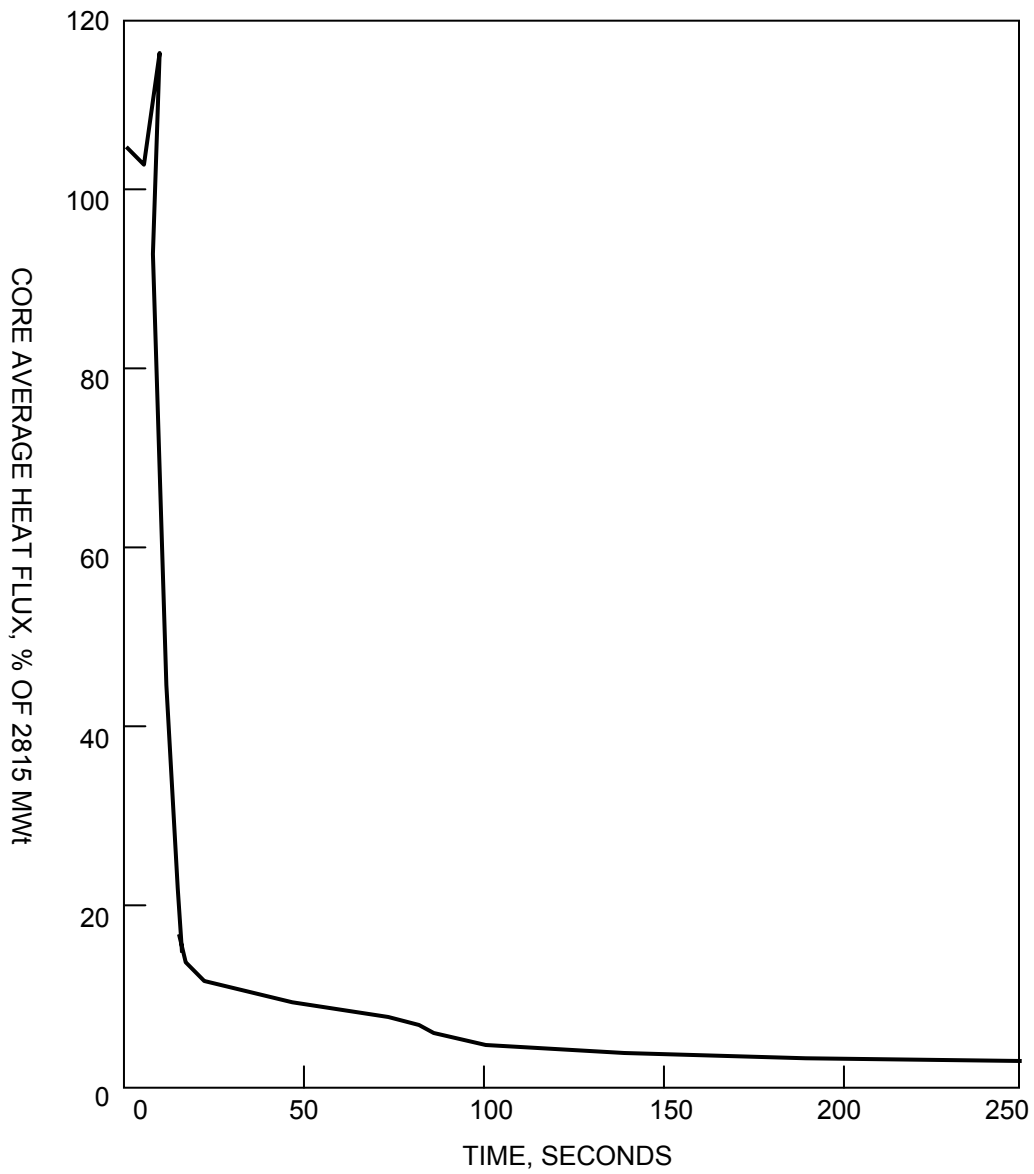

SAR FIGURE NO. 15.1.14-92

AMENDMENT 20

ARKANSAS NUCLEAR ONE
UNIT 2
RUSSELLVILLE, ARKANSAS



SCALE:	NONE
DRAWN:	
DESIGN:	ENTERGY
CAD NO:	

CYCLE 12 MSLB ANALYSIS HOT FULL POWER WITH AC AVAILABLE CORE AVERAGE HEAT FLUX VERSUS TIME

BASED ON DRAWING NO

SHEET

REV.

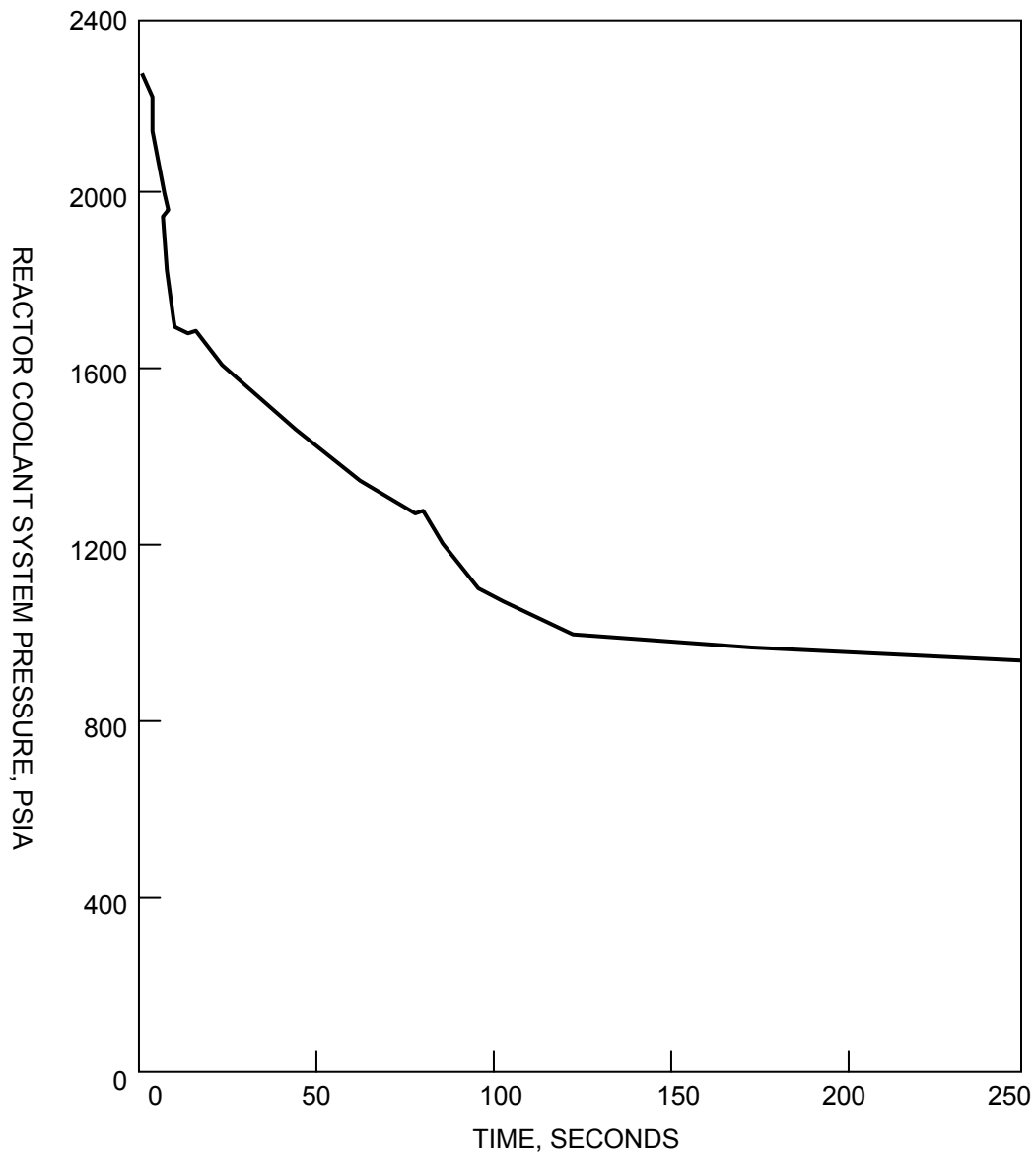

SAR FIGURE NO. 15.1.14-93

AMENDMENT 20

ARKANSAS NUCLEAR ONE
UNIT 2
RUSSELLVILLE, ARKANSAS



SCALE:	NONE
DRAWN:	
DESIGN:	ENERGY
CAD NO:	

CYCLE 12 MSLB ANALYSIS HOT FULL POWER WITH AC
AVAILABLE RCS PRESSURE VERSUS TIME

BASED ON DRAWING NO

SHEET

REV.

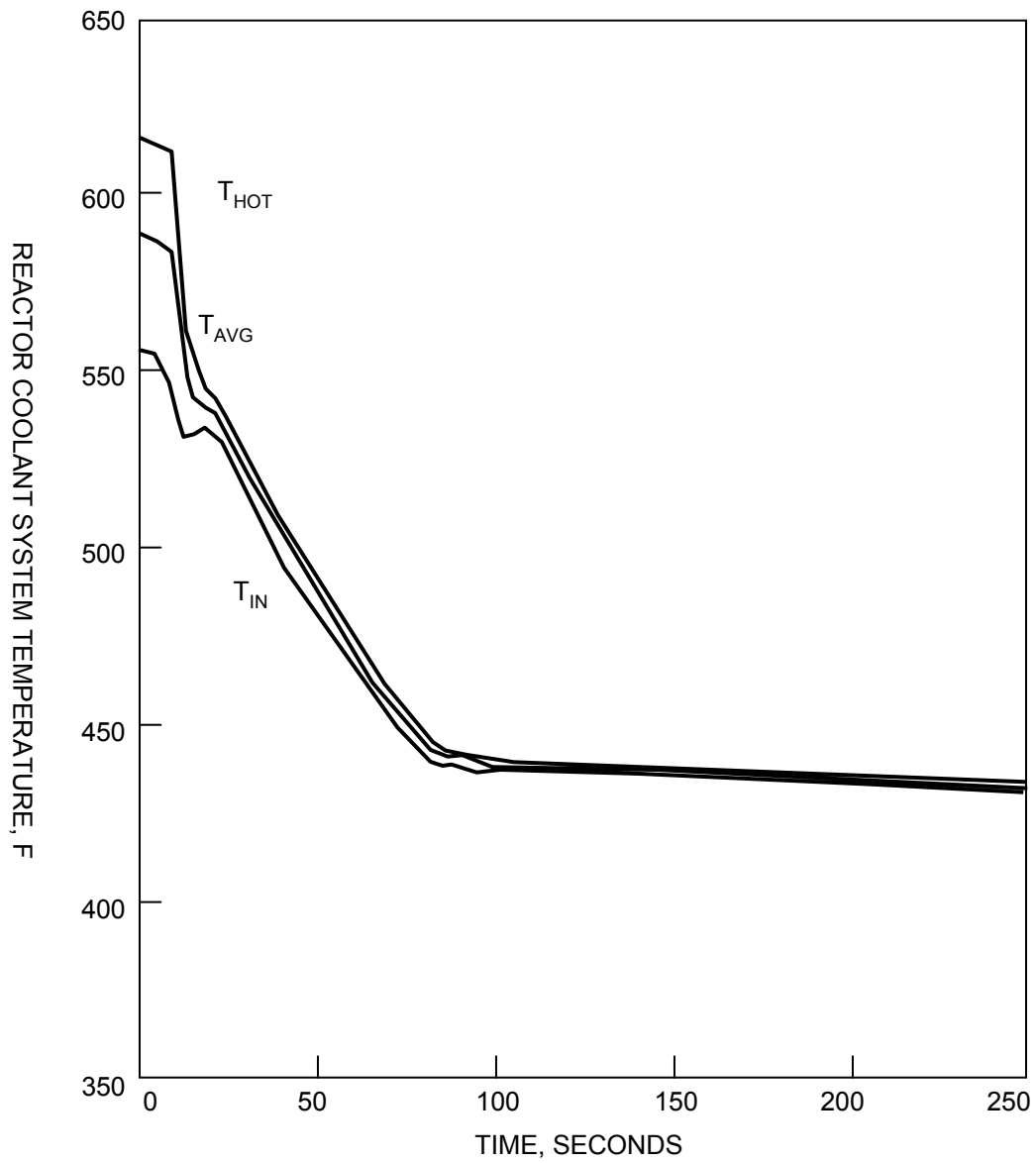

SAR FIGURE NO. 15.1.14-94

AMENDMENT 20

ARKANSAS NUCLEAR ONE
UNIT 2
RUSSELLVILLE, ARKANSAS



SCALE:	NONE
DRAWN:	
DESIGN:	ENERGY
CAD NO:	

CYCLE 12 MSLB ANALYSIS HOT FULL POWER WITH AC
AVAILABLE RCS TEMPERATURES VERSUS TIME

BASED ON DRAWING NO

SHEET

REV.

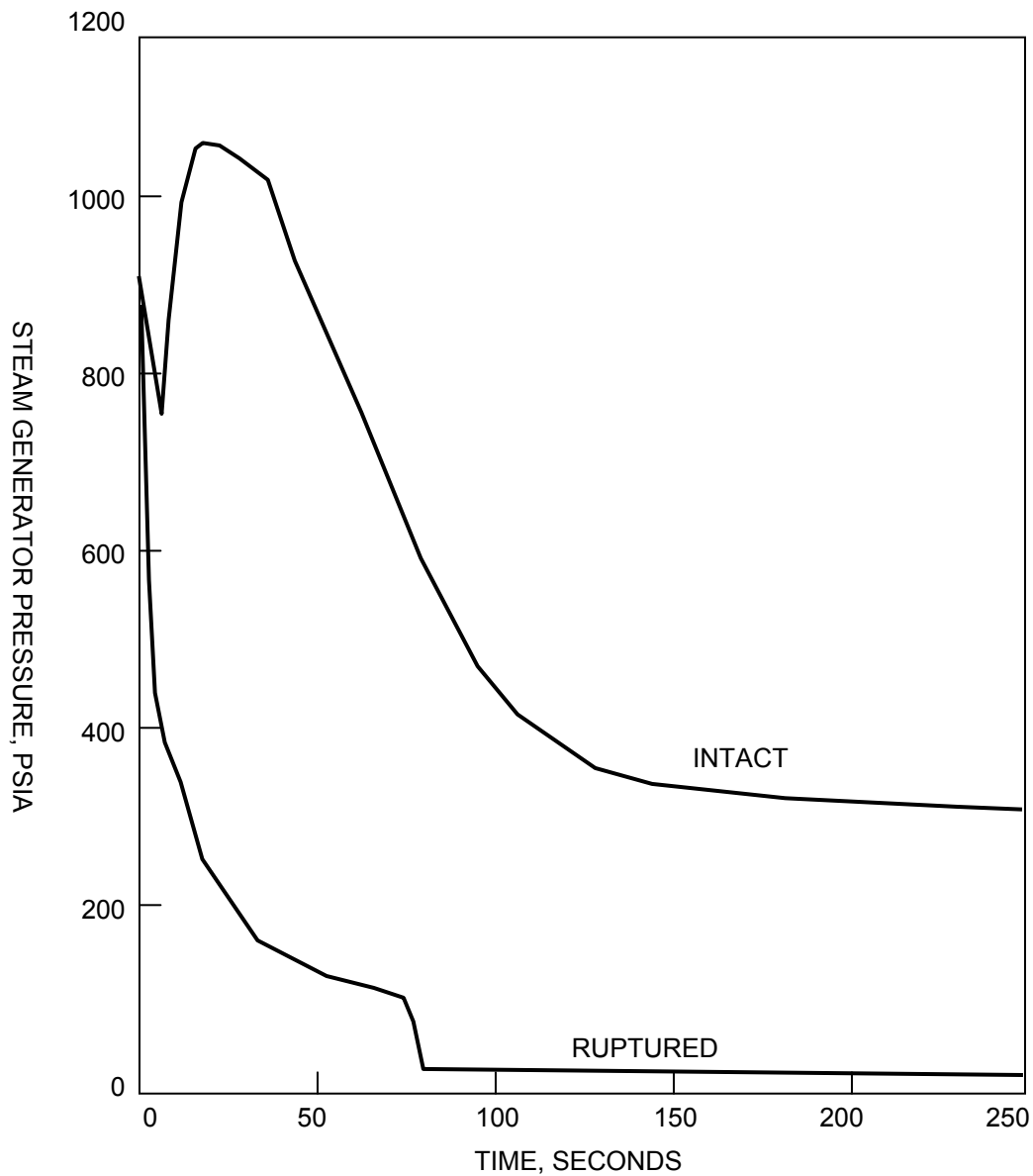

SAR FIGURE NO. 15.1.14-95

AMENDMENT 20

ARKANSAS NUCLEAR ONE
 UNIT 2
 RUSSELLVILLE, ARKANSAS



SCALE:	NONE
DRAWN:	
DESIGN:	ENERGY
CAD NO:	

CYCLE 12 MSLB ANALYSIS HOT FULL POWER WITH AC
 AVAILABLE STEAM GENERATOR PRESSURES VERSUS
 TIME

BASED ON DRAWING NO

SHEET

REV.

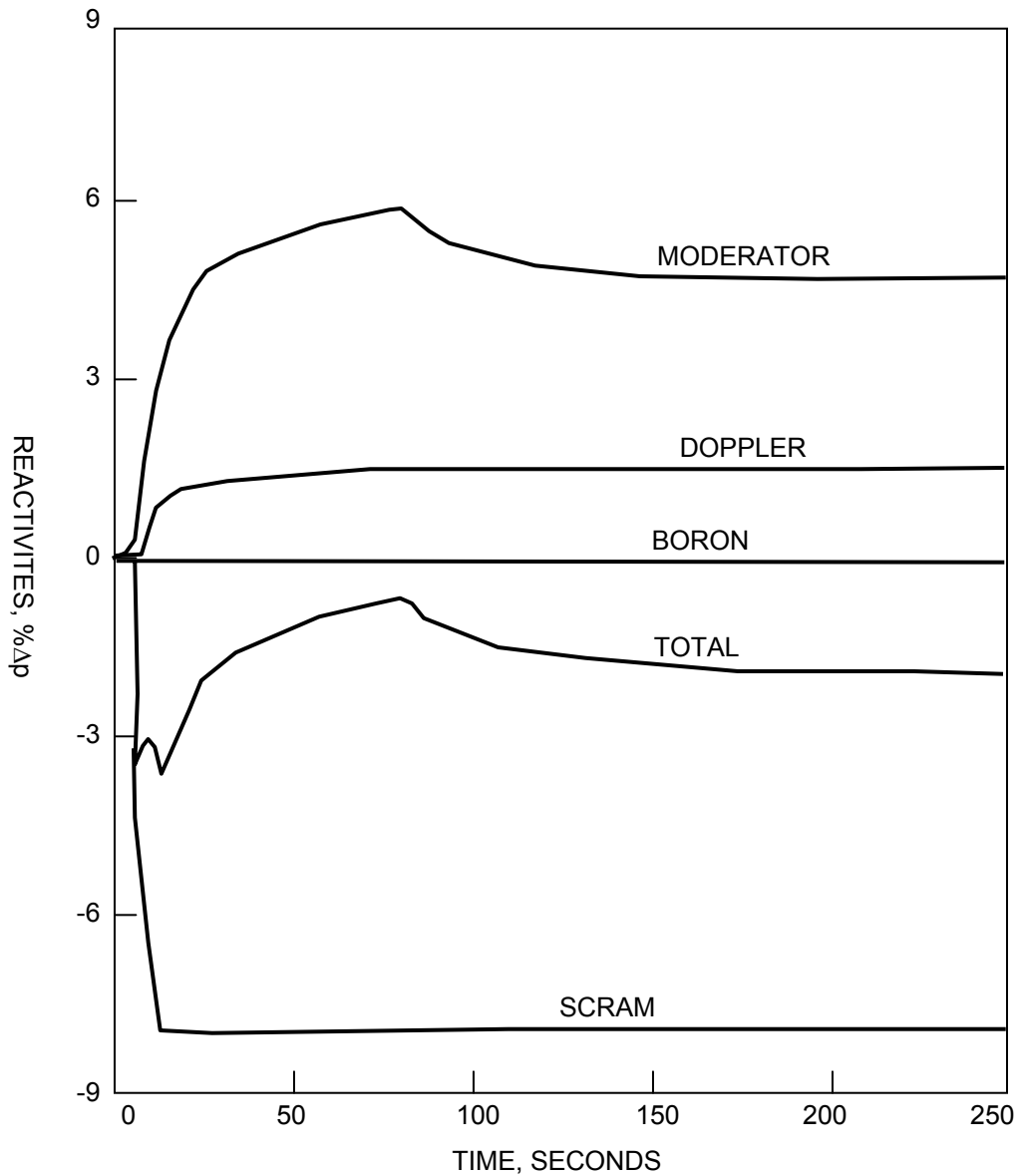

SAR FIGURE NO. 15.1.14-96

AMENDMENT 20

ARKANSAS NUCLEAR ONE
UNIT 2
RUSSELLVILLE, ARKANSAS



SCALE:	NONE
DRAWN:	
DESIGN:	ENERGY
CAD NO:	

CYCLE 12 MSLB ANALYSIS HOT FULL POWER WITH
AC AVAILABLE REACTIVITIES VERSUS TIME

BASED ON DRAWING NO

SHEET

REV.

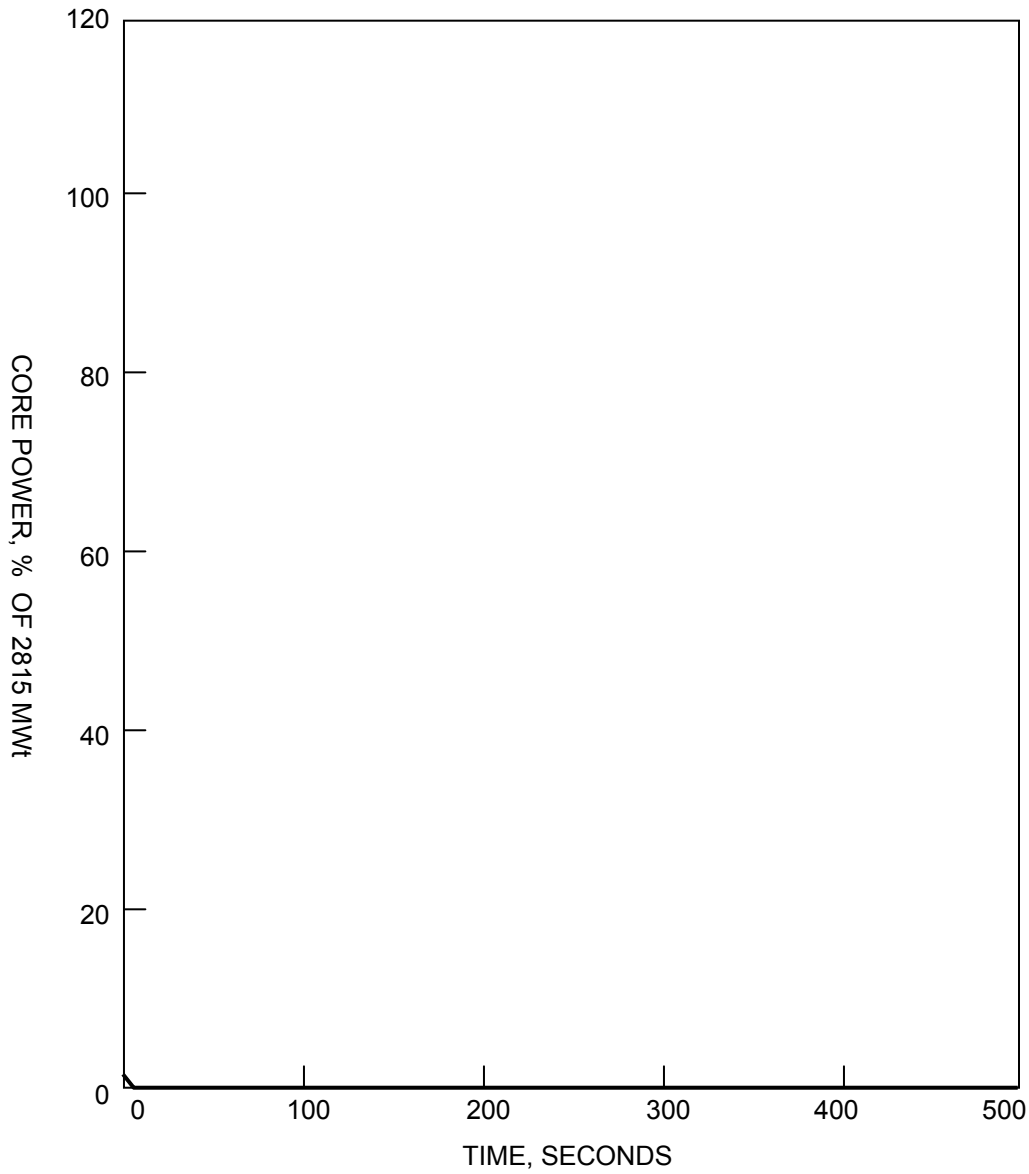

SAR FIGURE NO. 15.1.14-97

AMENDMENT 20

ARKANSAS NUCLEAR ONE
UNIT 2
RUSSELLVILLE, ARKANSAS



SCALE: NONE

DRAWN:

DESIGN: ENTERGY

CAD NO:

CYCLE 12 MSLB ANALYSIS HOT ZERO POWER
WITH LOSS OF AC CORE POWER VERSUS TIME

BASED ON DRAWING NO

SHEET

REV.

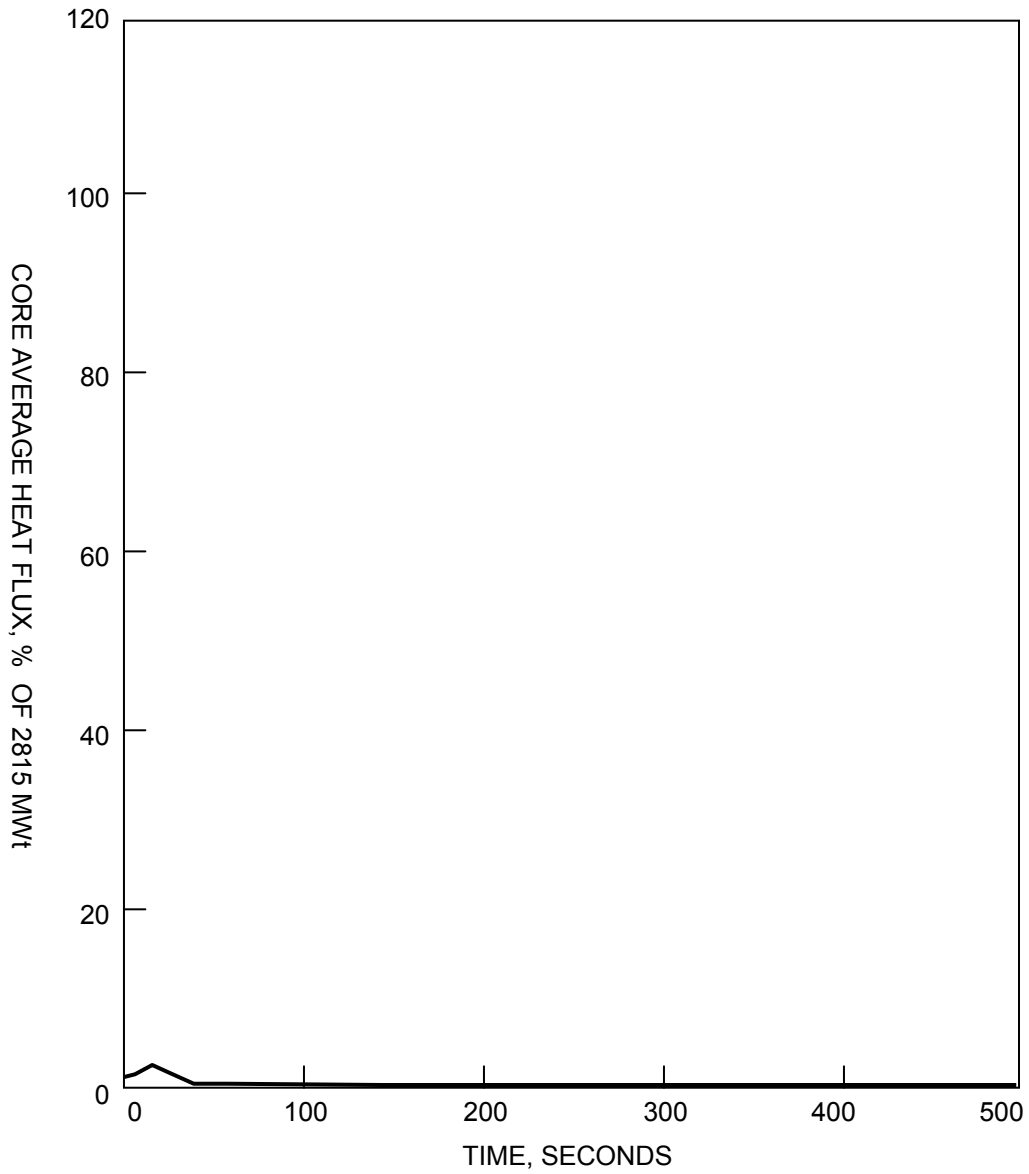

SAR FIGURE NO. 15.1.14-98

AMENDMENT 20

ARKANSAS NUCLEAR ONE
UNIT 2
RUSSELLVILLE, ARKANSAS



SCALE: NONE

DRAWN:

DESIGN: ENTERGY

CAD NO:

CYCLE 12 MSLB ANALYSIS HOT ZERO POWER WITH
LOSS OF AC CORE AVERAGE HEAT FLUX VERSUS TIME

BASED ON DRAWING NO

SHEET

REV.

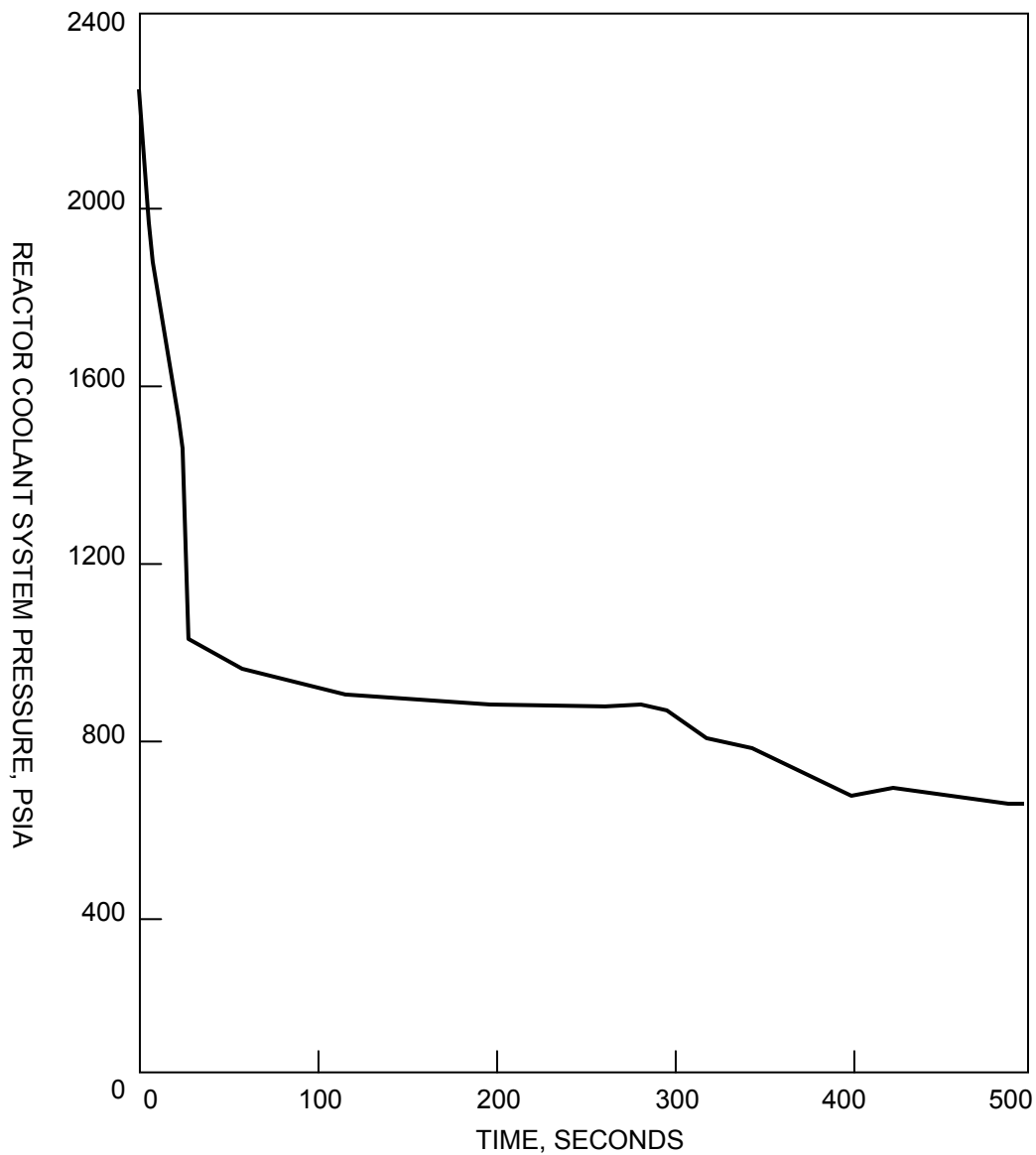

SAR FIGURE NO. 15.1.14-99

AMENDMENT 20

ARKANSAS NUCLEAR ONE
 UNIT 2
 RUSSELLVILLE, ARKANSAS



SCALE:	NONE
DRAWN:	
DESIGN:	ENTERGY
CAD NO:	

CYCLE 12 MSLB ANALYSIS HOT ZERO POWER WITH
 LOSS OF AC RCS PRESSURE VERSUS TIME

BASED ON DRAWING NO

SHEET

REV.

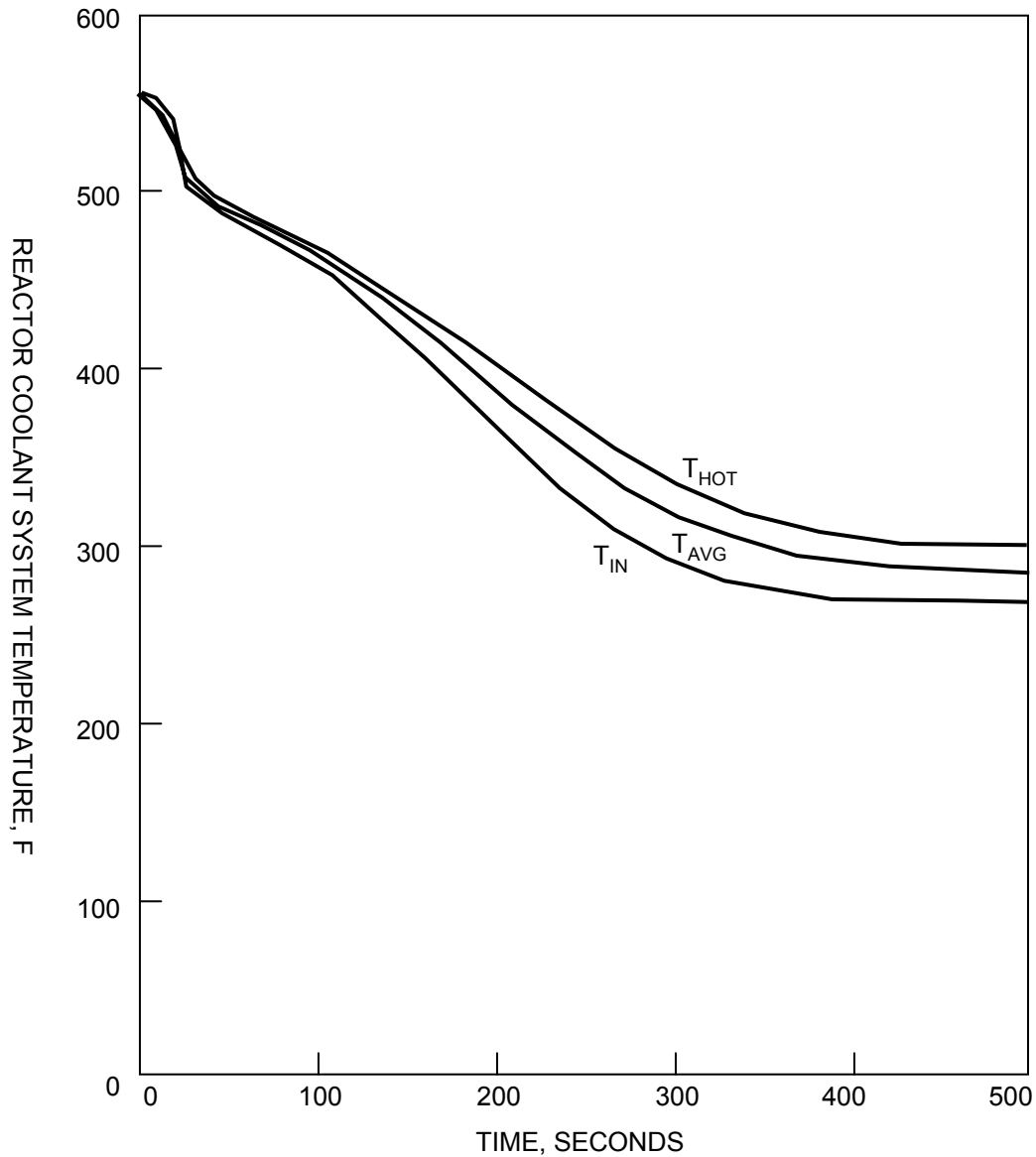

SAR FIGURE NO. 15.1.14-100

AMENDMENT 20

ARKANSAS NUCLEAR ONE
UNIT 2
RUSSELLVILLE, ARKANSAS



SCALE:	NONE
DRAWN:	
DESIGN:	ENERGY
CAD NO:	

CYCLE 12 MSLB ANALYSIS HOT ZERO POWER WITH
LOSS OF AC RCS TEMPERATURES VERSUS TIME

BASED ON DRAWING NO

SHEET

REV.

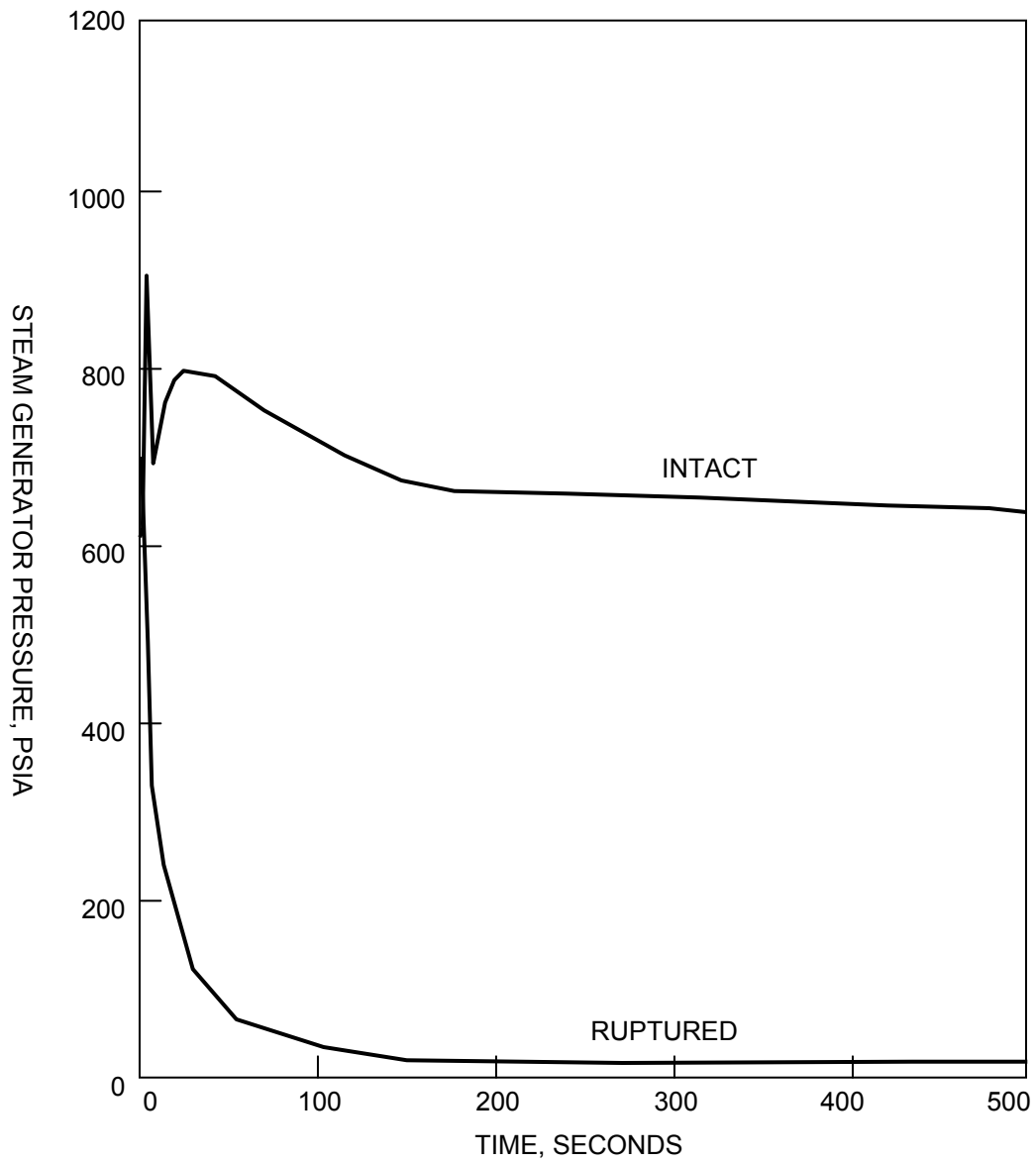

SAR FIGURE NO. 15.1.14-101

AMENDMENT 20

ARKANSAS NUCLEAR ONE
UNIT 2
RUSSELLVILLE, ARKANSAS



SCALE:	NONE
DRAWN:	
DESIGN:	ENERGY
CAD NO:	

CYCLE 12 MSLB ANALYSIS HOT ZERO POWER WITH
LOSS OF AC STEAM GENERATOR PRSSURES VERSUS
TIME

BASED ON DRAWING NO	SHEET	REV.

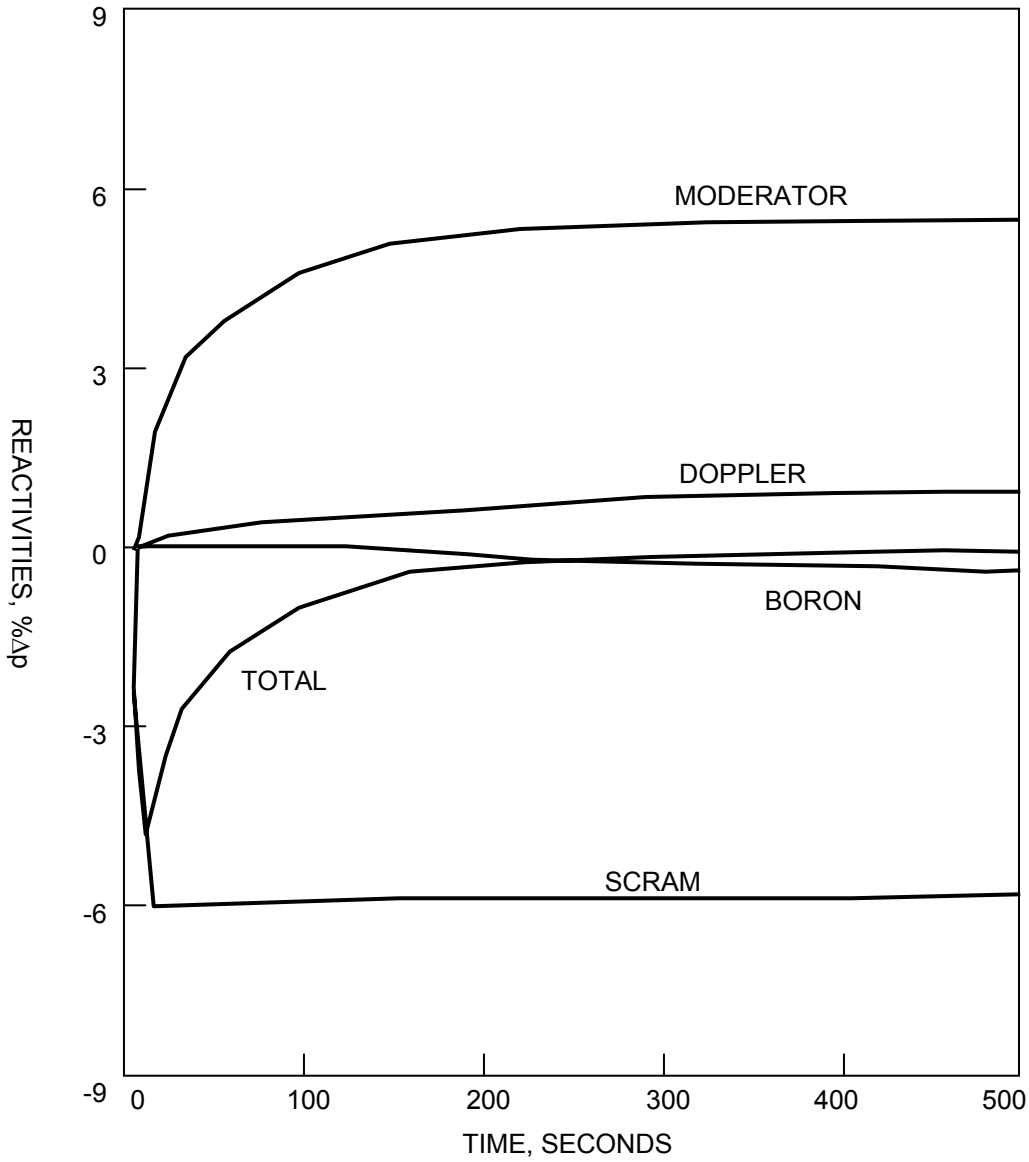

SAR FIGURE NO. 15.1.14-102

AMENDMENT 20

ARKANSAS NUCLEAR ONE
 UNIT 2
 RUSSELLVILLE, ARKANSAS



SCALE:	NONE
DRAWN:	
DESIGN:	ENERGY
CAD NO:	

CYCLE 12 MSLB ANALYSIS HOT ZERO POWER WITH
 LOSS OF AC REACTIVITIES VERSUS TIME

BASED ON DRAWING NO

SHEET

REV.

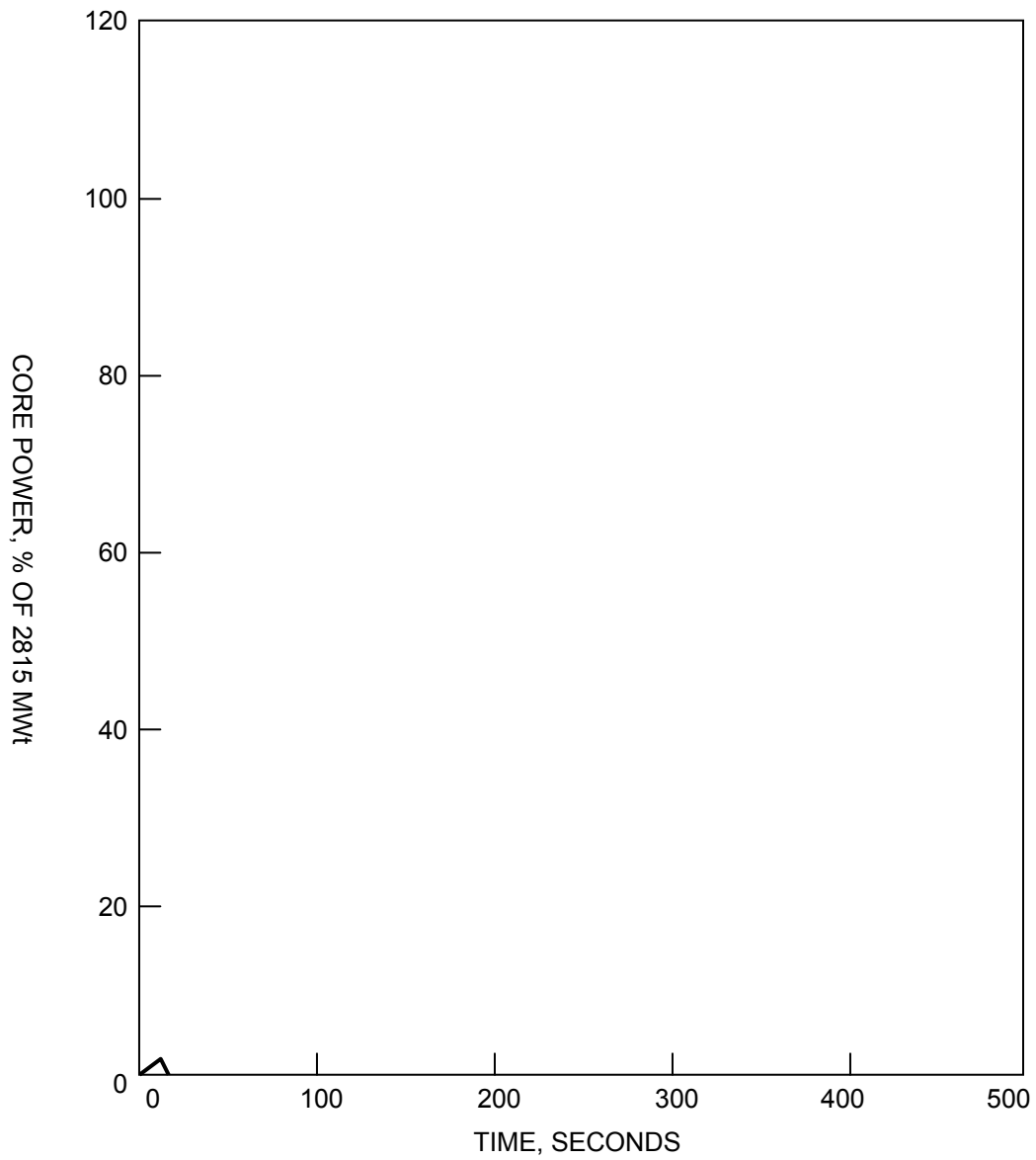

SAR FIGURE NO. 15.1.14-103

AMENDMENT 20

ARKANSAS NUCLEAR ONE
 UNIT 2
 RUSSELLVILLE, ARKANSAS



SCALE: NONE

DRAWN:

DESIGN: ENTERGY

CAD NO:

CYCLE 12 MSLB ANALYSIS HOT ZERO POWER WITH AC
 AVAILABLE CORE POWER VERSUS TIME

BASED ON DRAWING NO

SHEET

REV.

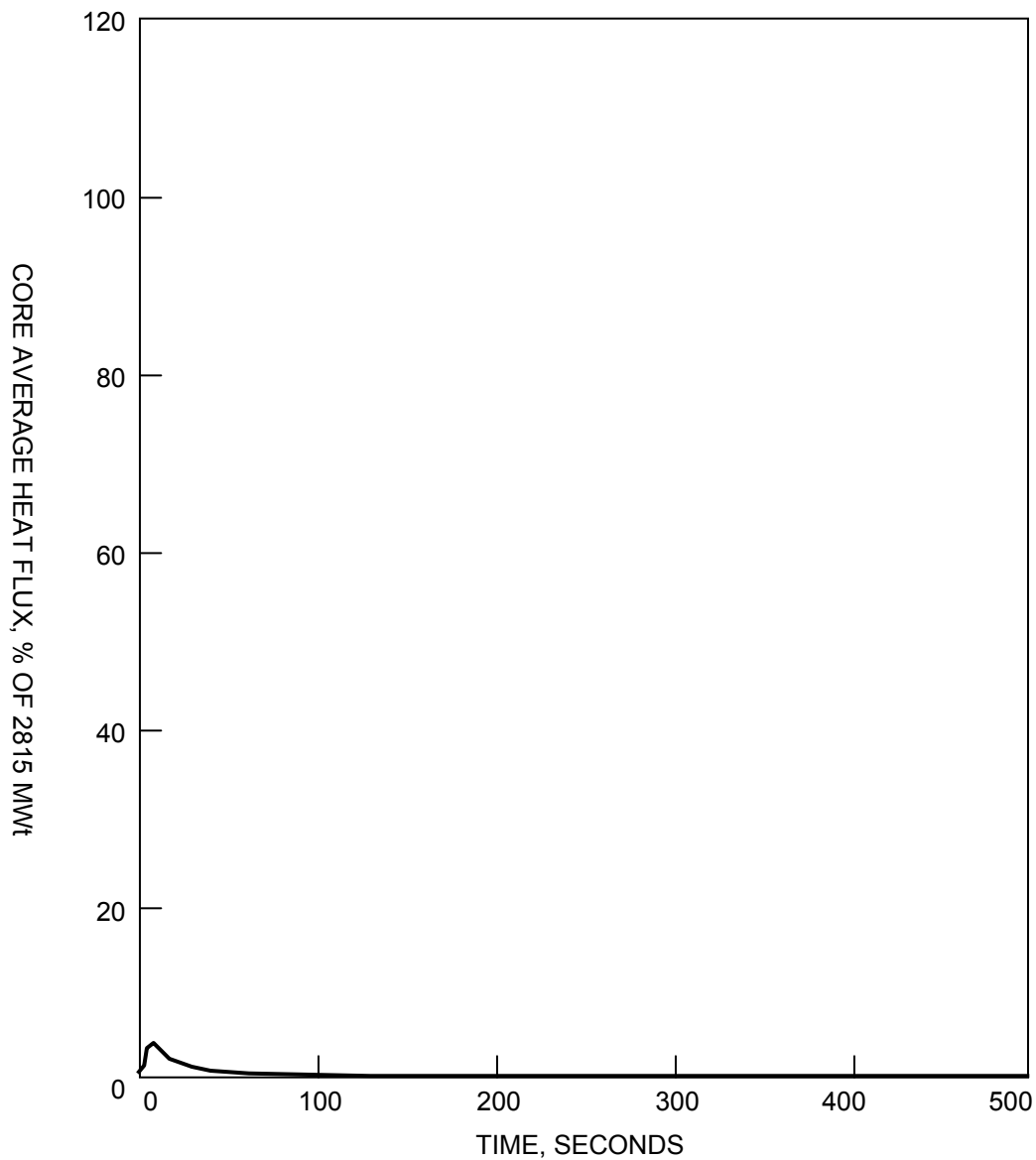

SAR FIGURE NO. 15.1.14-104

AMENDMENT 20

ARKANSAS NUCLEAR ONE
UNIT 2
RUSSELLVILLE, ARKANSAS



SCALE:	NONE
DRAWN:	
DESIGN:	ENTERGY
CAD NO:	

CYCLE 12 MSLB ANALYSIS HOT ZERO POWER WITH AC AVAILABLE CORE AVERAGE HEAT FLUX VERSUS TIME

BASED ON DRAWING NO

SHEET

REV.

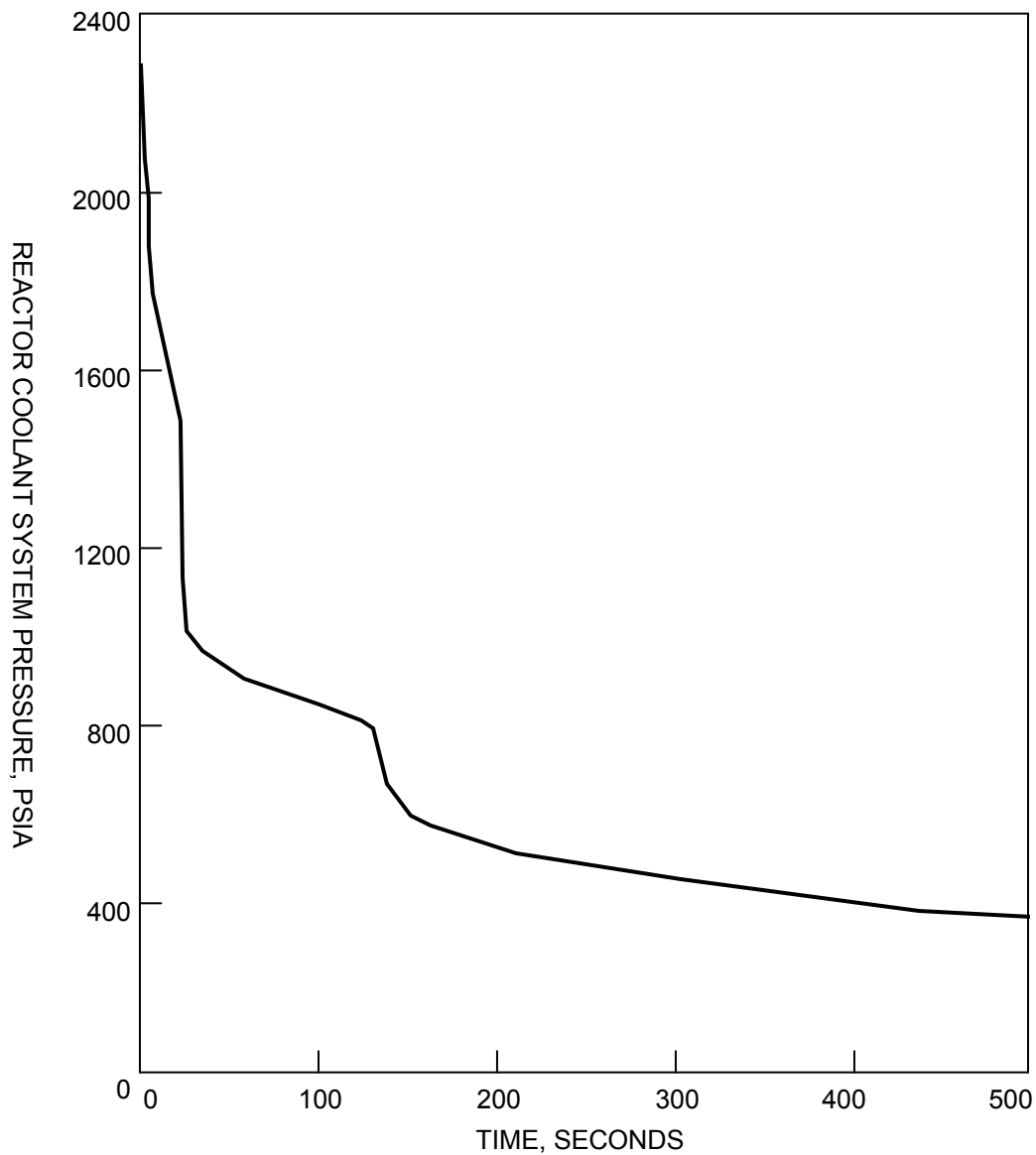

SAR FIGURE NO. 15.1.14-105

AMENDMENT 20

ARKANSAS NUCLEAR ONE
 UNIT 2
 RUSSELLVILLE, ARKANSAS



SCALE:	NONE
DRAWN:	
DESIGN:	ENERGY
CAD NO:	

CYCLE 12 MSLB ANALYSIS HOT ZERO POWER WITH AC
 AVAILABLE RCS PRESSURE VERSUS TIME

BASED ON DRAWING NO

SHEET

REV.

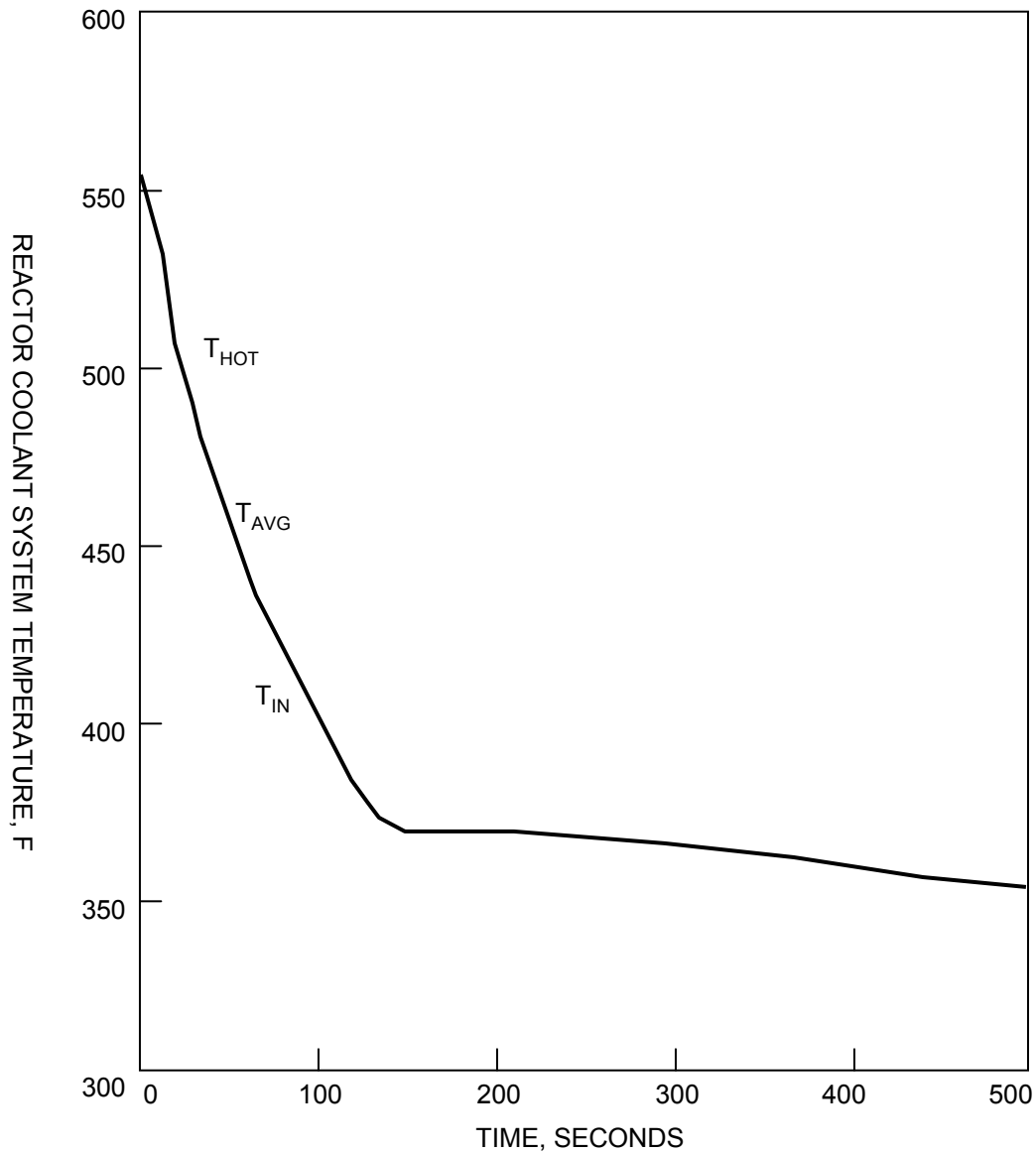

SAR FIGURE NO. 15.1.14-106

AMENDMENT 20

ARKANSAS NUCLEAR ONE
UNIT 2
RUSSELLVILLE, ARKANSAS



SCALE:	NONE
DRAWN:	
DESIGN:	ENERGY
CAD NO:	

CYCLE 12 MSLB ANALYSIS HOT ZERO POWER WITH AC
AVAILABLE RCS TEMPERATURES VERSUS TIME

BASED ON DRAWING NO

SHEET

REV.

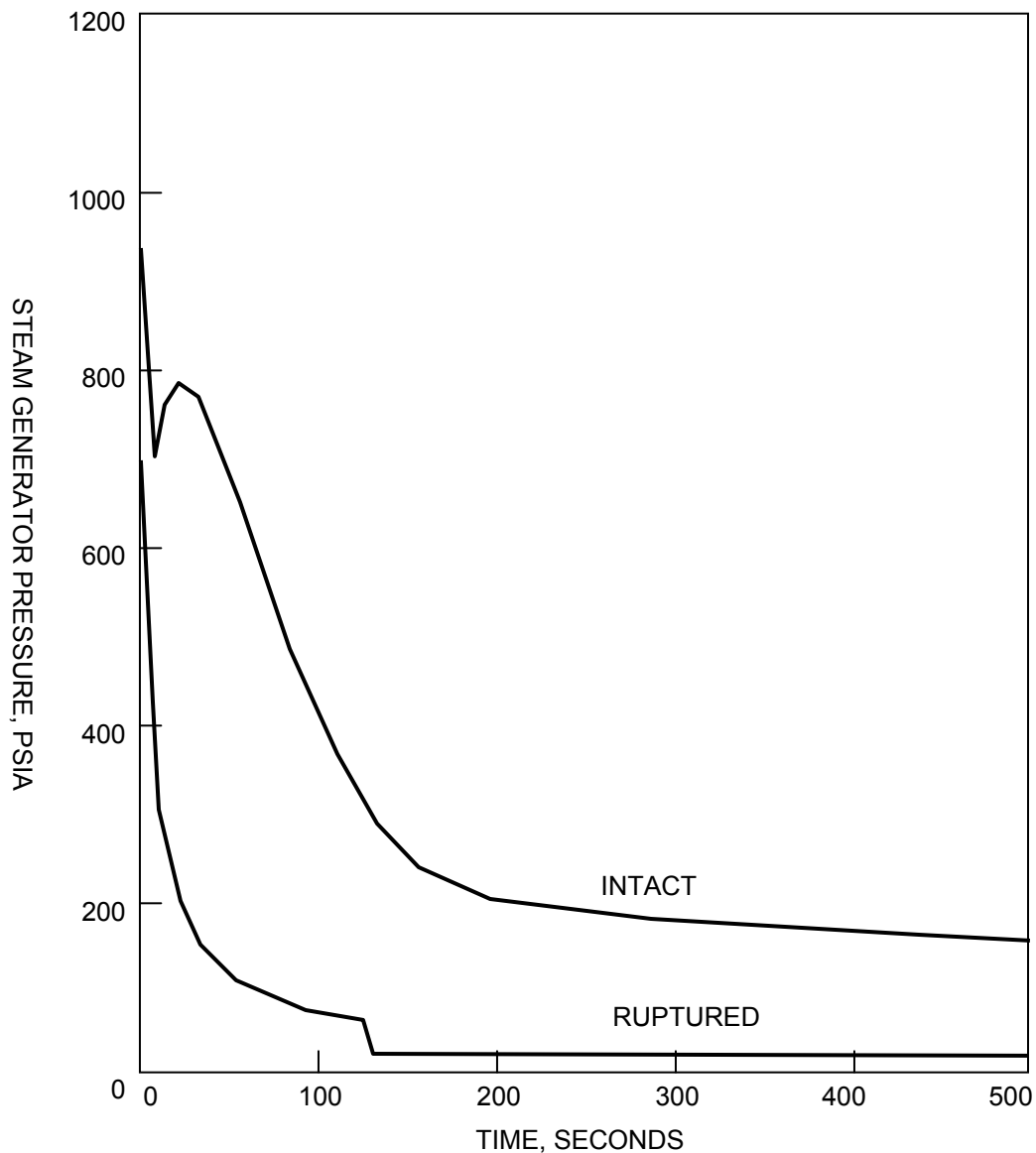

SAR FIGURE NO. 15.1.14-107

AMENDMENT 20

ARKANSAS NUCLEAR ONE
UNIT 2
RUSSELLVILLE, ARKANSAS



SCALE:	NONE
DRAWN:	
DESIGN:	ENERGY
CAD NO:	

CYCLE 12 MSLB ANALYSIS HOT ZERO POWER WITH AC
AVAILABLE STEAM GENERATOR PRESSURES VERSUS
TIME

BASED ON DRAWING NO

SHEET

REV.

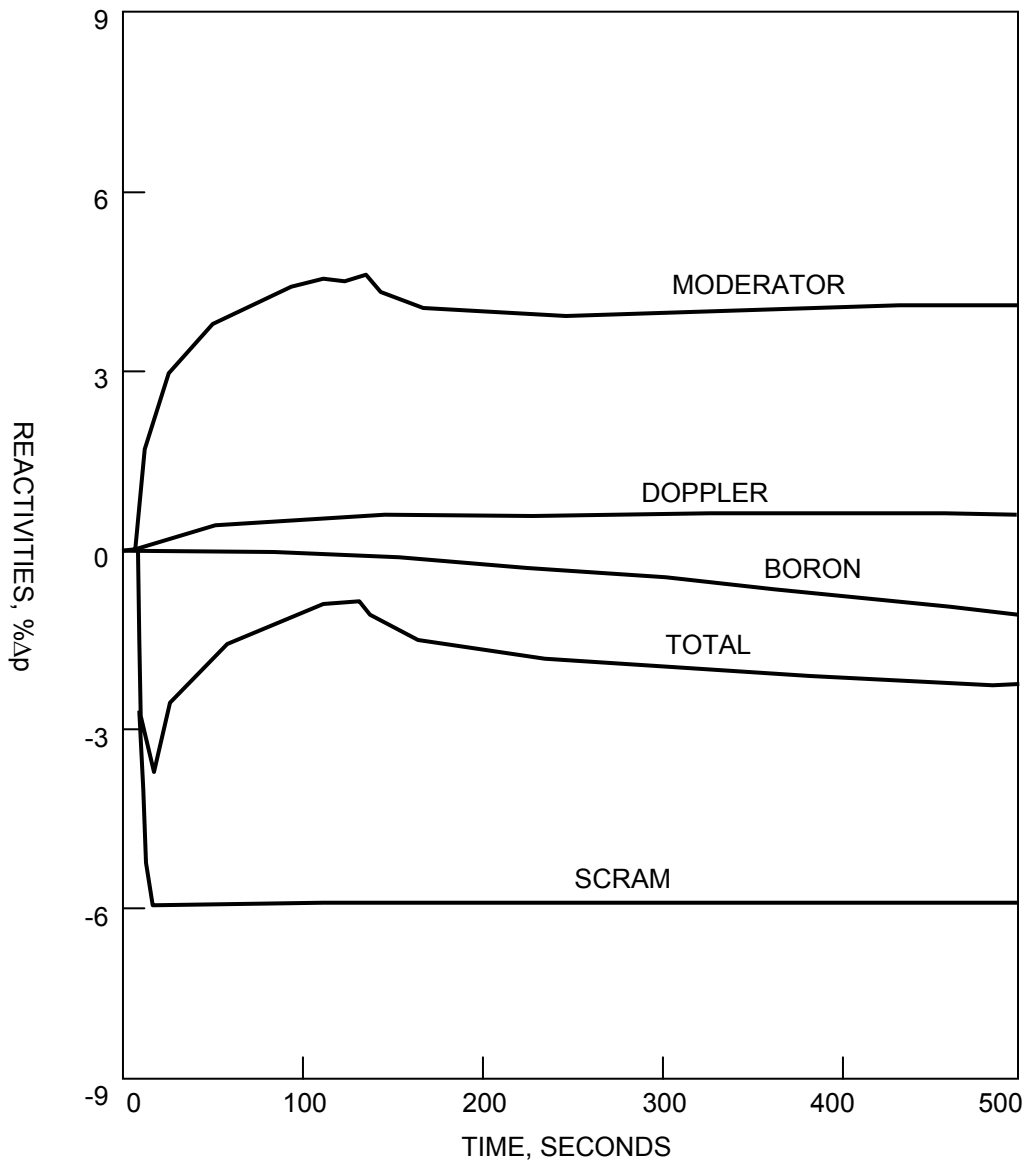

SAR FIGURE NO. 15.1.14-108

AMENDMENT 20

ARKANSAS NUCLEAR ONE
UNIT 2
RUSSELLVILLE, ARKANSAS



SCALE:	NONE
DRAWN:	
DESIGN:	ENERGY
CAD NO:	

CYCLE 12 MSLB ANALYSIS HOT ZERO POWER
WITH AC AVAILABLE REACTIVITIES VERSUS TIME

BASED ON DRAWING NO

SHEET

REV.

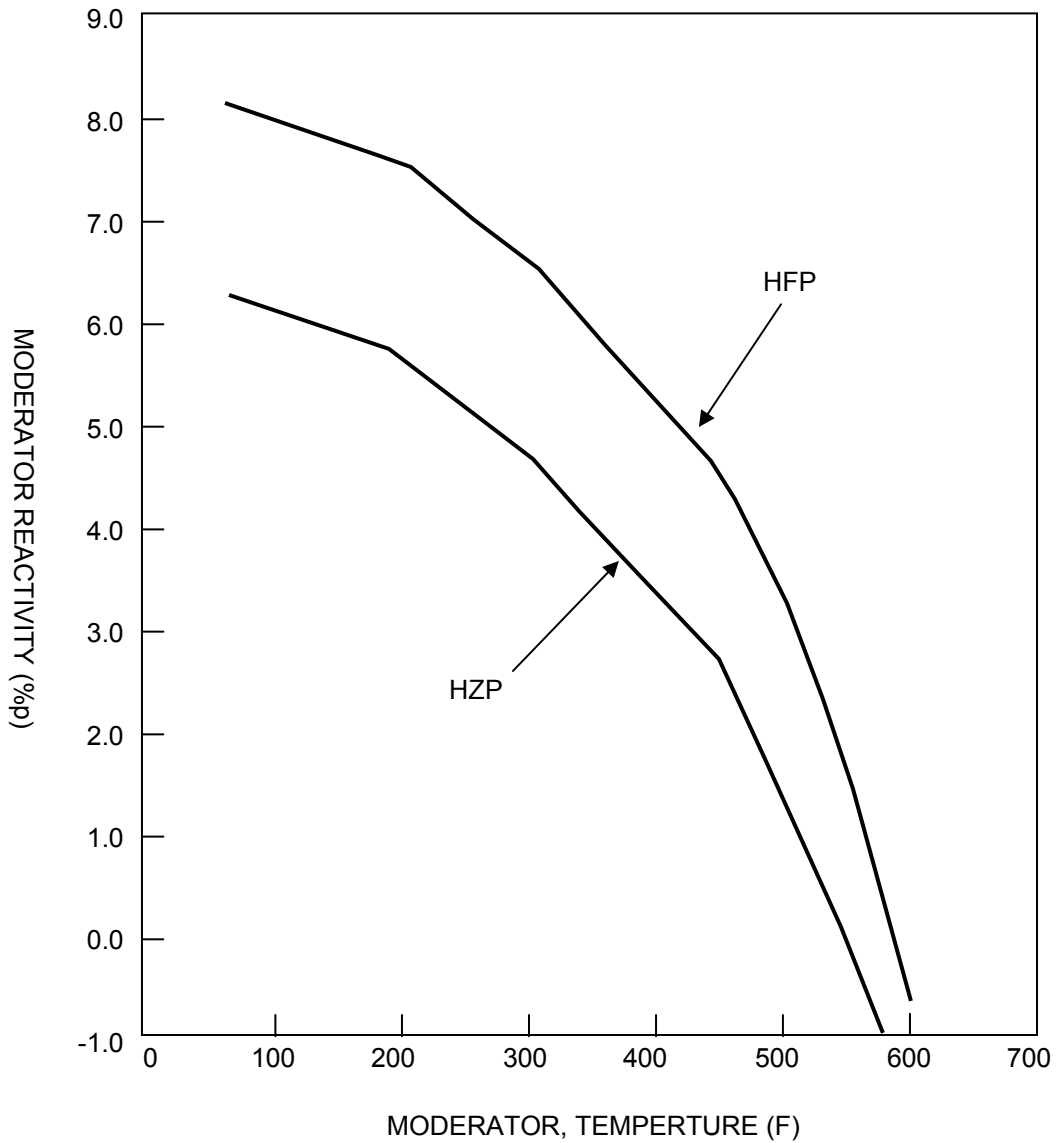

SAR FIGURE NO. 15.1.14-109

AMENDMENT 20

ARKANSAS NUCLEAR ONE
UNIT 2
RUSSELLVILLE, ARKANSAS



SCALE:	NONE
DRAWN:	
DESIGN:	ENERGY
CAD NO:	

ANO UNIT 2 COOLDOWN USED IN THE CYCLE
12 MSLB ANALYSIS

BASED ON DRAWING NO

SHEET

REV.

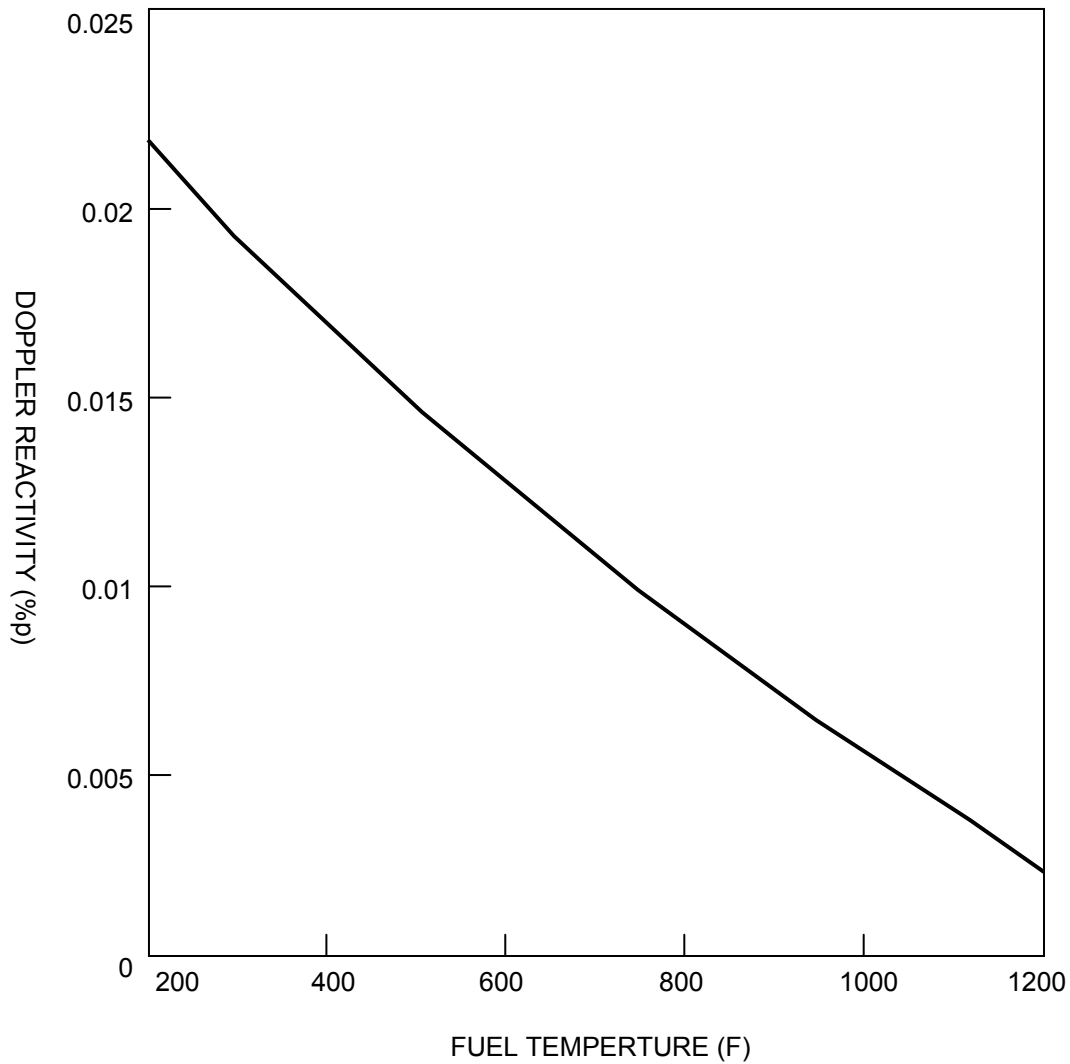

SAR FIGURE NO. 15.1.14-110

AMENDMENT 20

ARKANSAS NUCLEAR ONE
 UNIT 2
 RUSSELLVILLE, ARKANSAS



SCALE:	NONE
DRAWN:	
DESIGN:	ENTERGY
CAD NO:	

DOPPLER REACTIVITY VERSUS FUEL TEMPERATURE
 FOR THE CYCLE 12 MSLB ANALYSIS

BASED ON DRAWING NO

SHEET

REV.

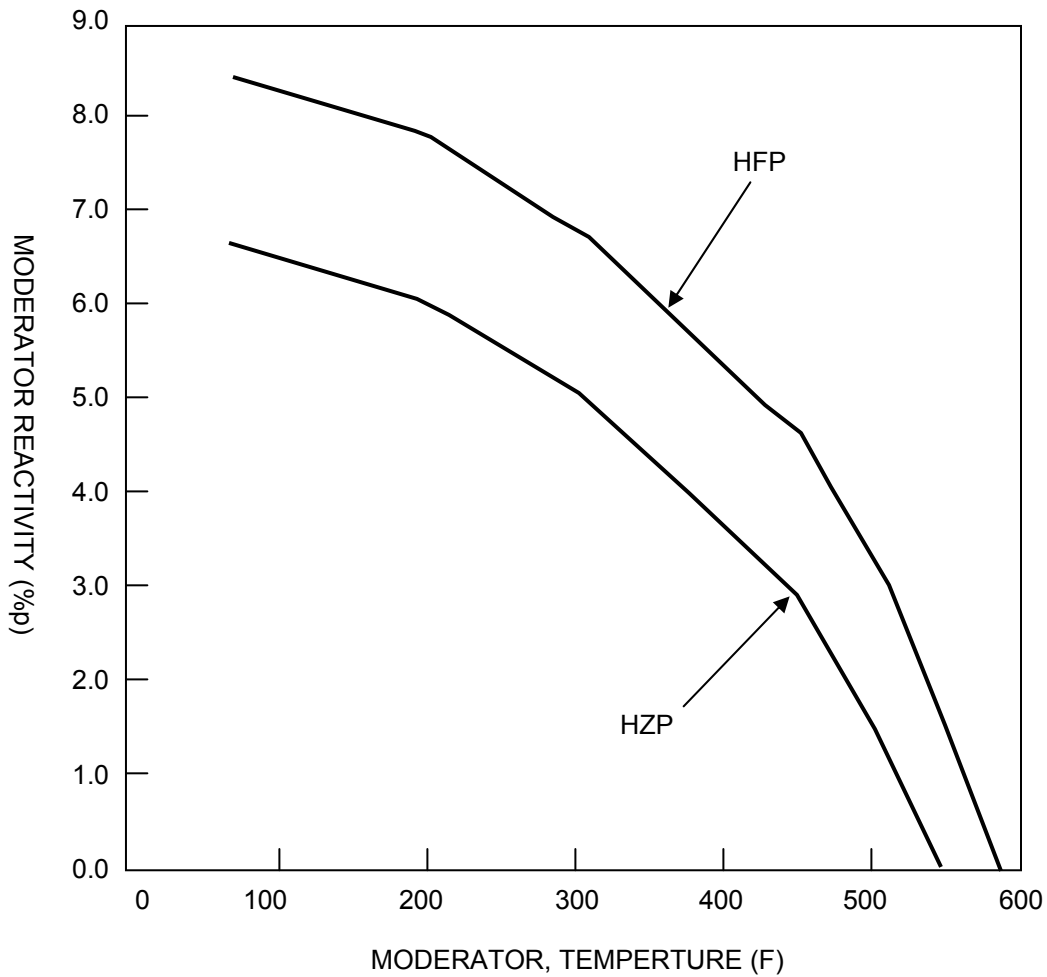

SAR FIGURE NO. 15.1.14-111

AMENDMENT 20

ARKANSAS NUCLEAR ONE
UNIT 2
RUSSELLVILLE, ARKANSAS



SCALE:	NONE
DRAWN:	
DESIGN:	ENERGY
CAD NO:	

COOLDOWN DATA FOR THE
CYCLE 12 MSLB ANALYSIS

BASED ON DRAWING NO

SHEET

REV.

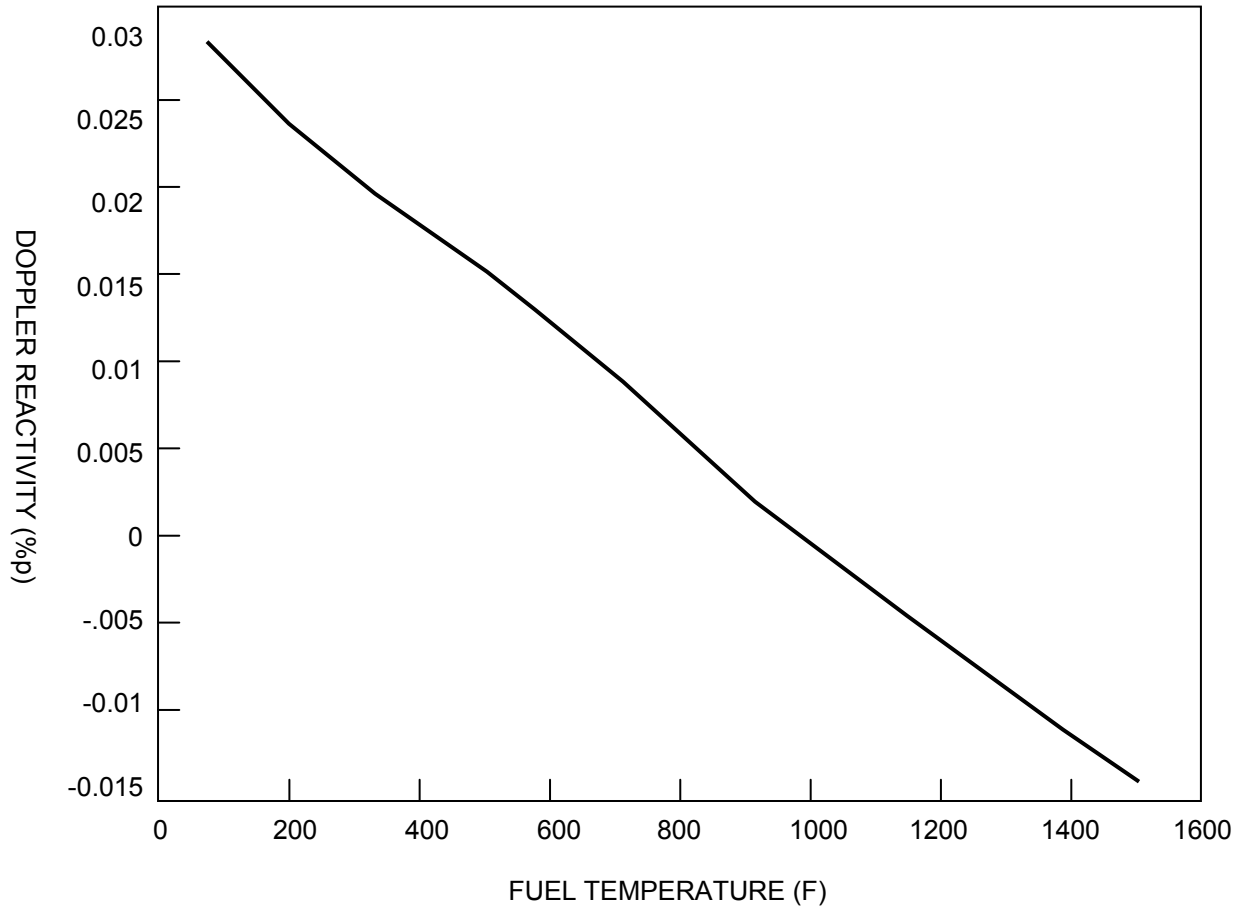

SAR FIGURE NO. 15.1.14-112

AMENDMENT 20

ARKANSAS NUCLEAR ONE
 UNIT 2
 RUSSELLVILLE, ARKANSAS



SCALE:	NONE
DRAWN:	
DESIGN:	ENERGY
CAD NO:	

COOLDOWN DATA FOR THE
 CYCLE 12 MSLB ANALYSIS

BASED ON DRAWING NO

SHEET

REV.

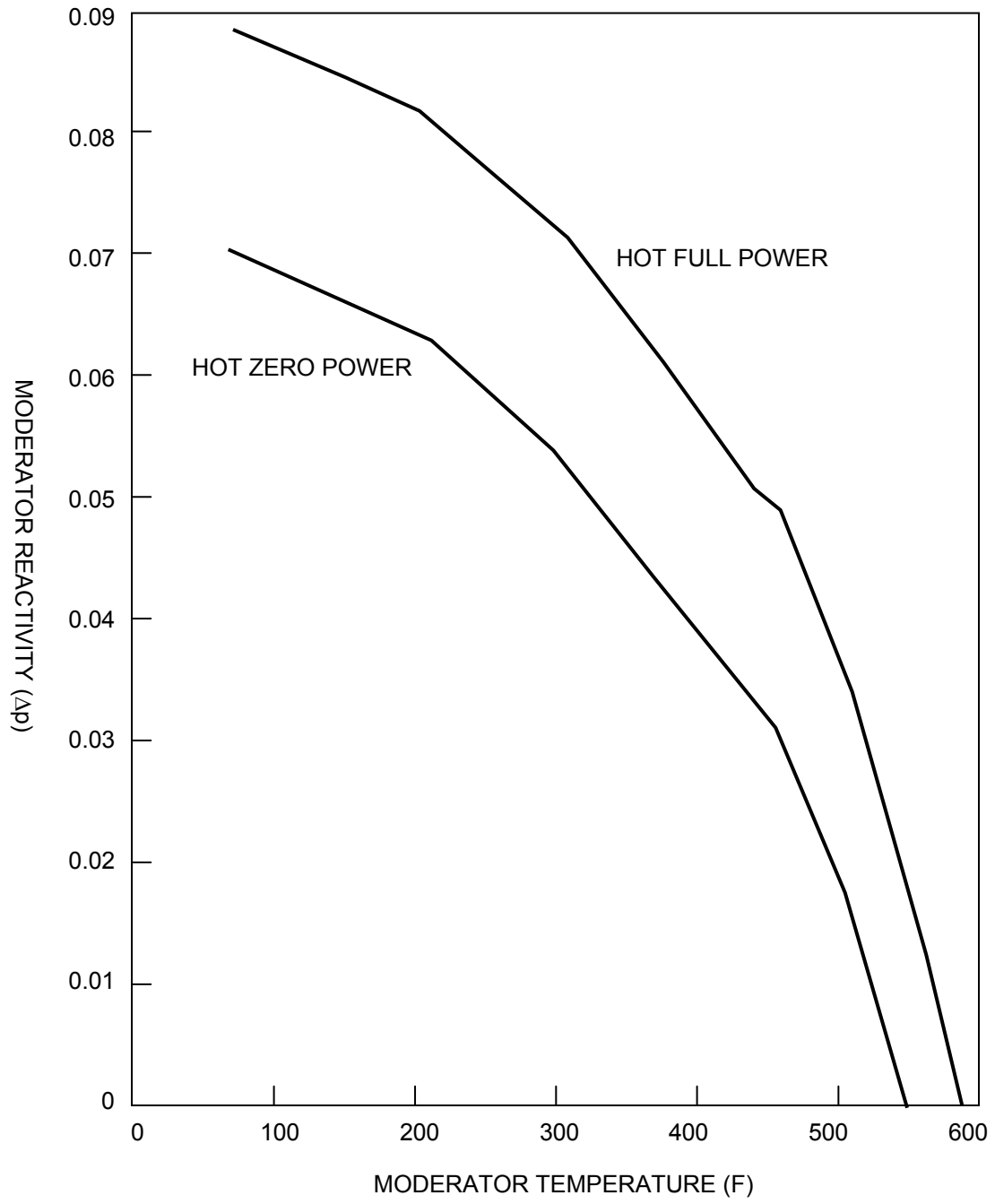

SAR FIGURE NO. 15.1.14-113

AMENDMENT 20

ARKANSAS NUCLEAR ONE
 UNIT 2
 RUSSELLVILLE, ARKANSAS



SCALE:	NONE
DRAWN:	
DESIGN:	ENERGY
CAD NO:	

CYCLE 15 AT 3026 MWt MODERATOR COOLDOWN
 CURVES MODERATOR REACTIVITY VERSUS
 MODERATOR TEMPERATURE

BASED ON DRAWING NO

SHEET

REV.

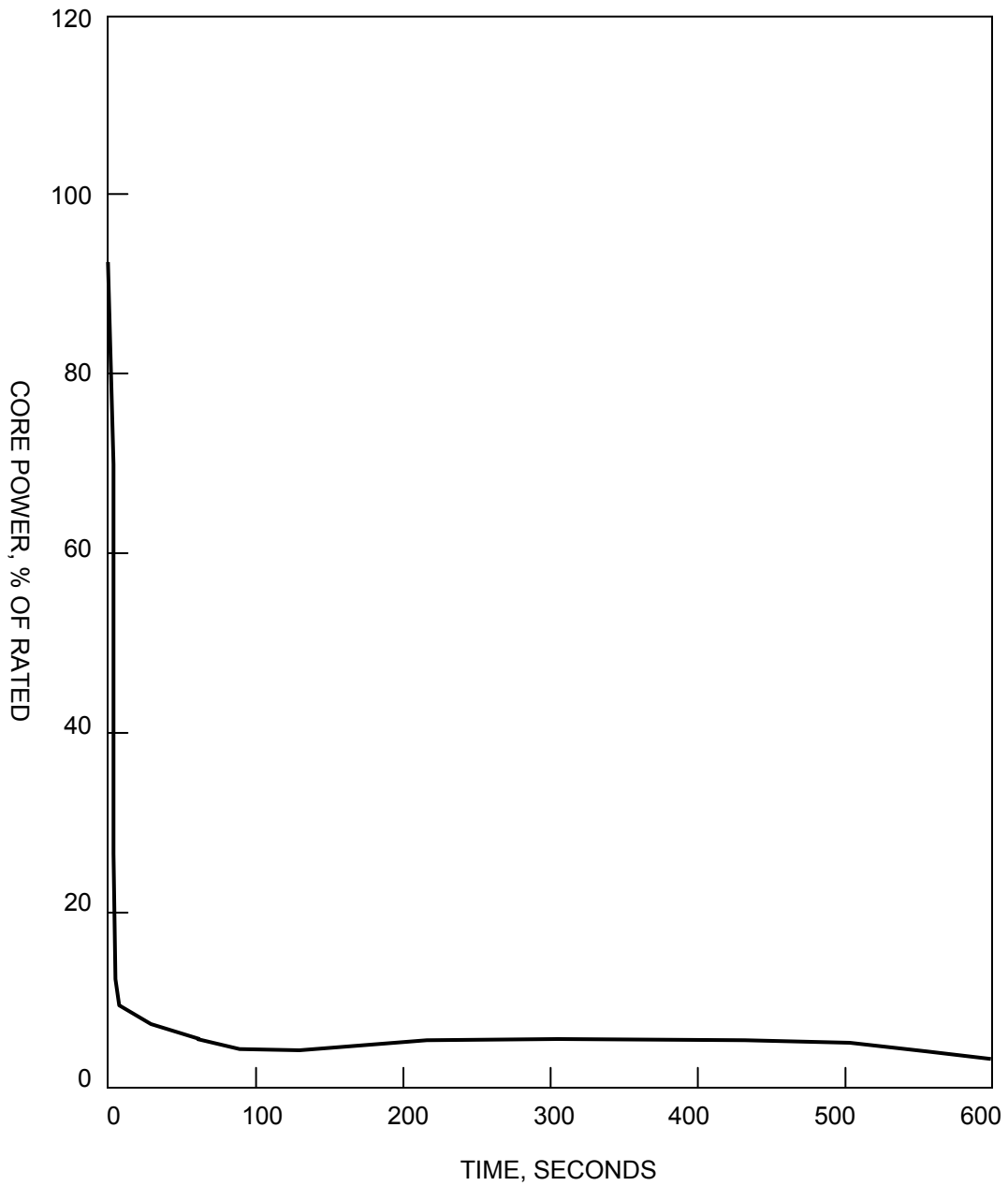

SAR FIGURE NO. 15.1.14-114

AMENDMENT 20

ARKANSAS NUCLEAR ONE
 UNIT 2
 RUSSELLVILLE, ARKANSAS



SCALE:	NONE
DRAWN:	
DESIGN:	ENERGY
CAD NO:	

CYCLE 15 AT 3026 MWt HOT FULL POWER MSLB WITH
 LOSS OF AC INSIDE CONTAINMENT BREAK CORE POWER
 VERSUS TIME

BASED ON DRAWING NO

SHEET

REV.

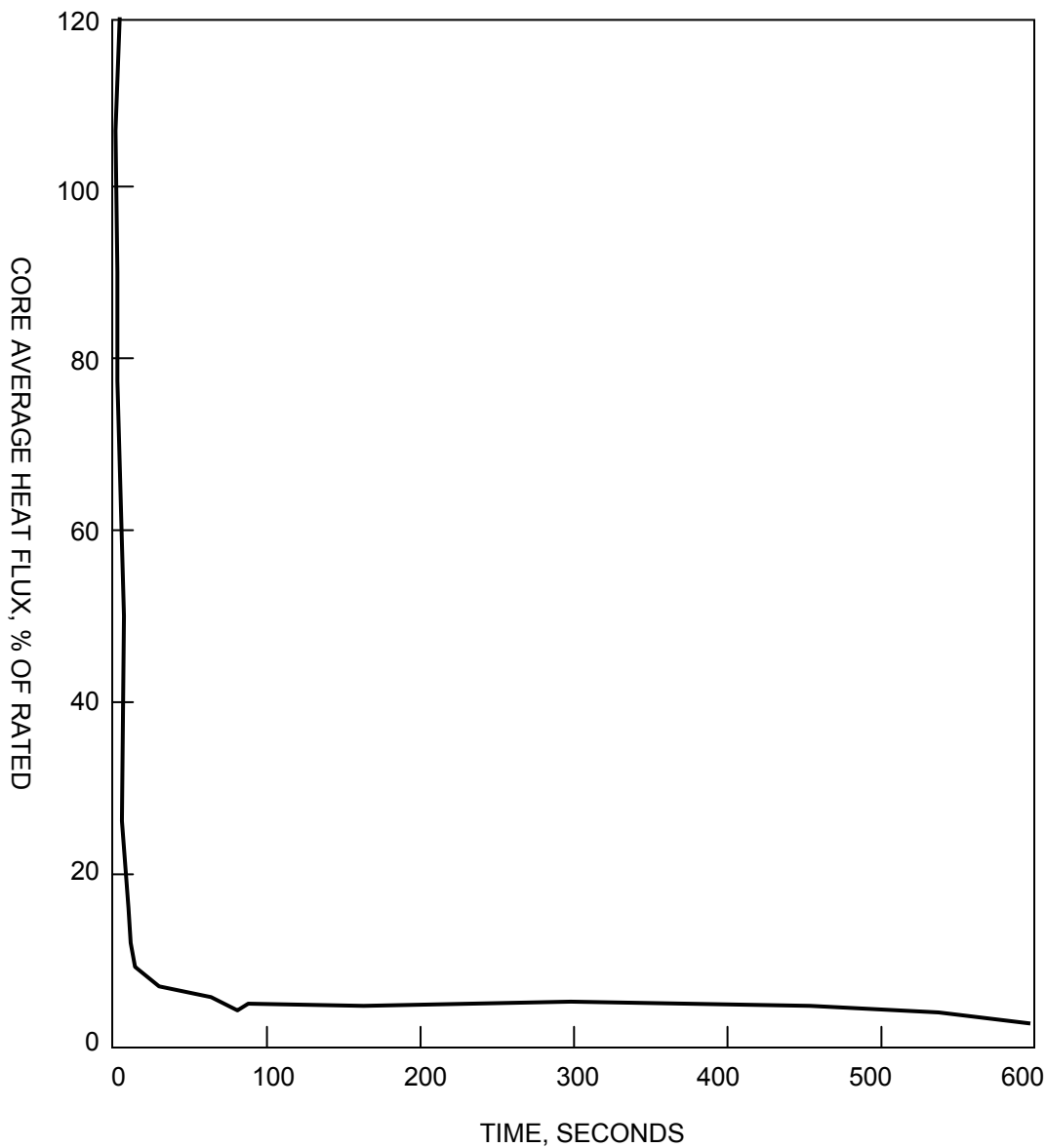

SAR FIGURE NO. 15.1.14-115

AMENDMENT 20

ARKANSAS NUCLEAR ONE
UNIT 2
RUSSELLVILLE, ARKANSAS



SCALE:	NONE
DRAWN:	
DESIGN:	ENTERGY
CAD NO:	

CYCLE 15 AT 3026 MWt HOT FULL POWER MSLB WITH
LOSS OF AC INSIDE CONTAINMENT BREAK CORE
AVERAGE HEAT FLUX VERSUS TIME

BASED ON DRAWING NO

SHEET

REV.

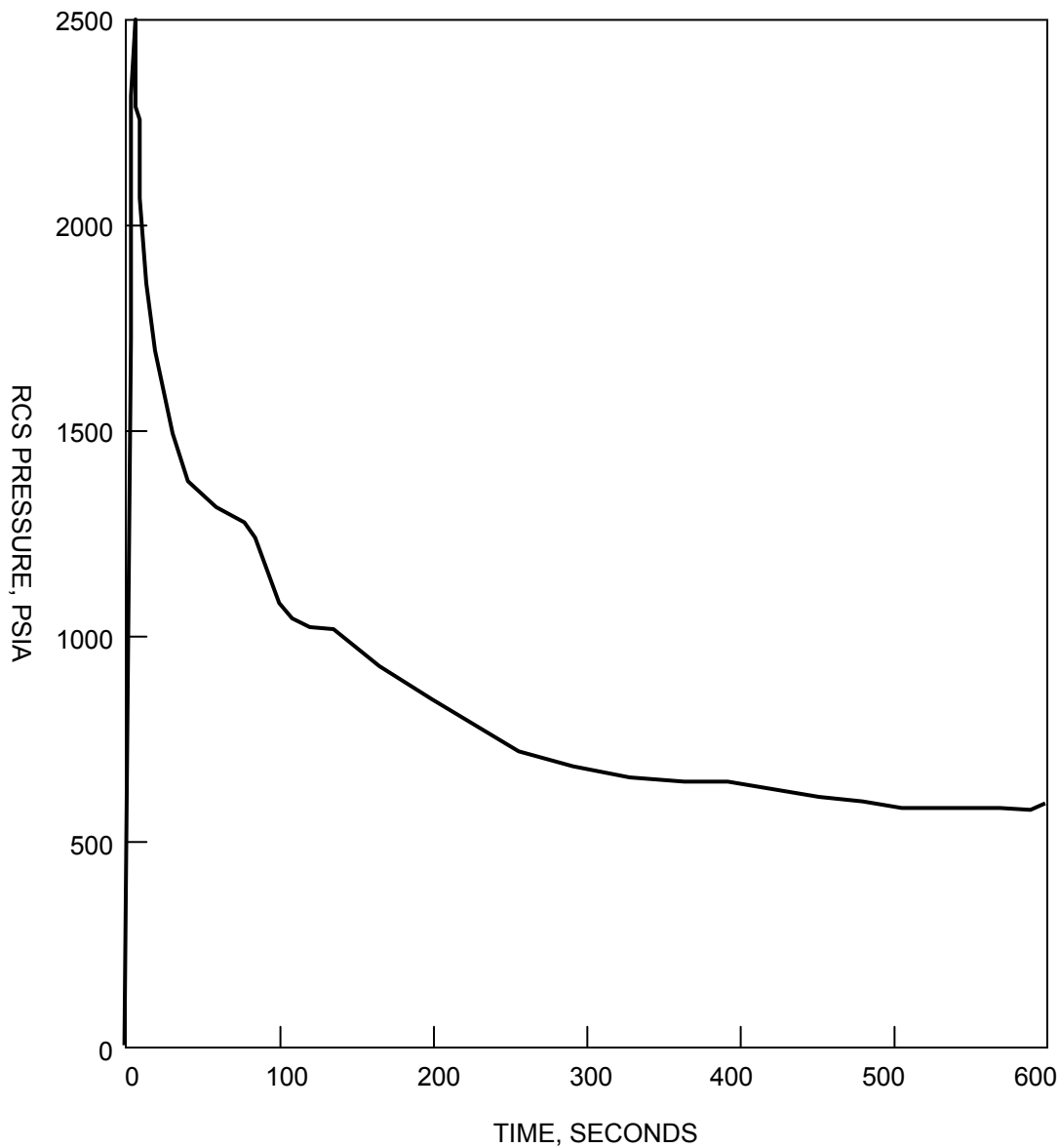

SAR FIGURE NO. 15.1.14-116

AMENDMENT 20

ARKANSAS NUCLEAR ONE
 UNIT 2
 RUSSELLVILLE, ARKANSAS



SCALE:	NONE
DRAWN:	
DESIGN:	ENERGY
CAD NO:	

CYCLE 15 AT 3026 MWt HOT FULL POWER MSLB WITH
 LOSS OF AC INSIDE CONTAINMENT BREAK CORE RCS
 PRESSURE VERSUS TIME

BASED ON DRAWING NO

SHEET

REV.

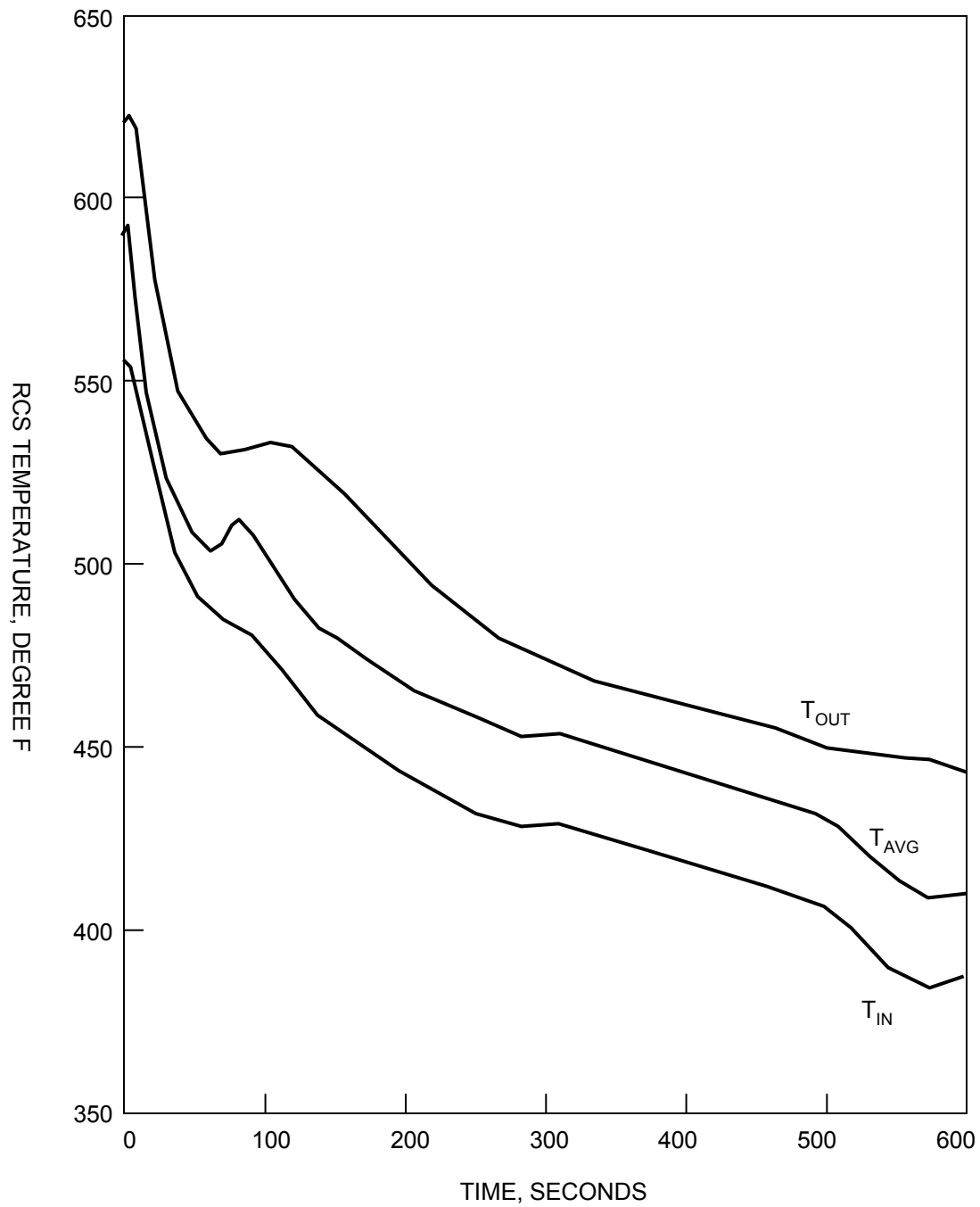

SAR FIGURE NO. 15.1.14-117

AMENDMENT 20

ARKANSAS NUCLEAR ONE
UNIT 2
RUSSELLVILLE, ARKANSAS



SCALE:	NONE
DRAWN:	
DESIGN:	ENERGY
CAD NO:	

CYCLE 15 AT 3026 MWt HOT FULL POWER MSLB WITH
LOSS OF AC INSIDE CONTAINMENT RCS TEMPERATURE
VERSUS TIME

BASED ON DRAWING NO

SHEET

REV.

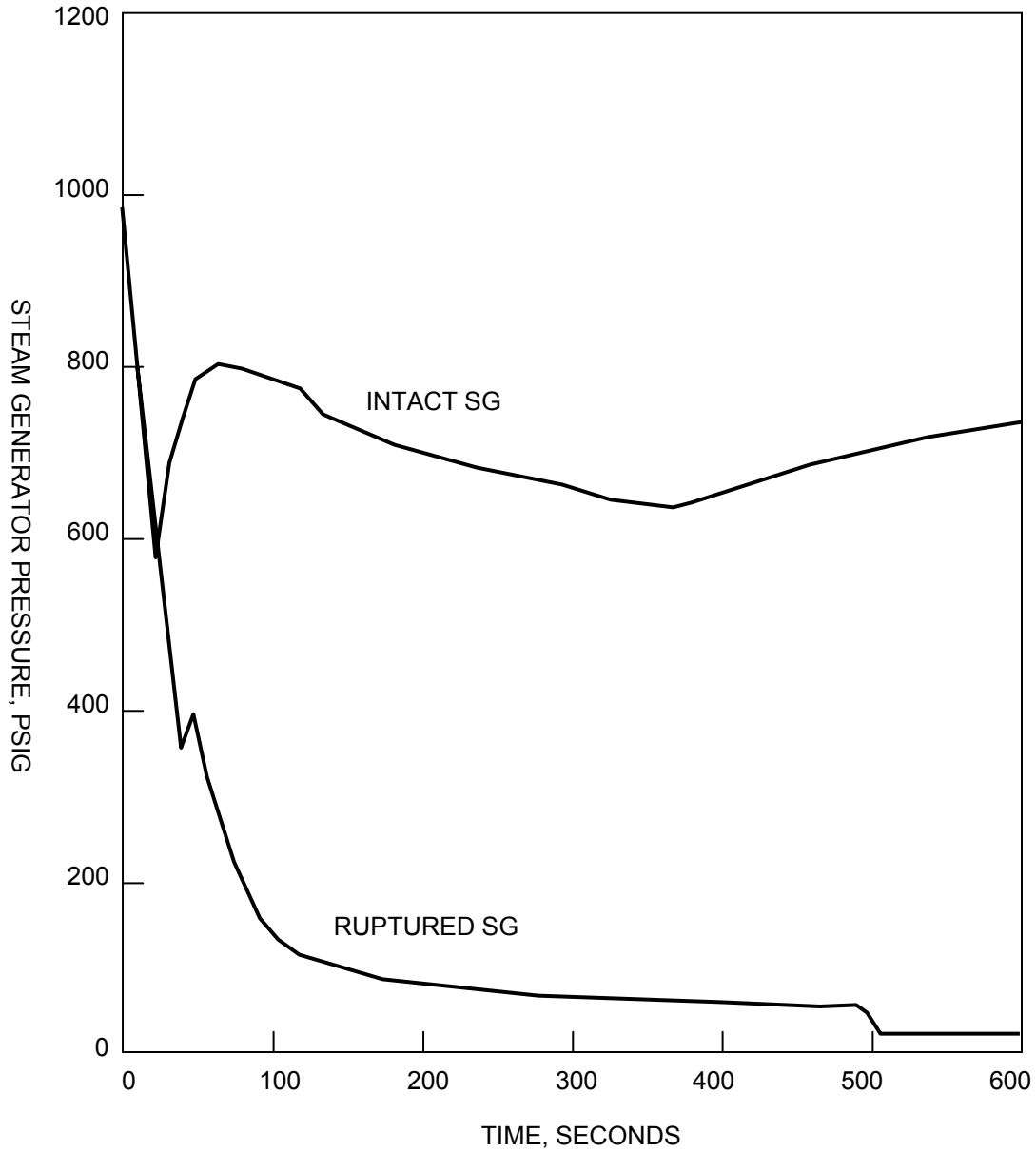

SAR FIGURE NO. 15.1.14-118

AMENDMENT 20

ARKANSAS NUCLEAR ONE
UNIT 2
RUSSELLVILLE, ARKANSAS



SCALE:	NONE
DRAWN:	
DESIGN:	ENERGY
CAD NO:	

CYCLE 15 AT 3026 MWt HOT FULL POWER MSLB WITH
LOSS OF AC INSIDE CONTAINMENT STEAM GENERATOR
PRESSURE VERSUS TIME

BASED ON DRAWING NO

SHEET

REV.

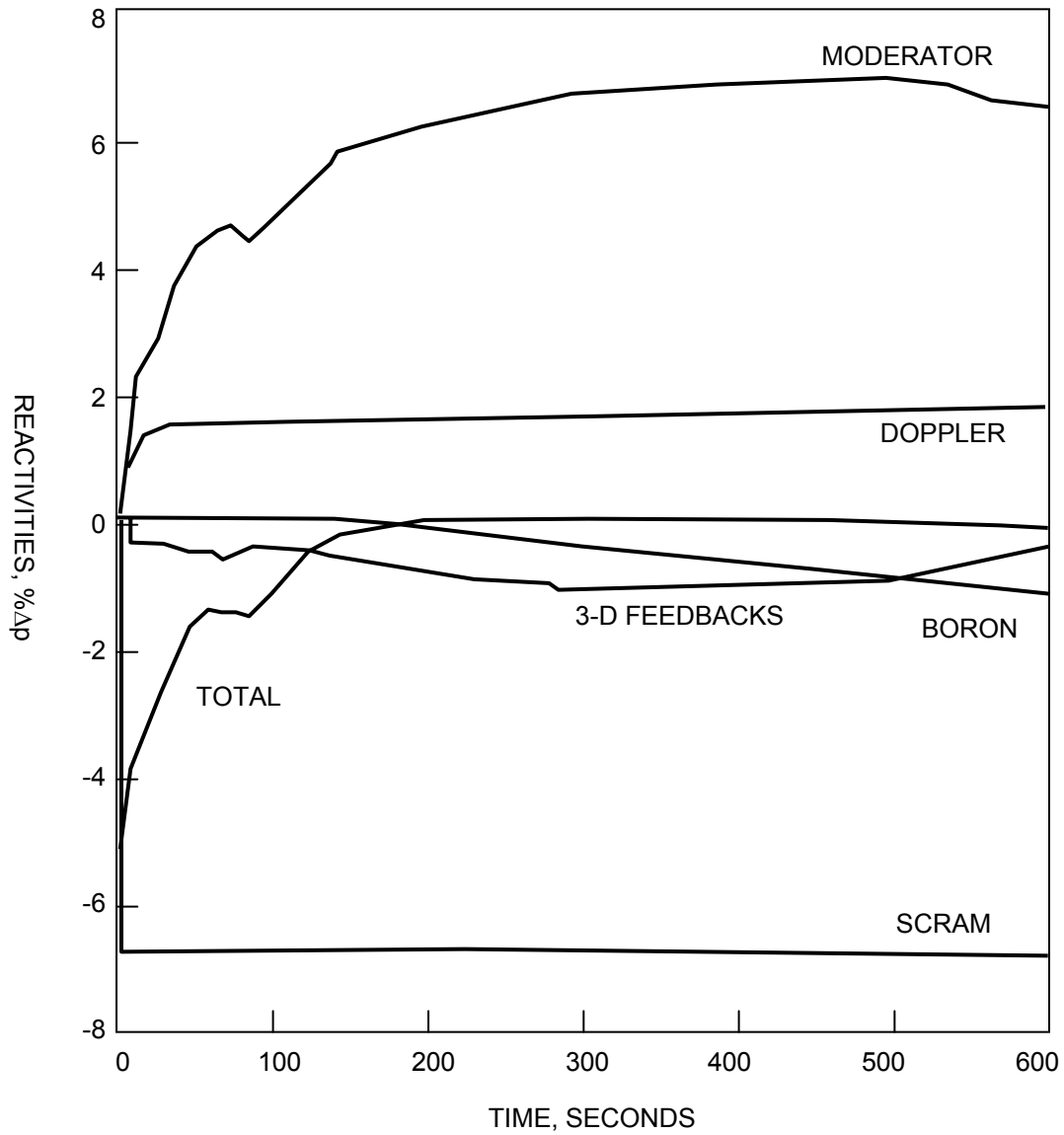

SAR FIGURE NO. 15.1.14-119

AMENDMENT 20

ARKANSAS NUCLEAR ONE
UNIT 2
RUSSELLVILLE, ARKANSAS



SCALE: NONE

DRAWN:

DESIGN: ENTERGY

CAD NO:

CYCLE 15 AT 3026 MWt HOT FULL POWER MSLB WITH
LOSS OF AC INSIDE CONTAINMENT BREAK REACTIVITIES
VERSUS TIME

BASED ON DRAWING NO

SHEET

REV.

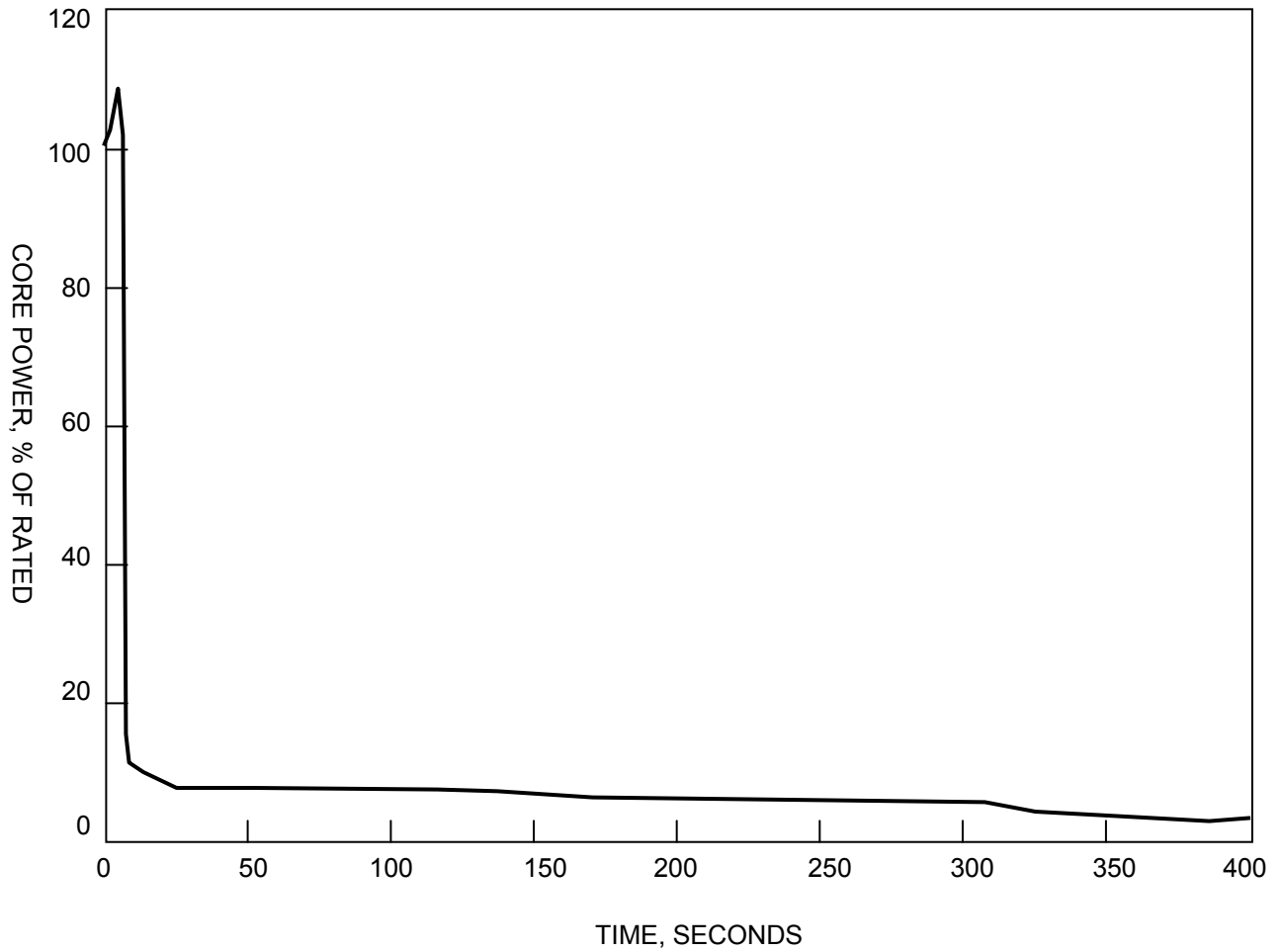

SAR FIGURE NO. 15.1.14-120

AMENDMENT 20

ARKANSAS NUCLEAR ONE
 UNIT 2
 RUSSELLVILLE, ARKANSAS



SCALE:	NONE
DRAWN:	
DESIGN:	ENERGY
CAD NO:	

CYCLE 15 AT 3026 MWt HOT FULL POWER MSLB WITH AC
 AVAILABLE INSIDE CONTAINMENT BREAK CORE POWER
 VERSUS TIME

BASED ON DRAWING NO

SHEET

REV.

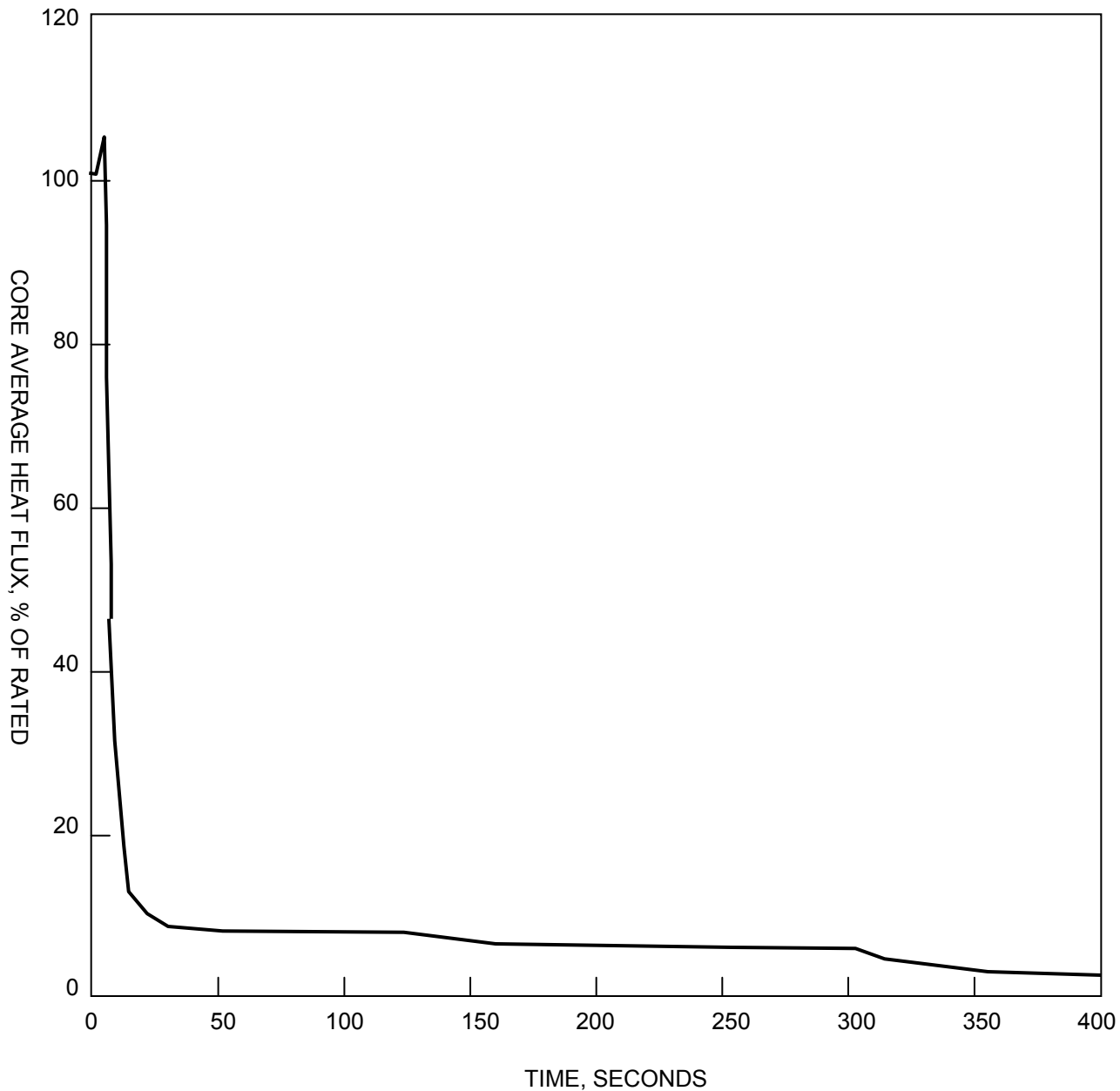

SAR FIGURE NO. 15.1.14-121

AMENDMENT 20

ARKANSAS NUCLEAR ONE
 UNIT 2
 RUSSELLVILLE, ARKANSAS



SCALE:	NONE
DRAWN:	
DESIGN:	ENERGY
CAD NO:	

CYCLE 15 AT 3026 MWt HOT FULL POWER MSLB WITH AC
 AVAILABLE INSIDE CONTAINMENT BREAK CORE
 AVERAGE HEAT FLUX VERSUS TIME

BASED ON DRAWING NO

SHEET

REV.

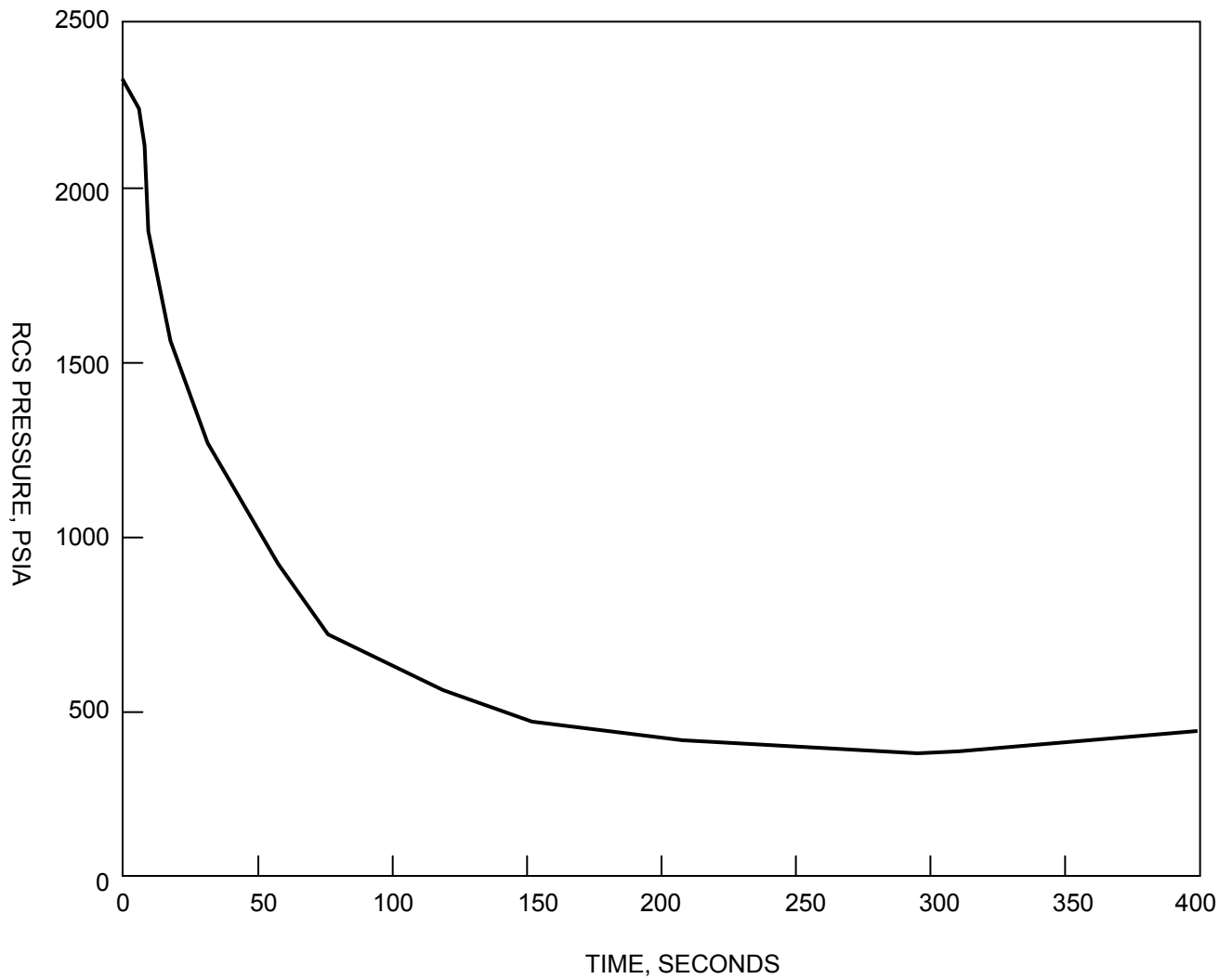

SAR FIGURE NO. 15.1.14-122

AMENDMENT 20

ARKANSAS NUCLEAR ONE
 UNIT 2
 RUSSELLVILLE, ARKANSAS



SCALE: NONE

DRAWN:

DESIGN: ENTERGY

CAD NO:

CYCLE 15 AT 3026 MWt HOT FULL POWER MSLB WITH AC
 AVAILABLE INSIDE CONTAINMENT BREAK RCS
 PRESSURE VERSUS TIME

BASED ON DRAWING NO

SHEET

REV.

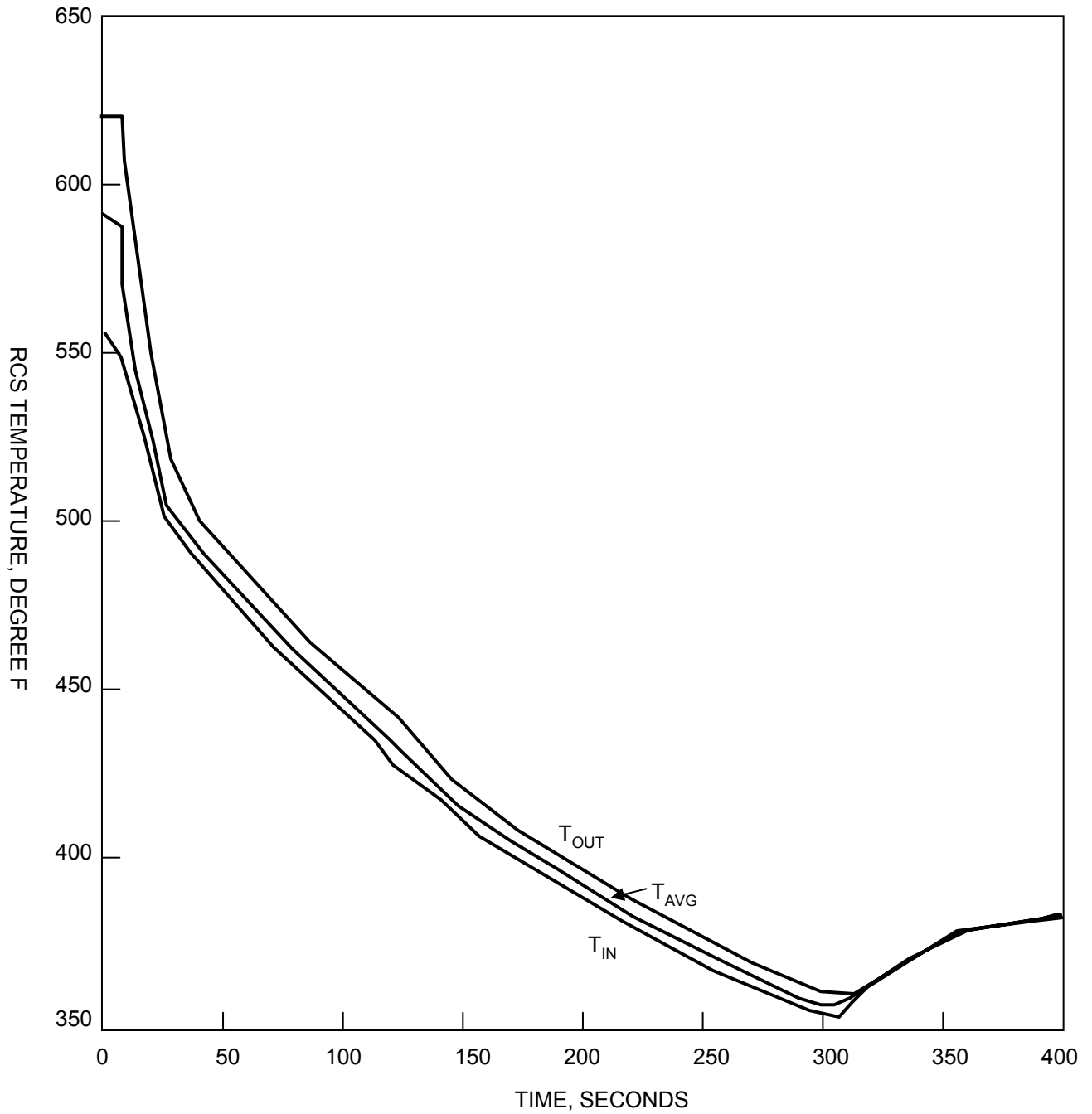

SAR FIGURE NO. 15.1.14-123

AMENDMENT 20

ARKANSAS NUCLEAR ONE
UNIT 2
RUSSELLVILLE, ARKANSAS



SCALE:	NONE
DRAWN:	
DESIGN:	ENERGY
CAD NO:	

CYCLE 15 AT 3026 MWt HOT FULL POWER MSLB WITH AC
AVAILABLE INSIDE CONTAINMENT BREAK RCS
TEMPERATURE VERSUS TIME

BASED ON DRAWING NO

SHEET

REV.

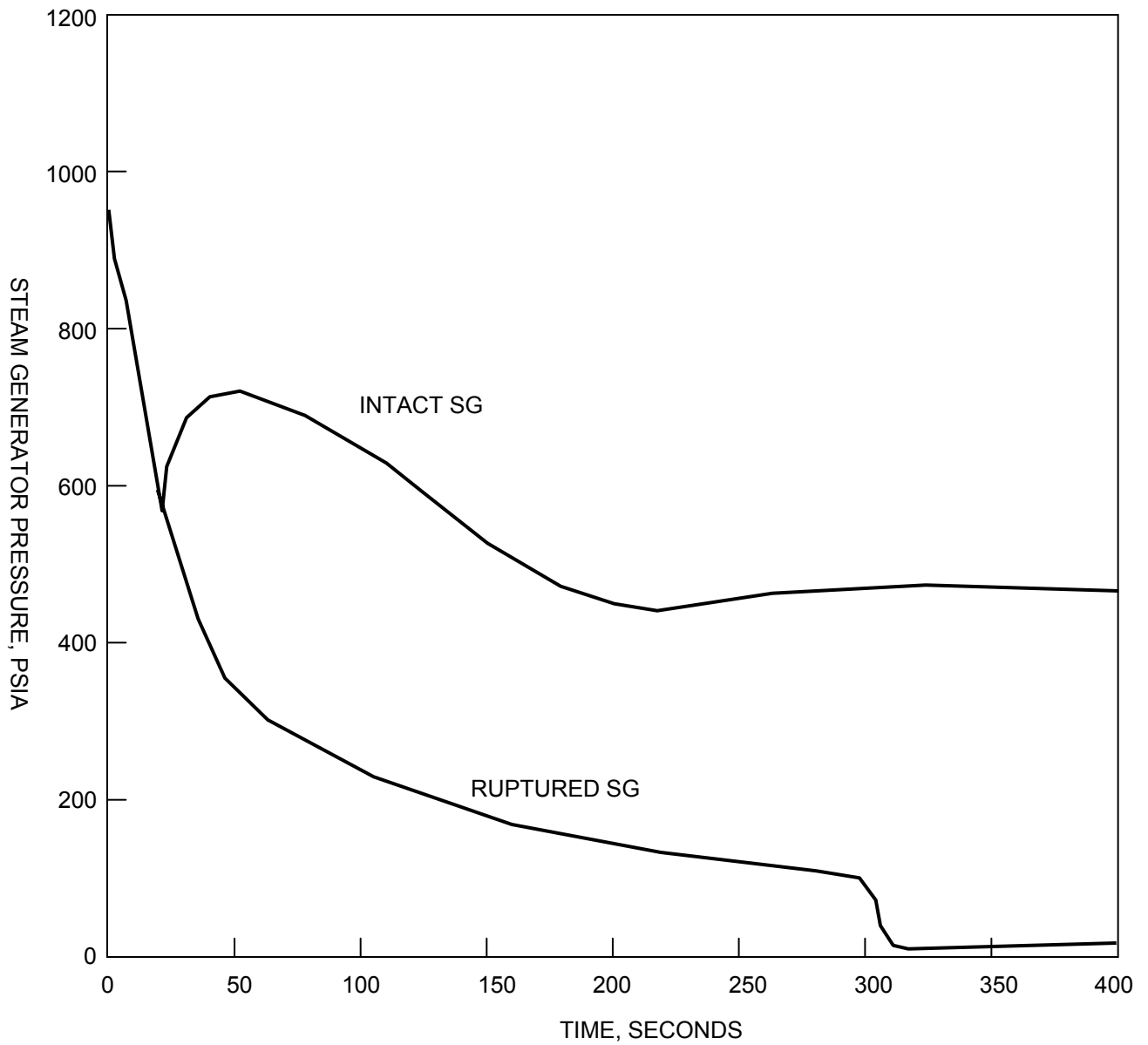

SAR FIGURE NO. 15.1.14-124

AMENDMENT 20

ARKANSAS NUCLEAR ONE
UNIT 2
RUSSELLVILLE, ARKANSAS



SCALE:	NONE
DRAWN:	
DESIGN:	ENERGY
CAD NO:	

CYCLE 15 AT 3026 MWt HOT FULL POWER MSLB WITH AC
AVAILABLE INSIDE CONTAINMENT BREAK STEAM
GENERATOR PRESSURE VERSUS TIME

BASED ON DRAWING NO

SHEET

REV.

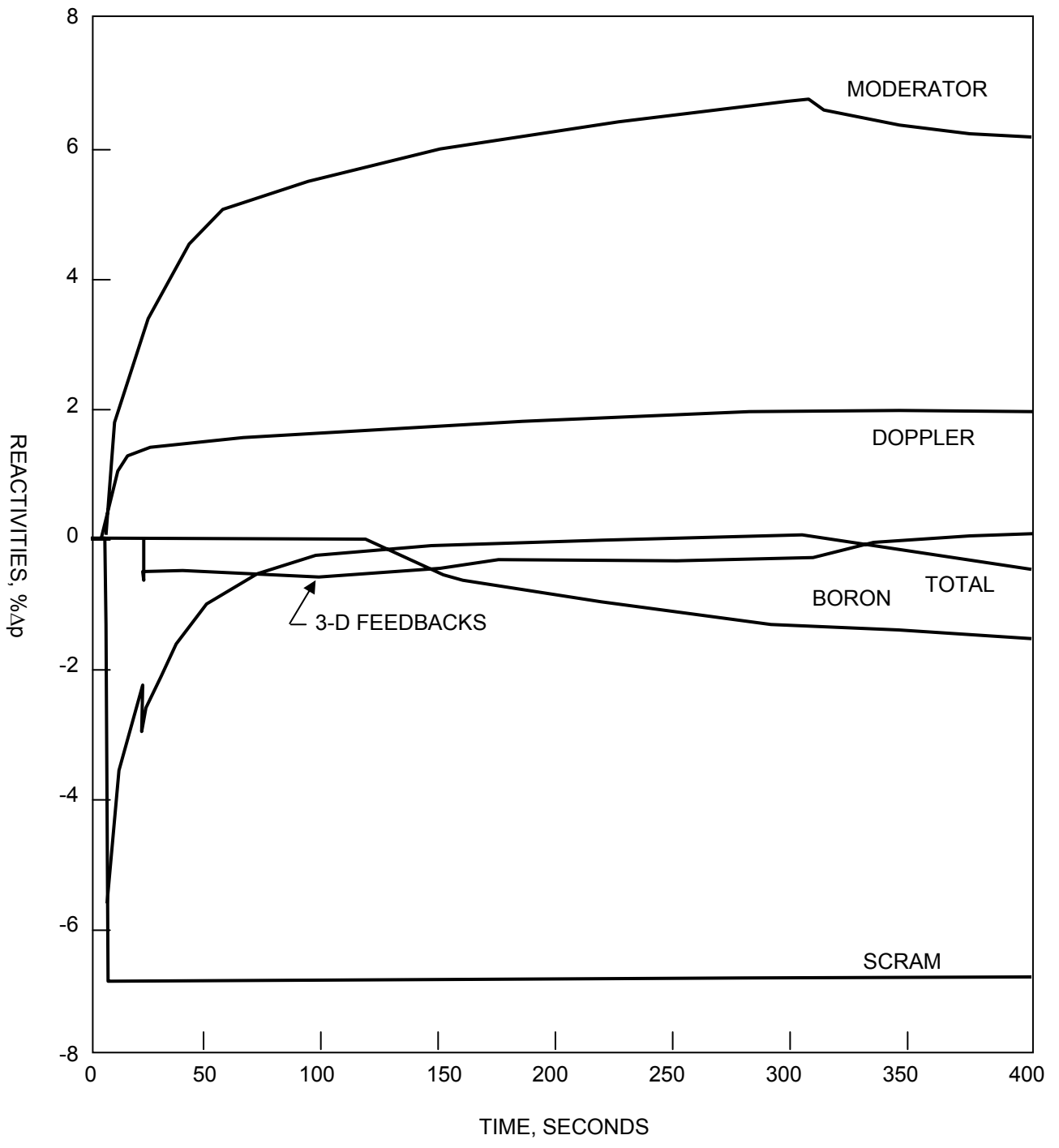

SAR FIGURE NO. 15.1.14-125

AMENDMENT 20

ARKANSAS NUCLEAR ONE
UNIT 2
RUSSELLVILLE, ARKANSAS



SCALE:	NONE
DRAWN:	
DESIGN:	ENERGY
CAD NO:	

CYCLE 15 AT 3026 MWt HOT FULL POWER MSLB WITH AC AVAILABLE INSIDE CONTAINMENT BREAK REACTIVITIES VERSUS TIME

BASED ON DRAWING NO

SHEET

REV.

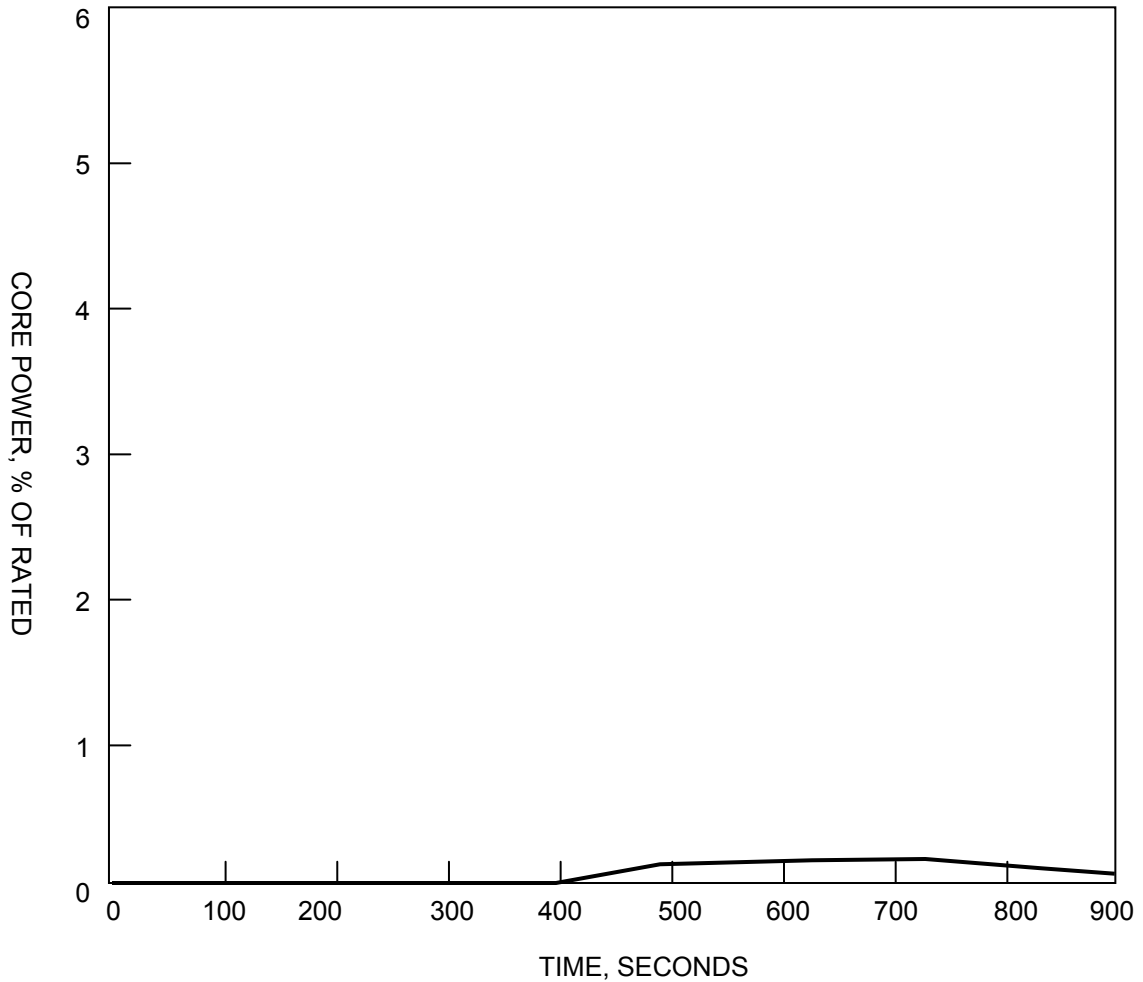

SAR FIGURE NO. 15.1.14-126

AMENDMENT 20

ARKANSAS NUCLEAR ONE
UNIT 2
RUSSELLVILLE, ARKANSAS



SCALE:	NONE
DRAWN:	
DESIGN:	ENTERGY
CAD NO:	

CYCLE 15 AT 3026 MWt HOT ZERO POWER MSLB WITH
LOSS OF AC INSIDE CONTAINMENT BREAK CORE POWER
VERSUS TIME

BASED ON DRAWING NO

SHEET

REV.

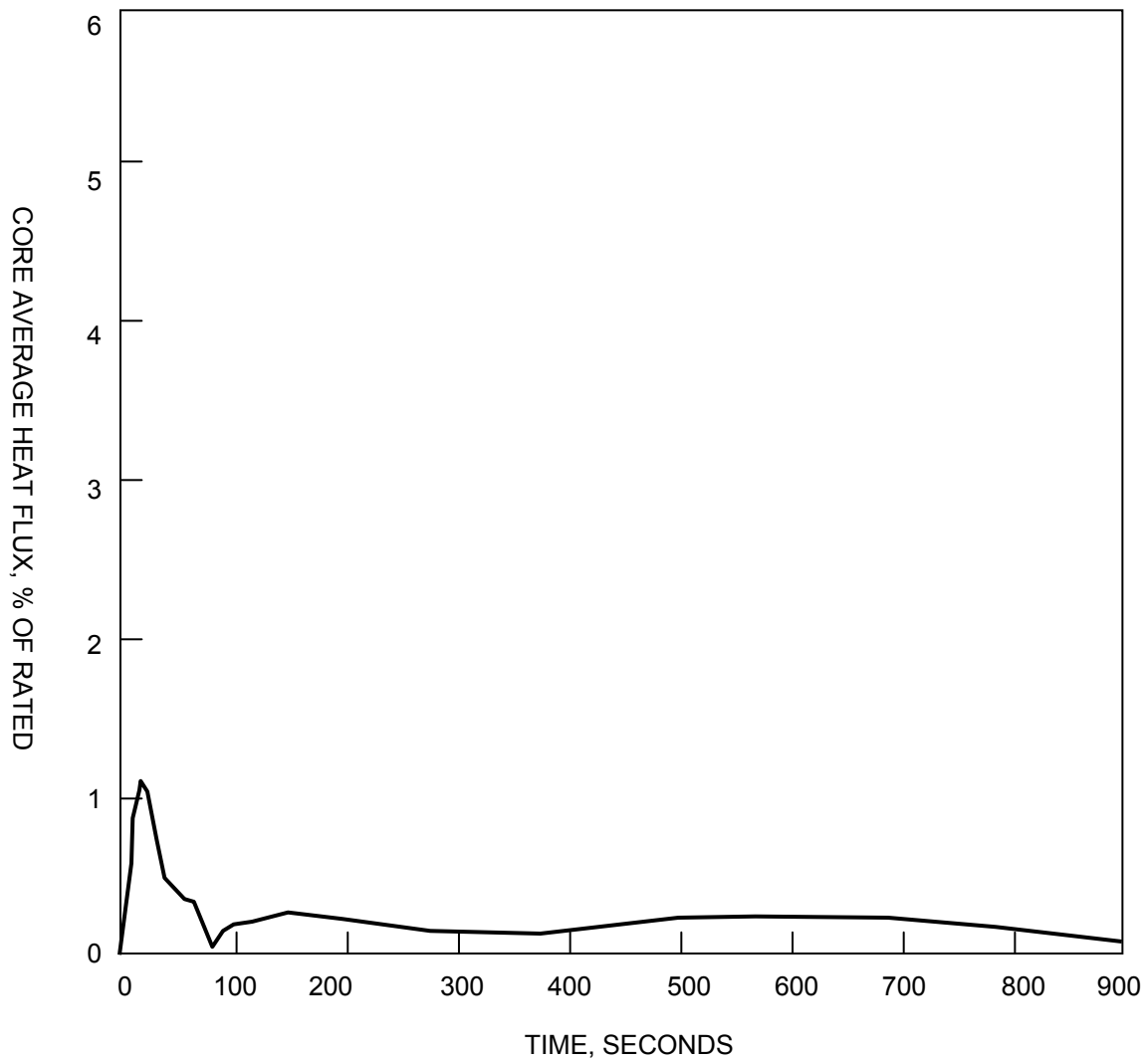

SAR FIGURE NO. 15.1.14-127

AMENDMENT 20

ARKANSAS NUCLEAR ONE
UNIT 2
RUSSELLVILLE, ARKANSAS



SCALE:	NONE
DRAWN:	
DESIGN:	ENERGY
CAD NO:	

CYCLE 15 AT 3026 MWt HOT ZERO POWER MSLB WITH
LOSS OF AC INSIDE CONTAINMENT BREAK CORE
AVERAGE HEAT FLUX VERSUS TIME

BASED ON DRAWING NO

SHEET

REV.

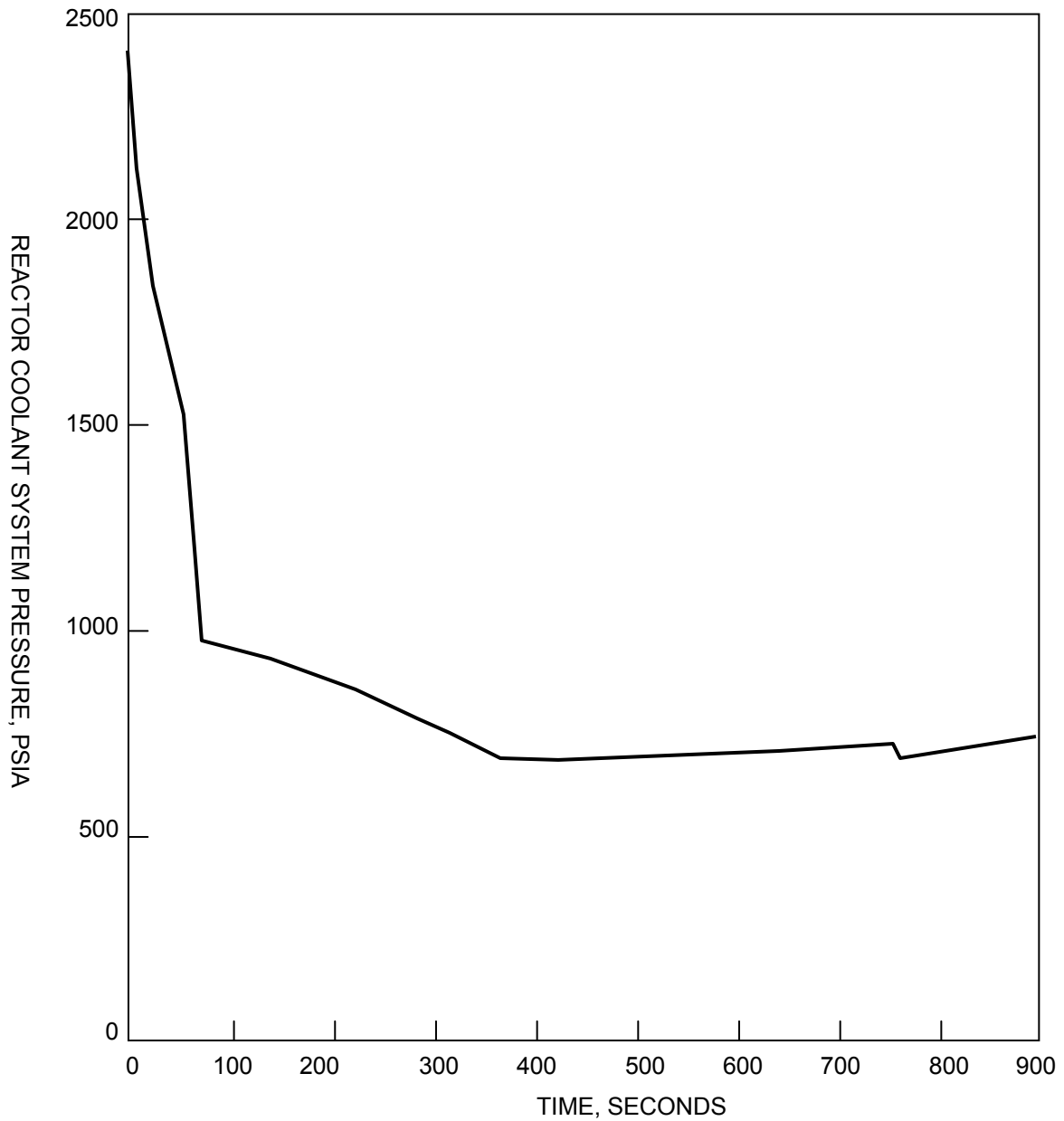

SAR FIGURE NO. 15.1.14-128

AMENDMENT 20

ARKANSAS NUCLEAR ONE
UNIT 2
RUSSELLVILLE, ARKANSAS



SCALE:	NONE
DRAWN:	
DESIGN:	ENERGY
CAD NO:	

CYCLE 15 AT 3026 MWt HOT ZERO POWER MSLB WITH
LOSS OF AC INSIDE CONTAINMENT BREAK RCS
PRESSURE VERSUS TIME

BASED ON DRAWING NO

SHEET

REV.

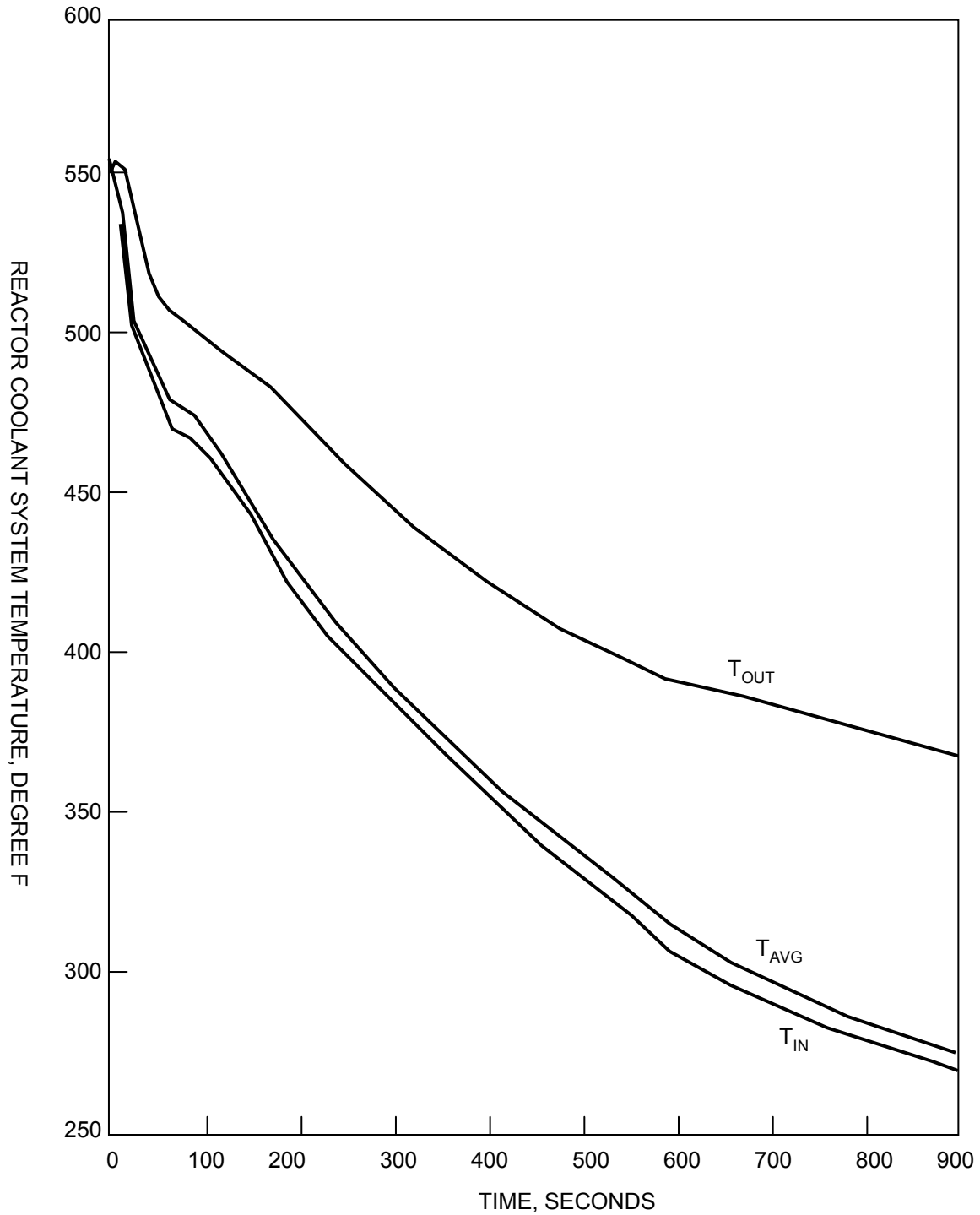

SAR FIGURE NO. 15.1.14-129

AMENDMENT 20

ARKANSAS NUCLEAR ONE
UNIT 2
RUSSELLVILLE, ARKANSAS



SCALE:	NONE
DRAWN:	
DESIGN:	ENERGY
CAD NO:	

CYCLE 15 AT 3026 MWt HOT ZERO POWER MSLB WITH
LOSS OF AC INSIDE CONTAINMENT BREAK RCS
TEMPERATURE VERSUS TIME

BASED ON DRAWING NO

SHEET

REV.

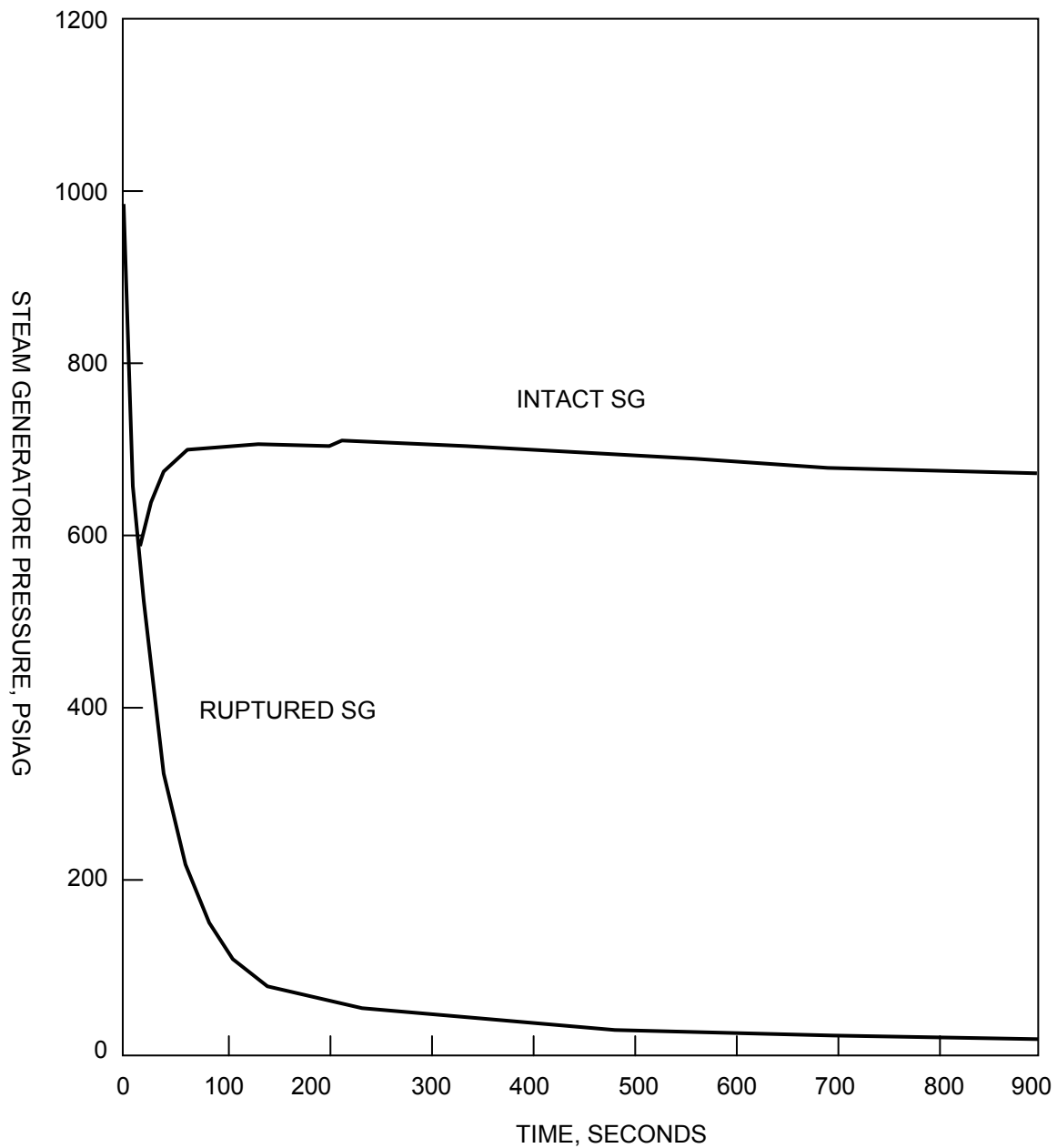

SAR FIGURE NO. 15.1.14-130

AMENDMENT 20

ARKANSAS NUCLEAR ONE
UNIT 2
RUSSELLVILLE, ARKANSAS



SCALE:	NONE
DRAWN:	
DESIGN:	ENERGY
CAD NO:	

CYCLE 15 AT 3026 MWt HOT ZERO POWER MSLB WITH
LOSS OF AC INSIDE CONTAINMENT BREAK STEAM
GENERATOR PRESSURE VERSUS TIME

BASED ON DRAWING NO

SHEET

REV.

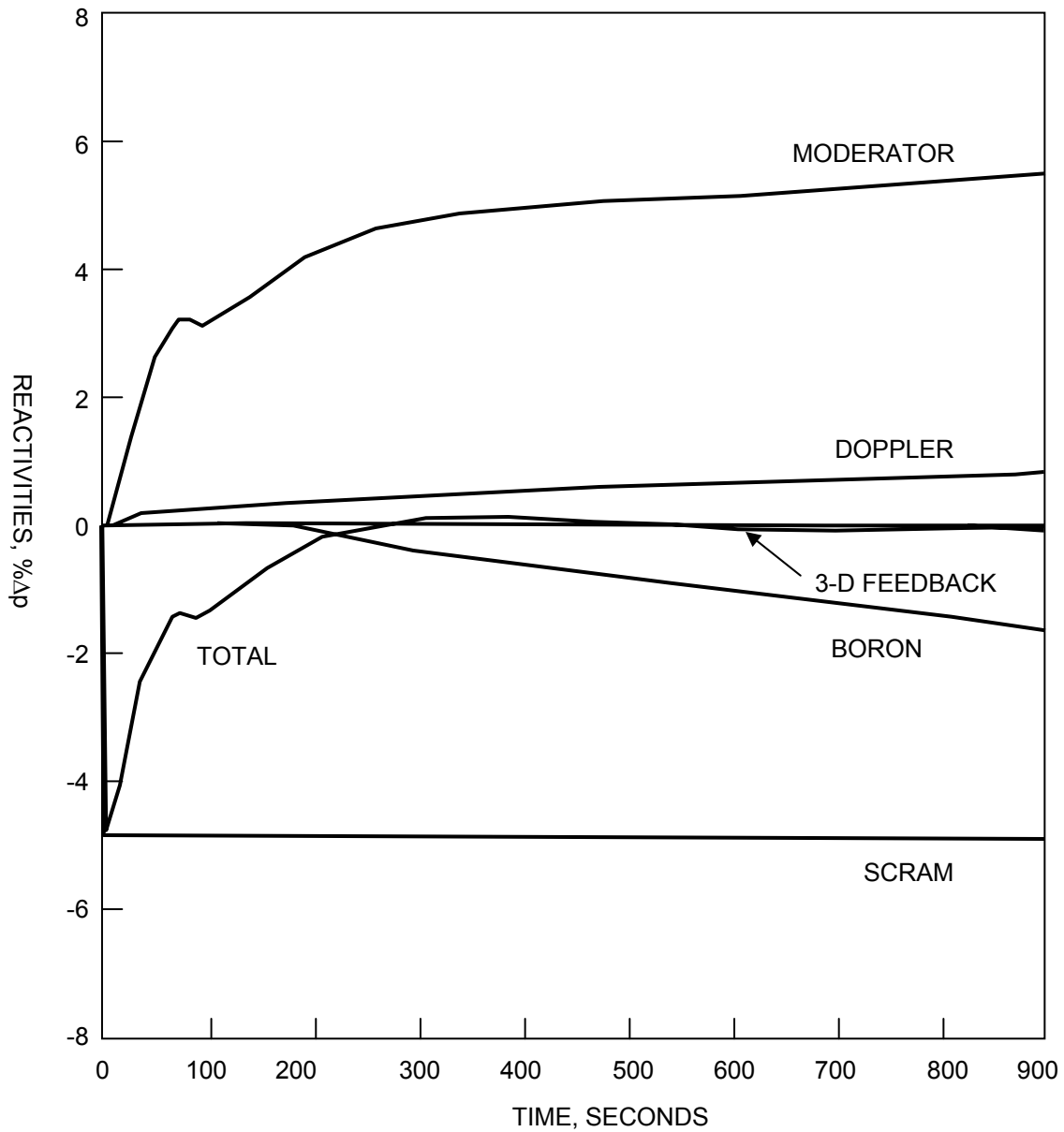

SAR FIGURE NO. 15.1.14-131

AMENDMENT 20

ARKANSAS NUCLEAR ONE
UNIT 2
RUSSELLVILLE, ARKANSAS



SCALE:	NONE
DRAWN:	
DESIGN:	ENERGY
CAD NO:	

CYCLE 15 AT 3026 MWt HOT ZERO POWER MSLB WITH
LOSS OF AC INSIDE CONTAINMENT BREAK
REACTIVITIES VERSUS TIME

BASED ON DRAWING NO

SHEET

REV.

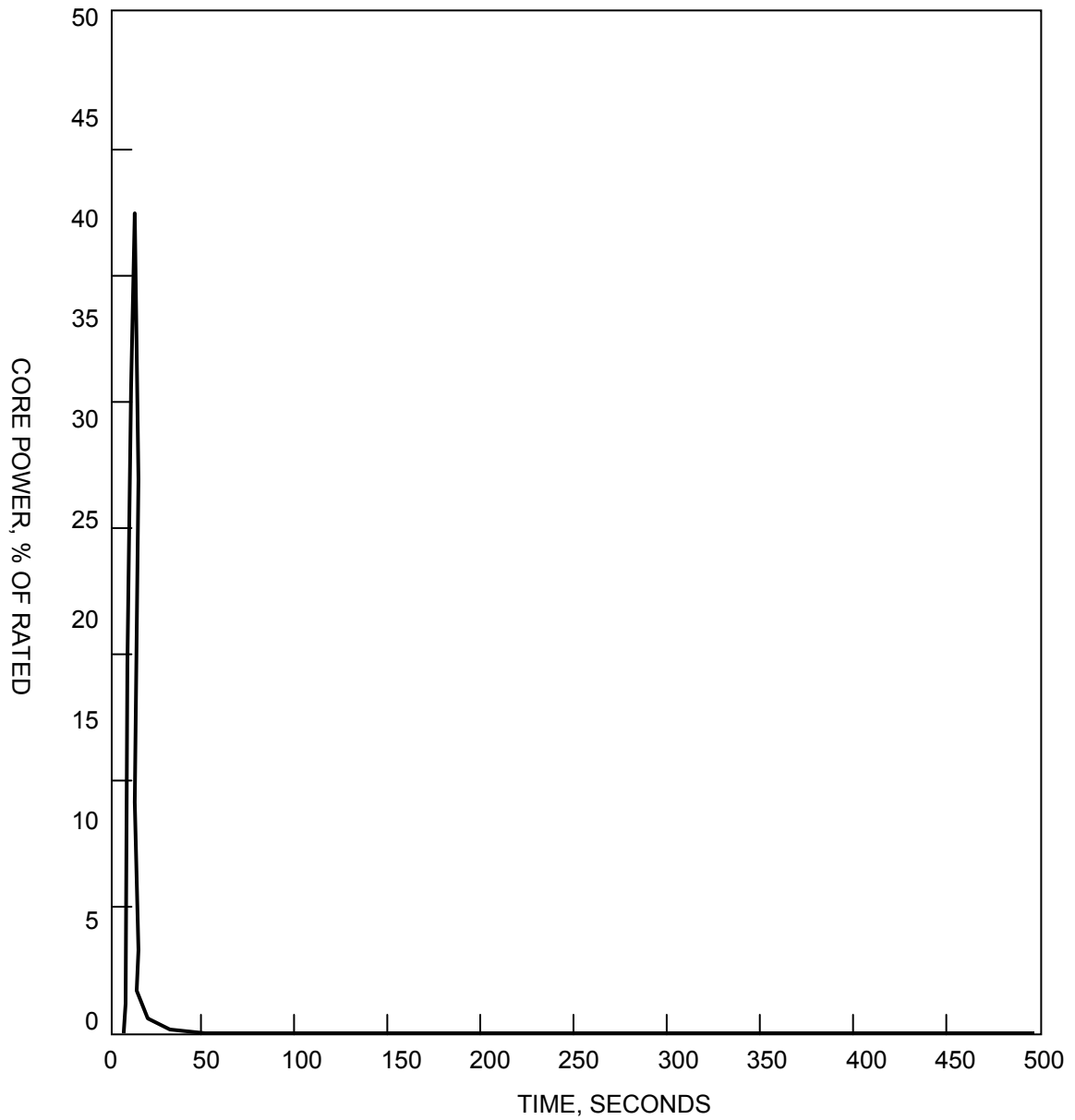

SAR FIGURE NO. 15.1.14-132

AMENDMENT 20

ARKANSAS NUCLEAR ONE
UNIT 2
RUSSELLVILLE, ARKANSAS



SCALE: NONE

DRAWN:

DESIGN: ENTERGY

CAD NO:

CYCLE 15 AT 3026 MWt HOT ZERO POWER MSLB WITH AC
AVAILABLE OUTSIDE CONTAINMENT BREAK
CORE POWER VERSUS TIME

BASED ON DRAWING NO

SHEET

REV.

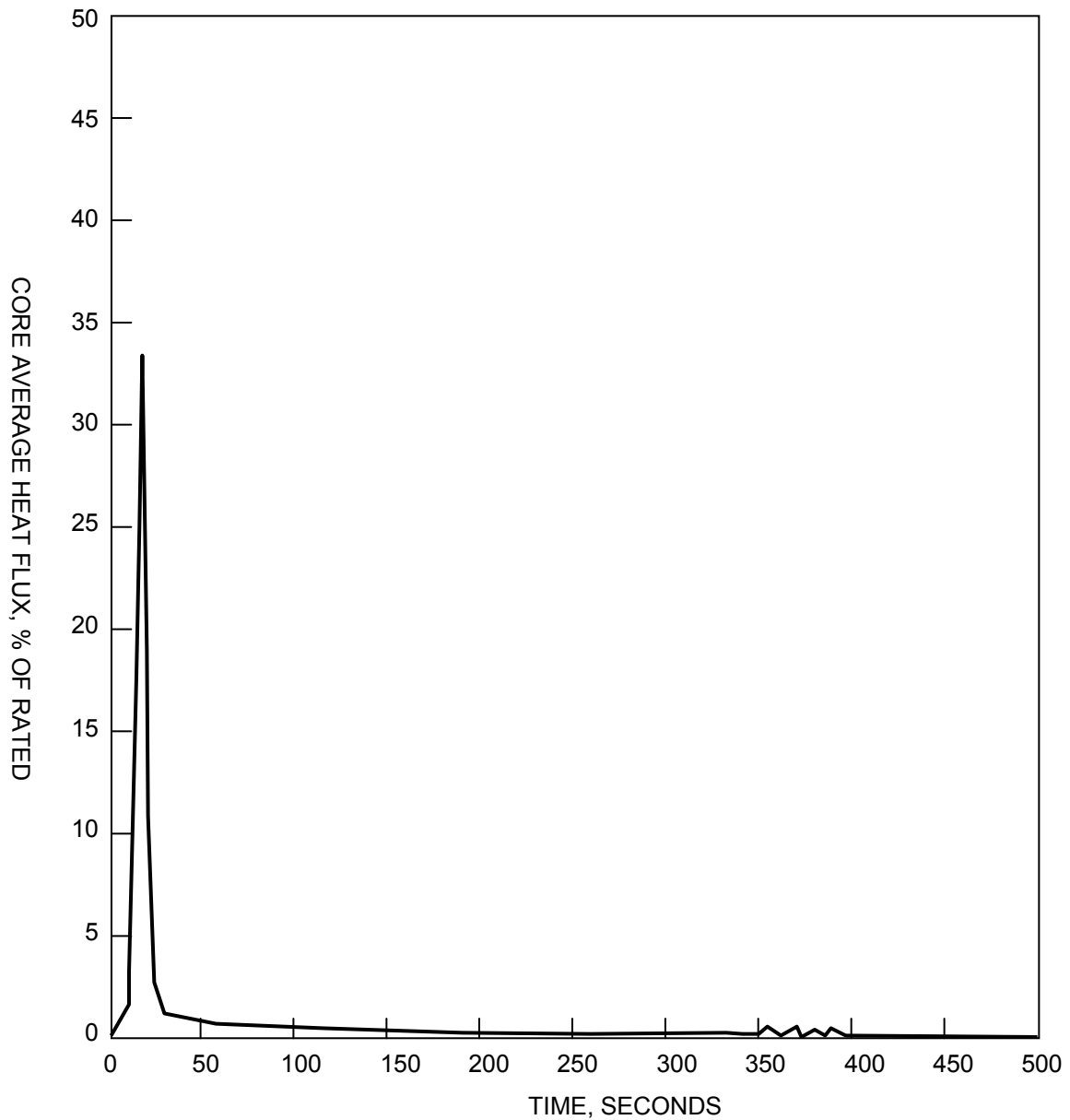

SAR FIGURE NO. 15.1.14-133

AMENDMENT 20

ARKANSAS NUCLEAR ONE
UNIT 2
RUSSELLVILLE, ARKANSAS



SCALE:	NONE
DRAWN:	
DESIGN:	ENTERGY
CAD NO:	

CYCLE 15 AT 3026 MWt HOT ZERO POWER MSLB WITH AC
AVAILABLE OUTSIDE CONTAINMENT BREAK
CORE AVERAGE HEAT FLUX VERSUS TIME

BASED ON DRAWING NO

SHEET

REV.

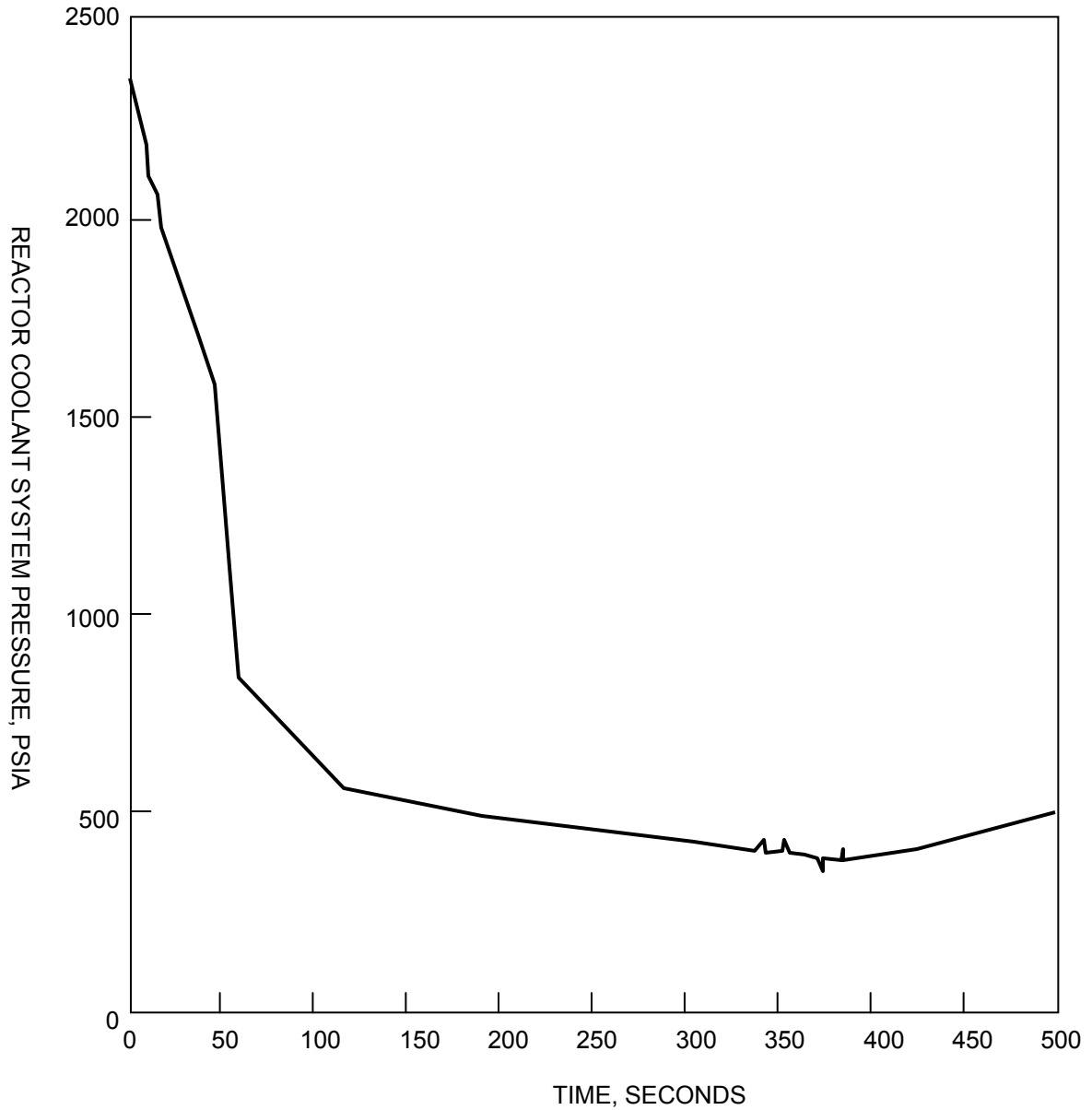

SAR FIGURE NO. 15.1.14-134

AMENDMENT 20

ARKANSAS NUCLEAR ONE
UNIT 2
RUSSELLVILLE, ARKANSAS



SCALE:	NONE
DRAWN:	
DESIGN:	ENERGY
CAD NO:	

CYCLE 15 AT 3026 MWt HOT ZERO POWER MSLB WITH AC
AVAILABLE OUTSIDE CONTAINMENT BREAK
RCS PRESSURE VERSUS TIME

BASED ON DRAWING NO

SHEET

REV.

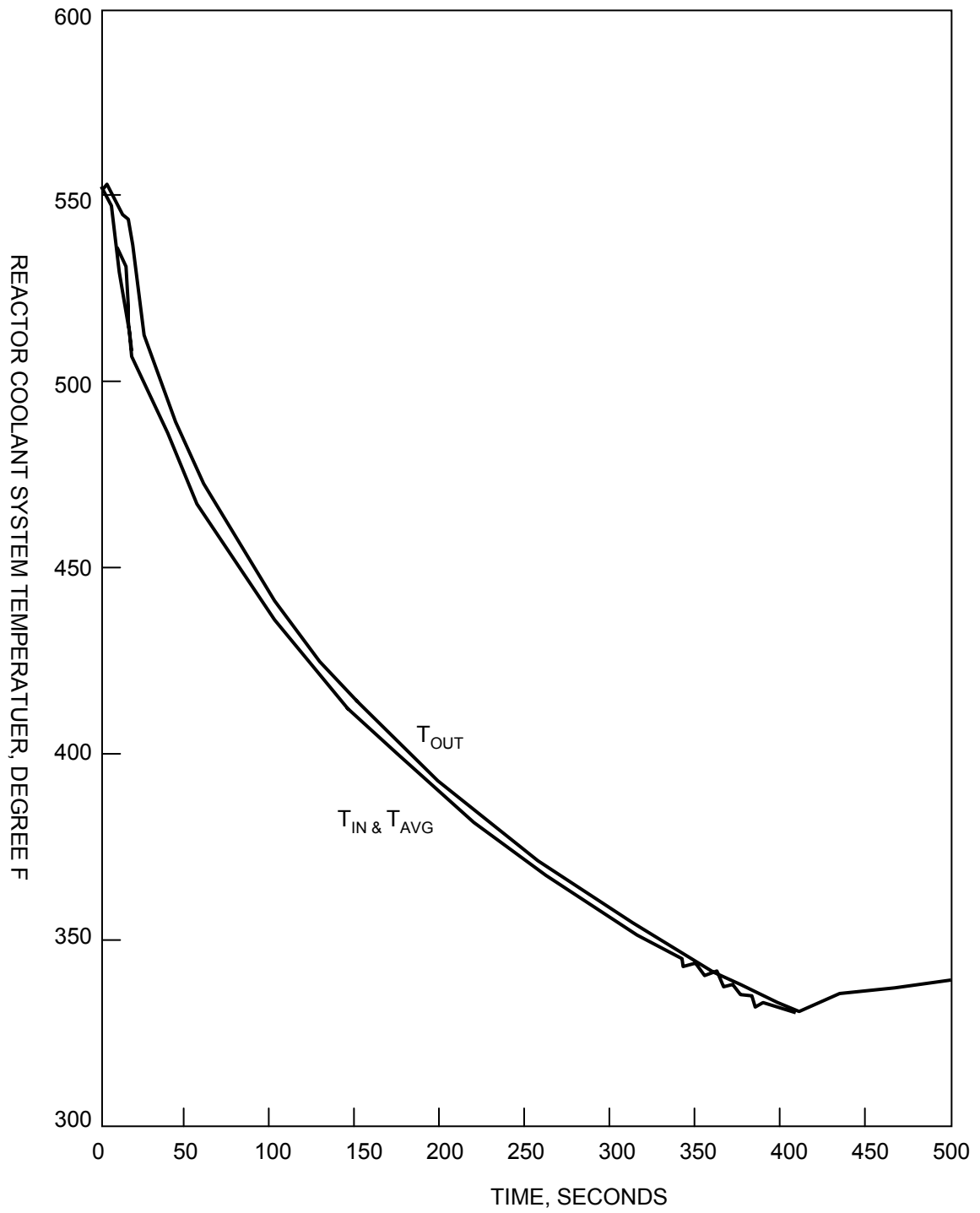

SAR FIGURE NO. 15.1.14-135

AMENDMENT 20

ARKANSAS NUCLEAR ONE
UNIT 2
RUSSELLVILLE, ARKANSAS



SCALE:	NONE
DRAWN:	
DESIGN:	ENERGY
CAD NO:	

CYCLE 15 AT 3026 MWt HOT ZERO POWER MSLB WITH AC AVAILABLE OUTSIDE CONTAINMENT BREAK RCS TEMPERATURE VERSUS TIME

BASED ON DRAWING NO	SHEET	REV.

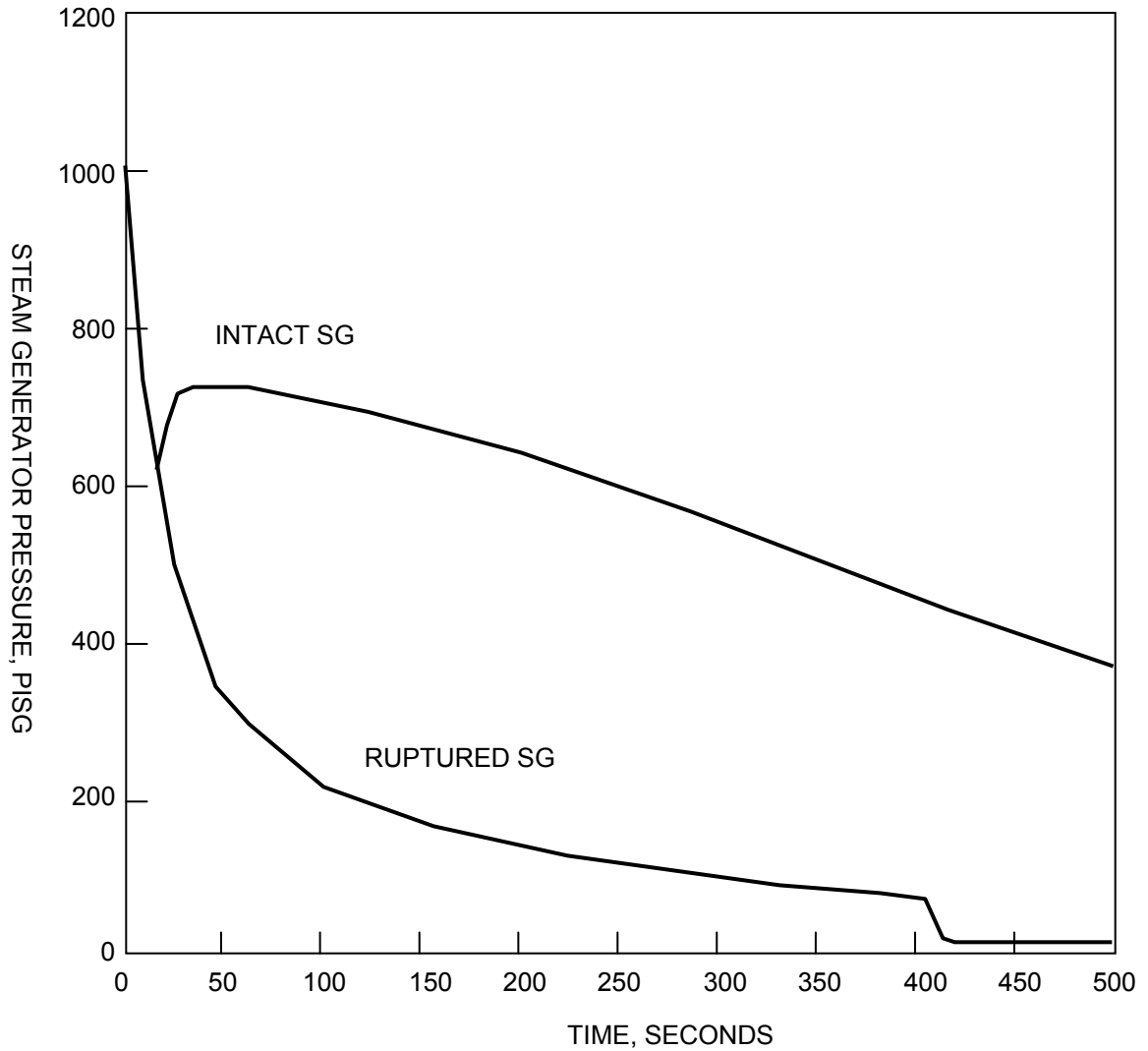

SAR FIGURE NO. 15.1.14-136

AMENDMENT 20

ARKANSAS NUCLEAR ONE
UNIT 2
RUSSELLVILLE, ARKANSAS



SCALE:	NONE
DRAWN:	
DESIGN:	ENERGY
CAD NO:	

CYCLE 15 AT 3026 MWt HOT ZERO POWER MSLB WITH AC
AVAILABLE OUTSIDE CONTAINMENT BREAK
STEAM GENERATOR PRESSURE VERSUS TIME

BASED ON DRAWING NO

SHEET

REV.

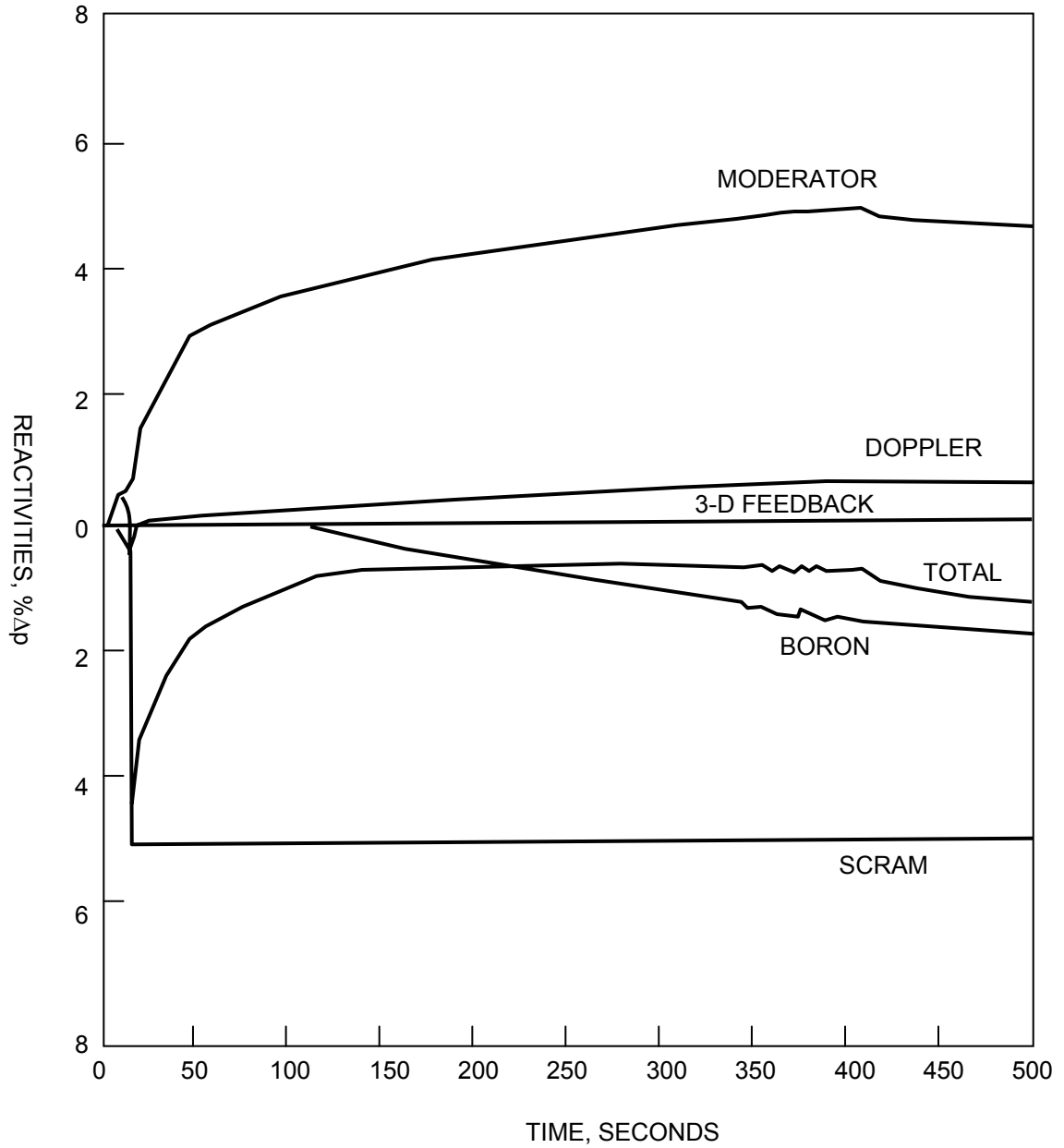

SAR FIGURE NO. 15.1.14-137

AMENDMENT 20

ARKANSAS NUCLEAR ONE
UNIT 2
RUSSELLVILLE, ARKANSAS



SCALE:	NONE
DRAWN:	
DESIGN:	ENERGY
CAD NO:	

CYCLE 15 AT 3026 MWt HOT ZERO POWER MSLB WITH AC
AVAILABLE OUTSIDE CONTAINMENT BREAK
REACTIVITIES VERSUS TIME

BASED ON DRAWING NO

SHEET

REV.

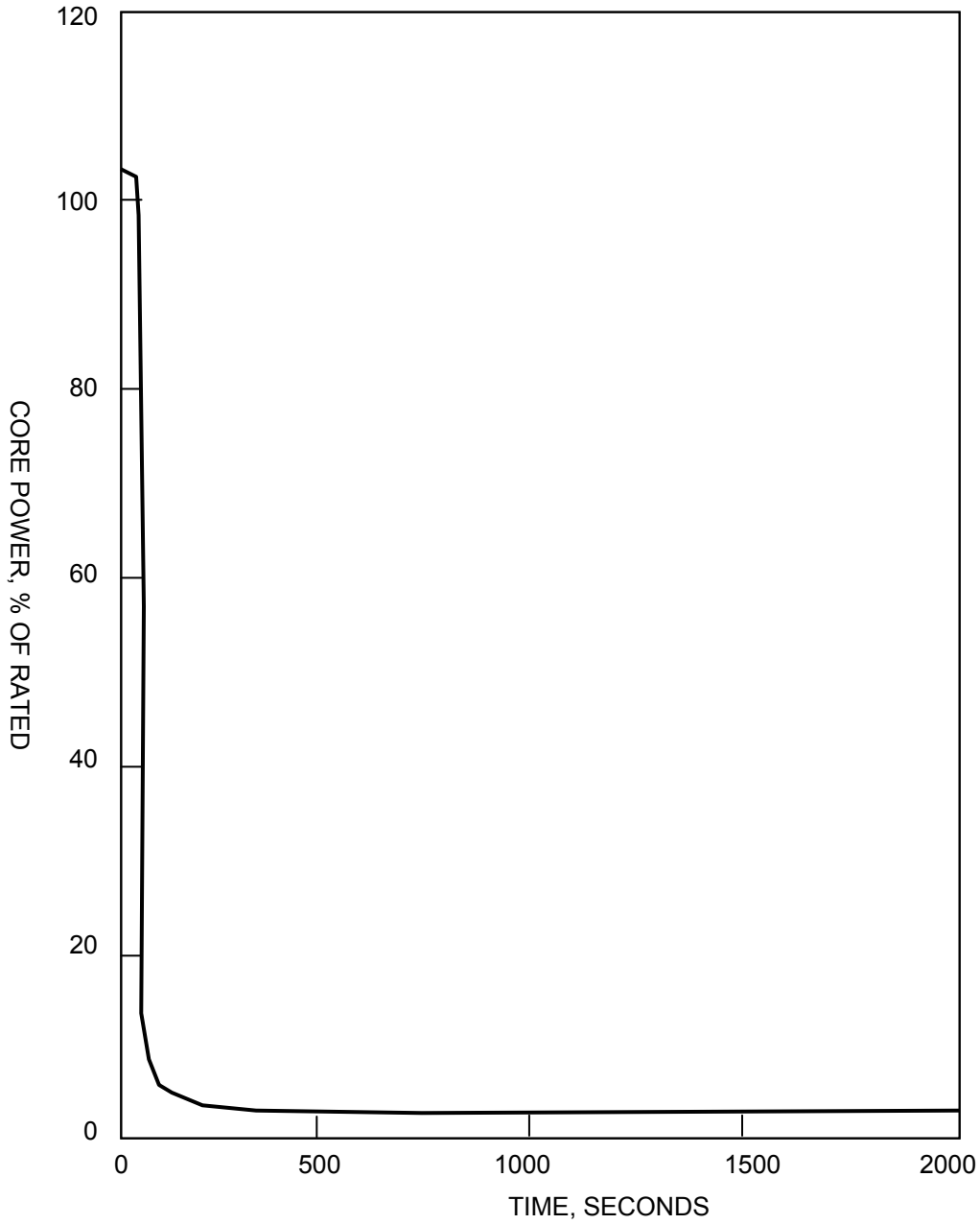

SAR FIGURE NO. 15.1.14-138

AMENDMENT 20

ARKANSAS NUCLEAR ONE
UNIT 2
RUSSELLVILLE, ARKANSAS



SCALE:	NONE
DRAWN:	
DESIGN:	ENERGY
CAD NO:	

CYCLE 15 AT 2815 MWt FEEDWATER LINE
BREAK CORE POWER VERSUS TIME

BASED ON DRAWING NO

SHEET

REV.

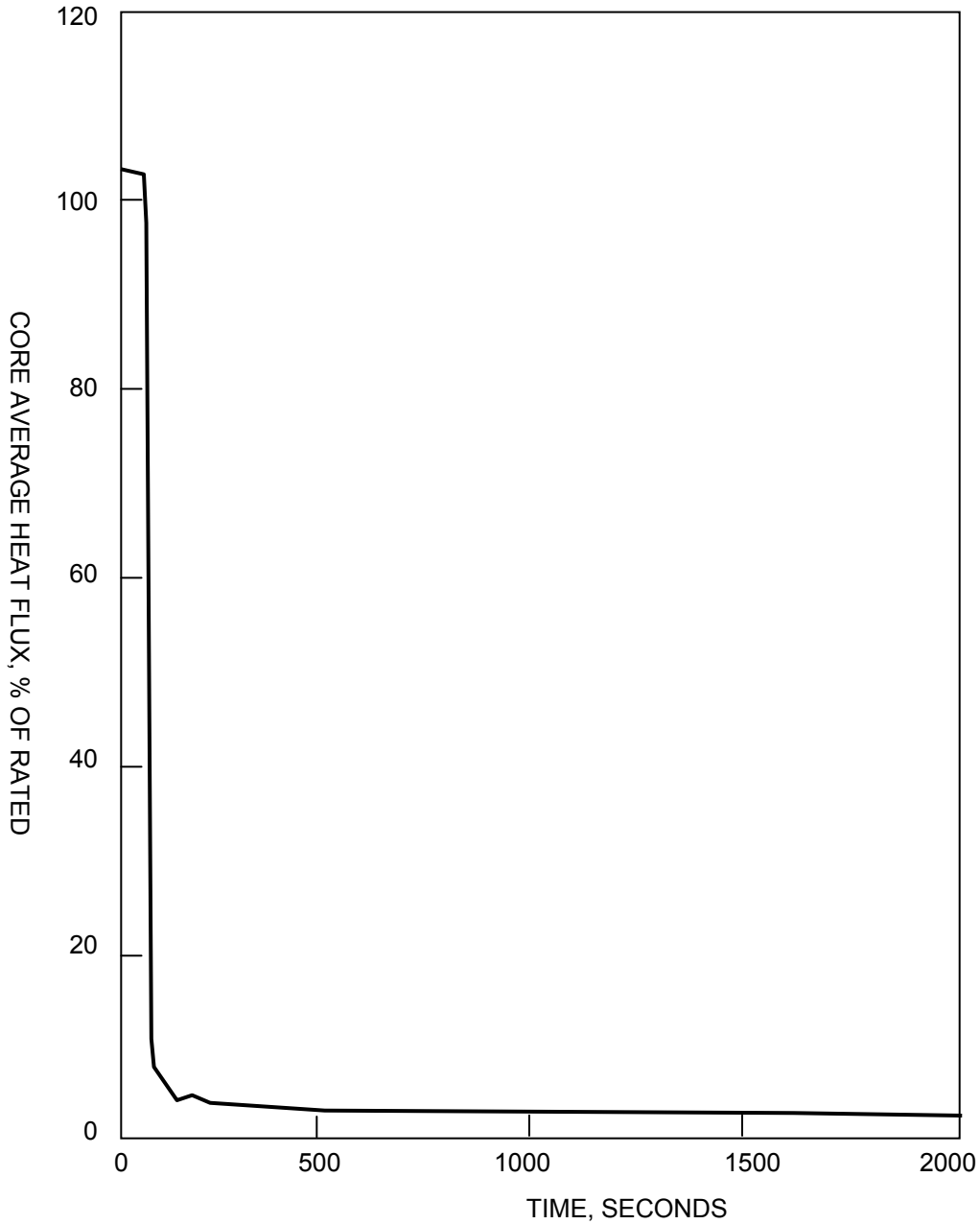

SAR FIGURE NO. 15.1.14-139

AMENDMENT 20

ARKANSAS NUCLEAR ONE
UNIT 2
RUSSELLVILLE, ARKANSAS



SCALE:	NONE
DRAWN:	
DESIGN:	ENTERGY
CAD NO:	

CYCLE 15 AT 2815 MWt FEEDWATER LINE BREAK
CORE AVERAGE HEAT FLUX VERSUS TIME

BASED ON DRAWING NO

SHEET

REV.

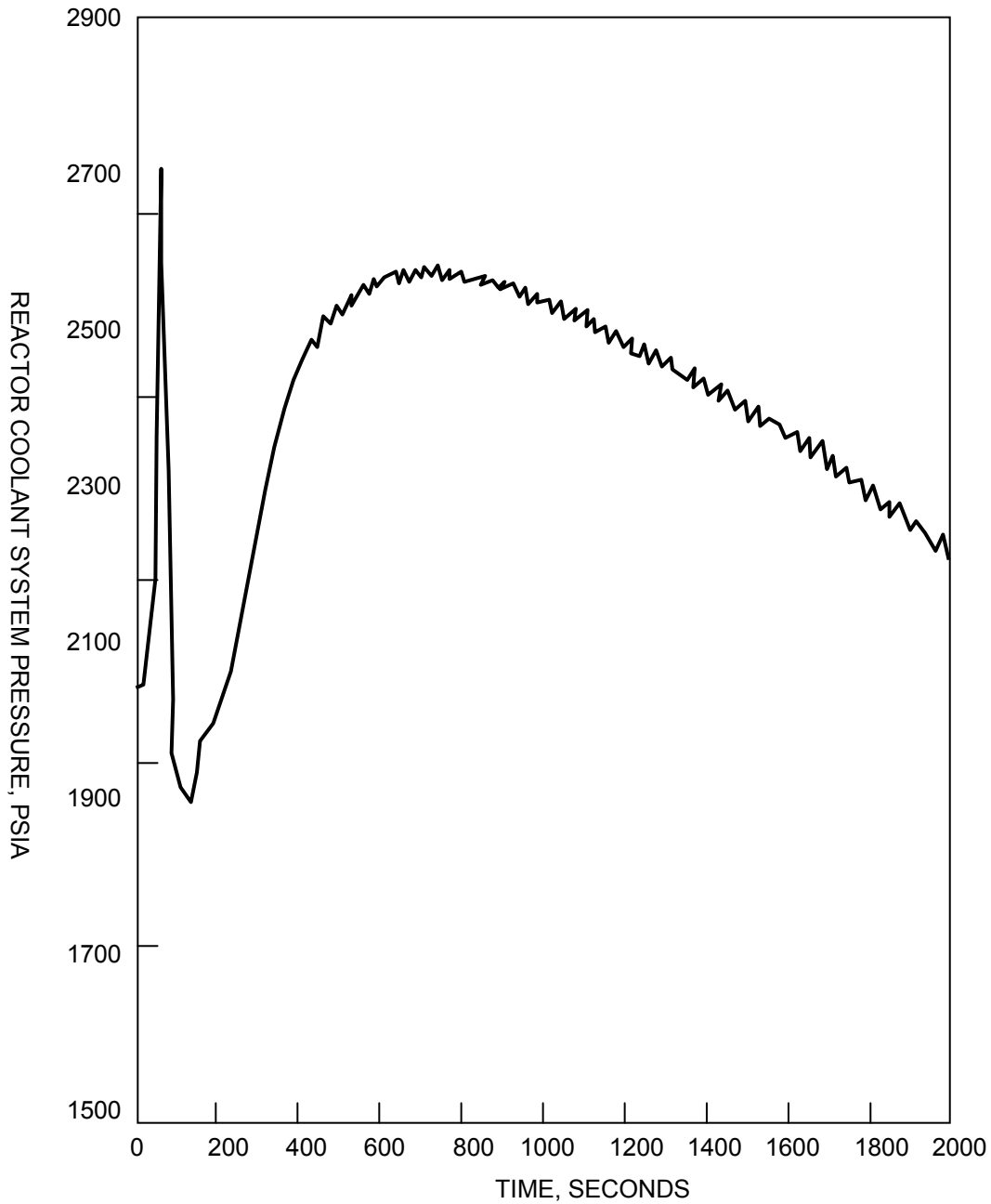

SAR FIGURE NO. 15.1.14-140

AMENDMENT 20

ARKANSAS NUCLEAR ONE
UNIT 2
RUSSELLVILLE, ARKANSAS



SCALE:	NONE
DRAWN:	
DESIGN:	ENERGY
CAD NO:	

CYCLE 15 AT 2815 MWt FEEDWATER LINE BREAK
RCS PRESSURE VERSUS TIME

BASED ON DRAWING NO

SHEET

REV.

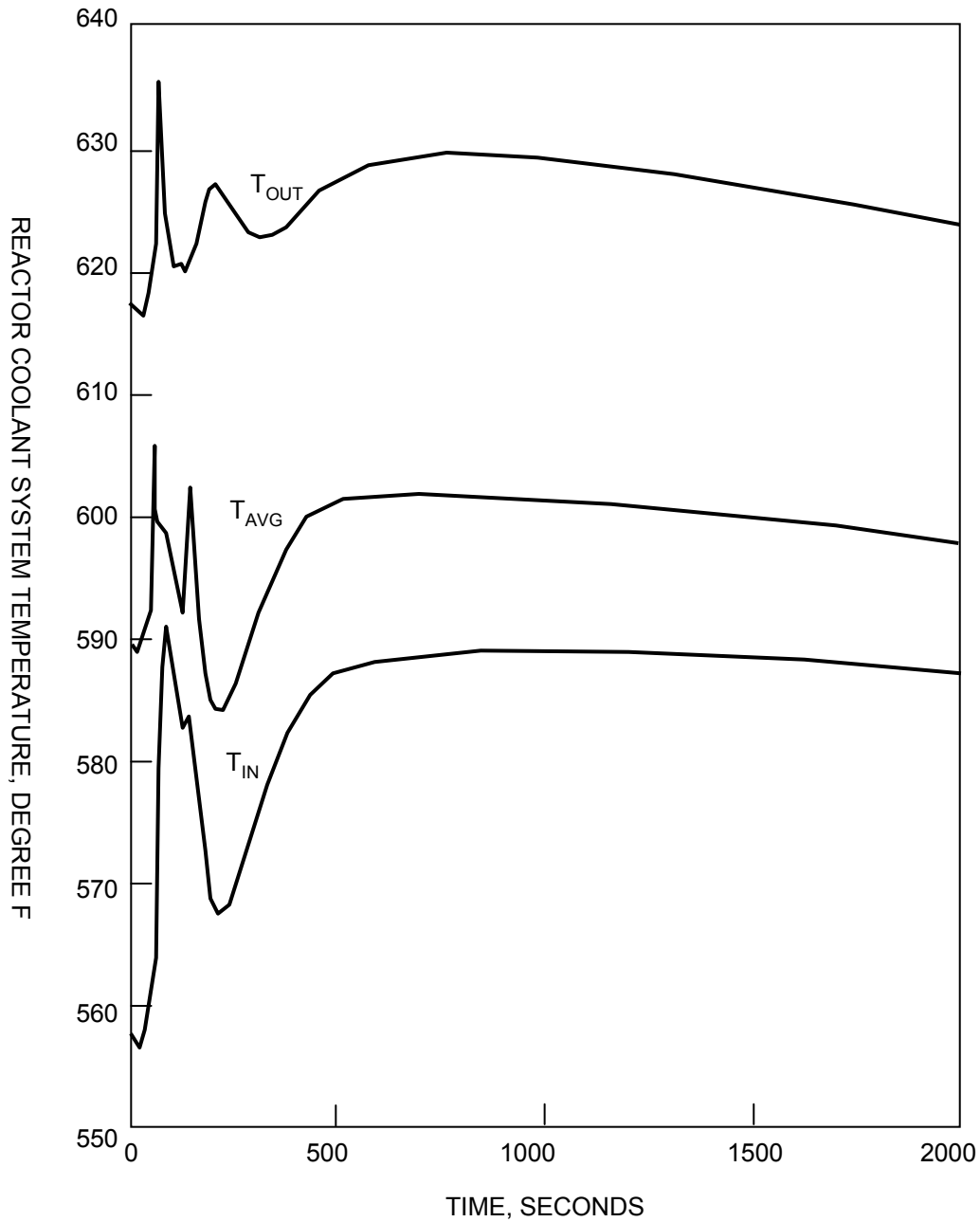

SAR FIGURE NO. 15.1.14-141

AMENDMENT 20

ARKANSAS NUCLEAR ONE
UNIT 2
RUSSELLVILLE, ARKANSAS



SCALE:	NONE
DRAWN:	
DESIGN:	ENERGY
CAD NO:	

CYCLE 15 AT 2815 MWt FEEDWATER LINE BREAK
RCS TEMPERATURE VERSUS TIME

BASED ON DRAWING NO

SHEET

REV.

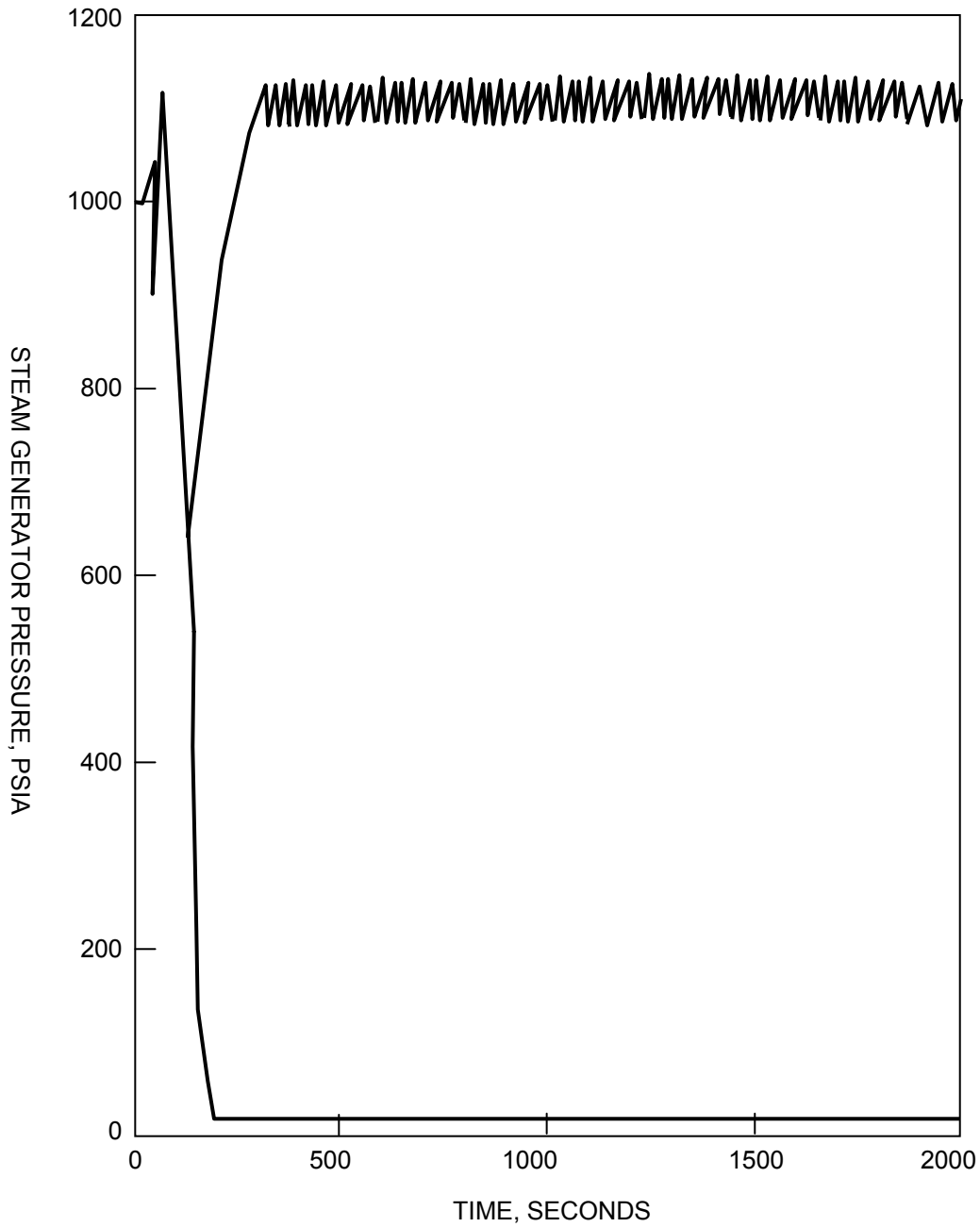

SAR FIGURE NO. 15.1.14-142

AMENDMENT 20

ARKANSAS NUCLEAR ONE
UNIT 2
RUSSELLVILLE, ARKANSAS



SCALE:	NONE
DRAWN:	
DESIGN:	ENERGY
CAD NO:	

CYCLE 15 AT 2815 MWt FEEDWATER LINE BREAK
STEAM GENERATOR PRESSURE VERSUS TIME

BASED ON DRAWING NO

SHEET

REV.

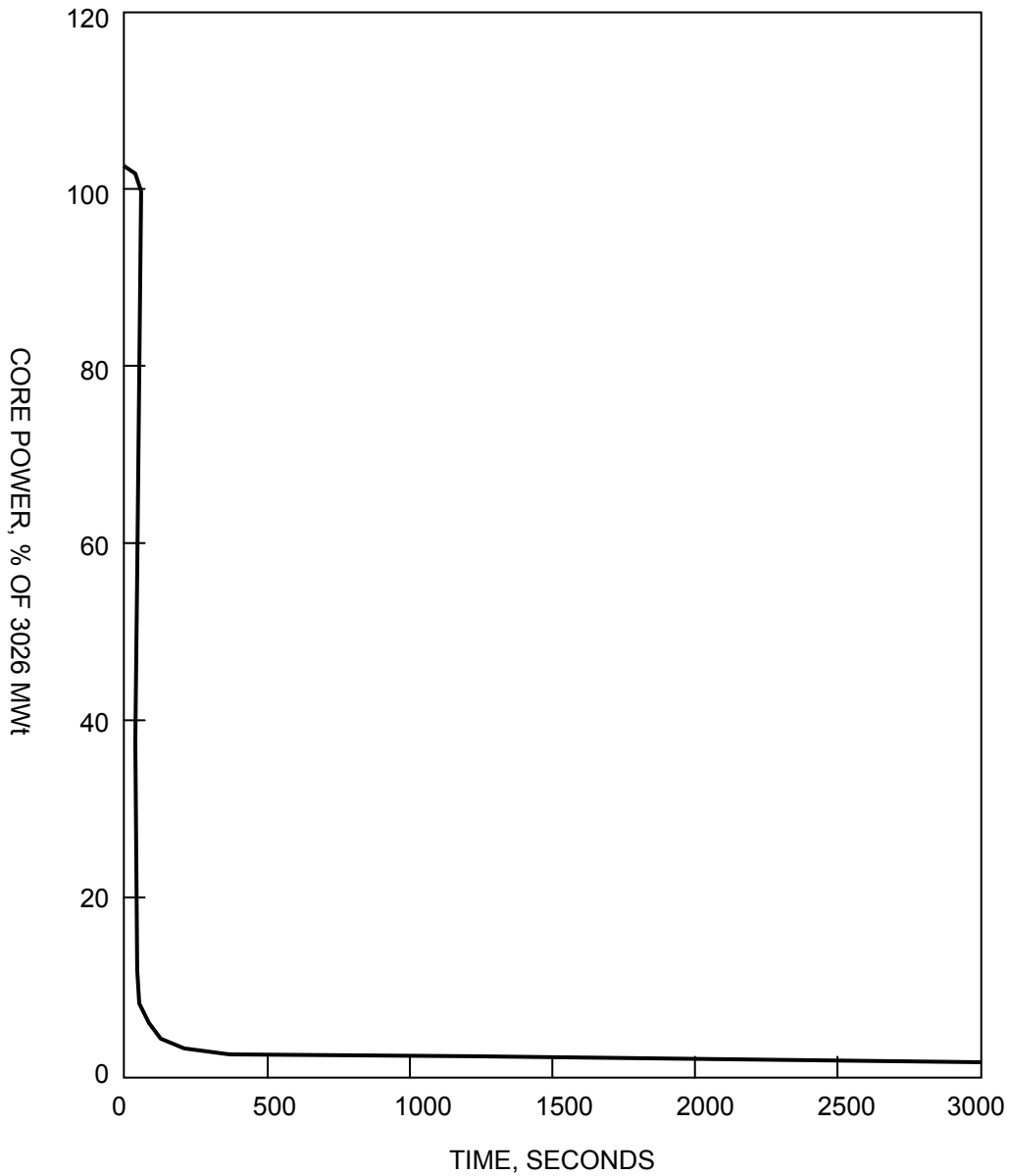

SAR FIGURE NO. 15.1.14-143

AMENDMENT 20

ARKANSAS NUCLEAR ONE
 UNIT 2
 RUSSELLVILLE, ARKANSAS



SCALE:	NONE
DRAWN:	
DESIGN:	ENTERGY
CAD NO:	

CYCLE 16 FEEDWATER LINE BREAK
 CORE POWER VERSUS TIME

BASED ON DRAWING NO

SHEET

REV.

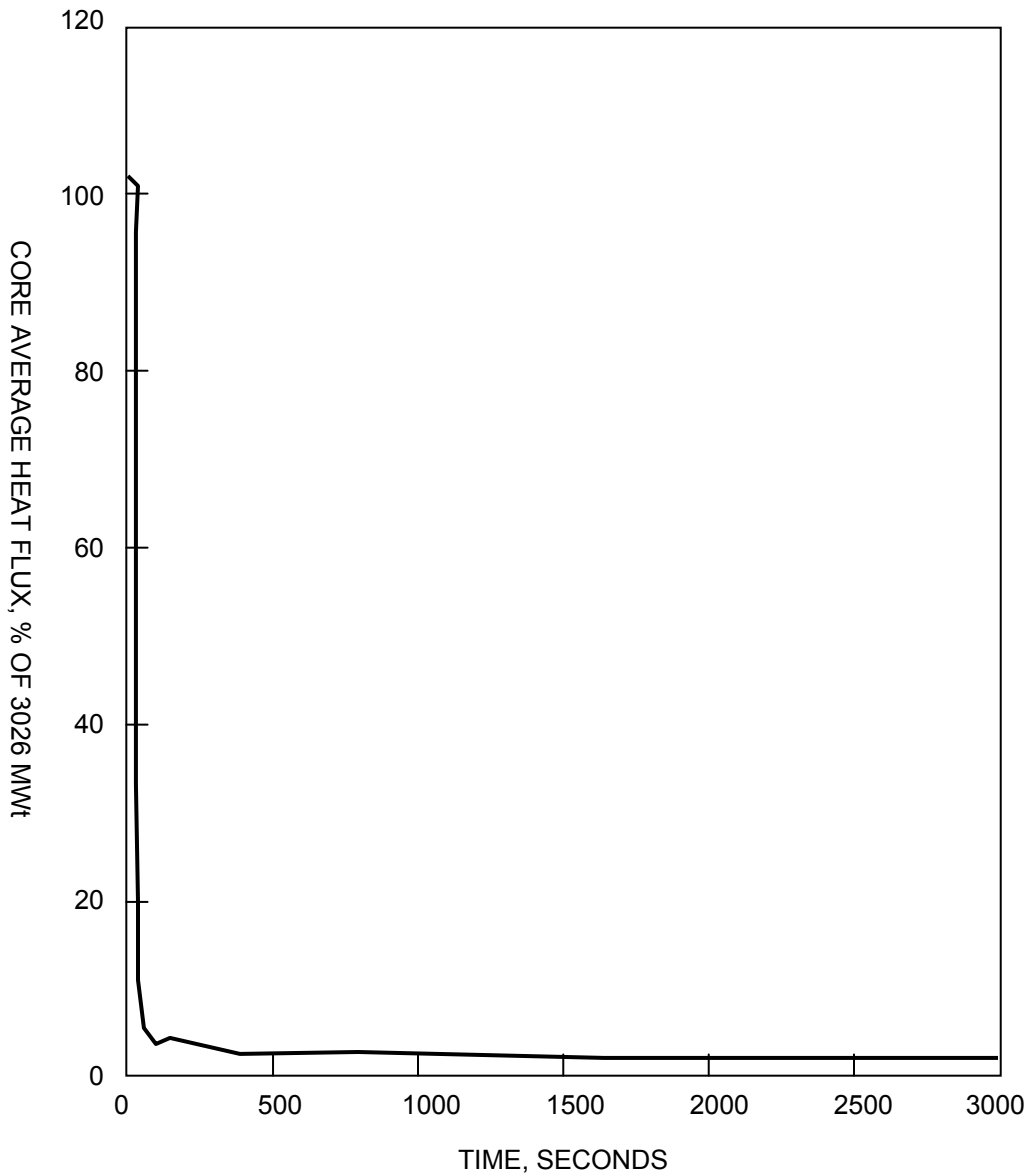

SAR FIGURE NO. 15.1.14-144

AMENDMENT 20

ARKANSAS NUCLEAR ONE
UNIT 2
RUSSELLVILLE, ARKANSAS



SCALE:	NONE
DRAWN:	
DESIGN:	ENERGY
CAD NO:	

CYCLE 16 FEEDWATER LINE BREAK
CORE AVERAGE HEAT FLUX VERSUS TIME

BASED ON DRAWING NO

SHEET

REV.

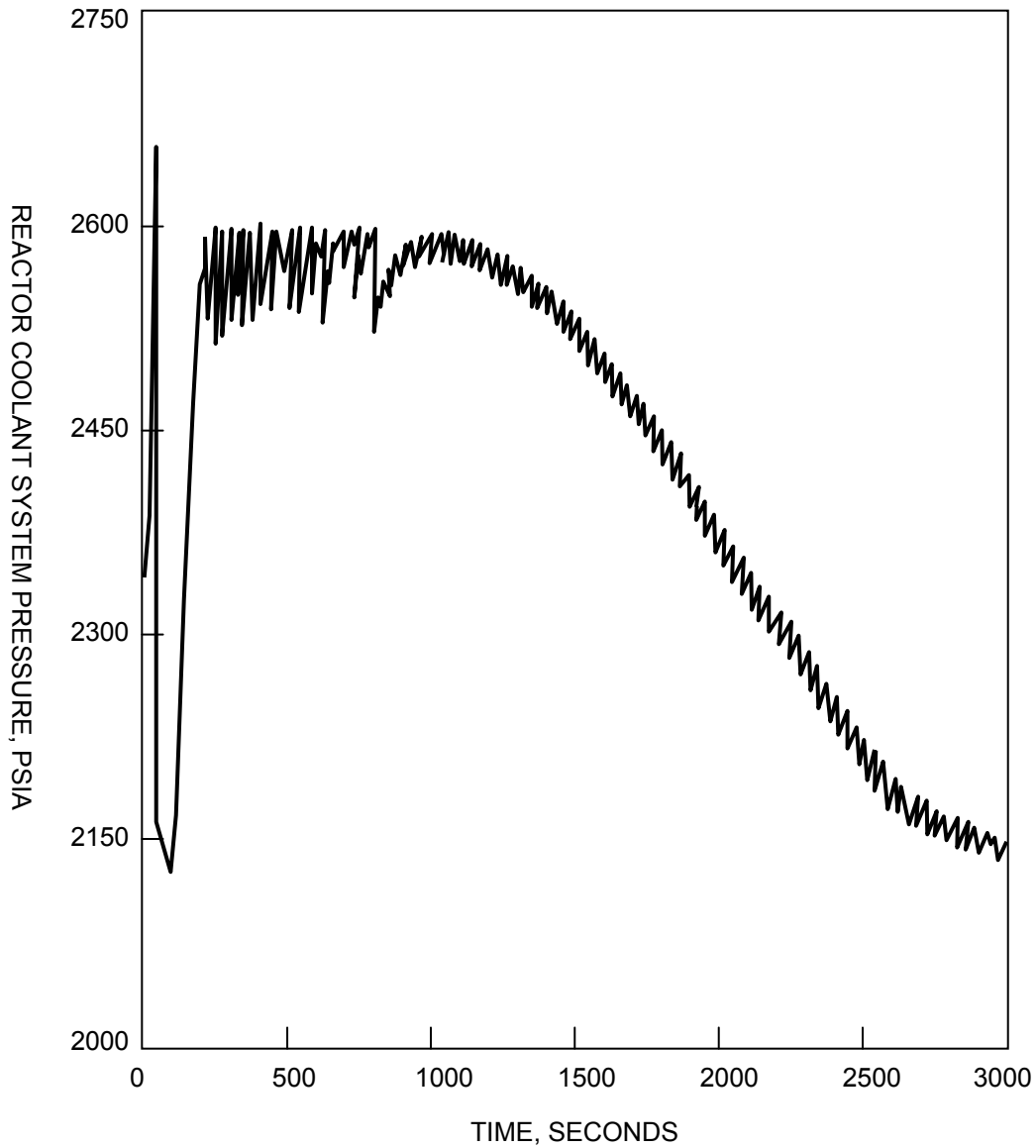

SAR FIGURE NO. 15.1.14-145

AMENDMENT 20

ARKANSAS NUCLEAR ONE
UNIT 2
RUSSELLVILLE, ARKANSAS



SCALE:	NONE
DRAWN:	
DESIGN:	ENERGY
CAD NO:	

CYCLE 16 FEEDWATER LINE BREAK
RCS PRESSURE VERSUS TIME

BASED ON DRAWING NO

SHEET

REV.

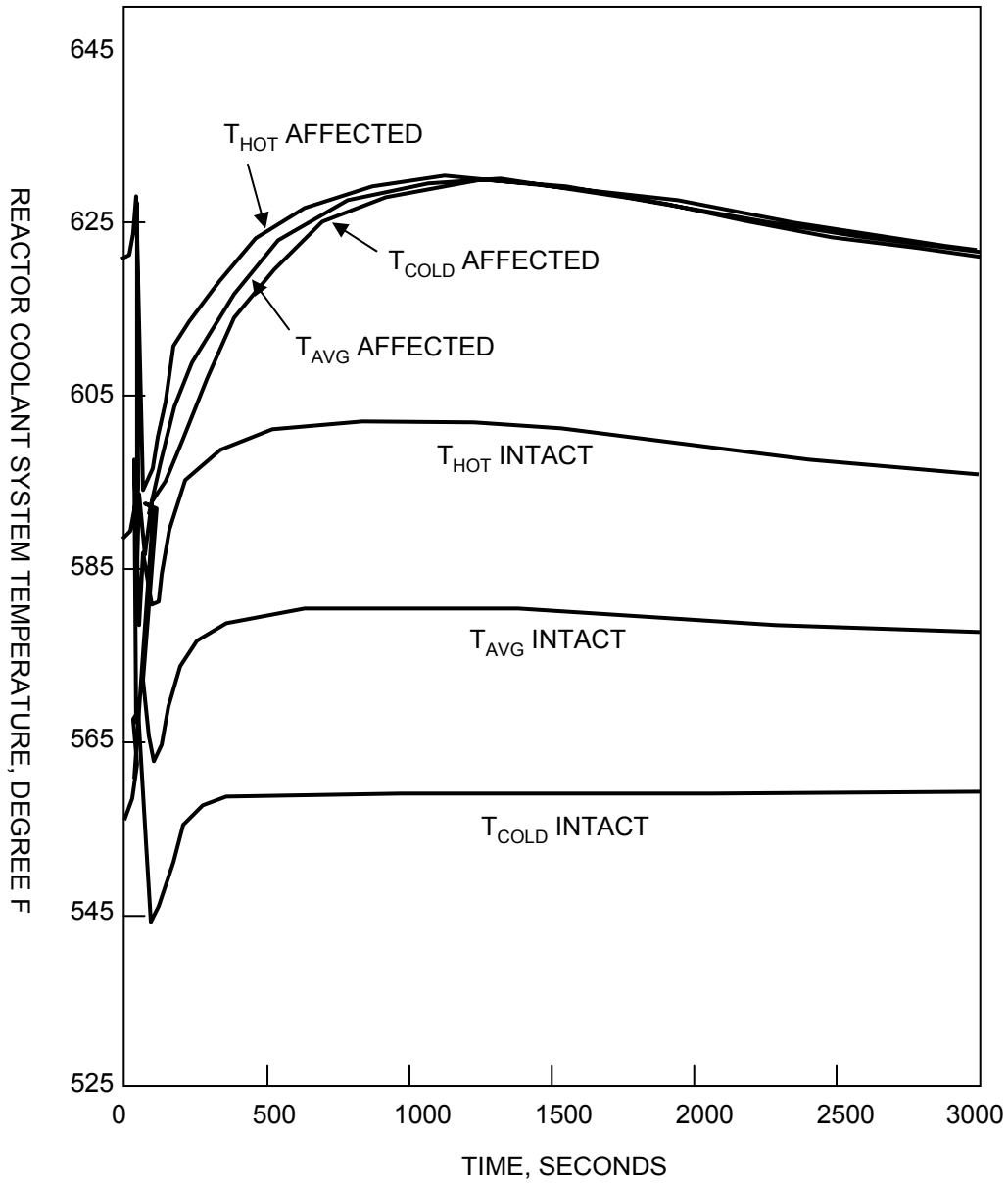

SAR FIGURE NO. 15.1.14-146

AMENDMENT 20

ARKANSAS NUCLEAR ONE
UNIT 2
RUSSELLVILLE, ARKANSAS



SCALE:	NONE
DRAWN:	
DESIGN:	ENERGY
CAD NO:	

CYCLE 16 FEEDWATER LINE BREAK
RCS TEMPERATURE VERSUS TIME

BASED ON DRAWING NO

SHEET

REV.

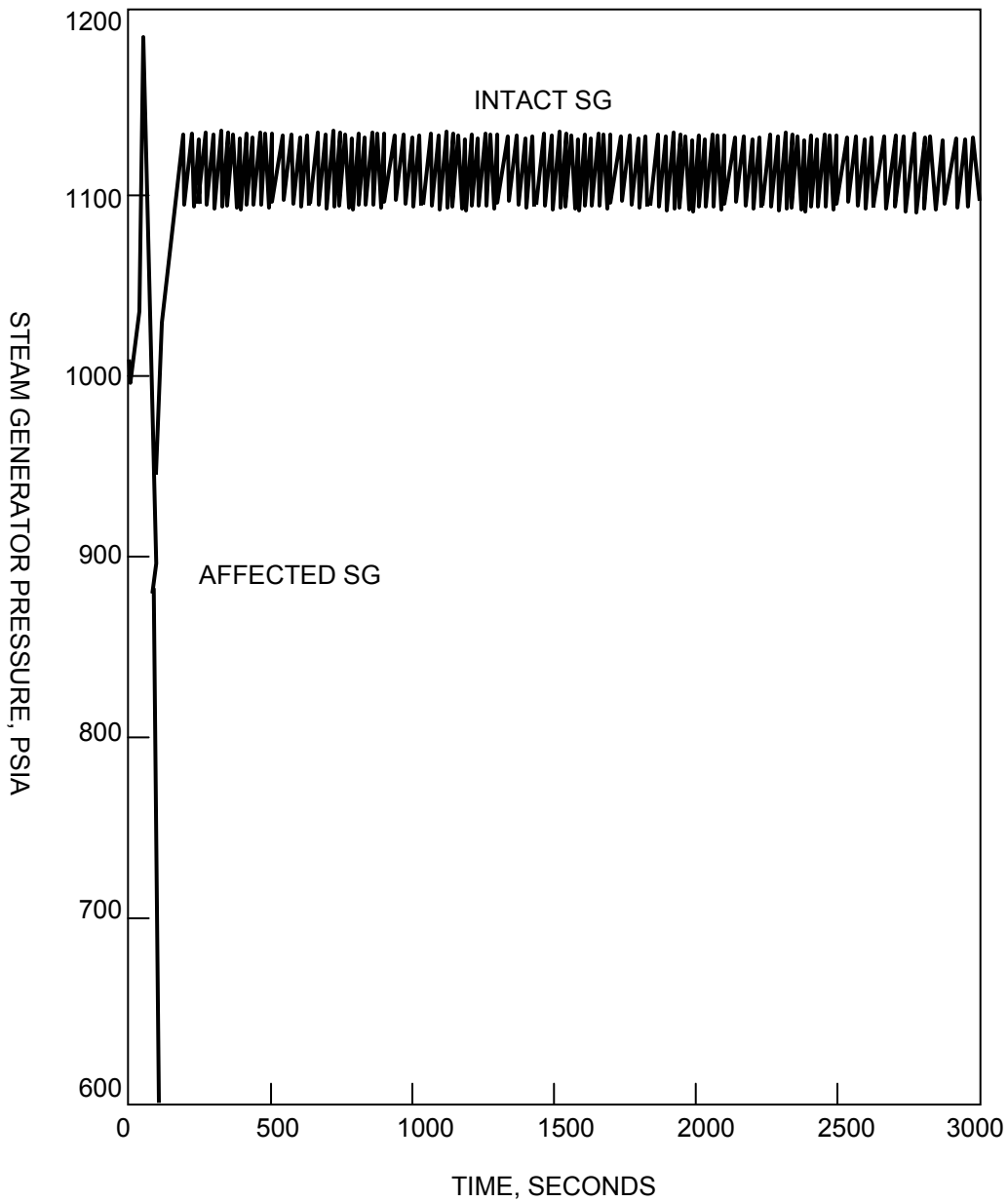

SAR FIGURE NO. 15.1.14-147

AMENDMENT 20

ARKANSAS NUCLEAR ONE
UNIT 2
RUSSELLVILLE, ARKANSAS



SCALE:	NONE
DRAWN:	
DESIGN:	ENERGY
CAD NO:	

CYCLE 16 FEEDWATER LINE BREAK STEAM GENERATOR PRESSURE VERSUS TIME

BASED ON DRAWING NO

SHEET

REV.

FIGURES 15.1.15-1
THROUGH 15.1.15-6
DELETED

SAR FIGURE NO. 15.1.15-1

AMENDMENT 20

ARKANSAS NUCLEAR ONE
UNIT 2
RUSSELLVILLE, ARKANSAS



SCALE:	NONE
DRAWN:	ENERGY
DESIGN:	ENERGY
CAD NO:	N/A

BASED ON DRAWING NO

SHEET

REV.

FIGURES 15.1.18-1
THROUGH 15.1.18-16
DELETED

SAR FIGURE NO. 15.1.18-1

AMENDMENT 23

ARKANSAS NUCLEAR ONE
UNIT 2
RUSSELLVILLE, ARKANSAS



SCALE: NONE

DRAWN:

DESIGN: ENTERGY

CAD NO:

BASED ON DRAWING NO

SHEET

REV.

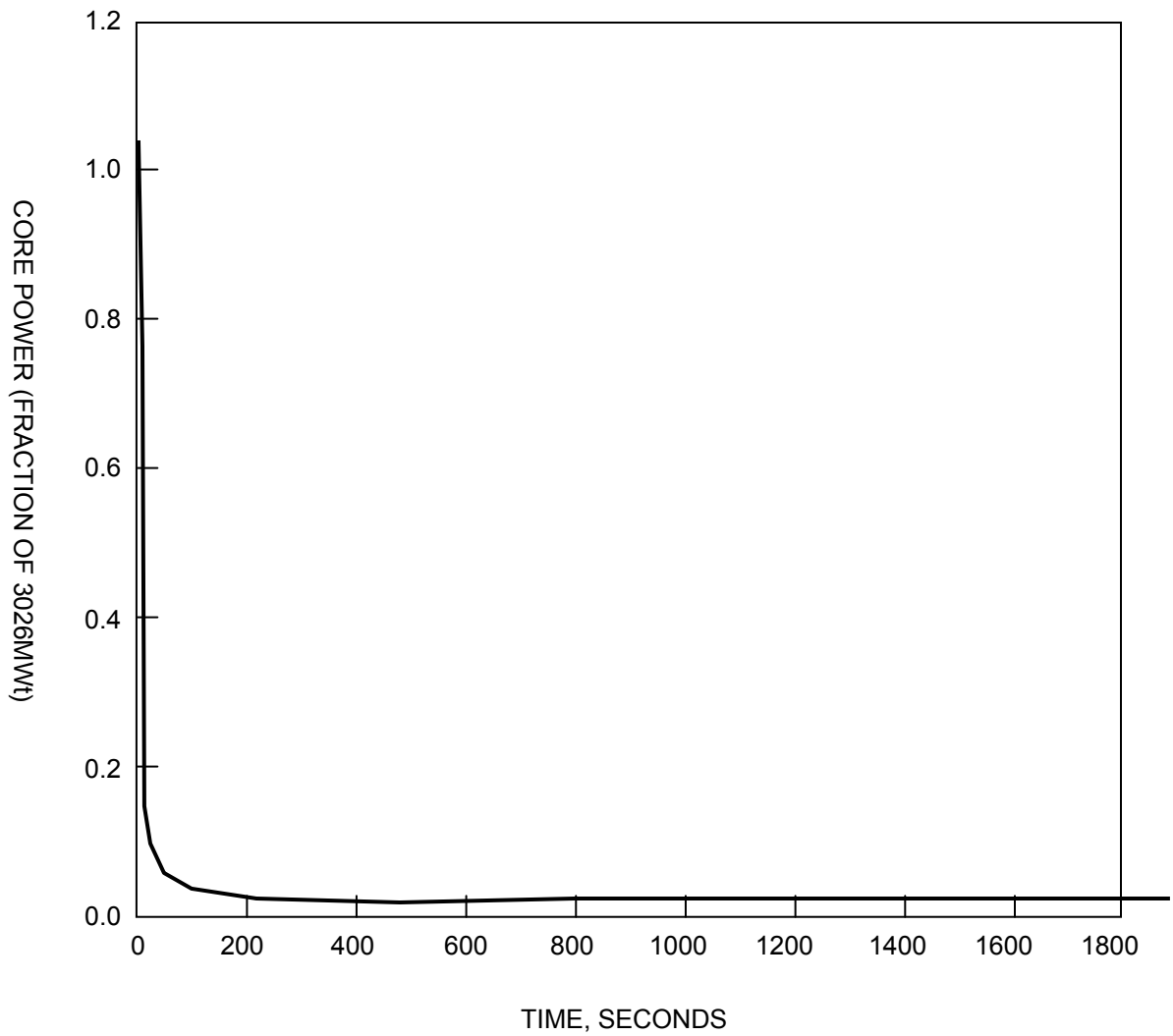

SAR FIGURE NO. 15.1.18-17

AMENDMENT 20

ARKANSAS NUCLEAR ONE
UNIT 2
RUSSELLVILLE, ARKANSAS



SCALE:	NONE
DRAWN:	
DESIGN:	ENTERGY
CAD NO:	

CYCLE 16 STEAM GENERATOR TUBE RUPTURE
ANALYSIS WITH LOSS OF AC POWER – CORE POWER
VERSUS TIME

BASED ON DRAWING NO

SHEET

REV.

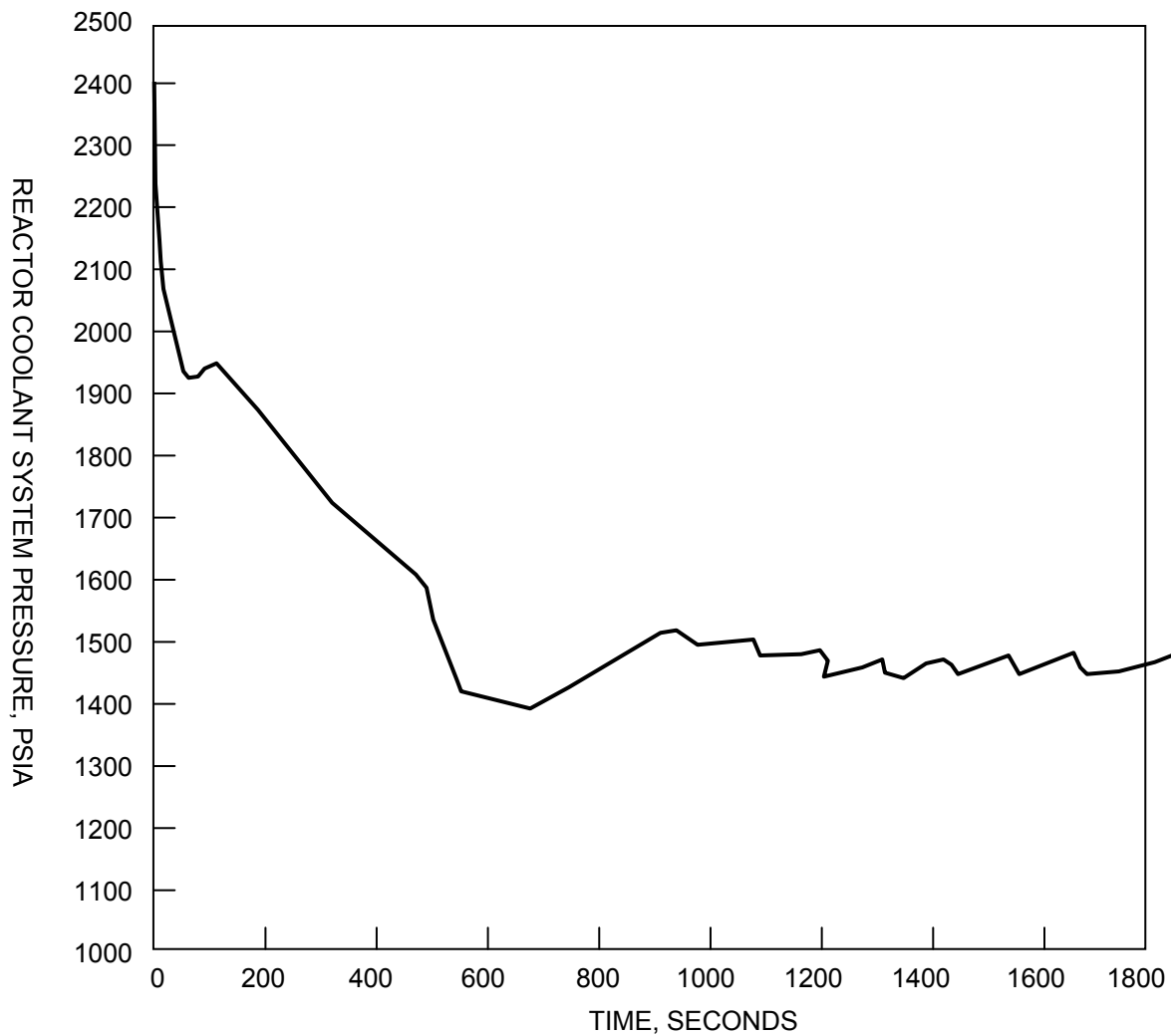

SAR FIGURE NO. 15.1.18-18

AMENDMENT 20

ARKANSAS NUCLEAR ONE
 UNIT 2
 RUSSELLVILLE, ARKANSAS



SCALE:	NONE
DRAWN:	
DESIGN:	ENTERGY
CAD NO:	

CYCLE 16 STEAM GENERATOR TUBE RUPTURE
 ANALYSIS WITH LOSS OF AC POWER – RCS PRESSURE
 VERSUS TIME

BASED ON DRAWING NO

SHEET

REV.

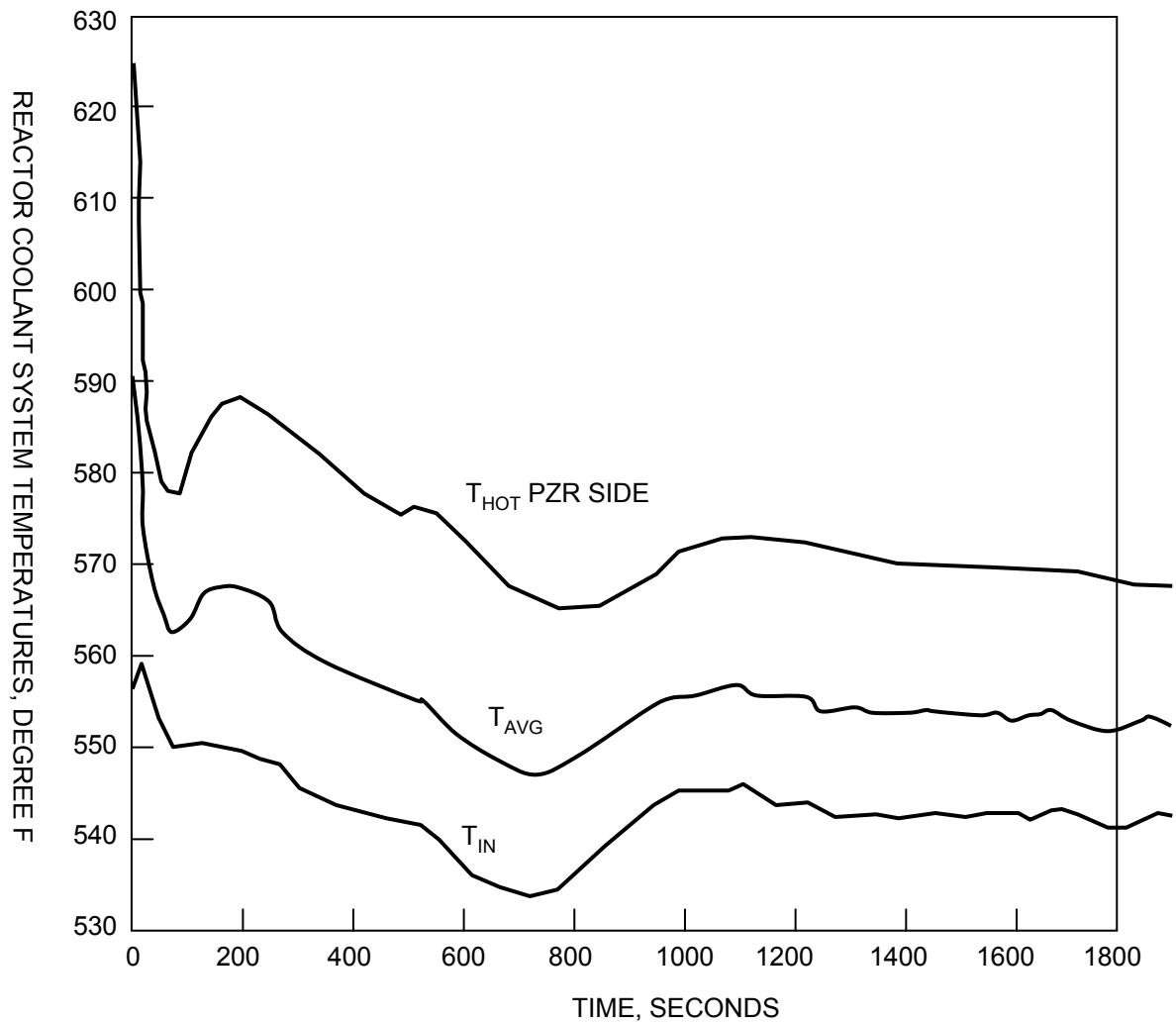

SAR FIGURE NO. 15.1.18-19

AMENDMENT 20

ARKANSAS NUCLEAR ONE
UNIT 2
RUSSELLVILLE, ARKANSAS



SCALE:	NONE
DRAWN:	
DESIGN:	ENERGY
CAD NO:	

CYCLE 16 STEAM GENERATOR TUBE RUPTURE
ANALYSIS WITH LOSS OF AC POWER - RCS
TEMPERATURES VERSUS TIME

BASED ON DRAWING NO

SHEET

REV.

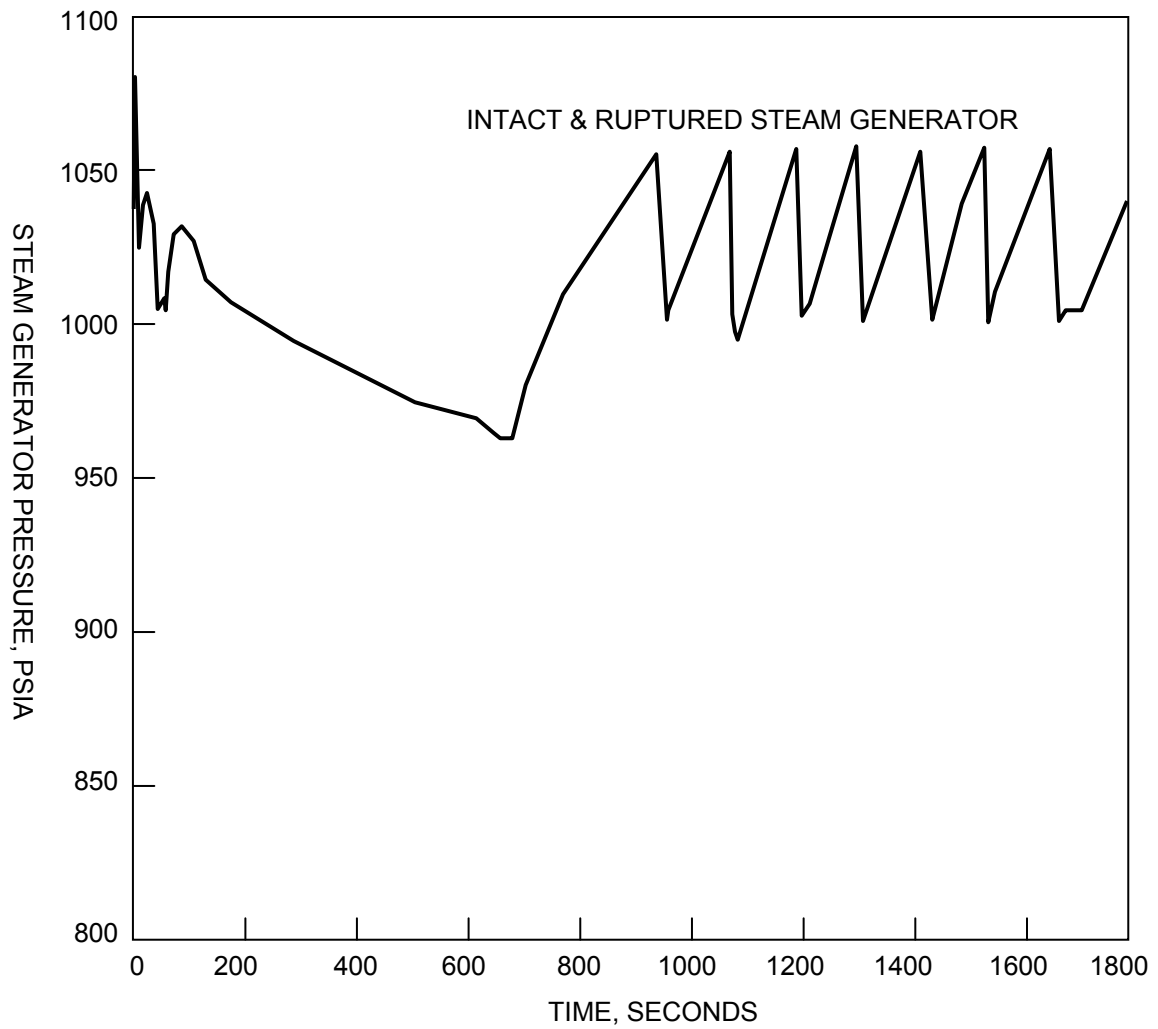

SAR FIGURE NO. 15.1.18-20

AMENDMENT 20

ARKANSAS NUCLEAR ONE
UNIT 2
RUSSELLVILLE, ARKANSAS



SCALE:	NONE
DRAWN:	
DESIGN:	ENERGY
CAD NO:	

CYCLE 16 STEAM GENERATOR TUBE RUPTURE
ANALYSIS WITH LOSS OF AC POWER – STEAM
GENERATOR PRESSURE VERSUS TIME

BASED ON DRAWING NO

SHEET

REV.

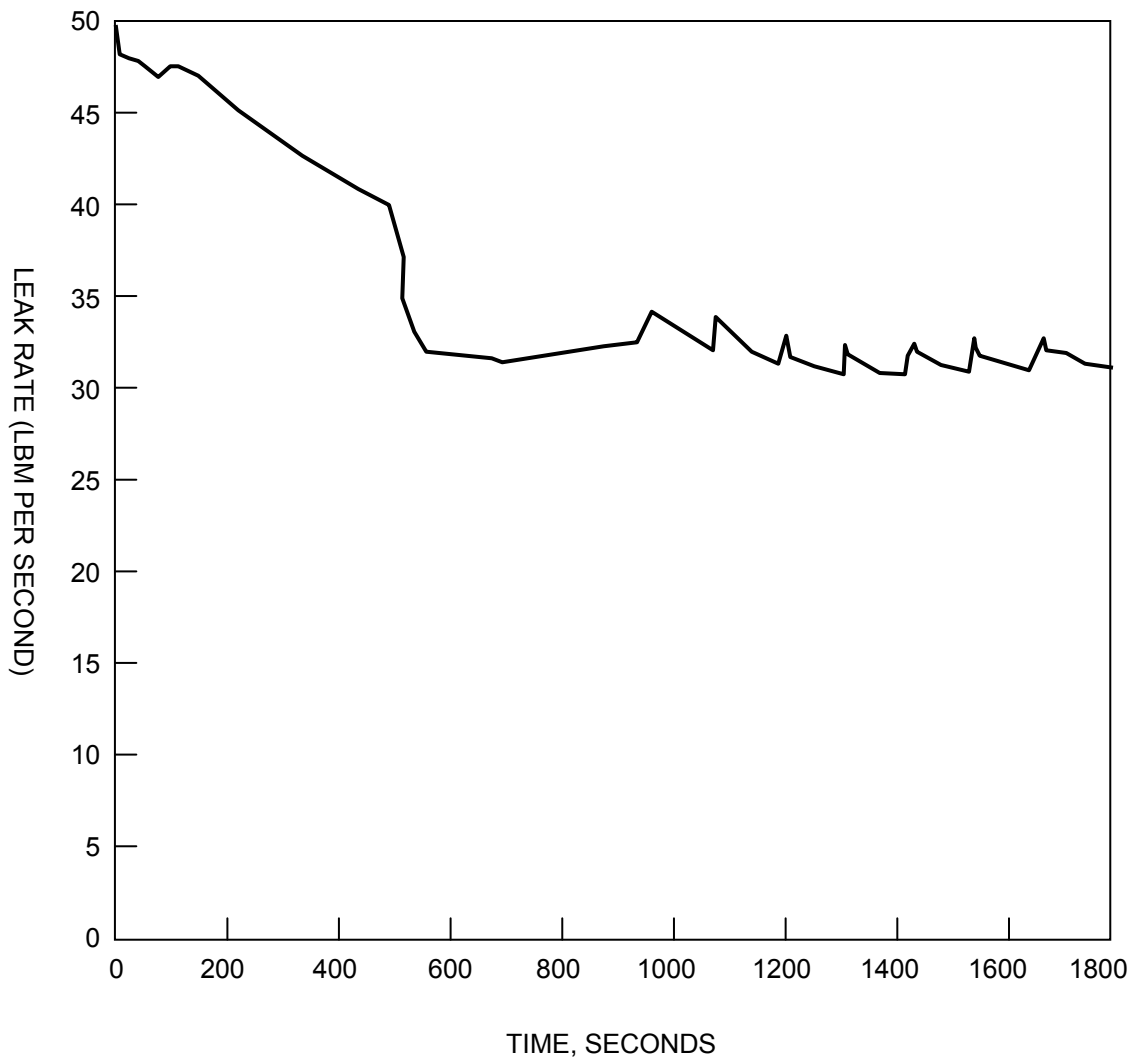

SAR FIGURE NO. 15.1.18-21

AMENDMENT 20

ARKANSAS NUCLEAR ONE
UNIT 2
RUSSELLVILLE, ARKANSAS



SCALE:	NONE
DRAWN:	
DESIGN:	ENTERGY
CAD NO:	

CYCLE 16 STEAM GENERATOR TUBE RUPTURE
ANALYSIS WITH LOSS OF AC POWER - RUPTURED
TUBE LEAK RATE VERSUS TIME

BASED ON DRAWING NO

SHEET

REV.

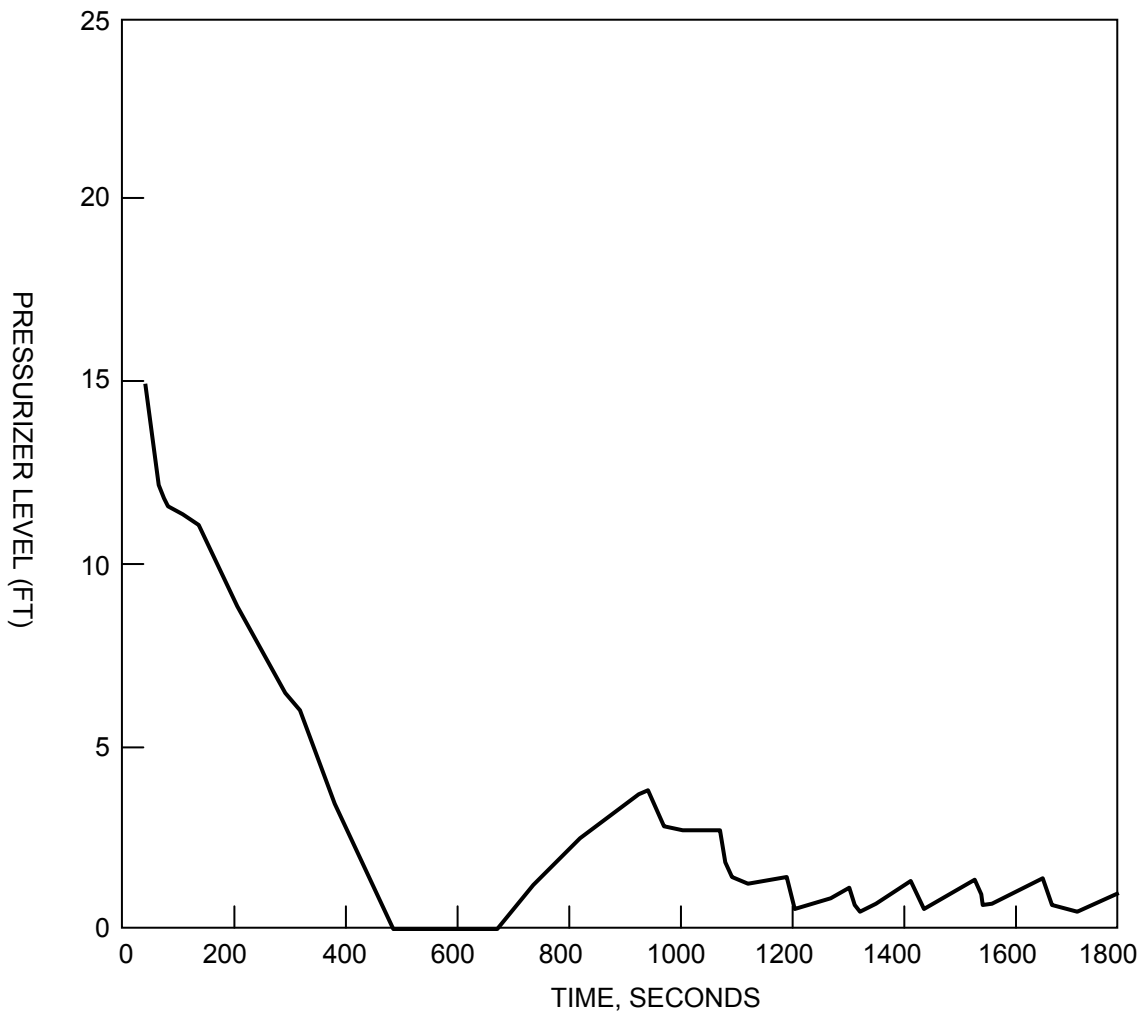

SAR FIGURE NO. 15.1.18-22

AMENDMENT 20

ARKANSAS NUCLEAR ONE
 UNIT 2
 RUSSELLVILLE, ARKANSAS



SCALE:	NONE
DRAWN:	
DESIGN:	ENTERGY
CAD NO:	

CYCLE 16 STEAM GENERATOR TUBE RUPTURE
 ANALYSIS WITH LOSS OF AC POWER - PRESSURIZER
 LEVEL VERSUS TIME

BASED ON DRAWING NO

SHEET

REV.

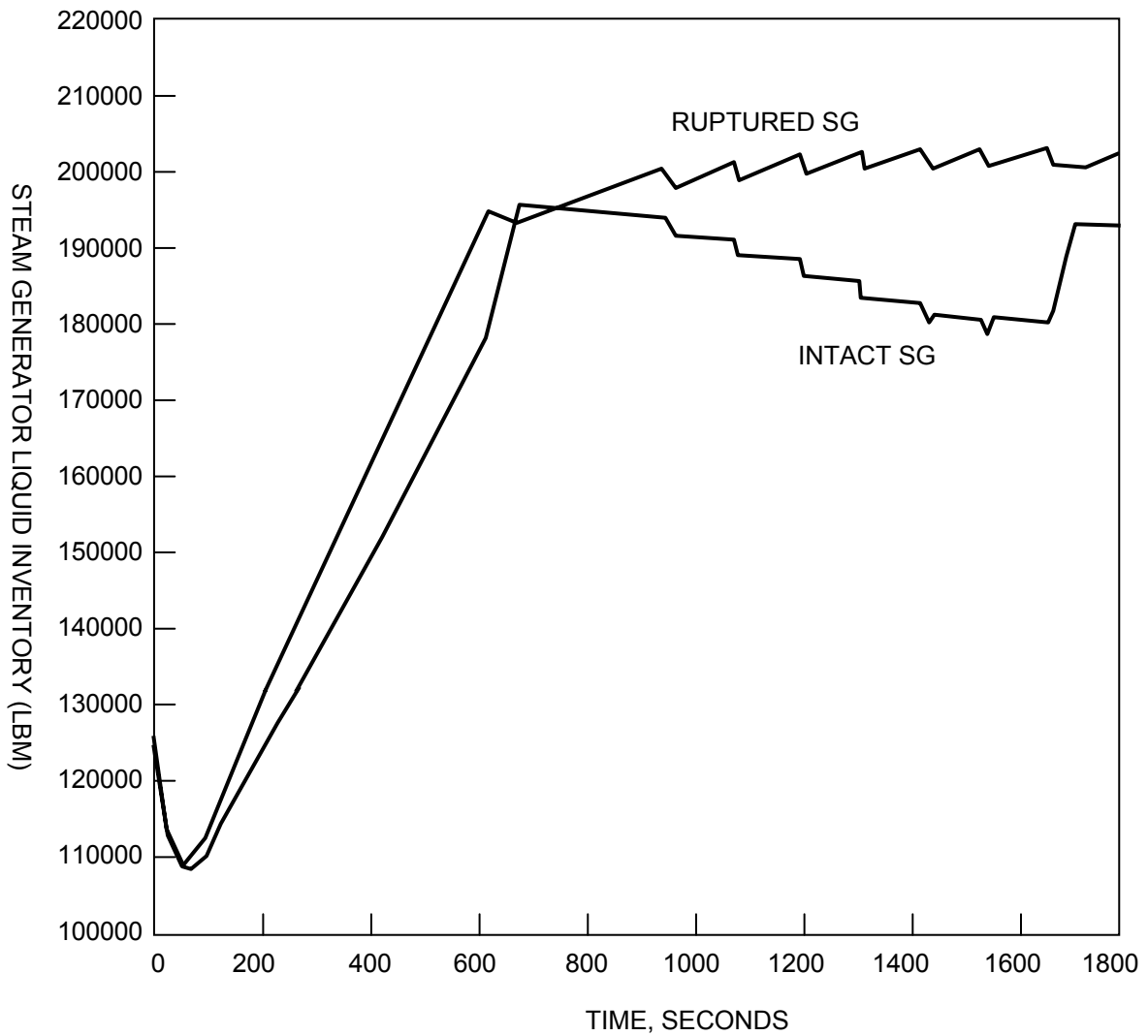

SAR FIGURE NO. 15.1.18-23

AMENDMENT 20

ARKANSAS NUCLEAR ONE
UNIT 2
RUSSELLVILLE, ARKANSAS



SCALE:	NONE
DRAWN:	
DESIGN:	ENERGY
CAD NO:	

CYCLE 16 STEAM GENERATOR TUBE RUPTURE
ANALYSIS WITH LOSS OF AC POWER – STEAM
GENERATOR LIQUID MASS VERSUS TIME

BASED ON DRAWING NO

SHEET

REV.

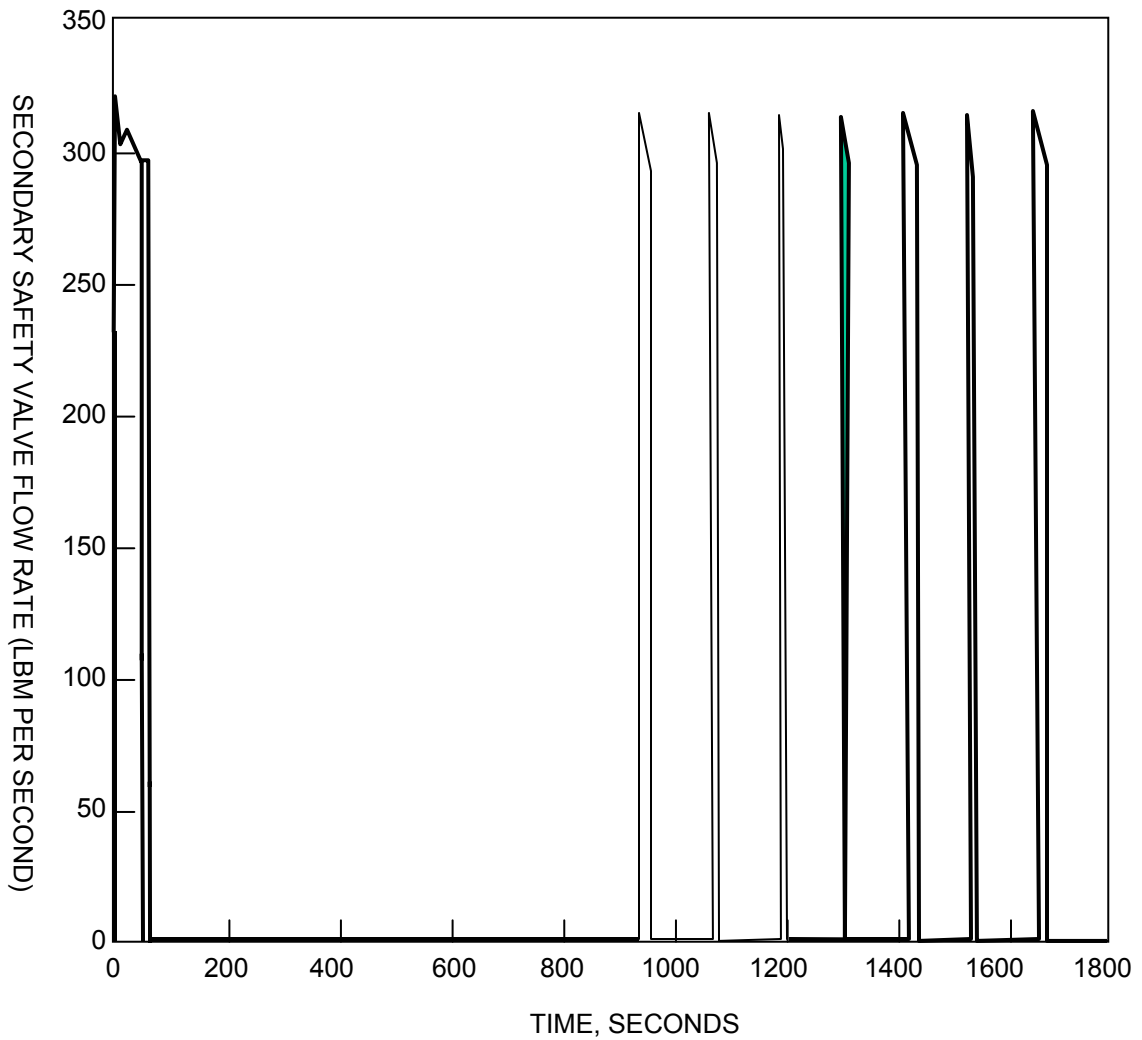

SAR FIGURE NO. 15.1.18-24

AMENDMENT 20

ARKANSAS NUCLEAR ONE
UNIT 2
RUSSELLVILLE, ARKANSAS



SCALE: NONE

DRAWN:

DESIGN: ENTERGY

CAD NO:

CYCLE 16 STEAM GENERATOR TUBE RUPTURE
ANALYSIS WITH LOSS OF AC POWER – SECONDARY
SAFETY VALVE FLOW RATE VVERSUS TIME

BASED ON DRAWING NO

SHEET

REV.

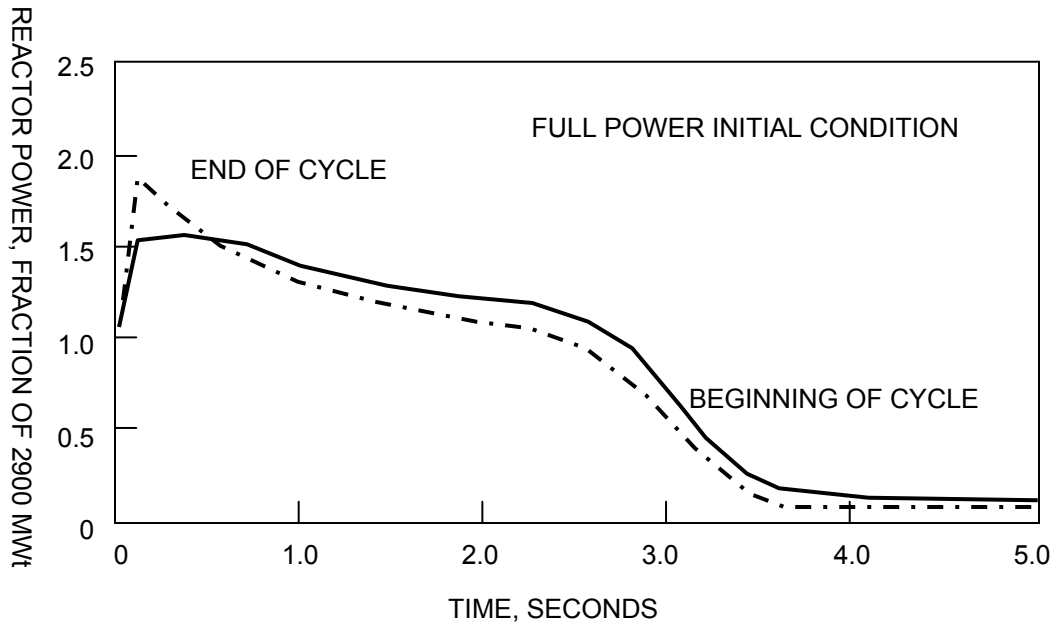

SAR FIGURE NO. 15.1.20-1

AMENDMENT 20

ARKANSAS NUCLEAR ONE
UNIT 2
RUSSELLVILLE, ARKANSAS



SCALE:	NONE
DRAWN:	
DESIGN:	ENERGY
CAD NO:	

CEA EJECTION INCIDENT
CORE POWER VERSUS TIME

BASED ON DRAWING NO

SHEET

REV.

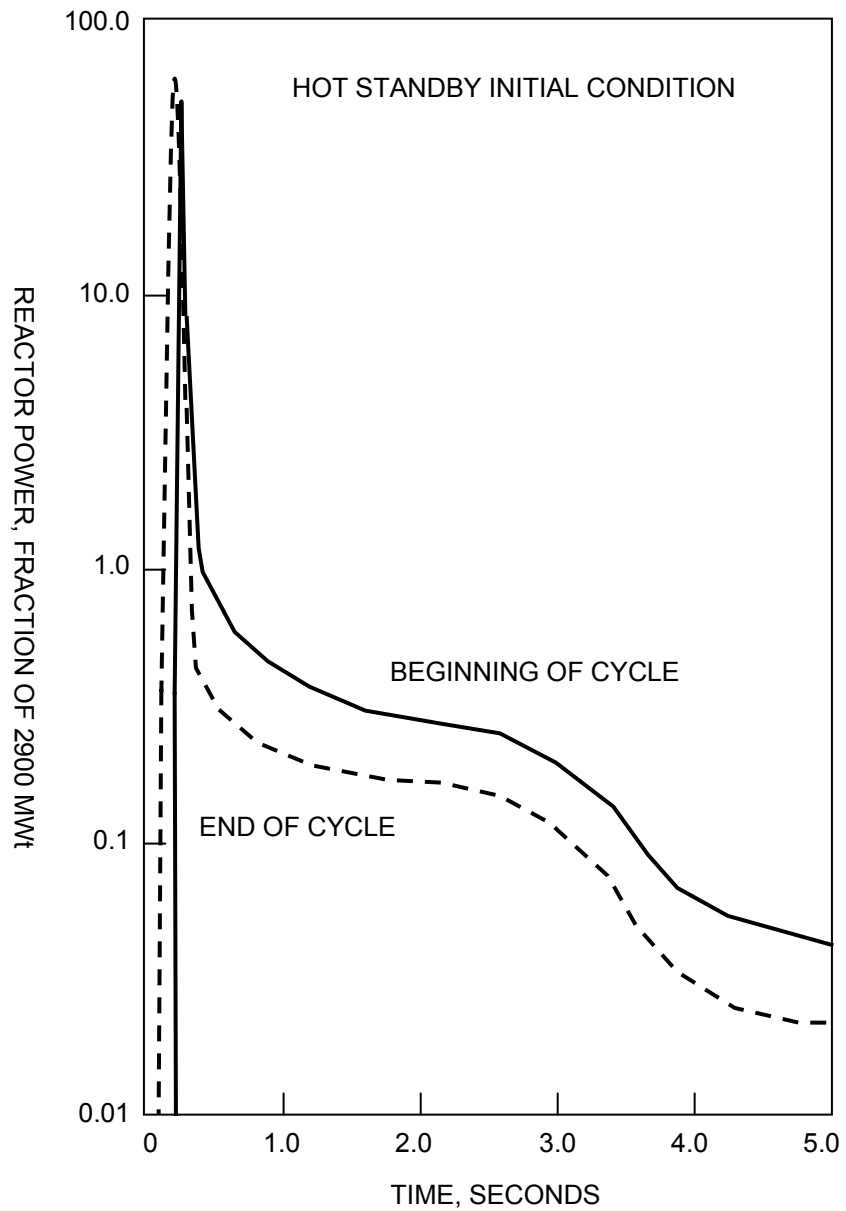

SAR FIGURE NO. 15.1.20-2

AMENDMENT 20

ARKANSAS NUCLEAR ONE
UNIT 2
RUSSELLVILLE, ARKANSAS



SCALE:	NONE
DRAWN:	
DESIGN:	ENERGY
CAD NO:	

CEA EJECTION INCIDENT
CORE POWER VERSUS TIME

BASED ON DRAWING NO

SHEET

REV.

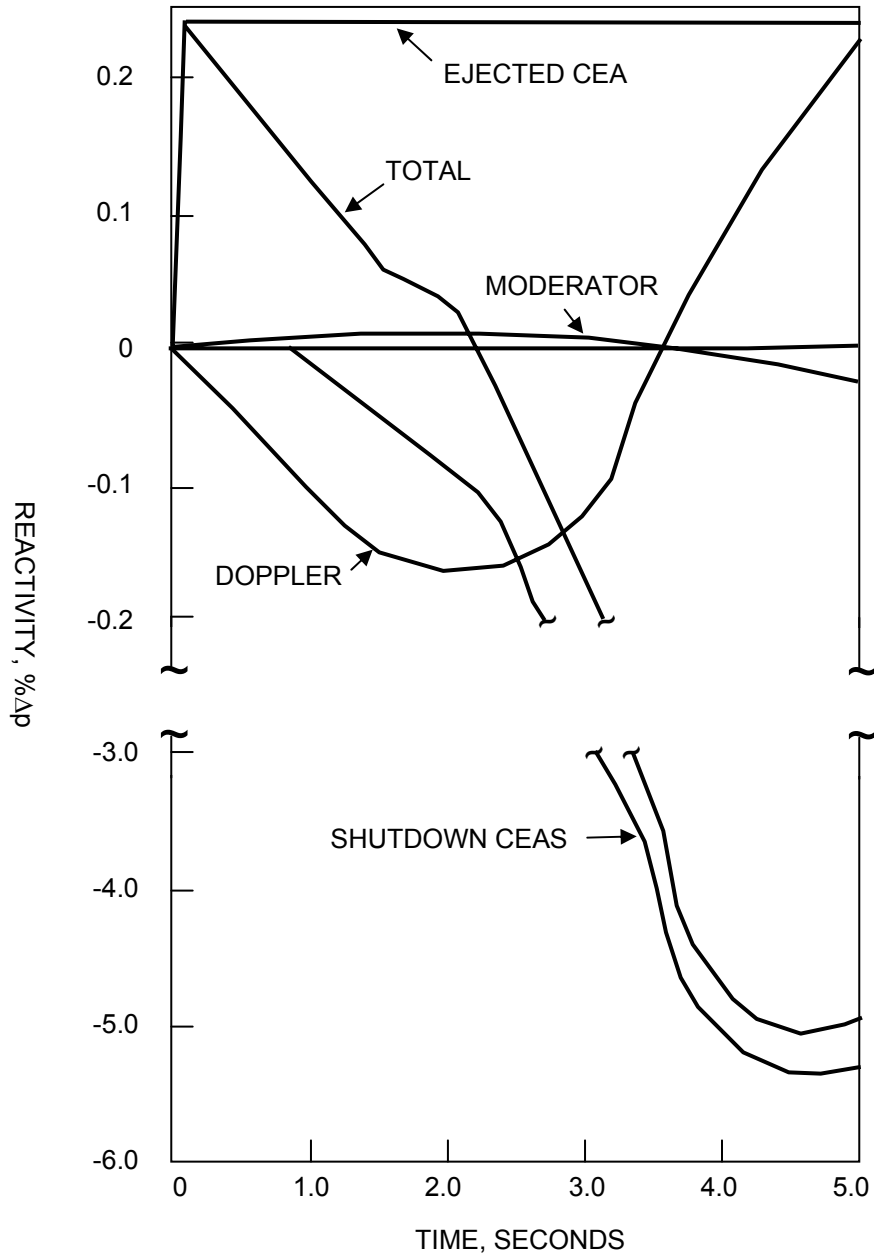

SAR FIGURE NO. 15.1.20-3

AMENDMENT 20

ARKANSAS NUCLEAR ONE
UNIT 2
RUSSELLVILLE, ARKANSAS



SCALE:	NONE
DRAWN:	
DESIGN:	ENERGY
CAD NO:	

CEA EJECTION INCIDENT FULL POWER, BOL INITIAL
CONDITIONS REACTIVITY COMPONENTS VERSUS TIME

BASED ON DRAWING NO

SHEET

REV.

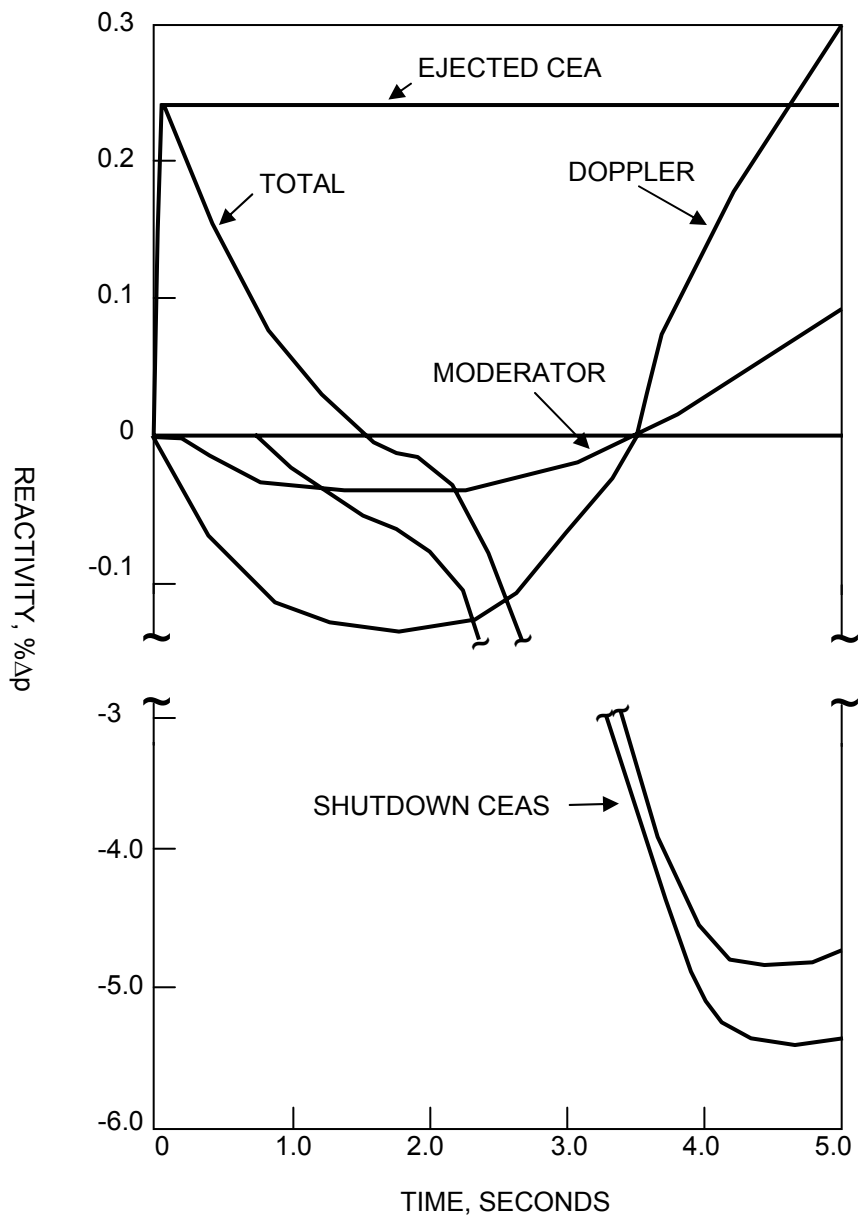

SAR FIGURE NO. 15.1.20-4

AMENDMENT 20

ARKANSAS NUCLEAR ONE
UNIT 2
RUSSELLVILLE, ARKANSAS



SCALE:	NONE
DRAWN:	
DESIGN:	ENERGY
CAD NO:	

CEA EJECTION INCIDENT FULL POWER, EOC INITIAL
CONDITIONS REACTIVITY COMPONENTS VERSUS TIME

BASED ON DRAWING NO

SHEET

REV.

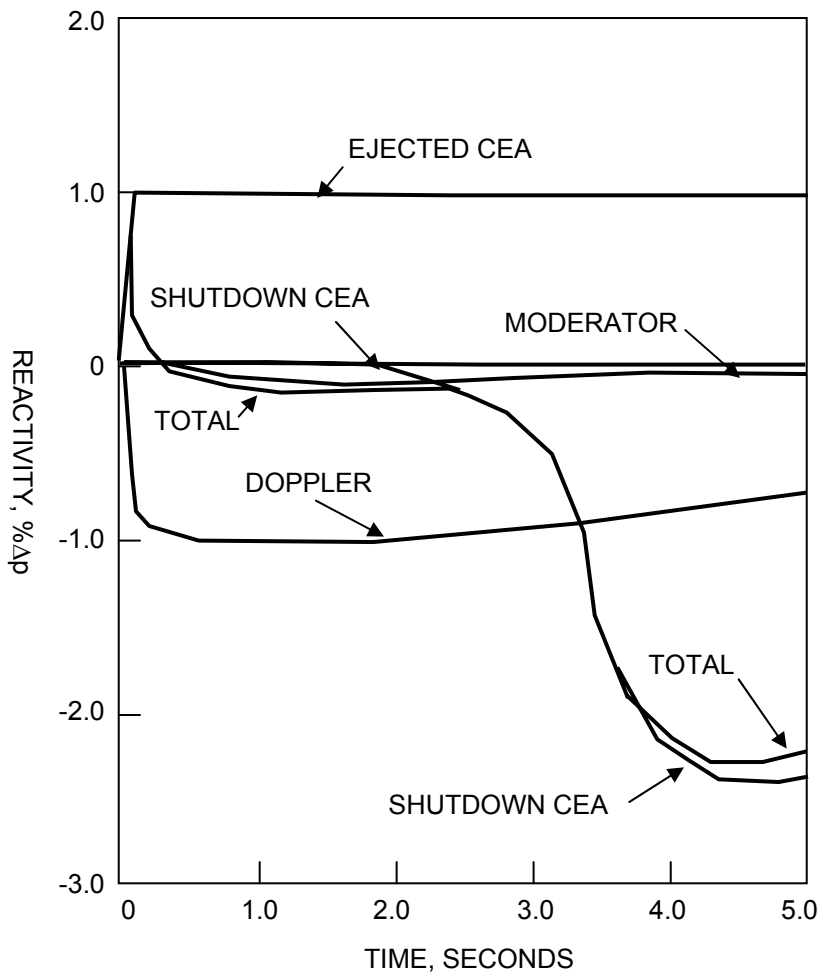

SAR FIGURE NO. 15.1.20-5

AMENDMENT 20

ARKANSAS NUCLEAR ONE
UNIT 2
RUSSELLVILLE, ARKANSAS



SCALE:	NONE
DRAWN:	
DESIGN:	ENERGY
CAD NO:	

CEA EJECTION INCIDENT ZERO POWER, EOC INITIAL
CONDITIONS REACTIVITY COMPONENTS VERSUS TIME

BASED ON DRAWING NO

SHEET

REV.

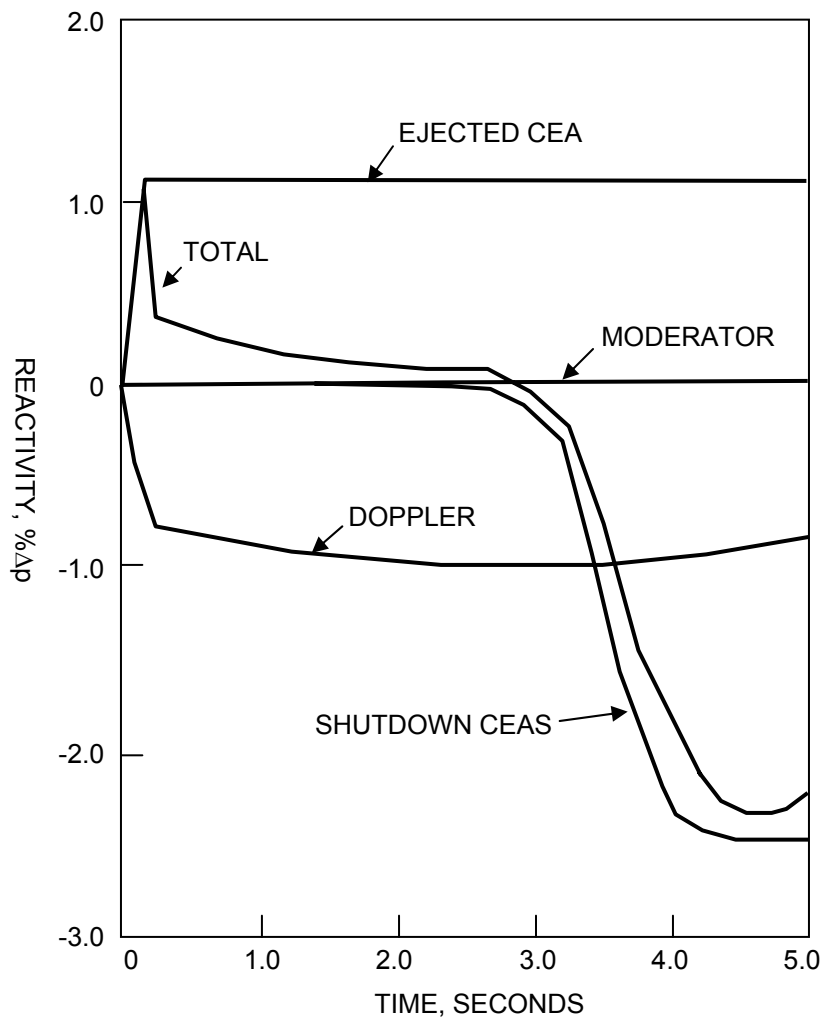

SAR FIGURE NO. 15.1.20-6

AMENDMENT 20

ARKANSAS NUCLEAR ONE
UNIT 2
RUSSELLVILLE, ARKANSAS



SCALE:	NONE
DRAWN:	
DESIGN:	ENERGY
CAD NO:	

CEA EJECTION INCIDENT ZERO POWER, BOL INITIAL
CONDITIONS REACTIVITY COMPONENTS VERSUS TIME

BASED ON DRAWING NO

SHEET

REV.

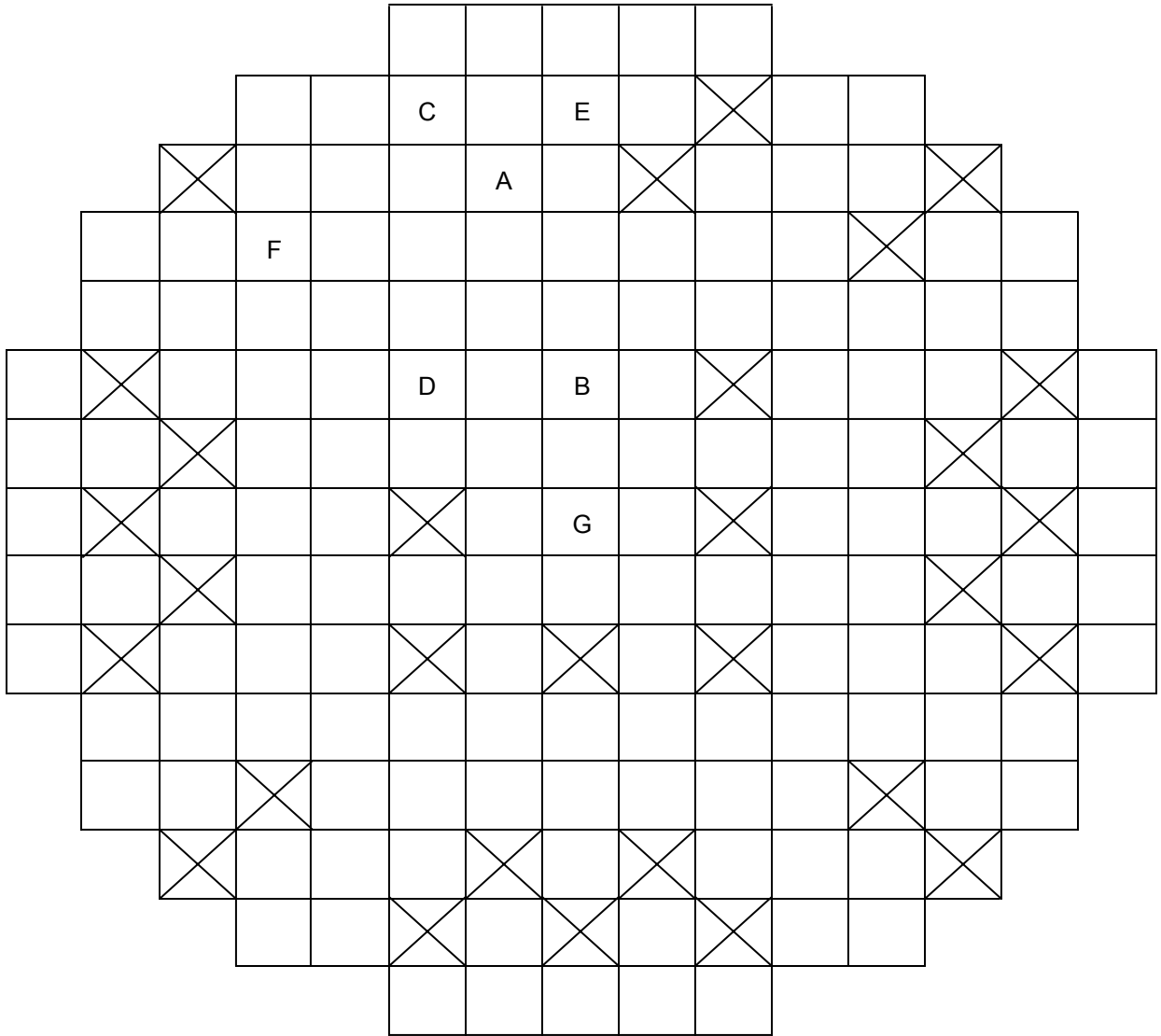

REGULATING CEA LOCATIONS



EJECTED CEA LOCATIONS

SAR FIGURE NO. 15.1.20-7

AMENDMENT 20

ARKANSAS NUCLEAR ONE
UNIT 2
RUSSELLVILLE, ARKANSAS



SCALE:	NONE
DRAWN:	WESTINGHOUSE
DESIGN:	ENERGY
CAD NO:	

IDENTIFICATION OF EJECTED CEA
LOCATIONS

BASED ON DRAWING NO

SHEET

REV.

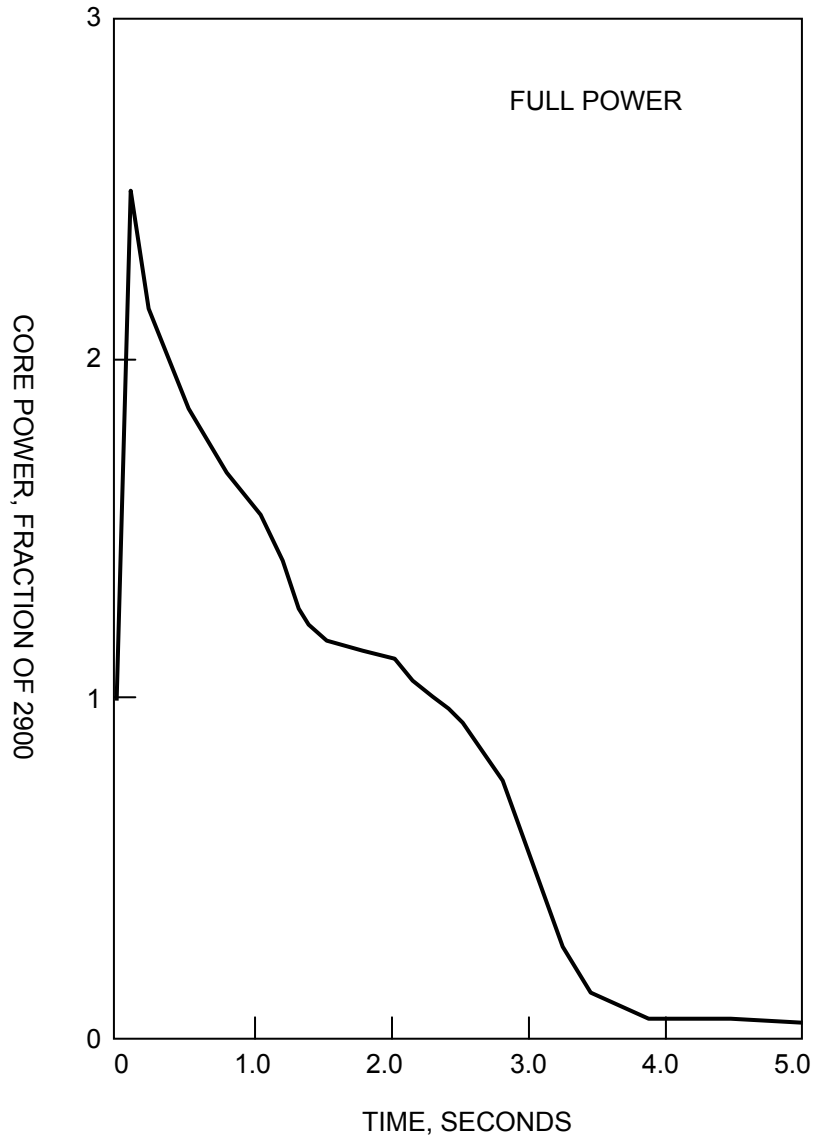

SAR FIGURE NO. 15.1.20-8

AMENDMENT 20

ARKANSAS NUCLEAR ONE
UNIT 2
RUSSELLVILLE, ARKANSAS



SCALE:	NONE
DRAWN:	
DESIGN:	ENERGY
CAD NO:	

CEA EJECTION INCIDENT FROM FULL CORE
POWER VERSUS TIME

BASED ON DRAWING NO

SHEET

REV.

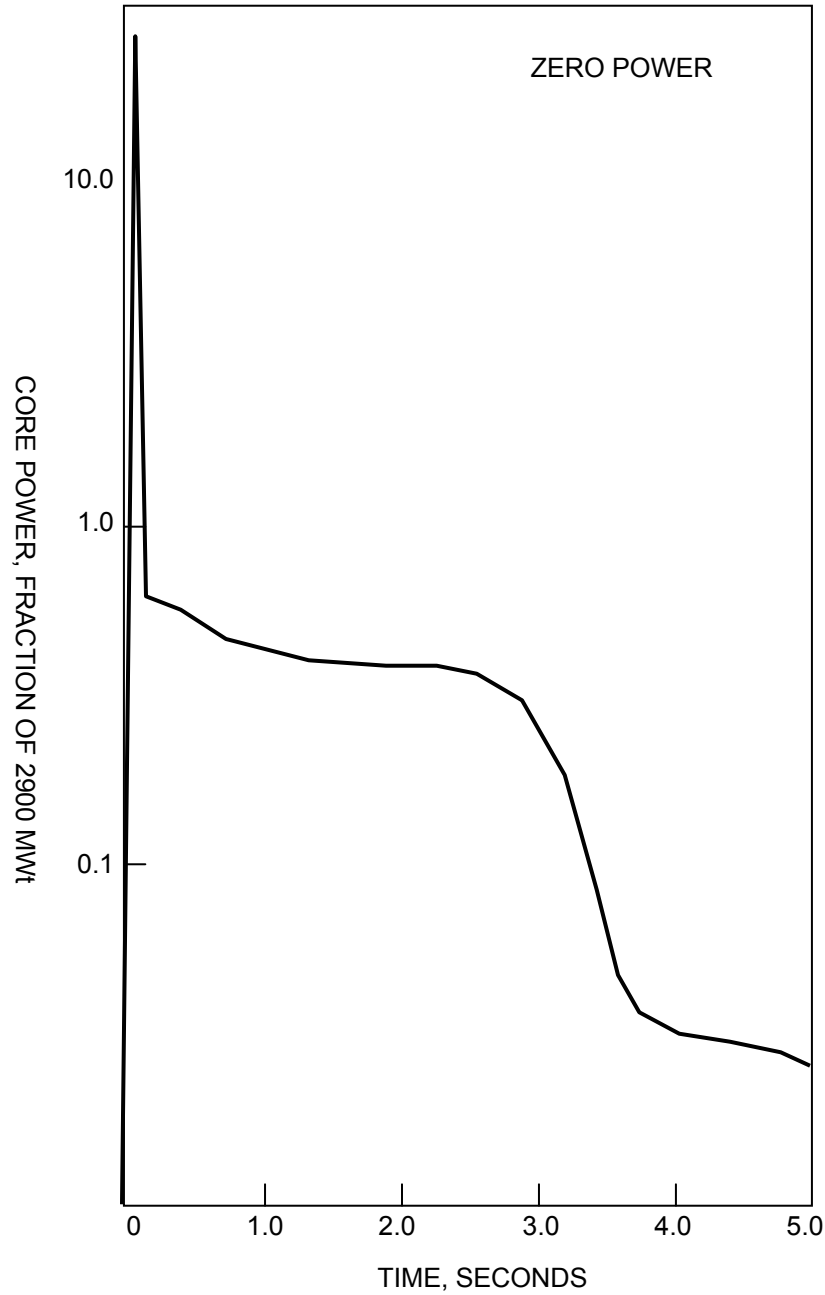

SAR FIGURE NO. 15.1.20-9

AMENDMENT 20

ARKANSAS NUCLEAR ONE
 UNIT 2
 RUSSELLVILLE, ARKANSAS



SCALE: NONE

DRAWN:

DESIGN: ENTERGY

CAD NO:

CEA EJECTION INCIDENT FROM ZERO
 POWER VERSUS TIME

BASED ON DRAWING NO

SHEET

REV.

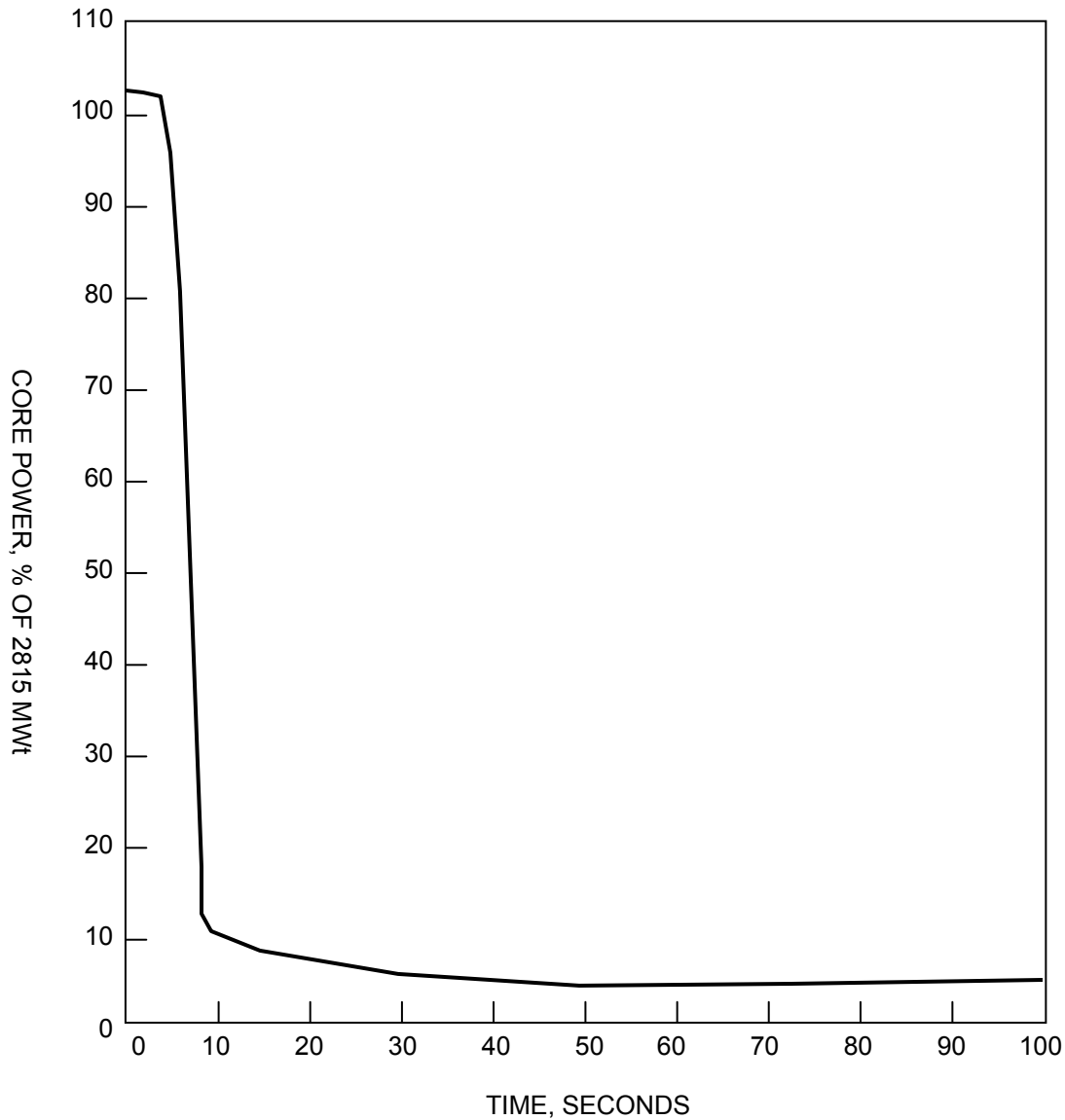

SAR FIGURE NO. 15.1.36-1

AMENDMENT 20

ARKANSAS NUCLEAR ONE
UNIT 2
RUSSELLVILLE, ARKANSAS



SCALE:	NONE
DRAWN:	
DESIGN:	ENERGY
CAD NO:	

LOSS OF LOAD / 1 STEAM GENERATOR
EVENT CORE POWER VERSUS TIME

BASED ON DRAWING NO

SHEET

REV.

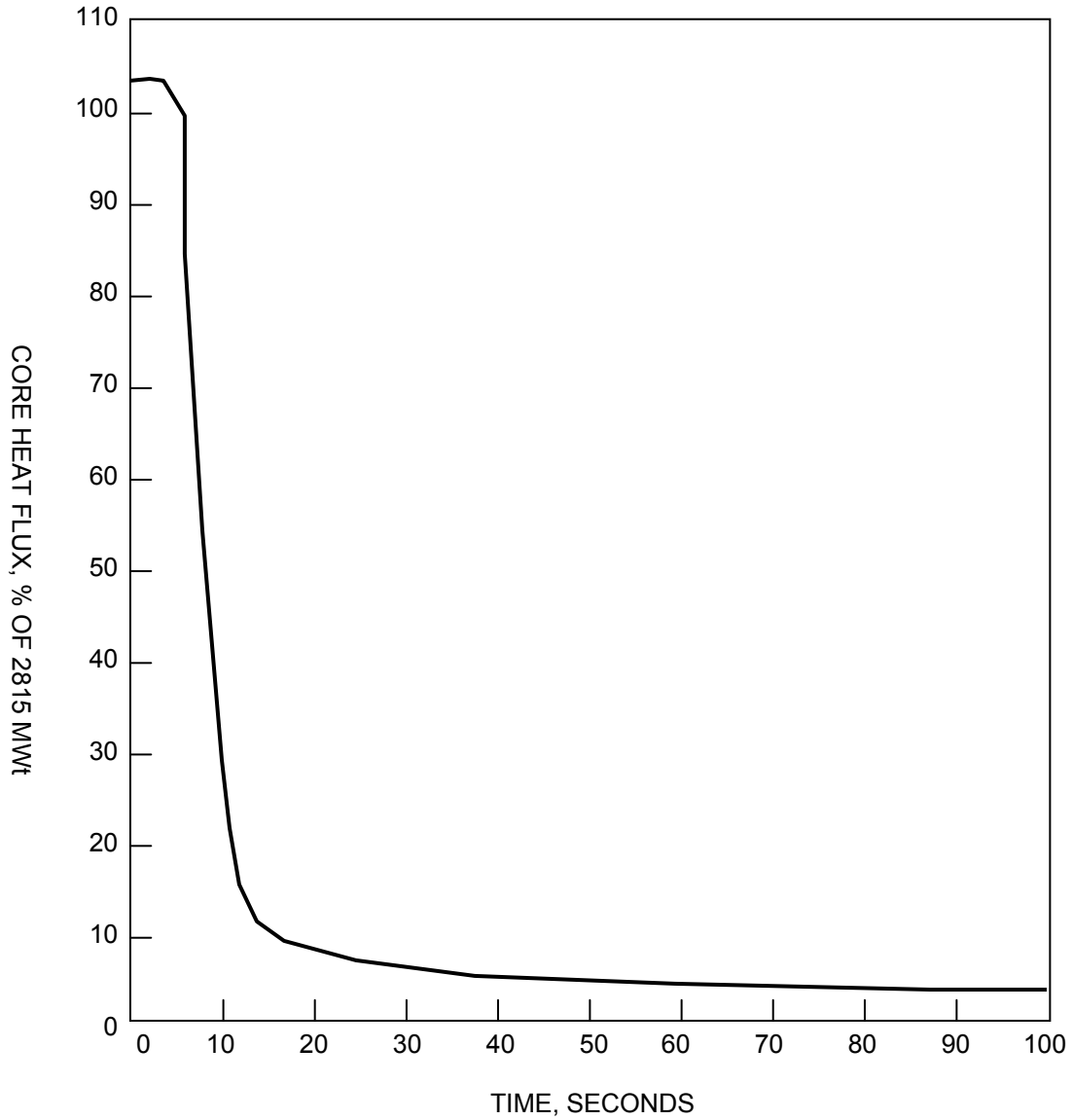

SAR FIGURE NO. 15.1.36-2

AMENDMENT 20

ARKANSAS NUCLEAR ONE
 UNIT 2
 RUSSELLVILLE, ARKANSAS



SCALE: NONE

DRAWN:

DESIGN: ENTERGY

CAD NO:

LOSS OF LOAD / 1 STEAM GENERATOR
 EVENT CORE HEAT FLUX VERSUS TIME

BASED ON DRAWING NO

SHEET

REV.

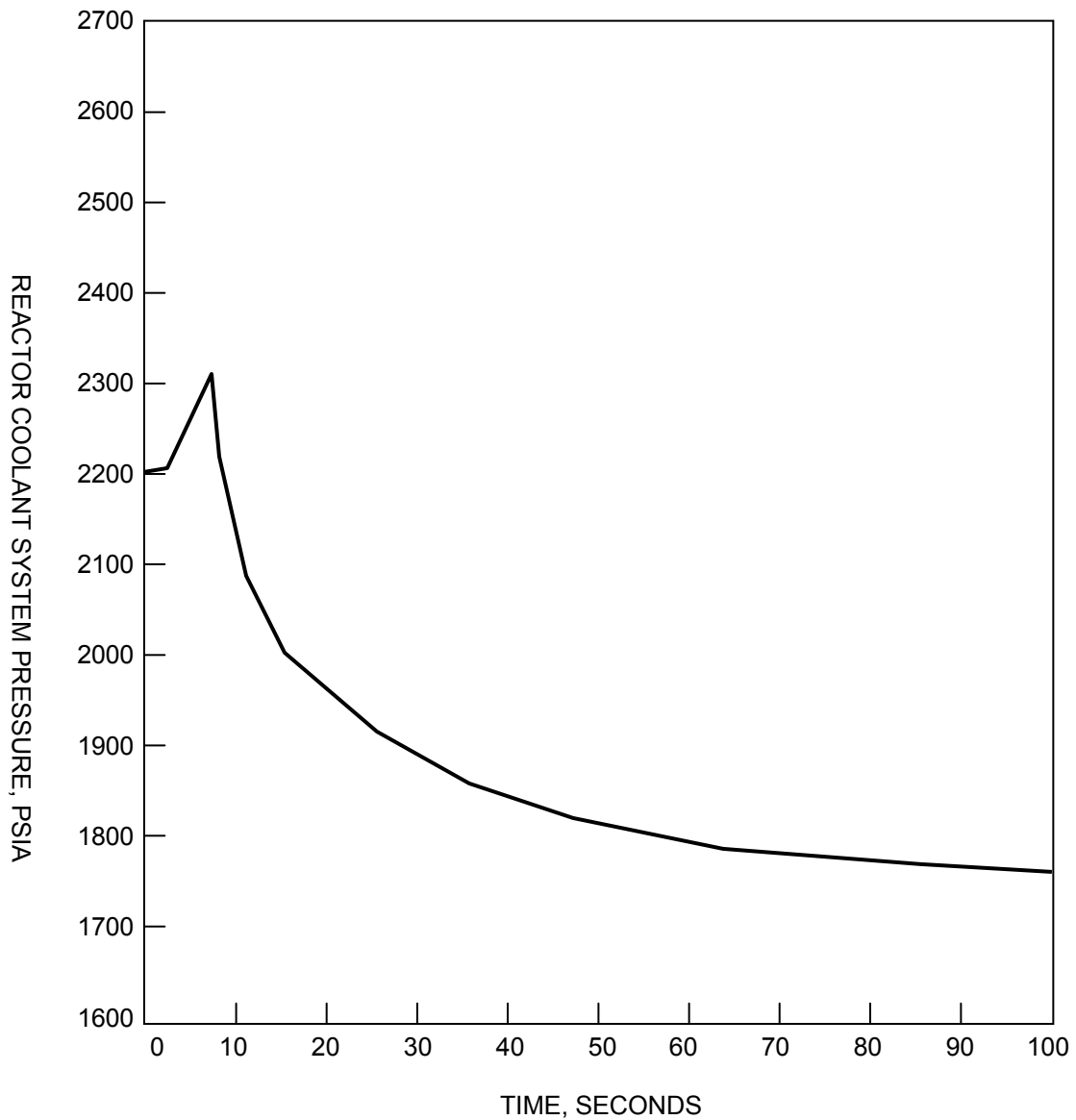

SAR FIGURE NO. 15.1.36-3

AMENDMENT 20

ARKANSAS NUCLEAR ONE
UNIT 2
RUSSELLVILLE, ARKANSAS



SCALE:	NONE
DRAWN:	
DESIGN:	ENERGY
CAD NO:	

LOSS OF LOAD / 1 STEAM GENERATOR
EVENT RCS PRESSURE VERSUS TIME

BASED ON DRAWING NO

SHEET

REV.

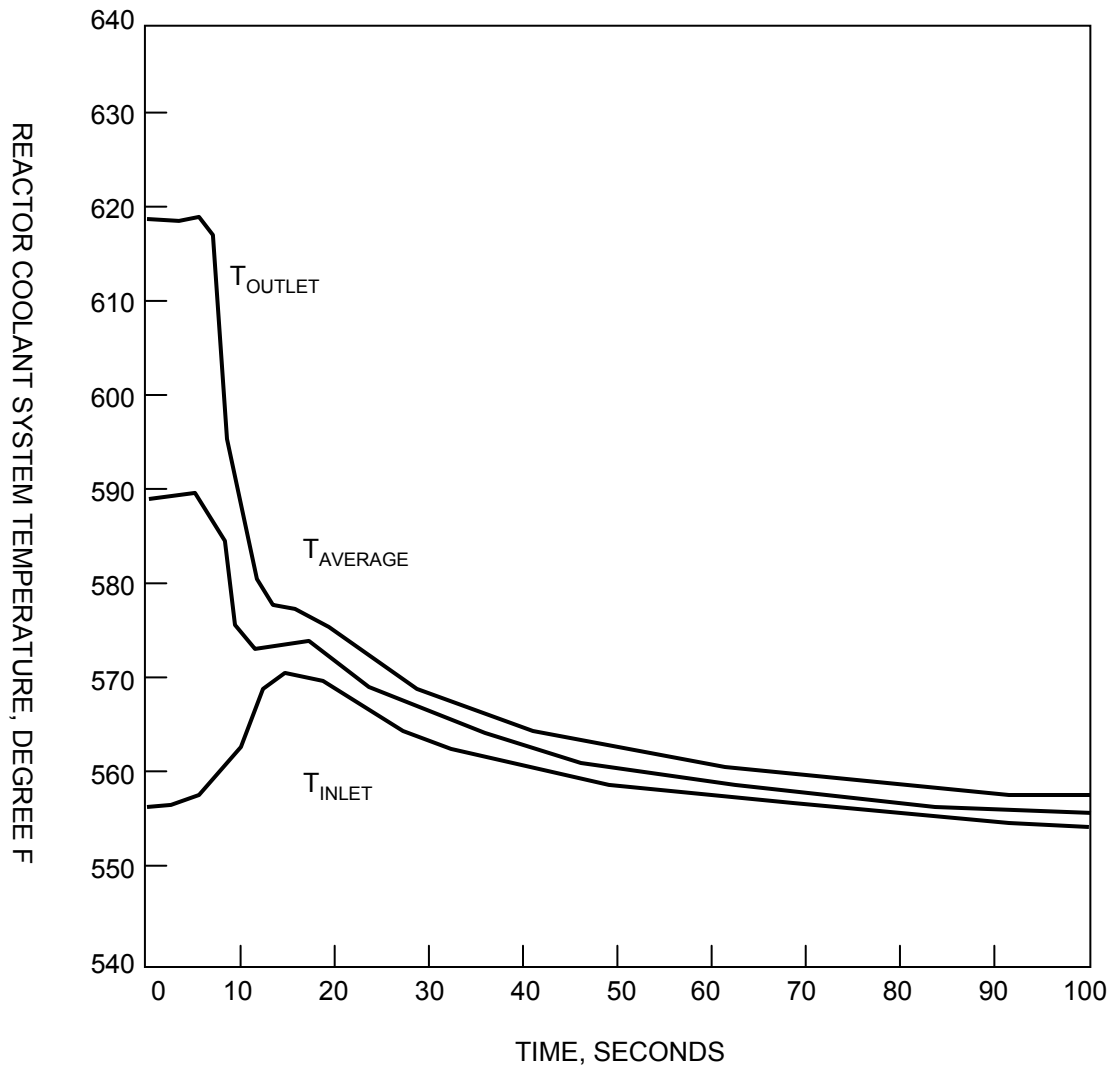

SAR FIGURE NO. 15.1.36-4

AMENDMENT 20

ARKANSAS NUCLEAR ONE
UNIT 2
RUSSELLVILLE, ARKANSAS



SCALE:	NONE
DRAWN:	
DESIGN:	ENERGY
CAD NO:	

LOSS OF LOAD / 1 STEAM GENERATOR
EVENT RCS TEMPERATURES VERSUS TIME

BASED ON DRAWING NO

SHEET

REV.

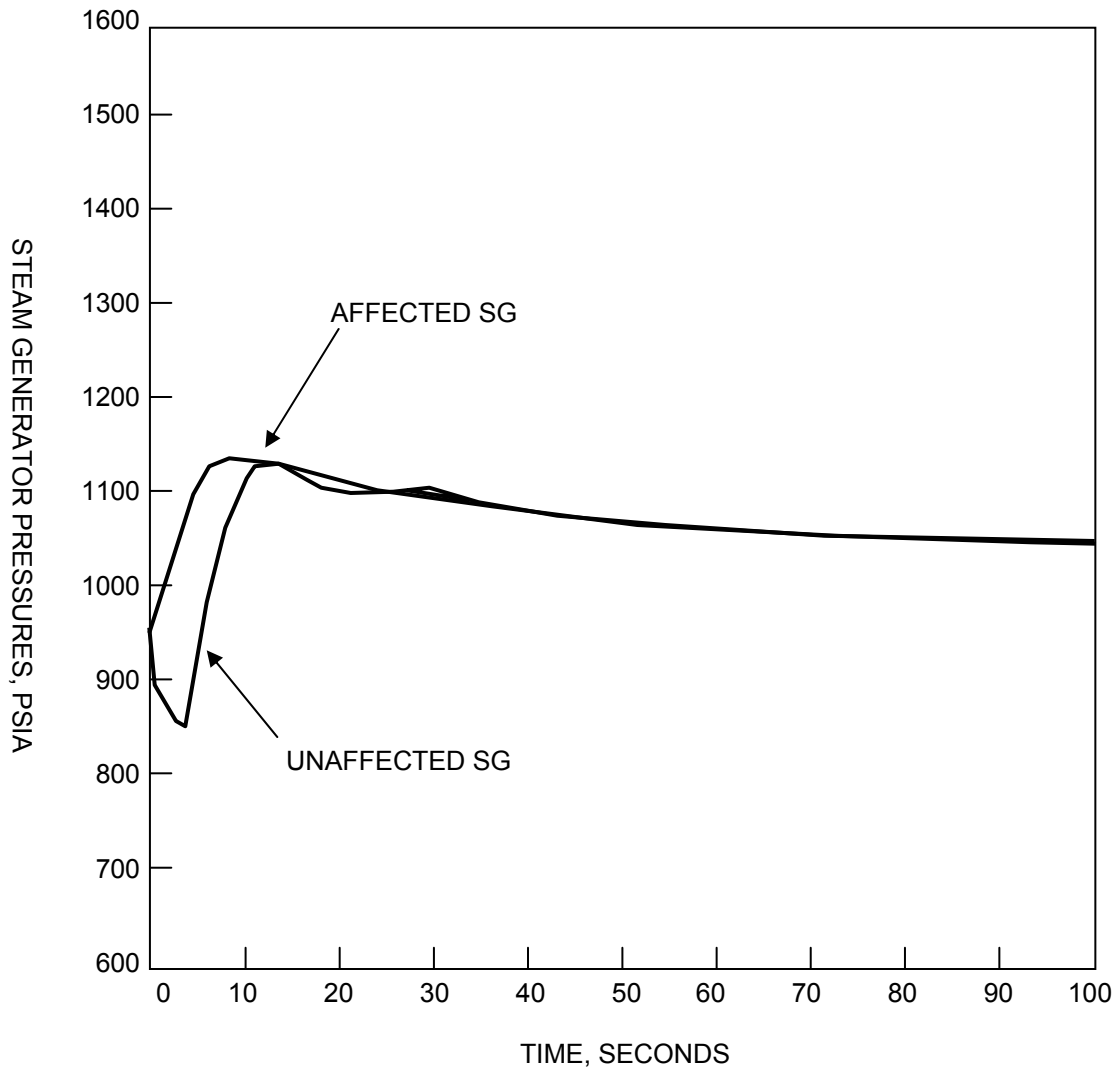

SAR FIGURE NO. 15.1.36-5

AMENDMENT 20

ARKANSAS NUCLEAR ONE
UNIT 2
RUSSELLVILLE, ARKANSAS



SCALE:	NONE
DRAWN:	
DESIGN:	ENERGY
CAD NO:	

LOSS OF LOAD / 1 STEAM GENERATOR EVENT
STEAM GENERATOR PRESSURES VERSUS TIME

BASED ON DRAWING NO

SHEET

REV.

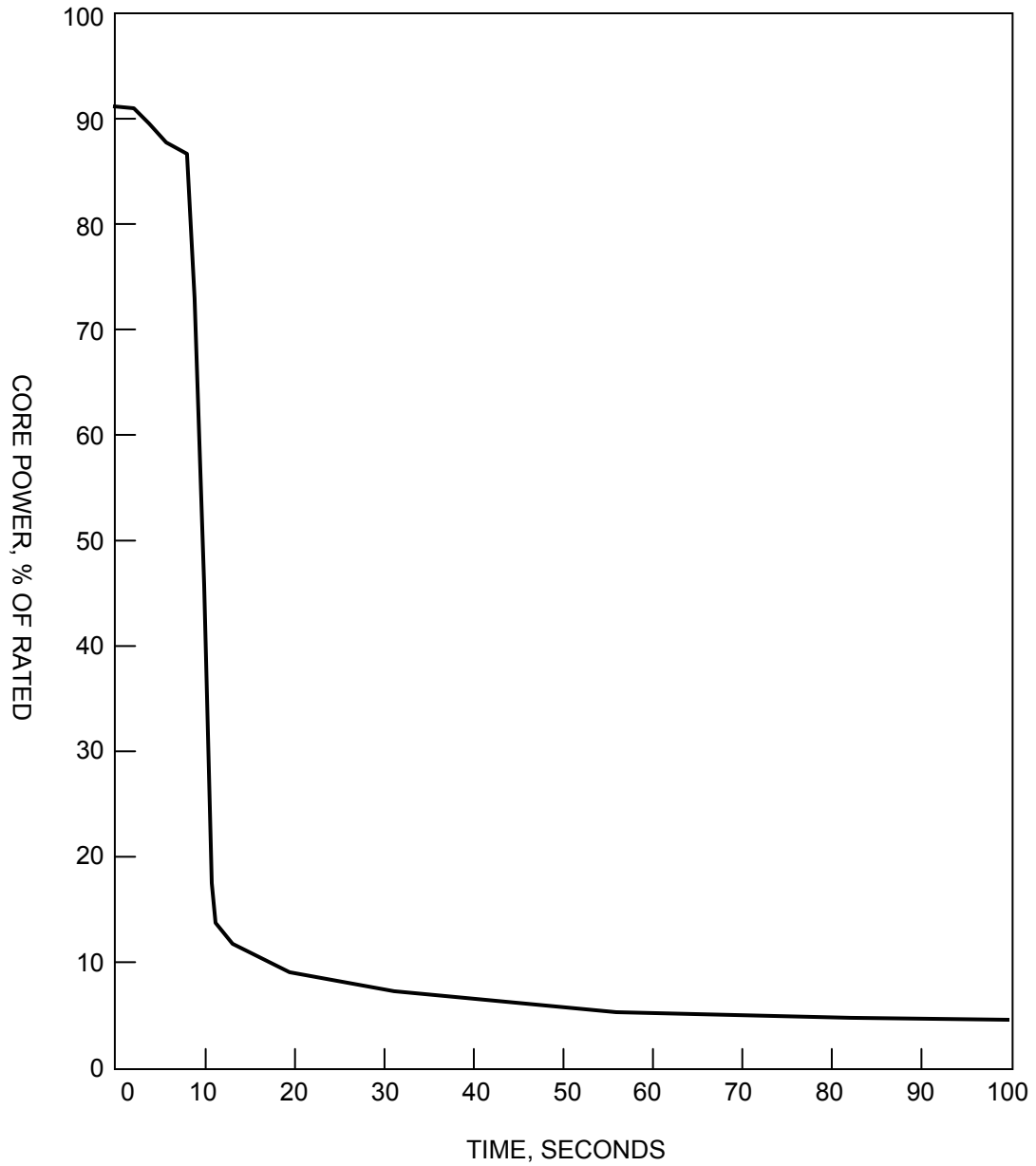

SAR FIGURE NO. 15.1.36-6

AMENDMENT 20

ARKANSAS NUCLEAR ONE
 UNIT 2
 RUSSELLVILLE, ARKANSAS



SCALE: NONE

DRAWN:

DESIGN: ENTERGY

CAD NO:

CYCLE 15 AT 3026 MWt ASYMMETRIC STEAM
 GENERATOR TRANSIENT CORE POWER VERSUS TIME

BASED ON DRAWING NO

SHEET

REV.

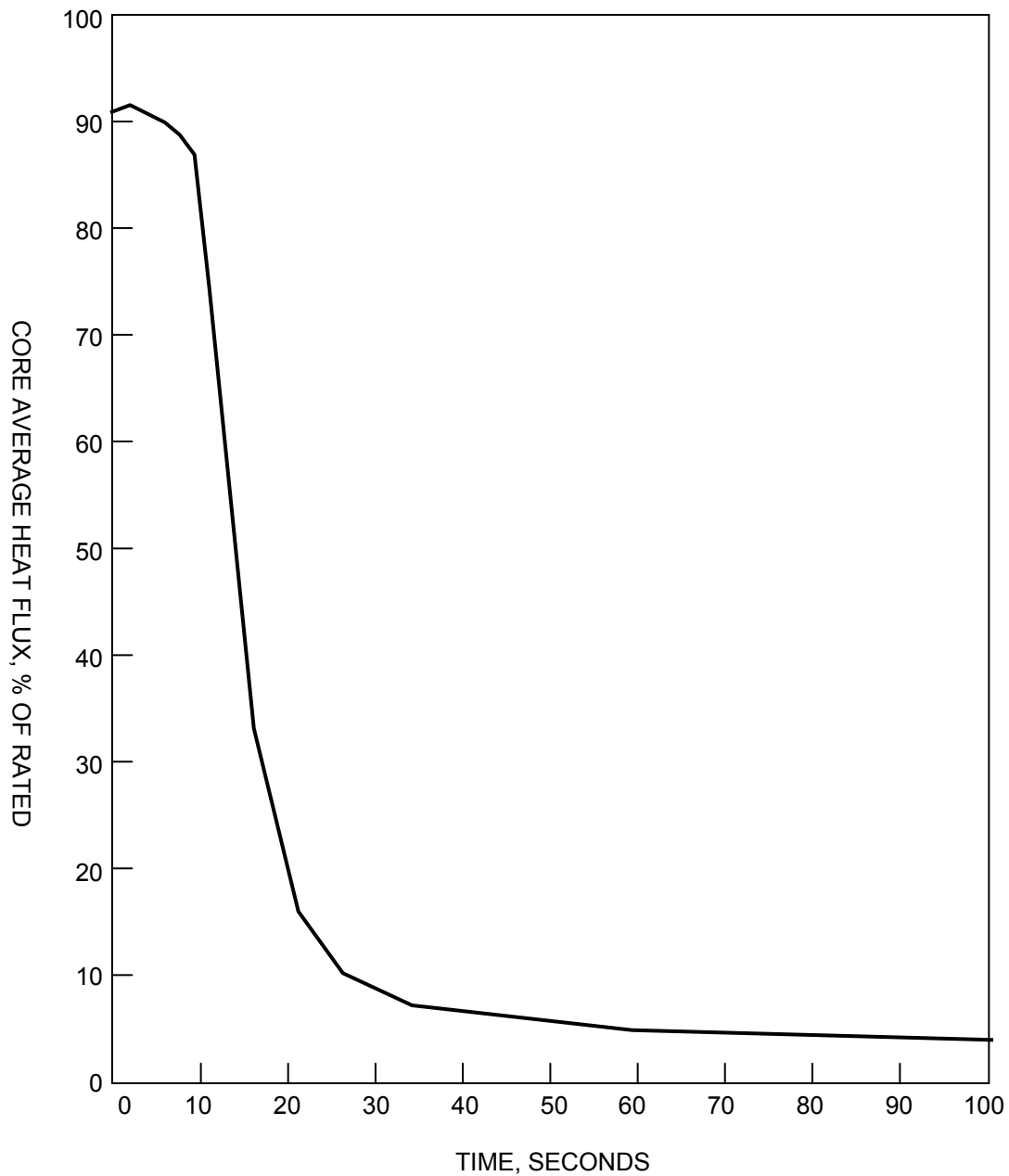

SAR FIGURE NO. 15.1.36-7

AMENDMENT 20

ARKANSAS NUCLEAR ONE
 UNIT 2
 RUSSELLVILLE, ARKANSAS



SCALE:	NONE
DRAWN:	
DESIGN:	ENERGY
CAD NO:	

CYCLE 15 AT 3026 MWt ASYMMETRIC STEAM
 GENERATOR TRANSIENT CORE AVERAGE HEAT FLUX
 VERSUS TIME

BASED ON DRAWING NO

SHEET

REV.

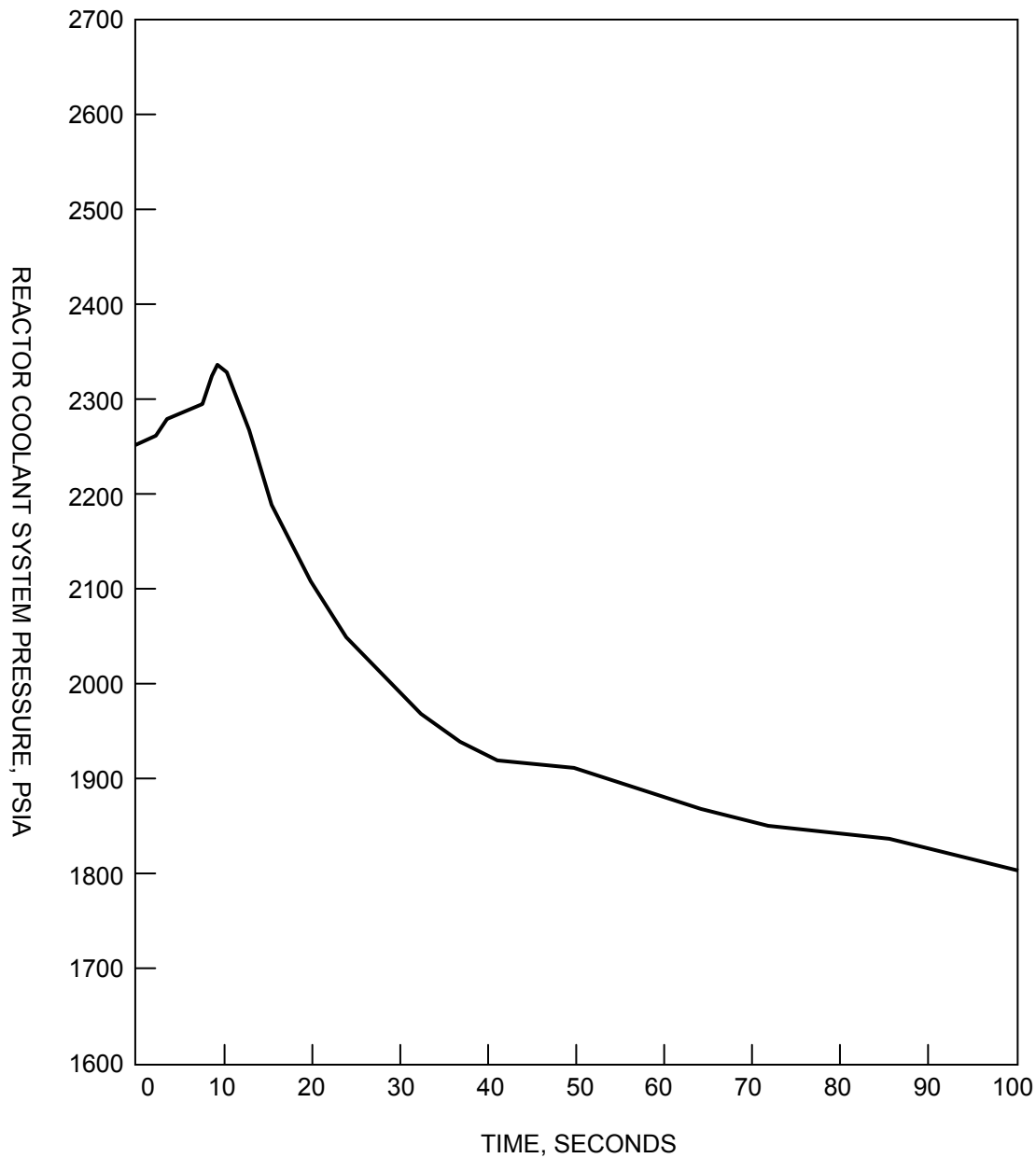

SAR FIGURE NO. 15.1.36-8

AMENDMENT 20

ARKANSAS NUCLEAR ONE
 UNIT 2
 RUSSELLVILLE, ARKANSAS



SCALE:	NONE
DRAWN:	
DESIGN:	ENERGY
CAD NO:	

CYCLE 15 AT 3026 MWt ASYMMETRIC STEAM
 GENERATOR TRANSIENT RCS PRESSURE VERSUS
 TIME

BASED ON DRAWING NO

SHEET

REV.

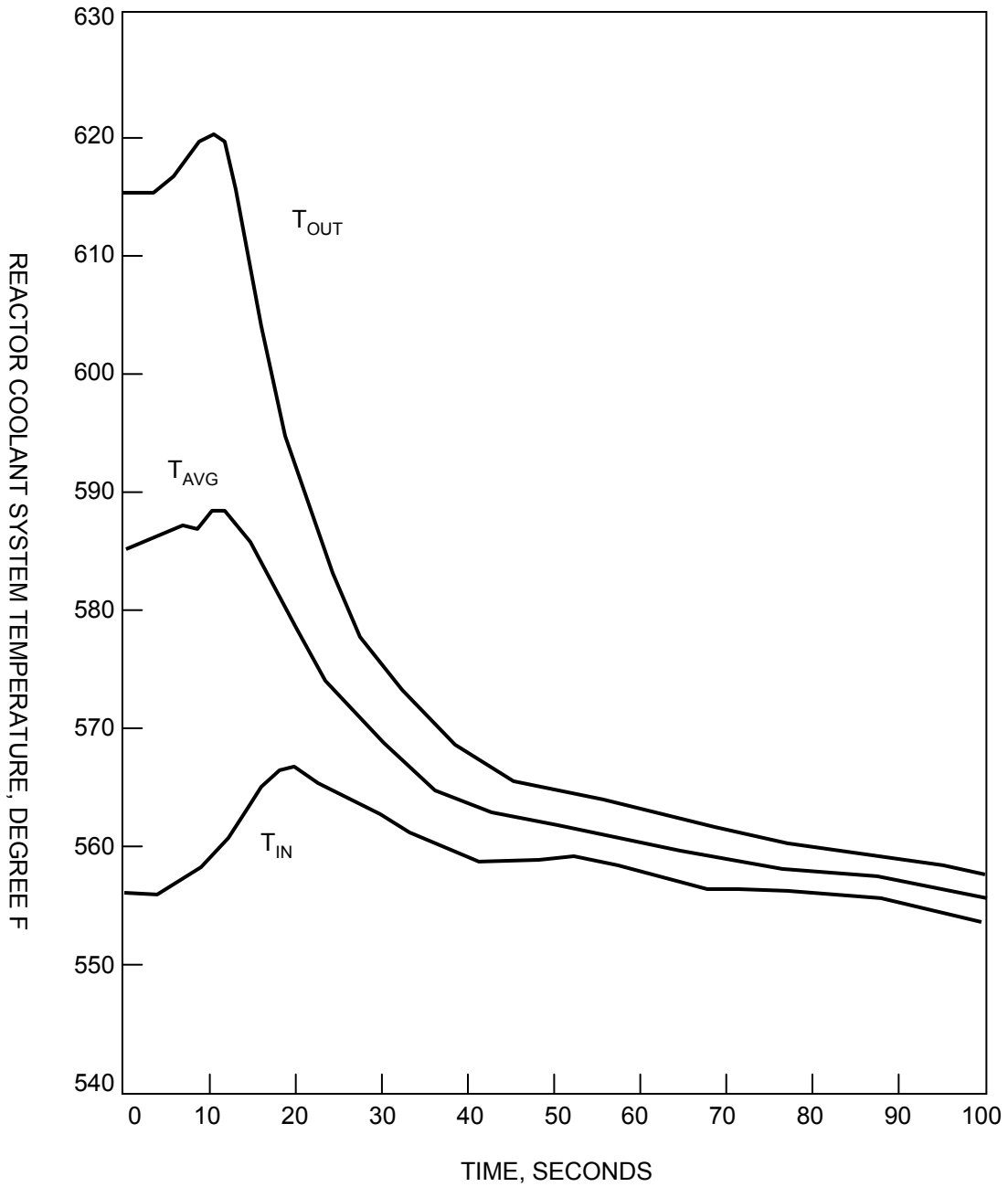

SAR FIGURE NO. 15.1.36-9

AMENDMENT 20

ARKANSAS NUCLEAR ONE
 UNIT 2
 RUSSELLVILLE, ARKANSAS



SCALE:	NONE
DRAWN:	
DESIGN:	ENERGY
CAD NO:	

CYCLE 15 AT 3026 MWt ASYMMETRIC STEAM
 GENERATOR TRANSIENT RCS TEMPERATURES
 VERSUS TIME

BASED ON DRAWING NO

SHEET

REV.

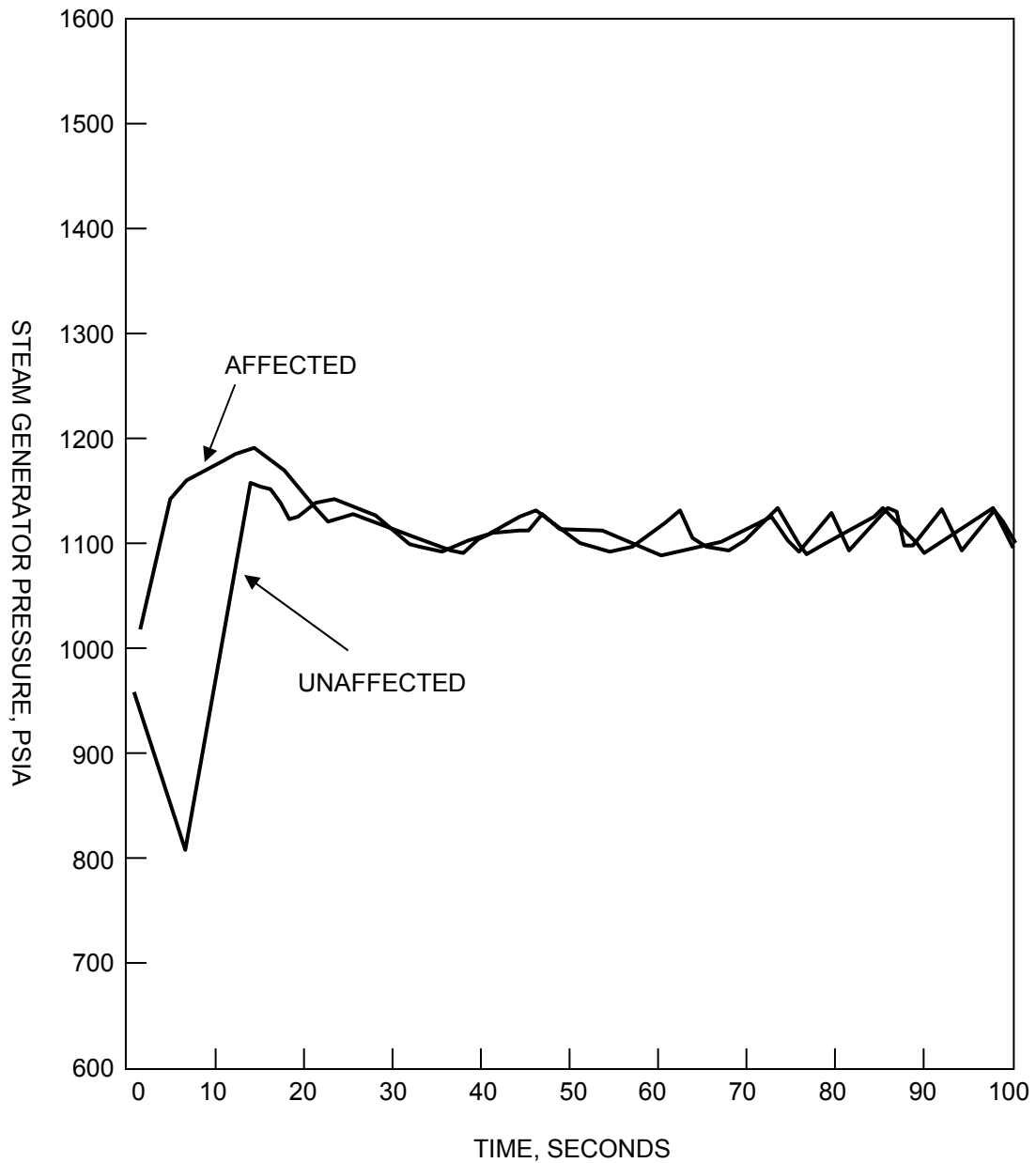

SAR FIGURE NO. 15.1.36-10

AMENDMENT 20

ARKANSAS NUCLEAR ONE
UNIT 2
RUSSELLVILLE, ARKANSAS



SCALE:	NONE
DRAWN:	
DESIGN:	ENERGY
CAD NO:	

CYCLE 15 AT 3026 MWt ASYMMETRIC STEAM
GENERATOR TRANSIENT STEAM GENERATOR
PRESSURE VERSUS TIME

BASED ON DRAWING NO

SHEET

REV.

ARKANSAS NUCLEAR ONE
Unit 2

CHAPTER 16

TABLE OF CONTENTS

<u>Section</u>	<u>Title</u>	<u>Page</u>
16	<u>TECHNICAL SPECIFICATIONS</u>	16.1-1
16.1	<u>MODE 4 TS END STATES</u>	16.1-1
16.1.1	MODE 4 TS END STATE IMPLEMENTATION AND RISK ASSESSMENT..	16.1-1

ARKANSAS NUCLEAR ONE
Unit 2

UPDATE REFERENCE LIST

Section and references listed below denote documents that contain additional cross reference information used to update the SAR

Section

Cross Reference

Amendment 26

16.1	TS Amendment 301, "Adoption of TSTF-522, "Change in Technical Specifications End States (CE NPSD-1186)"
16.1.1	

ARKANSAS NUCLEAR ONE
Unit 2

RECORD OF REVISIONS

PAGE # AMENDMENT #

TABLE OF CONTENTS

16-i	26
16-ii	26
16-iii	26

CHAPTER 16

16.1-1	26
--------	----

16 TECHNICAL SPECIFICATIONS

The final Technical Specifications (TSs) were issued with the Operating License, and have been updated periodically through various license amendments. The Technical Specifications currently exist as updated in a separate binder/volume.

16.1 MODE 4 TS END STATES

NRC Safety Evaluation Report (SER) (2CNA031502, ML15068A319) approved a Mode 4 end state for several ANO-2 TSs. Provided risk is appropriately managed, the shutdown statements within the subject TSs no longer require placing the unit in Mode 5.

16.1.1 MODE 4 TS END STATE IMPLEMENTATION AND RISK ASSESSMENT

The aforementioned SER is associated with ANO-2 TS Amendment 301, which adopted TSTF-422, "Change in Technical Specifications End States (CE NPSD-1186)." The NRC approved the Mode 4 end states for TSs specified in the SER provided the following implementation guidance is implemented:

- Entergy will follow the guidance established in Section 11 of NUMARC 93-01, "Industry Guidance for Monitoring the Effectiveness of Maintenance at Nuclear Power Plants," Nuclear Management and Resource Council, Revision 4A, April 2011.
- Entergy will follow the guidance established in WCAP-16364-NP, Revision 2, "Implementation Guidance for Risk Informed Modification to Selected Required Action End States at Combustion Engineering NSSS Plants (TSTF-422)," dated May 2010, with the exception that Section 11 of NUMARC 93-01, Revision 4A, will be utilized to meet 10 CFR 50.65(a)(4) requirements in lieu of NUMARC 93-01, Revision 3.

The implementation guidance of WCAP-16364-NP has been implemented into a common Operations directive. The directive, along with procedures associated with risk assessments, were also updated to ensure risk assessments would be performed in accordance with NUMARC 93-01, Revision 4A, Section 11.

ARKANSAS NUCLEAR ONE
Unit 2

CHAPTER 17

TABLE OF CONTENTS

<u>Section</u>	<u>Title</u>	<u>Page</u>
17	<u>QUALITY ASSURANCE</u>	17.1-1
17.1	<u>QUALITY ASSURANCE DURING OPERATIONS</u>	17.1-1

ARKANSAS NUCLEAR ONE
Unit 2

RECORD OF REVISIONS

PAGE # AMENDMENT #

TABLE OF CONTENTS

17-i	14
17-ii	14

CHAPTER 17

17.1-1	14
--------	----

ARKANSAS NUCLEAR ONE
Unit 2

17 QUALITY ASSURANCE

17.1 QUALITY ASSURANCE DURING OPERATIONS

NRC accepted Arkansas Power and Light Company's (AP&L's) Topical Report, AP&L-TOP-1A, "Quality Assurance Manual Operations" by letter dated May 5, 1980. This report describes the quality assurance (QA) program which AP&L applies to those operational phase activities involving safety-related structures, systems and components for ANO.

With the acceptance of AP&L-TOP-1A, the chapter section "Quality Assurance During Design and Construction," was deleted due to lack of applicability.

As of June 10, 1986, the Quality Assurance Manual Operations was reclassified as a quality program description in lieu of a Topical Report. This change did not reduce AP&L's quality commitments previously accepted by the NRC on May 5, 1980. Annual revisions to the Quality Assurance Manual Operations, which do not reduce commitments, shall be submitted in conjunction with [ANO-1](#) Safety Analysis Report submittals.

[As of April 30, 1999, the ANO QA Manual Operations was deleted and replaced with the EOI QA Program Manual \(QAPM\).](#)

ARKANSAS NUCLEAR ONE
Unit 2

CHAPTER 18

TABLE OF CONTENTS

<u>Section</u>	<u>Title</u>	<u>Page</u>
18	<u>AGING MANAGEMENT PROGRAMS AND ACTIVITIES</u>	18.1-1
18.1	<u>PROGRAMS AND ACTIVITIES</u>	18.1-1
18.1.1	ALLOY 600 AGING MANAGEMENT PROGRAM	18.1-1
18.1.2	BOLTING AND TORQUING ACTIVITIES	18.1-1
18.1.3	BORIC ACID CORROSION PREVENTION PROGRAM	18.1-1
18.1.4	BURIED PIPING INSPECTION PROGRAM	18.1-1
18.1.5	CAST AUSTENITIC STAINLESS STEEL (CASS) EVALUATION PROGRAM	18.1-2
18.1.6	CONTAINMENT LEAK RATE PROGRAM	18.1-2
18.1.7	DIESEL FUEL MONITORING PROGRAM	18.1-2
18.1.8	ENVIRONMENTAL QUALIFICATION (EQ) OF ELECTRIC COMPONENTS PROGRAM	18.1-2
18.1.9	FATIGUE MONITORING PROGRAM	18.1-2
18.1.10	FIRE PROTECTION PROGRAM	18.1-3
18.1.11	FIRE WATER SYSTEM PROGRAM	18.1-3
18.1.12	FLOW-ACCELERATED CORROSION PROGRAM	18.1-3
18.1.13	HEAT EXCHANGER MONITORING PROGRAM	18.1-3
18.1.14	INSERVICE INSPECTION – CONTAINMENT INSERVICE INSPECTION PROGRAM	18.1-3
18.1.15	INSERVICE INSPECTION – INSERVICE INSPECTION PROGRAM	18.1-4
18.1.16	NON-EQ INACCESSIBLE MEDIUM-VOLTAGE CABLE PROGRAM	18.1-4
18.1.17	NON-EQ INSULATED CABLES AND CONNECTIONS PROGRAM	18.1-4
18.1.18	OIL ANALYSIS PROGRAM	18.1-4
18.1.19	PERIODIC SURVEILLANCE AND PREVENTIVE MAINTENANCE PROGRAM	18.1-4

ARKANSAS NUCLEAR ONE
Unit 2

TABLE OF CONTENTS (continued)

<u>Section</u>	<u>Title</u>	<u>Page</u>
18.1.20	PRESSURIZER EXAMINATIONS PROGRAM	18.1-5
18.1.21	REACTOR VESSEL HEAD PENETRATION PROGRAM.....	18.1-5
18.1.22	REACTOR VESSEL INTEGRITY PROGRAM	18.1-5
18.1.23	REACTOR VESSEL INTERNALS CAST AUSTENITIC STAINLESS STEEL (CASS) PROGRAM	18.1-5
18.1.24	REACTOR VESSEL INTERNALS STAINLESS STEEL PLATES, FORGINGS, WELDS, AND BOLTING PROGRAM.....	18.1-5
18.1.25	SERVICE WATER INTEGRITY PROGRAM.....	18.1-5
18.1.26	STEAM GENERATOR INTEGRITY PROGRAM.....	18.1-6
18.1.27	STRUCTURES MONITORING – MASONRY WALL PROGRAM.....	18.1-6
18.1.28	STRUCTURES MONITORING – STRUCTURES MONITORING PROGRAM.....	18.1-6
18.1.29	SYSTEM WALKDOWN PROGRAM.....	18.1-6
18.1.30	WALL THINNING MONITORING PROGRAM	18.1-6
18.1.31	WATER CHEMISTRY CONTROL – AUXILIARY SYSTEMS WATER CHEMISTRY CONTROL PROGRAM	18.1-6
18.1.32	WATER CHEMISTRY CONTROL – CLOSED COOLING WATER CHEMISTRY CONTROL PROGRAM	18.1-7
18.1.33	WATER CHEMISTRY CONTROL – PRIMARY AND SECONDARY WATER CHEMISTRY CONTROL PROGRAM	18.1-7
18.1.34	ONE-TIME INSPECTION.....	18.1-7
18.1.35	SELECTIVE LEACHING	18.1-7
18.2	<u>TIME-LIMITED AGING ANALYSES (TLAAs)</u>	18.2-1
18.2.1	REACTOR VESSEL NEUTRON EMBRITTLEMENT.....	18.2-1
18.2.1.1	<u>Charpy Upper Shelf Energy</u>	18.2-1
18.2.1.2	<u>Pressurized Thermal Shock</u>	18.2-1
18.2.1.3	<u>Pressurize-Temperature Limits</u>	18.2-1

ARKANSAS NUCLEAR ONE
Unit 2

TABLE OF CONTENTS (continued)

<u>Section</u>	<u>Title</u>	<u>Page</u>
18.2.2	METAL FATIGUE	18.2-2
18.2.2.1	<u>Class 1 Metal Fatigue</u>	18.2-2
18.2.2.2	<u>Non-Class 1 Metal Fatigue</u>	18.2-2
18.2.2.3	<u>Environmentally-Assisted Fatigue</u>	18.2-2
18.2.2.4	<u>Thermal Stresses in Piping Connected to Reactor Coolant System</u>	18.2-3
18.2.2.5	<u>Pressurizer Surge Line Thermal Stratification</u>	18.2-3
18.2.3	ENVIRONMENTAL QUALIFICATION OF ELECTRICAL COMPONENTS.	18.2-4
18.2.4	CONCRETE CONTAINMENT TENDON PRESTRESS	18.2-4
18.2.5	CONTAINMENT LINER PLATE AND PENETRATION FATIGUE ANALYSES	18.2-4
18.2.6	OTHER PLANT-SPECIFIC TIME-LIMITED AGING ANALYSES	18.2-5
18.2.6.1	<u>RCS Piping Leak-Before-Break</u>	18.2-5
18.2.6.2	<u>RCP Code Case N-481</u>	18.2-5
18.2.6.3	<u>Steam Generator Tubes – Flow-Induced Vibration</u>	18.2-5
18.2.6.4	<u>Alloy 600 Nozzle Repairs</u>	18.2-5
18.2.6.5	<u>High Energy Line Break Analyses</u>	18.2-6
18.2.6.6	<u>RCP Motor Flywheel</u>	18.2-6
18.3	<u>REFERENCES</u>	18.3-1

ARKANSAS NUCLEAR ONE
Unit 2

UPDATE REFERENCE LIST

Section

Cross References

Amendment 19

Chpt 18 - ALL License Document Change Request 2-1.2-0049, "License Renewal"

Amendment 21

18.2.1.2 Condition Report CR-ANO-2-2007-0666, "Reactor Vessel Surveillance
18.2.1.3 Program Update In Accordance With BAW-2399"

18.3

Amendment 23

18.1.21 Condition Report CR-ANO-C-2010-0320, "Revise SAR to be Consistent with
10 CFR 50.55a"

Amendment 24

18.1.23 License Document Change Request 12-015, "Correct of Reactor Vessel
18.1.24 Internals Program Title"

Amendment 25

18.1.5 License Document Change Request 14-005, "Program Title Correction"

18.1.23

18.1.24

Amendment 28

18.1.11 Engineering Change EC-56948, "Fulfillment of License Renewal Commitments"

18.2.2.3 License Document Change Request 18-030, "Commitment Correction"

18.1.21 License Document Change Request 18-031, "License Renewal Commitments"

18.1.23

18.1.34

18.1.35

18.1.21 License Document Change Request 18-037, "License Renewal Commitments"

18.2.1 Engineering Change EC-69421, "Update SAR in accordance with TS
18.2.1.1 Amendment 311"

18.2.1.2

18.2.1.3

18.3

ARKANSAS NUCLEAR ONE
Unit 2

RECORD OF REVISIONS

<u>PAGE #</u>	<u>AMENDMENT #</u>	<u>PAGE #</u>	<u>AMENDMENT #</u>	<u>PAGE #</u>	<u>AMENDMENT #</u>
TABLE OF CONTENTS		CHAPTER 18 (CONT.)		CHAPTER 18 (CONT.)	
18-i	28				
18-ii	28				
18-iii	28				
18-iv	28				
18-v	28				
Chapter 18					
18.1-1	28				
18.1-2	28				
18.1-3	28				
18.1-4	28				
18.1-5	28				
18.1-6	28				
18.1-7	28				
18.2-1	28				
18.2-2	28				
18.2-3	28				
18.2-4	28				
18.2-5	28				
18.2-6	28				
18.3-1	28				
18.3-2	28				

18 AGING MANAGEMENT PROGRAMS AND ACTIVITIES

The integrated plant assessment for license renewal identified aging management programs necessary to provide reasonable assurance that systems, structures, and components within the scope of license renewal will continue to perform their intended functions consistent with the current licensing basis (CLB) for the period of extended operation. This section describes the aging management programs and activities that will be required during the period of extended operation. "The Quality Assurance Program implements the requirements of 10 CFR 50, Appendix B. The Quality Assurance Program includes the elements of corrective action, confirmation process, and administrative controls and is applicable to all aging management programs credited for license renewal including programs for safety-related and non-safety related structures, systems and components."

18.1 PROGRAMS AND ACTIVITIES

18.1.1 ALLOY 600 AGING MANAGEMENT PROGRAM

This program will manage aging effects of alloy 600/690 items and alloy 52/152 and 82/182 welds in the reactor coolant system that are not addressed by the Reactor Vessel Head Penetration Inspection Program, Section 18.1.21, and the Steam Generator Integrity Program, Section 18.1.26. This program will detect primary water stress corrosion cracking (PWSCC) by using the examination and inspection requirements of ASME Section XI, as augmented by commitments in NRC correspondence. During development of the ANO-2 Alloy 600 Aging Management Program, guidance developed by the EPRI MRP for selection, inspection, and evaluation of nickel-based alloy items will be considered. The Alloy 600 Aging Management Program will be initiated prior to the period of extended operation.

18.1.2 BOLTING AND TORQUING ACTIVITIES

The Bolting and Torquing Activities Program manages the loss of mechanical closure integrity for bolted connections and bolted closures in high temperature systems and in applications subject to significant vibration. The program relies on recommendations for a comprehensive bolting integrity program, as delineated in the Electric Power Research Institute EPRI NP-5067, Good Bolting Practices. This program also relies on industry recommendations for comprehensive bolting maintenance, as delineated in the EPRI TR-104213, Bolted Joint Maintenance and Applications Guide.

18.1.3 BORIC ACID CORROSION PREVENTION PROGRAM

The Boric Acid Corrosion Prevention Program relies on implementation of recommendations of NRC Generic Letter (GL) 88-05 to monitor the condition of ferritic steel and electrical components on which borated water may leak. The program will detect borated water leakage by periodic visual inspection of borated water containing systems for deposits of boric acid crystals and the presence of moisture. This program will manage loss of material, loss of mechanical closure integrity, and corrosion of connector surfaces.

18.1.4 BURIED PIPING INSPECTION PROGRAM

The Buried Piping Inspection Program will include preventive measures to mitigate corrosion and periodic inspection to manage the effects of corrosion on buried carbon steel piping. Preventive measures will be in accordance with standard industry practice for maintaining

ARKANSAS NUCLEAR ONE
UNIT 2

external coatings and wrappings. Buried pipes will be inspected when they are excavated during maintenance. The Buried Piping Inspection Program will be initiated prior to the period of extended operation.

18.1.5 CAST AUSTENITIC STAINLESS STEEL (CASS) EVALUATION PROGRAM

The Cast Austenitic Stainless Steel (CASS) Evaluation Program will augment the inspection of reactor coolant system components in accordance with the American Society of Mechanical Engineers (ASME) Boiler and Pressure Vessel Code, Section XI. The CASS Evaluation Program will manage the effects of loss of fracture toughness in reactor coolant system CASS components susceptible to thermal aging embrittlement using additional inspections and a component-specific flaw tolerance evaluation. This program will not include reactor vessel internals CASS components which are evaluated and inspected as part of the PWR Vessel Internals Program (Section 18.1.23 and Section 18.1.24). The CASS Evaluation Program will be initiated prior to the period of extended operation.

18.1.6 CONTAINMENT LEAK RATE PROGRAM

As described in 10 CFR Part 50, Appendix J, containment leak rate tests are required to assure that (a) leakage through the primary reactor containment and systems and components penetrating primary containment do not exceed allowable values and (b) periodic surveillance of reactor containment penetrations and isolation valves is performed so that proper maintenance and repairs are made during the service life of the containment. This program manages loss of material and cracking for equipment constituting the containment pressure boundary.

18.1.7 DIESEL FUEL MONITORING PROGRAM

The Diesel Fuel Monitoring Program ensures that adequate diesel fuel quality is maintained to prevent plugging of filters, fouling of injectors, and corrosion of fuel systems. This program manages aging effects on the internal surfaces of diesel fuel tanks and piping within the scope of license renewal. The program monitors fuel oil quality and the levels of water and microbiological organisms in the fuel oil. Visual inspections of tanks drained for cleaning ensures that significant degradation is not occurring. This program manages the loss of material and cracking for fuel oil system components.

18.1.8 ENVIRONMENTAL QUALIFICATION (EQ) OF ELECTRIC COMPONENTS PROGRAM

The EQ Program manages component thermal, radiation, and cyclical aging of electrical equipment important to safety as required by 10 CFR 50.49. The EQ Program manages aging effects through the use of aging evaluations based on 10 CFR 50.49(f) qualification methods. As required by 10 CFR 50.49, EQ components not qualified for the license term are to be refurbished, replaced, or have their qualification extended prior to reaching aging limits.

18.1.9 FATIGUE MONITORING PROGRAM

The Fatigue Monitoring Program tracks the number of critical thermal and pressure transients for selected reactor coolant system (RCS) components in order not to exceed the design limit on fatigue usage. The program ensures the validity of analyses containing explicit cycle count assumptions. The components managed by this program are those shown to be acceptable by analyses that explicitly addressed thermal and pressure fatigue transient limits.

ARKANSAS NUCLEAR ONE
UNIT 2

18.1.10 FIRE PROTECTION PROGRAM

The Fire Protection Program includes fire barrier inspections and a diesel-driven fire pump inspection. The fire barrier inspections entail periodic visual inspection of fire barrier penetration seals, fire barrier walls, ceilings, and floors, and periodic visual inspection and functional tests of fire rated doors. The diesel-driven fire pump inspection requires that the pump be periodically tested to ensure that the fuel supply line can perform its intended function.

18.1.11 FIRE WATER SYSTEM PROGRAM

The Fire Water System Program applies to water-based fire protection systems that consist of sprinklers, nozzles, fittings, valves, hydrants, hose stations, standpipes, and aboveground and underground piping and components that are tested in accordance with the applicable National Fire Protection Association (NFPA) codes and standards. Such testing assures the minimum functionality of the systems. These systems are normally maintained at required operating pressure and monitored such that leakage resulting in loss of system pressure is immediately detected and corrective actions initiated. [The sprinkler heads will be inspected using the guidance of NFPA 25. NFPA 25 states that “where sprinklers have been in place for 50 years, they shall be replaced or representative samples from one or more sample areas shall be submitted to a recognized testing laboratory for field service testing.”](#)

18.1.12 FLOW-ACCELERATED CORROSION PROGRAM

The Flow-Accelerated Corrosion Program manages loss of material due to flow-accelerated corrosion. This program includes (a) an analysis to determine critical locations, (b) limited baseline inspections to determine the extent of thinning at these locations, and (c) follow-up inspections to confirm the predictions, or component repair or replacement as necessary.

18.1.13 HEAT EXCHANGER MONITORING PROGRAM

The Heat Exchanger Monitoring Program will manage loss of material and cracking, as applicable, on heat exchangers in various systems. The Heat Exchanger Monitoring Program will inspect heat exchangers for degradation using non-destructive examinations, such as eddy-current inspections and visual inspections. If degradation is found, then an evaluation will be performed to determine its effects on the heat exchanger's design functions. The Heat Exchanger Monitoring Program will be initiated prior to the period of extended operation.

18.1.14 INSERVICE INSPECTION – CONTAINMENT INSERVICE INSPECTION PROGRAM

The Containment Inservice Inspection Program implements the applicable requirements of ASME Section XI, Subsections IWE and IWL as modified by 10 CFR 50.55a. Every 10 years the containment inservice inspection program for ANO-2 is updated to the latest ASME Section XI code edition and addendum approved by the Nuclear Regulatory Commission in 10 CFR 50.

ARKANSAS NUCLEAR ONE
UNIT 2

18.1.15 INSERVICE INSPECTION –INSERVICE INSPECTION PROGRAM

The Inservice Inspection Program implements the applicable requirements of ASME Section XI, Subsections IWB, IWC, IWD and IWF, and other requirements specified in 10 CFR 50.55a with approved NRC alternatives and relief requests. Every 10 years the Inservice Inspection Program for ANO-2 is updated to the latest ASME Section XI code edition and addendum approved by the Nuclear Regulatory Commission in 10 CFR 50.

18.1.16 NON-EQ INACCESSIBLE MEDIUM-VOLTAGE CABLE PROGRAM

The Non-EQ Inaccessible Medium-voltage Cable Program will apply to inaccessible (e.g., in conduit or direct buried) medium-voltage cables within the scope of license renewal that are exposed to significant moisture simultaneously with applied voltage. In this aging management program, periodic actions will be taken to prevent cables from being exposed to significant moisture. In-scope medium-voltage cables exposed to significant moisture and voltage will be tested to provide an indication of the condition of the conductor insulation. [The ANO-2 “Non-EQ Inaccessible Medium-Voltage Cable Program” will include testing of underground medium-voltage cables exposed to significant voltage that perform a license renewal intended function, regardless of preventive actions to prevent exposure to significant moisture.](#) The specific type of test performed will be determined prior to the initial test. The Non-EQ Inaccessible Medium-voltage Cable Program will be initiated prior to the period of extended operation.

18.1.17 NON-EQ INSULATED CABLES AND CONNECTIONS PROGRAM

The Non-EQ Insulated Cables and Connections Program will apply to accessible (i.e., able to be approached and viewed easily) insulated cables and connections installed in structures within the scope of license renewal and prone to adverse localized environments. An adverse localized environment is significantly more severe than the specified service condition for the insulated cable or connection. The program will visually inspect a representative sample of accessible insulated cables and connections for cable and connection jacket surface anomalies. The Non-EQ Insulated Cables and Connections Program will be initiated prior to the period of extended operation.

18.1.18 OIL ANALYSIS PROGRAM

The Oil Analysis Program ensures the oil environment in mechanical systems in the scope of license renewal is maintained to the required quality. By monitoring oil quality, the Oil Analysis Program maintains oil systems free of contaminants (primarily water and particulates) thereby preserving an environment that is not conducive to loss of material, cracking or fouling.

18.1.19 PERIODIC SURVEILLANCE AND PREVENTIVE MAINTENANCE PROGRAM

The Periodic Surveillance and Preventive Maintenance Program consists of periodic inspections and tests that are relied on to manage aging effects that are not managed by other aging management programs. Preventive maintenance and surveillance testing activities provide for periodic component inspections and testing to detect various aging effects applicable to those components included in the program for license renewal.

ARKANSAS NUCLEAR ONE
UNIT 2

18.1.20 PRESSURIZER EXAMINATIONS PROGRAM

The Pressurizer Examinations Program will use volumetric examinations required by ASME Section XI to manage cracking of the stainless steel and nickel-based alloy cladding and attachment welds to the cladding which may propagate into the underlying ferritic steel. Volumetric examination of the circumferential shell to head weld and the weld metal between the surge nozzle and the vessel lower head will be performed each inspection interval. The Pressurizer Examinations Program is an existing program.

18.1.21 REACTOR VESSEL HEAD PENETRATION PROGRAM

The Reactor Vessel Head Penetration Program manages cracking of nickel based alloy reactor vessel head penetrations exposed to borated water to assure that the pressure boundary function is maintained. The program consists of both visual and volumetric examinations in accordance with ASME Code requirements as reflected in the approved ISI Plan. The program will be modified as appropriate to implement evolving commitments in response to industry experience and regulatory requirements. The Inservice Inspection (Section 18.1.15) and Water Chemistry Control Programs (Section 18.1.33) are used in conjunction with this program to manage cracking of the reactor vessel head penetrations.

18.1.22 REACTOR VESSEL INTEGRITY PROGRAM

The Reactor Vessel Integrity Program manages reduction of fracture toughness of reactor vessel beltline materials to assure that the pressure boundary function of the reactor vessel is maintained. The program is based on ASTM E-185-82, "Standard Recommended Practice for Surveillance Tests for Nuclear Reactor Vessels," and includes an evaluation of radiation damage based on pre-irradiation and post irradiation testing of Charpy V-notch and tensile specimens. Through the Reactor Vessel Integrity Program, reports are submitted as required by 10 CFR Part 50 Appendix H.

18.1.23 Deleted

18.1.24 REACTOR VESSEL INTERNALS STAINLESS STEEL PLATES, FORGINGS, WELDS, AND BOLTING PROGRAM

The PWR Vessel Internals Program will manage aging effects of reactor vessel internals plates, forgings, welds, and bolting. This program will supplement the reactor vessel internals inspections required by the ASME Section XI Inservice Inspection Program. This program will manage the effects of crack initiation and growth due to stress corrosion cracking or irradiation assisted stress corrosion cracking, loss of fracture toughness due to neutron irradiation embrittlement, and distortion due to void swelling. This program will provide visual inspections and non-destructive examinations of reactor vessel internals. The PWR Vessel Internals Program will be initiated prior to the period of extended operation.

18.1.25 SERVICE WATER INTEGRITY PROGRAM

The Service Water Integrity Program relies on implementation of the recommendations of NRC Generic Letter (GL) 89-13 to ensure that the effects of aging on the service water (SW) system will be managed. The program includes surveillance and control techniques to manage aging effects in the SW system or structures and components serviced by the SW system.

ARKANSAS NUCLEAR ONE
UNIT 2

18.1.26 STEAM GENERATOR INTEGRITY PROGRAM

In the industry, steam generator tubes have experienced degradation related to corrosion phenomena, such as primary water stress corrosion cracking, outside diameter stress corrosion cracking, intergranular attack, pitting, and wastage, along with other mechanically induced phenomena, such as denting, wear, impingement damage, and fatigue. Using NEI 97-06 as a guideline, the Steam Generator Integrity Program uses nondestructive examination techniques to identify tubes that are defective and need to be removed from service or repaired in accordance with the guidelines of the Technical Specifications. In addition, the Steam Generator Integrity Program uses nondestructive examination techniques to manage the effect of aging on secondary side internals needed to maintain tubing integrity.

18.1.27 STRUCTURES MONITORING – MASONRY WALL PROGRAM

The Masonry Wall Program will manage cracking of masonry walls within the scope of license renewal. Masonry walls are visually inspected as part of the Structures Monitoring Program conducted for the maintenance rule, 10 CFR 50.65.

18.1.28 STRUCTURES MONITORING – STRUCTURES MONITORING PROGRAM

Structures monitoring as required by 10 CFR 50.65 (the maintenance rule) is based on the guidance in NRC Regulatory Guide (RG) 1.160, Rev. 2, and NUMARC 9301, Revision 2. These two documents provide guidance for development of licensee-specific programs to monitor the condition of structures and structural components within the scope of the maintenance rule and the scope of license renewal, such that there is no loss of structure or structural component intended function.

18.1.29 SYSTEM WALKDOWN PROGRAM

The System Walkdown Program will conduct inspections to manage loss of material, loss of mechanical closure integrity and cracking, as applicable, for systems and components within the scope of license renewal. The program will use general visual inspections of readily accessible system and component surfaces during system walkdowns.

18.1.30 WALL THINNING MONITORING PROGRAM

The Wall Thinning Monitoring Program will manage loss of material from components, as applicable, within the scope of license renewal. Inspections will be performed to ensure wall thickness is above the minimum required in order to avoid failures. The Wall Thinning Monitoring Program will be initiated prior to the period of extended operation.

18.1.31 WATER CHEMISTRY CONTROL – AUXILIARY SYSTEMS WATER CHEMISTRY CONTROL PROGRAM

The Auxiliary Systems Water Chemistry Control program manages loss of material, cracking, and fouling, as applicable, of components in the scope of license renewal. The program monitors and controls the relevant chemistry conditions for components exposed to treated water environments. The following Industry guidance was used in development of the Auxiliary Systems Water Chemistry Control Program.

ARKANSAS NUCLEAR ONE
UNIT 2

- EPRI TR-107396
- EPRI NP-5569
- CE-NPSD-448
- B&W Water Chemistry Manual
- EPRI TR-105504
- Technical Manual for Alternate AC (AAC) Diesel Generator System

18.1.32 WATER CHEMISTRY CONTROL – CLOSED COOLING WATER CHEMISTRY CONTROL PROGRAM

The Closed Cooling Water Chemistry Control Program includes preventive measures that manage loss of material, cracking, and fouling, as applicable, for component cooling water system components. These chemistry activities provide for monitoring and controlling component cooling water chemistry using procedures and processes based on EPRI TR-107396, "Closed Cooling Water Chemistry Guidelines."

18.1.33 WATER CHEMISTRY CONTROL – PRIMARY AND SECONDARY WATER CHEMISTRY CONTROL PROGRAM

The Primary and Secondary Water Chemistry Control Program manages loss of material, cracking, and fouling, as applicable, by control of contaminants. This water chemistry program relies on monitoring and control of water chemistry based on EPRI guidelines, TR-105714 and TR-102134, for primary water chemistry and for secondary water chemistry.

18.1.34 ONE-TIME INSPECTION

The One-Time Inspection Program confirms that aging effects are being adequately managed for components in raw or untreated water. This program will perform destructive or nondestructive inspections on internal surfaces of a sample of components in the following systems.

- Auxiliary building heating and ventilation
- Auxiliary building sump
- Drain collection header
- Liquid radwaste management
- Resin transfer
- Regenerative waste
- Spent resin
- [Turbine Building Sump](#)

The One-Time Inspection Program will be initiated prior to the period of extended operation.

18.1.35 SELECTIVE LEACHING

The Selective Leaching Program demonstrates the absence of selective leaching for susceptible materials and environments. The program involves performing visual inspections in addition to mechanical examination (chipping or scraping) or destructive testing with laboratory analysis.

Inspections will be performed every ten years during the period of extended operation.

ARKANSAS NUCLEAR ONE
UNIT 2

18.2 TIME-LIMITED AGING ANALYSES (TLAAs)

18.2.1 REACTOR VESSEL NEUTRON EMBRITTLEMENT

Three analyses that address the effects of neutron irradiation embrittlement of the reactor vessel have been identified as TLAAs. These analyses address:

- Charpy upper-shelf energy,
- Pressurized thermal shock, and
- Pressure-temperature (P-T) limits.

The analyses were updated to 54 effective full power years (EFPY) which represents the approximate end of the period of extended operation (60 years) assuming a capacity factor of 80%. The Reactor Vessel Integrity Program described in Section 18.1.22 will ensure that the time-dependent parameters used in these TLAAs remain valid through the period of extended operation. The reactor vessel neutron embrittlement TLAAs are projected to the end of the period of extended operation in accordance with 10 CFR 54.21(c)(1)(ii).

18.2.1.1 Charpy Upper Shelf Energy

Appendix G of 10 CFR 50 requires that reactor vessel beltline materials maintain a Charpy upper shelf energy (C_VUSE) of no less than 50 ft-lb throughout the life of the vessel. The C_VUSE values were calculated using Regulatory Guide 1.99, Revision 2, Positions 1 and 2. The C_VUSE is maintained above 50 ft-lb for all base metal (plates and forgings) and welds at 54 EFPY. Therefore, the analysis of upper shelf energy has been projected to the end of the period of extended operation in accordance with 10 CFR 54.21(c)(1)(ii).

18.2.1.2 Pressurized Thermal Shock

10 CFR 50.61(b)(1) provides rules for the protection of pressurized water reactors against pressurized thermal shock. The projected values of reference temperature for pressurized thermal shock, RT_{PTS} , are required to be assessed upon request for a change in the expiration date for the facility operating license.

10 CFR 50.61(b)(2) establishes screening criteria for RT_{PTS} : 270 °F for plates, forgings, and axial welds and 300 °F for circumferential welds. Projected values for RT_{PTS} at 54 EFPY for ANO-2 were calculated using 10 CFR 50.61 and are all within the established screening criteria for 54 EFPY. Therefore, calculations for RT_{PTS} have been projected to the end of the period of extended operation in accordance with 10 CFR 54.21(c)(1)(ii).

18.2.1.3 Pressure-Temperature Limits

Appendix G of 10 CFR 50 requires operation of the reactor pressure vessel within established pressure-temperature (P-T) limits. ANO-2 submitted, and the NRC approved, a license amendment request for reactor coolant system pressure-temperature curves for 54 EFPY (References 6, 7, 17, 18, 19, and 20). The curves specify limits on RCS pressure and temperature for up to 54 effective full power years with a 7.5% power uprate. These P-T curves are based on a fluence analysis methodology that complies with Regulatory Guide 1.190 and utilize ASME Code Cases N-640 and N-588. The ANO-2 P-T limit analyses have been extended to 54 EFPY and the operating window at 54 EFPY is sufficient to conduct normal heatup and cooldown operations. Therefore, pressure-temperature limits for ANO-2 have been projected to the end of the period of extended operation in accordance with 10 CFR 54.21(c)(1)(ii).

ARKANSAS NUCLEAR ONE
UNIT 2

18.2.2 METAL FATIGUE

The design analysis of metal fatigue is a TLAA for Class 1 and selected non-Class 1 mechanical components within the scope of license renewal. Industry experience and new research have found additional fatigue issues, such as thermal stratification and environmentally-assisted fatigue, which were not considered in the original plant design.

18.2.2.1 Class 1 Metal Fatigue

Fatigue evaluations performed in the design of the Class 1 RCS components were based on a number of design cycles assumed for the life of the plant. The RCS design transients used in the fatigue evaluations for the Class 1 components were reviewed for ANO-2. The numbers of actual RCS design transients from plant operating history were extrapolated to 60 years of operation. In all instances, the number of RCS design transients assumed in the original design was greater than the extrapolated number for 60 years of operation. Therefore, the fatigue evaluations for the Class 1 components remain valid for the period of extended operation in accordance with 10 CFR 54.21(c)(1)(i). The RCS design transients are monitored through the Fatigue Monitoring Program, which is discussed in Section 18.1.9.

18.2.2.2 Non-Class 1 Metal Fatigue

Piping components that may have normal or upset condition operating temperature in excess of 220 °F for carbon steel, or 270 °F for austenitic stainless steel, were evaluated for fatigue. The piping components were evaluated for their potential in 60 years of plant operation to exceed the limiting number of equivalent full temperature cycles used for the original design. Fatigue considerations for the original piping and component design are valid for the period of extended operation.

18.2.2.3 Environmentally-Assisted Fatigue

Recent test data indicate that certain environmental effects (such as temperature, oxygen, and stress) in the primary systems of light water reactors (LWR) could result in greater susceptibility to fatigue than would be predicted by fatigue analyses based on the ASME Section III design fatigue curves. The NRC has concluded that although not safety significant through the end of the initial license term, the environmental effects associated with fatigue life should be addressed for license renewal.

The effects of environmentally-assisted thermal fatigue for the limiting locations identified in NUREG-6260 were evaluated for ANO-2 in accordance with 10 CFR 54.21c(1)(i and ii) and all locations are acceptable for the period of extended operation with the exception of the charging nozzle, shutdown cooling line, [safety injection](#), and pressurizer surge line. The approach for addressing environmental fatigue for the above locations will include one or more of the following:

- (1) Further refinement of the fatigue analysis to lower the CUFs to below 1.0, or
- (2) Repair of the affected locations, or
- (3) Replacement of the affected locations, or

ARKANSAS NUCLEAR ONE
UNIT 2

- (4) Managing the effects of fatigue of the locations by an inspection program that has been reviewed and approved by the NRC (for example, periodic nondestructive examination of the affected locations at inspection intervals to be determined by a method accepted by the NRC). The inspections are expected to be able to detect cracking due to thermal fatigue prior to loss of function. Replacement or repair will then be implemented such that the intended function will be maintained for the period of extended operation, or
- (5) Monitoring ASME Code activities to use the environmental fatigue methodology approved by the code committee and NRC.

Should ANO-2 select Option 4 (inspection) to manage environmentally-assisted fatigue during the period of extended operation, details such as scope, qualification, method, and frequency will be provided to the NRC prior to entering the period of extended operation.

The effects of environmental-assisted thermal fatigue for the limiting locations identified in NUREG-6260 have been evaluated for ANO-2 in accordance with 10 CFR 54.21(c)(1)(i) and 10 CFR 54.21(c)(1)(ii) and all locations are acceptable for the period of extended operation with the exception of the charging nozzle, shutdown cooling line, and pressurizer surge line. Cracking by environmentally-assisted fatigue of these locations is addressed using one of the five approaches previously discussed in accordance with 10 CFR 54.21(c)(1).

18.2.2.4 Thermal Stresses in Piping Connected to Reactor Coolant System

ANO-2 provided responses to NRC Bulletin 88-08, Thermal Stresses in Piping Connected to Reactor Coolant Systems, in References 8 and 9. A review of 39 reactor coolant system (RCS) connected systems determined that none of these lines were determined to be subject to temperature distributions which would result in unacceptable thermal stresses. Supplement 3 to NRC Bulletin 88-08 was addressed for ANO-2 via a Combustion Engineering Owners Group (CEOG) task which revealed that only 3 piping systems (safety injection, shutdown cooling, and hot leg injection) could possibly be subject to excessive stresses due to outleakage from the RCS. Additional evaluations of these 3 systems determined that due to ANO-2's specific configuration and existing instrumentation, these systems will either not be subject to the outleakage type stratification as described in Supplement 3, or there is sufficient instrumentation and precautions in place to detect outleakage.

Subsequently, commitments regarding inspections at ANO-2 in response to NRC Bulletin 88-08 have been superseded by the ANO-2 risk-informed inspection (RIISI) of ASME Class 1 piping, as approved by the NRC (References 10, 11, 12, and 13). Aging effects due to thermal stratification as described in Bulletin 88-08 will be managed in accordance with 10 CFR 54.21(c)(1)(iii) by maintaining associated thermal fatigue calculations and augmented inspections (as part of RIISI) through the period of extended operation.

18.2.2.5 Pressurizer Surge Line Thermal Stratification

The ANO-2 response to NRC Bulletin 88-11, Pressurizer Surge Line Thermal Stratification (References 14 and 15), included analyses by the CEOG that demonstrated that the bounding surge line and nozzles for Combustion Engineering plants met the ASME Code stress and fatigue requirements for a 40-year design life considering thermal stratification and thermal striping. ANO-2 verified the applicability of the CEOG report and the plant-specific stress and fatigue analysis was completed as required by NRC Bulletin 88-11. Visual inspections of the pressurizer surge line were also performed.

ARKANSAS NUCLEAR ONE
UNIT 2

Subsequently, commitments regarding inspections at ANO-2 in response to NRC Bulletin 88-11 have been superseded by the ANO-2 risk-informed inspection (RIISI) of ASME Class 1 piping, as approved by the NRC (References 10, 11, 12, and 13). The RIISI program meets the requirements of 10 CFR 54.21(c)(1)(iii). Aging effects due to thermal stratification as described in Bulletin 88-11 will be managed by maintaining associated thermal fatigue calculations and augmented inspections (as part of RIISI) through the period of extended operation.

18.2.3 ENVIRONMENTAL QUALIFICATION OF ELECTRICAL COMPONENTS

The ANO-2 Environmental Qualification (EQ) of Electrical Components Program, discussed in Section 18.1.8, manages component thermal, radiation and cyclical aging, as applicable, through the use of aging evaluations based on the qualification methods of 10 CFR 50.49(f). Aging evaluations for EQ components that specify a qualification of at least 40 years are considered TLAAs for license renewal. The EQ Program ensures that the qualification of these EQ components will be maintained. The effects of aging will thus be managed in accordance with 10 CFR 54.21(c)(1)(iii).

18.2.4 CONCRETE CONTAINMENT TENDON PRESTRESS

The analysis of loss of prestress in the containment building post-tensioning system is a time-limited aging analysis. Loss of tendon prestress in the containment building post-tensioning system will be managed for license renewal in accordance with 10 CFR 54.21(c)(1)(iii), by the Containment ISI Program. This program, discussed in Section 18.1.14, includes tendon surveillance testing. Prior to the period of extended operation, trend lines for ANO-2 tendon prestressing forces will be developed using regression analysis in accordance with guidance provided in NRC IN 99-10. If prestressing force trend lines indicate that existing prestressing forces in the containment would go below the minimum required values (MRVs) prior to the next scheduled inspection (Reference 10 CFR 50.55a(b)(2)(ix)(B) or 10 CFR 50.55a(b)(2)(viii)(B)), then systematic retensioning of tendons, a reanalysis of the containment or a reanalysis of the post tensioning system is warranted to ensure the design adequacy of containment.

18.2.5 CONTAINMENT LINER PLATE AND PENETRATION FATIGUE ANALYSES

The interior surface of the containment is lined with welded carbon steel plate to provide an essentially leak tight barrier. At the penetrations, the containment liner plate is thickened to reduce stress concentrations. The criteria in SAR Sections 3.8.1.3.4 and 3.8.1.6.3 were applied to the containment design to ensure that the integrity of the liner plate is not exceeded under design basis accident conditions. The evaluation of this issue for license renewal is based on an analytical assessment of the containment liner and penetrations as described in SAR Section 3.8.1.4.2 and the results of recently completed containment liner plate evaluations for ANO-2. TLAAs for the ANO-2 reactor containment structure include containment liner and containment penetration fatigue analyses.

Mechanical penetrations are leak-tight, welded assemblies. As described in SAR Section 3.8.1.4.2, containment penetrations are designed to meet the requirements of ASME Section III. The evaluation for mechanical penetrations covers the penetration assembly and the weld to the process piping, but does not include the process piping within the penetration. The closure of the pipe to the liner plate is accomplished with special heads welded to the pipe and the liner plate reinforcement. Penetration anchorage to the containment wall is designed to resist pipe rupture, seismic and thermal loads.

ARKANSAS NUCLEAR ONE
UNIT 2

Liner plate stress analyses indicate a conservative maximum stress of approximately 30 ksi for worst case (DBA) conditions. Stresses from normal operating cycles such as heatup and cooldown are less than 30 ksi. Using ASME section III, Division 1 design fatigue curve, at 30 ksi the maximum cycles for the liner would be approximately 25,000. The number of normal operating cycles for the liner plate will be well below this value. On this basis, the liner plate and penetrations are suitable for the cyclic loads of normal operating conditions throughout the period of extended operation.

For license renewal, containment liner plate and penetration fatigue analyses remain valid for the period of extended operation in accordance with 10 CFR 54.21(c)(1)(i).

18.2.6 OTHER PLANT-SPECIFIC TIME-LIMITED AGING ANALYSES

Other ANO-2-specific TLAAs include leak-before-break (LBB) analyses, fracture mechanics evaluation of the RCP casing, steam generator flow-induced vibration analysis, alloy 600 nozzle repairs and fatigue evaluations for high energy line break analyses.

18.2.6.1 RCS Piping Leak-Before-Break

The leak-before-break analyses reported in CEN-367-A (Reference 16) are TLAAAs since they are based on the 40-year design limits for reactor coolant system fatigue transient cycles. As described for Class 1 metal fatigue in Section 18.2.2.1, the assumed number of RCS design transients are acceptable for 60 years so these analyses will remain valid during the period of extended operation in accordance with 10 CFR 54.21(c)(1)(i).

18.2.6.2 RCP Code Case N-481

Compliance of the primary loop pump casings to ASME Code Case N-481 was evaluated for ANO-2. The evaluation is based on the 40-year design limits for reactor coolant system fatigue transient cycles, and is therefore a TLAA. As described for Class 1 metal fatigue in Section 18.2.2.1, the assumed number of RCS design transients are acceptable for 60 years so the Code Case N-481 evaluation will remain valid during the period of extended operation in accordance with 10 CFR 54.21(c)(1)(i).

18.2.6.3 Steam Generator Tubes – Flow-Induced Vibration

The TLAA applicable to the steam generators is the analysis of steam generator tube flow induced vibration (FIV). The time dependent assumptions made within the FIV calculation are based on a forty-year design life of the steam generators. The ANO-2 replacement generators were installed in 2000 and their design life, which extends to 2040, surpasses the period of extended operation. Therefore, the steam generator FIV analysis remains valid for the period of extended operation.

18.2.6.4 Alloy 600 Nozzle Repairs

In 2000, repairs were made to a number of pressurizer heater penetrations, and resistance temperature detector (RTD) and pressure measurement nozzle penetrations on the RCS hot leg. The repair for the pressurizer heater penetration replaced the pressure boundary weld on the inside surface of the pressurizer nozzle with a weld on the outside of the pressurizer. The hot leg piping penetration modification consisted of removing a portion of the old RTD/pressure tap by cutting it near the outer wall of the RCS piping and replacing it with a new nozzle welded on the outside surface of the RCS piping.

ARKANSAS NUCLEAR ONE
UNIT 2

A fracture mechanics evaluation was performed to evaluate the potential for a crack in the remaining pressurizer and RCS hot leg penetration welds to propagate in the pressurizer vessel or hot leg pipe wall. The crack growth evaluations utilized operating transient cycles which were assumed over a 40 year plant lifetime. The replacement nozzles and attachment welds were qualified for structural adequacy in accordance with ASME code criteria. This analysis included a simplified fatigue evaluation which considered cyclic loads due to pressure, thermal gradients, and mechanical loads. As described for Class 1 metal fatigue in Section 18.2.2.1, the 40-year design limits for reactor coolant system transients are acceptable for 60 years. The fatigue crack growth analysis for the repairs will remain valid during the period of extended operation in accordance with 10 CFR 54.21(c)(1)(i). Similarly, the fatigue analysis for the replacement nozzles and attachment welds remains valid for the period of extended operation.

18.2.6.5 High Energy Line Break Analyses

For the high energy line break analyses, the selection of break locations for ASME Section III Class 1 piping was in part based on piping fatigue analyses. These fatigue evaluations, and thus the high energy line break analyses, are TLAAs since they are based on the 40-year design transients limits. As described for Class 1 metal fatigue in Section 18.2.2.1, the assumed number of RCS design transients are acceptable for 60 years so these analyses will remain valid during the period of extended operation in accordance with 10 CFR 54.21(c)(1)(i).

18.2.6.6 RCP Motor Flywheel

The flaw growth analysis associated with the reactor coolant pump motor flywheel is conservatively treated as a time-limited aging analysis. The analysis addresses the growth of pre-existing cracks subjected to 4,000 reactor coolant pump motor startup or shutdown cycles, which exceeds by a factor of eight the number of RCP cycles projected through the period of extended operation. Therefore, the flaw growth analysis remains valid for the period of extended operation.

ARKANSAS NUCLEAR ONE
Unit 2

18.3 REFERENCES

1. ANO-2 License Renewal Application, dated October 14, 2003 (2CAN100302).
2. NRC SER for ANO-2 License Renewal.
3. NUREG-1800, "Standard Review Plan for Review of License Renewal Applications for Nuclear Power Plants," U.S. Nuclear Regulatory Commission, July 2001.
4. NUREG-1801, "Generic Aging Lessons Learned (GALL) Report," U.S. Nuclear Regulatory Commission, July 2001.
5. NUREG-1743, "Safety Evaluation Report Related to the License Renewal of Arkansas Nuclear One, Unit 1," U.S. Nuclear Regulatory Commission, April 2001.
6. Anderson, Craig, Letter to US NRC (2CAN100101), "Proposed Technical Specification Change Request Regarding Revised ANO-2 Pressure/Temperature and Low Temperature Overpressure Protection Limits for 32 Effective Full Power Years," October 30, 2001.
7. US NRC, Letter to Craig G. Anderson (2CNA040205), "Arkansas Nuclear One, Unit 2 – Issuance of Amendment Re: Reactor Vessel Pressure Temperature Limits and Exemption from the Requirements of 10 CFR Part 50, Section 50.60(a)," April 15, 2002.
8. Letter from Dan R. Howard to US NRC (0CAN108806), "Arkansas Nuclear One – Units 1 & 2, Docket Nos. 50-313 and 50-368, License Nos. DPR-51 and NPF-6, NRC Bulletin No. 88-08: Thermal Stresses in Piping Connected to Reactor Coolant Systems," dated October 12, 1988.
9. Letter from James J. Fisicaro to US NRC (0CAN019102), "Arkansas Nuclear One – Units 1 & 2, Docket Nos. 50-313 and 50-368, License Nos. DPR-51 and NPF-6, NRC Bulletin No. 88-08: Thermal Stresses in Piping Connected to Reactor Coolant Systems," dated January 31, 1991.
10. Letter from Dwight C. Mims to US NRC (2CAN099706), "Arkansas Nuclear One – Unit 2, Docket 50-368, License No. NPF-6, Risk-Informed Inservice Inspection Pilot Plant Submittal for ANO-2," dated September 30, 1997.
11. Letter from Jimmy D. Vandergrift to US NRC (2CAN109801), "Arkansas Nuclear One – Unit 2, Docket 50-368, License No. NPF-6, Additional Information in Support of the Risk-Informed Inservice Inspection Pilot Application," dated October 8, 1998.
12. Letter from Jimmy D. Vandergrift to US NRC (2CAN119804), "Arkansas Nuclear One – Unit 2, Docket 50-368, License No. NPF-6, Information to Support Risk-Informed Inservice Inspection Pilot Application," dated November 25, 1998.
13. Letter from John N. Hannon (NRC) to C. Randy Hutchinson (EOI) (2CNA129805), "Request to Use Risk Informed Alternative to the Requirements of ASME Code Section XI, Table IWX-2500 at Arkansas Nuclear One, Unit No. 2 (TAC No. M99756)," dated December 29, 1998.

ARKANSAS NUCLEAR ONE
Unit 2

14. Combustion Engineering Report CEN-387-P, "Pressurizer Surge Line Flow Stratification Evaluation," Revision 1.
15. Letter from Thomas W. Alexion (NRC) to Jerry W. Yelverton (EOI) (2CNA079307), "Safety Evaluation for Combustion Engineering Owners Group Report CEN-387-P, Revision 1, Pressurizer Surge Line Thermal Stratification Evaluation (NRC Bulletin 88-11) (TAC No. M72109)," dated July 23, 1993.
16. Calculation 90-R-2006-04 (CEN-367-A), "Leak-Before-Break Evaluation of Primary Coolant Piping," May 1992.
17. Forbes, Jeffery, Letter to US NRC (2CAN040405), "License Amendment Request Technical Specification Change Request for Modification of ANO-2 RCS Pressure/Temperature Cooldown Rates," April 15, 2004.
18. US NRC, Letter to Jeffery S. Forbes (2CNA030501), "Arkansas Nuclear One, Unit 2 – Issuance of Amendment RE: Modification of ANO-2 Pressure/Temperature Cooldown Rates," March 7, 2005.
19. [Anderson, Richard L., Letter to US NRC \(2CAN111702\), "License Amendment Request – Updating the Reactor Coolant System Pressure-Temperature Limits," Arkansas Nuclear One, Unit 2, November 20, 2017.](#)
20. [US NRC, Letter to Richard L. Anderson \(2CNA111801\), "Arkansas Nuclear One, Unit 2 – Issuance of Amendment Re: Updating the Reactor Coolant System Pressure-Temperature Limits," November 27, 2018.](#)