

# NORD-LOCK WASHERS

The original wedge-locking solution



**NORD-LOCK®**

# The proven original



Since the Nord-Lock Group began operations in 1982 we have focused on providing the world's most effective bolt securing system. Our products are based on leading wedge-locking technology and are recognized for their ability to safely secure bolted joints exposed to severe vibration and dynamic loads.

When you choose Nord-Lock you do not only choose a supplier or a manufacturer, you also benefit from a partnership with an expert in bolted joint technology. Our global team of sales engineers work with our clients to solve bolt securing problems in the most demanding applications.

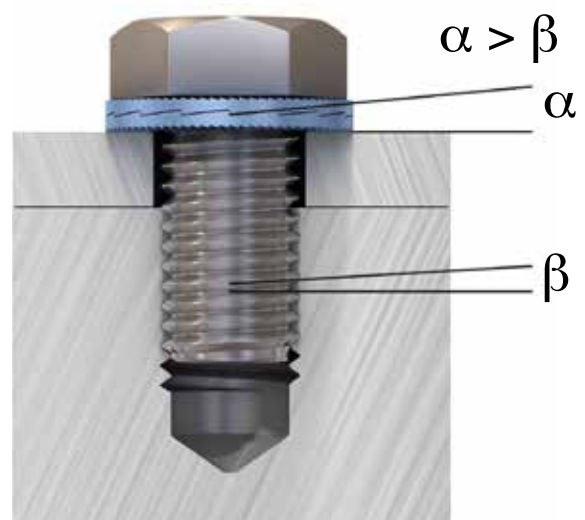

*Nord-Lock wedge-locking technology*



*Nord-Lock wedge-locking products are the ideal choice for critical bolted joints.*

Nord-Lock washers secure bolted joints with tension instead of friction. The system is comprised of a pair of washers with cams on one side and radial teeth on the opposite side. Since the cam angle ' $\alpha$ ' is greater than the thread pitch ' $\beta$ ' a wedge effect is created by the cams, preventing the bolt from rotating loose.



Over the years, Nord-Lock washers have been rigorously tested and approved by independent institutes as well as certification authorities.

### Proven in Junker vibration test

The Junker test, according to DIN 65151, is considered the most severe vibration test for bolted connections. During the test, the joint is exposed to transverse movements underneath the bolt head / nut, while the clamping force is continuously measured.

### Vibration test

Bolt M8 (8.8) with clamp length 25 mm

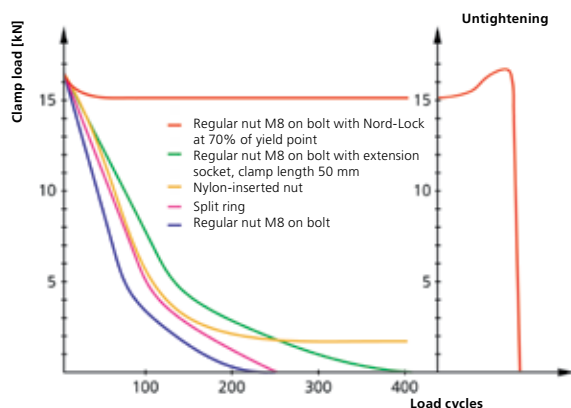

Fig 1: The Junker test shows that Nord-Lock washers safely secured the bolted connection; only a limited amount of tension is initially lost due to normal settlements. The wedge-locking function is verified through the clear increase in tension during untightening. All other bolt locking methods in the test failed to prevent loosening of the joint.

Nord-Lock washers are proven as a safe bolt securing system according to DIN 65151 tests performed by the independent research organizations IMA and CETIM. In addition, Nord-Lock personnel performs over 10,000 live Junker vibration tests around the globe every year. Would you like to see a live demonstration? Find your nearest representative through [www.nord-lock.com/contact](http://www.nord-lock.com/contact)

### Proven according to NASM impact & vibration test

The National Aerospace test, according to NASM 1312-7, is a test method originally developed by the U.S. military to test bolted connections' resilience against impact and vibration.

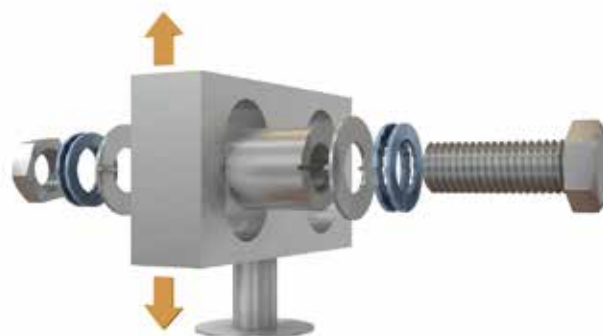

Fig 2: Drawing of the test rig. The assembled parts are vibrated vertically and the joints are subjected to two impacts per cycle. The impacts are parallel to the bolt. The arrow displays the direction of vibration during the test. After testing, the fasteners are inspected for rotation.

Nord-Lock washers are proven as a safe bolt securing system according to NASM 1312-7 tests performed by the independent organization Det Norske Veritas (DNV). If you wish to perform your own real-life testing and evaluation of Nord-Lock washers for your application, you can order samples through [www.nord-lock.com/contact](http://www.nord-lock.com/contact)

### Proven and certified by TÜV

Nord-Lock washers have been certified for safety and quality by TÜV, a leading international institute in quality and safety certification. In a two-step process, TÜV monitored and successfully approved both Nord-Lock washers and Nord-Lock's production facilities.





# Widely used & globally approved



Nord-Lock washers are high end products with documented success in many industries. Our washers are approved by several industry standards and specified by numerous international companies.

## Industries where Nord-Lock washers are used

Nord-Lock washers are used in industries such as: energy, transportation, offshore, mining and quarrying, construction and bridge building, manufacturing and processing, ship building, forestry and agriculture, heavy vehicles, and military. The number of industries that use Nord-Lock washers is continuously growing. Often joints do not start to loosen until an application is in regular use, therefore Nord-Lock washers are commonly retrofitted during maintenance, repair and overhaul procedures.

## Certificates & approvals

The most prominent certificates are from:

- DIBt (Deutsches Institut für Bautechnik)
- DNV (Det Norske Veritas)
- EBA (Eisenbahn-Bundesamt)
- TÜV (Technischer Überwachungs-Verein)



## Quality & environmental assurance

- ISO 9001
- ISO 14001
- Licensed by Dörken to perform Delta Protekt® surface coating in-house
- RoHs, ELV and Reach compliant
- Full traceability

For more information or a complete list of certificates and approvals, please visit our website or contact your nearest Nord-Lock representative.

## Traceability

Nord-Lock washers are rigorously tested in all steps of production to verify that the quality requirements are met. Each batch is assigned a control number which ensures full traceability and confirms that the washer is a genuine Nord-Lock article. The control number is printed on the package and products are laser marked, enabling full traceability down to first assembly – even when using bin systems for fastener supply.



Nord-Lock laser marks various sizes of our products with the Nord-Lock brand name, control number and a type code. This is to ensure that all of our customers receive genuine Nord-Lock washers and enables full traceability down to the first assembly.

## Laser marking, type code table

Washer type	Code
Steel, Delta Protekt® coating	fZn
Stainless steel	SS
254 SMO®	254
INCONEL® / HASTELLOY® C-276	276
INCONEL® 718	718

# The key to efficient & secure operations



Nord-Lock washers provide more than just a safe locking function, using our washers also improves the general performance of a bolted joint.

## Product benefits

- Maintains high clamp load and thereby ensures the function of the joint
- Quick and easy to install and remove with standard tools
- Locking function not affected by lubrication
- Defined and uniform friction conditions which result in a more accurate preload
- Same temperature characteristics as standard bolt / nut
- Reusable – in addition, Nord-Lock washers do not affect the reusability of fasteners
- The washers are hardened and can support and distribute great loads
- Washers with enlarged outer diameter available for flanged bolts / nuts
- High corrosion resistance
- Can be used with fasteners up to grade 12.9 (ASTM A574)
- Reliable locking, even for joints with short clamp length
- Secures fasteners at both high and low preloads
- No retightening needed
- Verifiable locking function
- Elegant solution and problem solving – modern engineering

## More than a physical product

Nord-Lock offers more than just secure bolted joints. When designing an application, it is important to consider the result it will generate throughout the entire lifespan. When using Nord-Lock products you also benefit from our experience and knowledge. We guide you towards the most beneficial and effective bolt design.

## Life Cycle Profitability

Over the operational life cycle, Nord-Lock products give increased operational reliability and lower maintenance costs while significantly reducing the risks of production stops, accidents and warranty claims. We help you examine all cost factors related to bolted joints.

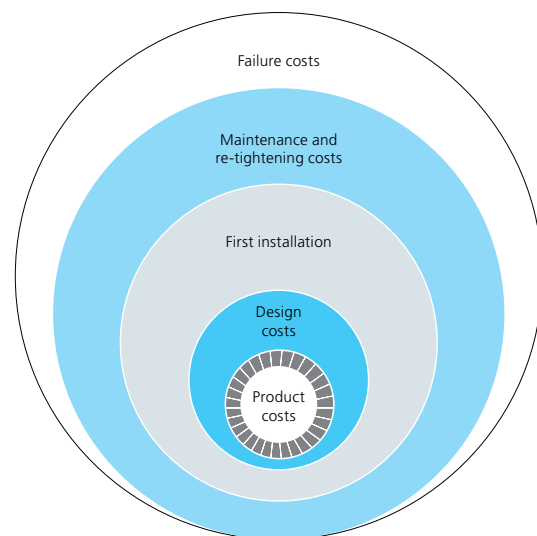

*Nord-Lock products can help you increase your profitability by considering the complete life cycle cost for bolt securing.*

## Technical Center

Our skilled and innovative staff is available to help, review and discuss your applications in order to optimize the design of your bolted connections. Many companies take advantage of the extended services we offer in our in-house laboratories located in Europe, North America and Asia. These services comprise customized tests, failure analysis and joint calculations. In addition, we offer on-site and remote product training and installation services.

# Using Nord-Lock washers



Nord-Lock washers are easy and effective to use while ensuring structural security for applications exposed to vibration and dynamic loads.

## Installing the washers

The pre-assembled washers are installed in pairs, cam face to cam face. Nord-Lock recommends lubrication when possible.

## Tightening

Tighten Nord-Lock washers with standard tools according to the guidelines (on page 9-11). Tightening guidelines for other bolt grades are available through your Nord-Lock representative.

## Untightening

Untightening Nord-Lock washers is as simple as tightening. Note that since the locking function is not based on increased friction, the untightening torque is generally lower than the tightening torque. Therefore it is not possible to measure off-torque as verification of locking function.

## Reusing Nord-Lock

Nord-Lock washers can normally be reused. As with all fasteners, they should be inspected for wear before reassembly. Make sure that the washers are reinstalled correctly cam face to cam face. Nord-Lock recommends lubrication of fasteners before reuse in order to minimize changes in friction conditions.



## Possible to verify the locking function

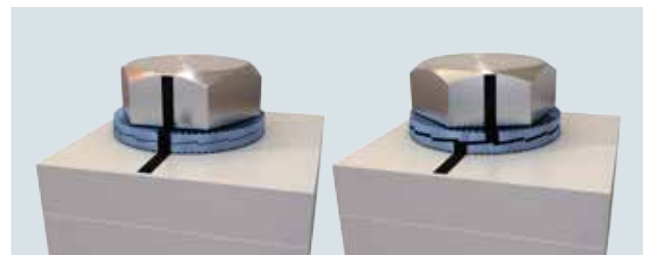

*When untightening a bolt secured by Nord-Lock washers, check that sliding occurs between the cam faces.*



*After disassembly, impression marks must be visible on both the fastener and the contact surface.*

*When the two criteria above are met, you have verified the locking function of the Nord-Lock washers.*

## Utilize the advantages of lubrication

Nord-Lock recommends the use of a high quality, anti-seize lubricant as it improves the tightening results. It is especially beneficial for large sized bolts and stainless steel applications. The Nord-Lock wedge-locking function provides safe locking in both dry and lubricated conditions. Benefits of lubricated fasteners include:

- Improved reusability
- Reduced friction and deviation
- Facilitated assembly and disassembly
- Reduced torsion stress due to minimized thread friction
- Avoided galling and thread seizure
- Additional protection against corrosion



## Nord-Lock washer material / type guide

Application parameter	Steel washers	Stainless steel (ss) washers	254 SMO® washers	INCONEL®/ HASTELLOY® C-276 washers	INCONEL® 718 washers
<b>Steel type (EN)</b>	1.7182 or equivalent	1.4404 or equivalent	1.4547 or equivalent	2.4819 or equivalent	2.4667 or equivalent
<b>Examples of applications</b>	General steel applications	General stainless steel applications. Non chlorine / acid environments	General salt water applications, pumps, chloride applications, heat exchangers, nuclear, desalination, food processing & medical equipment	General acidic environments, process and chemical industry, evaporators, offshore downhole tooling	Applications with high temperatures, gas turbines, turbo charges, incinerators
<b>Available for bolt sizes</b>	M3-M130 (see page 8 for dimensions)	M3-M80 (see page 10 for dimensions)	M3-M39 (see page 11 for dimensions)	M3-M39 available upon request	M3-M39 available upon request
<b>Washer types</b>	Regular outer diameter (NL3-NL130) Enlarged outer diameter (NL3,5sp-NL36sp)	Regular outer diameter (NL3ss-NL80ss) Enlarged outer diameter (NL3,5spss-NL30spss)	Regular outer diameter (NL3ss-254-NL39ss-254) Enlarged outer diameter (NL3,5spss-254-NL27spss-254)	Regular outer diameter (NL3ss-276-NL39ss-276) Enlarged outer diameter (NL3,5spss-276-NL27spss-276)	Regular outer diameter (NL3ss-718-NL39ss-718) Enlarged outer diameter (NL3,5spss-718-NL27spss-718)
<b>Treatment</b>	Through hardened	Surface hardened	Surface hardened	Surface hardened	Surface hardened
<b>Surface coating</b>	Delta Protekt® base coat (KL100) and top coat (VH302GZ)				
<b>Washer hardness*</b>	≥ 465 HV1	≥ 520HV0,05	≥ 600HV0,05	≥ 520HV0,05	≥ 620HV0,05
<b>Corrosion resistance</b>	Minimum 600 hours in salt spray test (according to ISO9227)	PREN 27**	PREN 45**	PREN 68**	PREN 29**
<b>Bolt grades</b>	Up to 12.9	Up to A4-80	Up to A4-80	Up to A4-80	Up to A4-80
<b>Temperature range***</b>	-50°C to 200°C	-160°C to 500°C	-160°C to 500°C	-160°C to 500°C	-160°C to 700°C

\* In order to assure the unique mechanical locking function of the Nord-Lock washers, the hardness of the mating surfaces must be lower than the hardness of the Nord-Lock washers (see table above).

\*\* PREN (Pitting Resistance Equivalent Number) = %Cr + 3,3x%Mo + 16x%N. Figures in table valid for base material. A higher PRE number indicates better corrosion resistance.

\*\*\* Temperature recommendations based on information from the raw material supplier and from tests. Locking function not affected within the specification.

# Nord-Lock steel washers

EN 1.7182 or equivalent, zinc flake coating (Delta Protekt®), through hardened

## Dimension chart

Washer size	Bolt size		ø [mm]	ø <sub>o</sub> [mm]	Thickness T [mm]	Min. package [pairs]	Approx. weight kg / 100 pairs
	Metric	UNC					
NL3	M3	#5	3,4	7,0	1,8	200	0,03
NL3,5	M3,5	#6	3,9	7,6	1,8	200	0,04
NL3,5sp	M3,5	#6	3,9	9,0	1,8	200	0,06
NL4	M4	#8	4,4	7,6	1,8	200	0,04
NL4sp	M4	#8	4,4	9,0	1,8	200	0,06
NL5	M5	#10	5,4	9,0	1,8	200	0,05
NL5sp	M5	#10	5,4	10,8	1,8	200	0,11
NL6	M6		6,5	10,8	1,8	200	0,07
NL6sp	M6		6,5	13,5	2,5	200	0,20
NL1/4"		1/4"	7,2	11,5	2,5	200	0,08
NL1/4"sp		1/4"	7,2	13,5	2,5	200	0,18
NL8	M8	5/16"	8,7	13,5	2,5	200	0,15
NL8sp	M8	5/16"	8,7	16,6	2,5	200	0,28
NL3/8"		3/8"	10,3	16,6	2,5	200	0,23
NL3/8"sp		3/8"	10,3	21,0	2,5	200	0,48
NL10	M10		10,7	16,6	2,5	200	0,22
NL10sp	M10		10,7	21,0	2,5	200	0,47
NL11	M11	7/16"	11,4	18,5	2,5	200	0,29
NL12	M12		13,0	19,5	2,5	200	0,29
NL12sp	M12		13,0	25,4	3,4	100	0,93
NL1/2"		1/2"	13,5	19,5	2,5	200	0,27
NL1/2"sp		1/2"	13,5	25,4	3,4	100	0,90
NL14	M14	9/16"	15,2	23,0	3,4	100	0,56
NL14sp	M14	9/16"	15,2	30,7	3,4	100	1,41
NL16	M16	5/8"	17,0	25,4	3,4	100	0,67
NL16sp	M16	5/8"	17,0	30,7	3,4	100	1,28
NL18	M18		19,5	29,0	3,4	100	0,89
NL18sp	M18		19,5	34,5	3,4	100	1,58
NL3/4"		3/4"	20,0	30,7	3,4	100	1,05
NL3/4"sp		3/4"	20,0	39,0	3,4	100	2,21
NL20	M20		21,4	30,7	3,4	100	0,93
NL20sp	M20		21,4	39,0	3,4	100	2,09
NL22	M22	7/8"	23,4	34,5	3,4	100	1,25
NL22sp	M22	7/8"	23,4	42,0	4,6	50	3,19
NL24	M24		25,3	39,0	3,4	100	1,74
NL24sp	M24		25,3	48,5	4,6	50	4,51
NL1"		1"	27,9	39,0	3,4	100	1,53
NL1"sp		1"	27,9	48,5	4,6	50	4,20
NL27	M27		28,4	42,0	5,8	50	3,14
NL27sp	M27		28,4	48,5	5,8	25	5,27
NL30	M30	1 1/8"	31,4	47,0	5,8	50	4,10
NL30sp	M30	1 1/8"	31,4	58,5	6,6	25	8,58
NL33	M33	1 1/4"	34,4	48,5	5,8	25	3,89
NL33sp	M33	1 1/4"	34,4	58,5	6,6	25	8,00
NL36	M36	1 3/8"	37,4	55,0	5,8	25	5,49
NL36sp	M36	1 3/8"	37,4	63,0	6,6	25	9,15
NL39	M39	1 1/2"	40,4	58,5	5,8	25	5,89
NL42	M42		43,2	63,0	5,8	25	7,97
NL45	M45	1 3/4"	46,2	70,0	7,0	25	10,20
NL48	M48		49,6	75,0	7,0	25	12,00
NL52	M52	2"	53,6	80,0	7,0	25	13,00
NL56	M56	2 1/4"	59,1	85,0	7,0	10	13,50
NL60	M60		63,1	90,0	7,0	10	15,20
NL64	M64	2 1/2"	67,1	95,0	7,0	10	16,70
NL68	M68		71,1	100,0	9,5	1	28,20
NL72	M72		75,1	105,0	9,5	1	30,70
NL76	M76	3"	79,1	110,0	9,5	1	33,30
NL80	M80	3 1/8"	83,1	115,0	9,5	1	36,00
NL85	M85		88,1	120,0	9,5	1	37,80
NL90	M90		92,4	130,0	9,5	1	47,70
NL95	M95		97,4	135,0	9,5	1	49,80
NL100	M100	4"	103,4	145,0	9,5	1	58,90
NL105	M105		108,4	150,0	9,5	1	61,30
NL110	M110		113,4	155,0	9,5	1	63,50
NL115	M115		118,4	165,0	9,5	1	75,30
NL120	M120		123,4	170,0	9,5	1	77,90
NL125	M125		128,4	173,0	9,5	1	76,60
NL130	M130	5"	133,4	178,0	9,5	1	79,20

NL3–NL8  
 $\varnothing_i \pm 0,1$  mm  
 NL10–NL42  
 $\varnothing_i \pm 0,2$  mm  
 NL45–NL130  
 $\varnothing_i +0,5 / -0,0$  mm

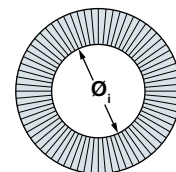

NL3–NL24  
 $\varnothing_o \pm 0,2$  mm  
 NL27–NL42  
 $\varnothing_o \pm 0,3$  mm  
 NL45–NL130  
 $\varnothing_o +0,0 / -2,0$  mm

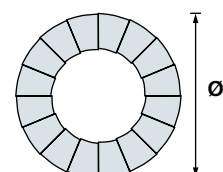

NL3–NL42  
 $T \pm 0,25$  mm

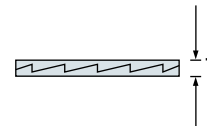

NL45–NL130  
 $T \pm 0,75$  mm

Note that washers with thickness 6,6 mm have a thickness tolerance  $+0,0 / -0,5$  mm

- Please consult our website for current dimensions and 2D / 3D CAD models:  
[www.nord-lock.com/cad](http://www.nord-lock.com/cad)

Nord-Lock steel washers of sizes 3-42 and with zinc flake coating are standard stock items, yet subject to prior sale.



# Torque guidelines

Nord-Lock steel washers with zinc flake coating (Delta Protokt®)

## Nord-Lock steel washers with electro zinc plated **bolt grade 8.8**

Washer size	Bolt size	Pitch [mm]	Oil, $G_f=75\%$ $\mu_{th}=0,15$ , $\mu_h=0,19$		Cu/C paste, $G_f=75\%$ $\mu_{th}=0,13$ , $\mu_h=0,18$		Dry, $G_f=62\%$ $\mu_{th}=0,18$ , $\mu_h=0,2$	
			Torque [Nm]	Clamp load [kN]	Torque [Nm]	Clamp load [kN]	Torque [Nm]	Clamp load [kN]
NL3	M3	0,5	1,7	2,4	1,5	2,4	1,5	2,0
NL4	M4	0,7	3,8	4,2	3,6	4,2	3,5	3,5
NL5	M5	0,8	7,5	6,8	6,9	6,8	6,8	5,6
NL6	M6	1,0	13	9,7	12,1	9,7	12	8,0
NL8	M8	1,25	32	18	29	18	29	15
NL10	M10	1,5	62	28	57	28	56	23
NL12	M12	1,75	107	40	99	40	97	33
NL14	M14	2,0	170	55	157	55	155	46
NL16	M16	2,0	260	75	240	75	237	62
NL18	M18	2,5	364	92	336	92	331	76
NL20	M20	2,5	510	118	470	118	464	97
NL22	M22	2,5	696	146	642	146	634	120
NL24	M24	3,0	878	169	809	169	800	140
NL27	M27	3,0	1284	221	1183	221	1172	182
NL30	M30	3,5	1750	269	1613	269	1596	222
NL33	M33	3,5	2360	333	2173	333	2155	275
NL36	M36	4,0	3043	392	2803	392	2776	324
NL39	M39	4,0	3931	468	3619	468	3589	387
NL42	M42	4,5	4860	538	4476	538	4436	445

Cu/C paste = copper/graphite paste (Molykote® 1000)

Oil = WD40 has been used.

$G_f$  = Ratio of yield point. When tightening according to guidelines and with no deviation, this is the pre-stress achieved expressed as % of yield point.

$\mu_{th}$  = thread friction coefficient

$\mu_h$  = under head friction coefficient

Thread friction coefficients have theoretical values but are verified through testing. Under head friction coefficients have been established by tests.

Torque guidelines for other bolt grades are available through your local Nord-Lock representative.

## Nord-Lock steel washers with non-plated **bolt grade 10.9**

Washer size	Bolt size	Pitch [mm]	Oil, $G_f=71\%$ $\mu_{th}=0,15$ , $\mu_h=0,15$		Cu/C paste, $G_f=75\%$ $\mu_{th}=0,13$ , $\mu_h=0,15$	
			Torque [Nm]	Clamp load [kN]	Torque [Nm]	Clamp load [kN]
NL3	M3	0,5	2,0	3,2	2,0	3,4
NL4	M4	0,7	4,5	5,6	4,5	5,9
NL5	M5	0,8	8,9	9,1	8,9	9,6
NL6	M6	1,0	15,5	12,9	15,5	13,6
NL8	M8	1,25	37	23	37	25
NL10	M10	1,5	73	37	73	39
NL12	M12	1,75	126	54	126	57
NL14	M14	2,0	201	74	201	78
NL16	M16	2,0	307	100	306	106
NL18	M18	2,5	430	123	429	130
NL20	M20	2,5	602	156	600	165
NL22	M22	2,5	821	194	818	205
NL24	M24	3,0	1036	225	1034	238
NL27	M27	3,0	1514	294	1509	310
NL30	M30	3,5	2064	358	2058	378
NL33	M33	3,5	2782	443	2772	468
NL36	M36	4,0	3589	522	3576	551
NL39	M39	4,0	4632	624	4613	659
NL42	M42	4,5	5731	716	5709	757

## Nord-Lock steel washers with non-plated **bolt grade 12.9**

Washer size	Bolt size	Pitch [mm]	Oil, $G_f=71\%$ $\mu_{th}=0,15$ , $\mu_h=0,13$		Cu/C paste, $G_f=75\%$ $\mu_{th}=0,13$ , $\mu_h=0,14$	
			Torque [Nm]	Clamp load [kN]	Torque [Nm]	Clamp load [kN]
NL3	M3	0,5	2,2	3,9	2,3	4,1
NL4	M4	0,7	5,1	6,7	5,3	7,1
NL5	M5	0,8	10,0	10,9	10,3	11,5
NL6	M6	1,0	17,4	15,4	18	16,3
NL8	M8	1,25	42	28	43	30
NL10	M10	1,5	82	44	85	47
NL12	M12	1,75	142	65	146	68
NL14	M14	2,0	226	89	233	94
NL16	M16	2,0	345	120	355	127
NL18	M18	2,5	483	148	498	156
NL20	M20	2,5	676	188	696	198
NL22	M22	2,5	921	233	948	246
NL24	M24	3,0	1165	270	1199	286
NL27	M27	3,0	1700	352	1749	372
NL30	M30	3,5	2316	430	2386	454
NL33	M33	3,5	3124	532	3213	562
NL36	M36	4,0	4029	626	4145	662
NL39	M39	4,0	5199	748	5346	790
NL42	M42	4,5	6434	860	6617	908

1 N = 0,225 lb

1 Nm = 0,738 ft-lb

# Nord-Lock stainless steel washers

EN 1.4404 (AISI 316L) or equivalent, surface hardened

EN 1.4404 is an austenitic chromium-nickel stainless steel containing molybdenum. This stainless steel also has extra low carbon content in order to reduce the risk of chromium-carbide precipitation. EN 1.4404 is one of the most commonly used stainless steel grades and Nord-Lock washers made of EN 1.4404 are suitable for most applications where no chlorides or acids are present.

## Dimension chart

Washer size	Bolt size		$\phi_i$ [mm]	$\phi_o$ [mm]	Thickness T [mm]	Min. package [pairs]	Approx. weight kg / 100 pairs
	Metric	UNC					
NL3ss	M3	#5	3,4	7,0	2,2	200	0,04
NL3,5ss	M3,5	#6	3,9	7,6	2,2	200	0,04
NL3,5spss	M3,5	#6	3,9	9,0	2,2	200	0,07
NL4ss	M4	#8	4,4	7,6	2,2	200	0,04
NL4spss	M4	#8	4,4	9,0	2,2	200	0,07
NL5ss	M5	#10	5,4	9,0	2,2	200	0,06
NL5spss	M5	#10	5,4	10,8	2,2	200	0,11
NL6ss	M6		6,5	10,8	2,2	200	0,09
NL6spss	M6		6,5	13,5	2,0	200	0,16
NL1/4"ss		1/4"	7,2	11,5	2,2	200	0,09
NL1/4"spss		1/4"	7,2	13,5	2,2	200	0,15
NL8ss	M8	5/16"	8,7	13,5	2,0	200	0,12
NL8spss	M8	5/16"	8,7	16,6	2,0	200	0,23
NL3/8"ss		3/8"	10,3	16,6	2,0	200	0,19
NL3/8"spss		3/8"	10,3	21,0	2,0	200	0,38
NL10ss	M10		10,7	16,6	2,0	200	0,18
NL10spss	M10		10,7	21,0	2,0	200	0,37
NL11ss	M11	7/16"	11,4	18,5	2,2	200	0,26
NL12ss	M12		13,0	19,5	2,0	200	0,23
NL12spss	M12		13,0	25,4	3,0	100	0,82
NL1/2"ss		1/2"	13,5	19,5	2,0	200	0,22
NL1/2"spss		1/2"	13,5	25,4	3,2	100	0,80
NL14ss	M14	9/16"	15,2	23,0	3,0	100	0,49
NL14spss	M14	9/16"	15,2	30,7	3,2	100	1,31
NL16ss	M16	5/8"	17,0	25,4	3,0	100	0,59
NL16spss	M16	5/8"	17,0	30,7	3,2	100	1,13
NL18ss	M18		19,5	29,0	3,2	100	0,80
NL18spss	M18		19,5	34,5	3,2	100	1,56
NL3/4"ss		3/4"	20,0	30,7	3,2	100	0,96
NL3/4"spss		3/4"	20,0	39,0	3,2	100	2,10
NL20ss	M20		21,4	30,7	3,0	100	0,82
NL20spss	M20		21,4	39,0	3,2	100	2,06
NL22ss	M22	7/8"	23,4	34,5	3,2	100	1,23
NL22spss	M22	7/8"	23,4	42,0	3,2	50	2,22
NL24ss	M24		25,3	39,0	3,2	100	1,59
NL24spss	M24		25,3	48,5	3,2	50	3,50
NL1"ss		1"	27,9	39,0	3,2	100	1,42
NL1"spss		1"	27,9	48,5	3,2	50	2,79
NL27ss	M27		28,4	42,0	6,8	50	3,45
NL27spss	M27		28,4	48,5	6,8	25	5,34
NL30ss	M30	1 1/8"	31,4	47,0	6,8	50	4,49
NL30spss	M30	1 1/8"	31,4	58,5	6,8	25	9,18
NL33ss	M33	1 1/4"	34,4	48,5	6,8	25	4,28
NL36ss	M36	1 3/8"	37,4	55,0	6,8	25	5,96
NL39ss	M39	1 1/2"	40,4	58,5	6,8	25	6,74
NL42ss	M42		43,2	63,0	6,8	25	7,50
NL45ss	M45	1 3/4"	46,2	70,0	6,8	25	10,20
NL48ss	M48		49,6	75,0	6,8	25	12,00
NL52ss	M52	2"	53,6	80,0	9,0	1	18,04
NL56ss	M56	2 1/4"	59,1	85,0	9,0	1	21,30
NL60ss	M60		63,1	90,0	9,0	1	23,50
NL64ss	M64	2 1/2"	67,1	95,0	9,0	1	25,80
NL68ss	M68		71,1	100,0	9,0	1	28,20
NL72ss	M72		75,1	105,0	9,0	1	30,70
NL76ss	M76	3"	79,1	110,0	9,0	1	33,30
NL80ss	M80	3 1/8"	83,1	115,0	9,0	1	36,00

Nord-Lock washers made of stainless steel are standard stock items, yet subject to prior sale.

NL3ss – NL8ss  
 $\phi_i \pm 0,1$  mm  
 NL10ss – NL42ss  
 $\phi_i \pm 0,2$  mm  
 NL45ss – NL80ss  
 $\phi_i +0,5 / -0,0$  mm

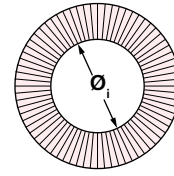

NL3ss – NL24ss  
 $\phi_o \pm 0,2$  mm  
 NL27ss – NL42ss  
 $\phi_o \pm 0,3$  mm  
 NL45ss – NL80ss  
 $\phi_o +0,0 / -2,0$  mm

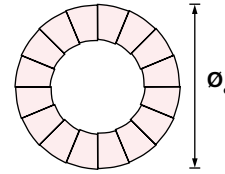

NL3ss – NL24ss  
 $T \pm 0,25$  mm  
 NL27ss – NL42ss  
 $T +0,0 / -0,5$  mm  
 NL45ss – NL80ss  
 $T \pm 0,75$  mm

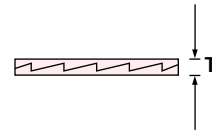

- Please consult our website for current dimensions and 2D / 3D CAD models: [www.nord-lock.com/cad](http://www.nord-lock.com/cad)

## Torque guidelines

Nord-Lock stainless steel washers with stainless steel bolt, lubricated with copper/graphite paste (Molykote® 1000).

Washer size	Bolt size	Pitch [mm]	A4-70, Cu/C paste, $G_r=65\%$ , $\mu_{th}=0,13$ , $\mu_u=0,13$		A4-80, Cu/C paste, $G_r=65\%$ , $\mu_{th}=0,13$ , $\mu_u=0,13$	
			Torque [Nm]	Clamp load [kN]	Torque [Nm]	Clamp load [kN]
NL3ss	M3	0,5	0,8	1,5	1,1	2,0
NL4ss	M4	0,7	1,8	2,6	2,4	3,4
NL5ss	M5	0,8	3,6	4,1	4,8	5,5
NL6ss	M6	1,0	6,3	5,9	8,4	7,8
NL8ss	M8	1,25	15	11	20	14
NL10ss	M10	1,5	30	17	39	23
NL12ss	M12	1,75	51	25	68	33
NL14ss	M14	2,0	81	34	108	45
NL16ss	M16	2,0	124	46	165	61
NL18ss	M18	2,5	173	56	231	75
NL20ss	M20	2,5	243	72	323	95
NL22ss	M22	2,5	330	89	440	118
NL24ss	M24	3,0	418	103	557	137
NL27ss	M27	3,0	609	134	812	179
NL30ss	M30	3,5	831	164	1108	219
NL36ss	M36	4,0	1444	239	1925	319

Cu/C paste = Copper/graphite paste (Molykote® 1000)

$G_r$  = ratio of yield point. When tightening according to guidelines and with no deviation, this is the pre-stress achieved expressed as % of yield point.

$\mu_{th}$  = thread friction coefficient

$\mu_u$  = under head friction coefficient

1 N = 0,225 lb

1 Nm = 0,738 ft-lb

Thread friction coefficients have theoretical values but are verified through testing. Under head friction coefficients have been established by tests. Torque guidelines for other bolt grades are available through your local Nord-Lock representative.

# Nord-Lock 254 SMO® washers

EN 1.4547 or equivalent, surface hardened

254 SMO® is a high performance austenitic stainless steel (according to EN 1.4547) with greater mechanical strength and resistance against corrosion than most austenitic stainless steel grades. The material is resilient against pitting and crevice corrosion due to high contents of chromium, nickel, molybdenum and nitrogen. Nord-Lock 254 SMO® washers are specially designed for chloride rich processes and salt water solutions / atmospheres, i.e. environments where stainless steel washers made of EN 1.4404 are not suitable.

## Dimension chart

Washer size	Bolt size		$\phi_i$ [mm]	$\phi_o$ [mm]	Thickness T [mm]	Min. package [pairs]	Approx weight kg / 100 pairs
	Metric	UNC					
NL3ss-254	M3	#5	3,4	7,0	2,2	200	0,04
NL3,5ss-254	M3,5	#6	3,9	7,6	2,2	200	0,04
NL3,5spss-254	M3,5	#6	3,9	9,0	2,2	200	0,07
NL4ss-254	M4	#8	4,4	7,6	2,2	200	0,04
NL4spss-254	M4	#8	4,4	9,0	2,2	200	0,07
NL5ss-254	M5	#10	5,4	9,0	2,2	200	0,06
NL5spss-254	M5	#10	5,4	10,8	2,2	200	0,11
NL6ss-254	M6		6,5	10,8	2,2	200	0,09
NL6spss-254	M6		6,5	13,5	2,0	200	0,16
NL1/4"-254		1/4"	7,2	11,5	2,2	200	0,09
NL1/4"spss-254		1/4"	7,2	13,5	2,2	200	0,15
NL8ss-254	M8	5/16"	8,7	13,5	2,0	200	0,12
NL8spss-254	M8	5/16"	8,7	16,6	2,2	200	0,22
NL3/8"ss-254		3/8"	10,3	16,6	2,0	200	0,19
NL3/8"spss-254		3/8"	10,3	21,0	2,2	200	0,38
NL10ss-254	M10		10,7	16,6	2,0	200	0,18
NL10spss-254	M10		10,7	21,0	2,2	200	0,37
NL11ss-254	M11	7/16"	11,4	18,5	2,2	200	0,26
NL12ss-254	M12		13,0	19,5	2,0	200	0,23
NL12spss-254	M12		13,0	25,4	3,2	100	0,83
NL1/2"ss-254		1/2"	13,5	19,5	2,0	200	0,23
NL1/2"spss-254		1/2"	13,5	25,4	3,0	100	0,80
NL14ss-254	M14	9/16"	15,2	23,0	3,0	100	0,49
NL14spss-254	M14	9/16"	15,2	30,7	3,0	100	1,13
NL16ss-254	M16	5/8"	17,0	25,4	3,0	100	0,59
NL16spss-254	M16	5/8"	17,0	30,7	3,2	100	1,13
NL18ss-254	M18		19,5	29,0	3,2	100	0,80
NL18spss-254	M18		19,5	34,5	3,2	100	1,56
NL3/4"ss-254		3/4"	20,0	30,7	3,2	100	0,96
NL3/4"spss-254		3/4"	20,0	39,0	3,2	100	2,14
NL20ss-254	M20		21,4	30,7	3,0	100	0,83
NL20spss-254	M20		21,4	39,0	3,2	100	1,98
NL22ss-254	M22	7/8"	23,4	34,5	3,2	100	1,19
NL22spss-254	M22	7/8"	23,4	42,0	3,2	50	2,44
NL24ss-254	M24		25,3	39,0	3,2	100	1,65
NL24spss-254	M24		25,3	48,5	3,2	50	3,50
NL1"ss-254		1"	27,9	39,0	3,2	100	1,42
NL1"spss-254		1"	27,9	48,5	5,8	50	5,40
NL27ss-254	M27		28,4	42,0	5,8	50	3,10
NL27spss-254	M27		28,4	48,5	5,8	25	5,34
NL30ss-254	M30	1 1/8"	31,4	47,0	5,8	50	4,04
NL33ss-254	M33	1 1/4"	34,4	48,5	5,8	25	3,86
NL36ss-254	M36	1 3/8"	37,4	55,0	5,8	25	5,50
NL39ss-254	M39	1 1/2"	40,4	58,5	5,8	25	6,74

Nord-Lock washers made of 254 SMO® quality are standard stock items, yet subject to prior sale.

NL3ss-254  
-NL8ss-254  
 $\phi_i \pm 0,1$  mm  
NL10ss-254  
-NL39ss-254  
 $\phi_i \pm 0,2$  mm

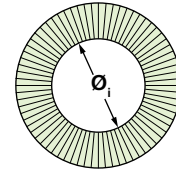

NL3ss254  
-NL24ss -254  
 $\phi_o \pm 0,2$  mm  
NL27ss-254  
-NL39ss-254  
 $\phi_o \pm 0,3$  mm

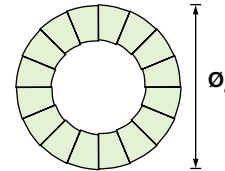

NL3ss-254  
-NL39ss-254  
T  $\pm 0,25$  mm

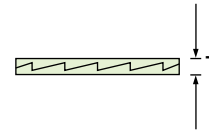

- Please consult our website for current dimensions and 2D / 3D CAD models: [www.nord-lock.com/cad](http://www.nord-lock.com/cad)

## Torque guidelines

Nord-Lock 254 SMO® washers with stainless steel bolt, lubricated with copper/graphite paste (Molykote® 1000).

Washer size	Bolt size	Pitch [mm]	A4-70, Cu/C paste, $G_f=65\%$ , $\mu_{th}=0,13$ , $\mu_h=0,13$		A4-80, Cu/C paste, $G_f=65\%$ , $\mu_{th}=0,13$ , $\mu_h=0,13$	
			Torque [Nm]	Clamp load [kN]	Torque [Nm]	Clamp load [kN]
NL3ss-254	M3	0,5	0,8	1,5	1,1	2,0
NL4ss-254	M4	0,7	1,8	2,6	2,4	3,4
NL5ss-254	M5	0,8	3,6	4,1	4,8	5,5
NL6ss-254	M6	1,0	6,3	5,9	8,4	7,8
NL8ss-254	M8	1,25	15	11	20	14
NL10ss-254	M10	1,5	30	17	39	23
NL12ss-254	M12	1,75	51	25	68	33
NL14ss-254	M14	2,0	81	34	108	45
NL16ss-254	M16	2,0	124	46	165	61
NL18ss-254	M18	2,5	173	56	231	75
NL20ss-254	M20	2,5	243	72	323	95
NL22ss-254	M22	2,5	330	89	440	118
NL24ss-254	M24	3,0	418	103	557	137
NL27ss-254	M27	3,0	609	134	812	179
NL30ss-254	M30	3,5	831	164	1108	219
NL36ss-254	M36	4,0	1444	239	1925	319

Cu/C paste = Copper/graphite paste (Molykote® 1000)

$G_f$  = ratio of yield point. When tightening according to guidelines and with no deviation, this is the pre-stress achieved expressed as % of yield point.

$\mu_{th}$  = thread friction coefficient

$\mu_h$  = under head friction coefficient

1 N = 0,225 lb

1 Nm = 0,738 ft-lb

Thread friction coefficients have theoretical values but are verified through testing. Under head friction coefficients have been established by tests. Torque guidelines for other bolt grades are available through your local Nord-Lock representative.

# Nord-Lock washers joint guide



## Tapped holes

Nord-Lock washers safely lock the bolt against the underlying surface.



## Counter bores

The outer diameter of regular Nord-Lock washers is designed for counter-bore holes according to DIN 974, i.e. the washers fit under the head of standard bolts.



## Through holes

As for all locking washers, through holes require two pairs of Nord-Lock washers – one pair for securing the bolt and a second pair for securing the nut.

Turn both fasteners in order to close the cams on both washer pairs before tightening to minimize settlements. Keep the nut secure whilst tightening the bolt.



## Stud bolts

Nord-Lock washers safely lock the nut on stud bolts and eliminate the need for adhesives.



Large / slotted holes



Soft underlying surfaces

## Applications with large / slotted holes or soft underlying surfaces

To optimize the load distribution for applications with large / slotted holes or with soft underlying surface, use a flanged nut / bolt together with Nord-Lock "sp" washers with enlarged outer diameter.



## Designs where Nord-Lock washers are not recommended

- Mating surfaces that are not locked in place (see left figure)
- Mating surfaces harder than the washers
- Very soft mating surface, e.g. wood, plastic
- Applications with extremely large settlements
- Non-preloaded joints

*If your application corresponds to one or more of the above mentioned design criteria, contact your Nord-Lock representative and we will help you find an alternative solution.*



## Nord-Lock "sp" (enlarged outer diameter) washers

Nord-Lock washers are available with an enlarged outer diameter, referred to as "sp" washers. "sp" washers are designed for use on large / slotted holes, painted / sensitive surfaces or soft materials. Use Nord-Lock "sp" washers with flanged bolts or nuts for optimum load distribution.

$\varnothing$  inner regular =  $\varnothing$  inner "sp"  
 $\varnothing$  outer regular <  $\varnothing$  outer "sp"

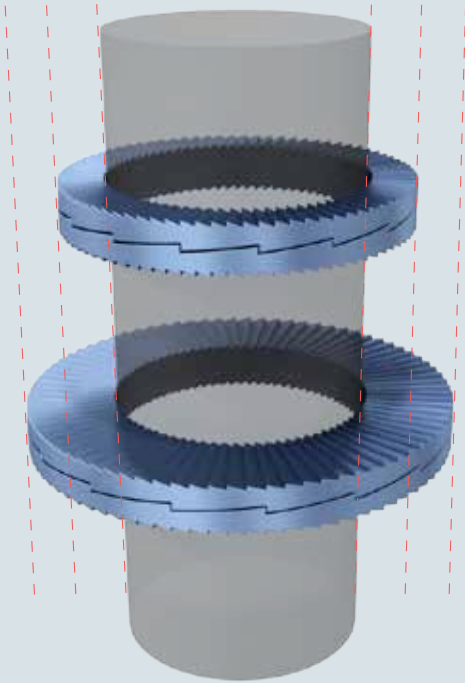

*A flanged nut and Nord-Lock "sp" washers increase the load supporting surface for applications with slotted holes.*

By using "sp" washers, the load is distributed over a larger surface which can be more gentle for sensitive surfaces. Please consult Nord-Lock to find the optimal solution for your application.

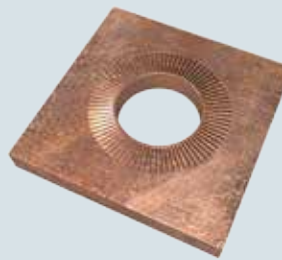

*Nord-Lock "sp" washers on soft metal.*

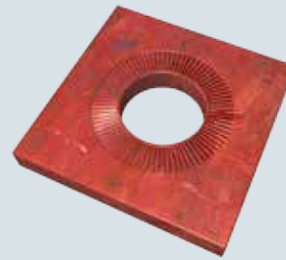

*Nord-Lock "sp" washers on painted surface.*

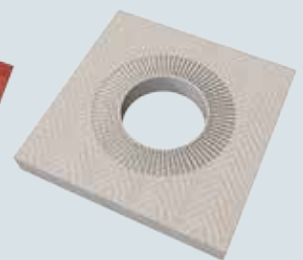

*Nord-Lock "sp" washers on fibre surface.*

## Uniform friction with Nord-Lock washers

It is important to have control over the friction conditions in order to obtain the desired preload when tightening a joint.

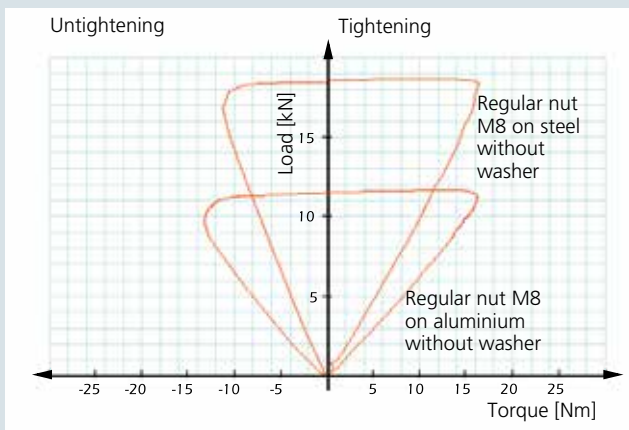

When no washer is used under the fastener, the friction depends on the contact surface. At a given torque, the obtained preload will vary depending on the contact material.

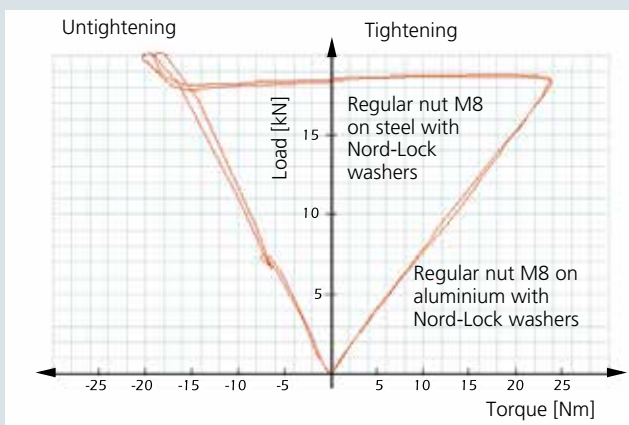

When using Nord-Lock washers, sliding always occurs between the upper washer and the bolt head / nut. At a given torque, the preload will be the same, regardless of the contact material.

Nord-Lock provides customized torque guidelines for your application, contact your nearest representative.

# Your partner for bolting solutions



The Nord-Lock Group is continuously developing new innovative solutions. In addition to the Nord-Lock washers, our product offering consists of several technologies, all developed and designed in-house. Contact us to learn more about our current range of products or please visit [www.nord-lock.com](http://www.nord-lock.com)

## Nord-Lock wedge-locking

Nord-Lock's innovative and multiple award-winning X-series washers provide maximum security for critical bolted joints that are exposed to spontaneous bolt loosening and slackening. Nord-Lock has also developed the SC-washers which increase the security for steel construction and are designed for HV/HR sets.

## Customer unique solutions

Over the years, the Nord-Lock Group has entered several partnerships to develop unique solutions for the most creative designs. Let us help you find the optimum solution for your specific requirements.

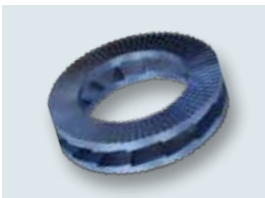

## SUPERBOLT™

### Multi-jackbolt tensioning

Superbolt multi-jackbolt tensioning is an innovative technology for tightening of medium to large bolts and studs. The method is simple, accurate and cost effective. Only hand tools are required to tighten even the largest of bolts. Superbolt tensioners can be threaded onto a new or existing bolt, stud, threaded rod or shaft.

### Expansion bolting

Superbolt Expansion bolts replace traditional interference or force fit bolts. They offer tremendous radial expansion and joint clamping power in one bolting system. Radial expansion is critical for rotating couplings or alignment systems that require the bolts to be able to handle transfer of forces in shear. Expansion bolts are available for blind hole and through hole applications.

## BOLTIGHT™

### Hydraulic bolt tensioning

Boltight bolt tensioning tools are used all over the world, from the high performance standard tool range to the uniquely designed tools to suit market and application requirements. The tools are lightweight, compact and easy to use with a focus on safe operation and product quality. Products include hydraulic bolt tensioners, subsea bolt tensioners, hydraulic nuts, echometer and more.



### Performance Services

Nord-Lock Performance Services will assist you in identifying ways which your company can increase its competitiveness. A Performance Services project can be initiated to solve a specific problem; alternatively the goal can be to create an overview of possible improvements. Each project is designed to meet customer specific needs and challenges. We can investigate current applications as well as future designs.

### Presence in your market

The Nord-Lock Group includes subsidiaries, in-house laboratories on three continents, and a worldwide network of authorized distributors. Our philosophy is to be close to our customers, to speak your language and to help you achieve secure and effective bolted joints. To find the complete list of Nord-Lock representatives, please go to [www.nord-lock.com/contact](http://www.nord-lock.com/contact)



### Nord-Lock global chain of services

#### Sourcing

Life Cycle Profitability and cost justification

Cost savings generated by optimized bolted joints.

#### Design / Production

Application Engineers, Technical Centers & Project Engineering

Joint calculation and simulation. Real life testing and validation. Custom designs.

#### Aftermarket

On-site and remote product training as well as service and retrofitting

Increasing the knowledge for operators and engineers. Installation support.



# When **safety** really matters



Joining parts together is one of the most critical steps when delivering a product or system. The Nord-Lock Group is focused on solving the toughest bolting challenges. We offer a unique combination of bolting expertise and a wide product range, including wedge-locking technology and Superbolt tensioners — all designed and developed in-house.

Nord-Lock holds decades of documented success in every major industry, including oil and gas, energy, transportation and mining. Our Production System includes rigorous internal testing and full traceability, and our products hold several certificates from independent institutes including ABS, DIBt, DNV and TÜV.

The tools available through Nord-Lock Performance Services add value throughout a project and ensure that your bolting application pays back multiple times. We can also assist you in the design phase with joint simulation and testing. Additionally, we help you ensure successful operations over time with our onsite support and remote product training.

Our mission is to safeguard human lives and customer investments by securing the world's most demanding applications. The Nord-Lock Group looks forward to being your partner in bolting solutions.

Authorized distributor:

© Copyright 2017 Nord-Lock Group. NORD-LOCK, SUPERBOLT, BOLTIGHT and EXPANDER SYSTEM are trademarks owned by different companies within the Nord-Lock Group. All other logos, trademarks, registered trademarks or service marks used herein are the property of the Nord-Lock Group. All rights reserved.