

Methodology for Modeling Fire Growth and Suppression Response for Electrical Cabinet Fires in Nuclear Power Plants

Draft Report for Comment

Electric Power Research Institute
3420 Hillview Avenue
Palo Alto, CA 94304-1338



U.S. Nuclear Regulatory Commission
Office of Nuclear Regulatory Research
Washington, D.C. 20555-0001



AVAILABILITY OF REFERENCE MATERIALS IN NRC PUBLICATIONS

NRC Reference Material

As of November 1999, you may electronically access NUREG-series publications and other NRC records at the NRC's Public Electronic Reading Room at <http://www.nrc.gov/reading-rm.html>. Publicly released records include, to name a few, NUREG-series publications; *Federal Register* notices; applicant, licensee, and vendor documents and correspondence; NRC correspondence and internal memoranda; bulletins and information notices; inspection and investigative reports; licensee event reports; and Commission papers and their attachments.

NRC publications in the NUREG series, NRC regulations, and Title 10, "Energy," in the *Code of Federal Regulations* may also be purchased from one of these two sources.

1. The Superintendent of Documents

U.S. Government Publishing Office
Mail Stop SSOP
Washington, DC 20402-0001
Internet: <http://bookstore.gpo.gov>
Telephone: 1-866-512-1800
Fax: (202) 512-2104

2. The National Technical Information Service

5301 Shawnee Road
Alexandria, VA 22161-0002
<http://www.ntis.gov>
1-800-553-6847 or, locally, (703) 605-6000

A single copy of each NRC draft report for comment is available free, to the extent of supply, upon written request as follows:

U.S. Nuclear Regulatory Commission
Office of Administration
Publications Branch
Washington, DC 20555-0001
E-mail: distribution.resource@nrc.gov
Facsimile: (301) 415-2289

Some publications in the NUREG series that are posted at the NRC's Web site address <http://www.nrc.gov/reading-rm/doc-collections/nuregs> are updated periodically and may differ from the last printed version. Although references to material found on a Web site bear the date the material was accessed, the material available on the date cited may subsequently be removed from the site.

Non-NRC Reference Material

Documents available from public and special technical libraries include all open literature items, such as books, journal articles, transactions, *Federal Register* notices, Federal and State legislation, and congressional reports. Such documents as theses, dissertations, foreign reports and translations, and non-NRC conference proceedings may be purchased from their sponsoring organization.

Copies of industry codes and standards used in a substantive manner in the NRC regulatory process are maintained at—

The NRC Technical Library

Two White Flint North
11545 Rockville Pike
Rockville, MD 20852-2738

These standards are available in the library for reference use by the public. Codes and standards are usually copyrighted and may be purchased from the originating organization or, if they are American National Standards, from—

American National Standards Institute

11 West 42nd Street
New York, NY 10036-8002
<http://www.ansi.org>
(212) 642-4900

Legally binding regulatory requirements are stated only in laws; NRC regulations; licenses, including technical specifications; or orders, not in NUREG-series publications. The views expressed in contractor-prepared publications in this series are not necessarily those of the NRC.

The NUREG series comprises (1) technical and administrative reports and books prepared by the staff (NUREG-XXXX) or agency contractors (NUREG/CR-XXXX), (2) proceedings of conferences (NUREG/CP-XXXX), (3) reports resulting from international agreements (NUREG/IA-XXXX), (4) brochures (NUREG/BR-XXXX), and (5) compilations of legal decisions and orders of the Commission and Atomic and Safety Licensing Boards and of Directors' decisions under Section 2.206 of NRC's regulations (NUREG-0750).

DISCLAIMER: This report was prepared as an account of work sponsored by an agency of the U.S. Government. Neither the U.S. Government nor any agency thereof, nor any employee, makes any warranty, expressed or implied, or assumes any legal liability or responsibility for any third party's use, or the results of such use, of any information, apparatus, product, or process disclosed in this publication, or represents that its use by such third party would not infringe privately owned rights.

COMMENTS ON DRAFT REPORT

Any interested party may submit comments on this report for consideration by the NRC staff. Comments may be accompanied by additional relevant information or supporting data. Please specify the report number **NUREG-2230** in your comments, and send them by the end of the comment period specified in the *Federal Register* notice announcing the availability of this report.

Addresses: You may submit comments by any one of the following methods. Please include Docket ID **NRC-2019-0119** in the subject line of your comments. Comments submitted in writing or in electronic form will be posted on the NRC website and on the Federal rulemaking website <http://www.regulations.gov>.

Federal Rulemaking Website: Go to <http://www.regulations.gov> and search for documents filed under Docket ID **NRC-2019-0119**.

Mail comments to: Office of Administration, Mail Stop: TWFN-7-A60M, U.S. Nuclear Regulatory Commission, Washington, DC 20555-0001, ATTN: Program Management, Announcements and Editing Staff.

For any questions about the material in this report, please contact: David Stroup, NRC Senior Fire Protection Engineer, at (301) 415-1649 or by e-mail at: David.Stroup@nrc.gov, or Nicholas Melly, NRC Fire Protection Engineer at (301) 415-2392 or by e-mail at: Nicholas.Melly@nrc.gov.

Please be aware that any comments that you submit to the NRC will be considered a public record and entered into the Agencywide Documents Access and Management System (ADAMS). Do not provide information you would not want to be publicly available.

DRAFT
for Public Comment

Methodology for Modeling Fire Growth and Suppression Response for Electrical Cabinet Fires in Nuclear Power Plants

Draft Report for Comment

June 2019

Electric Power Research Institute (EPRI)
3420 Hillview Avenue
Palo Alto, CA 94304-1338

EPRI Project Manager
A. Lindeman

U.S. Nuclear Regulatory Commission
Office of Nuclear Regulatory Research (RES)
Washington, D.C. 20555-0001

U.S. NRC-RES Project Manager
M. H. Salley

DISCLAIMER OF WARRANTIES AND LIMITATION OF LIABILITIES

THIS DOCUMENT WAS PREPARED BY THE ORGANIZATION(S) NAMED BELOW AS AN ACCOUNT OF WORK SPONSORED OR COSPONSORED BY THE ELECTRIC POWER RESEARCH INSTITUTE, INC. (EPRI). NEITHER EPRI, ANY MEMBER OF EPRI, ANY COSPONSOR, THE ORGANIZATION(S) BELOW, NOR ANY PERSON ACTING ON BEHALF OF ANY OF THEM:

(A) MAKES ANY WARRANTY OR REPRESENTATION WHATSOEVER, EXPRESS OR IMPLIED, (I) WITH RESPECT TO THE USE OF ANY INFORMATION, APPARATUS, METHOD, PROCESS, OR SIMILAR ITEM DISCLOSED IN THIS DOCUMENT, INCLUDING MERCHANTABILITY AND FITNESS FOR A PARTICULAR PURPOSE, OR (II) THAT SUCH USE DOES NOT INFRINGE ON OR INTERFERE WITH PRIVATELY OWNED RIGHTS, INCLUDING ANY PARTY'S INTELLECTUAL PROPERTY, OR (III) THAT THIS DOCUMENT IS SUITABLE TO ANY PARTICULAR USER'S CIRCUMSTANCE; OR

(B) ASSUMES RESPONSIBILITY FOR ANY DAMAGES OR OTHER LIABILITY WHATSOEVER (INCLUDING ANY CONSEQUENTIAL DAMAGES, EVEN IF EPRI OR ANY EPRI REPRESENTATIVE HAS BEEN ADVISED OF THE POSSIBILITY OF SUCH DAMAGES) RESULTING FROM YOUR SELECTION OR USE OF THIS DOCUMENT OR ANY INFORMATION, APPARATUS, METHOD, PROCESS, OR SIMILAR ITEM DISCLOSED IN THIS DOCUMENT.

REFERENCE HEREIN TO ANY SPECIFIC COMMERCIAL PRODUCT, PROCESS, OR SERVICE BY ITS TRADE NAME, TRADEMARK, MANUFACTURER, OR OTHERWISE, DOES NOT NECESSARILY CONSTITUTE OR IMPLY ITS ENDORSEMENT, RECOMMENDATION, OR FAVORING BY EPRI.

THE FOLLOWING ORGANIZATION(S) PREPARED THIS REPORT:

Electric Power Research Institute (EPRI)

Jensen Hughes, Inc.

U.S. Nuclear Regulatory Commission, Office of Nuclear Regulatory Research

THE TECHNICAL CONTENTS OF THIS PRODUCT WERE **NOT** PREPARED IN ACCORDANCE WITH THE EPRI QUALITY PROGRAM MANUAL THAT FULFILLS THE REQUIREMENTS OF 10 CFR 50, APPENDIX B. THIS PRODUCT IS **NOT** SUBJECT TO THE REQUIREMENTS OF 10 CFR PART 21.

NOTE

For further information about EPRI, call the EPRI Customer Assistance Center at 800.313.3774 or e-mail askepri@epri.com.

Electric Power Research Institute, EPRI, and TOGETHER...SHAPING THE FUTURE OF ELECTRICITY are registered service marks of the Electric Power Research Institute, Inc.

CITATIONS

This report was prepared by the following organizations:

Electric Power Research Institute
3420 Hillview Avenue
Palo Alto, CA 94304

Principal Investigator
A. Lindeman

Jensen Hughes, Inc.
111 Rockville Pike, Suite 550
Rockville, MD 20850

Principal Investigators
M. Chi-Miranda
S. Montanez
O. Gonzalez
J. Williamson
V. Ontiveros
E. Collins
J. Floyd
F. Joglar

U.S. Nuclear Regulatory Commission
Office of Nuclear Regulatory Research
Washington, D.C. 20555-0001

Principal Investigators
N. Melly
D. Stroup
S. Cooper

This publication is a corporate document that should be cited in the literature in the following manner:

Methodology for Modeling Fire Growth and Suppression Response for Electrical Cabinet Fires in Nuclear Power Plants Draft Report for Comment. EPRI, Palo Alto, CA, and the U.S. Nuclear Regulatory Commission, Office of Nuclear Regulatory Research (RES), Washington, D.C.: 2019. 3002016051/NUREG-2230.

DRAFT
for Public Comment

1 ABSTRACT

2 Over the past decade, modern fire probabilistic risk assessments (FPRAs) have been
3 developed using NUREG/CR-6850 (EPRI 1011989), *EPRI/NRC-RES Fire PRA Methodology for*
4 *Nuclear Power Facilities*. The results show that fire can be a significant portion of the overall site
5 risk profile; however, the methodology was never fully piloted before implementation. As a
6 result, additional research and development in the methods and data has been performed over
7 the past decade to refine the estimates of risk and to close technical gaps in the methodology.
8 One aspect of the FPRA methods and data that has not been explicitly re-analyzed is the fire
9 growth profile and plant personnel suppression response for electrical cabinets. A simplified
10 model of the average time to peak, steady state, and decay is used to model the ignition
11 source's heat release rate (HRR) profile. For manual suppression credit, a dense collection of
12 electrical ignition sources spanning three decades is used to represent the fire brigade and plant
13 suppression response.

14 Recent research efforts focused on obtaining more detailed information regarding the fire
15 incidents at nuclear power plants (NPPs). This data collection has enabled researchers to
16 obtain more details on the fire attributes, timeline, and plant impact. This report specifically
17 reviewed the available electrical cabinet fire incident data in an effort to update the methodology
18 to better reflect the observed operating experience. Insights from the data review served as the
19 basis for amending portions of the fire modeling and suppression response to more accurately
20 align with operating experience.

21 The outcome of this work is a revised set of parameters that address both the fire growth and
22 the suppression response in the context of fire scenario modeling. The set of electrical cabinet fire
23 events was classified into either a growing or interruptible fire categorization. Interruptible fires are
24 those that have observed ignition but no significant growth for a period of time. Growing fires, on
25 the other hand, experience growth immediately after ignition. Furthermore, the detection-
26 suppression event tree has been updated to better allow for early plant personnel suppression
27 actions. Additional manual non-suppression bins have been added to better reflect the scenario
28 characteristics. The results of this research might be implemented in new and existing FPRAs for
29 a more realistic representation of the scenario progression and suppression end states.

31 **Keywords**

32 Fire events
33 Fire growth profile
34 Fire ignition frequency
35 Fire probabilistic risk assessment (FPRA)
36 Manual suppression
37 Non-suppression probability (NSP)

38

DRAFT
for Public Comment

EXECUTIVE SUMMARY

PRIMARY AUDIENCE: Fire probabilistic risk assessment (FPRAs) engineers and fire protection engineers supporting the development and/or maintenance of FPRAs

SECONDARY AUDIENCE: Engineers, probabilistic risk assessment (PRA) managers, and other stakeholders who review FPRAs and who interface with FPRAs methods

KEY RESEARCH QUESTION

Fire event data in the United States have been collected for many decades. These data have been used to calculate fire ignition frequencies and manual non-suppression probabilities (NSPs) in FPRAs. In 2013, the Electric Power Research Institute (EPRI) published *The Updated Fire Events Database: Description of Content and Fire Event Classification Guidance* (EPRI 1025284). The updated fire events database captured recent fire operating experience through 2009, expanded and improved data fields, and provided more detailed incident data and better data source reference traceability. After the publication of the 2013 study, EPRI and the NRC jointly published updated fire ignition frequencies and manual NSPs, but no additional research was conducted to better use the fire event data to inform FPRAs methods. This report aims to narrow the gap through the review and analysis of the fire event operating experience and revision to the FPRAs methods and data to better reflect the operating experience observed.

RESEARCH OVERVIEW

The electrical cabinet (NUREG/CR-6850 (EPRI 1011989), *EPRI/NRC-RES Fire PRA Methodology for Nuclear Power Facilities*, Bin 15) fire event data from 2000–2014 were reviewed for insights. These include the operating experience cataloged in the study, *The Updated Fire Events Database: Description of Content and Fire Event Classification Guidance* (EPRI 1025284), from 2000–2009, and the study, *Fire Events Database Update for the Period 2010–2014: Revision 1* (EPRI 3002005302) to capture the most recent operating experience. The review of fire event data specifically looked at four fire attributes, including detection, fire duration, fire size, and suppression effort. These attributes were used to categorize each fire event as either *interruptible* or *growing*. After this categorization, the fire heat release rate (HRR) timing profiles were re-examined using the available experimental data.

After the data review, the structure of the detection-suppression event tree was updated to better reflect insights gained during the event review, for example, (1) numerous reports of operators responding to equipment alarms in the main control room (MCR) and discovering a fire, and (2) numerous events describing plant personnel discovering a fire in the early stages followed by suppression with minimal effort. The fire ignition frequency for Bin 15 (electrical cabinets) is now characterized with a split fraction for interruptible and growing fires, and NSP values for interruptible fires, growing fires, and the MCR are calculated.

KEY FINDINGS

- Of the 47 events reviewed, 34 (72.3%) fire events are classified as interruptible, and 13 (27.7%) fire events are classified as growing fires (see Section 3.4).
- The fire ignition frequency for Bin 15 (electrical cabinets) for the time period 2000–2014 is 3.43E-02 (see Section 3.6).
- The typical HRR profile for *interruptible* fires is a pre-growth period with a negligible HRR for up to 8 minutes, 12-minute time to peak, 8 minutes at steady state, and a 19-minute decay period (see Section 4.1.1).
- The HRR profile for *growing* fires is a 12-minute time to peak, 8 minutes at steady state, and a 19-minute decay period (see Section 4.1.2).
- Three new suppression curves are developed to better represent the manual suppression response to electrical cabinet fires. The mean suppression rates are interruptible (0.139) and growth (0.099). The existing MCR suppression curve was also updated to 0.385.
- The structure of the detection-suppression event trees is revised to better reflect the suppression outcomes observed in operating experience. These include new branches for early plant personnel suppression and response to main control board alarms.

WHY THIS MATTERS

Fire risk can be an important contributor to the overall site risk profile at nuclear power plants. A review of nearly 30 U.S. FPRAs yielded that electrical cabinets dominate the FPRA results. This research provides a more detailed and refined methodology to more realistically analyze electrical cabinet fire risk.

HOW TO APPLY RESULTS

The results of this research are intended to be applied to FPRAs to obtain a more realistic estimate of plant risk. The methodology and data presented in this report are intended to be incorporated into new FPRAs but also specifically designed to fit within the framework of existing FPRA analyses. Section 3 summarizes the data updates to ignition frequency, interruptible/growing split fraction, and NSP estimates. Section 4 and Section 5 present the structural changes and data for the detection-suppression event tree. Section 7 summarizes the findings, including revised ignition frequencies, interruptible/growing split fraction, HRR timing profiles, and updates to the detection-suppression event tree structure and data.

LEARNING AND ENGAGEMENT OPPORTUNITIES

Users of this report might be interested in Fire Analysis, Module III, of FPRA training, which is sponsored jointly between EPRI and the U.S. NRC-RES. The Fire Analysis module is geared toward PRA practitioners responsible for treating those aspects related to fire growth and damage assessment. The Fire Analysis module discusses the basics of plant partitioning, fire frequency analysis, and the development and analysis of fire scenarios from fire ignition to target impact and fire suppression.

EPRI CONTACT: Ashley Lindeman, Senior Technical Leader, 704-595-2538, alindeman@epri.com

NRC CONTACT: Nick Melly, Fire Protection Engineer, 301-415-2392, nicholas.melly@nrc.gov

PROGRAM: Risk and Safety Management, Program 41.07.01

IMPLEMENTATION CATEGORY: Plant Optimization

CONTENTS

| | | |
|----|---------------------------------------------------------------------------------|-------------|
| 2 | ABSTRACT | v |
| 3 | EXECUTIVE SUMMARY | vii |
| 4 | ACRONYMS | xvii |
| 5 | 1 INTRODUCTION | 1-1 |
| 6 | 1.1 Purpose | 1-1 |
| 7 | 1.2 Scope | 1-2 |
| 8 | 2 BACKGROUND | 2-1 |
| 9 | 3 METHODOLOGY FOR INTERRUPTIBLE FIRE DETERMINATION | 3-1 |
| 10 | 3.1 Introduction | 3-1 |
| 11 | 3.2 Assumptions | 3-2 |
| 12 | 3.3 Interruptible Fire Criteria | 3-2 |
| 13 | 3.3.1 Interruptible Fire Conditions | 3-2 |
| 14 | 3.3.1.1 Notification | 3-3 |
| 15 | 3.3.1.2 Passage of Time | 3-5 |
| 16 | 3.3.1.3 Small Fire | 3-6 |
| 17 | 3.3.1.4 Minimal Suppression Effort | 3-6 |
| 18 | 3.3.1.5 Special Case—Arc Flash | 3-7 |
| 19 | 3.3.2 Summary of Interruptible Fire Conditions | 3-8 |
| 20 | 3.4 Interruptible Fire Split Fraction | 3-9 |
| 21 | 3.5 Interruptible, Growing, Main Control Room, and Electrical Fires Suppression | |
| 22 | Rate | 3-9 |
| 23 | 3.5.1 Interruptible and Growing Fire Suppression Rate | 3-9 |
| 24 | 3.5.2 NSP Floor for the MCR | 3-12 |
| 25 | 3.5.3 NSP Numerical Results | 3-16 |
| 26 | 3.6 Updated Bin 15 Fire Ignition Frequency | 3-16 |

| | | |
|----|------------------------------------------------------------------------------|------------|
| 1 | 4 INTERRUPTIBLE AND GROWING FIRE HRR PROFILES | 4-1 |
| 2 | 4.1 Bin 15 Fire HRR Profiles | 4-1 |
| 3 | 4.1.1 Interruptible Fire HRR Profile | 4-1 |
| 4 | 4.1.2 Growing Fire HRR Profile | 4-5 |
| 5 | 4.2 Fire Modeling of Interruptible and Growing Fires | 4-7 |
| 6 | 5 REVISED DETECTION–SUPPRESSION EVENT TREE FOR CREDITING | |
| 7 | PERSONNEL SUPPRESSION | 5-1 |
| 8 | 5.1 Detection–Suppression Event Tree Introduction..... | 5-1 |
| 9 | 5.2 Detection–Suppression Event Tree | 5-1 |
| 10 | 5.3 New Parameters for Estimating the NSP | 5-4 |
| 11 | 5.3.1 Interruptible Fire Split Fraction | 5-4 |
| 12 | 5.3.2 Fire HRR Profiles | 5-5 |
| 13 | 5.3.3 Probability of Detection of Electrical Cabinet Fires..... | 5-5 |
| 14 | 5.3.3.1 Probability of Automatic Smoke Detection of Electrical Cabinet | |
| 15 | Fires..... | 5-5 |
| 16 | 5.3.3.2 MCR Indication | 5-7 |
| 17 | 5.3.3.3 MCR Operator Response | 5-8 |
| 18 | 5.3.3.4 Detection by Plant Personnel | 5-17 |
| 19 | 5.3.3.5 Probability of Presence of Personnel..... | 5-18 |
| 20 | 5.3.4 Time of Detection for Electrical Cabinets | 5-26 |
| 21 | 5.3.4.1 Interruptible Fire Time of Detection | 5-26 |
| 22 | 5.3.4.2 Growing Fire Time of Detection | 5-27 |
| 23 | 5.3.5 Probability of Failure—Detection..... | 5-27 |
| 24 | 6 EXAMPLES | 6-1 |
| 25 | 6.1 Example 1, NUREG/CR-6850..... | 6-1 |
| 26 | 6.2 Example 2, Revised NUREG/CR-6850, Personnel Detection Sensitivities..... | 6-8 |
| 27 | 6.3 Example 3, Revised NUREG/CR-6850, Enclosure Class/Function Group | |
| 28 | Sensitivities | 6-10 |
| 29 | 6.4 Example 4, Revised NUREG/CR-6850 (MCR Indication) | 6-11 |
| 30 | 6.5 Example 5, Revised NUREG/CR-6850 (Automatic Suppression)..... | 6-11 |
| 31 | 6.6 Example 6, 1-Minute Time to Damage..... | 6-11 |
| 32 | 7 SUMMARY | 7-1 |
| 33 | 7.1 Bin 15 Fire Ignition Frequency | 7-1 |
| 34 | 7.2 Interruptible/Growing Fire Split Fraction..... | 7-1 |

1 7.3 Interruptible/Growing Fire HRR Profiles7-1

2 7.4 New P_{ns} Event Tree Parameters7-1

3 7.5 NSP Estimation Update7-3

4 **8 REFERENCES.....8-1**

5 **A INSIGHTS FROM THE EPRI FIRE EVENTS DATABASE..... A-1**

6 **B INTERRUPTIBLE AND GROWING FIRE MONTE CARLO SAMPLING..... B-1**

7 **C PROBABILITY OF DETECTION TABLES..... C-1**

8 **D SENSITIVITY AND UNCERTAINTY..... D-1**

9

10

DRAFT
for Public Comment

DRAFT
for Public Comment

1 **LIST OF FIGURES**

| | | | |
|----|-------------|---------------------------------------------------------------------------------------------------------------------------|------|
| 2 | Figure 2-1 | Fire severity..... | 2-3 |
| 3 | Figure 2-2 | Fire detection..... | 2-3 |
| 4 | Figure 2-3 | Fire suppression response | 2-5 |
| 5 | Figure 2-4 | Means of fire suppression | 2-6 |
| 6 | Figure 2-5 | Fire damage | 2-7 |
| 7 | Figure 3-1 | Conceptual interruptible fire timeline, not to scale..... | 3-3 |
| 8 | Figure 3-2 | Detection method of reported Bin 15 fire events | 3-4 |
| 9 | Figure 3-3 | Non-suppression curve plot showing probability versus time to suppression | 3-11 |
| 10 | | | |
| 11 | Figure 3-4 | Non-suppression curve plot showing log(probability) versus time to suppression for MCR scenarios | 3-15 |
| 12 | | | |
| 13 | Figure 4-1 | HELEN-FIRE experimental tests with pre-growth period [11] | 4-2 |
| 14 | Figure 4-2 | HELEN-FIRE experimental tests without a pre-growth period of (A) no growth and (B) no pre-growth..... | 4-2 |
| 15 | | | |
| 16 | Figure 4-3 | Interruptible HRR Profile | 4-3 |
| 17 | Figure 4-4 | HRR profile for a growing fire | 4-5 |
| 18 | Figure 5-1 | Interruptible and growing fire detection and suppression event tree | 5-2 |
| 19 | Figure 5-2 | Pca: availability of information..... | 5-11 |
| 20 | Figure 5-3 | Pcb: failure of attention..... | 5-12 |
| 21 | Figure 5-4 | Pcc: misread/miscommunicate data..... | 5-13 |
| 22 | Figure 5-5 | Pcd: information misleading | 5-13 |
| 23 | Figure 5-6 | Pce: skip a step in procedure | 5-14 |
| 24 | Figure 5-7 | Pcf: misinterpret instructions | 5-14 |
| 25 | Figure 5-8 | Pcg: misinterpret decision logic..... | 5-15 |
| 26 | Figure 5-9 | Pch: deliberate violation | 5-15 |
| 27 | Figure 5-10 | Annunciator Response Model of the HRA calculator | 5-17 |
| 28 | Figure 5-11 | Probability of personnel present for detection, with and without crediting adjacent spaces | 5-22 |
| 29 | | | |
| 30 | Figure 5-12 | Probability of a detection fault tree for an interruptible fire with MCR indication and automatic smoke detection..... | 5-28 |
| 31 | | | |
| 32 | Figure 6-1 | Solution for the NUREG/CR-6850 detection-suppression event tree..... | 6-2 |
| 33 | Figure 6-2 | First detection for the interruptible path, NUREG/CR-6850 Appendix P example..... | 6-3 |
| 34 | | | |

| | | | |
|----|------------|---------------------------------------------------------------------|-----|
| 1 | Figure 6-3 | Second detection for the growing path, NUREG/CR-6850 Appendix P | |
| 2 | | example | 6-4 |
| 3 | Figure 6-4 | Solution for the detection-suppression event tree for NUREG/CR-6850 | |
| 4 | | Example 1: interruptible fire path | 6-6 |
| 5 | Figure 6-5 | Solution for the detection-suppression event tree for NUREG/CR-6850 | |
| 6 | | Example 1: growing path | 6-7 |
| 7 | Figure 6-6 | Solution for the detection-suppression event tree for NUREG/CR-6850 | |
| 8 | | Example 1: total P_{ns} | 6-8 |
| 9 | | | |
| 10 | | | |

DRAFT
for Public Comment

LIST OF TABLES

| | | | |
|----|-----------|----------------------------------------------------------------------------------------------------------------------------------|------|
| 2 | Table 3-1 | Conditions for an interruptible fire event determination..... | 3-8 |
| 3 | Table 3-2 | Interruptible and growing split fractions..... | 3-9 |
| 4 | Table 3-3 | Electrical ignition source probability distribution for rate of fires suppressed per unit time (1990–2014 [†])..... | 3-10 |
| 6 | Table 3-4 | ANOVA of electrical fire suppression data with and without events during the 1980–1989 period..... | 3-12 |
| 8 | Table 3-5 | Probability of non-suppression floor sensitivity analysis..... | 3-14 |
| 9 | Table 3-6 | Updated numerical results for electrical cabinet suppression curves..... | 3-16 |
| 10 | Table 3-7 | FPRA counts per time period..... | 3-17 |
| 11 | Table 3-8 | Reactor years for fire ignition frequency update..... | 3-17 |
| 12 | Table 3-9 | Fire ignition frequency distribution for Bin 15..... | 3-17 |
| 13 | Table 4-1 | HRR timing for interruptible electrical cabinet fires..... | 4-4 |
| 14 | Table 4-2 | HRR timing for growing electrical cabinet fires..... | 4-6 |
| 15 | Table 5-1 | Revised P _{ns} event tree sequences..... | 5-2 |
| 16 | Table 5-2 | Automatic smoke detection probability of no detection..... | 5-6 |
| 17 | Table 5-3 | Sensor and transmitter unreliability data..... | 5-7 |
| 18 | Table 5-4 | MCR operator response as calculated using CBDTM..... | 5-16 |
| 19 | Table 5-5 | Description of personnel presence influencing factors..... | 5-20 |
| 20 | Table 5-6 | Plant personnel presence probabilities..... | 5-24 |
| 21 | Table 5-7 | Plant personnel presence probabilities considering adjacent compartments..... | 5-25 |
| 22 | Table 6-1 | Example 2: occupancy and maintenance rating sensitivities..... | 6-8 |
| 23 | Table 6-2 | Example 2: enclosure class/function group sensitivities..... | 6-10 |
| 24 | Table 7-1 | Fire ignition frequency distribution for Bin 15..... | 7-1 |
| 25 | Table 7-2 | Summary of non-suppression event tree parameters..... | 7-2 |
| 26 | Table 7-3 | Probability distribution for rate of fires suppressed per unit time, λ..... | 7-4 |

27
28

DRAFT
for Public Comment

1 **ACRONYMS**

| | | |
|----|------------------|-------------------------------------------------------------|
| 2 | ANOVA | analysis of variance |
| 3 | AP | at-power |
| 4 | ARP | Alarm Response Procedure |
| 5 | CBD | Chesapeake Bay Detachment |
| 6 | CBDTM | cause-based decision tree method |
| 7 | CH | challenging |
| 8 | CO ₂ | carbon dioxide |
| 9 | CR | control room |
| 10 | ERP | Emergency Response Procedures |
| 11 | EPRI | Electric Power Research Institute |
| 12 | FACP | fire alarm control panel |
| 13 | FDS | Fire Dynamics Simulator |
| 14 | FDT ^s | Fire Dynamics Tools |
| 15 | FEDB | Fire Events Database |
| 16 | FPRA | fire probabilistic risk assessment |
| 17 | HCR/ORE | human cognitive reliability/operator reliability experiment |
| 18 | HEAF | high energy arcing fault |
| 19 | HEP | human error probability |
| 20 | HFE | human failure event |
| 21 | HRA | human reliability analysis |
| 22 | HRR | heat release rate |
| 23 | ICES | INPO Consolidated Event System |
| 24 | INPO | Institute of Nuclear Power Operations |
| 25 | LPSD | low power-shutdown |
| 26 | MCR | main control room |
| 27 | MCC | motor control center |
| 28 | NIST | National Institute of Standards and Technology |

| | | |
|----|--------|------------------------------------------------------------------|
| 1 | NPP | nuclear power plant |
| 2 | NRC | Nuclear Regulatory Commission |
| 3 | NSP | non-suppression probability |
| 4 | OD | optical density |
| 5 | OPEX | operating experience |
| 6 | PRA | probabilistic risk assessment |
| 7 | PSF | performance shaping factor |
| 8 | QTP | qualified thermoplastic |
| 9 | SFPE | Society of Fire Protection Engineers |
| 10 | SIS | Synthetic Insulated Switchboard Wire or XLPE-Insulated Conductor |
| 11 | SPAR-H | standardized plant analysis risk human reliability analysis |
| 12 | SNL | Sandia National Laboratories |
| 13 | THERP | technique for human error rate predication |
| 14 | T/G | turbine-generator |
| 15 | T/M | testing and maintenance |
| 16 | TP | thermoplastic |
| 17 | TS | thermoset |
| 18 | VEWFDS | very early warning fire detection system |
| 19 | VTT | Valtion Teknillinen Tutkimuskeskus |
| 20 | | |
| 21 | | |

for Public Comment

1

INTRODUCTION

Over the last decade, there has been significant experience applying the fire probabilistic risk assessment (FPRA) methodology published in NUREG/CR-6850 (EPRI 1011989), *EPRI/NRC-RES Fire PRA Methodology for Nuclear Power Facilities* [1]. Through this experience, certain aspects of the methodology were identified as candidates for additional research and development. One aspect of the FPRA methodology that has not undergone revision is the fire scenario progression and interaction between the fire ignition, growth, and suppression models.

NUREG/CR-6850 provided a simplified framework for calculating fire ignition frequency, the fire hazard, and the suppression effectiveness. This model captures actual U.S. nuclear power plant (NPP) experience to develop the fire ignition frequencies and manual non-suppression rates. The fire hazard, on the other hand, is derived from experimental fire tests to predict a distribution of heat release rates (HRRs). In addition to the HRR, fire testing informs the timing of the fire, specifically the rate at which the fire grows to its peak HRR, steady-state burning, and decay phases. When applied, the combination of operating experience (OPEX) and experimental testing has resulted in a high percentage of electrical cabinet fire scenarios damaging external targets. This does not align with the insights in the Electric Power Research Institute (EPRI) Fire Events Database (FEDB), which suggest that most fires are contained and limited to the ignition source [2].

Around 2010, the EPRI FEDB underwent an extensive upgrade to improve the data quality (including timing, event descriptions, and so on) and source document traceability, and added more recent U.S. NPP OPEX. This update marked a significant improvement over previous versions that provided minimal details. This version of the FEDB allowed for the revision of ignition frequencies and non-suppression probabilities (NSPs) through 2009 [3]. Although NUREG-2169 (EPRI 3002002936), *Nuclear Power Plant Fire Ignition Frequency and Non-Suppression Probability Estimation Using the Updated Fire Events Database: United States Fire Event Experience Through 2009* updated the data [3], it was recognized that further research would be needed to more realistically model the fire progressions observed in actual experience.

This report provides an updated framework for treatment of the fire scenario progression starting from ignition through suppression. The detection-suppression event tree described in Appendix P of NUREG/CR-6850 (EPRI 1011989) is revised to include additional fire sequences commonly observed in NPP fire events.

1.1 Purpose

The purpose of this report is to provide an approach that more closely models the types of fire progressions and response activities (for example, detection and suppression) observed in OPEX. Specifically, the methodology described in this report provides the following:

- An updated Bin 15 fire frequency that makes use of the most recent fire event data classified in the study, *Fire Events Database Update for the Period 2010–2014: Revision 1* (EPRI 3002005302) [4]

- 1 • Split fractions for *interruptible* and *growing* fires for use in the revised detection-
2 suppression event tree
- 3 • A conceptual fire event tree progression model developed through an event review of
4 insights from the FEDB (Subsequent to the review, a procedure and rule set were
5 developed to allow for consistent classification of fire events into two different growth
6 profiles, *interruptible* and *growing*.)
- 7 • A revised electrical cabinet HRR profile developed for use in the detailed fire modeling of
8 interruptible fires (This revised profile includes a pre-growth period of up to 8 minutes of
9 negligible HRR. The treatment for the HRR profile for growing fires was not updated in
10 this research.)
- 11 • Revisions to the detection-suppression event tree to include paths for crediting early
12 intervention by plant personnel, as well as developing new parameters to facilitate these
13 revisions (These new parameters include an opportunity to credit detection by general
14 plant personnel.)
- 15 • An opportunity for main control room (MCR) indications as a means for fire detection
16 when applicable in the detection-suppression event tree
- 17 • The fires observed in electrical cabinets do not always produce conditions significant
18 enough to actuate fixed detection systems, therefore introducing the probability of
19 automatic smoke detection effectiveness parameter to characterize the ability of spot
20 type smoke detection devices to operate in a range of geometric conditions and HRRs
- 21 • New suppression curves for electrical cabinets (Bin 15) applicable to *interruptible* and
22 *growing* electrical cabinet fire scenarios
- 23 • New suppression curve for MCR fires
- 24 • A new electrical fires suppression curve also generated for use with other non-cabinet
25 electrical ignition sources (for example, motors, pumps, transformers)

26 1.2 Scope

27 The scope of the methodology described in this report is limited to electrical cabinet sources
28 (Bin 15, electrical cabinets). It is noted, however, that due to the legacy treatment of manual
29 suppression curves, the research described in this report also produced new manual
30 suppression curves for the MCR and electrical equipment other than electrical cabinets (that is,
31 motors and dry transformers).

32

2

BACKGROUND

The fire ignition frequencies and manual non-suppression rates used in fire probabilistic risk assessments (FPRAs) are developed using evidence from actual U.S. nuclear power plant (NPP) experience. This experience is consolidated in the Electric Power Research Institute (EPRI) Fire Events Database (FEDB) [2]. During the development period of NUREG/CR-6850, the challenges of inconsistent recordkeeping and reporting practices associated with gathering fire event evidence were known and documented. Inconsistencies related to the quality of the data in terms of content, the amount and accuracy of the information in the records provided by the data sources and fires that were potentially unreported and therefore not included in the database, resulted in acknowledgement of incomplete or possibly inaccurate data to develop the fire ignition frequency and the manual non-suppression rates.

The concept of the potentially challenging fire, a fire that either did or had the potential to challenge plant nuclear safety, was also introduced in NUREG/CR-6850. The combination of limitations in event descriptions and limited data to develop the fire hazard associated with ignition resulted in relatively higher frequency of fire scenarios damaging targets external to the ignition source.

Since the publication of NUREG/CR-6850, the fire ignition frequencies, the fire hazard, and the manual suppression data were reviewed and updated in an attempt to bring the modeling of the risks associated with fires in NPPs into better agreement with actual NPP experience. In 2010, an extensive update of the FEDB was performed, which significantly improved the quality (event timing, descriptions, source document traceability, and so on) of the events recorded. A review of fixed ignition sources in the FEDB concluded that, "The majority of fires were confined to the ignition source at the time they were extinguished" [2]. The updated FEDB was used to revise the fire ignition frequency and the manual suppression effectiveness estimations as documented in NUREG-2169. Similarly, in 2015, NUREG/CR-7197 documented an experimental study of 112 full-scale electrical cabinet fires. A review of these fires resulted in updated heat release rate (HRR) profile distributions and peak values as documented in NUREG-2178 (EPRI 3002005578), *Refining and Characterizing Heat Release Rates from Electrical Enclosures During Fire (RACHELLE-FIRE), Volume 1: Peak Heat Release Rates and Effect of Obstructed Plume* [5].

Despite these revisions, it was recognized that further research was necessary to achieve more realistic modeling of fire risk from electrical cabinets at NPPs. Since the publication of NUREG/CR-6850, FPRA results have been compared against OPEX. This comparison suggested a number of differences in terms of fire severity, fire detection, and fire suppression.

The insights presented in this section are extracted from a review of the fire event data from the 15-year period from 2000 to 2014. This includes the latest time period of data in NUREG-2169 (2000–2009), supplemented by additional data reviewed and coded by both EPRI and the U.S. Nuclear Regulatory Commission (NRC) in the study *Fire Events Database Update for the Period 2010–2014: Revision 1* (EPRI 3002005302). During this 2000–2014-time period, 47 electrical fire cabinet events were classified as potentially challenging or greater in the EPRI FEDB.

1 **Fire Severity**

- 2 • Only 1 of 47 events was classified as undetermined fire severity (half-count event). This
3 is a marked improvement from both NUREG/CR-6850 (which has 24 undetermined
4 events in the 1990–2000 period) and NUREG-2169 (which had 21 undetermined events
5 in the 1990s and 3 in the 2000s). The definitive severity classification is the result of a
6 higher pedigree of data along with better source reference traceability. Additionally, as
7 part of this project, additional event details were requested as needed to clarify event
8 details. In two fire events, this helped classify the fire severity.
- 9 • Seven of the 47 events were of a challenging fire classification. The challenging
10 classification is used to denote fires “that had an observable and substantive effect on
11 the environment outside the initiating source, regardless of where in the plant the fire
12 occurred, what was potentially under threat, or what was actually been damaged by the
13 fire” [2]. The challenging classification is intended to capture fires that damage adjacent
14 objects (cables, components, or secondary combustibles) and capture significant
15 suppression actions (such as use of hose stream or automatic/manual activation of fixed
16 suppression). Three of the challenging fires actuated fixed automatic fire suppression
17 systems (events 588, 50912, and 51304). The four other events were classified as
18 challenging due to heavy smoke, delays in suppression, and extensive damage within
19 the cabinet. In all four events, damage was limited to the ignition source. For event 175,
20 grounding devices were left in three balance-of-plant incoming breaker cubicles. When
21 the main transformer was energized, the grounding devices provided a direct short to
22 ground, which induced fires in three cubicles. The damage was limited to the breaker
23 cubicles with grounding devices.
- 24 • The remaining 39 events were classified as potentially challenging. The potentially
25 challenging classification is used to denote fire events “that were not judged to be CH
26 (challenging) events, but that could, under foreseeable alternate circumstances, have
27 reached a CH state” [2].

28 The fire severity classifications are summarized in Figure 2-1. The predominant insight is that
29 most fire events are potentially challenging, indicating the presence of small fires and
30 intervention prior to the fire reaching a challenging state. Additionally, there are several
31 instances where manual fire suppression occurred around the 15-minute mark or later and the
32 fire was described as small and limited to the ignition source. This suggests that not all fires
33 grow and develop as postulated in Table G-2 of NUREG/CR-6850.

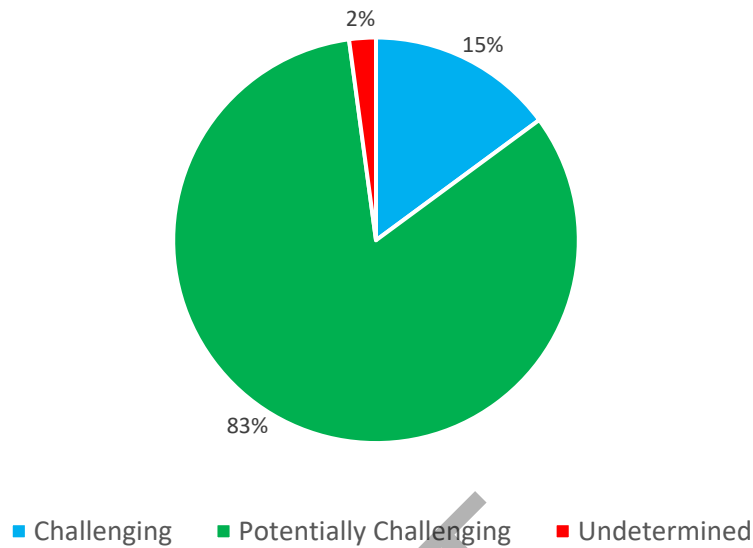

1
2 **Figure 2-1**
3 **Fire severity**
4 **Fire Detection**

5 The event review looked at the different ways the fires of interest were detected (Figure 2-2).
6 There are several instances where multiple forms of fire detection alarmed in close proximity,
7 but for simplicity the first indication is noted in this summary.
8

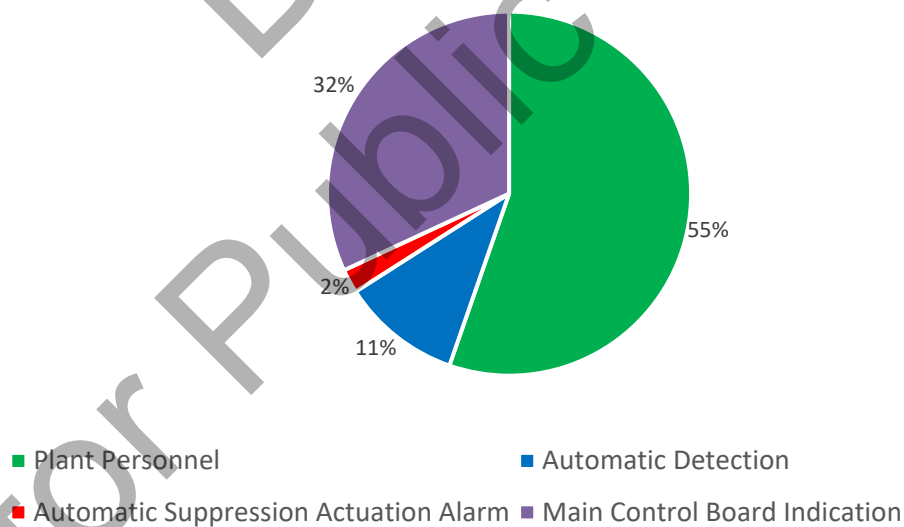

9
10 **Figure 2-2**
11 **Fire detection**
12

Background

1 The suppression model in NUREG/CR-6850 Appendix P is entered as soon as automatic
2 detection occurs. Therefore, to credit the manual response and any automatic suppression
3 systems, a calculation is performed for detector actuation. When detected, the fire suppression
4 system or plant personnel can respond (for example, the manual suppression curve is
5 applicable). For rooms without automatic detection, manual detection is presumed to occur
6 within 15 minutes. Using the fire growth profiles in NUREG/CR-6850, this detection would occur
7 during the peak heat release rate (HRR). In limited instances, prompt detection may be credited.
8 Prompt detection is implicitly credited in the main control room (MCR) (which is continuously
9 occupied) and for hot work (where a fire watch is procedurally required). In these cases, there is
10 no additional time for detection.

11 Automatic detection was observed as only the first indication in 13% of events (either automatic
12 suppression actuation alarm [2%] or fixed automatic detection [11%]). This suggests that some
13 of the fire events are detected in the early stages of the fire development and/or may smolder
14 for some period of time prior to having any potential of catching other nearby combustibles on
15 fire. There is also a chance that the fire may self-extinguish or fail to spread to nearby
16 secondary combustibles, thereby limiting fire growth.

17 The most common method of detection is plant personnel at 55%. The second most common
18 method of detection is an alarm or indication in the main control board (that is, a signal that
19 initiates the process of discovering the presence of fire and/or suppression activities when
20 appropriate). In this instance, an operator may send plant personnel to investigate an abnormal
21 condition.

22 Given the insights described previously, the detection-suppression event tree was modified to
23 account for detection by either plant personnel, main control board indication, or automatic
24 detection. The concept of a pre-growth time was also investigated.

Fire Suppression

26 The fire event review also focused on characterizing the suppression response. As outlined in
27 Figure 2-3, plant personnel play a strong role in the suppression of electrical cabinet fire events.
28 Approximately 33% of these fires are suppressed by the full fire brigade, whereas 57% are
29 suppressed by personnel discovering the fire, staff conducting testing and maintenance (T/M)
30 on equipment, or other general plant personnel. (Note: If the first responding personnel are
31 members of the fire brigade, they are still counted as plant personnel and not as the full fire
32 brigade in Figure 2-3.) This is not captured in the guidance described in Appendix P of
33 NUREG/CR-6850, which only credits plant personnel for prompt suppression in hot work and
34 MCR fire scenarios. The event review determined that 3% of the electrical cabinet fires were
35 suppressed by automatic systems.

36

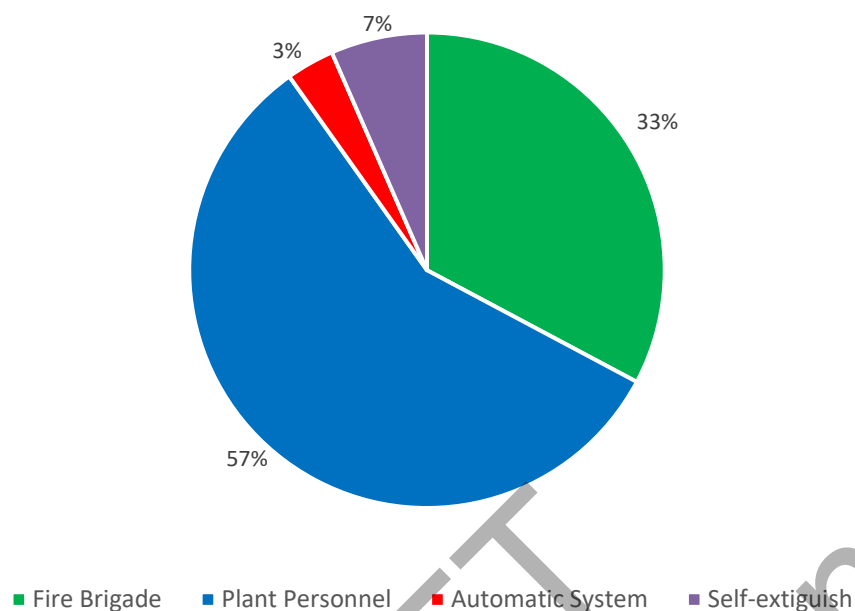

1

2 Figure 2-3**3 Fire suppression response**

4 As discussed in Section 3.3.1.4, a criterion important to the review of fire growth profiles was
5 analyzing the suppression response, specifically characterizing whether the suppression
6 response was simple. Examples of simple responses include de-energizing or removing power
7 (30%) to the ignition source and the use of a single portable extinguisher (30%) or a
8 combination of the two (11%). Figure 2-4 shows that 71% of the fire events were suppressed
9 using simple suppression actions.

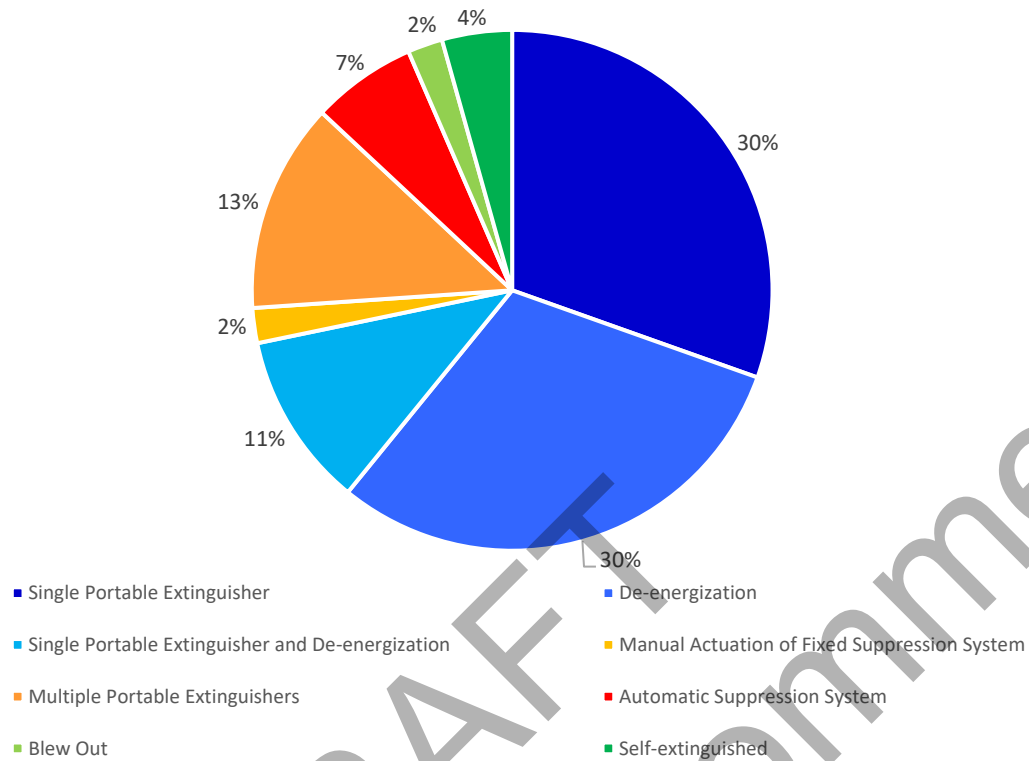

1
2 **Figure 2-4**
3 **Means of fire suppression**
4 **Fire Attributes**

5 There is limited information in the EPRI FEDB associated with fire size (HRR) and rate of fire
6 growth. The variability in fire event reporting can range from no description, simple descriptions
7 of fire size (for example, small or limited to ignition source), reports of flame size in inches, to
8 pictures of the damage. A review of the fire events in the EPRI FEDB associated with electrical
9 cabinets shows that a significant fraction, 85%, was limited to the ignition source; no fire
10 damage was found to have occurred to anything other than the ignition source (Figure 2-5). In
11 this context, the ignition source was defined as the electrical cabinet of origin. Additionally, there
12 was no evidence that electrical cabinets were found to cause ignition of secondary targets,
13 including adjacent cabinets or cable trays.

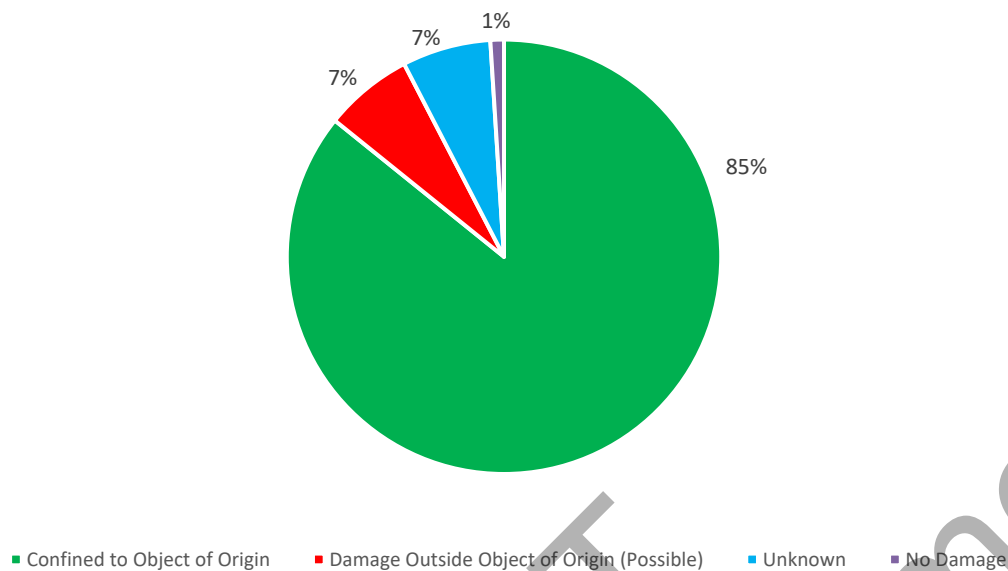

1
2
3
4
5
6
7
8
9
10

**Figure 2-5
Fire damage**

The fire events reviewed suggest a rate of fire growth and intensity that allows for detection, suppression, and control that limits damage to the ignition source in the majority of the events. Therefore, there is an additional time period that allows plant personnel to respond prior to external target damage.

The guidance outlined in this report provides an approach that more closely models these types of fire progressions observed in OPEX.

DRAFT
for Public Comment

3

METHODOLOGY FOR INTERRUPTIBLE FIRE DETERMINATION

3.1 Introduction

Experience with fire events at nuclear power plants (NPPs), as captured in the Fire Events Database (FEDB), indicates that a majority of electrical cabinet fires are extinguished by plant personnel, with minimal suppression efforts, prior to developing into a challenging state. Eighty-three percent (83%) of fires that ignite within electrical cabinets are classified as potentially challenging, 15% are classified as challenging, and the remaining 2% are undetermined. These are fires that do not reach a challenging state. In other words, the fire was not fully involved, did not impact surrounding equipment, or did not damage cable trays or conduit nearby. Following the approach described in NUREG/CR-6850 [1], all fires, regardless of fire severity classification (potentially challenging, challenging, and undetermined), are modeled with an assumed growth time of 12 minutes. The insights from a review of the FEDB data suggest that a significant fraction of fires grow in a manner that allows for plant personnel to respond. To capture this experience, events will be classified into two growth profile groups: (1) *Interruptible Fire*: events in which plant personnel could detect and perform early suppression activities; these are fires that progress at a rate so that plant personnel may discover and suppress prior to experiencing external target damage; and (2) *Growing Fire*: events in which the fire may grow in a manner of which plant personnel may not be able to provide suppression in the early stages of the fire development.

Each classification, *Interruptible Fire* and *Growing Fire*, will be assigned a unique fire growth profile for use in conjunction with the heat release rates (HRRs) found in NUREG/CR-6850 (EPRI 1011989), *EPRI/NRC-RES Fire PRA Methodology for Nuclear Power Facilities* or NUREG-2178 (EPRI 3002005578), *Refining and Characterizing Heat Release Rates from Electrical Enclosures During Fire (RACHELLE-FIRE), Volume 1: Peak Heat Release Rates and Effect of Obstructed Plume*. In addition, each classification will be assigned a unique non-suppression rate corresponding to the operating experience (OPEX) for each respective classification. The fractions of fires characterized as interruptible fire and growing fire serve as inputs to the detection-suppression event tree.

3.2 Assumptions

The following assumptions apply to the event review and determination of interruptible versus growing fires.

- The documentation provided by the NPP utility, describing each fire event in the FEDB, is an accurate representation of the fire event and contained sufficient information to support the event review and fire data classification. The pedigree of the source data contained in the current FEDB has significantly improved in recent years. This improvement has allowed for advancements in methodologies that agree with OPEX.
- A fire found by an operator while on a roving fire watch, routine walkdown, and so on, has ignited prior to the discovery of the fire (that is, some time has passed prior to the discovery of the fire and it has had enough time to grow). Similarly, it is assumed that a fire discovered by an operator or other plant personnel, working in the same fire compartment in which the ignition source is located, had an opportunity to grow in the time it takes for the operator to discern the location of the fire/ignition source.
- A fire may be controlled even if it has not been fully extinguished by the initial suppression attempt (manual), unless otherwise stated in the fire event described in the FEDB.
- When in place, event reviews assumed that detection and suppression systems were installed and maintained following code requirements and evaluated to be adequate for the fire hazard and assumed to have the capability to perform effectively.
- Equipment trouble alarms in the main control room (MCR) due to fire will occur in the early stages of the fire development.

3.3 Interruptible Fire Criteria

An interruptible fire is a fire that grew at a rate that is slow enough to allow for plant personnel to be notified of the event, locate the source, and suppress the fire with minimal effort. Such fires are limited to the ignition source and typically suppressed using portable fire extinguishers or by de-energizing the ignition source. To determine whether an event is an interruptible fire, there are two criteria that need to be met. These criteria are (1) the event describes or provides evidence that some time has passed (from the beginning of the fire to detection and start of suppression actions against the fire) and the fire has not grown beyond the criteria for a small fire (see Section 3.3.1.3), and (2) the event indicates that minimal suppression effort was required to extinguish the fire.

The intent of the first criteria is to ensure the fire had the opportunity to grow (time has passed) but has not grown to a point that prevents responding personnel from attempting a suppression response prior to damage of other targets or damage outside of the ignition source.

The intent of the second criteria is to ensure the fire event could be suppressed by plant personnel with minimal effort. Only events describing fires that were suppressed with minimal effort are counted as interruptible. A full explanation of the interruptible fire conditions available in the OPEX supporting these criteria is provided in Section 3.3.1.

3.3.1 Interruptible Fire Conditions

In review of the events classified as electrical cabinets (that is, Bin 15 fire events), a number of conditions have been consistently observed for fires that did not show appreciable fire growth and may be used to determine whether the criteria for interruptible fire have been met. These

1 conditions can be generally classified based on the detection and personnel response to a cue
 2 and the fire size and burning characteristics. Specifically evaluated conditions include the
 3 following:

- 4 1. Notification of an event
- 5 2. Indication of the passage of time, often recorded or logged as the following:
 - 6 – Time for personnel traveling to the ignition source
 - 7 – Time for confirmation of fire detection
 - 8 – Time for notification to MCR (for both fire and non-fire related initial notifications)
 - 9 – Time for the dispatch and arrival of the appropriate suppression capabilities
- 10 3. Fire size (that is, small fire observed)
- 11 4. Suppression of the fire with minimal effort

12 Figure 3-1 depicts a conceptual timeline of the conditions described in detail so that an
 13 interruptible fire may be classified.

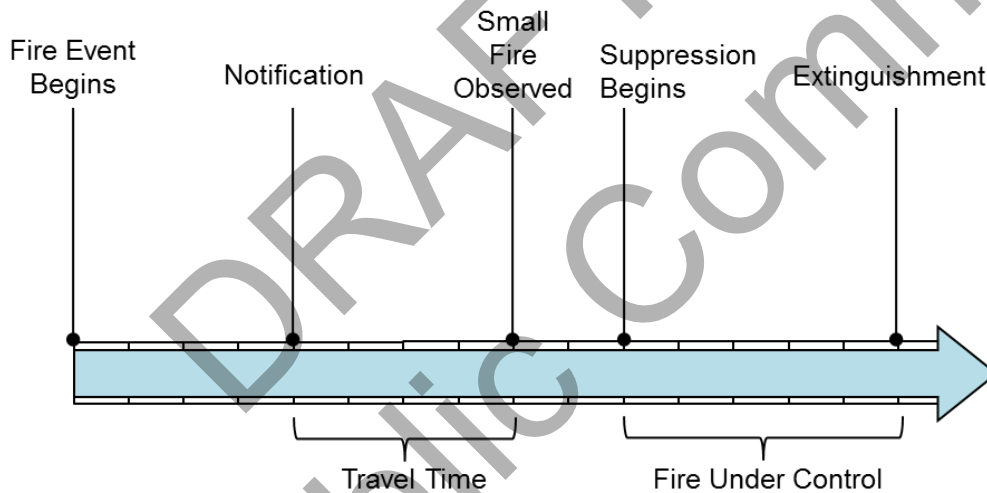

14
 15 **Figure 3-1**
 16 **Conceptual interruptible fire timeline, not to scale**

17 Although these conditions may be used to help clarify whether the fire described meets the two
 18 interruptible fire criteria described previously, observing these conditions should be used to
 19 justify the interruptible fire **criteria**, and not to directly classify an event as an interruptible fire.

20 **3.3.1.1 Notification**

21 For interruptible fire events, notification means an indication or alarm of a possible fire.
 22 Notification could come from a wide range of detection methods, including the following:

- 23 • **Automatic notification to the MCR.** This notification occurs in the form of an alarm or
 24 signal of the loss or malfunctioning of equipment, such as a pump, switchgear, motor
 25 control center (MCC), and so on, at the main control board. Given an indication that a
 26 component/equipment is no longer functioning as intended, personnel are often
 27 dispatched to locate the source and/or cause for this notification signal.

- **Automatic notification to the fire alarm control panel (FACP).** This notification or alarm at the MCR would represent the actuation of an automatic fire detection system. Unlike the MCR notification described previously, which not always signals a fire event, this type of alarm indicates a potential fire event is taking place.
- **Notification by plant personnel.** Many of the events recorded in the FEDB describe that the first indication of a fire comes from a call or report to the MCR by plant personnel. These are events where a fire watch, a roving fire watch, staff conducting testing and maintenance (T/M), or other plant personnel who happened to be in the vicinity of the ignition source, see smoke, smell smoke, or hear a loud noise and notify the MCR of the situation.

Due to the way the events in the FEDB are recorded, some indication of notification will occur and this condition will be met. After all, the plant staff can only respond to events that are known. Even if the fire is discovered by an operator on a roving fire watch and immediately suppressed, the event will be recorded that the fire was “detected” by plant personnel. The observed detection methods for Bin 15, electrical cabinet, events recorded in the FEDB are presented in Figure 3-2. As shown in Figure 3-2, there are many ways that plant staff can be notified of fires beyond traditional fixed fire detection systems. The event review concluded that most Bin 15 fire events are discovered by plant personnel.

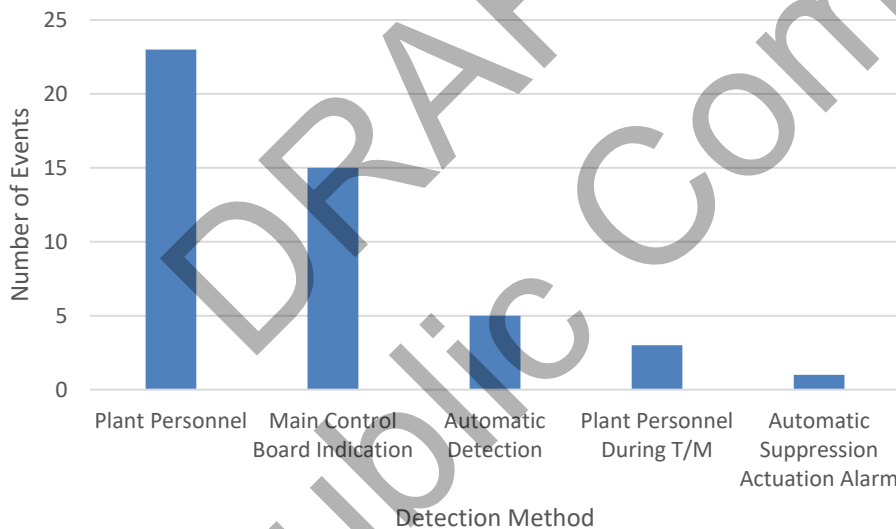

Figure 3-2
Detection method of reported Bin 15 fire events

Although the notification condition will occur, it is tied to the overall aspect of the criteria to help judge that some time has taken place to allow the fire to grow, but that this growth did not happen at a rate that precludes the ability for plant personnel to respond and suppress the fire with minimal effort.

In order to classify an event as *Interruptible Fire* and meet the notification condition, one of the following mechanisms should be present in the event description:

- MCR staff receiving a notification of a potential fire by control/instrumentation failures or indications (for example, a failed equipment alarm such as a tripped pump)

- 1 • Fire watch
- 2 • General plant personnel (in vicinity, or a passerby)
- 3 • Security personnel (in vicinity, or a passerby)
- 4 • Fixed automatic detection system (smoke)

5 Potential notification mechanisms that should not be used as evidence of an *Interruptible Fire*
6 type are the following:

- 7 • Automatic suppression system actuation alarms (sprinkler or water flow alarms, halon or
8 CO₂ discharge alarms)
- 9 • Plant personnel conducting T/M on the equipment of fire origin (Fires caught and
10 extinguished during T/M conditions would violate the passage of time criteria. These
11 fires may have developed into growing fires if personnel were not present at the onset of
12 the fire, that is, had the fire occurred at the next demand during normal operation.)
- 13 • Fixed automatic detection system (thermal)

14 After the fire has been detected, the second condition evaluates whether time passed from
15 detection. The passage of time condition, if observed, provides confidence that the fire had an
16 opportunity to grow.

17 3.3.1.2 Passage of Time

18 The passage of time condition is presented as a way to capture the intent of the interruptible fire
19 criteria that some time has passed allowing the fire an opportunity to grow. By noting that the
20 first responding personnel had to travel to the fire location provides evidence that the fire
21 described in the event had an opportunity to grow. This condition may be identified in the
22 description by one or more of the following:

- 23 • Time for plant personnel to travel to the location of the fire
- 24 • Time for confirmation of fire after detection
- 25 • Time for notification to the MCR
- 26 • Time to dispatch operators or plant personnel in response to the detection signal

27 In most cases, travel (passage of) time will be included in an event description as an indication
28 that an operator was dispatched to a location following a notification or alarm at or to the MCR.

29 In addition, if a fire is discovered while on roving fire watch or routine walkdown, it is assumed
30 that the fire started prior to the discovery and had an opportunity to grow. In this case, the
31 notification and passage of time conditions would be considered met simultaneously.

32 An event where plant personnel discover a fire while working in the same vicinity as the ignition
33 source should not be immediately excluded. Although there may not be clear indication of travel,
34 the passage of time may still take place because, in these cases, personnel would likely have to
35 search for this fire. These fire events are most likely to occur within the MCR, activities requiring
36 a continuous fire watch, or in areas where T/M is in progress. Examples of the passage of time
37 would include an indication of an odor of smoke or a noise (notification) and words and phrases
38 in the event description like *investigated*, *determined*, *discovered*, or *looking for indication of a*
39 *fire*. Again, this ensures that the fire had an opportunity to grow but was not found to do so.

1 The passage of time condition evaluates the time that has passed between detection and
2 suppression. This criterion would not be met for fires that occur where personnel are directly
3 adjacent to the source or directly involved with the equipment when the fire begins (for example,
4 personnel performing T/M) and are therefore able to suppress the fire immediately, with no clear
5 indication of the fire growth rate. For example, if the fire is discovered in equipment during T/M,
6 the notification condition is met when the fire is discovered; however, the passage of time
7 condition is not met given that personnel are already located at the fire source.

8 Next, the small fire condition is used to confirm the second half of the criteria, that the fire has
9 not grown quickly.

10 3.3.1.3 Small Fire

11 The small fire condition of an interruptible fire event means the fire has not grown larger than
12 could be suppressed by the initial responding plant personnel. In many cases, an event report
13 will include descriptions of *small* flame lengths, *small* flame heights, or even simply as a *small*
14 fire. This qualitative description does not mean that this condition has been met. Although the
15 qualifier *small* is often observed for events that should be classified as an interruptible fire, it
16 must be judged against the context of the entire event description. That is, a propagating or fully
17 involved fire discovered late in the progression does not constitute a small fire.

18 Because sometimes the only indication provided in an event is that the fire is *small*, one
19 indication of a small fire is that it was suppressed with minimal effort (such as the use of a single
20 portable fire extinguisher).

21 In order to meet the *small* fire condition, one of the following indications should be present in the
22 event description:

- 23 • Plant personnel or an operator describes the fire as “small.”
- 24 • The fire is limited to a subcomponent within the ignition source when discovered.
- 25 • The fire is suppressed with minimal effort.

26 Potential indications that should not be used as evidence of a small fire that fit the criteria of an
27 interruptible fire event are a (1) fully involved fire and (2) fire not limited to the ignition source,
28 damaging targets other than the ignition source

29 Observing these conditions, notification, passage of time, and a small fire allows for confidence
30 that the first criteria for classifying an event as an interruptible fire have been met. Recall that
31 these conditions are presented as a means of determining whether the criteria are met, not as
32 substitutions for the criteria. These conditions have been consistently observed for events
33 classified as interruptible fires but should be used to support the *interruptible* criteria only—a fire
34 that had the opportunity to, but has not grown quickly, and suppressed with minimal effort.

35 3.3.1.4 Minimal Suppression Effort

36 The minimal suppression effort condition includes the method(s): de-energization of the ignition
37 source and/or discharge of a single portable extinguisher (or parts of multiple extinguishers, as
38 long as there is an indication that the fire was successfully controlled by the initial attempt). This
39 condition also requires the suppression actions to be performed by the first responding
40 personnel (may be either plant personnel or fire brigade).

41 In the case of multiple, back-to-back, attempts to suppress the fire or an automatic suppression
42 system was activated, more than a minimal effort was required and the event should not be

1 counted as an *interruptible* fire. Examples of multiple attempts included more than one full fire
2 extinguisher (for example, multiple extinguishers in quick succession) was required for
3 suppression or observing the fire was not under control after each suppression attempt.

4 Recall that the intent of the conditions described previously is to provide a means of easily
5 determining whether the fire event described is one that suggests that plant personnel had an
6 opportunity to respond. However, lacking clear indication of notification, passage of time, and a
7 small fire that can be suppressed with minimal effort does not necessarily mean the fire
8 described was not a fire that grew at a rate that plant personnel had an opportunity to respond.

9 Potential indication of suppression efforts that should not be used as evidence of an *interruptible*
10 *fire* type are the following:

- 11 • A fire suppressed by a fixed automatic suppression system
- 12 • Use of multiple extinguishers in quick succession
- 13 • Suppression by hose stream
- 14 • Suppression by off-site assistance

15 There are a number of instances where the conditions described previously overlap. For
16 example, the *small fire* condition may be met if it was suppressed with minimal effort or the
17 *notification* and *passage of time* conditions may be met simultaneously when the fire is
18 discovered by a roving fire watch. These conditions, notification, passage of time, and small fire
19 observed are provided because they have been consistently observed in the event descriptions
20 for fires that did not grow at a rate exceeding the ability of plant personnel to respond and
21 successfully extinguish the fire with minimal effort.

22 3.3.1.5 Special Case—Arc Flash

23 The term *arc flash* has been used in fire event records to characterize the observed fire
24 phenomena. These events are often associated with power distribution equipment, including
25 MCCs and switchgears. These events have been classified as electrical cabinet (that is, Bin 15)
26 events because they differ from the high-energy arcing fault (HEAF) events, which are included
27 in Bin 16 [1]. Due to the relatively small intensity of the arc flash event, these events may be
28 counted and used in the determination of the fire ignition frequency and NSPs even if they did
29 not damage anything other than the ignition source.

30 There are two subpopulations of this type of event that may be classified as *Interruptible Fire*
31 events: (1) events for which any flaming fire, sparks, and smoldering are limited to the cubicle of
32 origin, and (2) events that trip an upstream breaker and self-extinguish prior to developing into a
33 fire that requires more than a minimal effort to suppress.

34 Although these events may have immediately reached their “peak” intensity, they do not
35 continue to growth prior to the arrival of plant personnel and are suppressed with minimal efforts
36 including de-energizing the cabinet and/or the use a single portable fire extinguisher.

37

1 **3.3.2 Summary of Interruptible Fire Conditions**

2 Table 3-1 summarizes the conditions described in a fire event that provide evidence of an
 3 interruptible fire. Conditions from each of the four *interruptible fire* attributes in the table should
 4 be used to support the criteria identified in Section 3.3 for a fire to be classified as an
 5 interruptible fire.

**Table 3-1
 Conditions for an interruptible fire event determination**

| Interruptible Fire Attribute | Condition Met | Condition Not Met |
|---------------------------------------|---------------------------------------------------------------------------------------------------------|--------------------------------------------------------------------------------------------------------------------------------|
| Notification | Plant staff communicating an observation to the MCR | Fixed suppression system actuation alarm in FACP |
| | Equipment alarm in MCR or malfunctioning/trouble signal | |
| | Fixed automatic detection reported on FACP | |
| | Discovery by plant personnel: general plant personnel | Fire starting in equipment while performing T/M when paired with immediate suppression |
| | Discovery by plant personnel: fire watch (roving or stationary) | |
| Discovery by plant security personnel | | |
| Passage of Time | Plant personnel dispatched to an event | Fire starting in equipment while performing T/M |
| | Plant personnel on roving fire watch or walkdown who notice the fire | |
| | Words and phrases like <i>investigated, determined, discovered, or looking for indication of a fire</i> | |
| Small Fire | Plant personnel describe a small fire, small flame lengths | Plant personnel describing a room full of smoke (challenging conditions requiring use of a self-contained breathing apparatus) |
| | Fire limited to the ignition source only or subcomponent within the ignition source | Fire not limited to ignition source—fire propagating to cable trays above or other equipment |
| | Fire suppressed with minimal effort | Fire not suppressed with minimal effort |
| Minimal Suppression Effort | Use of one (1) or more portable extinguishers at the same time | Fixed (automatic or manual fixed) suppression system activated |
| | Initial attack successful | Use of multiple extinguishers in quick succession |
| | Fire extinguished by de-energizing equipment | Suppression by hose stream |
| | Self-extinguished | Suppression requiring off-site assistance |

3.4 Interruptible Fire Split Fraction

Table 3-2 summarizes the classification of Bin 15 events against the criteria described in Section 3.3. Specific details of the event review and fire growth classifications are documented in Appendix A.

Table 3-2
Interruptible and growing split fractions

| Growth Profile | Count | Split Fraction |
|----------------|-------|----------------|
| Interruptible | 34 | 0.723 |
| Growing | 13 | 0.277 |

This split fraction is used in the detection-suppression event tree described in Section 5. These split fractions are presented as generic values to be used with an FPRA.

3.5 Interruptible, Growing, Main Control Room, and Electrical Fires Suppression Rate

3.5.1 Interruptible and Growing Fire Suppression Rate

In addition to the split between the fraction of interruptible and growing profile fires, the suppression rate for each growth profile was investigated. A unique suppression rate associated with the MCR already exists. This suppression rate includes the manual suppression rates associated with ignition events within the MCR. Following the review of events, additional suppression rates were developed, including rates for interruptible fires and growing fires. Therefore, a total of three suppression rates were developed for fires in electrical cabinets: *Interruptible*, *Growing*, and MCR. The review for developing these suppression rates used the period of 1990–2014 to allow for the inclusion of additional suppression data.

Just as in NUREG/CR-6850 Supplement 1 and NUREG-2169, the suppression time is defined as the time the fire was extinguished or the time the fire was reported to have been brought under control by responding plant personnel, personnel discovering the fire, or the fire brigade. As part of the event review, careful attention and additional details were sought out to best determine the appropriate time of detection and suppression actions. The details of the suppression binning are provided in Appendix A. A summary of the number of events, durations, and suppression rates is provided in Table 3-3 and shown graphically in Figure 3-3.

Table 3-3
Electrical ignition source probability distribution for rate of fires suppressed per unit time (1990–2014[†])

| Suppression Curve | Number of Events | Total Duration | Rate of Fire Suppressed (λ) | | | |
|--------------------------------------|------------------|----------------|---------------------------------------|-------------|--------------|--------------|
| | | | Mean | 5th Percent | 50th Percent | 95th Percent |
| Interruptible | 43 | 310 | 0.139 | 0.106 | 0.138 | 0.175 |
| Growing | 19 | 191 | 0.099 | 0.065 | 0.098 | 0.140 |
| Electrical fires* | 74 | 653 | 0.113 | 0.093 | 0.113 | 0.136 |
| Main control room (MCR) [†] | 10 | 26 | 0.385 | 0.209 | 0.372 | 0.604 |

1 *Electrical fires include non-cabinet electrical sources, such as electrical motors, indoor dry transformers, and junction boxes among
 2 other electrical equipment.

3 [†]Due to the limited number of events in the MCR, the development of the suppression rate includes data from the 1980s. For
 4 detailed information on the control room suppression rate, see NUREG-2178, Volume 2, EPRI 3002016052.

5 Similar to NUREG-2169, the 5th, 50th, and 95th percentiles for the suppression rate, λ ,
 6 presented in Table 3-3 are calculated using the chi-square distribution in the following Equation
 7 3-1:

$$P(x, v) / t_D / 2 \tag{3-1}$$

8 where $P(x, v)$ is the lower cumulative distribution function of the chi-square distribution, x is the
 9 desired percentile, v is the number of degrees of freedom (equal to the number of events used
 10 in the suppression curve), and t_D is the total duration suppression time for the suppression
 11 curve.

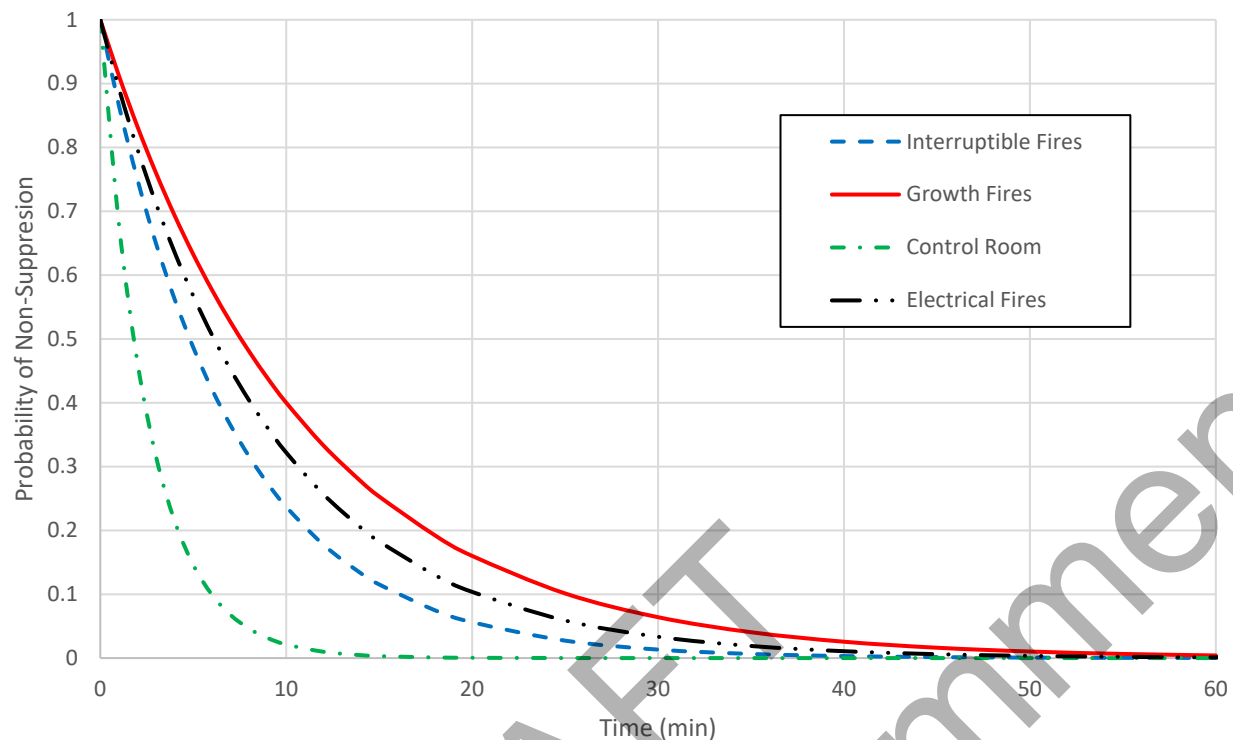

1

2 **Figure 3-3**3 **Non-suppression curve plot showing probability versus time to suppression**

4 Note that the total number of events for *interruptible*, *growing*, *electrical fires*, and *MCR*, in Table
5 3-3, does not add up to the total number of events listed in NUREG-2169 for electrical fires. The
6 suppression rate to be used with electrical cabinets (electrical fires in NUREG-2169) includes
7 electrical cabinets, electric motors, indoor dry transformers, and junction boxes, among other
8 electrical equipment. The interruptible and growing fire suppression rates developed as part of
9 this methodology are limited to electrical cabinets counted under Bin 15, as described in
10 NUREG/CR-6850 for the period 1990–2014. Fourteen of Bin 15 electrical cabinet events in this
11 period did not contain enough information to categorize them as interruptible or growing fires.
12 To capture these events, half of the count and suppression time was split evenly between the
13 two classifications. Due to the limited event information, the data from the 1980s period were
14 excluded from the suppression rate analysis. Similarly, for the electrical fires suppression rate
15 category, the 1980s suppression data were excluded. This was done primarily to keep the data
16 period between the interruptible, growing, and electrical fires categories the same. Assuming
17 that any error in the data is normally distributed, an analysis of variance (ANOVA)—a method
18 used to analyze and determine whether the differences between the sample means for groups
19 of information are statistically significant—was performed on the electrical fires (without Bin 15
20 electrical cabinets) suppression data with and without the 1980s data. The results presented in
21 Table 3-4 found no significant difference for the two data sets (P-value>0.05, F-statistic less
22 than the critical F-statistic.)

Table 3-4
ANOVA of electrical fire suppression data with and without events during the 1980–1989 period

| Source of Variation | SS | df | MS | F | P-value | F crit |
|---------------------|----------|-----|-------|------|---------|--------|
| Between groups | 153.5 | 1 | 153.5 | 1.13 | 0.29 | 3.89 |
| Within groups | 24012.6 | 177 | 135.7 | | | |
| Total | 24166.06 | 178 | | | | |

3.5.2 NSP Floor for the MCR

Appendix P of NUREG/CR-6850 recommended a floor value of 1E-03 for the manual NSP estimates. The objective of the floor value was to limit the use of the manual suppression probability model (that is, $EXP[-\lambda t]$) to values close to the range of fire durations available in OPEX. That is, the floor value was intended to bound the probability of manual suppression for potential fires larger than those included in the operational experience. In practice, this floor value has affected achieving realistic results for the faster manual suppression rates, such as the MCR manual suppression curve as the value of 1.0E-3 is reached in a relatively short period of time.

In practice, the floor value is interpreted as the best possible manual NSP that can be credited in the analysis. Therefore, the NSP floor should consider (1) the probability of having a fire at some point, and (2) the failure to manually suppress the fire within the time frame of the fire event. Under this formulation, the floor value would set a lower limit on the exponential manual suppression probability model that is governed not only by the ability to suppress a fire before target damage, but also by the probability of observing a fire within the FPRA mission time.

To estimate the floor value, a Monte Carlo sampling process was performed to approximate the best possible manual NSP for a fire in the MCR.

Probability of Fire in the MCR Within the Mission Time

In the MCR, typical ignition sources include the main control board (Bin 4), electrical cabinets (Bin 15), transient fires (Bin 7), and transient fires due to welding and cutting (Bin 6). The likelihood of fires associated with these sources is quantitatively characterized by their corresponding generic frequencies. For the purposes of establishing a floor value, the generic frequencies are treated (that is, apportioned to the MCR) as follows:

- The main control board frequency is fully apportioned to the MCR because there is only one main control board per unit. The generic frequency value is 2.05E-3/yr (NUREG-2178, Volume 2). The full frequency is included because the entire main control board is located within the MCR.
- The electrical cabinet frequency is based on the number of cabinets counted in the MCR in the FPRA. This count can vary widely from NPP to NPP. The generic frequency value is 3.43E-2/yr (NUREG-2230), which applies to a single NPP. To generalize the analysis, it is

1 assumed that the apportioning factor is a random variable sampled following a uniform
 2 distribution with a range between 1/300 and 1/700. The practical implication of this
 3 assumption is that there are on average 500 cabinets counted as ignition sources in a single
 4 unit NPP and align with experience performing FPRAs.

- 5 • The transient frequency is apportioned to the MCR because it is a generic value that covers
 6 the control building, auxiliary building for pressurized water reactors and reactor building for
 7 boiling water reactors. The generic frequency values are 3.33E-3/yr for general transient
 8 fires and 4.44E-3 for transient fires due to welding and cutting (NUREG-2169). To
 9 generalize the analysis, it is assumed that the apportioning factor is a random variable
 10 sampled following a uniform distribution with a range between 10% and 30%. The practical
 11 implication of this assumption is that, on average, 20% of the transient frequency is in the
 12 MCR. This conservatively assumes that the MCR represents 20% of the combined control,
 13 auxiliary, reactor building floor area.

14 The average of the Monte Carlo sampling results in a total ignition frequency of 3.7E-3/yr. This
 15 is interpreted as an approximation of the ignition frequency for a fire in the MCR. It should be
 16 noted that this value does not take credit for fire severity (severity level of the fire needed to
 17 cause damage) and assumes that any fire is significant enough to cause damage outside of the
 18 ignition source. This approximation of the MCR ignition frequency is for 1 year. In practice, the
 19 FPRA estimates the probability of an event occurring over a 24-hour mission time. This results
 20 in an ignition frequency for fires in the MCR of approximately $(2.05E-03/365 + 3.43E-02/365 +$
 21 $3.33E-03/365 + 4.44E-03/365 = 1.21E-04/\text{day})$. Assuming a constant frequency, the exponential
 22 distribution can be used for determining the probability of observing a fire in the MCR for a
 23 mission time of 24 hours as follows (Equation 3-2):

$$24 \quad Pr(t \leq 24) = 1.0E - 5 \quad \{3-2\}$$

25 This is the average probability (following the Monte Carlo runs) of a fire occurring in the MCR
 26 per day including the weights discussed in the preceding bullets (cabinet counts and transient
 27 floor area).

28 **Probability of Failing to Manually Suppress a Fire in the MCR**

29 The manual NSP for the MCR can be calculated using the manual suppression curve assuming
 30 a characteristic fire scenario duration treated as a random variable. For the MCR, it is practical
 31 to define the duration as the time available before abandoning due to fire. This provides a time
 32 frame for operators or the fire brigade to control the fire before having to evacuate the MCR. In
 33 this formulation, this period is treated as a uniform distribution ranging between 5 (occurs before
 34 a half of the growing fire growth period has passed which is used as an indication that the fire is
 35 relatively small for abandonment) and 20 minutes (reaches the NUREG/CR-6850, Appendix P
 36 floor value which is used as an indication that the limiting probability of non-suppression would
 37 have been reached). This range of times for evacuating the MCR for environmental conditions is
 38 conservative because it assigns equal probabilities to relatively short abandonment times and
 39 ignores fire scenarios where abandonment may not be necessary. The suppression rate
 40 constant for the MCR is 0.385. On average, these values calculate an NSP of 2.5E-2.

41 **Floor Value**

42 The resulting floor value is then the probability of a fire occurring during the FPRA mission time
 43 of 1 day (24 hours) multiplied by the average probability of non-suppression: $1.0E-05 \times 2.5E-2 =$
 44 $2.4E-7$. This value is specific to the MCR because it was developed using location-specific
 45 ignition frequencies and the MCR manual suppression curve. As mentioned earlier, this floor

1 represents a bounding probability of an unsuppressed fire within the mission time of an FPRA.
 2 The non-suppression floor value for a dual unit MCR is 3.5E-07.

3 **Sensitivity to Input Parameters**

4 The parameters used in this analysis are selected to provide a conservative analysis. The
 5 sensitivity of the proposed floor value to the input parameters chosen is reviewed in Table 3-5.

**Table 3-5
 Probability of non-suppression floor sensitivity analysis**

| Sensitivity Case | NSP Floor | Discussion |
|------------------------------------------------------------------------------------------|-----------|-------------------------------------------------------------------------------------------------------------------------------------------------------------------------------------------------------------------------------|
| Base case, single unit | 2.4E-07 | N/A |
| Two-unit NPP | 3.5E-07 | This sensitivity captures a shared (two unit) control room configuration. The result is an approximate 44% increase to the floor value. |
| All fires suppression rate: 0.067/yr (NUREG-2169) | 4.3E-06 | This sensitivity captures the effect of assuming a more challenging fire like those experienced in other areas of the plant occurs in the MCR. The result is an order of magnitude reduction in the approximated floor value. |
| Time to abandonment distribution reduced to 1 to 5 minutes | 3.3E-06 | This sensitivity highlights the effect of assuming times more representative of those associated with target damage. The result is an order of magnitude reduction in the approximated floor value. |
| Number of cabinets: uniform distribution from 100-300 | 2.5E-07 | This sensitivity highlights that the analysis is driven by the main control board frequency. The NSP floor is not sensitive to a reduction in the number of Bin 15 cabinets counted as ignition sources. |
| All cases: all fires suppression rate, 1 to 5 minute abandonment times, 100-300 cabinets | 8.5E-06 | In this sensitivity, each of the previously reviewed changes is all applied. The result is an order of magnitude reduction in the approximated floor value. |

6 Even with this estimated floor, the MCR still presents a unique case. The MCR suppression
 7 rate is developed using 10 fire events with a total combined suppression duration of 26 minutes
 8 (see Table 3-3), the longest of which is only 9 minutes in duration. Therefore, the fires capable
 9 of reaching the revised P_{ns} floor of 2.4E-07 would need to last for 39 minutes without being
 10 suppressed. By 39 minutes, it would be reasonable to expect that MCR personnel would have
 11 exhausted any readily available extinguishers and that further suppression efforts would
 12 require resources from outside of the MCR. To capture the possibility of such events, a two-
 13 step calculation process is suggested for fires in the MCR.

14 The first step uses the MCR suppression rate in Table 3-3 for calculations of the P_{ns} with a
 15 floor value of 1E-03. This results in fires that are suppressed prior to approximately 18
 16 minutes using a suppression rate of 0.385. The second step captures all remaining MCR fire
 17 durations up to the proposed floor of 2.4E-07 by making use of the ignition source bin
 18 specific suppression rate. For example, a fire in a cabinet located within the MCR will use the
 19 interruptible and growing suppression rates presented in Section 3.5 for fire durations in

1 excess of 18 minutes. This is expressed graphically in Figure 3-4. In essence, this treats
 2 longer duration fires in the MCR as if they were fires elsewhere in the plant where personnel
 3 and equipment for suppression may not be immediately available.

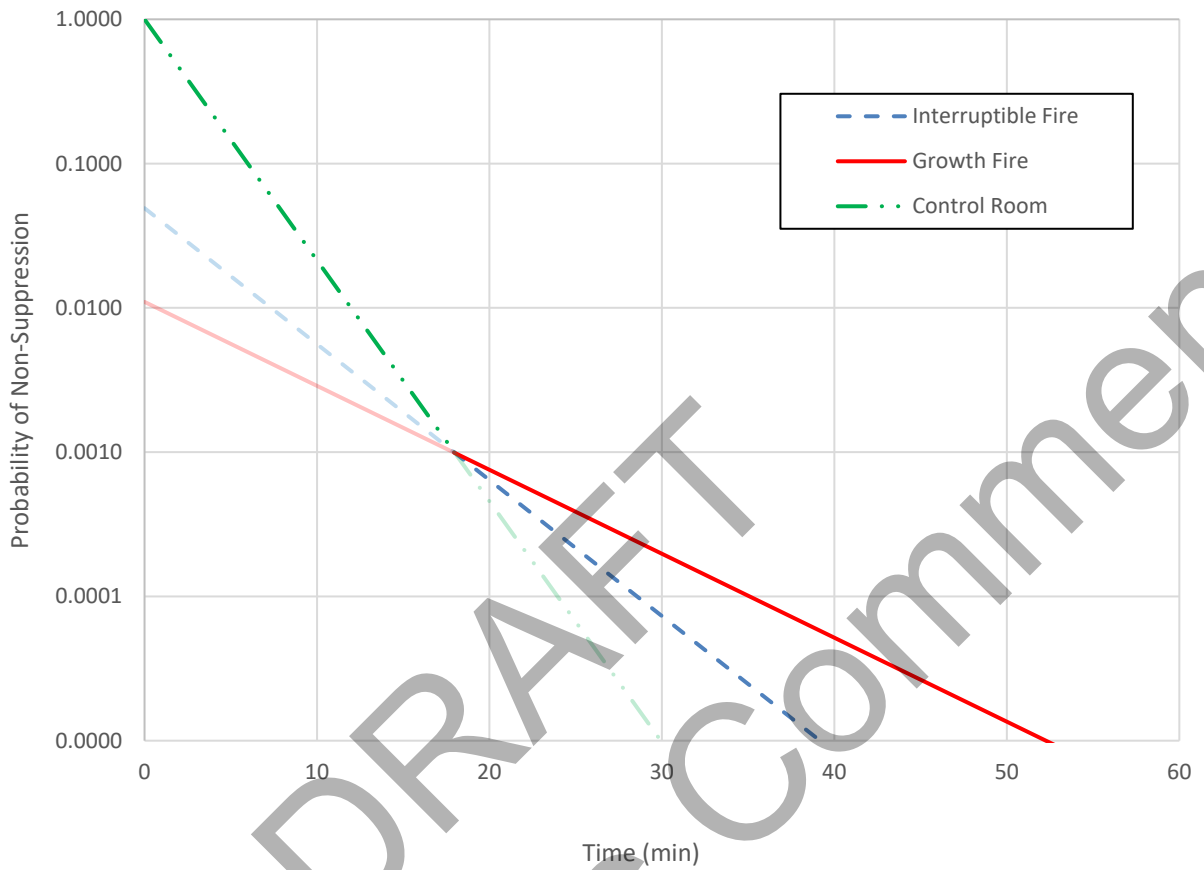

4
 5 **Figure 3-4**
 6 **Non-suppression curve plot showing log(probability) versus time to suppression for**
 7 **MCR scenarios**

1 **3.5.3 NSP Numerical Results**

2 The numerical results for interruptible, growing, the MCR, and the revised electrical fires
3 suppression curves are presented in Table 3-6.

4 **Table 3-6**
5 **Updated numerical results for electrical cabinet suppression curves**

| Time (min) | Interruptible | Growing | Main Control Room | Electrical Fires |
|------------|---------------|----------|--------------------------------|------------------|
| 0 | 1.00E+00 | 1.00E+00 | 1.00E+00 | 1.00E+00 |
| 5 | 5.00E-01 | 6.08E-01 | 1.46E-01 | 5.67E-01 |
| 10 | 2.50E-01 | 3.70E-01 | 2.14E-02 | 3.22E-01 |
| 15 | 1.25E-01 | 2.25E-01 | 3.12E-03 | 1.83E-01 |
| 20 | 6.24E-02 | 1.37E-01 | 6.40E-04/7.54E-04 [†] | 1.04E-01 |
| 25 | 3.12E-02 | 8.32E-02 | 2.16E-04/3.86E-04 [†] | 5.88E-02 |
| 30 | 1.56E-02 | 5.06E-02 | 7.31E-05/1.97E-04 [†] | 3.34E-02 |
| 35 | 7.79E-03 | 3.08E-02 | 2.47E-05/1.01E-04 [†] | 1.89E-02 |
| 40 | 3.89E-03 | 1.87E-02 | 8.34E-06/5.17E-05 [†] | 1.07E-02 |
| 45 | 1.95E-03 | 1.14E-02 | 2.82E-06/2.65E-05 [†] | 6.10E-03 |
| 50 | * | 6.92E-03 | 9.53E-07/1.35E-05 [†] | 3.46E-03 |
| 55 | * | 4.21E-03 | 3.22E-07/6.93E-06 [†] | 1.96E-03 |
| 60 | * | 2.56E-03 | §/3.55E-06 [†] | 1.11E-03 |
| 65 | * | 1.56E-03 | §/1.18E-06 [†] | * |
| 70 | * | * | §/9.28E-07 [†] | * |
| 75 | * | * | §/4.753E-07 [†] | * |
| 80 | * | * | §/2.43E-07 [†] | * |
| 85 | * | * | § | * |
| 90 | * | * | § | * |
| 95 | * | * | § | * |
| 100 | * | * | § | * |

6 *A value 1.0E-3 should be used.

7 §A value 2.4.0E-7 should be used.

8 [†]Designates split for interruptible/growing fires in electrical cabinets in the MCR. A similar split would be required for other HRR bins,
9 such as transients. Note that the growing fire split is bounding for electrical cabinets and transients in the MCR.

10 **3.6 Updated Bin 15 Fire Ignition Frequency**

11 After the publication of NUREG-2169, EPRI cataloged and classified the fire event data
12 available in the Institute of Nuclear Power Operations (INPO) Consolidated Event System
13 (ICES) database. The fire severity review is documented in EPRI study, *Fire Events Database*
14 *Update for the Period 2010–2014: Revision 1* (3002005302) [4]. This research makes use of the
15 latest fire event data that were classified for fire severity. The counts for Bin 15 are shown in
16 Table 3-7.

Table 3-7
FPRA counts per time period

| Bin | Location | Ignition Source | Power Modes | FPRA Counts | | | |
|-----|-----------------------|--------------------------------|-------------|-------------|-----------|-----------|-----------|
| | | | | 1968–1989 | 1990–1999 | 2000–2009 | 2010–2014 |
| 15 | Plant-wide components | Electrical cabinets (non-HEAF) | AA | 64.5 | 29.5 | 23.5 | 23 |

1 The time period 2000–2009 includes the 84 NPPs that completed the full data collection
2 protocol and plant review for the EPRI FEDB update. This is consistent with fire frequency
3 calculations performed in NUREG-2169. Fire event data for events occurring in 2010 or later are
4 collected and managed through INPO. This process is industry-wide, and, as a result, all
5 operating plants were included in the 2010–2014 time period. The reactor years for both at-
6 power and shutdown are presented in Table 3-8.

Table 3-8
Reactor years for fire ignition frequency update

| | 1968–1989 | 1990–1999 | 2000–2009 | 2010–2014 |
|------------------------|-----------|-----------|-----------|-----------|
| At-power reactor years | 899 | 848 | 771 | 467.7 |
| Shutdown reactor years | 383 | 233 | 78.8 | 45.7 |

7
8 The updated fire ignition frequency distribution for Bin 15 is presented in Table 3-9.

Table 3-9
Fire ignition frequency distribution for Bin 15

| Bin | Location | Ignition Source | Power Modes | PRA Type | Time Period | Mean | Median | 5th Percent | 95th Percent |
|-----|-----------------------|--------------------------------|-------------|----------|-------------|----------|----------|-------------|--------------|
| 15 | Plant-wide components | Electrical cabinets (non-HEAF) | AA | FPPIE | 2000–2014 | 3.43E-02 | 3.19E-02 | 1.13E-02 | 6.60E-02 |

9 Note: If a plant-specific Bayesian update of the fire ignition frequency is warranted, a revision of
10 the interruptible and growing fires split fraction is not necessary.

11

DRAFT
for Public Comment

4

INTERRUPTIBLE AND GROWING FIRE HRR PROFILES

4.1 Bin 15 Fire HRR Profiles

As discussed in Section 3, the *Interruptible* and *Growing* fire event classifications resulted in an application of different manual suppression rates. However, when applied to the detection-suppression event tree analysis, what is not captured in the revision of these suppression rates is the lack of growth observed and reported in the fire events prior to plant personnel having a chance to respond. As described in Section 3, interruptible fires are fires that do not damage items outside of the ignition source prior to there being an opportunity for plant personnel to respond. When modeled in the detection-suppression event tree, with the traditionally developed 12-minute growth-to-peak period, targets located near the ignition source would see little to no change in the time to damage with just a revised suppression rate. Therefore, in addition to a revised suppression rate, the heat release rate (HRR) profile associated with Bin 15 fires is investigated for both the *Interruptible* and *Growing* fire classifications.

The NUREG/CR-6850 growth profile associated with electrical cabinets is as follows [1]:

- The fire grows to its peak HRR in approximately 12 minutes.
- The fire burns at its peak HRR for approximately 8 additional minutes.
- The average time to decay is approximately 19 minutes.

To determine the appropriate HRR profiles for use in this methodology, additional experimental data were reviewed. The data reviewed included the test series considered in NUREG/CR-6850 and presented in NUREG/CR-4527 [6], as well as other test series focused on electrical cabinets, such as those performed by Valtion Teknillinen Tutkimuskeskus (VTT) [7-10] of Finland and the National Institute of Standards and Technology (NIST)/NRC presented in NUREG/CR-7197 [11].

4.1.1 Interruptible Fire HRR Profile

A key parameter of an interruptible fire is the time that separates ignition and the possibility of growth by the fire. A review of the experimental data shows that a number of experiments include a period where, following ignition, no discernible increase in the HRR is observed for a period of time—a pre-growth period (Figure 4-1).

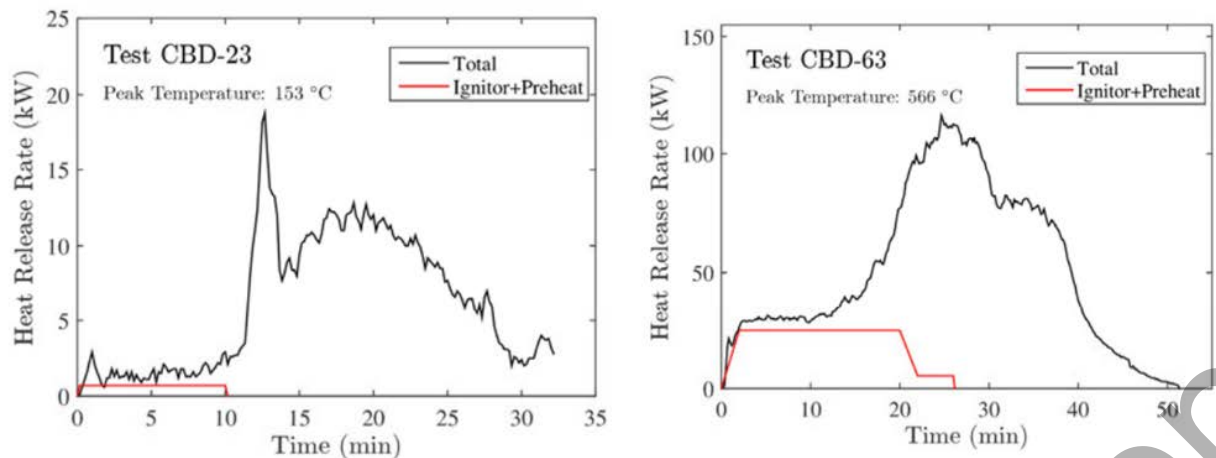

Figure 4-1
HELEN-FIRE experimental tests with pre-growth period [11]

This observation is similar to the delayed growth reported in many fire events [2] and observed in experiments performed by Sandia National Laboratories (SNL), VTT, and NIST/NRC which were performed in a manner to represent a challenging condition for an electrical cabinet. These tests included various cable loadings and a range of ignition sources, such as propane burners and liquid fuel pan fires [11].

Similar to the development of the HRR profile in NUREG/CR-6850, experimental data were used to determine the HRR profile for an interruptible fire. This profile includes four stages: pre-growth, growth, steady, and a decay period. A number of experiments were excluded from the analysis: If the experimental fire never grew (Figure 4-2, A) or did not include a pre-growth period (Figure 4-2, B), it was not included in the estimation of the interruptible HRR profile. Additionally, specific to the experiments performed as part of NUREG/CR-7197, portions of the tests with personnel intervening (for example, opening a cabinet door or jostling cables) during the experiment are excluded from the analysis.

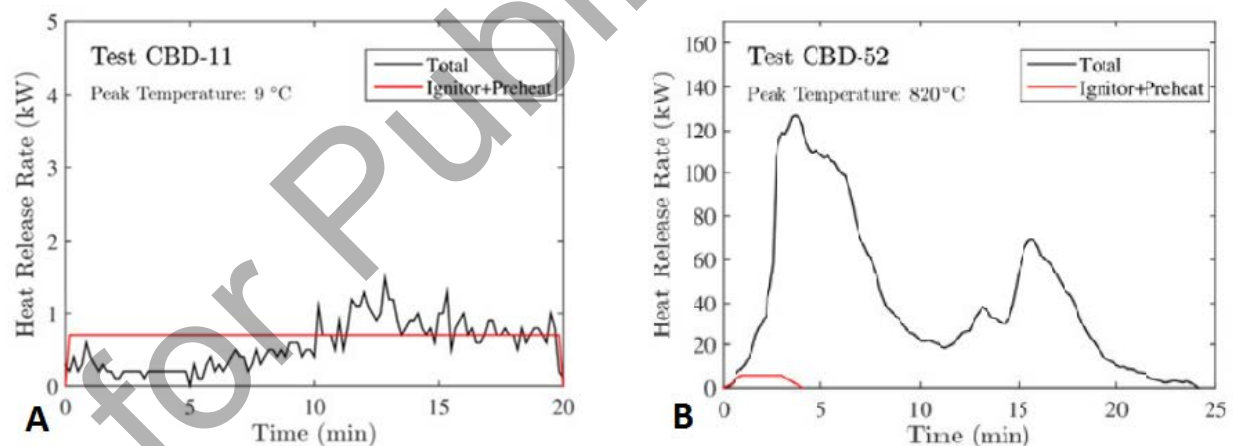
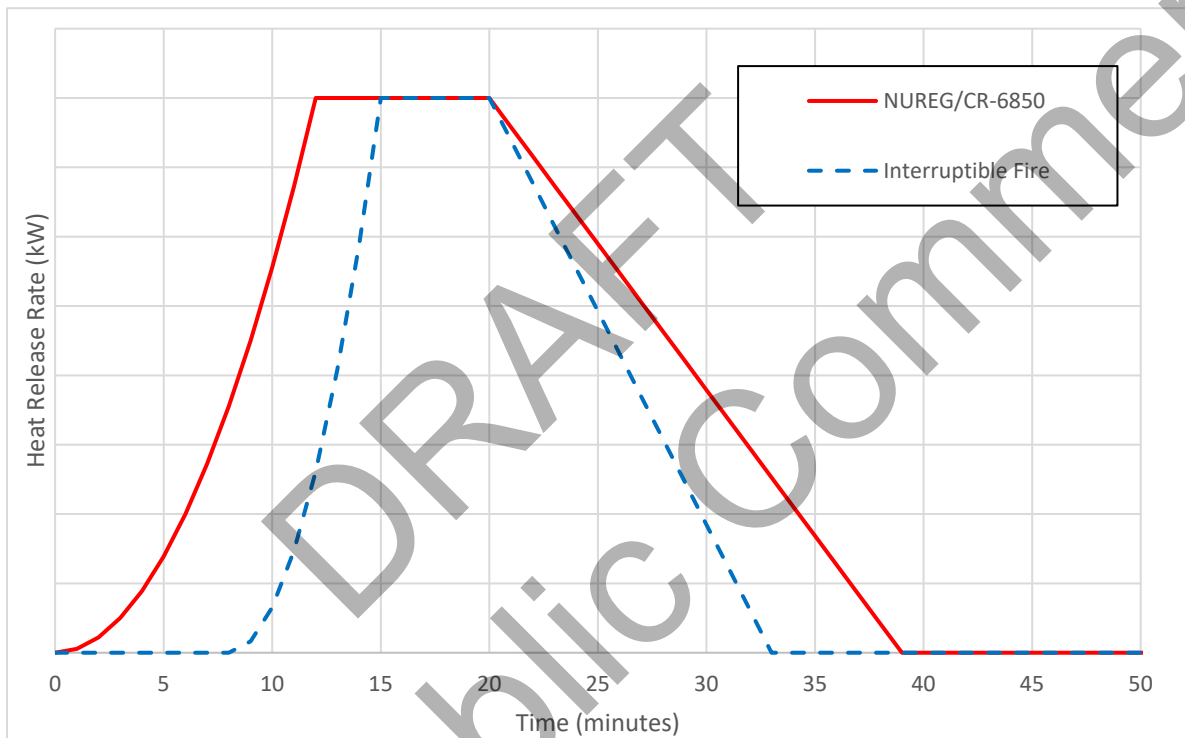

Figure 4-2
HELEN-FIRE experimental tests without a pre-growth period of (A) no growth and (B) no pre-growth

1 The resulting HRR profile for interruptible electrical cabinets, presented in Figure 4-3, is as
 2 follows:

- 3 • A period of up to 8 minutes with no measurable HRR may be included prior to the period
 4 of fire growth. If included, this pre-growth phase must be reflected in any calculations of
 5 the time to damage, time to detection, and time to suppression.
- 6 • The fire will grow to its peak HRR in approximately 7 minutes.
- 7 • The fire burns at its peak HRR for approximately 5 additional minutes.
- 8 • The fire decays linearly over a period of approximately 13 minutes.

9 A t^2 function should be used for representing the growth phase of the fire.



10

11 **Figure 4-3**
 12 **Interruptible HRR Profile**

13 This profile results in a fire with a shorter duration than the profile presented in NUREG/CR-
 14 6850. The fire reaches its peak approximately 15 minutes from the time of ignition, begins its
 15 decay period at 20 minutes, and is out after 33 minutes. The traditional HRR profile followed a
 16 12-minute peak, 20-minute start of decay, and was out after 39 minutes.

17 The *Interruptible* profile was obtained by averaging the pre-growth, growth, steady burning, and
 18 decay durations of the experiments conducted as part of NUREG/CR-4527 (SNL) [6],
 19 NUREG/CR-7197 Chesapeake Bay Detachment (CBD) [11], and by VTT [7-10]. These times
 20 are listed in Table 4-1.

Table 4-1
HRR timing for interruptible electrical cabinet fires

| Test | Units in Minutes | | | |
|----------------|-------------------|--------------|----------------|---------------|
| | Pre-Growth Period | Time to Peak | Steady Burning | Time to Decay |
| SNL-ST7 | 6 | 10 | 11 | 34 |
| SNL-PCT5 | 20 | 12 | 0 | 22 |
| SNL-Test24 | 20 | 7 | 0 | 6 |
| SNL-Test25 | 17 | 5 | 3 | 25 |
| VTT186-Exp2 | 10 | 4 | 2 | 29 |
| CBD-23 | 8 | 4 | 11 | 9 |
| CBD-25 | 9 | 12 | 11 | 4 |
| CBD-31 | 2 | 10 | 6 | 11 |
| CBD-42 | 4 | 13 | 0 | 14 |
| CBD-43 | 2 | 4 | 15 | 2 |
| CBD-44 | 2 | 16 | 0 | 13 |
| CBD-45 | 12 | 2 | 12 | 5 |
| CBD-51 | 2 | 3 | 0 | 15 |
| CBD-54 | 5 | 11 | 2 | 12 |
| CBD-56 | 4 | 2 | 28 | 2 |
| CBD-59_A | 10 | 7 | 4 | N/A |
| CBD-60 | 19 | 5 | 5 | 19 |
| CBD-62 | 21 | 6 | 0 | 13 |
| CBD-63 | 10 | 14 | 5 | 23 |
| CBD-68 | 2 | 5 | 5 | 11 |
| CBD-71 | 2 | 12 | 2 | 11 |
| CBD-79_A | 5 | 2 | 2 | 3 |
| CBD-83 | 9 | 4 | 0 | 16 |
| CBD-84 | 6 | 13 | 3 | 10 |
| CBD-87 | 7 | 5 | 0 | 13 |
| CBD-88 | 4 | 2 | 0 | 13 |
| CBD-89 | 10 | 6 | 0 | 12 |
| CBD-97_A | 7 | 3 | 6 | N/A |
| CBD-107 | 3 | 9 | 2 | 8 |
| CBD-108 | 1 | 6 | 0 | 13 |
| CBD-109 | 4 | 7 | 3 | 18 |
| CBD-111_A | 5 | 6 | 9 | N/A |
| Average | 8 | 7 | 5 | 13 |

4.1.2 Growing Fire HRR Profile

Valid experiments not counted in the development of the interruptible fire profile are used to develop a profile for growing fires. The resulting HRR profile for growing fires, presented in Figure 4-4, is as follows:

- The fire will grow to its peak HRR in approximately 12 minutes.
- The fire burns at its peak HRR for approximately 9 additional minutes.
- The fire decays linearly over a period of approximately 26 minutes.

A t^2 function should be used for representing the growth phase of the fire.

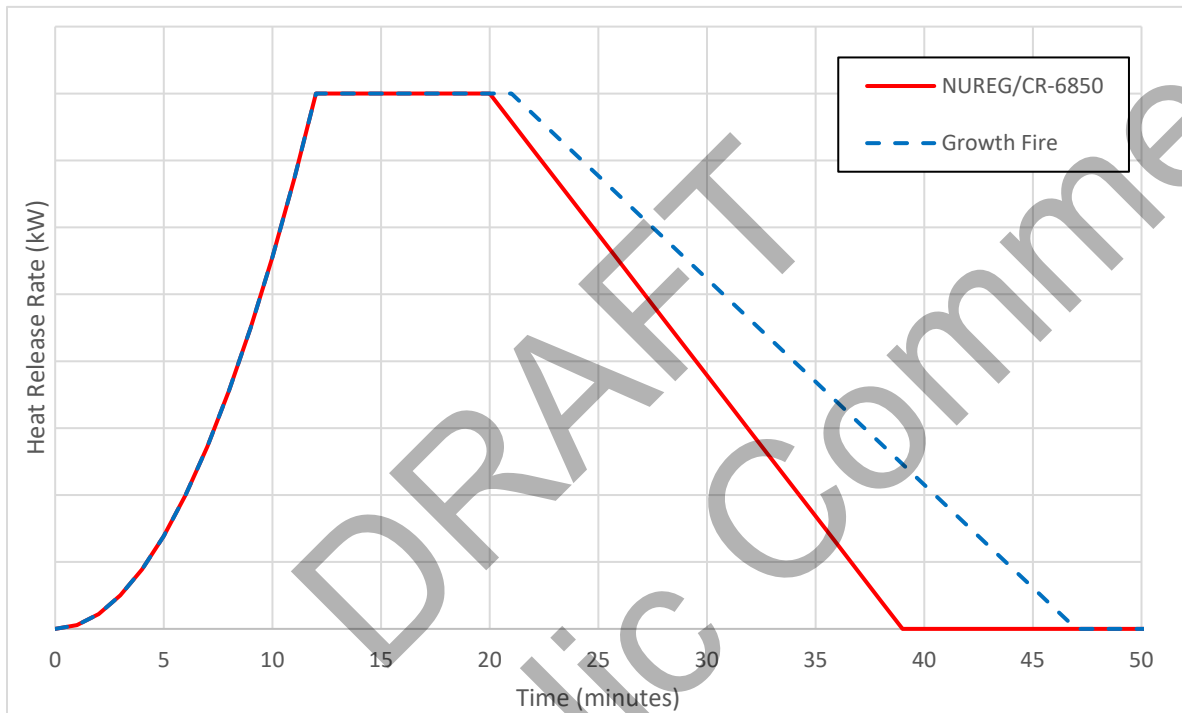

Figure 4-4
HRR profile for a growing fire

This profile results in a fire with a longer duration than the profile presented in NUREG/CR-6850. The fire reaches its peak approximately 12 minutes from the time of ignition, begins its decay period at 21 minutes, and is out after 47 minutes. The traditional HRR profile followed a 12-minute peak, 20-minute start of decay, and was out after 39 minutes.

This profile was obtained by averaging the growth, steady burning, and decay durations of the experiments conducted as part of NUREG/CR-4527 (SNL) [6], NUREG/CR-7197 (CBD) [11], and by VTT [7-10]. These times are listed in Table 4-2.

Table 4-2
HRR timing for growing electrical cabinet fires

| Test | Units in Minutes | | |
|---------------|------------------|----------------|---------------|
| | Time to Peak | Steady Burning | Time to Decay |
| SNL-ST3 | 10 | 0 | 22 |
| SNL-ST4 | 4 | 14 | 11 |
| SNL-ST5 | 9 | 0 | 22 |
| SNL-ST6 | 8 | 18 | 34 |
| SNL-ST8 | 11 | 20 | 28 |
| SNL-ST9 | 10 | 14 | 16 |
| SNL-ST10 | 11 | 20 | 30 |
| SNL-ST11 | 19 | 0 | 41 |
| SNL-PCT1 | 8 | 27 | 25 |
| SNL-PCT2 | 11 | 3 | 28 |
| SNL-PCT3 | 9 | 16 | 26 |
| SNL-PCT6 | 15 | 0 | 41 |
| VTT186-Exp1 | 41 | 0 | 64 |
| VTT186-Exp3-2 | 14 | 26 | 90 |
| VTT269-Exp1 | 40 | 20 | 46 |
| VTT269-Exp2C | 33 | 6 | 71 |
| VTT269-Exp3 | 13 | 0 | 122 |
| VTT521-Exp7 | 3 | 20 | 22 |
| VTT521-Exp8 | 5 | 26 | 14 |
| VTT521-Exp9 | 9 | 9 | 17 |
| VTT521-Exp10 | 6 | 24 | 16 |
| CBD-7 | 8 | 10 | 7 |
| CBD-20 | 39 | 21 | N/A |
| CBD-52 | 3 | 13 | 9 |
| CBD-53_A | 5 | 0 | 25 |
| CBD-58 | 5 | 2 | 24 |
| CBD-66_A | 17 | 0 | 6 |
| CBD-67_A | 9 | 0 | 4 |
| CBD-69 | 10 | 11 | 6 |
| CBD-75 | 8 | 30 | 0 |
| CBD-77_A | 10 | 7 | N/A |
| CBD-78_A | 11 | 0 | N/A |
| CBD-90 | 20 | 1 | 19 |
| CBD-92 | 6 | 0 | 29 |
| CBD-93 | 9 | 1 | 13 |
| CBD-94 | 12 | 2 | 12 |

Table 4-2
HRR timing for growing electrical cabinet fires

| Test | Units in Minutes | | |
|----------------|------------------|----------------|---------------|
| | Time to Peak | Steady Burning | Time to Decay |
| CBD-95 | 13 | 4 | 19 |
| CBD-96 | 9 | 0 | 18 |
| CBD-100 | 26 | 4 | 17 |
| CBD-102 | 5 | 10 | 10 |
| CBD-103 | 10 | 12 | 19 |
| CBD-105 | 7 | 0 | 6 |
| CBD-106_A | 8 | 2 | N/A |
| CBD-112 | 9 | 2 | 8 |
| Average | 12 | 9 | 26 |

1 4.2 Fire Modeling of Interruptible and Growing Fires

2 As presented in Section 4.1.1 and 4.1.2, the HRR profiles are developed using the average
 3 times generated from the experimental evidence. For the *Growing* fires, the fire grows to a peak
 4 value in an average of 12 minutes, which is similar to the recommended duration of the growth
 5 phase in Appendix G of NUREG/CR-6850. However, the steady burning and decay phases
 6 have longer durations than the ones recommended in Appendix G of NUREG/CR-6850.

7 The increase in the decay stage is primarily due to the durations of five tests performed by VTT
 8 [7, 8]. The decay stages for experiments VTT186-Exp1, VTT186-Exp3-2, VTT269-Exp1, VTT269-
 9 Exp2C, and VTT269-Exp3 all have durations that are longer than 89% of other durations included
 10 in the development of the average. Together, these five tests increase the average decay period
 11 by approximately 8 minutes. Although appropriate for estimating peak HRRs, these long
 12 duration fires with relatively low intensity in the later stages of the experiments do not
 13 necessarily represent the observed experience as described in Section 2. Therefore, the growth
 14 profile described in NUREG/CR-6850 is recommended for modeling growing fires.

15 For *Interruptible* fires, operational experience highlights the following: (1) The fire started
 16 sometime prior to the detection of the event, and (2) the fire did not grow prior to being
 17 suppressed with a minimal effort. In the experimental evidence, this would be represented by
 18 the “pre-growth period” column in Table 4-1. From these experimental results, the pre-growth
 19 period is, on average, approximately 8 minutes long. At the same time, fire events describing
 20 interruptible fires do not provide much insight into the time separating the start of the fire and the
 21 time that the fire was detected.

22 To reflect the operational and experimental evidence in the analysis, it is recommended that a
 23 period of up to 8 minutes of a pre-growth be included in the growth profile for interruptible fires.
 24 The fraction of the 8 minutes included in the fire modeling should be determined, considering the
 25 uncertainty in the unknown time separating the time between ignition and detection of the fire
 26 being modeled.

- 1 For the examples presented in Section 6, half of the average experimental pre-growth period, 4
- 2 minutes, is included as the pre-growth phase in the HRR profile for interruptible fires. The
- 3 inclusion of half of the average experimentally observed pre-growth period allows for the (1)
- 4 uncertainty in the time separating the ignition (start) of the fire and the detection (notification) of
- 5 the fire in the recorded fire events, and (2) time between ignition (start) of the fire and observed
- 6 appreciable growth known in experimental results.
- 7 To reconcile these two observations (the unknown duration in operating experience (OPEX) and
- 8 the known experimental times), an average value of 4 minutes is used.
- 9

DRAFT
for Public Comment

5

REVISED DETECTION–SUPPRESSION EVENT TREE FOR CREDITING PERSONNEL SUPPRESSION

5.1 Detection–Suppression Event Tree Introduction

This section describes the detection-suppression event tree model for characterizing fire detection and suppression activities in response to a fire event. The event tree is a modification of the model described in Appendix P of NUREG/CR-6850 [1] and Chapter 14 of Supplement 1 of NUREG/CR-6850 [12]. This modification is intended to capture the potential for plant personnel suppression during the early stages of a fire.

Numerous fire event records maintained in the EPRI Fire Event Database (FEDB) [2, 4] describe early suppression attempts by plant personnel, such as (1) suppression by operators responding to an equipment trouble alarm in the main control room (MCR) and discovering a fire in the alarming equipment, and (2) plant personnel discovering a fire in its early stages prior to the activation of any automatic detection or suppression systems and suppression using portable fire extinguishers.

This capability is not explicitly included in the detection-suppression event tree models described in NUREG/CR-6850 or Supplement 1 to NUREG/CR-6850. These models only credit prompt suppression for fires in the MCR or for fire scenarios associated with hot work activities. In order to expand plant personnel capability for early detection and suppression, a number of new parameters are developed to incorporate this capability (that is, plant personnel capability for suppression actions prior to the arrival of the plant fire brigade) in the detection-suppression event tree described in NUREG/CR-6850 [1].

5.2 Detection–Suppression Event Tree

To capture early intervention and suppression by plant personnel, the event tree in NUREG/CR-6850 [1] (for scenarios without incipient detection) is revised and split into two identical branch groups: one for capturing the non-suppression probability (NSP) for *Interruptible Fire* and one for *Growing Fire*. The revised event tree format is presented in Figure 5-1. The outcomes of each possible sequence in the revised event tree are listed in Table 5-1.

Revised Detection–Suppression Event Tree For Crediting Personnel Suppression

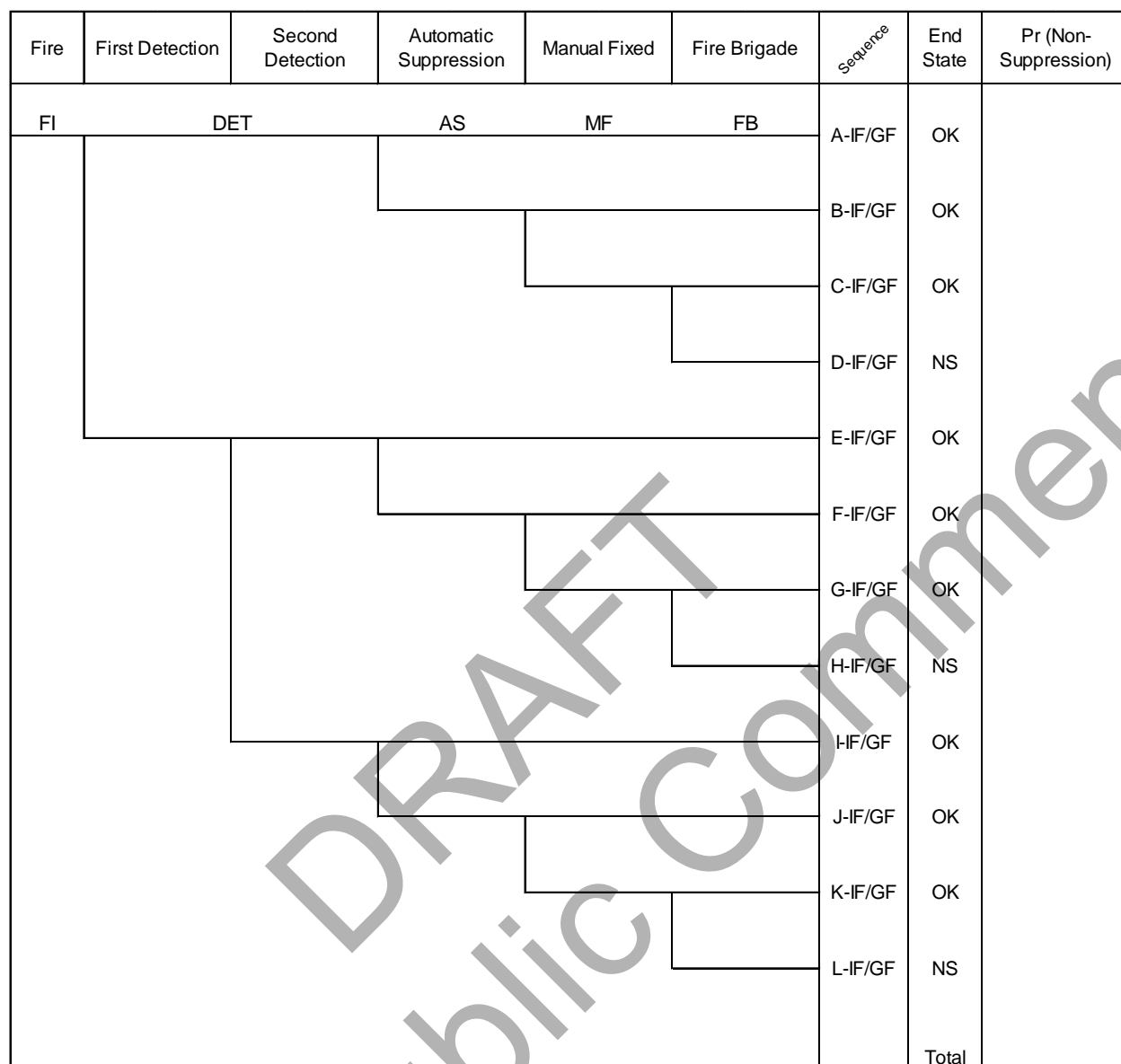

1
2 **Figure 5-1**
3 **Interruptible and growing fire detection and suppression event tree**

Table 5-1
Revised P_{ns} event tree sequences

| Sequence | Detection | Suppression |
|----------|-------------------------------------------------|------------------------------------------------------------|
| A-IF/GF | First detection (zero time of detection) | Fire suppression by an automatically actuated fixed system |
| B-IF/GF | | Fire suppression by a manually actuated fixed system |
| C-IF/GF | | Fire suppression by the fire brigade |
| D-IF/GF | | Fire damage to target items |
| E-IF/GF | Second detection (modeled time to detection) | Fire suppression by an automatically actuated fixed system |
| F-IF/GF | | Fire suppression by a manually actuated fixed system |

Table 5-1
Revised P_{ns} event tree sequences

| Sequence | Detection | Suppression |
|----------|--------------------------|------------------------------------------------------------|
| G-IF/GF | | Fire suppression by the fire brigade |
| H-IF/GF | | Fire damage to target items |
| I-IF/GF | Manual/delayed detection | Fire suppression by an automatically actuated fixed system |
| J-IF/GF | | Fire suppression by a manually actuated fixed system |
| K-IF/GF | | Fire suppression by the fire brigade |
| L-IF/GF | | Fire damage to target items |

1 Sequences A to L in Table 5-1 conclude with the identifiers *-IF* and *-GF*. This represents the two
 2 possible growth profiles: *Interruptible Fire* and *Growing Fire*. These two profiles are described in
 3 detail in Section 4. In this methodology, each profile is calculated using the same event tree
 4 sequences with the exception, as follows:

5 For the *Interruptible* portion of the scenario, the event tree dictates that the fire has not grown
 6 quickly prior to being discovered. Therefore, for sequences A to H, the time of detection will be
 7 set to $t=0$ for *Interruptible Fire*. Different suppression rates are used to calculate the probability
 8 of non-suppression for the *Interruptible Fire* and *Growing Fire* profiles (see Section 3.5). The P_{ns}
 9 for each profile is summed together to determine the total scenario specific NSP.

10 The revised *Interruptible* and *Growing* sequences (A-L, see Table 5-1) are conceptually similarly
 11 to sequences A-N in NUREG/CR-6850 [1]. With respect to calculating the NSP for a scenario,
 12 required changes are as follows:

- 13 • The probability of detection is no longer split between branches representing the failure
 14 of prompt and automatic. Detection is now split between the first detection opportunity
 15 (zero time of detection) and the second detection opportunity (modeled time of
 16 detection). Prompt detection, associated with a continuously occupied space or
 17 continuous fire watch, would be captured through the use of the section on plant
 18 personnel presence probabilities (see Section 5.3.3.5). For scenarios with incipient
 19 detection, see the guidance provided in NUREG-2180 [13].
- 20 • A unique sequence singling out prompt suppression is no longer included. The
 21 development of the *Interruptible* and *Growing* suppression rates makes use of zero and
 22 short suppression times.
- 23 • The sequence of events associated with delayed detection is retained in this
 24 methodology. In NUREG/CR-6850, these sequences were associated with detection by
 25 non-automatic means, such as a roving fire watch. NUREG/CR-6850 also associates
 26 what would be described as an example of MCR indication with delayed detection.
 27 Given a review of operating experience (OPEX), this means detection is no longer
 28 associated with a delay. See Sections 5.3.3.2 and 5.3.4 for a detailed discussion.
- 29 • It is assumed that a fire will always be detected, so what was formerly sequence N in the
 30 detection-suppression event tree in NUREG/CR-6850 no longer exists individually in the
 31 revised detection-suppression event tree and would be captured in the results of
 32 sequence L. The probability of failing to detect the fire in time is determined, as
 33 described in Section 5.3.5 for the entire scenario.
- 34 • The time to detection is assumed to be zero for the following:

- 1 – Detection by a non-fire trouble alarm in the MCR, plant personnel, and automatic
2 smoke detection for an interruptible fire
- 3 – Detection by a non-fire trouble alarm in the MCR and plant personnel for a
4 growing fire

5 For more discussion, see Section 5.3.4.

- 6 • The time to automatic detection for a growing fire may be modeled using the
7 NUREG/CR-6850 growth profile. As described in Section 4.1.3, the NUREG/CR-6850
8 profile grows to a peak HRR in 12 minutes following a t-squared profile.
- 9 • Special consideration of successful automatic suppression should be taken when
10 included in the interruptible fire path. The interruptible fire introduces the concept of a fire
11 that is not expected to grow to a point that would be capable of activating an automatic
12 suppression system. However, the fire probabilistic risk assessment (FPRA) must
13 account for the possibility that the fire could grow and be capable of not only damaging
14 targets, but also activating an automatic suppression system. Similar to a growing fire,
15 the interruptible fire HRR profile, as described in Section 4.1.3, should be used when
16 estimating the activation time of an automatic heat detection or thermally activated
17 automatic suppression system for an interruptible fire.

18 When the NSP for both interruptible and growing fire paths is calculated, the split fraction is
19 applied (see Section 3.4) and the two probabilities are summed to determine the scenario P_{ns} .

20 **5.3 New Parameters for Estimating the NSP**

21 Early detection and suppression by plant personnel is included in the detection-suppression
22 event tree model using the following parameters, which are described in detail in the following
23 sections:

- 24 • Interruptible fire/growing fire split fraction
- 25 • Electrical cabinets HRR profiles
- 26 • Automatic (smoke) detection effectiveness
- 27 • MCR indication
- 28 • MCR operator response
- 29 • Plant personnel response
- 30 • Plant personnel presence

31 **5.3.1 Interruptible Fire Split Fraction**

32 Fire event records in the FEDB include evidence that a majority of fires are extinguished by
33 plant personnel with a minimal suppression effort. This suggests that a significant fraction of
34 fires grow in a manner that allows for plant personnel to respond prior to significant growth and
35 potential propagation. To capture this experience, events are classified into two growth profile
36 groups: (1) interruptible fire: events in which plant personnel could detect and perform early
37 suppression activities. These are fires that progress in a manner that is at a rate so that plant
38 personnel may discover and suppress prior to experiencing external target damage; and (2)
39 growing fire: events where the fire may grow in a manner where plant personnel may not be
40 able to provide suppression in the early stages of the fire development.

1 These events have been classified based on the guidance provided in Section 3.

2 **5.3.2 Fire HRR Profiles**

3 Revised HRR profiles for both interruptible and growing fires are described in Section 4. The
4 profiles used for detailed fire modeling—for the times to damage, automatic detection, and
5 activation of automatic suppression systems—are described in Section 4.2.

6 **5.3.3 Probability of Detection of Electrical Cabinet Fires**

7 In the NUREG/CR-6850 detection-suppression event tree, detection (excluding prompt detection)
8 is split into two events: automatic and manual (delayed). The automatic detection branch
9 traditionally captures both the unreliability and unavailability of an automatic detection system
10 included in the analysis (for more, see Section 5.3.5). As reviewed in Section 2, a significant
11 fraction of Bin 15 electrical cabinet fires are detected by other means: plant personnel and non-fire
12 trouble alarms in the MCR. Given the prevalence of these means of detection over the
13 occurrence of automatic detection systems, the likelihood of successful detection by these
14 means is included in the general detection step of the detection-suppression event tree
15 described in this report.

16 **5.3.3.1 Probability of Automatic Smoke Detection of Electrical Cabinet Fires**

17 In the NSP calculations in NUREG/CR-6850, the probability of failure associated with automatic
18 detection is characterized with the unreliability and unavailability of the detection system.
19 Following that approach, it is assumed that any fire that occurs is capable of producing a
20 detection signal at some point in time based on a system effectiveness review consistent with
21 Section P.1.2 in NUREG/CR-6850. Given the revised treatment for detection described in this
22 report, an effectiveness parameter is added to explicitly capture fires that are too small to
23 activate an automatic smoke detection system. To capture the potential for smoke detectors
24 failing to activate due to fire size, a Monte Carlo sampling process was performed to calculate
25 the average probability of detection for both interruptible and growing fires. The effectiveness
26 term refers to the probability that a fire will be large enough to be detectable.

27 Using a randomized sample size of 20,000 occurrences for each electrical enclosure
28 classification and fuel type, the probability of detection was averaged. The parameters, the
29 distribution of the parameters, and the other defining statistical properties used in the variation
30 are provided in Table C-1. The results of the Monte Carlo analysis are provided for each
31 electrical enclosure classification, fuel load, and cable type included in NUREG-2178, and the
32 results are summarized in Table 5-2.

33

Table 5-2
Automatic smoke detection probability of no detection

| Enclosure Class/ Function Group | Enclosure Ventilation | Fuel Type | Default Fuel Loading Probability of Detection | Low Fuel Loading Probability of Detection | Very Low Fuel Loading Probability of Detection |
|------------------------------------------------------|--------------------------|------------|--------------------------------------------------------|----------------------------------------------------|---------------------------------------------------------|
| 1 – Switchgears and load centers | Closed | TS/QTP/SIS | 0.6 | N/A | N/A |
| 1 – Switchgears and load centers | Closed | TP | 0.32 | N/A | N/A |
| 2 – Motor control centers and battery chargers | Closed | TS/QTP/SIS | 0.62 | N/A | N/A |
| 2 – Motor control centers and battery chargers | Closed | TP | 0.33 | N/A | N/A |
| 3 – Power inverters | Closed | TS/QTP/SIS | 0.64 | N/A | N/A |
| 3 – Power inverters | Closed | TP | 0.45 | N/A | N/A |
| 4a - Large enclosures | Closed | TS/QTP/SIS | 0.56 | 0.65 | 0.69 |
| 4a - Large enclosures | Closed | TP | 0.34 | 0.45 | 0.53 |
| 4a - Large enclosures | Open | TS/QTP/SIS | 0.47 | 0.55 | 0.69 |
| 4a - Large enclosures | Open | TP | 0.31 | 0.4 | 0.53 |
| 4b - Medium enclosures | Closed | TS/QTP/SIS | 0.65 | 0.7 | 0.64 |
| 4b - Medium enclosures | Closed | TP | 0.45 | 0.58 | 0.64 |
| 4b - Medium enclosures | Open | TS/QTP/SIS | 0.6 | 0.72 | 0.64 |
| 4b - Medium enclosures | Open | TP | 0.37 | 0.63 | 0.64 |
| 4c – Small enclosures | N/A | All | 0.65 | N/A | N/A |

1 These values include variations in ceiling heights, horizontal separation distances, and HRR
 2 percentiles. For more details, see Appendix B.

3 The probabilities presented in Table 5-2 should be used for scenarios of fires limited to single
 4 electrical cabinets where relatively small fires may not activate automatic systems. The results
 5 of the Monte Carlo analysis highlight that a significant fraction of the HRRs not detected are of
 6 50 kW or less. An HRR in excess of 50 kW results in approximately 95% of the simulated cases
 7 covering all enclosure class/function groups being detected. Of the simulated fire sizes that are
 8 not detected, an increase of 120 kW would result in the detection of approximately 98% of all

1 the simulated fires sampled. In the FPRA, some of the most challenging and risk significant
 2 scenarios come from the involvement of secondary combustibles. When the contribution of the
 3 HRR associated with propagation to secondary combustibles is considered characterized by
 4 150 kW/m^2 or 250 kW/m^2 (see NUREG/CR-7010, Volume 1) for thermoset and thermoplastic
 5 cables, respectively, it is safe to assume that the fire is large enough to be detected. Therefore,
 6 the resulting probability of failure would be determined only by the unreliability and unavailability
 7 of the automatic smoke detection system only.

8 5.3.3.2 MCR Indication

9 Fifteen of the Bin 15 events recorded in the FEDB describe notification of an event by trouble
 10 alarms or indications in the MCR, such as a loss of power, reduced output alarms, and so on.
 11 This suggests that indication of a fire event does not always come from an automatic fire
 12 detection alarm or a phone call to the MCR.

13 To capture this in the revised detection-suppression event tree model, a new branch is included
 14 in the MCR Indication Response group. This event is a simple True/False option. The branch
 15 should be set to True when the ignition source involves equipment or components that are
 16 specifically monitored in the MCR (that is, there is both a trouble alarm and annunciation
 17 associated with the equipment that will provide indication or alarm in the event of a loss or
 18 degradation of function). The value of this event when it is set to True is developed from a
 19 review of industry average component failure data.

20 NUREG/CR-6928 [14] presents industry average component performance results, including
 21 those for sensor and transmitter components. Table 5-3 presents the sensor/transmitter
 22 unreliability data for various parameters (level, pressure, and temperature).

Table 5-3
Sensor and transmitter unreliability data [11]

| Component | Failure Mode | Failures | Demands |
|------------------------------------|--------------------|----------|---------|
| Sensor/transmitter: level | Failure to operate | 5 | 6750 |
| Sensor/transmitter: pressure | Failure to operate | 2.3 | 23960 |
| Sensor/transmitter: temperature | Failure to operate | 17.1 | 40759 |

23
 24 Summing the unreliability data for each component results in a value of approximately $5/6750 +$
 25 $2.3/23960 + 17.1/40759 = 1.26\text{E-}03$ failures per demand. While not directly representing the
 26 unreliability of trouble alarms, the general function of these sensors/transmitters is to convey an
 27 “out of spec” condition for key parameters associated with plant equipment that will then be
 28 annunciated in the MCR through a trouble alarm. Depending on the equipment, an operator
 29 may be sent to locally verify the equipment status. For this reason, the sensor/transmitter
 30 unreliability data are used to suggest an appropriate value for use with this methodology.
 31 Therefore, when set to True, the probability of the branch representing the success of a trouble
 32 alarm in the MCR is set to 0.99 to represent a bounding probability of alarm success. This value
 33 represents a $1-0.99 = 0.01$ failure probability, which bounds the value of $1.26\text{E-}03$ to account for
 34 other failure modes or indication systems not included in the unreliability data.

35 This function of MCR indication should only be used for ignition sources that are *specifically*
 36 *monitored, and any trouble with the equipment must be annunciated in the MCR.* If the ignition

1 source is not monitored in the MCR (upon a failure or degradation, there is no equipment or
2 component specific indication in the MCR), the probability of failure for this event must be set to
3 1. In some cases, monitoring may be limited to a component, or components, located within a
4 piece of equipment—a relay located within a cabinet, for example. In these cases, the MCR
5 indication should only be credited when modeling is performed at the component level and
6 should not be applied at the level of the cabinet.

7 5.3.3.3 MCR Operator Response

8 When an alarm (for example, automatic fire detection or equipment trouble) occurs, operators
9 must react and appropriately perform different actions to ensure a timely response to a potential
10 fire. The parameters discussed in this section capture the human error probability (HEP) of an
11 operator responding to a non-automatic fire alarm or equipment trouble indication in the MCR.

12 The human reliability analysis (HRA) presented here is a screening-type of generic analysis. If
13 plant-specific details do not match the qualitative elements given here, credit for this analysis
14 may not be possible. On the other hand, if plant-specific elements are somehow better than
15 described in the following list, increased credit may be possible, if supported by a plant-specific
16 detailed HRA.

17 *Qualitative Analysis*

18 Key features of the MCR operator response include the following:

- 19 • The scope of analysis includes only electrical cabinets and relates to fire NSPs.
- 20 • The alarm occurs before (and without) a reactor trip (or other problems that could
21 immediately lead to a reactor trip).
- 22 • Alarms are located on front panels in the MCR (which means that alarm panels and
23 associated annunciators are designed in accordance with NUREG-0700 [15] and other
24 human factors requirements).
- 25 • Alarm response is trained on and is part of normal operations.
- 26 • Alarm response is guided by the Alarm Response Procedures (ARPs), which are part of
27 the Emergency Response Procedures (ERPs). As such, ARPs are written following the
28 human factors guidance required for ERPs (for example, there is a required procedure
29 format, attention paid to logic, such as limited use of "AND" and "NOT").
- 30 • Formal, three-way communications are used within the MCR and with plant personnel
31 (by phone or radio) per conduct of operations, training, and so on.
- 32 • Peer checking within the MCR is performed per conduct of operations, training, and so
33 on.
- 34 • There is adequate staff in the MCR per NRC requirements.
- 35 • There is no specific time urgency for alarm response, except for operational "good
36 practice" (perhaps stated in the plant-specific conduct of operations).
- 37 • The key MCR operator tasks include the following:
 - 38 – Detect alarm
 - 39 – Select the appropriate ARP
 - 40 – Follow ARP guidance¹
 - 41 – Call and dispatch field operator (including communications regarding specific
42 alarm and associated equipment, location of equipment, and so on)

¹ In the rare cases where the ARP guidance does *not* include a verification step, this approach cannot be used because it presumes there is a documented, compelling reason to allow credit for field operator verification.

1 These qualitative elements are very similar to those stated in NUREG-2180 [13]. The key
2 differences include the following:

- 3 • Alarms for incipient fire detectors are few and unique (for example, they may have only a
4 handful of incipient fire alarms, may have separate panels, or have unique markings).
- 5 • MCR operators are expected to have specialized training for response to alarms for
6 incipient fire detectors.
- 7 • As part of MCR operator training on incipient fire detectors, operators are trained on the
8 need for immediate and urgent response (for example, "drop everything"), making
9 response to these alarms very similar to alarm response following a reactor trip.
- 10 • MCR operators are trained on the need for quick response to incipient fire detectors.

11 *Quantitative Analysis*

12 A comparative quantification using various methods available in the EPRI HRA calculator was
13 performed to evaluate an HEP for this action. The methods used were the following:

- 14 • Standardized plant analysis risk human reliability analysis (SPAR-H) [16, 17]
- 15 • Cause-based decision tree method (CBDTM) from the EPRI HRA approach [18]
- 16 • Technique for human error rate prediction (THERP) [19] Annunciator Response Model²

17 **Standardized Plant Analysis Risk Human Reliability Analysis (SPAR-H)**

18
19 As discussed in NUREG/CR-6883 [16], The SPAR-H method produces a simple best estimate
20 HEP for use in plant risk models. Based on review of first- and second-generation HRA
21 methods, the SPAR-H method assigns human activity to one of two general task categories:
22 action or diagnosis. Eight categories of performance shaping factors (PSFs) capable of
23 influencing human performance are accounted for in the SPAR-H quantification process by
24 addressing not only the negative effects, but also the potential beneficial influence of these
25 factors. The application of PSF multipliers in the SPAR-H method follows a "threshold
26 approach," wherein discrete multipliers are used that are associated with various PSF levels.
27

28 HRA for a context similar to that modeled in this report was performed in NUREG-2180 [13] for
29 response to incipient fire detectors. In NUREG-2180, only the diagnosis contribution of the
30 SPAR-H quantification guidance was used and was considered to include the potential failure to
31 properly communicate the equipment location to the field operator. Because of the parallels
32 between the context addressed by the HRA in NUREG-2180 and the context addressed in this
33 report, the same approach is used here (that is, the HEP assignment is based on diagnosis for
34 cognition only).
35
36

² This method was used for comparison purposes, but it should be noted that NUREG-2180 did *not* recommend its use for a similar MCR operator alarm diagnosis action based on incipient detection of a fire condition.

1 Taking into account the similarities and differences between this case of general alarms versus
2 incipient fire detector alarms, SPAR-H PSF assessments and the associated multipliers are
3 summarized in the following:

- 4
- 5 • Available time is nominal (multiplier = 1).
- 6 • Stress is nominal (multiplier = 1).
- 7 • Complexity is nominal (that is, there is little ambiguity) (multiplier = 1).
- 8 • Experience/training is nominal (multiplier = 1).
- 9 • Procedures are diagnostic/symptom-oriented (multiplier = 0.5).
- 10 • Ergonomics is nominal (multiplier = 1).
- 11 • Fitness for duty is nominal (multiplier = 1).
- 12 • Work processes are nominal (multiplier = 1).
- 13

14 In the SPAR-H PSF assessments for this scenario versus those used in NUREG-2180 for
15 incipient fire detectors, analysts should note the following differences:

- 16 • "Obvious diagnosis" is used for the incipient fire detector case.
- 17 • Ergonomics for the incipient fire detector case are judged to be "good" (that is, better
18 than nominal) because such installations also typically involve an additional computer
19 station for the incipient detectors.
- 20 • Work processes for the incipient fire detector case are judged to be "good" (that is,
21 better than nominal) because of the importance that nuclear power plant (NPP)
22 organizations place on such installations.
- 23

24 Using the multipliers noted along with the SPAR-H base HEP for diagnosis of $1E-2$, the
25 resultant HEP is $5.0E-3$. An argument that the complexity assessment be an "obvious
26 diagnosis" (that is, multiplier of 0.1) instead of nominal could be made, changing the resultant
27 HEP to $5.0E-4$.

29 **Cause-Based Decision Tree Method (CBDTM)**

30 The EPRI HRA approach [17] includes two quantification methods that address cognitive
31 failures. These methods have been applied to both internal events and fire HRA, the latter of
32 which is discussed in Appendix B of NUREG-1921 [20].

33
34 The EPRI human cognitive reliability/operator reliability experiment (HCR/ORE) method is a
35 time reliability correlation and typically used when available time is relatively short. However, the
36 HCR/ORE method is not appropriate for operator actions that are extremely well-practiced or
37 skill-based, such as manual reactor trip after trip signals and alarms are received. For this
38 reason, and because the HCR/ORE method provides little insight on the potential causes of
39 operator failure, EPRI's CBDTM is considered more appropriate for assessing the cognitive
40 contribution to operator failure for skill- or rule-based operator response actions that do not
41 involve a time constraint.

42
43 EPRI's CBDTM consists of eight decision trees (Figure 5-2 through Figure 5-9), four of which
44 address failures in the plant information-operator interface and another four that address failures
45 in operator-procedure interface. Both sets of these decision trees match well with the MCR
46 operator action modeled in this analysis.

1 Using the qualitative analysis inputs discussed at the beginning of this section, the CBDTM
 2 decision tree selections for the cognitive MCR operator action to notice the alarm and
 3 communicate with the field operator were assessed as follows:

4 Pca: Availability of Information (Figure 5-2)

5 Notes/assumptions include the following:

- 6 • Nominal initial conditions in plant
- 7 • Indication available and accurate in MCR
- 8 • Training in classroom and simulator on use of ARPs to respond to MCR equipment
- 9 trouble alarms

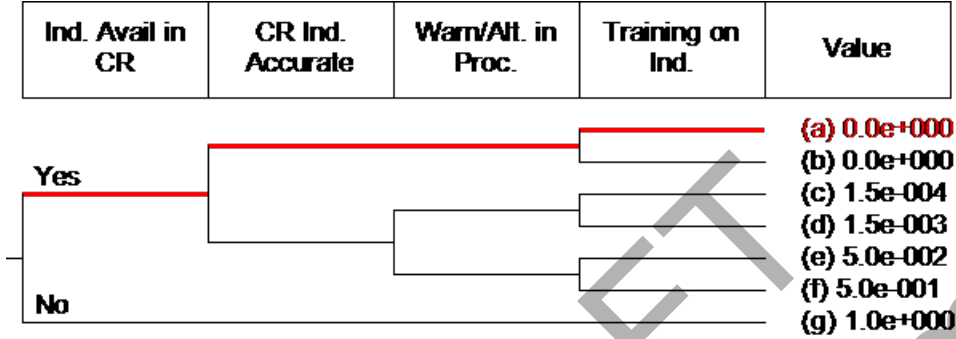

10
11
12
13
14

Figure 5-2
Pca: availability of information

DRAFT
for Public Comment

1 Pcb: Failure of Attention (Figure 5-3)

2 Notes/assumptions include the following:

- 3 • Workload presumed to be low for a nominal condition in the plant
- 4 • Operator "checking" the alarm (not presumed to be monitoring a condition or status when the anomalous condition occurs)
- 5
- 6 • Equipment trouble alarm located on MCR overhead or front panel

| Low vs. Hi Workload | Check vs. Monitor | Front vs. Back Panel | Alarmed vs. Not Alarmed | Value |
|---------------------|-------------------|----------------------|-------------------------|--------------|
| Low | Check | Front | | (a) 0.0e+000 |
| | | Back | | (b) 1.5e-004 |
| | Monitor | Front | | (c) 3.0e-003 |
| | | Back | | (d) 1.5e-004 |
| High | Check | Front | | (e) 3.0e-003 |
| | | Back | | (f) 3.0e-004 |
| | Monitor | Front | | (g) 6.0e-003 |
| | | Back | | (h) 0.0e+000 |
| | Check | Front | | (i) 0.0e+000 |
| | | Back | | (j) 7.5e-004 |
| | Monitor | Front | | (k) 1.5e-002 |
| | | Back | | (l) 7.5e-004 |
| | | | | (m) 1.5e-002 |
| | | | | (n) 1.5e-003 |
| | | | | (o) 3.0e-002 |

7
8 **Figure 5-3**
9 **Pcb: failure of attention**

10

Pcc: Misread/Miscommunicate Data (Figure 5-4)

Notes/assumptions include the following:

- Equipment trouble alarm easy to see on front panel or overhead panels in MCR
- Human-machine interface of annunciator considered to be optimal or familiar to the operator so that it is considered "good"
- Formal communication protocol used in transmitting information to field operator regarding equipment trouble and location

| Ind. Easy to Locate | Good/Bad Indicator | Formal Communication | Value |
|---------------------|--------------------|----------------------|--------------|
| Easy | Good | Yes | (a) 0.0e+000 |
| | | No | (b) 3.0e-003 |
| Not easy | Bad | Yes | (c) 1.0e-003 |
| | | No | (d) 4.0e-003 |
| | Good | Yes | (e) 3.0e-003 |
| | | No | (f) 6.0e-003 |
| | Bad | Yes | (g) 4.0e-003 |
| | | No | (h) 7.0e-003 |

Figure 5-4
Pcc: misread/miscommunicate data

Pcd: Information Misleading (Figure 5-5)

Notes/assumptions include the following:

- Plant nominal initial condition therefore all cues are as stated (in other words, no potential for spurious or erroneous alarms due to fire impacts)

| All Cues as Stated | Warning of Differences | Specific Training | General Training | Value |
|--------------------|------------------------|-------------------|------------------|--------------|
| Yes | | | | (a) 0.0e+000 |
| No | Yes | | | (b) 3.0e-003 |
| | No | Yes | | (c) 1.0e-002 |
| | | No | Yes | |
| | | | No | No |

Figure 5-5
Pcd: information misleading

1 Pce: Skip a Step in Procedure (Figure 5-6)

2 Notes/assumptions include the following:

- 3 • ARP steps are written to be brief, clear, and direct.
- 4 • Single ARP is used for response to annunciator.
- 5 • ARP steps are distinct.
- 6 • Presume that placekeeping aids are included in ARP.

| Obvious vs. Hidden | Single vs. Multiple | Graphically Distinct | Placekeeping Aids | Value |
|--------------------|---------------------|----------------------|-------------------|--------------|
| Obvious | Single | Yes | Yes | (a) 9.9e-004 |
| | | No | No | (b) 3.3e-003 |
| | Multiple | Yes | | (c) 3.0e-003 |
| | | No | | (d) 1.0e-002 |
| Hidden | Single | Yes | | (e) 2.0e-003 |
| | | No | | (f) 4.3e-003 |
| | Multiple | Yes | | (g) 6.0e-003 |
| | | No | | (h) 1.3e-002 |
| | | | | (i) 1.0e-001 |

7

8 **Figure 5-6**

9 **Pce: skip a step in procedure**

10

11 Pcf: Misinterpret Instructions (Figure 5-7)

12 Notes/assumptions include the following:

- 13 • ARPs are written using standard procedural language.
- 14 • All information is included to direct operator to verify condition and dispatch a field operator to investigate.

15

| Standard or Ambiguous Wording | All Required Information | Training on Step | Value |
|-------------------------------|--------------------------|------------------|--------------|
| Standard | Yes | | (a) 0.0e+000 |
| | No | Yes | (b) 3.0e-003 |
| Ambiguous | Yes | No | (c) 3.0e-002 |
| | | | (d) 3.0e-003 |
| | No | | (e) 3.0e-002 |
| | | | (f) 6.0e-003 |
| | | | (g) 6.0e-002 |

16

17 **Figure 5-7**

18 **Pcf: misinterpret instructions**

19

1 Pcg: Misinterpret Decision Logic (Figure 5-8)

2 Notes/assumptions include the following:

- 3 • ARP language is clear and direct and does not include *NOT*, *AND*, or statements
 4 requiring significant diagnosis
 5 • Response to an equipment trouble annunciator is well-practiced in simulator and
 6 classroom training.
 7

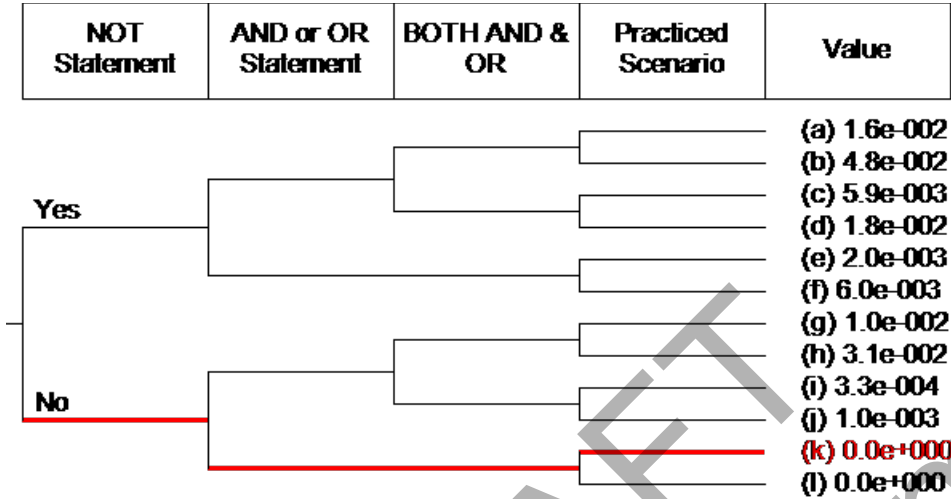

8
 9 **Figure 5-8**
 10 **Pcg: misinterpret decision logic**

11 Pch: Deliberate Violation (Figure 5-9)

12 Notes/assumptions include the following:

- 13 • Operators believe the appropriateness and efficacy of the ARPs.
 14

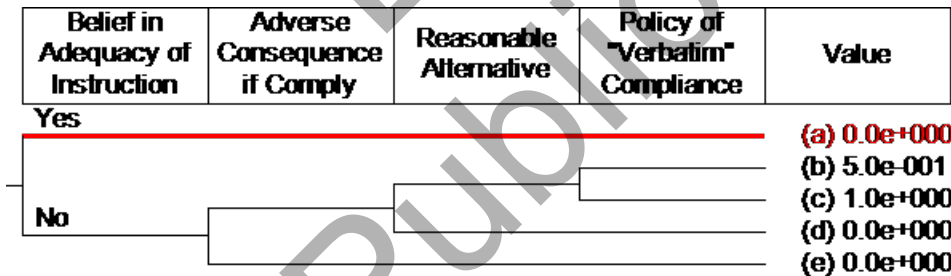

15
 16 **Figure 5-9**
 17 **Pch: deliberate violation**

18 EPRI's CBDTM assigns as negligible the contribution from all of the data decision trees, and all
 19 but one of the procedure decision trees. The results also show that the contribution from
 20 procedures for this human failure event (HFE) is the lowest possible HEP (that is, ~1E-3 in
 21 decision tree *pce*).

22 CBDTM gives analysts the opportunity to model peer checking through the Cognitive Recovered
 23 module, which was addressed by crediting extra crew, as shown in Table 5-4.

24

1 **Table 5-4**
 2 **MCR operator response as calculated using CBDTM**

| Cognitive Recovery | | | | | | | | |
|------------------------------------------|-------------|-------------|------------|------------|--------------|------------|-----------------|-------------|
| | Initial HEP | Self Review | Extra Crew | STA Review | Shift Change | ERF Review | Multiply HEP by | Final Value |
| Pca | N/A | - | - | - | - | - | 1.0E+00 | 0.0 |
| Pcb | N/A | - | - | - | - | - | 1.0E+00 | 0.0 |
| Pcc | N/A | - | - | - | - | - | 1.0E+00 | 0.0 |
| Pcd | N/A | - | - | - | - | - | 1.0E+00 | 0.0 |
| Pce | 9.9E-04 | - | 5.0E-01 | - | - | - | 1.0E+00 | 5.0E-04 |
| Pcf | N/A | - | - | - | - | - | 1.0E+00 | 0.0 |
| Pcg | N/A | - | - | - | - | - | 1.0E+00 | 0.0 |
| Pch | N/A | - | - | - | - | - | 1.0E+00 | 0.0 |
| Final Pc (with recovery credited) | | | | | | | | 5.0E-04 |

3
 4 The total estimated CBDTM HEP including peer checking is therefore 5.0E-04.

5 **THERP Annunciator Response Model**

6 As discussed in NUREG-2180 [13], technique for human error rate predication (THERP) was
 7 developed before the Three Mile Island 2 accident [21] and the ensuing upgrades to NPP
 8 control room designs, operating procedures, operator licensing, and training programs. In
 9 addition, the THERP Annunciator Response Model does not explicitly address cognition or
 10 diagnosis, as most modern HRA methods do, and does not appropriately take into account the
 11 pattern-matching of annunciator tiles that modern NPP operators do when responding to an
 12 event. HEPs for the Annunciator Response Model (shown in Table 20-23 of NUREG/CR-1278
 13 [19]) range from 1E-4 to 2.5E-1.

14
 15 A comparative quantification using the Annunciator Response Model is included here because
 16 industry has still found the model useful for specific instances, such as response to a single
 17 annunciator in the MCR.

18 The MCR operator response HEP is considered to be the sum of (1) the failure of the operator
 19 to notice the occurrence of the trouble alarm (annunciator), and (2) the failure to correctly
 20 interpret the trouble alarm on the MCR panel or above-panel display and dispatch the operators
 21 to the right location.

22 The Annunciator Response Model of the HRA calculator is applied to the failure of the operator
 23 to notice the annunciator occurrence. For one annunciator, the mean failure probability is 2.7E-
 24 04 (Figure 5-10).

Annunciator Response Model

Double click to change selection

| # of ANNs | 1 | 2 | 3 | 4 | 5 | 6 | 7 | 8 | 9 | 10 | Any |
|-----------|---------|---------|---------|---------|---------|---------|---------|---------|---------|---------|---------|
| 1 | 2.7e-04 | | | | | | | | | | 2.7e-04 |
| 2 | 2.7e-04 | 2.7e-03 | | | | | | | | | 1.5e-03 |
| 3 | 2.7e-04 | 2.7e-03 | 5.3e-03 | | | | | | | | 2.8e-03 |
| 4 | 2.7e-04 | 2.7e-03 | 5.3e-03 | 1.1e-02 | | | | | | | 4.7e-03 |
| 5 | 2.7e-04 | 2.7e-03 | 5.3e-03 | 1.1e-02 | 2.1e-02 | | | | | | 8.0e-03 |
| 6 | 2.7e-04 | 2.7e-03 | 5.3e-03 | 1.1e-02 | 2.1e-02 | 4.3e-02 | | | | | 1.4e-02 |
| 7 | 2.7e-04 | 2.7e-03 | 5.3e-03 | 1.1e-02 | 2.1e-02 | 4.3e-02 | 8.5e-02 | | | | 2.4e-02 |
| 8 | 2.7e-04 | 2.7e-03 | 5.3e-03 | 1.1e-02 | 2.1e-02 | 4.3e-02 | 8.5e-02 | 1.7e-01 | | | 4.2e-02 |
| 9 | 2.7e-04 | 2.7e-03 | 5.3e-03 | 1.1e-02 | 2.1e-02 | 4.3e-02 | 8.5e-02 | 1.7e-01 | 3.5e-01 | | 7.6e-02 |
| 10 | 2.7e-04 | 2.7e-03 | 5.3e-03 | 1.1e-02 | 2.1e-02 | 4.3e-02 | 8.5e-02 | 1.7e-01 | 3.5e-01 | 6.7e-01 | 1.4e-01 |
| 11 to 15 | | | | | | | | | | | 3.1e-01 |
| 16 to 20 | | | | | | | | | | | 4.0e-01 |
| 21 to 40 | | | | | | | | | | | 5.3e-01 |
| > 40 | | | | | | | | | | | 6.7e-01 |

Figure 5-10
Annunciator Response Model of the HRA calculator

For the interpretation portion of the HFE, standard THERP Table 20-10, Item 6, provides a value for an error of commission in reading and recording quantitative information using values from indicator lamps that are used as quantitative displays. This reflects the operator reading the information from the indicator and relaying it to the field operator. This results in an HEP of 1.3E-03. Crediting peer checking for this action with a conditional HEP of 5.0E-01 reduces the HEP to 6.5E-04.

Summing these two values: 2.7E-04+6.5E-04 results in an HEP of 9.2E-04 for the MCR operator response.

Conclusions

Based on the assumptions and task analysis in the qualitative analysis and the comparison of methods in the quantitative analysis, it is recommended that the analyst use a screening HEP of 1E-3 for the MCR operator response.

It should be noted that in NUREG-2180 [13], two HEPs are developed: MCR operator response and a field operator response. This methodology does not include the development or use of a field operator response HEP because the time required for and probability of success is already included in the development of the suppression rate. For more on the development of the suppression rate, see Section 3.5. An HEP for general plant personnel discovering a fire and responding appropriately is developed in Section 5.3.3.4.

5.3.3.4 Detection by Plant Personnel

As discussed in Section 2, almost half of the fires that have occurred in Bin 15 (electrical cabinets) are detected by plant personnel. Examples of detection by plant personnel for both interruptible and growing fires are listed as follows:

- Event 131 describes that technicians were working in the area, heard a loud bang, and upon investigating the source of the noise observed smoke and sparks coming from an electrical panel.
- Event 411 describes another event where personnel heard a loud noise while working and detected a fire.
- Event 10394 describes that personnel investigating an odor of something burning discovered a small fire.

The basic event of detection by plant personnel in the fault tree must be defined to be consistent with the operation experience underlying the NSPs discussed in Section 3.5. Because these

1 underlying data represent only those fires that are detected and suppressed by plant personnel,
2 there are only two things that must be represented through detection by plant personnel: (1)
3 plant personnel must be at or near where the fire is located (see Section 5.3.3.5 that addresses
4 the presence of personnel), and (2) plant personnel must be trained to respond to sensing a fire
5 (for example, smelling smoke) in the same way that plant personnel behaved in the operational
6 experience (for example, personnel both reported the fire to the MCR and suppressed the fire).

7 Consequently, the “detection by plant personnel” event is essentially a “go/no-go” feasibility test,
8 allowing only those NPPs that provide the appropriate training to take credit for this approach.
9 Note that, given what the data underlying the NSPs represent, this approach assumes that
10 appropriately trained plant personnel will detect the fire.³

11 In turn, the definition of *appropriate training* includes a key requirement related to fire detection
12 and suppression—all plant personnel who encounter any indications of fire should identify the
13 fire location, then report the fire to the MCR. Personnel should be trained to perform these
14 actions, and these actions should be a part of plant policy and expected conduct.

15 This requirement must be met for all plant personnel who are expected to occupy the area being
16 assessed (that is, each space must be evaluated separately, based on the personnel expected
17 to occupy that space).

18 This training requirement may be satisfied by general plant training that is required for all
19 badged plant personnel who are permitted to move around the NPP unescorted. Such training
20 may include specific requirements that all suspected occurrences of fire (such as smell or sight
21 of smoke and/or sight of flames) be reported to the MCR (including the location of the fire,
22 extent of the fire, type of material involved). Such training may be reinforced by plant policies
23 and/or conduct of operations.

24 Fire suppression training would be satisfied by fire brigade training. However, because fire
25 brigade training is not typically provided to all plant personnel, other plant-specific training on
26 fire suppression, including who is trained, when they are authorized to suppress a fire, and so
27 on, must be documented.

28 5.3.3.5 Probability of Presence of Personnel

29 Twenty-two events in the FEDB identify occasions where a fire was discovered by plant
30 personnel prior to, concurrent with, or independent of an automatic detection, suppression, or a
31 trouble alarm. The FPRA ranks personnel presence in the vicinity using the transient influence
32 factors. These factors, specifically those associated with occupancy and maintenance, are used
33 to develop a determination of the probability of plant personnel being present in a fire
34 compartment. The events listed in Section 5.3.3.4 describe the detection of fires by personnel
35 occupying or performing maintenance in a compartment.

³ Note that the fire being detected should not include an incipient fire. For detection of incipient fires, see NUREG-2180 [3].

1 NUREG/CR-6850 describes occupancy and maintenance influencing factors as the following:

- 2 • Occupancy: occupancy level, which includes traffic, of a compartment.
- 3 • Maintenance: frequency and nature of maintenance activities (preventive and/or
- 4 corrective) in a compartment.
 - 5 – FAQ 12-0064 [22] adds a hot work influencing factor. The rating levels
 - 6 associated with hot work weighted similarly to those of maintenance. For this
 - 7 analysis, the maximum of the ratings associated with maintenance and hot work
 - 8 should be selected to represent the contribution of personnel performing work for
 - 9 the detection of a fire.

10 The rating levels in FAQ 12-0064 [22] are assigned to each transient influencing factor, as

11 follows:

- 12 • **No: 0** – For compartments where transients are precluded by design or entrance is not
- 13 possible during plant operation
- 14 • **Very low: 0.5** – Compartment is subject to controls and procedures that result in a factor
- 15 less than a low rating level
- 16 • **Low: 1** – Reflects minimal level of the factor
- 17 • **Medium: 3** – Reflects average level of the factor
- 18 • **High: 10** – Reflects the higher-than-average level of the factor
- 19 • **Very high: 50** – Specific to maintenance, reflects a significantly higher-than-average
- 20 level of the factor

21 These rating levels are used to make an estimation of the probability that personnel would be

22 present in a compartment and therefore capable of detecting a fire. Note that the changes

23 described later apply only to estimating the numerical probability that personnel are expected to

24 be in a compartment. The influencing factors assigned for the purposes of apportioning the

25 transient ignition frequency should be maintained for estimating the probability of personnel

26 detection. No changes may be made to the use of the influencing factor values as applied to the

27 transient ranking scheme, as described in NUREG/CR-6850 and FAQ 12-0064.

28 Following some modifications, personnel presence rating levels for both the occupancy and

29 maintenance influencing factors are presented in Table 5-5. These modifications are the only

30 exceptions that may be made and are done so for the purposes of estimating personnel

31 detection.

Table 5-5
Description of personnel presence influencing factors

| Influencing Factor | No (0) | Very Low (0.5) | Low (1) | Medium (5) | High (10) | Very High (50) |
|-------------------------------------------------------------------------|-----------------------------------------------------------------------------------------------|-----------------------------------------------------------------------------------------------------------------------------------------------------------------------------------------------------------------------------------------------------------------------------------------------------------------------------------------------------------------------------------------------------------------------------------------------------------|------------------------------------------------------------------------------------------------------------------------------------------------------|-------------------------------------------------------------------------------------------------|----------------------------------------------------------------------------------------|----------------------------------------------------------------------------------------------------------------------------------------------------------|
| $\frac{Pr(n_o)}{\text{Maximum occupancy rating}}$ <p>Occupancy</p> | <p>0/10 = 0</p> <p>Entrance to the compartment is not possible during plant operation.</p> | <p>0.5/10 = 0.05</p> <p>Compartment is bounded on all sides by controlled physical barriers and is normally unoccupied during plant operations. The compartment is not used as an access pathway for any other plant location. Entrance to the compartment is strictly controlled. Compartment is not accessible to general plant personnel. Access requires prior approval and requires notification to on-shift operators in the main control room.</p> | <p>1/10 = 0.1</p> <p>Compartment with low foot traffic or out of the general traffic path (for example, a roving fire watch or security rounds).</p> | <p>5/10 = 0.5</p> <p>Compartments not continuously occupied, but with regular foot traffic.</p> | <p>10/10 = 1.0</p> <p>Continuously occupied compartment.</p> | <p>N/A</p> |
| $\frac{Pr(n_M)}{\text{Maximum maintenance rating}}$ <p>Maintenance*</p> | <p>0/50 = 0</p> <p>Maintenance activities during power operation are precluded by design.</p> | <p>(0.5/2)/50 = 0.005</p> <p>Access to the location is strictly controlled, contains only cables, fire detectors, and junction boxes. Hot working during operation is prohibited, and plant records confirm no violations of these procedures over some reasonable time.</p> | <p>(1/2)/50 = 0.01</p> <p>Small number of work orders compared with the average number of work orders for a typical compartment.</p> | <p>(5/2)/50 = 0.05</p> <p>Average number of work orders for a typical compartment.</p> | <p>(10/2)/50 = 0.1</p> <p>A large number of work orders for a typical compartment.</p> | <p>(50/2)/50 = 0.5</p> <p>Area experiences significantly more work orders compared with the average number of work orders for a typical compartment.</p> |

*Note: As shown, understanding that maintenance activities are not as strong an indication of personnel presence as the occupancy factor, all maintenance rating levels were reduced by 50%.

1 For occupancy, the rating level associated with *medium* was revised from 3 to 5. This change
 2 was made to better correlate the rating values with the rating description as being
 3 representative of the average level of the factor. With a maximum value of 10 (high), a value of
 4 5 also better correlates to the OPEX experience showing that 55% (see Figure 2-2) of the fire
 5 events have been detected by plant personnel.

6 For maintenance, two modifications were made. The same modification to rating associated
 7 with the medium factor was applied. In addition, understanding that maintenance activities are
 8 not as strong an indication of personnel presence as the occupancy factor, all maintenance
 9 rating levels were reduced by 50%.

10 Because the occupancy and maintenance ratings may not necessarily be mutually exclusive,
 11 the probability that personnel may be present is determined by estimating the amount of
 12 personnel expected to be in (occupancy) a compartment or an adjacent compartment,
 13 calculated as (Equation 5-1):

$$Pr(n_O \text{ or } n_M) = Pr(n_O \cup n_M) = Pr(n_O) + Pr(n_M) - Pr(n_O) \times Pr(n_M) \quad (5-1)$$

14 Where, n_O is the occupancy personnel influence factor rating for the compartment with the
 15 ignition source and n_M is the maintenance personnel influence factor.

16 Note that this method describes the development of probabilities for use in determining whether
 17 personnel are present in a compartment and do not require any normalizing factors of
 18 conservation of frequency.

19 In Section 3.3.1.2, it is noted that just because personnel discovering a fire are in the same
 20 vicinity or room as the fire, it should not immediately be discounted as lacking the passage of
 21 time condition used to support an *Interruptible Fire* classification. Although this note was
 22 included to call out the possibility of time passing as personnel locate a fire even if they are in
 23 the same compartment during ignition, many events simply state that personnel performed
 24 some *investigation, determination, discovery, or search for indication of (a) fire* and may not
 25 necessarily be in the same compartment as the fire when they begin any notification and
 26 passage of time (or lack thereof). Given this experience, the occupancy and maintenance
 27 ratings for adjacent rooms may also be considered when estimating the probability that
 28 personnel would be present to detect a fire. Therefore, credit for personnel may be taken when
 29 an adjacent room has an occupancy and maintenance rating factor equal to or higher than the
 30 source compartment. Recognizing that personnel in an adjacent compartment would not
 31 immediately experience the same conditions as personnel in the source compartment, a
 32 reduction of 50% will be applied to credit for an adjacent compartment, calculated as (Equation
 33 5-2):

$$\begin{aligned} Pr\left(n_O + \frac{n_O}{2} \text{ or } n_M + \frac{n_M}{2}\right) &= Pr\left(n_O + \frac{n_O}{2} \cup n_M + \frac{n_M}{2}\right) \\ &= Pr\left(n_O + \frac{n_O}{2}\right) + Pr\left(n_M + \frac{n_M}{2}\right) - Pr\left(n_O + \frac{n_O}{2}\right) \times Pr\left(n_M + \frac{n_M}{2}\right) \end{aligned} \quad (5-2)$$

34 The identifiers n_O and n_M are not changed to specify the rating of the adjacent room because
 35 credit may only be taken for ratings equal to those of the source compartment. As an example,
 36 the probability personnel are present to detect a fire in a compartment with the following:

- 37 • A medium occupancy and maintenance rating in the ignition source compartment
- 38 • A medium occupancy in an adjacent compartment

- A high maintenance in an adjacent compartment, determined as (Equation 5-3):

$$Pr\left(n_o + \frac{n_o}{2}\right) + Pr\left(n_M + \frac{n_M}{2}\right) - Pr\left(n_o + \frac{n_o}{2}\right) \times Pr\left(n_M + \frac{n_M}{2}\right) = \left(\frac{5 + 5/2}{10}\right) + \left(\frac{5/2 + (5/2)/2}{50}\right) - \left(\frac{5 + 5/2}{10}\right) \times \left(\frac{5/2 + (5/2)/2}{50}\right) = 0.769 \quad (5-3)$$

The denominator in Equation 5-3 comes from the maximum rating level value for the respective influencing factor.

Recalling Figure 2-2, almost 50% of the fires that have occurred in electrical cabinets have been detected by plant personnel. In Figure 5-11, the probabilities of having personnel present to detect a fire for the different possible occupancy and maintenance rating factors are presented graphically. The results for scenarios with and without taking credit for adjacent spaces are presented in Figure 5-11. One interesting point to note is that when credit is taken for personnel in an adjacent space, the average probability of having personnel present across all cases is approximately 46%, very similar to the 49% observed in OPEX. When only the ratings of the source compartment are considered, the average probability drops to 38%.

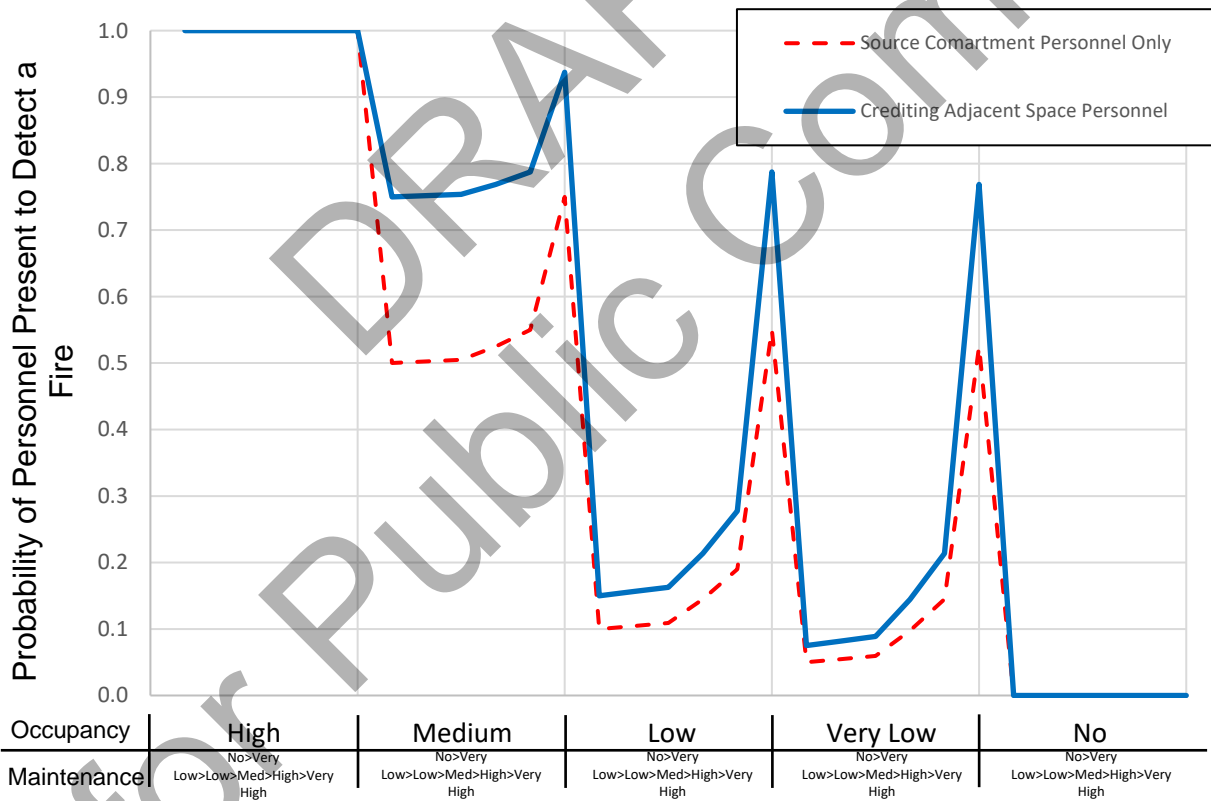

Figure 5-11
Probability of personnel present for detection, with and without crediting adjacent spaces

1 The rules applied independently of the personnel probability calculation are as follows:

- 2 • A high occupancy in the source compartment results in a 100% chance of personnel
3 being present, regardless of maintenance and adjacent compartment ratings
- 4 • A no-occupancy in the source compartment results in a 0% chance of personnel being
5 present, regardless of maintenance and adjacent compartment ratings
- 6 • Credit for maintenance is reduced by 50% to recognize that maintenance activities are
7 not as strong an indication of personnel presence as the occupancy factor
- 8 • Credit for adjacent spaces may only be taken for adjacent spaces, as follows:
 - 9 – With an influencing factor rating equal to or greater than that of the source
10 compartment
 - 11 – Within the same building
 - 12 – Located on the same floor/elevation as the compartment containing the ignition
13 source
 - 14 – Allowance may be taken for adjacent compartments with documented open
15 barriers to allow the smoke and other products of combustion to be shared
16 between compartments. Examples include the following:
 - 17 – Open stairways between floors
 - 18 – Unsealed barrier penetrations
 - 19 – Doors or dampers
- 20 • Credit for adjacent spaces may only be taken for a maximum of half of the rating of the
21 source compartment.
- 22 • Rooms with controlled ventilation and designated airflow directionality should be
23 considered when determining adjacent space influencing factors.

24 Example: A control room with a high occupancy may not necessarily be credited as the adjacent
25 room with a higher influencing factor rating, given that the differences in pressure will limit the
26 ability for occupants to detect a fire outside of the control room. The probability that plant
27 personnel would not be present in a compartment—calculated as $1 - Pr(n_O \text{ or } n_M)$ —without
28 considering adjacent spaces is presented in Table 5-6. When adjacent spaces may be credited,
29 the probability that plant personnel would not be present is shown in Table 5-7.

30
31

Table 5-6
Plant personnel presence probabilities

| Case | Occupancy Contributing Probability | Maintenance Contributing Probability | Probability of No Personnel Present |
|------|------------------------------------|--------------------------------------|--------------------------------------------------|
| 1 | High | All | 0 |
| 2 | High | Very low | 0 |
| 3 | High | Low | 0 |
| 4 | High | Medium | 0 |
| 5 | High | High | 0 |
| 6 | High | Very high | 0 |
| 7 | Medium: 0.5 | No: 0 | $1 - (0.5 + 0 - 0.5 \times 0) = 0.5$ |
| 8 | Medium: 0.5 | Very low: 0.005 | $1 - (0.5 + 0.005 - 0.5 \times 0.005) = 0.498$ |
| 9 | Medium: 0.5 | Low: 0.01 | $1 - (0.5 + 0.01 - 0.5 \times 0.01) = 0.495$ |
| 10 | Medium: 0.5 | Medium: 0.05 | $1 - (0.5 + 0.05 - 0.5 \times 0.05) = 0.475$ |
| 11 | Medium: 0.5 | High: 0.1 | $1 - (0.5 + 0.1 - 0.5 \times 0.1) = 0.45$ |
| 12 | Medium: 0.5 | Very high: 0.5 | $1 - (0.5 + 0.5 - 0.5 \times 0.5) = 0.25$ |
| 13 | Low: 0.1 | No 0 | $1 - (0.1 + 0 - 0.1 \times 0) = 0.9$ |
| 14 | Low: 0.1 | Very low 0.005 | $1 - (0.1 + 0.005 - 0.1 \times 0.005) = 0.896$ |
| 15 | Low: 0.1 | Low 0.01 | $1 - (0.1 + 0.01 - 0.1 \times 0.01) = 0.891$ |
| 16 | Low: 0.1 | Medium 0.05 | $1 - (0.1 + 0.05 - 0.1 \times 0.05) = 0.855$ |
| 17 | Low: 0.1 | High 0.1 | $1 - (0.1 + 0.1 - 0.1 \times 0.1) = 0.81$ |
| 18 | Low: 0.1 | Very high 0.5 | $1 - (0.05 + 0 - 0.05 \times 0.5) = 0.45$ |
| 19 | Very low: 0.05 | No 0 | $1 - (0.05 + 0 - 0.05 \times 0) = 0.95$ |
| 20 | Very low: 0.05 | Very low 0.005 | $1 - (0.05 + 0.005 - 0.05 \times 0.005) = 0.945$ |
| 21 | Very low: 0.05 | Low 0.01 | $1 - (0.05 + 0.01 - 0.05 \times 0.01) = 0.941$ |
| 22 | Very low: 0.05 | Medium 0.05 | $1 - (0.05 + 0.05 - 0.05 \times 0.05) = 0.903$ |
| 23 | Very low: 0.05 | High 0.1 | $1 - (0.05 + 0.1 - 0.05 \times 0.1) = 0.855$ |
| 24 | Very low: 0.05 | Very high 0.5 | $1 - (0.05 + 0.5 - 0.05 \times 0.5) = 0.475$ |
| 25 | No | No | 1.0 |
| 26 | No | Very low | 1.0 |
| 27 | No | Low | 1.0 |
| 28 | No | Medium | 1.0 |
| 29 | No | High | 1.0 |
| 30 | No | Very high | 1.0 |

1

Table 5-7
Plant personnel presence probabilities considering adjacent compartments

| Case | Occupancy Contributing Probability Including Adjacent Spaces | Maintenance Contributing Probability Including Adjacent Spaces | Probability of No Personnel Present Including Adjacent Spaces |
|------|--------------------------------------------------------------|----------------------------------------------------------------|---------------------------------------------------------------|
| 1 | High | No | 0 |
| 2 | High | Very low | 0 |
| 3 | High | Low | 0 |
| 4 | High | Medium | 0 |
| 5 | High | High | 0 |
| 6 | High | Very high | 0 |
| 7 | Medium: 0.750 | No: 0.000 | $1 - (0.75 + 0 - 0.75 \times 0.0) = 0.250$ |
| 8 | Medium: 0.750 | Very low: 0.008 | $1 - (0.75 + 0.008 - 0.75 \times 0.008) = 0.248$ |
| 9 | Medium: 0.750 | Low: 0.015 | $1 - (0.75 + 0.015 - 0.75 \times 0.015) = 0.246$ |
| 10 | Medium: 0.750 | Medium: 0.075 | $1 - (0.75 + 0.075 - 0.75 \times 0.075) = 0.231$ |
| 11 | Medium: 0.750 | High: 0.150 | $1 - (0.75 + 0.15 - 0.75 \times 0.15) = 0.213$ |
| 12 | Medium: 0.750 | Very high: 0.750 | $1 - (0.75 + 0.75 - 0.75 \times 0.75) = 0.063$ |
| 13 | Low: 0.150 | No 0.000 | $1 - (0.15 + 0.0 - 0.75 \times 0.0) = 0.850$ |
| 14 | Low: 0.150 | Very low 0.008 | $1 - (0.15 + 0.008 - 0.15 \times 0.008) = 0.844$ |
| 15 | Low: 0.150 | Low 0.015 | $1 - (0.15 + 0.015 - 0.15 \times 0.015) = 0.837$ |
| 16 | Low: 0.150 | Medium 0.075 | $1 - (0.15 + 0.075 - 0.15 \times 0.075) = 0.786$ |
| 17 | Low: 0.150 | High 0.150 | $1 - (0.15 + 0.15 - 0.15 \times 0.15) = 0.723$ |
| 18 | Low: 0.150 | Very high 0.750 | $1 - (0.15 + 0.75 - 0.15 \times 0.75) = 0.213$ |
| 19 | Very low: 0.075 | No 0.000 | $1 - (0.075 + 0 - 0.075 \times 0.0) = 0.925$ |
| 20 | Very low: 0.075 | Very low 0.008 | $1 - (0.075 + 0.008 - 0.075 \times 0.008) = 0.918$ |
| 21 | Very low: 0.075 | Low 0.015 | $1 - (0.075 + 0.015 - 0.075 \times 0.015) = 0.911$ |
| 22 | Very low: 0.075 | Medium 0.075 | $1 - (0.075 + 0.075 - 0.075 \times 0.075) = 0.856$ |
| 23 | Very low: 0.075 | High 0.150 | $1 - (0.075 + 0.15 - 0.075 \times 0.15) = 0.786$ |
| 24 | Very low: 0.075 | Very high 0.750 | $1 - (0.075 + 0.75 - 0.075 \times 0.75) = 0.231$ |
| 25 | No | No | 1.0 |
| 26 | No | Very low | 1.0 |
| 27 | No | Low | 1.0 |
| 28 | No | Medium | 1.0 |
| 29 | No | High | 1.0 |
| 30 | No | Very high | 1.0 |

1
2

5.3.4 Time of Detection for Electrical Cabinets

This section describes the approach for determining the time to detection in interruptible and growing fire scenarios.

5.3.4.1 Interruptible Fire Time of Detection

The time of detection is included in the calculation of the manual NSP as a reduction in the time available to suppress a fire prior to reaching the damage state of the scenario. As stated in NUREG/CR-6850 and then revised in NUREG-2169, the time available for manual suppression is shown in Equation 5-4.

$$t_{ms} = t_{dam} - t_{det}, \quad (5-4)$$

where, t_{ms} is the time available for manual suppression, t_{dam} is the time to target damage, and t_{det} is the time to detection.

Given the changes in the electrical cabinet growth profiles described in Section 4.2, specifically the period of negligible HRR associated with an interruptible fire, any fire modeling calculation used to determine the time of detection would be similarly delayed. A delay in detection, equal to that of any calculated damage, would negate the operational experience that interruptible fires are fires that are not only detected, but also suppressed, prior to growing and damaging targets.

The development of the suppression rates (see Section 3.5) uses the times recorded in fire events in the FEDB. Therefore, the earliest time that can be recorded in an event is the time that the fire was detected. Because interruptible fires are by definition fires that have not grown significantly, it is assumed for modeling purposes that the timeline for the fire scenario starts at detection. Therefore, for the interruptible path, time-dependent calculations of the NSP are calculated using only the time to damage of the scenario. Stated differently, t_{det} , for the purposes of determining the time to automatic smoke detection, detection by a non-fire trouble alarm in the MCR, or detection by plant personnel is set to zero for the interruptible fires to represent the start of activities following detection.

For interruptible fires, the delayed growth profile must be used when estimating the time of detection (or suppression) with heat detectors (or wet-pipe and pre-action sprinklers for suppression) just as it is used for the estimation of other temperature-related criteria, such as the time to damage.

For a scenario where the time to target damage is calculated to occur following the inclusion of a secondary combustible cable tray, the interruptible fires event tree may take credit for automatic smoke detection using the detailed fire modeling calculated time to automatic smoke detection in the second detection step. A second assessment of the probability of failing to detect a fire using the same automatic smoke detection system is appropriate because with the inclusion of the secondary combustible cable tray, the fire being modeled (with a non-zero time of detection) is essentially a different fire. Recall from Section 5.3.3.1 that results presented in Table 5-2 account for fires limited to the ignition source that may not create an atmosphere sufficient to activate an automatic smoke detection system. Results from the Monte Carlo analysis showed that the contribution of the HRR associated with propagation to secondary combustibles is sufficient to assume the fire is large enough to be detected by an available and reliable automatic system.

1 5.3.4.2 Growing Fire Time of Detection

2 For growing fire scenarios that include MCR indication, the time to MCR indication should be
3 considered as prior to the damage of zone of influence targets, which is consistent with
4 operational experience. For modeling purposes, this would result in a time of detection of 0
5 minutes.

6 Similarly, for growing fire scenarios, the time of detection for plant personnel should be modeled
7 as zero. The detection time of $t = 0$ is representative of prompt detection associated with
8 personnel being present in the location of a fire.

9 For growing fires, the time to detection for automatic detection systems should be determined
10 using detailed fire modeling in conjunction with the traditional electrical cabinet HRR profile as
11 described in NUREG/CR-6850.

12 **5.3.5 Probability of Failure—Detection**

13 NUREG/CR-6850 provides values for the probability of random failure of smoke detection
14 systems (0.05) using the estimated unreliability values presented in NSAC-179L [23]. The FPRA
15 should also consider plant-specific unavailability of detection (and suppression) systems to
16 account for maintenance activities or impairments. Often, in the FPRA, these two values are
17 simply added together. This addition comes from the simplification of a type of fault tree analysis
18 where the probability of failure in the detection system comes from the failure of the detection
19 (or suppression) system due to the system being unreliable or unavailable.

20 Mathematically, assuming the reliability and availability of the detection (or suppression)
21 systems are mutually exclusive, the probability of failure of the automatic detection system is
22 represented in Equation 5-5.

$$Pr(F \text{ or } U) = Pr(F \cup U) = Pr(F) + Pr(U) \quad (5-5)$$

23 where, F represents the unreliability of the system, and U represents the unavailability of the
24 system.

25 The screening probability of detection by plant personnel and average probability of smoke
26 detection, like the unavailability, may lead to the failure of the automatic smoke detection
27 system. Therefore, just as with the plant-specific unavailability and reliability, these should be
28 considered in estimating the probability of detecting a fire. Figure 5-12 represents an example
29 determination of the probability of failure for detection for an interruptible fire. In this example, an
30 motor control center (MCC), monitored in the MCR, is located in a fire compartment that has
31 been determined to have an occupancy rating level of *low* and a maintenance rating level of
32 *medium* and no contribution of adjacent spaces.

1

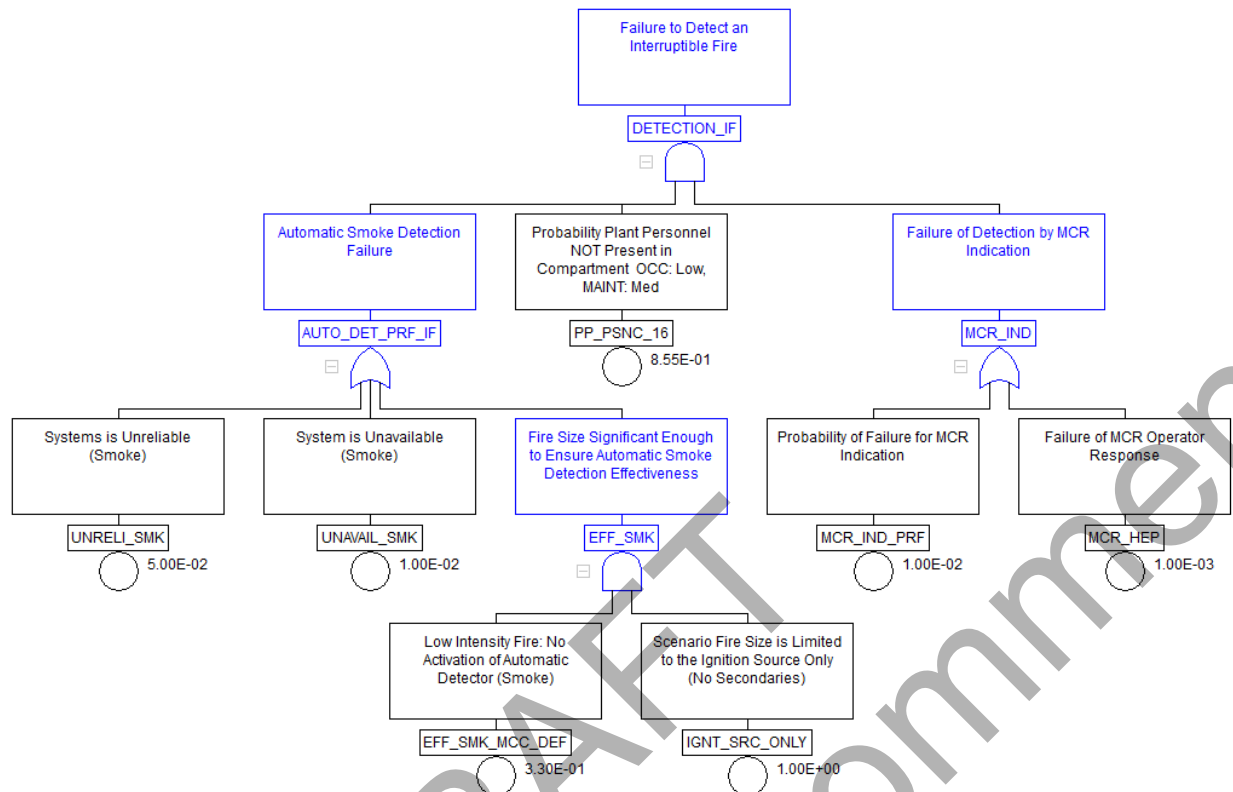

2

3 **Figure 5-12**
 4 **Probability of a detection fault tree for an interruptible fire with MCR indication and**
 5 **automatic smoke detection**

6 In Figure 5-12, the top event representing the probability for failure of detection for a fire,
 7 DETECTION_IF, is estimated using the following basic events:

- 8 • **MCR_IND_PRF.** The probability of failure associated with non-fire trouble alarms in the
 9 MCR (Section 5.3.3.2).
- 10 • **MCR-HEP.** The failure of an MCR operator to appropriately respond to a trouble
 11 indication (Section 5.3.3.3).
- 12 • **PP_PSNC_16.** The failure of plant personnel to be present in a compartment for low
 13 occupancy and medium maintenance ratings and no credit for adjacent spaces (see
 14 Section 5.3.3.5).
- 15 • **EFF_SMK_MCC_DEF.** The default fuel loading MCC does not reach a detectable
 16 smoke optical density (OD) and is not detected (see Section 5.3.3.1).
- 17 • **IGNT_SRC_ONLY.** A flag set to True (1) or False (0) used to include or exclude the
 18 detection effectiveness term when secondary combustibles are involved or not.
- 19 • **UNRELI_SMK.** The unreliability of a smoke detection system (NUREG/CR-6850,
 20 Appendix P).
- 21 • **UNAVAIL_SMK.** The plant-specific unavailability of a smoke detection system (assumed
 22 for this example).

1 Assuming the events are mutually exclusive, the cut-sets for estimating this probability of
2 detection would be the following (Equations 5-6 to 5-11):

$$MCR_IND_PRF \times EFF_SMK_MCC_DEF \times PP_PSNC_16 \rightarrow 0.01 \times 0.33 \times 0.855 \quad (5-6)$$

$$MCR_HEP \times EFF_SMK_MCC_DEF \times PP_PSNC_16 \rightarrow 0.001 \times 0.33 \times 0.855 \quad (5-7)$$

$$MCR_IND_PRF \times UNRELI_SMK \times PP_PSNC_16 \rightarrow 0.01 \times 0.05 \times 0.855 \quad (5-8)$$

$$MCR_IND_PRF \times UNAVAIL_SMK \times PP_PSNC_16 \rightarrow 0.01 \times 0.01 \times 0.855 \quad (5-9)$$

$$MCR_HEP \times UNRELI_SMK \times PP_PSNC_16 \rightarrow 0.001 \times 0.05 \times 0.855 \quad (5-10)$$

$$MCR_HEP \times UNAVAIL_SMK \times PP_PSNC_16 \rightarrow 0.001 \times 0.01 \times 0.855 \quad (5-11)$$

3 Adding these cut-sets, the detection probability of failure is approximately 3.67E-03.

4 Appendix C presents the probability of detection for a scenario with the following:

- 5 • An automatic smoke detection system having an assumed unavailability of 0.01
- 6 • With and without MCR indication
- 7 • For all occupancy and maintenance influencing factor rating levels
- 8 • For all electrical enclosure classification groups described in NUREG-2178

9

DRAFT
for Public Comment

6

EXAMPLES

A number of examples are presented to show the application of the methodology to different scenarios.

6.1 Example 1, NUREG/CR-6850

The example presented in Appendix P of NUREG/CR-6850 [1] is assessed using the methodology presented in this report. Information provided in the NUREG/CR-6850 example includes the following:

- Room is equipped with a smoke detection system. There is no very early warning fire detection system (VEWFDS), sometimes referred to as an *incipient detection system*, located in the compartment or monitoring the ignition source. The time to automatic smoke detection is 1 minute.
- Room is not equipped with an automatic fixed suppression system.
- Room is equipped with a manually activated fixed gaseous suppression system.
- The ignition source is an motor control center (MCC). It is assumed that the ignition source is limited to a single vertical section of the MCC.
- The target is a cable tray located away from the ignition source with a time to damage of approximately 15 minutes.
- The brigade response time is 7 minutes. As described in NUREG-2169 [3], the brigade response time is already included in the estimated suppression rate so this time is no longer included in the analysis.

Additional information is required to apply the revised methodology, as follows:

- The MCC is not monitored in the main control room (MCR), and there would be no special indication of a fault in the MCC prior to or concurrent with the automatic fire detection.
- The effectiveness of the automatic smoke detection system is 0.33, as described in Section 5.3.3.1.
- A pre-growth period of 4 minutes is included in the detailed fire modeling of the interruptible fraction of fires. For details, see Section 4.1.3.
- The MCC is located in a room that has been determined to have medium occupancy and medium maintenance rating levels. An adjacent space has also been classified with medium occupancy and maintenance ratings. This results in a probability that personnel are not present to detect the fire of 0.231. For details, see Section 5.3.3.5.
- The interruptible fire and growth fire suppression rates are 0.139 and 0.099, respectively, as described in Section 3.5.

Examples

- The split between interruptible and growing fire profiles is 0.72/0.28, respectively, as described in Section 3.4.

Figure 6-1 illustrates the solution of the P_{ns} event tree following the NUREG/CR-6850 [1] approach.

| Fire | Automatic | | Manual | | | Sequence | End State | Pr (Non-Suppression) |
|-------|-----------|-------------|-----------|-------|--------------|----------|-----------|----------------------|
| | Detection | Suppression | Detection | Fixed | Fire Brigade | | | |
| FI | AD | AS | MD | MF | FB | F | OK | 0.00E+00 |
| 1.000 | 0.95 | 0.00 | | | | G | OK | 8.08E-01 |
| | | 1.00 | | 0.85 | | H | OK | 1.06E-01 |
| | | | | 0.15 | 0.75 | I | NS | 3.61E-02 |
| | | | | | 0.25 | | | |
| | 0.05 | 0.00 | | | | J | OK | 0.00E+00 |
| | | 1.00 | 1.00 | 0.00 | | K | OK | 0.00E+00 |
| | | | | 1.00 | 0.00 | L | OK | 0.00E+00 |
| | | | | | 1.00 | M | NS | 5.00E-02 |
| | | | 0.00 | | | N | NS | 0.00E+00 |
| | | | | | | Total | | 8.61E-02 |

5
6 **Figure 6-1**
7 **Solution for the NUREG/CR-6850 detection-suppression event tree**

8 The first credited system for sequences F to I is automatic detection, which has a failure
9 probability of 0.05 as identified in NUREG/CR-6850. The probability of failure to activate the
10 gaseous suppression system in time is the summation of the human error activating the system
11 (assumed to be 0.1 in NUREG/CR-6850 for this example) and the unreliability of the system
12 (0.05 in NUREG/CR-6850 for this example). The probability of failure for the fire brigade is
13 calculated using the electrical suppression curve provided in NUREG-2169 [3] (lambda of
14 0.098). The resulting timing is 15-1=14 minutes and the P_{ns} becomes as shown in Equation 6-1.

$$e^{-\lambda t} \rightarrow e^{-0.098 \cdot 14} = 0.25 \quad (6-1)$$

- 1 If the automatic detection fails, delayed detection is credited. Sequences J to N refer to this
 2 situation. Assuming a delayed detection time of 15 minutes [1], the fire brigade has no time to
 3 suppress the fire before target damage, and the probability of non-suppression becomes 1.0.
 4 The sum of sequences I, M, and N provides to total scenario P_{ns} , which is $3.61E-02 + 5.0E-02 +$
 5 $0.0 = 0.0861$. Because the MCC is not monitored in the MCR (there would be no indication of
 6 trouble with the equipment), the detection branches would be calculated, as shown in Figure 6-2
 7 and Figure 6-3.

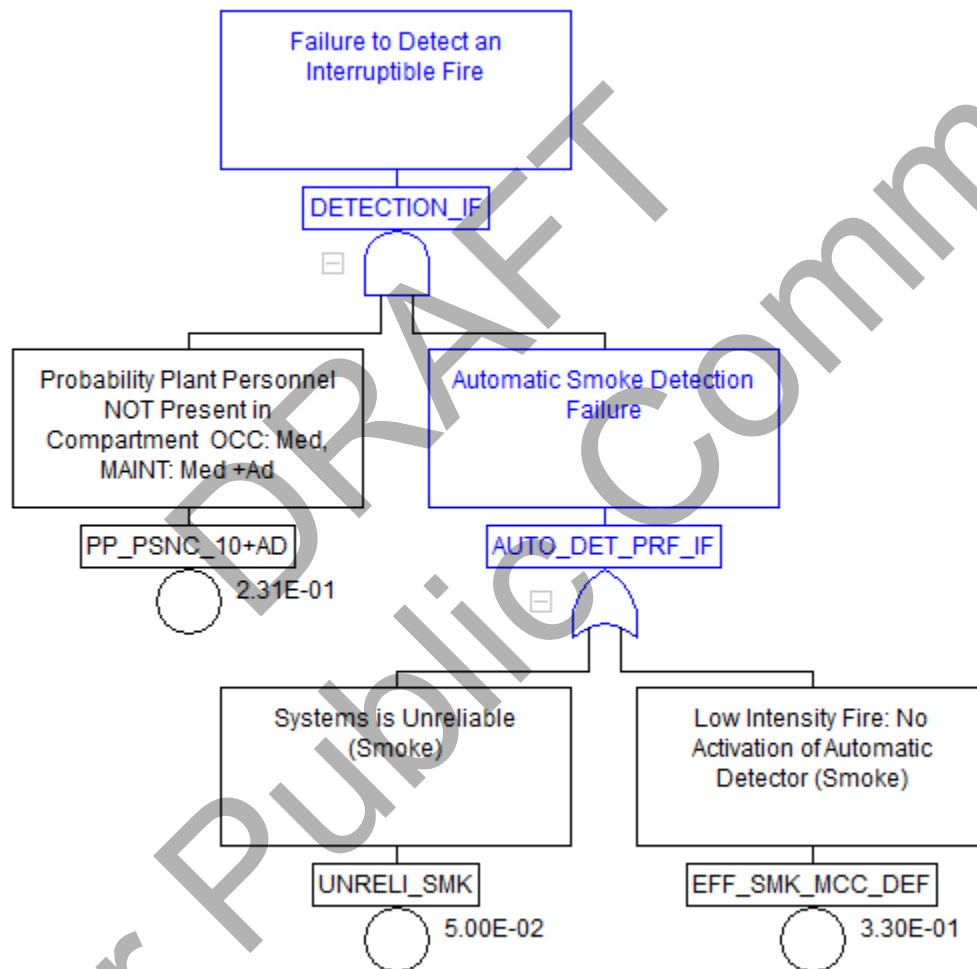

8

9 **Figure 6-2**10 **First detection for the interruptible path, NUREG/CR-6850 Appendix P example**

- 11 Because there is no thermally activated detection system in this example, there is no second
 12 detection option for the interruptible fire path. The first detection step for the growing path would
 13 simply be the probability of no personnel present in the compartment, or 0.231 from Table 5-7.

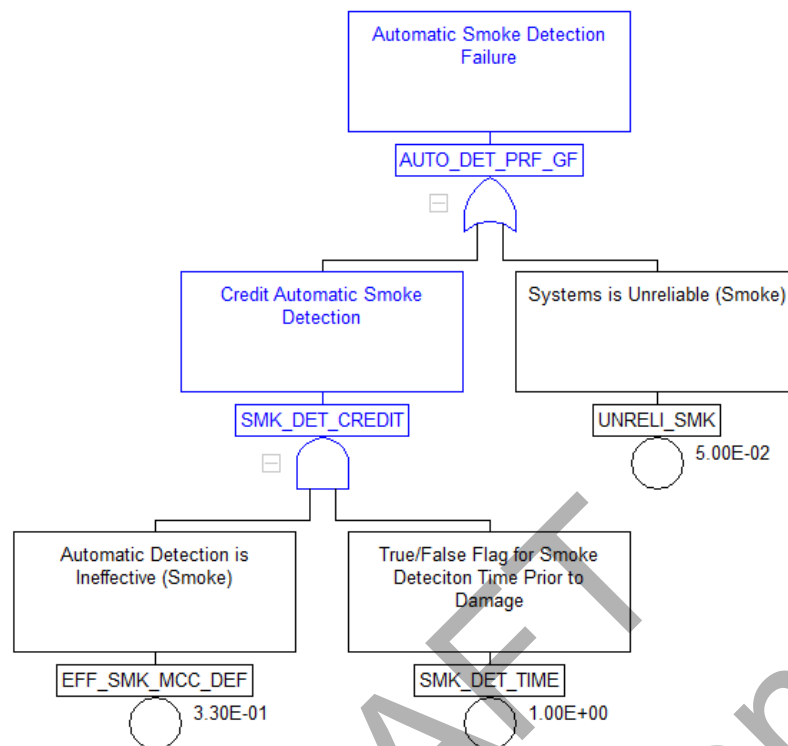

Figure 6-3
Second detection for the growing path, NUREG/CR-6850 Appendix P example

The resulting detection failure probabilities are the following:

- First interruptible: 8.41E-02
- Second interruptible: 1.0
- First growing: 2.31E-01
- Second growing: 3.64E-01

For the interruptible path, credit can be taken for the manual fixed system (no credit is taken for an automatic suppression system because there is not one present in the space). The non-suppression probability (NSP) for the fire brigade branch (D-IF) is calculated and shown in Equation 6-2.

$$e^{-\lambda t} \rightarrow e^{-0.139 \cdot (15+4)} = 0.07 \quad (6-2)$$

Note that 4 minutes is added to the time to damage to represent the pre-growth time associated with an interruptible fire. For more details, see Section 4.1.3.

Following a failure in the first detection branch, because there is no second detection (and therefore no probability of reaching sequences E to H), the next calculations are associated with the delayed detection (Equation 6-3):

$$e^{-\lambda t} \rightarrow e^{-0.139 \cdot (15+4-15)} = 0.57 \quad (6-3)$$

1 The growing path follows similarly to the interruptible path with a few small differences. The
2 NSP for the fire brigade branch (D-GF) following the first detection path is calculated and shown
3 in Equation 6-4.

$$e^{-\lambda t} \rightarrow e^{-0.099 \cdot (15-0)} = 0.23 \quad (6-4)$$

4 For the growing fire, there is a second detection success opportunity (represented by the
5 automatic smoke detection system). The NSP for the fire brigade branch (H-GF) is calculated
6 and shown in Equation 6-5.

$$e^{-\lambda t} \rightarrow e^{-0.099 \cdot (15-1)} = 0.25 \quad (6-5)$$

7 For the growing fire, there is not enough time to credit delayed detection because the time to
8 damage equals the 15 minutes of time associated with detection.

9 The scenario probability of non-suppression is calculated as (1) $9.79\text{E-}03 + 0.00 + 7.23\text{E-}03 =$
10 $1.70\text{E-}02$ for interruptible fire, and (2) $2.61\text{E-}02 + 5.51\text{E-}03 + 8.43\text{E-}02 = 1.16\text{E-}01$ for growing
11 fire. Considering the split fraction for interruptible and growing fire profiles, the total NSP
12 becomes 0.045. The result is a reduction in the NSP of 0.041.

13 Figure 6-4 through Figure 6-6 illustrate the solution of the NSP event tree following the updated
14 approach described previously.

15

Examples

1

| Fire | First Detection (MCR, Personnel, Smoke) | Second Detection (Heat) | Automatic Suppression | Manual Fixed | Fire Brigade | Sequence | End State | Pr (Non- Suppression) |
|-------|-----------------------------------------------|-------------------------------|--------------------------|--------------|--------------|----------|--------------|--------------------------|
| FI | DET | | AS | MF | FB | | | |
| 1.000 | 0.916 | | 0.00 | | | A-IF | OK | 0.00E+00 |
| | | | 1.00 | 0.85 | | B-IF | OK | 7.79E-01 |
| | | | | 0.15 | 0.93 | C-IF | OK | 1.28E-01 |
| | | | | | 0.07 | D-IF | NS | 9.79E-03 |
| | 0.084 | 0.00 | 0.00 | | | E-IF | OK | 0.00E+00 |
| | | | 1.00 | 0.85 | | F-IF | OK | 0.00E+00 |
| | | | | 0.15 | 0.93 | G-IF | OK | 0.00E+00 |
| | | | | | 0.07 | H-IF | NS | 0.00E+00 |
| | | 1.00 | 0.00 | | | IF | OK | 0.00E+00 |
| | | | 1.00 | 0.85 | | J-IF | OK | 7.15E-02 |
| | | | | 0.15 | 0.43 | K-IF | OK | 5.38E-03 |
| | | | | | 0.57 | L-IF | NS | 7.23E-03 |
| | | | | | | Total | | 1.70E-02 |

2

3

4

5

Figure 6-4
Solution for the detection-suppression event tree for NUREG/CR-6850 Example 1:
interruptible fire path

| Fire | First Detection (MCR & Personnel) | Second Detection (Automatic) | Automatic Suppression | Manual Fixed | Fire Brigade | Sequence | End State | Pr (Non- Suppression) |
|-------|-----------------------------------------|------------------------------------|--------------------------|--------------|--------------|----------|--------------|--------------------------|
| FI | DET | | AS | MF | FB | | | |
| 1.000 | 0.769 | | 0.00 | | | A-GF | OK | 0.00E+00 |
| | | | 1.00 | 0.85 | | B-GF | OK | 6.53E-01 |
| | | | | 0.15 | 0.77 | C-GF | OK | 8.92E-02 |
| | | | | | 0.23 | D-GF | NS | 2.61E-02 |
| | 2.31E-01 | 0.64 | 0.00 | | | E-GF | OK | 0.00E+00 |
| | | | 1.00 | 0.85 | | F-GF | OK | 1.25E-01 |
| | | | | 0.15 | 0.75 | G-GF | OK | 1.65E-02 |
| | | | | | 0.25 | H-GF | NS | 5.51E-03 |
| | | 0.36 | 0.00 | | | I-GF | OK | 0.00E+00 |
| | | | 1.00 | 0.00 | | J-GF | OK | 0.00E+00 |
| | | | | 1.00 | 0.00 | K-GF | OK | 0.00E+00 |
| | | | | | 1.00 | L-GF | NS | 8.43E-02 |
| | | | | | | Total | | 1.16E-01 |

1
2 **Figure 6-5**
3 **Solution for the detection-suppression event tree for NUREG/CR-6850 Example 1:**
4 **growing path**

Examples

| | | | |
|------|--------------------|---------------|----------------------|
| Fire | Interruptible Fire | Event Tree | Pr (Non-Suppression) |
| FI | Yes | Interruptible | 1.23E-02 |
| | 0.72 | 0.017 | |
| | No | Growing | 0.0324581 |
| | 0.28 | 0.116 | |
| | | Total | 0.04472 |

1

2 **Figure 6-6**
 3 **Solution for the detection-suppression event tree for NUREG/CR-6850 Example 1: total**
 4 **P_{ns}**

5 **6.2 Example 2, Revised NUREG/CR-6850, Personnel Detection Sensitivities**

6 The scenario described in Example 1 is repeated; however, occupancy and maintenance
 7 ratings of the compartment where the MCC is located are varied. The results of these changes
 8 are presented in Table 6-1.

Table 6-1
Example 2: occupancy and maintenance rating sensitivities

| Sensitivity Case | Rating Levels | Personnel Presence Probability and P _{ns} |
|-------------------------------|----------------------------------------------------------------------------------------------------------------------------------------------------|------------------------------------------------------------------------------------------------------------------|
| Example 1 | <u>Source compartment:</u> Occupancy: medium Maintenance: medium <u>Adjacent compartment:</u> Occupancy: medium Maintenance: medium | 0.231, Table 5-6 P _{ns} = 0.045 Results in a reduction of the P _{ns} of a 0.041. |
| No credit for adjacent spaces | <u>Source compartment:</u> Occupancy: medium | 0.475, Table 5-5 |

Table 6-1
Example 2: occupancy and maintenance rating sensitivities

| Sensitivity Case | Rating Levels | Personnel Presence Probability and P _{ns} |
|---------------------------------------------------------------------------------------------------------------------------------------------------------------------------------------------------------------------------------------|----------------------------------------------------------------------------------------------------------------------------------------------------|------------------------------------------------------------------------------------------------------------------------------------|
| | Maintenance: medium <u>Adjacent compartment:</u> Occupancy: N/A Maintenance: N/A | P _{ns} = 0.074 Results in a reduction of the P _{ns} of a 0.012. |
| Lower occupancy and maintenance ratings in adjacent spaces No credit may be taken for an adjacent space with lower ratings | <u>Source compartment:</u> Occupancy: medium Maintenance: medium <u>Adjacent compartment:</u> Occupancy: low Maintenance: low | 0.475, Table 5-5 P _{ns} = 0.074 Results in a reduction of the P _{ns} of a 0.012. |
| Lower occupancy and higher maintenance ratings in adjacent spaces (Note: No additional credit is given for the higher maintenance rating. Additionally, no credit may be taken for an adjacent occupancy with a lower rating.) | <u>Source compartment:</u> Occupancy: medium Maintenance: medium <u>Adjacent compartment:</u> Occupancy: low Maintenance: high | $(5+0/2)/10+(5+5/2)/50=$ 0.0575 P _{ns} = 0.085 Results in a reduction of the P _{ns} of a 0.001. |
| Higher occupancy and maintenance ratings in adjacent spaces | <u>Source compartment:</u> Occupancy: medium Maintenance: medium <u>Adjacent compartment:</u> Occupancy: high Maintenance: high | 0.231, Table 5-6 P _{ns} = 0.045 Results in a reduction of the P _{ns} of a 0.041. |
| Low occupancy and maintenance ratings | <u>Source compartment:</u> Occupancy: low Maintenance: low <u>Adjacent compartment:</u> Occupancy: low | 0.837, Table 5-6 P _{ns} = 0.117 |

Examples

Table 6-1
Example 2: occupancy and maintenance rating sensitivities

| Sensitivity Case | Rating Levels | Personnel Presence Probability and P_{ns} |
|------------------|------------------|---------------------------------------------------|
| | Maintenance: low | Results in an increase of the P_{ns} of a 0.03. |

1 **6.3 Example 3, Revised NUREG/CR-6850, Enclosure Class/Function Group**
 2 **Sensitivities**

3 The scenario described in Example 1 is repeated; however, the electrical cabinet source
 4 enclosure class/function group is varied. The results of these changes are presented in Table
 5 6-2.

Table 6-2
Example 2: enclosure class/function group sensitivities

| Sensitivity Case | Enclosure Group/Function Class | Automatic Smoke Detection Failure Probability and P_{ns} |
|-----------------------|--------------------------------------------------------------------------------------------------------------|-------------------------------------------------------------------------------|
| Example 1 | <u>Enclosure class/function group: 0.33, Table 5-2</u> Unreliability: 0.05 Unavailability: N/A | 0.3635 0.045 Results in a reduction of the P_{ns} of a 0.041. |
| Open, large enclosure | <u>Enclosure class/function group: 0.31, Table 5-2</u> Unreliability: 0.05 Unavailability: N/A | 0.3445 0.043 Results in a reduction of the P_{ns} of a 0.043 |
| Small enclosure | <u>Enclosure class/function group: 0.65, Table 5-2</u> Unreliability: 0.05 Unavailability: N/A | 0.6675 0.067 Results in a reduction of the P_{ns} of a 0.019. |

Table 6-2
Example 2: enclosure class/function group sensitivities

| Sensitivity Case | Enclosure Group/Function Class | Automatic Smoke Detection Failure Probability and P_{ns} |
|-------------------------------------------|---------------------------------------------------------------------------------------------------------------|-----------------------------------------------------------------------------|
| Include unavailability of smoke detection | <u>Enclosure class/function group: 0.33, Table 5-2</u> Unreliability: 0.05 Unavailability: 0.01 | 0.37 0.045 Results in a reduction of the P_{ns} of a 0.041. |

6.4 Example 4, Revised NUREG/CR-6850 (MCR Indication)

The scenario described in Example 1 is repeated; however, now the MCC *is* monitored in the MCR, and there would be a special indication of a fault in the MCC prior to or concurrent with the automatic detection.

Because the ignition source is now monitored by the MCR, the probability of detection includes the main control board indication (see Section 5.3.3.2) and the MCR operator response (see Section 5.3.3.3). These two changes result in a new P_{ns} of 0.018, a decrease of 0.068.

6.5 Example 5, Revised NUREG/CR-6850 (Automatic Suppression)

The scenario described in Example 1 is repeated; however, now the room is equipped with a wet pipe automatic suppression system. For this example, the initial fire modeling results show that the automatic suppression system activates 10 minutes into the scenario. Including the 4-minute pre-growth period for the interruptible fraction of fires results in an automatic suppression activation time of 14 minutes.

Because the activation of the automatic suppression system occurs prior to damage in both the interruptible and growing paths, the unreliability (0.02, NUREG/CR-6850) and unavailability (0.01, assumed for this example) is included in the calculation of the P_{ns} . These changes result in a new P_{ns} of 0.024, a reduction of 0.062.

6.6 Example 6, 1-Minute Time to Damage

In many instances, the first target damaged by an ignition source is located very close to the ignition source, and the time to damage may be only 1 minute. This example will compare the change in the P_{ns} between the methodology in this report and the value that would be reached following the NUREG/CR-6850 approach.

This scenario is provided with the following information:

- The target is a cable tray located close to the ignition source with a time to damage of 1 minute.
- The ignition source is an MCC. It is assumed that the ignition source is limited to a single vertical section of the MCC.

Examples

- 1 • The room is equipped with a smoke detection system. There is no VEWFDs (sometimes
2 referred to as an *incipient detection system*) located in the compartment or monitoring
3 the ignition source. The time to automatic smoke detection is 1 minute. The
4 effectiveness of the automatic smoke detection system is 0.33, as described in Section
5 5.3.3.1.
- 6 • The smoke detection system has an unavailability of 0.01.
- 7 • The room is not equipped with a fixed automatic or manually activated suppression
8 system.
- 9 • The ignition source is monitored in the MCR, and there would be an indication of a fault
10 prior to or concurrent with the automatic detection.
- 11 • The interruptible fire and growing fire suppression rates are 0.139 and 0.099,
12 respectively, as described in Section 3.5.
- 13 • The split between interruptible and growing fire profiles is 0.72/0.28, respectively, as
14 described in Section 3.4.
- 15 • A pre-growth period of 4 minutes is included in the detailed modeling of the interruptible
16 fraction of fires. For details, see Section 4.1.3.
- 17 • MCR indication unreliability is 0.01 as described in Section 5.3.3.2.
- 18 • The MCR operator human error probability (HEP) is 1.0E-03 as described in Section
19 5.3.3.3.
- 20 • The MCC is located in a room that has been determined to have medium occupancy and
21 medium maintenance rating levels. An adjacent space has also been classified with
22 medium occupancy and maintenance ratings. This results in a probability that personnel
23 are not present to detect the fire of 0.231. For details, see Section 5.3.3.5.

24 The P_{ns} following the approach presented in NUREG/CR-6850 is equal to 1.0. The P_{ns} following
25 the methodology presented in this report is equal to 0.61, a reduction of 0.39.

26

7

SUMMARY

This report provides an updated framework for treatment of the fire scenario progression starting from ignition, through fire growth, and suppression. The framework described in Appendix P of NUREG/CR-6850 is expanded to allow for additional fire progressions commonly observed in plant fire events.

7.1 Bin 15 Fire Ignition Frequency

The addition of events from the period of 2010–2014 (from EPRI study, *Fire Events Database Update for the Period 2010–2014: Revision 1* [3002005302]) requires the fire ignition frequency to be updated. Following the methods outlined in NUREG-2169, the updated fire ignition frequency distribution for Bin 15 is presented in Table 7-1.

Table 7-1
Fire ignition frequency distribution for Bin 15

| Bin | Location | Ignition Source | Power Modes | PRA Type | Period | Mean | Median | 5th Percent | 95th Percent |
|-----|-----------------------|--------------------------------|-------------|----------|-----------|----------|----------|-------------|--------------|
| 15 | Plant-wide components | Electrical cabinets (non-HEAF) | AA | FPIE | 2000–2014 | 3.43E-02 | 3.19E-02 | 1.13E-02 | 6.60E-02 |

7.2 Interruptible/Growing Fire Split Fraction

Section 3 discussed the event review process to determine the fraction of fires that exhibit interruptible fire behavior. Forty-seven fire events were reviewed, resulting in (1) 34 out of 47 events (or 0.723) for interruptible, and (2) 13 out of 47 events (or 0.277) for growing.

A summary of the classification and event review is found in Appendix A, Table A-1.

7.3 Interruptible/Growing Fire HRR Profiles

For the purposes of fire modeling, the NUREG/CR-6850 growth profile may be used with a suggested consideration for interruptible fires. For interruptible fires, a period of up to 8 minutes with no measurable heat release rate (HRR) may be included prior to the period of fire growth. If included, this pre-growth phase must be reflected in any calculations of the time to damage, time to detection, and time to suppression. For more detail, see Section 4.

7.4 New P_{ns} Event Tree Parameters

To support the revised event tree structure, additional parameters in the event tree are developed, including the following:

- Interruptible and growing fire split fractions: 0.723/0.277 (see Section 3.4/5.3.1)
- Probability of automatic smoke detection: Table 5-2 (see Section 5.3.3.1)

Summary

- 1 • Success of main control room (MCR) indication: 0.99 (see Section 5.3.3.2)
- 2 • MCR operator response human error probability (HEP): 1.0E-03 (see Section 5.3.3.3)
- 3 • Probability of plant personnel present: Table 5-6 and Table 5-7 (see Section 5.3.3.5)
- 4 • Time of detection, as follows:
 - 5 – Detection by a non-fire trouble alarm in the MCR room, plant personnel, and
 - 6 automatic smoke detection for an interruptible fire modeled as $t = 0$ (see Section
 - 7 5.3.4.1)
 - 8 – Detection by an automatic heat detection system determined using the
 - 9 *Interruptible* HRR profile for interruptible fires
 - 10 – Detection by a non-fire trouble alarm in the MCR room and plant personnel for a
 - 11 growing fire modeled as $t = 0$ (see Section 5.3.4.2)
 - 12 – Detection by any automatic detection system determined using the NUREG/CR-
 - 13 6850 HRR profile for growing fires

14 The new event tree parameters are summarized in Table 7-2.

**Table 7-2
Summary of non-suppression event tree parameters**

| Parameter | Interruptible Fire | Growing Fire |
|-----------------------------------------|--------------------------------------------------------------------------------------------------------------------------------------------------|--------------------------------------------------------------------|
| Split fraction | 0.723 | 0.277 |
| Automatic smoke detection effectiveness | Developed for each NUREG-2178 case (see Table 5-2) | |
| Time to automatic smoke detection | $t = 0$ for effective No credit for (1-effective) | $t =$ calculated time for effective No credit for (1-effective) |
| Main control room indication | MCR (non-fire alarm) indication reliability: 0.99 (see Section 5.3.3.2) MCR operator HEP: 1.0E-03 (see Section 5.3.3.3) | |
| Time to MCR indication | $t = 0$ for ignition sources monitored in the MCR (see Section 5.3.4) | |
| Personnel detection credit | Personnel presence estimation (see Table 5-6) | Personnel presence estimation (see Table 5-6) |
| Time to personnel detection | $t = 0$ for personnel present (see Section 5.3.4) | |
| Heat release rate profile | Interruptible fire profile (see Section 4.1.1) OR NUREG/CR-6850 profile + Up to 8 minutes pre-growth (see Section 4.2) | NUREG/CR-6850 profile (see Section 4.2) |

1 **7.5 NSP Estimation Update**

2 As a result of this research, two new suppression curves were generated. For electrical cabinet,
3 *Interruptible*, the data set contains events involving only electrical cabinets that were classified
4 as interruptible. Fire events in the control room are excluded from this curve, as well as high
5 energy arc faults (HEAFs). For electrical cabinet, *Growing*, this data set contains events
6 involving only electrical cabinets that were classified as growing. Fire events in the MCR are
7 excluded from this curve, as well as HEAFs.

8 The existing MCR suppression curve was updated. Events in this bin include fires occurring
9 within the MCR, regardless of ignition source (electrical cabinets, main control board, transients,
10 and so on).

11 The existing electrical fires suppression curve was updated. Events include non-cabinet
12 electrical sources, such as electric motors, indoor dry transformers, and junction boxes, among
13 other electrical equipment.

14 The numerical values of the P_{ns} curve probabilities are provided in Table 7-3.

15

16

DRAFT
for Public Comment

**Table 7-3
Probability distribution for rate of fires suppressed per unit time, λ**

| Calculation Source Document | Suppression Curve | Number of Events in Curve | Total Duration (minutes) | Rate of Fire Suppressed (λ) | | |
|-----------------------------|--------------------------------------------|---------------------------|--------------------------|---------------------------------------|-------------|--------------|
| | | | | Mean | 5th Percent | 95th Percent |
| NUREG-2169 | T/G fires | 30 | 1167 | 0.026 | 0.019 | 0.034 |
| NUREG-2178, Vol. II | Control room | 10 | 26 | 0.385 | 0.209 | 0.604 |
| NUREG-2169 | Pressurized water reactor containment (AP) | 3 | 40 | 0.075 | 0.020 | 0.157 |
| NUREG-2169 | Containment (LSPD) | 31 | 299 | 0.104 | 0.075 | 0.103 |
| NUREG-2169 | Outdoor transformers | 24 | 928 | 0.026 | 0.018 | 0.026 |
| NUREG-2169 | Flammable gas | 8 | 234 | 0.034 | 0.017 | 0.033 |
| NUREG-2169 | Oil fires | 50 | 562 | 0.089 | 0.069 | 0.088 |
| NUREG-2169 | Cable fires | 4 | 29 | 0.138 | 0.047 | 0.127 |
| NUREG-2230 | Electrical fires* | 74 | 653 | 0.113 | 0.093 | 0.113 |
| NUREG-2230 | Interruptible fires (Bin 15) | 43 | 310 | 0.139 | 0.106 | 0.138 |
| NUREG-2230 | Growing fires (Bin 15) | 19 | 191 | 0.099 | 0.065 | 0.098 |
| NUREG-2169 | Welding fires | 52 | 484 | 0.107 | 0.084 | 0.107 |
| NUREG-2169 | Transient fires | 43 | 386 | 0.111 | 0.085 | 0.111 |
| FAQ 17-003 | HEAFs | 8 | 602 | 0.013 | 0.007 | 0.013 |
| NUREG-2169 | All fires | 457 | 6691 | 0.068 | 0.063 | 0.068 |

*Electrical fires include non-cabinet electrical sources, such as electrical motors, indoor transformers, and junction boxes, among other electrical equipment.

8

REFERENCES

1. NUREG/CR-6850/EPRI 10191989, *EPRI/NRC-RES Fire PRA Methodology for Nuclear Power Facilities: Volume 2: Detailed Methodology*, EPRI, Palo Alto, CA, U.S. Nuclear Regulatory Commission, Washington, DC, and Electric Power Research Institute (EPRI), Palo Alto, CA, 2005.
2. EPRI 1025284, *The Updated Fire Events Database: Description of Content and Fire Event Classification Guidance*. EPRI, Palo Alto, CA, 2013.
3. NUREG-2169/EPRI 3002002936, *Nuclear Power Plant Fire Ignition Frequency and Non-Suppression Probability Estimation Using the Updated Fire Events Database*, U.S. Nuclear Regulatory Commission, Washington, DC, and EPRI, Palo Alto, CA, 2015.
4. EPRI 3002005302, *Fire Events Database Update for the Period 2010–2014: Revision 1*, EPRI, Palo Alto, CA, 2016.
5. NUREG-2178/EPRI 3002005578, *Refining and Characterizing Heat Release Rates From Electrical Enclosures During Fire (RACHELLE-FIRE), Volume 1: Peak Heat Release Rates and Effect of Obstructed Plume*, U.S. Nuclear Regulatory Commission, Washington, DC, and EPRI, Palo Alto, CA, 2015.
6. NUREG/CR-4527 and SAND86-0336, *An Experimental Investigation of Internally Ignited Fires in Nuclear Power Plant Control Cabinets Part I: Cabinet Effects Testing*, U.S. Nuclear Regulatory Commission, Washington, DC, and Sandia National Laboratories, Albuquerque, NM, April 1987.
7. Mangs, J., and O. Keski-Rahkonen, "Full scale fire experiments on electronic enclosures," VTT Publications 186, VTT Technical Research Centre of Finland, Espoo, Finland, 1994.
8. Mangs, J., and O. Keski-Rahkonen, "Full scale fire experiments on electronic enclosures II," VTT Publications 269, VTT Technical Research Centre of Finland, Espoo, Finland, 1996.
9. Mangs, J., J. Paananen, and O. Keski-Rahkonen, "Calorimetric fire experiments on electronic enclosures," *Fire Safety Journal*, 38:165-186, 2003.
10. Mangs, J., "On the fire dynamics of vehicles and electrical equipment," VTT Publications 521, VTT Technical Research Centre of Finland, Espoo, Finland, 2004.
11. NUREG/CR-7197, *Heat Release Rates of Electrical Enclosure Fires (HELEN-FIRE)*, U.S. Nuclear Regulatory Commission, NRC, Washington, DC, April 2016.
12. EPRI 1019259/NUREG/CR-6850, Supplement 1, *Fire Probabilistic Risk Assessment Methods Enhancements*, EPRI, Palo Alto, CA, and the U.S. Nuclear Regulatory Commission, Washington, DC, 2010.
13. NUREG-2180, *Determining the Effectiveness, Limitations, and Operator Response for Very Early Warning Fire Detection Systems in Nuclear Facilities (DELORES-FIRE)*, U.S. Nuclear Regulatory Commission, Washington, DC, 2016.

References

- 1 14. NUREG/CR-6928, *Industry-Average Performance for Components and Initiating Events*
2 *at U.S. Commercial Nuclear Power Plants*, U.S. Nuclear Regulatory Commission,
3 Washington, DC, 2007.
- 4 15. NUREG-0700, *Human-System Interface Design Review Guidelines, Revision 2*, U.S.
5 Nuclear Regulatory Commission, Washington, DC, May 2002.
- 6 16. NUREG/CR-6883, *The SPAR-H Reliability Analysis Method*, U.S. Nuclear Regulatory
7 Commission, Washington, DC, August 2005.
- 8 17. Idaho National Laboratory, INL/EXT-10-18533, Revision 2, *SPAR-H Step-by-Step*
9 *Guidance*, May 2011.
- 10 18. EPRI TR-100259, *An Approach to the Analysis of Operator Actions in Probabilistic Risk*
11 *Assessment*. EPRI, Palo Alto, CA, 1992. TR-100259.
- 12 19. NUREG/CR-1278, *Handbook of Human Reliability Analysis with Emphasis on Nuclear*
13 *Power Plant Applications*, U.S. Nuclear Regulatory Commission, Washington, DC,
14 August 1983.
- 15 20. NUREG-1921/EPRI 1023001, *EPRI/NRC-RES Fire Human Reliability Analysis*
16 *Guidelines*, U.S. Nuclear Regulatory Commission, Washington, DC, and EPRI, Palo
17 Alto, CA, 2012.
- 18 21. NUREG-1355, *The Status of Recommendations of the President's Commission on the*
19 *Accident at Three Mile Island, A Ten Year Review*, U.S. Nuclear Regulatory
20 Commission, Washington, DC, March 1989.
- 21 22. *FAQ 12-0064, Hot Work/Transient Fire Frequency: Influence Factors*, U.S. Nuclear
22 Regulatory Commission, ADAMS Accession Number ML121780013.
- 23 23. NSAC-78L, *Automatic and Manual Suppression Reliability Data for Nuclear Power Plant*
24 *Fire Risk Analyses*, EPRI, Palo Alto, CA, 1994.
- 25 24. NUREG-1805, *Fire Dynamic Tools (FDT³)*, *Quantitative Fire Hazard Analysis Methods*
26 *for the U.S. Nuclear Regulatory Commission Fire Protection Inspection Program*, U.S.
27 Nuclear Regulatory Commission, Washington, DC, 2013.
- 28 25. Alpert, R. L., "Calculation of response time of ceiling-mounted fire detectors," *Fire*
29 *Technology*, 8:181, 1972.
- 30 26. Claperyon, E., "Memoire sur la puissance motrice de la chaleur," *Journal de l'Ecole*
31 *Polytechnique*, XIV:153-190, 1834.
- 32 27. Van Wylen, G., and R. Sonntag, *Fundamentals of Classical Thermodynamics*, 3rd
33 Edition, John Wiley & Sons, New York, NY, 1986.
- 34 28. NUREG/CR-7010, *Cable Heat Release, Ignition, and Spread in Tray Installation During*
35 *Fire (CHRISTIFIRE), Volume 1: Horizontal Tray*, U.S. Nuclear Regulatory Commission,
36 Washington, DC, 2010.
- 37 29. Hurley, M. J., *The SFPE Handbook of Fire Protection Engineering*, 5th Edition, Society
38 of Fire Protection Engineers (SFPE), Bethesda, MD, 2016.
- 39 30. Muholland, G. W., and C. Croarkin, "Specific extinction coefficient of flame generated
40 smoke," *Fire and Materials*, 24(5):39-55, 2000.
- 41 31. Milke, J. A., F. W. Mowrer, and P. Gandhi, *Validation of a Smoke Detection Performance*
42 *Prediction Methodology*, Fire Protection Research Foundation, Quincy, MA, 2008.

- 1 32. Bukowski, R., et al., *Performance of Home Smoke Alarms*, NIST Tech. Note 1455-1,
2 National Institute of Standards and Technology, Gaithersburg, MD, 2008.
- 3 33. NUREG-1824/EPRI 3002002182, Supplement 1 *Verification and Validation of Selected*
4 *Fire Models for Nuclear Power Plant Applications*, U.S. Nuclear Regulatory Commission
5 Washington, DC, and EPRI, Palo Alto, CA, 2015.
- 6 34. Overholt, K., *Verification and Validation of Commonly Used Empirical Correlations for*
7 *Fire Scenarios*, NIST Special Publication 1169, National Institute of Standards and
8 Technology, Gaithersburg, MD, March 2014.
- 9 35. McGrattan, K. B., et al., *Fire Dynamics Simulator, Technical Reference Guide, Volume*
10 *3: Validation*, 6th Edition, National Institute of Standards and Technology and VTT
11 Technical Research Centre of Finland, Gaithersburg, MD, November 2019.
- 12 36. United States Committee on Extension to the Standard Atmosphere, et al., U.S.
13 Standard Atmosphere, National Aeronautics and Space Administration, U.S. Air Force,
14 United States Weather Bureau, 1962.
- 15 37. McGrattan, K., and S. Miles, Modeling enclosure fires using computational fluid
16 dynamics (CFD), Section 3-8, *The SFPE Handbook of Fire Protection Engineering*, 4th
17 Edition, Society of Fire Protection Engineers (SFPE), Bethesda, MD, 2008.
- 18

DRAFT
for Public Comment

A

INSIGHTS FROM THE EPRI FIRE EVENTS DATABASE

Appendix A contains data extracted from the EPRI fire events database. The supporting information contained in the fire events database serves as the basis for revision of several fire modeling parameters. A description of the tables in Appendix A include the following:

- **Table A-1.** This table documents the overall results from the review of the Bin 15 fire events from 2000–2014. The data fields updated as part of this project include the fire growth classification, P_{ns} category, and suppression time.
- **Table A-2.** This table documents the review of the 1990–1999 electrical cabinet fire events that were used to supplement the manual non-suppression probability curves.
- **Table A-3.** This table documents the important attributes of the fire event review that led to the classification of growth profiles. During the review of fire events, the attributes most important to fire growth were documented, including notification, passage of time, fire size, and suppression effort.
- **Table A-4.** This table includes fire events that were originally classified as potentially challenging or greater in either NUREG-2169 (EPRI 3002002936) [3] or EPRI 3002005302 [4]. Upon further review and/or additional supporting information, these events are no longer applicable. This table contains a description and disposition for the seven events that were dispositioned as part of this project.

DRAFT
for Public Comment

**Table A-1
Fire event data from 2000–2014**

| Incident Number | Event Date | Ignition Source | Power Condition | Fire Severity | Bin Designation | Fire Growth Classification | P _{ns} Category | Suppression Time | Suppression Notes |
|-----------------|------------|---------------------|-----------------|---------------|-----------------|----------------------------|--------------------------|------------------|--------------------------------------------------------------------------------------------------------------------------------------|
| 131 | 1/14/2005 | Electrical cabinets | PO | PC | 15 | Interruptible | Interruptible | 9 | The fire brigade report stated that the fire was out after 9 minutes. Fire brigade called to respond. |
| 144 | 10/30/2006 | Electrical cabinets | PO | PC | 15 | Interruptible | Interruptible | 10 | 12:38 MCR alarms; 12:48 MCR informed fire was out. |
| 146 | 2/27/2007 | Electrical cabinets | PO | PC | 15 | Interruptible | Excluded | N/A | Supervised burnout. |
| 152 | 10/23/2007 | Electrical cabinets | PO | PC | 15 | Growth | Excluded | N/A | Self-extinguish (load center breaker tripped). |
| 161 | 4/22/2009 | Electrical cabinets | PO | PC | 15 | Interruptible | Interruptible | 5 | |
| 175 | 11/22/2009 | Electrical cabinets | CD | CH | 15 | Growth | Growth | 40 | Note in Event Classification Sheet |
| 303 | 3/1/2000 | Electrical cabinets | CD | PC | 15 | Growth | Growth | 2 | |
| 320 | 10/24/2000 | Electrical cabinets | PO | PC | 15 | Interruptible | Interruptible | 2 | |
| 381 | 3/6/2005 | Electrical cabinets | PO | PC | 15 | Interruptible | Interruptible | 13 | |
| 411 | 3/8/2001 | Electrical cabinets | PO | PC | 15 | Interruptible | Excluded | N/A | Self-extinguish (no plant intervention). |
| 517 | 3/23/2006 | Electrical cabinets | PO | PC | 15 | Interruptible | Interruptible | 12 | XX:46-XX:34=12, time CO2 put on fire. |
| 520 | 6/6/2006 | Electrical cabinets | PO | PC | 15 | Interruptible | Interruptible | 8 | First smoke alarm at 1:19 (first indication at 1:16). Fire Extinguished at 1:27. 27-19=8. FB opened breaker and extinguished flames. |

**Table A-1
Fire event data from 2000–2014**

| Incident Number | Event Date | Ignition Source | Power Condition | Fire Severity | Bin Designation | Fire Growth Classification | P _{ns} Category | Suppression Time | Suppression Notes |
|-----------------|------------|---------------------|-----------------|---------------|-----------------|----------------------------|--------------------------|------------------|-----------------------------------------------------------------------------------------------|
| 588 | 11/30/2006 | Electrical cabinets | PO | CH | 15 | Growth | Excluded | N/A | Extinguished by automatic suppression only. |
| 10338 | 9/13/2001 | Electrical cabinets | PO | PC | 15 | Growth | Growth | 2 | |
| 10394 | 2/22/2005 | Electrical cabinets | PO | PC | 15 | Interruptible | Excluded | N/A | Self-extinguished (no plant intervention). |
| 30276 | 7/24/2006 | Electrical cabinets | PO | PC | 15 | Interruptible | Control room | 2 | |
| 30338 | 3/30/2006 | Electrical cabinets | PO | PC | 15 | Interruptible | Interruptible | 3 | |
| 30478 | 9/9/2005 | Electrical cabinets | PO | PC | 15 | Growth | Growth | 5 | Incident Commander (FB?) was not the one to discover the fire, but the first to challenge it. |
| 30513 | 5/27/2008 | Electrical cabinets | PO | PC | 15 | Growth | Control room | 2 | HALON - MANUAL |
| 30522 | 9/12/2000 | Electrical cabinets | PO | PC | 15 | Interruptible | Excluded | N/A | Suppression time indeterminate. |

Table A-1
Fire event data from 2000–2014

| Incident Number | Event Date | Ignition Source | Power Condition | Fire Severity | Bin Designation | Fire Growth Classification | P _{ns} Category | Suppression Time | Suppression Notes |
|-----------------|------------|---------------------|-----------------|---------------|-----------------|----------------------------|--------------------------|------------------|---------------------------------------------------------------------------------------------------------|
| 50473 | 6/26/2000 | Electrical cabinets | PO | PC | 15 | Interruptible | Interruptible | 3 | |
| 50784 | 11/20/2005 | Electrical cabinets | PO | U | 15 | Growth | Growth | 0 | From T&M |
| 50811 | 1/9/2001 | Electrical cabinets | PO | PC | 15 | Interruptible | Interruptible | N/A | No time, but looks quick, can we estimate? Not sure we can defend much with the information in the CAP. |

**Table A-1
Fire event data from 2000–2014**

| Incident Number | Event Date | Ignition Source | Power Condition | Fire Severity | Bin Designation | Fire Growth Classification | P _{ns} Category | Suppression Time | Suppression Notes |
|-----------------|------------|---------------------|-----------------|---------------|-----------------|----------------------------|--------------------------|------------------|-----------------------------------------------------------------------------------------------|
| 50874 | 7/12/2002 | Electrical cabinets | CD | PC | 15 | Interruptible | Interruptible | 2 | |
| 50912 | 5/5/2010 | Electrical cabinets | CD | CH | 15 | Growth | Excluded | N/A | Auto-suppression actuation. |
| 50914 | 6/8/2010 | Electrical cabinets | HS | PC | 15 | Interruptible | Control room | 3 | |
| 50916 | 7/13/2010 | Electrical cabinets | PO | PC | 15 | Growth | Control room | 0.5 | ICES report says 0. |
| 50921 | 10/11/2010 | Electrical cabinets | PO | PC | 15 | Interruptible | Interruptible | 7 | Under control at 8:31 and detected at 8:24:7 minutes, FB (team) extinguished the fire. |
| 50923 | 12/19/2010 | Electrical cabinets | PO | PC | 15 | Interruptible | Interruptible | 16 | Sounds like FB opened the breakers. |
| 50925 | 2/8/2011 | Electrical cabinets | PO | PC | 15 | Interruptible | Interruptible | 8 | FB appears to have removed cards/applied CO2. |
| 50936 | 6/25/2011 | Electrical cabinets | PO | CH | 15 | Growth | Growth | 37 | FB team was what extinguished the fire. |
| 50939 | 10/4/2011 | Electrical cabinets | CD | PC | 15 | Interruptible | Interruptible | 6 | |
| 50944 | 11/16/2011 | Electrical cabinets | CD | PC | 15 | Interruptible | Interruptible | 3 | E-mail with notes on arc flash only; 3 minutes to open breaker, no suppression actions taken. |
| 50946 | 1/23/2012 | Electrical cabinets | RF | PC | 15 | Interruptible | Interruptible | 10 | |

Table A-1
Fire event data from 2000–2014

| Incident Number | Event Date | Ignition Source | Power Condition | Fire Severity | Bin Designation | Fire Growth Classification | P _{ns} Category | Suppression Time | Suppression Notes |
|-----------------|------------|---------------------|-----------------|---------------|-----------------|----------------------------|--------------------------|------------------|-----------------------------------------------------------------------------------------------------------------------------------|
| 50956 | 10/22/2012 | Electrical cabinets | PO | CH | 15 | Interruptible | Interruptible | 6 | First report at 18:48 and de-energized at 18:54:6 minutes. |
| 51007 | 1/6/2013 | Electrical cabinets | PO | PC | 15 | Interruptible | Interruptible | 8 | FB Dispatched at 9:00 (before detection?), Manual suppression at 9:08. |
| 51090 | 2/15/2013 | Electrical cabinets | PO | PC | 15 | Interruptible | Interruptible | 1 | Time of detection is 8:59, and time fire was under control was 9:00. |
| 51118 | 4/12/2011 | Electrical cabinets | RF | PC | 15 | Interruptible | Interruptible | 4 | Maintenance person controlled the fire with extinguisher - out with FB de-energized - not sure if should be FB suppression curve. |
| 51146 | 4/3/2013 | Electrical cabinets | PO | PC | 15 | Interruptible | Interruptible | 17 | XX:49 Inverter loads realigned (assume this is the point of fire under control) and 1st trouble alarm at XX:62. 49-32 = 17. |
| 51172 | 3/21/2013 | Electrical cabinets | CD | PC | 15 | Interruptible | Interruptible | 5 | |
| 51180 | 5/16/2010 | Electrical cabinets | PO | PC | 15 | Interruptible | Interruptible | 2 | |
| 51190 | 4/2/2012 | Electrical cabinets | PO | PC | 15 | Interruptible | Interruptible | 11 | 1st alert at 6:18, and fire suppressed at 6:29 = 11. |
| 51216 | 1/3/2010 | Electrical cabinets | PO | PC | 15 | Interruptible | Interruptible | 5 | Estimated, could ask Exelon for more info. Don't think it could hurt to ask for more info. |

Table A-1
Fire event data from 2000–2014

| Incident Number | Event Date | Ignition Source | Power Condition | Fire Severity | Bin Designation | Fire Growth Classification | P _{ns} Category | Suppression Time | Suppression Notes |
|-----------------|------------|---------------------|-----------------|---------------|-----------------|----------------------------|--------------------------|------------------|------------------------------------------------------------|
| 51304 | 1/18/2014 | Electrical cabinets | PO | CH | 15 | Growth | Excluded | N/A | Auto-suppression actuation. |
| 51324 | 5/23/2014 | Electrical cabinets | PO | PC | 15 | Interruptible | Interruptible | 15 | 19:46-19:31=15 first indication of trouble to suppression. |
| 51332 | 10/6/2014 | Electrical cabinets | PO | CH | 15 | Growth | Growth | 2 | |
| 51377 | 12/12/2013 | Electrical cabinets | CD | PC | 15 | Interruptible | Interruptible | 2 | |

1

Table A-2
Fire event data from 1990–1999

| Incident Number | Event Date | Ignition Source | Power Condition | Fire Severity | Bin Designation | Fire Growth Classification | P _{ns} Category | Suppression Time | Suppression Notes |
|-----------------|------------|-----------------|-----------------|---------------|-----------------|----------------------------|--------------------------|------------------|--------------------------------------------------------------------------------------------------------------------------------------------------------------------|
| 29 | 2/23/1991 | 15 | HS | PC | 15 | Interruptible | Interruptible | 7 | Fire was extinguished before the FB reached the scene. |
| 38 | 3/21/1992 | 15 | CD | CH | 15 | Interruptible | Interruptible | 8 | |
| 41 | 6/17/1992 | 15 | PO | PC | 15 | Interruptible | Interruptible | 8 | Within 8 minutes from discovery of the fire, the fire brigade reported that the "D" RWS breaker had been racked out and the fire had been completely extinguished. |
| 45 | 7/29/1992 | 15 | PO | PC | 15 | Growth | Growth | 16 | 4:31 (FB extinguished fire with CO2) - 4:15 (Fire starts) = 16. |

Table A-2
Fire event data from 1990–1999

| Incident Number | Event Date | Ignition Source | Power Condition | Fire Severity | Bin Designation | Fire Growth Classification | P _{ns} Category | Suppression Time | Suppression Notes |
|-----------------|------------|-----------------|-----------------|---------------|-----------------|----------------------------|--------------------------|------------------|-----------------------------------------------------------------------------------------------------------|
| 69 | 8/29/1994 | 15 | PO | U | 15 | Undetermined | Undetermined | 10 | Most likely description of degradation/self-extinguished fire. |
| 89 | 10/15/1996 | 15 | PO | PC | 15 | Interruptible | Interruptible | 10 | 13:25 (fire declared out) - 13:15 (fire reported) = 10. |
| 98 | 10/8/1998 | 15 | RF | PC | 15 | Interruptible | Excluded | 0 | Appears to be self-extinguished. |
| 187 | 8/16/1999 | 15 | PO | PC | 15 | Interruptible | Interruptible | 8 | Use 8 minutes suppression time as designated by plant. |
| 188 | 8/24/1999 | 15 | PO | PC | 15 | Growth | Growth | 13 | |
| 203 | 4/6/1990 | 15 | RF | CH | 15 | Undetermined | Undetermined | 24 | Report suggests damage outside ignition source/ignition of combustible materials outside ignition source. |
| 206 | 6/11/1990 | 15 | CD | U | 15 | Undetermined | Undetermined | 2 | Discovered while on rounds, power supply removed. No information on fire size. |
| 209 | 8/22/1990 | 15 | PO | PC | 15 | Interruptible | Interruptible | 2 | |
| 211 | 11/2/1990 | 15 | RF | PC | 15 | Undetermined | Undetermined | 2 | Description: transformer failure, fire extinguished by de-energizing transformer. |
| 219 | 9/27/1991 | 15 | PO | PC | 15 | Undetermined | Undetermined | 10 | Description: insulation failure of transformer. Fire extinguished by de-energizing breaker. |

Table A-2
Fire event data from 1990–1999

| Incident Number | Event Date | Ignition Source | Power Condition | Fire Severity | Bin Designation | Fire Growth Classification | P _{ns} Category | Suppression Time | Suppression Notes |
|-----------------|------------|-----------------|-----------------|---------------|-----------------|----------------------------|--------------------------|------------------|--------------------------------------------------------------------------------------------------------------------------|
| 224 | 3/8/1992 | 15 | RF | U | 15 | Undetermined | Undetermined | 6 | Caused by electrician, Damage confined to object (?), power removed. |
| 253 | 7/6/1995 | 15 | PO | PC | 15 | Interruptible | Interruptible | 10 | |
| 254 | 9/25/1995 | 15 | RF(1), PO(2) | PC | 15 | Interruptible | Interruptible | 4 | The condition was reported at 14:06 and out at 14:10 = 4. |
| 20264 | 1/19/1990 | 15 | PO/SD | U | 15 | Undetermined | Undetermined | 10 | Light amount of smoke coming from an MCC. Hold in coil overheated, suppressed with extinguisher, unclear how discovered. |
| 20267 | 3/12/1990 | 15 | CD | U | 15 | Undetermined | Undetermined | N/A | Discovered by plant personnel. |
| 20268 | 4/19/1990 | 15 | PO | U | 15 | Undetermined | Undetermined | N/A | Discovered by plant personnel, just overheating? |
| 20269 | 4/30/1990 | 15 | PO | U | 15 | Undetermined | Electrical | N/A | Discovered by plant personnel, just overheating? |
| 20270 | 6/7/1990 | 15 | RF | U | 15 | Undetermined | Undetermined | 2 | Discovered by fire watch, unclear if time passed. |
| 20272 | 9/10/1990 | 15 | PO(1), SD(2) | U | 15 | Undetermined | Undetermined | 5 | Discovered by a security guard. |
| 20273 | 9/18/1990 | 15 | PO | PC | 15 | Undetermined | Undetermined | N/A | Heavy smoke due to failed trip coil. |
| 20275 | 10/11/1990 | 15 | PO(1), SD(2) | U | 15 | Undetermined | Undetermined | N/A | Control transformer burned up. |

Table A-2
Fire event data from 1990–1999

| Incident Number | Event Date | Ignition Source | Power Condition | Fire Severity | Bin Designation | Fire Growth Classification | P _{ns} Category | Suppression Time | Suppression Notes |
|-----------------|------------|-----------------|-----------------|---------------|-----------------|----------------------------|--------------------------|------------------|-----------------------------------------------------------------------------|
| 20276 | 10/12/1990 | 15 | RF | U | 15 | Undetermined | Excluded | N/A | Discovered by Operations, self-extinguished. |
| 20282 | 9/17/1991 | 15 | PO | U | 15 | Undetermined | Undetermined | N/A | Discovered by plant personnel (on rounds?); saw smoke from MCC. |
| 20287 | 2/29/1992 | 15 | RF(1), PO(2) | U | 15 | Undetermined | Undetermined | 5 | Discovered by roving fire watch. |
| 20295 | 33889 | 15 | PO | U | 15 | Undetermined | Undetermined | 2 | Discovered by plant personnel. |
| 20302 | 34175 | 15 | PO | U | 15 | Undetermined | Undetermined | 35 | Discovered by plant personnel. |
| 20312 | 34542 | 15 | PO | U | 15 | Undetermined | Undetermined | N/A | Discovered by detection system, extinguished by portable fire extinguisher. |
| 20325 | 35811 | 15 | PO | U | 15 | Growth | Growth | 10 | |
| 20328 | 36286 | 15 | PO | U | 15 | Growth | Growth | 2 | |
| 20329 | 36404 | 15 | PO | U | 15 | Growth | Growth | 2 | Growth (SRO present). |
| 20334 | 32924 | 15 | PO | U | 15 | Undetermined | Undetermined | N/A | Discovered by plant personnel. |
| 20346 | 34423 | 15 | RF | U | 15 | Undetermined | Excluded | N/A | Discovered by maintenance, self-extinguished? |
| 20356 | 34749 | 15 | PO | PC | 15 | Undetermined | Undetermined | 5 | Discovered by plant personnel, de-energized. |

Table A-2
Fire event data from 1990–1999

| Incident Number | Event Date | Ignition Source | Power Condition | Fire Severity | Bin Designation | Fire Growth Classification | P _{ns} Category | Suppression Time | Suppression Notes |
|-----------------|------------|-----------------|-----------------|---------------|-----------------|--------------------------------|--------------------------|------------------|----------------------------------------------------------------------------------|
| 20357 | 34843 | 15 | PO | PC | 15 | Growth (personnel right there) | Undetermined | N/A | Discovered by plant personnel. No, personnel was right there. Self-extinguished. |
| 20362 | 35491 | 15 | PO | PC | 15 | Undetermined | Undetermined | 2 | Discovered by equipment alarm, de-energized. |

Table A-3
Significant attributes derived from fire event review

| Incident Number | Event Date | Fire Growth Classification | Notification | Passage of Time | Fire Size | Suppression Effort | Review Notes |
|-----------------|------------|----------------------------|------------------------------------------------------------------------------------------------------------|-------------------------------|----------------------------------------|------------------------------------------------------------------------------|--------------------------------------------------------------------------------------------------------------------------------------------------------------------------------------------------------------------|
| 131 | 1/14/2005 | Interruptible | Discovered by plant personnel | Personnel dispatched to event | Sparks and smoke | Water mist extinguishers | T: While attempting to investigate the source of the noise, sparks and smoke were observed coming from a power distribution panel. S: Water mist fire extinguishers were used to cool off the electrical panel. |
| 144 | 10/30/2006 | Interruptible | MCR indication/equipment trouble alarm (first) Automatic detection/fire alarm control panel (secondary) | Personnel dispatched to event | Small fire; limited to ignition source | De-energizing the ignition source; suppression by first responding personnel | No extinguishing agent used. Fire terminated once power source was removed. |

**Table A-3
Significant attributes derived from fire event review**

| Incident Number | Event Date | Fire Growth Classification | Notification | Passage of Time | Fire Size | Suppression Effort | Review Notes |
|-----------------|------------|----------------------------|---------------------------------------------------------------------------------------------------------------|---------------------------------------------------------------------------------------------|------------------------------------------|------------------------------------------------------------------|-------------------------------------------------------------------------------------------------------------------------------------------------------------------------------------------------------------------------------------------------------------------------------|
| 146 | 2/27/2007 | Interruptible | MCR Indication/equipment trouble alarm Discovered by plant personnel | Personnel dispatched to event | Limited to ignition source | De-energized + CO2 extinguishers | Incident Commander (I-C) arrived on the scene within 3 minutes of the initial dispatch. Confirmed presence of smoke. Instructed FB to search for source. Smoke worsened, chose to don self-contained breathing apparatus. Fire appears to have had ample time to grow. |
| 152 | 10/23/2007 | Growth | MCR Indication/equipment trouble alarm (first) Automatic detection/fire alarm control panel (secondary) | Personnel investigated, determined, discovered, looking for indication of a fire, and so on | Small fire Limited to ignition source | Minimal suppression effort | Received several alarms simultaneously while starting charging pump for test. Then fire alarm went off. Fire appears self-extinguished when feeder breaker tripped. |
| 161 | 4/22/2009 | Interruptible | Discovered by plant personnel | Personnel investigated, determined, discovered, looking for indication of a fire, and so on | Small fire | Minimal suppression effort Single portable extinguisher | Strong odor observed, operators investigated and found 6-inch (152.4 mm) fire. |
| 175 | 11/22/2009 | Growth | Fire caused by plant personnel during T/M automatic detection/fire alarm control panel (simultaneous) | Personnel dispatched to event | Fire in 3 cubicles | Multiple fire extinguishers (FEDB); offsite assistance requested | Event occurred while the plant was in Mode 5. Grounding devices were left in 3 balance of plant incoming breaker cubicles. When the main transformer was energized the grounding devices provided a direct short to ground which induced fires. |

**Table A-3
Significant attributes derived from fire event review**

| Incident Number | Event Date | Fire Growth Classification | Notification | Passage of Time | Fire Size | Suppression Effort | Review Notes |
|-----------------|------------|----------------------------|----------------------------------------|---------------------------------------------------------------------------------------------|---------------------------------------|----------------------------------------------------------|---------------------------------------------------------------------------------------------------------------------------------------------------------------------------------------------------------------------------------------------------|
| 303 | 3/1/2000 | Growth | Discovered by plant personnel | Personnel dispatched to event | Small fire limited to ignition source | Multiple portable extinguishers | Operators investigated smell of burning insulation. Upon arriving at the ignition source, the cabinet doors were found open with flames coming out of the cabinet and paint burning off the top. |
| 320 | 10/24/2000 | Interruptible | Discovered by plant personnel | Personnel investigated, determined, discovered, looking for indication of a fire, and so on | Small fire | Minimal suppression effort; single portable extinguisher | - |
| 381 | 3/6/2005 | Interruptible | MCR Indication/equipment trouble alarm | Personnel dispatched to event | Small fire | De-energizing the ignition source | Personnel dispatched reported a flame on the fan motor. The fire was extinguished as soon as the power was cut to the fan assembly. No other damage to the cubicle or surrounding wiring. |
| 411 | 3/8/2001 | Interruptible | Discovered by plant personnel | Personnel investigated, determined, discovered, looking for indication of a fire, and so on | Limited to the ignition source | De-energizing the ignition source | Meets LEAF criteria. Heard loud noise and lights dimmed. Time passed as the crew was asked to evacuate the tunnel. Fire damage limited to one breaker cabinet (no flames observed by fire blew door open). Cables appear to be in good condition. |

**Table A-3
Significant attributes derived from fire event review**

| Incident Number | Event Date | Fire Growth Classification | Notification | Passage of Time | Fire Size | Suppression Effort | Review Notes |
|-----------------|------------|----------------------------|---------------------------------------------------------------------------------------------------------------|-------------------------------|---------------------------------------|----------------------------------------|-------------------------------------------------------------------------------------------------------------------------------------------------------------------------------------------------------------------------------------------------------------------------------------------------------------------------------------------------------|
| 517 | 3/23/2006 | Interruptible | MCR Indication/equipment trouble alarm (first) Automatic detection/fire alarm control panel (secondary) | Personnel dispatched to event | Small fire | Multiple portable extinguishers | Annunciator and alarm in MCR. Smoke alarm actuates around 5 minutes after annunciator. RO sent to investigate (time lapsed as he exited the RCA and reported to location). Ten minutes elapsed by the time the RO arrived and found a 6-inch (152.4-mm) flame in the bottom of the cabinet. Two personnel applied to extinguishers in parallel. |
| 520 | 6/6/2006 | Interruptible | MCR Indication/equipment trouble alarm (first) Automatic detection/fire alarm control panel (secondary) | Personnel dispatched to event | Small fire limited to ignition source | De-energizing the ignition source | |
| 588 | 11/30/2006 | Growth | MCR Indication/equipment trouble alarm (first) Automatic detection/fire alarm control panel (secondary) | Personnel dispatched to event | | Automatic suppression system activated | Switchgear trouble alarm, followed 30 seconds later by fire alarm. Sprinkler system had dumped. |
| 10338 | 9/13/2001 | Growth | Fire caused by plant personnel during T/M | None | Small fire limited to ignition source | Single portable extinguisher | Classified as growth due to limited/no passage of time and fire attributes. Report of flash by technicians at breaker monitoring relays. Although the fire was small, the breaker failure was more severe than plant personnel could recall. |

**Table A-3
Significant attributes derived from fire event review**

| Incident Number | Event Date | Fire Growth Classification | Notification | Passage of Time | Fire Size | Suppression Effort | Review Notes |
|-----------------|------------|----------------------------|-------------------------------|---------------------------------------------------------------------------------------------|---------------------------------------|-------------------------------------------------------------------|-----------------------------------------------------------------------------------------------------------------------------------------------------------------------------------------------------------------------------------------------------------------------------------------------------|
| 10394 | 2/22/2005 | Interruptible | Discovered by plant personnel | Personnel investigated, determined, discovered, looking for indication of a fire, and so on | Small fire limited to ignition source | Self-extinguished | Plant personnel investigating aroma of something burning. Flames last only a few seconds and then self-extinguished. Three circuit cards were replaced. |
| 30276 | 7/24/2006 | Interruptible | Discovered by plant personnel | Personnel investigated, determined, discovered, looking for indication of a fire, and so on | Small fire limited to ignition source | De-energizing the ignition source | Upon a smell of smoke in the MCR, operators investigated and found flames in the area of a transformer inside the housing. No extinguisher was used, power supply breaker opened to de-energize component. |
| 30338 | 3/30/2006 | Interruptible | Discovered by plant personnel | Personnel investigated, determined, discovered, looking for indication of a fire, and so on | Limited to the ignition source | Single portable extinguisher De-energizing the ignition source | Fire discovered during routine observation. |
| 30478 | 9/9/2005 | Growth | Discovered by plant personnel | Personnel dispatched to event | | Multiple portable extinguishers | Upon investigation, opened panel and saw heavy smoke and small flames. Physical fire damage limited to three relays, adjacent wiring, and plastic duct sleeve. Wiring in the cable chase directly above the relays sustained significant damage. 1 CO2 extinguisher and parts of another were used. |

**Table A-3
Significant attributes derived from fire event review**

| Incident Number | Event Date | Fire Growth Classification | Notification | Passage of Time | Fire Size | Suppression Effort | Review Notes |
|-----------------|------------|----------------------------|----------------------------------------------|---------------------------------------------------------------------------------------------|---------------------------------------|----------------------------------------------------------------|------------------------------------------------------------------------------------------------------------------------------------------------------------------|
| 30513 | 5/27/2008 | Growth | Automatic detection/fire alarm control panel | Personnel dispatched to event | Limited to the ignition source | Manual activation of fixed suppression system | Classified as growth due to manual activation of Halon system and fire reflash. |
| 30522 | 9/12/2000 | Interruptible | Automatic detection/fire alarm control panel | Personnel dispatched to event | Limited to the ignition source | Single portable extinguisher de-energizing the ignition source | Fire damage internal to the component (noticeable charring and smoke damage). External box had some heat and smoke damage, but fire kept to the electrical unit. |
| 50473 | 6/26/2000 | Interruptible | MCR Indication/equipment trouble alarm | Personnel dispatched to event | Small fire | Self-extinguished | Investigated burning odor noted while responding to trouble alarm. Small flame observed from a relay along with visible smoke. Fire self-extinguished. |
| 50784 | 11/20/2005 | Growth | Fire caused by plant personnel during T/M | None | Small fire limited to ignition source | | |
| 50811 | 1/9/2001 | Interruptible | MCR Indication/equipment trouble alarm | Personnel dispatched to event | Small fire limited to ignition source | Single portable extinguisher | |
| 50874 | 7/12/2002 | Interruptible | Discovered by plant personnel | Personnel investigated, determined, discovered, looking for indication of a fire, and so on | Small fire | De-energizing the ignition source | Small electrical fire in the breaker trip coil. |

**Table A-3
Significant attributes derived from fire event review**

| Incident Number | Event Date | Fire Growth Classification | Notification | Passage of Time | Fire Size | Suppression Effort | Review Notes |
|-----------------|------------|----------------------------|---------------------------------------------------------------------------------------------------------------|---------------------------------------------------------------------------------------------|--------------------------------|-------------------------------------------------------------------|----------------------------------------------------------------------------------------------------------------------------------------------------------------------|
| 50912 | 5/5/2010 | Growth | Automatic suppression actuation alarm | | | Automatic suppression system activated | |
| 50914 | 6/8/2010 | Interruptible | Discovered by plant personnel | Personnel investigated, determined, discovered, looking for indication of a fire, and so on | Small fire | Single portable extinguisher | RC suppressor caught fire and spread directly above (3 in. [76.2 mm]) |
| 50916 | 7/13/2010 | Growth | Fire caused by plant personnel during T/M | None | Limited to the ignition source | Single portable extinguisher De-energizing the ignition source | Classified as growth due to maintenance and no evidence of time passing. |
| 50921 | 10/11/2010 | Interruptible | Discovered by plant personnel | Personnel dispatched to event | Arcing and smoke | Single portable extinguisher | Fire caused damage to the feeder cable and control panel. |
| 50923 | 12/19/2010 | Interruptible | MCR Indication/equipment trouble alarm (first) Automatic detection/fire alarm control panel (secondary) | Personnel dispatched to event | Limited to the ignition source | De-energizing the ignition source | Intermittent trouble alarms followed by two alarms on fire alarm computer. Fire was contained to the heater control panel and breakers were opened to isolate power. |
| 50925 | 2/8/2011 | Interruptible | MCR Indication/equipment trouble alarm | Personnel dispatched to event | Small fire | Single portable extinguisher De-energizing the ignition source | Numerous alarms led operators to investigate. Fire damaged 2 adjacent circuit cards. |

**Table A-3
Significant attributes derived from fire event review**

| Incident Number | Event Date | Fire Growth Classification | Notification | Passage of Time | Fire Size | Suppression Effort | Review Notes |
|-----------------|------------|----------------------------|----------------------------------------------|---------------------------------------------------------------------------------------------|---------------------------------------|-----------------------------------|------------------------------------------------------------------------------------------------------------------------------------------------------------------------------------------------------------------------------------------------------------------------------------------------------------------------------------------------------------------------------------------|
| 50936 | 6/25/2011 | Growth | Automatic detection/fire alarm control panel | Personnel dispatched to event | | Multiple portable extinguishers | Classified as growth due to fire attributes (heavy smoke and delays in suppression) and notes of multiple portable extinguishers used. |
| 50939 | 10/4/2011 | Interruptible | Automatic detection/fire alarm control panel | Personnel dispatched to event | Limited to the ignition source | De-energizing the ignition source | Third harmonic choke on inverter on fire with some damage to a circuit card and transformer. Lesser damage on a cable in cabinet. |
| 50944 | 11/16/2011 | Interruptible | Discovered by plant personnel | Personnel investigated, determined, discovered, looking for indication of a fire, and so on | Small fire | De-energizing the ignition source | Meets LEAF criteria. As electricians and Shift Engineer were walking down hallway an arc flash around a breaker handle occurred and smoke was observed coming out of MCC doors. No flames observed, just arc flash. Three minutes passed until the breaker was opened. Personnel were standing by, but did not feel the need to apply fire suppression. Fire limited to breaker cubicle. |
| 50946 | 1/23/2012 | Interruptible | Discovered by plant personnel | Personnel dispatched to event | Small fire | De-energizing the ignition source | Electrical transient with smoke damage and burned wiring. Fire was in control and effectively out when power was removed. |
| 50956 | 10/22/2012 | Interruptible | Discovered by security | Personnel dispatched to event | Small fire limited to ignition source | De-energizing the ignition source | Security observed bright light and loud sound. Fire Brigade leader called and confirmed smoke. The CPT overheated and fire was limited to breaker cubicle and did not affect surrounding equipment or plant operators. Fire extinguished after breaker tripped. |

**Table A-3
Significant attributes derived from fire event review**

| Incident Number | Event Date | Fire Growth Classification | Notification | Passage of Time | Fire Size | Suppression Effort | Review Notes |
|-----------------|------------|----------------------------|---------------------------------------------------------------------------------------------------------------|---------------------------------------------------------------------------------------------|---------------------------------------|-----------------------------------|---------------------------------------------------------------------------------------------------------------------------------------------------------------------------------------------------------------------------------------------------------------------------------------------------------------------------------------------------------------------------------------------------------------------------------------------------------------------------------------------------|
| 51007 | 1/6/2013 | Interruptible | Discovered by plant personnel Automatic suppression actuation alarm | Personnel dispatched to event | Limited to the ignition source | Single portable extinguisher | Confined to source (electrical box associated with gantry crane). Detection by plant personnel (Notification), Suppression by FB using extinguisher (travel, small fire). Operators reported dense smoke to MCR (along with MCR indications/trouble alarms and automatic detection). A CPT was melting and fire extinguished when power removed. The MCC bucket was repaired and returned to service. Believe dense was specific to smoke coming from source, not with respect to room. |
| 51090 | 2/15/2013 | Interruptible | Discovered by plant personnel | Operators contact MCR and receive permission to open breaker | No visible flames | De-energizing the ignition source | |
| 51118 | 4/12/2011 | Interruptible | Discovered by plant personnel | Personnel investigated, determined, discovered, looking for indication of a fire, and so on | Small fire | Single portable extinguisher | Fire limited to single card with some damage to adjacent cards. |
| 51146 | 4/3/2013 | Interruptible | MCR Indication/equipment trouble alarm (first) Automatic detection/fire alarm control panel (secondary) | Personnel dispatched to event | Small fire limited to ignition source | De-energizing the ignition source | Inverter trouble and fire alarm concurrent. Dispatched operator reports small fire contained to internal transformer with no damage to surrounding components. Fire ceased when de-energized. |

**Table A-3
Significant attributes derived from fire event review**

| Incident Number | Event Date | Fire Growth Classification | Notification | Passage of Time | Fire Size | Suppression Effort | Review Notes |
|-----------------|------------|----------------------------|---------------------------------------------------------------------------------------------------------------|---------------------------------------------------------------------------------------------|---------------------------------------|----------------------------------------|------------------------------------------------------------------------------------------------------|
| 51172 | 3/21/2013 | Interruptible | Discovered by plant personnel | Personnel dispatched to event | Limited to the ignition source | Single portable extinguisher | No damage outside breaker. |
| 51180 | 5/16/2010 | Interruptible | MCR Indication/equipment trouble alarm | Personnel investigated, determined, discovered, looking for indication of a fire, and so on | Small fire limited to ignition source | Minimal suppression effort | |
| 51190 | 4/2/2012 | Interruptible | Automatic detection/fire alarm control panel | Personnel dispatched to event | Small fire | Single portable extinguisher | Damage limited to 25 kVA inverter within cabinet. |
| 51216 | 1/3/2010 | Interruptible | Discovered by plant personnel | Personnel dispatched to event | Small fire | Single portable extinguisher | Small fire on relays in panel. Used CO2 to extinguish. |
| 51304 | 1/18/2014 | Growth | MCR Indication/equipment trouble alarm (first) Automatic detection/fire alarm control panel (secondary) | Personnel dispatched to event | | Automatic suppression system activated | Inverter trouble alarm first, followed by additional alarms and fire alarm. Automatic Halon release. |
| 51324 | 5/23/2014 | Interruptible | MCR Indication/equipment trouble alarm | Personnel dispatched to event | Small fire limited to ignition source | Single portable extinguisher | 6-in (152.4-mm) wound transformer on fire. |
| 51332 | 10/6/2014 | Growth | Discovered by plant personnel | None | | Single portable extinguisher | No time lapsed and substantial fire damage within cabinet. |

**Table A-3
Significant attributes derived from fire event review**

| Incident Number | Event Date | Fire Growth Classification | Notification | Passage of Time | Fire Size | Suppression Effort | Review Notes |
|-----------------|------------|----------------------------|-------------------------------|---------------------------------------------------------------------------------------------|--------------------------------|------------------------------|-----------------------------------------------------------------------------------------------------------------------------|
| 51377 | 12/12/2013 | Interruptible | Discovered by plant personnel | Personnel investigated, determined, discovered, looking for indication of a fire, and so on | Limited to the ignition source | Single portable extinguisher | Plant personnel heard loud buzzing noise 3 seconds after energizing equipment. Damage limited to MCC loose connection area. |

**Table A-4
Fire events disposition**

| Fire ID | Fire Event Description | Fire Event Disposition |
|---------|-----------------------------------------------------------------------------------------------------------------------------------------------------------------------------------------------------------------------------------------------------------------------------------------------------------------------------------------------------------------------------------------------------------------------------------------------------------------------------------------------------------------------------------------------------------------------------------------------------------------------------------------------------------------------------------------------------------------------------------------------------------------------------------------------------------------------------------------------------------------------------------------------------------------------------------------------------------------------------------------------------------------------------------------------------------------------------------------------------------------------|------------------------------------------------------------------------------------------------------------------------------------------------------------------------------------------------------------------------------------------------------------------------------------------------------------------------------------------------------------------------------------------------------------------------------------------------------------------------------------------------------------------------------------------------------------------------------------------------------------------------------------------------------------------|
| 20382 | There is no description of this event. This event first appeared in the EPRI 1003111 (published November 2001). | No information was received on this event in the FEDB update (EPRI 1025284). EPRI reached out to the plant during this project. The PRA and fire protection groups investigated and found no such fire event at the plant. |
| 30281 | Relay 2AF in panel XCP6222-EG failed resulting in smoke emanating from this and adjoining panels in the CB-463. At approximately 1313, the evidence of smoke and the prevailing odor lent credence to a possibly failed relay. Upon opening the rear panel doors, Relay 2AF showed evidence of failed insulation. This was the source of the smoke. At no time were flames present. Parts of three CO2 fire extinguishers were discharged. As a precaution, the control room watch standers donned self-contained breathing apparatus but never went on air. Another operator in appropriate ISP-027 gear pulled all adjoining fuses to de-energize the relay. Live-dead-live checks indicated that Relay 2AF was de-energized. A reflash watch was stationed. The procedure, EMP-190.059, used for lockout testing, had the synch switches for the Main XFMR, the emergency Aux XFMRs and the main generator all energized simultaneously. This allowed 230 kV potential to be cross fed across the 120 V synch bus which couldn't handle that amount of voltage, resulting in overheating and failing the synch PT. | Meets smoke event criteria in 1025284 (Page 58, 5-6) -Events may be screened out of smoke is light/no evidence of flaming combustion -Human intervention to stop light smoke events prior to becoming actual fires is acceptable when screening these events from the FEDB, if personnel were continuously present during the evolution leading to the smoking condition such as a surveillance test, maintenance work, or other activity. From CR: It appears they were in a shutdown condition, and notes "the procedure used for testing the synch switches," which led to the conclusion that testing was ongoing and led to the condition in the MCR. |
| 30578 | The Control Room initiated a Fire Brigade response to a reported fire in an electrical box (the power supply for the cask handling crane). The fire reported by the Work Control Supervisor in the area. The WCS called back to say the fire was out at 10:58 and the Health and Safety Coordinator (former fire brigade leader) verified the fire was out at 11:03. (9 minutes from initiation). The fire brigade responded to the scene and found no fire or smoke in the area and stood by until 11:40. At this time, damage appears to be limited to a piece of heat shrink tubing on a connector. | This location is within the protected area (waste processing building); however, it contains no FPRA related equipment or cables. This event is re-classified as non-challenging as this is an event that is not of interest to the FPRA and is not in a location relevant to plant operations or safety. |

**Table A-4
Fire events disposition**

| Fire ID | Fire Event Description | Fire Event Disposition |
|---------|------------------------------------------------------------------------------------------------------------------------------------------------------------------------------------------------------------------------------------------------------------------------------------------------------------------------------------------------------------------------------------------------------------------------------------------------------------------------------------------------------------------------------------------------------------------------------------------------------------------------------------------------------------------------------------------------------------------------------------------------------------------------------------------------------------------------------------------------------------------------------------------------------------------------------------------------|-------------------------------------------------------------------------------------------------------------------------------------------------------------------------------------------------------------------------------------------------------------------------------------------------------------------------------------------------------------------------------------------------------------------------------------------------------------------------------------------------------|
| 50467 | <p>Breaker was found to have smoke coming out of the breaker cube. Once the breaker was removed, it was found that breaker closing coil was (frozen) burnt in the close position, therefore keeping the closing springs in the charged position. This condition happened when OPS surveillance tried to close the breaker and breaker started to smoke.</p> | <p>Meets smoke event criteria in 1025284 (Page 58, 5-6) -Events may be screened out of smoke is light / no evidence of flaming combustion -Human intervention to stop light smoke events prior to becoming actual fires is acceptable when screening these events from the FEDB, if personnel were continuously present during the evolution leading to the smoking condition such as a surveillance test, maintenance work, or other activity.</p> |
| 51088 | <p>While performing work, 3-day shift electrical technicians were beginning to perform a step to verify the integrity of the inverter after new components had been installed. The steps were to perform a load test of the inverter. The new components were installed and the cables for the test were terminated on the prior nightshift. The output voltage was not within range, and the lead electrical tech realized they needed another meter. He went to the shop to get another meter. The other two electricians remained at the energized inverter. After 20 minutes, the lead paged one of the techs to read voltage. The tech reported voltage and also presence of some smoke coming out of inverter. The lead electrician told them to shut down the inverter and they responded by turning off the AC and DC breakers. Soon after the inverter was turned off, the Halon alarm sounded and all personnel exited the room.</p> | <p>The smoking condition was terminated (power de-energized) prior to the Halon release. Therefore, this event should screen under 1025284 under the following: -Equipment failures during monitored T/M activities: Return to service (Page 91) -Smoke events (Page 58) -Would need to have noticeable temperature increase (Page 86) and meet an additional criterion (Page 88) to be PC or greater.</p> |
| 51257 | <p>During a planned transfer of the cooling water lift station 4 kV bus to its alternate source, the transfer solenoid caught fire due to failure of the solenoid. The fire was put out with a carbon dioxide fire extinguisher.</p> | <p>This is not a countable fire as the lift station is located over a mile away from the plant. This building is not modeling in the PRA and has no PRA interlocks.</p> |
| 51309 | <p>Electrical fire inside protected area in non-vital power panel outside power block</p> | <p>Not a PRA countable fire. This is a 480-V disconnect switch outside the power block that feeds support buildings.</p> |

B

INTERRUPTIBLE AND GROWING FIRE MONTE CARLO SAMPLING

B.1 Monte Carlo Simulation for Characterizing the Time and Probability of Automatic Smoke Detection

The Monte Carlo sampling technique to approximate the probability of automatic smoke detection is calculated given the possible range of determining factors.

The Monte Carlo simulation consists of four parts, as follows:

1. Generate a fire heat release rate profile over time (randomized peak heat release rate [HRR]). See Section 4.2.
2. Calculate the time-dependent smoke concentration at a randomized radial distance and ceiling height above the fuel source. See Section B.2.
3. Calculate the time response of the simulated smoke detector given randomized activation optical density (OD) values. See Section B.2.
4. Average all smoke detection results over 20,000 occurrences. See Section 5.3.3.1.

The specifics of this process are described in further detail in the following sections with an overall summary of the input parameters provided in Table B-1.

Table B-1
Summary of Monte Carlo parameters for modeling automatic smoke detection

| Parameter | Distribution Type | Values | Notes |
|-----------------------------------------------------------------|-------------------|----------------------------|--------------------------------------------------------------------------------------------------------------------------------------------------------------|
| Peak heat release rate | Gamma | Varies | See NUREG-2178, Tables 4-1 and 4-2 |
| Duration of the pre-growth and growth phases of the HRR profile | Constant | 12 | Total of pre- and growth phase (see Section 4.1) |
| Duration of the steady state heat release rate profile stage | Constant | 8 | Steady burning duration (see Section 4.1) |
| Duration of the decay state heat release rate profile stage | Constant | 19 | Decay burning duration (see Section 4.1) |
| Ceiling height above fuel source | Uniform | 1.5 - 6.1 m (5 - 20 ft) | Random value independently sampled assuming a uniform distribution. The range of values is assumed to capture likely ceiling heights in nuclear power plants |

Table B-1
Summary of Monte Carlo parameters for modeling automatic smoke detection

| Parameter | Distribution Type | Values | Notes |
|-----------------------------|-------------------|---------------------------------|--------------------------------------------------------------------------------------------------------------------------------------------------------|
| Radial distance to detector | Uniform | 0 to 6.5 m (0 – 21.2 ft) | Random value independently sampled assuming a uniform distribution. The range of values are assumed to be within acceptable code compliance distances. |
| Activation OD | Gamma | α : 4.62, β : 0.07 | Average OD Thresholds (see Section C.2) |
| Soot yield | Uniform | 0.076 – 0.175 g/g | Random value independently sampled assuming a uniform distribution. Minimum and Maximum values for electrical cables. (see Section C.2) |
| HRR radiant fraction | Constant | 0.3 | Typical fire radiant fraction |
| Ambient temperature | Constant | 25 °C | Typical ambient temperature in an NNP |
| Ambient pressure | Constant | 101325 Pa | Typical ambient pressure in an NPP |
| Obstructed plume bias | Constant | 0.62 | Plume calculated conservatively assuming an obstructed plume. See NUREG-2178. |

B.2 Automatic Smoke Detection

To determine the detection system activation, several parameters must be calculated assuming that the smoke detector is located within the ceiling jet produced by the fire. These include the following:

- Ceiling jet temperature
- Ceiling jet density
- Average ceiling jet velocity
- Dilution factor
- Soot density
- OD

Ceiling Jet Temperature

As presented in NUREG-1805, Chapter 11, Section 5.1 [24], the Alpert ceiling jet temperature correlations [25] of a fire plume can be calculated using Equations B-1 and B-2.

$$T_{jet} = T_{amb} + B \cdot 16.9 \left(\frac{Q^{\frac{2}{3}}}{(H_{pau})^{\frac{5}{3}}} \right) \text{ for } r_{det}/H \leq 0.18, \quad (B-1)$$

$$T_{jet} = T_{amb} + B \cdot 5.38 \left(\frac{\frac{Q^{\frac{2}{3}}}{H_{pau}^{\frac{5}{3}}}}{\left(\frac{r}{H_{pau}}\right)^{\frac{2}{3}}} \right) \text{ for } r_{det}/H > 0.18 \quad (\text{B-2})$$

1 where T_{jet} is the ceiling jet temperature in °C, T_{amb} is the ambient temperature in °C, Q is the
 2 total heat release rate (HRR) in kW, H_{pau} is the height of the ceiling above the fuel source in
 3 meters, r_{det} is the radial distance from the plume center line to the detector in meters, and
 4 $B=0.62$ is the obstructed plume bias from NUREG-2178. In this formulation, the reduction in the
 5 ceiling jet temperatures is assumed to be equivalently proportional to the obstructed plume
 6 correction when applied.

7 Due to the direct association with the thermal plume, the obstructed plume bias is
 8 conservatively included in the estimation of the ceiling jet temperature. The inclusion of this bias
 9 results in an increased heat release rate required to reach a detectable OD.

10 Ceiling Jet Density

11 The ceiling jet density is the density of the ceiling jet at the radial distance of the smoke
 12 detector. This can be computed using the Alpert ceiling jet temperature equations presented
 13 previously and the ideal gas law [26] (Equation B-3).

$$\rho_{jet} = \frac{mw_{air} P_{atm}}{(T_{jet} + 273.15)R_{gas}} \quad (\text{B-3})$$

14 where ρ_{jet} is the density of the ceiling jet in kg/m³, mw_{air} is the molecular weight of air equal to
 15 0.0288 kg/mol, P_{atm} is atmospheric pressure equal to 101325 Pa, and R_{gas} is the gas constant
 16 equal to 8.314 J/mol·K.

17 Dilution Factor

18 The conservation of energy and the first law of thermodynamics [27] can be applied to
 19 determine how much entrainment has occurred into the fire plume and ceiling jet in order to
 20 achieve the final gas temperature at the detector. A unit mass of fuel can be considered to have
 21 an enthalpy equal to its heat of combustion. Post-combustion, the convective fraction of that
 22 enthalpy results in a hot fire plume and ceiling jet. Ignoring convective heat loss to the ceiling, at
 23 any radial distance in the ceiling jet, the total energy flux at that distance is equal to the
 24 convective heat release of the fire. Because smoke detection is expected to occur when the
 25 temperature is relatively small, the specific heat of air can be considered a constant, $c_p=1$
 26 kJ/(kg·K) [24] (Equation B-4).

$$\Delta H_c (1 - X_r) = m_{jet} c_p (T_{jet} - T_{amb}) \quad (\text{B-4})$$

27 where ΔH_c is the heat of combustion in kJ/kg, $1-X_r$ is the convective fraction equal to 0.7, and
 28 m_{jet} is the mass flux of the ceiling jet normalized to 1 kg/s of fuel; this includes both the mass of
 29 fuel and the air that has diluted the fuel. A value of 16,000 kJ/kg is assumed for the heat of
 30 combustion as suggested by NUREG-7010 [28].

31 The mass flux of fuel products of combustion in the ceiling jet is very small compared to the total
 32 mass flux and can be ignored. This means one can compute a dilution factor, DF , as shown in
 33 Equation B-5.

$$DF = \Delta H_c \frac{(1 - X_r)}{T_{jet} - T_{amb} + 0.001} \quad (B-5)$$

1 The 0.001 is included in the numerical computation to avoid dividing by zero for cases where
2 the fire size is near zero and the ceiling jet temperature is approximately the same as the
3 ambient temperature.

4 **Soot Density**

5 The dilution factor applies on a per kg of fuel basis. For each kg of fuel consumed, y_s kg of soot
6 are produced. Within the ceiling jet that soot is diluted by the dilution factor, DF ; therefore, the
7 overall soot density at the detector, ρ_{soot} , can be computed as shown in Equation B-6.

$$\rho_{soot} = \frac{y_s}{DF} \rho_{jet} \quad (B-6)$$

8 Where y_s is the soot yield of the fuel in kg/kg and all other parameters have been identified. The
9 soot yield values used in the Monte Carlo sampling process are taken from the values for
10 electric cables in the SFPE handbook [29; Table A.39]. The soot yield is a random value
11 independently sampled assuming a uniform distribution between the values of 0.076 and 0.175
12 kg/kg selected as approximate lower and upper bounds for electric cables from the Society of
13 Fire Protection Engineers (SFPE) handbook [29; Table A.39].

14 **Optical Density**

15 The OD measurement quantifies the exponential decay of light passing through a path length of
16 smoke [24]. For smoke detection activation, once the calculated OD exceeds the activation OD,
17 the detector will activate. Equation B-7 is used to calculate OD of the smoke in the ceiling jet at
18 the detector.

$$OD = \frac{(\rho_{soot})(K_m)}{\ln(10)} \quad (B-7)$$

19 where K_m is the specific light extinction coefficient in m^2/kg . A value of $8700 m^2/kg$ is suggested
20 by Mulholland and Croarkin [30]. This value is then compared against a detector threshold to
21 determine whether a given scenario will activate the detector.

22 The activation OD values used in the Monte Carlo sampling process were developed from the
23 average OD alarm thresholds for ionization and photoelectric smoke detectors [31]. The values,
24 presented in Table B-2 (and graphically in Figure B-1), are used to fit a gamma distribution. The
25 alpha and beta parameters from this best fit gamma distribution are used in the Monte Carlo
26 sampling process to provide a randomized activation OD for the smoke detection calculation.

27

1

Table B-2
Smoke detection OD thresholds

| OD Alarm Threshold (%) | Ionization (OD/m) | Photoelectric (OD/m) | Average | Best Fit (Gamma) |
|------------------------|-------------------|----------------------|---------|------------------|
| 0% | 0 | 0 | 0 | 0 |
| 20% | 0.091 | 0.116 | 0.103 | 0.187 |
| 50% | 0.256 | 0.319 | 0.287 | 0.287 |
| 80% | 0.390 | 0.450 | 0.420 | 0.420 |
| | Alpha = | 4.62 | Beta = | 0.067 |

2

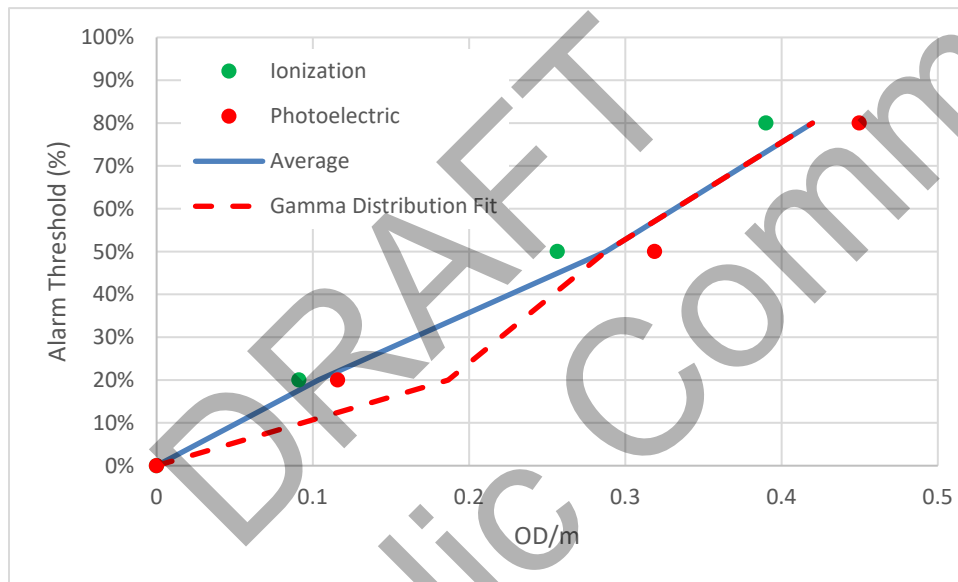

3

Figure B-1
Alarm threshold OD gamma distribution fit

4

5

B.3 OD Smoke Detection Validation

6

7 Validation of the OD smoke detection method was performed using results from home smoke
 8 alarm performance test results summarized in NIST Technical Note 1455-1 [32]. NIST Technical
 9 Note 1455-1 contains data from a series of smoke alarm tests that were used to estimate the
 10 performance of smoke detectors in residences. Tests were performed in a manufactured home
 11 using various ignition sources (upholstered chair and mattress) and detector locations. For this
 12 validation, only the results from detectors located within the same room were used as the
 13 ignition source. The results of the Fire Dynamics Tools (FDT^s) (temperature rise) smoke
 14 detector activation times were a bias of +7% (slower time to detection) and a standard deviation
 15 of 58%.

16 The activation times for three detectors (ionization and photoelectric) over eight of the NIST
 17 home smoke alarm test series [32] are used in this validation study. These test series are also
 18 used in the validation of smoke detector activation times summarized in Supplement 1 to

- 1 NUREG-1824 [33]. The inputs used to perform the OD smoke detector validation results are
- 2 presented in Table B-3.

Table B-3
Optical smoke detection validation parameters

| Parameter | Value(s) | Notes |
|---------------------------------------------------------|-------------------------------------------------------------------------------------------------------------------------------------------------------------|--------------------------------------------------------------------------------------------------------------------------------------------------------------------------------------------------------------------------------------------------------------|
| Heat release rate profile (FDT ^s validation) | $\dot{Q} = \alpha t^2$ α range: 0.00309 to 0.0104580 | As noted in Special Publication 1169 [34], the fire growth was specified by the t-squared growth rate up to a cutoff time of 300 seconds. |
| Heat release rate profile (FDS validation) | $\dot{Q} = \dot{Q}_0 \left(\frac{t}{\tau}\right)^2$ \dot{Q}_0 : range from 100-350 kW τ : 180 seconds Time offset: range from 10-40 seconds | As noted in the Fire Dynamics Simulator (FDS) Validation Guide [35], the HRR was determined by approximating the fire growth using a t-squared ramp calibrated using the temperature measured in the highest thermocouple in the tree during the experiment. |
| Vertical separation | 2.0 to 2.1 m | Heights specified for applicable tests as presented in Special Publication 1169 [34]. |
| Horizontal separation | 1.3 to 1.8 m | Distances specified for applicable tests as presented in Special Publication 1169 [34]. |
| Activation OD | 0.42 OD/m | Average OD for an approximate 80% cumulative activation for ionization and photoelectric smoke detectors [31] |
| Soot yield | 0.0975 g/g | Average, unweighted, soot yield for polyurethane (flexible foams), polyester, and wood [29] |
| Ambient temperature | 21 to 26 °C | Ambient temperatures specified for applicable tests as presented in Special Publication 1169 [34]. |
| Heat of combustion | 30,000 kJ/g | Approximate, unweighted, soot yield for polyurethane (flexible foams) and polyester [29] |
| Ambient pressure | 101325 Pa | Constant [36] |
| Gravity | 9.81 m/s ² | Constant [36] |
| Radiative fraction | 0.3 | The radiant fraction for the fire was set to 0.3, which is at the |

Table B-3
Optical smoke detection validation parameters

| Parameter | Value(s) | Notes |
|-------------------------|--------------|---------------------------------------------------------------------|
| | | lower end of the suggested range of 0.3 – 0.4 [37]. |
| Molecular weight of air | 0.029 | Constant [36] |
| Molar gas constant, R | 8.31 J/mol·K | NIST reference on constant, units and uncertainty, physics.nist.gov |

1
2 Results are shown in Figure B-2. The bias in the OD smoke detector activation model are +12%
3 assuming the FDT^s validation HRR profile and +24% assuming the FDS validation HRR profiles.
4 The standard deviation is slightly reduced, 50% and 46% for the FDT^s and FDS validation
5 HRRs, respectively. These validation results demonstrate that the OD smoke detection method
6 results in an average over-prediction for modeling the activation times for smoke detectors.

DRAFT
for Public Comment

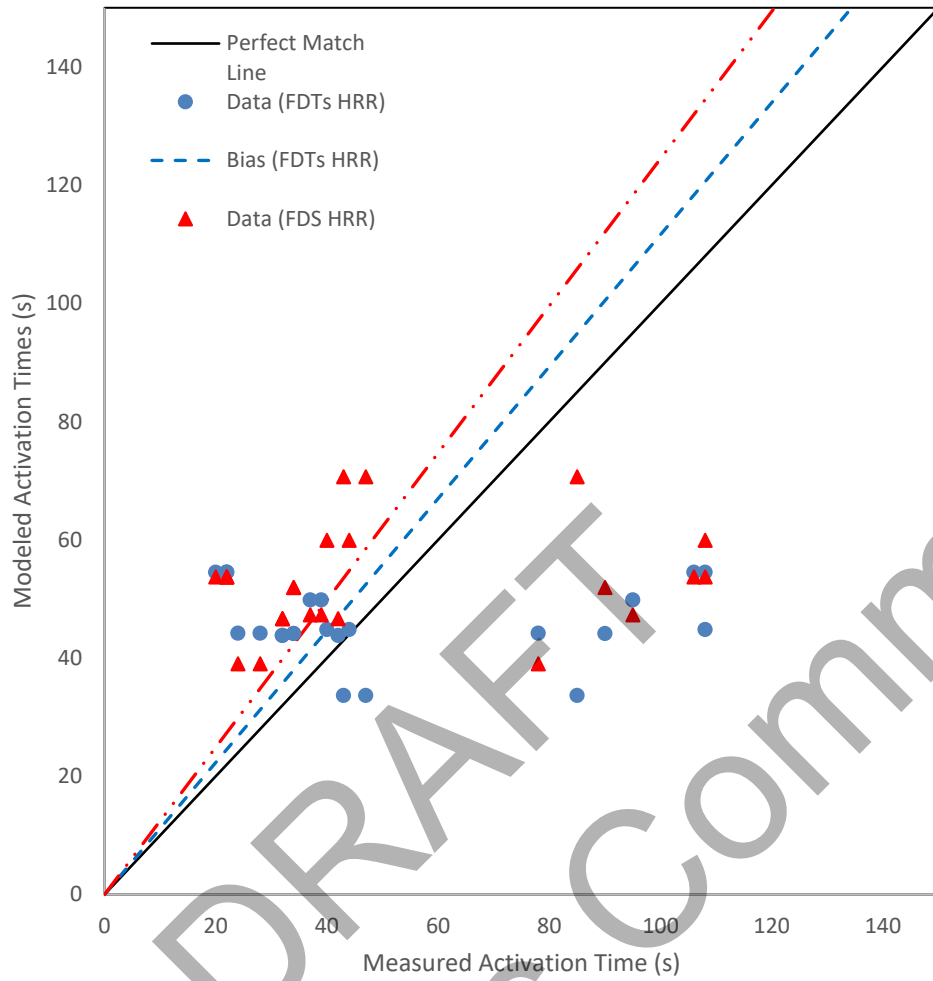

1
2
3
4
5

Figure B-2
Results comparing NIST home smoke detector activation times with OD modeled activation times

for Public Comment

1 **C** PROBABILITY OF DETECTION TABLES

2 The probability of detection for a scenario in an electrical cabinet with and without MCR
3 indication and an assumed automatic smoke detection system unavailability of 0.01 for all fuel
4 loading conditions are presented in the following tables.

5

DRAFT
for Public Comment

DRAFT
for Public Comment

The general calculation form for each table is presented immediately following the tables.

Table C-1
Probability of detection tables

| Table | Detection Step | Growth Profile | MCR Indication | Credit Personnel in an Adjacent Space | Propagation to Secondary Combustibles | Loading | Unavailability | NUREG-2178 Enclosure Class/Function Group |
|------------|------------------|----------------|----------------|---------------------------------------|---------------------------------------|----------|----------------|-------------------------------------------|
| Table C-2 | First detection | Interruption | Yes | No | No | Default | 0.01 | 1, 2, & 3 |
| Table C-3 | First detection | Interruption | Yes | Yes | No | Default | 0.01 | 1, 2, & 3 |
| Table C-4 | First detection | Interruption | Yes | No | No | Default | 0.01 | 4a, 4b, & 4c |
| Table C-5 | First detection | Interruption | Yes | Yes | No | Default | 0.01 | 4a, 4b, & 4c |
| Table C-6 | First detection | Interruption | Yes | No | No | Low | 0.01 | 4a & 4b |
| Table C-7 | First detection | Interruption | Yes | Yes | No | Low | 0.01 | 4a & 4b |
| Table C-8 | First detection | Interruption | Yes | No | No | Very Low | 0.01 | 4a & 4b |
| Table C-9 | First detection | Interruption | Yes | Yes | No | Very Low | 0.01 | 4a & 4b |
| Table C-10 | First detection | Interruption | No | No | No | Default | 0.01 | 1, 2, & 3 |
| Table C-11 | First detection | Interruption | No | Yes | No | Default | 0.01 | 1, 2, & 3 |
| Table C-12 | First detection | Interruption | No | No | No | Default | 0.01 | 4a, 4b, & 4c |
| Table C-13 | First detection | Interruption | No | Yes | No | Default | 0.01 | 4a, 4b, & 4c |
| Table C-14 | First detection | Interruption | No | No | No | Low | 0.01 | 4a, 4b, & 4c |
| Table C-15 | First detection | Interruption | No | Yes | No | Low | 0.01 | 4a, 4b, & 4c |
| Table C-16 | First detection | Interruption | No | No | No | Very Low | 0.01 | 4a & 4b |
| Table C-17 | First detection | Interruption | No | Yes | No | Very Low | 0.01 | 4a & 4b |
| Table C-18 | First detection | Growing | Yes | No | N/A | All | N/A | All |
| Table C-19 | First detection | Growing | Yes | Yes | N/A | All | N/A | All |
| Table C-20 | First detection | Growing | No | No | N/A | All | N/A | All |
| Table C-21 | First detection | Growing | No | Yes | N/A | All | N/A | All |
| Table C-22 | Second detection | Growing | N/A | N/A | No | Default | 0.01 | 1, 2, & 3 |
| Table C-23 | Second detection | Growing | N/A | N/A | No | Default | 0.01 | 4a, 4b, & 4c |
| Table C-24 | Second detection | Growing | N/A | N/A | No | Low | 0.01 | 4a & 4b |
| Table C-25 | Second detection | Growing | N/A | N/A | No | Very Low | 0.01 | 4a & 4b |

Table C-1
Probability of detection tables

| Table | Detection Step | Growth Profile | MCR Indication | Credit Personnel in an Adjacent Space | Propagation to Secondary Combustibles | Loading | Unavailability | NUREG-2178 Enclosure Class/Function Group |
|------------|------------------|----------------|----------------|---------------------------------------|---------------------------------------|----------|----------------|-------------------------------------------|
| Table C-26 | Second detection | Growing | N/A | N/A | Yes | Low | 0.01 | 4a & 4b |
| Table C-27 | Second detection | Growing | N/A | N/A | Yes | Very Low | 0.01 | 4a & 4b |

Table C-2
First detection, interruptible fire,
with MCR indication,
without crediting personnel in adjacent spaces,
no propagation to secondary combustibles (smoke detector probability of no detection included)
default fuel loading, unavailability of 0.01,
NUREG-2178 Classification Groups 1, 2, and 3 enclosures

| Occupancy | Maintenance | 1 – Switchgears and Load Centers, TS/QTP/SIS | 1 – Switchgears and Load Centers, TP | 2 – MCCs and Battery Chargers, TS/QTP/SIS | 2 – MCCs and Battery Chargers, TP | 3 – Power Inverters, TS/QTP/SIS | 3 – Power Inverters, TP |
|-----------|-------------|----------------------------------------------|--------------------------------------|-------------------------------------------|-----------------------------------|---------------------------------|-------------------------|
| High | All | 0.00E+00 | 0.00E+00 | 0.00E+00 | 0.00E+00 | 0.00E+00 | 0.00E+00 |
| Medium | No | 3.63E-03 | 2.09E-03 | 3.74E-03 | 2.14E-03 | 3.85E-03 | 2.80E-03 |
| Medium | Very low | 3.61E-03 | 2.08E-03 | 3.72E-03 | 2.13E-03 | 3.83E-03 | 2.79E-03 |
| Medium | Low | 3.59E-03 | 2.07E-03 | 3.70E-03 | 2.12E-03 | 3.81E-03 | 2.77E-03 |
| Medium | Medium | 3.45E-03 | 1.98E-03 | 3.55E-03 | 2.04E-03 | 3.65E-03 | 2.66E-03 |
| Medium | High | 3.26E-03 | 1.88E-03 | 3.36E-03 | 1.93E-03 | 3.46E-03 | 2.52E-03 |
| Medium | Very high | 1.81E-03 | 1.04E-03 | 1.87E-03 | 1.07E-03 | 1.92E-03 | 1.40E-03 |
| Low | No | 6.53E-03 | 3.76E-03 | 6.73E-03 | 3.86E-03 | 6.92E-03 | 5.04E-03 |
| Low | Very low | 6.50E-03 | 3.74E-03 | 6.70E-03 | 3.84E-03 | 6.89E-03 | 5.02E-03 |
| Low | Low | 6.46E-03 | 3.72E-03 | 6.66E-03 | 3.82E-03 | 6.85E-03 | 4.99E-03 |
| Low | Medium | 6.20E-03 | 3.57E-03 | 6.39E-03 | 3.66E-03 | 6.58E-03 | 4.79E-03 |
| Low | High | 5.88E-03 | 3.38E-03 | 6.05E-03 | 3.47E-03 | 6.23E-03 | 4.54E-03 |
| Low | Very high | 3.26E-03 | 1.88E-03 | 3.36E-03 | 1.93E-03 | 3.46E-03 | 2.52E-03 |
| Very Low | No | 6.89E-03 | 3.97E-03 | 7.10E-03 | 4.07E-03 | 7.31E-03 | 5.32E-03 |
| Very Low | Very low | 6.85E-03 | 3.95E-03 | 7.06E-03 | 4.05E-03 | 7.27E-03 | 5.30E-03 |
| Very Low | Low | 6.83E-03 | 3.93E-03 | 7.03E-03 | 4.03E-03 | 7.24E-03 | 5.27E-03 |
| Very Low | Medium | 6.55E-03 | 3.77E-03 | 6.75E-03 | 3.87E-03 | 6.95E-03 | 5.06E-03 |
| Very Low | High | 6.20E-03 | 3.57E-03 | 6.39E-03 | 3.66E-03 | 6.58E-03 | 4.79E-03 |
| Very Low | Very high | 3.45E-03 | 1.98E-03 | 3.55E-03 | 2.04E-03 | 3.65E-03 | 2.66E-03 |
| No | All | 7.25E-03 | 4.18E-03 | 7.47E-03 | 4.29E-03 | 7.69E-03 | 5.60E-03 |

1 (Probability of No Personnel Present [Table 5-6]) x ((MCR Indication Unreliability [Section 5.3.3.2] + MCR Operator HEP [Section 5.3.3.3]) – (MCR
 2 Indication Unreliability [Section 5.3.3.2] x MCR Operator HEP [Section 5.3.3.3])) x (Smoke Detection Ineffectiveness [Table 5-2] + Smoke
 3 Detection Unreliability [NUREG/CR-6850] + Smoke Detection Unavailability [0.01, assumed])

Table C-3
First detection, interruptible fire, with MCR indication, with crediting personnel in adjacent spaces, no propagation to secondary combustibles (smoke detector probability of no detection included) default fuel loading, unavailability of 0.01, NUREG-2178 Classification Groups 1, 2, and 3 enclosures

| Occupancy | Maintenance | 1 – Switchgears and Load Centers, TS/QTP/SIS | 1 – Switchgears and Load Centers, TP | 2 – MCCs and Battery Chargers, TS/QTP/SIS | 2 – MCCs and Battery Chargers, TP | 3 – Power Inverters, TS/QTP/SIS | 3 – Power Inverters, TP |
|-----------|-------------|----------------------------------------------|--------------------------------------|-------------------------------------------|-----------------------------------|---------------------------------|-------------------------|
| High | All | 0.00E+00 | 0.00E+00 | 0.00E+00 | 0.00E+00 | 0.00E+00 | 0.00E+00 |
| Medium | No | 1.81E-03 | 1.04E-03 | 1.87E-03 | 1.07E-03 | 1.92E-03 | 1.40E-03 |
| Medium | Very low | 1.80E-03 | 1.04E-03 | 1.85E-03 | 1.06E-03 | 1.91E-03 | 1.39E-03 |
| Medium | Low | 1.78E-03 | 1.03E-03 | 1.84E-03 | 1.05E-03 | 1.89E-03 | 1.38E-03 |
| Medium | Medium | 1.68E-03 | 9.65E-04 | 1.73E-03 | 9.90E-04 | 1.78E-03 | 1.29E-03 |
| Medium | High | 1.54E-03 | 8.90E-04 | 1.59E-03 | 9.13E-04 | 1.64E-03 | 1.19E-03 |
| Medium | Very high | 4.57E-04 | 2.63E-04 | 4.71E-04 | 2.70E-04 | 4.85E-04 | 3.53E-04 |
| Low | No | 6.17E-03 | 3.55E-03 | 6.35E-03 | 3.64E-03 | 6.54E-03 | 4.76E-03 |
| Low | Very low | 6.12E-03 | 3.52E-03 | 6.31E-03 | 3.62E-03 | 6.49E-03 | 4.73E-03 |
| Low | Low | 6.07E-03 | 3.50E-03 | 6.26E-03 | 3.59E-03 | 6.44E-03 | 4.69E-03 |
| Low | Medium | 5.70E-03 | 3.28E-03 | 5.87E-03 | 3.37E-03 | 6.05E-03 | 4.41E-03 |
| Low | High | 5.24E-03 | 3.02E-03 | 5.40E-03 | 3.10E-03 | 5.56E-03 | 4.05E-03 |
| Low | Very high | 1.54E-03 | 8.90E-04 | 1.59E-03 | 9.13E-04 | 1.64E-03 | 1.19E-03 |
| Very Low | No | 6.71E-03 | 3.86E-03 | 6.91E-03 | 3.96E-03 | 7.12E-03 | 5.18E-03 |
| Very Low | Very low | 6.66E-03 | 3.83E-03 | 6.86E-03 | 3.93E-03 | 7.06E-03 | 5.15E-03 |
| Very Low | Low | 6.61E-03 | 3.80E-03 | 6.81E-03 | 3.90E-03 | 7.01E-03 | 5.11E-03 |
| Very Low | Medium | 6.21E-03 | 3.57E-03 | 6.40E-03 | 3.67E-03 | 6.59E-03 | 4.80E-03 |
| Very Low | High | 5.70E-03 | 3.28E-03 | 5.87E-03 | 3.37E-03 | 6.05E-03 | 4.41E-03 |
| Very Low | Very high | 1.68E-03 | 9.65E-04 | 1.73E-03 | 9.90E-04 | 1.78E-03 | 1.29E-03 |
| No | All | 7.25E-03 | 4.18E-03 | 7.47E-03 | 4.29E-03 | 7.69E-03 | 5.60E-03 |

1 (Probability of No Personnel Present [Table 5-7]) x ((MCR Indication Unreliability [Section 5.3.3.2] + MCR Operator HEP [Section 5.3.3.3]) – (MCR
 2 Indication Unreliability [Section 5.3.3.2] x MCR Operator HEP [Section 5.3.3.3])) x (Smoke Detection Ineffectiveness [Table 5-2] + Smoke
 3 Detection Unreliability [NUREG/CR-6850] + Smoke Detection Unavailability [0.01, assumed])

Table C-4
First detection, interruptible fire, with MCR indication, without crediting personnel in adjacent spaces, no propagation to secondary combustibles (smoke detector probability of no detection included), default fuel loading, unavailability of 0.01, NUREG-2178 Classification Group 4 (all other) electrical enclosures

| Occupancy | Maintenance | 4a - Large Enclosures | | 4a - Large Enclosures | | 4b - Medium Enclosures | | 4b - Medium Enclosures | | 4b - Medium Enclosures | | 4c - Small Enclosures | |
|-----------|-------------|-----------------------|----------|-----------------------|----------|------------------------|----------|------------------------|----------|------------------------|----------|-----------------------|----------|
| | | Closed, TS/QTP/SIS | Open, TP | Closed, TS/QTP/SIS | Open, TP | Closed, TS/QTP/SIS | Open, TP | Closed, TS/QTP/SIS | Open, TP | Closed, TS/QTP/SIS | Open, TP | N/A, All | |
| High | All | 0.00E+00 | 0.00E+00 | 0.00E+00 | 0.00E+00 | 0.00E+00 | 0.00E+00 | 0.00E+00 | 0.00E+00 | 0.00E+00 | 0.00E+00 | 0.00E+00 | 0.00E+00 |
| Medium | No | 3.41E-03 | 2.20E-03 | 2.91E-03 | 2.03E-03 | 3.90E-03 | 2.80E-03 | 3.63E-03 | 2.36E-03 | 3.90E-03 | 2.36E-03 | 3.90E-03 | 3.90E-03 |
| Medium | Very low | 3.39E-03 | 2.19E-03 | 2.90E-03 | 2.03E-03 | 3.89E-03 | 2.79E-03 | 3.61E-03 | 2.35E-03 | 3.89E-03 | 2.35E-03 | 3.89E-03 | 3.89E-03 |
| Medium | Low | 3.37E-03 | 2.18E-03 | 2.88E-03 | 2.01E-03 | 3.86E-03 | 2.77E-03 | 3.59E-03 | 2.34E-03 | 3.86E-03 | 2.34E-03 | 3.86E-03 | 3.86E-03 |
| Medium | Medium | 3.24E-03 | 2.09E-03 | 2.77E-03 | 1.93E-03 | 3.71E-03 | 2.66E-03 | 3.45E-03 | 2.24E-03 | 3.71E-03 | 2.24E-03 | 3.71E-03 | 3.71E-03 |
| Medium | High | 3.07E-03 | 1.98E-03 | 2.62E-03 | 1.83E-03 | 3.51E-03 | 2.52E-03 | 3.26E-03 | 2.13E-03 | 3.51E-03 | 2.13E-03 | 3.51E-03 | 3.51E-03 |
| Medium | Very high | 1.70E-03 | 1.10E-03 | 1.46E-03 | 1.02E-03 | 1.95E-03 | 1.40E-03 | 1.81E-03 | 1.18E-03 | 1.95E-03 | 1.18E-03 | 1.95E-03 | 1.95E-03 |
| Low | No | 6.13E-03 | 3.96E-03 | 5.24E-03 | 3.66E-03 | 7.02E-03 | 5.04E-03 | 6.53E-03 | 4.25E-03 | 7.02E-03 | 4.25E-03 | 7.02E-03 | 7.02E-03 |
| Low | Very low | 6.11E-03 | 3.94E-03 | 5.22E-03 | 3.64E-03 | 6.99E-03 | 5.02E-03 | 6.50E-03 | 4.23E-03 | 6.99E-03 | 4.23E-03 | 6.99E-03 | 6.99E-03 |
| Low | Low | 6.07E-03 | 3.92E-03 | 5.19E-03 | 3.62E-03 | 6.95E-03 | 4.99E-03 | 6.46E-03 | 4.21E-03 | 6.95E-03 | 4.21E-03 | 6.95E-03 | 6.95E-03 |
| Low | Medium | 5.83E-03 | 3.76E-03 | 4.98E-03 | 3.48E-03 | 6.67E-03 | 4.79E-03 | 6.20E-03 | 4.04E-03 | 6.67E-03 | 4.04E-03 | 6.67E-03 | 6.67E-03 |
| Low | High | 5.52E-03 | 3.56E-03 | 4.72E-03 | 3.29E-03 | 6.32E-03 | 4.54E-03 | 5.88E-03 | 3.83E-03 | 6.32E-03 | 3.83E-03 | 6.32E-03 | 6.32E-03 |
| Low | Very high | 3.07E-03 | 1.98E-03 | 2.62E-03 | 1.83E-03 | 3.51E-03 | 2.52E-03 | 3.26E-03 | 2.13E-03 | 3.51E-03 | 2.13E-03 | 3.51E-03 | 3.51E-03 |
| Very Low | No | 6.47E-03 | 4.18E-03 | 5.53E-03 | 3.86E-03 | 7.41E-03 | 5.32E-03 | 6.89E-03 | 4.49E-03 | 7.41E-03 | 4.49E-03 | 7.41E-03 | 7.41E-03 |
| Very Low | Very low | 6.44E-03 | 4.15E-03 | 5.50E-03 | 3.84E-03 | 7.37E-03 | 5.30E-03 | 6.85E-03 | 4.47E-03 | 7.37E-03 | 4.47E-03 | 7.37E-03 | 7.37E-03 |
| Very Low | Low | 6.41E-03 | 4.14E-03 | 5.48E-03 | 3.83E-03 | 7.34E-03 | 5.27E-03 | 6.83E-03 | 4.45E-03 | 7.34E-03 | 4.45E-03 | 7.34E-03 | 7.34E-03 |
| Very Low | Medium | 6.15E-03 | 3.97E-03 | 5.26E-03 | 3.67E-03 | 7.05E-03 | 5.06E-03 | 6.55E-03 | 4.27E-03 | 7.05E-03 | 4.27E-03 | 7.05E-03 | 7.05E-03 |
| Very Low | High | 5.83E-03 | 3.76E-03 | 4.98E-03 | 3.48E-03 | 6.67E-03 | 4.79E-03 | 6.20E-03 | 4.04E-03 | 6.67E-03 | 4.04E-03 | 6.67E-03 | 6.67E-03 |
| Very Low | Very high | 3.24E-03 | 2.09E-03 | 2.77E-03 | 1.93E-03 | 3.71E-03 | 2.66E-03 | 3.45E-03 | 2.24E-03 | 3.71E-03 | 2.24E-03 | 3.71E-03 | 3.71E-03 |
| No | All | 6.81E-03 | 4.40E-03 | 5.82E-03 | 4.07E-03 | 7.80E-03 | 5.60E-03 | 7.25E-03 | 4.73E-03 | 7.80E-03 | 4.73E-03 | 7.80E-03 | 7.80E-03 |

1 (Probability of No Personnel Present [Table 5-6]) x ((MCR Indication Unreliability [Section 5.3.3.2] + MCR Operator HEP [Section 5.3.3.3]) - (MCR
 2 Indication Unreliability [Section 5.3.3.2] x MCR Operator HEP [Section 5.3.3.3])) x (Smoke Detection Ineffectiveness [Table 5-2] + Smoke
 3 Detection Unreliability [NUREG/CR-6850] + Smoke Detection Unavailability [0.01, assumed])

Table C-5
First detection, interruptible fire,
with MCR indication,
with crediting personnel in adjacent spaces,
no propagation to secondary combustibles (smoke detector probability of no detection included),
default fuel loading, unavailability of 0.01,
NUREG-2178 Classification Group 4 (all other) electrical enclosures

| Occupancy | Maintenance | 4a - Large Enclosures Closed, TS/QTP/SIS | 4a - Large Enclosures Closed, TP | 4a - Large Enclosures Open, TS/QTP/SIS | 4a - Large Enclosures Open, TP | 4b - Medium Enclosures Closed, TS/QTP/SIS | 4b - Medium Enclosures Closed, TP | 4b - Medium Enclosures Open, TS/QTP/SIS | 4b - Medium Enclosures Open, TP | 4c - Small Enclosures N/A, All |
|-----------|-------------|------------------------------------------|----------------------------------|----------------------------------------|--------------------------------|-------------------------------------------|-----------------------------------|-----------------------------------------|---------------------------------|--------------------------------|
| High | All | 0.00E+00 | 0.00E+00 | 0.00E+00 | 0.00E+00 | 0.00E+00 | 0.00E+00 | 0.00E+00 | 0.00E+00 | 0.00E+00 |
| Medium | No | 1.70E-03 | 1.10E-03 | 1.46E-03 | 1.02E-03 | 1.95E-03 | 1.40E-03 | 1.81E-03 | 1.18E-03 | 1.95E-03 |
| Medium | Very low | 1.69E-03 | 1.09E-03 | 1.44E-03 | 1.01E-03 | 1.94E-03 | 1.39E-03 | 1.80E-03 | 1.17E-03 | 1.94E-03 |
| Medium | Low | 1.68E-03 | 1.08E-03 | 1.43E-03 | 1.00E-03 | 1.92E-03 | 1.38E-03 | 1.78E-03 | 1.16E-03 | 1.92E-03 |
| Medium | Medium | 1.57E-03 | 1.02E-03 | 1.35E-03 | 9.39E-04 | 1.80E-03 | 1.29E-03 | 1.68E-03 | 1.09E-03 | 1.80E-03 |
| Medium | High | 1.45E-03 | 9.36E-04 | 1.24E-03 | 8.66E-04 | 1.66E-03 | 1.19E-03 | 1.54E-03 | 1.01E-03 | 1.66E-03 |
| Medium | Very high | 4.29E-04 | 2.77E-04 | 3.67E-04 | 2.56E-04 | 4.92E-04 | 3.53E-04 | 4.57E-04 | 2.98E-04 | 4.92E-04 |
| Low | No | 5.79E-03 | 3.74E-03 | 4.95E-03 | 3.46E-03 | 6.63E-03 | 4.76E-03 | 6.17E-03 | 4.02E-03 | 6.63E-03 |
| Low | Very low | 5.75E-03 | 3.71E-03 | 4.92E-03 | 3.43E-03 | 6.59E-03 | 4.73E-03 | 6.12E-03 | 3.99E-03 | 6.59E-03 |
| Low | Low | 5.70E-03 | 3.68E-03 | 4.88E-03 | 3.40E-03 | 6.53E-03 | 4.69E-03 | 6.07E-03 | 3.96E-03 | 6.53E-03 |
| Low | Medium | 5.36E-03 | 3.46E-03 | 4.58E-03 | 3.20E-03 | 6.13E-03 | 4.41E-03 | 5.70E-03 | 3.71E-03 | 6.13E-03 |
| Low | High | 4.93E-03 | 3.18E-03 | 4.21E-03 | 2.94E-03 | 5.64E-03 | 4.05E-03 | 5.24E-03 | 3.42E-03 | 5.64E-03 |
| Low | Very high | 1.45E-03 | 9.36E-04 | 1.24E-03 | 8.66E-04 | 1.66E-03 | 1.19E-03 | 1.54E-03 | 1.01E-03 | 1.66E-03 |
| Very Low | No | 6.30E-03 | 4.07E-03 | 5.39E-03 | 3.76E-03 | 7.22E-03 | 5.18E-03 | 6.71E-03 | 4.37E-03 | 7.22E-03 |
| Very Low | Very low | 6.26E-03 | 4.04E-03 | 5.35E-03 | 3.73E-03 | 7.16E-03 | 5.15E-03 | 6.66E-03 | 4.34E-03 | 7.16E-03 |
| Very Low | Low | 6.21E-03 | 4.00E-03 | 5.31E-03 | 3.70E-03 | 7.11E-03 | 5.11E-03 | 6.61E-03 | 4.31E-03 | 7.11E-03 |
| Very Low | Medium | 5.83E-03 | 3.76E-03 | 4.99E-03 | 3.48E-03 | 6.68E-03 | 4.80E-03 | 6.21E-03 | 4.05E-03 | 6.68E-03 |
| Very Low | High | 5.36E-03 | 3.46E-03 | 4.58E-03 | 3.20E-03 | 6.13E-03 | 4.41E-03 | 5.70E-03 | 3.71E-03 | 6.13E-03 |
| Very Low | Very high | 1.57E-03 | 1.02E-03 | 1.35E-03 | 9.39E-04 | 1.80E-03 | 1.29E-03 | 1.68E-03 | 1.09E-03 | 1.80E-03 |
| No | All | 6.81E-03 | 4.40E-03 | 5.82E-03 | 4.07E-03 | 7.80E-03 | 5.60E-03 | 7.25E-03 | 4.73E-03 | 7.80E-03 |

1 (Probability of No Personnel Present [Table 5-7]) x ((MCR Indication Unreliability [Section 5.3.3.2] + MCR Operator HEP [Section 5.3.3.3]) - (MCR
 2 Indication Unreliability [Section 5.3.3.2] x MCR Operator HEP [Section 5.3.3.3])) x (Smoke Detection Ineffectiveness [Table 5-2] + Smoke
 3 Detection Unreliability [NUREG/CR-6850] + Smoke Detection Unavailability [0.01, assumed])

Table C-6
First detection, interruptible fire,
with MCR indication,
without crediting personnel in adjacent spaces,
no propagation to secondary combustibles (smoke detector probability of no detection included),
low fuel loading, unavailability of 0.01,
NUREG-2178 Classification Group 4 (all other) electrical enclosures

| Occupancy | Maintenance | 4a - Large Enclosures, Closed, TS/QTP/SIS | 4a - Large Enclosures, Closed, TP | 4a - Large Enclosures, Open, TS/QTP/SIS | 4a - Large Enclosures, Open, TP | 4b - Medium Enclosures, Closed, TS/QTP/SIS | 4b - Medium Enclosures, Closed, TP | 4b - Medium Enclosures, Open, TS/QTP/SIS | 4b - Medium Enclosures, Open, TP |
|-----------|-------------|-------------------------------------------|-----------------------------------|-----------------------------------------|---------------------------------|--------------------------------------------|------------------------------------|------------------------------------------|----------------------------------|
| High | All | 0.00E+00 | 0.00E+00 | 0.00E+00 | 0.00E+00 | 0.00E+00 | 0.00E+00 | 0.00E+00 | 0.00E+00 |
| Medium | No | 3.90E-03 | 2.80E-03 | 3.35E-03 | 2.53E-03 | 4.18E-03 | 3.52E-03 | 4.29E-03 | 3.79E-03 |
| Medium | Very low | 3.89E-03 | 2.79E-03 | 3.34E-03 | 2.52E-03 | 4.16E-03 | 3.50E-03 | 4.27E-03 | 3.78E-03 |
| Medium | Low | 3.86E-03 | 2.77E-03 | 3.32E-03 | 2.50E-03 | 4.13E-03 | 3.48E-03 | 4.24E-03 | 3.75E-03 |
| Medium | Medium | 3.71E-03 | 2.66E-03 | 3.18E-03 | 2.40E-03 | 3.97E-03 | 3.34E-03 | 4.07E-03 | 3.60E-03 |
| Medium | High | 3.51E-03 | 2.52E-03 | 3.02E-03 | 2.27E-03 | 3.76E-03 | 3.17E-03 | 3.86E-03 | 3.41E-03 |
| Medium | Very high | 1.95E-03 | 1.40E-03 | 1.68E-03 | 1.26E-03 | 2.09E-03 | 1.76E-03 | 2.14E-03 | 1.90E-03 |
| Low | No | 7.02E-03 | 5.04E-03 | 6.03E-03 | 4.55E-03 | 7.52E-03 | 6.33E-03 | 7.71E-03 | 6.82E-03 |
| Low | Very low | 6.99E-03 | 5.02E-03 | 6.01E-03 | 4.53E-03 | 7.48E-03 | 6.30E-03 | 7.68E-03 | 6.79E-03 |
| Low | Low | 6.95E-03 | 4.99E-03 | 5.97E-03 | 4.50E-03 | 7.44E-03 | 6.27E-03 | 7.64E-03 | 6.76E-03 |
| Low | Medium | 6.67E-03 | 4.79E-03 | 5.73E-03 | 4.32E-03 | 7.14E-03 | 6.01E-03 | 7.33E-03 | 6.48E-03 |
| Low | High | 6.32E-03 | 4.54E-03 | 5.43E-03 | 4.09E-03 | 6.77E-03 | 5.70E-03 | 6.94E-03 | 6.14E-03 |
| Low | Very high | 3.51E-03 | 2.52E-03 | 3.02E-03 | 2.27E-03 | 3.76E-03 | 3.17E-03 | 3.86E-03 | 3.41E-03 |
| Very Low | No | 7.41E-03 | 5.32E-03 | 6.37E-03 | 4.80E-03 | 7.93E-03 | 6.68E-03 | 8.14E-03 | 7.20E-03 |
| Very Low | Very low | 7.37E-03 | 5.30E-03 | 6.34E-03 | 4.78E-03 | 7.89E-03 | 6.65E-03 | 8.10E-03 | 7.17E-03 |
| Very Low | Low | 7.34E-03 | 5.27E-03 | 6.31E-03 | 4.76E-03 | 7.86E-03 | 6.62E-03 | 8.07E-03 | 7.14E-03 |
| Very Low | Medium | 7.05E-03 | 5.06E-03 | 6.05E-03 | 4.57E-03 | 7.54E-03 | 6.35E-03 | 7.74E-03 | 6.85E-03 |
| Very Low | High | 6.67E-03 | 4.79E-03 | 5.73E-03 | 4.32E-03 | 7.14E-03 | 6.01E-03 | 7.33E-03 | 6.48E-03 |
| Very Low | Very high | 3.71E-03 | 2.66E-03 | 3.18E-03 | 2.40E-03 | 3.97E-03 | 3.34E-03 | 4.07E-03 | 3.60E-03 |
| No | All | 7.80E-03 | 5.60E-03 | 6.70E-03 | 5.06E-03 | 8.35E-03 | 7.03E-03 | 8.57E-03 | 7.58E-03 |

1 (Probability of No Personnel Present [Table 5-6]) x ((MCR Indication Unreliability [Section 5.3.3.2] + MCR Operator HEP [Section 5.3.3.3]) - (MCR
 2 Indication Unreliability [Section 5.3.3.2] x MCR Operator HEP [Section 5.3.3.3])) x (Smoke Detection Ineffectiveness [Table 5-2] + Smoke
 3 Detection Unreliability [NUREG/CR-6850] + Smoke Detection Unavailability [0.01, assumed])

Table C-7
First detection, interruptible fire,
with MCR indication,
with crediting personnel in adjacent spaces,
no propagation to secondary combustibles (smoke detector probability of no detection included),
low fuel loading, unavailability of 0.01,
NUREG-2178 Classification Group 4 (all other) electrical enclosures

| Occupancy | Maintenance | 4a - Large Enclosures, Closed, TS/QTP/SIS | 4a - Large Enclosures, Closed, TP | 4a - Large Enclosures, Open, TS/QTP/SIS | 4a - Large Enclosures, Open, TP | 4b - Medium Enclosures, Closed, TS/QTP/SIS | 4b - Medium Enclosures, Closed, TP | 4b - Medium Enclosures, Open, TS/QTP/SIS | 4b - Medium Enclosures, Open, TP |
|-----------|-------------|-------------------------------------------|-----------------------------------|-----------------------------------------|---------------------------------|--------------------------------------------|------------------------------------|------------------------------------------|----------------------------------|
| High | All | 0.00E+00 | 0.00E+00 | 0.00E+00 | 0.00E+00 | 0.00E+00 | 0.00E+00 | 0.00E+00 | 0.00E+00 |
| Medium | No | 1.95E-03 | 1.40E-03 | 1.68E-03 | 1.26E-03 | 2.09E-03 | 1.76E-03 | 2.14E-03 | 1.90E-03 |
| Medium | Very low | 1.94E-03 | 1.39E-03 | 1.66E-03 | 1.25E-03 | 2.07E-03 | 1.74E-03 | 2.13E-03 | 1.88E-03 |
| Medium | Low | 1.92E-03 | 1.38E-03 | 1.65E-03 | 1.24E-03 | 2.05E-03 | 1.73E-03 | 2.11E-03 | 1.87E-03 |
| Medium | Medium | 1.80E-03 | 1.29E-03 | 1.55E-03 | 1.17E-03 | 1.93E-03 | 1.62E-03 | 1.98E-03 | 1.75E-03 |
| Medium | High | 1.66E-03 | 1.19E-03 | 1.43E-03 | 1.08E-03 | 1.78E-03 | 1.50E-03 | 1.83E-03 | 1.62E-03 |
| Medium | Very high | 4.92E-04 | 3.53E-04 | 4.22E-04 | 3.18E-04 | 5.26E-04 | 4.43E-04 | 5.40E-04 | 4.78E-04 |
| Low | No | 6.63E-03 | 4.76E-03 | 5.70E-03 | 4.30E-03 | 7.10E-03 | 5.98E-03 | 7.29E-03 | 6.45E-03 |
| Low | Very low | 6.59E-03 | 4.73E-03 | 5.66E-03 | 4.27E-03 | 7.05E-03 | 5.94E-03 | 7.23E-03 | 6.40E-03 |
| Low | Low | 6.53E-03 | 4.69E-03 | 5.61E-03 | 4.23E-03 | 6.99E-03 | 5.89E-03 | 7.17E-03 | 6.35E-03 |
| Low | Medium | 6.13E-03 | 4.41E-03 | 5.27E-03 | 3.97E-03 | 6.56E-03 | 5.53E-03 | 6.74E-03 | 5.96E-03 |
| Low | High | 5.64E-03 | 4.05E-03 | 4.85E-03 | 3.66E-03 | 6.04E-03 | 5.09E-03 | 6.20E-03 | 5.48E-03 |
| Low | Very high | 1.66E-03 | 1.19E-03 | 1.43E-03 | 1.08E-03 | 1.78E-03 | 1.50E-03 | 1.83E-03 | 1.62E-03 |
| Very Low | No | 7.22E-03 | 5.18E-03 | 6.20E-03 | 4.68E-03 | 7.73E-03 | 6.51E-03 | 7.93E-03 | 7.01E-03 |
| Very Low | Very low | 7.16E-03 | 5.15E-03 | 6.15E-03 | 4.64E-03 | 7.67E-03 | 6.46E-03 | 7.87E-03 | 6.96E-03 |
| Very Low | Low | 7.11E-03 | 5.11E-03 | 6.11E-03 | 4.61E-03 | 7.61E-03 | 6.41E-03 | 7.81E-03 | 6.91E-03 |
| Very Low | Medium | 6.68E-03 | 4.80E-03 | 5.74E-03 | 4.33E-03 | 7.15E-03 | 6.02E-03 | 7.34E-03 | 6.49E-03 |
| Very Low | High | 6.13E-03 | 4.41E-03 | 5.27E-03 | 3.97E-03 | 6.56E-03 | 5.53E-03 | 6.74E-03 | 5.96E-03 |
| Very Low | Very high | 1.80E-03 | 1.29E-03 | 1.55E-03 | 1.17E-03 | 1.93E-03 | 1.62E-03 | 1.98E-03 | 1.75E-03 |
| No | All | 7.80E-03 | 5.60E-03 | 6.70E-03 | 5.06E-03 | 8.35E-03 | 7.03E-03 | 8.57E-03 | 7.58E-03 |

1 (Probability of No Personnel Present [Table 5-7]) x ((MCR Indication Unreliability [Section 5.3.3.2] + MCR Operator HEP [Section 5.3.3.3]) - (MCR
 2 Indication Unreliability [Section 5.3.3.2] x MCR Operator HEP [Section 5.3.3.3])) x (Smoke Detection Ineffectiveness [Table 5-2] + Smoke
 3 Detection Unreliability [NUREG/CR-6850] + Smoke Detection Unavailability [0.01, assumed])

Table C-8
First detection, interruptible fire, with MCR indication, without crediting personnel in adjacent spaces, no propagation to secondary combustibles (smoke detector probability of no detection included), very low fuel loading, unavailability of 0.01, NUREG-2178 Classification Group 4 (all other) electrical enclosures

| Occupancy | Maintenance | 4a - Large Enclosures, Closed, TS/QTP/SIS | 4a - Large Enclosures, Closed, TP | 4a - Large Enclosures, Open, TS/QTP/SIS | 4a - Large Enclosures, Open, TP | 4b - Medium Enclosures, Closed, TS/QTP/SIS | 4b - Medium Enclosures, Closed, TP | 4b - Medium Enclosures, Open, TS/QTP/SIS | 4b - Medium Enclosures, Open, TP |
|-----------|-------------|-------------------------------------------|-----------------------------------|-----------------------------------------|---------------------------------|--------------------------------------------|------------------------------------|------------------------------------------|----------------------------------|
| High | No | 0.00E+00 | 0.00E+00 | 0.00E+00 | 0.00E+00 | 0.00E+00 | 0.00E+00 | 0.00E+00 | 0.00E+00 |
| Medium | No | 4.12E-03 | 3.24E-03 | 4.12E-03 | 3.24E-03 | 3.85E-03 | 3.85E-03 | 3.85E-03 | 3.85E-03 |
| Medium | Very low | 4.10E-03 | 3.23E-03 | 4.10E-03 | 3.23E-03 | 3.83E-03 | 3.83E-03 | 3.83E-03 | 3.83E-03 |
| Medium | Low | 4.08E-03 | 3.21E-03 | 4.08E-03 | 3.21E-03 | 3.81E-03 | 3.81E-03 | 3.81E-03 | 3.81E-03 |
| Medium | Medium | 3.92E-03 | 3.08E-03 | 3.92E-03 | 3.08E-03 | 3.65E-03 | 3.65E-03 | 3.65E-03 | 3.65E-03 |
| Medium | High | 3.71E-03 | 2.92E-03 | 3.71E-03 | 2.92E-03 | 3.46E-03 | 3.46E-03 | 3.46E-03 | 3.46E-03 |
| Medium | Very high | 2.06E-03 | 1.62E-03 | 2.06E-03 | 1.62E-03 | 1.92E-03 | 1.92E-03 | 1.92E-03 | 1.92E-03 |
| Low | No | 7.42E-03 | 5.84E-03 | 7.42E-03 | 5.84E-03 | 6.92E-03 | 6.92E-03 | 6.92E-03 | 6.92E-03 |
| Low | Very low | 7.39E-03 | 5.81E-03 | 7.39E-03 | 5.81E-03 | 6.89E-03 | 6.89E-03 | 6.89E-03 | 6.89E-03 |
| Low | Low | 7.34E-03 | 5.78E-03 | 7.34E-03 | 5.78E-03 | 6.85E-03 | 6.85E-03 | 6.85E-03 | 6.85E-03 |
| Low | Medium | 7.05E-03 | 5.54E-03 | 7.05E-03 | 5.54E-03 | 6.58E-03 | 6.58E-03 | 6.58E-03 | 6.58E-03 |
| Low | High | 6.68E-03 | 5.25E-03 | 6.68E-03 | 5.25E-03 | 6.23E-03 | 6.23E-03 | 6.23E-03 | 6.23E-03 |
| Low | Very high | 3.71E-03 | 2.92E-03 | 3.71E-03 | 2.92E-03 | 3.46E-03 | 3.46E-03 | 3.46E-03 | 3.46E-03 |
| Very Low | No | 7.83E-03 | 6.16E-03 | 7.83E-03 | 6.16E-03 | 7.31E-03 | 7.31E-03 | 7.31E-03 | 7.31E-03 |
| Very Low | Very low | 7.79E-03 | 6.13E-03 | 7.79E-03 | 6.13E-03 | 7.27E-03 | 7.27E-03 | 7.27E-03 | 7.27E-03 |
| Very Low | Low | 7.76E-03 | 6.10E-03 | 7.76E-03 | 6.10E-03 | 7.24E-03 | 7.24E-03 | 7.24E-03 | 7.24E-03 |
| Very Low | Medium | 7.44E-03 | 5.86E-03 | 7.44E-03 | 5.86E-03 | 6.95E-03 | 6.95E-03 | 6.95E-03 | 6.95E-03 |
| Very Low | High | 7.05E-03 | 5.54E-03 | 7.05E-03 | 5.54E-03 | 6.58E-03 | 6.58E-03 | 6.58E-03 | 6.58E-03 |
| Very Low | Very high | 3.92E-03 | 3.08E-03 | 3.92E-03 | 3.08E-03 | 3.65E-03 | 3.65E-03 | 3.65E-03 | 3.65E-03 |
| No | No | 8.24E-03 | 6.48E-03 | 8.24E-03 | 6.48E-03 | 7.69E-03 | 7.69E-03 | 7.69E-03 | 7.69E-03 |

(Probability of No Personnel Present [Table 5-6]) x ((MCR Indication Unreliability [Section 5.3.3.2] + MCR Operator HEP [Section 5.3.3.3]) - (MCR Indication Unreliability [Section 5.3.3.2] x MCR Operator HEP [Section 5.3.3.3])) x (Smoke Detection Ineffectiveness [Table 5-2] + Smoke Detection Unreliability [NUREG/CR-6850] + Smoke Detection Unavailability [0.01, assumed])

- 1
- 2
- 3
- 4

Table C-9
First detection, interruptible fire,
with MCR indication,
with crediting personnel in adjacent spaces,
no propagation to secondary combustibles (smoke detector probability of no detection included),
very low fuel loading, unavailability of 0.01,
NUREG-2178 Classification Group 4 (all other) electrical enclosures

| Occupancy | Maintenance | 4a - Large Enclosures, Closed, TS/QTP/SIS | 4a - Large Enclosures, Closed, TP | 4a - Large Enclosures, Open, TS/QTP/SIS | 4a - Large Enclosures, Open, TP | 4b - Medium Enclosures, Closed, TS/QTP/SIS | 4b - Medium Enclosures, Closed, TP | 4b - Medium Enclosures, Open, TS/QTP/SIS | 4b - Medium Enclosures, Open, TP |
|-----------|-------------|-------------------------------------------|-----------------------------------|-----------------------------------------|---------------------------------|--------------------------------------------|------------------------------------|------------------------------------------|----------------------------------|
| High | All | 0.00E+00 | 0.00E+00 | 0.00E+00 | 0.00E+00 | 0.00E+00 | 0.00E+00 | 0.00E+00 | 0.00E+00 |
| Medium | No | 2.06E-03 | 1.62E-03 | 2.06E-03 | 1.62E-03 | 1.92E-03 | 1.92E-03 | 1.92E-03 | 1.92E-03 |
| Medium | Very low | 2.04E-03 | 1.61E-03 | 2.04E-03 | 1.61E-03 | 1.91E-03 | 1.91E-03 | 1.91E-03 | 1.91E-03 |
| Medium | Low | 2.03E-03 | 1.60E-03 | 2.03E-03 | 1.60E-03 | 1.89E-03 | 1.89E-03 | 1.89E-03 | 1.89E-03 |
| Medium | Medium | 1.90E-03 | 1.50E-03 | 1.90E-03 | 1.50E-03 | 1.78E-03 | 1.78E-03 | 1.78E-03 | 1.78E-03 |
| Medium | High | 1.76E-03 | 1.38E-03 | 1.76E-03 | 1.38E-03 | 1.64E-03 | 1.64E-03 | 1.64E-03 | 1.64E-03 |
| Medium | Very high | 5.19E-04 | 4.08E-04 | 5.19E-04 | 4.08E-04 | 4.85E-04 | 4.85E-04 | 4.85E-04 | 4.85E-04 |
| Low | No | 7.01E-03 | 5.51E-03 | 7.01E-03 | 5.51E-03 | 6.54E-03 | 6.54E-03 | 6.54E-03 | 6.54E-03 |
| Low | Very low | 6.96E-03 | 5.47E-03 | 6.96E-03 | 5.47E-03 | 6.49E-03 | 6.49E-03 | 6.49E-03 | 6.49E-03 |
| Low | Low | 6.90E-03 | 5.43E-03 | 6.90E-03 | 5.43E-03 | 6.44E-03 | 6.44E-03 | 6.44E-03 | 6.44E-03 |
| Low | Medium | 6.48E-03 | 5.10E-03 | 6.48E-03 | 5.10E-03 | 6.05E-03 | 6.05E-03 | 6.05E-03 | 6.05E-03 |
| Low | High | 5.96E-03 | 4.69E-03 | 5.96E-03 | 4.69E-03 | 5.56E-03 | 5.56E-03 | 5.56E-03 | 5.56E-03 |
| Low | Very high | 1.76E-03 | 1.38E-03 | 1.76E-03 | 1.38E-03 | 1.64E-03 | 1.64E-03 | 1.64E-03 | 1.64E-03 |
| Very Low | No | 7.62E-03 | 6.00E-03 | 7.62E-03 | 6.00E-03 | 7.12E-03 | 7.12E-03 | 7.12E-03 | 7.12E-03 |
| Very Low | Very low | 7.57E-03 | 5.95E-03 | 7.57E-03 | 5.95E-03 | 7.06E-03 | 7.06E-03 | 7.06E-03 | 7.06E-03 |
| Very Low | Low | 7.51E-03 | 5.91E-03 | 7.51E-03 | 5.91E-03 | 7.01E-03 | 7.01E-03 | 7.01E-03 | 7.01E-03 |
| Very Low | Medium | 7.06E-03 | 5.55E-03 | 7.06E-03 | 5.55E-03 | 6.59E-03 | 6.59E-03 | 6.59E-03 | 6.59E-03 |
| Very Low | High | 6.48E-03 | 5.10E-03 | 6.48E-03 | 5.10E-03 | 6.05E-03 | 6.05E-03 | 6.05E-03 | 6.05E-03 |
| Very Low | Very high | 1.90E-03 | 1.50E-03 | 1.90E-03 | 1.50E-03 | 1.78E-03 | 1.78E-03 | 1.78E-03 | 1.78E-03 |
| No | All | 8.24E-03 | 6.48E-03 | 8.24E-03 | 6.48E-03 | 7.69E-03 | 7.69E-03 | 7.69E-03 | 7.69E-03 |

1 (Probability of No Personnel Present [Table 5-7]) x ((MCR Indication Unreliability [Section 5.3.3.2] + MCR Operator HEP [Section 5.3.3.3]) - (MCR
 2 Indication Unreliability [Section 5.3.3.2] x MCR Operator HEP [Section 5.3.3.3])) x (Smoke Detection Ineffectiveness [Table 5-2] + Smoke
 3 Detection Unreliability [NUREG/CR-6850] + Smoke Detection Unavailability [0.01, assumed])

Table C-10
First detection, interruptible fire, without MCR indication, without crediting personnel in adjacent spaces, no propagation to secondary combustibles (smoke detector probability of no detection included), default fuel loading, unavailability of 0.01, NUREG-2178 Classification Groups 1, 2, and 3 enclosures

| Occupancy | Maintenance | 1 – Switchgears and Load Centers, TS/QTP/SIS | 1 – Switchgears and Load Centers, TP | 2 – MCCs and Battery Chargers, TS/QTP/SIS | 2 – MCCs and Battery Chargers, TP | 3 – Power Inverters, TS/QTP/SIS | 3 – Power Inverters, TP |
|-----------|-------------|----------------------------------------------|--------------------------------------|-------------------------------------------|-----------------------------------|---------------------------------|-------------------------|
| High | No | 0.00E+00 | 0.00E+00 | 0.00E+00 | 0.00E+00 | 0.00E+00 | 0.00E+00 |
| Medium | No | 3.30E-01 | 1.90E-01 | 3.40E-01 | 1.95E-01 | 3.50E-01 | 2.55E-01 |
| Medium | Very low | 3.29E-01 | 1.89E-01 | 3.39E-01 | 1.94E-01 | 3.49E-01 | 2.54E-01 |
| Medium | Low | 3.27E-01 | 1.88E-01 | 3.37E-01 | 1.93E-01 | 3.47E-01 | 2.52E-01 |
| Medium | Medium | 3.14E-01 | 1.80E-01 | 3.23E-01 | 1.85E-01 | 3.33E-01 | 2.42E-01 |
| Medium | High | 2.97E-01 | 1.71E-01 | 3.06E-01 | 1.75E-01 | 3.15E-01 | 2.29E-01 |
| Medium | Very high | 1.65E-01 | 9.50E-02 | 1.70E-01 | 9.75E-02 | 1.75E-01 | 1.27E-01 |
| Low | No | 5.94E-01 | 3.42E-01 | 6.12E-01 | 3.51E-01 | 6.30E-01 | 4.59E-01 |
| Low | Very low | 5.91E-01 | 3.40E-01 | 6.09E-01 | 3.49E-01 | 6.27E-01 | 4.57E-01 |
| Low | Low | 5.88E-01 | 3.39E-01 | 6.06E-01 | 3.47E-01 | 6.24E-01 | 4.54E-01 |
| Low | Medium | 5.64E-01 | 3.25E-01 | 5.81E-01 | 3.33E-01 | 5.99E-01 | 4.36E-01 |
| Low | High | 5.35E-01 | 3.08E-01 | 5.51E-01 | 3.16E-01 | 5.67E-01 | 4.13E-01 |
| Low | Very high | 2.97E-01 | 1.71E-01 | 3.06E-01 | 1.75E-01 | 3.15E-01 | 2.29E-01 |
| Very Low | No | 6.27E-01 | 3.61E-01 | 6.46E-01 | 3.70E-01 | 6.65E-01 | 4.84E-01 |
| Very Low | Very low | 6.24E-01 | 3.59E-01 | 6.43E-01 | 3.69E-01 | 6.61E-01 | 4.82E-01 |
| Very Low | Low | 6.21E-01 | 3.58E-01 | 6.40E-01 | 3.67E-01 | 6.59E-01 | 4.80E-01 |
| Very Low | Medium | 5.96E-01 | 3.43E-01 | 6.14E-01 | 3.52E-01 | 6.32E-01 | 4.61E-01 |
| Very Low | High | 5.64E-01 | 3.25E-01 | 5.81E-01 | 3.33E-01 | 5.99E-01 | 4.36E-01 |
| Very Low | Very high | 3.14E-01 | 1.80E-01 | 3.23E-01 | 1.85E-01 | 3.33E-01 | 2.42E-01 |
| No | All | 6.60E-01 | 3.80E-01 | 6.80E-01 | 3.90E-01 | 7.00E-01 | 5.10E-01 |

(Probability of No Personnel Present [Table 5-6] x (Smoke Detection Ineffectiveness [Table 5-2] + Smoke Detection Unreliability [NUREG/CR-6850] + Smoke Detection Unavailability [0.01, assumed])

- 1
- 2
- 3

Table C-11
First detection, interruptible fire, without MCR indication, with crediting personnel in adjacent spaces, no propagation to secondary combustibles (smoke detector probability of no detection included), default fuel loading, unavailability of 0.01, NUREG-2178 Classification Groups 1, 2, and 3 enclosures

| Occupancy | Maintenance | 1 – Switchgears and Load Centers, TS/QTP/SIS | 1 – Switchgears and Load Centers, TP | 2 – MCCs and Battery Chargers, TS/QTP/SIS | 2 – MCCs and Battery Chargers, TP | 3 – Power Inverters, TS/QTP/SIS | 3 – Power Inverters, TP |
|-----------|-------------|----------------------------------------------|--------------------------------------|-------------------------------------------|-----------------------------------|---------------------------------|-------------------------|
| High | All | 0.00E+00 | 0.00E+00 | 0.00E+00 | 0.00E+00 | 0.00E+00 | 0.00E+00 |
| Medium | No | 1.65E-01 | 9.50E-02 | 1.70E-01 | 9.75E-02 | 1.75E-01 | 1.27E-01 |
| Medium | Very low | 1.64E-01 | 9.42E-02 | 1.69E-01 | 9.67E-02 | 1.74E-01 | 1.26E-01 |
| Medium | Low | 1.62E-01 | 9.35E-02 | 1.67E-01 | 9.59E-02 | 1.72E-01 | 1.25E-01 |
| Medium | Medium | 1.52E-01 | 8.78E-02 | 1.57E-01 | 9.01E-02 | 1.62E-01 | 1.18E-01 |
| Medium | High | 1.41E-01 | 8.09E-02 | 1.45E-01 | 8.31E-02 | 1.49E-01 | 1.09E-01 |
| Medium | Very high | 4.16E-02 | 2.39E-02 | 4.28E-02 | 2.46E-02 | 4.41E-02 | 3.21E-02 |
| Low | No | 5.61E-01 | 3.23E-01 | 5.78E-01 | 3.31E-01 | 5.95E-01 | 4.33E-01 |
| Low | Very low | 5.57E-01 | 3.21E-01 | 5.74E-01 | 3.29E-01 | 5.91E-01 | 4.30E-01 |
| Low | Low | 5.52E-01 | 3.18E-01 | 5.69E-01 | 3.26E-01 | 5.86E-01 | 4.27E-01 |
| Low | Medium | 5.19E-01 | 2.99E-01 | 5.34E-01 | 3.07E-01 | 5.50E-01 | 4.01E-01 |
| Low | High | 4.77E-01 | 2.75E-01 | 4.92E-01 | 2.82E-01 | 5.06E-01 | 3.69E-01 |
| Low | Very high | 1.41E-01 | 8.09E-02 | 1.45E-01 | 8.31E-02 | 1.49E-01 | 1.09E-01 |
| Very Low | No | 6.11E-01 | 3.51E-01 | 6.29E-01 | 3.61E-01 | 6.48E-01 | 4.72E-01 |
| Very Low | Very low | 6.06E-01 | 3.49E-01 | 6.24E-01 | 3.58E-01 | 6.43E-01 | 4.68E-01 |
| Very Low | Low | 6.01E-01 | 3.46E-01 | 6.19E-01 | 3.55E-01 | 6.38E-01 | 4.65E-01 |
| Very Low | Medium | 5.65E-01 | 3.25E-01 | 5.82E-01 | 3.34E-01 | 5.99E-01 | 4.37E-01 |
| Very Low | High | 5.19E-01 | 2.99E-01 | 5.34E-01 | 3.07E-01 | 5.50E-01 | 4.01E-01 |
| Very Low | Very high | 1.52E-01 | 8.78E-02 | 1.57E-01 | 9.01E-02 | 1.62E-01 | 1.18E-01 |
| No | All | 6.60E-01 | 3.80E-01 | 6.80E-01 | 3.90E-01 | 7.00E-01 | 5.10E-01 |

(Probability of No Personnel Present [Table 5-7]) x (Smoke Detection Ineffectiveness [Table 5-2] + Smoke Detection Unreliability [NUREG/CR-6850] + Smoke Detection Unavailability [0.01, assumed])

Table C-12
First detection, interruptible fire, without MCR indication, without crediting personnel in adjacent spaces, no propagation to secondary combustibles (smoke detector probability of no detection included), default fuel loading, unavailability of 0.01, NUREG-2178 Classification Group 4 (all other) electrical enclosures

| Occupancy | Maintenance | 4a - Large Enclosures Closed, TS/QTP/SIS | 4a - Large Enclosures Closed, TP | 4a - Large Enclosures Open, TS/QTP/SIS | 4a - Large Enclosures Open, TP | 4b - Medium Enclosures Closed, TS/QTP/SIS | 4b - Medium Enclosures Closed, TP | 4b - Medium Enclosures Open, TS/QTP/SIS | 4b - Medium Enclosures Open, TP | 4c - Small Enclosures N/A, All |
|-----------|-------------|------------------------------------------|----------------------------------|----------------------------------------|--------------------------------|-------------------------------------------|-----------------------------------|-----------------------------------------|---------------------------------|--------------------------------|
| High | All | 0.00E+00 | 0.00E+00 | 0.00E+00 | 0.00E+00 | 0.00E+00 | 0.00E+00 | 0.00E+00 | 0.00E+00 | 0.00E+00 |
| Medium | No | 3.10E-01 | 2.00E-01 | 2.65E-01 | 1.85E-01 | 3.55E-01 | 2.55E-01 | 3.30E-01 | 2.15E-01 | 3.55E-01 |
| Medium | Very low | 3.09E-01 | 1.99E-01 | 2.64E-01 | 1.84E-01 | 3.54E-01 | 2.54E-01 | 3.29E-01 | 2.14E-01 | 3.54E-01 |
| Medium | Low | 3.07E-01 | 1.98E-01 | 2.62E-01 | 1.83E-01 | 3.51E-01 | 2.52E-01 | 3.27E-01 | 2.13E-01 | 3.51E-01 |
| Medium | Medium | 2.95E-01 | 1.90E-01 | 2.52E-01 | 1.76E-01 | 3.37E-01 | 2.42E-01 | 3.14E-01 | 2.04E-01 | 3.37E-01 |
| Medium | High | 2.79E-01 | 1.80E-01 | 2.39E-01 | 1.67E-01 | 3.20E-01 | 2.29E-01 | 2.97E-01 | 1.94E-01 | 3.20E-01 |
| Medium | Very high | 1.55E-01 | 1.00E-01 | 1.33E-01 | 9.25E-02 | 1.78E-01 | 1.27E-01 | 1.65E-01 | 1.07E-01 | 1.78E-01 |
| Low | No | 5.58E-01 | 3.60E-01 | 4.77E-01 | 3.33E-01 | 6.39E-01 | 4.59E-01 | 5.94E-01 | 3.87E-01 | 6.39E-01 |
| Low | Very low | 5.56E-01 | 3.58E-01 | 4.75E-01 | 3.32E-01 | 6.36E-01 | 4.57E-01 | 5.91E-01 | 3.85E-01 | 6.36E-01 |
| Low | Low | 5.52E-01 | 3.56E-01 | 4.72E-01 | 3.30E-01 | 6.33E-01 | 4.54E-01 | 5.88E-01 | 3.83E-01 | 6.33E-01 |
| Low | Medium | 5.30E-01 | 3.42E-01 | 4.53E-01 | 3.16E-01 | 6.07E-01 | 4.36E-01 | 5.64E-01 | 3.68E-01 | 6.07E-01 |
| Low | High | 5.02E-01 | 3.24E-01 | 4.29E-01 | 3.00E-01 | 5.75E-01 | 4.13E-01 | 5.35E-01 | 3.48E-01 | 5.75E-01 |
| Low | Very high | 2.79E-01 | 1.80E-01 | 2.39E-01 | 1.67E-01 | 3.20E-01 | 2.29E-01 | 2.97E-01 | 1.94E-01 | 3.20E-01 |
| Very Low | No | 5.89E-01 | 3.80E-01 | 5.03E-01 | 3.52E-01 | 6.74E-01 | 4.84E-01 | 6.27E-01 | 4.08E-01 | 6.74E-01 |
| Very Low | Very low | 5.86E-01 | 3.78E-01 | 5.01E-01 | 3.50E-01 | 6.71E-01 | 4.82E-01 | 6.24E-01 | 4.06E-01 | 6.71E-01 |
| Very Low | Low | 5.83E-01 | 3.76E-01 | 4.99E-01 | 3.48E-01 | 6.68E-01 | 4.80E-01 | 6.21E-01 | 4.05E-01 | 6.68E-01 |
| Very Low | Medium | 5.60E-01 | 3.61E-01 | 4.79E-01 | 3.34E-01 | 6.41E-01 | 4.61E-01 | 5.96E-01 | 3.88E-01 | 6.41E-01 |
| Very Low | High | 5.30E-01 | 3.42E-01 | 4.53E-01 | 3.16E-01 | 6.07E-01 | 4.36E-01 | 5.64E-01 | 3.68E-01 | 6.07E-01 |
| Very Low | Very high | 2.95E-01 | 1.90E-01 | 2.52E-01 | 1.76E-01 | 3.37E-01 | 2.42E-01 | 3.14E-01 | 2.04E-01 | 3.37E-01 |
| No | All | 6.20E-01 | 4.00E-01 | 5.30E-01 | 3.70E-01 | 7.10E-01 | 5.10E-01 | 6.60E-01 | 4.30E-01 | 7.10E-01 |

(Probability of No Personnel Present [Table 5-6]) x (Smoke Detection Ineffectiveness [Table 5-2] + Smoke Detection Unreliability [NUREG/CR-6850] + Smoke Detection Unavailability [0.01, assumed])

Table C-13
First detection, interruptible fire, without MCR indication, with crediting personnel in adjacent spaces, no propagation to secondary combustibles (smoke detector probability of no detection included), default fuel loading, unavailability of 0.01, NUREG-2178 Classification Group 4 (all other) electrical enclosures

| Occupancy | Maintenance | 4a - Large Enclosures Closed, TS/QTP/SIS | 4a - Large Enclosures Closed, TP | 4a - Large Enclosures Open, TS/QTP/SIS | 4a - Large Enclosures Open, TP | 4b - Medium Enclosures Closed, TS/QTP/SIS | 4b - Medium Enclosures Closed, TP | 4b - Medium Enclosures Open, TS/QTP/SIS | 4b - Medium Enclosures Open, TP | 4c - Small Enclosures N/A, All |
|-----------|-------------|------------------------------------------|----------------------------------|----------------------------------------|--------------------------------|-------------------------------------------|-----------------------------------|-----------------------------------------|---------------------------------|--------------------------------|
| High | All | 0.00E+00 | 0.00E+00 | 0.00E+00 | 0.00E+00 | 0.00E+00 | 0.00E+00 | 0.00E+00 | 0.00E+00 | 0.00E+00 |
| Medium | No | 1.55E-01 | 1.00E-01 | 1.33E-01 | 9.25E-02 | 1.78E-01 | 1.27E-01 | 1.65E-01 | 1.07E-01 | 1.78E-01 |
| Medium | Very low | 1.54E-01 | 9.92E-02 | 1.31E-01 | 9.18E-02 | 1.76E-01 | 1.26E-01 | 1.64E-01 | 1.07E-01 | 1.76E-01 |
| Medium | Low | 1.53E-01 | 9.84E-02 | 1.30E-01 | 9.10E-02 | 1.75E-01 | 1.25E-01 | 1.62E-01 | 1.06E-01 | 1.75E-01 |
| Medium | Medium | 1.43E-01 | 9.24E-02 | 1.22E-01 | 8.55E-02 | 1.64E-01 | 1.18E-01 | 1.52E-01 | 9.93E-02 | 1.64E-01 |
| Medium | High | 1.32E-01 | 8.52E-02 | 1.13E-01 | 7.88E-02 | 1.51E-01 | 1.09E-01 | 1.41E-01 | 9.16E-02 | 1.51E-01 |
| Medium | Very high | 3.91E-02 | 2.52E-02 | 3.34E-02 | 2.33E-02 | 4.47E-02 | 3.21E-02 | 4.16E-02 | 2.71E-02 | 4.47E-02 |
| Low | No | 5.27E-01 | 3.40E-01 | 4.51E-01 | 3.15E-01 | 6.04E-01 | 4.33E-01 | 5.61E-01 | 3.65E-01 | 6.04E-01 |
| Low | Very low | 5.23E-01 | 3.38E-01 | 4.47E-01 | 3.12E-01 | 5.99E-01 | 4.30E-01 | 5.57E-01 | 3.63E-01 | 5.99E-01 |
| Low | Low | 5.19E-01 | 3.35E-01 | 4.44E-01 | 3.10E-01 | 5.94E-01 | 4.27E-01 | 5.52E-01 | 3.60E-01 | 5.94E-01 |
| Low | Medium | 4.87E-01 | 3.14E-01 | 4.17E-01 | 2.91E-01 | 5.58E-01 | 4.01E-01 | 5.19E-01 | 3.38E-01 | 5.58E-01 |
| Low | High | 4.48E-01 | 2.89E-01 | 3.83E-01 | 2.68E-01 | 5.13E-01 | 3.69E-01 | 4.77E-01 | 3.11E-01 | 5.13E-01 |
| Low | Very high | 1.32E-01 | 8.52E-02 | 1.13E-01 | 7.88E-02 | 1.51E-01 | 1.09E-01 | 1.41E-01 | 9.16E-02 | 1.51E-01 |
| Very Low | No | 5.74E-01 | 3.70E-01 | 4.90E-01 | 3.42E-01 | 6.57E-01 | 4.72E-01 | 6.11E-01 | 3.98E-01 | 6.57E-01 |
| Very Low | Very low | 5.69E-01 | 3.67E-01 | 4.87E-01 | 3.40E-01 | 6.52E-01 | 4.68E-01 | 6.06E-01 | 3.95E-01 | 6.52E-01 |
| Very Low | Low | 5.65E-01 | 3.64E-01 | 4.83E-01 | 3.37E-01 | 6.47E-01 | 4.65E-01 | 6.01E-01 | 3.92E-01 | 6.47E-01 |
| Very Low | Medium | 5.31E-01 | 3.42E-01 | 4.54E-01 | 3.17E-01 | 6.08E-01 | 4.37E-01 | 5.65E-01 | 3.68E-01 | 6.08E-01 |
| Very Low | High | 4.87E-01 | 3.14E-01 | 4.17E-01 | 2.91E-01 | 5.58E-01 | 4.01E-01 | 5.19E-01 | 3.38E-01 | 5.58E-01 |
| Very Low | Very high | 1.43E-01 | 9.24E-02 | 1.22E-01 | 8.55E-02 | 1.64E-01 | 1.18E-01 | 1.52E-01 | 9.93E-02 | 1.64E-01 |
| No | All | 6.20E-01 | 4.00E-01 | 5.30E-01 | 3.70E-01 | 7.10E-01 | 5.10E-01 | 6.60E-01 | 4.30E-01 | 7.10E-01 |

(Probability of No Personnel Present [Table 5-7]) x (Smoke Detection Ineffectiveness [Table 5-2] + Smoke Detection Unreliability [NUREG/CR-6850] + Smoke Detection Unavailability [0.01, assumed])

Table C-14
First detection, interruptible fire, without MCR indication, without crediting personnel in adjacent spaces, no propagation to secondary combustibles (smoke detector probability of no detection included), low fuel loading, unavailability of 0.01, NUREG-2178 Classification Group 4 (all other) electrical enclosures

| Occupancy | Maintenance | 4a - Large Enclosures, Closed, TS/QTP/SIS | 4a - Large Enclosures, Closed, TP | 4a - Large Enclosures, Open, TS/QTP/SIS | 4a - Large Enclosures, Open, TP | 4b - Medium Enclosures, Closed, TS/QTP/SIS | 4b - Medium Enclosures, Closed, TP | 4b - Medium Enclosures, Open, TS/QTP/SIS | 4b - Medium Enclosures, Open, TP |
|-----------|-------------|-------------------------------------------|-----------------------------------|-----------------------------------------|---------------------------------|--------------------------------------------|------------------------------------|------------------------------------------|----------------------------------|
| High | All | 0.00E+00 | 0.00E+00 | 0.00E+00 | 0.00E+00 | 0.00E+00 | 0.00E+00 | 0.00E+00 | 0.00E+00 |
| Medium | No | 3.55E-01 | 2.55E-01 | 3.05E-01 | 2.30E-01 | 3.80E-01 | 3.20E-01 | 3.90E-01 | 3.45E-01 |
| Medium | Very low | 3.54E-01 | 2.54E-01 | 3.04E-01 | 2.29E-01 | 3.78E-01 | 3.19E-01 | 3.88E-01 | 3.44E-01 |
| Medium | Low | 3.51E-01 | 2.52E-01 | 3.02E-01 | 2.28E-01 | 3.76E-01 | 3.17E-01 | 3.86E-01 | 3.42E-01 |
| Medium | Medium | 3.37E-01 | 2.42E-01 | 2.90E-01 | 2.18E-01 | 3.61E-01 | 3.04E-01 | 3.70E-01 | 3.28E-01 |
| Medium | High | 3.20E-01 | 2.29E-01 | 2.75E-01 | 2.07E-01 | 3.42E-01 | 2.88E-01 | 3.51E-01 | 3.11E-01 |
| Medium | Very high | 1.78E-01 | 1.27E-01 | 1.53E-01 | 1.15E-01 | 1.90E-01 | 1.60E-01 | 1.95E-01 | 1.73E-01 |
| Low | No | 6.39E-01 | 4.59E-01 | 5.49E-01 | 4.14E-01 | 6.84E-01 | 5.76E-01 | 7.02E-01 | 6.21E-01 |
| Low | Very low | 6.36E-01 | 4.57E-01 | 5.47E-01 | 4.12E-01 | 6.81E-01 | 5.73E-01 | 6.99E-01 | 6.18E-01 |
| Low | Low | 6.33E-01 | 4.54E-01 | 5.44E-01 | 4.10E-01 | 6.77E-01 | 5.70E-01 | 6.95E-01 | 6.15E-01 |
| Low | Medium | 6.07E-01 | 4.36E-01 | 5.22E-01 | 3.93E-01 | 6.50E-01 | 5.47E-01 | 6.67E-01 | 5.90E-01 |
| Low | High | 5.75E-01 | 4.13E-01 | 4.94E-01 | 3.73E-01 | 6.16E-01 | 5.18E-01 | 6.32E-01 | 5.59E-01 |
| Low | Very high | 3.20E-01 | 2.29E-01 | 2.75E-01 | 2.07E-01 | 3.42E-01 | 2.88E-01 | 3.51E-01 | 3.11E-01 |
| Very Low | No | 6.74E-01 | 4.84E-01 | 5.80E-01 | 4.37E-01 | 7.22E-01 | 6.08E-01 | 7.41E-01 | 6.55E-01 |
| Very Low | Very low | 6.71E-01 | 4.82E-01 | 5.76E-01 | 4.35E-01 | 7.18E-01 | 6.05E-01 | 7.37E-01 | 6.52E-01 |
| Very Low | Low | 6.68E-01 | 4.80E-01 | 5.74E-01 | 4.33E-01 | 7.15E-01 | 6.02E-01 | 7.34E-01 | 6.49E-01 |
| Very Low | Medium | 6.41E-01 | 4.61E-01 | 5.51E-01 | 4.15E-01 | 6.86E-01 | 5.78E-01 | 7.04E-01 | 6.23E-01 |
| Very Low | High | 6.07E-01 | 4.36E-01 | 5.22E-01 | 3.93E-01 | 6.50E-01 | 5.47E-01 | 6.67E-01 | 5.90E-01 |
| Very Low | Very high | 3.37E-01 | 2.42E-01 | 2.90E-01 | 2.18E-01 | 3.61E-01 | 3.04E-01 | 3.70E-01 | 3.28E-01 |
| No | All | 7.10E-01 | 5.10E-01 | 6.10E-01 | 4.60E-01 | 7.60E-01 | 6.40E-01 | 7.80E-01 | 6.90E-01 |

(Probability of No Personnel Present [Table 5-6]) x (Smoke Detection Ineffectiveness [Table 5-2] + Smoke Detection Unreliability [NUREG/CR-6850] + Smoke Detection Unavailability [0.01, assumed])

Table C-15
First detection, interruptible fire, without MCR indication, with crediting personnel in adjacent spaces, no propagation to secondary combustibles (smoke detector probability of no detection included), low fuel loading, unavailability of 0.01, NUREG-2178 Classification Group 4 (all other) electrical enclosures

| Occupancy | Maintenance | 4a - Large Enclosures, Closed, TS/QTP/SIS | 4a - Large Enclosures, Closed, TP | 4a - Large Enclosures, Open, TS/QTP/SIS | 4a - Large Enclosures, Open, TP | 4b - Medium Enclosures, Closed, TS/QTP/SIS | 4b - Medium Enclosures, Closed, TP | 4b - Medium Enclosures, Open, TS/QTP/SIS | 4b - Medium Enclosures, Open, TP |
|-----------|-------------|-------------------------------------------|-----------------------------------|-----------------------------------------|---------------------------------|--------------------------------------------|------------------------------------|------------------------------------------|----------------------------------|
| High | All | 0.00E+00 | 0.00E+00 | 0.00E+00 | 0.00E+00 | 0.00E+00 | 0.00E+00 | 0.00E+00 | 0.00E+00 |
| Medium | No | 1.78E-01 | 1.27E-01 | 1.53E-01 | 1.15E-01 | 1.90E-01 | 1.60E-01 | 1.95E-01 | 1.73E-01 |
| Medium | Very low | 1.76E-01 | 1.26E-01 | 1.51E-01 | 1.14E-01 | 1.88E-01 | 1.59E-01 | 1.93E-01 | 1.71E-01 |
| Medium | Low | 1.75E-01 | 1.25E-01 | 1.50E-01 | 1.13E-01 | 1.87E-01 | 1.57E-01 | 1.92E-01 | 1.70E-01 |
| Medium | Medium | 1.64E-01 | 1.18E-01 | 1.41E-01 | 1.06E-01 | 1.76E-01 | 1.48E-01 | 1.80E-01 | 1.59E-01 |
| Medium | High | 1.51E-01 | 1.09E-01 | 1.30E-01 | 9.80E-02 | 1.62E-01 | 1.36E-01 | 1.66E-01 | 1.47E-01 |
| Medium | Very high | 4.47E-02 | 3.21E-02 | 3.84E-02 | 2.90E-02 | 4.79E-02 | 4.03E-02 | 4.91E-02 | 4.35E-02 |
| Low | No | 6.04E-01 | 4.33E-01 | 5.19E-01 | 3.91E-01 | 6.46E-01 | 5.44E-01 | 6.63E-01 | 5.87E-01 |
| Low | Very low | 5.99E-01 | 4.30E-01 | 5.15E-01 | 3.88E-01 | 6.41E-01 | 5.40E-01 | 6.58E-01 | 5.82E-01 |
| Low | Low | 5.94E-01 | 4.27E-01 | 5.11E-01 | 3.85E-01 | 6.36E-01 | 5.36E-01 | 6.53E-01 | 5.78E-01 |
| Low | Medium | 5.58E-01 | 4.01E-01 | 4.79E-01 | 3.62E-01 | 5.97E-01 | 5.03E-01 | 6.13E-01 | 5.42E-01 |
| Low | High | 5.13E-01 | 3.69E-01 | 4.41E-01 | 3.33E-01 | 5.49E-01 | 4.63E-01 | 5.64E-01 | 4.99E-01 |
| Low | Very high | 1.51E-01 | 1.09E-01 | 1.30E-01 | 9.80E-02 | 1.62E-01 | 1.36E-01 | 1.66E-01 | 1.47E-01 |
| Very Low | No | 6.57E-01 | 4.72E-01 | 5.64E-01 | 4.26E-01 | 7.03E-01 | 5.92E-01 | 7.22E-01 | 6.38E-01 |
| Very Low | Very low | 6.52E-01 | 4.68E-01 | 5.60E-01 | 4.22E-01 | 6.98E-01 | 5.88E-01 | 7.16E-01 | 6.33E-01 |
| Very Low | Low | 6.47E-01 | 4.65E-01 | 5.56E-01 | 4.19E-01 | 6.92E-01 | 5.83E-01 | 7.11E-01 | 6.29E-01 |
| Very Low | Medium | 6.08E-01 | 4.37E-01 | 5.22E-01 | 3.94E-01 | 6.51E-01 | 5.48E-01 | 6.68E-01 | 5.91E-01 |
| Very Low | High | 5.58E-01 | 4.01E-01 | 4.79E-01 | 3.62E-01 | 5.97E-01 | 5.03E-01 | 6.13E-01 | 5.42E-01 |
| Very Low | Very high | 1.64E-01 | 1.18E-01 | 1.41E-01 | 1.06E-01 | 1.76E-01 | 1.48E-01 | 1.80E-01 | 1.59E-01 |
| No | All | 7.10E-01 | 5.10E-01 | 6.10E-01 | 4.60E-01 | 7.60E-01 | 6.40E-01 | 7.80E-01 | 6.90E-01 |

(Probability of No Personnel Present [Table 5-7]) x (Smoke Detection Ineffectiveness [Table 5-2] + Smoke Detection Unreliability [NUREG/CR-6850] + Smoke Detection Unavailability [0.01, assumed])

1
2
3
4
5

Table C-16
First detection, interruptible fire, without MCR indication, without crediting personnel in adjacent spaces, no propagation to secondary combustibles (smoke detector probability of no detection included), very low fuel loading, unavailability of 0.01, NUREG-2178 Classification Group 4 (all other) electrical enclosures

| Occupancy | Maintenance | 4a - Large Enclosures, Closed, TS/QTP/SIS | 4a - Large Enclosures, Closed, TP | 4a - Large Enclosures, Open, TS/QTP/SIS | 4a - Large Enclosures, Open, TP | 4b - Medium Enclosures, Closed, TS/QTP/SIS | 4b - Medium Enclosures, Closed, TP | 4b - Medium Enclosures, Open, TS/QTP/SIS | 4b - Medium Enclosures, Open, TP |
|-----------|-------------|-------------------------------------------|-----------------------------------|-----------------------------------------|---------------------------------|--------------------------------------------|------------------------------------|------------------------------------------|----------------------------------|
| High | All | 0.00E+00 | 0.00E+00 | 0.00E+00 | 0.00E+00 | 0.00E+00 | 0.00E+00 | 0.00E+00 | 0.00E+00 |
| Medium | No | 3.75E-01 | 2.95E-01 | 3.75E-01 | 2.95E-01 | 3.50E-01 | 3.50E-01 | 3.50E-01 | 3.50E-01 |
| Medium | Very low | 3.73E-01 | 2.94E-01 | 3.73E-01 | 2.94E-01 | 3.49E-01 | 3.49E-01 | 3.49E-01 | 3.49E-01 |
| Medium | Low | 3.71E-01 | 2.92E-01 | 3.71E-01 | 2.92E-01 | 3.47E-01 | 3.47E-01 | 3.47E-01 | 3.47E-01 |
| Medium | Medium | 3.56E-01 | 2.80E-01 | 3.56E-01 | 2.80E-01 | 3.33E-01 | 3.33E-01 | 3.33E-01 | 3.33E-01 |
| Medium | High | 3.38E-01 | 2.66E-01 | 3.38E-01 | 2.66E-01 | 3.15E-01 | 3.15E-01 | 3.15E-01 | 3.15E-01 |
| Medium | Very high | 1.88E-01 | 1.48E-01 | 1.88E-01 | 1.48E-01 | 1.75E-01 | 1.75E-01 | 1.75E-01 | 1.75E-01 |
| Low | No | 6.75E-01 | 5.31E-01 | 6.75E-01 | 5.31E-01 | 6.30E-01 | 6.30E-01 | 6.30E-01 | 6.30E-01 |
| Low | Very low | 6.72E-01 | 5.29E-01 | 6.72E-01 | 5.29E-01 | 6.27E-01 | 6.27E-01 | 6.27E-01 | 6.27E-01 |
| Low | Low | 6.68E-01 | 5.26E-01 | 6.68E-01 | 5.26E-01 | 6.24E-01 | 6.24E-01 | 6.24E-01 | 6.24E-01 |
| Low | Medium | 6.41E-01 | 5.04E-01 | 6.41E-01 | 5.04E-01 | 5.99E-01 | 5.99E-01 | 5.99E-01 | 5.99E-01 |
| Low | High | 6.08E-01 | 4.78E-01 | 6.08E-01 | 4.78E-01 | 5.67E-01 | 5.67E-01 | 5.67E-01 | 5.67E-01 |
| Low | Very high | 3.38E-01 | 2.66E-01 | 3.38E-01 | 2.66E-01 | 3.15E-01 | 3.15E-01 | 3.15E-01 | 3.15E-01 |
| Very Low | No | 7.12E-01 | 5.60E-01 | 7.12E-01 | 5.60E-01 | 6.65E-01 | 6.65E-01 | 6.65E-01 | 6.65E-01 |
| Very Low | Very low | 7.09E-01 | 5.58E-01 | 7.09E-01 | 5.58E-01 | 6.61E-01 | 6.61E-01 | 6.61E-01 | 6.61E-01 |
| Very Low | Low | 7.06E-01 | 5.55E-01 | 7.06E-01 | 5.55E-01 | 6.59E-01 | 6.59E-01 | 6.59E-01 | 6.59E-01 |
| Very Low | Medium | 6.77E-01 | 5.33E-01 | 6.77E-01 | 5.33E-01 | 6.32E-01 | 6.32E-01 | 6.32E-01 | 6.32E-01 |
| Very Low | High | 6.41E-01 | 5.04E-01 | 6.41E-01 | 5.04E-01 | 5.99E-01 | 5.99E-01 | 5.99E-01 | 5.99E-01 |
| Very Low | Very high | 3.56E-01 | 2.80E-01 | 3.56E-01 | 2.80E-01 | 3.33E-01 | 3.33E-01 | 3.33E-01 | 3.33E-01 |
| No | All | 7.50E-01 | 5.90E-01 | 7.50E-01 | 5.90E-01 | 7.00E-01 | 7.00E-01 | 7.00E-01 | 7.00E-01 |

(Probability of No Personnel Present [Table 5-6]) x (Smoke Detection Ineffectiveness [Table 5-2] + Smoke Detection Unreliability [NUREG/CR-6850] + Smoke Detection Unavailability [0.01, assumed])

- 1
- 2
- 3
- 4

Table C-17
First detection, interruptible fire, without MCR indication, with crediting personnel in adjacent spaces, no propagation to secondary combustibles (smoke detector probability of no detection included), very low fuel loading, unavailability of 0.01, NUREG-2178 Classification Group 4 (all other) electrical enclosures

| Occupancy | Maintenance | 4a - Large Enclosures, Closed, TS/QTP/SIS | 4a - Large Enclosures, Closed, TP | 4a - Large Enclosures, Open, TS/QTP/SIS | 4a - Large Enclosures, Open, TP | 4b - Medium Enclosures, Closed, TS/QTP/SIS | 4b - Medium Enclosures, Closed, TP | 4b - Medium Enclosures, Open, TS/QTP/SIS | 4b - Medium Enclosures, Open, TP |
|-----------|-------------|-------------------------------------------|-----------------------------------|-----------------------------------------|---------------------------------|--------------------------------------------|------------------------------------|------------------------------------------|----------------------------------|
| High | All | 0.00E+00 | 0.00E+00 | 0.00E+00 | 0.00E+00 | 0.00E+00 | 0.00E+00 | 0.00E+00 | 0.00E+00 |
| Medium | No | 1.88E-01 | 1.48E-01 | 1.88E-01 | 1.48E-01 | 1.75E-01 | 1.75E-01 | 1.75E-01 | 1.75E-01 |
| Medium | Very low | 1.86E-01 | 1.46E-01 | 1.86E-01 | 1.46E-01 | 1.74E-01 | 1.74E-01 | 1.74E-01 | 1.74E-01 |
| Medium | Low | 1.84E-01 | 1.45E-01 | 1.84E-01 | 1.45E-01 | 1.72E-01 | 1.72E-01 | 1.72E-01 | 1.72E-01 |
| Medium | Medium | 1.73E-01 | 1.36E-01 | 1.73E-01 | 1.36E-01 | 1.62E-01 | 1.62E-01 | 1.62E-01 | 1.62E-01 |
| Medium | High | 1.60E-01 | 1.26E-01 | 1.60E-01 | 1.26E-01 | 1.49E-01 | 1.49E-01 | 1.49E-01 | 1.49E-01 |
| Medium | Very high | 4.73E-02 | 3.72E-02 | 4.73E-02 | 3.72E-02 | 4.41E-02 | 4.41E-02 | 4.41E-02 | 4.41E-02 |
| Low | No | 6.37E-01 | 5.02E-01 | 6.37E-01 | 5.02E-01 | 5.95E-01 | 5.95E-01 | 5.95E-01 | 5.95E-01 |
| Low | Very low | 6.33E-01 | 4.98E-01 | 6.33E-01 | 4.98E-01 | 5.91E-01 | 5.91E-01 | 5.91E-01 | 5.91E-01 |
| Low | Low | 6.28E-01 | 4.94E-01 | 6.28E-01 | 4.94E-01 | 5.86E-01 | 5.86E-01 | 5.86E-01 | 5.86E-01 |
| Low | Medium | 5.90E-01 | 4.64E-01 | 5.90E-01 | 4.64E-01 | 5.50E-01 | 5.50E-01 | 5.50E-01 | 5.50E-01 |
| Low | High | 5.42E-01 | 4.27E-01 | 5.42E-01 | 4.27E-01 | 5.06E-01 | 5.06E-01 | 5.06E-01 | 5.06E-01 |
| Low | Very high | 1.60E-01 | 1.26E-01 | 1.60E-01 | 1.26E-01 | 1.49E-01 | 1.49E-01 | 1.49E-01 | 1.49E-01 |
| Very Low | No | 6.94E-01 | 5.46E-01 | 6.94E-01 | 5.46E-01 | 6.48E-01 | 6.48E-01 | 6.48E-01 | 6.48E-01 |
| Very Low | Very low | 6.89E-01 | 5.42E-01 | 6.89E-01 | 5.42E-01 | 6.43E-01 | 6.43E-01 | 6.43E-01 | 6.43E-01 |
| Very Low | Low | 6.83E-01 | 5.37E-01 | 6.83E-01 | 5.37E-01 | 6.38E-01 | 6.38E-01 | 6.38E-01 | 6.38E-01 |
| Very Low | Medium | 6.42E-01 | 5.05E-01 | 6.42E-01 | 5.05E-01 | 5.99E-01 | 5.99E-01 | 5.99E-01 | 5.99E-01 |
| Very Low | High | 5.90E-01 | 4.64E-01 | 5.90E-01 | 4.64E-01 | 5.50E-01 | 5.50E-01 | 5.50E-01 | 5.50E-01 |
| Very Low | Very high | 1.73E-01 | 1.36E-01 | 1.73E-01 | 1.36E-01 | 1.62E-01 | 1.62E-01 | 1.62E-01 | 1.62E-01 |
| No | All | 7.50E-01 | 5.90E-01 | 7.50E-01 | 5.90E-01 | 7.00E-01 | 7.00E-01 | 7.00E-01 | 7.00E-01 |

(Probability of No Personnel Present [Table 5-7]) x (Smoke Detection Ineffectiveness [Table 5-2] + Smoke Detection Unreliability [NUREG/CR-6850] + Smoke Detection Unavailability [0.01, assumed])

1
2
3
4

Table C-18
First detection, growing fire,
with MCR indication,
without crediting personnel in adjacent spaces,
all fuel loadings,
NUREG-2178 Classification Groups 1, 2, 3, and 4 enclosures

| Occupancy | Maintenance | All Electrical Cabinets |
|-----------|-------------|-------------------------|
| High | All | 0.00E+00 |
| Medium | No | 5.49E-03 |
| Medium | Very low | 5.47E-03 |
| Medium | Low | 5.44E-03 |
| Medium | Medium | 5.22E-03 |
| Medium | High | 4.95E-03 |
| Medium | Very high | 2.75E-03 |
| Low | No | 9.89E-03 |
| Low | Very low | 9.85E-03 |
| Low | Low | 9.79E-03 |
| Low | Medium | 9.40E-03 |
| Low | High | 8.90E-03 |
| Low | Very high | 4.95E-03 |
| Very Low | No | 1.04E-02 |
| Very Low | Very low | 1.04E-02 |
| Very Low | Low | 1.03E-02 |
| Very Low | Medium | 9.92E-03 |
| Very Low | High | 9.40E-03 |
| Very Low | Very high | 5.22E-03 |
| No | All | 1.10E-02 |

(Probability of No Personnel Present [Table 5-6]) x ((MCR Indication Unreliability [Section 5.3.3.2] + MCR Operator HEP [Section 5.3.3.3]) – (MCR Indication Unreliability [Section 5.3.3.2] x MCR Operator HEP [Section 5.3.3.3]))

Table C-19
First detection, growing fire,
with MCR indication,
with crediting personnel in adjacent spaces,
all fuel loadings,
NUREG-2178 Classification Groups 1, 2, 3, and 4 enclosures

| Occupancy | Maintenance | All Electrical Cabinets |
|-----------|-------------|-------------------------|
| High | No | 0.00E+00 |
| Medium | No | 2.75E-03 |
| Medium | Very low | 2.73E-03 |
| Medium | Low | 2.70E-03 |
| Medium | Medium | 2.54E-03 |
| Medium | High | 2.34E-03 |
| Medium | Very high | 6.92E-04 |
| Low | No | 9.34E-03 |
| Low | Very low | 9.28E-03 |
| Low | Low | 9.20E-03 |
| Low | Medium | 8.64E-03 |
| Low | High | 7.95E-03 |
| Low | Very high | 2.34E-03 |
| Very Low | No | 1.02E-02 |
| Very Low | Very low | 1.01E-02 |
| Very Low | Low | 1.00E-02 |
| Very Low | Medium | 9.41E-03 |
| Very Low | High | 8.64E-03 |
| Very Low | Very high | 2.54E-03 |
| No | No | 1.10E-02 |

(Probability of No Personnel Present [Table 5-7]) x ((MCR Indication Unreliability [Section 5.3.3.2] + MCR Operator HEP [Section 5.3.3.3]) – (MCR Indication Unreliability [Section 5.2.3.2] x MCR Operator HEP [Section 5.3.3.3]))

Table C-20
First detection, growing fire,
without MCR indication,
without crediting personnel in adjacent spaces
all fuel loadings,
NUREG-2178 Classification Groups 1, 2, 3, and 4 enclosures

| Occupancy | Maintenance | All Electrical Cabinets |
|-----------|-------------|-------------------------|
| High | All | 0.00E+00 |
| Medium | No | 5.00E-01 |
| Medium | Very low | 4.98E-01 |
| Medium | Low | 4.95E-01 |
| Medium | Medium | 4.75E-01 |
| Medium | High | 4.50E-01 |
| Medium | Very high | 2.50E-01 |
| Low | No | 9.00E-01 |
| Low | Very low | 8.96E-01 |
| Low | Low | 8.91E-01 |
| Low | Medium | 8.55E-01 |
| Low | High | 8.10E-01 |
| Low | Very high | 4.50E-01 |
| Very Low | No | 9.50E-01 |
| Very Low | Very low | 9.45E-01 |
| Very Low | Low | 9.41E-01 |
| Very Low | Medium | 9.03E-01 |
| Very Low | High | 8.55E-01 |
| Very Low | Very high | 4.75E-01 |
| No | All | 1.00E+00 |

(Probability of No Personnel Present [Table 5-6])

1
2
3
4

Table C-21
First detection, growing fire,
without MCR indication,
with crediting personnel in adjacent spaces,
all fuel loadings,
NUREG-2178 Classification Groups 1, 2, 3, and 4 enclosures

| Occupancy | Maintenance | All Electrical Cabinets |
|-----------|-------------|-------------------------|
| High | All | 0.00E+00 |
| Medium | No | 2.50E-01 |
| Medium | Very low | 2.48E-01 |
| Medium | Low | 2.46E-01 |
| Medium | Medium | 2.31E-01 |
| Medium | High | 2.13E-01 |
| Medium | Very high | 6.30E-02 |
| Low | No | 8.50E-01 |
| Low | Very low | 8.44E-01 |
| Low | Low | 8.37E-01 |
| Low | Medium | 7.86E-01 |
| Low | High | 7.23E-01 |
| Low | Very high | 2.13E-01 |
| Very Low | No | 9.25E-01 |
| Very Low | Very low | 9.18E-01 |
| Very Low | Low | 9.11E-01 |
| Very Low | Medium | 8.56E-01 |
| Very Low | High | 7.86E-01 |
| Very Low | Very high | 2.31E-01 |
| No | All | 1.00E+00 |

(Probability of No Personnel Present [Table 5-7])

1
2
3
4

Table C-22
Second detection, growing fire,
no propagation to secondary combustibles (smoke detector probability of no detection included),
default fuel loading, unavailability of 0.01,
NUREG-2178 Classification Groups 1, 2, and 3 enclosures

| | | | | | | | |
|------------------|--------------------|-----------------------------------------------------|---------------------------------------------|--------------------------------------------------|------------------------------------------|----------------------------------------|--------------------------------|
| | | 1 – Switchgears and Load Centers, TS/QTP/SIS | 1 – Switchgears and Load Centers, TP | 2 – MCCs and Battery Chargers, TS/QTP/SIS | 2 – MCCs and Battery Chargers, TP | 3 – Power Inverters, TS/QTP/SIS | 3 – Power Inverters, TP |
| Occupancy | Maintenance | TS/QTP/SIS | TP | TS/QTP/SIS | TP | TS/QTP/SIS | TP |
| All | All | 6.60E-01 | 3.80E-01 | 6.80E-01 | 3.90E-01 | 7.00E-01 | 5.10E-01 |

(Smoke Detection Ineffectiveness [Table 5-2] + Smoke Detection Unreliability [NUREG/CR-6850] + Smoke Detection Unavailability [0.01, assumed])

1
2
3

Table C-23
Second detection, growing fire,
no propagation to secondary combustibles (smoke detector probability of no detection included),
default fuel loading, unavailability of 0.01,
NUREG-2178 Classification Group 4 (all other) electrical enclosures

| | | | | | | | | |
|------------------|--------------------|-------------------------------------------------|-----------------------------------------------|---------------------------------------|--------------------------------------------------|------------------------------------------------|----------------------------------------|---------------------------------------|
| | | 4a - Large Enclosures Closed, TS/QTP/SIS | 4a - Large Enclosures Open, TS/QTP/SIS | 4a - Large Enclosures Open, TP | 4b - Medium Enclosures Closed, TS/QTP/SIS | 4b - Medium Enclosures Open, TS/QTP/SIS | 4b - Medium Enclosures Open, TP | 4c – Small Enclosures N/A, All |
| Occupancy | Maintenance | TS/QTP/SIS | TP | TP | TS/QTP/SIS | TS/QTP/SIS | Open, TP | Enclosures N/A, All |
| All | All | 6.20E-01 | 4.00E-01 | 5.30E-01 | 7.10E-01 | 5.10E-01 | 4.30E-01 | 7.10E-01 |

(Smoke Detection Ineffectiveness [Table 5-2] + Smoke Detection Unreliability [NUREG/CR-6850] + Smoke Detection Unavailability [0.01, assumed])

4
5
6

Table C-24
Second detection, growing fire,
no propagation to secondary combustibles (smoke detector probability of no detection included),
low fuel loading, unavailability of 0.01,
NUREG-2178 Classification Group 4 (all other) electrical enclosures

| | | | | | | | | |
|-----------|-------------------------------------------|-----------------------------------|-----------------------------------------|---------------------------------|--------------------------------------------|------------------------------------|------------------------------------------|----------------------------------|
| | 4a - Large Enclosures, Closed, TS/QTP/SIS | 4a - Large Enclosures, Closed, TP | 4a - Large Enclosures, Open, TS/QTP/SIS | 4a - Large Enclosures, Open, TP | 4b - Medium Enclosures, Closed, TS/QTP/SIS | 4b - Medium Enclosures, Closed, TP | 4b - Medium Enclosures, Open, TS/QTP/SIS | 4b - Medium Enclosures, Open, TP |
| Occupancy | 7.10E-01 | 5.10E-01 | 6.10E-01 | 4.60E-01 | 7.60E-01 | 6.40E-01 | 7.80E-01 | 6.90E-01 |
| All | All | All | All | All | All | All | All | All |

(Smoke Detection Ineffectiveness [Table 5-2] + Smoke Detection Unreliability [NUREG/CR-6850] + Smoke Detection Unavailability [0.01, assumed])

1
2
3
4

Table C-25
Second detection, growing fire,
no propagation to secondary combustibles (smoke detector probability of no detection included),
very low fuel loading, unavailability of 0.01,
NUREG-2178 Classification Group 4 (all other) electrical enclosures

| | | | | | | | | |
|-----------|-------------------------------------------|-----------------------------------|-----------------------------------------|---------------------------------|--------------------------------------------|------------------------------------|------------------------------------------|----------------------------------|
| | 4a - Large Enclosures, Closed, TS/QTP/SIS | 4a - Large Enclosures, Closed, TP | 4a - Large Enclosures, Open, TS/QTP/SIS | 4a - Large Enclosures, Open, TP | 4b - Medium Enclosures, Closed, TS/QTP/SIS | 4b - Medium Enclosures, Closed, TP | 4b - Medium Enclosures, Open, TS/QTP/SIS | 4b - Medium Enclosures, Open, TP |
| Occupancy | 7.50E-01 | 5.90E-01 | 7.50E-01 | 5.90E-01 | 7.00E-01 | 7.00E-01 | 7.00E-01 | 7.00E-01 |
| All | All | All | All | All | All | All | All | All |

(Smoke Detection Ineffectiveness [Table 5-2] + Smoke Detection Unreliability [NUREG/CR-6850] + Smoke Detection Unavailability [0.01, assumed])

5
6
7
8

Table C-26
Second detection, interruptible and growing fire,
assumes propagation to secondary combustibles (smoke detector probability of no detection not included),
unavailability of 0.01,
NUREG-2178 Classification Groups 1, 2, and 3 enclosures

| | | | | | | |
|------------------|--------------------|---------------------------------------------|------------------------------------------|------------------------------------------|--------------------------------|--------------------------------|
| | | 1 – Switchgears and Load Centers, TP | 2 – MCCs and Battery Chargers, TP | 2 – MCCs and Battery Chargers, TP | 3 – Power Inverters, TP | 3 – Power Inverters, TP |
| Occupancy | Maintenance | TS/QTP/SIS | TS/QTP/SIS | TS/QTP/SIS | TS/QTP/SIS | TS/QTP/SIS |
| All | All | 5.95E-02 | 5.95E-02 | 5.95E-02 | 5.95E-02 | 5.95E-02 |

(Smoke Detection Unreliability [NUREG/CR-6850] + Smoke Detection Unavailability [0.01, assumed]) - Smoke Detection Unreliability [NUREG/CR-6850] x Smoke Detection Unavailability [0.01, assumed])

- 1
- 2
- 3
- 4

Table C-27
Second detection, interruptible and growing fire,
assumes propagation to secondary combustibles (smoke detector probability of no detection not included),
unavailability of 0.01,
NUREG-2178 Classification Group 4 (all other) electrical enclosures

| | | | | | | | |
|------------------|--------------------|-------------------------------------------------|-----------------------------------------------|--------------------------------------------------|------------------------------------------------|----------------------------------------|---------------------------------------|
| | | 4a - Large Enclosures Closed, TS/QTP/SIS | 4a - Large Enclosures Open, TS/QTP/SIS | 4b - Medium Enclosures Closed, TS/QTP/SIS | 4b - Medium Enclosures Open, TS/QTP/SIS | 4b - Medium Enclosures Open, TP | 4c - Small Enclosures N/A, All |
| Occupancy | Maintenance | TS/QTP/SIS | TS/QTP/SIS | TS/QTP/SIS | TS/QTP/SIS | TS/QTP/SIS | TS/QTP/SIS |
| All | All | 5.95E-02 | 5.95E-02 | 5.95E-02 | 5.95E-02 | 5.95E-02 | 5.95E-02 |

(Smoke Detection Unreliability [NUREG/CR-6850] + Smoke Detection Unavailability [0.01, assumed]) - Smoke Detection Unreliability [NUREG/CR-6850] x Smoke Detection Unavailability [0.01, assumed])

- 5
- 6
- 7

DRAFT
for Public Comment

D

SENSITIVITY AND UNCERTAINTY

The input parameters developed as part of the methodology described in this report are studied to determine their sensitivity on the calculation of the probability of non-suppression. These sensitivities are developed based on uncertainty ranges of the different input parameters. In this Appendix D, parameter sensitivity cases and results are presented in Table D-1. Sensitivities on the function (for example, personnel detection, MCR indication, and probability of no detection by a reliable and available automatic smoke detection system) are presented in Table D-2.

DRAFT
for Public Comment

DRAFT
for Public Comment

Table D-1
Parameter sensitivity cases

| Sensitivity | P_{ns} | Percentage Difference | Discussion |
|-------------------------------------------------------------------------------------------|----------|-----------------------|------------------------------------------------------------------------------------------------------------------------------------------------------------------------------------------------------------------------------------------------------------------------------------------------------------------------------------------------------------------------------------------------------------------------------------------------------------------------------------------------------------------------------------------------------------------------------------|
| Base Case, Example #4, Section 6.4 | 0.018 | N/A | Motor control center (MCC) is monitored for equipment trouble in the MCR. The Interruptible Fire and Growth Fire suppression rates are 0.139 and 0.099 respectively. Occupancy and Medium Maintenance rating levels. This results in a probability that personnel are not present to detect the fire of 0.475. The MCC is located in a room that has been determined to have Medium A pre-growth period of 4 minutes is included in the detailed fire modeling of the Interruptible fraction of fires. The effectiveness of the automatic smoke detection system is 0.33. |
| MCR Indication: Sum Sensor/Transmitter Level probabilities of failure: 1.26E-03 | 0.017 | 5.6 | The results of the analysis show that the calculation of P_{ns} is sensitive to change in the MCR Indication probability of failure. An order of magnitude change in the MCR Indication probability of failure results in an approximate 5% change in the calculated P_{ns} . |
| MCR Indication: Sum Sensor/Transmitter Level probabilities of failure: 4.91E-04 | 0.017 | 5.6 | The results of the analysis show that the calculation of P_{ns} is sensitive to change in the MCR Indication probability of failure. An order of magnitude change in the MCR Indication probability of failure results in an approximate 5% change in the calculated P_{ns} . |
| MCR Operator Response: Screening HEP with Error Factor of 5: 5E-03 | 0.018 | 0.0 | The results of the analysis show that the calculation of P_{ns} is not sensitive to a change by a factor of 5 MCR Operator HEP. |
| 5th Percentile Suppression Rates, Interruptible Fires: 0.106 Growth Fire: 0.065 | 0.031 | 72.2 | The results of the analysis show that the calculation of P_{ns} is sensitive to a change in the suppression rate. The <i>Interruptible</i> and <i>Growing Fires</i> suppression rates reduction of around 40% results in an approximate 70% increase in the P_{ns} . |
| 95th Percentile Suppression Rates, Interruptible Fires: 0.175 Growth Fire: 0.140 | 0.009 | 50.0 | The results of the analysis show that the calculation of P_{ns} is sensitive to a change in the suppression rate. The <i>Interruptible</i> and <i>Growing Fires</i> suppression rates increase of around 30% results in an approximate 50% decrease in the P_{ns} . |
| Personnel Detection: Equal weight to Maintenance | 0.017 | 5.6 | The results of the analysis show that the calculation of P_{ns} is sensitive to a change of treating maintenance ratings as equal to that of occupancy ratings. This change results in an approximate 5% change in the calculated P_{ns} . |

Table D-1
Parameter sensitivity cases

| Sensitivity | P_{ns} | Percentage Difference | Discussion |
|-----------------------------------------------------------------------------------------------------------------------------|----------|-----------------------|------------------------------------------------------------------------------------------------------------------------------------------------------------------------------------------------------------------------------------------------------------------------------------------------------------------|
| Interruptible Fire Pre-growth period: 1 minute | 0.022 | 22.2 | The results of the analysis show that the calculation of P_{ns} is sensitive to a in the pre-growth period associated with the modeling of an <i>Interruptible</i> fire. This change results in an approximate 20% change in the calculated P_{ns} . |
| Interruptible Fire Pre-growth period: 8 minutes | 0.014 | 22.2 | The results of the analysis show that the calculation of P_{ns} is sensitive to a in the pre-growth period associated with the modeling of an <i>Interruptible</i> fire. This change results in an approximate 20% change in the calculated P_{ns} . |
| Smoke Detection Probability of No Detection: 98th HRR Only in Monte Carlo analysis | 0.017 | 5.6 | The results of the analysis show that the calculation of P_{ns} is sensitive when the probability of no detection is assessed assuming only 98 th percentile fires are occurring. This change results in an approximate 5% change in the calculated P_{ns} . |
| Smoke Detection Probability of No Detection: Ceiling Height Above Source can only be 1.5 m in Monte Carlo analysis | 0.017 | 5.6 | The results of the analysis show that the calculation of P_{ns} is sensitive when the probability of no detection is assessed assuming the vertical distance separating the fire and the smoke detector is fixed to 1.5 m (5 ft). This change results in an approximate 5% change in the calculated P_{ns} . |
| Smoke Detection Probability of No Detection: Ceiling Height Above Source can only be 6.1 m in Monte Carlo analysis | 0.018 | 0.0 | The results of the analysis show that the calculation of P_{ns} is not sensitive when the probability of no detection is assessed assuming the vertical distance separating the fire and the smoke detector is fixed to 6.1 m (20 ft). |
| Smoke Detection Probability of No Detection: Radial Distance to Detector can only be 0 m in Monte Carlo analysis | 0.017 | 5.6 | The results of the analysis show that the calculation of P_{ns} is sensitive when the probability of no detection is assessed assuming the radial distance separating the fire and the smoke detector is fixed to 0 m. This change results in an approximate 5% change in the calculated P_{ns} . |
| Smoke Detection Probability of No Detection: Radial Distance to Detector can only be 6.5 m in Monte Carlo analysis | 0.018 | 0.0 | The results of the analysis show that the calculation of P_{ns} is not sensitive when the probability of no detection is assessed assuming the radial distance separating the fire and the smoke detector is fixed to 6.5 m (21.3 ft). |
| Smoke Detection Probability of No Detection: Unobstructed Cabinet Top in Monte Carlo analysis | 0.017 | 5.6 | The results of the analysis show that the calculation of P_{ns} is sensitive when the probability of no detection is assessed assuming the cabinet is modeled without the obstructed plume bias. This change results in an approximate 5% change in the calculated P_{ns} . |

Table D-1
Parameter sensitivity cases

| Sensitivity | P_{ns} | Percentage Difference | Discussion |
|-------------------------------------------------------------------------|----------|-----------------------|------------------------------------------------------------------------------------------------------------------------------------------------------------------------------------------------------------------------------------------------------|
| Interruptible and Growing Fires Split Fraction: 0.5/0.05 | 0.23 | 27.8 | The results of the analysis show that the calculation of P_{ns} is sensitive when the <i>Interruptible</i> and <i>Growing Fires</i> split fraction is split equally. This change results in an approximate 28% change in the calculated P_{ns} . |
| Interruptible and Growing Fires Split Fraction: All Interruptible Fires | 0.011 | 38.9 | The results of the analysis show that the calculation of P_{ns} is sensitive when all fires treated as <i>Interruptible Fires</i> . This change results in an approximate 40% change in the calculated P_{ns} . |
| Interruptible and Growing Fires Split Fraction: All Growing Fires | 0.035 | 94.4 | The results of the analysis show that the calculation of P_{ns} is sensitive when all fires treated as <i>Growing Fires</i> . This change results in an approximate 95% change in the calculated P_{ns} . |

Table D-2
Function sensitivity cases

| Sensitivity | P_{ns} | Percentage Difference | Discussion |
|--------------------------------------------|----------|-----------------------|----------------------------------------------------------------------------------------------------------------------------------------------------------------------------------------------------------------------------------------------------------------------------------------------------------------------------------------------------------------------------------------------------------------------------------------------------------------------------------------------------------------------------------------------------|
| Base Case, Example #4, Section 6.4 | 0.018 | N/A | MCC is monitored for equipment trouble in the MCR. The Interruptible Fire and Growth Fire suppression rates are 0.139 and 0.099 respectively. Occupancy and Medium Maintenance rating levels. This results in a probability that personnel are not present to detect the fire of 0.475. The MCC is located in a room that has been determined to have Medium A pre-growth period of 4 minutes is included in the detailed fire modeling of the Interruptible fraction of fires. The effectiveness of the automatic smoke detection system is 0.33. |
| No MCR Indication, Example #1, Section 6.1 | 0.045 | 150 | The results of the analysis show that the calculation of P_{ns} is sensitive to the inclusion of the Plant Personnel means of detection. This change results in an approximate 150% change in the calculated P_{ns} . |
| No Personnel Detection, Section 5.3.3.4 | 0.019 | 5.6 | The results of the analysis show that the calculation of P_{ns} is sensitive to the inclusion of the MCR Indication means of detection. This change results in an approximate 5% change in the calculated P_{ns} . |

Table D-2
Function sensitivity cases

| Sensitivity | P_{ns} | Percentage Difference | Discussion |
|----------------------------------------------------------------------------------------|----------|-----------------------|-----------------------------------------------------------------------------------------------------------------------------------------------------------------------------------------------------------------------------------------------------------------------------------|
| Exclude <i>Automatic Smoke Detection Probability of No Detection</i> , Section 5.3.3.1 | 0.018 | 0 | The results of the analysis show that the calculation of P_{ns} is not sensitive to the inclusion of the Automatic Smoke Detection Probability of No Detection for a reliable and available system. |
| Exclude MCR Indication AND Personnel Detection | 0.037 | 105.6 | The results of the analysis show that the calculation of P_{ns} is sensitive to the inclusion of the MCR Indication and Plant Personnel means of detection. This change results in an approximate 100% change in the calculated P_{ns} . |
| Exclude Personnel Detection and Automatic Smoke Detection Probability of No Detection | 0.017 | 5.6 | The results of the analysis show that the calculation of P_{ns} is sensitive to the inclusion of the Automatic Smoke Detection Probability of No Detection and Plant Personnel means of detection. This change results in an approximate 5% change in the calculated P_{ns} . |
| Exclude MCR Indication AND Automatic Smoke Detection Probability of No Detection | 0.021 | 16.7 | The results of the analysis show that the calculation of P_{ns} is sensitive to the inclusion of the MCR Indication and Automatic Smoke Detection Probability means of detection. This change results in an approximate 15% change in the calculated P_{ns} . |

1 The results of these sensitivity cases highlight that greatest impact in the calculation of the P_{ns}
2 results from the inclusion or exclusion of the following:

- 3 • The MCR Indication means of detection
- 4 • The interruptible and growing fires suppression rates
- 5 • The interruptible and growing fires split fraction

6 Sensitivity in the calculation of the P_{ns} to the suppression rate is not an unexpected result.
7 Increasing or decreasing the rate at which fires are estimated to be suppressed should impact
8 the probability of failing to suppress a fire. The sensitivity to the split fraction highlights the
9 difference between the P_{ns} modeled as interruptible fires, with a greater suppression rate and a
10 zero time of detection.

11 The sensitivity to the MCR Indication means of detection likely results from the magnitude of the
12 parameters associated with this means of detection. As presented in Figure 5-12, when
13 included, this means of detection multiplies a factor of 0.011 ($0.01+0.001- 0.01\times 0.001$) to the
14 estimated probability of detection failure. Outside of occupancy spaces with high and no ratings,
15 the probabilities associated with personnel detection range from 0.25 to 0.925 and are less
16 influential to the successful detection of a fire.

17

DRAFT
for Public Comment

DRAFT
for Public Comment

BIBLIOGRAPHIC DATA SHEET

(See instructions on the reverse)

NUREG-2230
Draft

2. TITLE AND SUBTITLE

Methodology for Modeling Fire Growth and Suppression for Electrical Cabinet Fires in Nuclear Power Plants

3. DATE REPORT PUBLISHED

MONTH

YEAR

June

2019

4. FIN OR GRANT NUMBER

5. AUTHOR(S)

N. Melly (NRC), D. Stroup (NRC), S. Cooper (NRC), A. Lindeman (EPRI),
M. Chi-Miranda (Jensen-Hughes), E. Collins (Jensen-Hughes), J. Floyd (Jensen-Hughes),
O. Gonzalez (Jensen-Hughes), F. Joglar (Jensen-Hughes), S. Montanez (Jensen-Hughes),
V. Ontiveros (Jensen-Hughes), J. Williamson (Jensen-Hughes)

6. TYPE OF REPORT

Technical

7. PERIOD COVERED (Inclusive Dates)

8. PERFORMING ORGANIZATION - NAME AND ADDRESS (If NRC, provide Division, Office or Region, U. S. Nuclear Regulatory Commission, and mailing address; if contractor, provide name and mailing address.)

9. SPONSORING ORGANIZATION - NAME AND ADDRESS (If NRC, type "Same as above", if contractor, provide NRC Division, Office or Region, U. S. Nuclear Regulatory Commission, and mailing address.)

Division of Risk Analysis
Office of Nuclear Regulatory Research
U.S. Nuclear Regulatory Commission
Washington, DC 20555-0001

Electric Power Research Institute
3420 Hillview Avenue
Palo Alto, CA 94304

10. SUPPLEMENTARY NOTES

M.H. Salley, NRC Project Manager

11. ABSTRACT (200 words or less)

One aspect of the fire PRA methods and data that has not been explicitly re-analyzed is the fire growth profile and plant personnel suppression response for electrical cabinets. A simplified model of the average time to peak, steady state, and decay are used to model the ignition source's heat release rate profile. For manual suppression credit, a dense collection of electrical ignition sources spanning three decades is used to represent the fire brigade and plant suppression response. Recent research efforts focused on obtaining more detailed information regarding the fire incidents at nuclear power plants. This data collection has enabled researchers to obtain more details on the fire attributes, timeline, and plant impact. This project specifically reviewed the available electrical cabinet fire incident data in an effort to update the methodology to better reflect the observed operating experience. Insights from the data review served as the basis for amending portions of the fire modeling and suppression response to more accurately align with operating experience. The outcome of this work is a revised set of parameters that address both the fire growth and the suppression response in the context of fire scenario modeling. The set of electrical cabinet fire events were classified into either a growing or interruptible fire categorization. Interruptible fires are those that have observed ignition, but no significant growth for a period of time. Growing fires, on the other hand, experience growth immediately after ignition. Furthermore, the detection-suppression event tree has been updated to better allow for early plant personnel suppression actions. Additional manual non-suppression bins have been added to better reflect the scenario characteristics. The results of this research may be implemented in new and existing FPRA for a more realistic representation of the scenario progression and suppression end states.

12. KEY WORDS/DESCRIPTORS (List words or phrases that will assist researchers in locating the report.)

Fire events, Fire growth profile, Fire ignition frequency (FIF), Fire probabilistic risk assessment (FPRA), Manual suppression, Non-suppression probability (NSP)

13. AVAILABILITY STATEMENT

unlimited

14. SECURITY CLASSIFICATION

(This Page)

unclassified

(This Report)

unclassified

15. NUMBER OF PAGES

16. PRICE