

## CHAPTER 6

## TABLE OF CONTENTS

<u>Section</u>	<u>Title</u>	<u>Page</u>
6	ENGINEERED SAFETY FEATURES	6.1-1
6.1	ENGINEERED SAFETY FEATURE MATERIALS	6.1-1
6.1.1	Metallic Material	6.1-1
6.1.2	Organic Materials	6.1-4
6.1.3	References for Section 6.1	6.1-7
6.2	CONTAINMENT SYSTEMS	6.2-1
6.2.1	Containment Functional Design	6.2-1
6.2.2	Containment Heat Removal System	6.2-44
6.2.3	Secondary Containment Functional Design	6.2-56
6.2.4	Containment Isolation System	6.2-56a
6.2.5	Combustible Gas Control System	6.2-66
6.2.6	Containment Leakage Testing	6.2-72
6.2.7	Fracture Prevention of Containment Pressure Boundary	6.2-76
6.2.8	References for Section 6.2	6.2-76
6.3	EMERGENCY CORE COOLING SYSTEM	6.3-1
6.3.1	Design Bases	6.3-1
6.3.2	System Design	6.3-2
6.3.3	Performance Evaluation	6.3-16
6.3.4	Inspection and Testing Requirements	6.3-22
6.3.5	Instrumentation Requirements	6.3-25
6.3.6	Reference for Section 6.3	6.3-28
6.4	HABITABILITY SYSTEMS	6.4-1
6.4.1	Design Bases	6.4-1
6.4.2	System Design	6.4-2
6.4.3	System Operational Procedures	6.4-6
6.4.4	Design Evaluation	6.4-7
6.4.5	Inspection and Testing Requirements	6.4-9
6.4.6	Instrumentation Requirements	6.4-9
6.4.7	References for Section 6.4	6.4-10
6.5	FISSION PRODUCT REMOVAL AND CONTROL SYSTEMS	6.5-1
6.5.1	Engineered Safety Feature Filter Systems	6.5-1
6.5.2	Containment Spray as a Fission Product Cleanup System	6.5-3
6.5.3	Fission Product Control Systems	6.5-12
6.5.4	References for Section 6.5	6.5-19

## TABLE OF CONTENTS (Cont)

<u>Section</u>	<u>Title</u>	<u>Page</u>
6.6	IN-SERVICE INSPECTION OF ASME CODE CLASS 2 AND CLASS 3 COMPONENTS	6.6-1
6.6.1	Components Subject to Examination	6.6-1
6.6.2	Accessibility	6.6-1
6.6.3	Examination Techniques and Procedures	6.6-2
6.6.4	Inspection Intervals	6.6-2
6.6.5	Examination Categories and Requirements	6.6-3
6.6.6	Evaluation of Examination Results	6.6-3
6.6.7	System Pressure Tests	6.6-3
6.6.8	Augmented In-service Inspection to Protect Against Postulated Piping Failures	6.6-4

## LIST OF TABLES

<u>Table Number</u>	<u>Title</u>
6.1-1	Typical Materials Employed for Components of Engineered Safety Features Systems Balance of Plant
6.1-2	Typical Materials Employed for Components of Engineered Safety Features Systems Nuclear Steam Supply System
6.1-3	Protective Coatings on Westinghouse-Supplied Equipment Inside the Containment
6.2-1	Thermophysical Properties of Passive Heat Sink Materials
6.2-2	Beaver Valley MAAP-DBA Parameter File Summary of Containment Nominal Volumes and Metal Heat Sinks
6.2-2A	Beaver Valley MAAP-DBA Parameter File Summary of Containment Concrete Heat Sinks
6.2-3	Containment Design Evaluation Parameters
6.2-4	Key Input Data to MAAP-DBA (Peak Pressure Calculations)
6.2-5	Beaver Valley MAAP-DBA Parameter File Summary of Junction Flow Areas
6.2-6	Containment Peak Pressure Results for A Design Basis Large Break LOCA Beaver Valley
6.2-7	Double-Ended Hot-Leg Break Sequence of Events
6.2-8	BVPS-2 Double-Ended Pump Suction Break Minimum Safeguards Sequence of Events
6.2-9	Double-Ended Pump Suction Break Maximum Safeguards Sequence of Events (CIB Failure)
6.2-9B	Deleted
6.2-10	MAAP-DBA Peak Pressure Results for a Design Basis Main Steam Line Break Beaver Valley
6.2-10a	Deleted
6.2-11	MAAP-DBA Peak Temperature Results for a Design Basis Main Steam Line Break Beaver Valley

## LIST OF TABLES (Cont)

<u>Table Number</u>	<u>Title</u>
6.2-11a	Deleted
6.2-12	Sequence of Events - Peak Containment Pressure Case 1.069 Ft <sup>2</sup> Double-Ended Rupture (DER) With a Main Steam Isolation Valve (MSIV) Failure at Thirty Percent Power (Case 11m)
6.2-13	Sequence of Events - Peak Containment Temperature Case 1.069 Ft <sup>2</sup> Double-Ended Rupture (DER) With a Main Steam Isolation Valve (MSIV) Failure at Full Power (Case 1m)
6.2-14	System Parameters Initial Conditions for Thermal Uprate
6.2-14A	Safety Injection Flow Minimum Safeguards
6.2-14B	Safety Injection Flow Maximum Safeguards
6.2-14C	Double-Ended Hot-Leg Break Blowdown Mass and Energy Releases
6.2-14D	Double-Ended Pump Suction Break Blowdown Mass and Energy Releases (Same for all DEPS Runs)
6.2-14E	Double-Ended Pump Suction Break Minimum Safeguards Reflood Mass and Energy Releases
6.2-14F	Double-Ended Pump Suction Break - Minimum Safeguards Principle Parameters During Reflood
6.2-14G	Double-Ended Pump Suction Break Minimum Safeguards Post-Reflood Mass and Energy Releases
6.2-14H	Double-Ended Pump Suction Break Maximum Safeguards Reflood Mass and Energy Releases
6.2-14I	Principle Parameters During Reflood Double-Ended Pump Suction Break - Maximum Safeguards
6.2-14J	Double-Ended Pump Suction Break Maximum Safeguards Post-Reflood Mass and Energy Releases
6.2-14K	Double-Ended Hot-Leg Break Mass Balance
6.2-14L	Double-Ended Pump Suction Break Mass Balance Minimum Safeguards
6.2-14M	Double-Ended Pump Suction Break Mass Balance Maximum Safeguards
6.2-14N	Double-Ended Hot-Leg Break Energy Balance

## LIST OF TABLES (Cont)

<u>Table Number</u>	<u>Title</u>
6.2-14O	Double-Ended Pump Suction Break Energy Balance Minimum Safeguards
6.2-14P	Double-Ended Pump Suction Break Energy Balance - Maximum Safeguards)
6.2-14Q	Double-Ended Pump Suction Break (SW Failure) - Maximum Safeguards Reflood Mass And Energy Releases
6.2-14R	Double-Ended Pump Suction (SW Failure) - Maximum Safeguards Principle Parameters During Reflood
6.2-14S	Double-Ended Pump Suction (SW Failure) Maximum Safeguards Post-Reflood Mass And Energy Releases
6.2-14T	Double-Ended Pump Suction (SW Failure) Mass Balance Maximum Safeguards
6.2.14U	Double-Ended Pump Suction (SW Failure) Energy Balance Maximum Safeguards
6.2.14V	LOCA Mass And Energy Release Analysis ANS 1979 Core Decay Heat Power Fraction
6.2-15	Deleted
6.2-15a	Deleted
6.2-16	Deleted
6.2-17	Deleted
6.2-18	Deleted
6.2-19	Deleted
6.2-20	Deleted
6.2-21	Pressurizer Subcompartment Vent Path Description
6.2-22	Pressurizer Subcompartment Nodal Description
6.2-23	Mass and Energy Release Rates Pressurizer Spray Line Double Ended Rupture
6.2-24	Mass and Energy Release Rates Pressurizer Surge Line Double-Ended Rupture

## LIST OF TABLES (Cont)

<u>Table Number</u>	<u>Title</u>
6.2-25	Summary of Subcompartment Peak Calculated Pressure Differential Used in Structural Analysis
6.2-26	Deleted
6.2-27	Steam Generator Subcompartment Vent Path Description
6.2-28	Steam Generator Subcompartment Nodal Description
6.2-29	Mass and Energy Release Rates 360 in <sup>2</sup> LDR at the Steam Generator Outlet Nozzle
6.2-30	Mass and Energy Flow Rates
6.2-31	Mass and Energy Release Rates 707 in <sup>2</sup> Longitudinal Intrados Split at the Steam Generator Inlet ELBOW
6.2-32	Deleted
6.2-33	Deleted
6.2-34	Deleted
6.2-35	Deleted
6.2-36	Deleted
6.2-37	Deleted
6.2-38	Deleted
6.2-39	Deleted
6.2-40	Deleted
6.2-41	Deleted
6.2-42	Deleted
6.2-43	Deleted
6.2-44	Deleted
6.2-45	Deleted
6.2-46	Deleted
6.2-47	Deleted
6.2-48	Deleted

## LIST OF TABLES (Cont)

<u>Table Number</u>	<u>Title</u>
6.2-49	Deleted
6.2-50	Beaver Valley Power Station Unit 2 Initial Condition Assumptions MSLB Mass and Energy Releases Inside Containment
6.2-51	Beaver Valley Power Station Unit 2 Balance of Plant Assumptions MSLB Mass and Energy Releases Inside Containment
6.2-52	LBLOCA Mass and Energy Releases from BCL Vessel-Side
6.2-53	LBLOCA Mass and Energy Releases from BCL Vessel-Side
6.2-54	Active Heat Sinks for Minimum Containment Pressure Analysis
6.2-55	Large Break LOCA Containment Wall Data Used for Calculation of Containment Pressure
6.2-56	Quench Spray System Component Design Data
6.2-57	Component Design Data Recirculation Spray System
6.2-58	Supplementary Leak Collection and Release System Air Flow Rates
6.2-59	Net Positive Suction Head for Containment Heat Removal System
6.2-60	Containment Isolation Features
6.2-61	Deleted
6.2-62	Deleted
6.3-1	Emergency Core Cooling System Component Parameters
6.3-2	Emergency Core Cooling System Relief Valve Data
6.3-3	Motor-Operated Isolation Valves in Emergency Core Cooling Systems
6.3-4	Materials Employed for Emergency Core Cooling System Components
6.3-5	Failure Modes and Effects Analysis Emergency Core Cooling System - Active Components

## LIST OF TABLES (Cont)

<u>Table Number</u>	<u>Title</u>
6.3-6	Emergency Core Cooling System Recirculation Piping Passive Failure Analysis Long Term Phase
6.3-7	Sequence of Switchover Operation from Injection to Recirculation
6.3-8	Emergency Core Cooling System Shared Functions Evaluation
6.3-9	Normal Operating Status of Emergency Core Cooling System Components for Core Cooling
6.4-1	Control Room Envelope Ventilation Parameters
6.4-1a	Control Room Envelope Ventilation Parameters Used for LOCA and CREA Analyses
6.4-2	Deleted
6.4-3	Locations of Control Room Air Intake, Toxic Gas Storage, and Radiation Release Points
6.5-1	Comparison of Engineered Safety Features Filter System Design Features with Regulatory Guide 1.52
6.5-2	Containment Thermodynamic Data - Loss of Coolant Accident
6.5-3	Deleted
6.5-4	Parameters for Calculating Minimum and Maximum Spray pH during Quench Spray Operation
6.5-5	Parameters for Minimum Ultimate Sump pH Calculation
6.5-6	Primary Containment Information
6.5-7	Supplementary Leak Collection and Release System Principal Components and Design Parameters
6.5-8	Supplementary Leak Collection and Release System Air Flow Rates



## LIST OF FIGURES

<u>Figure Number</u>	<u>Title</u>
6.2-1	MAAP-DBA Containment Nodalization
6.2-2	MAAP-DBA Containment Nodalization (Plan View)
6.2-3	MAAP5 Node and Junction Arrangement
6.2-4	Deleted
6.2-5	Containment Pressure Time-History for the DEHL Break Case
6.2-6	Containment Temperature Time-History for the DEHL Break Case
6.2-7	Containment Pressure Time-History for the DEPS Min SI Break Case
6.2-8	Containment Temperature Time-History for the DEPS Min SI Break Case
6.2-9	Containment Pressure Time-History for the DEPS Max SI (CIB Failure) Break Case
6.2-10	Containment Temperature Time-History for DEPS Max SI (CIB Failure) Break Case
6.2-10A	Deleted
6.2-10B	Deleted
6.2-11	Containment Sump Temperature Time-Histories for the DEPS Min SI and DEPS Max SI (CIB Failure) Break Case
6.2-11A	Deleted
6.2-11B	Deleted
6.2-12	Containment Pressure Time-History for the Limiting MSLB Pressure Case
6.2-13	Containment Temperature Time-History for the Limiting MSLB Pressure Case
6.2-14	Containment Pressure Time-History for the Limiting MSLB Temperature Case

## LIST OF FIGURES (Cont)

<u>Figure Number</u>	<u>Title</u>
6.2-15	Containment Temperature Time-History for the Limiting MSLB Temperature Case
6.2-16	Deleted
6.2-17	Deleted
6.2-18	Staggered Mesh Control Volume Approximately for THREED
6.2-19	Computational Block Diagram for THREED
6.2-20	Pressurizer Subcompartment Nodalization Diagram
6.2-21	Pressurizer Cubicle Nodalization - Plan View El. 767'-10" - 23 Node Model
6.2-22	Pressurizer Cubicle Nodalization - Plan View El. 738'-10" - 23 Node Model
6.2-23	Pressurizer Relief Tank Cubicle Nodalization Plan View El. 718'-6" - 23 Node Model
6.2-24	Pressurizer Cubicle Elevation View Section 1-1
6.2-25	Pressurizer Cubicle Average Pressure vs Time-Spray Line DER Nodes 1 and 3
6.2-26	Pressurizer Cubicle Average Pressure vs Time-Spray Line DER Nodes 2 and 4
6.2-27	Pressurizer Cubicle Average Pressure vs Time-Spray Line DER Nodes 5 and 7
6.2-28	Pressurizer Cubicle Average Pressure vs Time-Spray Line DER Nodes 6 and 8
6.2-29	Pressurizer Cubicle Average Pressure vs Time-Spray Line DER Nodes 9 to 12
6.2-29A	Pressurizer Cubicle Average Pressure vs Time-Spray Line DER Nodes 13 to 16
6.2-29B	Pressurizer Cubicle Average Pressure vs Time-Spray Line DER Nodes 17 to 20
6.2-29C	Pressurizer Cubicle Average Pressure vs Time-Spray Line DER Nodes 21 to 23

## LIST OF FIGURES (Cont)

<u>Figure Number</u>	<u>Title</u>
6.2-30	Pressurizer Cubicle Average Pressure vs Time-Surge Line DER at the Pressurizer Nozzle Nodes 1, 2, 3, and 4
6.2-31	Pressurizer Cubicle Average Pressure vs Time-Surge Line DER at the Pressurizer Nozzle Nodes 5, 6, 7, and 8
6.2-32	Pressurizer Cubicle Average Pressure vs Time-Surge Line DER at the Pressurizer Nozzle Nodes 9, 10, 11, and 12
6.2-33	Pressurizer Cubicle Average Pressure vs Time-Surge Line DER at the Pressurizer Nozzle Nodes 13 and 15
6.2-34	Pressurizer Cubicle Average Pressure vs Time-Surge Line DER at the Pressurizer Nozzle Nodes 14, 16, 17, and 19
6.2-35	Pressurizer Cubicle Average Pressure vs Time-Surge Line DER at the Pressurizer Nozzle Node 18
6.2-36	Pressurizer Cubicle Average Pressure vs Time-Surge Line DER at the Pressurizer Nozzle Nodes 20, 21, 22, and 23
6.2-37	Pressurizer Cubicle Average Pressure vs Time Surge Line DER in the Pressurizer Relief Tank Cubicle Nodes 1, 2, 3, and 4
6.2-38	Pressurizer Cubicle Average Pressure vs Time Surge Line DER in the Pressurizer Relief Tank Cubicle Nodes 5, 6, 7, and 8
6.2-39	Pressurizer Cubicle Average Pressure vs Time Surge Line DER in the Pressurizer Relief Tank Cubicle Nodes 9, 10, 11, and 12
6.2-40	Pressurizer Cubicle Average Pressure vs Time Surge Line DER in the Pressurizer Relief Tank Cubicle Node 13
6.2-41	Pressurizer Cubicle Average Pressure vs Time Surge Line DER in the Pressurizer Relief Tank Cubicle Nodes 14, 15, and 16
6.2-42	Pressurizer Cubicle Average Pressure vs Time Surge Line DER in the Pressurizer Relief Tank Cubicle Nodes 17, 18, and 19

## LIST OF FIGURES (Cont)

<u>Figure Number</u>	<u>Title</u>
6.2-43	Pressurizer Cubicle Average Pressure vs Time Surge Line DER in the Pressurizer Relief Tank Cubicle Nodes 20, 21, 22, and 23
6.2-44	Steam Generator Subcompartment Nodalization Diagram
6.2-45	Steam Generator Subcompartment Nodalization Plan View Elevation 718'-6" to 727'-2"
6.2-46	Steam Generator Subcompartment Nodalization Plan View El. 727'-0" to 740'-3"
6.2-47	Steam Generator Subcompartment Nodalization Plan View El. 740'-3" to 767'-10"
6.2-48	Steam Generator Subcompartment Nodalization Plan View El. 767'-10"
6.2-49	Steam Generator Subcompartment Nodalization Elevation Views Sections 1-1 and 2-2
6.2-50	BV-2 33 Node Steam Generator Cubicle Absolute Pressure vs Time - 320 Sq Break Nodes 1 and 5
6.2-51	BV-2 33 Node Steam Generator Cubicle Absolute Pressure vs Time - 320 Sq In Break Nodes 2 and 6
6.2-52	BV-2 33 Node Steam Generator Cubicle Absolute Pressure vs Time - 320 Sq In Break Nodes 3 and 4
6.2-53	BV-2 33 Node Steam Generator Cubicle Absolute Pressure vs Time - 320 Sq In Break Nodes 7 and 11
6.2-54	BV-2 33 Node Steam Generator Cubicle Absolute Pressure vs Time - 320 Sq In Break Nodes 8 and 12
6.2-55	BV-2 33 Node Steam Generator Cubicle Absolute Pressure vs Time - 320 Sq In Break Nodes 9 and 10
6.2-56	BV-2 33 Node Steam Generator Cubicle Absolute Pressure vs Time - 320 Sq In Break Nodes 13 and 17
6.2-57	BV-2 33 Node Steam Generator Cubicle Absolute Pressure vs Time - 320 Sq In Break Nodes 14 and 18

## LIST OF FIGURES (Cont)

<u>Figure Number</u>	<u>Title</u>
6.2-58	BV-2 33 Node Steam Generator Cubicle Absolute Pressure vs Time - 320 Sq In Break Nodes 15 and 16
6.2-59	BV-2 33 Node Steam Generator Cubicle Absolute Pressure vs Time - 320 Sq In Break Nodes 19 and 23
6.2-60	BV-2 33 Node Steam Generator Cubicle Absolute Pressure vs Time - 320 Sq In Break Nodes 20 and 24
6.2-61	BV-2 33 Node Steam Generator Cubicle Absolute Pressure vs Time - 320 Sq In Break Nodes 21 and 22
6.2-62	BV-2 33 Node Steam Generator Cubicle Absolute Pressure vs Time - 320 Sq In Break Nodes 25 and 27
6.2-63	BV-2 33 Node Steam Generator Cubicle Absolute Pressure vs Time - 320 Sq In Break Nodes 26 and 28
6.2-64	BV-2 33 Node Steam Generator Cubicle Absolute Pressure vs Time - 320 Sq In Break Nodes 29 and 30
6.2-65	BV-2 33 Node Steam Generator Cubicle Absolute Pressure vs Time - 320 Sq In Break Nodes 31, 32, and 33
6.2-66	BV-2 33 Node Steam Generator Cubicle Absolute Pressure vs Time - 180 Sq In Break Nodes 1 and 5
6.2-67	BV-2 33 Node Steam Generator Cubicle Absolute Pressure vs Time - 180 Sq In Break Nodes 2 and 6
6.2-68	BV-2 33 Node Steam Generator Cubicle Absolute Pressure vs Time - 180 Sq In Break Nodes 3 and 4
6.2-69	BV-2 33 Node Steam Generator Cubicle Absolute Pressure vs Time - 180 Sq In Break Nodes 7 and 11
6.2-70	BV-2 33 Node Steam Generator Cubicle Absolute Pressure vs Time - 180 Sq In Break Nodes 8 and 12
6.2-71	BV-2 33 Node Steam Generator Cubicle Absolute Pressure vs Time - 180 Sq In Break Nodes 9 and 10
6.2-72	BV-2 33 Node Steam Generator Cubicle Absolute Pressure vs Time - 180 Sq In Break Nodes 13 and 17

## LIST OF FIGURES (Cont)

<u>Figure Number</u>	<u>Title</u>
6.2-73	BV-2 33 Node Steam Generator Cubicle Absolute Pressure vs Time - 180 Sq In Break Nodes 14 and 18
6.2-74	BV-2 33 Node Steam Generator Cubicle Absolute Pressure vs Time - 180 Sq In Break Nodes 15 and 16
6.2-75	BV-2 33 Node Steam Generator Cubicle Absolute Pressure vs Time - 180 Sq In Break Nodes 19 and 23
6.2-76	BV-2 33 Node Steam Generator Cubicle Absolute Pressure vs Time - 180 Sq In Break Nodes 20 and 24
6.2-77	BV-2 33 Node Steam Generator Cubicle Absolute Pressure vs Time - 180 Sq In Break Nodes 21 and 22
6.2-78	BV-2 33 Node Steam Generator Cubicle Absolute Pressure vs Time - 180 Sq In Break Nodes 25 and 27
6.2-79	BV-2 33 Node Steam Generator Cubicle Absolute Pressure vs Time - 180 Sq In Break Nodes 26 and 28
6.2-80	BV-2 33 Node Steam Generator Cubicle Absolute Pressure vs Time - 180 Sq In Break Nodes 29 and 31
6.2-81	BV-2 33 Node Steam Generator Cubicle Absolute Pressure vs Time - 180 Sq In Break Nodes 30, 32, and 33
6.2-82	BV-2 33 Node Steam Generator Cubicle Absolute Pressure vs Time - 707 Sq In Steam Generator Inlet Elbow Split Nodes 1 and 5
6.2-83	BV-2 33 Node Steam Generator Cubicle Absolute Pressure vs Time - 707 Sq In Steam Generator Inlet Elbow Split Nodes 2 and 6
6.2-84	BV-2 33 Node Steam Generator Cubicle Absolute Pressure vs Time - 707 Sq In Steam Generator Inlet Elbow Split Nodes 3 and 4
6.2-85	BV-2 33 Node Steam Generator Cubicle Absolute Pressure vs Time - 707 Sq In Steam Generator Inlet Elbow Split Nodes 7 and 11
6.2-86	BV-2 33 Node Steam Generator Cubicle Absolute Pressure vs Time - 707 Sq In Steam Generator Inlet Elbow Split Nodes 8 and 12

## LIST OF FIGURES (Cont)

<u>Figure Number</u>	<u>Title</u>
6.2-87	BV-2 33 Node Steam Generator Cubicle Absolute Pressure vs Time - 707 Sq In Steam Generator Inlet Elbow Split Nodes 9 and 10
6.2-88	BV-2 33 Node Steam Generator Cubicle Absolute Pressure vs Time - 707 Sq In Steam Generator Inlet Elbow Split Nodes 13 and 17
6.2-89	BV-2 33 Node Steam Generator Cubicle Absolute Pressure vs Time - 707 Sq In Steam Generator Inlet Elbow Split Nodes 14 and 18
6.2-90	BV-2 33 Node Steam Generator Cubicle Absolute Pressure vs Time - 707 Sq In Steam Generator Inlet Elbow Split Nodes 15 and 16
6.2-91	BV-2 33 Node Steam Generator Cubicle Absolute Pressure vs Time - 707 Sq In Steam Generator Inlet Elbow Split Nodes 19 and 23
6.2-92	BV-2 33 Node Steam Generator Cubicle Absolute Pressure vs Time - 707 Sq In Steam Generator Inlet Elbow Split Nodes 20 and 24
6.2-93	BV-2 33 Node Steam Generator Cubicle Absolute Pressure vs Time - 707 Sq In Steam Generator Inlet Elbow Split Nodes 21 and 22
6.2-94	BV-2 33 Node Steam Generator Cubicle Absolute Pressure vs Time - 707 Sq In Steam Generator Inlet Elbow Split Nodes 25 and 27
6.2-95	BV-2 33 Node Steam Generator Cubicle Absolute Pressure vs Time - 707 Sq In Steam Generator Inlet Elbow Split Nodes 26 and 28
6.2-96	BV-2 33 Node Steam Generator Cubicle Absolute Pressure vs Time - 707 Sq In Steam Generator Inlet Elbow Split Nodes 29 and 31
6.2-97	BV-2 33 Node Steam Generator Cubicle Absolute Pressure vs Time - 707 Sq In Steam Generator Inlet Elbow Split Nodes 30, 32 and 33
6.2-98	Deleted

## LIST OF FIGURES (Cont)

<u>Figure Number</u>	<u>Title</u>	
6.2-99	Deleted	
6.2-100	Deleted	
6.2-101	Deleted	
6.2-102	Deleted	
6.2-103	Deleted	
6.2-104	Deleted	
6.2-105	Deleted	
6.2-106	Deleted	
6.2-107	Deleted	
6.2-108	Deleted	
6.2-109	Deleted	
6.2-110	Deleted	
6.2-111	Deleted	
6.2-112	Deleted	
6.2-113	Deleted	
6.2-114	Deleted	



## LIST OF FIGURES (Cont)

<u>Figure Number</u>	<u>Title</u>
6.2-115	Deleted
6.2-116	Deleted
6.2-117	Deleted
6.2-118	Schematic Diagram of Secondary System
6.2-119	Lower Bound Containment Pressure
6.2-120	Deleted
6.2-121	Quench Spray System
6.2-122	Recirculation Spray System
6.2-123	Containment Quench and Recirculating Spray Piping
6.2-124	Tandem Mechanical Seal Arrangement for Recirculation Pumps
6.2-125	Spatial Droplet Size Distribution
6.2-126	Quench Spray Coverage on Operating Floor, El. 767'-10"
6.2-127	Quench Spray Coverage in Containment Dome
6.2-128	Containment Sump
6.2-129	Energy Absorbed by Passive Heat Sinks - Containment Peak Pressure Analysis for LOCA (HLDER & PSDER Min. ESF-3300 Sec.)
6.2-130	Containment Depressurization Energy Removed by Recirculation Coolers for LOCA (PSDER - Min. ESF)
6.2-130A	Energy Removed by Recirculation Spray Coolers, Subatmospheric Peak Pressure (PSDER - Min. ESF)
6.2-131	Combustible Gas Control System

## LIST OF FIGURES (Cont)

<u>Figure Number</u>	<u>Title</u>	
6.2-132	Deleted	
6.2-133	Deleted	
6.2-134	Deleted	
6.2-135	Deleted	
6.2-136	Deleted	
6.2-137	Deleted	
6.2-138	Containment Internal Structure	
6.2-139	Expected Long-term Circulation Patterns in Containment	
6.2-140	Deleted	
6.2-141	Deleted	
6.3-1	Safety Injection System	
6.3-2	Safety Injection Accumulators	
6.3-3	DELETED	
6.3-4	Pump Head Characteristic Curve - Low Head - Safety Injection Pumps	
6.3-5	Pump Head Characteristic Curve - High Head - Centrifugal Charging Pumps	
6.3-6	Process Flow Diagram Safety Injection System	
6.4-1	DELETED	
6.4-2	Section 1-1	
6.4-3	Section 2-2	

## LIST OF FIGURES (Cont)

<u>Figure Number</u>	<u>Title</u>
6.4-4	Section 3-3
6.4-5	Control Room Air Intakes, Toxic Gas Storage, and Radiation Release Points
6.5-1	DELETED
6.5-2	Supplementary Leak Collection and Release System
6.5-3	Aerosol Removal Rates Within Sprayed Region
6.5-4	Aerosol Removal Rates Within Unsprayed Region

## CHAPTER 6

## ENGINEERED SAFETY FEATURES

## 6.1 ENGINEERED SAFETY FEATURE MATERIALS

## 6.1.1 Metallic Material

## 6.1.1.1 Materials Selection and Fabrication

## 6.1.1.1.1 Balance of Plant

Materials are specified in accordance with ASME III, NC-2160 and NC-3120, on the basis of their compatibility with the core and containment spray solutions described in Section 6.1.1.2. General corrosion, intergranular corrosion, caustic, and chloride stress corrosion have been considered. Mechanical properties of the materials used in the engineered safety features (ESF) are in accordance with ASME Boiler and Pressure Vessel Code Section II, Parts A, B, and C.

The specifications for the principal pressure-retaining materials for components of the ESF are compiled in Table 6.1-1.

During a loss-of-coolant accident (LOCA), negligible general corrosion of stainless steel is anticipated (Griess and Baccarella 1969). The probability of stress corrosion is reduced due to chloride control (Scharfstein and Brindley 1958), the short time at elevated temperatures (Griess and Creek 1969; Uhlig 1948; National Association of Corrosion Engineers (NACE) 1967) and the low concentration of free caustic (NACE 1967; Berry 1971). Westinghouse Electric Corporation (Westinghouse) has evaluated the integrity of the construction materials for ESF equipment when exposed to post-design accident (DBA) conditions (Whyte and Picone 1971). Based on the results of this investigation, as well as testing by Oak Ridge National Laboratory (ORNL) and others, the behavior of austenitic stainless steels in the post-DBA environment is acceptable.

Intergranular corrosion in the heat-affected zone of austenitic stainless steel welds will not occur due to controlled welding processes to limit sensitization (Section 1.8), limited time at elevated temperature, and the fact that the chemicals used at low concentrations are not significant intergranular corrosives (Uhlig 1948; Perry and Chilton 1973). Because all austenitic stainless steel base materials are provided in the solution annealed condition, they are immune to intergranular corrosion.

Negligible attack of carbon and low alloy steels is anticipated during a LOCA because these materials are resistant to basic solutions.

The use of stainless steel is in accordance with Regulatory Guide 1.44, as discussed in Section 1.8. Contamination and cleanliness control are provided consistent with Regulatory Guides 1.37 and 1.44, and as discussed in Section 1.8.

Insulation for austenitic stainless steel is in accordance with Regulatory Guide 1.36 as discussed in Section 1.8. The amounts of leachable chloride, fluoride, sodium, and silicates are comparable to the values listed in Regulatory Guide 1.36. To avoid hot cracking, all production welding on austenitic stainless steel is in accordance with Regulatory Guide 1.31, as discussed in Section 1.8.

Cold worked austenitic stainless steels exhibiting a yield strength in excess of 90,000 psi are not used.

#### 6.1.1.1.2 Westinghouse Scope of Supply

Typical materials specifications used for components in the ESF are listed in Table 6.1-2. Materials utilized conform with the requirements of the ASME Boiler and Pressure Vessel Code, Section III, plus applicable and appropriate Addenda and Code Cases.

The welding materials used for joining the ferritic base materials of the ESF conform, or are equivalent, to ASME Material Specifications SFA-5.1, SFA-5.2, SFA-5.5, SFA-5.17, SFA-5.18, and SFA-5.20. The welding materials used for joining nickel-chromium-iron alloys in similar base material combination and in dissimilar ferritic or austenitic base material combination conform to ASME Material Specifications SFA-5.11 and SFA-5.14. The welding materials used for joining the austenitic stainless steel base materials conform to ASME Material Specifications SFA-5.4 and SFA-5.9. These materials are qualified to the requirements of the ASME Code Section III and Section IX and are used in procedures which have been qualified to these same rules. The methods utilized to control delta ferrite content in austenitic stainless steel weldments are discussed in Sections 5.2.3 and 1.8.

All parts of components in contact with borated water are fabricated of, or clad with, austenitic stainless steel or equivalent corrosion-resistant material. The integrity of the safety-related components of the ESF is maintained during all stages of component manufacture. Austenitic stainless steel is utilized in the final heat treated condition as required by the respective ASME Code Section II material specification. Furthermore, austenitic stainless steel materials used in the ESF components are required to be handled, protected, stored, and cleaned according to recognized and accepted methods designed to minimize contamination which could lead to stress corrosion cracking. Section 5.2.3 discusses the rules covering these controls stipulated in Westinghouse specifications and provides additional information concerning austenitic stainless steel, including the avoidance of sensitization and the prevention of intergranular attack. No cold worked austenitic stainless steels

having yield strengths greater than 90,000 psi are used for components of the ESF within the Westinghouse standard scope.

Westinghouse supplied ESF components within the containment that would be exposed to core cooling water and containment sprays in the event of a LOCA utilize materials listed in Table 6.1-2. These components are manufactured primarily of stainless steel or other corrosion-resistant material. Westinghouse has conducted a test program to evaluate the integrity of construction materials for ESF equipment when exposed to post-DBA conditions wherein the test conditions conservatively represented post-DBA conditions (Whyte and Picone 1971). The test program considered spray and core cooling solutions of the design chemical compositions, as well as the design chemical compositions contaminated with corrosion and deterioration products which may be transferred to the solution during recirculation. The effects of sodium (free caustic), chlorine (chloride), and fluorine (fluoride) on austenitic stainless steels were considered. Based on the results of this investigation, as well as testing by ORNL and others, the behavior of austenitic stainless steels in the post-DBA environment is acceptable. No cracking is anticipated on any equipment even in the presence of postulated levels of contaminants, provided the core cooling and spray solution pH is maintained at an adequate level. The inhibitive properties of alkalinity (hydroxyl ion) against chloride cracking and the inhibitive characteristic of boric acid on fluoride cracking have been demonstrated.

Section 1.8 provides information concerning compliance with Regulatory Guides 1.31, 1.37, and 1.44.

The integrity of safety-related balance of plant and primary plant components of the ESF has been maintained throughout component manufacture and installation.

#### 6.1.1.2 Composition, Compatibility, and Stability of Containment Spray and Safety Injection Coolants

The method used for controlling the recirculated sump solution pH is discussed in Section 6.2.2.

Following an accident that initiates sprays, the aqueous phase inside containment is maintained in the long term by the containment sump pH control system using sodium tetraborate consistent with the description in Section 6.5.2.

Stress corrosion cracking of stainless steel piping in simulated pressure-suppression and fission product absorption sprays was investigated by Griess and Creek (1971) for the USAEC. It was found that the higher pH borate solutions (pH of 6.5 and 7.5) caused little or no stress corrosion cracking of this material.

Hydrogen generation due to the corrosion of metals and the control of the hydrogen within the containment following a LOCA are discussed in Section 6.2.5.

The vessels used for storing ESF coolants include the safety injection accumulators, and the refueling water storage tank (RWST).

The accumulators are filled with borated water and pressurized with nitrogen gas. The accumulators are carbon steel clad with austenitic stainless steel. Principal design parameters of the accumulators are listed in Table 6.3-1.

The RWST is the source of borated cooling water for quench spray and safety injection. The RWST is austenitic stainless steel. Principal design parameters of the RWST are given in Section 6.2.2.2.

The containment sump pH control system contains sodium tetraborate in stainless steel baskets. Principal design parameters are given in Section 6.2.2.2.

Significant corrosive attack on the vessels used for storing the ESF coolants is not expected because of the corrosion resistance of the materials used and the absence of chlorides.

The quantity and identity of all soluble acids and bases within containment, and an estimate of the time-history of the pH of the aqueous phase in the containment sump, are identified in Section 6.5.

#### 6.1.2 Organic Materials

##### 6.1.2.1 Balance of Plant (Inside Containment)

The organic materials existing inside the containment consist principally of paint, coatings, and insulation. There are no significant quantities of wood, plastics, lubricants, or other organic materials inside the containment.

The containment is composed of concrete and steel, neither of which is subject to radiolytic or pyrolytic decomposition. All concrete surfaces of the containment structure are coated with paint with a normal dry film thickness of 0.042 in. All steel surfaces of the containment structure, except for approximately 4600 ft.<sup>2</sup> of steel, are coated with paint with a normal dry film thickness of 0.008 in. Approximately 4600 ft.<sup>2</sup> of steel are coated with only primer paint. The primed surfaces comprise a small percentage and will not adversely affect plant operability or significantly impact decontaminability, since steel surfaces can be easily washed down. The following criteria utilized for the selection of protective coatings and paints for use within the containment:

1. Major surfaces

- a. This category includes the containment liner, structural steel, large equipment supports, hangers, embedments, the polar crane, restraints, etc.
- b. The coatings comply with Regulatory Guide 1.54, as discussed in Section 1.8.
- c. The coatings are tested in an environment at least as severe (in terms of maximum temperature and pressure and their transient gradients) as those anticipated within the containment in the event of a DBA to demonstrate their ability to maintain their integrity.
- d. The DBA simulation tests conducted for the purpose of validating the acceptability of the coatings to be used are, in general, in accordance with ANSI N101.2-1972.

2. Minor surfaces

- a. This category includes routine touchup of damaged coatings, spot priming of bare areas, damaged galvanizing, bolt heads, nuts, miscellaneous fasteners, tack and stud welds, concrete patches, color codings, surfaces inaccessible for optimal processing, etc.
- b. Protective coating systems, which have been independently laboratory type-tested to LOCA or other applicable DBAs, are applied whenever feasible. The significant process control parameters verified by testing (for example, surface preparation and film thickness) are imposed.

However, imposing the extensive, explicit quality assurance (QA) criteria of ANSI N101.4-1972 is deemed impractical. Appropriate quality control (QC) criteria are imposed and verified via QA surveillance. Although tested paint provides a high degree of assurance of post-DBA film integrity when applied under proper processing conditions and monitored to assure a quality application, surfaces painted in this manner are recorded as unidentified coatings in accordance with the following item 3.

3. Miscellaneous surfaces

- a. This category includes components such as valve bodies, handwheels, electrical cabinetry, control panels, loudspeakers, emergency light cases, and miscellaneous off-the-shelf components.



- b. Because of the impracticability of imposing the Regulatory Guide requirements on the standard shop processes used in painting these items, Regulatory Guide 1.54 is not invoked when shop priming and, subsequently, when finish painting, since the total surface of such items is relatively small when compared to the total surface area for which QA requirements are imposed. The total estimated surface area covered by unqualified paint (that is, coating work which is not in accordance with any particular material, process, or QC criteria) is recorded. This category includes certain portions and subassemblies of components and equipment generally painted in accordance with the full QA requirements outlined in the previously mentioned item 1 (for example, it is not practical to procure pipe hanger spring cans with anything other than unqualified paint).
- c. In general, stainless steel and corrosion-resistant alloys are not painted.
- d. No special QA requirement is imposed when painting surfaces which will be insulated.

The amounts of such coatings are evaluated to ensure that the coatings do not prevent the ESF from performing their intended function.

Final choice of paint type depends on the results of testing. Tests to date indicate neither radiolytic nor pyrolytic decomposition.

Overcoating is not intended during the service life. However, when specific areas require it, the total coating thickness expected to be accumulated will not be in excess of the thicknesses qualified by simulated DBA tests or these areas will be evaluated as discussed previously for miscellaneous surfaces.

Plastics and elastomers used in ESF components are selected based on their ability to maintain satisfactory properties after exposure to design radiation levels. No adverse interactions with ESF are likely as a result of materials released by radiation decomposition or chemical reaction of the organic materials in the post-accident environment.

#### 6.1.2.2 Westinghouse Scope of Supply

Compared with the total painted surfaces inside the containment, the painted surfaces of Westinghouse-supplied equipment comprise a small percentage. Table 6.1-3 quantifies the significant amounts of protective coatings on Westinghouse-supplied components located inside the containment building.

For large equipment requiring protective coatings (Table 6.1-3), Westinghouse specifies or approves the type of coating systems utilized; requirements with which the coating system must comply are stipulated in Westinghouse process specifications which supplement the equipment specifications. For these components, the generic types of coatings used are zinc-rich silicate or epoxy-based primer with or without chemically-cured epoxy or epoxy-modified phenolic top coat.

The remaining equipment, which requires protective coatings on much smaller surface areas, is procured from numerous vendors. For this equipment, Westinghouse specification require that high quality coatings be applied using good commercial practices. Table 6.1-3 identifies the typical types of equipment and the approximate quantities of protective coatings on such equipment.

Westinghouse has conducted tests to evaluate the suitability, during post-DBA conditions, of protective coatings to be used in the reactor containment (Westinghouse 1971). Tests have shown that certain epoxy and modified phenolic systems are satisfactory for use in the containment. This evaluation considered resistance to high temperature and chemical conditions anticipated during a LOCA, as well as high radiation resistance.

Information regarding compliance with QA requirements for protective coatings has been submitted to the U.S. Nuclear Regulatory Commission (USNRC) for review (Westinghouse 1977) and has been accepted as satisfactory (USNRC 1977).

#### 6.1.3 References for Section 6.1

Berry, W.E. 1971. Corrosion in Nuclear Applications. John Wiley and Sons, New York, N.Y.

Griess, J.C. and Baccarella, A.L. 1969. Design Considerations of Reactor Containment Spray Systems, The Corrosion of Materials in Spray Solutions. USAEC Report ORNL-TM-2412, Part III, Oak Ridge National Laboratory.

Griess, J.C. and Creek, G.E. 1969. Design Considerations of Reactor Containment Spray Systems, Corrosion Tests with Low pH Spray Solution. USAEC Report ORNL-TM-2412, Oak Ridge National Laboratory.

Griess, J.C., and Creek, G.E. 1971. Design Considerations of Reactor Containment Spray Systems, The Stress Corrosion Cracking of Types 304 and 316 Stainless Steel in Boric Acid Solutions. USAEC Report ORNL-TM-2412, Part X, Oak Ridge National Laboratory.

National Association of Corrosion Engineers (NACE) 1967. Proceedings of Conference: Fundamental Aspects of Stress Corrosion Cracking. Ohio State University.

Perry, R.H. Chilton, C.H. 1973. Chemical Engineers Handbook. Fifth Edition, McGraw-Hill Book Co., New York, N.Y.

Scharfstein, L.R. and Brindley, W.F. 1958. Corrosion, Vol. 14, National Association of Corrosion Engineers, Houston, Texas, 558t.

Uhlig, H.H. 1948. Corrosion Handbook. John Wiley and Sons, New York, N.Y.

U.S. Nuclear Regulatory Commission (USNRC) 1977. Personal communication between C.J. Heltemes, Jr., USNRC, Quality Assurance Branch and C. Eicheldinger, Westinghouse, PWRSD, letter-dated April 27, 1977.

Westinghouse Electric Corporation (Westinghouse) 1971. Evaluation of Protective Coatings for Use in Reactor Containment. WCAP-7825.

Westinghouse 1977. Personal communication between C. Eicheldinger Westinghouse, PWRSD, Nuclear Safety Department and C. J. Heltemes, Jr. USNRC, Quality Assurance Branch), letter NS-CE-1352 dated February 1, 1977.

Whyte, D.D. and Picone, L.F. 1971. Behavior of Austenitic Stainless Steel in Post Hypothetical Loss of Coolant Environment. WCAP-7803, Westinghouse.

BVPS-2 UFSAR

Tables for Section 6.1

TABLE 6.1-1

TYPICAL MATERIALS EMPLOYED FOR COMPONENTS OF ENGINEERED  
SAFETY FEATURES SYSTEMS BALANCE OF PLANT

<u>Component and Material</u> <sup>(1)</sup>	<u>Material</u> <sup>(1)</sup> <u>Specification</u>
Piping	
Stainless steel	SA-312 Tp. 304, SA-376 Tp. 316, SA-312 Tp. 316, SA-358 Tp. 304 Cl. 1, SA-376 Tp. 304, SA-358 Tp. 316 Cl. 1
Carbon Steel	SA-106, Gr. B, SA-155 Gr. KC 70 Cl. 1, SA-155 Gr. C 55 Cl. 1
Fittings, connections and flanges	
Stainless steel	SA-403 WP 304, SA-182 F 316, SA-403 WP 316 W, SA-403 WP 316, SA-182 F 304, SA-403 WP 304 W
Carbon Steel	SA-105, SA-234 WPB, SA-181 Gr. 1, SA-234 WPC, SA-216 WCB
Bolting	
Studs	SA-193 Gr. B6, SA-193 Gr. B7
Nuts	SA-194, Gr. 6, SA-194 Gr. 2H, SA-194 Gr. 7
Containment spray nozzles	SA-351 CF8, 304 S/S
Recirculation spray pumps	
Suction casing	SA-358 Tp. 304 Cl. 1 and SA-240 304L
Discharge column	SA-312 Tp. 304L
Discharge head`	SA-312 Tp. 304L, SA-182 F 304L, SA-240 Tp. 304L
Discharge flange	SA-182 F 304L
Bolting	SA-193 G4. B8 Cl. 1
Bowls	A-351 CF8
Mechanical seal	Tungsten carbide, carbon, SA-182-304L, SA-312-304L, SA-340-304L

TABLE 6.1-1 (Cont)

<u>Component and Material</u> <sup>(1)</sup>	<u>Material</u> <sup>(1)</sup> <u>Specification</u>
ESF sumps	
Plate	SA-240 Tp. 304
Trash racks	304 stainless steel
Perforated plate	304 stainless steel
Valves	
Stainless steel	
Bonnet studs	SA-193 Gr. B6, SA-193 Gr. B8, SA-193 Gr. B8M
Valve stems	17-4 PH, 316 S/S
Body castings	SA-351 CF8, SA-351 CF8M
Body forgings	SA-182 F304, SA-182 F316
Packing	John Crane 187-I-CR or equal
Bonnet nuts	SA-194 Gr. 8, SA-194 Gr. 6, SA-194 Gr. 7
Carbon steel	
Bonnet studs	SA-193 Gr. B7
Bonnet nuts	SA-194 Gr. 2H/7
Valve stems	SA-182 F6 tempered, forged 13% Cr
Body castings	SA-216 WCB
Body forgings	SA-105 Gr. II
Packing	John Crane 187-I-CR or equal
Seat seals and seal rings	
Metallic	Austenitic SS, SA-182 F6, 12% Cr
Plastic	Polyethylene, nylon
Elastomers	Rubber, viton
Recirculation spray coolers	
Tubes	SA-249 Tp. 304
Shell	304 S/S
Tube sheet	304 S/S
Cross and long baffles	304 S/S
Channel and channel cover	Carbon steel
Quench Pumps	
Casing	SA-351 CF8
Impeller	SA-351 CF8
Impeller rings	304 S/S overlaid with Colmonoy 6
Casing rings	304 S/S overlaid with Colmonoy 4
Shaft	17-4pH - condition H1100

TABLE 6.1-1 (Cont)

<u>Component and Material</u> <sup>(1)</sup>	<u>Material</u> <sup>(1)</sup> <u>Specification</u>
Welding material	
Ferritic steels	ASME SFA-5.1, 5.5, 5.17, 5.18, and 5.20
Austenitic stainless steel Ferritic to austenitic	ASME SFA-5.4 and 5.9
Field installation	ASME SFA-5.11 and 5.14 or ASME SFA-5.4 and 5.9 Type 309 S/S
Shop fabrication	ASME SFA-5.11 and 5.14 or ASME SFA-5.4 and 5.9 Type 309 S/S

## NOTE:

- (1) Materials listed in this table may have been replaced with materials of equivalent design characteristics. The term equivalent is described in UFSAR Section 1.12, "Equivalent Materials".

TABLE 6.1-2

TYPICAL MATERIALS EMPLOYED FOR COMPONENTS OF ENGINEERED  
SAFETY FEATURES SYSTEMS NUCLEAR STEAM SUPPLY SYSTEM

<u>Component and Material</u> <sup>(1)</sup>	<u>Material</u> <sup>(1)</sup> <u>Specification</u>
Valves	
Bodies	SA-182, Tp. F316; SA-351, Gr. CF8 or CF8M, SA-105, Gr. II, SA-476, Tp. 316; A216 Gr. WCB
Bonnets	SA-182, Tp. F316; SA-351, Gr. CF8 or CF8M, SA-479; Tp. 316; A216 Gr. WCB; Haynes alloy No. 6B; SA-240, Tp. 316
Discs	SA-182, Tp. F316; SA-564, Gr. 630; SA-351, Gr. CF8 or CF8M, SA-479, Tp. 316; Stellite No. 6
Pressure-retaining bolting	SA-453, Gr. 660, SA-193 Gr. B7
Pressure-retaining nuts	SA-453, Gr. 660; SA-194, Gr. 6; SA-193, Gr. B6, SA-194, C12H, SA-194 Gr. 7
Auxiliary heat exchangers	
Heads	SA-240, Tp. 304; SA-515-70
Nozzle necks	SA-182, Gr. F304; SA-312, Tp. 304; SA-240, Tp. 304
Tubes	SA-213, Tp. 304; SA-249, Tp. 304
Tubesheets	SA-182, Gr. F304; SA-240, Tp. 304; SA-516, Gr. 70 with Stainless Steel Cladding A-7 Analysis
Shells	SA-240 and SA-312, Tp. 304 LS SA-285C



TABLE 6.1-2 (Cont)

<u>Component and Material</u> <sup>(1)</sup>	<u>Material</u> <sup>(1)</sup> <u>Specification</u>
Auxiliary pressure vessels, tanks, filters, etc.	
Shells and heads	SA-351, Gr. CF8A; SA-240, Tp. 304; SA-264 Clad Plate of SA-537, Cl 1 with SA-240, Tp. 304 Clad and Stainless Steel Weld Overlay A-8 Analysis
Flanges and nozzles	SA-182, Gr. F304; SA-350, Gr. LF2 with SA-240, Tp. 304 and Stainless Steel Weld Overlay A-8 Analysis
Piping	SA-312 and SA-240, Tp. 304 or Tp. 316 Seamless
Pipe fittings	SA-403, Tp. 304 Seamless
Closure bolting and nuts	SA-193, Gr. B7 and SA-194, Gr. 2H
Auxiliary pumps	
Pump casing and heads	SA-182, Gr. F304 or F316; SA-351, Gr. CF8
Flanges and nozzles	SA-182, Gr. F304 or F316; SA-403, Gr. WP 316L Seamless
Stuffing or packing box cover	SA-182, Gr. F304; SA-351, Gr. CF8 or CF8M; SA-240, Tp. 304 or 316
Closure bolting and nuts	SA-193, Gr. B6 and B7; SA- 453, Gr. 600; and Nuts, SA-194, Gr. 6 and 7 SA-193, Gr. B6X; SA-194, Gr. 2H
Piping	SA-312, Tp. 304 or 316 Seamless
Pipe fittings	SA-403, Gr. WP316L Seamless SA-182, F316

## NOTES

- (1) Materials listed in this table may have been replaced with materials of equivalent design characteristics. The term equivalent is described in UFSAR Section 1.12, "Equivalent Materials".

TABLE 6.1-3

PROTECTIVE COATINGS ON WESTINGHOUSE-SUPPLIED EQUIPMENT  
INSIDE THE CONTAINMENT

<u>Component</u>	<u>Painted Surface Area (ft<sup>(2)</sup>)</u>
Reactor coolant pump motors	2,500
Accumulator tanks	4,200
Manipulator crane	2,600
Other refueling equipment	2,125
Remaining equipment (such as valves, auxiliary tanks, heat exchanger supports, transmitters, alarm horns, and small instruments)	<1,300

## 6.2 CONTAINMENT SYSTEMS

### 6.2.1 Containment Functional Design

#### 6.2.1.1 Containment Structure

##### 6.2.1.1.1 Design Bases

The containment structure is designed in accordance with General Design Criteria (GDC) 13, 16, 38, 50, and 64 (Section 3.1). The criteria are amplified as follows:

1. The peak calculated containment pressure following the design basis accident (DBA) remains below the containment design pressure of 45 psig. The loss-of-coolant accident (LOCA), which results in the highest calculated containment pressure, is the DBA for the containment structure (containment integrity DBA) design.
2. A spectra of accidents and single failures, combined with simultaneous occurrences such as seismic events and loss of offsite power (LOOP), are considered to establish the containment peak pressure and depressurization time.
3. The containment minimum design pressure is the minimum calculated pressure that results from inadvertent actuation of the containment depressurization system. Section 6.2.1.1.3.5 provides a description of the analysis.
4. The design bases for the containment internal structures (subcompartments) are given in Section 6.2.1.2.
5. The sources and rates of mass and energy released into the containment for the LOCA and the main steam line break (MSLB) accidents are described in Sections 6.2.1.3 and 6.2.1.4, respectively.
6. The design bases of the containment depressurization system as an energy removal system are described in Section 6.2.2.
7. The calculated containment pressure is reduced to less than half of the peak pressure within 24 hours.
8. After depressurization, the containment pressure is maintained below atmospheric pressure for at least 30 days. The accident conditions which result in the maximum subatmospheric pressure is the DBA for maintaining subatmosphere pressure.

9. The capability for post-accident pressure reduction and energy removal from the containment under various single failure conditions in the engineered safety features (ESF) is discussed in Section 6.2.2.
10. The containment system is designed to limit fission product leakage following a LOCA. Chapter 15 discusses the analysis.
11. The bases for the containment back pressure analysis used for the emergency core cooling system (ECCS) analysis are discussed in Section 6.2.1.5.
12. Instrumentation capable of operating in the post-accident environment is provided to monitor the containment atmosphere pressure and temperature and the sump water temperature and level following a LOCA. Section 7.5 describes the equipment and the parameters recorded. Section 3.11 gives a discussion of the qualification of the instrumentation for post-accident environment operation.
13. The containment structure is designated Seismic Category I. (Section 3.2),

#### 6.2.1.1.2 Design Features

The containment structure is a cylindrical, carbon steel-lined, reinforced concrete structure which encloses the components and major piping within the reactor coolant pressure boundary. The structure is designed to contain the radioactive fluids and fission products that may result from postulated LOCAs inside the containment.

The containment is an atmospheric type containment. During normal operation, the containment structure is maintained near atmospheric pressure (typically 12.8 to 14.2 psia).

Arrangements and crosssections of the containment structure are shown on Figures 3.8-1, 3.8-2, 3.8-3, 3.8-4, 3.8-5, 3.8-6 and 3.8-7. The structural design is described in Section 3.8. The design provisions to protect the containment structure and ESF systems against loss of function from dynamic effects (for example, missiles and pipe whip) that could occur following postulated LOCAs are described in Sections 3.5 and 3.6. Applicable codes and standards are identified in Section 3.8.1.2.

The containment structure is designed to withstand internal pressurization from high energy pipe breaks within the structure (Section 6.2.1.1.3.2) and external pressurization due to inadvertent actuation of the containment depressurization system (Section 6.2.1.1.3.5). The containment maximum internal design pressure is 45.0 psig and the minimum internal design pressure is 8 psia.

The internal design of the containment structure allows air to circulate freely. All cubicles and compartments within the containment are open at their tops to allow air circulation. Convective mixing in conjunction with containment spray assures a uniform mixture of hydrogen in the containment. Section 6.2.5 discusses combustible gas control in the containment.

The containment structure is equipped with a containment sump located at the outer wall of the containment (Figure 6.2-128). Sufficient openings exist in the upper floors and structure of the containment to allow water generated from accident conditions to drain to the containment sump.

Spray water that falls into the refueling cavity will drain into either the fuel transfer canal or the reactor cavity. The entrapment of this water in these areas has been accounted for in the DBA analysis.

Section 6.2.2.3.2 discusses the net positive suction head (NPSH) requirements for the recirculation spray pumps.

#### 6.2.1.1.3 Design Evaluation

This section describes the method used to evaluate the functional capability of the containment design. It also describes the computer code MAAP-DBA developed by Fauske and Associates (FAI 2005) that is utilized to evaluate the spectrum of pipe ruptures.

Sections 6.2.1.1.3.6 through 6.2.1.1.3.8 provide the results of analyzing a spectrum of pipe ruptures for the primary and secondary systems.

#### 6.2.1.1.3.1 Internal Pressures

A pressure peak occurs near the end of the initial blowdown of the RCS after a double-ended rupture (DER) of either a hot leg or in the crossover leg at the pump suction. Its magnitude is a function of the following parameters:

1. The containment free volume,
2. The mass of air inside the containment structure (a function of initial pressure and temperature),
3. The amount of mass and energy that flows out of the break during the initial blowdown of the RCS, and
4. The rate of heat removal from the containment atmosphere by the containment heat sinks.

The highest peak pressure occurs after a DER of a hot leg. This event releases the most energy to the containment atmosphere during the initial blowdown, since the hot leg pipe size is larger than that of an RCS pump suction, and there is no resistance to flow due to an RCS pump as is the case with a pump suction DER. The magnitude of this peak pressure is independent of the active ESF (minimum or normal) because they do not become effective until after the first peak is reached. However, the accumulators do have a small effect on the first peak.

Following the core reflooding period, the containment depressurization systems and the containment passive heat sinks remove energy from the containment atmosphere at a rate sufficient to rapidly reduce the pressure. The depressurization time is a function of the following parameters:

1. The containment free volume,
2. The mass of air inside the containment structure,
3. The rate of heat removal (or addition) from (or to) the containment atmosphere by the passive heat sinks within the containment structure,
4. The rate of heat removal from the containment atmosphere by the CHRS,
5. The rate of mass and energy release to the containment from the break following the end of core reflooding, and
6. The mass of nitrogen added to the containment from the accumulators' gas space.

After the containment is depressurized, the systems continue to remove energy from the containment at a rate sufficient to maintain the containment depressurization. The passive heat sinks may add energy back to the containment atmosphere following depressurization. The containment experiences two other pressure peaks when the capacity of the depressurization systems are reduced. The first pressure peak occurs after one-half of the operating recirculation pumps are switched from containment spray to core injection. The second pressure peak occurs when the refueling water storage tank (RWST) empties (termination of quench spray).

#### 6.2.1.1.3.2 Containment Analysis Analytical Model

The MAAP-DBA code was developed to allow the calculation of containment response attributes for a spectrum of postulated LOCA and main steam line break sequences as part of design basis calculations for BVPS-2 containment. The containment assessment for a design basis application is implemented in a manner consistent with the NRC guidance provided in the Standard Review Plan. This includes the use of Tagami and Uchida heat transfer correlations for the quantification of the passive heat sink responses. The spectrum of containment response attributes to be quantified include the peak containment pressure, the short and long-term containment temperature, the containment liner temperature, the long-term sump water temperature, the available NPSH for ECCS and containment spray pumps, and the maximum service water outlet temperature for the containment heat removal heat exchanger. To address this set of containment response attributes for the spectrum of loss of coolant accident break sizes, both single node and multiple node containment models are used. The single node models apply for those design basis sequences and attributes that employ the Tagami and Uchida heat transfer correlations. For the multiple node applications, a heat and mass transfer analogy based on natural convection is used.

A single node model is used to calculate peak containment pressure and containment liner temperature as well as post accident containment global gas temperature profiles for equipment qualification. A multi-node model is used for NPSH and sump water temperature. This provides improved accountability of water hold up for NPSH and debris transport calculations.

The design bases events analyzed and evaluated include the rupture of a pipe in the Reactor Coolant System (LOCA) and the Main Steam Line Break (MSLB) between the top of the steam generator and the penetration through the containment wall. See Section 6.2.1.1.3.6 for the LOCA results and Section 6.2.1.1.3.7 for the MSLB results. LOCA breaks were evaluated at hot leg, cold leg, and pump suction locations. All these design bases events assumed a 2917.4 Mwt core power. Evaluations for the limiting containment design basis events were evaluated to assess the peak containment pressure, peak containment gas temperature, long term temperatures within the containment, and the peak liner temperatures attributes. To ensure that the most conservative value of each of the attributes was identified and evaluated the most conservative value (max or min) of each input parameter for each attribute was selected.

The mass and energy released to the containment can also vary depending upon a combination of variables such as break size, break location, single active failure, power level, and containment air pressure at the time of the break. The consequences of the breaks can further vary dependent on a variety of possible single active failures that may occur concurrent with the breaks and affect the availability of engineered safety features (ESFs). Single active failures that were considered to identify the "worst single failure" that maximizes the challenge to the containment integrity include:

1. the failure of a single train of engineered safety features such as might occur with the failure of an Emergency Diesel Generator (EDG) coincident with a loss of off-site power,
2. the single failure of the containment isolation phase B signal (CIB), which would result in the failure of one complete train of quench and recirculation sprays to start, which means that the remaining train of sprays would be available to cool the containment atmosphere,
3. the failure of a service water pump to supply cooling water to one train of the recirculation spray heat exchangers (two heat exchangers) which are part of the containment heat removal system,
4. the failure of a timer start relay which would result in the failure of one train of recirculation spray,
5. the failure of a main steam isolation valve (MSLB only),
6. the failure of a main feedwater isolation valve (MSLB only),
7. the failure of one train of quench spray



Operational conditions in the reactor coolant system including the reactor and steam generators were also examined for the worst possible conditions that could influence the mass and energy releases from the break. Section 6.2.1.3 discusses the spectrum of LOCA mass and energy releases and Section 6.2.1.4 discusses the spectrum of MSLB mass and energy releases used as input to the containment analysis.

Thus, the containment analyses were performed in a manner that ensured that the evaluations identified and examined the most severe challenges to successful operation of the containment and its supporting mechanical and electrical safety systems.

#### 6.2.1.1.3.2.1 Application of MAAP-DBA to Containment Analysis

The MAAP-DBA Generalized Containment Model (GCM), which is discussed in detail in BVPS-2 Licensing Amendment 153, was used for DBA evaluations.

#### 6.2.1.1.3.2.2 Parameter File/Nodalization

##### Nodalization

The application of the MAAP-DBA containment model to a commercial nuclear power plant begins with the characterization of the containment building geometry, emergency safeguard systems, etc., in the plant specific parameter file. This parameter file includes specifications for the entire plant, with primary emphasis on the containment information. Secondary information, such as generic data, including the reactor core and the reactor coolant system, are also included in the parameter file. The mass and energy releases are specified as external input data.

When formulating a containment parameter file, the most important decision lies in the specification of the number of nodes used to represent the building. To be consistent with the previous BVPS DBA analyses, the evaluations for peak pressure and temperature are performed using single node models. However, those evaluations which are sensitive to potential water accumulation (holdup) in various locations within the building are performed with multi-node models.

There are a few guidelines to be followed for multi-node models.

1. Each building region which is a separate room or compartment with limited connections (flow paths) to the remainder of the building should be treated as a separate node. For example, the reactor cavity in a typical PWR large dry containment is generally separated from the remainder of the building by a thick concrete biological shield. Furthermore, the walls around the in-core instrument tubes that penetrate through the bottom of the reactor vessel in most PWR designs segregate the region from other compartments. Hence, this region should be one of the nodes. Furthermore, specific rooms such as the in-core instrumentation seal table room that may also be compartmentalized for shielding purposes should also be a separate node.

2. Typically the design basis accident conditions include analyses for a large break RCS LOCA as well as evaluations for a main steam line break. For those accident analyses requiring a multi-node model such as maximum recirculation sump temperature following a large break LOCA, the containment nodalization should include the region surrounding the reactor coolant system, the loop compartment(s), and the region above the operating deck as individual nodes. In this regard, the LOCA conditions considered include any sensitivities related to whether the LOCA is postulated to occur in any of the reactor coolant loops. Consequently, if the reactor coolant loops are in one large compartment, a single node is sufficient. Conversely, if the loop compartments and other RCS components, such as the pressurizer, are in individual rooms, then the nodalization scheme should be expanded to include each of these compartments as a separate node.
3. An important parameter of the DBA evaluations is the sump temperature under accident conditions. Thus, that region in the bottom of the containment which includes the recirculation sump and the floor of the containment outside the reactor cavity should be considered as a separate node.
4. The nodalization scheme needs to be sufficient to represent the potential for light gas stratification in the top of the containment building. Consequently, there should be at least two nodes (one above the other) in the region above the operating deck where light gases, such as steam could accumulate. This is the only region of the BVPS containment model that uses multiple nodes to represent an open region.

Comparisons with large scale experiments have shown that the number of nodes required to represent a large dry containment building is between 10 and 30 nodes depending upon the extent of compartmentalization inside the containment. In general, with the relatively open configuration above the operating deck and in the annular region, the number of nodes to be used to represent a typical large dry containment is less than 20. The nodalization used for Beaver Valley Unit 2 included 17 nodes.

#### Flow Paths/Junctions

The junctions or flow paths connecting the various nodes are also defined in the TOPOLOGY section of the parameter file. These junctions include those paths which are doorways, hatchways, open areas, grating, etc., as well as those flow paths which could be identified for the ventilation systems such as the Containment Air Recirculation Fans. These junctions enable the major flow transport paths to be clearly specified and quantified with respect to their available area, their potential to be flooded by water accumulation, the potential for water accumulation within containment nodes, etc. Hence, this topology entry in the parameter file is very important in providing a realistic characterization, including the potential for global and countercurrent natural circulation, of the containment response to DBA conditions.

### Structural Heat Sinks

Structural heat sink information including the surface areas, thicknesses, materials, whether they are steel lined, whether the outer surface is painted, etc., is also described in the parameter file. During DBA conditions the heat sink response is typically sufficiently slow that only a few heat sinks have the thermal conduction developed through the entire width of the heat sink. Nonetheless the MAAP-DBA parameter file has the capability for all of these heat sinks to be identified as two-sided structures, thereby enabling the parameter file to be used for DBA evaluations as well as for accident analyses evaluations over an extended time period, i.e., hours or days. To accomplish this, the node facing each heat sink surface is identified in the parameter file, i.e., a heat sink face is pointed to the specific node with which it interacts, and its opposite face is pointed to another node.

### Engineered Safeguards

Engineered safeguards that are specific to the containment are also defined in the parameter file, including the containment spray pumps, and the heat exchangers that are used to remove decay heat from the containment during recirculation. The configuration of the ECCS and containment spray pumps must be specified in terms of:

1. those pumps which take suction only from the Refueling Water Storage Tank (RWST),
2. those pumps which take suction from the RWST and are switched over to take suction from the containment sump at containment recirculation,
3. those pumps which only take suction from the containment sump under recirculation conditions.

Heat removal capabilities are identified with the type of pumping system. Issues related to the single failure criterion are addressed in the input decks assembled for each sequence. The parameter file is meant to represent the nominal operating condition for specific systems. As part of this, the configuration also defines whether any pumps are "piggybacked" to the discharge of a lower pressure pump to increase their discharge pressure.

#### 6.2.1.1.3.2.3 Treatment of the Mass and Energy Releases

As discussed in Section 6.2.1.3 and Section 6.2.1.4, there are a number of LOCA and MSLB accident conditions that are analyzed for the containment response. The discharge from the break location is the mass and energy source that is input into the containment analysis.

There are two means of treating the mass and energy releases input to MAAP-DBA for LOCA. For instance, the evaluations for the maximum temperatures within containment following an accident focus on those set of conditions which result in the hottest steam being released to the containment atmosphere, i.e., a double-ended break where the mass

and energy streams from the two sides of the break (the hot water flow rate from the cold leg side and the steam flow from the steam generator side) are discharged into the containment atmosphere as separate streams. Conversely, the evaluations for the minimum available NPSH focus on those conditions which could result in the maximum sump temperature and the largest recirculation flow rate to maximize the frictional losses. In this case, the mass and energy releases from the two sides of the guillotine break are mixed together before entering the containment such that there is minimal steam released to the containment environment and the temperature of the water added to the containment sump is maximized. Therefore, from this description, the mass and energy releases for a similar type of break are manipulated to cover the potential uncertainties related to the break configuration and how this influences the specific attributes that must be evaluated to ensure that the containment is capable of remaining within its design basis envelope for all of the accident conditions considered.

For those accident sequences, which result in the long term response of the containment, after containment recirculation, the mass and energy releases from the RCS are dependent upon the temperature of the containment sump due to the recirculated and injected water. (The sump water may pass through a heat exchanger prior to this injection). Since the sump temperature changes with time, long term evaluations require feedback from the containment evaluation. Specifically, the mass and energy releases need the sump water temperature history such that long term analyses properly incorporate the decreasing temperature of the containment sump. Because of this, the long-term (greater than 3600 seconds) mass and energy release calculations are performed with the MAAP-DBA code. These input functions are used to incorporate the sump water temperature history, and are consistent with the methodology discussed in Section 6.2.1.3. These user defined functions are characterized for the long term discharge from the break for both a mixed discharge and for an unmixed discharge of steam and water. In both cases, the flow rates that are used are those calculated with the methodology discussed in Section 6.2.1.3 and only the specific enthalpies of the discharge flows are calculated to represent the influence of the time dependent RCS injection temperature as the containment cools.

#### 6.2.1.1.3.2.4 Influence of Varying Containment Operating Conditions

Another aspect of the evaluation is the spectrum of operating conditions that could be experienced by the containment at the time that the accident is initiated. For example, the containment pressure may vary between 12.8 and 14.2 psia. Furthermore, the containment atmosphere temperature could be at its maximum value or its minimum value. These types of operating parameters have an influence on the specific attribute being evaluated, and the different boundaries of these operating conditions were investigated to determine the set of conditions which maximizes the challenge to the attributes being evaluated.

#### 6.2.1.1.3.2.5 Input Parameters, Assumptions and Model

Table 6.2-1 through Table 6.2-2a list the heat sink input data and net free volumes utilized in the containment analysis. Table 6.2-3 lists the design evaluation parameters. Table 6.2-4 lists the key input data to MAAP-DBA for pressure calculations.

Based on detailed drawing reviews and site visits and considering the plant-specific features, it was determined that the containment would most appropriately be represented with a 17 node model of the containment (see Figures 6.2-1, 6.2-2 and 6.2-3). This scheme enables the model to represent the individual compartments for each of the three Reactor Coolant System (RCS) loops, the recirculation sump region, the reactor cavity region, the annular region outside of the cooling loops, and three nodes above the operating deck. Using multiple nodes above the operating deck enables the stratification of light gases to be calculated when this is part of the evaluation. The physical flow paths between the containment compartments are also included, as junctions, in the containment model. The junction areas and loss coefficients are based on the plant dimensions and are summarized in Table 6.2-5. MAAP-DBA calculates the quasi steady state nodal pressure distribution at each time step such that inertial effects due to flow acceleration are not required nor calculated due to the relatively slow containment pressurization (containment pressure benchmarks have demonstrated this behavior). Thus, inertial coefficients for each junction are not included in the parameter file.

Major parts of the parameter file include the individual nodal volumes that make up the total containment volume, the volume vs. height function of these nodes such that water accumulation can be properly evaluated, the structural and containment heat sinks within these individual nodes, the surface characterization of the heat sink in terms of whether the surface is painted, how it is painted (number of layers, their thicknesses and the thermal conductivity of each layer), whether the heat sink is concrete, steel or steel lined concrete, etc. Furthermore, the setpoints for system actuation, pump curves, heat exchanger capacities, etc., are also contained in the unit-specific parameter file. The containment node volumes, metal heat sink areas and masses, and concrete heat sink areas and thicknesses included in the containment model, are tabulated in Tables 6.2-2 and 6.2-2a. The heat sinks include structural steel, concrete liners, ventilation ducts and supports, pipes, pipe supports and restraints, and heavy equipment.

The characteristics of the containment spray systems (header elevations and flow rates) are also included in the parameter file. A quench spray (QS) system is actuated on a containment high-high pressure signal and after a start delay, directs cold water from the RWST to the quench spray ring header in containment. A variable quench spray flow rate in gpm is used per train as determined by the pump curve.

After a RWST Low Level coincident with a Containment Pressure High-High Signal, a recirculation spray (RS) system is actuated, which directs water from the containment recirculation sump, through a heat exchanger, and then to the recirculation spray ring header in containment. Containment heat removal is accomplished by the RS heat exchanger. The recirculation spray flow rate as determined by the pump curve is input per train.

#### 6.2.1.1.3.2.6 Acceptance Criteria

An acceptance criterion was developed for each of the types of analyses being performed. These are as follows:

1. peak containment pressure less than 45 psig and the pressure is less than half the peak pressure within 24 hours,
2. peak containment temperature less than the equipment qualification curve,
3. peak liner temperature less than 280°F.

#### 6.2.1.1.3.3 Mass and Energy Releases to Containment

##### Loss-of-Coolant Accident

The rates of mass and energy release to the containment during the blowdown, reflood, and post-reflood periods are discussed in Section 6.2.1.3 for pipe failures at the following locations:

1. Hot leg (between vessel and steam generator)
2. Pump suction (between steam generator and pump)

##### Main Steam Line Break Accident

Section 6.2.1.4 discusses the mass and energy release analysis for secondary system pipe rupture inside the containment.

#### 6.2.1.1.3.4 Description of Passive Heat Sinks

The passive heat sinks include the containment structure, internal concrete, and miscellaneous metal equipment within the containment. The metal heat sinks are distributed within the 17 containment nodes and the concrete heat sinks are modeled with >75 elements for the purpose of this analysis. The thermal properties of the heat sink materials are given in Table 6.2-1.

A description of the sinks used in the containment analysis with a listing of the metal mass and surface area for the metal heat sinks and the slab thicknesses and surface areas for the concrete heat sinks is given in Table 6.2-2.

Each concrete heat sink except the reactor cavity and lower compartment floors are treated as two sided. All of the metal heat sinks are exposed to the containment atmosphere and are treated as single sided slabs.

Resistance to heat transfer at the liner-concrete interface is considered in the containment analysis by use of a conservatively low value of thermal contact conductance of 100 Btu/hr-ft<sup>2</sup> - °F. Since the steel liner is used as a form for pouring of the concrete, and since the concrete mix is very wet, the liner is, in effect, in good thermal contact with the concrete.

The model considers transient heat conduction to the containment structure through the composite thermal resistance made up of the paint film on the steel liner, the liner itself, the liner-concrete interface, and the concrete. See Section 6.2.1.1.3.2.2.1 for further discussion of the treatment of the structural heat sinks.

#### 6.2.1.1.3.5 External Pressure

Inadvertent operation of the containment depressurization system will cause a decrease in the pressure inside the containment, thereby increasing the normal external pressure differential on the containment structure.

The analysis of maximum external differential pressure assumes inadvertent actuation of the quench spray system caused by a single spurious containment isolation Phase B (CIB) signal.

The maximum external pressure differential is calculated by determining the minimum attainable pressure inside the containment and subtracting this value from the average barometric pressure (14.36 psia).

The minimum pressure possible is calculated to be 11.4 psia, based on the following assumptions:

1. Minimum initial air partial pressure,
2. Maximum initial containment temperature, and
3. Final containment temperature which equals the minimum RWST, temperature.

Table 6.2-3 depicts the containment design evaluation parameters.

#### 6.2.1.1.3.6 Loss-of-Coolant Accident Results

The LOCA containment transient analysis was performed with the MAAP-DBA computer code (Section 6.2.1.1.3.2) for a spectrum of pipe break locations. Containment analysis were conducted for large break LOCAs including a double-ended hot leg break (DEHL) and a double-ended pump suction break (DEPS).

Sensitivity analyses were conducted to determine the most challenging set of plant conditions related to the specific attribute being evaluated (i.e., the peak calculated containment pressure). The initial containment conditions which yield the highest peak calculated containment pressure are as follows:

1. Initial containment pressure of 14.2 psia,
2. Initial containment temperature of 108°F, and
3. Initial containment relative humidity of 15%.

The mass and energy releases used in this analysis are discussed in Section 6.2.1.3.

Table 6.2-6 summarizes the peak containment pressures for the large break LOCA cases. The DEHL break case results in the peak calculated pressure of 44.8 psig. The pressures are reported as psig and referenced to an atmospheric pressure of 14.3 psi. As illustrated by this table, all of these sequences result in a pressurization which is less than the design basis value of 45 psig.

Figure 6.2-5 and Figure 6.2-6 illustrate the containment pressure and temperature time history for the DEHL break case. Figure 6.2-7 and 6.2-8 illustrate the containment pressure and temperature time histories for the DEPS break with minimum containment safeguards (Min SI) and Figure 6.2-9, and 6.2-10 illustrate the containment pressure and temperature time histories for the DEPS break with maximum containment safeguards (Max SI) cases. The containment sump temperature transients for each of the DEPS cases are given on Figure 6.2-11.

The sequence of events are summarized in Tables 6.2-7, 6.2-8 and 6.2-9. See Section 6.2.1.3 for an illustration of the energy distribution in the nuclear steam supply system (NSSS) prior to the break, at the end of the primary system blowdown, and during other periods of the postulated accident.

As mentioned previously, the acceptability of the results for the containment pressure is that the design basis break conditions analyzed using design basis methodology for the mass and energy releases to the containment must be less than the design basis structural capability of 45 psig. As demonstrated by analyses for various types of break conditions and mass and energy releases, these results meet the acceptance criteria of less than 45 psig. Also, the calculated pressure transients demonstrate that the containment pressure is reduced to below one-half of the peak pressure within 24 hours.



#### 6.2.1.1.3.7 Main Steam Line Pipe Break Results

The MSLB containment transient analysis was performed with the MAAP-DBA computer code (Section 6.2.1.1.3.2). The program is used to calculate the thermodynamic state of the containment due to the mass and energy addition to the containment atmosphere.

Main steam line breaks can be postulated to occur with the plant in any operating condition, ranging from hot shutdown to full power. Because of the opposing effects of changing power level on MSLB mass and energy releases, no single power level can be singled out as a worst initial condition for the MSLB. Therefore a spectra of power levels, spanning the operating range (100.6 percent, 70 percent, and 30 percent), as well as the hot shutdown condition, have been analyzed. A spectra of MSLB accidents covering different break areas, single-active failures and reactor operating power levels are analyzed. The mass and energy releases are discussed in Section 6.2.1.4.

The single-active failures addressed include:

1. The failure of the containment isolation phase B (CIB), which results in the failure of one complete train of quench spray to start (this failure also results in the failure of one train of recirculation spray, however no credit is taken in the MSLB containment analysis for the recirculation spray system),
2. the failure of a main steam isolation valve (MSIV),
3. the failure of a main feedwater isolation valve (MFIV), and
4. the failure of an Emergency Diesel Generator (EDG) which results in the failure of one train each of Safety Injection, Quench Spray, and Service Water.

In addition, the containment initial conditions (pressure, temperature and relative humidity) are also factors in selecting the governing MSLB cases. Sensitivity analyses were conducted to determine the most challenging set of plant conditions related to the specific attribute being evaluated (i.e., the peak calculated containment temperature). Table 6.2-3 presents the input data used in the peak pressure analysis.

The containment pressure history was analyzed for each sequence using the mass and energy releases, assuming that the main steam line break occurred in the region immediately above the operating deck where the steam lines exit the steam generator and then run horizontally toward the containment wall.

More than 20 Break cases were analyzed to cover the different possibilities of power level, break type and size, single active failure, and initial conditions. Results show that the peak containment pressure occurs following a 1.069 ft<sup>2</sup> Double-ended Rupture (DER) with a Main Steam Isolation Valve (MSIV) Failure at 30 percent Power. The peak calculated containment pressure for this case is 39.3 psig. Results show that the peak containment temperature occurs following a 1.069 ft<sup>2</sup> Double-ended Rupture (DER) with a Main Steam Isolation Valve (MSIV) Failure at Full Power. The peak calculated containment temperature for this case is 343.9°F.

Table 6.2-10 and Table 6.2-11 summarize the peak containment pressure and peak containment temperature results respectively. Figures 6.2-12, 6.2-13, 6.2-14 and 6.2-15 illustrate the containment pressure and containment temperature transients for the two limiting cases.

The qualification of safety-related equipment inside the containment to the pressure and temperature cases resulting from a MSLB is discussed in Section 3.11.

The chronology of events for the limiting containment pressure and temperature cases is given in Tables 6.2-12 and 6.2-13.

#### 6.2.1.1.3.8 Feedwater Pipe Break Results

The feedwater pipe break is not as severe as the main steam line break since the break effluent is at a lower specific enthalpy. Therefore, the feedwater pipe break is not analyzed.

#### 6.2.1.2 Containment Subcompartments

##### 6.2.1.2.1 Design Bases

The containment subcompartments are designed in accordance with GDC 4 and 50.

Break locations, types, and areas used for the design of containment subcompartments are as follows and described in Section 6.2.1.2.3.1:

1. Pressurizer subcompartments
  - a. Upper pressurizer cubicle - spray line DER,
  - b. Lower pressurizer cubicle - surge line DER, and
  - c. Pressurizer relief tank cubicle - surge line DER.
2. Steam generator subcompartments - RCS 707 in<sup>2</sup> longitudinal intrados split break at the steam generator inlet elbow.
3. Reactor cavity subcompartment - RCS 150 in<sup>2</sup> cold leg limited displacement rupture (LDR) at the reactor vessel nozzle. Justification for each break, size, and location, and the use of pipe restraints to limit the break area are described in Section 3.6.

##### 6.2.1.2.2 Design Features

Figures 3.8-1, 3.8-2, 3.8-3, 3.8-4, 3.8-5, 3.8-6 and 3.8-7 provide detailed plan and elevation drawings of the containment subcompartments showing the component and equipment locations. The volume and vent areas for each subcompartment are discussed in Section 6.2.1.2.3.3.

##### 6.2.1.2.3 Design Evaluation

Containment subcompartment analyses are performed to calculate the pressure gradient transient across major equipment, supports, and walls that will result from postulated pipe ruptures. The resulting pressure gradients are used to calculate the loads and moments on major equipment and supports. The maximum differential pressures across the subcompartment walls are used as the design basis for the structures.

A model is developed for each subcompartment to predict a conservative transient pressure response. Each subcompartment is subdivided into a network of control volumes or nodes. Boundaries between control volumes, which represent junctions or vent paths, are located at physical discontinuities where geometric influences are expected to create a pressure differential. A detailed description of each subcompartment model is given in Section 6.2.1.2.3.3.

The assumed initial conditions for the subcompartment volumes are conservatively chosen to maximize the resultant differential pressure responses. The values selected are as follows:

Maximum temperature (°F)	105
Minimum air partial pressure (psia)	8.9
Minimum relative humidity (%)	50

The containment subcompartment design evaluations used the THREED computer program (Boyle 1975, Meyer 1981), which considers two-phase, two-component (steam and water-air) flow through the vents and accounts for the fluid inertial effects. Section 6.2.1.2.3.2 provides a detailed description of THREED.

The critical flow correlation typically selected for each vent path is the homogeneous equilibrium model (HEM).

The description of, and justification for, the subsonic and sonic flow model and the degree of entrainment used in the vent flow calculations are given in Section 6.2.1.2.3.2.

In those situations, however, where the component is most vulnerable to a loading induced by the rupture of a pipe not immediately adjacent to the component or where the worst loading results from an overturning moment created by loads away from the break, the Moody choked flow correlation (Moody 1965), with a discharge coefficient of 1.0, is used to yield corresponding high values of flow.

The vent loss coefficients used in the subcompartment analyses depend on the geometry of the particular vent. The values of the total loss coefficients for both forward and reverse flow directions are simply the sum of the head losses for the separate parts of the system. These head losses consist of the following:

1. Contraction and expansion losses are determined as a function of the ratio of the upstream and/or downstream cross-sectional area to the cross-sectional area of the vent.
2. Bend losses resistance is determined by the angle and length of the bend and the hydraulic diameter of the vent.
3. Friction losses, although generally very small, are calculated as an  $fl/d$  term.

4. Form losses are due to objects in the flow path such as grating, and are calculated based on the methods by Idel'chik (1966).

The previous list of losses are defined specifically by Idel'chik. The values of the loss coefficients used in the subcompartment analyses are given in Section 6.2.1.2.3.3.

The RCS mass and energy release rates are provided by the NSSS vendor for each break. The release rates are computed by the SATAN Program (Shepard et al 1975). The initial BVPS-2 operating conditions are selected to yield the maximum calculated blowdown.

#### 6.2.1.2.3.1 Break Type Definitions and Areas

Two types of breaks are used to analyze containment subcompartments. The first type is a guillotine break, which results in complete pipe separation. A guillotine break which results in a break flow area of two pipe cross sections is called a double ended rupture (DER). In some subcompartments, pipe restraints limit the displacement of two broken ends of the pipe so that the break flow area is less than two pipe cross-sectional areas. This type of break is called a limited displacement rupture (LDR).

The second type of break is a longitudinal split which is equivalent to a hole in the pipe.

The break type(s), location(s), and area(s) to which the subcompartment walls and equipment supports are designed are listed in Table 6.2-25. All breaks analyzed within a particular subcompartment are described in Section 6.2.1.2.3.3. Pipe restraints will limit the break area to an equal or smaller area than that analyzed.

The RCS break type(s) and location(s) which are considered in the subcompartment analyses are given by Clout (1973).

Double-ended ruptures are considered in the analysis for the pressurizer cubicle. Breaks with less than two cross-sectional flow areas are used in the analyses for the reactor cavity and steam generator subcompartments.

#### 6.2.1.2.3.2 Subcompartment Analytical Model

##### Functional description of THREED code

The THREED computer program is used to calculate the transient conditions of pressure, temperature, and humidity in various subcompartments following a postulated rupture in a moderate or high energy pipeline. The results obtained from THREED analyses are used to calculate loads on structures and to define environmental conditions for equipment qualification.

The THREED computer program is similar to RELAP4 (Moore and Rettig 1974; Aerojet Nuclear Company (ANC) 1976) and will give the same results as RELAP4 if similar options are chosen. THREED was formulated to perform subcompartment analyses with capabilities and operations extended beyond those available in RELAP4. A significant improvement in THREED is that the HEM has been extended to include two-phase, two-component flow which is encountered in subcompartment analysis.

##### Description of the model

The THREED computer code can be viewed as a numerical integrator for the macroscopic form of the basic field equations describing the conservation of mass, energy, and momentum. The conservation equations, along with the equation of state for the fluid, give a complete solution to the fluid flow phenomena. THREED solves a stream tube form of the field equations based on the assumptions of one-dimensional, homogeneous, thermal-equilibrium flow. Although THREED does not prohibit the use of multidimensional flow paths, the flow paths are modeled to approximate a one-dimensional equation.

Subcompartments are modeled in THREED as a hydraulic network that consists of a series of interconnecting, user-defined nodes (mass and energy control volumes). Nodes are connected by internal junctions (momentum control volumes) with the internodal flow rates determined by the solution of the momentum equation. An internal junction

control volume is defined as the composite volume between the centers of adjacent nodes. This inconsistency in control volumes (a different control volume for momentum than for mass and energy) is illustrated on Figure 6.2-18. This staggered mesh approximation is necessary for purposes of solving the equations.

Fill junctions are dissimilar to internal junctions in that they have no initial node, and their flow rate is dependent only on the junction area and time. These junctions are used to simulate flow originating external to the network (blowdown). Mathematically, they are treated as boundary conditions.

THREED numerically solves finite difference equations which account for mass and energy flows into and out of a node. Figure 6.2-19 summarizes the computational approach used in THREED.

The fluid conservation equations used by THREED can be obtained by integrating the stream tube equations over a fixed volume,  $V$ . The mass and energy equations are developed for the generalized  $i$ -th node, while the momentum equations are developed for the generalized  $j$ -th internal junction connecting nodes  $K$  and  $L$ . Neglecting kinetic energy effects, the resulting equations are as follows:

Conservation of Mass: The mass equation is (ANC 1976).

$$\frac{dM_i}{dt} = \sum_j W_{ij} \quad (6.2-14)$$

where:

$M_i$  = Total mass in node  $i$ : ( $M_i = M_{wi} + M_{ai}$ )

$M_{wi}$  = Total mass of water in node  $i$

$M_{ai}$  = Total mass of air in node  $i$

$W_{ij}$  = Mass flow rate into node  $i$  from junction  $j$

Conservation of Energy: The energy equation for homogeneous flow is (ANC 1976):

$$\frac{dU_i}{dt} = \sum_j W_{ij} (h_{ij} + Z_{ij} - \bar{Z}_i) \quad (6.2-15)$$

where:

$$\begin{aligned}
 U_i &= \text{Total fluid internal energy of water in node } i \\
 h_{ij} &= \text{Local enthalpy at junction } j \text{ of the fluid} \\
 &\quad \text{entering or leaving node } i \\
 Z_{ij} - \bar{Z}_i &= \text{Elevation change from the center of mass in} \\
 &\quad \text{node } i \text{ at } \bar{Z}_i \text{ to junction } j
 \end{aligned}$$

Conservation of Momentum: The incompressible equation for homogeneous flow is (ANC 1976):

$$I_j \frac{dW_j}{dt} = (P_K + P_{Kg_j}) - (P_L + P_{Lg_j}) - f_j \quad (6.2-16)$$

where:

$$\begin{aligned}
 I_j &= \text{Geometric inertia for junction } j \\
 W_j &= \text{Mass flow rate in junction } j \\
 P_K &= \text{Total static pressure in node } K \text{ (at center)} \\
 P_{Kgi} &= \text{Gravity pressure differential from the center of} \\
 &\quad \text{node } K \text{ to junction } j \\
 P_L &= \text{Total static pressure in node } L \text{ (at center)} \\
 P_{Lgi} &= \text{Gravity pressure differential from junction } j \text{ to the} \\
 &\quad \text{center of node } L \\
 F_j &= \text{Static pressure change term}
 \end{aligned}$$

Equation of State: The functional form of the equation of state is:

$$P_i = f(U_i, M_{wi}, M_{ai}) \quad (6.2-17)$$

where:

$$P_i = \text{Total static pressure in node } i$$

The following assumptions are made in deriving the equation of state:

1. The components of water and air form a homogeneous mixture with a uniform temperature.



2. Water, if present, occupies the entire volume. Air, if present, occupies the same volume as the water vapor according to the Gibbs-Dalton Law. Air is assumed to be insoluble in water, and there can be no air present if the volume is filled with liquid water.
3. Air is treated as a perfect gas,
4. If air and liquid water are present, the atmosphere is saturated with water vapor (relative humidity of 100 percent).
5. If air is present, the liquid water conditions are the saturated conditions for  $P_{wi}$ . A more accurate model would have liquid water at the subcooled conditions corresponding to  $P_i$  and  $T_i$ . This assumption is made to limit calls to the water property routines to one per iteration. If no water is present in the volume ( $M_w = 0$ ), the detailed form of the equation of state is:

$$U_i = M_{ai} C_{va} T_i \quad (6.2-18)$$

$$P_i = \frac{M_{ai} R_a T_i}{V_i} \quad (6.2-19)$$

where:

$C_{va}$  = Constant volume heat capacity of air

$T_i$  = Temperature of node i

$R_a$  = Gas constant of air

$V_i$  = Volume of node i

If water is present in the volume ( $M_w \neq 0$ ), the detailed form of the equation state is:

$$V_{wi} = M_{wi} / V_i \quad (6.2-20)$$

$$U_i = M_{wi} U_{wi} (T_i, V_{wi}) + M_{ai} C_{va} T_i \quad (6.2-21)$$

$$P_{ai} = \frac{M_{ai} R_a T_i}{X_i M_{wi} V_{gi} (T_i, V_{wi})} \quad (6.2-22)$$

$$P_i = P_{wi}(T_i, V_{wi}) + P_{ai} \quad (6.2-23)$$

where:

- $V_{wi}$  = Specific volume of water in node i
- $U_{wi}$  = Specific internal energy of water in node i
- $P_{ai}$  = Partial pressure of air in node i
- $X_i$  = Quality of node i
- $V_{gi}$  = Specific volume of water vapor in node i
- $P_{wi}$  = Partial pressure of water in node i

It should be noted that the internal code calculations are done in Systeme Internationale units. The reference temperature used for the calculation of the internal energy of air is zero degrees Kelvin. The properties of steam are based on the 1967 ASME formulation of the properties of steam.

Fill Junctions: These are normally used to input blowdown (mass and energy release) into a node(s). Their functional form is:

$$W_j = f(t) \quad (6.2-24)$$

$$h_{ij} = f(t) \quad (6.2-25)$$

Fan Junctions: These junctions may be used to model ventilation fan operation in situations where such modeling is appropriate. Their functional form is:

$$W_j = f(H_j) \quad (6.2-26)$$

where:

$H_j$  = Head difference across the fan junction

#### 1. Choked Flow Options for Internal Junctions

Since an incompressible flow model has no mechanism to restrict flow through a junction to the maximum allowable (choked) flow rate, it is necessary to use a separate calculation to restrict the flow rate. To determine if the flow is choked, the momentum Equation 6.2-16, is solved using a forward finite difference approximation and compared with a calculated choked flow (HEM or Moody). The lesser flow is selected as the junction flow rate for the time step.

Both the HEM and the Moody (1965) flow model are based on stagnation properties. Since it is not usually possible to calculate the velocity in a node, it is assumed that the static and stagnation properties in a node are the same (neglecting kinetic energy effects). This may result in an underprediction of the choked flow rate, which is conservative in most cases.

#### 2. Homogeneous Equilibrium Model

The HEM is approximated in THREEED using an ideal gas approximation. That is, the choked isentropic ideal gas flow equation is utilized and the isentropic exponent is modified to accommodate two-phase, two-component flow. The isentropic exponent is defined as:

$$\gamma_i = \frac{V_{wi}}{P_i} \left( \frac{\partial P_i}{\partial V_{wi}} \right)_s \quad (6.2-27)$$

where:

$\gamma_i$  = Isentropic exponent in node i

The equation utilized by THREEED to calculate the HEM is:

$$W_j = 12A_j \left( \frac{2}{\gamma_i - 1} \right)^b \sqrt{g_c \gamma_i \frac{P_{ai}}{V_{ai}}} \quad (6.2-28)$$

where:

- b =  $(\gamma_i + 1) / 2 (\gamma_i - 1)$  (6.2-28A)
- A<sub>j</sub> = Flow area of junctions j (ft<sup>2</sup>)
- γ<sub>i</sub> = Isentropic exponent of source node i
- g<sub>c</sub> = Proportionality constant - 32.17 (ft-lbm / lbf-sec<sup>2</sup>)
- P<sub>ai</sub> = Stagnation pressure in source node i (psia)
- V<sub>ai</sub> = Stagnation specific volume of air source node i (ft<sup>3</sup>/lbm)
- W<sub>j</sub> = Mass flow in junction j (lbm/sec)

### 3. Moody Choked Flow Model

The Moody flow model used in THREEED is based on the interpolation of tables from RELAP4/MOD 5 (ANC 1976). The model is for one-component flow and, when air is present, the tables are accessed with the total pressure and average enthalpy of the node.

### 4. Junction Check Valves

A valve may be modeled in any non-fan internal junction as follows:

- Normally closed - trips open instantaneously
- Normally open - trips closed instantaneously

### 5. Time Step Control

If the automatic time step control option is selected, the maximum time step will be limited by the following calculation based on the nodal conditions (ANC 1976):

$$DT = \min \left\{ 0.01 \left| \frac{P_i}{\dot{P}_i} \right| \right\} \quad (6.2-29)$$

where:

$i$  = Node number, from 1 to  $n$

$DT$  = Time step size

$\dot{P}_i$  =  $dP_i / dt$

#### Assumptions employed in THREED

The following assumptions are employed in THREED:

1. Lumped parameter (control volume) approach is utilized,
2. Adiabatic process,
3. Independent inflow (blowdown),
4. Thermodynamic equilibrium in each node,
5. One-dimensional formulation,
6. Staggered mesh for the conservation equations,
7. Incompressible form of the momentum equation,
8. Kinetic energy effects are neglected,
9. For choked flow models, static properties in the nodes considered to be stagnation properties, and
10. Valves open or close instantaneously.

#### 6.2.1.2.3.3 Containment Subcompartment Analysis Results

##### Pressurizer Cubicle and Pressurizer Relief Tank Cubicle

The pressurizer cubicle and the pressurizer relief tank cubicle are analyzed according to the nodalization diagrams shown on Figure 6.2-20. Plan and elevation views depicting the nodal arrangement are shown on Figures 6.2-21, 6.2-22, 6.2-23, and 6.2-24. This nodalization models all significant physical obstructions to flow and is used for predicting loads on the subcompartment walls, pressurizer, and supports.

Vent data and nodal net volumes for the model are listed in Tables 6.2-21 and 6.2-22, respectively.

The following three RCS breaks, listed with the corresponding blowdown distribution, are analyzed:

1. Spray line DER in the upper pressurizer cubicle (100 percent of the blowdown deposited into node 7).
2. Surge line DER at the pressurizer nozzle (100 percent of the blowdown deposited into node 18).
3. Surge line DER in the pressurizer relief tank cubicle (100 percent of the blowdown deposited into node 15).

The mass and energy release rates for the spray line DER and the surge line DER are given in Tables 6.2-23 and 6.2-24, respectively.

The nodal pressure responses for each break described previously are presented on Figures 6.2-25 through 6.2-43.

The peak calculated differential pressures across the pressurizer cubicle walls for the three breaks analyzed are tabulated in Table 6.2-25. These differential pressures are used in the structural analysis of the pressurizer cubicle.

A simultaneous rupture of three 6-inch safety lines in the upper pressurizer cubicle is enveloped by the spray line DER.

#### Steam Generator Cubicle

Steam generator cubicle 2 is nodalized using a 33 node model. The three steam generator cubicles are similar in design, thus the results obtained from analyzing pipe ruptures in cubicle 2 will be representative of the other steam generator cubicles.

The nodalization schematic used in the steam generator subcompartment analysis is shown on Figure 6.2-44. Plan and elevation views of the steam generator cubicle depicting the nodal arrangement are shown on Figures 6.2-45, 6.2-46, 6.2-47, 6.2-48, and 6.2-49. This nodalization models all significant physical obstructions to flow and is used for predicting loads on both the subcompartment walls and major components within the subcompartment.

Vent data and net volumes for the model are listed in Tables 6.2-27 and 6.2-28, respectively.

Three RCS breaks are analyzed to calculate transient pressure responses for the evaluation of loads on components and structures.

The following three RCS breaks, listed with the corresponding blowdown distribution, are analyzed:

1. A 320 in<sup>2</sup> LDR at the steam generator outlet nozzle. One hundred percent of the blowdown is deposited into node 32. The mass and energy release rates are given in Table 6.2-29.
2. A 180 in<sup>2</sup> LDR at the reactor coolant pump (RCP) outlet nozzle. Fifty percent of the blowdown is deposited into both nodes 8 and 9. The mass and energy release rates are given in Table 6.2-30.
3. A 707 in<sup>2</sup> longitudinal intrados split break at the steam generator inlet elbow. Fifty percent of the blowdown is deposited into node 32 and 25 percent into both nodes 7 and 8. The mass and energy release rates are given in Table 6.2-31.

Main steam lines are not routed through any portion of the steam generator cubicle and are not considered in the analysis.

The preceding three breaks are chosen to evaluate loads on the subcompartment walls and component supports. These breaks were chosen from the nine breaks listed in a report by Clout (1973) as limiting cases which envelop conditions resulting from all nine breaks.

The nodal pressure responses for each break analyzed are given on Figures 6.2-50, 6.2-51, 6.2-52, 6.2-53, 6.2-54, 6.2-55, 6.2-56, 6.2-57, 6.2-58, 6.2-59, 6.2-60, 6.2-61, 6.2-62, 6.2-63, 6.2-64, 6.2-65, 6.2-66, 6.2-67, 6.2-68, 6.2-69, 6.2-70, 6.2-71, 6.2-72, 6.2-73, 6.2-74, 6.2-75, 6.2-76, 6.2-77, 6.2-78, 6.2-79, 6.2-80, 6.2-81, 6.2-82, 6.2-83, 6.2-84, 6.2-85, 6.2-86, 6.2-87, 6.2-88, 6.2-89, 6.2-90, 6.2-91, 6.2-92, 6.2-93, 6.2-94, 6.2-95, 6.2-96 and 6.2-97.

The peak calculated pressure differentials (with respect to the bulk containment pressure) are tabulated in Table 6.2-25. These pressure differentials are used in the structural analysis of the steam generator cubicle.

The design of the steam generator cubicle walls above the operating floor (el 767 feet-10 inches) are based on the pressure transients that result from analyzing a 707 in<sup>2</sup> longitudinal intrados split break at the steam generator inlet elbow. The Moody flow correlation with a 1.0 discharge coefficient is used to conservatively calculate high flow rates from the area of the break into the nodes above the operating floor.

The peak calculated pressure differentials (with respect to the bulk containment pressure) are tabulated in Table 6.2-25 for the nodes above the operating floor. These pressure differentials are used in the structural analysis of the steam generator cubicle.

#### Reactor Cavity

The reactor cavity is analyzed utilizing the nodalization schematic shown on Figure 6.2-98. Plan and elevation views of the reactor cavity depicting the nodal arrangement are shown on Figures 6.2-99, 6.2-100, and 6.2-101. This nodalization models all significant

physical obstructions to flow and is consistent with the recommended reactor cavity nodalization presented in the LASL (1979) Report.

The insulation on the ruptured inlet pipe is assumed to block the shield wall pipe penetration vent area instantaneously, thus causing higher pressure differential across the reactor vessel. The neutron shielding material draped over the ruptured pipe is assumed to be ejected from the reactor cavity.

Insulation on the remaining pipes is unaffected by the rupture. However, the neutron shielding material on the outlet pipes on either side of the break are assumed to be displaced, lodging under the other two inlet pipes, thus blocking flow below the cold legs coincidentally with the break occurrence and further increasing the differential pressure across the reactor vessel.

High pressure is assumed to collapse the neutron shielding material that surrounds the reactor vessel in nodes 3, 4, 5, 9, 10, and 11 (Figure 6.2-100), thus preventing the flow from the reactor cavity (nodes 3, 4, and 5) into the reactor annular region (nodes 15, 16, and 17). This assumption is conservative in that it creates a greater overturning moment on the reactor vessel.

The reactor cavity water seal limits air flow out of the top of the annulus and directs the normal ventilation flow through the pipe penetrations to provide cooling for the concrete.

Blowout panels are also located in the incore instrumentation tunnel to prevent overpressurization. The blowout panels are designed to open when the differential pressure across the panels reaches 1.5 to 2.0 psi.

Panels are membranes of approximately 1 lb each, and the probability of impacting critical items of larger mass is extremely small. If impact occurs, no damage to the critical item will result.

The vent area from the upper reactor cavity into the incore instrumentation tunnel (via the reactor annulus and lower reactor cavity) is limited by the neutron shield design. The net vent area out of the incore instrumentation tunnel (52 ft<sup>2</sup>) after the panels open is more than adequate to prevent exceeding the compartment design pressure. This additional vent area, available after the incore instrumentation tunnel blowout panels open, is not included in



the reactor cavity model to conservatively calculate the pressure transients.

A 150 in<sup>2</sup> LDR at the reactor vessel inlet nozzle is analyzed to evaluate loads on the subcompartment walls and component supports. This rupture envelops a 150 in<sup>2</sup> LDR at the reactor outlet nozzle. The blowdown from the break is deposited equally into nodes 4, 5, 10, and 11.

The peak calculated and differentials (with respect to the bulk containment) are tabulated in Table 6.2-25. These pressure differentials are used in the structural analysis of the reactor cavity.

#### 6.2.1.3 Mass and Energy Release Analyses for Postulated Loss-of-Coolant Accidents

The LOCA mass and energy releases for the containment are generated using the Westinghouse March 1979 LOCA mass and energy release model. These releases are used in the containment response calculation. The Westinghouse March 1979 LOCA mass and energy release model has been reviewed and approved by the NRC for use on Westinghouse-designed PWRs, including the conversion to atmospheric containment for the Beaver Valley Units.

The Westinghouse generated LOCA mass and energy releases for the first hour are used in the MAAP-DBA containment response analysis. After this time the Westinghouse rates are still used, however the break enthalpy is calculated, along with the containment response, by MAAP-DBA. This is done in order to account for the influence of the time-dependent safety injection temperature during the recirculation mode of operation.

This section describes the LOCA mass and energy release calculation methodology for the hypothetical double-ended pump suction (DEPS) and double-ended hot-leg (DEHL) break cases. It also explains that the analysis of the DEPS and DEHL LOCAs bounds all current licensing basis LOCAs, including the double-ended cold leg (DECL) break.

##### 6.2.1.3.1 Input Parameters and Assumptions

The mass and energy release analysis is sensitive to the characteristics of various plant systems, in addition to other key modeling assumptions. Where appropriate, bounding inputs are utilized and instrumentation uncertainties are included. Nominal parameters are used in certain instances.

All input parameters are chosen consistent with accepted analysis methodology. Some of the most critical items are the RCS initial conditions, core decay heat, safety injection flow, and primary and secondary metal mass and steam generator heat release modeling. Specific assumptions concerning each of these items are discussed next. Tables 6.2-14, 6.2-14a, and 6.2-14b present key data assumed in the analysis.

Higher RCS operating temperatures to bound the highest average coolant temperature range were used as bounding analysis conditions. The use of higher temperatures is conservative because the initial fluid energy is based on coolant temperatures that are at the maximum levels attained in steady state operation. Additionally, an allowance to account for instrument error and deadband is reflected in the initial RCS temperatures.

The rate at which the RCS blows down is initially more severe at the higher RCS pressure. Additionally the RCS has a higher fluid density at the higher pressure (assuming a constant temperature) and subsequently has a higher RCS mass available for releases.

The selection of the fuel design features for the long-term mass and energy release calculation is based on the need to conservatively maximize the energy stored in the fuel at the beginning of the postulated accident (i.e., to maximize the core stored energy).

The nominal RCS volume is increased because this assumption helps maximize the initial RCS mass and energy.

A minimum uniform steam generator tube plugging (SGTP) level is modeled. This assumption maximizes the reactor coolant volume and fluid release by considering the RCS fluid in all SG tubes. The SGTP assumption maximizes heat transfer area and therefore, the transfer of secondary heat across the SG tubes. Additionally, this assumption reduces the reactor coolant loop resistance, which reduces the pressure drop upstream of the break for the pump suction breaks and increases break flow.

The initial steam generator fluid mass is calculated at full power, and then increased to cover uncertainties. The steam generator water mass and metal mass used conservatively bounds the Model 51 steam generator.

Portions of the SG secondary metal, such as the upper elliptical head, upper shell, and miscellaneous upper internals, have poor heat transfer due to their location in the steam region. The mass of this metal is approximately 216,300 lbm per SG. The stored energy in this metal will be transferred to the RCS and released to the containment at a much slower rate and is not considered during the first hour of the LOCA mass and energy release calculation for the double-ended pump suction breaks. The stored energy in the rest of the SG secondary metal and fluid is released to the containment within the first hour.

After one hour, the Westinghouse LOCA mass and energy calculation has extracted all of the stored energy from the RCS, except for the stored metal energy in the steam generator upper internals and upper elliptical heads. This energy is assumed to be removed at a constant rate over the next six hours and is added to the core decay heat as an energy source for the long-term steaming rate calculation.

Regarding safety injection flow, the mass and energy release calculation considered configurations/failures to conservatively bound respective alignments. These cases include (1) a Minimum Safeguards case (one Charging/High Head Safety Injection pump (CH/HHSI) and one Low Head Safety Injection (LHSI) pump) and (2) a Maximum Safeguards case (two CH/HHSI and two LHSI pumps).

In summary, the following assumptions were employed so that the LOCA mass and energy releases are conservatively calculated, thereby maximizing the energy release to containment:

1. The nominal RCS volume is increased by 3 percent (1.6-percent allowance for thermal expansion and 1.4 percent for uncertainty)
2. The reactor is assumed to be operating at full core rated thermal power (2900 MWT) and an allowance for calorimetric error (+0.6 percent of power) is added.
3. Core-stored energy is based on the time in life for maximum fuel densification. The assumptions used to calculate the fuel temperatures for the core-stored energy calculation account for appropriate uncertainties associated with the models in the PAD code (e.g., calibration of the thermal model, peller densification model, and cladding creep model). In addition, the fuel temperatures for the core-stored energy calculation account for appropriate uncertainties associated with manufacturing tolerances (e.g., pellet as-built density). The total uncertainty for the fuel temperature calculation is a statistical combination of these effects and is dependent upon fuel type, power level, and burn up.
4. The RCS is assumed to be at the maximum expected full power operating temperature and an allowance for temperature measurement uncertainty of +4.0°F is added. These uncertainties conservatively include both deadband and bias.
5. The RCS is assumed to be at the nominal RCS pressure and an allowance for pressure measurement uncertainty of +42 psi was added.
6. Conservatively high heat transfer coefficients (i.e., steam generator primary/secondary heat transfer and reactor coolant system metal heat transfer) are modeled. The SG secondary stored energy is released in one hour. All of the additional stored energy in the upper elliptical head, upper shell, and miscellaneous upper internals, is released at a constant rate over the next 6 hours.
7. The LOCA back-pressure is assumed to remain at the containment design pressure (45 psig). This assumption determines the end of the blowdown phase and minimizes the safety injection flow rate during the reflood phase.
8. A uniform SGTP level of 0% is assumed. This assumption:
  - Maximizes reactor coolant volume and fluid release,
  - Maximizes heat transfer area across the SG tubes,
  - Reduces coolant loop resistance, which reduces the  $\Delta P$  upstream of the break for the pump suction breaks and increases break flow.

9. The full power SG level is used to calculate the initial secondary mass and 10% is added to cover uncertainty.

Thus, based on the previously discussed conditions and assumptions, a bounding analysis was made for the release of mass and energy releases from the RCS in the event of a LOCA at the future uprated conditions.

#### 6.2.1.3.2 Description of Analyses

The evaluation model used for the long-term LOCA mass and energy release calculations is the March 1979 model. This evaluation model has been reviewed and approved generically by the Nuclear Regulatory Commission (NRC). The approval letter is included with WCAP-10325-P-A, Westinghouse, 1983.

#### 6.2.1.3.3 LOCA Mass and Energy Release Phases

The containment system receives mass and energy releases following a postulated rupture in the RCS. These releases continue over a time period, which, for the LOCA mass and energy release analysis, is typically divided into four phases.

**Blowdown** - the period of time from accident initiation (when the reactor is at steady state operation) to the time that the RCS and containment reach an equilibrium state.

**Refill** - the period of time when the lower plenum is being filled by accumulator and Emergency Core Cooling System (ECCS) water. At the end of blowdown, a large amount of water remains in the cold legs, downcomer, and lower plenum. To conservatively consider the refill period for the purpose of containment mass and energy releases, it is assumed that this water is instantaneously transferred to the lower plenum along with sufficient accumulator water to completely fill the lower plenum. This allows an uninterrupted release of mass and energy releases to containment. Thus, the refill period is conservatively neglected in the mass and energy release calculation.

**Reflood** - begins when the water from the lower plenum enters the core and ends when the core is completely quenched.

**Post-reflood (Froth)** - describes the period following the reflood phase. For the pump suction break, a two-phase mixture exits the core, passes through the hot legs, and is superheated in the steam generators prior to exiting the break as steam. After the broken loop steam generator cools, the break flow becomes two-phase.

#### 6.2.1.3.4 Computer Codes

The March 1979 model mass and energy release evaluation model is comprised of mass and energy release versions of the following codes: SATAN VI, WREFLOOD, FROTH, and EPITOME.

SATAN VI calculates blowdown, the first portion of the thermal-hydraulic transient following break initiation, including pressure, enthalpy, density, mass and energy flow rates, and energy transfer between primary and secondary systems as a function of time.

The WREFLOOD code addresses the portion of the LOCA transient where the core reflooding phase occurs after the primary coolant system has depressurized (blowdown) due to the loss of water through the break and when water supplied by the ECCS refills the reactor vessel and provides cooling to the core. The most important feature of WREFLOOD is the steam/water mixing model, discussed in subsection 6.2.1.3.8.2.

FROTH models the post-reflood portion of the transient. The FROTH code calculates the heat release from the energy stored in the secondary fluid and metal masses, excluding the upper internals and upper elliptical head. This part of the steam generator metal mass is not actively cooled by the two-phase fluid circulating through steam generator tubes and takes longer to cooldown.

EPITOME continues the FROTH post-reflood portion of the transient from the time at which the secondary equilibrates to containment design pressure to the end of the transient (1 hour). It also compiles a summary of data on the entire transient, including formal instantaneous mass and energy release tables and mass and energy releases balance tables with data at critical times.

After one hour, the Westinghouse LOCA mass and energy releases calculation has extracted all of the stored energy from the RCS, except for the stored metal energy in the steam generator upper internals and upper elliptical heads. This energy is assumed to be removed at a constant rate over the next six hours and is added to the core decay heat as an energy source for the long-term steaming rate calculation. See Section 6.2.1.1.3.2.2.2.

#### 6.2.1.3.5 Break Size and Location

Generic studies (March 1979 model, WCAP-10325-P-A, Westinghouse, 1983, Section 3) have been performed to determine the effect of postulated break size on the LOCA mass and energy releases. The double-ended guillotine break has been found to be limiting due to larger mass flow rates during the blowdown phase of the transient. During the reflood and post-reflood phases, the break size has little effect on the releases.

Three distinct locations in the reactor coolant system loop can be postulated for pipe rupture for any release purposes:

1. Hot leg (between vessel and steam generator)
2. Cold leg (between pump and vessel)
3. Pump suction (between steam generator and pump)

The DEHL break location yields the highest blowdown mass and energy release rates (March 1979 model, WCAP-10325-P-A, Westinghouse, 1983, Section 3.3). Although the core flooding rate would be the highest for this break location, the amount of energy released from the steam generator secondary side is minimal because the majority of fluid that exits the core vents directly to containment, bypassing the steam generators. As a result, the reflood mass and energy releases are reduced significantly as compared to either the pump suction, or cold-leg break locations where the core exit mixture must pass through the steam generators before venting through the break. Studies have confirmed that there is no reflood peak (i.e., from the end of the blowdown period the containment pressure would continually decrease) for the hot leg break. Therefore, the mass and energy releases for the blowdown phase of the hot-leg break are calculated and used in the containment peak pressure and temperature response calculation.

Studies have determined that the blowdown transient for the DECL break is, in general, less limiting than that for the pump suction break (March 1979 model, WCAP-10325-P-A, Westinghouse, 1983, Section 3.3). The cold leg blowdown is faster than that of the pump suction break, and more mass is released into the containment. However, the core heat transfer is greatly reduced, and this results in a considerably lower energy release into containment. The flooding rate during the reflood phase is greatly reduced, and the energy release rate into the containment is reduced. Therefore, the cold-leg break is bounded by other breaks and no further evaluation is necessary.

The pump suction break combines the effects of the relatively high core-flooding rate, as in the hot-leg break, and the additional stored energy in the steam generators. As a result, the pump suction break yields the highest energy flow rates during the post-blowdown period by including all of the available energy of the RCS in calculating the releases to containment.

Therefore, the break locations that were analyzed for this program were the DEPS rupture (10.5 ft<sup>2</sup>) and the DEHL rupture (9.2 ft<sup>2</sup>). LOCA mass and energy releases have been calculated for the blowdown, reflood, and post-reflood phases for the DEPS cases. For the DEHL case, the releases were calculated only for the blowdown phase with this methodology.

#### 6.2.1.3.6 Application of Single-Failure Criterion

The mass and energy release calculation assumes a complete loss of all offsite power coincident with the LOCA. The emergency diesel generators are actuated to provide power for the safety injection system. The combination of signal delay plus diesel delay and additional delays in starting the ECCS pumps results in the delivery of SI after the end of blowdown.

Two cases are analyzed to assess the effects of a single failure in the mass and energy release calculation. The first case assumes a single failure of one of the emergency diesel generators, resulting in the loss of one train of safeguards equipment. This, in combination with other conservative assumptions (maximum resistances, minimum pump head-flow curves), minimizes the safety injection flow rate. The second case assumes a failure in the containment spray system. The safety injection flow rate for this case is maximized by assuming both trains of safeguards equipment are operating and by including other conservative assumptions (minimum resistances, maximum pump head-flow curves). In addition to these two cases, a third case that assumes a failure of one service water (SW) train was analyzed.

#### 6.2.1.3.7 Acceptance Criteria

A large break LOCA is classified as an ANS Condition IV event, an infrequent fault. To satisfy the NRC acceptance criteria presented in the Standard Review Plan Section 6.2.1.3, the relevant requirements are as follows:

1. 10 CFR 50, Appendix A
2. 10 CFR 50, Appendix K, paragraph I.A

To meet these requirements, the following must be addressed:

1. Sources of energy
2. Break size and location
3. Calculation of each phase of the accident

#### 6.2.1.3.8 Results

##### 6.2.1.3.8.1 Blowdown Mass and Energy Release Data

The SATAN-VI code is used for computing the blowdown transient. The code utilizes the control volume (element) approach with the capability for modeling a large variety of thermal fluid system configurations. The fluid properties are considered uniform, and thermodynamic equilibrium is assumed in each element. A point kinetics model is used with weighted feedback effects. The major feedback effects include moderator density, moderator temperature, and Doppler broadening. A critical flow calculation for subcooled (modified Zaloudek), two-phase (Moody), or superheated break flow is incorporated into the analysis. The methodology for the use of this model is described in WCAP-10325-P-A, Westinghouse, 1983.

Table 6.2-14C presents the calculated mass and energy release for the blowdown phase of the DEHL break. For the hot-leg break mass and energy release tables, break path 1 refers to the mass and energy releases exiting from the reactor vessel side of the break; and break path 2 refers to the mass and energy releases exiting from the steam generator side of the break.

Table 6.2-14D presents the calculated mass and energy releases for the blowdown phase of the DEPS break with either minimum or maximum ECCS flows. For the pump suction breaks, break path 1 in the mass and energy release tables refers to the mass and energy releases exiting from the steam generator side of the break; break path 2 refers to the mass and energy releases exiting from the pump side of the break.

#### 6.2.1.3.8.2 Reflood Mass and Energy Release Data

The WREFLOOD code is used for computing the reflood transient. The WREFLOOD code consists of two basic hydraulic models—one for the contents of the reactor vessel and one for the coolant loops. The two models are coupled through the interchange of the boundary conditions applied at the vessel outlet nozzles and at the top of the downcomer. Additional transient phenomena, such as pumped safety injection and accumulators, reactor coolant pump performance, and steam generator releases are included as auxiliary equations that interact with the basic models as required. The WREFLOOD code permits the capability to calculate variations during the core reflooding transient of basic parameters such as core flooding rate, core and downcomer water levels, fluid thermodynamic conditions (pressure, enthalpy, density) throughout the primary system, and mass flow rates through the primary system. The code permits hydraulic modeling of the two flow paths available for discharging steam and entrained water from the core to the break, the path through the broken loop and the path through the unbroken loops.

A complete thermal equilibrium mixing condition for the steam and ECCS injection water during the reflood phase has been assumed for each loop receiving ECCS water. This is consistent with the usage and application of the March 1979 mass and energy release evaluation model in recent analyses, for example, D.C. Cook (Docket 50-315). Even though the March 1979 model credits steam/water mixing only in the intact loop and not in the broken loop, the justification, applicability, and NRC approval for using the mixing model in the broken loop has been documented (D.C. Cook Docket 50-315). Moreover, this assumption is supported by test data and is further discussed below.

The model assumes a complete mixing condition (i.e., thermal equilibrium) for the steam/water interaction. The complete mixing process, however, is made up of two distinct physical processes. The first is a two-phase interaction with condensation of steam by cold ECCS water. The second is a single-phase mixing of condensate and ECCS water. Since the steam release is the most important influence to the containment pressure transient, the steam condensation part of the mixing process is the only part that needs to be considered. (Any spillage directly heats only the sump.)

The most applicable steam/water mixing test data has been reviewed for validation of the WREFLOOD steam/water mixing model. This data, generated in 1/3-scale tests (EPRI report 294-2), are the largest scale data available and thus, most clearly simulate the flow regimes and gravitational effects that would occur in a Pressurized Water Reactor (PWR). These tests were designed specifically to study the steam/water interaction for PWR reflood conditions.



A group of 1/3-scale tests corresponds directly to the reflood conditions. The injection flow rates for this group cover all phases and mixing conditions calculated during the reflood transient. The data from these tests were reviewed and discussed in detail in WCAP-10325-P-A, Westinghouse, 1983. For all of these tests, the data clearly indicate the occurrence of very effective mixing with rapid steam condensation. The mixing model used in the WREFLOOD calculation is therefore wholly supported by the 1/3-scale steam/water mixing data. Descriptions of the test and test results are contained in Docket 50-315, Amendment No. 126, June 1989 and EPRI report 294-2, June 1975.

The calculated DEPS reflood phase LOCA mass and energy releases are given in Table 6.2-14E for the minimum safeguards case and in Table 6.2-14H for the maximum safeguards case and Table 6.2-14Q for the service water failure case. The transient responses of the principal parameters during reflood are given in Table 6.2-14F for the DEPS minimum safeguards case and in Table 6.2-14I for the DEPS maximum safeguards case and Table 6.2-14R for the service water failure case.

#### 6.2.1.3.8.3 Post-Reflood Mass and Energy Release Data

The FROTH code, as described by Shepard, et. al., is used for computing the post-reflood transient. The FROTH code calculates the heat release rates resulting from a two-phase mixture present in the steam generator tubes. The mass and energy releases that occur during this phase are typically superheated due to the depressurization and equilibration of the broken-loop and intact-loop steam generators. During this phase of the transient, the RCS has equilibrated with the containment pressure, but the steam generators contain a secondary inventory at an enthalpy that is much higher than the primary side. Therefore, there is a significant amount of reverse heat transfer that occurs. Steam is produced in the core due to core decay heat. For a pump suction break, a two-phase fluid exits the core, flows through the hot legs, and becomes superheated as it passes through the steam generator. Once the broken loop cools, the break flow becomes two-phase. During the FROTH calculation, ECCS injection is addressed for both the injection phase and the recirculation phase. The FROTH code calculation stops when the secondary side equilibrates to the saturation temperature ( $T_{sat}$ ) at the containment design pressure. After this point, the EPITOME code completes the SG depressurization. The methodology for the use of this model is described in the March 1979 topical. (See subsection 6.2.1.3.8.5 and subsection 6.2.1.3.8.6 for additional information.)

Table 6.2-14G presents the two-phase post-reflood mass and energy release data for the double-ended pump suction case minimum safeguards case. Table 6.2-14J presents the two-phase post-reflood mass and energy release data for the double-ended pump suction maximum safeguards case. Table 6.2-14S presents the release data for the double-ended pump suction service water failure case.

#### 6.2.1.3.8.4 Decay Heat Power Model

The American Nuclear Society Standard ANSI/ANS-5.1 1979 has been used for the determination of decay heat in the mass and energy release analysis. Table 6.2-14V, lists the generic decay heat curve used in the Beaver Valley mass and energy release calculations applying the March 1979 LOCA mass and energy release methodology.

Significant assumptions in the generation of the decay heat curve for use in the LOCA mass and energy release analysis include the following:

1. Decay heat sources considered are fission product decay and heavy element decay of U-239 and Np-239.
2. Decay heat power from the following fissioning isotopes is included: U-238, U-235, and Pu-239.
3. Fission rate is constant over the operating history of maximum power level.
4. The factor accounting for neutron capture in fission products has been taken from Equation 11 (ANSI/ANS-5.1 1979, August 1979) for up to 10,000 seconds and from Table 10 (ANSI/ANS-5.1 1979, August 1979) for beyond 10,000 seconds.
5. The fuel has been assumed to be at full power for  $10^8$  seconds.
6. The number of atoms of U-239 produced per second has been assumed to be equal to 70 percent of the fission rate.
7. The total recoverable energy associated with one fission has been assumed to be 200 MeV/fission.
8. Two-sigma uncertainty (two times the standard deviation) has been applied to the fission product decay.

Based upon NRC staff review, Safety Evaluation Report (SER) of the March 1979 evaluation model, use of the ANS Standard ANSI/ANS-5.1-1979 decay heat model was approved for the calculation of mass and energy releases to the containment following a LOCA.

#### 6.2.1.3.8.5 Steam Generator Equilibration and Depressurization

Steam generator equilibration and depressurization is the process by which secondary side energy is removed from the steam generators in stages. The FROTH computer code calculates the heat removal from the secondary mass until the secondary temperature is the saturation temperature ( $T_{sat}$ ) at the containment design pressure. After the FROTH calculations, the EPITOME code continues the FROTH calculation for SG cooldown removing steam generator secondary energy at different rates (i.e., first and second stage rates). The first stage rate is applied until the steam generator reaches  $T_{sat}$  at the user specified intermediate equilibration pressure, when the secondary pressure is assumed to reach the containment pressure. Then the second stage rate is used until the final depressurization, when the secondary reaches the reference temperature of  $T_{sat}$  at 14.7 psia, or 212°F. The heat removal of the broken-loop and intact-loop steam generators is calculated separately.

During the FROTH calculations, steam generator heat removal rates are calculated using the secondary side temperature, primary side temperature, and a secondary side heat transfer coefficient determined using a modified McAdam's correlation. Steam generator energy is removed during the FROTH transient until the secondary side temperature reaches saturation temperature at the containment design pressure.

The constant heat removal rate used during the first heat removal stage is based on the final heat removal rate calculated by FROTH. The SG energy available to be released during the first stage interval is determined by calculating the difference in secondary energy available at the containment design pressure and that at the (lower) user specified intermediate equilibration pressure, assuming saturated conditions. The intermediate equilibrium pressures are chosen as discussed in Shepard, et. al., Sections 2.3 and 3.3. This energy is then divided by the first stage energy removal rate, resulting in an intermediate equilibration time.

At this time, the rate of energy release drops substantially to the second stage rate. The second stage rate is determined as the fraction of the difference in secondary energy available between the intermediate equilibration and final depressurization at 212°F, and the time difference from the time of the intermediate equilibration to the user-specified time of the final depressurization at 212°F. With current methodology (WCAP-10325-P-A, Westinghouse, 1983), all of the secondary energy remaining after the intermediate equilibration is conservatively assumed to be released by imposing a mandatory cooldown and subsequent depressurization down to atmospheric pressure at 3600 seconds, i.e., 14.7 psia and 212°F.

#### 6.2.1.3.8.6 Long Term Mass & Energy Releases

The long-term (greater than 3600 seconds) mass and energy release calculations are performed through user defined input functions which is an option in the MAAP-DBA code. The MAAP-DBA code was used for convenience. This method of determining the long-term mass and energy releases is consistent with past applications of Westinghouse methodology. These user defined functions are characterized for the long term discharge from the break for (a) a mixed discharge and (b) for an unmixed discharge of steam and water. In both cases, the flow rates that are used are those calculated by the EPITOME code and only the specific enthalpies of the discharge flows are calculated to represent the influence of the time dependent RCS injection temperature as the containment cools.

#### 6.2.1.3.8.7 Sources of Mass and Energy

The sources of mass considered in the LOCA mass and energy release analysis are given in Tables 6.2-14K, and 6.2-14L and 6.2-14M and 6.2-14T. These sources are the reactor coolant system, accumulators, and pumped safety injection.

The energy inventories considered in the LOCA mass and energy release analysis are given in Tables 6.2-14N and 6.2-14O and 6.2-14P and 6.2-14U. The energy sources are listed below.

1. RCS water
2. Accumulator water (all three inject)
3. Pumped SI water
4. Decay heat
5. Core stored energy
6. RCS metal (includes the reactor vessel and internals, hot and cold leg piping, SG inlet and outlet plenums, and SG tubes)
7. SG metal (includes transition cone, shell, wrapper, and other internals)

Note: The DEHL cases also conservatively include the upper internals and upper elliptical head.

8. SG secondary energy (includes fluid mass and steam mass)
9. Secondary transfer of energy (feedwater into, and steam out of, the SG secondary)

The energy reference points are as follows.

1. Available energy: 212°F; 14.7 psia
2. Total energy content: 32°F; 14.7 psia

The mass and energy inventories are presented at the following times, as appropriate:

1. Time zero (initial conditions)
2. End of blowdown time
3. End of refill time
4. End of reflood time
5. Time of broken loop steam generator equilibration to pressure setpoint
6. Time of intact loop steam generator equilibration to pressure setpoint
7. Time of full depressurization (3600 seconds)

The Zirc-water reaction energy was not considered in the mass and energy release data presented because the clad temperature was not assumed to increase high enough for the rate of the Zirc-water reaction to be of any significance.

#### 6.2.1.3.9 Conclusions

Plant specific LOCA mass and energy release analyses were developed using approved design basis methodology. The analysis bounds core operation at uprated conditions with the current SGs. The results of this analysis were provided for use in the containment analysis.

The consideration of the various energy sources in the long-term mass and energy release analysis provides assurance that all available sources of energy have been included in this analysis. Thus, the review guidelines presented in Standard Review Plan Section 6.2.1.3 have been satisfied.

#### 6.2.1.4 Mass and Energy Release Analysis for Postulated Main Steam Line Break Inside Containment

Main Steam Line Breaks occurring inside a reactor containment structure may result in significant releases of high-energy fluid to the containment environment and elevated containment temperatures and pressures. The magnitude of the releases following a steam line rupture is dependent upon the plant initial operating conditions and the size of the rupture as well as the configuration of the plant steam system and the containment design. These variations make it difficult to determine the absolute worst cases for either containment pressure or temperature evaluation following a steam line break. The main steam line break (MSLB) analysis considers a variety of postulated pipe breaks encompassing wide variations in plant operation, safety system performance, and break size in determining the mass and energy (M&E) releases for use in containment analysis. A spectrum of MSLB accidents, covering different break areas and reactor operating power levels, is analyzed and discussed in the following sections. As stated in Section 6.2.1.1.3.8, a feedwater line break is not analyzed since an MSLB is the most limiting, conservative case with regard to containment design, integrity of the containment pressure boundary, and the resulting containment environmental conditions.

##### 6.2.1.4.1 Mass and Energy Release Data

To determine the effects of plant power level and break area on the mass and energy releases from a ruptured steamline, spectra of both variables have been evaluated. At nominal full NSSS power levels of 100.6 percent, 70 percent, 30 percent, and 0 percent of nominal full-load power, two break types have been defined. These breaks are defined as the following.

1. A full double-ended rupture (DER) downstream of the steamline flow restrictor, which is integral with the steam generator nozzle. For this case, the actual break area equals the cross-sectional area of the steamline, but the blowdown from the steam generator with the broken line is controlled by the flow restrictor throat area (1.069 ft<sup>2</sup>). The reverse flow from the intact steam generators is controlled by the total flow restrictor throat area in the intact loops. Since these flow restrictors are part of the steam generator nozzle, no pipe breaks can occur with a flow area greater than the throat area of 1.069 ft<sup>2</sup>.
2. A split rupture that represents the largest break that will neither generate a steamline isolation signal from the Westinghouse Solid-State Protection System (SSPS) nor result in water entrainment in the break effluent. Reactor protection and safety injection actuation functions are obtained from containment pressure signals.

#### 6.2.1.4.2 Single-Failure Assumptions

To avoid unnecessary conservatism, bounding multiple failure assumptions have not been made for most of the MSLB cases in the analysis. Most cases analyzed considered only one single failure. One of these failures is considered as part of the containment response analysis as discussed in Section 6.2.1.1.3.7. The postulated single failures (discussed also in Land 1976) that increase the MSLB M&E releases to containment are discussed below.

- a. Failure of the Main Steam Isolation Valve (MSIV) in the Faulted Loop

The main steamline isolation function is accomplished via the MSIV in each of the three steamlines. Each valve closes on an isolation signal to terminate steam flow from the associated steam generator. The Main Steam Line Break upstream of this valve, as postulated for the inside-containment analysis, creates a situation in which the steam generator on the faulted loop cannot be isolated, even when the MSIV successfully closes. The break location allows a continued blowdown from the faulted-loop steam generator until it is empty and all sources of feedwater and auxiliary feedwater addition are terminated. If the faulted-loop MSIV fails to close, blowdown from more than one steam generator is prevented by the closure of the corresponding MSIV for each intact-loop steam generator. Therefore, there is no failure of a single MSIV that could cause continued blowdown from multiple steam generators.

In addition to the continued blowdown from the faulted-loop steam generator after MSIV closure, the steam in the unisolable section of the steamline needs to be considered. An MSIV failure can impact the mass and energy releases, since a failed MSIV will result in a larger unisolable steamline volume.

- b. Failure of the Main Feedwater Isolation Valve (MFIV) in the Faulted Loop

If the MFIV in the feedwater line to the faulted steam generator is assumed to fail in the open position, backup isolation is provided via the main feedwater flow control valve (FCV) closure. The additional inventory between the MFIV and the FCV in the faulted loop would be available to be released to containment.

#### 6.2.1.4.3 Initial Conditions

Main Steam Line Breaks can be postulated to occur with the plant in any operating condition ranging from hot shutdown to full power. Since steam generator water mass decreases with increasing power level, breaks occurring at lower power levels will generally result in a greater total mass release to the containment. However, because of increased stored energy in the primary side of the plant, increased heat transfer in the steam generators, and additional energy generation in the fuel, the energy release to the containment from breaks postulated to occur during full-power, or near full-power, operation may be greater than for breaks occurring with the plant in a low-power, or hot-shutdown, condition. Additionally, pressure in the steam generators changes with increasing power and has a significant influence on the rate of blowdown.

Because of the opposing effects on mass versus energy release for the MSLB due to a change in initial power level, a single power level cannot be specified as the worst case for either the containment pressure cases or the containment temperature cases. Therefore, representative power levels including 100.6 percent, 70 percent, 30 percent, and 0 percent of nominal full NSSS power conditions have been investigated for BVPS-2 based on the information in Land (1976).

In general, the plant initial conditions are assumed to be at the nominal value corresponding to the initial power for that case, with appropriate uncertainties included. Table 6.2-50 identifies the values assumed for RCS vessel average temperature, RCS flow, RCS pressure, pressurizer water volume, feedwater enthalpy, steam generator pressure, and steam generator water level corresponding to each power level analyzed. Main steam line break mass and energy releases assuming an RCS average temperature at the high end of the Tav<sub>g</sub> window are conservative with respect to similar releases at the low end of the Tav<sub>g</sub> window. At the high end, there is more mass and energy available for release into containment. The thermal design flowrate has been used for the RCS flow input consistent with the assumptions documented in Land (1976).

Uncertainties on the initial conditions assumed in the analysis for the BVPS-2 power uprating analysis program have been applied only to the RCS average temperature, the steam generator mass and the power fraction at full power. Nominal values are adequate for the initial conditions associated with pressurizer pressure and pressurizer water level. Uncertainty conditions are only applied to those parameters that could increase the amount of mass or energy discharged into containment.



#### 6.2.1.4.4 Description of the Blowdown Model

The LOFTRAN code (Burnett, et al., 1984) calculates mass and energy releases to the containment following a Main Steam Line Break, as specifically described in this report and which is summarized as follows.

##### 1. Primary system fluid temperatures and pressures calculations

The LOFTRAN code is used for studies of transient response of a PWR system to specified perturbations in process parameters. LOFTRAN is a versatile program suited to both accident evaluations and control system studies. LOFTRAN simulates a multiloop system by a model containing a reactor vessel, hot and cold leg piping, steam generators (tube and shell sides), and the pressurizer. The pressurizer heaters, spray, relief and safety valves are considered in the program. Point-model neutron kinetics and reactivity effects of the moderator, fuel, boron, and control rods are included. The secondary side of the steam generator uses a homogeneous, saturated mixture for the thermal transients and a water level correlation for indication and control. Core decay heat generation assumed in calculating the MSLB mass and energy releases is based on the ANS (1979) decay heat +  $2\sigma$  model.

Blowdown mass and energy releases determined using LOFTRAN include the effects of core power generation, main and auxiliary feedwater additions, engineered safeguards systems, reactor coolant system thick-metal heat storage including steam generator thick-metal mass and tubing, and reverse steam generator heat transfer.

The use of the LOFTRAN code for the analysis of the MSLB M&E releases is documented in Osborne and Love (1985) and has been reviewed and approved by the NRC (1986) for this application.

##### 2. Steam generator fluid mass

A maximum initial steam generator mass in the faulted-loop steam generator has been used in the analysis of the MSLB inside containment. The use of a high faulted-loop initial steam generator mass maximizes the steam generator inventory available for release to containment. The initial mass has been calculated as the value corresponding to the programmed level +7 percent narrow-range span and assuming 0 percent tube plugging. The initial mass uncertainty is a conservative value with respect to the BVPS-2 plant-specific value. This assumption is conservative with respect to the RCS cooldown through the faulted-loop steam generator resulting from the Main Steam Line Break.

3. Steam generator reverse heat transfer

Once the steamline isolation is complete, the steam generators in the intact loops become sources of energy that can be transferred to the steam generator with the broken steamline. This energy transfer occurs via the primary coolant. As the primary plant cools, the temperature of the coolant flowing in the steam generator tubes could drop below the temperature of the secondary fluid in the intact steam generators, resulting in energy being returned to the primary coolant. This energy is then available to be transferred to the steam generator with the broken main steam line.

4. Reactor coolant system metal heat capacity

As the primary side of the plant cools, the temperature of the reactor coolant could drop below the temperature of the reactor coolant piping, the reactor vessel, the reactor coolant pumps, and the steam generator thick-metal mass and tubing. As this occurs, the heat stored in the metal is available to be transferred to the steam generator with the broken line. The effects of this RCS metal heat are included in the results using conservative thick-metal masses and heat transfer coefficients.

5. Break flow model

Blowdown properties are determined using the Moody (1965) correlation with a discharge coefficient of 1.0. The quality of the blowdown is input as a function of time for mass and energy release calculations. An input quality of 1.0 is used for all main steam line breaks inside containment. The assumption of saturated steam being released for all breaks is a conservative assumption that maximizes the energy release into containment.

6. Loss of offsite power

Loss of offsite power is not assumed in the MSLB analysis. The assumption of a trip of all the reactor coolant pumps (RCPs) coincident with reactor trip is less limiting than with offsite power available since the mass and energy releases are reduced due to the loss of forced reactor coolant flow, resulting in less primary-to-secondary heat transfer (Land 1976). Therefore, all MSLB M&E release cases are analyzed with the RCPs continuing to operate.

7. Core reactivity coefficients

Since the main steam line break is a cooldown event, it is conservative to use large negative moderator coefficients and low Doppler coefficients as characteristic of end-of-cycle (EOC) life. Most limiting core reactivity coefficients at EOC are used to maximize the reactivity feedback effects resulting from the MSLB. Use of maximum reactivity feedback results in higher power generation if the reactor returns to

criticality, thus maximizing heat transfer to the secondary side of the steam generators. Also, for all MSLBs, the most reactive control rod is assumed to be stuck out of the core.

#### 6.2.1.4.5 Energy Inventories

The rapid depressurization that occurs following a main steam line break typically results in large amounts of water being added to the steam generators through the main feedwater system. Rapid-closing FIVs or FCVs in the main feedwater lines limit this effect. The feedwater addition that occurs prior to closing of the FIVs or FCVs influences the steam generator blowdown in several ways. First, because the water entering the steam generator is subcooled, it lowers the steam pressure thereby reducing the flowrate out of the break. As the steam generator pressure decreases, some of the fluid in the feedwater lines downstream of the isolation valves will flash into the steam generators providing additional secondary fluid which may exit out of the break. Secondly, the increased flow causes an increase in the total heat transfer from the primary to secondary systems resulting in greater integrated energy being released out of the break.

Following the initiation of the MSLB, main feedwater flow is conservatively modeled by assuming an increase in feedwater flow prior to reactor trip. The initial increase in feedwater flow (until fully isolated) is in response to the feedwater control valve opening up in response to the steam flow/feedwater flow mismatch, or the decreasing steam generator water level as well as due to a lower backpressure on the feedwater pump as a result of the depressurizing steam generator. This maximizes the total mass addition prior to feedwater isolation. The feedwater isolation response time, following the safety injection signal, is assumed to account for delays associated with signal processing plus MFIV stroke time. For the circumstance in which the MFIV in the faulted loop fails to close, there is no effect on the feedwater isolation response time since the total delay for the FCV closure is also 7 seconds.

Following feedwater isolation, as the steam generator pressure decreases, some of the fluid in the feedwater lines downstream of the isolation or control valve may flash to steam if the feedwater temperature exceeds the saturation temperature. This unisolable feedwater line volume is an additional source of fluid that can increase the mass discharged out of the break. The unisolable volume in the feedwater lines is maximized for the faulted loop. Feedwater line piping volumes available for steam flashing in this analysis are shown in Table 6.2-51.

Generally, within the first minute following a main steam line break, the auxiliary feedwater (AFW) system is initiated on any one of several protection system signals. Addition of auxiliary feedwater to the steam generators will increase the secondary mass available for release to containment as well as increase the heat transferred to the secondary fluid. The auxiliary feedwater flow to the faulted and intact steam generators has been assumed to be a function of the backpressure on the AFW pumps as a result of the depressurizing steam generator in the MSLB analysis inside containment. A range of cavitating venturi sizes in each of the AFW supply lines to the steam

generators has been assumed that maximizes flow to the faulted-loop steam generator and minimizes flow to the intact-loop steam generators. Auxiliary feedwater flow to the faulted-loop steam generator has been assumed up until the time of operator action to isolate the flow to the steam generator near the break location. Auxiliary feedwater system assumptions that have been used in the analysis are presented in Table 6.2-51.

#### 6.2.1.4.6 Additional Information Required for Confirmatory Analyses

For the DER cases, the forward-flow cross-sectional area from the faulted-loop steam generator is limited by the integral flow restrictor area of 1.069 ft<sup>2</sup>, which is less than the actual area of 4.9 ft<sup>2</sup> for the main steam piping inside containment. The cross-sectional area of the steam piping at this location is larger than the sum of the flow restrictors in the intact-loop steam generators. Therefore, the larger cross-sectional area of the ruptured steamline expels steam faster than the smaller cross-sectional area of the intact-loop steam generator flow restrictors can fill it. Thus, the blowdown of the initial steam in the steamline header piping is modeled in the first few seconds of the event, followed by the reverse-flow blowdown from the intact-loop steam generators until MSIV closure. At the time of MSIV closure, the steam flow from the intact-loop steam generators is terminated, but it is assumed that all steam that has exited the steam generator prior to steamline isolation is released through the break.

The contribution to the mass and energy releases from the steam in the secondary plant main steam loop piping and header has been included in the mass and energy release calculations. The initial flowrate is determined using the Moody correlation, the pipe cross-sectional area, and the initial steam pressure. A conservative steam piping volume is used in this blowdown calculation representing the main steam piping from the steam generator to the turbine throttle valve.

The full DER represents the break producing the highest mass flowrate from the faulted-loop steam generator. Smaller DER break sizes are represented by a reduction in the initial steam blowdown rate at the time of the break. Therefore, no other DER break sizes have been considered other than the full DER.

For the split-break MSLB cases, the break area is smaller than the area of a single integral flow restrictor. The flowrate from all steam generators prior to MSIV closure and the flowrate from a single steam generator after MSIV closure supply the steam flow to the break. The steam in the unisolable portion of the steamline does not affect the blowdown until the time of steam generator dry out, when the flowrate from the steam generator would decrease below the critical flowrate out of the break. At this point, the additional steam in the piping begins to have an effect on break flowrate until the steamline piping is empty. To model this effect, the mass of the unisolable steam in the steamline is added to the initial mass of the faulted steam generator. This accurately reflects both the total mass and energy that will be released from the break, and the timing of the effect of the unisolable steamline volume on the blowdown.

Steamline isolation is assumed in all three loops to terminate the blowdown from the two intact steam generators. A time accounting for delays associated with signal processing plus MSIV stroke time, with unrestricted steam flow through the valve during the valve stroke, has been assumed.

#### 6.2.1.5 Minimum Containment Pressure Analysis for Performance Capability Studies on Emergency Core Cooling System

The containment backpressure used for the limiting case double-ended cold leg guillotine break for the ECCS analysis presented in Section 15.6.5 is shown on Figure 6.2-119. The containment backpressure is calculated, using the methods and assumptions described in Appendix A by Bordelon (et al 1974a). Input parameters, including the containment initial conditions, net free containment volume, passive heat sink materials, thicknesses, and surface areas, and starting time and number of containment cooling systems used in the analysis, are described in the following paragraphs.

##### 6.2.1.5.1 Mass and Energy Release Data

The mass and energy releases to the containment during the transient includes the break flow and ECCS spill through the broken cold leg from the vessel side and loop side, and are presented in Tables 6.2-52 and 6.2-53, respectively.

The mathematical models which calculate the mass and energy releases to the containment are described in Section 15.6.5 and conform to 10 CFR 50, Appendix K, ECCS Evaluation Models. A break spectrum analysis is performed (Section 15.6.5) that considers various Moody discharge coefficients for the double-ended cold leg guillotines. During refill, the break mass and energy released to the containment is assumed to be zero, which minimizes the containment pressure. During reflood, the effect of steam water mixing between the safety injection water and the steam flowing through the RCS intact loops reduces the available energy released to the containment vapor spaces and therefore tends to minimize containment pressure.

## 6.2.1.5.2 Initial Containment Internal Conditions

The following initial values were used in the analysis:

1. A minimum containment pressure of 14.3 psia, |
2. A nominal containment temperature of 70°F, |
3. A minimum RWST temperature of 45°F,
4. A minimum outside air temperature of -20°F,
5. A minimum outside ground temperature of 32°,
6. A maximum relative humidity of 100 percent.

#### 6.2.1.5.3 Containment Volume

The volume used in the analysis was  $1.804 \times 10^6 \text{ ft}^3$ .

#### 6.2.1.5.4 Active Heat Sinks

The containment spray system operates to remove heat from the containment.

Pertinent data for this system which were used in the analysis are presented in Table 6.2-54. No containment air coolers were modeled in this analysis. In addition, heat transfer between the sump water and the containment vapor space was not considered in the analysis.

#### 6.2.1.5.5 Steam-Water Mixing

Water spillage rates from the broken loop accumulator are determined as part of the core reflooding calculation and are included in the containment code calculational model.

#### 6.2.1.5.6 Passive Heat Sinks

The passive heat sinks used in the analysis, with their thermophysical properties, are given in Table 6.2-55. The passive heat sinks and their thermophysical properties were determined to be representative of plant conditions which would produce conservatively high heat removal.

#### 6.2.1.5.7 Other Parameters

No other parameters have a substantial effect on the minimum containment pressure analysis.

#### 6.2.1.6 Inspection and Testing Requirements

Containment testing is classified in two categories as follows:

1. Structural acceptance integrity testing verifies the structural integrity of the reactor containment exterior structure. This is described in Section 3.8.1.7.
2. Containment leak rate testing verifies the leakage rates are within allowable limits. This is described in Section 6.2.6.

#### 6.2.1.7 Instrumentation Requirements

Indicators are provided in the main control room to monitor containment atmosphere temperature and humidity. These are also monitored by the Beaver Valley Power Station - Unit 2 (BVPS-2) computer.

A detailed discussion of the instrumentation, actuations, and logic functions may be found in Section 7.1, 7.2, 7.3, and 7.5.

#### 6.2.2 Containment Heat Removal System

The CHRS, which is also called the containment depressurization system, is composed of two systems: the quench spray system (QSS) and the recirculation spray system (RSS).

The containment depressurization system reduces the containment temperature and returns the containment pressure to subatmospheric following a break in either the primary or secondary system piping inside the containment.

Heat that is removed from the containment atmosphere by the QSS and RSS is transferred to the containment sump. Heat is then removed from the containment by the service water system via the recirculation spray coolers.

##### 6.2.2.1 Design Bases

The containment depressurization system is designed in accordance with the following criteria:

1. General Design Criterion 38, with respect to containment heat removal.
2. General Design Criterion 39, with respect to permitting periodic inspection of the containment depressurization system.
3. General Design Criterion 40, with respect to permitting periodic testing of the containment depressurization system.



4. General Design Criterion 41, as it relates to the control of fission products. Section 6.5.2 discusses iodine removal.
5. Regulatory Guide 1.1, as it relates to the NPSH available (NPSHA) to the ECCS and containment depressurization system pumps.
6. Regulatory Guide 1.26, as it relates to quality group standards. The system is designed in accordance with ASME Section III Class 2, and is designated Safety Class 2 except as indicated on CHRS figures referenced in Table 3.2-3.
7. Regulatory Guide 1.29, as it relates to seismic classification. The system is designed to Seismic Category I.
8. Regulatory Guide 1.82, as it relates to the design of sumps for ECCS and CSSs. Design exception and justifications are discussed in Section 6.2.2.3.1.
9. The containment spray headers are capable of delivering spray water to the containment atmosphere in sufficient quantity and with an average droplet diameter to ensure adequate heat removal.
10. The containment depressurization system will perform its design function properly, assuming the worst single active failure in the short term or an active or passive failure in the long term (after 24 hours).
11. The potential for surface fouling of the secondary sides of the recirculation spray heat exchangers is considered in calculating heat transfer rates.
12. Instrumentation is provided to monitor the containment depressurization system and system component performance under normal and accident conditions to satisfy the design requirement of GDC 38.
13. Provisions are made to allow drainage of spray and ECCS water to the containment sump. The sources and quantities of energy that must be removed from the containment to meet the design bases are given in the energy distribution tables in Section 6.2.1.
14. The containment atmosphere pressure is reduced to less than half of the peak pressure within 24 hours (Section 6.2.1).
15. The RSS of the containment depressurization system is capable of operating in the post-accident environment for 30 days following the DBA.

### 6.2.2.2 System Design

The containment depressurization system consists of two systems: the QSS and the RSS. The design of each system is described in the following sections.

The entire containment depressurization system is constructed of corrosion-resistant materials, primarily stainless steel.

The components of the containment depressurization system have been selected so that the conditions of service (pressure, temperature, and fluid composition) do not prevent the system from performing its intended function. Section 3.11 discusses the environmental design conditions of the containment depressurization system components.

#### 6.2.2.2.1 Quench Spray System

The QSS, shown on Figure 6.2-121, is composed of two redundant parallel trains: Train A and Train B. Each train contains one quench spray pump which draws water independently from the RWST and is capable of providing 100 percent of the required spray capacity. Separate emergency diesel generators provide power to the electrically-operated components of Train A and Train B. The two trains connect to two common 360 degree spray headers connected in parallel, with risers 180 degrees apart. Component design data for the QSS are given in Table 6.2-56. The quench spray pumps are activated after receipt of a CIB signal and are effective 87.6 seconds after a design basis LOCA (85.5 seconds after a CIB signal setpoint). This delay (assuming design basis LOCA coincident with LOOP and emergency diesel generator start signal) is made up of the following delays:

Emergency diesel generator start-up	10	seconds
Sequencer delay	16.5	seconds
Pump acceleration to rated speed	3	seconds
Piping fill time (maximum)	45	seconds
Total delay	74.5	seconds

Each quench spray pump operating alone is capable of supplying approximately 3,000 gpm of spray flow to the quench spray headers. Both quench spray pumps operating together can supply approximately 4,500 gpm to the spray headers. The actual flow rate is determined by the difference between the containment total pressure and the RWST water level. This system flow curve is based upon the pump head versus capacity curve supplied by the pump manufacturer, the pressure losses in the lines, headers, and nozzles, and elevation differences in the system.

The quench spray pumps are located in separate cubicles adjacent to both the containment structure and the RWST and are flood- and missile-protected. Each quench spray pump discharge line contains a weight-loaded check valve inside containment and a motor-operated valve (MOV) outside containment.

The two quench spray ring headers are located at el 78 ft-6 in and 103 ft-8 in, respectively, above the operating floor, with centerline diameters of 100 ft-6 in and 31 ft-6 in, also respectively.

There are a total of 159 nozzles on the two quench spray ring headers: 120 nozzles on the lower header and 39 nozzles on the upper header. The orientation of the quench spray nozzles on each header is shown on Figure 6.2-123. The nozzle spacing and direction of the spray are designed to maximize spray coverage. The quench spray coverage is discussed in Section 6.2.2.3.1.

The mean diameter of the spray droplets is less than 1,000 microns.

The quench spray nozzles are manufactured by Spray Engineering Company (SPRACO) and are Model 1713A. These nozzles have no moving parts and are of a design which minimizes clogging. The orifice size of these nozzles is 3/8-inch diameter. The analysis of the spray effectiveness is based on information provided on this model nozzle (SPRACO undated).

The RWST is a Seismic Category I vertical, cylindrical tank with a flat bottom and hemispherical top, mounted on and secured to a reinforced concrete foundation. The tank is fabricated of Type 304L stainless steel plates. The tank has a vent that is sized to provide adequate protection against overpressurization and excessive internal vacuum. The RWST is vented via a 12-inch stainless steel vent pipe located at the highest point on the tank roof, well above the overflow line. The layout of the vent line has a 180° return shape with no low points which could become clogged. The stainless steel material is corrosion resistant and the entire length of the vent line is heat traced to prevent freezing. Component design data for the RWST is given in Table 6.2-56.

The water temperature in the RWST is controlled by circulating it through a heat exchanger which uses chilled water. The tank is insulated to limit the temperature rise of 50°F water to 0.5°F per 24-hour period with the outside mean temperature at its maximum value for the site of 104°F. The tank is provided with a manhole for access into the tank for inspection during the refueling periods and an overflow to the nuclear equipment vent and drain system.

The tank is designed as a Seismic Category I component to withstand design seismic loadings. An evaluation is made to establish that there is no loss of function following the safe shutdown earthquake conditions. The RWST is not itself required for post-earthquake safe shutdown. Piping of the connecting systems, including the connection to the fuel pool, is also designed to withstand seismic loading to ensure the functioning of the systems.

The connecting piping from the RWST is isolated from the non-safety Fuel Pool Purification System by two series isolation valves that receive a safety injection signal to close during a DBA requiring use of the RWST as a borated water source.

#### 6.2.2.2.2 Recirculation Spray System

The RSS, shown on Figure 6.2-122, consists of two 360-degree spray ring headers and four pumps and heat exchangers. Each 360-degree spray ring header is fed by two risers, where each riser originates from one of the recirculation coolers. The two redundant recirculation spray pumps that are connected to the same spray ring header are supplied with emergency power from separate emergency diesel generators. The design recirculation flow from the spray headers is maintained following failure of an emergency bus.

The design of the RSS is sufficiently independent and redundant so that an active failure in the recirculation spray mode, or an active or passive failure in the cold leg or hot leg recirculation mode of ECCS, has no effect on its ability to perform its safety function.

The recirculation spray pumps are started automatically after receipt of a CIB signal coincident with a RWST level low signal. The spray becomes effective approximately 77 seconds after pump start. When the water in the RWST has reached a predetermined extreme low level, two of the recirculation spray pumps are automatically switched to the cold leg recirculation mode of ECCS, as discussed in Section 6.3.

The two recirculation spray ring headers are located at el 81 ft-2 in and 84 ft-5 in, respectively, above the operating floor, with centerline diameters of 97 ft-6 in and 93 ft, also respectively.

Each recirculation spray ring header contains 292 nozzles. The nozzles are Model 1713A, manufactured by SPRACO. The orientation of the recirculation spray nozzles is shown on Figure 6.2-123.

The four recirculation spray pumps take suction from the containment sump, which is enclosed by a protective screen assembly. The containment sump screen assembly consists of 113 top-hat strainer assemblies placed in a rectangular grid arrangement. The top-hats are constructed of a series of perforated plate tubes as shown in Figure 6.2-128. The perforated plate has a 3/32" opening size which is slightly smaller than the size of the smallest coolant passage in the reactor core and the orifice size of the spray nozzles. The strainer design incorporates a grating structure covered in solid plate to prevent damage to the top-hat assemblies. Accessible regions of the strainer are inspected each outage for cleanliness, structural integrity, and corrosion.

The containment sump pH control system improves the iodine removal capability of the recirculation spray system. A minimum of 13,980 pounds of sodium tetraborate is installed in 6 stainless steel baskets located around the perimeter of the containment bottom floor elevation of 690'-11". These basket structures are seismically designed. Upon flooding of the containment, the NaTB in solution with the borated water provides a minimum containment sump water pH of 7.0.

The four recirculation spray pumps and associated motors are located in separate cubicles outside the containment. The four pumps are of the vertical deep-well type and have shaft extensions to permit locating the pump suctions at a level below the containment sump, with the motors at an elevation slightly above grade. Each pump has a design capacity of approximately 3,500 gpm.

The pumps are fitted with a tandem mechanical seal arrangement, which provides a seal fluid between the double mechanical seals on the recirculation pumps to preclude outleakage of radioactive fluid during pump operation. The recirculation pump tandem mechanical seal is shown on Figure 6.2-124. The seal arrangement consists of two mechanical face seals (Items No. 2 and No. 7) arranged to enclose a nonradioactive seal fluid. After the pump is started, the pressure between the seals is maintained higher than the pressure outside either seal by an accumulator (Item No. 5) with a weight-loaded diaphragm. The accumulator is fitted with two sealed level indicator alarms (Item No. 9) for annunciation in the main control room. The seal fluid is cooled by being pumped through an air cooler (Item No. 4) by a pumping ring (Item No. 6). The accumulator is conservatively sized to allow for sufficient volume of demineralized water outleakage during operation of the pump.

The accumulator and piping are constructed of stainless steel, are designed for service at peak operating conditions, and are designed in accordance with ASME Section III, Class 2.

The tandem mechanical seal arrangement provides a double barrier against leakage of radioactive fluid from the seals of the

recirculation pumps. The seal arrangement also provides adequate lubrication and cooling to prevent scoring of the seals. Level alarms are provided to ensure that adequate accumulator water volume is available and to indicate the failure of either seal.

All portions of the recirculation spray pumps which come in contact with pumped fluid are constructed of austenitic stainless steel or other materials of superior corrosion resistance. The recirculation spray pumps are designed in accordance with the criteria in Tables 6.2-57 and 6.5-1.

The recirculation spray pumps are designed to accommodate the anticipated debris present in the containment sump. Parts of the pump running with close tolerances are provided with surface hardness and finish to withstand particulate matter. Specifically, the bearings of the pump are carbon/graphite type with flushing grooves. The pump's shaft sleeves are Type 304L stainless steel with hardfacing. The combination of the two provides a highly reliable bearing surface in the presence of particulates. Similarly, the pump's wearing rings, both impeller and bowl, are hardened to provide wear resistance if particulate matter is in pumpage. The impeller wearing ring is hardfaced with a carbide material and the bowl ring is a heat treated stainless steel brought to a hardness to provide a difference in Brinell hardness between the stationary and rotating ring.

An endurance test has been performed to verify that the required performance will not be degraded during extended operation. The endurance test consisted of a total run time of 150 hours in a 12 hours on/1 hour off cyclic operation. The following parameters were monitored throughout the test period: flow rate, suction and discharge pressure, and vibration. Pump performance throughout the test did not vary outside the acceptable performance criteria of  $\pm 2$  percent of the pump performance curve established at the start of the test. After completion of the test, inspection of the internal surfaces of the pump indicated that only minimal wear was experienced during the duration of the test.

The recirculation water flows through recirculation coolers, where it is cooled by service water (Ohio River) (Section 9.2) flowing at approximately 5,500 gpm per cooler. The overall heat transfer coefficients for each recirculation cooler include fouling factors for the tube side and shell side of  $0.0003 \text{ hour}^{-1} \text{ } ^\circ\text{F}\text{-ft}^2/\text{Btu}$ . Since the recirculation water pressure in the coolers is greater than the service water pressure, only leakage can occur and dilution of the borated water by service water in the containment is not possible. This ensures that the necessary cold shutdown margin by boron is maintained. Component design data for the RSS are given in Table 6.2-57.

### 6.2.2.2.3 Insulation

There are four basic types of insulation used inside the reactor containment building: reflective metallic insulation, calcium silicate, fiberglass, and encapsulated berated Temp Mat.

Reflective metallic insulation is used to cover the majority of the reactor coolant loop piping, reactor coolant pump, pressurizer vessel, the lower portion of the steam generator up to the top of the transition cone, and a portion of the reactor vessel. Piping and equipment inside the reactor coolant pump cubicles between the operating floor elevation 740'-3" and elevation 718'-6" are generally insulated with the reflective metallic insulation. This zone has the highest potential insulation target area for impact due to jet impingement forces from a LOCA, and the resulting metallic insulation debris has the least potential of transport to the containment sump screens.

The reflective metallic insulation consists of multiple layers of Type 304 austenitic stainless steel sheets. The minimum thickness of the inner and outer jacketing is 22 gage. Design details permit tight interlocking of adjacent sections of the assembled insulation. Where removable insulation is required, quick-release mechanical fasteners are provided.

In the unlikely event of a pipe break, some insulation in the immediate vicinity of the break could possibly be removed by direct jet impingement. Since the insulation is fabricated and installed in overlapping sections, only sections in the immediate vicinity of the break would be affected.

Insulation that breaks away from the piping will fall to the floor below the piping and remain there. This is due to the weight of the reflective insulation and the low coolant velocity.

If the insulation could become entrained in the coolant flow, it is extremely unlikely that it would be transported to the containment sump. This is due to the tortuous path that the insulation will be required to follow and the relatively high water velocities required to move metallic insulation.

Calcium silicate insulation is used inside the reactor containment on the following systems: Main Steam, Feedwater, Steam Generator Blowdown, Residual Heat Removal, Primary and Secondary Plant Sampling, portions of the Reactor Coolant System, and portions of the Chemical Volume Control System. The majority of the calcium silicate insulation used on these systems is not impacted by jet impingement loads resulting from a LOCA.

Glass cloth encapsulated fiberglass insulation is used to cover the surface of the steam generator upper shell and head. Glass cloth encapsulated fiberglass insulation is used as an antisweat insulation for the service water piping and chilled water system piping.

The fiberglass insulation installed on the steam generators and the borated Temp Mat installed on the reactor vessel is located such that it is not impacted by potential jet impingement loads resulting from a LOCA.

The potential for containment sump screen blockage for secondary system line breaks is not a safety concern because the use of the recirculation system to mitigate the effects for these breaks is not required.

#### 6.2.2.2.4 Paint

The paint used inside containment is qualified for the design basis accident (DBA) environments discussed in Section 6.2.1. However, a small amount of unqualified paint primer was used for touch-up purposes. Post-DBA, the unqualified paint primer was postulated to peel and its transportability to the containment recirculation sump screens calculated. Approximately 121 cubic inches of paint were shown to transport to the screens. This is an insignificant amount and will not cause sump screen blockage.



### 6.2.2.3 Design Evaluation

#### 6.2.2.3.1 Heat Removal System Performance

The effectiveness of the containment sprays to cool the containment atmosphere following a LOCA is greater than 99 percent for the quench spray and greater than 95 percent for the recirculation spray. The small droplets of the quench and recirculation sprays approach 100 percent of thermal equilibrium with the containment atmosphere while falling through the containment atmosphere. These results are based on the (Parsly) 1970 method. It is conservatively assumed in all containment design analyses that the spray effectiveness for heat removal is 95 percent.

The droplet size spectrum for the Model 1713A nozzle was determined by SPRACO, utilizing the procedure described as follows.

Droplet size spectrum tests were accomplished by using high speed photography. A special chamber was used to house the photographic equipment. A slot on the roof of this chamber made it possible for a portion of the spray to project into the photographic chamber. This photographic equipment was mounted on a traversing rack which traversed outward from the spray axis. Photographs were taken in each size zone of the quadrant. The images of stopped motion droplets recorded on the negatives were measured and counted. Histograms, which are the incremented frequency plots, were constructed for each test condition (SPRACO undated). A typical histogram is shown on Figure 6.2-125. Figures 6.2-126 and 6.2-127 are plan and elevation views, respectively, of the containment which show expected spray patterns and the spray overlap. These spray patterns are for the quench spray only with one quench spray pump operating. With only one quench spray pump operating, approximately 100 percent of the containment operating floor area is covered and approximately 79 percent of the containment free volume is sprayed. Table 6.2-58 lists the containment subvolumes covered by the quench spray. The quench spray coverage is determined from the typical coverage charts from the nozzle manufacturer for the SPRACO Model 1713A nozzle at 40 psig across each nozzle, corrected for elevation, pressure and temperature.

The containment sump strainer has a total surface area of approximately 3300 ft<sup>2</sup>. The entire strainer area services both trains of recirculation spray pumps. The top of the top-hat assemblies is approximately at elevation 696'-0" which is approximately 1'0" below the minimum long term post-accident water level. With the large screen surface area, it is not credible that the screens would become clogged. Prototype testing has been performed which demonstrates that the maximum quantity of debris transported to the screen does not result in unacceptable head loss. Debris transported to the screen will not result in unacceptable clogging of the containment sump screen. A single passive structural failure is not credible for the containment sump screens, therefore the total surface area is available for both trains. Sufficient area has been provided to ensure that system operation during accident conditions is not

impaired and approach flow velocities are low enough to prevent entrainment of most small particles. System design allows for the maximum quantity of debris generated due to a LOCA to be transported to the screen. Figure 6.2-128 illustrates plan and elevation views of the containment sump screen assembly. The maximum elevation of water inside the containment following a LOCA is 708 ft-1 in, which is approximately 12 ft-1 in above the top of the screen assembly.

The design of the containment sump is in accordance with Regulatory Guide 1.82, with the following exceptions and justification for each:

1. The recirculation spray pumps take a suction from a single sump. A passive failure of the containment sump screen has been determined to be not credible and is therefore not assumed.
2. A portion of the containment floor slopes down toward the sump, but a raised lip is provided, which directs normal floor drainage to the segmented section of the containment sump and will prevent small debris from being swept directly into the sump.

Heat is transferred to the structural steel and concrete inside the containment by conduction and condensation. The energy absorption rate by the passive heat sinks is shown on Figure 6.2-129.

Heat is also removed from the containment atmosphere by the quench and recirculation sprays and is transferred to the containment sump water.

The energy in the containment sump water is transferred to the service water via the recirculation spray coolers. The energy removal rate by the recirculation spray coolers from sump water is shown on Figures 6.2-130 and 6.2-130A. Minimum ESF is assumed for this calculation.

#### 6.2.2.3.2 Net Positive Suction Head Available to Recirculation Pumps

Sufficient NPSH is available to the recirculation pumps during both the recirculation spray mode and the recirculation mode of low head safety injection. The following equation is used to calculate the NPSHA.

$$\text{NPSHA} = P_c + Z - H_f - P_v$$

where:

$P_c$  = Containment atmosphere total pressure

$Z$  = Elevation head of water above first stage impeller

- $H_f$  = Head loss from friction in pump suction pipe
- $P_v$  = Vapor pressure of sump liquid (saturation pressure at liquid temperatures)

All preceding parameters are expressed in feet of head.

It should be noted that NPSH is referenced to the inlet of the first stage impeller.

Table 6.2-59 compares DBA LOCA NPSHA to required NPSH for recirculation pump at start of recirculation spray, assuming minimum ESF (one train).

The DBA LOCA NPSHA is conservatively low; the actual NPSHA will always be higher for the following reasons:

1. As time progresses, containment water level used to calculate the elevation head will continually increase due to quench spray and break effluent release inside containment.
2. Spray and condensed water hold up at different floors and cavities inside containment is conservatively calculated and subtracted from the sump water inventory. Condensed water film on heat sink surfaces is also subtracted from the sump water inventory.
3. The time delays for spray, drainage, and condensed water to reach the sump are considered.

For these reasons, i.e., conservatively low NPSHA and conservatively high NPSH required, a higher margin between available and required NPSH is assured.

Sensitivity analyses are used to determine the limiting input parameters, break locations and single failures which predict the minimum NPSH available.

#### 6.2.2.3.3 Iodine Removal by Containment Spray System

The spray nozzles are selected to provide adequate iodine removal capability and containment coverage. The resulting iodine removal coefficients are evaluated in Section 6.5.2.

#### 6.2.2.3.4 Failure Analysis

A failure modes and effects analysis (FMEA) to determine if the instrumentation and controls (I&C) and electrical portions meet the single failure criterion, and to demonstrate and verify how the GDC and IEEE Standard 279-1971 requirements are satisfied, has been performed on the QSS and RSS. The FMEA methodology is discussed in Section 7.3.2. The results of this analysis can be found in the separate FMEA document (Section 1.7).

#### 6.2.2.4 Inspection and Testing Requirements

Preoperational tests are performed on the containment depressurization system as described in Section 14.2.12. Section 6.6 describes the in-service periodic inspection and system pressure tests.

On January 11, 2008, the NRC issued Generic Letter 2008-01, "Managing Gas Accumulation in Emergency Core Cooling, Decay Heat Removal, and Containment Spray Systems." Generic Letter 2008-01 requested licensees to evaluate the licensing basis, design, testing, and corrective action programs for the emergency core cooling, decay heat removal, and containment spray systems.

As a result, FENOC performed evaluations that included the review of gas susceptible piping locations, the development of activities to monitor various piping locations as appropriate based on industry experience and plant specific experience, and acceptance of some generic locations that normally accumulate voids that do not adversely affect the design function(s) of the system.

FENOC established a gas accumulation prevention and management program to ensure that gas accumulation is reasonably prevented or maintained less than the amount that challenges the functionality of the applicable systems and that appropriate action is taken when conditions adverse to quality are identified.

#### 6.2.2.5 Instrumentation Requirements

Control switches with indicating lights are provided in the main control room for the quench spray pumps. These pumps can be started manually or automatically. While in the automatic mode of operation, a diesel loading sequence signal combined with a CIB signal, or a CIB signal without a loss of power, will initiate the QSS. These pumps can be stopped manually after CIB is reset.

These pumps deliver cold water from the RWST to the spray headers inside the containment.

Control switches with indicating lights are provided in the main control room for the quench spray pumps suction and discharge MOVs. A CIB signal being present provides a signal to open these valves even though the quench spray pumps suction and discharge valves are normally open during plant operation. When a CIB signal is not present and a respective quench spray pump is not running, these valves can be closed manually.

Ammeters are provided on the main board in the main control room for each of the quench spray pumps.

Pressure indicators are provided in the main control room for each quench spray pump discharge and suction pressures.

Annunciation is provided in the main control room for the quench spray pumps auto start/stop and QSS trouble, which consists of the quench spray pumps low flow. These are also monitored by the plant computer system.

Control switches with indicating lights are provided in the main control room for the recirculation spray pumps. These pumps may be started manually or automatically. During the automatic mode of operation, the pumps are started when a CIB signal is present coincident with a RWST low level with normal or emergency ac power. Two of the operating recirculation spray pumps (C and D) are automatically switched to the cold leg recirculation mode of the ECCS when an extreme low level is reached in the RWST. The recirculation pumps may be stopped when a CIB signal is not present. The recirculation spray pumps take suction from the containment sump.

Control switches with indicating lights are provided in the main control room for the recirculation pump suction valves. These suction valves open automatically from a CIB and are normally open during plant operation.

Control switches with indicating lights are provided in the main control room for the recirculation pump discharge valves. Two of these discharge valves (A and B) operate the same as the suction valves.

The other two discharge valves (C and D) open when a CIB signal is present, and close when a recirculation mode initiation signal is present, and a respective safety injection discharge header valve is open. All of the discharge valves are normally open during plant operation.

Minimum flow recirculation valves are provided for two of the recirculation spray pumps (C and D). These valves will open automatically when a low flow signal from the recirculation spray pumps is present. These valves will close when a normal discharge flow is present from the recirculation spray pumps. These valves are used during recirculation mode of safety injection to maintain minimum flow of the recirculation spray pumps.

Pressure indicators are provided in the main control room for each recirculation spray pump discharge pressure. Flow indicators are provided in the main control room for each recirculation spray pump discharge flow. Temperature indicators are provided in the main control room for each recirculation spray pump discharge temperature. Ammeters are provided in the main control room for each recirculation spray pump. Level indicators are provided in the main control room for the containment sump level and the recirculation spray sump level.

Temperature indicators are provided in the main control room for the containment sump temperature. A temperature recorder is provided in the main control room for the containment sump temperature. A level recorder is provided in the main control room for the containment sump water level. Flow recorders are provided in the main control room for the recirculation spray pump discharge flow.

Annunciation is provided in the main control room for recirculation spray system trouble, which consists of: recirculation spray pumps seal water level off normal/low, recirculation spray pumps clean-out pit water level high, and recirculation spray pumps vibration high. Annunciation is also provided in the main control room for incore instrument room/containment sump level high/valve not reset, recirculation spray pumps auto start/stop, and recirculation spray sump level high. These conditions are monitored by the BVPS-2 computer system.

### 6.2.3 Secondary Containment Functional Design

Beaver Valley Power Station - Unit 2 does not have a dual containment structure, therefore this section does not apply.

#### 6.2.4 Containment Isolation System

The purpose of the containment isolation system (CIS) is to isolate piping lines which penetrate the containment and to prevent the release of radioactive materials from the primary containment in the event of a LOCA.

##### 6.2.4.1 Design Bases

The design of the CIS is in accordance with the following criteria:

1. All fluid system components, which are part of the CIS, are designed, fabricated, installed, and tested in accordance with Quality Assurance Category I, Seismic Category I, and

Safety Class 2 requirements described in Section 3.2 and in the particular fluid system sections referenced in Table 6.2-60. General Design Criterion 1 is met by implementation of QA Category I requirements.

2. All components of the containment isolation fluid, electrical, and controls systems are located in Seismic Category I structures, protected from the effects of natural phenomena, thus meeting GDC 2.
3. All containment isolation fluid system components as well as electrical and control components required for initiation are evaluated for the effects of postulated missiles as described in Section 3.5. This analysis plus the pipe break effects analysis described in Section 3.6 ensures that containment isolation can be achieved, thus meeting the requirements of GDC 4.
4. General Design Criterion 16 as it relates to providing a leaktight barrier against the uncontrolled release of radioactivity to the environment.

General Design Criteria 54 through 57 and Regulatory Guide 1.11 requirements are met, as applicable, in the design bases that follows.

5. Containment isolation consists of at least two barriers between the atmosphere outside containment and: 1) the atmosphere inside the containment; 2) the RCS; and 3) systems which could become connected to either the containment atmosphere or the RCS as a result of, or subsequent to, a LOCA.

The two barriers consist of one of the following arrangements :

- a. One normally closed, administratively controlled isolation valve inside containment, and one normally closed, administratively controlled isolation valve outside containment,
- b. One automatic isolation valve inside containment and one normally closed, administratively controlled isolation valve outside containment,
- c. One normally closed, administratively controlled isolation valve inside containment and one automatic isolation valve outside containment; however, a simple check valve may not be used as the automatic isolation valve outside containment,



- d. One automatic isolation valve inside containment and one automatic isolation valve outside containment; however, a simple check valve may not be used as the automatic isolation valve outside containment,
- e. A sealed system inside containment and one isolation valve outside containment which is either automatic, normally closed, administratively controlled, or remote manually operated (a sealed system is one which is neither part of the reactor coolant pressure boundary nor connected directly to the containment atmosphere), or
- f. In the case of the containment sump suction pipe and valve arrangements, a conservatively designed and fabricated single valve and suction pipe arrangement that prevents gross system leakage.

Check valves are weight-loaded or spring-loaded to have positive closure in the direction of flow. This ensures that these check valves will remain closed when the inside containment atmosphere returns to subatmospheric conditions following a DBA.

- 6. Containment isolation valves outside containment are located so as to require a minimum length of piping between the isolation valves and their respective penetrations.
- 7. The containment penetrations are designed such that operational test procedures, when used in conjunction with test connections (where required), can be used to check the leaktightness of each automatic containment isolation valve, including weight-loaded and spring-loaded check valves in accordance with 10 CFR 50, Appendix J, and as described in Section 6.2.6.
- 8. Determination of the extent of fuel failure (source term, Section 15.6.5) used in radiological calculations is in accordance to 10 CFR 50, Appendix K.
- 9. Instrumentation and adjunct control circuits associated with automatic valve closure shall cause the valves to fail in the position that provides greater safety upon loss of voltage or control air. Circuits which control redundant automatic valves are redundant to the extent that no single failure will preclude isolation.
- 10. Means are provided to periodically test the functions of the automatic isolation equipment, such as the set point of sensors, speed of response, and operability of fail-safe features.

11. The CIS is designed to be in compliance with Regulatory Guides 1.26, 1.29, and 1.141.

12. All remotely actuated valves of the CIS have their positions indicated in the main control room by separate limit switches installed directly on the valve actuator.
13. The CIS meets the intent of NUREG-0737, Action Item II.E.4.1, requiring dedicated hydrogen penetrations for recombiners to be located external to the containment (Section 6.2.5).
14. The CIS meets the intent of NUREG-0737, Action Item II.E.4.2, with regard to containment isolation dependability. The CIS is activated automatically when monitored system variables exceed pre-established set points. It is neither necessary nor desirable that every containment isolation valve close simultaneously upon a containment isolation signal. The plant design allows selected valves in the ESF systems, which are essential to mitigate the effects of an accident, to remain in or move to their open position. These pre-selected valves are remote, manually-operated, and are operated from the main control room. Table 6.2-60 lists the position of each valve in the CIS, under various plant conditions, and the valve position in response to containment isolation signal. The initiating conditions for containment isolation are presented in Section 7.3 in discussions of circuits, isolation functions and setting, logics, resetting, and redundancy. Section 9.4.7.3 discusses the containment purge system and its valve operations in relation to the requirements of the action item.
15. Section 8.3.1 discusses Class 1E electrical power supplies utilized for initiating and completing valve closures. All controls and electrical systems for containment isolation are Class 1E, and environmentally qualified in accordance with Section 3.11.
16. Spare penetrations are welded closed inside the containment.
17. A detailed pipe break and dynamic effects analysis, including pipe break exclusion and crack exclusion as applicable, is done for all piping systems inside and outside containment and is described in Section 3.6 to ensure that all essential safety-related components can perform their safety function following a postulated pipe rupture.
18. The CIS meets the single failure criterion described in Section 3.1.1.

#### 6.2.4.2 System Description

The CIS is initiated by diverse parameters, such as containment pressure and various reactor parameters. The initiation signals are train-operated with redundant and electrical separation being supplied from the initiating device to the individual isolation valve. Control circuits for initiation of containment isolation and the resetting of these initiation signals are discussed in Section 7.3.

Containment isolation is accomplished in two phases. Initiation of a containment isolation Phase A (CIA) signal shuts most of the automatic isolation valves as shown in Table 6.2-60. Selected other critical lines such as component cooling water to the reactor coolant pumps (RCPs), service water to the containment air recirculation coolers or control rod drive mechanism shroud coolers are considered important enough to delay until the next phase - CIB. Initiating signals for this phase closes all required automatic valves.

Following a DBA, the ambient temperatures in the containment may rise as high as 333.3°F. Although such high temperatures are short-lived, it is possible that water trapped between isolation barriers may expand due to the thermal effects, creating pressures greater than the piping design limit. Overpressure protection is provided by: 1) relief valves between the isolation valves with set points in excess of the containment design pressure by 50 percent (minimum) but at or below the piping design limit. These valves are designed to reseal when the overpressure conditions subside; 2) a check valve located on a bypass line, around the isolation valve inside the containment, to relieve pressure between the isolation valves; 3) it is inherent in lines which utilize a weight-loaded or spring-loaded check valve as an isolation valve inside containment since a high pressure condition between the check valve and the outside containment isolation valve will open the check valve to relieve pressure; or 4) isolation barriers and associated piping arrangements that are conservatively designed.

Containment isolation valves and valve operators are chosen based on the following requirements: fluid type, closure time, actuator failure position, secondary mode of operation, and overall space envelope. As an example, lines which are part of an ESF are isolated by MOV rather than air-operated valves (AOVs). They also fail as-is. An AOV, however, provides a very rapid (10 seconds or less) closure time for lines which will not be used post-accident. The maximum closure time for any containment isolation valve is 60 seconds or less. Solenoid-operated valves are utilized in place of AOVs when greater reliability post-accident use and safe failure positions are required. No secondary mode of operation is provided. The containment purge system isolation valves are only open during plant shutdown. The valves, however, will close automatically within 10 seconds upon receipt of a high radiation signal (Section 9.4.7.3).

Mechanical redundancy is provided by designing two isolation barriers between the RCS or atmosphere inside containment and the atmosphere outside containment. Electrical redundancy, including control circuitry, is provided by two Class 1E power sources. For example, in a containment isolation arrangement with an MOV inside containment and an MOV outside containment, each valve is powered from a different Class 1E source. The electrical or control signal power received by the containment isolation valves (including limit switches, etc) is designated as a Class 1E component, as discussed in Section 8.3.1, thereby ensuring containment integrity under the most severe anticipated environment. Environmental qualification of Class 1E components is discussed in Section 3.11.

Table 6.2-60 lists each fluid system penetrating the containment structure and indicates the isolation criteria to which it conforms. The details of containment isolation arrangements which differ in some manner from the specific arrangements allowed by GDC 54, 55, 56, and 57 are indicated as follows:

1. Emergency core cooling system safety injection lines,

The safety injection portion of the ECCS must be operable after a DBA to keep the reactor core covered with water. The RCS cold leg injection lines are either opened immediately or during the transfer to ECCS recirculation mode (short-term), following a DBA. The RCS hot leg injection lines are opened for long-term recirculation. Section 6.3 describes ECCS operation in detail. Table 6.2-60 lists the ECCS containment penetrations which must be opened. All ECCS lines penetrating the containment, which must be open at any time following an accident, include a remotely operable MOV outside containment and a weight-loaded check valve inside containment. None of the MOVs receive a containment isolation signal to close since post-accident opening is required.

2. Recirculation spray pump suction lines.

The suction line and valve arrangement for the recirculation spray pumps are conservatively designed to prevent significant system leakage. The major portion of this piping is buried in the reinforced concrete base mat of the containment. Approximately 10 inches of open-ended pipe is exposed above the containment sump bottom. The piping between the outside of the containment wall and the isolation valve (including the valve) is contained within a specially designed encapsulation. These isolation valves, one in each line, are normally open, remotely controlled, and motor-operated. These isolation valves do not receive an automatic safety signal for closure.

The isolation valves do receive a CIB signal to ensure an open position. This arrangement ensures that water can be taken from the containment sump for recirculation following a DBA in addition to providing the required containment isolation function. The valves can be remote manually closed by the operator, if necessary.

3. Containment vacuum pump and hydrogen recombiner suction lines.

These lines are normally provided with two remotely-controlled, solenoid-operated isolation valves in series outside containment (Section 6.2.5). The containment vacuum system valves are normally open, the valves of the hydrogen control system (HCS) are normally closed. The valves are located as close as possible to the containment wall. The piping is designed in accordance with the break/crack exclusion criteria set forth in Branch Technical Position MEB 3-1, Postulated Rupture Locations in Fluid System Piping Inside and Outside Containments, and as described in Section 3.6B. Leakage detection is not required as the valves are hermetically sealed. The containment vacuum system containment isolation valves close automatically upon receipt of a CIA signal. The post-DBA HCS is an ESF and the system's normally closed containment isolation valves must be opened manually by the operator for long-term hydrogen control.

4. Containment depressurization.

The containment depressurization systems must be capable of operating following a DBA to reduce containment pressure to near initial atmospheric conditions. The isolation valves in these systems open upon receipt of a CIB signal, if not already open.

Each of the quench spray pump discharge and recirculation spray pump discharge lines is provided with a normally open, remotely-controlled, motor-operated isolation valve outside containment and a weight-loaded check valve inside containment. These containment isolation physical arrangements comply with GDC 56, and also allow the depressurization systems to perform their post-DBA design function.

5. Containment leakage monitoring system

This system consists of four open-tap instrument lines. These lines are used for either normal operation or accident condition containment pressure monitoring. Each line is provided with a flow restriction orifice to limit the amount of release in case of line rupture, and a normally open, remotely-controlled, solenoid-operated isolation valve. The valves are operated by control switches in the main control room and have indicating lights and alarms. In addition, the transmitters used for sensing containment pressure are seismically qualified. This arrangement complies with Regulatory Guide 1.11, Instrument Lines Penetrating Primary Reactor Containment.

6. Fuel transfer tube.

The fuel transfer tube penetrates the containment and is used to transfer spent fuel between the reactor and the fuel pool (Section 9.1.2). The tube is provided with a blank flange with dual O-rings inside containment and a normally closed, manually-operated valve outside containment. This arrangement will be tested to Type B leak test requirements of 10 CFR 50, Appendix J (Section 6.2.6). In addition, this tube is enclosed in another penetration encapsulation which is provided with a leak detection drain just inside the containment wall.

7. Auxiliary feedwater.

Auxiliary feedwater is used for long term cooldown post-accident and is provided with electro-hydraulic hand control valves (HCV) outside containment and check valves inside containment. The outside containment valves do not receive an automatic closure signal but may be closed by the operator if necessary.

8. Personnel air lock and equipment hatch.

The personnel air lock (PAL) is supplied with doors both inside and outside containment. The doors are secured by a rotating locking ring and sealed with a double O-ring gasket system. Each door is equipped with two normally closed, manually operated pressure equalizing valves (one from each side of the door). Each door is also equipped with an 18" breech design manway which incorporates double O-ring seals that seal using a wedged rotating locking ring. All the valves are administratively closed. Leak test connections are supplied and the air lock is tested to Type B leak test requirements in accordance with 10 CFR 50, Appendix J (Section 6.2.6).

The equipment hatch is supplied with a bolted hatch cover which may only be opened from inside the containment. The equipment hatch seals are similar to those used for the personnel hatch. Bolted to the equipment hatch is the emergency air lock (EAL), which is equivalent in sealing, security, and testing to the personnel hatch. The bolted connection between the EAL and equipment hatch has seals and leak test connections. The EAL and equipment hatch are Type B leak-tested in accordance with 10 CFR 50, Appendix J. The EAL has a manually-operated, administratively closed, isolation valve inside and outside containment.



9. Reactor coolant pump seal injection.

Each seal injection line to the RCPs includes a remote manual MOV outside containment and a weight-loaded check valve inside containment. The valve outside containment does not receive an automatic closure signal since seal injection should be maintained to the RCPs as long as the pumps are operating. When the pumps have stopped operating, the MOVs are closed, remote-manually, by the operator for the long term.

10. Hydrogen recombiner return lines.

The hydrogen recombiner return lines from each recombiner contain a motor-operated and a manual isolation valve in series outside containment. The manual valves are administratively controlled and remain in the shut position until the recombiners are required for operation. The piping is designed in accordance with the crack exclusion criteria set forth in Branch Technical Position MEB 3-1, Postulated Rupture Locations in Fluid System Piping Inside and Outside Containments, and as described in Section 3.6B.2.1.2.2.

11. Reactor Vessel Level Instrumentation System.

The Reactor Vessel Level Instrumentation System (RVLIS) provides indication of the reactor vessel fluid level or relative void content. Connections at the reactor vessel head, hot legs A and B, and the seal table provide the RVLIS sensing points. Tubing from these connections runs to high volume sensors which isolate the reactor coolant system from the remainder of the RVLIS tubing. The remainder of RVLIS tubing is filled with deaerated demineralized water.

Capillary tubing runs from the high volume sensors, penetrates the containment, and runs to the hydraulic isolators. Tubing then connects the hydraulic isolators to differential pressure transmitters.

Containment isolation is provided by the hydraulic isolator and connecting capillary tubing. The hydraulic isolator located outside containment serves as an air isolation valve on the containment building.

Within the high volume sensor is a check valve which will close under reactor coolant system pressure if the connecting capillary tubing fails.

#### 6.2.4.3 Safety Evaluation

The design pressure of piping and components within the isolation boundaries afforded by the CIS are equal to, or greater than, the design pressure of the containment structure. Piping, valves, and

penetrations of the CIS are designed, constructed, and installed in accordance with QA Category I, Seismic Category I, and ASME Section III, Class 2.

Systems penetrating the reactor containment are designated as "essential" or "nonessential," as shown in Table 6.2-60. The designation of a system as "essential" is based on the requirement that it remains operable during and after a design basis accident to mitigate the effects of the accident. All "nonessential" systems are automatically isolated, as delineated in Table 6.2-60.

Essential lines penetrating containment that utilize single or double isolation valves outside containment employ conservative piping and valve design in accordance with SRP 3.6.2.

System design also includes check valves to preclude flow from containment to atmosphere from leakage outside containment. Leakage detection is also facilitated by monitoring of system parameters indicative of moderate system leakage, i.e., flow, pressure, and level indication. A discussion of the specific system parameters monitored for each listed essential system can be found in these sections:

Quench and Recirculation Spray Systems	Section 6.2.2.5
Auxiliary Feedwater System	Section 10.4.9.5
Main Steam System	Section 10.3.7
Charging and Volume Control System	Section 6.3
Combustible Gas Control System	Section 6.2.5.5
Safety Injection System	Section 6.3
Leakage Monitoring System	Section 6.2.4.2

The ESF lines containing isolation valves that are open following a DBA are monitored so that containment integrity is ensured following DBA conditions. This monitoring is provided in the form of safety-related sump level indication (outside containment) as described in Section 7.3. A rise in sump level would indicate a possible problem in a functioning ESF line(s), which would require isolation, at least until the source of water was identified.

Containment isolation valve operability and containment isolation barrier leakage rate testing are described in Section 6.2.6.

A FMEA to determine if the I&C and electrical portions meet the single failure criterion has been performed on the CIS. The results of this analysis can be found in the separate FMEA document (Section 1.7).

#### 6.2.4.4 Inspection and Testing Requirements

Prior to initial unit operation and during each major refueling period, as specified in 10 CFR 50, Appendix J, tests are conducted to ascertain the leaktightness and operability of the CIS.

Section 6.2.6 provides a description of the Type B and Type C test programs. In addition, fail-safe positions, sensor accuracy and set points, and response time are all tested and verified to be in accordance with technical requirements. The inspection and testing requirements of the ESF actuation system is discussed in Section 7.1. The mechanical components and pressure boundaries of all fluid system containment penetrations will be tested and inspected in accordance with the ASME OM Code and ASME Section XI.

#### 6.2.5 Combustible Gas Control in Containment

The combustible gas control system (CGCS) mixes and monitors the hydrogen concentration within the containment and maintains this concentration at a safe level following DBA.

The CGCS, which includes subsystems capable of monitoring the combustible gas concentrations within containment regions and reducing this combustible gas concentration, is shown on Figure 6.2-131.

Mixing of hydrogen in the containment following a postulated LOCA results from three mechanisms: 1) momentum transfer from the fluid jet exiting the break; 2) forced and natural convection flows within the containment atmosphere; and 3) molecular diffusion. All of these mechanisms will work together to enhance mixing within the containment to provide a homogeneous gas mixture and prevent local accumulation of hydrogen.

Good containment compartment mixing will occur during the blowdown period of the postulated LOCA due to the break effluent. The momentum of the jet from the break will cause turbulent mixing within the containment. This was demonstrated in a test performed for a high velocity jet source (Bloom 1982). Results from this test showed that "when the jet was initiated, local gas velocities, even far from the source, increased by a factor of three to five times over background velocities caused by natural convection and fan-induced recirculation." Although this test was performed for an ice condenser lower compartment geometry, the test results would be applicable to subcompartments (e.g., steam generator cubicle, pressurizer cubicle) which are open to the containment.

Forced convection in the containment atmosphere will be generated by the containment spray systems which are designed to cool the containment atmosphere (Section 6.2.2). Approximately 3,500 gpm long-term recirculation spray flow rate (assuming minimum safeguards) is provided.

The spray will induce mixing by imparting momentum to the containment atmosphere. Air entrainment by the spray causes bulk mass motion which creates both large- and small-scale turbulence. Therefore,

complete mixing should occur within a few minutes following a LOCA with containment spray operation (Sandia 1983).

In addition, steam condensation and cooling of the containment atmosphere by the sprays will result in flow to low pressure regions. This does not result in significant mixing within individual compartments, although significant intercompartment fluid transfer can occur (IDCOR 1983).

Natural convection due to density differences (buoyant effects) is another source which will cause mixing to occur in the containment atmosphere. Gas flow occurs whenever there is a temperature difference between the wall and the bulk atmosphere. Gases heated or cooled by the walls will rise or fall, respectively, due to the density differences between the gas and the surrounding atmosphere. This buoyant force imparts momentum to the gas and significant turbulent mixing will result.

The presence of large heat sinks in the containment, such as internal walls, together with localized heat sources, such as hot equipment surfaces, will be expected to set up large-scale natural circulation cells. These circulation cells will help decrease any stratification that may occur in areas with the absence of jet induced or forced convection flows. Tests conducted during the containment systems experiment (CSE) program in a steam/air atmosphere indicated that natural convection caused good mixing in a large vessel (Hillard and Coleman 1970, Knudsen and Hillard 1969).

After completion of the blowdown period of the postulated LOCA, natural convection flows within the containment atmosphere will also be developed due to the break effluent. Cooling water is injected into the reactor core by the ECCS (Section 6.3). The injected water will exit the break as steam/water mixture. Buoyancy forces will cause the released steam to rise. This upward steam flow will generate containment mixing due to the entrainment of the atmosphere gases in the steam plume. The extent of mixing in areas away from the break due to the buoyant thermal plume discharging into the containment is a function of geometry, plume to atmosphere density ratio, and ratio of momentum to buoyancy forces (IDCOR 1983).

Molecular diffusion is another mechanism which would provide mixing within the containment following a postulated LOCA. Diffusion occurs due to concentration gradients. The rate of diffusion is too slow to expect mixing of large containment volumes in short times by itself, although molecular diffusion would add to the other mixing processes previously discussed.

The containment internal structures (Section 3.8.1) are designed to be as open as practical to allow the circulation and mixing mechanisms to function. The volume above the operating floor, which comprises the majority of the containment volume, does not have significant barriers to obstruct mixing from the various mechanisms.

The steam generator and pressurizer subcompartments, the annulus between the crane wall and containment wall, and the hoisting spaces are open at the top (near the top for the upper pressurizer cubicle) and bottom and connect with each other at various elevations (Figure 6.2-138). Extensive use is made of gratings at intermediate levels within the compartments. The quench and recirculation spray nozzles are located and oriented to cover as much area as possible. This design arrangement enhances mixing by establishing air movements and flow paths.

Containment compartments have direct circulation between each other as follows:

1. Dome - Fully open to operating floor and annulus
2. Operating Floor - Open to annulus, dome, steam generators (1, 2, and 3), pressurizer, RHR, hoist space, reactor vessel annulus, and upper pressurizer
3. Annulus - Open to dome, operating floor, steam generator 1, pressurizer, RHR hoist, RHR, hoist space, and basement
4. Steam Generator 1 - Open to operating floor, annulus, RHR hoist, RHR, and basement
5. Steam Generator 2 - Open to operating floor, pressurizer, hoist space, and basement
6. Steam Generator 3 - Open to operating floor, pressurizer, RHR hoist, RHR, and basement
7. Pressurizer - Open to operating floor, annulus, steam generator 2, steam generator 3, and upper pressurizer
8. Upper pressurizer - Open to pressurizer and operating floor
9. RHR Hoist - Open to annulus, steam generator 1, and steam generator 3
10. RHR - Open to annulus, steam generator 1, steam generator 3, and instrumentation tunnel
11. Hoist Space - Open to operating floor, annulus, steam generator 2, and basement
12. Basement - Open to annulus, steam generator 1, steam generator 2, steam generator 3, RHR, and hoist space
13. Incore Instrumentation Tunnel - Open to reactor vessel annulus and open to the basement through ventilation ducts

14. Reactor Vessel Annulus - Open to incore instrumentation tunnel and open to operating floor through reactor cavity water seal access ports

As discussed above, each compartment has openings to allow free circulation and there are no dead end compartments. Since there is a direct or indirect circulation between each compartment, an effective mixing will be achieved. Figure 6.2-139 shows the expected long-term circulation patterns within the containment that are caused by recirculation spray.

In summary, the design of the internal containment structure allows free circulation and mixing of gases through numerous large openings in the ceilings, floors, and walls of each compartment while the spray system enhances the circulation process throughout the containment.

Hydrogen generation from oxidation of zircaloy fuel cladding, radiolysis of the water in the core, and hydrogen present in the reactor coolant system would be released through the break opening to the containment. Local accumulation of hydrogen within the compartment where the break occurred due to these sources would not occur. This is due to the combined action of the mixing mechanisms and the internal design of the containment structures which allows air to circulate freely. Hydrogen generation from the radiolysis of water in the sump and corrosion of metals (i.e., aluminum and zinc) by the containment spray would be generated over long periods of time. Because of the slow rates of release, diffusion and convection mechanisms will be more than enough to prevent hydrogen accumulation (IDCOR 1983).

It can be concluded that following a postulated LOCA with spray operation, good mixing will occur within the containment to prevent the localized accumulation of hydrogen.

#### 6.2.5.1 Design Bases

The design of the CGCS is in accordance with the following criteria:

1. General Design Criterion 41, as it relates to the control of hydrogen concentration in the containment atmosphere following an accident.
2. General Design Criterion 42, as it relates to periodic inspection of the containment cleanup system to assure its integrity and capability.

3. General Design Criterion 43, as it relates to periodic testing of the atmosphere cleanup system.
4. Deleted
5. Regulatory Guide 1.26, as it relates to the system being designed to Safety Class 2 and ASME Section III, Class 2, standards, except the purge system which is non-nuclear safety (NNS) class and nonseismic and process sample tubing connected to the hydrogen analyzers which is Quality Assurance Category I, Seismic Category I, Safety Class 2.
6. Regulatory Guide 1.29, with respect to the CGCS being Seismic Category I except for the purge system. The CGCS is protected from the effects of tornadoes, external missiles, pipe ruptures, pipe whip, and jet impingement forces.
7. Regulatory Guide 1.97, as it relates to the capability of the instrumentation to monitor and sample the combustible gas concentrations within the containment during normal and post-accident conditions.
8. Deleted
9. The containment atmosphere is maintained uniformly mixed by the containment spray to prevent excessive stratification of combustible gases (Kundson and Hilliard 1969; Hilliard et al 1970).
10. Deleted
11. The CGCS is designed for all environmental conditions (Section 3.11).

12. Deleted
13. The CGCS meets the intent of NUREG-0737, Action Item II.E.4.1, that requires dedicated hydrogen penetrations for recombiners to be located external to the containment.
14. The CGCS meets the intent of NUREG-0737, action item II.F.1.6, concerning the monitoring of hydrogen concentration of the containment atmosphere.
15. The QA Category I portions of the CGCS suction and discharge piping are exempt from consideration of passive failures in accordance with NUREG 0800, Section 6.2.5 "Combustible Gas Control in Containment."

#### 6.2.5.2 System Description

The CGCS is shown in a simplified manner on Figure 6.2-131.

The containment penetration design is discussed in Section 6.2.4.

The two hydrogen analyzers shown on Figure 6.2-131 are located in the cable vault area. A remote control panel located in the service building is provided with each analyzer. The analyzers may be controlled locally at the remote control panel, but this control will be overridden manually from a control switch located on the main control board or automatically by a safety injection signal. Opening of the associated containment isolation valves is controlled in the same manner. Indicators and a recorder (one channel only) mounted on the main control board provide continuous monitoring of containment hydrogen concentration when the analyzers are operating. Annunciation is provided in the main control room when either or both analyzers are unavailable; in addition, the unavailability is monitored by the main plant computer system. Containment hydrogen concentration indication is also provided on the remote control panel.



### 6.2.5.3 Design Evaluation

The five major sources of hydrogen generation assumed following a DBA are:

1. Metal-water reaction involving the zirconium fuel cladding and the reactor coolant.

The reaction of the zirconium clad with water is assumed to occur instantaneously after a DBA and the hydrogen evolved is added to the containment atmosphere immediately. Section 15.6.5 discusses the calculated amount of hydrogen generated from the chemical reaction.

2. Pressurizer gas space and RCS water.

The hydrogen present in the pressurizer gas space and reactor coolant is assumed to be released to the containment atmosphere instantaneously after a DBA.

3. Radiolytic generation in the water collected on the containment floor.

Radiolytic decomposition of water is given by the following chemical equation:



The energy for this reaction is supplied by the decay of fission products which have escaped from the reactor core and are dissolved in the sump water. The fission product distribution and energy absorption used in the analysis are in conformance with Regulatory Guide 1.7.

4. Radiolytic generation in the reactor core.

The chemical reaction presented for sump radiolysis is also applicable to radiolytic decomposition of water in the reactor core. In this case, the energy is supplied by the decay of fission products in the fuel.

Sump and core radiolysis is based on American Nuclear Society (ANS) draft standard ANSI 56.1, Combustible Gas Control dated June, 1976.

5. Corrosion of metals by solutions used for containment spray.

The use of aluminum and zinc inside the containment is minimized. These materials are not utilized in the manufacture of safety-related components which are in contact with the core cooling fluid.

Aluminum and zinc bearing materials, such as galvanized steel, within the containment may react with the containment spray and produce hydrogen. The inventories of aluminum and zinc inside containment are documented and administratively controlled by plant procedures. |

The volume control tank (VCT) is automatically isolated from the charging pumps by redundant valves on receipt of a safety injection signal. The valves close within 10 seconds after receipt of the signal. The liquid inventory in the tank is sufficient to prevent hydrogen from reaching the charging pump suction before isolation of the tank by virtue of a water seal. Thus, the VCT hydrogen is unable to reach the containment after a LOCA and is not considered a source of hydrogen in the analysis.

The total amount of hydrogen in the containment is calculated by summing the hydrogen produced by each of the five hydrogen generation sources. The partial pressure of the hydrogen is calculated assuming a perfect gas. The total pressure in the containment is then calculated by summing the partial pressures of the vapor and the noncondensables. The volume percent of the hydrogen is calculated from the ratio of the partial pressure of the hydrogen to the total containment pressure. |

The internal design of the containment structures allows air to circulate freely. All cubicles and compartments within the containment are provided with openings near the top as well as openings in the floor to allow air circulation. Convective mixing in conjunction with containment spray assures a uniform mixture of hydrogen in the containment.

Containment system experiment tests (Knudsen and Hilliard 1969; Hilliard et al 1970) have verified that adequate mixing of the containment atmosphere is achieved by the CSS. The design of the BVPS-2 containment is similar to those of the Surry Power Station, Unit 1 and Unit 2, for which it has been concluded by the U.S. Atomic Energy Commission (USAEC 1972b) that there is adequate mixing of hydrogen in the post-LOCA environment.

The inlet isolation valve (2HCS\*MOV110A) for the containment atmosphere purge subsystem has its electrical power supply deenergized during normal and post-accident operation to prevent a spurious signal from affecting the hydrogen control system safety function. Section 8.3.1.2.1 provides details on the method.

A FMEA to determine if the I&C and electrical portions meet the single failure criterion, and to demonstrate and verify how the GDC and IEEE Standard 279-1971 requirements are satisfied, has been performed on the CGCS. The FMEA methodology is discussed in Section 7.3,2. The results of this analysis can be found in the separate FMEA document (Section 1.7).

#### 6.2.5.4 Inspection and Testing Requirements

Chapter 14 provides a detailed discussion on preoperational testing performed on the CGCS. In-service periodic inspection and system pressure tests are discussed in Section 6.6.

#### 6.2.5.5 Instrumentation Requirements

Control switches are provided locally on the hydrogen recombiner panels in the safeguards area for the positive displacement blower.

Controls are provided at the control panel in the service building (near the hydrogen analyzers) for all automatic valves associated with the purge blower.

Annunciation is provided in the main control room for hydrogen control system local panel trouble. The input to this annunciator from the local panels is also monitored by the BVPS-2 computer system. Indicators are provided in the main control room to monitor hydrogen gas concentrations. A recorder for hydrogen gas concentrations. A recorder for hydrogen gas concentration (channel A only) is provided.

The following controls and instruments are located on the hydrogen analyzer panel: a stream selector switch for stream to be analyzed, indicating lights for reference/zero gas pressure, or calibration/sample gas pressure low alarm, and high gas concentration.

#### 6.2.6 Containment Leakage Testing

The containment leakage rate tests are performed in accordance with 10 CFR 50, Appendix J, Option B, and GDC 52, 53, and 54.

The purpose of the containment leakage test program is to assure that leakage through the reactor containment, systems, and components penetrating the containment boundary does not exceed the allowable leakage rate values as specified in the Technical Specifications (Chapter 16) or other design base documents.

The containment leak testing program includes the performance of Type A tests to measure the containment overall integrated leak rate; Type B tests to detect local resilient seal leakage at electrical penetrations, equipment hatch, personnel hatch, emergency escape trunk, and fuel transfer tube flange; and Type C tests to measure containment isolation valve leakage rates.

##### 6.2.6.1 Containment Integrated Leak Rate Test - Type A

The periodic Type A leakage rate test will be conducted in accordance with 10 CFR 50, Appendix J, Option B. Pretest requirements will be identified and included as part of the Type A test procedure to ensure that the necessary preparations, precautions, and temporary modifications have been completed prior to Type A test commencement. Such pretest requirements will include unit status, instrumentation requirements, support systems status, temporary test or measurement equipment requirements, supplementary testing requirements, general containment inspection requirements prior to containment closeout, personnel assignment, shift briefings, etc.

In accordance with the Containment Leakage Rate Testing Program (CLRTP), a general inspection of the accessible interior and exterior surfaces of the containment structure will be performed for the purpose of identifying evidence of deterioration which may affect the containment structural integrity or leaktightness. Visual inspection will be performed to detect and observe: gross deformations of the interior surfaces of steel containment liner; paint failure due to massive rusting, electrolysis, or abrasion; evidence of exterior concrete spalling or cracking; high stress areas of the containment concrete such as equipment hatch, personnel hatch, electrical and valve penetration areas; accessible areas at the bend line; shake space integrity, etc. Should evidence of containment degradation be found, the Type A or structural acceptance test will not be performed until an evaluation has been performed and repairs made, if required. Such structural deterioration and subsequent corrective actions taken will be reported in accordance with the CLRTP.

### System Venting and Draining

To place the primary reactor containment system as close to post-accident conditions as possible, those portions of the fluid systems that are part of the reactor containment boundary that may be opened directly to the containment or outside atmosphere under post-accident conditions will be opened or vented to the appropriate atmosphere during the test.

Those lines which are normally fluid-filled and which may be drained or have the fluid driven off by the accident, including portions of systems inside or outside containment that penetrate the containment and may rupture as a result of a LOCA, will be drained to the extent necessary to expose the containment isolation valve seats to the containment atmosphere, except as noted by the following. Systems that are required for proper conduct of the test or to maintain BVPS-2 in a safe condition during the test shall be operable in their normal mode and need not be vented or drained. Additionally, systems that are normally filled with water and operable under post-accident conditions, such as the CHRS, need not be vented or drained. The CLRTP may provide additional exceptions for not venting or draining penetrations. Systems that are not vented or drained during the Type A test and which could become exposed to the containment atmosphere during a leakage DBA will be Type C tested, and the Type C test leakage rate for the penetration path will be added to the upper confidence limit.

The test pressure to which the containment is subjected during the Type A test is equivalent to the calculated peak containment pressure following the design basis accident. Temporary air compressors will be utilized to raise containment pressure. When the containment has reached test pressure, containment temperature will be monitored for a period of not less than 4 hours until stabilization criteria have been met. Once stabilized, the containment parameters of temperature, pressure, and vapor pressure will be observed and recorded for the duration of testing. The duration of the test period will be sufficient to enable adequate data to be accumulated and analyzed so that a leakage rate and upper confidence unit can be accurately determined. During this period, the containment leak rate will be calculated by the mass point or total time analysis technique to verify that it is within the limits of the BVPS-2 Technical Specifications requirements. Upon determination of an acceptable leakage rate, a verification test will be performed to confirm the capability of the method and the test instrumentation used to determine the containment leakage rate. Having met all test criteria, the containment will be vented and reduced to atmospheric conditions.

The "as left" acceptance criteria for an acceptable leakage rate test requires that containment leakage be less than 0.75 La, as defined by the CLRTP. A superimposed leak test will be conducted immediately following the Type A test. The results from this test will be considered acceptable provided the superimposed leak test data are within the acceptance criteria specified in ANSI/ANS 56.8 2002.

#### 6.2.6.2 Containment Penetration Leakage Rate Test - Type B

Type B containment penetration leakage tests are conducted in accordance with the CLRTP. Type B leakage tests are intended to detect local leakage and to measure leakage across containment electrical penetrations, equipment and personnel hatches, emergency escape trunk, and fuel transfer tube flange. A list identifying all containment penetrations is provided in Table 6.2-60.

The makeup air method of testing, which will primarily be used to measure Type B leakage, consists of the pressurization of a component with air or nitrogen and measuring leakage using a flowmeter installed in the pressurization line.

The test pressure to which Type B tests will be conducted is identical to that specified in Section 6.2.6.1 for Type A testing.

The periodic retest schedule for Type B testing will be in accordance with the CLRTP.

#### 6.2.6.3 Containment Isolation Valve Leak Rate Tests - Type C

Type C testing is performed on containment isolation valves to verify their sealing capability and leaktightness. All testing will be performed in accordance with the requirements of the CLRTP.

Type C tests will be performed by local pressurization applied in the same direction as that when the valve would be required to perform its safety function, unless it can be demonstrated that testing in a reverse direction is as conservative. Each valve to be tested will be closed by its normal means, that is, motor, solenoid, diaphragm, handwheel, etc, and will receive no additional adjustments (hand-tightening after closure by motor) or preliminary exercising.

The containment isolation valves will be tested by local pressurization to the pressure specified in Section 6.2.6.1 for the Type A test. The test method will be to vent and drain a system, or portions thereof, and to pressurize across one, or a series of valves with air or nitrogen using primarily the makeup air method described in Section 6.2.6.2. Test connections located on both the inlet and outlet sides of a valve, or pair of valves, are provided to facilitate system draining and/or pressurization. Leakage will be measured using an installed flow meter in the pressure supply line. On multiple valve penetrations, only the highest leaking valve shall be recorded as the "as left" penetration leak rate. Valves, and their respective system status which must be Type C tested, are listed in Table 6.2-60. Test vents, drains, and connections located between isolation valves will have two barriers (valve with cap, and valve with flange) and will be administratively controlled. These connections will not be leak tested.

The test pressure will be as specified in Section 6.2.6.1 for Type A testing.

The acceptance criteria for allowable leakage associated with Type B and Type C combined leakages is to be in accordance with the CLRTP.

Scheduling for each periodic Type C test will be in accordance with the CLRTP.

#### 6.2.6.4 Scheduling and Reporting of Periodic Tests

The schedules for periodic tests are in accordance with the CLRTP. Report preparation for periodic Type A, B, and C testing will be in accordance with the CLRTP.



### 6.2.7 Fracture Prevention of Containment Pressure Boundary Materials

A summary of the fracture toughness characteristics of the containment pressure boundary materials and the confirmation of compliance to GDC 51 can be found in the DLC transmittal to the NRC (Woolever 1983).

### 6.2.8 References for Section 6.2

Aerojet Nuclear Company (ANC) 1976. RELAP4/MOD 5: A Computer Program for Transient Thermal Hydraulic Analysis of Nuclear Reactors and Related Systems. User's Manual Vol I-III, Report ANCR-NUREG-1335.

American National Standards for Containment System Leakage Testing Requirements. ANSI/ANS-56.8-2002. (This document used only as a guideline.)

American Nuclear Society (ANS) 1978. Decay Heat Power in Light Water Reactors. ANS Proposed Standard 5.1, Revised September 1978.

Anderson, T.M. (Westinghouse) 1979. Personal Communication (Letter NS-TMA-2075 dated April 25, 1979) to J.F. Stolz, USNRC. Westinghouse LOCA Mass and Energy Release Model for Containment Design - March 1979 Version.

ANSI/ANS-5.1 1979, "American National Standard for Decay Heat Power in Light Water Reactors," August 1979.

Bloom, G. R., et al. 1982. Hydrogen Distribution in a Containment with a High Velocity Hydrogen-Steam Source, presented at the Second International Workshop on the Impact of Hydrogen on Water Reactor Safety, Albuquerque, New Mexico.

Bordelon, F.M., Massie, H.W., Sr., Zordan, T.A. 1974a. Westinghouse Emergency Core Cooling Evaluation Model Summary. WCAP-8339.

Bordelon, F.M., et al 1947b. SATAN-VI Program: Comprehensive Space-Time Dependent Analysis of Loss-of-Coolant, WCAP-8302 (Proprietary) and WCAP-8306.

Boyle, J.C. 1975; Meyer, S.P. 1981. Subcompartment Transient Response Code THREED. NU-092 (Proprietary).

Burnett, T. W. T, McIntyre, C. J., and Buker, J. C. 1984, LOFTRAN Code Description, WCAP-7907-P-A (Proprietary) and WCAP-7907-A (Nonproprietary).

Clout, R.L. 1973. Pipe Breaks for the LOCA Analysis of Westinghouse Primary Coolant Loop. WCAP-8082 (Proprietary) and WCAP-8172.

Collier G., et al 1974. Calculational Model for Core Reflooding After a Loss-of-Coolant Accident (WREFLOOD Code). WCAP-8170.

Docket No. 50-315, "Amendment No. 126 Facility Operating License No. DPR-58 (TAC No. 7106) for D. C. Cook Nuclear Plant Unit 1, June 9, 1989.

Docket No. 50-472, "Amendment No. 153 Facility Operating License No. NPF-73 for BVPS-2, February 2006.

EPRI 294-2, Mixing of Emergency Core Cooling Water with Steam: 1/3 Scale Test and Summary, (WCAP-8423), Final Report, June 1975.

Hilliard, R. K. and Coleman, L. F. 1970. Natural Transport Effects on Fission Product Behavior in the Containment Systems Experiment, BNWL-1474, Battelle Pacific Northwest Laboratories, Richland, Washington.

Hilliard, R. K., Coleman, L.F; Linderoth, C.E; McCormack, J.D; and Pastma, A.K. 1970. Removal of Iodine and Particles from Containment Atmosphere by Sprays. Battelle - Northwest, Richland, Wash., BNWL-1244.

Idaho National Engineering Laboratory 1975. CONTEMPT LT/026. A Computer Code for Predicting the Containment Pressure Temperature Response to a Loss-of-Coolant Accident.

IDCOR 1983. IDCOR Program Report, Technical Report 12.2, Hydrogen Distribution in Reactor Containment Building.

Idel'chik, I.E. 1966. Handbook of Hydraulic Resistances. U.S. Department of Commerce, National Bureau of Standards, Institute for Applied Technology, U.S. Atomic Energy Commission Report AEC-TR-6630.

Knudsen, J. G. and Hilliard, R. K. 1969. Fission Product Transport by Natural Processes in Containment Vessels. Battelle - Northwest, Richland, Wash., BNWL-943.

Land, R. E. 1976, Mass and Energy Releases Following a Steam Line Rupture, WCAP-8822 (Proprietary) and WCAP-8860 (Nonproprietary).

Los Alamos Scientific Laboratory (LASL) 1979. Subcompartment Analysis Procedures Report. NUREG/CR-1199, LA-8169-MS.

McAdams, W.H. 1954. Heat Transmission. Third Edition, p. 44.

Moody, L.J. 1965. Maximum Flow Rate of a Single Component, Two-Phase Mixture. Journal of Heat Transfer Transactions, ASME Vol. 87, p 134-142.

Moore, K.V. and Rettig, W.H. 1974. RELAP4 - A Computer Program for Thermal Hydraulic Analysis. Aerojet Nuclear Company Report ANCR-1127.

Norberg, J.A.; Bingham, G.E.; Schmidt, R.C.; Waddops, D.A. 1969. Simulated Design Basis Accident Tests of the Carolinas Virginia Tube Reactor Containment - Preliminary Results. IN-1324, Idaho Nuclear Corporation.

Osborne, M. P., and Love, D. S. 1985, Mass and Energy Releases Following a Steam Line Rupture, Supplement 1 - Calculations of Steam Superheat in Mass/Energy Releases Following a Steam Line Rupture, WCAP-8822-S1-P-A (Proprietary) and WCAP-8860-S1-A (Nonproprietary).

Parsly, L.F. 1970. Design Considerations of Reactor Containment Spray Systems - Part VI, The Heating of Spray Drops in Air/Steam Atmosphere. ORNL-TM-2412.

Sandia National Laboratories and General Physics 1983. NUREG/CR-2726, SAND82-1137, R3, Light Water Reactor Hydrogen Manual.

Schmidt, R.C.; Bingham, G.E.; Norberg, J.A.; 1970. Simulated Design Basis Accident Tests of the Carolina Virginia Tube Reactor Containment - Final Report. UC-80, Idaho Nuclear Corporation.

Shepard R.M.; Massie, H.W.; Mark, R.H.; and Docherty, P.J. 1975. Westinghouse Mass and Energy Release Data for Containment Design. WCAP-8312-A, Revision 2, WCAP-8264-P-A (Proprietary).

Slaughterbeck, D.C. 1970. A Review of Heat Transfer Coefficients for Condensing Steam in a Containment Building Following a Loss-of-Coolant Accident. Interim Task Report, Subtask 4.2.2.1, Idaho Nuclear Corporation.

Spray Engineering Company (undated). Spray Analysis on SPRACO Model 1713A Nozzles. Nashua, N.H.

Stone & Webster Engineering Corporation (SWEC) 1971. LOCTIC - A Computer Code to Determine the Pressure and Temperature Response of Dry Containment to a Loss-of-Coolant Accident. SWND-1, Letter from W.J.L. Kennedy to P.A. Monis, et al, Boston, Mass, 1967.

Uchida, H.; Oyama A.; and Togo, Y. 1964. Evaluation of Post-Incident Cooling Systems of Light-Water Power Reactors. Proceedings of the Third International Conference on the Peaceful Uses of Atomic Energy, Geneva, Switzerland, August 31-September 9, 1964, Volume 13, New York United Nations 93-104.

U.S. Atomic Energy Commission (USAEC) 1970. Safety Evaluation by the Division of Reactor Licensing in the Matter of Virginia Electric and Power Company. North Anna Power Station Units 1 and 2, Docket Nos. 50-338 and 50-339.

U.S. Atomic Energy Commission 1972a. Safety Evaluation by the Division of Reactor Licensing in the Matter of Virginia Electric and Power Company. Surry Power Station Units 1 and 2, Docket Nos. 50-280 and 50-281.

U.S. Atomic Energy Commission 1972b. Safety Evaluation by the Division of Reactor Licensing in the Matter of Virginia Electric and Power Company. Maine Yankee Atomic Power Station, Docket No. 50-309.

U.S. Atomic Energy Commission 1974a. Evaluation Report by the Directorate of Licensing in the Matter of Duquesne Light Company, Toledo Edison Company, Pennsylvania Power Company. Beaver Valley Power Station Unit 1, Docket No. 50-334.

U.S. Atomic Energy Commission 1974b. Supplement No. 1 to Safety Evaluation Report by the Directorate of Licensing in the Matter of the Millstone Point Company, et al. Millstone Nuclear Power Station Unit 3, Docket No. 50-423.

U.S. Nuclear Regulatory Commission 1976b. Safety Evaluation Report Related to the Preliminary Design of the SWESSAR-PI Standard PWR Reference Nuclear Power Plant and Its Relationship to the RESAR-41 Standard Reference System. Docket No. STN 50-495.

U.S. Nuclear Regulatory Commission 1977. Safety Evaluation Report Related to the Preliminary Design of the SWESSAR-PI Standard PWR Reference Nuclear Power Plant and Its Relationship to the RESAR-3S Standard Reference System. Docket No. STN 50-495.

WCAP-10325-P-A (Proprietary), WCAP 10326-A (Non-Proprietary), "Westinghouse LOCA Mass & Energy Release Model for Containment Design, March 1979 Version," May 1983.

Westinghouse 1978. ECCS Evaluation Model, February 1978 Version WCAP-9220 (Proprietary).

Woolever, E. J. 1983. Letter from E. J. Woolever, DLC, to H. R. Denton, NRC, November 14, 1983.

BVPS-2 UFSAR

Tables for Section 6.2

TABLE 6.2-1

## THERMOPHYSICAL PROPERTIES OF PASSIVE HEAT SINK MATERIALS

<u>Material</u>	<u>Thermal Conductivity (Btu/hr/ft/°F)</u>	<u>Specific Heat Capacity (Btu/lbm/°F)</u>	<u>Density (lbm/ft<sup>3</sup>)</u>
Concrete	0.8	0.21	144
Stainless steel	11	0.11	491
Carbon steel	31	0.11	489

Paint is assumed to absorb no heat and to merely present a resistance to heat transfer with a heat conductance in the range of 42 to 252 Btu/hr/ft<sup>2</sup>/°F in concrete and 266 to 2000 Btu/hr/ft<sup>2</sup>/°F for steel.

TABLE 6.2-2

## BEAVER VALLEY MAAP-DBA PARAMETER FILE SUMMARY OF CONTAINMENT NOMINAL VOLUMES AND METAL HEAT SINKS

	Net Free Volume (ft3)	Metal Heat Sinks	
		Mass (lbm)	Surface Area (ft2)
1 Reactor cavity	11,826	425,023	2,975
2 Lower compartment	200,063	655,459	60,526
3 Instrument room	30,872	1,094	216
4 RHR platform	31,264	17,446	431
5 Loop C compartment	52,311	264,057	8,744
6 PZR compartment	48,637	50,933	2,431
7 Loop B compartment	49,141	267,633	11,410
8 RV head laydown area	45,542	17,075	2,898
9 Loop A compartment	51,429	284,087	11,462
10 Lower annulus north half	85,457	299,948	41,642
11 Lower annulus south half	85,663	280,947	37,869
12 Upper annulus north half	80,082	148,581	24,295
13 Upper annulus south half	80,294	224,330	23,716
14 Refueling cavity	36,620	131,960	5,522
15 Upper compartment cylindrical section	347,071	481,486	15,340
16 Upper compartment lower dome region	413,523	583,731	34,062
17 Upper compartment upper dome region	108,635	0	0
TOTAL	1,758,480	4,133,790	283,539

## NOTES:

- 1 Metal heat sinks do not include major equipment, such as steam generators or RCS loop piping. Realistic heat sink values without any uncertainty included.
- 2 The containment steel liner mass is included with concrete heat sinks, therefore the liner mass is not reflected in the metal heat sink summary.

Table 6.2-2A

Beaver Valley MAAp-DBA Parameter File Summary of  
Containment Concrete Heat Sinks

Heat Sink#	Description	Total Thickness ft	One-Sided Area ft <sup>2</sup>	No. Sides Inside Ctmt	Total Area ft <sup>2</sup>
1	Shield wall to lower	4.50	1,524	2	3,049
2	Refuel cavity wall to loop B	4.00	958	2	1,915
3	Shield wall to loop C	4.50	195	2	389
4	Refuel cavity wall to PZR	4.00	924	2	1,848
5	Shield wall to loop B	4.50	211	2	421
6	Shield wall to RV laydown	4.50	62	2	124
7	Shield wall to loop A	4.50	155	2	309
8	Instrument tunnel to lower	3.00	954	2	1,908
9	Refuel cavity wall to loop C	4.00	826	2	1,653
10	Reactor cavity floor <sup>(1)</sup>	10.00	621	1	621
11	14 crane wall support columns	2.00	2,352	2	4,704
12	Lower compartment floor	10.00	10,094	1	10,094
13	Lower compartment outer wall <sup>(1)</sup>	4.50	8,445	1	8,445
14	Instrument room floor	4.00	1,017	2	2,034
15	Instrument room wall to loop C	3.25	929	2	1,858
16	Instrument room wall to loop A	3.25	704	2	1,408
17	Instrument room crane wall	2.00	1,545	2	3,091
18	Instrument room ceiling	2.00	923	2	1,846
19	Loop C floor	4.50	912	2	1,824
20	Loop C wall to PZR	3.00	1,043	2	2,085
21	Loop C crane wall	2.75	2,290	2	4,579
22	SG cubicle support columns	3.50	633	2	1,265
23	Loop C ceiling	2.00	923	2	1,846
24	PZR floor	2.00	880	2	1,761



Table 6.2-2A (Cont)

Beaver Valley MAAP-DBA Parameter File Summary of  
Containment Concrete Heat Sinks

Heat Sink#	Description	Total Thickness ft	One-Sided Area ft <sup>2</sup>	No. Sides Inside Ctmt	Total Area ft <sup>2</sup>
25	PZR wall to loop B	3.00	1,253	2	2,506
26	PZR crane wall	2.00	2,568	2	5,136
27	PZR intermediate deck	4.00	984	2	1,969
28	PZR ceiling	2.00	923	2	1,846
29	Loop B floor	4.50	914	2	1,828
30	Loop B wall to RV head laydown	3.00	717	2	1,435
31	Loop B crane wall	2.75	1,768	2	3,536
32	Loop B intermediate roof	6.00	131	2	261
33	Loop B ceiling	2.00	923	2	1,846
34	RV head laydown wall to fuel transfer canal	4.00	885	2	1,771
35	RV head laydown crane wall	2.75	915	2	1,829
36	RV head laydown ceiling	2.00	923	2	1,846
37	Loop A floor	4.50	1,082	2	2,165
38	Loop A crane wall	2.75	2,114	2	4,228
39	Loop A wall to fuel transfer canal	4.00	1,623	2	3,247
40	Loop A interior walls	2.00	271	2	543
41	Loop A ceiling	2.00	923	2	1,846
42	Lower annulus south half outer wall <sup>(1)</sup>	4.50	8,432	1	8,432
43	Lower annulus north half outer wall <sup>(1)</sup>	4.50	8,432	1	8,432
44	Upper annulus south half crane wall	2.75	8,226	2	16,452
45	Upper annulus south half outer wall <sup>(1)</sup>	4.50	7,569	1	7,569
46	Upper annulus north half crane wall	2.75	9,038	2	18,076
47	Upper annulus north half outer wall <sup>(1)</sup>	4.50	7,569	1	7,569

Table 6.2-2A (Cont)

Beaver Valley MAAp-DBA Parameter File Summary of  
Containment Concrete Heat Sinks

Heat Sink#	Description	Total Thickness ft	One-Sided Area ft <sup>2</sup>	No. Sides Inside Ctmt	Total Area ft <sup>2</sup>
48	Fuel transfer canal floor	4.00	471	2	942
49	Lower dome outer wall	2.50	9,929	1	9,929
50	Upper dome outer wall	2.50	8,774	1	8,774
51	Pressurizer interior walls	2.00	527	2	1,054
52	Instrument room interior wall	1.25	147	2	295
53	RV laydown to Loop A misc wall	3.00	164	2	328
54	Support beam at 718'-6"	4.50	274	2	548
55	Cubicle walls above op. deck	1.50	3,262	2	6,523
56	RHR room wall to loop C	3.25	539	2	1,078
57	RHR room wall to loop A	3.25	568	2	1,135
58	RHR room crane wall	2.75	1,342	2	2,684
59	Refuel cavity wall to upper annulus south half	4.00	1,033	2	2,066
60	Refuel cavity wall to upper annulus north half	4.00	1,181	2	2,361
61	Containment shell sections with embedment plates in lower compartment <sup>(2)</sup>	4.50	338	1	338
62	Containment shell sections with embedment plates in lower south annulus <sup>(1)</sup>	4.50	492	1	492
63	Containment shell sections with embedment plates in lower north annulus <sup>(1)</sup>	4.50	492	1	492
64	Containment shell sections with embedment plates in upper south annulus <sup>(1)</sup>	4.50	525	1	525

Table 6.2-2A (Cont)

Beaver Valley MAAP-DBA Parameter File Summary of  
Containment Concrete Heat Sinks

Heat Sink#	Description	Total Thickness ft	One-Sided Area ft <sup>2</sup>	No. Sides Inside Ctmt	Total Area ft <sup>2</sup>
65	Containment shell sections with embedment plates in upper north annulus <sup>(1)</sup>	4.50	525	1	525
66	Lower dome sections with embedment plates	2.50	3,313	1	3,313
67	Upper dome sections with embedment plates	2.50	2,922	1	2,922
68	Wall Adjacent to Reactor Enclosure	3.00	705	2	1,410
69	Cubicle	1.50	1,590	2	3,179
70	Elevator Pit	1.00	94	2	188
71	Unlined portion of lower compartment outer wall	4.50	640	1	640
72	Unlined portion of lower annulus south half outer wall	4.50	836	1	836
73	Unlined portion of lower annulus north half outer wall	4.50	836	1	836
74	Unlined portion of upper annulus south half outer wall	4.50	856	1	856
75	Unlined portion of upper annulus north half outer wall	4.50	856	1	856
	TOTAL				218,566

## Note:

- (1) Includes painted carbon steel liner and gap resistance between liner and concrete.

TABLE 6.2-3

## CONTAINMENT DESIGN EVALUATION PARAMETERS

## General Information - Containment

Interior minimum design pressure (psia)	8.0
Internal design pressure (psig)	45
Design temperature (°F)	280
Minimum free volume (ft <sup>3</sup> )	1.75 x 10 <sup>6</sup>
Design leak rate (vol %/day)	0.1

## Initial Containment Conditions

## Containment

Pressure (psia)	12.8 to 14.2
Inside temperature (°F)	70-108
Outside temperature (°F)	(-20) to 103
Relative humidity (%)	15 to 100
Service water temperature (°F)	32 to 89

## Refueling Water Storage Tank

Useable volume (gal)	866,592
RWST temperature (°F)	45 to 65

TABLE 6.2-4

## KEY INPUT DATA TO MAAP-DBA (PEAK PRESSURE CALCULATIONS)

Containment volume	1,750,867 ft <sup>3</sup>
Initial containment pressure	14.2 psia
Initial containment temperature	108°F
Initial containment relative humidity	15%
Steel liner to concrete gap effective heat transfer coefficient	100 BTU/hr/ft <sup>2</sup> /°F
Paint thickness on carbon steel heat sinks	0.009 inches
Effective heat transfer coefficient for the paint on the carbon steel	266 BTU/hr/ft <sup>2</sup> /°F
Paint thickness on concrete heat sinks	0.0105 inches (walls/ceiling), 0.036 inches (floors)
Effective heat transfer coefficient for the paint on the concrete heat sinks	50 BTU/hr/ft <sup>2</sup> /°F 42 BTU/hr/ft <sup>2</sup> /°F (floor), 144 BTU/hr/ft <sup>2</sup> /°F (ceiling/walls)
Zinc thickness on carbon steel	0.00234 in
RWST temperature	65°F
Containment high-high quench spray setpoint	26.8 psia (max); 24.0 psia (min)
Containment high (SI actuation, FW isolation and CIA) safety analysis limit setpoint range	22 psia (max); 18 psia (min)
Containment intermediate high-high (steam line isolation) safety analysis limit setpoint	24 psia (max); 20 psia (min)
Start delay for quench spray	74.5 seconds
Quench spray flow rate	Determined by pump curve variable gpm
Start delay for recirculation spray	Variable, determined by RWST drawdown

TABLE 6.2-5

## BEAVER VALLEY MAAP-DBA PARAMETER FILE SUMMARY OF JUNCTION FLOW AREAS

Junction Number	Upstream Node Number	Downstream Node Number	Junction Flow Area (ft <sup>2</sup> )	Junction Loss Coefficient
1	1	4	3.14	.594
2	1	5	6.0	.583
3	1	7	6.0	.583
4	1	9	6.0	.583
5	2	4	417.0	.510
6	2	5	160.0	.535
7	2	6	33.5	.526
8	2	7	155.0	.535
9	2	8	976.0	1.0
10	2	9	140.6	.535
11	2	10	1166.0	.894
12	2	11	1166.0	.894
13	3	5	28.0	.547
14	12	13	903.2	1.0
15	4	5	28.0	.547
16	4	10	517.8	.511
17	5	6	56.0	.547
18	5	15	384.8	.590
19	6	7	56.0	.547
20	6	11	56.0	.547
21	6	15	64.2	.617
22	7	15	389.4	.584
23	8	11	800.0	.516
24	8	15	673.4	.894
25	9	10	56.0	.547
26	9	15	389.4	.584
27	10	11	493.3	1.0
28	10	12	1257.3	.894

TABLE 6.2-5 (Cont.)

## BEAVER VALLEY MAAP-DBA PARAMETER FILE SUMMARY OF JUNCTION FLOW AREAS

Junction Number	Upstream Node Number	Downstream Node Number	Junction Flow Area (ft <sup>2</sup> )	Junction Loss Coefficient
29	11	13	1257.3	.894
30	12	15	792.3	.519
31	13	15	130.0	.522
32	17	16	7980.0	1.0
33	16	15	8120.0	1.0
34	16	13	1822.0	1.0
35	16	12	1822.0	1.0
36	15	14	1105.0	1.0
37	14	2	0.0 (Refueling canal drain path)	.756
38	14	1	20.04	.538
39	*	-	-	-
40	*	-	-	-
41	1	2	.785	.474

Note: Junction 39 represents design basis leakage and 40 is the containment failure junction set to add when containment pressure exceeds a pre-set value.

TABLE 6.2-6

CONTAINMENT PEAK PRESSURE RESULTS FOR A DESIGN BASIS LARGE BREAK  
LOCA BEAVER VALLEY

Description	Single Failure	Peak Pressure (psig) <sup>(2)</sup>
DEPS MIN SI	DG	42.3
DEPS MAX SI	CIB	42.3
DEHL	None	44.8

Single Failures - Failed Equipment

DG One train each, SI, QSS, RSS

CIB One train each, QSS, RSS

(1) Only blowdown was quantified. Peak pressure occurs before any active failure could occur.

(2) Gauge pressure is referenced to 14.3 psi atmospheric pressure. Reported peak pressure is for break node.



TABLE 6.2-7

## DOUBLE-ENDED HOT-LEG BREAK SEQUENCE OF EVENTS

Time (sec)	Event Description
0.0	Break Occurs, Reactor Trip and Loss of Offsite Power are assumed
1.8	Containment High-High Setpoint is reached
3.0	Low Pressurizer Pressure SI Setpoint is reached (1760 psia)
11.5	Broken Loop Accumulator Begins Injecting Water
11.6	Intact Loop Accumulator Begins Injecting Water
18.2	Peak Containment Pressure During Blowdown
19.2	End of Blowdown Phase

Table 6.2-8

BVPS-2 Double-Ended Pump Suction Break Minimum Safeguards  
Sequence of Events

Time (sec)	Event Description
0.0	Break Occurs, Reactor Trip and Loss of Offsite Power are assumed
1.7	Containment High-High Setpoint is reached
3.0	Low Pressurizer Pressure SI Setpoint is reached (1760 psia)
12.9	Broken Loop Accumulator Begins Injecting Water
13.0	Intact Loop Accumulator Begins Injecting Water
17.4	Peak Containment Pressure During Blowdown
21.4	End of Blowdown Phase
27.0	Safety Injection Begins
63.2	Accumulator Water Injection Ends
76.5	Quench Spray is initiated
214.2	End of Reflood Phase
3134.2	Recirculation Spray is initiated
3462.2	ECCS Recirculation Begins
3600 <sup>(1)</sup>	Transient Modeling Terminated

(1) Except for long term attributes such as EQ profiles, sump and water temperature.

TABLE 6.2-9

DOUBLE-ENDED PUMP SUCTION BREAK MAXIMUM SAFEGUARDS SEQUENCE OF EVENTS  
(CIB FAILURE)

Time (sec)	Event Description
0.0	Break Occurs, Reactor Trip and Loss of Offsite Power are assumed
1.7	Containment High-High Setpoint is reached
3.0	Low Pressurizer Pressure SI Setpoint is reached (1760 psia)
12.9	Broken Loop Accumulator Begins Injecting Water
13.0	Intact Loop Accumulator Begins Injecting Water
17.4	Peak Containment Pressure During Blowdown
21.4	End of Blowdown Phase
27.0	Safety Injection Begins
63.9	Accumulator Water Injection Ends
76.5	Quench Spray is initiated
213.4	End of Reflood Phase
2472.0	Recirculation Spray is initiated
2732.0	ECCS Recirculation Begins
3600 <sup>(1)</sup>	Transient Modeling Terminated

(1) Except for long term attributes such as EQ profiles, sump and water temperature.

TABLE 6.2-10

MAAP-DBA PEAK PRESSURE RESULTS FOR A DESIGN BASIS  
MAIN STEAM LINE BREAK BEAVER VALLEY

Description	Power Level, %	Single* Failure	Peak Pressure (psig)
1M-1.069 ft <sup>2</sup> DER	100.6	MSIV	36.8
2M-1.069 ft <sup>2</sup> DER	100.6	MFIV/CIB	36.6
3M-0.753 ft <sup>2</sup> Split	100.6	CIB	31.5
4M-0.753 ft <sup>2</sup> Split	100.6	MSIV	32.3
5M-0.753 ft <sup>2</sup> Split	100.6	MFIV	31.5
6M-1.069 ft <sup>2</sup> DER	70	MSIV	37.0
7M-1.069 ft <sup>2</sup> DER	70	MFIV/CIB	36.8
8M-0.757 ft <sup>2</sup> Split	70	CIB	32.8
9M-0.757 ft <sup>2</sup> Split	70	MSIV	33.6
10M-0.757 ft <sup>2</sup> Split	70	MFIV	32.4
11M-1.069 ft <sup>2</sup> DER	30	MSIV	39.3
12M-1.069 ft <sup>2</sup> DER	30	MFIV/CIB	38.6
13M-0.756 ft <sup>2</sup> Split	30	CIB	35.4
14M-0.756 ft <sup>2</sup> Split	30	MSIV	36.3
15M-0.756 ft <sup>2</sup> Split	30	MFIV	34.6
16M-1.069 ft <sup>2</sup> DER	0	MSIV	38.9
17M-1.069 ft <sup>2</sup> DER	0	MFIV/CIB	36.7
18M-0.608 ft <sup>2</sup> Split	0	CIB	33.3

TABLE 6.2-10 (Cont.)

MAAP-DBA PEAK PRESSURE RESULTS FOR A DESIGN BASIS  
MAIN STEAM LINE BREAK BEAVER VALLEY

Description	Power Level, %	Single* Failure	Peak Pressure (psig)
19M-0.608 ft <sup>2</sup> Split	0	MSIV	32.7
20M-0.608 ft <sup>2</sup> Split	0	MFIV	31.0

Single Failures - Failed Equipment

CIB One train QSS

DG One train each, SI, QSS, SW

MSIV One main steam isolation valve

MFIV One main feedwater isolation valve

\* Some of these cases assumed two active failures, one for M&E release and the other for containment response. This is a conservatism that helps control the number of cases in the run matrix. The M&Es for the double failure cases were not significantly different than if only a single failure had been assumed.

TABLE 6.2-11

MAAP-DBA PEAK TEMPERATURE RESULTS FOR A DESIGN BASIS  
MAIN STEAM LINE BREAK BEAVER VALLEY

Description	Power Level, %	Single* Failure	Peak Temperature (°F)
1M-1.069 ft <sup>2</sup> DER	100.6	MSIV	343.9
2M-1.069 ft <sup>2</sup> DER	100.6	MFIV/CIB	343.9
3M-0.753 ft <sup>2</sup> Split	100.6	CIB	315.0
4M-0.753 ft <sup>2</sup> Split	100.6	MSIV	315.4
5M-0.753 ft <sup>2</sup> Split	100.6	MFIV	314.9
6M-1.069 ft <sup>2</sup> DER	70	MSIV	335.8
7M-1.069 ft <sup>2</sup> DER	70	MFIV/CIB	335.8
8M-0.757 ft <sup>2</sup> Split	70	CIB	312.7
9M-0.757 ft <sup>2</sup> Split	70	MSIV	313.1
10M-0.757 ft <sup>2</sup> Split	70	MFIV	312.7
11M-1.069 ft <sup>2</sup> DER	30	MSIV	333.5
12M-1.069 ft <sup>2</sup> DER	30	MFIV/CIB	333.5
13M-0.756 ft <sup>2</sup> Split	30	CIB	309.6
14M-0.756 ft <sup>2</sup> Split	30	MSIV	310.1
15M-0.756 ft <sup>2</sup> Split	30	MFIV	309.6
16M-1.069 ft <sup>2</sup> DER	0	MSIV	336.8
17M-1.069 ft <sup>2</sup> DER	0	MFIV/CIB	335.1
18M-0.608 ft <sup>2</sup> Split	0	CIB	300.1
19M-0.608 ft <sup>2</sup> Split	0	MSIV	301.1
20M-0.608 ft <sup>2</sup> Split	0	MFIV	300.1

Single Failures - Failed Equipment

CIB One train QSS

DG One train each, SI, QSS, SW

MSIV One main steam isolation valve

MFIV One main feedwater isolation valve

\* Some of these cases assumed two active failures, one for M&E release and the other for containment response. This is a conservatism that helps control the number of cases in the run matrix. The M&Es for the double failure cases were not significantly different than if only a single failure had been assumed.

\*\* These two sequences were analyzed using a maximum spray setpoint of 36.7 psia.

TABLE 6.2-12

SEQUENCE OF EVENTS - PEAK CONTAINMENT PRESSURE CASE  
 1.069 FT<sup>2</sup> DOUBLE-ENDED RUPTURE (DER) WITH A MAIN STEAM ISOLATION VALVE  
 (MSIV) FAILURE AT THIRTY PERCENT POWER (Case 11m)

Time (sec)	Event Description
0.0	Accident occurs; ruptured loop steam generator and turbine plant piping blowdown into containment begins.
1.26	Low steamline pressure setpoint for closing the MSIV and FWIV is reached.
1.59	Turbine plant piping blowdown is complete; intact loop steam generators begin blowdown into containment.
3.26	Containment pressure setpoint for spray initiation is reached
8.26	MSIV and MFIV are fully closed; intact loop steam generators end blowdown into containment.
32	Peak containment temperature is reached.
77.75	Containment quench spray enters containment atmosphere.
216	Peak containment pressure is reached.
1800/1803	Auxiliary feedwater to ruptured steam generator manually isolated; steam release to containment ends.

TABLE 6.2-13

SEQUENCE OF EVENTS - PEAK CONTAINMENT TEMPERATURE CASE  
 1.069 FT<sup>2</sup> DOUBLE-ENDED RUPTURE (DER) WITH A MAIN STEAM ISOLATION VALVE  
 (MSIV) FAILURE AT FULL POWER (Case 1m)

Time (sec)	Event Description
0.0	Accident occurs; ruptured loop steam generator and turbine plant piping blowdown into containment begins.
1.58	Turbine plant piping blowdown is complete; intact loop steam generators begin blowdown into containment.
3.40	Low steamline pressure setpoint for closing the MSIV and FWIV is reached.
4.73	Containment pressure setpoint for spray initiation is reached
10.40	MSIV and MFIV are fully closed; intact loop steam generators end blowdown into containment.
22	Peak containment temperature is reached.
79.25	Containment quench spray enters containment atmosphere.
166	Peak containment pressure is reached.
1800/1804	Auxiliary feedwater to ruptured steam generator manually isolated; steam release to containment ends.



TABLE 6.2-14

## SYSTEM PARAMETERS INITIAL CONDITIONS FOR THERMAL UPRATE

Parameters	Value
Core Thermal Power (MWt)*	2917.4
Reactor Coolant System Total Flowrate (lbm/sec)	27583.3
Vessel Outlet Temperature (°F)*	621
Core Inlet Temperature (°F)*	547.1
Vessel Average Temperature (°F)*	584
Initial Steam Generator Steam Pressure (psia)	826
Steam Generator Design	51
Steam Generator Tube Plugging (percent)	0
Initial Steam Generator Secondary Side Mass (lbm)*	127881
Assumed Maximum Containment Backpressure (psia)	59.7
Accumulator	
Water Volume (ft <sup>3</sup> ) per accumulator	1127.8
N <sub>2</sub> Cover Gas Pressure (psia)	575
Temperature (°F)	105**

## Notes:

\* The Core Power, RCS Temperatures, and Secondary Side Mass values listed above include uncertainty allowance.

\*\* This value is lower than the containment maximum average temperature limit of 108°F, however, it is a conservative value for the accumulators which are located in the lowest part of the containment structure.

TABLE 6.2-14A

## SAFETY INJECTION FLOW MINIMUM SAFEGUARDS

RCS Pressure (psig)	Total Flow (GPM)
Injection Mode (Reflood Phase)	
0	4254.9
20	3895.7
50	3264.7
95	1679.6
100	1412.5
150	388.8
200	383.6
400	362.8
600	341.8
Cold Leg Recirculation Mode	
0	3767

## Note:

A maximum RWST temperature of 65°F was used during the Injection Phase. A maximum recirculation temperature of 120°F was used during the Recirculation Phase.

TABLE 6.2-14B  
SAFETY INJECTION FLOW MAXIMUM SAFEGUARDS

RCS Pressure (psig)	Total Flow (GPM)
Injection Mode (Reflood Phase)	
0	6148.5
20	5696.8
50	5019.3
100	3265.5
130	1481.0
150	847.9
200	840.0
400	803.7
600	771.0
Cold Leg Recirculation Mode	
0	6228.6

Note:

A maximum RWST temperature of 65°F was used during the Injection Phase. A maximum recirculation temperature of 120°F was used during the Recirculation Phase for the CIB failure case 150°F was used for the SW failure case.

TABLE 6.2-14C

## DOUBLE-ENDED HOT-LEG BREAK BLOWDOWN MASS AND ENERGY RELEASES

Time (sec)	<u>Break Path No. 1 Flow*</u>		<u>Break Path No. 2 Flow**</u>	
	(lbm/sec)	(Thousand Btu/sec)	(lbm/sec)	(Thousand Btu/sec)
.00000	.0	.0	.0	.0
.00110	46506.1	29844.9	46504.5	29843.1
.00214	46366.6	29754.2	46133.9	29599.7
.101	41311.9	26879.3	26481.2	16957.0
.201	34980.7	22842.8	23912.4	15242.1
.301	34192.1	22255.7	21041.5	13262.6
.401	33317.1	21650.8	19607.0	12161.5
.502	32470.5	21091.0	18714.2	11411.2
.602	32391.2	21031.5	18148.0	10894.0
.701	32410.5	21055.5	17608.8	10426.7
.801	32014.1	20841.8	17255.8	10094.8
.902	31474.9	20557.3	16960.8	9818.1
1.00	31197.4	20470.2	16684.8	9571.9
1.10	30928.9	20413.4	16497.6	9391.0
1.20	30573.5	20308.0	16344.4	9239.6
1.30	30169.3	20163.3	16252.2	9131.9
1.40	29740.4	20003.3	16213.2	9060.6
1.50	29287.3	19827.8	16220.9	9021.2
1.60	28761.6	19606.8	16261.8	9003.7
1.70	28147.8	19322.1	16325.4	9002.8
1.80	27476.6	18995.0	16405.4	9013.9
1.90	26804.3	18663.2	16493.0	9032.5
2.00	26155.8	18342.7	16579.9	9054.3
2.10	25493.2	18003.5	16664.1	9077.9

TABLE 6.2-14C (Cont.)

## DOUBLE-ENDED HOT-LEG BREAK BLOWDOWN MASS AND ENERGY RELEASES

Time (sec)	<u>Break Path No. 1 Flow*</u>		<u>Break Path No. 2 Flow**</u>	
	(lbm/sec)	(Thousand Btu/sec)	(lbm/sec)	(Thousand Btu/sec)
2.20	24793.6	17624.1	16742.3	9101.3
2.30	24103.8	17236.2	16809.8	9122.1
2.40	23435.8	16850.3	16867.0	9140.0
2.50	22788.1	16467.0	16913.2	9154.2
2.60	22157.1	16083.7	16946.5	9163.7
2.70	21562.7	15712.5	16966.1	9167.6
2.80	20999.5	15344.6	16971.5	9165.5
2.90	20499.3	15010.2	16963.7	9157.6
3.00	20034.1	14686.4	16942.7	9143.7
3.10	19628.5	14391.5	16909.2	9124.1
3.20	19285.5	14129.6	16865.5	9099.9
3.30	18980.9	13882.7	16811.7	9070.9
3.40	18721.7	13659.4	16748.3	9037.4
3.50	18506.3	13459.3	16677.2	9000.3
3.60	18320.5	13273.7	16597.5	8959.0
3.70	18171.4	13109.6	16511.1	8914.5
3.80	18047.1	12959.4	16417.7	8866.6
3.90	17946.8	12824.1	16317.5	8815.3
4.00	17867.0	12702.5	16211.5	8761.2
4.20	17776.0	12507.4	15983.3	8645.0
4.40	17808.4	12393.5	15726.1	8514.1
4.60	17927.7	12343.5	15429.9	8363.2
4.80	18115.9	12329.6	15074.2	8181.1
5.00	18396.0	12352.9	14740.5	8012.5
5.20	18767.1	12418.9	14296.3	7783.7
5.40	19352.6	12607.5	13848.4	7553.6

TABLE 6.2-14C (Cont.)

## DOUBLE-ENDED HOT-LEG BREAK BLOWDOWN MASS AND ENERGY RELEASES

Time (sec)	<u>Break Path No. 1 Flow*</u>		<u>Break Path No. 2 Flow**</u>	
	(lbm/sec)	(Thousand Btu/sec)	(lbm/sec)	(Thousand Btu/sec)
5.60	14305.2	10429.7	13391.3	7319.0
5.80	14241.6	10255.5	12931.5	7083.4
6.00	14364.3	10266.5	12515.2	6872.0
6.20	14439.6	10292.3	12097.5	6659.0
6.40	14689.4	10301.9	11637.4	6421.2
6.60	15049.1	10399.0	11192.0	6191.2
6.80	14999.6	10249.0	10769.6	5973.6
7.00	15365.5	10330.1	10353.6	5758.9
7.20	15683.6	10402.0	9948.6	5549.8
7.40	15971.8	10469.1	9571.7	5355.7
7.60	16258.9	10543.6	9214.4	5171.8
7.80	16594.6	10651.0	8875.1	4997.0
8.00	17158.0	10907.0	8556.8	4833.1
8.20	17053.0	10792.2	8246.6	4673.3
8.40	16725.6	10538.7	7949.2	4520.3
8.60	14694.9	9424.6	7660.0	4371.6
8.80	13878.9	8964.1	7380.7	4228.8
9.00	13826.1	8916.4	7115.7	4094.4
9.20	13789.1	8883.5	6866.0	3969.2
9.40	13740.1	8844.0	6639.3	3856.8
9.60	13672.9	8787.6	6416.5	3745.9
9.80	13461.2	8649.8	6204.1	3640.7
10.0	12878.5	8314.2	5996.5	3538.1
10.2	12189.5	7927.5	5796.5	3440.0
10.4	11803.9	7705.9	5599.5	3344.4
10.4	11799.7	7703.4	5596.6	3342.9
10.4	11796.0	7701.2	5594.1	3341.7

TABLE 6.2-14C (Cont.)

## DOUBLE-ENDED HOT-LEG BREAK BLOWDOWN MASS AND ENERGY RELEASES

Time (sec)	<u>Break Path No. 1 Flow*</u>		<u>Break Path No. 2 Flow**</u>	
	(lbm/sec)	(Thousand Btu/sec)	(lbm/sec)	(Thousand Btu/sec)
10.6	11564.5	7566.0	5411.4	3254.3
10.8	11330.9	7432.4	5230.6	3168.7
11.0	11053.8	7277.7	5055.7	3086.6
11.2	10712.5	7091.0	4886.8	3007.9
11.4	10331.8	6886.4	4722.8	2931.8
11.6	9964.0	6691.8	4566.3	2859.7
11.8	9625.7	6515.9	4413.7	2789.9
12.0	9308.6	6355.2	4265.5	2722.9
12.2	8992.6	6198.7	4122.2	2658.5
12.4	8650.4	6032.5	3981.1	2595.1
12.6	8260.6	5847.8	3839.5	2531.7
12.8	7824.8	5648.0	3689.7	2464.3
13.0	7355.1	5441.4	3528.5	2392.9
13.2	6851.5	5229.8	3350.6	2316.8
13.4	6334.7	5023.8	3157.0	2236.8
13.6	5794.9	4815.8	2947.5	2153.0
13.8	5241.0	4606.0	2732.2	2068.6
14.0	4683.9	4393.7	2518.7	1983.8
14.2	4106.9	4114.4	2321.9	1903.4
14.4	3655.6	3782.3	2145.6	1826.3
14.6	3390.8	3538.3	1997.8	1757.7
14.8	3204.0	3361.8	1873.2	1695.8
15.0	3043.7	3210.9	1771.0	1645.7
15.2	2853.9	3053.5	1677.5	1598.2
15.4	2616.4	2882.7	1596.2	1554.9
15.6	2347.8	2697.4	1518.1	1516.8
15.8	2093.8	2499.3	1435.1	1485.2

TABLE 6.2-14C (Cont.)

## DOUBLE-ENDED HOT-LEG BREAK BLOWDOWN MASS AND ENERGY RELEASES

Time (sec)	<u>Break Path No. 1 Flow*</u>		<u>Break Path No. 2 Flow**</u>	
	(lbm/sec)	(Thousand Btu/sec)	(lbm/sec)	(Thousand Btu/sec)
16.0	1893.8	2304.3	1350.3	1450.4
16.2	1707.1	2093.3	1263.9	1416.2
16.4	1547.9	1912.1	1182.6	1368.2
16.6	1412.2	1757.7	1132.2	1346.8
16.8	1340.1	1676.1	1022.5	1239.5
17.0	1261.1	1583.5	953.6	1166.7
17.2	1162.6	1461.4	899.6	1105.5
17.4	1067.4	1343.3	858.0	1056.8
17.6	998.4	1256.2	811.0	1000.7
17.8	915.2	1153.4	726.6	898.5
18.0	836.1	1056.2	630.5	782.0
18.2	758.4	959.6	562.2	698.7
18.4	664.0	841.2	523.1	651.9
18.6	593.8	753.6	405.0	503.7
18.7	559.5	710.5	369.6	461.6
18.8	317.2	402.1	344.0	430.2
19.0	.0	.0	160.9	201.8
19.2	.0	.0	.0	.0

\* Mass and Energy exiting from the RV side of the break

\*\* Mass and Energy exiting from the SG side of the break



TABLE 6.2-14D

DOUBLE-ENDED PUMP SUCTION BREAK BLOWDOWN MASS AND ENERGY RELEASES  
(SAME FOR ALL DEPS RUNS)

Time (sec)	<u>Break Path No. 1 Flow*</u>		<u>Break Path No. 2 Flow**</u>	
	(lbm/sec)	(Thousand Btu/sec)	(lbm/sec)	(Thousand Btu/sec)
.00000	.0	.0	.0	.0
.00109	88813.2	47922.9	40351.7	21722.1
.101	40209.7	21715.8	20435.8	10994.1
.202	41011.2	22298.7	22609.3	12171.8
.301	44814.9	24586.6	23088.2	12441.9
.401	45435.3	25200.1	22751.7	12274.7
.501	44833.6	25178.3	22031.3	11896.1
.602	44232.4	25156.0	21364.1	11542.5
.702	44540.0	25626.6	20891.4	11291.2
.801	44177.2	25680.9	20541.8	11106.2
.901	43156.3	25326.6	20278.1	10967.8
1.00	41991.4	24872.3	20086.3	10867.0
1.10	40887.0	24443.5	19955.7	10798.7
1.20	39821.3	24030.8	19897.4	10768.6
1.30	38772.9	23621.4	19905.5	10774.0
1.40	37783.2	23230.6	19936.5	10791.0
1.50	36908.7	22887.7	19940.9	10792.8
1.60	36142.5	22591.2	19917.5	10778.9
1.70	35446.0	22327.1	19885.1	10759.9
1.80	34731.2	22053.6	19850.2	10739.8
1.90	33965.9	21761.5	19793.1	10707.8
2.00	33145.0	21449.3	19693.9	10653.2
2.10	32124.1	21021.3	19534.0	10565.6
2.20	30989.8	20520.6	19217.8	10393.1

TABLE 6.2-14D (Cont).

DOUBLE-ENDED PUMP SUCTION BREAK BLOWDOWN MASS AND ENERGY RELEASES  
(SAME FOR ALL DEPS RUNS)

Time (sec)	<u>Break Path No. 1 Flow*</u>		<u>Break Path No. 2 Flow**</u>	
	(lbm/sec)	(Thousand Btu/sec)	(lbm/sec)	(Thousand Btu/sec)
2.30	29718.8	19926.4	18898.7	10220.1
2.40	28370.0	19265.1	18585.8	10050.1
2.50	26271.4	18046.5	18237.6	9861.0
2.60	22526.4	15619.5	17936.3	9698.1
2.70	20341.8	14248.6	17630.1	9533.0
2.80	19301.7	13612.7	17291.8	9350.7
2.90	18053.8	12758.2	16997.9	9193.2
3.00	17127.4	12122.9	16751.9	9062.3
3.10	16396.6	11622.5	16516.2	8937.0
3.20	15708.0	11149.0	16291.8	8818.0
3.30	15096.6	10734.6	16088.7	8710.8
3.40	14548.9	10370.0	15901.7	8612.5
3.50	14063.1	10050.5	15727.2	8520.8
3.60	13636.3	9772.8	15539.9	8422.0
3.70	13269.5	9536.7	15426.3	8364.0
3.80	12948.4	9329.5	15291.4	8293.5
3.90	12609.6	9105.9	15123.9	8205.2
4.00	12288.5	8895.2	14986.8	8133.8
4.20	11754.8	8549.6	14723.3	7996.4
4.40	11324.6	8258.2	14466.5	7862.6
4.60	10987.7	8022.4	14240.5	7745.6
4.80	10702.1	7816.8	14000.8	7621.4
5.00	10461.2	7642.5	13753.4	7492.8
5.20	10236.1	7478.4	13395.5	7303.5
5.40	10103.0	7378.3	13027.1	7109.3

TABLE 6.2-14D (Cont).

DOUBLE-ENDED PUMP SUCTION BREAK BLOWDOWN MASS AND ENERGY RELEASES  
(SAME FOR ALL DEPS RUNS)

Time (sec)	<u>Break Path No. 1 Flow*</u>		<u>Break Path No. 2 Flow**</u>	
	(lbm/sec)	(Thousand Btu/sec)	(lbm/sec)	(Thousand Btu/sec)
5.60	10296.5	7512.6	14648.7	8004.6
5.80	10519.3	7740.8	14501.0	7929.5
6.00	9862.2	7865.5	14373.1	7867.2
6.20	8477.2	7510.2	14106.8	7727.0
6.40	7876.2	7245.0	13799.5	7564.8
6.60	7591.4	7038.1	13470.1	7390.4
6.80	7492.7	6810.1	13184.9	7239.5
7.00	7587.5	6652.4	12948.4	7113.8
7.20	7790.2	6576.2	12740.3	6999.6
7.40	7953.2	6499.0	12637.0	6938.7
7.60	8022.6	6416.0	12505.7	6858.8
7.80	8024.0	6352.5	12337.7	6758.3
8.00	7926.6	6244.8	12148.7	6647.7
8.20	7812.6	6139.8	12007.4	6565.3
8.40	7690.2	6041.2	11864.5	6482.9
8.60	7561.1	5950.0	11693.4	6385.2
8.80	7428.3	5864.5	11518.0	6285.8
9.00	7289.7	5779.9	11351.7	6192.3
9.20	7145.6	5694.1	11181.4	6097.4
9.40	6996.8	5606.2	11002.6	5998.2
9.60	6847.7	5517.9	10828.1	5901.7
9.80	6698.6	5429.1	10659.4	5808.7
10.0	6555.3	5346.1	10488.0	5714.3
10.2	6411.9	5258.8	10311.2	5617.0
10.4	6275.6	5171.5	10141.4	5524.2
10.6	6144.5	5084.6	9972.5	5432.1

TABLE 6.2-14D (Cont).

DOUBLE-ENDED PUMP SUCTION BREAK BLOWDOWN MASS AND ENERGY RELEASES  
(SAME FOR ALL DEPS RUNS)

Time (sec)	<u>Break Path No. 1 Flow*</u>		<u>Break Path No. 2 Flow**</u>	
	(lbm/sec)	(Thousand Btu/sec)	(lbm/sec)	(Thousand Btu/sec)
10.8	6017.4	4999.1	9805.3	5340.9
11.0	5892.8	4915.0	9643.4	5252.7
11.2	5771.6	4833.4	9483.7	5165.6
11.4	5647.4	4750.4	9325.8	5079.5
11.6	5513.4	4661.3	9141.1	4978.6
11.8	5368.9	4563.2	8967.0	4884.5
12.0	5226.4	4458.3	8806.8	4798.4
12.2	5093.0	4350.7	8629.6	4702.5
12.4	4969.0	4243.7	8462.8	4612.5
12.6	4846.9	4136.6	8287.8	4518.0
12.8	4723.7	4028.9	8117.7	4426.6
13.0	4602.9	3923.7	7878.7	4296.7
13.2	4490.6	3826.3	7607.2	4150.3
13.4	4390.7	3739.2	7478.0	4077.9
13.6	4297.3	3660.8	7252.9	3927.2
13.8	4205.1	3592.2	7209.6	3851.5
14.0	4112.3	3533.8	7192.1	3772.8
14.2	4017.5	3484.4	7146.4	3671.8
14.4	3913.0	3439.8	6964.3	3502.6
14.6	3800.2	3402.0	6677.3	3287.1
14.8	3675.5	3368.9	6392.0	3081.2
15.0	3543.1	3342.6	6195.1	2929.4
15.2	3403.2	3321.2	5974.9	2779.0
15.4	3253.9	3306.0	5754.2	2635.7
15.6	3057.1	3259.2	5532.0	2497.5
15.8	2763.2	3138.5	5062.7	2251.5

TABLE 6.2-14D (Cont).

DOUBLE-ENDED PUMP SUCTION BREAK BLOWDOWN MASS AND ENERGY RELEASES  
(SAME FOR ALL DEPS RUNS)

Time (sec)	<u>Break Path No. 1 Flow*</u>		<u>Break Path No. 2 Flow**</u>	
	(lbm/sec)	(Thousand Btu/sec)	(lbm/sec)	(Thousand Btu/sec)
16.0	2468.0	2958.4	4680.7	2042.7
16.2	2250.5	2759.1	4428.1	1892.9
16.4	2048.5	2529.8	4163.1	1746.1
16.6	1874.5	2323.3	3778.8	1555.6
16.8	1723.6	2142.6	3381.0	1362.8
17.0	1594.6	1986.4	3022.3	1189.2
17.2	1469.3	1833.8	2783.7	1067.8
17.4	1352.3	1690.7	2650.6	992.2
17.6	1228.0	1538.0	2602.1	952.7
17.8	1122.4	1407.9	2570.5	921.5
18.0	1022.8	1284.4	2615.4	915.7
18.2	911.4	1146.5	2760.6	941.6
18.4	809.0	1019.0	2941.7	976.9
18.6	704.7	888.5	3034.8	983.8
18.8	603.4	761.4	3003.2	952.9
19.0	509.2	643.1	2786.6	867.7
19.2	424.2	536.2	2538.9	778.1
19.4	349.8	442.5	2287.9	691.3
19.6	287.7	364.2	2025.4	604.1
19.8	250.1	316.8	1762.7	519.4
20.0	199.4	252.7	1510.9	440.4
20.2	125.5	159.4	1244.0	359.1
20.4	48.7	62.0	966.5	276.8
20.6	70.3	89.8	709.7	202.1
20.8	.0	.0	462.7	131.4

TABLE 6.2-14D (Cont).

DOUBLE-ENDED PUMP SUCTION BREAK BLOWDOWN MASS AND ENERGY RELEASES  
(SAME FOR ALL DEPS RUNS)

Time (sec)	<u>Break Path No. 1 Flow*</u>		<u>Break Path No. 2 Flow**</u>	
	(lbm/sec)	(Thousand Btu/sec)	(lbm/sec)	(Thousand Btu/sec)
21.0	.0	.0	214.2	60.9
21.2	.0	.0	32.0	9.1
21.4	.0	.0	.0	.0

\* Mass and Energy exiting the SG side of the break

\*\* Mass and Energy exiting the pump side of the break

TABLE 6.2-14E

DOUBLE-ENDED PUMP SUCTION BREAK MINIMUM SAFEGUARDS  
REFLOOD MASS AND ENERGY RELEASES

Time (sec)	<u>Break Path No. 1 Flow*</u>		<u>Break Path No. 2 Flow**</u>	
	(lbm/sec)	(Thousand Btu/sec)	(lbm/sec)	(Thousand Btu/sec)
21.4	.0	.0	.0	.0
21.9	.0	.0	.0	.0
22.1	.0	.0	.0	.0
22.2	.0	.0	.0	.0
22.3	.0	.0	.0	.0
22.4	.0	.0	.0	.0
22.4	.0	.0	.0	.0
22.5	57.4	67.5	.0	.0
22.6	20.7	24.4	.0	.0
22.7	18.2	21.4	.0	.0
22.9	21.6	25.4	.0	.0
23.0	31.8	37.4	.0	.0
23.1	37.0	43.6	.0	.0
23.2	43.0	50.6	.0	.0
23.3	48.3	56.8	.0	.0
23.4	53.7	63.3	.0	.0
23.5	58.3	68.6	.0	.0
23.6	61.7	72.7	.0	.0
23.7	65.1	76.7	.0	.0
23.8	66.8	78.7	.0	.0
23.8	68.4	80.6	.0	.0
23.9	71.6	84.3	.0	.0
24.0	74.7	87.9	.0	.0
24.1	77.6	91.4	.0	.0

TABLE 6.2-14E (Cont.)

DOUBLE-ENDED PUMP SUCTION BREAK MINIMUM SAFEGUARDS  
REFLOOD MASS AND ENERGY RELEASES

Time (sec)	<u>Break Path No. 1 Flow*</u>		<u>Break Path No. 2 Flow**</u>	
	(lbm/sec)	(Thousand Btu/sec)	(lbm/sec)	(Thousand Btu/sec)
24.2	80.5	94.8	.0	.0
24.3	83.3	98.1	.0	.0
24.4	86.0	101.3	.0	.0
25.4	109.9	129.5	.0	.0
26.4	129.7	152.9	.0	.0
27.4	155.3	183.0	551.6	47.2
28.4	372.2	440.4	3820.8	431.3
28.5	374.6	443.4	3840.0	436.1
29.5	374.3	443.0	3826.9	440.5
30.5	367.7	435.1	3756.9	434.8
31.5	360.8	426.8	3683.8	428.3
32.5	353.9	418.7	3610.7	421.8
33.2	349.2	413.1	3560.3	417.2
33.5	347.3	410.7	3538.9	415.3
34.5	340.8	403.1	3468.9	408.9
35.5	334.6	395.7	3400.9	402.6
36.5	328.7	388.6	3335.0	396.5
37.5	322.9	381.8	3271.1	390.6
38.5	317.4	375.3	3209.3	384.8
39.5	312.2	369.0	3149.4	379.3
40.5	307.1	363.0	3091.4	373.9
41.5	302.2	357.1	3035.2	368.6
42.5	297.5	351.6	2980.7	363.5
43.5	293.0	346.2	2927.8	358.5
44.5	288.6	341.0	2876.4	353.7
45.5	284.4	336.0	2826.4	349.0



TABLE 6.2-14E (Cont.)

DOUBLE-ENDED PUMP SUCTION BREAK MINIMUM SAFEGUARDS  
REFLOOD MASS AND ENERGY RELEASES

Time (sec)	<u>Break Path No. 1 Flow*</u>		<u>Break Path No. 2 Flow**</u>	
	(lbm/sec)	(Thousand Btu/sec)	(lbm/sec)	(Thousand Btu/sec)
46.5	280.3	331.1	2777.8	344.4
46.9	278.7	329.2	2758.7	342.6
47.5	276.4	326.4	2730.5	339.9
48.5	272.5	321.9	2684.4	335.6
49.5	268.8	317.5	2639.5	331.3
50.5	265.2	313.2	2595.7	327.2
51.5	261.8	309.1	2553.0	323.1
52.5	258.4	305.1	2511.2	319.1
53.5	255.1	301.2	2470.4	315.2
54.5	251.9	297.4	2430.5	311.4
55.1	250.0	295.2	2407.0	309.2
55.5	248.8	293.7	2391.5	307.7
56.5	245.8	290.2	2353.3	304.0
57.5	242.8	286.7	2315.9	300.4
58.5	240.0	283.3	2279.2	296.9
59.5	237.2	279.9	2243.3	293.4
60.5	234.4	276.7	2208.0	290.0
61.5	231.8	273.5	2173.4	286.6
62.5	229.1	270.4	2139.5	283.3
63.5	218.0	257.2	232.5	100.6
64.5	239.8	283.0	238.2	111.6
65.5	236.1	278.7	237.1	109.8
66.5	232.4	274.3	235.9	107.9
67.5	228.7	269.9	234.7	106.0
68.5	225.1	265.6	233.5	104.2
69.5	221.5	261.4	232.4	102.5

TABLE 6.2-14E (Cont.)

DOUBLE-ENDED PUMP SUCTION BREAK MINIMUM SAFEGUARDS  
REFLOOD MASS AND ENERGY RELEASES

Time (sec)	<u>Break Path No. 1 Flow*</u>		<u>Break Path No. 2 Flow**</u>	
	(lbm/sec)	(Thousand Btu/sec)	(lbm/sec)	(Thousand Btu/sec)
70.5	218.1	257.3	231.3	100.8
71.5	214.6	253.2	230.3	99.1
72.5	211.2	249.2	229.2	97.5
73.3	208.5	246.0	228.4	96.2
73.5	207.8	245.2	228.1	95.8
74.5	204.6	241.4	227.1	94.3
75.5	201.8	238.1	226.1	93.0
76.5	199.0	234.8	225.2	91.6
77.5	196.3	231.5	224.2	90.4
78.5	193.6	228.4	223.3	89.1
79.5	191.0	225.3	222.4	87.9
80.5	188.5	222.3	221.6	86.7
81.5	185.9	219.3	220.7	85.6
82.5	183.5	216.4	219.9	84.5
84.5	178.8	210.8	218.3	82.3
86.5	174.2	205.5	216.8	80.3
88.5	169.9	200.4	215.4	78.4
90.5	165.9	195.6	214.1	76.6
92.5	162.0	191.0	212.9	74.9
94.5	158.3	186.6	211.7	73.3
95.0	157.4	185.6	211.4	73.0
96.5	154.9	182.6	210.6	71.9
98.5	151.6	178.7	209.6	70.5
100.5	148.5	175.1	208.6	69.2
102.5	145.6	171.6	207.7	68.0
104.5	142.9	168.4	206.9	66.9

TABLE 6.2-14E (Cont.)

DOUBLE-ENDED PUMP SUCTION BREAK MINIMUM SAFEGUARDS  
REFLOOD MASS AND ENERGY RELEASES

Time (sec)	<u>Break Path No. 1 Flow*</u>		<u>Break Path No. 2 Flow**</u>	
	(lbm/sec)	(Thousand Btu/sec)	(lbm/sec)	(Thousand Btu/sec)
106.5	140.4	165.4	206.1	65.8
108.5	138.0	162.6	205.4	64.8
110.5	135.8	160.0	204.7	64.0
112.5	133.7	157.6	204.1	63.1
114.5	131.8	155.4	203.5	62.4
116.5	130.1	153.3	203.0	61.7
118.5	128.5	151.4	202.5	61.0
120.5	127.0	149.6	202.1	60.4
120.8	126.8	149.4	202.0	60.3
122.5	125.6	148.0	201.7	59.9
124.5	124.4	146.6	201.3	59.4
126.5	123.2	145.2	201.0	58.9
128.5	122.2	144.0	200.7	58.5
130.5	121.3	142.9	200.4	58.1
132.5	120.4	141.9	200.1	57.8
134.5	119.7	141.0	199.9	57.5
136.5	119.0	140.2	199.7	57.2
138.5	118.4	139.5	199.5	57.0
140.5	117.9	138.9	199.3	56.7
142.5	117.4	138.3	199.2	56.5
144.5	117.0	137.8	199.0	56.4
146.5	116.6	137.4	198.9	56.2
148.5	116.3	137.1	198.8	56.1
149.8	116.2	136.9	198.8	56.0
150.5	116.1	136.8	198.7	55.9
152.5	115.9	136.5	198.6	55.8

TABLE 6.2-14E (Cont.)

DOUBLE-ENDED PUMP SUCTION BREAK MINIMUM SAFEGUARDS  
REFLOOD MASS AND ENERGY RELEASES

Time (sec)	<u>Break Path No. 1 Flow*</u>		<u>Break Path No. 2 Flow**</u>	
	(lbm/sec)	(Thousand Btu/sec)	(lbm/sec)	(Thousand Btu/sec)
154.5	116.0	136.7	198.7	55.9
156.5	116.2	136.9	199.3	56.0
158.5	116.3	137.0	200.2	56.3
160.5	116.3	137.1	201.7	56.6
162.5	116.4	137.1	203.5	57.0
164.5	116.4	137.2	205.7	57.5
166.5	116.4	137.1	208.2	58.1
168.5	116.3	137.0	211.0	58.7
170.5	116.1	136.8	214.1	59.3
172.5	115.8	136.5	217.4	60.0
174.5	115.5	136.0	220.9	60.7
176.5	115.0	135.4	224.6	61.4
178.5	114.3	134.7	228.4	62.2
180.5	113.6	133.8	232.4	62.9
180.6	113.5	133.7	232.6	62.9
182.5	112.6	132.7	236.6	63.7
184.5	111.6	131.5	241.0	64.4
186.5	110.4	130.0	245.4	65.2
188.5	109.0	128.4	250.1	66.0
190.5	107.4	126.5	254.9	66.8
192.5	107.0	126.0	258.2	67.2
194.5	106.7	125.7	261.2	67.5
196.5	106.4	125.4	263.8	67.8
198.5	106.1	125.0	266.3	68.0
200.5	105.7	124.6	268.7	68.1
202.5	105.4	124.1	270.8	68.1

TABLE 6.2-14E (Cont.)

DOUBLE-ENDED PUMP SUCTION BREAK MINIMUM SAFEGUARDS  
REFLOOD MASS AND ENERGY RELEASES

Time (sec)	<u>Break Path No. 1 Flow*</u>		<u>Break Path No. 2 Flow**</u>	
	(lbm/sec)	(Thousand Btu/sec)	(lbm/sec)	(Thousand Btu/sec)
204.5	104.9	123.6	272.8	68.1
206.5	104.5	123.1	274.7	68.1
208.5	104.1	122.6	276.4	68.0
210.5	103.6	122.0	278.1	67.9
212.5	103.1	121.5	279.7	67.7
214.2	102.7	121.0	280.9	67.6

\* Mass and Energy exiting the SG side of the break

\*\* Mass and Energy exiting the pump side of the break

TABLE 6.2-14F

## DOUBLE-ENDED PUMP SUCTION BREAK - MINIMUM SAFEGUARDS PRINCIPAL PARAMETERS DURING REFLOOD

Flooding										
Time (sec)	Temp (°F)	Rate (in/sec)	Carryover Fraction	Core Height (ft)	Downcomer Height (ft)	Flow Frac	Total	Injection Accum (lbm/sec)	Spill	Enthalpy (Btu/lbm)
21.4	169.0	.000	.000	.00	.00	.333	.0	.0	.0	.00
22.2	166.4	22.694	.000	.67	1.40	.000	6117.9	6117.9	.0	74.50
22.4	165.1	24.146	.000	1.07	1.32	.000	6067.6	6067.6	.0	74.50
22.7	164.5	2.530	.113	1.32	1.96	.298	5952.2	5952.2	.0	74.50
22.9	164.4	2.633	.130	1.35	2.40	.310	5934.5	5934.5	.0	74.50
23.0	164.4	2.595	.163	1.37	2.69	.361	5887.9	5887.9	.0	74.50
23.2	164.4	2.604	.205	1.41	3.34	.390	5842.1	5842.1	.0	74.50
23.8	164.4	2.494	.302	1.50	4.99	.427	5710.0	5710.0	.0	74.50
24.4	164.5	2.425	.386	1.59	6.83	.442	5574.6	5574.6	.0	74.50
28.4	164.9	4.268	.635	2.01	15.61	.663	4786.7	4404.9	.0	71.19
30.5	165.1	3.918	.684	2.25	15.62	.658	4491.7	4109.2	.0	70.97
33.2	165.6	3.627	.710	2.51	15.62	.651	4221.1	3828.9	.0	70.64
39.5	167.5	3.232	.731	3.00	15.62	.635	3718.3	3307.3	.0	69.91
46.9	170.4	2.942	.739	3.50	15.62	.617	3263.8	2837.3	.0	69.08
55.1	174.1	2.711	.741	4.00	15.62	.599	2862.7	2423.8	.0	68.14
62.5	177.6	2.547	.741	4.42	15.62	.584	2560.4	2113.3	.0	67.25

TABLE 6.2-14F (Cont.)

## DOUBLE-ENDED PUMP SUCTION BREAK - MINIMUM SAFEGUARDS PRINCIPAL PARAMETERS DURING REFLOOD

Flooding										
Time (sec)	Temp (°F)	Rate (in/sec)	Carryover Fraction	Core Height (ft)	Downcomer Height (ft)	Flow Frac	Total	Injection Accum (lbm/sec)	Spill	Enthalpy (Btu/lbm)
63.5	178.1	2.534	.741	4.48	15.61	.578	454.2	.0	.0	33.00
64.5	178.6	2.631	.744	4.53	15.49	.589	442.9	.0	.0	33.00
73.3	183.8	2.357	.741	5.00	14.63	.574	452.9	.0	.0	33.00
84.5	191.7	2.098	.738	5.54	13.96	.555	458.3	.0	.0	33.00
95.0	199.7	1.912	.737	6.00	13.65	.537	461.5	.0	.0	33.00
108.5	210.1	1.743	.736	6.54	13.57	.518	464.1	.0	.0	33.00
120.8	218.6	1.644	.736	7.00	13.73	.504	465.5	.0	.0	33.00
136.5	227.9	1.572	.738	7.55	14.10	.493	466.5	.0	.0	33.00
149.8	234.7	1.541	.741	8.00	14.51	.490	466.8	.0	.0	33.00
152.5	236.0	1.537	.742	8.09	14.60	.489	466.9	.0	.0	33.00
154.5	236.9	1.537	.742	8.16	14.67	.489	466.9	.0	.0	33.00
166.5	242.2	1.531	.745	8.55	15.04	.491	466.8	.0	.0	33.00
180.6	247.9	1.496	.748	9.00	15.37	.488	467.2	.0	.0	33.00
198.5	254.0	1.419	.750	9.55	15.57	.480	467.8	.0	.0	33.00
214.2	258.7	1.364	.752	10.00	15.61	.482	467.8	.0	.0	33.00

TABLE 6.2-14G

DOUBLE-ENDED PUMP SUCTION BREAK MINIMUM SAFEGUARDS POST-REFLOOD  
MASS AND ENERGY RELEASES

Time (sec)	<u>Break Path No. 1 Flow*</u>		<u>Break Path No. 2 Flow**</u>	
	(lbm/sec)	(Thousand Btu/sec)	(lbm/sec)	(Thousand Btu/sec)
214.2	121.2	152.6	347.1	84.9
219.2	121.9	153.4	346.5	84.6
224.2	121.5	153.0	346.8	84.5
229.2	121.2	152.6	347.1	84.4
234.2	120.8	152.2	347.5	84.3
239.2	121.5	153.0	346.8	84.0
244.2	121.1	152.5	347.2	83.9
249.2	120.8	152.1	347.5	83.8
254.2	120.4	151.7	347.9	83.7
259.2	121.1	152.5	347.2	83.4
264.2	120.7	152.0	347.6	83.3
269.2	120.4	151.6	347.9	83.2
274.2	120.0	151.1	348.3	86.0
279.2	120.7	151.9	347.7	85.6
284.2	120.3	151.5	348.0	85.6
289.2	119.9	151.0	348.4	85.5
294.2	120.6	151.8	347.7	85.1
299.2	120.2	151.4	348.1	85.0
304.2	119.8	150.9	348.5	84.9
309.2	119.5	150.5	348.8	84.8
314.2	120.1	151.2	348.2	84.5
319.2	119.7	150.8	348.6	84.4



TABLE 6.2-14G (Cont.)

DOUBLE-ENDED PUMP SUCTION BREAK MINIMUM SAFEGUARDS POST-REFLOOD  
MASS AND ENERGY RELEASES

Time (sec)	<u>Break Path No. 1 Flow*</u>		<u>Break Path No. 2 Flow**</u>	
	(lbm/sec)	(Thousand Btu/sec)	(lbm/sec)	(Thousand Btu/sec)
324.2	119.4	150.3	349.0	84.3
329.2	119.9	151.0	348.4	83.9
334.2	119.6	150.6	348.7	83.9
339.2	119.2	150.1	349.1	83.8
344.2	118.8	149.6	349.5	83.7
349.2	119.4	150.4	348.9	83.3
354.2	119.0	149.9	349.3	83.2
359.2	118.7	149.4	349.6	83.1
364.2	119.2	150.1	349.1	82.8
369.2	118.8	149.6	349.5	82.7
374.2	118.5	149.2	349.8	82.6
379.2	119.0	149.9	349.3	82.3
384.2	118.6	149.4	349.7	82.2
389.2	118.2	148.9	350.1	82.1
394.2	118.8	149.6	349.5	81.7
399.2	118.4	149.1	349.9	81.6
404.2	118.1	148.7	350.2	81.5
409.2	117.8	148.4	350.5	81.4
414.2	118.5	149.2	349.8	81.0
419.2	118.2	148.8	350.1	80.9
424.2	117.9	148.5	350.4	80.8
429.2	117.6	148.1	350.7	80.7
434.2	118.3	148.9	350.1	80.3
439.2	118.0	148.6	350.3	80.2
444.2	117.7	148.2	350.6	80.1
449.2	117.4	147.8	350.9	79.9

TABLE 6.2-14G (Cont.)

DOUBLE-ENDED PUMP SUCTION BREAK MINIMUM SAFEGUARDS POST-REFLOOD  
MASS AND ENERGY RELEASES

Time (sec)	<u>Break Path No. 1 Flow*</u>		<u>Break Path No. 2 Flow**</u>	
	(lbm/sec)	(Thousand Btu/sec)	(lbm/sec)	(Thousand Btu/sec)
454.2	118.0	148.6	350.3	79.6
459.2	117.7	148.2	350.6	79.5
464.2	117.4	147.9	350.9	79.3
469.2	117.1	147.5	351.2	79.2
474.2	117.7	148.2	350.6	78.9
479.2	117.4	147.9	350.9	78.7
484.2	117.1	147.5	351.2	81.3
489.2	117.7	148.2	350.6	80.9
494.2	117.4	147.8	350.9	80.8
499.2	117.1	147.4	351.2	80.6
504.2	116.8	147.0	351.5	80.5
509.2	117.3	147.7	351.0	80.1
514.2	117.0	147.3	351.3	80.0
519.2	116.7	146.9	351.6	79.9
524.2	117.2	147.6	351.1	79.5
529.2	116.9	147.2	351.4	79.4
534.2	116.6	146.8	351.7	79.2
539.2	117.1	147.4	351.2	78.9
544.2	116.7	147.0	351.6	78.8
549.2	116.4	146.6	351.9	78.6
554.2	116.9	147.2	351.4	78.3
559.2	116.6	146.8	351.8	78.1
564.2	116.2	146.3	352.1	78.0
569.2	116.7	146.9	351.6	77.7
574.2	116.3	146.5	352.0	77.5
579.2	116.0	146.0	352.3	77.4

TABLE 6.2-14G (Cont.)

DOUBLE-ENDED PUMP SUCTION BREAK MINIMUM SAFEGUARDS POST-REFLOOD  
MASS AND ENERGY RELEASES

Time (sec)	<u>Break Path No. 1 Flow*</u>		<u>Break Path No. 2 Flow**</u>	
	(lbm/sec)	(Thousand Btu/sec)	(lbm/sec)	(Thousand Btu/sec)
584.2	116.4	146.6	351.9	77.1
589.2	116.1	146.1	352.2	79.4
594.2	116.5	146.7	351.8	79.1
599.2	116.1	146.2	352.2	78.9
604.2	115.8	145.8	352.5	78.8
609.2	116.2	146.4	352.1	78.4
614.2	115.9	145.9	352.4	78.3
619.2	116.3	146.5	352.0	77.9
624.2	116.0	146.0	352.3	77.8
629.2	115.6	145.6	352.7	77.6
634.2	116.0	146.1	352.3	77.3
639.2	115.7	145.6	352.6	77.1
644.2	116.1	146.1	352.3	76.8
649.2	115.7	145.7	352.6	76.6
654.2	116.0	146.1	352.3	76.3
659.2	115.7	145.6	352.7	76.1
664.2	115.3	145.1	353.1	78.4
669.2	115.6	145.6	352.7	78.1
674.2	115.2	145.0	353.1	77.9
679.2	115.5	145.4	352.8	77.5
684.2	115.8	145.8	352.5	77.2
689.2	115.4	145.3	352.9	77.0
694.2	115.7	145.6	352.7	76.7
699.2	115.2	145.1	353.1	76.6
704.2	115.5	145.4	352.9	76.2
709.2	115.0	144.8	353.3	76.1

TABLE 6.2-14G (Cont.)

DOUBLE-ENDED PUMP SUCTION BREAK MINIMUM SAFEGUARDS POST-REFLOOD  
MASS AND ENERGY RELEASES

Time (sec)	<u>Break Path No. 1 Flow*</u>		<u>Break Path No. 2 Flow**</u>	
	(lbm/sec)	(Thousand Btu/sec)	(lbm/sec)	(Thousand Btu/sec)
714.2	115.2	145.1	353.1	75.7
719.2	115.4	145.3	352.9	75.4
724.2	114.9	144.7	353.4	77.6
729.2	115.1	144.9	353.2	77.3
734.2	115.2	145.1	353.1	76.9
739.2	114.7	144.5	353.6	76.8
744.2	114.8	144.6	353.5	76.4
749.2	114.9	144.7	353.4	76.1
754.2	115.0	144.8	353.3	75.8
759.2	115.1	144.9	353.3	75.5
764.2	115.1	144.9	353.2	75.2
769.2	114.5	144.1	353.8	75.0
774.2	114.5	144.1	353.9	77.0
779.2	114.4	144.1	353.9	76.7
784.2	114.3	144.0	354.0	76.4
789.2	114.8	144.6	353.5	75.9
794.2	114.7	144.4	353.6	75.7
799.2	114.5	144.2	353.8	75.4
804.2	114.3	144.0	354.0	75.1
809.2	114.7	144.4	353.6	74.7
814.2	114.4	144.0	353.9	74.4
819.2	114.1	143.6	354.2	76.4
824.2	114.2	143.8	354.1	76.0
829.2	114.3	144.0	354.0	75.6
834.2	66.6	83.8	401.7	87.8
1089.1	66.6	83.8	401.7	87.8

TABLE 6.2-14G (Cont.)

DOUBLE-ENDED PUMP SUCTION BREAK MINIMUM SAFEGUARDS POST-REFLOOD  
MASS AND ENERGY RELEASES

Time (sec)	<u>Break Path No. 1 Flow*</u>		<u>Break Path No. 2 Flow**</u>	
	(lbm/sec)	(Thousand Btu/sec)	(lbm/sec)	(Thousand Btu/sec)
1089.2	66.1	82.9	402.2	85.0
1089.2	66.1	82.9	402.2	85.0
1367.4	66.1	82.9	402.2	85.0
1367.5	57.6	66.3	410.7	13.6
2948.0	48.0	55.3	420.3	13.9
2948.1	50.5	58.1	453.9	40.0
3600.0	47.5	54.7	456.9	40.3

\* Mass and Energy exiting the SG side of break

\*\* Mass and Energy exiting the pump side of break

TABLE 6.2-14H

## DOUBLE-ENDED PUMP SUCTION BREAK MAXIMUM SAFEGUARDS REFLOOD MASS AND ENERGY RELEASES

Time (sec)	<u>Break Path No. 1 Flow*</u>		<u>Break Path No. 2 Flow**</u>	
	(lbm/sec)	(Thousand Btu/sec)	(lbm/sec)	(Thousand Btu/sec)
21.4	.0	.0	.0	.0
21.9	.0	.0	.0	.0
22.1	.0	.0	.0	.0
22.2	.0	.0	.0	.0
22.3	.0	.0	.0	.0
22.4	.0	.0	.0	.0
22.4	.0	.0	.0	.0
22.5	57.4	67.5	.0	.0
22.6	20.7	24.4	.0	.0
22.7	18.2	21.4	.0	.0
22.9	21.6	25.4	.0	.0
23.0	31.8	37.4	.0	.0
23.1	37.0	43.6	.0	.0
23.2	43.0	50.6	.0	.0
23.3	48.3	56.8	.0	.0
23.4	53.7	63.3	.0	.0
23.5	58.3	68.6	.0	.0
23.6	61.7	72.7	.0	.0
23.7	65.1	76.7	.0	.0
23.8	66.8	78.7	.0	.0
23.8	68.4	80.6	.0	.0
23.9	71.6	84.3	.0	.0
24.0	74.7	87.9	.0	.0

TABLE 6.2-14H (Cont.)

## DOUBLE-ENDED PUMP SUCTION BREAK MAXIMUM SAFEGUARDS REFLOOD MASS AND ENERGY RELEASES

Time (sec)	<u>Break Path No. 1 Flow*</u>		<u>Break Path No. 2 Flow**</u>	
	(lbm/sec)	(Thousand Btu/sec)	(lbm/sec)	(Thousand Btu/sec)
24.1	77.6	91.4	.0	.0
24.2	80.5	94.8	.0	.0
24.3	83.3	98.1	.0	.0
24.4	86.0	101.3	.0	.0
25.4	109.9	129.5	.0	.0
26.4	129.7	152.9	.0	.0
27.4	160.1	188.8	742.5	60.5
28.4	387.0	458.1	3989.5	437.1
28.5	389.5	461.0	4008.0	441.8
29.5	389.1	460.6	3995.0	446.1
30.5	382.5	452.7	3926.3	440.4
31.5	375.6	444.5	3854.3	434.0
32.5	368.7	436.3	3782.2	427.5
33.0	365.3	432.3	3746.6	424.3
33.5	362.0	428.3	3711.3	421.0
34.5	355.5	420.6	3642.1	414.7
35.5	349.3	413.2	3574.8	408.5
36.5	343.3	406.0	3509.6	402.4
37.5	337.5	399.2	3446.5	396.5
38.5	332.0	392.6	3385.3	390.8
39.2	328.2	388.1	3343.6	386.9
39.5	326.7	386.2	3326.0	385.3
40.5	321.5	380.1	3268.6	379.9
41.5	316.6	374.3	3213.0	374.7
42.5	311.8	368.6	3159.1	369.6

TABLE 6.2-14H (Cont.)

## DOUBLE-ENDED PUMP SUCTION BREAK MAXIMUM SAFEGUARDS REFLOOD MASS AND ENERGY RELEASES

Time (sec)	<u>Break Path No. 1 Flow*</u>		<u>Break Path No. 2 Flow**</u>	
	(lbm/sec)	(Thousand Btu/sec)	(lbm/sec)	(Thousand Btu/sec)
43.5	307.3	363.2	3106.7	364.7
44.5	302.8	357.9	3055.8	359.9
45.5	298.6	352.8	3006.4	355.3
46.3	295.3	348.9	2967.8	351.6
46.5	294.4	347.9	2958.3	350.7
47.5	290.5	343.2	2911.5	346.3
48.5	286.6	338.6	2866.0	342.0
49.5	282.8	334.1	2821.5	337.8
50.5	279.2	329.8	2778.2	333.7
51.5	275.7	325.6	2736.0	329.7
52.5	272.2	321.6	2694.7	325.7
53.5	268.9	317.6	2654.4	321.9
54.2	266.6	314.9	2626.7	319.2
54.5	265.7	313.8	2615.0	318.1
55.5	262.5	310.0	2576.4	314.4
56.5	259.4	306.4	2538.7	310.8
57.5	256.4	302.8	2501.8	307.2
58.5	253.5	299.3	2465.6	303.8
59.5	250.7	295.9	2430.1	300.3
60.5	247.9	292.6	2395.3	297.0
61.5	245.1	289.4	2361.2	293.7
62.5	242.5	286.2	2327.7	290.4
63.5	239.9	283.2	2294.9	287.2
64.5	149.2	175.9	430.0	95.7



TABLE 6.2-14H (Cont.)

## DOUBLE-ENDED PUMP SUCTION BREAK MAXIMUM SAFEGUARDS REFLOOD MASS AND ENERGY RELEASES

Time (sec)	<u>Break Path No. 1 Flow*</u>		<u>Break Path No. 2 Flow**</u>	
	(lbm/sec)	(Thousand Btu/sec)	(lbm/sec)	(Thousand Btu/sec)
65.5	148.9	175.5	430.6	95.5
66.5	148.6	175.2	431.2	95.4
67.5	148.3	174.8	431.8	95.2
68.5	148.0	174.5	432.5	95.1
69.5	147.7	174.1	433.1	94.9
70.5	147.4	173.8	433.8	94.8
71.5	147.1	173.4	434.4	94.6
72.5	146.8	173.1	435.1	94.5
73.5	146.5	172.7	435.7	94.3
73.6	146.5	172.7	435.8	94.3
74.5	146.2	172.4	436.4	94.2
75.5	145.9	172.0	437.0	94.1
76.5	145.6	171.7	437.7	93.9
77.5	145.4	171.3	438.3	93.8
78.5	145.1	171.0	439.0	93.6
79.5	144.8	170.6	439.6	93.5
80.5	144.5	170.3	440.3	93.3
81.5	144.2	169.9	440.9	93.2
82.5	143.9	169.6	441.6	93.1
84.5	143.3	168.9	442.9	92.8
86.5	142.7	168.2	444.2	92.5
88.5	142.1	167.5	445.5	92.2
90.5	141.5	166.8	446.9	91.9
92.5	140.9	166.1	448.2	91.7
94.5	140.3	165.4	449.5	91.4

TABLE 6.2-14H (Cont.)

## DOUBLE-ENDED PUMP SUCTION BREAK MAXIMUM SAFEGUARDS REFLOOD MASS AND ENERGY RELEASES

Time (sec)	<u>Break Path No. 1 Flow*</u>		<u>Break Path No. 2 Flow**</u>	
	(lbm/sec)	(Thousand Btu/sec)	(lbm/sec)	(Thousand Btu/sec)
96.5	139.7	164.7	450.9	91.1
97.0	139.6	164.5	451.2	91.0
98.5	139.1	164.0	452.2	90.8
100.5	138.5	163.3	453.6	90.6
102.5	137.9	162.6	455.0	90.3
104.5	137.3	161.8	456.3	90.0
106.5	136.7	161.1	457.7	89.7
108.5	136.1	160.4	459.1	89.5
110.5	135.4	159.6	460.5	89.2
112.5	134.8	158.9	461.9	88.9
114.5	134.2	158.1	463.3	88.7
116.5	133.6	157.4	464.7	88.4
118.5	132.9	156.6	466.1	88.1
120.5	132.3	155.9	467.5	87.8
122.1	131.8	155.3	468.7	87.6
122.5	131.6	155.1	468.9	87.5
124.5	131.0	154.4	470.3	87.3
126.5	130.3	153.6	471.7	87.0
128.5	129.7	152.8	473.1	86.7
130.5	129.0	152.0	474.5	86.4
132.5	128.4	151.3	475.9	86.1
134.5	127.7	150.5	477.3	85.9
136.5	127.0	149.7	478.7	85.6
138.5	126.4	148.9	480.1	85.3
140.5	125.7	148.1	481.5	85.0

TABLE 6.2-14H (Cont.)

## DOUBLE-ENDED PUMP SUCTION BREAK MAXIMUM SAFEGUARDS REFLOOD MASS AND ENERGY RELEASES

Time (sec)	<u>Break Path No. 1 Flow*</u>		<u>Break Path No. 2 Flow**</u>	
	(lbm/sec)	(Thousand Btu/sec)	(lbm/sec)	(Thousand Btu/sec)
142.5	125.0	147.3	482.9	84.7
144.5	124.4	146.5	484.3	84.4
146.5	123.7	145.7	485.7	84.1
148.5	123.0	144.9	487.1	83.9
149.6	122.6	144.5	487.8	83.7
150.5	122.3	144.1	488.4	83.6
152.5	121.6	143.3	489.8	83.3
154.5	120.9	142.5	491.2	83.0
156.5	120.2	141.7	492.6	82.7
158.5	119.6	140.9	494.0	82.4
160.5	118.9	140.1	495.4	82.1
162.5	118.2	139.2	496.8	81.8
164.5	117.5	138.4	498.2	81.5
166.5	116.8	137.6	499.5	81.3
168.5	116.1	136.7	500.9	81.0
170.5	115.4	135.9	502.3	80.7
172.5	114.6	135.1	503.7	80.4
174.5	113.9	134.2	505.1	80.1
176.5	113.2	133.4	506.4	79.8
178.5	112.5	132.6	507.8	79.5
179.8	112.1	132.0	508.7	79.3
180.5	111.8	131.7	509.2	79.2
182.5	111.3	131.1	510.2	79.2
184.5	110.8	130.5	511.1	79.1
186.5	110.3	129.9	512.0	79.1

TABLE 6.2-14H (Cont.)

## DOUBLE-ENDED PUMP SUCTION BREAK MAXIMUM SAFEGUARDS REFLOOD MASS AND ENERGY RELEASES

Time (sec)	<u>Break Path No. 1 Flow*</u>		<u>Break Path No. 2 Flow**</u>	
	(lbm/sec)	(Thousand Btu/sec)	(lbm/sec)	(Thousand Btu/sec)
188.5	109.8	129.3	512.9	79.1
190.5	109.3	128.7	513.8	79.0
192.5	108.8	128.1	514.7	79.0
194.5	108.3	127.6	515.6	78.9
196.5	107.8	127.0	516.5	78.9
198.5	107.3	126.4	517.3	78.8
200.5	106.8	125.8	518.2	78.8
202.5	106.3	125.3	519.1	78.7
204.5	105.8	124.7	520.0	78.7
206.5	105.3	124.1	520.8	78.6
208.5	104.9	123.5	521.7	78.6
210.5	104.4	123.0	522.6	78.5
212.5	103.9	122.4	523.4	78.4
213.4	103.7	122.2	523.8	78.4

\* Mass and Energy exiting the SG side of the break

\*\* Mass and Energy exiting the pump side of the break

TABLE 6.2-14I

## PRINCIPAL PARAMETERS DURING REFLOOD DOUBLE-ENDED PUMP SUCTION BREAK - MAXIMUM SAFEGUARDS

Flooding										
Time (sec)	Temp (°F)	Rate (in/sec)	Carryover Fraction	Core Height (ft)	Downcomer Height (ft)	Flow Frac	Total	Injection Accum (lbm/sec)	Spill	Enthalpy (Btu/lbm)
21.4	169.0	.000	.000	.00	.00	.333	.0	.0	.0	.00
22.2	166.4	22.694	.000	.67	1.40	.000	6117.9	6117.9	.0	74.50
22.4	165.1	24.146	.000	1.07	1.32	.000	6067.6	6067.6	.0	74.50
22.7	164.5	2.530	.113	1.32	1.96	.298	5952.2	5952.2	.0	74.50
22.9	164.4	2.633	.130	1.35	2.40	.310	5934.5	5934.5	.0	74.50
23.0	164.4	2.595	.163	1.37	2.69	.361	5887.9	5887.9	.0	74.50
23.2	164.4	2.604	.205	1.41	3.34	.390	5842.1	5842.1	.0	74.50
23.8	164.4	2.494	.302	1.50	4.99	.427	5710.0	5710.0	.0	74.50
24.4	164.5	2.425	.386	1.59	6.83	.442	5574.6	5574.6	.0	74.50
28.4	164.9	4.389	.635	2.01	15.61	.670	4980.9	4363.1	.0	69.35
29.5	165.0	4.190	.667	2.15	15.62	.667	4799.2	4184.3	.0	69.18
33.0	165.5	3.747	.710	2.50	15.62	.659	4434.4	3806.6	.0	68.63
39.2	167.3	3.345	.732	3.00	15.62	.644	3937.5	3290.5	.0	67.68
46.3	169.9	3.057	.740	3.50	15.62	.628	3498.4	2835.5	.0	66.64
54.2	173.4	2.826	.742	4.00	15.62	.611	3107.7	2432.0	.0	65.48
63.5	177.6	2.615	.743	4.54	15.62	.594	2731.6	2044.9	.0	64.07
64.5	178.1	2.030	.732	4.59	15.62	.483	712.1	.0	.0	33.00

TABLE 6.2-14I (Cont.)

## PRINCIPAL PARAMETERS DURING REFLOOD DOUBLE-ENDED PUMP SUCTION BREAK - MAXIMUM SAFEGUARDS

Flooding										
Time (sec)	Temp (°F)	Rate (in/sec)	Carryover Fraction	Core Height (ft)	Downcomer Height (ft)	Flow Frac	Total	Injection Accum (lbm/sec)	Spill	Enthalpy (Btu/lbm)
73.6	182.7	1.988	.733	5.00	15.62	.484	712.1	.0	.0	33.00
86.5	190.9	1.930	.735	5.56	15.62	.484	712.1	.0	.0	33.00
97.0	198.6	1.882	.736	6.00	15.62	.485	712.1	.0	.0	33.00
110.5	208.9	1.819	.739	6.55	15.62	.485	712.1	.0	.0	33.00
122.1	217.3	1.764	.740	7.00	15.62	.485	712.1	.0	.0	33.00
136.5	226.4	1.696	.743	7.54	15.62	.486	712.1	.0	.0	33.00
149.6	233.6	1.633	.744	8.00	15.62	.486	712.1	.0	.0	33.00
164.5	240.7	1.562	.746	8.51	15.62	.485	712.2	.0	.0	33.00
179.8	246.9	1.489	.747	9.00	15.62	.485	712.2	.0	.0	33.00
196.5	252.8	1.424	.749	9.51	15.62	.486	712.2	.0	.0	33.00
213.4	258.0	1.361	.751	10.00	15.62	.488	712.2	.0	.0	33.00

TABLE 6.2-14J

DOUBLE-ENDED PUMP SUCTION BREAK MAXIMUM  
SAFEGUARDS POST-REFLOOD MASS AND ENERGY RELEASES

Time (sec)	<u>Break Path No. 1 Flow*</u>		<u>Break Path No. 2 Flow**</u>	
	(lbm/sec)	(Thousand Btu/sec)	(lbm/sec)	(Thousand Btu/sec)
213.4	123.8	156.1	589.5	94.4
218.4	123.5	155.6	589.8	94.3
223.4	123.1	155.2	590.2	94.2
228.4	122.8	154.8	590.5	94.1
233.4	123.5	155.6	589.9	93.7
238.4	123.1	155.2	590.2	93.6
243.4	122.8	154.7	590.6	93.6
248.4	122.4	154.3	590.9	93.5
253.4	123.1	155.1	590.3	93.1
258.4	122.7	154.6	590.6	93.0
263.4	122.3	154.2	591.0	92.9
268.4	123.0	155.0	590.3	92.6
273.4	122.6	154.5	590.7	92.5
278.4	122.3	154.1	591.1	92.4
283.4	121.9	153.6	591.4	92.3
288.4	122.5	154.4	590.8	92.0
293.4	122.2	154.0	591.2	91.9
298.4	121.8	153.5	591.5	91.8
303.4	121.4	153.0	591.9	91.7
308.4	122.1	153.8	591.3	91.3
313.4	121.7	153.4	591.7	91.2
318.4	121.3	152.9	592.0	91.2
323.4	121.9	153.6	591.4	90.8

TABLE 6.2-14J (Cont.)

DOUBLE-ENDED PUMP SUCTION BREAK MAXIMUM  
SAFEGUARDS POST-REFLOOD MASS AND ENERGY RELEASES

Time (sec)	<u>Break Path No. 1 Flow*</u>		<u>Break Path No. 2 Flow**</u>	
	(lbm/sec)	(Thousand Btu/sec)	(lbm/sec)	(Thousand Btu/sec)
328.4	121.5	153.2	591.8	90.7
333.4	121.2	152.7	592.2	90.6
338.4	121.8	153.4	591.6	90.3
343.4	121.4	153.0	592.0	90.2
348.4	121.0	152.5	592.3	90.1
353.4	120.6	152.0	592.7	90.0
358.4	121.2	152.7	592.2	89.7
363.4	120.8	152.2	592.5	89.6
368.4	120.4	151.7	592.9	89.5
373.4	121.0	152.4	592.4	89.1
378.4	120.6	151.9	592.8	89.1
383.4	120.2	151.4	593.2	89.0
388.4	120.7	152.1	592.6	88.6
393.4	120.3	151.6	593.0	88.5
398.4	119.9	151.1	593.4	88.4
403.4	120.5	151.9	592.8	88.1
408.4	120.2	151.5	593.1	88.0
413.4	120.0	151.2	593.4	87.9
418.4	119.7	150.8	593.7	90.4
423.4	120.3	151.6	593.0	90.1
428.4	120.0	151.3	593.3	89.9
433.4	119.7	150.9	593.6	89.8
438.4	119.4	150.5	593.9	89.7
443.4	120.1	151.3	593.3	89.3



TABLE 6.2-14J (Cont.)

DOUBLE-ENDED PUMP SUCTION BREAK MAXIMUM  
SAFEGUARDS POST-REFLOOD MASS AND ENERGY RELEASES

Time (sec)	<u>Break Path No. 1 Flow*</u>		<u>Break Path No. 2 Flow**</u>	
	(lbm/sec)	(Thousand Btu/sec)	(lbm/sec)	(Thousand Btu/sec)
448.4	119.8	150.9	593.6	89.2
453.4	119.5	150.5	593.9	89.0
458.4	120.1	151.3	593.3	88.7
463.4	119.7	150.9	593.6	88.6
468.4	119.4	150.5	593.9	88.4
473.4	119.1	150.1	594.2	88.3
478.4	119.7	150.9	593.6	87.9
483.4	119.4	150.5	593.9	87.8
488.4	119.1	150.1	594.3	87.7
493.4	119.6	150.8	593.7	87.3
498.4	119.3	150.4	594.0	87.2
503.4	119.0	149.9	594.4	87.1
508.4	119.5	150.6	593.8	86.7
513.4	119.2	150.2	594.1	86.6
518.4	118.9	149.8	594.5	86.5
523.4	119.4	150.4	594.0	86.1
528.4	119.0	150.0	594.3	86.0
533.4	118.7	149.6	594.6	88.4
538.4	119.2	150.2	594.1	88.0
543.4	118.8	149.8	594.5	87.9
548.4	118.5	149.3	594.8	87.8
553.4	119.0	149.9	594.4	87.4
558.4	118.6	149.5	594.7	87.3
563.4	118.2	149.0	595.1	87.1
568.4	118.7	149.6	594.6	86.8

TABLE 6.2-14J (Cont.)

DOUBLE-ENDED PUMP SUCTION BREAK MAXIMUM  
SAFEGUARDS POST-REFLOOD MASS AND ENERGY RELEASES

Time (sec)	<u>Break Path No. 1 Flow*</u>		<u>Break Path No. 2 Flow**</u>	
	(lbm/sec)	(Thousand Btu/sec)	(lbm/sec)	(Thousand Btu/sec)
573.4	118.3	149.1	595.0	86.6
578.4	118.8	149.7	594.6	86.3
583.4	118.4	149.2	595.0	86.1
588.4	118.0	148.7	595.3	86.0
593.4	118.4	149.2	594.9	85.7
598.4	118.0	148.7	595.3	85.5
603.4	118.4	149.3	594.9	85.2
608.4	118.1	148.8	595.3	85.0
613.4	117.7	148.3	595.6	84.9
618.4	118.1	148.9	595.2	87.0
623.4	117.7	148.4	595.6	86.8
628.4	118.1	148.9	595.2	86.5
633.4	117.7	148.4	595.6	86.3
638.4	118.1	148.8	595.2	86.0
643.4	117.7	148.3	595.6	85.8
648.4	118.1	148.8	595.3	85.5
653.4	117.6	148.3	595.7	85.3
658.4	118.0	148.7	595.4	85.0
663.4	117.5	148.1	595.8	84.8
668.4	117.8	148.5	595.5	84.5
673.4	117.4	147.9	596.0	84.3
678.4	117.7	148.3	595.7	84.0
683.4	117.2	147.7	596.1	86.2
688.4	117.4	148.0	595.9	85.9
693.4	117.7	148.3	595.7	85.5

TABLE 6.2-14J (Cont.)

DOUBLE-ENDED PUMP SUCTION BREAK MAXIMUM  
SAFEGUARDS POST-REFLOOD MASS AND ENERGY RELEASES

Time (sec)	<u>Break Path No. 1 Flow*</u>		<u>Break Path No. 2 Flow**</u>	
	(lbm/sec)	(Thousand Btu/sec)	(lbm/sec)	(Thousand Btu/sec)
698.4	117.2	147.7	596.2	85.4
703.4	117.4	147.9	596.0	85.0
708.4	117.6	148.1	595.8	84.7
713.4	117.0	147.5	596.3	84.6
718.4	117.2	147.7	596.2	84.2
723.4	117.3	147.8	596.0	83.9
728.4	117.4	147.9	595.9	83.6
733.4	116.8	147.2	596.5	83.5
738.4	116.9	147.3	596.5	85.4
743.4	116.9	147.3	596.4	85.1
748.4	116.9	147.4	596.4	84.8
753.4	116.9	147.4	596.4	84.5
758.4	116.9	147.3	596.5	84.2
763.4	116.8	147.2	596.5	83.9
768.4	116.7	147.1	596.6	83.6
773.4	116.6	146.9	596.7	83.3
778.4	116.4	146.7	596.9	83.0
783.4	116.8	147.2	596.5	84.8
788.4	116.6	146.9	596.8	84.6
793.4	116.3	146.5	597.1	84.3
798.4	116.5	146.8	596.8	83.9
803.4	116.7	147.1	596.6	83.5
808.4	116.3	146.5	597.1	83.3
813.4	116.3	146.6	597.0	82.9
818.4	116.3	146.6	597.0	82.6

TABLE 6.2-14J (Cont.)

DOUBLE-ENDED PUMP SUCTION BREAK MAXIMUM  
SAFEGUARDS POST-REFLOOD MASS AND ENERGY RELEASES

Time (sec)	<u>Break Path No. 1 Flow*</u>		<u>Break Path No. 2 Flow**</u>	
	(lbm/sec)	(Thousand Btu/sec)	(lbm/sec)	(Thousand Btu/sec)
823.4	66.8	84.1	646.6	97.4
1079.6	66.8	84.1	646.6	97.4
1079.7	65.7	82.4	647.7	93.9
1083.4	65.6	82.4	647.7	94.4
1390.6	65.6	82.4	647.7	94.4
1390.7	55.7	64.0	657.7	21.7
2782.0	47.1	54.1	666.3	22.0
2782.1	49.5	57.0	454.9	40.1
3600.0	45.7	52.6	458.7	40.4

\* Mass and Energy exiting the SG side of the break

\*\* Mass and Energy exiting the pump side of the break

TABLE 6.2-14K  
 DOUBLE-ENDED HOT-LEG BREAK  
 MASS BALANCE

		Time (Sec)		
		.00	19.20	19.20*
		Mass (Thousand lbm)		
Initial	In RCS and ACC	626.47	626.47	626.47
Added Mass	Pumped Injection	.00	.00	.00
	Total Added	.00	.00	.00
Total Available		626.47	626.47	626.47
Distribution	Reactor Coolant	416.98	49.96	49.96
	Accumulator	209.49	173.99	173.99
	Total Contents	626.47	223.96	223.96
Effluent	Break Flow	.00	402.50	402.50
	ECCS Spill	.00	.00	.00
	Total Effluent	.00	402.50	402.50
Total Accountable		626.47	626.45	626.45

\* This time is the bottom of core recovery time, which is identical to the end of blowdown time due to the assumption of instantaneous refill.

TABLE 6.2-14L

## DOUBLE-ENDED PUMP SUCTION BREAK MASS BALANCE MINIMUM SAFEGUARDS

		Time (Sec)						
		.00	21.40 <sup>(1)</sup>	21.40 <sup>(2)</sup>	214.19 <sup>(3)</sup>	1089.17 <sup>(4)</sup>	1367.37 <sup>(5)</sup>	3600.0 <sup>(6)</sup>
		Mass (Thousand lbm)						
Initial	In RCS & Accumulator	626.47	626.47	626.47	626.47	626.47	626.47	626.47
Added Mass	Pumped Injection	.00	.00	.00	85.24	495.00	625.28	1694.38
	Total Added	.00	.00	.00	85.24	495.00	625.28	1694.38
Total Available		626.47	626.47	626.47	711.71	1121.47	1251.76	2320.85
Distribution	Reactor Coolant	416.98	40.95	66.41	117.33	117.33	117.33	117.33
	Accumulator	209.49	167.73	142.28	.00	.00	.00	.00
	Total Contents	626.47	208.68	208.68	117.33	117.33	117.33	117.33
Effluent	Break Flow	.00	417.78	417.78	585.53	995.29	1125.57	2194.67
	ECCS Spill	.00	.00	.00	.00	.00	.00	.00
	Total Effluent	.00	417.78	417.78	585.53	995.29	1125.57	2194.67
Total Accountable		626.47	626.46	626.46	702.86	1112.62	1242.91	2312.00

## Notes:

- (1) End of Blowdown
- (2) Bottom of core recovery time, which is identical to the end of blowdown time due to the assumption of instantaneous refill.
- (3) End of Reload
- (4) Time at which the Broken Loop SG equilibrates at the first intermediate pressure
- (5) Time at which the Intact Loop SG equilibrates at the second intermediate pressure
- (6) Time at which both SGs equilibrate to 14.7 psia

TABLE 6.2-14M

DOUBLE-ENDED PUMP SUCTION BREAK MASS BALANCE MAXIMUM SAFEGUARDS

		Time (Sec)						
		.00	21.40 <sup>(1)</sup>	21.40 <sup>(2)</sup>	213.36 <sup>(3)</sup>	1079.74 <sup>(4)</sup>	1390.62 <sup>(5)</sup>	3600.00 <sup>(6)</sup>
		Mass (Thousand lbm)						
Initial	In RCS & Accumulator	626.47	626.47	626.47	626.47	626.47	626.47	626.47
Added Mass	Pumped Injection	.00	.00	.00	130.69	748.68	970.44	2375.56
	Total Added	.00	.00	.00	130.69	748.68	970.44	2375.56
Total Available		626.47	626.47	626.47	757.16	1375.15	1596.91	3002.04
Distribution	Reactor Coolant	416.98	40.95	66.41	117.53	117.53	117.53	117.53
	Accumulator	209.49	167.73	142.28	.00	.00	.00	.00
	Total Contents	626.47	208.68	208.68	117.53	117.53	117.53	117.53
Effluent	Break Flow	.00	417.78	417.78	630.78	1248.77	1470.53	2875.67
	ECCS Spill	.00	.00	.00	.00	.00	.00	.00
	Total Effluent	.00	417.78	417.78	630.78	1248.77	1470.53	2875.67
Total Accountable		626.47	626.46	626.46	748.31	1366.30	1588.06	2993.20

Notes:

- (1) End of Blowdown
- (2) Bottom of core recovery time, which is identical to the end of blowdown time due to the assumption of instantaneous refill
- (3) End of Reflood
- (4) Time at which the Broken Loop SG equilibrates at the first intermediate pressure.
- (5) Time at which the Intact Loop SG equilibrates at the second intermediate pressure.
- (6) Time at which both SGs equilibrate to 14.7 psia.

TABLE 6.2-14N  
DOUBLE-ENDED HOT-LEG BREAK ENERGY BALANCE

		Time (Sec)		
		.00	19.20	19.20*
		Energy (Million Btu)		
Initial Energy	In RCS, Acc, SG	675.94	675.94	675.94
Added Energy	Pumped Injection	.00	.00	.00
	Decay Heat	.00	5.77	5.77
	Heat From Secondary	.00	-.35	-.35
	Total Added	.00	5.42	5.42
Total Available		675.94	681.36	681.36
Distribution	Reactor Coolant	245.25	11.99	11.99
	Accumulator	15.62	12.97	12.97
	Core Stored	22.87	9.19	9.19
	Primary Metal	115.85	108.47	108.47
	Secondary Metal	69.35	69.00	69.00
	Steam Generator	207.00	205.72	205.72
	Total Contents	675.94	417.34	417.34
Effluent	Break Flow	.00	263.52	263.52
	ECCS Spill	.00	.00	.00
	Total Effluent	.00	263.52	263.52
Total Accountable		675.94	680.86	680.86

\* This time is the bottom of core recovery time, which is identical to the end of blowdown time due to the assumption of instantaneous refill.



TABLE 6.2-140

DOUBLE-ENDED PUMP SUCTION BREAK ENERGY BALANCE MINIMUM SAFEGUARDS

		Time (Sec)						
		.00	21.40 <sup>(1)</sup>	21.40 <sup>(2)</sup>	214.19 <sup>(3)</sup>	1089.17 <sup>(4)</sup>	1367.37 <sup>(5)</sup>	3600.00 <sup>(6)</sup>
		Energy (Million Btu)						
Initial Energy	In RCS, Acc, SG	640.99	640.99	640.99	640.99	640.99	640.99	640.99
Added Energy	Pumped Injection	.00	.00	.00	2.81	16.33	20.63	74.05
	Decay Heat	.00	5.79	5.79	24.82	85.54	101.78	209.46
	Heat From Secondary	.00	.43	.43	.43	9.95	10.04	10.04
	Total Added	.00	6.22	6.22	28.06	111.83	132.46	293.56
Total Available		640.99	647.21	647.21	669.04	752.81	773.45	934.54
Distribution	Reactor Coolant	245.25	8.59	10.49	29.17	29.17	29.17	29.17
	Accumulator	15.62	12.51	10.61	.00	.00	.00	.00
	Core Stored	22.87	12.50	12.50	3.91	3.17	3.12	2.71
	Primary Metal	115.85	109.61	109.61	88.92	50.61	45.22	40.05
	Secondary Metal	34.40	34.82	34.82	31.86	19.12	16.34	14.61
	Steam Generator	207.00	210.21	210.21	188.90	116.55	100.61	90.81
	Total Contents	640.99	388.24	388.24	342.76	218.61	194.45	177.35
Effluent	Break Flow	.00	258.48	258.48	318.23	526.15	549.53	730.23
	ECCS Spill	.00	.00	.00	.00	.00	.00	.00
	Total Effluent	.00	258.48	258.48	318.23	526.15	549.53	730.23
Total Accountable		640.99	646.72	646.72	660.99	744.76	743.98	907.58

Notes:

- (1) End of Blowdown
- (2) Bottom of core recovery time. This time is identical to the end of blowdown time due to the assumption of instantaneous refill.
- (3) End of Reload
- (4) Time at which the Broken Loop SG equilibrates at the first intermediate pressure
- (5) Time at which the Intact Loop SG equilibrates at the second intermediate pressure
- (6) Time at which both SGs equilibrate to 14.7 psia

TABLE 6.2-14P

DOUBLE-ENDED PUMP SUCTION BREAK ENERGY BALANCE - MAXIMUM SAFEGUARDS

		Time (sec)						
		.00	21.40 <sup>(1)</sup>	21.40 <sup>(2)</sup>	213.36 <sup>(3)</sup>	1079.74 <sup>(4)</sup>	1390.62 <sup>(5)</sup>	3600.00 <sup>(6)</sup>
		Energy (Million Btu)						
Initial Energy	In RCS, Acc, SG	640.99	640.99	640.99	640.99	640.99	640.99	640.99
Added Energy	Pumped Injection	.00	.00	.00	4.31	24.71	32.02	101.15
	Decay Heat	.00	5.79	5.79	24.75	84.97	103.09	209.42
	Heat From Secondary	.00	.43	.43	.43	9.86	9.93	9.93
	Total Added	.00	6.22	6.22	29.49	119.54	145.04	320.50
Total Available		640.99	647.21	647.21	670.47	760.52	786.02	961.49
Distribution	Reactor Coolant	245.25	8.59	10.49	29.17	29.17	29.17	29.17
	Accumulator	15.62	12.51	10.61	.00	.00	.00	.00
	Core Stored	22.87	12.50	12.50	3.91	3.10	3.05	2.71
	Primary Metal	115.85	109.61	109.61	88.61	49.94	43.94	39.96
	Secondary Metal	34.40	34.82	34.82	31.84	18.94	15.82	14.56
	Steam Generator	207.00	210.21	210.21	188.76	115.44	97.55	90.42
	Total Contents	640.99	388.24	388.24	342.31	216.59	189.53	176.82

TABLE 6.2-14P (Cont.)

DOUBLE-ENDED PUMP SUCTION BREAK ENERGY BALANCE - MAXIMUM SAFEGUARDS

		Time (sec)						
		.00	21.40 <sup>(1)</sup>	21.40 <sup>(2)</sup>	213.36 <sup>(3)</sup>	1079.74 <sup>(4)</sup>	1390.62 <sup>(5)</sup>	3600.00 <sup>(6)</sup>
		Energy (Million Btu)						
Effluent	Break Flow	.00	258.48	258.48	320.12	535.87	566.71	757.09
	ECCS Spill	.00	.00	.00	.00	.00	.00	.00
	Total Effluent	.00	258.48	258.48	320.12	535.87	566.71	757.09
Total Accountable		640.99	646.72	646.72	662.42	752.47	756.25	933.91

Notes:

- (1) End of Blowdown
- (2) Bottom of core recovery time. This time is identical to the end of blowdown time due to the assumption of instantaneous refill.
- (3) End of Reflood
- (4) Time at which the Broken Loop SG equilibrates at the first intermediate pressure.
- (5) Time at which the Intact Loop SG equilibrates at the second intermediate pressure.
- (6) Time at which both SGs equilibrate to 14.7 psia.

TABLE 6.2-14Q

DOUBLE-ENDED PUMP SUCTION BREAK (SW FAILURE) - MAXIMUM SAFEGUARDS  
REFLOOD MASS AND ENERGY RELEASES

<u>Time (sec)</u>	<u>Break Path No. 1 Flow*</u>		<u>Break Path No. 2 Flow**</u>	
	<u>(lbm/sec)</u>	<u>(Thousand Btu/sec)</u>	<u>(lbm/sec)</u>	<u>(Thousand Btu/sec)</u>
21.4	.0	.0	.0	.0
21.9	.0	.0	.0	.0
22.1	.0	.0	.0	.0
22.2	.0	.0	.0	.0
22.3	.0	.0	.0	.0
22.4	.0	.0	.0	.0
22.4	.0	.0	.0	.0
22.5	57.4	67.5	.0	.0
22.6	20.7	24.4	.0	.0
22.7	18.2	21.4	.0	.0
22.9	21.6	25.4	.0	.0
23.0	31.8	37.4	.0	.0
23.1	37.0	43.6	.0	.0
23.2	43.0	50.6	.0	.0
23.3	48.3	56.8	.0	.0
23.4	53.7	63.3	.0	.0
23.5	58.3	68.6	.0	.0
23.6	61.7	72.7	.0	.0
23.7	65.1	76.7	.0	.0
23.8	66.8	78.7	.0	.0
23.8	68.4	80.6	.0	.0
23.9	71.6	84.3	.0	.0
24.0	74.7	87.9	.0	.0
24.1	77.6	91.4	.0	.0
24.2	80.5	94.8	.0	.0

TABLE 6.2-14Q (Cont.)

DOUBLE-ENDED PUMP SUCTION BREAK (SW FAILURE) - MAXIMUM SAFEGUARDS  
REFLOOD MASS AND ENERGY RELEASES

<u>Time (sec)</u>	<u>Break Path No. 1 Flow*</u>		<u>Break Path No. 2 Flow**</u>	
	<u>(lbm/sec)</u>	<u>(Thousand Btu/sec)</u>	<u>(lbm/sec)</u>	<u>(Thousand Btu/sec)</u>
24.3	83.3	98.1	.0	.0
24.4	86.0	101.3	.0	.0
25.4	109.9	129.5	.0	.0
26.4	129.7	152.9	.0	.0
27.4	160.1	188.8	742.5	60.5
28.4	387.0	458.1	3989.5	437.1
28.5	389.5	461.0	4008.0	441.8
29.5	389.1	460.6	3995.0	446.1
30.5	382.5	452.7	3926.3	440.4
31.5	375.6	444.5	3854.3	434.0
32.5	368.7	436.3	3782.2	427.5
33.0	365.3	432.3	3746.6	424.3
33.5	362.0	428.3	3711.3	421.0
34.5	355.5	420.6	3642.1	414.7
35.5	349.3	413.2	3574.8	408.5
36.5	343.3	406.0	3509.6	402.4
37.5	337.5	399.2	3446.5	396.5
38.5	332.0	392.6	3385.3	390.8
39.2	328.2	388.1	3343.6	386.9
39.5	326.7	386.2	3326.0	385.3
40.5	321.5	380.1	3268.6	379.9
41.5	316.6	374.3	3213.0	374.7
42.5	311.8	368.6	3159.1	369.6

TABLE 6.2-14Q (Cont.)

DOUBLE-ENDED PUMP SUCTION BREAK (SW FAILURE) - MAXIMUM SAFEGUARDS  
REFLOOD MASS AND ENERGY RELEASES

<u>Time (sec)</u>	<u>Break Path No. 1 Flow*</u>		<u>Break Path No. 2 Flow**</u>	
	<u>(lbm/sec)</u>	<u>(Thousand Btu/sec)</u>	<u>(lbm/sec)</u>	<u>(Thousand Btu/sec)</u>
43.5	307.3	363.2	3106.7	364.7
44.5	302.8	357.9	3055.8	359.9
45.5	298.6	352.8	3006.4	355.3
46.3	295.3	348.9	2967.8	351.6
46.5	294.4	347.9	2958.3	350.7
47.5	290.5	343.2	2911.5	346.3
48.5	286.6	338.6	2866.0	342.0
49.5	282.8	334.1	2821.5	337.8
50.5	279.2	329.8	2778.2	333.7
51.5	275.7	325.6	2736.0	329.7
52.5	272.2	321.6	2694.7	325.7
53.5	268.9	317.6	2654.4	321.9
54.2	266.6	314.9	2626.7	319.2
54.5	265.7	313.8	2615.0	318.1
55.5	262.5	310.0	2576.4	314.4
56.5	259.4	306.4	2538.7	310.8
57.5	256.4	302.8	2501.8	307.2
58.5	253.5	299.3	2465.6	303.8
59.5	250.7	295.9	2430.1	300.3
60.5	247.9	292.6	2395.3	297.0
61.5	245.1	289.4	2361.2	293.7
62.5	242.5	286.2	2327.7	290.4
63.5	239.9	283.2	2294.9	287.2
64.5	149.2	175.9	430.0	95.7

TABLE 6.2-14Q (Cont.)

DOUBLE-ENDED PUMP SUCTION BREAK (SW FAILURE) - MAXIMUM SAFEGUARDS  
REFLOOD MASS AND ENERGY RELEASES

<u>Time (sec)</u>	<u>Break Path No. 1 Flow*</u>		<u>Break Path No. 2 Flow**</u>	
	<u>(lbm/sec)</u>	<u>(Thousand Btu/sec)</u>	<u>(lbm/sec)</u>	<u>(Thousand Btu/sec)</u>
65.5	148.9	175.5	430.6	95.5
66.5	148.6	175.2	431.2	95.4
67.5	148.3	174.8	431.8	95.2
68.5	148.0	174.5	432.5	95.1
69.5	147.7	174.1	433.1	94.9
70.5	147.4	173.8	433.8	94.8
71.5	147.1	173.4	434.4	94.6
72.5	146.8	173.1	435.1	94.5
73.5	146.5	172.7	435.7	94.3
73.6	146.5	172.7	435.8	94.3
74.5	146.2	172.4	436.4	94.2
75.5	145.9	172.0	437.0	94.1
76.5	145.6	171.7	437.7	93.9
77.5	145.4	171.3	438.3	93.8
78.5	145.1	171.0	439.0	93.6
79.5	144.8	170.6	439.6	93.5
80.5	144.5	170.3	440.3	93.3
81.5	144.2	169.9	440.9	93.2
82.5	143.9	169.6	441.6	93.1
84.5	143.3	168.9	442.9	92.8
86.5	142.7	168.2	444.2	92.5
88.5	142.1	167.5	445.5	92.2
90.5	141.5	166.8	446.9	91.9
92.5	140.9	166.1	448.2	91.7

TABLE 6.2-14Q (Cont.)

DOUBLE-ENDED PUMP SUCTION BREAK (SW FAILURE) - MAXIMUM SAFEGUARDS  
REFLOOD MASS AND ENERGY RELEASES

<u>Time (sec)</u>	<u>Break Path No. 1 Flow*</u>		<u>Break Path No. 2 Flow**</u>	
	<u>(lbm/sec)</u>	<u>(Thousand Btu/sec)</u>	<u>(lbm/sec)</u>	<u>(Thousand Btu/sec)</u>
94.5	140.3	165.4	449.5	91.4
96.5	139.7	164.7	450.9	91.1
97.0	139.6	164.5	451.2	91.0
98.5	139.1	164.0	452.2	90.8
100.5	138.5	163.3	453.6	90.6
102.5	137.9	162.6	455.0	90.3
104.5	137.3	161.8	456.3	90.0
106.5	136.7	161.1	457.7	89.7
108.5	136.1	160.4	459.1	89.5
110.5	135.4	159.6	460.5	89.2
112.5	134.8	158.9	461.9	88.9
114.5	134.2	158.1	463.3	88.7
116.5	133.6	157.4	464.7	88.4
118.5	132.9	156.6	466.1	88.1
120.5	132.3	155.9	467.5	87.8
122.1	131.8	155.3	468.7	87.6
122.5	131.6	155.1	468.9	87.5
124.5	131.0	154.4	470.3	87.3
126.5	130.3	153.6	471.7	87.0
128.5	129.7	152.8	473.1	86.7
130.5	129.0	152.0	474.5	86.4
132.5	128.4	151.3	475.9	86.1
134.5	127.7	150.5	477.3	85.9
136.5	127.0	149.7	478.7	85.6



TABLE 6.2-14Q (Cont.)

DOUBLE-ENDED PUMP SUCTION BREAK (SW FAILURE) - MAXIMUM SAFEGUARDS  
REFLOOD MASS AND ENERGY RELEASES

<u>Time (sec)</u>	<u>Break Path No. 1 Flow*</u>		<u>Break Path No. 2 Flow**</u>	
	<u>(lbm/sec)</u>	<u>(Thousand Btu/sec)</u>	<u>(lbm/sec)</u>	<u>(Thousand Btu/sec)</u>
138.5	126.4	148.9	480.1	85.3
140.5	125.7	148.1	481.5	85.0
142.5	125.0	147.3	482.9	84.7
144.5	124.4	146.5	484.3	84.4
146.5	123.7	145.7	485.7	84.1
148.5	123.0	144.9	487.1	83.9
149.6	122.6	144.5	487.8	83.7
150.5	122.3	144.1	488.4	83.6
152.5	121.6	143.3	489.8	83.3
154.5	120.9	142.5	491.2	83.0
156.5	120.2	141.7	492.6	82.7
158.5	119.6	140.9	494.0	82.4
160.5	118.9	140.1	495.4	82.1
162.5	118.2	139.2	496.8	81.8
164.5	117.5	138.4	498.2	81.5
166.5	116.8	137.6	499.5	81.3
168.5	116.1	136.7	500.9	81.0
170.5	115.4	135.9	502.3	80.7
172.5	114.6	135.1	503.7	80.4
174.5	113.9	134.2	505.1	80.1
176.5	113.2	133.4	506.4	79.8
178.5	112.5	132.6	507.8	79.5
179.8	112.1	132.0	508.7	79.3
180.5	111.8	131.7	509.2	79.2

TABLE 6.2-14Q (Cont.)

DOUBLE-ENDED PUMP SUCTION BREAK (SW FAILURE) - MAXIMUM SAFEGUARDS  
REFLOOD MASS AND ENERGY RELEASES

<u>Time (sec)</u>	<u>Break Path No. 1 Flow*</u>		<u>Break Path No. 2 Flow**</u>	
	<u>(lbm/sec)</u>	<u>(Thousand Btu/sec)</u>	<u>(lbm/sec)</u>	<u>(Thousand Btu/sec)</u>
182.5	111.3	131.1	510.2	79.2
184.5	110.8	130.5	511.1	79.1
186.5	110.3	129.9	512.0	79.1
188.5	109.8	129.3	512.9	79.1
190.5	109.3	128.7	513.8	79.0
192.5	108.8	128.1	514.7	79.0
194.5	108.3	127.6	515.6	78.9
196.5	107.8	127.0	516.5	78.9
198.5	107.3	126.4	517.3	78.8
200.5	106.8	125.8	518.2	78.8
202.5	106.3	125.3	519.1	78.7
204.5	105.8	124.7	520.0	78.7
206.5	105.3	124.1	520.8	78.6
208.5	104.9	123.5	521.7	78.6
210.5	104.4	123.0	522.6	78.5
212.5	103.9	122.4	523.4	78.4
213.4	103.7	122.2	523.8	78.4

\* Mass and Energy exiting the SG side of break

\*\* Mass and Energy exiting the pump side of break

TABLE 6.2-14R

DOUBLE-ENDED PUMP SUCTION (SW FAILURE) - MAXIMUM SAFEGUARDS PRINCIPAL PARAMETERS DURING REFLOOD

Time (sec)	Temp (°F)	Rate (in/sec)	Carryover Fraction	Core Height (ft)	Downcomer Height (ft)	Flow Frac	Injection			Enthalpy (Btu/lbm)
							Total	Accum (lbm/sec)	Spill	
21.4	169.0	.000	.000	.00	.00	.333	.0	.0	.0	.00
22.2	166.4	22.694	.000	.67	1.40	.000	6117.9	6117.9	.0	74.50
22.4	165.1	24.146	.000	1.07	1.32	.000	6067.6	6067.6	.0	74.50
22.7	164.5	2.530	.113	1.32	1.96	.298	5952.2	5952.2	.0	74.50
22.9	164.4	2.633	.130	1.35	2.40	.310	5934.5	5934.5	.0	74.50
23.0	164.4	2.595	.163	1.37	2.69	.361	5887.9	5887.9	.0	74.50
23.2	164.4	2.604	.205	1.41	3.34	.390	5842.1	5842.1	.0	74.50
23.8	164.4	2.494	.302	1.50	4.99	.427	5710.0	5710.0	.0	74.50
24.4	164.5	2.425	.386	1.59	6.83	.442	5574.6	5574.6	.0	74.50
28.4	164.9	4.389	.635	2.01	15.61	.670	4980.9	4363.1	.0	69.35
29.5	165.0	4.190	.667	2.15	15.62	.667	4799.2	4184.3	.0	69.18
33.0	165.5	3.747	.710	2.50	15.62	.659	4434.4	3806.6	.0	68.63
39.2	167.3	3.345	.732	3.00	15.62	.644	3937.5	3290.5	.0	67.68
46.3	169.9	3.057	.740	3.50	15.62	.628	3498.4	2835.5	.0	66.64
54.2	173.4	2.826	.742	4.00	15.62	.611	3107.7	2432.0	.0	65.48

TABLE 6.2-14R (Cont.)

DOUBLE-ENDED PUMP SUCTION (SW FAILURE) - MAXIMUM SAFEGUARDS PRINCIPAL PARAMETERS DURING REFLOOD

Flooding										
Time (sec)	Temp (°F)	Rate (in/sec)	Carryover Fraction	Core Height (ft)	Downcomer Height (ft)	Flow Frac	Total	Injection		Enthalpy (Btu/lbm)
								Accum (lbm/sec)	Spill	
63.5	177.6	2.615	.743	4.54	15.62	.594	2731.6	2044.9	.0	64.07
64.5	178.1	2.030	.732	4.59	15.62	.483	712.1	.0	.0	33.00
73.6	182.7	1.988	.733	5.00	15.62	.484	712.1	.0	.0	33.00
86.5	190.9	1.930	.735	5.56	15.62	.484	712.1	.0	.0	33.00
97.0	198.6	1.882	.736	6.00	15.62	.485	712.1	.0	.0	33.00
110.5	208.9	1.819	.739	6.55	15.62	.485	712.1	.0	.0	33.00
122.1	217.3	1.764	.740	7.00	15.62	.485	712.1	.0	.0	33.00
136.5	226.4	1.696	.743	7.54	15.62	.486	712.1	.0	.0	33.00
149.6	233.6	1.633	.744	8.00	15.62	.486	712.1	.0	.0	33.00
164.5	240.7	1.562	.746	8.51	15.62	.485	712.2	.0	.0	33.00
179.8	246.9	1.489	.747	9.00	15.62	.485	712.2	.0	.0	33.00
213.4	258.0	1.361	.751	10.00	15.62	.488	712.2	.0	.0	33.00

TABLE 6.2-14S

DOUBLE-ENDED PUMP SUCTION (SW FAILURE) MAXIMUM SAFEGUARDS  
POST-REFLOOD MASS AND ENERGY RELEASES

<u>Time (sec)</u>	<u>Break Path No. 1 Flow*</u>		<u>Break Path No. 2 Flow**</u>	
	<u>(lbm/sec)</u>	<u>(Thousand Btu/sec)</u>	<u>(lbm/sec)</u>	<u>(Thousand Btu/sec)</u>
213.4	123.8	156.1	589.5	94.4
218.4	123.5	155.6	589.8	94.3
223.4	123.1	155.2	590.2	94.2
228.4	122.8	154.8	590.5	94.1
233.4	123.5	155.6	589.9	93.7
238.4	123.1	155.2	590.2	93.6
243.4	122.8	154.7	590.6	93.6
248.4	122.4	154.3	590.9	93.5
253.4	123.1	155.1	590.3	93.1
258.4	122.7	154.6	590.6	93.0
263.4	122.3	154.2	591.0	92.9
268.4	123.0	155.0	590.3	92.6
273.4	122.6	154.5	590.7	92.5
278.4	122.3	154.1	591.1	92.4
283.4	121.9	153.6	591.4	92.3
288.4	122.5	154.4	590.8	92.0
293.4	122.2	154.0	591.2	91.9
298.4	121.8	153.5	591.5	91.8
303.4	121.4	153.0	591.9	91.7
308.4	122.1	153.8	591.3	91.3
313.4	121.7	153.4	591.7	91.2
318.4	121.3	152.9	592.0	91.2
323.4	121.9	153.6	591.4	90.8
328.4	121.5	153.2	591.8	90.7
333.4	121.2	152.7	592.2	90.6

TABLE 6.2-14S (Cont.)

DOUBLE-ENDED PUMP SUCTION (SW FAILURE) MAXIMUM SAFEGUARDS  
POST-REFLOOD MASS AND ENERGY RELEASES

<u>Time (sec)</u>	<u>Break Path No. 1 Flow*</u>		<u>Break Path No. 2 Flow**</u>	
	<u>(lbm/sec)</u>	<u>(Thousand Btu/sec)</u>	<u>(lbm/sec)</u>	<u>(Thousand Btu/sec)</u>
338.4	121.8	153.4	591.6	90.3
343.4	121.4	153.0	592.0	90.2
348.4	121.0	152.5	592.3	90.1
353.4	120.6	152.0	592.7	90.0
358.4	121.2	152.7	592.2	89.7
363.4	120.8	152.2	592.5	89.6
368.4	120.4	151.7	592.9	89.5
373.4	121.0	152.4	592.4	89.1
378.4	120.6	151.9	592.8	89.1
383.4	120.2	151.4	593.2	89.0
388.4	120.7	152.1	592.6	88.6
393.4	120.3	151.6	593.0	88.5
398.4	119.9	151.1	593.4	88.4
403.4	120.5	151.9	592.8	88.1
408.4	120.2	151.5	593.1	88.0
413.4	120.0	151.2	593.4	87.9
418.4	119.7	150.8	593.7	90.4
423.4	120.3	151.6	593.0	90.1
428.4	120.0	151.3	593.3	89.9
433.4	119.7	150.9	593.6	89.8
438.4	119.4	150.5	593.9	89.7
443.4	120.1	151.3	593.3	89.3
448.4	119.8	150.9	593.6	89.2
453.4	119.5	150.5	593.9	89.0

TABLE 6.2-14S (Cont.)

DOUBLE-ENDED PUMP SUCTION (SW FAILURE) MAXIMUM SAFEGUARDS  
POST-REFLOOD MASS AND ENERGY RELEASES

<u>Time (sec)</u>	<u>Break Path No. 1 Flow*</u>		<u>Break Path No. 2 Flow**</u>	
	<u>(lbm/sec)</u>	<u>(Thousand Btu/sec)</u>	<u>(lbm/sec)</u>	<u>(Thousand Btu/sec)</u>
458.4	120.1	151.3	593.3	88.7
463.4	119.7	150.9	593.6	88.6
468.4	119.4	150.5	593.9	88.4
473.4	119.1	150.1	594.2	88.3
478.4	119.7	150.9	593.6	87.9
483.4	119.4	150.5	593.9	87.8
488.4	119.1	150.1	594.3	87.7
493.4	119.6	150.8	593.7	87.3
498.4	119.3	150.4	594.0	87.2
503.4	119.0	149.9	594.4	87.1
508.4	119.5	150.6	593.8	86.7
513.4	119.2	150.2	594.1	86.6
518.4	118.9	149.8	594.5	86.5
523.4	119.4	150.4	594.0	86.1
528.4	119.0	150.0	594.3	86.0
533.4	118.7	149.6	594.6	88.4
538.4	119.2	150.2	594.1	88.0
543.4	118.8	149.8	594.5	87.9
548.4	118.5	149.3	594.8	87.8
553.4	119.0	149.9	594.4	87.4
558.4	118.6	149.5	594.7	87.3
563.4	118.2	149.0	595.1	87.1
568.4	118.7	149.6	594.6	86.8
573.4	118.3	149.1	595.0	86.6

TABLE 6.2-14S (Cont.)

DOUBLE-ENDED PUMP SUCTION (SW FAILURE) MAXIMUM SAFEGUARDS  
POST-REFLOOD MASS AND ENERGY RELEASES

<u>Time (sec)</u>	<u>Break Path No. 1 Flow*</u>		<u>Break Path No. 2 Flow**</u>	
	<u>(lbm/sec)</u>	<u>(Thousand Btu/sec)</u>	<u>(lbm/sec)</u>	<u>(Thousand Btu/sec)</u>
578.4	118.8	149.7	594.6	86.3
583.4	118.4	149.2	595.0	86.1
588.4	118.0	148.7	595.3	86.0
593.4	118.4	149.2	594.9	85.7
598.4	118.0	148.7	595.3	85.5
603.4	118.4	149.3	594.9	85.2
608.4	118.1	148.8	595.3	85.0
613.4	117.7	148.3	595.6	84.9
618.4	118.1	148.9	595.2	87.0
623.4	117.7	148.4	595.6	86.8
628.4	118.1	148.9	595.2	86.5
633.4	117.7	148.4	595.6	86.3
638.4	118.1	148.8	595.2	86.0
643.4	117.7	148.3	595.6	85.8
648.4	118.1	148.8	595.3	85.5
653.4	117.6	148.3	595.7	85.3
658.4	118.0	148.7	595.4	85.0
663.4	117.5	148.1	595.8	84.8
668.4	117.8	148.5	595.5	84.5
673.4	117.4	147.9	596.0	84.3
678.4	117.7	148.3	595.7	84.0
683.4	117.2	147.7	596.1	86.2
688.4	117.4	148.0	595.9	85.9
693.4	117.7	148.3	595.7	85.5



TABLE 6.2-14S (Cont.)

DOUBLE-ENDED PUMP SUCTION (SW FAILURE) MAXIMUM SAFEGUARDS  
POST-REFLOOD MASS AND ENERGY RELEASES

<u>Time (sec)</u>	<u>Break Path No. 1 Flow*</u>		<u>Break Path No. 2 Flow**</u>	
	<u>(lbm/sec)</u>	<u>(Thousand Btu/sec)</u>	<u>(lbm/sec)</u>	<u>(Thousand Btu/sec)</u>
698.4	117.2	147.7	596.2	85.4
703.4	117.4	147.9	596.0	85.0
708.4	117.6	148.1	595.8	84.7
713.4	117.0	147.5	596.3	84.6
718.4	117.2	147.7	596.2	84.2
723.4	117.3	147.8	596.0	83.9
728.4	117.4	147.9	595.9	83.6
733.4	116.8	147.2	596.5	83.5
738.4	116.9	147.3	596.5	85.4
743.4	116.9	147.3	596.4	85.1
748.4	116.9	147.4	596.4	84.8
753.4	116.9	147.4	596.4	84.5
758.4	116.9	147.3	596.5	84.2
763.4	116.8	147.2	596.5	83.9
768.4	116.7	147.1	596.6	83.6
773.4	116.6	146.9	596.7	83.3
778.4	116.4	146.7	596.9	83.0
783.4	116.8	147.2	596.5	84.8
788.4	116.6	146.9	596.8	84.6
793.4	116.3	146.5	597.1	84.3
798.4	116.5	146.8	596.8	83.9
803.4	116.7	147.1	596.6	83.5
808.4	116.3	146.5	597.1	83.3

TABLE 6.2-14S (Cont.)

DOUBLE-ENDED PUMP SUCTION (SW FAILURE) MAXIMUM SAFEGUARDS  
POST-REFLOOD MASS AND ENERGY RELEASES

<u>Time (sec)</u>	<u>Break Path No. 1 Flow*</u>		<u>Break Path No. 2 Flow**</u>	
	<u>(lbm/sec)</u>	<u>(Thousand Btu/sec)</u>	<u>(lbm/sec)</u>	<u>(Thousand Btu/sec)</u>
813.4	116.3	146.6	597.0	82.9
818.4	116.3	146.6	597.0	82.6
823.4	66.8	84.1	646.6	97.4
1075.0	66.8	84.1	646.6	97.4
1075.1	64.8	81.5	648.5	93.4
1078.4	64.8	81.4	648.6	93.9
1403.5	64.8	81.4	648.6	93.9
1403.6	54.3	62.5	659.0	21.7
2128.0	48.7	56.0	664.6	21.9
2128.1	52.7	60.7	781.3	92.2
3600.0	45.7	52.6	788.3	93.0

\* Mass and Energy exiting the SG side of break

\*\* Mass and Energy exiting the pump side of break

TABLE 6.2-14T

DOUBLE-ENDED PUMP SUCTION (SW FAILURE) MASS BALANCE  
MAXIMUM SAFEGUARDS

		Time (Sec)						
		.00	21.40 <sup>(1)</sup>	21.40 <sup>(2)</sup>	213.36 <sup>(3)</sup>	1075.07 <sup>(4)</sup>	1403.54 <sup>(5)</sup>	3600.00 <sup>(6)</sup>
		Mass (Thousand lbm)						
Initial	In RCS & Accumulator	626.47	626.47	626.47	626.47	626.47	626.47	626.47
Added Mass	Pumped Injection	.00	.00	.00	130.69	745.35	979.66	2724.09
	Total Added	.00	.00	.00	130.69	745.35	979.66	2724.09
Total Available		626.47	626.47	626.47	757.16	1371.83	1606.13	3350.56
Distribution	Reactor Coolant	416.98	40.95	66.41	117.53	117.53	117.53	117.53
	Accumulator	209.49	167.73	142.28	.00	.00	.00	.00
	Total Contents	626.47	208.68	208.68	117.53	117.53	117.53	117.53
Effluent	Break Flow	.00	417.78	417.78	630.78	1245.45	1479.75	3224.18
	ECCS Spill	.00	.00	.00	.00	.00	.00	.00
	Total Effluent	.00	417.78	417.78	630.78	1245.45	1479.75	3224.18
Total Accountable		626.47	626.46	626.46	748.31	1362.97	1597.28	3341.71

Notes:

- (1) End of Blowdown
- (2) Bottom of core recovery time. This time is identical to the end of blowdown time due to the assumption of instantaneous refill.
- (3) End of Reflood
- (4) Time at which the Broken Loop SG equilibrates at the first intermediate pressure.
- (5) Time at which the Intact Loop SG equilibrates at the second intermediate pressure.
- (6) Time at which both SGs equilibrate to 14.7 psia.

TABLE 6.2-14U

DOUBLE-ENDED PUMP SUCTION (SW FAILURE) ENERGY BALANCE  
MAXIMUM SAFEGUARDS

		Time (Sec)						
		.00	21.40 <sup>(1)</sup>	21.40 <sup>(2)</sup>	213.36 <sup>(3)</sup>	1075.07 <sup>(4)</sup>	1403.54 <sup>(5)</sup>	3600.00 <sup>(6)</sup>
		Energy (Million Btu)						
Initial Energy	In RCS, Acc, SG	640.99	640.99	640.99	640.99	640.99	640.99	640.99
Added Energy	Pumped Injection	.00	.00	.00	4.31	24.60	32.33	194.25
	Decay Heat	.00	5.79	5.79	24.75	84.69	103.81	209.42
	Heat From Secondary	.00	.43	.43	.43	9.81	9.93	9.93
	Total Added	.00	6.22	6.22	29.49	119.09	146.07	413.59
Total Available		640.99	647.21	647.21	670.47	760.08	787.05	1054.58
Distribution	Reactor Coolant	245.25	8.59	10.49	29.17	29.17	29.17	29.17
	Accumulator	15.62	12.51	10.61	.00	.00	.00	.00
	Core Stored	22.87	12.50	12.50	3.91	2.98	2.95	2.71
	Primary Metal	115.85	109.61	109.61	88.61	49.14	42.92	39.96
	Secondary Metal	34.40	34.82	34.82	31.84	18.80	15.53	14.56
	Steam Generator	207.00	210.21	210.21	188.76	114.65	95.92	90.42
	Total Contents	640.99	388.24	388.24	342.31	214.75	186.49	176.82
	Effluent	Break Flow	.00	258.48	258.48	320.12	537.28	568.50
	ECCS Spill	.00	.00	.00	.00	.00	.00	.00
	Total Effluent	.00	258.48	258.48	320.12	537.28	568.50	846.95
Total Accountable		640.99	646.72	646.72	662.42	752.03	754.99	1023.77

Notes:

- (1) End of Blowdown
- (2) Bottom of core recovery time. This time is identical to the end of blowdown time due to the assumption of instantaneous refill.
- (3) End of Reflood
- (4) Time at which the Broken Loop SG equilibrates at the first intermediate pressure.
- (5) Time at which the Intact Loop SG equilibrates at the second intermediate pressure.
- (6) Time at which both SGs equilibrate to 14.7 psia.

TABLE 6.2-14V

LOCA MASS AND ENERGY RELEASE ANALYSIS ANS 1979 CORE DECAY HEAT  
POWER FRACTION

Time (sec)	ANS 1979 Decay Heat Fraction
10	0.053876
15	0.050401
20	0.048018
40	0.042401
60	0.039244
80	0.037065
100	0.035466
150	0.032724
200	0.030936
400	0.027078
600	0.024931
800	0.023389
1000	0.022156
1500	0.019921
2000	0.018315
4000	0.014781
6000	0.013040
8000	0.012000
10000	0.011262
15000	0.010097
20000	0.009350
40000	0.007778
60000	0.006958
80000	0.006424
100000	0.006021
150000	0.005323
400000	0.003770
600000	0.003201
800000	0.002834
1000000	0.002580
2592000	0.001745

TABLE 6.2-21

PRESSURIZER SUBCOMPARTMENT VENT PATH DESCRIPTION

Vent Path No.	From Node No.	To Node No.	Area (ft <sup>2</sup> )	Geom. Inertia (ft <sup>-1</sup> )	Head Loss Coefficient K				
					Expansion + Contraction*		Grating Loss Factor	Total	
					Fwd	Rvs		Fwd	Rvs
1	1	2	59.20	.146	.283	.270		.283	.270
2	2	3	120.00	.109	.135	.080		.135	.080
3	3	4	123.80	.059	.152	.089		.152	.089
4	4	1	55.40	.144	.201	.203		.201	.203
5	1	19	16.00	.115	2.450	2.064		2.450	2.064
6	4	19	16.00	.098	2.530	2.233		2.530	2.230
7	5	1	11.21	.523	.457	.457	.204	.661	.661
8	6	2	15.91	.362	.471	.471	.204	.675	.675
9	6	2	84.12	.068	.511	.511		.511	.511
10	7	3	39.59	.126	.580	.580	.204	.784	.784
11	7	3	41.54	.120	.620	.620		.620	.620
12	8	4	27.75	.205	.479	.479	.204	.683	.683
13	5	19	37.50	.066	2.331	1.684		2.331	1.684
14	6	19	17.03	.086	2.562	2.406		2.562	2.406
15	8	19	20.76	.075	2.543	2.253	.260	2.803	2.513
16	5	6	43.29	.109	.754	.688		.754	.688
17	6	7	125.64	.081	.271	.283		.271	.283
18	7	8	101.57	.044	.448	.505		.448	.505
19	5	8	40.76	.107	.661	.647		.661	.647
20	9	5	1.74	2.609	1.810	1.790		1.810	1.790
21	10	6	2.22	1.864	1.850	1.840		1.850	1.840
22	11	7	1.40	2.896	1.870	1.870		1.870	1.870
23	12	8	1.62	2.634	1.830	1.830		1.830	1.830
24	10	19	35.10	.100	1.906	1.385	.260	2.166	1.645
25	9	10	39.78	.081	.979	.903		.979	.903
26	10	11	190.86	.047	.361	.393		.361	.393
27	11	12	184.29	.025	.417	.468		.417	.468
28	12	9	70.43	.046	.690	.711		.690	.711
29	12	13	273.70	.041	.079	.052		.079	.052
30	13	14	156.60	.066	.398	.373		.398	.373
31	14	19	66.00	.086	2.400	1.971		2.400	1.971
32	14	19	25.91	.108	2.442	2.136	.260	2.702	2.396
33	20	18	8.89	.213	.445	.715		.445	.715
34	21	18	11.32	.149	.511	.942		.511	.942
35	22	18	7.16	.231	.525	.997		.525	.997
36	23	18	8.25	.212	.495	.887		.495	.887

TABLE 6.2-21 (Cont)

Vent Path No.	From Node No.	To Node No.	Area (ft <sup>2</sup> )	Geom. Inertia (ft <sup>1</sup> )	Head Loss Coefficient K				
					Expansion + Contraction*		Grating Loss Factor	Total	
					Fwd	Rvs		Fwd	Rvs
37	20	9	23.32	.285	.496	.496		.496	.496
38	21	10	119.60	.080	.219	.219		.219	.219
39	22	11	168.06	.069	.080	.080		.080	.080
40	23	12	66.07	.150	.190	.190		.190	.190
41	21	19	14.45	.309	1.780	1.371	.260	2.040	1.631
42	23	13	38.75	.291	.078	.138		.078	.138
43	15	17	10.62	.268	1.997	2.001	.170	2.167	2.171
44	15	17	10.62	.268	1.997	2.001	.170	2.167	2.171
45	15	16	55.42	.212	.485	.559		.485	.559
46	16	19	63.00	.101	1.629	1.108		1.629	1.108
47	16	19	20.99	.160	2.122	1.759	.260	2.382	2.019
48	15	19	44.85	.102	1.867	1.741	.260	2.127	2.001
49	20	21	16.71	.574	.180	.205		.180	.205
50	21	22	38.10	.333	.145	.100		.145	.101
51	22	23	37.17	.177	.189	.161		.189	.161
52	23	20	21.05	.326	.313	.360		.313	.360
53	15	20	8.02	.725	2.130	2.120	.400	2.530	2.520
54	15	21	24.18	.238	2.220	2.150	.400	2.620	2.550
55	15	22	31.43	.185	2.150	2.130	.400	2.550	2.530
56	15	23	6.96	.814	2.420	2.230	.400	2.820	2.630
57	15	13	62.95	.130	2.050	2.090	.400	2.450	2.490
58	13	19	70.59	.071	2.440	2.006		2.440	2.006
59	5	1	20.26	.289	.498	.498		.498	.498
60	8	4	11.61	.490	.520	.520		.520	.520
61	16	19	6.78	.397	1.698	1.570		1.698	1.570

NOTE:

\* Includes wall friction.

TABLE 6.2-22

## PRESSURIZER SUBCOMPARTMENT NODAL DESCRIPTION

<u>Node Number</u>	<u>Net Volume (ft<sup>3</sup>)</u>
1	484
2	1,703
3	1,645
4	650
5	564
6	2,130
7	2,139
8	794
9	628
10	2,915
11	3,703
12	1,526
13	7,346
14	1,330
15	9,450
16	1,306
17	1,469
18	93
19	1,704,527
20	135
21	470
22	559
23	258



TABLE 6.2-23

MASS AND ENERGY RELEASE RATES  
PRESSURIZER SPRAY LINE DOUBLE-ENDED RUPTURE

<u>Time (sec)</u>	<u>Mass Flow Rate (10<sup>3</sup> lb/sec)</u>	<u>Energy Flow Rate (10<sup>6</sup> Btu/sec)</u>
0.0	0.0	0.0
1.010000D-03	4.027320	2.447550
2.000000D-03	4.544090	2.728269
3.020000D-03	4.646500	2.783795
4.020000D-03	4.712340	2.819180
5.000000D-03	4.741150	2.834352
6.000000D-03	4.743450	2.835017
1.304000D-02	4.678960	2.796182
2.406000D-02	5.051880	2.995971
3.106000D-02	5.198920	3.074445
4.108000D-02	5.059970	2.995857
4.517000D-02	5.017230	2.971817
5.810000D-02	5.109640	3.020708
6.401000D-02	5.128790	3.030622
7.000000D-02	5.144170	3.038526
8.115000D-02	5.000720	2.959195
8.908000D-02	4.888690	2.897659
9.714000D-02	4.962250	2.937598
1.080300D-01	5.226390	3.081829
1.121500D-01	5.246540	3.092737
1.302100D-01	4.994680	2.954570
1.361000D-01	4.994680	2.954499
1.400300D-01	5.000900	2.957848
1.620400D-01	4.907370	2.906511
1.720900D-01	4.934890	2.921379
1.881400D-01	4.957180	2.933351
2.051100D-01	4.858290	2.879170
2.151700D-01	4.855020	2.877278
2.351100D-01	4.916120	2.910353
2.451300D-01	4.909340	2.906563
2.650800D-01	4.946760	2.926725
2.950600D-01	4.896720	2.899199
3.300500D-01	4.825090	2.859695
3.500300D-01	4.850850	2.873396
3.750500D-01	4.846340	2.870517
4.251300D-01	4.897380	2.897620
4.600100D-01	4.848700	2.870605
4.900400D-01	4.854760	2.873406
5.201500D-01	4.837170	2.863345
5.700700D-01	4.874680	2.883823
6.400400D-01	4.843360	2.864974
7.200300D-01	4.846360	2.865421
7.900100D-01	4.824500	2.852574
8.700200D-01	4.816650	2.846887

TABLE 6.2-23 (Cont)

<u>Time</u> <u>(sec)</u>	<u>Mass Flow Rate</u> <u>(10<sup>3</sup> lb/sec)</u>	<u>Energy Flow Rate</u> <u>(10<sup>6</sup> Btu/sec)</u>
9.500200D-01	4.794910	2.834357
1.030160D+00	4.779360	2.824859
1.130120D+00	4.747150	2.806104
1.500010D+00	4.656570	2.752474

TABLE 6.2-24

MASS AND ENERGY RELEASE RATES  
PRESSURIZER SURGE LINE DOUBLE-ENDED RUPTURE

<u>Time (sec)</u>	<u>Mass Flow Rate (10<sup>4</sup> lb/sec)</u>	<u>Energy Flow Rate (Btu/sec)</u>
0.0	1.025600	6.464500D+06
2.502000D-02	2.328200	1.529800D+07
5.005000D-02	2.343900	1.541100D+07
7.510000D-02	2.289400	1.507000D+07
1.001600D-01	2.138500	1.412500D+07
1.250500D-01	2.043400	1.355400D+07
1.500200D-01	2.002100	1.334100D+07
1.750200D-01	1.811100	1.216100D+07
2.000700D-01	1.602700	1.087800D+07
2.250100D-01	1.567700	1.074500D+07
2.500100D-01	1.511500	1.048000D+07
2.750300D-01	1.490300	1.039400D+07
3.000200D-01	1.449200	1.015200D+07
3.250100D-01	1.472700	1.029600D+07
3.500900D-01	1.503600	1.047400D+07
3.750100D-01	1.480200	1.034300D+07
4.000000D-01	1.472300	1.028200D+07
4.251500D-01	1.479700	1.031300D+07
4.500300D-01	1.476800	1.028800D+07
4.750300D-01	1.487800	1.033800D+07
5.000000D-01	1.499000	1.039200D+07
5.250900D-01	1.469700	1.022200D+07
5.500400D-01	1.459200	1.014500D+07
5.750500D-01	1.480200	1.025200D+07
6.000100D-01	1.478500	1.023800D+07
6.251900D-01	1.458600	1.011700D+07
6.501000D-01	1.454100	1.007900D+07
6.750500D-01	1.465900	1.013600D+07
7.000900D-01	1.469700	1.015000D+07
7.250700D-01	1.465400	1.011600D+07
7.500700D-01	1.466000	1.010700D+07
7.750200D-01	1.471400	1.012700D+07
8.000200D-01	1.473400	1.012800D+07
8.250600D-01	1.472700	1.011400D+07
8.500900D-01	1.474000	1.011000D+07
8.752100D-01	1.475900	1.011000D+07
9.000100D-01	1.476400	1.010200D+07
9.251100D-01	1.476600	1.009300D+07
9.501000D-01	1.477500	1.008700D+07
9.752000D-01	1.473900	1.004900D+07
1.000080D+00	1.480100	1.008200D+07
1.100050D+00	1.475200	1.000700D+07
1.200050D+00	1.473000	9.953400D+06

TABLE 6.2-24 (Cont)

<u>Time</u> <u>(sec)</u>	<u>Mass Flow Rate</u> <u>(10<sup>4</sup> lb/sec)</u>	<u>Energy Flow Rate</u> <u>(Btu/sec)</u>
1.300040D+00	1.469600	9.893500D+06
1.375040D+00	1.467200	9.849600D+06
1.500140D+00	1.492700	9.961300D+06
1.600000D+00	1.549600	1.027700D+07
1.700090D+00	1.597700	1.053300D+07
1.800050D+00	1.628500	1.068300D+07
1.900090D+00	1.650400	1.077800D+07
1.975310D+00	1.660200	1.081100D+07
2.100080D+00	1.634900	1.063800D+07
2.200090D+00	1.601700	1.042500D+07
2.300080D+00	1.561300	1.016600D+07
2.400080D+00	1.521600	9.912100D+06
2.500070D+00	1.486600	9.687700D+06
2.600210D+00	1.457200	9.498900D+06
2.700220D+00	1.426400	9.299600D+06
2.800100D+00	1.418800	9.249000D+06
2.900130D+00	1.413000	9.210400D+06
3.000090D+00	1.405800	9.163600D+06

TABLE 6.2-25

SUMMARY OF SUBCOMPARTMENT PEAK CALCULATED  
PRESSURE DIFFERENTIAL USED IN STRUCTURAL ANALYSIS

<u>Subcompartment</u>	<u>Break Considered</u>	<u>Blowdown Distribution</u>	<u>Peak Calculated Pressure Differential <math>\Delta P</math> (PSID)</u>	<u>Time (sec)</u>
Pressurizer cubicle	Spray line DER	Node 7		
Node #				
1			5.20	0.603
2			5.26	0.264
3			5.23	0.602
4			5.22	0.601
5			5.07	0.599
6			5.28	0.322
7			5.38	0.295
8			5.23	0.296
9			0.15	0.091
10			0.16	0.093
11			0.12	0.110
12			0.12	0.100
13			0.07	0.109
14			0.04	0.271
15			0.09	0.119
16			0.02	0.119
17			0.14	0.134
18			0.11	0.104
20			0.13	0.105
21			0.11	0.100
22			0.12	0.108
23			0.11	0.102

TABLE 6.2-25 (Cont)

<u>Subcompartment</u>	<u>Break Considered</u>	<u>Blowdown Distribution</u>	<u>Peak Calculated Pressure Differential</u>	
			<u>ΔP (PSID)</u>	<u>Time (sec)</u>
	Surge line DER	Node 18		
Node #				
1			0.20	0.096
2			0.21	0.102
3			0.22	0.081
4			0.21	0.087
5			0.17	0.094
6			0.16	0.056
7			0.19	0.075
8			0.18	0.130
9			11.26	0.163
10			11.26	0.154
11			11.19	0.151
12			10.76	0.163
13			10.70	0.179
14			10.19	0.186
15			6.68	0.196
16			2.74	0.203
17			6.73	0.199
18			199.32*	0.053
20			18.28	0.056
21			11.48	0.154
22			11.18	0.157
23			11.09	0.154

NOTE:

\* This ΔP is across the pressurizer support skirt.

TABLE 6.2-25 (Cont)

<u>Subcompartment</u>	<u>Break Considered</u>	<u>Blowdown Distribution</u>	<u>Peak Calculated Pressure Differential <math>\Delta P</math> (PSID)</u>	<u>Time (sec)</u>
Pressurizer relief tank cubicle	Surge line DER	Node 15		
Node #				
1			0.07	0.145
2			0.06	0.135
3			0.06	0.151
4			0.06	0.144
5			0.07	0.089
6			0.09	0.126
7			0.06	0.126
8			0.07	0.114
9			6.19	0.202
10			6.18	0.204
11			6.19	0.195
12			6.17	0.205
13			6.19	0.204
14			5.87	0.211
15			18.21	0.161
16			7.30	0.179
17			18.47	0.161
18			6.18	0.190
20			6.20	0.185
21			6.17	0.191
22			6.18	0.188
23			6.17	0.192

TABLE 6.2-25 (Cont)

<u>Subcompartment</u>	<u>Break Considered</u>	<u>Blowdown Distribution</u>	<u>Peak Calculated Pressure Differential <math>\Delta P</math> (PSID)</u>	<u>Time (sec)</u>
Steam generator subcompartment	320° in <sup>2</sup> LDR at the stm. gen. outlet nozzle	100% Node 32		
Node#				
1			6.25	0.028
2			5.60	0.111
3			5.86	0.114
4			5.80	0.037
5			6.89	0.029
6			6.69	0.025
7			5.83	0.079
8			5.65	0.106
9			5.78	0.106
10			5.05	0.312
11			6.04	0.098
12			6.14	0.102
13			4.98	0.157
14			5.03	0.162
15			5.08	0.097
16			4.76	0.312
17			4.90	0.264
18			4.96	0.147
19			4.77	0.283
20			4.72	0.298
21			4.72	0.300
22			4.72	0.250
23			4.76	0.152
24			4.76	0.274
25			0.82	0.131
26			0.74	0.354
27			0.60	0.372
28			0.61	0.131
29			3.62	0.313
31			12.59	0.102
33			12.66	0.099



TABLE 6.2-25 (Cont)

<u>Subcompartment</u>	<u>Break Considered</u>	<u>Blowdown Distribution</u>	<u>Peak Calculated Pressure Differential <math>\Delta P</math> (PSID)</u>	<u>Time (sec)</u>
	180 in <sup>2</sup> at the reactor coolant pump outlet nozzle	50%-Node 8 50%-Node 9		
Node #				
1			5.07	0.065
2			5.24	0.061
3			6.24	0.055
4			3.93	0.065
5			4.32	0.074
6			4.20	0.082
7			4.98	0.073
8			5.84	0.068
9			7.08	0.010
10			3.82	0.104
11			4.16	0.100
12			4.24	0.096
13			4.72	0.053
14			5.49	0.058
15			5.80	0.051
16			4.04	0.056
17			4.51	0.090
18			4.12	0.092
19			3.93	0.077
20			3.51	0.072
21			3.53	0.112
22			3.63	0.103
23			3.52	0.102
24			3.60	0.087
25			0.76	0.079
26			0.59	0.086
27			0.53	0.091
28			0.67	0.082
29			2.26	0.054
31			4.98	0.082
33			4.75	0.083

TABLE 6.2-25 (Cont)

<u>Subcompartment</u>	<u>Break Considered</u>	<u>Blowdown Distribution</u>	<u>Peak Calculated Pressure Differential <math>\Delta P</math> (PSID)</u>	<u>Time (sec)</u>
	707 in <sup>2</sup> longitudinal split break at the stm. gen. inlet elbow	50%-Node 32 25%-Node 7 25%-Node 8		
Node#				
1			15.08	0.025
2			10.50	0.074
3			10.34	0.166
4			10.66	0.039
5			10.44	0.032
6			9.86	0.133
7			12.32	0.014
8			10.62	0.143
9			10.68	0.055
10			10.25	0.102
11			10.08	0.102
12			9.96	0.151
13			9.92	0.064
14			9.85	0.061
15			10.52	0.093
16			9.62	0.098
17			9.43	0.102
18			9.29	0.107
19			9.34	0.122
20			9.16	0.079
21			9.09	0.102
22			9.54	0.102
23			9.19	0.088
24			9.13	0.131
25			1.50	0.066
26			1.37	0.069
27			1.09	0.079
28			1.01	0.092
29			8.18	0.171
31			13.27	0.025
32			12.66	0.033

TABLE 6.2-25 (Cont)

<u>Subcompartment</u>	<u>Break Considered</u>	<u>Blowdown Distribution</u>	<u>Peak Calculated Pressure Differential</u>	
			<u>ΔP (PSID)</u>	<u>Time (sec)</u>
Upper steam generator cubicle	707 in <sup>2</sup> longitudinal split break at stm. gen. inlet elbow	50%-Node 32 25% Node 7 25%-Node 8 (1.0 Moody Flow Correlation)		
	Node #			
	25		1.82	.091
	26		1.58	.085
	27		1.28	.138
	28		1.32	.131

TABLE 6.2-27

STEAM GENERATOR SUBCOMPARTMENT VENT PATH DESCRIPTION

Vent Path No.	From Node No.	To Node No.	Area (ft <sup>2</sup> )	Geom. Inertia (ft <sup>4</sup> )	Head Loss Coefficient K					
					Expansion + Contraction		Wall Friction	Grating Loss Factor	Total	
					Fwd	Rvs			Fwd	Rvs
1	1	29	81.74	.042	.63	.47	.04		.67	.51
2	2	29	113.46	.028	.54	.51	.04		.55	.55
3	3	29	45.02	.039	1.01	.88	.04		1.05	.92
4	2	5	27.22	.285	.76	.67	.04		.80	.71
5	1	2	99.98	.125	.01	.02	.04		.05	.06
6	2	3	180.13	.042	.06	.08	.04		.10	.12
7	3	4	55.84	.252	.20	.23	.04		.24	.27
8	4	5	70.84	.129	.23	.22	.04		.27	.26
9	5	6	34.23	.248	.26	.27	.04		.30	.31
10	6	30	45.00	.142	1.64	1.64	.04		1.68	1.68
11	29	30	240.22	.011	1.01	1.01	.04		1.05	1.05
12	4	30	48.00	.150	1.67	1.67	.04		1.71	1.71
13	1	7	121.64	.079	.04	.04	.04		.08	.08
14	2	8	127.82	.05	.39	.39	.04		.79	.79
15	2	8	61.50	.05	.88	.88	.04	.224	1.14	1.14
16	3	9	138.80	.072	.02	.02	.04		.06	.06
17	4	10	111.74	.131	.007	.007	.04		.05	.05
18	5	11	180.33	.064	.004	.004	.04		.04	.04
19	6	12	72.80	.172	.003	.02	.04		.04	.06
20	7	12	12.81	.327	1.01	1.03	.04		1.05	1.07
21	8	11	51.00	.113	.77	.72	.04		.81	.76
22	7	8	80.09	.073	.54	.51	.04		.58	.55
23	8	9	178.20	.033	.34	.32	.04		.38	.37
24	9	10	30.08	.162	.97	.82	.04		1.01	.86
25	10	11	56.74	.093	.69	.68	.04		.73	.72
26	11	12	59.00	.111	.57	.57	.04		.61	.61
27	12	30	4.81	.658	1.55	1.55	.04		1.59	1.59
28	10	30	20.52	.242	1.50	1.50	.04		1.54	1.54
29	7	13	70.44	.111	.20	.20	.04	.224	.46	.46
30	8	14	173.70	.041	.24	.23	.04	.224	.50	.49
31	9	15	88.13	.088	.21	.22	.04	.224	.47	.48
32	10	16	84.46	.111	.08	.14	.04	.224	.34	.40
33	11	17	168.51	.041	.21	.21	.04	.224	.47	.47
34	12	18	98.49	.061	.21	.21	.04	.224	.47	.47
35	13	18	28.86	.213	.73	.73	.04		.77	.77
36	14	17	54.38	.106	.60	.57	.04		.64	.61
37	13	14	61.63	.102	.42	.37	.04		.46	.41

TABLE 6.2-27 (Cont)

Vent Path No.	From Node No.	To Node No.	Area (ft <sup>2</sup> )	Geom. Inertia (ft <sup>-1</sup> )	Head Loss Coefficient K					
					Expansion + Contraction		Wall Friction	Grating Loss Factor	Total	
					Fwd	Rvs			Fwd	Rvs
38	14	15	119.66	.074	.10	.11	.04		.14	.15
39	15	16	25.38	.291	.72	.56	.04		.76	.60
40	16	17	40.48	.169	.57	.52	.04		.61	.56
41	17	18	44.39	.121	.63	.62	.04		.67	.66
42	18	30	34.56	.128	2.14	2.14	.04		2.18	2.18
43	16	30	37.50	.187	1.55	1.55	.04		1.59	1.59
44	13	19	87.72	.157	.00	.00	.04		.04	.04
45	14	20	123.77	.053	.53	.53	.04	.224	.79	.79
46	15	21	75.33	.116	.32	.32	.04	.224	.58	.58
47	16	22	105.18	.121	.05	.05	.04		.09	.09
48	17	23	209.86	.057	.09	.09	.04		.13	.13
49	18	24	105.57	.10	.17	.17	.04		.21	.21
50	19	24	65.76	.076	.75	.75	.04		.79	.79
51	20	23	194.51	.038	.42	.39	.04		.46	.43
52	19	20	146.26	.037	.55	.49	.04		.59	.53
53	20	21	248.74	.029	.33	.32	.04		.37	.36
54	21	22	128.31	.109	.22	.23	.04		.26	.27
55	22	23	202.41	.060	.10	.12	.04		.14	.16
56	23	24	143.44	.043	.53	.51	.04		.57	.55
57	24	30	48.00	.077	2.39	2.39	.04		2.43	2.43
58	20	30	48.62	.142	1.57	1.57	.04	.177	1.79	1.79
59	21	30	26.50	.236	1.49	1.49	.04	.177	1.71	1.71
60	22	30	14.00	.376	1.58	1.58	.04		1.62	1.62
61	22	30	53.07	.163	1.52	1.52	.04	.177	1.74	1.74
62	23	30	48.97	.124	1.68	1.68	.04	.177	1.90	1.90
63	19	25	29.19	.280	.99	.95	.04		1.03	.99
64	20	26	29.86	.190	1.25	1.41	.04		1.29	1.45
65	23	27	26.10	.202	1.31	1.40	.04		1.35	1.44
66	24	28	27.26	.232	1.25	1.24	.04		1.29	1.28
67	25	28	19.70	.140	1.01	1.01	.04		1.05	1.05
68	25	26	34.70	.093	.80	.80	.04		.84	.84
69	26	27	34.70	.121	.80	.80	.04		.84	.84
70	27	28	75.50	.065	.51	.51	.04		.55	.55
71	25	30	48.59	.051	1.25	1.25	.04		1.29	1.29
72	26	30	68.72	.039	1.23	1.23	.04		1.27	1.27
73	27	30	89.89	.033	1.21	1.21	.04		1.25	1.25
74	28	30	90.44	.035	1.18	1.18	.04		1.22	1.22
75	1	31	31.50	.169	1.42	1.22	.04		1.46	1.26
76	2	31	81.97	.131	.76	.62	.04		.80	.66

TABLE 6.2-27 (Cont)

Vent Path No.	From Node No.	To Node No.	Area (ft <sup>2</sup> )	Geom. Inertia (ft <sup>4</sup> )	Head Loss Coefficient K					
					Expansion + Contraction		Wall Friction	Grating Loss Factor	Total	
					Fwd	Rvs			Fwd	Rvs
77	5	31	73.79	.114	.90	.78	.04		.94	.82
78	6	31	35.41	.120	1.43	1.32	.04		1.47	1.36
79	31	32	99.46	.063	.76	.76	.04	.224	1.02	1.02
80	7	32	12.69	.214	1.73	1.77	.04		1.77	1.81
81	8	32	38.53	.146	1.32	1.45	.04		1.72	1.85
82	11	32	39.91	.132	1.29	1.46	.04		1.33	1.50
83	12	32	20.26	.158	1.52	1.65	.04		1.56	1.69
84	33	12	13.30	.336	1.08	.68	.04		1.12	.72
85	33	7	13.30	.352	1.01	.66	.04		1.05	.70
86	33	6	10.30	.348	1.10	.80	.04		1.14	.84
87	33	1	10.30	.391	1.06	.79	.04		1.10	.83
88	32	33	31.86	.163	1.69	1.22	.04		1.73	1.26
89	31	33	84.45	.084	1.06	.72	.04		1.10	.76
90	33	7	11.03	.452	1.09	.71	.04		1.13	.75
91	33	12	11.03	.519	.98	.68	.04		1.02	.72

TABLE 6.2-28

## STEAM GENERATOR SUBCOMPARTMENT NODAL DESCRIPTION

<u>Node Number</u>	<u>Net Volume (ft<sup>3</sup>)</u>
1	1,024
2	1,765
3	1,124
4	907
5	1,439
6	735
7	1,317
8	2,537
9	1,487
10	986
11	2,308
12	1,074
13	603
14	1,490
15	756
16	717
17	1,445
18	834
19	1,530
20	4,056
21	1,795
22	1,602
23	3,689
24	2,019
25	561
26	770
27	1,143
28	960
29	1,027
30	1,716,078
31	1,473
32	710
33	378

TABLE 6.2-29

MASS AND ENERGY RELEASE RATES  
360 IN<sup>2</sup> LDR AT THE STEAM GENERATOR OUTLET NOZZLE

<u>Time (sec)</u>	<u>Mass Flow Rate (10<sup>4</sup> lb/sec)</u>	<u>Energy Flow Rate (10<sup>7</sup> Btu/sec)</u>
0.0	0.0	0.0
1.0100D-03	1.46644	0.7301
2.0000D-03	1.89019	1.005
3.0200D-03	2.24415	1.193
4.0100D-03	2.70989	1.443
5.0000D-03	3.01268	1.649
6.0000D-03	3.22944	1.710
8.0000D-03	3.43589	1.825
1.0020D-02	3.39021	1.800
1.2030D-02	3.34821	1.777
1.5020D-02	3.51762	1.866
2.0020D-02	3.11841	1.654
2.3030D-02	2.95165	1.565
2.5000D-02	3.01085	1.597
2.9010D-02	2.80254	1.485
3.1010D-02	2.90247	1.539
3.4000D-02	2.75738	1.461
3.7020D-02	2.84539	1.507
3.0100D-02	2.79718	1.482
4.1020D-02	3.55730	1.387
4.2020D-02	3.53498	1.874
4.5010D-02	3.62314	1.921
5.0010D-02	3.94872	2.096
5.5010D-02	4.36179	2.315
6.0050D-02	4.38023	2.326
6.6050D-02	4.62400	2.455
7.1040D-02	4.44237	2.358
8.0020D-02	4.75770	2.527
8.6020D-02	4.80056	2.550
8.8030D-02	4.82318	2.561
1.0004D-01	4.59401	2.438
1.0807D-01	4.38502	2.326
1.2407D-01	4.56874	2.426
1.3008D-01	4.50811	2.393
1.4014D-01	4.46467	2.370
1.5005D-01	4.40963	2.340
1.6010D-01	4.44297	2.359
1.7203D-01	4.49341	2.386
1.7806D-01	4.47923	2.370
2.0502D-01	4.58427	2.436
2.2002D-01	4.52172	2.403
2.4003D-01	4.56181	2.406



TABLE 6.2-29 (Cont)

<u>Time</u> <u>(sec)</u>	<u>Mass Flow Rate</u> <u>(10<sup>4</sup> lb/sec)</u>	<u>Energy Flow Rate</u> <u>(10<sup>7</sup> Btu/sec)</u>
3.00010D-01	4.55787	2.428
3.80010D-01	4.49416	2.401
4.05100D-01	4.52948	2.423
5.00260D-01	4.44197	2.387
6.00020D-01	4.32854	2.332
7.00010D-01	4.23482	2.299
8.00090D-01	4.13227	2.255
9.00040D-01	4.03755	2.215
1.00007D+00	3.97331	2.190
1.20002D+00	3.84359	2.139
1.40009D+00	3.78736	2.581
1.80004D+00	3.56703	2.381
1.80002D+00	3.44952	1.956
2.00005D+00	3.34527	1.904
2.20003D+00	3.22943	1.844
2.40012D+00	3.15043	1.805
2.60007D+00	3.62537	1.738
2.30017D+00	2.02537	1.603
3.00001D+00	2.76955	1.595

TABLE 6.2-30

## MASS AND ENERGY FLOW RATES

180 IN<sup>2</sup> LDR AT THE REACTOR COOLANT PUMP OUTLET NOZZLE

<u>Time</u> <u>(sec)</u>	<u>Mass Flow Rate</u> <u>(10<sup>4</sup> lb/sec)</u>	<u>Energy Flow Rate</u> <u>(10<sup>7</sup> Btu/sec)</u>
0.0	1.02564	0.5481
1.0000D-03	1.85908	0.9858
2.0100D-03	1.89412	1.007
3.0100D-03	2.04654	1.088
4.0100D-03	2.08563	1.109
5.0000D-03	2.11194	1.123
6.0100D-03	2.11314	1.124
7.0000D-03	2.10392	1.119
8.0300D-03	2.08910	1.111
1.0030D-02	2.05897	1.095
1.2020D-02	2.03615	1.082
1.4010D-02	2.02302	1.075
1.5000D-02	2.01992	1.074
1.6010D-02	2.02035	1.074
2.0000D-02	2.08074	1.107
2.2010D-02	2.13166	1.134
2.4000D-02	2.16966	1.155
2.6020D-02	2.18859	1.165
2.7010D-02	2.19191	1.166
2.8000D-02	2.30884	1.230
2.9000D-02	2.57437	1.369
3.0010D-02	2.95307	1.574
3.2000D-02	3.20083	1.705
3.4010D-02	3.34822	1.785
3.6020D-02	3.41168	1.819
3.8040D-02	3.42248	1.825
4.0020D-02	3.45159	1.841
4.2010D-02	3.49307	1.863
4.8030D-02	3.35292	1.787
5.7080D-02	3.49781	1.866
6.4010D-02	3.40959	1.818
6.6180D-02	3.40543	1.815
8.0030D-02	3.24940	1.731
9.5060D-02	2.99803	1.595
9.6120D-02	2.99717	1.594
9.7040D-02	2.99805	1.595
1.0605D-01	3.03307	1.613
1.2005D-01	2.99649	1.594
1.3412D-01	2.95979	1.574
1.5012D-01	2.99959	1.596
1.8207D-01	2.95729	1.573

TABLE 6.2-30 (Cont)

<u>Time (sec)</u>	<u>Mass Flow Rate (10<sup>4</sup> lb/sec)</u>	<u>Energy Flow Rate (10<sup>7</sup> Btu/sec)</u>
1.98100D-01	2.98057	1.586
2.80090D-01	3.01695	1.605
3.50100D-01	2.91402	1.550
3.85020D-01	3.00367	1.598
4.10130D-01	2.90241	1.543
4.40010D-01	2.97684	1.584
4.70010D-01	2.91813	1.552
6.00030D-01	3.00351	1.598
6.90040D-01	2.95459	1.572
7.20060D-01	2.98387	1.588
8.20000D-01	2.97004	1.580
1.00006D+00	2.99995	1.597
1.20006D+00	3.01732	1.607
1.70006D+00	3.03020	1.614
1.56603D+00	3.04140	1.621
1.80012D+00	3.03994	1.622
2.00005D+00	3.03584	1.622
2.20002D+00	3.01368	1.622
2.40003D+00	2.98586	1.595
2.60019D+22	2.95262	1.582
2.80003D+00	2.82415	1.558
3.00007D+00	2.74881	1.530

TABLE 6.2-31

MASS AND ENERGY RELEASE RATES  
707 IN<sup>2</sup> LONGITUDINAL INTRADOS SPLIT AT THE STEAM GENERATOR  
INLET ELBOW

<u>Time (sec)</u>	<u>Mass Flow Rate (10<sup>4</sup> lb/sec)</u>	<u>Energy Flow Rate (10<sup>7</sup> Btu/sec)</u>
0.0	0.0	0.0
1.0000D-03	0.85935	0.541
2.0100D-03	1.21117	0.762
3.0200D-03	2.35905	1.483
4.0200D-03	3.43611	2.161
5.0200D-03	4.08434	2.568
6.0200D-03	4.45081	2.798
7.0000D-03	4.63897	2.915
8.0100D-03	4.72311	2.967
1.8010D-02	4.94518	3.103
2.3010D-02	5.01624	3.146
2.8010D-02	4.97659	3.121
2.9010D-02	4.97371	3.120
3.8050D-02	5.09590	3.198
4.8010D-02	5.19863	3.263
5.1010D-02	5.87217	3.690
5.4020D-02	5.43402	3.416
5.6020D-02	5.67902	3.570
5.8010D-02	5.62479	3.535
6.8000D-02	5.27236	3.316
7.8030D-02	5.15338	3.247
8.8000D-02	5.01559	3.167
9.8090D-02	4.86576	3.079
1.0805D-01	4.77536	3.027
1.1808D-01	4.73526	3.006
1.2805D-01	4.79491	3.048
1.4004D-01	4.83096	3.075
1.4810D-01	4.82055	3.071
1.6805D-01	4.75589	3.036
1.8804D-01	4.70265	3.006
2.0013D-01	4.65914	2.980
2.1512D-01	4.62556	2.961
2.5001D-01	4.66057	2.985
2.8004D-01	4.60615	2.951
3.0511D-01	4.54212	2.911
3.5012D-01	4.57662	2.932
4.0515D-01	4.48985	2.876
4.5516D-01	4.50214	2.884
5.0005D-01	4.43712	2.843
5.5011D-01	4.44384	2.847
6.0009D-01	4.38624	2.811
6.3011D-01	4.39090	2.814

TABLE 6.2-31 (Cont)

<u>Time (sec)</u>	<u>Mass Flow Rate (10<sup>4</sup> lb/sec)</u>	<u>Energy Flow Rate (10<sup>7</sup> Btu/sec)</u>
6.5014D-01	4.37980	2.808
7.00010D-01	4.33078	2.778
7.50100D-01	4.31362	2.768
8.00090D-01	4.27366	2.745
8.50060D-01	4.24616	2.730
9.00100D-01	4.21213	2.711
9.50100D-01	4.17778	2.693
1.00001D+00	4.14529	2.676
1.05013D+00	4.10699	2.655
1.10018D+00	4.07349	2.637
1.15010D+00	4.03232	2.614
1.20040D+00	3.99611	2.594
1.25002D+00	3.95083	2.569
1.30003D+00	3.91050	2.546
1.35014D+00	3.86170	2.517
1.40004D+00	3.81716	2.491
1.45018D+00	3.76844	2.463
1.50013D+00	3.72217	2.436
1.55009D+00	3.67627	2.409
1.60004D+00	3.63134	2.383
1.65002D+00	3.58140	2.353
1.70007D+00	3.54292	2.330
1.75012D+00	3.50783	2.309
1.80021D+00	3.47465	2.288
1.90025D+00	3.41871	2.251
2.00002D+00	3.36742	2.215
2.10034D+00	3.31227	2.180
2.20026D+00	3.27017	2.146
2.30010D+00	3.22098	2.113
2.40001D+00	3.16928	2.081
2.50024D+00	3.11821	2.048
2.60022D+00	3.06548	2.015
2.70000D+00	3.01331	1.982
2.80002D+00	2.95994	1.948
2.90020D+00	2.90539	1.914
3.00019D+00	2.25279	1.881

TABLE 6.2-50

Beaver Valley Power Station Unit 2  
Initial Condition Assumptions

MSLB Mass and Energy Releases Inside Containment

Initial Conditions Parameter	NSSS Power, MWt			
	2910			
	Power Level (%)			
	100.6	70	30	0
RCS Average Temperature (°F)	588.5	578.6	565.4	547.0
RCS Flowrate (gpm) (Thermal Design Flow)	261,600	261,600	261,600	261,600
RCS Pressure (psia)	2250	2250	2250	2250
Pressurizer Water Volume (ft3)	834.3	693.3	505.3	364.3
Feedwater Enthalpy (Btu/lbm)	436.0	385.4	305.3	70.7
SG Pressure (psia)	885	935	1011	1004
SG Water Level (% NRS)	51	51	51	51

TABLE 6.2-51

Beaver Valley Power Station Unit 2  
Balance of Plant Assumptions

MSLB Mass and Energy Releases Inside Containment

Main Feedwater System

Flowrate - DERs @ all powers (until main feedwater isolation)	Feedwater flow based on system performance as a function of SG pressure.
Flowrate - split ruptures @ all powers (until main feedwater isolation)	Feedwater flow matches steam flow.
Unisolable volume from SG nozzle to MFIV (faulted loop)	157 ft <sup>3</sup>
Unisolable volume from SG nozzle to FCV assuming a single failure of the MFIV (faulted loop)	264 ft <sup>3</sup>
Total response time for feedwater isolation (instrument response, signal processing, and MFIV closure)	7.0 seconds

Auxiliary Feedwater System

Flowrate to all steam generators	Maximum flow to each SG is 310 gpm. The actual data used is a function of SG pressure.
Temperature (maximum value)	120°F
Actuation delay time	0 seconds
Assumed time of manual termination	30 minutes

Main Steam System

Total piping volume	7,192 ft <sup>3</sup>
Volume between the break and the nearest MSIV	
No failure of the faulted-loop MSIV	1,038 ft <sup>3</sup>
Failure of the faulted-loop MSIV	6,023 ft <sup>3</sup>
Total response time for steamline isolation (instrument response, signal processing, and MSIV closure)	7.0 seconds

TABLE 6.2-51 (Cont)

Beaver Valley Power Station Unit 2  
Balance of Plant Assumptions

MSLB Mass and Energy Releases Inside Containment

Isolation Setpoints

For all double-ended ruptures,

Feedwater isolation from a safety injection signal via low pressurizer pressure	1760 psia
Feedwater isolation from a safety injection signal via low steamline pressure in any loop	460 psia
dynamic compensation lead	50 seconds
lag	5 seconds
Steamline isolation from low steamline pressure in any loop	460 psia
dynamic compensation lead	50 seconds
lag	5 seconds

Isolation Setpoints

For all split ruptures,

Feedwater isolation from a safety injection signal via Hi-1 containment pressure	containment scope
Steamline isolation from Hi-2 containment pressure	containment scope



TABLE 6.2-52

## LBLOCA Mass and Energy Releases from BCL Vessel-Side

Time (sec)	Mass Flow (lbm/s)	Energy Flow (Btu/s)
0	0	0
0.5	53899	28773060
1	47583	25544458
2	30986	17130028
3	25674	14228740
4	22701	12581345
5	20696	11479648
10	6987	5271856
15	4265	1963534
20	4464	879868
25	176	26980
30	93	0
35	32	0
40	6240	797967
45	1623	445206
50	204	142040
55	225	182306
60	156	47575
65	89	77304
70	33	25664
75	75	75761
80	37	26438
85	87	86789
90	224	74083
95	81	77320
100	302	109665
110	839	223422
120	944	240389
130	847	223149

Table 6.2-52 (cont.)  
LBLOCA Mass and Energy Releases from BCL Vessel-Side

Time (sec)	Mass Flow (lbm/s)	Energy Flow (Btu/s)
140	418	119726
150	21	20756
160	21	22151
170	17	18681
180	35	37810
190	96	51695
200	812	205873
210	518	148513
220	741	189364
230	214	76856
240	33	34324
250	52	36638
260	73	45672
270	145	70845
280	79	54907
290	120	61814
300	172	82874
310	210	103847
320	815	210784
330	542	153176
340	283	89386
350	105	64664
360	56	46956
370	216	83446
379	243	89934

TABLE 6.2-53

## LBLOCA Mass and Energy Releases from BCL Vessel-Side

Time (sec)	Mass Flow (lbm/s)	Energy Flow (Btu/s)
0	0	0
0.5	24639	13159514
1	24097	13037813
2	19067	10775565
3	14143	8275659
4	10118	6355736
5	7684	5246894
10	3168	2664892
15	771	821017
20	190	229993
25	-26	0
30	19	23663
35	20	26050
40	172	215294
45	114	139243
50	42	53484
55	62	78158
60	25	31981
65	39	49578
70	28	35314
75	42	53075
80	25	32428
85	49	61813
90	31	38924
95	43	54250
100	37	47537
110	41	52688
120	45	56783
130	38	48576

Table 6.2-53 (cont.)  
LBLOCA Mass and Energy Releases from BCL Loop-Side

Time (sec)	Mass Flow (lbm/s)	Energy Flow (Btu/s)
140	32	40828
150	23	29517
160	22	28307
170	24	30994
180	31	38953
190	34	42830
200	39	49393
210	36	46134
220	36	45468
230	32	40281
240	31	38891
250	28	36135
260	34	42784
270	37	46983
280	38	47575
290	40	51167
300	43	54819
310	47	59217
320	47	58865
330	41	51856
340	38	47558
350	37	46814
360	35	43723
370	38	48498
379	41	51508

TABLE 6.2-54

ACTIVE HEAT SINKS FOR MINIMUM CONTAINMENT PRESSURE ANALYSIS

Containment Spray Parameters

Number of pumps operating	2
---------------------------	---

Maximum spray flow	4450 gpm
--------------------	----------

Fastest post-LOCA initiation of spray pumps, assuming offsite power available	37 sec
---	--------

Fastest post-LOCA initiation of spray pumps, assuming offsite power loss and no diesel failure	52 sec
--	--------

Containment Fan Coolers	None
-------------------------	------

TABLE 6.2-55

Large Break LOCA Containment Wall Data Used for  
Calculation of Containment Pressure

Wall	T <sub>Air</sub> (°F)	Area (ft <sup>2</sup> )	Height (ft)	T <sub>Init</sub> (°F)	Thickness / Material (inches)
1. Painted Concrete	70	129,776	10	70	0.0035 / Paint 12.0 / Concrete
2. Stainless Steel Piping	70	8,400	10	70	0.28 / Stainless Steel
3. Galvanized Structural Steel	70	21,783	10	70	0.0625 / Galvanized Steel
4. Galvanized Ventilation Ducts	70	15,856	10	70	0.125 / Galvanized Steel
5. Carbon Structural Steel	70	6,406	10	70	0.0045 / Paint 0.0625 / Carbon Steel
6. Carbon Structural Steel	70	67,418	10	70	0.0045 / Paint 0.125 / Carbon Steel
7. Carbon Steel Liner / Concrete Shell	-20	42,469	100	70	0.0045 / Paint 0.375 / Carbon Steel 54.0 / Concrete
8. Carbon Steel Liner / Concrete Dome	-20	19,638	100	70	0.0045 / Paint 0.5 / Carbon Steel 30.0 / Concrete
9. Carbon Steel Liner / Concrete Dome Liner Plates	-20	9,036	100	70	0.0045 / Paint 1.0 / Carbon Steel 30.0 / Concrete
10. Concrete / Carbon Steel Liner / Concrete Floor	32	11,251	10	70	0.0035 / Paint 24.0 / Concrete 0.25 / Carbon Steel 120.0 / Concrete
11. Carbon Structural Steel, Ducts, and Equipment	70	25,785	10	70	0.0045 / Paint 0.1879 / Carbon Steel
12. Carbon Structural Steel, Pipe Supports, and Piping	70	45,738	10	70	0.0045 / Paint 0.2565 / Carbon Steel
13. Carbon Structural Steel	70	17,720	10	70	0.0045 / Paint 0.3158 / Carbon Steel
14. Stainless Steel Refueling Cavity Liner / Concrete	70	13,394	10	70	0.25 / Stainless Steel 24.0 / Concrete
15. Stainless Steel Refueling Cavity Liner / Concrete	70	3,348	10	70	1.0 / Stainless Steel 24.0 / Concrete

TABLE 6.2-55 (Cont)

Large Break LOCA Containment Wall Data Used for  
Calculation of Containment Pressure

Wall	T <sub>Air</sub> (°F)	Area (ft <sup>2</sup> )	Height (ft)	T <sub>Init</sub> (°F)	Thickness / Material (inches)
16. Carbon Steel Equipment	70	32,214	10	70	0.0045 / Paint 0.438 / Carbon Steel
17. Carbon Steel Pipe Rupture Restraints and Structural Steel	70	11,489	10	70	0.0045 / Paint 0.6068 / Carbon Steel
18. Carbon Steel Pipe Rupture Restraints	70	2,615	10	70	0.0045 / Paint 1.0312 / Carbon Steel
19. Carbon Steel Equipment and Structural Steel	70	3,843	10	70	0.0045 / Paint 1.4683 / Carbon Steel
20. Carbon Steel Equipment	70	7,648	10	70	0.0045 / Paint 4.593 / Carbon Steel

TABLE 6.2-56

## QUENCH SPRAY SYSTEM COMPONENT DESIGN DATA

<u>Components</u>	<u>Design Parameters</u>
Refueling Water Storage Tank	
Quantity	1
Capacity (gal)*	900,000
Design pressure	Atmospheric
Design temperature (°F)	150
Operating pressure	Atmospheric
Operating temperature (°F)	45-50
Material <sup>(1)</sup>	Type 304L
Quench Pumps	
Quantity	2
Type	Horizontal, Centrifugal
Motor horsepower (hp) (each)	350
Seals	Single mechanical
Capacity (gal)	3,000
Head at rated capacity (ft)	330
Design pressure (psig)	250
Operating temperature (°F)	50
Design temperature	150
Material <sup>(1)</sup>	
Pump casing	ASTM A351 Gr CF8
Shaft	17-4 PH Cond. H-1100
Impeller	ASTM A351 Gr CF8

\*Nominal volume of the straight sided portion of the tank



TABLE 6.2-56 (Cont)

<u>Components</u>	<u>Design Parameters</u>
Material <sup>(1)</sup>	
Pump casing	SA 351-Type 304L
Shaft	Type 316 Stainless Steel
Rotor	Nitronic 60
Idler	Nitronic 50
Quench Spray Headers	
Quantity	2
Elevation	871 ft 6 in and 846 ft-4 in
Nozzles per header	39 and 120
Nozzle type	SPRACO Model 1713A

NOTES(1) Materials listed in this table may have been replaced with materials of equivalent design characteristics. The term equivalent is described in UFSAR Section 1.12, "Equivalent Materials."

TABLE 6.2-57

COMPONENT DESIGN DATA  
RECIRCULATION SPRAY SYSTEM

<u>Components</u>	<u>Design Parameters</u>	
Recirculation Pumps		
Quantity	4	
Type	Vertical, deep-well type turbine	
Motor power (hp) (each)	350	
Seal type	Tandem mechanical	
Capacity (gpm)	3,500	
Total dynamic head at rated capacity (ft)	266	
Design pressure (psig)	268	
Design temperature (°F)	280	
Material <sup>(1)</sup>		
Suction well casing	SA-358 Type 304	
Pump bowl	ASTM A351 Gr. CF8	
Shaft	A-276 Type 304 Cond A	
Impeller	ASTM A351 Gr. CF8	
Recirculation Coolers		
Quantity	4	
Design duty (Btu/hr)	1.43 x 10 <sup>8</sup>	
	<u>Shell</u>	<u>Tube</u>
Fluid	Recirculated spray water	Ohio River water (service water)
Design pressure (psig)	250	150
Design temperature (°F)	250	250
Operating temperature		
In/Out (°F)	196.4/114.5	86/143.3
Operating pressure	100	100
Material <sup>(1)</sup>	Stainless Steel-	Stainless Steel-
	Type 304	Type 304
Recirculation Spray Headers		
Quantity	2	
Elevation	852 ft-5 in and 849 ft	
Nozzles per header	292	
Nozzle type	SPRACO Model 1713A	

NOTES(1) Materials listed in this table may have been replaced with materials of equivalent design characteristics. The term equivalent is described in UFSAR Section 1.12, "Equivalent Materials."

TABLE 6.2-58

## CONTAINMENT VOLUMES COVERED BY QUENCH SPRAY

<u>Location</u>	<u>Net Volume ft<sup>3</sup></u>	<u>Spray Volume ft<sup>3</sup></u>	<u>Percent Sprayed</u>
Dome	519,274	519,274	100.0
Operating floor to bend line (outside crane wall)	160,370	157,983	98.5
Operating floor to bend line (inside crane wall)	343,795	328,603	95.6
Refueling cavity	35,001	30,724	87.8
Reactor cavity	7,892	1,889	23.9
Annulus outside crane wall (738 ft 10 in to 767 ft 10 in)	98,885	74,945	75.8
Annulus outside crane wall (718 ft 6 in to 738 ft 10 in)	69,920	65,077	93.1
Basement	196,484	64,724	32.9
Steam generator cubicles - total	135,371 48,772	79,153 29,006	58.5 59.5
steam generator cubicle 1	43,001	23,250	54.1
steam generator cubicle 2	43,598	26,897	61.7
steam generator cubicle 3			
Pressurizer cubicle	23,819	2,546	10.7
Reactor head storage hatch (738 ft 10 in to 767 ft 10 in)	12,565	12,565	100.0
Incore instrumentation room	29,150	0	0
Pressurizer relief tank cubicle	16,286	0	0
Residual heat removal cubicle	28,667	0	0
Reactor head storage hatch (692 ft 11 in to 738 ft 10 in)	35,422	18,452	52.1
Incore instrumentation tunnel	3,732	0	0
Total	1,716,633	1,355,935	79.0

TABLE 6.2-59

NET POSITIVE SUCTION HEAD  
FOR CONTAINMENT HEAT REMOVAL SYSTEM

	<u>At Start of Recirculation Spray</u>
Elevation head (ft)	27.02
Pipe and sump losses (ft)	6.82
Available NPSH (ft)	20.2
Pump flow (gpm)	3,684
Required NPSH (ft)	15.9
Margin (ft)	4.3

TABLE 6.2-60  
CONTAINMENT ISOLATION FEATURES

System Name	Penet No.	Line No. (1)	Fluid	Isolation Valves		General Design Criteria	Valve Type	Valve Position				Cnmt Isolation Signal (16)	Isolation/Safety Function (7)	Type C Leak Test Required		Overpressure Protection/ Set point (psig)	Distance from Outermost Valve to Containment Wall	Valve Actuation		Valve Closure Time (sec) (24)		Safety-Related Power Source		Ref. FSAR Sect.			
				Inside	Outside			Normal	Shutdown	Power Failure	DBA			Inside	Outside			Primary	Secondary	Inside	Outside	Inside	Outside				
Chemical and volume control system	X-28	2-CHS-002-2-2	Rx coolant	2CHS*AOV200A	2CHS*AOV204	55	Globe	Open	Open	Closed	Closed	CIA	IO	Yes	Yes	RV/600	24'-3"	Air	None	10	60	BATT*2-1	BATT*2-2	9.3.4			
				2CHS*AOV200B		55	Globe	Open	Open	Closed	Closed	CIA	IO	Yes													
				2CHS*AOV200C		55	Globe	Open	Open	Closed	Closed	CIA	IO	Yes													
				2CHS*HCV142		55	Globe	Admin Closed	Open	Open	Closed	Closed	None (19)	IO	Yes	Yes											
				2CHS*RV203		55	Relief	-	-	-	-																
	X-15	2-CHS-003-120-2	Rx coolant	(Weight Loaded) Check	2CHS*MOV289	55	Gate	Open	Open	As is	Closed	SIS	IO	No	No	Inherent-2CHS*RV8144/2735	15'-4"	Elect	Manual	None	10	None	MCC*2-E05	9.3.4			
	X-46	2-CHS-002-124-2	Borated water	(Weight Loaded) Check	2CHS*FCV160	55	Globe	Admin Closed	Closed	Closed	Closed	None (19)	IO	No	No	Inherent-2CHS*RV160/2690	14'-0"	Air	None	None	N/A	None	None	9.3.4			
	X-19	2-CHS-003-106-2 2-CHS-025-396-2	Rx coolant	(Weight Loaded) Check	2CHS*MOV378 2CHS*MOV381	55	Gate	Open	Open	As is	Closed	CIA	IO	Yes	Yes	Bypass to RV 382A/150	28'-4"	Elect	Manual	<60	<60	MCC*2-E05 None	MCC*2-E06	9.3.4			
	X-35	2-CHS-002-95-2	Rx coolant	(Weight Loaded) Check	2CHS*MOV308A	55	Globe	Open	Open	As is	(9)	(9)	(9)	IO	No	No	Inherent-2CHS*RV260A/2690	15'-4"	Elect	Manual	None	N/A	None	MCC*2-E05	9.3.4		
	X-36	2-CHS-002-94-2	Rx coolant	(Weight Loaded) Check	2CHS*MOV308B	55	Globe	Open	Open	As is	(9)	(9)	(9)	IO	No	No	Inherent-2CHS*RV260B/2690	20'-0"	Elect	Manual	None	N/A	None	MCC*2-E05	9.3.4		
	X-37	2-CHS-002-93-2	Rx coolant	(Weight Loaded) Check	2CHS*MOV308C	55	Globe	Open	Open	As is	(9)	(9)	(9)	IO	No	No	Inherent-2CHS*RV260C/2690	27'-0"	Elect	Manual	None	N/A	None	MCC*2-E05	9.3.4		
Steam generator blowdown system	X-39	2-BDG-025-11-2	Demin water	None (4)	2BDG*AOV100A1	(20)	Globe	Open	Closed	Closed	Closed	(4)	IO	-	No	(10)	4'-4"	Air	None		<60		BATT*2-1	10.4.8			
	X-40	2-BDG-025-262-2	Demin water	None (4)	2BDG*AOV100B1	(20)	Globe	Open	Closed	Closed	Closed	(4)	IO	-	No	(10)	13'-4"	Air	None		<60		BATT*2-1	10.4.8			
	X-41	2-BDG-025-264-2	Demin water	None (4)	2BDG*AOV100C1	(20)	Globe	Open	Closed	Closed	Closed	(4)	IO	-	No	(10)	11'-4"	Air	None		<60		BATT*2-1	10.4.8			
Component cooling water system	X-2	2-CCP-018-30-2	(13)	2CCP*MOV150-2 2CCP*RV102	2CCP*MOV150-1	57	Btffy Relief	Open	Open	As is	Closed	CIB None	IO	Yes	Yes	RV/150	6'-0"	Elect	Manual	<60	<60	MCC*2-E05	MCC*2-E06	9.2.2			
	X-4	2-CCP-018-33-2	(13)	2CCP*MOV151-2 2CCP*RV103	2CCP*MOV151-1	57	Btffy Relief	Open	Open	As is	Closed	CIB None	IO	Yes	Yes	RV/150	3'-8"	Elect	Manual	<60	<60	MCC*2-E06	MCC*2-E05	9.2.2			
	X-1	2-CCP-018-39-2	(13)	2CCP*MOV157-2 2CCP*RV105	2CCP*MOV157-1	57	Btffy Relief	Open	Open	As is	Closed	CIB None	IO	Yes	Yes	RV/150	5'-8"	Elect	Manual	<60	<60	MCC*2-E06	MCC*2-E05	9.2.2			
	X-5	2CCP-018-36-2	(13)	2CCP*MOV156-2 2CCP*RV104	2CCP*MOV156-1	57	Btffy Relief	Open	Open	As is	Closed	CIB None	IO	Yes	Yes	RV/150	5'-8"	Elect	Manual	<60	<60	MCC*2-E05	MCC*2-E06	9.2.2			

TABLE 6.2-60 (Cont)

System Name	Penet No.	Line No. (1)	Fluid	Isolation Valves		General Design Criteria	Valve Type	Valve Position				Cnmt Isolation Signal (16)	Isolation/Safety Function (7)	Type C Leak Test Required		Overpressure Protection/ Set point (psig)	Distance from Outermost Valve to Containment Wall	Valve Actuation		Valve Closure Time (sec) (24)		Safety-Related Power Source		Ref. FSAR Sect.
				Inside	Outside			Normal	Shutdown	Power Failure	DBA			Inside	Outside			Primary	Secondary	Inside	Outside	Inside	Outside	
Vent and drain systems	X-38	2-DAS-002-19-2	Borated Water	2DAS*AOV100A	2DAS*AOV100B 2DAS*RV110	56	Globe Relief	Open	Open	Closed	Closed	CIA None	IO	Yes	Yes Yes	RV/70	11'-4"	Air	None	<60	<60	BATT*2-1	BATT*2-2	9.3.3
	X-48	2VRS-150-12-2	(14)	2VRS*AOV109A2	2VRS*AOV109A1	56	Globe	Open	Open	Closed	Closed	CIA	IO	Yes	Yes	(10)	1'-6"	Air	None	<60	<60	BATT*2-2	BATT*2-1	9.3.3
	X-29	2-DGS-002-13-2	Borated water	2DGS*AOV108A	2DGS*AOV108B 2DGS*RV115	56	Globe Relief	Open	Open	Closed	Closed	CIA None	IO	Yes	Yes Yes	RV/125	5'-8"	Air	None	<60	<60	BATT*2-1	BATT*2-1	9.3.3
Fuel pool cooling and purification system	X-103	2-FNC-006-112-2	Dry	Manual	Manual	56	Ball	Admin Closed	Closed	Closed	Closed	None	IO	Yes	Yes	(10)	6'-8"	Manual	None	-	-	None	None	9.1.3
	X-104	2-FNC-006-111-2	Dry	Manual	Manual	56	Ball	Admin Closed	Closed	Closed	Closed	None	IO	Yes	Yes	(10)	3'-4"	Manual	None	-	-	None	None	9.1.3
Reactor coolant system	X-45	2-RCS-003-151-2	Borated water	(Weight Check	Loaded) 2RCS*AOV519 2RCS*RV100	55	Globe Relief	Closed	Closed	Closed	Closed	CIA None	IO	Yes	Yes Yes	RV/150	16'-4"	Air	None	-	60	None	BATT*2-2	5.1, 9.2.8
	X-49	2-RCS-750-120-2	Nitrogen	(Weight Check	Loaded) 2RCS*AOV101	55	Globe	Closed	Closed	Closed	Closed	CIA	IO	Yes	Yes	(10)	12'-0"	Air	None	-	60	None	BATT*2-2	5.1, 9.5.9
	X-119a thru X-119f	2-RCS-750-301-2 2-RCS-750-302-2 2-RCS-750-303-2 (RVLIS)	(22)	None	(21)	(21)	(21)	-	-	-	-	None	S/M	No	No	(10)	(21)	(21)	(21)	(21)	(21)	(21)	(21)	6.2.4, 7.5.3.2
Post-DBA hydrogen control system	X-55c	2-HCS-375-65-2	Cont atm	2HCS*SOV136A	2HCS*SOV136B	56	Globe	Closed	Closed	Closed	Open	None	S/M	Yes	Yes	(10)	(later)	Elect	None	N/A	N/A	PNL*DC2-15	PNL*DC2-15	6.2.5
	X-57c	2-HCS-375-65-2	Cont atm	2HCS*SOV135A	2HCS*SOV135B	56	Globe	Closed	Closed	Closed	Open	None	S/M	Yes	Yes	(10)	(later)	Elect	None	N/A	N/A	PNL*DC2-16	PNL*DC2-16	6.2.5
	X-87	2-HCS-002-52-2	Cont atm	None	2HCS*MOV117	56	Ball	Closed	Closed	As is	Closed (12)	None	HC	-	Yes	(10)	3'-0"	Elect	Manual	-	N/A	None	MCC*2-E12	6.2.5
					Manual	56	Ball	Admin Closed	Closed	Closed	Open	-	HC	Yes	(10)	9'-6"								
	X-88	2-HCS-002-51-2	Cont atm	None	2HCS*MOV116	56	Ball	Closed	Closed	As is	Closed (12)	None	HC	-	Yes	(10)	2'-3"	Elect	Manual	-	N/A	None	MCC*2-E11	6.2.5
					Manual	56	Ball	Admin Closed	Closed	Closed	Open	-	HC	Yes	(10)	9'-6"								
	X-92	2-HCS-002-19-2	Cont atm	None	2HCS*SOV114B	(8)	(11)	Closed	Closed	Closed	Closed (12)	None	HC	-	Yes	(10)	6'-3"	Elect	None	-	N/A	None	PNL*AC2-E1	6.2.5
					2HCS*SOV115B	(8)	(11)	Closed	Closed	Closed	Closed (12)	None	HC	Yes	(10)	9'-3"	Elect	None	-	N/A	None	PNL*AC2-E2		
X-93	2-HCS-002-15-2	Cont atm	None	2HCS*SOV114A	(8)	(11)	Closed	Closed	Closed	Closed (12)	None	HC	-	Yes	(10)	9'-3"	Elect	None	-	N/A	None	PNL*AC2-E1	6.2.5	
				2HCS*SOV115A	(8)	(11)	Closed	Closed	Closed	Closed (12)	None	HC	-	Yes	(10)	11'-9"	Elect	None	-	N/A	None	PNL*AC2-E2		
X-97b	2HCS-375-68-2	Cont atm	2HCS*SOV133B	2HCS*SOV134B	56	Globe	Closed	Closed	Closed	Open	None	S/M	Yes	Yes	(10)	(later)	Elect	None	N/A	N/A	PNL*DC2-16	PNL-DC2-16	6.2.5	
X-105b	2HCS-375-67-2	Cont atm	2HCS*SOV133A	2HCS*SOV134A	56	Globe	Closed	Closed	Closed	Open	None	S/M	Yes	Yes	(10)	(later)	Elect	None	N/A	N/A	PNL*DC2-15	PNL-DC2-15	6.2.5	

TABLE 6.2-60 (Cont)

System Name	Penet No.	Line No. (1)	Fluid	Isolation Valves		General Design Criteria	Valve Type	Valve Position				Cnmt Isolation Signal (16)	Isolation/Safety Function (7)	Type C Leak Test Required		Overpressure Protection/ Set point (psig)	Distance from Outermost Valve to Containment Wall	Valve Actuation		Valve Closure Time (sec) (24)		Safety-Related Power Source		Ref. FSAR Sect.
				Inside	Outside			Normal	Shutdown	Power Failure	DBA			Inside	Outside			Primary	Secondary	Inside	Outside	Inside	Outside	
Containment vacuum and leakage monitoring systems	X-93	2-CVS-002-21-2	Cont atm	None	2CVS*SOV151A 2CVS*SOV152A	(8)	(11)	Open Open	Open Open	Closed Closed	Closed Closed	CIA CIA	IO IO	-	Yes Yes	(10) (10)	13'-6" 16'-6"	Elect Elect	None None	-	< 5 < 5	None	PNL*DC2-07 PNL*DC2-07	9.5.10
	X-92	2-CVS-002-22-2	Cont atm	None	2CVS*SOV151B 2CVS*SOV152B	(8)	(11)	Open Open	Open Open	Closed Closed	Closed Closed	CIA CIA	IO IO	-	Yes Yes	(10) (10)	16'-0" 18'-3"	Elect Elect	None None	-	< 5 < 5	None	PNL*DC2-07 PNL*DC2-06	9.5.10
	X-94	2-CVS-008-28-2	Cont atm	Manual	Manual	56	Btly	Admin Closed	Closed	Closed	Closed	None	IO	Yes	Yes	(10)	<1'-0"	Manual	None	-	-	None	None	9.5.10

TABLE 6.2-60 (Cont)

System Name	Penet No.	Line No. (1)	Fluid	Isolation Valves		General Design Criteria	Valve Type	Valve Position				Cnmt Isolation Signal (16)	Isolation/Safety Function (7)	Type C Leak Test Required		Overpressure Protection/ Set point (psig)	Distance from Outermost Valve to Containment Wall	Valve Actuation		Valve Closure Time (sec) (24)		Safety-Related Power Source		Ref. FSAR Sect.
				Inside	Outside			Normal	Shutdown	Power Failure	DBA			Inside	Outside			Primary	Secondary	Inside	Outside	Inside	Outside	
	X-44	2-CVS-001-210-2	Cont atm	2CVS*SOV153B	2CVS*SOV153A	56	(11)	Open	Open	Closed	Closed	CIA	IO	Yes	Yes	(10)	13'-8"	Elect	None	<60	<60	PNL*DC2-06	PNL*DC2-07	9.5.10
	X-43	2-CVS-001-211-2	Cont atm	(Spring Loaded) Check	2CVS*SOV102	56	Globe	Open	Open	Closed	Closed (12)	CIA	SM	Yes	Yes	(10)	24'-4"	Elect	None		<60		BATT*2-2	9.5.10
	X-55b	2-LMS-375-3-2	Cont atm	None	2LMS*SOV953	(8)	(11)	Open	Open	Open	Open	None	ESF	-	No	(10)	5'-0"	Elect	None	-	<60	None	BATT*2-2	9.5.10
	X-57b	2-LMS-375-19-2	Cont atm	None	2LMS*SOV950	(8)	(11)	Open	Open	Open	Open	None	ESF	-	No	(10)	12'-0"	Elect	None	-	<60	None	BATT*2-1	9.5.10
	X-97a	2-LMS-375-1-2	Cont atm	None	2LMS*SOV952	(8)	(11)	Open	Open	Open	Open	None	ESF	-	No	(10)	11'-0"	Elect	None	-	<60	None	BATT*2-2	9.5.10
	X-105c	2-LMS-375-2-2	Cont atm	None	2LMS*SOV951	(8)	(11)	Open	Open	Open	Open	None	ESF	-	No	(10)	6'-0"	Elect	None	-	<60	None	BATT*2-1	9.5.10
	X-105d	2-LMS-375-30-2	Cont atm	None	Manual	(8)	Globe	Admin Closed	Closed	Closed	Closed	None	IO	-	Yes	(10)	<1'-0"	Manual	None	-	-	None	None	
				None	Manual	(8)	Globe	Admin Closed	Closed	Closed	Closed	None	IO		Yes	(10)	1'-6"	Manual	None			None	None	
Main steam system	X-73	2-MSS-032-35-2	Steam	None	2MSS*AOV101A	(20)	Globe	Open	Closed	Closed	Closed	SLI	IO	-	No	(6)	20'-2"	Air	None	-	6	None	(2)	10.3
		2-MSS-002-920-2	Steam	None	2MSS*AOV102A		Globe	Closed	Closed	Closed	Closed	SLI	IO	-	No	(6)	8'-4"	Air	None	-	N/A	None	(2)	
		2-MSS-003-902-2	Steam	None	2MSS*SOV105A		(11)	Closed	Closed	Open	Open	SIS	ESF	-	No	(6)	24'-11"	Elect	None	-	N/A	None	PNL*DC2-07	
		2-MSS-375-244-2	Steam	None	2MSS*SOV120	(20)	Globe	Closed	Closed	Closed	Open	SIS	SM	-	No	(6)	11'-10"	Elect	None	-	N/A	None	PNL*DC2-03	10.3
		2-MSS-006-158-2	Steam	None	2MSS*SV101A	(20)	-	-	-	-	-	None	-	-	No	(6)	14'-5"	-	-	-	-	None	None	10.3
		2-MSS-006-157-2	Steam	None	2MSS*SV102A	(20)	-	-	-	-	-	None	-	-	No	(6)	14'-5"	-	-	-	-	None	None	10.3
		2-MSS-006-156-2	Steam	None	2MSS*SV103A	(20)	-	-	-	-	-	None	-	-	No	(6)	14'-5"	-	-	-	-	None	None	10.3
		2-MSS-006-155-2	Steam	None	2MSS*SV104A	(20)	-	-	-	-	-	None	-	-	No	(6)	14'-5"	-	-	-	-	None	None	10.3
		2-MSS-006-154-2	Steam	None	2MSS*SV105A	(20)	-	-	-	-	-	None	-	-	No	(6)	14'-5"	-	-	-	-	None	None	10.3
	X-74	2-MSS-032-39-2	Steam	None	2MSS*AOV101B	(20)	Globe	Open	Closed	Closed	Closed	SLI	IO	-	No	(6)	18'-8"	Air	None	-	6	None	(2)	10.3
		2-MSS-002-921-2	Steam	None	2MSS*AOV102B		Globe	Closed	Closed	Closed	Closed	SLI	IO	-	No	(6)	8'-0"	Air	None	-	N/A	None	(2)	
		2-MSS-003-903-2	Steam	None	2MSS*SOV105B		(11)	Closed	Closed	Open	Open	SIS	ESF	-	No	(6)	23'-5"	Elect	None	-	N/A	None	PNL*DC2-07	
		2-MSS-375-244-2	Steam	None	2MSS*SOV120	(20)	Globe	Closed	Closed	Closed	Open	SIS	SM	-	No	(6)	11'-10"	Elect	None	-	N/A	None	PNL*DC2-03	10.3
		2-MSS-006-163-2	Steam	None	2MSS*SV101B	(20)	-	-	-	-	-	None	-	-	No	(6)	11'-5"	-	-	-	-	None	None	10.3
		2-MSS-006-162-2	Steam	None	2MSS*SV102B	(20)	-	-	-	-	-	None	-	-	No	(6)	11'-5"	-	-	-	-	None	None	10.3
		2-MSS-006-161-2	Steam	None	2MSS*SV103B	(20)	-	-	-	-	-	None	-	-	No	(6)	11'-5"	-	-	-	-	None	None	10.3
		2-MSS-006-160-2	Steam	None	2MSS*SV104B	(20)	-	-	-	-	-	None	-	-	No	(6)	11'-5"	-	-	-	-	None	None	10.3
		2-MSS-006-159-2	Steam	None	2MSS*SV105B	(20)	-	-	-	-	-	None	-	-	No	(6)	11'-5"	-	-	-	-	None	None	10.3
	X-75	2-MSS-032-43-2	Steam	None	2MSS*AOV101C	(20)	Globe	Open	Closed	Closed	Closed	SLI	IO	-	No	(6)	20'-2"	Air	None	-	6	None	(2)	10.3
		2-MSS-002-922-2	Steam	None	2MSS*AOV102C		Globe	Closed	Closed	Closed	Closed	SLI	IO	-	No	(6)	8'-4"	Air	None	-	N/A	None	(2)	
		2-MSS-003-904-2	Steam	None	2MSS*SOV105C		(11)	Closed	Closed	Open	Open	SIS	ESF	-	No	(6)	20'-0"	Elect	None	-	N/A	None	PNL*DC2-07	
		2-MSS-375-244-2	Steam	None	2MSS*SOV120	(20)	Globe	Closed	Closed	Closed	Open	SIS	SM	-	No	(6)	11'-10"	Elect	None	-	N/A	None	PNL*DC2-03	10.3
		2-MSS-006-168-2	Steam	None	2MSS*SV101C	(20)	-	-	-	-	-	None	-	-	No	(6)	14'-5"	-	-	-	-	None	None	10.3
		2-MSS-006-167-2	Steam	None	2MSS*SV102C	(20)	-	-	-	-	-	None	-	-	No	(6)	14'-5"	-	-	-	-	None	None	10.3
		2-MSS-006-166-2	Steam	None	2MSS*SV103C	(20)	-	-	-	-	-	None	-	-	No	(6)	14'-5"	-	-	-	-	None	None	10.3
		2-MSS-006-165-2	Steam	None	2MSS*SV104C	(20)	-	-	-	-	-	None	-	-	No	(6)	14'-5"	-	-	-	-	None	None	10.3
		2-MSS-006-164-2	Steam	None	2MSS*SV105C	(20)	-	-	-	-	-	None	-	-	No	(6)	14'-5"	-	-	-	-	None	None	10.3



TABLE 6.2-60 (Cont)

System Name	Penet No.	Line No. (1)	Fluid	Isolation Valves		General Design Criteria	Valve Type	Valve Position				Cnmt Isolation Signal (16)	Isolation/Safety Function (7)	Type C Leak Test Required		Over-pressure Protection/ Set point (psig)	Distance from Outermost Valve to Containment Wall	Valve Actuation		Valve Closure Time (sec)(24)		Safety-Related Power Source		Ref. FSAR Sect.
				Inside	Outside			Normal	Shutdown	Power Failure	DBA			Inside	Outside			Primary	Secondary	Inside	Outside	Inside	Outside	
Steam drains system	X-73	2-SDS-150-76-2 2-SDS-001-97-2	Drains/ Steam	None	2SDS*AOV111A-1	(20)	Globe	Open	Open	Closed	Closed	SLI	IO	-	No	(6)	17'-4"	Air	None	-	<60	None	BATT*2-1	10.3
				None	2SDS*AOV129B	(20)	Globe	Open	Open	Closed	Closed	SLI	IO	-	No	(6)	86'	Air	None	-	<60	None	BATT*2-2	10.3
	X-74	2-SDS-150-77-2 2-SDS-001-97-2	Drains/ Steam	None None	2SDS*AOV111B-1 2SDS*AOV129B	(20) (20)	Globe Globe	Open Open	Open Open	Closed Closed	Closed Closed	SLI SLI	IO IO	- -	No No	(6) (6)	15'-4" 86'	Air Air	None None	- -	<60 <60	None None	BATT*2-1 BATT*2-2	10.3 10.3
Steam vent system	X-73	2-SVS-010-170-2 2-SVS-010-177-2	Steam Steam	None	2SVS*PCV101A	(20)	Globe	Closed	Open	Closed	Open	None	IO/ESF	-	No	(6)	25'-6"	Hyd Press	Hand-Pump	-	N/A	None	MCC*2-E05	10.3
				None	2SVS*HCV104	(20)	Globe	Closed	Open	Closed	Open	None	IO/ESF	-	No	(6)	85'	Hyd Press	Hand-Pump	-	N/A	None	MCC*2-E14	10.3
	X-74	2-SVS-010-172-2 2-SVS-010-177-2	Steam Steam	None None	2SVS*PCV101B 2SVS*HCV104	(20) (20)	Globe Globe	Closed Closed	Open Open	Closed Closed	Open Open	None None	IO/ESF IO/ESF	- -	No No	(6) (6)	26'-6" 85'	Hyd Press Hyd Press	Hand-Pump Hand-Pump	- -	N/A N/A	None None	MCC*2-E13 MCC*2-E14	10.3 10.3
Gas supply system	X-75	2-SDS-150-78-2 2-SDS-001-97-2	Drains/ Steam	None	2SDS*AOV111C-1	(20)	Globe	Open	Open	Closed	Closed	SLI	IO	-	No	(6)	17'-4"	Air	None	-	<60	None	BATT*2-1	10.3
				None	2SDS*AOV129B	(20)	Globe	Open	Open	Closed	Closed	SLI	IO	-	No	(6)	86'	Air	None	-	<60	None	BATT*2-2	10.3
	X-75	2-SVS-010-174-2 2-SVS-010-177-2	Steam Steam	None None	2SVS*PCV101C 2SVS*HCV104	(20) (20)	Globe Globe	Closed Closed	Open Open	Closed Closed	Open Open	None None	IO/ESF IO/ESF	- -	No No	(6) (6)	27'-0" 85'	Hyd Press Hyd Press	Hand-Pump Hand-Pump	- -	N/A N/A	None None	MCC*2-E13 MCC*2-E14	10.3 10.3
X-53	2-GNS-001-10-2	Nitrogen	2GNS*AOV101-2	2GNS*AOV101-1	55	Globe	Open	Open	Closed	Closed	CIA	IO	Yes	Yes	(10)	15'-4"	Air	None	10	60	BATT*2-2	BATT*2-1	9.5.9	
Containment purge system	X-90	2-HVR-042-1-2	Cont atm	2HVR*MOD23B	2HVR*MOD23A	56	Btfy	Admin Closed	(15)	Closed	Closed	RM	IO	Yes	Yes	(10)	2'-9"	Elect	None	10	10	MCC*2-E14	MCC*2-E13	9.4.7.3
				2HVR*MOD25B	2HVR*MOD25A	56	Btfy	Admin Closed	(15)	Closed	Closed	RM	IO	Yes	Yes	(10)	2'-9"	Elect	None	10	10	MCC*2-E14	MCC*2-E13	9.4.7.3
	X-91	2-HVR-042-2-2 2-HVR-008-3-2	Cont atm Cont air	-	2HVR*DMP206	56	Ball	Admin Closed	(15)	Closed	Closed	RM	IO		Yes	(10)	2'-9"	Manual	None	-	-	None	None	9.4.7.3
Feedwater and auxiliary feedwater systems	X-76	2-FWS-016-12-2	Demin water	None	2FWS*HYV157A	(20)	Gate	Open	Closed	As is	Closed	FWI	IO	-	No	(6)	6'-8"	Hyd Press	None	-	(26)	None	MCC*2-E09	10.4.7
				None	2FWS*HYV157B	(20)	Gate	Open	Closed	As is	Closed	FWI	IO	-	No	(6)	5'-0"	Hyd Press	None	-	(26)	None	MCC*2-E09	10.4.7
	X-78	2-FWS-016-22-2	Demin water	None	2FWS*HYV157C	(20)	Gate	Open	Closed	As is	Closed	FWI	IO	-	No	(6)	5'-8"	Hyd Press	None	-	(26)	None	MCC*2-E09	10.4.7
				X-79	2-FWE-003-18-2	Demin water	None	2FWE*HCV100E	(20)	Globe (3)	Open	Open	As is	Open	None	ESF		No	(6)	40'-8"	Elect/Hyd	Hand-pump	-	N/A
							None	2FWE*HCV100F	(20)	Globe	Open	Open	As is	Open	None	ESF		No	(6)	50'-9"	Elect/Hyd	Hand-pump	-	N/A
X-80	2-FWE-003-16-2	Demin water	None	2FWE*HCV100C	(20)	Globe (3)	Open	Open	As is	Open	None	ESF		No	(6)	42'-0"	Elect/Hyd	Hand-pump	-	N/A	None	MCC*2-E13	10.4.9	
						None	2FWE*HCV100D		Globe	Open	Open	As is	Open	None	ESF		No	(6)	22'-8"	Elect/Hyd	Hand-pump	-	N/A	

TABLE 6.2-60 (Cont)

System Name	Penet No.	Line No. (1)	Fluid	Isolation Valves		General Design Criteria	Valve Type	Valve Position				Cnmt Isolation Signal (16)	Isolation/Safety Function (7)	Type C Leak Test Required		Over-pressure Protection/ Set point (psig)	Distance from Outermost Valve to Containment Wall	Valve Actuation		Valve Closure Time (sec)(24)		Safety-Related Power Source		Ref. FSAR Sect.
				Inside	Outside			Normal	Shutdown	Power Failure	DBA			Inside	Outside			Primary	Secondary	Inside	Outside	Inside	Outside	
	X-83	2-FWE-003-13-2	Demin water	None	2FWE*HCV100A 2FWE*HCV100B	(20)	Globe (3) Globe (3)	Open Open	Open Open	As is As is	Open Open	None None	ESF ESF	No No	No No	(6) (6)	27'-9" 39'-7"	Elect/hyd Elect/hyd	Hand-pump Hand-pump	- -	N/A N/A	None	MCC*2-E13 MCC*2-E14	10.4.9
Residual heat removal system	X-24	2-RHS-006-14-2	Borated water	Manual	Manual 2RHS*RV100	55	Globe Relief	Admin Closed	Closed	Closed	Closed	None	IO -	Yes -	Yes Yes	RV/455 -	3'-3" -	Manual -	None -	- -	- -	None	None	5.4.7
Quench spray system	X-63	2-QSS-010-4-2	Borated water	(Weight Loaded) Check	2QSS*MOV101A 2QSS*RV101A	(8)	Gate (5) Relief	Open -	Open -	As is -	Open -	CIB(17) None	CS -	Yes -	Yes Yes	(10) -	9'-0" -	Elect -	Manual -	- -	N/A (25) -	None	MCC*2-E11 None	6.2.2
	X-64	2-QSS-010-3-2	Borated water	(Weight Loaded) Check	2QSS*MOV101B 2QSS*RV101B	(8)	Gate (5) Relief	Open -	Open -	As is -	Open -	CIB(17) None	CS -	Yes -	Yes Yes	(10) -	10'-0" -	Elect -	Manual -	- -	N/A (25) -	None	MCC*2-E12 None	6.2.2
Recirculation spray system	X-66	2-RSS-012-5-2	Borated water	None	2RSS*MOV155A	(8)	Btfy	Open	Open	As is	Open	CIB(17)	CS	-	No	(10)	1'-6"	Elect	Manual	-	N/A (25) -	-	MCC*2-E11	6.2.2
	X-67	2-RSS-012-6-2	Borated water	None	2RSS*MOV155C	(8)	Btfy	Open	Open	As is	Open	CIB(17)	CS/ESF	-	No	(10)	1'-6"	Elect	Manual	-	N/A (25) -	-	MCC*2-E11	6.2.2
	X-68	2-RSS-012-7-2	Borated water	None	2RSS*MOV155D	(8)	Btfy	Open	Open	As is	Open	CIB(17)	CS/ESF	-	No	(10)	1'-6"	Elect	Manual	-	N/A (25) -	-	MCC*2-E12	6.2.2
	X-69	2-RSS-012-8-2	Borated water	None	2RSS*MOV155B	(8)	Btfy	Open	Open	As is	Open	CIB(17)	CS	-	No	(10)	1'-6"	Elect	Manual	-	N/A (25) -	-	MCC*2-E12	6.2.2
	X-70	2-RSS-012-3-2	Borated water	(Weight Loaded) Check	2RSS*MOV156A 2RSS*RV156A	56 -	Gate(5) Relief	Open -	Open -	As is -	Open -	CIB(17) None	CS -	No -	No No	(10) -	6'-11' -	Elect -	Manual -	- -	N/A (25) -	None	MCC*2-E11 None	6.2.2
	X-71	2-RSS-012-4-2	Borated water	(Weight Loaded) Check	2RSS*MOV156C 2RSS*RV156C	56 -	Gate(5) Relief	Open -	Open -	As is -	Open -	CIB(17) None	CS -	No -	No No	(10) -	7'-6' -	Elect -	Manual -	- -	<60 -	None	MCC*2-E11 None	6.2.2
	X-114	2-RSS-012-11-2	Borated water	(Weight Loaded) Check	2RSS*MOV156D 2RSS*RV156D	56 -	Gate(5) Relief	Open -	Open -	As is -	Open -	CIB(17) None	CS -	No -	No No	(10) -	7'-5' -	Elect -	Manual -	- -	<60 -	None	MCC*2-E12 None	6.2.2
	X-115	2-RSS-012-12-2	Borated water	(Weight Loaded) Check	2RSS*MOV156B 2RSS*RV156B	56 -	Gate(5) Relief	Open -	Open -	As is -	Open -	CIB(17) None	CS -	No -	No No	(10) -	7'-5' -	Elect -	Manual -	- -	N/A (25) -	None	MCC*2-E12 None	6.2.2
Air supply systems	X-11	2-IAC-004-31-2	Cont air	inst	2IAC*MOV133 2IAC*MOV134	56	Ball	Open	Open	As is	Closed	CIA	IO	Yes	Yes	(10)	25'-6"	Elect	Manual	<60	<60	MCC*2-E13	MCC*2-E14	9.3.1
	X-59	2-IAC-003-49-2	Cont air	inst	(Weight Loaded) Check 2IAC*MOV130	56	Ball	Open	Open	As is	Closed	CIA	IO	Yes	Yes	(10)	15'-3"	Elect	Manual	-	<60	None	MCC*2-E13	9.3.1

TABLE 6.2-60 (Cont)

System Name	Penet No.	Line No. (1)	Fluid	Isolation Valves		General Design Criteria	Valve Type	Valve Position				Cnmt Isolation Signal (16)	Isolation/Safety Function (7)	Type C Leak Test Required		Overpressure Protection/ Set point (psig)	Distance from Outermost Valve to Containment Wall	Valve Actuation		Valve Closure Time (sec) (24)		Safety-Related Power Source		Ref. FSAR Sect.	
				Inside	Outside			Normal	Shutdown	Power Failure	DBA			Inside	Outside			Primary	Secondary	Inside	Outside	Inside	Outside		
	X-42	2-SAS-002-66-2	Service air	Manual	Manual	56	Globe	Admin Closed	Closed	Closed	Closed	None	IO	Yes	Yes	(10)	4'-9"	Manual	None	-	-	None	None	9.3.1	
Service system	water	X-21	2-SWS-008-291-2	Service water	2SWS*MOV155-2	2SWS*MOV155-1 2SWS*RV155	57	Btffy Relief	Open	Open	As is	Closed	CIB None	IO	Yes	Yes Yes	RV/150	9'-4"	Elect	Manual	<60	<60	MCC*2-E06	MCC*2-E05 None	9.2.1
		X-25	2-SWS-008-290-2	Service water	2SWS*MOV154-2	2SWS*MOV154-1 2SWS*RV154	57	Btffy Relief	Admin Closed	Closed	As is	Closed	CIB (27) None	IO	Yes	Yes Yes	RV/150	9'-4"	Manual	None	N/A	N/A	None	None	9.2.1
		X-14	2-SWS-008-285-2	Service water	2SWS*MOV153-2	2SWS*MOV153-1 2SWS*RV153	57	Btffy Relief	Admin Closed	Closed	As is	Closed	CIB (27) None	IO	Yes	Yes Yes	RV/150	9'-4"	Manual	None	N/A	N/A	None	None	9.2.1
		X-27	2SWS-008-284-2	Service water	2SWS*MOV152-2	2SWS*MOV152-1 2SWS*RV152	57	Btffy Relief	Open	Open	As is	Closed	CIB None	IO	Yes	Yes Yes	RV/150	9'-4"	Elect	Manual	<60	<60	MCC*2-E06	MCC*2-E05 None	9.2.1
Safety system	injection	X-61	2-SIS-010-9-2	Borated water	(Weight Check	Loaded) 2SIS*MOV8889	(8)	Gate	Closed	Closed	As is	Open	None	ESF	No	No	Inherent	5'-6"	Elect	Manual	-	N/A	None	MCC*2-E12	6.3
		X-7	2-SIS-003-101-2	Borated water	(Weight Check	Loaded) 2SIS*MOV869A	(8)	Gate	Closed	Closed	As is	Open	None	ESF	No	No	Inherent	26'-8"	Elect	Manual	-	N/A	None	MCC*2-E05	6.3
		X-17	2-SIS-003-88-2	Borated water	(Weight Check	Loaded) 2SIS*MOV869B	(8)	Gate	Closed	Closed	As is	Open	None	ESF	No	No	Inherent	35'-0"	Elect	Manual	-	N/A	None	MCC*2-E06	6.3
		X-60	2-SIS-010-11-2	Borated water	(Weight Check	Loaded) 2SIS*MOV8888B	(8)	Gate	Open	Open	As is	Open	None	ESF	No	No	Inherent	13'-0"	Elect	Manual	-	N/A	None	MCC*2-E12	6.3
		X-62	2-SIS-010-10-2	Borated water	(Weight Check	Loaded) 2SIS*MOV8888A	(8)	Gate	Open	Open	As is	Open	None	ESF	No	No	Inherent	6'-0"	Elect	Manual	-	N/A	None	MCC*2-E11	6.3
		X-34	2-SIS-003-102-2	Borated water	(Weight Check	Loaded) 2SIS*MOV836	(8)	Gate	Closed	Closed	As is	Open	None	ESF	No	No	Inherent	21'-4"	Elect	Manual	-	N/A	None	MCC*2-E05	6.3
			2-SIS-001-393-2	Borated water		2SIS*MOV840			Closed	Open	Closed	Closed	None	-	-	No	Inherent	31'-4"	Elect	None	-	N/A	-	PNL*AC2-E1	
		X-113	2-SIS-003-96-2	Borated water	(Weight Check	Loaded) 2SIS*MOV867C	(8)	Gate	Closed	Closed	As is	Open	SIS(17)	ESF	No	No	Inherent	9'-4"	Elect	Manual	-	10	None	MCC*2-E05	6.3
						2SIS*MOV867D		Gate	Closed	Closed	As is	Open	SIS(17)	-	-	No	Inherent	13'-8"	Elect	Manual	-	10	-	MCC*2-E06	
		X-20	2-SIS-001-32-2	Borated water	(Weight Check	Loaded) Manual 2SIS*RV130	55	Globe	Admin Closed	Closed	Closed	Closed	None	IO	Yes	Yes	RV/700	6'-8"	Manual	None	-	-	None	None	6.3
									-	-	-	-	None	-	-	Yes	-	-	-	-	-	-	None		
		X-106	2-SIS-750-53-2	Borated water	2SIS*MOV842	2SIS*AOV889 2SIS*RV175	55	Globe Relief	Closed/ Closed	Open/ Closed	As is/ Closed	Closed/ Closed	CIA	IO	Yes	Yes Yes	RV/700	9'-0"	Elect/ Air	Manual/ None	<60	60	MCC*E-06	BATT*2-1	6.3

TABLE 6.2-60 (Cont)

System Name	Penet No.	Line No. (1)	Fluid	Isolation Valves		General Design Criteria	Valve Type	Valve Position				Cnmt Isolation Signal (16)	Isolation/Safety Function (7)	Type C Leak Test Required		Overpressure Protection/ Set point (psig)	Distance from Outermost Valve to Containment Wall	Valve Actuation		Valve Closure Time (sec) (24)		Safety-Related Power Source		Ref. FSAR Sect.
				Inside	Outside			Normal	Shutdown	Power Failure	DBA			Inside	Outside			Primary	Secondary	Inside	Outside	Inside	Outside	
				(Weight Loaded)	(Weight Loaded)																			
Fire protection water system	X-99	2-FPW-006-10-2	Dry or water & air	(Weight Check)	Loaded) 2FPW*AOV206	56	Globe	Closed	Open	Closed	Closed	CIA	IO	Yes	Yes	(10)	20'-0"	Air	None	None	<60	None	PNL*DC2-07	9.5.1
	X-101	2-FPW-004-13-2	Dry	(Weight Check)	Loaded) 2FPW*AOV205	56	Globe	Closed	Open	Closed	Closed	CIA	IO	Yes	Yes	(10)	9'-3"	Air	None	None	<60	None	PNL*DC2-07	9.5.1
Sample system	X-55a	2-SSR-375-62-2	Nitrogen Borated water	2SSR*SOV130A1	2SSR*SOV130A2	55	Globe	Open	Open	Closed	Closed	CIA	S/M	Yes	Yes	(10)	13'-8"	Elect	None	<60	<60	BATT*2-1	BATT*2-2	9.3.2
	X-55d	2-SSR-375-17-2		2SSR*AOV109A1	2SSR*AOV109A2	55	Globe Relief	Open	Open	Closed	Closed	CIA	IO	Yes	Yes	-	12'-8"	Air	None	<60	<60	BATT*2-1	BATT*2-2	-
	X-56c	2-SSR-375-225-2	Borated water	2SSR*AOV102A1	2SSR*AOV102A2	55	Globe Relief	Closed	Closed	Closed	Closed	CIA	IO	Yes	Yes	RV/700	8'-4"	Air	None	<60	<60	BATT*2-1	BATT*2-2	9.3.2
	X-56b	2-SSR-375-224-2	Borated water	2SSR*AOV102A1	2SSR*AOV102A2	55	Globe Relief	Closed	Closed	Closed	Closed	CIA	S/M	Yes	Yes	RV/2485	15'-8"	Elect	None	<60	<60	BATT*2-1	BATT*2-2	9.3.2
	X-56d	2-SSR-375-221-2	Borated water	2SSR*AOV100A1	2SSR*AOV100A2	55	Globe Relief	Closed	Closed	Closed	Closed	CIA	IO	Yes	Yes	RV/2485	12'-0"	Air	None	<60	<60	BATT*2-1	BATT*2-2	9.3.2
	X-56a	2-SSR-750-65-2	Demin water	None	2SSR*AOV117A	(8)	Globe	Open	Open	Closed	Closed	None	IO	-	No	(10)	9'-4"	Air	None	-	<60	None	BATT*2-1	9.3.2
	X-57d	2-SSR-750-76-2	Demin water	None	2SSR*AOV117B	(8)	Globe	Open	Open	Closed	Closed	None	IO	-	No	(10)	15'-8"	Air	None	-	<60	None	BATT*2-1	9.3.2
	X-57a	2-SSR-375-54-2	Steam	2SSR*AOV112A1	2SSR*AOV112A2	55	Globe Relief	Closed	Closed	Closed	Closed	CIA	IO	Yes	Yes	RV/2485	6'-8"	Air	None	<60	<60	BATT*2-1	BATT*2-2	None
	X-97d	2-SSR-750-71-2	Demin water	None	2SSR*AOV117C	(8)	Globe	Open	Open	Closed	Closed	None	IO	-	No	(10)	6'-8"	Air	None	-	<60	None	BATT*2-1	9.3.2
	X-97c	2-SSR-375-64-2	Borated water	2SSR*SOV129A1	2SSR*SOV129A2	55	Globe Relief	Closed	Closed	Closed	Closed	CIA	S/M	Yes	Yes	RV/600	6'-8"	Elect	None	<60	<60	BATT*2-1	BATT*2-2	None
Post Accident Sampling	X-105a	2-PAS-375-46-2	Cont atm	2PAS*SOV105A1	2PAS*SOV105A2	56	Globe	Closed	Closed	Closed	Closed	CIA	S/M	Yes	Yes	(10)	(Later)	Elect	None	<60	<60	PNL*DC2-03	PNL*DC2-10	
Personnel air lock	None	None	Air	2PHS*112	2PHS*110	56	Ball	Admin closed	Closed	Closed	Closed	None	IO	(8)	(8)	(10)	10'-0"	Manual	None	-	-	-	-	3.8.1
				2PHS*113	2PHS*111	56	Ball	Admin closed	Closed	Closed	Closed	None	IO	(8)	(8)	(10)	10'-0"	Manual	None	-	-	-	-	
				2PHS*101	2PHS*100	56	Ball	Admin closed	Closed	Closed	Closed	None	IO	(8)	(8)	(10)	10'-0"	Manual	None	-	-	None	None	
Emergency air lock	None	None	Air	2PHS*202	2PHS*201	56	Ball	Admin closed	Closed	Closed	Closed	None	IO	(8)	(8)	(10)	3'-0"	Manual	None	-	-	None	None	3.8.1
Fuel transfer tube	X-65	None	Air	Bld. Flange	Manual	56	Gate	Admin closed	Closed	Closed	Closed	None	IO	(8)	(23)	(10)	-	Manual	None	-	-	None	None	

TABLE 6.2-60 (Cont)

NOTES

1. The middle set of digits represents the line size. For example, for 2-CHS-002-2-2, 002 indicates a 2-inch line. All line sizes are represented by 3 digits, as indicated below:

<u>Pipe Size, In.</u>	<u>Pipe Size Per Line Designation</u>
1/4	250
3/8	375
1/2	500
3/4	750
1	001
1 1/4	125
1 1/2	150
1 3/4	175
2	002
2 1/2	025
3	003
4	004
6	006
8	008
10	010
12	012
14	014
16	016
18	018
20	020
22	022
24	024
26	026
28	028
30	030
32	032
34	034
36	036
38	038
42	042
108	108

2. Power is available from either BATT\*2-1 or BATT\*2-2.
3. Valve is a "Globe" type.
4. Valves close automatically from control signals which indicate that the motor-driven auxiliary feedwater pumps have started, or that steam supplies have been initiated to the turbine-driven auxiliary feedwater pump, that steam generator sample radiation is high, or that blowdown tank level is high-high. Valves do not receive a CIA or CIB signal.
5. Relief valve is actually part of the isolation valve.
6. The ASME III, Class 2 lines in the main steam, steam generator blowdown, feedwater, and auxiliary feedwater systems have overpressure protection from the main steam safety valves. These valves range from a low set point of 1,075 psig to a high point of 1,125 psig.

TABLE 6.2-60 (Cont)

NOTES (Cont)

7. Isolation/Safety Function - The listed function defines the isolation requirement or need for operability of the penetration after the containment isolation signal is generated. The systems identified as ESF, CS, and HC are considered essential systems.
- IO - Isolation only
  - ESF - Engineered safety features operations to mitigate consequences of accident
  - CS - Containment depressurization
  - HC - Post-accident H<sub>2</sub> control
  - S/M - Post-accident sampling/monitoring.
8. Section 6.2.4.2 discusses the exceptions to the General Design Criteria.
9. Valves remain open following an accident to ensure seal water supply to the reactor coolant pump and will be manually closed by the operator from the control room for long-term containment isolation.
10. Overpressure protection is provided by means other than noted, such as conservative pipe and valve design, post-DBA operating system, no fluid in lines, open to containment, credit for insulation, etc.
11. Valve is a "Y" pattern disc type.
12. Valve must be opened/reopened in the long term to fulfill its safety function.
13. Component cooling water composition - demineralized water and corrosion inhibitor.
14. Steam, noncondensibles, and water vapor.
15. Valve is opened only during cold shutdown or refueling.
16. Containment Isolation Signals:
- CIA - Containment Isolation Phase A
  - CIB - Containment Isolation Phase B
  - SIS - Safety Injection Signal
  - SLI - Steam Line Isolation Signal
  - FWI - Feedwater Isolation Signal
  - RM - Containment High Radiation Signal
17. Containment Isolation Signal opens the isolation valve to ensure availability for accident condition use.
18. Containment Isolation Phase B (CIB) Signal closes and extreme low-low RWST signal coincident with CIB opens valves.
19. Associated instrumentation for 2CHS\*FCV160 and 2CHS\*HCV142 is not seismically or environmentally qualified and does not receive Class 1E power. Containment isolation automatic signal is not required since valves are administratively closed during normal operation.

TABLE 6.2-60 (Cont)

NOTES (Cont)

20. Main steam, steam generator blowdown, feedwater penetrations.

All isolation valves on these lines, including sampling lines for the steam generator blowdown (SGB) system, are located outside containment since these systems are considered closed inside containment and are designed to Safety Class 2, QA Category I, Seismic Category I inside containment. The isolation arrangements comply with GDC 57. The outside isolation valves of the main steam, feedwater, and SGB systems receive a closure signal from either main steam isolation, feedwater isolation or initiation of the auxiliary feedwater system, respectively. Branch lines connecting to the main steam or feedwater piping between the MSIVs and the containment wall include the atmospheric steam dump lines and the steam lines to the turbine-driven auxiliary feedwater pump. The steam supply lines to the turbine driven auxiliary feedwater pump contain two valves in series, the nearest to containment is designated the containment isolation valve; however, the redundant valve is equivalent and may be used in place of the designated containment isolation valve. All of these lines have at least one remotely-operated valve which can be manually closed by the operator. However, the steam lines to the turbine-driven auxiliary feedwater pump are used for safe-shutdown operation and therefore receive an auxiliary feedwater initiation signal to open. The branch lines to the main steam discharge radiation monitor (2MSS\*RQ1101) are not isolated, but instead, the isolation valve (2MSS\*SOV120) receives a signal to open on safety injection.

21. Hydraulic isolation device.

22. Deaerated and deionized water.

23. This valve is not required to be type C leak tested due to the double barrier seal arrangement on the fuel transfer tube inside containment isolation flange.

24. The closure times shown are based on maximum limits set by offsite dose calculations. Many valves have faster closure times. These faster closure times, as established by preoperational or post-maintenance testing, will be used as the basis for ASME OM Code closure time testing.

25. No stroke time will be applicable to this valve. This valve is open during normal and shutdown conditions, Fails as-is, and receives a CIA or CIB signal to open.

26. Feedwater isolation for these penetrations is 7 seconds, composed of signal processing and valve stroke time.

27. No credit is taken for the CIB actuation. The valve is locked shut in Modes 1, 2, 3 & 4.

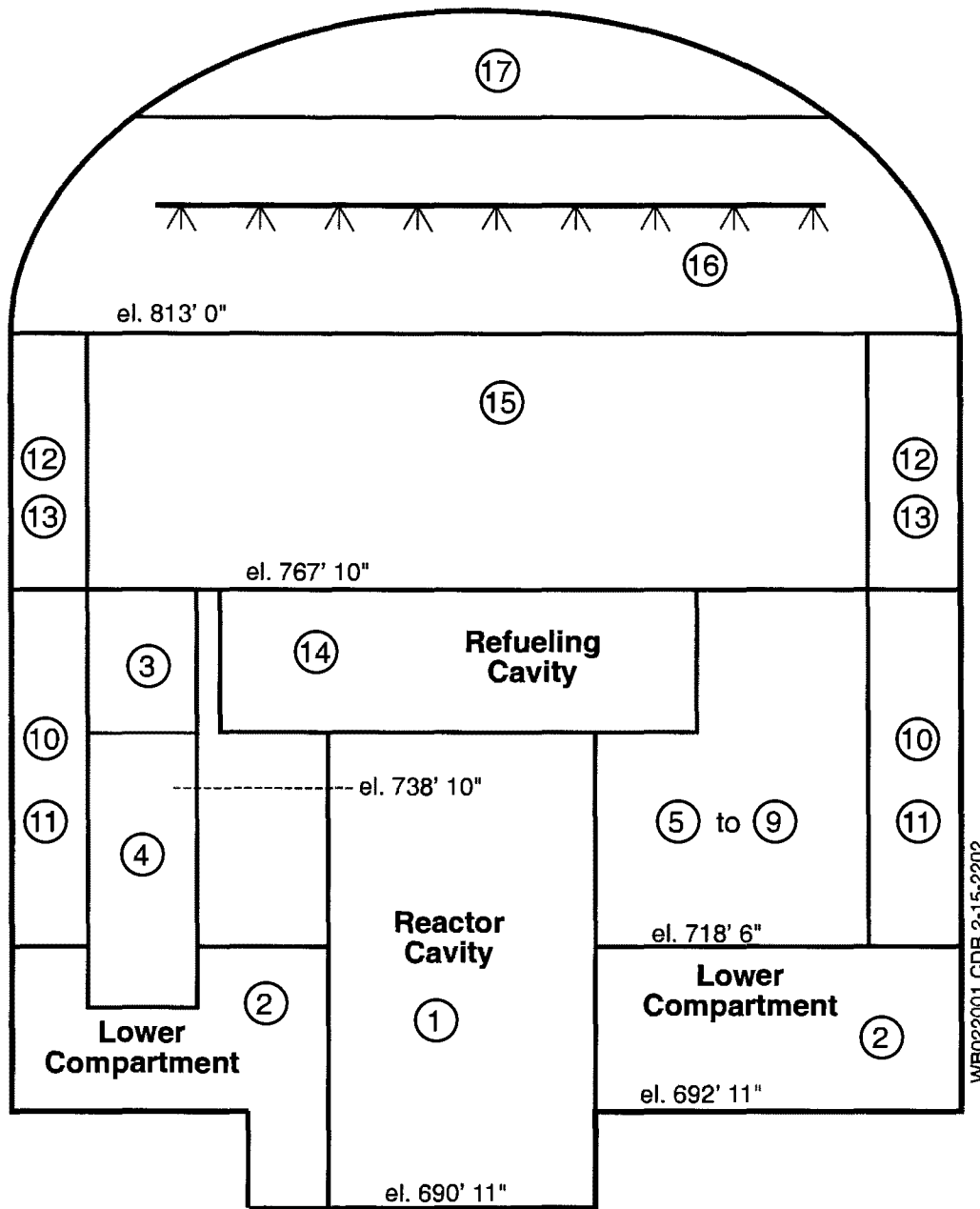
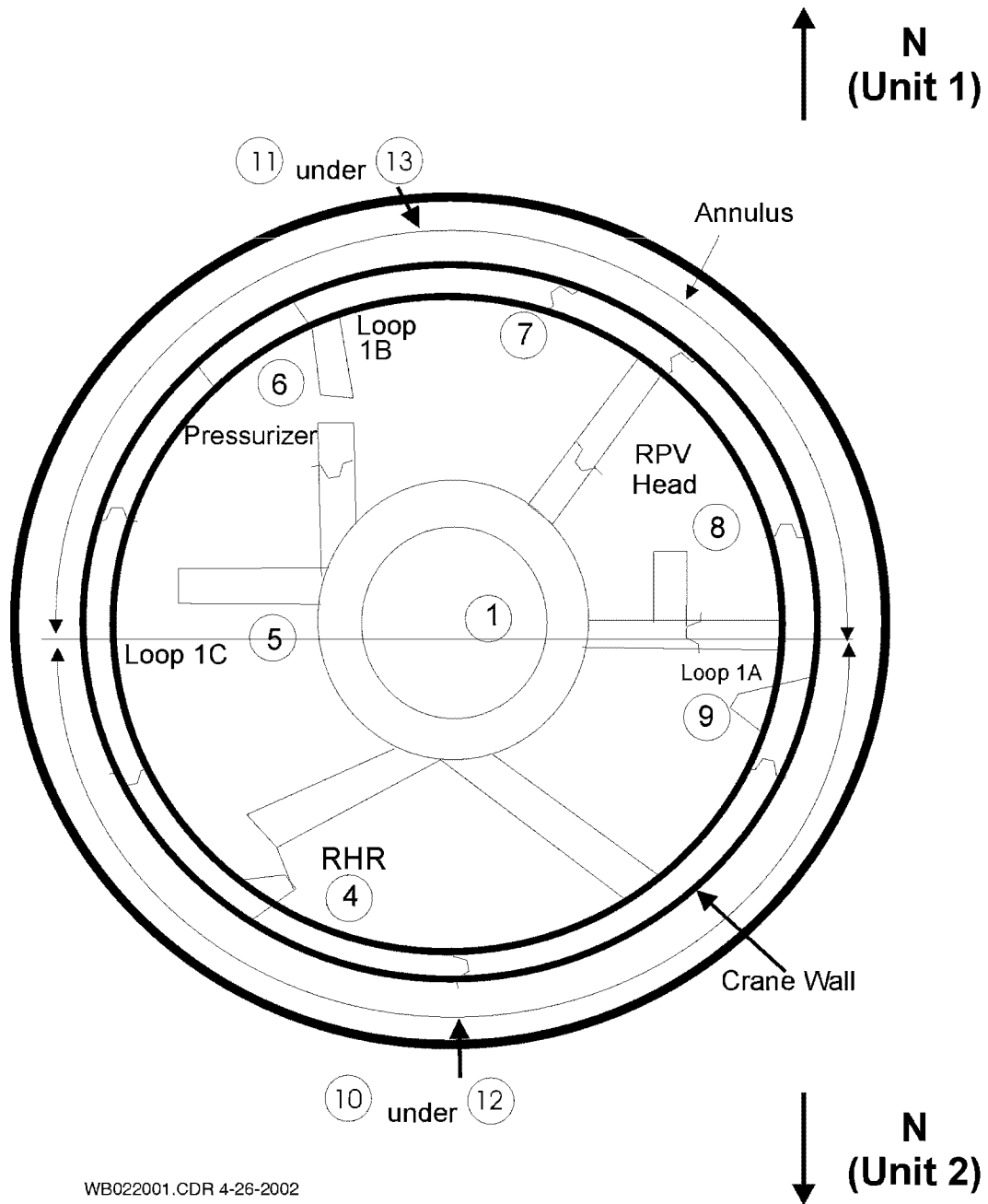

Figure 6.2-1  
MAAP-DBA Containment  
Nodalization  
Beaver Valley Power Station Unit No. 2  
Updated Final Safety Analysis Report





WB022001.CDR 4-26-2002

**Figure 6.2-2**  
**MAAP-DBA Containment**  
**Nodalization (Plan View)**  
**Beaver Valley Power Station Unit No. 2**  
**Updated Final Safety Analysis Report**

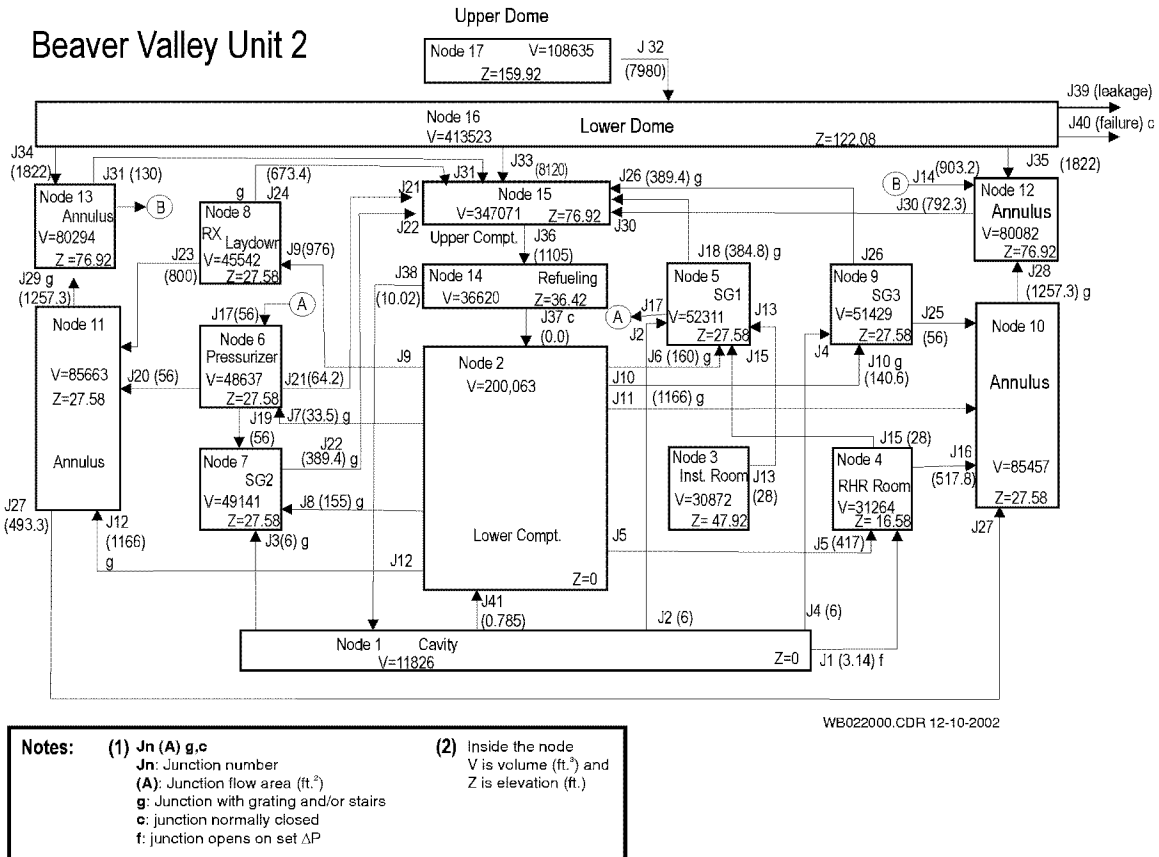

**Figure 6.2-3**

**MAAP5 Node and Junction Arrangement**

**Beaver Valley Power Station Unit No. 2  
Updated Final Safety Analysis Report**

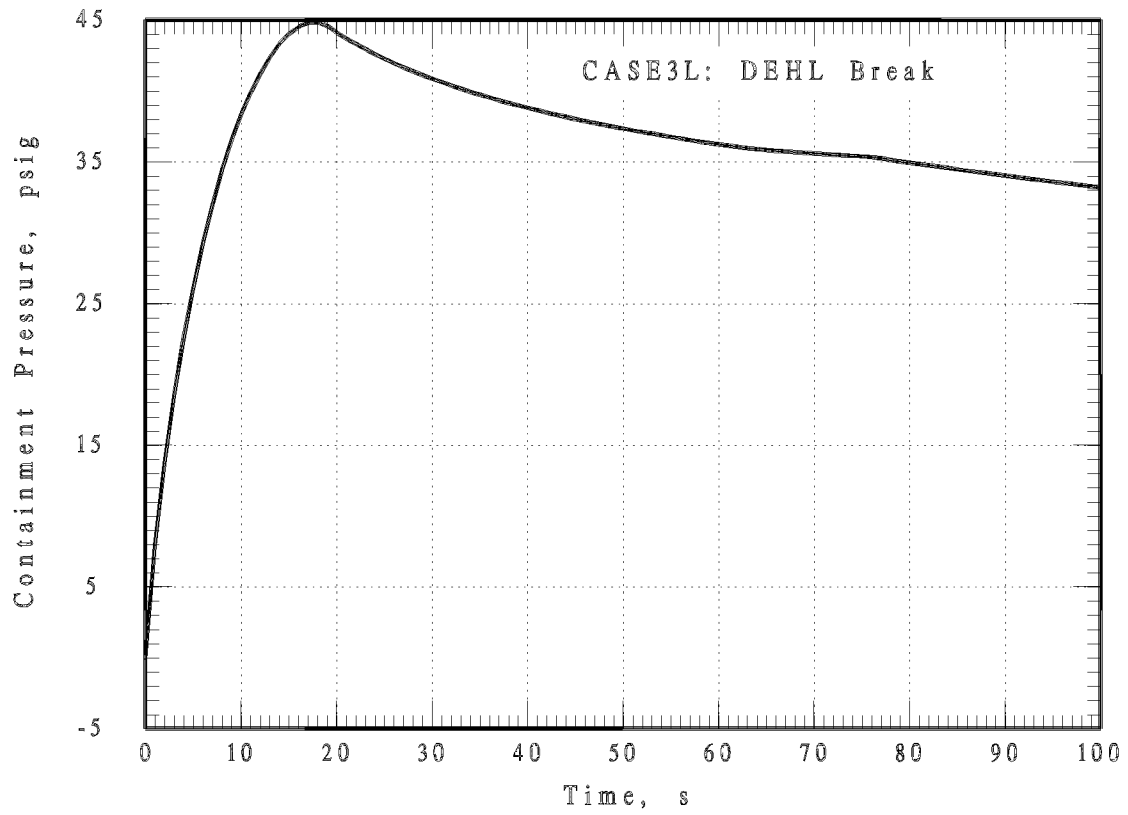

**Figure 6.2-5**

**Containment Pressure Time-History  
for the DEHL Break Case**

**Beaver Valley Power Station Unit No. 2  
Updated Final Safety Analysis Report**

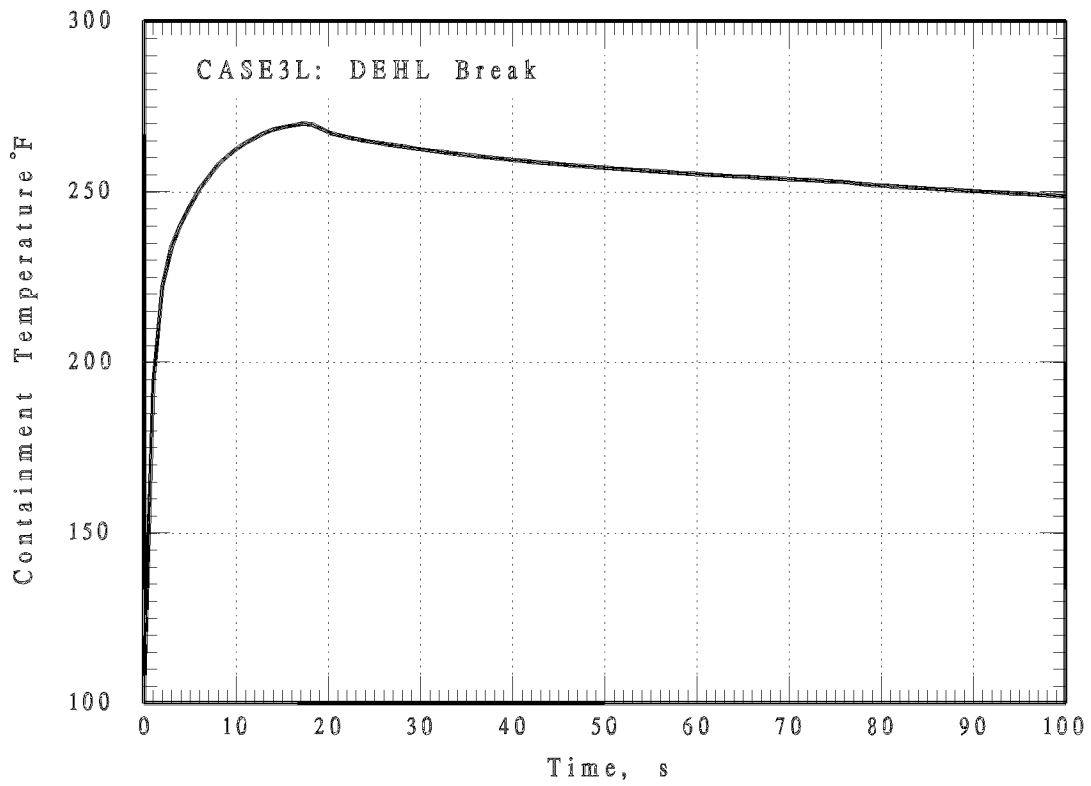

**Figure 6.2-6**

**Containment Temperature Time-History for the DEHL Break Case**

**Beaver Valley Power Station Unit No. 2  
Updated Final Safety Analysis Report**

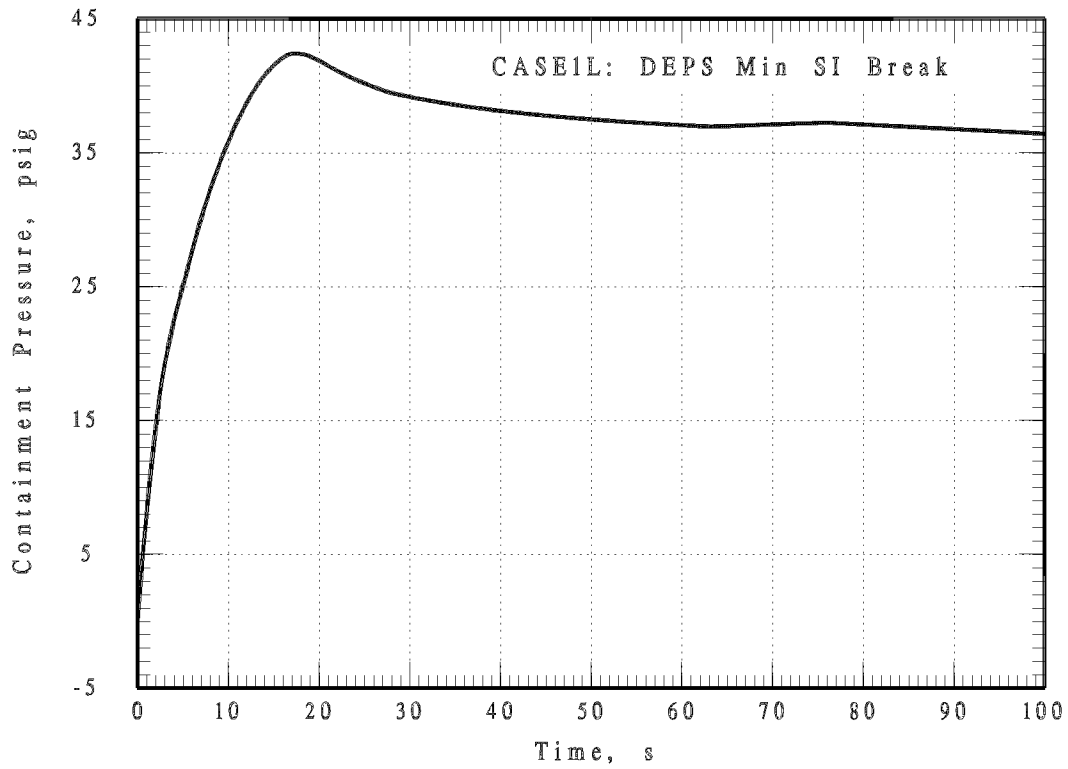

**Figure 6.2-7**

**Containment Pressure Time-History  
for the DEPS Min Si Break Case**

**Beaver Valley Power Station Unit No. 2  
Updated Final Safety Analysis Report**

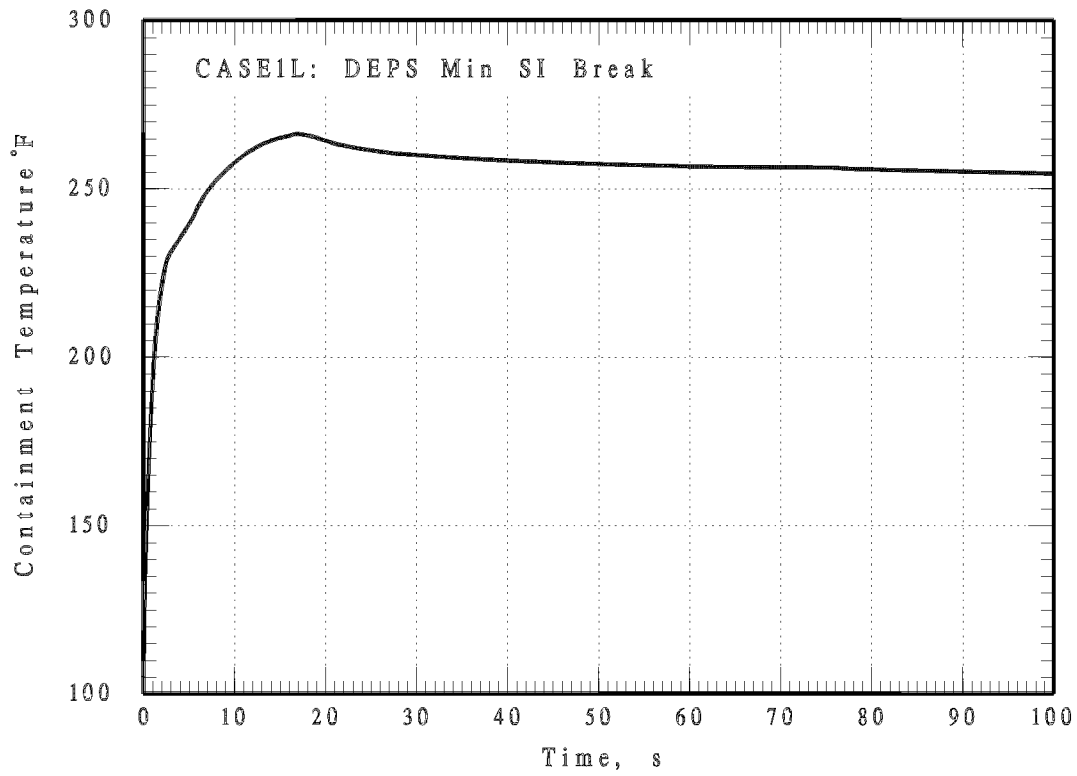

**Figure 6.2-8**

**Containment Temperature Time-History for the DEPS Min Si Break Case**

**Beaver Valley Power Station Unit No. 2  
Updated Final Safety Analysis Report**

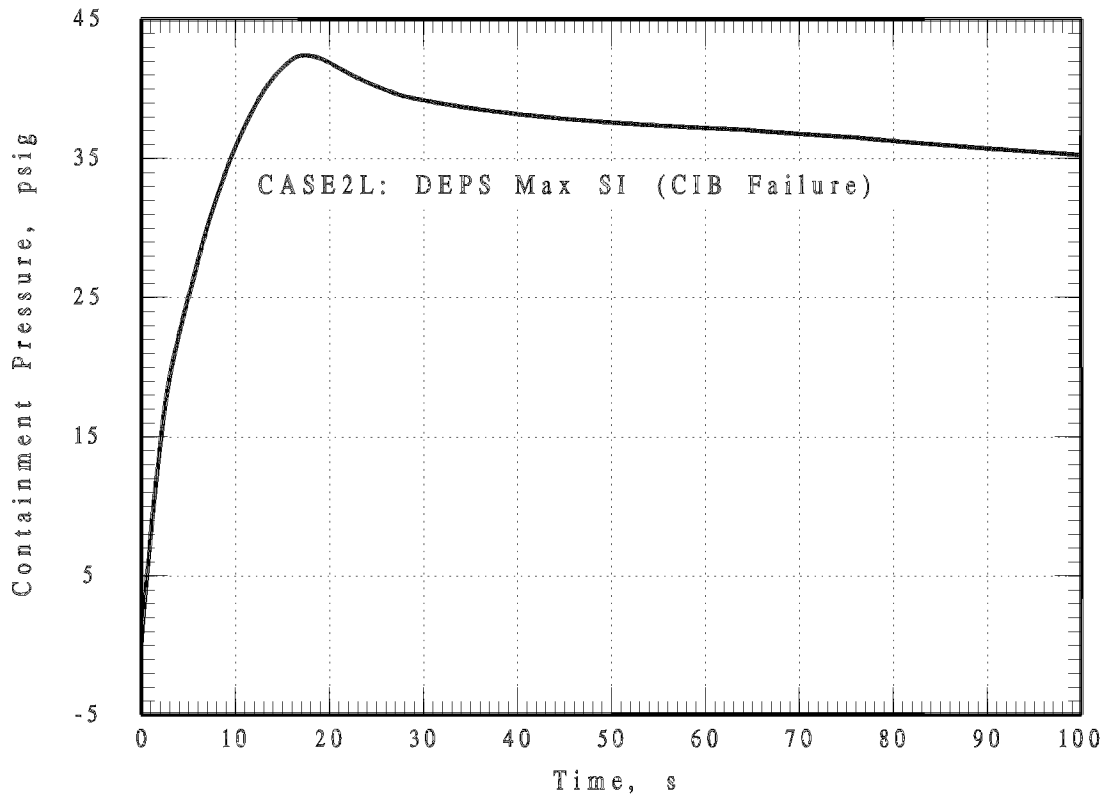

**Figure 6.2-9**

**Containment Pressure Time-History  
for the DEPS Max Si (CIB Failure)  
Break Case**

**Beaver Valley Power Station Unit No. 2  
Updated Final Safety Analysis Report**

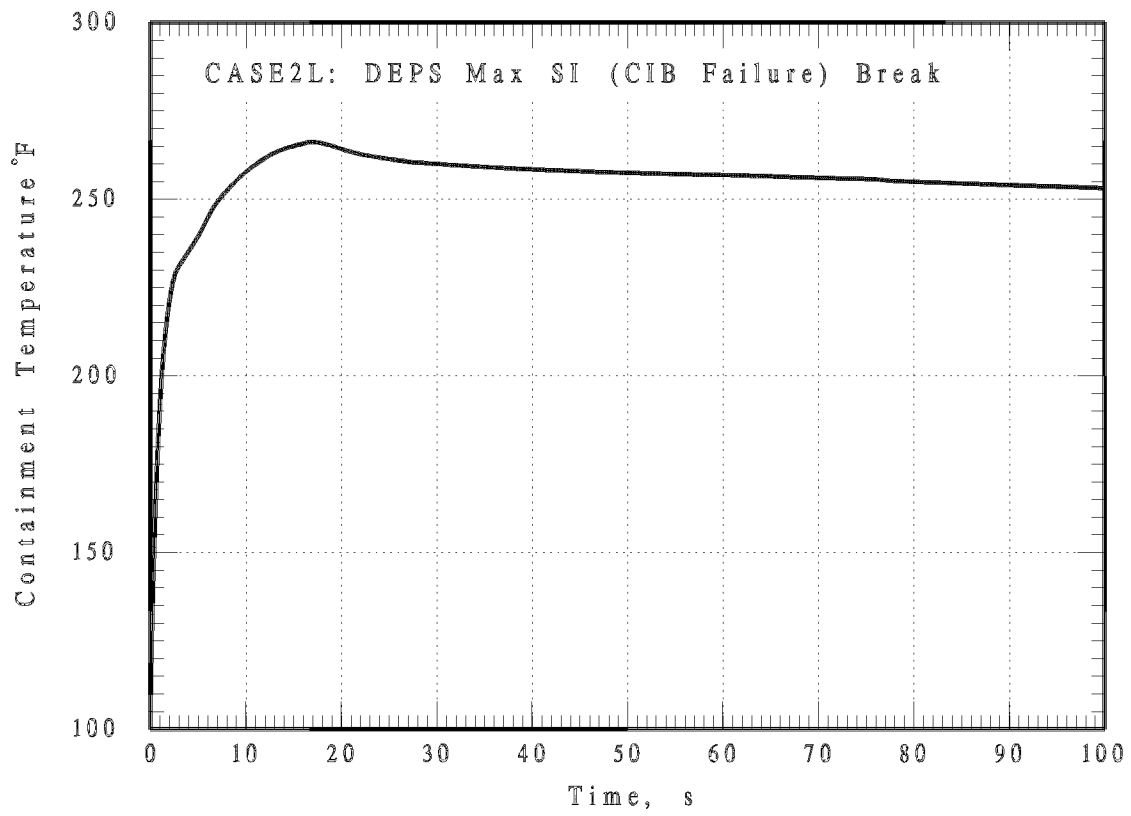
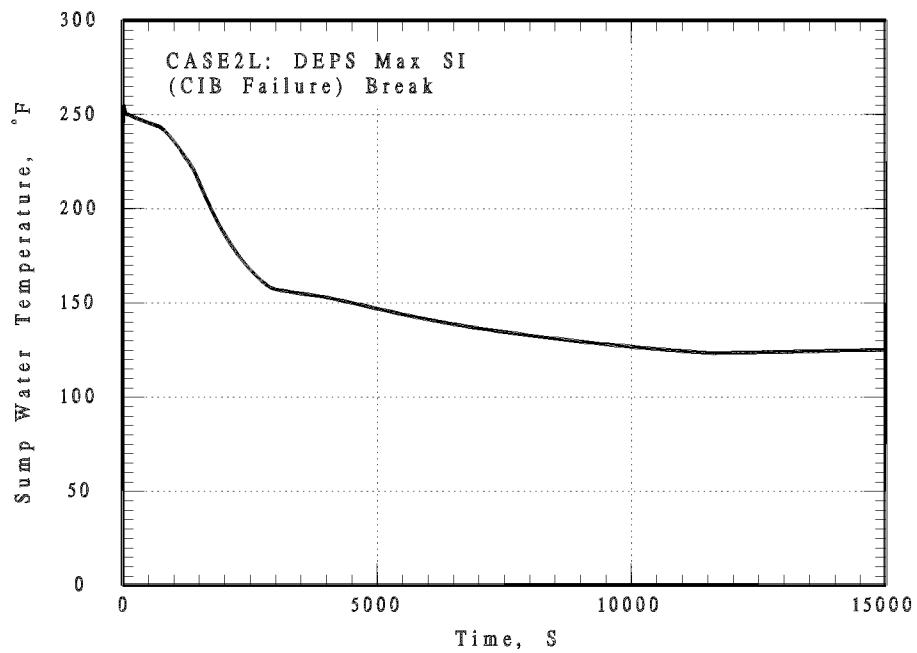
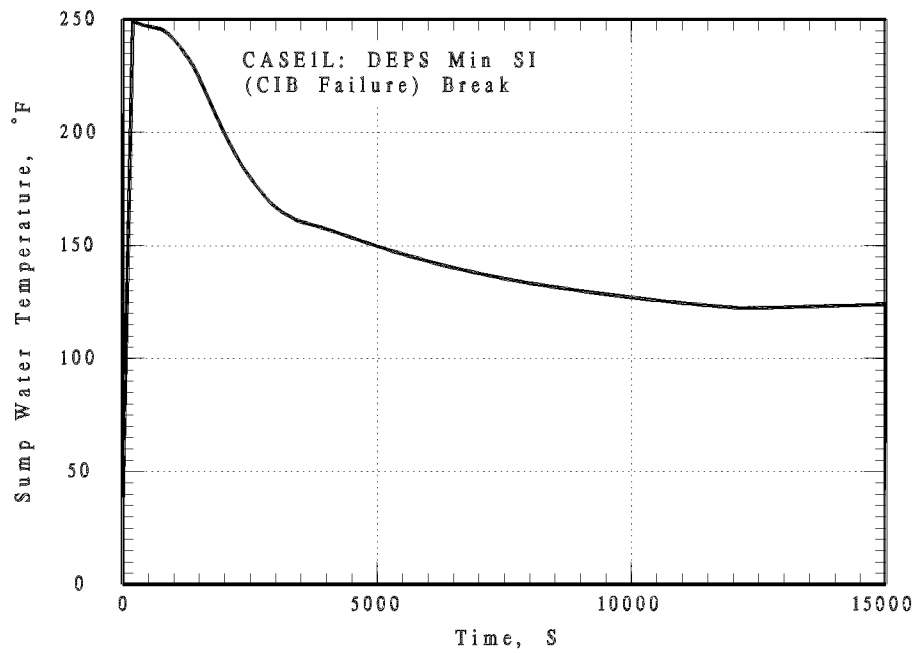

**Figure 6.2-10**

**Containment Temperature Time-History for the DEPS Max Si (CIB Failure) Break Case**

**Beaver Valley Power Station Unit No. 2  
Updated Final Safety Analysis Report**





**Figure 6.2-11**

**Containment Sump Temperature  
Time-Histories for the DEPS Min Si  
and DEPS Max Si (CIB Failure) Break  
Case**

**Beaver Valley Power Station Unit No. 2  
Updated Final Safety Analysis Report**

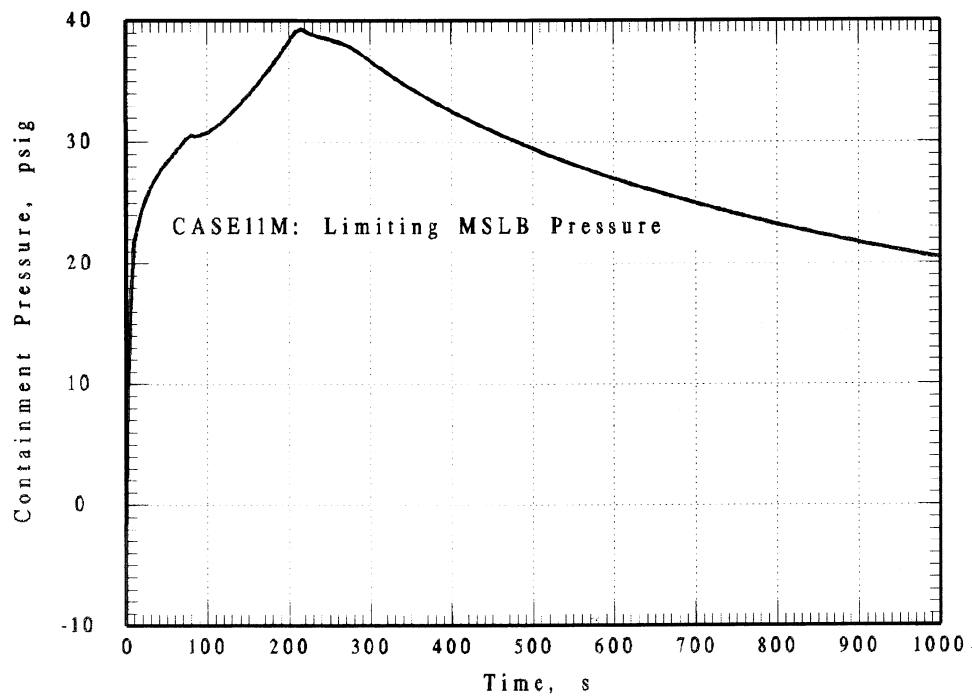
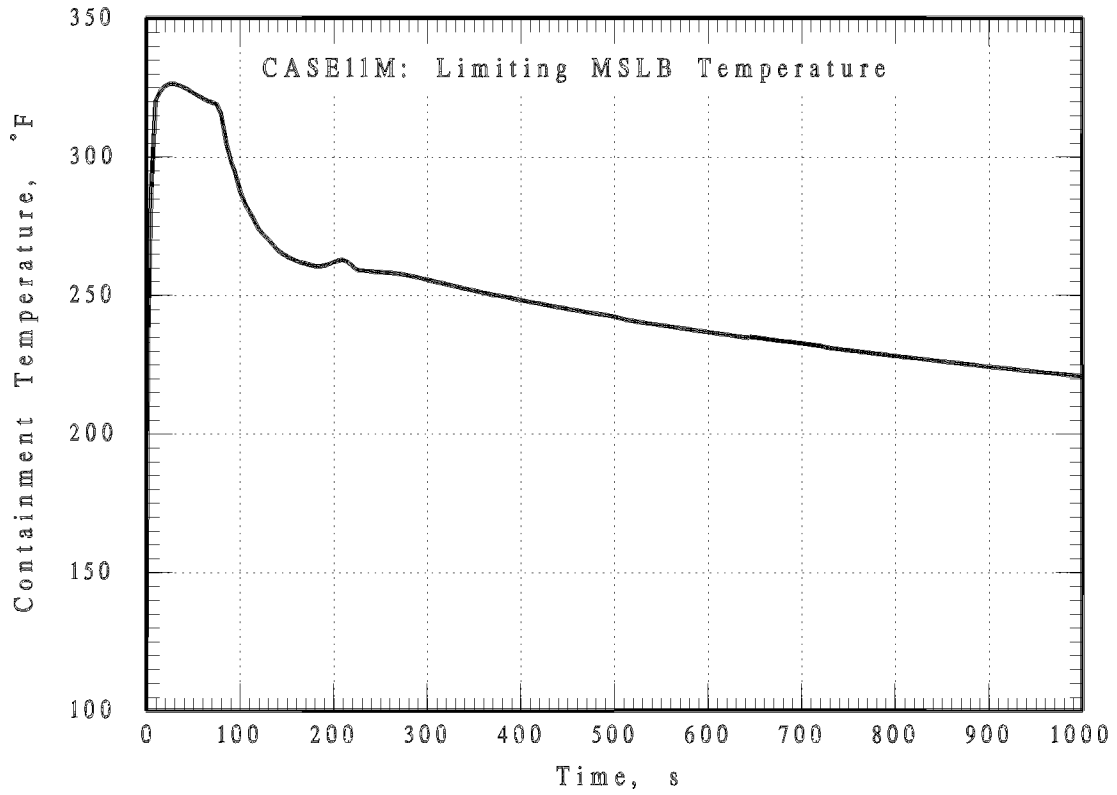

FIGURE 6.2-12

CONTAINMENT PRESSURE  
TIME-HISTORY FOR THE LIMITING MSLB  
PRESSURE CASE

BEAVER VALLEY POWER STATION UNIT No. 2  
UPDATED FINAL SAFETY ANALYSIS REPORT



**Figure 6.2-13**

**Containment Temperature Time-History for the Limiting MSLB Pressure Case**

**Beaver Valley Power Station Unit No. 2  
Updated Final Safety Analysis Report**

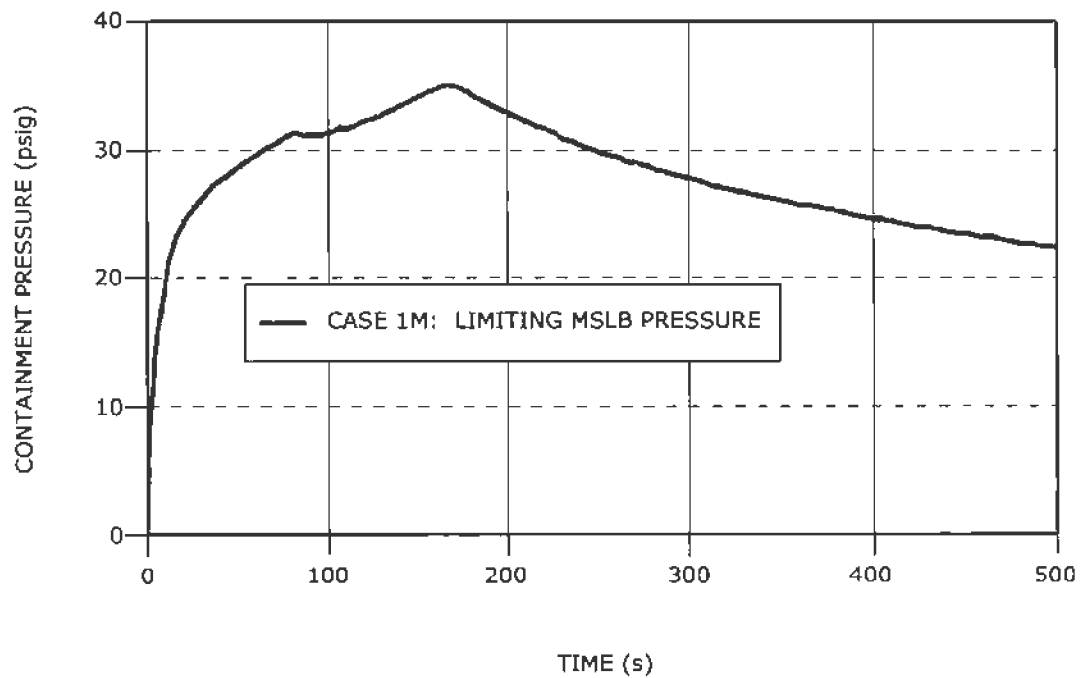

FIGURE 6.2-14

CONTAINMENT PRESSURE TIME -  
HISTORY FOR THE LIMITING MSLB  
TEMPERATURE CASE

BEAVER VALLEY POWER STATION UNIT No. 2  
UPDATED FINAL SAFETY ANALYSIS REPORT

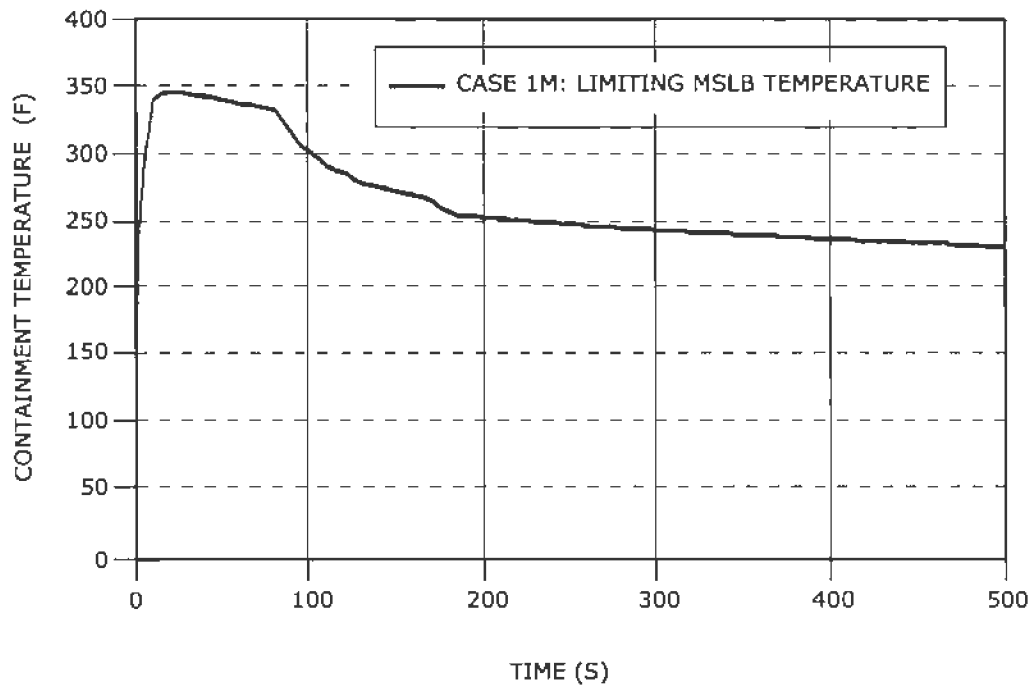
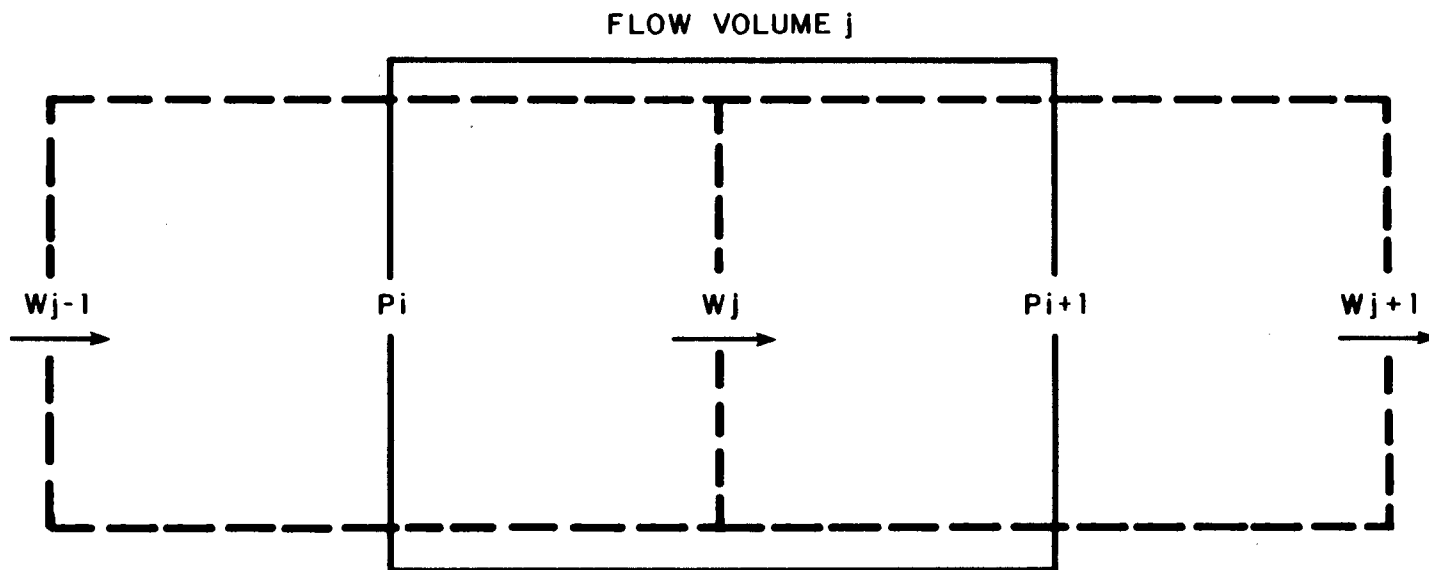

FIGURE 6.2-15

CONTAINMENT TEMPERATURE TIME -  
HISTORY FOR THE LIMITING MSLB  
TEMPERATURE CASE

BEAVER VALLEY POWER STATION UNIT No. 2  
UPDATED FINAL SAFETY ANALYSIS REPORT



**NOTES:**

DASHED LINES INDICATE NODE BOUNDARIES  
OR MASS AND ENERGY CONTROL VOLUMES

SOLID LINES INDICATE INTERNAL JUNCTION  
OR MOMENTUM CONTROL VOLUMES

FIGURE 6.2-18  
STAGGERED MESH CONTROL VOLUME  
APPROXIMATION FOR THREE-D  
BEAVER VALLEY POWER STATION-UNIT 2  
FINAL SAFETY ANALYSIS REPORT

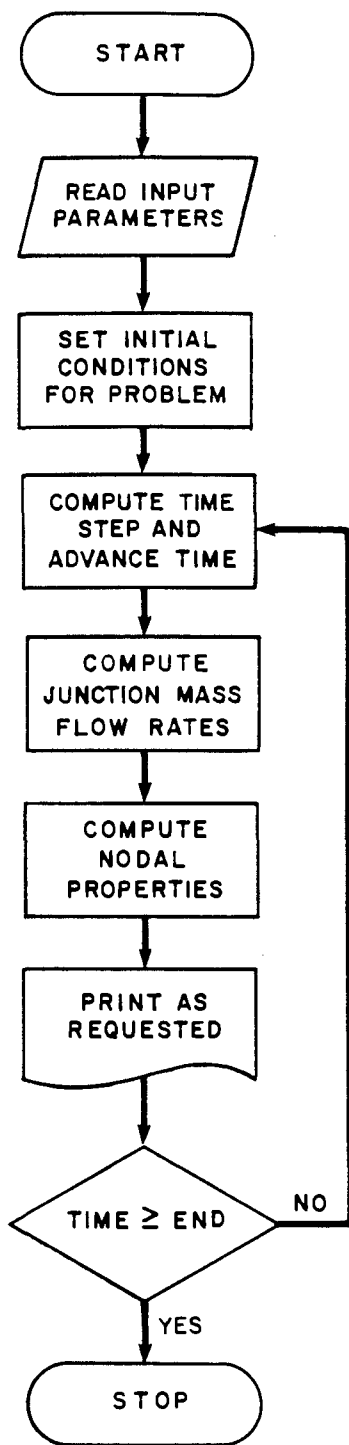
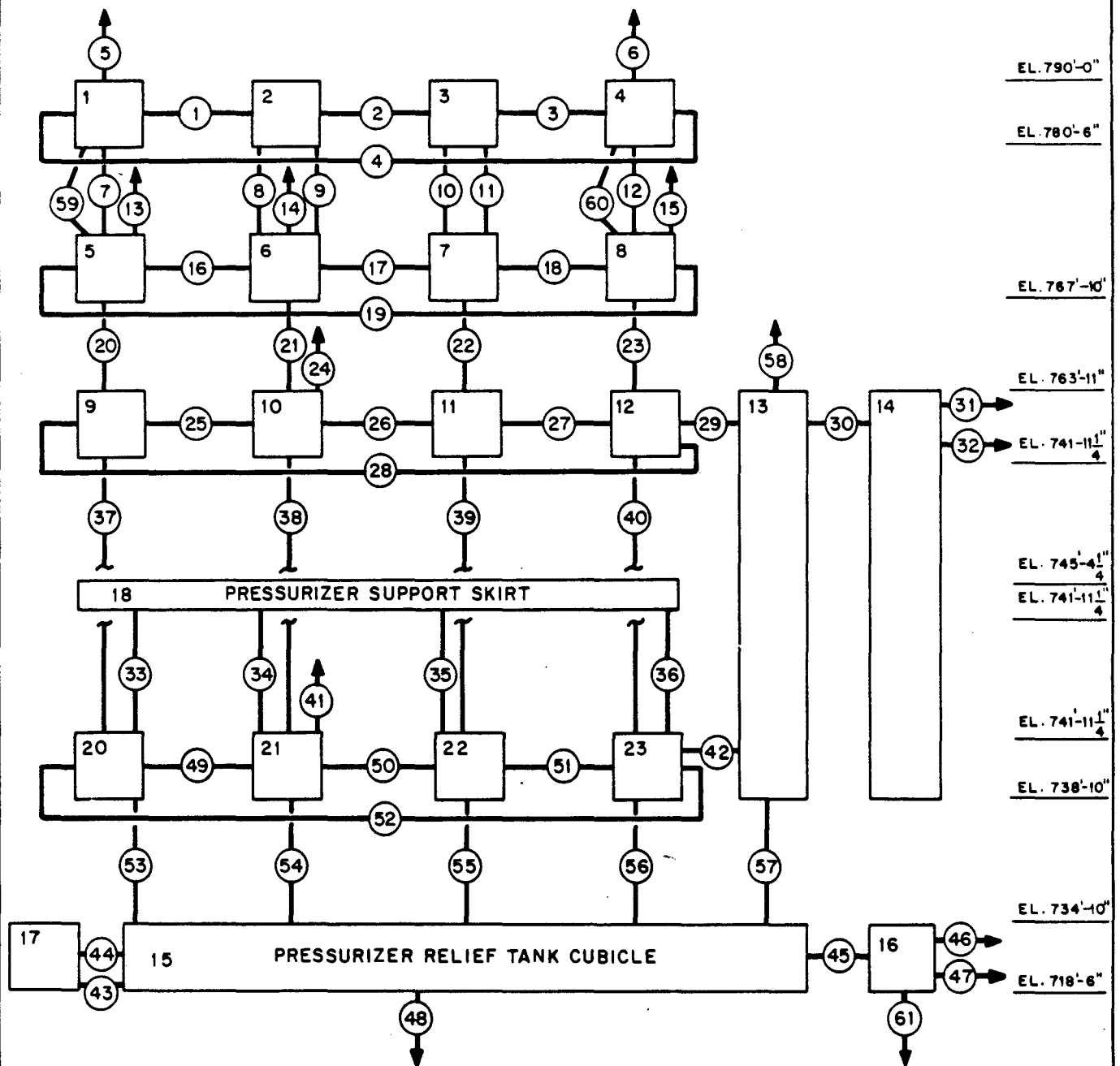

FIGURE 6.2-19  
COMPUTATIONAL BLOCK  
DIAGRAM FOR THREED  
BEAVER VALLEY POWER STATION-UNIT 2  
FINAL SAFETY ANALYSIS REPORT



NOTES:

1) NODE 19 IS THE CONTAINMENT

2) SYMBOLS

a)  CONTROL VOLUME (OR NODE)

b)  JUNCTION NUMBER

c)  INDICATES VENT PATHS TO THE CONTAINMENT

FIGURE 6.2-20  
 PRESSURIZER SUBCOMPARTMENT  
 NODALIZATION DIAGRAM  
 BEAVER VALLEY POWER STATION-UNIT 2  
 FINAL SAFETY ANALYSIS REPORT



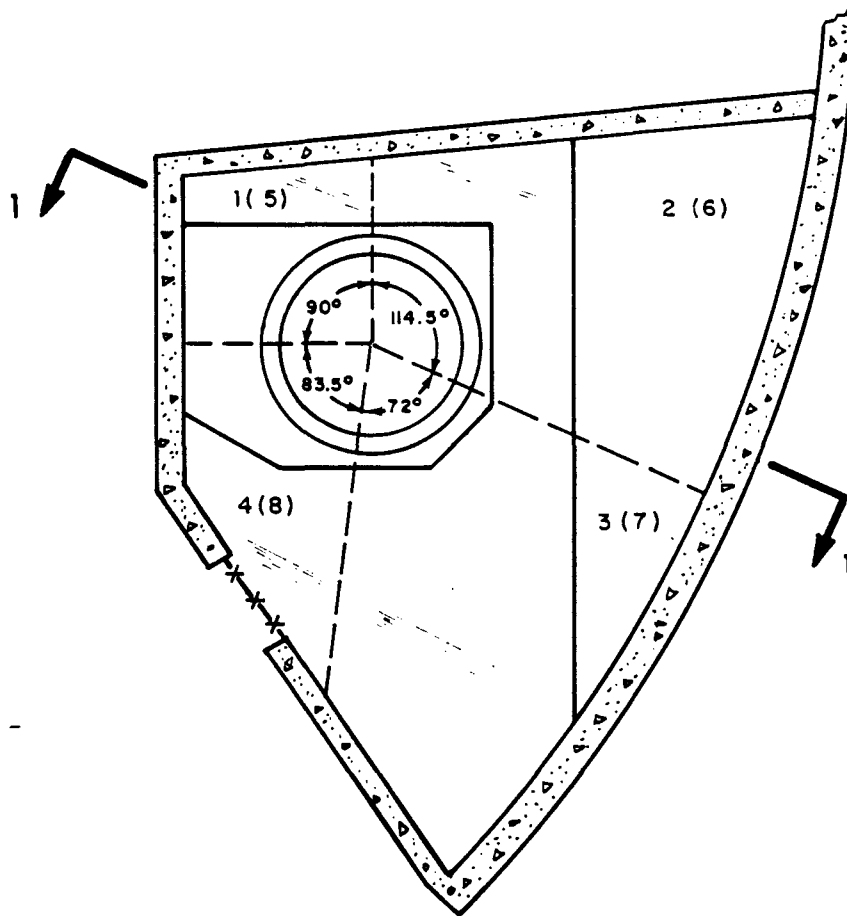

**NOTES:**

1. NODES 5 THROUGH 8 ARE LOCATED DIRECTLY BELOW NODES 1 THROUGH 4 RESPECTIVELY
2. INDICATES PLATFORM GRATING EL. 780'-6"  
XXX INDICATES WIRE MESH DOOR
3. DASHED LINES INDICATE NODAL BOUNDARIES

**FIGURE 6.2-21  
PRESSURIZER CUBICLE  
NODALIZATION - PLAN VIEW  
EL. 767'-10" - 23 NODE MODEL  
BEAVER VALLEY POWER STATION-UNIT 2  
FINAL SAFETY ANALYSIS REPORT**

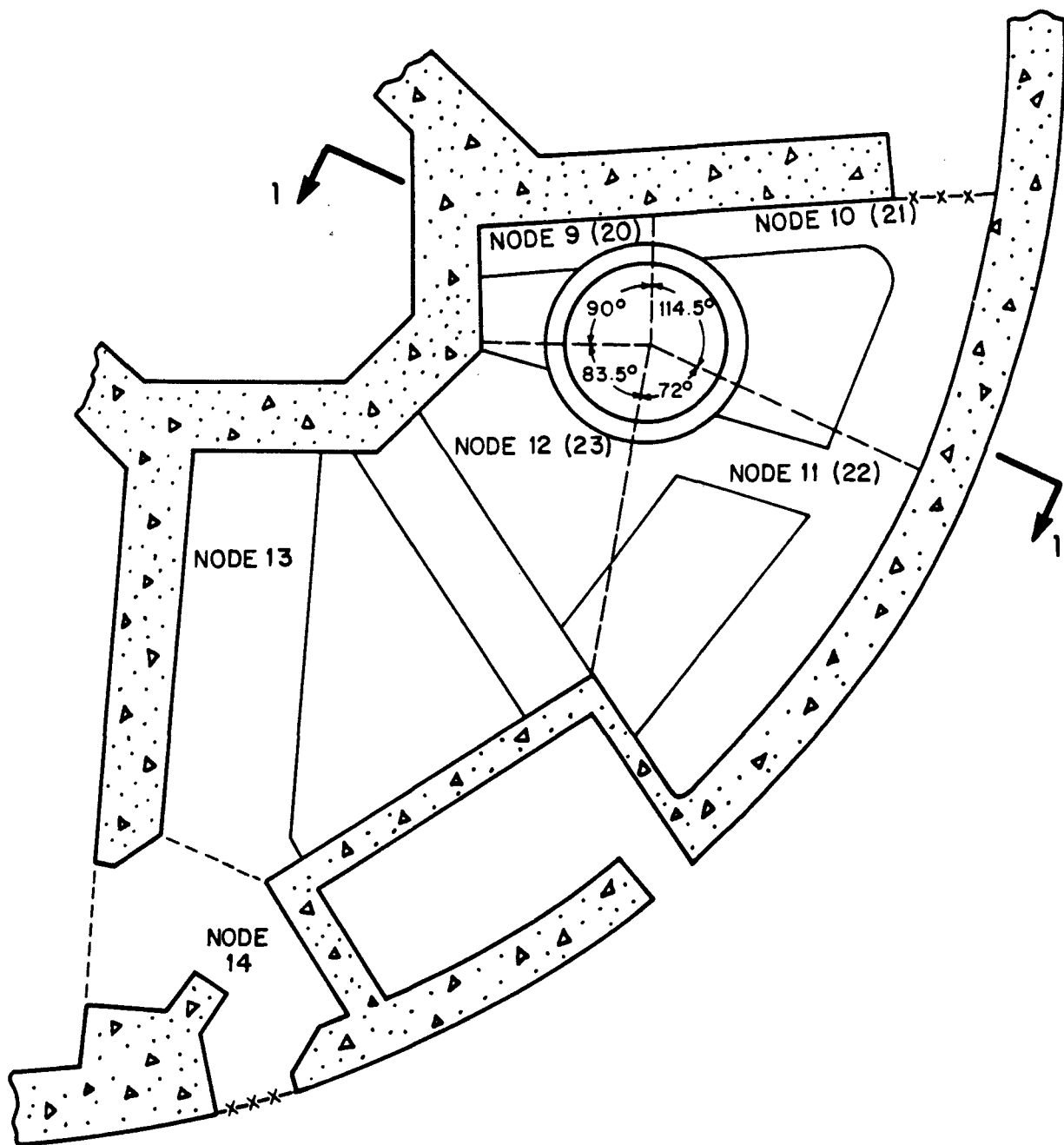

NOTES:

1. NODES 20 THROUGH 23 ARE LOCATED DIRECTLY BELOW NODES 9 THROUGH 12 RESPECTIVELY
2. X X X INDICATES WIRE MESH DOORS
3. DASHED LINES INDICATE NODAL BOUNDARIES

FIGURE 6.2-22  
 PRESSURIZER CUBICLE  
 NODALIZATION  
 PLAN VIEW EL. 738'-10"  
 23 NODE MODEL  
 BEAVER VALLEY POWER STATION-UNIT 2  
 FINAL SAFETY ANALYSIS REPORT

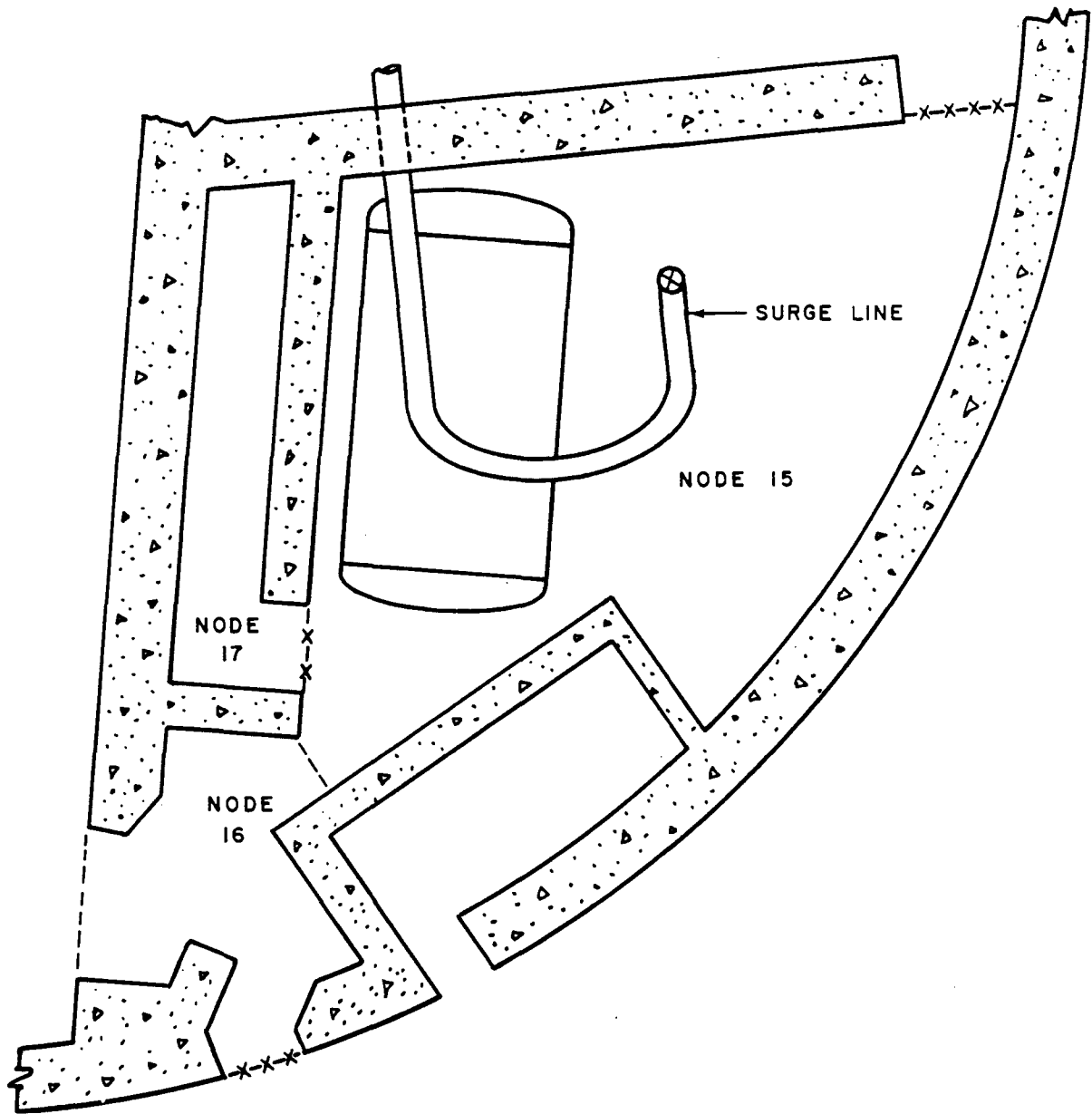

NOTES:

1. X X X INDICATES WIRE MESH DOOR
2. DASH LINE INDICATES NODAL BOUNDARY

FIGURE 6.2-23  
 PRESSURIZER RELIEF  
 TANK CUBICLE NODALIZATION  
 PLAN VIEW EL. 718'-6"  
 23 NODE MODEL  
 BEAVER VALLEY POWER STATION-UNIT 2  
 FINAL SAFETY ANALYSIS REPORT

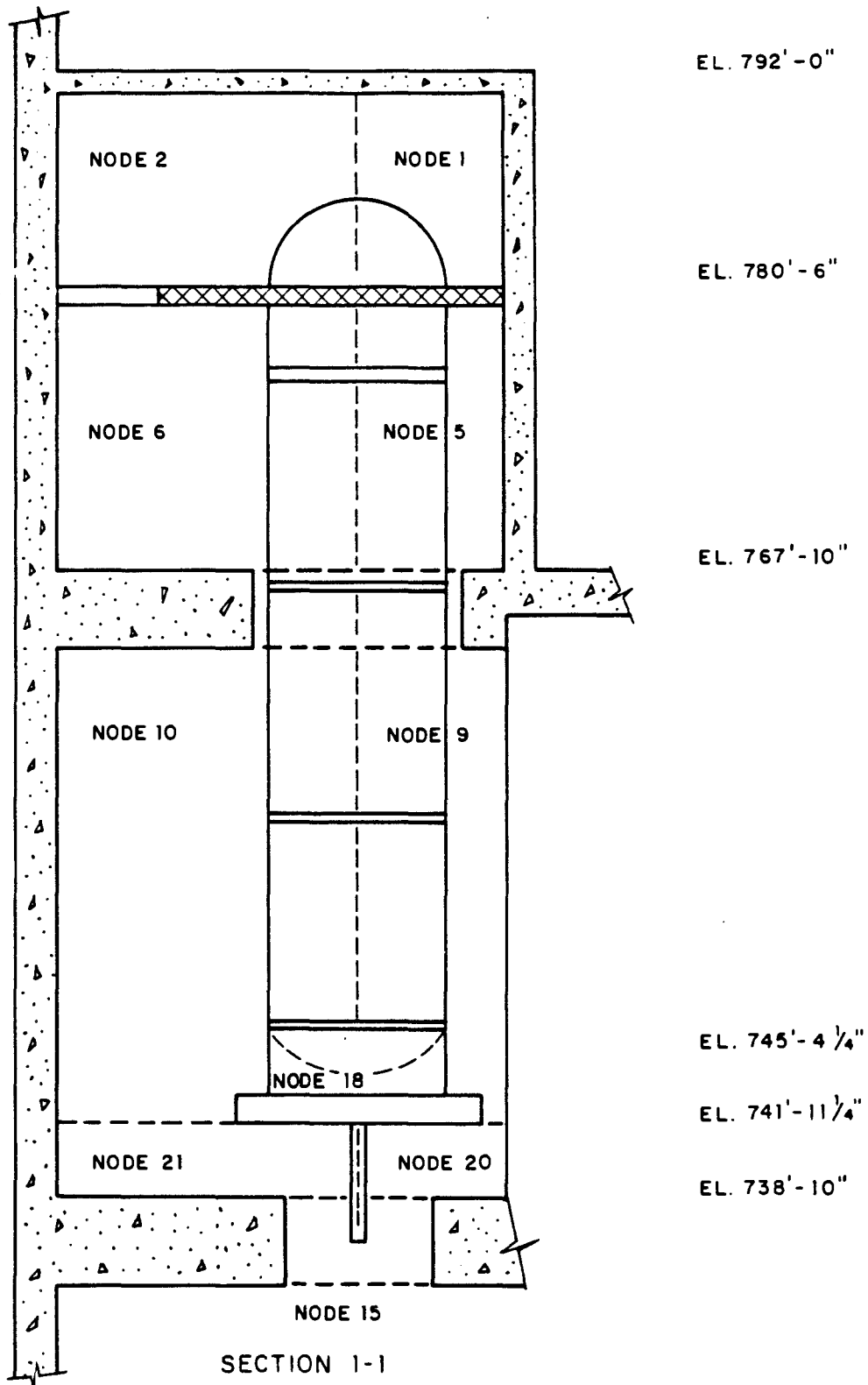

NOTES:

1) NODE 18 IS LOCATED INSIDE THE PRESSURIZER SUPPORT SKIRT

2) SYMBOLS

XXXX INDICATES GRATING

--- NODAL BOUNDARIES

FIGURE 6.2-24  
 PRESSURIZER CUBICLE  
 ELEVATION VIEW SECTION 1-1  
 BEAVER VALLEY POWER STATION- UNIT 2  
 FINAL SAFETY ANALYSIS REPORT

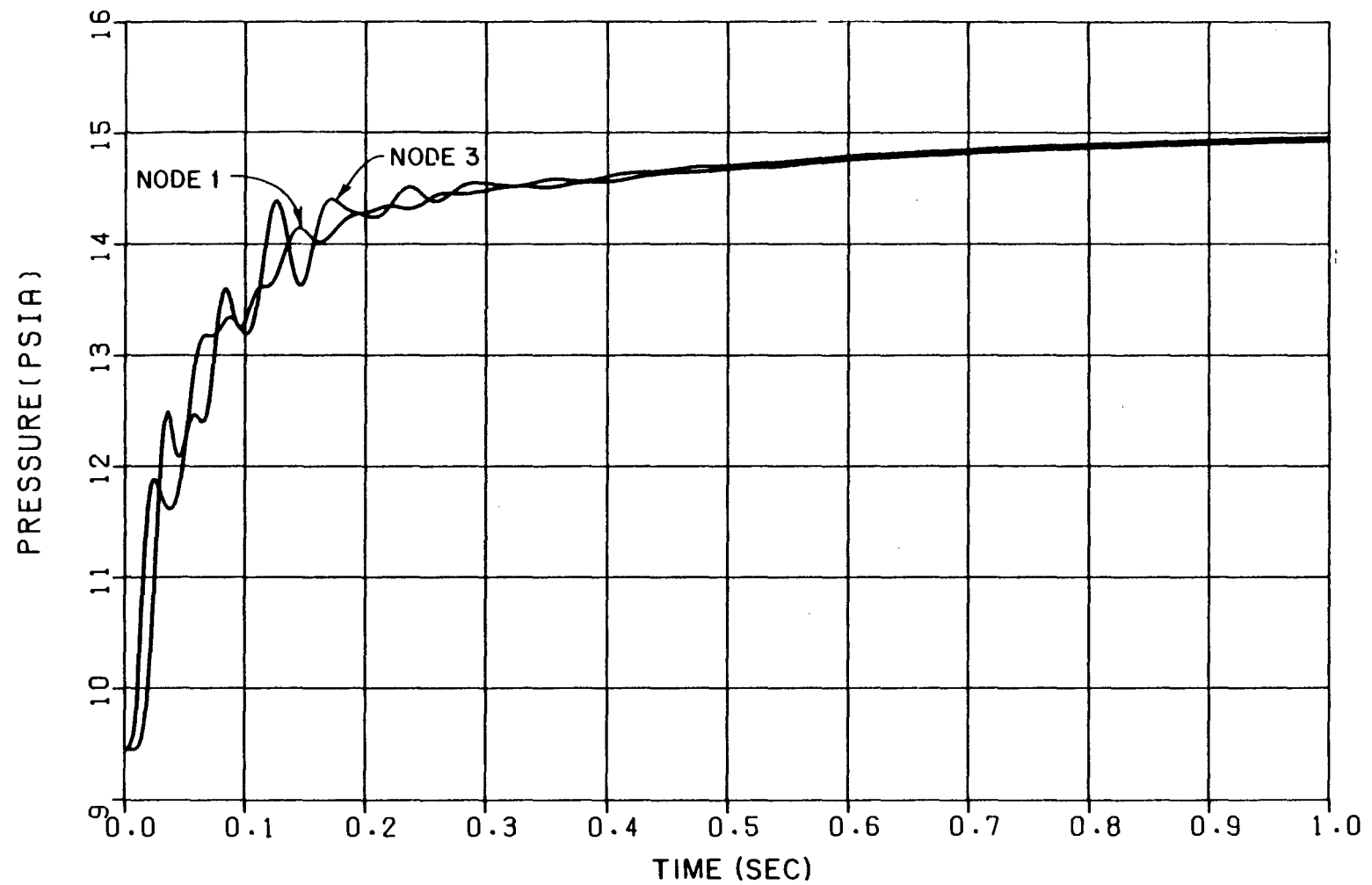

FIGURE 6.2-25  
PRESSURIZER CUBICLE  
AVERAGE PRESSURE VERSUS TIME  
SPRAY LINE DER  
NODES 1 & 3  
BEAVER VALLEY POWER STATION-UNIT 2  
FINAL SAFETY ANALYSIS REPORT

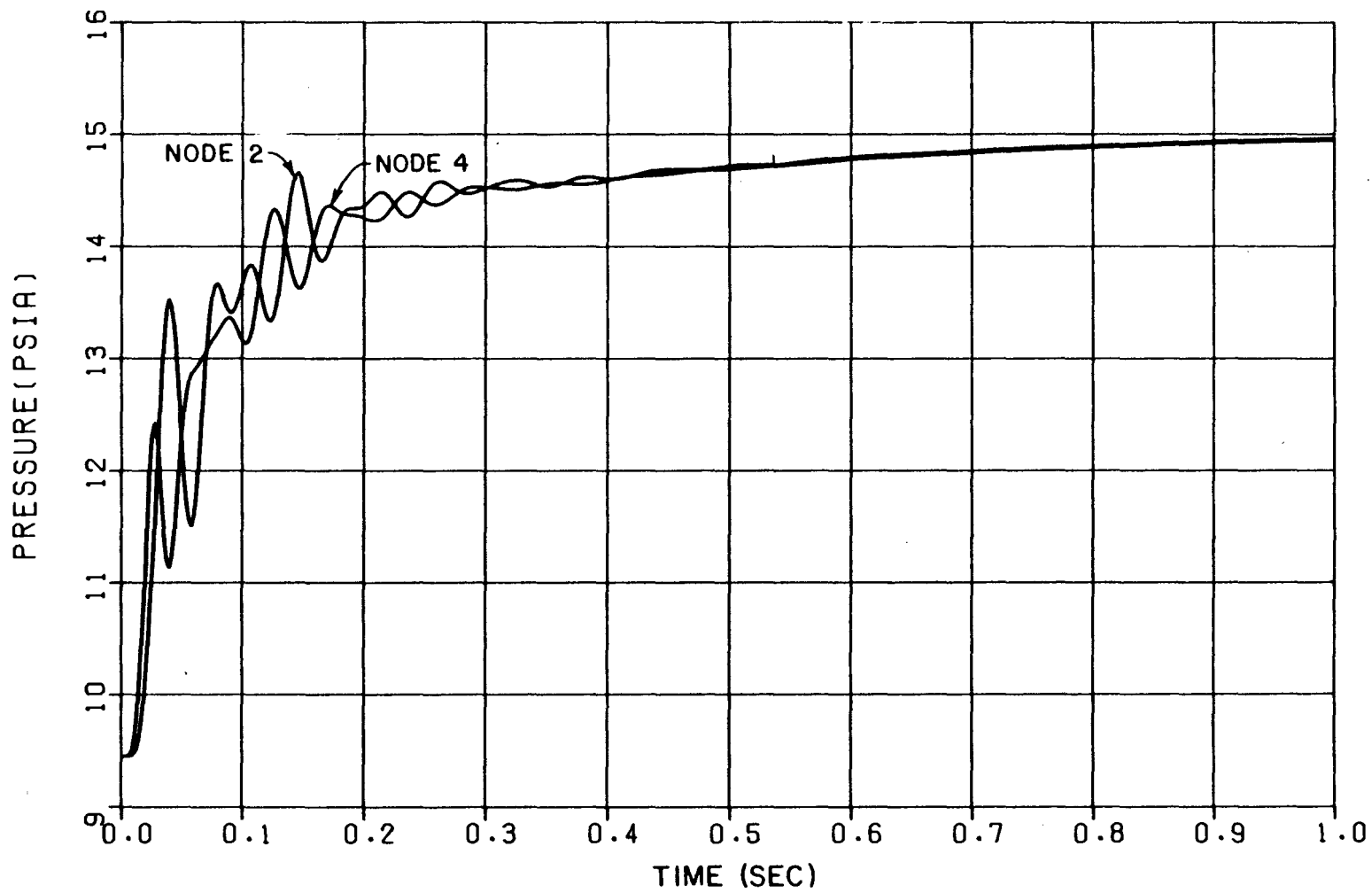

FIGURE 6.2-26  
PRESSURIZER CUBICLE  
AVERAGE PRESSURE VERSUS TIME  
SPRAY LINE DER  
NODES 2 & 4  
BEAVER VALLEY POWER STATION-UNIT 2  
FINAL SAFETY ANALYSIS REPORT

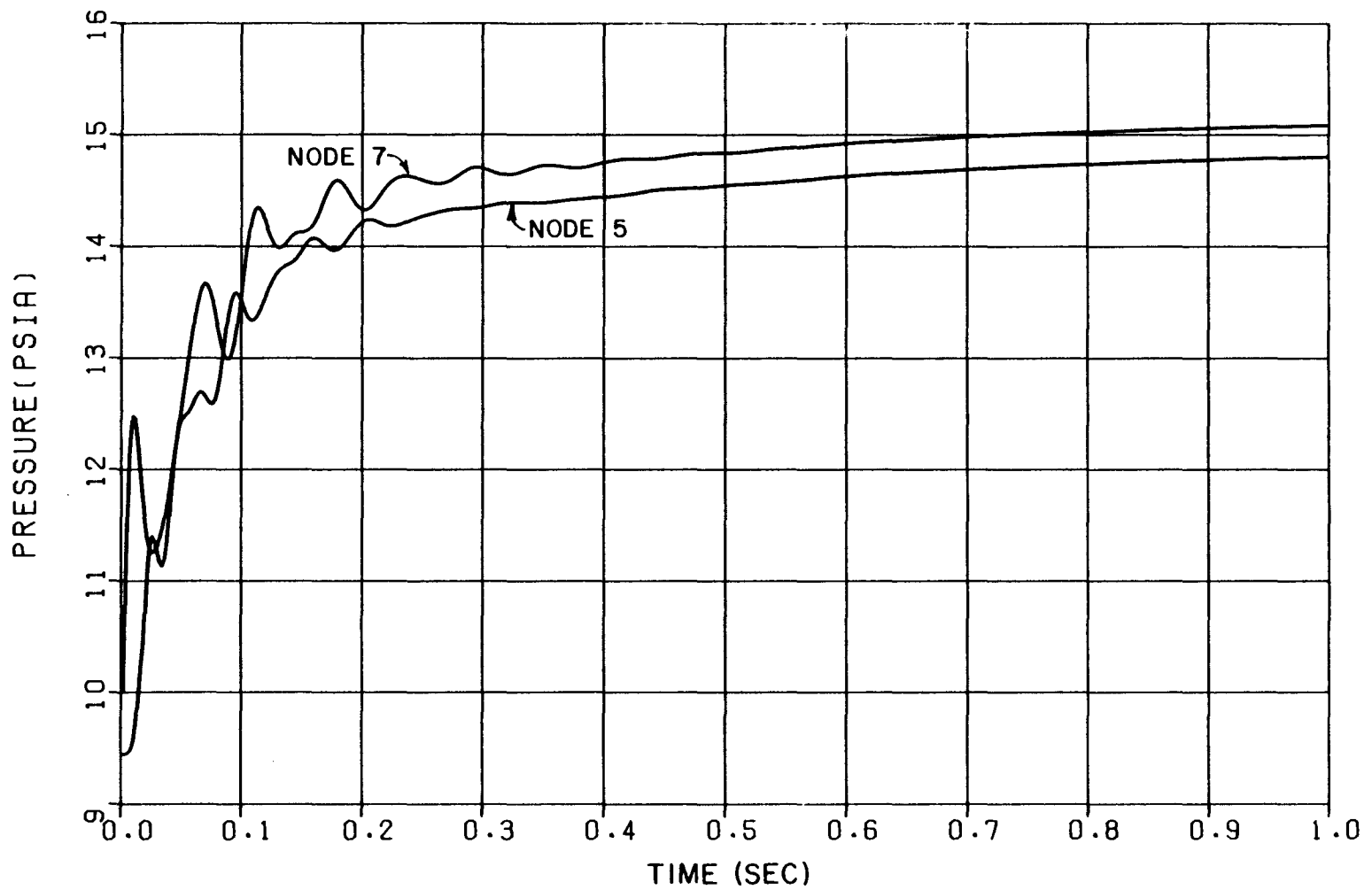

FIGURE 6.2-27  
 PRESSURIZER CUBICLE  
 AVERAGE PRESSURE VERSUS TIME  
 SPRAY LINE DER  
 NODES 5 & 7  
 BEAVER VALLEY POWER STATION-UNIT 2  
 FINAL SAFETY ANALYSIS REPORT

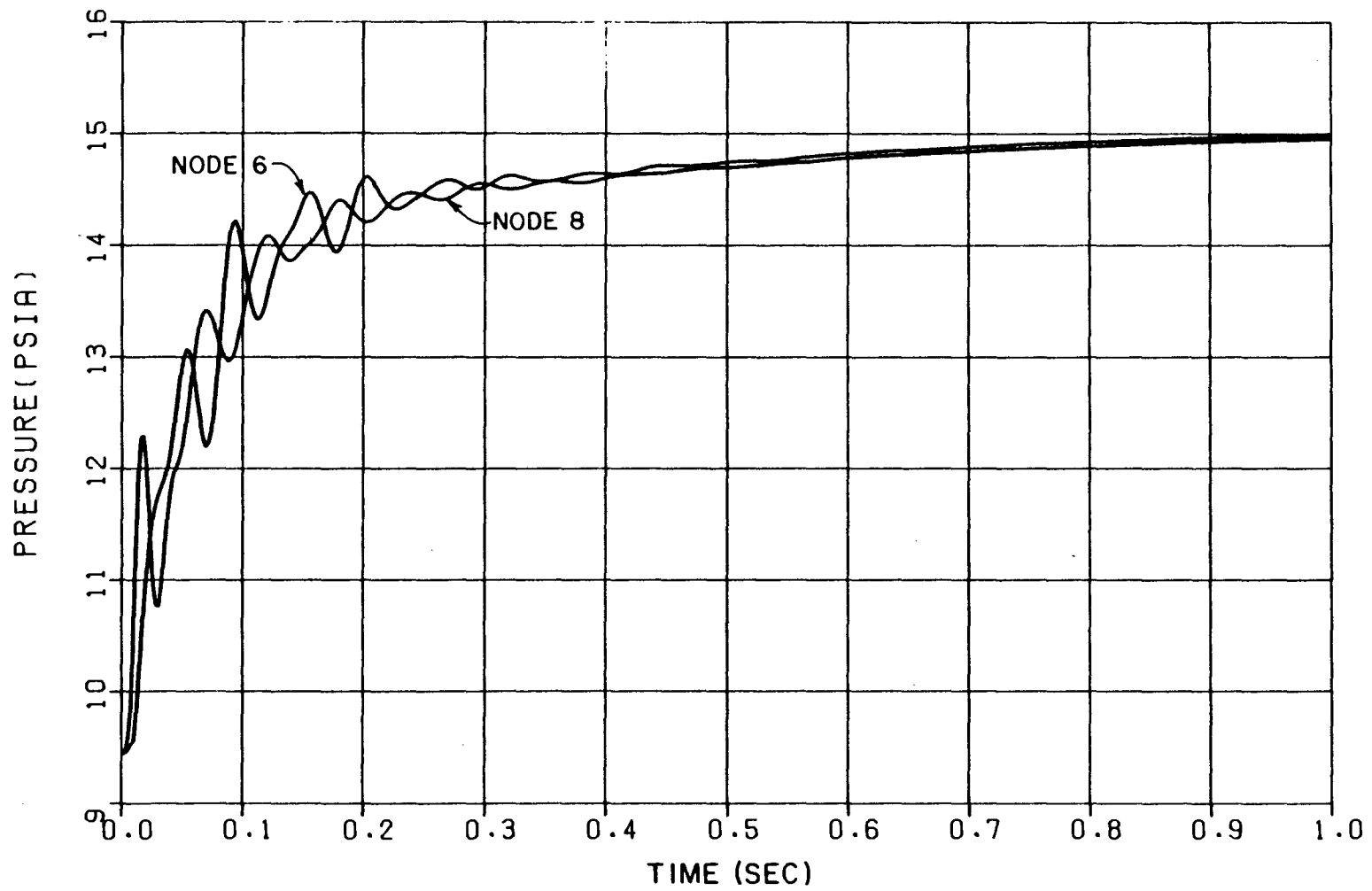

FIGURE 6.2-28  
PRESSURIZER CUBICLE  
AVERAGE PRESSURE VERSUS TIME  
SPRAY LINE DER  
NODES 6 & 8  
BEAVER VALLEY POWER STATION-UNIT 2  
FINAL SAFETY ANALYSIS REPORT



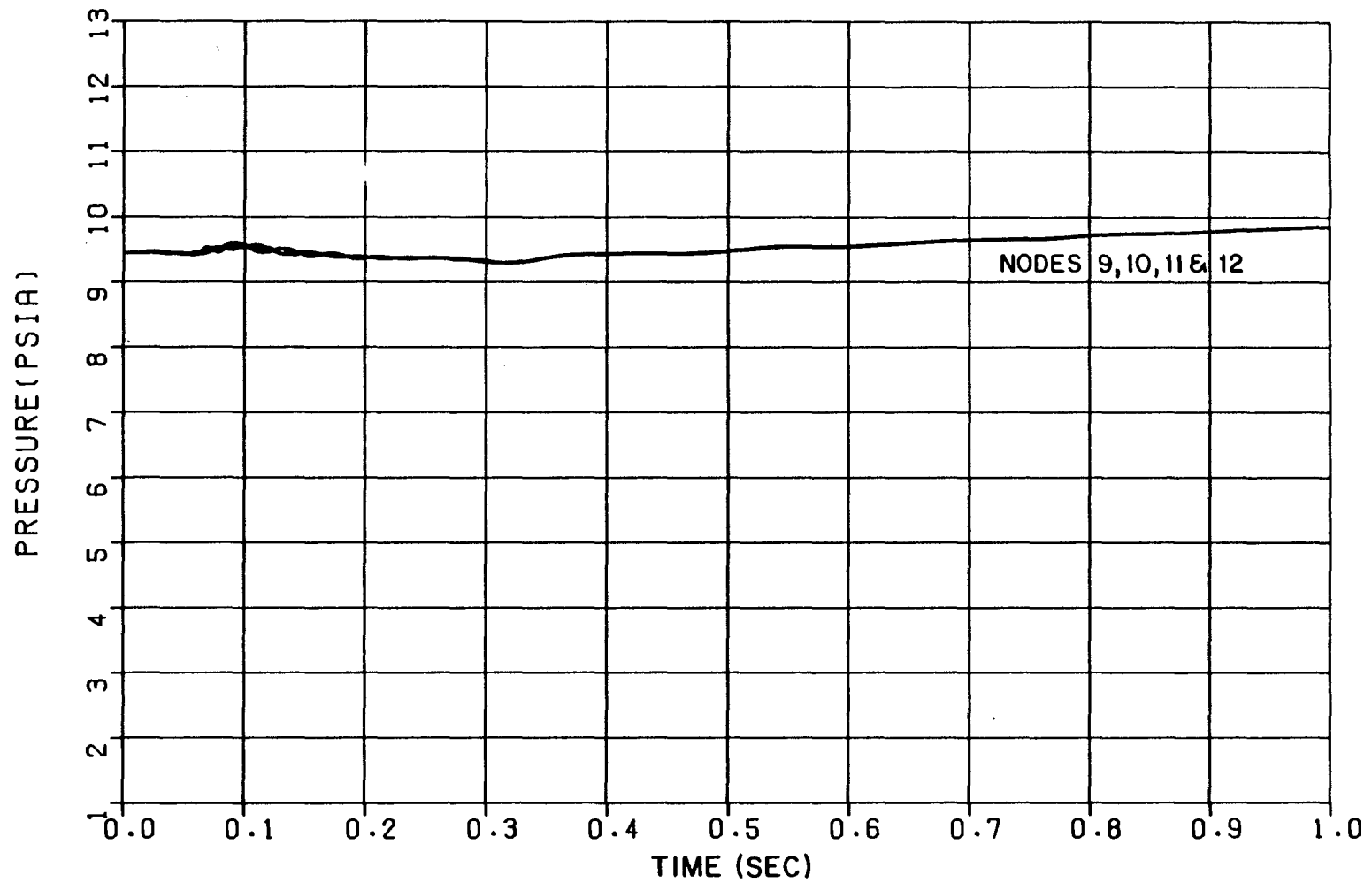

FIGURE 6.2-29  
PRESSURIZER CUBICLE  
AVERAGE PRESSURE VERSUS TIME  
SPRAY LINE DER  
NODES 9,10,11 & 12  
BEAVER VALLEY POWER STATION-UNIT 2  
FINAL SAFETY ANALYSIS REPORT

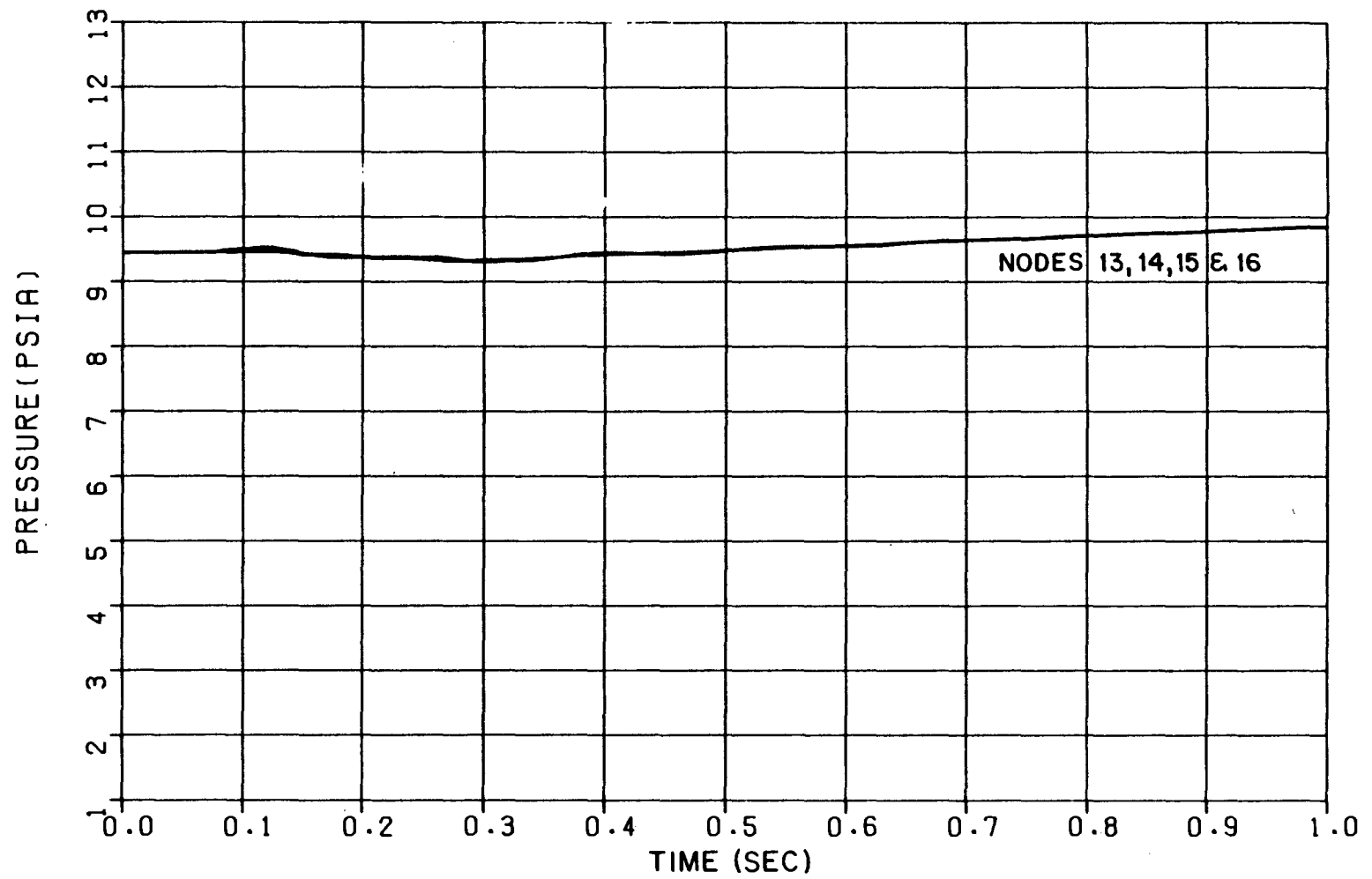

FIGURE 6.2-29A  
PRESSURIZER CUBICLE  
AVERAGE PRESSURE VERSUS TIME  
SPRAY LINE DER  
NODES 13, 14, 15 & 16  
BEAVER VALLEY POWER STATION-UNIT 2  
FINAL SAFETY ANALYSIS REPORT

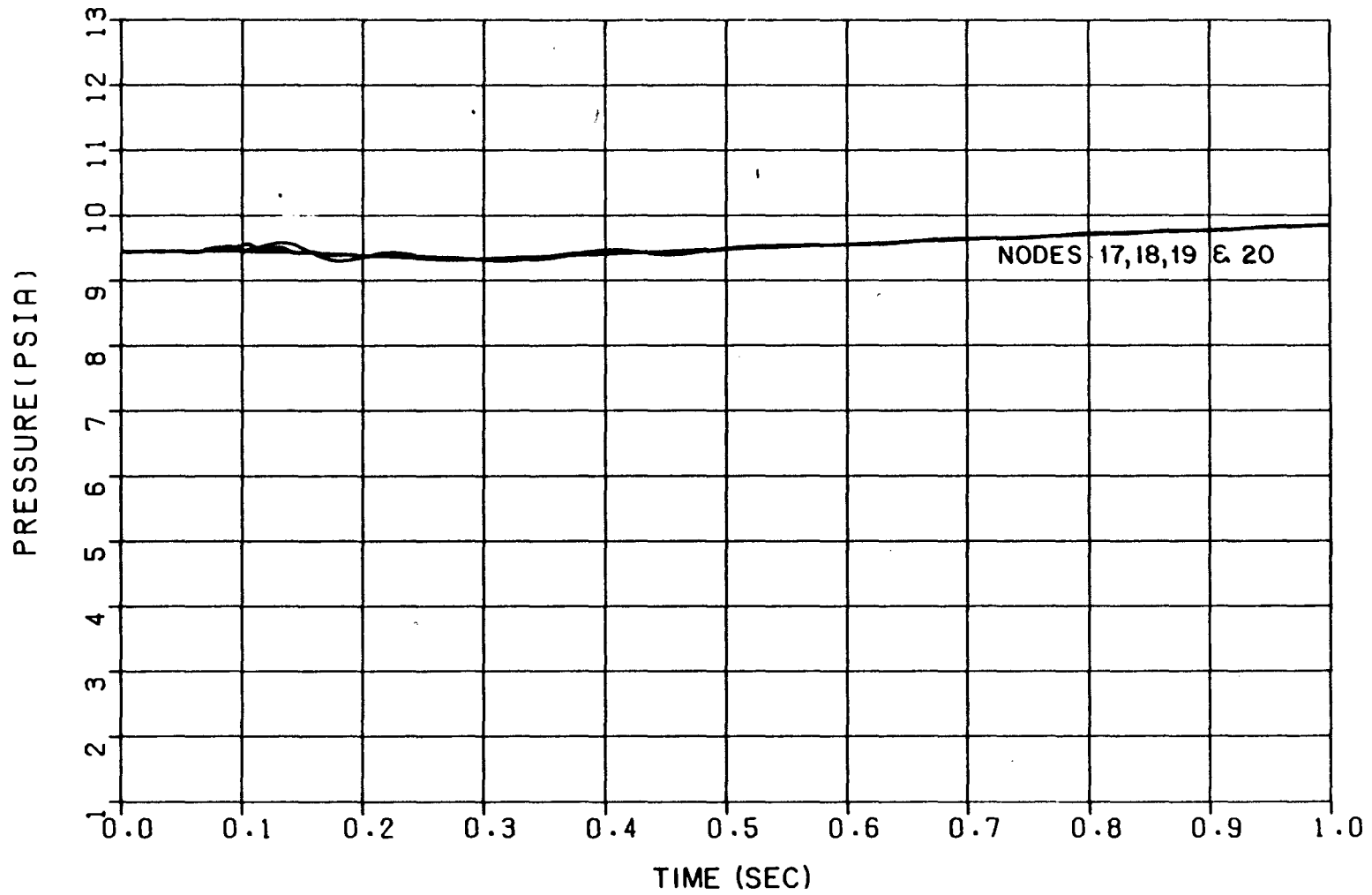

FIGURE 6.2-29B  
PRESSURIZER CUBICLE  
AVERAGE PRESSURE VERSUS TIME  
SPRAY LINE DER  
NODES 17,18,19 & 20  
BEAVER VALLEY POWER STATION-UNIT 2  
FINAL SAFETY ANALYSIS REPORT

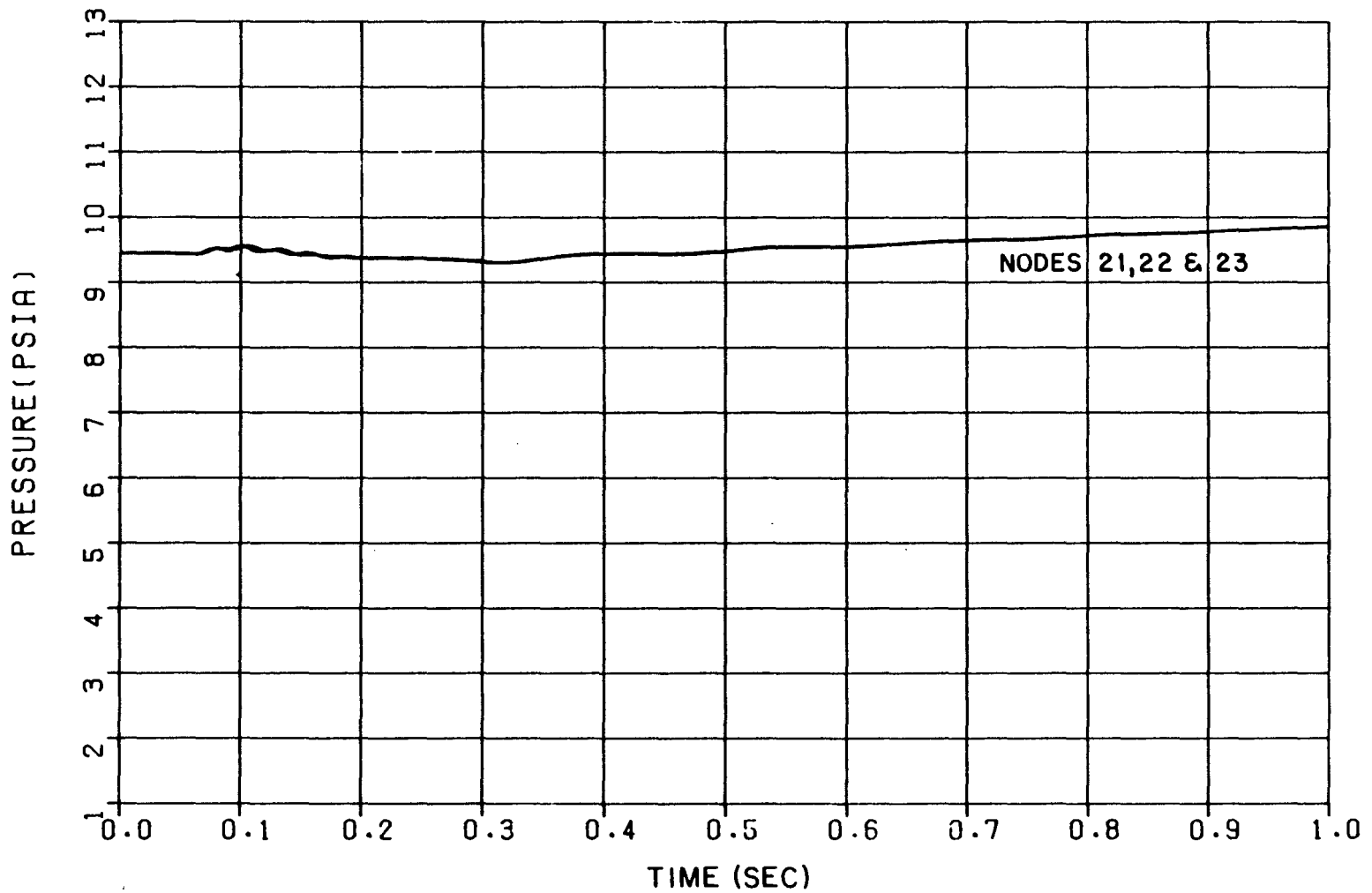

FIGURE 6.2-29C  
PRESSURIZER CUBICLE  
AVERAGE PRESSURE VERSUS TIME  
SPRAY LINE DER  
NODES 21, 22 & 23  
BEAVER VALLEY POWER STATION-UNIT 2  
FINAL SAFETY ANALYSIS REPORT

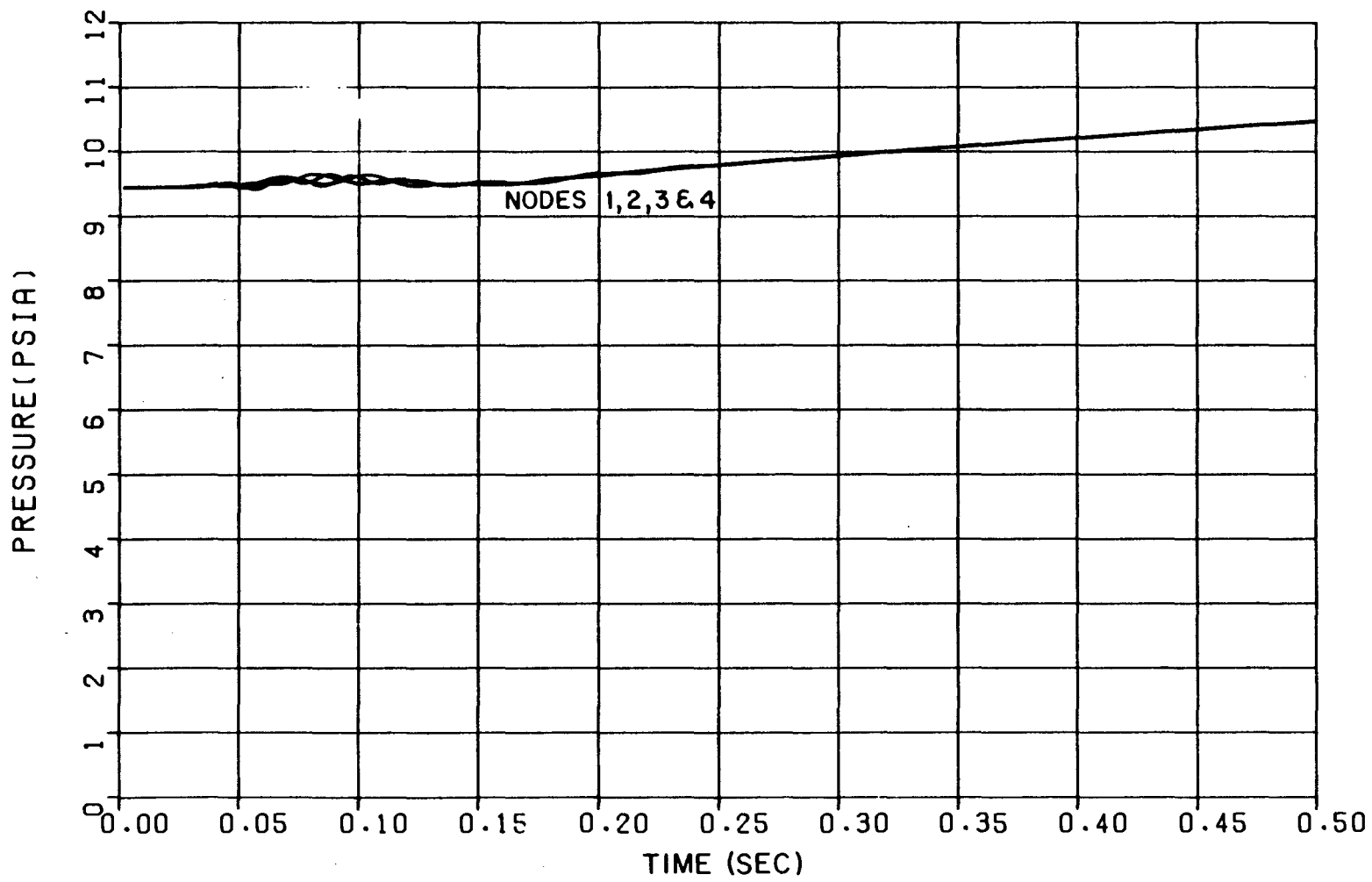

FIGURE 6.2-30  
PRESSURIZER CUBICLE  
AVERAGE PRESSURE VERSUS TIME  
SURGE LINE DER AT THE PRESSURIZER NOZZLE  
NODES 1,2,3 & 4  
BEAVER VALLEY POWER STATION-UNIT 2  
FINAL SAFETY ANALYSIS REPORT

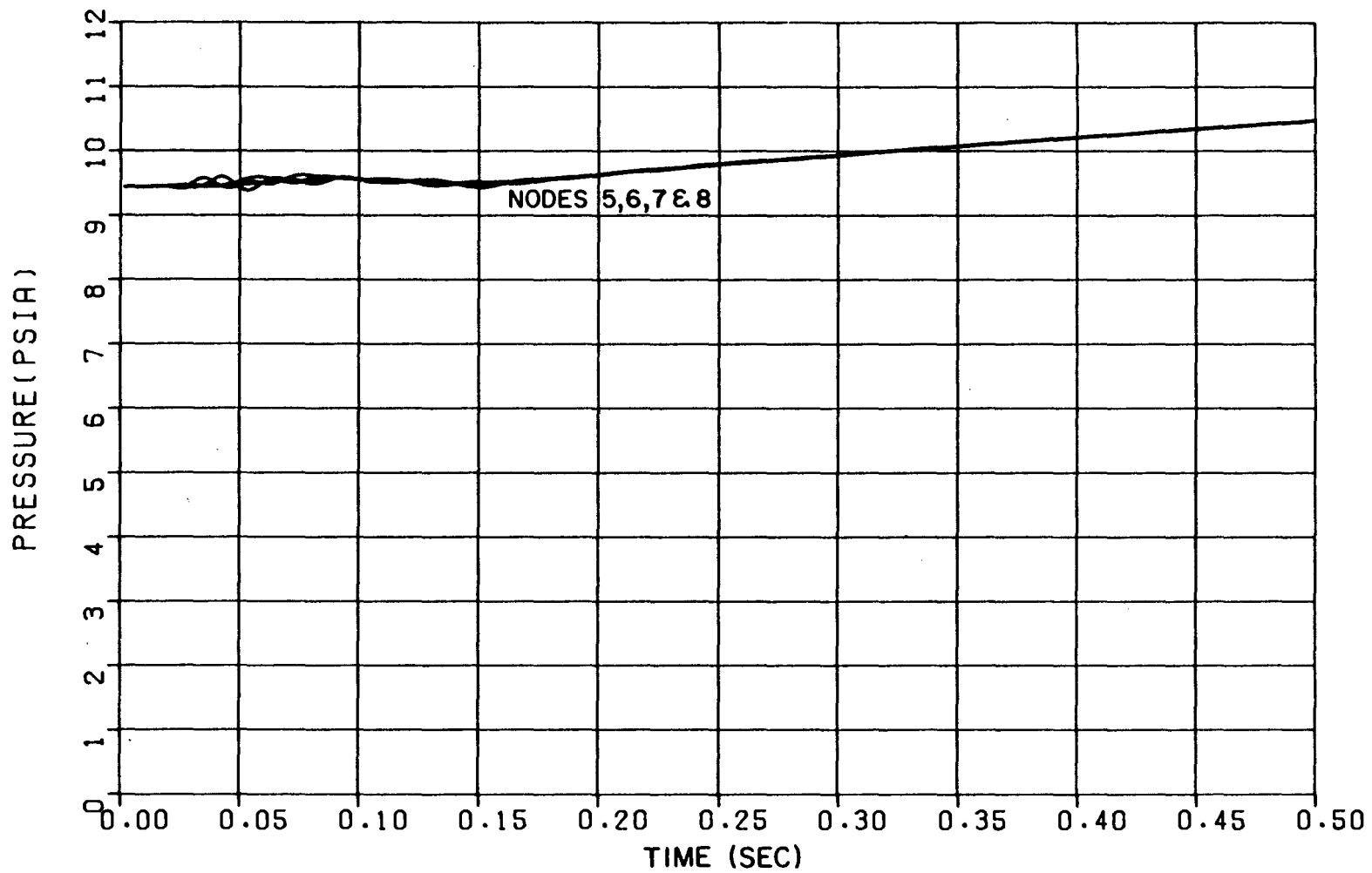

FIGURE 6.2-31  
PRESSURIZER CUBICLE  
AVERAGE PRESSURE VERSUS TIME  
SURGE LINE DER AT THE PRESSURIZER NOZZLE  
NODES 5,6,7 & 8  
BEAVER VALLEY POWER STATION-UNIT 2  
FINAL SAFETY ANALYSIS REPORT

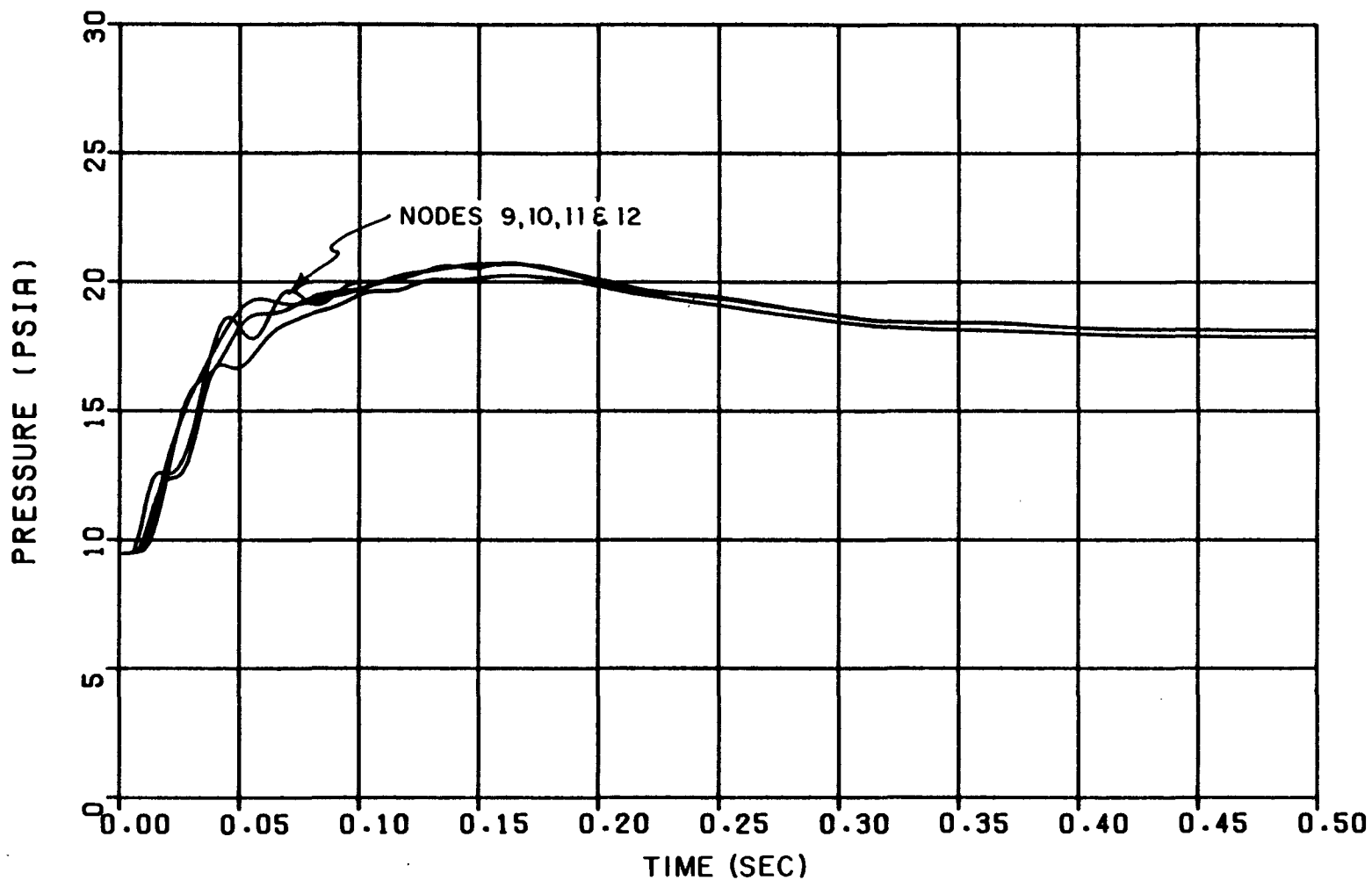

FIGURE 6.2-32  
PRESSURIZER CUBICLE  
AVERAGE PRESSURE VERSUS TIME  
SURGE LINE DER AT THE PRESSURIZER NOZZLE  
NODES 9,10,11 & 12  
BEAVER VALLEY POWER STATION-UNIT 2  
FINAL SAFETY ANALYSIS REPORT

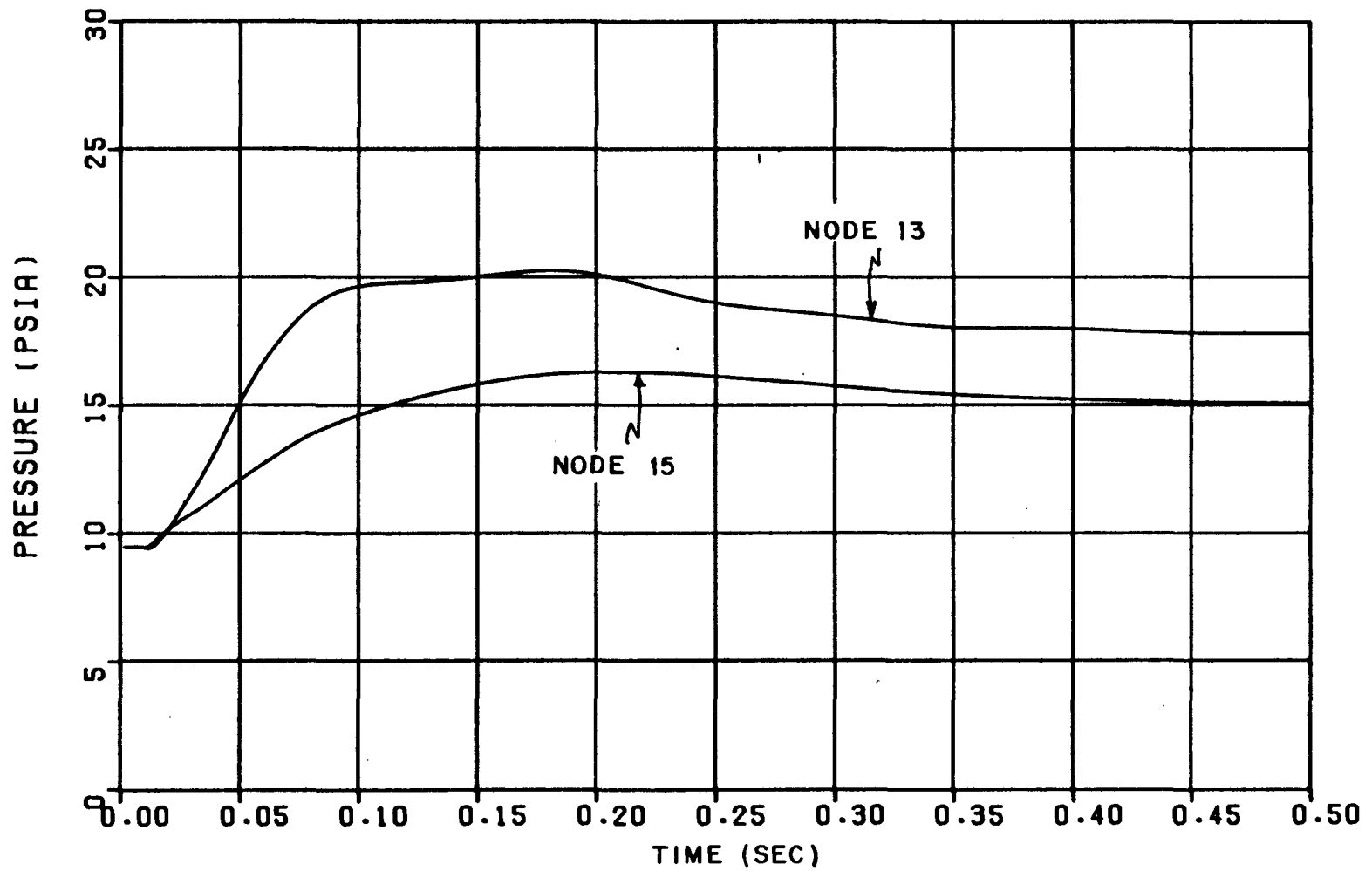

FIGURE 6.2-33  
 PRESSURIZER CUBICLE  
 AVERAGE PRESSURE VERSUS TIME  
 SURGE LINE DER AT THE PRESSURIZER NOZZLE  
 NODES 13 & 15  
 BEAVER VALLEY POWER STATION-UNIT 2  
 FINAL SAFETY ANALYSIS REPORT



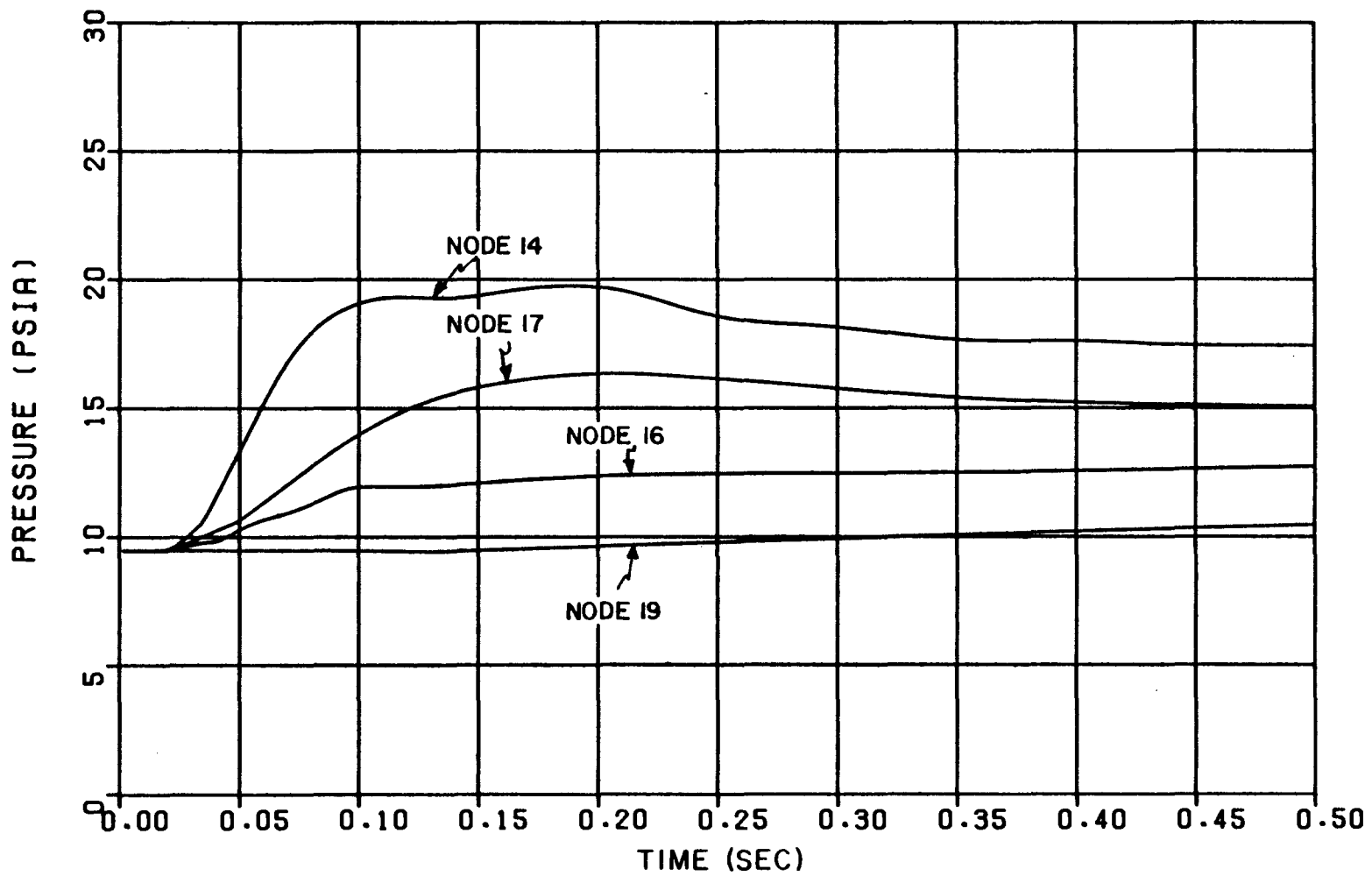

FIGURE 6.2-34  
 PRESSURIZER CUBICLE  
 AVERAGE PRESSURE VERSUS TIME  
 SURGE LINE DER AT THE PRESSURIZER NOZZLE  
 NODES 14, 16, 17 & 19  
 BEAVER VALLEY POWER STATION-UNIT 2  
 FINAL SAFETY ANALYSIS REPORT

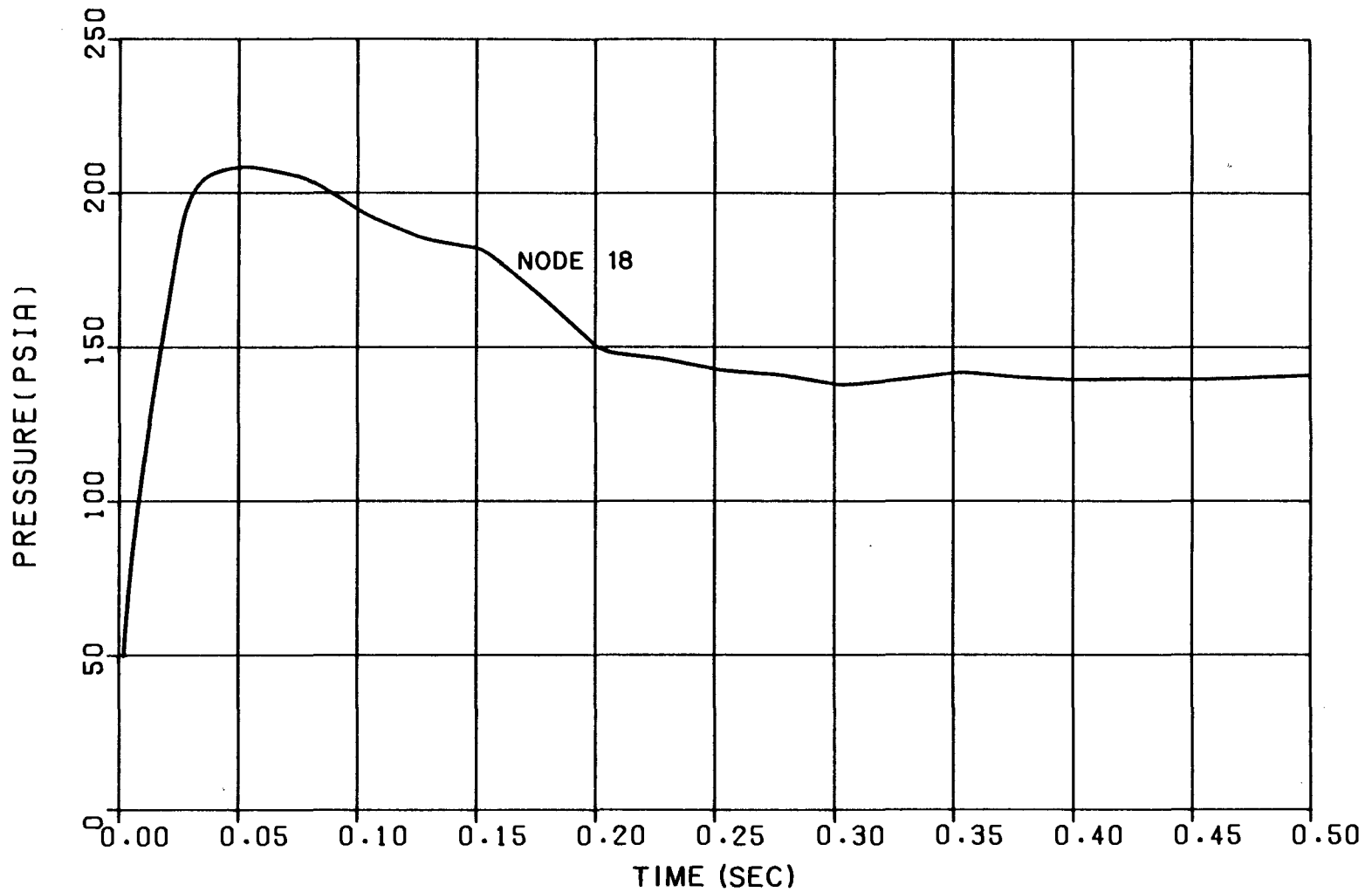

FIGURE 6.2-35  
PRESSURIZER CUBICLE  
AVERAGE PRESSURE VERSUS TIME  
SURGE LINE DER AT THE PRESSURIZER NOZZLE  
NODE 18  
BEAVER VALLEY POWER STATION-UNIT 2  
FINAL SAFETY ANALYSIS REPORT

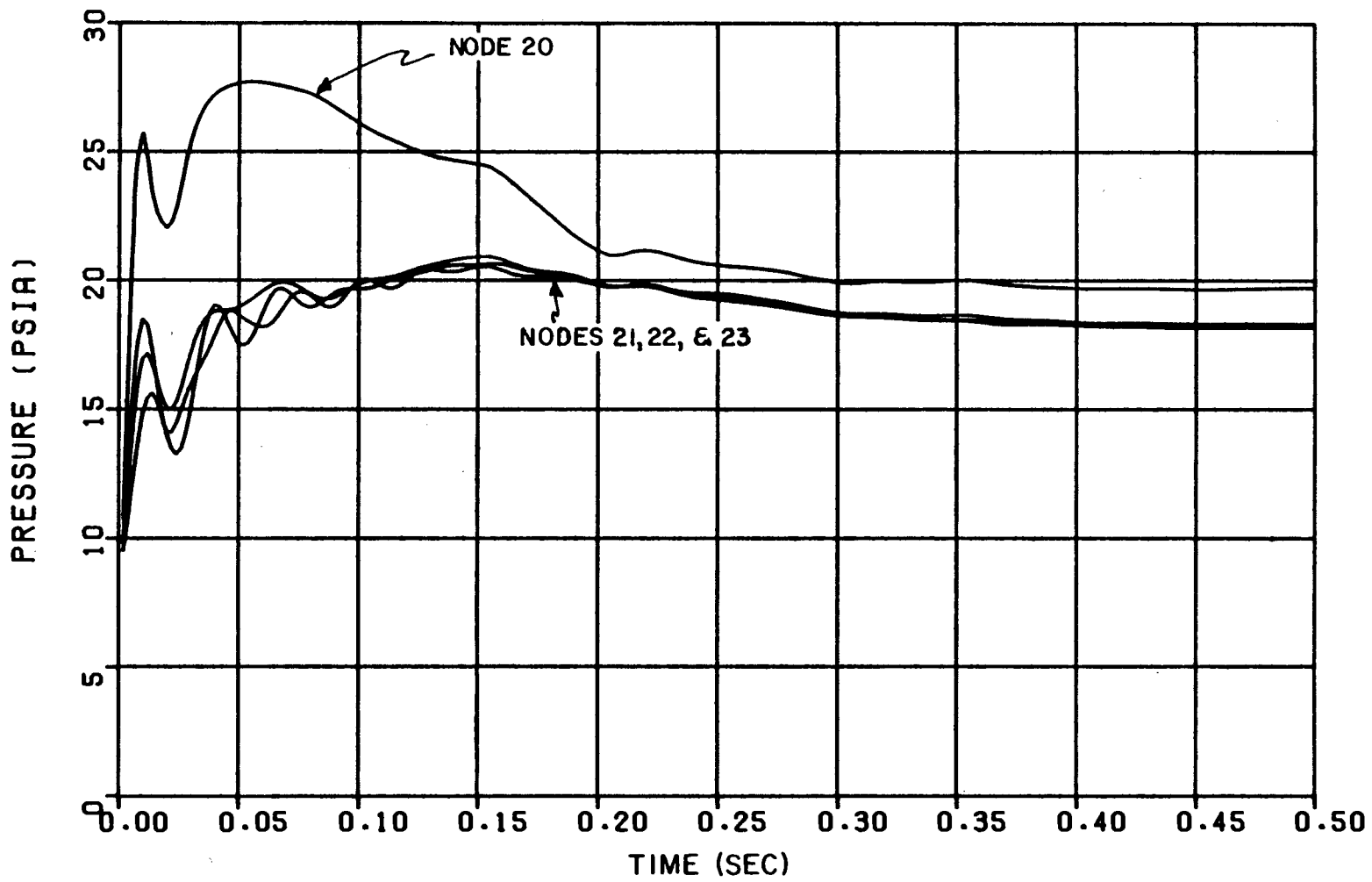

FIGURE 6.2-36  
 PRESSURIZER CUBICLE  
 AVERAGE PRESSURE VERSUS TIME  
 SURGE LINE DER AT THE PRESSURIZER NOZZLE  
 NODES 20,21,22 & 23  
 BEAVER VALLEY POWER STATION-UNIT 2  
 FINAL SAFETY ANALYSIS REPORT

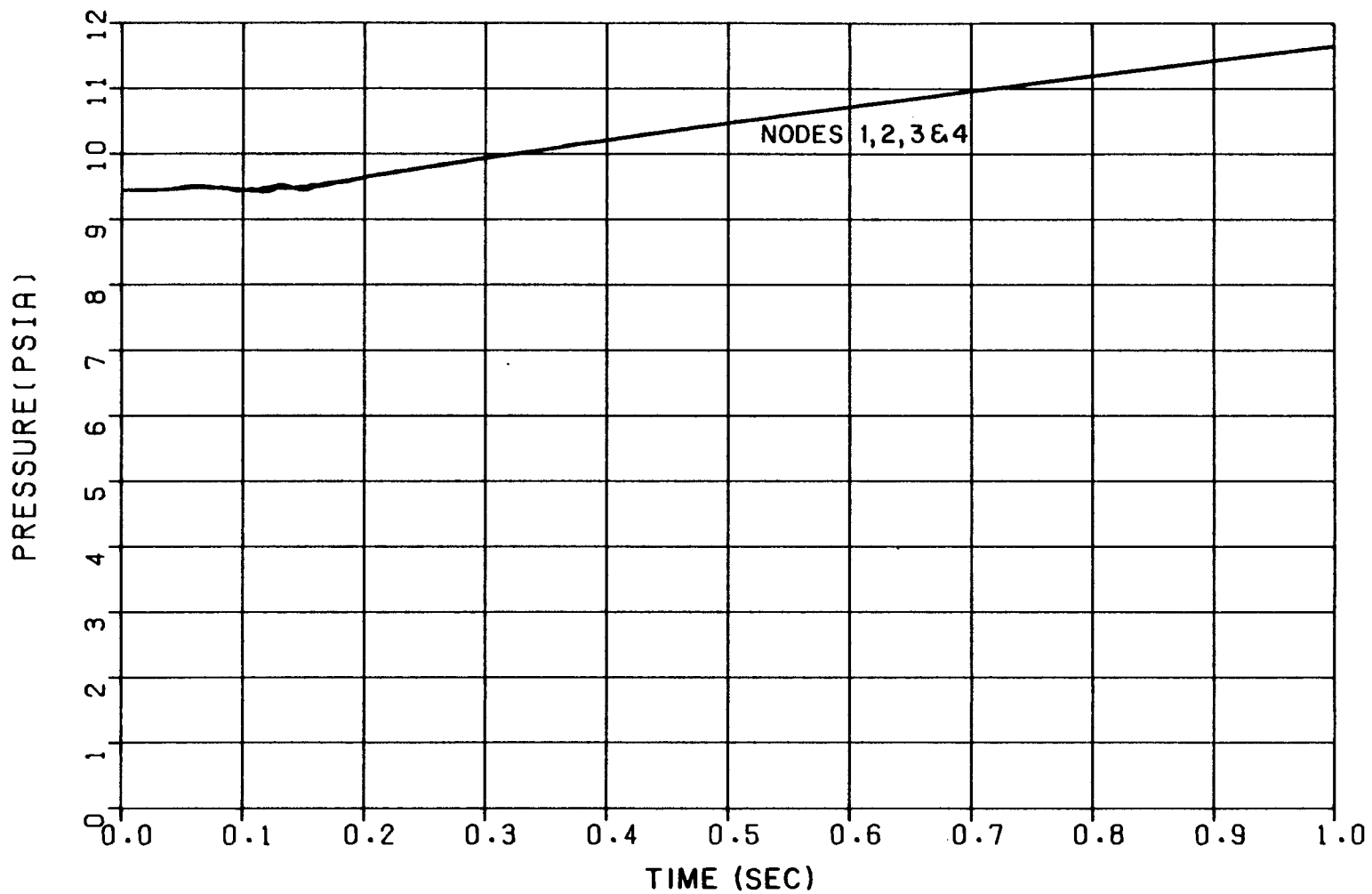

FIGURE 6.2-37  
PRESSURIZER CUBICLE  
AVERAGE PRESSURE VERSUS TIME  
SURGE LINE DER IN THE PRESSURIZER  
RELIEF TANK CUBICLE  
NODES 1,2,3 & 4  
BEAVER VALLEY POWER STATION-UNIT 2  
FINAL SAFETY ANALYSIS REPORT

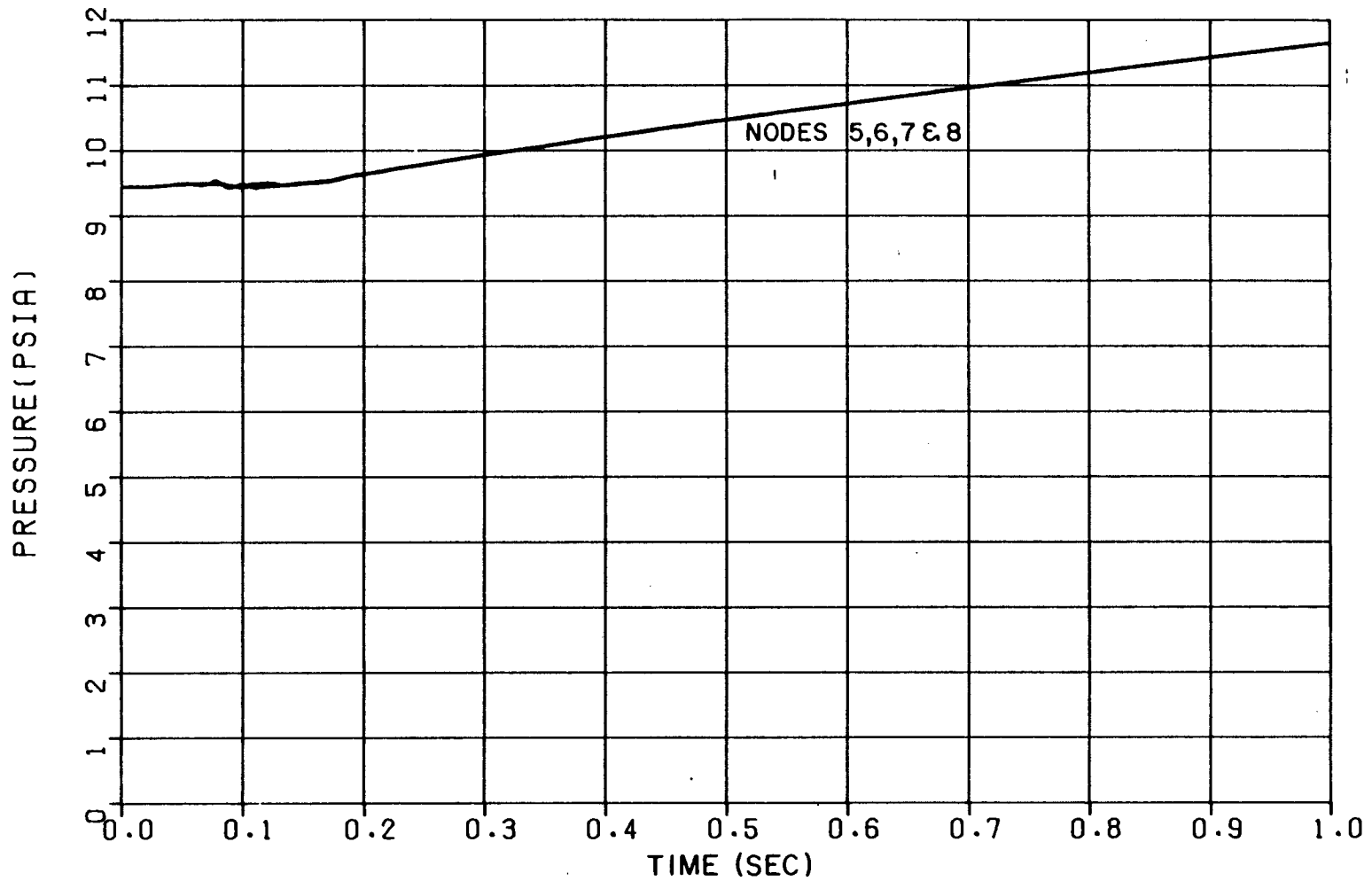

FIGURE 6.2-38  
PRESSURIZER CUBICLE  
AVERAGE PRESSURE VERSUS TIME  
SURGE LINE DER IN THE PRESSURIZER  
RELIEF TANK CUBICLE  
NODES 5,6,7 & 8  
BEAVER VALLEY POWER STATION-UNIT 2  
FINAL SAFETY ANALYSIS REPORT

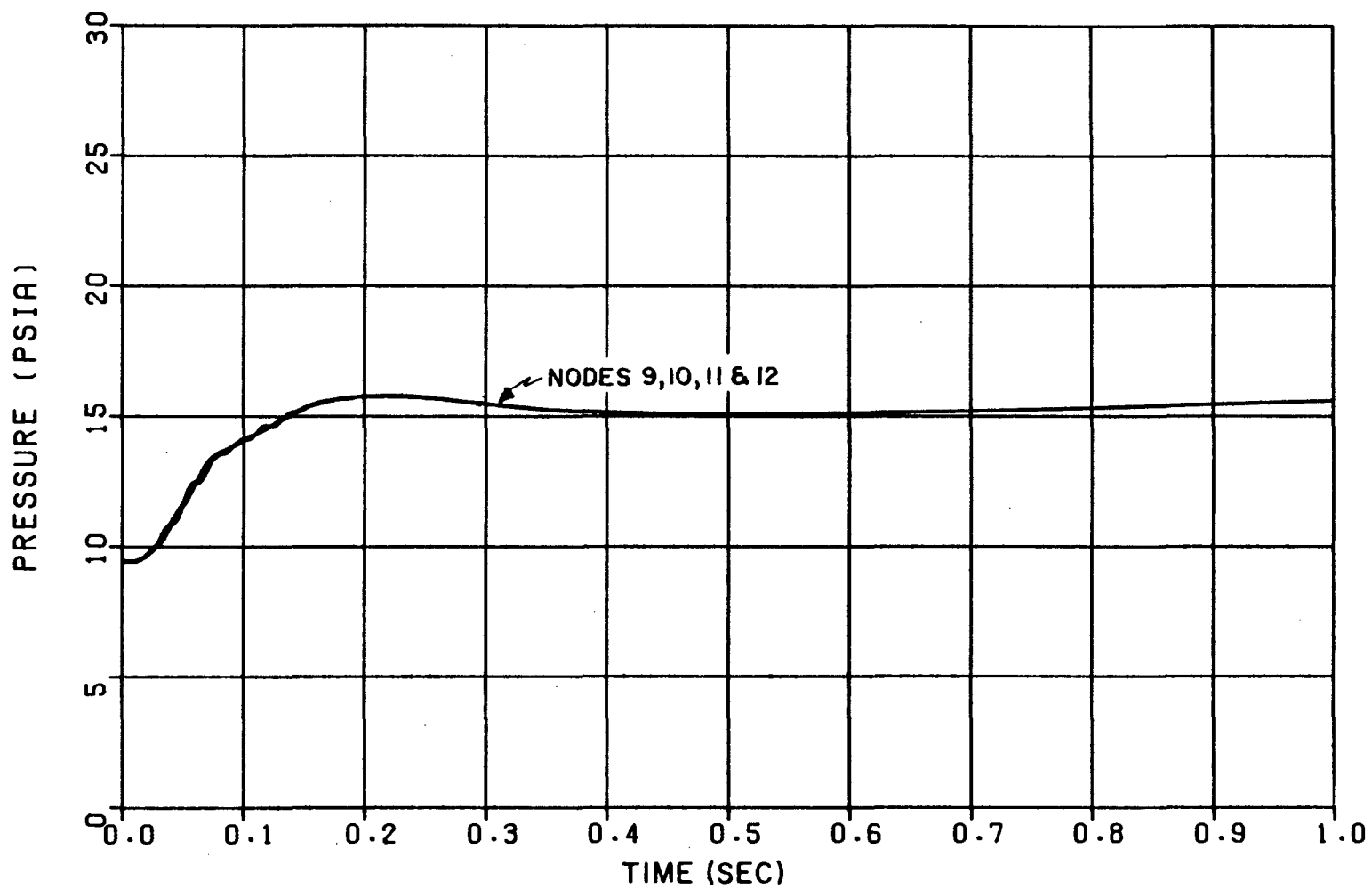

FIGURE 6.2-39  
 PRESSURIZER CUBICLE  
 AVERAGE PRESSURE VERSUS TIME  
 SURGE LINE DER IN THE PRESSURIZER  
 RELIEF TANK CUBICLE  
 NODES 9, 10, 11 & 12  
 BEAVER VALLEY POWER STATION-UNIT 2  
 FINAL SAFETY ANALYSIS REPORT

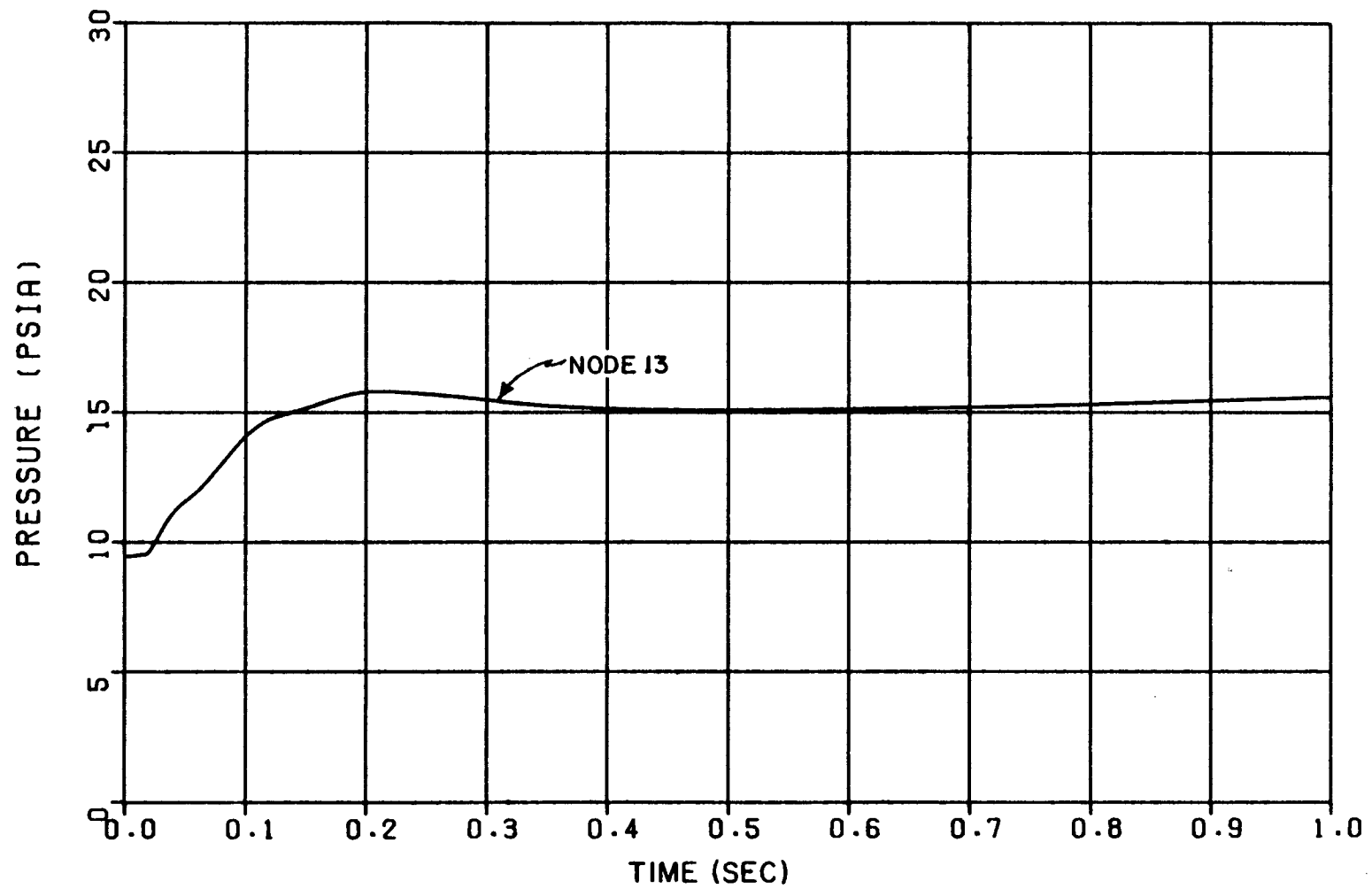

FIGURE 6.2-40  
PRESSURIZER CUBICLE  
AVERAGE PRESSURE VERSUS TIME  
SURGE LINE DER IN THE PRESSURIZER  
RELIEF TANK CUBICLE  
NODE 13  
BEAVER VALLEY POWER STATION-UNIT 2  
FINAL SAFETY ANALYSIS REPORT

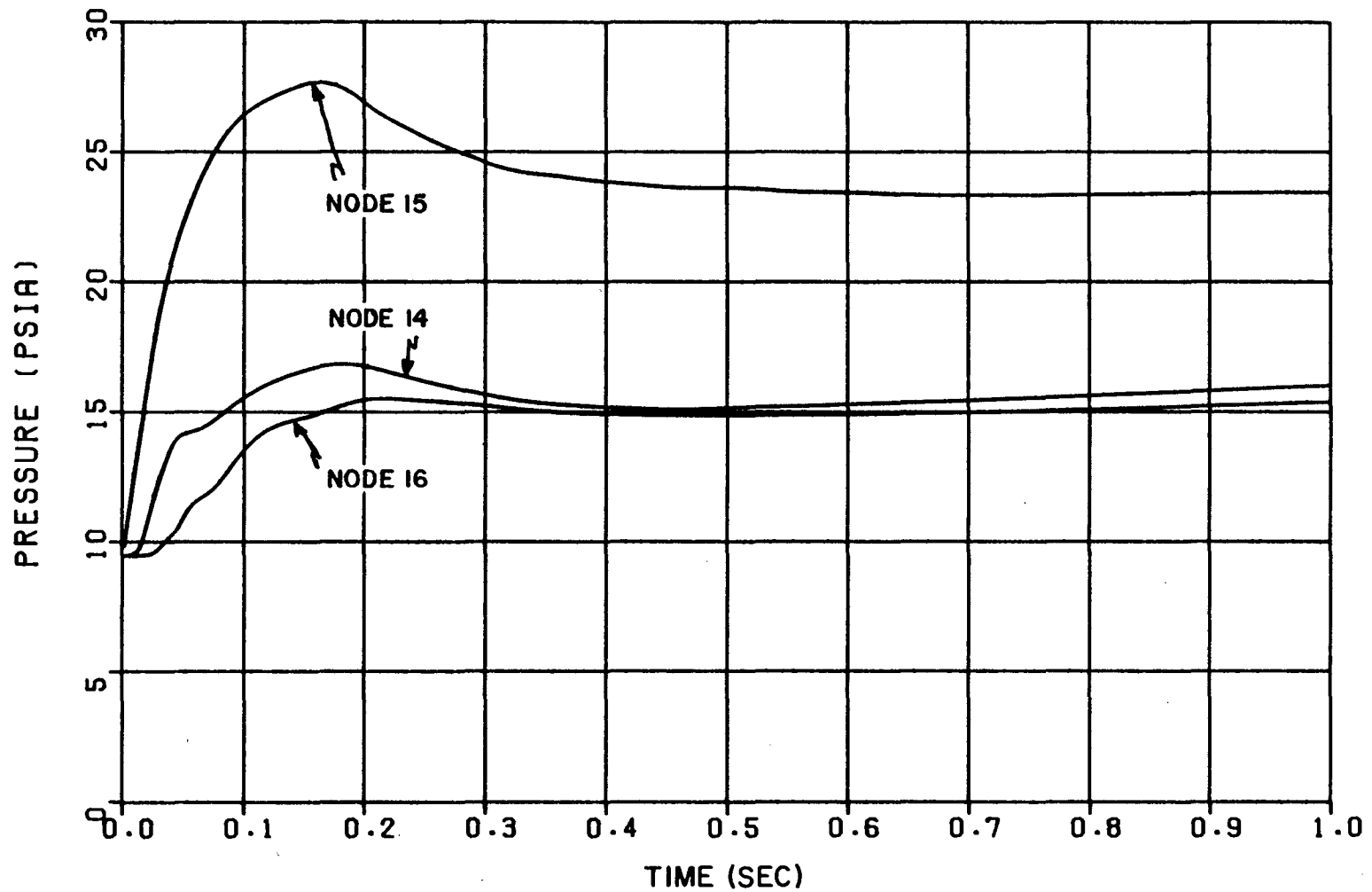

FIGURE 6.2-41  
 PRESSURIZER CUBICLE  
 AVERAGE PRESSURE VERSUS TIME  
 SURGE LINE DER IN THE PRESSURIZER  
 RELIEF TANK CUBICLE  
 NODES 14, 15 & 16  
 BEAVER VALLEY POWER STATION-UNIT 2  
 FINAL SAFETY ANALYSIS REPORT



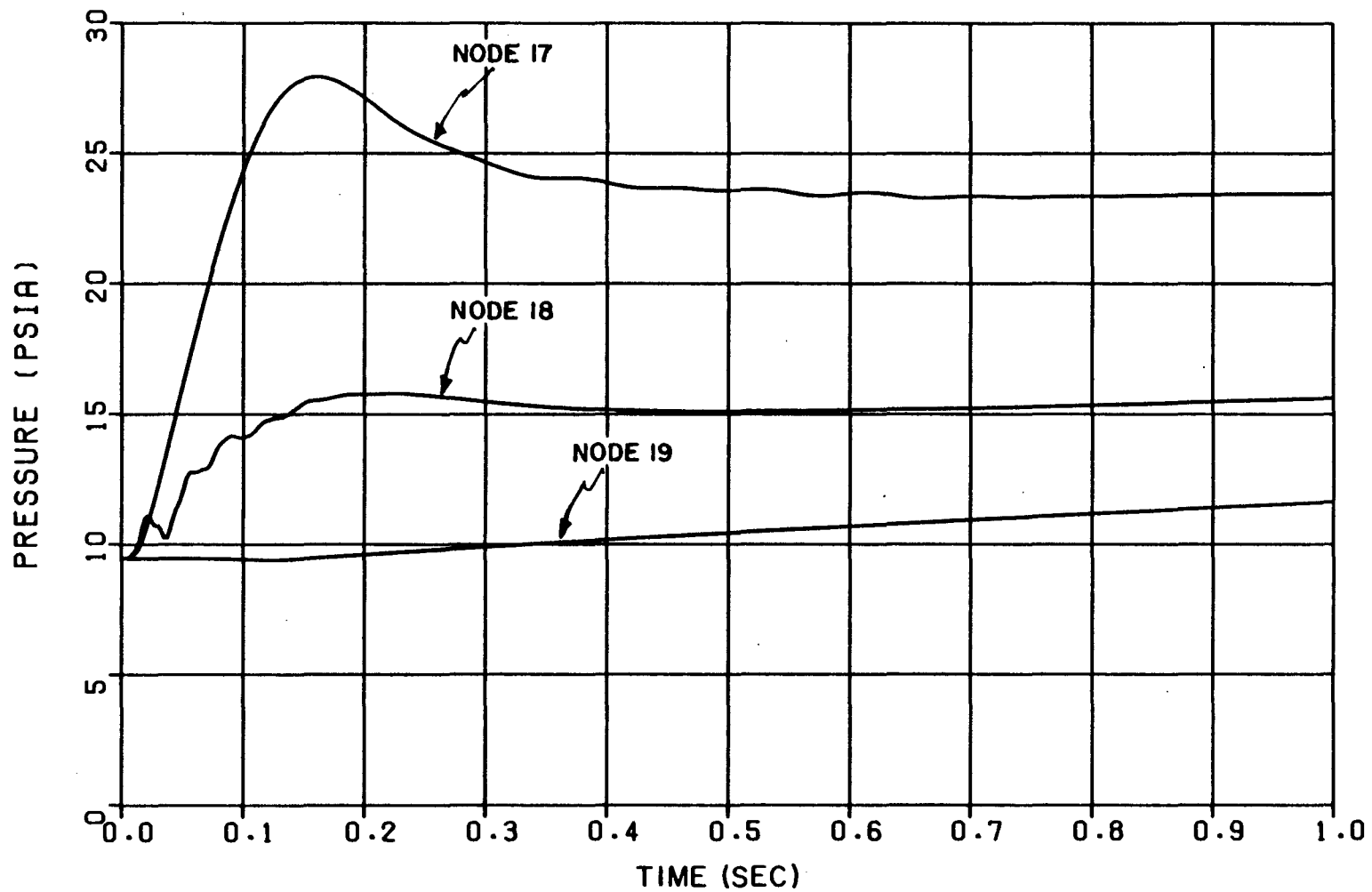

FIGURE 6.2-42  
 PRESSURIZER CUBICLE  
 AVERAGE PRESSURE VERSUS TIME  
 SURGE LINE DER IN THE PRESSURIZER  
 RELIEF TANK CUBICLE  
 NODES 17, 18 & 19  
 BEAVER VALLEY POWER STATION-UNIT 2  
 FINAL SAFETY ANALYSIS REPORT

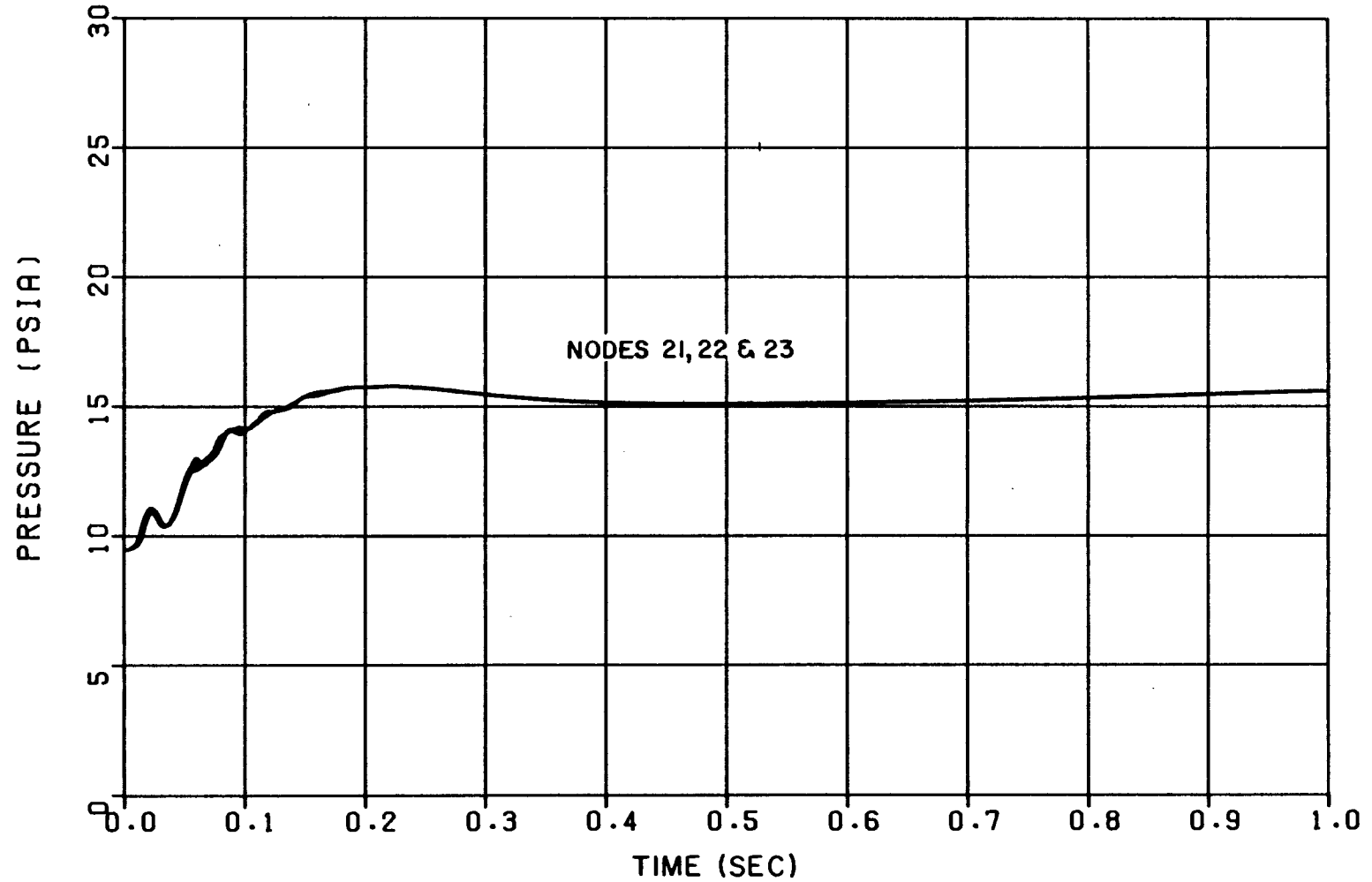
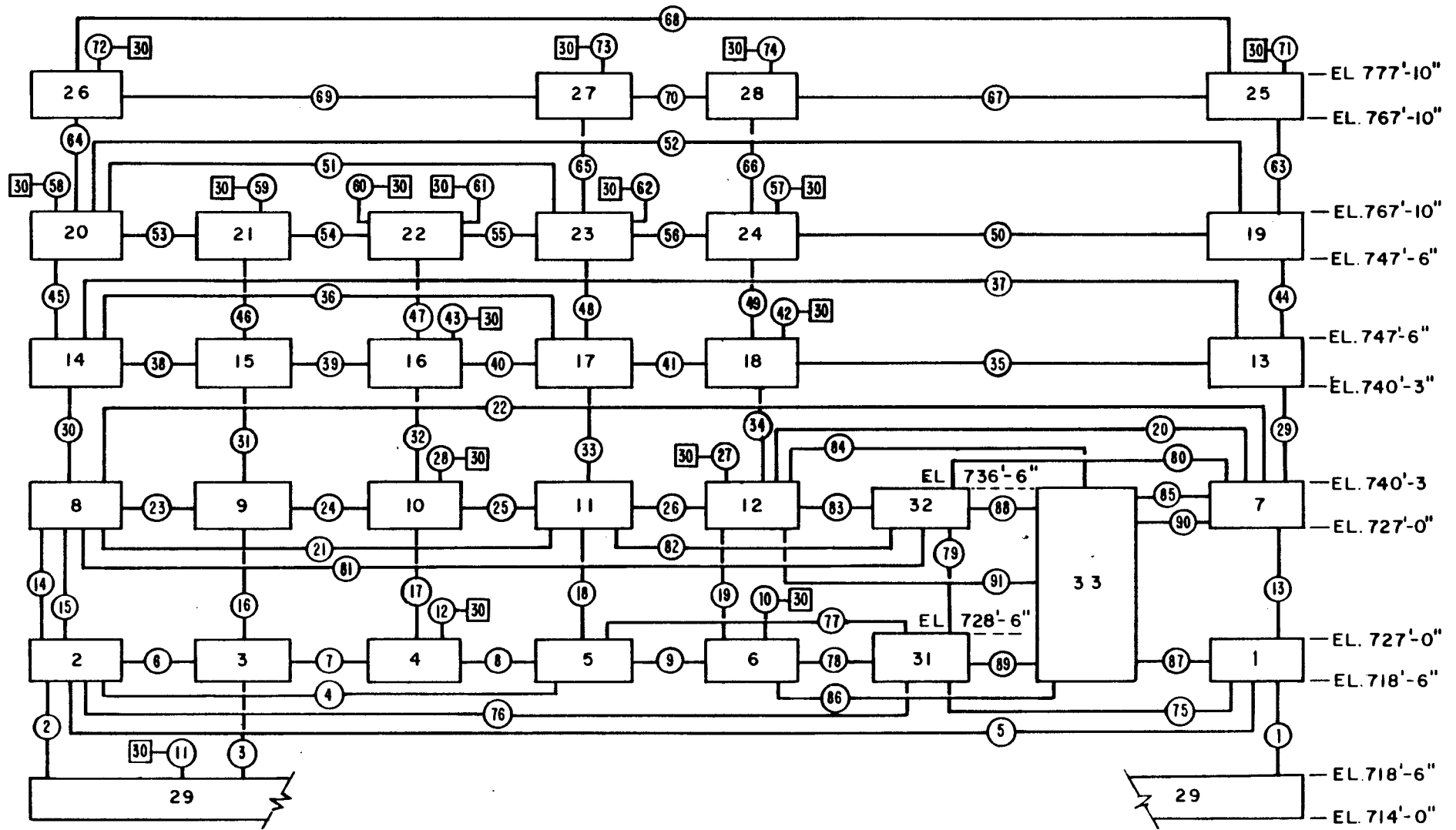

FIGURE 6.2-43  
PRESSURIZER CUBICLE  
AVERAGE PRESSURE VERSUS TIME  
SURGE LINE DER IN THE PRESSURIZER  
RELIEF TANK CUBICLE  
NODES 21, 22 & 23  
BEAVER VALLEY POWER STATION-UNIT 2  
FINAL SAFETY ANALYSIS REPORT



NOTES

1. NODE 30 IS THE CONTAINMENT

2. SYMBOLS

a)  CONTROL VOLUME (OR NODE)

b)  JUNCTION NUMBER

FIGURE 6.2-44

**STEAM GENERATOR SUBCOMPARTMENT  
NODALIZATION DIAGRAM**  
BEAVER VALLEY POWER STATION-UNIT 2  
FINAL SAFETY ANALYSIS REPORT

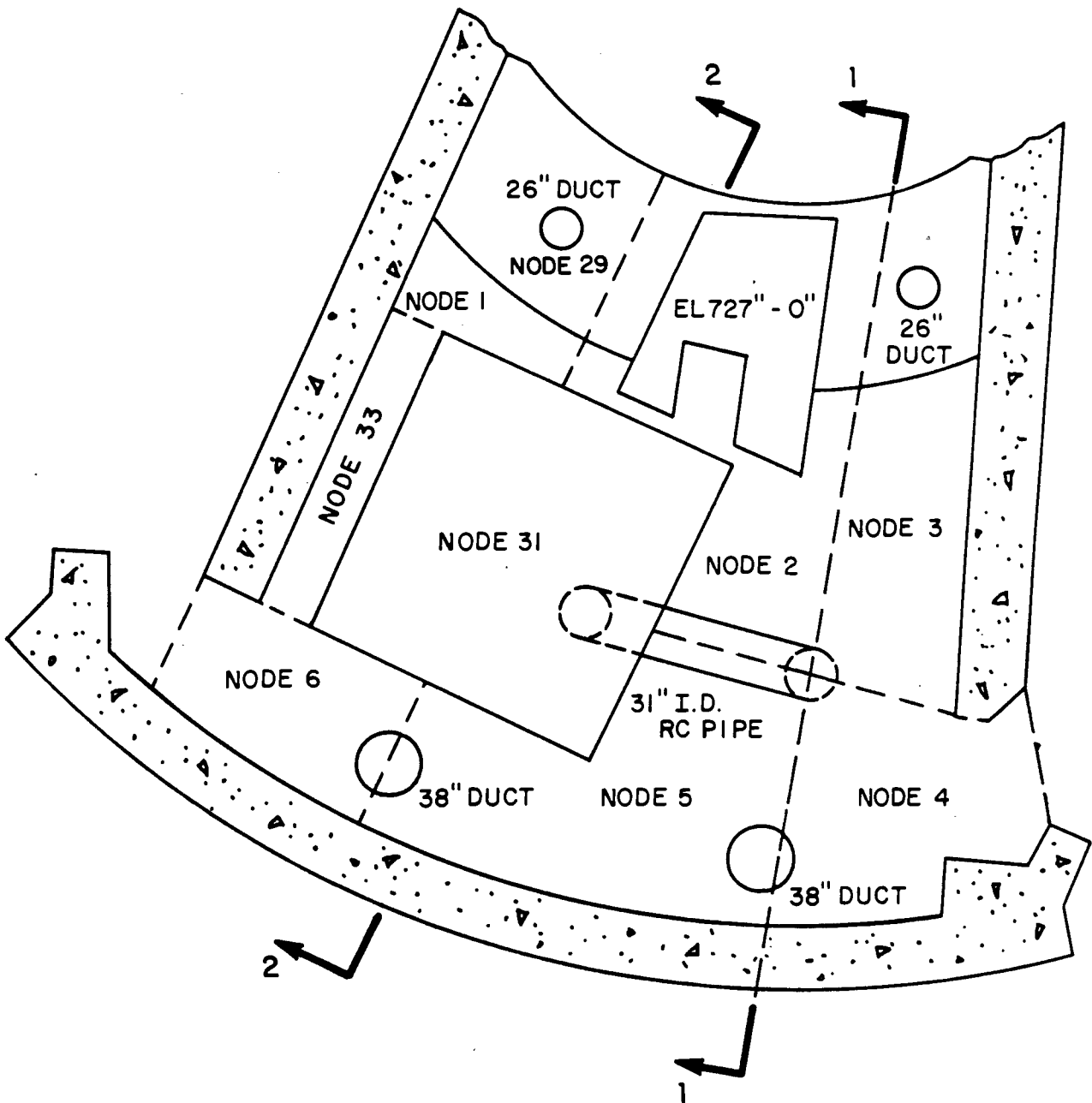

FIGURE 6.2-45  
 STEAM GENERATOR  
 SUBCOMPARTMENT NODALIZATION  
 PLAN VIEW ELEVATION 718'-6" TO 727'-2"  
 BEAVER VALLEY POWER STATION-UNIT 2  
 FINAL SAFETY ANALYSIS REPORT

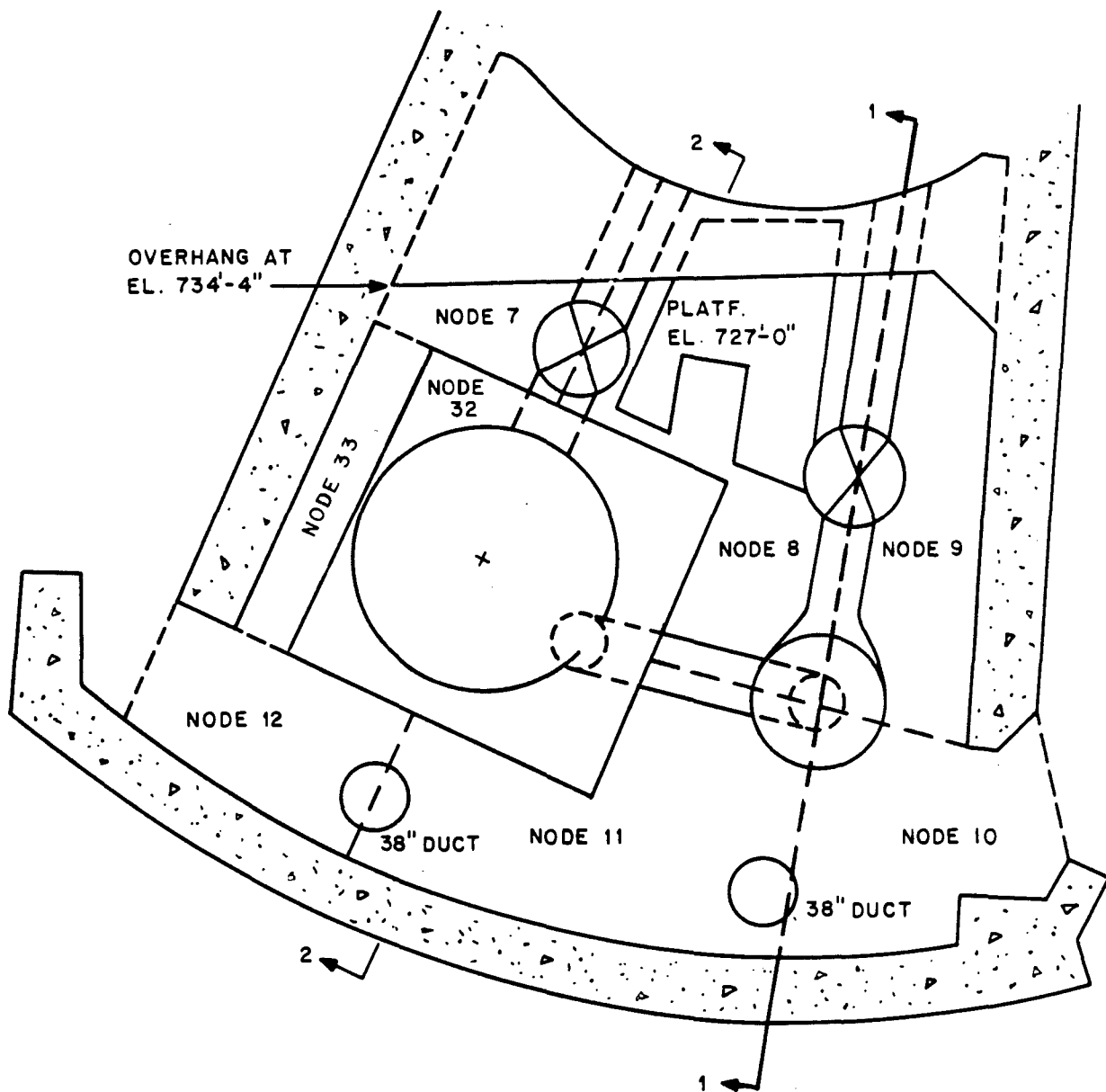
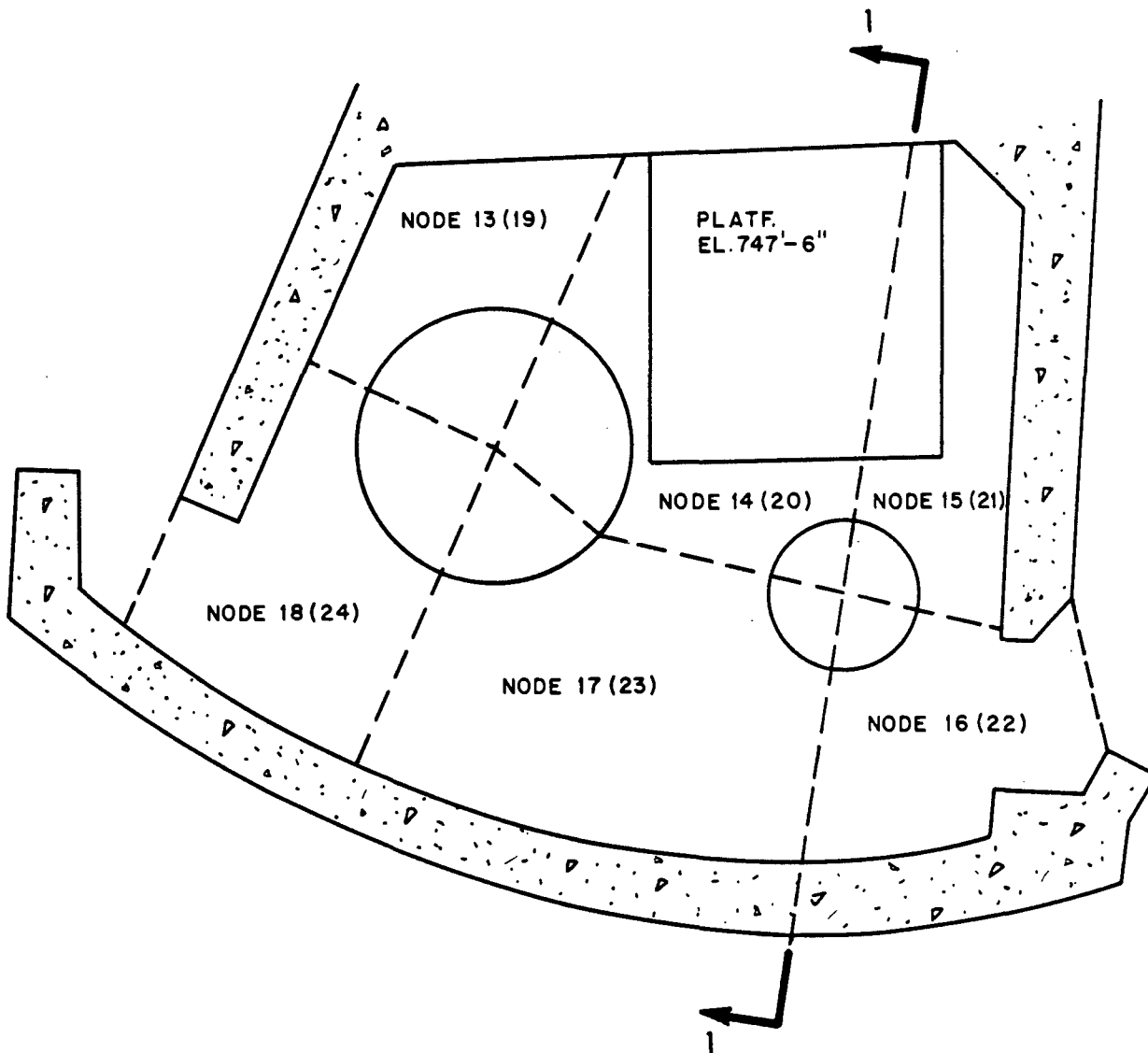

FIGURE 6.2-46  
 STEAM GENERATOR  
 SUBCOMPARTMENT NODALIZATION  
 PLAN VIEW EL. 727'-0" TO 740'-3"  
 BEAVER VALLEY POWER STATION-UNIT 2  
 FINAL SAFETY ANALYSIS REPORT



**NOTE:**

NODES 19 THROUGH 24 ARE LOCATED  
DIRECTLY ABOVE NODES 13 THROUGH  
18, RESPECTIVELY

**FIGURE 6.2-47  
STEAM GENERATOR  
SUBCOMPARTMENT NODALIZATION  
PLAN VIEW EL. 740'-3" TO 767'-10"  
BEAVER VALLEY POWER STATION-UNIT 2  
FINAL SAFETY ANALYSIS REPORT**

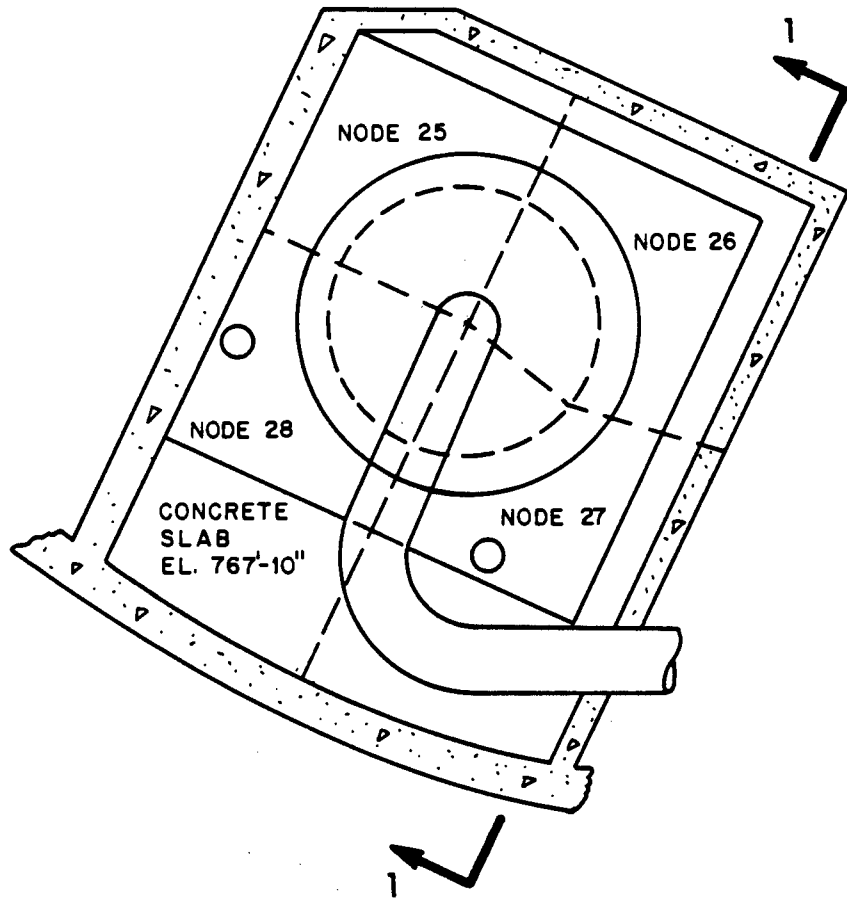

FIGURE 6.2-48  
 STEAM GENERATOR  
 SUBCOMPARTMENT NODALIZATION  
 PLAN VIEW EL. 767'-10"  
 BEAVER VALLEY POWER STATION-UNIT 2  
 FINAL SAFETY ANALYSIS REPORT

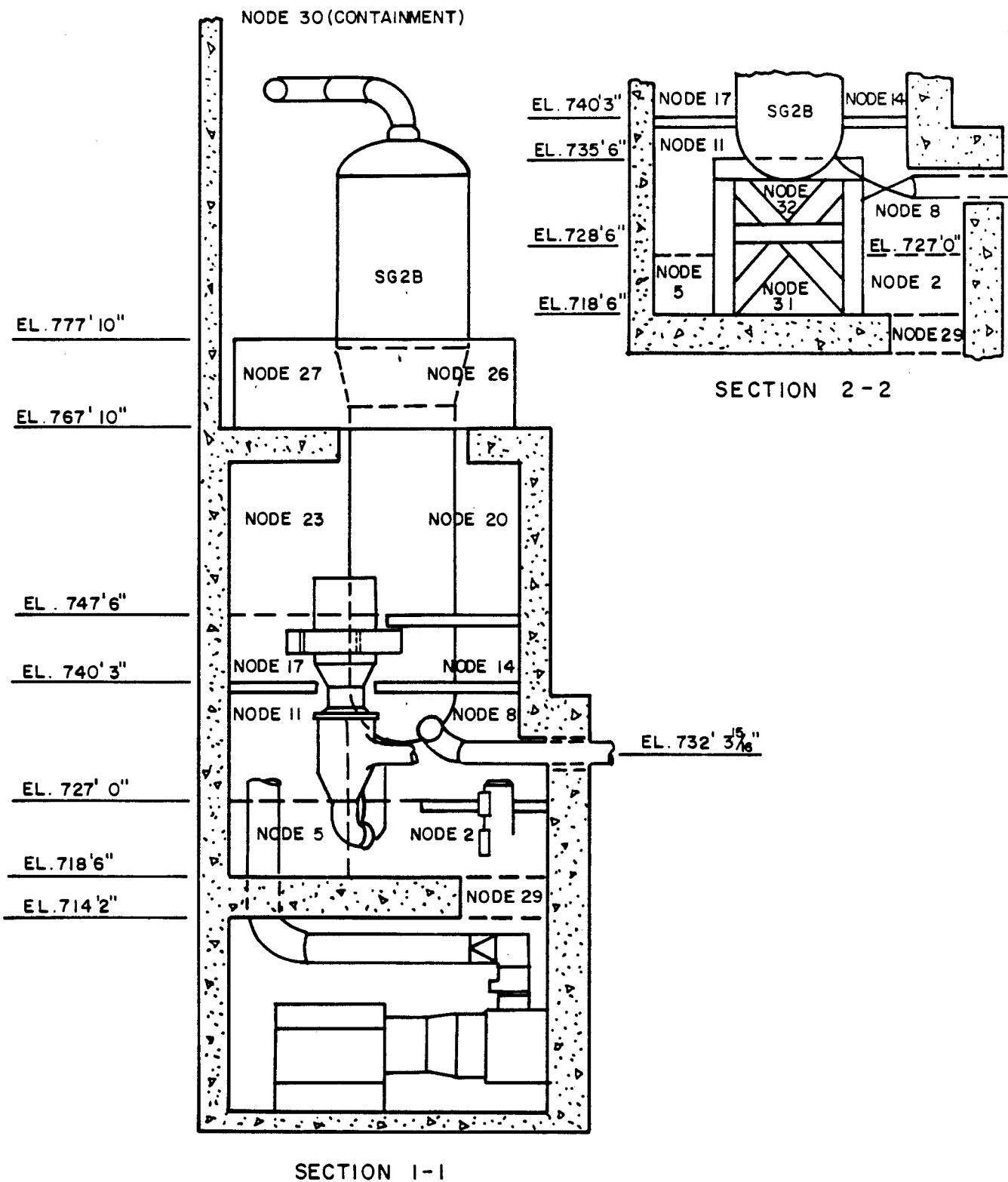
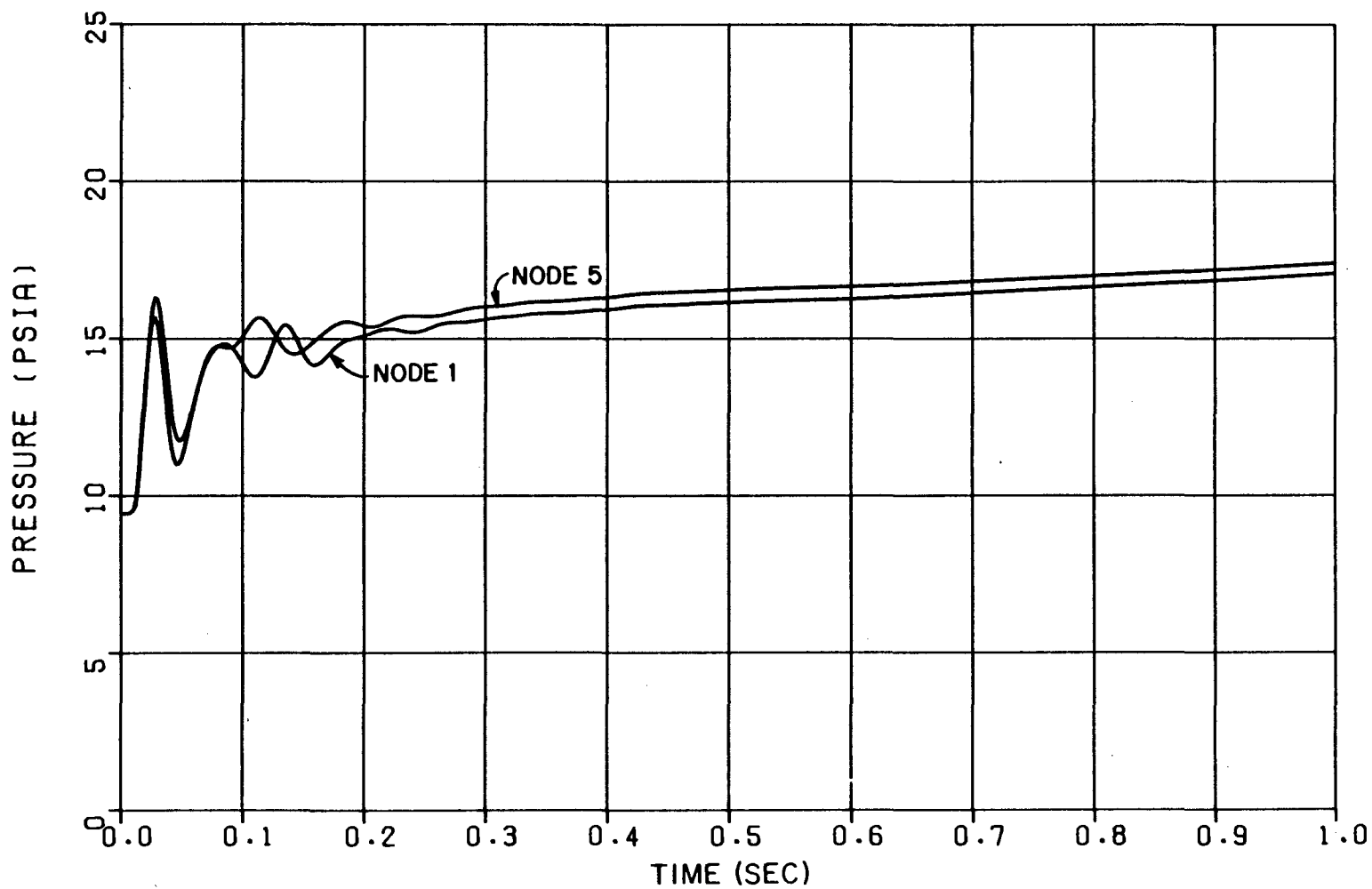

FIGURE 6.2-49  
 STEAM GENERATOR SUBCOMPARTMENT  
 NODALIZATION ELEVATION VIEWS  
 SECTIONS 1-1 AND 2-2  
 BEAVER VALLEY POWER STATION-UNIT 2  
 FINAL SAFETY ANALYSIS REPORT





**FIGURE 6.2-50**  
**BV-2 33 NODE STEAM GENERATOR CUBICLE**  
**ABSOLUTE PRESSURE VERSUS TIME**  
**320 SQ. IN. BREAK**  
**NODES 1 & 5**  
**BEAVER VALLEY POWER STATION-UNIT 2**  
**FINAL SAFETY ANALYSIS REPORT**

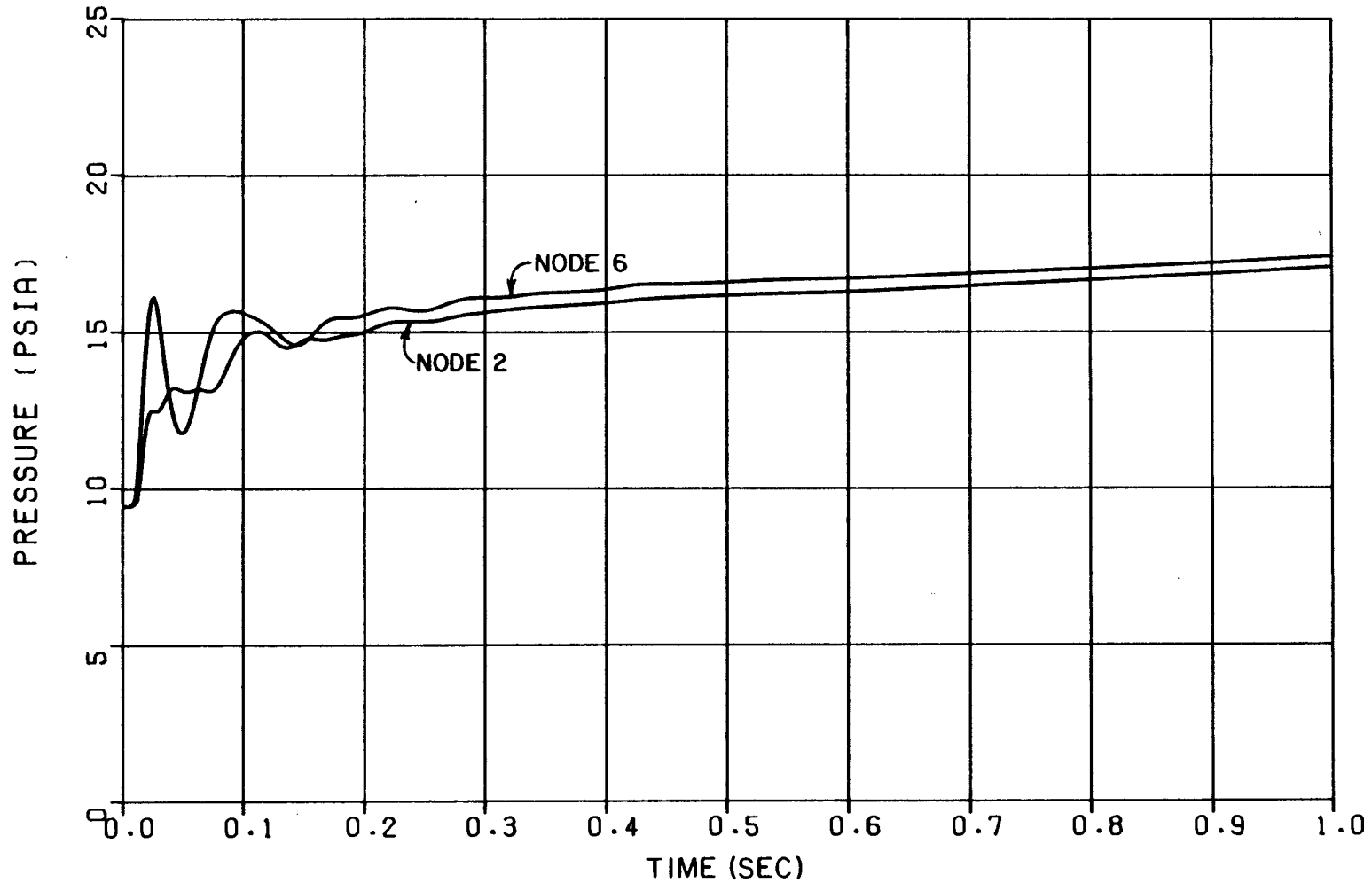

FIGURE 6.2-51  
BV-2 33 NODE STEAM GENERATOR CUBICLE  
ABSOLUTE PRESSURE VERSUS TIME  
320 SQ. IN. BREAK  
NODES 2 & 6  
BEAVER VALLEY POWER STATION-UNIT 2  
FINAL SAFETY ANALYSIS REPORT

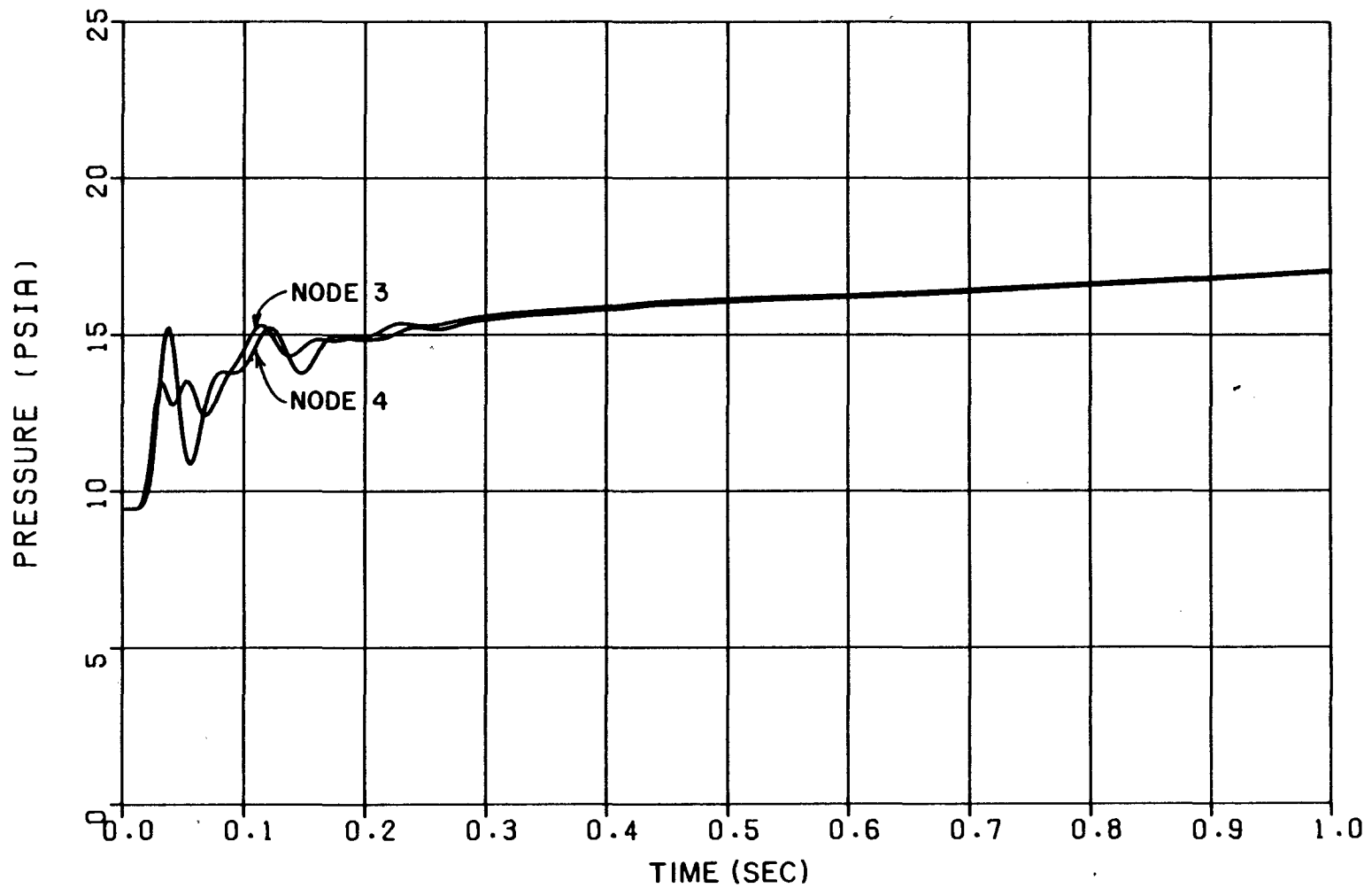
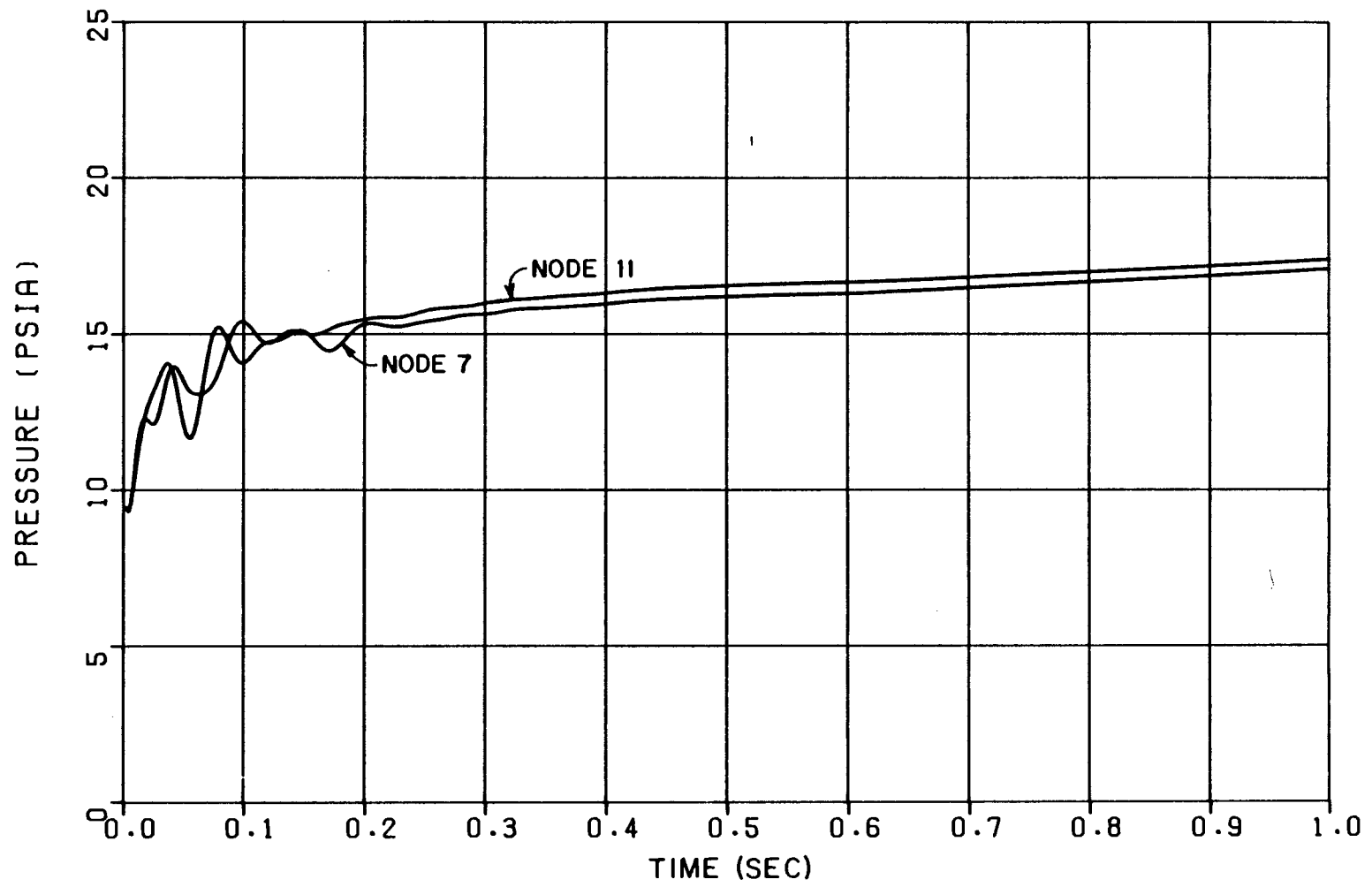

FIGURE 6.2-52  
BV-2 33 NODE STEAM GENERATOR CUBICLE  
ABSOLUTE PRESSURE VERSUS TIME  
320 SQ. IN. BREAK  
NODES 3 & 4  
BEAVER VALLEY POWER STATION-UNIT 2  
FINAL SAFETY ANALYSIS REPORT



**FIGURE 6.2-53**  
**BV-2 33 NODE STEAM GENERATOR CUBICLE**  
**ABSOLUTE PRESSURE VERSUS TIME**  
**320 SQ. IN. BREAK**  
**NODES 7 & 11**  
**BEAVER VALLEY POWER STATION-UNIT 2**  
**FINAL SAFETY ANALYSIS REPORT**

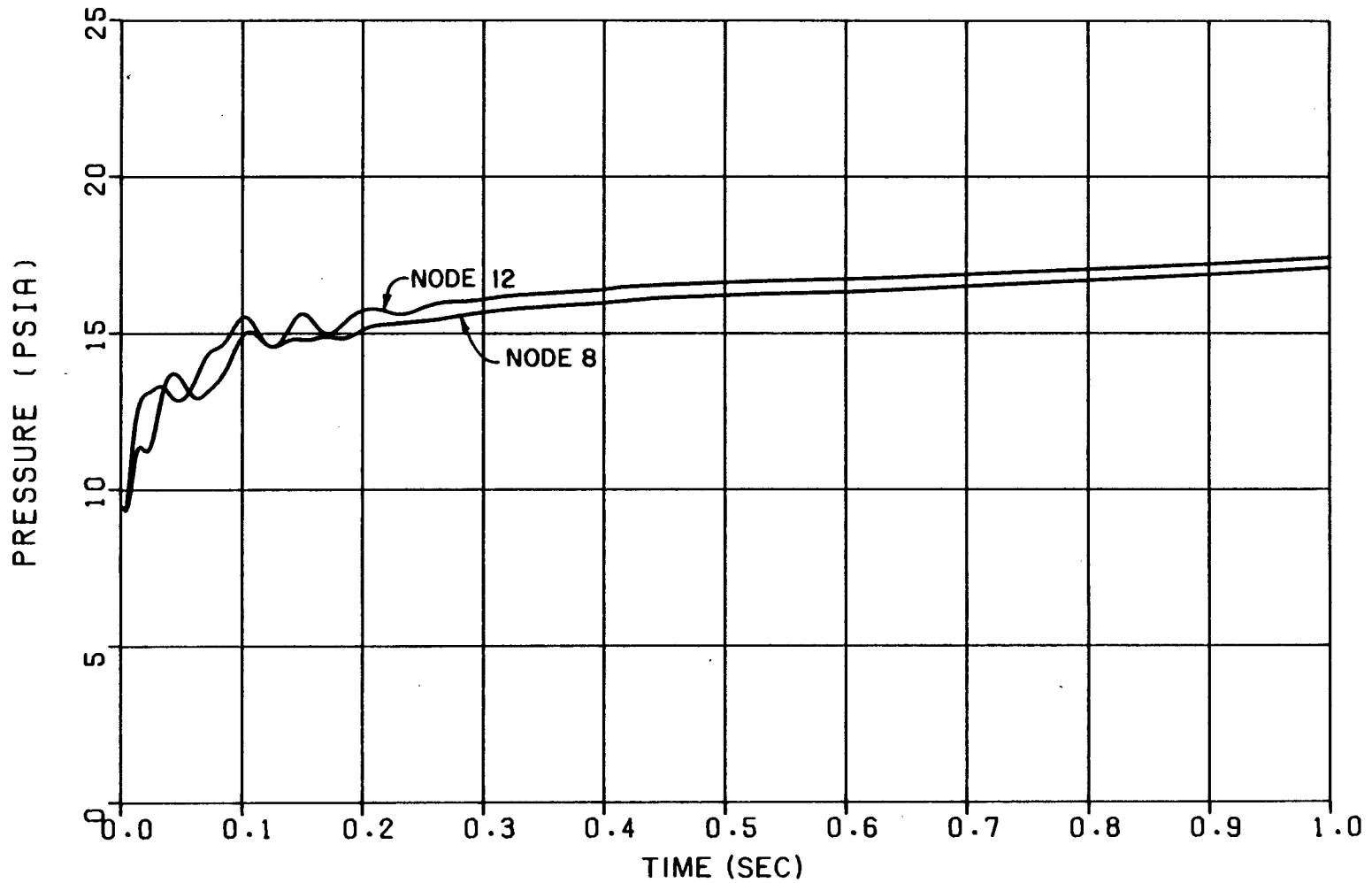

FIGURE 6.2-54  
BV-2 33 NODE STEAM GENERATOR CUBICLE  
ABSOLUTE PRESSURE VERSUS TIME  
320 SQ. IN. BREAK  
NODES 8 & 12  
BEAVER VALLEY POWER STATION-UNIT 2  
FINAL SAFETY ANALYSIS REPORT

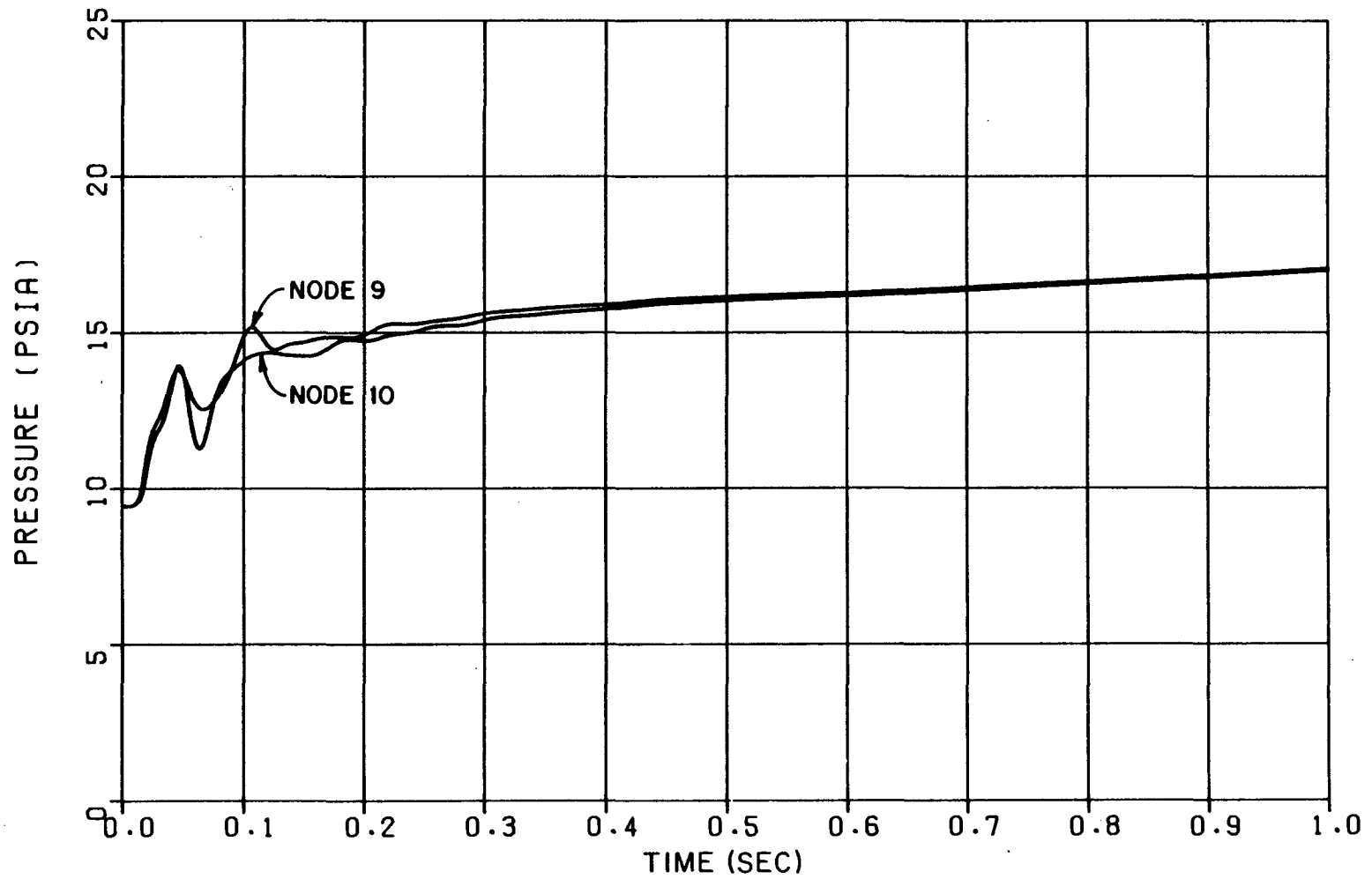
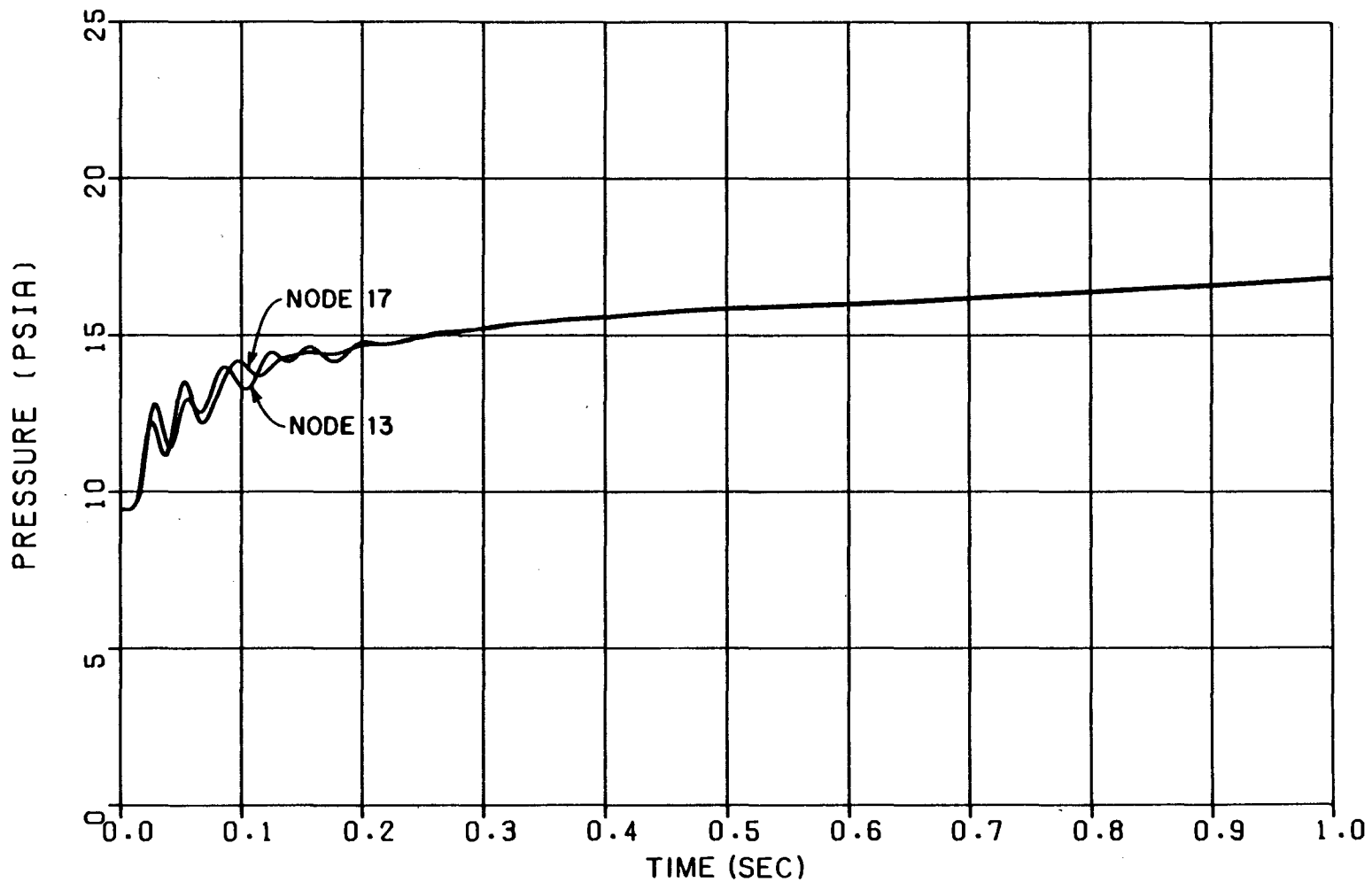

FIGURE 6.2-55  
BV-2 33 NODE STEAM GENERATOR CUBICLE  
ABSOLUTE PRESSURE VERSUS TIME  
320 SQ. IN. BREAK  
NODES 9 & 10  
BEAVER VALLEY POWER STATION-UNIT 2  
FINAL SAFETY ANALYSIS REPORT



**FIGURE 6.2-56**  
**BV-2 33 NODE STEAM GENERATOR CUBICLE**  
**ABSOLUTE PRESSURE VERSUS TIME**  
**320 SQ. IN. BREAK**  
**NODES 13 & 17**  
**BEAVER VALLEY POWER STATION-UNIT 2**  
**FINAL SAFETY ANALYSIS REPORT**

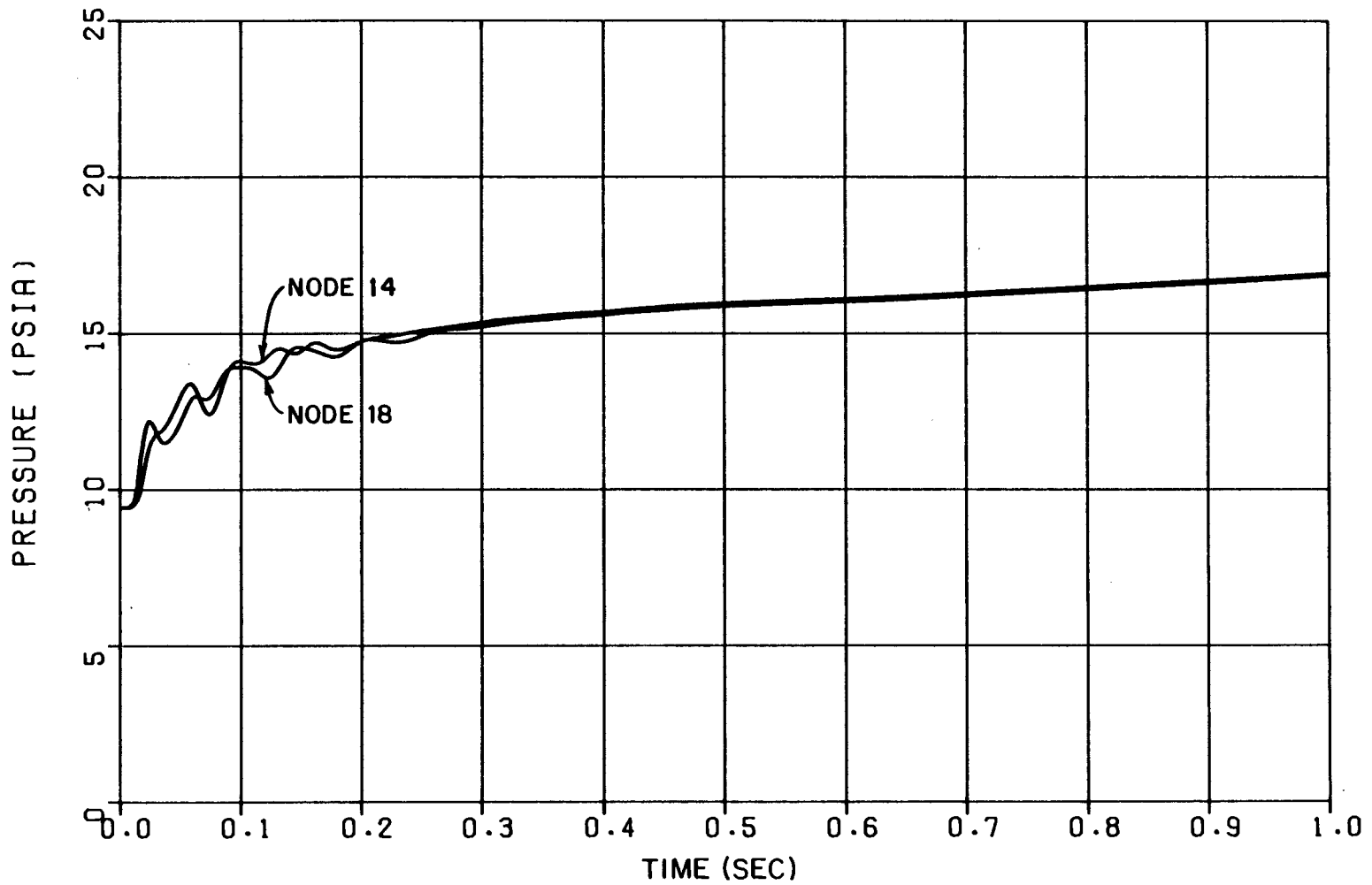
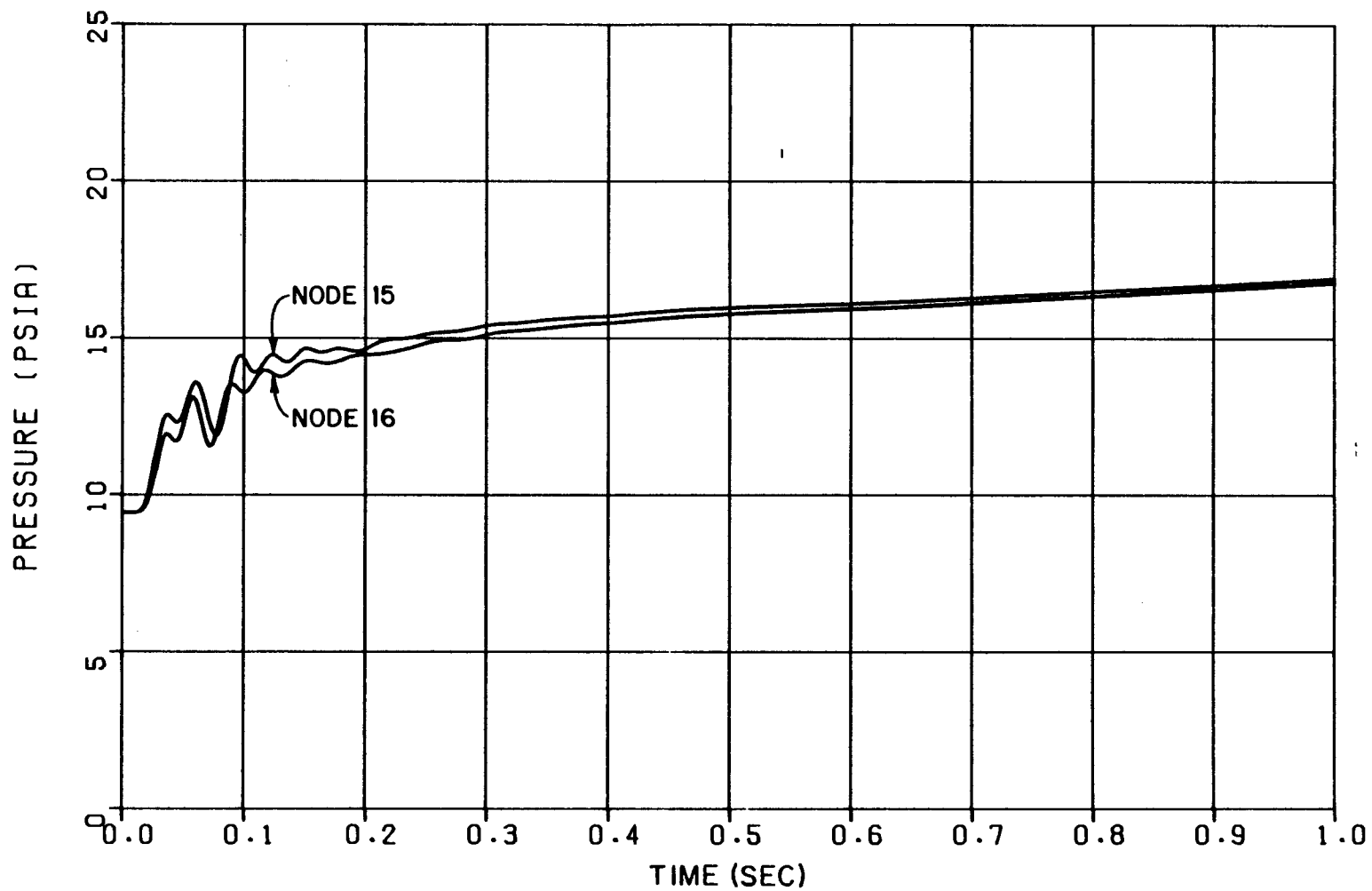

FIGURE 6.2-57  
BV-2 33 NODE STEAM GENERATOR CUBICLE  
ABSOLUTE PRESSURE VERSUS TIME  
320 SQ. IN. BREAK  
NODES 14 & 18  
BEAVER VALLEY POWER STATION-UNIT 2  
FINAL SAFETY ANALYSIS REPORT





**FIGURE 6.2-58**  
**BV-2 33 NODE STEAM GENERATOR CUBICLE**  
**ABSOLUTE PRESSURE VERSUS TIME**  
**320 SQ. IN. BREAK**  
**NODES 15 & 16**  
**BEAVER VALLEY POWER STATION-UNIT 2**  
**FINAL SAFETY ANALYSIS REPORT**

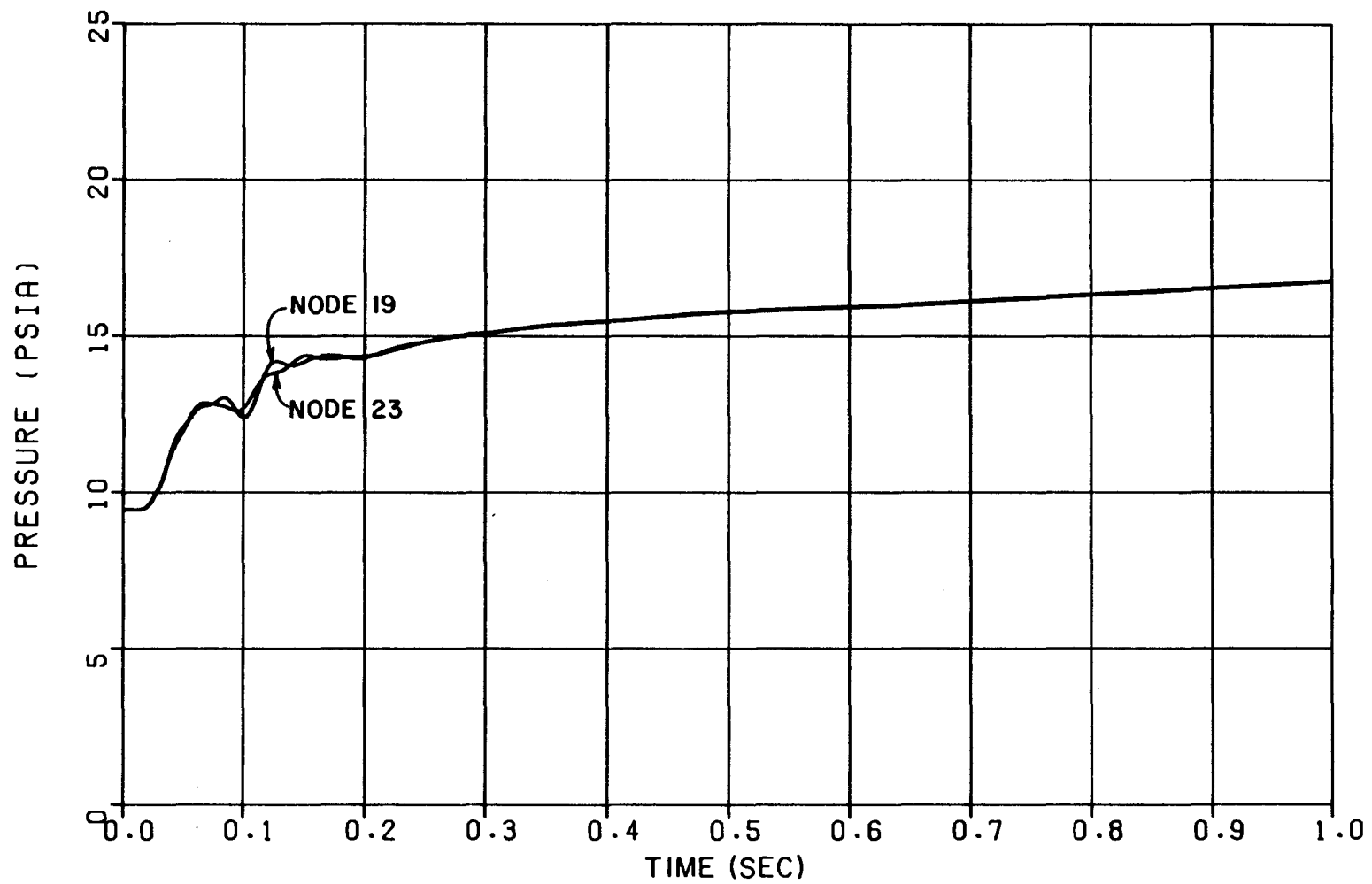

FIGURE 6.2-59  
BV-2 33 NODE STEAM GENERATOR CUBICLE  
ABSOLUTE PRESSURE VERSUS TIME  
320 SQ. IN. BREAK  
NODES 19 & 23  
BEAVER VALLEY POWER STATION-UNIT 2  
FINAL SAFETY ANALYSIS REPORT

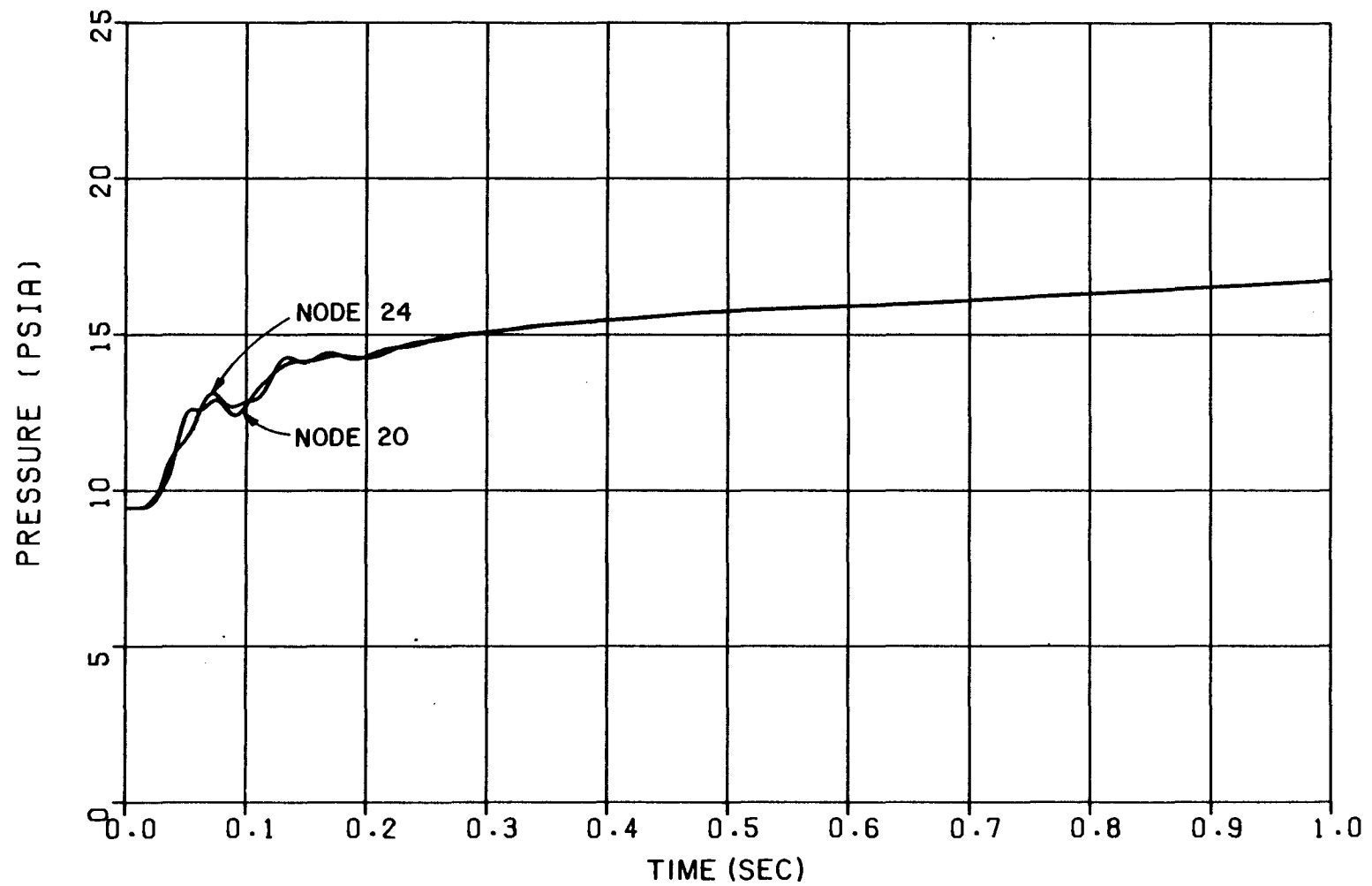

FIGURE 6.2-60  
BV-2 33 NODE STEAM GENERATOR CUBICLE  
ABSOLUTE PRESSURE VERSUS TIME  
320 SQ. IN. BREAK  
NODES 20 & 24  
BEAVER VALLEY POWER STATION-UNIT 2  
FINAL SAFETY ANALYSIS REPORT

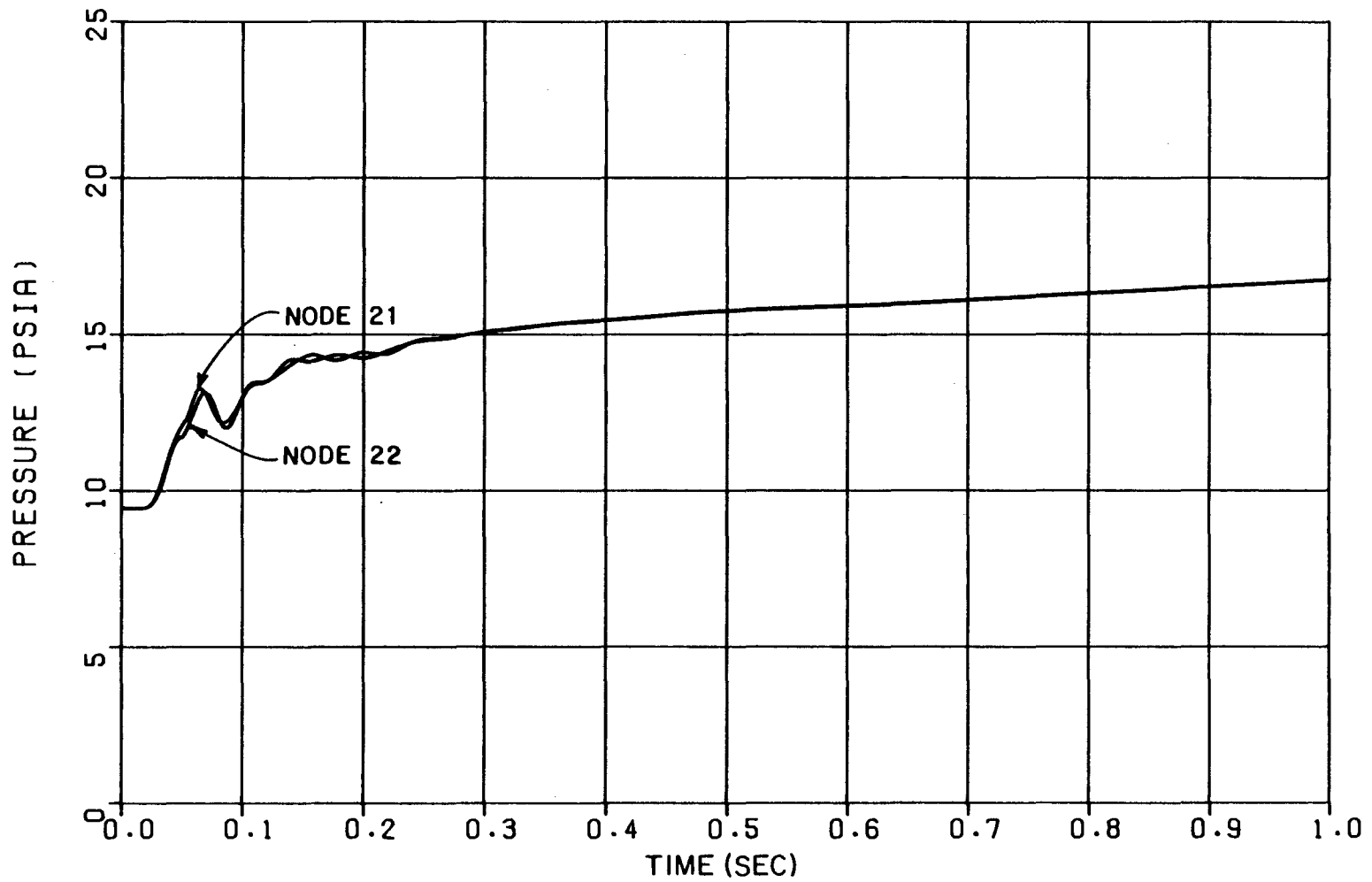
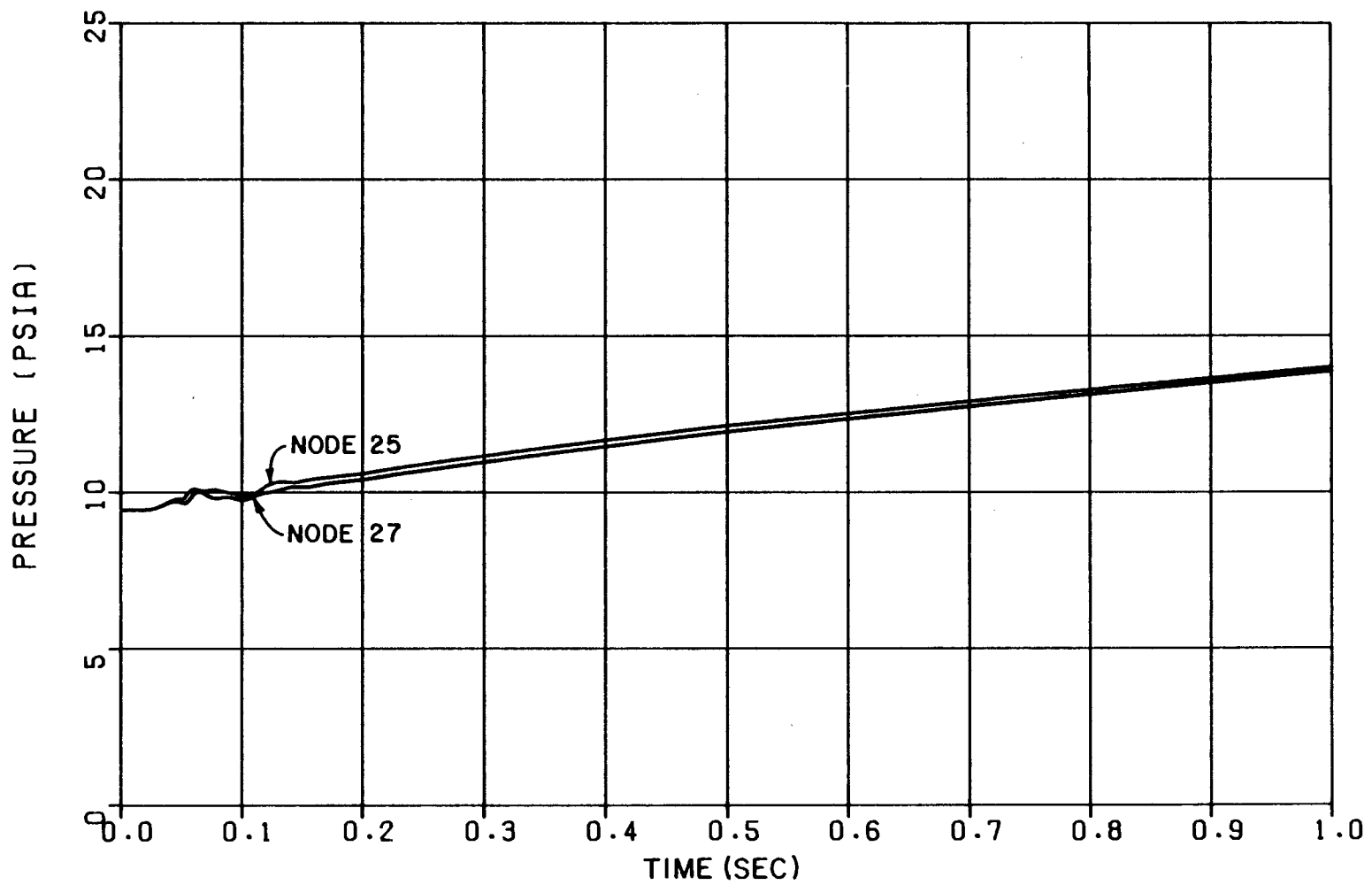
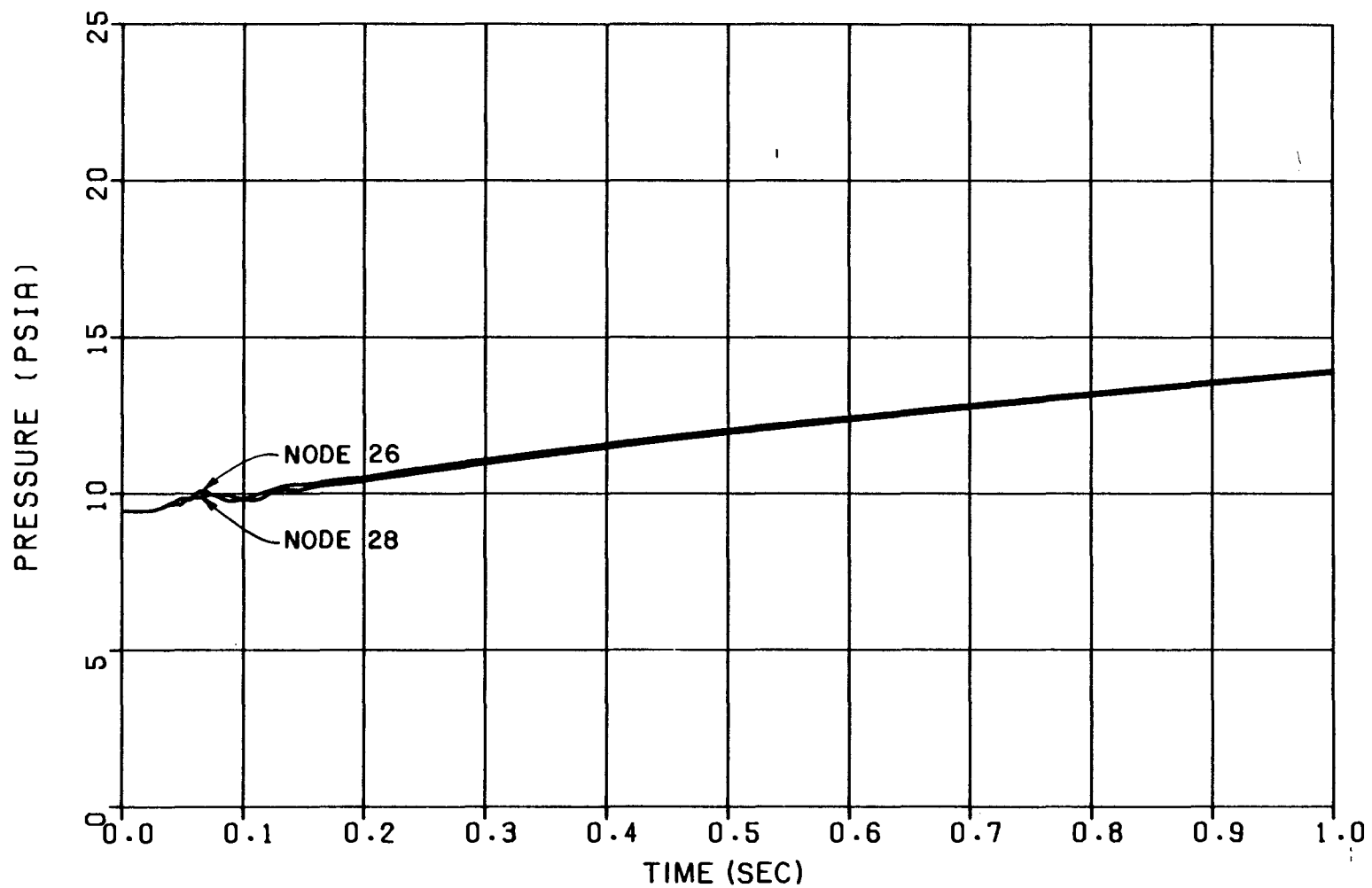

FIGURE 6.2-61  
BV-2 33 NODE STEAM GENERATOR CUBICLE  
ABSOLUTE PRESSURE VERSUS TIME  
320 SQ. IN. BREAK  
NODES 21 & 22  
BEAVER VALLEY POWER STATION-UNIT 2  
FINAL SAFETY ANALYSIS REPORT



**FIGURE 6.2-62**  
**BV-2 33 NODE STEAM GENERATOR CUBICLE**  
**ABSOLUTE PRESSURE VERSUS TIME**  
**320 SQ. IN. BREAK**  
**NODES 25 & 27**  
**BEAVER VALLEY POWER STATION-UNIT 2**  
**FINAL SAFETY ANALYSIS REPORT**



**FIGURE 6.2-63**  
**BV-2 33 NODE STEAM GENERATOR CUBICLE**  
**ABSOLUTE PRESSURE VERSUS TIME**  
**320 SQ. IN. BREAK**  
**NODES 26 & 28**  
**BEAVER VALLEY POWER STATION-UNIT 2**  
**FINAL SAFETY ANALYSIS REPORT**

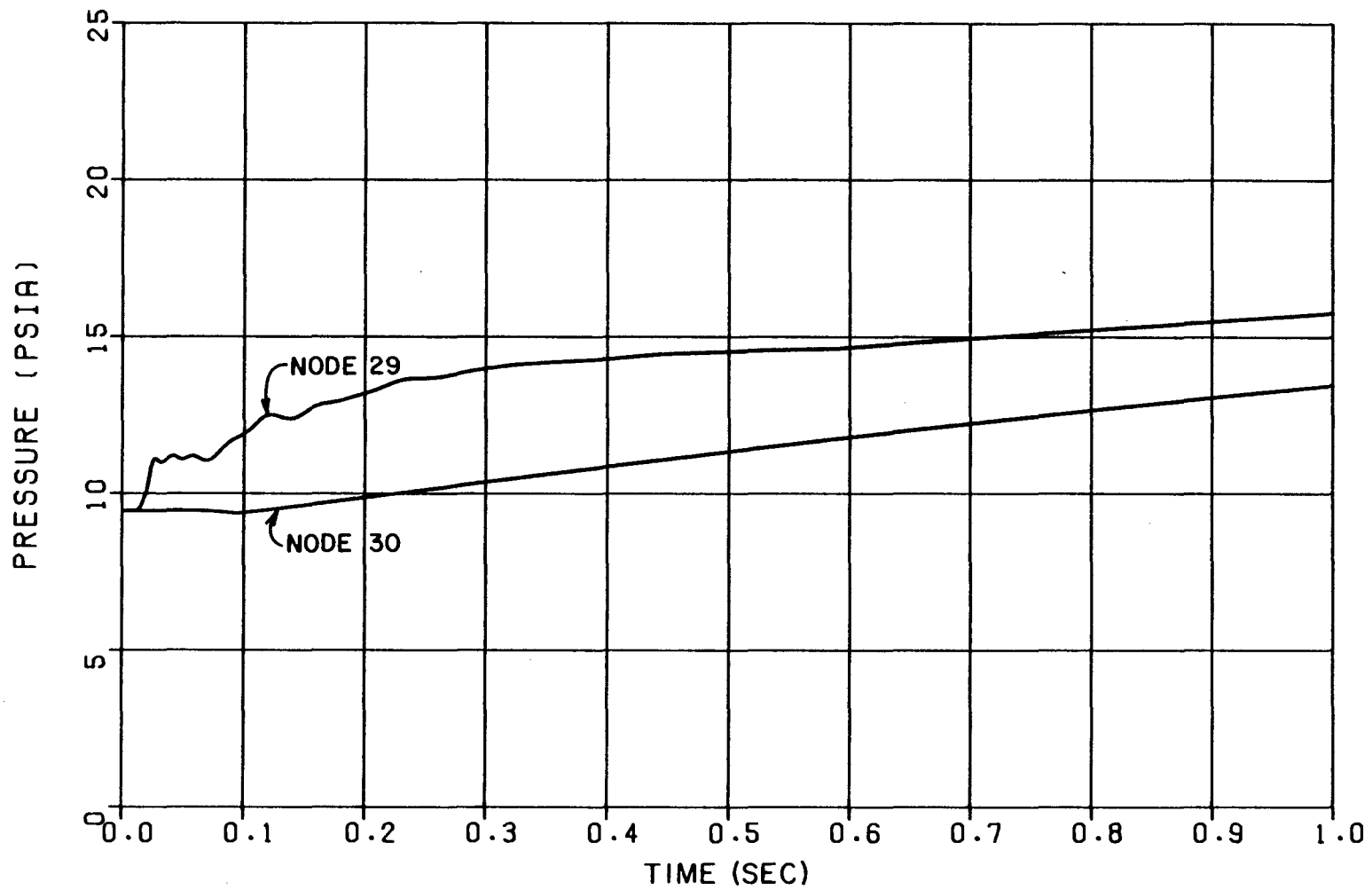
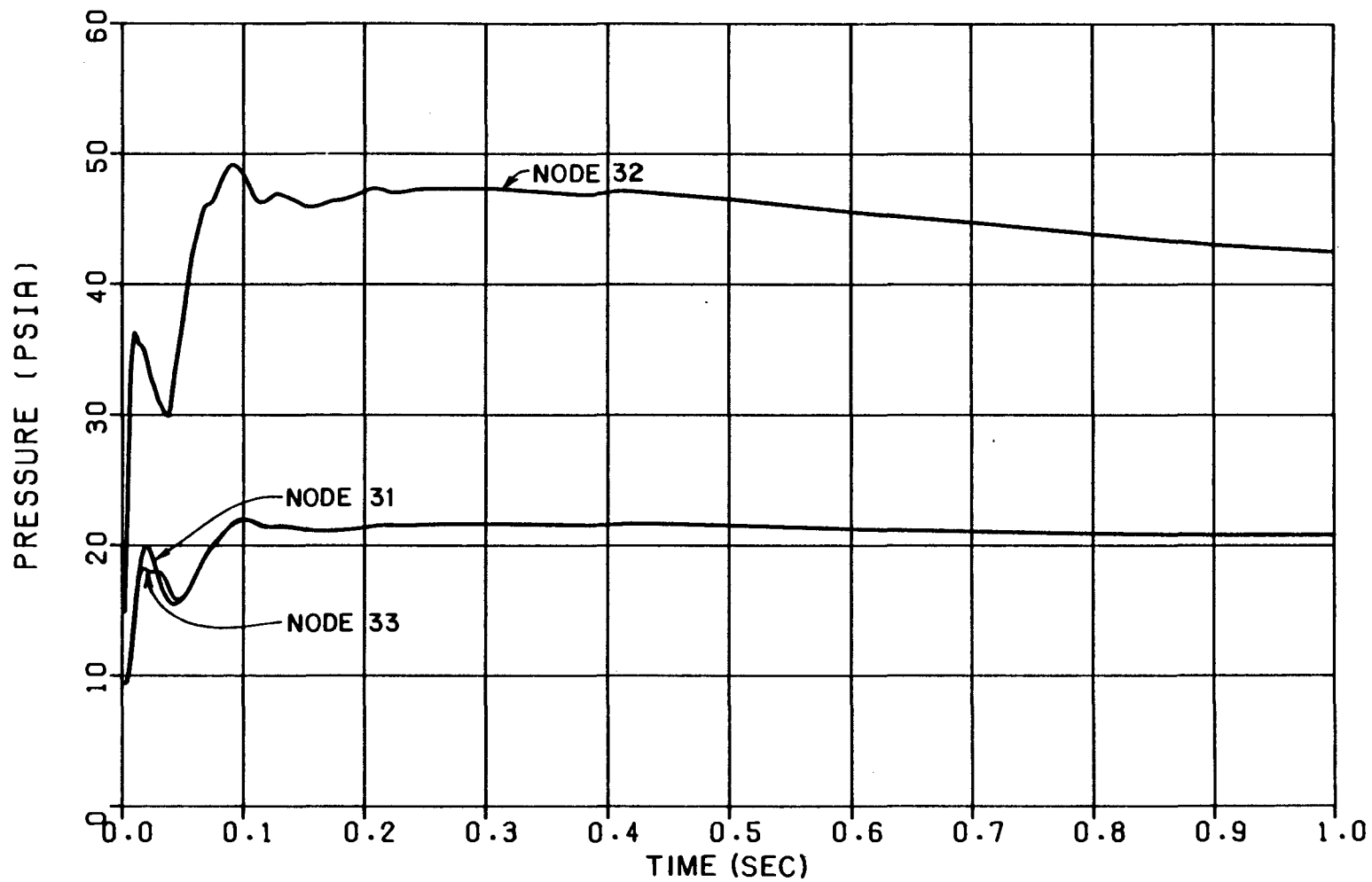

FIGURE 6.2-64  
 BV-2 33 NODE STEAM GENERATOR CUBICLE  
 ABSOLUTE PRESSURE VERSUS TIME  
 320 SQ. IN. BREAK  
 NODES 29 & 30  
 BEAVER VALLEY POWER STATION-UNIT 2  
 FINAL SAFETY ANALYSIS REPORT



**FIGURE 6.2-65**  
**BV-2 33 NODE STEAM GENERATOR CUBICLE**  
**ABSOLUTE PRESSURE VERSUS TIME**  
**320 SQ. IN. BREAK**  
**NODES 31, 32 & 33**  
**BEAVER VALLEY POWER STATION-UNIT 2**  
**FINAL SAFETY ANALYSIS REPORT**



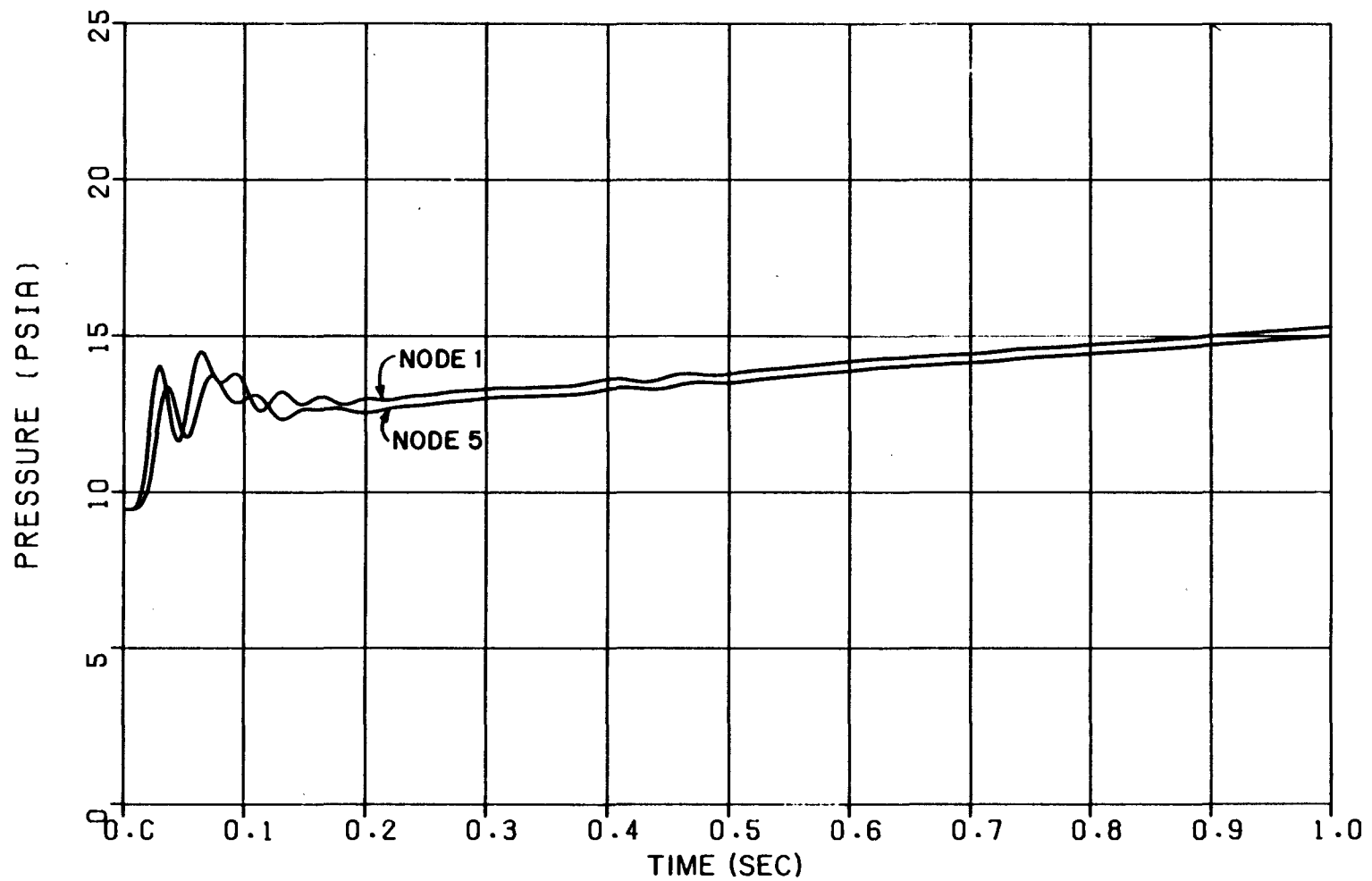

FIGURE 6.2-66  
BV-2 33 NODE STEAM GENERATOR CUBICLE  
ABSOLUTE PRESSURE VERSUS TIME  
180 SQ. IN. BREAK  
NODES 1 & 5  
BEAVER VALLEY POWER STATION-UNIT 2  
FINAL SAFETY ANALYSIS REPORT

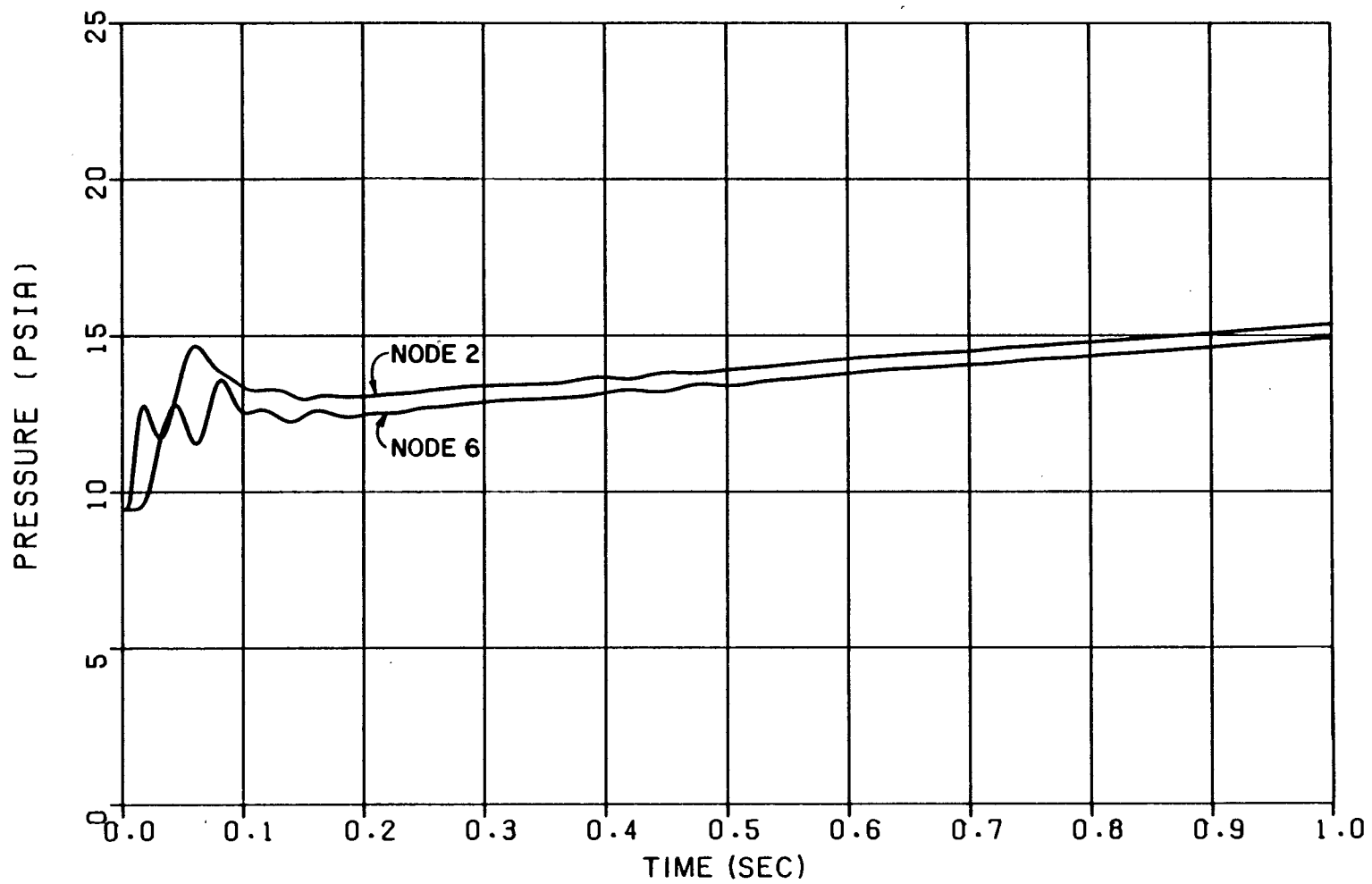

FIGURE 6.2-67  
BV-2 33 NODE STEAM GENERATOR CUBICLE  
ABSOLUTE PRESSURE VERSUS TIME  
180 SQ. IN. BREAK  
NODES 2 & 6  
BEAVER VALLEY POWER STATION-UNIT 2  
FINAL SAFETY ANALYSIS REPORT

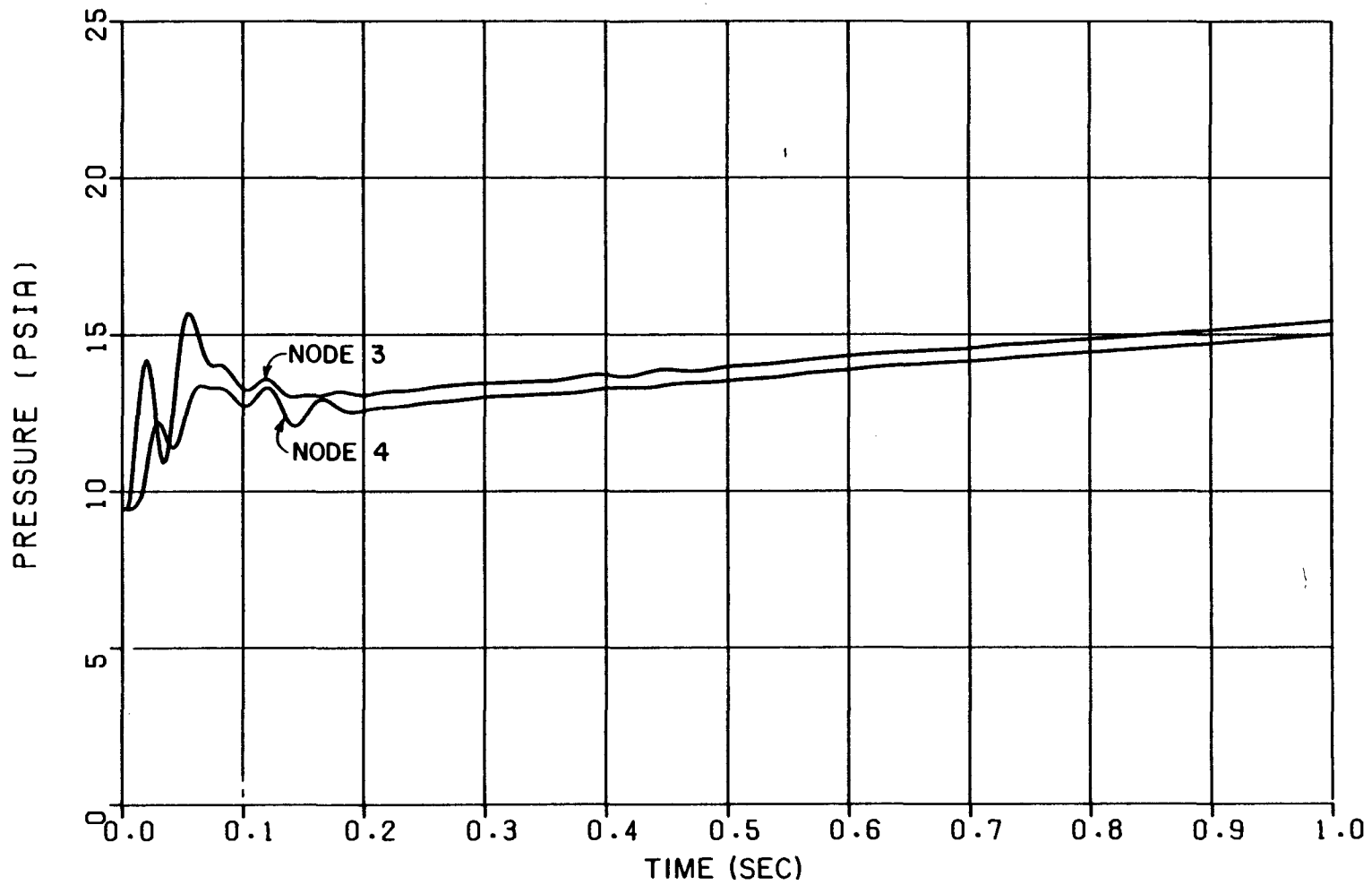

FIGURE 6.2-68  
BV-2 33 NODE STEAM GENERATOR CUBICLE  
ABSOLUTE PRESSURE VERSUS TIME  
180 SQ. IN. BREAK  
NODES 3 & 4  
BEAVER VALLEY POWER STATION-UNIT 2  
FINAL SAFETY ANALYSIS REPORT

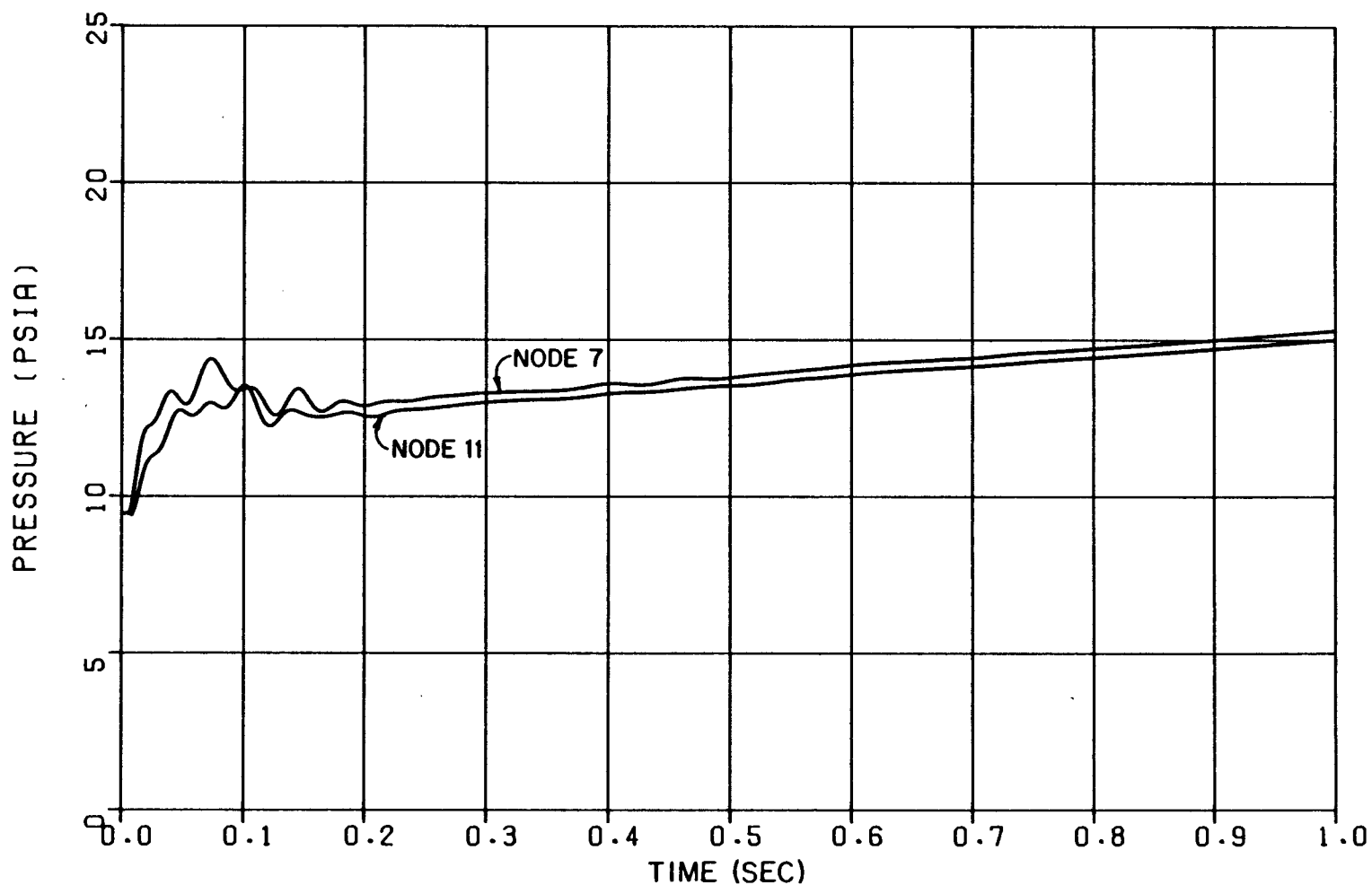

FIGURE 6.2-69  
BV-2 33 NODE STEAM GENERATOR CUBICLE  
ABSOLUTE PRESSURE VERSUS TIME  
180 SQ. IN. BREAK  
NODES 7 & 11  
BEAVER VALLEY POWER STATION-UNIT 2  
FINAL SAFETY ANALYSIS REPORT

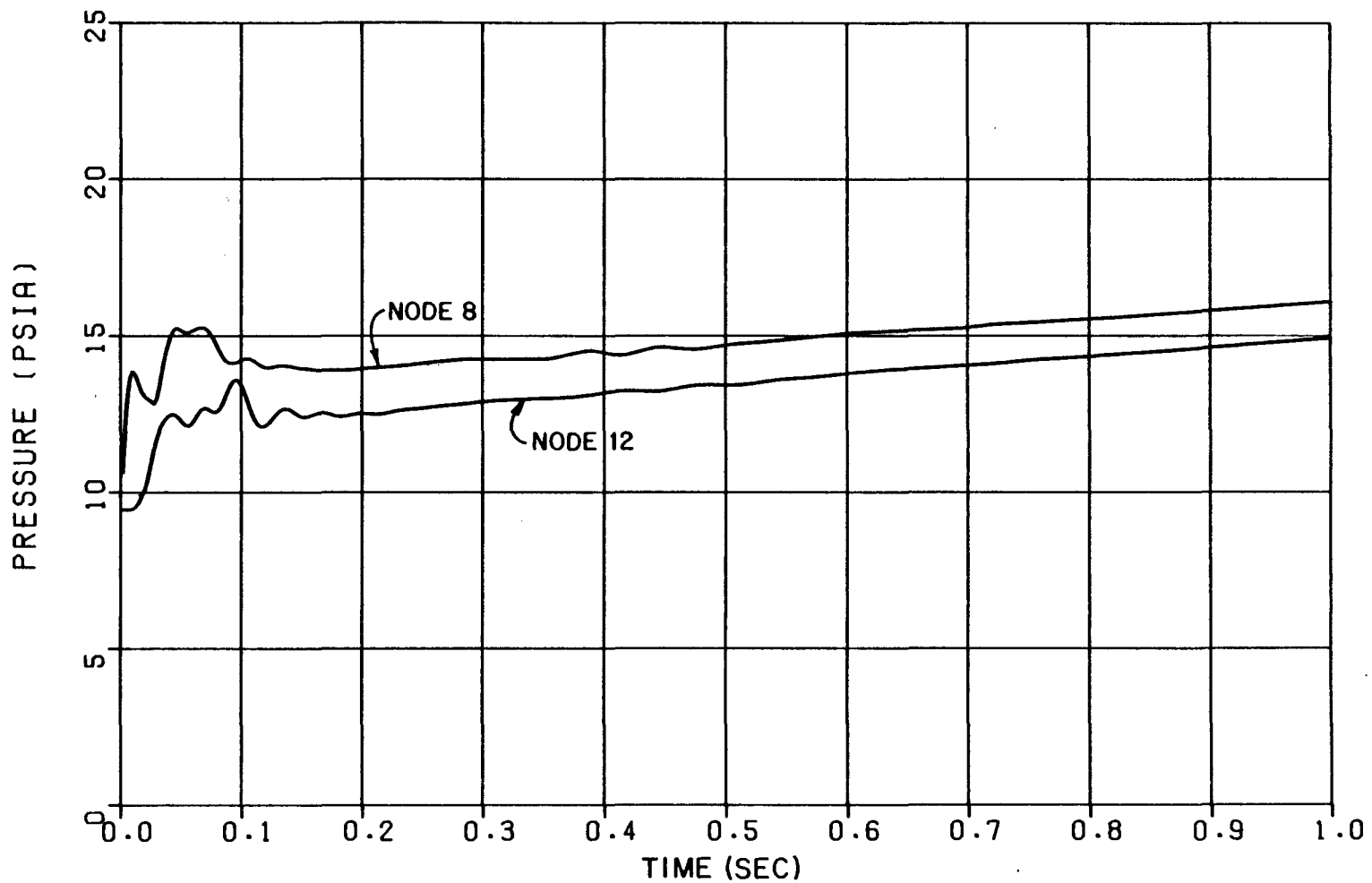

FIGURE 6.2-70  
BV-2 33 NODE STEAM GENERATOR CUBICLE  
ABSOLUTE PRESSURE VERSUS TIME  
180 SQ. IN. BREAK  
NODES 8 & 12  
BEAVER VALLEY POWER STATION-UNIT 2  
FINAL SAFETY ANALYSIS REPORT

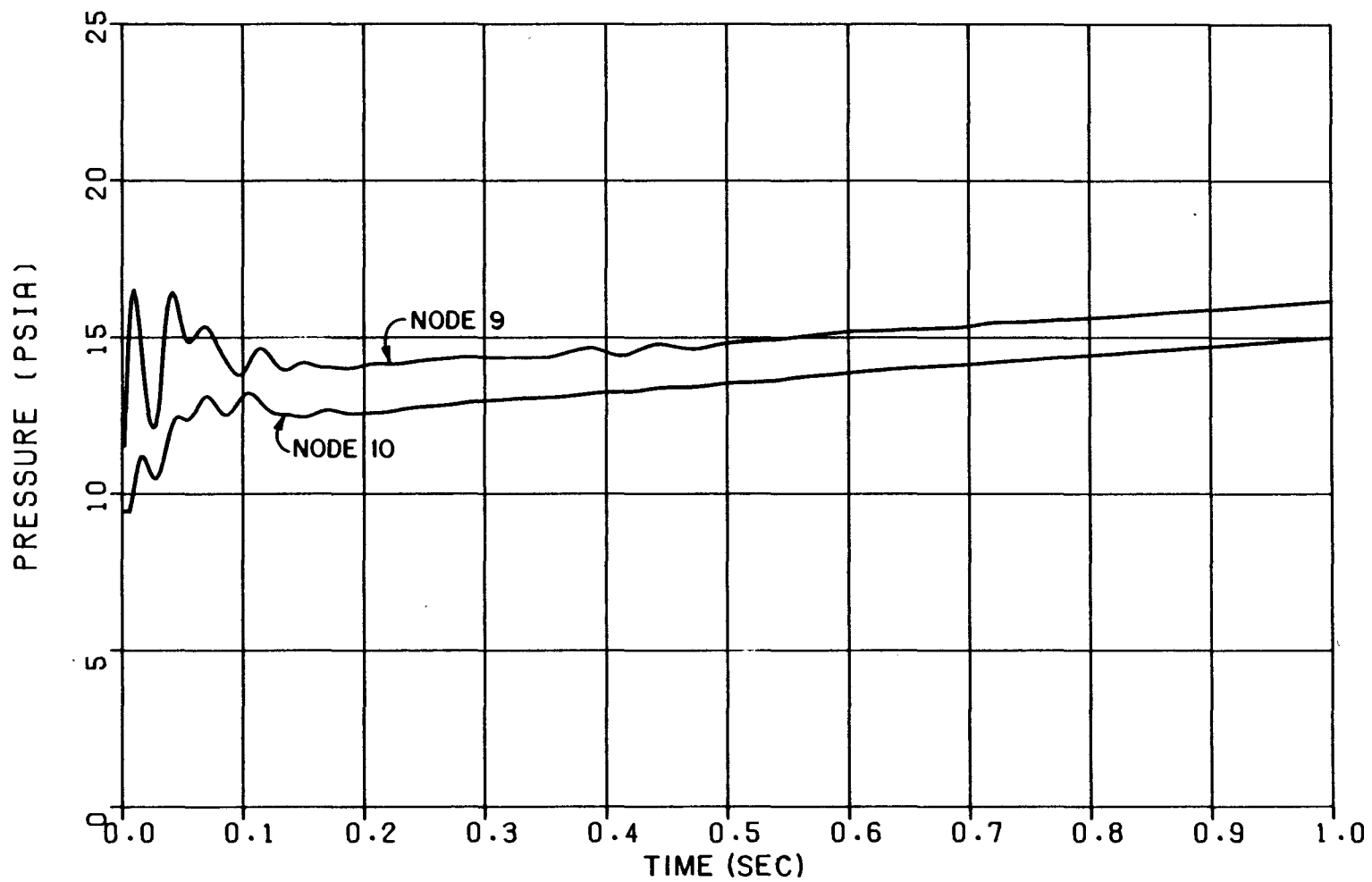

FIGURE 6.2-71  
BV-2 33 NODE STEAM GENERATOR CUBICLE  
ABSOLUTE PRESSURE VERSUS TIME  
180 SQ. IN. BREAK  
NODES 9 & 10  
BEAVER VALLEY POWER STATION-UNIT 2  
FINAL SAFETY ANALYSIS REPORT

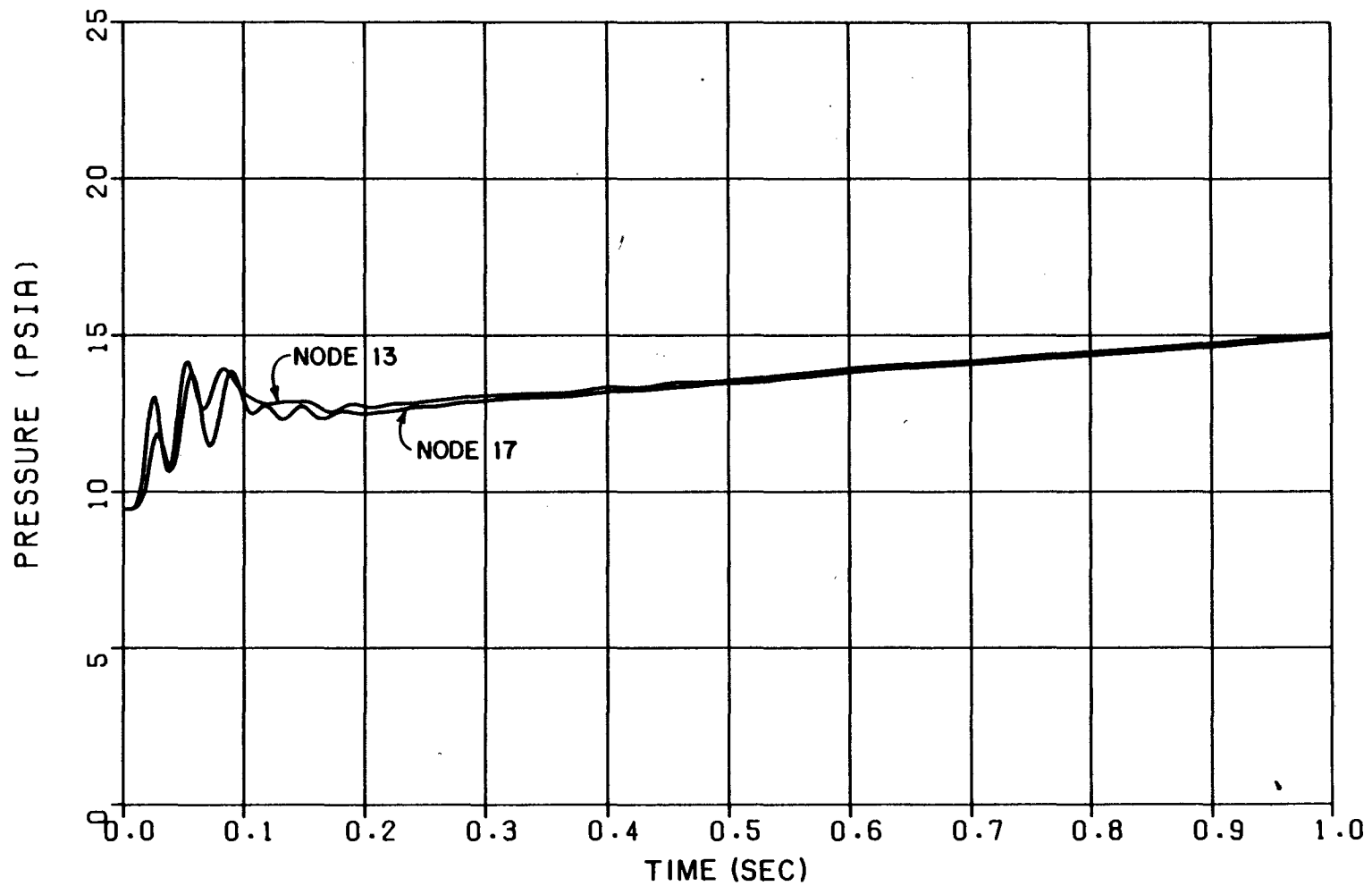

FIGURE 6.2-72  
BV-2 33 NODE STEAM GENERATOR CUBICLE  
ABSOLUTE PRESSURE VERSUS TIME  
180 SQ. IN. BREAK  
NODES 13 & 17  
BEAVER VALLEY POWER STATION-UNIT 2  
FINAL SAFETY ANALYSIS REPORT

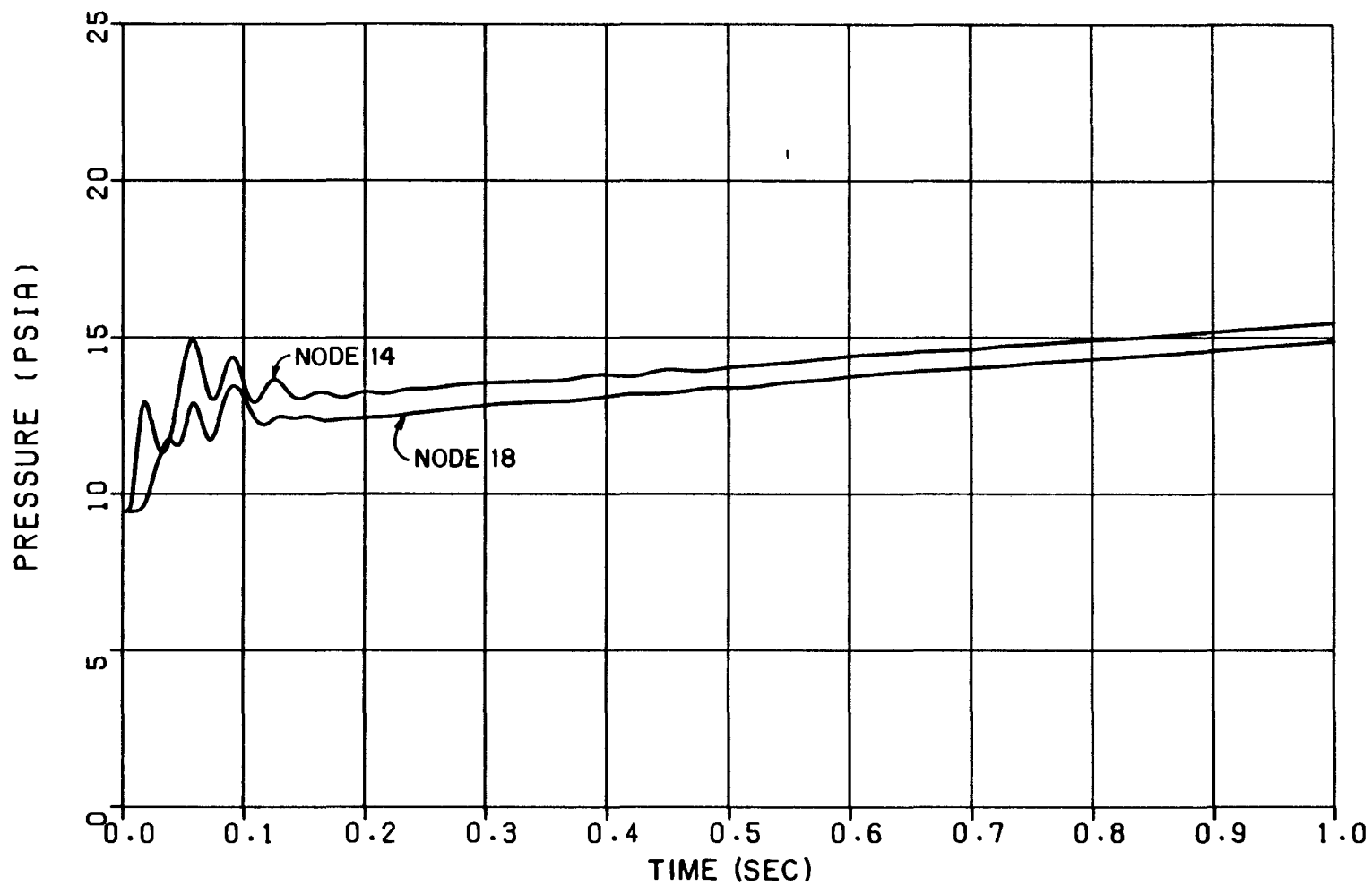

FIGURE 6.2-73  
 BV-2 33 NODE STEAM GENERATOR CUBICLE  
 ABSOLUTE PRESSURE VERSUS TIME  
 180 SQ. IN. BREAK  
 NODES 14 & 18  
 BEAVER VALLEY POWER STATION-UNIT 2  
 FINAL SAFETY ANALYSIS REPORT



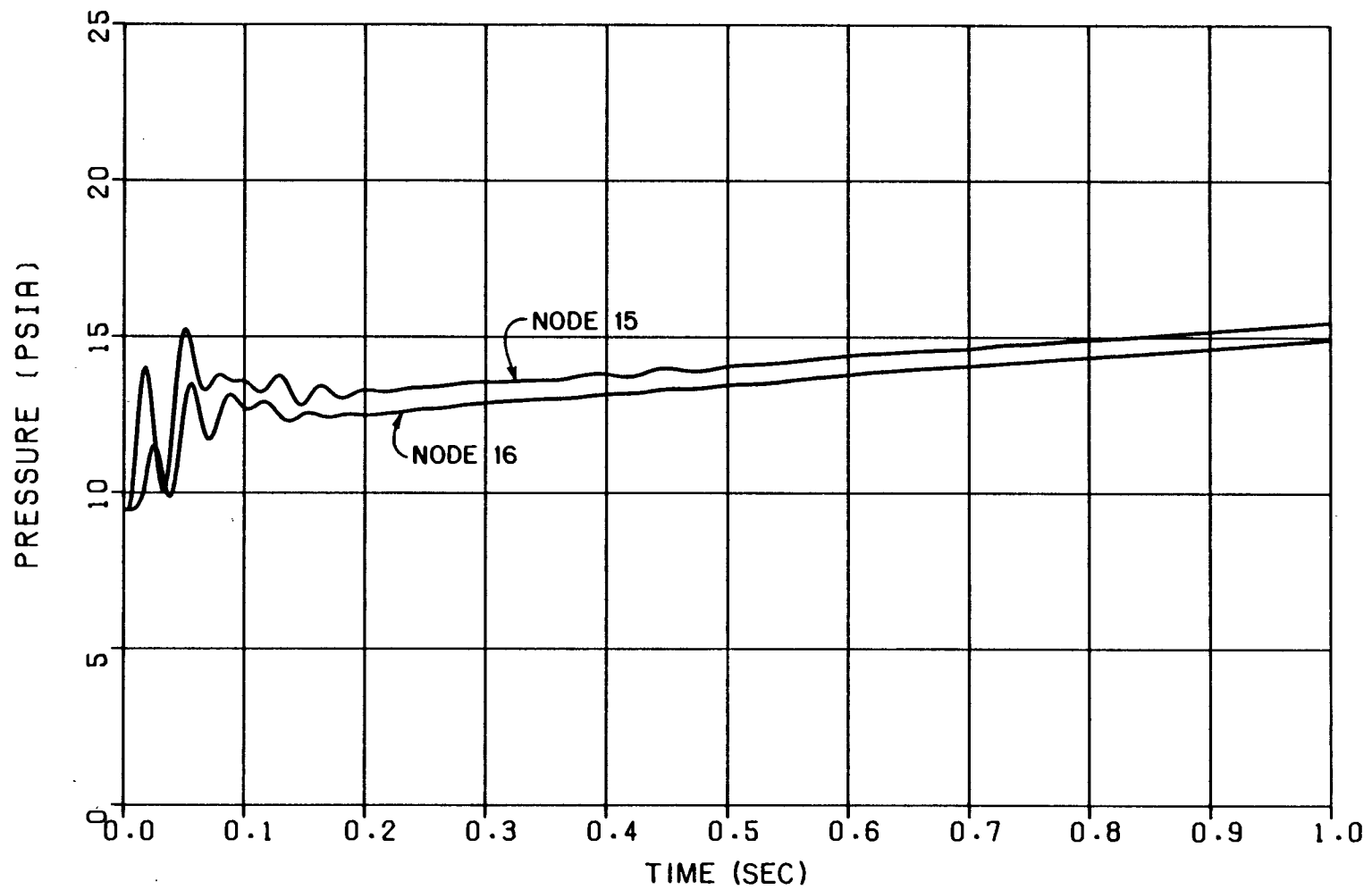

FIGURE 6.2-74  
 BV-2 33 NODE STEAM GENERATOR CUBICLE  
 ABSOLUTE PRESSURE VERSUS TIME  
 180 SQ. IN. BREAK  
 NODES 15 & 16  
 BEAVER VALLEY POWER STATION-UNIT 2  
 FINAL SAFETY ANALYSIS REPORT

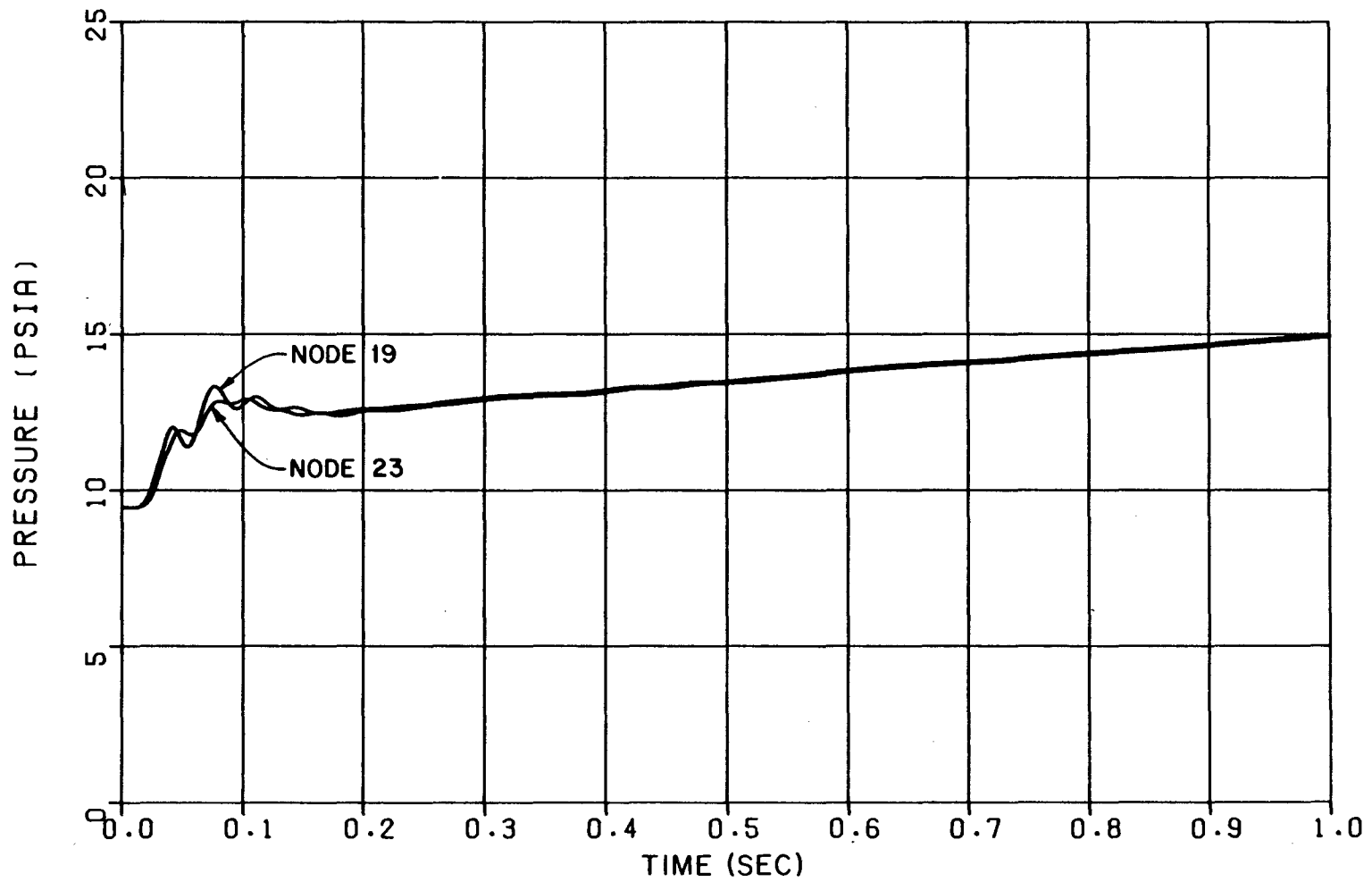

FIGURE 6.2-75  
BV-2 33 NODE STEAM GENERATOR CUBICLE  
ABSOLUTE PRESSURE VERSUS TIME  
180 SQ. IN. BREAK  
NODES 19 & 23  
BEAVER VALLEY POWER STATION-UNIT 2  
FINAL SAFETY ANALYSIS REPORT

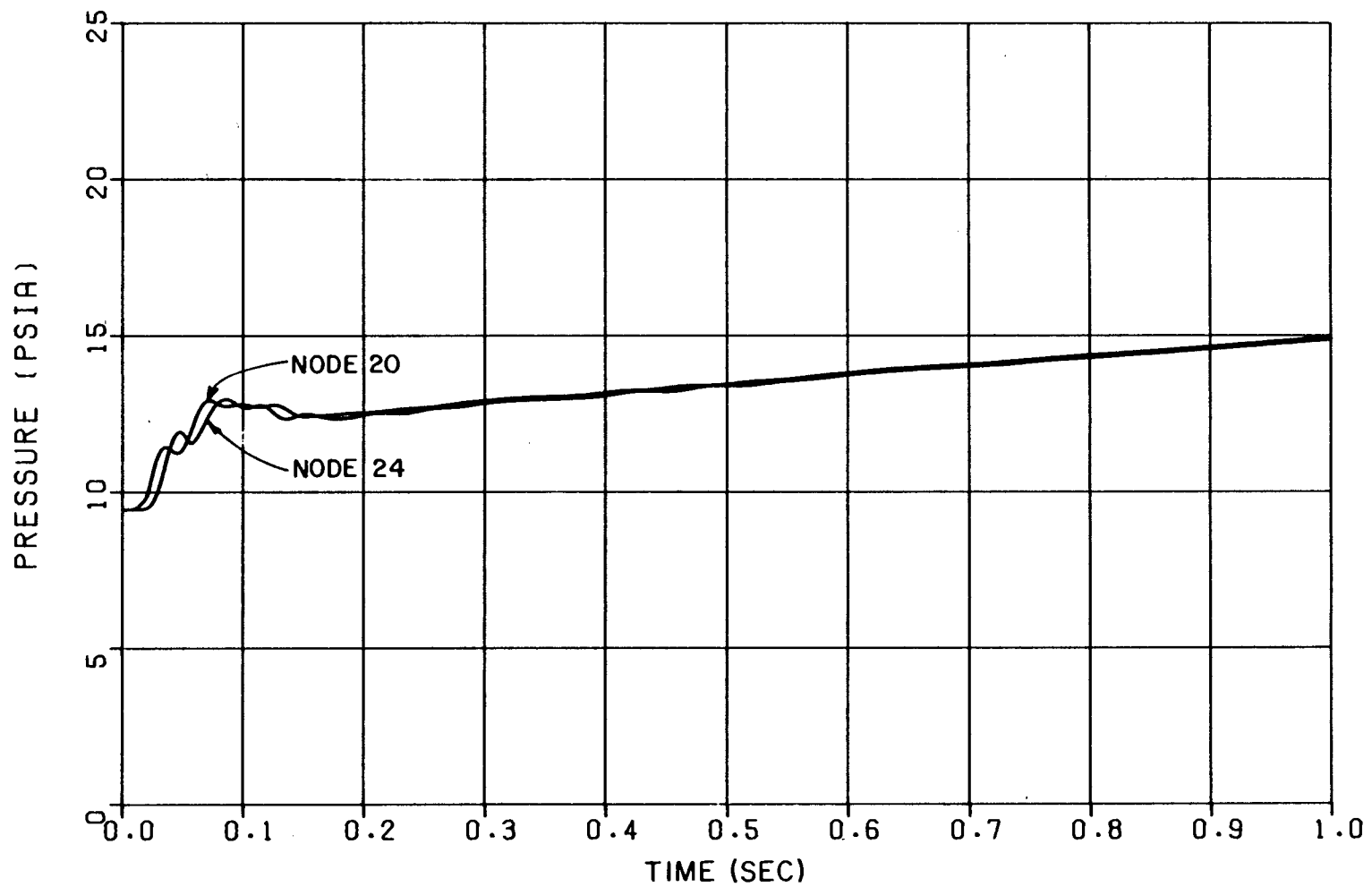

FIGURE 6.2-76  
BV-2 33 NODE STEAM GENERATOR CUBICLE  
ABSOLUTE PRESSURE VERSUS TIME  
180 SQ. IN. BREAK  
NODES 20 & 24  
BEAVER VALLEY POWER STATION-UNIT 2  
FINAL SAFETY ANALYSIS REPORT

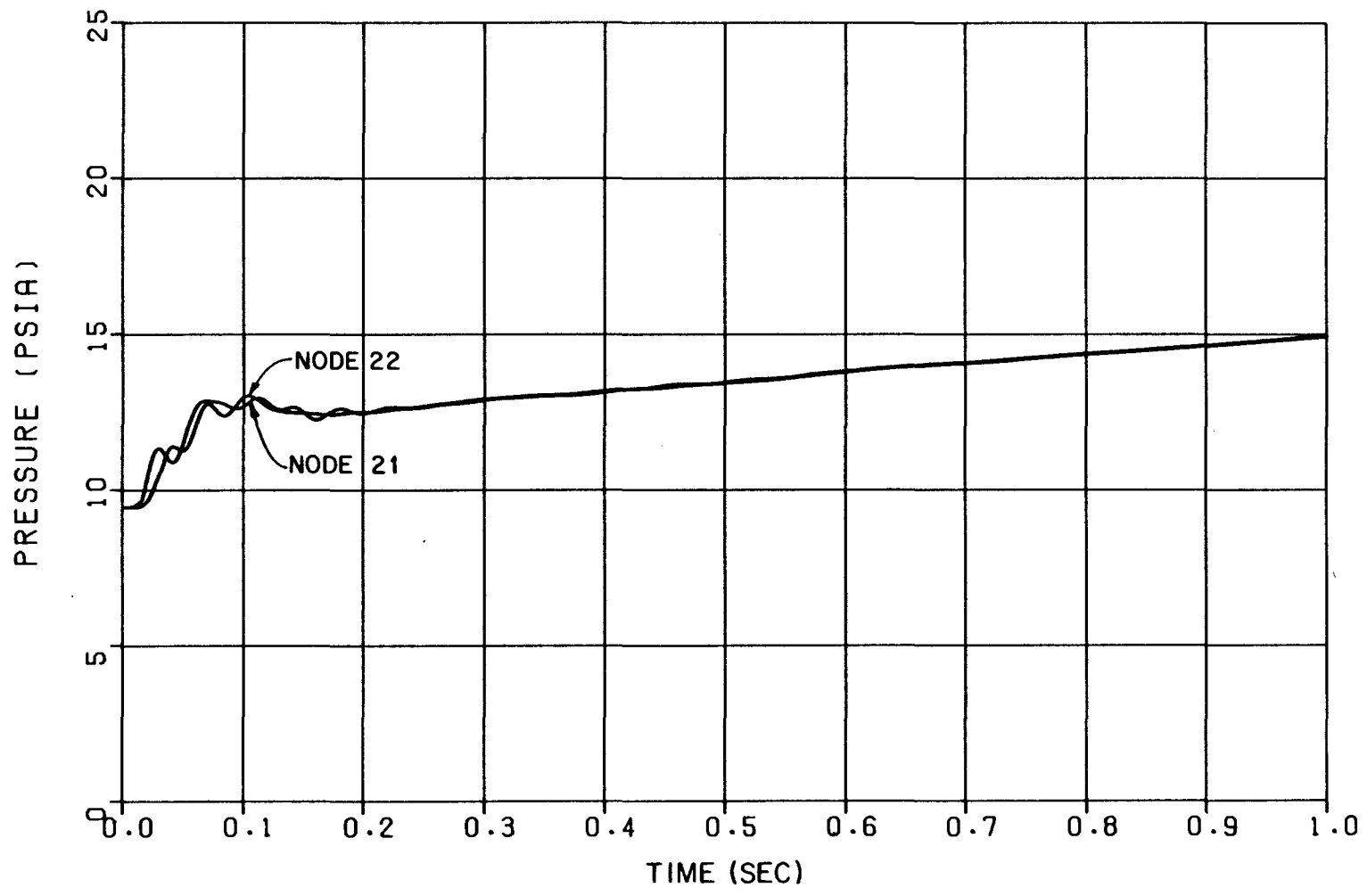

FIGURE 6.2-77  
 BV-2 33 NODE STEAM GENERATOR CUBICLE  
 ABSOLUTE PRESSURE VERSUS TIME  
 180 SQ. IN. BREAK  
 NODES 21 & 22  
 BEAVER VALLEY POWER STATION-UNIT 2  
 FINAL SAFETY ANALYSIS REPORT

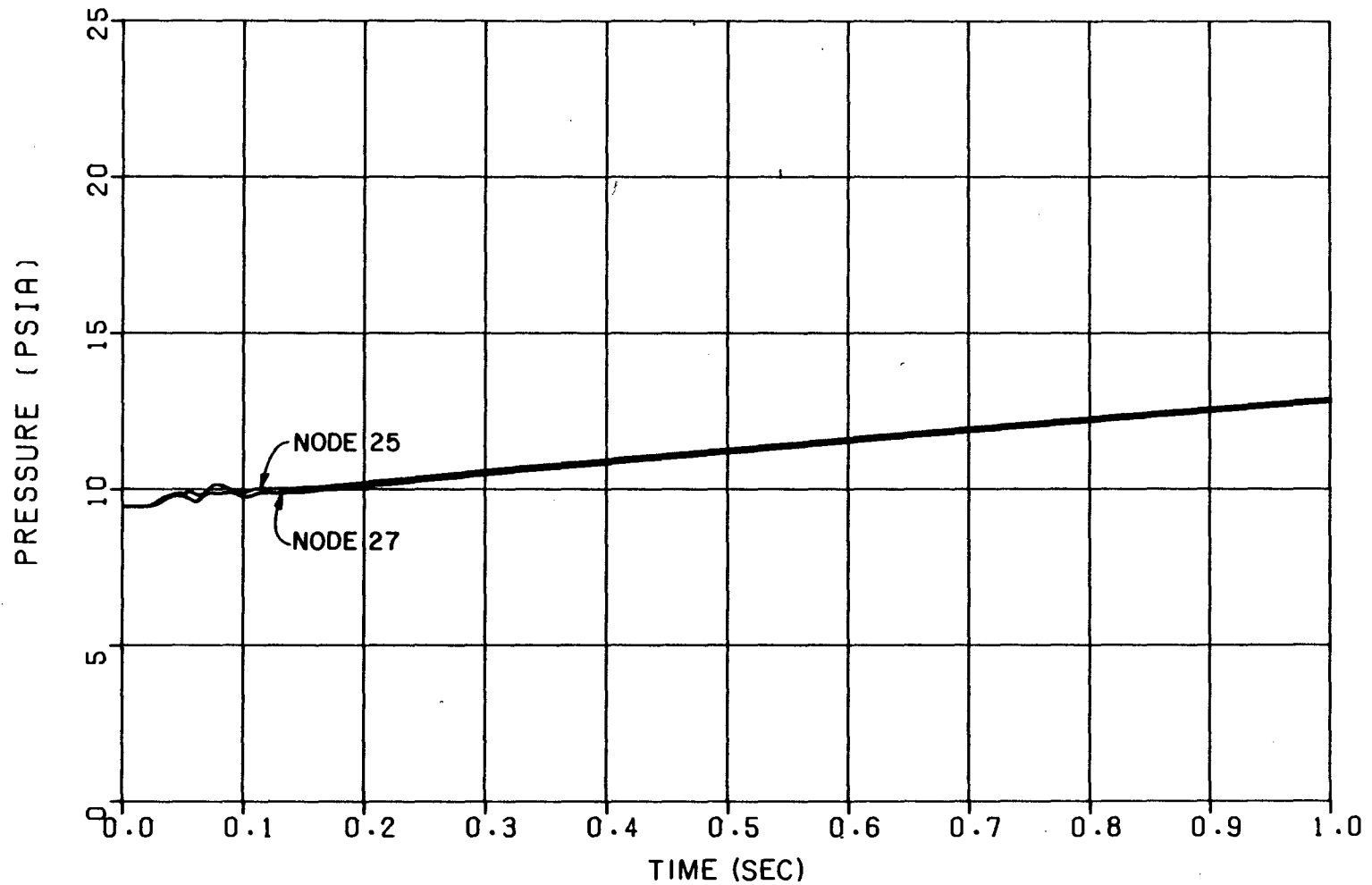

FIGURE 6.2-78  
BV-2 33 NODE STEAM GENERATOR CUBICLE  
ABSOLUTE PRESSURE VERSUS TIME  
180 SQ. IN. BREAK  
NODES 25 & 27  
BEAVER VALLEY POWER STATION-UNIT 2  
FINAL SAFETY ANALYSIS REPORT

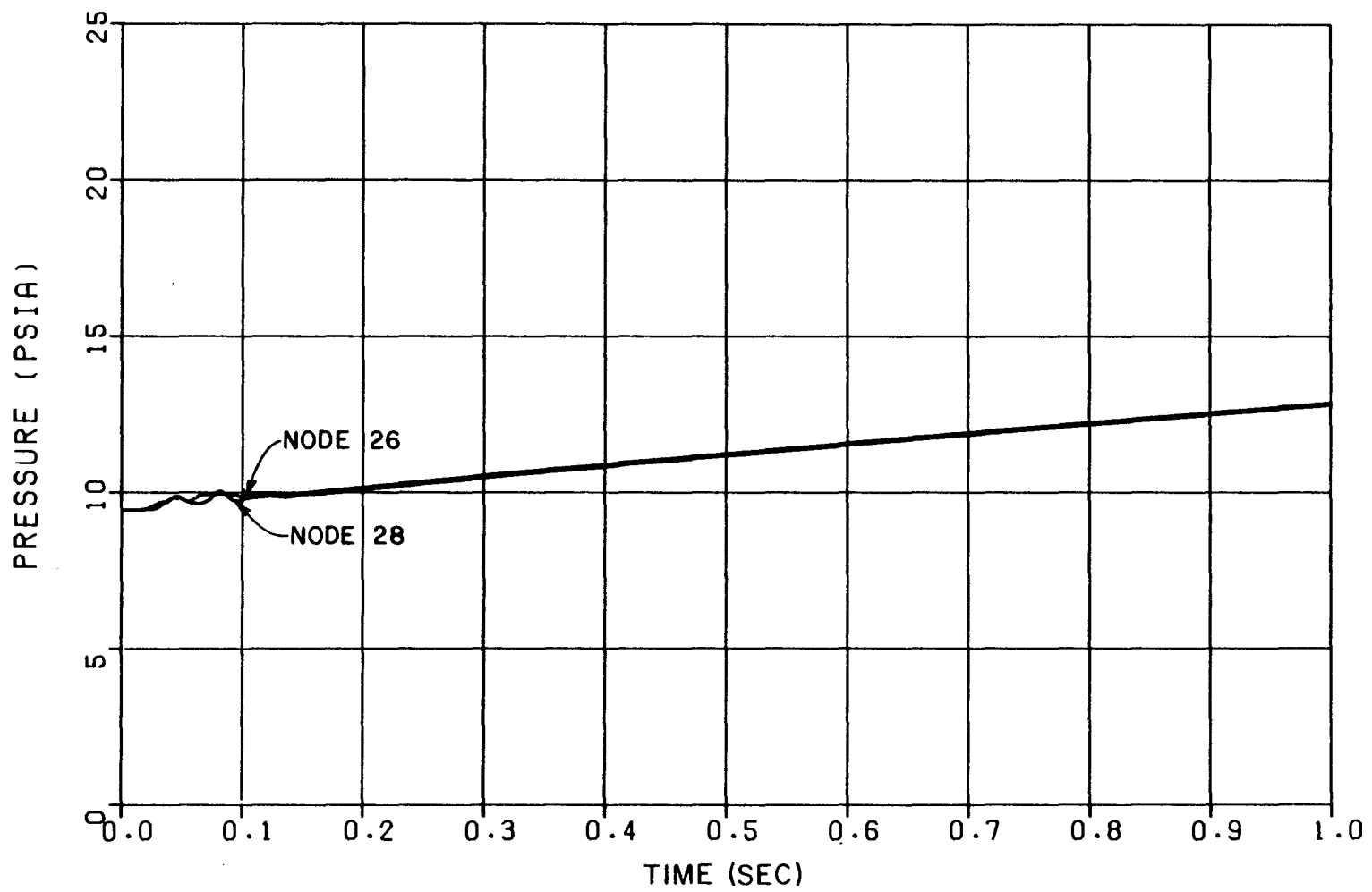

FIGURE 6.2-79  
 BV-2 33 NODE STEAM GENERATOR CUBICLE  
 ABSOLUTE PRESSURE VERSUS TIME  
 180 SQ. IN. BREAK  
 NODES 26 & 28  
 BEAVER VALLEY POWER STATION-UNIT 2  
 FINAL SAFETY ANALYSIS REPORT

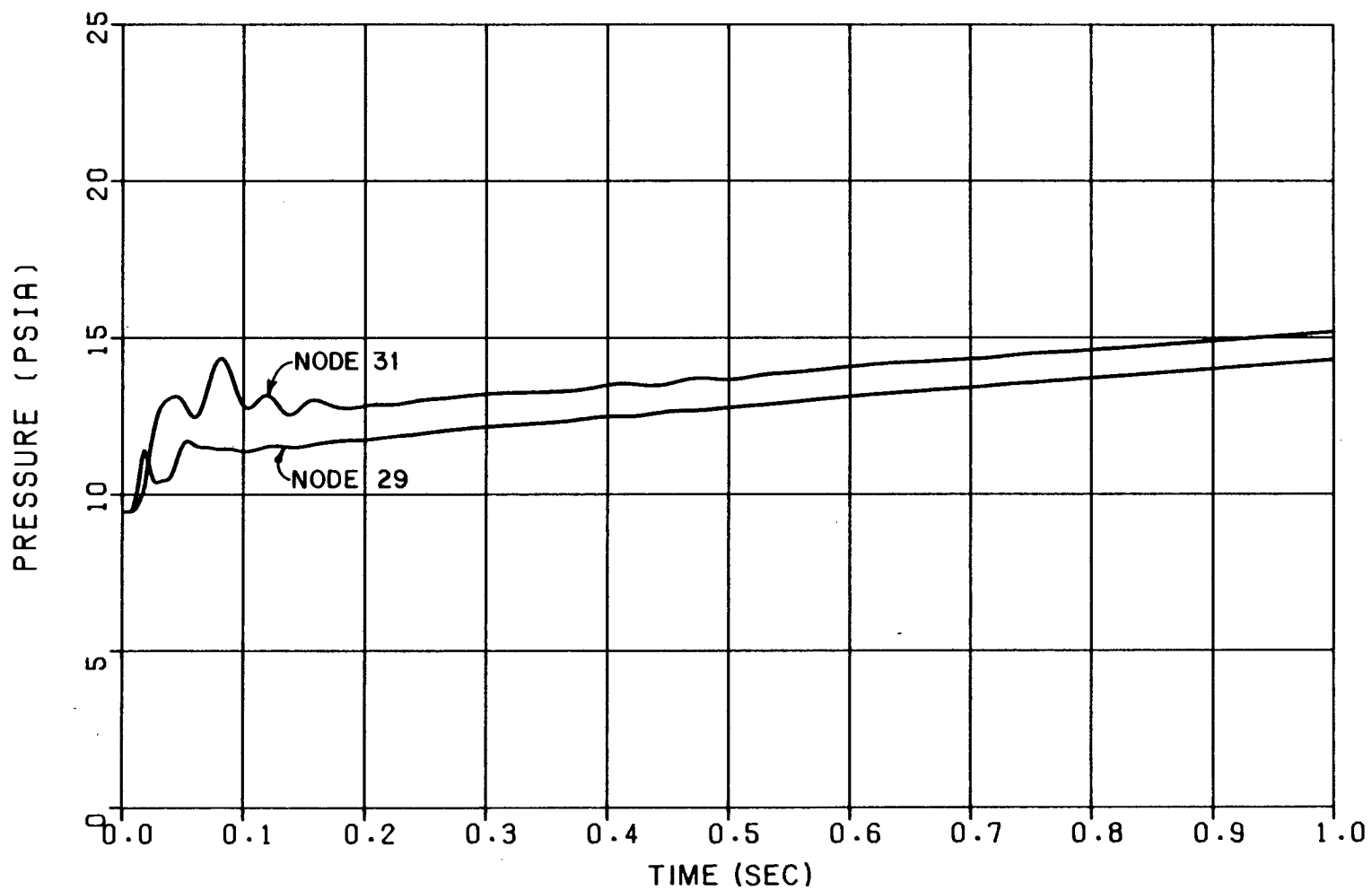

FIGURE 6.2-80  
BV-2 33 NODE STEAM GENERATOR CUBICLE  
ABSOLUTE PRESSURE VERSUS TIME  
180 SQ. IN. BREAK  
NODES 29 & 31  
BEAVER VALLEY POWER STATION-UNIT 2  
FINAL SAFETY ANALYSIS REPORT

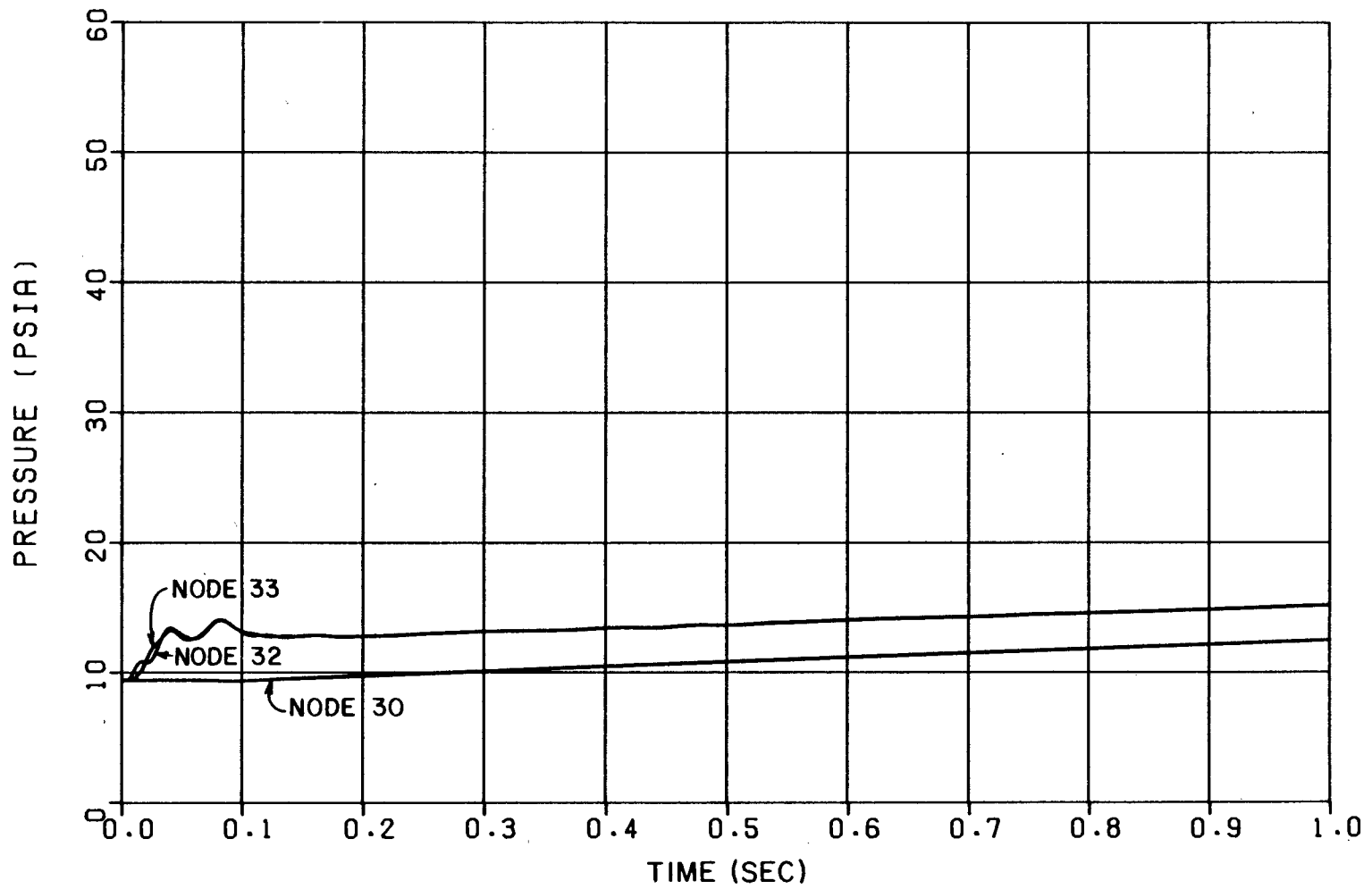

FIGURE 6.2-81  
 BV-2 33 NODE STEAM GENERATOR CUBICLE  
 ABSOLUTE PRESSURE VERSUS TIME  
 180 SQ. IN. BREAK  
 NODES 30, 32 & 33  
 BEAVER VALLEY POWER STATION-UNIT 2  
 FINAL SAFETY ANALYSIS REPORT



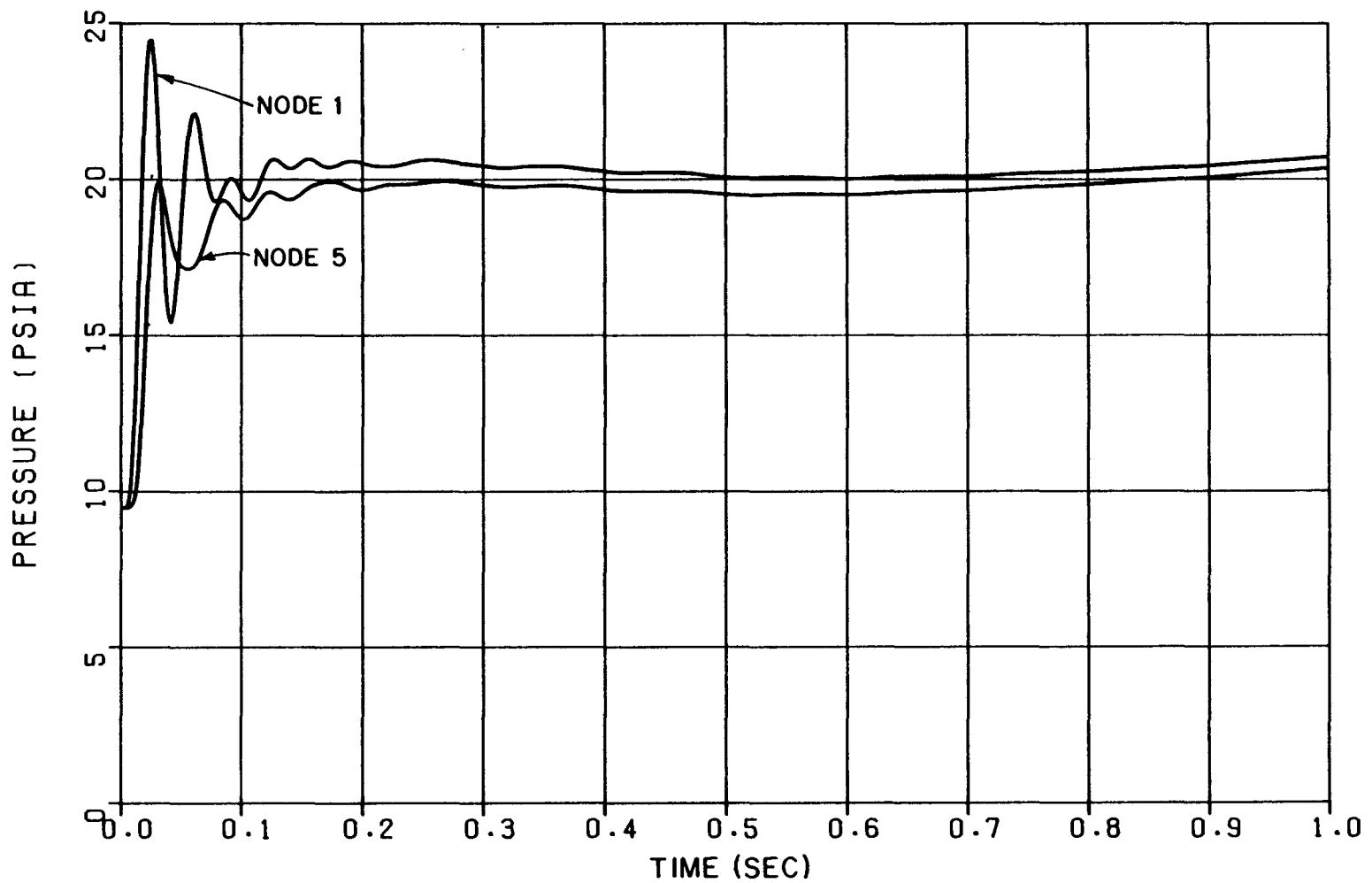

FIGURE 6.2-82  
BV2-33 NODE STEAM GENERATOR CUBICLE  
ABSOLUTE PRESSURE VERSUS TIME  
707 SQ. IN. STM. GEN. INLET ELBOW SPLIT  
NODES 1 & 5  
BEAVER VALLEY POWER STATION-UNIT 2  
FINAL SAFETY ANALYSIS REPORT

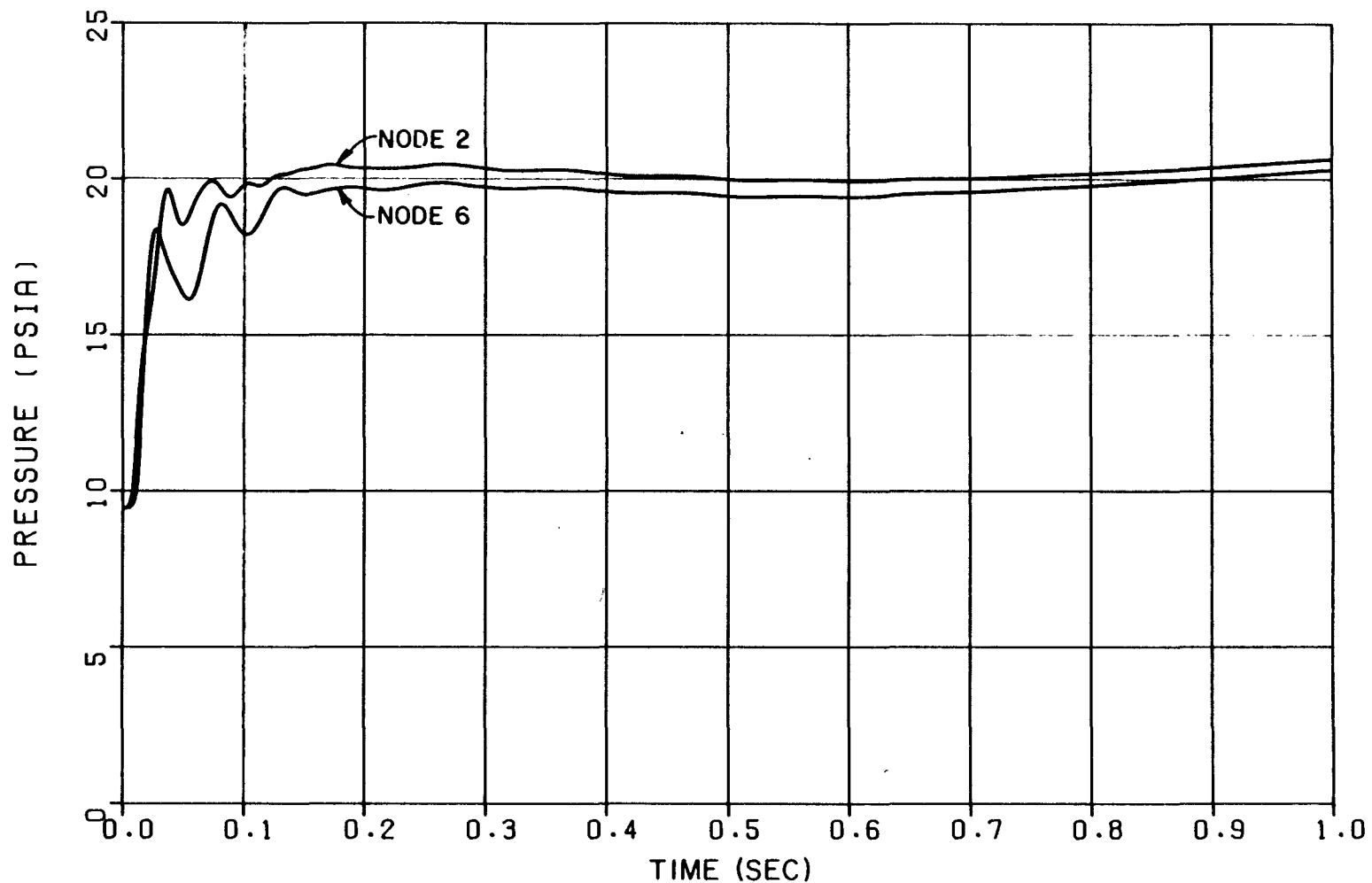

FIGURE 6.2-83  
 BV-2 33 NODE STEAM GENERATOR CUBICLE  
 ABSOLUTE PRESSURE VERSUS TIME  
 707 SQ. IN. STM. GEN. INLET ELBOW SPLIT  
 NODES 2 & 6  
 BEAVER VALLEY POWER STATION-UNIT 2  
 FINAL SAFETY ANALYSIS REPORT

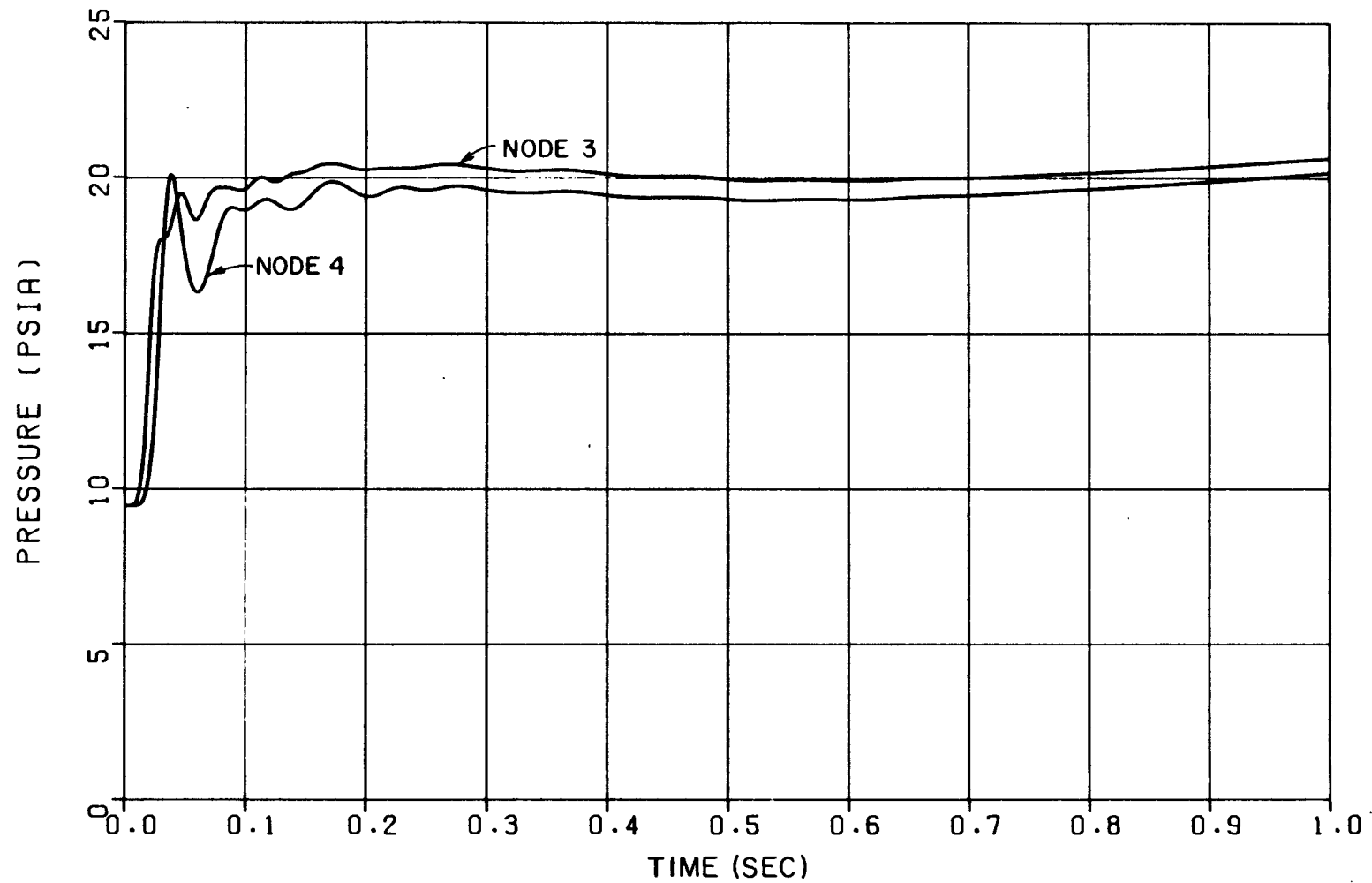

FIGURE 6.2 -84  
 BV-2 33 NODE STEAM GENERATOR CUBICLE  
 ABSOLUTE PRESSURE VERSUS TIME  
 707 SQ. IN. STM. GEN. INLET ELBOW SPLIT  
 NODES 3 & 4  
 BEAVER VALLEY POWER STATION-UNIT 2  
 FINAL SAFETY ANALYSIS REPORT

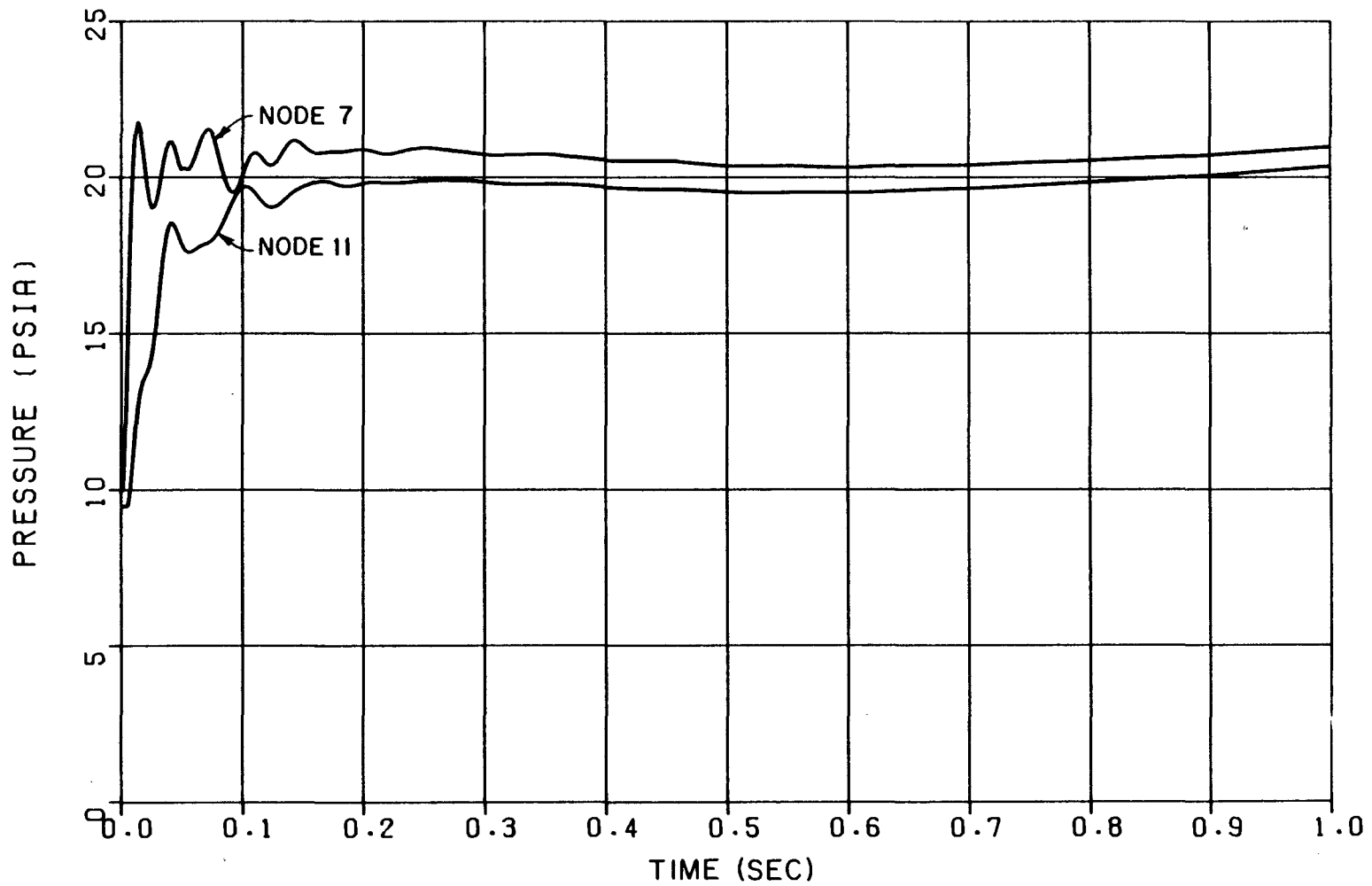

FIGURE 6.2-85  
BV-2 33 NODE STEAM GENERATOR CUBICLE  
ABSOLUTE PRESSURE VERSUS TIME  
707 SQ. IN. STM. GEN. INLET ELBOW SPLIT  
NODES 7 & 11  
BEAVER VALLEY POWER STATION-UNIT 2  
FINAL SAFETY ANALYSIS REPORT

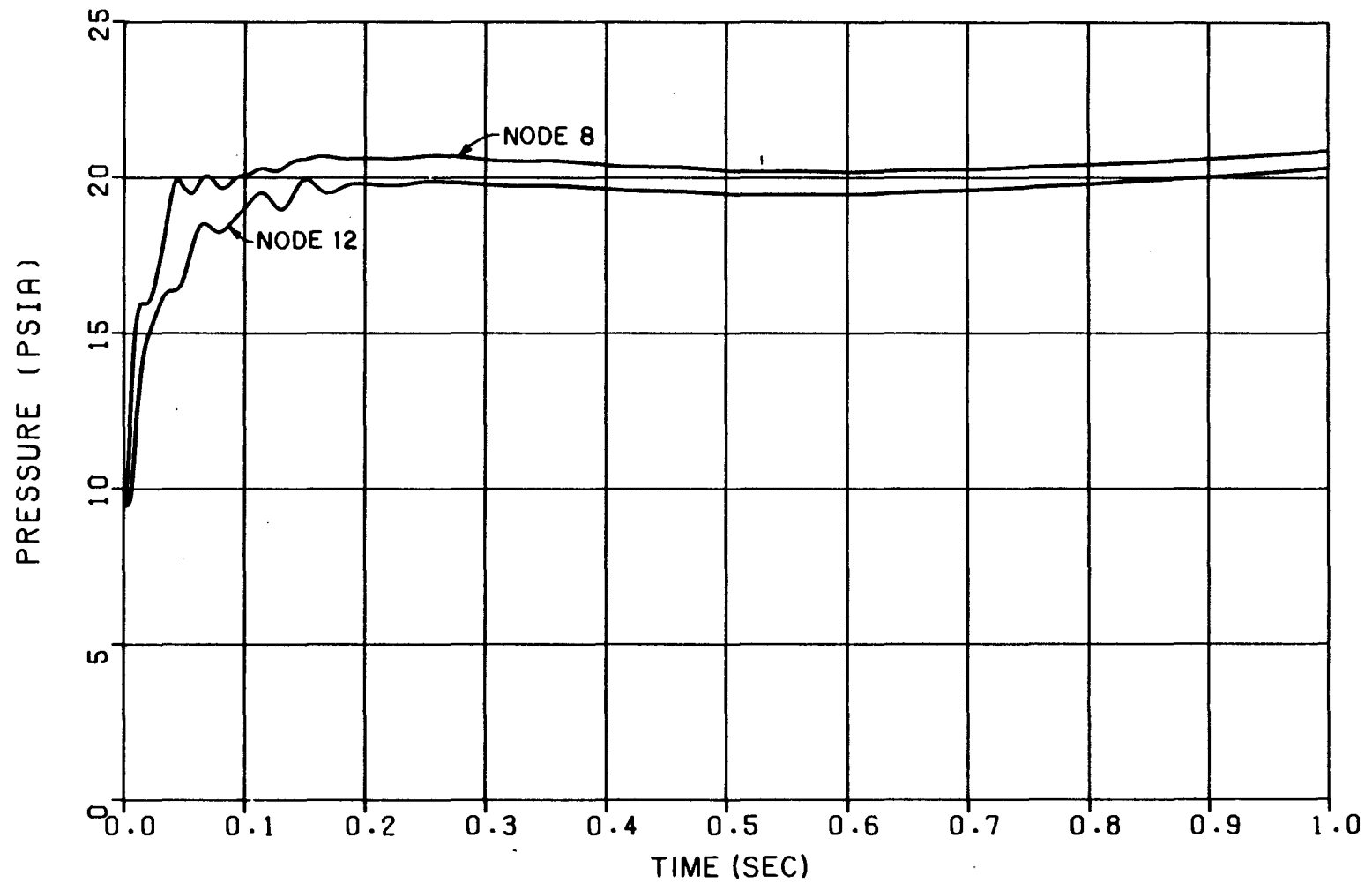

FIGURE 6.2-86  
 BV-2 33 NODE STEAM GENERATOR CUBICLE  
 ABSOLUTE PRESSURE VERSUS TIME  
 707 SQ. IN. STM. GEN. INLET ELBOW SPLIT  
 NODES 8 & 12  
 BEAVER VALLEY POWER STATION-UNIT 2  
 FINAL SAFETY ANALYSIS REPORT

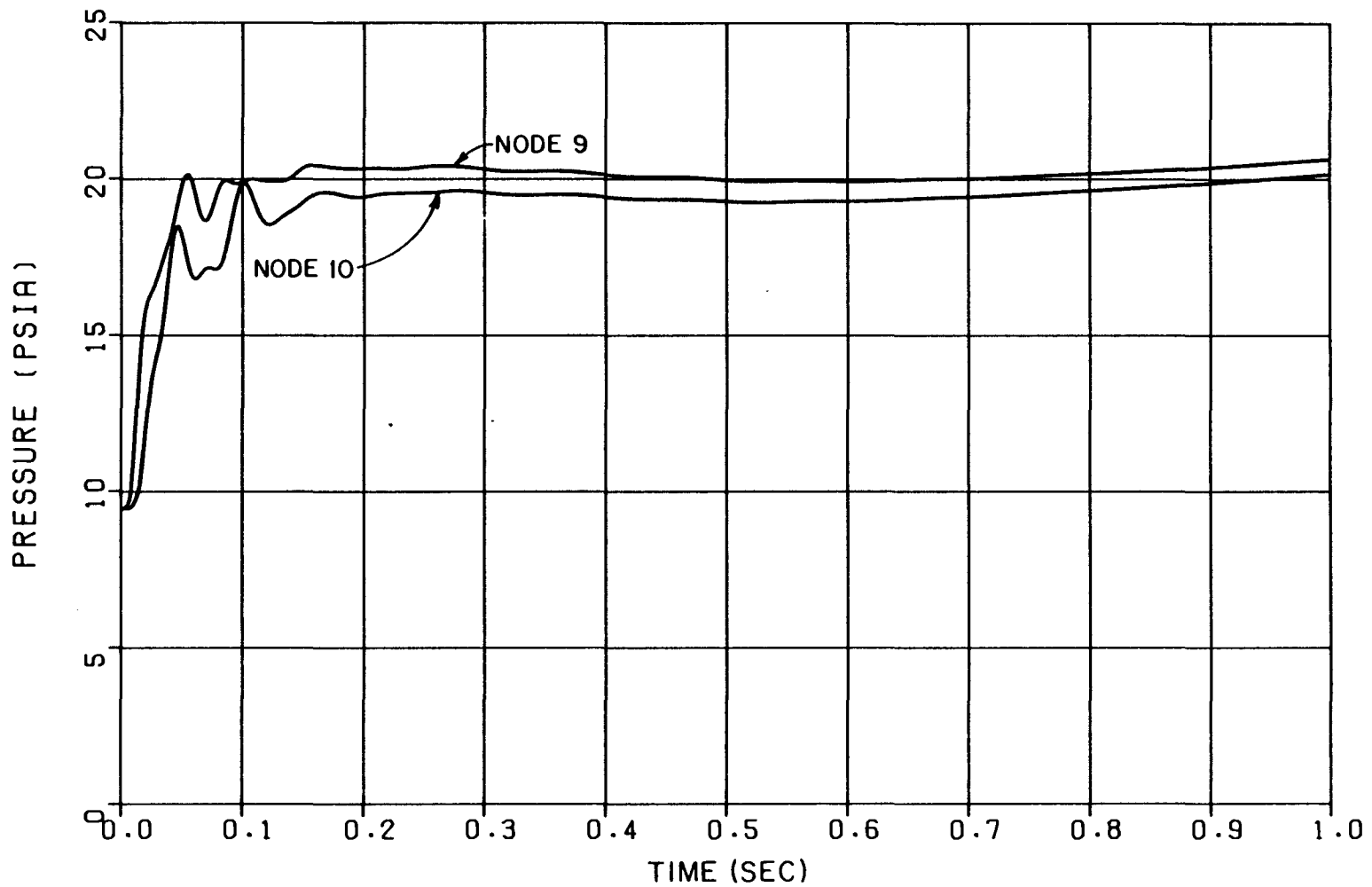

FIGURE 6.2-87  
BV-2 33 NODE STEAM GENERATOR CUBICLE  
ABSOLUTE PRESSURE VERSUS TIME  
707 SQ. IN. STM. GEN. INLET ELBOW SPLIT  
NODES 9 & 10  
BEAVER VALLEY POWER STATION-UNIT 2  
FINAL SAFETY ANALYSIS REPORT

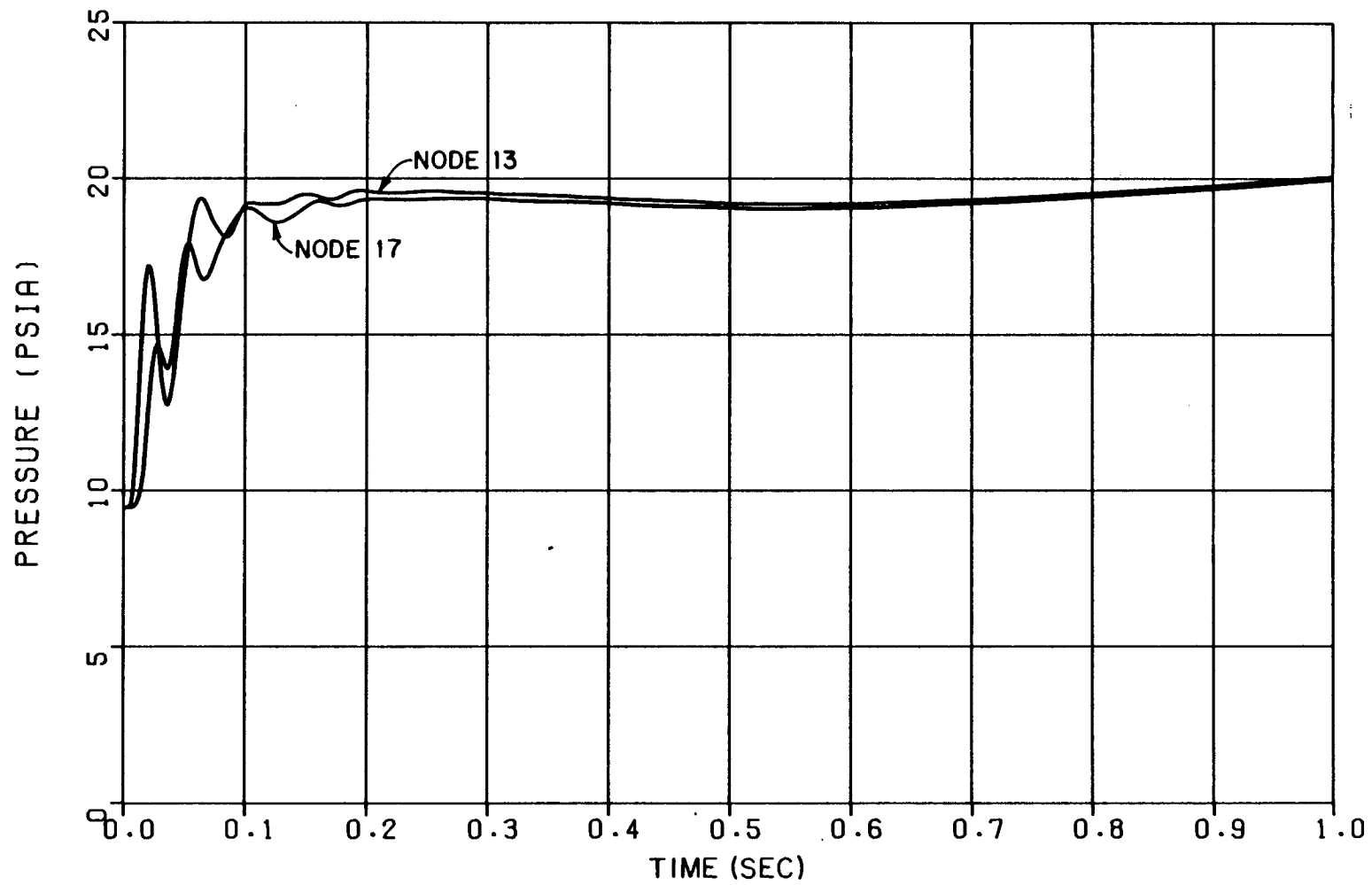

FIGURE 6.2-88  
 BV-2 33 NODE STEAM GENERATOR CUBICLE  
 ABSOLUTE PRESSURE VERSUS TIME  
 707 SQ. IN. STM. GEN. INLET ELBOW SPLIT  
 NODES 13 & 17  
 BEAVER VALLEY POWER STATION-UNIT 2  
 FINAL SAFETY ANALYSIS REPORT

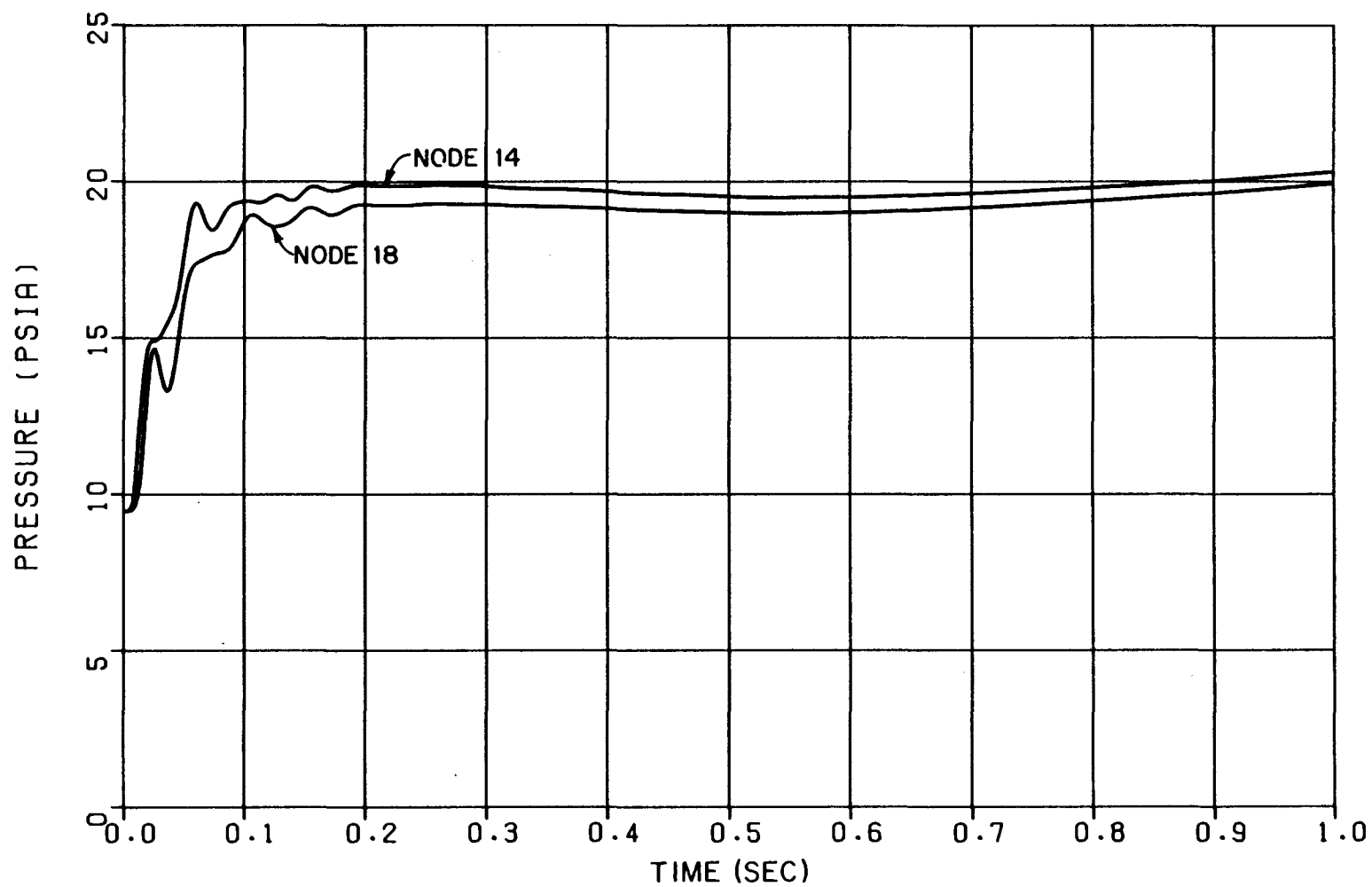

FIGURE 6.2-89  
BV-2 33 NODE STEAM GENERATOR CUBICLE  
ABSOLUTE PRESSURE VERSUS TIME  
707 SQ. IN. STM. GEN. INLET ELBOW SPLIT  
NODES 14 & 18  
BEAVER VALLEY POWER STATION-UNIT 2  
FINAL SAFETY ANALYSIS REPORT



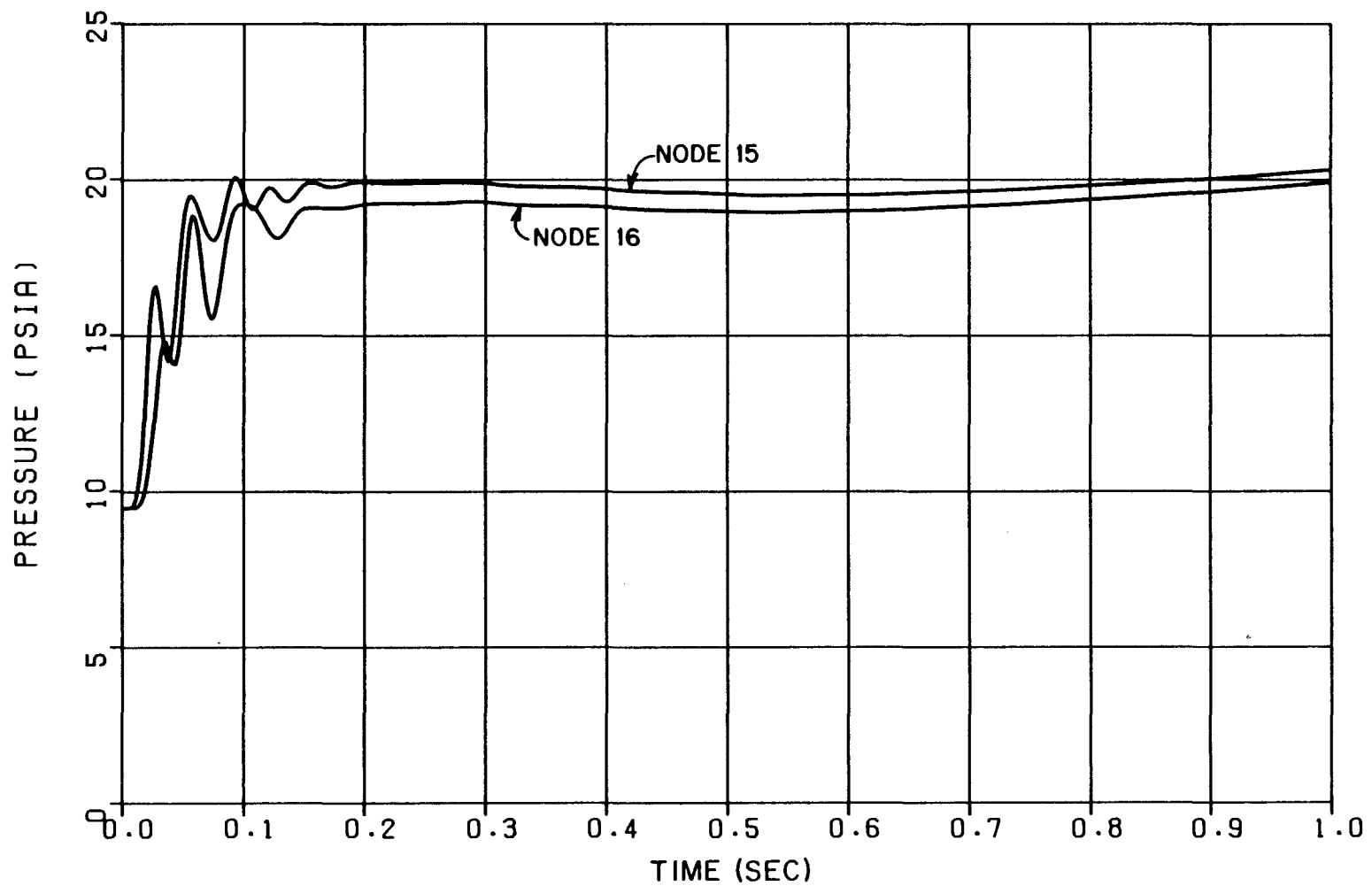

FIGURE 6.2-90  
 BV-2 33 NODE STEAM GENERATOR CUBICLE  
 ABSOLUTE PRESSURE VERSUS TIME  
 707 SQ. IN. STM. GEN. INLET ELBOW SPLIT  
 NODES 15 & 16  
 BEAVER VALLEY POWER STATION-UNIT 2  
 FINAL SAFETY ANALYSIS REPORT

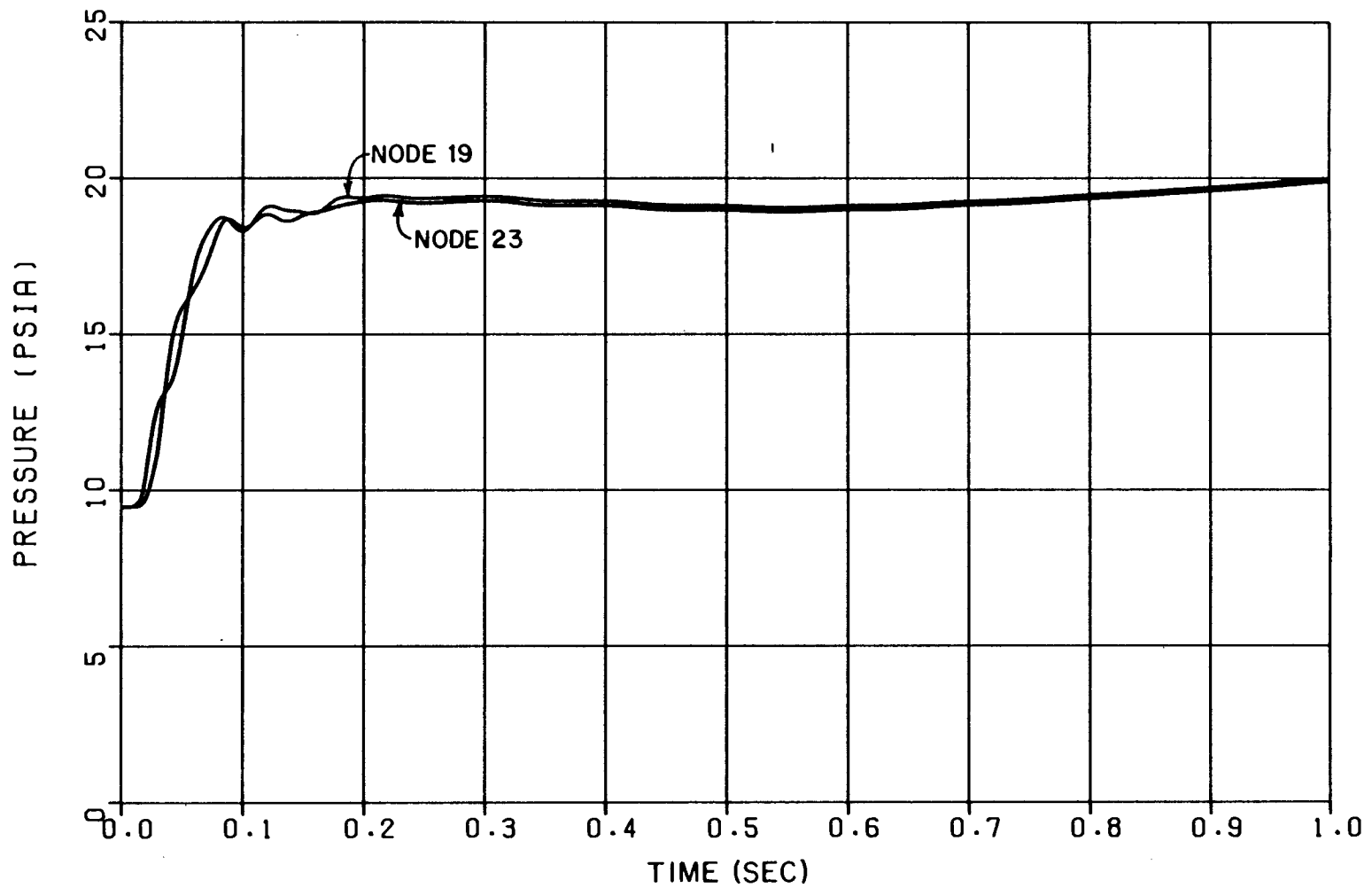

FIGURE 6.2-91  
 BV-2 33 NODE STEAM GENERATOR CUBICLE  
 ABSOLUTE PRESSURE VERSUS TIME  
 707 SQ. IN. STM. GEN. INLET ELBOW SPLIT  
 NODES 19 & 23  
 BEAVER VALLEY POWER STATION-UNIT 2  
 FINAL SAFETY ANALYSIS REPORT

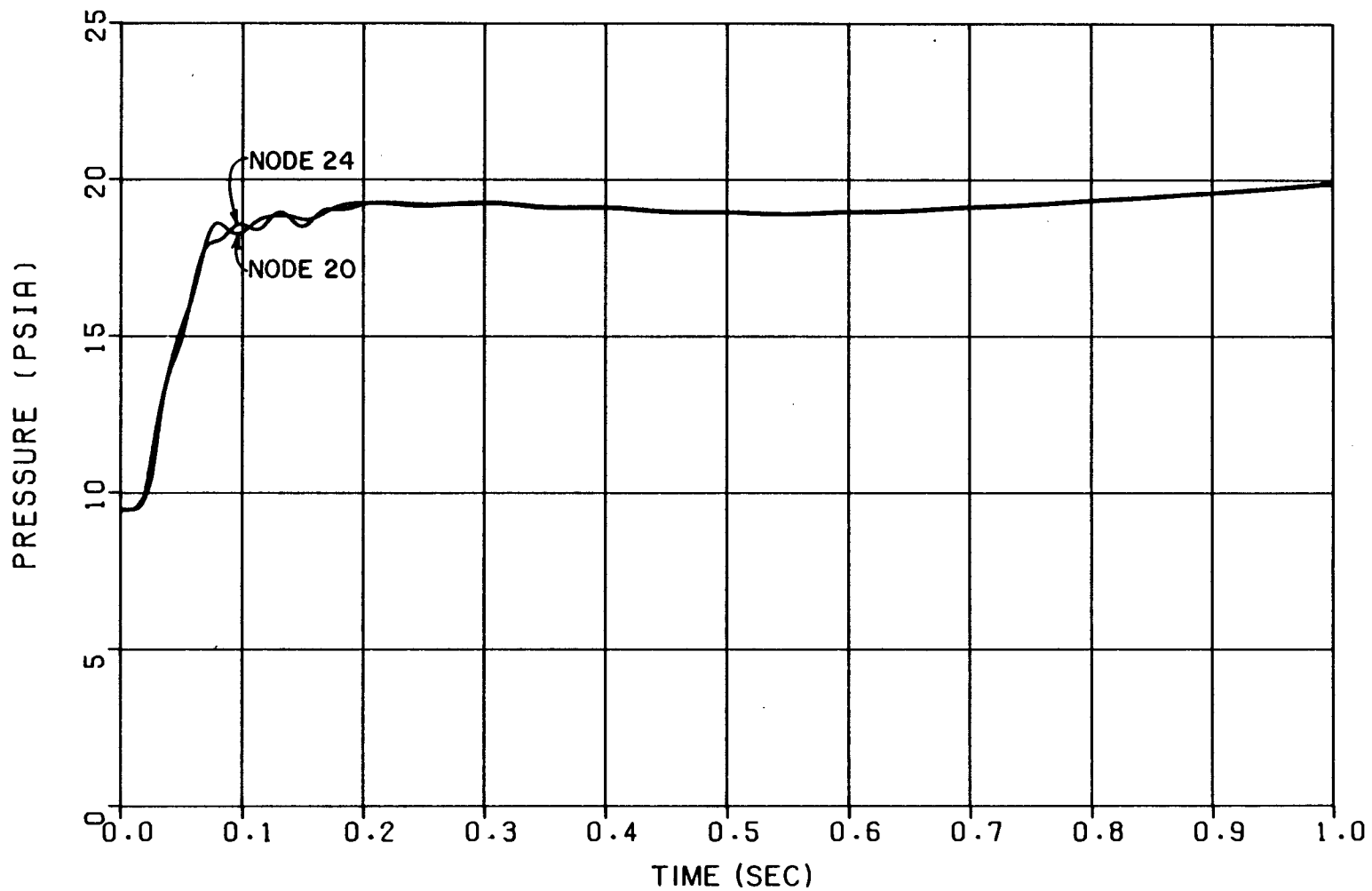

FIGURE 6.2-92  
BV-2 33 NODE STEAM GENERATOR CUBICLE  
ABSOLUTE PRESSURE VERSUS TIME  
707 SQ. IN. STM. GEN. INLET ELBOW SPLIT  
NODES 20 & 24  
BEAVER VALLEY POWER STATION-UNIT 2  
FINAL SAFETY ANALYSIS REPORT

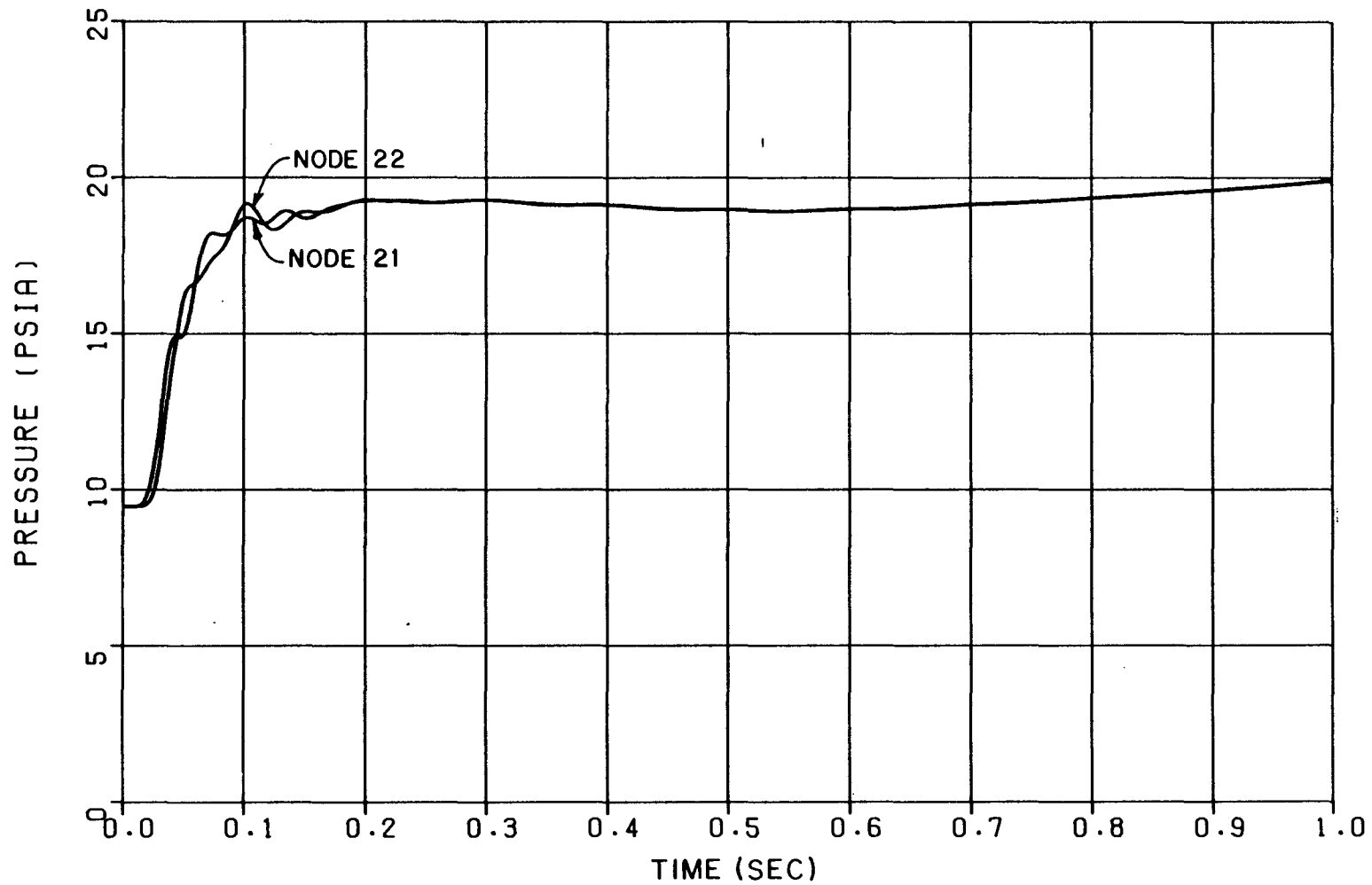

FIGURE 6.2-93  
BV-2 33 NODE STEAM GENERATOR CUBICLE  
ABSOLUTE PRESSURE VERSUS TIME  
707 SQ. IN. STM. GEN. INLET ELBOW SPLIT  
NODES 21 & 22  
BEAVER VALLEY POWER STATION-UNIT 2  
FINAL SAFETY ANALYSIS REPORT

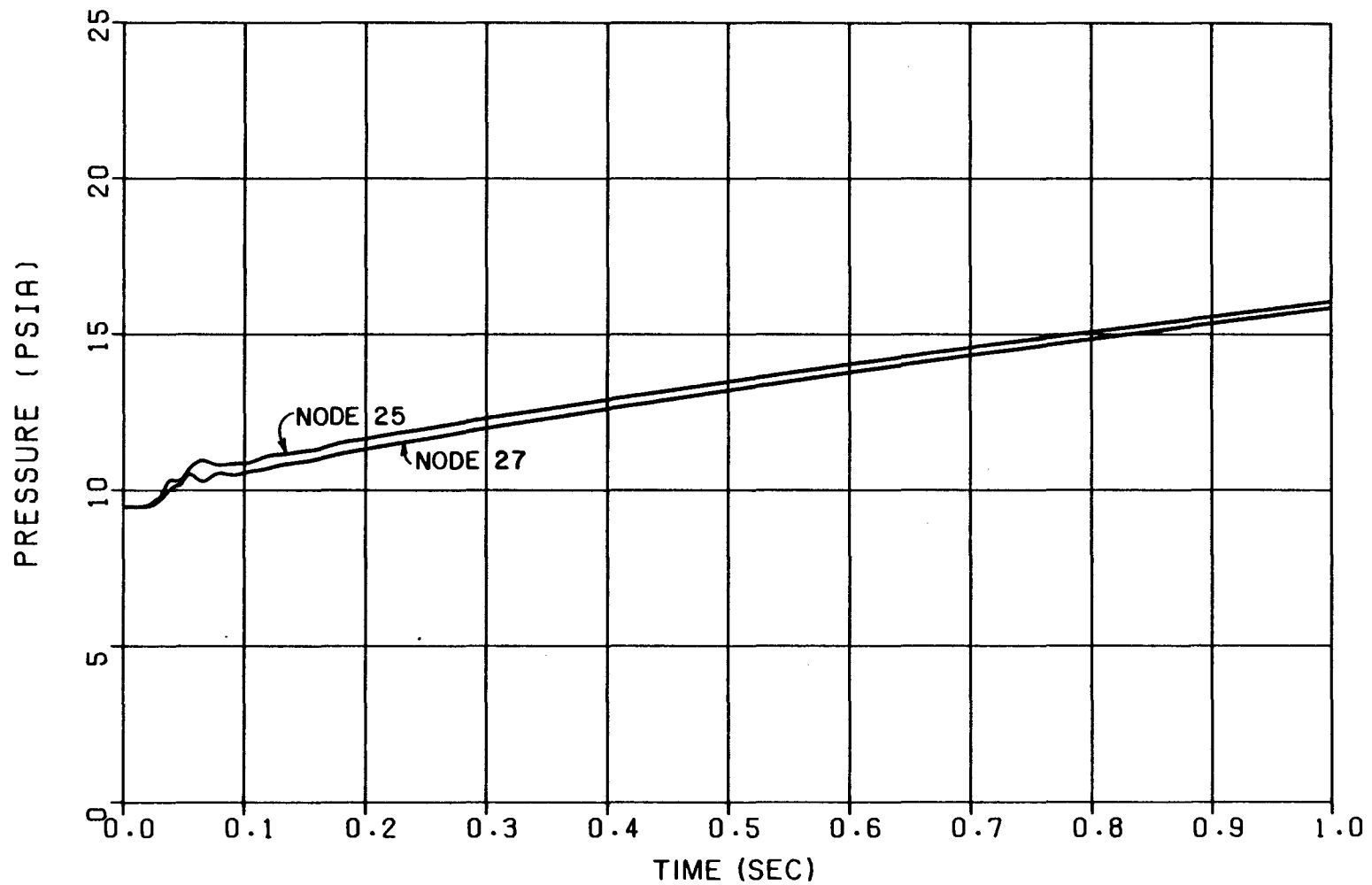

FIGURE 6.2-94  
BV-2 33 NODE STEAM GENERATOR CUBICLE  
ABSOLUTE PRESSURE VERSUS TIME  
707 SQ. IN. STM. GEN. INLET ELBOW SPLIT  
NODES 25 & 27  
BEAVER VALLEY POWER STATION-UNIT 2  
FINAL SAFETY ANALYSIS REPORT

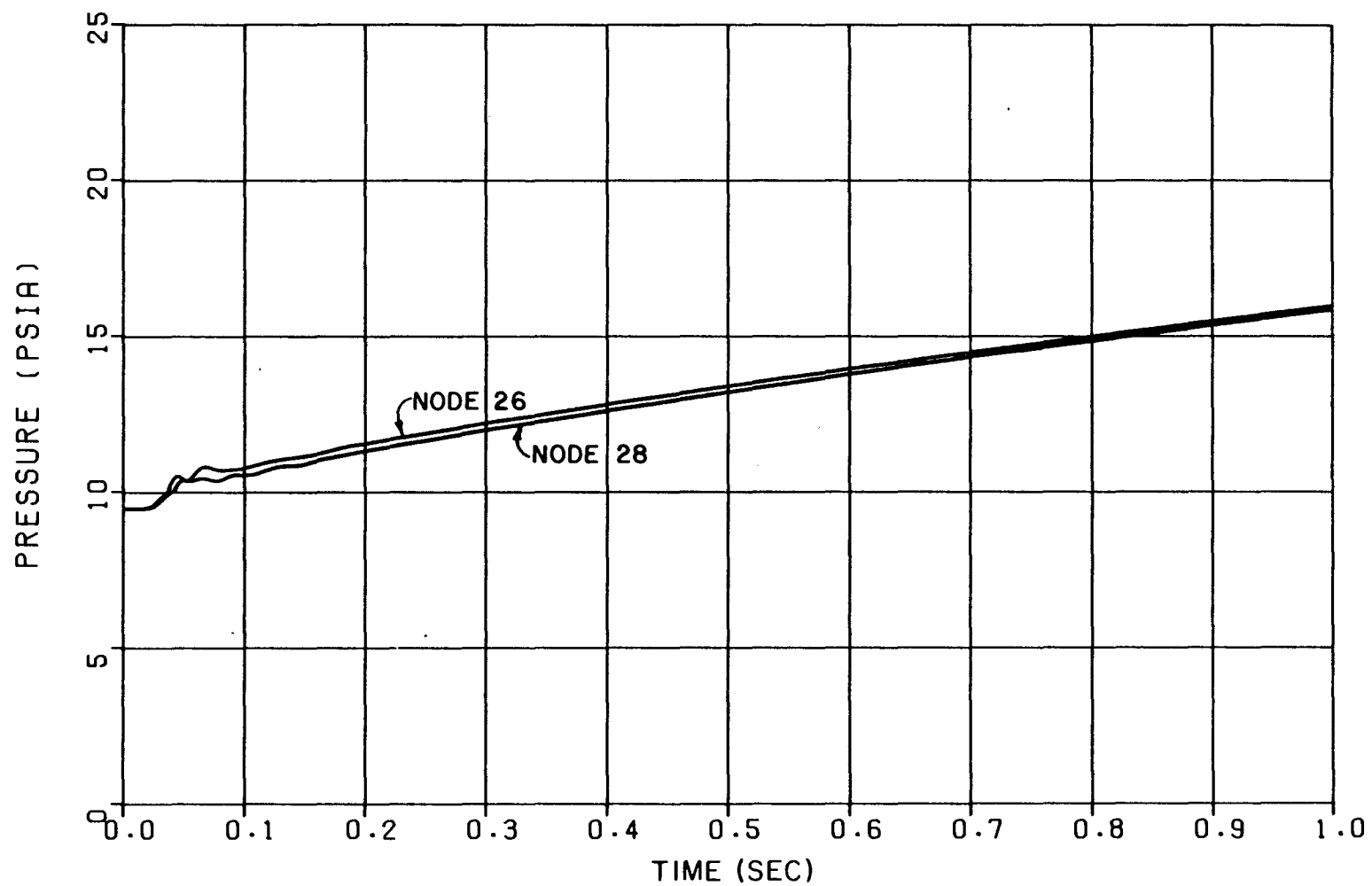

FIGURE 6.2-95  
BV-2 33 NODE STEAM GENERATOR CUBICLE  
ABSOLUTE PRESSURE VERSUS TIME  
707 SQ. IN. STM. GEN. INLET ELBOW SPLIT  
NODES 26 & 28  
BEAVER VALLEY POWER STATION-UNIT 2  
FINAL SAFETY ANALYSIS REPORT

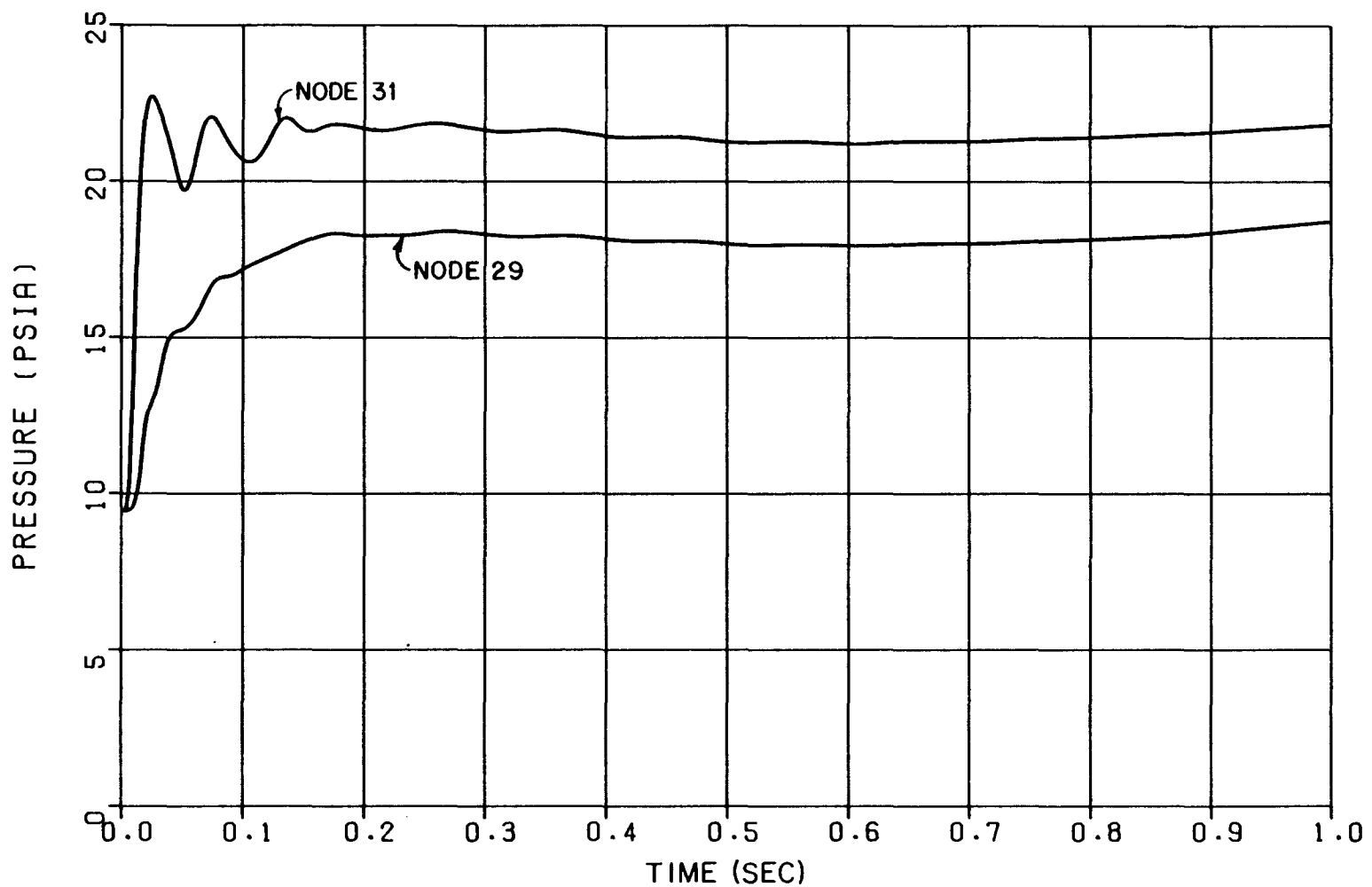

FIGURE 6.2-96  
BV-2 33 NODE STEAM GENERATOR CUBICLE  
ABSOLUTE PRESSURE VERSUS TIME  
707 SQ. IN. STM. GEN. INLET ELBOW SPLIT  
NODES 29 & 31  
BEAVER VALLEY POWER STATION-UNIT 2  
FINAL SAFETY ANALYSIS REPORT

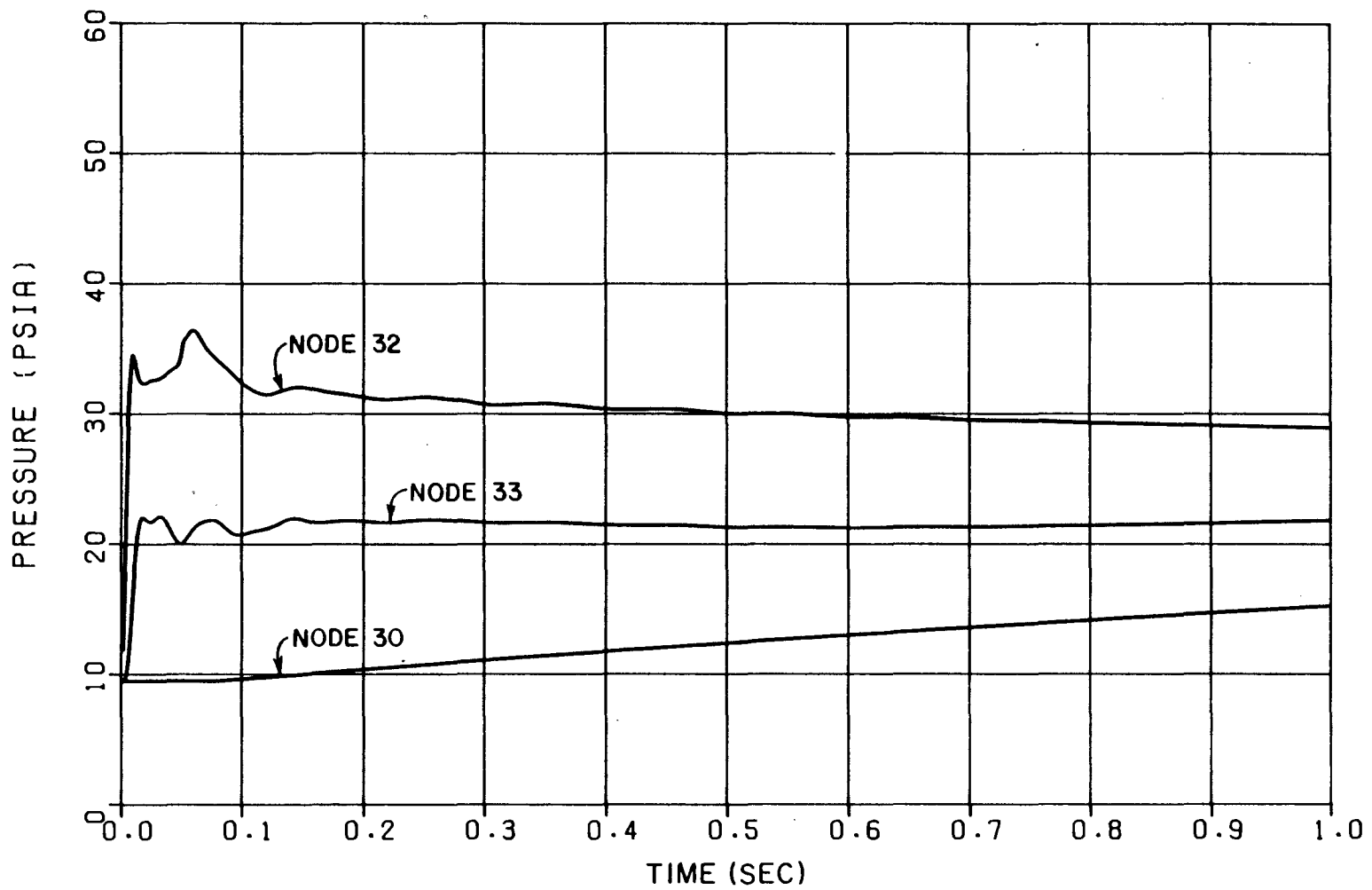
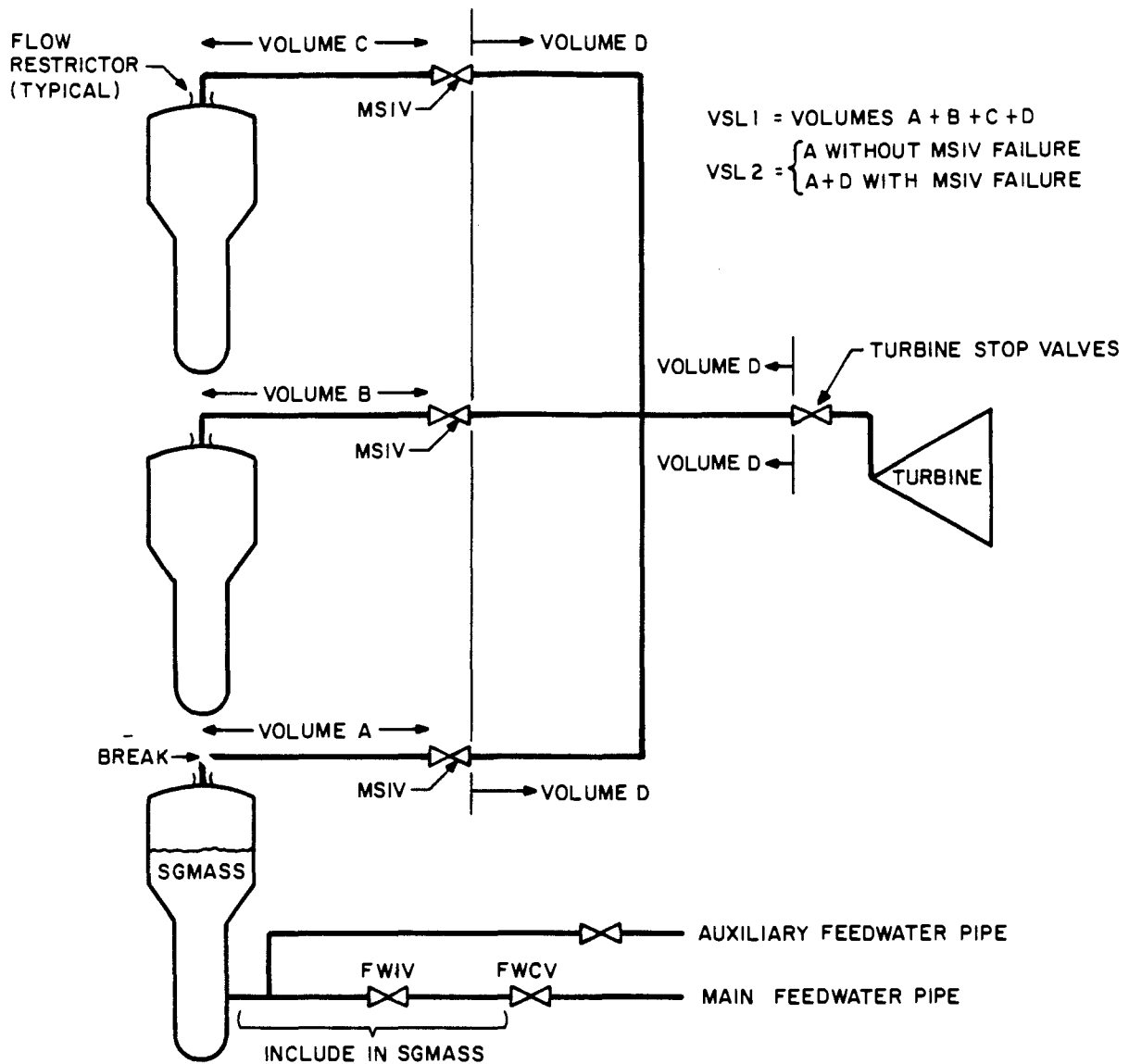

FIGURE 6.2-97  
 BV-2 33 NODE STEAM GENERATOR CUBICLE  
 ABSOLUTE PRESSURE VERSUS TIME  
 707 SQ. IN. STM. GEN. INLET ELBOW SPLIT  
 NODES 30, 32 & 33  
 BEAVER VALLEY POWER STATION-UNIT 2  
 FINAL SAFETY ANALYSIS REPORT





WHERE:

- MSIV ≡ MAIN STEAM ISOLATION VALVE
- SGMASS ≡ INITIAL STEAM GENERATOR INVENTORY
- VSL1 ≡ TOTAL STEAM PIPING VOLUME
- VSL2 ≡ VOLUME BETWEEN BREAK AND NEAREST FUNCTIONING MSIV
- FWIV ≡ FEEDWATER ISOLATION VALVE
- FWCV ≡ FEEDWATER CONTROL VALVE

FIGURE 6.2-118  
 SCHEMATIC DIAGRAM OF  
 SECONDARY SYSTEM  
 BEAVER VALLEY POWER STATION-UNIT 2  
 FINAL SAFETY ANALYSIS REPORT

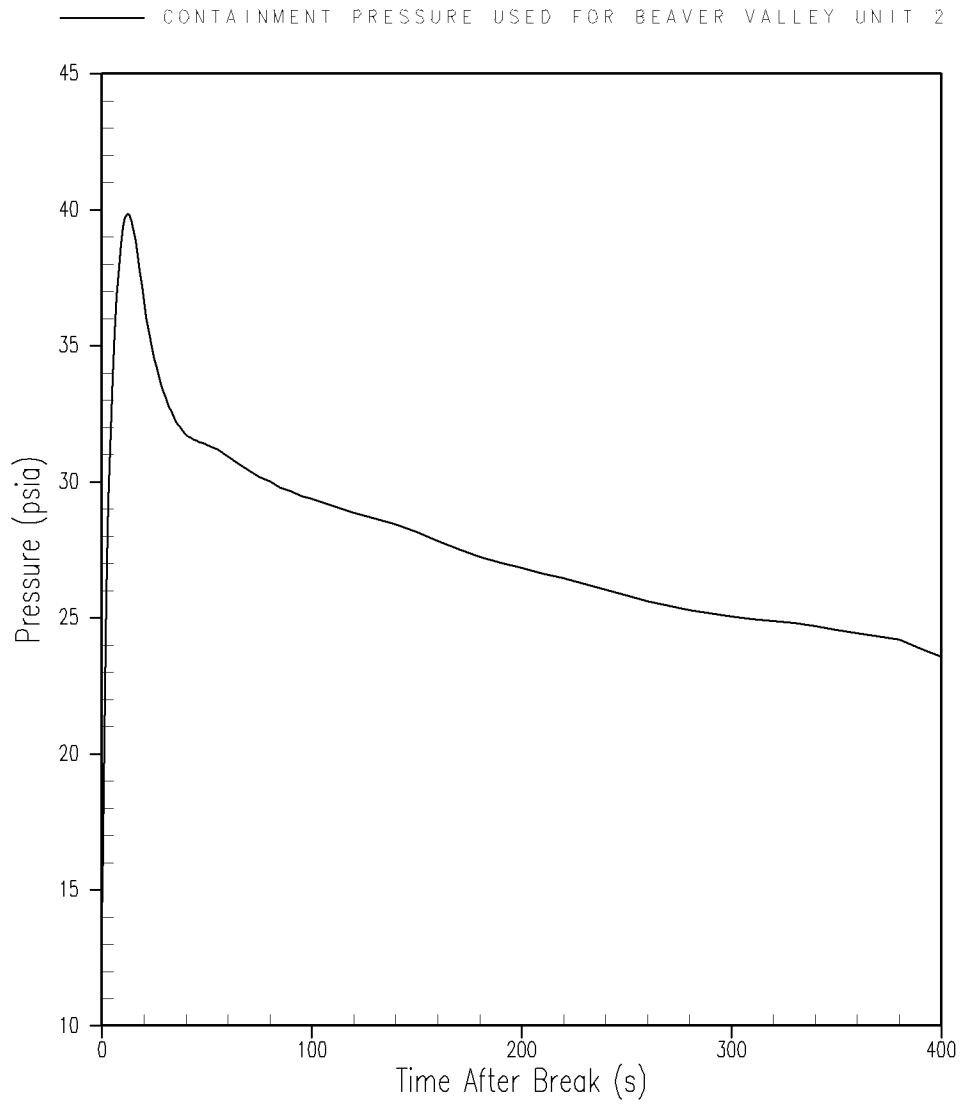

**Figure 6.2-119**  
**Lower Bound Containment Pressure**  
**Beaver Valley Power Station Unit No. 2**  
**Updated Final Safety Analysis Report**

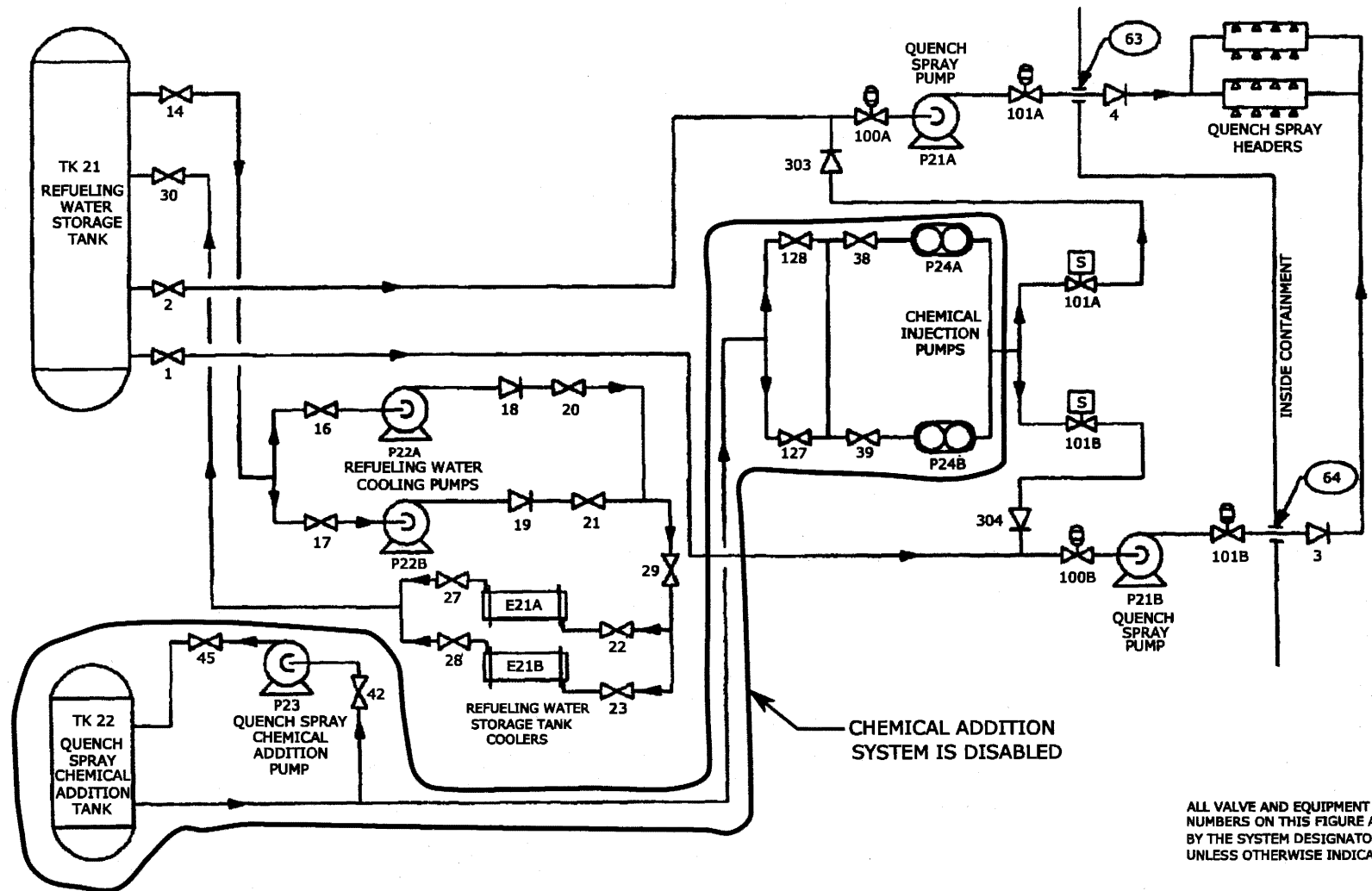
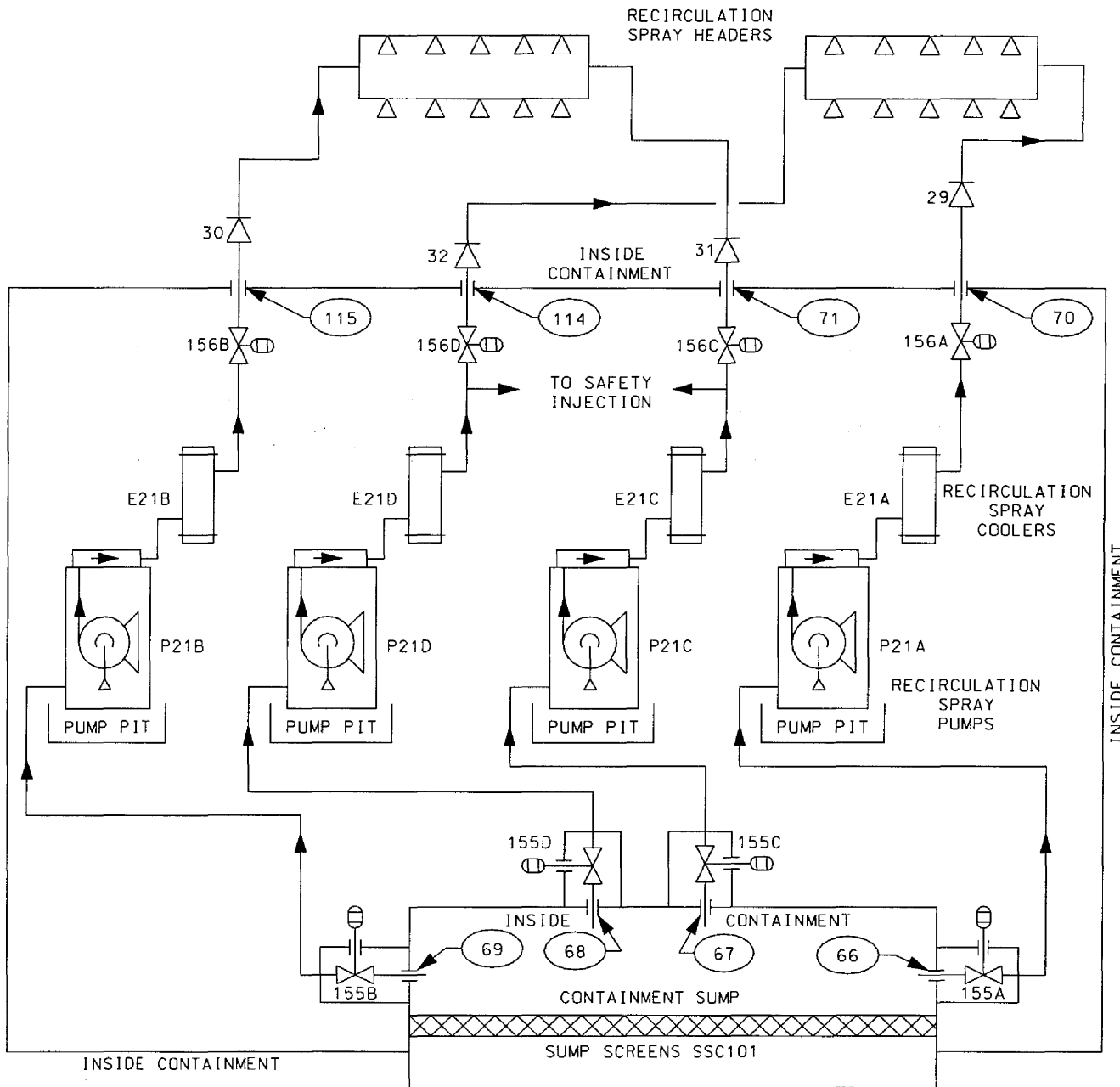

FIGURE 6.2-121  
QUENCH SPRAY SYSTEM

BEAVER VALLEY POWER STATION - UNIT 2  
UPDATED FINAL SAFETY ANALYSIS REPORT



ALL VALVE AND EQUIPMENT IDENTIFICATION NUMBERS ON THIS FIGURE ARE PRECEDED BY THE SYSTEM DESIGNATOR "2RSS" UNLESS OTHERWISE INDICATED.

**FIGURE 6.2-122  
RECIRCULATION SPRAY SYSTEM**

REFERENCE: STATION DRAWING OM 13-1  
BEAVER VALLEY POWER STATION UNIT NO. 2  
UPDATED FINAL SAFETY ANALYSIS REPORT

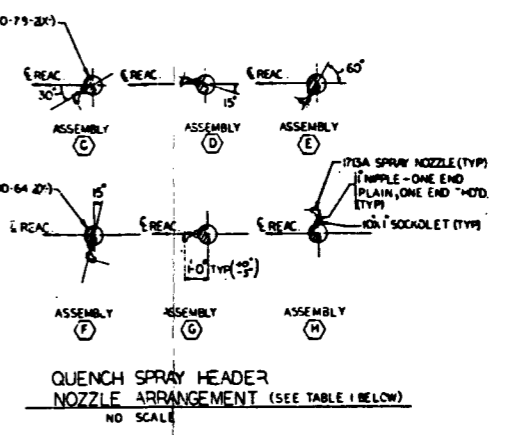
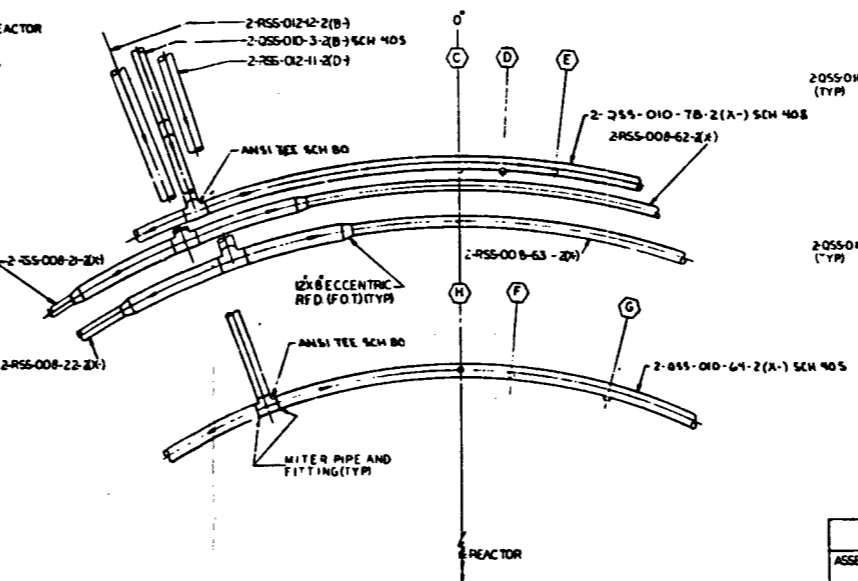
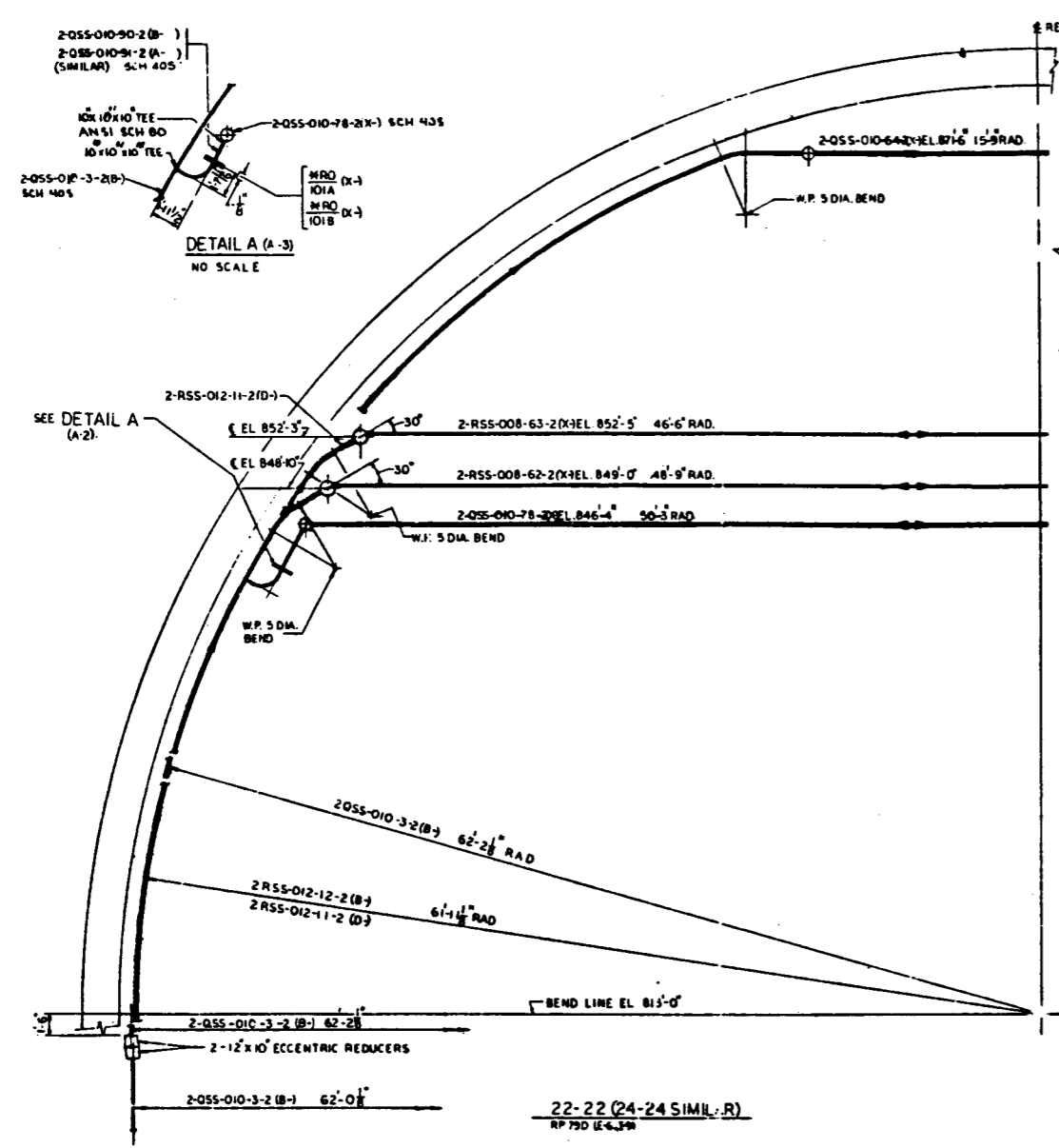

ASSEMBLY	LINE IDENTIFICATION	INITIAL AZIMUTH	INTERNAL AZIMUTH	NUMBER OF NOZZLE ASSEMBLIES
C	2-055-010-78-2(X)	0°	6°	60
D	2-055-010-78-2(X)	3°	10°	36
E	2-055-010-78-2(X)	7°	15°	24
F	2-055-010-64-2(X)	5°	20°	18
G	2-055-010-64-2(X)	15°	24°	15
H	2-055-010-64-2(X)	0°	60°	6

ALL NOZZLE AXIS ARE IN A MERIDIAN PLANE

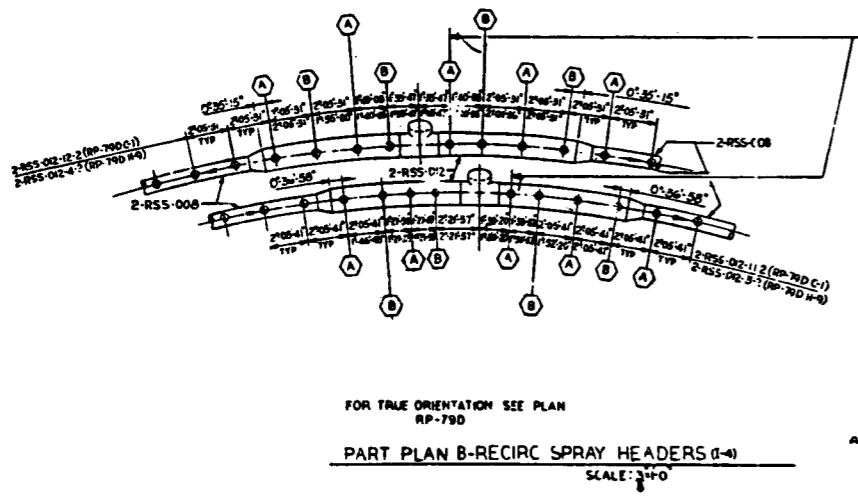
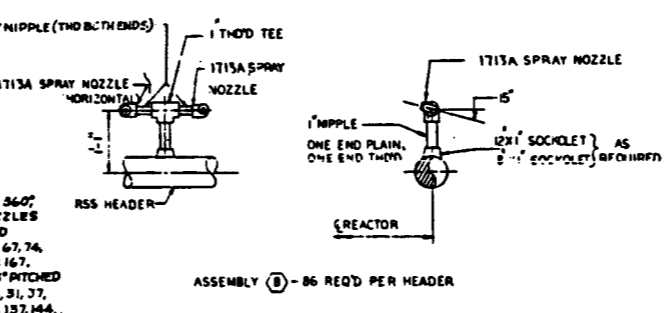
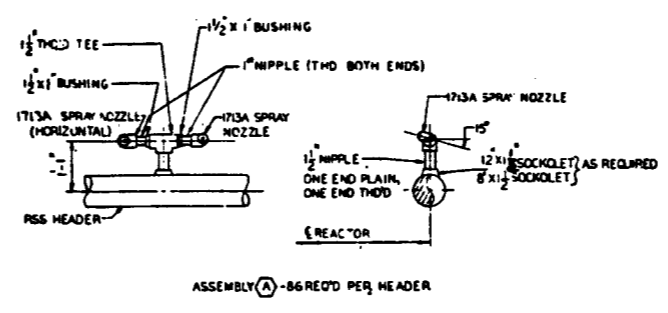

(UNLESS OTHERWISE NOTED ON RP-790) STARTING HERE IN A CLOCKWISE DIRECTION FOR 360°, THIS BEING NOZZLE NO. 1, THE FOLLOWING NOZZLES SHALL HAVE THE HORIZONTAL NOZZLE PLUGGED (SEE DET. 'AE'-'G') 1, 7, 14, 21, 27, 34, 41, 47, 54, 61, 67, 74, 81, 87, 94, 101, 107, 114, 121, 127, 134, 141, 147, 154, 161, 167. THE FOLLOWING NOZZLES SHALL HAVE THE 15° PITCHED NOZZLE PLUGGED (SEE DET. 'AF'-'H') 4, 11, 17, 24, 31, 37, 44, 51, 57, 64, 71, 77, 84, 91, 97, 104, 111, 117, 124, 131, 137, 144, 151, 157, 164, 171.

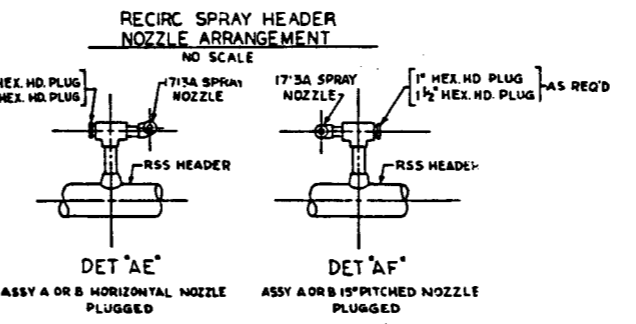
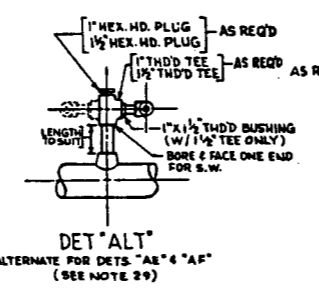
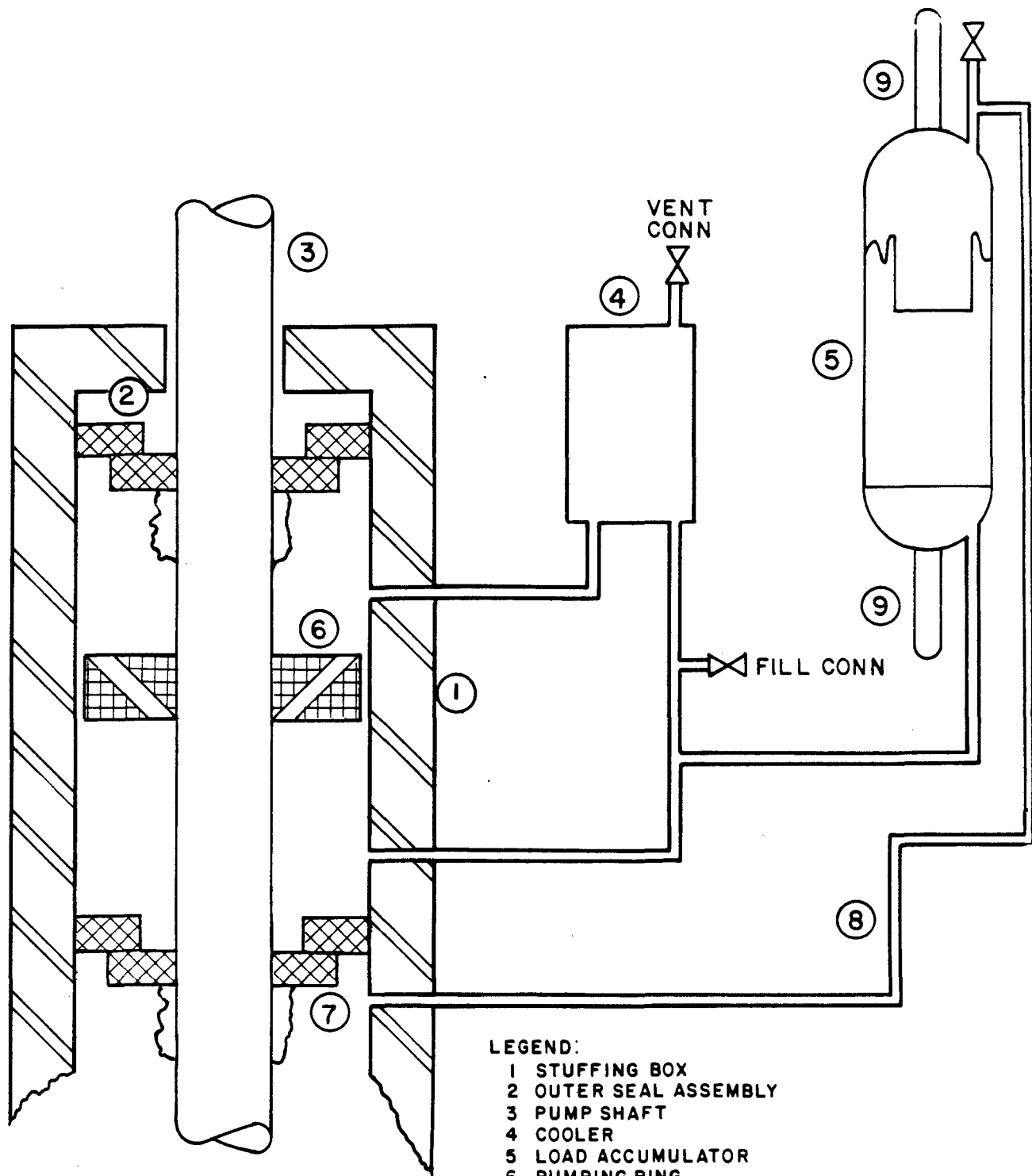

FIGURE 6.2-123  
CONTAINMENT QUENCH AND  
RECIRCULATING SPRAY PIPING  
BEAVER VALLEY POWER STATION-UNIT 2  
FINAL SAFETY ANALYSIS REPORT



**LEGEND:**

- 1 STUFFING BOX
- 2 OUTER SEAL ASSEMBLY
- 3 PUMP SHAFT
- 4 COOLER
- 5 LOAD ACCUMULATOR
- 6 PUMPING RING
- 7 INNER SEAL ASSEMBLY
- 8 CONNECTION TO PROCESS SIDE PRESSURE
- 9 LEVEL INDICATOR ALARM TO MAIN CONTROL ROOM

**FIGURE 6.2-124  
TANDEM MECHANICAL SEAL  
ARRANGEMENT  
FOR RECIRCULATION PUMPS  
BEAVER VALLEY POWER STATION-UNIT 2  
FINAL SAFETY ANALYSIS REPORT**

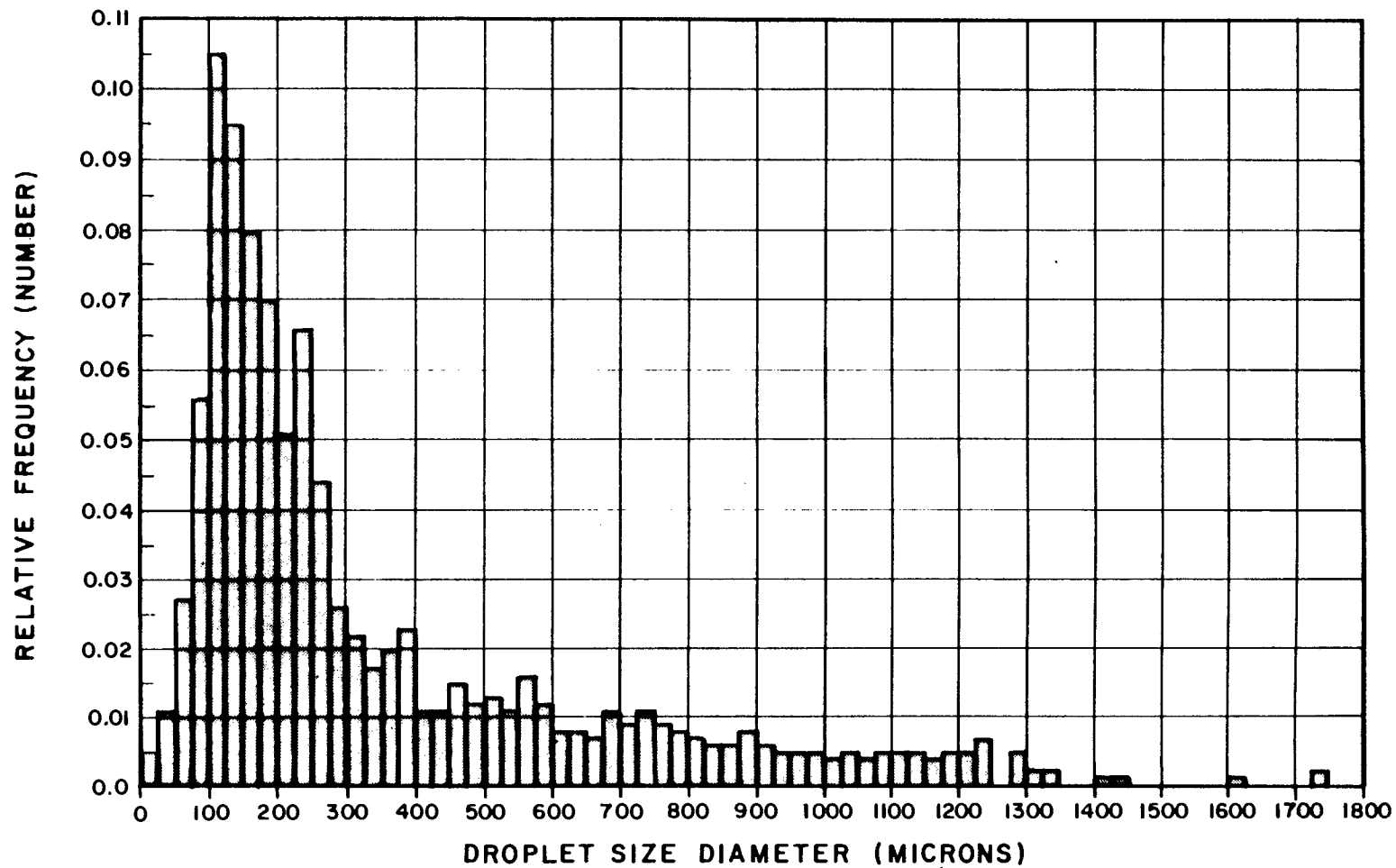

**NOTES**

1. NUMBER MEDIAN DIAMETER 230  $\mu$
2. SPATIAL DROPLET SIZE DISTRIBUTION OF SPRACO 1713A NOZZLE APPLYING SURFACE AREA CORRECTION AND SPRAYING WATER AT 40 PSIG UNDER LABORATORY CONDITIONS

**FIGURE 6.2-125  
SPATIAL DROPLET SIZE DISTRIBUTION  
BEAVER VALLEY POWER STATION - UNIT 2  
FINAL SAFETY ANALYSIS REPORT**

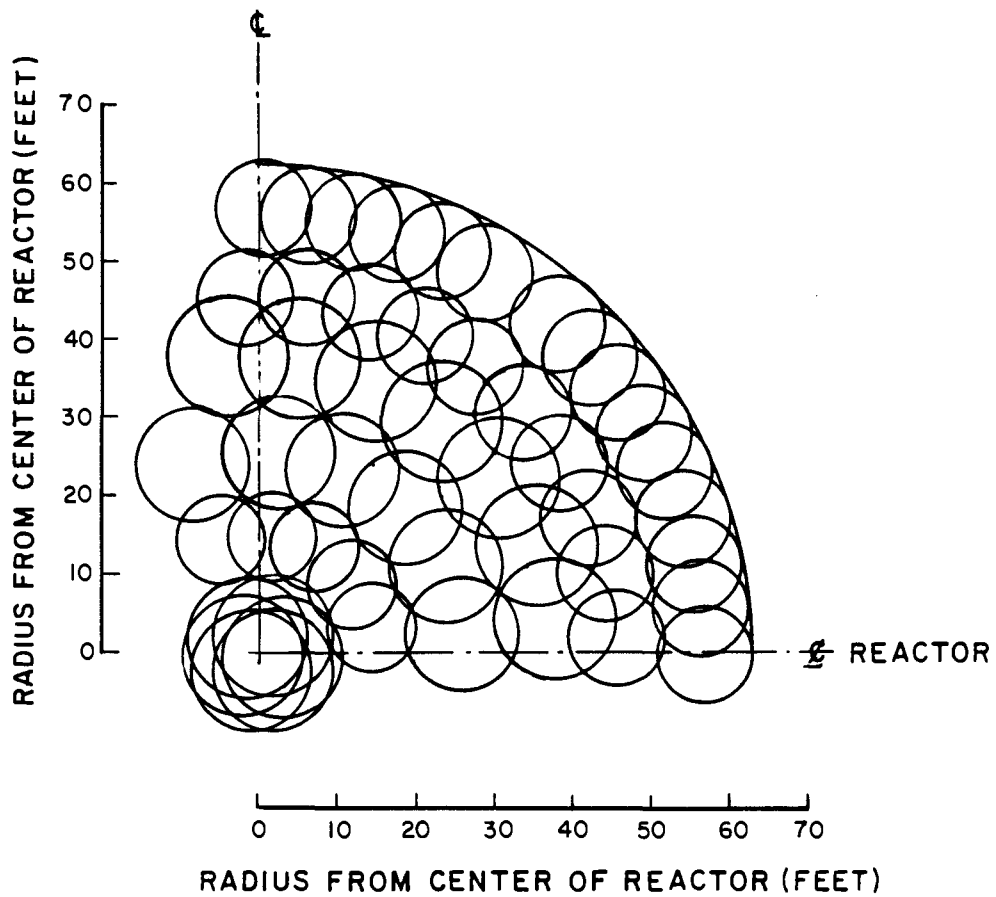

**NOTE:**

- I. OPERATING FLOOR IS COVERED 100 PERCENT BY THE QUENCH SPRAY. THE ONLY NON-SPRAYED AREAS ARE THE INTERSPACES BETWEEN THE SPRAY PATTERNS OF THE NOZZLES.

**FIGURE 6.2-126  
 QUENCH SPRAY COVERAGE ON  
 OPERATING FLOOR, EL. 767'-10"  
 BEAVER VALLEY POWER STATION - UNIT 2  
 FINAL SAFETY ANALYSIS REPORT**



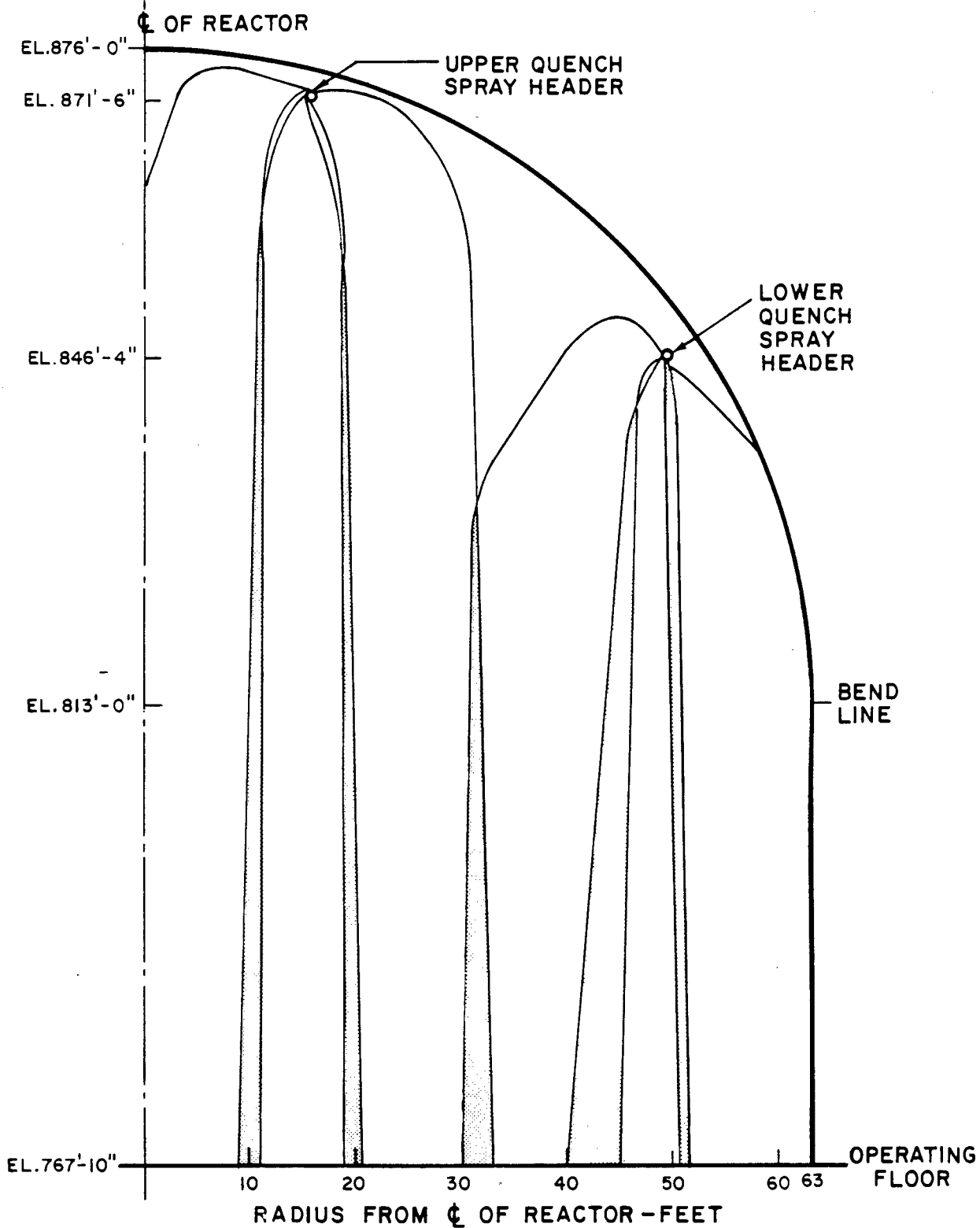

FIGURE 6.2-127  
 QUENCH SPRAY COVERAGE IN  
 CONTAINMENT DOME  
 BEAVER VALLEY POWER STATION-UNIT 2  
 FINAL SAFETY ANALYSIS REPORT

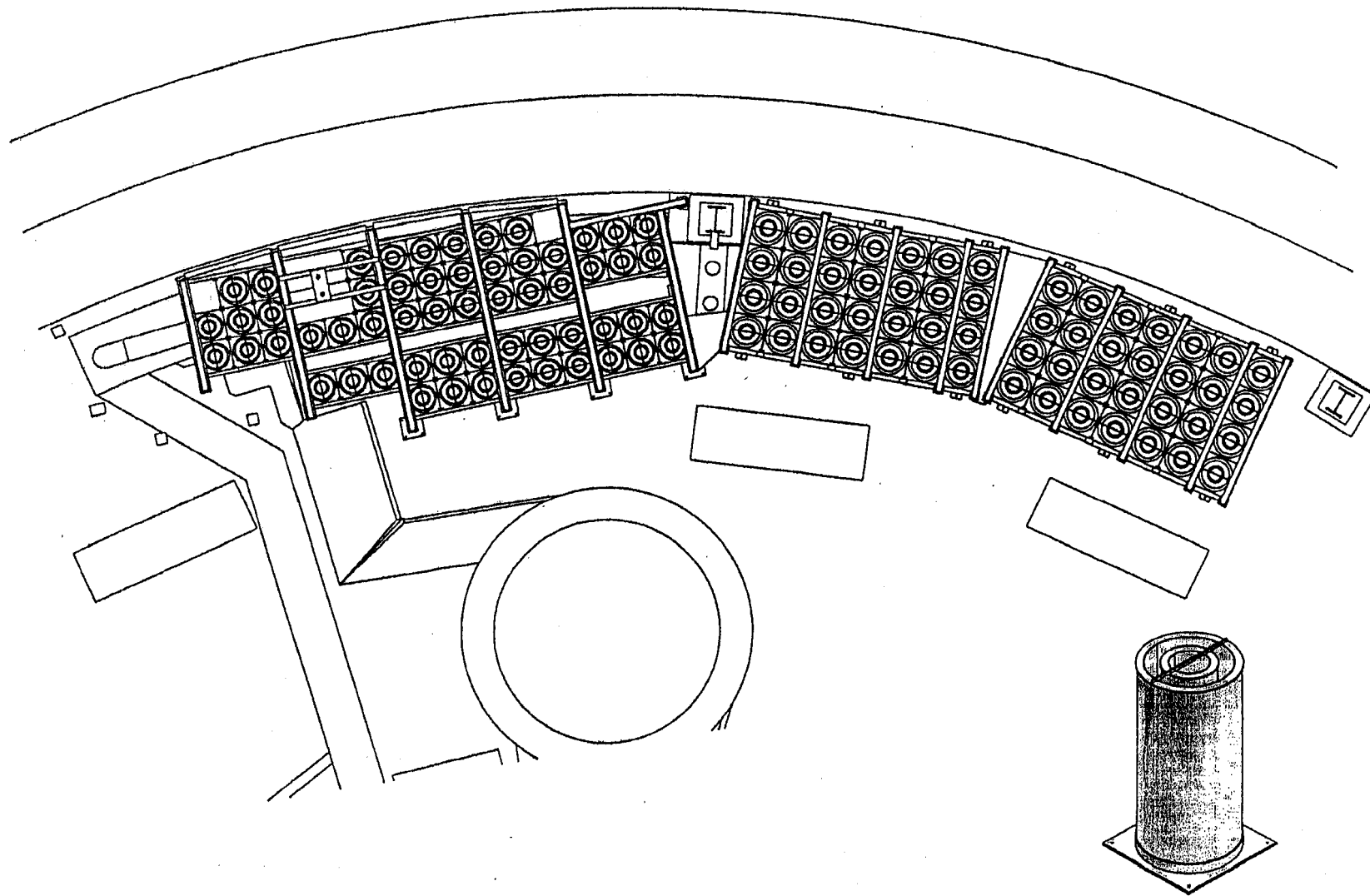

FIGURE 6.2-128  
CONTAINMENT SUMP  
BEAVER VALLEY POWER STATION-UNIT 2  
FINAL SAFETY ANALYSIS REPORT

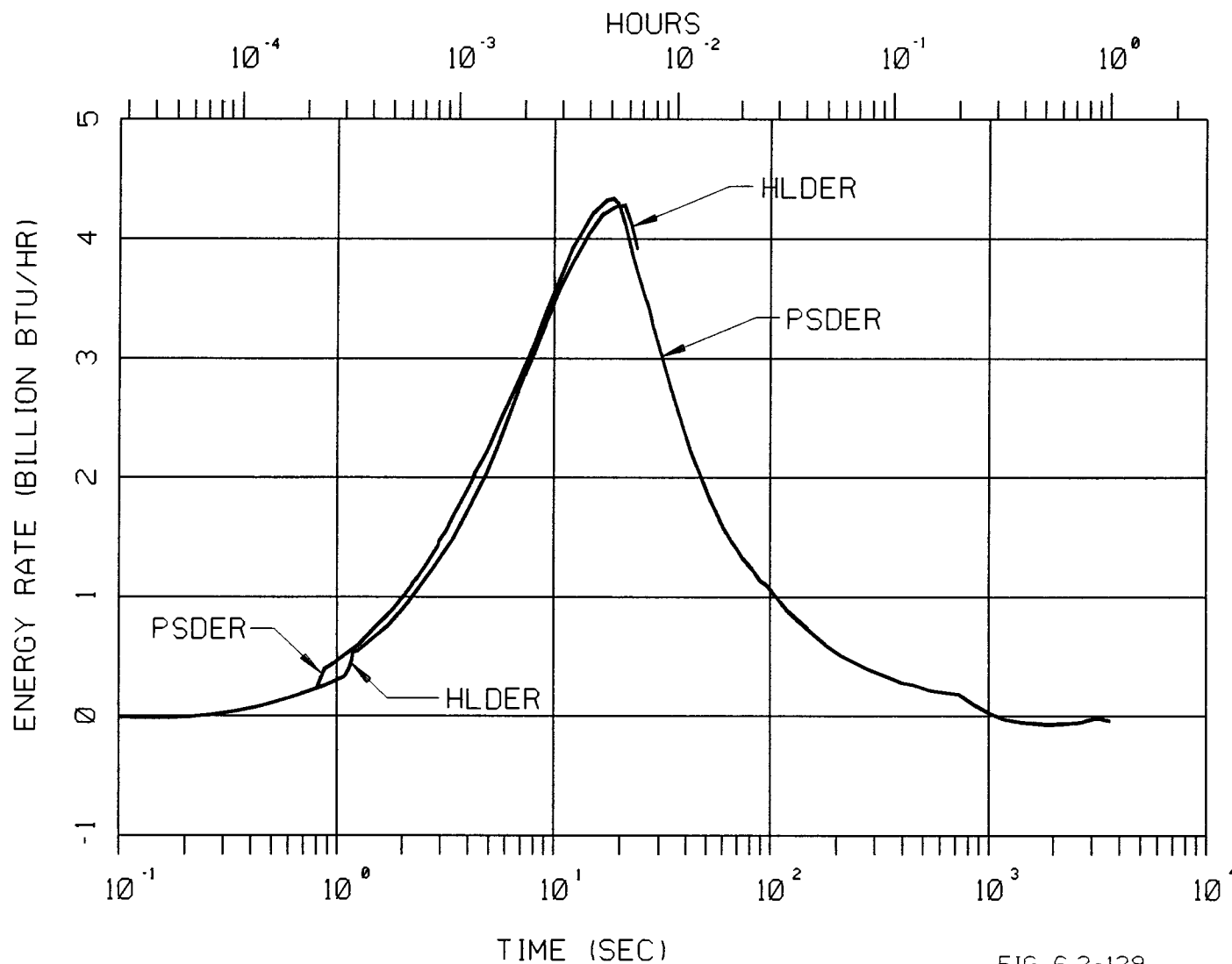

FIG. 6.2-129  
 ENERGY ABSORBED BY PASSIVE  
 HEAT SINKS PEAK PRESSURE  
 (HLDER & PSDER.MIN ESF)  
 BEAVER VALLEY POWER STATION-UNIT 2  
 FINAL SAFETY ANALYSIS REPORT

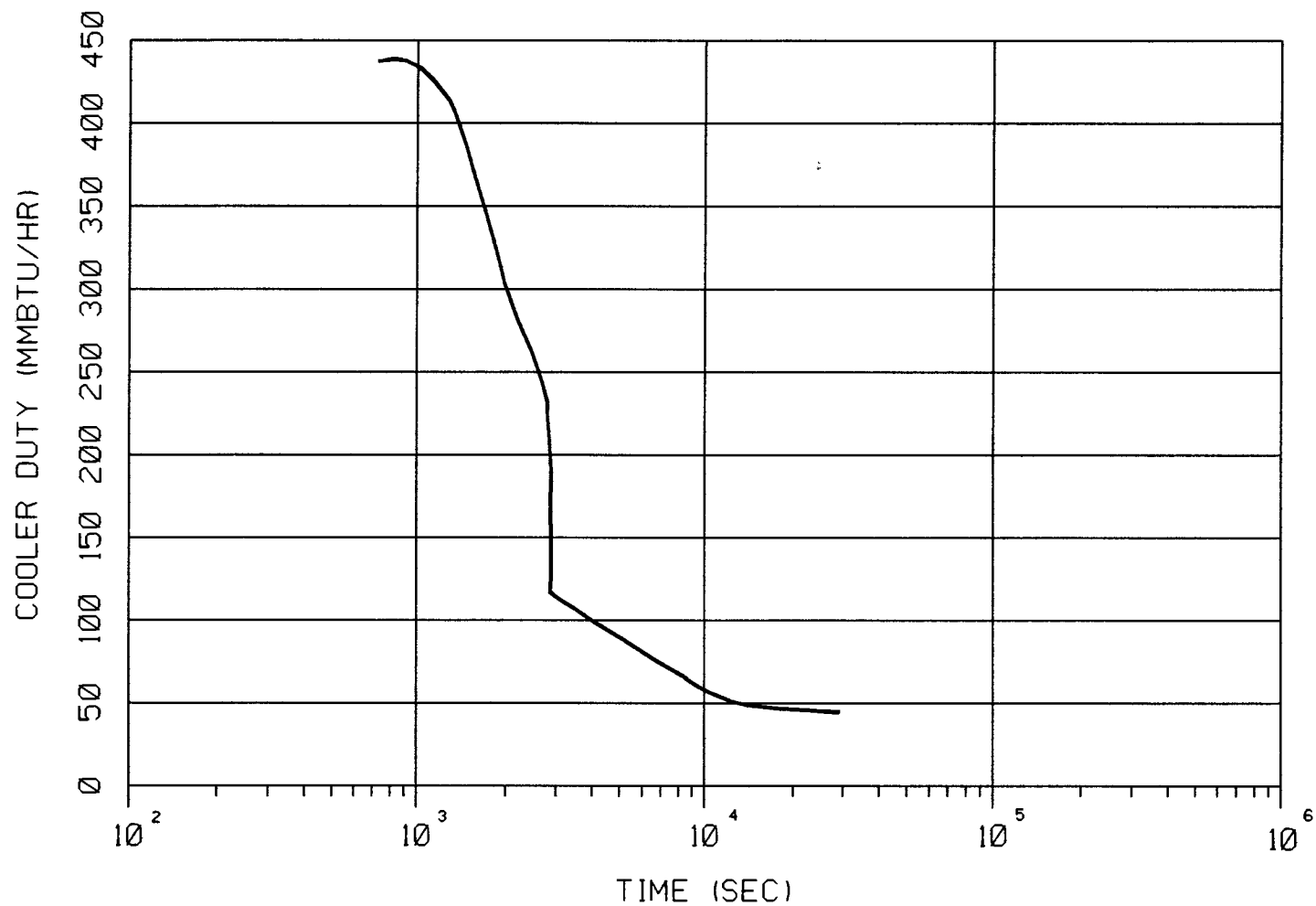

FIG. 6.2-130

ENERGY REMOVED BY RECIRC.  
DEPRESSURIZATION CASE  
PSDER (MIN ESF)

BEAVER VALLEY POWER STATION-UNIT 2  
FINAL SAFETY ANALYSIS REPORT

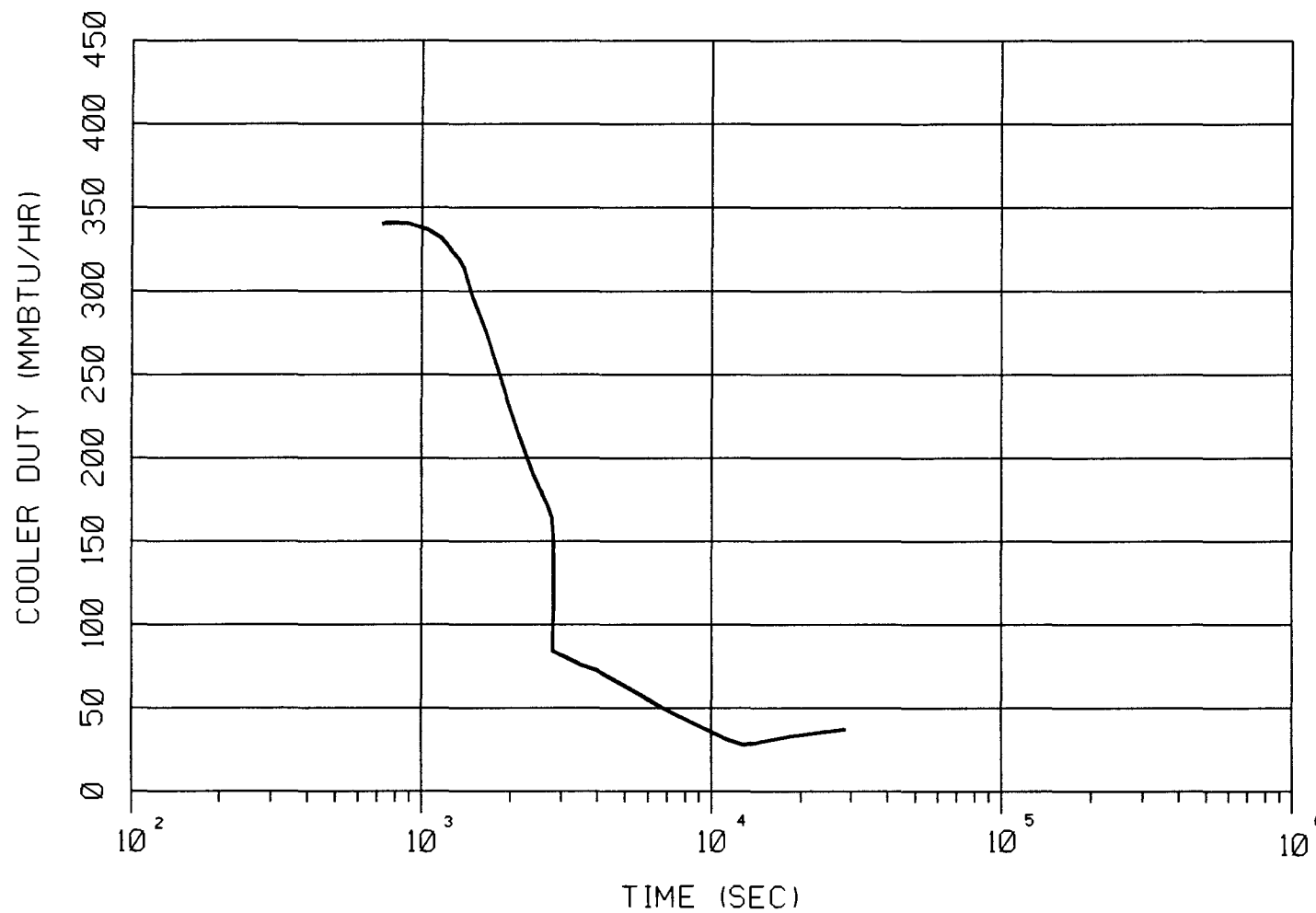
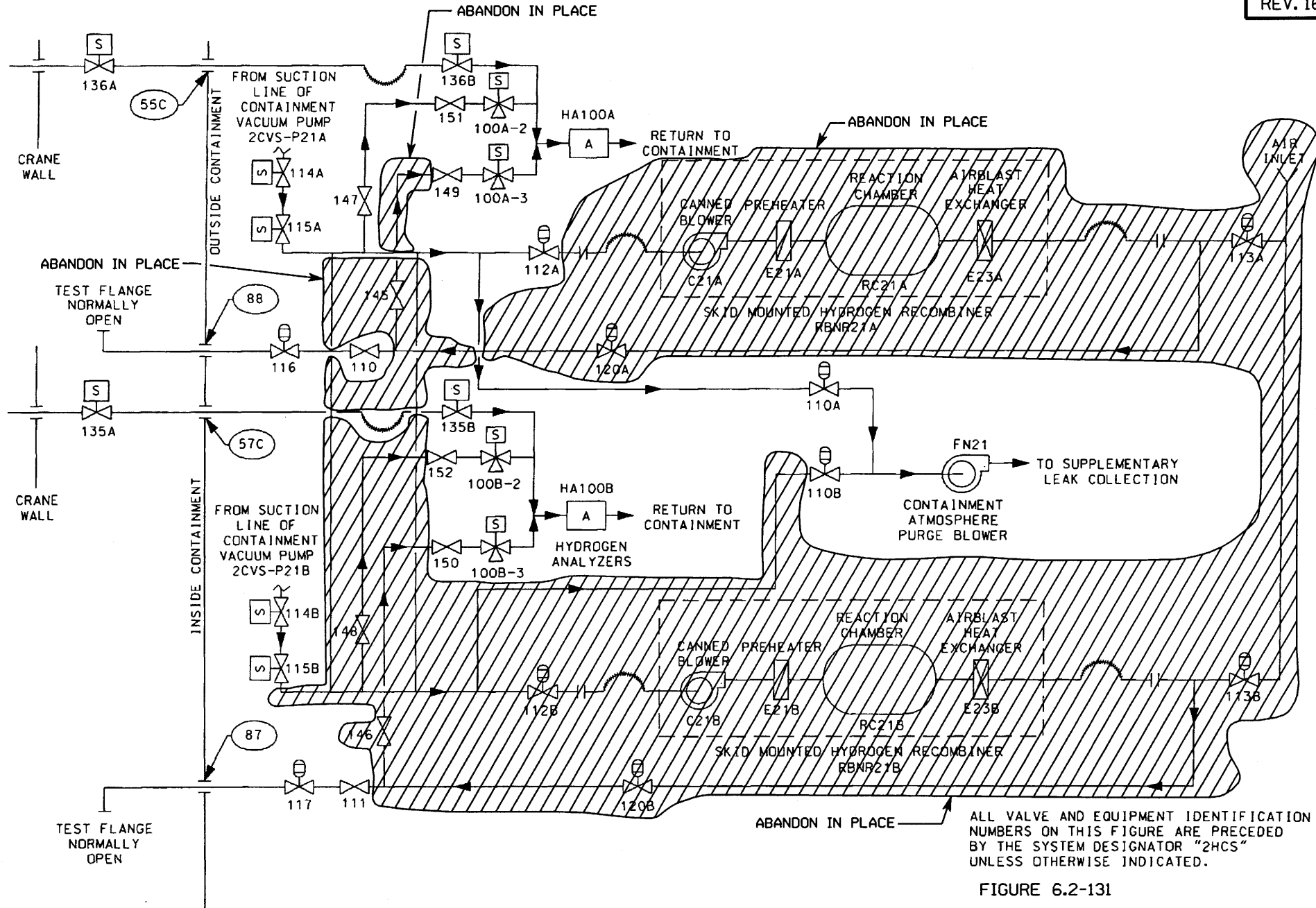

FIG. 6.2-130 A

ENERGY REMOVED BY RECIRC.  
COOLERS SUB. ATM. PEAK PRES.  
PSDER (MIN ESF)

BEAVER VALLEY POWER STATION-UNIT 2  
FINAL SAFETY ANALYSIS REPORT



ALL VALVE AND EQUIPMENT IDENTIFICATION NUMBERS ON THIS FIGURE ARE PRECEDED BY THE SYSTEM DESIGNATOR "2HCS" UNLESS OTHERWISE INDICATED.

FIGURE 6.2-131  
 COMBUSTIBLE GAS CONTROL SYSTEM  
 REFERENCE: STATION DRAWING OM 46-1  
 BEAVER VALLEY POWER STATION UNIT NO. 2  
 UPDATED FINAL SAFETY ANALYSIS REPORT

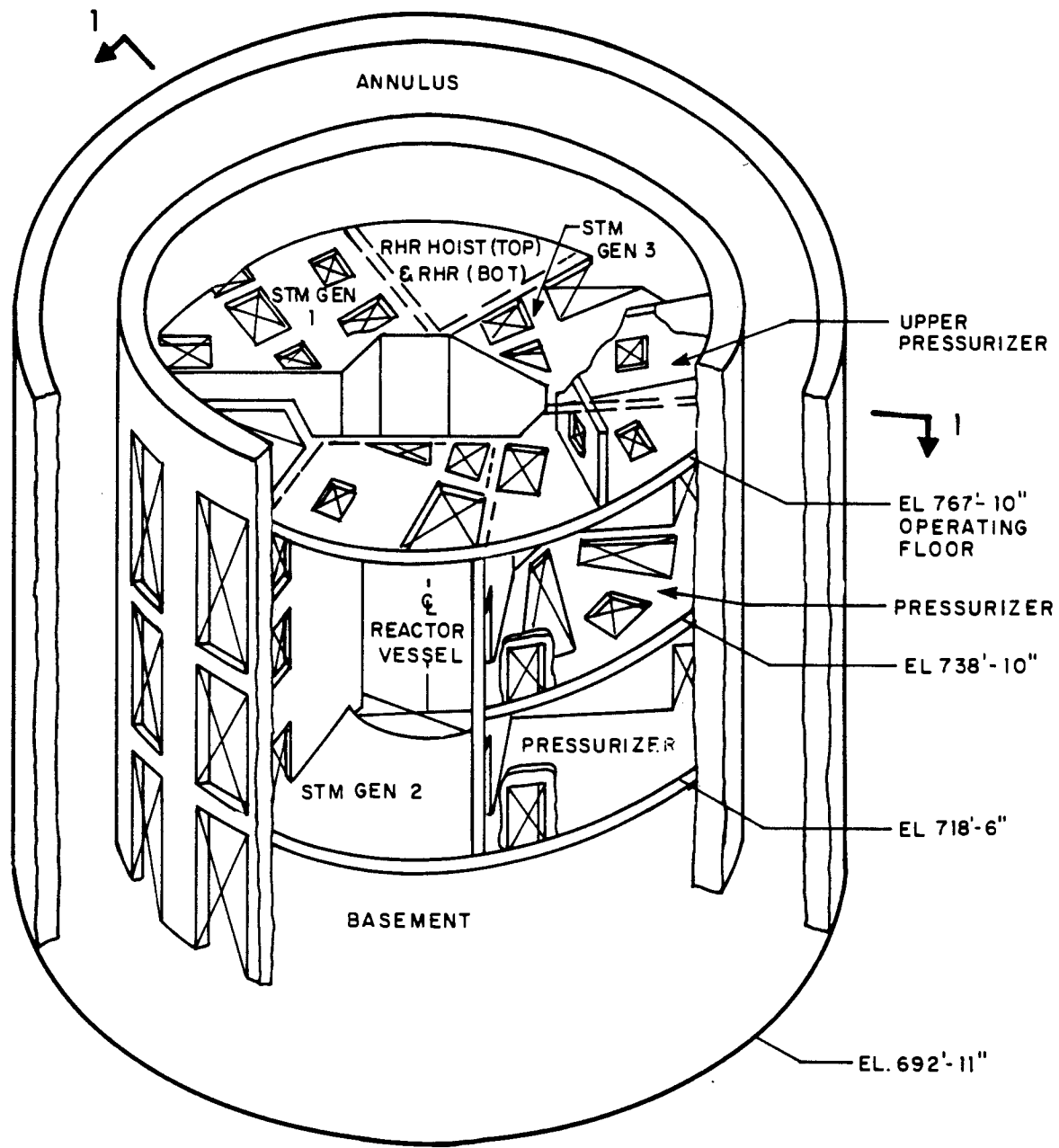

**LEGEND**

 OPENINGS

**NOTE:**

STEAM GENERATOR SHIELD WALL  
 ABOVE OPERATING FLOOR NOT  
 SHOWN FOR CLARITY

**FIGURE 6.2-138**  
**CONTAINMENT INTERNAL**  
**STRUCTURE**  
**BEAVER VALLEY POWER STATION - UNIT 2**  
**FINAL SAFETY ANALYSIS REPORT**

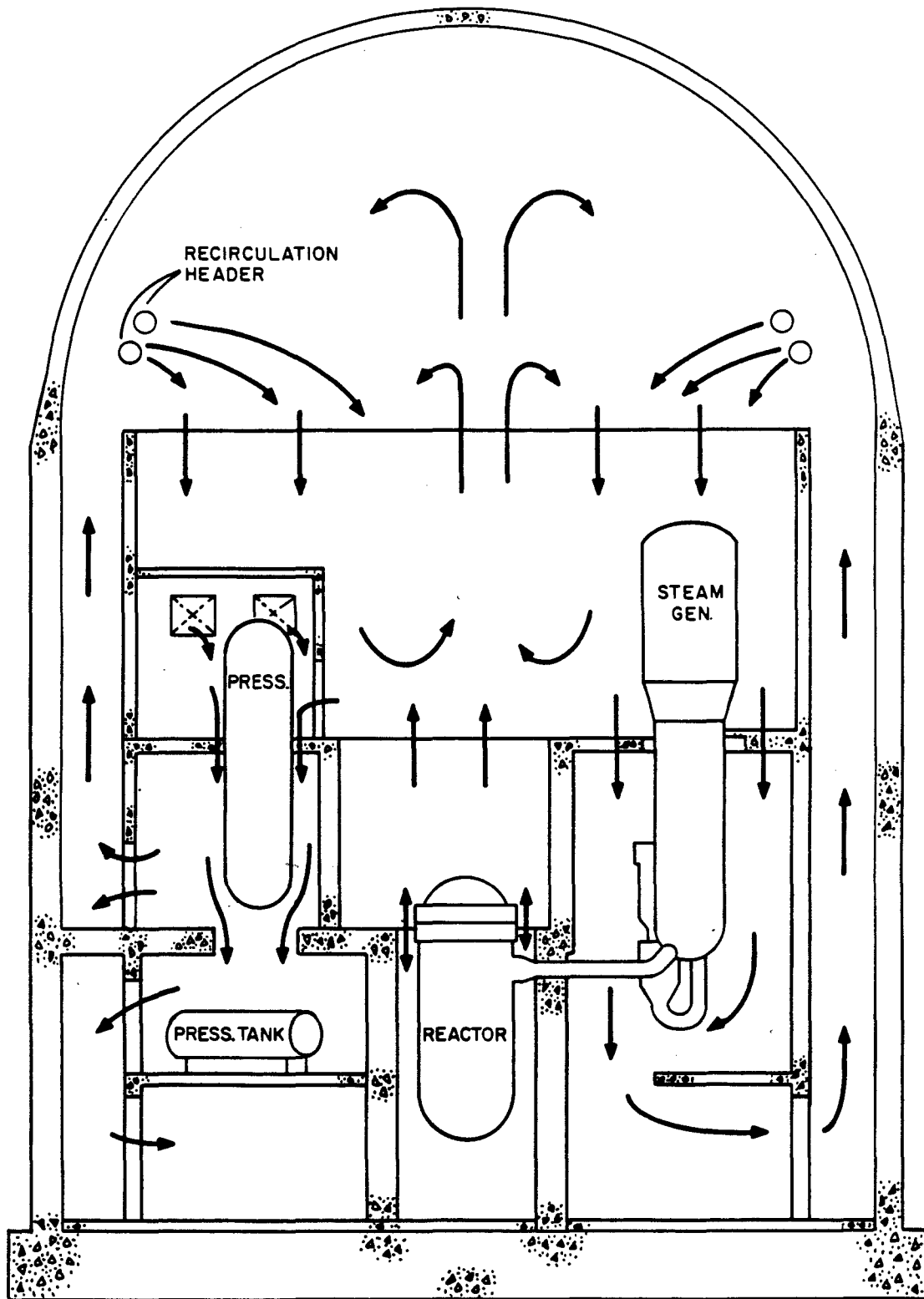

SECTION 1-1

FIGURE 6.2-139  
 EXPECTED LONG-TERM CIRCULATION  
 PATTERNS IN CONTAINMENT  
 BEAVER VALLEY POWER STATION-UNIT 2  
 FINAL SAFETY ANALYSIS REPORT



## 6.3 EMERGENCY CORE COOLING SYSTEM

### 6.3.1 Design Bases

#### Summary Description

The primary function of the emergency core cooling system (ECCS) following a loss-of-coolant accident (LOCA) is to remove the stored and fission product decay heat from the reactor core such that fuel rod damage, to the extent that it would impair effective cooling of the core, is prevented.

The ECCS consists of the high head safety injection (HHSI)/charging pumps, the refueling water storage tank (RWST), low head safety injection (LHSI) pumps, recirculation spray pumps, and the safety injection (SI) accumulators with the associated valves, instrumentation, and piping.

Plants listed in Section 1.3 have essentially similar systems as Beaver Valley Power Station - Unit 2. The ECCS is designed to cool the reactor core as well as to provide additional shutdown capability following initiation of the following accident conditions:

1. A LOCA, including a pipe break or a spurious relief or safety valve opening in the reactor coolant system (RCS), which would result in a discharge larger than that which could be made up by the normal make-up system.
2. A rupture of a control rod drive mechanism causing a rod cluster control assembly (RCCA) ejection accident.
3. A steam or feedwater system break accident, including a pipe break or a spurious relief or safety valve opening in the secondary steam system which would result in an uncontrolled steam release or a loss of feedwater.
4. A steam generator tube rupture.

The acceptance criteria for the consequences of each of these accidents are described in Chapter 15 in the respective accident analyses sections.

The bases used in design and for selection of ECCS functional requirements are derived from 10 CFR 50 Appendix K limits for fuel cladding temperature, etc following any of the preceding accidents as delineated in 10 CFR 50.46. The subsystem functional parameters are selected so that, when integrated, the 10 CFR 50 Appendix K requirements are met over the range of anticipated accidents and single failure assumptions.

The reliability of the ECCS has been considered in selection of the functional requirements, selection of the particular components, and location of components and connected piping. Redundant components are provided where the loss of one component would impair reliability. Valves are provided in series where isolation is desired and in parallel when flow paths are to be established for ECCS performance. Redundant sources of the SI actuation signal are available so that the proper and timely operation of the ECCS will be assured. Sufficient instrumentation is available so that a failure of an instrument will not impair readiness of the system. The active components of the ECCS are powered from separate buses that are normally energized from the unit station service transformers. In addition, redundant sources of onsite power are available through the use of the emergency diesel generators to assure adequate power for all ECCS requirements. Each emergency diesel generator is capable of driving all pumps, valves, and necessary instruments associated with one train of the ECCS.

All motor-operated valves (MOVs) required to be moved from one position to another following the injection phase are located to prevent vulnerability to flooding. Spurious repositioning of valves due to the actuation of its positioning device coincident with a LOCA has been analyzed and is not considered credible. However, those valves whose spurious repositioning could result in a loss of the ECCS function have their power removed.

The environmental qualification of active ECCS equipment is discussed in Section 3.11.

Protection of the ECCS from missiles is discussed in Section 3.5. Protection of the ECCS against dynamic effects associated with ruptures of piping is described in Section 3.6.

The elevated temperature of the sump solution during recirculation is well within the design temperature of all ECCS components. In addition, consideration has been given to the potential for corrosion of various types of metals exposed to the fluid conditions prevalent immediately after the accident or during long term recirculation operations (Section 6.1.1).

#### 6.3.2 System Design

The ECCS components are designed such that adequate core cooling in the event of a design basis LOCA is provided: 1) in the injection phase by a minimum of two accumulators, one HHSI/charging pump and one LHSI pump, and 2) in the recirculation phase by a minimum of one charging pump and one recirculation spray pump with their associated valves and piping. The redundant onsite emergency diesel generators assure adequate emergency power to all required electrically-operated components in the event that a loss-of-offsite power (LOOP) occurs simultaneously with a LOCA, even assuming a single failure in the emergency power system.

### 6.3.2.1 Schematic Piping and Instrumentation Diagrams

The ECCS is shown on Figures 6.3-1 and 6.3-2.

The components of the ECCS are interlocked as listed:

1. The SI signal is interlocked with the following components and initiates the indicated actions:
  - a. The HHSI/charging pumps start,
  - b. The LHSI pumps, start,
  - c. The HHSI/charging pump discharge to cold legs isolation valves 2SIS\*MOV867A,B and 2SIS\*MOV867C,D open,
  - d. The RWST to HHSI/charging pump valves 2CHS\*LCV115B,D open,
  - e. The normal charging line isolation valves close,
  - f. The volume control tank (VCT) to HHSI/charging pump suction isolation valves 2CHS\*LCV115C,E close, and
  - g. The accumulator isolation valves open, if closed (these valves are normally open and have their power removed).
2. The following valves close on a containment isolation Phase A (CIA) signal:
  - a. Isolation valves in the nitrogen (N2) supply line to the accumulators,
  - b. Isolation valves in the check valve test lines, and
  - c. Isolation valves in the sampling lines from the accumulators, pressurizer, and hot and cold legs.
3. The recirculation spray pump suction isolation valves from the containment sump are interlocked to open upon receipt of a containment isolation Phase B (CIB) signal.
4. On an extreme low RWST level concurrent with an SI signal the following actions occur:
  - a. The LHSI pump discharge crossover isolation valves 2SIS\*MOV8887A,B close,

- b. The recirculation spray pump discharge valves 2SIS\*MOV8811A,B to the LHSI discharge lines into the RCS open,
- c. The recirculation spray header isolation valves 2RSS\*MOV156C,D are closed,
- d. The LHSI pumps stop on the limit switch signals "open" from valves 2SIS\*MOV8811A,B,
- e. The HHSI/charging pump suction isolation valves from the LHSI header 2SIS\*MOV863A,B are opened on limit switch signal "open" from valves 2SIS\*MOV8811A,B,
- f. The HHSI/charging pump suction isolation valves from the RWST 2CHS\*LCV115B,D are closed on limit switch signal "open" from valves 2SIS\*MOV863A,B, and
- g. The LHSI pump suction isolation valves from the RWST 2SIS\*MOV8809A,B are closed on "stop" signal from LHSI pumps.

The LHSI pump miniflow valves open on low flow and close on high flow coincident with the LHSI pump operation. The valves close when the LHSI pumps are stopped.

#### 6.3.2.2 Equipment and Component Descriptions

The component design and operating conditions are specified to the most severe conditions to which each respective component is exposed during either normal plant operation, or during operation of the ECCS. For each component, these conditions are considered in relation to the code to which it is designed. By designing the components in accordance with applicable codes, and with due consideration for the design and operating conditions, the fundamental assurance of structural integrity of the ECCS components is maintained. Components of the ECCS are designed to withstand the appropriate seismic loadings in accordance with their safety class as given in Table 3.2-1. Specific equipment parameters are shown in Table 6.3-1. Sections 3.7N and 3.9N describe the seismic and mechanical component designs.

The major mechanical components of the ECCS are:

##### Accumulators

The accumulators are pressure vessels partially filled with borated water and pressurized with nitrogen gas. During normal operation each accumulator is isolated from the RCS by two check valves in series. Should the RCS pressure fall below the accumulator pressure, the check valves open and borated water is forced into the RCS. One accumulator is attached to each of the cold legs of the RCS.

Mechanical operation of the swing-disc check valves is the only action required to open the injection path from the accumulators to the core via the cold leg. Connections are provided for remotely adjusting the level and boron concentration of the borated water in each accumulator during normal plant operation as required. Accumulator water level may be adjusted either by draining to the Primary Drains Transfer Tank or by pumping borated water from the RWST to the accumulator. Samples of the solution in the accumulators are taken periodically to check boron concentration. Reduction of accumulator water level is detected by level indicators and low level alarms to allow the operator to take prompt action to maintain plant operation within the requirements of the Technical Specifications covering accumulator operability.

Accumulator pressure is provided by a supply of nitrogen gas and can be adjusted as required during normal plant operation; however, the accumulators are normally isolated from this nitrogen supply. Gas relief valves on the accumulators protect them from pressures in excess of design pressure.

The accumulators are located within the containment but outside of the secondary shield wall which protects them from missiles. Since the accumulators are located within the containment, a release of the nitrogen gas in the accumulators would cause an increase in normal containment pressure. Containment pressure increase following release of the gas from all accumulators has been calculated and is well below the containment pressure set point for ECCS actuation. Depressurization of the accumulators due to a loss of the nitrogen gas would be detected by the accumulator pressure indicators and alarms. Thus, the operator could take action promptly to maintain plant operation within the requirements of the Technical Specification covering accumulator operability.

Isolation and/or depressurization of the accumulators to permit cold shutdown operations is discussed in Section 5.4.7.

#### Low Head Safety Injection Pumps

The LHSI pumps start automatically on receipt of an SI signal and deliver water to the RCS from the RWST during the injection phase. The pumps are horizontal centrifugal type, with a self-contained mechanical seal.

A minimum flow bypass line is provided for the pumps to recirculate and return the pump discharge fluid to the RWST should these pumps be started with their normal flow paths blocked. Once flow greater than 1,000 gpm is established to the RCS, the bypass line is automatically closed. This line prevents dead-heading of the pumps and permits pump testing during normal operation.

During the switchover from injection to recirculation, these pumps are stopped and the LHSI function is provided by two of the four recirculation spray pumps.

The low head pump performance curve is given on Figure 6.3-4.

#### High Head Safety Injection/Charging Pumps

The HHSI/charging pumps are started automatically on receipt of a SI signal and are automatically aligned to take suction from the RWST during injection. During recirculation, suction is provided from the containment sump via the recirculation spray pumps and portions of the LHSI piping.

The charging pumps deliver flow to the RCS at the prevailing RCS pressure. Each centrifugal charging pump is a multistage diffuser design, barrel-type casing with vertical suction and discharge nozzles.

A minimum flow recirculation path is provided to protect the two operable charging pumps by preventing the pumps from reaching a deadhead condition. That is, if the reactor coolant pressure is too high to allow any operating charging pump to deliver flow through the injection lines, sufficient flow to prevent pump damage will be recirculated through the seal water heat exchanger and back to the pump suction header.

During normal plant operation, at least one charging pump is continuously in service. The other charging pumps may be tested during power operation via the minimum flow bypass lines.

The high head pump performance curve is given on Figure 6.3-5.

Available and required net positive suction head (NPSH) for ECCS pumps are shown in Table 6.3-1. The safety intent of Regulatory Guide 1.1 is met by the design of the ECCS such that adequate NPSH is provided to system pumps.

### Positive Displacement Hydrostatic Test Pump

This pump serves two functions, neither of which is safety-related. Permanent connections are provided to the accumulators to allow addition of borated water from the RWST. Temporary connections permit the use of this pump in hydro-testing the plant piping systems.

### Recirculation Spray Pumps

The recirculation spray pumps provide containment spray during the injection phase as well as maintaining long term ECCS recirculation during the recirculation phase. Two of the four recirculation spray pumps are automatically realigned to LHSI during the transfer from

injection to recirculation. In the recirculation mode, these two pumps provide water directly to the RCS as well as to the suction of the HHSI/charging pumps.

Section 6.2.2 discusses component design and NPSH considerations for these pumps.

#### Valves

Design features employed to minimize valve leakage include:

1. Where possible, packless valves are used.
2. Valves with packed stuffing boxes are provided with intermediate stem leakoff connections when possible.
3. Valves that are not packless which are normally open, except check valves and those which perform a control function, are provided with backseats to limit stem leakage.
4. Normally closed globe valves are installed with recirculation fluid pressure under the seat to prevent stem leakage of recirculated (radioactive) water.
5. Relief valves are enclosed, that is, they are provided with a closed bonnet.



Motor-operated valves which must function against system pressure are designed such that they function with a pressure drop equal to full system pressure across the valve disc.

Weight-loaded, swing-type check valves are used as the inside containment check valve on the SI lines. This type of weight-loaded check valve is also used on each line from the recirculation spray pump discharges to the LHSI headers.

Carbon steel manual valves are employed to pass non-radioactive fluids only.

During normal operation the accumulator check valves are in the closed position with a nominal differential pressure across the disc of approximately 1,650 psi. Since the valves remain in this position, except for testing or when called upon to open following an accident, and are therefore not subject to the abuse of flowing operation or impact loads caused by sudden flow reversal and seating, they do not experience significant wear of the moving parts and are expected to function with minimal back-leakage. This back-leakage can be checked via the test connection as described in Section 6.3.4.

Relief valves are installed in various sections of the ECCS to protect lines which have a lower design pressure than the RCS. Table 6.3-2 lists the ECCS relief valves with their capacities and set points.

### Accumulator Motor-Operated Valve Controls

As part of the plant normal shutdown administrative procedures, the operator is required to energize and close these valves. This prevents a loss of accumulator water inventory to the RCS and is done shortly after the RCS has been depressurized below the SI unblock set point. The redundant pressure and level alarms on each accumulator would remind the operator to close these valves, if any were inadvertently left open. Power is disconnected after the valves are closed.

During plant start-up, the operator is instructed, via procedures, to energize and open these valves when the RCS pressure reaches the SI set point. Monitor lights in conjunction with an audible alarm will alert the operator should any of these valves be left inadvertently closed once the RCS pressure increases beyond the SI unblock set point. In addition, these valves will automatically receive a signal to open when the RCS pressure exceeds the unblock pressure.

The accumulator isolation valves are not required to move during power operation or in a post-accident situation. For a discussion of limiting conditions for operation and surveillance requirements of these valves, refer to the Technical Specifications (Chapter 16).

The accumulator isolation valves receive a SI signal to ensure that they are open in the event of an accident which initiates SI. Instrumentation associated with these valves is discussed in Sections 6.3.5, 7.3.1.1.2, and 7.6.4.

### Motor-Operated Valves and Controls

Remotely-operated valves for the injection mode (that is, valves which normally are in their ready position and do not require a SI signal) have their positions indicated on a common portion of the control board. If a component is out of its proper position, its monitor light will indicate this on the control board. At any time during operation when one of these valves is not in the ready position for injection, this condition is shown visually on the control board, and an audible alarm is sounded in the main control room.

Inadvertent mispositioning of MOVs due to failures in the control circuitry has been examined and found not to be a credible concern. However, those valves which are not required to change position during the injection and automatic transfer to recirculation phases have received additional review. For these valves, power has been removed from the valves for which spurious repositioning would affect the ECCS function. The ECCS valves which have power removed are:

1. Accumulator discharge isolation valves (2SIS\*MOV865A, B, C),
2. The HHSI/charging pump discharge to the cold legs (2SIS\*MOV841),
3. The HHSI/charging pump discharge to the hot legs (2SIS\*MOV869A/B),
4. The LHSI pump discharge to the hot legs (2SIS\*MOV8889),
5. The HHSI/charging pump discharge header cross-connect valves (2CHS\*MOV8132A,B and 2CHS\*MOV8133A,B), and
6. The HHSI/charging pump minimum flow discharge header isolation valve (2CHS\*MOV373).

During normal plant operation the accumulator discharge isolation valves (2SIS\*MOV865A,B, & C) can have their power removed to prevent spurious operation (see Note 3 on Figure 7.3-83). This is accomplished by a banana plug disconnect on the main control board. This similar power removal scheme is available for other previously mentioned ECCS valves with the exception of 2CHS\*MOV373 which has its power isolated at the motor control center.

Table 6.3-3 provides information on various MOVs such as valve position indication, valve interlocks, and alarms.

#### 6.3.2.3 Applicable Codes and Classifications

Section 3.2 discusses the applicable codes and standards which apply to individual ECCS components.

#### 6.3.2.4 Materials Specifications and Compatibility

Materials employed for components of the ECCS are given in Table 6.3-4. Materials are selected to meet the applicable material requirements of the codes in Table 3.2-1 and the following additional requirements:

1. All parts of components in contact with borated water are fabricated of or clad with austenitic stainless steel or equivalent corrosion resistant material.
2. All parts of components in contact (internal) with sump solution during recirculation are fabricated of austenitic stainless steel or equivalent corrosion resistant material.
3. Valve seating surfaces are hard-faced with Stellite Number 6 or equivalent to prevent galling and to reduce wear.
4. Valve stem materials are selected for their corrosion resistance, high tensile properties, and resistance to surface scoring by the packing.

The elevated temperature of the sump solution during recirculation is well within the design temperature of all ECCS components. In

addition, consideration has been given to the potential for corrosion of various types of metals exposed to the fluid conditions prevalent immediately after the accident or during long term recirculation operations (Section 6.1.1).

Environmental testing of ECCS equipment inside the containment is discussed in Section 3.11. This equipment is required to operate following a LOCA.

#### 6.3.2.5 System Reliability

Reliability of the ECCS is considered in all aspects of the system from initial design to periodic testing of the components during plant operation. The ECCS is a two train, fully redundant, standby safeguard feature. The system has been designed and proven by analysis to withstand any single credible active failure during injection, or any single active or passive failure during recirculation, and maintain the performance objectives discussed in Section 6.3.1. Separate series-aligned trains of pumps and flow paths are provided for redundancy as only one train and flow path is needed to satisfy the performance requirements. The initiating signals for the ECCS are derived from independent sources as measured from process (for example, low pressurizer pressure) or environmental variables (for example, containment pressure). Redundant as well as functionally independent variables are measured to initiate the safeguards signal. Each train is physically separated and protected where necessary so that a single event cannot initiate a common failure. Power sources for the ECCS are divided into two independent trains supplied from separate emergency buses powered from offsite power. Sufficient diesel generating capacity is maintained onsite to provide required power to each train should offsite power be unavailable. The diesel generators and their auxiliary systems are completely independent and a diesel generator is dedicated to each one of the two ECCS trains.

The preoperational testing program assures that the systems, as designed and constructed, will meet the functional requirements as calculated in the design. The ECCS is designed with the ability for on-line testing of most components so the availability and operational status can be readily determined. In addition, the integrity of the ECCS is assumed through examination of critical components during the routine in-service inspection (ISI).

The reliability program further extends to the procurement of ECCS components such that only designs which have been proven by past use in similar applications are acceptable for use. The quality assurance program, as described in Chapter 17, assures receipt of components only after manufacture and test to the applicable codes and standards.

#### Definitions of Terms

**Period of Recovery:** The time necessary to bring the plant to a cold shutdown and regain access to failed equipment. The recovery period is the sum of the short and long term periods as further defined.

Incident: Any natural or accidental event of infrequent occurrence and its related consequences which affect plant operation and require the use of engineered safeguards systems. Such events, which are analyzed independently and are not assumed to occur simultaneously, include the LOCA, steam line ruptures, steam generator tube ruptures, etc. A system blackout may be an isolated occurrence or may be concurrent with any event requiring engineered safeguards systems use.

Short Term: The time immediately following the incident during which automatic actions are performed, system responses are checked, type of incident is identified, and preparations for long term recovery operation are made. The short term for the LOCA, for example, is the injection phase.

Long Term: The remainder of the recovery period following the short term. In comparison with the short term where the main concern is to prevent or limit site release, the long term period of operation involves bringing the plant to cold shutdown conditions where access to the containment can be gained and repair effected. The long term for the LOCA, for example, is the recirculation phase.

Active Failure: The failure of a powered component such as a piece of mechanical equipment, a component of the electrical supply system, or instrumentation and control equipment to act on command to perform its design function. Examples include the failure of a MOV to move to its correct position, the failure of an electrical breaker or relay to respond, the failure of a pump, fan, or diesel generator to start, etc.

Passive Failure: The structural failure of a static component which limits the component's effectiveness in carrying out its design function. Examples include cracks in pipes, sprung flanges, valve packing leaks, or pump seal failures.

#### Active Failure Criteria

The ECCS is designed to accept a single failure following the incident without loss of its protective function. The system design will tolerate the failure of any single active component in the ECCS itself or in the necessary associated service systems at any time during the period of required system operations following the incident.

A single active failure analysis is presented in Table 6.3-5, and demonstrates that the ECCS can sustain the failure of any single active component in either the short or long term and still meet the level of performance for core cooling.

Since the operation of the active components of the ECCS following a steam line rupture is identical to that following a LOCA, the same analysis is applicable and the ECCS can sustain the failure of any

single active component and still meet the level of performance for the addition of shutdown reactivity.

#### Passive Failure Criteria

The following philosophy provides for necessary redundancy in component and system arrangement to meet the intent of the general design criteria on single failure as it specifically applies to failure of passive components in the ECCS. Thus, for the long term, the system design is based on accepting either a passive or an active failure, assuming no failures in the short term.

#### Redundancy of Flow Paths and Components for Long Term Emergency Core Cooling

The design of the ECCS utilizes the following criteria:

1. During the long term cooling period following a LOCA, the emergency core cooling flow paths shall be separable into two subsystems, either of which can provide minimum core cooling functions and return spilled water from the floor of the containment back to the RCS.
2. Either of the two subsystems can be isolated and removed from service in the event of a leak outside the containment.
3. Adequate redundancy of check valves is provided to tolerate failure of a check valve during the long term as a passive component.
4. Should one of these two subsystems be isolated in this long term period, the other subsystems remain operable.
5. Provisions are also made in the design to detect leakage from components outside the containment, collect this leakage, and to provide the maintenance of the affected equipment.

Thus, for the long term emergency core cooling function, adequate core cooling capacity exists with one flow path removed from service.

#### Subsequent Leakage From Components in Safeguards Systems

The features described in this section meet the intent of NUREG-0737, Item III.D.1.1 (USNRC 1980), for the ECCS.

With respect to piping and mechanical equipment outside the containment, considering the provisions for visual inspection and leak detection, leaks will be detected before they propagate to major proportions. A review of the equipment in the system indicates that the largest sudden leak potential would be the sudden failure of a pump shaft seal. Evaluation of leak rate, assuming only the presence

of a seal retention ring around the pump shaft, showed that flows less than 50 gpm would result. Piping leaks, valve packing leaks, or flange gasket leaks have been of a nature to build up slowly with time and are considered less severe than the pump seal failure.

Larger leaks in the ECCS are prevented by the following:

1. The piping is classified in accordance with ANS Safety Class 2 and receives the ASME Section III Class 2 quality assurance program associated with this safety class.
2. The piping, equipment and supports are designed to ANS Safety Class 2 seismic classification permitting no loss of function for the design basis earthquake.
3. The system piping is located within a controlled area on the plant site.
4. The piping system receives periodic pressure tests and is accessible for periodic visual inspection.
5. The piping is austenitic stainless steel which, due to its ductility, can withstand severe distortion without failure.

Therefore, the design of the auxiliary building and related equipment is based upon handling of leaks up to a maximum of 50 gpm. Means are also provided to detect and isolate such leaks in the emergency core cooling flow path within 30 minutes. With these design ground rules, continued function of the ECCS will meet minimum core cooling requirements.

A single passive failure analysis is presented in Table 6.3-6. It demonstrates that the ECCS can sustain a single passive failure during the long term phase and still retain an intact flow path to the core to supply sufficient flow to maintain the core covered and effect the removal of decay heat. The procedure followed to establish the alternate flow path also isolates the component which failed.

#### Potential Boron Precipitation

Boron precipitation in the reactor vessel can be prevented by a backflush of cooling water through the core.

During the long term cooling phase of ECCS operation, recirculation flow will be redirected from the cold legs to the hot legs. Each of the two charging pumps has a separate flow path through hot leg connections to provide backflushing through the core. In addition, the recirculation spray pumps can be aligned to deliver flow to the hot legs through the common cross connection. Hot leg recirculation, in addition to preventing boron precipitation by backflushing the core, provides subcooled water to terminate boil off.



### Lag Times

Lag time for initiation and operation of the ECCS is limited by pump start-up time and consequential loading sequence of the motor onto the emergency buses. Most valves are normally in the position conducive to safety, therefore valve opening time is not considered for these valves. In the case of a blackout, a 10 second delay is assumed for diesel start-up. The HHSI/charging pumps and all valves are then applied to the buses and the LHSI pumps will start 5 seconds later. If there is no LOOP the same starting sequence is followed without delay, the first load being started upon receipt of the SI signal.

#### 6.3.2.6 Protection Provisions

The provisions taken to protect the system from damage that might result from dynamic effects of pipe rupture are discussed in Section 3.6. The provisions taken to protect the system from missiles are discussed in Section 3.5. The provisions taken to protect the system from seismic damage are discussed in Sections 3.7, 3.9, and 3.10. Thermal stresses on the RCS are discussed in Section 3.9.

#### 6.3.2.7 Provisions for Performance Testing

Provisions to facilitate performance testing are discussed in Section 6.3.4.

#### 6.3.2.8 Manual Actions

No manual actions are required during the short term injection phase. Transfer from injection to cold leg recirculation is initiated automatically and only limited operator actions are required to complete the transfer. The manual actions required of the operator to complete the transfer are:

1. The isolation valve in the redundant HHSI flow path to the cold legs is opened (2SIS\*MOV836), and
2. The redundant HHSI flow paths are separated by closing the isolation valves in both the common suction and discharge headers of the HHSI/charging pumps (2CHS\*MOV8130A, B; 2CHS\*MOV8131A, B; 2CHS\*MOV8132A, B; and 2CHS\*MOV8133A, B).
3. If HHSI pump C is operating, then on the pump suction side either 2CHS\*MOV8130A (2CHS\*MOV8130B-analogous) or 2CHS\*MOV8131A (2CHS\*MOV8131B-analogous) is closed, but not both. Similarly, on the HHSI pump C discharge side, either 2CHS\*MOV8132A (2CHS\*MOV8132B-analogous) or 2CHS\*MOV8133A (2CHS\*MOV8133B-analogous) is closed, but not both. This is to prevent isolation of HHSI pump C should it be operating to supply one of two SI trains.

The switchover to hot leg recirculation for long term cooling requires further manual actions as described in Table 6.3-7. The operator terminates recirculation spray pump flow to the RCS cold legs and establishes flow to the RCS hot legs. Similar actions need to be taken to switch HHSI/charging pump flow to provide hot leg recirculation.

Those valves in the ECCS and recirculation spray system, which are essential to ECCS operation, have been evaluated for accessibility in the event these valves must be manually positioned during the long term. All critical valves are either accessible or have been provided with reach rods for manual operation.

### 6.3.3 Performance Evaluation

The accidents discussed in Chapter 15 which result in ECCS operation are as listed:

1. Accidental depressurization of the main steam system (MSS),
2. Small LOCAs,
3. Major rupture of reactor coolant pipe,
4. Major steam system pipe rupture,
5. Steam generator tube rupture,
6. Feedwater system pipe break,
7. Inadvertent RCS depressurization, or
8. A RCCA ejection accident.

Simplified functional flow diagrams are shown on Figure 6.3-6. The time sequence for ECCS component actuation is discussed in Chapter 15 with the appropriate accident analysis.

#### Accidental Depressurization of the Main Steam System

The most severe core conditions resulting from an accidental depressurization of the MSS are associated with an inadvertent opening of a single steam dump, relief, or safety valve.

Safety injection is actuated from any of the following:

1. Two out of three low pressurizer pressure signals,
2. Two out of three Hi-1 containment pressure signals,
3. Two out of three low steam line pressure signals in any one loop, or

4. Manual initiation of the safety injection signal from main control room.

The SI signal (and other actuation signals resulting from a SI signal) will close all feedwater control valves, trip the main feedwater pumps, and close the main feedwater isolation valves. Following the SI signal, the HHSI/charging pump suction is switched from the VCT to the RWST. At this time, isolation valves 2SIS\*MOV867A,B,C, and D open and the HHSI/charging pumps discharge

water into the RCS cold legs. At the same time, the LHSI pumps are started but they only provide recirculation flow back to the RWST since the RCS pressure remains above the shutoff head of the pumps. The accumulators do not discharge since the RCS pressure also remains above accumulator pressure.

#### Results and Conclusions of Accidental Depressurization of Main Steam System

The assumed steam release is typical of the capacity of any single steam dump relief or safety valve. The boron solution provides sufficient negative reactivity to meet the departure from nucleate boiling (DNB) design basis. The cooldown for this case is more rapid than the case of steam release from all steam generators through one steam dump, relief, or safety valve. The transient is quite conservative with respect to cooldown, because no credit is taken for the energy stored in the system metal other than that of the fuel elements or the energy stored in the steam generators. Since the transient occurs over a period of about 5 minutes, the neglected stored energy is likely to have a significant effect in slowing the cooldown. The analysis shows that there will be no violation of the DNB design basis after reactor trip assuming a stuck RCCA, with offsite power available, and assuming a single failure in the ECCS. Therefore, a departure from nucleate boiling ratio less than 1.30 does not exist.

#### Loss of Reactor Coolant From Small Ruptured Pipes or From Cracks In Large Pipes Which Actuates the Emergency Core Cooling System

A LOCA is defined as a rupture of the RCS piping or of any line connected to the system. Ruptures of small cross section will cause expulsion of the coolant at a rate which can be accommodated by the HHSI/charging pumps, which would maintain an operational water level in the pressurizer permitting the operator to execute an orderly shutdown.

The maximum break size for which the normal makeup system can maintain the pressurizer level is obtained by comparing the calculated flow from the RCS through the postulated break against the charging pump makeup flow at normal RCS pressure, that is 2,250 psia. A makeup flow rate from one centrifugal charging pump is typically adequate to sustain pressurizer level and pressure for a break through a 3/8-inch diameter hole. As part of the normal makeup system, a second charging pump is available to provide additional makeup flow to help maintain pressurizer level and pressure. A small break, as considered in this section, is then defined as a rupture of the RCS with a total cross-sectional area less than 1.0 ft<sup>2</sup> and for which makeup via normal charging flow is not sufficient.

The ECCS operation following a small break LOCA is similar to that for a large break LOCA except that the time periods for ECCS component actuation are substantially longer. Additionally, in the event the small break LOCA does not result in the containment pressure initiating the CIB signal, the operator would be required to

manually start the recirculation spray pumps when the RWST reaches low level.

#### Results and Conclusions from Analysis for Small Break LOCA

The analysis of this break has shown that the high head portion of the ECCS, together with the accumulator, provides sufficient core flooding to keep the calculated peak clad temperature below required limits of 10 CFR 50.46. Hence, adequate protection is afforded by the ECCS in the event of a small break LOCA.

#### Major Reactor Coolant System Pipe Ruptures (Loss-of-Coolant Accident)

Should a major break occur, depressurization of the RCS results in a pressure decrease in the pressurizer. Reactor trip signal occurs when the pressurizer low pressure trip set point is reached. A SI signal is actuated when the appropriate set point is reached. These provisions limit the consequences of the accident in two ways:

1. Reactor trip and borated water injection provide additional negative reactivity insertion to supplement void fraction in causing rapid reduction of power to a residual level corresponding to fission product decay heat.
2. Injection of borated water provides heat transfer from the core and prevents excessive clad temperature.

The operation of the ECCS is as described in Section 6.3.2.1

#### Results and Conclusions for Major Reactor Coolant System Pipe Rupture

##### Conclusions - Thermal Analysis

For breaks up to and including the double-ended severance of a reactor coolant pipe, the ECCS will meet the acceptance criteria as presented in 10 CFR 50.46. That is:

1. The calculated peak fuel element clad temperature provides margin to the requirement of 2,200°F.
2. The amount of fuel element cladding that reacts chemically with water or steam does not exceed 1 percent of the total amount of Zircaloy in the reactor.
3. The clad temperature transient is terminated at a time when the core geometry is still amenable to cooling. The cladding oxidation limits of 17 percent are not exceeded during or after quenching.

4. The core temperature is reduced and decay heat is removed for an extended period of time, as required by the long-lived radioactivity remaining in the core.

#### Major Secondary System Pipe Rupture

The steam release arising from a main steam line break would result in an initial increase in steam flow, which decreases during the accident as the steam pressure falls. The energy removal from the RCS causes a reduction of coolant temperature and pressure. The cooldown results in a reduction of core shutdown margin when the moderator temperature coefficient is negative. If it is assumed that the most reactive RCCA is stuck in the fully withdrawn position after reactor trip, there is an increased probability that the core will return to power. This return to power is a potential problem because of the high peaking factors which exist, assuming the most reactive RCCA to be stuck in its fully withdrawn position.

Safety injection is actuated from any of the following:

1. Two out of three low pressurizer pressure signals,
2. Two out of three Hi-1 containment pressure signals,
3. Two out of three low steam line pressure signals in any one loop, or
4. Manual initiation of the safety injection signal from the main control room.

The HHSI/charging pumps begin pumping RWST water into the RCS. This pumping action occurs as the RCS pressure is decreasing and restores the RCS to the correct volume.

#### Results and Conclusions of Major Secondary System Pipe Rupture

The analysis has shown that even assuming a stuck RCCA with or without offsite power, and assuming a single failure in the engineered safeguards, the core remains in place and intact. Radiation doses will not exceed 10 CFR 100 guidelines.

Although DNB and possible clad perforation following a Main Steam Line Break are not necessarily unacceptable and not precluded in the criterion, the preceding analysis shows that no DNB occurs for any rupture assuming the most reactive RCCA stuck in its fully withdrawn position.

#### Steam Generator Tube Rupture

The postulated accident is the complete severance of a steam generator tube occurring at power. The higher pressure reactor coolant causes inflow to the affected steam generator and loss of volume and pressure in the pressurizer. The steam side experiences a steam flow-feed flow mismatch in one steam generator. The reactor

trips on low pressurizer pressure or overtemperature  $\Delta T$  from the continued loss of RCS inventory and SI is also initiated at the same time.

Since the initial signals available to the operator are also indicative of other accident types, the operator must determine that a tube rupture has occurred. Steam generator water level rising more rapidly in one steam generator than the others is a unique indication of this accident.

Using the recovery procedure outlined in Chapter 15 the operator identifies the affected steam generator, and after reduction of the RCS to the proper set points, initiates operation of the residual heat removal (RHR) system.

#### Results and Conclusions of Steam Generator Tube Rupture

A steam generator tube rupture will cause no subsequent damage to the RCS or the reactor core. An orderly recovery from the accident can be completed even assuming simultaneous LOOP.

#### Existing Criteria Used to Judge the Adequacy of the ECCS

In order to assure the performance of the ECCS in the accident analysis, minimum performance levels are designated. To assure that these performance levels are maintained, Technical Specifications have been established and documented in Chapter 16.

The following criteria are used to judge the adequacy of the ECCS performance:

1. Criteria from 10 CFR 50.46
  - a. Peak cladding temperature calculated shall not exceed 2,200°F.
  - b. The calculated total oxidation of the cladding shall nowhere exceed 0.17 times the total cladding thickness before oxidation.
  - c. The calculated total amount of hydrogen generated from the chemical reaction of the cladding with water or steam shall not exceed 0.01 times the hypothetical amount that would be generated if all of the metal in the cladding cylinders surrounding the fuel, excluding the cladding around the plenum, were to react.
  - d. Calculated changes in core geometry shall be such that the core remains amenable to cooling.
  - e. After any calculated successful initial operation of the ECCS, the calculated core temperature shall be maintained at an acceptably low value and decay heat shall be removed for the extended period of time required by long-lived radioactivity remaining in the core.

2. In the case of the accidental depressurization of the MSS, an additional criteria for the adequacy of the ECCS is: assuming a stuck RCCA, with or without offsite power, and assuming a single failure in the engineered safety features (ESF), there will be no violation of the DNB design basis after reactor trip for a steam release equivalent to the accidental opening, with failure to close, of the largest of any single steam dump, relief, or safety valve.
3. For a major secondary system pipe rupture, the additional criterion is: assuming a stuck RCCA with or without offsite power, and assuming a single failure in the ESF, the core remains in place and intact.

#### Shared Function Components

During normal operation, some components of the ECCS may be used to support power operation. In this case, these components will automatically realign to the safeguards mode upon receipt of a SI signal. These components are as listed:

1. The HHSI/charging pumps are normally aligned to provide seal water to the reactor coolant pumps and for replacement of letdown. During ECCS operation these pumps inject refueling water into the cold legs. In emergency operation, the charging pump suction is automatically switched to the RWST.
2. The RWST and LHSI pumps are used to fill the refueling canal for refueling operations. For other periods of operation the RWST and the LHSI pumps are aligned for injection.

An evaluation of all components required for operation of the ECCS demonstrates that either:

1. The component is not shared with other systems.
2. If the component is shared with other systems, it is either aligned during normal plant operation to perform its accident function or if not aligned to its accident function, two valves in parallel are provided to align the system for injection, and two valves in series are provided to isolate portions of the system not utilized for injection. (These valves are automatically actuated by the SI signal.)
3. The component shared with another system is used for a different ESF in the short term then subsequently realigned for the ECCS operation in the recirculation phase.

Table 6.3-8 indicates the alignment of components during normal operation and the realignment required to perform the accident function. In all cases of component operation, safeguards operation



has the priority usage such that a safeguard signal will override all other signals and start or align systems for their safeguards function.

#### Limits on System Parameters

The analyses show that the design basis performance characteristic of the ECCS is adequate to meet the requirements for cooling following an accident with the minimum ESF equipment operating. In order to ensure this capability in the event of the simultaneous failure to operate any single active component, Technical Specifications are established for reactor operation (Chapter 16).

Normal operating status of ECCS components is given in Table 6.3-9.

The ECCS components are available whenever the coolant energy is high and the reactor is critical. During low temperature physics tests, there is a negligible amount of stored energy in the coolant and low decay heat. Therefore, an accident comparable in severity to accidents occurring at operating conditions is not possible and ECCS components are not required.

The principal system parameters and the number of components which may be out of operation in test, quantities and concentrations of coolant available, and allowable time in a degraded status, are addressed in Chapter 16. If efforts to repair the faulty component are not successful, the plant is placed into a lower operational status, that is, hot standby to hot shutdown, hot shutdown to cold shutdown, etc.

#### 6.3.4 Inspection and Testing Requirements

##### 6.3.4.1 Emergency Core Cooling System Performance Tests

Pre-operational testing of the ECCS is conducted during the hot functional testing of the RCS following flushing and hydrostatic testing to demonstrate the capability of HHSI and accumulator injection at operating temperature and pressure.

After HFT with the system cold and the reactor vessel head removed, pre-operational testing of the recirculation spray pumps in the recirculation mode will be conducted with water drawn from the containment sump and delivered to the suction of the HHSI/charging pumps. During this test, the HHSI/charging pumps are not started and water is not injected into the RCS.

Separate flow tests of the LHSI and HHSI/charging pumps are conducted during pre-operational testing (with the reactor vessel head off) to check operation. Each pump would be aligned to take suction from the RWST and to discharge into the reactor vessel through the injection lines. At this time, the throttle valves in the HHSI lines are positioned to limit pump runout and equalize injection flow to all RCS loops. Data will be taken to determine pump head and flow at this time.

Pumps are also run with only the miniflow circuits open and data taken to determine a second point on the head/flow characteristic curve.

Each accumulator is filled with water from the RWST and pressurized with nitrogen, with the isolation valve in the discharge line closed. The valve is opened and the accumulator allowed to discharge into the reactor vessel as part of pre-operational testing with the reactor cold and vessel head off.

The SI block switch is reset and the breakers on the lines supplying offsite power are tripped manually so that operation of the emergency diesel generators is tested in conjunction with the ECCS. During the test in the HHSI/charging and LHSI pumps would inject into the reactor vessel, via the RCS cold legs, with the overflow from the reactor vessel spilling into the refueling canal.

Section 14.2.12 discusses the testing to be performed on these systems.

#### 6.3.4.2 Reliability Tests and Inspections Description of Test Planned.

Where possible, without interruption of service, routine periodic testing of the ECCS components and all necessary support systems at power is planned. Valves which must operate as part of the system safety function are operated through a complete cycle, and pumps are operated individually recirculating through their miniflow lines with the exception of the charging pumps, which are tested by their normal charging function. If such testing indicates a need for corrective maintenance, the redundancy of equipment in these system permits such maintenance to be performed without shutting down or reducing load under certain conditions. These conditions include consideration such as a period within which the component should be restored to service and the capability of the remaining equipment to provide the minimum required level of performance during such a period.

The operation of the remote isolation valve and the upstream check valve in each accumulator tank discharge line may be tested by opening the remote test line valves just downstream of the isolation

valve and check valve, respectively. Flow through the test line can be observed on instruments, and the opening and closing of the discharge line isolation valve can be monitored by position indication lights in the main control room.

Where series pairs of check valves form the high pressure to low pressure isolation barrier between the RCS and ECCS piping outside the reactor containment, periodic testing of these check valves must be performed to provide assurance that certain postulated failure modes will not result in a loss-of-coolant from the low pressure system outside containment with a simultaneous loss of SI pumping capacity.

A manual testing procedure is used for determination of the integrity of the pressure boundary formed by series check valves. The tests performed verify that each of the series check valves can independently sustain differential pressure across its disc, and also verify that the valve is in its closed position. The required periodic tests are to be performed after each refueling just prior to plant start-up, after the RCS has been pressurized.

Lines in which the series check valves are to be tested are the LHSI pump cold leg injection lines. To implement the periodic component testing requirements, Technical Specifications (Chapter 16) are established. During periodic system testing, a visual inspection of pump seals, valve packings, flanged connection, and relief valves is made to detect leakage. An ISI provides further confirmation that no significant deterioration is occurring in the ECCS fluid boundary.

Design measures have been taken to assure that the following testing can be performed:

1. Active components may be tested periodically for operability (pumps on miniflow, certain valves, etc).
2. An integrated system actuation test (details of the testing of the sensors and logic circuits associated with the generation of a SI signal together with the application of this signal to the operation of each active component are given in Section 7.2) can be performed when the plant is cooled down and the RHR system is in operation. The ECCS will be arranged so that no flow will be introduced into the RCS for this test.
3. An initial flow test of the full operational sequence can be performed.

The design features which assure this test capability are specifically:

1. Power sources are provided to permit individual actuation of each active component of the ECCS.

2. The LHSI pumps are tested periodically when the plant is at power, using the miniflow recirculation lines.
3. The HHSI/charging pumps are either normally in use for charging service or can be tested periodically using miniflow recirculation lines.
4. Remotely-operated valves can be exercised during routine plant maintenance.
5. Level and pressure instrumentation is provided for each accumulator tank for continuous monitoring of these parameters during plant operation.
6. Flow from each accumulator tank can be directed at any time through a test line to determine check valve leakage and to demonstrate operation of the accumulator MOVs.
7. A flow indicator is provided in the LHSI pump headers. Pressure instrumentation is also provided in these lines.
8. An integrated system test can be performed when the plant is cooled down and the RHR system is in operation. This test demonstrates the operation of the valve, pump circuit breakers, and automatic circuitry, including diesel starting and the automatic loading of ECCS components on the diesels (by simulating a LOOP to the Class 1E electrical buses).

Chapter 16 discusses the selection of test frequency, acceptability of testing, and measured parameters. A description of the ISI program is also included in Section 6.6. The ECCS and its components are designed to meet the intent of ASME Section XI for ISI.

On January 11, 2008, the NRC issued Generic Letter 2008-01, "Managing Gas Accumulation in Emergency Core Cooling, Decay Heat Removal, and Containment Spray Systems." Generic Letter 2008-01 requested licensees to evaluate the licensing basis, design, testing, and corrective action programs for the emergency core cooling, decay heat removal, and containment spray systems.

As a result, FENOC performed evaluations that included the review of gas susceptible piping locations, the development of activities to monitor various piping locations as appropriate based on industry experience and plant specific experience, and acceptance of some generic locations that normally accumulate voids that do not adversely affect the design function(s) of the system.

FENOC established a gas accumulation prevention and management program to ensure that gas accumulation is reasonably prevented or maintained less than the amount that challenges the functionality of the applicable systems and that appropriate action is taken when conditions adverse to quality are identified.

### 6.3.5 Instrumentation Requirements.

#### 6.3.5.1 Actuation Signal

The actuation signal which initiates SI is referred to as the SI signal. The SI signal would primarily be used to automatically start the LHSI and HHSI/charging pumps.

Two separate and redundant actuation trains are provided. Each actuation train is assigned to a corresponding electrical power train to ensure that, in the event of a single failure in the actuation logic, at least one emergency diesel generator, one LHSI, and one HHSI/charging pump would receive an actuation signal.

Each actuation train is driven by a separate protection logic train to ensure that, in the event of a single failure in the protection logic, the minimum safeguards equipment would still receive an actuation signal.

The signals which are generated by the protection logic and used to initiate the SI signal are the following:

1. Two out of three low pressurizer pressure signals,
2. Hi-1 containment pressure trip signal produced by two out of three Hi-1 containment pressure signals,
3. Low steam line pressure signal produced by two out of three low steam line pressure signals in one line, or
4. Manual SI actuation from the main control board.

In addition to the SI signal, the protection logic initiates the following actuation signals which are not specifically related to the operation of the ECCS (specifically excluded is a description of the protection logic signals which are generated to initiate steam line isolation):

The CIA Signal - The actuation signal which would initiate CIA and containment ventilation isolation is referred to as the CIA signal. The CIA signal is initiated from the same protection logic signals which produced the SI signal, with the exception that a separate manual actuation switch is provided on the main control board which would permit the operator to initiate the CIA actuation without initiating SI actuation.

The CIB Signal - The actuation signal which would initiate spray actuation and CIB is referred to as the CIB signal. The signals which are generated by the protection logic and used to initiate the CIB signal are the following:

1. Hi-3 containment pressure trip signal produced by two out of four Hi-3 containment pressure signals, or
2. Manual actuation from the main control board.

#### 6.3.5.2 Pressure Indication

##### Low Head Safety Injection Pump Suction and Discharge Pressure

The LHSI pump suction and discharge pressure are indicated locally.

##### Accumulator Pressure

Duplicate pressure channels are installed on each accumulator. Pressure indication in the main control room, and high and low pressure alarms, are provided by each channel.

#### Test Line Pressure

A local pressure indicator used to check for proper seating of the accumulator check valves between the injection lines and the RCS is installed on the leakage test line.

#### Hydrotest Pump Discharge

Local pressure indication is provided to monitor hydro-test pump discharge pressure.

#### 6.3.5.3 Flow Indication

##### Charging Pump Injection Flow

Charging pump injection and recirculation header flow are indicated in the main control room.

##### Low Head Safety Injection Pump Minimum Flow

A flow meter installed in each LHSI pump discharge header provides control for the valves located in the pump minimum flow line.

##### Low Head Safety Injection Flow

Low head safety injection flow during injection and recirculation is indicated in the main control room.

##### Test Line Flow

Local indication of the leakage test line flow is provided to check for proper seating of the accumulator check valves between the injection lines and the RCS.

#### 6.3.5.4 Level Indication

##### Refueling Water Storage Tank Level

The RWST is provided with eight water level transmitters. Two transmitters are provided for wide range level measurement, with indicators provided in the main control room. Two transmitters are provided for narrow range level indication, with indicators provided in the main control room.

Level alarms are provided to protect against possible overflow of the RWST to assure that a sufficient volume of water is always available in the RWST in conformance with the Technical Specifications, and to indicate that the useable volume of the RWST has been exhausted.

Four transmitters (four channels) are provided to automatically actuate the ECCS and containment spray system switchover from injection mode to recirculation mode following an accident.

### Accumulator Water Level

Duplicate water level channels are provided for each accumulator. Both channels provide indication in the main control room and actuate high and low water level alarms.

#### 6.3.5.5 Valve Position Indication

Valve positions are indicated on the main control board by red (open) and green (closed) lights. When both lights are on, they indicate a valve in an intermediate position.

### Accumulator Isolation Valve Position Indication

The accumulator isolation MOVs are provided with two sets of red (open) and green (closed) position indicating lights located at the main control board switch for each valve. One set of these lights is powered by the valve control power and actuated by valve motor operator limit switches. This set of indication lights is not deenergized when MOV control power is removed during normal power operation in accordance with Table 8.3-5. The other set of lights is powered by a separate 120 V ac supply and are actuated by stem-mounted limit switches on the valve.

An alarm annunciator point is activated by a valve motor operator limit switch whenever an accumulator valve is not fully open for any reason with the system at pressure (the pressure at which the SI block is unblocked is approximately 1,900 psig). This alarm will be recycled at approximately 1-hour intervals to remind the operator of the improper valve lineup (Section 7.6.3).

#### 6.3.6 Reference for Section 6.3

U.S. Nuclear Regulatory Commission 1980. Clarification of TMI Action Plan Requirements. NUREG-0737.

BVPS-2 UFSAR

Tables for Section 6.3



TABLE 6.3-1

EMERGENCY CORE COOLING SYSTEM  
COMPONENT PARAMETERSAccumulators

Quantity	3
Design pressure (psig)	700
Design temperature (°F)	300
Operating temperature (°F)	70 to 150
Nominal operating pressure (psig)	640
Total volume (ft <sup>3</sup> ) (each)	1,450
Nominal water volume (ft <sup>3</sup> ) (each)	925
Nominal volume N <sub>2</sub> Gas (ft <sup>3</sup> ) (each)	525
Boric acid concentration (ppm)	2,300 to 2,600
Relief valve set point (psig)	700

HHSI/Charging Pumps

Quantity	3
Design pressure (psig)	2,800
Design temperature (°F)	300
Design flow rate (gpm)*	150
Design head at design flow rate (ft)	5,800 (minimum)
Maximum flow rate (gpm)	580 runout ****
Design head at maximum flow rate (ft)	1,250-1,650
Design discharge head at shutoff (ft)	6,000-6,200
Motor rating (bhp)**	600
NPSH, available at 580 gpm maximum flow rate (ft)	≥ 47
NPSH, maximum required at 580 gpm maximum flow rate(ft)	40

Low Head Safety Injection Pumps

Quantity	2
Design pressure (psig)	240
Design temperature (°F)	200
Design flow rate (gpm)	3,000
Design head (ft)	225
Maximum flow rate (gpm)	5,000
Design discharge head of shutoff (ft)	350
NPSH, available (ft)	38
NPSH, maximum required (ft)	18

TABLE 6.3-1 (Cont)

Hydrotest Pump

Quantity	1
Design pressure (psig)	3,125
Design temperature (°F)	250
Normal operating temperature (°F)	130
Normal flow rate (gpm)	15
Design flow rate (gpm)	26.5
Developed head at design flow rate (psig)	3,125
Motor rating (bhp)	60

Recirculating Pumps

(Section 6.2.2 - design parameters)

Motor-Operated Valves

Maximum opening or closing time

Up to and including 8 inches	10 to 15 sec***
Over 8 inches	15 to 20 sec***

NOTES:

\*Includes miniflow

\*\*1.15 service factor not included

\*\*\*Times vary depending upon size, valve type, and type of actuator.

\*\*\*\*Maximum runout flow rate is 585 gpm during recirculation mode of ECCS (580 gpm is injection phase of ECCS).

TABLE 6.3-2

## EMERGENCY CORE COOLING SYSTEM RELIEF VALVE DATA

<u>Description</u>	<u>Fluid Dis-charged</u>	<u>Fluid Inlet Temperature, Normal (°F)</u>	<u>Set Pressure (psig)</u>	<u>Back Pressure Constant (psig)</u>	<u>Back Developed (psig)</u>	<u>Capacity</u>
N <sub>2</sub> supply to accumulators	N <sub>2</sub> Gas	Ambient	700	0	0	1,500 scfm
Low head cold leg safety injection lines	Water	100	220	3	50	25 gpm
Accumulator to containment	N <sub>2</sub> Gas	120	700	0	0	1,500 scfm
Hydrotest pump discharge	Water	100	700	0	0	30 gpm
Low head hot leg safety injection lines	Water	100	220	3	50	25 gpm

TABLE 6.3-3

## MOTOR-OPERATED ISOLATION VALVES IN EMERGENCY CORE COOLING SYSTEMS

<u>Location</u>	<u>Automatic Features</u>	<u>Position Indication</u>	<u>Alarms on</u>	<u>Comments</u>
HHSI/charging pump discharge to cold legs (2SIS*MOV867A, B, C, D)	Opens on SI signal	MCB	Incorrect position	
Accumulator discharge (2SIS*MOV865A, B, C)	1. Open (if closed) on SI signal 2. Open (if closed) on RCS pressure above SI unblock pressure	MCB	Incorrect position	These valves are normally open during power operation and have their power removed.
LHSI pump suction from RWST (2SIS*MOV8809A, B)	Close on LHSI pump stop signal coincident with SI signal	MCB	Incorrect position	These valves are normally open during power operation.
Recirculation spray pump discharge to LHSI paths to cold legs (2SIS*MOV8811A,B)	Open on RWST level extreme low signal coincident with SI signal	MCB	Incorrect position	
Recirculation spray pump discharge to HHSI/charging pump suction (2SIS*MOV863A, B)	Open a stem position signal (open) from valves 2SIS*MOV8811A, B	MCB	Incorrect position	
HHSI/charging pump discharge to hot legs (2SIS*MOV869A, B)	None	MCB	Incorrect position	These valves are normally closed and have their power removed. They are opened by the operator during the transfer from cold leg to hot leg recirculation.

TABLE 6.3-3 (Cont)

<u>Location</u>	<u>Automatic Features</u>	<u>Position Indication</u>	<u>Alarms on</u>	<u>Comments</u>
HHSI/charging pump discharge to cold legs (2SIS*MOV836)	None	MCB	Incorrect position	This valve is normally closed and has its power removed. The valve is opened by the operator to provide redundant HHSI subsystems during the transfer from injection to cold leg recirculation.
LHSI pump discharge cross-connect (2SIS*MOV8887A, B)	Close on RWST extreme low level signal coincident with a SI signal	MCB	Incorrect position	
LHSI pump discharge to cold legs (2SIS*MOV8888A, B)	None	MCB	Incorrect position	These valves are normally open and are closed by the operator during the transfer from cold leg to hot leg recirculation.
LHSI pump discharge to hot legs (2SIS*MOV8889)	None	MCB	Incorrect position	This valve is normally closed and has its power removed. The valve is opened by the operator during the transfer from cold leg to hot leg recirculation.
Recirculation spray pump suction from containment sump (2RSS*MOV155C, D)	Open on CIB signal	MCB	Incorrect position	These valves are normally open and receive a CIB signal to open (if closed).
Recirculation spray pump discharge to containment spray header (2RSS*MOV156C, D)	Close on RWST extreme low level signal coincident with a SI signal	MCB	Incorrect position	

TABLE 6.3-3 (Cont)

<u>Location</u>	<u>Automatic Features</u>	<u>Position Indication</u>	<u>Alarms on</u>	<u>Comments</u>
HHSI/charging pump suction from VCT (2CHS*LCV115C, E)	1.Close on SI signal 2.Close on VCT low-level signal	MCB	Incorrect position	These valves are interlocked with HHSI/charging pump suction valves 2CHS*LCV15B, D from RWST. The valves will close after the RWST valves open.
HHSI/charging pump suction from RWST (2CHS*LCV115B, D)	1. Open on SI signal 2. Open on VCT low-level signal	MCB	Incorrect position	
HHSI/charging pump miniflow (2CHS*MOV373 and 2CHS*MOV275B)	None	MCB	Incorrect position	These valves are normally open and have their power removed.
HHSI/charging pump miniflow (2CHS*MOV275A, C)	None	MCB	Incorrect position	
HHSI/charging pump discharge to normal charging path (2CHS*MOV289 and 2CHS*MOV310)	Close on SI signal	MCB	None	
HHSI/charging pump suction header (2CHS*MOV8130 A, B and 2CHS*MOV8131 A, B)	None	MCB	Incorrect position	These valves are normally open and are closed by the operator during the transfer from injection to cold leg recirculation.

TABLE 6.3-3 (Cont)

<u>Location</u>	<u>Automatic Features</u>	<u>Position Indication</u>	<u>Alarms on</u>	<u>Comments</u>
HHSI/charging pump discharge header (2CHS*MOV8132 A, B and 2CHS*MOV8133 A, B)	None	MCB	Incorrect position	These valves are normally open and have their power removed. They are closed by the operator during the transfer from injection to cold leg recirculation.
HHSI/charging pump discharge to cold legs (2SIS*MOV841)	None	MCB	Incorrect position	This valve is normally open and has its power removed. This valve is part of the cold shutdown design (Section 5.4.7).

TABLE 6.3-4

MATERIAL<sup>(1)</sup> EMPLOYED FOR  
EMERGENCY CORE COOLING SYSTEM COMPONENTS

<u>Component</u>	<u>Material</u> <sup>(1)</sup>
Accumulators	Carbon steel, clad with austenitic stainless steel
Pumps	
HHSI/Charging	Austenitic stainless steel
Low head safety injection	Austenitic stainless steel
Valves	
Motor-operated valves containing radioactive fluids	
Pressure containing parts	Austenitic stainless steel or equivalent
Body-to-bonnet bolting and nuts	Low alloy steel
Seating and surfaces	Stellite Number 6 or equivalent
Stems	Austenitic stainless steel or 17-4 pH stainless steel
Diaphragm Valves	Austenitic stainless steel
Accumulator Check Valves	
Parts contacting borated water	Austenitic stainless steel
Clapper arm shaft	17-4 pH stainless steel
Relief Valves	
Stainless steel bodies	Stainless steel
Carbon steel bodies	Carbon steel
All nozzles, discs, spindles, and guides	Austenitic stainless steel



TABLE 6.3-4 (Cont)

<u>Component</u>	<u>Material</u> <sup>(1)</sup>
Bonnets for stainless valves without a balancing bellows	Stainless steel or steel plated carbon steel
All other bonnets	Carbon steel
Piping	
All piping in contact with borated water	Austenitic stainless steel

NOTES(1) Materials listed in this table may have been replaced with materials of equivalent design characteristics. The term equivalent is described in UFSAR Section 1.12, "Equivalent Materials".

TABLE 6.3-5  
 FAILURE MODES AND EFFECTS ANALYSIS  
 EMERGENCY CORE COOLING SYSTEM - ACTIVE COMPONENTS

<u>Component</u>	<u>Failure Mode</u>	<u>Function</u>	<u>Effect On System Operation</u>	<u>Failure Detection Method</u>	<u>Remarks</u>
1. Motor-operated gate valve 2CHS*LCV115C (2CHS*LCV115E analogous)	Fails to close on demand.	Provides charging pump suction isolation from VCT.	HHSI/ isolation from VCT. Failure reduces redundancy of providing VCT isolation. No effect on system operation as redundant isolation valve 2CHS*LCV115E (2CHS*LCV115C) provides tank discharge isolation.	Valve position indication (open to closed position change) at MCB. Valve close position monitor light for group monitoring of components at MCB.	Valve is interlocked with HHSI/charging pump suction valve 2CHS*LCV115B (2CHS*LCV115D) from RWST. Valve closes on actuation by SI signal after valve 2CHS*LCV115B (2CHS*LCV115D) reaches the full open position.
2. Motor-operated gate valve 2CHS*LCV115B (2CHS*LCV115D analogous)	a. Fails to open on demand.	Provides charging pump suction isolation from RWST.	HHSI/ isolation from RWST. a. Failure reduces redundancy of providing a flow path from RWST to suction of HHSI/charging pumps. Additionally, permissive for VCT isolation valve 2CHS*LCV115C (2CHS*LCV115E) to close will not be generated. No effect on system operation as a redundant RWST to HHSI/charging pump suction path will be provided by valve 2CHS*LCV115D (2CHS*LCV115B). VCT isolation will be provided by re-	Valve position indication (closed to open position change) at MCB. Valve open position monitor light for group monitoring of components at MCB.	a. Valve is interlocked with VCT level instrumentation. Valve opens upon actuation by a SI signal or by a VCT low-low level signal.

TABLE 6.3-5 (Cont)

<u>Component</u>	<u>Failure Mode</u>	<u>Function</u>	<u>Effect On System Operation</u>	<u>Failure Detection Method</u>	<u>Remarks</u>
	b. Once open, fails to close on demand.		<p>dundant isolation valve 2CHS*LCV115E (2CHS*LCV115C). See item 1.</p> <p>b. Failure reduces redundancy of isolating the RWST during sump recirculation following a LOCA. No effect on safety for system operation. Backflow of radioactive fluid into the RWST is precluded by a check valve.</p>		b. Valve is automatically closed during the switchover from injection to recirculation following a LOCA.
3. HHSI/charging pump 2CHS*P21A (pumps 2CHS*P21B, C analogous)	Fails to deliver working fluid.	Provides high pressure injection flow during injection and recirculation phases.	Failure reduces redundancy of providing fluid flow to RCS. Redundant HHSI/charging pump will provide minimum flow requirements.	HHSI/charging pump discharge header flow (FI-943) at MCB. Open pump switchgear circuit breaker indication at MCB. Circuit breaker close position monitor light for group monitoring of components at MCB.	One HHSI/charging pump is used for normal charging of RCS during plant operation. Pump circuit breaker is aligned to close on actuation by a SI signal.

TABLE 6.3-5 (Cont)

<u>Component</u>	<u>Failure Mode</u>	<u>Function</u>	<u>Effect On System Operation</u>	<u>Failure Detection Method</u>	<u>Remarks</u>
4. Intentionally Deleted					
5. Motor-operated gate valve 2CHS*MOV289 (2CHS*MOV310 analogous)	Fails to close on demand.	Provides isolation of normal charging line during the injection and recirculation phases.	Failure reduces redundancy of isolating HHSI/charging pump discharge to normal charging line. No effect on safety for system operation. Isolation will be provided by alternate isolation valve 2CHS*MOV310 (2CHS*MOV289).	Same methods of detection as stated in item 1.	Valve is aligned to close upon actuation by a SI signal.
6. Motor-operated gate valve 2SIS*MOV867A (2SIS*MOV867B analogous)	a. Fails to open on demand.	Provides HHSI flow path to RCS for both HHSI/charging pumps during injection and for HHSI/charging pump during cold leg recirculation.	a. Failure reduces redundancy of providing HHSI flow paths. No effect on safety for system operation. Alternate path will be provided by valve 2SIS*MOV867B (2SIS*MOV867A).	Same methods of detection as those stated for Item 2. In addition, valve open position alarm for group monitoring of components at MCB.	a. Valve is aligned to open upon actuation by a SI signal.

TABLE 6.3-5 (Cont)

<u>Component</u>	<u>Failure Mode</u>	<u>Function</u>	<u>Effect On System Operation</u>	<u>Failure Detection Method</u>	<u>Remarks</u>
	b. Once open, fails to close on demand.		b. Failure reduces redundancy of isolating HHSI flow to cold legs during switchover to hot leg recirculation. No effect for system operation. Redundant valves 2SIS*MOV867C,D will provide isolation capability. Should failure be caused by loss of a Class 1E bus, core flushing would be accomplished by the operable RSS pump and HHSI/charging pump.		b. Valve is closed by the operator during the switchover from cold leg to hot leg recirculation.
7. Motor-operated gate valve 2SIS*MOV867C (2SIS*MOV867D analogous)	Same as item 6.	Same as item 6.	Same effect as item 6 except for valve numbers.	Same methods of detection as those stated for item 6.	
8. Motor-operated gate valve 2SIS*MOV8890A (2SIS*MOV8890B analogous)	a. Fails to close on demand.	Controls LHSI pump miniflow during injection phase.	a. Failure reduces fluid flow delivered to RCS from LHSI pump 2SIS*P21A (2SIS*P21B). Minimum flow requirements for LHSI will be met by the redundant LHSI pump.	Valve position indication (open to closed position change) at MCB. The LHSI pump discharge flow indication, FI-946 (FI-945) at MCB.	Valve is regulated by a signal from a flow transmitter located in the pump discharge header. The control valve opens when the LHSI pump discharge flow is less than a low flow set point and closes when the flow

TABLE 6.3-5 (Cont)

<u>Component</u>	<u>Failure Mode</u>	<u>Function</u>	<u>Effect On System Operation</u>	<u>Failure Detection Method</u>	<u>Remarks</u>
	b. Fails to open on demand.		b. Failure results in insufficient LHSI pump flow for a small LOCA or steam line break, resulting in possible pump damage. Should the pump become inoperable, adequate LHSI flow will be provided by the redundant LHSI pump.		exceeds a high flow set point coincident with LHSI pump running.
9. LHSI pump 2SIS*P21A (2SIS*P21B analogous)	Fails to deliver working fluid.	Provides LHSI flow during injection phase.	Failure reduces redundancy of providing emergency coolant to the RCS from the RWST at low pressure. Minimum flow requirements will be met by the redundant LHSI pump.	LHSI pump discharge flow, FI-946 (FI-945) at MCB. Open pump switchgear circuit breaker indication at MCB. Circuit breaker close position monitor light for group monitoring of components at MCB. Common breaker trip alarm at MCB.	Pump circuit breaker is aligned to close on actuation by a SI signal.
10. Motor-operated gate valve 2SIS*MOV8811A (2SIS*MOV8811B analogous)	Fails to open on demand.	Provides LHSI flow path from RSS pump 2RSS*P21C (2RSS*P21D) to RCS during recirculation phase.	Failure reduces redundancy of providing emergency coolant during recirculation. Minimum flow requirements will be provided by the redundant RSS pump 2RSS*P21D (2RSS*P21C) through valve 2SIS*MOV8811B (2SIS*MOV8811A).	Same methods of detection as those stated for item 6. In addition, failure may be detected through monitoring of LHSI pump discharge flow, FI-946 (FI-945) at MCB.	Valve is aligned to open on actuation by RWST extreme low level signal coincident with a SI signal.

TABLE 6.3-5 (Cont)

<u>Component</u>	<u>Failure Mode</u>	<u>Function</u>	<u>Effect On System Operation</u>	<u>Failure Detection Method</u>	<u>Remarks</u>
11. Motor-operated gate valve 2SIS*MOV863A (2SIS*MOV863B analogous)	Fails to open on demand.	Provides flow from RSS pump 2RSS*P21C (2RSS*P21D) to suction of HHSI/charging pump 2CHS*P21A (2CHS*P21B) during recirculation.	Failure reduces redundancy of providing flow from RSS pump to suction of HHSI/charging pumps. No effect on safety for system operation. Redundant valve 2SIS*MOV863B (2SIS*MOV863A) opens to provide flow path to suction of HHSI/charging pumps.	Same methods of detection as those stated for item 6.	Valve is aligned to open on actuation by position signal open from valve 2SIS*MOV8811A (2SIS*MOV8811B).
12. Motor-operated gate valve 2SIS*MOV8887A (2SIS*MOV8887B analogous)	a. Fails to close on demand.	Provides LHSI train separation during cold leg recirculation.	a. Failure reduces redundancy of providing LHSI train separation. No effect on safety for system operation. Redundant valve 2SIS*MOV8887B (2SIS*MOV8887A) closes to provide separation.	Valve position indication (open to closed position change) at MCB.	a. Valve is aligned to close on actuation by a RWST extreme low level signal coincident with a SI signal.
	b. Once closed, fails to open on demand.		b. Failure reduces redundancy of providing LHSI flow to RCS hot legs for core flushing. No effect on safety for system operation. The LHSI flow to RCS hot legs will be provided through redundant valve 2SIS*MOV8887B (2SIS*MOV8887A).		b. Valve is opened by the operator during the switchover from cold leg to hot leg recirculation.

TABLE 6.3-5 (Cont)

<u>Component</u>	<u>Failure Mode</u>	<u>Function</u>	<u>Effect On System Operation</u>	<u>Failure Detection Method</u>	<u>Remarks</u>
13. Motor-operated gate valve 2SIS*MOV8809A (2SIS*MOV8809B analogous)	Fails to close on demand.	Provides isolation of LHSI pump 2SIS*P21A (2SIS*P21B) from RWST during recirculation.	Failure reduces redundancy of isolating the RWST during the recirculation phase following a LOCA. No effect on safety for system operation. Back flow of radioactive fluid into the RWST is precluded by a check valve.	Same methods of detection as stated for item 4.	Valve is automatically closed during the switchover from injection to recirculation following a LOCA.
14. Motor-operated gate valve 2CHS*MOV8130A (2CHS*MOV8130B analogous)	Fails to close on demand.	Provides HHSI train separation during recirculation.	Failure reduces redundancy of separating HHSI trains. No effect on safety for system operation. Train separation will be provided by redundant isolation valve 2CHS*MOV8130B (2CHS*MOV8130A)	Same methods of detection as stated for item 4.	Valve is closed by the operator during the switchover from injection to cold leg recirculation following a LOCA. If HHSI pump C is operating, then either 2CHS*MOV8130A (2CHS*MOV8130B) or 2CHS*MOV8131A (2CHS*MOV8131B) will be closed, but not both.
15. Motor-operated gate valve 2CHS*MOV8131A (2CHS*MOV8131B analogous)	Fails to close on demand.	Same as item 14.	Same as item 14.	Same methods of detection as stated for item 4.	Same as item 14.



TABLE 6.3-5 (Cont)

<u>Component</u>	<u>Failure Mode</u>	<u>Function</u>	<u>Effect On System Operation</u>	<u>Failure Detection Method</u>	<u>Remarks</u>
16. Motor-operated gate valve 2CHS*MOV8132A (2CHS*MOV8132B analogous)	Fails to close on demand.	Same as item 14.	Same as item 14.	Same methods of detection as stated for item 4.	Valve is normally open with power removed. Valve is closed by the operator during the switchover from injection to cold leg recirculation following a LOCA. If HHSI pump C is operating, then either 2CHS*MOV8132A (2CHS*MOV8132B) or 2CHS*MOV8133A (2CHS*MOV8133B) will be closed, but not both.
17. Motor-operated gate valve 2CHS*MOV8133A (2CHS*MOV8133B analogous)	Fails to close on demand.	Same as item 14.	Same as item 14.	Same methods of detection as stated for item 4.	Same as item 16.
18. Motor-operated gate valve 2CHS*MOV836	a. Fails to open on demand.	Provides redundant HHSI path to RCS cold legs during recirculation.	a. Failure prevents separation of HHSI flow into two separate trains. The HHSI flow will be provided by alternate path through valves 2SIS*MOV867A,B, and 2SIS*MOV867C,D.	Same methods of detection as stated for item 6.	a. Valve is normally closed with power removed. Valve is opened by the operator during the switchover from injection to cold leg recirculation.

TABLE 6.3-5 (Cont)

<u>Component</u>	<u>Failure Mode</u>	<u>Function</u>	<u>Effect On System Operation</u>	<u>Failure Detection Method</u>	<u>Remarks</u>
	b. Once open, fails to close on demand.		b. Failure reduces redundancy of providing HHSI flow to RCS hot legs for core flushing. No effect on safety for system operation. The HHSI flow to RCS hot legs will be provided by HHSI/charging pump 2CHS*P21C through valve 2SIS*MOV869B.		b. Valve is closed by the operator during the switchover from cold leg to hot leg recirculation.

TABLE 6.3-5 (Cont)

<u>Component</u>	<u>Failure Mode</u>	<u>Function</u>	<u>Effect On System Operation</u>	<u>Failure Detection Method</u>	<u>Remarks</u>
19. Recirculation spray Pump 2RSS*P21C (2RSS*P21D analogous)	Fails to deliver working fluid.	Provides LHSI during recirculation phase.	Failure reduces redundancy of providing LHSI flow directly to RCS and to suction of HHSI/charging pump 2CHS*P21A (2CHS*P21B). The LHSI flow to the RCS and to the suction of both HHSI/charging pumps will be provided by the redundant pump 2RSS*P21D (2RSS*P21C).	Same as item 9 except for flow indication FI-157C (FI-157D).	Pump is part of RSS and is aligned automatically during switchover from injection to recirculation (Section 6.2.2).
20. Motor-operated gate valve 2SIS*MOV8889	Fails to open on demand.	Provides LHSI flow path to RCS hot legs.	Failure prevents use of LHSI flow for core flushing during hot leg recirculation. Core flushing will be provided by HHSI/charging pumps through valves 2SIS*MOV869A,B and by RSS pumps through valves 2SIS*MOV8888A,B.	Valve position indication (closed to open position change) at MCB. Valve closed position monitor light and alarm for group monitoring of components at MCB.	Valve is normally closed with power removed. Valve is opened by the operator during the switchover from cold leg to hot leg recirculation.
21. Motor-operated gate valve 2SIS*MOV869A (2SIS*MOV869B analogous)	Fails to open on demand.	Provides HHSI flow path to RCS hot legs.	Failure prevents use of HHSI/charging pump 2CHS*P21A (2CHS*P21B) for core flushing during hot leg recirculation. Core flushing will be provided by the redundant HHSI/charging pump and LHSI flow from RSS pumps 2RSS*P21C,D.	Same methods of detection as stated for item 20.	Same as item 20.

TABLE 6.3-5 (Cont)

<u>Component</u>	<u>Failure Mode</u>	<u>Function</u>	<u>Effect On System Operation</u>	<u>Failure Detection Method</u>	<u>Remarks</u>
22. Motor-operated gate valve 2SIS*MOV8888A (2SIS*MOV8888B analogous)	Fails to close on demand.	Provides LHSI flow path to RCS cold legs.	Failure reduces redundancy of using LHSI flow for core flushing during hot leg recirculation. Core flushing will be provided by redundant LHSI path through valve 2SIS*MOV8887B (2SIS*MOV8887A) and HHSI flow through 2SIS*MOV869A and B.	Same methods of detection as stated for item 4.	Valve is closed by the operator during the switchover from cold leg to hot leg recirculation.
23. Motor-operated gate valve 2RSS*MOV156C (2RSS*MOV156D analogous)	Fails to close on demand.	Provides RSS pump flow path to RSS header.	Failure reduces LHSI flow to RCS cold legs and to suction of HHSI/charging pump 2CHS*P21A (2CHS*P21B). Minimum flow requirements will be provided by redundant LHSI train.	Same method of detection as stated for item 4.	Valve closes on actuation by RWST extreme low level coincident with an SI signal.

List of Abbreviations and Acronyms

- |                                   |                                     |
|-----------------------------------|-------------------------------------|
| HHSI - High head safety injection | RWST - Refueling water storage tank |
| LHSI - Low head safety injection  | SI - Safety Injection               |
| LOCA - Loss-of-coolant accident   | VCT - Volume control tank           |
| MCB - Main control board          |                                     |
| RCS - Reactor coolant system      |                                     |
| RSS - Recirculation spray system  |                                     |

TABLE 6.3-6

EMERGENCY CORE COOLING SYSTEM  
 RECIRCULATION PIPING PASSIVE FAILURE ANALYSIS  
 LONG TERM PHASE

<u>Flow Path</u>	<u>Indication of Loss of Flow Path</u>	<u>Alternate Flow Path</u>
Low Head Recirculation		
From recirculation spray to low head injection header	Accumulation of water in a recirculation spray pump compartment or auxiliary building sump	Via the independent, identical low head flow path utilizing the second recirculation spray pump
High Head Recirculation		
From containment sump to the high head injection header	Accumulation of water in a recirculation spray pump compartment, charging pump compartment, or the auxiliary building sump	From containment sump to the high head injection headers via alternate recirculation spray

TABLE 6.3-7

SEQUENCE OF SWITCHOVER OPERATION FROM  
INJECTION TO RECIRCULATION

The injection mode of ECCS operation is initiated automatically and requires no operator action. During injection the LHSI and HHSI/charging pumps take suction from the RWST and deliver borated water to the cold legs. The accumulators discharge into the cold legs as RCS pressure drops below their set pressure.

Upon a CIB signal coincident with an RWST low level signal (as defined in Section 6.2.2.2.2), the recirculation spray pumps start automatically and provide recirculation of the containment sump water through the recirculation coolers to the recirculation spray headers. During the switchover from injection to cold leg recirculation, two of the four recirculation spray pumps are automatically realigned to provide the LHSI pump function and to provide flow to the suction of the HHSI/charging pumps.

Switchover from injection to cold leg recirculation occurs automatically as the level in the RWST drops to the extreme low level set point. On RWST extreme low level coincident with a SI signal, the following actions occur automatically:

1. The LHSI crossover isolation valves close (2SIS\*MOV8887A, B),
2. The recirculation spray pump discharge valves to the LHSI discharge lines into the RCS open (2SIS\*MOV8811A, B),
3. The recirculation spray header isolation valves close (2RSS\*MOV156C, D),
4. The HHSI/charging pump suction isolation valves from the LHSI pumps (2SIS\*MOV863A, B) open on limit switch signal open from valves 2SIS\*MOV8811A, B,
5. The LHSI pumps stop on limit switch signal open from valves 2SIS\*MOV8811A, B,
6. The HHSI/charging pump suction isolation valves from the RWST (2CHS\*LCV115B, D) close on limit switch signal open from valves 2SIS\*MOV863A, B, and
7. The LHSI pump suction valves from the RWST (2SIS\*MOV8809A, B) close on signal from LHSI pump stop.

Following these automatic actions, the operator performs the following manual actions:

TABLE 6.3-7 (Cont)

1. Opens the alternate HHSI path isolation valve (2SIS\*MOV836), and
2. Separates the two HHSI/charging subsystems by closing the appropriate isolation valves in the HHSI/charging pump suction header (either 2CHS\*MOV8130A, B or 2CHS\*MOV8131A, B) and the HHSI/charging pump discharge header (either 2CHS\*MOV8132A, B or 2CHS\*MOV8133A, B).

The ECCS is now aligned for cold leg recirculation. Two of the four recirculation spray pumps provide LHSI into the cold legs while also providing suction to the HHSI/charging pumps. Two separate subsystems are provided, each consisting of a recirculation spray pump and a HHSI/charging pump.

At approximately 6.0 hours following the LOCA, the operator would realign the ECCS for hot leg recirculation by the following actions:

1. Closes the LHSI discharge isolation valves to the cold legs (2SIS\*MOV8888A, B),
2. Opens the LHSI crossover isolation valves (2SIS\*MOV8887A, B),
3. Opens the isolation valve in the common LHSI discharge line to the hot legs (2SIS\*MOV8889) (during the switchover of the HHSI/charging pumps to hot leg recirculation, the HHSI/charging pumps are stopped individually while respective isolation valves are realigned),
4. After HHSI/charging pump A is stopped, the isolation valve to the cold legs is closed (2SIS\*MOV836),
5. The corresponding isolation valve to the hot legs is opened (2SIS\*MOV869A), and
6. The HHSI/charging pump is restarted.

The other HHSI/charging pump is then realigned in the same manner. Both cold leg isolation valves (either 2SIS\*MOV867A, B or 2SIS\*MOV867C, D) are closed and hot leg isolation valve (2SIS\*MOV869B) is opened.

The ECCS is now aligned for hot leg recirculation with two recirculation spray pumps and two HHSI/charging pumps providing flow to the hot legs.

TABLE 6.3-8

## ECCS SHARED FUNCTIONS EVALUATION

<u>Component</u>	<u>Normal Operating Arrangement</u>	<u>Accident Arrangement</u>
Refueling water storage tank	Lined up to suction of LHSI pumps	Lined up to suction of HHSI/charging and LHSI pumps
HHSI/charging pumps	Lined up for charging service	Line up for HHSI. Valves for realignment meet single failure criteria
Recirculation spray pumps	Lined up to provide flow from the containment sump to the recirculation spray headers	Lined up to the recirculation spray headers in the short term (two of the four pumps are aligned to the LHSI header) and to the HHSI/charging pump suction in the recirculation phase
Low head safety injection pumps	Lined up to cold legs of reactor coolant piping	Lined up to cold legs of reactor coolant piping



TABLE 6.3-9

NORMAL OPERATING STATUS OF EMERGENCY CORE COOLING SYSTEM  
COMPONENTS FOR CORE COOLING

Number of LHSI pumps operable	2
Number of HHSI charging pumps operable	2
Refueling water storage tank minimum useable volume (gal)	859,248
Boron concentration in RWST (minimum ppm)	2,400
Boron concentration in accumulators (nominal ppm)	1,900
Number of accumulators	3
Minimum accumulator pressure (psig)	600
Nominal accumulator water volume (ft <sup>3</sup> )	925
System valves, interlocks, and piping required for the above components which are operable	All

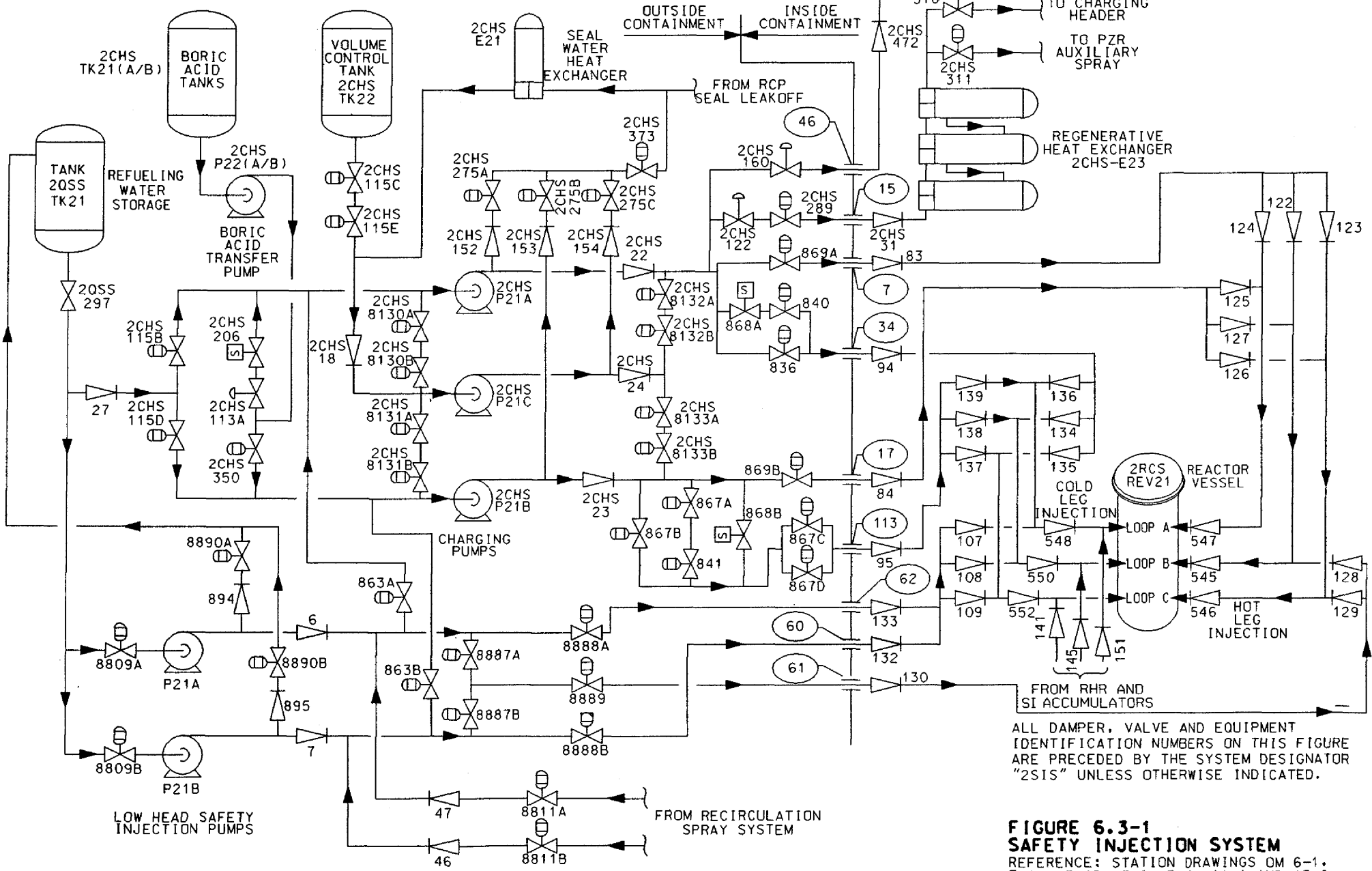

ALL DAMPER, VALVE AND EQUIPMENT IDENTIFICATION NUMBERS ON THIS FIGURE ARE PRECEDED BY THE SYSTEM DESIGNATOR "2SIS" UNLESS OTHERWISE INDICATED.

**FIGURE 6.3-1**  
**SAFETY INJECTION SYSTEM**  
 REFERENCE: STATION DRAWINGS OM 6-1, 7-1A, 7-1B, 7-2, 7-3, 11-1 AND 13-2  
 BEAVER VALLEY POWER STATION UNIT NO. 2  
 UPDATED FINAL SAFETY ANALYSIS REPORT

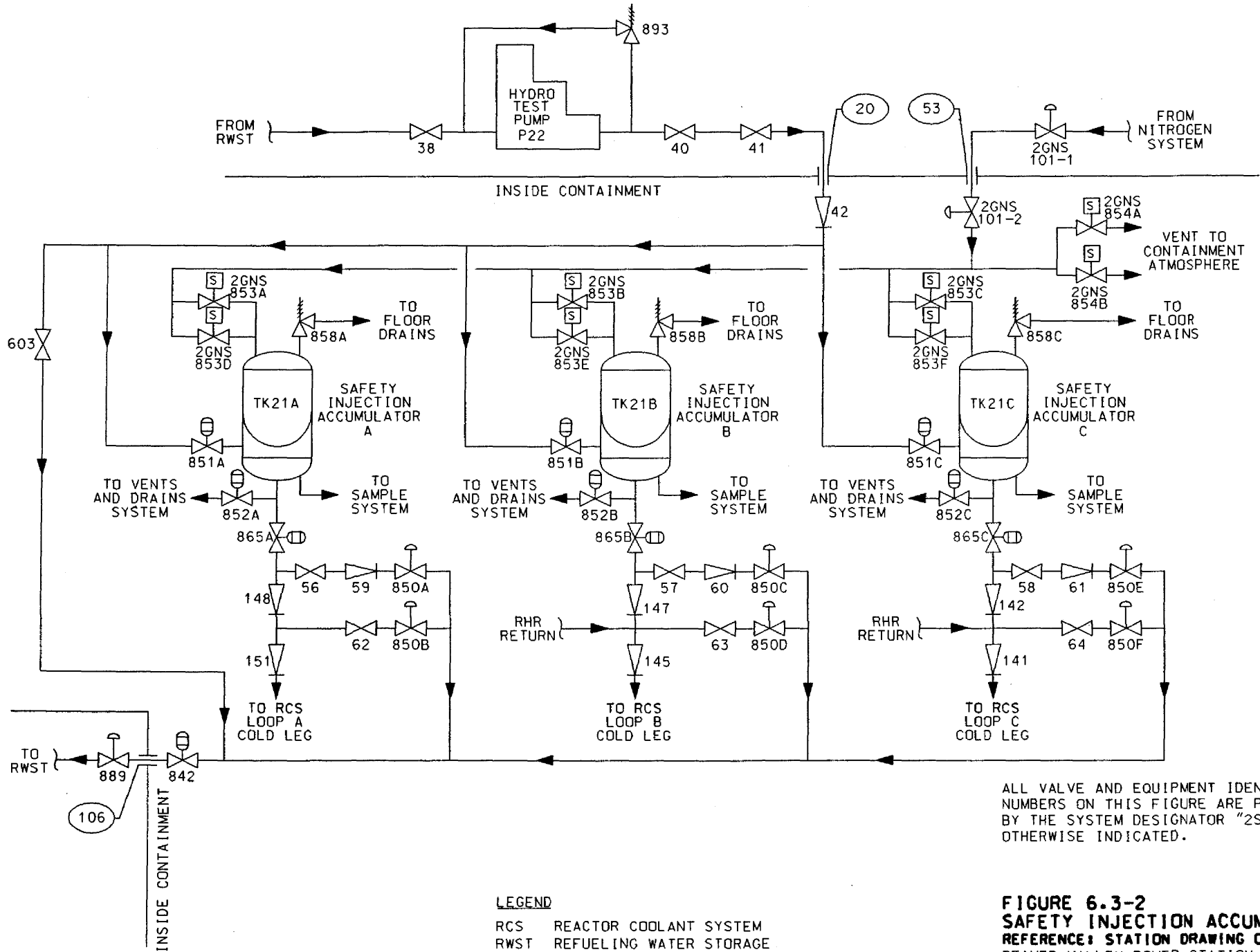

ALL VALVE AND EQUIPMENT IDENTIFICATION NUMBERS ON THIS FIGURE ARE PRECEDED BY THE SYSTEM DESIGNATOR "2SIS" UNLESS OTHERWISE INDICATED.

**LEGEND**

RCS REACTOR COOLANT SYSTEM  
 RWST REFUELING WATER STORAGE TANK

**FIGURE 6.3-2**  
**SAFETY INJECTION ACCUMULATORS**  
 REFERENCE: STATION DRAWING OM 11-2  
 BEAVER VALLEY POWER STATION UNIT NO. 2  
 UPDATED FINAL SAFETY ANALYSIS REPORT

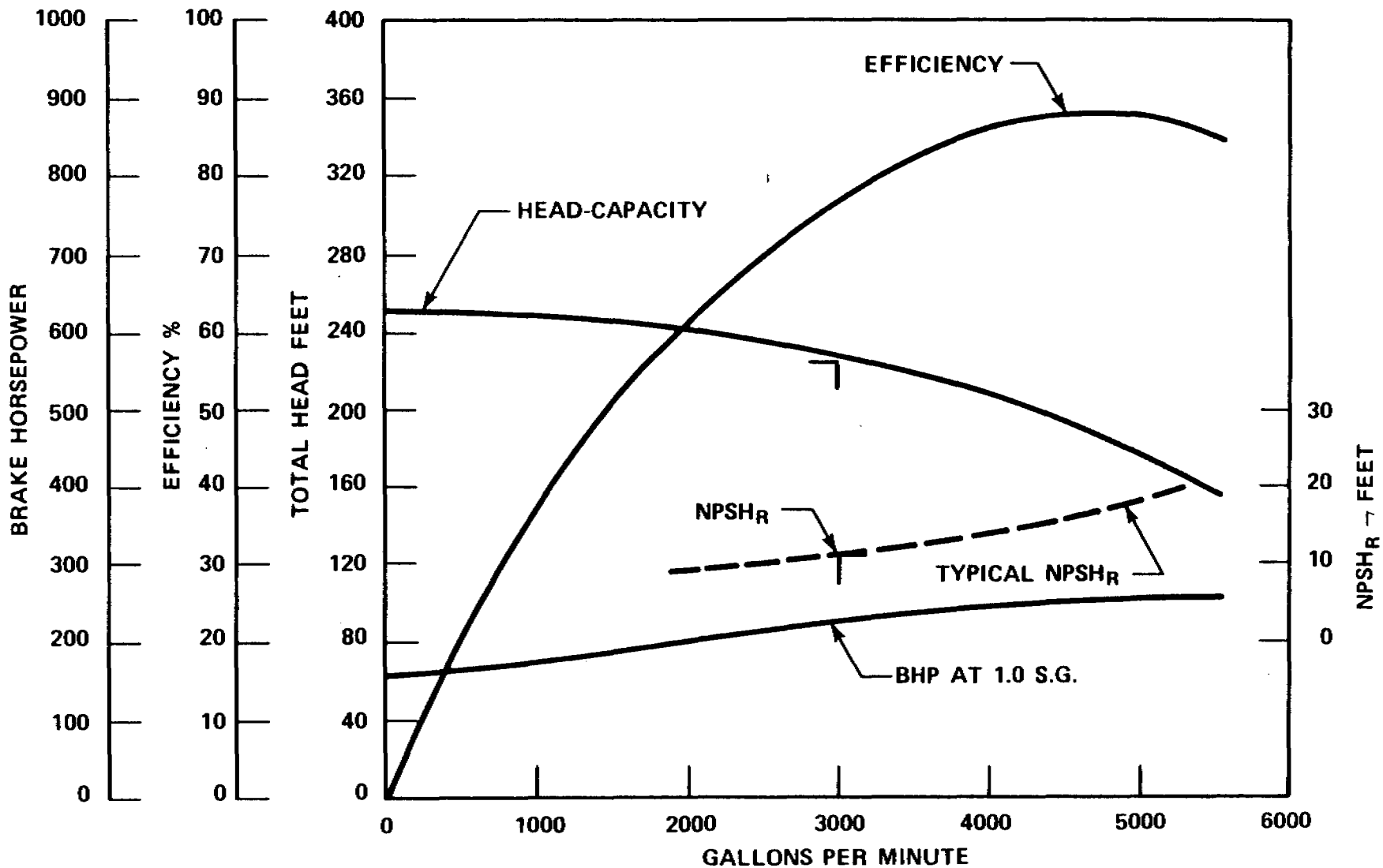
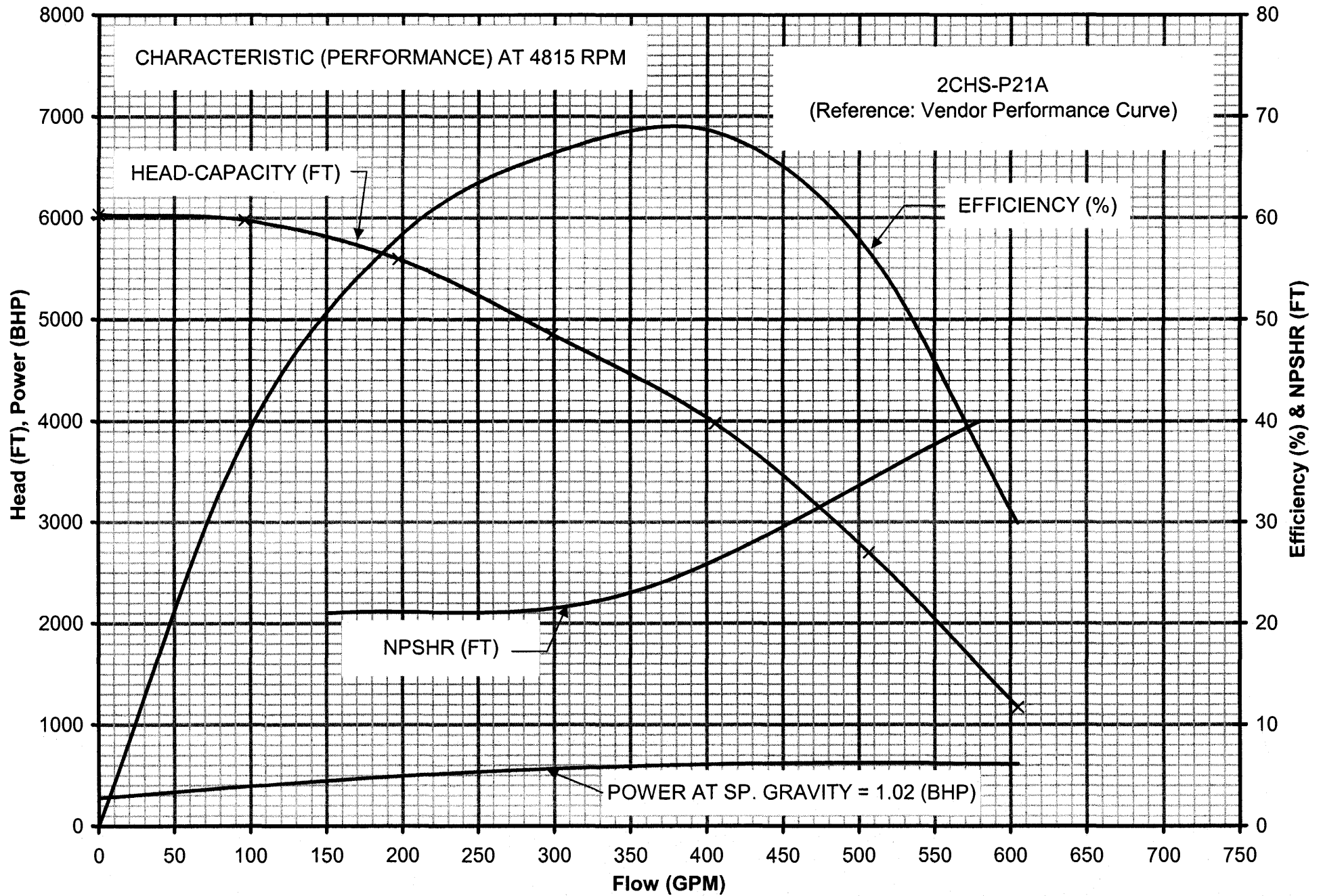

FIGURE 6.3-4  
 PUMP HEAD CHARACTERISTIC  
 CURVE - LOW HEAD-SAFETY  
 INJECTION PUMPS  
 BEAVER VALLEY POWER STATION-UNIT 2  
 FINAL SAFETY ANALYSIS REPORT

Pump Head Characteristic Curve

High Head-Centrifugal Charging Pump

Beaver Valley Power Station-Unit 2 Final Safety Analysis Report



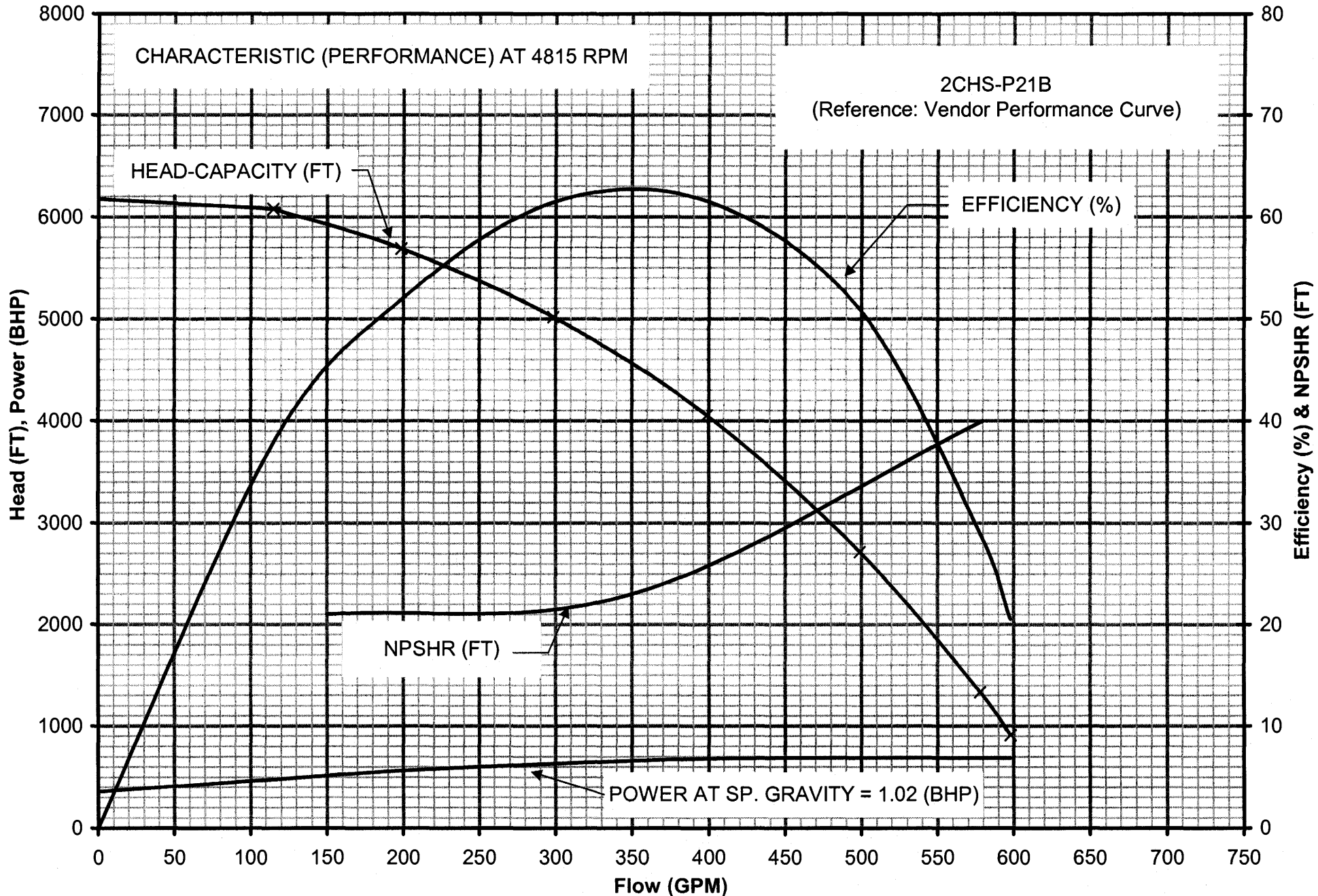

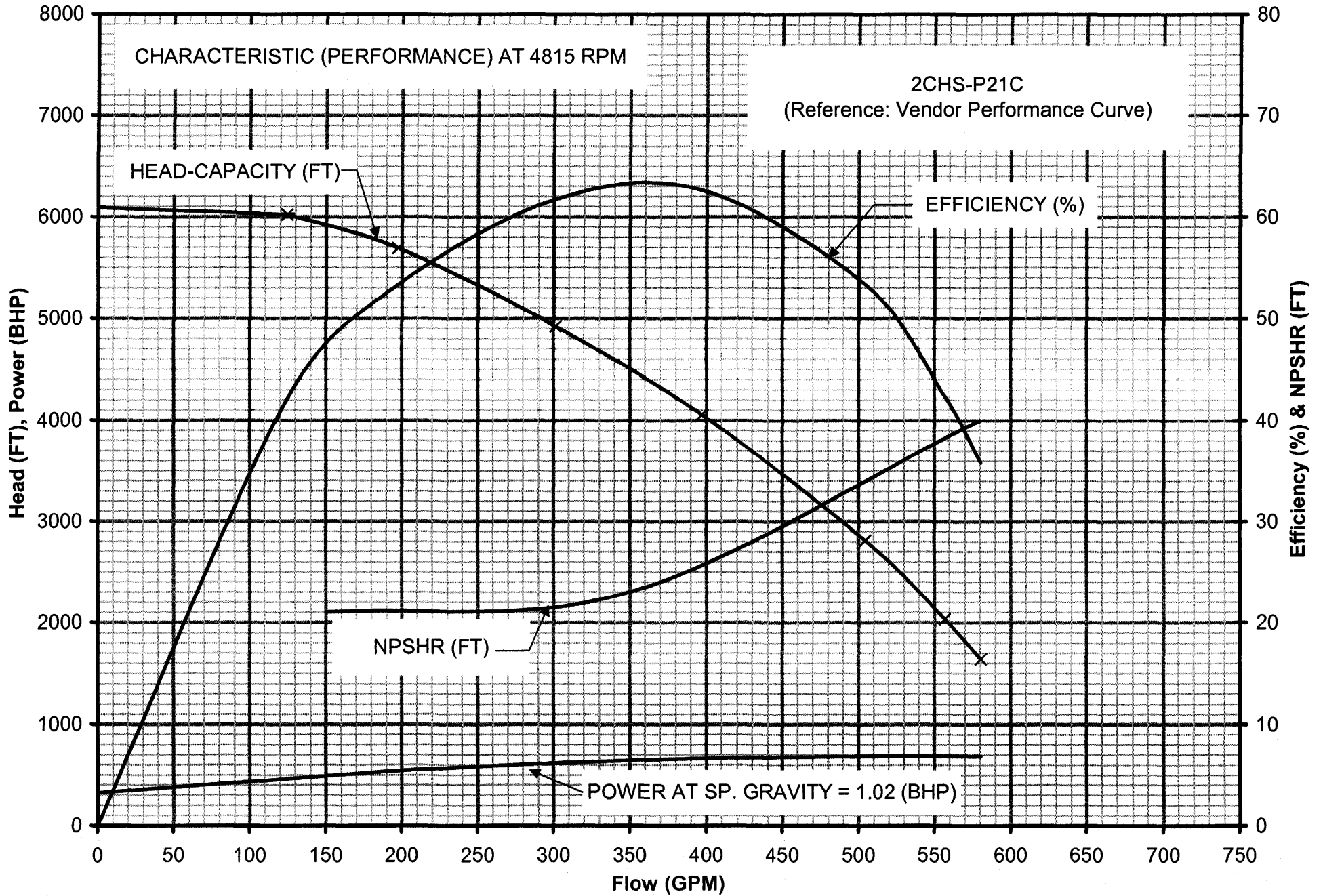

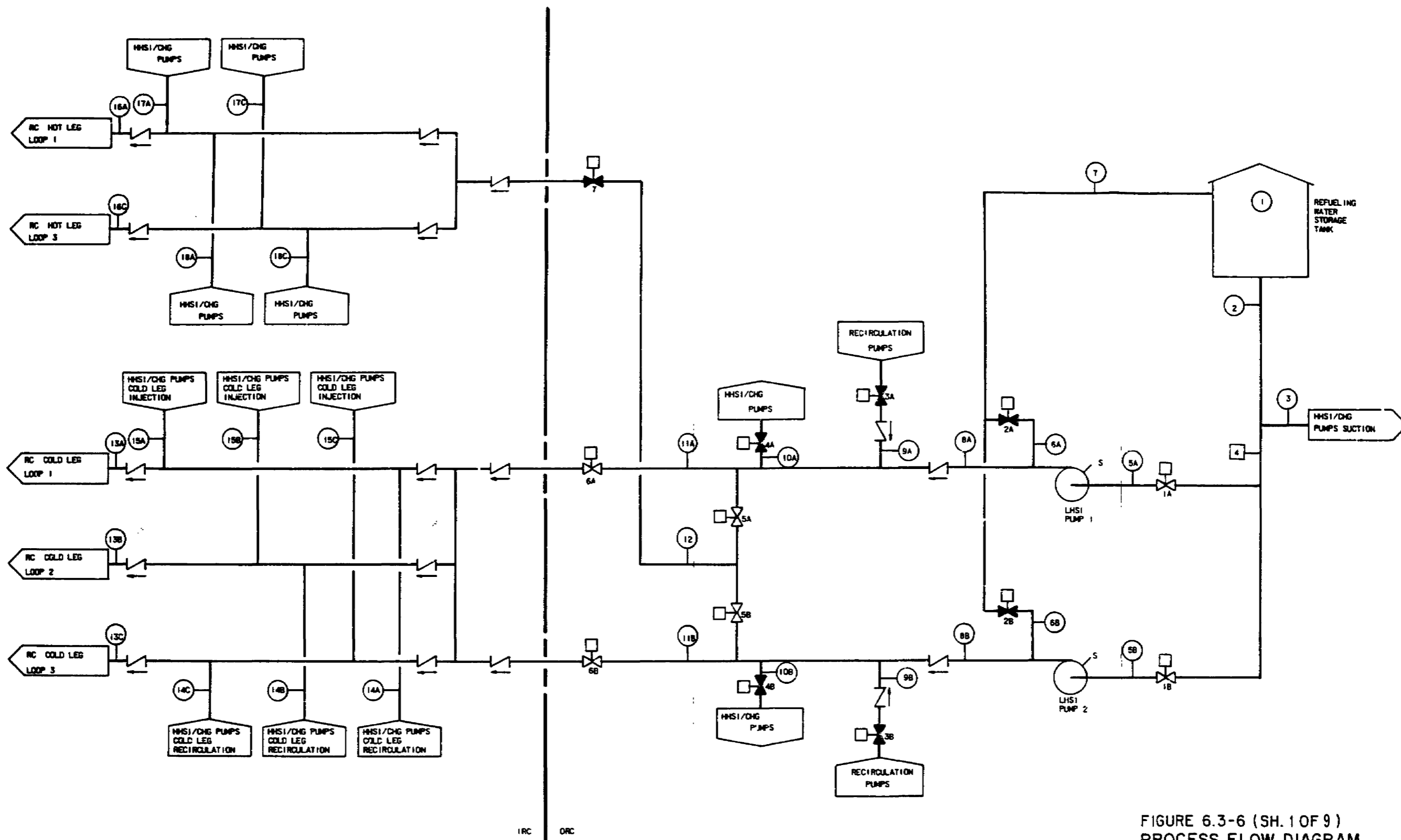

FIGURE 6.3-6 (SH. 1 OF 9)  
PROCESS FLOW DIAGRAM  
SAFETY INJECTION SYSTEM  
BEAVER VALLEY POWER STATION-UNIT 2  
FINAL SAFETY ANALYSIS REPORT



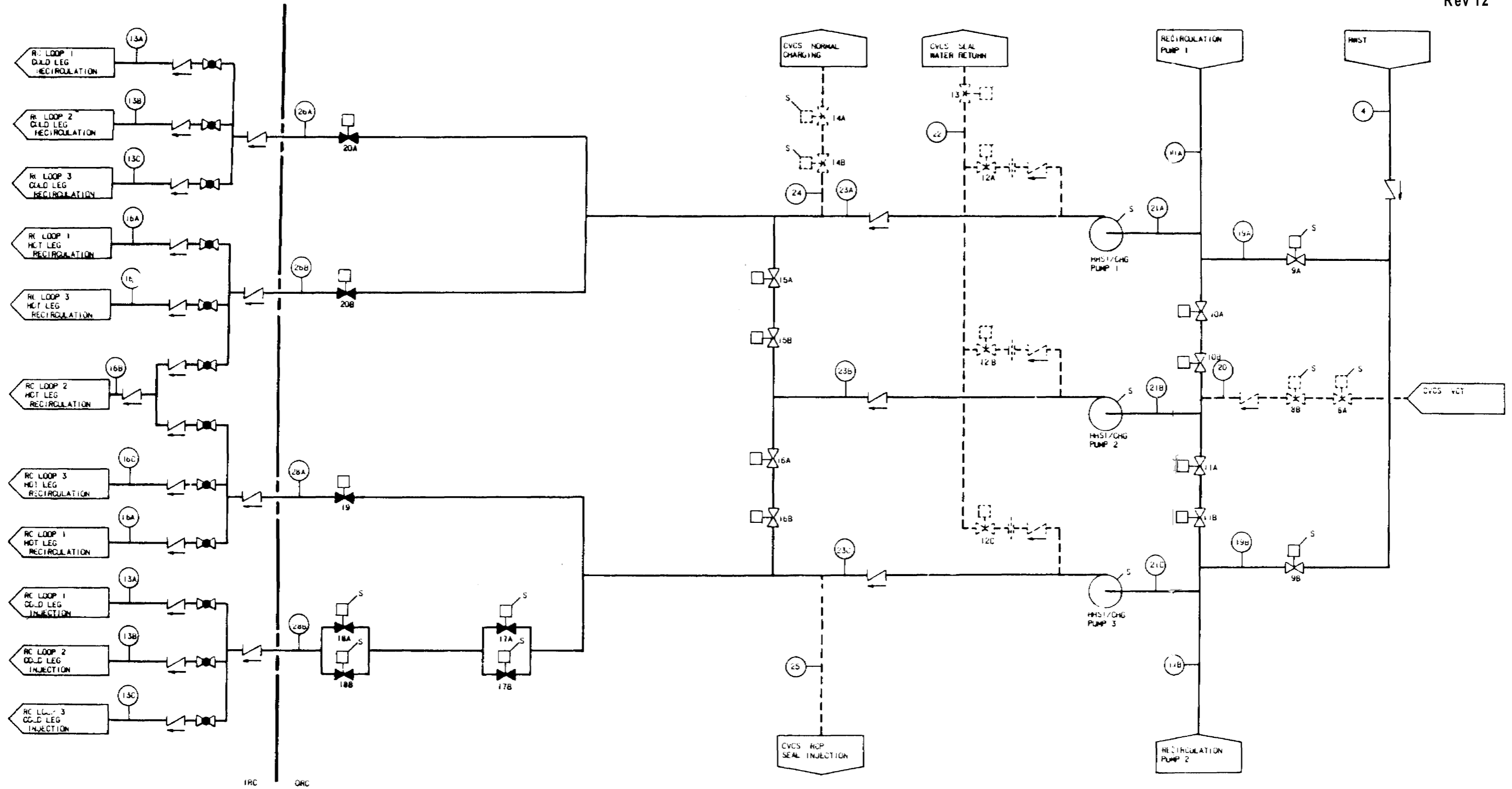

FIGURE 6.3-6 (SH. 2 OF 9)  
PROCESS FLOW DIAGRAM  
SAFETY INJECTION SYSTEM  
BEAVER VALLEY POWER STATION-UNIT 2  
FINAL SAFETY ANALYSIS REPORT

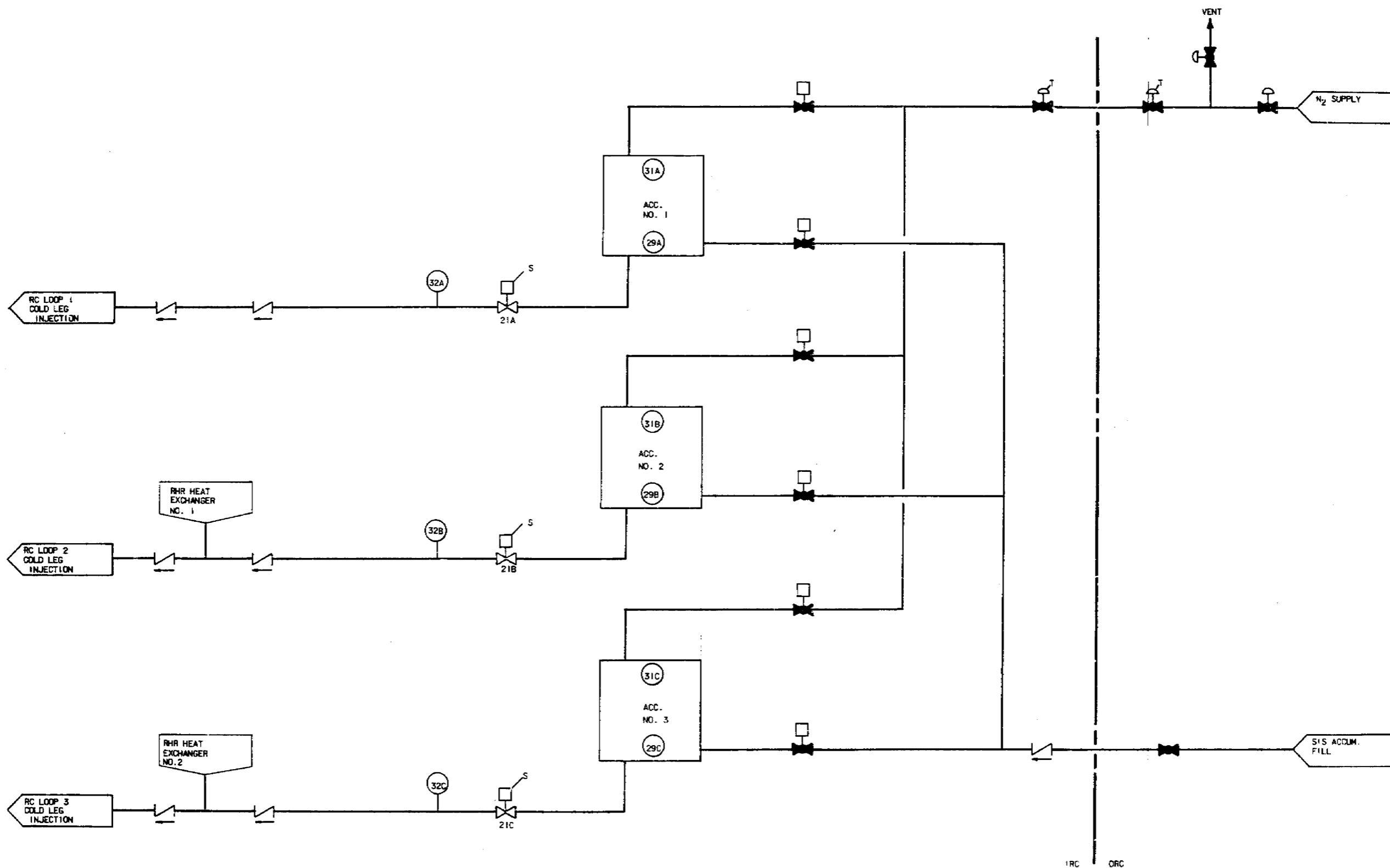

FIGURE 6.3-6 (SH. 3 OF 9)  
PROCESS FLOW DIAGRAM  
SAFETY INJECTION SYSTEM  
BEAVER VALLEY POWER STATION-UNIT 2  
FINAL SAFETY ANALYSIS REPORT

## NOTES TO FIGURE 6.3-6

The following general assumptions were utilized to develop the system modes of operation:

1. The process flow diagrams are provided for illustrative purposes only and are not intended to represent the flow rates used in the various accident analyses. Flow rates to the RCS are provided in Chapter 15, where appropriate. The process flow diagrams are developed assuming typical pump curves and balanced system resistances. The flow rates for FSAR accident analyses are developed using either maximum design pump curves enhanced by 10 percent or minimum design pump curves degraded by 5 percent (whichever is appropriate) and worst case assumptions pertaining to design system resistances (for example, maximum allowable resistances in lines connected to unbroken loops and minimum allowable resistances in lines connected to the broken loop).
2. The system operating conditions presented for the injection and recirculation modes are all based on the assumption of the RCS being fully depressurized and in equilibrium with the containment at 0 psig.
3. The accumulator delivery is considered as an independent mode of operation and the process conditions presented are based on the assumption that the accumulators are fully discharged and depressurized at 0 psig.

## NOTES TO FIGURE 6.3-6 (Cont)

## Modes of Operation

## Mode A: Normal Standby

This mode presents the process conditions for the case of normal ECCS standby.

## Mode B: Injection/Maximum Safeguards

This mode represents the case of maximum safeguards, where all safeguards pumps operate following accumulator delivery. Two LHSI pumps and two HHSI/charging pumps operate, taking suction from the RWST and delivering to the reactor through three cold leg connections.

## Mode C: Injection/Minimum Safeguards - Train A Operating

This mode represents the process conditions for the case of minimum safeguards with LHSI pump C and HHSI/charging pump A taking suction from the RWST and delivering to the reactor through three cold leg connections.

## Mode D: Injection/Minimum Safeguards - Train B Operating

This mode represents the case of minimum safeguards with LHSI pump B and HHSI/charging pump C taking suction from the RWST and delivering to the reactor through three cold leg connections.

This mode of operation is similar to that of Mode C.

## Mode E: Cold Leg Recirculation/Maximum Safeguards

This mode represents the case of cold leg recirculation with recirculation spray pumps C and D, and HHSI/charging pumps A and C operating.

In this mode the safeguards pumps operate in series, with only the recirculation spray pumps capable of taking suction from the containment sump. The recirculated coolant is then delivered by the recirculation spray pumps through the recirculation spray coolers to the HHSI/charging pumps, which deliver to the reactor through three cold leg connections. The recirculation spray pumps also deliver flow directly to the reactor through the same three cold leg connections.

## Mode F: Cold Leg Recirculation/Minimum Safeguards - Train A Operating

This mode represents the case of cold leg recirculation with recirculation spray pump C and HHSI/charging pump A operating.

## NOTES TO FIGURE 6.3-6 (Cont)

In this mode the safeguards pumps operate in series, with only the recirculation spray pump capable of taking suction from the containment sump. The recirculated coolant is then delivered by the recirculation spray pump through a recirculation spray cooler to the HHSI/charging pump, which delivers to the reactor through three cold leg connections. The recirculation spray pump also delivers flow directly to the reactor through the same three cold leg connections.

**Mode G: Cold Leg Recirculation/Minimum Safeguards - Train B  
Operating**

This mode represents the case of cold leg recirculation with recirculation spray pump D and HHSI/charging pump C operating. As such, this mode of operation is similar to that of Mode F.

**Mode H: Hot Leg Recirculation/Maximum Safeguards**

This mode represents the case of hot leg recirculation with recirculation spray pumps C and D and HHSI/charging pumps A and C operating.

In this mode, the safeguards pumps again operate in series with the recirculation spray pumps taking suction from the containment sump. The recirculated coolant is then delivered by the recirculation spray pumps through the recirculation spray coolers to the HHSI/charging pumps and which deliver to the reactor through three hot leg connections. The recirculation spray pumps also deliver directly to the reactor through two hot leg connections.

**Mode I: Hot Leg Recirculation/Minimum Safeguards - Train A  
Operating**

This mode represents the case of hot leg recirculation with recirculation spray pump C and HHSI/charging pump A operating.

In this mode, the safeguards pumps again operate in series with only the recirculation spray pump taking suction from the containment sump. The recirculated coolant is then delivered by the recirculation spray pump through a recirculation spray cooler to the HHSI/charging pump, which delivers to the reactor through three hot leg connections. The recirculation spray pump also delivers directly to the reactor through two hot leg connections.

**Mode J: Hot Leg Recirculation/Minimum Safeguards - Train B  
Operating**

This mode represents the case of hot leg recirculation with recirculation spray pump D and HHSI/charging pump C operating. As such, this mode of operation is similar to that of Mode I.

## NOTES TO FIGURE 6.3-6 (Cont)

Valve Alignment Chart

Valve No.	<u>A</u>	<u>B</u>	<u>C</u>	<u>D</u>	<u>E</u>	<u>F</u>	<u>G</u>	<u>H</u>	<u>I</u>	<u>J</u>
1A	O*	O	O	O	C	C	O	C	C	O
1B	O	O	O	O	C	O	C	C	O	C
2A	C**	C	C	C	C	C	C	C	C	C
2B	C	C	C	C	C	C	C	C	C	C
3A	C	C	C	C	O	O	C	O	O	C
3B	C	C	C	C	O	C	O	O	C	O
4A	C	C	C	C	O	O	C	O	O	C
4B	C	C	C	C	O	C	O	O	C	O
5A	O	O	O	O	C	C	O	O	O	O
5B	O	O	O	O	C	O	C	O	O	O
6A	O	O	O	O	O	O	O	C	C	C
6B	O	O	O	O	O	O	O	C	C	C
7	C	C	C	C	C	C	C	O	O	O
8A	O	C	C	O	C	C	O	C	C	O
8B	O	C	O	C	C	O	C	C	O	C
9A	C	O	O	C	C	C	C	C	C	C
9B	C	O	C	O	C	C	C	C	C	C
10A	O	O	O	O	C	O	O	C	O	O
10B	O	O	O	O	C	O	O	C	O	O
11A	O	O	O	O	C	O	O	C	O	O
11B	O	O	O	O	C	O	O	C	O	O
12A	O	C	C	O	C	C	O	C	C	O
12B	O	C	C	O	C	C	O	C	C	O
12C	O	C	C	O	C	C	O	C	C	O
13	O	C	O	C	C	O	C	C	O	C
14A	O	C	C	O	C	C	O	C	C	O
14B	O	C	O	C	C	O	C	C	O	C
15A	O	O	O	O	C	O	O	C	O	O
15B	O	O	O	O	C	O	O	C	O	O
16A	O	O	O	O	C	O	O	C	O	O
16B	O	O	O	O	C	O	O	C	O	O
17A	C	O	O	C	O	O	C	C	C	C
17B	C	O	C	O	O	C	O	C	C	C
18A	C	O	O	C	O	O	C	C	C	C
18B	C	O	C	O	O	C	O	C	C	C
19	C	C	C	C	C	C	C	O	C	O
20A	C	C	C	C	O	C	C	C	C	C
20B	C	C	C	C	C	C	C	O	O	C
21A	O	O	O	O	O	O	O	O	O	O
21B	O	O	O	O	O	O	O	O	O	O
21C	O	O	O	O	O	O	O	O	O	O

## NOTES TO FIGURE 6.3-6 (Cont)

MODE C: Injection Phase 1 Minimum Safeguards - Train A Operating  
(Runout Conditions Following Accumulator Delivery)

Location	Fluid	Pressure (psig)	Temperature (°F)	Flow		Volume
				(gpm)***	(lb/hr)****	
1	Refueling Water	atm.	55	-	-	50,000 gal.
2	"	25	55	4,223	2.11	
3	"	-	55	535	0.268	
4	"	-	55	3,688	1.85	
5A	"	-	55	3,688	1.85	
5B	"	-	55	0	0	
6A	"	91	55	0	0	
6B	"	-	55	0	0	
7	"	-	55	0	0	
8A	"	91	55	3,688	1.85	
8B	"	-	55	0	0	
9A	"	91	55	0	0	
9B	"	54	55	0	0	
10A	"	54	55	0	0	
10B	"	54	55	0	0	
11A	"	52	55	1,982	0.992	
11B	"	52	55	1,706	0.854	
12	"	54	55	0	0	
13A	"	0	55	1,272	0.637	
13B	"	0	55	1,404	0.750	
13C	"	0	55	1,498	0.703	
14A	Refueling Water	23	55	0	0	
14B	"	29	55	0	0	
14C	"	31	55	0	0	
15A	"	23	55	162	0.081	
15B	"	29	55	161	0.081	
15C	"	31	55	162	0.081	
16A	"	0	55	0	0	
16C	"	0	55	0	0	
17A	"	0	55	0	0	
17C	"	0	55	0	0	
18A	"	0	55	0	0	
18C	"	0	55	0	0	
19A	"	0	55	535	0.268	
19B	"	-	55	0	0	
20	"	-	55	0	0	
21A	"	0	55	535	0.268	
21B	"	-	55	0	0	
21C	"	-	55	0	0	
22	"	-	55	0	0	

NOTES TO FIGURE 6.3-6 (Cont)

Location	Fluid	Pressure (psig)	Temperature (°F)	Flow		Volume
				(gpm) <sup>***</sup>	(lb/hr) <sup>****</sup>	
23A	"	841	55	535	0.268	
23B	Refueling Water	838	55	0	0	
23C	"	833	55	0	0	
24	"	841	55	0	0	
25	"	833	55	50	0.025	
26A	"	0	55	0	0	
26B	"	0	55	0	0	
27	"	833	55	485	0.243	900 gal.
28A	Refueling Water	0	55	0	0	
28B	"	617	55	485	0.243	
29A	N <sub>2</sub>	0	100	0	0	1,450 ft <sup>3</sup>
29B	N <sub>2</sub>	0	100	0	0	1,450 ft <sup>3</sup>
29C	N <sub>2</sub>	0	100	0	0	1,450 ft <sup>3</sup>
30A	N <sub>2</sub>	0	100	0	0	
30B	N <sub>2</sub>	0	100	0	0	
30C	N <sub>2</sub>	0	100	0	0	

NOTES:

\*O = Open

\*\*C = Closed

\*\*\*At reference conditions 55°F and 0 psig

\*\*\*\*x 10<sup>6</sup>



## 6.4 HABITABILITY SYSTEMS

The habitability system for the control room envelope encompasses equipment and supplies to ensure that the main control room operators are able to remain in the area and take action to operate Beaver Valley Power Station - Unit 2 (BVPS-2) safely under normal conditions, as well as during all postulated design basis accidents (DBA). The habitability systems include radiation shielding, redundant radiation monitors with automatic control room isolation capability, redundant air supply and filtration systems, redundant air-conditioning systems, fire protection, personnel protective and first aid equipment, food and water storage, emergency lighting, utility and sanitary facilities.

For detailed descriptions of the individual systems, refer to specific sections of this Final Safety Analysis Report.

### 6.4.1 Design Bases

The habitability system of the control room is designed in accordance with the following criteria:

1. General Design Criterion 2, as it relates to the ability of structures housing the facility and the facility components to withstand the effects of natural phenomena such as earthquakes, hurricanes, and floods, as established in Chapters 2 and 3.
2. General Design Criterion 3, as it relates to protection against fire hazards.
3. General Design Criterion 4, with respect to structures housing the facility and the facility components being capable of withstanding the effects of external missiles and internally-generated missiles, pipe whip, and jet impingement forces associated with pipe breaks, such that safety functions will not be precluded.
4. General Design Criterion 5, as it relates to shared systems and components important to safety being capable of performing required safety functions.
5. General Design Criterion 19, and 10 CFR 50.67 as it relates to providing adequate radiation protection during LOCA, CREA, and FHA accident conditions.
6. Regulatory Guide 1.26, as it relates to the quality group classification of system components.
7. Regulatory Guide 1.29, as it relates to the seismic design classification of systems and components.

8. Regulatory Guide 1.52, regarding air filtration equipment requirements.
9. Regulatory Guide 1.76, regarding design basis tornado for nuclear power plants.
10. Regulatory Guide 1.78, regarding assumptions for evaluating the habitability of the main control room following postulated chemical releases.
11. Regulatory Guide 1.95, regarding protection of main control room operators from a postulated chlorine release.
12. Regulatory Guide 1.117, regarding tornado design classification.
13. Meets the intent of NUREG-0737, Action Item III.D.3.4 (USNRC 1980) as it relates to control room habitability.

#### 6.4.2 System Design

##### 6.4.2.1 Definition of Control Room Envelope

The Beaver Valley Power Station is served by a single control room that supports both units. Each unit has a separate control area in the control room. The two control areas are contained in a single control room envelope, and are modeled as a single region. The control room envelope is defined in the Control Room Envelope Habitability Program. Table 6.4-1 compares the ventilation parameters between BVPS-1 and BVPS-2.

Operators must occupy the main control room continually and the computer room frequently. The mechanical equipment rooms are seldom occupied but, due to their configuration and function, they are also part of the envelope.

##### 6.4.2.2 Ventilation System Design

The control room air-conditioning system is safety-related and maintains the main control room ambient air temperature, under normal conditions, at 75°F. Detailed system and component information is provided in Section 9.4.1. Figure 3.8-25 shows the layout of the control room.

The emergency diesel generators supply power to emergency lighting and electrically-powered motors and controls associated with redundant air-conditioning and filtration systems in the event of a loss of normal power. In addition, the emergency 125 V dc system (Section 8.3.2) provides power for emergency lighting in the main control room. All spaces served by these two air-conditioning and filtration units form the control room envelope and are shown on Figure 9.4-1.

Fresh air is supplied to the control room envelope at a rate of 500 cfm or less, total for both units, during normal plant operation. Two redundant emergency supply filtration units are provided to filter the fresh air for breathing and pressurization after an accident. Each of the emergency supply filtration units has a capacity of 1,000 cfm.

The main components of the filtration unit have the following characteristics:

1. A high efficiency particulate air filter (HEPA) capable of removing 99.97 percent of the 0.3 micron or larger particles which impinge on the filter.
2. The impregnated carbon material in the charcoal filters is capable of removing 99 percent methyl iodide ( $\text{CH}_3\text{I}$ ) and 99.5 percent of elemental iodine from the air at entering conditions of 90 percent relative humidity and 30°C.
3. A moisture separator and electric heating coil to maintain low relative humidity.

The design, testing, and maintenance of the control room emergency supply filtration unit is in accordance with Regulatory Guide 1.52, with the exception of those items discussed in Section 1.8. When the main control room must be isolated manually (for example, due to smoke) or automatically (for example, due to a loss-of-coolant accident (LOCA), or high radiation levels in the control room), the supply air isolation butterfly valves in the outdoor air intake ducts close. The locations of the BVPS-1 and BVPS-2 control room air intakes are shown on Table 6.4-3 and Figure 6.4-5. Hazardous materials released from accidents offsite are identified in Section 2.2.3. The intent of NUREG-0737, Action Item III.D.3.4, is met in accordance with the control room habitability study for BVPS-1 and BVPS-2 for hazardous chemical releases.

Following a containment isolation Phase B signal or a high radiation signal, about 1,000 cfm of outdoor air will be taken through the air intake and supplied to the control room envelope through one of the redundant emergency supply filtration units. Introduction of  $\text{CO}_2$  from the  $\text{CO}_2$  storage facility is not possible since the facility is not installed within the control room envelope. Sufficient ventilation is provided to prevent a buildup of noxious gases from batteries installed within the control room envelope.

#### 6.4.2.3 Leaktightness

The control room emergency ventilation system is designed to provide a positive pressure in the control room envelope using filtered outside air to minimize unfiltered inleakage during emergency operation through doors, ducts, pipes, and cable penetrations that could be caused by wind effects and pressure variations. Special construction features are provided to maintain the leaktightness of the control room envelope including compression seals for access doors and equipment removal hatches, penetration seals for pipes, ducts, and electrical penetrations, and water trap seals for sanitary piping.

Control room envelope unfiltered air inleakage testing is performed in accordance with the Control Room Envelope Habitability Program.

In addition to meeting the requirements related to radiation, the following design features are provided:

1. Centrally located redundant Category I area radiation monitors.
2. Automatic main control room isolation on radiation detection.
3. Construction details to control main control room leakage agree with recommended practices (Atomics International 1965). Concrete and concrete block surfaces are coated with a surface treatment to reduce leakage due to porosity, cracks, and construction joints.

#### 6.4.2.4 Interaction with Other Zones and Pressure-Containing Equipment

The air-conditioning units for the control room envelope do not supply air to any other area. The return air in this system is only from the control room envelope area.

With the exception of the portable fire extinguishers, service water piping, refrigerant piping, and potable water system, there are no pressurized tanks, steam or hot water lines, or other pressurized pipes in the control room envelope. The seismically designed hose stations serving the control room envelope are located in the stairways on the next floor below and outside the envelope. There are no carbon dioxide supply pipes to the control room envelope. A 24-ton CO<sub>2</sub> storage tank is located outside the west wall of the Auxiliary Building approximately 100 ft. from the BV-2 Control Room Air Intake. Failure of this tank has been analyzed and it has been determined that control room habitability will be maintained.

#### 6.4.2.5 Shielding Design

The design of the control room envelope includes adequate radiation shielding and ventilation control to maintain acceptable radiation levels in the main control room under accident conditions, as discussed in Section 12.3.2.

In accordance with General Design Criterion 19, personnel exposure is limited, for the duration of any accident postulated in Chapter 15, to 5 Rem TEDE, per 10 CFR 50.67 and R.G. 1.183.

The postulated accident radioactivity sources inside and outside the control room envelope are stated in Chapter 15.

The effects of the LOCA and all other design basis accidents are evaluated to determine the doses which the main control room personnel might receive at BVPS-2. The LOCA analysis is based on:

1. Major reactor coolant system (RCS) pipe rupture (LOCA) at BVPS-2 or a
2. Major RCS pipe rupture (LOCA) at BVPS-1.

For purposes of analysis, it is assumed that each accident occurs with and without a loss of offsite power. Accidents are not postulated to occur simultaneously.

The main control room personnel are potentially exposed to sources from several locations following the LOCA. The sources considered for the design of control room shielding include: 1) the containment building (direct and sky shine dose), 2) the external cloud (from containment and emergency core cooling system (ECCS) leakage), 3) sources in adjacent buildings, and 4) iodine collection on the main control room intake filter, and 5) the refueling water storage tank (RWST).

The containment building is considered as one of the sources of radiation used for main control room shielding design due to its location and the large amount of activity contained within its bounds. A significant fraction of the containment free air volume is located above grade and its dose contribution is evaluated to determine the main control room 30 day whole body gamma dose. The containment shine source is based on the time-dependent airborne activity inside containment released during the fuel gap and reactor in-vessel release periods, as described in Section 15.6.5.4.

The external cloud is due to containment leakage during the LOCA plus the ECCS and RWST leakage over 30 days. The containment leakage contribution to the cloud source is a function of the containment airborne inventory available for leakage and the containment leak rate of 0.1 percent of the containment volume per day for the first 24 hours, and 0.05 percent per day for the remaining duration of the accident. The airborne inventory available for leakage and the leakage pathways are described in Section 15.6.5.4.

The ECCS leakage and RWST back-leakage contribution to the control room dose is based on containment sump water containing all non-gaseous activity released during the fuel gap and reactor in-vessel release phases, and at an assumed leakage rate of twice the maximum allowable ECCS leakage.

Two adjacent areas that potentially contain airborne sources due to leakage from the containment, the ECCS, or the RWST are considered contributors to the main control room dose due to shine. These source locations are the cable spreading area below the BVPS-2 control room, and the cable tray mezzanine below the BVPS-1 control room. The amount of radioactive iodine collected on the intake filters due to these leakage sources is considered in determining the direct shine dose in the control room. The direct shine dose from the BVPS-2 RWST is negligible, because it is shielded by the Unit 2 Containment building.

The main control room walls and adjacent structures provide shielding required to minimize exposure to operating personnel, as shown on Figures 6.4-2, 6.4-3 and 6.4-4, while a description of the shielding can be found in Section 12.3.2.9.

Figure 6.4-2 shows a cross-sectional view of the main control room and the relative distances to the BVPS-1 and BVPS-2 containments. Also shown are shield wall and floor thicknesses. Figures 6.4-3 and 6.4-4 show cross-sectional views from the BVPS-2 main control room facing BVPS-1 and BVPS-2 containments, respectively. Table 6.4-3 and Figure 6.4-5 identify the radiation release points for both BVPS-1 and BVPS-2.

#### 6.4.3 System Operational Procedures

The air-conditioning systems for the control room are in continuous operation and under automatic control. The operation of the units are controlled by thermostats which, by varying parameters of the refrigeration unit and operating the room reheat coils, maintain the main control room at 75°F.

Except for the air distribution ductwork within each area, the air-conditioning system for the control room is segregated into two 100 percent capacity trains. The redundant standby equipment starts with the loss of static pressure across the operating unit.

If static pressure is not lost and the temperature in the control room continues to rise above the normally maintained 75°F (indicating loss of refrigerant supply to air-conditioning unit), a manual transfer of air-conditioning units is required.

If smoke is detected, isolation of control room ventilation is under administrative control. (Refer to Section 9.4.1.)

#### 6.4.4 Design Evaluation

The main control room air-conditioning system maintains a suitable environment for personnel occupancy and equipment operation during normal and emergency conditions. Two service water cooling coils in the return air stream are also provided as an additional back-up method of cooling the main control room area if required. Components of the air-conditioning systems are seismically designed and are housed in the Seismic Category I control building. Control room envelope ventilation parameters are shown in Table 6.4-1.

##### 6.4.4.1 Radiological Protection

Upon receipt of a containment isolation Phase B signal, or a high radiation signal from the control room area monitors, the normal outside air supply dampers automatically close, thus isolating the control room envelope.

This signal also initiates the control room emergency ventilation system (CREVS). The system is capable of maintaining the control room envelope ambient pressure slightly above atmospheric pressure, thereby limiting inleakage for an indefinite period of time. Periodic control room envelope unfiltered air inleakage tests are performed to confirm that the control room envelope is operable.

Following the accident, the control room envelope is maintained at a positive pressure for an indefinite period of time due to the operation of the redundant emergency supply systems. Each system can draw outside air through an emergency supply filtration unit, which consists of a HEPA filter and carbon adsorber, with assumed effective iodine removal efficiencies of 99% for particulate aerosols and 98% for radioiodines. These emergency supply filtration units and associated air handling equipment are designed to Seismic Category I and Safety Class 3 requirements.

The control room emergency ventilation system recirculation flow is not filtered, but may remain in service during accident conditions to maintain the control room within design temperature limits.

Control room ventilation design parameters used for the LOCA and CREA analyses are presented in Table 6.4-1a. The atmospheric dispersion factors were calculated using ARCON96 for these accidents, and the factors are presented in Tables 15.0-14 and 15.0-14a.

The information and data required to develop the radiological consequences for the main control room are presented in the respective sections describing the design basis accident analysis. Radiation doses to a control room operator due to the various postulated DBAs are summarized in Table 15.0-13. Exposure from inhalation is principally attributable to airborne radioactivity in the main control room envelope due to:

1. Intake prior to main control room isolation,
2. Inleakage during main control room isolation, prior to pressurization,
3. Post-pressurization ventilation filtered intake and unfiltered inleakage.

The CIB signal isolates the control room envelope almost immediately after a LOCA in either Unit. For other accidents, manual operator action by t=30 minutes post-accident is assumed when necessary to maintain habitability.

The analyses consider a conservative selection of parameters to calculate the accident dose. Ventilation intake prior to control room envelope isolation, and unfiltered inleakage are the main contributors to the dose. The allowance for inleakage is based on the results of tracer gas testing in the isolated mode, and includes 10 cfm for ingress and egress.

The maximum normal ventilation intake rate (for both BVPS-1 and BVPS-2 intakes) prior to isolation and an appropriate clean up rate post-isolation are used to maximize the dose estimate. The CREVS filtered intake flow varies between 600 and 1030 cfm, including allowance for uncertainties. Sensitivity studies have shown that assuming the minimum intake flow is more limiting.



The analysis also assumes coincident loss of offsite power. Considering the time delay for startup and load sequencing on the emergency diesel generator and CREVS fan logic relay delays, a total auto start delay of 137 seconds was assumed in the analysis.

For DBAs that do not initiate a CIB signal, the accident duration is 8 hours (except for the fuel handling accident (FHA) for which releases are assumed to occur over a two-hour period).

The main control room doses presented in Table 15.0-13 have been calculated to be less than the limit specified in General Design Criterion 19 and for LOCA, CREA, and FHA less than 5.0 Rem TEDE per 10 CFR 50.67. The main control room may, therefore, be safely occupied during any condition of operation.

#### 6.4.4.2 Toxic Gas Protection

The main control room design provides protection of the personnel in the main control room from any toxic effects from spills of chemicals stored onsite. The effects of spills of chemicals along transportation routes are evaluated in Section 2.2.3.

Self-contained breathing apparatus units and sufficient reserve air cylinders are available to support the minimum control room shift composition for at least six hours. This satisfies Regulatory Guide 1.78 and 1.95. Sufficient additional units are provided to support the members of the emergency squad stationed outside the control room for one hour, after which these personnel would move away from the area affected by the toxic release. Air cylinders brought from off-site locations may be used to extend capacity beyond six hours.

The storage areas of toxic gases and chemicals that could produce toxic gases are shown in Table 6.4-3 and on Figure 6.4-5.

#### 6.4.5 Inspection and Testing Requirements

The major items of equipment that maintain the habitability of the main control room are the emergency supply filtration units, their fans, mechanical refrigeration units, air-conditioning units, and their control systems. The system is inspected, tested, and air balanced periodically. Portions of the system are in continuous operation. Periodic operation of the standby equipment, in conjunction with routine observation and maintenance during normal operation, ensure system availability.

#### 6.4.6 Instrumentation Requirements

The instrumentation and controls included for main control room habitability are addressed in Section 9.4.1.5.

## 6.4.7 References for Section 6.4

American Nuclear Society (ANS) 1977. American National Standard Neutron and Gamma-Ray Flux-to-Dose-Rate Factors. ANSI/ANS-6.1.1-1977 (N666).

Atomics International 1965. Application data in: Conventional Buildings for Reactor Containment, Section IV. NAA-SR-10100.

DiNunno, J.J.; Anderson, F.D.; Baker, R.E.; Waterfield, R.L. 1962. Calculation of Distance Factors for Power and Test Reactor Sites, U.S. Atomic Energy Commission Technical Information Document TID-14844.

U.S. Nuclear Regulatory Commission (USNRC) 1980. Clarification of TMI Action Plan Requirements. NUREG-0737.

U.S. Nuclear Regulatory Commission 1982. Control Room Habitability Study for BVPS-1 and BVPS-2. Personal Communication between J.J. Carey, VP, DLC, and D.A. Chaney, USNRC, Project Manager, Operating Reactor Branch No. 1, Division of Licensing. Letter dated February 9, 1982.

U.S. Nuclear Regulatory Commission (USNRC) 1995. Voltage-based Repair Criteria for Westinghouse Steam Generator Tubes Affected by Outside Diameter Stress Corrosion Cracking, Generic Letter 95-05.

Regulatory Guide 1.183, Revision 0, "Alternative Radiological Source Terms for Evaluating Design Basis Accidents at Nuclear Power Reactors," July 2000.

BVPS-2 UFSAR

Tables for Section 6.4

TABLE 6.4-1

## CONTROL ROOM ENVELOPE VENTILATION DESIGN PARAMETERS

<u>Parameter</u>	<u>BVPS-1 Value</u>	<u>BVPS-2 Value</u>
Gross volume (ft <sup>3</sup> )	151,000	79,400
Net free volume (ft <sup>3</sup> )	114,000	59,000
Normal air makeup rate (cfm)	300	200
Post-accident air makeup rate (cfm)	1,000	1,000
Air changes per hour	---	0.35*
Recirculation air flow rate (cfm)	33,500	19,800
Control room emergency supply filtration unit characteristics		
Type	Moisture separator, **electric heating coil, HEPA, charcoal, HEPA	
Filter bed depth	2 inches charcoal	2 inches charcoal
Iodine filter efficiency		
Methyl iodide (at 30°C and 70% RH)	---	99%
Recirculation air filter characteristics		
Type	Roll and high efficiency	Roll and high efficiency
Redundant automatic detection equipment		
Area radiation monitors setpoint (mr/hr)	.47	0.476

NOTE:

\* Based on 1,000 cfm air makeup rate and combined net free volume.

\*\*Unit 2 only

TABLE 6.4-1a

CONTROL ROOM ENVELOPE VENTILATION PARAMETERS USED FOR  
LOCA AND CREA ANALYSES**Control Room Parameters**

Free Volume	173,000 ft <sup>3</sup>
Unfiltered Normal Operation Intake	500 cfm
Isolation Mode Inleakage	300 cfm
Emergency Intake Rate	600 to 1030 cfm
Emergency Recirculation Rate	Not Credited
Emergency Intake Filter Efficiency	99% (aerosols) 98% (elemental/organic iodine)
Unfiltered Emergency Mode Inleakage	30 cfm
Occupancy Factors	0 to 24 hr (1.0) 1 to 4 d (0.6) 4 to 30 d (0.4)
Operator Breathing Rate	0 to 30 d (3.5E-04 m <sup>3</sup> /sec)

**Delay in Initiation of Control Room Emergency Ventilation due to  
LOOP**

## Auto-Start on receipt of CIB (LOCA only)

CR isolated (includes diesel start up/ sequencing)	T=77 seconds
CR in emergency pressurization mode (not credited in analysis)	T=137 seconds

## Manual

CR in emergency pressurization mode	T=30 minutes
-------------------------------------	--------------

TABLE 6.4-3

LOCATIONS OF CONTROL ROOM AIR INTAKE, TOXIC GAS  
STORAGE, AND RADIATION RELEASE POINTS\*

	<u>Station Coordinate</u>		<u>Elevation</u>
	<u>N (ft)</u>	<u>E (ft)</u>	
<u>Radiation Release Points</u>			
D. BVPS-1 Elevated Release	3730	7550	885'
E. BVPS-1 Ventilation Vent	3946.5	7753	815'
F. BVPS-1 Turbine Building Vent	4014	7637.5	805'
G. BVPS-1 and BVPS-2 Process Vent	4290	8395	1210'
H. BVPS-2 Elevated Release	3907	8121	890'6"
I. BVPS-2 Ventilation Vent	3843	8025	820'
J. BVPS-2 Turbine Building Vent	3676	8100	847'
 <u>Toxic Gas Storage</u>			
K. Ammonium Hydroxide/Hydrazine	3740	7960	752'6"
L. Nitrogen	3570	7820	735'6"
M. Carbon Dioxide			
1 - 10-ton tank (Unit 1)	3677	7717	735'6"
1 - 5-ton tank (Unit 1)	4056	7735	735'6"
2 - 10-ton tank (Unit 2)	3890	7950	735'6"
1 - 24-ton tank (Unit 2)	3830	7909	735'6"
1 - 7.5-ton tank (Unit 2)	3623	8263	730'6"
N. Hydrogen	3570	7840	735'6"
Q. Morpholine/Sulfuric Acid	4020	7400	713'6"
 <u>Control Room Air Intakes</u>			
R. BVPS-1 Control Room Intake	3870	7770	735'6"
S. BVPS-2 Control Room Intake	3890	7820	746'10"

NOTE:

\*Refer to Figure 6.4-5.

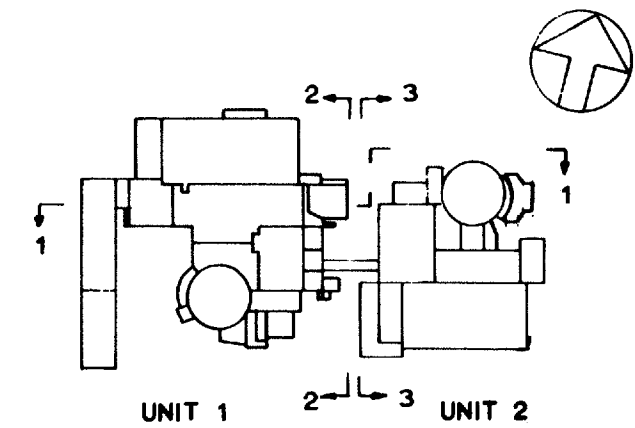

KEY PLAN  
SCALE 1" = 400'-0"

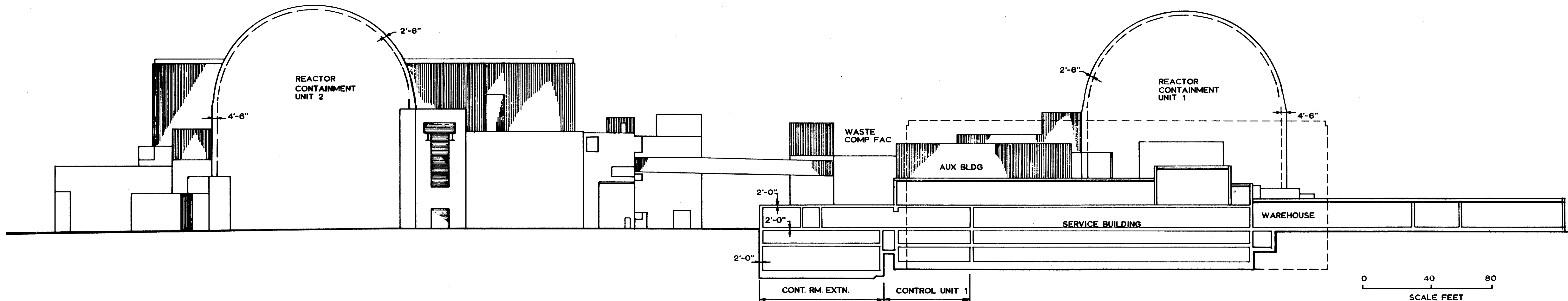

SECTION LOOKING SOUTH  
UNIT 1 & 2

FIGURE 6.4-2  
SECTION 1-1  
BEAVER VALLEY POWER STATION-UNIT 2  
FINAL SAFETY ANALYSIS REPORT

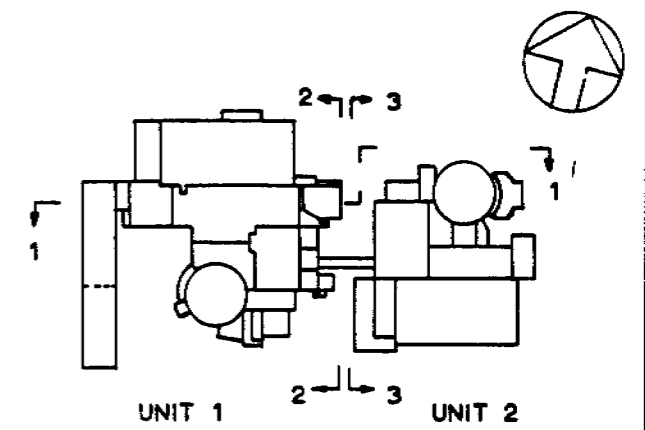

KEY PLAN  
SCALE 1" = 400'-0"

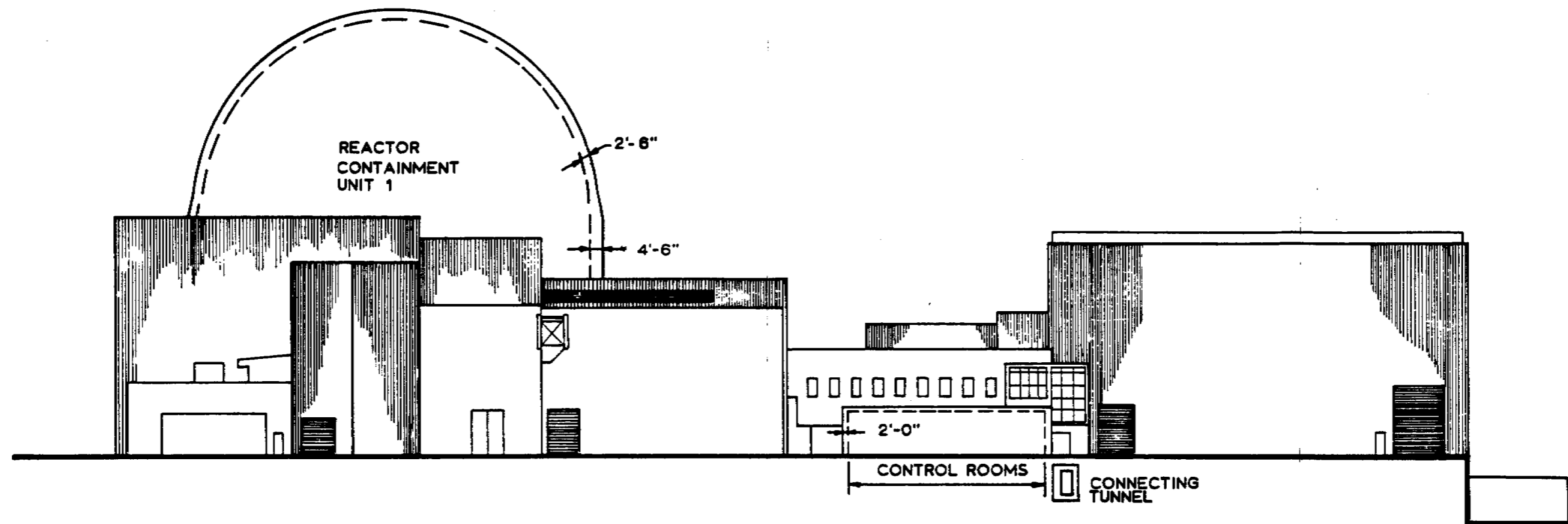

SECTION LOOKING WEST  
UNIT 1

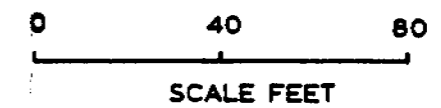
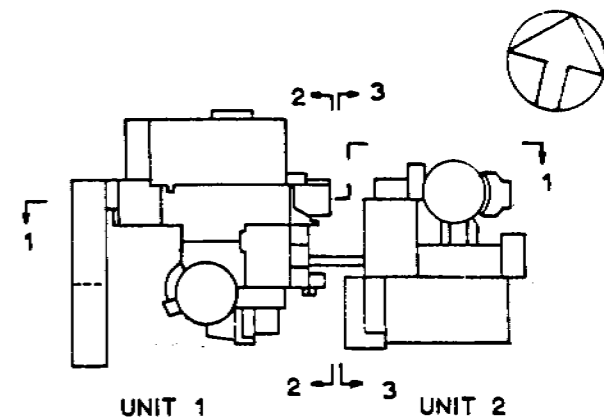
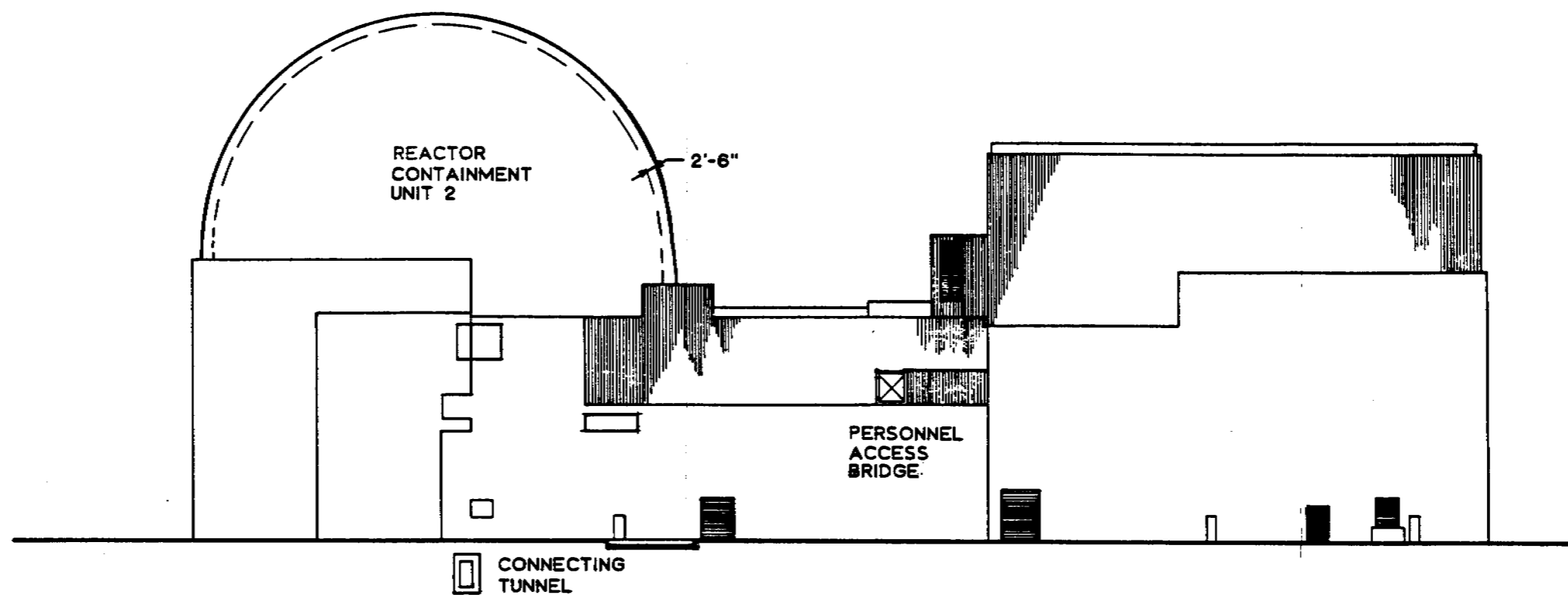

FIGURE 6.4-3  
SECTION 2-2  
BEAVER VALLEY POWER STATION-UNIT 2  
FINAL SAFETY ANALYSIS REPORT





KEY PLAN  
SCALE 1"=400'-0"



SECTION LOOKING EAST  
UNIT 2

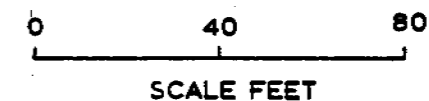

FIGURE 6.4-4  
SECTION 3-3  
BEAVER VALLEY POWER STATION-UNIT 2  
FINAL SAFETY ANALYSIS REPORT

Removed in Accordance with RIS 2015-17

FIGURE 6.4-5  
CONTROL ROOM AIR INTAKES  
TOXIC GAS STORAGE AND  
RADIATION RELEASE POINTS  
BEAVER VALLEY POWER STATION-UNIT 2  
UPDATED FINAL SAFETY ANALYSIS REPORT

## 6.5 FISSION PRODUCT REMOVAL AND CONTROL SYSTEMS

### 6.5.1 Engineered Safety Feature Filter Systems

The main control room area emergency supply filtration system, as described in Section 9.4.1, is an Engineered Safety Feature (ESF) filter system that is used to mitigate the consequences of accidents.

The supplementary leak collection and release system (SLCRS) filters are not credited for accident mitigation. The system is described in Section 6.5.3.2.

#### 6.5.1.1 Design Bases

The ESF filter systems are designed in accordance with the following criteria:

1. General Design Criterion 2, as it relates to the system being capable of withstanding the effects of natural phenomena, as established in Chapters 2 and 3.
2. General Design Criterion 5, as it relates to shared systems. No portion of the system is shared. However, dampers in all control room envelope normal intakes must close in order to isolate the common control room envelope.
3. General Design Criterion 19, as it relates to systems designed for habitability of the main control room for all accident conditions, with the exception of the Loss of Coolant Accident (LOCA), the Control Rod Ejection Accident (CREA) and the Fuel Handling Accident (FHA) which follow the criteria provided in 10 CFR 50.67.
4. General Design Criterion 41, as it relates to the design of systems to be used for containment atmosphere cleanup following postulated accidents and to control releases to the environment.
5. General Design Criteria 42 and 43, as they relate to the design of systems to permit the inspection and testing of containment ESF atmosphere cleanup systems.
6. General Design Criterion 60, as it relates to the control of the release of radioactive materials to the environment.
7. General Design Criterion 61, as it relates to the design of systems for radioactivity control under normal and postulated accident conditions.
8. General Design Criterion 64, as it relates to monitoring radioactive releases under normal, anticipated operational occurrences, and postulated accident conditions from ESF atmosphere cleanup systems.

9. Regulatory Guide 1.26, as it relates to the quality group classification of systems and components, as discussed in Section 1.8.
10. Regulatory Guide 1.29, as it relates to the seismic design classification of system components, as discussed in Section 1.8.
11. Regulatory Guide 1.52, as it relates to system design requirements, maximum system flow requirements, and system functional requirements, as discussed in Section 1.8.
12. Regulatory Guide 1.183, as it relates to use of the Alternative Source Term design criteria in 10 CFR 50.67 for LOCA, CREA, and FHA.

#### 6.5.1.2 System Design

The ESF filter systems are designed in accordance with Regulatory Guide 1.52, except as stated in Section 1.8. Table 6.5-1 compares design features of the ESF filter systems with Regulatory Guide 1.52.

#### 6.5.1.3 Safety Evaluation

The ESF filter systems are evaluated in Sections 15.6.5 and 15.7.4 to show that they adequately remove airborne radioactive material during the postulated accident. The system design features ensure that the systems operate before and after the postulated accidents, as described in Sections 6.5.3.2.3 and 9.4.1.3.

#### 6.5.1.4 Inspection and Testing Requirements

The ESF filter systems are inspected after installation to ensure that the equipment is properly installed and operates correctly. The systems are tested and balanced after installation. Preliminary tests are performed as described in Section 14.2.12.

#### 6.5.1.5 Instrumentation Requirements

The following instrumentation is supplied on ESF systems, as required by operating conditions:

1. High differential pressure drop indication across moisture separators, prefilters, high efficiency particulate air filters (HEPA), and charcoal adsorber banks. All the indicators have a high pressure drop alarm,
2. High and high-high temperature alarms on charcoal adsorbers,
3. Humidity indication upstream and downstream of the heater, with high humidity alarm downstream of heater,
4. Temperature indication upstream and downstream of the heater,
5. Open and closed indicators on motor-operated damper, and
6. Low airflow to heater alarm.

Instrumentation for the main control room emergency supply filtration system and for the SLCRS is described in Sections 9.4.1.5 and 6.5.3.2.5, respectively.

#### 6.5.1.6 Materials

The ESF filter systems utilize the following materials:

1. Ductwork, filter housings, filter component mounting frames, and water drains are fabricated from corrosion-resistant or painted carbon steel. Paints used for carbon steel can withstand all expected radiolytic and environmental conditions.
2. Prefilters meet Underwriters Laboratory (UL) Class 1 requirements in conformance with UL 900-1977 (UL 1977) and are listed in the current UL Building Materials List. The HEPA filters are qualified in accordance with UL 586-1977 and MIL-F-51068E (1981).
3. The adsorbent is steam-activated, virgin coconut shell carbon with physical properties in accordance with Table 2 of Regulatory Guide 1.52.
4. Elastomeric materials are capable of withstanding all expected radiolytic and environmental conditions.

#### 6.5.2 Containment Spray as a Fission Product Cleanup System

The quench spray system (QSS) and recirculation spray system (RSS), as described in Section 6.2.2, are safety-related systems that provide water spray to the containment during the unlikely event of a LOCA. Both systems function to depressurize the containment and to minimize the release of radioactive iodine and other aerosols to the environment. The analysis of the radiological consequences of the LOCA is given in Section 15.6.

##### 6.5.2.1 Design Bases

The following are the design bases of the QSS and RSS for removing iodine from the containment atmosphere:

1. General Design Criterion 41, as it relates to the design which permits containment atmosphere cleanup.
2. General Design Criterion 42, as it relates to the design which permits inspection of containment atmosphere cleanup systems.
3. General Design Criterion 43, as it relates to the design which permits testing of containment atmosphere cleanup systems.

4. The system is capable of functioning effectively with the single failure of an active component in the spray system, any of its subsystems, or any of its support systems.
5. The amount of radioactive iodine and other aerosols in the containment atmosphere following a DBA is reduced so that the outleakage will result in a Total Effective Dose Equivalent (TEDE) below the recommended limits of 10 CFR 50.67.
6. The spray system is designed to obtain adequate coverage of the containment volume in order to limit the site boundary dose following a DBA to a value less than that established in 10 CFR 50.67.
7. The spray nozzles are designed to minimize the possibility of clogging while producing droplet sizes effective for iodine absorption.
8. The QSS and RSS remove elemental iodines and particulates from the containment atmosphere. Iodine removal coefficients used for dose calculations are discussed in Section 6.5.2.3.1.
9. The long-term pH of the sump water using sodium tetraborate as a buffer is expected to remain above 7.0, considering radiolysis of the sump water and electric cable jacketing materials.
10. The QSS is designed to initiate automatically by an appropriate accident signal and is capable of continuous operation until the refueling water storage tank is emptied (Section 6.2.2).

#### 6.5.2.2 System Design

The QSS consists of two parallel flow paths. Each flow path consists of one spray pump and associated piping and valves. Both flow paths provide quench spray to opposite sides of the two spray headers. The QSS design is discussed in detail in Section 6.2.2, and component data are given in Table 6.2-56.

The quench spray nozzles are manufactured by Spray Engineering Company (SPRACO) and are Model 1713A. Section 6.2.2 discusses the quench spray header design and the regions of the containment that are sprayed.

The QSS is capable of operating continuously until RWST is emptied. The system meets the redundancy requirements of an ESF and will satisfy the system performance requirements despite the most limiting single active failure in the short term, or the most limiting single active or passive failure in the long term.

The QSS becomes effective in less than 90 seconds after the postulated event. The chronology of events for system operation is discussed in Section 6.2.2.

### 6.5.2.3 Design Evaluation

#### 6.5.2.3.1 Fission Product Cleanup

In the effectively sprayed region, fission product cleanup is actively accomplished by the quench and recirculation spray systems and passively by transport of particulates to the spray droplets and heat sink surfaces as a result of steam condensation on these surfaces (diffusiophoresis). In the unsprayed region, only passive gravitational settling promotes particulate removal.

The bounding fission product cleanup calculation for Units 1 and 2 is performed with the containment atmospheric conditions and with power uprating conditions. Since the bounding plant parameters applied for the fission product cleanup calculation such as the spray flow rates, spray droplet size, RWST temperature are conservative for the Unit 2 operation with the containment at sub-atmospheric conditions, all fission product cleanup results are applicable whether the plant is operating at sub-atmospheric or atmospheric conditions.

#### Removal of Particulates by Sprays

The particulates are effectively removed from the containment atmosphere by the quench and recirculation spray systems. The particulate removal rate is calculated with Stone & Webster's proprietary SWNAUA Computer Program (Lischer 1993). The SWNAUA Program is a derivative of the NAUA/MOD4 Computer Program (Bunz 1982) which has been modified for DBA calculations to include a conservative model for aerosol removal by sprays.

The model correlations that were implemented into SWNAUA tend to underestimate the spray removal coefficient. The spray model was originally described in Elia, 1993. For the effectively sprayed region of the containment, SWNAUA employs only the conservatively developed spray removal model and conservative condensation rates for the diffusiophoresis calculation when performing DBA calculations. While agglomeration is considered, its impact on the resulting particulate removal rates is negligible. In summary, the aerosol removal rates calculated by SWNAUA are conservative lower bound estimates.

There are several aerosol mechanics phenomena that promote the depletion of aerosols from the containment atmosphere. These include the natural phenomena of agglomeration, gravitational settling, diffusional plate-out, and diffusiophoresis; and removal by fluid mechanical interaction with the falling droplets that enter the containment atmosphere through the spray system nozzles. The particulate removal calculation for the effectively sprayed region takes credit for the removal effectiveness of only diffusiophoresis and sprays. Agglomeration of the aerosol is considered. If gravitational settling and diffusional plate-out were considered, the spray removal coefficients would be slightly reduced but the total removal effectiveness by all removal mechanisms would increase. In the unsprayed region, only gravitational settling of aerosols is credited.

The spray model in SWNAUA evaluates the particulate removal efficiency for each particle size in the aerosol by the following mechanisms: inertial impaction, interception, and Brownian diffusion. The aerosol removal constant due to spray is presented in NUREG-0772 as:

$$\lambda_{\text{spray}} = \frac{3 F_m h \varepsilon}{4 R_{\text{sp}} \rho_w V} \times \frac{V_{\text{spray}} - V_{\text{sed}}}{V_{\text{spray}}}$$

where

- $\lambda_{\text{spray}}$  = Particulate removal constant for spray
- $F_m$  = Spray mass flow rate
- $h$  = Spray fall height
- $\varepsilon$  = Collision efficiency
- $R_{\text{sp}}$  = Spray droplet radius
- $\rho_w$  = Density of the spray droplet
- $V$  = Effectively sprayed volume of containment
- $V_{\text{spray}}$  = Velocity of the spray droplets
- $V_{\text{sed}}$  = Aerosol sedimentation velocity

The collision efficiency is divided into three contributing mechanisms as described in BMI-2104:

$$\varepsilon = \varepsilon_i + \varepsilon_r + \varepsilon_d$$

where

- $\varepsilon_i$  = Efficiency due to inertial impaction
- $\varepsilon_r$  = Efficiency due to interception
- $\varepsilon_d$  = Efficiency due to Brownian diffusion



For viscous flow around the spray droplet, the inertial impaction efficiency is given in NUREG-0772:

$$\epsilon_i = \frac{1}{\left[1 + \frac{0.75 \ln(2 \text{Stk})}{\text{Stk} - 1.214}\right]^2}$$

The critical Stokes number,  $\text{Stk}$ , for viscous flow is 1.214; for  $\text{Stk}$  below this value, the model assumes the efficiency of inertial impaction is 0. The  $\text{Stk}$  is calculated from BMI-2104:

$$\text{Stk} = \frac{2 \rho_p r^2 C_c (v_{\text{spray}} - v_{\text{sed}})}{9 \mu R_{\text{sp}}}$$

where

- $r$  = Aerosol particle radius
- $\rho_p$  = Aerosol density
- $C_c$  = Cunningham slip correction factor
- $\mu$  = Gas viscosity

For droplet sizes typical of nuclear plant spray systems, the data of Walton and Woolcock show that the inertial impaction efficiency will be closer to that predicted for potential flow around the droplet. Calvert fitted this data to the expression:

$$\epsilon_i = \left(\frac{\text{Stk}}{\text{Stk} + 0.7}\right)^2$$

The inertial impaction efficiency predicted by this equation is always higher than that predicted by the viscous flow expression given above. Calvert's fit is employed in this calculation.

For the remaining constituents of the collision efficiency, the spray model employs an interception efficiency of the form:

$$\epsilon_r \cong \frac{3}{2} \left(\frac{r}{R_{\text{sp}}}\right)^2 \times \left(1 - \frac{1}{3} \frac{r}{R_{\text{sp}}}\right)$$

which is a conservative approximation of the expression given by BMI-2104. The efficiency due to Brownian motion is also taken from this report:

$$\epsilon_d = 3.5 \text{Pe}^{-2/3}$$

where

Pe = Peclet number

$$= 2v_{\text{spray}}R_{\text{sp}}/D_{\text{B}}$$

$D_{\text{B}}$  = Aerosol diffusion coefficient

$$= k_{\text{Boltz}}TB \text{ (Fuchs 1964)}$$

$k_{\text{Boltz}}$  = Boltzmann constant

$$= 1.3804 \times 10^{-16} \text{ erg/K}$$

T = Temperature, K

Fuchs gives the aerosol mobility, B:

$$B = \frac{C_c}{6\pi\mu r}$$

In most cases, the collision efficiency is dominated by inertial impaction, but for small aerosols, Brownian diffusion may become dominant. The inertial impaction efficiency increases as aerosol size is increased, whereas the Brownian diffusion efficiency increases as aerosol size decreases.

The model can handle a distribution of up to 20 droplet radii with the spray removal efficiency being determined for each aerosol size bin. However, the droplet diameter distribution can be accurately represented by a single diameter equal to the mass mean diameter (Elia 1993).

The bounding plant parameters for Units 1 and 2 are listed below.

Bounding Plant Parameters for Fission Product Cleanup Calculations

Parameter	Value
Sprayed Containment Volume	$3.1973 \times 10^{10} \text{ cm}^3$
Fall Height	2,403 cm
Spray Flow Rate	1,821 gpm (120-2,080 sec) 2,956 gpm (2,080-3,870 sec) 6,108 gpm (3,870-10,938 sec) 3,267 gpm (10,938-346,000 sec)
Spray droplet radius Mass mean radius	500 $\mu\text{m}$

The containment pressure, temperature, relative humidity, and steam condensing rate transients following the NUREG-1465 style DBA are presented in Table 6.5-2.

Description of Aerosol

The chemical composition of the aerosol is important only as it relates to the aerosol density utilized in the development of spray lambdas. The chemical composition during the gap release phase is assumed to be predominantly CsOH. The chemical composition during the in-vessel release phase is assumed to be 20 percent CsOH, 20 percent indium, and 60 percent silver. These compositions are based on a review of the SASCHA experimental results (Albrecht 1984). The aerosol input data for SWNAUA are provided below.

Description of Aerosol	
Minimum Aerosol Radius	1.0E-07 cm
Maximum Aerosol Radius	1.0E-02 cm
Maximum Number of Aerosol Size Bins	100
From 30 sec to 1830.0 sec	
Aerosol Injection Rate	6.13 (gm/sec)
Mean Geometric Radius	7.5E-06 cm
Geometric Standard Deviation	1.56
Aerosol Density	3.7 gm/cc
From 1830 sec to 6510.0 sec	
Aerosol Injection Rate	58.53 (gm/sec)
Mean Geometric Radius	4.0E-05 cm
Geometric Standard Deviation	1.46
Aerosol Density	4.6 gm/cc

#### Removal of Particulates by Diffusiophoresis

Diffusiophoresis entrains particulate matter in steam as it flows toward condensation surfaces. In this calculation, steam is assumed to condense on the spray droplets, on particulate matter, and on heat sinks. The diffusiophoresis model in the SWNAUA computer code is the same as that in the NAUA/MOD4 computer code.

The steam condensation rates used by SWNAUA are calculated by the LOCTIC computer code (Cho 1993). The LOCTIC code calculates conservative DBA containment pressure and temperature responses. Because LOCTIC predicts a conservatively high containment pressure transient, the rate of steam condensation from the containment atmosphere is minimized. The steam condensation rates that are input to the diffusiophoresis calculation of SWNAUA are taken as the steam removal rates from the containment atmosphere determined by LOCTIC.

The coefficient for removal of particulates from the effectively sprayed and unsprayed regions of the containment are plotted versus time in Figures 6.5-3 and 6.5-4, respectively. For the effectively sprayed region, the aerosol removal is due to sprays and diffusiophoresis. The particulate removal coefficient in the unsprayed region is due to gravitational settling only.

### Removal of Elemental Iodine

The calculated removal rate for elemental iodine in the vapor phase by sprays always exceeds  $20 \text{ hr}^{-1}$ , the maximum value permitted by NUREG-0800, Standard Review Plan Section 6.5.2. Therefore, elemental iodine is conservatively assumed to be removed by sprays at either the same rate as the aerosol particles when the aerosol removal rate is lower than  $20 \text{ hr}^{-1}$  or at  $20 \text{ hr}^{-1}$  when the aerosol removal rate is calculated to be higher than the NRC limit.

A plateout removal coefficient for elemental iodine is calculated with the model provided in NUREG-0800, Standard Review Plan Section 6.5.2. In the effectively sprayed region, a minimum plateout coefficient of  $2 \text{ hr}^{-1}$  is calculated.

No credit is taken for elemental iodine removal in the unsprayed region.

### Effectively Sprayed Containment Volume Fraction

The sprayed volume fraction of the containment is determined by superimposing spray patterns for various spray nozzle orientations onto containment arrangement drawings. The sprayed volume is the volume of unblocked spray patterns. The spray patterns are based on the nozzle manufacturer's laboratory tests at atmospheric conditions. The patterns have been compressed to account for the higher density atmosphere that exists during a DBA. The effectively sprayed volume is calculated by combining highly mixed unsprayed regions with directly sprayed regions.

The effective spray coverage fraction is determined to be 63.0 percent of the containment free volume. The concentration of fission products is expected to be uniform in the containment volume above the operating floor since this volume is open with very few obstructions to mixing. The sprayed volume is taken as the free volume above the operating floor plus the volume below the operating floor that is covered by recirculation spray. Actually, the whole containment is expected to be uniform in fission product concentration based on the discussion in Section 6.2.5, but the sprayed volume fraction has been limited to 63.0 percent.

### Containment Mixing

The mixing rate between the effectively sprayed volume and the unsprayed volume of the containment is assumed to be  $2 \text{ hr}^{-1}$ , the rate permitted by NUREG-0800, the Standard Review Plan Section 6.5.2.

#### 6.5.2.3.2 Range of Spray pH

Quench spray consists of a boric acid solution with a spray pH as low as 4.6. As indicated in Standard Review Plan (SRP), Section 6.5.2, Rev 2, "Containment Spray as A Fission Product Cleanup System," fresh sprays (sprays with no dissolved iodine) are effective at scrubbing elemental iodine and thus a spray additive is unnecessary during the initial injection phase when the spray solution is being drawn from the Refueling Water Storage Tank (RWST). As described in the SRP, research has shown that elemental iodine can be scrubbed from the atmosphere with borated water, even at low pH. The SRP provides an equation for calculating a first order removal coefficient that is not dependent on pH.

The conditions assumed in calculating the minimum expected spray pH for the system are given in Table 6.5-4. The spray pH will remain at or above the value given in the table for all operating modes of the system. The values of the parameters used in calculating the limiting pHs are those Technical Specification limits which tend to minimize pH as appropriate.

#### 6.5.2.3.3 Ultimate Sump pH

The minimum expected ultimate sump pH is given in Table 6.5-5 along with the boric acid and NaTB sources considered in the analysis. The values of the parameters listed in this table are consistent with the appropriate Technical Specification limits which minimize the pH.

#### 6.5.2.4 Inspection and Testing Requirements

The inspection and testing of the quench spray system is described in Section 6.2.2.4.

#### 6.5.2.5 Instrumentation Requirements

The instrumentation required by the QSS is given in Section 6.2.2.5.

#### 6.5.2.6 Materials

The boric acid solution shows little change at high temperatures (130°C) with or without radiation (Eggleton 1967; Fittel and Row 1971; Greiss and Bacarella 1969). The solution is not susceptible to significant radiolytic or pyrolytic decomposition under conditions found in nuclear power plant containments.

### 6.5.3 Fission Product Control Systems

#### 6.5.3.1 Primary Containment

##### 6.5.3.1.1 Design Bases

The containment is a steel-lined, reinforced concrete construction. A complete description of the primary containment is presented in Sections 3.8.1, 3.8.2, and 6.2.1.

##### 6.5.3.1.2 Deleted

##### 6.5.3.1.3 Containment Purge System

Section 9.4.7.3 provides a description of the containment purge system.

#### 6.5.3.1.4 Primary Containment Leakage

Although the primary containment is designed to be leaktight, a design leakage rate is established and periodically verified at 0.1 percent of containment mass per day or less (Table 6.5-6). During a DBA, this leakage value is assumed for the initial 1 hour period, after which the reduction in containment pressure to subatmospheric levels precludes any further leakage. Section 6.2.6 provides a description of the containment leakage testing program and monitoring system, and Section 15.6.5 discusses the fission product release via the containment during a DBA. Information on the fission product removal system (containment spray system) is provided in Section 6.5.2.

#### 6.5.3.2 Supplementary Leak Collection and Release System

The function of the SLCRS is to collect potential containment leakage to the cable vault and rod control area, charging pump cubicles, component cooling water (CCW) pumps area, safeguards area, auxiliary building, and fuel building. The air is processed and filtered before release to the atmosphere at an elevated point. The system is designated as Safety Class 3. The SLCRS is shown on Figure 6.5-2. Design parameters of the SLCRS are listed in Table 6.5-7.

##### 6.5.3.2.1 Design Bases

The SLCRS is designed to the following criteria:

1. The SLCRS provides safety related cooling to the cable vault and rod control area by maintaining temperature at or below 120°F during loss of offsite power, containment isolation phase B, or loss of chilled water cooling to the area. SLCRS is not required for cooling this area in the event of a tornado.
2. General Design Criterion 2, as it relates to the system being capable of withstanding the effects of natural phenomena, as established in Chapters 2 and 3.
3. General Design Criterion 4, as it relates to the portion of structures housing the system, and the portion of the system itself necessary for safe shutdown being capable of withstanding the effects of external and internally-generated missiles, pipe whip, and jet impingement forces associated with pipe breaks. The ventilation equipment room of the SLCRS, located on the top of the auxiliary building, is not required to be protected against tornadoes, hurricanes, or missiles because these natural phenomena are assumed not to occur within 24 hours before or after a DBA.
4. General Design Criterion 5, as it relates to shared systems and components important to safety.
5. General Design Criterion 17, as it relates to assuring proper functioning of the essential electric power system.
6. General Design Criterion 41, as it relates to the containment atmosphere cleanup system being designed to control fission product releases to the environment following postulated accidents.

7. General Design Criterion 42, as it relates to the containment atmosphere cleanup system being designed to permit periodic inspection.
8. General Design Criterion 43, as it relates to the containment atmosphere cleanup system being designed to permit appropriate functional testing.
9. General Design Criterion 60, as it relates to the control of the release of radioactive materials to the environment.
10. Regulatory Guide 1.26, as it relates to the quality group classification of systems and components. This system is classified as QA Category I, Safety Class 3.
11. Regulatory Guide 1.29, as it relates to the seismic design classification of system components. This system is classified as Seismic Category I.
12. Regulatory Guide 1.52, with exceptions as indicated in Section 1.8, as it relates to system design requirements, maximum system flow requirements, design provisions for radiation detection, and isolation provisions for air filtration and adsorption unit.
13. Regulatory Guide 1.140, as it relates to the design, testing, and maintenance criteria for atmospheric cleanup systems.
14. Branch Technical Positions ASB 3-1 and MEB 3-1, as they relate to breaks in high and moderate energy piping system outside containment.

Other design bases include:

1. The maintenance of negative pressure in areas contiguous to the containment (except the main steam and feedwater valve area) and in the fuel building.
2. Filtration by impregnated charcoal absorber banks for radioactive iodine removal utilizing gasketless type module design, thus eliminating elastomer seals. Charcoal beds are seal-welded to the assembly and have a filling device to allow filling to a minimum density of 30 lb/ft<sup>3</sup>.
3. The provision of continual monitoring for radioactive particulate, iodine, and gaseous nuclides in the exhaust air being discharged at an elevated release point.
4. The use of redundant demister assemblies, each with an electric heating coil, filter banks, and exhaust fans operable on emergency power.
5. The system is designated as nuclear safety-related.



6. Equipment and system capability of withstanding the design basis earthquake without loss of function.
7. Continuous exhaust through the HEPA filters and charcoal filtration units from the auxiliary building, charging pump cubicles, fuel building, and solid waste handling building.
8. Safety-related equipment in the Charging Pump Cubicles, Component Cooling Pump Area, Auxiliary Personnel Airlock, and the Cable Vault Areas Elev. 735' and 755' requires SLCRS flow for cooling. An Emergency Ventilation System, discussed in Section 9.4.3.2, as available for cooling those areas in the rare circumstances where SLCRS is unavailable.

#### 6.5.3.2.2 System Description

The components and operation of the SLCRS are shown on Figure 6.5-2 (design basis analysis (DBA) flow rates are also provided) and in Tables 6.5-7 and 6.5-8. The primary function of the SLCRS is to ensure that radioactive leakage from the primary containment following a DBA is collected and filtered for iodine removal prior to discharge to the atmosphere at an elevated release point through a ventilation vent. This ventilation vent also discharges the exhaust from the gland seal steam exhaust system as described in Section 9.4.15.

The SLCRS consists of: 1) one 10,500 cfm and one 29,000 cfm leak collection normal exhaust fans powered from the normal buses, 2) two 34,000 cfm leak collection filter exhaust fans powered from the emergency buses, 3) four 28,500 cfm filter banks, and 4) two 13,000 cfm emergency charging pump cubicle exhaust fans.

Air is exhausted from the fuel building, solid waste handling building, auxiliary building, charging pump cubicles, CCW pump area, post accident sampling system panel and personnel sampling area, and from the areas contiguous to the reactor containment except the main steam and feedwater valve area. The areas contiguous to the reactor containment are the personnel access hatch area, equipment hatch enclosure, purge duct area, main steam and feedwater valve area, cable vault and rod control building at el 735 ft-6 in and el 755 ft-6 in, pipe tunnel, and safeguards areas.

The capacity of each leak collection filter exhaust fan is in excess of the estimated air leakage to the containment contiguous areas and the other buildings delineated in the previous paragraph. The excess capacity of the fan ensures a negative pressure in the areas being exhausted. Tables 6.5-7 and 6.5-8 list nominal air flow rates required to ensure the negative pressure.

In order to limit air leakage into these structures to less than the design capacity of a leak collection exhaust fan, all penetration pipes, ducts, and cables are sealed at or near the point where they pass from the contiguous structure to some other structure, such as for example, the auxiliary building. A flexible sealing compound is used between electrical cables and sleeves. Doors are either locked or self-closing, and are under administrative control.

The modes of operation of the SLCRS and nominal air flow rates are shown in Table 6.5-8. One of the leak collection normal exhaust fans is used to exhaust the various areas listed previously. The other fan is used as a standby. After plant shutdown, the standby fan is used for purging the reactor containment.

During normal plant operation, the inlet vanes of "A" Train normal exhaust fan is manually set to exhaust unfiltered air at the nominal rate of 10,500 cfm from the SLCRS areas, except for the solid waste handling building, auxiliary building, charging pump cubicles, CCW pump area, and the fuel building. The exhaust air from the excepted SLCRS areas is demisted, filtered, and exhausted by the leak collection filter exhaust fans. The other demister assemblies and main filter banks are used as standby.

On a containment isolation Phase A signal, or on a high radiation signal from monitors in the ventilation exhaust from the areas contiguous to the containment, the air that is normally exhausted by the leak collection normal exhaust fans (Figure 6.5-2) is diverted so that it first flows through one of the two parallel demister assemblies and then through the aligned main filter banks before flowing to the leak collection filter exhaust fans. Each demister assembly consists of a moisture separator and an electric heating coil. The moisture separator removes entrained water droplets while the electric heating coil reduces the relative humidity to less than 70 percent before the exhaust air stream passes through the main filter banks. Moisture separators are effective for the removal of at least 99 percent by weight of the entrained moisture in an air stream containing 0.005 lb of entrained moisture per ft<sup>3</sup>, and at least 99 percent by count of the 1 to 10 micrometer diameter droplets without visible carryover when operating at rated capacity of 57,000 cfm. Each main filter bank consists of HEPA filter, charcoal, and a second set of HEPA filter.

The charcoal filters are effective for radioactive iodine removal and the second HEPA filters remove particulates and charcoal fines at a rated efficiency of 99.97 percent when tested with 0.30 micron dioctyl phthalate. The charcoal filters are rated for 0.25 second residence time. The charcoal filters are shown on Figure 6.5-2. They are of flat parallel bed design, containing approximately 500 pounds of charcoal per bed. The media is new, impregnated, activated, coconut shell charcoal. The qualification of impregnated carbon will be in accordance with Table 5-1 of ANSI N509-1980. Charcoal cells are leak-tested according to ANSI 510. A heat detection alarm and manual water spray system is provided to prevent ignition in the event of decay heat buildup. Overtemperature conditions are alarmed locally and in the main control room.

The leak collection filter exhaust fans discharge through a duct to an elevated release point 150 feet above grade. This elevated release point is located on the top of the containment structure, which is 144 feet above grade. The duct and supporting structure is designed to accommodate seismic forces.

The leak collection normal exhaust and filter exhaust fans are also used for reactor containment purging after plant shutdown to remove radioactivity from containment atmosphere. Section 9.4.7, Containment Ventilation System, provides additional information about the purge system.

Should the SLCRS suffer a loss of function, the emergency exhaust fan system, as shown on Figure 9.4-4, may be started manually from the main control room to remove the heat generated by the charging pumps and the CCW pumps. The emergency exhaust fan system consists of ducting, motor-operated dampers, and two axial flow fans with back draft dampers located within the tornado missile-protected portion of the auxiliary building. The fans are powered from the emergency buses.

#### 6.5.3.2.3 Safety Evaluation

The SLCRS incorporates redundant 100 percent capacity leak collection exhaust fans, demister assemblies, and main filter banks. In addition, there are redundant dampers where required. The redundant fans, electric heating coils, and dampers are connected to redundant emergency buses, which are capable of being supplied either from normal 4,160 V buses 2A and 2D or emergency diesel generators 2-1 and 2-2 (Figure 8.3-1). Thus, there is sufficient redundancy in the system to ensure system reliability. The SLCRS collects, filters, and releases at an elevated point, the leakage from the containment following a DBA. Essentially, all the leakage from the containment following a DBA flows into containment contiguous areas. These areas house the various containment penetrations, ESF equipment circulating radioactive water, and equipment used for plant shutdowns. The SLCRS, with the exception of the ESF portion of the system, is not tornado missile-protected.

The elevated release point in the SLCRS is located above the top of the containment and has a discharge flow rate of about 57,000 cfm. The contiguous area exhaust is normally exhausted directly to atmosphere, but the exhaust is automatically diverted through one of the demister assemblies and main filter banks on an accident signal and is discharged at this elevated release point. Upon failure of both hydrogen recombiners, the hydrogen control system purge blower will take suction from either recombiner suction line. The discharge of the blower is connected directly into the SLCRS contiguous area exhaust ductwork (see Section 6.2.5).

A FMEA to determine if the I&C and electrical portions meet the single failure criterion, and to demonstrate and verify how the GDC and IEEE Standard 279-1971 requirements are satisfied, has been performed on the supplementary leak collection and release system. The FMEA methodology is discussed in Section 7.3.2. The results of this analysis can be found in the separate FMEA document (Section 1.7).

#### 6.5.3.2.4 Inspection and Testing Requirements

The system is inspected after installation to ensure that the equipment is properly installed and operates correctly. The system is tested and balanced after installation. Preliminary tests are performed as described in Section 14.2.12.

#### 6.5.3.2.5 Instrumentation Requirements

The fans and dampers for the SLCRS have manual controls and indicating lights in the main control room.

During normal operation, one leak collection normal exhaust fan is manually started. Upon failure of this fan, the standby normal exhaust fan is manually started. After plant shutdown, the normal exhaust fan is manually started for reactor containment purging; however, if high radiation is detected in the containment, the normal exhaust fan is automatically stopped and the air is diverted through the leak collection filters. During normal operation, both leak collection filter exhaust fans are manually started. Isolation dampers for both demister assemblies are manually opened. The outlet isolation dampers of the inservice filter bank are manually opened. The total flow through the leak collection filter exhaust fans is maintained constant by the automatic modulation of the variable inlet vanes mounted on each fan.

Following an accident signal, or when high radiation is detected in the areas contiguous to the containment, the leak collection normal exhaust fans are automatically isolated and the standby demister assembly and filter bank are automatically started so that all flow is routed through the leak collection filter exhaust fans. Each leak collection exhaust fan can be manually started or stopped from the main control room to supply emergency ventilation to the charging pump cubicles and the CCW pumps.

The following indications of system operation are provided in the main control room:

1. Auto trip of each leak collection normal exhaust fan is annunciated,
2. Auto trip of each leak collection filter exhaust fan is annunciated,
3. Auto trip of each emergency exhaust fan is annunciated,
4. High radiation in the containment and the exhausted air are annunciated, and
5. High differential pressure across each filter and low flow through a heater are annunciated.

## 6.5.4 References for Section 6.5

ANSI/ANS Standard 56.5. 1979. PWR and BWR Containment Spray System Design Criteria.

Eggleton, A.E.J. 1967. A Theoretical Examination of Iodine-Water Partition Coefficients. UKAEA, AERE-R4887.

Fittel, H.E. and Row, T. H. 1971. Radiation and Thermal Stability of Spray Solutions. Nuclear Technology, p 442.

Griess, J. C. and Bacarella, A. A. 1969. Design Considerations of Reactor Containment Spray System - Part III, The Corrosion of Materials in Spray Solutions. ORNL-TM-2412, Part III, p 15.

Underwriter Laboratories 1977. Test Performance of Air Filter Units. UL 586-1977.

Underwriter Laboratories 1977. Test Performance of High Efficiency Particulate Air Filter Units. UL 900-1977.

U.S. Department of Defence 1981. Filter, Particulate High Efficiency, Fire Resistant. MIL-F-51068E.

Lischer, D.J., User's Manual, *Aerosol Behavior in a Condensing Atmosphere (SWNAUA)*, June 1993, (Stone & Webster Proprietary)

Bunz, H., Kayro, M., Schöck, W., 1982, NAUA/Mod4 - A Code for Calculating Aerosol Behaviour in LWR Core Melt Accidents, Code Description and User Manual, KfK.

Elia, Frank A. Jr. and Lischer, D. Jeffrey, *Advanced Method for Calculating the Removal of Airborne Particles with Sprays*, 1993, ASME paper no. 93-WA/SERA-5.

NUREG-0772, 1981, "Technical Bases for Estimating Fission Product Behavior During LWR Accidents."

Battelle Columbus Laboratories, BMI-2104, Vol. III, draft report, 1984, "Radionuclide Release Under Specific LWR Accident Conditions."

Walton, W. H., and Woolcock, A., 1960, "The Suppression of Airborne Dust by Water Spray," Intern. J. Air Pollution 3, 129-153.

Calvert, S., 1970, "Venturi and Other Atomizing Scrubbers Efficiency and Pressure Drop," AIChE Journal 16, 392-396.

Fuchs, N.A., 1964, "The Mechanics of Aerosols," revised and enlarged edition, Dover Publications, Inc.

Albrecht, H. and H. Wild, "Review of the Main Results of the SASCHA Program on Fission Product Release Under Core Melting Conditions," ANS Meeting on Fission Product Behavior and Source Term Research, Snowbird, Utah, 15-19 July 1984.

Cho, J. H., User's Manual, *Loss of Coolant Transient Inside Containment (LOCTIC)*, January 1993, (Stone & Webster Proprietary)

NUREG-0800, 1988, Standard Review Plan, "Containment Spray as a Fission Product Cleanup System," Section 6.5.2, Revision 2.

BVPS-2 UFSAR

Tables for Section 6.5

TABLE 6.5-1

COMPARISON OF ENGINEERED SAFETY FEATURES  
 FILTER SYSTEM DESIGN FEATURES WITH  
 REGULATORY GUIDE 1.52

<u>Regulatory Guide 1.52 Paragraph</u>	<u>Control Room Area Pressurization Filtration System</u>	<u>Supplementary Leak Collection System</u>
C.1.a	A	A
C.1.b	A	A
C.1.c	A	A
C.1.d	A	A
C.1.e	A	A
C.2.a	A	A
C.2.b	A	B
C.2.c	A	A
C.2.d	A	A
C.2.e	A	A
C.2.f	A	B
C.2.g	B	B
C.2.h	B	B
C.2.i	A	A
C.2.j	B	B
C.2.k	A	A
C.2.l	B	B
C.3.a	B	B
C.3.b	A	A
C.3.c	A	A
C.3.d	A	A
C.3.e	B	B
C.3.f	A	B
C.3.g	B	B
C.3.h	A	A
C.3.i	B	B
C.3.j	A	A
C.3.k	A	A
C.3.l	B	B
C.3.m	A	A
C.3.n	B	B
C.3.o	A	A
C.3.p	B	B
C.4.a	B	B
C.4.b	A	A
C.4.c	A	A
C.4.d	B	B
C.4.e	A	A



TABLE 6.5-1 (Cont)

<u>Regulatory Guide 1.52 Paragraph</u>	<u>Control Room Area Pressurization Filtration System</u>	<u>Supplementary Leak Collection System</u>
C.5.a	B	B
C.5.b	B	B
C.5.c	B	B
C.5.d	B	B
C.6.a	A	A
C.6.b	B	B

NOTES:

- A - Designed in accordance with Regulatory Guide 1.52.  
 B - Section 1.8 discusses design exceptions and justifications.

TABLE 6.5-2

## CONTAINMENT THERMODYNAMIC DATA - LOSS OF COOLANT ACCIDENT

TIME (SEC)	TEMP (°F)	PRESSURE (PSIA)	RELATIVE HUMIDITY	RATE OF STEAM CONDENSING (G/SEC)
0.0	105.0	16.0	0.5	0.0
5.0	268.1	43.4	0.579	0.0
10.0	258.7	54.3	1.0	662517.1
15.8	267.0	59.8	1.0	865230.2
20.0	265.2	58.6	1.0	711550.4
30.0	260.7	55.6	1.0	421296.6
40.0	257.5	53.7	1.0	270885.4
50.0	255.3	52.3	1.0	194772.6
86.5	251.3	50.0	1.0	99195.4
135.0	247.2	47.8	1.0	87661.3
235.0	241.5	44.9	1.0	63167.3
301.5	238.6	43.5	1.0	79700.7
435.0	228.3	39.1	1.0	72919.5
585.0	218.6	35.4	1.0	59647.4
670.0	213.7	33.7	1.0	54571.7
720.0	211.0	32.9	1.0	51922.7
1220.0	190.5	27.4	1.0	35625.1
1720.0	178.6	24.9	1.0	29102.5
2220.0	156.6	21.5	1.0	12795.8
2720.0	143.4	20.1	1.0	7389.0
3220.0	137.2	19.6	1.0	5892.2
5139.0	127.3	19.3	1.0	4964.0
6220.0	124.7	19.3	1.0	4880.7
6470.0	124.2	19.4	1.0	4808.1
6520.0	138.6	20.7	1.0	13285.7
6570.0	175.9	25.9	1.0	52149.5
6620.0	194.0	29.7	1.0	79732.5
6670.0	205.5	32.8	1.0	95658.1
6720.0	213.8	35.4	1.0	104380.7
6770.0	220.2	37.7	1.0	108835.0
6820.0	225.4	39.6	1.0	111157.4
6870.0	229.6	41.3	1.0	111610.9
6920.0	233.0	42.8	1.0	111270.8
6970.0	235.7	44.0	1.0	109542.6
7020.0	237.7	44.9	1.0	107474.2
7070.0	239.0	45.5	1.0	104947.7
7120.0	239.7	45.8	1.0	102285.1
7220.0	238.9	45.5	1.0	94288.3

TABLE 6.5-2 (Cont)

Containment Thermodynamic Data - Loss of Coolant Accident

<b>TIME (SEC)</b>	<b>TEMP (°F)</b>	<b>PRESSURE (PSIA)</b>	<b>RELATIVE HUMIDITY</b>	<b>RATE OF STEAM CONDENSING (G/SEC)</b>
7270.0	237.4	44.8	1.0	90038.1
7320.0	235.0	43.7	1.0	85302.6
7370.0	231.5	42.1	1.0	80145.2
7520.0	215.9	36.2	1.0	60609.0
7820.0	185.4	27.9	1.0	34005.8
8120.0	160.3	23.5	1.0	18356.9
8420.0	144.8	21.5	1.0	9806.7
8720.0	137.6	20.8	1.0	6418.3
9120.0	133.7	20.4	1.0	5261.7
9320.0	138.1	20.8	1.0	2263.4
10020.0	140.4	21.1	1.0	4195.7
11770.0	138.0	20.8	1.0	4390.8
14020.0	136.0	20.6	1.0	4418.0
18020.0	134.1	20.4	1.0	4463.3

TABLE 6.5-4

PARAMETERS FOR CALCULATING MINIMUM  
SPRAY PH DURING QUENCH SPRAY OPERATION

	Minimum* <u>pH = 4.6</u>
Quench spray flow rate (gpm)	4,450
Boron concentration in the RWST (ppm)	2,600

NOTES:

\*Minimum quench spray pH is calculated utilizing the following:

1. Maximum quench spray flow rates
2. Maximum boron concentration in the RWST

TABLE 6.5-5

## PARAMETERS FOR MINIMUM ULTIMATE SUMP PH CALCULATION

RWST volume (gal)	866,592
Boron concentration in RWST (ppm)	2,600
Reactor coolant system (RCS) volume (gal)	66,386
Boron concentration in RCS (ppm)	2,400
Safety injection (SI) accumulator volume (gal)	8,020
Boron concentration in accumulators (ppm)	2,600
Weight of NaTB in Containment Sump pH Control (lbs.)	13,980 (Minimum)
Resulting minimum ultimate sump pH*	7.0

NOTE:

\*The minimum ultimate sump pH is calculated utilizing the following:

1. Maximum boron concentration in the RWST, RCS, and SI accumulators,
2. Maximum volume of the RWST, RCS, and SI accumulators, and
3. Minimum weight of NaTB in the containment sump pH control system.

TABLE 6.5-6

## PRIMARY CONTAINMENT INFORMATION

<u>Data Description</u>	<u>Parameter Value</u>
Type of structure	Steel-lined reinforced concrete
Primary containment design leak rate	≤ 0.1% per day
Primary containment operation	13.5 psia
Primary containment internal fission product removal systems	
Ice condenser	Not applicable
Spray system (accident)	3,000 gpm each pump
Filter system (normal operation)	2 at 10,000 cfm each
H <sub>2</sub> purge mode (direct; to recirculation systems; to annulus)	
Purge initiation time	Long term backup
Purge rate	50 cfm
Primary containment purge	
Normal plant operation	Containment not purged
At cold shutdown	29,000 cfm max*
Valve arrangement	Figure 6.5-2

\*As Built Parameter

TABLE 6.5-7

SUPPLEMENTARY LEAK COLLECTION AND RELEASE SYSTEM  
PRINCIPAL COMPONENTS AND DESIGN PARAMETERS

<u>Components</u>	<u>Design Parameters</u>	
Leak collection normal exhaust fan		
Quantity	1*	1*
Capacity, (cfm) each	29,000*	17,350*
Static pressure (in WG)	6.6*	9.4*
Motor (hp) each	50	50
Leak collection filter exhaust fan		
Quantity	2	
Capacity (cfm) each	34,000*	
Static pressure (in WG)	21.1	
Motor (hp) each	200	
Emergency charging pump cubicle exhaust fan		
Quantity	2	
Capacity (cfm) each	13,000	
Static pressure (in WG)	6.0	
Motor (hp) each	30	
Filter house assembly		
Quantity	4	
Capacity (cfm) each	28,500	
Charcoal filter pressure drop (in WG)	0.9	
Elemental iodine removal efficiency (at 30°C and 95% RH)	99.5%	
Upstream HEPA pressure drop (in WG)		
New	1.3 @ 1500 cfm per cell	
Dirty (requires replacement)	3	
HEPA efficiency	99.97%	
Downstream HEPA pressure drop (in WG)		
New	1.3 @ 1500 cfm per cell	
Dirty (requires replacement)	2	
HEPA efficiency	99.97%	

\*As Built Parameters

TABLE 6.5-8

SUPPLEMENTARY LEAK COLLECTION AND RELEASE SYSTEM  
AIR FLOW RATES

<u>Modes of Plant Operation</u>	<u>Normal</u>		<u>Normal</u>		<u>Normal</u>		<u>Reactor Trip</u>		<u>Purge</u>		<u>Purge</u>		<u>Refueling</u>		<u>Refueling</u>	
	<u>Incident condition</u>	None	None	Rad. Signal in RC Contg. Areas	Loss of Filter Exhaust Fan	DBA or Loss of Normal Power	High Activity in Reactor Contmnt	No Activity in Reactor Contmnt	No Activity in Fuel Bldg.	High Activity in Fuel Bldg.	Filtered	Unfilt	Filtered	Unfilt	Filtered	Unfilt
<u>Filtration modes</u>	Filtered	Unfilt	Filtered	Unfilt	Filtered	Unfilt	Filtered	Unfilt	Filtered	Unfilt	Filtered	Unfilt	Filtered	Unfilt	Filtered	Unfilt
<u>Air Flow (cfm) From:</u>																
Aux bldg and Solid Waste Handling Building	39,250	0	26,750	0	17,000	0	0	0	20,500	0	17,000	0	20,500	0	20,500	0
Aux bldg charging and component cooling pumps area	14,750	0	14,550	0	15,000	0	16,750	0	12,500	0	15,000	0	12,500	0	12,500	0
Main steam valve area**	0	0	0	0	0	0	0	0	0	0	0	0	0	0	0	0
Fuel bldg	3,000	0	3,000	0	2,000	0	3,500	0	2,500	0	2,000	0	2,500	0	2,500	0
RC contiguous area	0	10,500	11,100	0	0	10,500	15,000	0	0	10,500	0	10,500	0	10,500	0	10,500
RC purge	0	0	0	0	0	0	0	0	9,400***	0	0	29,000	7,500	0	7,500	0
Total flow (cfm):	57,000	10,500	55,400	0	34,000	10,500	35,250	0	44,900	10,500	34,000	39,500	43,000	10,500	43,000	10,500
Exhausted by: exh fan	Filter** exh fan	Normal*** exh fan	Filter exh fan	Normal exh fan	Filter exh fan	Normal exh fan	Filter exh fan	Normal exh fan	Filter exh fan	Normal exh fan	Filter exh fan	Normal exh fan	Filter exh fan	Normal exh fan	Filter exh fan	Normal exh fan
Flow per fan (cfm):																
Fan "A"	28,500	10,500	27,700	0	34,000	10,500	35,250	0	44,900	10,500	34,000	10,500	43,000	10,500	43,000	10,500
Fan "B"	28,500	Standby	27,700	Standby	Lost	Standby	0 (single failure)	0	0	Standby	0	29,000	Standby	Standby	Standby	Standby
<u>Filter Capacity (cfm):</u>																
Main filter - Bank "A"	59,000	--	59,000	0	59,000	--	59,000	--	59,000	--	59,000	--	59,000	--	59,000	--
Main filter - Bank "B"	Standby	--	Standby	--	Standby	--	Standby	--	Standby	--	Standby	--	Standby	--	Standby	--

NOTES:

\*\*Flow path is not used - the duct is blanked off.

\*\*\*Flow path isolates on High High Activity in Reator Containment, flow is zero at that time. Air flow limitation is not required for the purpose of controlling a fuel handling accident radiological release.



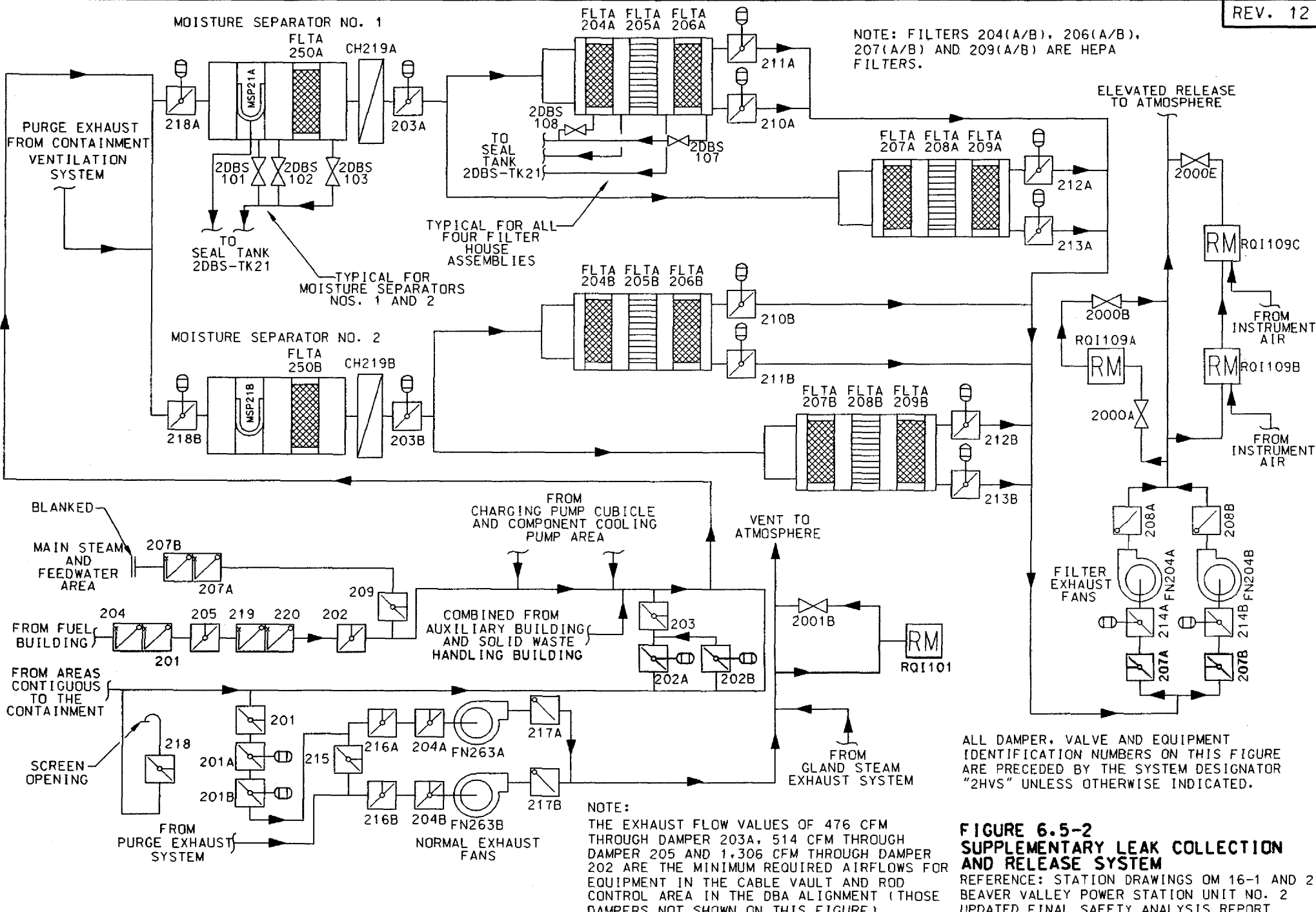

NOTE: FILTERS 204(A/B), 206(A/B), 207(A/B) AND 209(A/B) ARE HEPA FILTERS.

TYPICAL FOR ALL FOUR FILTER HOUSE ASSEMBLIES

TYPICAL FOR MOISTURE SEPARATORS NOS. 1 AND 2

ALL DAMPER, VALVE AND EQUIPMENT IDENTIFICATION NUMBERS ON THIS FIGURE ARE PRECEDED BY THE SYSTEM DESIGNATOR "2HVS" UNLESS OTHERWISE INDICATED.

NOTE:  
 THE EXHAUST FLOW VALUES OF 476 CFM THROUGH DAMPER 203A, 514 CFM THROUGH DAMPER 205 AND 1,306 CFM THROUGH DAMPER 202 ARE THE MINIMUM REQUIRED AIRFLOWS FOR EQUIPMENT IN THE CABLE VAULT AND ROD CONTROL AREA IN THE DBA ALIGNMENT (THOSE DAMPERS NOT SHOWN ON THIS FIGURE).

**FIGURE 6.5-2**  
**SUPPLEMENTARY LEAK COLLECTION AND RELEASE SYSTEM**  
 REFERENCE: STATION DRAWINGS OM 16-1 AND 2  
 BEAVER VALLEY POWER STATION UNIT NO. 2  
 UPDATED FINAL SAFETY ANALYSIS REPORT

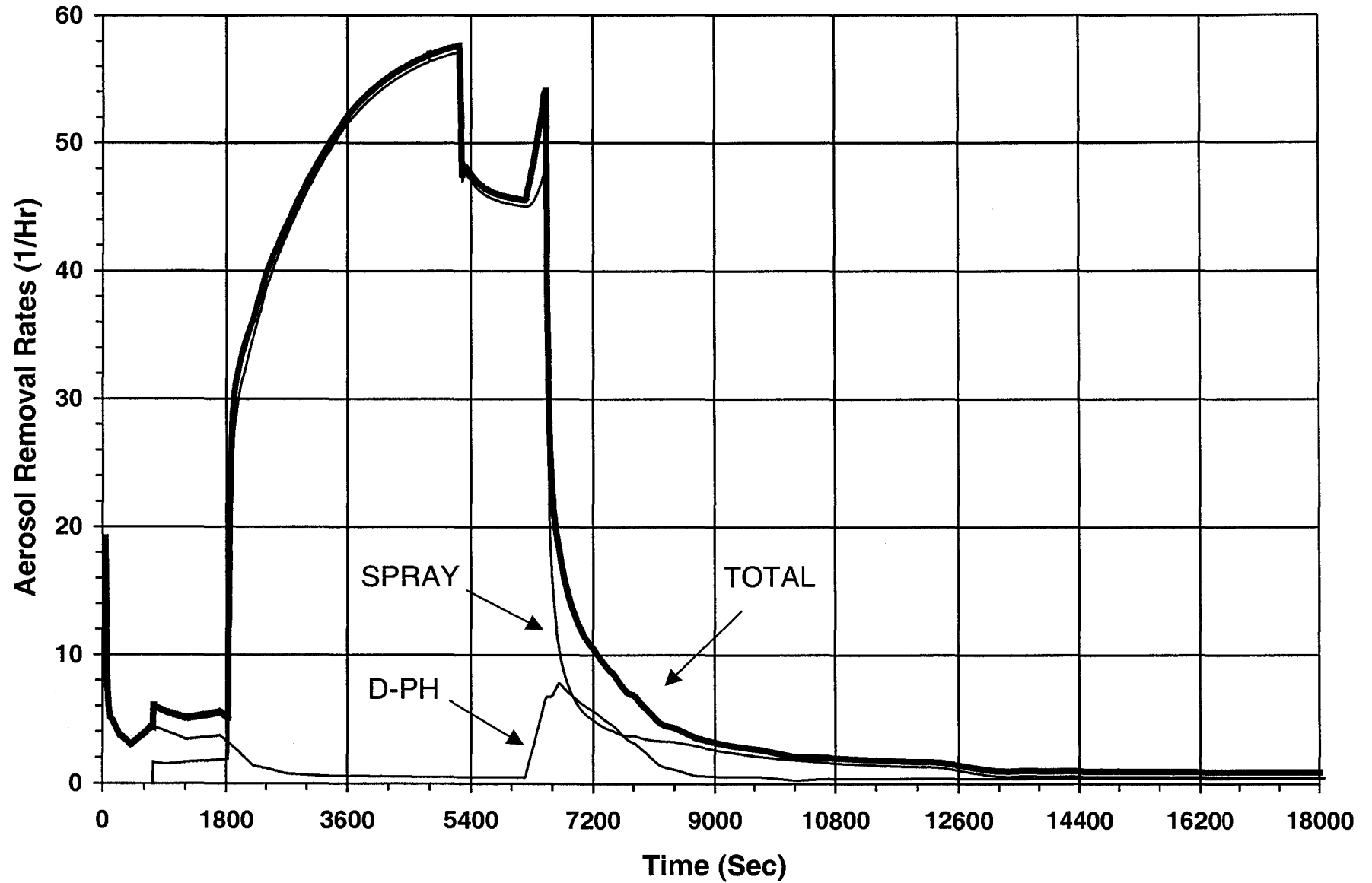

FIGURE 6.5-3  
**Aerosol Removal Rates Within Sprayed Region**  
 (NUREG 1465 HLDER Min. Case)  
 BEAVER VALLEY POWER STATION-UNIT 2  
 UPDATED FINAL SAFETY ANALYSIS REPORT

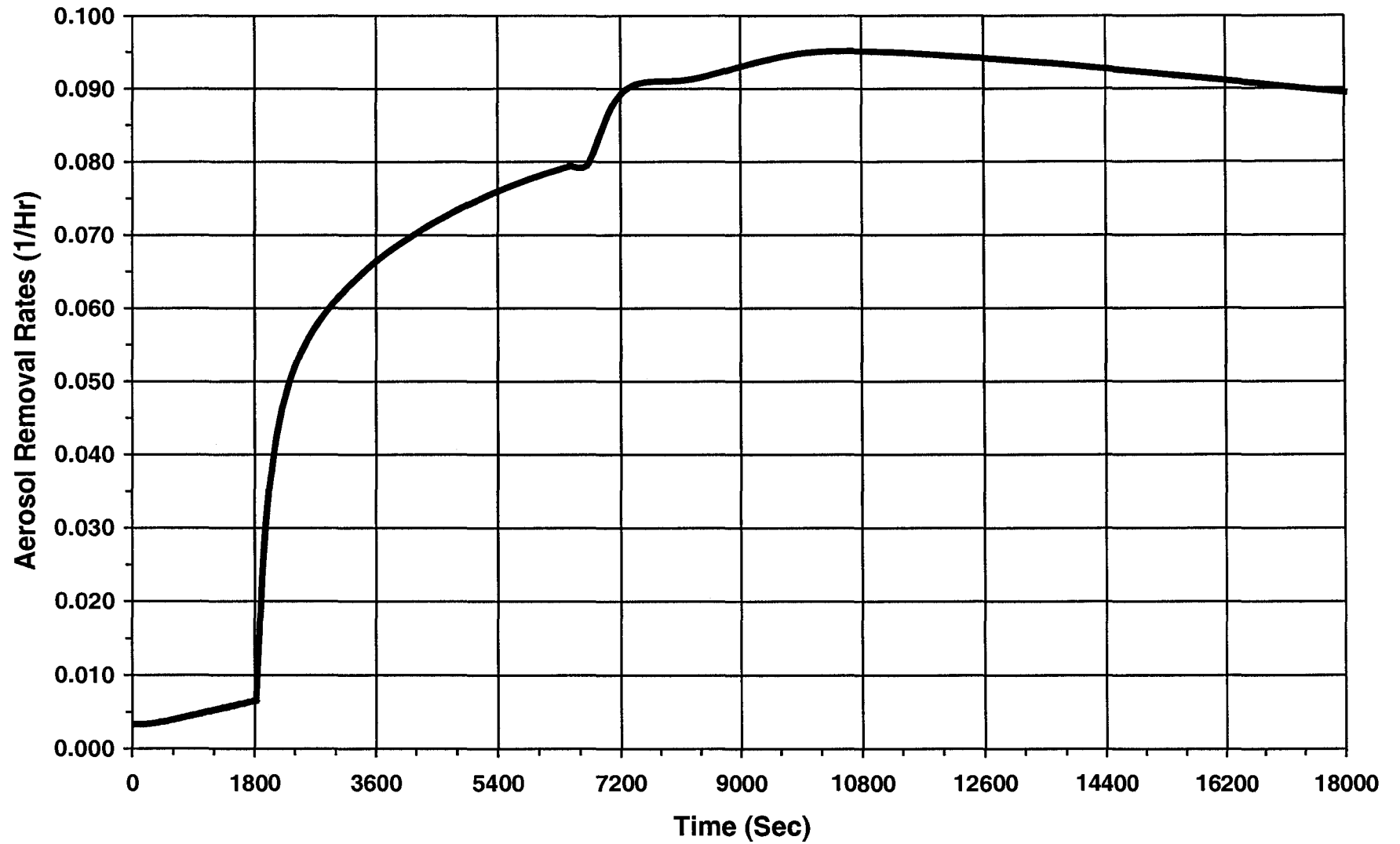

FIGURE 6.5-4  
**Aerosol Removal Rates Within Unsprayed  
Region (NUREG 1465 HLLER Min. Case)**  
BEAVER VALLEY POWER STATION-UNIT 2  
UPDATED FINAL SAFETY ANALYSIS REPORT

## 6.6 IN-SERVICE INSPECTION OF ASME CODE CLASS 2 AND CLASS 3 COMPONENTS

This section addresses the in-service inspection (ISI) of ASME Boiler and Pressure Vessel Code, Section III, Class 2 and Class 3 components, as required by the 1983 edition of the ASME Boiler and Pressure Vessel Code, Section XI, with addenda through Summer 1983.

After Beaver Valley Power Station - Unit 2 (BVPS-2) becomes operable, the ISI program shall be periodically updated and subsequent ISIs shall be performed, to the extent practical, to meet the latest applicable addendum to ASME XI that has been endorsed by the U.S. Nuclear Regulatory Commission (USNRC) in accordance with 10 CFR 50.55a(g).

### 6.6.1 Components Subject to Examination

Code Class 2 systems and components will be in-service inspected in accordance with and to the extent required by ASME XI, Subsection IWC and Table IWC-2500-1. Code Class 3 systems and components will be in-service inspected in accordance with and to the extent required by ASME XI, Subsection IWD and Table IWD-2500-1.

All components in Class 2 and Class 3 fluid systems comprising the ISI program will be examined at regular intervals during BVPS-2 service lifetime by nondestructive examinations, pressure tests, operational surveillance, or combinations of these inspections, as set forth in the BVPS-2 ISI program. The general requirements of ASME XI, Subsection IWA, are used as a guideline for the BVPS-2 ISI program examinations, procedures, and records. Certain exceptions may be taken whenever specific written relief is granted by the USNRC in accordance with 10 CFR 50.55a(g)(6)(i).

### 6.6.2 Accessibility

The design and arrangement of Code Class 2 systems and components provide access for all ISIs required by ASME XI, Subsection IWC. Adequate access is provided for performance of required volumetric and surface examinations specified in ASME XI, Table IWC-2500-1.

The design and arrangement of Code Class 3 systems and components provide for performance of all visual inspections and surveys to meet the requirements of ASME XI, Subsection IWD, Table IWD-2500-1. Special design considerations are given to those systems that are intended to be examined during normal plant operation.

Code Class 2 welds which receive ultrasonic examination are contoured and finished to permit meaningful examination of the welds by eliminating irregular or rough surfaces and sharp discontinuities which would interrupt the flow of sound between the transducer and the weld. Irregular weld geometry that would tend to scatter ultrasonic beams has been avoided. Removable insulation is provided on those piping systems requiring volumetric and surface inspection.

In addition, the placement of pipe hangers and supports with respect to those welds requiring inspection has been reviewed and modified, where necessary, to permit adequate access to these areas for inspection.

A verification review will be performed to assure compliance with ASME XI code requirements. The review and documentation will consist of the following tasks:

1. Listing of all ASME III Class 2 and 3 lines requiring examination.
2. Developing a set of piping isometric drawings showing the location of welds requiring inspection.
3. Tabulating all candidates for weld examination and identifying the type of inspection required.
4. Review that all welds have adequate clearance and accessibility for inspection personnel and equipment. This review will be performed on the 1/16 scale engineering model and on installed components.
5. Documentation of the clearance and access study.

This documentation will be reviewed periodically during BVPS-2 construction to ensure its accuracy and the information will be updated and maintained.

#### 6.6.3 Examination Techniques and Procedures

In-service inspection examination techniques for Code Class 2 systems and components are volumetric, surface, and visual to meet the requirements of Table IWC-2500-1 of ASME XI. Ultrasonic techniques are generally employed where volumetric examination is required, and either liquid penetrant or magnetic particle techniques are employed where surface examination is required. Visual examinations are conducted in accordance with the requirements of ASME XI, Table IWC-2500-1 and Subarticle IWA-2210.

Code Class 3 systems and components are given a visual survey examination during system in-service tests, component functional tests, or system pressure tests to detect evidence of component leakage, structural distress, or corrosion, in accordance with the requirements of Table IWD-2500-1 and Subarticle IWA-2210 of ASME XI.

#### 6.6.4 Inspection Intervals

For Code Class 2 and Class 3 systems and components, the ISIs will be conducted in accordance with ASME XI Subarticle IWA-2400. The inspection schedule for Class 2 systems and components will be per Program B, Table IWC-2412-1. In-service inspections for Code Class 3

systems and components are conducted when systems are undergoing either a system in-service test, component functional test, or system pressure test, as specified by ASME XI, Subarticle IWD-2400 and Table IWD-2500-1.

To the extent practicable, it is intended that ISIs be performed during normal plant outages, such as refueling shutdowns or maintenance shutdowns occurring during the inspection interval.

#### 6.6.5 Examination Categories and Requirements

The ISI categories and requirements for Code Class 2 systems and components are in agreement with, and are designed to permit ISI required by, ASME XI, Table IWC-2500-1.

In-service inspection categories and requirements for Code Class 3 systems and components are in agreement with, and are designed to permit ISI required by, ASME XI, Table IWD-2500-1.

All welds requiring volumetric or surface examination must be identified by number for inspection. For identification and tracking of welds (requiring volumetric and surface examination) during the design and fabrication stages, the pipe fabricators weld joint numbering system is utilized.

#### 6.6.6 Evaluation of Examination Results

Evaluation of Code Class 2 and Class 3 component examination results will be made in accordance with the requirements of ASME XI, Article IWB-3000. Repair procedures for Code Class 2 components will comply with the repair rules of ASME XI, Article IWC-4000. Repair procedures for Class 3 components will comply with the repair rules of ASME XI, Article IWD-4000.

When Section XI promulgates rules for flaw evaluation under Articles IWC-3000 and IWD-3000, and if the associated addenda are referenced by 10 CFR 50.55a, these rules will be incorporated into this section, if applicable. Components found to contain unacceptable indications will be repaired under the rules of Articles IWC-4000 for Class 2 and IWD-4000 for Class 3, or will be replaced under the rules of Article IWA-4000 and Articles IWC-4000 for Class 2 and IWD-4000 for Class 3.

#### 6.6.7 System Pressure Tests

System pressure tests on Code Class 2 systems and components will be conducted to comply with the criteria established in ASME XI, Article IWC-5000. System pressure tests on Code Class 3 systems and components will be conducted to comply with the criteria established in ASME XI, Article IWD-5000. The general requirements of Article IWA-5000 apply to pressure testing of both classes of components.

#### 6.6.8 Augmented In-Service Inspection to Protect Against Postulated Piping Failures

The augmented ISI program provides for examination of high energy piping that penetrates the primary containment. The examination requirement for piping welds will be defined by Table 4.1-1 of WCAP-14572, Revision 1-NP-A.

Welds located between the containment wall outside the containment, and the main steam valve house wall (as defined by FSAR Figures 3.6B-13 and 3.6-14), consisting of only the main steam and feedwater lines in the main steam valve house; all high energy branch lines within the main steam valve house up to the first relief or non-manual isolation valve; and those lines identified as "extended" break exclusion zone piping (reference Table 210.5-1 in response to NRC Question 210.5) are examined using volumetric techniques for circumferential butt or longitudinal welds at locations selected with the risk-informed methodology described in WCAP-14572, Revision 1-NP-A, and WCAP-14572, Revision 1-NP-A, Addendum 1-A. During each inspection interval, these welds will be volumetrically examined.