

where

$$D_{\text{effective}} = 307,702 \text{ (Section 3.8.5.3.3)}$$

$$L_{\text{NS1}} = \text{moment arm} = \text{half width of North-South width of foundation} = 81.25'$$

$$M_3 = 307,702 \times 81.25 = 25,000,824 \text{ kip-ft}$$

The resultant frictional resistance to North-South overturning is:

$$M_{\text{NS}} = M_1 + M_2 + M_3$$

RXB Resistance to East-West Overturning

The resisting moment resulting from friction on the North and South walls is:

$$M_4 = (F_{\text{NORTH}} + F_{\text{SOUTH}}) \times r_{\text{cg}} \quad \text{Eq. 3.8-8}$$

where

$$F_{\text{NORTH}} = \text{total friction on the North wall}$$

$$F_{\text{SOUTH}} = \text{total friction on the South wall}$$

$$r_{\text{cg}} = \text{moments arm} = \text{perpendicular distance from pivot (edge of West Wall) to line of friction force} = (346'/2) + 6' = 179'$$

The resistant moment resulting from friction on the East wall:

$$M_5 = (F_{\text{EAST}}) \times L_{\text{EW}} \quad \text{Eq. 3.8-9}$$

where

$$F_{\text{EAST}} = \text{Total friction on the East wall}$$

$$L_{\text{EW}} = \text{moment arm} = \text{East-West width of the foundation} = 352'$$

The resisting moment resulting from buoyant dead weight is:

$$M_6 = (D_{\text{effective}}) \times L_{\text{EW}} \quad \text{Eq. 3.8-10}$$

where

$$D_{\text{effective}} = 307,702 \text{ kips (Section 3.8.5.3.3)}$$

$$L_{\text{EW}} = \text{moment arm} = \text{half of East-West width of foundation} = 179'$$

$$M_6 = 307,702 \times 179 = 55,078,739 \text{ kip-ft}$$

The resultant resistance to East-West overturning is:

$$M_{EW} = M_4 + M_5 + M_6$$

3.8.5.5.4 Bearing Pressure Approach

Average Bearing Pressure

Average static bearing pressure is calculated by dividing the building weight by the building footprint. Seismic average bearing pressure is calculated by the algebraic summation of reaction time histories in the rigid springs below the basemat. The springs connect the basemat with the free-field soil. The algebraic summation yields three time histories of total basemat reactions in the three global directions due to each seismic input. From the time histories, the maximum reactions can be obtained. The vertical reaction divided by the total area of the basemat yields the average bearing pressure.

Localized Bearing Pressure

Localized bearing pressure under each building's basemat is calculated using the forces in the rigid springs, which connect the RXB and the CRB basemats to the excavated free-field soil (or to a fixed support for the static case). The vertical force in a spring is divided by the tributary area of the spring to obtain the localized nodal soil pressure. For the seismic case, reactions are obtained as a result of the four-step post-processing method described in Section 3.7.2.4.1.

3.8.5.5.5 Settlement Approach

A large-scale SAP2000 finite element model is used to determine the effect of foundation differential movements. To maximize the effect of the differential movements, the soil is modeled using the softest soil profile, i.e., Soil Type 11. In addition, the soil stiffnesses are further reduced by 50 percent to amplify the effect of differential movements or settlements. The 50 percent reduction in soil stiffness includes the areas below the triple building basemats and is extended to the entire free-field soil model. The size of the soil included in the model is so large that the static displacements induced by the static loads of the structures become negligible on the edges of the freefield soil model. The model is analyzed for both the cracked and uncracked concrete conditions.

The size of the freefield soil block in the model is 2005.5' long, 768.5' wide, and 360' deep. Figure 3.8.5-41 shows the overall size of the freefield soil block with the three embedded buildings.

As discussed in Section 3.8.4, Load combination 10 using Equation 9-6 of ACI 349 governs

$$U = D + F + H + 0.8L + C_{cr} + T_o + R_o + E_{sse}$$

For the dynamic analyses, the dead weight of the building was increased to account for the effect of live and snow loads.

The results presented in the NuScale Power Plant design certification application for which the soil stiffness is reduced by 50 percent include the following:

- 1) Determination of static demand forces for the RXB foundation design.
- 2) Determination of static demand forces for the CRB building and foundation design.
- 3) Determination of maximum differential displacements within each building foundation over 50 feet in length and maximum foundation bottom tilt angle of the CRB.

Results presented in the FSAR which include the effects of the 50 percent reduction in soil stiffness can be found in Table 3B-36 through Table 3B-38.

3.8.5.6 Results Compared with Structural Acceptance Criteria

3.8.5.6.1 RXB Stability

Factors of safety (FOS) were determined for 16 cases for the RXB. The cases include enveloping seismic loads from two RXB models (a standalone RXB model and an integrated RWB+RXB+CRB triple building model), two concrete conditions (cracked and uncracked with 7 percent damping) and four soil profiles (Soil Types 7, 8, 9, and 11) and are shown in Table 3.8.5-5. The results in this table indicate that the linear analysis for RXB sliding stability did not yield a FOS of greater than 1.

The minimum acceptable factor of safety for flotation, uplift, sliding and overturning is 1.1. This was not achieved for RXB sliding. Table 3.8.5-5 summarizes the factors of safety for the RXB.

A nonlinear analysis was performed for the RXB to show sliding was insignificant.

Bearing pressure is used to establish a design parameter for bearing capacity for site selection. The bearing capacity of the soil should provide a factor of safety of 3.0 for the static bearing pressure and a factor of safety of 2.0 for dynamic bearing pressure. The maximum allowable tilt settlement for the Reactor Building is 1" total or ½" per 50 feet in any direction at any point in the structure. The maximum allowable total settlement at any foundation node is four inches.

3.8.5.6.1.1 RXB Uplift

As shown in Section 3.8.5.5.1,

$$FOS = \frac{F_{\text{resisting}}}{F_{\text{driving}}} \quad FOS_{\text{flotation}} = \frac{D}{B} \quad FOS_{\text{uplift}} = \frac{D + F}{B + Rz}$$

The FOS for flotation is shown in Table 3.8.5-5 for each of the 16 cases considered, including cracked and uncracked conditions, Soil Types 7, 8, 9 and 11, and for RXB model and the triple building model. For each of the cases, an acceptable FOS for overturning was met.

3.8.5.6.1.1.1 Dynamic RXB Uplift Ratio

The effect of foundation uplift has been evaluated for the RXB. The linear SSI analysis methods are acceptable if the ground contact ratio is equal to or greater than 80 percent. The ground contact ratio can be calculated from the linear SSI analysis using the minimum basemat area that remains in compression with the soil. The seismic total vertical base reactions are calculated by the time step-by-time step algebraic summation of all nodal vertical reactions of the nodes of the RXB basemat. The maximum seismic vertical reactions for the cracked and uncracked concrete conditions for the two models are summarized in Table 3.8.5-4. The base vertical reaction results for the uncracked condition are similar to those for the cracked concrete condition.

As shown in Table 3.8.5-4, the seismic reactions are much less than the total dead weight reaction of 471,487 kips over the rectangle basemat area. The dead weight reaction corresponds to the self-weight of the concrete structures, equipment, and water weight. Thus, the net reactions are always in compression.

The typical total basemat vertical reaction time histories are shown in Figure 3.8.5-42 through Figure 3.8.5-47. Figure 3.8.5-42 and Figure 3.8.5-43 show the reactions for comparison between the cracked and uncracked concrete conditions. Each of the CSDRS- and CSDRS-HF-compatible seismic inputs contain three acceleration components, X (EW), Y (NS), and Z (vertical).

Figure 3.8.5-44 through Figure 3.8.5-47 are for the cracked concrete condition for the CSDRS Capitola input and CSDRS-HF Lucerne input. As can be seen in these figures, the total reactions are always in compression. The cracked and uncracked total reactions can be compared using Figure 3.8.5-42 for the cracked reaction and Figure 3.8.5-43 for the uncracked reaction due to Capitola input for Soil Type 7. The differences in total reactions are small because the differences between the cracked and uncracked seismic reactions and between standalone RXB and triple building models are small as shown in Table 3.8.5-4.

Based on the examination of the total vertical reaction force underneath the basemat, all net vertical reactions are in compression. Thus, the basemat is 100 percent in contact.

3.8.5.6.1.2 Reactor Building Sliding

As shown in Section 3.8.5.5.1,

$$FOS_{\text{sliding}} = \frac{R_{\text{resisting}}}{R_{\text{driving}}} \quad \text{Eq. 3.8-11}$$

Linear evaluations have shown that an acceptable FOS for sliding is not met, as shown on Table 3.8.5-5. Therefore, a nonlinear sliding analysis has been performed to show that sliding is insignificant.

Nonlinear Analysis

Figure 3.8.5-52 shows the designations used (A through D) for the locations on the RXB basemat where lateral displacements (sliding) were assessed between two end nodes of CONTA178 elements.

Figure 3.8.5-53 through Figure 3.8.5-60 show the E-W and N-S sliding displacements for Soil Type 7 for the four foundation locations (A, B, C, and D).

Figure 3.8.5-61 through Figure 3.8.5-68 show the E-W and N-S sliding displacements for Soil Type 11 for the four foundation locations (A, B, C, and D).

Figure 3.8.5-69 through Figure 3.8.5-76 show the E-W and N-S sliding displacements for Soil Type 8 for the four foundation locations (A, B, C, and D).

A detailed summary of the sliding displacement results are provided in Table 3.8.5-11. The results indicate that the deeply embedded RXB experiences less than 1/8" of sliding horizontal displacement. The magnitude of the displacements presented is insignificant.

3.8.5.6.1.3 RXB Overturning

As shown in Section 3.8.5.5.3,

$$FOS_{\text{overturning}} = \frac{M_{\text{restoring}}}{M_{\text{overturning}}}$$

The FOS for overturning is shown in Table 3.8.5-5 for each of the 16 cases considered, including cracked and uncracked conditions, Soil Types 7, 8, 9, and 11, and for RXB model and the triple building model. For each of the cases, an acceptable FOS for overturning was met.

3.8.5.6.2 CRB Stability

The minimum acceptable factor of safety for flotation, uplift, sliding, and overturning is 1.1. This was not achieved for the CRB uplift.

Linear analyses were overly conservative and showed unsatisfactory results for the CRB Stability Analyses, so nonlinear evaluation was used. The uplift, sliding, and overturning stability analysis of the Control Building is performed using a nonlinear sliding and uplift analysis. A nonlinear sliding, overturning, and uplift analysis was performed for the CRB to show that sliding, overturning, and uplift are insignificant.

Figure 3.8.5-48 shows the designations used (A through I) for the locations on the CRB basemat where the relative vertical displacements (uplift) and lateral displacements (sliding) were assessed between the two end nodes of the CONTA178 elements.

Bearing pressure is used to establish a design parameter for bearing capacity for site selection. The bearing capacity of the soil should provide a factor of safety of 3.0 for the static bearing pressure and a factor of safety of 2.0 for dynamic bearing pressure. The maximum allowable tilt settlement for the Control Building is 1" total or 1/2" per 50 feet in any direction at any point in the structure. The maximum allowable total settlement at any foundation node is 4 inches.

3.8.5.6.2.1 CRB Uplift

The key results are:

The relative displacements between the nodes at the basemat of the CRB are considered as actual uplift between CRB and surrounding soil. (Negative displacement values are considered as penetrations; a negligible amount of penetration is expected for penalty stiffness based contact algorithms.)

The elements transfer loads only when the contact is made. Therefore, the reactions drop to zero when there is a contact gap or uplift. This can be clearly seen from the force versus uplift comparison at location A in Figure 3.8.5-49 and Figure 3.8.5-50. The CRB is in an uplifted state at this corner location A for an infinitesimal duration of time just before the 10 seconds mark, resulting in zero reaction forces. The maximum uplift at location A is less than 1/64". The magnitude of this displacement is insignificant. Thus, the potential for uplift is insignificant.

3.8.5.6.2.1.1 Dynamic CRB Uplift Ratio

The effect of the foundation uplift has been evaluated for the CRB. The linear SSI analysis methods are acceptable if the ground contact ratio is equal to or greater than 80%. The ground contact ratio can be calculated from the linear SSI analysis using the minimum basemat area that remains in compression with the soil. The seismic total vertical base reactions are calculated by the time step-by-time step algebraic summation of all nodal vertical reactions of the nodes of the CRB basemat. The maximum seismic vertical reactions for the cracked and uncracked concrete conditions are summarized in Table 3.8.5-14. The base vertical reaction results for the uncracked condition are similar to those for the cracked concrete condition.

As shown in Table 3.8.5-14, the seismic reactions are much less than the total dead weight reaction over the rectangle basemat area of 45,774 kips. The dead weight reaction corresponds to the self-weight of the concrete and steel structures, and equipment (based on SAP2000 calculations). Thus, the net reactions are always in compression.

The typical total basemat vertical reaction time histories are shown in Figure 3.8.5-77 through Figure 3.8.5-82. The first two show the reactions for comparison between the cracked and uncracked concrete conditions. Others are all for the cracked concrete condition for the CSDRS Capitola input and CSDRS-HF Lucerne input. As can be seen in these figures, the total reactions are always in compression. Each of the CSDRS- and CSDRS-HF-compatible seismic inputs contain three acceleration components, X (EW), Y (NS), and Z (vertical).

The cracked and uncracked total reactions can be compared using Figure 3.8.5-77 for the cracked reaction and Figure 3.8.5-78 uncracked reaction due to Capitola input for Soil Type 7. The differences in total reactions are small because the differences between the cracked and uncracked seismic reactions are small as shown in Table 3.8.5-14.

Based on the examination of the total vertical reaction force underneath the basemat, all net vertical reactions are in compression. Thus, the basemat is 100 percent in contact.

3.8.5.6.2.2 Control Building Sliding

Figure 3.8.5-51 shows the relative sliding between the nodes at location A. In contrast to penetration compatibility, sliding can exhibit both positive and negative values equally since the nodes could move away from each other, towards one side or the other. Maximum sliding at A is approximately 0.006".

A summary of the results is provided in Table 3.8.5-12. The magnitudes of these displacements are insignificant. Thus, the potential for sliding is insignificant.

3.8.5.6.2.3 Control Building Overturning

The results provided in Table 3.8.5-12 show that the deeply embedded Control Building experiences less than 1/10" of sliding displacement and less than 1/64" of total vertical uplift displacement. The magnitudes of these displacements are insignificant. Thus, the potential for overturning is insignificant.

3.8.5.6.3 Average Bearing Pressure

As stated in Section 3.8.5.5.4, the average static bearing pressure is the dead load of the building divided by the footprint.

The seismic weight of the RXB is 587,147 kips and the calculated footprint is 58,175 ft². This results in an average pressure of 10.1 ksf. This results in a factor of safety of 7.4 to the minimum soil bearing capacity of 75 ksf specified in Table 2.0-1. The seismic weight of the CRB, including the tunnel, is 49,041 kips. The rectangular basemat area is 11,800 ft², the tunnel area is 501 ft², which makes a total area of 12,301 ft². This results in an average static bearing pressure of 4.0 ksf. This provides a factor of safety of 19 to the minimum soil bearing pressure of 75 ksf provided in Table 2.0-1.

The average dynamic bearing pressure is obtained as described in Section 3.8.5.5.4, with the vertical reaction for the entire basemat computed at each time step. The RXB foundation average dynamic pressure is 4.6 ksf. The CRB average foundation dynamic pressure on the rectangular basemat is 2.3 ksf. The average dynamic pressure on the tunnel area is not calculated. Maximum dynamic pressures across the entire CRB basemat, including the tunnel basemat, are shown on Figure 3.8.5-3a. These pressures are obtained by the post-processing approach indicated in Section 3.7.2.4.1.

3.8.5.6.4 Settlement

Displacement values are provided for selected nodes in the foundation in Table 3.8.5-7a. The location of these nodes is shown in Figure 3.8.5-10. As can be seen from the values in Table 3.8.5-7a and Table 3.8.5-7b, total settlement at any foundation node, tilt settlement, and differential settlement are minimal. The maximum allowable differential settlement between the RXB and CRB, and between the RXB and RWB is 0.5 inch.

The RXB settles approximately 1¾ inch on the west end and approximately 2 inches on the east end. The tilt settlement of 0.25" is less than 1" as cited in Section 3.8.5.6.1. There is negligible tilt north to south. The east end of the building contains the pool and the NPMs.

The CRB settles approximately 1¾ inch on the west end and approximately 1 inch on the east end. The tilt settlement of 0.75" is less than the 1" limit cited in Section 3.8.5.6.2. North to south tilt is negligible. The CRB tilts toward the RXB. Differential settlement between the two buildings is on the order of ¼ inch. The displacements at the four corners of the tunnel foundation calculated for the cracked concrete condition are provided in Table 3.8.5-17, and the rotation of the tunnel foundation is -0.0361°, as shown in Table 3.8.5-18. The tunnel foundation has negligible differential settlement in the north-south direction, and the differential settlement over 50 ft length in the east-west direction is -0.36."

The Seismic Category II Radioactive Waste Building settles approximately ½ inch on the west end and approximately 1½ inch on the east end. The RWB tilts toward the RXB. The RWB tilts approximately 1/5 inch in the north-south direction. Differential settlement between the RWB and the RXB is also on the order of ¼ inch.

3.8.5.6.5 Thermal Loads

During normal operation, a linear temperature gradient across the RXB foundation may develop.

An explicit analysis considering these loads has not been performed, as thermal loads are a minor consideration. Thermal loads are, by nature, self-relieving by means of concrete cracking and moment distribution. This is especially true of the NuScale RXB, as it is not a traditional pre-stressed/post-tensioned, cylindrical containment vessel, but, rather, a rectangular reinforced concrete building with several members framing into the roof, external walls, and basemat.

3.8.5.6.6 Construction Loads

The entire RXB basemat is poured in a very short time. The building is essentially constructed from the bottom up. The main loads (the reactor pool and the NPMs) are not added until the building is complete. Therefore, there are no construction-induced settlement concerns. The CRB basemat is much smaller and will be poured later than the RXB basemat in the construction sequence.

3.8.5.6.7 Basemat Soil Pressures along Basemat Edges (Toe Pressures)

The static deadweight reaction at an edge node is added to the seismic reaction of the node to calculate the total reaction. The seismic reaction is obtained with the approach shown in Section 3.7.2.4.1, for combining seismic analysis results. The bearing pressure is calculated by dividing the total reaction by the tributary area of the node (i.e., localized bearing pressure). The edge bearing pressures, or toe pressures, along the edges are averaged to obtain the average toe pressures of the basemat. The average toe pressures for the RXB and CRB are shown in Table 3.8.5-13 and Table 3.8.5-15, respectively. The values shown in these tables indicate that two times the maximum toe pressure is less than the minimum soil bearing pressure capacity of 75 ksf as specified in Table 2.0-1.

3.8.5.6.8 Leak Detection

Groundwater has the potential to leak through the RXB exterior walls through microscopic concrete cracks. Due to the exterior concrete wall thickness, these leaks will be very slow ($\ll 1$ gallon per day (gpd)). This leak rate through the wall is not enough to cause an interior flood in any of the rooms that share an exterior wall. Leaks of this nature will be discovered and dealt with in accordance with plant concrete maintenance specifications. Further reduction of groundwater seepage can be accomplished with a building dewatering system surrounding the RXB.

A leak chase system is provided in the RXB basemat to detect any leakage from the reactor pool.

3.8.5.7 Materials, Quality Control, and Special Construction Techniques

Section 3.8.4.6 describes the materials, quality control, and special construction techniques applicable to the RXB and CRB including the foundations.

3.8.5.8 Testing and Inservice Inspection Requirements

Section 3.8.4.7 identifies the testing and inservice surveillances applicable to the RXB and CRB including the foundations.

Table 3.8.5-1: RXB Stability Evaluation Input Parameters

Data Description	Value
RXB Seismic Weight (kips)	587,147
RXB East-West Length (ft) (between exterior faces of walls)	346
RXB North-South Length (ft) (between exterior faces of walls)	150.5
RXB Height (ft)	167
RXB Embedment Depth (ft)	86
Foundation East-West Length (ft)	358
Foundation North-South Length (ft)	162.5
Foundation Area (ft ²)	58,175
Soil Density, γ_{soil} (pcf)	130
Coefficient of Friction between Wall and Soil	0.5
Coefficient of Friction between Basemat and Soil	0.58
Effective Soil Density, $\gamma_{\text{eff}} = \gamma_{\text{soil}} - \gamma_{\text{water}}$ (pcf)	67.6
Angle of Internal Friction	30°
Soil Coefficient of Pressure at Rest, K_0	0.5
Surcharge (psf)	250

Table 3.8.5-2: Reactor Building Static Effective Soil Force

Definition	Symbol	Results	Units
Reactor Building			
Total Effective Soil Force on North Wall	F_{y1}	46,967	Kips
Total Effective Force on South Wall	F_{y2}	46,967	Kips
Total Effective Force on West Wall	F_{x1}	20,429	Kips
Total Effective Force on East Wall	F_{x2}	20,429	Kips
Total Static Wall Force	F_{total}	134,792	Kips

Table 3.8.5-3: Seismic Base Reactions

Model	Concrete Case	Soil Type	Seismic Load Case	Global FX (kips)	Global Fy (kips)	Global Fz (kips)	
Reactor Building	Cracked 7% Damping	S7 CSDRS	Capitola	326528	177221	222932	
			Chi Chi	303442	185109	254142	
			El Centro	253932	190969	264163	
			Izmit	273116	171747	234397	
			Yermo	277421	196458	254684	
		S8 CSDRS	Capitola	306274	206799	205032	
			Chi Chi	318687	200201	229313	
			El Centro	250271	212788	234071	
			Izmit	298958	211286	226435	
			Yermo	268717	235929	233072	
		S11 CSDRS	Capitola	151960	135837	185963	
			Chi Chi	188520	126654	182918	
			El Centro	143366	166150	191453	
			Izmit	146440	168663	199958	
			Yermo	171040	135521	199400	
		S7 CSDRS- HF	Lucerne	119790	77946	147529	
		S9 CSDRS- HF	Lucerne	126622	82652	162443	
		Uncracked 7% Damping	S7 CSDRS	Capitola	331587	203856	225014
	Chi Chi			306830	192224	258618	
	El Centro			271625	197785	254444	
	Izmit			272082	190891	242807	
	Yermo			281972	190668	257452	
	S8 CSDRS		Capitola	311880	212752	208268	
			Chi Chi	320551	215363	234958	
			El Centro	263147	219067	230481	
			Izmit	296880	212060	228292	
			Yermo	281020	234460	238766	
	S11 CSDRS		Capitola	152056	138287	186456	
			Chi Chi	188000	128106	185511	
			El Centro	143524	167620	189535	
Izmit			147560	170244	201724		
Yermo			172026	135712	201374		
S7 CSDRS- HF	Lucerne		114361	82076	156119		
S9 CSDRS- HF	Lucerne		155572	99573	167031		
Control Building	Cracked 7% Damping		S7 CSDRS	Capitola	23416	31065	22228
		Chi-Chi		22129	26172	26415	
		El Centro		20588	25473	27118	
		Izmit		21529	29205	24628	
		Yermo		21544	27899	25374	
		S9 CSDRS-HF	Lucerne	15018	19859	21209	
		Uncracked 7% Damping	S7 CSDRS	Capitola	25705	32251	23455
				Chi Chi	23304	28272	26333
	El Centro			21920	26926	26885	
	Ismit			23147	31104	25146	
	Yermo			23161	28982	23616	
	S9 CSDRD-HF		Lucerne	16523	20795	21017	

Table 3.8.5-3: Seismic Base Reactions (Continued)

Model	Concrete Case	Soil Type	Seismic Load Case	Global FX (kips)	Global Fy (kips)	Global Fz (kips)
Triple Building	Cracked 7% Damping	S7 CSDRS	Capitola	343944	244056	231397
			Chi Chi	336167	239971	250624
			El Centro	267968	269922	256483
			Izmit	297510	245331	251341
			Yermo	297715	236510	263351
		S8 CSDRS	Capitola	290751	274276	196053
			Chi Chi	303767	234230	223377
			El Centro	248628	267201	229007
			Izmit	287011	252901	216609
			Yermo	263706	265195	232279
		S11 CSDRS	Capitola	168396	119565	181518
			Chi Chi	199376	117941	179024
			El Centro	149150	165393	186060
			Izmit	152976	161973	193875
			Yermo	173035	120733	195737
	S7 CSDRS- HF	Lucerne	110986	91038	139697	
	S9 CSDRS- HF	Lucerne	129899	98212	162049	
	Uncracked 7% Damping	S7 CSDRS	Capitola	345847	277296	233754
			Chi Chi	340014	239492	255071
			El Centro	284727	285248	253962
			Izmit	289695	248614	241686
			Yermo	300881	233505	267641
		S8 CSDRS	Capitola	292384	271970	202190
			Chi Chi	305827	241469	226832
			El Centro	259244	267925	221740
			Izmit	284855	249438	219512
			Yermo	273286	261749	236003
		S11 CSDRS	Capitola	170042	122301	180745
			Chi Chi	200463	119167	180987
			El Centro	151215	166685	183803
Izmit			153733	163189	195697	
Yermo			174920	125096	196915	
S7 CSDRS- HF	Lucerne	105895	95761	134547		
S9 CSDRS- HF	Lucerne	143621	102666	165813		
			Maximum:	345847	285248	267641

These loads are the maximums of the total base reaction time histories obtained by the step-by-step combination of the reactions in all springs below the foundation

Table 3.8.5-4: Seismic Vertical RXB Base Reactions and Dead Weight

Soil Type	Seismic Load Case	Standalone Model		Triple Building Model		Dead Weight (kips)
		Cracked Seismic Vertical Reaction (kips)	Uncracked Seismic Vertical Reaction (kips)	Cracked Seismic Vertical Reaction (kips)	Uncracked Seismic Vertical Reaction (kips)	
S7[†] CSDRS	Capitola	222,932	225,014	231397	233754	471,487
	Chi-Chi	254,142	258,618	250624	255071	471,487
	El Centro	264,163	254,444	256483	253962	471,487
	Izmit	234,397	242,807	251341	241686	471,487
	Yermo	254,684	257,452	263351	267641	471,487
S8 CSDRS	Capitola	205,032	208,268	196053	202190	471,487
	Chi-Chi	229,313	234,958	223377	226832	471,487
	El Centro	234,071	230,481	229007	221740	471,487
	Izmit	226,435	228,292	216609	219512	471,487
	Yermo	233,072	238,766	232279	236003	471,487
S11 CSDRS	Capitola	185,963	186,456	181518	180745	471,487
	Chi-Chi	182,918	185,511	179024	180987	471,487
	El Centro	191,453	189,535	186060	183803	471,487
	Izmit	199,958	201,724	193875	195697	471,487
	Yermo	199,400	201,374	195737	196915	471,487
S7 CSDRS-HF	Lucerne	147,529	156,119	139697	134547	471,487
S9 CSDRS-HF	Lucerne	162,443	167,031	162049	165813	471,487

[†]S7, S8, S9, S11 designate Soil Types 7, 8, 9, and 11, respectively.

Table 3.8.5-5: Factors of safety - RXB Stability

Cracked Condition				Uncracked Condition			
Stability	Vertical	N-S	E-W	Stability	Vertical	N-S	E-W
Case 1: Cracked RXB Model, Soil Type 7				Case 2: Uncracked RXB Model, Soil Type 7			
Flotation	2.34	-	-	Flotation	2.34	-	-
Sliding	-	1.06	0.78	Sliding	-	1.00	0.76
Overturning	-	1.52	1.53	Overturning	-	1.51	1.52
Case 3: Cracked Triple Model, Soil Type 7				Case 4: Uncracked Triple Model, Soil Type 7			
Flotation	2.34	-	-	Flotation	2.34	-	-
Sliding	-	0.79	0.76	Sliding	-	0.86	0.75
Overturning	-	1.49	1.50	Overturning	-	1.50	1.50
Case 5: Cracked RXB Model, Soil Type 8				Case 6: Uncracked RXB Model, Soil Type 8			
Flotation	2.34	-	-	Flotation	2.34	-	-
Sliding	-	1.03	0.82	Sliding	-	1.00	0.80
Overturning	-	1.66	1.66	Overturning	-	1.64	1.65
Case 7: Cracked Triple Model, Soil Type 8				Case 8: Uncracked Triple Model, Soil Type 8			
Flotation	2.34	-	-	Flotation	2.34	-	-
Sliding	-	0.85	0.84	Sliding	-	0.85	0.83
Overturning	-	1.71	1.71	Overturning	-	1.69	1.70
Case 9: Cracked RXB Model, Soil Type 11				Case 10: Uncracked RXB Model, Soil Type 11			
Flotation	2.34	-	-	Flotation	2.34	-	-
Sliding	-	1.50	1.47	Sliding	-	1.49	1.47
Overturning	-	1.95	1.96	Overturning	-	1.94	1.95
Case 11: Cracked Triple Model, Soil Type 11				Case 12: Uncracked Triple Model, Soil Type 11			
Flotation	2.34	-	-	Flotation	2.34	-	-
Sliding	-	1.60	1.40	Sliding	-	1.58	1.38
Overturning	-	2.00	2.00	Overturning	-	2.00	2.00
Case 13: Cracked RXB Model, Soil Type 9				Case 14: Uncracked RXB Model, Soil Type 9			
Flotation	2.34	-	-	Flotation	2.34	-	-
Sliding	-	2.66	1.86	Sliding	-	2.21	1.51
Overturning	-	2.31	2.31	Overturning	-	2.24	2.25
Case 15: Cracked Triple Model, Soil Type 9				Case 16: Uncracked Triple Model, Soil Type 9			
Flotation	2.34	-	-	Flotation	2.34	-	-
Sliding	-	2.24	1.81	Sliding	-	2.14	1.64
Overturning	-	2.31	2.32	Overturning	-	2.26	2.26

Table 3.8.5-6: RXB ANSYS Model Summary

Items	ANSYS
Number of Joints	40009
Number of Joint with Restraints	5822
Number of Joint with Lumped Mass	7877
Number of Frame Elements	1541
Number of Shell Elements	15851
Number of Solid Elements	15012
Number of Link/Spring Elements	120
Number of Nonlinear Contact Elements	2100
Number of Nonlinear Gap Elements	5822

Table 3.8.5-7: Overturning Forces and Overturning Arms

Overturning Force	Overturning Moment Arm	Arm Length
Overturning Moment about the Y-Axis (E-W)		
Vertical Seismic Reaction	Half of East-West Width of Basemat	179'
Friction Forces on North and South Walls	Perpendicular Distance between Line of Action of Friction Force Centroid and Pivot	179'
Friction Force on East Wall	East-West Width of Basemat	352'
Effective Structural Dead Weight (Buoyant Weight)	Half of East-West Width of Basemat	179'
Overturning Moment about the X-Axis (N-S)		
Vertical Seismic Reaction	Half of North-South Width of Basemat	81.25'
Friction Forces on East and West Walls	Perpendicular Distance between Line of Action of Friction Force Centroid and Pivot	81.25
Friction Force on South Wall	North-South Width of Basemat	156.5'
Effective Structural Dead Weight (Buoyant Weight)	Half of North-South Width of Basemat	81.25'

Table 3.8.5-7a: Displacement at Bottoms of Foundations of Uncracked Triple Building Model

Building	Node Location	Node No.	Coordinates (inch)			Displacement (inch)		
			X	Y	Z	U1(EW)	U2(NS)	U3(Vert)
RWB	West	41173	-2460	-825	570	-0.1	0.01	-0.6
		41189	-2460	96	570	-0.1	0.01	-0.61
		41206	-2460	1149	570	-0.08	0.02	-0.52
	Middle	41887	-1380	-825	570	-0.11	0.01	-1.04
		41903	-1380	96	570	-0.1	0.01	-1.04
		41920	-1380	1149	570	-0.09	0	-0.9
	East	42517	-300	-825	570	-0.12	0.01	-1.63
		42533	-300	96	570	-0.11	0.01	-1.62
		42550	-300	1149	570	-0.12	0.03	-1.46
RXB	West	129	0	-873	0	-0.02	-0.03	-1.75
		140	0	0	0	-0.03	0	-1.81
		151	0	873	0	-0.02	0.04	-1.75
	Middle	801	1872	-873	0	-0.01	-0.01	-1.89
		812	1872	0	0	-0.02	0.01	-2.05
		823	1872	873	0	-0.01	0.03	-1.88
	East	1616	4092	-873	0	0.02	-0.02	-1.95
		1627	4092	0	0	0.02	0.02	-2
		1638	4092	873	0	0.01	0.05	-1.94
CRB	West	31066	4470	-705	345	0.15	0.01	-1.75
		31078	4470	-8	345	0.15	0.01	-1.78
		31089	4470	705	345	0.15	0.02	-1.73
	Middle	31327	4980	-705	345	0.16	0.01	-1.36
		31339	4980	-8	345	0.16	0.01	-1.36
		31350	4980	705	345	0.16	0.02	-1.34
	East	31559	5406	-705	345	0.16	0.01	-1.04
		31571	5406	-8	345	0.16	0.01	-1.05
		31582	5406	705	345	0.17	0.02	-1.02

Table 3.8.5-7b: Displacement at Bottoms of Foundations of Cracked Triple Building Model

Building	Node Location	Node No.	Coordinates (inch)			Displacement (inch)		
			X	Y	Z	U1(EW)	U2(NS)	U3(Vert)
RWB	West	41173	-2460	-825	570	-0.1	0.01	-0.6
		41189	-2460	96	570	-0.1	0.01	-0.61
		41206	-2460	1149	570	-0.08	0.03	-0.53
	Middle	41887	-1380	-825	570	-0.11	0.01	-1.04
		41903	-1380	96	570	-0.1	0.01	-1.04
		41920	-1380	1149	570	-0.09	0	-0.89
	East	42517	-300	-825	570	-0.12	0.01	-1.64
		42533	-300	96	570	-0.11	0.01	-1.63
		42550	-300	1149	570	-0.12	0.03	-1.46
RXB	West	129	0	-873	0	-0.02	-0.04	-1.75
		140	0	0	0	-0.03	0	-1.81
		151	0	873	0	-0.02	0.04	-1.75
	Middle	801	1872	-873	0	-0.01	-0.01	-1.89
		812	1872	0	0	-0.02	0.01	-2.06
		823	1872	873	0	-0.02	0.03	-1.88
	East	1616	4092	-873	0	0.02	-0.02	-1.95
		1627	4092	0	0	0.02	0.02	-2
		1638	4092	873	0	0.01	0.05	-1.94
CRB	West	31066	4470	-705	345	0.14	0.01	-1.75
		31078	4470	-8	345	0.14	0.01	-1.78
		31089	4470	705	345	0.15	0.02	-1.74
	Middle	31327	4980	-705	345	0.15	0.01	-1.36
		31339	4980	-8	345	0.15	0.01	-1.36
		31350	4980	705	345	0.16	0.02	-1.34
	East	31559	5406	-705	345	0.16	0.01	-1.04
		31571	5406	-8	345	0.16	0.01	-1.05
		31582	5406	705	345	0.16	0.02	-1.02

Table 3.8.5-8: CRB Stability Input Evaluation Parameters

Data Description	Value
CRB Seismic Weight (kips)	49,041
Buoyancy Load (kips)	40,500
CRB East-West Length (ft) (between exterior faces of walls)	81'-0"
CRB North-South Length (ft) (between exterior faces of walls)	119'-8"
CRB Height (ft)	95'-0"
CRB Embedment Depth (ft)	55'-0"
CRB Main Foundation East-West Length (ft)	91'-0"
CRB Main Foundation North-South Length (ft)	129'-8"
Main Foundation Area (ft ²)	11,800
CRB Tunnel Foundation East-West Length (ft)	19'-6"
CRB Tunnel Foundation North-South Length (ft)	25'-8"
Tunnel Foundation Area (ft ²)	500.6
Soil Density, γ_{soil} (pcf)	130
Soil Coefficient of Pressure at Rest, K_0	0.5
Ground water level	Less than plant elevation 98'-0"
Flood level	Less than plant elevation 99'-0"
Surcharge (psf)	250
Coefficient of Friction between Wall and Soil	0.5
Coefficient of Friction between Basemat and Soil (static analysis)	0.58
Coefficient of Friction between Basemat and Soil (nonlinear analysis)	0.55

† Buoyancy load based on the water level at Elevation 100'-0" for conservatism.

Table 3.8.5-9: CRB Total Static Lateral Soil Pressure

Elevation	Lateral Static Soil Pressure (psi)
100'-0" to 76'-6"	12
76'-6" to 50'-0"	31
50'-0" to 45'-0"	38

Note:
The highlighted region at EL 50'-0" & 45'-0" represents the pressure on the 5 ft thick foundation.

Table 3.8.5-10: CRB SAP2000, SASSI2010, and ANSYS Model Summary

Items	SAP2000	SASSI	ANSYS
Number of Joints	8872	17055	12142
Number of Joint with Restraints	864	0	2029
Number of Frame Elements	1393	1393	2098
Number of Shell Elements	4069	4069	3974
Number of Solid Elements	3966	3966	3967

Table 3.8.5-11: Reactor Building Sliding Displacements for Soil Type 7, 8 and 11 (Dead Weight + Buoyancy)

Direction of Input Motion	Description of Results	Maximum Sliding - inch		
		Soil Type 7	Soil Type 11	Soil Type 8
E-W (X)	E-W Sliding (X)	0.11	0.03	0.10
N-S (Y)	N-S Sliding (Y)	0.06	0.04	0.06

Table 3.8.5-12: Control Building Sliding and Uplift Displacements for Soil Type 7 and 11

Description of Results	Maximum Sliding and Uplift Displacement - inch	
	Soil Type 7 (Location/Excitation)	Soil Type 11 (Location/Excitation)
DW+Buoyancy+Static Pressure Vertical (Z) Displacement - Static	0.0353	0.0353
DW+Buoyancy+Static Pressure + Seismic E-W (X)	0.044 (A /E-W)	0.017 (C/E-W)
DW+Buoyancy+Static Pressure + Seismic N-S (Y)	0.08 (D/N-S)	0.029 (D/N-S)
DW+Buoyancy+Static Pressure + Seismic Vertical (Z) Uplift	0.01 (C/E-W) ¹	0.015 (D/Vertical)

¹ Excitation in the E-W direction produces uplift displacement,

Table 3.8.5-13: Average Soil Bearing Pressures (Toe Pressures) along Edges of RXB Basemat

Basemat Edges	WEST	EAST	NORTH	SOUTH
Total Reaction (kips)	61,580	73,004	133,073	133,321
Total Tributary Area (ft ²)	1,869	1,950	4,296	4,296
Average Toe Pressure in ksf	33.0	37.4	31.0	31.0
Average Toe Pressure in psi	229	260	215	216

Table 3.8.5-14: Seismic Vertical CRB Base Reactions and Dead Weight

Concrete Case	Soil Type	Seismic Load Case	Cracked Seismic Vertical Reaction (kips)	Uncracked Seismic Vertical Reaction (kips)	Dead Weight (kips)
Cracked 7% Damping	S7† CSDRS	Capitola	22,228	23,455	45,774
		Chi Chi	26,415	26,333	45,774
		El Centro	27,118	26,885	45,774
		Izmit	24,628	25,146	45,774
		Yermo	26,253	26,015	45,774
	S8 CSDRS	Capitola	22,129	22,284	45,774
		Chi Chi	26,196	26,074	45,774
		El Centro	26,565	26,562	45,774
		Izmit	24,857	25,868	45,774
		Yermo	26,284	26,267	45,774
	S11 CSDRS	Capitola	20,173	20,103	45,774
		Chi Chi	24,121	23,885	45,774
		El Centro	24,400	24,413	45,774
		Izmit	21,793	21,150	45,774
		Yermo	24,260	24,132	45,774
	S7 CSDRS-HF	Lucerne	18,371	19,126	45,774
	S9 CSDRS-HF	Lucerne	21,209	20,637	45,774

†S7, S8, S9, S11 designate Soil Types 7, 8, 9, and 11, respectively.

Table 3.8.5-15: Average Soil Bearing Pressures (Toe Pressures) along Edges of CRB Basemat

Basemat Edges	WEST	EAST	NORTH	SOUTH
Total Reaction (kips)	18,620	21,078	16,974	15,338
Total Tributary Area (ft²)	1,190.4	1,199.4	853.1	853.1
Average Toe Pressure (ksf)	15.64	17.57	19.90	17.98
Average Toe Pressure (Psi)	108.6	122.0	138.2	124.9

Table 3.8.5-16: Reactor Building SAP2000 Basemat Model Summary

Item	RXB Basemat SAP2000
Number of joints	2,360
Number of joints with restraints	559
Number of frame elements	40
Number of shell elements	2,366
Number of solid element	0

Table 3.8.5-17: CRB Tunnel Foundation Corner Displacements

Node No.	Displacement (inch)		
	U1 (EW)	U2 (NS)	U3 (Vertical)
9590	0.05	0.02	-2
9594	0.05	0.01	-2.01
31071	0.14	0.01	-1.79
31075	0.14	0.01	-1.8

Table 3.8.5-18: CRB Tunnel Differential Settlement over 50 Feet and Tilt Angle

West Settlement (inch)	East Settlement (inch)	Foundation Tilt over 50' (inch)[†]	Tilt Angle about NS Axis (degree)
-2	-1.8	-0.36	-0.0361

[†]-0.36" = [(-2.00")-(-1.80")]/27.5'x50'; EW Tunnel Foundation Model Width = 27.5'

Figure 3.8.5-1: SAP2000 Model for Evaluation of Design Forces in the Reactor Building Basemat Model (X Axis is in the Longitudinal Direction, Y Axis is in the Transverse Direction, and Z Axis in the Vertical Upward Direction)

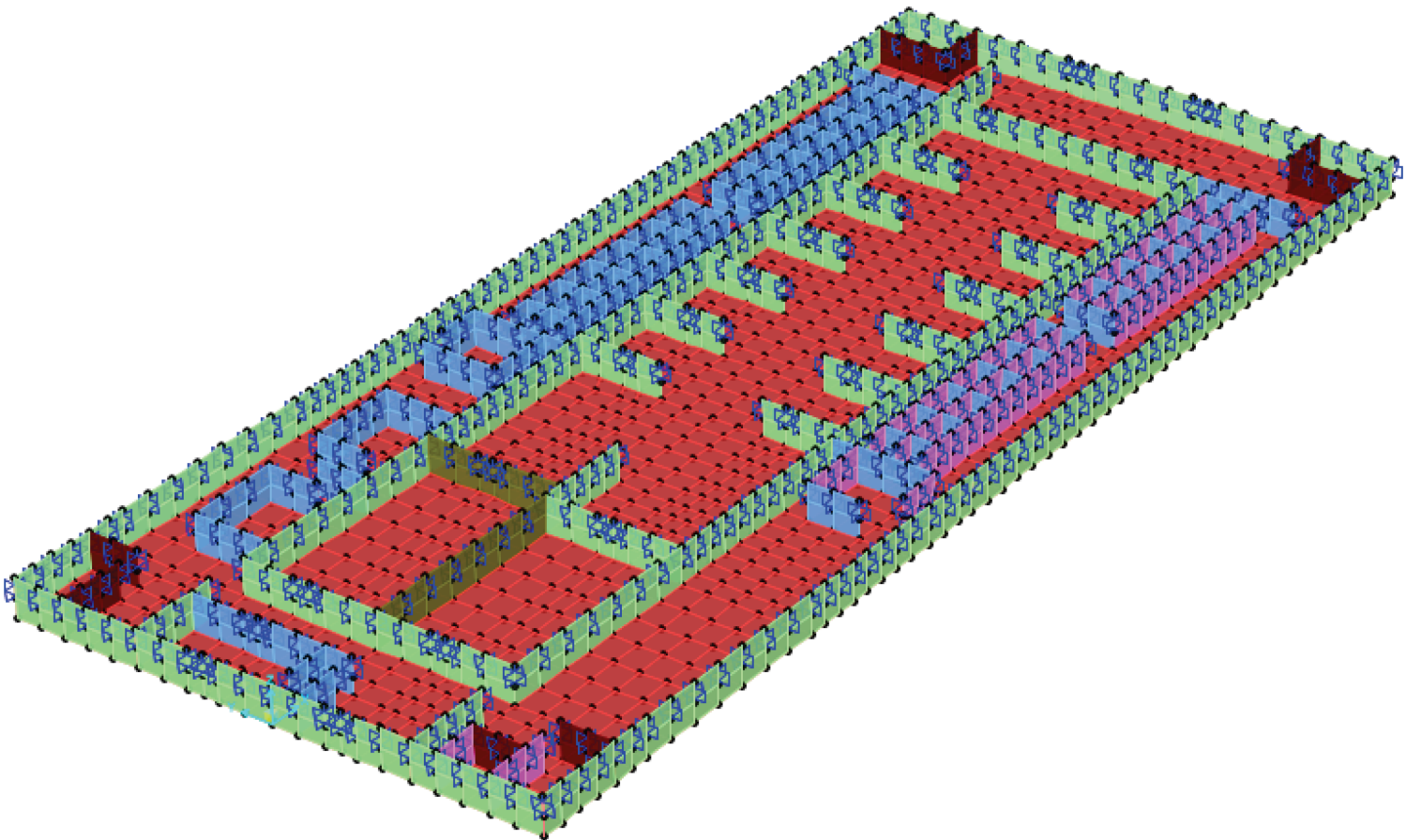

Figure 3.8.5-2: Static Base Pressure Contours for American Concrete Institute Load Combination 9-6 in the Reactor Building Basemat (psi) (Positive X Axis is to the Right of the Image and Positive Y is to the Top of the Image)

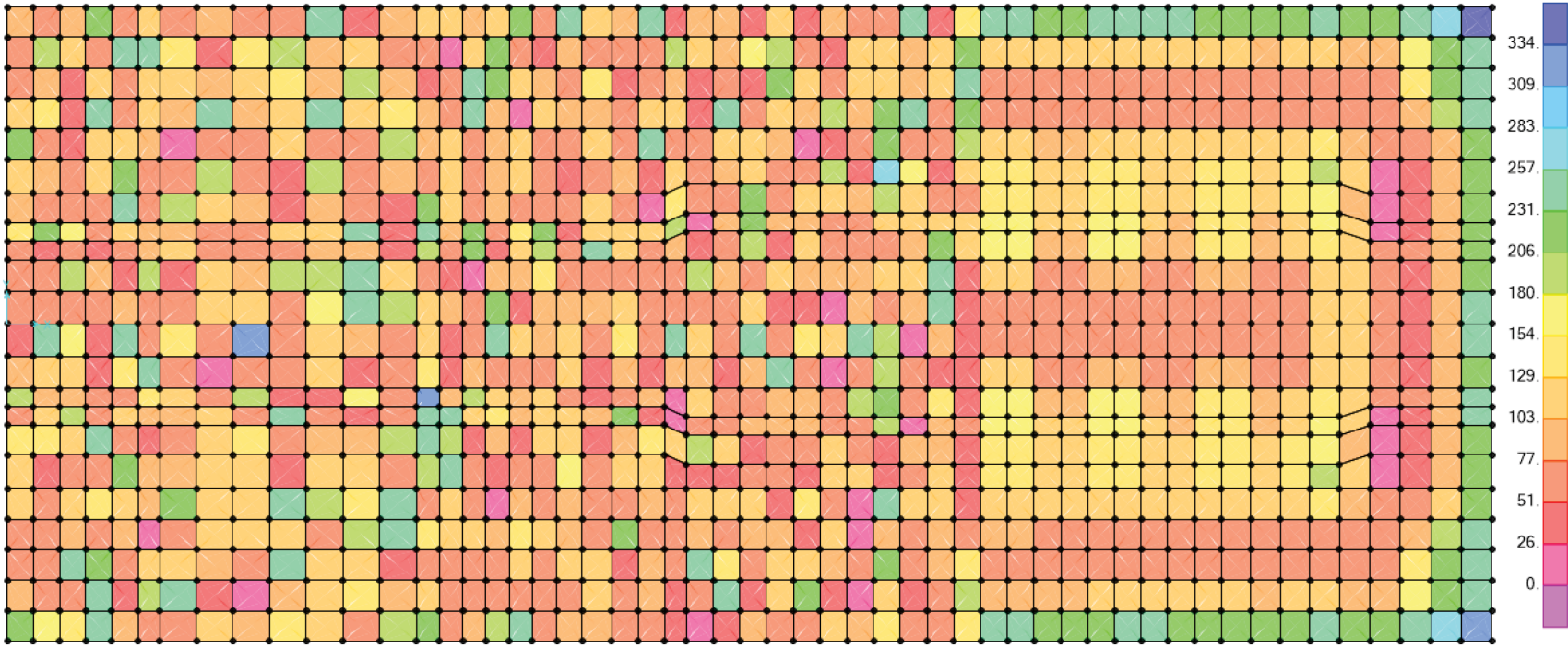

Figure 3.8.5-2a: Static Base Pressure Contours for American Concrete Institute Load Combination 9-6 in the Control Building Basemat (psi) (Positive X Axis is to the Right of the Image and Positive Y is to the Top of the Image)

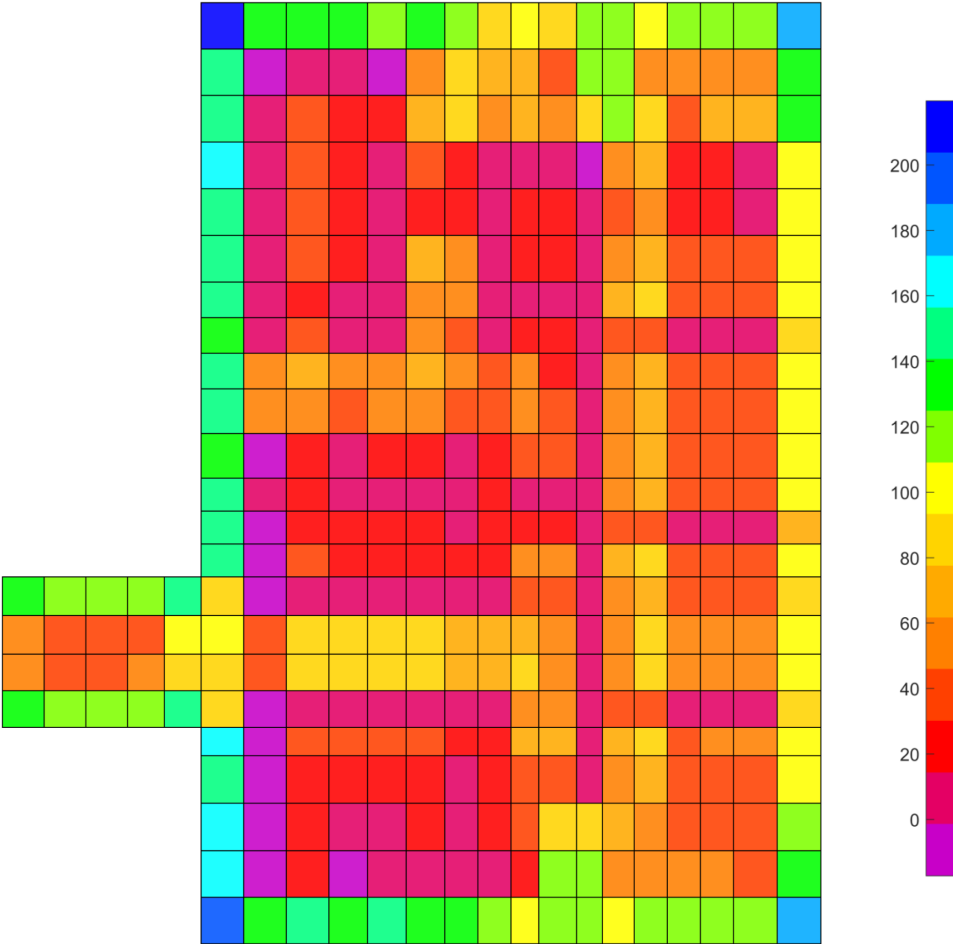

Figure 3.8.5-3: Seismic Base Pressure Contours from SASSI2010 Analysis in the Reactor Building Basemat (psi) (Positive X Axis is to the Right of the Image and Positive Y is to the Top of the Image)

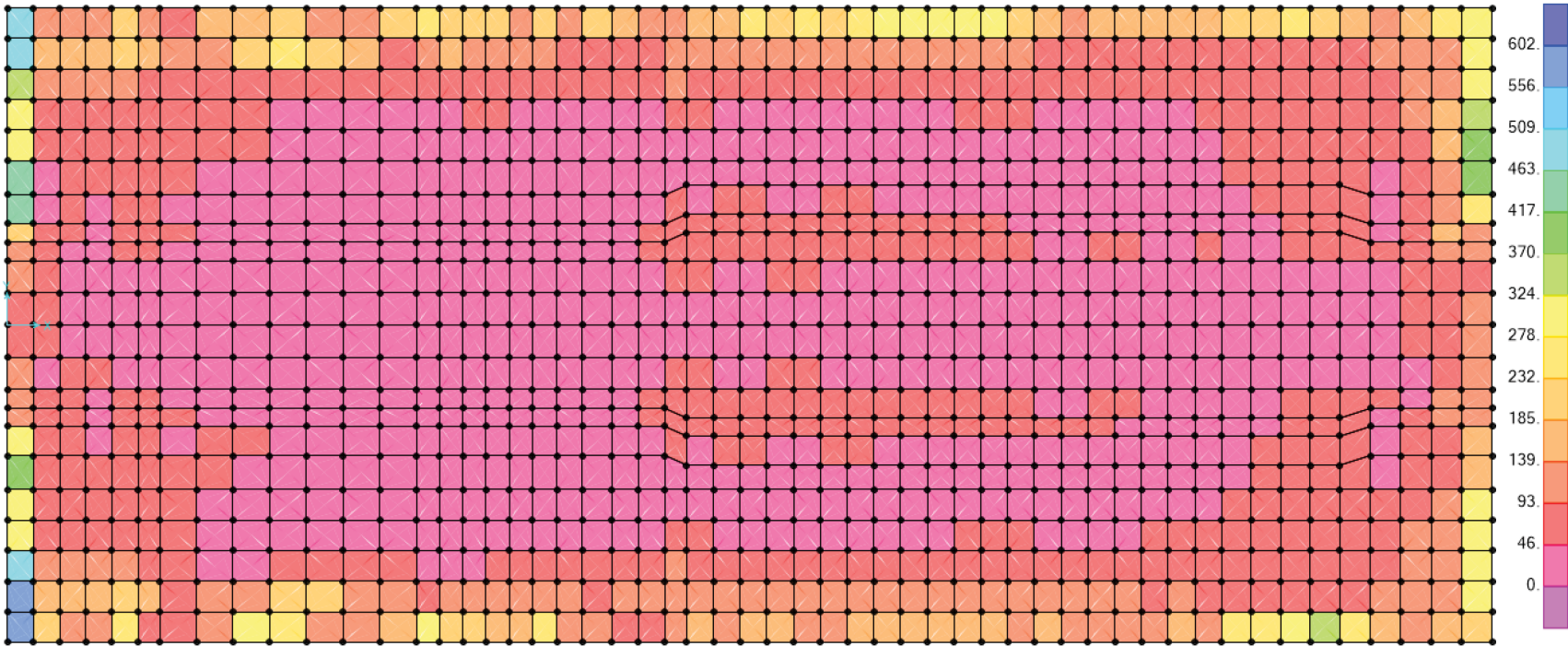

Figure 3.8.5-3a: Dynamic Pressure Contours on Control Building Basemat (psi) (Positive X Axis is to the Right of the Image and Positive Y is to the Top of the Image)

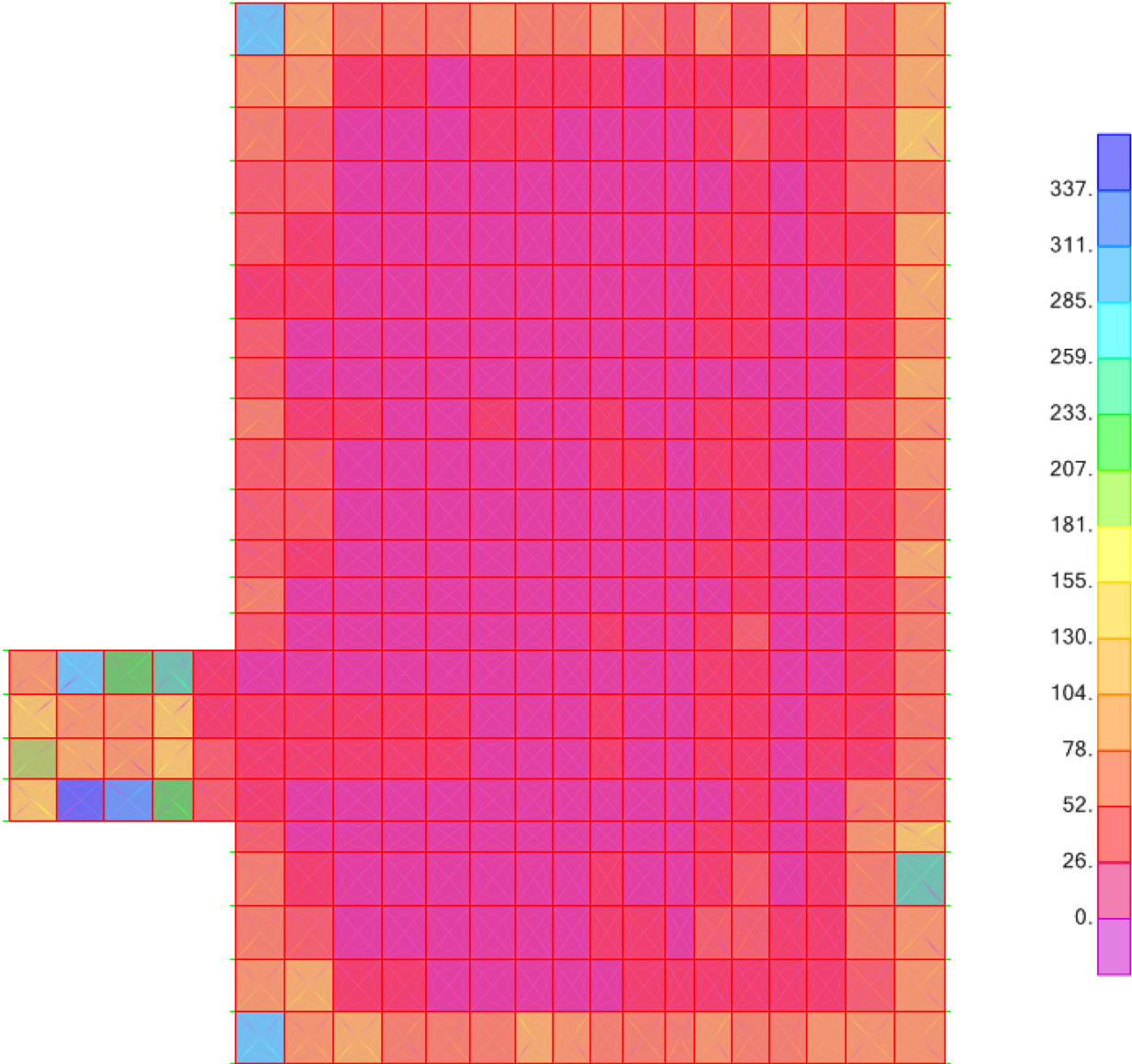
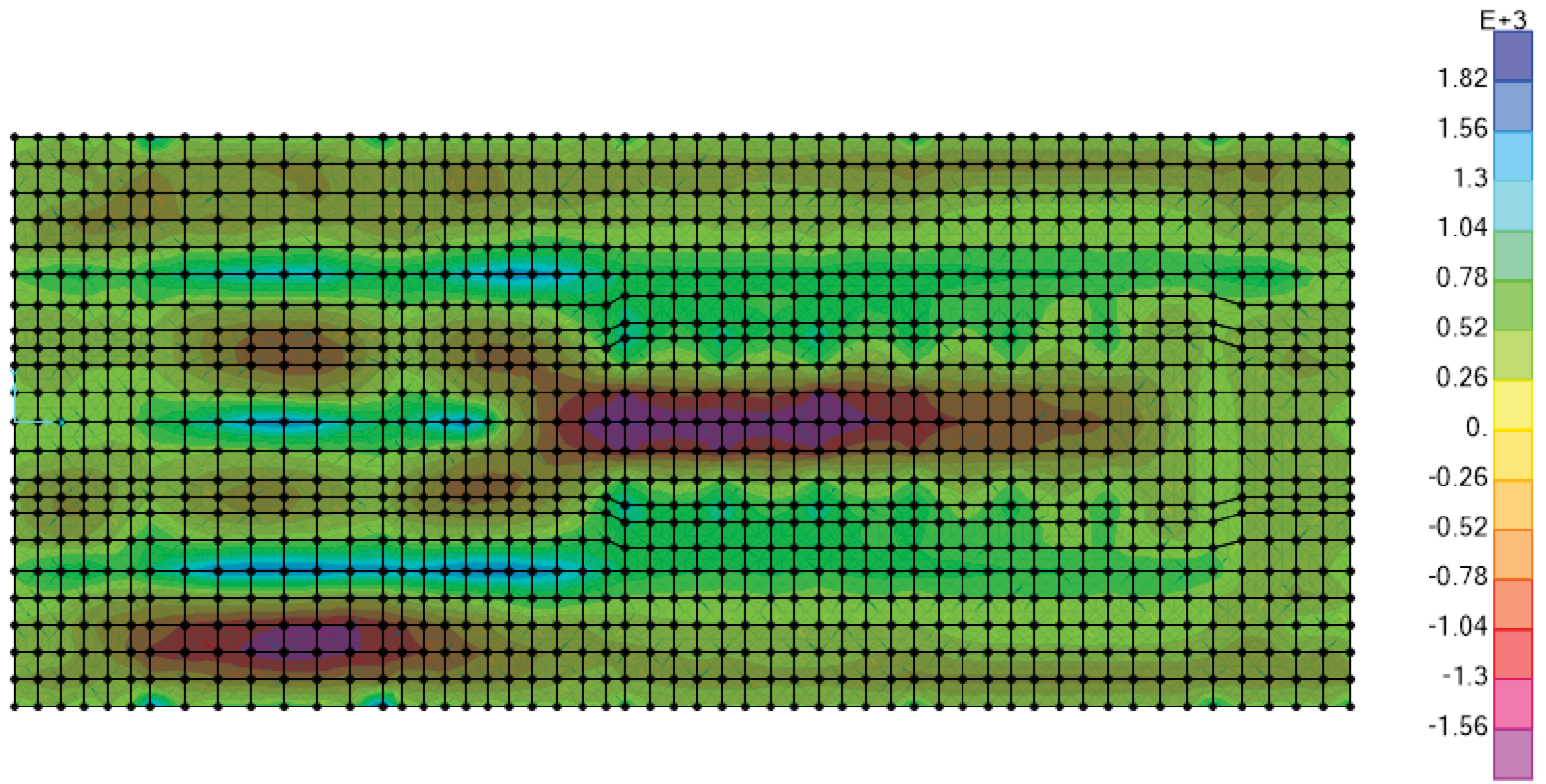

Figure 3.8.5-4: Myy Due to Static Base Pressure on Reactor Building Basemat (kip-ft/ft) in the Reactor Building Basemat Model (Positive X Axis is to the Right of the Image and Positive Y is to the Top of the Image)



**Figure 3.8.5-4a: Myy Due to Static Loads on Control Building Basemat, Stand-Alone SAP2000 Model (kip-ft/ft)
(Positive X Axis is to the Right of the Image and Positive Y is to the Top of the Image)**

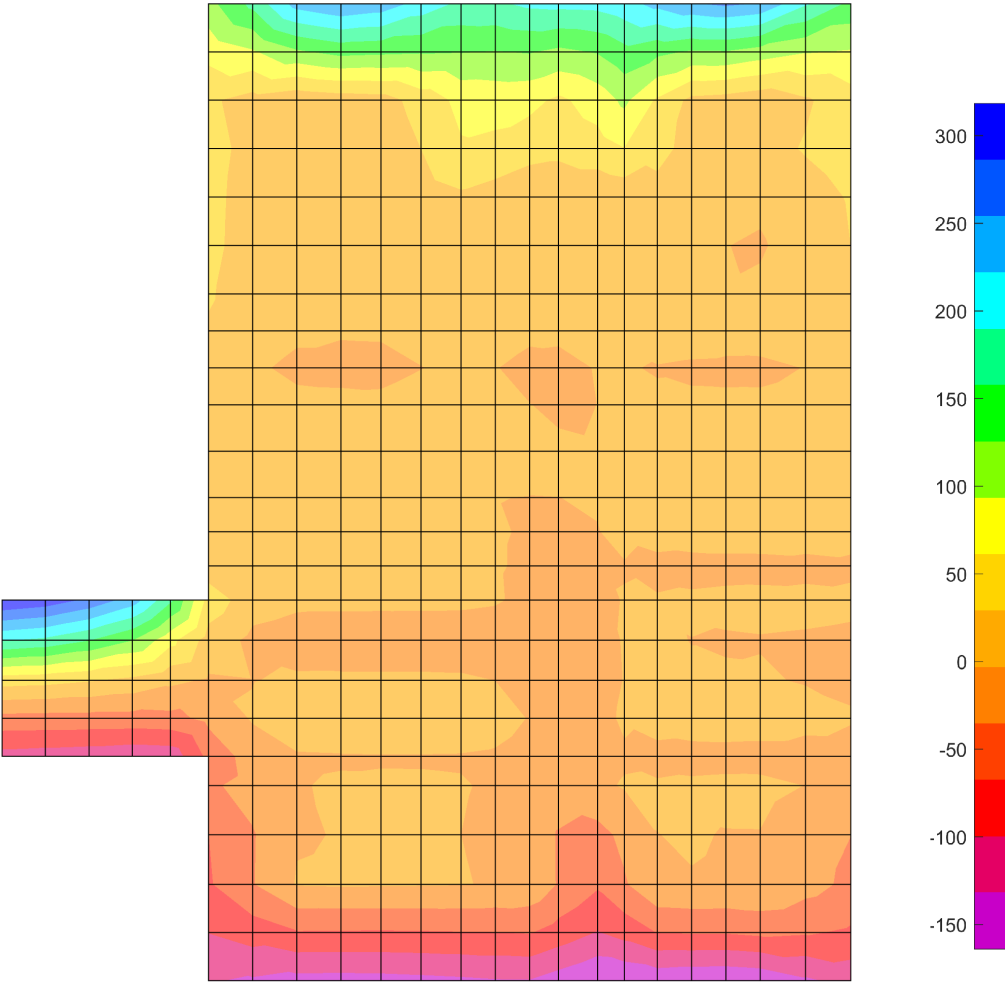
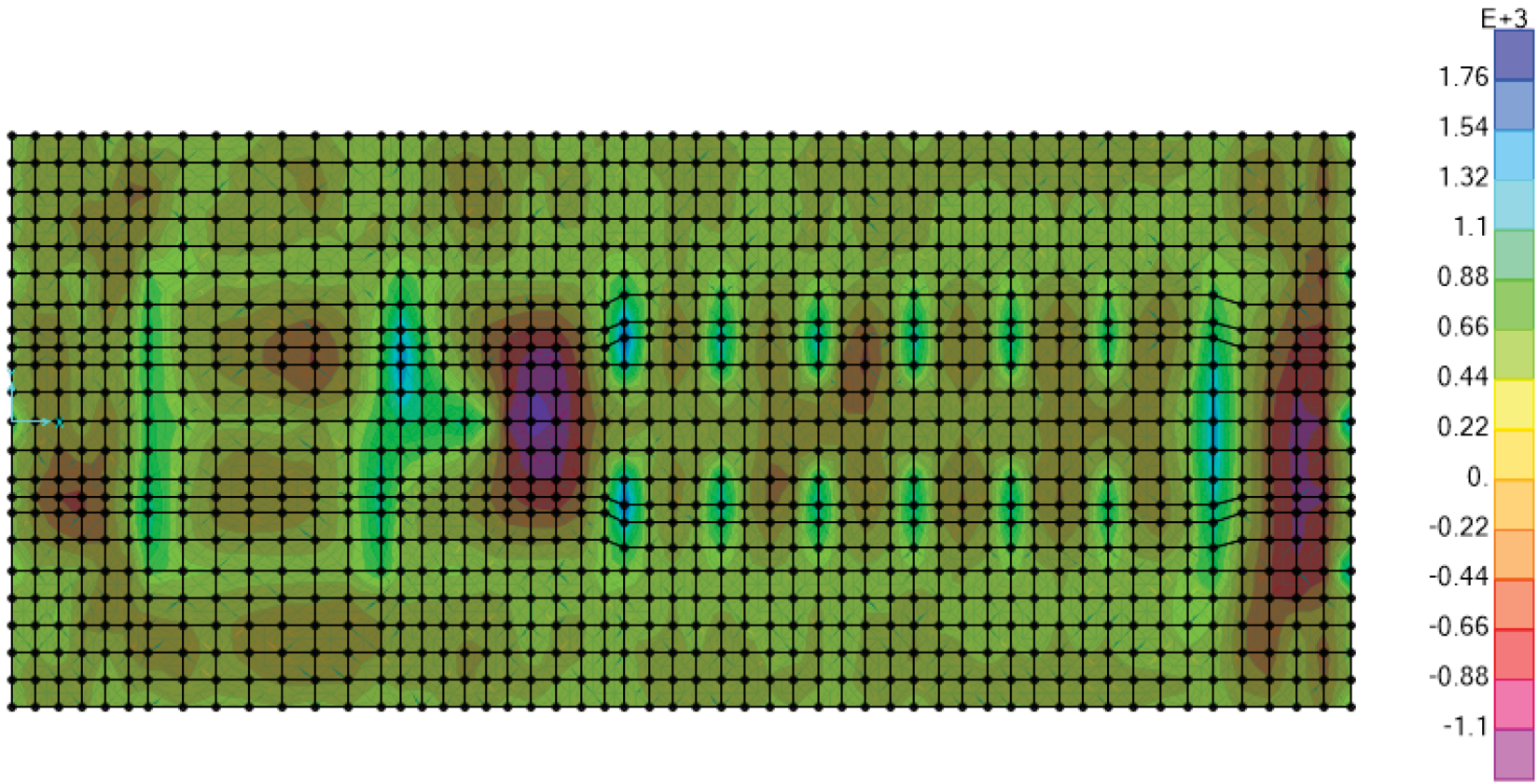

Figure 3.8.5-5: Mxx Due to Static Base Pressure on Reactor Building Basemat (kip-ft/ft) in the Reactor Building Basemat Model (Positive X Axis is to the Right of the Image and Positive Y is to the Top of the Image)



**Figure 3.8.5-5a: Mxx Due to Static Loads on Control Building Basemat, Stand-Alone SAP2000 Model (kip-ft/ft)
(Positive X Axis is to the Right of the Image and Positive Y is to the Top of the Image)**

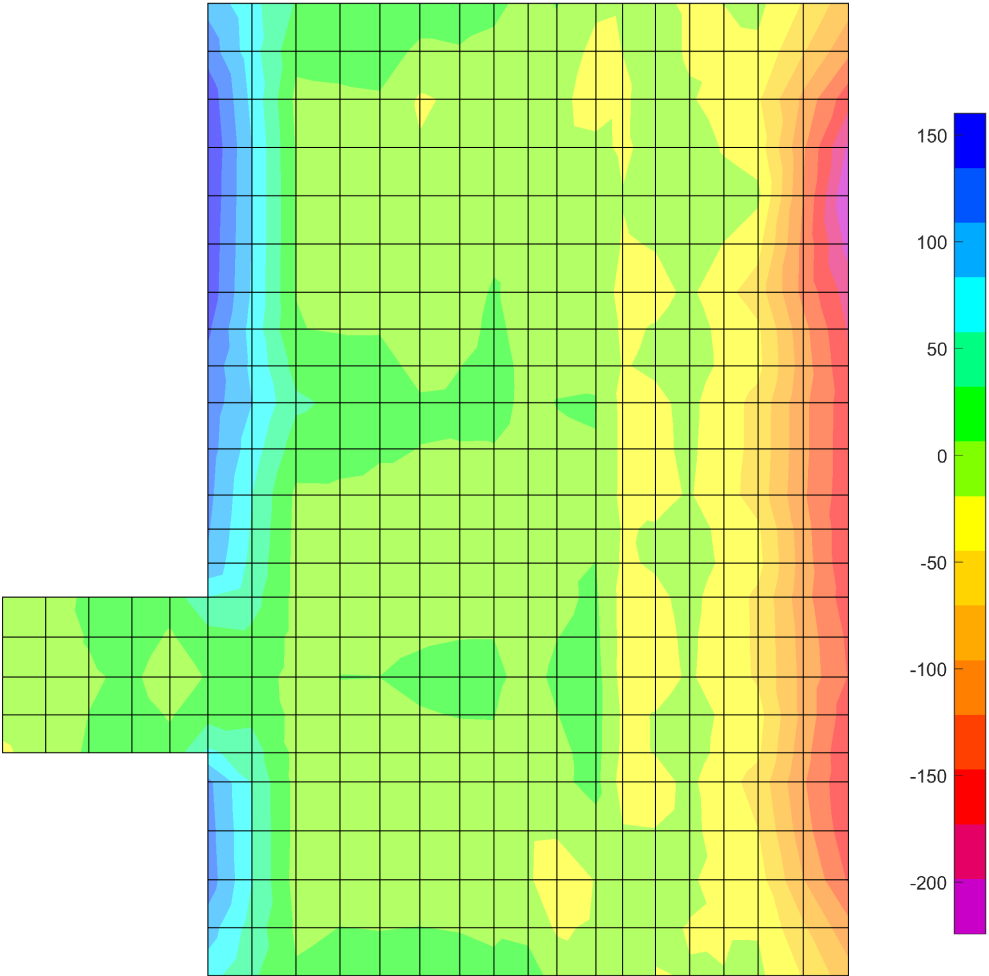

Figure 3.8.5-6: Myy Due to Seismic Base Pressure on Reactor Building Basemat (kip-ft/ft) in the Reactor Building Basemat Model (Positive X Axis is to the Right of the Image and Positive Y is to the Top of the Image)

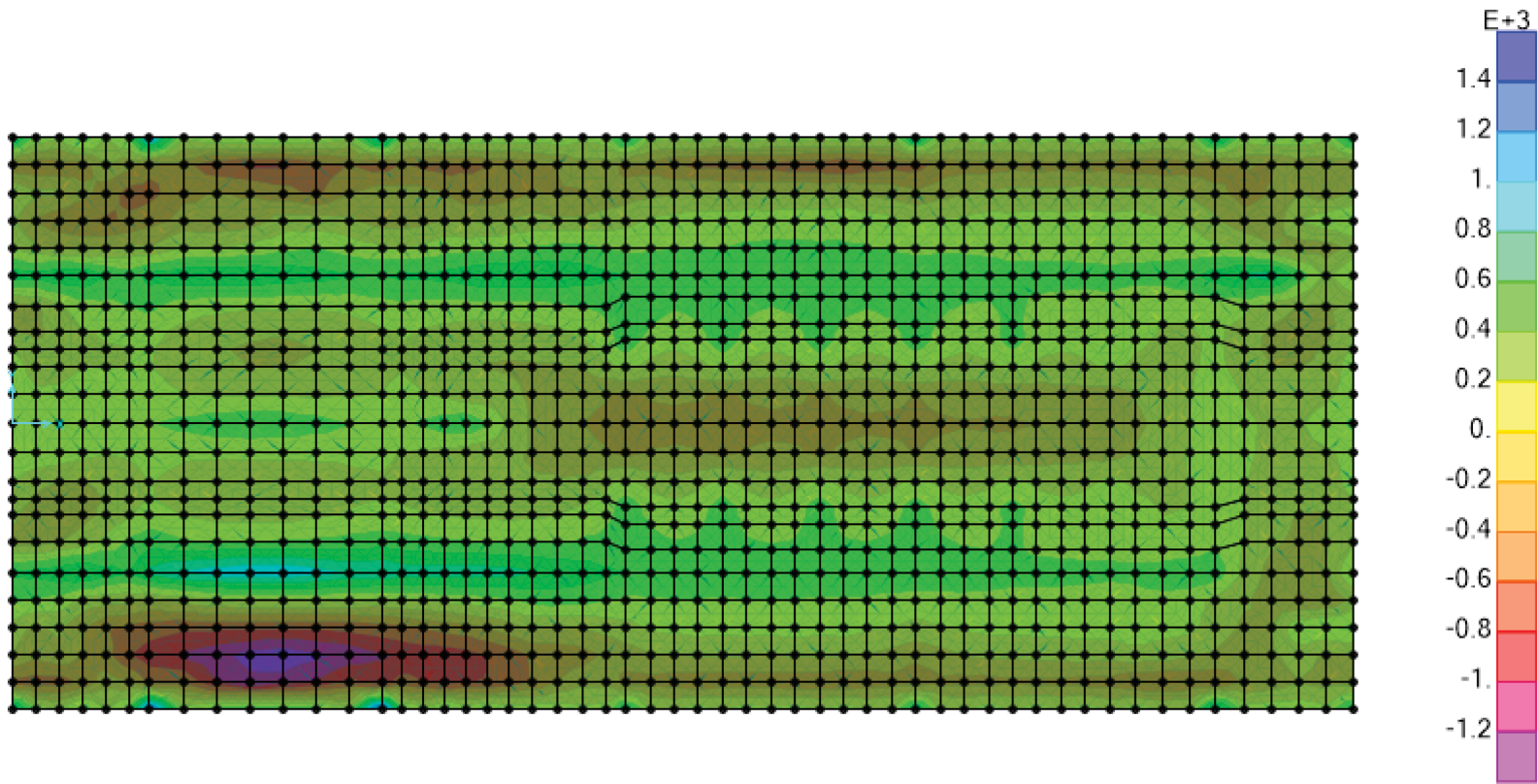

Figure 3.8.5-6a: Myy Due to Seismic Base Pressure on Control Building Basemat (kip-ft/ft) (Positive X Axis is to the Right of the Image and Positive Y is to the Top of the Image)

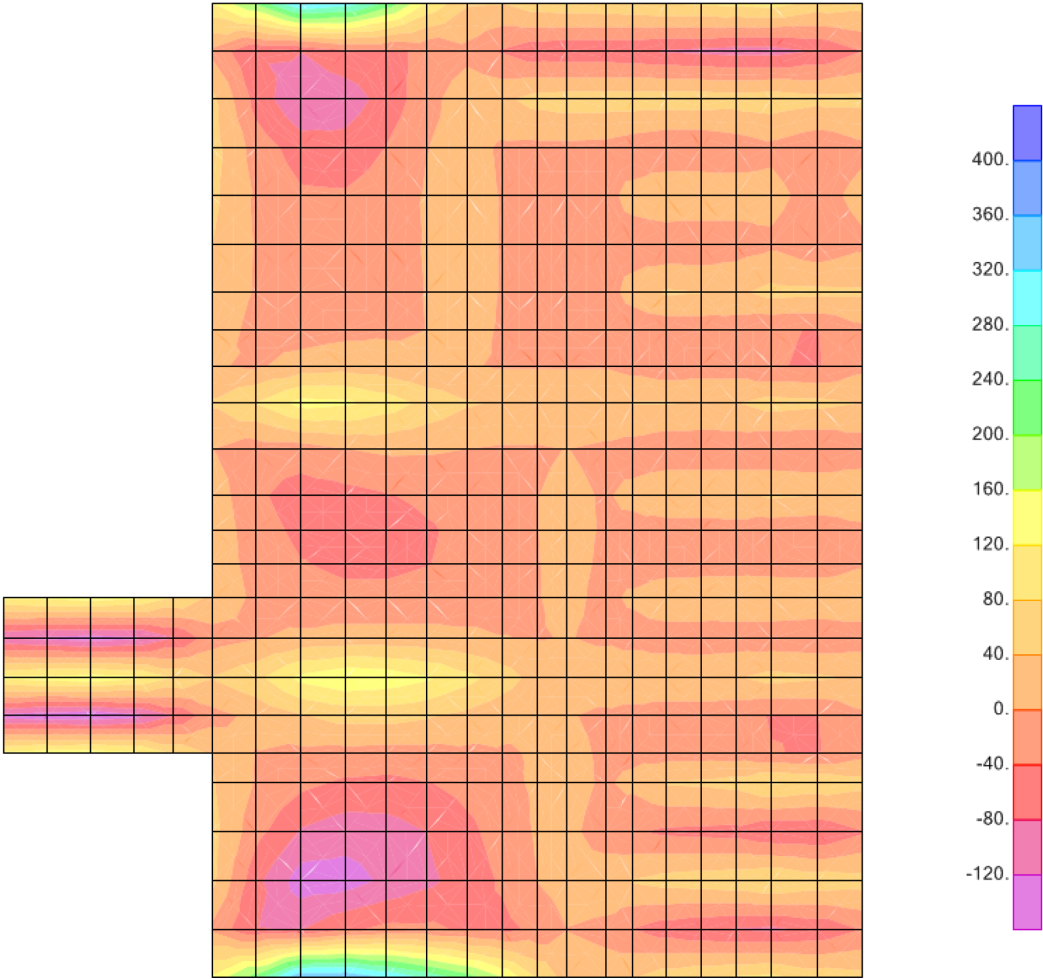

Figure 3.8.5-7: Mxx Due to Seismic Base Pressure on Reactor Building Basemat (kip-ft/ft) in the Reactor Building Basemat Model (Positive X Axis is to the Right of the Image and Positive Y is to the Top of the Image)

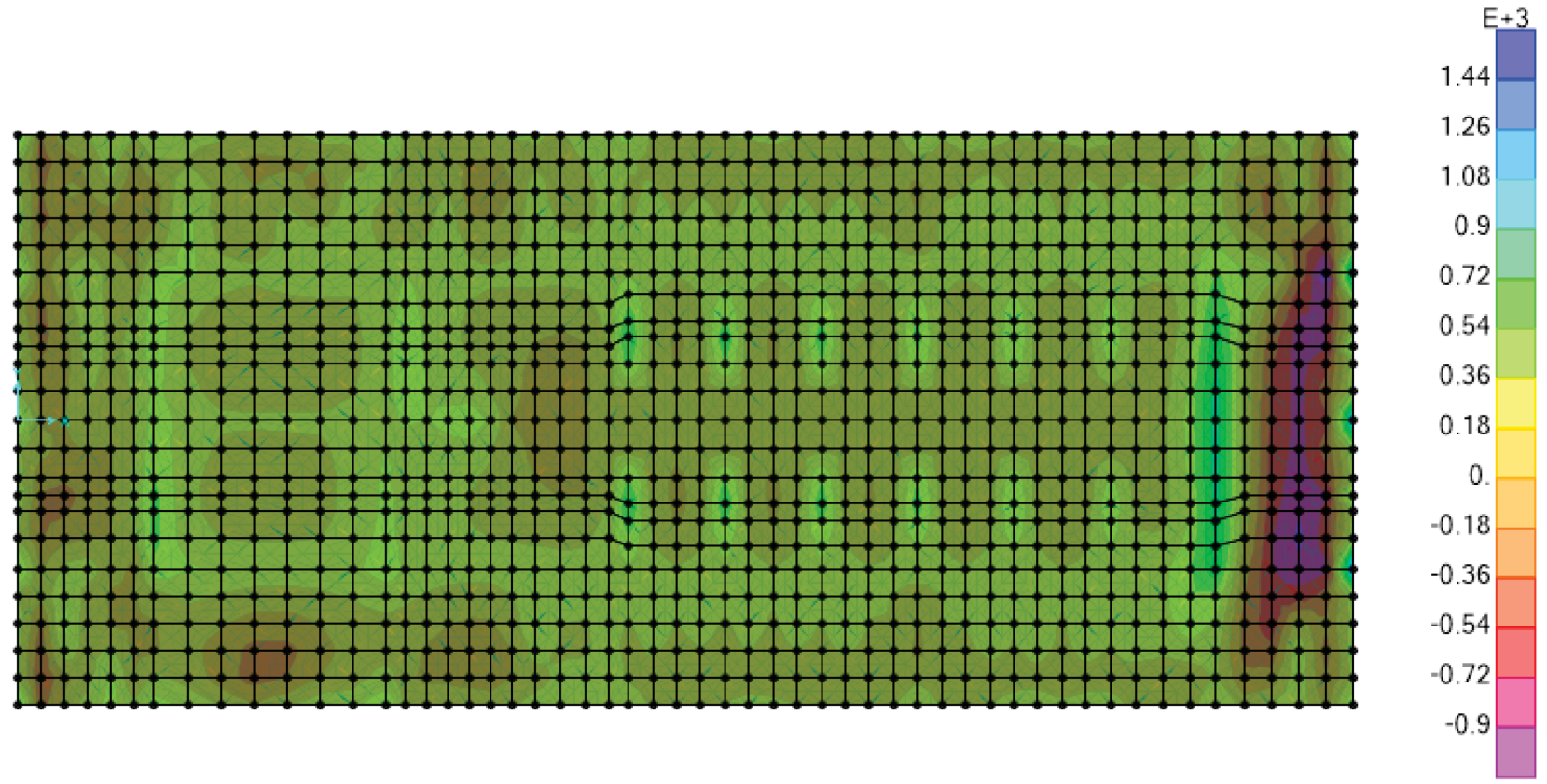

Figure 3.8.5-7a: Mxx Due to Seismic Base Pressure on Control Building Basemat (kip-ft/ft) (Positive X Axis is to the Right of the Image and Positive Y is to the Top of the Image)

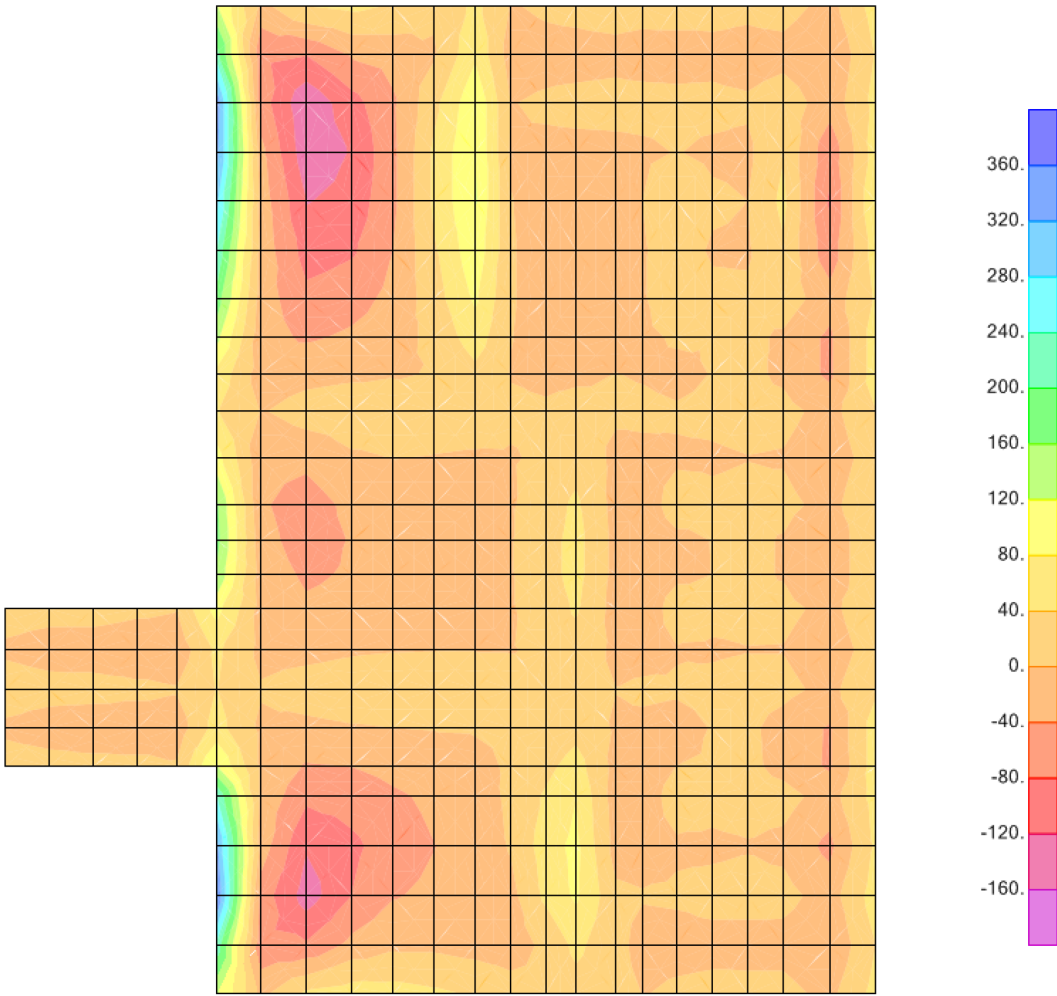

Figure 3.8.5-8: RXB ANSYS Model with Backfill Soil

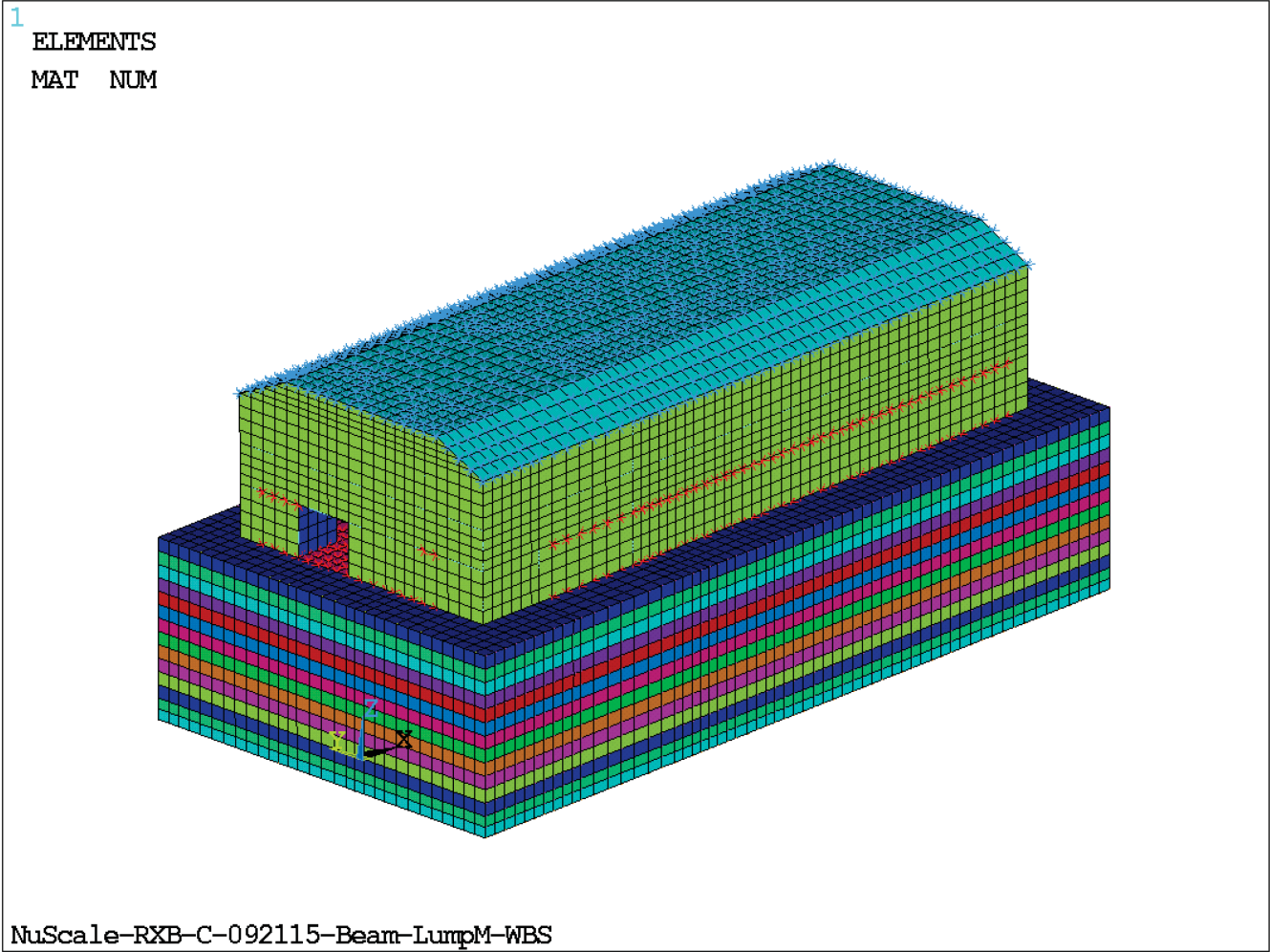

Figure 3.8.5-9: Nonlinear Contact Region between Building and Soil

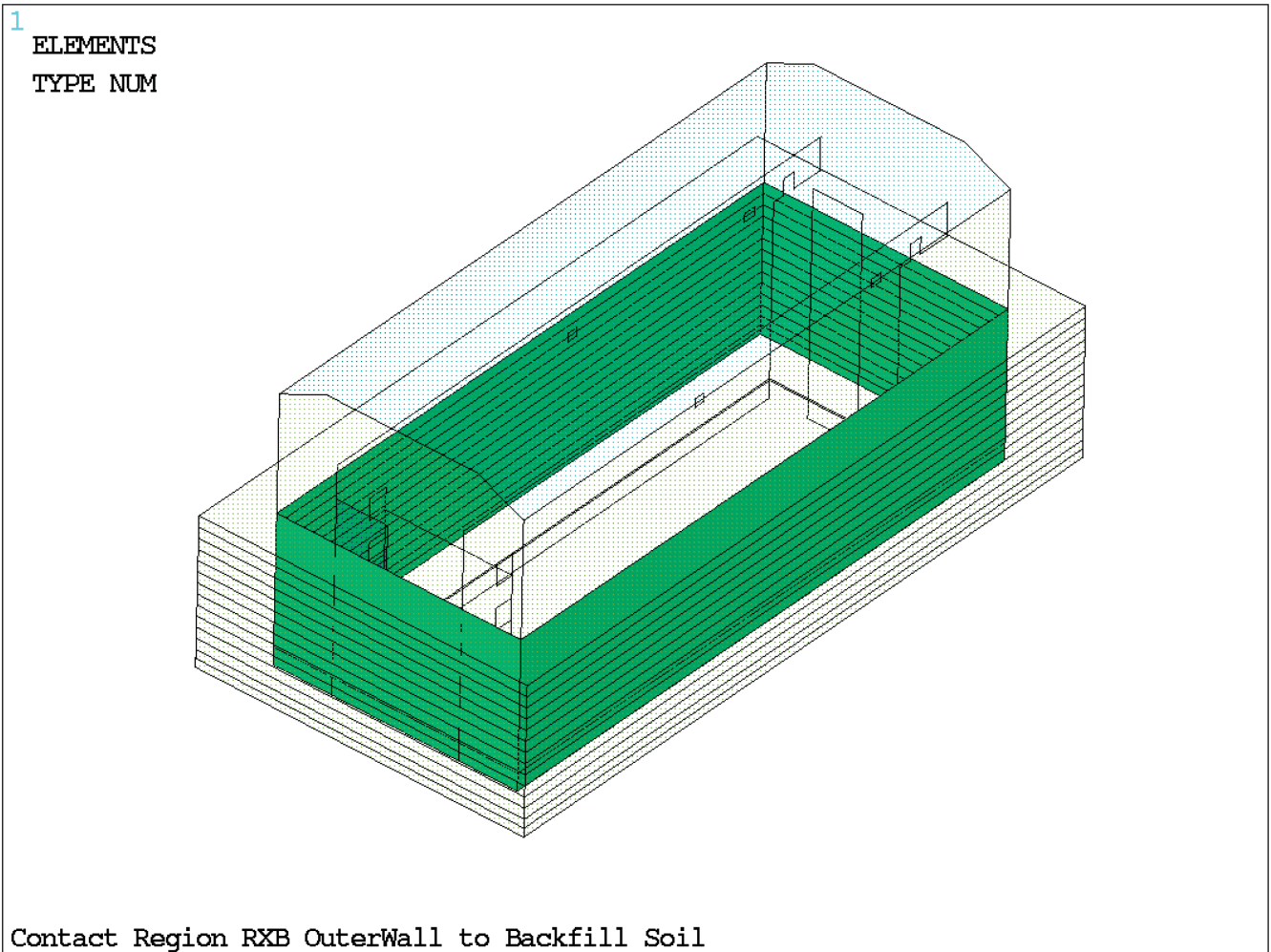

Figure 3.8.5-10: Edge and Center Nodes at Bottom of Foundations Selected for Building Settlement Assessment

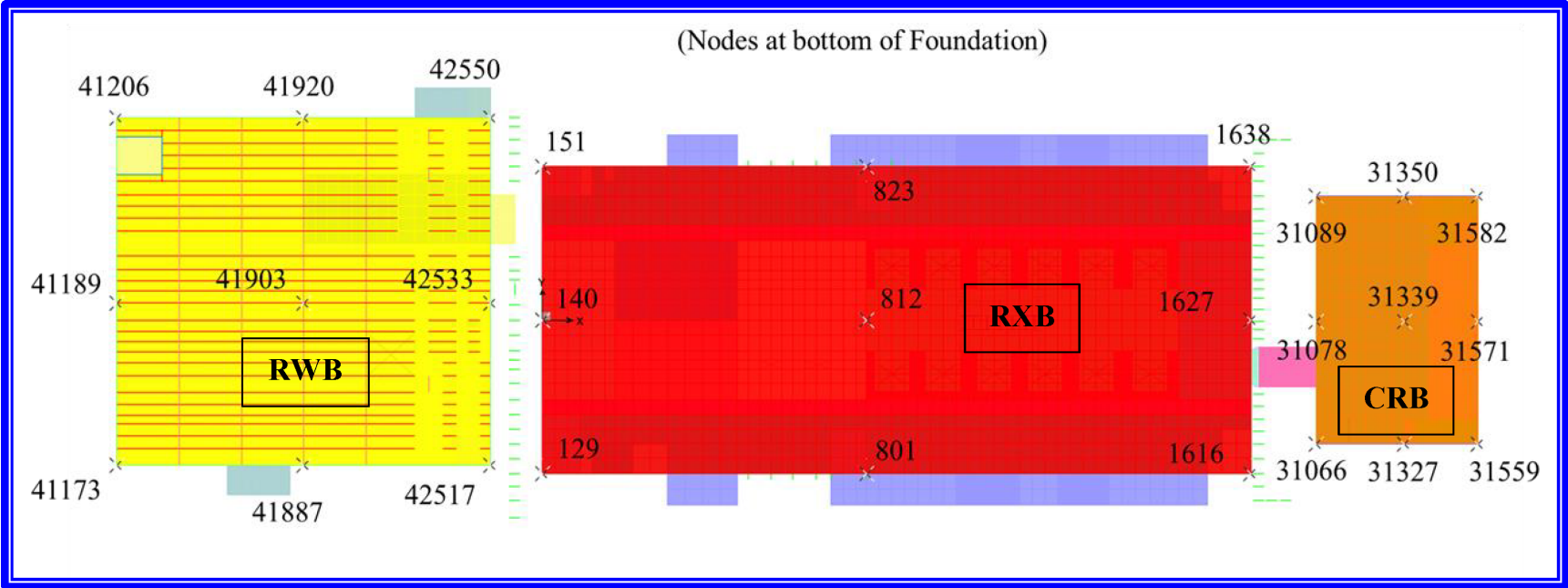

Figure 3.8.5-11: RXB Skin Nodes on Backfill Soil Vertical Boundaries for Applying SASSI Acceleration Time Histories

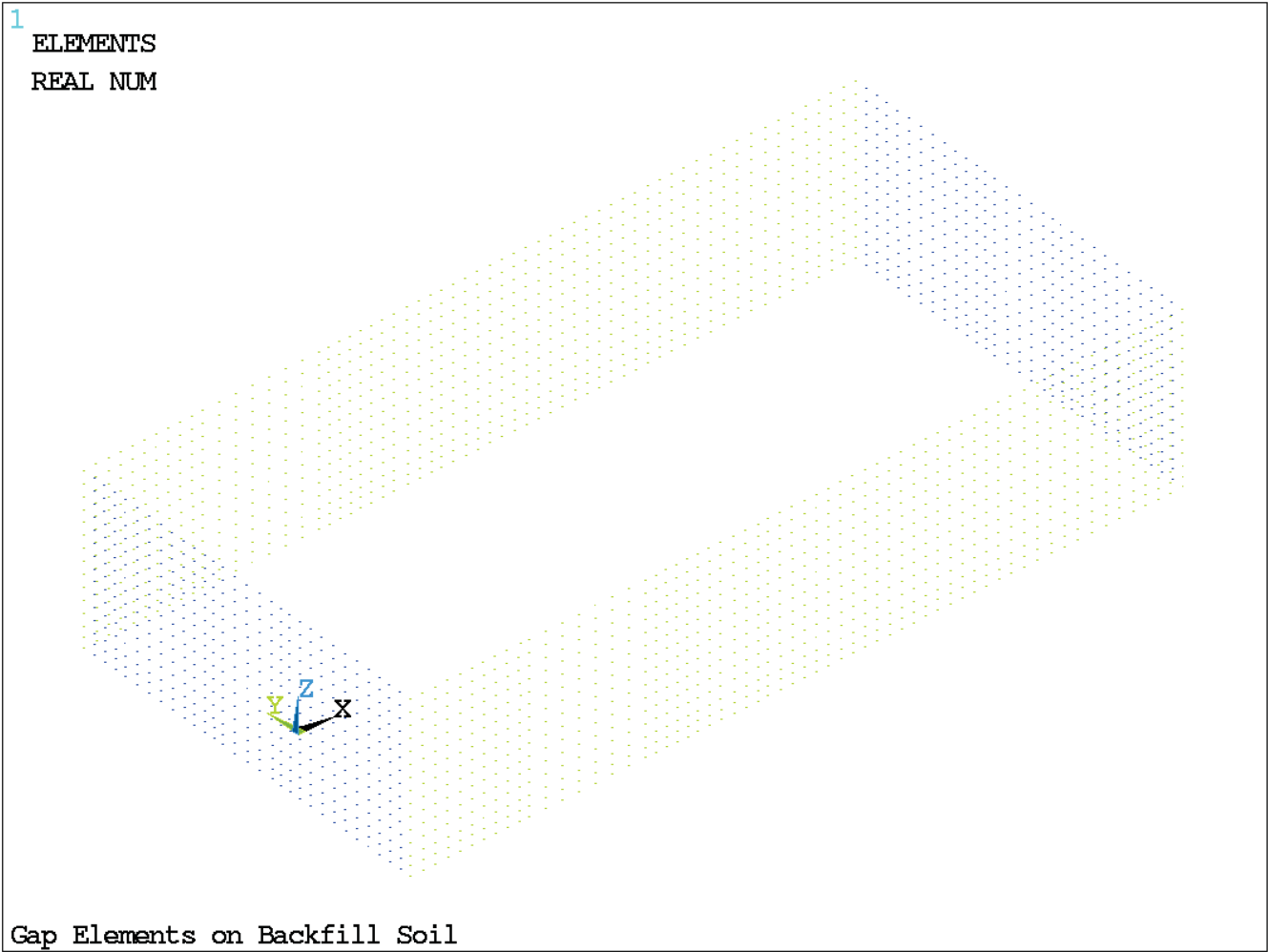

Figure 3.8.5-12: RXB Foundation Bottom Skin Nodes for Applying SASSI Acceleration Time Histories

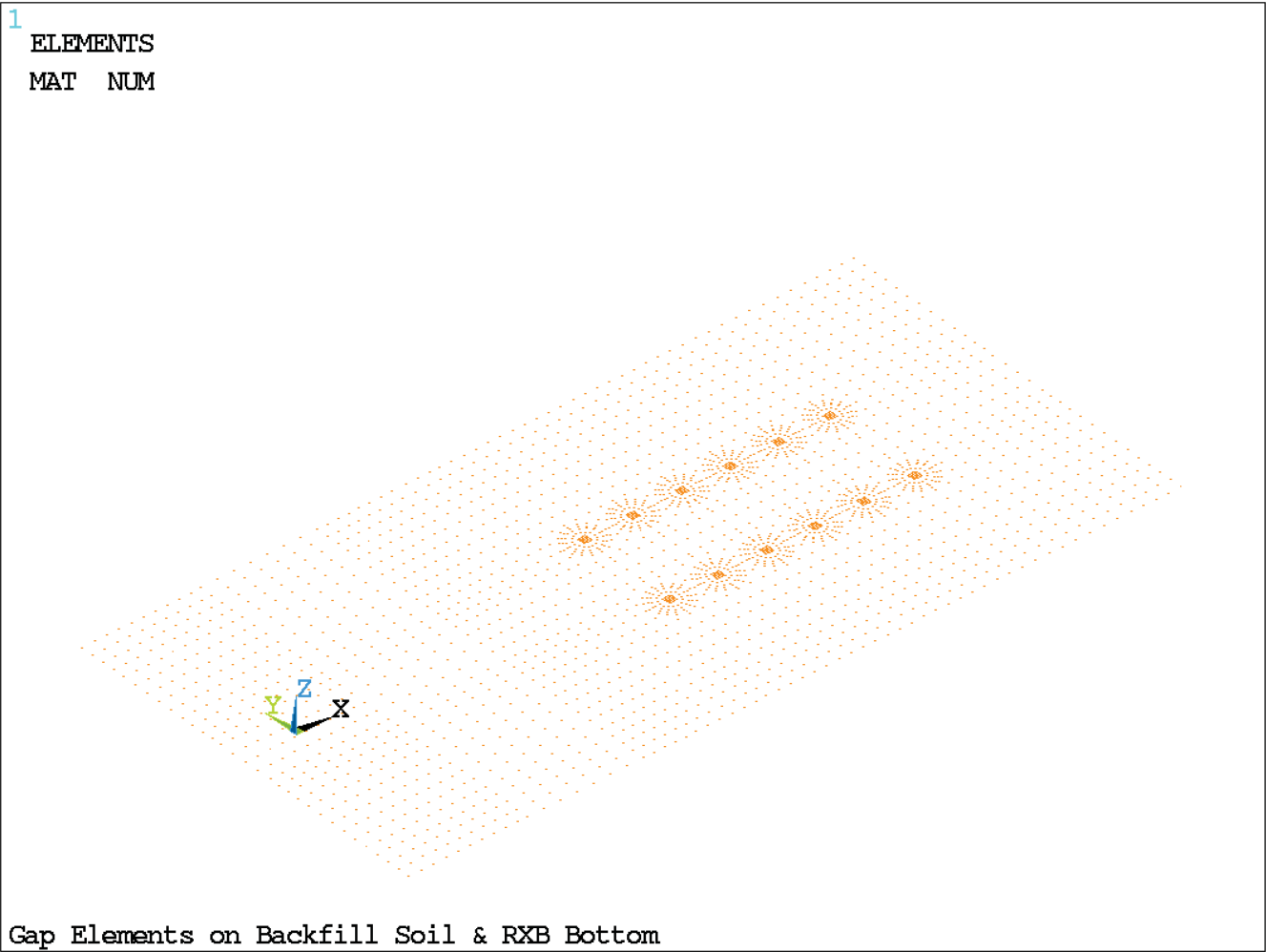

Figure 3.8.5-13: Displacements from SASSI Applied to ANSYS Model Boundary

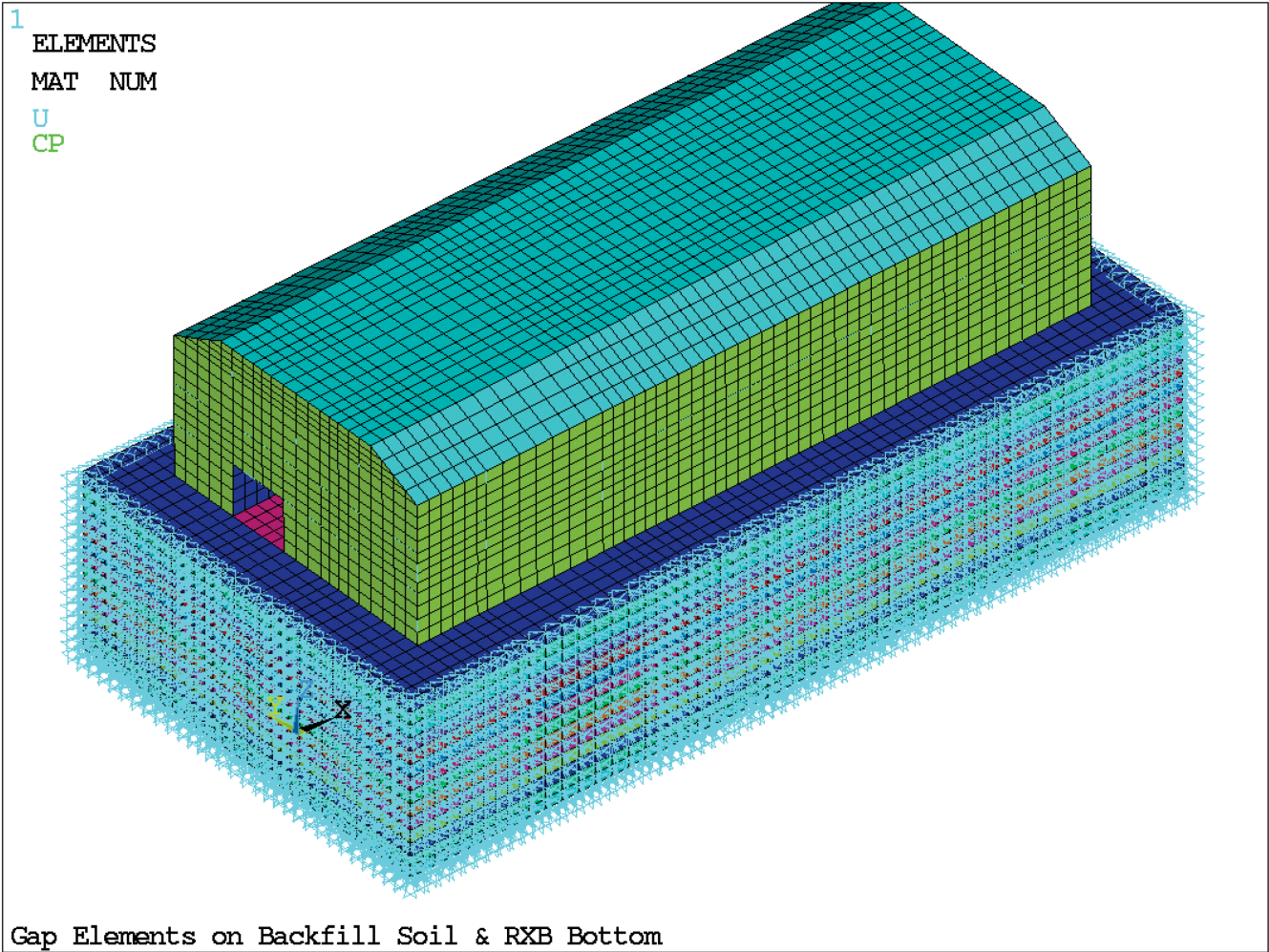

Figure 3.8.5-14: Displacements from SASSI Applied to ANSYS Model Boundary

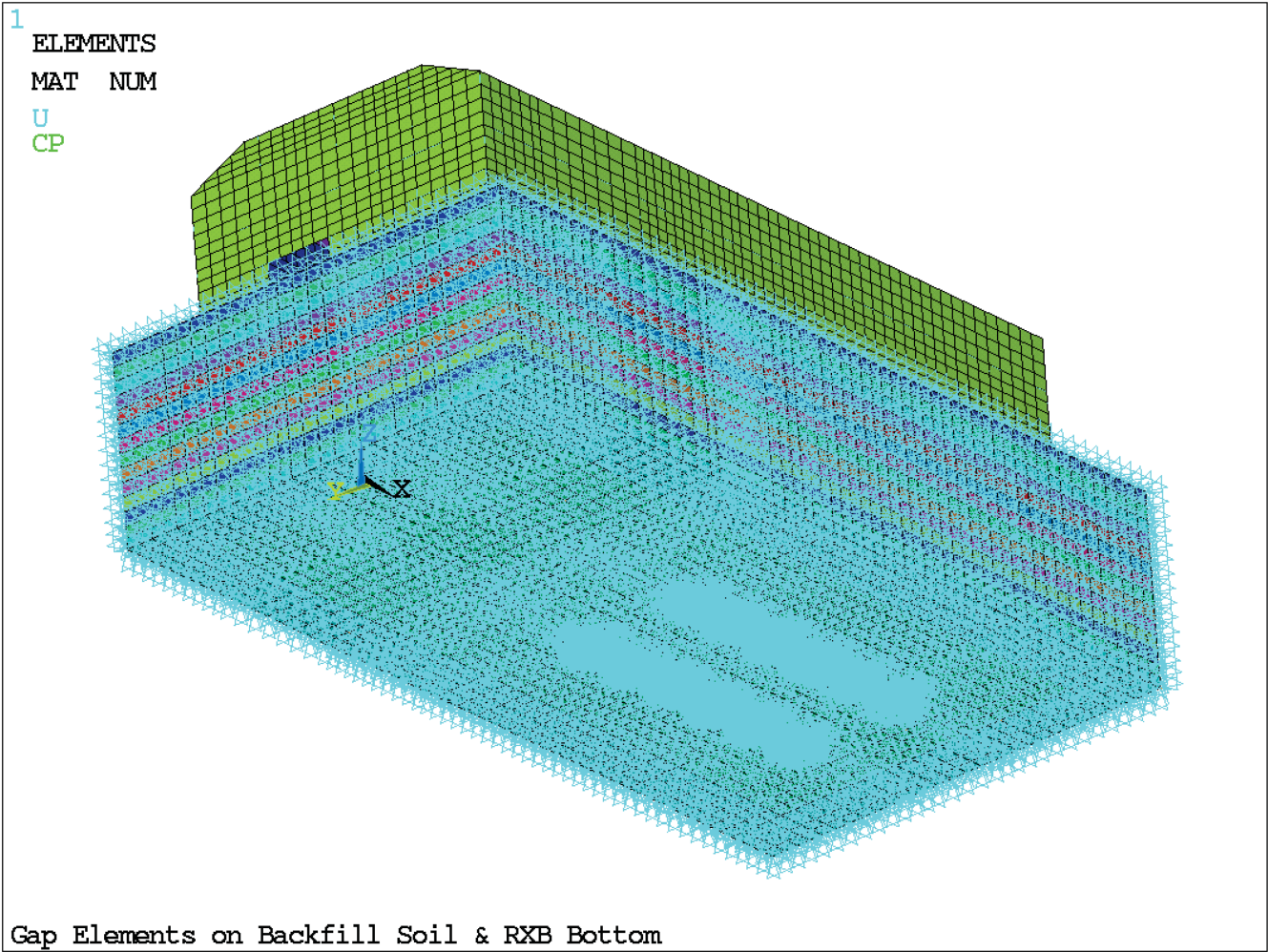

Figure 3.8.5-15: Nonlinear Contact Element between Backfill and Surrounding Soil

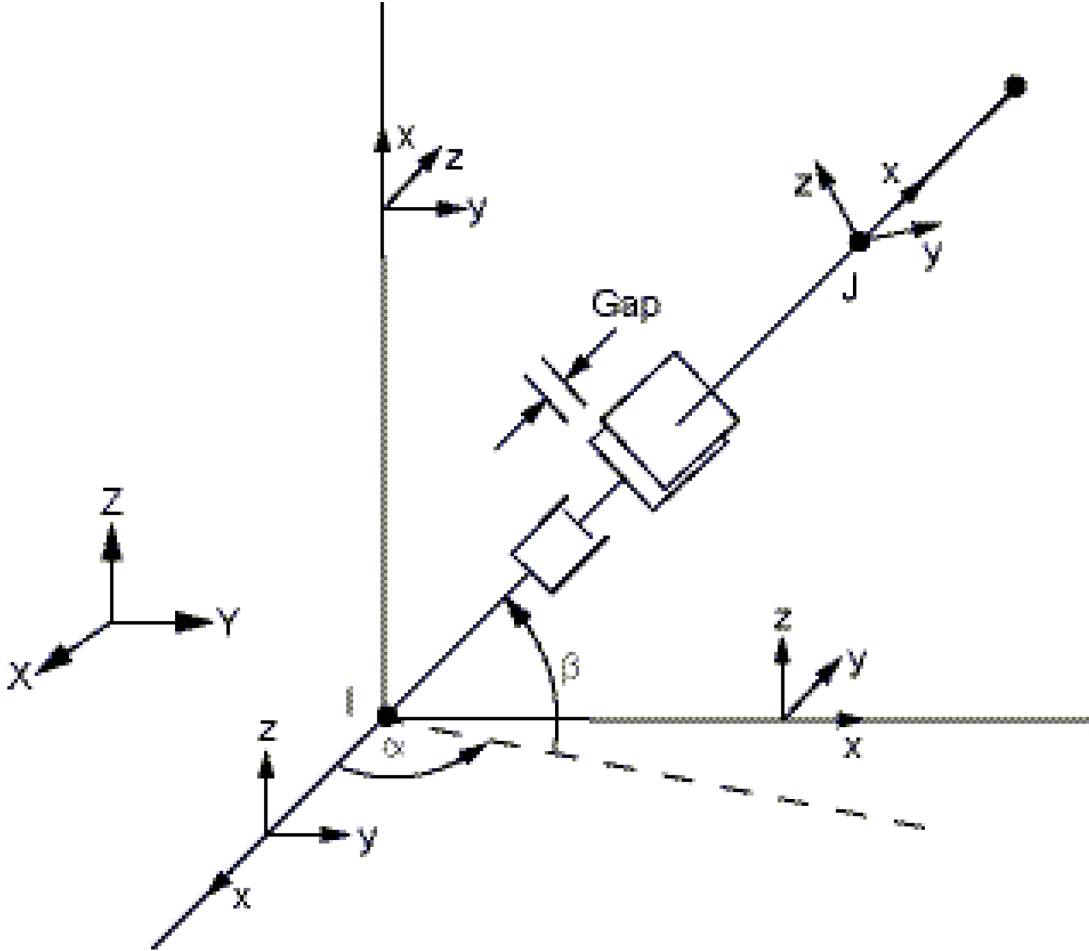

Figure 3.8.5-16: Buoyancy Load on Basemat

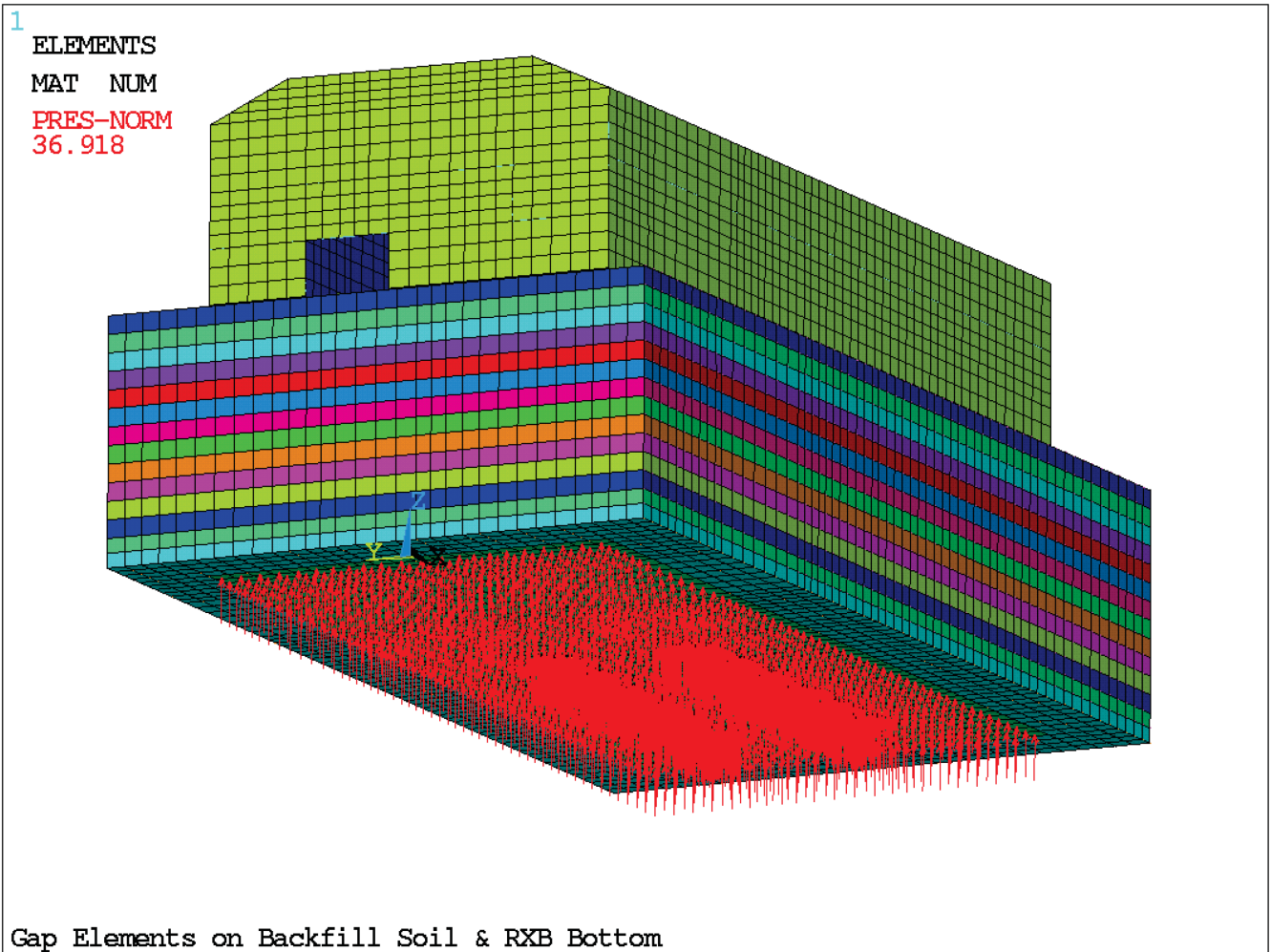

Figure 3.8.5-17: Soil Type 7 - Acceleration Time History - Vertical

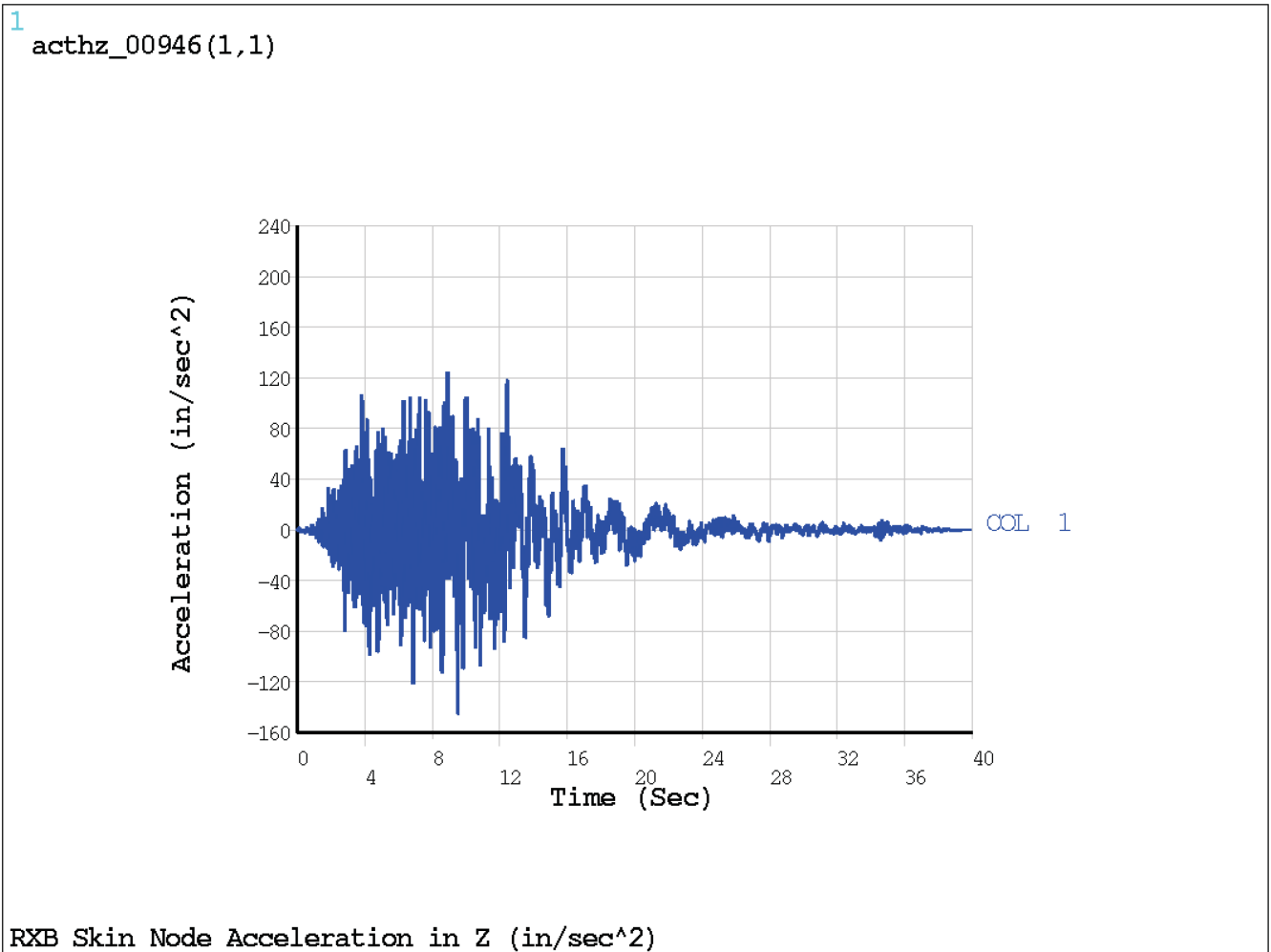

Figure 3.8.5-18: Soil Type 7 - Acceleration Time History - E-W

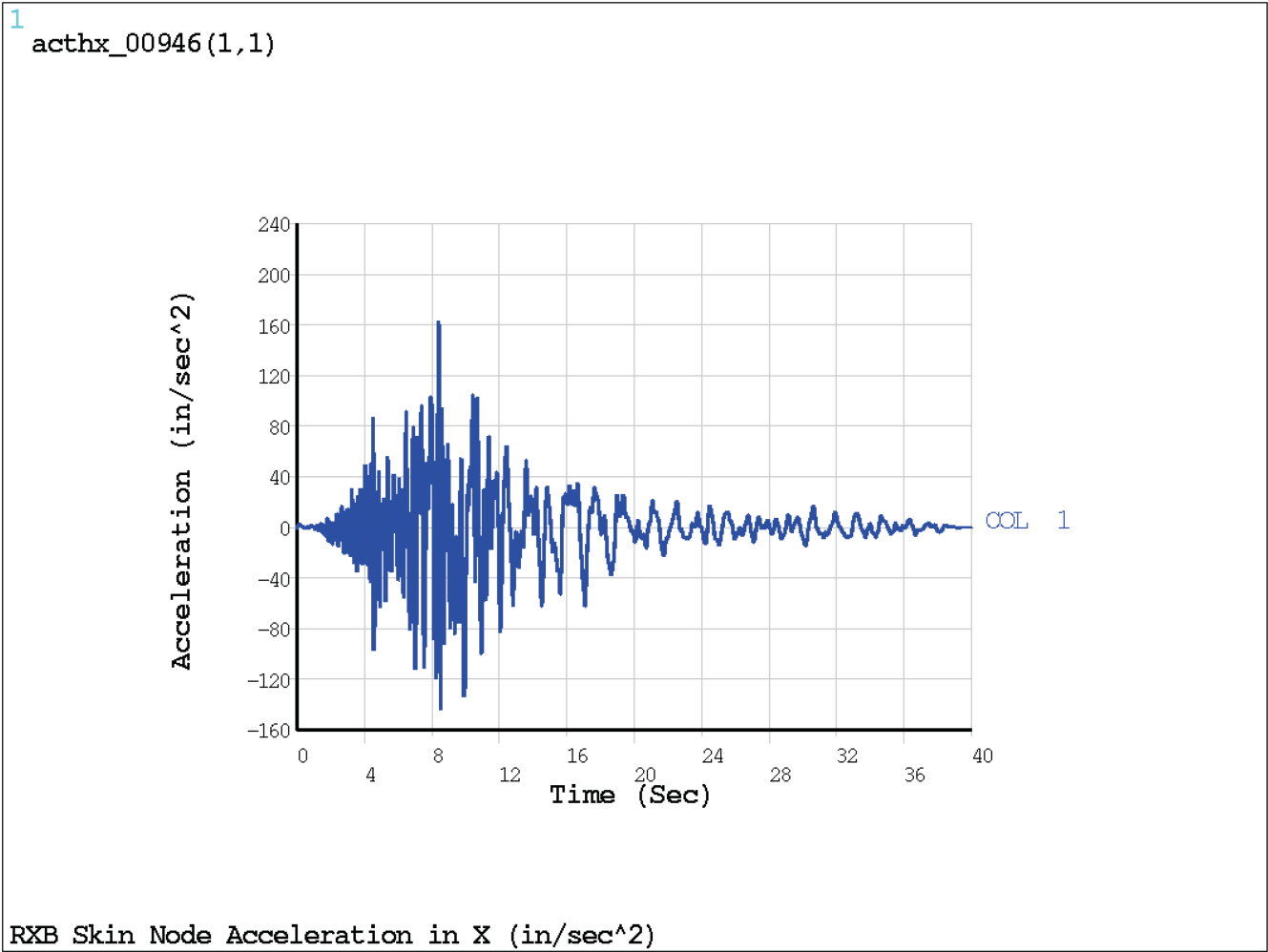

Figure 3.8.5-19: Soil Type 7 - Acceleration Time History - N-S

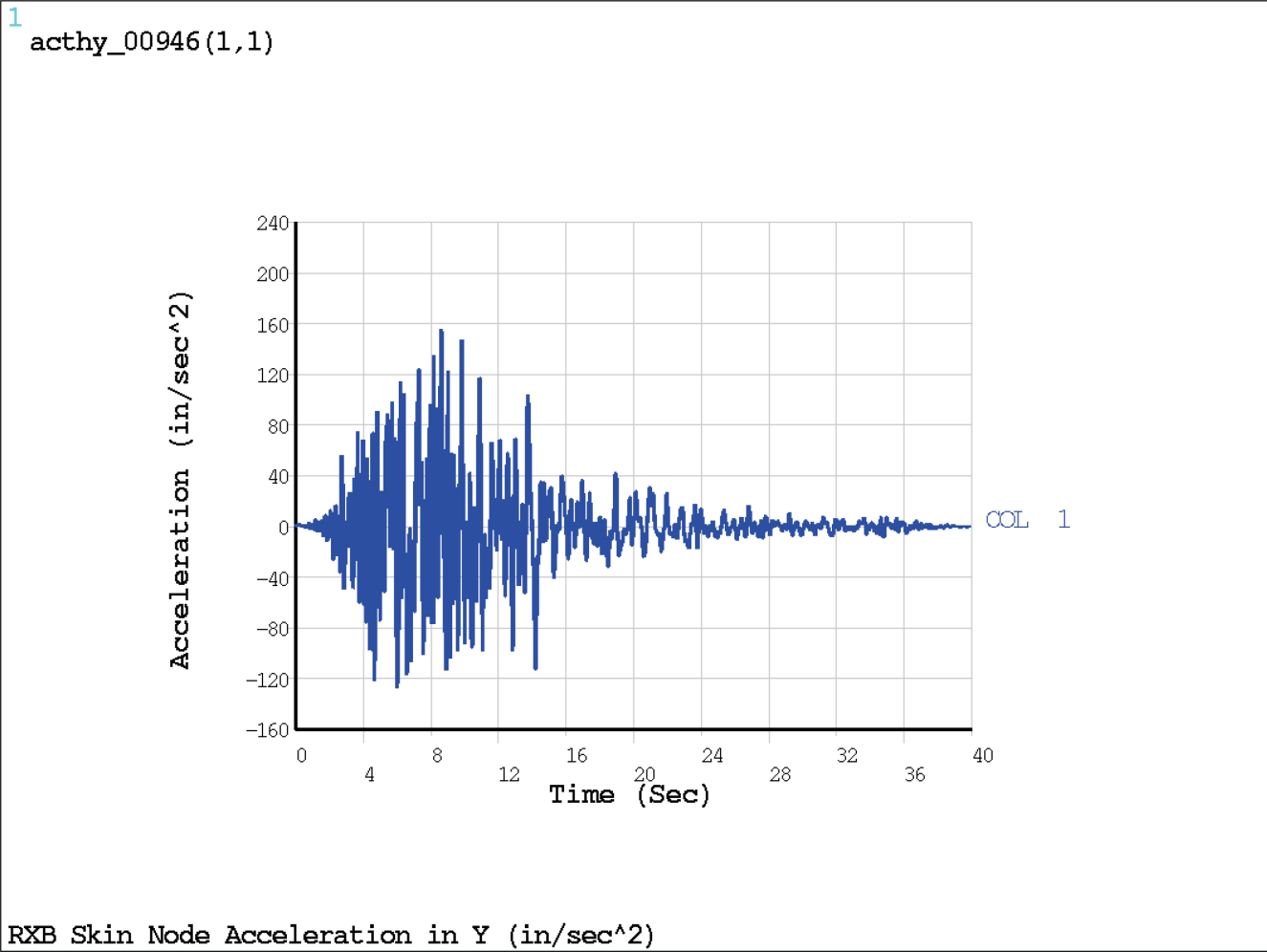

Figure 3.8.5-20: Soil Type 8 - Acceleration Time History - Vertical

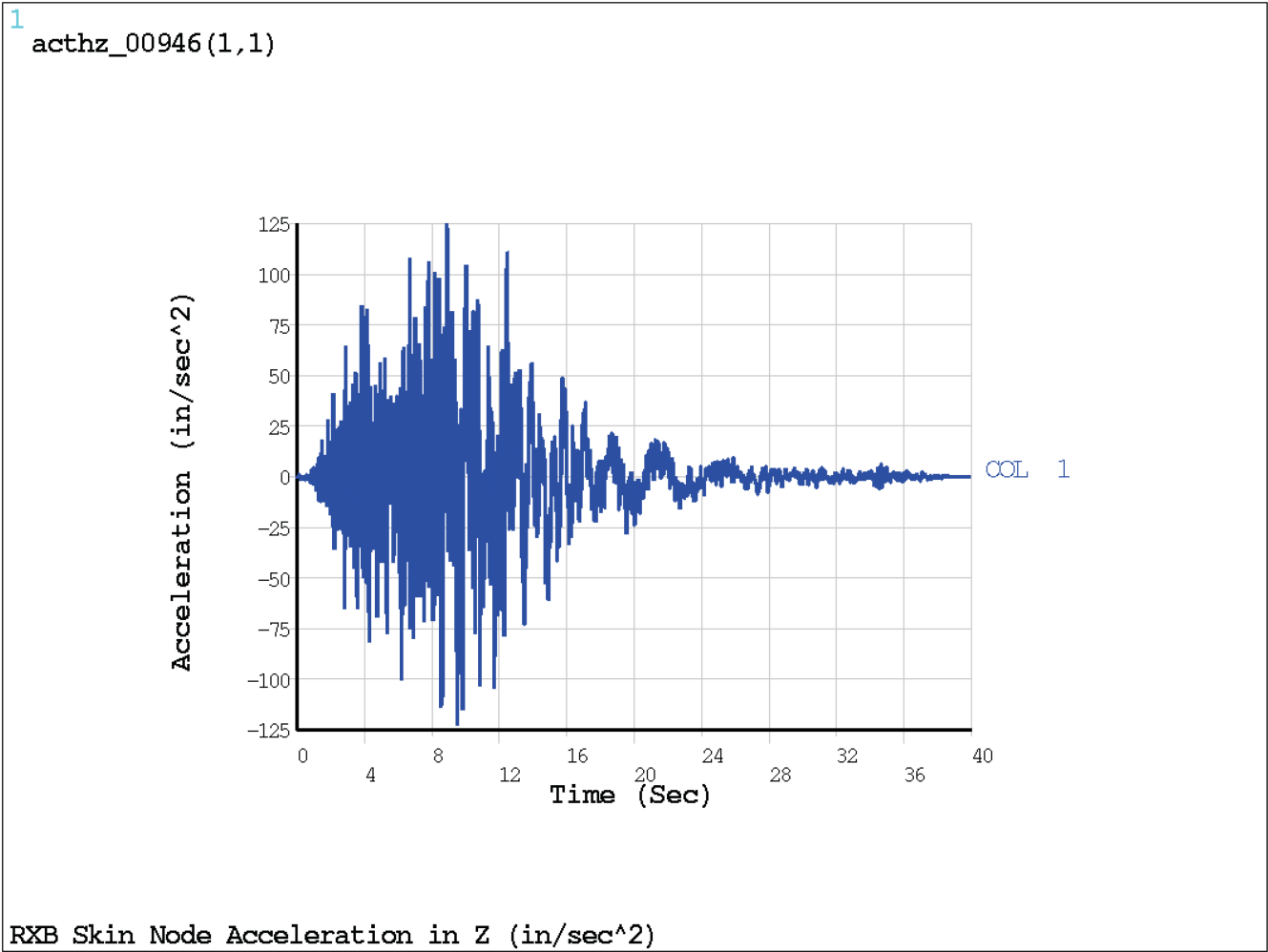

Figure 3.8.5-21: Soil Type 8 - Acceleration Time History - E-W

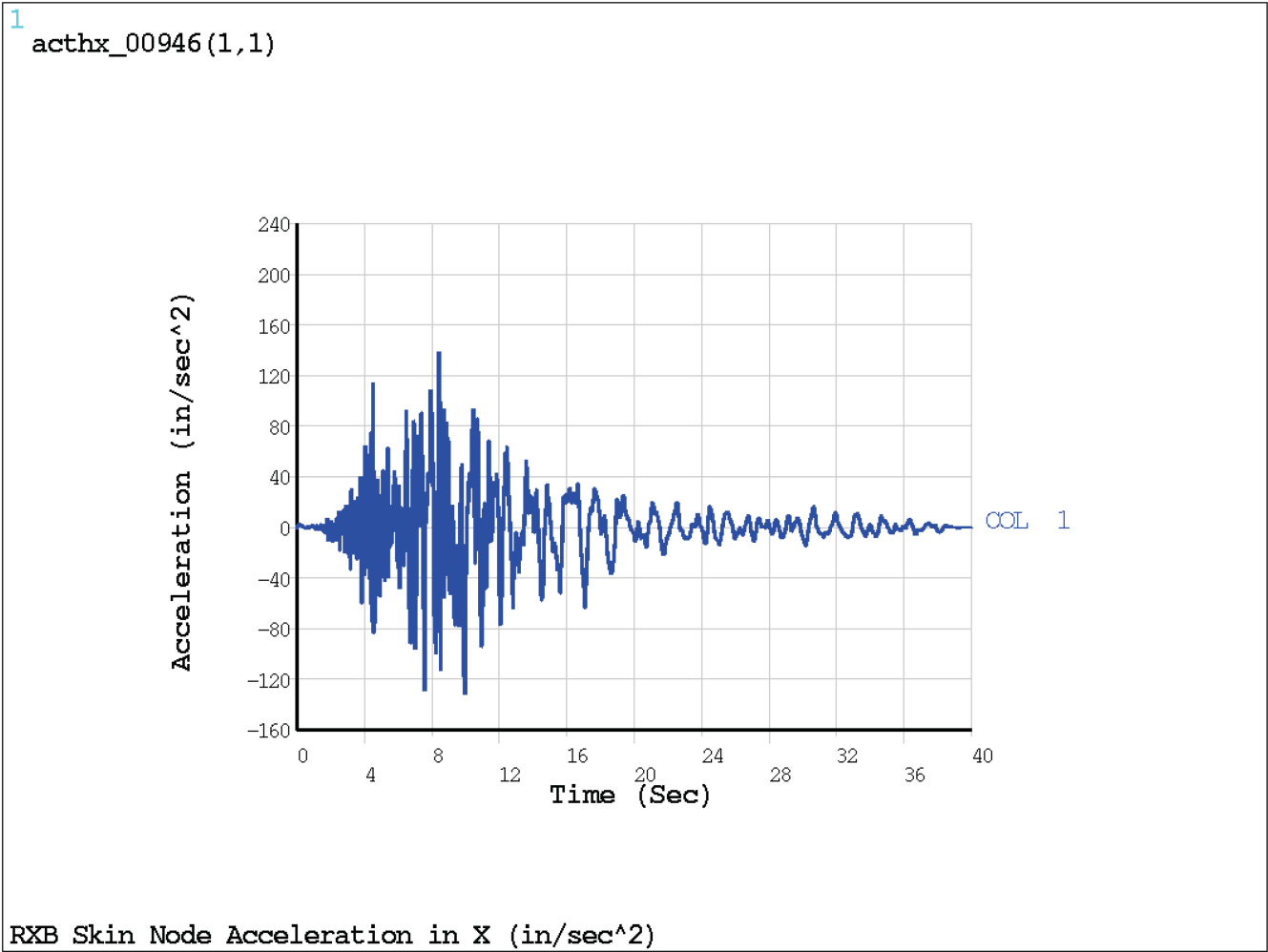

Figure 3.8.5-22: Soil Type 8 - Acceleration Time History - N-S

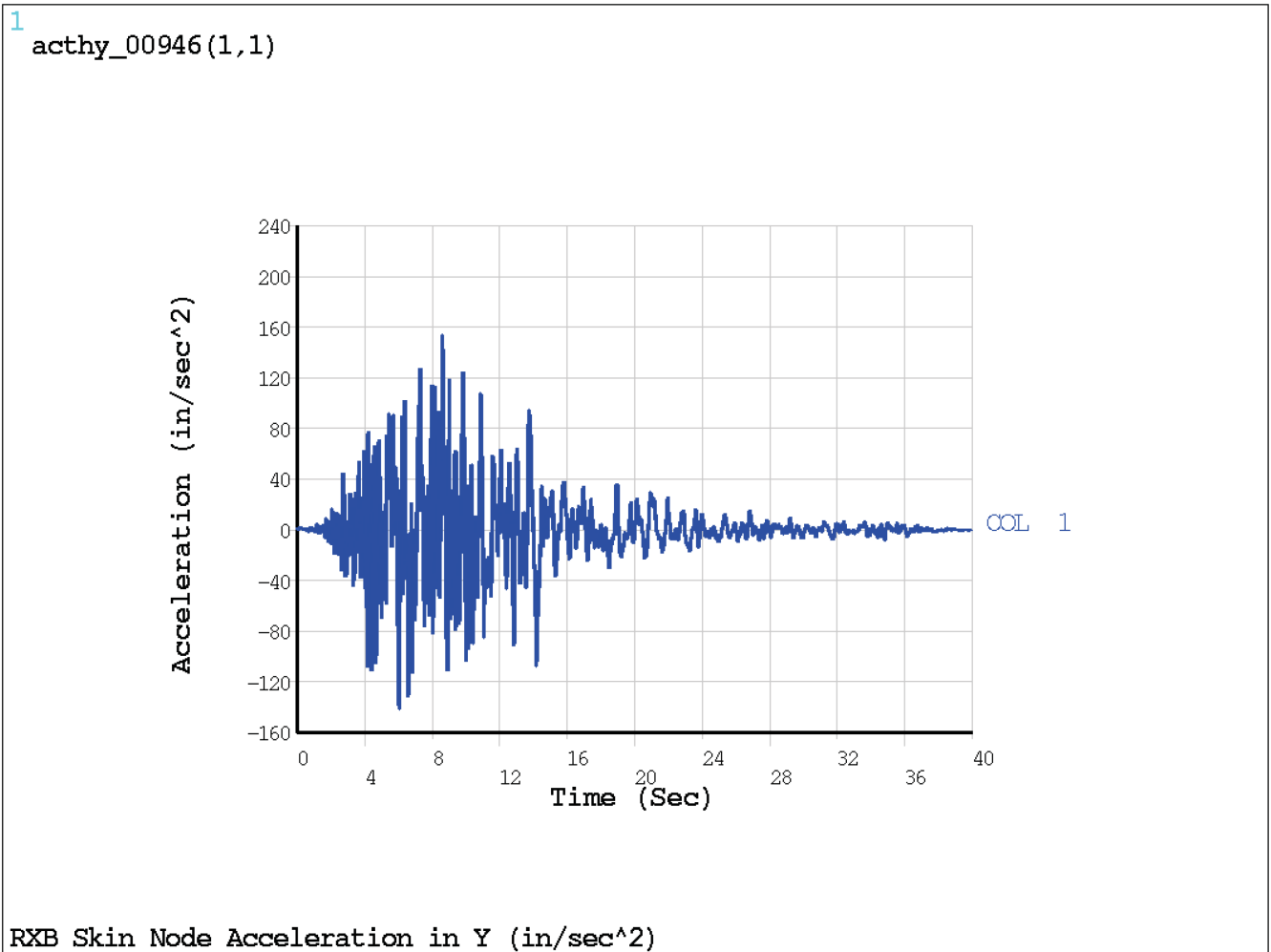

Figure 3.8.5-23: Soil Type 11 - Acceleration Time History - Vertical

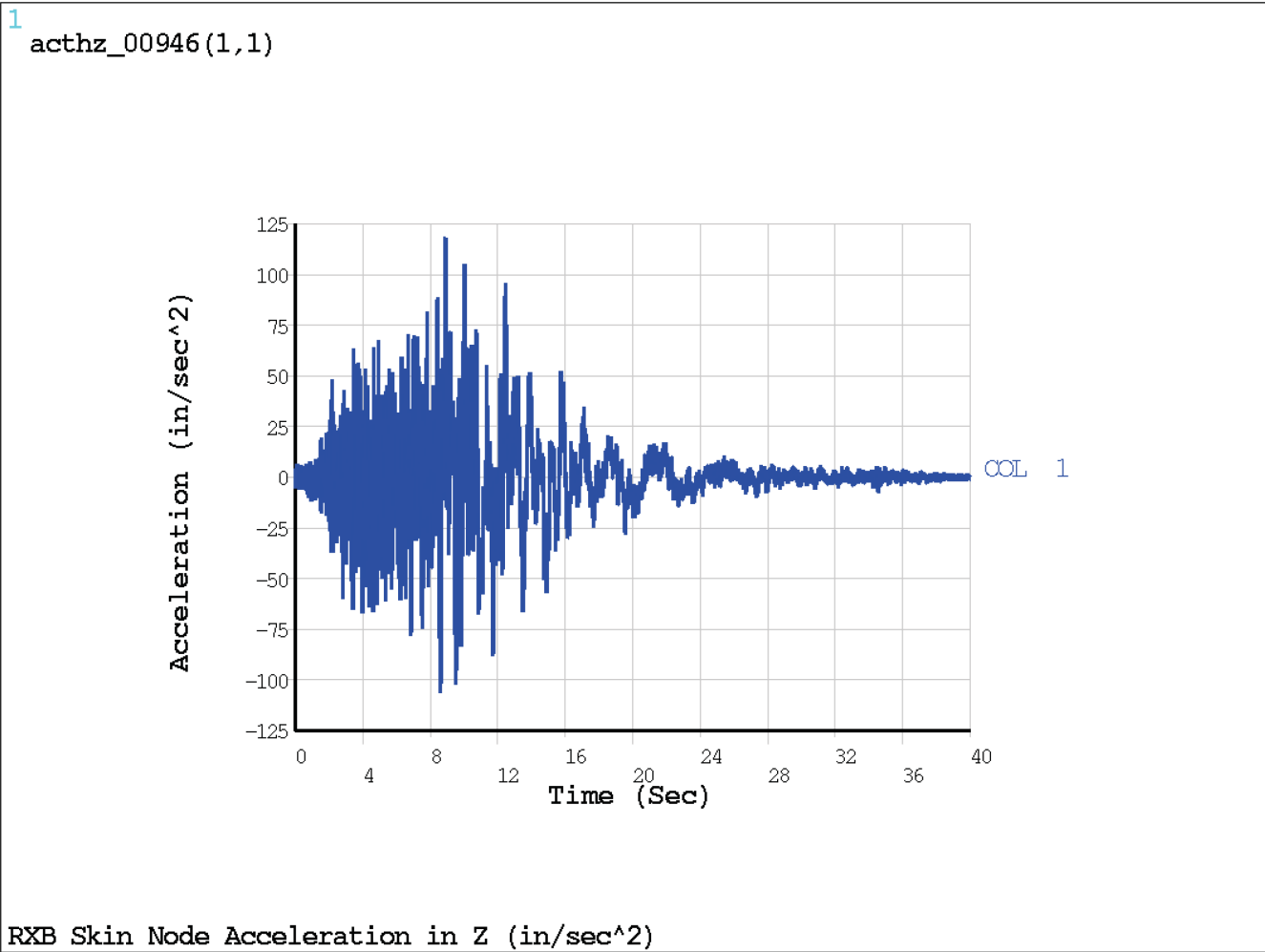

Figure 3.8.5-24: Soil Type 11 - Acceleration Time History - E-W

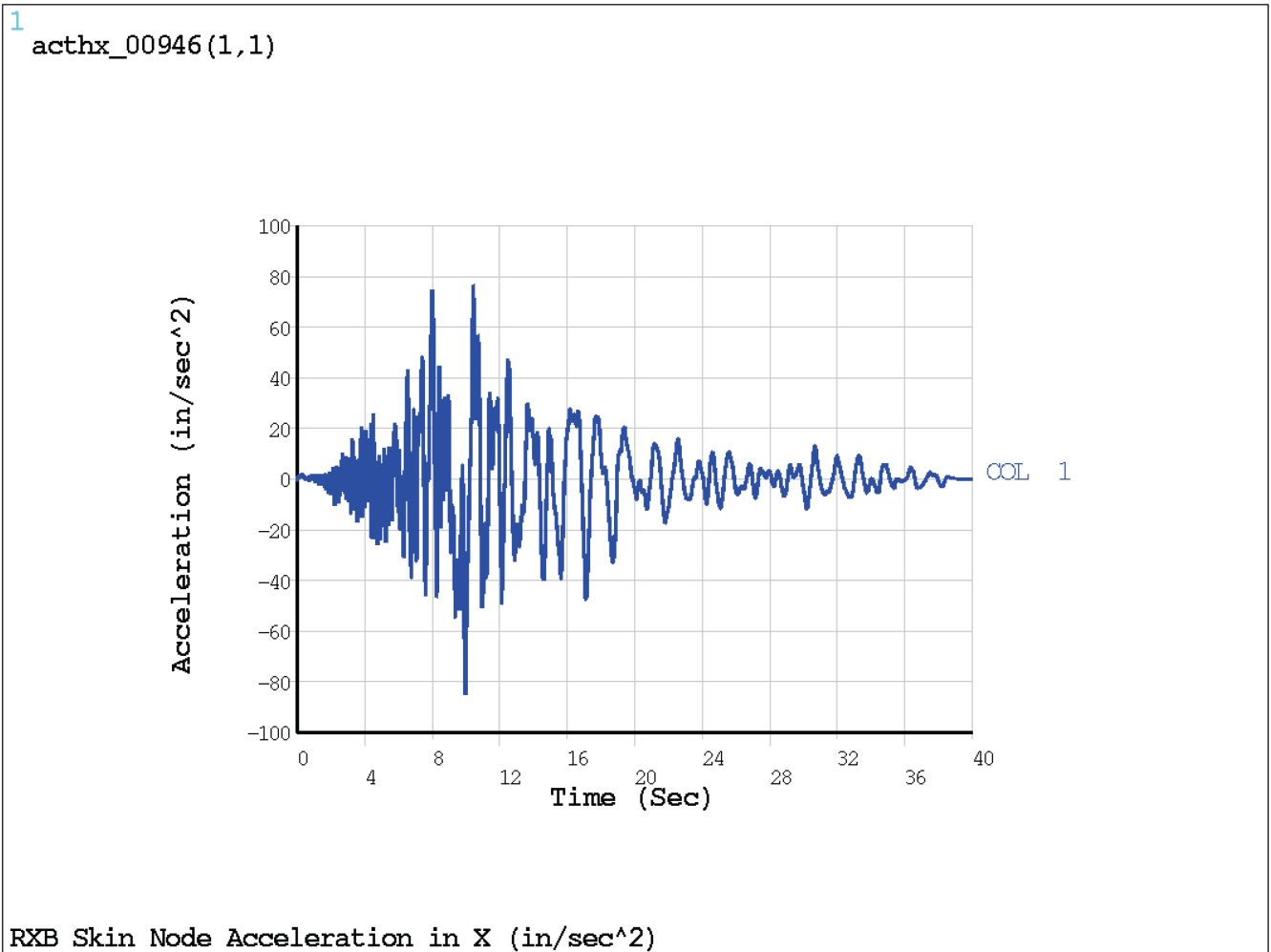

Figure 3.8.5-25: Soil Type 11 - Acceleration Time History - N-S

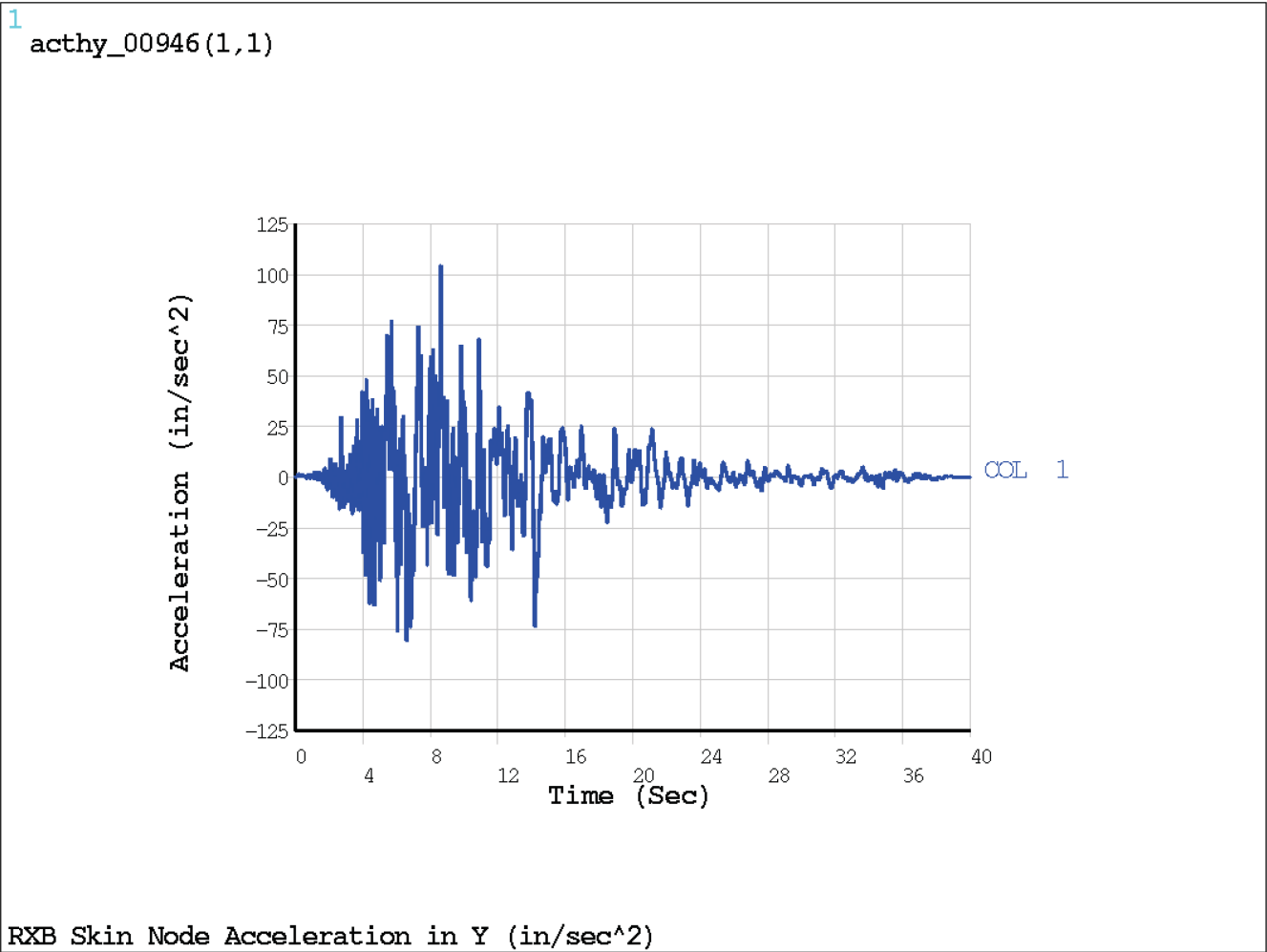

Figure 3.8.5-26: Nonlinear Contact Region between CRB and Soil

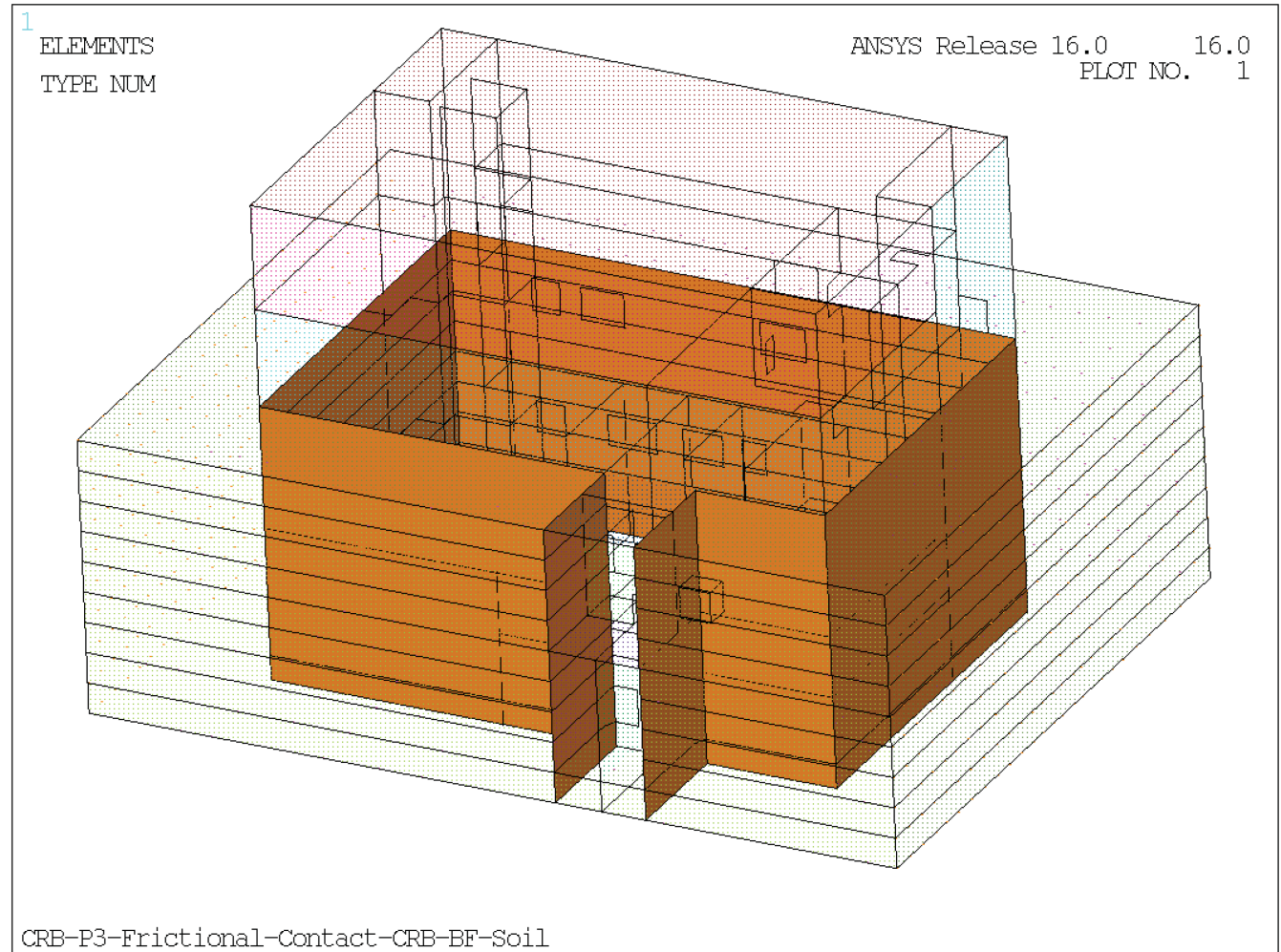

Figure 3.8.5-27: CRB Time Histories from SASSI Applied to ANSYS Model Boundary

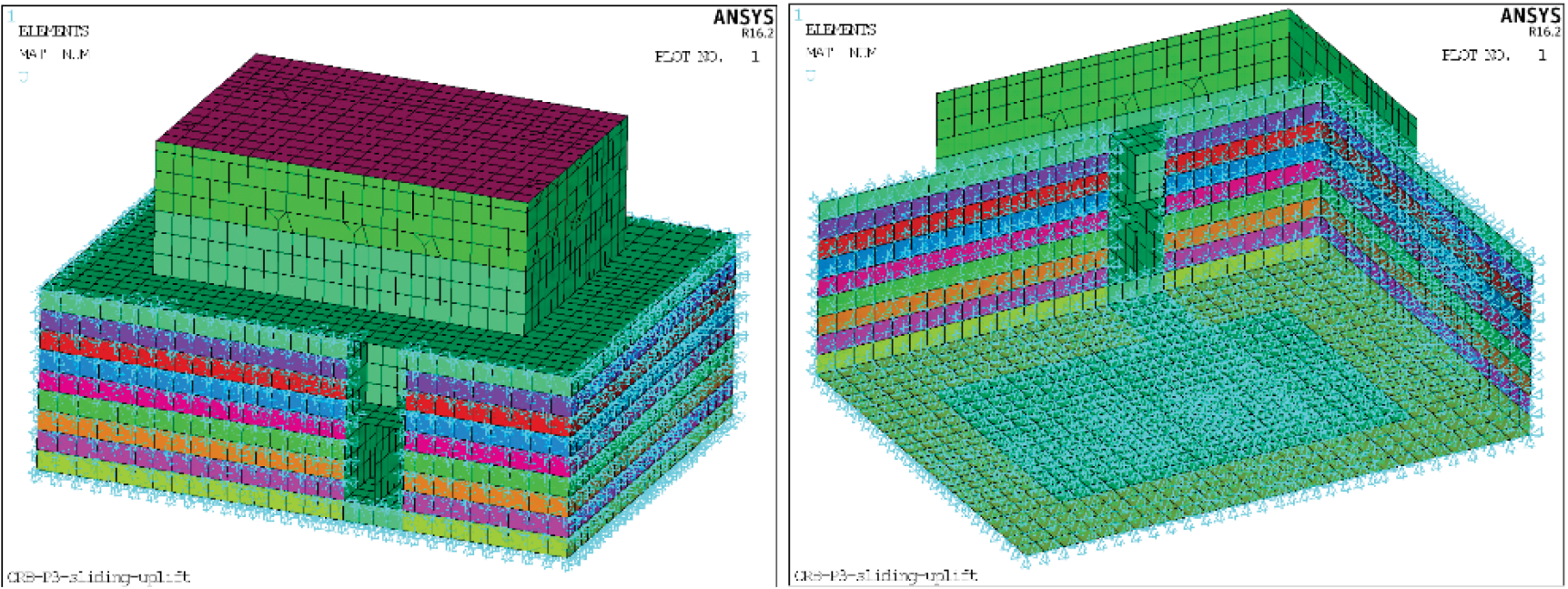

Figure 3.8.5-28: Soil Type 11, Capitola Input - Acceleration Time History - Vertical

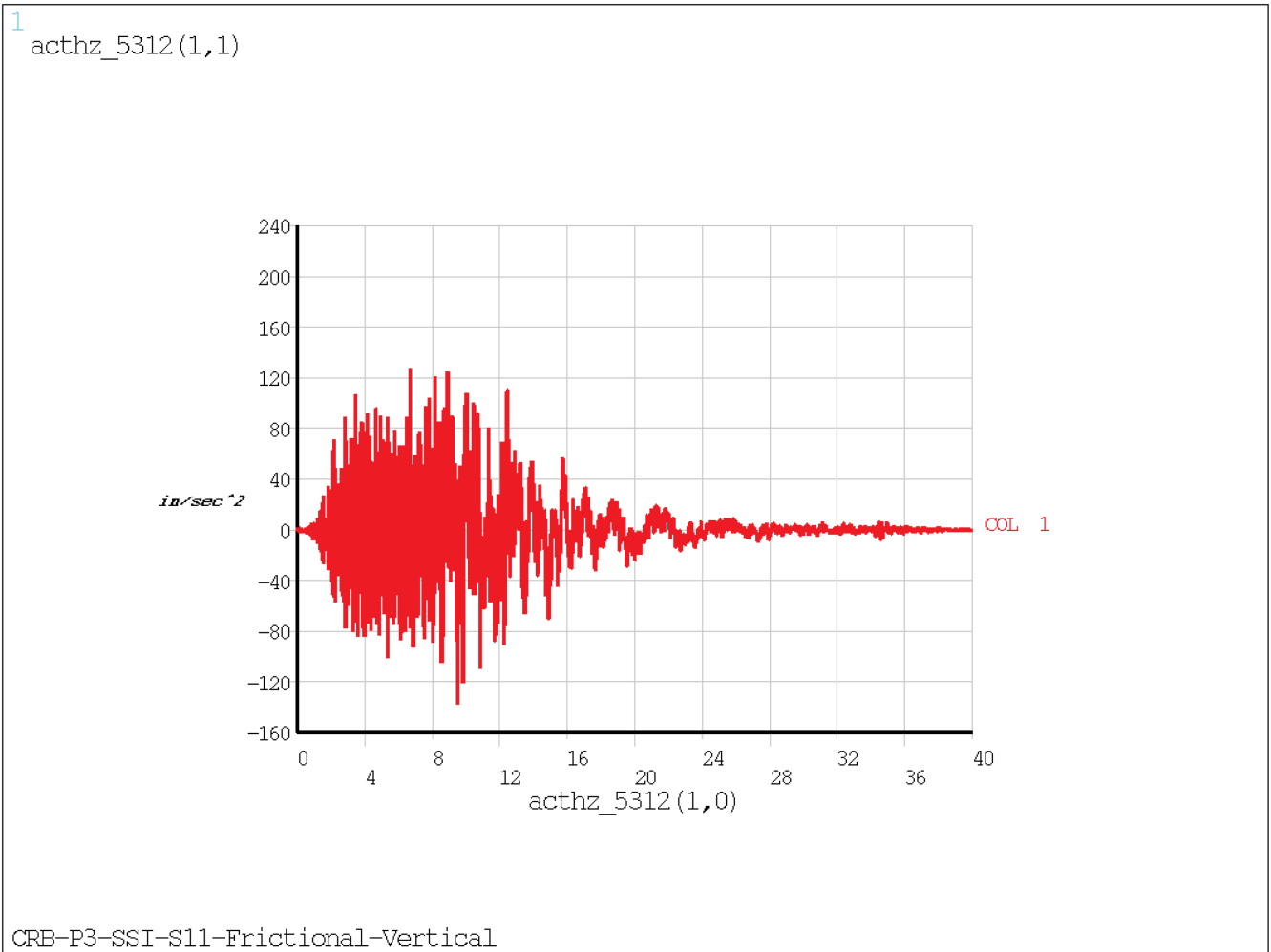

Figure 3.8.5-29: Soil Type 11, Capitola Input - Acceleration Time History - E-W

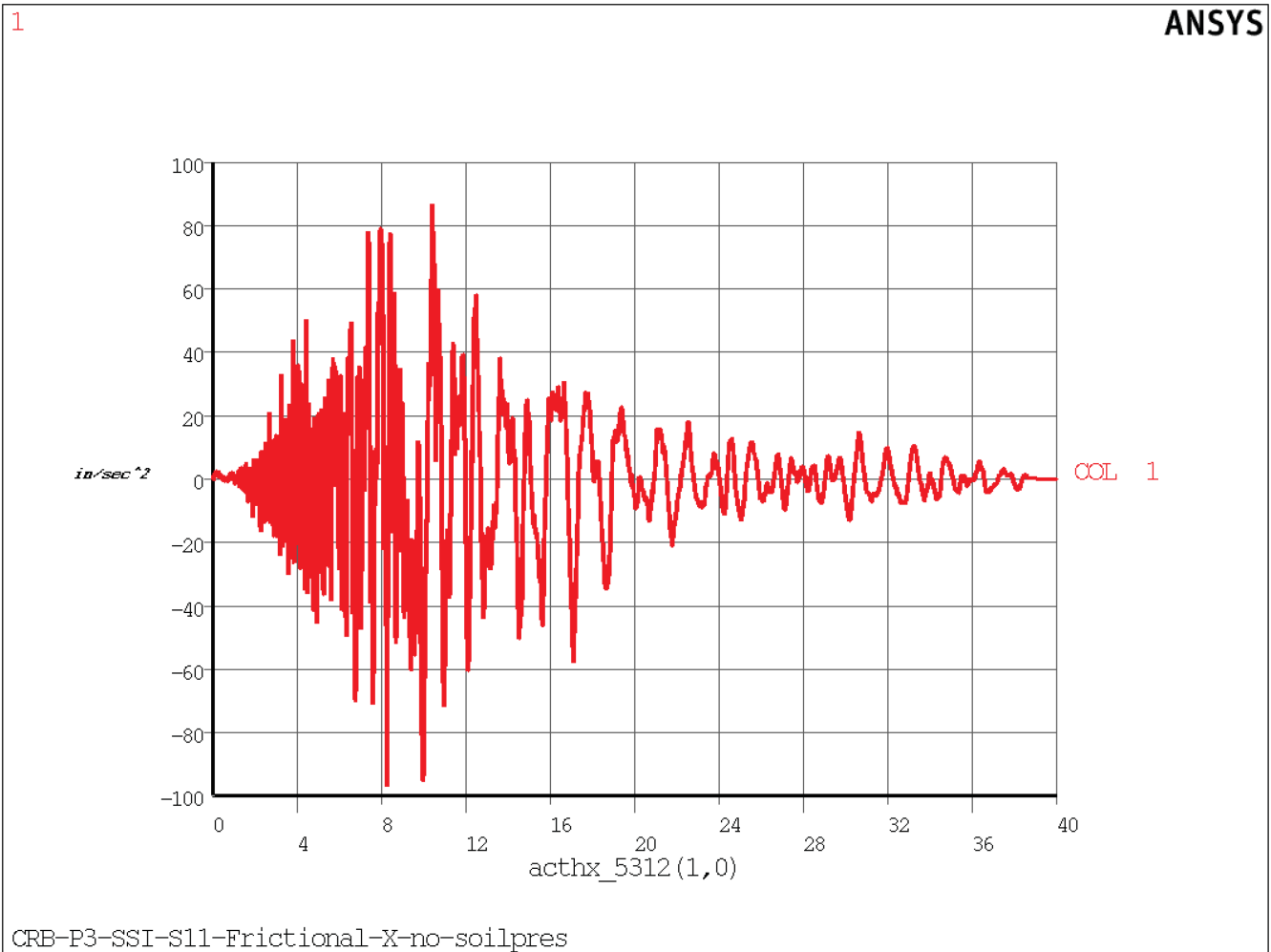

Figure 3.8.5-30: Soil Type 11, Capitola Input - Acceleration Time History - N-S

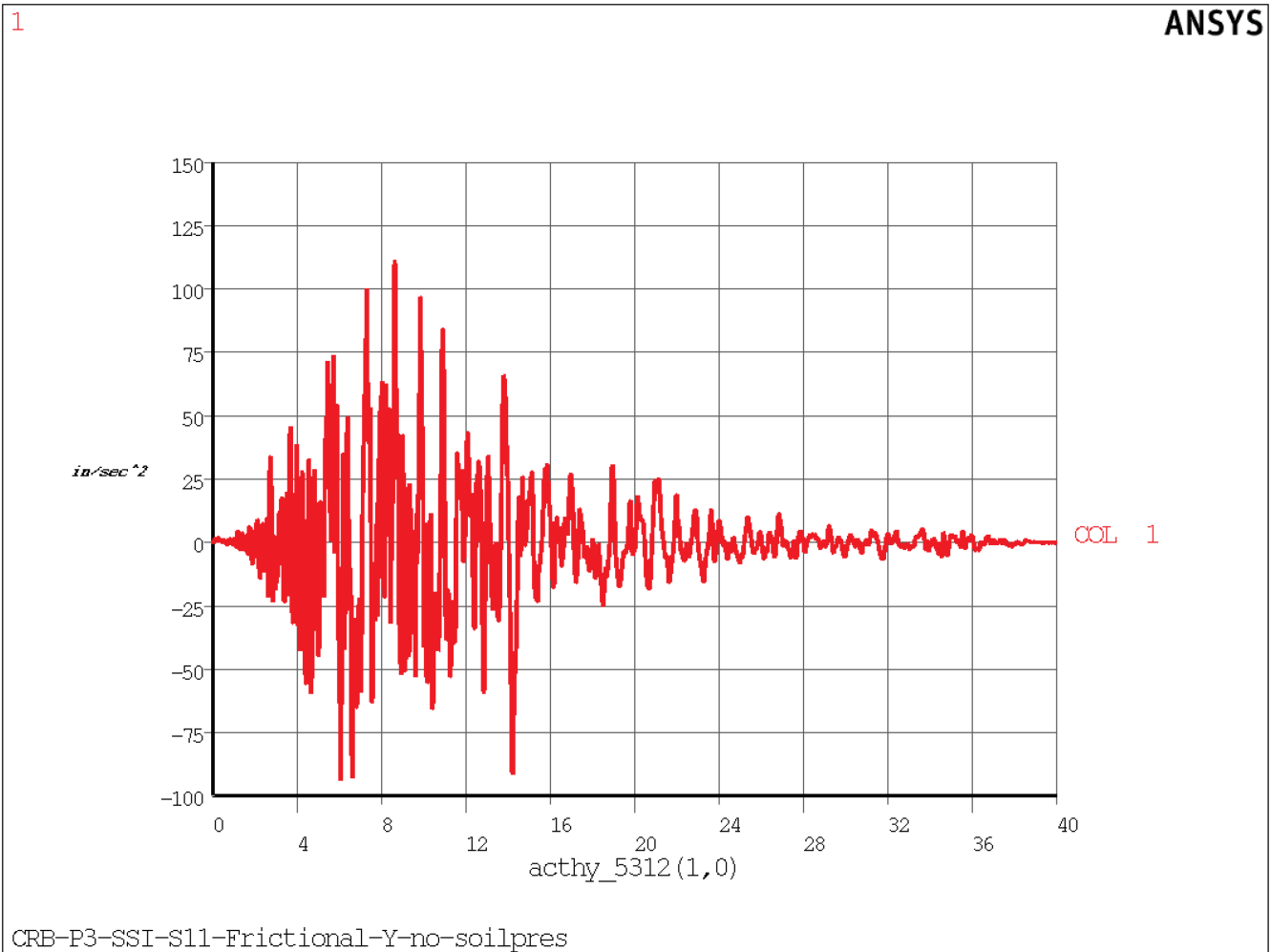

Figure 3.8.5-31: Soil Type 7, Capitola Input - Acceleration Time History - Vertical

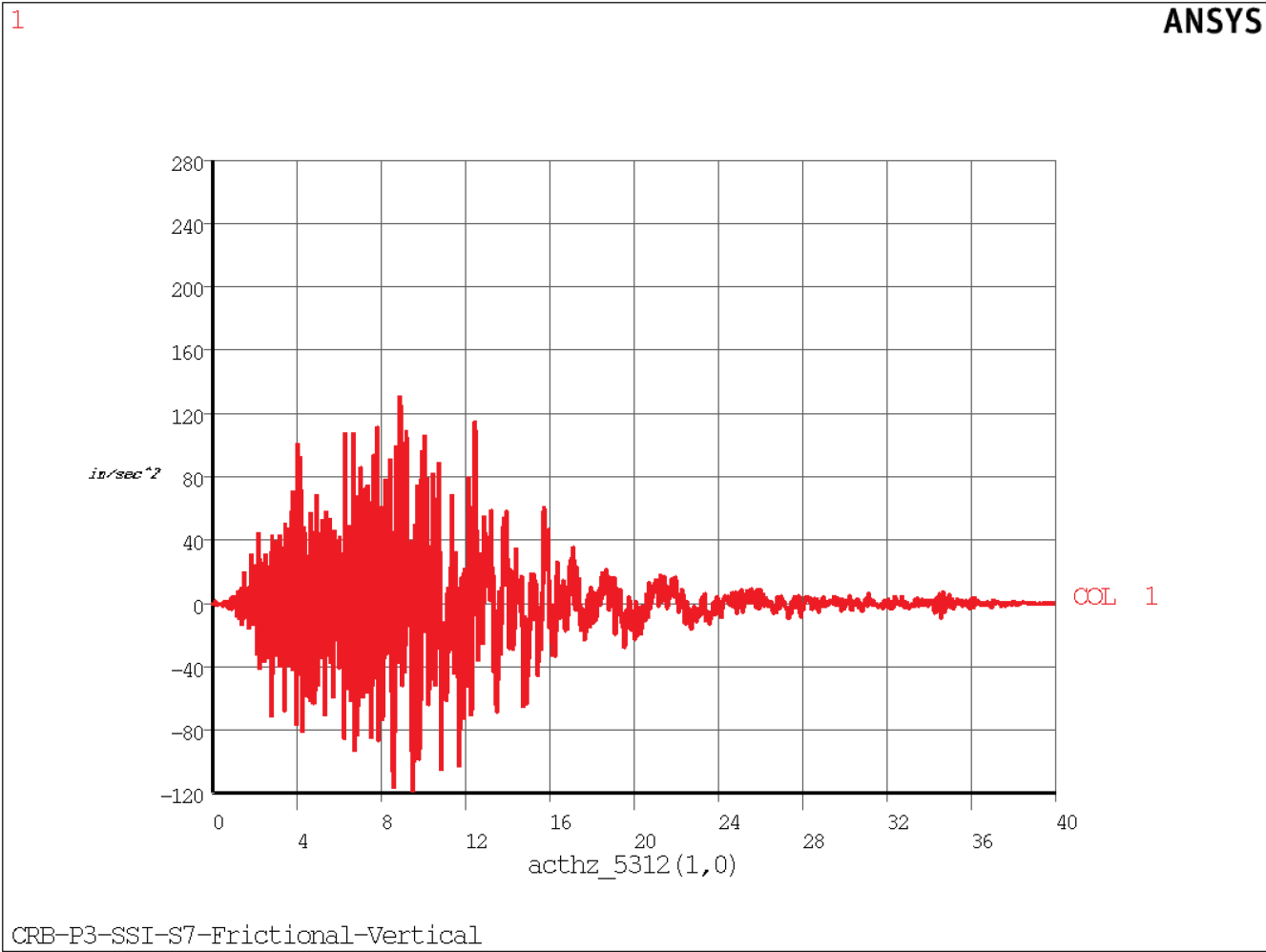

Figure 3.8.5-32: Soil Type 7, Capitola Input - Acceleration Time History - E-W

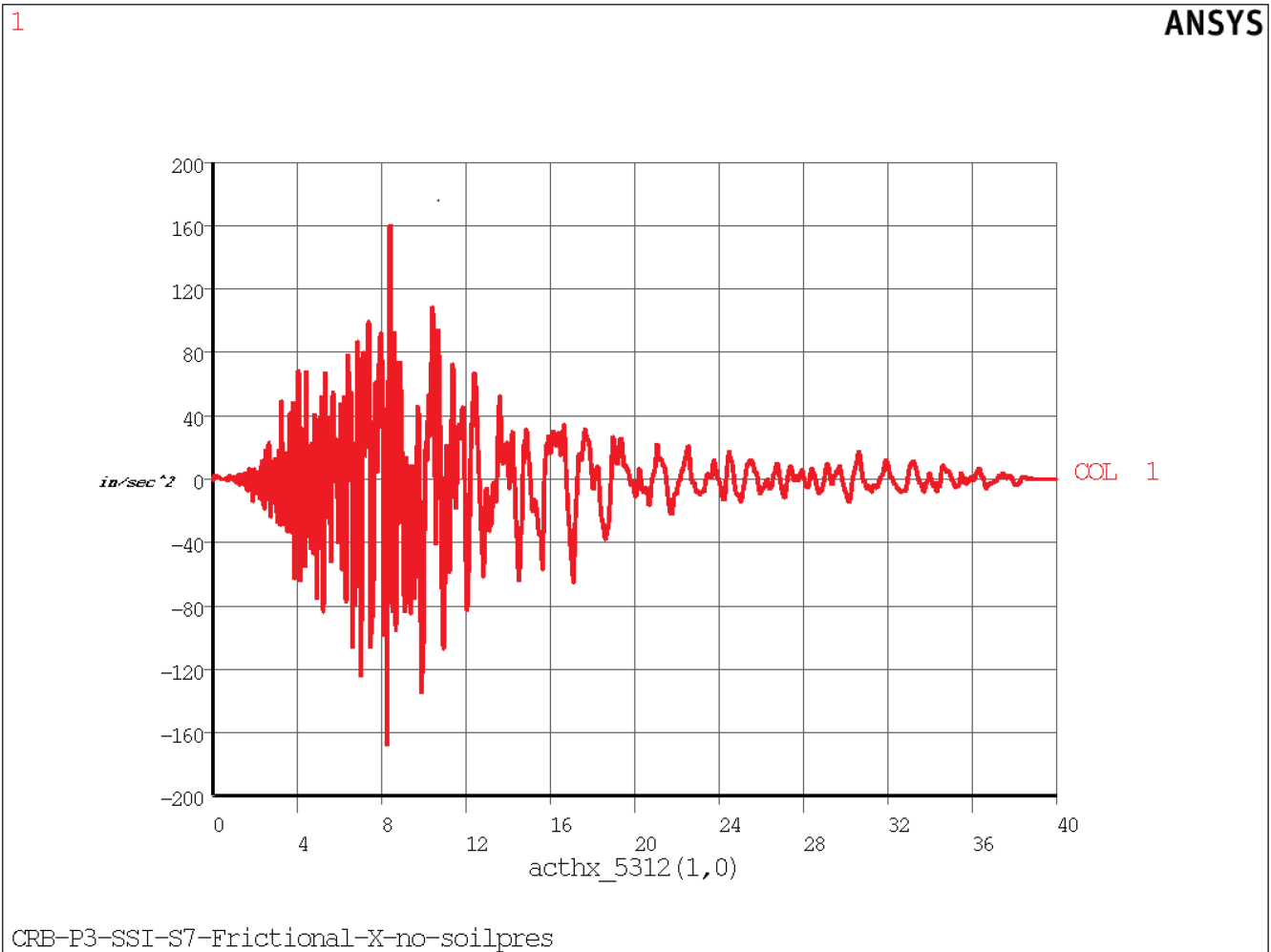

Figure 3.8.5-33: Soil Type 7, Capitola Input - Acceleration Time History - N-S

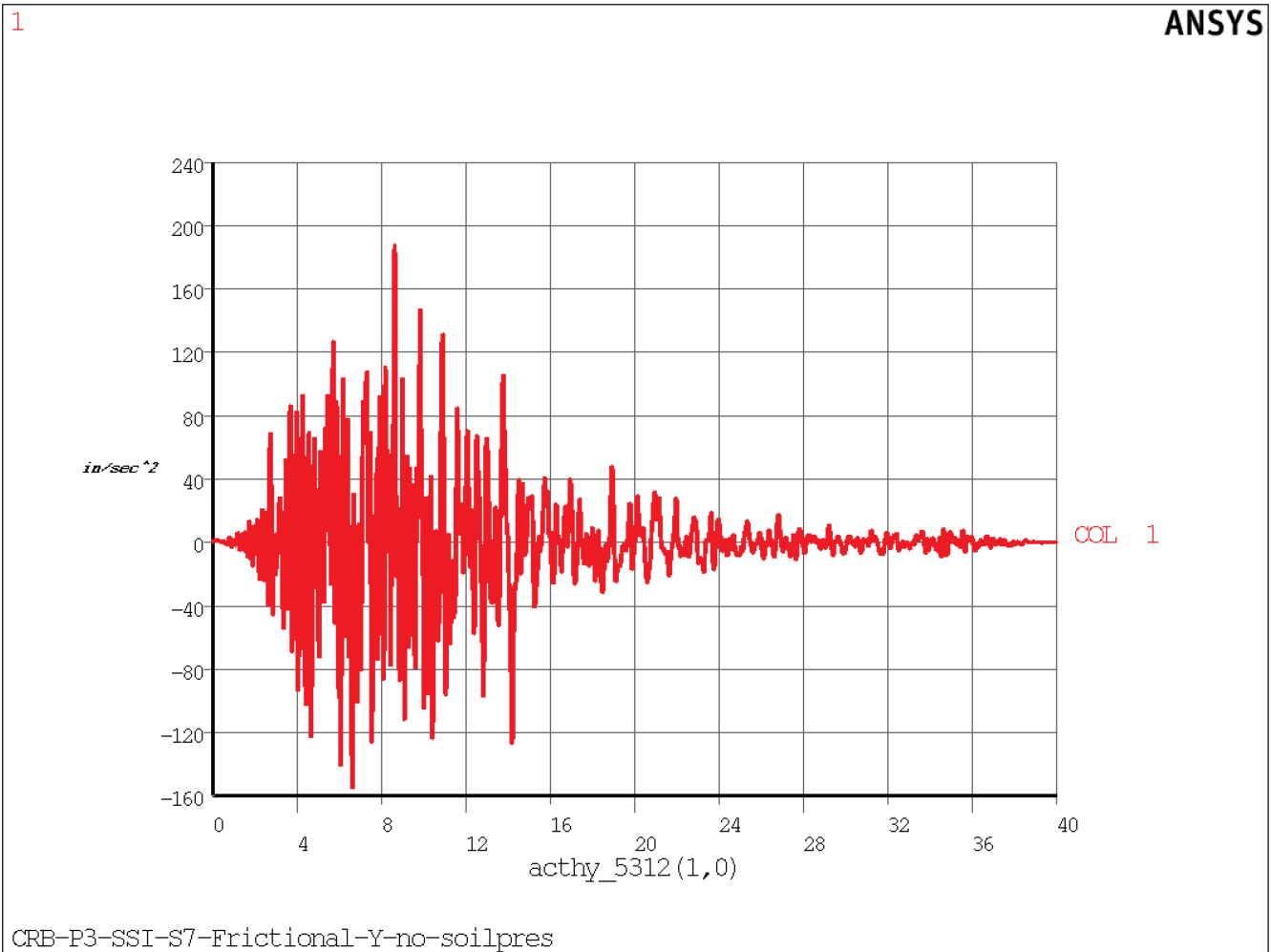

Figure 3.8.5-34: CRB Skin Nodes on Backfill Outer Boundaries for Applying SASSI Time Histories

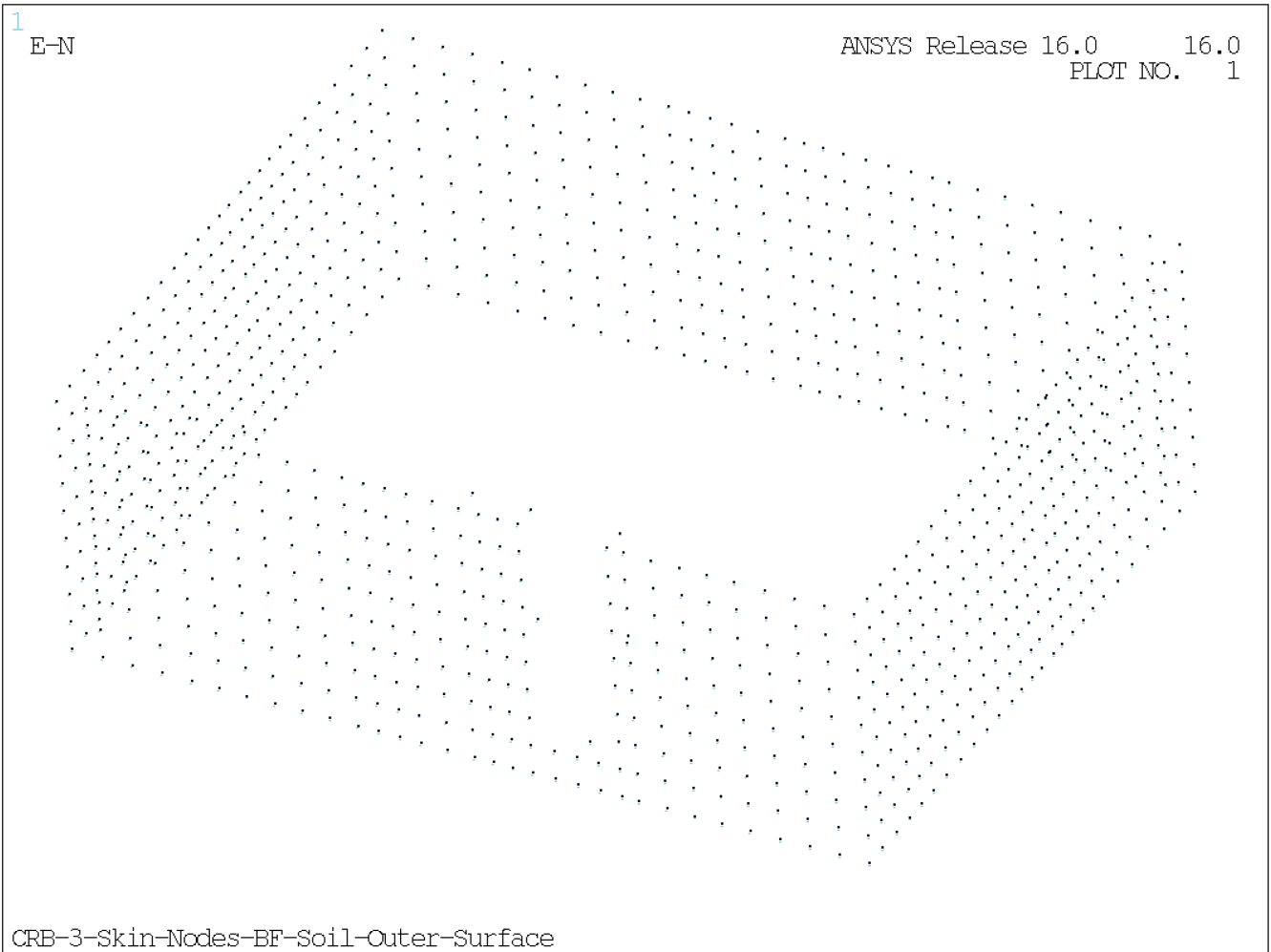

Figure 3.8.5-35: CRB Foundation Bottom Skin Nodes for Applying SASSI Time Histories

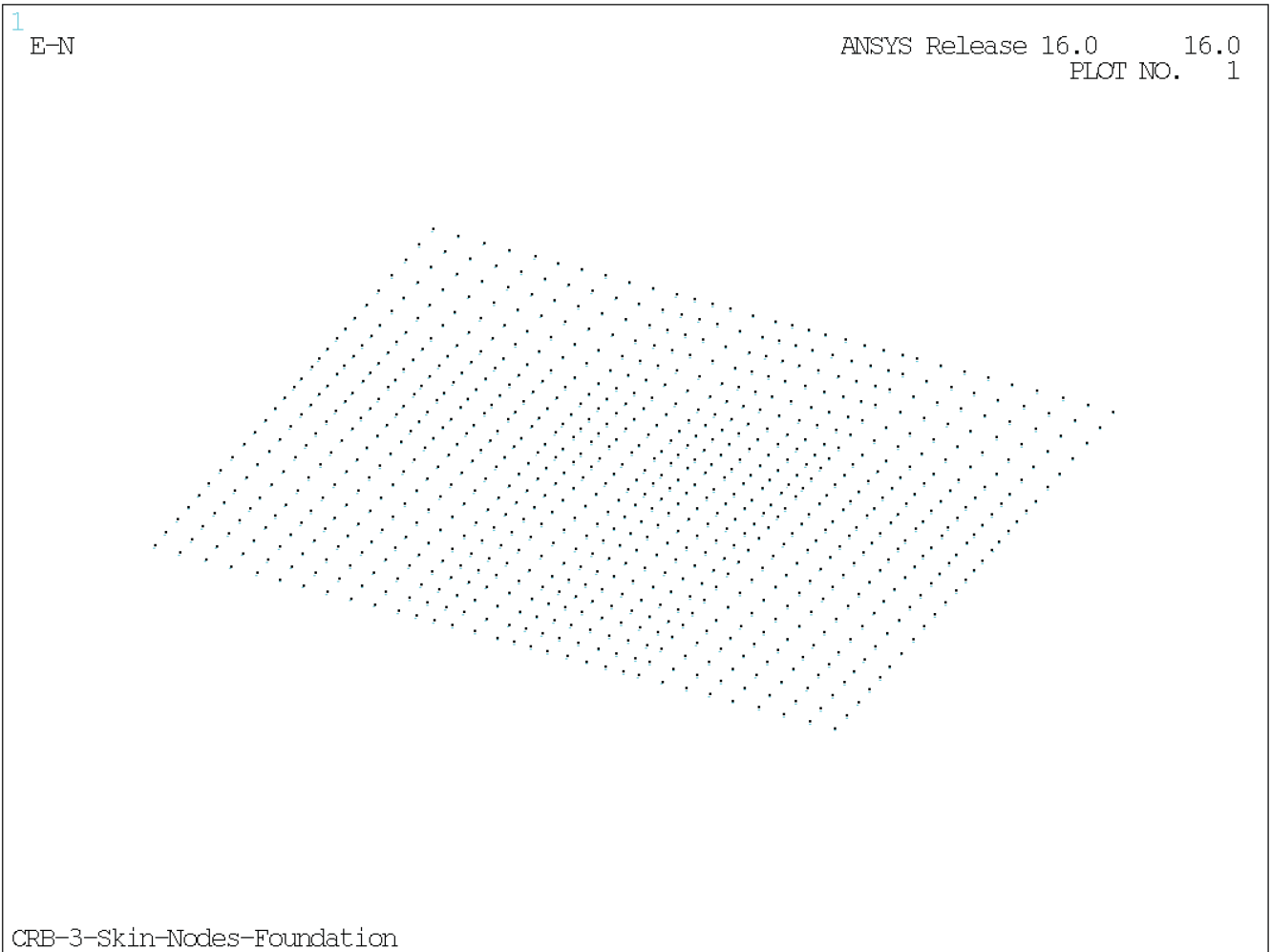

Figure 3.8.5-36: Buoyancy Load on Basemat

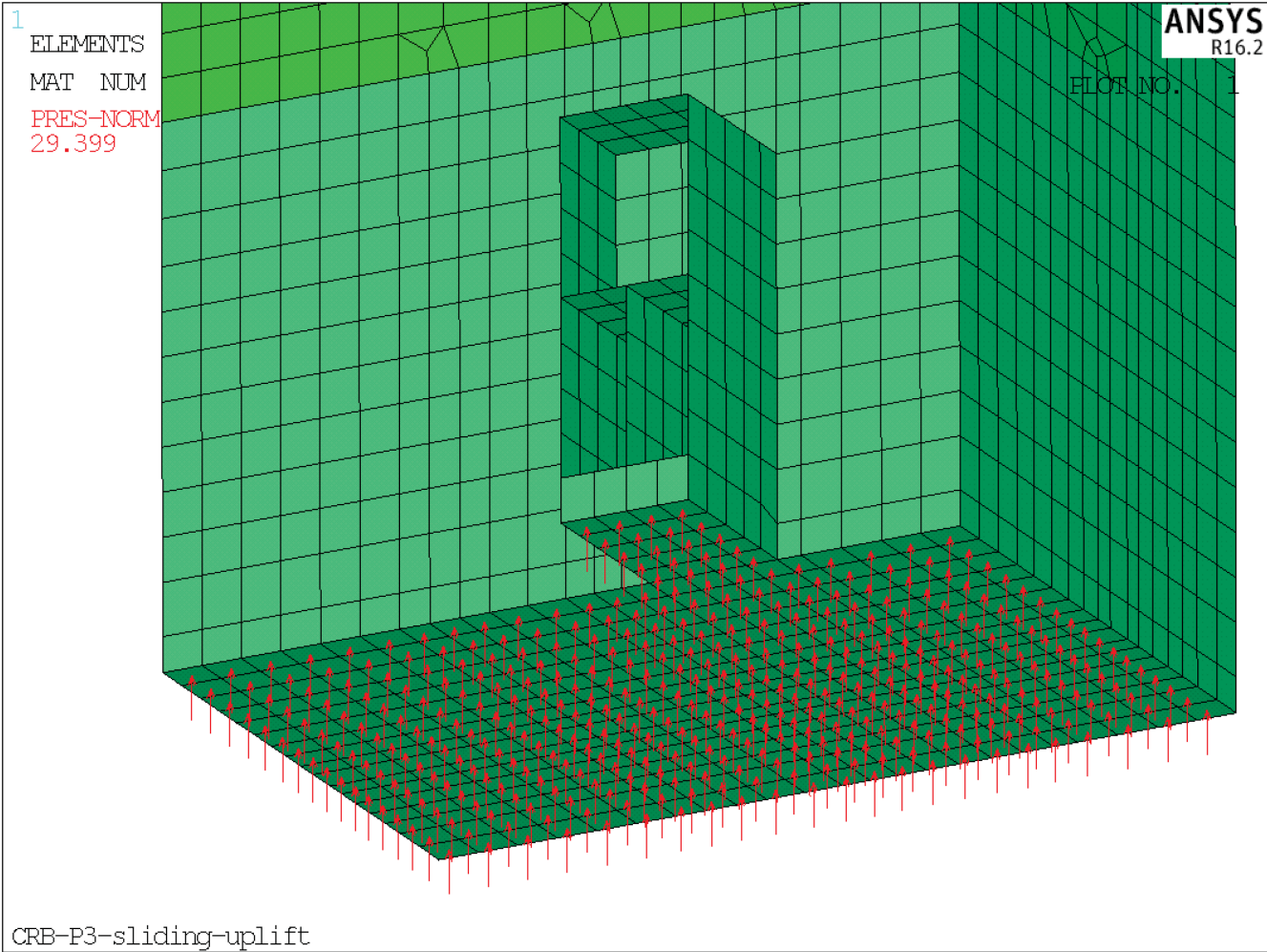

Figure 3.8.5-37: Static Soil Pressure on CRB Outer Walls

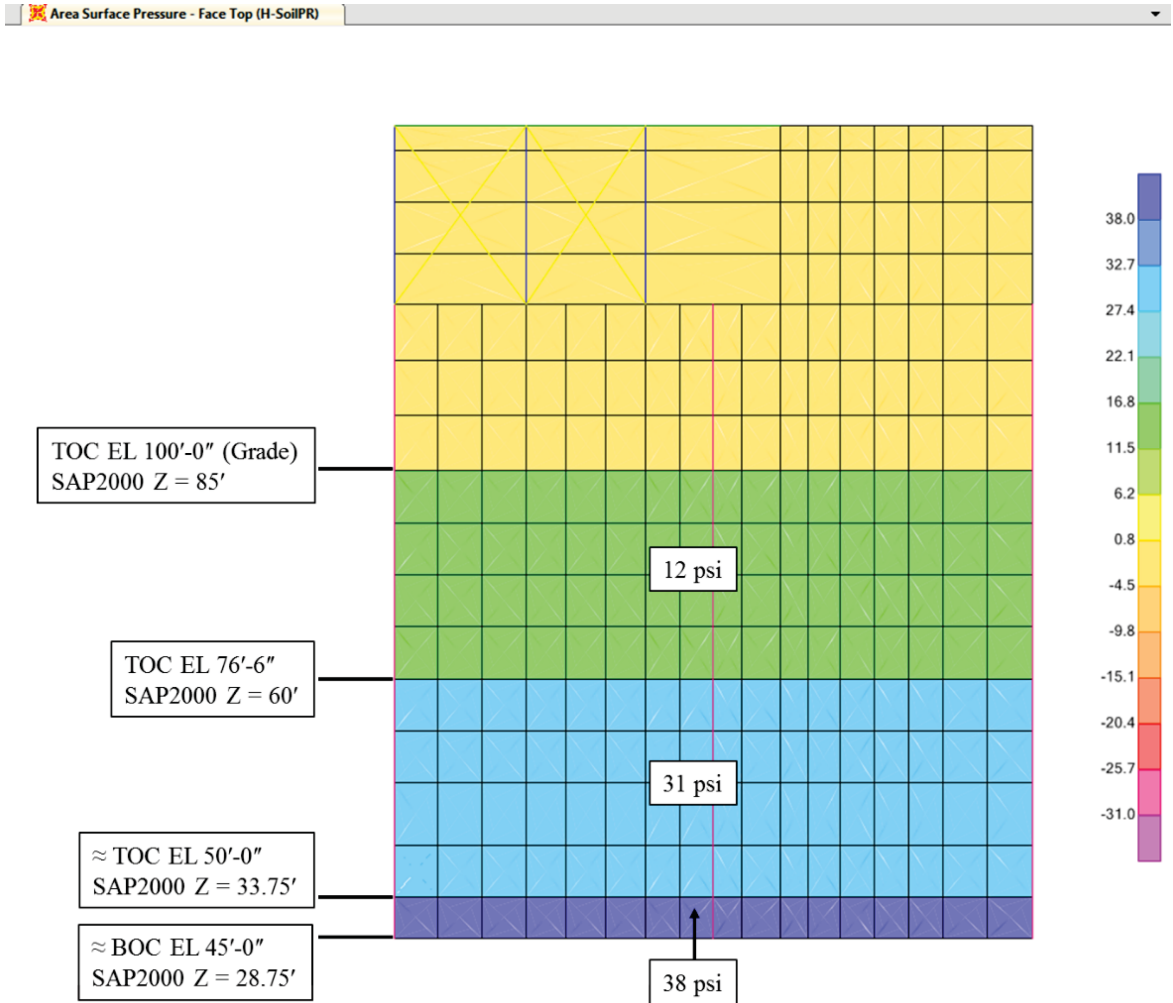

Figure 3.8.5-38: CRB Static Soil Pressure from Poisson's Ratio Effect - Soil Type 11

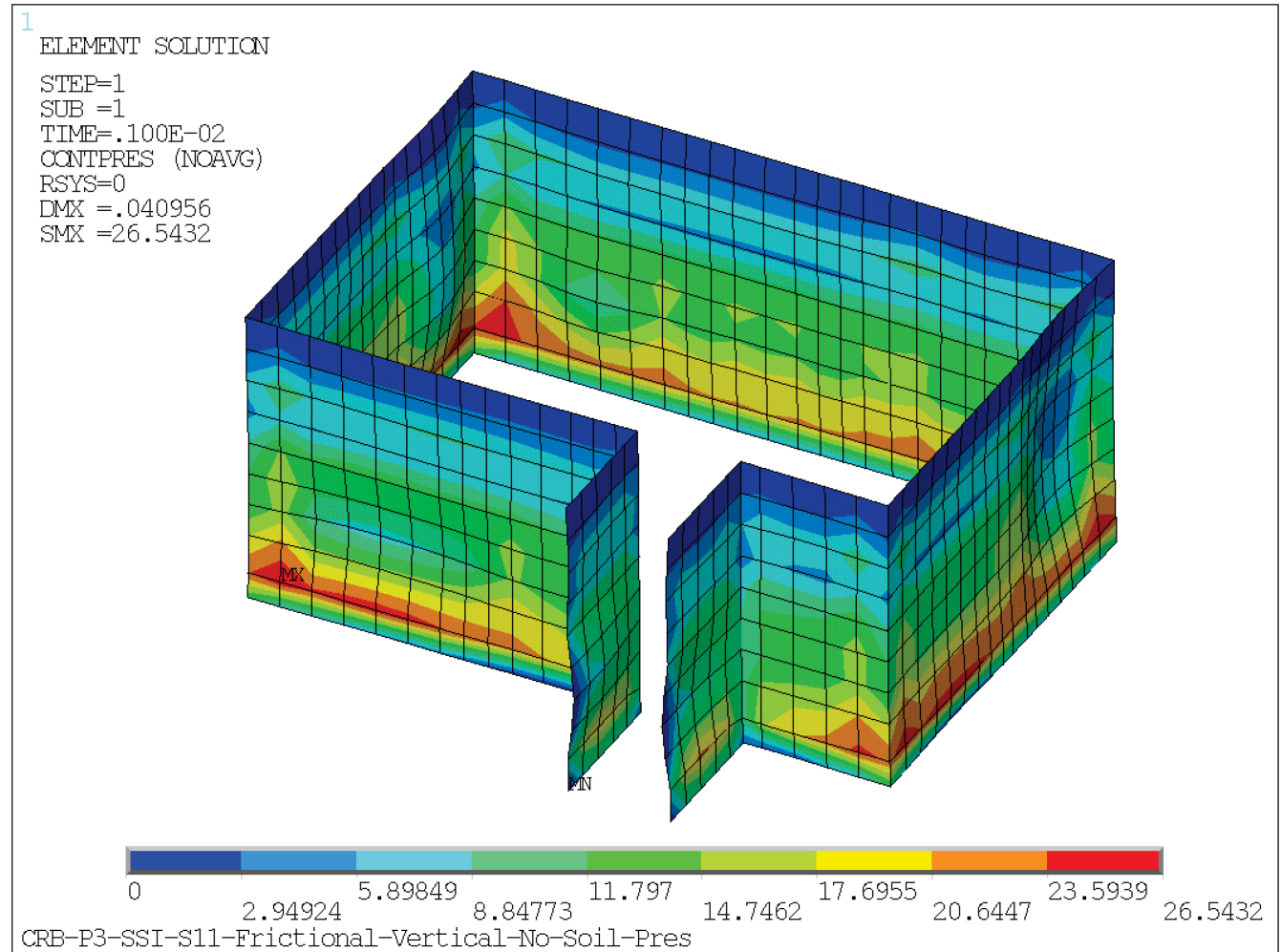

Figure 3.8.5-39: CRB Static Soil Pressure from Poisson's Ratio Effect - Soil Type 7

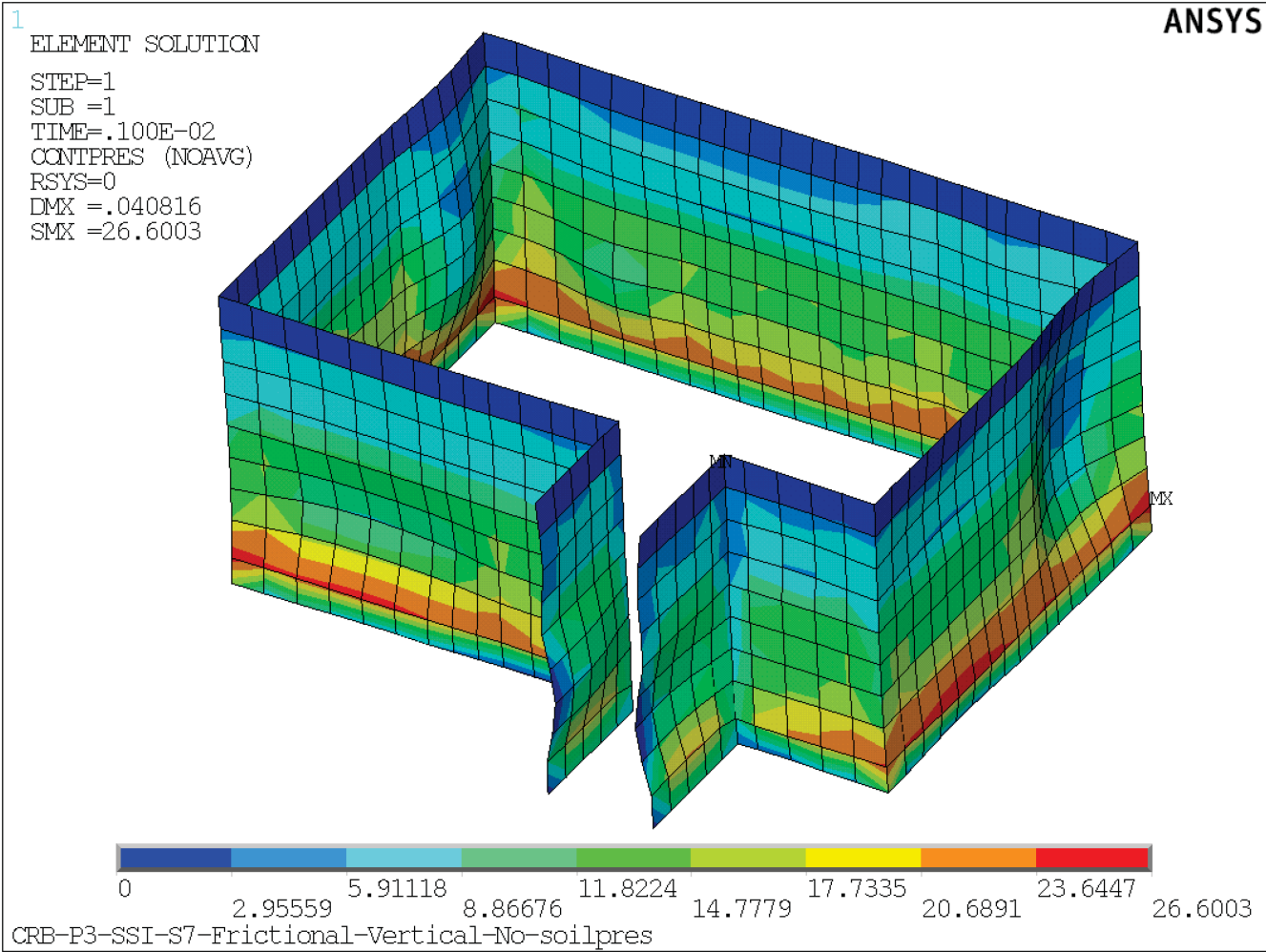

Figure 3.8.5-40: CRB SAP2000 Model with Backfill Soil

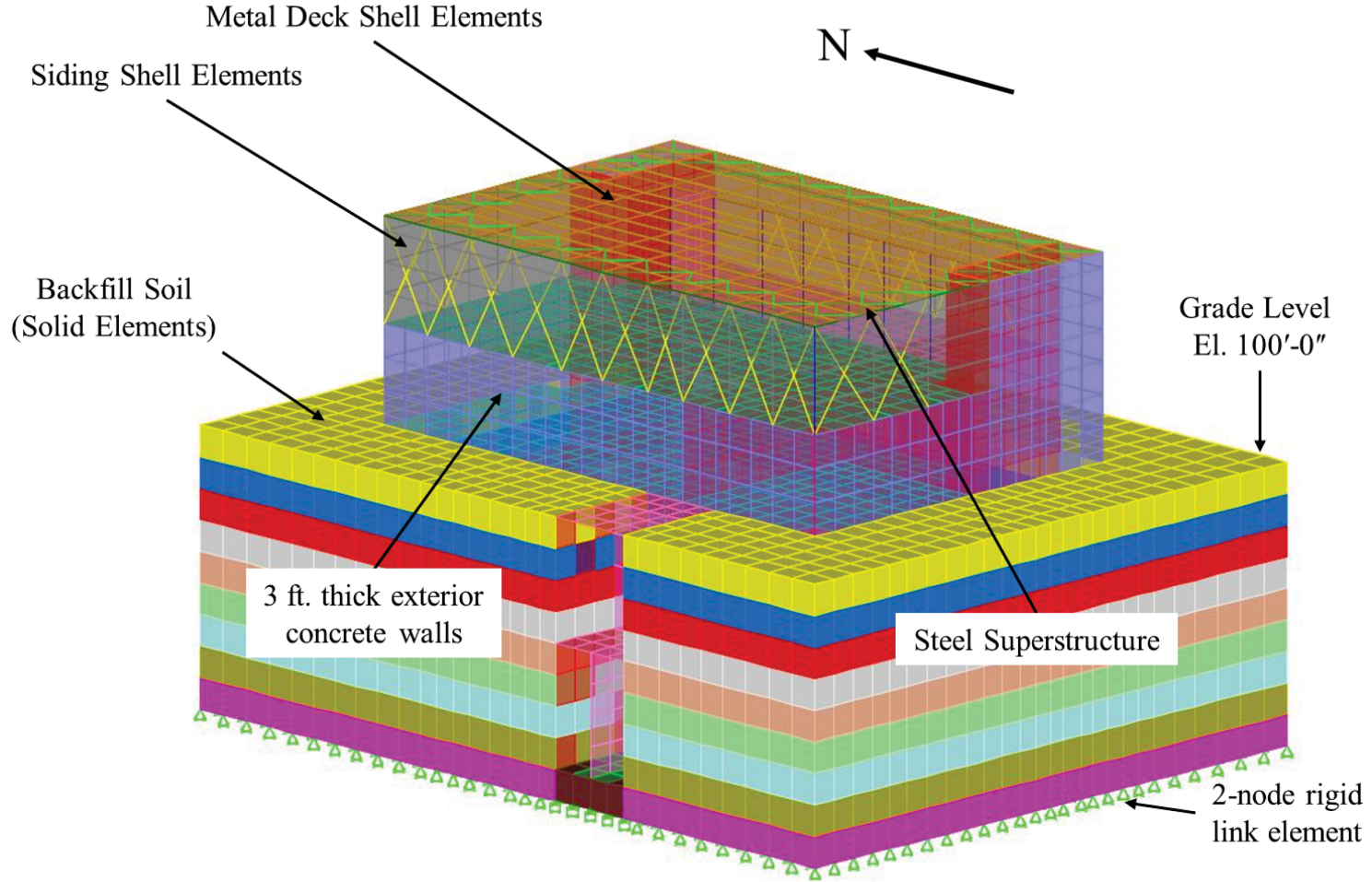

Figure 3.8.5-41: SAP2000 Model for Settlement

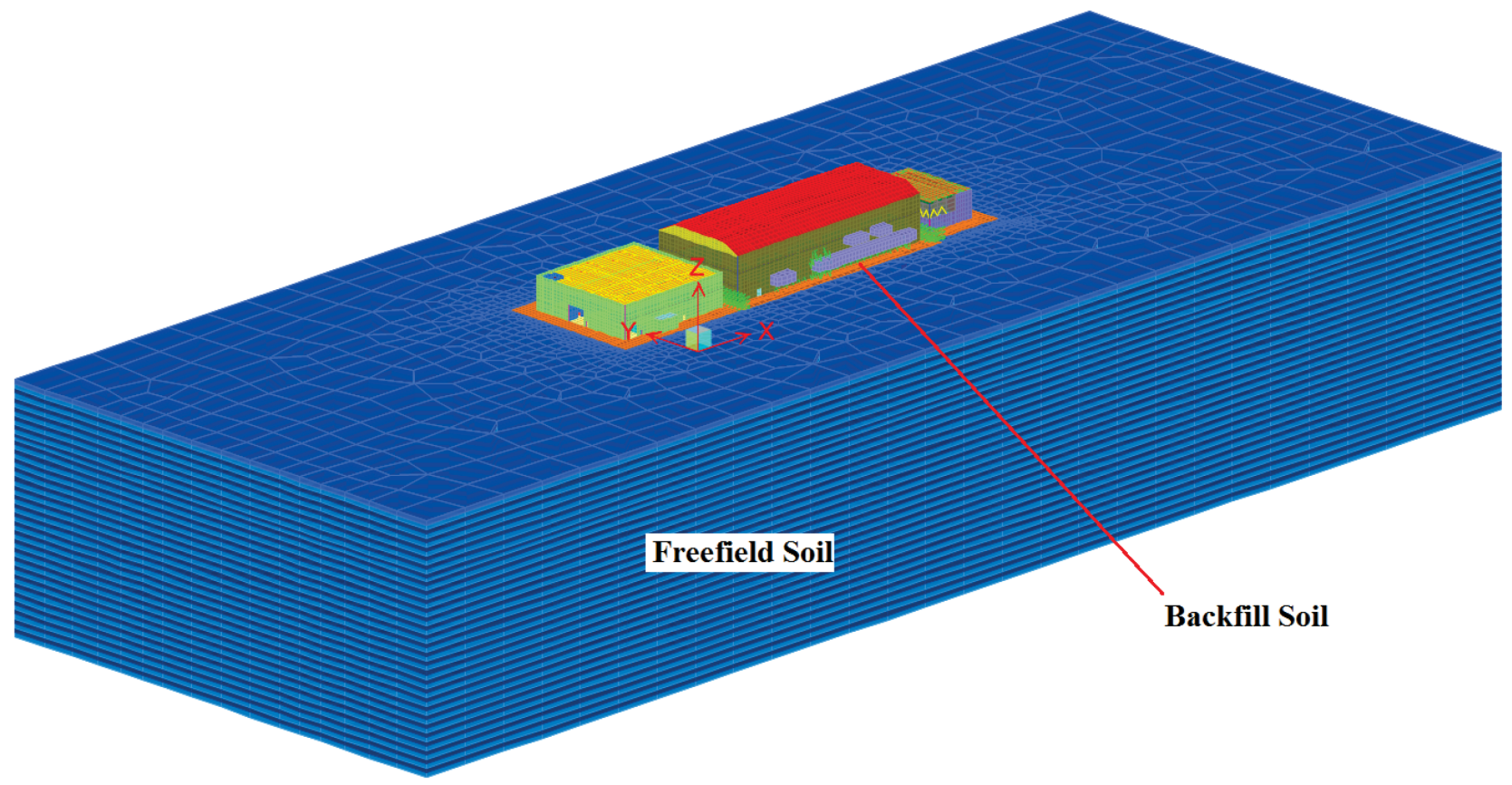

Figure 3.8.5-42: Total Cracked Base Vertical Reaction Time History due to Capitola for Soil Type 7

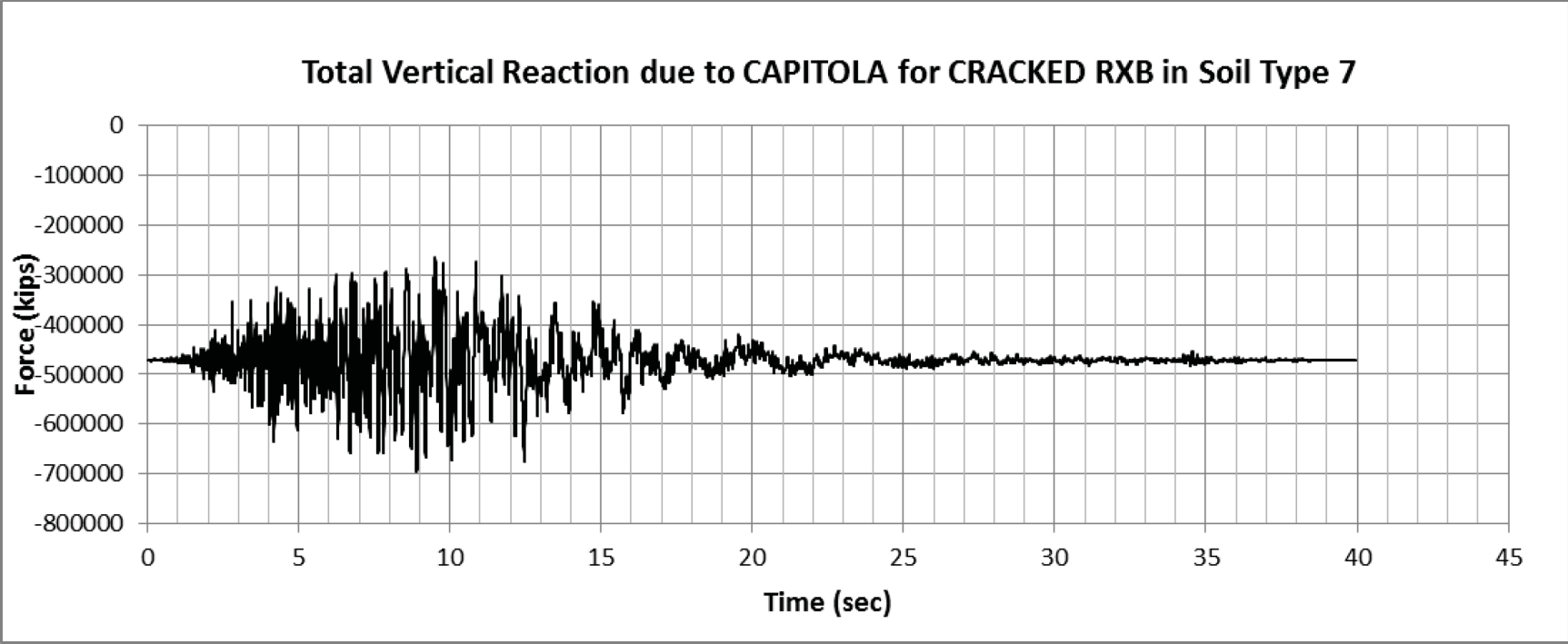

Figure 3.8.5-43: Total Uncracked Base Vertical Reaction Time History due to Capitola for Soil Type 7

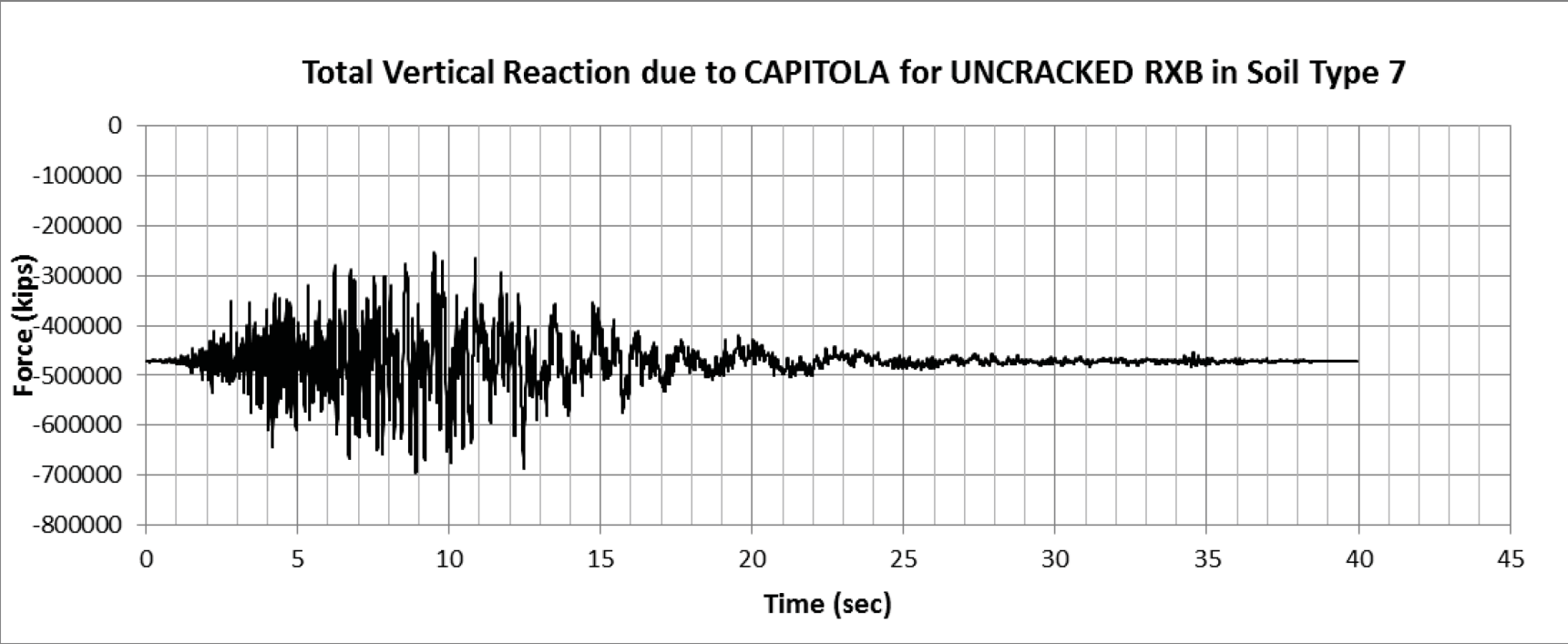

Figure 3.8.5-44: Total Cracked Base Vertical Reaction Time History due to Capitola for Soil Type 8

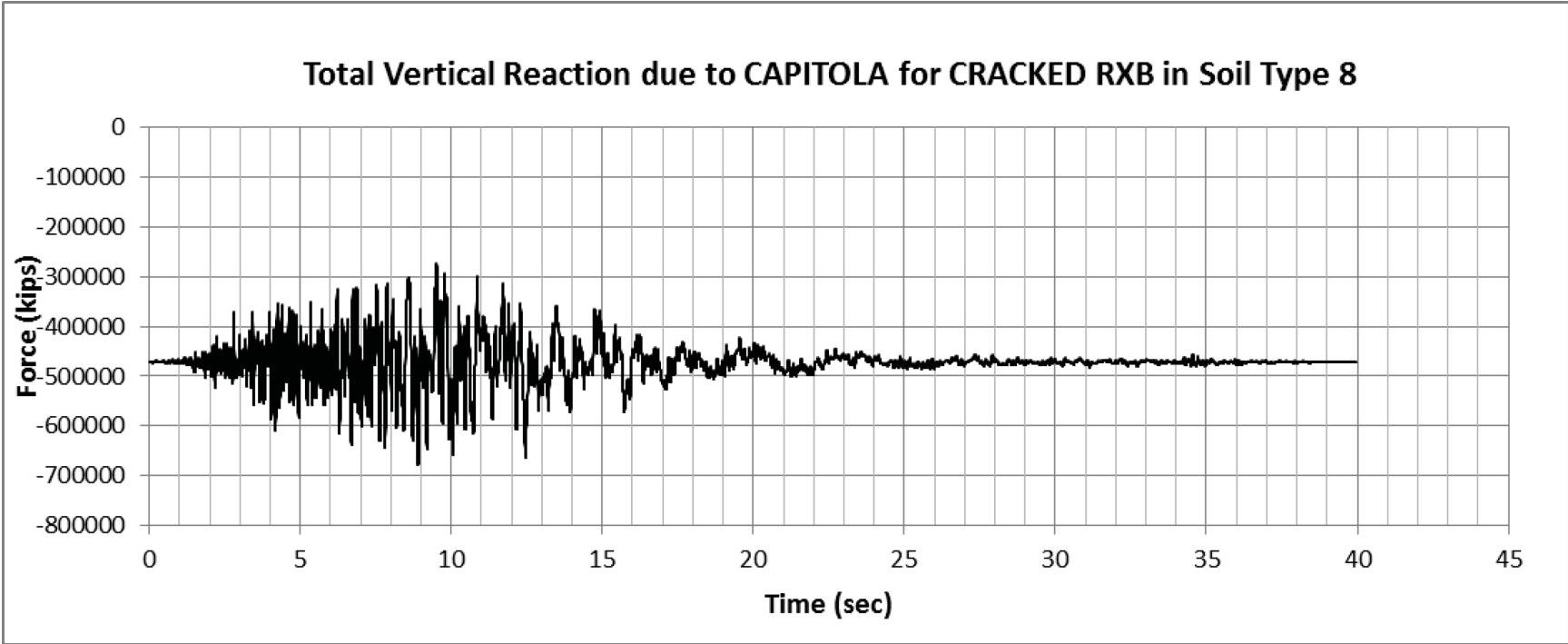

Figure 3.8.5-45: Total Cracked Base Vertical Reaction Time History due to Capitola for Soil Type 11

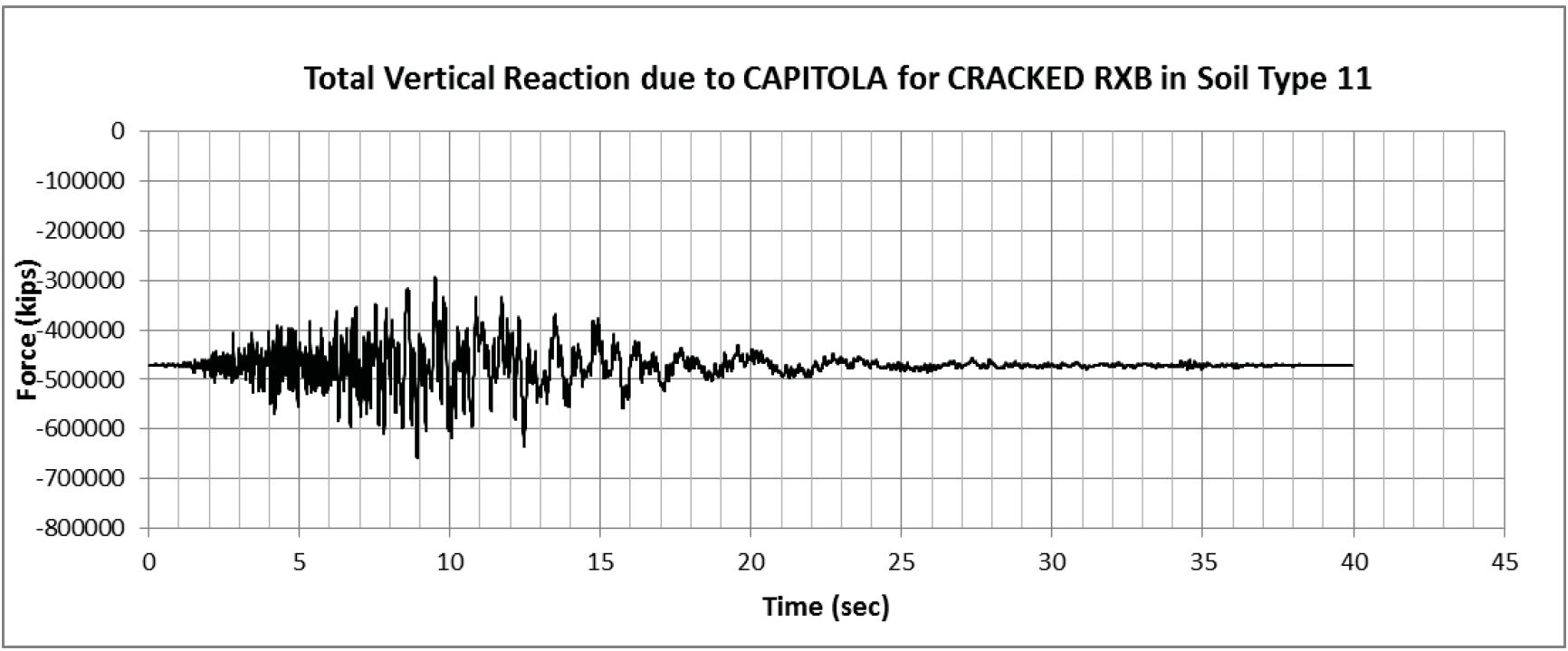

Figure 3.8.5-46: Total Cracked Base Vertical Reaction Time History due to Lucerne for Soil Type 7

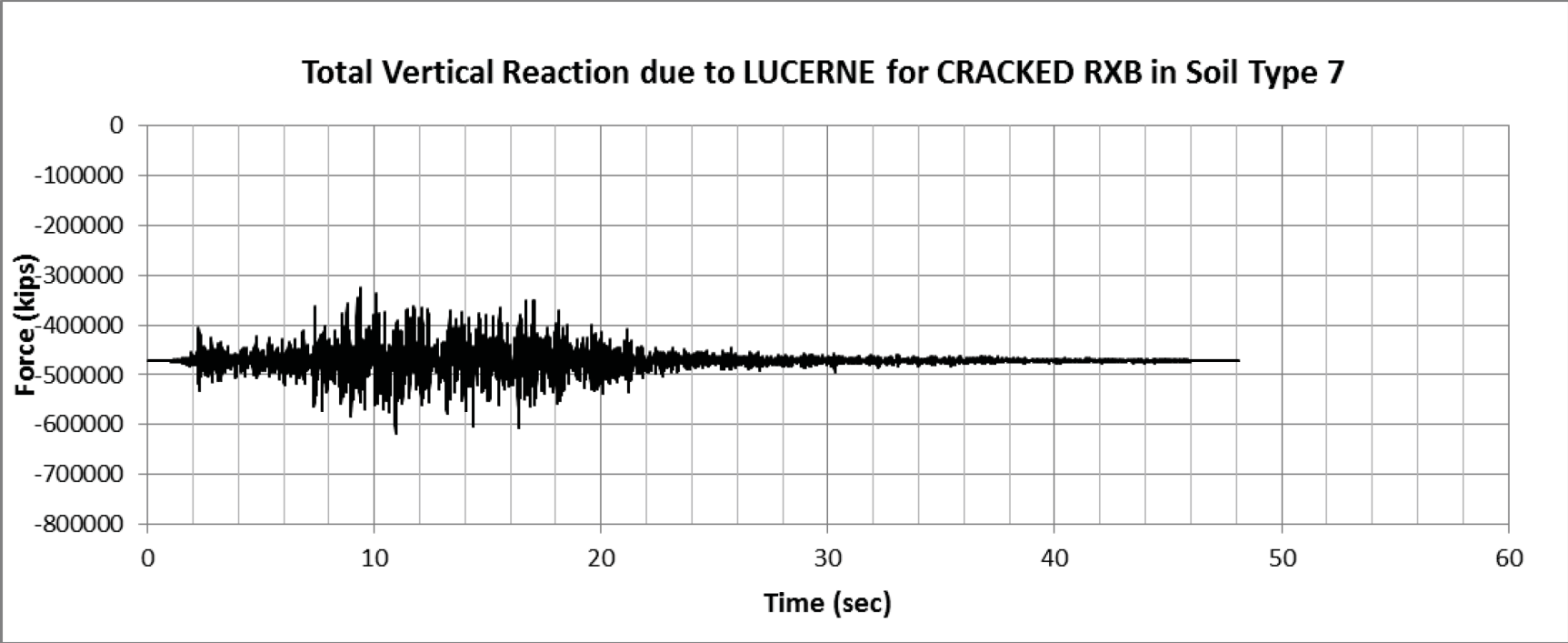

Figure 3.8.5-47: Total Cracked Base Vertical Reaction Time History due to Lucerne for Soil Type 9

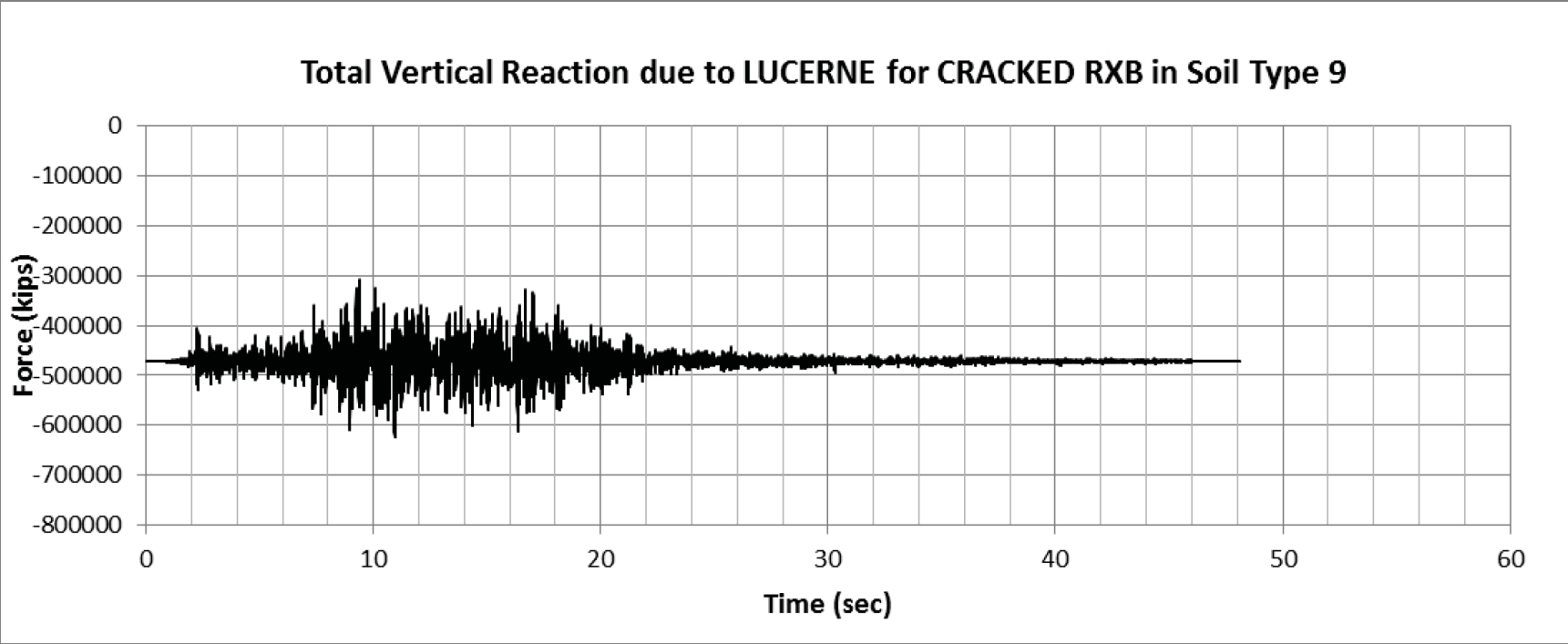

Figure 3.8.5-48: CRB Foundation Time History Location Designations

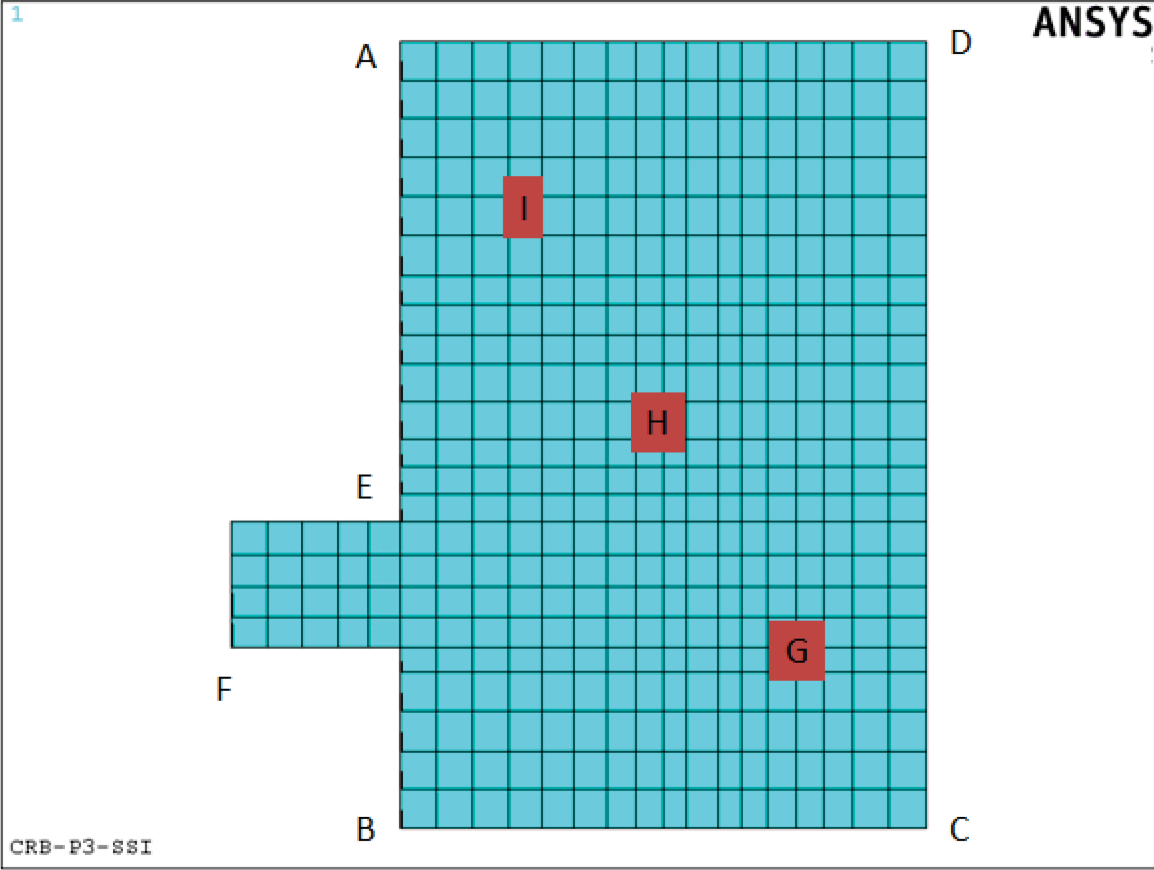

Figure 3.8.5-49: Reaction Force at Location A (S11 - Vertical Excitation)

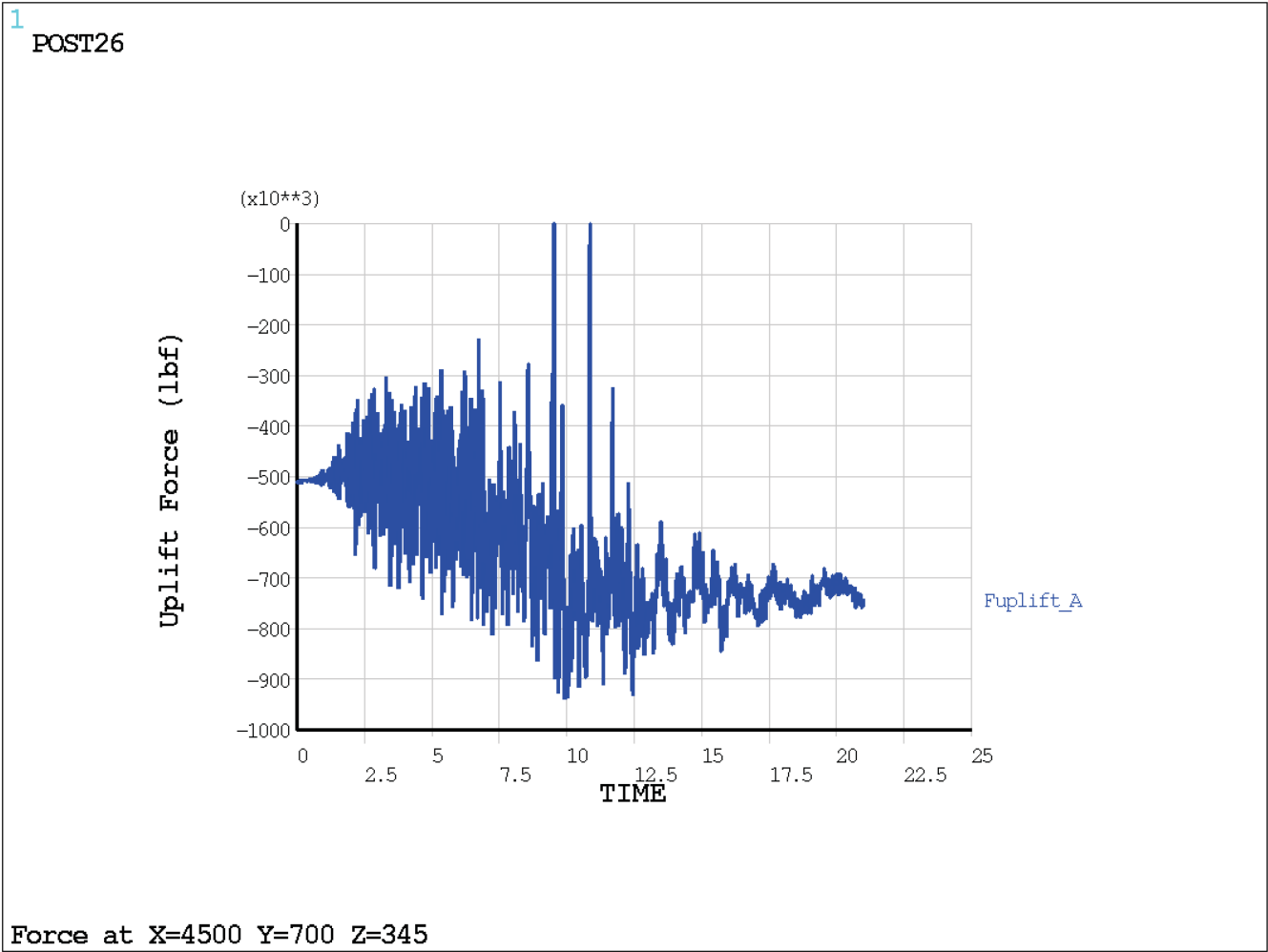

Figure 3.8.5-50: Relative Displacement (Uplift) at Location A (S11 - Vertical Excitation)

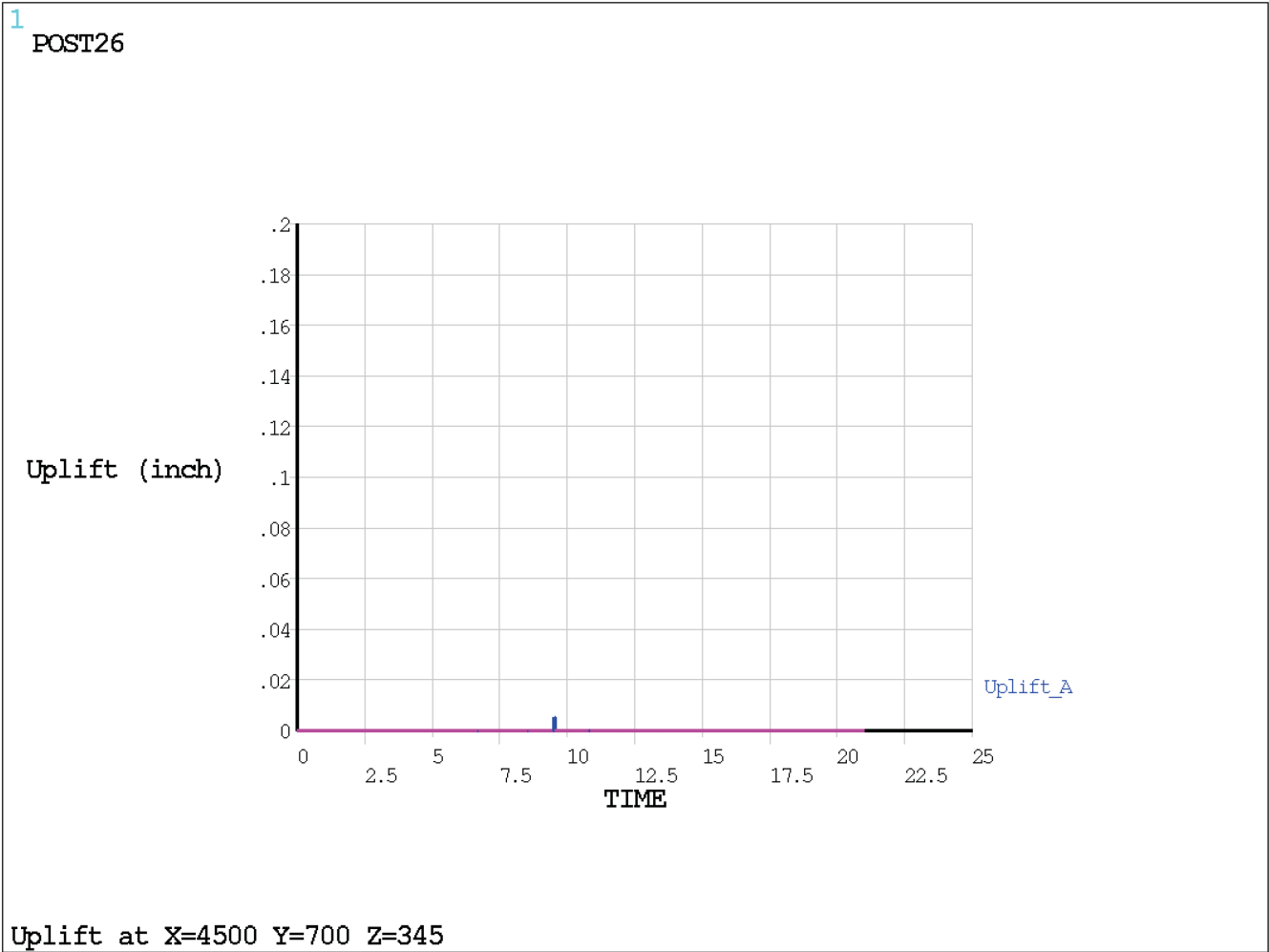

Figure 3.8.5-51: Lateral Relative Displacements (Sliding) at Location A (S11 - Vertical Excitation)

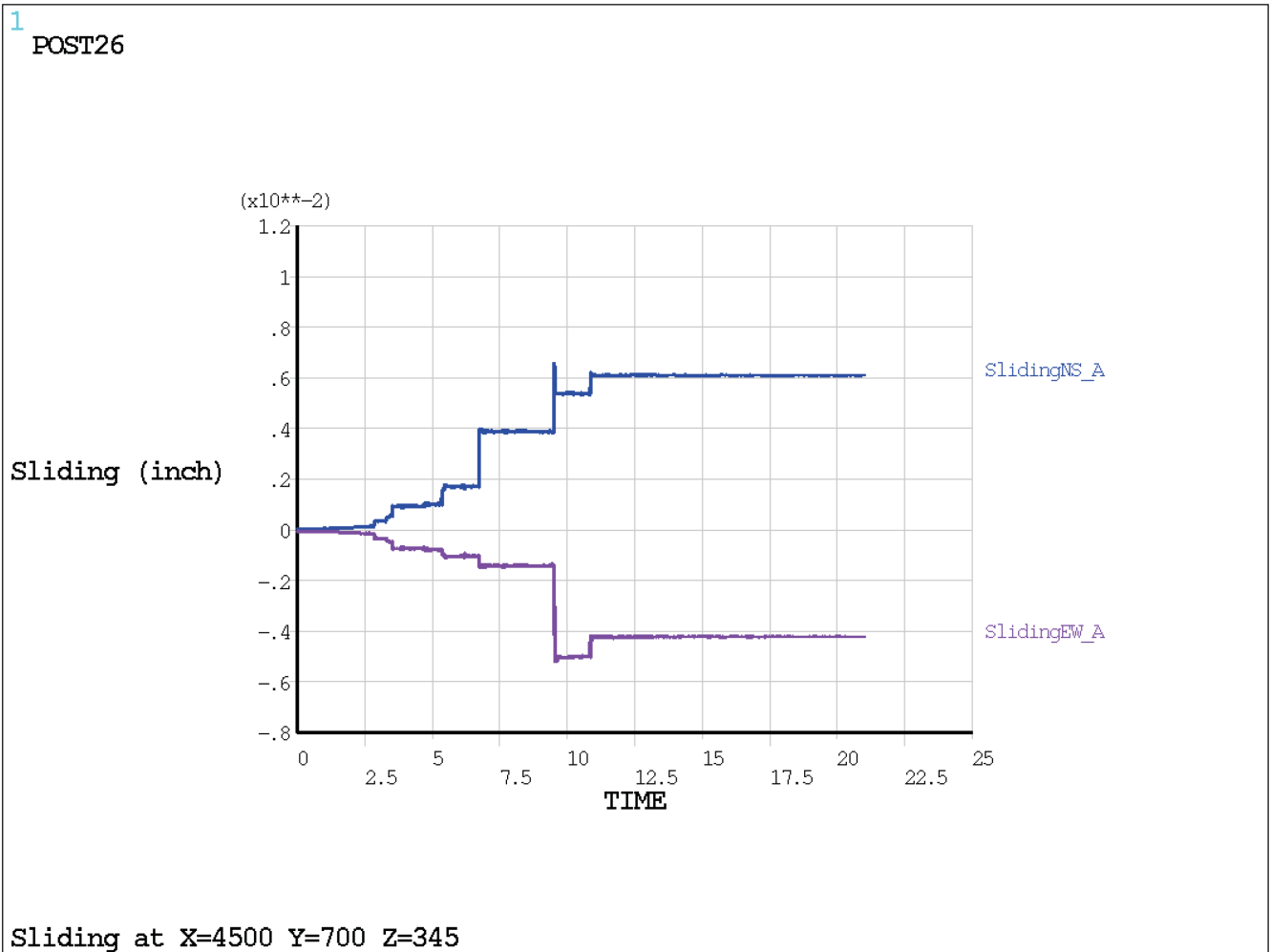

Figure 3.8.5-52: RXB Foundation Time History Location Designations

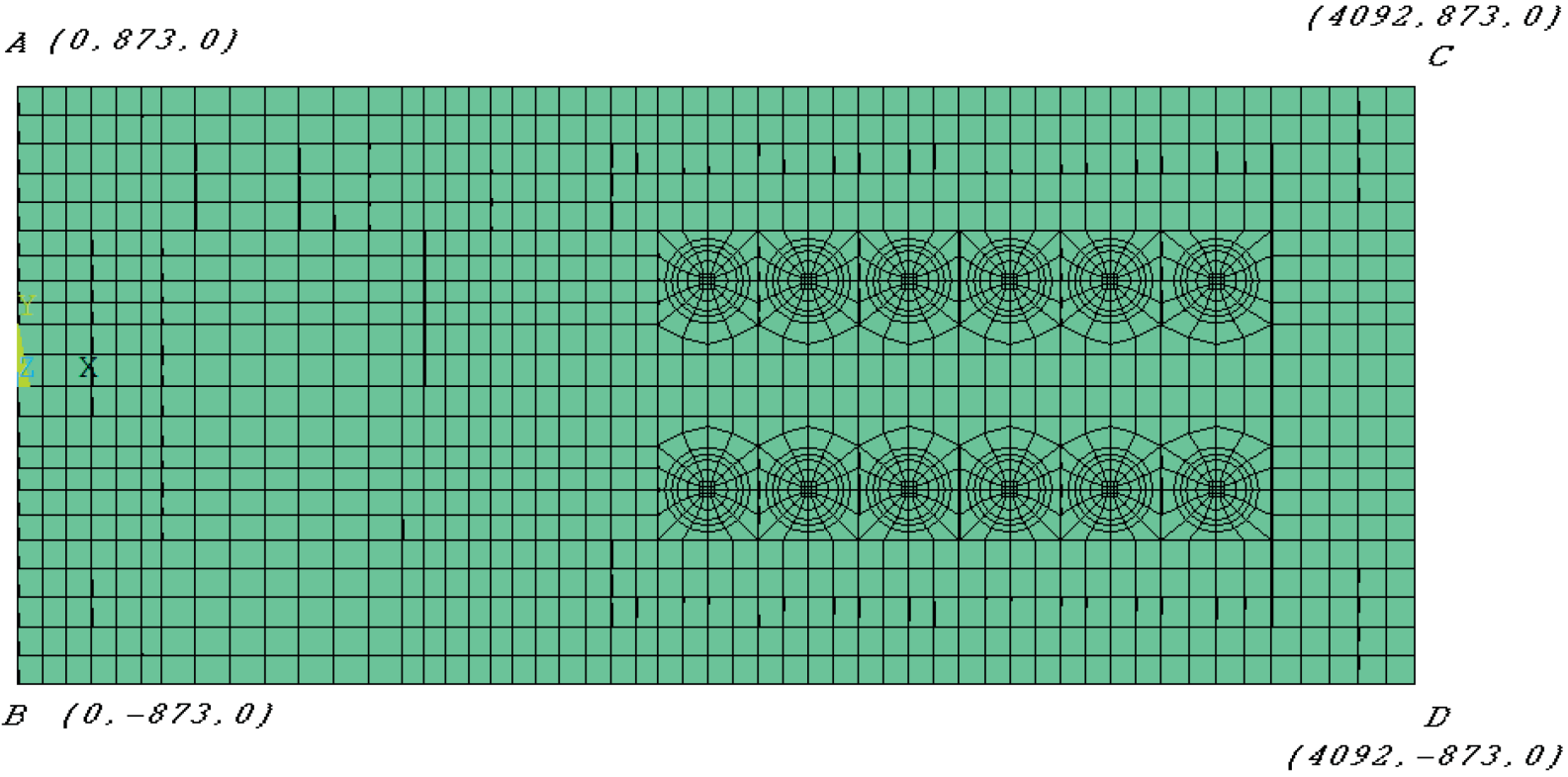

Figure 3.8.5-53: Lateral Relative Displacements (Sliding) at Location A (S7 - E-W Excitation)

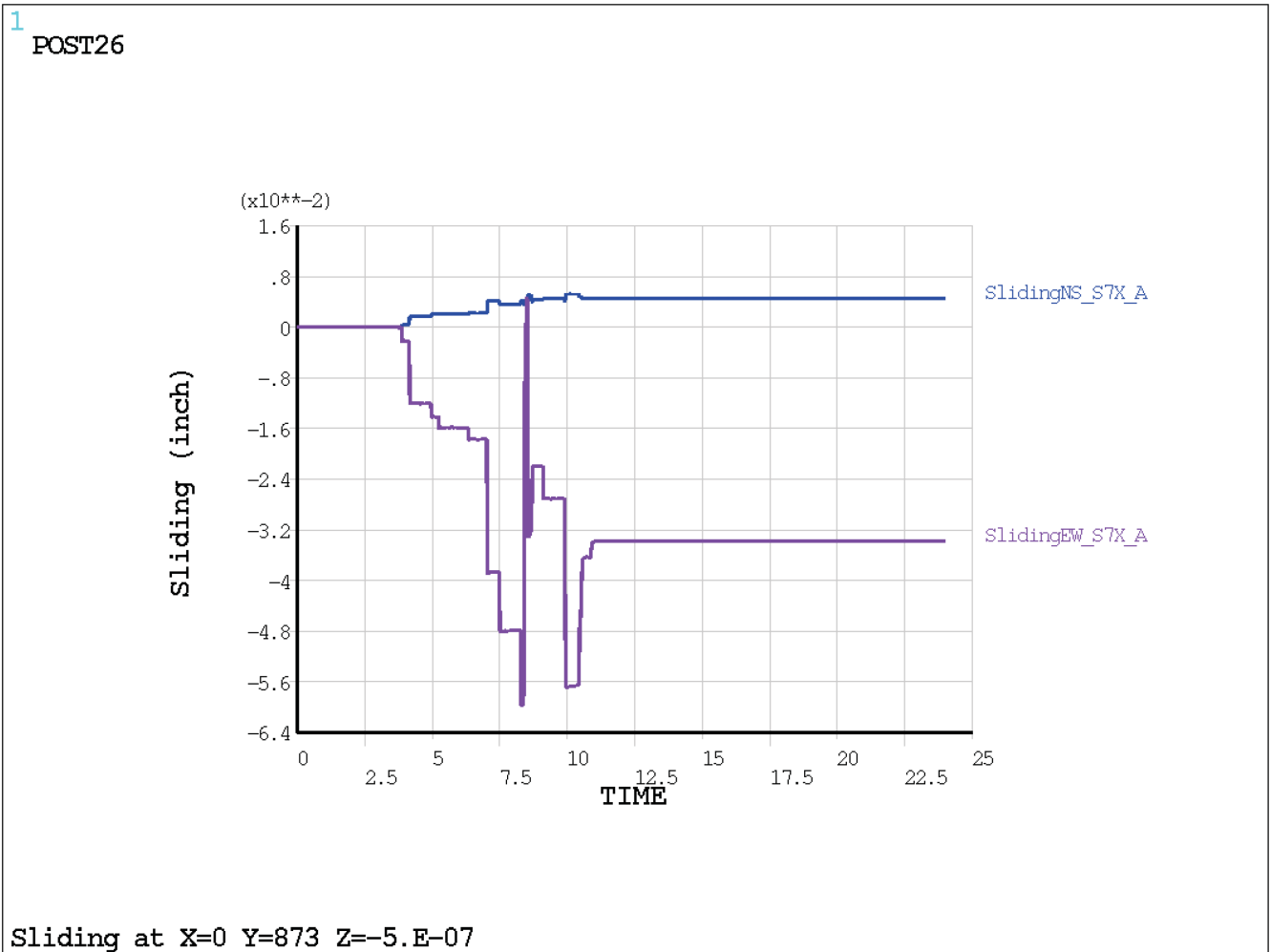

Figure 3.8.5-54: Lateral Relative Displacements (Sliding) at Location B (S7 – E-W Excitation)

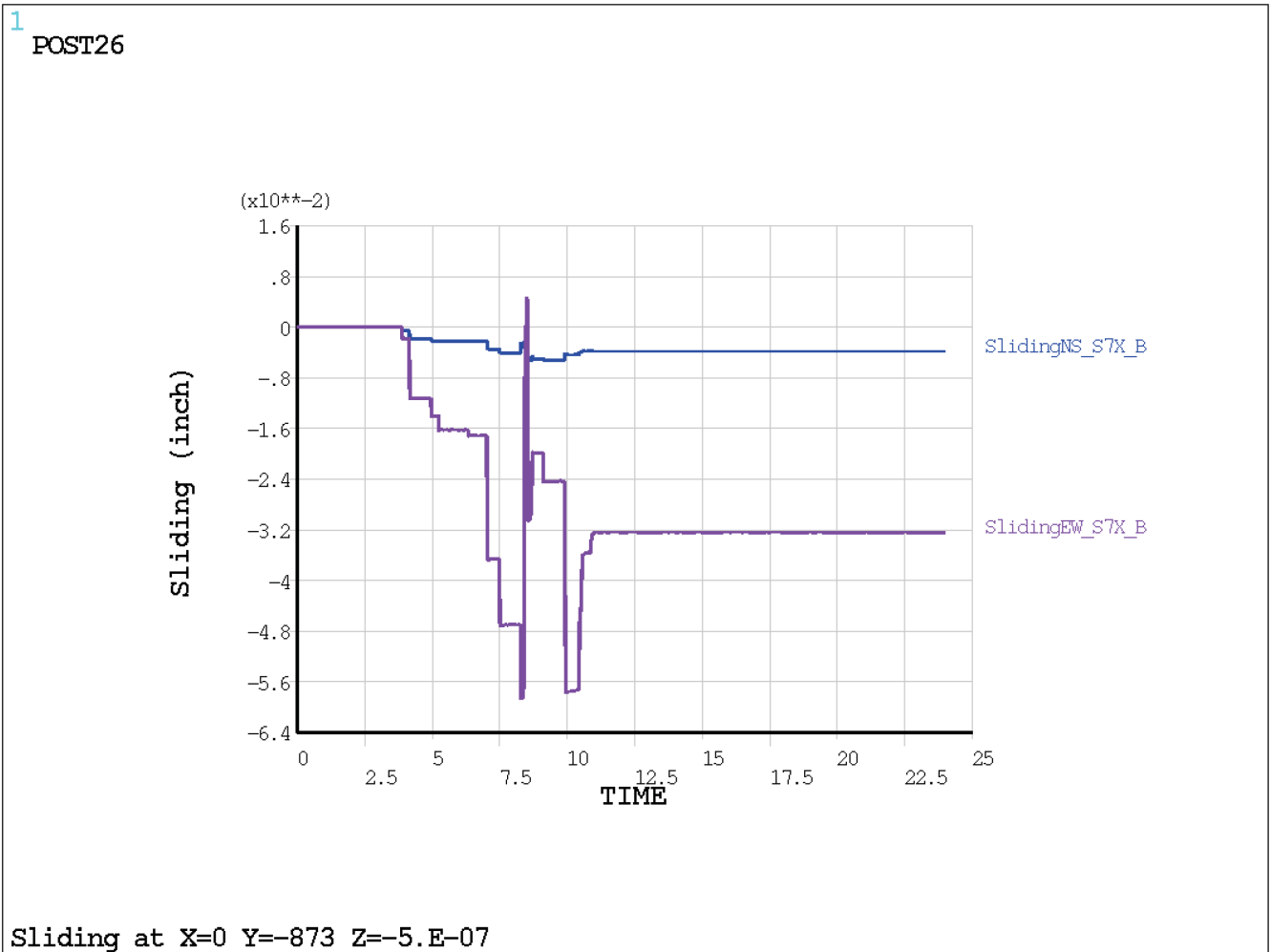

Figure 3.8.5-55: Lateral Relative Displacements (Sliding) at Location C (S7 - E-W Excitation)

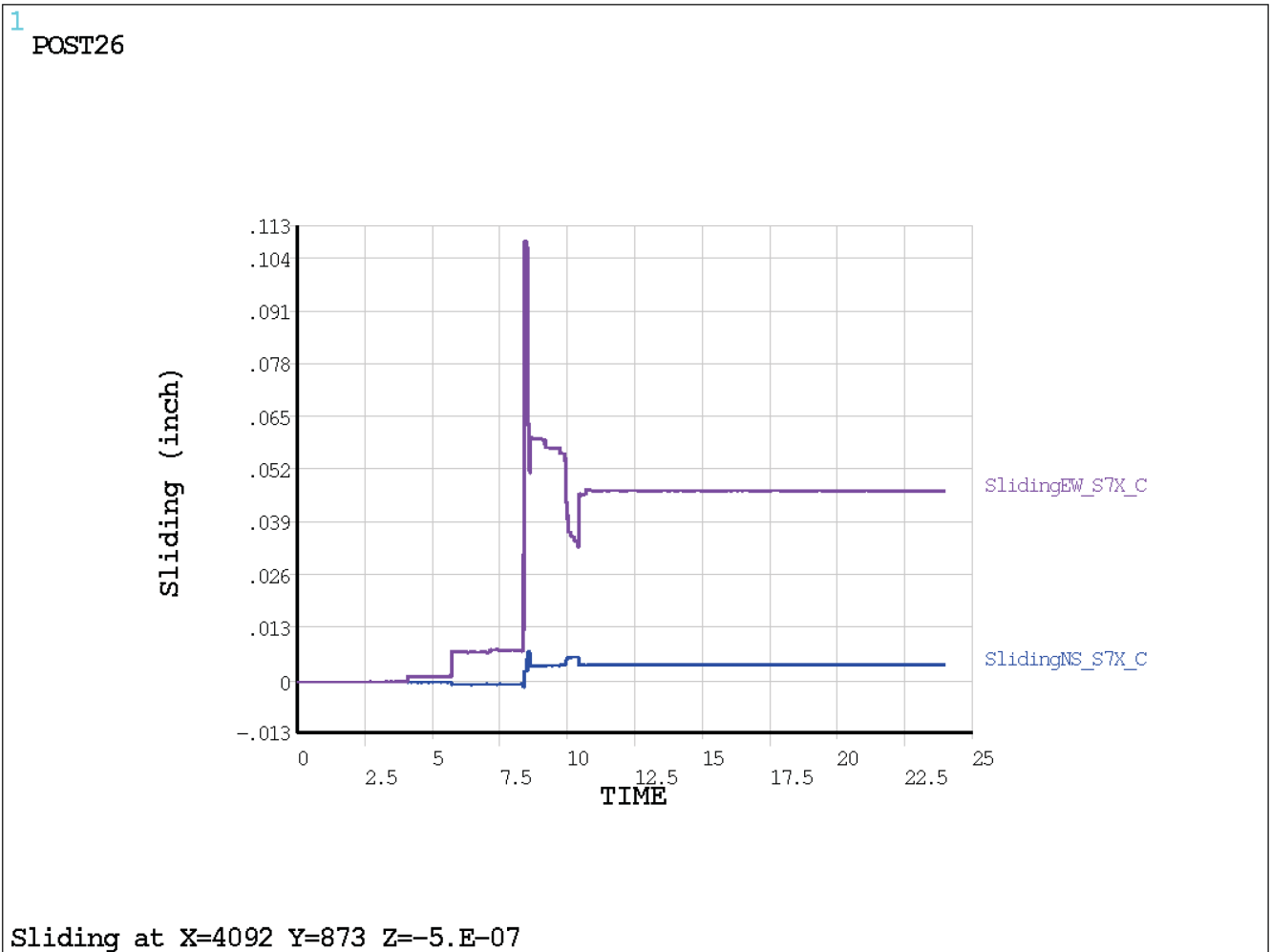

Figure 3.8.5-56: Lateral Relative Displacements (Sliding) at Location D (S7 - E-W Excitation)

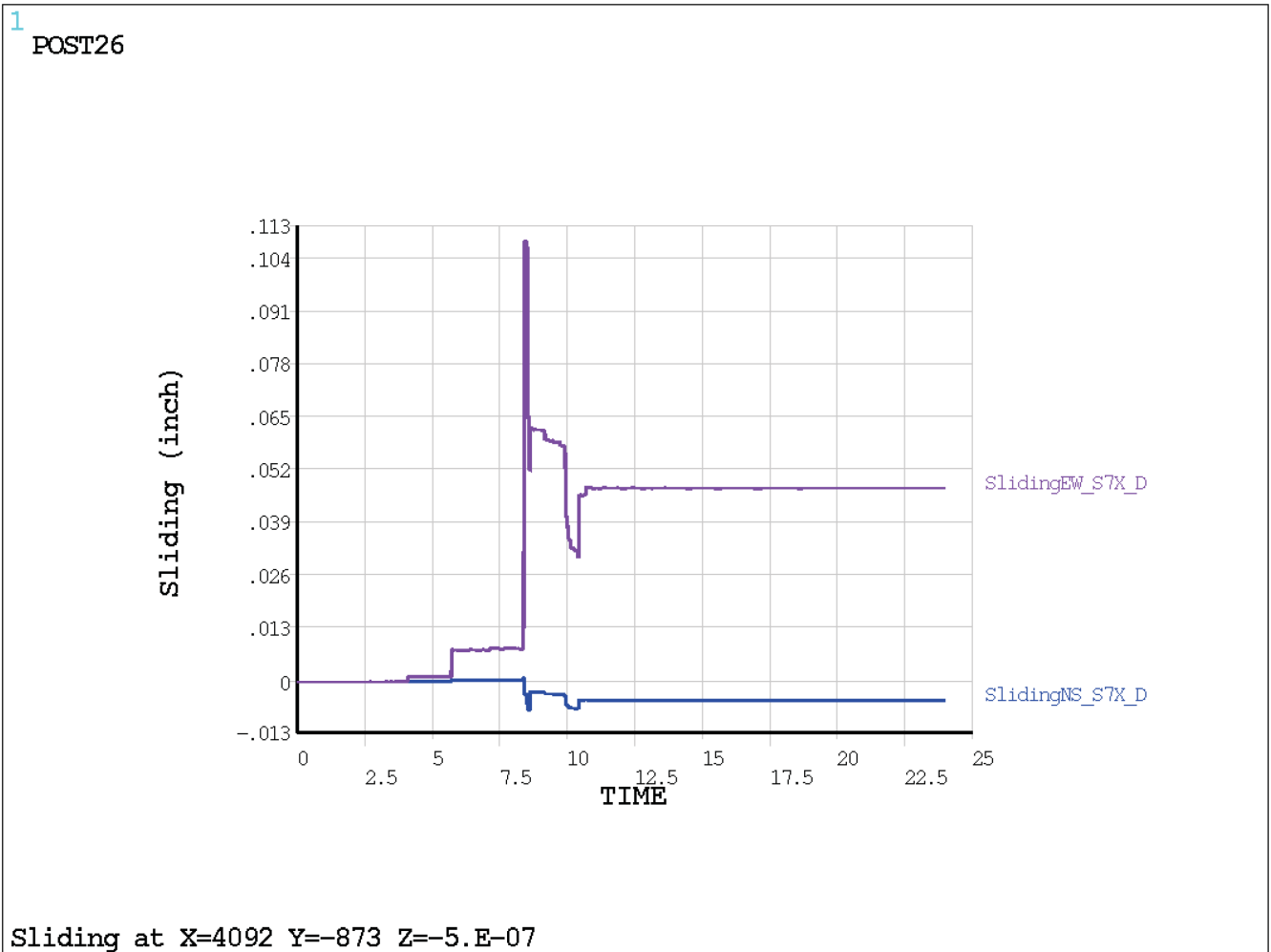

Figure 3.8.5-57: Lateral Relative Displacements (Sliding) at Location A (S7 - N-S Excitation)

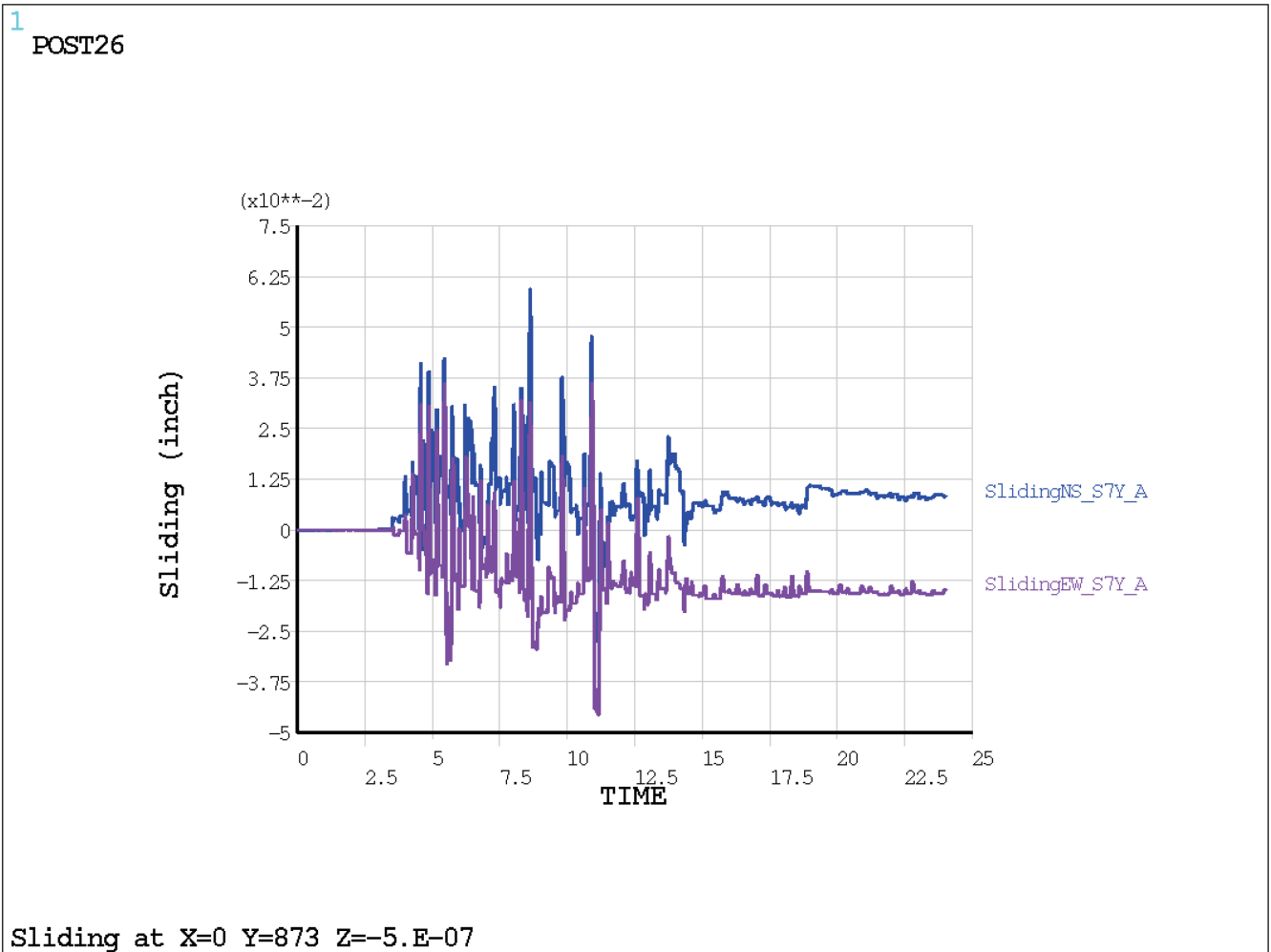

Figure 3.8.5-58: Lateral Relative Displacements (Sliding) at Location B (S7 - N-S Excitation)

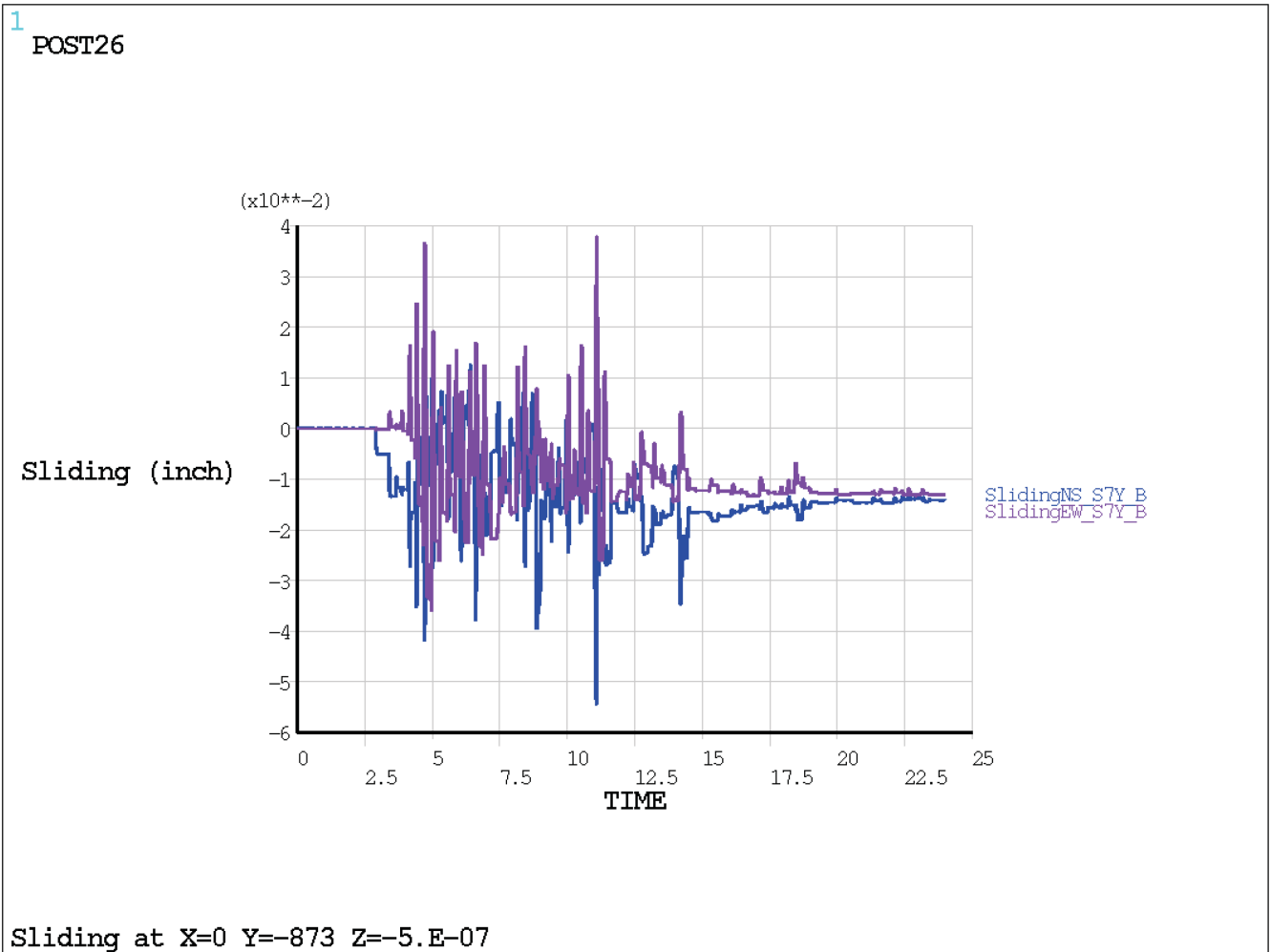

Figure 3.8.5-59: Lateral Relative Displacements (Sliding) at Location C (S7 - N-S Excitation)

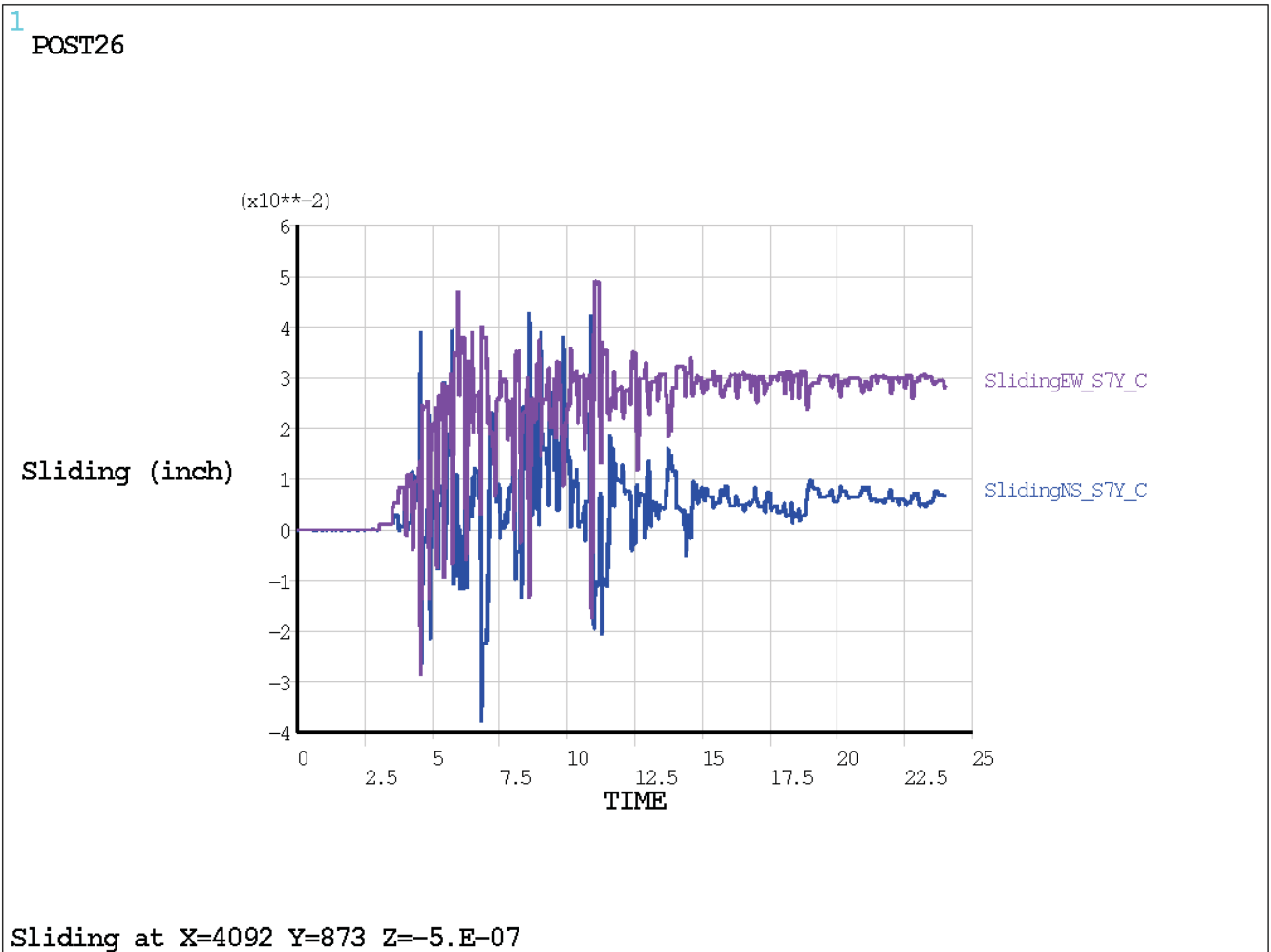

Figure 3.8.5-60: Lateral Relative Displacements (Sliding) at Location D (S7 - N-S Excitation)

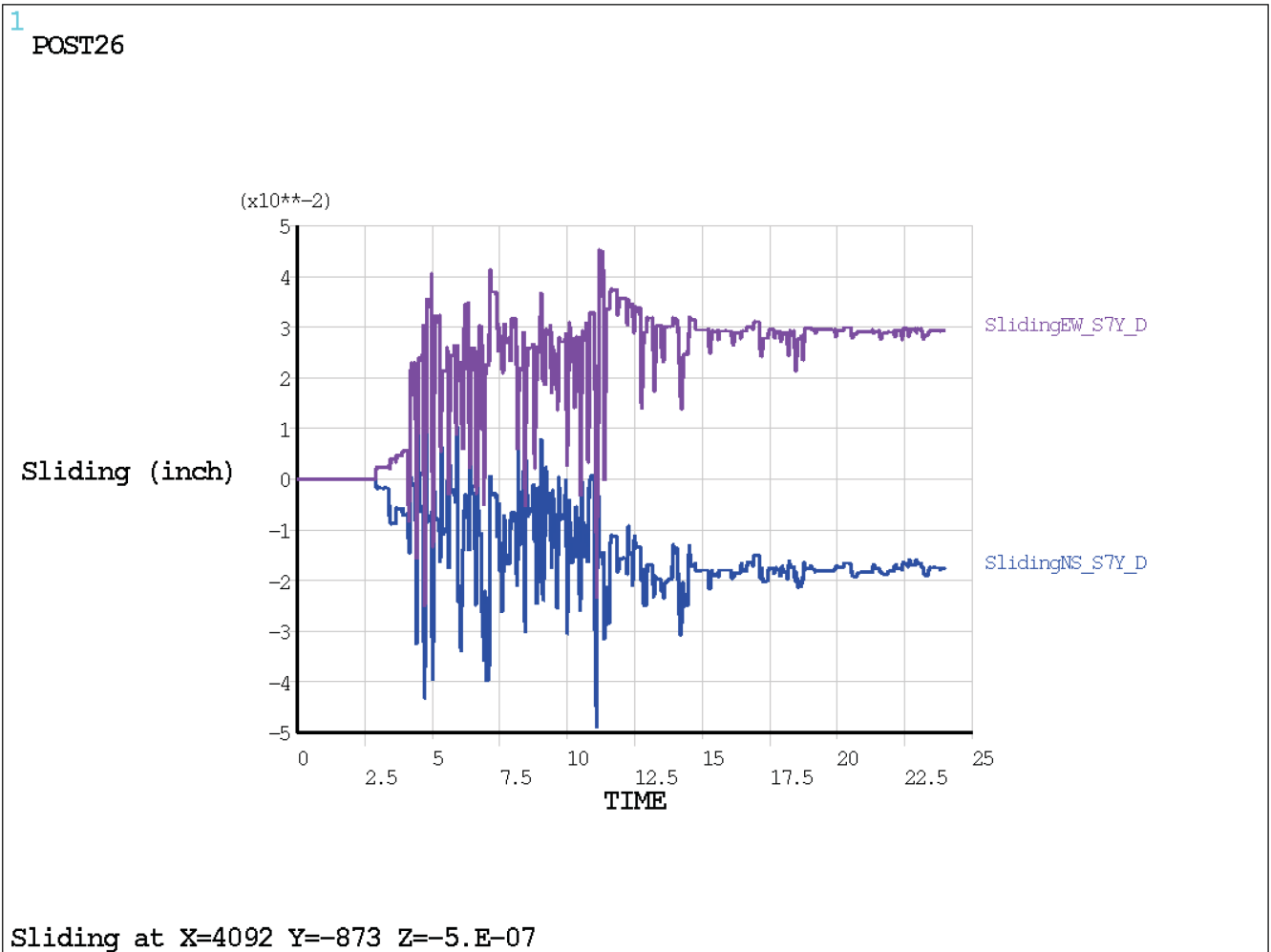

Figure 3.8.5-61: Lateral Relative Displacements (Sliding) at Location A (S11 - E-W Excitation)

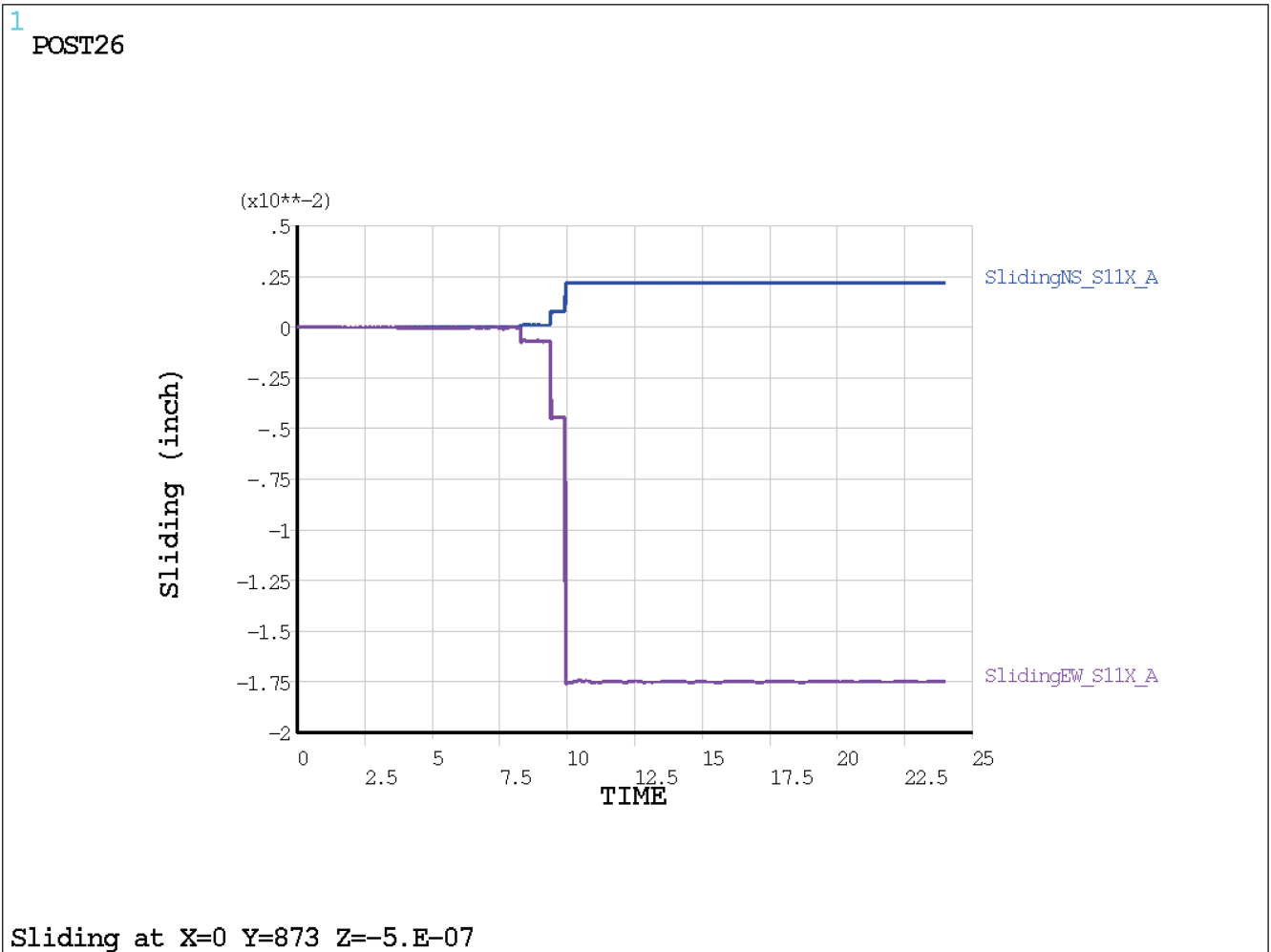

Figure 3.8.5-62: Lateral Relative Displacements (Sliding) at Location B (S11 - E-W Excitation)

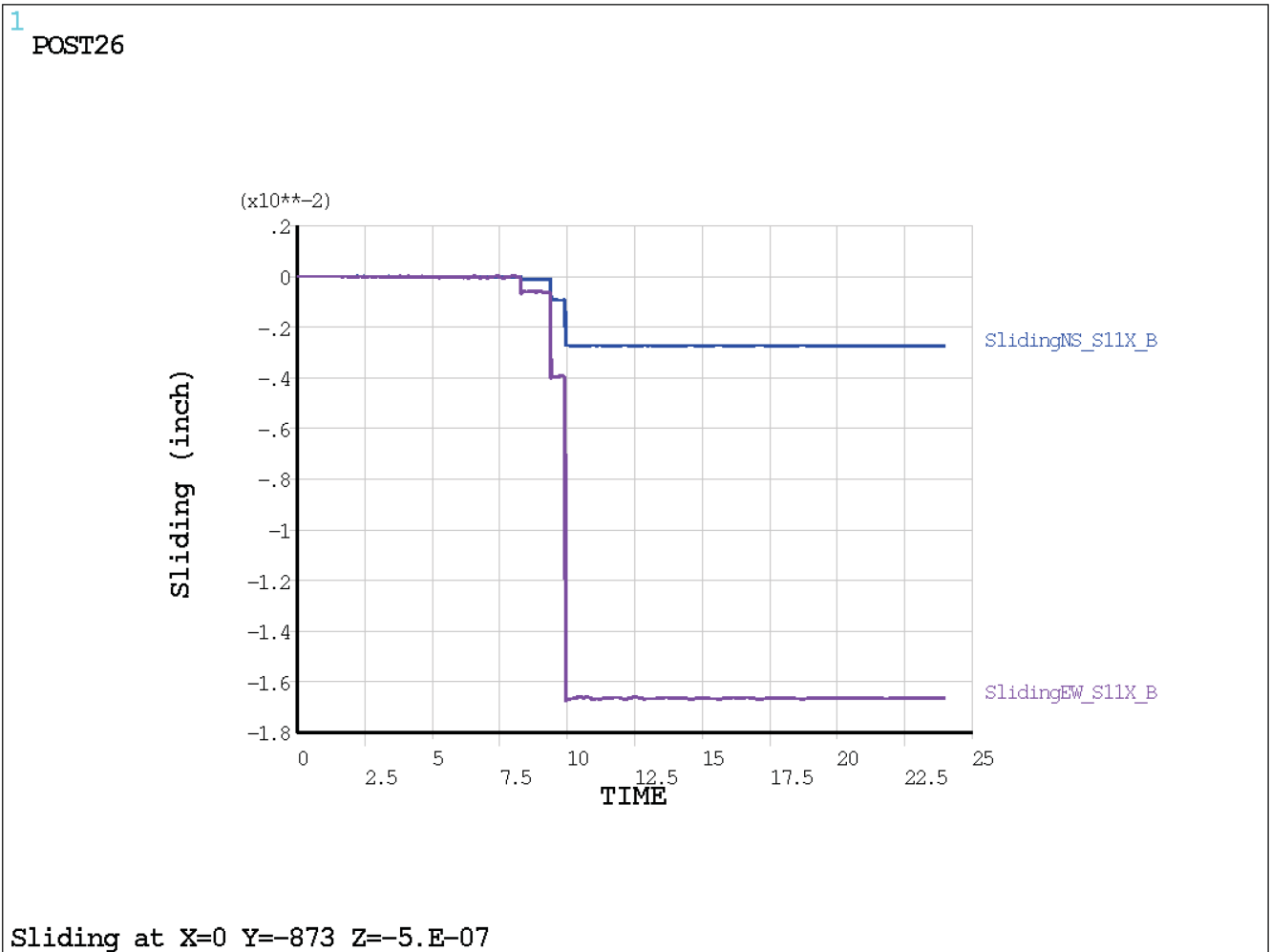

Figure 3.8.5-63: Lateral Relative Displacements (Sliding) at Location C (S11 - E-W Excitation)

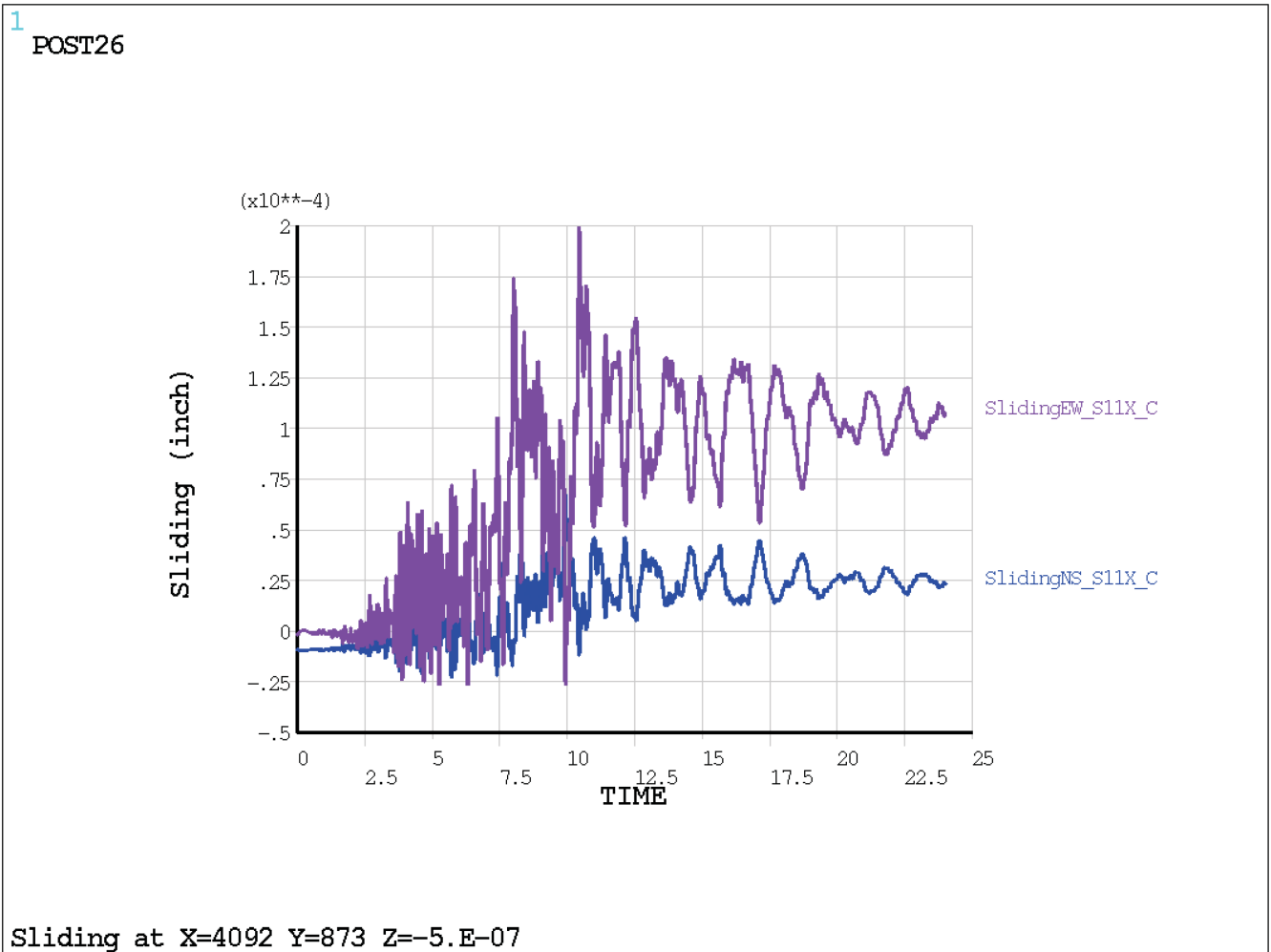

Figure 3.8.5-64: Lateral Relative Displacements (Sliding) at Location D (S11 - E-W Excitation)

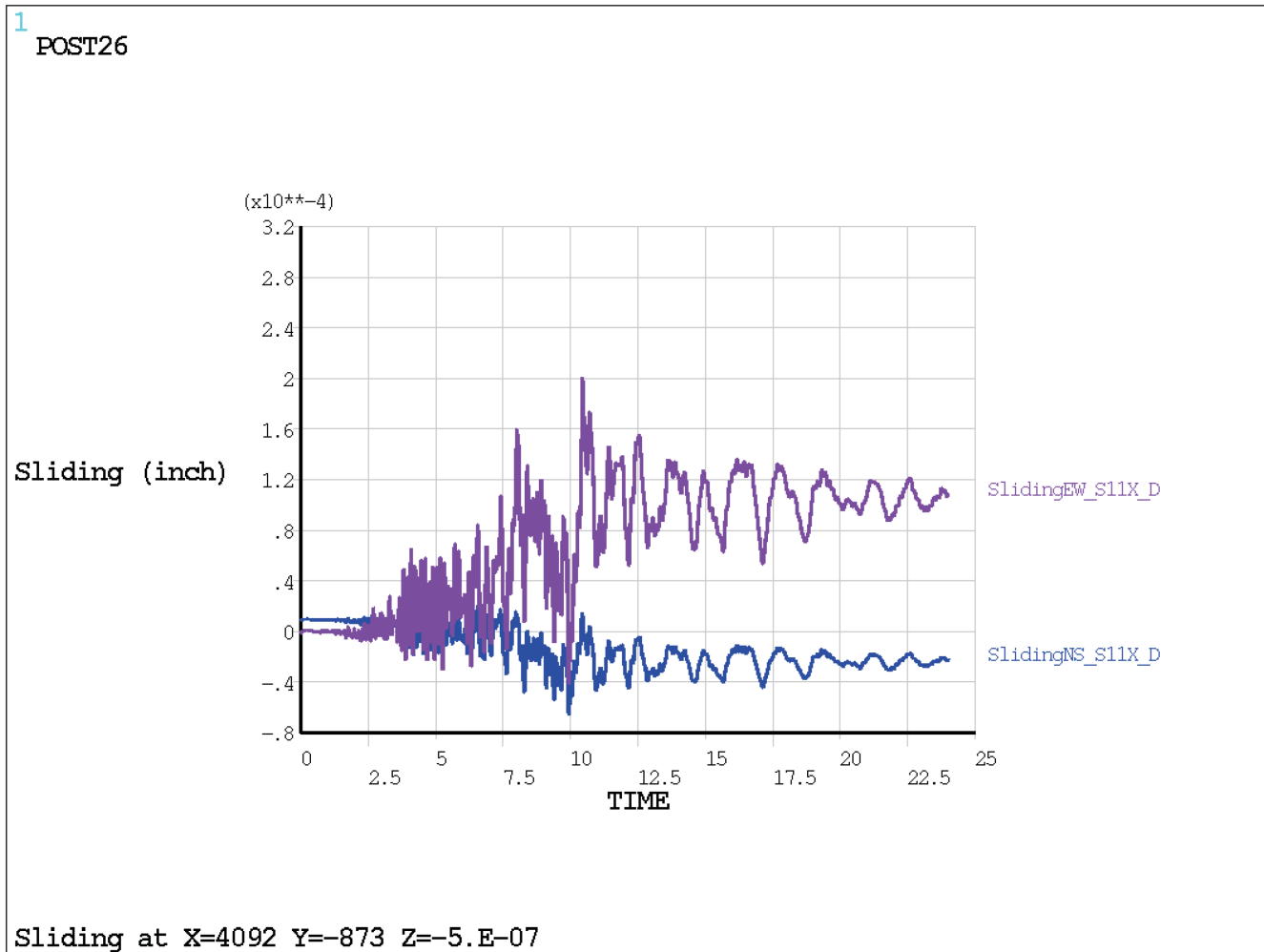

Figure 3.8.5-65: Lateral Relative Displacements (Sliding) at Location A (S11 - N-S Excitation)

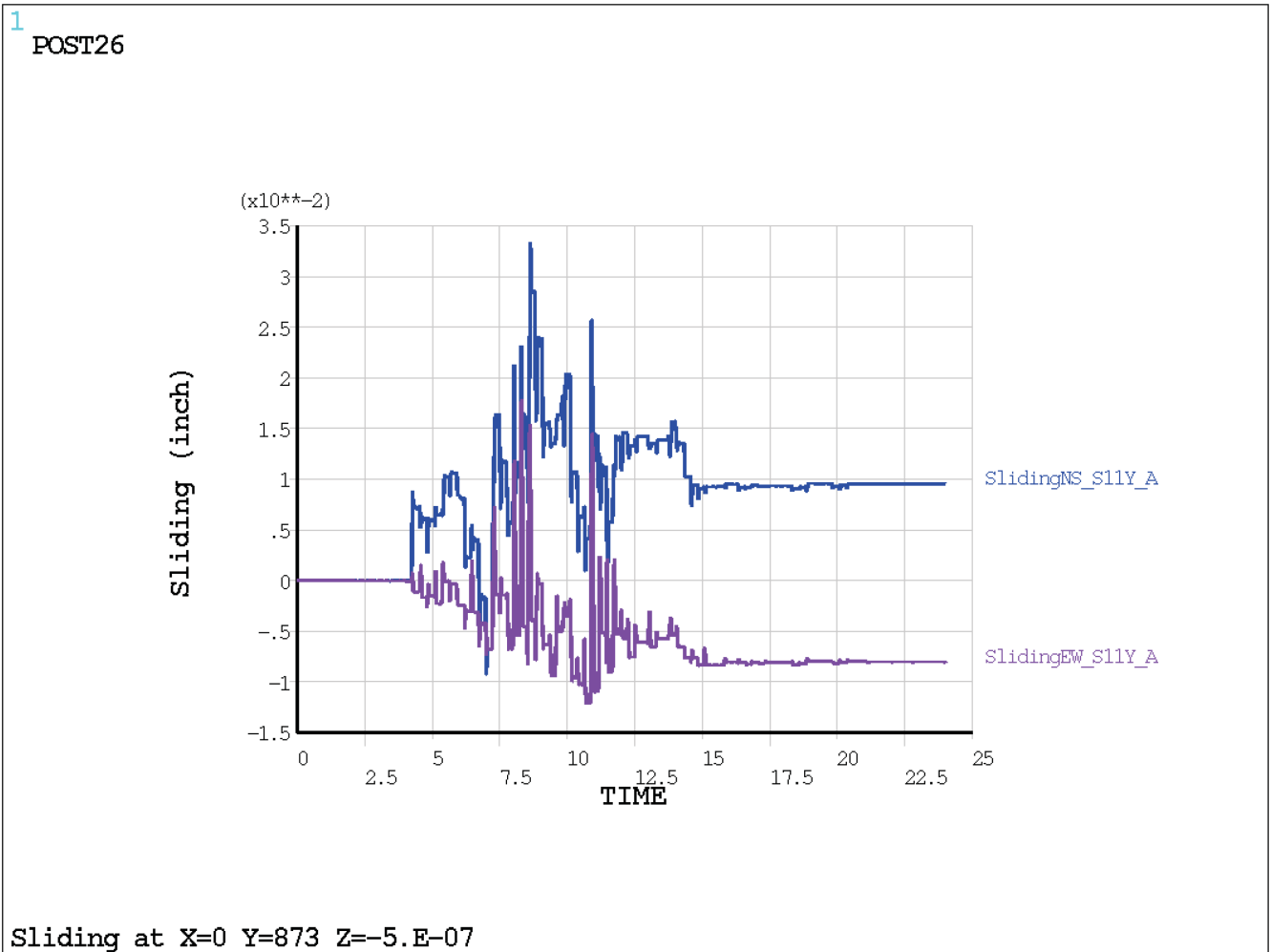

Figure 3.8.5-66: Lateral Relative Displacements (Sliding) at Location B (S11 - N-S Excitation)

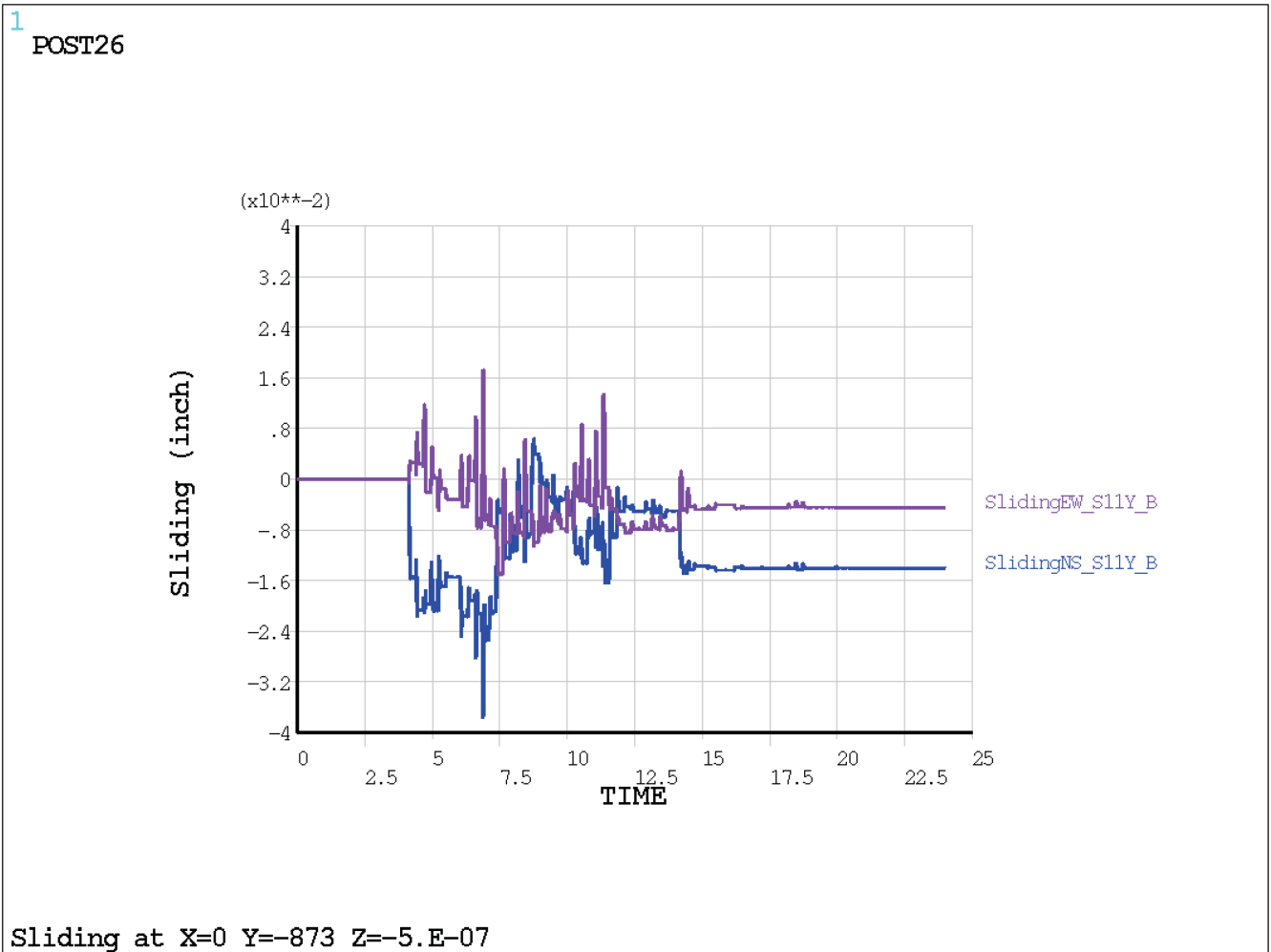

Figure 3.8.5-67: Lateral Relative Displacements (Sliding) at Location C (S11 - N-S Excitation)

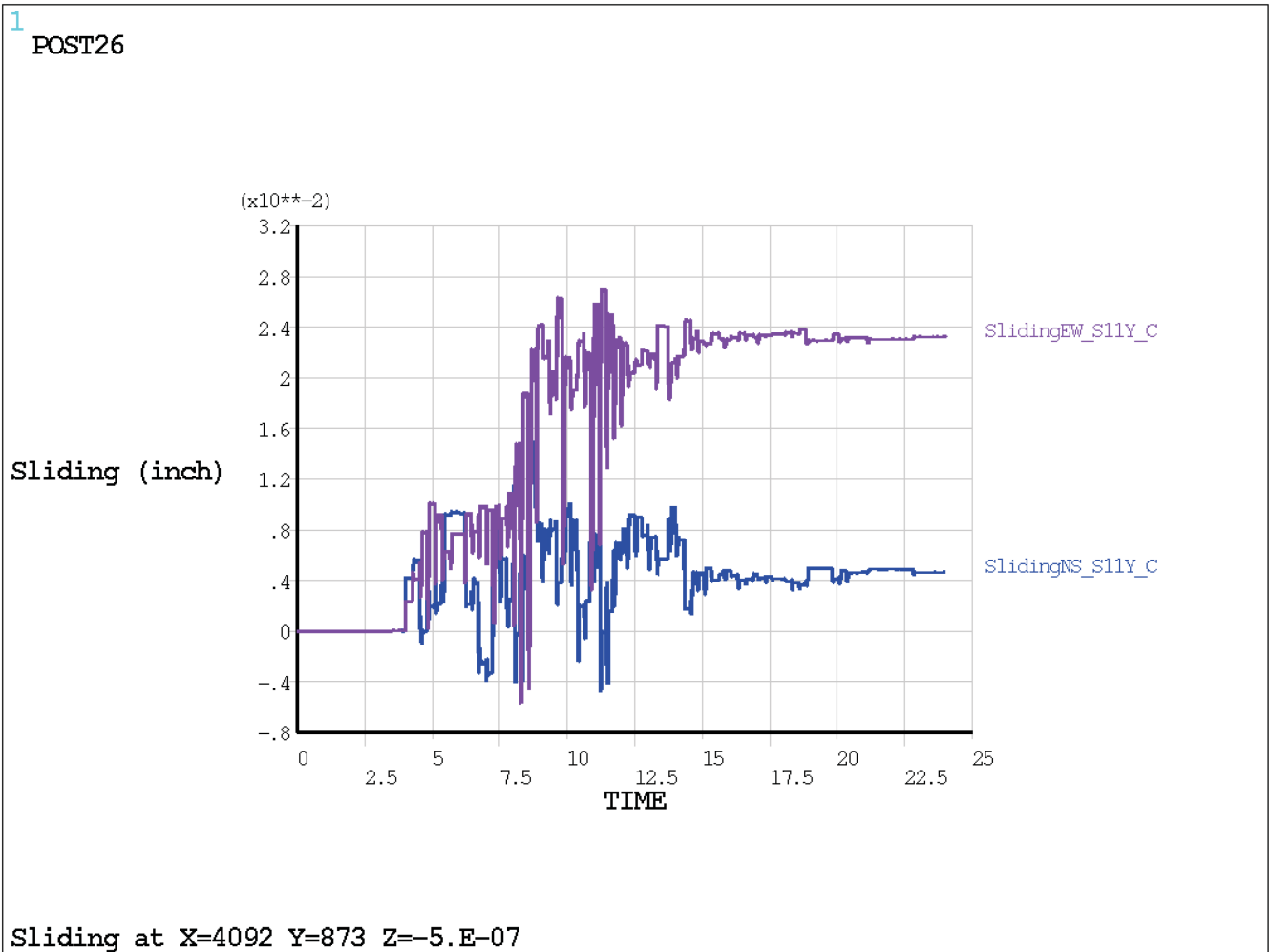

Figure 3.8.5-68: Lateral Relative Displacements (Sliding) at Location D (S11 - N-S Excitation)

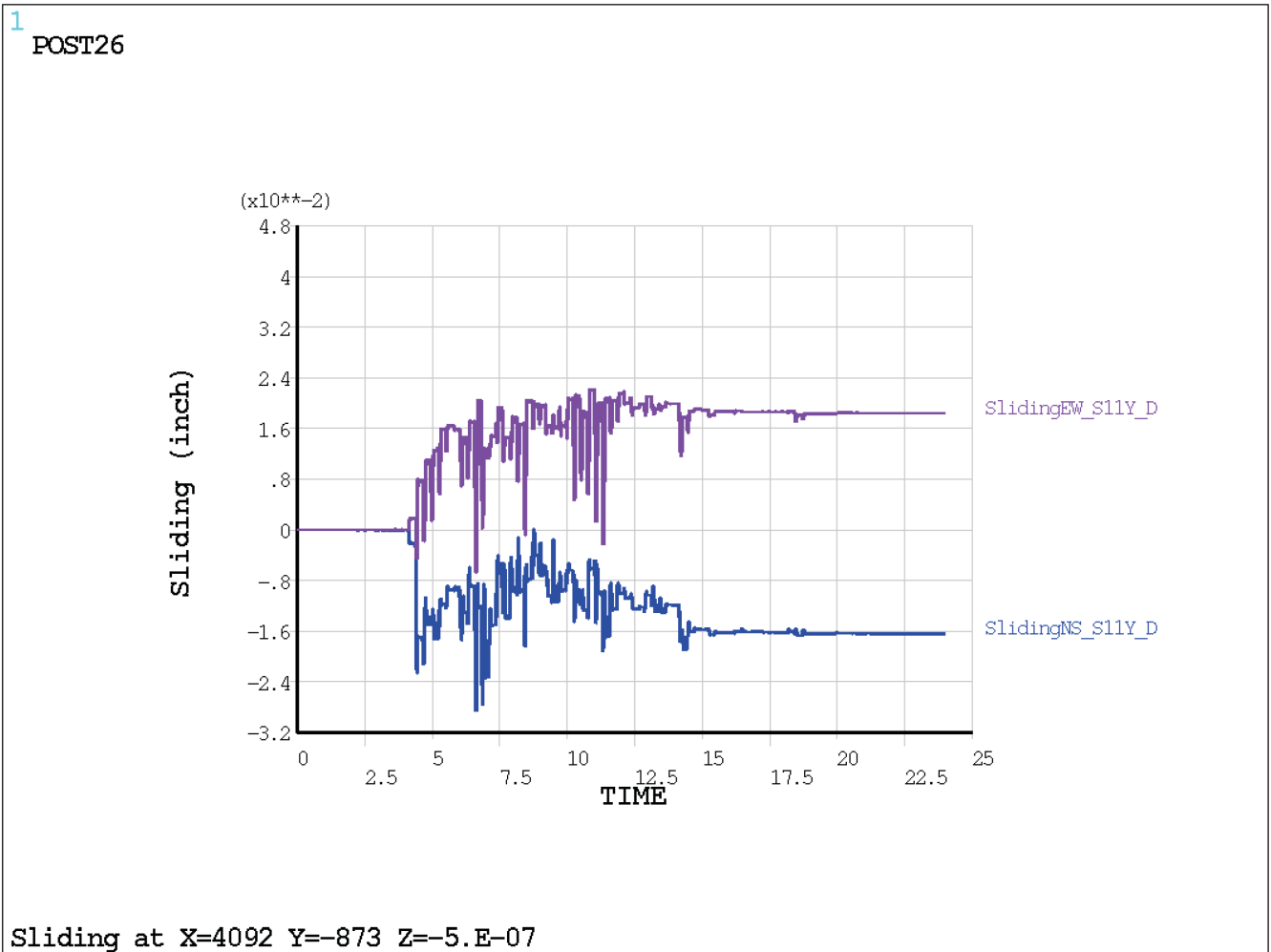

Figure 3.8.5-69: Lateral Relative Displacements (Sliding) at Location A (S8 - E-W Excitation)

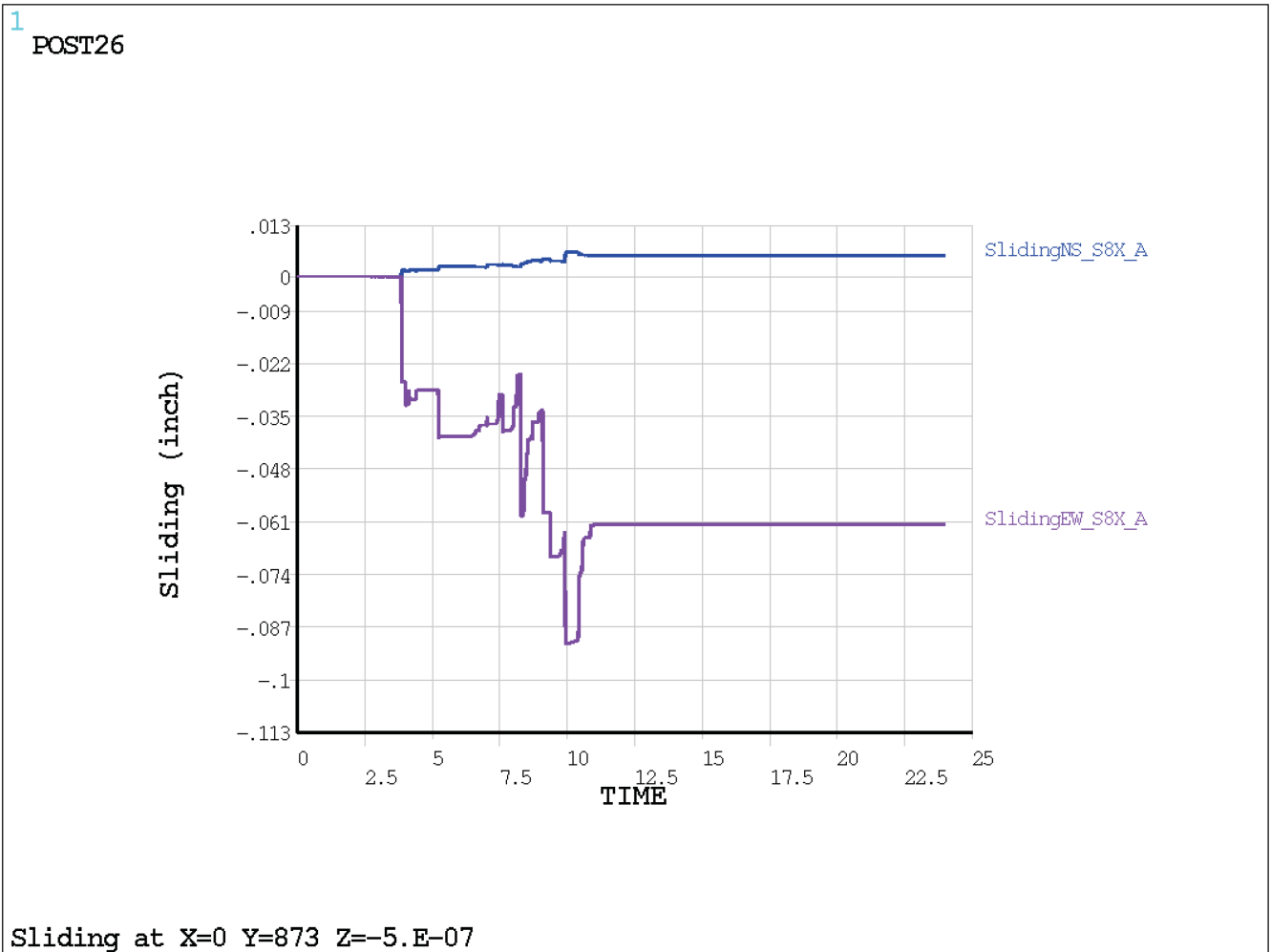

Figure 3.8.5-70: Lateral Relative Displacements (Sliding) at Location B (S8 - E-W Excitation)

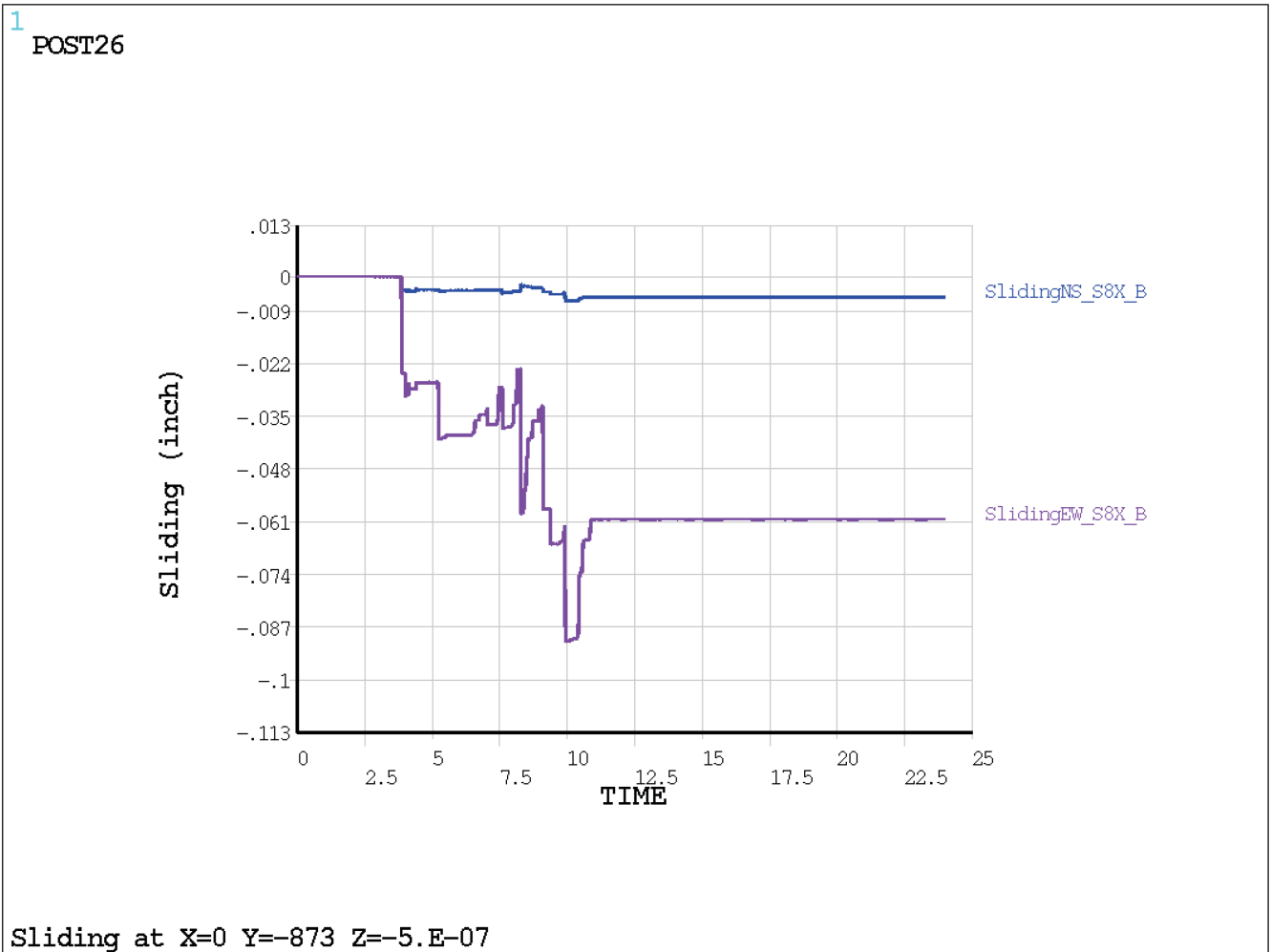

Figure 3.8.5-71: Lateral Relative Displacements (Sliding) at Location C (S8 - E-W Excitation)

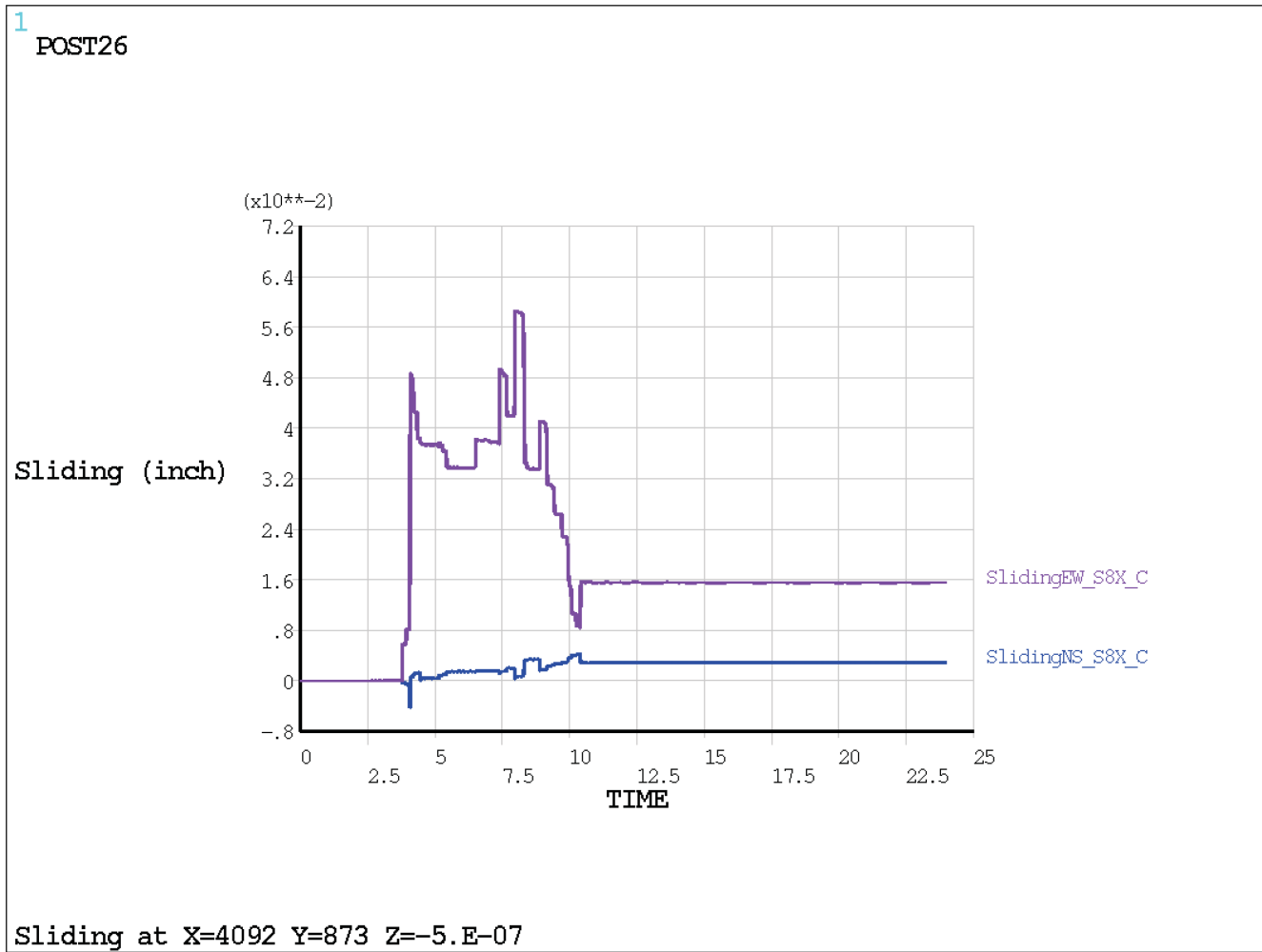

Figure 3.8.5-72: Lateral Relative Displacements (Sliding) at Location D (S8 - E-W Excitation)

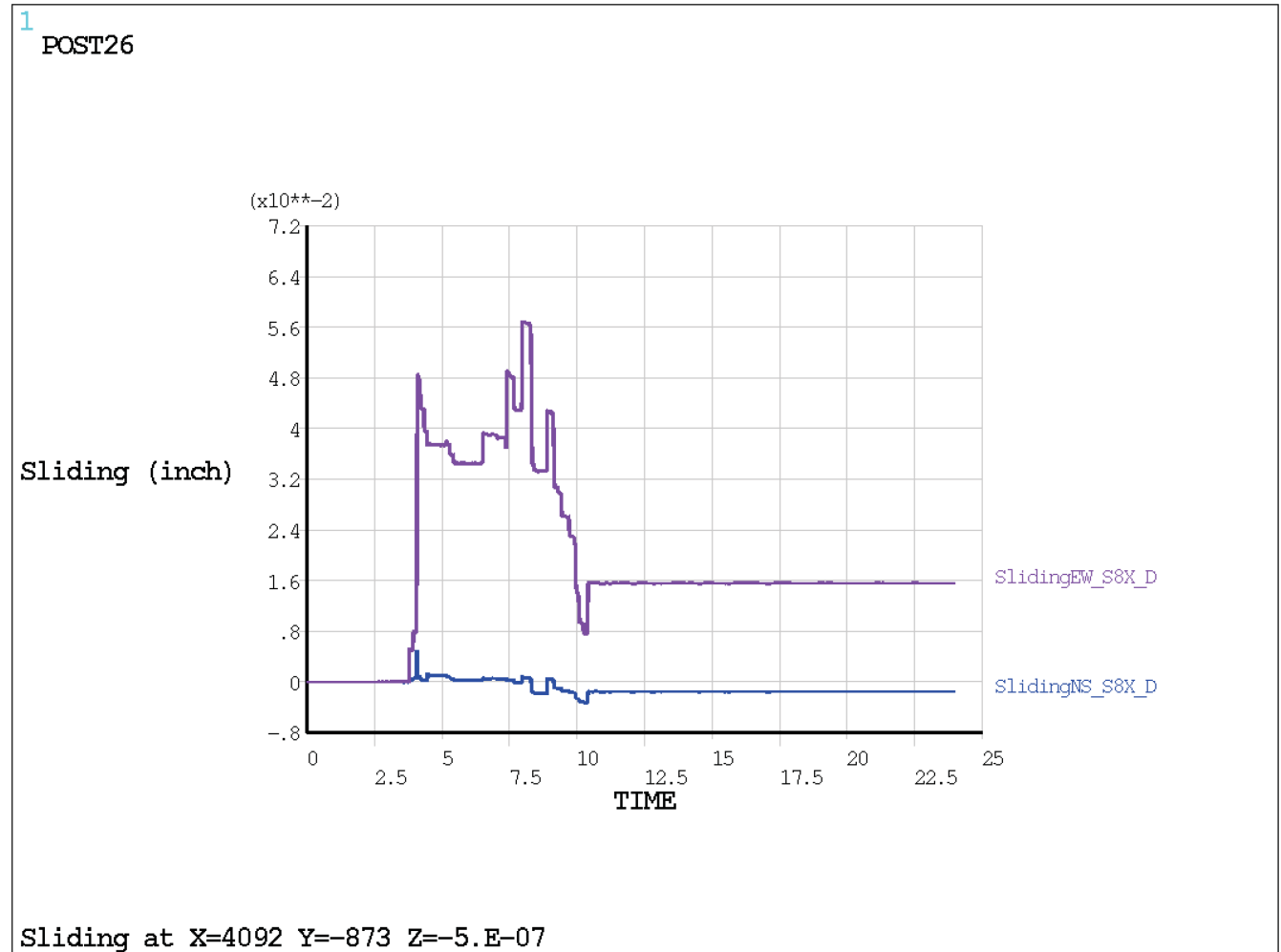

Figure 3.8.5-73: Lateral Relative Displacements (Sliding) at Location A (S8 - N-S Excitation)

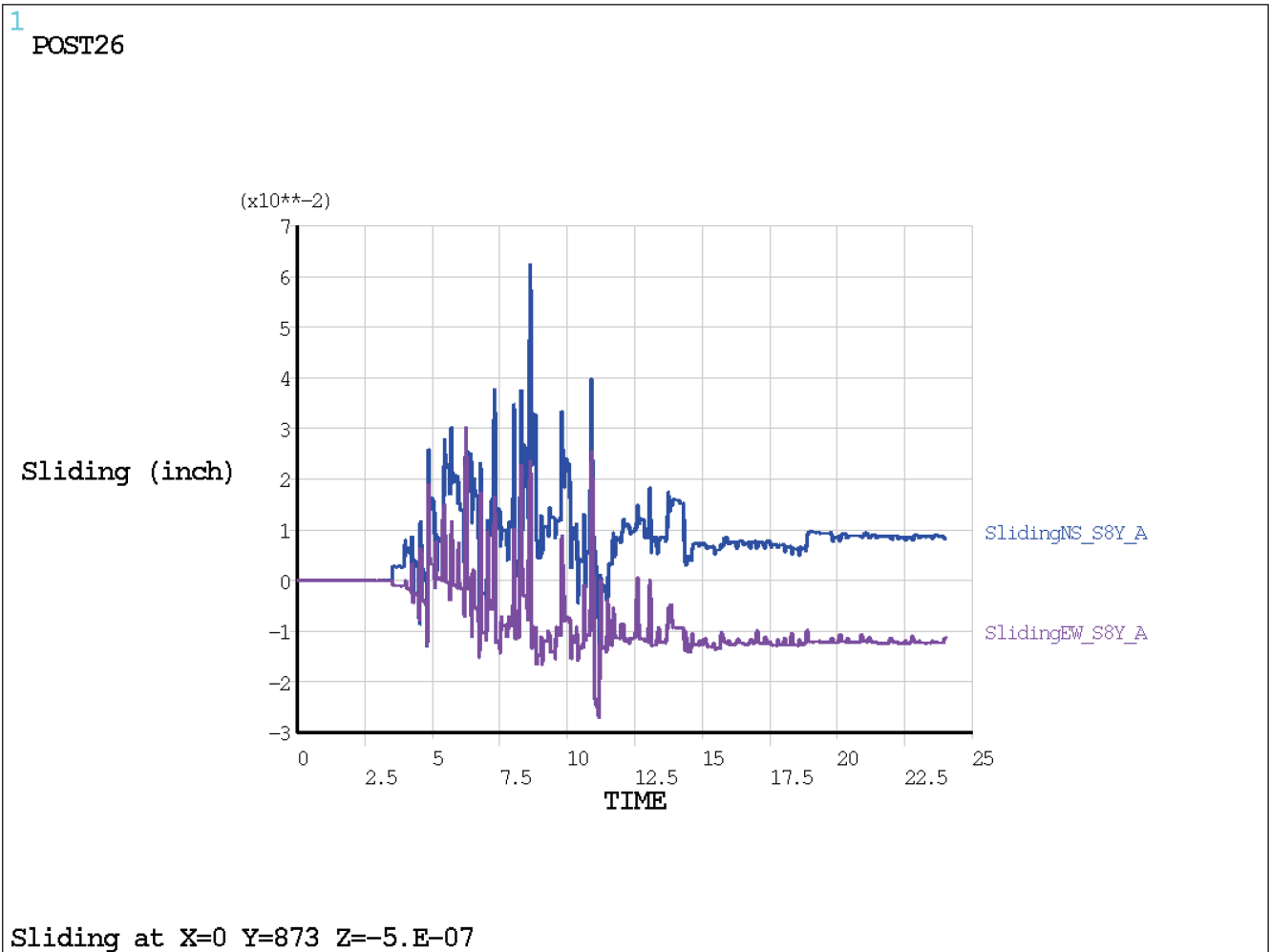

Figure 3.8.5-74: Lateral Relative Displacements (Sliding) at Location B (S8 - N-S Excitation)

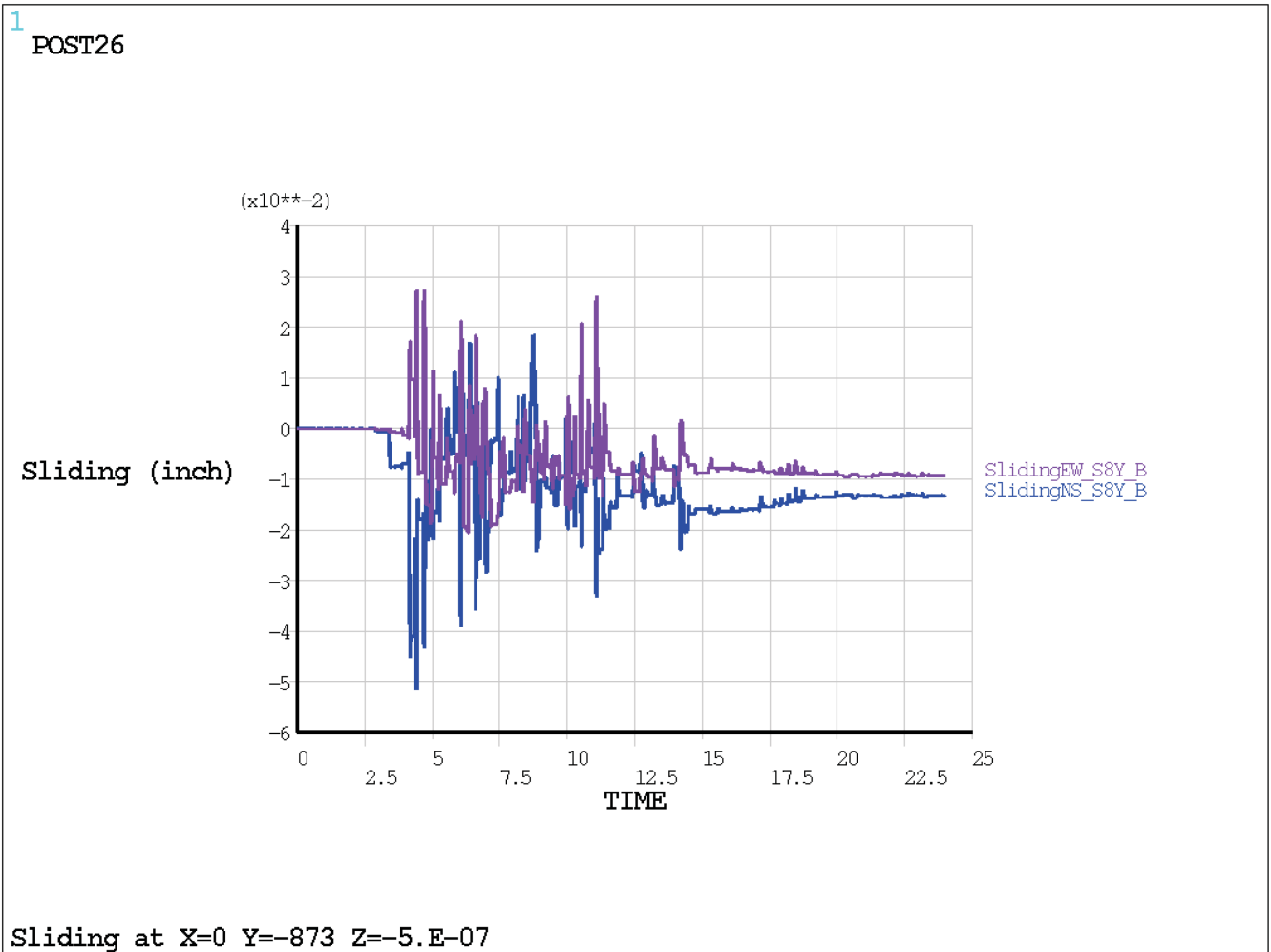

Figure 3.8.5-75: Lateral Relative Displacements (Sliding) at Location C (S8 - N-S Excitation)

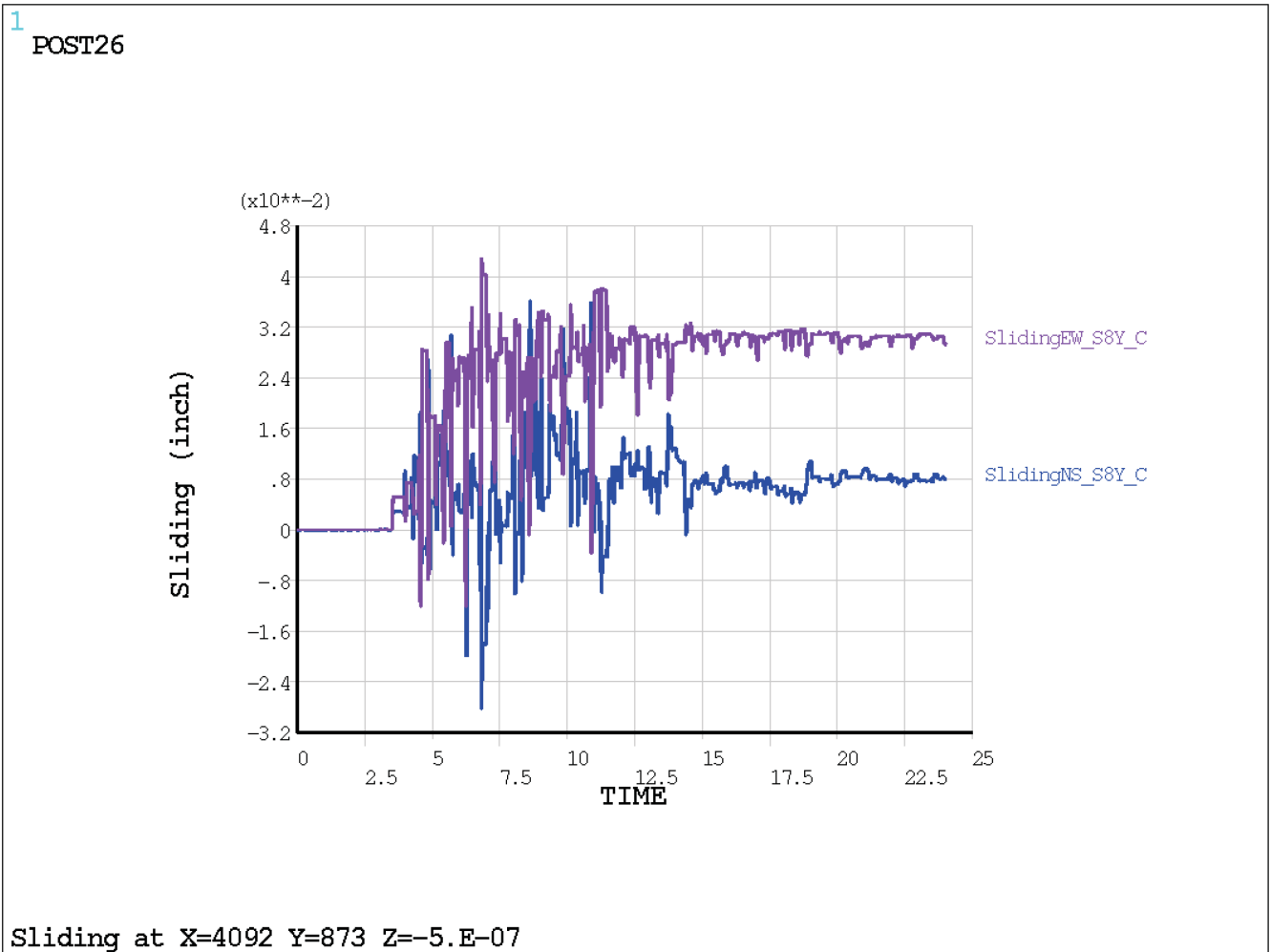

Figure 3.8.5-76: Lateral Relative Displacements (Sliding) at Location D (S8 - N-S Excitation)

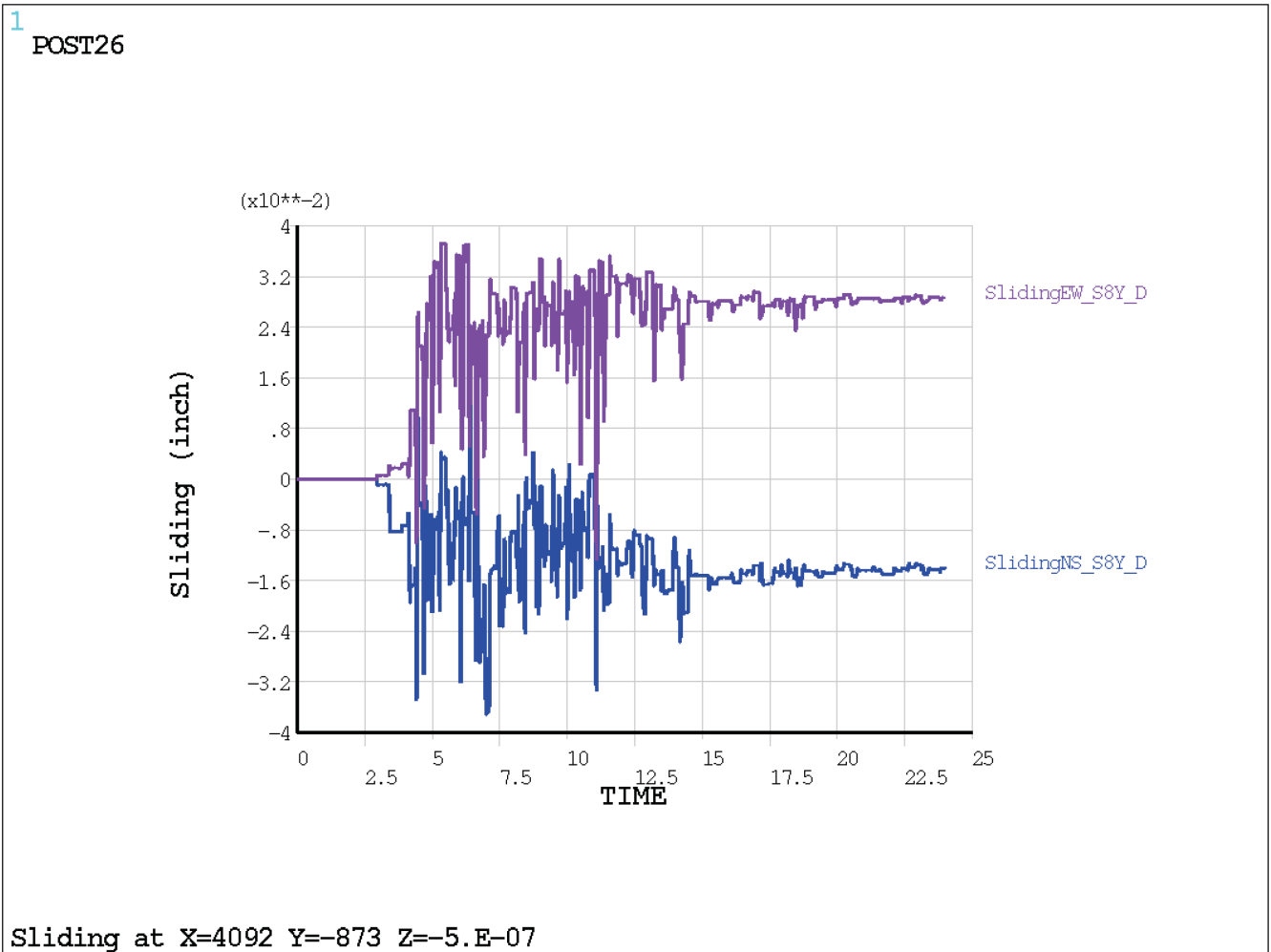

Figure 3.8.5-77: Total CRB Cracked Base Vertical Reaction Time History due to Capitola for Soil Type 7

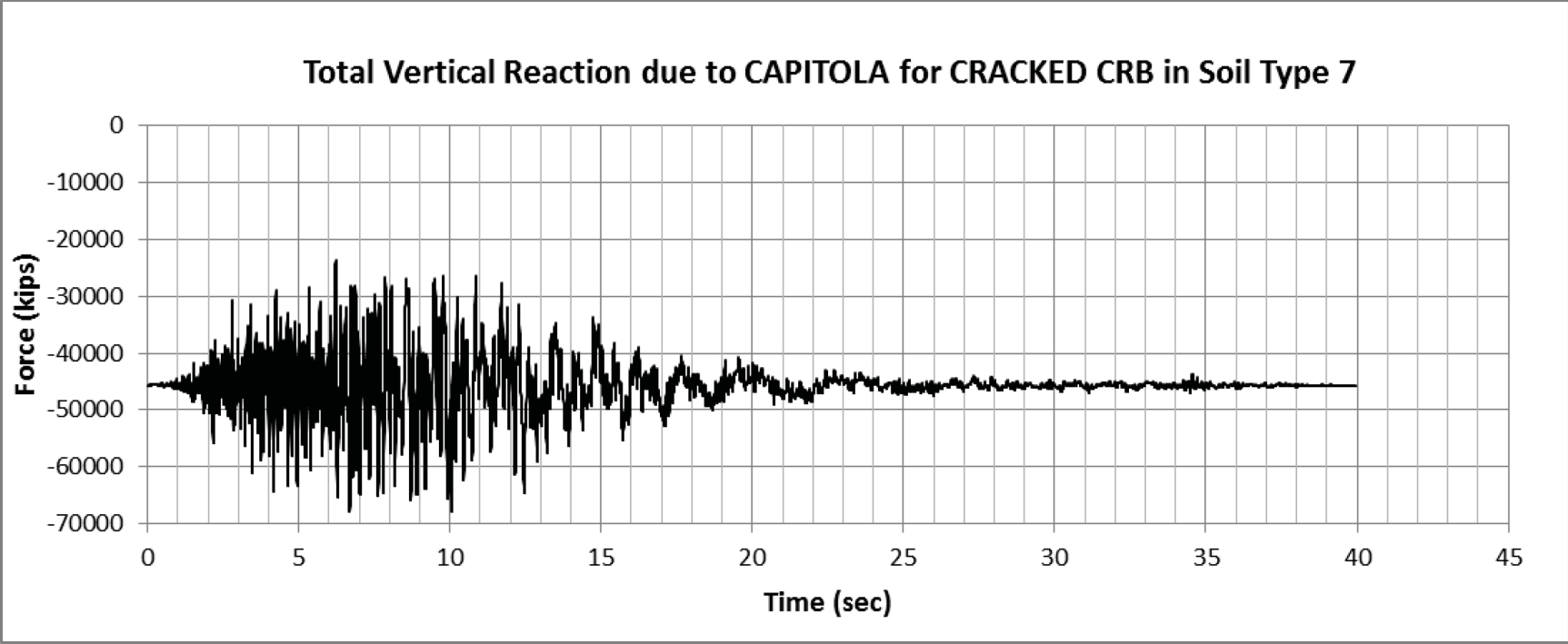

Figure 3.8.5-78: Total CRB Uncracked Base Vertical Reaction Time History due to Capitola for Soil Type 7

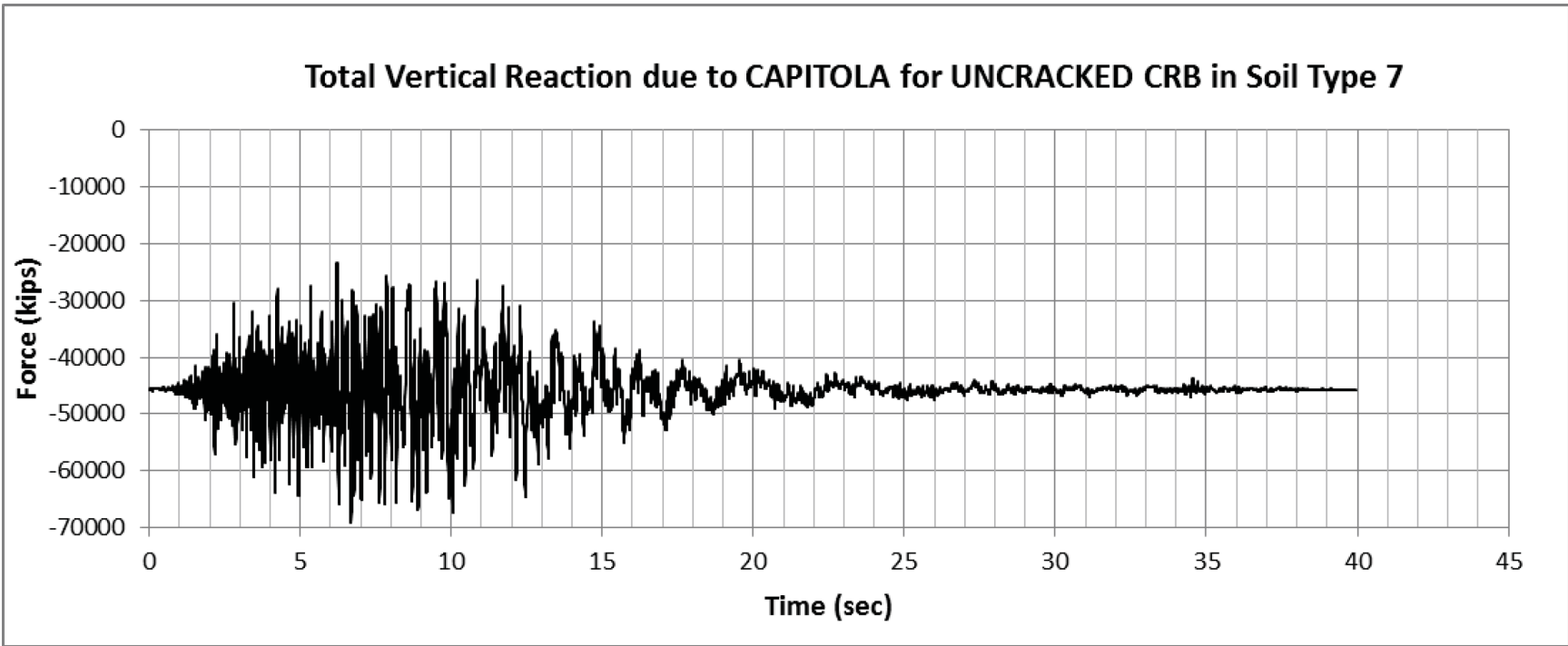

Figure 3.8.5-79: Total CRB Cracked Base Vertical Reaction Time History due to Capitola for Soil Type 8

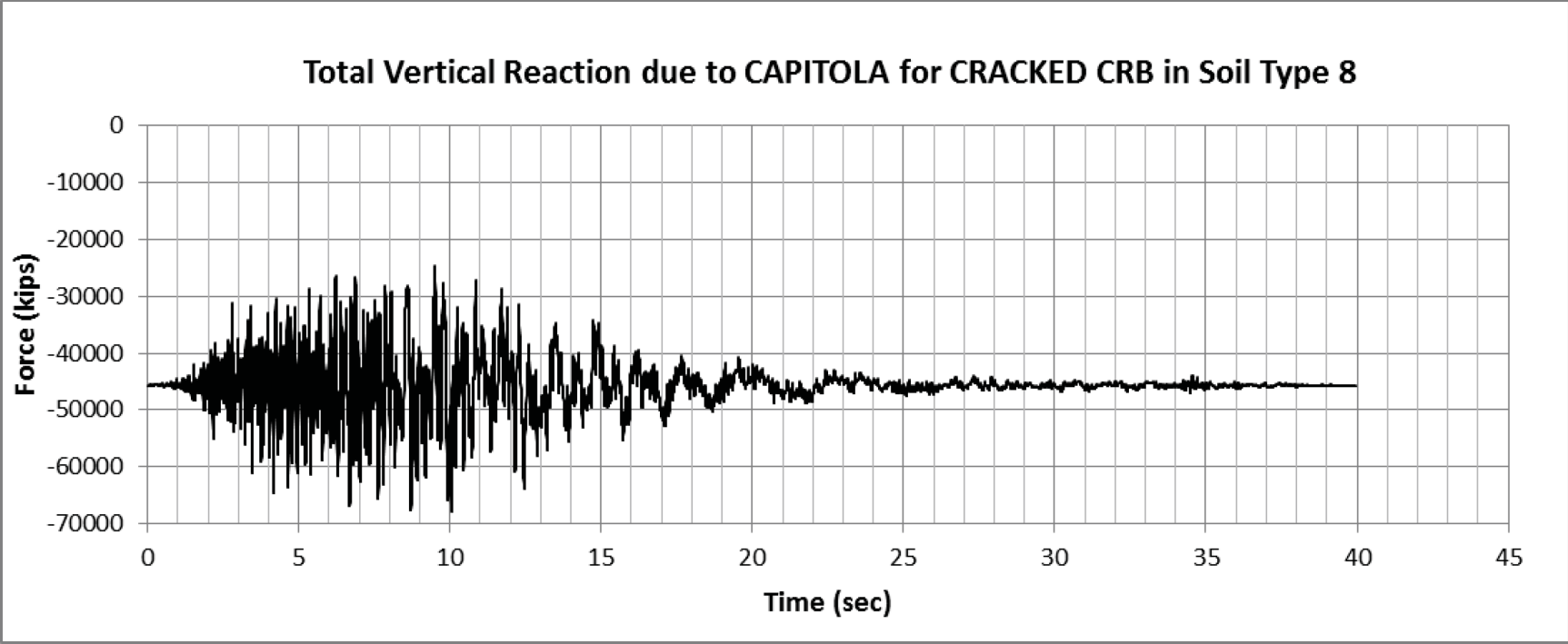

Figure 3.8.5-80: Total CRB Cracked Base Vertical Reaction Time History due to Capitola for Soil Type 11

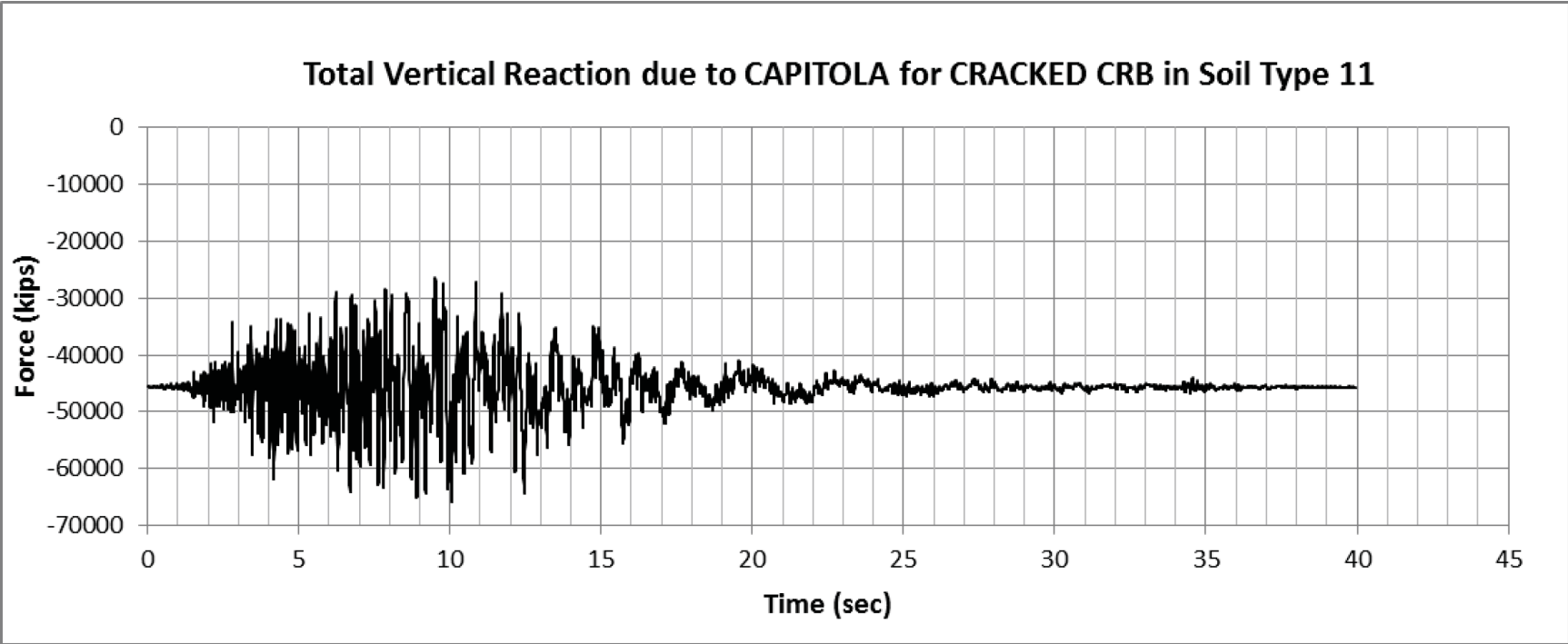

Figure 3.8.5-81: Total CRB Cracked Base Vertical Reaction Time History due to Lucerne for Soil Type 7

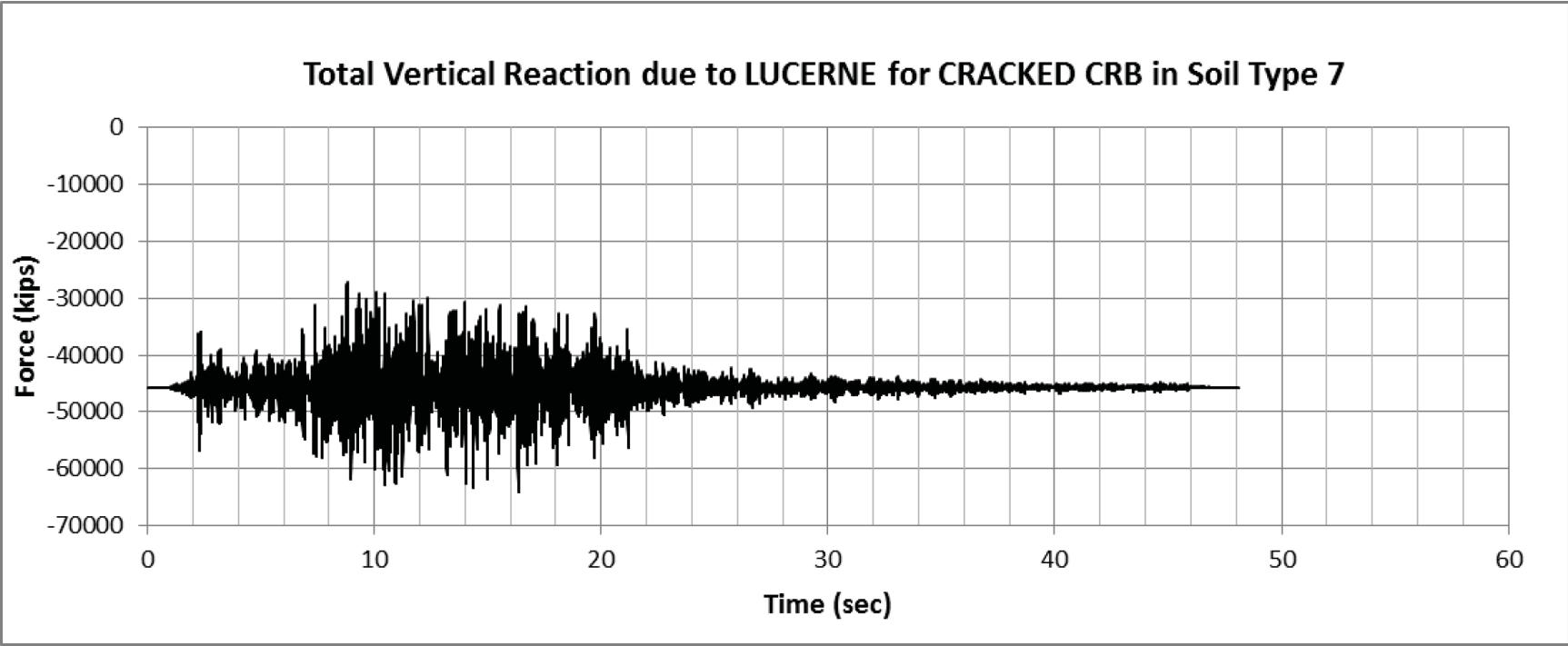

Figure 3.8.5-82: Total CRB Cracked Base Vertical Reaction Time History due to Lucerne for Soil Type 9

