



**UPDATED FSAR**  
**INTRODUCTION AND SUMMARY**  
**CHAPTER 1 FIGURES**

Revision: 25  
Chapter: 1  
Page: 1 of 1

## ***LIST OF FIGURES***

**FIGURE**

**NUMBER            TITLE**

---

FIGURE 1-1	DELETED BY REVISION 21
FIGURE 1-2	GENERAL ARRANGEMENT PLAN – ELEVATION (-) 17'-0"
FIGURE 1-3	GENERAL ARRANGEMENT PLAN – ELEVATION 20'-0"
FIGURE 1-4	GENERAL ARRANGEMENT PLAN – ELEVATION 50'-0"
FIGURE 1-5	GENERAL ARRANGEMENT PLAN – ELEVATION 80'-0"
FIGURE 1-6	GENERAL ARRANGEMENT PLAN – ELEVATION 117'-4"
FIGURE 1-7	GENERAL ARRANGEMENT – SECTIONS A-A AND B-B
FIGURE 1-8	GENERAL ARRANGEMENT – SECTION C-C
FIGURE 1-9	DELETED
FIGURE 1-10	GENERAL ARRANGEMENT – SHOP WAREHOUSE AND STOCKROOM BUILDINGS
FIGURE 1-11	NITROGEN & AUGMENTED OFF-GAS BUILDING
FIGURE 1-12	DELETED
FIGURE 1-13	DELETED
FIGURE 1-14	GE REACTOR SYSTEM HEAT BALANCE



**UPDATED FSAR**  
*DESIGN OF STRUCTURES, COMPONENTS, EQUIPMENT, AND SYSTEMS*  
*CHAPTER 1 FIGURES*

Revision: 24  
Figure: 1-2  
Page: 1 of 1

SECURITY-RELATED INFORMATION WITHHOLD UNDER 10 CFR  
2.390

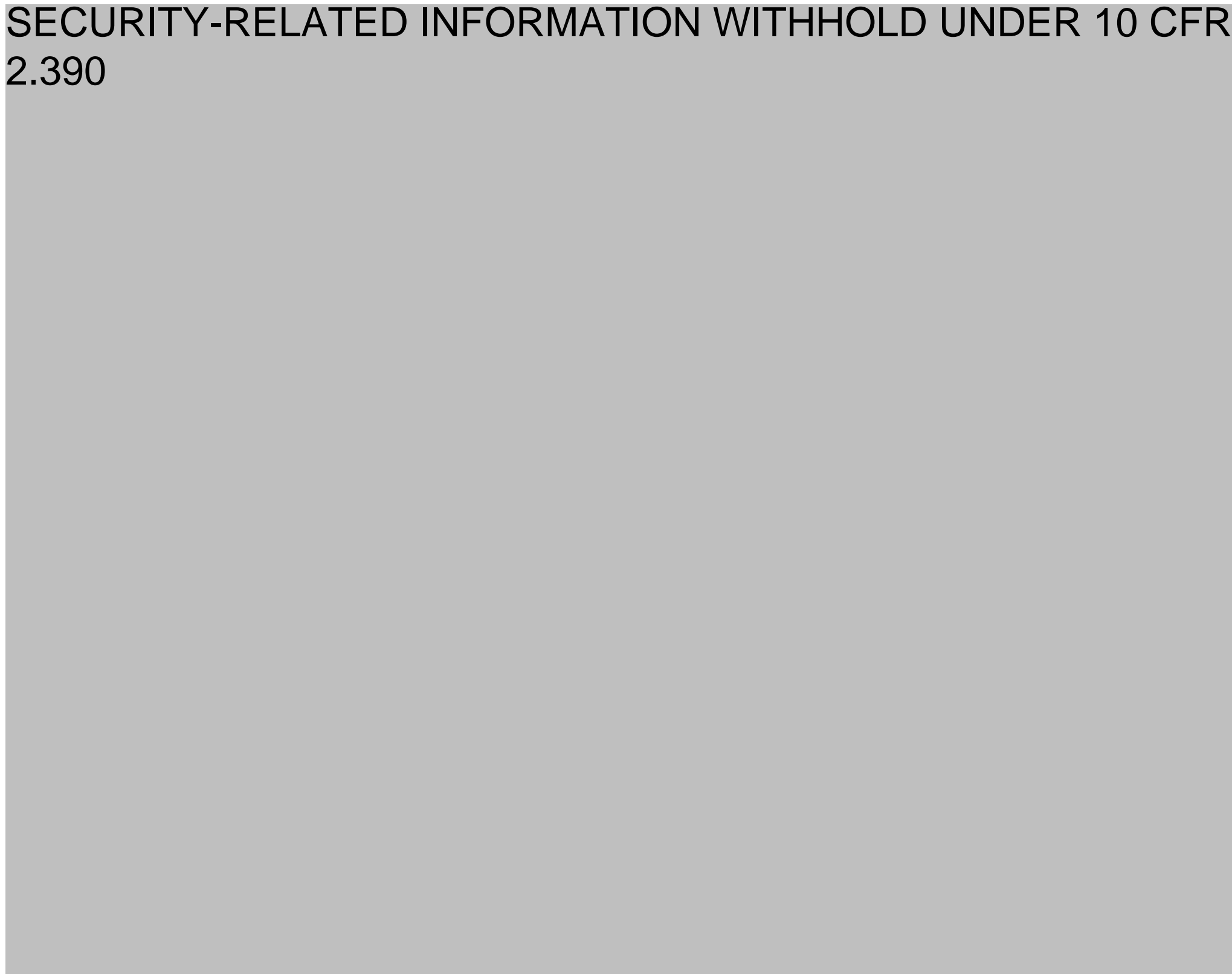



**UPDATED FSAR**  
*DESIGN OF STRUCTURES, COMPONENTS, EQUIPMENT, AND SYSTEMS*  
*CHAPTER 1 FIGURES*

Revision: 24  
Figure: 1-3  
Page: 1 of 1

SECURITY-RELATED INFORMATION WITHHOLD UNDER 10  
CFR 2.390

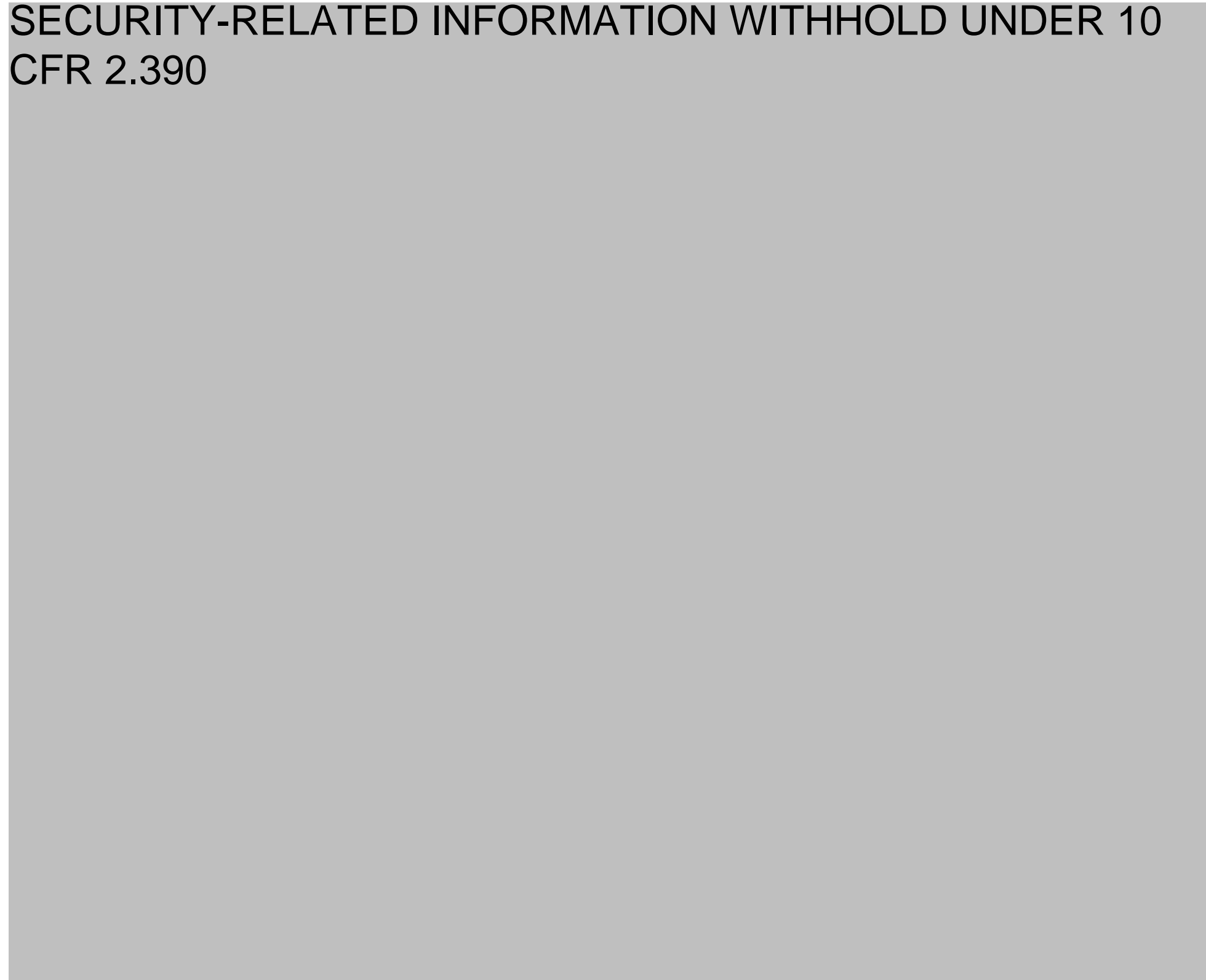



**UPDATED FSAR**  
*DESIGN OF STRUCTURES, COMPONENTS, EQUIPMENT, AND SYSTEMS*  
**CHAPTER 1 FIGURES**

Revision: 24  
Figure: 1-4  
Page: 1 of 1

SECURITY-RELATED INFORMATION WITHHOLD UNDER 10 CFR 2.390

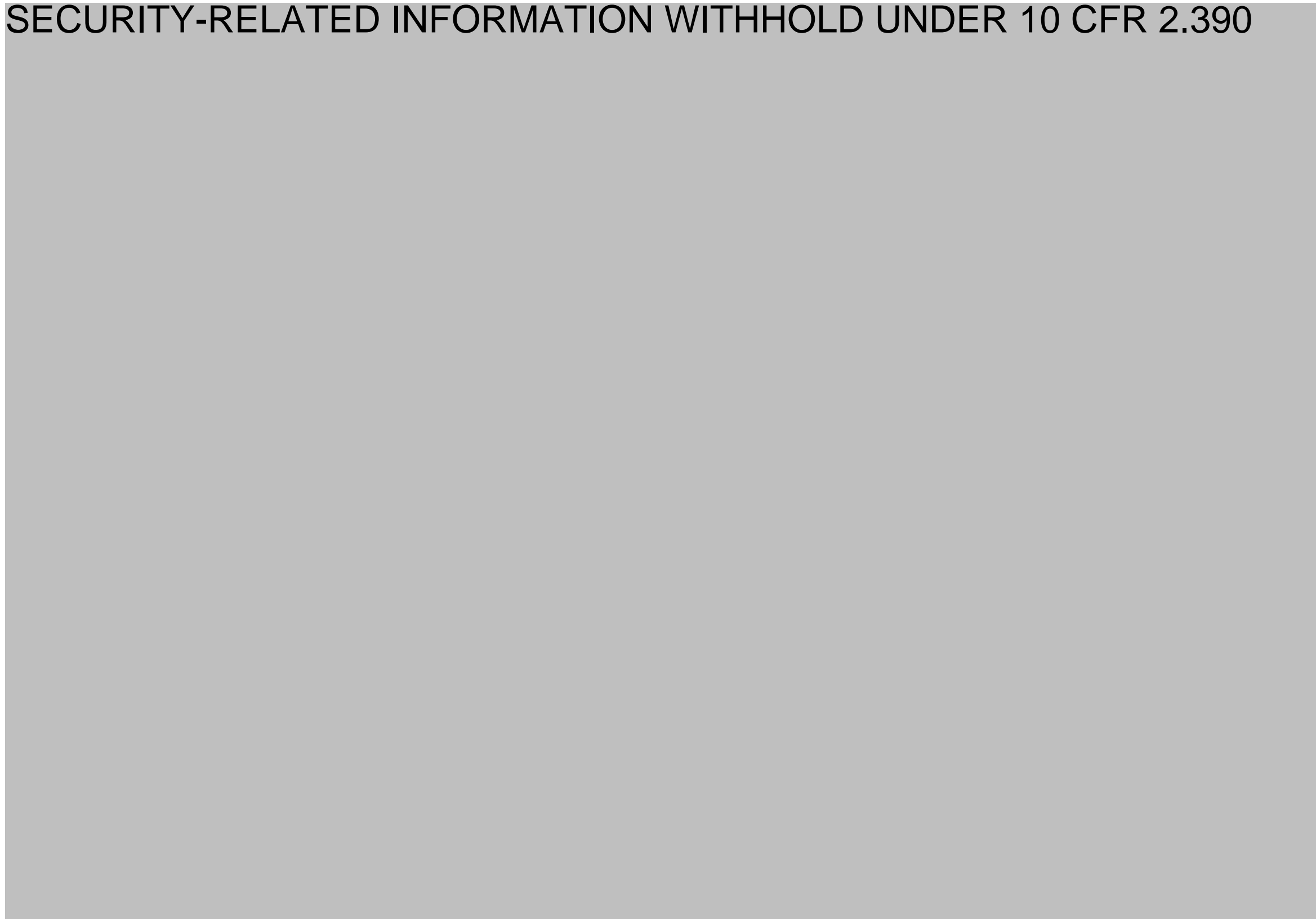



**UPDATED FSAR**  
*DESIGN OF STRUCTURES, COMPONENTS, EQUIPMENT, AND SYSTEMS*  
*CHAPTER 1 FIGURES*

Revision: 24  
Figure: 1-5  
Page: 1 of 1

SECURITY-RELATED INFORMATION WITHHOLD UNDER 10  
CFR 2.390

[A large grey rectangular area covers the majority of the page, indicating that the content has been withheld under 10 CFR 2.390.]



**UPDATED FSAR**  
*DESIGN OF STRUCTURES, COMPONENTS, EQUIPMENT, AND SYSTEMS*  
*CHAPTER 1 FIGURES*

Revision: 24  
Figure: 1-6  
Page: 1 of 1

SECURITY-RELATED INFORMATION WITHHOLD UNDER 10 CFR  
2.390

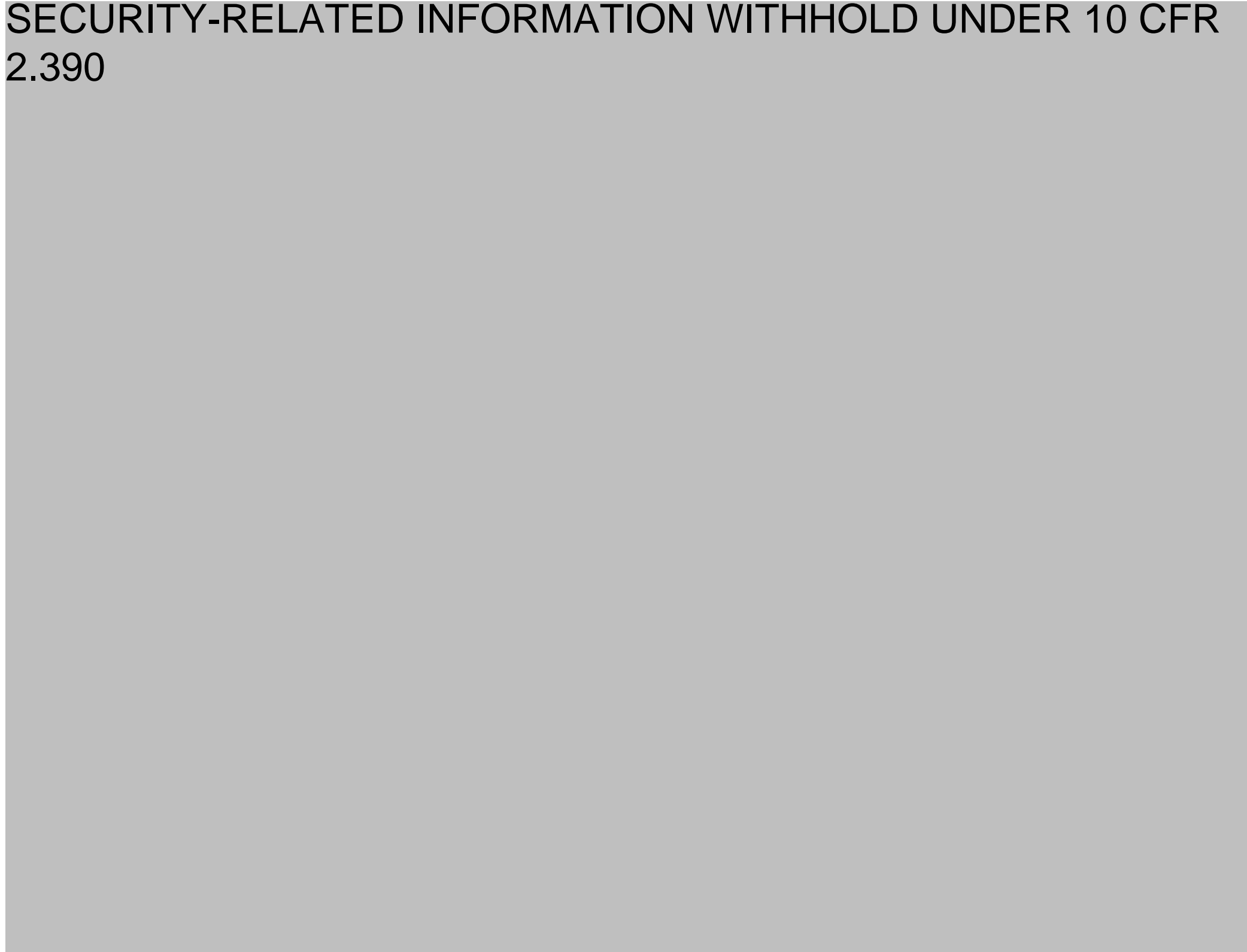



**UPDATED FSAR**  
*DESIGN OF STRUCTURES, COMPONENTS, EQUIPMENT, AND SYSTEMS*  
*CHAPTER 1 FIGURES*

Revision: 24  
Figure: 1-7  
Page: 1 of 1

SECURITY-RELATED INFORMATION WITHHOLD UNDER 10  
CFR 2.390

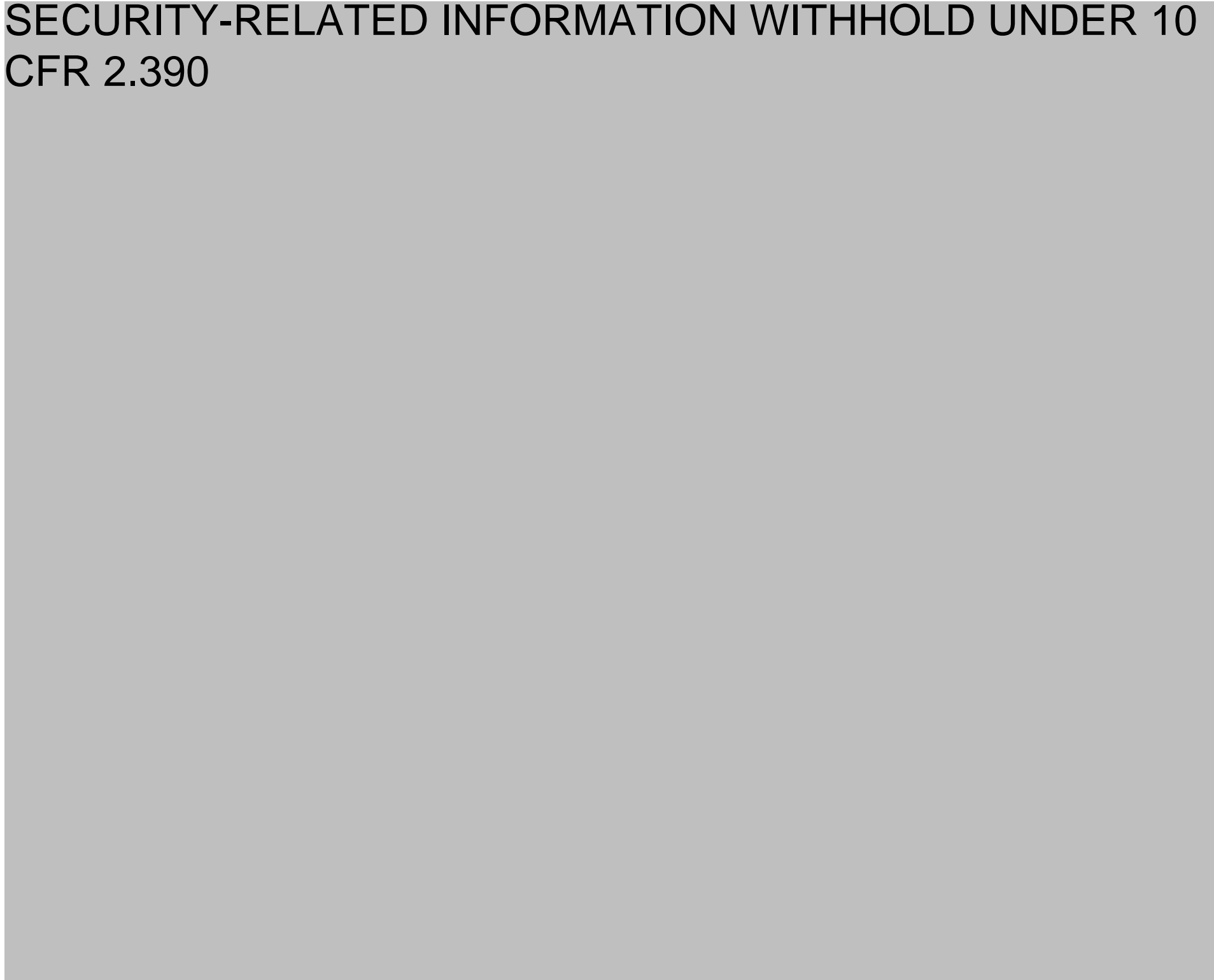



**UPDATED FSAR**  
*DESIGN OF STRUCTURES, COMPONENTS, EQUIPMENT, AND SYSTEMS*  
*CHAPTER 1 FIGURES*

Revision: 24  
Figure: 1-8  
Page: 1 of 1

SECURITY-RELATED INFORMATION WITHHOLD UNDER 10 CFR 2.390

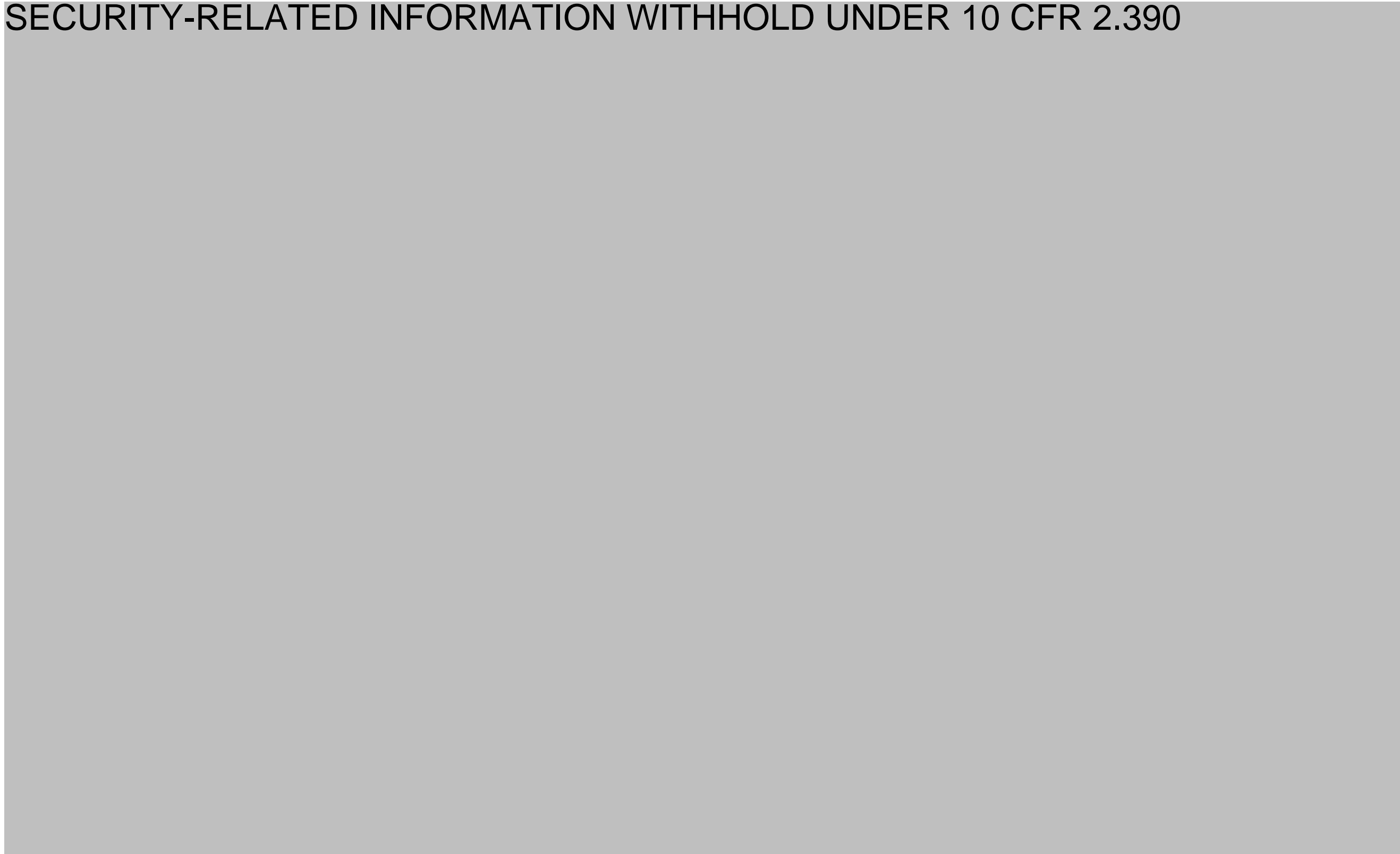



SECURITY-RELATED INFORMATION WITHHOLD UNDER 10 CFR 2.390



**UPDATED FSAR**  
*DESIGN OF STRUCTURES, COMPONENTS, EQUIPMENT, AND SYSTEMS*  
*CHAPTER 1 FIGURES*

Revision: 24  
Figure: 1-10  
Page: 1 of 1

SECURITY-RELATED INFORMATION WITHHOLD UNDER 10 CFR 2.390

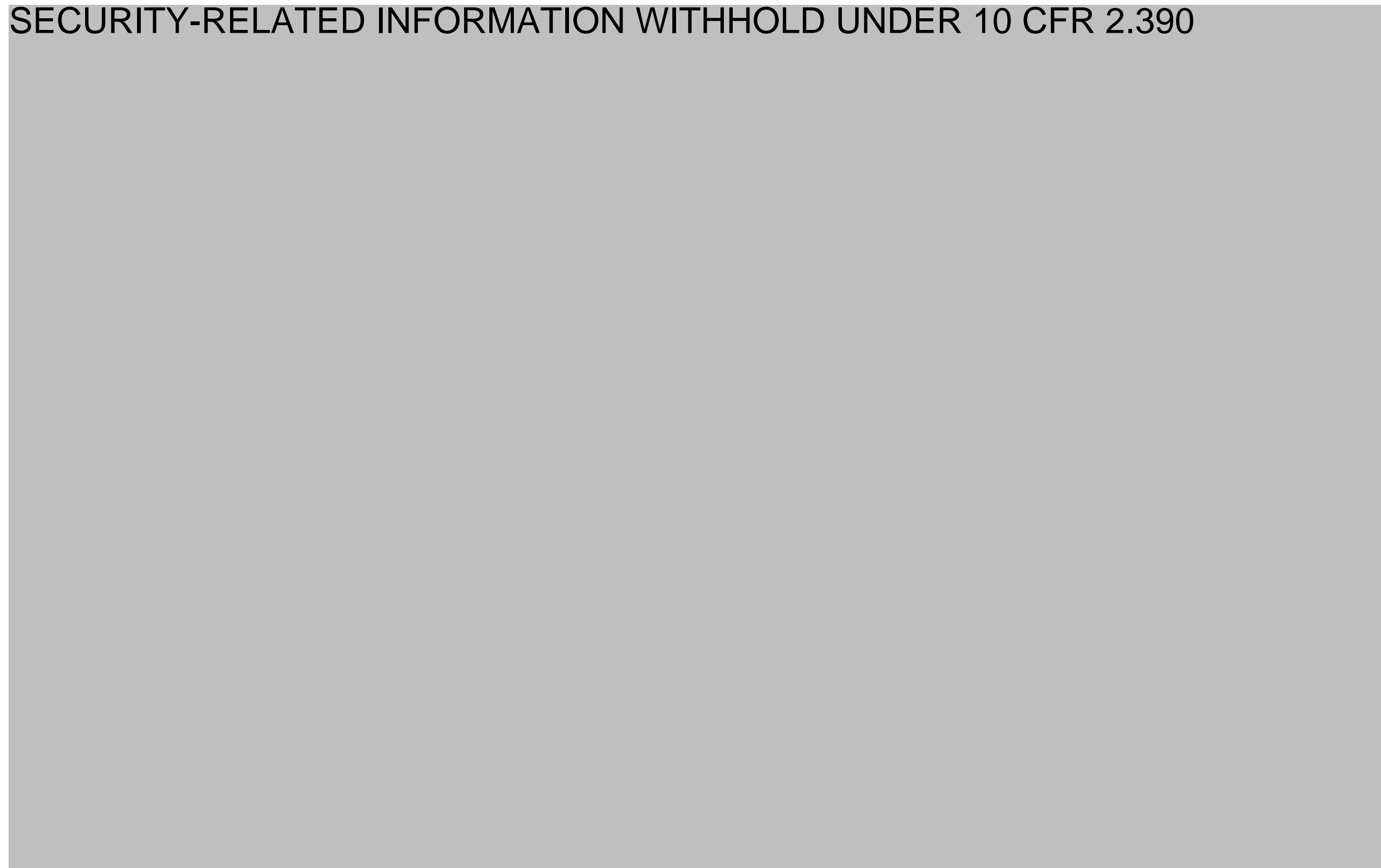



**UPDATED FSAR**  
*DESIGN OF STRUCTURES, COMPONENTS, EQUIPMENT, AND SYSTEMS*  
*CHAPTER 1 FIGURES*

Revision: 24  
Figure: 1-11  
Page: 1 of 1

SECURITY-RELATED INFORMATION WITHHOLD UNDER 10 CFR 2.390

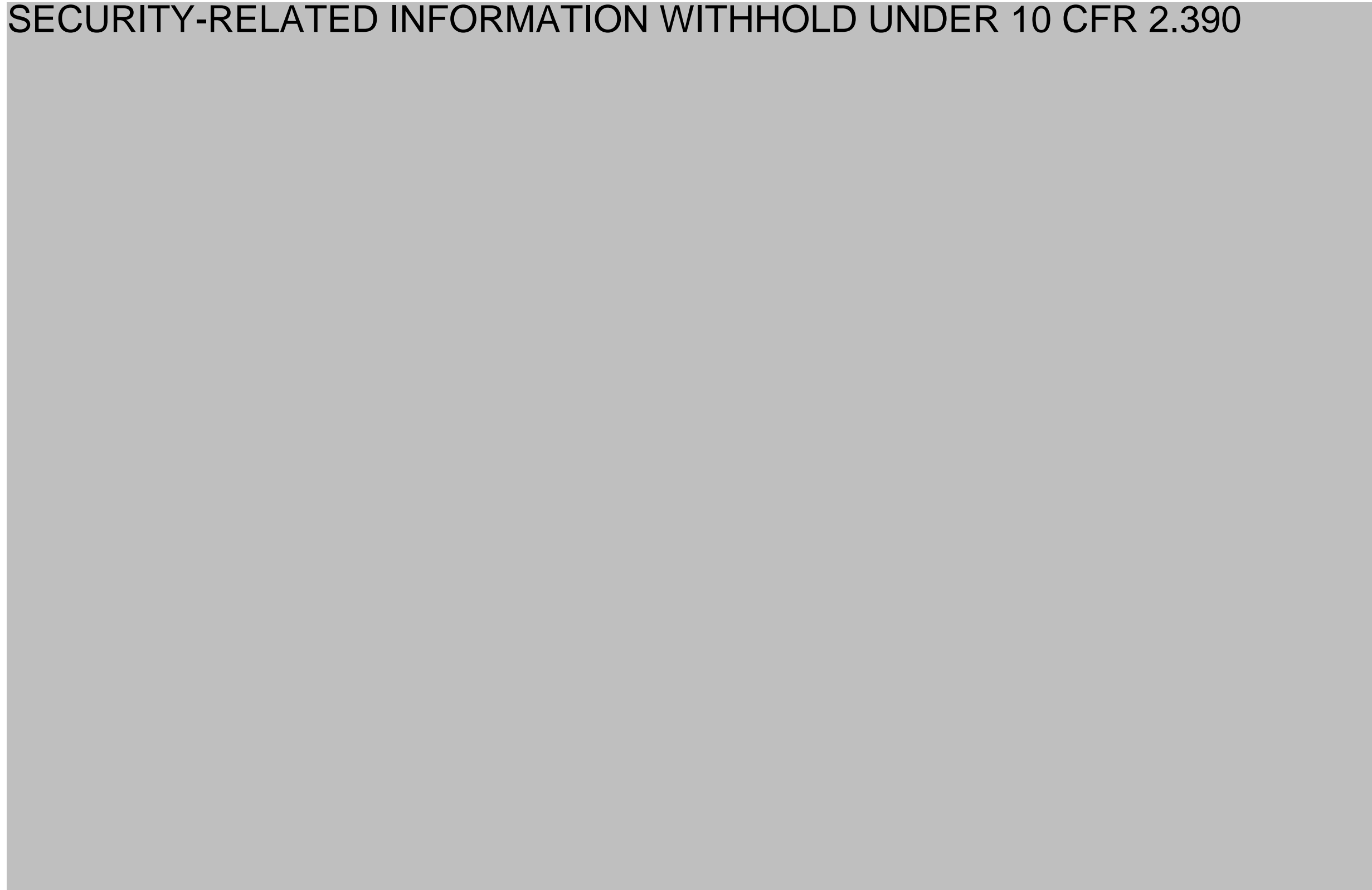

## REACTOR HEAT BALANCE FOR 120 PERCENT OF ORIGINAL POWER

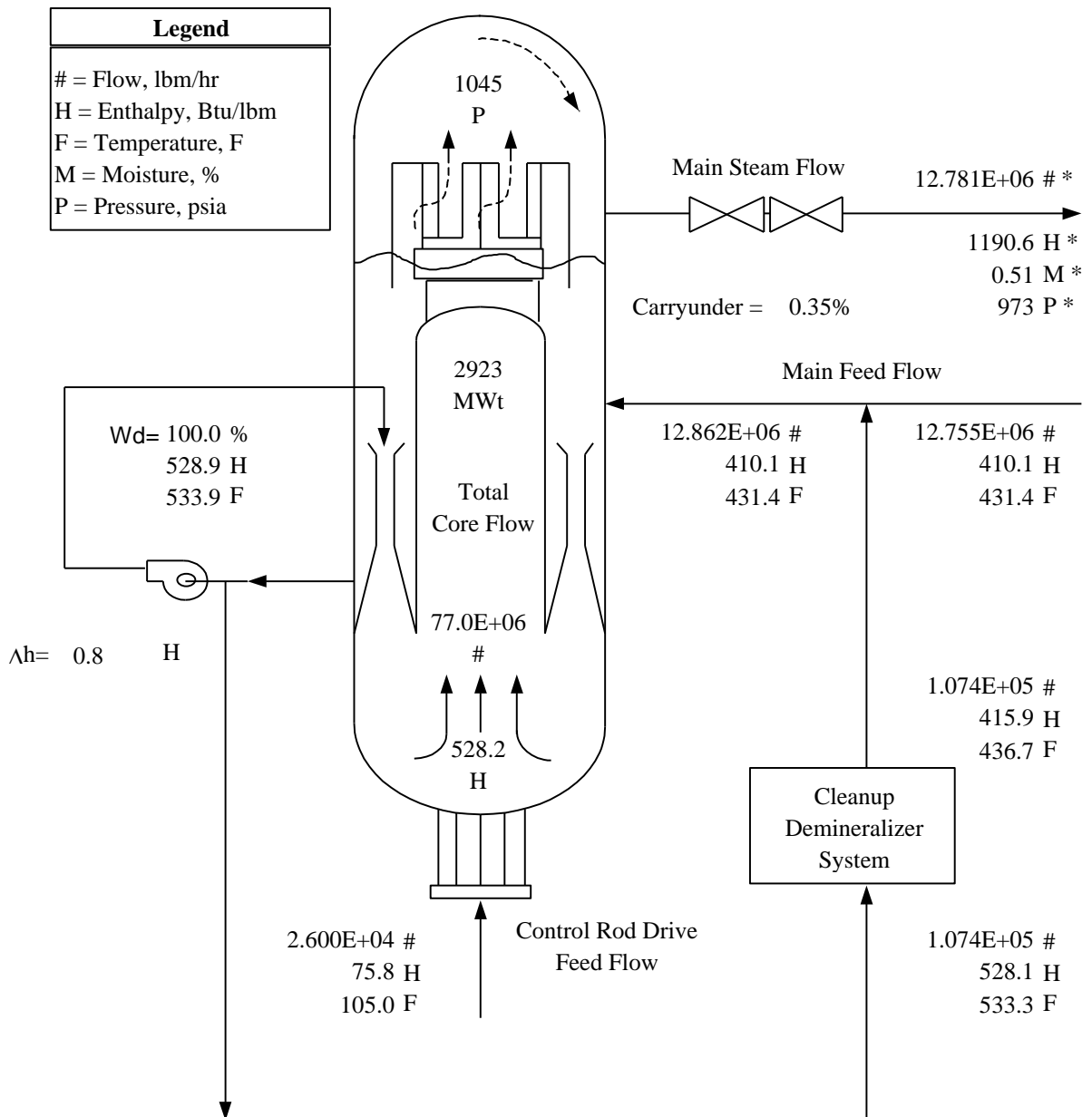

\* Conditions at upstream side of TSV

Core Thermal Power	2923.0
Pump Heating	7.8
Cleanup Losses	-3.5
Other System Losses	-1.1
Turbine Cycle Use	2926.2 MWt