

CH-ODCM-0001

Off-Site Dose Calculation Manual (ODCM)

Revision 26

Safety Classification:

Non-Safety

Usage Level:

Reference

| | |
|---------------------------|---|
| Change No.: | EC 69135, EC68871 |
| Reason for Change: | Revised ODCM to reflect the 2016 Land Use Survey |
| Requestor: | J. Glantz |
| Preparer: | J. Glantz |
| Issued: | 03-30-17 3:00 pm |

Fort Calhoun Station

Table of Contents

PART I

| | | |
|-----|---|----|
| 1.0 | PURPOSE AND SCOPE..... | 6 |
| 1.1 | Purpose..... | 6 |
| 1.2 | Scope..... | 6 |
| 2.0 | DEFINITIONS..... | 6 |
| 3.0 | INSTRUMENTATION..... | 10 |
| 3.1 | Radioactive Liquid Effluent Instrumentation..... | 10 |
| 3.2 | Radioactive Gaseous Effluent Instrumentation..... | 14 |
| 4.0 | RADIOACTIVE EFFLUENTS..... | 20 |
| 4.1 | Radioactive Liquid Effluents..... | 20 |
| 4.2 | Radioactive Gaseous Effluents..... | 26 |
| 4.3 | Uranium Fuel Cycle..... | 35 |
| 5.0 | RADIOLOGICAL ENVIRONMENTAL MONITORING PROGRAM (REMP)..... | 36 |
| 5.1 | Monitoring Program..... | 36 |
| 5.2 | Land Use Survey..... | 48 |
| 5.3 | Interlaboratory Comparison Program..... | 49 |
| 6.0 | ADMINISTRATIVE CONTROLS..... | 50 |
| 6.1 | Responsibilities..... | 50 |
| 6.2 | Radioactive Effluent Reporting Requirements..... | 50 |
| 6.3 | Change Mechanism..... | 54 |
| 6.4 | Meteorological Data..... | 55 |
| 6.5 | References..... | 55 |
| 7.0 | BASIS..... | 56 |
| 7.1 | Instrumentation..... | 56 |
| 7.2 | Radioactive Effluents..... | 57 |
| 7.3 | Radiological Environmental Monitoring..... | 64 |
| 7.4 | Abnormal Release or Abnormal Discharge Reporting..... | 65 |

List of Tables

PART I

| | |
|---|----|
| Table 1.2 - Frequency Notation..... | 8 |
| Table 1.3 - Radiological Effluent Controls Program Technical Specification Implementation.. | 9 |
| Table 3.1.1 - Radioactive Liquid Effluent Monitoring Instrumentation..... | 11 |
| Table 3.1.2 - Radioactive Liquid Effluent Monitoring Instrumentation Surveillance Requirements | 13 |
| Table 3.2.1 - Radioactive Gaseous Effluent Monitoring Instrumentation | 15 |
| Table 3.2.2 - Radioactive Gaseous Effluent Monitoring Instrumentation Surveillance Requirements..... | 19 |
| Table 4.1 - Radioactive Liquid Effluent Sampling and Analysis | 22 |
| Table 4.2 - Radioactive Airborne Effluent Sampling and Analysis | 27 |
| Table 4.3 - Sampler Deposition/Transportation Correction Factors..... | 29 |
| Table 5.1 - Radiological Environmental Monitoring Program..... | 38 |
| Table 5.2 - Radiological Environmental Sampling Locations And Media | 40 |
| Table 5.3 - Detection Capabilities for Environmental Sample Analysis Lower Limit of Detection (LLD) | 46 |
| Table 5.4 - Reporting Levels for Radioactivity Concentrations in Environmental Samples | 47 |

List of Figures

PART I

| | |
|--|----|
| Figure 1 – Environmental Radiological Sampling Points..... | 45 |
|--|----|

Table of Contents

PART II

| | | |
|-----|--|-----|
| 1.0 | EFFLUENT MONITOR SETPOINTS..... | 68 |
| 1.1 | Liquid Effluents..... | 68 |
| 1.2 | Airborne Effluents..... | 73 |
| 2.0 | EFFLUENT CONCENTRATIONS | 86 |
| 2.1 | Liquid Effluent Concentrations..... | 86 |
| 2.2 | Airborne Effluent Concentrations..... | 87 |
| 3.0 | RADIOACTIVE EFFLUENT DOSE CALCULATIONS | 88 |
| 3.1 | Liquid Effluent Dose Calculations..... | 88 |
| 3.2 | Airborne Effluent Dose Calculations..... | 92 |
| 4.0 | LOWER LIMIT OF DETECTION (LLD)..... | 105 |

List of Tables

PART II

| | | |
|----------|---|-----|
| Table 1 | - Allocation Factors for Simultaneous Releases | 80 |
| Table 2 | - Dose Factors for Exposure to a Semi-Infinite Cloud of Noble Gases | 106 |
| Table 3 | - Bioaccumulation Factors | 107 |
| Table 4 | - Highest Potential Exposure Pathways for Estimating Dose..... | 108 |
| Table 5 | - Stable Element Transfer Data | 109 |
| Table 6 | - Recommended Values for U_{ap} to Be Used for the Maximum Exposed Individual in Lieu of Site Specific Data..... | 110 |
| Table 7 | - Animal Consumption Rates | 110 |
| Table 8 | - External Dose Factors for Standing on Contaminated Ground..... | 111 |
| Table 9 | - Inhalation Dose Factors for Adult | 113 |
| Table 10 | - Inhalation Dose Factors for Teenager | 115 |
| Table 11 | - Inhalation Dose Factors for Child | 117 |
| Table 12 | - Inhalation Dose Factors for Infant | 119 |
| Table 13 | - Ingestion Dose Factors for Adult | 121 |
| Table 14 | - Ingestion Dose Factors for Teenager | 123 |
| Table 15 | - Ingestion Dose Factors for Child | 125 |
| Table 16 | - Ingestion Dose Factors for Infant | 127 |
| Table 17 | - Recommended Values for Other Parameters..... | 129 |
| Table 18 | - Estimated Doses Received by the General Public from On-Site Exposure | 131 |

List of Figures

PART II

| | |
|---|----|
| Figure 1 - Exclusion and Site Boundary Map | 81 |
| Figure 2 - Liquid Radioactive Discharge Pathways | 82 |
| Figure 3 - Liquid Radioactive Waste Disposal System | 83 |
| Figure 4 - Airborne Effluent Discharge Pathways | 84 |
| Figure 5 - Airborne Radioactive Waste Disposal System | 85 |

1.0 PURPOSE AND SCOPE

1.1 Purpose

- 1.1.1 Contains methodologies for and parameters necessary for calculating offsite doses, determination of gaseous and liquid radiation monitor set points, and administrative controls for effluent instrumentation, Radiological Effluent Tech Specs (RETS), and the Radiological Environmental Monitoring Program (REMP).

1.2 Scope

- 1.2.1 Radioactive effluents are generated from station operations. These controls provide methodologies ensuring these effluents are properly monitored and quantified to promote accurate dose reporting. Additional controls ensure station equipment and processes are used to minimize release to the environment. The combination of minimizing release, accurately reporting dose, and monitoring the plant environs provides the basis for ensuring that station operation is not negatively impacting public health and the environment.

2.0 DEFINITIONS

- 2.1 Abnormal Discharge - The unplanned or uncontrolled emission of an effluent (i.e., containing plant-related, licensed radioactive material) into the unrestricted area.
- 2.2 Abnormal Release - The unplanned or uncontrolled emission of an effluent (i.e., containing plant-related, licensed radioactive material).
- 2.3 Channel Check - A CHANNEL CHECK shall be the qualitative assessment of channel behavior during operation by observation. This determination shall include, where possible, comparison of the channel indication and/or status with other indications and/or status derived from independent instrument channels measuring the same parameter.
- 2.4 Channel Function Test - Injection of a simulated signal into the channel to verify that it is operable, including any alarm and/or trip initiating action.
- 2.5 Effluent Concentration Limit (ECL) - Radionuclide limits listed in 10 CFR Part 20, Appendix B, Table 2, Column 1.
- 2.6 Member(s) of the Public - Member(s) of the Public means any individual except when that individual is receiving occupational dose.

- 2.7 Operable-Operability - A system, subsystem, train, component or device shall be OPERABLE or have OPERABILITY when it is capable of performing its specified safety function(s) and when all necessary attendant instrumentation, controls, normal or emergency electrical power sources, cooling and seal water, lubrication, and other auxiliary equipment that are required for the system, subsystem, train, component, or device to perform its specified safety function(s) are also capable of performing their related support function(s).
- 2.8 Purge-Purging - PURGE or PURGING shall be any controlled process of discharging air or gas from a confinement to maintain temperature, pressure, humidity, concentration or other operating condition, in such a manner that replacement air or gas is required to purify the confinement.
- 2.9 Residual Radioactivity - Residual radioactivity means radioactivity in structures, materials, soils, ground water, and other media at a site resulting from activities under the licensee's control. This includes radioactivity from all licensed and unlicensed sources used by the licensee, but it excludes background radiation. It also includes radioactive materials remaining at the site as a result of routine or accidental releases of radioactive material at the site and previous burials at the site, even if those burials were made in accordance with the provisions of 10 CFR Part 20.
- 2.10 Site Boundary - The Site Boundary is the line beyond which the land is neither owned, or leased, nor controlled by the licensee.
- 2.11 Source Check - A SOURCE CHECK shall be the qualitative assessment of channel response when the channel sensor is exposed to a source of increased radioactivity.
- 2.12 Special Liquid - Non-routine release pathway in which normally non-radioactive liquid streams (such as Raw Water) found to contain radioactive material, are non-routine, and will be treated on a case specific basis if and when this occurs.
- 2.13 Unrestricted Area - An UNRESTRICTED AREA shall be any area at or beyond the SITE BOUNDARY access to which is not controlled by the licensee for purposes of protection of individuals from exposure to radiation and radioactive materials, or any area within the SITE BOUNDARY used for residential quarters or for industrial, commercial, institutional, and/or recreational purposes.
- 2.14 Venting - VENTING shall be the controlled process of discharging air or gas from a confinement to maintain temperature, pressure, humidity, concentration, or other operating condition, in such a manner that replacement air or gas is not provided or required during VENTING. Vent, used in system names, does not imply a VENTING process.
- 2.15 Water Effluent Concentration (WEC) - Radionuclide limits listed in 10 CFR Part 20, Appendix B, Table 2, Column 2.

Table 1.2 - Frequency Notation

The surveillance intervals are defined as follows:

| Notation | Title | Frequency^A |
|-----------------|--------------|--|
| S | Shift | At least once per 12 hours |
| D | Daily | At least once per 24 hours |
| W | Weekly | At least once per 7 days |
| BW | Biweekly | At least once per 14 days |
| M | Monthly | At least once per 31 days |
| Q | Quarterly | At least once per 92 days |
| SA | Semiannual | At least once per 184 days |
| A | Annually | At least once per 366 days |
| R | Refueling | At least once per 18 months |
| P | Prior to | Prior to each release (Performance within 24 hrs.) |

A. Each surveillance requirement shall be performed within the specified surveillance interval with a maximum allowable extension not to exceed 25 percent of the specified surveillance interval.

Table 1.3 - Radiological Effluent Controls Program Technical Specification Implementation

| Technical Specification | ODCM Implementing Step |
|-------------------------|------------------------|
| 5.16.1.a | 3.1.1, 3.2.1 |
| 5.16.1.b | 4.1.1 |
| 5.16.1.c | Table 4.1, Table 4.2 |
| 5.16.1.d | 4.1.2 |
| 5.16.1.e | 4.1.2B.1, 4.2.2B.1 |
| 5.16.1.f | 4.1.3A, 4.2.4A |
| 5.16.1.g | 4.2.1 |
| 5.16.1.h | 4.2.2 |
| 5.16.1.i | 4.2.3 |
| 5.16.1.j | 4.3.1 |
| 5.16.2.a | 5.1.1 |
| 5.16.2.b | 5.2.1 |
| 5.16.2.c | 5.3.1 |
| 5.17 | 6.3, 6.2.1D |
| 5.18 | 6.2.1D |

3.0 INSTRUMENTATION

3.1 Radioactive Liquid Effluent Instrumentation

3.1.1 Limiting Condition for Operation

- A. The radioactive liquid effluent monitoring instrumentation channels shown in Table 3.1.1 shall be OPERABLE with their alarm/trip setpoints set to ensure that the limits of Specification 3.1.1 are not exceeded. The alarm/trip setpoints of these channels shall be determined in accordance with Part II of the Off-Site Dose Calculation Manual.

APPLICABILITY: At all times

ACTION:

1. With a radioactive liquid effluent monitoring instrumentation channel alarm/trip setpoint less conservative than required by the above specification, immediately suspend the releases of radioactive liquid effluents monitored by the affected channel or declare the channel inoperable.
2. With less than the minimum number of radioactive liquid effluent monitoring instrumentation channels operable, take the action shown in Table 3.1.1. Restore inoperable effluent monitoring instrumentation to OPERABLE status within 30 days and, if unsuccessful, explain in the next Annual Radiological Effluent Release Report why this inoperability was not corrected in a timely manner. The reporting requirement is limited to the following instrumentation that monitors effluent streams: RM-055, RM-054A, and RM-054B.

3.1.2 Surveillance Requirements

- A. Each radioactive liquid effluent monitoring instrumentation channel shall be demonstrated OPERABLE by performance of the CHANNEL CHECK, SOURCE CHECK, CALIBRATION, and CHANNEL FUNCTIONAL TEST at the frequencies shown in Table 3.1.2.

Table 3.1.1 - Radioactive Liquid Effluent Monitoring Instrumentation

| Instrument | | Minimum Channels Operable | Action |
|--|--|---------------------------|--------|
| 1. Radioactivity Monitors Providing Alarm and Automatic Termination of Release. | | | |
| 1.1 | Liquid Radwaste Effluent Line (RM-055) | 1 | 1, 5 |
| 1.2 | Steam Generator Blowdown Effluent Line (RM-054A and B) | 1 ^A | 2, 5 |
| 2. Flow Rate Measurement Devices | | | |
| 2.1 | Liquid Radwaste Effluent Line | 1 | 3 |
| 2.2 | Steam Generator Blowdown Effluent Line | 1 | 3 |
| 3. Radioactivity Recorders | | | |
| 3.1 | Liquid Radwaste Effluent Line | 1 | 4 |
| 3.2 | Steam Generator Blowdown Effluent Line | 1 | 4 |
| <p>A. If one of the two radiation monitors is inoperable, the activity of both blowdown lines shall be monitored by the operable monitor within 2 hours of the declaration of inoperability by the Shift Manager, or the action steps of ACTION 2, Table 3.1.1 should be performed on the Steam Generator that is not being monitored.</p> | | | |

Table 3.1.1 (continued)

| Table Notation | |
|-----------------------|--|
| ACTION 1 | <p>With the number of channels OPERABLE less than required by the Minimum Channels OPERABLE requirement, effluent releases may continue provided that prior to initiating a release:</p> <ol style="list-style-type: none"> 1. At least two independent samples are analyzed in accordance with applicable chemistry procedures. 2. At least two qualified individuals independently verify the release rate calculations. |
| ACTION 2 | <p>With the number of channels OPERABLE less than required by the Minimum Channels OPERABLE requirement, effluent releases may continue provided that grab samples are analyzed for principal gamma emitters at a sensitivity of 5.0E-07 $\mu\text{Ci}/\text{gram}$:</p> <ol style="list-style-type: none"> 1. At least once per 12 hours when the specific activity of the secondary coolant is greater than 0.01 $\mu\text{Ci}/\text{gram}$ dose equivalent I-131. 2. At least daily when the specific activity of the secondary coolant is less than or equal to 0.01 $\mu\text{Ci}/\text{gram}$ equivalent I-131. Otherwise, suspend release of radioactive effluents via this pathway. |
| ACTION 3 | <p>With the number of channels OPERABLE less than required by the Minimum Channels OPERABLE requirement, effluent releases may continue provided the flow rate is determined at least once per four hours during the actual release.</p> |
| ACTION 4 | <p>With the number of channels OPERABLE less than required by the Minimum Channels OPERABLE requirement, effluent releases may continue provided the radioactivity is recorded manually at least once per four hours during the actual release.</p> |
| ACTION 5 | <p>During the performance of source checks the effluent radiation monitor is unable to respond, hence is considered inoperable. Effluent releases may continue uninterrupted during the performance of source checks provided the operator is stationed at the monitor during the check. If the effluent radiation monitor fails the source check, carryout the action(s) of the Off-Site Dose Calculation Manual for the inoperable monitor or terminate the effluent release.</p> |

Table 3.1.2 - Radioactive Liquid Effluent Monitoring Instrumentation Surveillance Requirements

| Instrument | Channel Check | Channel | | Source Check |
|---|----------------|-------------|---------------|--------------|
| | | Calibration | Function Test | |
| 1. Radioactivity Monitors Providing Alarm and Automatic Isolation | | | | |
| 1.1 RM-054A/054B | D ^A | R | Q | M |
| 1.2 RM-055 | --- | R | Q | P |
| 2. Flowrate Monitors | | | | |
| 2.1 Steam Generator Blowdown | D | R | Q | --- |

A. Visual Flowcheck Daily

3.2 Radioactive Gaseous Effluent Instrumentation

3.2.1 Limiting Condition for Operation

- A. The radioactive gaseous effluent monitoring instrumentation channels shown in Table 3.2.1 shall be OPERABLE with their alarm/trip setpoints set to ensure that the limits of Specification 3.2.1 are not exceeded. The alarm/trip setpoints of these channels shall be determined in accordance with Part II of the Off-Site Dose Calculation Manual.

APPLICABILITY: At all times

ACTION:

1. With a radioactive gaseous effluent monitoring instrumentation channel alarm/trip setpoint less conservative than required by the above specification, immediately suspend the releases of radioactive gaseous effluents monitored by the affected channel or declare the channel inoperable.
2. With less than the minimum number of radioactive gaseous effluent monitoring instrumentation channels operable, take the action shown in Table 3.2.1. Restore inoperable effluent monitoring instrumentation to OPERABLE status within 30 days and, if unsuccessful, explain in the next Annual Radiological Effluent Release Report why this inoperability was not corrected in a timely manner. The reporting requirement is limited to the following instrumentation that monitors effluent streams: RM-057, RM-043, RM-062, RM-063, and RM-052.

3.2.2 Surveillance Requirements

- A. Each radioactive gaseous effluent monitoring instrumentation channel shall be demonstrated OPERABLE by performance of the CHANNEL CHECK, SOURCE CHECK, CALIBRATION, and CHANNEL FUNCTIONAL TEST at the frequencies shown in Table 3.2.2.

Table 3.2.1 - Radioactive Gaseous Effluent Monitoring Instrumentation

| Instrument | | Minimum Channels Operable | Action |
|------------|---|---------------------------|-----------------|
| 1. | Auxiliary Bldg. Exhaust Stack (RM-052, RM-062) | | |
| 1.1 | Noble Gas | 1 | 1, 9, 11 |
| 1.2 | Iodine and Particulate | 1 | 2, 9, 11 |
| 2. | Laboratory and Radwaste Processing Building Stack (RM-043) | | |
| 2.1 | Noble Gas | 1 | 3, 9 |
| 2.2 | Iodine and Particulate | 1 | 4, 9 |
| 3. | Condenser Off Gas (RM-057) | | |
| 3.1 | Noble Gas | 1 | 5, 9 |
| 4. | Containment Purge Line (RM-051, RM-052) | | |
| 4.1 | Noble Gas | 1 | 1, 6, 9, 11, 12 |
| 4.2 | Iodine and Particulate | 1 | 2, 9, 11, 12 |
| 5. | Containment Pressure Relief Line (RM-051, RM-052) | | |
| 5.1 | Noble Gas | 1 | 1, 9, 11 |
| 5.2 | Iodine and Particulate | 1 | 2, 9, 11 |
| 6. | Containment Penetrations M72 and M74 (Integrated Leak Rate Test Depressurization Vent Path) | N/A | 10 |
| 7. | Flow Rate Measurement Devices | | |
| 7.1 | Waste Gas Discharge Header | 1 | 7 |

Table 3.2.1 - Radioactive Gaseous Effluent Monitoring Instrumentation

| Instrument | Minimum Channels Operable | Action |
|---|---------------------------|--------|
| 7.2 Auxiliary Building Stack | 1 | 7 |
| 7.3 Laboratory and Radwaste Processing Building Stack | 1 | 7 |
| 7.4 Containment Purge Line | 1 | 7 |
| 7.5 Containment Pressure Relief Line Annubar D/P | 1 | 7 |
| 8. Radioactivity Chart Recorders | | |
| 8.1 Auxiliary Building Exhaust Stack | 1 | 8 |

Table 3.2.1 Radioactive Gaseous Effluent Monitoring Instrumentation

| TABLE NOTATION | |
|-----------------|--|
| ACTION 1 | If the Auxiliary Building Exhaust Stack Noble Gas Monitor is inoperable, releases from the containment pressure relief line and the containment purge line are to be secured in the most expeditious manner. Ventilation of the auxiliary building via the Auxiliary Building Exhaust Stack may continue provided grab samples are taken once per 12 hours. (See Table 4.2) |
| ACTION 2 | If the Auxiliary Building Exhaust Stack Iodine and Particulate Sampler is inoperable, ventilation of the Auxiliary Building and releases from the gaseous waste discharge header, containment pressure relief line or the containment purge line may continue through the Auxiliary Building Exhaust Stack provided sample collection in accordance with Table 4.2 using auxiliary sample collection equipment is initiated within 2 hours of the declaration of inoperability by the Shift Manager. |
| ACTION 3 | If the Noble Gas Monitor is inoperable, ventilation of the LRWPB may continue via the LRWPB stack provided grab samples are taken at least once per 12 hours. (See Table 4.2) |
| ACTION 4 | If the Iodine and Particulate Sampler is inoperable, ventilation of the LRWPB may continue via the LRWPB Stack provided sample collection using auxiliary sample collection equipment is initiated within 2 hours of the declaration of inoperability, by the Shift Manager, in accordance with Table 4.2. |
| ACTION 5 | During power operation, when the condenser air ejector is in service, the condenser off gas discharge shall be monitored for gross radioactivity. If this monitor is inoperable, grab samples are taken at least once per 12 hours. (See Table 4.2) |
| ACTION 6 | The release of airborne effluents from the Containment purge line will be secured if a noble gas monitor is unavailable to monitor the containment building atmosphere. |
| ACTION 7 | With the number of channels OPERABLE less than required by the Minimum Channels OPERABLE requirement, effluent releases may continue provided the flowrate is estimated or recorded manually at least once per four hours during the actual release. |
| ACTION 8 | With the number of channels OPERABLE less than required by the Minimum Channels OPERABLE requirement, effluent releases may continue provided the radioactivity level is recorded manually at least once per four hours during the actual release. |
| ACTION 9 | During the performance of source checks the effluent radiation monitor is unable to respond, hence is considered inoperable. Effluent releases may continue uninterrupted during the performance of source checks provided the operator is stationed at the monitor during the check. If the effluent radiation monitor fails the source check, carryout the Action(s) of the Off-Site Dose Calculation Manual for the inoperable monitor or terminate the effluent release. |

Table 3.2.1 Radioactive Gaseous Effluent Monitoring Instrumentation

| TABLE NOTATION | |
|----------------|---|
| ACTION 10 | Automatic release termination capability is not required provided manual isolation can be accomplished in accordance with the requirements of SE-ST-ILRT-0001, Containment Integrated Leakage Rate Test (CILRT). |
| ACTION 11 | During the ventilation of airborne effluents from the Auxiliary Building Stack at least one Auxiliary Building Exhaust fan shall be in operation. |
| ACTION 12 | IF containment purges are made without processing through at least one of the Containment Air Cooling and Filtering Units, and it is confirmed that one half of the annual dose objective listed in Section 4.2.2 will be exceeded during the calendar quarter, a special report shall be submitted to the NRC as defined in Section 4.2.4. |

Table 3.2.2 - Radioactive Gaseous Effluent Monitoring Instrumentation Surveillance Requirements

| Instrument | Channel Check | Calibration | Channel Function Test | Source Check |
|---|-------------------------|-------------|-----------------------------|-------------------|
| 1. Radioactivity Monitors Providing Alarm and Automatic Isolation | | | | |
| 1.1 RM-043 | D | R | Q | M |
| 1.2 RM-057 | D | R | Q | M |
| 1.3 RM-062 | D | R | Q | M, P |
| 1.4 RM-052 ^A | D | R | Q | M, P ^A |
| 2. Flowrate Monitors | | | | |
| 2.1 RM-043 Sampler | D | R | Q | --- |
| 2.2 RM-062 Sampler | D | R | Q | --- |
| 2.3 RM-052 Sampler | D | R | Q | --- |
| 2.4 Auxiliary Bldg Exhaust Stack | D | R | Q | --- |
| 2.5 Laboratory and Radwaste Process Bldg Exhaust Stack | D | R | Q | --- |
| | Operations Check | | Air Flow Calibration | |
| 3. Environmental Monitors | | | | |
| 3.1 RM-023 - Sample Station #40 | | M | | A |
| 3.2 RM-024 - Sample Station #41 | | M | | A |
| 3.3 RM-025 - Sample Station #28 | | --- | | --- |
| 3.4 RM-026 - Sample Station #36 | | --- | | --- |
| 3.5 RM-027 - Sample Station #37 | | M | | A |
| 3.6 RM-028 - Sample Station #38 | | --- | | --- |
| 3.7 RM-029 - Sample Station #39 | | --- | | --- |
| 3.8 RM-035 - Sample Station #1 | | --- | | --- |
| 3.9 RM-036 - Sample Station #2 | | M | | A |
| 3.10 RM-037 - Sample Station #3 | | --- | | --- |
| 3.11 RM-038 - Sample Station #4 | | M | | A |
| 3.12 RM-039 - Sample Station #5 | | --- | | --- |
| 3.13 RM-040 - Sample Station #32 | | M | | A |

A. Required when RM-052 is sampling the Auxiliary Building Exhaust Stack.

4.0 **RADIOACTIVE EFFLUENTS**

4.1 Radioactive Liquid Effluents

4.1.1 Concentration

A. Limiting Condition for Operation

1. The release rate of radioactive material in liquid effluents shall be controlled such that the instantaneous concentrations for radionuclides, other than dissolved or entrained noble gases, do not exceed the values specified in 10 CFR Part 20 for liquid effluents at site discharge. To support plant operations, Supervisor-System Chemistry may increase this limit up to the limit specified in Technical Specifications 5.16.1.b. For dissolved or entrained noble gases, the concentration shall be limited to 2.0E-04 $\mu\text{Ci/ml}$, total activity.
2. Technical Specification 5.16.1.b establishes the administrative control limit on concentration of radioactive material, other than dissolved or entrained noble gases, released in liquid effluents to unrestricted areas conforming to ten times 10 CFR Part 20.1001-20.2401, Appendix B, Table 2, Column 2. For dissolved or entrained noble gases, the concentration shall be limited to 2.0E-04 $\mu\text{Ci/ml}$ total activity.

APPLICABILITY: At all times

ACTION:

- a. When the concentration of radioactive material released at site discharge exceeds the above limits, appropriate corrective actions shall be taken immediately to restore concentrations within the above limits.

B. Surveillance Requirements

| | | |
|----------|---|----------|
| i | <u>NOTE</u> | i |
| | Radioactive liquid waste includes water used for fire suppression in areas of the plant that may contain radioactivity. These liquids are required to be monitored prior to release in accordance with SO-G-28. | |

1. Radioactive liquid waste shall be sampled and analyzed according to the sampling and analysis program in Table 4.1.

2. The results of the radioactivity analysis shall be used with the calculational methods in Part II of the Off-Site Dose Calculation Manual.
3. To assure that the concentration at the point of release is maintained within the limits of Technical Specification 5.16.1.b.

4.1.1B (continued)

4. Records shall be maintained of the radioactive concentrations and volume before dilution of each batch of liquid effluent released and of the average dilution flow and length of time over which each discharge occurred. Analytical results shall be submitted to the Commission in accordance with Part I, Section 6.0 of the Off-Site Dose Calculation Manual.

Table 4.1 - Radioactive Liquid Effluent Sampling and Analysis

A. Monitor, Hotel Waste Tanks & Special Liquid, Releases

| Sampling Frequency | Type of Activity Analysis | Lower Limit of Detection (LLD) ($\mu\text{Ci/ml}$) ^A |
|----------------------------------|---|---|
| Each Batch | Principal Gamma Emitters ^B | 5.0E-07 |
| Each Batch | I-131 | 1.0E-06 |
| Each Batch | Dissolved Noble Gases (Gamma Emitters) ^B | 1.0E-05 |
| Monthly Composite ^D | H-3 | 1.0E-05 |
| Monthly Composite ^D | Gross Alpha | 1.0E-07 |
| Quarterly Composite ^D | Sr-89, Sr-90 | 5.0E-08 |
| Quarterly Composite ^D | Fe-55 | 1.0E-06 |

B. Steam Generator Blowdown

| Sampling Frequency | Type of Activity Analysis | Lower Limit of Detection (LLD) ($\mu\text{Ci/ml}$) ^A |
|----------------------------------|---|---|
| Weekly Composite ^D | Principal Gamma Emitters ^B | 5.0E-07 |
| Weekly Composite ^D | I-131 ^C | 1.0E-06 |
| Weekly Composite ^D | Dissolved Noble Gases (Gamma Emitters) ^B | 1.0E-05 |
| Monthly Composite ^D | H-3 | 1.0E-05 |
| Monthly Composite ^D | Gross Alpha | 1.0E-07 |
| Quarterly Composite ^D | Sr-89, Sr-90 | 5.0E-08 |
| Quarterly Composite ^D | Fe-55 | 1.0E-06 |

NOTES:

- A. LLD is defined in Part II of the Off-Site Dose Calculation Manual.
- B. The principal gamma emitters for which the LLD specification applies exclusively are the following radionuclides: Kr-87, Kr-88, Xe-133, Xe-133m, Xe-135, and Xe-138 for dissolved or entrained gases and Mn-54, Fe-59, Co-58, Co-60, Zn-65, Mo-99, Cs-134, Cs-137, and Ce-141 for fission and corrosion products. Ce-144 shall also be measured, but with a LLD of 5.0E-06.
- C. A weekly grab sample and analyses program including gamma isotopic identification will be initiated for the turbine building sump effluent when the steam generator blowdown water composite analysis indicates the I-131 concentration is greater than 1.0E-06 $\mu\text{Ci/ml}$.
- D. To be representative of the average quantities and concentrations of radioactive materials in liquid effluents, samples should be collected in proportion to the rate of flow of the effluent stream. Prior to analyses, all samples taken for the composite should be mixed in order for the composite sample to be representative of the average effluent release.

4.1.2 Dose from Radioactive Liquid Effluents

A. Limiting Condition for Operation

1. The dose or dose commitment to an individual in unrestricted areas from radioactive materials in liquid effluents shall be limited to the following:
 - a. During any calendar quarter: Less than or equal to 1.5 mrem to the total body and 5 mrem to any organ; and
 - b. During any calendar year: Less than or equal to 3 mrem to the total body and 10 mrem to any organ.

APPLICABILITY: At all times

ACTION:

- a. If the dose contribution, due to the cumulative release of radioactive materials in liquid effluents, exceeds the annual or quarterly dose objectives, submit a Special Report to the NRC, per Section 6.2.3, within 30 days.

B. Surveillance Requirements

1. Cumulative dose contributions from liquid effluents for the current calendar quarter and the current calendar year shall be determined in accordance with the methodology and parameters in Part II of the Off-Site Dose Calculation Manual at least once per quarter.

4.1.3 Liquid Radwaste Treatment

A. Limiting Condition for Operation

1. The Liquid Radwaste Treatment System shall be OPERABLE, and appropriate portions of these systems shall be used to reduce releases of radioactivity when the projected doses due to the liquid effluent, from each unit, to UNRESTRICTED AREAS would exceed 0.06 mrem to the whole body or 0.2 mrem to any organ in a 31-day period.

APPLICABILITY: At all times

ACTION:

- a. With radioactive liquid waste being discharged without treatment and in excess of the above limits and any portion of the Liquid Radwaste Treatment System not in operation, prepare and submit to the Nuclear Regulatory Commission within 30 days, pursuant to 10 CFR 50, Appendix I, a Special Report that includes the following information:
 - 1) Explanation of why liquid radwaste was being discharged without treatment, identification of equipment or subsystem(s) not operable and reasons for inoperability.
 - 2) Action(s) taken to restore the inoperable equipment to operable status.
 - 3) Summary description of action(s) taken to prevent a recurrence.

B. Surveillance Requirements

1. Dose due to liquid releases shall be projected frequently and at least once per quarter, in accordance with the methodology and parameters in Part II of the Off-Site Dose Calculation Manual, when Liquid Radwaste Treatment Systems are not fully OPERABLE.
2. OPERABLE is defined as follows:
 - a. A filtration/ion exchange (FIX) system will be utilized for processing liquid radwaste. The system consists of a booster pump, charcoal pretreatment filter, and pressure vessels containing organic/inorganic resins, which can be configured for optimum performance. The effluent from the FIX system is directed to the monitor tanks for release.

4.1.3B.2 (continued)

- b. Waste filters (WD-17A and WD-17B) are used only on those occasions when considered necessary, otherwise the flows from the low activity fluids may bypass the filters. No credit for decontamination factors (iodines, Cs, Rb, others) was taken for these filters during the 10 CFR Part 50 Appendix I dose design objective evaluation; therefore, the inoperability of these filters does not affect the dose contributions to any individual in the unrestricted areas via liquid pathways. The inoperability of waste filters will not be considered a reportable event in accordance with the Action listed above.

4.1.4 Liquid Holdup Tanks

Tanks included in this Specification are those outdoor tanks that are not surrounded by liners, dikes, or walls capable of holding the tanks contents and that do not have tank overflows and surrounding area drains connected to the liquid radwaste treatment system.

A. Limiting Condition for Operation

1. The quantity of radioactive material contained in each unprotected outdoor liquid holdup tank shall not exceed 10 curies, excluding tritium and dissolved or entrained noble gases.

APPLICABILITY: At all times

ACTION:

- a. When the quantity of radioactive material in any unprotected outdoor liquid holdup tank exceeds 10 curies, excluding tritium and dissolved or entrained noble gasses, immediately suspend all additions of radioactive material to the tank and within 48 hours reduce the tank contents to within the limit.

B. Surveillance Requirements

1. The quantity of radioactive material contained in each outdoor liquid holdup tank shall be determined to be within the above limit by analyzing a representative sample of the tank's contents at least once per 7 days when radioactive material is being added to the tank.

4.2 Radioactive Gaseous Effluents

4.2.1 Concentration

A. Limiting Condition for Operation

1. The release rate of radioactive material in airborne effluents shall be controlled such that the instantaneous concentrations of radionuclides does not exceed the values specified in 10 CFR Part 20 for airborne effluents at the unrestricted area boundary. To support plant operations, Supervisor-System Chemistry may increase this limit up to the limits specified in Technical Specification 5.16.1.g.
2. Technical Specification 5.16.1.g establishes the administrative control limit on the concentration resulting from radioactive material, other than noble gases, released in gaseous effluents to unrestricted areas conforming to ten times 10 CFR Part 20.1001-20.2401, Appendix B, Table 2, Column 1. For noble gases, the concentration shall be limited to five times 10 CFR Part 20.1001-20.2401, Appendix B, Table 2, Column 1.

APPLICABILITY: At all times

ACTION:

- a. When the concentration of radioactive material released to unrestricted areas exceeds the above limits, appropriate corrective actions shall be taken immediately to restore concentrations within the above limits.

B. Surveillance Requirements

| | | |
|----------|--|----------|
| i | <u>NOTE</u> | i |
| | Radioactive gaseous wastes include atmospheres in areas where gaseous fire suppression systems are utilized or where smoke is produced as a result of fire in areas of the plant that may contain radioactivity. These atmospheres are required to be monitored prior to gaseous release to unrestricted areas in accordance with SO-G-28. | |

1. Radioactive gaseous wastes shall be sampled and analyzed according to the sampling and analysis program of Table 4.2. The results of the radioactivity analysis shall be used to assure the limits in Step 4.2.1A are not exceeded.

Table 4.2 - Radioactive Airborne Effluent Sampling and Analysis

A. Gas Decay Tank Releases

| Sampling Frequency | Type of Activity Analysis | Lower Limit of Detection (LLD) ($\mu\text{Ci/ml}$) ^A |
|-----------------------|---------------------------------------|---|
| Prior to each release | Principal Gamma Emitters ^B | 1.0E-04 |

B. Containment Purge Releases or Containment Pressure Relief Line Releases^E

| Sampling Frequency | Type of Activity Analysis | Lower Limit of Detection (LLD) ($\mu\text{Ci/ml}$) ^A |
|-----------------------|---------------------------------------|---|
| Prior to each release | Principal Gamma Emitters ^B | 1.0E-04 |
| Prior to each release | H-3 | 1.0E-06 |

C. Condenser Off Gas Releases^E

| Sampling Frequency | Type of Activity Analysis | Lower Limit of Detection (LLD) ($\mu\text{Ci/ml}$) ^A |
|----------------------|---------------------------------------|---|
| Monthly ^C | Tritium (H-3) | 1.0E-06 |
| Monthly | Principal Gamma Emitters ^B | 1.0E-04 |

D. Auxiliary Building Exhaust Stack^E

| Sampling Frequency | Type of Activity Analysis | Lower Limit of Detection (LLD) ($\mu\text{Ci/ml}$) ^A |
|---|---------------------------------------|---|
| Weekly (Charcoal Sample) | I-131 | 1.0E-12 |
| Weekly (Particulate Sample) | Principal Gamma Emitters ^B | 1.0E-11 |
| Weekly (Noble Gases) | Principal Gamma Emitters ^B | 1.0E-4 |
| Weekly | Tritium (H-3) | 1.0E-06 |
| Monthly Composite ^D | Gross Alpha | 1.0E-11 |
| Quarterly Composite (Particulate Samples) | Sr-89, Sr-90 | 1.0E-11 |

Table 4.2 - Radioactive Airborne Effluent Sampling and Analysis

E. Laboratory and Radwaste Building Exhaust Stack ^E

| Sampling Frequency | Type of Activity Analysis | Lower Limit of Detection (LLD) ($\mu\text{Ci/ml}$) ^A |
|---|---------------------------------------|---|
| Weekly (Charcoal Sample) | I-131 | 1.0E-12 |
| Weekly (Particulate Sample) | Principal Gamma Emitters ^B | 1.0E-11 |
| Weekly (Noble Gases) | Principal Gamma Emitters ^B | 1.0E-4 |
| Monthly Composite ^D | Gross Alpha | 1.0E-11 |
| Quarterly Composite (Particulate Sample) | Sr-89, Sr-90 | 1.0E-11 |

NOTES:

- A. LLD is defined in Part II of the Off-Site Dose Calculation Manual.
- B. The principal gamma emitters for which the LLD specification applies exclusively are the following radionuclides: Kr-87, Kr-88, Xe-133, Xe-133m, Xe-135, and Xe-138 for noble gas releases and Mn-54, Fe-59, Co-58, Co-60, Zn-65, Mo-99, Cs-134, Cs-137, Ce-141, and Ce-144 for iodine and particulate releases.
- C. Required only when steam generator blowdown radioactivity for tritium (Table 4.1, Item B) exceeds $3.0\text{E-}03 \mu\text{Ci/milliliter}$.
- D. Frequency requirement may be satisfied using weekly gross alpha results from particulate sampling media.
- E. Particulate and iodine samples shall be corrected for sampler deposition/transportation efficiency by using the approved software programs or by multiplying the activity obtained by the associated sampler multiplication factor (See Table 4.3).

Table 4.3 - Sampler Deposition/Transportation Correction Factors

| Sampler | Sample | Particulate | | Iodine | |
|----------|--------|-------------|---------|--------|---------|
| | | DF | ACTMULT | DF | ACTMULT |
| RM-062 | AB | 0.411 | 2.433 | 0.669 | 1.495 |
| RM-052 | AB | 0.638 | 1.567 | 0.653 | 1.531 |
| RM-052 | CONT | 0.525 | 1.905 | 0.688 | 1.453 |
| RM-051 | CONT | 0.624 | 1.603 | 0.714 | 1.401 |
| RM-043 | LRWPB | 0.809 | 1.236 | 0.873 | 1.236 |
| PORTABLE | CONT | 1.000 | 1.000 | 0.950 | 1.053 |

ACRONYM DEFINITIONS:

- AB - Auxiliary Building Exhaust Stack
- CONT - Containment Building
- LRWPB - Laboratory and Rad Waste Processing Building
- DF - Deposition Factor
- ACTMULT - Activity multiplication factor to correct for sample loss.

4.2.2 Dose - Noble Gases

A. Limiting Condition for Operation

1. The dose or dose commitment to an individual at the site boundary from release of noble gases in airborne effluents shall be limited to the following:
 - a. During any calendar quarter: Less than or equal to 5 mrad for gamma radiation and less than or equal to 10 mrad for beta radiation; and
 - b. During any calendar year: Less than or equal to 10 mrad for gamma radiation and less than or equal to 20 mrad for beta radiation.

APPLICABILITY: At all times

ACTION:

- a. If the dose contribution, due to the cumulative release of noble gases in airborne effluents, exceeds the annual or quarterly dose objectives, submit a Special Report to the NRC, per Section 6.2.3, within 30 days.

B. Surveillance Requirements

1. The radiation dose contributions from radioactive noble gases in airborne effluents shall be determined, in accordance with the methodologies and parameters of Part II of the Off-Site Dose Calculation Manual, on a quarterly basis.

4.2.3 Dose - I-131, I-133, H-3, C-14, and Radioactive Material in Particulate Form with Half-Lives Greater than 8 Days (Other than Noble Gases)

A. Limiting Condition for Operation

1. The dose to an individual or dose commitment to any organ of an individual in unrestricted areas due to the release of I-131, I-133, H-3, C-14, and radioactive materials in particulate form with half-lives greater than eight days (excluding noble gases) in airborne effluents shall be limited to the following:
 - a. During any calendar quarter: Less than or equal to 7.5 mrem to any organ; and

4.2.3A.1 (continued)

- b. During any calendar year: Less than or equal to 15 mrem to any organ.

APPLICABILITY: At all times

ACTION:

- a. If the dose contribution, due to the cumulative release of I-131, I-133, H-3, C-14, and radioactive materials in particulate form with half-lives greater than eight days, exceeds the annual or quarterly dose objectives, submit a Special Report to the NRC per Section 6.2.3, within 30 days.

B. Surveillance Requirements

- 1. The radiation dose contributions from I-131, I-133, H-3, C-14 and radioactive materials in particulate form with half-lives greater than eight days (excluding noble gases) in airborne effluents shall be determined, in accordance with the methodologies and parameters of Part II of the Off-Site Dose Calculation Manual, on a quarterly basis.

4.2.4 Gaseous Radwaste Treatment

A. Limiting Condition for Operation

- 1. In accordance with Technical Specification 5.16.1.f, the Waste Gas System and the Ventilation Exhaust Systems shall be OPERABLE, and appropriate portions of these systems shall be used to reduce the releases of radioactivity when the projected doses in 31 days due to gaseous effluent releases to areas at and beyond the SITE BOUNDARY would exceed:
 - a. 0.2 mrad to air from gamma radiation, or
 - b. 0.4 mrad to air from beta radiation, or
 - c. 0.3 mrem to any organ of a MEMBER OF THE PUBLIC

4.2.4A.1 (continued)

APPLICABILITY: At all times

ACTION:

- a. With radioactive gaseous waste being discharged without treatment and in excess of the above limits, prepare and submit a report to the Nuclear Regulatory Commission within 30 days, pursuant to 10 CFR 50, Appendix I, a special report that includes the following information:
 - 1) Identification of equipment or subsystem(s) not operable and reasons for inoperability.
 - 2) Action(s) taken to restore the inoperable equipment to operable status.
 - 3) Summary description of action(s) taken to prevent a recurrence.

B. Surveillance Requirements

1. Dose due to gaseous releases shall be projected frequently and at least once per quarter, in accordance with the methodology and parameters in Part II of the Off-Site Dose Calculation Manual, when Waste Gas Systems and Ventilation Exhaust Systems are not fully OPERABLE.

4.2.4B (continued)

2. OPERABLE is defined as follows:

a. Waste Gas System

- 1) The waste airborne radioactive material at Fort Calhoun Station is collected in the vent header where the gas compressors take suction, compress the gas and deliver it to one of the four gas decay tanks. The waste airborne radioactive material is treated in these gas decay tanks by holding for radioactive decay prior to final controlled release to the environs. In order to provide conformance with the dose design objectives, gas decay tanks are normally stored for approximately 30 days and thus achieve decay of short half-life radioactive materials, e.g., I-131, Xe-133. Earlier release is allowed when a plant need exists and analytical results are in accordance with ALARA release objectives. If the radioactive airborne wastes from the gas decay tanks are discharged without processing in accordance with the above conditions, and it is confirmed that one half of the annual dose objective will be exceeded during the calendar quarter, a special report shall be submitted to the Commission pursuant to Section 4.2.4A.

b. Ventilation Exhaust Systems

- 1) The radioactive effluents from the controlled access area of the auxiliary building are filtered by the HEPA filters in the auxiliary building ventilation system. If the radioactive effluents are discharged without the HEPA filters, a special report shall be submitted to the NRC as defined in Action 4.2.4B.2.a above.
- 2) The discharge from the gas decay tanks is routed through charcoal and HEPA filter unit VA-82. No credit was taken for the operation of hydrogen purge filters during the 10 CFR Part 50, Appendix I dose design evaluation and doses through the airborne effluent pathways were well below the design objectives. The unavailability of hydrogen purge filters will not be considered a reportable event.

4.2.4B.2.b (continued)

- 3) The containment air is processed through at least one of the redundant containment HEPA and charcoal filters in the Containment Air Cooling and Filtering Units prior to purging. If the containment purges are made without processing through one of the Containment Air Cooling and Filtering Units, and it is confirmed that one half of the annual dose objective will be exceeded during the calendar quarter, a special report shall be submitted to the NRC as defined in Action 4.2.4B.2.a above.

4.3 Uranium Fuel Cycle

4.3.1 Total Dose-Uranium Fuel Cycle

A. Limiting Condition for Operation

1. The dose to any real individual from uranium fuel cycle sources shall be limited to ≤ 25 mrem to the total body or any organ (except the thyroid, which shall be limited to ≤ 75 mrem) during each calendar year.

APPLICABILITY: At all times

ACTION:

- a. With the calculated dose from the release of radioactive materials in liquid or gaseous effluents exceeding twice the limits of specifications 4.1.2A, 4.2.2A, or 4.2.3A, calculations shall be made including direct radiation contribution from the plant and outside storage tanks to determine whether the above limits have been exceeded. If such is the case, in lieu of any other report required by Section 6.2, prepare and submit a Special Report to the Commission pursuant to Technical Specification 5.16 that defines the corrective action to be taken to reduce subsequent releases to prevent recurrence of exceeding the above limits and includes the schedule for achieving conformance with the above limits. This Special Report, as defined in 10 CFR Part 20.2203(a)(4) and 20.2203(b), shall include an analysis that estimates the radiation exposure (dose) to a MEMBER OF THE PUBLIC from uranium fuel cycle sources, including all effluent pathways and direct radiation, for the calendar year that includes the release(s) covered by this report. It shall also describe levels of radiation and concentration of radioactive material involved, and the cause of exposure levels or concentrations. If the estimated dose(s) exceeds the above limits, and if the release condition resulting in the violation of 40 CFR Part 190 or 10 CFR Part 72.104 has not already been corrected, the Special Report shall include a request for a variance in accordance with the provisions of 40 CFR Part 190 or 10 CFR Part 72.104. Submittal of the report is considered a timely request, and a variance is granted until staff action on the request is complete.

4.3.1 (continued)

B. Surveillance Requirements

1. Cumulative dose contributions from liquid and gaseous effluents shall be determined in accordance with surveillance requirements 4.1.2B, 4.2.2B and 4.2.3B and in accordance with the methodology and parameters in Part II of the Off-Site Dose Calculation Manual.

5.0 RADIOLOGICAL ENVIRONMENTAL MONITORING PROGRAM (REMP)

5.1 Monitoring Program

5.1.1 Limiting Condition for Operation

- A. The Radiological Environmental Monitoring Program shall be conducted as specified in Table 5.1.

APPLICABILITY: At all times

ACTION:

1. Analytical results of this program and deviations from the sampling schedule shall be reported to the Nuclear Regulatory Commission in the Annual Radiological Environmental Operating Report (Section 6.2).
2. If the level of radioactivity from calculated doses leads to a higher exposure pathway to individuals, this pathway shall be added to the Radiological Environmental Monitoring Program. Modifications to the program shall be reported in the Annual Radiological Environmental Operating Report to the Nuclear Regulatory Commission.
3. If the level of radioactivity in an environmental sampling medium exceeds the reporting level specified in Table 5.4, and the activity is attributable to plant operation, a Special Report shall be prepared and submitted to the Nuclear Regulatory Commission within 30 days (Section 6.2.3). The detection capabilities of the equipment used for the analysis of environmental samples must meet the requirements of Table 5.3 for Lower Level of Detection (LLD).

5.1.1A (continued)

4. If the level of radioactivity in a sample from either an onsite or offsite well, performed per the Site Groundwater Protection Program, exceeds the reporting level specified in Table 5.4, and the activity is attributable to plant operation, a Special Report shall be prepared and submitted to the Nuclear Regulatory Commission within 30 days (Section 6.2.3). The detection capabilities of the equipment used for the analysis of environmental samples must meet the requirements of Table 5.3 for Lower Level of Detection (LLD). Copies of the Special Report will be forwarded to State/Local authorities. **[AR 39127]**
5. If the level of radioactivity from either an onsite or offsite well, performed per the Site Groundwater Protection Program exceeds the reporting level specified in Table 5.4, and the activity is attributable to plant operations, state and local authorities shall be notified by the end of the next business day. NRC shall be notified per SO-R-1, Reportability Determinations. **[AR 39127]**
6. Radiological environmental sampling locations and the media that is utilized for analysis are presented in Table 5.2. Sampling locations are also illustrated on the map, Figure 1. Details of the quarterly emergency TLD locations are contained in surveillance test CH-ST-RV-0003, Environmental Sample Collection – Quarterly/Environmental Dosimeters (TLDs). Each TLD sample location contains one dosimeter that is exchanged quarterly for REMP sampling and as needed for Emergency Planning Zone monitoring.
7. Deviations from the monitoring program, presented in this section and detailed in Table 5.2, are permitted if specimens are unobtainable due to mitigating circumstances such as hazardous conditions, seasonal unavailability, malfunction of equipment, or if a person discontinues participation in the program, etc. If the equipment malfunctions, corrective actions will be completed as soon as practicable. If a person no longer supplies samples, a replacement will be made if possible. All deviations from the sampling schedule will be described in the Annual Radiological Environmental Operating Report, pursuant to Section 6.2.

5.1.2 Surveillance Requirements

- A. The Radiological Environmental Monitoring Program (REMP) samples shall be collected and analyzed in accordance with Tables 5.1, 5.2, and 5.3.

Table 5.1 - Radiological Environmental Monitoring Program

| Exposure Pathway and/or Sample | Collection Site ^A | Type of Analysis ^B | Frequency |
|--------------------------------|---|--|---|
| 1. Direct Radiation | A. 14 TLD indicator stations, one background station ^F , total of 15. | Gamma dose | Quarterly |
| | B. An inner-ring of 16 stations, one in each cardinal sector in the general area of the unrestricted area boundary and within 2.5 miles. | Gamma dose | Quarterly |
| | C. An outer-ring of 16 stations, one in each cardinal sector located outside of the inner-ring, but no more distant than approximately 5 miles. | Gamma dose | Quarterly |
| 2. Air Monitoring | A. Indicator Stations <ol style="list-style-type: none"> 1. Three stations in the general area of the unrestricted area boundary 2. City of Blair 3. Desoto Township | Filter for Gross Beta ^C Charcoal for I-131 Filter for Gamma Isotopic | Weekly Weekly Quarterly composite of weekly filters |
| | B. One background station ^F | | |
| 3. Water | A. Missouri River at nearest downstream drinking water intake. | Gamma Isotopic, H-3 ¹³¹ I analysis on each composite when the dose calculated for the consumption of water is > 1 mrem/year ^G | Composite sample over 2 week period when ¹³¹ I analysis is performed, monthly otherwise for Gamma isotopic analysis. Quarterly composite for H-3 Analysis |
| | B. Missouri River downstream near the mixing zone. | | |
| | C. Missouri River upstream of Plant intake (background) ^F . | | |
| 4. Milk ^D | A. Nearest milk animal (cow or goat) within 5 miles | Gamma Isotopic and I-131 | Biweekly grazing season (May to October), monthly at other times. |
| | B. Milk animal (cow or goat) between 5 miles and 18.75 miles (background) ^F . | | |
| 5. Fish | A. Four fish samples within vicinity of Plant discharge. | Gamma Isotopic | Once per season (May to October) |
| | B. One background sample upstream of Plant discharge. | | |

Table 5.1 - Radiological Environmental Monitoring Program

| Exposure Pathway and/or Sample | Collection Site ^A | Type of Analysis ^B | Frequency |
|---|---|--|----------------------------------|
| 6. Sediment | A. One sample from downstream area on the station side of the Missouri River. | Gamma Isotopic | Semiannually |
| | B. One sample from upstream of Plant Intake (background) ^F . | | |
| 7. Vegetables or Food Products ^E | A. One sample in the highest exposure pathway. | Gamma Isotopic | Once per season (May to October) |
| | B. One sample from onsite crop field | | |
| | C. One sample outside of 5 miles (background) ^F . | | |
| 8. Groundwater | A. Three samples from sources potentially affected by plant operations. | H ₃ , Gross Beta, Gamma Isotopic, Sr-90 | Quarterly |
| | B. One sample outside of 5 miles (background) ^F . | | |
| 9. Vegetation in lieu of milk | A. One sample at the highest annual average D/Q offsite location. | Gamma Isotopic | Monthly (when available) |
| | B. One sample at the second highest annual average D/Q offsite location. | | |
| | C. One sample outside of 5 miles (background) ^F . | | |

NOTES:

- A. See Table 5.3 for required detection limits.
- B. The Lower Limit of Detection (LLD) for analysis is defined in the Off-Site Dose Calculation Manual in accordance with the wording of NUREG-1301.
- C. When a gross beta count indicates radioactivity greater than 2.5E-13 µCi/ml or 0.25 pCi/m³, (ten times the yearly mean), a gamma spectral analysis will be performed.
- D. If milk samples are temporarily not available at a sampling site due to mitigating circumstances, then vegetation (broadleaf, pasture grass, etc.) shall be collected as an alternate sample at the site. If there are no milk producers within the entire 5-mile radius of the plant, then vegetation shall be collected monthly, when available, at two offsite locations having the highest calculated annual average ground level D/Q and a background locale. (Reference Off-Site Dose Calculation Manual, Part II, Table 4 "Highest Potential Exposure Pathways for Estimating Dose")
- E. Samples should be collected from garden plots of 500 ft² or more. (Reference Reg. Guide 4.8 "Environmental Technical Specifications for Nuclear Power Plants," Dec. 1975).
- F. This sample may not be located in the least prevalent wind direction. The Branch Technical Position paper, Table 1, subnote "d" says this regarding background information, or control locations. **"The purpose of this sample is to obtain background information. If it is not practical to establish control locations in accordance with the distance and wind direction criteria, other sites which provide valid background data may be substituted"**.
- G. The dose shall be calculated for the maximum organ and age group, using methodology and parameters in the Off-Site Dose Calculation Manual.

Table 5.2 - Radiological Environmental Sampling Locations And Media

| Sample Station No. | Approximate Collection Sites | Approximate Distance from Center of Containment (miles) | Approximate Direction (degrees from true north) | Sector | Air Monitoring | | TLD | Water | Milk | Sedi-ment | Fish | Vegetables and Food Products | Ground-water |
|--------------------|---|---|---|--------|----------------------|-----------------|-----|-------|------|-----------|------|------------------------------|--------------|
| | | | | | Airborne Particulate | Airborne Iodine | | | | | | | |
| 1 | Onsite Station, 110-meter weather tower | 0.53 | 293°/WNW | P | | | X | | | | | | |
| 2 ^{C,E} | Onsite Station, adjacent to old plant access road | 0.59 | 207°/SSW | K | X | X | X | | | | | | |
| 3 | Offsite Station, Intersection of Hwy. 75 and farm access road | 0.94 | 145°/SE | G | | | X | | | | | | |
| 4 | Blair OPPD office | 2.86 | 305°/NW | Q | X | X | X | | | | | | |
| 5 ^A | | | | | | | | | | | | | |
| 6 | Fort Calhoun, NE City Hall | 5.18 | 150°/SSE | H | | | X | | | | | | |
| 7 | Fence around intake gate; Desoto Wildlife Refuge | 2.07 | 102°/ESE | F | | | X | | | | | | |
| 8 | Onsite Station, entrance to Plant Site from Hwy. 75 | 0.55 | 191°/S | J | | | X | | | | | | |
| 9 | Onsite Station, NW of Plant | 0.68 | 305°/NW | Q | | | X | | | | | | |
| 10 | Onsite Station, WSW of Plant | 0.61 | 242°/WSW | M | | | X | | | | | | |
| 11 | Offsite Station, SE of Plant | 1.07 | 39°/SE | G | | | X | | | | | | |

Table 5.2 - Radiological Environmental Sampling Locations And Media

| Sample Station No. | Approximate Collection Sites | Approximate Distance from Center of Containment (miles) | Approximate Direction (degrees from true north) | Sector | Air Monitoring | | TLD | Water | Milk | Sediment | Fish | Vegetables and Food Products | Ground-water |
|--------------------|---|---|---|--------|----------------------|-----------------|-----|-------|------|----------|------|------------------------------|--------------|
| | | | | | Airborne Particulate | Airborne Iodine | | | | | | | |
| 28 ^A | | | | | | | | | | | | | |
| 29 ^A | | | | | | | | | | | | | |
| 30 ^A | | | | | | | | | | | | | |
| 31 ^A | | | | | | | | | | | | | |
| 32 ^D | Valley Substation #902 | 19.6 | 221°/SW | L | X | X | X | | | | | | |
| 33 ^A | | | | | | | | | | | | | |
| 34 ^A | | | | | | | | | | | | | |
| 35 | Onsite Farm Field | 0.52 | 118°/ESE | F | | | | | | | | X | |
| 36 | Offsite Station Intersection Hwy 75/Co. Rd. P37 | 0.75 | 227°/SW | L | | | X | | | | | | |
| 37 | Offsite Station Desoto Township | 1.57 | 144°/SE | G | X | X | X | | | | | | |
| 38 ^A | | | | | | | | | | | | | |
| 39 ^A | | | | | | | | | | | | | |
| 40 ^A | | | | | | | | | | | | | |
| 41 ^C | Dowler Acreage | 0.73 | 175°/S | J | X | X | X | | B,C | | | | |
| 42 | Sector A-1 | 1.94 | 0°/NORTH | A | | | X | | | | | | |
| 43 | Sector B-1 | 1.97 | 16°/NNE | B | | | X | | | | | | |
| 44 | Sector C-1 | 1.56 | 41°/NE | C | | | X | | | | | | |
| 45 | Sector D-1 | 1.34 | 71°/ENE | D | | | X | | | | | | |
| 46 | Sector E-1 | 1.54 | 90°/EAST | E | | | X | | | | | | |
| 47 | Sector F-1 | 0.45 | 108°/ESE | F | | | X | | | | | | |

Table 5.2 - Radiological Environmental Sampling Locations And Media

| Sample Station No. | Approximate Collection Sites | Approximate Distance from Center of Containment (miles) | Approximate Direction (degrees from true north) | Sector | Air Monitoring | | TLD | Water | Milk | Sedi-ment | Fish | Vegetables and Food Products | Ground-water |
|--------------------|------------------------------|---|---|--------|----------------------|-----------------|-----|-------|------|-----------|------|------------------------------|--------------|
| | | | | | Airborne Particulate | Airborne Iodine | | | | | | | |
| 48 | Sector G-1 | 1.99 | 134°/SE | G | | | X | | | | | | |
| 49 | Sector H-1 | 1.04 | 159°/SSE | H | | | X | | | | | | |
| 50 | Sector J-1 | 0.71 | 179°/SOUTH | J | | | X | | | | | | |
| 51 | Sector K-1 | 0.61 | 205°/SSW | K | | | X | | | | | | |
| 52 | Sector L-1 | 0.74 | 229°/SW | L | | | X | | | | | | |
| 53 | Sector M-1 | 0.93 | 248°/WSW | M | | | X | | | | | | |
| 54 | Sector N-1 | 1.31 | 266°/WEST | N | | | X | | | | | | |
| 55 | Sector P-1 | 0.60 | 291°/WNW | P | | | X | | | | | | |
| 56 | Sector Q-1 | 0.67 | 307°/NW | Q | | | X | | | | | | |
| 57 | Sector R-1 | 2.32 | 328°/NNW | R | | | X | | | | | | |
| 58 | Sector A-2 | 4.54 | 350°/NORTH | A | | | X | | | | | | |
| 59 | Sector B-2 | 2.95 | 26°/NNE | B | | | X | | | | | | |
| 60 | Sector C-2 | 3.32 | 50°/NE | C | | | X | | | | | | |
| 61 | Sector D-2 | 3.11 | 75°/ENE | D | | | X | | | | | | |
| 62 | Sector E-2 | 2.51 | 90°/EAST | E | | | X | | | | | | |
| 63 | Sector F-2 | 2.91 | 110°/ESE | F | | | X | | | | | | |
| 64 | Sector G-2 | 3.00 | 140°/SE | G | | | X | | | | | | |
| 65 | Sector H-2 | 2.58 | 154°/SSE | H | | | X | | | | | | |
| 66 | Sector J-2 | 3.53 | 181°/SOUTH | J | | | X | | | | | | |
| 67 | Sector K-2 | 2.52 | 205°/SSW | K | | | X | | | | | | |
| 68 | Sector L-2 | 2.77 | 214°/SW | L | | | X | | | | | | |
| 69 | Sector M-2 | 2.86 | 243°/WSW | M | | | X | | | | | | |

Table 5.2 - Radiological Environmental Sampling Locations And Media

| Sample Station No. | Approximate Collection Sites | Approximate Distance from Center of Containment (miles) | Approximate Direction (degrees from true north) | Sector | Air Monitoring | | TLD | Water | Milk | Sedi-ment | Fish | Vegetables and Food Products | Ground-water |
|--------------------|------------------------------|---|---|--------|----------------------|-----------------|-----|-------|------|-----------|------|------------------------------|--------------|
| | | | | | Airborne Particulate | Airborne Iodine | | | | | | | |
| 70 | Sector N-2 | 2.54 | 263°/WEST | N | | | X | | | | | | |
| 71 | Sector P-2 | 2.99 | 299°/WNW | P | | | X | | | | | | |
| 72 | Sector Q-2 | 3.37 | 311°/NW | Q | | | X | | | | | | |
| 73 | Sector R-2 | 3.81 | 328°/NNW | R | | | X | | | | | | |
| 74 | D. Miller Farm | 0.65 | 203°/SSW | K | | | | | | | | | X |
| 75 ^C | Lomp Acreage | 0.65 | 163°/SSE | H | X | X | X | | B, C | | | X | X |
| 76 | Stangl Farm | 3.40 | 169°/S | J | | | | | X | | | | |

NOTES:

- A. Location is either not in use or currently discontinued and is documented in the table for reference only.
- B. If milk samples are temporarily not available at a sampling site due to mitigating circumstances, then vegetation (broadleaf, pasture grass, etc.) shall be collected as an alternate sample at the site. If there are no milk producers within the entire 5-mile radius of the plant, then vegetation shall be collected monthly, when available, at two offsite locations having the highest calculated annual average ground level D/Q and a background locale. (Reference Off-Site Dose Calculation Manual, Part II, Table 4 "Highest Potential Exposure Pathways for Estimating Dose")
- C. Locations represent highest potential exposure pathways as determined by the biennial Land Use Survey, performed in accordance with Part I, Section 7.3.2, of the Off-Site Dose Calculation Manual and are monitored as such.
- D. Background location (control). All other locations are indicators.
- E. Location for monitoring Sector K High Exposure Pathway Resident Receptor for inhalation.
- F. When broad leaf (pasture grasses) are being collected in lieu of milk, background broad leaf samples will be collected at a background locale.

Figure 1 – Environmental Radiological Sampling Points

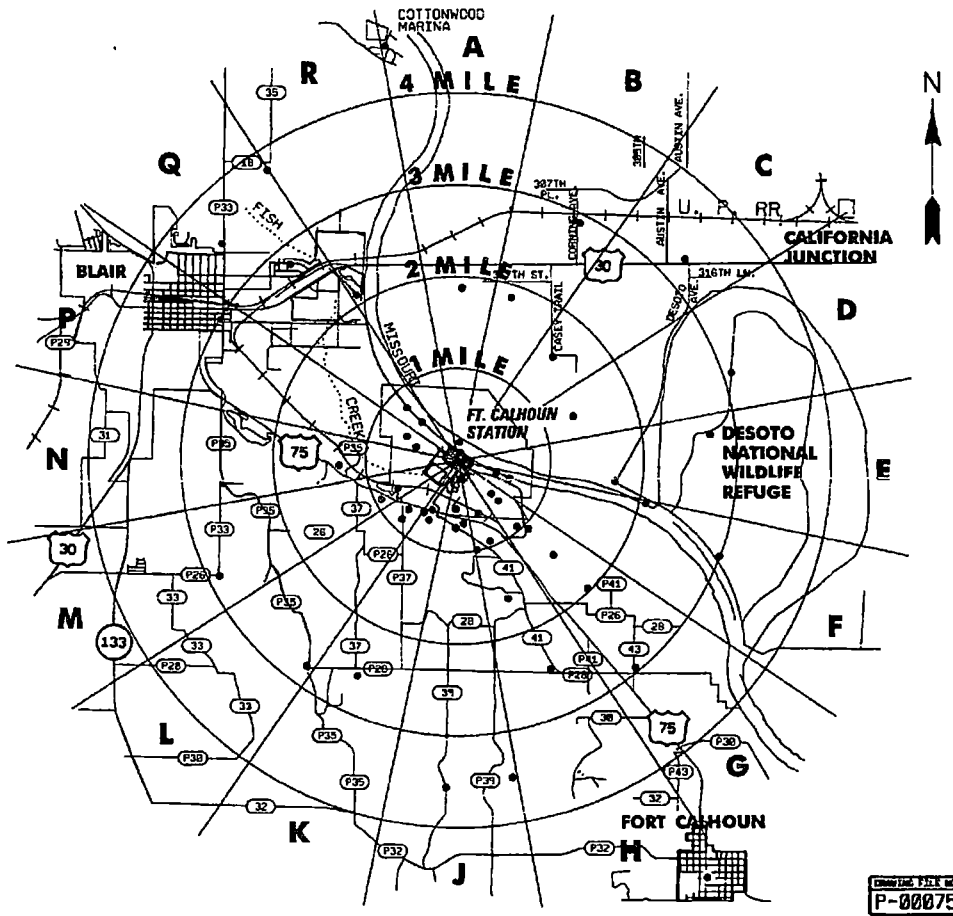

(*) Locations currently discontinued are not illustrated.

Table 5.3 - Detection Capabilities for Environmental Sample Analysis Lower Limit of Detection (LLD) ^{A, B, C}

| Sample | Units | Gross Beta | H-3 | Mn-54 | Fe-59 | Co-58, Co-60 | Zn-65 | Zr-95 | Nb-95 | I-131 | Cs-134 | Cs-137 | Ba-140 La-140 |
|---|--------------------|------------|---------|---------|---------|--------------|---------|---------|---------|----------------------|---------|---------|---------------|
| Water | pCi/L | 4 | 2.0E+03 | 1.5E+01 | 3.0E+01 | 1.5E+01 | 3.0E+01 | 1.5E+01 | 1.5E+01 | 1.0E+00 ^D | 1.5E+01 | 1.8E+01 | 1.5E+01 |
| Fish | pCi/kg (wet) | --- | --- | 1.3E+02 | 2.6E+02 | 1.3E+02 | 2.6E+02 | --- | --- | --- | 1.3E+02 | 1.5E+02 | --- |
| Milk | pCi/L | --- | --- | --- | --- | --- | --- | --- | --- | 1.0E+00 | 1.5E+01 | 1.8E+01 | 1.5E+01 |
| Airborne Particulates or Gases | pCi/m ³ | 1.0E-02 | --- | --- | --- | --- | --- | --- | --- | 7.0E-02 | 1.0E-02 | 1.0E-02 | --- |
| Sediment | pCi/kg (dry) | --- | --- | --- | --- | --- | --- | --- | --- | --- | 1.5E+02 | 1.8E+02 | --- |
| Grass or Broad Leaf Vegetation/ Vegetables or Food Products | pCi/kg (wet) | --- | --- | --- | --- | --- | --- | --- | --- | 6.0E+01 | 6.0E+01 | 8.0E+01 | --- |

- A. This list does not mean that only these nuclides are to be considered. Other peaks that are identifiable as Plant effluents, together with those of the above nuclides, shall also be analyzed and reported in the Annual Radiological Environmental Operating Report pursuant to Part I, Section 6.2, of the Off-Site Dose Calculation Manual.
- B. Required detection capabilities for thermoluminescent dosimeters used for environmental measurements shall be in accordance with the recommendations of Regulatory Guide 4.13.
- C. The LLD is defined in Part II of the Off-Site Dose Calculation Manual.
- D. LLD for drinking water samples. If no drinking water pathway exists, the LLD of gamma isotopic analysis may be used.
- E. I-131 analysis performed on broadleaf/pasture grass samples when milk is unavailable. Gamma isotopic analysis performed on food products/vegetables.

Table 5.4 - Reporting Levels for Radioactivity Concentrations in Environmental Samples ^A

| Sample | Units | H-3 | Mn-54 | Fe-59 | Co-58 | Co-60 | Zn-65 | Zr-95 | Nb-95 | I-131 | Cs-134 | Cs-137 | Ba-140 La-140 |
|---|--------------------|---------|---------|---------|---------|---------|---------|---------|---------|----------------------|---------|---------|------------------|
| Water | pCi/L | 2.0E+04 | 1.0E+03 | 4.0E+02 | 1.0E+03 | 3.0E+02 | 3.0E+02 | 4.0E+02 | 4.0E+02 | 2.0E+00 ^B | 3.0E+01 | 5.0E+01 | 2.0E+02 |
| Fish | pCi/kg (wet) | --- | 3.0E+04 | 1.0E+04 | 3.0E+04 | 1.0E+04 | 2.0E+04 | --- | --- | --- | 1.0E+03 | 2.0E+03 | --- |
| Milk | pCi/L | --- | --- | --- | --- | --- | --- | --- | --- | 3.0E+00 | 6.0E+01 | 7.0E+01 | 3.0E+02 |
| Airborne Particulates or Gases | pCi/m ³ | --- | --- | --- | --- | --- | --- | --- | --- | 9.0E-01 | 1.0E+01 | 2.0E+01 | --- |
| Grass or Broad Leaf Vegetation/ Vegetables or Food Products | pCi/kg (wet) | --- | --- | --- | --- | --- | --- | --- | --- | 1.0E+02 | 1.0E+03 | 2.0E+03 | --- |

A. A Non-routine report shall be submitted when more than one of the radionuclides listed above are detected in the sampling medium and:

$$\frac{\text{Concentration 1}}{\text{Reporting Level 1}} + \frac{\text{Concentration 2}}{\text{Reporting Level 2}} + \frac{\text{Concentration 3}}{\text{Reporting Level 3}} + \dots \geq 1.0$$

When radionuclides other than those listed above are detected and are the result of Plant effluents, this report shall be submitted if the potential annual dose to a member of the general public is equal to or greater than the dose objectives of Part I, Section 4.1 and 4.2, of the Off-Site Dose Calculation Manual. This report is not required if the measured level of radioactivity was not the result of Plant effluents; however, in such an event, the condition shall be reported and described in the Annual Radiological Environmental Operating Report.

B. If no drinking water pathway exists, the LLD of gamma isotopic analysis may be used.

5.2 Land Use Survey

5.2.1 Limiting Condition for Operation

- A. A Land Use Survey shall identify the location of the nearest milk animal, nearest meat animal, nearest vegetable garden, nearest groundwater source and the nearest residence in each of the 16 cardinal sectors within a distance of five miles. The survey shall be conducted under the following conditions:
1. Within a one-mile radius from the Plant site, enumeration by door-to-door or equivalent counting techniques.
 2. Within a Five-mile radius, enumeration may be conducted door-to-door or by using referenced information from county agricultural agents or other reliable sources.

APPLICABILITY: At all times

ACTION:

- a. If it is learned from this survey that milk animals, vegetable gardens and resident receptors are present at a location which yields a calculated dose greater than 20% from previously sampled location(s), the new location(s) shall be added to the monitoring program. Milk and vegetable garden sampling location(s) having the lowest calculated dose may then be dropped from the monitoring program at the end of the grazing and/or growing season during which the survey was conducted and the new location added to the monitoring program. Groundwater monitoring is based on a determination if source(s) are potentially affected by plant operations. Modifications to the air monitoring locations, vegetable garden sampling locations, and milk sampling locations will be made as soon as practicable. The Nuclear Regulatory Commission shall be notified of modifications to the program in the Annual Radiological Environmental Operating Report (Section 6.2).

5.2.1A.2 (continued)

- b. If it is learned from this survey that a pathway for dose to a MEMBER OF THE GENERAL PUBLIC no longer exists, an additional pathway has been identified or site specific factors affecting the dose calculations for a pathway have changed, then this information should be documented in the Land Use Survey, the Annual Radiological Environmental Operating Report and the Annual Radioactive Effluent Release Report. This information can be used to increase the accuracy of the dose models for the Annual Radioactive Effluent Release Report as well as dose estimates performed during the reporting period (i.e., quarterly dose estimates).

5.2.2 Surveillance Requirements

- A. A land use survey shall be conducted once per 24 months between the dates of June 1 and October 1. The results of the land use survey shall be submitted to the Nuclear Regulatory Commission in the Annual Radiological Environmental Operating Report (Section 6.2) for the year it was performed.

5.3 Interlaboratory Comparison Program

5.3.1 Limiting Condition for Operation

- A. Analyses shall be performed on radioactive materials as part of an Interlaboratory Comparison Program that has been approved by the Nuclear Regulatory Commission.

APPLICABILITY: At all times

ACTION:

1. With analysis not being performed as required above, report the corrective actions taken to prevent a recurrence to the Commission in the Annual Radiological Environmental Operating Report (Section 6.2).

5.3.2 Surveillance Requirements

- A. The results of these analyses shall be included in the Annual Radiological Environmental Operating Report (Section 6.2).

6.0 ADMINISTRATIVE CONTROLS

6.1 Responsibilities

- 6.1.1 FCS Chemistry Department is responsible for the implementation and maintenance of the Off-Site Dose Calculation Manual.
- 6.1.2 FCS Operations Department is responsible for the compliance with the Off-Site Dose Calculation Manual in the operation of Fort Calhoun Station.

6.2 Radioactive Effluent Reporting Requirements

The reporting requirements for radioactive effluents stated in this Section are to provide assurance that the limits set forth in Part I of the Off-Site Dose Calculation Manual are complied with. These reports will meet the requirements for documentation of radioactive effluents contained in 10 CFR Part 50.36a; Reg. Guide 1.21, Rev. 2; Reg. Guide 4.8, Table 1; and Reg. Guide 1.109, Rev. 1.

6.2.1 Annual Radioactive Effluent Release Report

A report covering the operation of the Fort Calhoun Station during the previous calendar year shall be submitted prior to May 1 of each year per the requirements of Technical Specifications 5.9.4.a. and 10 CFR Part 50.

The Radioactive Effluent Release Report shall include:

- A. A summary of the quantities of radioactive liquid and airborne effluents and solid waste released from the plant as outlined in Regulatory Guide 1.21, Revision 2.
- B. A summary of the annual meteorological data that provides joint frequency distributions of wind direction and wind speed by atmospheric stability class will be included in the annual report. In addition, hourly meteorological data is recorded and retained on site as outlined in Regulatory Guide 1.21, Revision 2.
- C. An assessment of radiation doses from the radioactive liquid and airborne effluents released from the unit during each calendar quarter as outlined in Regulatory Guide 1.21, Revision 2. The assessment of radiation doses shall be performed in accordance with calculational methodology of the Regulatory Guide 1.109, Revision 1.
- D. Changes to the Process Control Program (PCP) or to the Offsite Dose Calculation Manual (ODCM) made during the reporting period. Each change shall be identified by markings in the margin of the affected pages clearly indicating the area of the page that was changed and shall indicate the date the change was implemented.

6.2.1 (continued)

- E. A list and description of abnormal releases or abnormal discharges from the site to unrestricted areas of radioactive materials in gaseous and liquid effluents made during the reporting period.
- F. An explanation of why instrumentation designated in Part I, Sections 3.1.1 and 3.2, of the Off-Site Dose Calculation Manual, was not restored to OPERABLE status within 30 days.
- G. A description of any major design changes or modifications made to the Liquid and/or Gaseous Radwaste Treatment Systems or Ventilation Exhaust Systems during the reporting period.
- H. An explanation of why the liquid and/or gaseous radwaste treatment systems were not OPERABLE, causing the limits of specifications 4.1.3A and 4.2.4A to be exceeded.
- I. The results of sampling from offsite and onsite groundwater wells per the Site Groundwater Protection Plan. [AR 39127]
- J. Non-routine planned discharges (e.g., discharges from remediation efforts like pumping contaminated groundwater from a leak).

6.2.2 Annual Radiological Environmental Operating Report

The Annual Radiological Environmental Operating Report for the previous one year of operation shall be submitted prior to May 1 of each year. This report contains the data gathered from the Radiological Environmental Monitoring Program. The content of the report shall include:

- A. Summarized and tabulated results of the radiological environmental sampling/analysis activities following the format of Regulatory Guide 4.8, Table 1. In the event that some results are not available, the report shall be submitted noting and explaining the reasons for the missing results. The missing data shall be submitted as soon as possible in a supplementary report.
- B. Interpretations and statistical evaluation of the results, including an assessment of the observed impacts of the plant operation and environment.
- C. The results of participation in a NRC approved Interlaboratory Comparison Program.
- D. The results of land use survey required by Section 5.2.

6.2.2 (continued)

- E. The results of specific activity analysis in which the primary coolant exceeded the limits of Technical Specification 2.1.3. The following information shall be included:
1. Reactor power history starting 48 hours prior to the first sample in which the limit was exceeded.
 2. Results of the last isotopic analysis for radioiodine performed prior to exceeding the limit, results of analysis while limit was exceeded and results of one analysis after the radioiodine activity was reduced to less than the limit. Each result should include date and time of sampling and the radioiodine concentrations.
 3. Purification system flow history starting 48 hours prior to the first sample in which the limit was exceeded.
 4. Graph of the I-131 concentration and one other radioiodine isotope concentration in micro-curies per gram as a function of time for the duration of the specific activity above the steadystate level, AND
 5. The time duration when the specific activity of the primary coolant exceeded the radioiodine limit.
- F. A map of the current environmental monitoring sample locations.

6.2.3 Special Report

If the limits or requirements of Sections 4.1.2A, 4.1.3A, 4.2.2A, 4.2.3A, 4.2.4A, 4.3.1A, and/or 5.1.1A.3 and/or 5.1.1A.4 are exceeded, a Special Report shall be issued to the Commission, pursuant to Technical Specification 5.16. This report shall include: **[AR 39127]**

- A. The results of an investigation to identify the causes for exceeding the specification.
- B. Define and initiate a program of action to reduce levels to within the specification limits.
- C. The report shall also include an evaluation of any release conditions, environmental factors, or other aspects necessary to explain the condition.

6.2.4 EPA 40 CFR Part 190 Reporting Requirements

With the calculated dose from the release of radioactive materials in liquid or gaseous effluents exceeding twice the limits of dose from specifications 4.1.2A, 4.2.2A, or 4.2.3A, calculations shall be made including direct radiation calculations, to prepare and submit a special report to the Commission within 30 days and limit the subsequent releases such that the dose to any real individual from uranium fuel cycle sources is limited to ≤ 25 mrem to the total body or any organ (except thyroid, which is limited to ≤ 75 mrem) over the calendar year. This special report shall include an analysis which demonstrates that radiation exposures to any member of the public from uranium fuel cycle sources (including all effluent pathways and direct radiation) are less than the 40 CFR Part 190 standard. Otherwise, obtain a variance from the Commission to permit releases which exceed the 40 CFR Part 190 standard. The submittal of the report is to be considered a timely request and a variance is granted pending the final action on the variance request from the Commission.

6.2.5 ISFSI 10 CFR Part 72.104 Reporting Requirements

The regulatory requirements of 10CFR20, 10CFR72 and 40CFR190 each limit total dose to individual members of the public without regard to specific pathways. The only significant exposure pathways for light water reactors included in 10CFR20, 10CFR72 and 40CFR190 not addressed by 10CFR50 Appendix I are the direct radiation pathway and exposure from on-site activity by members of the public.

The 10CFR72.104 dose limits are the same as those specified in 40CFR190. ISFSI dose contribution is in the form of direct radiation as no liquid or gas releases are expected to occur. If the dose limits of 40CFR190 or 10CFR72.104 are exceeded, a special report to the NRC, as well as an appropriate request for exemption/variance, is required to be submitted to the NRC.

The requirement that the dose limits of 10CFR72.104 apply to any 'real individual' is controlled for ISFSI activities in the ISFSI 72.212 report. Therefore, for the purposes of analyzing dose from the ISFSI, the member of the public as defined in 40CFR190 is the same as for the 'real individual'.

The report of the annual direct radiation required by 10CFR72 shall be submitted prior to 60 days from January 1 of each year.

The external Total Body Dose is comprised of:

- 1) Total Body Dose due to noble gas radionuclides in gaseous effluents
- 2) Dose due to radioactive waste and the ISFSI

- 3) Total Body Dose due to radioactivity deposited on the ground (this dose is accounted for in the determination of the non-noble gas dose and is not considered here)

The Total Body Dose, external is given by:

$$D_{\text{ext}} = D_{\text{tb}} + D_{\text{osf}}$$

Where D_{ext} is the external dose

D_{tb} is the total body dose

D_{osf} is the dose from on-site storage

The Total Dose is then given by:

$$D_{\text{tot}} = D_{\text{ext}} + D_{\text{liq}} + D_{\text{nng}}$$

Where D_{tot} is the total dose

D_{ext} is the external dose

D_{liq} is the dose from liquid effluents

D_{nng} is the dose from non-noble gases

Dose Limits

| | |
|----------------------|---------|
| Total Body, annual | 25 mrem |
| Thyroid, annual | 75 mrem |
| Other Organs, annual | 25 mrem |

6.3 Change Mechanism

The Off-Site Dose Calculation Manual is the controlling document for all radioactive effluent releases. It is defined as a procedure under the guidance of Technical Specification 5.8. It will be revised and reviewed by the Plant Operations Review Committee and approved by the Plant Manager in accordance with Technical Specification 5.17. All changes to the Off-Site Dose Calculation Manual will be forwarded to the Nuclear Regulatory Commission during the next reporting period for the Annual Radioactive Effluent Release Report in accordance with the requirements of Technical Specification 5.17.

6.4 Meteorological Data

The Annual Average χ/Q is utilized to determine the concentrations of radionuclides at the unrestricted area boundary. It is also the factor used in conjunction with the parameters and methodologies in Part II, of the Off-Site Dose Calculation Manual to determine unrestricted area dose on a quarterly bases or as needed. It is based on an average of the highest calculated sector χ/Q values, using all 16 sectors for each of the three previous year Annual Radioactive Effluent Release Reports, and the XOQDOQ plume trajectory model. An additional 10 percent will be added to the average for unrestricted area dose estimates performed quarterly or as needed for conservatism. When calculating χ/Q data for the Annual Radiological Effluent Release Report, if the highest calculated χ/Q for the reporting period is observed to be greater than $\pm 10\%$ of the Annual Average χ/Q previously calculated, contact the Supervisor-System Chemistry for further instructions. This model conforms with the Nuclear Regulatory Commissions Regulatory Guide 1.111.

Current year meteorological data will be utilized in the preparation of the Annual Radioactive Effluent Release Report. This data is used to calculate the joint frequency table, the dispersion coefficients and deposition factors in all 16 sectors. These are used in the calculation of doses to individuals in unrestricted areas as a result of the operation of Fort Calhoun Station. The models used, GASPAR 2 and LADTAP 2, meet the intent of Nuclear Regulatory Commissions Reg. Guide 1.109 and 1.21 for the reporting of doses due to routine radioactive effluent releases.

6.5 References

- 6.5.1 Regulatory Guide 1.109, Rev. 1 - Calculation of Annual Dose to man from Routine Releases of Reactor Effluents for the purpose of evaluation compliance with 10 CFR Part 50, Appendix I
- 6.5.2 Regulatory Guide 1.111, Rev. 1 - Methods for Estimating Atmospheric Transport and Dispersion of Gaseous Effluents in Routine Releases from Light-Water-Cooled Reactors.
- 6.5.3 Regulatory Guide 1.113, Rev. 1 - Estimating Aquatic Dispersion of Effluents from Accidental and Routine Releases for the purpose of Implementing Appendix I.
- 6.5.4 Regulatory Guide 4.8, Environmental Technical Specification for Nuclear Power Plants.
- 6.5.5 NRC Branch Technical Position, March 1978
- 6.5.6 NUREG-0133 - Preparation of Radiological Effluent Technical Specifications for Nuclear Power Plants.
- 6.5.7 NUREG-1301 - Offsite Dose Calculation Manual Guidance.

- 6.5.8 Regulatory Guide 1.21, Rev. 2 - Measuring, Evaluating, and Reporting Radioactivity in solid wastes and Releases of Radioactivity Materials in Liquid and Gaseous Effluents from Light-Water-Cooled Nuclear Power Plants.
- 6.5.9 Code of Federal Regulations, Title 10, Part 20
- 6.5.10 Code of Federal Regulations, Title 10, Part 50
- 6.5.11 Code of Federal Regulations, Title 40, Part 190
- 6.5.12 Fort Calhoun Revised Environmental Report (Unit No. 1)-1972
- 6.5.13 Fort Calhoun Technical Specifications (Unit No. 1)
- 6.5.14 Updated Safety Analysis Report
- 6.5.15 AR 12357, Implement Recommendations of Memo FC-0133-92, Part I, Table 3.2.1 Action 4, of the Off-Site Calculation Manual
- 6.5.16 AR 39127, NEI Industry Initiative on Groundwater Protection
- 6.5.17 Regulatory Guide 4.1, Rev. 2 – Radiological Environmental Monitoring for Nuclear Power Plants
- 6.5.18 SO-G-28 – Station Fire Plan

7.0 **BASIS**

7.1 Instrumentation

7.1.1 Radioactive Liquid Effluent Instrumentation

The Radioactive liquid effluent instrumentation is provided to monitor and control, as applicable, the releases of radioactive material in liquid effluents during actual or potential releases of liquid effluents. The Alarm/Trip setpoints for these instruments shall be calculated in accordance with Part II of the Offsite Dose Calculation Manual to ensure that the alarm/trip will occur prior to exceeding the limits of 10 CFR Part 20. The OPERABILITY and use of this instrumentation is consistent with the requirements of General Design Criteria 60, 63 and 64 of Appendix A to 10 CFR Part 50.

7.1.2 Radioactive Gaseous Effluent Instrumentation

The Radioactive gaseous effluent instrumentation is provided to monitor and control, as applicable, the releases of radioactive material in gaseous effluents during actual or potential releases of gaseous effluents. The Alarm/Trip setpoints for these instruments shall be calculated in accordance with Part II of the Offsite Dose Calculation Manual to ensure that the alarm/trip will occur prior to exceeding the limits of 10 CFR Part 20. The OPERABILITY and use of this instrumentation is consistent with the requirements of General Design Criteria 60, 63 and 64 of Appendix A to 10 CFR Part 50.

7.2 Radioactive Effluents

7.2.1 Radioactive Liquid Effluents

A. Concentration

This specification is provided to ensure that the concentration of radioactive materials released in liquid waste effluents from the site to unrestricted areas will be less than 10 times the concentration levels specified in 10 CFR Part 20, Appendix B, Table II, Column 2. This limitation provides additional assurance that the levels of radioactive materials in bodies of water outside the site will result in exposures within (1) the Section II.A design objectives of Appendix I, 10 CFR Part 50, and (2) the limits of 10 CFR Part 20.1001-20.2401 to the population. The concentration limit for dissolved or entrained noble gases is based upon the assumption that Xe-133 is the controlling isotope and its effluent concentration in air (submersion) was converted to an equivalent concentration in water.

7.2.1 (continued)

B. Dose

This specification is provided to implement the requirements of Sections II.A, III.A and IV.A of Appendix I, 10 CFR Part 50. The Limiting Condition for Operation implements the guides set forth in Section II.A of Appendix I. The ACTION statements provide the required operating flexibility and at the same time implement the guides set forth in Section IV.A of Appendix I to assure that the releases of radioactive material in liquid effluents will be kept "as low as is reasonably achievable". Also, with fresh water sites with drinking water supplies which can be potentially affected by plant operations, there is reasonable assurance that the operation of the facility will not result in radionuclide concentrations in the finished drinking water that are in excess of the requirements of 40 CFR Part 141. The dose calculation methodology and parameters in Part II of the Off-Site Dose Calculation Manual, implement the requirements in Section III.A that conformance with the guides of Appendix I is to be shown by calculational procedures based on models and data such that the actual exposure of an individual through appropriate pathways is unlikely to be substantially underestimated. The equations specified in Part II of the Off-Site Dose Calculation Manual, for calculating the doses due to the actual release rates of radioactive material in liquid effluents are consistent with the methodology provided in Regulatory Guide 1.109, "Calculation of Annual Doses to Man from Routine Releases of Reactor Effluents for the Purpose of Evaluating Compliance with 10 CFR Part 50, Appendix I," Revision 1, October 1977, and Regulatory Guide 1.113, "Estimating Aquatic Dispersion of Effluents from Accidental and Routine Reactor Releases for the Purpose of Implementing Appendix I," April 1977.

C. Liquid Waste Treatment System

The OPERABILITY of the liquid radwaste treatment system ensures that this system will be available for use whenever liquid effluents require treatment prior to release to the environment. The requirement that appropriate portions of this system be used when specified provides assurance that the releases of radioactive materials in liquid effluents will be kept "as low as is reasonably achievable". This specification implements the requirements of 10 CFR Part 50.36a, General Design Criterion 60 of Appendix I to 10 CFR Part 50 and design objective and in Section II.D of Appendix A to 10 CFR Part 50. The specified limits governing the use of appropriate portions of the liquid radwaste treatment system were specified to ensure the design objectives set forth in Section II.A of Appendix I, 10 CFR Part 50 for liquid effluents are not exceeded.

7.2.1 (continued)

D. Liquid Holdup Tanks

Restricting the quantity of radioactive material contained in the specified tanks provides assurance that in the event of an uncontrolled release of the tanks' contents, the resulting concentrations would be less than the limits of 10 CFR Part 20, Appendix B, Table II, Column 2, at the nearest potable water supply and the nearest surface water supply in an unrestricted area.

7.2.2 Radioactive Gaseous Effluents

A. Concentration

This specification, in conjunction with Steps 4.2.2A and 4.2.3A, is provided to ensure that the dose at or beyond the Site Boundary from gaseous effluents will be within the annual dose limits of 10 CFR Part 20 for MEMBERS OF THE PUBLIC. The release rate of radioactive material in airborne effluents shall be controlled such that the instantaneous concentrations for these radionuclides do not exceed the values specified in 10 CFR Part 20 for airborne effluents at the unrestricted area boundary. To support plant operations, Supervisor-System Chemistry may increase this limit up to the limits specified in Technical Specifications 5.16.1.g. Technical Specification 5.16.1.g. establishes the administrative control limit on the concentration resulting from radioactive material, other than noble gases, released in gaseous effluents to unrestricted areas conforming to ten times 10 CFR Part 20.1001-20.2401, Appendix B, Table 2, Column 1. For noble gases, the concentration shall be limited to five times 10 CFR Part 20.1001-20.2401, Appendix B, Table 2, Column 1. Because these concentrations are applied on an instantaneous basis and because of the overriding 10 CFR Part 50 Appendix I cumulative dose limitations, these limits provide reasonable assurance that radioactive material discharged in gaseous effluents will not result in the exposure of a MEMBER OF THE PUBLIC either within or outside the Site Boundary, to annual average concentrations that would result in exceeding the annual total effective dose equivalent limit specified in 10 CFR Part 20.1301(a).

7.2.2 (continued)

B. Dose - Noble Gases

This specification is provided to implement the requirements of Sections II.B, III.A and IV.A of Appendix I, 10 CFR Part 50. The Limiting Condition For Operation implements the guides set forth in Section II.B of Appendix I. The ACTION statements provide the required operating flexibility and at the same time implement the guides set forth in Section IV.A of Appendix I assure that the releases of radioactive material in gaseous effluents will be kept as low as is reasonably achievable. The surveillance requirements implement the requirements in Section III.A of Appendix I that conform with the guides of Appendix I to be shown by calculational procedures based on models and data such that the actual exposure of an individual through the appropriate pathways is unlikely to be substantially underestimated. The dose calculation methodology and parameters established in Part II of the Off-Site Dose Calculation Manual, for calculating the doses due to actual release rates of radioactive noble gases in gaseous effluents are consistent with the methodology provided in Regulatory Guide 1.109, Calculation of Annual Doses to Man from Routine Releases of Reactor Effluents for the Purpose of Evaluating Compliance with 10 CFR Part 50, Appendix I, Revision 1, October 1977 and Regulatory Guide 1.111, Methods for Estimating Atmospheric Transport and Dispersion of Gaseous Effluents in Routine Releases from Light-Water-Cooled Reactors, Revision 1, July 1977. The Off-Site Dose Calculation Manual, equations provided for determining the air doses at the site boundary are consistent with Regulatory Guides 1.109 and 1.111.

7.2.2 (continued)

C. Dose - I-131, Radioactive Material in Particulate Form with Half-Lives Greater than Eight Days (Other than Noble Gases) and Tritium

This specification is provided to implement the requirements of Sections II.C, III.A and IV.A of Appendix I, 10 CFR Part 50. The Limiting Condition For Operation implements the guides set forth in Section II.C of Appendix I. The ACTION statements provide the required operating flexibility and at the same time implement the guides set forth in Section IV.A of Appendix I assure that the releases of radioactive material in gaseous effluents will be kept as low as is reasonably achievable. The surveillance requirements implement the requirements in Section III.A of Appendix I that conform with the guides of Appendix I to be shown by calculational procedures based on models and data such that the actual exposure of an individual through the appropriate pathways is unlikely to be substantially underestimated. The dose calculation methodology and parameters established in Part II of the Off-Site Calculation Manual, for calculating the doses due to actual release rates of radioactive noble gases in gaseous effluents are consistent with the methodology provided in Regulatory Guide 1.109, Calculation of Annual Doses to Man from Routine Releases of Reactor Effluents for the Purpose of Evaluating Compliance with 10 CFR Part 50, Appendix I, Revision 1, October 1977 and Regulatory Guide 1.111, Methods for Estimating Atmospheric Transport and Dispersion of Gaseous Effluents in Routine Releases from Light-Water-Cooled Reactors, Revision 1, July 1977. The release rate specification for I-131, radioactive material in particulate form with half-lives greater than eight days (other than noble gases) and tritium are dependent on the existing radionuclide pathways to man in the areas at or beyond the site boundary. The pathways that were examined in the development of these calculations were:

1) individual inhalation of airborne radionuclides, 2) deposition of radionuclides onto green leafy vegetation with subsequent consumption by man, 3) deposition onto grassy areas where milk animals and meat producing animals graze with consumption of the milk and meat by man, and 4) deposition on the ground with subsequent exposure of man.

7.2.2 (continued)

D. Gaseous Waste Treatment

The OPERABILITY of the gaseous radwaste treatment system and the ventilation exhaust treatment systems ensures that the systems will be available for use whenever gaseous effluents require treatment prior to release to the environment. The requirement that appropriate portions of this system be used when specified provides assurance that the releases of radioactive materials in gaseous effluents will be kept as low as is reasonably achievable. This specification implements the requirements of 10 CFR Part 50.36a, General Design Criterion 60 of Appendix I to 10 CFR Part 50 and design objective and in Section II.D of Appendix A to 10 CFR Part 50. The specified limits governing the use of appropriate portions of the systems were specified to ensure the design objectives set forth in Section II.B and II.C of Appendix I, 10 CFR Part 50 for gaseous effluents are not exceeded.

7.2.2 (continued)

E. Total Dose - Uranium Fuel Cycle

This specification is provided to meet the dose limitations of 40 CFR Part 190 that have been incorporated into 10 CFR Part 20.1301(d). This requires the preparation and submittal of a Special Report whenever the calculated doses due to releases of radioactivity and to radiation from uranium fuel cycle sources exceed 25 mRems to the total body or any organ, except the thyroid, which shall be limited to less than or equal to 75 mRems. It is highly unlikely that the resultant dose to a MEMBER OF THE PUBLIC will exceed the dose limits of 40 CFR Part 190 if the plant remains within twice the dose design objectives of Appendix I, 10 CFR Part 50, and if direct radiation doses (including outside storage tanks, etc.) are kept small. The Special Report shall describe a course of action that should result in the limitation of the annual dose to a MEMBER OF THE PUBLIC to within the 40 CFR Part 190 limits. For purposes of the Special Report, it may be assumed that the dose commitment to the MEMBER OF THE PUBLIC from other uranium fuel cycle sources is negligible, with the exception that dose contributions from other nuclear fuel cycle facilities at the same site or within a radius of 8 km must be considered. If the dose to any MEMBER OF THE PUBLIC is estimated to exceed the requirements of 40 CFR Part 190, the Special Report, with a request for a variance (provided the release conditions resulting in violation of 40 CFR Part 190 have not already been corrected), in accordance with the provisions of 40 CFR Part 190.11 and 10 CFR Part 20.2203(a)(4) and 20.2203(b) is considered to be a timely request and fulfills the requirements 40 CFR Part 190 until NRC staff action is completed. The variance only relates to the limits of 40 CFR Part 190, and does not apply in any way to the other requirements for dose limitation of 10 CFR Part 20. An individual is not considered a MEMBER OF THE PUBLIC during any period in which he/she is engaged in carrying out any operation that is part of the nuclear fuel cycle. Demonstration of compliance with the limits of 40 CFR Part 190 or with the design objectives of Appendix I to 10 CFR Part 50 will be considered to demonstrate compliance with the 0.1 rem limit of 10 CFR Part 20.1301.

7.3 Radiological Environmental Monitoring

7.3.1 Monitoring Program

The radiological environmental monitoring program required by this specification provides measurements of radiation and radioactive materials in those exposure pathways and for radionuclides which lead to the highest potential radiation exposures of individuals resulting from the station operation. This monitoring program thereby supplements the radiological effluent monitoring program by verifying that the measurable concentrations of radioactive materials and levels of radiation are not higher than expected on the basis of the effluent measurements and modeling of the environmental exposure pathways. The initially specified monitoring program was effective for at least the first three years of commercial operation. Following this period, program changes are initiated based on operational experience.

7.3.2 Land Use Survey

This specification is provided to ensure that changes in the use of unrestricted areas are identified and that modifications to the monitoring program are made if required by the results of this survey. The frequency of the Land Use Survey has been reduced to a biennial requirement in site procedures because persons knowledgeable in land use census monitor usage characteristics perform routine REMP sampling. This approach allows knowledge gained during sample collection to be integrated into the program, maintaining its effectiveness. The best survey information from door to door, aerial or consulting with local agricultural authorities, or equivalent, shall be used. This survey satisfies the requirements of Section IV.B.3 of Appendix I to 10 CFR Part 50. Restricting the survey to gardens of greater than 500 square feet provides assurance that significant exposure pathways via leafy vegetables will be identified and monitored since a garden of this size is the minimum required to produce the quantity (26 kg/year) of leafy vegetables assumed in Regulatory Guide 1.109 for consumption by a child. To determine this minimum garden size, the following assumptions were used, 1) that 20% of the garden was used for growing broad leaf vegetation (i.e., similar to lettuce and cabbage), and 2) a vegetation yield of 2 kg/m².

For milk, the survey is restricted to only milk animals (cow or goat) producing milk for human consumption. Air monitoring stations are strategically located to monitor the resident receptors who could potentially receive the highest doses from airborne radioactive material. For groundwater, samples shall be taken when sources are determined to potentially be affected by plant operations, and when sources are tapped for drinking or irrigation purposes in areas where the hydraulic gradient or recharge properties are suitable for contamination. Guidance provided in the Branch Technical Position and Technical Specification 5.16.2 is used to meet the intent of NUREG-1301.

7.3.3 Interlaboratory Comparison Program

The requirement for participation in an Interlaboratory Comparison Program is provided to ensure that independent checks on the precision and accuracy of the measurements of radioactive material in environmental sample matrices are performed as part of a quality assurance program for environmental monitoring in order to demonstrate that the results are reasonably valid for the purposes of Section IV.B.2 of Appendix I to 10 CFR Part 50.

7.4 Abnormal Release or Abnormal Discharge Reporting

7.4.1 Specific information should be reported concerning abnormal (airborne and/or liquid) releases on site and abnormal discharges to the unrestricted area. The report should describe each event in a way that would enable the NRC to adequately understand how the material was released and if there was a discharge to the unrestricted area. The report should describe the potential impact on the ingestion exposure pathway involving surface water and ground water, as applicable. The report should also describe the impact (if any) on other affected exposure pathways (e.g., inhalation from pond evaporation).

7.4.2 The following are the thresholds for reporting abnormal releases and abnormal discharges in the supplemental information section:

- A. Abnormal release or Abnormal Discharges that are voluntarily reported to local authorities under NEI 07-07, Industry Ground Water Protection Initiative. [AR 39127]
- B. Abnormal release or Abnormal discharges estimated to exceed 100 gallons of radioactive liquid where the presence of licensed radioactive material is positively identified (either in the on-site environs or in the source of the leak or spill) as greater than the minimum detectable activity for the laboratory instrumentation.
- C. Abnormal releases to on-site areas that result in detectable residual radioactivity after remediation.
- D. Abnormal releases that result in a high effluent radiation alarm without an anticipated trip occurring.
- E. Abnormal discharges to an unrestricted area.

7.4.3 Information on Abnormal releases or Abnormal discharges should include the following, as applicable:

- Date and duration
- Location
- Volume
- Estimated activity of each radionuclide
- Effluent monitoring results (if any)
- On-site monitoring results (if any)
- Depth to the local water table
- Classification(s) of subsurface aquifer(s) (e.g., drinking water, unfit for drinking water, not used for drinking water)
- Size and extent of any ground water plume
- Expected movement/mobility of any ground water plume
- Land use characteristics (e.g., water used for irrigation)
- Remedial actions considered or taken and results obtained
- Calculated member of the public dose attributable to the release
- Calculated member of the public dose attributable to the discharge
- Actions taken to prevent recurrence, as applicable
- Whether the NRC was notified, the date(s), and the contact organization

PART II
CALCULATIONS

1.0 EFFLUENT MONITOR SETPOINTS

1.1 Liquid Effluents

- 1.1.1 There are two liquid discharge pathways to the Missouri River. These pathways originate with the radioactive liquid waste processing system (monitor or hotel tanks) and the steam generator blowdown system. Both of these pathways empty into the circulating water system which discharges to the Missouri River (see Figure 1). Figure 2 depicts the liquid discharge pathways and associated radiation monitors. Figure 3 depicts the methods of liquid effluent treatment.
- 1.1.2 The flowrate for dilution water varies with the number of circulating water pumps in service, the number of raw water pumps in service, and with the operation of the warm water recirculation. Some warm water from the condenser outlet is diverted from the circulating water discharge to upstream of the intake structure to help prevent ice from forming on the circulating water pump intakes during winter months. The varying dilution flowrate and utilization of warm water recirculation is accounted for in the dilution calculations for monitor tank and stream generation releases.
- 1.1.3 Technical Specification 5.16.1.b establishes the administrative control limit on concentration of radioactive material, other than dissolved or entrained noble gases, released in liquid effluents to unrestricted areas conforming to ten times 10 CFR Part 20.1001-20.2401, Appendix B, Table 2, Column 2. For dissolved or entrained noble gases, the concentration shall be limited to $2.0 \text{ E-}04 \text{ } \mu\text{Ci/ml}$ total activity.
- 1.1.4 The liquid effluent monitoring instrumentation ALERT setpoints shall be established low enough to ensure that the concentration of radioactive material released in liquid effluents at site discharge will be less than the concentrations specified in 10 CFR Part 20, Appendix B, Table 2, Column 2.
- 1.1.5 The liquid effluent monitoring instrumentation HIGH ALARM setpoints shall be established low enough to ensure that the concentration of radioactive material released in liquid effluents at site discharge will be less than 10 times the concentrations specified in 10 CFR Part 20, Appendix B, Table 2, Column 2.
- 1.1.6 Cs-137 is used to calibrate the liquid effluent monitors.

| |
|--|
| NOTE |
| <p>If the annual average χ/Q value exceeds $1.4E-04 \text{ sec/m}^3$, consideration should be given to basing liquid radiation monitor setpoints on an I-131 instantaneous limit of $2.0E-09 \text{ } \mu\text{Ci/ml}$ at the unrestricted area boundary with 10% vapor/liquid separation. Contact the Supervisor-System Chemistry for further instructions.</p> |

1.1.7 Liquid Effluent Radiation Monitors

A. Steam Generator Blowdown Monitors (RM-054A and B)

1. These process radiation detectors monitor the flow through the steam generator blowdown lines and automatically close the blowdown isolation valves if the monitor high alarm setpoint is reached. The monitor controls liquid effluent releases so that 10 times the 10 CFR Part 20 limit at the unrestricted area boundary of $1.0E-06 \text{ } \mu\text{Ci/cc}$, is not exceeded at the site discharge.
2. The following calculations for maximum concentration and alarm setpoints are valid for simultaneous radioactive liquid releases of steam generator blowdown and monitor tank discharge.
3. The maximum allowable concentration in the blowdown line is calculated as follows:

$$C_{MAX} = \frac{(1.0E - 05 \text{ } \mu\text{Ci/ml})(F)}{f}$$

Where:

- $1.0E-05 \text{ } \mu\text{Ci/ml}$ = Ten times 10 CFR Part 20 Limit for unidentified radionuclides at site discharge (10 CFR Part 20, Appendix B, Note 2).
- F = Total dilution flow in the discharge tunnel (gpm). (Normal flow is based on 1 circulating water pump at 120,000 gpm. Other flowrates may be used, as required.)
- f = Blowdown flow rate (gpm). (Normal blowdown flow rate is based on 2 transfer pumps with a design flow of 135 gpm each, 270 gpm total. Other flow rates may be used, as required.)
- C_{MAX} = Maximum allowable blowdown concentration ($\mu\text{Ci/ml}$).

1.1.7A (continued)

| | | |
|----------|---|----------|
| i | NOTE | i |
| | Setpoints may be recalculated based on adjusted dilution flow and adjusted blowdown flow. | |

The **High Alarm Setpoint** (CPM):

$$\text{Setpoint} = 0.75 \left[\left((K_4)(S_f)(C_{MAX}) \right) + B \right]$$

Where:

- 0.75 = An administrative correction factor which includes the following:
- 15% tolerance to ensure radmonitor response in accordance with License Event Report 77-17, Docket Number 050-0285 and Telecon FC-472-77.
 - 10% tolerance to account for the difference in detector sensitivity for the range of isotopes detected.
- S_f = Detector sensitivity factor (CPM/μCi/ml). (Sensitivity based on Cs-137).
- K₄ = Allocation factor for Individual Steam Generator Release (See Table 1)
- B = Background (CPM)
- C_{MAX} = Maximum allowable blowdown line activity (μCi/ml).

The **Alert Setpoint** will be chosen less than or equal to one tenth (1/10) the value of the high alarm setpoint value so that significant increases in activity will be identified prior to exceeding an Unrestricted Area fractional sum of 1.0. It will also provide additional time for corrective actions prior to exceeding the Alarm Setpoint.

1.1.7 (continued)

B. Overboard Discharge Header Monitor (RM-055)

1. This process radiation monitor provides control of the waste monitor tank effluent by monitoring the overboard header prior to its discharge into the circulating water discharge tunnel. The concentration of activity at discharge is controlled below ten times the 10 CFR Part 20 limit of $1.0E-06 \mu\text{Ci/ml}$ at site discharge for unidentified isotopes by the high alarm setpoint which closes the overboard flow control valve.
2. The following calculations for maximum concentration and alarm setpoints are valid for simultaneous radioactive liquid releases of monitor tank discharge and steam generator blowdown.
3. The maximum allowable concentration in the overboard discharge header is:

$$C_{MAX} = \frac{(1.0E - 05 \mu\text{Ci/ml}) (F)}{f}$$

Where:

- $1.0E-05 \mu\text{Ci/ml}$ = Ten times 10 CFR Part 20 Limit for unidentified radionuclides at site discharge (10 CFR Part 20, Appendix B, Note 2).
- F = Total dilution flow in the discharge tunnel (gpm).
(Normal flow is based on 1 circulating water pump at 120,000 gpm. Other flowrates such as raw water pump(s) may be used, as required.)
- f = Maximum monitor tank discharge flow rate (gpm).
(Normal monitor tank maximum flow is 50 gpm. Other flow rates such as raw water pump(s) may be used, as required.)
- C_{MAX} = Maximum allowable activity in discharge header ($\mu\text{Ci/ml}$).

1.1.7B (continued)

The High Alarm Setpoint (CPM):

$$\text{Setpoint} = 0.75 \left[\left((K_5)(S_f)(C_{MAX}) \right) + B \right]$$

Where:

- 0.75 = An administrative correction factor which includes the following:
- 15% tolerance to ensure radmonitor VIAS response in accordance with License Event Report 77-17, Docket Number 050-0285 and Telecon FC-472-77.
 - 10% tolerance to account for the difference in detector sensitivity for the range of isotopes detected.
- S_f = Detector sensitivity factor (CPM/ μ Ci/ml). (Sensitivity based on Cs-137).
- K_5 = Allocation factor for Waste Liquid Releases (See Table 1)
- C_{MAX} = Maximum allowable concentration in discharge header (μ Ci/ml).
- B = Background (CPM)

The **Alert Setpoint** will be chosen less than or equal to one tenth (1/10) the value of the high alarm setpoint value so that significant increases in activity will be identified prior to exceeding an Unrestricted Area fractional sum of 1.0. It will also provide additional time for corrective actions prior to exceeding the Alarm Setpoint.

1.2 Airborne Effluents

1.2.1 There are three air effluent discharge pathways at the Fort Calhoun Station: Condenser Offgas, Laboratory and Radioactive Waste Processing Building Exhaust Stack, and the Auxiliary Building Exhaust Stack. An airborne radioactive waste flow diagram with the applicable, associated radiation monitoring instrumentation and controls is presented as Figure 4. The airborne waste disposal system is presented in Figure 5.

- Auxiliary Building - The Auxiliary Building Exhaust Stack receives discharges from the waste gas decay tanks, containment purge, containment vent systems and the auxiliary building ventilation system. Radiation Monitor RM-062 provides noble gas monitoring and iodine and particulate sampling for the Auxiliary Building Exhaust Stack. Backup noble gas monitoring and iodine and particulate sampling is provided by RM-052. Ventilation Isolation Actuation Signal (VIAS) is actuated by exceeding a monitor's alarm setpoint. Actuation of VIAS will isolate releases from containment and waste gas decay tanks. The Auxiliary Building Exhaust fans will remain in operation.
- Laboratory and Radioactive Waste Processing Building (LRWPB) - Noble gas monitoring and particulate and iodine sampling is provided by RM-043. This radiation monitor/sampler does not serve a control function.
- Condenser Off-Gas Monitors - Noble gas activity is monitored by RM-057. The condenser off-gas is discharged directly to the environment. Exceeding the high alarm setpoint on RM-057 will activate isolation of main steam to the Auxiliary Steam System.

Technical Specification 5.16.1.g. establishes the administrative control limit on the concentration resulting from radioactive material, other than noble gases, released in gaseous effluents to unrestricted areas conforming to ten times 10 CFR Part 20.1001-20.2401, Appendix B, Table 2, Column 1. For noble gases, the concentration shall be limited to five times 10 CFR Part 20.1001-20.2401, Appendix B, Table 2, Column 1.

The airborne effluent monitoring instrumentation ALERT setpoints shall be established low enough to ensure that the concentration of radioactive material released in air effluents at site discharge will be less than the concentrations specified in 10 CFR Part 20, Appendix B, Table 2, Column 1.

The airborne effluent monitoring instrumentation HIGH ALARM setpoints shall be established low enough to ensure that the concentration of radioactive material released in air effluents at site discharge will be less than 5 times the concentrations specified in 10 CFR Part 20, Appendix B, Table 2, Column 1.

1.2.2 Airborne Effluent Radiation Monitors

A. Auxiliary Building Exhaust Stack Noble Gas Activity Monitor (RM-062/RM-052)

1. Either of these monitors may be used to measure the noble gas activity in the exhaust stack. The noble gas is monitored after passing through a particulate filter, and charcoal cartridge. The monitor controls airborne releases so that five times the 10 CFR Part 20 limit at the unrestricted area boundary of $5.0E-07 \mu\text{Ci/cc}$, based upon Xe-133, is not exceeded. The Ventilation Isolation Actuation Signal is initiated when the high alarm setpoint is reached.
2. The following calculations for maximum release rate and alarm setpoint are valid for simultaneous airborne releases from Auxiliary Building Exhaust Stack, Condenser Off-gas and the LRWPB Exhaust Stack.
3. The maximum allowable release rate for stack airborne activity is calculated as follows:

$$R_{MAX} \mu\text{Ci/sec} = \left(\frac{2.5E-06 \mu\text{Ci/cc}}{\chi/Q \text{ sec/m}^3} \right) 1.0E+06 \text{ cc/m}^3$$

Where:

$2.5E-06 \mu\text{Ci/cc}$ = 5 times the 10 CFR Part 20 Limit at the unrestricted area boundary (based upon Xe-133).

$\chi/Q \text{ sec/m}^3$ = Annual average dispersion factor at the unrestricted area boundary from Part II Table 4, of the Off-Site Dose Calculation Manual.

$1.0E+06 \text{ cc/m}^3$ = Constant of unit conversion.

1.2.2A (continued)

The High Alarm Setpoint (CPM):

$$\text{Setpoint} = 0.75 \left[K_1 \left(\frac{(R_{MAX})(S_f)(60)}{(F_v)(28317)} \right) + B \right]$$

Where:

- 0.75 = An administrative correction factor which includes the following:
- 15% tolerance to ensure radmonitor VIAS response in accordance with License Event Report 77-17, Docket Number 050-0285 and Telecon FC-472-77.
 - 10% tolerance to allow for the contribution of noble gases other than Xe-133 towards the total ECL fraction sum.
- S_f = Detector sensitivity factor (CPM/μCi/cc). (Sensitivity based on Xe-133)
- K₁ = Allocation factor for Auxiliary Building Exhaust Stack (See Table 1)
- 60 = Conversion (seconds to minutes).
- 28317 = Conversion factor (ft³ to cc).
- F_v = Auxiliary Building Exhaust stack flow rate (SCFM). (Default maximum flow rate is 122,500 cfm for 3 Auxiliary Building exhaust fans and 2 containment purge fans in operation. Other flow rates may be used, as required.)
- R_{MAX} = Maximum Allowable Release Rate in μCi/sec
- B = Background (CPM)

The Alert Setpoint will be chosen less than or equal to one fifth (1/5) the value of the high alarm setpoint value so that significant increases in activity will be identified, prior to exceeding an Unrestricted Area fractional sum of 1.0. It will also provide additional time for corrective actions prior to exceeding the Alarm Setpoint and VIAS actuation.

1.2.2 (continued)

B. Condenser Off Gas Monitor (RM-057)

1. This monitor is located in the turbine building and monitors the condenser off-gas. The purpose of this monitor is to monitor the condenser off-gas discharges so that five times the 10 CFR Part 20 limit at the unrestricted area boundary of $5.0E-07 \mu\text{Ci/cc}$, based upon Xe-133, is not exceeded.
2. The following calculations for maximum release rate and alarm setpoint are valid for simultaneous airborne releases from condenser off-gas, Auxiliary Building Exhaust Stack, and the LRWPB Exhaust Stack.
3. The maximum allowable release rate for condenser air ejector monitor is as follows:

$$R_{MAX} \mu\text{Ci}/\text{sec} = \left(\frac{2.5E-06 \mu\text{Ci}/\text{cc}}{\chi/Q \text{ sec}/\text{m}^3} \right) 1.0E+06 \text{ cc}/\text{m}^3$$

Where:

$2.5E-06 \mu\text{Ci}/\text{cc}$ = 5 times the 10 CFR Part 20 Limit at the unrestricted area boundary (based upon Xe-133).

$\chi/Q \text{ sec}/\text{m}^3$ = Annual average dispersion factor at the unrestricted area boundary from Part II, Table 4, of the Off-Site Dose Calculation Manual.

$1.0E+06 \text{ cc}/\text{m}^3$ = Constant of unit conversion.

1.2.2B (continued)

The High Alarm Setpoint (CPM):

$$\text{Setpoint} = 0.75 \left[K_2 \left(\frac{(R_{MAX})(S_f)(60)}{(F_v)(28317)} \right) + B \right]$$

Where:

- 0.75 = An administrative correction factor which includes the following:
- 15% tolerance to ensure radmonitor VIAS response in accordance with License Event Report 77-17, Docket Number 050-0285 and Telecon FC-472-77.
 - 10% tolerance to allow for the contribution of noble gases other than Xe-133 towards the total ECL fraction sum.
- S_f = Detector sensitivity factor (CPM/μCi/cc). (Sensitivity based on Xe-133)
- K₂ = Allocation factor for Condenser Off Gas (See Table 1)
- 60 = Conversion (seconds to minutes).
- 28317 = Conversion factor (ft³ to cc).
- F_v = Vent stack flow rate (SCFM). Default maximum flow rate is 4,755 scfm (3 vacuum pumps in hogging mode. Other flow rates may be used, as required.)
- R_{MAX} = Maximum Allowable Release Rate in μCi/sec.
- B = Background (CPM)

The **Alert Setpoint** will be chosen less than or equal to one fifth (1/5) the value of the high alarm setpoint value so that significant increases in activity will be identified, prior to exceeding an Unrestricted Area fractional sum of 1.0. It will also provide additional time for corrective actions prior to exceeding the Alarm Setpoint and tripping of the auxiliary steam supply valve, RCV-978.

1.2.2 (continued)

C. Laboratory and Radioactive Waste Processing Building Exhaust Stack Noble Gas Activity Monitor and Iodine and Particulate Sampler (RM-043)

1. RM-043 is located in the Radwaste Building and samples the LRWPB Exhaust Stack. The monitor alarm setpoint is based on five times the 10 CFR Part 20 limit for Xe-133 at the unrestricted area boundary.
2. The following calculations for maximum release rate and alarm setpoint are valid for simultaneous airborne releases from condenser off-gas, Auxiliary Building Exhaust Stack, and the LRWPB Exhaust Stack.

$$R_{MAX} \mu Ci/sec = \left(\frac{2.5E-06 \mu Ci/cc}{\chi/Q \text{ sec}/m^3} \right) 1.0E+06 \text{ cc}/m^3$$

The maximum allowable release rate for RM-043 is as follows:

Where:

2.5E-06 $\mu Ci/cc$ = 5 times the 10 CFR Part 20 Limit at the unrestricted area boundary (based upon Xe-133).

χ/Q = Annual average dispersion factor at the unrestricted area boundary from Part II of the Off-Site Dose Calculation Manual, Table 4.

1.0E+06 cc/m^3 = Constant of unit conversion

1.2.2C (continued)

| |
|--|
| NOTE |
| <p>This monitor alarms in the Control Room. There are no automatic control functions associated with the actuation of the alarm.</p> |

The High Alarm Setpoint (CPM):

$$\text{Setpoint} = 0.75 \left[K_3 \left(\frac{(R_{MAX})(S_f)(60)}{(F_v)(28317)} \right) + B \right]$$

Where:

- 0.75 = An administrative correction factor which includes the following:
- 15% tolerance to ensure radmonitor VIAS response in accordance with License Event Report 77-17, Docket Number 050-0285 and Telecon FC-472-77.
 - 10% tolerance to allow for the contribution of noble gases other than Xe-133 towards the total ECL fraction sum.
- S_f = Detector sensitivity factor (CPM/ μ Ci/cc). (Sensitivity based on Xe-133)
- K_3 = Allocation factor for LRWPB Exhaust Stack (See Table 1)
- 60 = Conversion (seconds to minutes).
- 28317 = Conversion factor (ft³ to cc).
- F_v = LRWPB Exhaust stack flow rate (SCFM). (Default flow rate is 28,700 cfm. Other flow rates may be used if required.)
- R_{MAX} = Maximum Allowable Release Rate in μ Ci/sec.
- B = Background (CPM)

The Alert Setpoint will be chosen less than or equal to one fifth (1/5) the value of the high alarm setpoint value so that significant increases in activity will be identified, prior to exceeding an Unrestricted Area fractional sum of 1.0. It will also provide additional time for corrective actions prior to exceeding the Alarm Setpoint.

Table 1 - Allocation Factors for Simultaneous Releases

| NOTE | | |
|---|--|--------------------|
| i | The Fort Calhoun Station is capable of performing simultaneous airborne releases. The factors below may be adjusted to meet release requirements, provided that the sum of the Unrestricted Area Fraction Sum for all airborne releases remains less than or equal to 1.0. | i |
| A. Allocation Factors for Simultaneous Airborne Releases | | |
| 1. | Auxiliary Building Exhaust Stack | Total: 0.80 |
| K1 | Noble Gases (RM-062 or RM-052) | 0.70 |
| | Iodine/Particulate/Tritium | 0.10 |
| | Contributing Pathways: | |
| | a) Auxiliary Building | 0.10 |
| | b) Containment Building | 0.65 |
| | c) Waste Gas Decay Tanks | 0.05 |
| 2. | Condenser/Off Gas | Total: 0.10 |
| K2 | Noble Gases (RM-057) | 0.05 |
| | Tritium | 0.05 |
| | Contributing Pathways: | |
| | a) Condenser Off Gas | 0.10 |
| 3. | Laboratory and Radioactive Waste Building Exhaust Stack | Total: 0.10 |
| K3 | Noble Gases (RM-043) | 0.05 |
| | Iodine/Particulate | 0.05 |
| | Contributing Pathways: | |
| | a) Laboratory and Radioactive Waste Building Exhaust Stack | 0.10 |
| Airborne Release Total | | 1.00 |
| NOTE | | |
| i | The Fort Calhoun Station is capable of performing simultaneous liquid releases. The factors below may be adjusted to meet release requirements provided that the sum of the Unrestricted Area Fraction Sum for all liquid releases remains less than or equal to 1.0. | i |
| B. Allocation Factors for Simultaneous Liquid Releases | | |
| 1. | K4 Steam Generator Releases (RM-054A/054B) | Total: 0.30 |
| | Contributing Pathways: | |
| | a) Alpha Steam Generator (RM-054A) | 0.15 |
| | b) Bravo Steam Generator (RM-054B) | 0.15 |
| 2. | K5 Waste Liquid Releases (RM-055) | 0.70 |
| Liquid Release Total | | 1.00 |

Figure 1 - Exclusion and Site Boundary Map

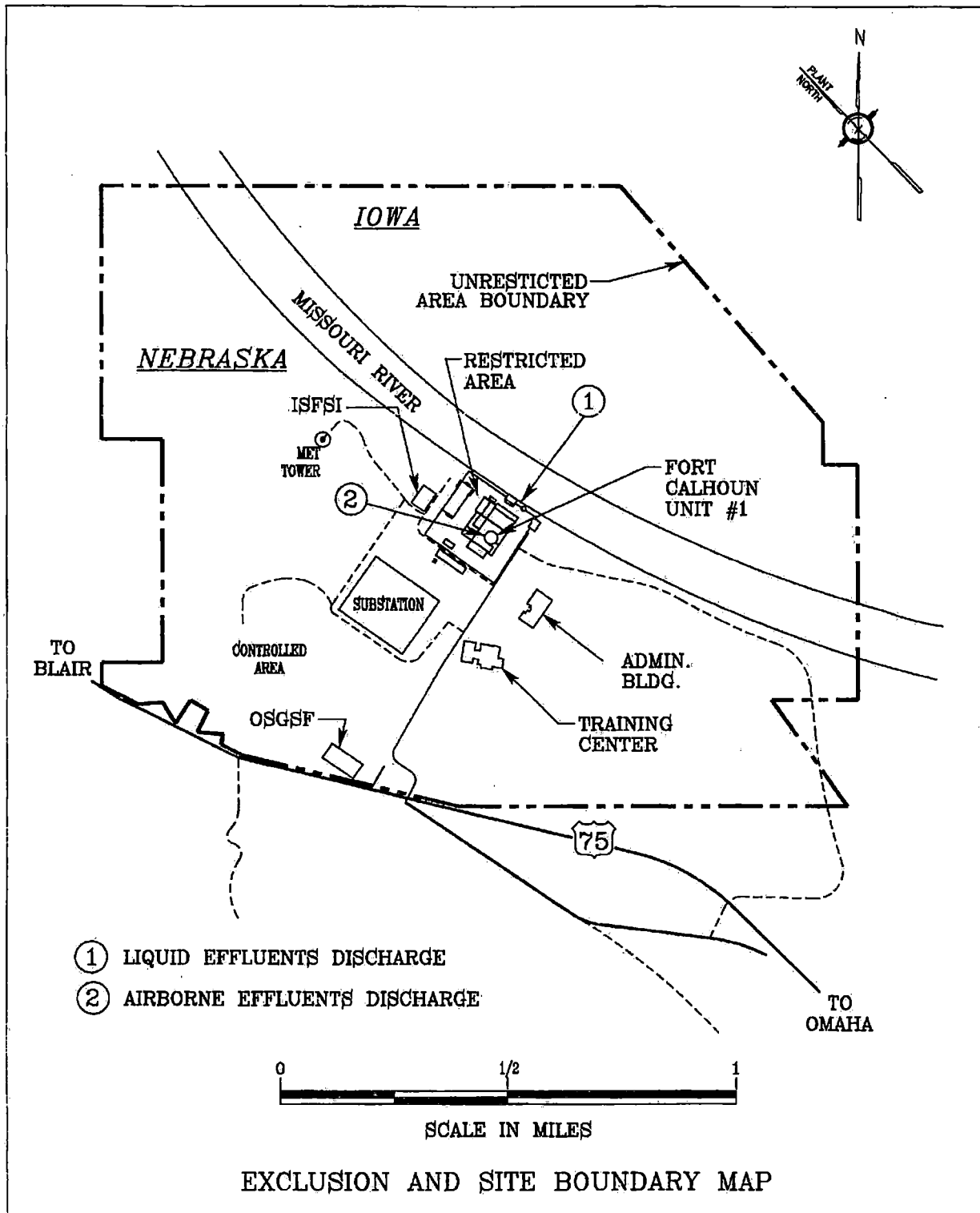
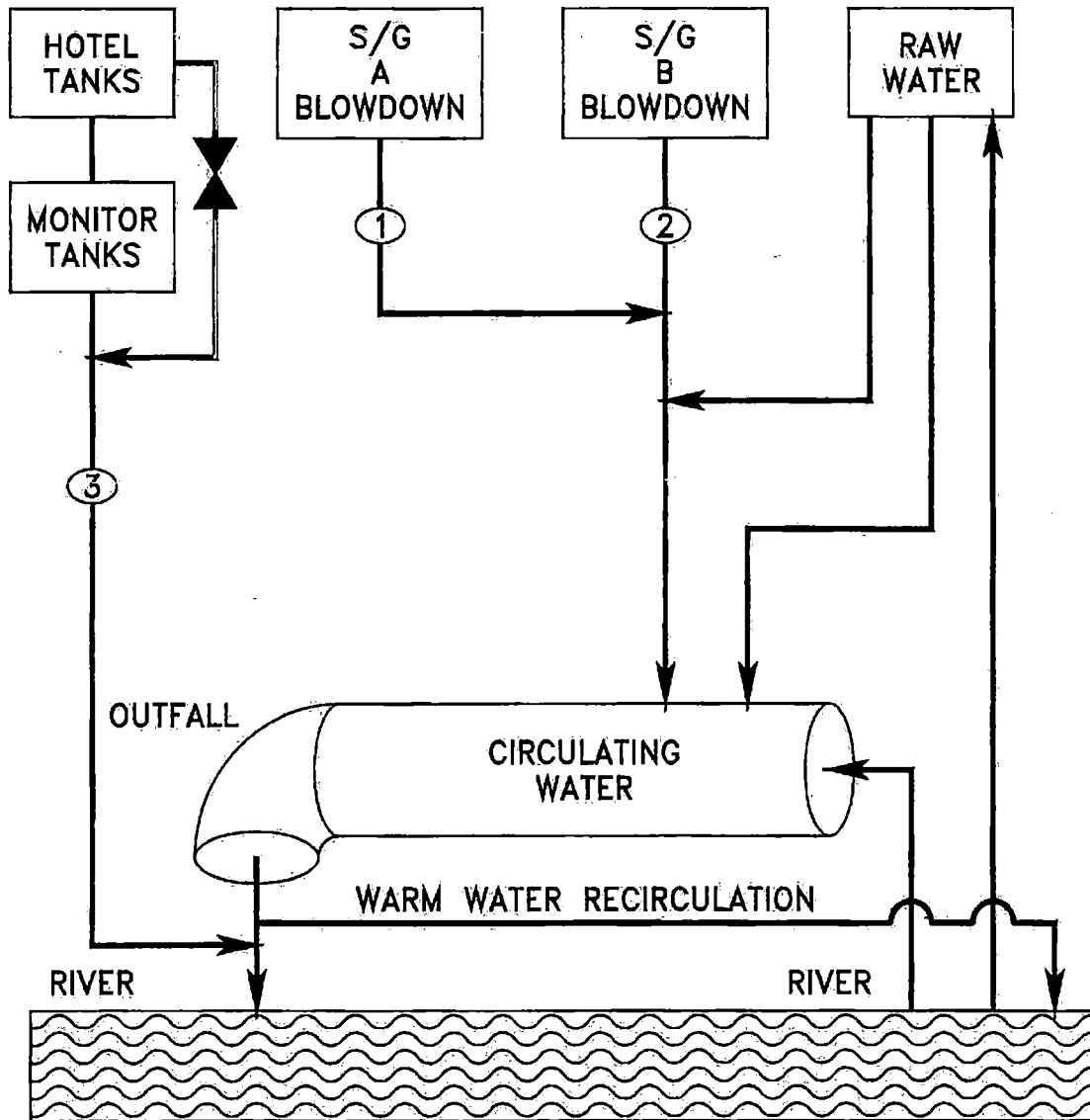

Figure 2 - Liquid Radioactive Discharge Pathways



- ① RM-054A
- ② RM-054B
- ③ RM-055

LIQUID RADIOACTIVE DISCHARGE PATHWAYS

Figure 3 - Liquid Radioactive Waste Disposal System

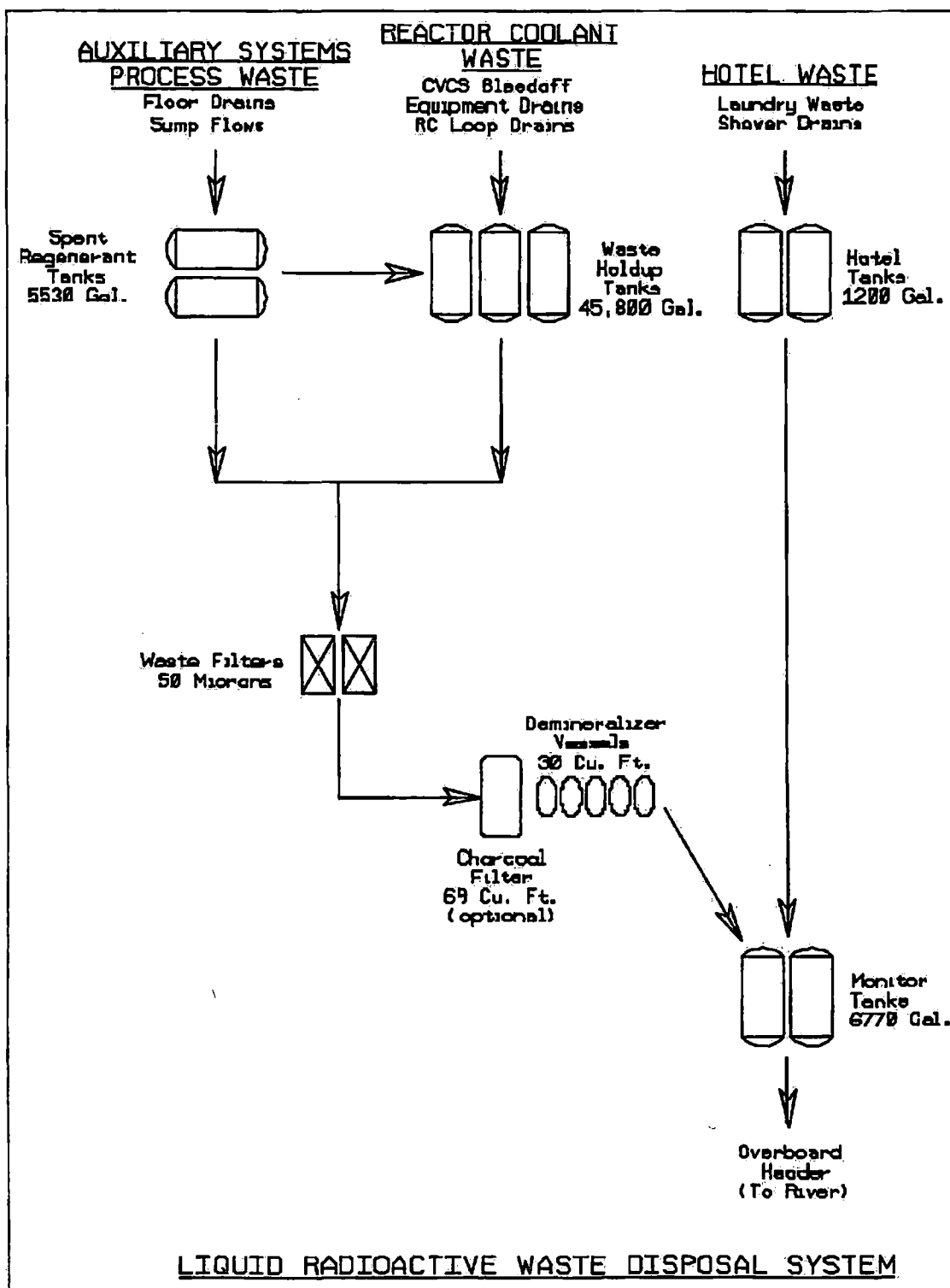

Figure 4 - Airborne Effluent Discharge Pathways

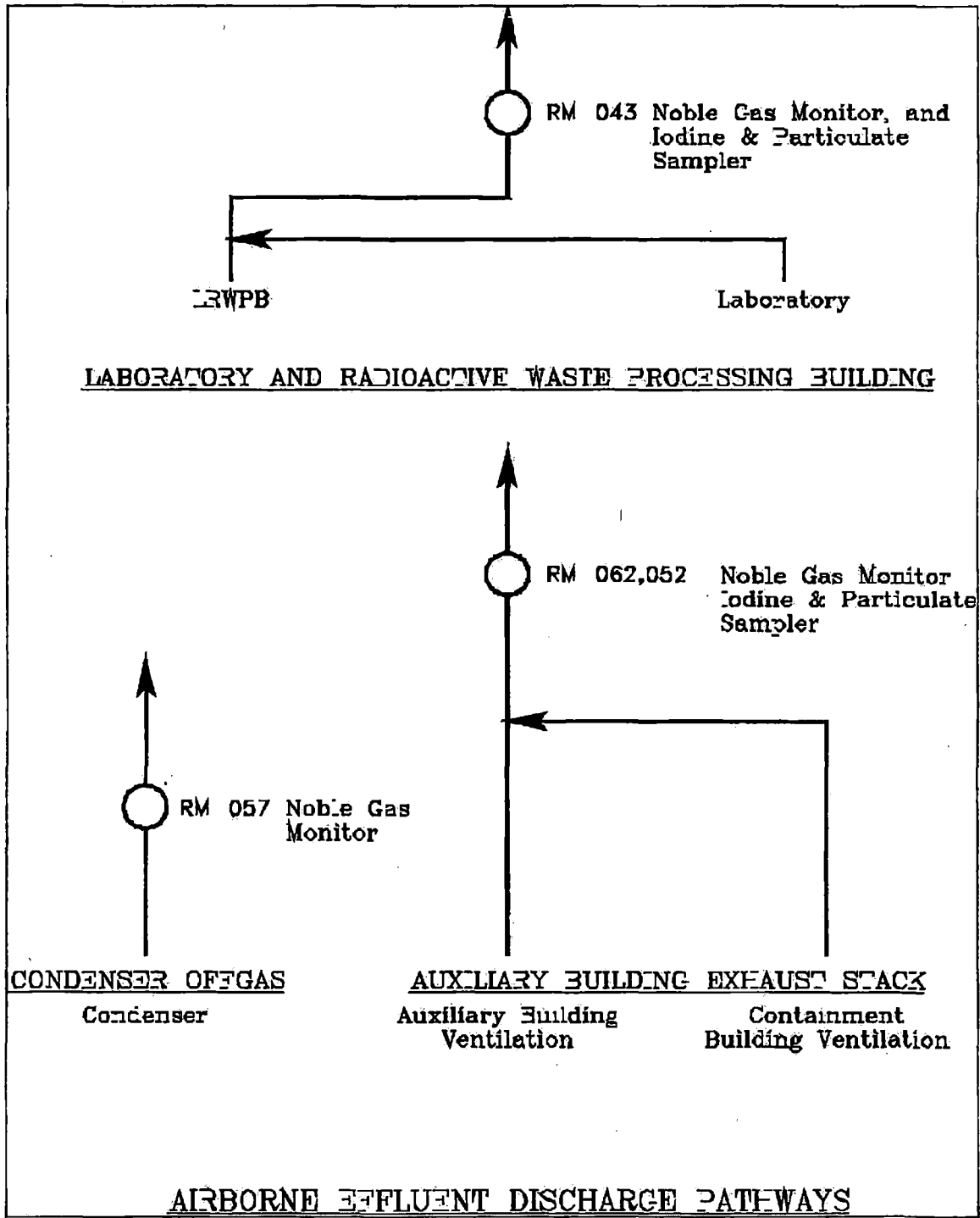
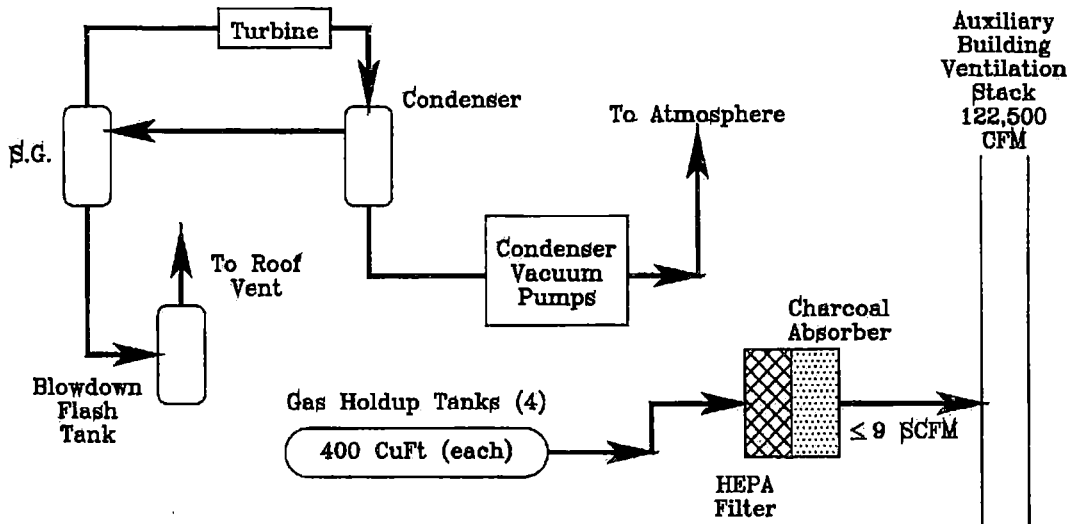
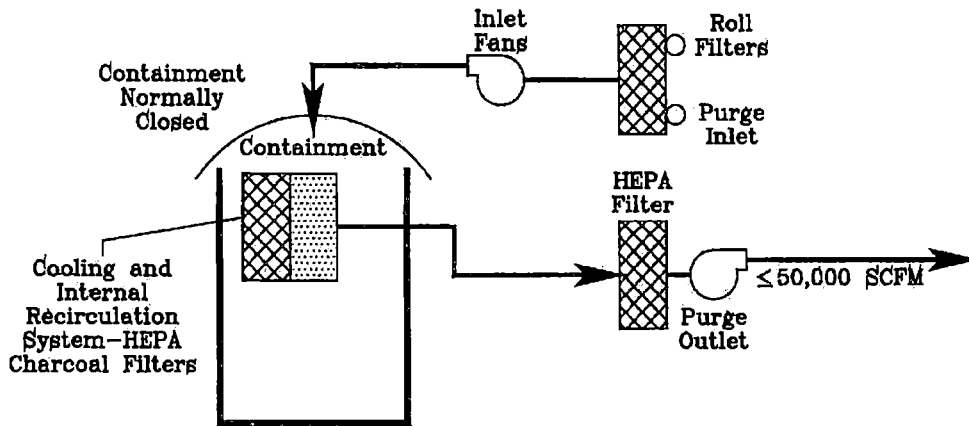

Figure 5 - Airborne Radioactive Waste Disposal System



WASTE GAS AND CONDENSER OFF-GAS SYSTEMS



CONTAINMENT BUILDING VENTILATION CONTROL

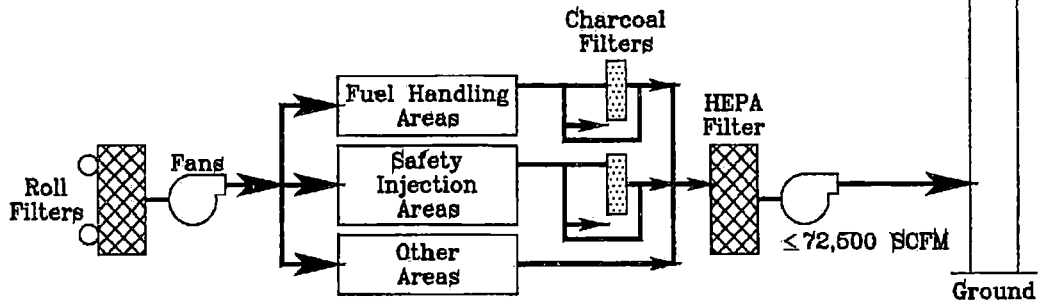

AIRBORNE RADIOACTIVE WASTE DISPOSAL SYSTEM

2.0 EFFLUENT CONCENTRATIONS

2.1 Liquid Effluent Concentrations

2.1.1 The concentration of radioactive material in liquid effluents (after dilution in the Circulating Water System) will be limited to the concentrations as specified in 10 CFR Part 20, Appendix B, Table 2, Column 2. For batch releases (Monitor and Hotel Waste Tanks and Steam Generators) and for continuous releases (Steam Generator Blowdown), the analyses will be performed in accordance with Part I, Table 4.1, of the Off-Site Dose Calculation Manual, and the concentration of each radionuclide at site discharge will be calculated, based on the following equation:

$$A_i = \frac{a_i f}{F + f}$$

$$\text{and } \sum_{i=1}^n \frac{A_i}{wec_i} \leq 1$$

Radionuclide concentration at site discharge:

Where:

- A_i = concentration at site discharge for radionuclide (I), in $\mu\text{Ci/ml}$.
- a_i = concentration of radionuclide (I) in the undiluted effluent, in $\mu\text{Ci/ml}$.
- f = undiluted effluent flowrate, in gpm.
- F = total diluted effluent flowrate in gpm.
- wec_i = water effluent concentration limit for radionuclide (I) per 10 CFR Part 20, Appendix B, Table 2, Column 2.

| | | |
|----------|--|----------|
| i | NOTE | i |
| | In addition to the above defined method, Notes 1 through 4 of 10 CFR Part 20, Appendix B, will also be applicable. | |

2.2 Airborne Effluent Concentrations

2.2.1 The concentration at the unrestricted area boundary, due to airborne effluent releases, will be limited to less than Appendix B, Table 2, Column 1, values. Radiation monitor alarm setpoints are established to ensure that these release limits are not exceeded. In the event an airborne effluent release from the station result in an alarm setpoint being exceeded, an evaluation of the unrestricted area boundary concentration resulting from the release will be performed:

2.2.2 To determine the concentration and air effluent concentration (aec) fraction summation at the unrestricted area boundary, the following equations will be used:

$$A_i = K_0 Q_i (\chi/Q)$$

$$\text{and } \sum_{i=1}^n \frac{A_i}{ECL_i} \leq 1$$

Where:

A_i = Concentration of radionuclide (I) at the unrestricted area boundary

K_0 = Constant of unit conversion. (1.0E-6 m3/cc)

ECL_i = Effluent concentration limit (10 CFR Part 20, Appendix B, Table 2, Column 1 value for radionuclide(I))

Q_i = The release rate of radionuclide (I) in airborne effluents from all vent releases (in $\mu\text{Ci/sec.}$)

(χ/Q) = Annual Average Dispersion Factor at the Unrestricted Area Boundary from Part II, Table 4, of the Off-Site Dose Calculation Manual.

2.2.3 As appropriate, simultaneous releases from the Auxiliary Building Ventilation Stack, Laboratory and Radwaste Building Stack and condenser off gas will be considered in evaluating compliance with the release rate limits of 10 CFR Part 20. Monitor indications (readings) may be averaged over a time period not to exceed 15 minutes when determining noble gas release rate based on correlation of the monitor reading and monitor sensitivity. Historical annual average dispersion parameters, as presented in Table 4, may be used for evaluating the airborne effluent dose rate.

- 2.2.4 For administrative purposes, more conservative alarm setpoints than those as prescribed above may be imposed. However, conditions exceeding those more limiting alarm setpoints do not necessarily indicate radioactive material release rates exceeding 10 CFR Part 20 limits. Provided actual releases do not result in radiation monitor indications exceeding alarm setpoint values based upon the above criteria, no further analyses are required for demonstrating compliance with 10 CFR Part 20.

3.0 RADIOACTIVE EFFLUENT DOSE CALCULATIONS

3.1 Liquid Effluent Dose Calculations

- 3.1.1 Three pathways for human exposure to liquid releases from FCS to the Missouri River exists: 1) fish, 2) drinking water, and 3) Shoreline deposition. Fish are considered to be taken from the vicinity of the plant discharge. The drinking water for Omaha is located 19 miles downstream from FCS. The dilution factors for these pathways are derived from the Revised Environmental Report for FCS, (1974), (page 4-29 and 4-31). This report states that during Low-Low river conditions, the concentration at Omaha's water intake will be $\leq 14\%$ of the concentration at discharge from FCS and will average 3%. This equates to a dilution factor of 7.14, which is used to calculate the maximum dose to an individual from liquid pathways and a dilution factor of 33.33, for calculating the average dose. All pathways combine to give the dose to an individual in unrestricted areas.
- 3.1.2 10 CFR Part 50, Appendix I restricts the dose to individuals in the unrestricted areas from radioactive materials in liquid effluents from the Fort Calhoun Station to the following limits:

- during any calendar quarter
 - ≤ 1.5 mrem to total body
 - ≤ 5.0 mrem to any organ

and

- during any calendar year
 - ≤ 3.0 mrem to total body
 - ≤ 10.0 mrem to any organ

The following calculational methods shall be used for determining the dose or dose commitment from liquid effluents.

3.1.3 Doses from Liquid Effluent Pathways

A. Potable Water

$$R_{apj} = 1100 \frac{U_{ap} M_p}{F} \sum_{i=1}^n Q_i D_{aipj} \exp(-\lambda_i t_p)$$

Where:

R_{apj} = is the total annual dose to organ(j) of individuals of age group (a) from all of the radionuclides (I) in pathway (p), in mrem/yr.

U_{ap} = is a usage factor that specifies the intake rate for an individual of age group (a) associated with pathway (p), in ℓ /yr. (Table 6)

M_p = is the mixing ratio (reciprocal of the dilution factor) at the point of withdrawal of drinking water, dimensionless. (Table 17)

F = is the flow rate of the liquid effluent, in ft^3/sec .

Q_i = is the annual release rate of radionuclide (I), in Ci/yr.

D_{aipj} = is the dose factor specific to a given age group (a), radionuclide (I), pathway (p), and organ (j) which can be used to calculate the radiation dose from an intake of a radionuclide, in mrem/pCi. (Tables 13-16)

λ_i = is the radiological decay constant of radionuclide (I), in hr^{-1} .

t_p = is the average transit time required for radionuclides to reach the point of exposure. For internal dose, t_p is the total time elapsed between release of the radionuclides and ingestion of water, in hours. (Table 17)

1100 = Constant ($\text{pCi} \cdot \text{yr} \cdot \text{ft}^3/\text{Ci} \cdot \text{sec} \cdot \text{L}$)

3.1.3 (continued)

B. Aquatic Foods

$$R_{apj} = 1100 \frac{U_{ap} M_p}{F} \sum_{i=1}^n Q_i B_{ip} D_{aipj} \exp(-\lambda_i t_p)$$

Where:

- R_{apj} = is the total annual dose to organ (j) of individuals of age group (a) from all of the radionuclides (I) in pathway (p), in mrem/yr.
- U_{ap} = is a usage factor that specifies the intake rate for an individual of age group (a) associated with pathway (p), in kg/yr. (Table 6)
- M_p = is the mixing ratio (reciprocal of the dilution factor) at the point of harvest of aquatic food, dimensionless. (Table 17)
- F = is the flow rate of the liquid effluent, in ft³/sec.
- Q_i = is the annual release rate of radionuclide (I), in Ci/yr.
- B_{ip} = is the equilibrium bioaccumulation factor for radionuclide (I) in pathway (p) expressed as the ratio of the concentration in biota (in pCi/kg) to the radionuclide concentration in water (in pCi/liter), in (pCi/kg)/(pCi/liter). (Table 3)
- D_{aipj} = is the dose factor specific to a given age group (a), radionuclide (I), pathway (p), and organ (j), which can be used to calculate the radiation dose from an intake of a radionuclide, in mrem/pCi. (Tables 13-16)
- λ_i = is the radiological decay constant of radionuclide (I), in hr⁻¹.
- t_p = is the average transit time required for radionuclides to reach the point of exposure. For internal dose, t_p is the total time elapsed between release of the radionuclides and ingestion of food, in hours. (Table 17)
- 1100 = Constant (pCi * yr * ft³/Ci * sec * L)

3.1.3 (continued)

C. Shoreline Deposits

$$R_{apj} = 110,000 \frac{U_{ap} M_p W}{F} \sum_{i=1}^n Q_i T_{ip} D_{aipj} [\exp(-\lambda_i t_p)] [1 - \exp(-\lambda_i t_b)]$$

Where:

R_{apj} = is the total annual dose to organ (j) of individuals of age group (a) from all of the radionuclides (I) in pathway (p), in mrem/yr.

U_{ap} = is a usage factor that specifies the exposure time for an individual of age group (a) associated with pathway (p), in hr/yr. (Table 6)

M_p = is the mixing ratio (reciprocal of the dilution factor) at the point of exposure, dimensionless. (Table 17)

W = is the shore-width factor, dimensionless. (Table 17)

F = is the flow rate of the liquid effluent, in ft³/sec.

Q_i = is the annual release rate of radionuclide (I), in Ci/yr.

T_{ip} = is the radioactive half life of radionuclide (I), in days.

D_{aipj} = is the dose factor specific radionuclide (I) which can be used to calculate the radiation dose from exposure to a given concentration of a radionuclide in sediment, expressed as a ratio of the dose rate (in mrem/hr) and the real radionuclide concentration (in pCi/m²). (Table 8)

λ_i = is the radiological decay constant of radionuclide (I), in hr⁻¹.

t_p = is the average transit time required for radionuclides to reach the point of exposure, in hours. (Table 17)

t_b = is the period of time for which sediment or soil is exposed to the contaminated water, in hours. (Table 17)

110,000 = Constant [(100 * pCi * yr * ft³)/(Ci * sec * L)]

3.2 Airborne Effluent Dose Calculations

3.2.1 Noble Gas

10 CFR Part 50, Appendix I, restricts the dose to individuals in the unrestricted areas from noble gases in airborne effluents from the Fort Calhoun Station to the following limits:

- During any calendar quarter
 - ≤ 5 mrad-gamma air dose
 - ≤ 10 mrad-beta air dose

and

- During any calendar year
 - ≤ 10 mrad-gamma air dose
 - ≤ 20 mrad-beta air dose

The following general equations shall be used to calculate the gamma-air and beta-air doses:

A. Doses from Noble Gases

1. Annual Gamma/Beta Air Dose from All Other Noble Gas Releases

$$D^{\gamma}(r, \theta) \text{ or } D^{\beta}(r, \theta) = 3.17 \times 10^4 \sum_{i=1}^n Q_i [\chi/Q]^D(r, \theta) (DF_i^{\gamma} \text{ or } DF_i^{\beta})$$

Where:

DF_i^{γ} or DF_i^{β} = are the gamma and beta air dose factors for a uniform semi-infinite cloud of radionuclide (I), in mrad-m³/pCi-yr. (Table 2)

$D^{\gamma}(r, \theta)$ or $D^{\beta}(r, \theta)$ = are the annual gamma and beta air doses at distance r, in the sector at angle θ , from the discharge point, in mrad/yr.

Q_i = is the annual release rate of radionuclide (I), in Ci/yr.

$[\chi/Q]^D(r, \theta)$ = is the annual average gaseous dispersion factor at distance r, in the sector at angle θ , in sec/m³. (Table 4)

3.17×10^4 = is the number of pCi per Ci divided by the number of seconds per year.

3.2.1A (continued)

2. Annual Total Body Dose from All Other Noble Gas Releases

$$D_{\infty}^T(r, \theta) = S_f \sum_{i=1}^n X_i(r, \theta) DFB_i$$

Where:

- DFB_i = is the total body dose factor for a semi-infinite cloud of the radionuclide (I), which includes the attenuation of 5 g/cm² of tissue, in mrem-m³/pCi-yr. (Table 2)
- D_∞^T(r,θ) = is the annual total body dose due to immersion in a semi-infinite cloud at distance r, in the sector at angle θ, in mrem/yr.
- X_i(r,θ) = is the annual average ground-level concentration of radionuclide (I) at distance r, in the sector at angle θ, in pCi/m³. (Table 4)
- S_f = Shielding Factor (Table 17)

3. Annual Skin Dose from All Other Noble Gas Releases

$$D_{\infty}^T(r, \theta) = 1.11 S_f \sum_{i=1}^n X_i(r, \theta) DF_i^Y + \sum_{i=1}^n X_i(r, \theta) DFS_i$$

Where:

- D_∞^T(r,θ) = is the annual skin dose due to immersion in a semi-infinite cloud at distance r, in the sector at angle θ, in mrem/yr.
- DFS_i = is the beta skin dose factor for a semiinfinite cloud of radionuclide (I), in mrem-m³/pCi-yr. (Table 2)
- 1.11 = is the average ratio of tissue to air energy absorption coefficients.

3.2.2 Radioiodine, Tritium, and Particulates

10 CFR Part 50, Appendix I, restricts the dose to individuals in the unrestricted areas from radioactive materials in gaseous airborne from the Fort Calhoun Station to:

- During any calendar quarter
≤ 7.5 mrem to any organ

and

- During any calendar year
≤ 15 mrem to any organ

The dose to an individual from radioiodines, radioactive materials in particulate form, and radionuclides other than noble gases with half-lives greater than 8 days in airborne effluents released to unrestricted areas should be determined by the following expressions:

Radioiodine, Tritium, and Particulates (continued)

3.2.2 (continued)

| | | |
|----------|--|----------|
| i | NOTE | i |
| | In all cases, for releases of tritium, use the dispersion parameter for inhalation (χ/Q). | |

A. Annual Organ Dose from External Irradiation from Radioactivity Deposited on the Ground Plane

The ground plane concentration of radionuclide (I) at distance r, in the sector at angle θ , with respect to the release point, may be determined by:

$$C_i^G(r, \theta) = \frac{[1.0 \times 10^{12}][\delta_i(r, \theta)Q_i]}{\lambda_i} [1 - \exp(-\lambda_i t_b)]$$

Where:

- C_i^G = is the ground plane concentration of the radionuclide (I) at distance r, in the sector at angle θ , from the release point, in pCi/m².
- Q_i = is the annual release rate of radionuclide (I) to the atmosphere, in Ci/yr.
- t_b = is the time period over which the accumulation is evaluated, which is assumed to be 20 years (mid-point of plant operating life). (Table 17)
- $\delta_i(r, \theta)$ = is the annual average relative deposition of radionuclide (I) at distance r, in the sector at angle θ , considering depletion of the plume by deposition during transport, in m⁻². Table 4
- λ_i = is the radiological decay constant for radionuclide (I), in yr⁻¹.
- 1.0×10^{12} = is the number of pCi/Ci

3.2.2A (continued)

The annual organ dose is then calculated using the following equation:

$$D_i^G(r, \theta) = 8760 S_f \sum_{i=1}^n C_i^G(r, \theta) DFG_{ij}$$

Where:

- $C_i^G(r, \theta)$ = is the ground plane concentration of radionuclide (i) at distance r, in the sector at angle θ , in pCi/m².
- DFG_{ij} = is the open field ground plane dose conversion factor for organ (j) from radionuclide (i), in mrem-m²/pCi-hr. (Table 8)
- $D_j^G(r, \theta)$ = is the annual dose to the organ (j) at distance r, in the sector at angle θ , in mrem/yr.
- S_f = is the shielding factor that accounts for the dose reduction due to shielding provided by residential structures during occupancy, dimensionless. (Table 17)
- 8760 = is the number of hours in a year

B. Annual Dose from Inhalation of Radionuclides in Air

The annual average airborne concentration of radionuclide (i) at distance r, in the sector at angle θ , with respect to the release point, may be determined as:

$$X_i(r, \theta) = 3.17 \times 10^4 Q_i [\chi/Q]^D(r, \theta)$$

Where:

- Q_i = is the annual release rate of radionuclide (i) to the atmosphere, in Ci/yr.
- $X_i(r, \theta)$ = is the annual average ground-level concentration of radionuclide (i) in air at distance r, in the sector at angle θ , in pCi/m³.
- $[\chi/Q]^D(r, \theta)$ = is the annual average atmosphere dispersion factor, in sec/m³ (see Reg Guide 1.111). This includes depletion (for radioiodines and particulates) and radiological decay of the plume. (Table 4)
- 3.17×10^4 = is the number of pCi/Ci divided by the number of sec/yr.

3.2.2B (continued)

The annual dose associated with inhalation of all radionuclides to organ (j) of an individual in age group (a), is then:

$$D_{ja}^A(r, \theta) = R_a \sum_{i=1}^n X_i(r, \theta) DFA_{ija}$$

Where:

$D_{ja}^A(r, \theta)$ = is the annual dose to organ (j) of an individual in the age group (a) at distance r, in the sector at angle θ , due to inhalation, in mrem/yr.

R_a = is the annual air intake for individuals in the age group (a), in m³/yr. (Table 6)

DFA_{ija} = is the inhalation dose factor for radionuclide (i), organ (j), and age group (a), in mrem/pCi. (Tables 9-12)

3.2.3 Concentrations of Radionuclides in Foods and Vegetation from Atmospheric Releases

A. Parameters for Calculating Concentrations in Forage, Produce, and Leafy Vegetables, excluding Tritium

$$C_i^v(r, \theta) = d_i(r, \theta) \left[\frac{r[1 - \exp(-\lambda_{Ei}t_e)]}{Y_v \lambda_{Ei}} + \frac{B_{iv}[1 - \exp(-\lambda_i t_b)]}{P \lambda_i} \right] \exp(-\lambda_i t_h)$$

Where:

$C_i^v(r, \theta)$ = is the concentration of radionuclide (i) in and on vegetation at distance r, in the sector at angle θ , in pCi/kg.

$d_i(r, \theta)$ = is the deposition rate of radionuclide (i) at distance r, in the sector at angle θ , in pCi/m² hr.

3.2.3A (continued)

The deposition rate from the plume is defined by (Reg. Guide 1.109, Rev. 1, Page 1.109-26, Equa. C-6):

$$d_i(r, \theta) = 1.1 \times 10^8 \delta_i(r, \theta) Q_i$$

Where:

- $d_i(r, \theta)$ = is the deposition rate of radionuclide (i).
- $\delta_i(r, \theta)$ = is the relative deposition of radionuclide (i), considering depletion and decay, in m^{-2} (see Reg Guide 1.111). (Table 4)
- 1.1×10^8 = is the number of pCi/Ci (10^{12}) divided by the number of hours per year (8760).
- Q_i = is the annual release rate of radionuclide (i) to the atmosphere, in Ci/yr.

3.2.3 (continued)

- B. For radioiodines, the model considers only the elemental fraction of the effluent:

$$d_i(r, \theta) = 3.3 \times 10^7 \delta_i(r, \theta) Q_i$$

Where:

- $d_i(r, \theta)$ = The deposition rate of radioiodine (i).
 3.3×10^7 = The number of pCi/Ci (1012) divided by the number of hours per year (8760), then multiplied by the amount of radioiodine emissions considered to be elemental (0.5).
- $\delta_i(r, \theta)$ = The relative deposition of radioiodine (i), considering depletion and decay, in m⁻². (Table 4)
- Q_i = The total (elemental and nonelemental) radioiodine (i) emission rate.
- r = is the fraction of deposited activity retained on crops, dimensionless. (Table 17)
- λ_{Ei} = is the effective removal rate constant for radionuclide (i) from crops, in hr⁻¹.
 $\lambda_{Ei} = \lambda_i + \lambda_w$
 $\lambda_w = 0.0021/\text{hr}$. (Table 17)
- t_e = is the time period that crops are exposed to contamination during the growing season, in hours. (Table 17)
- Y_v = is the agricultural productivity (yield) in kg (wet weight)/m². (Table 17)
- B_{iv} = is the concentration factor for uptake of radionuclide (i) from soil by edible parts of crops, in pCi/ kg (wet weight) per pCi/kg dry soil. (Table 5)
- λ_i = is the radiological decay constant of radionuclide (i), in hr⁻¹
- t_b = is the period of time for which sediment or soil is exposed to the contaminated water, in hours (mid-point of plant life). (Table 17)
- P = is the effective "surface density" for soil, in kg (dry soil)/m². (Table 17)
- t_h = is the holdup time that represents the time interval between harvest and consumption of the food, in hours. (Table 17)

Different values for the parameters t_e , Y_v , and t_h , may be used to allow the use of the Equation for different purposes: estimating concentrations in produce consumed by man; in leafy vegetables consumed by man; in forage consumed directly as pasture grass by dairy cows, beef cattle, or goats; and in forage consumed as stored feed by dairy cows, beef cattle or goats. See Table 17.

3.2.3 (continued)

C. Parameters for Calculating the Concentration of Radionuclide (i) in the Animal's Feed (Milk Cow, Beef Cow, and Goat)

$$C_i^V(r, \theta) = f_p f_s C_i^P(r, \theta) + (1 - f_p) C_i^S(r, \theta) + f_p (1 - f_s) C_i^S(r, \theta)$$

Where:

- $C_Y(r, \theta)$ = is the concentration of radionuclide (i) in the animal's feed, in pCi/kg.
- $C^P(r, \theta)$ = is the concentration of radionuclide (i) on pasture grass (calculated using Equation 3.2.3C with $t_h=0$), in pCi/kg.
- $C^S(r, \theta)$ = is the concentration of radionuclide (i) in stored feeds (calculated using Equation 3.2.3C with $t_h=90$ days), in pCi/kg.
- f_p = is the fraction of the year that animals graze on pasture. (Table 17)
- f_s = is the fraction of daily feed that is pasture grass while the animal grazes on pasture. (Table 17)

3.2.4 Parameters for Calculating Radionuclide Concentration in Cow and Goat Milk

$$C_i^M(r, \theta) = F_m C_i^V(r, \theta) Q_F \exp(-\lambda_i t_f)$$

Where:

- $C^M(r, \theta)$ = is the concentration of radionuclide (i) in milk, in pCi/liter.
- $C_Y(r, \theta)$ = is the concentration of radionuclide (i) in the animal's feed, in pCi/kg.
- F_m = is the average fraction of the animal's daily intake of radionuclide (i) which appears in each liter of milk, in days/liter. (Table 5)
- Q_F = is the amount of feed consumed by the animal per day, in kg/day. (Table 7)
- t_f = is the average transport time of the radionuclide (i) from the feed to the milk and to the receptor (a value of 2 days is assumed). (Table 17)
- λ_i = is the radiological decay constant of radionuclide (i), in days⁻¹.

3.2.5 Parameters for Calculating Radionuclide Concentration in Cow Meat, excluding Tritium

$$C_i^F(r, \theta) = F_f C_i^V(r, \theta) Q_F \exp(-\lambda_i t_s)$$

Where:

$C_i^F(r, \theta)$ = is the concentration of radionuclide (i) in meat, in pCi/liter.

F_f = is the average fraction of the animal's daily intake of radionuclide (i) which appears in each kilogram of flesh, in days/kilogram. (Table 5)

t_s = is the average time from slaughter to consumption. (Table 17)

3.2.6 Parameters for Calculating Tritium Concentrations in Vegetation

The concentration of tritium in vegetation is calculated from its concentration in the air surrounding the vegetation.

$$C_T^V(r, \theta) = 3.17 \times 10^7 Q_T \frac{[X/Q](r, \theta)(0.75)(0.5)}{H} = 1.2 \times 10^7 Q_T \frac{[X/Q](r, \theta)}{H}$$

Where:

$C_T^V(r, \theta)$ = is the concentration of tritium in vegetation grown at distance r, in the sector at angle θ , in pCi/kg.

H = is the absolute humidity of the atmosphere at distance r, in the sector at angle θ , in g/m³. H=8 gm/kg.

Q_T = is the annual release rate of tritium, in Ci/yr.

$[X/Q](r, \theta)$ = is the atmospheric dispersion factor, in sec/m³. (Table 4)

0.5 = is the ratio of tritium concentration in plant water to tritium concentration in atmospheric water, dimensionless.

0.75 = is the fraction of total plant mass that is water, dimensionless.

3.2.7 Annual Dose from Atmospherically Released Radionuclides in Foods

- A. The total annual dose to organ (j) of an individual in age group (a) resulting from ingestion of all radionuclides in produce, milk, and leafy vegetables is given by:

$$D_{ja}^D(r, \theta) = \sum_i DFI_{ija} [U_a^V f_g C_i^V(r, \theta) + U_a^M C_i^M(r, \theta) + U_a^F C_i^F(r, \theta) + U_a^L f_\ell C_i^L(r, \theta)]$$

Where:

- $D_{ja}^D(r, \theta)$ = is the annual dose to organ (j) of an individual in age group (a) from dietary intake of atmospherically released radionuclides, in mrem/yr.
- DFI_{ija} = is the dose conversion factor for the ingestion of radionuclide (i), organ (j), and age group (a), in mrem/pCi. Tables 13-16.
- U_a^V, U_a^M = are the ingestion rates of produce (non-leafy vegetables, fruits, and grains); milk, meat, and leafy U_a^F, U_a^L vegetables, respectively for individuals in age group (a). (Table 6)
- f_g = Fraction of ingested produce grown in garden of interest (Table 17)
- f_ℓ = Fraction of leafy vegetables grown in garden of interest (Table 17)

3.2.7 (continued)

- B. Calculating the Ingested Dose from Leafy and Non-Leafy (produce) Vegetation for Radionuclide (i) to Each Organ (j) and Age Group (a)

$$D_{ja}^D(r, \theta) = DFI_{ja} [U_a^L f_\ell C_i^L(r, \theta) + U_a^V f_g C_i^V(r, \theta)]$$

Where:

- $D_{ja}^D(r, \theta)$ = is the annual dose from the ingestion of radionuclide (i) to organ (j) of an individual in age group (a) from dietary intake of

atmospherically released radionuclides in vegetation, in mrem/yr.

- DFI_{ija} = is the dose conversion factor for the ingestion of radionuclide (i), organ (j), and age group (a), in mrem/pCi. Tables 13-16
- U_{La}, U_{Va} = are the ingestion rates of leafy vegetables and produce (non-leafy vegetables, fruits, and grains), for individuals in age group (a), in kg/yr. (Table 6)
- CL_i = is the concentration of radionuclide (i) in and on leafy vegetation, in pCi/kg.
- CV = is the concentration of radionuclide (i) in and on produce, in pCi/kg.

C. Calculation Determining the Ingested Dose from Cow Milk for Radionuclide (i), Organ (j), and Age Group (a)

$$D_{ja}^D(r, \theta) = DFI_{ija} [U_a^M C_i^M(r, \theta)]$$

Where:

- $D_{ja}^D(r, \theta)$ = is the annual dose from the ingestion of radionuclide (i), organ (j) of an individual in age group (a) from dietary intake of atmospherically released radionuclides in cow milk, in mrem/yr.
- DFI_{ija} = is the dose conversion factor for the ingestion of radionuclide (i), organ (j), and age group (a), in mrem/pCi. (Tables 13-16)
- U_a^M = is the ingestion rate of cow milk for individuals in age group (a), in l/yr. (Table 6)
- C_i^M = is the radionuclide concentration in cow milk, in pCi/kg. Equation 3.2.4

3.2.7 (continued)

D. Calculation Determining the Ingested Dose from Meat for Radionuclide (i) to Organ (j) and Age Group (a)

$$D_{ja}^D(r, \theta) = DFI_{ija} [U_a^F C_i^F(r, \theta)]$$

Where:

- $D_{ja}^D(r,\theta)$ = is the annual dose from the ingestion of radionuclide (i), organ (j) of an individual in age group (a) from dietary intake of atmospherically released radionuclides in meat, in mrem/yr.
- DF_{ija} = is the dose conversion factor for the ingestion of radionuclide (i), organ (j), and age group (a), in mrem/pCi. (Tables 13-16)
- UF_a = is the ingestion rate of meat for individuals in age group (a), in kg/yr. (Table 6)
- C_i = is the radionuclide (i) concentration in meat, in pCi/kg.

3.2.8 Annual Dose from Carbon 14

- A. This is a calculated value based on power generation and days of operation. Critical organ doses from C-14 were calculated using a ratio of 15% as CO₂. This ratio was determined during an NRC in-plant source term study conducted at the Fort Calhoun Station between 1976 and 1977, NUREG/CR-0140.

4.0 LOWER LIMIT OF DETECTION (LLD)

4.1 The lower limit of detection (LLD) for liquid and airborne effluent discharges and environmental samples referenced in Part I, Tables 4.1, 4.2 and 5.3, of the Off-Site Dose Calculation Manual, is defined as the smallest concentration of radioactive material in a sample that will yield a net count, above system background, that will be detected with 95 percent probability with only 5 percent probability of falsely concluding that a blank observation represents a "real" signal.

4.2 For a particular measurement system, which may include radiochemical separation:

$$LLD = \frac{4.66 * S_b}{E * V * D * Y * \exp(-\lambda \Delta t)}$$

Where:

LLD = the lower limit of detection as defined above, in either picoCuries or microCuries, per unit mass or volume as a function of the value of D

S_b = the standard deviation of the background counting rate or of the counting rate of a blank sample, as appropriate, as counts per minute

E = the counting efficiency, as counts per disintegration

V = the sample size in units of mass or volume

D = 2.22E+06 of disintegrations per minute per microCurie or 2.22 disintegrations per minute per picoCurie

Y = the fractional radiochemical yield, when applicable

λ = the radioactive decay constant for the particular radionuclide

Δt = the elapsed time between the midpoint of sample collection and time of counting

Appropriate values of E, V, Y, and Δt should be used in the calculation.

4.3 It should be recognized that the LLD is defined as an A Priori limit representing the capability of a measurement system and not as a limit for a particular measurement.

4.4 LLD verifications will be performed on a periodic basis. This determination is to ensure that the counting system is able to detect levels of radiation at the LLD values for the specific type of analysis required. They will be performed with a blank (non-radioactive) sample in the same counting geometry as the actual sample.

Table 2 - Dose Factors for Exposure to a Semi-Infinite Cloud of Noble Gases

| Nuclide | β -Air ¹ (Df ^{β} _i) | β -Skin ² (DFS _i) | γ -Air ¹ (Df ^{γ} _i) | γ -Body ² (DFB _i) |
|---------|--|--|--|---|
| Kr-83m | 2.88E-04 | --- | 1.93E-05 | 7.56E-08 |
| Kr-85m | 1.97E-03 | 1.46E-03 | 1.23E-03 | 1.17E-03 |
| Kr-85 | 1.95E-03 | 1.34E-03 | 1.72E-05 | 1.61E-05 |
| Kr-87 | 1.03E-02 | 9.73E-03 | 6.17E-03 | 5.92E-03 |
| Kr-88 | 2.93E-03 | 2.37E-03 | 1.52E-02 | 1.47E-02 |
| Kr-89 | 1.06E-02 | 1.01E-02 | 1.73E-02 | 1.66E-02 |
| Kr-90 | 7.83E-03 | 7.29E-03 | 1.63E-02 | 1.56E-02 |
| Xe-131m | 1.11E-03 | 4.67E-04 | 1.56E-04 | 9.15E-05 |
| Xe-133m | 1.48E-03 | 9.94E-04 | 3.27E-04 | 2.51E-04 |
| Xe-133 | 1.05E-03 | 3.06E-04 | 3.53E-04 | 2.94E-04 |
| Xe-135m | 7.39E-04 | 7.11E-04 | 3.36E-03 | 3.12E-03 |
| Xe-135 | 2.46E-03 | 1.86E-03 | 1.92E-03 | 1.81E-03 |
| Xe-137 | 1.27E-02 | 1.22E-02 | 1.51E-03 | 1.42E-03 |
| Xe-138 | 4.75E-03 | 4.13E-03 | 9.21E-03 | 8.83E-03 |
| Ar-41 | 3.28E-03 | 2.69E-03 | 9.30E-03 | 8.84E-03 |

1. $\frac{mrad - m^3}{pCi - yr}$

2. $\frac{mrem - m^3}{pCi - r}$

3. $2.88E - 04 = 2.88 \times 10^{-4}$

Table 3 - Bioaccumulation Factors
 (pCi/kg per pCi/liter)

FRESHWATER

| Element | Fish | Invertebrate |
|---------|---------|--------------|
| H | 9.0E-01 | 9.0E-01 |
| C | 4.6E+03 | 9.1E+03 |
| Na | 1.0E+02 | 2.0E+02 |
| P | 1.0E+05 | 2.0E+04 |
| Cr | 2.0E+02 | 2.0E+03 |
| Mn | 4.0E+02 | 9.0E+04 |
| Fe | 1.0E+02 | 3.2E+03 |
| Co | 5.0E+01 | 2.0E+02 |
| Ni | 1.0E+02 | 1.0E+02 |
| Cu | 5.0E+01 | 4.0E+02 |
| Zn | 2.0E+03 | 1.0E+04 |
| Br | 4.2E+02 | 3.3E+02 |
| Rb | 2.0E+03 | 1.0E+03 |
| Sr | 3.0E+01 | 1.0E+02 |
| Y | 2.5E+01 | 1.0E+03 |
| Zr | 3.3E+00 | 6.7E+00 |
| Nb | 3.0E+04 | 1.0E+02 |
| Mo | 1.0E+01 | 1.0E+01 |
| Tc | 1.5E+01 | 5.0E+00 |
| Ru | 1.0E+01 | 3.0E+02 |
| Rh | 1.0E+01 | 3.0E+02 |
| Te | 4.0E+02 | 6.1E+03 |
| I | 1.5E+01 | 5.0E+00 |
| Cs | 2.0E+03 | 1.0E+03 |
| Ba | 4.0E+00 | 2.0E+02 |
| La | 2.5E+01 | 1.0E+03 |
| Ce | 1.0E+00 | 1.0E+03 |
| Pr | 2.5E+01 | 1.0E+03 |
| Nd | 2.5E+01 | 1.0E+03 |
| W | 1.2E+03 | 1.0E+01 |
| Np | 1.0E+01 | 4.0E+02 |

Table 4 - Highest Potential Exposure Pathways for Estimating Dose

| | | |
|----------|---|----------|
| i | NOTE | i |
| | The Annual Radiological Effluent Report uses the highest calculated value from real time meteorological data obtained for the entire year for calculating dose. | |

| Exposure Pathway | Location ^B | Direction ^B | Distance from Containment (miles) ^B | X/Q ^A { $\chi/Q(r,\theta)$ } (sec/m ³) | D/Q ^A { $\delta(r,\theta)$ } (m ⁻²) |
|------------------|-----------------------|------------------------|--|---|--|
| Direct Exposure | Site Boundary | SSE | 0.60 | 1.30E-05 | N/A |
| Inhalation | Site Boundary | SSE | 0.60 | 1.30E-05 | N/A |
| Ingestion | Residence | SSE | 0.60 | N/A | 7.6E-08 |

- A. These values are used for calculating quarterly dose estimates during the annual reporting period and are based on a 2 year average, updated only upon a +10% change from the previous value. At least ten percent (10%) should be added to these values for dose estimates during the reporting periods.
- B. The location is subject to change based on an annual evaluation and is utilized only for ingestion exposure pathway dose estimates. This location may differ from the highest ingestion exposure pathway for offsite air monitoring locations as determined by the Land Use Survey performed biennially in accordance with Part 1, Section 7.3.2, of the Off-Site Dose Calculation Manual.

Table 5 - Stable Element Transfer Data

| Element | B_{iv} Veg./Soil | F_m (cow) Milk (d/l) | F_r Meat (d/kg) |
|---------|-----------------------|---------------------------|----------------------|
| H | 4.8E+00 | 1.0E-02 | 1.2E-02 |
| C | 5.5E+00 | 1.2E-02 | 3.1E-02 |
| Na | 5.2E-02 | 4.0E-02 | 3.0E-02 |
| P | 1.1E+00 | 2.5E-02 | 4.6E-02 |
| Cr | 2.5E-04 | 2.2E-03 | 2.4E-03 |
| Mn | 2.9E-02 | 2.5E-04 | 8.0E-04 |
| Fe | 6.6E-04 | 1.2E-03 | 4.0E-02 |
| Co | 9.4E-03 | 1.0E-03 | 1.3E-02 |
| Ni | 1.9E-02 | 6.7E-03 | 5.3E-02 |
| Cu | 1.2E-01 | 1.4E-02 | 8.0E-03 |
| Zn | 4.0E-01 | 3.9E-02 | 3.0E-02 |
| Rb | 1.3E-01 | 3.0E-02 | 3.1E-02 |
| Sr | 1.7E-02 | 8.0E-04 | 6.0E-04 |
| Y | 2.6E-03 | 1.0E-05 | 4.6E-03 |
| Zr | 1.7E-04 | 5.0E-06 | 3.4E-02 |
| Nb | 9.4E-03 | 2.5E-03 | 2.8E-01 |
| Mo | 1.2E-01 | 7.5E-03 | 8.0E-03 |
| Tc | 2.5E-01 | 2.5E-02 | 4.0E-01 |
| Ru | 5.0E-02 | 1.0E-06 | 4.0E-01 |
| Rh | 1.3E+1 | 1.0E-02 | 1.5E-03 |
| Ag | 1.5E-01 | 5.0E-02 | 1.7E-02 |
| Te | 1.3E+00 | 1.0E-03 | 7.7E-02 |
| I | 2.0E-02 | 6.0E-03 | 2.9E-03 |
| Cs | 1.0E-02 | 1.2E-02 | 4.0E-03 |
| Ba | 5.0E-03 | 4.0E-04 | 3.2E-03 |
| La | 2.5E-03 | 5.0E-06 | 2.0E-04 |
| Ce | 2.5E-03 | 1.0E-04 | 1.2E-03 |
| Pr | 2.5E-03 | 5.0E-06 | 4.7E-03 |
| Nd | 2.4E-03 | 5.0E-06 | 3.3E-03 |
| W | 1.8E-02 | 5.0E-04 | 1.3E-03 |
| Np | 2.5E-03 | 5.0E-06 | 2.0E-04 |

Table 6 - Recommended Values for U_{ap} to Be Used for the Maximum Exposed Individual in Lieu of Site Specific Data

| Pathway | Infant | Child | Teen | Adult |
|-------------------------------------|--------|-------|------|-------|
| Fruits, vegetables, & grain (kg/yr) | --- | 520 | 630 | 520 |
| Leafy vegetables (kg/yr) | --- | 26 | 42 | 64 |
| Milk (ℓ/yr) | 330 | 330 | 400 | 310 |
| Meat & poultry (kg/yr) | --- | 41 | 65 | 110 |
| Fish (fresh or salt)(kg/yr) | --- | 6.9 | 16 | 21 |
| Other Seafood (kg/yr) | --- | 1.7 | 3.8 | 5 |
| Drinking water (ℓ/yr) | 330 | 510 | 510 | 730 |
| Shoreline recreation (hr/yr) | --- | 14 | 67 | 12 |
| Inhalation (m ³ /yr) | 1400 | 3700 | 8000 | 8000 |

Table 7 - Animal Consumption Rates

| Animal | Q_F Feed or Forage [Kg/day (wet weigh)] | Q_{AW} Water (ℓ/day) |
|-------------|---|------------------------|
| Milk Cow | 50 | 60 |
| Beef Cattle | 50 | 50 |
| Goats | 6 | 8 |

Table 8 - External Dose Factors for Standing on Contaminated Ground
(mrem/hr per pCi/m²)

| Element | Total Body | Skin |
|---------|------------|----------|
| H-3 | --- | --- |
| C-14 | --- | --- |
| Na-24 | 2.50E-08 | 2.90E-08 |
| P-32 | --- | --- |
| Cr-51 | 2.20E-10 | 2.60E-10 |
| Mn-54 | 5.80E-09 | 6.80E-09 |
| Mn-56 | 1.10E-08 | 1.30E-08 |
| Fe-55 | --- | --- |
| Fe-59 | 8.00E-09 | 9.40E-09 |
| Co-58 | 7.00E-09 | 8.20E-09 |
| Co-60 | 1.70E-08 | 2.00E-08 |
| Ni-63 | --- | --- |
| Nr-65 | 3.70E-09 | 4.30E-09 |
| Cu-64 | 1.50E-09 | 1.70E-09 |
| Zn-65 | 4.00E-09 | 4.60E-09 |
| Zn-69 | --- | --- |
| Br-83 | 6.40E-11 | 9.30E-11 |
| Br-84 | 1.20E-08 | 1.40E-08 |
| Br-85 | --- | --- |
| Rb-86 | 6.30E-10 | 7.20E-10 |
| Rb-88 | 3.50E-09 | 4.00E-09 |
| Rb-89 | 1.50E-08 | 1.80E-08 |
| Sr-89 | 5.60E-13 | 6.50E-13 |
| Sr-91 | 7.10E-09 | 8.30E-09 |
| Sr-92 | 9.00E-09 | 1.00E-08 |
| Y-90 | 2.20E-12 | 2.60E-12 |
| Y-91M | 3.80E-09 | 4.40E-09 |
| Y-91 | 2.40E-11 | 2.70E-11 |
| Y-92 | 1.60E-09 | 1.90E-09 |
| Y-93 | 5.70E-10 | 7.80E-10 |
| Zr-95 | 5.00E-09 | 5.80E-09 |
| Zr-97 | 5.50E-09 | 6.40E-09 |
| Nb-95 | 5.10E-09 | 6.00E-09 |
| Mo-99 | 1.90E-09 | 2.20E-09 |
| Tc-99M | 9.60E-10 | 1.10E-09 |
| Tc-101 | 2.70E-09 | 3.00E-09 |
| Ru-103 | 3.60E-09 | 4.20E-09 |

Table 8 - External Dose Factors for Standing on Contaminated Ground
(mrem/hr per pCi/m²)

| Element | Total Body | Skin |
|---------|------------|----------|
| Ru-105 | 4.50E-09 | 5.10E-09 |
| Ru-106 | 1.50E-09 | 1.80E-09 |
| Ag-110M | 1.80E-08 | 2.10E-08 |
| Te-125M | 3.50E-11 | 4.80E-11 |
| Te-127M | 1.10E-12 | 1.30E-12 |
| Te-127 | 1.00E-11 | 1.10E-11 |
| Te-129M | 7.70E-10 | 9.00E-10 |
| Te-129 | 7.10E-10 | 8.40E-10 |
| Te-131M | 8.40E-09 | 9.90E-09 |
| Te-131 | 2.20E-09 | 2.60E-06 |
| Te-132 | 1.70E-09 | 2.00E-09 |
| I-130 | 1.40E-08 | 1.70E-08 |
| I-131 | 2.80E-09 | 3.40E-09 |
| I-132 | 1.70E-08 | 2.00E-08 |
| I-133 | 3.70E-09 | 4.50E-09 |
| I-134 | 1.60E-08 | 1.90E-08 |
| I-135 | 1.20E-08 | 1.40E-08 |
| Cs-134 | 1.20E-08 | 1.40E-08 |
| Cs-136 | 1.50E-08 | 1.70E-08 |
| Cs-137 | 4.20E-09 | 4.90E-09 |
| Cs-138 | 2.10E-08 | 2.40E-08 |
| Ba-139 | 2.40E-09 | 2.70E-09 |
| Ba-140 | 2.10E-09 | 2.40E-09 |
| Ba-141 | 4.30E-09 | 4.90E-09 |
| Ba-142 | 7.90E-09 | 9.00E-09 |
| La-140 | 1.50E-08 | 1.70E-08 |
| La-142 | 1.50E-08 | 1.80E-08 |
| Ce-141 | 5.50E-10 | 6.20E-10 |
| Ce-143 | 2.20E-09 | 2.50E-09 |
| Ce-144 | 3.20E-10 | 3.70E-10 |
| Pr-143 | --- | --- |
| Pr-144 | 2.00E-10 | 2.30E-10 |
| Nd-147 | 1.00E-09 | 1.20E-09 |
| W-187 | 3.10E-09 | 3.60E-09 |
| Np-239 | 9.50E-10 | 1.10E-09 |

Table 9 - Inhalation Dose Factors for Adult
(mrem per pCi Inhaled)

| Nuclide | Bone | Liver | T. Body | Thyroid | Kidney | Lung | GI-LLI |
|---------|----------|----------|----------|----------|----------|----------|----------|
| H-3 | --- | 8.98E-08 | 8.98E-08 | 8.98E-08 | 8.98E-08 | 8.98E-08 | 8.98E-08 |
| C-14 | 2.27E-06 | 4.26E-07 | 4.26E-07 | 4.26E-07 | 4.26E-07 | 4.26E-07 | 4.26E-07 |
| Na-24 | 1.28E-06 | 1.28E-06 | 1.28E-06 | 1.28E-06 | 1.28E-06 | 1.28E-06 | 1.28E-06 |
| P-32 | 1.65E-04 | 9.64E-06 | 6.26E-06 | --- | --- | --- | 1.08E-05 |
| Cr-51 | --- | --- | 1.25E-08 | 7.44E-09 | 2.85E-09 | 1.80E-06 | 4.15E-07 |
| Mn-54 | --- | 4.95E-06 | 7.87E-07 | --- | 1.23E-06 | 1.75E-04 | 9.67E-06 |
| Mn-56 | --- | 1.55E-10 | 2.29E-11 | --- | 1.63E-10 | 1.18E-06 | 2.53E-06 |
| Fe-55 | 3.07E-06 | 2.12E-06 | 4.93E-07 | --- | --- | 9.01E-06 | 7.54E-07 |
| Fe-59 | 1.47E-06 | 3.47E-06 | 1.32E-06 | --- | --- | 1.27E-04 | 2.35E-05 |
| Co-58 | --- | 1.98E-07 | 2.59E-07 | --- | --- | 1.16E-04 | 1.33E-05 |
| Co-60 | --- | 1.44E-06 | 1.85E-06 | --- | --- | 7.46E-04 | 3.56E-05 |
| Ni-63 | 5.40E-05 | 3.93E-06 | 1.81E-06 | --- | --- | 2.23E-05 | 1.67E-06 |
| Ni-65 | 1.92E-10 | 2.62E-11 | 1.14E-11 | --- | --- | 7.00E-07 | 1.54E-06 |
| Cu-64 | --- | 1.83E-10 | 7.69E-11 | --- | 5.78E-10 | 8.48E-07 | 6.12E-06 |
| Zn-65 | 4.05E-06 | 1.29E-05 | 5.82E-06 | --- | 8.62E-06 | 1.08E-04 | 6.68E-06 |
| Zn-69 | 4.23E-12 | 8.14E-12 | 5.65E-13 | --- | 5.27E-12 | 1.15E-07 | 2.04E-09 |
| Br-83 | --- | --- | 3.01E-08 | --- | --- | --- | 2.90E-08 |
| Br-84 | --- | --- | 3.91E-08 | --- | --- | --- | 2.05E-13 |
| Br-85 | --- | --- | 1.60E-09 | --- | --- | --- | --- |
| Rb-86 | --- | 1.69E-05 | 7.37E-06 | --- | --- | --- | 2.08E-06 |
| Rb-88 | --- | 4.84E-08 | 2.41E-08 | --- | --- | --- | 4.18E-19 |
| Rb-89 | --- | 3.20E-08 | 2.12E-08 | --- | --- | --- | 1.16E-21 |
| Sr-89 | 3.80E-05 | --- | 1.09E-06 | --- | --- | 1.75E-04 | 4.37E-05 |
| Sr-90 | 3.59E-03 | --- | 7.21E-05 | --- | --- | 1.20E-03 | 9.02E-05 |
| Sr-91 | 7.74E-09 | --- | 3.13E-10 | --- | --- | 4.56E-06 | 2.39E-05 |
| Sr-92 | 8.43E-10 | --- | 3.64E-11 | --- | --- | 2.06E-06 | 5.38E-06 |
| Y-90 | 2.61E-07 | --- | 7.01E-09 | --- | --- | 2.12E-05 | 6.32E-05 |
| Y-91M | 3.26E-11 | --- | 1.27E-12 | --- | --- | 2.40E-07 | 1.66E-10 |
| Y-91 | 5.78E-05 | --- | 1.55E-06 | --- | --- | 2.13E-04 | 4.81E-05 |
| Y-92 | 1.29E-09 | --- | 3.77E-11 | --- | --- | 1.96E-06 | 9.19E-06 |
| Y-93 | 1.18E-08 | --- | 3.26E-10 | --- | --- | 6.06E-06 | 5.27E-05 |
| Zr-95 | 1.34E-05 | 4.30E-06 | 2.91E-06 | --- | 6.77E-06 | 2.21E-04 | 1.88E-05 |
| Zr-97 | 1.21E-08 | 2.45E-09 | 1.13E-09 | --- | 3.71E-09 | 9.84E-06 | 6.54E-05 |
| Nb-95 | 1.76E-06 | 9.77E-07 | 5.26E-07 | --- | 9.67E-07 | 6.31E-05 | 1.30E-05 |
| Mo-99 | --- | 1.51E-08 | 2.87E-09 | --- | 3.64E-08 | 1.14E-05 | 3.10E-05 |
| Tc-99M | 1.29E-13 | 3.64E-13 | 4.63E-12 | --- | 5.52E-12 | 9.55E-08 | 5.20E-07 |
| Tc-101 | 5.22E-15 | 7.52E-15 | 7.38E-14 | --- | 1.35E-13 | 4.99E-08 | 1.36E-21 |

Table 9 - Inhalation Dose Factors for Adult
(mrem per pCi Inhaled)

| Nuclide | Bone | Liver | T. Body | Thyroid | Kidney | Lung | GI-LLI |
|---------|----------|----------|----------|----------|----------|----------|----------|
| Ru-103 | 1.91E-07 | --- | 8.23E-08 | --- | 7.29E-07 | 6.31E-05 | 1.38E-05 |
| Ru-105 | 9.88E-11 | --- | 3.89E-11 | --- | 1.27E-10 | 1.37E-06 | 6.02E-06 |
| Ru-106 | 8.64E-06 | --- | 1.09E-06 | --- | 1.67E-05 | 1.17E-03 | 1.14E-04 |
| Ag-110M | 1.35E-06 | 1.25E-06 | 7.43E-07 | --- | 2.46E-06 | 5.79E-04 | 3.78E-05 |
| Te-125M | 4.27E-07 | 1.98E-07 | 5.84E-08 | 1.31E-07 | 1.55E-06 | 3.92E-05 | 8.83E-06 |
| Te-127M | 1.58E-06 | 7.21E-07 | 1.96E-07 | 4.11E-07 | 5.72E-06 | 1.20E-04 | 1.87E-05 |
| Te-127 | 1.75E-10 | 8.03E-11 | 3.87E-11 | 1.32E-10 | 6.37E-10 | 8.14E-07 | 7.17E-06 |
| Te-129M | 1.22E-06 | 5.84E-07 | 1.98E-07 | 4.30E-07 | 4.57E-06 | 1.45E-04 | 4.79E-05 |
| Te-129 | 6.22E-12 | 2.99E-12 | 1.55E-12 | 4.87E-12 | 2.34E-11 | 2.42E-07 | 1.96E-08 |
| Te-131M | 8.74E-09 | 5.45E-09 | 3.63E-09 | 6.88E-09 | 3.86E-08 | 1.82E-05 | 6.95E-05 |
| Te-131 | 1.39E-12 | 7.44E-13 | 4.49E-13 | 1.17E-12 | 5.46E-12 | 1.74E-07 | 2.30E-09 |
| Te-132 | 3.25E-08 | 2.69E-08 | 2.02E-08 | 2.37E-08 | 1.82E-07 | 3.60E-05 | 6.37E-05 |
| I-130 | 5.72E-07 | 1.68E-06 | 6.60E-07 | 1.42E-04 | 2.61E-06 | --- | 9.61E-07 |
| I-131 | 3.15E-06 | 4.47E-06 | 2.56E-06 | 1.49E-03 | 7.66E-06 | --- | 7.85E-07 |
| I-132 | 1.45E-07 | 4.07E-07 | 1.45E-07 | 1.43E-05 | 6.48E-07 | --- | 5.08E-08 |
| I-133 | 1.08E-06 | 1.85E-06 | 5.65E-07 | 2.69E-04 | 3.23E-06 | --- | 1.11E-06 |
| I-134 | 8.05E-08 | 2.16E-07 | 7.69E-08 | 3.73E-06 | 3.44E-07 | --- | 1.26E-10 |
| I-135 | 3.35E-07 | 8.73E-07 | 3.21E-07 | 5.60E-05 | 1.39E-06 | --- | 6.56E-07 |
| Cs-134 | 4.66E-05 | 1.06E-04 | 9.10E-05 | --- | 3.59E-05 | 1.22E-05 | 1.30E-06 |
| Cs-136 | 4.88E-06 | 1.83E-05 | 1.38E-05 | --- | 1.07E-05 | 1.50E-06 | 1.46E-06 |
| Cs-137 | 5.98E-05 | 7.76E-05 | 5.35E-05 | --- | 2.78E-05 | 9.40E-06 | 1.05E-06 |
| Cs-138 | 4.14E-08 | 7.76E-08 | 4.05E-08 | --- | 6.00E-08 | 6.07E-09 | 2.33E-13 |
| Ba-139 | 1.17E-10 | 8.32E-14 | 3.42E-12 | --- | 7.78E-14 | 4.70E-07 | 1.12E-07 |
| Ba-140 | 4.88E-06 | 6.13E-09 | 3.21E-07 | --- | 2.09E-09 | 1.59E-04 | 2.73E-05 |
| Ba-141 | 1.25E-11 | 9.41E-15 | 4.20E-13 | --- | 8.75E-15 | 2.42E-07 | 1.45E-17 |
| Ba-142 | 3.29E-12 | 3.38E-15 | 2.07E-13 | --- | 2.86E-15 | 1.49E-07 | 1.96E-26 |
| La-140 | 4.30E-08 | 2.17E-08 | 5.73E-09 | --- | --- | 1.70E-05 | 5.73E-05 |
| La-142 | 8.54E-11 | 3.88E-11 | 9.65E-12 | --- | --- | 7.91E-07 | 2.64E-07 |
| Ce-141 | 2.49E-06 | 1.69E-06 | 1.91E-07 | --- | 7.83E-07 | 4.52E-05 | 1.50E-05 |
| Ce-143 | 2.33E-08 | 1.72E-08 | 1.91E-09 | --- | 7.60E-09 | 9.97E-06 | 2.83E-05 |
| Ce-144 | 4.29E-04 | 1.79E-04 | 2.30E-05 | --- | 1.06E-04 | 9.72E-04 | 1.02E-04 |
| Pr-143 | 1.17E-06 | 4.69E-07 | 5.80E-08 | --- | 2.70E-07 | 3.51E-05 | 2.50E-05 |
| Pr-144 | 3.76E-12 | 1.56E-12 | 1.91E-13 | --- | 8.81E-13 | 1.27E-07 | 2.69E-18 |
| Nd-147 | 6.59E-07 | 7.62E-07 | 4.56E-08 | --- | 4.45E-07 | 2.76E-05 | 2.16E-05 |
| W-187 | 1.06E-09 | 8.85E-10 | 3.10E-10 | --- | --- | 3.63E-06 | 1.94E-05 |
| Np-239 | 2.87E-08 | 2.54E-08 | 1.55E-09 | --- | 8.75E-09 | 4.70E-06 | 1.49E-05 |

Table 10 - Inhalation Dose Factors for Teenager
(mrem per pCi Inhaled)

| Nuclide | Bone | Liver | T. Body | Thyroid | Kidney | Lung | GI-LLI |
|---------|----------|----------|----------|----------|-----------|----------|----------|
| H-3 | --- | 9.06E-08 | 9.06E-08 | 9.06E-08 | 9.06E-08 | 9.06E-08 | 9.06E-08 |
| C-14 | 3.25E-06 | 6.09E-07 | 6.09E-07 | 6.09E-07 | 6.019E-07 | 6.09E-07 | 6.09E-07 |
| Na-24 | 1.72E-06 | 1.72E-06 | 1.72E-06 | 1.72E-06 | 1.72E-06 | 1.72E-06 | 1.72E-06 |
| P-32 | 2.36E-04 | 1.37E-05 | 8.95E-06 | --- | --- | --- | 1.16E-05 |
| Cr-51 | --- | --- | 1.69E-08 | 9.37E-09 | 3.84E-09 | 2.62E-06 | 3.75E-07 |
| Mn-54 | --- | 6.39E-06 | 1.05E-06 | --- | 1.59E-06 | 2.48E-04 | 8.35E-06 |
| Mn-56 | --- | 2.12E-10 | 3.15E-11 | --- | 2.24E-10 | 1.90E-06 | 7.18E-06 |
| Fe-55 | 4.18E-06 | 2.98E-06 | 6.93E-07 | --- | --- | 1.55E-05 | 7.99E-07 |
| Fe-59 | 1.99E-06 | 4.62E-06 | 1.79E-06 | --- | --- | 1.91E-04 | 2.23E-05 |
| Co-58 | --- | 2.59E-07 | 3.47E-07 | --- | --- | 1.68E-04 | 1.19E-05 |
| Co-60 | --- | 1.89E-06 | 2.48E-06 | --- | --- | 1.09E-03 | 3.24E-05 |
| Ni-63 | 7.25E-05 | 5.43E-06 | 2.47E-06 | --- | --- | 3.84E-05 | 1.77E-06 |
| Ni-65 | 2.73E-10 | 3.66E-11 | 1.59E-11 | --- | --- | 1.17E-06 | 4.59E-06 |
| Cu-64 | --- | 2.54E-10 | 1.06E-10 | --- | 8.01E-10 | 1.39E-06 | 7.68E-06 |
| Zn-65 | 4.82E-06 | 1.67E-05 | 7.80E-06 | --- | 1.08E-05 | 1.55E-04 | 5.83E-06 |
| Zn-69 | 6.04E-12 | 1.15E-11 | 8.07E-13 | --- | 7.53E-12 | 1.98E-07 | 3.56E-08 |
| Br-83 | --- | --- | 4.30E-08 | --- | --- | --- | --- |
| Br-84 | --- | --- | 5.41E-08 | --- | --- | --- | --- |
| Br-85 | --- | --- | 2.29E-09 | --- | --- | --- | --- |
| Rb-86 | --- | 2.38E-05 | 1.05E-05 | --- | --- | --- | 2.21E-06 |
| Rb-88 | --- | 6.82E-08 | 3.40E-08 | --- | --- | --- | 3.65E-15 |
| Rb-89 | --- | 4.40E-08 | 2.91E-08 | --- | --- | --- | 4.22E-17 |
| Sr-89 | 5.43E-05 | --- | 1.56E-06 | --- | --- | 3.02E-04 | 4.64E-05 |
| Sr-90 | 4.14E-03 | --- | 8.33E-05 | --- | --- | 2.06E-03 | 9.56E-05 |
| Sr-91 | 1.10E-08 | --- | 4.39E-10 | --- | --- | 7.59E-06 | 3.24E-05 |
| Sr-92 | 1.19E-09 | --- | 5.08E-11 | --- | --- | 3.43E-06 | 1.49E-05 |
| Y-90 | 3.73E-07 | --- | 1.00E-08 | --- | --- | 3.66E-05 | 6.99E-05 |
| Y-91M | 4.63E-11 | --- | 1.77E-12 | --- | --- | 4.00E-07 | 3.77E-09 |
| Y-91 | 8.26E-05 | --- | 2.21E-06 | --- | --- | 3.67E-04 | 5.11E-05 |
| Y-92 | 1.84E-09 | --- | 5.36E-11 | --- | --- | 3.35E-06 | 2.06E-05 |
| Y-93 | 1.69E-08 | --- | 4.65E-10 | --- | --- | 1.04E-05 | 7.24E-05 |
| Zr-95 | 1.82E-05 | 5.73E-06 | 3.94E-06 | --- | 8.42E-06 | 3.36E-04 | 1.86E-05 |
| Zr-97 | 1.72E-08 | 3.40E-09 | 1.57E-09 | --- | 5.15E-09 | 1.62E-05 | 7.88E-05 |
| Nb-95 | 2.32E-06 | 1.29E-06 | 7.08E-07 | --- | 1.25E-06 | 9.39E-05 | 1.21E-05 |
| Mo-99 | --- | 2.11E-08 | 4.03E-09 | --- | 5.14E-08 | 1.92E-05 | 3.36E-05 |
| Tc-99M | 1.73E-13 | 4.83E-13 | 6.24E-12 | --- | 7.20E-12 | 1.44E-07 | 7.66E-07 |
| Tc-101 | 7.40E-15 | 1.05E-14 | 1.03E-13 | --- | 1.90E-13 | 8.34E-08 | 1.09E-16 |

Table 10 - Inhalation Dose Factors for Teenager
(mrem per pCi Inhaled)

| Nuclide | Bone | Liver | T. Body | Thyroid | Kidney | Lung | GI-LLI |
|---------|----------|----------|----------|----------|----------|----------|----------|
| Ru-103 | 2.63E-07 | --- | 1.12E-07 | --- | 9.29E-07 | 9.79E-05 | 1.36E-05 |
| Ru-105 | 1.40E-10 | --- | 5.42E-11 | --- | 1.76E-10 | 2.27E-06 | 1.13E-05 |
| Ru-106 | 1.23E-05 | --- | 1.55E-06 | --- | 2.38E-05 | 2.01E-03 | 1.20E-04 |
| Ag-110M | 1.73E-06 | 1.64E-06 | 9.99E-07 | --- | 3.13E-06 | 8.44E-04 | 3.41E-05 |
| Te-125M | 6.10E-07 | 2.80E-07 | 8.34E-08 | 1.75E-07 | --- | 6.70E-05 | 9.38E-06 |
| Te-127M | 2.25E-06 | 1.02E-06 | 2.73E-07 | 5.48E-07 | 8.17E-06 | 2.07E-04 | 1.99E-05 |
| Te-127 | 2.51E-10 | 1.14E-10 | 5.52E-11 | 1.77E-10 | 9.10E-10 | 1.40E-06 | 1.01E-05 |
| Te-129M | 1.74E-06 | 8.23E-07 | 2.81E-07 | 5.72E-07 | 6.49E-06 | 2.47E-04 | 5.06E-05 |
| Te-129 | 8.87E-12 | 4.22E-12 | 2.20E-12 | 6.48E-12 | 3.32E-11 | 4.12E-07 | 2.02E-07 |
| Te-131M | 1.23E-08 | 7.51E-09 | 5.03E-09 | 9.06E-09 | 5.49E-08 | 2.97E-05 | 7.76E-05 |
| Te-131 | 1.97E-12 | 1.04E-12 | 6.30E-13 | 1.55E-12 | 7.72E-12 | 2.92E-07 | 1.89E-09 |
| Te-132 | 4.50E-08 | 3.63E-08 | 2.74E-08 | 3.07E-08 | 2.44E-07 | 5.61E-05 | 5.79E-05 |
| I-130 | 7.80E-07 | 2.24E-06 | 8.96E-07 | 1.86E-04 | 3.44E-06 | --- | 1.14E-06 |
| I-131 | 4.43E-06 | 6.14E-06 | 3.30E-06 | 1.83E-03 | 1.05E-05 | --- | 8.11E-07 |
| I-132 | 1.99E-07 | 5.47E-07 | 1.97E-07 | 1.89E-05 | 8.65E-07 | --- | 1.59E-07 |
| I-133 | 1.52E-06 | 2.56E-06 | 7.78E-07 | 3.65E-04 | 4.49E-06 | --- | 1.29E-06 |
| I-134 | 1.11E-07 | 2.90E-07 | 1.05E-07 | 4.94E-06 | 4.58E-07 | --- | 2.55E-09 |
| I-135 | 4.62E-07 | 1.18E-06 | 4.36E-07 | 7.76E-05 | 1.86E-06 | --- | 8.69E-07 |
| Cs-134 | 6.28E-05 | 1.41E-04 | 6.86E-05 | --- | 4.69E-05 | 1.83E-05 | 1.22E-06 |
| Cs-136 | 6.44E-06 | 2.42E-05 | 1.71E-05 | --- | 1.38E-05 | 2.22E-06 | 1.36E-06 |
| Cs-137 | 8.38E-05 | 1.06E-04 | 3.89E-05 | --- | 3.80E-05 | 1.51E-05 | 1.06E-06 |
| Cs-138 | 5.82E-08 | 1.07E-07 | 5.58E-08 | --- | 8.28E-08 | 9.84E-09 | 3.38E-11 |
| Ba-139 | 1.67E-10 | 1.18E-13 | 4.87E-12 | --- | 1.11E-13 | 8.08E-07 | 8.06E-07 |
| Ba-140 | 6.84E-06 | 8.38E-09 | 4.40E-07 | --- | 2.85E-09 | 2.54E-04 | 2.86E-05 |
| Ba-141 | 1.78E-11 | 1.32E-14 | 5.93E-13 | --- | 1.23E-14 | 4.11E-07 | 9.33E-14 |
| Ba-142 | 4.62E-12 | 4.63E-15 | 2.84E-13 | --- | 3.92E-15 | 2.39E-07 | 5.99E-20 |
| La-140 | 5.99E-08 | 2.95E-08 | 7.82E-09 | --- | --- | 2.68E-05 | 6.09E-05 |
| La-142 | 1.20E-10 | 5.31E-11 | 1.32E-11 | --- | --- | 1.27E-06 | 1.50E-06 |
| Ce-141 | 3.55E-06 | 2.37E-06 | 2.71E-07 | --- | 1.11E-06 | 7.67E-05 | 1.58E-05 |
| Ce-143 | 3.32E-08 | 2.42E-08 | 2.70E-09 | --- | 1.08E-08 | 1.63E-05 | 3.19E-05 |
| Ce-144 | 6.11E-04 | 2.53E-04 | 3.28E-05 | --- | 1.51E-04 | 1.67E-03 | 1.08E-04 |
| Pr-143 | 1.67E-06 | 6.64E-07 | 8.28E-08 | --- | 3.86E-07 | 6.04E-05 | 2.67E-05 |
| Pr-144 | 5.37E-12 | 2.20E-12 | 2.72E-13 | --- | 1.26E-12 | 2.19E-07 | 2.94E-14 |
| Nd-147 | 9.83E-07 | 1.07E-06 | 6.41E-08 | --- | 6.28E-07 | 4.65E-05 | 2.28E-05 |
| W-187 | 1.50E-09 | 1.22E-09 | 4.29E-10 | --- | --- | 5.92E-06 | 2.21E-05 |
| Np-239 | 4.23E-08 | 3.60E-08 | 2.21E-09 | --- | 1.25E-08 | 8.11E-06 | 1.65E-05 |

Table 11 - Inhalation Dose Factors for Child
(mrem per pCi Inhaled)

| Nuclide | Bone | Liver | T. Body | Thyroid | Kidney | Lung | GI-LLI |
|---------|----------|----------|----------|----------|----------|----------|----------|
| H-3 | --- | 1.73E-07 | 1.73E-07 | 1.73E-07 | 1.73E-07 | 1.73E-07 | 1.73E-07 |
| C-14 | 9.70E-06 | 1.82E-06 | 1.82E-06 | 1.82E-06 | 1.82E-06 | 1.82E-06 | 1.82E-06 |
| Na-24 | 4.35E-06 | 4.35E-06 | 4.35E-06 | 4.35E-06 | 4.35E-06 | 4.35E-06 | 4.35E-06 |
| P-32 | 7.04E-04 | 3.09E-05 | 2.67E-05 | --- | --- | --- | 1.14E-05 |
| Cr-51 | --- | --- | 4.17E-08 | 2.31E-08 | 6.57E-09 | 4.59E-06 | 2.93E-07 |
| Mn-54 | --- | 1.16E-05 | 2.57E-06 | --- | 2.71E-06 | 4.26E-04 | 6.19E-06 |
| Mn-56 | --- | 4.48E-10 | 8.43E-11 | --- | 4.52E-10 | 3.55E-06 | 3.33E-05 |
| Fe-55 | 1.28E-05 | 6.80E-06 | 2.10E-06 | --- | --- | 3.00E-05 | 7.75E-07 |
| Fe-59 | 5.59E-06 | 9.04E-06 | 4.51E-06 | --- | --- | 3.43E-04 | 1.91E-05 |
| Co-58 | --- | 4.79E-07 | 8.55E-07 | --- | --- | 2.99E-04 | 9.29E-06 |
| Co-60 | --- | 3.55E-06 | 6.12E-06 | --- | --- | 1.91E-03 | 2.60E-05 |
| Ni-63 | 2.22E-04 | 1.25E-05 | 7.56E-06 | --- | --- | 7.43E-05 | 1.71E-06 |
| Ni-65 | 8.08E-10 | 7.99E-11 | 4.44E-11 | --- | --- | 2.21E-06 | 2.27E-05 |
| Cu-64 | --- | 5.39E-10 | 2.90E-10 | --- | 1.63E-09 | 2.59E-06 | 9.92E-06 |
| Zn-65 | 1.15E-05 | 3.06E-05 | 1.90E-05 | --- | 1.93E-05 | 2.69E-04 | 4.41E-06 |
| Zn-69 | 1.81E-11 | 2.61E-11 | 2.41E-12 | --- | 1.58E-11 | 3.84E-07 | 2.75E-06 |
| Br-83 | --- | --- | 1.28E-07 | --- | --- | --- | --- |
| Br-84 | --- | --- | 1.48E-07 | --- | --- | --- | --- |
| Br-85 | --- | --- | 6.84E-09 | --- | --- | --- | --- |
| Rb-86 | --- | 5.36E-05 | 3.09E-05 | --- | --- | --- | 2.16E-06 |
| Rb-88 | --- | 1.52E-07 | 9.90E-08 | --- | --- | --- | 4.66E-09 |
| Rb-89 | --- | 9.33E-08 | 7.85E-08 | --- | --- | --- | 5.11E-10 |
| Sr-89 | 1.62E-04 | --- | 4.66E-06 | --- | --- | 5.83E-04 | 4.52E-05 |
| Sr-90 | 1.04E-02 | --- | 2.07E-04 | --- | --- | 3.99E-03 | 9.28E-05 |
| Sr-91 | 3.28E-08 | --- | 1.24E-09 | --- | --- | 1.44E-05 | 4.70E-05 |
| Sr-92 | 3.54E-09 | --- | 1.42E-10 | --- | --- | 6.49E-06 | 6.55E-05 |
| Y-90 | 1.11E-06 | --- | 2.99E-08 | --- | --- | 7.07E-05 | 7.24E-05 |
| Y-91M | 1.37E-10 | --- | 4.98E-12 | --- | --- | 7.60E-07 | 4.64E-07 |
| Y-91 | 2.47E-04 | --- | 6.59E-06 | --- | --- | 7.10E-04 | 4.97E-05 |
| Y-92 | 5.50E-09 | --- | 1.57E-10 | --- | --- | 6.46E-06 | 6.46E-05 |
| Y-93 | 5.04E-08 | --- | 1.38E-09 | --- | --- | 2.01E-05 | 1.05E-04 |
| Zr-95 | 5.13E-05 | 1.13E-05 | 1.00E-05 | --- | 1.61E-05 | 6.03E-04 | 1.65E-05 |
| Zr-97 | 5.07E-08 | 7.34E-09 | 4.32E-09 | --- | 1.05E-08 | 3.06E-05 | 9.49E-05 |
| Nb-95 | 6.35E-06 | 2.48E-06 | 1.77E-06 | --- | 2.33E-06 | 1.66E-04 | 1.00E-05 |
| Mo-99 | --- | 4.66E-08 | 1.15E-08 | --- | 1.06E-07 | 3.66E-05 | 3.42E-05 |
| Tc-99M | 4.81E-13 | 9.41E-13 | 1.56E-11 | --- | 1.37E-11 | 2.57E-07 | 1.30E-06 |
| Tc-101 | 2.19E-14 | 2.30E-14 | 2.91E-13 | --- | 3.92E-13 | 1.58E-07 | 4.41E-09 |

Table 11 - Inhalation Dose Factors for Child
(mrem per pCi Inhaled)

| Nuclide | Bone | Liver | T. Body | Thyroid | Kidney | Lung | GI-LLI |
|---------|----------|----------|----------|----------|----------|----------|----------|
| Ru-103 | 7.55E-07 | --- | 2.90E-07 | --- | 1.90E-06 | 1.79E-04 | 1.21E-05 |
| Ru-105 | 4.13E-10 | --- | 1.50E-10 | --- | 3.63E-10 | 4.30E-06 | 2.69E-05 |
| Ru-106 | 3.68E-05 | --- | 4.57E-06 | --- | 4.97E-05 | 3.87E-03 | 1.16E-04 |
| Ag-110M | 4.56E-06 | 3.08E-06 | 2.47E-06 | --- | 5.74E-06 | 1.48E-03 | 2.71E-05 |
| Te-125M | 1.82E-06 | 6.29E-07 | 2.47E-07 | 5.20E-07 | --- | 1.29E-04 | 9.13E-06 |
| Te-127M | 6.72E-06 | 2.31E-06 | 8.16E-07 | 1.64E-06 | 1.72E-05 | 4.00E-04 | 1.93E-05 |
| Te-127 | 7.49E-10 | 2.57E-10 | 1.65E-10 | 5.30E-10 | 1.91E-09 | 2.71E-06 | 1.52E-05 |
| Te-129M | 5.19E-06 | 1.85E-06 | 8.22E-07 | 1.71E-06 | 1.36E-05 | 4.76E-04 | 4.91E-05 |
| Te-129 | 2.64E-11 | 9.45E-12 | 6.44E-12 | 1.93E-11 | 6.94E-11 | 7.93E-07 | 6.89E-06 |
| Te-131M | 3.63E-08 | 1.60E-08 | 1.37E-08 | 2.64E-08 | 1.08E-07 | 5.56E-05 | 8.32E-05 |
| Te-131 | 5.87E-12 | 2.28E-12 | 1.78E-12 | 4.59E-12 | 1.59E-11 | 5.55E-07 | 3.60E-07 |
| Te-132 | 1.30E-07 | 7.36E-08 | 7.12E-08 | 8.58E-08 | 4.79E-07 | 1.02E-04 | 3.72E-05 |
| I-130 | 2.21E-06 | 4.43E-06 | 2.28E-06 | 4.99E-04 | 6.61E-06 | --- | 1.38E-06 |
| I-131 | 1.30E-05 | 1.30E-05 | 7.37E-06 | 4.39E-03 | 2.13E-05 | --- | 7.68E-07 |
| I-132 | 5.72E-07 | 1.10E-06 | 5.07E-07 | 5.23E-05 | 1.69E-06 | --- | 8.65E-07 |
| I-133 | 4.48E-06 | 5.49E-06 | 2.08E-06 | 1.04E-03 | 9.13E-06 | --- | 1.48E-06 |
| I-134 | 3.17E-07 | 5.84E-07 | 2.69E-07 | 1.37E-05 | 8.92E-07 | --- | 2.58E-07 |
| I-135 | 1.33E-06 | 2.36E-06 | 1.12E-06 | 2.14E-04 | 3.62E-06 | --- | 1.20E-06 |
| Cs-134 | 1.76E-04 | 2.74E-04 | 6.07E-05 | --- | 8.93E-05 | 3.27E-05 | 1.04E-06 |
| Cs-136 | 1.76E-05 | 4.62E-05 | 3.14E-05 | --- | 2.58E-05 | 3.93E-06 | 1.13E-06 |
| Cs-137 | 2.45E-04 | 2.23E-04 | 3.47E-05 | --- | 7.63E-05 | 2.81E-05 | 9.78E-07 |
| Cs-138 | 1.71E-07 | 2.27E-07 | 1.50E-07 | --- | 1.68E-07 | 1.84E-08 | 7.29E-08 |
| Ba-139 | 4.98E-10 | 2.66E-13 | 1.45E-11 | --- | 2.33E-13 | 1.56E-06 | 1.56E-05 |
| Ba-140 | 2.00E-05 | 1.75E-08 | 1.17E-06 | --- | 5.71E-09 | 4.71E-04 | 2.75E-05 |
| Ba-141 | 5.29E-11 | 2.95E-14 | 1.72E-12 | --- | 2.56E-14 | 7.89E-07 | 7.44E-08 |
| Ba-142 | 1.35E-11 | 9.73E-15 | 7.54E-13 | --- | 7.87E-15 | 4.44E-07 | 7.41E-10 |
| La-140 | 1.74E-07 | 6.08E-08 | 2.04E-08 | --- | --- | 4.94E-05 | 6.10E-05 |
| La-142 | 3.50E-10 | 1.11E-10 | 3.49E-11 | --- | --- | 2.35E-06 | 2.05E-05 |
| Ce-141 | 1.06E-05 | 5.28E-06 | 7.83E-07 | --- | 2.31E-06 | 1.47E-04 | 1.53E-05 |
| Ce-143 | 9.89E-08 | 5.37E-08 | 7.77E-09 | --- | 2.26E-08 | 3.12E-05 | 3.44E-05 |
| Ce-144 | 1.83E-03 | 5.72E-04 | 9.77E-05 | --- | 3.17E-04 | 3.23E-03 | 1.05E-04 |
| Pr-143 | 4.99E-06 | 1.50E-06 | 2.47E-07 | --- | 8.11E-07 | 1.17E-04 | 2.63E-05 |
| Pr-144 | 1.61E-11 | 4.99E-12 | 8.10E-13 | --- | 2.64E-12 | 4.23E-07 | 5.32E-08 |
| Nd-147 | 2.92E-06 | 2.36E-06 | 1.84E-07 | --- | 1.30E-06 | 8.87E-05 | 2.22E-05 |
| W-187 | 4.41E-09 | 2.61E-09 | 1.17E-09 | --- | --- | 1.11E-05 | 2.46E-05 |
| Np-239 | 1.26E-07 | 8.14E-08 | 6.35E-09 | --- | 2.63E-08 | 1.57E-05 | 1.73E-05 |

Table 12 - Inhalation Dose Factors for Infant
(mrem per pCi Inhaled)

| Nuclide | Bone | Liver | T. Body | Thyroid | Kidney | Lung | GI-LLI |
|---------|----------|----------|----------|----------|----------|----------|----------|
| H-3 | --- | 2.63E-07 | 2.63E-07 | 2.63E-07 | 2.63E-07 | 2.63E-07 | 2.63E-07 |
| C-14 | 1.89E-05 | 3.79E-06 | 3.79E-06 | 3.79E-06 | 3.79E-06 | 3.79E-06 | 3.79E-06 |
| Na-24 | 7.54E-06 | 7.54E-06 | 7.54E-06 | 7.54E-06 | 7.54E-06 | 7.54E-06 | 7.54E-06 |
| P-32 | 1.45E-03 | 8.03E-05 | 5.53E-05 | --- | --- | --- | 1.15E-05 |
| Cr-51 | --- | --- | 6.39E-08 | 4.11E-08 | 9.45E-09 | 9.17E-06 | 2.55E-07 |
| Mn-54 | --- | 1.81E-05 | 3.56E-06 | --- | 3.56E-06 | 7.14E-04 | 5.04E-06 |
| Mn-56 | --- | 1.10E-09 | 1.58E-10 | --- | 7.86E-10 | 8.95E-06 | 5.12E-05 |
| Fe-55 | 1.41E-05 | 8.39E-06 | 2.38E-06 | --- | --- | 6.21E-05 | 7.82E-07 |
| Fe-59 | 9.69E-06 | 1.68E-05 | 6.77E-06 | --- | --- | 7.25E-04 | 1.77E-05 |
| Co-58 | --- | 8.71E-07 | 1.30E-06 | --- | --- | 5.55E-04 | 7.95E-06 |
| Co-60 | --- | 5.73E-06 | 8.41E-06 | --- | --- | 3.22E-03 | 2.28E-05 |
| Ni-63 | 2.42E-04 | 1.46E-05 | 8.29E-06 | --- | --- | 1.49E-04 | 1.73E-06 |
| Ni-65 | 1.71E-09 | 2.03E-10 | 8.79E-11 | --- | --- | 5.80E-06 | 3.58E-05 |
| Cu-64 | --- | 1.34E-09 | 5.53E-10 | --- | 2.84E-09 | 6.64E-06 | 1.07E-05 |
| Zn-65 | 1.38E-05 | 4.47E-05 | 2.22E-05 | --- | 2.32E-05 | 4.62E-04 | 3.67E-05 |
| Zn-69 | 3.85E-11 | 6.91E-11 | 5.13E-12 | --- | 2.87E-11 | 1.05E-06 | 9.44E-06 |
| Br-83 | --- | --- | 2.72E-07 | --- | --- | --- | --- |
| Br-84 | --- | --- | 2.86E-07 | --- | --- | --- | --- |
| Br-85 | --- | --- | 1.46E-08 | --- | --- | --- | --- |
| Rb-86 | --- | 1.36E-04 | 6.30E-05 | --- | --- | --- | 2.17E-06 |
| Rb-88 | --- | 3.98E-07 | 2.05E-07 | --- | --- | --- | 2.42E-07 |
| Rb-89 | --- | 2.29E-07 | 1.47E-07 | --- | --- | --- | 4.87E-08 |
| Sr-89 | 2.84E-04 | --- | 8.15E-06 | --- | --- | 1.45E-03 | 4.57E-05 |
| Sr-90 | 1.11E-02 | --- | 2.23E-04 | --- | --- | 8.03E-03 | 9.36E-05 |
| Sr-91 | 6.83E-08 | --- | 2.47E-09 | --- | --- | 3.76E-05 | 5.24E-05 |
| Sr-92 | 7.50E-09 | --- | 2.79E-10 | --- | --- | 1.70E-05 | 1.00E-04 |
| Y-90 | 2.35E-06 | --- | 6.30E-08 | --- | --- | 1.92E-04 | 7.43E-05 |
| Y-91M | 2.91E-10 | --- | 9.90E-12 | --- | --- | 1.99E-06 | 1.68E-06 |
| Y-91 | 4.20E-04 | --- | 1.12E-05 | --- | --- | 1.75E-03 | 5.02E-05 |
| Y-92 | 1.17E-08 | --- | 3.29E-10 | --- | --- | 1.75E-05 | 9.04E-05 |
| Y-93 | 1.07E-07 | --- | 2.91E-09 | --- | --- | 5.46E-05 | 1.19E-04 |
| Zr-95 | 8.24E-05 | 1.99E-05 | 1.45E-05 | --- | 2.22E-05 | 1.25E-03 | 1.55E-05 |
| Zr-97 | 1.07E-07 | 1.83E-08 | 8.36E-09 | --- | 1.85E-08 | 7.88E-05 | 1.00E-04 |
| Nb-95 | 1.12E-05 | 4.59E-06 | 2.70E-06 | --- | 3.37E-06 | 3.42E-04 | 9.05E-06 |
| Mo-99 | --- | 1.18E-07 | 2.31E-08 | --- | 1.89E-07 | 9.63E-05 | 3.48E-05 |
| Tc-99M | 9.98E-13 | 2.06E-12 | 2.66E-11 | --- | 2.22E-11 | 5.79E-07 | 1.45E-06 |
| Tc-101 | 4.65E-14 | 5.88E-14 | 5.80E-13 | --- | 6.99E-13 | 4.17E-07 | 6.03E-07 |

Table 12 - Inhalation Dose Factors for Infant
(mrem per pCi Inhaled)

| Nuclide | Bone | Liver | T. Body | Thyroid | Kidney | Lung | GI-LLI |
|---------|------------|----------|----------|----------|----------|----------|----------|
| Ru-103 | 1.44E-06 | --- | 4.85E-07 | --- | 3.03E-06 | 3.94E-04 | 1.15E-05 |
| Ru-105 | 8.74E-10 | --- | 2.93E-10 | --- | 6.42E-10 | 1.12E-05 | 3.46E-05 |
| Ru-106 | 6.20E-05 | --- | 7.77E-06 | --- | 7.61E-05 | 8.26E-03 | 1.17E-04 |
| Ag-110M | 7.13E-06 | 5.16E-06 | 3.57E-06 | --- | 7.80E-06 | 2.62E-03 | 2.36E-05 |
| Te-125M | 3.40E-06 | 1.42E-06 | 4.70E-07 | 1.16E-06 | --- | 3.19E-04 | 9.22E-06 |
| Te-127M | 1.19E-05 | 4.93E-06 | 1.48E-06 | 3.48E-06 | 2.68E-05 | 9.37E-04 | 1.95E-05 |
| Te-127 | 1.59E-09 | 6.81E-10 | 3.40E-10 | 1.32E-09 | 3.47E-09 | 7.39E-06 | 1.74E-05 |
| Te-129M | 1.01E-05 | 4.35E-06 | 1.59E-06 | 3.91E-06 | 2.27E-05 | 1.20E-03 | 4.93E-05 |
| Te-129 | 5.63E-11 | 2.48E-11 | 1.34E-11 | 4.82E-11 | 1.25E-10 | 2.14E-06 | 1.88E-05 |
| Te-131M | 7.62E-08 | 3.93E-08 | 2.59E-08 | 6.38E-08 | 1.89E-07 | 1.42E-04 | 8.51E-05 |
| Te-131 | 1.24E-11 | 5.87E-12 | 3.57E-12 | 1.13E-11 | 2.85E-11 | 1.47E-06 | 5.87E-06 |
| Te-132 | 2.66E-07 | 1.69E-07 | 1.26E-07 | 1.99E-07 | 7.39E-07 | 2.43E-04 | 3.15E-05 |
| I-130 | 4.54E-06 | 9.91E-06 | 3.98E-06 | 1.14E-03 | 1.09E-05 | --- | 1.42E-06 |
| I-131 | 2.71E-05 | 3.17E-05 | 1.40E-05 | 1.06E-02 | 3.70E-05 | --- | 7.56E-07 |
| I-132 | 1.21E-06 | 2.53E-06 | 8.99E-07 | 1.21E-04 | 2.82E-06 | --- | 1.36E-06 |
| I-133 | 9.46E-06 | 1.37E-05 | 4.00E-06 | 2.54E-03 | 1.60E-05 | --- | 1.54E-06 |
| I-134 | 6.58E-07 | 1.34E-06 | 4.75E-07 | 3.18E-05 | 1.49E-06 | --- | 9.21E-07 |
| I-135 | 2.76E-06 | 5.43E-06 | 1.98E-06 | 4.97E-04 | 6.05E-06 | --- | 1.31E-06 |
| Cs-134 | 2.83E-04 | 5.02E-04 | 5.32E-05 | --- | 1.36E-04 | 5.69E-05 | 9.53E-07 |
| Cs-136 | 3.45E-05 | 9.61E-05 | 3.78E-05 | --- | 4.03E-05 | 8.40E-06 | 1.02E-06 |
| Cs-137 | 3.92E-04 | 4.37E-04 | 3.25E-05 | --- | 1.23E-04 | 5.09E-05 | 9.53E-07 |
| Cs-138 | 3.61E-07 | 5.58E-07 | 2.84E-07 | --- | 2.93E-07 | 4.67E-08 | 6.26E-07 |
| Ba-139 | 120.06E-09 | 7.03E-13 | 3.07E-11 | --- | 4.23E-13 | 4.25E-06 | 3.64E-05 |
| Ba-140 | 4.00E-05 | 4.00E-08 | 2.07E-06 | --- | 9.59E-09 | 1.14E-03 | 2.74E-05 |
| Ba-141 | 1.12E-10 | 7.70E-14 | 3.55E-12 | --- | 4.64E-14 | 2.12E-06 | 3.39E-06 |
| Ba-142 | 2.84E-11 | 2.36E-14 | 1.40E-12 | --- | 1.36E-14 | 1.11E-06 | 4.95E-07 |
| La-140 | 3.61E-07 | 1.43E-07 | 3.68E-08 | --- | --- | 1.20E-04 | 6.06E-05 |
| La-142 | 7.36E-10 | 2.69E-10 | 6.46E-11 | --- | --- | 5.87E-06 | 4.25E-05 |
| Ce-141 | 1.98E-05 | 1.19E-05 | 1.42E-06 | --- | 3.75E-06 | 3.69E-04 | 1.54E-05 |
| Ce-143 | 2.09E-07 | 1.38E-07 | 1.58E-08 | --- | 4.03E-08 | 8.30E-05 | 3.55E-05 |
| Ce-144 | 2.28E-03 | 8.65E-04 | 1.26E-04 | --- | 3.84E-04 | 7.03E-03 | 1.06E-04 |
| Pr-143 | 1.00E-05 | 3.74E-06 | 4.99E-07 | --- | 1.41E-06 | 3.09E-04 | 2.66E-05 |
| Pr-144 | 3.42E-11 | 1.32E-11 | 1.72E-12 | --- | 4.80E-12 | 1.15E-06 | 3.06E-06 |
| Nd-147 | 5.67E-06 | 5.81E-06 | 3.57E-07 | --- | 2.25E-06 | 2.30E-04 | 2.23E-05 |
| W-187 | 9.26E-09 | 6.44E-09 | 2.23E-09 | --- | --- | 2.83E-05 | 2.54E-05 |
| Np-239 | 2.65E-07 | 2.13E-07 | 1.34E-08 | --- | 4.73E-08 | 4.25E-05 | 1.78E-05 |

Table 13 - Ingestion Dose Factors for Adult
(mrem per pCi Ingested)

| Nuclide | Bone | Liver | T. Body | Thyroid | Kidney | Lung | GI-LLI |
|---------|----------|----------|----------|----------|----------|----------|----------|
| H-3 | --- | 5.99E-08 | 5.99E-08 | 5.99E-08 | 5.99E-08 | 5.99E-08 | 5.99E-08 |
| C-14 | 2.84E-06 | 5.68E-07 | 5.68E-07 | 5.68E-07 | 5.68E-07 | 5.68E-07 | 5.68E-07 |
| Na-24 | 1.70E-06 | 1.70E-06 | 1.70E-06 | 1.70E-06 | 1.70E-06 | 1.70E-06 | 1.70E-06 |
| P-32 | 1.93E-04 | 1.20E-05 | 7.46E-06 | --- | --- | --- | 2.17E-05 |
| Cr-51 | --- | --- | 2.66E-09 | 1.59E-09 | 5.86E-10 | 3.53E-09 | 6.69E-07 |
| Mn-54 | --- | 4.57E-06 | 8.72E-07 | --- | 1.36E-06 | --- | 1.40E-05 |
| Mn-56 | --- | 1.15E-07 | 2.04E-08 | --- | 1.46E-07 | --- | 3.67E-06 |
| Fe-55 | 2.75E-06 | 1.90E-06 | 4.43E-07 | --- | --- | 1.06E-06 | 1.09E-06 |
| Fe-59 | 4.34E-06 | 1.02E-05 | 3.91E-06 | --- | --- | 2.85E-06 | 3.40E-05 |
| Co-58 | --- | 7.45E-07 | 1.67E-06 | --- | --- | --- | 1.51E-05 |
| Co-60 | --- | 2.14E-06 | 4.72E-06 | --- | --- | --- | 4.02E-05 |
| Ni-63 | 1.30E-04 | 9.01E-06 | 4.36E-06 | --- | --- | --- | 1.88E-06 |
| Ni-65 | 5.28E-07 | 6.86E-08 | 3.13E-08 | --- | --- | --- | 1.74E-06 |
| Cu-64 | --- | 8.33E-08 | 3.91E-08 | --- | 2.10E-07 | --- | 7.10E-06 |
| Zn-65 | 4.84E-06 | 1.54E-05 | 6.96E-06 | --- | 1.03E-05 | --- | 9.70E-06 |
| Zn-69 | 1.03E-08 | 1.97E-08 | 1.37E-09 | --- | 1.28E-08 | --- | 2.96E-09 |
| Br-83 | --- | --- | 4.02E-08 | --- | --- | --- | 5.79E-08 |
| Br-84 | --- | --- | 5.21E-08 | --- | --- | --- | 4.09E-13 |
| Br-85 | --- | --- | 2.14E-09 | --- | --- | --- | --- |
| Rb-86 | --- | 2.11E-05 | 9.83E-06 | --- | --- | --- | 4.16E-06 |
| Rb-88 | --- | 6.05E-08 | 3.21E-08 | --- | --- | --- | 8.36E-19 |
| Rb-89 | --- | 4.01E-08 | 2.82E-08 | --- | --- | --- | 2.33E-21 |
| Sr-89 | 3.08E-04 | --- | 8.84E-06 | --- | --- | --- | 4.94E-05 |
| Sr-90 | 8.71E-03 | --- | 1.75E-04 | --- | --- | --- | 2.19E-04 |
| Sr-91 | 5.67E-06 | --- | 2.29E-07 | --- | --- | --- | 2.70E-05 |
| Sr-92 | 2.15E-06 | --- | 9.30E-08 | --- | --- | --- | 4.26E-05 |
| Y-90 | 9.62E-09 | --- | 2.58E-10 | --- | --- | --- | 1.02E-04 |
| Y-91M | 9.09E-11 | --- | 3.52E-12 | --- | --- | --- | 2.67E-10 |
| Y-91 | 1.41E-07 | --- | 3.77E-09 | --- | --- | --- | 7.76E-05 |
| Y-92 | 8.45E-10 | --- | 2.47E-11 | --- | --- | --- | 1.48E-05 |
| Y-93 | 2.68E-09 | --- | 7.40E-11 | --- | --- | --- | 8.50E-05 |
| Zr-95 | 3.04E-08 | 9.75E-09 | 6.60E-09 | --- | 1.53E-08 | --- | 3.09E-05 |
| Zr-97 | 1.68E-09 | 3.39E-10 | 1.55E-10 | --- | 5.12E-10 | --- | 1.05E-04 |
| Nb-95 | 6.22E-09 | 3.46E-09 | 1.86E-09 | --- | 3.42E-09 | --- | 2.10E-05 |
| Mo-99 | --- | 4.31E-06 | 8.20E-07 | --- | 9.76E-06 | --- | 9.99E-06 |
| Tc-99M | 2.47E-10 | 6.98E-10 | 8.89E-09 | --- | 1.06E-08 | 3.42E-10 | 4.13E-07 |
| Tc-101 | 2.54E-10 | 3.66E-10 | 3.59E-09 | --- | 6.59E-09 | 1.87E-10 | 1.10E-21 |

Table 13 - Ingestion Dose Factors for Adult
(mrem per pCi Ingested)

| Nuclide | Bone | Liver | T. Body | Thyroid | Kidney | Lung | GI-LLI |
|---------|----------|----------|----------|----------|----------|----------|----------|
| Ru-103 | 1.85E-07 | --- | 7.97E-08 | --- | 7.06E-07 | --- | 2.16E-05 |
| Ru-105 | 1.54E-08 | --- | 6.08E-09 | --- | 1.99E-07 | --- | 9.42E-06 |
| Ru-106 | 2.75E-06 | --- | 3.48E-07 | --- | 5.31E-06 | --- | 1.78E-04 |
| Ag-110M | 1.60E-07 | 1.48E-07 | 8.79E-08 | --- | 2.91E-07 | --- | 6.04E-05 |
| Te-125M | 2.68E-06 | 9.71E-07 | 3.59E-07 | 8.06E-07 | 1.09E-05 | --- | 1.07E-05 |
| Te-127M | 6.77E-06 | 2.42E-06 | 8.25E-07 | 1.73E-06 | 2.75E-05 | --- | 2.27E-05 |
| Te-127 | 1.10E-07 | 3.95E-08 | 2.38E-08 | 8.15E-08 | 4.48E-07 | --- | 8.68E-06 |
| Te-129M | 1.15E-05 | 4.29E-06 | 1.82E-06 | 3.95E-06 | 4.80E-05 | --- | 5.79E-05 |
| Te-129 | 3.14E-08 | 1.18E-08 | 7.65E-09 | 2.41E-08 | 1.32E-07 | --- | 2.37E-08 |
| Te-131M | 1.73E-06 | 8.46E-07 | 7.05E-07 | 1.34E-06 | 8.57E-06 | --- | 8.40E-05 |
| Te-131 | 1.97E-08 | 8.23E-09 | 6.22E-09 | 1.62E-08 | 8.63E-08 | --- | 2.79E-09 |
| Te-132 | 2.52E-06 | 1.63E-06 | 1.53E-06 | 1.80E-06 | 1.57E-05 | --- | 7.71E-05 |
| I-130 | 7.56E-07 | 2.23E-06 | 8.80E-07 | 1.89E-04 | 3.48E-06 | --- | 1.92E-06 |
| I-131 | 4.16E-06 | 5.95E-06 | 3.41E-06 | 1.95E-03 | 1.02E-05 | --- | 1.57E-06 |
| I-132 | 2.03E-07 | 5.43E-07 | 1.90E-07 | 1.90E-05 | 8.65E-07 | --- | 1.02E-07 |
| I-133 | 1.42E-06 | 2.47E-06 | 7.53E-07 | 3.63E-04 | 4.31E-06 | --- | 2.22E-06 |
| I-134 | 1.06E-07 | 2.88E-07 | 1.03E-07 | 4.99E-06 | 4.58E-07 | --- | 2.51E-10 |
| I-135 | 4.43E-07 | 1.16E-06 | 4.28E-07 | 7.65E-05 | 1.86E-06 | --- | 1.31E-06 |
| Cs-134 | 6.22E-05 | 1.48E-04 | 1.21E-04 | --- | 4.79E-05 | 1.59E-05 | 2.59E-06 |
| Cs-136 | 6.51E-06 | 2.57E-05 | 1.85E-05 | --- | 1.43E-05 | 1.96E-06 | 2.92E-06 |
| Cs-137 | 7.97E-05 | 1.09E-04 | 7.14E-05 | --- | 3.70E-05 | 1.23E-05 | 2.11E-06 |
| Cs-138 | 5.52E-08 | 1.09E-07 | 5.40E-08 | --- | 8.01E-08 | 7.91E-09 | 4.65E-13 |
| Ba-139 | 9.70E-08 | 6.91E-11 | 2.84E-09 | --- | 6.46E-11 | 3.92E-11 | 1.72E-07 |
| Ba-140 | 2.03E-05 | 2.55E-08 | 1.33E-06 | --- | 8.67E-09 | 1.46E-08 | 4.18E-05 |
| Ba-141 | 4.71E-08 | 3.56E-11 | 1.59E-09 | --- | 3.31E-11 | 2.02E-11 | 2.22E-17 |
| Ba-142 | 2.13E-08 | 2.19E-11 | 1.34E-09 | --- | 1.85E-11 | 1.24E-11 | 3.00E-26 |
| La-140 | 2.50E-09 | 1.26E-09 | 3.33E-10 | --- | --- | --- | 9.25E-05 |
| La-142 | 1.28E-10 | 5.82E-11 | 1.45E-11 | --- | --- | --- | 4.25E-07 |
| Ce-141 | 9.36E-09 | 6.33E-09 | 7.18E-10 | --- | 2.94E-09 | --- | 2.42E-05 |
| Ce-143 | 1.65E-09 | 1.22E-06 | 1.35E-10 | --- | 5.37E-10 | --- | 4.56E-05 |
| Ce-144 | 4.88E-07 | 2.04E-07 | 2.62E-08 | --- | 1.21E-07 | --- | 1.65E-04 |
| Pr-143 | 9.20E-09 | 3.69E-09 | 4.56E-10 | --- | 2.13E-09 | --- | 4.03E-05 |
| Pr-144 | 3.01E-11 | 1.25E-11 | 1.53E-12 | --- | 7.05E-12 | --- | 4.33E-18 |
| Nd-147 | 6.29E-09 | 7.27E-09 | 4.35E-10 | --- | 4.25E-09 | --- | 3.49E-05 |
| W-187 | 1.03E-07 | 8.61E-08 | 3.01E-08 | --- | --- | --- | 2.82E-05 |
| Np-239 | 1.19E-09 | 1.17E-10 | 6.45E-11 | --- | 3.65E-10 | --- | 2.40E-05 |

Table 14 - Ingestion Dose Factors for Teenager
(mrem per pCi Ingested)

| Nuclide | Bone | Liver | T. Body | Thyroid | Kidney | Lung | GI-LLI |
|---------|----------|----------|----------|----------|----------|----------|----------|
| H-3 | -- | 6.04E-08 | 6.04E-08 | 6.04E-08 | 6.04E-08 | 6.04E-08 | 6.04E-08 |
| C-14 | 4.06E-06 | 8.12E-07 | 8.12E-07 | 8.12E-07 | 8.12E-07 | 8.12E-07 | 8.12E-07 |
| Na-24 | 2.30E-06 | 2.30E-06 | 2.30E-06 | 2.30E-06 | 2.30E-06 | 2.30E-06 | 2.30E-06 |
| P-32 | 2.76E-04 | 1.71E-05 | 1.07E-05 | --- | --- | --- | 2.32E-05 |
| Cr-51 | --- | --- | 3.60E-09 | 2.00E-09 | 7.89E-10 | 5.14E-09 | 6.05E-07 |
| Mn-54 | --- | 5.90E-06 | 1.17E-06 | --- | 1.76E-06 | --- | 1.21E-05 |
| Mn-56 | --- | 1.58E-07 | 2.81E-08 | --- | 2.00E-07 | --- | 1.04E-05 |
| Fe-55 | 3.78E-06 | 2.68E-06 | 6.25E-07 | --- | --- | 1.70E-06 | 1.16E-06 |
| Fe-59 | 5.87E-06 | 1.37E-05 | 5.29E-06 | --- | --- | 4.32E-06 | 3.24E-05 |
| Co-58 | --- | 9.72E-07 | 2.24E-06 | --- | --- | --- | 1.34E-05 |
| Co-60 | --- | 2.81E-06 | 6.33E-06 | --- | --- | --- | 3.66E-05 |
| Ni-63 | 1.77E-04 | 1.25E-05 | 6.00E-06 | --- | --- | --- | 1.99E-06 |
| Ni-65 | 7.49E-07 | 9.57E-08 | 4.36E-08 | --- | --- | --- | 5.19E-06 |
| Cu-64 | --- | 1.15E-07 | 5.41E-08 | --- | 2.91E-07 | --- | 8.92E-06 |
| Zn-65 | 5.76E-06 | 2.00E-05 | 9.33E-06 | --- | 1.28E-05 | --- | 8.47E-06 |
| Zn-69 | 1.47E-08 | 2.80E-08 | 1.96E-09 | --- | 1.83E-08 | --- | 5.16E-08 |
| Br-83 | --- | --- | 5.74E-08 | --- | --- | --- | --- |
| Br-84 | --- | --- | 7.22E-08 | --- | --- | --- | --- |
| Br-85 | --- | --- | 3.05E-09 | --- | --- | --- | --- |
| Rb-86 | --- | 2.98E-05 | 1.40E-05 | --- | --- | --- | 4.41E-06 |
| Rb-88 | --- | 8.52E-08 | 4.54E-08 | --- | --- | --- | 7.30E-15 |
| Rb-89 | --- | 5.50E-08 | 3.89E-08 | --- | --- | --- | 8.43E-17 |
| Sr-89 | 4.40E-04 | --- | 1.26E-05 | --- | --- | --- | 5.24E-05 |
| Sr-90 | 1.02E-02 | --- | 2.04E-04 | --- | --- | --- | 2.33E-04 |
| Sr-91 | 8.07E-06 | --- | 3.21E-07 | --- | --- | --- | 3.66E-05 |
| Sr-92 | 3.05E-06 | --- | 1.30E-07 | --- | --- | --- | 7.77E-05 |
| Y-90 | 1.37E-08 | --- | 3.69E-10 | --- | --- | --- | 1.13E-04 |
| Y-91M | 1.29E-10 | --- | 4.93E-12 | --- | --- | --- | 6.09E-09 |
| Y-91 | 2.01E-07 | --- | 5.39E-09 | --- | --- | --- | 8.24E-05 |
| Y-92 | 1.21E-09 | --- | 3.50E-11 | --- | --- | --- | 3.32E-05 |
| Y-93 | 3.83E-09 | --- | 1.05E-10 | --- | --- | --- | 1.17E-04 |
| Zr-95 | 4.12E-08 | 1.30E-08 | 8.94E-09 | --- | 1.91E-08 | --- | 3.00E-05 |
| Zr-97 | 2.37E-09 | 4.69E-10 | 2.16E-10 | --- | 7.11E-10 | --- | 1.27E-04 |
| Nb-95 | 8.22E-09 | 4.56E-09 | 2.51E-09 | --- | 4.42E-09 | --- | 1.95E-05 |
| Mo-99 | --- | 6.03E-06 | 1.15E-06 | --- | 1.38E-05 | --- | 1.08E-05 |
| Tc-99M | 3.32E-10 | 9.26E-10 | 1.20E-08 | --- | 1.38E-08 | 5.14E-10 | 6.08E-07 |
| Tc-101 | 3.60E-10 | 5.12E-10 | 5.03E-09 | --- | 9.26E-09 | 3.12E-10 | 8.75E-17 |

Table 14 - Ingestion Dose Factors for Teenager
(mrem per pCi Ingested)

| Nuclide | Bone | Liver | T. Body | Thyroid | Kidney | Lung | GI-LLI |
|---------|----------|----------|----------|----------|----------|----------|----------|
| Ru-103 | 2.55E-07 | --- | 1.09E-07 | --- | 8.99E-07 | --- | 2.13E-05 |
| Ru-105 | 2.18E-08 | --- | 8.46E-09 | --- | 2.75E-07 | --- | 1.76E-05 |
| Ru-106 | 3.92E-06 | --- | 4.94E-07 | --- | 7.56E-06 | --- | 1.88E-04 |
| Ag-110M | 2.05E-07 | 1.94E-07 | 1.18E-07 | --- | 3.70E-07 | --- | 5.45E-05 |
| Te-125M | 3.83E-06 | 1.38E-06 | 5.12E-07 | 1.07E-06 | --- | --- | 1.13E-05 |
| Te-127M | 9.67E-06 | 3.43E-06 | 1.15E-06 | 2.30E-06 | 3.92E-05 | --- | 2.41E-05 |
| Te-127 | 1.58E-07 | 5.60E-08 | 3.40E-08 | 1.09E-07 | 6.40E-07 | --- | 1.22E-05 |
| Te-129M | 1.63E-05 | 6.05E-06 | 2.58E-06 | 5.26E-06 | 6.82E-05 | --- | 6.12E-05 |
| Te-129 | 4.48E-08 | 1.67E-08 | 1.09E-08 | 3.20E-08 | 1.88E-07 | --- | 2.45E-07 |
| Te-131M | 2.44E-06 | 1.17E-06 | 9.76E-07 | 1.76E-06 | 1.22E-05 | --- | 9.39E-05 |
| Te-131 | 2.79E-08 | 1.15E-08 | 8.72E-09 | 2.15E-08 | 1.22E-07 | --- | 2.29E-09 |
| Te-132 | 3.49E-06 | 2.21E-06 | 2.08E-06 | 2.33E-06 | 2.12E-05 | --- | 7.00E-05 |
| I-130 | 1.03E-06 | 2.98E-06 | 1.19E-06 | 2.43E-04 | 4.59E-06 | --- | 2.29E-06 |
| I-131 | 5.85E-06 | 8.19E-06 | 4.40E-06 | 2.39E-03 | 1.41E-05 | --- | 1.62E-06 |
| I-132 | 2.79E-07 | 7.30E-07 | 2.62E-07 | 2.46E-05 | 1.15E-06 | --- | 3.18E-07 |
| I-133 | 2.01E-06 | 3.41E-06 | 1.04E-06 | 4.76E-04 | 5.98E-06 | --- | 2.58E-06 |
| I-134 | 1.46E-07 | 3.87E-07 | 1.39E-07 | 6.45E-06 | 6.10E-07 | --- | 5.10E-09 |
| I-135 | 6.10E-07 | 1.57E-06 | 5.82E-07 | 1.01E-04 | 2.48E-06 | --- | 1.74E-06 |
| Cs-134 | 8.37E-05 | 1.97E-04 | 9.14E-05 | --- | 6.26E-05 | 2.39E-05 | 2.45E-06 |
| Cs-136 | 8.59E-06 | 3.38E-05 | 2.27E-05 | --- | 1.84E-05 | 2.90E-06 | 2.72E-06 |
| Cs-137 | 1.12E-04 | 1.49E-04 | 5.19E-05 | --- | 5.07E-05 | 1.97E-05 | 2.12E-06 |
| Cs-138 | 7.76E-08 | 1.49E-07 | 7.45E-08 | --- | 1.10E-07 | 1.28E-08 | 4.76E-11 |
| Ba-139 | 1.39E-07 | 9.78E-11 | 4.05E-09 | --- | 9.22E-11 | 6.74E-11 | 1.24E-06 |
| Ba-140 | 2.84E-05 | 3.48E-08 | 1.83E-06 | --- | 1.18E-08 | 2.34E-08 | 4.38E-05 |
| Ba-141 | 6.71E-08 | 5.01E-11 | 2.24E-09 | --- | 4.65E-11 | 3.43E-11 | 1.43E-13 |
| Ba-142 | 2.99E-08 | 2.99E-11 | 1.84E-09 | --- | 2.53E-11 | 1.99E-11 | 9.18E-20 |
| La-140 | 3.48E-09 | 1.71E-09 | 4.55E-10 | --- | --- | --- | 9.28E-05 |
| La-142 | 1.79E-10 | 7.95E-11 | 1.98E-11 | --- | --- | --- | 2.42E-06 |
| Ce-141 | 1.33E-08 | 8.88E-09 | 1.02E-09 | --- | 4.18E-09 | --- | 2.54E-05 |
| Ce-143 | 2.35E-09 | 1.71E-06 | 1.91E-10 | --- | 7.67E-10 | --- | 5.14E-05 |
| Ce-144 | 6.96E-07 | 2.88E-07 | 3.74E-08 | --- | 1.72E-07 | --- | 1.75E-04 |
| Pr-143 | 1.31E-08 | 5.23E-09 | 6.52E-10 | --- | 3.04E-09 | --- | 4.31E-05 |
| Pr-144 | 4.30E-11 | 1.76E-11 | 2.18E-12 | --- | 1.01E-11 | --- | 4.74E-14 |
| Nd-147 | 9.38E-09 | 1.02E-08 | 6.11E-10 | --- | 5.99E-09 | --- | 3.68E-05 |
| W-187 | 1.46E-07 | 1.19E-07 | 4.17E-08 | --- | --- | --- | 3.22E-05 |
| Np-239 | 1.76E-09 | 1.66E-10 | 9.22E-11 | --- | 5.21E-10 | --- | 2.67E-05 |

Table 15 - Ingestion Dose Factors for Child
(mrem per pCi Ingested)

| Nuclide | Bone | Liver | T. Body | Thyroid | Kidney | Lung | GI-LLI |
|---------|----------|----------|----------|----------|----------|----------|----------|
| H-3 | --- | 1.16E-07 | 1.16E-07 | 1.16E-07 | 1.16E-07 | 1.16E-07 | 1.16E-07 |
| C-14 | 1.21E-05 | 2.42E-06 | 2.42E-06 | 2.42E-06 | 2.42E-06 | 2.42E-06 | 2.42E-06 |
| Na-24 | 5.80E-06 | 5.80E-06 | 5.80E-06 | 5.80E-06 | 5.80E-06 | 5.80E-06 | 5.80E-06 |
| P-32 | 8.25E-04 | 3.86E-05 | 3.18E-05 | --- | --- | --- | 2.28E-05 |
| Cr-51 | --- | --- | 8.90E-09 | 4.94E-09 | 1.35E-09 | 9.02E-09 | 4.72E-07 |
| Mn-54 | --- | 1.07E-05 | 2.85E-06 | --- | 3.00E-06 | --- | 8.98E-06 |
| Mn-56 | --- | 3.34E-07 | 7.54E-08 | --- | 4.04E-07 | --- | 4.84E-05 |
| Fe-55 | 1.15E-05 | 6.10E-06 | 1.89E-06 | --- | --- | 3.45E-06 | 1.13E-06 |
| Fe-59 | 1.65E-05 | 2.67E-05 | 1.33E-05 | --- | --- | 7.74E-06 | 2.78E-05 |
| Co-58 | --- | 1.80E-06 | 5.51E-06 | --- | --- | --- | 1.05E-05 |
| Co-60 | --- | 5.29E-06 | 1.56E-05 | --- | --- | --- | 2.93E-05 |
| Ni-63 | 5.38E-04 | 2.88E-05 | 1.83E-05 | --- | --- | --- | 1.94E-06 |
| Ni-65 | 2.22E-06 | 2.09E-07 | 1.22E-07 | --- | --- | --- | 2.56E-05 |
| Cu-64 | --- | 2.45E-07 | 1.48E-07 | --- | 5.92E-07 | --- | 1.15E-05 |
| Zn-65 | 1.37E-05 | 3.65E-05 | 2.27E-05 | --- | 2.30E-05 | --- | 6.41E-06 |
| Zn-69 | 4.38E-08 | 6.33E-08 | 5.85E-09 | --- | 3.84E-08 | --- | 3.99E-06 |
| Br-83 | --- | --- | 1.71E-07 | --- | --- | --- | --- |
| Br-84 | --- | --- | 1.98E-07 | --- | --- | --- | --- |
| Br-85 | --- | --- | 9.12E-09 | --- | --- | --- | --- |
| Rb-86 | --- | 6.70E-05 | 4.12E-05 | --- | --- | --- | 4.31E-06 |
| Rb-88 | --- | 1.90E-07 | 1.32E-07 | --- | --- | --- | 9.32E-09 |
| Rb-89 | --- | 1.17E-07 | 1.04E-07 | --- | --- | --- | 1.02E-09 |
| Sr-89 | 1.32E-03 | --- | 3.77E-05 | --- | --- | --- | 5.11E-05 |
| Sr-90 | 2.56E-02 | --- | 5.15E-04 | --- | --- | --- | 2.29E-04 |
| Sr-91 | 2.40E-05 | --- | 9.06E-07 | --- | --- | --- | 5.30E-05 |
| Sr-92 | 9.03E-06 | --- | 3.62E-07 | --- | --- | --- | 1.71E-04 |
| Y-90 | 4.11E-08 | --- | 1.10E-09 | --- | --- | --- | 1.17E-04 |
| Y-91M | 3.82E-10 | --- | 1.39E-11 | --- | --- | --- | 7.48E-07 |
| Y-91 | 6.02E-07 | --- | 1.61E-08 | --- | --- | --- | 8.02E-05 |
| Y-92 | 3.60E-09 | --- | 1.03E-10 | --- | --- | --- | 1.04E-04 |
| Y-93 | 1.14E-08 | --- | 3.13E-10 | --- | --- | --- | 1.70E-04 |
| Zr-95 | 1.16E-07 | 2.55E-08 | 2.27E-08 | --- | 3.65E-08 | --- | 2.66E-05 |
| Zr-97 | 6.99E-09 | 1.01E-09 | 5.96E-10 | --- | 1.45E-09 | --- | 1.53E-04 |
| Nb-95 | 2.25E-08 | 8.76E-09 | 6.26E-09 | --- | 8.23E-09 | --- | 1.62E-05 |
| Mo-99 | --- | 1.33E-05 | 3.29E-06 | --- | 2.84E-05 | --- | 1.10E-05 |
| Tc-99M | 9.23E-10 | 1.81E-09 | 3.00E-08 | --- | 2.63E-08 | 9.19E-10 | 1.03E-06 |
| Tc-101 | 1.07E-09 | 1.12E-09 | 1.42E-08 | --- | 1.91E-08 | 5.92E-10 | 3.56E-09 |

Table 15 - Ingestion Dose Factors for Child
(mrem per pCi Ingested)

| Nuclide | Bone | Liver | T. Body | Thyroid | Kidney | Lung | GI-LLI |
|---------|----------|----------|----------|----------|----------|----------|----------|
| Ru-103 | 7.31E-07 | --- | 2.81E-07 | --- | 1.84E-06 | --- | 1.89E-05 |
| Ru-105 | 6.45E-08 | --- | 2.34E-08 | --- | 5.67E-07 | --- | 4.21E-05 |
| Ru-106 | 1.17E-05 | --- | 1.46E-06 | --- | 1.58E-05 | --- | 1.82E-04 |
| Ag-110M | 5.39E-07 | 3.64E-07 | 2.91E-07 | --- | 6.78E-07 | --- | 4.33E-05 |
| Te-125M | 1.14E-05 | 3.09E-06 | 1.52E-06 | 3.20E-06 | --- | --- | 1.10E-05 |
| Te-127M | 2.89E-05 | 7.78E-06 | 3.43E-06 | 6.91E-06 | 8.24E-05 | --- | 2.34E-05 |
| Te-127 | 4.71E-07 | 1.27E-07 | 1.01E-07 | 3.26E-07 | 1.34E-06 | --- | 1.84E-05 |
| Te-129M | 4.87E-05 | 1.36E-05 | 7.56E-06 | 1.57E-05 | 1.43E-04 | --- | 5.94E-05 |
| Te-129 | 1.34E-07 | 3.74E-08 | 3.18E-08 | 9.56E-08 | 3.92E-07 | --- | 8.34E-06 |
| Te-131M | 7.20E-06 | 2.49E-06 | 2.65E-06 | 5.12E-06 | 2.41E-05 | --- | 1.01E-04 |
| Te-131 | 8.30E-08 | 2.53E-08 | 2.47E-08 | 6.35E-08 | 2.51E-07 | --- | 4.36E-07 |
| Te-132 | 1.01E-05 | 4.47E-06 | 5.40E-06 | 6.51E-06 | 4.15E-05 | --- | 4.50E-05 |
| I-130 | 2.92E-06 | 5.90E-06 | 3.04E-06 | 6.50E-04 | 8.82E-06 | --- | 2.76E-06 |
| I-131 | 1.72E-05 | 1.73E-05 | 9.83E-06 | 5.72E-03 | 2.84E-05 | --- | 1.54E-06 |
| I-132 | 8.00E-07 | 1.47E-06 | 6.76E-07 | 6.82E-05 | 2.25E-06 | --- | 1.73E-06 |
| I-133 | 5.92E-06 | 7.32E-06 | 2.77E-06 | 1.36E-03 | 1.22E-05 | --- | 2.95E-06 |
| I-134 | 4.19E-07 | 7.78E-07 | 3.58E-07 | 1.79E-05 | 1.19E-06 | --- | 5.16E-07 |
| I-135 | 1.75E-06 | 3.15E-06 | 1.49E-06 | 2.79E-04 | 4.83E-06 | --- | 2.40E-06 |
| Cs-134 | 2.34E-04 | 3.84E-04 | 8.10E-05 | --- | 1.19E-04 | 4.27E-05 | 2.07E-06 |
| Cs-136 | 2.35E-05 | 6.46E-05 | 4.18E-05 | --- | 3.44E-05 | 5.13E-06 | 2.27E-06 |
| Cs-137 | 3.27E-04 | 3.13E-04 | 4.62E-05 | --- | 1.02E-04 | 3.67E-05 | 1.96E-06 |
| Cs-138 | 2.28E-07 | 3.17E-07 | 2.01E-07 | --- | 2.23E-07 | 2.40E-08 | 1.46E-07 |
| Ba-139 | 4.14E-07 | 2.21E-10 | 1.20E-08 | --- | 1.93E-10 | 1.30E-10 | 2.39E-05 |
| Ba-140 | 8.31E-05 | 7.28E-08 | 4.85E-06 | --- | 2.37E-08 | 4.34E-08 | 4.21E-05 |
| Ba-141 | 2.00E-07 | 1.12E-10 | 6.51E-09 | --- | 9.69E-11 | 6.58E-10 | 1.14E-07 |
| Ba-142 | 8.74E-08 | 6.29E-11 | 4.88E-09 | --- | 5.09E-11 | 3.70E-11 | 1.14E-09 |
| La-140 | 1.01E-08 | 3.53E-09 | 1.19E-09 | --- | --- | --- | 9.84E-05 |
| La-142 | 5.24E-10 | 1.67E-10 | 5.23E-11 | --- | --- | --- | 3.31E-05 |
| Ce-141 | 3.97E-08 | 1.98E-08 | 2.94E-09 | --- | 8.68E-09 | --- | 2.47E-05 |
| Ce-143 | 6.99E-09 | 3.79E-06 | 5.49E-10 | --- | 1.59E-09 | --- | 5.55E-05 |
| Ce-144 | 2.08E-06 | 6.52E-07 | 1.11E-07 | --- | 3.61E-07 | --- | 1.70E-04 |
| Pr-143 | 3.93E-08 | 1.18E-08 | 1.95E-09 | --- | 6.39E-09 | --- | 4.24E-05 |
| Pr-144 | 1.29E-10 | 3.99E-11 | 6.49E-12 | --- | 2.11E-11 | --- | 8.59E-08 |
| Nd-147 | 2.79E-08 | 2.26E-08 | 1.75E-09 | --- | 1.24E-08 | --- | 3.58E-05 |
| W-187 | 4.29E-07 | 2.54E-07 | 1.14E-07 | --- | --- | --- | 3.57E-05 |
| Np-239 | 5.25E-09 | 3.77E-10 | 2.65E-10 | --- | 1.09E-09 | --- | 2.79E-05 |

Table 16 - Ingestion Dose Factors for Infant
(mrem per pCi Ingested)

| Nuclide | Bone | Liver | T. Body | Thyroid | Kidney | Lung | GI-LLI |
|---------|----------|----------|----------|----------|----------|----------|----------|
| H-3 | --- | 1.76E-07 | 1.76E-07 | 1.76E-07 | 1.76E-07 | 1.76E-07 | 1.76E-07 |
| C-14 | 2.37E-05 | 5.06E-06 | 5.06E-06 | 5.06E-06 | 5.06E-06 | 5.06E-06 | 5.06E-06 |
| Na-24 | 1.01E-05 | 1.01E-05 | 1.01E-05 | 1.01E-05 | 1.01E-05 | 1.01E-05 | 1.01E-05 |
| P-32 | 1.70E-03 | 1.00E-04 | 6.59E-05 | --- | --- | --- | 2.30E-05 |
| Cr-51 | --- | --- | 1.41E-08 | 9.20E-09 | 2.01E-09 | 1.79E-08 | 4.11E-07 |
| Mn-54 | --- | 1.99E-05 | 4.51E-06 | --- | 4.41E-06 | --- | 7.31E-06 |
| Mn-56 | --- | 8.18E-07 | 1.41E-07 | --- | 7.03E-07 | --- | 7.43E-05 |
| Fe-55 | 1.39E-05 | 8.98E-06 | 2.40E-06 | --- | --- | 4.36E-06 | 1.14E-06 |
| Fe-59 | 3.08E-05 | 5.38E-05 | 2.12E-05 | --- | --- | 1.59E-05 | 2.57E-05 |
| Co-58 | --- | 3.60E-06 | 8.98E-06 | --- | --- | --- | 8.97E-06 |
| Co-60 | --- | 1.08E-05 | 2.55E-05 | --- | --- | --- | 2.57E-05 |
| Ni-63 | 6.34E-04 | 3.92E-05 | 2.20E-05 | --- | --- | --- | 1.95E-06 |
| Ni-65 | 4.70E-06 | 5.32E-07 | 2.42E-07 | --- | --- | --- | 4.05E-05 |
| Cu-64 | --- | 6.09E-07 | 2.82E-07 | --- | 1.03E-06 | --- | 1.25E-05 |
| Zn-65 | 1.84E-05 | 6.31E-05 | 2.91E-05 | --- | 3.06E-05 | --- | 5.33E-05 |
| Zn-69 | 9.33E-08 | 1.68E-07 | 1.25E-08 | --- | 6.98E-08 | --- | 1.37E-05 |
| Br-83 | --- | --- | 3.63E-07 | --- | --- | --- | --- |
| Br-84 | --- | --- | 3.82E-07 | --- | --- | --- | --- |
| Br-85 | --- | --- | 1.94E-08 | --- | --- | --- | --- |
| Rb-86 | --- | 1.70E-04 | 8.40E-05 | --- | --- | --- | 4.35E-06 |
| Rb-88 | --- | 4.98E-07 | 2.73E-07 | --- | --- | --- | 4.85E-07 |
| Rb-89 | --- | 2.86E-07 | 1.97E-07 | --- | --- | --- | 9.74E-08 |
| Sr-89 | 2.51E-03 | --- | 7.20E-05 | --- | --- | --- | 5.16E-05 |
| Sr-90 | 2.83E-02 | --- | 5.74E-04 | --- | --- | --- | 2.31E-04 |
| Sr-91 | 5.00E-05 | --- | 1.81E-06 | --- | --- | --- | 5.92E-05 |
| Sr-92 | 1.92E-05 | --- | 7.13E-07 | --- | --- | --- | 2.07E-04 |
| Y-90 | 8.69E-08 | --- | 2.33E-09 | --- | --- | --- | 1.20E-04 |
| Y-91M | 8.10E-10 | --- | 2.76E-11 | --- | --- | --- | 2.70E-06 |
| Y-91 | 1.13E-06 | --- | 3.01E-08 | --- | --- | --- | 8.10E-05 |
| Y-92 | 7.65E-09 | --- | 2.15E-10 | --- | --- | --- | 1.46E-04 |
| Y-93 | 2.43E-08 | --- | 6.62E-10 | --- | --- | --- | 1.92E-04 |
| Zr-95 | 2.06E-07 | 5.02E-08 | 3.56E-08 | --- | 5.41E-08 | --- | 2.50E-05 |
| Zr-97 | 1.48E-08 | 2.54E-09 | 1.16E-09 | --- | 2.56E-09 | --- | 1.62E-04 |
| Nb-95 | 4.20E-08 | 1.73E-08 | 1.00E-08 | --- | 1.24E-08 | --- | 1.46E-05 |
| Mo-99 | --- | 3.40E-05 | 6.63E-06 | --- | 5.08E-05 | --- | 1.12E-05 |
| Tc-99M | 1.92E-09 | 3.96E-09 | 5.10E-08 | --- | 4.26E-08 | 2.07E-09 | 1.15E-06 |
| Tc-101 | 2.27E-09 | 2.86E-09 | 2.83E-08 | --- | 3.40E-08 | 1.56E-09 | 4.86E-07 |

Table 16 - Ingestion Dose Factors for Infant
(mrem per pCi Ingested)

| Nuclide | Bone | Liver | T. Body | Thyroid | Kidney | Lung | GI-LLI |
|---------|----------|----------|----------|----------|----------|----------|----------|
| Ru-103 | 1.48E-06 | --- | 4.95E-07 | --- | 3.08E-06 | --- | 1.80E-05 |
| Ru-105 | 1.36E-07 | --- | 4.58E-08 | --- | 1.00E-06 | --- | 5.41E-05 |
| Ru-106 | 2.41E-05 | --- | 3.01E-06 | --- | 2.85E-05 | --- | 1.83E-04 |
| Ag-110M | 9.96E-07 | 7.27E-07 | 4.81E-07 | --- | 1.04E-06 | --- | 3.77E-05 |
| Te-125M | 2.33E-05 | 7.79E-06 | 3.15E-06 | 7.84E-06 | --- | --- | 1.11E-05 |
| Te-127M | 5.85E-05 | 1.94E-05 | 7.08E-06 | 1.69E-05 | 1.44E-04 | --- | 2.36E-05 |
| Te-127 | 1.00E-06 | 3.35E-07 | 2.15E-07 | 8.14E-07 | 2.44E-06 | --- | 2.10E-05 |
| Te-129M | 1.00E-04 | 3.43E-05 | 1.54E-05 | 3.84E-05 | 2.50E-04 | --- | 5.97E-05 |
| Te-129 | 2.84E-07 | 9.79E-08 | 6.63E-08 | 2.38E-07 | 7.07E-07 | --- | 2.27E-05 |
| Te-131M | 1.52E-05 | 6.12E-06 | 5.05E-06 | 1.24E-05 | 4.21E-05 | --- | 1.03E-04 |
| Te-131 | 1.76E-07 | 6.50E-08 | 4.94E-08 | 1.57E-07 | 4.50E-07 | --- | 7.11E-06 |
| Te-132 | 2.08E-05 | 1.03E-05 | 9.61E-06 | 1.52E-05 | 6.44E-05 | --- | 3.81E-05 |
| I-130 | 6.00E-06 | 1.32E-05 | 5.30E-06 | 1.48E-03 | 1.45E-05 | --- | 2.83E-06 |
| I-131 | 3.59E-05 | 4.23E-05 | 1.86E-05 | 1.39E-02 | 4.94E-05 | --- | 1.51E-06 |
| I-132 | 1.66E-06 | 3.37E-06 | 1.20E-06 | 1.58E-04 | 3.76E-06 | --- | 2.73E-06 |
| I-133 | 1.25E-05 | 1.82E-05 | 5.33E-06 | 3.31E-03 | 2.14E-05 | --- | 3.08E-06 |
| I-134 | 8.69E-07 | 1.78E-06 | 6.33E-07 | 4.15E-05 | 1.99E-06 | --- | 1.84E-06 |
| I-135 | 3.64E-06 | 7.24E-06 | 2.64E-06 | 6.49E-04 | 8.07E-06 | --- | 2.62E-06 |
| Cs-134 | 3.77E-04 | 7.03E-04 | 7.10E-05 | --- | 1.81E-04 | 7.42E-05 | 1.91E-06 |
| Cs-136 | 4.59E-05 | 1.35E-04 | 5.04E-05 | --- | 5.38E-05 | 1.10E-05 | 2.05E-06 |
| Cs-137 | 5.22E-04 | 6.11E-04 | 4.33E-05 | --- | 1.64E-04 | 6.64E-05 | 1.91E-06 |
| Cs-138 | 4.81E-07 | 7.82E-07 | 3.79E-07 | --- | 3.90E-07 | 6.09E-08 | 1.25E-06 |
| Ba-139 | 8.81E-07 | 5.84E-10 | 2.55E-08 | --- | 3.51E-10 | 3.54E-10 | 5.58E-05 |
| Ba-140 | 1.71E-04 | 1.71E-07 | 8.81E-06 | --- | 4.06E-08 | 1.05E-07 | 4.20E-05 |
| Ba-141 | 4.25E-07 | 2.91E-10 | 1.34E-08 | --- | 1.75E-10 | 1.77E-10 | 5.19E-06 |
| Ba-142 | 1.84E-07 | 1.53E-10 | 9.06E-09 | --- | 8.81E-11 | 9.26E-11 | 7.59E-07 |
| La-140 | 2.11E-08 | 8.32E-09 | 2.14E-09 | --- | --- | --- | 9.77E-05 |
| La-142 | 1.10E-09 | 4.04E-10 | 9.67E-11 | --- | --- | --- | 6.86E-05 |
| Ce-141 | 7.87E-08 | 4.80E-08 | 5.65E-09 | --- | 1.48E-08 | --- | 2.48E-05 |
| Ce-143 | 1.48E-08 | 9.82E-06 | 1.12E-09 | --- | 2.86E-09 | --- | 5.73E-05 |
| Ce-144 | 2.98E-06 | 1.22E-06 | 1.67E-07 | --- | 4.93E-07 | --- | 1.71E-04 |
| Pr-143 | 8.13E-08 | 3.04E-08 | 4.03E-09 | --- | 1.13E-08 | --- | 4.29E-05 |
| Pr-144 | 2.74E-10 | 1.06E-10 | 1.38E-11 | --- | 3.84E-11 | --- | 4.93E-06 |
| Nd-147 | 5.53E-08 | 5.68E-08 | 3.48E-09 | --- | 2.19E-08 | --- | 3.60E-05 |
| W-187 | 9.03E-07 | 6.28E-07 | 2.17E-07 | --- | --- | --- | 3.69E-05 |
| Np-239 | 1.11E-08 | 9.93E-10 | 5.61E-10 | --- | 1.98E-09 | --- | 2.87E-05 |

Table 17 - Recommended Values for Other Parameters

| Parameter Symbol | Definition | Values |
|------------------|---|--|
| f_g | Fraction of ingested produce grown in garden of interest. | 0.76 |
| f_e | Fraction of leafy vegetables grown in garden of interest. | 1.0 |
| P | Effective surface density of soil (assumes a 15 cm plow layer, expressed in dry weight) | 240 kg/m ² |
| r | Fraction of deposited activity retained on crops, leafy vegetables, or pasture grass | 0.25 1.0 (iodines) 0.2 (other particulates) |
| S_r | Attenuation factor accounting for shielding provided by residential structures | 0.7 (maximum individual) 0.5 (general population) |
| t_b | Period of long-term buildup for activity in sediment or soil (20 years) | 1.752E5 hr |
| t_e | Period of crop, leafy vegetable, or pasture grass exposure during growing season | 30 days (grass-cow-milk-man pathway) 60 days (crop/vegetation-man pathway) |
| f | Transport time from animal feed-milk-man provided by residential structures | 2 days (maximum individual) 4 days (general population) |
| t_h | Time delay between harvest of vegetation or crops and ingestion: | |
| | • For ingestion of forage by animals | Zero (pasture grass) 90 days (stored feed) |
| | • For ingestion of crops by man | 1 day (leafy vegetables and max. individual feed) 60 days (produce and max. individual) 14 days (general population) |
| f_s | The fraction of daily feed that is pasture grass while the animals graze on pasture. | 1.0 |
| M_p | The mixing ratio at the point of withdrawal of drinking water. | Site Discharge 7.14 M.U.D. Intake 30.8 |
| f_p | Fraction of the year that animals graze on pasture. | 0.5 |

Table 17 - Recommended Values for Other Parameters

| Parameter Symbol | Definition | Values |
|------------------|---|---|
| t_p | Environmental transit time, release to receptor (add time from release to exposure individual point to minimums shown for distribution) | 12 hrs. (maximum) 1 day (maximum individual) 1 day (general population) 7 days (population-sport fish doses) 10 days (population-commercial fish doses) |
| t_s | Average time from slaughter of meat animal to consumption | 20 days |
| Y_v | Agricultural productivity by unit area (measured in wet weight) | 0.7 kg/m ² (grass-cow-milk-man pathway) 2.0 kg/m ² (produce or leafy vegetable ingested by man) |
| W | Shore-width factor for river shoreline | 0.2 |
| λ_w | Rate constant for removal of activity on plant or leaf structures by weathering (corresponds to a 14-day half-life) | 0.0021 hr ⁻¹ |
| %CO ₂ | Fraction of C-14 used for organ dose calculations from gaseous releases. | 0.15 |

Table 18 - Estimated Doses Received by the General Public from On-Site Exposure

| | | |
|---|-------------|----------|
| i | NOTE | i |
| The Dose Estimates are based on normal public activities conducted within the Fort Calhoun Station Site Boundary. | | |

| Location | Direction | Distance from Containment (miles) | Estimated Individual Dose Rate (mR/hour) | | Estimated Total Combined Annual Dose (mRem) ^B | |
|----------------------------------|-----------|-----------------------------------|--|---|--|---|
| | | | Direct Exposure (Total Body) | Inhalation (Critical Organ ^A) | Direct Exposure (Total Body) | Inhalation (Critical Organ ^A) |
| Firing Range | 200° | 0.24 | 4.08E-05 | 9.67E-06 | 5.08E+00 | 1.20E+00 |
| Burn Pad | 241° | 0.33 | 1.95E-05 | 4.63E-06 | 1.41E-01 | 3.34E-02 |
| On-Site Farming | 118° | 0.52 | 2.12E-05 | 5.03E-06 | 2.38E-02 | 5.64E-03 |
| On-Site Farming | 200° | 0.51 | 1.03E-05 | 2.45E-06 | 2.30E-02 | 5.50E-03 |
| On-Site Farming | 308° | 0.50 | 2.77E-05 | 6.64E-06 | 4.66E-02 | 1.12E-02 |
| Site Maintenance Admin Bldg | 145° | 0.20 | 1.18E-04 | 2.84E-05 | 5.50E-02 | 1.33E-02 |
| Site Maintenance Training Center | 180° | 0.20 | 1.45E-04 | 3.50E-05 | 6.78E-02 | 1.64E-02 |

- A. Critical organ doses are based on adult thyroid.
- B. Estimated totals are based on summation of all individual doses for members of the General Public while within the Fort Calhoun Station site boundary.