



Jan. 23rd,2018

Mr. Richard K Struckmeyer  
Materials Safety Licensing Branch  
Division of Materials Safety, State, Tribal, and Rulemaking Programs  
Office of Nuclear Material Safety and Safeguards  
U.S Nuclear Regulatory Commission  
Mail Stop: T-8E 18  
Washington DC 20555

Dear Mr. Richard,

This letter is to in response to your mail dated on Jan 23rd, 2018 regard about second request for additional information for our exempt distribution license.

If you have question or concerns regarding this application, please contact us at 858-381-7234, or at [info@growersc.com](mailto:info@growersc.com) .

Sincerely,

  
Leonardo Day

CEO

1. Please note that an exempt distribution license will not be issued until we receive a copy of your possession and use license.

CA Radioactive Material License Attached in the email.

3. Please provide the appropriate units of each drawings, translate written text into English of the drawings and specify whether each drawing identifies a particular lamp model, or a series containing lamps that are similar but have varying model numbers.

Please noted that all units of the drawing is mm(millimeter).

I will translate all the written text into English in attachment.

Please find below chart for overall dimensions, the minimum and maximum dimensions for each device for your reference.

Product Type	Overall Dimension	Inside Tube Main Part Minimum Dimension	Inside tube Main Part Maximum Dimension
MH-DE600W	388mm	323.5mm	326.5mm
MH-DE1000W	388mm	323.5mm	326.5mm
SE600W	320+/-4.0mm	193mm	187mm
SE1000W	320+/-4.0mm	197mm	203mm
CMH500W	191.5+/-3.0mm	92mm	86mm
CMH315W	194.5+/-3.0mm	92mm	86mm
CMH630W	388+/-3.0mm	330mm	N/A
CMH945W	392+/-2.0mm	330mm	N/A
CMH1000W	390+/-2.0mm	N/A	N/A

lease see below chart for light bulbs we are planning to distribute. We are planing to distribute two type of bulbs.

One is Arc Tube-Quartz bulb, the other one is Arc Tube-Ceramic Poly crystalline bulb.

We have four series under Arc Tube-Quartz bulb, each series contains 3 different models. These models are very similar but have varying model number which is 4K,6K and 10K. 4K,6K and 10K is also refer to the spectrum of the bulbs.

We have five series under Arc Tube-Ceramic Poly crystalline bulb,each series contains 1 to 3 different models. These models are very similar but have varying model number which mainly is 3K, 4K and 3KR. 3K,4K and 3KR is also refer to the spectrum of the bulbs.

Please find below chart for each series bulbs and model details which we are planning to distribute for your reference.

Arc Tube-Quartz	MH-DE600W	MH-DE600W-4K	MH-DE600W-6K	MH-DE600W-10K
	MH-DE1000W	MH-DE1000W-4K	MH-DE1000W-6K	MH-DE1000W-10K
	SE600W	SE600W-4K	SE600W-6K	SE600W-10K
	SE1000W	SE1000W-4K	SE1000W-6K	SE1000W-10K
Arc Tube-Ceramic poly crystalline	CMH500W	CMH500W-3K	CMH500W-4K	CMH500W-3KR
	CMH315W	CMH315W-3K	CMH315W-4K	CMH315W-3KR
	CMH630W	CMH630W-3K	CHM630W-4K	CMH630W-3KR
	CMH945W	CMH945W-3K		
	CMH 1000W	CMH1000W-3K	CMH1000W-4K	CMH1000W-3KR

All drawings contains contain written text translate in another Word file.

5. Please provide examples of your labels in the form of drawings, copies, or photographs.

I am attaching a picture with Kr-85 labeling on the bubble pack containing the electron tube.

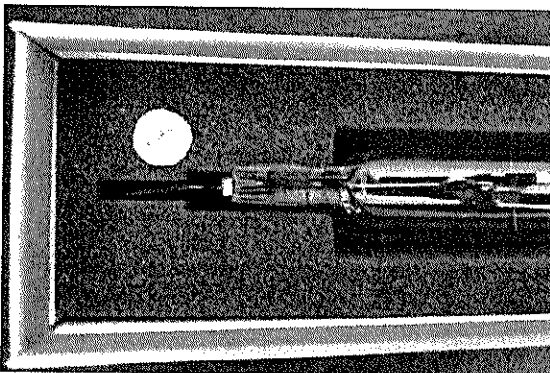
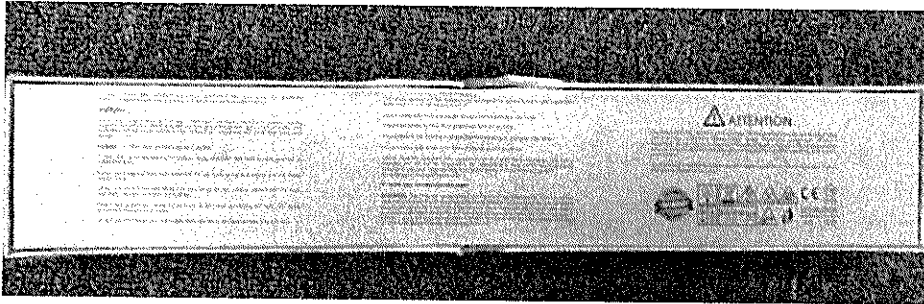
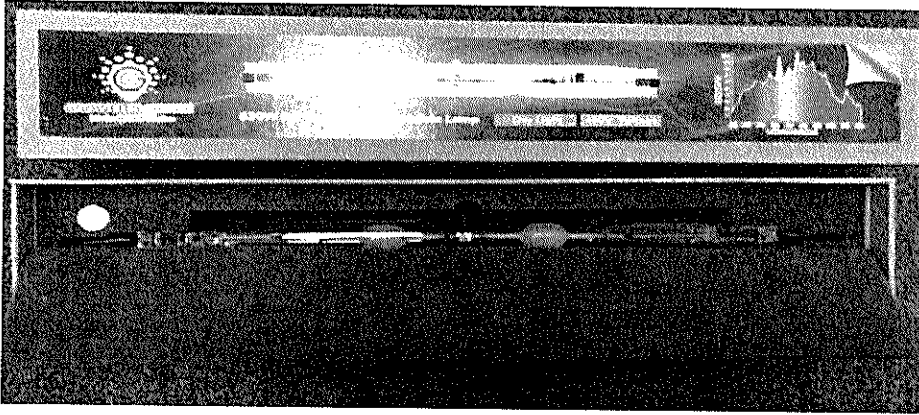

8. Please describe how you will prevent the transfer to other person for use under Section 30.15 of this chapter or equivalent regulations of an Agreement State any part or product tested and found defective under the criteria and procedures specified in the license issued under Section 32.14. Corrected Statement.

All product containers are labeled with "Contains Kr-85" or "Arc Tube Contains Kr-85". All defective or broken product will be isolated in a dedicated area of the facility and disposed of properly. It would not be transfer to any other facility or users. Given the very low activity of Kr-85 stored and being a chemically inert gas, radioactive waste is not expected to be generated at the TOP SHELF facility.

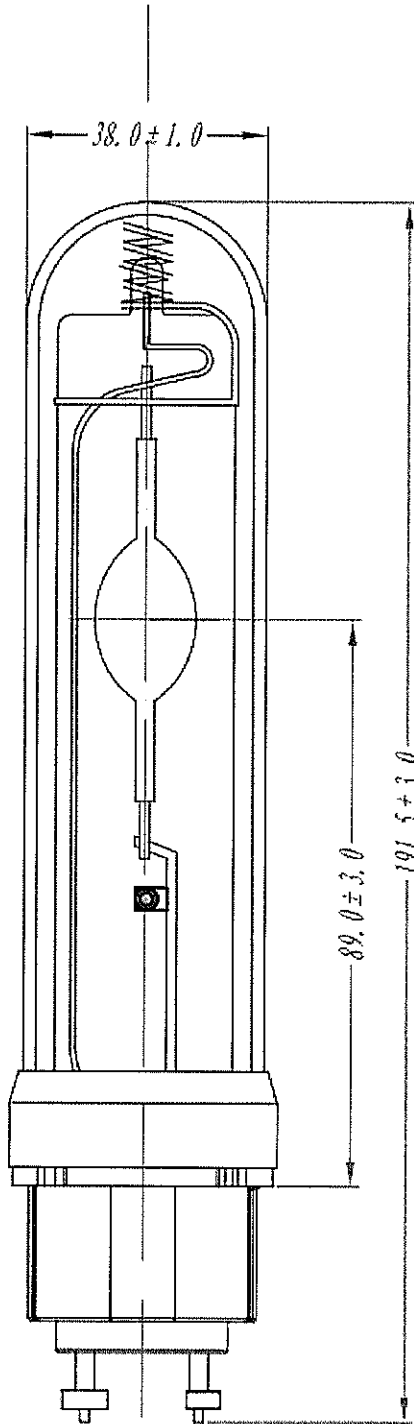

Mode I#	Version #	Unit	Manufacture
CMH 315W	HGZM A/0	Millimeter	Hangzhouhanguang Illumination Co., Ltd

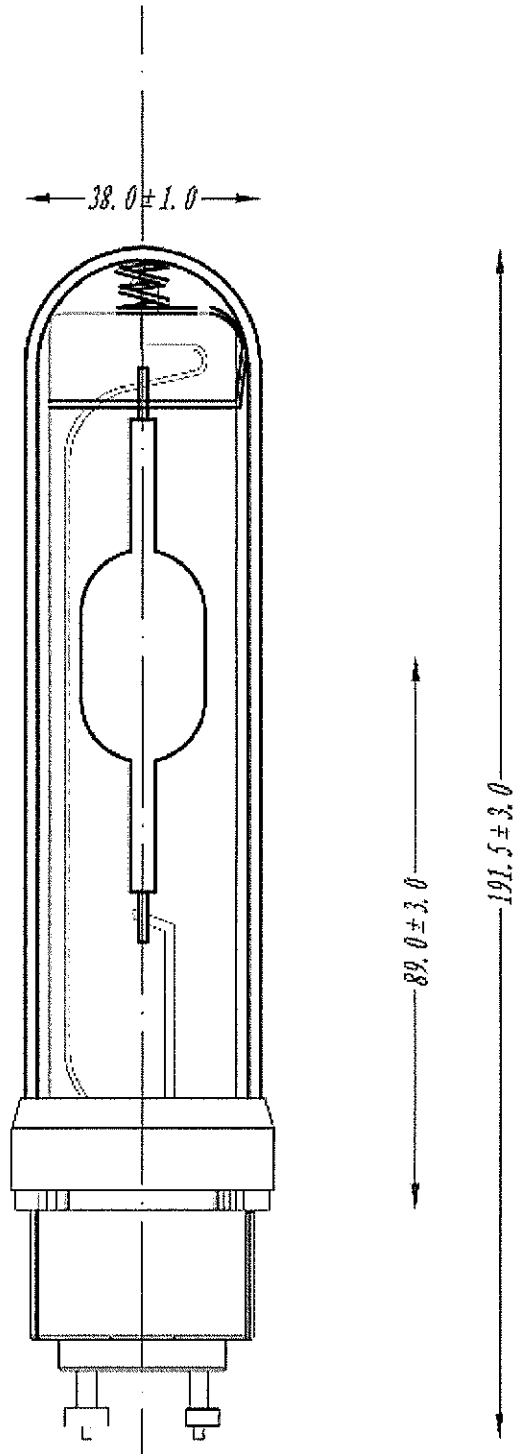

Mode I#	Version #	Unit	Manufacture
CMH 500W	HGZM A/0	Millimeter	Hangzhouhanguang Illumination Co., Ltd

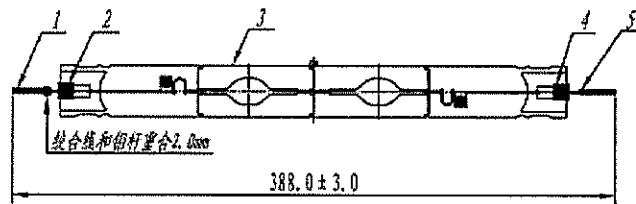
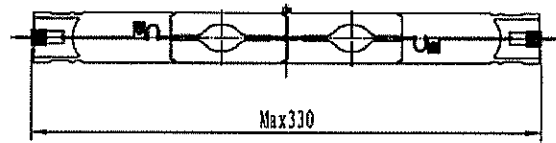

Mode I#	Version #	Unit	Manufacture
CMH 630W	HGZM 130500001D00	Millimeter	Hangzhouhanguang Illumination Co., Ltd

Part 1	Part 2	Part 3	Part 4	Part 5
Electrical lanyard 28*1.8	Double ended lamp mud	E ceramic metal halite CMH 630.830.T32.5DE.B2 High light efficiency	Ceramic part	Nickel part 4*10*0.1



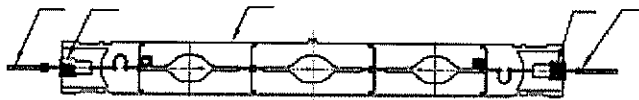
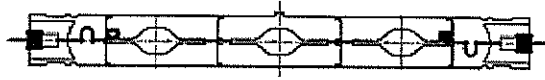

Mode l#	Version #	Unit	Manufacture
CMH 945W	HGZM 130500001F00	Millimeter	Hangzhouhanguang Illumination Co., Ltd

Part 1	Part 2	Part 3	Part 4	Part 5
Electrical lanyard 28*1.8	Double ended lamp mud	E ceramic metal halite CMH 630.830.T32.5DE.B2 High light efficiency	Ceramic part	Nickel part 4*10*0.1

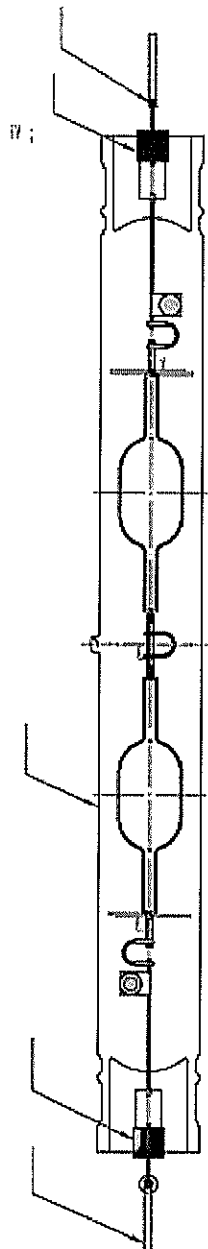

Mode l#	Version #	Unit	Manufacture
CMH 1000W	HGZM 130500001F00	Millimeter	Hangzhouhanguang Illumination Co., Ltd

Part 1	Part 2	Part 3	Part 4	Part 5
Electrical lanyard 28*1.8	Double ended lamp mud	E ceramic metal halite CMH 630.830.T32.5DE.B2 High light efficiency	Ceramic part	Nickel part 4*10*0.1

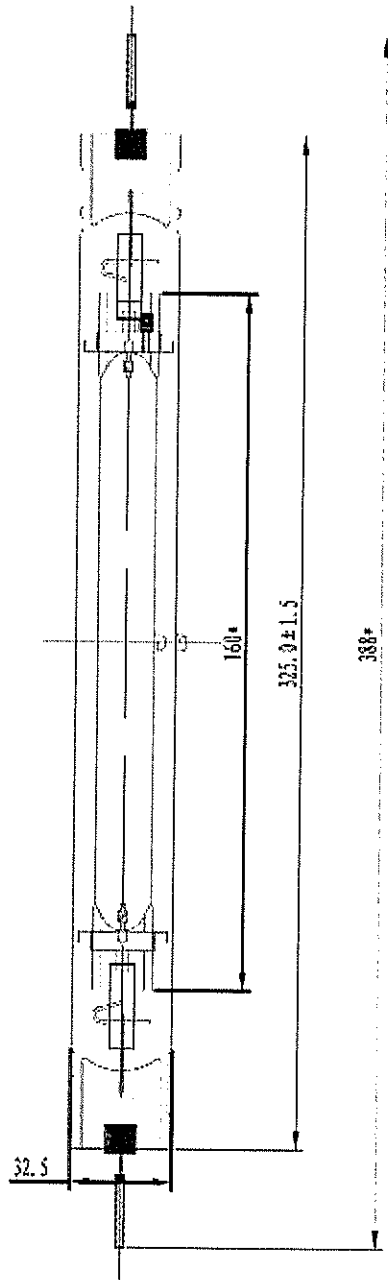

Mode I#	Version #	Unit	Manufacture
MH 600W	HGZM	Millimeter	Hangzhouhanguang Illumination Co., Ltd

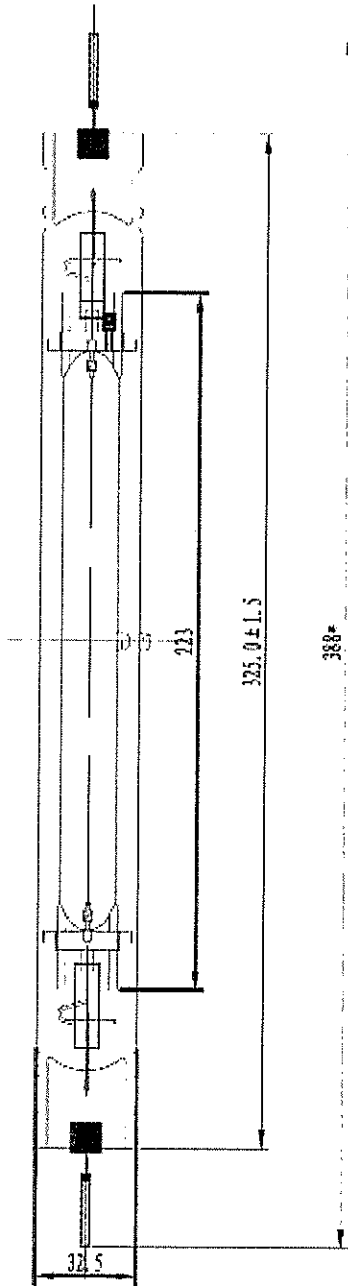

Mode l#	Version #	Unit	Manufacture
MH 600W	HGZM	Millimeter	Hangzhouhanguang Illumination Co., Ltd

Production Technical Requirement for all bulbs

1. Ceramic parts must install firmly in the electron tub.
2. Appropriated amount of light mud apply for each bulb, it can not have any extra mud on the tub.
3. After installing of ceramic part, using ballast CWA-1000W to aging the bulbs for 4 minutes, tube pressure :  $210 \pm 15V$
4. All the wire require stay firmly.
5. Unit Dimension: millimeter (mm).

**RADIOACTIVE MATERIAL LICENSE**

*Pursuant to the California Code of Regulations, Division 1, Title 17, Chapter 5, Subchapter 4, Group 2, Licensing of Radioactive Material, and in reliance on statements and representations heretofore made by the licensee, a license is hereby issued authorizing the licensee to receive, use, possess, transfer, or dispose of radioactive material listed below; and to use such radioactive material for the purpose(s) and at the place(s) designated below. This license is subject to all applicable rules, regulations, and orders of the California Department of Public Health now or hereafter in effect and to any standard or specific condition specified in this license.*

1. Licensee: Top Shelf LED Inc. dba Grower's Choice	3. License Number: 8227-36	Amendment Number :
2. Address: 1500 S Milliken Ave. Unit B Ontario, CA 91761	4. Expiration date: February 15, 2028	(5)
Attention: Leonardo Day Radiation Safety Officer	5. Inspection agency: Radiologic Health Branch South	

6. Nuclide	7. Form	8. Possession Limit
A. Krypton-85	A. Sealed electron tubes	A. Not to exceed 5.188 kilobecquerels (140 nanocuries) each. Total not to exceed 3.70 megabecquerels (100 microcuries).

9. Authorized Use

A. Storage and Possession only.

LICENSE CONDITIONS

10. Radioactive material shall be used only at the following location:

(a) 1500 S Milliken Ave. Unit B, Ontario, CA.

11. This license is subject to an annual fee for sources of radioactive material authorized to be possessed at any one time as specified in Items 6, 7, 8 and 9 of this license. The annual fee for this license is required by and computed in accordance with Title 17, California Code of Regulations, Sections 30230-30232 and is also subject to an annual cost-of-living adjustment pursuant to Section 100425 of the California Health and Safety Code.

12. Radioactive material shall be used by, or under the supervision of, the following individual:

(a) Leonardo Day

13. Except as specifically provided otherwise by this license, the licensee shall possess and use radioactive material described in Items 6, 7, 8 and 9 of this license in accordance with the statements, representations, and procedures contained in the documents listed below. The Department's regulations shall govern unless the statements, representations, and procedures in the licensee's application and correspondence are more restrictive than the regulations.

(a) The letter with attachments including the license application dated August 30, 2017, the emails with attachments dated October 18, 2017, and November 6, 2017, and the letter with attachments dated December 14, 2017, all by Leonardo Day, CEO and Radiation Safety Officer.

14. (a) The Radiation Safety Officer in this program shall be Leonardo Day.

15. This license does not authorize commercial distribution of radioactive material.

**RADIOACTIVE MATERIAL LICENSE**

License Number: 8227-36

Amendment Number:

- 16. The licensee shall conduct a physical inventory every six months to account for all sealed sources and/or devices received and possessed under the license. Records of the inventories shall be maintained for inspection, and may be disposed of, following Department inspection.
- 17. At least 30 days prior to vacating any address of use listed in Condition 10 of this license, the licensee shall provide written notification of intent to vacate to the California Department of Public Health, in accordance with Title 17, California Code of Regulations, Section 30256 (b). Control of all licensed areas must be maintained until such areas are released by the Department for unrestricted use or the license is terminated, in accordance with Title 17, California Code of Regulations, Section 30256 (j).
- 18. A copy of this license and a copy of all records and documents pertaining to this license shall be maintained available for inspection at 1500 S Milliken Ave, Unit B, Ontario, CA.
- 19. The licensee will provide the Low Level Radioactive Waste (LLRW) reports specified in the California Health and Safety Code section 115000.1(h) to the California Department of Public Health (CDPH) on an annual basis for both shipped and stored LLRW. Alternatively, LLRW shipment information may be provided on a per shipment basis. LLRW shipment information and annual reports shall be mailed to:

Attn: LLRW Tracking Program  
 California Department of Public Health  
 Radiologic Health Branch, MS 7610  
 P.O. Box 997414  
 Sacramento, CA 95899-7414

---

Issued for the State of California Department of Public Health

Date: February 15, 2018

By: \_\_\_\_\_

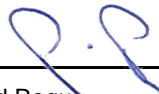

Ronald Rogus  
 Senior Health Physicist  
 Radiologic Health Branch,  
 MS 7610, P.O. Box 997414  
 Sacramento, CA 95899-7414