

HI-STAR 100 Transportation CoC (9261) Amendment 11 HI-STAR 100 Version MB

Pre-Submittal Presentation to NRC
January 23, 2018

a generation ahead by design

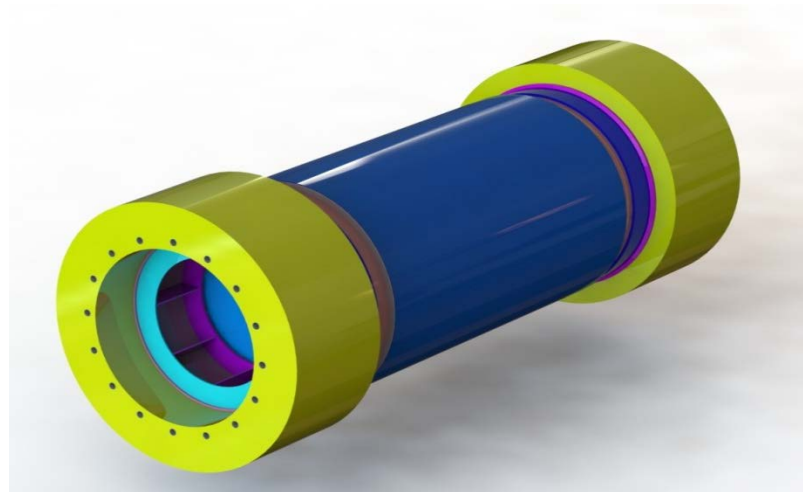

Holtec copyrighted material

Agenda

- Amendment 11 Proposed Change
- Design Overview HI-STAR 100MB and Fuel Packages
- Technical disciplines, criteria and methods
 - Structural
 - Thermal
 - Shielding
 - Criticality
 - Containment
- Summary and Schedule

HI-STAR 100 Transport CoC (9261) Amd. 11 Proposed Change

- HI-STAR 100 Version MB (HI-STAR 100MB)
 - HI-STAR 100MB is an enhanced version of the HI-STAR 100 transport package initially licensed by the NRC in 1998.
 - Enhancements focus on HBF transportation
 - Based on HI-STAR 190 and HI-STAR 180/180D
 - Same Cavity Inner Diameter as the HI-STAR 100.
 - Suitable to transport all currently licensed MPCs for the HI-STAR 100
 - Single Lid (HI-STAR 190, HI-STAR 100) and Double Lid (HI-STAR 180 and 180D) versions
 - Two cask length (HI-STAR 190)
- MPC-32M Fuel Package
 - 32 PWR assembly MPC with a Metamic Basket, enhanced version of the MPC-32 currently approved
 - Similar to MPC-68M for MPC-68 in the HI-STORM 100
- F-24M and F-32M Fuel packages
 - Bare Metamic Baskets for 24 and 32 PWR assemblies
 - Similar to HI-STAR 180 baskets
- Amendment focusses on approval of those designs

HI-STAR 100MB

a generation ahead by design

- Single Cavity Diameter, compatible with all MPCs currently approved in HI-STAR 100 Docket 71-9261
- Two Cavity Lengths
 - Type XL – Extra Long for MPCs
 - Type SL – Short Length for Bare Baskets

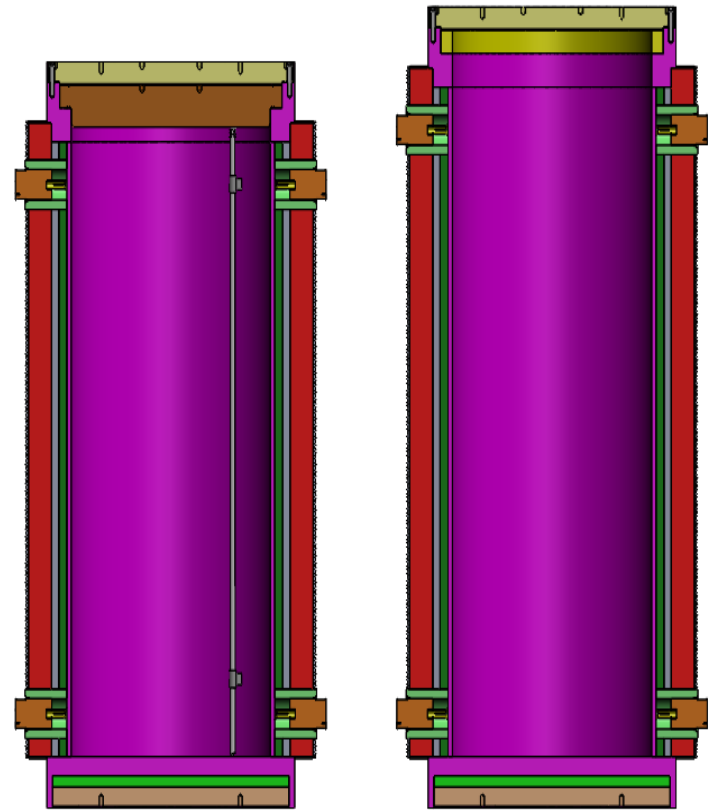

HI-STAR 100MB Single and Double Lid Designs

a generation ahead by design

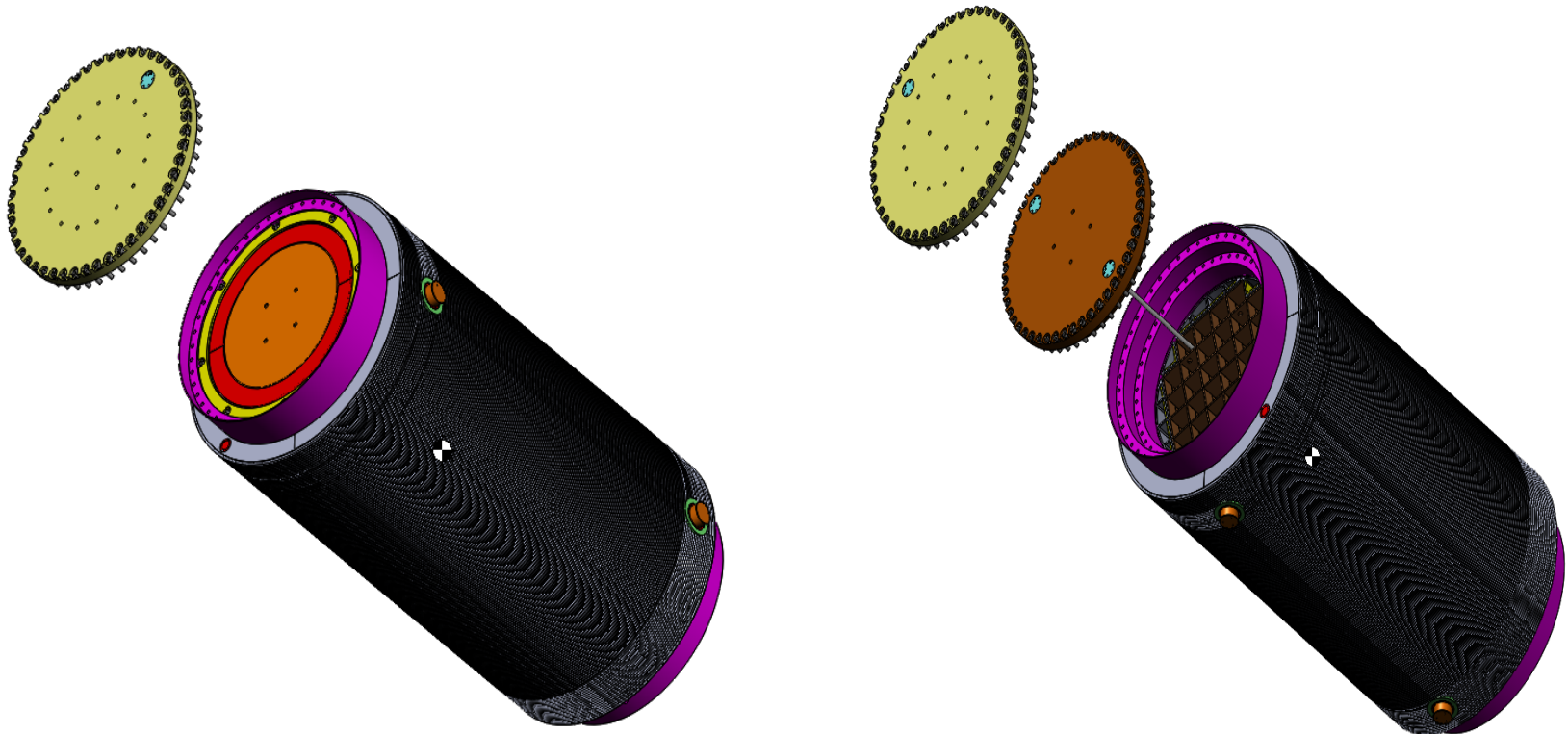

HI-STAR 100MB Cask Containment

- Standard Holtec Design
- Same as HI-STAR 60, 100, 180, 180D, 190
- Components include:
 - Containment Shell
 - Baseplate
 - Top Forging
 - Bolted Closure Lids
 - Double Lid for Bare Basket (Viz, HI-STAR 180, 180D)
 - Single Lid for MPC (Viz, HI-STAR 100, 190)
 - Double elastomeric seals for each closure lid
 - Forgings and Shells connected by welds

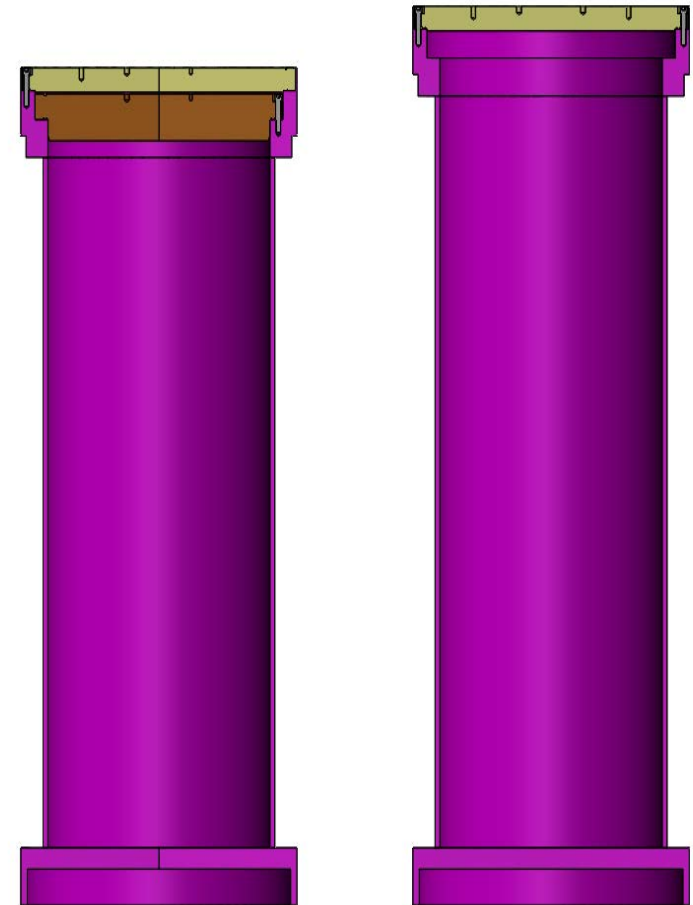

HI-STAR 100MB Cask Major Shielding Components

- Same shielding design as HI-STAR 190
 - Lead for gamma shielding
 - Holtite-B for neutron shielding

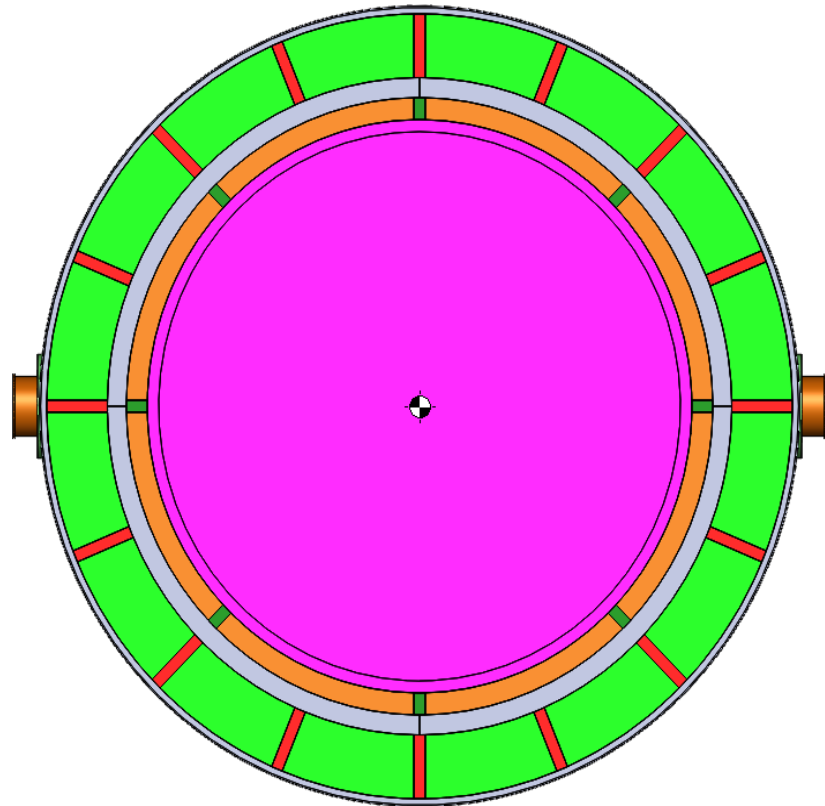

HI-STAR 100MB Fuel Packages

a generation ahead by design

| Canister/ Basket ID | Fuel Type | Fuel Package Type | Max number of fuel assemblies in the Fuel Package | Basket structural Material |
|---------------------------|--------------|-------------------|---|-------------------------------|
| MPC-32M | PWR | MPC | 32 | Metamic-HT |
| F-32M | PWR | Bare Basket | 32 | Metamic-HT |
| F-24M | PWR | Bare Basket | 24 | Metamic-HT |

- Amendment 11 is focused on design approval. Other MPCs currently qualified for the HI-STAR 100 and/or HI-STORM 100 will be added in a future amendment

HI-STAR 100MB Fuel Packages

a generation ahead by design

- F-24M Basket

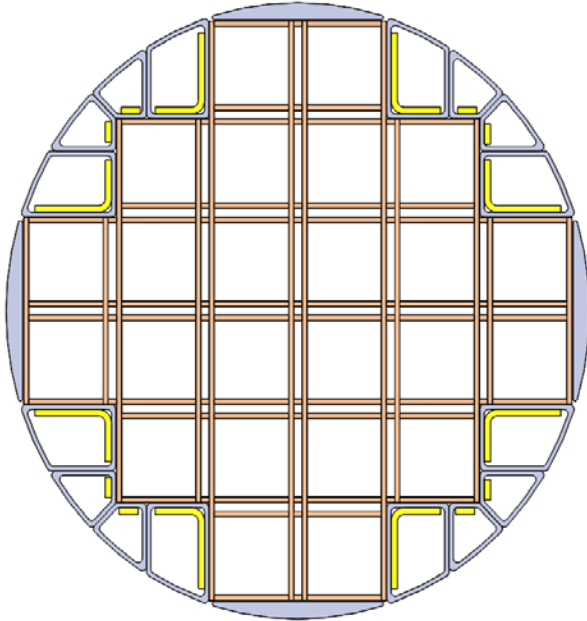

- F-32M Basket

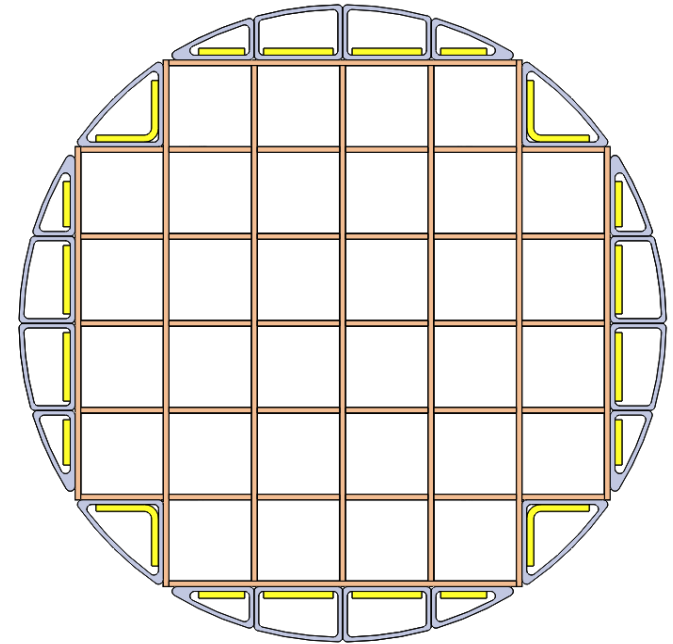

- Bare Basket: Approach Identical to that for HI-STAR 180 and HI-STAR 180D.
 - Second bolted lid provides the additional water barrier credited for moderator exclusion under accident conditions.
- MPC: Approach Identical to that for HI-STAR 190.
 - MPC lid provides the additional water barrier credited for moderator exclusion under accident conditions.
- Additional safety analyses provide Defense-in-depth
 - Fuel rod with degraded material properties under axial load.
 - Criticality evaluations assuming fuel reconfigurations.

HI-STAR 100MB

Structural Criteria, Modeling, Methodology

- Predominantly following HI-STAR 190
- Acceptance Criteria
 - General Criteria: Type B(U)F Provisions of 10CFR71
 - Containment Integrity: ASME B&PV Code Division 1 Subsection NB
 - Closure Lid Seal Joint: remains “leaktight” under NCT and HAC
 - Fuel Basket: Basket deflection based criterion - Global Avg. permanent deformation of panel below 0.5 mm.
 - Shielding Components: Remain functional after impactful events.
 - Defense in Depth Fuel Assembly Integrity: Fuel pin evaluation
 - > Strain Limit of 1.7%: Same as HI-STAR 180 and further endorsed by NUREG/CR-7198 (2015).
 - Impact Limiters: Sufficient energy absorption to protect fuel pins, fuel basket and containment boundary and to maintain attachment to the cask.

HI-STAR 100MB

Structural Criteria, Modeling, Methodology (Continued)

- Safety Analysis Approach: Same as HI-STAR 180/180D/190
 - FEM (LS-DYNA/ANSYS), Hand Calculations, and Comparative Evaluations
 - 10CFR71.71 and 10CFR71.73 Dynamic Analysis
 - > 0.3 meter drop (horizontal cask)
 - > 9 meter drop (side, end, slapdown)
 - > 1 meter puncture on cask outer closure lid - top end down and 1 meter puncture on enclosure shell – side drop
 - Static Analysis
 - > Design pressure, lifting, immersion, component stability, fire accident, etc. summarized in SAR with separate supporting report (methodology used previously for HI-STAR 180,180D and 190)

HI-STAR 100MB

Thermal Criteria, Modeling, Methodology

- Acceptance Criteria
 - Cask Components Temperature Limits are the same as those presented in HI-STAR 190 SAR
 - PCT Limits Per ISG-11, Revision 3
- Safety Analysis Approach
 - Same as HI-STAR 180D/190, ANSYS-FLUENT CFD Analyses
 - For normal conditions of transport, a heat event consisting of an ambient temperature of 38 °C (100 °F) in still air and prescribed insolation is evaluated [§71.71(c)(1)].
 - For normal conditions of transport, a cold event consisting of an ambient temperature of -40 °C (-40 °F) in still air and shade must be evaluated [§71.71(c)(2)].
 - For hypothetical accident conditions, a thermal event consisting of a fully engulfing hydrocarbon fuel/air fire with an average emissivity coefficient of at least 0.9, with an average flame temperature of at least 802°C(1475 °F) for a period of 30 minutes [§71.73(c)(4)].

HI-STAR 100MB

Shielding Criteria, Modeling, Methodology

- Shielding Criteria, Modeling, Methodology
- Acceptance Criteria
 - Standard
 - > Normal Conditions of Transportation: 10 CFR 71.51(a)(1) and 71.47(b)
 - > Hypothetical Accident Conditions: 10 CFR 71.51(a)(2)
- Safety Analysis Approach
 - MCNP5 Dose Rate Calculations
 - TRITON/ORIGEN/ORIGAMI (Scale 6.21) Source Term Calculations
 - Adopted from HI-STAR 190 and HI-STAR 80 SAR

HI-STAR 100MB

Criticality Criteria, Modeling, Methodology

- Acceptance Criteria
 - 10CFR71.55 and 71.59
 - Maximum $K_{eff} \leq 0.95$, including all biases and uncertainties for 95% probability at a 95-percent confidence level.
- Safety Analysis Approach
 - All Monte Carlo calculations performed using MCNP5.
 - Utilize ISG-8 Rev. 3 for Burnup Credit.
 - Normal and Accident Conditions analyses same as HI-STAR 80 and HI-STAR 190.
 - Efficiency through referencing HI-STAR 190

HI-STAR 100MB

Containment Criteria, Modeling, Methodology

- Acceptance Criteria
 - Design and Testing to ANSI N14.5 reference leakage rate of “Leaktight”.
 - Package maintains leaktightness under normal and accident condition events.
- Safety Analysis Approach
 - Same as HI-STAR 80, 100 and 190.
 - Structural (and thermal) evaluation confirms containment boundary integrity under normal and accident conditions of transport.

HI-STAR 100MB Summary

- HI-STAR 100MB is an enhanced version of the HI-STAR 100 transport package initially licensed by the NRC in 1998, with a main focus on HBF transportation
- Fuel Packages include an MPC and bare baskets
- HI-STAR 100MB and fuel package designs are directly based on current designs approved by US NRC (HI-STAR 100, 180, 180D, 190). This should allow for an efficient review process.
- Planned Submittal February 2018

Questions / Discussions

Thank you!