



GROWER'S CHOICE

Dec. 1st,2017

Mr.Richard K Struckmeyer
Materials Safety Licensing Branch
Divison of Materials Safety, State, Tribal, and Rulemaking Programs
Office of Nuclear Material Safety and Safeguards
U.S Nuclear Regulatory Commission
Mail Stop: T-8E 18
Washington DC 20555

Dear Mr. Richard,

This letter is to in response to your mail dated on Dec 1st, 2017 regard about requesting additional information for our exempt distribution license.

If you have question or concerns regarding this application, please contact us

at 858-381-7234,or at info@growersc.com .

Sincerely,

Leonardo Day

12/22/2017

CEO

1. Please note that an exempt distribution license will not be issued until we receive a copy of your possession and use license.

We are fully aware that we are not able to get our exempt distribution license before we obtain the state possession and use license. We have already submitted our application for the state possession and use license and we are expecting the license in four to six weeks. We will update NRC the state license status once we obtain the license.

2. Explain why these quantities differ, and clearly state the maximum activities of each item you plan to distribute.

The reason why the quantity difference is because when we first asked the manufacture back in china to provide the data for us to apply for the NRC license, they are not willing to. So they did not provide us exact data. During the process of preparing the NRC license material, we realized that we should hire a consultant company to help us do a test on our light bulbs to make sure the number they provided us is correct. From the test report made by the Plexus Scientific Corporation, we are sure the Kr-85 action level is fairly low. I am attaching a detail report in the end of this letter showing all the require information for your reference.

Please see attachment PLEXUS SCIENTIFIC CORPORATION RADIOLOGICAL SURVERY FORM.

3. Your application appears to indicate two types of arc tubes, quartz and ceramic poly crystalline alumina. The requested information must be provide for each type of material used in each type of tube. If you plan to distribute various models of devices within groups or series, you should specify the above information for each series type.

Please see below chart for light bulbs we are planning to distribute.

Arc Tube-Quartz	MH-DE600W	MH-DE600W-4K	MH-DE600W-6K	MH-DE600W-10K
	MH-DE1000W	MH-DE1000W-4K	MH-DE1000W-6K	MH-DE1000W-10K
	SE600W	SE600W-4K	SE600W-6K	SE600W-10K
	SE1000W	SE1000W-4K	SE1000W-6K	SE1000W-10K

Arc Tube-Ceramic poly crystalline	CMH500W			
	CMH315W	CMH315W-3K	CMH315W-4K	
	CMH630W	CMH630W-3K	CHM630W-4K	CMH630W-3KR
	CMH945W	CMH945W-3K		
	CMH 1000W	CMH1000W-3K	CMH1000W-4K	CMH1000W-3KR

Please see below chart for overall dimensions, the minimum and maximum dimensions for each device below.

Product Type	Overall Dimension	Inside Tube Main Part Minimum Dimension	Inside tube Main Part Maximum Dimension
MH-DE600W	388mm	323.5mm	326.5mm
MH-DE1000W	388mm	323.5mm	326.5mm
SE600W	320+/-4.0mm	193mm	187mm
SE1000W	320+/-4.0mm	197mm	203mm
CMH500W	191.5+/-3.0mm	92mm	86mm
CMH315W	194.5+/-3.0mm	92mm	86mm
CMH630W	388+/-3.0mm	330mm	N/A
CMH945W	392+/-2.0mm	330mm	N/A
CMH1000W	390+/-2.0mm	N/A	N/A

We are also attaching all of the products detail of construction and design of each product. Please see attachment for ALL LIGHT BULBS CONSTRUCTION AND DESIGN.

4. Please describe the method by which Kr-85 gas is introduced and the glass tube is seal.

The manufacture use arc tube exhaust machine to introduce Kr-85 and seal the glass tube.

5. Please provide examples of your labels in the form of drawings, copies, or photograph.

Please see attachment GROWER'S CHOICE LABEL AND PACKAGE DESIGN.

6. Please indicate how you made this determination; i.e., your method of measurement or calculation.

All of calculation and method of measurement is made by the consulting company PLEXUS SCIENTIFIC CORPORATION RADIOLOGICAL SURVERY FORM. They are one of the certify organization that has the ability to perform this kind of measurement.

7. Provide information to show that the product material is properly contained in the product under the most severe conditions that are likely to be encountered in normal use and handling.

All of the lamps are under strict quality control. This quality control process is to make sure the product material is properly contained in the product under the most severe condition that are likely to be encountered in normal use and handling. The whole quality control process is below. After manufacture, all quartz arc tubes are tested for electrical function. A quartz arc tube failing this test is considered a possible leaker and discarded. Each tank of the Argon-Krypton-85 mixture received from the supplier comes with certification as to the Krypton-85 concentration. The quantity of Krypton-85 in an arc tube is a function of the volume of the tube and the specific activity of the gas. These parameters are set at the factory and strictly monitored during production. Krypton-85 is the only radioactive gas used at the production facility, eliminating the possible use of any other radioactive material. Each tank of the Argon-Krypton-85 mixture received from the supplier comes with a certification as to the Krypton-85 concentration. During manufacture, the mixture is injected into the arc tubes so a specified pressure. The arc tube production output from each of three ovens is checked for proper pressure on an ongoing basis. A destructive test is performed of each selected arc tube in a sealed chamber and the resultant pressure gradient measured. If the pressure is not within specification, the production run since the last successful QC test of the oven in question is withheld from further production and the necessary adjustments made to the oven, prior to any further production.

8. Please describe how you will prevent the transfer to other person for use under Section 30.15 of this chapter or equivalent regulations of an Agreement State any part or product tested and found defective under the criteria and procedures specified in the license issued under Section 32.14.

All product containers are labeled with "Contains Kr-85" or "Arc Tube Contains Kr-85". All defective or broken product will be isolated in a dedicated area of the facility and disposed of properly. It would be transfer to any other facility or users. Given the very low activity of Kr-85 stored and being a chemically inert gas, radioactive waste is not expected to be generated at the TOP SHELF facility.

**PLEXUS SCIENTIFIC CORPORATION
RADIOLOGICAL SURVEY FORM**

Survey No.: 01			
Instrument/SN: 908/25007790	Calibration Due: 4-18-18	Date: 12-18-17	Time: 10:30 AM
Instrument/SN	Calibration Due:	Location: Cleveland office	
Purpose: Dose rate measurements on Top Shelf, LCC Lighting/Lamp products w/ Kr-85			
Survey Performed By (Signature): Jack Budderbaum <i>Jack Budderbaum</i>		Survey Checked By (Signature): same <i>J. Budderbaum</i>	
<input checked="" type="checkbox"/> Battery OK <input checked="" type="checkbox"/> HV OK <input checked="" type="checkbox"/> Source Check OK	Action Level: 1 millrad/m <input checked="" type="checkbox"/> μ R/hr <input type="checkbox"/> mR/hr <input type="checkbox"/> cpm <input type="checkbox"/> dpm	Grid Dimensions: _____ x _____ <input type="checkbox"/> meters <input type="checkbox"/> inches <input type="checkbox"/> feet <input type="checkbox"/> centimeters	

	A	B	C	D	E	F	G	H	I	J	K	L	M	N	O	P	Q	R	S	T	U	V	W	X	Y	Z
1																										
2																										
3																										
4																										
5																										
6																										
7																										
8																										
9																										
10																										
11																										
12																										
13																										
14																										
15																										
16																										
17																										
18																										
19																										
20																										
21																										
22																										
23																										
24																										
25																										

1. 315W Ceramic Metal Halide Lamp

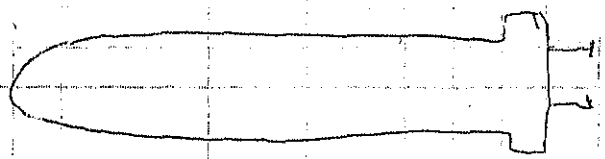

14 μ R/hr

2. 1000W LEC DC

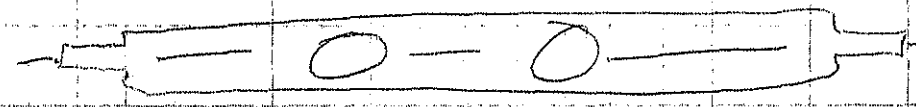

14 μ R/hr

3. 630W DE Ceramic Metal Halide Lamp

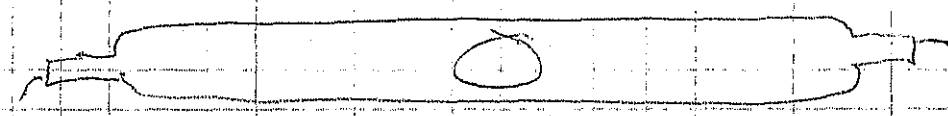

14 μ R/hr

Notes: Background Readings 11 μ R/hr - 15 μ R/hr.

- All lamps readings equal to background levels.
- Photographs attached
- Instrument Cal. Serv. Certificate attached.



0
PEAK VALUE
147
HR/hr
51.2 HR/hr
500

LUDLUM

Model
9DP

MODE
FUNCTION
ADD
RESET

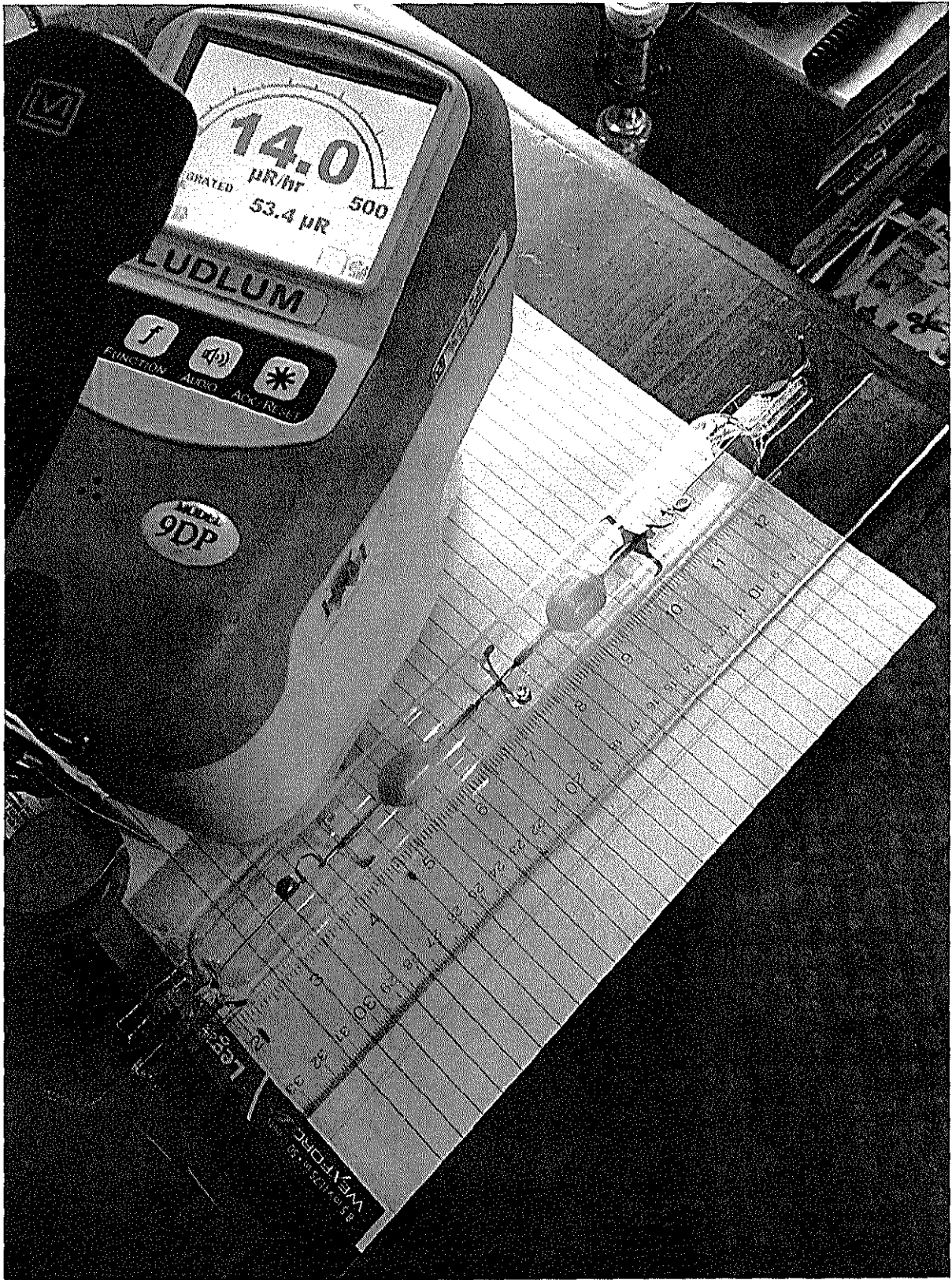



Designer and Manufacturer
of
Scientific and Industrial
Instruments

www.ludlums.com

CERTIFICATE OF CALIBRATION

LUDLUM MEASUREMENTS, INC.

501 Oak Street
325-235-5494

Sweetwater, TX 79556, U.S.A.



CERT # 4084.01

Customer PLEXUS SCIENTIFIC CORP ORDER NO. 20310061/448534

Mfg. Ludlum Measurements, Inc. Model 9DP Serial No. 25007790

Mfg. _____ Model _____ Serial No. _____

Cal. Date 18-Apr-17 Cal Due Date 18-Apr-18 Cal. Interval 1 Year Meterface Digital

Check mark applies to applicable instr. and/or detector IAW/mfg. spec. T. 73 °F RH 49 % Alt 705.0 mm Hg

New Instrument Instrument Received Within Toler. +/-10% 10-20% Out of Tol. Requiring Repair Other-See comments

Mechanical ck. Meter Zeroed Background Subtract Input Sens. Linearity

F/S Resp. ck Reset ck. Window Operation Geotropism

Audio ck. Alarm Setting ck. Batt. ck.

Calibrated in accordance with LMI SOP 14.8 Calibrated in accordance with LMI SOP 14.9

Instrument Volt Set _____ V Input Sens. _____ mV Det. Oper. _____ V at _____ mV Threshold Dial Ratio _____ = _____ mV

HV Readout (2 points) Ref./Inst. _____ / _____ V Ref./Inst. _____ / _____ V

COMMENTS:

Instrument is auto-ranging.
Peak Value & Integrated Dose are the available functions.
All undocumented features are currently set to off.

Gamma Calibration: GM detectors positioned perpendicular to source except for M 44-9 in which the front of probe faces source.

RANGE/MULTIPLIER	REFERENCE CAL. POINT	INSTRUMENT REC'D "AS FOUND READING"	INSTRUMENT METER READING*
Auto	4 R/hr	3.50 R/hr	4.00 R/hr
Auto	1 R/hr	0.92 I	1.04 I
	400 mR/hr	397 mR/hr	397 mR/hr
	100 mR/hr	100	100
	40 mR/hr	37.4	40.0
	10 mR/hr	8.91	9.48
	4 mR/hr	3.80	4.00
	1 mR/hr	0.94	1.01
	400 µR/hr	415 µR/hr	400 µR/hr
	100 µR/hr	98.2 I	92.6 I

*Uncertainty within ± 10% C.F. within ± 20%

Range(s) Calibrated Electronically

Digital Readout	REFERENCE CAL. POINT	INSTRUMENT RECEIVED	INSTRUMENT METER READING*	Log Scale	REFERENCE CAL. POINT	INSTRUMENT RECEIVED	INSTRUMENT METER READING*
	_____	_____	_____		_____	_____	_____
_____	_____	_____	_____	_____	_____	_____	_____
_____	_____	_____	_____	_____	_____	_____	_____

Ludlum Measurements, Inc. certifies that the above instrument has been calibrated by standards traceable to the National Institute of Standards and Technology, or to the calibration facilities of other International Standards Organization members, or have been derived from accepted values of natural physical constants or have been derived by the ratio type of calibration techniques. The calibration system conforms to the requirements of ANSI/NCSL Z540-1-1994 and ANSI N323-1978 ISO/IE 17025:2005(E) State of Texas Calibration License No. LO-1963

Reference Instruments and/or Sources: Cs-137 S/N: 059 2171CP 2261CP 720 734 781 1131 1616 1696 1908 1916CP 2324/2521

5717CO 5719CO 60646 70897 73410 E552 G112 2168CP S-394 S-1054 T10081 T10082 Neutron Am-241 Be T-304 Ra-226 Y982

Alpha S/N _____ Beta S/N _____ Other _____

m 500 S/N _____ Oscilloscope S/N _____ Multimeter S/N _____

Calibrator James McBeth Title Calibrator Date 18APR17

QC'd By [Signature] Title Senior Test QC Date 18 Apr 17

Dimension Configuration Manager - Calibration Report

Ludlum Measurements, Inc.

501 Oak Street
Sweetwater, Texas 79556 USA
Toll Free: (800) 622-0828
Voice: (325) 235-5494
Fax: (325) 235-4672
<http://www.ludlums.com/>

Report Generated: 18 Apr 2017 10:19:39

LMI Model	9DP
Firmware Version	29307.01.02.17
LMI Serial Number	25007790
Calibration Date	18 Apr 2017
Calibration Due Date	18 Apr 2018
Time Format	12 Hours (AM/PM)
ADC Offset Reading	0
ADC Offset	0
High Voltage DAC 1 Offset	-11
HV Correction	978
High Voltage Reading 1	-97.7
Battery Correction	979
Battery Reading	11.23
Meter Offset 1	900
Meter Offset 2	952
Meter Offset 3	1029
Electrometer Offset	1507
Electrometer Temperature	26.8
Cold Temperature Offset	0.000
Hot Temperature Offset	-1.500
Jitter Threshold	30.0
Checkout Technician	James McBeth
Checkout Date	18 Apr 2017
Calibration Constant Range x1	892
Calibration Constant Range x10	863
Calibration Constant Range x100	1016
Calibration Constant Range x1k	1004
Calibration Constant Range x10k	1093
Calibration Technician	James McBeth

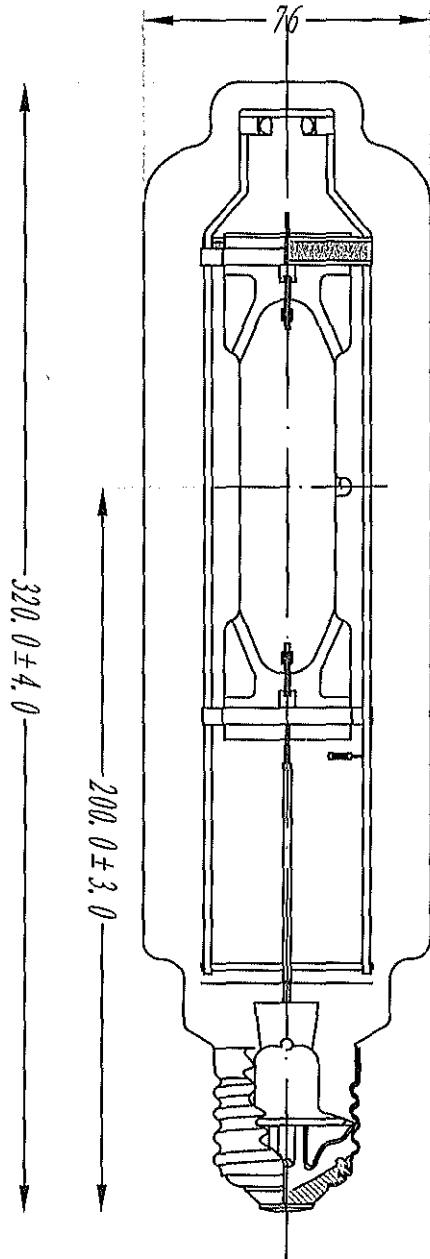

MH1000W TT76

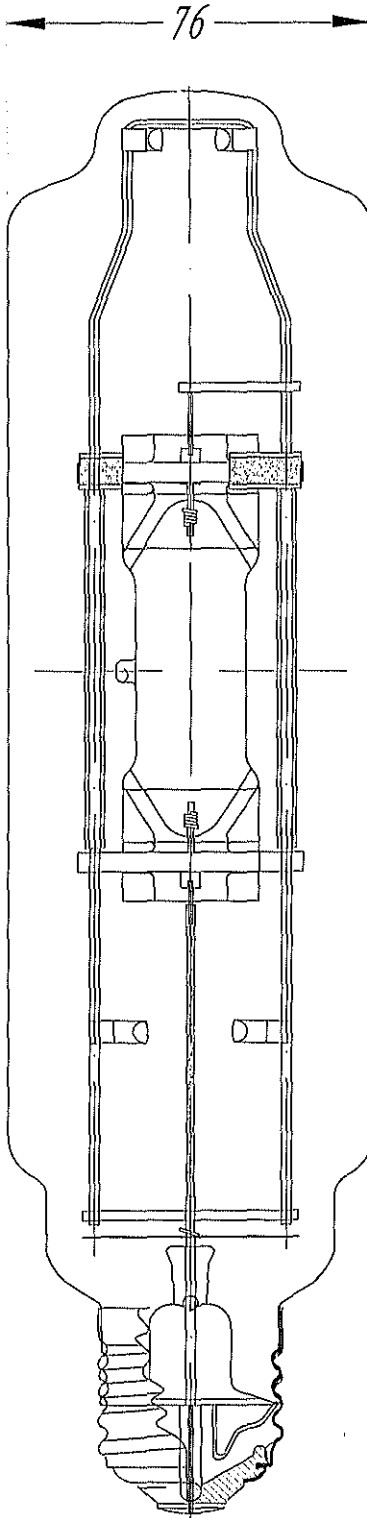

MH600W/TT76

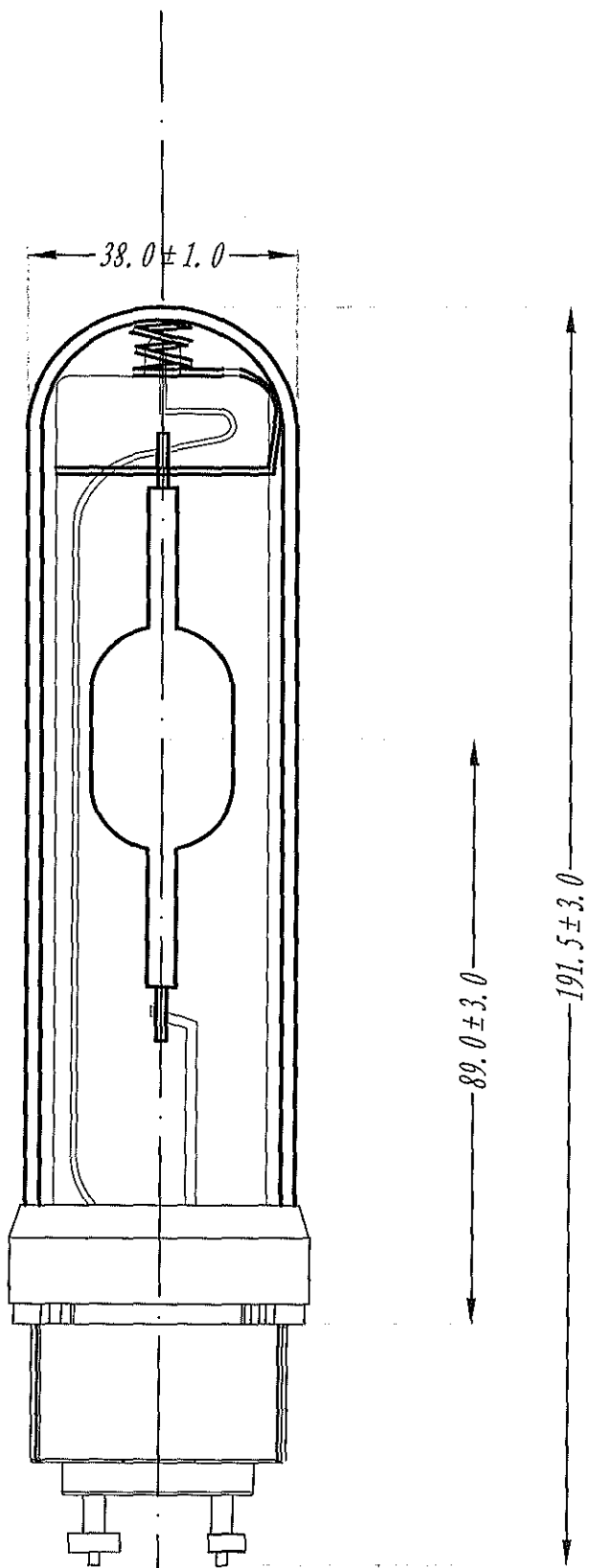

旧底图总号	标记	处数	更改单号	序号	代号	版本	描述	数量	单位	备注
	设计						CMH500W			
	审核									
						版本:	HGZM			阶段: MS 3
						A/0				第 1 页
	标准化					比例:	杭州汉光照明有限公司			
	批准					1: 1				

技术要求:

1. 陶瓷件安装无松动, 脏, 歪斜现象;
2. 灯泥适量, 夹板上不能有过多的灯泥;
3. 陶瓷件组装后配用CWA-400W镇流器老练4分钟, 管压: $190 \pm 15V$;
4. 绞合线焊接牢固, 不能分叉, 刺手;
5. 单位: mm .

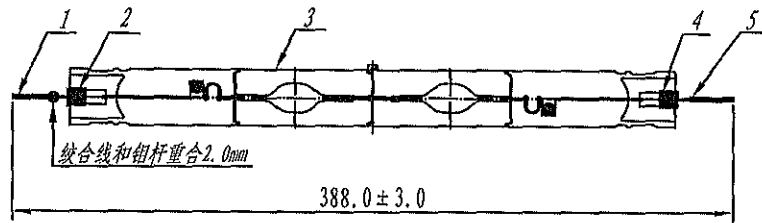
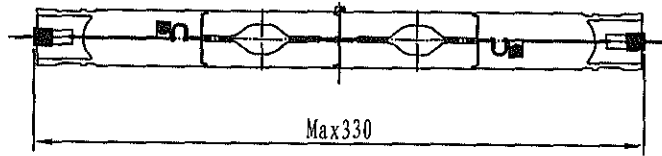

5	300D00001400	A/0	镍皮4×10×0.1	2	pc	
4	300F00002000	A/0	陶瓷件(白色)	2	pc	
3	240I00006000	A/0	E陶瓷金卤灯CMH630.830.T32.5.DE.B2-高光效	1	pc	
2	400C00000400	A/0	双端灯泥	2	g	
1	300B00005600	A/0	绞合线28×Φ1.8	2	pc	
序号	代 号	版 本	描 述	数 量	单 位	备 注

旧底图总号						陶瓷金卤灯CMH630.830.T32.5.DE.B2-高光效
	标记	处数	更改单号	签 字	更改日期	
底图总号	设计	审核			重量:	
					版本:	HGZM130500001D00
					A/0	
媒体编号	标准化				比例:	阶段: MS 3
	批准				1: 4	第 1 页 共 1 页
						杭州汉光照明有限公司

技术要求:

1. 陶瓷件安装无松动, 脏, 歪斜现象;
2. 灯泥适量, 夹板上不能有过多的灯泥;
3. 陶瓷件组装后配用CWA-1000W镇流器老炼4分钟, 管压: $270 \pm 15V$;
4. 绞合线焊接牢固, 不能分叉, 刺手;
5. 单位: mm .

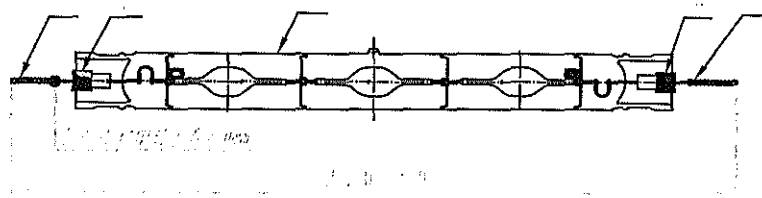
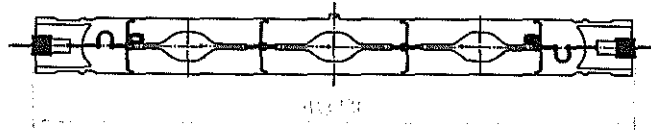

5	300D00001400	A/0	橡皮 $1 \times 10 \times 0.1$	2	pc	
4	300F00002000	A/0	陶瓷件 (白色)	2	pc	
3	240500000A00	A/0	E陶瓷金卤灯CMH945.830.T32.5.DE.B2 (高光效)	1	pc	
2	400C00000400	A/0	双端灯泥	2	g	
1	300B00005600	A/0	绞合线 $28 \times \Phi 1.8$	2	pc	
序号	代号	版本	描述	数量	单位	备注

旧底图总号									
	标记	处数	更改单号	签字	更改日期	陶瓷金卤灯CMH945.830.T32.5.DE.B2 (高光效)			
	设计				重量:				
底图总号	审核								
					版本:	HGZM130500001F00		阶段:	MIS 3
					A/0			第 1 页	共 1 页
媒体编号	标准化				比例:	杭州汉光照明有限公司			
	批准				1: 4				

技术要求:

1. 陶瓷件安装无松动, 脏, 歪斜现象;
2. 灯泥适量, 夹板上不能有过多的灯泥;
3. 陶瓷件组装后配用CWA-1000W镇流器老炼4分钟, 管压: $210 \pm 15V$;
4. 绞合线焊接牢固, 不能分叉, 刺手;
5. 单位: mm.

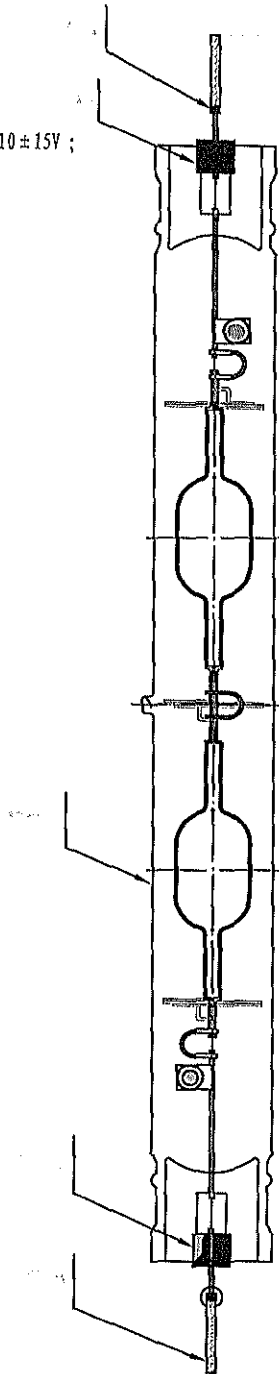

5	300D00001400	A/0	镍皮 $4 \times 10 \times 0.1$	2	pc	
4	300F00002000	A/0	陶瓷件 (白色)	2	pc	
3	240500000A00	A/0	陶瓷金卤灯CMH1000, 830, T32, 5, DB, B2 (高光效)	1	pc	
2	400C00000400	A/0	灯端灯泥	2	g	
1	300B00005600	A/0	绞合线 $28 \times \Phi 1.8$	2	pc	
序号	代号	版本	描述	数量	单位	备注

旧底图总号									
	标记	处数	更改单号	签字	更改日期	陶瓷金卤灯CMH1000, 830, T32, 5, DB, B2 (高光效)			
	设计				重量:				
底图总号	审核								
					版本:	HGZM130500001F00		阶段:	MS 3
					A/0			第 1 页	共 1 页
媒体编号	标准化				比例:	杭州汉光照明有限公司			
	批准				1: 4				

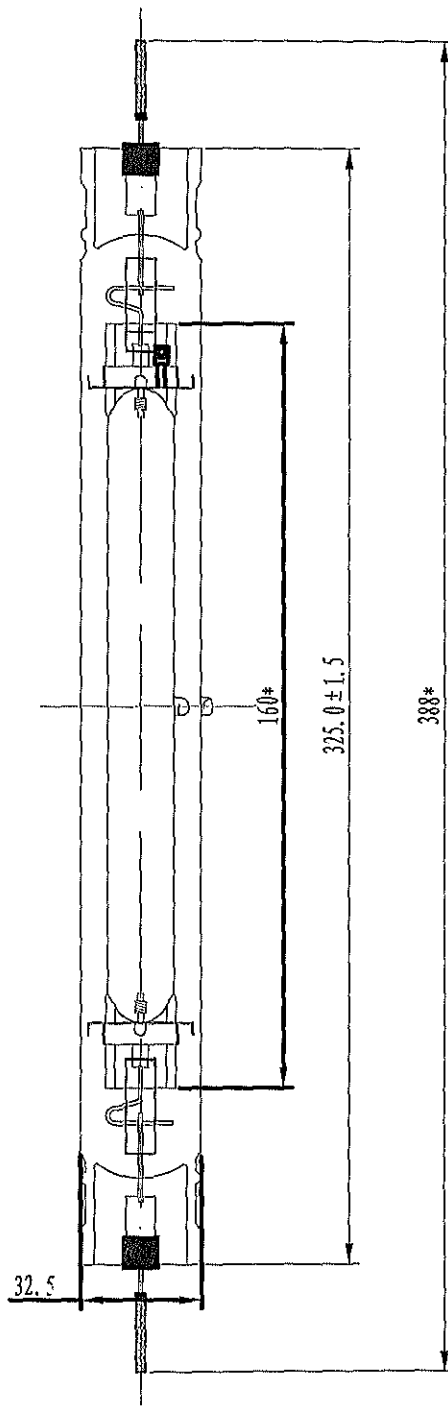

旧底图总号	序号	代号	版本	描述	数量	单位	备注
	标记	处数	更改单号	签字	更改日期	MH600W	
	设计				重量:		
底图总号	审核						
			版本:	HGZM	阶段: MS 3		
			A/O		第 1 页	共 1 页	
媒体编号	标准化		比例:	杭州汉光照明有限公司			
	批准		1: 1				

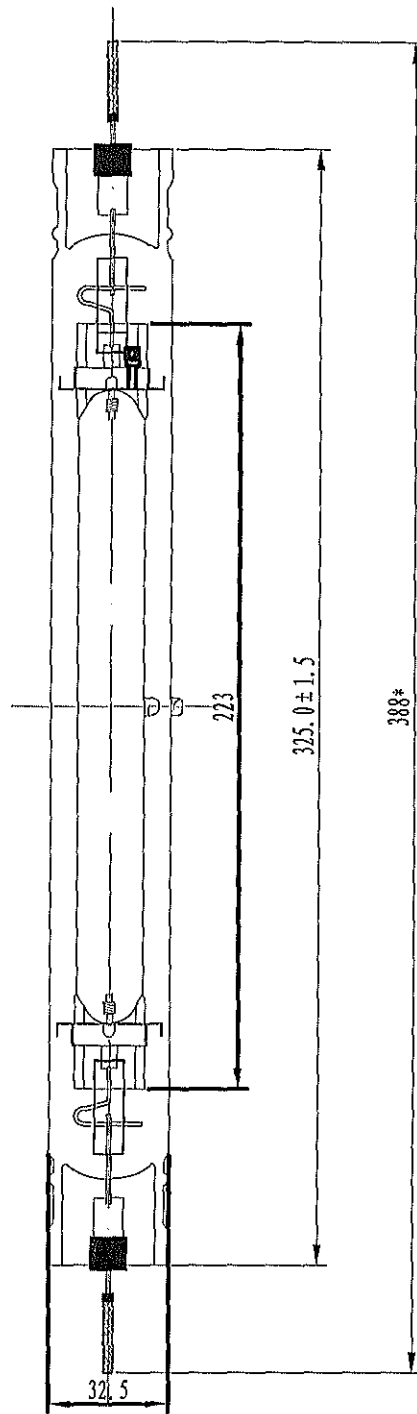

旧底图总号	标记	处数	更改单号	序号	代号	版本	描述	数量	单位	备注
	设计						MH1000W			
底图总号	审核									
						版本:	HGZM	阶段: MS 3		
					A/0			第 1 页	共 1 页	
媒体编号	标准化					比例:	杭州汉光照明有限公司			
	批准				1: 1					

GC CMH315W 3K

53*53*215MM

250g灰板纸裱白E瓦 覆亮膜



CMH315W 中性盒
 尺寸: 220*90* 65mm
 材质: 牛皮纸+灰板纸

