

REGULATOR INFORMATION DISTRIBUTION SYSTEM (RIDS)

ACCESSION NBR: 8310250146 DOC. DATE: 83/10/19 NOTARIZED: YES DOCKET #
 FACIL: STN-50-528 Palo Verde Nuclear Station, Unit 1, Arizona Public 05000528
 AUTH. NAME AUTHOR AFFILIATION
 VAN BRUNT, E.E. Arizona Public Service Co.
 RECIP. NAME RECIPIENT AFFILIATION
 BISHOP, T.W. Division of Resident, Reactor Project & Engineering Program

SUBJECT: Forwards documents re recent reactor coolant pump problems per FOIA Request 83-448. Documents contain no proprietary info.

DISTRIBUTION CODE: B001S COPIES RECEIVED: LTR 1 ENCL 1 SIZE: 11
 TITLE: Licensing Submittal: PSAR/FSAR Amdts & Related Correspondence.

NOTES: Standardized plant.

05000528

| | RECIPIENT | | COPIES | | | RECIPIENT | | COPIES | |
|-----------|-----------------|-----------|--------|------|------------------|-----------|-----------|--------|------|
| | ID | CODE/NAME | LTTR | ENCL | | ID | CODE/NAME | LTTR | ENCL |
| | NRR/DL/ADL | | 1 | 0 | NRR LB3 BC | | 1 | 0 | |
| | NRR LB3 LA | | 1 | 0 | LICITRA, E. | 01 | 1 | 1 | |
| INTERNAL: | ELD/HDS3 | | 1 | 0 | IE FILE | | 1 | 1 | |
| | IE/DEPER/EPB | 36 | 3 | 3 | IE/DEPER/IRB | 35 | 1 | 1 | |
| | IE/DEGA/GAB | 21 | 1 | 1 | NRR/DE/AEAB | | 1 | 0 | |
| | NRR/DE/CEB | 11 | 1 | 1 | NRR/DE/EHEB | | 1 | 1 | |
| | NRR/DE/EQB | 13 | 2 | 2 | NRR/DE/GB | 28 | 2 | 2 | |
| | NRR/DE/MEB | 18 | 1 | 1 | NRR/DE/MTEB | 17 | 1 | 1 | |
| | NRR/DE/SAB | 24 | 1 | 1 | NRR/DE/SGEB | 25 | 1 | 1 | |
| | NRR/DHFS/HFEB40 | | 1 | 1 | NRR/DHFS/LQB | 32 | 1 | 1 | |
| | NRR/DHFS/PSRB | | 1 | 1 | NRR/DL/SSPB | | 1 | 0 | |
| | NRR/DSI/AEB | 26 | 1 | 1 | NRR/DSI/ASB | | 1 | 1 | |
| | NRR/DSI/CPB | 10 | 1 | 1 | NRR/DSI/CSB | 09 | 1 | 1 | |
| | NRR/DSI/ICSB | 16 | 1 | 1 | NRR/DSI/METB | 12 | 1 | 1 | |
| | NRR/DSI/PSB | 19 | 1 | 1 | NRR/DSI/RAB | 22 | 1 | 1 | |
| | NRR/DSI/RSB | 23 | 1 | 1 | <u>REG FILE</u> | 04 | 1 | 1 | |
| | RGN5 | | 3 | 3 | RM/DDAMI/MIB | | 1 | 0 | |
| EXTERNAL: | ACRS | 41 | 6 | 6 | BNL (AMDTS ONLY) | | 1 | 1 | |
| | DMB/DSS (AMDTS) | | 1 | 1 | FEMA-REP DIV | 39 | 1 | 1 | |
| | LPDR | 03 | 1 | 1 | NRC PDR | 02 | 1 | 1 | |
| | NSIC | 05 | 1 | 1 | NTIS | | 1 | 1 | |

*Add: T. W. Bishop
 ADM / DR R
 REGION V*

56

49

TOTAL NUMBER OF COPIES REQUIRED: LTTR 56 ENCL 49

1. The purpose of this document is to provide a comprehensive overview of the current state of the project. It is intended for the use of all project stakeholders and is subject to change without notice.

2. The information contained herein is confidential and should be handled accordingly. It is not to be distributed outside the project team without the express written consent of the project manager.

3. This document is the property of the organization and is loaned to you for your use only. It is not to be reproduced, copied, or disseminated in any form without the prior written approval of the project manager.

4. The project manager reserves the right to modify, update, or delete any information contained in this document at any time without notice.

| Item ID | Description | Quantity | Unit Price | Total Price |
|---------|-------------|----------|------------|-------------|
| 1 | Item 1 | 1 | 10 | 10 |
| 2 | Item 2 | 1 | 20 | 20 |
| 3 | Item 3 | 1 | 30 | 30 |
| 4 | Item 4 | 1 | 40 | 40 |
| 5 | Item 5 | 1 | 50 | 50 |
| 6 | Item 6 | 1 | 60 | 60 |
| 7 | Item 7 | 1 | 70 | 70 |
| 8 | Item 8 | 1 | 80 | 80 |
| 9 | Item 9 | 1 | 90 | 90 |
| 10 | Item 10 | 1 | 100 | 100 |
| 11 | Item 11 | 1 | 110 | 110 |
| 12 | Item 12 | 1 | 120 | 120 |
| 13 | Item 13 | 1 | 130 | 130 |
| 14 | Item 14 | 1 | 140 | 140 |
| 15 | Item 15 | 1 | 150 | 150 |
| 16 | Item 16 | 1 | 160 | 160 |
| 17 | Item 17 | 1 | 170 | 170 |
| 18 | Item 18 | 1 | 180 | 180 |
| 19 | Item 19 | 1 | 190 | 190 |
| 20 | Item 20 | 1 | 200 | 200 |
| 21 | Item 21 | 1 | 210 | 210 |
| 22 | Item 22 | 1 | 220 | 220 |
| 23 | Item 23 | 1 | 230 | 230 |
| 24 | Item 24 | 1 | 240 | 240 |
| 25 | Item 25 | 1 | 250 | 250 |
| 26 | Item 26 | 1 | 260 | 260 |
| 27 | Item 27 | 1 | 270 | 270 |
| 28 | Item 28 | 1 | 280 | 280 |
| 29 | Item 29 | 1 | 290 | 290 |
| 30 | Item 30 | 1 | 300 | 300 |

Arizona Public Service Company

P.O. BOX 21666 • PHOENIX, ARIZONA 85036

October 19, 1983
ANPP-28032 - ACR/WFQ

U. S. Nuclear Regulatory Commission
Region V
1450 Maria Lane, Suite 210
Walnut Creek, California 94596

Attention: Mr. T. W. Bishop, Director
Resident, Reactor Projects and
Engineering Programs Division

Subject: Palo Verde Nuclear Generating Station (PVNGS)
Units 1, 2 and 3
Docket Nos. STN-50-528/529/530
File: 83-056-026

Reference: Letter from T. W. Bishop (NRC, Region V) to E. E. Van Brunt,
dated September 16, 1983, Subject: Proprietary Review of
Information Requested by a Public Group.

Dear Mr. Bishop:

Your referenced letter discussed receipt of "Freedom of Information Act Request" (number 83-448) which requested information within the agency files dealing with recent reactor coolant pump problems at Unit 1. This letter identified additional records in the possession of an inspector, who was out of the office at the time of the original request, and requested our review of the records.

We have reviewed the records identified in the referenced request. These records included the following (and are shown on the attachments to this letter).

- A portion of a drawing showing a cutaway view of a reactor coolant pump (copy enclosed).
- A drawing showing the reactor coolant thermowell and nozzle arrangement (copy enclosed).
- Photographs of RCP components taken by the inspector during an inspection in July, 1983 (copy enclosed).
- Information regarding thermowell failures, dated June 21, 1983 (copy enclosed).
- A copy of CE-KSB Drawing E-8000-101-2000 Revision 4, obtained at the site by the inspector during a recent inspection (copy not enclosed).

8310250146 831019
PDR ADCK 05000528
A PDR

ADD: T.W. Bishop
ADM/DRN
Region V
Boal
1/1

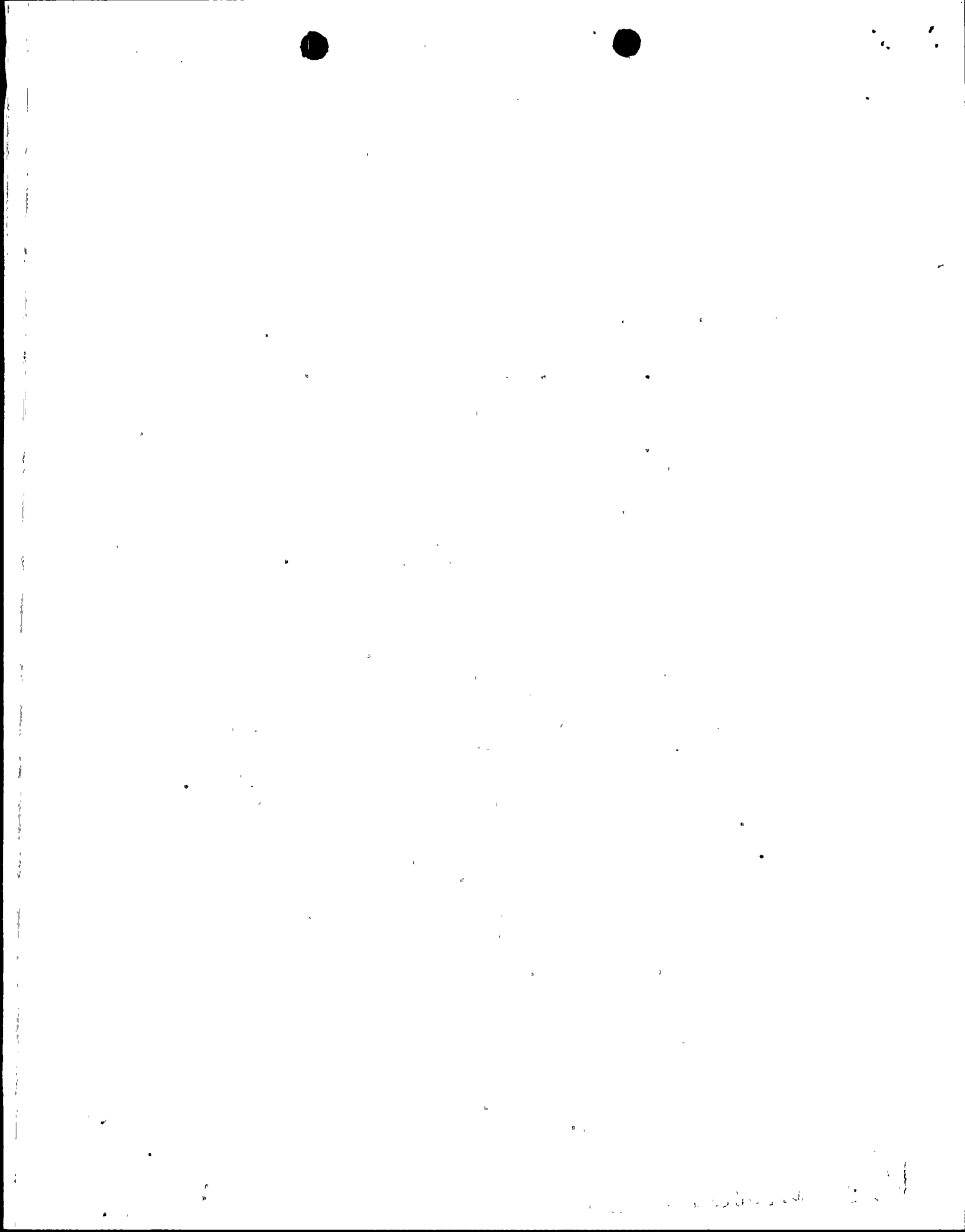

Mr. T. W. Bishop
Page 2
October 19, 1983
ANPP-28032 - ACR/WFQ

The results of our review confirm that these records do not include any proprietary information or other category of exempted material as defined in 10CFR 2.790(a). Also, the GE-KSB Drawing E-8000-101-2000, Revision 4 may be reproduced.

Very truly yours,

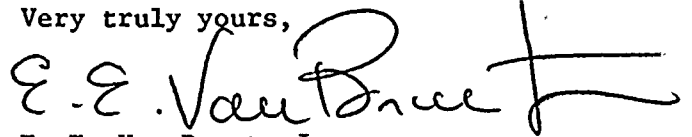

E. E. Van Brunt, Jr.
APS Vice President
Nuclear Projects Management
ANPP Project Director

EEVB/WFQ/sp
Attachments

cc: E. A. Licitra (w/a)
A. C. Gehr "
Director of Nuclear
Reactor Regulation
C. Ferguson "

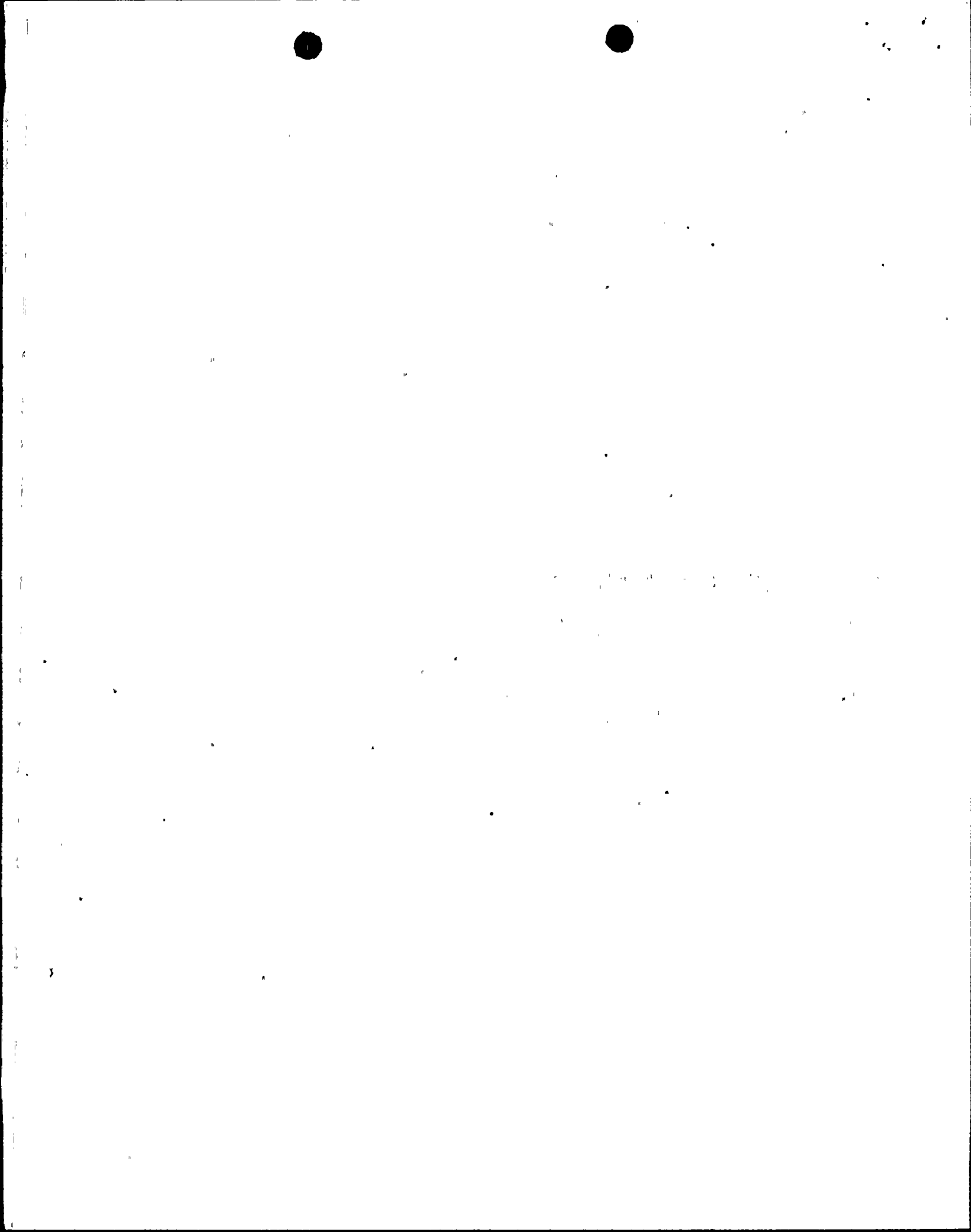

Mr. T. W. Bishop

Page 3

October 19, 1983

ANPP-28032 - ACR/WFQ

bcc:

A. C. Rogers

J. A. Roedel

K. E. Jones

M. F. Hodge

B. S. Kaplan

W. E. Ide

(w/a)

G. C. Andognini

K. W. Gross

S. R. Frost

J. E. Kirby

J. R. Bynum

T. G. Woods

W. H. Wilson

D. Canady

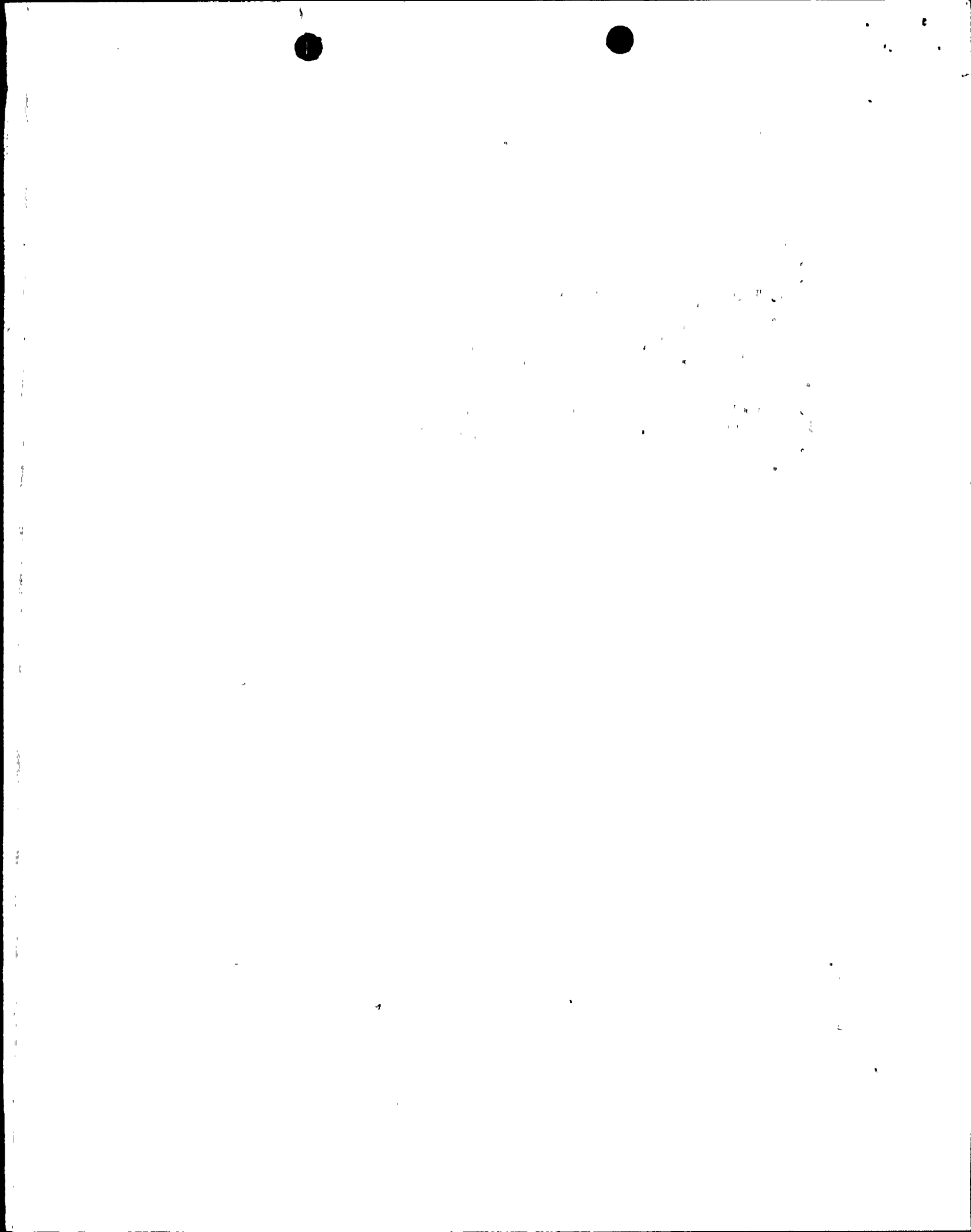

October 19, 1983
ANPP-18032 - ACR/WFQ

STATE OF ARIZONA)
) ss.
COUNTY OF MARICOPA)

I, Edwin E. Van Brunt, Jr., represent that I am Vice President, Nuclear Projects of Arizona Public Service Company, that the foregoing document has been signed by me on behalf of Arizona Public Service Company with full authority to do so, that I have read such document and know its contents, and that to the best of my knowledge and belief, the statements made therein are true.



Edwin E. Van Brunt, Jr.

Sworn to before me this 18 day of October, 1983.

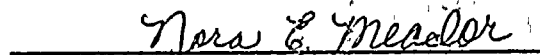

Notary Public

My Commission Expires:

My Commission Expires April 6, 1987



1911

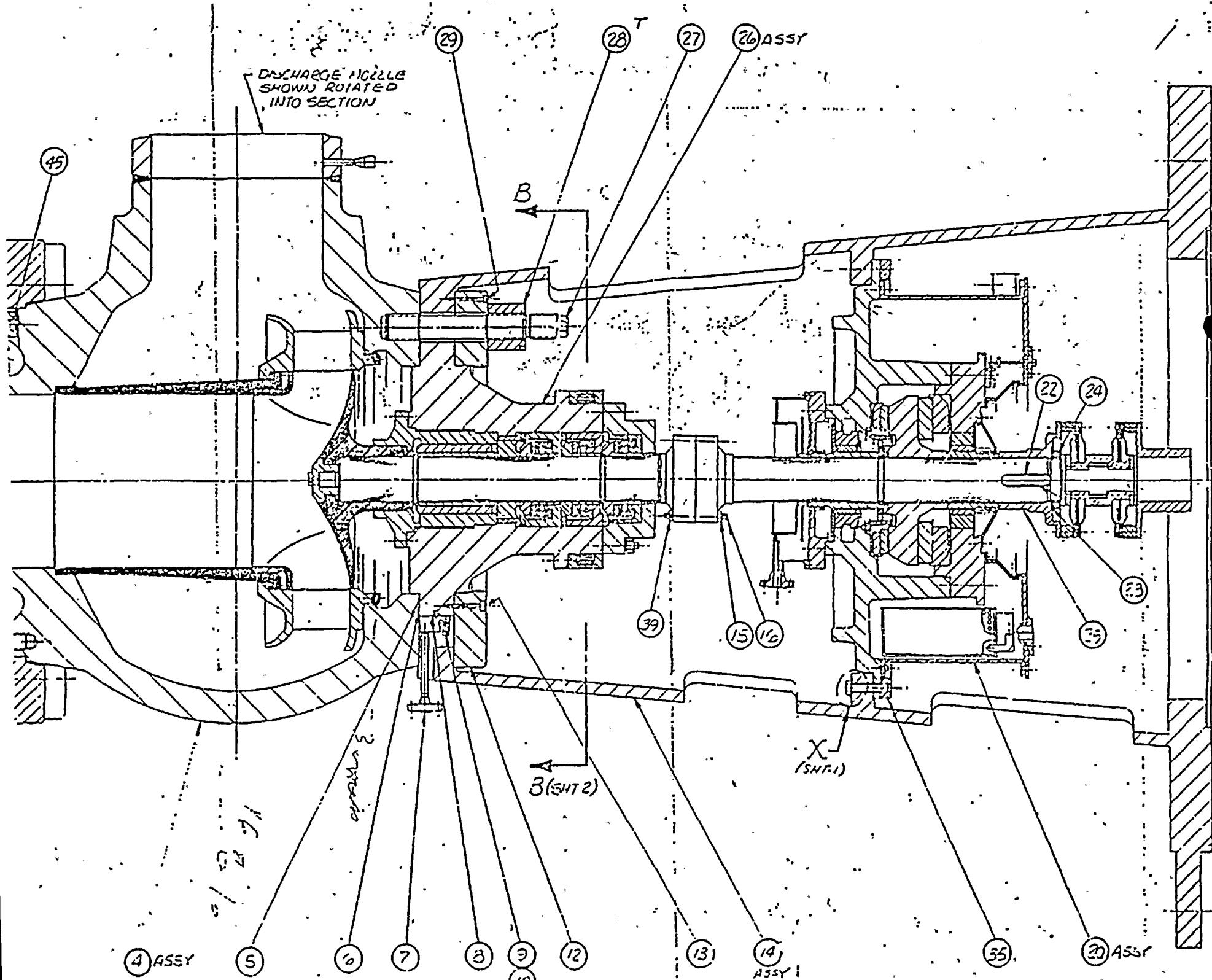

DISCHARGE NOZZLE
SHOWN ROTATED
INTO SECTION

B
C
A

X
(SHT. 1)

3 (SHT 2)

3 (SHT 1)

10/28 7/1

4 ASSY

5

6

7

8

9 (10)

12

13

14 ASSY

35

20 ASSY

29

28

27

26 ASSY

22

24

23

25

39

15

1/2

45

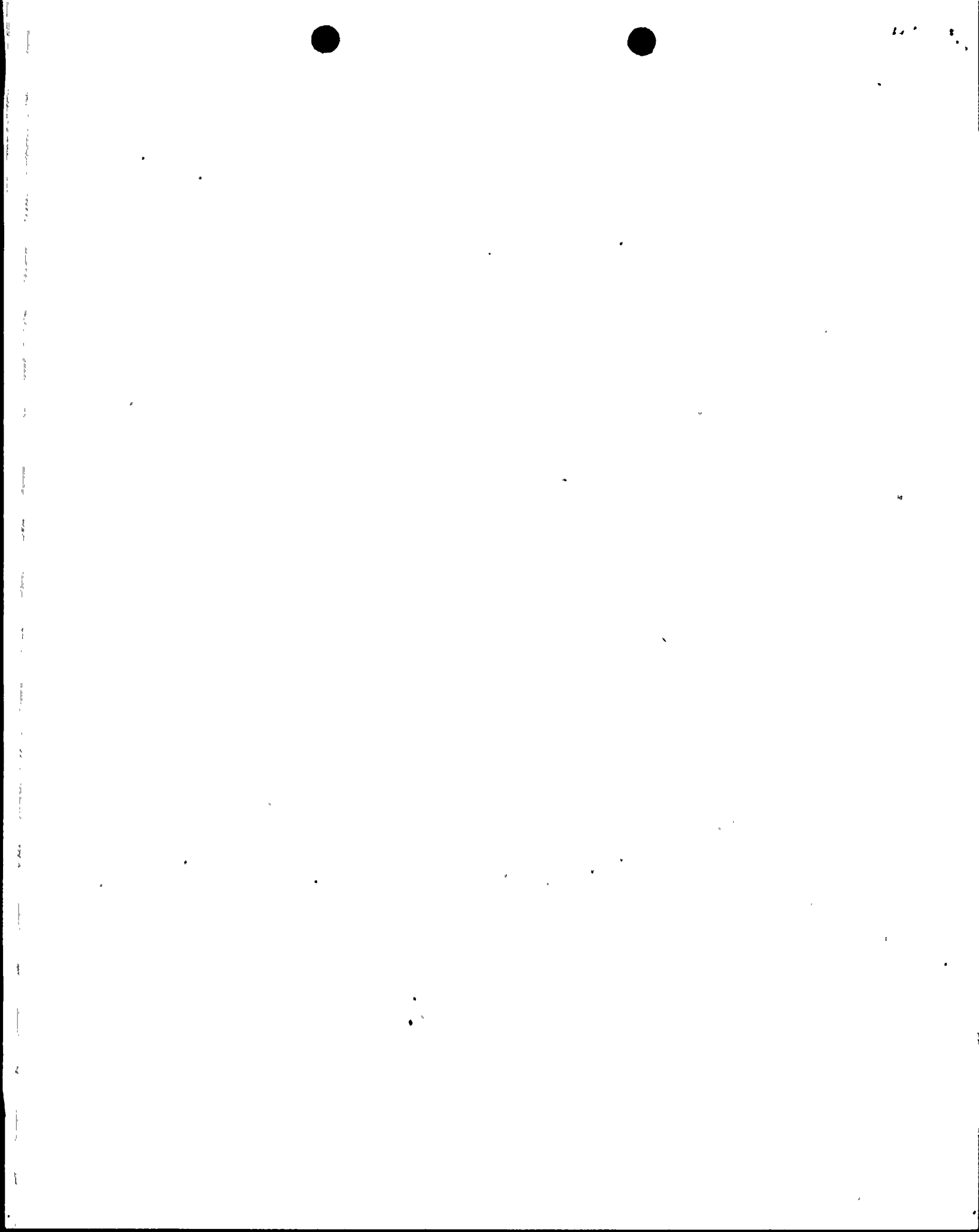

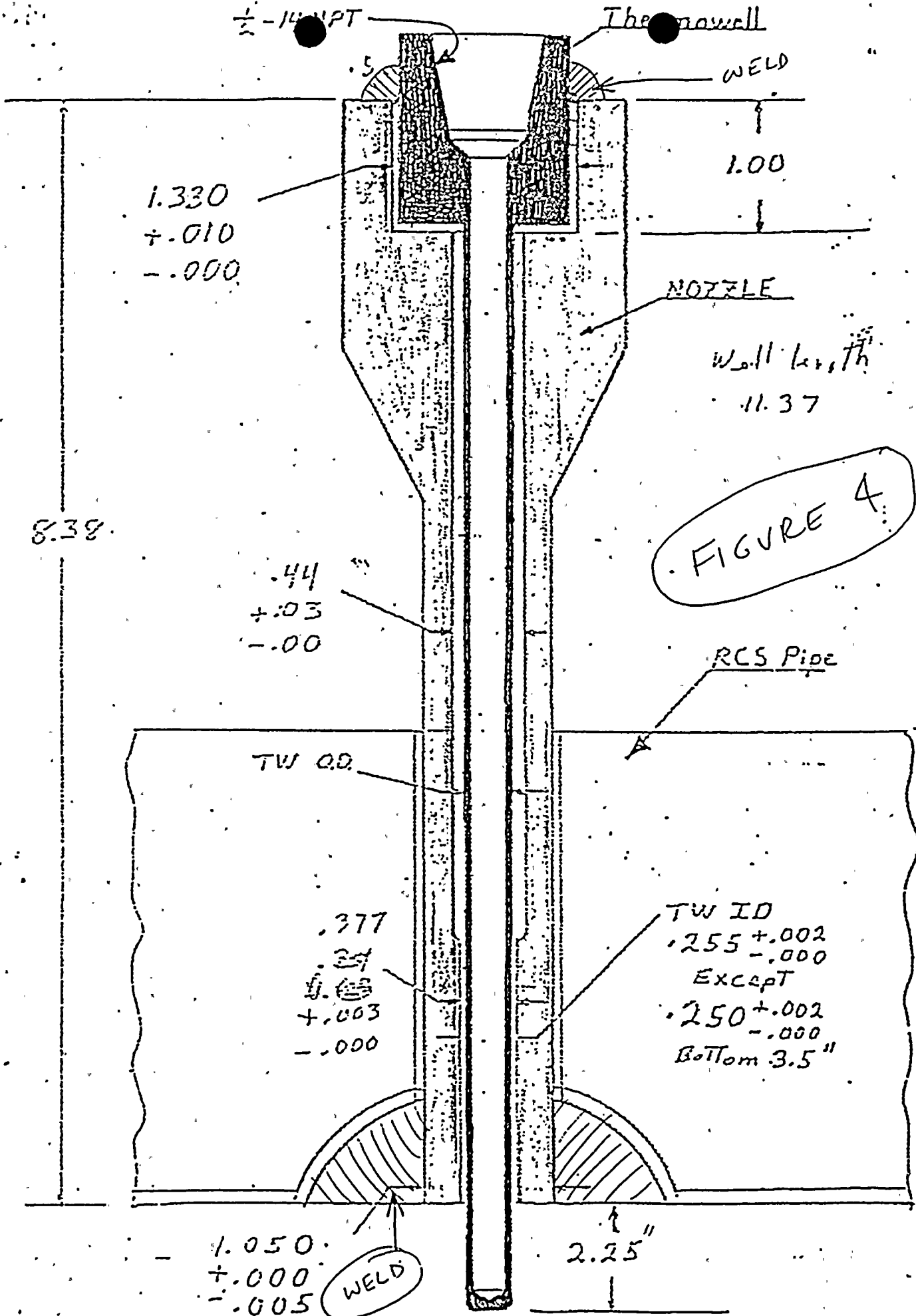
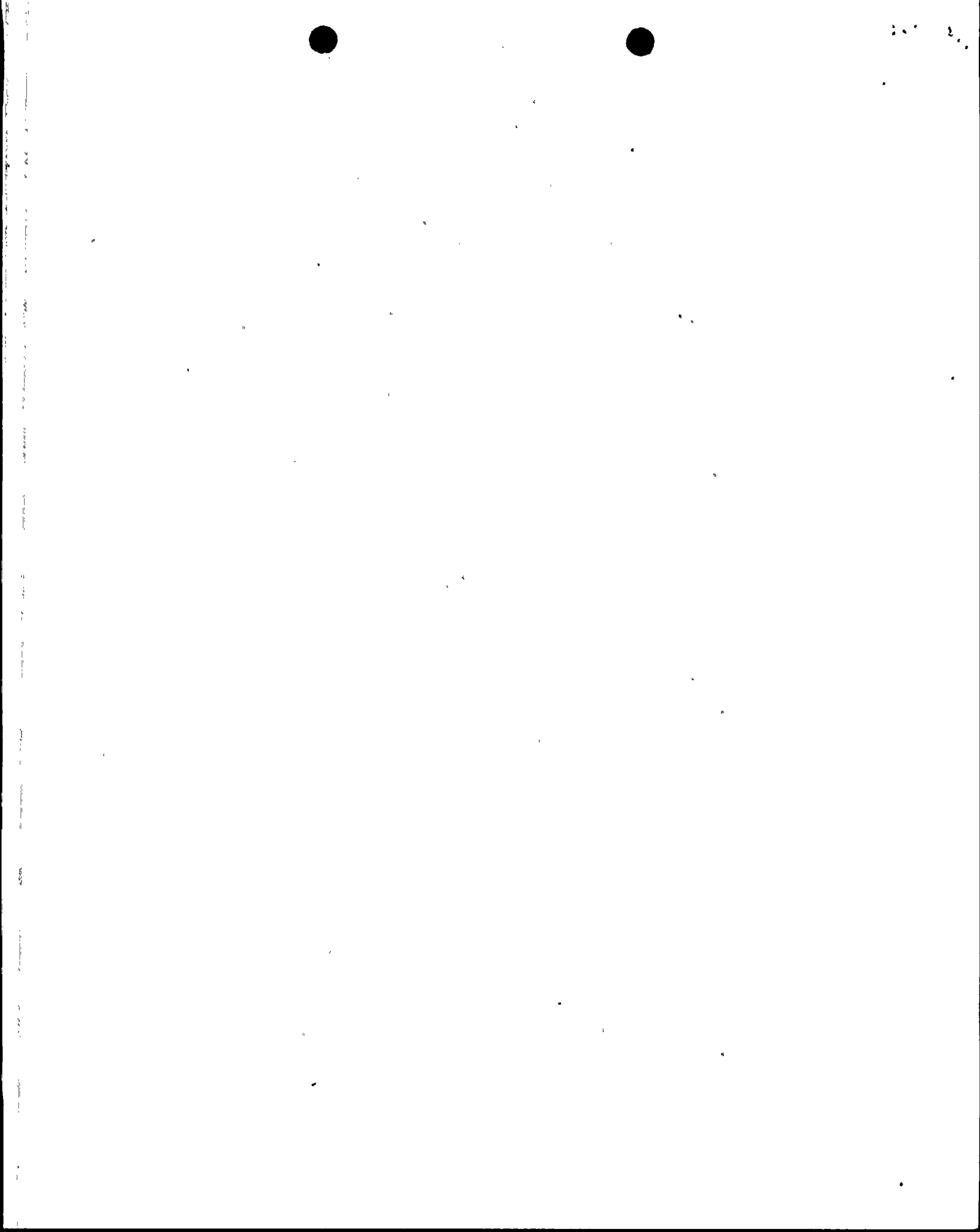
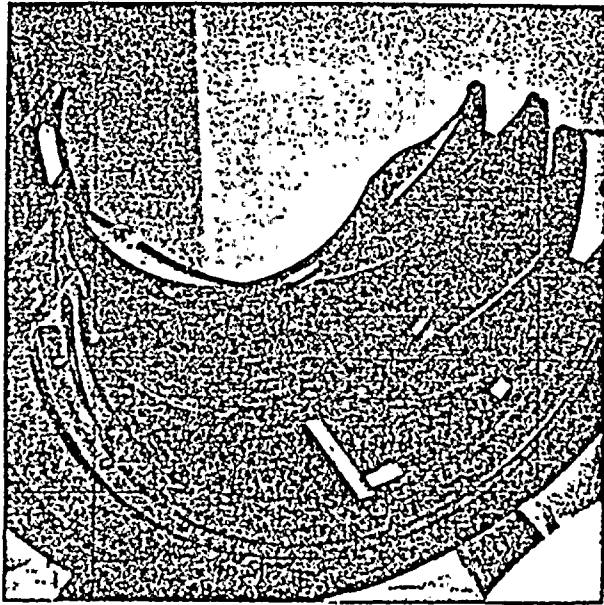
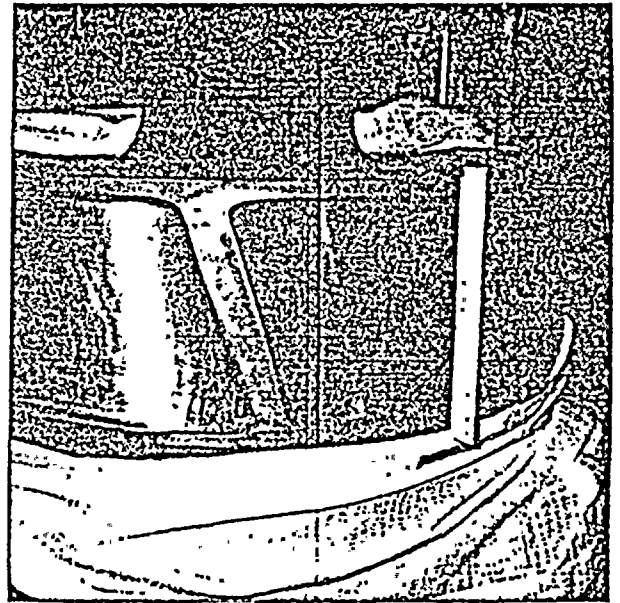

FIGURE 4





1B Diffuser



1B Impeller

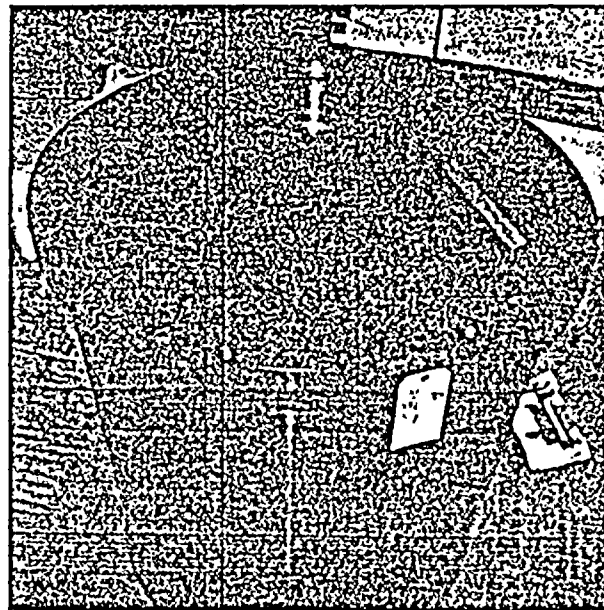

1A Suction Pipe

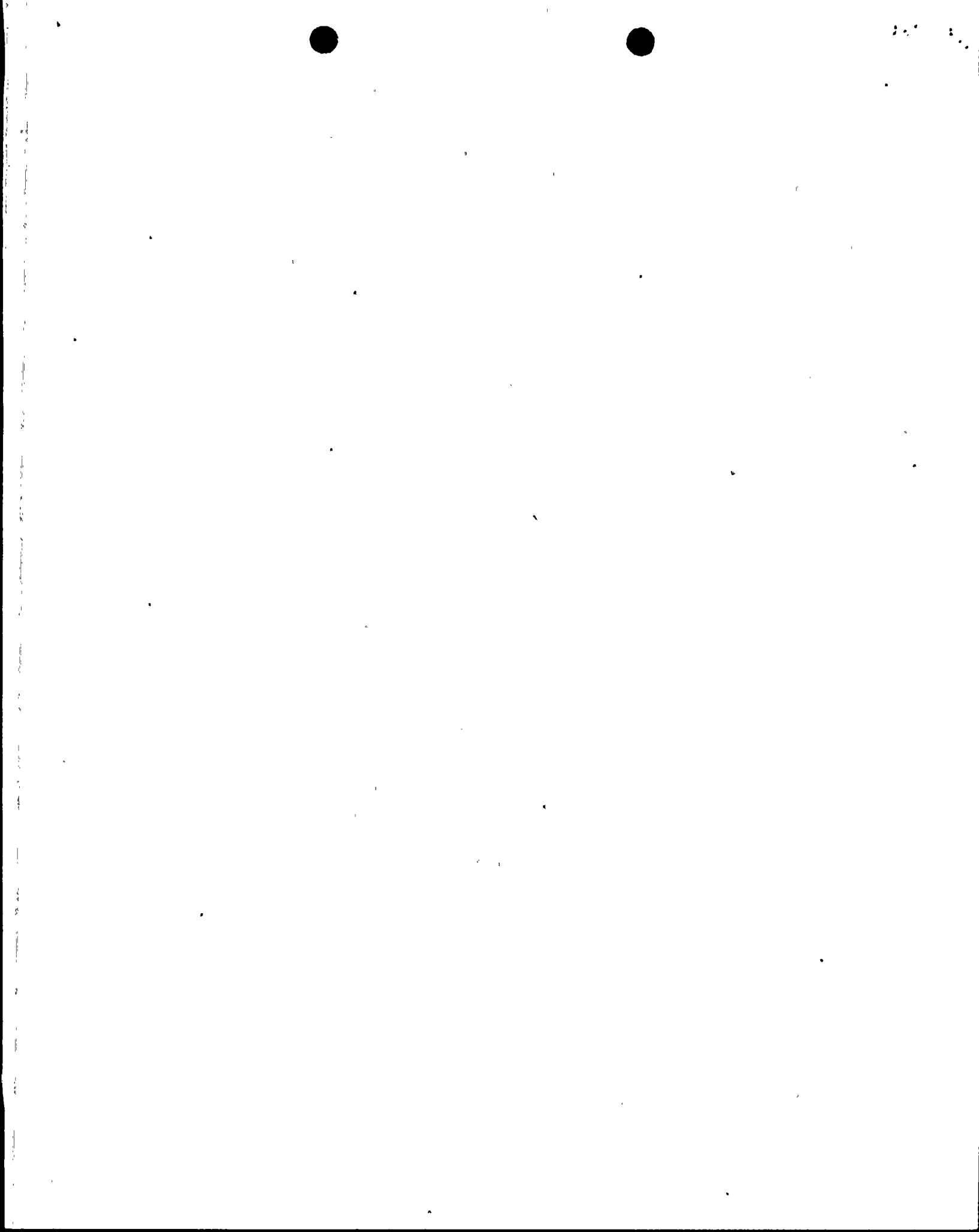

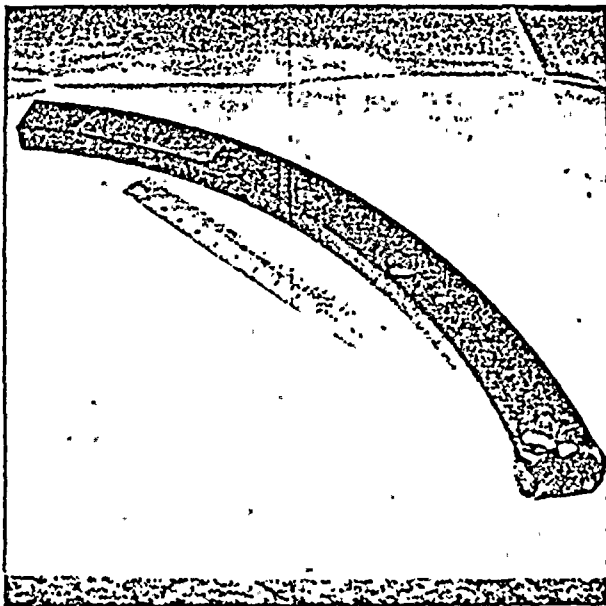

1A Diff. Clamp

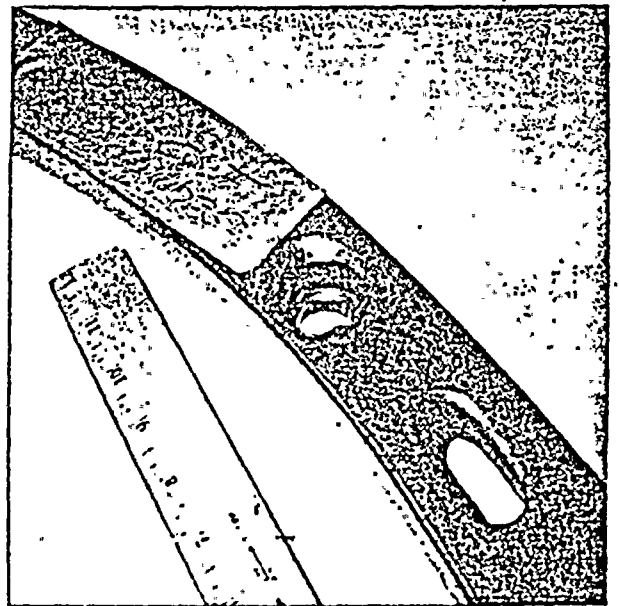

1A Diff. Clamp

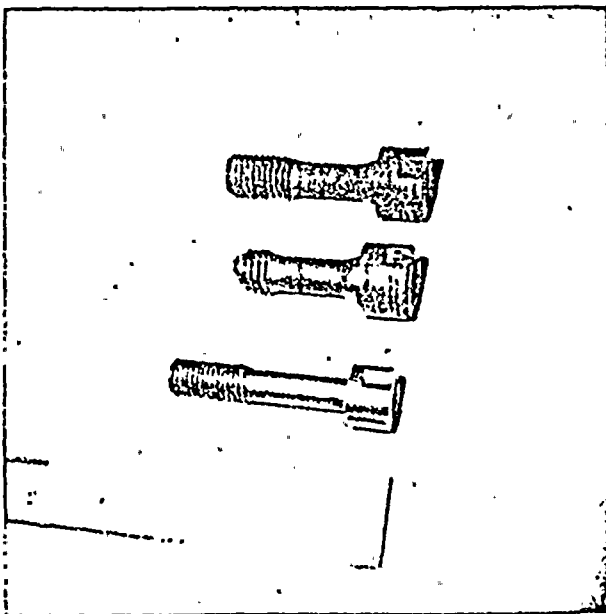

Bolts

Diffuser clamp Bolt (Top)
Broken Diffuser clamp Bolt
Suction pipe Bolt (bottom)

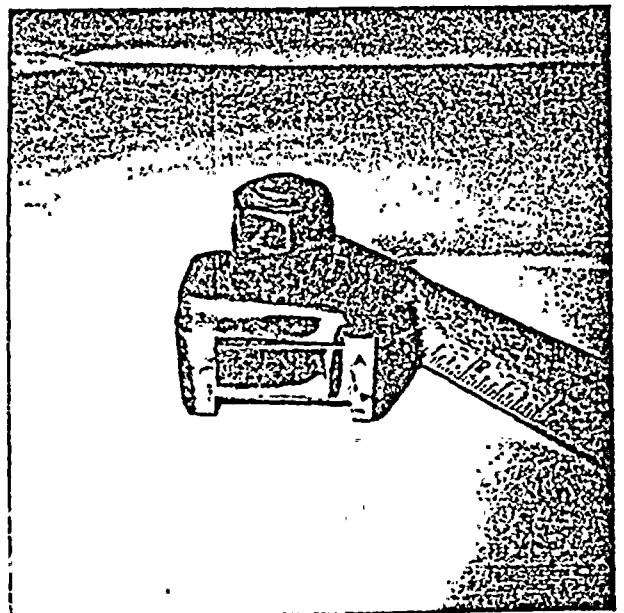

1A Wedge Assy

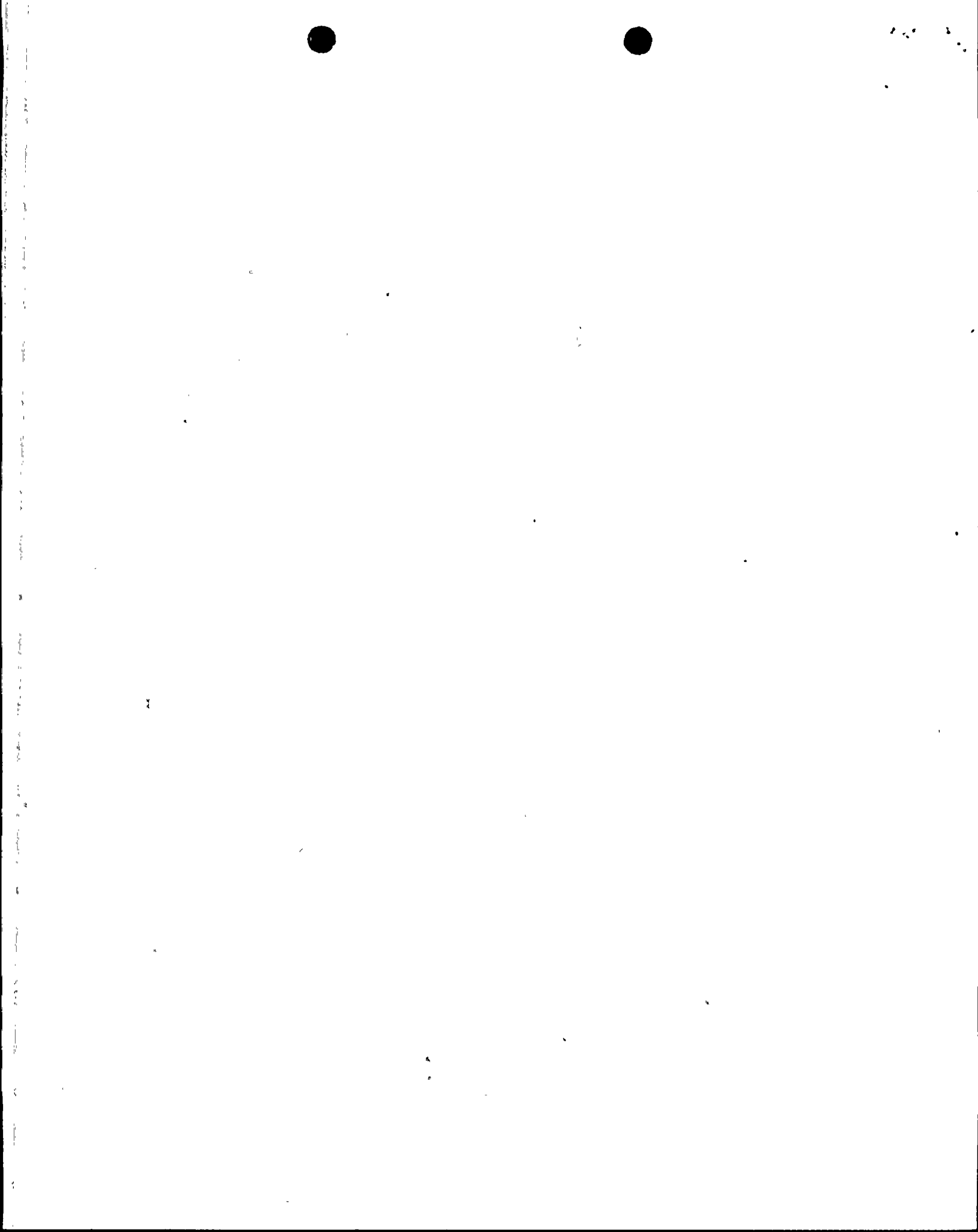

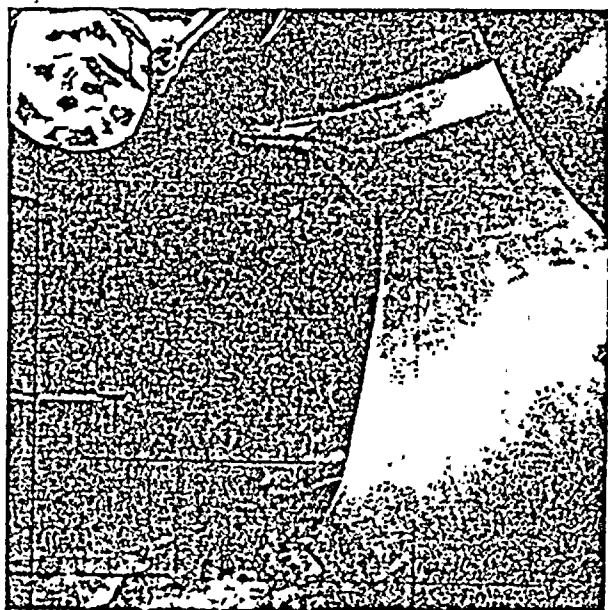

IB Impeller

IB Impeller
IB Impeller
IB Impeller



IB Impeller

To Glen McCoy Fm Phil Parker
6/21/83

- 112 CA SN130
- 112 CC SN180
- 112 CD SN188
- 122 CB SN135
- 122 CA
- 111Y SN 227
- 115 SN235

↑
Plot
North

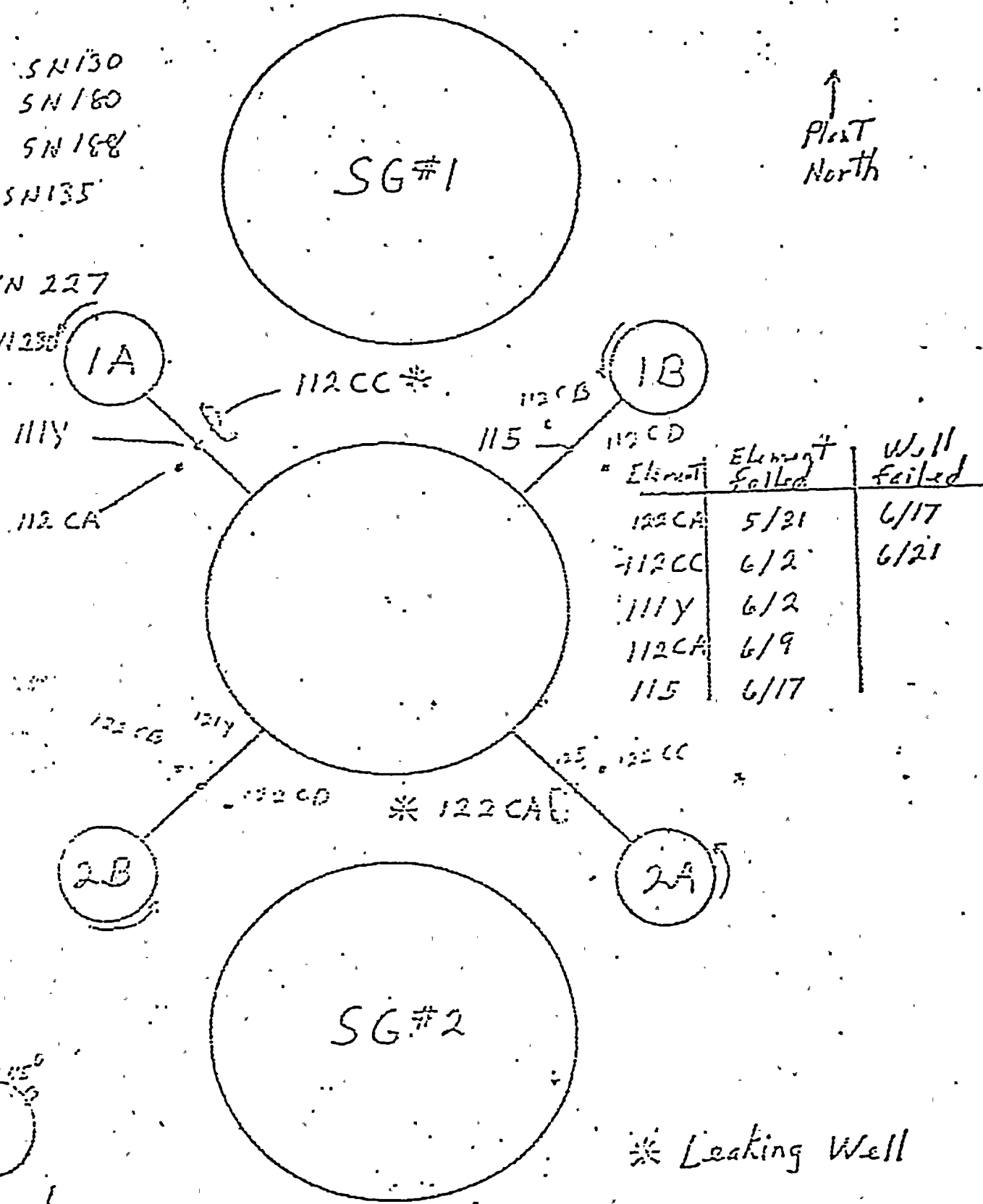

Typical Contic

* Leaking Well

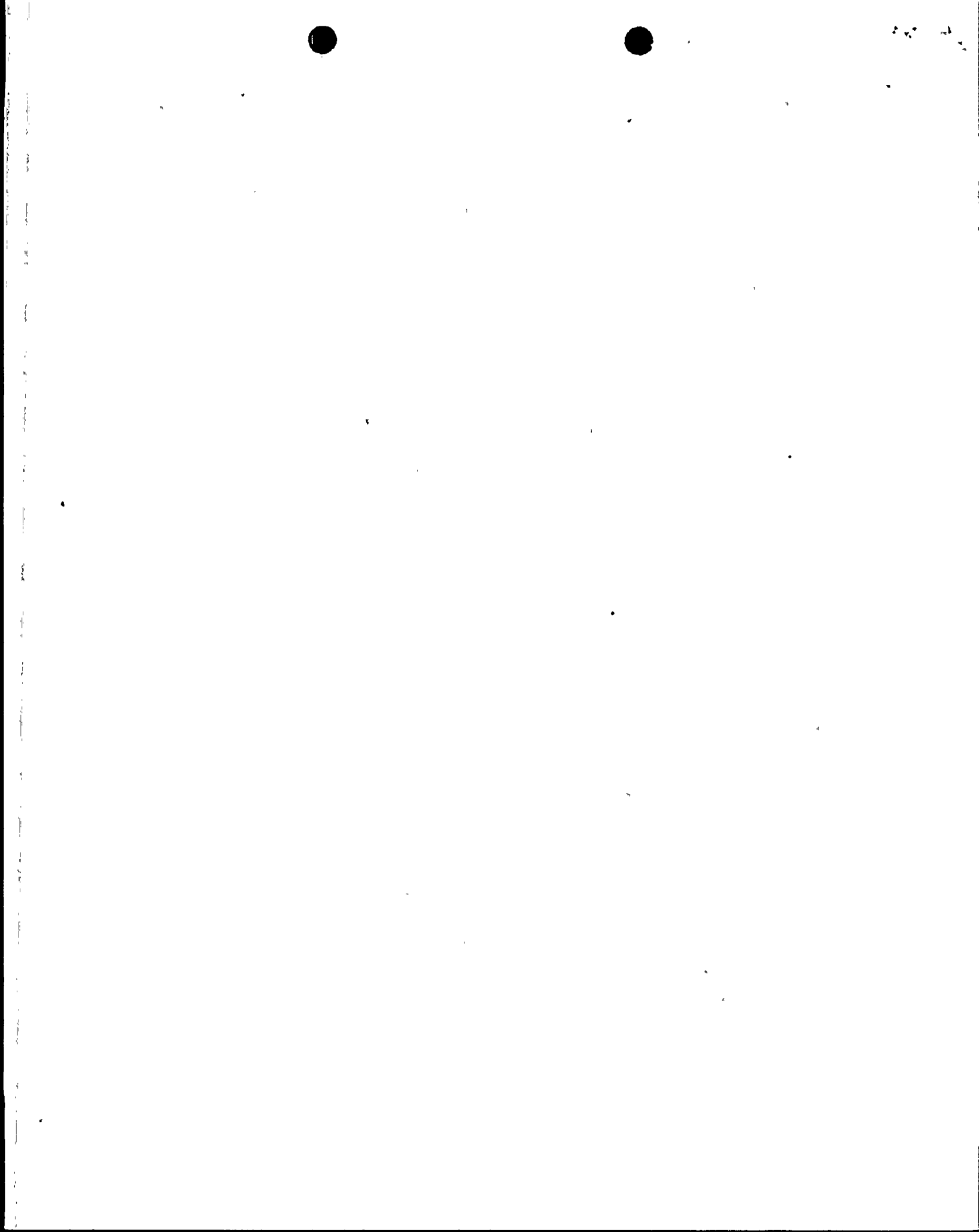

| | LOOP | Failed Element | Failed Wall | Plugged Wall | Elements Remaining | Singls Dual | Start with ACE-20303 | |
|--------|------|----------------|-------------|--------------|--------------------|-------------|----------------------|---------|
| 112 CA | 1A | X | | X | X | D | | CFR 189 |
| 112 CC | 1A | X | X | X | X | S | | CFR 187 |
| 111 Y | 1A | X | | X | X | S | | |
| 112 CB | 1B | | | | | S | | |
| 112 CD | 1B | | | X | X | S | | |
| 115 | 1B | X | | X | X | S | | CFR 185 |
| 122 CA | 2A | X | X | X | X | D | | |
| 122 CC | 2A | | | | | S | | |
| 125 | 2A | | | | | S | | |
| 122 CB | 2B | | | X | X | D | | |
| 122 CD | 2B | | | | | S | | |
| 121 Y | 2B | | | | | S | | |
| 112 HA | 1 | | | | | D | X | |
| 112 HB | 1 | | | | | D | | |
| 112 HC | 1 | | | | | S | | |
| 112 HD | 1 | | | | | S | | |
| 111 HA | 1 | | | | | | | |
| 111 HB | 1 | | | | | SPACE | X | |
| 111 HC | 1 | | | | | WALL | X | |
| 111 HD | 1 | | | | | | | |
| 111 X | 1 | | | | | S | | |
| 123 HA | 2 | | | | | D | X | |
| 123 HB | 2 | | | | | D | | |
| 123 HC | 2 | | | | | S | | |
| 123 HD | 2 | | | | | S | X | |
| 121 HA | 2 | | | | | | | |
| 121 HB | 2 | | | | | SPACE | | |
| 121 HC | 2 | | | | | WALL | X | |
| 121 HD | 2 | | | | | | | |
| 121 X | 2 | | | | | S | | |

