

# CATEGORY 1

## REGULATORY INFORMATION DISTRIBUTION SYSTEM (RIDS)

ACCESSION NBR: 9909100134      DOC.DATE: 99/09/02      NOTARIZED: NO      DOCKET #  
 FACIL: 50-387 Susquehanna Steam Electric Station, Unit 1, Pennsylv      05000387  
       50-388 Susquehanna Steam Electric Station, Unit 2, Pennsylv      05000388  
 AUTH.NAME                      AUTHOR AFFILIATION  
 FIELDS, J.S.                    Pennsylvania Power & Light Co.  
 RECIP.NAME                    RECIPIENT AFFILIATION  
 SWERDON, P.M.                 Pennsylvania, Commonwealth of

SUBJECT: Submits info to update water treatment info previously submitted for NPDES Permit PA 0047325. Approval of Depositrol PY5206, scale inhibitor, for use in Emergency Spray Pond, requested.

DISTRIBUTION CODE: C001D      COPIES RECEIVED: LTR 1 ENCL 1      SIZE: 16  
 TITLE: Licensing Submittal: Environmental Rept Amdt & Related Correspondence

NOTES: 05000387

	RECIPIENT		COPIES		RECIPIENT		COPIES	
	ID	CODE/NAME	LTR	ENCL	ID	CODE/NAME	LTR	ENCL
	NERSES, V		1	1				
INTERNAL:	ACRS		1	1	FILE CENTER 01		1	1
	LA		1	1	NUDOCS-ABSTRACT		1	1
	OGC/RP		1	0	RGN1 DRS/RSB		1	1
EXTERNAL:	NOAC		1	1	NRC PDR		1	1
NOTES:			1	1				

RECEIVED  
 SEP 11 1999  
 ENVIRONMENTAL PROTECTION AGENCY  
 WASHINGTON, DC 20460

NOTE TO ALL "RIDS" RECIPIENTS:  
 PLEASE HELP US TO REDUCE WASTE. TO HAVE YOUR NAME OR ORGANIZATION REMOVED FROM DISTRIBUTION LISTS OR REDUCE THE NUMBER OF COPIES RECEIVED BY YOU OR YOUR ORGANIZATION, CONTACT THE DOCUMENT CONTROL DESK (DCD) ON EXTENSION 415-2083

TOTAL NUMBER OF COPIES REQUIRED: LTR 10 ENCL 9

Er

This proposed NPDES Amendment is being submitted pursuant to Section 3.2 of the Environmental Protection Plan (Appendix B to the OL)

Jerome Fields  
Sr. Environmental Scientist - Nuclear

PP&L, Inc.  
Two North Ninth Street  
Allentown, PA 18101-1179  
Tel. 610.774.7889 Fax 610.774.7205  
jsfields@papl.com



ppl

September 2, 1999

Mr. Paul M. Swerdon  
Chief, Facilities and Construction Grants Section  
Bureau of Water Quality Management  
Pennsylvania Department of Environmental Protection  
Two Public Square  
Wilkes-Barre, PA 18711-0790

SUSQUEHANNA STEAM ELECTRIC STATION  
USE OF DEPOSITROL PY5206  
CCN 741326 FILE R9-8A  
PLE-21515

Dear Mr. Swerdon:

PP&L, Inc. is submitting information to the Pennsylvania Department of Environmental Protection (PaDEP) for the Susquehanna Steam Electric Station (SES) to update water treatment information previously submitted for NPDES Permit No. PA 0047325. PP&L, Inc. requests approval of Depositrol PY5206, a scale inhibitor, for use in the Emergency Spray Pond. PP&L believes that there will be no additional impacts to the waters of the Commonwealth resulting from use of Depositrol PY5206.

Previously the PaDEP approved another scale inhibitor, Powerline PPL 11, however, because of the continued drought and warm weather, Powerline PPL 11 is not inhibiting scale in this pond. Depositrol PY5206 has an active ingredient, alkyl epoxy carboxylate (AEC), a non-phosphate calcium carbonate inhibitor, while Powerline PPL 11 has an active ingredient of hydroxy ethylidene diphosphonic acid (HEDP). A comparison of bioassay data shows that Depositrol PY5206 is less toxic than Powerline PPL 11.

In response to the requirements of "Permitting Guidance on Conditioned Water Discharges and Use of Chemical Additives, Revised July 24, 1992," PP&L has submitted this request for approval for the use of Depositrol PY5206, a scale inhibitor. Attachment 1, Data for Chemical Additive Depositrol PY5206, provides information required in the PaDEP permitting guidance document. Attachment 2 is a Material Safety Data Sheet for this product, and Attachment 3 is a Product Facts Sheet about this product's active ingredient, AEC.

9909100134 990902  
PDR ADDCK 05000387  
P PDR



11

September 2, 1999

2

To: Mr. Paul M. Swerdon  
PLE-21515

We understand that the PaDEP review process takes up to 60 days; however, if scale in this Emergency Spray Pond should impact operation of Susquehanna SES emergency systems, we will notify your office and request an emergency approval. It is PP&L's understanding that Depositrol PY5206 can control scaling during extended drought conditions.

If you have any questions please contact Jim Wolfer at the Susquehanna SES, (570) 542-3981 or me.

Sincerely,

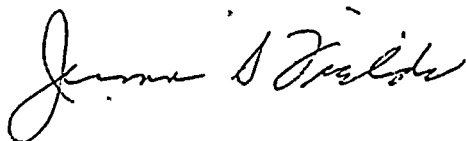

Jerome S. Fields  
Sr. Environmental Scientist-Nuclear

Enclosure (in Triplicate)

bc:

T. D. Belles	NUCSA1
G. W. Castleberry	NUCSA1
R. L. Doty	GENA93
N. A. Evans	GENTW8
R. D. Kichline	GENA61
J. L. McCormick	GENA93
D. J. Morgan	GENA63
C. H. Saxton	NUCSA1
R. S. Tombaugh	GENA63
J. L. Tripoli	NUCSA1
J. R. Wolfer	NUCSA1
NR File	GENA62

U.S. Nuclear Regulatory Commission  
Attn: Document Control Desk  
Mail Station OP1-17  
Washington, DC 20555

copy: NRC Region I  
Mr. S. Hansell, NRC Sr. Resident Inspector  
Mr. V. Nerses, NRC Sr. Project Manager

jsf/th5225c(26)



**DATA FOR CHEMICAL ADDITIVE DEPOSITROL PY5206****1. TRADE NAME OF ADDITIVE**

The commercial product is Depositrol PY5206  
The active component is Continuum AEC (alkyl epoxy carboxylate)

**2. NAME AND ADDRESS OF ADDITIVE MANUFACTURER**

BetzDearborn Inc.  
4636 Somerton Road  
Trevose, PA 19053

**3. MATERIAL SAFETY DATA SHEET (MSDS) OR OTHER AVAILABLE**

MSDS is attached and includes toxicological data.

**4. BIOASSAY DATA INCLUDING THE 96-HOUR LC50 ON THE WHOLE PRODUCT**

The 96-hour LC50 for Fathead Minnows is 1,680 mg/l and the 48-hour LC50 for Daphnia magna is 1,635 mg/l.

**5. PROPOSED AVERAGE AND MAXIMUM ADDITIVE USAGE RATES IN LBS/DAY**

Average usage rate - 96 lbs./day as product

Maximum usage rate - 385 lbs./day as product

**6. A FLOW DIAGRAM SHOWING THE POINT OF CHEMICAL ADDITION AND AFFECTED OUTFALLS**

The addition point is the Spray Pond. The Spray Pond outfall discharges into the Cooling Tower Blowdown line. See attached line drawing.



7. **THE EXPECTED CONCENTRATION OF PRODUCT AT FINAL OUTFALL**

The expected concentration of Depositrol PY5206 in the Emergency Spray Pond will be 32 mg/l as product. The expected concentration of product discharged from the pond through the final outfall, the Cooling Tower Blowdown (Outfall 071) as product is between 0.67 to 1.14 mg/l. See the response to No. 10 for additional information.

8. **THE PRODUCT DENSITY FOR LIQUIDS (lb./gal) USED TO CONVERT USAGE RATE (gpd) TO IN-SYSTEM CONCENTRATIONS (mg/l)**

The quantity of product used daily is based on the average Spray Pond discharge rate of 250 gpm, and a maximum pond concentration of 32 mg/l as product.

At 250 gpm, the pond daily blowdown in pounds equals:

$$250 \text{ gpm} \times 1440 \text{ min/day} \times 8.33 \text{ lbs./gal} = 3.0E6 \text{ lbs./day}$$

At 32ppm, the weight of product discharged per day equals:

$$32 \text{ mg/l} \times (3.0E6 \text{ lbs./day} / 1E6 \text{ mg/l}) = 96 \text{ lbs./day.}$$

At 96 lbs./day, the daily usage rate in gallons per day equals:

$$\text{Wt/gal product} = \text{sp gr } 1.27 \times 8.33 \text{ lbs./gal} = 10.6 \text{ lbs./gal}$$

$$96 \text{ lbs./day} / 10.6 \text{ lbs./gal} = 9 \text{ gallons per day.}$$

Product in-system concentration (mg/l):

The product in-system maximum concentration, as recommended by the supplier will be a maximum of 32mg/L.

9. **THE ANALYTICAL TEST METHOD THAT COULD BE USED TO VERIFY FINAL DISCHARGE CONCENTRATIONS WHEN THE PRODUCT IS IN USE AND THE ASSOCIATED MINIMUM ANALYTICAL DETECTION LEVEL (mg/l)**

The recommended analytical method is the Turbidimetric Method. The minimum analytical detection level is 12 mg/L as product.





**10. CONDITIONED WATER DISCHARGE RATE (BLOWDOWN RATE) AND DURATION (HOURS)**

The conditioned water discharge rate from the Emergency Spray Pond into Cooling Tower Blowdown (Outfall 071) will be approximately 250 gpm, 24 hours per day. Cooling Tower Blowdown discharge rate for two-unit operation is between 7,000 and 12,000 gpm. The as-product concentration of Depositrol PY5206 will be between 0.67 and 1.14 mg/l at Outfall 071 when product is being used.

$$250 \text{ gpm} / 12,000 \text{ gpm} \times 32 \text{ mg/l} = 0.67 \text{ mg/l}$$

$$250 \text{ gpm} / 7,000 \text{ gpm} \times 32 \text{ mg/l} = 1.14 \text{ mg/l}$$

**11. AVAILABLE DATA ON THE DEGRADATION OR DECOMPOSITION OF THE ADDITIVE IN THE AQUATIC ENVIRONMENT**

Biodegradation data listed below can be found in Ecological Information Section 12, page 7 of the MSDS.

COD (mg/gm)	130
TOC (mg/gm)	70
BOD-5 (mg/gm)	9
BOD-28 (mg/gm)	9

**12. ANY OTHER DATA OR INFORMATION THE PERMITTEE BELIEVES WOULD BE HELPFUL TO THE DEPARTMENT IN COMPLETING ITS REVIEW**

Depositrol PY5206 treatment of the Emergency Spray Pond at the Susquehanna SES is needed to effectively control common scales such as calcium carbonate, and also fouling which occur due to iron and other suspended solids. During the present severe drought conditions, this chemical will replace previously approved Hydroxy Ethylidene Diphosphonic Acid (HEDP) another scale inhibitor. The active component (AEC) is more stable and has a greater protection range than HEDP.

jsf/msh5226c(26)



SECTION B - (continued)

7. Line Drawing. - See instructions

No. 6

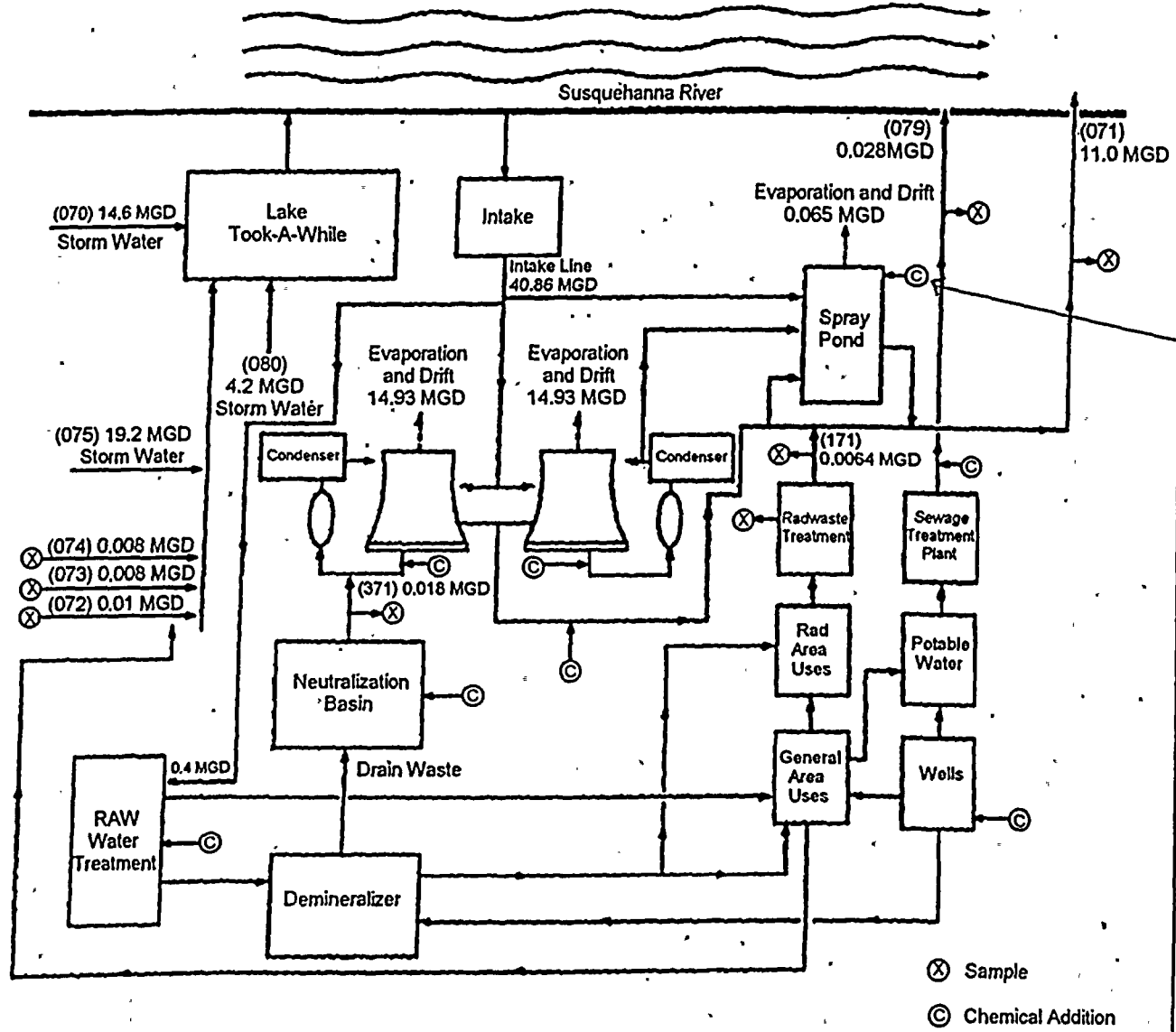

Notes:

Data averaged over years 1996, 1997 and 1998 were used to determine river water withdrawal, consumptive use, and blowdown back to the river.

Outfalls 077 and 078 have not been included in this line drawing or permit renewal application since they do not discharge to the stormdrains.



**BETZDEARBORN MATERIAL  
SAFETY DATA SHEET**



ATTACHMENT 2  
1 of 2  
**BetzDearborn**

EFFECTIVE DATE: 08-MAR-1999  
PRINTED DATE: 14-JUN-1999

---

**1) CHEMICAL PRODUCT AND COMPANY IDENTIFICATION**

**PRODUCT NAME : DEPOSITROL PY5206**

**PRODUCT APPLICATION AREA: WATER-BASED CORROSION  
INHIBITOR/DEPOSIT CONTROL AGENT.**

**COMPANY ADDRESS:**

BetzDearborn Inc.  
4636 Somerton Road, Trevoise, Pa. 19053  
Information phone number: (215) - 355-3300

**EMERGENCY TELEPHONE (HEALTH/ACCIDENT): (800)-877-1940 (USA)**

---

**2) COMPOSITION / INFORMATION ON INGREDIENTS**

Information for specific product ingredients as required by the U.S. OSHA HAZARD COMMUNICATION STANDARD is listed. Refer to additional sections of this MSDS for our assessment of the potential hazards of this formulation. This product is subject to the Pennsylvania and New Jersey Worker and Community Right to Know Law.

**HAZARDOUS INGREDIENTS:**

This product is not hazardous as defined by OSHA regulations.

No component is considered to be a carcinogen by the National Toxicology Program, the International Agency for Research on Cancer, or the Occupational Safety and Health Administration at Pennsylvania thresholds for carcinogens.



PRODUCT NAME : DEPOSITPOL PY5206

EFFECTIVE DATE: 08-MAR-1988

2 of 8

NON-HAZARDOUS INGREDIENTS:

CAS#	CHEMICAL NAME
7732-18-5	WATER TRADE SECRET (N320) TSRN: 125438 - 6148



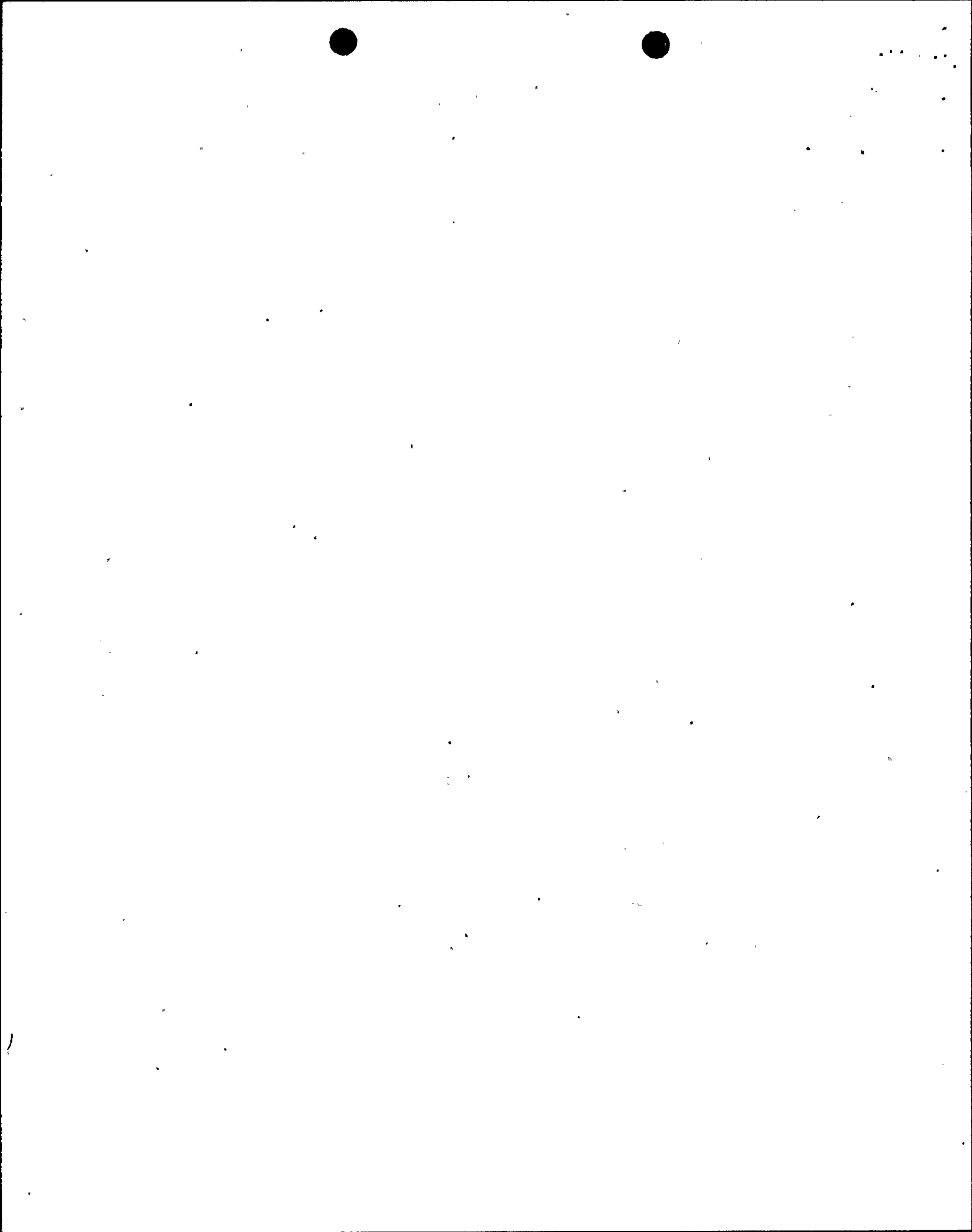

### 3) HAZARDS IDENTIFICATION

\*\*\*\*\*  
**EMERGENCY OVERVIEW**

#### CAUTION

May cause slight irritation to the skin. May cause slight irritation to the eyes. Mists/aerosols may cause irritation to upper respiratory tract.

DOT hazard is not applicable  
Emergency Response Guide is not applicable  
Odor: Mild; Appearance: Pale Yellow, Liquid

Fire fighters should wear positive pressure self-contained breathing apparatus(full face-piece type). Proper fire-extinguishing media: dry chemical, carbon dioxide, foam or water

\*\*\*\*\*  
**POTENTIAL HEALTH EFFECTS**

#### ACUTE SKIN EFFECTS:

Primary route of exposure; May cause slight irritation to the skin.

#### ACUTE EYE EFFECTS:

May cause slight irritation to the eyes.

#### ACUTE RESPIRATORY EFFECTS:

Mists/aerosols may cause irritation to upper respiratory tract.

#### INGESTION EFFECTS:

May cause gastrointestinal-irritation-with-possible-nausea, vomiting, abdominal discomfort and diarrhea.

#### TARGET ORGANS:

No evidence of potential chronic effects.

#### MEDICAL CONDITIONS AGGRAVATED:

Not known.

#### SYMPTOMS OF EXPOSURE:

May cause redness or itching of skin.

---

#### 4) FIRST AID MEASURES

**SKIN CONTACT:**

Remove contaminated clothing. Wash exposed area with a large quantity of soap solution or water for 15 minutes.

**EYE CONTACT:**

Immediately flush eyes with water for 15 minutes. Immediately contact a physician for additional treatment.

**INHALATION:**

Remove victim from contaminated area to fresh air. Apply appropriate first aid treatment as necessary.

**INGESTION:**

Do not feed anything by mouth to an unconscious or convulsive victim. Do not induce vomiting. Immediately contact physician. Dilute contents of stomach using 3-4 glasses milk or water.

---

#### 5) FIRE FIGHTING MEASURES

**FIRE FIGHTING INSTRUCTIONS:**

Fire fighters should wear positive pressure self-contained breathing apparatus (full face-piece type).

**EXTINGUISHING MEDIA:**

dry chemical, carbon dioxide, foam or water

**HAZARDOUS DECOMPOSITION PRODUCTS:**

Thermal decomposition (destructive fires) yields elemental oxides.

**FLASH POINT:**

> 200F > 93C P-M(CC)

---

#### 6) ACCIDENTAL RELEASE MEASURES

**PROTECTION AND SPILL CONTAINMENT:**

Ventilate area. Use specified protective equipment. Contain and absorb on absorbent material. Place in waste disposal container. Flush area with water. Wet area may be slippery. Spread sand/grit.

**DISPOSAL INSTRUCTIONS:**

Water contaminated with this product may be sent to a sanitary sewer treatment facility, in accordance with any local agreement, a permitted waste treatment facility or discharged under a permit. Product as is - Incinerate or land dispose in an approved landfill.

---

#### 7) HANDLING AND STORAGE

**HANDLING:**

Alkaline. Do not mix with acidic material.

**STORAGE:**

Keep containers closed when not in use. Protect from freezing. Do not store at elevated temperatures.

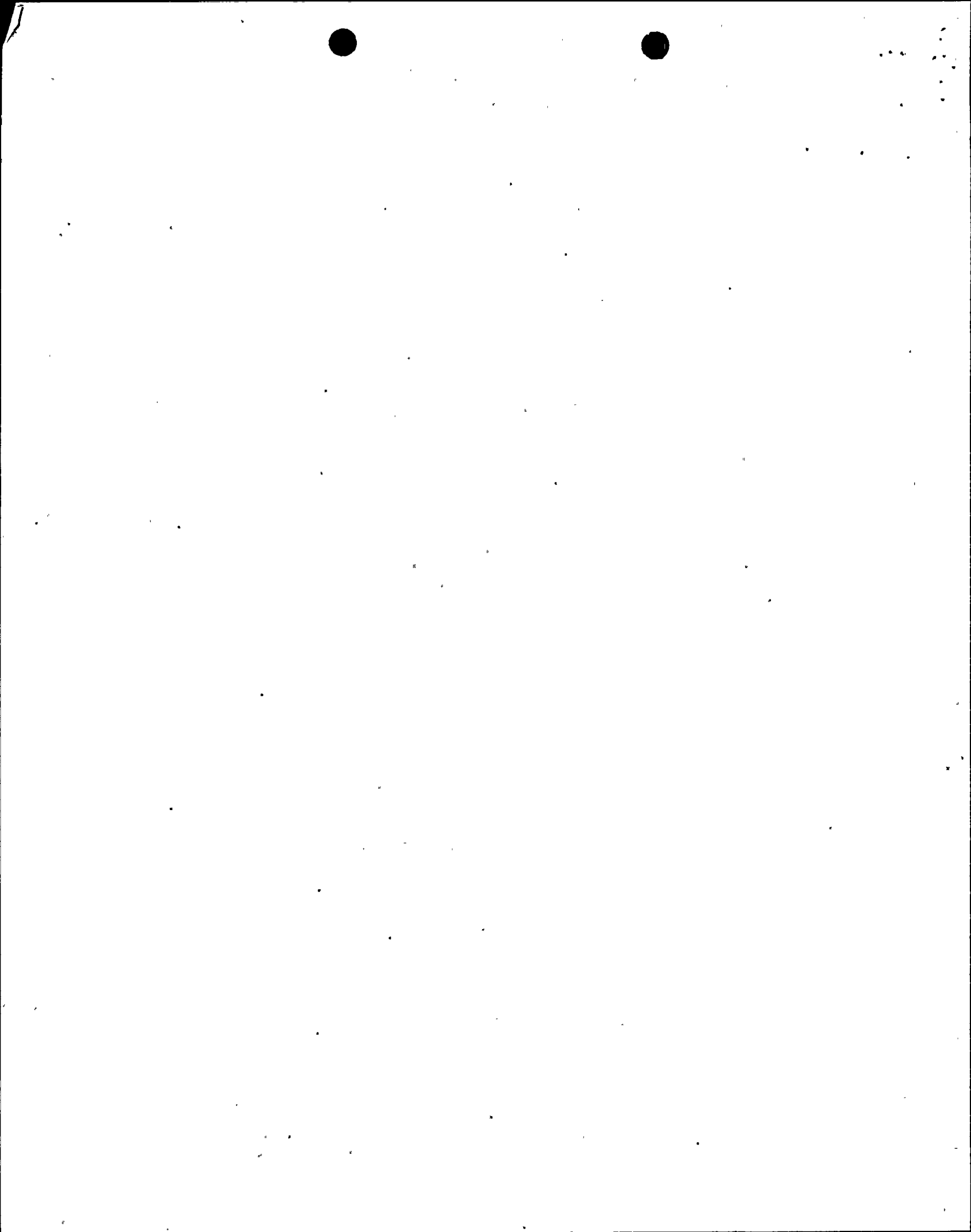

## 8) EXPOSURE CONTROLS/PERSONAL PROTECTION

### EXPOSURE LIMITS

This product is not hazardous as defined by OSHA regulations.

#### ENGINEERING CONTROLS:

adequate ventilation

#### PERSONAL PROTECTIVE EQUIPMENT:

Use protective equipment in accordance with 29CFR 1910 Subpart I

#### RESPIRATORY PROTECTION:

A RESPIRATORY PROTECTION PROGRAM THAT MEETS OSHA'S 29 CFR 1910.134 AND ANSI Z88.2 REQUIREMENTS MUST BE FOLLOWED WHENEVER WORKPLACE CONDITIONS WARRANT A RESPIRATOR'S USE.

USE AIR PURIFYING RESPIRATORS WITHIN USE LIMITATIONS ASSOCIATED WITH THE EQUIPMENT OR ELSE USE SUPPLIED AIR-RESPIRATORS.

If air-purifying respirator use is appropriate, use a respirator with dust/mist filters.

#### SKIN PROTECTION:

neoprene gloves— Wash off after each use. Replace as necessary.

#### EYE PROTECTION:

splash proof chemical goggles

## 9) PHYSICAL AND CHEMICAL PROPERTIES

Specific Grav. (70F, 21C)	1.270	Vapor Pressure (mmHG)	~ 18.0
Freeze Point (F)	27	Vapor Density (air=1)	< 1.00
Freeze Point (C)	-3		
Viscosity (cps, 70F, 21C)	22	% Solubility (water)	100.0
Odor	Mild		
Appearance	Pale Yellow		
Physical State	Liquid		
Flash Point	P-M(CC)	> 200F > 93C	
pH As Is (approx.)		13.1	
Evaporation Rate (Ether=1)		< 1.00	

NA = not applicable ND = not determined

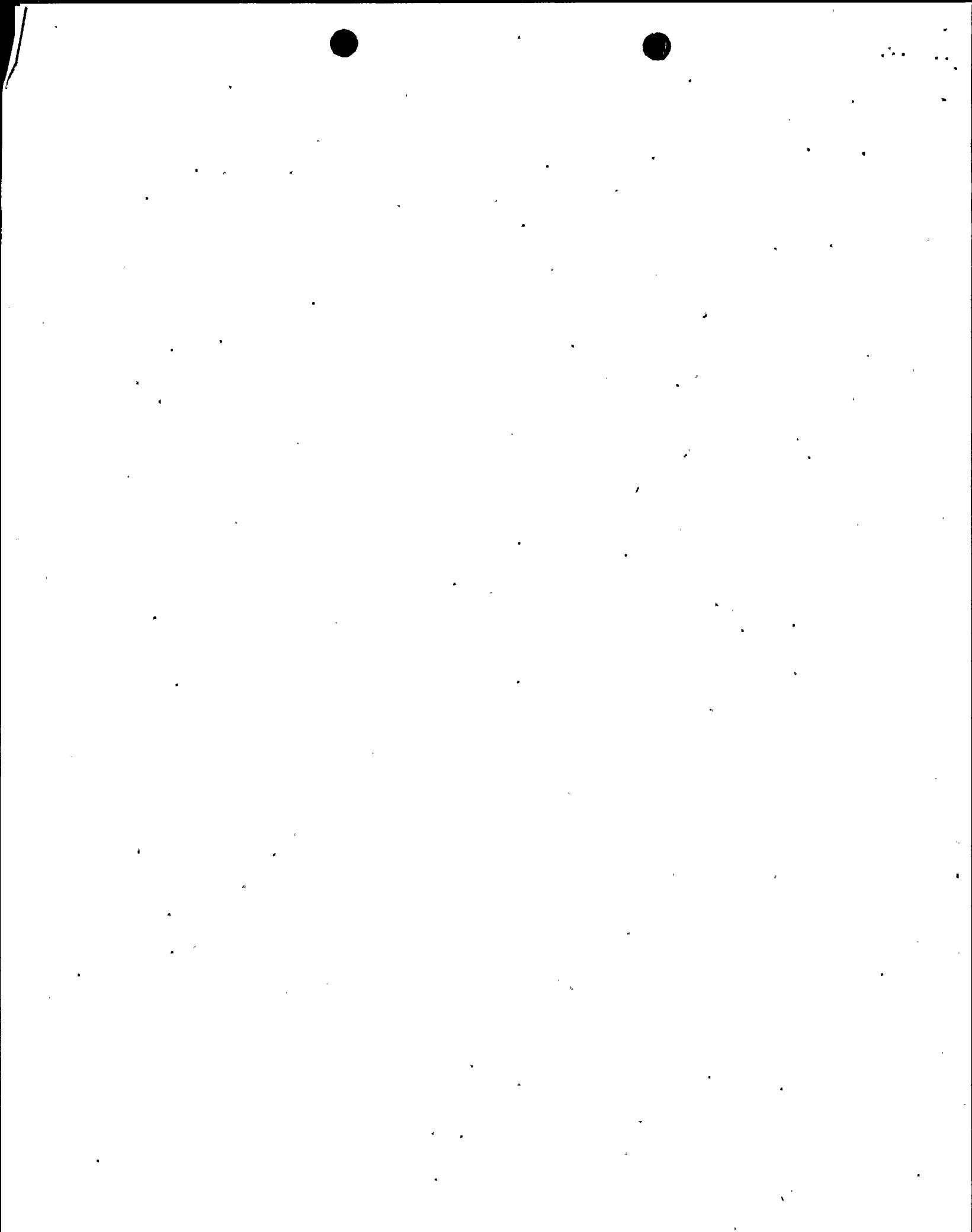

---

## 10) STABILITY AND REACTIVITY

### STABILITY:

Stable under normal storage conditions.

### HAZARDOUS POLYMERIZATION:

Will not occur.

### INCOMPATIBILITIES:

May react with strong oxidizers.

### DECOMPOSITION PRODUCTS:

Thermal decomposition (destructive fires) yields elemental oxides.

### BETZDEARBORN INTERNAL PUMPOUT/CLEANOUT CATEGORIES:

"B"

---

## 11) TOXICOLOGICAL INFORMATION

Oral LD50 RAT:	3,050 mg/kg
28 Day Oral RAT:	1,000 mg/kg/day
NOTE - No clear indications of treatment related toxicity (dose adjusted to 100% active)	
Dermal LD50 RABBIT:	>1,000 mg/kg
NOTE - Estimated value	
Skin Irritation Score RABBIT:	0.3
NOTE - DOT HM181: noncorrosive	
Eye Irritation Score RABBIT:	3.3
NOTE - Maximum score at 48 hrs; completely reversible by day 4	
Non-Ames Mutagenicity MOUSE:	NEGATIVE
NOTE - In Vivo Bone Marrow Micronucleus Assay	

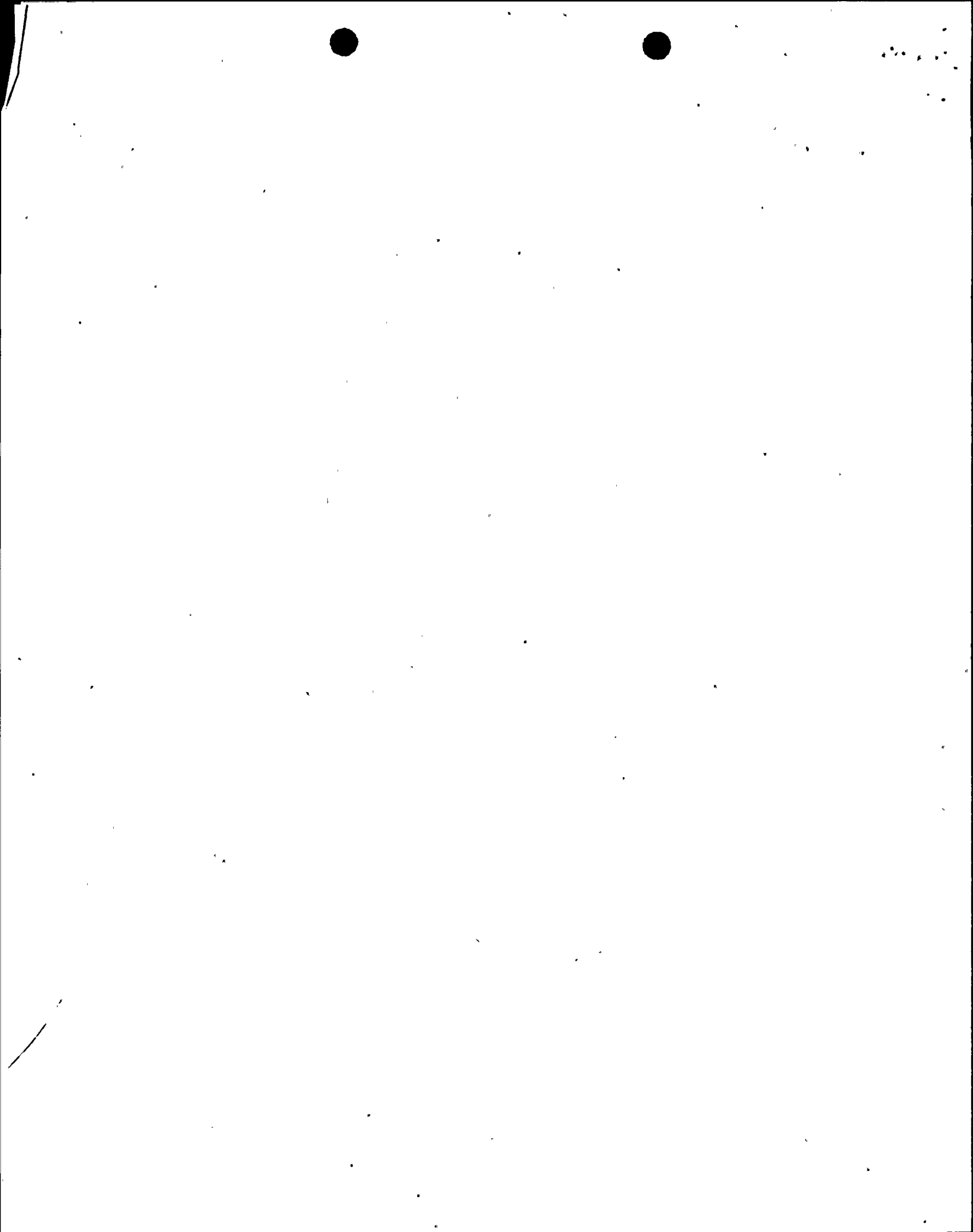



## 12) ECOLOGICAL INFORMATION

### AQUATIC TOXICOLOGY

Fathead Minnow 96 Hour Static Acute Bioassay

LC50: 1680 mg/L  
No Effect Level: 1350 mg/L

Daphnia magna 48 Hour Static Acute Bioassay

LC50: 1635 mg/L  
No Effect Level: 870 mg/L

Mysid Shrimp 48 Hour Static Renewal Bioassay

LC50: 9900 mg/L  
5% Mortality: 4000 mg/L

Sheepshead Minnow 96 Hour Static Renewal Bioassay

LC50: 28300 mg/L  
No Effect Level: 20000 mg/L

### BIODEGRADATION

COD (mg/gm): 130  
TOC (mg/gm): 70  
BOD-5 (mg/gm): 9  
BOD-28 (mg/gm): 9

## 13) DISPOSAL CONSIDERATIONS

If this undiluted product is discarded as a waste, the US RCRA hazardous waste identification number is :  
D002=Corrosive(pH).

Please be advised; however, that state and local requirements for waste disposal may be more restrictive or otherwise different from federal regulations. Consult state and local regulations regarding the proper disposal of this material.

## 14) TRANSPORT INFORMATION

DOT HAZARD: Not Applicable  
UN / NA NUMBER: Not applicable  
DOT EMERGENCY RESPONSE GUIDE #: Not applicable

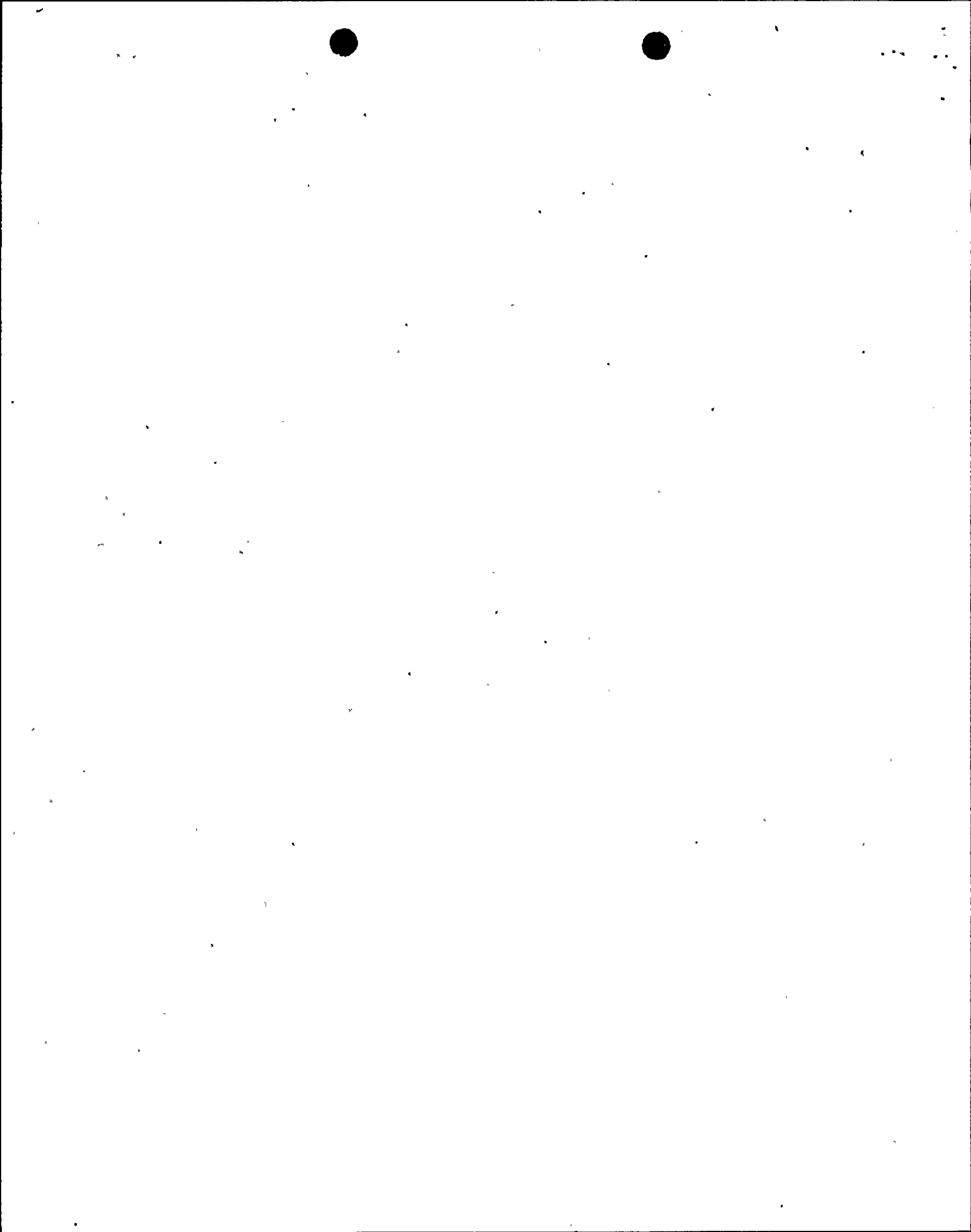

### 15) REGULATORY INFORMATION

**TSCA:**

All components of this product are listed in the TSCA inventory.

**CERCLA AND/OR SARA REPORTABLE QUANTITY (RQ):**

No regulated constituent present at OSHA thresholds

**SARA SECTION 312 HAZARD CLASS:**

Product is non-hazardous under Section 311/312

**SARA SECTION 302 CHEMICALS:**

No regulated constituent present at OSHA thresholds

**SARA SECTION 313 CHEMICALS:**

No regulated constituent present at OSHA thresholds

### CALIFORNIA REGULATORY INFORMATION

**CALIFORNIA SAFE DRINKING WATER AND TOXIC ENFORCEMENT ACT (PROPOSITION 65) CHEMICALS PRESENT:**

No regulated constituent present at OSHA thresholds

### MICHIGAN REGULATORY INFORMATION

No regulated constituent present at OSHA thresholds

### 16) OTHER INFORMATION

**NFPA/HMIS**

**CODE TRANSLATION**

Health	1	Slight Hazard
Fire	1	Slight Hazard
Reactivity	0	Minimal Hazard
Special	ALK	pH above 12.0
(1) Protective Equipment	B	Goggles, Gloves

(1) refer to section 8 of MSDS for additional protective equipment recommendations.

### CHANGE LOG

	EFFECTIVE DATE	REVISIONS TO SECTION:	SUPERCEDES
MSDS status:	21-MAY-1997		** NEW **
	08-MAR-1999	12	21-MAY-1997



11

JUL 19 1999

ENVIRONMENTAL SERVICES

107 2



## Product Facts

### CONTINUUM® AEC Alkaline Cooling Water Treatment

- Controls deposition and scale with patented AEC non-phosphonate technology
- Maximizes corrosion protection without heavy metals
- Minimizes or eliminates acid feed
- Stable in presence of halogens

#### DESCRIPTION AND USE

Continuum® AEC products are custom designed blends containing alkyl epoxy carboxylate (AEC). AEC, a non-phosphonate calcium carbonate inhibitor, is the primary ingredient used for patented deposit control technology.

These Continuum products control corrosion and scale formation in open recirculating cooling water systems over the alkaline pH range of 7.8 to 9.0. Continuum products with AEC are versatile and have been successfully used in a broad range of systems operating under varying conditions.

#### TYPICAL APPLICATIONS

Continuum AEC programs are designed for cooling water systems operating at alkaline pH, typically 7.8 or above. This means that acid feed and the costs and concerns associated with it may be reduced or eliminated.

Continuum products with AEC effectively control common scales, such as calcium carbonate, and fouling which occur due to iron and other suspended solids.

AEC technology is a major breakthrough in calcium carbonate scale control. Figure 1 demonstrates the ability of AEC to inhibit calcium carbonate scale compared to other conventional inhibitors.

Organic phosphate inhibitors are susceptible to breakdown or reversion in the presence of chlorine. Figure 2 demonstrates that there is no loss of calcium carbonate scale inhibition by AEC in the presence of chlorine.

Continuum AEC programs inhibit the corrosion of mild steel, copper, and copper alloys.

#### THE BETZDEARBORN ENVIRO-GUARD COMMITMENT

BetzDearborn is committed to the preservation and enhancement of our global environment, improving health and safety, and fostering environmental awareness. We pledge to provide a Return on Environment (ROE®) to our customers, employees, neighbors, and the public by holding ourselves accountable to the highest standards of environmental responsibility.

*Continuum AEC programs were designed to enhance workplace safety and minimize impact on the environment.*

#### TREATMENT AND FEEDING REQUIREMENTS

The particular combination of active ingredients required to give the best results depends on the system metallurgy, temperature, water chemistry, and other system characteristics. Your BetzDearborn sales representative will recommend the most effective treatment for your system.

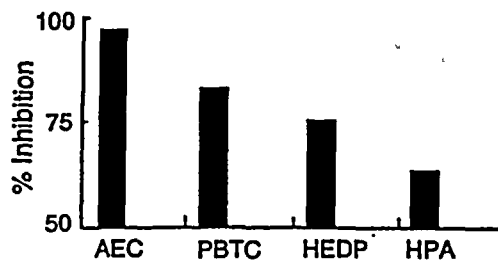
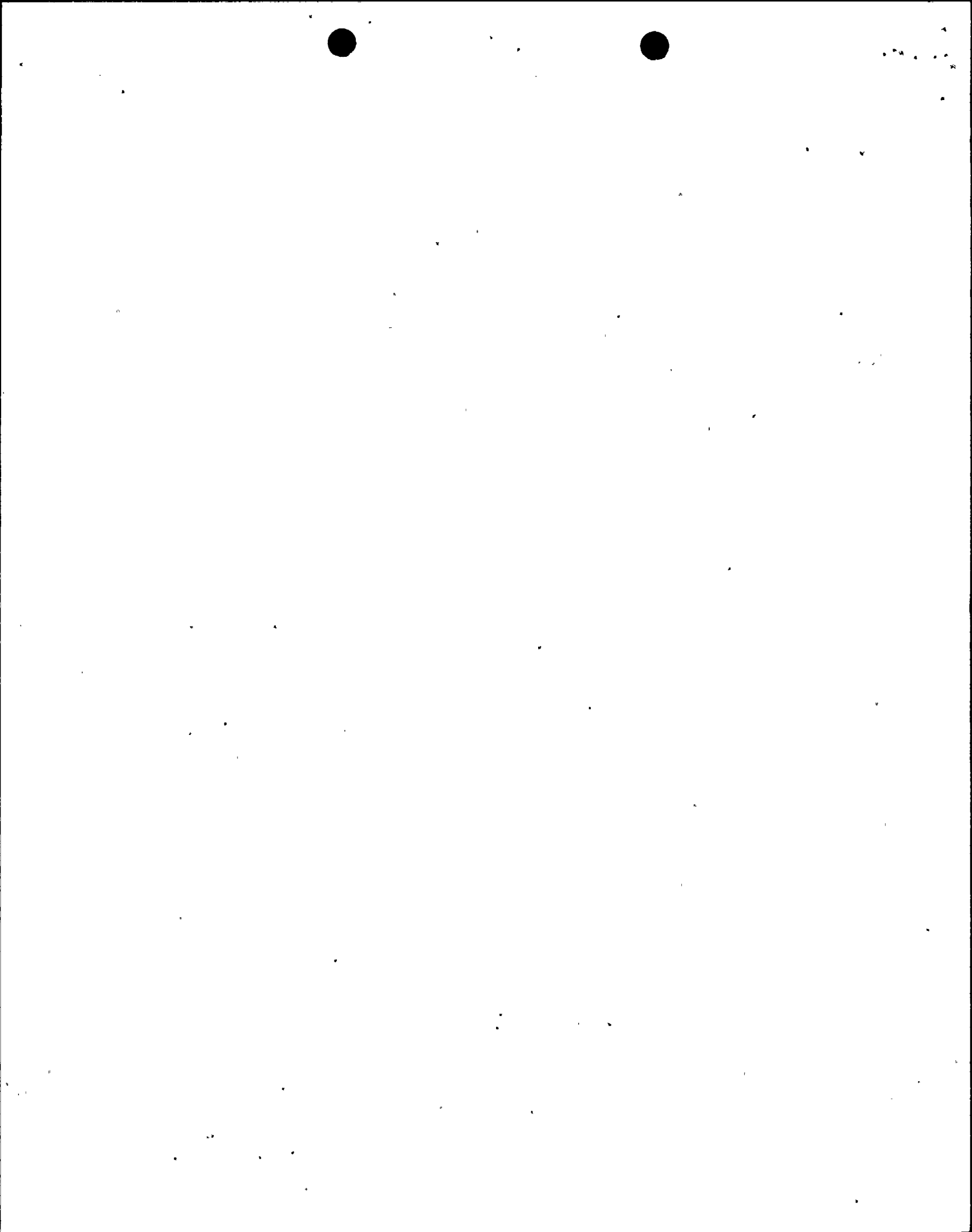
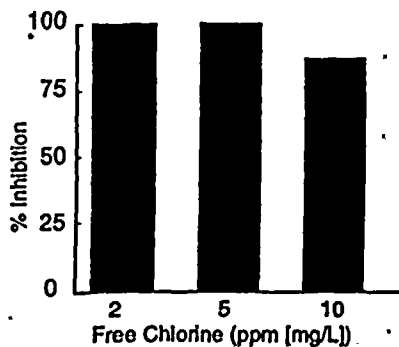

Figure 1: Calcium Carbonate Inhibition with Equal Actives Concentration in a High LSI System.



**BetzDearborn**  
Water Management Group





**Figure 2: Stability of 10 ppm (mg/L) AEC at High LSI in the Presence of Chlorine.**

**Dosage** - The proper treatment level of Continuum AEC products depends on the needs of your system and the product selected. The product should be fed in accordance with control parameters that BetzDearborn Water Management establishes for your particular application. For consistent protection, continuous feed is recommended.

**Feedpoint** - Continuum AEC should be fed to a point in the cooling system where it rapidly mixes with the bulk cooling water.

**Dilution** - For best results, Continuum AEC products should be fed neat. Dilutions, if necessary, can only be made with low hardness water.

**Feed Equipment** - Tanks, pumps, piping, and valves should be made of stainless steel, polyethylene, or PVC. Equipment recommendations for specific blends are available upon request.

**ENVIRONMENTAL INFORMATION**

Aquatic toxicology data and regulatory information is available for each Continuum AEC program. Contact your BetzDearborn Water Management Group sales representative for detailed information about a specific product.

**PACKAGING INFORMATION**

Continuum AEC products are liquid blends, available in a wide variety of customized containers and delivery methods. Contact your BetzDearborn sales representative for details.

**SAFETY PRECAUTIONS**

Material Safety Data Sheets containing detailed information about products in this series are available upon request.

