

Robert L. Justice  
General Manager, Nuclear Plant Operations  
803.345.4707

April 28, 2017



Document Control Desk  
U. S. Nuclear Regulatory Commission  
Washington, DC 20555

Dear Sir / Madam:

Subject: VIRGIL C. SUMMER NUCLEAR STATION UNIT 1  
DOCKET NO. 50-395  
OPERATING LICENSE NO. NPF-12  
ANNUAL RADIOACTIVE EFFLUENT RELEASE REPORT

Enclosed is the South Carolina Electric & Gas Company Annual Radioactive Effluent Release Report as required by 10CFR50.36a, Section 6.9.1.8 of the Virgil C. Summer Nuclear Station Technical Specifications and Section 1.6.2 of the Offsite Dose Calculation Manual (ODCM). Also enclosed for your review is a copy of Revision 30 of the ODCM. This submittal covers the period of January 1 through December 31, 2016.

Should there be any questions, please contact Ms. Susan B. Reese at (803) 345-4591.

Very truly yours,

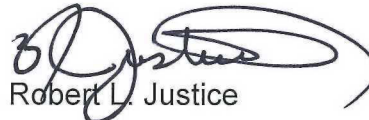

Robert L. Justice

SBR/RLJ/wm

Enclosures:

- I. Annual Radioactive Effluent Release Report
- II. Offsite Dose Calculation Manual

c: w/o enclosures unless noted

K. B. Marsh  
S. A. Byrne  
J. B. Archie  
N. S. Carns  
J. H. Hamilton  
S. M. Shealy  
W. M. Cherry  
C. Haney  
S. A. Williams  
K. M. Sutton

NRC Resident Inspector  
K. T. Ellison  
T. D. Riley  
NSRC  
Susan Jenkins (SCDHEC)  
C. S. Logan (ANI), (w/enclosures)  
RTS (LTD 313)  
File (818.02-1, RR 8350)  
PRSF (RC-17-0059), (w/enclosures)



# ANNUAL RADIOACTIVE EFFLUENT RELEASE REPORT VIRGIL C. SUMMER NUCLEAR STATION UNIT 1

FOR THE OPERATING PERIOD  
JANUARY 1, 2016 - DECEMBER 31, 2016

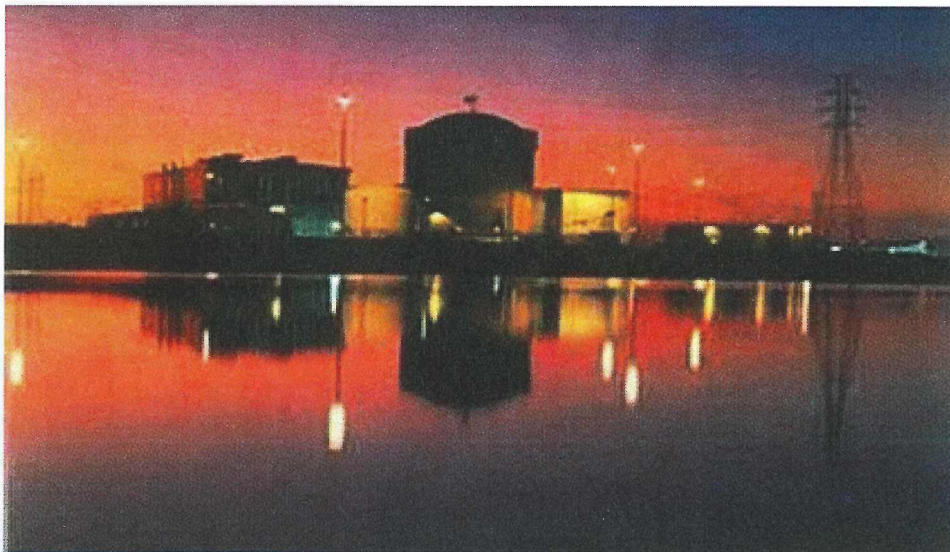

Prepared by:

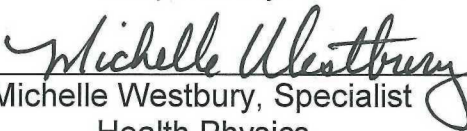
  
Michelle Westbury, Specialist  
Health Physics

Reviewed by:

  
Timothy D. Riley, Supervisor  
Health Physics

Approved by:

  
Todd Ellison, Manager  
Health Physics and Safety Services

# ANNUAL RADIOACTIVE EFFLUENT RELEASE REPORT

JANUARY – DECEMBER, 2016

## VIRGIL C. SUMMER NUCLEAR STATION SOUTH CAROLINA ELECTRIC & GAS

### Introduction

This report is being submitted as a summary of quantities of radioactive liquid and gaseous effluents and solid waste released from the Virgil C. Summer Nuclear Station. This report is submitted in fulfillment of the requirements in the Virgil C. Summer Nuclear Station Operating License Technical Specifications Section 6.9.1.8, Offsite Dose Calculation Manual (ODCM) Section 1.6.2 and 10CFR50.36(a) and follows the reporting details specified in USNRC Regulatory guide 1.21<sup>(1)</sup>.

Summary information of radioactive gaseous and liquid effluents is presented along with a summary of radioactive waste disposal as well as an evaluation of the radiological impact on man due to operation of the Virgil C. Summer Nuclear Station. Supplemental information including release limits also required by USNRC Regulatory Guide 1.21 is provided as Appendix A.

During the reporting period there was one revision made to the Offsite Dose Calculation Manual (ODCM) during the 12-month period. Details are presented below.

#### A. Supplemental Information

Regulatory limits for doses, dose rate and effluent concentration limits presented in Supplemental Information are from the Virgil C. Summer Nuclear Station ODCM and 40 CFR 190. Average energy ( $E_{\text{bar}}$ ) is not applicable to the method for determining release rate limits for fission and activation gaseous effluents, therefore, it has been omitted. A compilation of required supplemental information is provided in Appendix A.

#### B. Gaseous Effluents

Gaseous effluents released from ground level are summarized in Tables 1 and 2. An elevated release pathway does not exist at the Virgil C. Summer Nuclear Station. Cumulative doses are discussed in Section E.

The error for both liquid and gaseous release totals is estimated as twenty percent for radionuclides sampled and released in effluent pathways. Error was derived using root sum of squares methodology considering known sources of error including calibration of detectors and flow measurement equipment, sample preparation, and analysis counting error.

# ANNUAL RADIOACTIVE EFFLUENT RELEASE REPORT

JANUARY – DECEMBER, 2016

## VIRGIL C. SUMMER NUCLEAR STATION SOUTH CAROLINA ELECTRIC & GAS

### C. Liquid Effluents

Liquid effluents are summarized in Tables 3 and 4. Estimated total errors are expressed as in Section B above.

### D. Solid Waste Shipments

Solid waste shipments are summarized in Table 5. Curie content of radioactive waste packages is determined by dose rates and/or gamma spectroscopy analysis of samples. The total error for each type of curie content determination is conservatively estimated to be the sum of a 15% systematic error and a 20% photon response error for the detector used.

### E. Radiological Impact on Man

Dose to the maximum exposed individual in the unrestricted area was calculated using measured plant gaseous effluents and meteorological data in accordance with the Offsite Dose Calculation Manual. The source term involved one abnormal Waste Gas Decay Tank (WGDT) release, 54 minutes of 6-inch Reactor Building purge releases, no 36-inch Reactor Building purge releases and a continuous 12-month Main Plant Vent release. Doses are summarized in Table 6. The total gaseous activities released are presented in Tables 1 and 2. The highest quarterly air doses at the station boundary resulting from the release of noble gases were  $1.16\text{E-}05$  mrad for gamma during the second quarter and  $1.03\text{E-}05$  mrad for beta during the second quarter. The maximum quarterly organ dose attributed to the releases, excluding Carbon-14, was  $5.52\text{E-}06$  mrem. Cumulative annual dose was  $1.16\text{E-}05$  mrad,  $1.03\text{E-}05$  mrad and  $5.52\text{E-}06$  mrem for gamma, beta, and organ dose, respectively. Discussion of the impact of Carbon-14 is included in Section K.

Measured plant liquid effluent data was used to calculate estimates of doses to individuals in accordance with the Offsite Dose Calculation Manual. The source term consisted of the radioisotope content of 138 Waste Monitor Tank batch releases, 1 Condensate Backwash Receiver Tank batch release, 4 NaOH Sump batch releases, 2.1 days of Steam Generator Blowdown release and a continuous Turbine Building Sump release.

Doses are summarized in Table 6 and total liquid radioactivity released is described in Tables 3 and 4. The highest quarterly total body dose to the maximum exposed individual resulting from the release of radioactive liquid



# ANNUAL RADIOACTIVE EFFLUENT RELEASE REPORT

JANUARY – DECEMBER, 2016

## VIRGIL C. SUMMER NUCLEAR STATION SOUTH CAROLINA ELECTRIC & GAS

was 2.78E-03 mrem during the fourth quarter. The highest organ dose was 2.79E-03 mrem to the Liver for the fourth quarter. Cumulative annual doses for the hypothetical maximum exposed individual were 3.74E-03 mrem for the total body and 4.04E-03 mrem for the GI-LLI, the maximum annual organ. The GI-LLI was the maximum exposed organ for the first and second quarter and the Liver was the maximum exposed organ for the third and fourth quarter.

Dose rates and concentrations were below station limits as specified in Supplemental Information, Section II A, B, and C during all the effluent releases.

Radiation exposure to members of the public within the site boundary was assessed through calculation of gamma and beta air dose at 0.25 miles of the gaseous effluent release point and direct measurement of exposure using thermoluminescent dosimeters. Onsite air dose for this reporting period was 3.78E-05 mrad gamma and 3.35E-05 mrad beta, well below levels that can be distinguished above background. Quarterly thermoluminescent dosimetry (TLD) data from four onsite monitoring locations within 0.2 miles of the Reactor Building and eight locations at the site boundary were analyzed and compared with respective pre-operational background and previous year history. Results showed that the 2016 quarterly dose rates did not differ from the pre-operational or 2015 dose rates.

The impact of Independent Spent Fuel Storage Installation (ISFSI) operation which began cask storage on March 26, 2016 was assessed using six TLD locations monitoring the perimeter of the ISFSI site. The TLD locations were monitored for three quarters prior to fuel storage and the three quarters of 2016 during which fuel storage casks were stored. Analysis of monitoring results showed no statistically significant increase in perimeter dose as a result of ISFSI operation.

Based on review of gaseous effluent dose calculations and analysis of onsite TLD monitoring it was concluded that doses to members of the public inside the site boundary were indistinguishable from normal background dose.

Radiation doses from radioactive effluents to workers at the Fairfield Hydro Station for this reporting period were calculated to be 5.49E-07 and 4.87E-07 mrad for gamma and beta, respectively.

Radiation doses from radioactive effluents to workers at the New

# ANNUAL RADIOACTIVE EFFLUENT RELEASE REPORT

JANUARY – DECEMBER, 2016

## VIRGIL C. SUMMER NUCLEAR STATION SOUTH CAROLINA ELECTRIC & GAS

Nuclear Site for this reporting period were calculated to be 4.72E-06 and 4.19E-06 mrad for gamma and beta, respectively.

Radiation doses from nearby uranium fuel cycle sources were not assessed. The ODCM, Sections 1.3.1 and B/1.3 establish a five (5) mile limit beyond which doses from nearby plants are insignificant. There are no uranium fuel cycle plants within a five (5) mile radius of the Virgil C. Summer Nuclear Station.

### F. Abnormal Releases

Between May 23, 2016 at 2300 and May 24, 2016 at 0130, pressure dropped unexpectedly from approximately 7.5 psig to 0.3 psig on Waste Gas Decay Tank "B"(WGDT B). The Waste Gas System was shutdown to investigate and repair the leak. The contents of the tank were suspected to have slowly leaked out of the system into the Auxiliary Building. Radiation monitors showed no increase in the Auxiliary Building or the Main Plant Vent.

The content of WGDT "B" at a pressure of 11.8 psig was last sampled on May 13<sup>th</sup> at 0935. To be conservative, a permit and dose calculation were generated using the May 13<sup>th</sup> tank analysis. The calculated total activity released for the period was 2.53E-02 Curies. The dose rate to Total Body was 4.37E-02 mrem/yr equating to 0.09 % of the yearly limit .

### G. Meteorology

The meteorological data for 2016 was collected and analyzed. An annual meteorological summary report providing joint frequency distributions of wind direction and speed by atmospheric stability class is maintained in plant records.

The wind direction and wind speed data used were acquired from the 10-meter level of the primary monitoring tower. Stability was determined by the primary differential temperature (61 to 10 meter).

The combined annual data recovery for wind direction, wind speed and stability was 99.9%. Primary variable recovery rates were as follows: wind direction (10 m) – 99.9%, wind speed (10 m) – 99.9%, and differential temperature (61 - 10 m) – 99.9%.

# ANNUAL RADIOACTIVE EFFLUENT RELEASE REPORT

JANUARY – DECEMBER, 2016

## VIRGIL C. SUMMER NUCLEAR STATION SOUTH CAROLINA ELECTRIC & GAS

### H. Offsite Dose Calculation Manual

The Virgil C. Summer Nuclear Station ODCM was revised on March 8, 2016. See Enclosure A for a complete copy.

The revision was required to implement the Radiological Effluents Administration System (RADEAS) software which has replaced the VAX based Effluent Management System (EMS) and to address dry fuel storage monitoring requirements. Revision 30 includes a change in organ dose calculation methodology for gaseous radiological releases. To demonstrate compliance with ODCM Specification 1.2.4.1, the previous ODCM methodology used a “maximum hypothetical organ” concept in which the dose was summed from the maximum organ for each radioisotope. The revised methodology calculates dose for each individual organ for each isotope and then sums the doses for all individual organs. The highest organ dose is then selected for use in demonstrating compliance with ODCM Specification 1.2.4.1.

Setpoint methodology related to liquid effluent releases was revised to be consistent with the RADEAS setpoint algorithm. Effectively, the result is a more limiting permissible discharge flow rate calculation. Reference to dilution and discharge flow rate setpoints including dilution flow setpoint formulas were deleted. It was recognized in Revision 5 of the ODCM that there is no physical/electrical setpoints for discharge and dilution flowrates other than the penstock minimum flow interlock. The setpoint wording was removed for clarity.

ISFSI was added as a fuel cycle source and 6 TLD locations and their reporting requirements were also added.

### I. Offsite Dose Calculation Manual Reportable Incidents

There were no ODCM reportable incidents in 2016.

### J. Major Changes to Radioactive Waste Treatment Systems

During 2016, there were no major changes to the Radioactive Waste Treatment System.

# ANNUAL RADIOACTIVE EFFLUENT RELEASE REPORT

JANUARY – DECEMBER, 2016

## VIRGIL C. SUMMER NUCLEAR STATION SOUTH CAROLINA ELECTRIC & GAS

### K. Carbon-14 Gaseous Effluents

Carbon-14 production and release estimates were calculated using EPRI Report 1021106<sup>(2)</sup>, “Estimation of Carbon-14 in Nuclear Plant Gaseous Effluents”. This calculation uses active core coolant mass, average neutron flux by energy and reactor coolant nitrogen concentrations to determine Carbon-14 generation based upon an effective full power year. The estimated generation for the Virgil C. Summer Nuclear station for 2016 was 10.2 curies.

Public dose estimates were performed using Regulatory Guide 1.109<sup>(3)</sup> methodology. Carbon dioxide is assumed to make up 20% of the Carbon-14 gaseous emissions from the station based upon available references and on-site testing. Carbon-14 is the highest dose contributor of all radionuclides released in gaseous effluents. Annual dose resulting from Carbon-14 releases in gaseous effluents is estimated to be 1.66E-01 mrem total body and 8.32E-01 mrem to the maximum organ (bone).

### References

1. Regulatory Guide 1.21, “*Measuring, Evaluating, and Reporting Radioactivity in Solid Wastes and Releases of Radioactive Materials in Liquid and Gaseous Effluents From Light Water Cooled Nuclear Power Plants*”, Revision 1, US Nuclear Regulatory Commission, Washington D.C., 1974.
2. EPRI Report 1021106, “*Estimation of Carbon-14 in Nuclear Power Plant Gaseous Effluents*”, Electric Power Research Institute, Palo Alto, CA, 2010.
3. Regulatory Guide 1.109, “*Calculation of Annual Doses to Man from Routine Releases of ‘Reactor effluents for the Purpose of Demonstrating compliance with 10 CFR50, Appendix I’*”, US Nuclear Regulatory Commission, Washington D.C., 1976.

**APPENDIX A  
ANNUAL RADIOACTIVE EFFLUENT RELEASE REPORT**

**JANUARY – DECEMBER, 2016**

**VIRGIL C. SUMMER NUCLEAR STATION  
SOUTH CAROLINA ELECTRIC & GAS**

**SUPPLEMENTAL INFORMATION**

I. Regulatory Dose Limits:

A. Fission and Activation Gases:

The air dose to an individual due to noble gases released in gaseous effluents shall be limited to less than or equal to 5 mrad for gamma radiation and 10 mrad for beta radiation during any calendar quarter and 10 mrad for gamma radiation and 20 mrad for beta radiation during any calendar year (ODCM, Section 1.2.3.1).

B. Iodines, Particulates (half-lives > 8 days) and Tritium:

The dose to an individual from radioidines, tritium and radioactive materials in particulate form with half-lives greater than 8 days in gaseous effluents shall be limited to less than or equal to 7.5 mrem to any organ during any calendar quarter and 15 mrem to any organ during any calendar year (ODCM, Section 1.2.4.1).

C. Liquid Effluents:

The dose or dose commitment to an individual from radioactive materials in liquid effluents released shall be limited to less than or equal to 1.5 mrem to the total body and 5 mrem to any organ during any calendar quarter and 3 mrem to the total body and 10 mrem to any organ during any calendar year (ODCM, Section 1.1.3.1).

D. All Sources:

The annual dose equivalent shall not exceed 25 mrem to the whole body, 75 mrem to the thyroid and 25 mrem to any other organ (40 CFR 190).

II. Dose Rate and Effluent Concentration Limits:

A. Fission and Activation Gases

The dose rate in unrestricted areas due to radioactive materials released in gaseous effluents shall be limited to less than or equal to 500 mrem/year to the total body and less than or equal to 3000 mrem/year to the skin (ODCM, Section 1.2.2.1).



**APPENDIX A  
ANNUAL RADIOACTIVE EFFLUENT RELEASE REPORT**

**JANUARY – DECEMBER, 2016**

**VIRGIL C. SUMMER NUCLEAR STATION  
SOUTH CAROLINA ELECTRIC & GAS**

**B. Iodines, Particulates (half-lives > 8 days) and Tritium:**

The dose rate in unrestricted areas due to radioactive materials in effluents shall be limited to less than or equal to 1500 mrem/year to any organ (ODCM, Section 1.2.2.1).

**C. Liquid Effluents:**

The concentration of radioactive materials released from the site shall be limited to 10 times the concentrations specified in 10 CFR 20, Appendix B, Table 2, Column 2 for radionuclides other than dissolved or entrained noble gases. For dissolved or entrained noble gases, the concentration shall be limited to 2E-04  $\mu\text{Ci/ml}$  total activity (ODCM, Section 1.1.2.1).

**III. Average Energy:**

Not Applicable

**IV. Measurements and Approximations of Total Radioactivity:**

**A. Fission and activation gases: Gamma spectrometry (HPGe)**

**B. Iodines: Gamma spectrometry (HPGe)**

**C. Particulates: Gamma spectrometry (HPGe), beta proportional counting, alpha proportional counting**

**D. Tritium: Liquid scintillation**

**E. Liquid effluents: Gamma spectrometry (HPGe), liquid scintillation (H-3), beta proportional counting, alpha proportional counting..**

**APPENDIX A  
ANNUAL RADIOACTIVE EFFLUENT RELEASE REPORT**

**JANUARY – DECEMBER, 2016**

**VIRGIL C. SUMMER NUCLEAR STATION  
SOUTH CAROLINA ELECTRIC & GAS**

V. Batch Releases:

A. Gaseous:

1. Number of batch releases: 0
2. Total time period for batch releases: 0
3. Maximum time period for a batch release: 0
4. Average time period for a batch release: 0
5. Minimum time period for a batch release: 0

B. Liquid:

1. Number of batch releases:

38	For first quarter, 2016
27	For second quarter, 2016
40	For third quarter, 2016
38	For fourth quarter, 2016
2. Total time period for batch releases:

2.80E+03	min. for first quarter, 2016
2.10E+03	min. for second quarter, 2016
3.21E+03	min. for third quarter, 2016
2.64E+03	min. for fourth quarter 2016
3. Maximum time period for a batch release:

1.14E+02	min. for first quarter, 2016
9.60E+01	min. for second quarter, 2016
9.70E+01	min. for third quarter, 2016
8.90E+01	min. for fourth quarter, 2016

# ANNUAL RADIOACTIVE EFFLUENT RELEASE REPORT

JANUARY – DECEMBER, 2016

## VIRGIL C. SUMMER NUCLEAR STATION SOUTH CAROLINA ELECTRIC & GAS

4. Average time period for batch releases:  

7.38E+01	min. for first quarter, 2016
7.77E+01	min. for second quarter, 2016
8.02E+01	min. for third quarter, 2016
6.94E+01	min. for fourth quarter, 2016
  
5. Minimum time period for a batch release:  

4.00E+00	min. for first quarter, 2016*
1.00E+00	min. for second quarter, 2016*
6.10E+01	min. for third quarter, 2016
1.00E+00	min. for fourth quarter, 2016*

\* NaOH sump release
  
6. Average stream flow during periods of release of effluent into a flowing stream:  

3.82E+06	gpm for first quarter, 2016
6.52E+06	gpm for second quarter, 2016
9.03E+06	gpm for third quarter, 2016
3.65E+06	gpm for fourth quarter, 2016

### VI. Abnormal Releases:

#### A. Gaseous:

1. Number of releases: 1
2. Total activity released: 2.53E-02 Ci

#### B. Liquid:

1. Number of releases: 0
2. Total activity released: 0

**ENCLOSURE A  
ANNUAL RADIOACTIVE EFFLUENT RELEASE REPORT**

**JANUARY – DECEMBER, 2016**

**VIRGIL C. SUMMER NUCLEAR STATION  
SOUTH CAROLINA ELECTRIC & GAS**

**OFFSITE DOSE CALCULATION MANUAL**  
Revision 30 (March 2016)

**OFFSITE DOSE CALCULATION MANUAL**  
**FOR**  
**SOUTH CAROLINA ELECTRIC AND GAS COMPANY**  
**VIRGIL C. SUMMER NUCLEAR STATION**

SAFETY RELATED

Approval \_\_\_\_\_ Original signed by **Robert Justice** / 03/08/2016 \_\_\_\_\_  
General Manager, Date  
Nuclear Plant Operations

PSRC Approval \_\_\_\_\_ Original signed by **Robert Justice** / 03/08/2016 \_\_\_\_\_  
Date

**Revision 30**  
**(March 2016)**

Reviewed by: \_\_\_\_\_ Original signed by **Timothy Riley** / 03/08/2016 \_\_\_\_\_  
Date

Approved by: \_\_\_\_\_ Original signed by **Moses Coleman** / 03/08/2016 \_\_\_\_\_  
Date

**NUCLEAR OPERATIONS**

**COPY NO. \_\_\_\_\_**



**LIST OF EFFECTIVE PAGES**

<b><u>Page</u></b>	<b><u>Revision</u></b>	<b><u>Page</u></b>	<b><u>Revision</u></b>
i	30	1.0-34	29
ii	30	1.0-35	23
iii	30	1.0-36	24
iv	30	1.0-37	23
v	30	1.0-38	24
vi	30	1.0-39	24
vii	21	1.0-40	21
viii	21	1.0-41	21
ix	30	1.0-42	21
x	30	1.0-43	23
xi	30	1.0-44	21
		1.0-45	21
		1.0-46	29
1.0-1	24	1.0-47	29
1.0-2	24	1.0-48	24
1.0-3	27	1.0-49	30
1.0-4	27	1.0-50	25
1.0-5	24	1.0-51	25
1.0-6	21	1.0-52	24
1.0-7	24	1.0-53	30
1.0-8	25	1.0-54	26
1.0-9	24	1.0-55	26
1.0-10	30	1.0-56	21
1.0-11	29	1.0-57	24
1.0-12	24		
1.0-13	25	2.0-1	21
1.0-14	24	2.0-2	21
1.0-15	24	2.0-3	21
1.0-16	24	2.0-4	21
1.0-17	24	2.0-5	21
1.0-18	24	2.0-6	21
		2.0-7	21
1.0-19	27	2.0-8	21
1.0-20	24	2.0-9	21
1.0-21	24	2.0-10	30
1.0-22	29	2.0-11	21
1.0-23	29	2.0-12	30
1.0-24	24	2.0-13	21
1.0-25	24	2.0-14	29
		2.0-14A	29
1.0-26	29	2.0-15	21
1.0-27	24	2.0-16	21
1.0-28	24	2.0-17	30
1.0-29	30	2.0-18	21
1.0-30	25	2.0-19	30
1.0-31	23	2.0-20	30
1.0-32	23	2.0-21	30
1.0-33	30	2.0-22	21

LIST OF EFFECTIVE PAGES (continued)

<u>Page</u>	<u>Revision</u>	<u>Page</u>	<u>Revision</u>
2.0-23	21	3.0-28	30
2.0-24	21	3.0-29	30
2.0-25	21	3.0-30	30
2.0-26	21	3.0-31	30
2.0-27	21	3.0-32	30
2.0-28	21	3.0-33	30
2.0-29	21	3.0-34	30
2.0-30	21	3.0-35	30
2.0-31	21	3.0-36	30
2.0-32	28	3.0-37	30
2.0-33	21	3.0-38	30
2.0-34	21	3.0-39	30
2.0-35	21	3.0-40	30
2.0-36	22	3.0-41	30
2.0-37	21	3.0-42	30
2.0-38	24	3.0-43	30
2.0-39	24	3.0-44	30
2.0-40	21	3.0-45	30
2.0-41	30	3.0-46	30
2.0-42	21	3.0-47	30
2.0-43	21	3.0-48	30
		3.0-49	30
3.0-1	13	3.0-50	17
3.0-2	13	3.0-51	30
3.0-3	17	3.0-52	30
3.0-4	13	3.0-53	30
3.0-5	13	3.0-54	30
3.0-6	28	3.0-55	30
3.0-7	13	3.0-56	13
3.0-8	18	3.0-57	16
3.0-9	13	3.0-58	16
3.0-10	28	3.0-59	16
3.0-10A	24	3.0-60	13
3.0-11	13	3.0-61	13
3.0-12	30	3.0-62	13
3.0-13	30	3.0-63	13
3.0-14	30	3.0-64	13
3.0-15	30	4.0-1	26
3.0-16	30	4.0-2	26
3.0-17	30	4.0-3	26
3.0-18	30	4.0-4	30
3.0-19	30	4.0-5	29
3.0-20	30	4.0-6	28
3.0-21	30	4.0-7	28
3.0-22	30	4.0-8	23
3.0-23	30	4.0-9	26
3.0-24	30	4.0-10	23
3.0-25	30	4.0-11	23
3.0-26	30	4.0-12	30
3.0-27	30	4.0-13	30

Table of Contents

	<u>PAGE</u>
List of Effective Pages.....	i
Table of Contents .....	iii
List of Tables.....	v
List of Figures .....	vi
References .....	vii
Introduction.....	viii
Responsibilities .....	ix
<b>1.0    <u>SPECIFICATION OF CONTROLS</u></b>	
<b>1.1    <u>Liquid Effluents</u></b> .....	1.0-1
1.1.1    Radioactive Liquid Effluent Monitoring Instrumentation.....	1.0-1
1.1.2    Liquid Effluents: Concentration .....	1.0-8
1.1.3    Liquid Effluents: Dose.....	1.0-14
1.1.4    Liquid Waste Treatment .....	1.0-15
<b>1.2    <u>Gaseous Effluents</u></b> .....	1.0-17
1.2.1    Radioactive Gaseous Effluent Monitoring Instrumentation.....	1.0-17
1.2.2    Gaseous Effluents: Dose Rate.....	1.0-22
1.2.3    Gaseous Effluents: Dose - Noble Gas.....	1.0-25
1.2.4    Gaseous Effluents: Dose - Radioiodines, Tritium and Radioactive Materials in Particulate Form .....	1.0-26
1.2.5    Gaseous Radwaste Treatment .....	1.0-27
<b>1.3    <u>Radioactive Effluents: Total Dose</u></b> .....	1.0-29
<b>1.4    <u>Radiological Environmental Monitoring</u></b> .....	1.0-31
1.4.1    Monitoring Program .....	1.0-31
1.4.2    Land Use Census .....	1.0-41
1.4.3    Interlaboratory Comparison Program.....	1.0-43
<b>1.5    <u>Bases</u></b> .....	1.0-44
<b>1.6    <u>Reporting Requirements</u></b> .....	1.0-52
1.6.1    Annual Radiological Environmental Operating Report.....	1.0-52
1.6.2    Annual Radioactive Effluent Release Report .....	1.0-53
1.6.3    Major Changes to Radioactive Waste Treatment System (Liquid and Gaseous) .....	1.0-54
1.6.4    V. C. Summer Groundwater Protection Program.....	1.0-55
<b>1.7    <u>Definitions</u></b> .....	1.0-56

Table of Contents

<b>2.0</b>	<b><u>LIQUID EFFLUENT</u></b>	
2.1	<b><u>Liquid Effluent Monitor Setpoint Calculation</u></b> .....	2.0-1
2.1.1	<b>Liquid Effluent Monitor Setpoint Calculation Parameters</b> .....	2.0-2
2.1.2	<b>Liquid Radwaste Effluent Line Monitors</b> .....	2.0-6
2.1.3	<b>Liquid Radwaste Discharge Via Industrial and Sanitary Waste System</b> .....	2.0-14A
2.1.4	<b>Steam Generator Blowdown, Turbine Building Sump, and Condensate Demineralizer Backwash Effluent Lines</b> .....	2.0-15
2.2	<b><u>Dose Calculation for Liquid Effluents</u></b> .....	2.0-32
2.2.1	<b>Liquid Effluent Dose Calculation Parameters</b> .....	2.0-32
2.2.2	<b>Methodology</b> .....	2.0-33
2.3	<b><u>Liquid Effluent Releases through the Neutralization Basin</u></b> .....	2.0-35
2.3.1	<b>Rainwater Tank</b> .....	2.0-35
2.3.2	<b>NaOH Spray Tank and Stored NaOH</b> .....	2.0-36
<b>3.0</b>	<b><u>GASEOUS EFFLUENT</u></b>	
3.1	<b><u>Gaseous Effluent Monitor Setpoint</u></b> .....	3.0-1
3.1.1	<b>Gaseous Effluent Monitor Setpoint Calculation Parameters</b> .....	3.0-1
3.1.2	<b>Station Vent Noble Gas Monitors</b> .....	3.0-5
3.1.3	<b>Waste Gas Decay System Monitor</b> .....	3.0-7
3.1.4	<b>Alternative Methodology for Establishing Conservative Setpoints</b> .....	3.0-8
3.1.5	<b>Oil Incineration</b> .....	3.0-10
3.1.6	<b>Meteorological Release Criteria for Batch Releases</b> .....	3.0-10
3.2	<b><u>Dose Calculation for Gaseous Effluent</u></b> .....	3.0-12
3.2.1	<b>Gaseous Effluent Dose Calculation Parameters</b> .....	3.0-12
3.2.2	<b>Unrestricted Area Boundary Dose</b> .....	3.0-14
3.2.3	<b>Unrestricted Area Dose to Individual</b> .....	3.0-15
3.3	<b><u>Meteorological Model for Dose Calculations</u></b> .....	3.0-57
3.3.1	<b>Meteorological Model Parameters</b> .....	3.0-57
3.3.2	<b>Meteorological Model</b> .....	3.0-58
<b>4.0</b>	<b><u>RADIOLOGICAL ENVIRONMENTAL MONITORING</u></b> .....	4.0-1

LIST OF TABLES

<u>Table No.</u>		<u>Page No.</u>
1.1-1	Radioactive Liquid Effluent Monitoring Instrumentation .....	1.0-2
1.1-2	Radioactive Liquid Effluent Monitoring Instrumentation Surveillance Requirements.....	1.0-5
1.1-3	Frequency Notation .....	1.0-7
1.1-4	Radioactive Liquid Waste Sampling and Analysis Program.....	1.0-10
1.2-1	Radioactive Gaseous Effluent Monitoring Instrumentation.....	1.0-18
1.2-2	Radioactive Gaseous Effluent Monitoring Instrumentation Surveillance Requirements.....	1.0-20
1.2-3	Radioactive Gaseous Waste Sampling and Analysis Program.....	1.0-23
1.4-1	Radiological Environmental Monitoring Program .....	1.0-33
1.4-2	Reporting Levels for Radioactivity Concentrations in Environmental Samples Reporting Levels.....	1.0-38
1.4-3	Maximum Values for the Lower Limits of Detection (LLD) <sup>a,c</sup> Reporting Levels.....	1.0-39
2.2-1	Bioaccumulation Factors .....	2.0-37
2.2-2	Adult Ingestion Dose Factors .....	2.0-38
2.2-3	Site Related Ingestion Dose Commitment Factor ( $A_{ir}$ ).....	2.0-40
3.1-1	Dose Factors for Exposure to a Semi-Infinite Cloud of Noble Gases.....	3.0-4
3.1-2	Favorable Meteorology .....	3.0-10A
3.2-1	Pathway Dose Factors(R <sub>aij</sub> ).....	3.0-18
3.2-2	Controlling Receptors, Locations, and Pathways* .....	3.0-49
3.2-3	Atmospheric Dispersion Parameters for Controlling Receptor Locations .....	3.0-51
3.2-4	Parameters Used In Dose Factor Calculations .....	3.0-52
4.0-1	Radiological Environmental Monitoring Program .....	4.0-2



LIST OF FIGURES

<u>Figure No.</u>		<u>Page No.</u>
2.1-1	Example Liquid Monitor Calibration Curve .....	2.0-31
2.2-1	Liquid Radwaste Treatment System .....	2.0-42
3.1-1	Example Noble Gas Monitor Calibration Curve .....	3.0-11
3.2-1	Gaseous Radwaste Treatment System.....	3.0-56
3.3-1	Plume Depletion Effect for Ground Level Releases ( $\delta$ ) .....	3.0-61
3.3-2	Vertical Standard Deviation of Material in a Plume ( $\sigma_z$ ).....	3.0-62
3.3-3	Relative Deposition for Ground Level Releases ( $D_g$ ).....	3.0-63
3.3-4	Open Terrain Recirculation Factor.....	3.0-64
4.0-1	Radiological Environmental Sampling Locations (Remote) .....	4.0-10
4.0-2	Radiological Environmental Sampling Locations (Local).....	4.0-11
4.0-3	Radiological Environmental Sampling Locations (Local).....	4.0-12
4.0-4	Radiological Environmental Sampling Locations (Local).....	4.0-13

## REFERENCES

1. Boegli, T.S., R.R. Bellamy, W.L. Britz, and R.L. Waterfield, "Preparation of Radiological Effluent Technical Specifications for Nuclear Power Plants" NUREG-0133 (October 1978).
2. "Calculation of Annual Doses to Man from Routine Releases of Reactor Effluents for the Purpose of Evaluating Compliance with 10CFR 50, Appendix I", U.S. NRC Regulatory Guide 1.109 (March 1976).
3. "Calculation of Annual Doses to Man from Routine Releases of Reactor Effluents for the Purpose of Evaluating Compliance with 10CFR 50, Appendix I", U.S. NRC Regulatory Guide 1.109, Rev. 1 (October 1977).
4. "Final Safety Analysis Report", South Carolina Electric and Gas Company, Virgil C. Summer Nuclear Station.
5. "Operating License Environmental Report", South Carolina Electric and Gas Company, Virgil C. Summer Nuclear Station.
6. Wahlig, B.G., "Estimation of the Radioactivity Release Rate/Equilibrium Concentration Relationship for the Parr Pumped Storage System", Applied Physical Technology, Inc., February 1981.
7. "Methods for Estimating Atmospheric Transport and Dispersion of Gaseous Effluents in Routine Releases from Light - Water - Cooled Reactors", U.S. NRC Regulatory Guide 1.111 (March 1976).
8. "Methods for Estimating Atmospheric Transport and Dispersion of Gaseous Effluents in Routine Releases from Light - Water - Cooled Reactors", U.S. NRC Regulatory Guide 1.111, Rev. 1 (July 1977).
9. Slade, D.H., (editor), "Meteorology and Atomic Energy"; U.S. Atomic Energy Commission, AEC TID-24190, 1968.
10. "Measuring, Evaluating, and Reporting Radioactivity in Solid Wastes and Releases of Radioactive Materials in Liquid and Gaseous Effluents from Light-Water-Cooled Nuclear Power Plants", U.S. NRC Regulatory Guide 1.21, Rev. 1 (June 1974).
11. "Standard Radiological Effluent Technical Specifications for Pressurized Water Reactors", NUREG-0472, Revision 3 (January 1983).
12. "Quality Assurance for Radiological Monitoring Programs (Normal Operations) - Effluent Streams and the Environment", USNRC Regulatory Guide 4.15, Revision 1 (February 1979).
13. "Age-Specific Radiation Dose Commitment Factors for a One-Year Chronic Intake", NUREG-0172 (November 1977).
14. Generic Letter 89-01, "Implementation of Programmatic Controls for Radiological Effluent Technical Specifications", January 31, 1989.
15. "Offsite Dose Calculation Manual Guidance: Standard Radiological Effluent Controls for Pressurized Water Reactors", Generic Letter 89-01, Supplement No. 1, NUREG-1301, April 1, 1991.

## INTRODUCTION

**CO2→** The OFFSITE DOSE CALCULATION MANUAL (ODCM) is an implementing and supporting document of the RADIOLOGICAL EFFLUENT TECHNICAL SPECIFICATIONS (RETS). In accordance with USNRC Generic Letter 89-01, entitled "Implementation of Programmatic Controls for Radiological Effluent Technical Specifications in the Administrative Controls Section of the Technical Specifications and the Relocation of Procedural Details of RETS to the Offsite Dose Calculation Manual or to the Process Control Program", the procedural details for implementing the Radiological Controls have been incorporated into the ODCM. The ODCM describes the methodology and parameters to be used in the calculation of offsite doses due to radioactive liquid and gaseous effluents and in the calculation of liquid and gaseous effluent monitoring instrumentation alarm/trip setpoints. The ODCM contains a list and graphical description of the specific sample locations for the radiological environmental monitoring program. Configurations of the liquid and gaseous radwaste treatment systems are also included.

The ODCM will be maintained at the Station as the reference which details the Radiological Effluent Controls of the V. C. Summer Nuclear Station. Additionally the ODCM will be maintained as the guide for accepted calculational methodologies. Changes in calculation methods or parameters will be incorporated into the ODCM in order to ensure that the ODCM represents the current methodology in all applicable areas. Computer software to perform described calculations will be maintained current with this ODCM.

## RESPONSIBILITIES

The ODCM contains the radiological effluent controls, their applicability, remedial actions, surveillance requirements, and their bases. Plant procedures implement responsibilities for compliance with the ODCM that include:

The Operations group is responsible for:

- Declaring radioactive liquid and gaseous effluent monitor channels operable or inoperable.
- Ensuring the minimum number of operable channels for radioactive liquid and gaseous effluent monitors.
- Notifying the responsible group to implement appropriate action if less than the minimum number of radioactive liquid and gaseous effluent monitor channels are operable.
- Initiating a Condition Report (CR) in accordance with SAP-0999 when less than the minimum number of channels operable condition prevails for more than 30 days.
- Restoring to within limits, the concentration of liquid radioactive material exceeding ODCM limits released from the site.
- Ensuring radioactive liquid and gaseous effluent monitor setpoints are set as prescribed in the effluent release permit.
- Suspending release if radioactive liquid and gaseous effluent monitor setpoints are less conservative than ODCM requirements.
- Declaring liquid and gaseous radwaste treatment systems operable or inoperable.
- Ensuring operability of gaseous and liquid radwaste treatment systems and ventilation exhaust treatment system.
- Ensuring appropriate portions of the gaseous and liquid radwaste treatment systems are used to reduce the radioactive materials in liquid and gaseous waste prior to their discharge when the projected doses exceed limits specified by the ODCM.
- Initiating a CR in accordance with SAP-0999 when liquid or gaseous radwaste system is inoperable for more than 31 days.
- Performing channel check and source check at the frequencies shown in Tables 1.1-2 and 1.2-2 for each radioactive liquid and gaseous effluent monitoring instrumentation channel.

Instrumentation and Controls group is responsible for:

- Performing channel calibration and analog channel operational test at the frequencies shown in Tables 1.1-2 and 1.2-2 for each radioactive liquid and gaseous effluent monitoring instrumentation channel.
- Informing the Operations group of surveillance test results.

The Health Physics group is responsible for:

- Establishing setpoints for radioactive liquid and gaseous effluent monitors, consistent with ODCM methodology, and providing setpoints information to Operations.
- Implementing remedial actions as requested by Operations. These actions include grab sampling and analysis and providing the results to Operations.
- Performing periodic radioactive effluent monitor checks to determine backgrounds, normal indications and verifying monitor correlation graphs, and providing this information as necessary to Operations.
- Implementing radioactive gaseous and liquid waste sampling and analysis program in accordance with ODCM Tables 1.1-4 and 1.2-3.
- Informing Operations when at least one Circulating Water Pump or the Circulating Water Jockey Pump is required to provide dilution to the discharge structure.
- Calculating cumulative dose contributions and performing dose projections from liquid and gaseous effluents in accordance with the ODCM and providing the information to Operations.
- Initiating a CR in accordance with SAP-0999 when calculated dose from the discharge of radioactive materials in liquid or gaseous effluents are in excess of the limits specified by ODCM Sections 1.1.3.1 or 1.2.3.1.
- Initiating a CR in accordance with SAP-0999 when liquid or gaseous waste is discharged without treatment and is in excess of the limits specified by ODCM Sections 1.1.4.1 or 1.2.3.1.
- Initiating a CR in accordance with SAP-0999 when the dose or dose commitment to any member of the public due to releases of radioactivity and radiation is in excess of 25 mrem to the total body or any organ (except the thyroid, which shall be limited to less than or equal to 75 mrem) over 12 consecutive months.
- Implementing the Radiological Environmental Monitoring Program as specified in Section 1.4 of the ODCM.

- Initiating a CR in accordance with SAP-0999 when the Radiological Environmental Monitoring Program limiting conditions for operation are exceeded.
- Preparation of the Annual Radioactive Effluent Release Report and the Annual Environmental Operating Report.

## 1.0 SPECIFICATION OF CONTROLS

### 1.1 LIQUID EFFLUENTS

#### 1.1.1 Radioactive Liquid Effluent Monitoring Instrumentation

## CONTROLS

---

1.1.1.1 The radioactive liquid effluent monitoring instrumentation channels shown in Table 1.1-1 shall be OPERABLE with their alarm/trip setpoints set to ensure that the limits of ODCM Specification 1.1.2.1 are not exceeded. The alarm/trip setpoints of these channels shall be determined in accordance with ODCM, Section 2.1.

APPLICABLE: At all times.

ACTION:

- a. With a radioactive liquid effluent monitoring instrumentation channel alarm/ trip setpoint less conservative than required by the above specification, immediately suspend the release of radioactive liquid effluents monitored by the affected channel or declare the channel inoperable.
- b. With less than the minimum number of radioactive liquid effluent monitoring instrumentation channels OPERABLE, take the ACTION shown in Table 1.1-1. Additionally, if this condition prevails for more than 30 days, in the next Annual Radioactive Effluent Release Report explain why this condition was not corrected in a timely manner.
- c. The provisions of Technical Specifications 3.0.3 and 3.0.4 are not applicable.

## SURVEILLANCE REQUIREMENTS

---

1.1.1.2 Each radioactive liquid effluent monitoring instrumentation channel shall be demonstrated OPERABLE by performance of the CHANNEL CHECK, SOURCE CHECK, CHANNEL CALIBRATION and ANALOG CHANNEL OPERATIONAL TEST operations at the frequencies shown in Table 1.1-2.

**Table 1.1-1**

**RADIOACTIVE LIQUID EFFLUENT MONITORING INSTRUMENTATION**

	<u>INSTRUMENT</u>	<u>MINIMUM CHANNELS OPERABLE</u>	<u>ACTION</u>
1.	GROSS RADIOACTIVITY MONITORS PROVIDING ALARM AND AUTOMATIC TERMINATION OF RELEASE		
a.	Liquid Radwaste Effluent Line - RM-L5 or RM-L9	1	1
b.	Nuclear (Processed Steam Generator) Blowdown Effluent Line RM-L7 or RM-L9	1	1
c.	Steam Generator Blowdown Effluent Line		
1.	Unprocessed during Power Operation - RM-L10 or RM-L3	1	2
2.	Unprocessed during Startup - RM-L3	1	2
d.	Turbine Building Sump Effluent Line - RM-L8	1	3
e.	Condensate Demineralizer Backwash Effluent Line RM-L11	1	6
2.	FLOW RATE MEASUREMENT DEVICES*		
a.	Liquid Radwaste Effluent Line - Tanks 1 and 2	1/tank	4
b.	Penstock Minimum Flow Interlock**	1	4
c.	Nuclear Blowdown Effluent Line	1	4
d.	Steam Generator (Unprocessed) Blowdown Effluent Line	1	4
3.	TANK LEVEL INDICATING DEVICES		
a.	Condensate Storage Tank	1	5

\* In the event that simultaneous releases from both WMT and NBMT are required (which normally will be prevented by procedure) the flow rate for monitor RM-L9 will be determined by adding flow rates for monitors RM-L5 and RM-L7.

\*\* Minimum dilution flow is assured by an interlock that terminates liquid waste releases if the minimum dilution flow is not available.



Table 1.1-1 (Continued)

TABLE NOTATION

ACTION 1	<p>With the number of channels OPERABLE less than required by the Minimum Channels OPERABLE requirement, effluent releases may continue provided that prior to initiating a release:</p> <ul style="list-style-type: none"><li>a. At least two independent samples are analyzed in accordance with ODCM Specification 1.1.2.4 and</li><li>b. At least two technically qualified members of the Facility Staff independently verify the release rate calculations and discharge line valving.</li></ul> <p>Otherwise, suspend release of radioactive effluents via this pathway.</p>
ACTION 2	<p>With the number of channels OPERABLE less than required by the Minimum Channels OPERABLE requirement, effluent releases via this pathway may continue provided grab samples are analyzed by gamma spectroscopy for radioactivity at the LLD specified in Table 1.1-4 or samples are analyzed for gross radioactivity (beta and gamma) at a limit of detection of at least 1E-7 microcuries/gram.</p> <ul style="list-style-type: none"><li>a. At least once per 12 hours when the specific activity of the secondary coolant is greater than 0.01 microcuries/gram DOSE EQUIVALENT I-131, or</li><li>b. At least once per 24 hours when the specific activity of the secondary coolant is less than or equal to 0.01 microcuries/gram DOSE EQUIVALENT I-131.</li></ul>
ACTION 3	<p>With the number of channels OPERABLE less than required by the Minimum Channels OPERABLE requirement, effluent releases via this pathway may continue provided that, at least once per 12 hours, grab samples are collected and analyzed by gamma spectroscopy for radioactivity at the LLD specified in Table 1.1-4 or samples are analyzed for gross radioactivity (beta and gamma) at a limit of detection of at least 1E-7 microcuries/gram.</p>

Table 1.1-1 (Continued)

TABLE NOTATION

ACTION 4	With the number of channels OPERABLE less than required by the Minimum Channels OPERABLE requirement, effluent releases via this pathway may continue provided the flow rate is estimated at least once per 4 hours during actual releases. Pump curves may be used to estimate flow.
ACTION 5	With the number of channels OPERABLE less than required by the Minimum Channels OPERABLE requirement, liquid additions to this tank may continue for up to 30 days provided the tank liquid level is estimated during all liquid additions to the tank to prevent overflow.
ACTION 6	With the number of channels OPERABLE less than required by the Minimum Channels OPERABLE requirement, effluent releases may continue for up to 30 days provided that samples are analyzed in accordance with ODCM Specification 1.1.2.2 and Technical Specification 4.11.1.5.

**Table 1.1-2**

**RADIOACTIVE LIQUID EFFLUENT MONITORING INSTRUMENTATION  
SURVEILLANCE REQUIREMENTS**

<u>INSTRUMENT</u>	<u>CHANNEL CHECK</u>	<u>SOURCE CHECK</u>	<u>CHANNEL CALIBRA- TION</u>	<u>ANALOG CHANNEL OPERATIONAL TEST</u>
1. GROSS RADIOACTIVITY MONITORS PROVIDING ALARM AND AUTOMATIC TERMINATION OF RELEASE				
a. Liquid Radwaste Effluent Line - RM-L5 or RM-L9	D	P	R(2)	Q(1)
b. Nuclear Blowdown Effluent Line RM-L7	D	P	R(2)	Q(1)
c. Steam Generator Blowdown Effluent Line - RM-L3, RM-L10	D	M	R(2)	Q(1)
d. Turbine Building Sump Effluent Line - RM-L8	D	M	R(2)	Q(1)
e. Condensate Demineralizer Backwash Effluent Line RM-L11	D	M	R(2)	Q(4)
2. FLOW RATE MEASUREMENT DEVICES				
a. Liquid Radwaste Effluent Line	D(3)	N.A.	R	Q
b. Penstocks Minimum Flow Interlock	D(3)	N.A.	R	Q
c. Nuclear Blowdown Effluent Line	D(3)	N.A.	R	Q
d. Steam Generator Blowdown Effluent Line	D(3)	N.A.	R	Q
3. TANK LEVEL INDICATING DEVICES				
a. Condensate Storage Tank	D	N.A.	R	Q

**See Table 1.1-3 for explanation of frequency notation.**

Table 1.1-2 (Continued)  
TABLE NOTATION

- (1) The ANALOG CHANNEL OPERATIONAL TEST shall also demonstrate that automatic isolation of this pathway and control room alarm annunciation occurs if any of the following conditions exists:
  1. Instrument indicates measured levels above the alarm/trip setpoint.
  2. Loss of Power (alarm only).
  3. Low Flow (alarm only).
  4. Instrument indicates a Downscale Failure (alarm only).
  5. Normal/Bypass switch set in Bypass (alarm only).
  6. Other instrument controls not set in Operate mode.
  
- (2) The initial CHANNEL CALIBRATION shall be performed using one or more of the reference standards certified by the National Institute of Standards and Technology (NIST) or using standards that have been obtained from suppliers that participate in measurement assurance activities with NIST. These standards shall permit calibrating the system over its intended energy and measurement range. For subsequent CHANNEL CALIBRATION, sources that have been related to the initial calibration shall be used.
  
- (3) CHANNEL CHECK shall consist of verifying indication of flow during periods of release. CHANNEL CHECK shall be made at least once per 24 hours on days on which continuous, periodic or batch releases are made.
  
- (4) The ANALOG CHANNEL OPERATIONAL TEST shall also demonstrate that automatic isolation of this pathway and local panel alarm annunciation occurs if any of the following conditions exists:
  1. Instrument indicates measured levels above the alarm/trip setpoint.
  2. Loss of Power (alarm only).
  3. Low Flow (alarm only).
  4. Instrument indicates a Downscale Failure (alarm only).
  5. Normal/Bypass switch set in Bypass (alarm only).
  6. Other instrument controls not set in Operate mode.

**Table 1.1-3**

FREQUENCY NOTATION

<b>Notation</b>	<b>Frequency</b>
D	At least once per 24 hours.
W	At least once per 7 days.
M	At least once per 31 days.
Q	At least once per 92 days.
SA	At least once per 184 days.
R	At least once per 18 months.
P	Completed prior to each release.
N.A.	Not applicable.

Note: Each surveillance requirement shall be performed within the specified surveillance interval with a maximum allowable extension of 25% of the specified surveillance interval.

## 1.1.2 Liquid Effluents: Concentration

### CONTROLS

---

1.1.2.1 The concentration of radioactive material released from the site (see Technical Specification Figure 5.1-4) shall be limited to 10 times the concentration values specified in 10 CFR Part 20, Appendix B, Table 2, Column 2 for radionuclides other than dissolved or entrained noble gases. For dissolved or entrained noble gases, the concentration shall be limited to 2E-4 microcuries/ml total activity.

APPLICABLE: At all times.

ACTION:

- a. With the concentration of radioactive material released to unrestricted areas exceeding the above limits, immediately restore the concentration to within the above limits.
- b. The provisions of Technical Specifications 3.0.3 and 3.0.4 are not applicable.

### SURVEILLANCE REQUIREMENTS

---

1.1.2.2 The radioactivity content of each batch of radioactive liquid waste shall be determined prior to release by sampling and analysis in accordance with Table 1.1-4. The results of pre-release analyses shall be used with the calculational methods in ODCM Section 2.1 to assure that the concentration at the point of release is maintained within the limits of ODCM Specification 1.1.2.1.

1.1.2.3 Post-release analyses of samples composited from batch releases shall be performed in accordance with Table 1.1-4. The results of the previous post-release analyses shall be used with the calculational methods in ODCM Section 2.1 to assure that the concentrations at the point of release were maintained within the limits of ODCM Specification 1.1.2.1.

1.1.2.4 The radioactivity concentration of liquids discharged from continuous release points shall be determined by collection and analysis of samples in accordance with Table 1.1-4. The results of the analyses shall be used with the calculational methods in ODCM Section 2.1 to assure that the concentrations at the point of release are maintained within the limits of ODCM Specification 1.1.2.1.

1.1.2.5 At least one Circulating Water Pump or the Circulating Water Jockey Pump shall be determined to be in operation and providing dilution to the discharge structure at least once per 4 hours whenever dilution is required to meet the site radioactive effluent concentration limits of ODCM Specification 1.1.2.1.

**Table 1.1-4**

**RADIOACTIVE LIQUID WASTE SAMPLING AND ANALYSIS PROGRAM**

<b>Liquid Release Type</b>	<b>Sampling Frequency</b>	<b>Minimum Analysis Frequency</b>	<b>Type of Activity Analysis</b>	<b>Lower Limit of Detection (LLD) (<math>\mu\text{Ci/ml}</math>)<sup>a</sup></b>
A. Batch Waste Release <sup>d</sup> Tanks	P Each Batch	P Each Batch	Principal Gamma Emitters <sup>f</sup> I-131	$5 \times 10^{-7}$ $1 \times 10^{-6}$
1. Waste Monitor Tanks	P One Batch/M	M	Dissolved and Entrained Gases (Gamma Emitters)	$1 \times 10^{-5}$
2. Condensate Demineralizer Backwash Receiving Tank	P Each Batch	M Composite <sup>b</sup>	H-3 Gross Alpha	$1 \times 10^{-5}$ $1 \times 10^{-7}$
3. Nuclear Blowdown Monitor Tank	P Each Patch	Q Composite <sup>b</sup>	Sr-89, Sr-90 Fe-55, Ni-63 #	$5 \times 10^{-8}$ $1 \times 10^{-6}$
B. Continuous Release <sup>e</sup>	D Grab Sample	W Composite <sup>c</sup>	Principal Gamma Emitters <sup>f</sup> I-131	$5 \times 10^{-7}$ $1 \times 10^{-6}$
1. Steam Generator Blowdown	M Grab Sample	M	Dissolved and Entrained Gases (Gamma Emitters)	$1 \times 10^{-5}$
2. Turbine Building Sump	D Grab Sample	M Composite <sup>c</sup>	H-3 Gross Alpha	$1 \times 10^{-5}$ $1 \times 10^{-7}$
3. Service Water	D Grab Sample	Q Composite <sup>c</sup>	Sr-89, Sr-90 Fe-55	$5 \times 10^{-8}$ $1 \times 10^{-6}$

See Table 1.1-3 for explanation of frequency notation.

# Ni-63 required for Waste Monitor Tanks only.



**Table 1.1-4 (Continued)**

**TABLE NOTATION**

- a. The Lower Limit of Detection (LLD) is the smallest concentration of radioactive material in a sample that will yield a net count above background that will be detected with a 95% probability. LLD also yields a 5% probability of falsely concluding that a blank observation represents a “real” signal.

For a particular measurement system (which may include radiochemical separation):

$$LLD = \frac{2.71 + 4.66s_b}{(E)(V)(2.22)(Y)(\exp(-\lambda\Delta t))}$$

Where:

LLD is the “a priori” lower limit of detection as defined above (as pCi per unit mass or volume). Current literature defines the LLD as the detection capability for the instrumentation only and the MDC, the minimum detectable concentration, as the detection capability for a given instrument procedure and type of sample.

4.66 is a factor which corrects for the smallest activity that has a probability,  $p$ , of being detected, and a probability,  $1-p$ , of falsely concluding its presence.

2.71 may be used to account for minor deviations of the Poisson distribution from Normality.

$$4.66 = 2k \sqrt{1 + (t_b / t_s)}$$

$k$  = a constant whose value depends on the chosen confidence level (NRC recommends a confidence level of 95%)

= 1.6545 at 95% confidence level

$t_b$  = background time

$t_s$  = sample time

$s_b$  is the standard deviation of the background counting rate or the counting rate of blank sample as appropriate (as counts per minute).

$E$  is the counting efficiency (as counts per transformation).

**Table 1.1-4 (Continued)**

**TABLE NOTATION**

V is the sample size (in units of mass or volume).

2.22 is the number of transformations per minute per picoCurie.

Y is the fractional radiochemical yield (when applicable).

$\lambda$  is the radioactive decay constant for the particular radionuclide.

$\Delta t$  is the elapsed time between midpoint of sample collection and time of counting (for plant effluents, not environmental samples).

The value of  $s_b$  used in the calculation of the LLD for a detection system shall be used on the actual observed variance of the background counting rate or of the counting rate of the blank samples (as appropriate) rather than on an unverified theoretically predicted variance. In calculating the LLD for a radionuclide determined by gamma-ray spectrometry the background should include the typical contributions of other radionuclides normally present in the samples. Typical values of E, V, Y and  $\Delta t$  shall be used in the calculation.

It should be recognized that the LLD is defined as an a priori (before the fact) limit representing the capability of a measurement system and not as a posteriori (after the fact) limit for particular measurement.\*

---

\*For a more complete discussion of the LLD, and other detection limits, see the following:

- (1) HASL Procedures Manual, HASL-300 (revised annually).
- (2) Currie, L. A., "Limits for Qualitative Detection and Quantitative Determination - Application to Radiochemistry" Anal. Chem. 40, 586-93 (1968).
- (3) Hartwell, J. K., "Detection Limits for Radioisotopic Counting Techniques," Atlantic Richfield Handford Company Report ARH-2537 (June 22, 1972).

**Table 1.1-4 (Continued)**

**TABLE NOTATION**

- b. A composite sample is one in which the quantity of liquid sampled is proportional to the quantity of liquid waste discharged and in which the method of sampling employed results in a specimen which is representative of the liquids released.
- c. To be representative of the quantities and concentrations of radioactive materials in liquid effluents, samples shall be composited in proportion to the rate of flow of the effluent stream. Prior to analyses, all samples taken for the composite shall be thoroughly mixed in order for the composite sample to be representative of the effluent release.
- d. A batch release is the discharge of liquid wastes of a discrete volume. Prior to sampling for analyses, each batch shall be isolated, and then thoroughly mixed, by a method described in ODCM Section 2.0, to assure representative sampling.
- e. A continuous release is the discharge of liquid wastes of a nondiscrete volume; e.g., from a volume of system that has an input flow during the continuous release.
- f. The principal gamma emitters for which the LLD specification applies exclusively are the following radionuclides: Mn-54, Fe-59, Co-58, Co-60, Zn-65, Mo-99, Cs-134, Cs-137, and Ce-141. Ce-144 shall also be measured, but with an LLD of  $5 \times 10^{-6}$ . This list does not mean that only these nuclides are to be detected and reported. Other peaks which are measurable and identifiable, together with the above nuclides, shall also be identified and reported.

### 1.1.3 Liquid Effluents: Dose

#### CONTROLS

---

1.1.3.1 The dose or dose commitment to an individual from radioactive materials in liquid effluents released from the site (see Technical Specification Figure 5.1-4) shall be limited:

- a. During any calendar quarter to less than or equal to 1.5 mrem to the total body and to less than or equal to 5 mrem to any organ.
- b. During any calendar year to less than or equal to 3 mrem to the total body and to less than or equal to 10 mrem to any organ.

APPLICABLE: At all times.

#### ACTION:

- a. With the calculated dose from the release of radioactive materials in liquid effluents exceeding any of the above limits, in lieu of any other report required by ODCM Section 1.6, prepare and submit to the Commission within 30 days, pursuant to Technical Specification 6.9.2, a Special Report which identifies the cause (s) for exceeding the limit (s) and defines the corrective actions to be taken to the releases and the proposed actions to be taken to assure that subsequent releases will be in compliance with ODCM Specification 1.1.3.1.
- b. The provisions of Technical Specifications 3.0.3 and 3.0.4 are not applicable.

#### SURVEILLANCE REQUIREMENTS

---

1.1.3.2 Dose Calculations Cumulative dose contributions from liquid effluents shall be determined in accordance with ODCM Section 2.2 at least once per 31 days.

#### 1.1.4 Liquid Waste Treatment

### CONTROLS

---

1.1.4.1 The liquid radwaste treatment system shall be OPERABLE. The appropriate portions of the system shall be used to reduce the radioactive materials in liquid wastes prior to their discharge when the projected doses due to the liquid effluent from the site (See Technical Specification Figure 5.1-4) when averaged on a sliding 31 day calendar basis, would exceed 0.06 mrem to the total body or 0.2 mrem to any organ.

APPLICABLE: At all times.

ACTION:

- a. With the liquid radwaste treatment system inoperable for more than 31 days or with radioactive liquid waste being discharged without treatment and in excess of the above limits, in lieu of any other report required by ODCM Section 1.6, prepare and submit to the Commission within 30 days, pursuant to Technical Specification 6.9.2, a Special Report which includes the following information:
  1. Identification of the inoperable equipment or subsystems and the reason for inoperability.
  2. Action(s) taken to restore the inoperable equipment to OPERABLE status.
  3. Summary description of action(s) taken to prevent a recurrence.
- b. With radioactive waste being discharged, the requirements to process effluents are:
  1. If all streams are unprocessed and projected dose(s) exceed the limits of ODCM Specification 1.1.4.1, process the appropriate streams to the point that the projected dose is within limits.

2. With a combination of processed and unprocessed streams producing a dose projection exceeding the limits of specification 1.1.4.1, process the unprocessed streams if they contribute greater than or equal to 10 percent of Specification 1.1.4.1 limits.
- c. The provisions of Technical Specifications 3.0.3 and 3.0.4 are not applicable.

## SURVEILLANCE REQUIREMENTS

---

1.1.4.2 Doses due to liquid releases shall be projected at least once per 31 days.

1.1.4.3 The liquid radwaste treatment system shall be demonstrated OPERABLE by operating the liquid radwaste treatment system equipment for at least 30 minutes at least once per 92 days unless the liquid radwaste system has been utilized to process radioactive liquid effluents during the previous 92 days.

## 1.2 GASEOUS EFFLUENTS

### 1.2.1 Radioactive Gaseous Effluent Monitoring Instrumentation

#### CONTROLS

---

1.2.1.1 The radioactive gaseous effluent monitoring instrumentation channels shown in Table 1.2.-1 shall be OPERABLE with their alarm/trip setpoints set to ensure that the limits of ODCM Specification 1.2.2.1 are not exceeded. The alarm/trip setpoints of these channels shall be determined in accordance with ODCM Section 3.1.

APPLICABLE: As shown in Table 1.2-1

ACTION:

- a. With a radioactive gaseous effluent monitoring instrumentation channel alarm/trip setpoint less conservative than required by the above ODCM Specification, immediately suspend the release of radioactive gaseous effluents monitored by the affected channel or declare the channel inoperable.
- b. With less than the minimum number of radioactive gaseous effluent monitoring instrumentation channels OPERABLE, take the ACTION shown in Table 1.2-1. Additionally if this condition prevails for more than 30 days, in the next Annual Radioactive Effluent Release Report, explain why this condition was not corrected in a timely manner.
- c. The provisions of Technical Specifications 3.0.3 and 3.0.4 are not applicable.

#### SURVEILLANCE REQUIREMENTS

---

1.2.1.2 Each radioactive gaseous effluent monitoring instrumentation channel shall be demonstrated OPERABLE by performance of the CHANNEL CHECK, SOURCE CHECK, CHANNEL CALIBRATION and an ANALOG CHANNEL OPERATIONAL TEST operations at the frequencies shown in Table 1.2-2.

**Table 1.2-1****RADIOACTIVE GASEOUS EFFLUENT  
MONITORING INSTRUMENTATION**

	<b><u>INSTRUMENT</u></b>	<b><u>MINIMUM CHANNELS OPERABLE</u></b>	<b><u>APPLICA- BILITY</u></b>	<b><u>ACTION</u></b>
1.	WASTE GAS HOLDUP SYSTEM			
a.	Noble Gas Activity Monitor - Providing Alarm and Automatic Termination of Release (RM-A10 or RM-A3)	1	*	7
2.	MAIN PLANT VENT EXHAUST SYSTEM			
a.	Noble Gas Activity Monitor - Providing Alarm and Automatic Termination of Release from Waste Gas Holdup System (RM-A3)	1	*	9
b.	Iodine Sampler	1	*	11
c.	Particulate Sampler	1	*	11
d.	Flow Rate Measuring Device	1	*	8
e.	Sampler Flow Rate Measuring Device	1	*	8
3.	REACTOR BUILDING PURGE SYSTEM			
a.	Noble Gas Activity Monitor Providing Alarm & Automatic Termination of Release (RM-A4)	1	*	10
b.	Iodine Sampler	1	*	11
c.	Particulate Sampler	1	*	11
d.	Flow Rate Measuring Device			
	1. For 36" Purge (IFT09287)	1	*	8
	2. For 6" Purge (IFT08252)	1	*	8
e.	Sampler Flow Rate Measuring Device	1	*	8



**Table 1.2-1 (Continued)**  
**TABLE NOTATION**

\* At all times during releases via this pathway.

ACTION 7 - With the number of channels OPERABLE less than required by the Minimum Channels OPERABLE requirement, the contents of the tank(s) may be released to the environment provided that prior to initiating the release:

- a. At least two independent samples of the tank's contents are analyzed.
- b. At least two technically qualified members of the Facility Staff independently verify the release rate calculations and discharge valve lineup.

Otherwise, suspend release of radioactive effluents via this pathway.

ACTION 8 - With the number of channels OPERABLE less than required by the Minimum Channels OPERABLE requirement, effluent releases via this pathway may continue provided the flow rate is estimated at least once per 4 hours.

ACTION 9 - With the number of channels OPERABLE less than required by the Minimum Channels OPERABLE requirement, effluent releases via this pathway may continue provided grab samples are taken at least once per 12 hours and these samples are analyzed for gross activity within 24 hours.

ACTION 10 - With the number of channels OPERABLE less than required by the Minimum Channels OPERABLE requirement, immediately suspend PURGING of radioactive effluents via this pathway.

ACTION 11 - With the number of channels OPERABLE less than required by the Minimum Channels OPERABLE requirement, effluent releases via the affected pathway may continue provided samples, as specified in Table 1.2-3, are continuously collected with auxiliary sampling equipment.

- a. With the monitor taken out of service, by a condition other than a planned action, the action statement is considered met if a conscious, concerted and continuous effort is being made to initiate the collection of the required sample(s) with auxiliary sampling equipment.
- b. A planned removal of the monitor from service requires that the auxiliary sampling equipment be staged in the area to reduce the amount of time for the change over from sampling by the installed monitor to the auxiliary sampling equipment.

**Table 1.2-2**

**RADIOACTIVE GASEOUS EFFLUENT  
MONITORING INSTRUMENTATION SURVEILLANCE REQUIREMENTS**

	<b>INSTRUMENT</b>	<b>CHANNEL CHECK</b>	<b>SOURCE CHECK</b>	<b>CHANNEL CALIBRATION</b>	<b>ANALOG CHANNEL OPERATIONAL TEST</b>	<b>MODES IN WHICH SURVEILLANCE REQUIRED</b>
1.	WASTE GAS HOLDUP SYSTEM					
a.	Noble Gas Activity Monitor - RM-A10 or RM-A3	P	P	R(3)	Q(1)	*
2.	MAIN PLANT VENT EXHAUST SYSTEM					
a.	Noble Gas Activity Monitor - RM-A3	D	M	R(3)	Q(2)	*
b.	Iodine Sampler	W	N.A.	N.A.	N.A.	*
c.	Particulate Sampler	W	N.A.	N.A.	N.A.	*
d.	Flow Rate Measuring Device	D	N.A.	R	Q	*
e.	Sampler Flow Rate Monitor	D	N.A.	R	Q	*
3.	REACTOR BUILDING PURGE SYSTEM					
a.	Noble Gas Activity Monitor - RM-A4	D	P,M	R(3)	Q(1)	*
b.	Iodine Sampler	W	N.A.	N.A.	N.A.	*
c.	Particulate Sampler	W	N.A.	N.A.	N.A.	*
d.	Flow Rate Measuring Device	D	N.A.	R	Q	*
	1. For 36" Purge (IFT09287)	D	N.A.	R	Q	*
	2. For 6" Purge (IFT08252)	D	N.A.	R	Q	*
e.	Sampler Flow Rate Monitor	D	N.A.	R	Q	*

See Table 1.1-3 for explanation of frequency notation.

**Table 1.2-2 (Continued)**

**TABLE NOTATION**

\* At all times.

- (1) The ANALOG CHANNEL OPERATIONAL TEST shall also demonstrate that automatic isolation of this pathway and control room alarm annunciation occurs if any of the following conditions exists:
  1. Instrument indicates measured levels above the alarm/trip setpoint.
  2. Loss of Power (alarm only).
  3. Low Flow (alarm only).
  4. Instrument indicates a Downscale Failure (alarm only).
  5. Normal/Bypass switch set in Bypass (alarm only).
  6. Other instrument controls not set in Operate mode.
  
- (2) The ANALOG CHANNEL OPERATIONAL TEST shall also demonstrate that control room alarm annunciation occurs if any of the following conditions exists:
  1. Instrument indicates measured levels above the alarm setpoint.
  2. Loss of Power.
  3. Low Flow.
  4. Instrument indicates a Downscale Failure.
  5. Instrument controls not set in Operate mode.
  
- (3) The initial CHANNEL CALIBRATION shall be performed using one or more of the reference standards certified by the National Institute of Standards and Technology (NIST) or using standards that have been obtained from suppliers that participate in measurement assurance activities with NIST. These standards shall permit calibrating the system over its intended range of energy and measurement. For subsequent CHANNEL CALIBRATION, sources that have been related to the initial calibration shall be used.

## 1.2.2 Gaseous Effluents: Dose Rate

### CONTROLS

---

1.2.2.1 The dose rate in unrestricted areas due to radioactive materials released in gaseous effluents from the site ( see Technical Specification Figure 5.1-3) shall be limited to the following:

- a. For noble gases: Less than or equal to 500 mrem/yr to the total body and less than or equal to 3000 mrem/yr to the skin.
- b. For Iodine-131, Iodine-133 and for all radioactive materials in particulate form and tritium with half lives greater than 8 days: Less than or equal to 1500 mrem/yr to any organ.

APPLICABLE: At all times.

ACTION:

With the dose rate(s) exceeding the above limits, immediately decrease the release rate to within the above limit(s).

### SURVEILLANCE REQUIREMENTS

---

1.2.2.2 The dose rate due to noble gases in gaseous effluents shall be determined to be within the above limits in accordance with the methods and procedures of the ODCM.

1.2.2.3 The dose rate due to radioiodines, tritium and radioactive materials in particulate form with half lives greater than 8 days in gaseous effluents shall be determined to be within the above limits in accordance with the methods and procedures of ODCM Section 3.2.2 by obtaining representative samples and performing analyses in accordance with the sampling and analysis program specified in Table 1.2-3.

**Table 1.2-3  
RADIOACTIVE GASEOUS WASTE SAMPLING AND ANALYSIS PROGRAM**

<b>Gaseous Release Type</b>	<b>Sampling Frequency</b>	<b>Minimum Analysis Frequency</b>	<b>Type of Activity Analysis</b>	<b>Lower Limit of Detection (LLD) (<math>\mu\text{Ci/ml}</math>)<sup>a</sup></b>
A. Waste Gas Storage Tank	P Each Tank Grab Sample	P Each Tank	Principal Gamma Emitters <sup>g</sup>	$1 \times 10^{-4}$
B1 Reactor Building - 36" Purge Line	P Each Purge <sup>b,c</sup>	P Each Purge <sup>b</sup>	Principal Gamma Emitters <sup>g</sup>	$1 \times 10^{-4}$
- 6" Purge Line			H-3	$1 \times 10^{-6}$
B2 Reactor Building - 6" Purge Line	M <sup>b</sup> Grab Sample	M <sup>b</sup>	Principal Gamma Emitters <sup>g</sup>	$1 \times 10^{-4}$
(if continuous)			H-3	$1 \times 10^{-6}$
C Main Plant Vent	M <sup>b,e</sup> Grab Sample	M <sup>b</sup>	Principal Gamma Emitters <sup>g</sup>	$1 \times 10^{-4}$
			H-3	$1 \times 10^{-6}$
D1. Reactor Building Purge	Continuous Sampler <sup>f</sup>	W <sup>d</sup> Charcoal Sample	I-131 I-133	$1 \times 10^{-12}$ $1 \times 10^{-10}$
2. Main Plant Vent	Continuous Sampler <sup>f</sup>	W <sup>d</sup> Particulate Sample	Principal Gamma Emitters <sup>g</sup> I-131, others	$1 \times 10^{-11}$
	Continuous Sampler <sup>f</sup>	M Composite Particulate Sample	Gross Alpha	$1 \times 10^{-11}$
	Continuous Sampler <sup>f</sup>	Q Composite Particulate Sample	Sr-89, Sr-90	$1 \times 10^{-11}$
	Continuous Monitor	Noble Gas Monitor	Noble Gases Gross Beta	$1 \times 10^{-6}$

See Table 1.1-3 for explanation of frequency notation.

**Table 1.2-3 (Continued)**  
**TABLE NOTATION**

- a. See Table 1.1-4 notation (a) for definition of LLD.
- b. Analyses shall be also be performed within 24 hours following shutdown, startup, or a THERMAL POWER change exceeding 15 percent of the RATED THERMAL POWER within a one hour period.
- c. Tritium grab samples shall be taken at least once per 24 hours when the refueling canal is flooded.
- d. Samples shall be changed at least once per 7 days and analyses shall be completed within 48 hours after changing (or after removal from sampler). Sampling shall also be performed at least once per 24 hours for at least 7 days following each shutdown, startup or THERMAL POWER change exceeding 15 percent of RATED THERMAL POWER in one hour and analyses shall be completed within 48 hours of changing. When samples collected for 24 hours are analyzed, the corresponding LLD's may be increased by a factor of 10.
- e. Tritium grab samples shall be taken at least once per 7 days from the ventilation exhaust from the spent fuel pool area, whenever spent fuel is in the spent fuel pool.
- f. The ratio of the sample flow rate to the sampled stream flow rate shall be known for the time period covered by each dose or dose rate calculation made in accordance with ODCM Specifications 1.2.2.1, 1.2.3.1 and 1.2.4.1.
- g. The principal gamma emitters for which the LLD specification applies exclusively are the following radionuclides: Kr-87, Kr-88, Xe-133, Xe-133m, Xe-135 and Xe-138 for gaseous emissions and Mn-54, Fe-59, Co-58, Co-60, Zn-65, Mo-99, Cs-134, Cs-137, Ce-141 and Ce-144 for particulate emissions. This list does not mean that only these nuclides are to be detected and reported. Other peaks which are measurable and identifiable, together with the above nuclides, shall also be identified and reported.
- h. Prior to sampling for analysis, each batch of oil shall be isolated and representative samples obtained by methods described in ASTM D 4057-81, Volume 05.03, "Standard Practice for Manual Sampling of Petroleum and Petroleum Products".
- i. This LLD refers to the liquid sample.

1.2.3 Gaseous Effluents: Dose - Noble Gas

CONTROLS

---

1.2.3.1 The air dose due to noble gases released in gaseous effluents from the site (see Technical Specification Figure 5.1-3) shall be limited to the following:

- a. During any calendar quarter: Less than or equal to 5 mrad for gamma radiation and less than or equal to 10 mrad for beta radiation.
- b. During any calendar year: Less than or equal to 10 mrad for gamma radiation and less than or equal to 20 mrad for beta radiation.

APPLICABLE: At all times.

ACTION:

- a. With the calculated air dose from radioactive noble gases in gaseous effluents exceeding any of the above limits, in lieu of any other report required by ODCM Section 1.6, prepare and submit to the Commission within 30 days, pursuant to Technical Specification 6.9.2, a Special Report which identifies the cause(s) for exceeding the limit(s) and defines the corrective actions to be taken to releases and the proposed corrective actions to be taken to assure that subsequent releases will be in compliance with ODCM Specification 1.2.3.1.
- b. The provisions of Technical Specifications 3.0.3 and 3.0.4 are not applicable.

SURVEILLANCE REQUIREMENTS

---

1.2.3.2 Dose Calculations Cumulative dose contributions for the current calendar quarter and current calendar year shall be determined in accordance with ODCM Section 3.2.3 at least once per 31 days.

1.2.4 Gaseous Effluents: Dose - Radioiodines, Tritium, and Radioactive Materials in Particulate Form.

CONTROLS

---

1.2.4.1 The dose to an individual from radioiodines, tritium, and radioactive materials in particulate form, and radionuclides (other than noble gases) with half-lives greater than 8 days in gaseous effluents (see Technical Specification Figure 5.1-3) shall be limited to the following:

- a. During any calendar quarter: Less than or equal to 7.5 mrem to any organ.
- b. During any calendar year: Less than or equal to 15 mrem to any organ.

APPLICABLE: At all times.

ACTION:

- a. With the calculated dose from the release of tritium, radioiodines, and radioactive materials in particulate form with half lives greater than 8 days in gaseous effluents exceeding any of the above limits, in lieu of any other report required by ODCM Section 1.6, prepare and submit to the Commission within 30 days, pursuant to Technical Specification 6.9.2, a Special Report which identifies the cause(s) for exceeding the limit and defines the corrective actions to be taken to releases and the proposed actions to be taken to assure that subsequent release will be in compliance with ODCM Specification 1.2.4.1.
- b. The provisions of Technical Specifications 3.0.3 and 3.0.4 are not applicable.

SURVEILLANCE REQUIREMENTS

---

1.2.4.2 Dose Calculations Cumulative dose contributions for the current calendar quarter and current calendar year shall be determined in accordance with ODCM Section 3.2.3 at least once per 31 days.



## 1.2.5 Gaseous Effluents: Gaseous Radwaste Treatment

### CONTROLS

---

1.2.5.1 The GASEOUS RADWASTE TREATMENT SYSTEM and the VENTILATION EXHAUST TREATMENT SYSTEM shall be OPERABLE. The appropriate portions of the GASEOUS RADWASTE TREATMENT SYSTEM shall be used to reduce radioactive materials in gaseous waste prior to their discharge when the projected gaseous effluent air doses due to gaseous effluent releases from the site (See Technical Specification Figure 5.1-3), when averaged over 31 days, would exceed 0.2 mrad for gamma radiation and 0.4 mrad for beta radiation. The appropriate portions of the VENTILATION EXHAUST TREATMENT SYSTEM shall be used to reduce radioactive materials in gaseous waste prior to their discharge when the projected doses due to gaseous effluent releases from the site when averaged over 31 days would exceed 0.3 mrem to any organ.

APPLICABLE: At all times\*.

ACTION:

- a. With the GASEOUS RADWASTE TREATMENT SYSTEM and/or the VENTILATION EXHAUST TREATMENT SYSTEM inoperable for more than 31 days or with gaseous waste being discharged without treatment and in excess of the above limits, in lieu of any other report required by ODCM Section 1.6, prepare and submit to the Commission within 30 days, pursuant to Technical Specification 6.9.2, a Special Report which includes the following information:
  1. Identification of the inoperable equipment or subsystems and the reason for inoperability.
  2. Action(s) taken to restore the inoperable equipment to OPERABLE status.

---

\*The Waste Gas System may be secured during refueling and defueled operations since there is no gas in the system to be removed and processed. The system is considered "inoperable" during these conditions due to the instrumentation being out of calibration when flow is stopped through the recombiner. This "inoperable" state is the normal system condition during refueling and defueled modes.

3. Summary description of action(s) taken to prevent a recurrence.
- b. The provisions of Technical Specifications 3.0.3 and 3.0.4 are not applicable.

### SURVEILLANCE REQUIREMENTS

---

1.2.5.2 Doses due to gaseous releases from the reactor shall be projected at least once per 31 days.

1.2.5.3 The GASEOUS RADWASTE TREATMENT SYSTEM and VENTILATION EXHAUST TREATMENT SYSTEM shall be demonstrated OPERABLE by operating the GASEOUS RADWASTE TREATMENT SYSTEM equipment and VENTILATION EXHAUST TREATMENT SYSTEM equipment for at least 30 minutes, at least once per 92 days unless the appropriate system has been utilized to process radioactive gaseous effluents during the previous 92 days.

### 1.3 RADIOACTIVE EFFLUENTS: TOTAL DOSE

#### CONTROLS

---

- 1.3.1 The dose or dose commitment to any member of the public, due to releases of radioactivity and radiation, from uranium fuel cycle sources including the Independent Spent Fuel Storage Installation (ISFSI) shall be limited to less than or equal to 25 mrem to the total body or any organ (except the thyroid, which shall be limited to less than or equal to 75 mrem) over 12 consecutive months.

APPLICABLE: At all times.

ACTION:

- a. With the calculated doses from the release of radioactive materials in liquid or gaseous effluents exceeding twice the limits of ODCM Specification 1.1.3.1.a, 1.1.3.1.b, 1.2.3.1.a, 1.2.3.1.b, 1.2.4.1.a or 1.2.4.1.b, in lieu of any other report required and ODCM Section 1.6, prepare and submit to the Commission, within 30 days, pursuant to Technical Specification 6.9.2, a Special Report which defines the corrective action to be taken to reduce subsequent releases to prevent recurrence of exceeding the limits of ODCM Specification 1.3.1. This Special Report, defined in 10 CFR 20.2203(a)(4), shall include an analysis which estimates the radiation exposure (dose) to a member of the public from uranium fuel cycle sources (including all effluent pathways and direct radiation) for a 12 consecutive month period that includes the release(s) covered by this report. The report shall also describe levels of radiation and concentrations of radioactive material involved and the cause of the exposure levels or concentrations. If the estimated dose(s) exceeds the limits of ODCM Specification 1.3.1, and if the release condition resulting in violation of 40 CFR 190 has not already been corrected, the Special Report shall include a request for a variance in accordance with the provisions of 40 CFR 190 and including information of § 190.11 (b). Submittal of the report is considered a timely request, and a variance is granted until staff action on the request is complete. The variance only relates to the limits of 40 CFR 190, and does not apply in any way to the requirements for dose limitation of 10 CFR Part 20, as addressed in ODCM Specifications 1.1.2 and 1.2.2.
- b. The provisions of Technical Specifications 3.0.3 and 3.0.4 are not applicable.

**ODCM, V. C. Summer, SCE&G: Revision 30 (March 2016)**

## SURVEILLANCE REQUIREMENTS

---

1.3.2 Dose Calculations Cumulative dose contributions from liquid and gaseous effluents shall be determined in accordance with ODCM Specifications 1.1.3.2, 1.2.3.2 and 1.2.4.2.

## 1.4 RADIOLOGICAL ENVIRONMENTAL MONITORING

### 1.4.1 Monitoring Program

#### CONTROLS

---

---

1.4.1.1 The radiological environmental monitoring program shall be conducted as specified in Table 1.4-1.

APPLICABILITY: At all times.

ACTION:

- a. With the radiological environmental monitoring program not being conducted as specified in Table 1.4-1 in lieu of any other report required by ODCM Section 1.6, prepare and submit to the Commission, in the Annual Radiological Environmental Operating Report, a description of the reasons for not conducting the program as required and the plans for preventing a recurrence.
- b. With the level of radioactivity in an environmental sampling medium exceeding the reporting levels of Table 1.4-2 when averaged over any calendar quarter, in lieu of any other report required by ODCM Section 1.6, prepare and submit to the Commission within 30 days from the end of the affected calendar quarter a Special Report. When more than one of the radionuclides in Table 1.4-2 are detected in the sampling medium, this report shall be submitted if:

$$\frac{\text{Concentration (1)}}{\text{Limit Level (1)}} + \frac{\text{Concentration (2)}}{\text{Limit Level (2)}} + \dots \geq 1.0$$

When radionuclides other than those in Table 1.4-2 are detected and are the result of plant effluents, this report shall be submitted if the potential annual dose to an individual is equal to or greater than the calendar year limits of ODCM Specifications 1.1.3.1, 1.2.3.1 and 1.2.4.1. This report is not required if the measured level of radioactivity was not the result of plant effluents; however, in such an event, the condition shall be reported and described in the Annual Radiological Environmental Operating Report.

- c. With milk or fresh leafy vegetable samples permanently unavailable from one or more of the sample locations required by Table 1.4-1, in lieu of any other report required by ODCM Section 1.6 prepare and submit to the Commission within 30 days, pursuant to Technical Specification 6.9.2, a Special Report which identifies the cause of the unavailability of samples and identifies locations for obtaining replacement samples. The locations from which samples were unavailable may then be deleted from those required by Table 1.4-1, provided the locations from which the replacement samples were obtained are added to the environmental monitoring program as replacement locations.
- d. The provisions of Technical Specifications 3.0.3 and 3.0.4 are not applicable.

### SURVEILLANCE REQUIREMENTS

---

1.4.1.2 The radiological environmental monitoring samples shall be collected pursuant to Table 1.4-1 and shall be analyzed pursuant to the requirements of Tables 1.4-1 and 1.4-3.

**Table 1.4-1 Radiological Environmental Monitoring Program  
Virgil C. Summer Nuclear Station**

Exposure Pathway and/or Sample	Minimum Number of Sample Locations and Criteria for Selection	Sampling and Collection Frequency	Type & Frequency of Analysis
AIRBORNE: I. Particulates	A) 3 Indicator samples from locations close to the site boundary, in different sectors, of the highest calculated annual average ground level D/Q or dose.  B) 1 Indicator sample to be taken close to the site boundary in the sector corresponding to the residence having the highest anticipated offsite ground level concentration or dose.  C) 1 Indicator sample to be taken at the location of one of the dairies being sampled meeting the criteria of VII(A). <sup>2</sup>  D) 1 Control sample to be taken at a location at least 10 air miles from the site and not in the most prevalent wind directions.	Continuous sampler operation with weekly collection.  Continuous sampler operation with weekly collection.  Continuous sampler operation with weekly collection.  Continuous sampler operation with weekly collection.	Gross beta following filter change; quarterly <sup>6</sup> composite (by location) for gamma isotopic.  Gross beta following filter change; quarterly <sup>6</sup> composite (by location) for gamma isotopic.  Gross beta following filter change; quarterly <sup>6</sup> composite (by location) for gamma isotopic.  Gross beta following filter change; quarterly <sup>6</sup> composite (by location) for gamma isotopic.
II. Radioiodine	A) 3 Indicator samples to be taken at two locations as given in I(A) above.  B) 1 Indicator sample to be taken at the location as given in I(B) above.  C) 1 Indicator sample to be taken at the location as given in I(C) above.  D) 1 Control sample to be taken at a location as given in I(D) above.	Continuous sampler operation with weekly canister collection.  Continuous sampler operation with weekly canister collection.  Continuous sampler operation with weekly canister collection.  Continuous sampler operation with weekly canister collection.	Gamma isotopic for I-131 weekly.  Gamma isotopic for I-131 weekly.  Gamma isotopic for I-131 weekly.  Gamma isotopic for I-131 weekly.
III. Direct	A) 13 Indicator stations with two or more dosimeters to form an inner ring of stations in the 13 accessible sectors within 1 to 2 miles of the plant.  B) 16 Indicator stations with two or more dosimeters to form an outer ring of stations in the 16 accessible sectors within 3 to 5 miles of the plant.  C) 11 Stations with two or more dosimeters to be placed in special interest areas such as population centers, nearby residences, schools and in 4 or 5 areas to serve as control stations.  D) 6 Stations with two or more dosimeters to be placed around the ISFSI boundary.	Monthly <sup>5</sup> or quarterly <sup>6</sup> .  Monthly <sup>5</sup> or quarterly <sup>6</sup> .  Monthly <sup>5</sup> or quarterly <sup>6</sup> .  Monthly <sup>5</sup> or quarterly <sup>6</sup> .	Gamma dose monthly <sup>5</sup> or quarterly <sup>6</sup>  Gamma dose monthly <sup>5</sup> or quarterly <sup>6</sup>  Gamma dose monthly <sup>5</sup> or quarterly <sup>6</sup>  Gamma and neutron dose monthly <sup>5</sup> or quarterly <sup>6</sup>

**Table 1.4-1 Radiological Environmental Monitoring Program  
Virgil C. Summer Nuclear Station**

<b>Exposure Pathway and/or Sample</b>	<b>Minimum Number of Sample Locations and Criteria for Selection</b>	<b>Sampling and Collection Frequency</b>	<b>Type &amp; Frequency of Analysis</b>
<b>WATERBORNE:</b> IV. Surface Water	A) 1 Indicator sample downstream to be taken at a location which allows for mixing and dilution in the ultimate receiving river.  B) 1 Control sample to be taken at a location on the receiving river sufficiently far upstream such that no effects of pumped storage operation are anticipated.  C) 1 Indicator sample to be taken in the upper reservoir of the pumped storage facility in the plant discharge canal.	Time composite samples with collection every month. <sup>5</sup>  Time composite samples with collection every month. <sup>5</sup>  Time composite samples with collection every month. <sup>5</sup>	Gamma isotopic monthly <sup>5</sup> with quarterly <sup>6</sup> composite (by location) or monthly <sup>5</sup> sample to be analyzed for tritium.  Gamma isotopic monthly <sup>5</sup> with quarterly <sup>6</sup> composite (by location) or monthly <sup>5</sup> sample to be analyzed for tritium.  Gamma isotopic monthly <sup>5</sup> with quarterly <sup>6</sup> composite (by location) or monthly <sup>5</sup> sample to be analyzed for tritium.
V. Ground Water	A) 12 Indicator samples to be taken within the exclusion boundary and in the direction of potentially affected ground water supplies.  B) 1 Control sample from unaffected location.	Quarterly <sup>6</sup> grab sampling.  Quarterly <sup>6</sup> grab sampling.	Gamma isotopic and tritium analyses quarterly <sup>6</sup>  Gamma isotopic and tritium analyses quarterly <sup>6</sup>
VI. Drinking Water	A) 1 Indicator sample from a nearby public ground water supply source.  B) 1 Indicator (finished water) sample from the nearest downstream water supply.  C) 1 Control (finish water) sample from the nearest unaffected public water supply.	Monthly <sup>5</sup> grab sampling.  Monthly <sup>5</sup> composite sampling.  Monthly <sup>5</sup> composite sampling.	Monthly <sup>5</sup> gamma isotopic and gross beta analyses and quarterly <sup>6</sup> composite for tritium analyses.  Monthly <sup>5</sup> gamma isotopic and gross beta analyses and quarterly <sup>6</sup> composite for tritium analyses.  Monthly <sup>5</sup> gamma isotopic and gross beta analyses and quarterly <sup>6</sup> composite for tritium analyses.



**Table 1.4-1 Radiological Environmental Monitoring Program  
Virgil C. Summer Nuclear Station**

Exposure Pathway and/or Sample	Minimum Number of Sample Locations and Criteria for Selection	Sampling and Collection Frequency	Type & Frequency of Analysis
<b>INGESTION:</b> VII. Milk <sup>2</sup>	A) Samples from milking animals in 3 locations within 5 km distance having the highest dose potential. If there are none then 1 sample from milking animals in each of 3 areas between 5 to 8 km distance where doses are calculated to be greater than 1 mrem per year <sup>1</sup> .  B) 1 Control sample to be taken at the location of a dairy greater than 20 miles distance and not in the most prevalent wind direction.  C) 1 Indicator grass (forage) sample to be taken at the location of one of the dairies being sampled meeting the criteria of VII(A), above, when animals are on pasture.  D) 1 Control grass (forage) sample to be taken at the location of VII(B) above.	Semimonthly <sup>4</sup> when animals are on pasture, monthly <sup>5</sup> other times.  Semimonthly <sup>4</sup> when animals are on pasture, monthly <sup>5</sup> other times <sup>8</sup> .  Monthly <sup>5</sup> when available.  Monthly <sup>5</sup> when available. <sup>8</sup>	Gamma isotopic and I-131 analysis semimonthly <sup>4</sup> when animals are on pasture; monthly <sup>5</sup> at other times.  Gamma isotopic and I-131 analysis semimonthly <sup>4</sup> when animals are on pasture; monthly <sup>5</sup> at other times.  Gamma isotopic.  Gamma isotopic.
VIII. Food Products	A) 2 samples of broadleaf vegetation grown in the 2 nearest offsite locations of highest calculated annual average ground level D/Q if milk sampling is not performed within 3 km or if milk sampling is not performed at a location within 5 to 8 km where the doses are calculated to be greater than 1 mrem/yr <sup>1</sup> .  B) 1 Control sample for the same foods taken at a location at least 10 miles distance and not in the most prevalent wind direction if milk sampling is not performed within 3 km or if milk sampling is not at a location within 5 to 8 km where doses are calculated to be greater than 1 mrem/yr <sup>1</sup> .	Monthly <sup>5</sup> when available.  Monthly <sup>5</sup> when available.	Gamma Isotopic on edible portion.  Gamma Isotopic on edible portion.
IX. Fish	A) 1 Indicator sample to be taken at a location in the upper reservoir.  B) 1 Indicator sample to be taken at a location in the lower reservoir.  C) 1 Control sample to be taken at a location on the receiving river sufficiently far upstream such that no effects of pumped storage operation are anticipated.	Semiannual <sup>7</sup> collection of the following specie types if available: bass; bream, crappie; catfish, carp.  Semiannual <sup>7</sup> collection of the following specie types if available: bass; bream, crappie; catfish, carp.  Semiannual <sup>7</sup> collection of the following specie types if available: bass; bream, crappie; catfish, carp.	Gamma isotopic on edible portions semiannually <sup>7</sup> .  Gamma isotopic on edible portions semiannually <sup>7</sup> .  Gamma isotopic on edible portions semiannually <sup>7</sup> .

**Table 1.4-1 Radiological Environmental Monitoring Program  
Virgil C. Summer Nuclear Station**

Exposure Pathway and/or Sample	Minimum Number of Sample Locations and Criteria for Selection	Sampling and Collection Frequency	Type & Frequency of Analysis
<b>AQUATIC:</b> X. Sediment	A) 1 Indicator sample to be taken at a location in the upper reservoir.  B) 1 Indicator sample to be taken on or near the shoreline of the lower reservoir.  C) 1 Control sample to be taken at a location on the receiving river sufficiently far upstream such that no effects of pumped storage operation are anticipated.	Semiannual <sup>7</sup> grab sample.  Semiannual <sup>7</sup> grab sample.  Semiannual <sup>7</sup> grab sample.	Gamma isotopic.  Gamma isotopic.  Gamma isotopic.

**Table 1.4-1 (Continued)**  
**TABLE NOTATION**

1. The dose shall be calculated for the maximum organ and age group, using the guidance/methodology contained in Regulatory Guide 1.109, Revision 1 and the parameters particular to the Site. The locations are selected based on potential for highest exposure.
2. Milking animal and garden survey results will be analyzed annually. Should the survey indicate new dairying activity, the owners shall be contacted with regard to a contract for supplying sufficient samples. If contractual arrangements can be made, Site(s) will be added for additional milk sampling up to a total of 3 Indicator Locations.
3. Time composite samples are samples which are collected with equipment capable of collecting an aliquot at time intervals which are short (e.g., hourly) relative to the compositing period.
4. At least once per 18 days.
5. Not to exceed 35 days.
6. At least once per 100 days
7. At least once per 200 days.
8. Milk and grass (forage) sampling at the control location is only required when locations meeting the criteria of VII(A) are being sampled.

NOTE: Deviations from this sampling schedule may occasionally be necessary if sample media are unobtainable due to hazardous conditions, seasonal unavailability, insufficient sample size, malfunctions of automatic sampling or analysis equipment and other legitimate reasons. If specimens are unobtainable due to sampling equipment malfunction, every effort shall be made to complete corrective action prior to the end of the next sampling period. Deviations from sampling analysis schedules will be described in the annual report.

**Table 1.4-2**

Reporting Levels for Radioactivity Concentrations in Environmental Samples

<b>Analysis</b>	<b>Water (pCi/l)</b>	<b>Airborne Particulate or Gases (pCi/m<sup>3</sup>)</b>	<b>Fish (pCi/Kg, wet)</b>	<b>Milk (pCi/l)</b>	<b>Food Products (pCi/Kg, wet)</b>
H-3	20,000(a)	N.A.	N.A.	N.A.	N.A.
Mn-54	1,000	N.A.	30,000	N.A.	N.A.
Fe-59	400	N.A.	10,000	N.A.	N.A.
Co-58	1,000	N.A.	30,000	N.A.	N.A.
Co-60	300	N.A.	10,000	N.A.	N.A.
Zn-65	300	N.A.	10,000	N.A.	N.A.
Zr-95	400	N.A.	20,000	N.A.	N.A.
Nb-95	400	N.A.	20,000	N.A.	N.A.
I-131	2	0.9	N.A.	3	100
Cs-134	30	10	1,000	60	1,000
Cs-137	50	20	2,000	70	2,000
Ba-140	200	N.A.	N.A.	300	N.A.
La-140	200	N.A.	N.A.	300	N.A.

(a) For drinking water samples. This is the 40 CFR Part 141 value.

**Table 1.4-3**

Maximum Values for the Lower Limits of Detection (LLD)<sup>a,c</sup>

<b>Analysis</b>	<b>Water (pCi/l)</b>	<b>Airborne Particulate or Gases (pCi/m<sup>3</sup>)</b>	<b>Fish (pCi/Kg, wet)</b>	<b>Milk (pCi/l)</b>	<b>Food Products (pCi/Kg, wet)</b>	<b>Sediment (pCi/Kg, dry)</b>
Gross Beta	4	1 X 10 <sup>-2</sup>	N.A.	N.A.	N.A.	N.A.
H-3	2000(b)	N.A.	N.A.	N.A.	N.A.	N.A.
Mn-54	15	N.A.	130	N.A.	N.A.	N.A.
Fe-59	30	N.A.	260	N.A.	N.A.	N.A.
Co-58	15	N.A.	130	N.A.	N.A.	N.A.
Co-60	15	N.A.	130	N.A.	N.A.	N.A.
Zn-65	30	N.A.	260	N.A.	N.A.	N.A.
Zr-95	30	N.A.	N.A.	N.A.	N.A.	N.A.
Nb-95	15	N.A.	N.A.	N.A.	N.A.	N.A.
I-131	1 <sup>b</sup>	7 X 10 <sup>-2</sup>	N.A.	1	60	N.A.
Cs-134	15	5 X 10 <sup>-2</sup>	130	15	60	150
Cs-137	18	6 X 10 <sup>-2</sup>	150	18	80	180
Ba-140	60	N.A.	N.A.	60	N.A.	N.A.
La-140	15	N.A.	N.A.	15	N.A.	N.A.

Table 1.4-3 (Continued)

TABLE NOTATION

- a. Table 1.4-3 lists detection capabilities for radioactive materials in environmental samples. These detection capabilities are tabulated in terms of the lower limits of detection (LLDs). See Table 1.1-4 notation (a) for definition of LLD.
- b. LLD for drinking water samples.
- c. Other peaks potentially due to reactor operations (fission and activation products) which are measurable and identifiable, together with the radionuclides in Table 1.4-3, shall be identified and reported.

## 1.4.2 Land Use Census

### CONTROLS

---

1.4.2.1 A land use census shall be conducted and shall identify the location of the nearest milk animal, the nearest residence and the nearest garden\* of greater than 500 square feet producing fresh leafy vegetables in each of the 16 meteorological sectors within a distance of five miles.

APPLICABILITY: At all times.

ACTION:

- a. With a land use census identifying a location(s) which yields a calculated dose or dose commitment greater than the values currently being calculated in ODCM Specification 1.2.4.2, in lieu of any other report required by ODCM Section 1.6, prepare and submit to the Commission within 30 days, pursuant to Technical Specification 6.9.2, a Special Report which identifies the new location(s).
- b. With a land use census identifying a location(s) which yields a calculated dose or dose commitment (via the same exposure pathway) 20 percent greater than at a location from which samples are currently being obtained in accordance with ODCM Specification 1.4.1.1, in lieu of any other report required by ODCM Section 1.6, prepare and submit to the Commission within 30 days, pursuant to Technical Specification 6.9.2, a Special Report which identifies the new location. The new location shall be added to the radiological environmental monitoring program within 30 days. The sampling location, excluding the control station location, having the lowest calculated dose or dose commitment (via the same exposure pathway) may be deleted from this monitoring program after October 31 of the year in which this land use census was conducted.

---

\*Broad leaf vegetation sampling may be performed at the site boundary in the direction sector with the highest D/Q in lieu of the garden census.

- c. The provisions of Technical Specifications 3.0.3 and 3.0.4 are not applicable.

## SURVEILLANCE REQUIREMENTS

---

1.4.2.2 The land use census shall be conducted at least once per 12 months between the dates of June 1 and October 1 using that information which will provide the best results, such as by a door-to-door survey, aerial survey, or by consulting local agriculture authorities.



### 1.4.3 Interlaboratory Comparison Program

#### CONTROLS

---

- 1.4.3.1 Analyses shall be performed on radioactive materials supplied by a National Institute of Standards and Technology traceable Laboratory as part of an Interlaboratory Comparison Program.

APPLICABILITY: At all times.

ACTION:

- a. With analyses not being performed as required above, report the corrective actions taken to prevent a recurrence to the Commission in the Annual Radiological Environmental Operating Report.
- b. The provisions of Technical Specifications 3.0.3 and 3.0.4 are not applicable.

#### SURVEILLANCE REQUIREMENTS

---

- 1.4.3.2 A summary of the results obtained as part of the above required Interlaboratory Comparison Program shall be included in the Annual Radiological Environmental Operating Report.

## 1.5 BASES

### B/1.1 LIQUID EFFLUENTS

#### B/1.1.1 Radioactive Liquid Effluent Monitoring Instrumentation

The radioactive liquid effluent instrumentation is provided to monitor and control, as applicable, the releases of radioactive materials in liquid effluents during actual or potential releases of liquid effluents. The alarm/trip setpoints for these instruments shall be calculated in accordance with the procedures in the ODCM to ensure that the alarm/trip will occur prior to exceeding 10 times the concentration levels specified in 10 CFR 20, Appendix B, Table 2, Column 2. The OPERABILITY and use of this instrumentation is consistent with the requirements of General Design Criteria 60, 63 and 64 of Appendix A to 10 CFR Part 50.

#### B/1.1.2 Concentration

This control is provided to ensure that concentration of radioactive materials released in liquid waste effluents from the site (see Technical Specification Figure 5.1-4) will be less than 10 times the concentration levels specified in 10 CFR Part 20, Appendix B, Table 2, Column 2. It provides operational flexibility for releasing liquid effluents in concentrations to follow the Section II.A design objectives of Appendix I to 10 CFR 50. This limitation provides additional assurance that the levels of radioactive materials in bodies of water outside the site will result in exposures within:

- (1) the Section II.A design objectives of Appendix I, 10 CFR 50, to an individual and
- (2) restrictions authorized by 10 CFR 20.1301 (e).

The concentration limit for dissolved or entrained noble gases is based upon the assumption that Xe-135 is the controlling radionuclide and its Effluent concentration in air (submersion) was converted to an equivalent concentration in water. This specification does not affect the requirement to comply with the annual limitations of 10 CFR 20.1301(a).

#### B/1.1.3 Dose

This control is provided to implement the requirements of Sections II.A, III.A and IV.A of Appendix I, 10 CFR Part 50. The CONTROLS

implement the guides set forth in Section II.A. of Appendix I. The ACTION statements provide the required operating flexibility and at the same time implement the guides set forth in Section IV.A of Appendix I to assure that the releases of radioactive material in liquid effluents will be kept "as low as is reasonably achievable". Also, for fresh water sites with drinking water supplies which can be potentially affected by plant operations, there is reasonable assurance that the operation of the facility will not result in radionuclide concentrations in the finished drinking water that are in excess of the requirements of 40 CFR 141. The dose calculations in the ODCM implement the requirements in Section III.A of Appendix I that conformance with guides of Appendix I be shown by calculational procedures based on models and data, such that the actual exposure of an individual through appropriate pathways is unlikely to be substantially underestimated. The equations specified in the ODCM for calculating the doses due to the actual release rates of radioactive materials in liquid effluents are consistent with the methodology provided in NUREG-0133, "Preparation of Radiological Effluent Technical Specifications for Nuclear Power Plants", section 4.3. NUREG-0133 implements Regulatory Guide 1.109, Revision 1, October 1977 (Section C.1 and Appendix A) and Regulatory Guide 1.113, April 1977. Regulatory Guide 1.109, October 1977, is titled "Calculation of Annual Doses to Man from Routine Releases of Reactor Effluents for the Purpose of Evaluating Compliance with 10 CFR Part 50, Appendix I". Regulatory Guide 1.113, April 1977, is titled "Estimating Aquatic Dispersion of Effluents from Accidental and Routine Reactor Releases for the Purpose of Implementing Appendix I".

B/1.1.4      Liquid Waste Treatment

The OPERABILITY of the liquid radwaste treatment system ensures that this system will be available for use whenever liquid effluents require treatment prior to release to the environment. The requirement that the appropriate portions of this system be used when specified provides assurance that the releases of radioactive materials in liquid effluents will be kept "as low as is reasonably achievable". This control implements the requirements of 10 CFR Part 50.36a, General Design Criterion 60 of Appendix A to 10 CFR Part 50 and the design objective given in Section II.D of Appendix I to 10 CFR Part 50. The specified limits governing the use of appropriate portions of the liquid radwaste treatment system were specified as a suitable

fraction of the dose design objectives set forth in Section II.A of Appendix I, 10 CFR Part 50, for liquid effluents.

## B/1.2 GASEOUS EFFLUENTS

### B/1.2.1 Radioactive Gaseous Effluent Monitoring Instrumentation

The radioactive gaseous effluent instrumentation is provided to monitor and control, as applicable, the releases of radioactive materials in gaseous effluents during actual or potential releases of gaseous effluents. The alarm/trip setpoints for these instruments shall be calculated in accordance with the procedures in the ODCM to ensure that the alarm/trip will occur prior to exceeding the limits of 10 CFR Part 20. The OPERABILITY and use of this instrumentation is consistent with the requirements of General Design Criteria 60, 63 and 64 of Appendix A to 10 CFR Part 50.

### B/1.2.2 Dose Rate

This control along with controls 1.2.3 and 1.2.4 provide reasonable assurance that radioactive material discharged in gaseous effluents will not result in the exposure of a member of the public in an unrestricted area, either at or beyond the site boundary in excess of the design objectives of Appendix I to 10 CFR 50. This control is provided to ensure that gaseous effluent from all units on the site will be appropriately controlled yet provides operational flexibility for releasing gaseous effluents to satisfy the section II.B and II.C design objectives of Appendix I to 10 CFR 50.

The restrictions of Control 1.2.3 along with limited occupancy times for a member of the public within the site boundary are sufficient to control exposure to gaseous effluent within 10 CFR 20, Appendix B, Table 2, Column 1 effluent concentrations.

The specified release rate limits restrict, at all times, the corresponding gamma and beta dose rates above background to an individual at or beyond the site boundary to less than or equal to 500 mrem/year to the total body or to less than or equal 3000 mrem/year to the skin. These release rate limits also restrict, at all times, the corresponding thyroid dose rate above

background to a child via the inhalation pathway to less than or equal to 1500 mrem/year.

This control does not affect the requirement to comply with the annual limitations of 10 CFR 20.1301(a).

B/1.2.3 Dose - Noble Gases

This control is provided to implement the requirements of Sections II.B, III.A and IV.A of Appendix I, 10 CFR Part 50. The CONTROLS implement the guides set forth in Section II.B of Appendix I. The ACTION statements provide the required operating flexibility and at the same time implement the guides set forth in Section IV.A of Appendix I to assure that the release of radioactive material in gaseous effluents will be kept “as low as is reasonably achievable”. The Surveillance Requirements implement the requirements in Section III.A of Appendix I that conformance with the guides of Appendix I be shown by calculational procedures based on models and data such that the actual exposure of an individual through appropriate pathways is unlikely to be substantially underestimated. The dose calculations established in the ODCM for calculating the doses due to the actual release rates of radioactive noble gases in gaseous effluents are consistent with the methodology provided in NUREG-0133, “Preparation of Radiological Effluent Technical Specifications for Nuclear Power Plants”, section 5.3. NUREG-0133 implements Regulatory Guide 1.109, Revision 1, October 1977 and Regulatory Guide 1.111, Revision 1, July 1977. Regulatory Guide 1.109 is entitled “Calculation of Annual Doses to Man from Routine Releases of Reactor Effluents for the Purpose of Evaluating Compliance with 10 CFR Part 50, Appendix I, “Revision 1, October 1977 and Regulatory Guide 1.111 is entitled “Methods for Estimating Atmospheric Transport and Dispersion of Gaseous Effluents in Routine Releases from Light-Water Cooled Reactors”, Revision 1, July 1977. The ODCM equations provided for determining the air doses at the site boundary are based upon the historical average atmospheric conditions.

This control applies to the release of gaseous effluents from all reactors at the site.

B/1.2.4 Dose-Radioiodines, Tritium and Radioactive Materials in Particulate Form

This control is provided to implement the requirements of Sections II.C, III.A and IV.A of Appendix I, 10 CFR Part 50. The Limiting Conditions for Operation are the guides set forth in Section II.C of Appendix I. The ACTION statements provide the required operating flexibility and at the same time implement the guides set forth in Section IV.A Appendix I to assure that the releases of radioactive materials in gaseous effluents will be kept “as low as is reasonably achievable”. The ODCM calculational methods specified in the Surveillance Requirements implement the requirements in Section III.A of Appendix I that conformance with the guides of Appendix I be shown by calculational procedures based on models and data, such that the actual exposure of an individual through appropriate pathways is unlikely to be substantially underestimated. The ODCM calculational methods for calculating the doses due to the actual release rates of the subject materials are consistent with the methodology provided in NUREG-0133, “Preparation of Radiological Effluent Technical Specifications for Nuclear Power Plants”, section 5.3. NUREG-0133 implements Regulatory Guide 1.109, Revision 1, October 1977 and Regulatory Guide 1.111, Revision 1, July 1977. Regulatory Guide 1.109 is entitled “Calculation of Annual Doses to Man from Routine Releases of Reactor Effluents for the Purpose of Evaluating Compliance with 10 CFR Part 50, Appendix ”, Revision 1, October 1977 and Regulatory Guide 1.111 is entitled “Methods for Estimating Atmospheric Transport and Dispersion of Gaseous Effluents in Routine Releases from Light-Water-Cooled Reactors”, Revision 1, July 1977. These equations also provide for determining the actual doses based upon the historical average atmospheric conditions. The release rate controls for radioiodines, tritium, and radioactive materials in particulate form are dependent on the existing radionuclide pathways to man, in the unrestricted area. The pathways which were examined in the development of these calculations were: 1) individual inhalation of airborne radionuclides, 2) deposition of radionuclides onto green leafy vegetation with subsequent consumption by man, 3) deposition onto grassy areas where milk animals and meat producing animals graze with consumption of the milk and meat by man and 4) deposition on the ground with subsequent exposure of man.

This specification applies to the release of gaseous effluents from all reactors at the site.

**B/1.2.5      Gaseous Radwaste Treatment**

The OPERABILITY of the GASEOUS RADWASTE TREATMENT SYSTEM and the VENTILATION EXHAUST TREATMENT SYSTEM ensures that the systems will be available for use whenever gaseous effluents require treatment prior to release to the environment. The requirement that the appropriate portions of these systems be used, when specified, provides reasonable assurance that the releases of radioactive materials in gaseous effluents will be kept “as low as is reasonably achievable”. This specification implements the requirements of 10 CFR Part 50.36a, General Design Criterion 60 of Appendix A to 10 CFR Part 50, and the design objectives given in Section II.D of Appendix I to 10 CFR Part 50. The specified limits governing the use of appropriate portions of the systems were specified as a suitable fraction of the dose design objectives set forth in Sections II.B and II.C of Appendix I, 10 CFR Part 50, for gaseous effluents.

**B/1.3      RADIOACTIVE EFFLUENTS: TOTAL DOSE**

The control is provided to meet the dose limitations of 40 CFR 190 which have been incorporated into 10 CFR 20.1301(d) and 10 CFR 72.104. The specification requires the preparation and submittal of a Special Report whenever the calculated doses from plant radioactive effluents exceed twice the design objective doses of Appendix I. For sites containing up to 4 reactors, it is highly unlikely that the resultant dose to a member of the public will exceed the dose limits of 40 CFR 190 if the individual reactors remain within twice the 10 CFR 50 Appendix I dose design objectives and if direct radiation doses from the units (including outside storage tanks, etc.) are kept small. Direct radiation due to ISFSI must be included.

The Special Report will describe a course of action which should result in the limitation of dose to a member of the public for 12 consecutive months to within the 40 CFR 190 limits. For the purposes of the Special Report, it may be assumed that the dose commitment to the member of the public from other uranium fuel cycle sources is negligible, with the exception that dose contributions from other nuclear fuel cycle facilities at the same site or within a radius of 5 miles must be considered. If the dose to any member of

the public is estimated to exceed the requirements of 40 CFR 190, the Special Report with a request for a variance (provided the release conditions resulting in violation of 40 CFR 190 have not already been corrected), in accordance with the provisions of 40 CFR 190.11, is considered to be a timely request and fulfills the requirements of 40 CFR 190 until NRC staff action is completed. The variance only relates to the limits of 40 CFR 190 and does not apply in any way to other dose requirements for dose limitation of 10 CFR 20, as addressed in ODCM Controls 1.1.2.1 and 1.2.2.1. An individual is not considered a member of the public during any period in which he/she is engaged in carrying out any operation which is part of the nuclear fuel cycle.

Demonstration of compliance with the limits of 40 CFR 190 or with the design objectives of Appendix I to 10 CFR 50 will be considered to demonstrate compliance with the 0.1 rem limit of 10 CFR 20.1301.

#### B/1.4.1 Monitoring Program

The radiological monitoring program required by this control provides measurements of radiation of radioactive materials in those exposure pathways and for those radionuclides, which lead to the highest potential radiation exposures of individuals resulting from the station operation. This monitoring program thereby supplements the radiological effluent monitoring program by verifying that the measurable concentrations of radioactive materials and levels of radiation are not higher than expected on the basis of the effluent measurements and modeling of the environmental exposure pathways. The initially specified monitoring program will be effective for at least the first three years of commercial operation. Following this period, program changes may be initiated based on operational experience.

The detection capabilities required by Table 1.4-3 are state-of-the-art for routine environmental measurements in industrial laboratories. It should be recognized that the LLD is defined as an a priori (before the fact) limit representing the capability of a measurement system and not as a posteriori (after the fact) limit for a particular measurement. Analyses shall be performed in such a manner that the stated LLDs will be achieved under routine conditions. Occasionally background fluctuations, unavoidably small sample sizes, the presence of interfering nuclides, or other uncontrollable circumstances may render these LLDs unachievable. In such cases, the contributing factors will be identified and described in the Annual Radiological Environmental Operating Report.



B/1.4.2 Land Use Census

This control is provided to ensure that changes in the use of unrestricted areas are identified and that modifications to the monitoring program are made if required by the results of this census. The best survey information from the door-to-door, aerial or consulting with local agricultural authorities shall be used. This census satisfies the requirements of Section IV.B.3 of Appendix I to 10 CFR Part 50. Restricting the census to gardens of greater than 500 square feet provides assurance that significant exposure pathways via leafy vegetables will be identified and monitored since a garden of this size is the minimum required to produce the quantity (26 kg/year) of leafy vegetables assumed in Regulatory Guide 1.109 for consumption by a child. To determine this minimum garden size, the following assumptions were used, 1) that 20% of the garden was used for growing broad leaf vegetation (i.e., similar to lettuce and cabbage), and 2) a vegetation yield of 2 kg/square meter.

B/1.4.3 Interlaboratory Comparison Program

The requirement for participation in an Interlaboratory Comparison Program is provided to ensure that independent checks on the precision and accuracy of the measurements of radioactive material in environmental sample matrices are performed as part of the quality assurance program for environmental monitoring in order to demonstrate that the results are reasonably valid.

## 1.6 REPORTING REQUIREMENTS

### 1.6.1 Annual Radiological Environmental Operating Report

1.6.1.1 Routine radiological environmental operating reports covering the operation of the unit during the previous calendar year shall be submitted prior to May 1 of each year. The initial report shall be submitted prior to May 1 of the year following initial criticality.

1.6.1.2 The Annual Radiological Environmental Operating Report shall include summaries, interpretations, and an analysis of trends of the results of the radiological environmental surveillance activities for the report period, including a comparison with preoperational studies, operational controls (as appropriate), and previous environmental surveillance reports and an assessment of the observed impacts of the plant operation on the environment. The reports shall also include the results of land use censuses required by ODCM Specification 1.4.2.1. If harmful effects or evidence of irreversible damage are detected by the monitoring, the report shall provide an analysis of the problem and a planned course of action to alleviate the problem.

The Annual Radiological Environmental Operating Report shall include summarized and tabulated results in the format of Regulatory Guide 4.8, December 1975 of all radiological environmental samples taken during the report period. In the event that some results are not available for inclusion with the report, the report shall be submitted noting and explaining the reasons for missing results. The missing data shall be submitted as soon as possible in a supplementary report.

The report shall also include the following: a summary description of the radiological environmental monitoring program; a map of all sampling locations keyed to a table giving distances and directions from one reactor; and the results of licensee participation in the Interlaboratory Comparison Program, required by ODCM Specification 1.4.3.1.

## 1.6.2 Annual Radioactive Effluent Release Report

1.6.2.1 A radioactive effluent release report covering the operation of the unit during the previous year of operation shall be submitted prior to May 1 of each year. The period of the first report shall begin with the date of initial criticality.

1.6.2.2 The Radioactive Effluent Release Report shall include a summary of the quantities of radioactive liquid and gaseous effluents and solid waste released from the unit as outlined in Regulatory Guide 1.21, "Measuring, Evaluating, and Reporting Radioactivity in Solid Wastes and Releases of Radioactive Materials in Liquid and Gaseous Effluents from Light-Water-Cooled Nuclear Power Plants", Revision 1, June 1974, with data summarized on a quarterly basis following the format of Appendix B thereof.

The Radioactive Effluent Release Report shall include an annual summary of hourly meteorological data collected over the previous year. This annual summary may be either in the form of an hour-by-hour listing of wind speed, wind direction, and atmospheric stability, and precipitation (if measured) on magnetic tape, or in the form of joint frequency distributions of wind speed, wind direction, and atmospheric stability. This same report shall include an assessment of the radiation doses due to the radioactive liquid and gaseous effluents released from the unit during the previous calendar year. This same report shall also include an assessment of the radiation doses from radioactive liquid and gaseous effluents to members of the public due to their activities inside the site boundary (Figures 5.1-3 and 5.1-4 of the VCSNS Technical Specifications) during the year. All assumptions used in making these assessments (i.e., specific activity, exposure time and location) shall be included in these reports. Historical annual average meteorology or meteorological conditions concurrent with the time of release of radioactive materials in gaseous effluents (as determined by sampling frequency and measurement) shall be used for determining the gaseous pathway doses. The assessment of radiation doses shall be performed in accordance with the OFFSITE DOSE CALCULATION MANUAL (ODCM).

The Radioactive Effluent Release Report shall also include an assessment of radiation doses to the likely most exposed member of the public from reactor releases and other nearby uranium fuel cycle sources (including doses from primary effluent pathways, ISFSI and direct radiation) for the previous 12 consecutive months to show conformance with 40 CFR 190, Environmental Radiation Protection Standards for Nuclear Power Operation. Acceptable methods for calculating the dose contribution from liquid and gaseous effluents are given in Regulatory Guide 1.109, Rev. 1.

The Radioactive Effluent Release Report shall include unplanned releases from site to unrestricted areas of radioactive materials in gaseous and liquid effluents on a quarterly basis.

The Radioactive Effluent Release Report shall also include the following: an explanation as to why the inoperability of liquid or gaseous effluent monitoring instrumentation was not corrected within the time specified in ODCM Specifications 1.1.1.1 and 1.2.1.1, respectively.

1.6.3 Major Changes To Radioactive Waste Treatment Systems (Liquid and Gaseous)

1.6.3.1 Licensee initiated major changes to the radioactive waste systems (liquid and gaseous):

1. Shall be reported to the Commission in the Annual Radioactive Effluent Release Report for the period in which the evaluation was reviewed by the Plant Safety Review Committee. The discussion of each change shall contain:
  - a. A summary of the evaluation that led to the determination that the change could be made in accordance with 10 CFR 50.59.
  - b. Sufficient detailed information to totally support the reason for the change without benefit of additional or supplemental information.
  - c. A detailed description of the equipment, components and processes involved and the interfaces with other plant systems.
  - d. An evaluation of the change which shows the predicted releases or radioactive materials in liquid and gaseous effluents that differs from those previously predicted in the license application and amendments thereto.
  - e. An evaluation of the change which shows the expected maximum exposures to individual in the unrestricted area and to the general population that differ from those previously estimated in the license application and amendments thereto.
  - f. A comparison of the predicted releases of radioactive materials, in liquid and gaseous effluents, to the actual releases for the period prior to when the changes are to be made.
  - g. An estimate of the exposure to plant operating personnel as a result of the change.
  - h. Documentation of the fact that the change was reviewed and found acceptable by the PSRC.
2. Shall become effective upon review and acceptance as set forth in Technical Specification 6.5.

#### 1.6.4 V. C. Summer Groundwater Protection Program

1.6.4.1 The NEI Industry Groundwater Protection Initiative was established to address operating experience with groundwater contamination at several nuclear power stations.

1.6.4.2 The following criteria have been established to require notification of the NRC and South Carolina Department of Health and Environmental Control (SCDHEC).

1. A radioactive leak or spill that exceeds 100 gallons or of an unknown volume likely to exceed 100 gallons.
2. Any leak or spill, regardless of the volume or activity, deemed by station management to warrant voluntary communication.
3. A water sample from offsite groundwater or surface water which exceeds the reporting criterion of Table 1.4-2.
4. A water sample from an onsite groundwater monitoring well or surface water that is hydrologically connected to groundwater that exceeds the reporting criterion of Table 1.4-2.

1.6.4.3 If any of the above criteria are met, a telephone notification of the NRC and SCDHEC shall be made in accordance with plant procedures.

1.6.4.4 Prepare and submit a written report to the Commission within 30 days.

1.6.4.5 A description of any spill or leak will be included in the Annual Radioactive Effluent Release Report

1.6.4.6 A description of any sample exceeding the reporting criteria of Table 1.4-2 will be included in the Annual Radiological Environmental Operating Report.

## 1.7 Definitions

### **ACTION**

1.7.1 ACTION shall be that part of a specification which prescribes measures required under designated conditions.

### **ANALOG CHANNEL OPERATIONAL TEST**

1.7.2 An ANALOG CHANNEL OPERATIONAL TEST shall be the injection of a simulated signal into the channel as close to the sensor as practicable to verify OPERABILITY of alarm, interlock and/or trip functions. The ANALOG CHANNEL OPERATIONAL TEST shall include adjustments, as necessary, of the alarm, interlock and/or trip setpoints such that the setpoints are within the required range and accuracy.

### **CHANNEL CALIBRATION**

1.7.3 A CHANNEL CALIBRATION shall be the adjustment, as necessary, of the channel such that it responds within the required range and accuracy to known values of input. The CHANNEL CALIBRATION shall encompass the entire channel including the sensors and alarm, interlock and/or trip functions, and may be performed by any series of sequential, overlapping or total channel steps such that the entire channel is calibrated.

### **CHANNEL CHECK**

1.7.4 A CHANNEL CHECKS shall be the qualitative assessment of channel behavior during operation by observation. This determination shall include, where possible, comparison of the channel indication and/or status with other indications and/or status derived from independent instrument channels measuring the same parameter.

### **GASEOUS RADWASTE TREATMENT SYSTEM**

1.7.5 A GASEOUS RADWASTE TREATMENT SYSTEM is any system designed and installed to reduce radioactive gaseous effluents by collecting primary coolant system off gases from the primary system and providing for delay or holdup for the purpose of reducing the total radioactivity prior to release to the environment.

### **OPERABLE - OPERABILITY**

1.7.6 A system, subsystem, train, component or device shall be OPERABLE or have OPERABILITY when it is capable of performing its specified function(s), and when all necessary attendant instrumentation, controls, electrical power, cooling or seal water, lubrication or other auxiliary equipment that are required for the system, subsystem, train, component or device to perform its function(s) are also capable of performing their related support function(s).

### **SOURCE CHECK**

1.7.7 A SOURCE CHECK shall be the qualitative assessment of channel response when the channel sensor is exposed to a radioactive source.

### **VENTILATION EXHAUST TREATMENT SYSTEM**

1.7.8 A VENTILATION EXHAUST TREATMENT SYSTEM is any system designed and installed to reduce gaseous radioiodine or radioactive material in particulate form in effluents by passing ventilation or vent exhaust gases through charcoal absorbers and/or HEPA filters for the purpose of removing iodines or particulates from the gaseous exhaust stream prior to the release to the environment (such a system is not considered to have any effect on noble gas effluents). Engineered Safety Feature (ESF) atmospheric cleanup systems are not considered to be VENTILATION EXHAUST TREATMENT SYSTEM components.

## 2.0 LIQUID EFFLUENT

### 2.1 Liquid Effluent Monitor Setpoint Calculation

The Virgil C. Summer Nuclear Station is located on the Monticello Reservoir which provides supply and discharge for the plant circulating water. This reservoir also provides supply and discharge capacity for the Fairfield Pumped Storage Facility. The Parr Reservoir located below the pumped storage facility is formed by the Parr Dam.

There are two analyzed release pathways and sources of dilution for liquid effluents: the circulating water discharge canal and the liquid effluent line to the penstocks of the pumped storage facility. All liquid effluent pathways discharge to one of these release points. Generally speaking, very low concentrations of radioactive waste are discharged to the circulating water discharge while higher concentrations of radioactive waste are released to the penstocks of the pumped storage facility during the generation cycle.

The calculated setpoint values will be regarded as upper bounds for the actual setpoint adjustments. That is, setpoint adjustments are not required to be performed if the existing setpoint level corresponds to a lower count rate than the calculated value. Setpoints may be established at values lower than the calculated values, if desired.

Calculated monitor setpoints may be added to the ambient background count rate.

GENERAL NOTE: If no discharge is planned for a specific pathway or if the sum of the effluent concentrations of gamma emitting nuclides equals zero, the monitor setpoint should be established as close to background as practical to prevent spurious alarms and yet alarm should an inadvertent release occur.



## 2.1.1 Liquid Effluent Monitor Setpoint Calculation Parameters

<u>Term</u>	<u>Definition*</u>	<u>Section of Initial Use</u>
A	= Penstock discharge adjustment factor which will allow the set point to be established in a convenient manner and to prevent spurious alarms. = $f_t/f_{dx}$	2.1.2
B	= Steam Generator Blowdown adjustment factor which will allow the set point to be established in a convenient manner and to prevent spurious alarms. = $f_d/f_{ds}$	2.1.4.1
$C_{ECL}$	= the effluent concentration limit (ODCM Control 1.1.2.1) implementing 10 CFR 20 for the site, in $\mu\text{Ci/ml}$ .	2.1.2
$C_a$	= the effluent concentration of alpha emitting nuclides observed by gross alpha analysis of the monthly composite sample, in $\mu\text{Ci/ml}$ .	2.1.2
$C_f$	= the measured concentration of Fe-55 in liquid waste as determined by analysis of the most recent available quarterly composite sample, in $\mu\text{Ci/ml}$ .	2.1.2
$C_g$	= the effluent concentration of a gamma emitting nuclide, g, observed by gamma-ray spectroscopy of the waste sample, in $\mu\text{Ci/ml}$ .	2.1.2
$C_i$	= the concentration of nuclide i, in $\mu\text{Ci/ml}$ , as determined by the analysis of the waste sample.	2.1.2
$C_{ir}$	= the concentration of radionuclide i, in $\mu\text{Ci/ml}$ , in the Monticello Reservoir. Inclusion of this term will correct for possible long-term buildup of radioactivity due to recirculation and for the presence of activity recently released to the Monticello Reservoir by plant activities.	2.1.2
$C_s$	= the concentration of Sr-89 or Sr-90 in liquid wastes as determined by analysis of the quarterly composite sample, in $\mu\text{Ci/ml}$ .	2.1.2
$C_t$	= the measured concentration of H-3 in liquid waste as determined by analysis of the monthly composite, in $\mu\text{Ci/ml}$ .	2.1.2
c	= the setpoint, in $\mu\text{Ci/ml}$ , of the radioactivity monitor measuring the radioactivity concentration in the effluent line prior to dilution and subsequent release. This setpoint which is proportional to the volumetric flow to the effluent line and inversely proportional to the volumetric flow of the dilution stream plus the effluent stream, represents a value which, if exceeded, would result in concentrations exceeding the limits of 10 CFR 20 in the unrestricted area.	2.1.2

\*All concentrations are in units of  $\mu\text{Ci/ml}$  unless otherwise noted.

<u>Term</u>	<u>Definition</u>	<u>Section of Initial Use</u>
$C_B$	= the monitor setpoint concentration for RM-L7, the Nuclear Blowdown Monitor Tank discharge line monitor, in $\mu\text{Ci/ml}$ .	2.1.2.2
$C_C$	= the monitor setpoint concentration for RM-L9, the combined Liquid Waste Processing System and Nuclear Blowdown System effluent discharge line monitor, in $\mu\text{Ci/ml}$ .	2.1.2.3
$C_D$	= the monitor setpoint concentration for RM-L11, the Condensate Demineralizer Backwash discharge line monitor, in $\mu\text{Ci/ml}$ .	2.1.4.2.2
$C_M$	= the monitor setpoint concentration for RM-L5, the Waste Monitor Tank discharge line monitor, in $\mu\text{Ci/ml}$ .	2.1.2.1
$C_{Sa}$	= the monitor setpoint concentration for RM-L3, the initial Steam Generator Blowdown Effluent line monitor, in $\mu\text{Ci/ml}$ .	2.1.4.1.1
$C_{Sb}$	= the monitor setpoint concentration for RM-L10, the final Steam Generator Blowdown Effluent line monitor, in $\mu\text{Ci/ml}$ .	2.1.4.1.1
$C_T$	= the monitor setpoint concentration for RM-L8, the Turbine Building Sump Effluent line monitor, in $\mu\text{Ci/ml}$ .	2.1.4.2.1
$CF_D$	= the Condensate Demineralize Backwash Effluent Concentration Factor.	2.1.4.2
$CF_S$	= the Steam Generator Blowdown Effluent Concentration Factor.	2.1.4.3
$CF_T$	= the Turbine Building Sump Effluent Concentration Factor.	2.1.4.2
DF	= the dilution factor, which is the ratio of the total dilution flow rate to the effluent stream flow rate(s).	2.1.2
F	= the dilution water flow setpoint as determined prior to the release, in volume per unit time.	2.1.2
$F_d$	= the flow rate of the Circulating Water System during the time of release of the Turbine Building Sump and/or the Steam Generator Blowdown, in volume per unit time.	2.1.4.1
$F_{dc}$	= the dilution flow rate of the Circulating Water System used for effluent monitor setpoint calculations, based on 90 percent of expected Circulating Water System flow rate during the time of release and corrected for recirculated Monticello Reservoir activity, in volume per unit time.	2.1.4.1
$F_{dp}$	= the dilution flow rate through the penstock(s) receiving the radioactive liquid release upon which the effluent monitor setpoint is based, as corrected for any recirculated radioactivity, in volume per unit time.	2.1.2
$F_k$	= The near field dilution factor for $C_i$ during release from Turbine Building sump.	2.1.4.4.1
$F_t$	= the flow rate of water through the Fairfield Pumped Storage Station penstock(s) to which radioactive liquids are being discharged during the period of effluent release. This flow rate is dependent upon operational status of Fairfield Pumped Storage Station, in volume per unit time.	2.1.2
f	= the effluent line flow setpoint as determined for the radiation monitor location, in volume per unit time.	2.1.2
$f_d$	= the maximum permissible discharge flow rate for releases to the	2.1.4.1

**ODCM, V. C. Summer, SCE&G: Revision 21 (March 1996)**

<u>Term</u>	<u>Definition</u>	<u>Section of Initial Use</u>
	Circulating Water, in volume per unit time.	
$f_{db}^*$	= the flow rate of the Nuclear Blowdown Monitor Tank discharge, in volume per unit time.	2.1.2
$f_{dm}^*$	= the flow rate of a Waste Monitor Tank discharge, in volume per unit time.	2.1.2
$f_{ds}^*$	= the flow rate of the Steam Generator Blowdown discharge, in volume per unit time.	2.1.4.1
$f_{dx}$	= the flow rate of the tank discharge, either $f_{dm}$ or $f_{db}$ , in volume per unit time.	2.1.2
$f_r$	= the recirculation flow rate used to mix the contents of a tank, in volume per unit time.	2.1.2
$f_t$	= the maximum permissible discharge flow rate for batch releases to the penstocks, in volume per unit time.	2.1.2
$ECL_i$	= $ECL_g$ , $ECL_a$ , $ECL_s$ , $ECL_f$ , and $ECL_t$ = the limiting concentrations of the appropriate gamma emitting, alpha emitting, and strontium radionuclides, Fe-55, and tritium, respectively, from 10 CFR, Part 20, Appendix B, Table 2, Column 2.	2.1.2
SF	= the safety factor, a conservative factor used to compensate for engineering and measurement uncertainties. SF = 0.5, corresponding to a 100 percent variation.	2.1.2
$[C_i]_{LLD}$	= the Lower Limit of Detection (LLD) for radionuclide i in liquid waste in the Waste Monitor Tank, as determined by the analysis required in ODCM Table 1.1-4, in $\mu\text{Ci/ml}$ .	2.1.3
$[C_i]_M$	= the concentration of radionuclide i in the waste contained within the Waste Monitor Tank serving as the holding facility for sampling and analysis prior to discharge, in $\mu\text{Ci/ml}$ .	2.1.3
$\sum_g C_g$	= the sum of the concentrations $C_g$ of each measured gamma emitting nuclide observed by gamma-ray spectroscopy of the waste sample, in $\mu\text{Ci/ml}$ .	2.1.2
$\left[ \sum_g C_g \right]_B$	= the gamma isotopic concentrations of the Nuclear Blowdown Monitor Tank as obtained from the sum of the measured concentrations determined by the analysis required in ODCM Table 1.1-4, in $\mu\text{Ci/ml}$ .	2.1.2

\* (Conservatively this value will be either zero, if no release is to be conducted from this system, or the maximum measured capacity of the discharge pump if a release is to be conducted.)

<u>Term</u>	<u>Definition</u>	<u>Section of Initial Use</u>
$\left[ \sum_g C_g \right]_D$	= the gamma isotopic concentrations of the Condensate Demineralizer Backwash effluent (including solids) as obtained from the sum of the measured concentrations determined by the analysis required in ODCM Table 1.1-4, in $\mu\text{Ci/ml}$ .	2.1.4.2.2
$\left[ \sum_g C_g \right]_M$	= the gamma isotopic concentrations of the Waste Monitor Tank as obtained from the sum of the measured concentrations determined by the analysis required in ODCM Table 1.1-4, in $\mu\text{Ci/ml}$ .	2.1.2
$\left[ \sum_g C_g \right]_S$	= the gamma isotopic concentrations of the Steam Generator Blowdown as obtained from the sum of the measured concentrations determined by the analysis required in ODCM Table 1.1-4, in $\mu\text{Ci/ml}$ .	2.1.4.1.1
$\left[ \sum_g C_g \right]_T$	= the gamma isotopic concentrations of the Turbine Building Sump as obtained from the sum of the measured concentrations determined by the analysis required in ODCM Table 1.1-4, in $\mu\text{Ci/ml}$ .	2.1.4.2.1
$t_r$	= the minimum time for recirculating the contents of a tank prior to sampling, in minutes.	2.1.2
$V$	= the volume of liquid in a tank to be sampled, in gallons.	2.1.2
$V_j$	= release volume for Turbine Building sump release permit $j$ , in gallons.	2.1.4.4.1

## 2.1.2 Liquid Radwaste Effluent Line Monitors

(RM-L5, RM-L7, RM-L9)

Liquid Radwaste Effluent Line Monitors provide alarm and automatic termination of release functions prior to exceeding 10 times the concentration limits specified in 10 CFR 20, Appendix B, Table 2, Column 2 at the release point to the unrestricted area. To meet this specification, the alarm/trip setpoints for liquid effluent monitors and flow measurement devices are set to assure that the following equation is satisfied:

$$10C_{ECL} \geq \frac{cf}{F + f} \quad (1)$$

where:

- $C_{ECL}$  = the effluent concentration limit specified in 10 CFR 20 Appendix B, Table 2, Column 2. Note that Control 1.1.2.1 limits release concentrations to 10 times the Appendix B, Table 2, Column 2 values.
- $c$  = the setpoint, in  $\mu\text{Ci/ml}$ , of the radioactivity monitor measuring the radioactivity concentration in the effluent line prior to dilution and subsequent release; the setpoint, which is inversely proportional to the volumetric flow of the effluent line and proportional to the volumetric flow of the dilution stream plus the effluent stream, represents a value which, if exceeded, would result in concentrations exceeding 10 times the effluent concentrations of 10 CFR 20 in the unrestricted area.
- $F$  = the dilution water flow setpoint as determined prior to the release point, in volume per unit time.
- $f$  = the effluent line flow setpoint as determined at the radiation monitor location, in volume per unit time.

At the Virgil C. Summer Nuclear Station the Liquid Waste Processing System (LWPS) and the Nuclear Blowdown System (NBS) both discharge to the penstocks of the Fairfield Pumped Storage (FPS) Facility through a

common line. The available dilution water flow ( $F_{dp}$ ) is assumed to be 90 percent of the flow through the FPS penstock(s) to which liquid effluent is being discharged and is dependent upon operational status of the FPS Facility. The waste tank flow rates ( $f_{dm}$  and  $f_{db}$ ) and the monitor setpoints ( $c_M$ ,  $c_B$  and  $c_C$ ) are set to meet the condition of equation (1) for a given effluent concentration,  $C$ . The three monitor setpoints are determined in accordance with the monitor system configuration for this discharge pathway. The LWPS discharges through RM-L5, which has setpoint  $c_M$  for alarm/control functions over releases from either Waste Monitor Tanks 1 or 2. The Nuclear Blowdown discharges through RM-L7, which has setpoint  $c_B$  for alarm/ control functions over releases from the Nuclear Blowdown Monitor Tank. These two release pathways merge into a common line monitored by RM-L9, which has setpoint  $c_C$  for control functions over the common effluent line. Although the piping is arranged so that simultaneous batch releases from the two systems could be practiced, operational releases shall be from only one of the two batch systems at any given time. The method by which their setpoints are determined is as follows:

- 1) The isotopic concentration for a waste tank to be released is obtained from the sum of the measured concentrations as determined by the analysis required in Table 1.1-4:

$$\sum_i C_i = \sum_g C_g + C_a + C_s + C_t + C_f \quad (2)$$

where:

$C_i$  = the concentration of nuclide  $i$ , in  $\mu\text{Ci/ml}$ , as determined by the analysis of the waste sample.\*

$\sum_g C_g$  = the sum of the concentrations  $C_g$  of each measured gamma emitting nuclide observed by gamma-ray spectroscopy of the waste sample, in  $\mu\text{Ci/ml}$ .

---

\* Values for  $C_a$ ,  $C_s$ ,  $C_t$  and  $C_f$  will be based on most recent available composite sample analyses as required by Table 1.14.

$C_a^*$  = the effluent concentration of alpha emitting nuclides observed by gross alpha analysis of the monthly composite sample, in  $\mu\text{Ci/ml}$ .

$C_s^*$  = the concentration of Sr-89 and Sr-90 in liquid waste as determined by analysis of the quarterly composite sample, in  $\mu\text{Ci/ml}$ .

$C_t^*$  = the measured concentration of H-3 in liquid waste as determined by analysis of the monthly composite sample, in  $\mu\text{Ci/ml}$ .

$C_f^*$  = the measured concentration of Fe55 in liquid waste as determined by analysis of the quarterly composite sample, in  $\mu\text{Ci/ml}$ .

The  $C_g$  term will be included in the analysis of each batch; terms for alpha, strontium, Fe-55, and tritium shall be included as appropriate\*. Isotopic concentrations for both the Waste Monitor Tanks (WMT) and the Nuclear Blowdown Monitor Tank (NBMT) may be calculated using equation (2).

Prior to being sampled for analysis, the contents of a tank shall be isolated and recirculated. The minimum recirculation time shall be:

$$t_r = 2V/f_r \quad (3)$$

$t_r$  = the minimum time for recirculating the contents of a tank prior to sampling.

$V$  = the volume of liquid in the tank to be sampled.

$f_r$  = the recirculation flow rate used to mix the contents of a tank.

This is done to ensure that a representative sample will be obtained. Mechanical mixers shall ensure a similar minimum turnover.

---

\*Based on most recent available composite sample analysis as required by Table 1.1-4.

- 2) Once isotopic concentrations for either Waste Monitor Tank or the Nuclear Blowdown Monitor Tank have been determined, these values are used to calculate a Dilution Factor, DF, which is the ratio of dilution flow rate to tank flow rate(s) required to assure that 10 times the limiting concentration of 10 CFR 20, Appendix B, Table 2, Column 2 are met at the point of discharge for whichever tank is having its contents discharged.

$$DF = \left[ \sum_i \frac{C_i}{10 (ECL)_i} \right]_X \div SF \quad (4)$$

(5)

$$DF = \left[ \sum_g \frac{C_g}{10 (ECL)_g} + \left[ \frac{C_a}{10 (ECL)_a} + \frac{C_s}{10 (ECL)_s} + \frac{C_f}{10 (ECL)_f} + \frac{C_t}{10 (ECL)_t} \right] \right]_X \div SF$$

where:

$$\left[ \sum_i \frac{C_i}{10(ECL)_i} \right]_X = \text{the sum of the ratios of the measured concentration of nuclide } i \text{ to 10 times its limiting ECL value for the tank whose contents are being considered for release. For a WMT, } X = M. \text{ For the NBMT, } X = B.$$

$ECL_i$  =  $ECL_g$ ,  $ECL_a$ ,  $ECL_s$ ,  $ECL_f$ , and  $ECL_t$ , = effluent concentration limits of the appropriate gamma emitting, alpha emitting, and strontium radionuclides, Fe-55, and tritium, respectively, given in 10 CFR, Part 20, Appendix B, Table 2, Column 2.

SF = the safety factor; a conservative factor used to compensate for engineering and measurement uncertainties.

= 0.5, Corresponding to a 100 percent variation.



- 3) The maximum permissible discharge flow rate,  $f_t$ , may be calculated for the release of either the WMT or NBMT. First the appropriate Dilution Factor is calculated by applying equation (4), using the appropriate concentration ratio term (i.e. M or B). An additional safety factor is used for  $f_t$  based on 90 percent FPS Station expected flowrate.

Then,

$$f_t = (0.9) \frac{(F_{dp} + f_{dx})}{DF} \cong \frac{(0.9)F_{dp}}{DF} \text{ for } F_{dp} \gg f_{dx} \quad (6)$$

where:

$F_{dp}$  = dilution flow rate to be used in effluent monitor setpoint calculations, as corrected for any recirculated radioactivity:

$$F_{dp} = F_t \left( 1 - \sum_i \frac{C_{ir}}{10 (ECL)_i} \right) \quad (7)$$

where:

$F_t$  = the flow rate through the Fairfield Pumped Storage Station penstock(s) to which radioactive liquids are being discharged.  $F_t$  should normally fall between 2500 and 44800 cfs.

$C_{ir}$  = the concentration of radionuclide  $i$ , in  $\mu\text{Ci/ml}$ , in the intake of Fairfield Pumped Storage Station (that is, in the Monticello Reservoir). Inclusion of this term will correct for possible long-term buildup of radioactivity due to recirculation and for the presence of activity recently released to the Monticello Reservoir by plant activities. For expected discharges of liquid wastes, the summation will be much less than 1.0 and can be ignored (Reference 6).

$f_{dx}$  = the flow rate of the tank discharge, either  $f_{dm}$  or  $f_{db}$ .

$f_{db}$  = flow rate of Nuclear Blowdown Monitor Tank discharge.  
(Conservatively this value will be either zero, if no release is

to be conducted from this system, or the maximum measured capacity of the discharge pump if a release is to be conducted.)

$f_{dm}$  = flow rate of Waste Monitor Tank discharge. (Conservatively this value will either be zero, if no release is to be conducted from this system, or the maximum measured capacity of the discharge pump if a release is to be conducted.)

DF = the Dilution Factor from Step 2.

If  $f_t \geq f_{dx}$ , the release may be made as planned and the flow rate monitor setpoints should be established as in Step 4 (below). Because  $F_{dp}$  is normally very large compared to the maximum discharge pump capacities for the Waste Monitor Tank and the Nuclear Blowdown Monitor Tank, it is extremely unlikely that  $f_t < f_{dx}$ . However, if a situation should arise such that  $f_t < f_{dx}$ , steps must be taken to assure that equation (1) is satisfied prior to making the release. These steps may include decreasing  $f_{dx}$  by decreasing the flow rate of  $f_{dm}$  or  $f_{db}$ , and/or increasing  $F_{dp}$ .

When new candidate flow rates are chosen, the calculations above should be repeated to verify that they combine to form an acceptable release. If they do, the establishment of flow rate monitor setpoints may proceed as follows in Step 4. If they do not, the choice of candidate flow rates must be repeated until an acceptable set is identified.

Note that if  $DF \leq 1$ , the waste tank concentration for which the calculation is being performed includes safety factors in Step 2 and meets the instantaneous release rate limits without further dilution. Even though no dilution would be required, there will be no discharge if minimum dilution flow is not available, since the penstock minimum flow interlock will prevent discharge.

- 4) The dilution flow rate\*, F, is established at 90 percent of the expected available dilution flow rate.
- 5) The radiation monitor setpoints may now be determined based on the values of  $\sum C_i$ , F, and f which were specified to ensure releases are limited to 10 times the values of 10 CFR 20, Appendix B, Table 2, Column 2. The monitor response is primarily to gamma radiation, therefore, the actual setpoint is based on  $\sum C_g$ .

The setpoint concentration, c, is determined as follows:

$$c \leq \sum_g C_g XA \quad (9)$$

A = Adjustment factor which will allow the setpoint to be established in a practical manner for convenience and to prevent spurious alarms.

$$A = f_t / f_{dx} \quad (10)$$

If  $A \geq 1$ , Calculate c and determine the maximum value for the actual monitor setpoint (cpm) from the monitor calibration graph.

---

\* Setpoints for flow rates are administrative limits.

If  $A < 1$ , No release may be made. Reevaluate the alternatives presented in Step 3.

NOTE: If calculated setpoint values are near actual concentrations planned for release, it may be impractical to set the monitor alarm at this value. In this case a new setpoint may be calculated following the remedial methodology presented in Step 3 for the case of  $f_t < f_{dx}$ .

Within the limits of the conditions stated above, the specific monitor setpoint concentrations for the three liquid radiation monitors RM-L5, RM-L7, and RM-L9 are determined as follows:

2.1.2.1 RM-L5, Waste Monitor Tank Discharge Line Monitor:

$$C_M \leq \left[ \sum_g C_g \right] M^{(A)} \quad (11)$$

$C_M$  is in  $\mu\text{Ci/ml}$

\*See GENERAL NOTE under 2.1.

2.1.2.2 RM-L7, Nuclear Blowdown Monitor Tank Discharge Line Monitor:

$$C_B \leq \left[ \sum_g C_g \right] B^{(A)} \quad (12)$$

$C_B$  is in  $\mu\text{Ci/ml}$

NOTE: In no case should discharge be made directly from the Nuclear Blowdown Holdup Tank to the penstocks.

\*See GENERAL NOTE under 2.1.

2.1.2.3 RM-L9, Combined Liquid Waste Processing System and Nuclear Blowdown Waste Effluent Discharge Line Monitor

The monitor setpoint concentration on the common line,  $c_C$ , should be the same as the setpoint

concentration for the monitor on the active individual discharge line (i.e.,  $c_M$ , or  $c_B$  as determined above):

$$C_C \leq \text{MAX} (C_M, C_B) \quad (13)$$

\*See GENERAL NOTE under 2.1.

NOTE: In all cases,  $c_M$ ,  $c_B$ , and  $c_c$  are the setpoint concentration values in  $\mu\text{Ci/ml}$ . The actual monitor setpoints (cpm) for RM-L5, RM-L7, and RM-L9 are determined from the calibration graph for the particular monitor. Initially, the calibration curves were determined conservatively from families of response curves supplied by the monitor manufacturers. A sample is shown in Figure 2.1-1. As releases occur, a historical correlation will be prepared and placed in service when sufficient data are accumulated.

#### 2.1.2.4 RML-5 / RML-9 Alternate Setpoint Methodology

For low gamma activity releases with relatively high tritium concentrations, an alternate setpoint methodology can be used as follows which assumes that the tritium concentrations will not increase greater than the value used in the calculation. The tritium concentration used for the calculation is established based on known plant conditions.

Setpoint concentration,  $c$ , is determined as follows:

$$c \leq \sum_g C_g \times \left[ \frac{\frac{0.9F_t}{f_{dx}}}{\left[ \frac{\sum_{i \neq H-3} \left( \frac{C_i}{10 (ECL_i)} \right) \right]}{SF}} \right] \times C_{f_{H-3}}$$

Where,

$Cf_{H-3}$  = tritium correction factor

$$= \left[ 1 - \left( \frac{C_{H-3}}{\frac{10ECL_{H-3}}{0.9F_t}} \right) \right]$$

$C_{H-3}$  = Concentration of tritium in  $\mu\text{Ci/mL}$

$ECL_{H-3}$  = tritium ECL

### 2.1.3 Liquid Radwaste Discharge Via Industrial and Sanitary Waste System (RM-L5)

In the Virgil C. Summer Nuclear Station liquid waste effluent system design, there exists a mechanism for discharging liquid wastes via the Industrial Sanitary Waste System. The sample point prior to discharge is one of the Waste Monitor Tanks. The analysis requirements are the requirements listed in Table 1.14.

This effluent pathway shall only be used when the following condition is met for all radionuclides, i:

$$[C_i]_M \leq [C_i]_{LLD} \quad (14)$$

$[C_i]_M$  = the concentration of radionuclide i in the waste contained within the Waste Monitor Tank serving as the holding facility for sampling and analysis prior to discharge, in  $\mu\text{Ci/ml}$ .

$[C_i]_{LLD}$  = the Lower Limit of Detection, (LLD) for radionuclide i in the liquid waste in the Waste Monitor Tank as determined by the analysis required in Table 1.1-4, in  $\mu\text{Ci/ml}$ .

When the conditions of equation (14) are met, liquid waste may be released via the Industrial and Sanitary Waste System pathway. The RM-L5 setpoint should be established as close to background as practical to prevent spurious alarms and yet alarm should an inadvertent high concentration release occur.

#### 2.1.4 Steam Generator Blowdown, Turbine Building Sump, and Condensate Demineralizer Backwash Effluent Lines

(RM-L3, RM-L10, RM-L8, RM-L11)

Concentrations of radionuclides in the liquid effluent discharges made via the Turbine Building Sump, Steam Generator Blowdown, and Condensate Demineralizer Backwash are expected to be very low or nondetectable. The first two releases are expected to be continuous in nature and the last a batch release. All will be sampled in an appropriate manner as specified in Table 1.1-4 of the ODCM. The Steam Generator Blowdown Monitors, the Turbine Building Sump Monitor, and the Condensate Demineralizer Backwash Monitor provide alarm and automatic termination.

In reality, all of these effluent pathways utilize the circulating water as dilution to the effluent stream, with the circulating water discharge canal being the point of release into an unrestricted area. Steam Generator Blowdown Effluent may be released to the Circulating Water either directly in the Condenser outflow (the normal flow path) or in the first hours following startup via the Industrial and Sanitary Waste System (ISWS) for chemical reasons. The Turbine Building Sump and Condensate Demineralizer Backwash Effluents enter Circulating Water via the sumps and ponds of the Industrial and Sanitary Waste System.

CO3↓

To ensure compliance with ODCM specification 1.1.2.1, normally no dilution is assumed for discharges to the Industrial and Sanitary Waste System. Additionally, releases are normally limited to 1 ECL to ensure that the conditions of 10 CFR 20.1301 are met. These administrative controls provide assurance that ODCM specification 1.1.2.1 would not be compromised in the event circulating water dilution is lost. To add operational flexibility for abnormal conditions (radionuclide concentration in Turbine Building sump > 1 ECL), discharges from the Turbine Building sump and concentrations in the discharging ponds of the ISWS may exceed the operational objective, 1 ECL, provided circulating water dilution is sufficient to ensure compliance with ODCM specification 1.1.2.1 and liquid effluents are being discharged in compliance with ODCM specification 1.1.4.1.

CO3↑

Two separate setpoint calculations are given for Turbine Building sump discharges (RM-L8). Section 2.1.4.2.1 describes the setpoint calculation normally used, limiting discharges to 1 ECL. Section 2.1.4.4 provides an alternate setpoint methodology which may be used during abnormal conditions. RM-L8 setpoints are considered in compliance with ODCM specification 1.1.1.1 provided the setpoints are adequate to prevent releases in excess of ODCM specification 1.1.2.1.

Two mutually exclusive setpoint calculation processes are outlined below for steam generator blowdown. Section 2.1.4.1 is to be used whenever Steam Generator Blowdown is being released directly to the Circulating Water in the Condenser outflow, which is the normal mode. Section 2.1.4.2 is to be used whenever Steam Generator Blowdown is being released to the Industrial and Sanitary Waste System, or diverted to the Nuclear Blowdown Processing System, both of which are alternate modes.

Normally, water collected by the Nuclear Blowdown Processing System has very low specific activity. This water may be processed to the Turbine Building sump.

NOTE: When Circulating Water is unavailable for effluent dilution and water is being directed to a releasing ISWS pond, releases containing activity above LLD (excluding tritium) should be discouraged via pathways which lead to it. Steam Generator Blowdown should be diverted to the Nuclear Blowdown



Processing System. Condensate Demineralizer Backwash may be diverted to the Turbine Building sump or not released. Turbine Building sump effluent should be processed through temporary demineralizers or diverted to the Excess Liquid Waste Processing System. (These steps are to keep the calculated dose to individuals as low as reasonably achievable.)

An option for directing water from the TBS with specific activity > LLD to a non releasing pond is provided in Section 2.1.4.5.

#### 2.1.4.1 Steam Generator Blowdown Effluent Direct to Circulating Water (Normal Mode)

Equation (1) is again used to assure that effluents are in compliance with the aforementioned specification:

$$10 C_{ECL} \geq \frac{cf}{(F + f)}$$

The available dilution water flow ( $F_{dc}$ ) is dependent upon the mode of operation of the Circulating Water System. Any change in this value will be accounted for in a recalculation of equation (1). The Steam Generator Blowdown flow rate ( $f_{ds}$ ) and the Steam Generator Blowdown monitor setpoints ( $c_{sa}$  and  $c_{sb}$ ) are set to meet the condition of equation (1).

RM-L3, the first monitor in the Steam Generator Blowdown discharge pathway, alarms and terminates release of the stream. The discharge is then automatically diverted to the Nuclear Blowdown Processing System. RM-L10, the last monitor in the Steam Generator Blowdown discharge pathway, alarms and terminates the release. Thus, RM-L10 is redundant to RM-L3 and the setpoint ( $c_{sb}$ ) will be determined in the same manner as RM-L3( $c_{sa}$ ).

The method by which the monitor setpoints are determined is as follows:

- 1) The isotopic concentrations for any release source to be or being released are obtained from the sum of the measured

concentrations as determined in Table 1.1-4. Equation (2) is again employed for this calculation:

$$\sum_i C_i = \sum_g C_g + C_a + C_s + C_t + C_f$$

where:

$\sum_i C_i$  = the sum of the measured concentrations as determined by the analysis of the waste sample, in  $\mu\text{Ci/ml}$ .

$\sum_g C_g$  = the sum of the concentrations  $C_g$  of each measured gamma emitting nuclide observed by gamma-ray spectroscopy of the waste sample, in  $\mu\text{Ci/ml}$ .

$C_a$  = the measured concentration  $C_a$  of alpha emitting composite sample, in  $\mu\text{Ci/ml}$ .

$C_s$  = the measured concentrations of Sr-89 and Sr-90 in liquid waste as determined by analysis of the most recent available quarterly composite sample, in  $\mu\text{Ci/ml}$ .

$C_t$  = the measured concentration of H-3 in liquid waste determined by analysis of the monthly composite sample, in  $\mu\text{Ci/ml}$ .

$C_f$  = the measured concentration of Fe-55 in liquid waste as determined by analysis of the most recent available quarterly composite sample, in  $\mu\text{Ci/ml}$ .

Isotopic concentrations for the Steam Generator Blowdown System effluent, the Turbine Building Sump Effluent, and the Condensate Demineralizer Backwash effluent may be calculated using equation (2).

- 2) Once isotopic concentrations for the Steam Generator Blowdown have been determined, these values are used to calculate a Dilution Factor (DF) which is the ratio of the total dilution flow rate to effluent stream flow rate

required to limit the effluent concentration at the point of discharge to less than 10 times the values in 10 CFR 20, Appendix B, Table 2, Column 2.

$$DF = \left[ \sum_i \frac{C_i}{10(ECL)_i} \right]_s \div SF \quad (15)$$

$$DF = \left[ \sum_g \frac{C_g}{10(ECL)_g} + \frac{C_a}{10(ECL)_a} + \frac{C_s}{10(ECL)_s} + \frac{C_f}{10(ECL)_f} + \frac{C_t}{10(ECL)_t} \right]_s \div SF \quad (16)$$

where:

$C_i$  =  $C_g, C_a, C_s, C_f,$  and  $C_t$ ; measured concentrations as defined in Step 1. Terms  $C_a, C_s, C_f,$  and  $C_t$  will be included in the calculation as appropriate.

$\left[ \sum_i \frac{C_i}{10(ECL)_i} \right]_s$  = the sum of the ratios of the measured concentration of nuclide  $i$  to its limiting value  $ECL_i$  for the Steam Generator Blowdown effluent.

$ECL_i$  =  $ECL_g, ECL_a, ECL_s, ECL_f,$  and  $ECL_t$  are limiting concentrations of the appropriate radionuclide from 10 CFR, Part 20, Appendix B, Table 2, Column 2 limits.

SF = the same generic term as used in Section 2.1.2, Step 2.  
= 0.5

3) The maximum permissible effluent discharge flow rate,  $f_d$ , may now be calculated for a release from the Steam Generator Blowdown. An additional safety factor is used for  $f_d$ . based on 90 percent of the expected flow rate of the Circulating Water System during the time of release.

Based

$$f_d = (0.9) \frac{(F_{dc} + f_{ds})}{DF} \cong \frac{(0.9)F_{dc}}{DF} \text{ for } F_{dc} \gg f_{ds} \quad (17)$$

where:

$F_{dc}$  = Dilution flow rate for use in effluent monitor setpoint calculations, corrected for any recirculated activity:

$$F_{dc} = F_d \left[ 1 - \sum_i \frac{C_{ir}}{10(ECL)_i} \right] \quad (18)$$

where:

$F_d$  = the flow rate of the Circulating Water System during the time of the release.  $F_d$  should normally fall between  $1.78 \times 10^5$  and  $5.34 \times 10^5$  gpm when the plant is operating and should be 5000 gpm when the plant is shutdown and the Circulating Water Jockey pump is operating.

$C_{ir}$  = the concentration of radionuclide  $i$ , in  $\mu\text{Ci/ml}$ , in the Circulating Water System intake, (that is, in the Monticello Reservoir). Inclusion of this term will correct for possible long-term buildup of radioactivity due to recirculation and for the presence of activity recently released to the Monticello Reservoir by plant activities. For expected discharges of liquid wastes, the summation will be much less than 1.0 and can be ignored (Reference 6).

$f_{ds}$  = Flow rate of Steam Generator Blowdown discharge. (This value normally will be either zero, if no release is to be conducted, or the maximum rated capacity of the discharge pump (250 gpm), if a release is to be conducted.)

Note that the equation is valid only for  $DF > 1$ ; for  $DF \leq 1$ , the effluent concentration meets the release criteria without dilution as well as being in compliance with the conservatism imposed by the Safety Factor in Step 2.

If  $f_d \geq f_{ds}$ , releases may be made as planned. Because  $F_{dc}$  is normally very large compared to the maximum discharge pump capacity of the Steam Generator Blowdown System, it is extremely unlikely that  $f_d < f_{ds}$ . However, if a situation should arise such that  $f_d < f_{ds}$ , steps must be taken to assure that equation (1) is satisfied prior to making the release. These steps may include diverting Steam Generator Blowdown to the Nuclear Blowdown Processing System or decreasing the effluent flow rate.

When new candidate flow rates are chosen, the calculations above should be repeated to verify that they combine to form an acceptable release. If they do, the establishment of flow rate monitor setpoints should proceed as follows in Step 4. If they do not provide an acceptable release, the choice of candidate flow rates must be repeated until an acceptable set is identified.

- 4) The dilution flow rate for minimum flow rate,  $F$ , is established at 90 percent of the expected available dilution flow rate.
- 5) The Steam Generator Monitor setpoints may be specified based on the values of  $\sum C_i$ ,  $F$ , and  $f$  which were specified to

limit discharge within 10 times the limits of 10CFR 20, Appendix B, Table 2, Column 2. Since the monitor responds primarily to gamma radiation, therefore, the actual setpoint is based on  $\sum C_g$ . The monitor setpoint in cpm which corresponds to the calculated value  $c$  is taken from the monitor calibration graph. (See NOTE, page 2.0-14.) The setpoint concentration,  $c$ , is determined as follows:

$$c \leq \sum_g C_g \times B \quad (20)$$

$$B = f_d / f_{ds} \quad (21)$$

If  $B \geq 1$ , Calculate  $c$  and determine the maximum value for the actual monitor setpoint (cpm) from the monitor calibration graph.

If  $B < 1$ , No release may be made. Reevaluate the alternatives presented in step 3.

NOTE: If the calculated setpoint value is near actual concentrations being released or planned for release, it may be impractical to set the monitor alarm at this value. In this case a new setpoint may be calculated following the remedial methodology presented in steps 3 and 4 for the case  $f_d < f_{ds}$ .

Within the conditions stated above, the specific monitor setpoint concentrations for the two steam generator blowdown monitors RM-L3 and RM-L10 are calculated as shown on the following page.

2.1.4.1.1 For RM-L3, Steam Generator Blowdown Discharge initial monitor, and for RM-L10, Steam Generator Blowdown Discharge final monitor:

$$c_{Sa} \text{ or } c_{Sb} \leq \left[ \sum_g C_g \right]_S (B) \quad (22)$$

$\left[ \sum_g C_g \right]_S$  = the isotopic concentration of the Steam Generator Blowdown effluent as obtained from the sum of the measured concentrations determined by the analysis required in ODCM Table 1.1-4, in  $\mu\text{Ci/ml}$ .

\*See GENERAL NOTE under 2.1.

#### 2.1.4.2 Turbine Building Sump and Condensate Demineralizer Backwash (Normal Mode)

For conservatism, the Turbine Building Sump and Condensate Demineralizer Backwash monitor setpoints ( $c_T$  and  $c_D$ ) will claim no dilution from the Circulating Water, and will be set at the applicable concentration limit. That is:

$$C_{ECL} \geq c \quad (23)$$

The Turbine Building sump monitor, RM-L8, alarms and terminates release upon exceeding the monitor setpoint ( $c_T$ ). The discharge can then be manually diverted to the Excess Waste Processing System. RM-L11, the Condensate Demineralizer Backwash monitor, alarms and terminates release upon exceeding the monitor setpoint ( $c_D$ ). The discharge may then be manually diverted to the Turbine Building sump or simply delayed.

The Turbine Building Sump and Condensate Demineralizer Backwash monitor setpoints are to be established independently of each other and without crediting dilution. They are to be based on the measured radionuclide concentrations of the effluent stream and are to ensure that discharge concentrations do not exceed the ECLs specified in 10 CFR 20, Appendix B, Table 2, Column 2 prior to discharge.

For each effluent stream, a concentration factor (CF) is calculated by summing the ratios of detected radionuclides in the

effluent stream to the applicable ECLs, the calculated values normalize the effluent mixture to terms of ODCM Control 1.1.2.1 release criteria and includes a safety factor for engineering uncertainty.

$$CF = \left[ \sum_i \frac{C_i}{(ECL)_i} \right] \div SF \quad (24)$$

$$CF_T = \left[ \sum_i \frac{C_i}{(ECL)_i} \right]_T \div SF \quad (25)$$

$$CF_D = \left[ \sum_i \frac{C_i}{(ECL)_i} \right]_D \div SF \quad (26)$$

where:

$\left[ \sum_i \frac{C_i}{(ECL)_i} \right]_T$  = the sum of the ratios of the measured concentration of nuclide i to its limiting value  $ECL_i$  for the Turbine Building sump effluent.

$\left[ \sum_i \frac{C_i}{(ECL)_i} \right]_D$  = the sum of the measured concentration of nuclide i (in liquid only) to its limiting value  $ECL_i$  for the Condensate Demineralizer Backwash effluent.

$CF_T$  = the concentration factor for the Turbine Building Sump Effluent.

$CF_D$  = the concentration factor for the Condensate Demineralizer Backwash Effluent.

SF = the generic engineering safety factor used in Section 2.1.2, Step 2.

= 0.5

If  $CF \leq 1$ , calculate c and determine the actual monitor setpoint (cpm) from the calibration curve.

If  $CF > 1$ , no release may be made via this path. The release must either be delayed, diverted, or processed.



If the concentration factor cannot be reduced to less than or equal to 1, proceed to section 2.1.4.4 or 2.1.4.5 for additional guidance for processing Turbine Building Sump releases.

Within the limits of the conditions stated above, the specific monitor setpoint concentrations for RM-L8 and RM-L11 may now be calculated. Because they are primarily sensitive to gamma radiation, their setpoints will be based on the concentrations of gamma emitting radionuclides as follows:

2.1.4.2.1 For RM-L8, Turbine Building Sump Discharge Monitor:

$$c_T \leq \left[ \sum_g C_g \right] T \div CF_T \quad (27)$$

Where:

- $\left[ \sum_g C_g \right] T$  = The gamma isotopic concentration of the Turbine Building sump effluent as obtained from the sum of the measured concentrations determined by the analysis required in ODCM Table 1.1-4, in  $\mu\text{Ci/ml}$ .
- $CF_T$  = The Turbine Building sump Effluent Concentration Factor from equation (25).

\*See GENERAL NOTE under 2.1.

2.1.4.2.2 For RM-L11, Condensate Demineralizer Backwash Discharge Monitor:

$$c_D \leq \left[ \sum_g C_g \right]_D \div CF_D \quad (28)$$

where:

$\left[ \sum_g C_g \right]_D$  = The gamma isotopic concentration of the Condensate Demineralizer Backwash effluent (including solids) as obtained from the sum of the measured concentrations determined by the analysis required ODCM Table 1.1-4, in  $\mu\text{Ci/ml}$ .

$CF_D$  = The Condensate Demineralizer Backwash Effluent Concentration Factor from equation (26).  
\*See GENERAL NOTE under 2.1.

2.1.4.3 Steam Generator Blowdown Effluent Not Directly to Circulating Water (Alternate Mode)

Equation (23) is again used to assure that effluents are in compliance with the aforementioned specification before dilution in the receiving water:

$$C_{ECL} \geq c$$

Because dilution is not considered in the setpoint calculation, it is not necessary to calculate maximum permissible discharge flow rates or anticipated available dilution flow rate.

The functions of the two monitors whose setpoints are to be established are described in Section 2.1.4.1 above. The method for the determination is as follows:

- 1) If a release is found to be permissible, flow rate monitors for the active effluent streams (Steam Generator Blowdown -  $f_{ds}$ , Turbine Building sump -  $f_{dt}$ , and Condensate Demineralizer -  $f_{dd}$ ) may have their setpoints established at any operationally convenient value.

- 2) The Concentration Factor of equation (24) is again used to ensure the permissibility of the release.

$$CF = \left[ \sum_i \frac{C_i}{(ECL)_i} \right] \div SF$$

$$CF_s = \left[ \sum_i \frac{C_i}{(ECL)_i} \right]_s \div SF \quad (29)$$

All terms are defined in subsection 1.1.3.1 and subscript S refers to the Steam Generator Blowdown Effluent.

If  $CF \leq 1$ , calculate c and determine the actual monitor setpoint (cpm) from the calibration curve.

If  $CF > 1$ , no release may be made via this path. The release must either be delayed or diverted for additional processing.

Within the above limitation, setpoint concentrations may now be calculated for the two effluent monitors. Because they are primarily sensitive to gamma radiation, their setpoints will be based on the concentrations of gamma emitting radionuclides as follows:

- 2.1.4.3.1 For RM-L3, Steam Generator Blowdown Discharge initial monitor, and RML-10, Steam Generator Blowdown Discharge final monitor:

$$c_{Sa} \text{ or } c_{Sb} \leq \left[ \sum_g C_g \right]_s \div CF_s \quad (30)$$

Where:

$\left[ \sum_g C_g \right]_S$  = The isotopic concentration of the Steam Generator Blowdown effluent as obtained from the sum of the measured concentrations determined by the analysis required in ODCM Table 1.1-4, in  $\mu\text{Ci/ml}$ .

$CF_S$  = The Steam Generator Blowdown Effluent Concentration Factor from equation (29).

\*See GENERAL NOTE under 2.1.

#### CO3 → 2.1.4.4 Turbine Building Sump (Abnormal Conditions)

Provided circulating water is available, 1 to 3 circulating water pumps, effluent exceeding 1 ECL may be released from the Turbine Building sump to the industrial and sanitary waste system, using the setpoint in this section, provided the following conditions are met:

- 1) Instantaneous release rate limits of ODCM Specification 1.1.2.1 are not exceeded in the circulating water discharge canal.
- 2) Annual average concentrations of radioactivity in ISWS ponds will not exceed 1 ECL.
- 3) The limits of ODCM specification 1.1.4.1 will not be exceeded with actual liquid effluent releases over a 31 day period.
- 4) Average discharge flow does not exceed values used in setpoint determination.

In addition, the source of radioactivity should be identified and isolated. Radionuclide concentration in Turbine Building sump effluent should be restored to <1 ECL as soon as possible and normal setpoint reestablished. Radionuclide concentration in Pond 6B should be restored to < LLD (excluding tritium) using dilution as necessary (normal flow from the TBS would normally be adequate). Turbine Building sump samples should be obtained and analyzed every twelve hours while the alternate setpoint is being used to ensure that the setpoint remains conservative with respect to the isotopic mixture and to ensure offsite doses are within ODCM limits.

Alternate setpoint methodology for Turbine Building sump (RM-L8) is available to ensure operational flexibility in the event radioactivity is detected in the Turbine Building sump > 1 ECL and the release would result in minimal offsite dose. The alternate setpoint methodology is not intended to be used continuously. To remove restrictions on operation of circulating water, pond concentrations should be restored to < LLD as soon as possible. The setpoint methodology follows:

2.1.4.4.1 For RM-L8, Turbine Building Sump (alternate methodology)

$$c_T \leq \frac{\sum C_g}{CF_T} \times \frac{1}{F_k} \quad (57)$$

where,

$$F_k = \text{The near field dilution factor for } C_i \text{ during release from Turbine Building sump.}$$

$$= \frac{\text{(average undiluted waste flow)}}{\text{(average flow from discharge structure)}}$$

For purpose of implementing section 2.1.4.4 release condition 2, the following must be satisfied.

$$\frac{\sum_{j=1}^n \left[ \left[ \sum_{i=1}^x (C_i / ECL_i) \right]_{T_j} * V_j \right]}{\sum_{j=1}^n V_j} < 1.0 \quad (58)$$

where,  $[\sum(C_i/ECL_i)]_{T_j}$  = the sum of the ratios of the measured concentration of nuclide  $i$  to its limiting value  $ECL_i$  for the Turbine Building sump effluent for release permit  $j$ , including proposed permit,

$V_j$  = Release volume for Turbine Building sump release permit  $j$  (gal), and

$j$  = index for batch release permits during the calendar year.

#### 2.1.4.5 Turbine Building Sump - Special Considerations During Station Shutdowns

During periods in which circulating water (CW) is not available for diluting Turbine Building Sump (TBS) discharges, effluent from the TBS may be directed to a non-releasing pond and offsite dose calculations required by Specification 1.1.3.1 deferred until CW is restored. RM-L8 setpoint requirement specified by Specification 1.1.1.1 is not applicable when directing water from the TBS to a non-releasing ISWS pond provided the following conditions are met.

- 1) Sufficient freeboard is available in the non-releasing pond to ensure that pond contents will not be released to the CW discharge canal prior to reestablishing CW flow.
- 2) Release of ISWS contents will be in compliance with Specifications 1.1.2.1, 1.1.3.1 and 1.1.4.1 once CW flow has been reestablished.
- 3) ISWS pond radioactivity will not exceed 1 ECL.
- 4) TBS samples are obtained and analyzed every 12 hours while water is being directed to a non-releasing pond.
- 5) Sample non-releasing pond within 12 hours of adding water > 1 ECL and every 12 hours thereafter while TBS discharge concentrations exceed 1 ECL.

Once samples have been obtained and release acceptability determined, RM-L8 setpoint may be increased to 2 times indication to allow release of sump contents to a non-releasing pond.

Demonstrating compliance with item 3 can be performed by calculations using TBS samples and discharge volumes or by sampling ISWS ponds.

**Figure 2.1-1**  
**Example Liquid Effluent Monitor**  
**Calibration Curve**

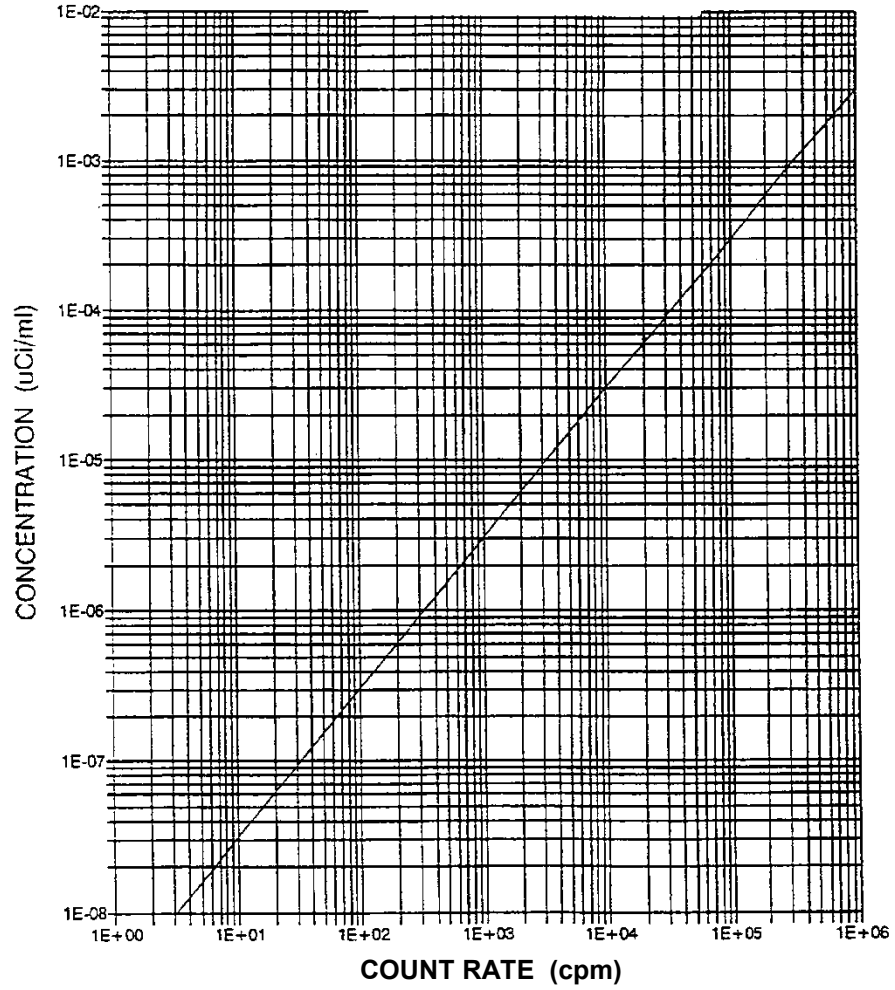

## 2.2 Dose Calculation for Liquid Effluents

The method of this section is to be used in all cases for calculating doses to individuals from routine liquid effluents. Five notes at the end of the section confirm the values which certain parameters are to be assigned in some special cases.

### 2.2.1 Liquid Effluent Dose Calculation Parameters

<u>Term</u>	<u>Definition</u>	<u>Section of Initial Use</u>
$A_{i\tau}$	= the site related ingestion dose commitment factor to the total body or any organ $\tau$ , for each identified principal gamma and beta emitter listed in Table 2.2-3 in mrem-ml per hr- $\mu$ Ci.	2.2.2
$BF_i$	= Bioaccumulation Factor for nuclide $i$ , in fish, pCi/Kg per pCi/l, from Table 2.2-1.	2.2.2
$C_{ik}$	= the average concentration of radionuclide, $i$ , in undiluted liquid effluent during time period $\Delta t_k$ from any liquid released, in $\mu$ Ci/ml.	2.2.2
$DF_{i\tau}$	= a dose conversion factor for nuclide, $i$ , for adults in preselected organ, $\tau$ , in mrem/pCi found in Table 2.2-2.	2.2.2
$D_\tau$	= the cumulative dose commitment to the total body or any organ, $\tau$ , from the liquid effluents for the total time period, $\Sigma\Delta t_k$ in mrem (Ref. 1).	2.2.2
$D_w$	= Dilution Factor from the near field area within one-quarter mile of the release points to the potable water intake for adult water consumption; for V. C. Summer, $D_w = 1$ .	2.2.2
$F_k$	= the near field average dilution factor for $C_{ik}$ during any liquid effluent release.	2.2.2
$K_o$	= $1.14 \times 10^5$ , units conversion factor = $(10^6 \text{ pCi}/\mu\text{Ci}) (10^3 \text{ ml/l}) \div 8760 \text{ hr/yr}$	2.2.2
$\Delta t_k$	= the length (in hours) of a time period over which concentrations and flow rates are averaged for dose calculations.	2.2.2
$U_F$	= 21 kg/yr, fish consumption (adult) (Reference 3).	2.2.2
$U_w$	= 730 kg/yr, water consumption (adult) (Reference 3).	2.2.2
$Z$	= applicable near-field dilution factor when no additional dilution is to be considered; $Z = 1$ .	2.2.2



### 2.2.2 Methodology

The dose contribution from all radionuclides identified in liquid effluents released to unrestricted areas is calculated using the following expression:

$$D_{\tau} = \sum_i \left[ A_{i\tau} \sum_{k=1}^{\Delta t_k} C_{ik} F_k \right] \quad (31)$$

$$A_{i\tau} = K_o \left( (U_w / D_w) + U_F B F_i \right) D F_{i\tau} \quad (32)$$

$$F_k = \frac{\text{(average undiluted liquid waste flow)}}{\text{(average flow from the discharge structure) (Z)}} \quad (33)$$

NOTE 1: If radioactivity in the Monticello Reservoir ( $C_{ir}$ ) becomes  $>$  the LLD specified in ODCM, Table 1.1-4, that concentration must be included in the Dose determination. For this part of the dose calculation,  $F_k = 1$  and  $\Delta t_k =$  the entire time period for which the dose is being calculated.

NOTE 2: Prior to termination of Circulating Water Pumps, an assessment of the dose resulting from pond radioactivity concentrations and discharge flow rates from the Industrial And Sanitary Waste System (ISWS) will be performed as follows. Sampling of the liquid in the ISWS will be initiated, and the measured concentrations of radionuclides will be used in the dose calculations with  $F_k = 1$  and  $\Delta t_k =$  the entire time period for which the dose is being calculated.

NOTE 3: For releases through the ISWS pathway when circulating water is not available, dose projections for assessment of release acceptability should be based on the most representative samples obtained from in plant sumps. Normally sump samples are also used to assess actual release. However, due to the ultraconservative assumptions when circulating water is not available, i.e. dose calculations are based on radioactive material concentration in the discharge stream regardless of release volume, representative samples from the ISWS may be used to evaluate impact of releases.

NOTE 4: During periods when the Circulating Water Pumps are in operation, any releases to the ISWS are to be credited with dilution in Circulating Water for dose calculation purposes, even though such dilution is normally not claimed in the setpoint calculation. When taken in union with the note above, this procedure results in some overestimation of dose to the population because discharges made to the ISWS just before loss of Circulating Water will be counted twice in the dose calculation process.

NOTE 5: If radioactivity in the Service Water becomes > LLD as determined by the analysis required by ODCM, Table 1.1-4, that concentration must be included in the Dose determination. For this part of the dose calculation,  $F_k = 1$  and  $\Delta t_k =$  the entire time since the last Service Water sample was taken.

## 2.3 Liquid Effluent Releases through the Neutralization Basin

Releases of slightly contaminated liquids from pathways feeding the Neutralization Basin (Pond 007) through Circulating Water (CW) may be made under strictly controlled conditions. Releases from these pathways (e.g., NaOH sump, RWST sump) will be allowed if the following conditions are adhered to in controlling the radioactive materials released.

### 2.3.1 Rainwater Tank

Rainwater collected in the RWST sump is pumped to the RWST Pit Drain Tank (Rainwater Tank) for analysis and subsequent release. Normally the rainwater is sampled, found to contain no detectable radioactivity, and is released to the environment via the storm drain system. If measurable amounts of radioactive materials are found in Rainwater Tank samples, the tank may be pumped to a Waste Monitor Tank and released without processing. In order to allow for operational flexibility, the Rainwater Tank containing radioactive materials may be drained to the NaOH sump and discharged to the circulating water (CW) system via the Neutralization basin (007). The following constraints are to be applied for releases through this pathway:

- (1) At least one CW pump must be used for dilution to release through this pathway.
- (2) Chemistry Services must be notified to verify that conditions in the Neutralization Basin are such that additions to the basin can be made.
- (3) Using the Rainwater Tank analysis and available circulating water, a release calculation must be performed that shows that releases will be less than  $6.0E-4$  mrem (whole body) and  $2.0E-3$  mrem (any organ). These limits represent 1% of unprocessed effluent 31-day dose limits (ODCM Section 1.1.4.1).

- (4) If these limits are met, the Rainwater Tank may be drained through the NaOH sump to the Neutralization Basin. Chemistry will then release the Neutralization Basin contents through circulating water as soon as possible once their procedural and NPDES release criteria are met.

### 2.3.2 NaOH Spray Tank and Stored NaOH

- (1) The same limits and conditions as 2.3.1(1-4) apply for releases from the NaOH sump.
- (2) Samples should be obtained and analyzed during performance of NaOH Spray Tank activities that require the draining of NaOH from the tank or sight glass.
- (3) If the sample show concentrations of radionuclides that would exceed the dose limits above and the tank must have liquid removed from it, the contaminated NaOH may be drained to appropriate holding containers for temporary storage. Once the conditions for release become favorable (e.g. return of CW), the containers used for temporary storage may be sampled and analyzed for release. If the dose limitations in 2.3.1 (3) are met and Chemistry approval is obtained, a release permit is generated and the containers can be drained through the NaOH sump or emptied directly to the Neutralization Basin for release through CW.

**TABLE 2.2-1**  
**BIOACCUMULATION FACTORS\***  
 (pCi/kg per pCi/liter)

<u>ELEMENT</u>	<u>FRESHWATER FISH</u>
H	9.0E- 01
C	4.6E 03
F	1.0E 01
Na	1.0E 02
P	1.0E 05
Cr	2.0E 02
Mn	4.0E 02
Fe	1.0E 02
Co	5.0E 01
Ni	1.0E 02
Cu	5.0E 01
Zn	2.0E 03
Br	4.2E 02
Rb	2.0E 03
Sr	3.0E 01
Y	2.5E 01
Zr	3.3E 00
Nb	3.0E 04
Mo	1.0E 01
Tc	1.5E 01
Ru	1.0E 01
Rh	1.0E 01
Sb	1.0E 00
Te	4.0E 02
I	1.5E 01
Cs	2.0E 03
Ba	4.0E 00
La	2.5E 01
Ce	1.0E 00
Pr	2.5E 01
Nd	2.5E 01
W	1.2E 03
Np	1.0E 01

\*Values in Table 2.2-1 are taken from Reference 3, Table A-1.

TABLE 2.2-2  
Page 1 of 2  
ADULT INGESTION DOSE FACTORS\*  
(mrem/pCi ingested)

NUCLIDE	BONE	LIVER	T-BODY	THYROID	KIDNEY	LUNG	GI-LLI
H-3	NO DATA	1.05E-07	1.05E-07	1.05E-07	1.05E-07	1.05E-07	1.05E-07
C-14	2.84E-06	5.68E-07	5.68E-07	5.68E-07	5.68E-07	5.68E-07	5.68E-07
†F-18	6.24E-07	NO DATA	6.92E-08	NO DATA	NO DATA	NO DATA	1.85E-08
NA-24	1.70E-06	1.70E-06	1.70E-06	1.70E-06	1.70E-06	1.07E-06	1.70E-06
P-32	1.93E-04	1.20E-05	7.46E-06	NO DATA	NO DATA	NO DATA	2.17E-05
CR-51	NO DATA	NO DATA	2.66E-09	1.59E-09	5.86E-10	3.53E-09	6.69E-07
MN-54	NO DATA	4.57E-06	8.72E-07	NO DATA	1.36E-06	NO DATA	1.40E-05
MN-56	NO DATA	1.15E-07	2.04E-08	NO DATA	1.46E-07	NO DATA	3.67E-06
FE-55	2.75E-06	1.90E-06	4.43E-07	NO DATA	NO DATA	1.06E-06	1.09E-06
FE-59	4.34E-06	1.02E-05	3.91E-06	NO DATA	NO DATA	2.85E-06	3.40E-05
†CO-57	NO DATA	1.75E-07	2.91E-07	NO DATA	NO DATA	NO DATA	4.44E-06
CO-58	NO DATA	7.45E-07	1.67E-06	NO DATA	NO DATA	NO DATA	1.51E-05
CO-60	NO DATA	2.14E-06	4.72E-06	NO DATA	NO DATA	NO DATA	4.02E-05
NI-63	1.30E-04	9.01E-06	4.36E-06	NO DATA	NO DATA	NO DATA	1.88E-06
NI-65	5.28E-07	6.86E-08	3.13E-08	NO DATA	NO DATA	NO DATA	1.74E-06
CU-64	NO DATA	8.33E-08	3.91E-08	NO DATA	2.10E-07	NO DATA	7.10E-06
ZN-65	4.84E-06	1.54E-05	6.96E-06	NO DATA	1.03E-05	NO DATA	9.70E-06
ZN-69	1.03E-08	1.97E-08	1.37E-09	NO DATA	1.28E-08	NO DATA	2.96E-09
†Zn-69m†	1.70E-07	4.08E-07	3.73E-08	NO DATA	2.47E-07	NO DATA	2.49E-05
†BR-82	NO DATA	NO DATA	2.26E-06	NO DATA	NO DATA	NO DATA	2.59E-06
BR-83†	NO DATA	NO DATA	4.02E-08	NO DATA	NO DATA	NO DATA	5.79E-08
BR-84	NO DATA	NO DATA	5.21E-08	NO DATA	NO DATA	NO DATA	4.09E 13
BR-85	NO DATA	NO DATA	2.14E-09	NO DATA	NO DATA	NO DATA	LT E-24**
RB-86	NO DATA	2.11E-05	9.83E-06	NO DATA	NO DATA	NO DATA	4.16E-06
RB-88	NO DATA	6.05E-8	3.21E-08	NO DATA	NO DATA	NO DATA	8.36E-19
RB-89†	NO DATA	4.01E-8	2.82E-08	NO DATA	NO DATA	NO DATA	2.33E-21
SR-89†	3.08E-04	NO DATA	8.84E-06	NO DATA	NO DATA	NO DATA	4.94E-05
SR-90†	7.58E-03	NO DATA	1.86E-03	NO DATA	NO DATA	NO DATA	2.19E-04
SR-91†	5.67E-06	NO DATA	2.29E-07	NO DATA	NO DATA	NO DATA	2.70E-05
SR-92†	2.15E-06	NO DATA	9.30E-08	NO DATA	NO DATA	NO DATA	4.26E-05
Y-90	9.62E-09	NO DATA	2.58E-10	NO DATA	NO DATA	NO DATA	1.02E-04
Y-91M†	9.09E-11	NO DATA	3.52E-12	NO DATA	NO DATA	NO DATA	2.67E-10
Y-91	1.41E-07	NO DATA	3.77E-09	NO DATA	NO DATA	NO DATA	7.76E-05
Y-92	8.45E-10	NO DATA	2.47E-11	NO DATA	NO DATA	NO DATA	1.48E-05
Y-93	2.68E-09	NO DATA	7.40E-11	NO DATA	NO DATA	NO DATA	8.50E-05
ZR-95†	3.04E-08	9.75E-09	6.60E-09	NO DATA	1.53E-08	NO DATA	3.09E-05
ZR-97†	1.68E-09	3.39E-10	1.55E.10	NO DATA	5.12E-10	NO DATA	1.05E-04
NB-95	6.22E-09	3.46E-09	1.86E-09	NO DATA	3.42E-09	NO DATA	2.10E-05
†NB-97	5.22E-11	1.32E-11	4.82E-12	NO DATA	1.54E-11	NO DATA	4.87E-08
MO-99†	NO DATA	4.31E-06	8.20E-07	NO DATA	9.76E-06	NO DATA	9.99E-06

† Daughter contributions are included (see Reference 13).

‡ Values taken from Reference 13, Table 4.

\* Values other than those footnoted in Table 2.2-2 are taken from Reference 3, Table E-11.

\*\* Less than E-24.

TABLE 2.2-2 (continued)

Page 2 of 2

NUCLIDE	BONE	LIVER	T-BODY	THYROID	KIDNEY	LUNG	GI-LLI
TC-99M	2.47E-10	6.98E-09	8.89E-09	NO DATA	1.06E-08	3.42E-10	4.13E-07
TC-101	2.54E-10	3.66E-10	3.59E-09	NO DATA	6.59E-09	1.87E-10	1.10E-21
RU-103‡	1.85E-07	NO DATA	7.97E-08	NO DATA	7.06E-07	NO DATA	2.16E-05
RU-105‡	1.54E-08	NO DATA	6.08E-07	NO DATA	1.99E-07	NO DATA	9.42E-06
RU-106‡	2.75E-06	NO DATA	3.48E-07	NO DATA	5.31E-06	NO DATA	1.78E-04
AG-110M‡	1.60E-07	1.48E-07	8.79E-08	NO DATA	2.91E-07	NO DATA	6.04E-05
‡SB-124	2.80E-06	5.29E-08	1.11E-06	6.79E-09	NO DATA	2.18E-06	7.95E-05
‡ST-125	1.79E-06	2.00E-08	4.26E-07	1.82E-09	NO DATA	1.38E-06	1.97E-05
‡SB-126	1.15E-06	2.34E-08	4.15E-07	7.04E-09	NO DATA	7.05E-07	9.40E-05
‡SB-127	2.58E-07	5.65E-09	9.90E-08	3.10E-09	NO DATA	1.53E-07	5.90E-05
TE-125M	2.68E-06	9.71E-07	3.59E-07	8.06E-07	1.09E-05	NO DATA	1.07E-05
TE-127M‡	6.77E-06	2.42E-06	8.25E-07	1.73E-06	2.75E-05	NO DATA	2.27E-05
TE-127	1.10E-07	3.95E-08	2.38E-08	8.15E-08	4.48E-07	NO DATA	8.68E-06
TE-129M‡	1.15E-05	4.29E-06	1.82E-06	3.95E-06	4.80E-05	NO DATA	5.79E-05
TE-129	3.14E-08	1.18E-08	7.65E-09	2.41E-08	1.32E-07	NO DATA	2.37E-08
TE-131M‡	1.73E-06	8.46E-07	7.05E-07	1.34E-06	8.57E-06	NO DATA	8.40E-05
TE-131‡	1.97E-08	8.23E-09	6.22E-09	1.62E-08	8.63E-08	NO DATA	2.79E-09
TE-132‡	2.52E-06	1.63E-06	1.53E-06	1.80E-06	1.57E-05	NO DATA	7.71E-05
I-130	7.56E-07	2.23E-06	8.80E-07	1.89E-04	3.48E-06	NO DATA	1.92E-06
I-131‡	4.16E-06	5.95E-06	3.41E-06	1.95E-03	1.02E-05	NO DATA	1.57E-06
I-132	2.03E-07	5.43E-07	1.90E-07	1.90E-05	8.65E-07	NO DATA	1.02E-07
I-133‡	1.42E-06	2.47E-06	7.53E-07	3.63E-04	4.31E-06	NO DATA	2.22E-06
I-134	1.06E-07	2.88E-07	1.03E-07	4.99E-06	4.58E-07	NO DATA	2.51E-10
I-135‡	4.43E-07	1.16E-06	4.28E-07	7.65E-05	1.86E-06	NO DATA	1.31E-06
CS-134	6.22E-05	1.48E-04	1.21E-04	NO DATA	4.79E-05	1.59E-05	2.59E-06
CS-136	6.51E-06	2.57E-05	1.85E-05	NO DATA	1.43E-05	1.96E-06	2.92E-06
CS-137‡	7.97E-05	1.09E-04	7.14E-05	NO DATA	3.70E-05	1.23E-05	2.11E-06
CS-138	5.52E-08	1.09E-07	5.40E-08	NO DATA	8.01E-08	7.91E-09	4.65E-13
BA-139	9.70E-08	6.91E-11	2.84E-09	NO DATA	6.46E-11	3.92E-11	1.72E-07
BA-140‡	2.03E-05	2.55E-08	1.33E-06	NO DATA	8.67E-09	1.46E-08	4.18E-05
BA-141‡	4.71E-08	3.56E-11	1.59E-09	NO DATA	3.31E-11	2.02E-11	2.22E-17
BA-142‡	2.13E-08	2.19E-11	1.34E-09	NO DATA	1.85E-11	1.24E-11	3.00E-26
LA-140	2.50E-09	1.26E-09	3.33E-10	NO DATA	NO DATA	NO DATA	9.25E-05
LA-142	1.28E-10	5.82E-11	1.45E-11	NO DATA	NO DATA	NO DATA	4.25E-07
CE-141	9.36E-09	6.33E-09	7.18E-10	NO DATA	2.94E-09	NO DATA	2.42E-05
CE-143‡	1.65E-09	1.22E-06	1.35E-10	NO DATA	5.37E-10	NO DATA	4.56E-05
CE-144‡	4.88E-07	2.04E-07	2.62E-08	NO DATA	1.21E-07	NO DATA	1.65E-04
PR-143	9.20E-09	3.69E-09	4.56E-10	NO DATA	2.13E-09	NO DATA	4.03E-05
PR-144	3.01E-11	1.25E-11	1.53E-12	NO DATA	7.05E-12	NO DATA	4.33E-18
ND-147‡	6.29E-09	7.27E-09	4.35E-10	NO DATA	4.25E-09	NO DATA	3.49E-05
W-187	1.03E-07	8.61E-08	3.01E-08	NO DATA	NO DATA	NO DATA	2.82E-05
NP-239	1.19E-09	1.17E-10	6.45E-11	NO DATA	3.65E-10	NO DATA	2.40E-05

**TABLE 2.2-3**  
**SITE RELATED INGESTION**  
**DOSE COMMITMENT FACTOR, A<sub>ii</sub>\***  
(mrem/hr per  $\mu$ Ci/ml)  
Page 1 of 2

NUCLIDE	BONE	LIVER	T-BODY	THYROID	KIDNEY	LUNG	GI-LLI
H-3	NO DATA	8.96E + 00	8.96E + 00	8.96E + 00	8.96E + 00	8.96E + 00	8.96E + 00
C-14	3.15E + 04	6.30E + 03	6.30 + 03	6.30E + 03	6.30E + 03	6.30E + 03	6.30E + 03
F-18	6.69E + 01	NO DATA	7.42E + 00	NO DATA	NO DATA	NO DATA	1.98E + 00
NA-24	5.48E + 02	5.48E + 02	5.48E + 02	5.48E + 02	5.48E + 02	5.48E + 02	5.48E + 02
P-32	4.62E + 07	2.87E + 06	1.79E + 06	NO DATA	NO DATA	NO DATA	5.20E + 06
CR-51	NO DATA	NO DATA	1.49E + 00	8.94E-01	3.29E-01	1.98E + 00	3.76E + 02
MN-54	NO DATA	4.76E + 03	9.08E + 02	NO DATA	1.42E + 03	NO DATA	1.46E + 04
MN-56	NO DATA	1.20E + 02	2.12E + 01	NO DATA	1.52E + 02	NO DATA	3.82E + 03
FE-55	8.87E + 02	6.13E + 02	1.43E + 02	NO DATA	NO DATA	3.42E + 02	3.52E + 02
FE-59	1.40E + 03	3.29E + 03	1.26E + 03	NO DATA	NO DATA	9.19E + 02	1.10E + 04
CO-57	NO DATA	3.55E + 01	5.91E + 01	NO DATA	NO DATA	NO DATA	9.01E + 02
CO-58	NO DATA	1.51E + 02	3.39E + 02	NO DATA	NO DATA	NO DATA	3.06E + 03
CO-60	NO DATA	4.34E + 02	9.58E + 02	NO DATA	NO DATA	NO DATA	8.16E + 03
NI-63	4.19E + 04	2.91E + 03	1.41E + 03	NO DATA	NO DATA	NO DATA	6.07E + 02
NI-65	1.70E + 02	2.21E + 01	1.01E + 01	NO DATA	NO DATA	NO DATA	5.61E + 02
CU-64	NO DATA	1.69E + 01	7.93E + 00	NO DATA	4.26E + 01	NO DATA	1.44E + 03
ZN-65	2.36E + 04	7.50E + 04	3.39E + 04	NO DATA	5.02E + 04	NO DATA	4.73E + 04
ZN-69	5.02E + 01	9.60E + 01	6.67E + 00	NO DATA	6.24E + 01	NO DATA	1.44E + 01
Zn-69m‡	8.28E + 02	1.99E + 03	1.82E + 02	NO DATA	1.20E + 03	NO DATA	1.21E + 05
BR-82	NO DATA	NO DATA	2.46E + 03	NO DATA	NO DATA	NO DATA	2.82E + 03
BR-83‡	NO DATA	NO DATA	4.38E + 01	NO DATA	NO DATA	NO DATA	6.30E + 01
BR-84	NO DATA	NO DATA	5.67E + 01	NO DATA	NO DATA	NO DATA	4.45E - 04
RB-85	NO DATA	NO DATA	2.33E + 00	NO DATA	NO DATA	NO DATA	1.09E - 15
RB-86	NO DATA	1.03E + 05	4.79E + 04	NO DATA	NO DATA	NO DATA	2.03E + 04
RB-88	NO DATA	2.95E + 02	1.56E + 02	NO DATA	NO DATA	NO DATA	4.07E - 09
RB-89‡	NO DATA	1.95E + 02	1.37E + 02	NO DATA	NO DATA	NO DATA	1.13E - 11
SR-89‡	4.78E + 04	NO DATA	1.37E + 03	NO DATA	NO DATA	NO DATA	7.66E + 03
SR-90‡	1.18E + 06	NO DATA	2.88E + 05	NO DATA	NO DATA	NO DATA	3.48E + 04
SR-91‡	8.79E + 02	NO DATA	3.55E + 01	NO DATA	NO DATA	NO DATA	4.19E + 03
SR-92‡	3.33E + 02	NO DATA	1.44E + 01	NO DATA	NO DATA	NO DATA	6.60E + 03
Y-90	1.38E + 00	NO DATA	3.69E - 02	NO DATA	NO DATA	NO DATA	1.46E + 04
Y-91M‡	1.30E - 02	NO DATA	5.04E - 04	NO DATA	NO DATA	NO DATA	3.82E - 02
Y-91	2.02E + 01	NO DATA	5.39E - 01	NO DATA	NO DATA	NO DATA	1.11E + 04
Y-92	1.21E - 01	NO DATA	3.53E - 03	NO DATA	NO DATA	NO DATA	2.12E + 03
Y-93	3.83E - 01	NO DATA	1.06E - 02	NO DATA	NO DATA	NO DATA	1.22E + 04
ZR-95‡	2.77E + 00	8.88E - 01	6.01E - 01	NO DATA	1.39E + 00	NO DATA	2.82E + 03
ZR-97‡	1.53E - 01	3.09E - 02	1.41E - 02	NO DATA	4.67E - 02	NO DATA	9.57E + 03
NB-95	4.47E + 02	2.49E + 02	1.34E + 02	NO DATA	2.46E + 02	NO DATA	1.51E + 06
NB-97	3.75E + 00	9.49E - 01	3.47E - 01	NO DATA	1.11E + 00	NO DATA	3.50E + 03

‡ Daughter contributions are included (see Reference 13).

\*Calculated using equation (32) and Tables 2.2-1 and 2.2-2



**TABLE 2.2-3**  
**SITE RELATED INGESTION**  
**DOSE COMMITMENT FACTOR, A<sub>ir</sub>\***  
(mrem/hr per μCi /ml)  
Page 2 of 2

NUCLIDE	BONE	LIVER	T-BODY	THYROID	KIDNEY	LUNG	GI-LLI
MO-99‡	NO DATA	4.62E + 02	8.79E + 01	NO DATA	1.05E + 03	NO DATA	1.07E + 03
TC-99M	2.94E-02	8.32E - 02	1.06E - 00	NO DATA	1.26E + 00	4.07E - 02	4.92E + 01
TC-101	3.03E - 02	4.36E - 02	4.28E - 01	NO DATA	7.85E - 01	2.23E - 02	1.31E - 13
RU-103‡	1.98E + 01	NO DATA	8.54E - 01	NO DATA	7.57E + 01	NO DATA	2.31E + 03
RU-105‡	1.65E + 00	NO DATA	6.52E - 01	NO DATA	2.13E + 01	NO DATA	1.01E + 03
RU-106‡	2.95E + 02	NO DATA	3.73E + 01	NO DATA	5.69E + 02	NO DATA	1.91E + 04
AG-110M‡	1.42E + 01	1.31E + 01	7.80E + 00	NO DATA	2.58E + 01	NO DATA	5.36E + 03
SB-124	2.40E + 02	4.53E + 00	9.50E + 01	5.81E-01	NO DATA	1.87E + 02	6.81E + 03
SB-125‡	1.53E + 02	1.71E + 00	3.65E + 01	1.56E-01	NO DATA	1.18E + 02	1.69E + 03
SB-126	9.85E + 01	2.00E + 00	3.55E + 01	6.03E-01	NO DATA	6.04E + 01	8.05E + 03
SB-127	2.21E + 01	4.84E-01	8.47E + 00	2.65E-01	NO DATA	1.31E + 01	5.05E + 03
TE-125M	2.79E + 03	1.01E + 03	3.74E + 02	8.39E + 02	1.13E + 04	NO DATA	1.11E + 04
TE-127M‡	7.05E + 03	2.52E + 03	8.59E + 02	1.80E + 03	2.86E + 04	NO DATA	2.36E + 04
TE-127	1.14E + 02	4.11E + 01	2.48E + 01	8.48E + 01	4.66E + 02	NO DATA	9.03E + 03
TE-129M‡	1.20E + 04	4.47E + 03	1.89E + 03	4.11E + 03	5.00E + 04	NO DATA	6.03E + 04
TE-129	3.27E + 01	1.23E + 01	7.96E + 00	2.51E + 01	1.37E + 02	NO DATA	2.47E + 01
TE-131M‡	1.88E + 03	8.81E + 02	7.34E + 02	1.39E + 01	8.92E + 03	NO DATA	8.74E + 04
TE-131‡	2.05E + 01	8.57E + 00	6.47E + 00	1.69E + 01	8.98E + 01	NO DATA	2.90E + 00
TE-132‡	2.62E + 03	1.70E + 03	1.59E + 03	1.87E + 03	1.63E + 04	NO DATA	8.02E + 04
I-130	9.01E + 01	2.66E + 02	1.05E + 02	2.25E + 04	4.15E + 02	NO DATA	2.29E + 02
I-131‡	4.96E + 02	7.09E + 02	4.06E + 02	2.32E + 05	1.22E + 03	NO DATA	1.87E + 02
I-132	2.42E + 01	6.47E + 01	2.26E + 01	2.26E + 03	1.03E + 02	NO DATA	1.22E + 01
I-133‡	1.69E + 02	2.94E + 02	8.97E + 01	4.32E + 04	5.13E + 02	NO DATA	2.64E + 02
I-134	1.26E + 01	3.43E + 01	1.23E + 01	5.94E + 02	5.46E + 01	NO DATA	2.99E - 02
I-135‡	5.28E + 01	1.38E + 02	5.10E + 01	9.11E + 03	2.22E + 02	NO DATA	1.56E + 02
CS-134	3.03E + 05	7.21E + 05	5.89E + 05	NO DATA	2.33E + 05	7.75E + 04	1.26E + 04
CS-136	3.17E + 04	1.25E + 05	9.01E + 04	NO DATA	6.97E + 04	9.55E + 03	1.42E + 04
CS-137‡	3.88E + 05	5.31E + 05	3.48E + 05	NO DATA	1.80E + 05	5.99E + 04	1.03E + 04
CS-138	2.69E + 02	5.31E + 02	2.63E + 02	NO DATA	3.90E + 02	3.85E + 01	2.27E - 03
BA-139	9.00E + 00	6.41E - 03	2.64E - 01	NO DATA	5.99E - 03	3.64E - 03	1.60E + 01
BA-140‡	1.88E + 03	2.37E + 00	1.23E + 02	NO DATA	8.05E - 01	1.35E + 00	3.88E + 03
BA-141‡	4.27E + 00	3.30E - 03	1.48E - 01	NO DATA	3.07E - 03	1.87E - 03	2.06E - 09
BA-142‡	1.98E + 00	2.03E - 03	1.24E - 01	NO DATA	1.72E - 03	1.15E - 03	2.78E - 18
LA-140	3.58E - 01	1.80E - 01	4.76E - 02	NO DATA	NO DATA	NO DATA	1.32E + 04
LA-142	1.83E - 02	8.33E - 03	2.07E - 03	NO DATA	NO DATA	NO DATA	6.08E + 01
CE-141	8.01E - 01	5.42E - 01	6.15E - 02	NO DATA	2.52E - 01	NO DATA	2.07E + 03
CE-143‡	1.41E - 01	1.04E + 02	1.16E - 02	NO DATA	4.60E - 02	NO DATA	3.90E + 03
CE-144‡	4.18E + 01	1.77E + 01	2.24E + 00	NO DATA	1.04E + 01	NO DATA	1.41E + 04
PR-143	1.32E + 00	5.28E - 011	6.52E - 02	NO DATA	3.05E - 01	NO DATA	5.77E + 03
PR-144	4.31E - 03	1.79E - 03	2.19E - 04	NO DATA	1.01E - 03	NO DATA	6.19E - 10
ND-147‡	9.00E - 01	1.04E + 00	6.22E - 02	NO DATA	6.08E - 01	NO DATA	4.99E + 03
W-187	3.04E + 02	2.55E + 02	8.90E + 01	NO DATA	NO DATA	NO DATA	8.34E + 04
NP-239	1.28E - 01	1.25E - 02	6.91E - 03	NO DATA	3.91E - 02	NO DATA	2.57E + 03

LIQUID RADWASTE TREATMENT SYSTEM  
FIGURE 2-2-1

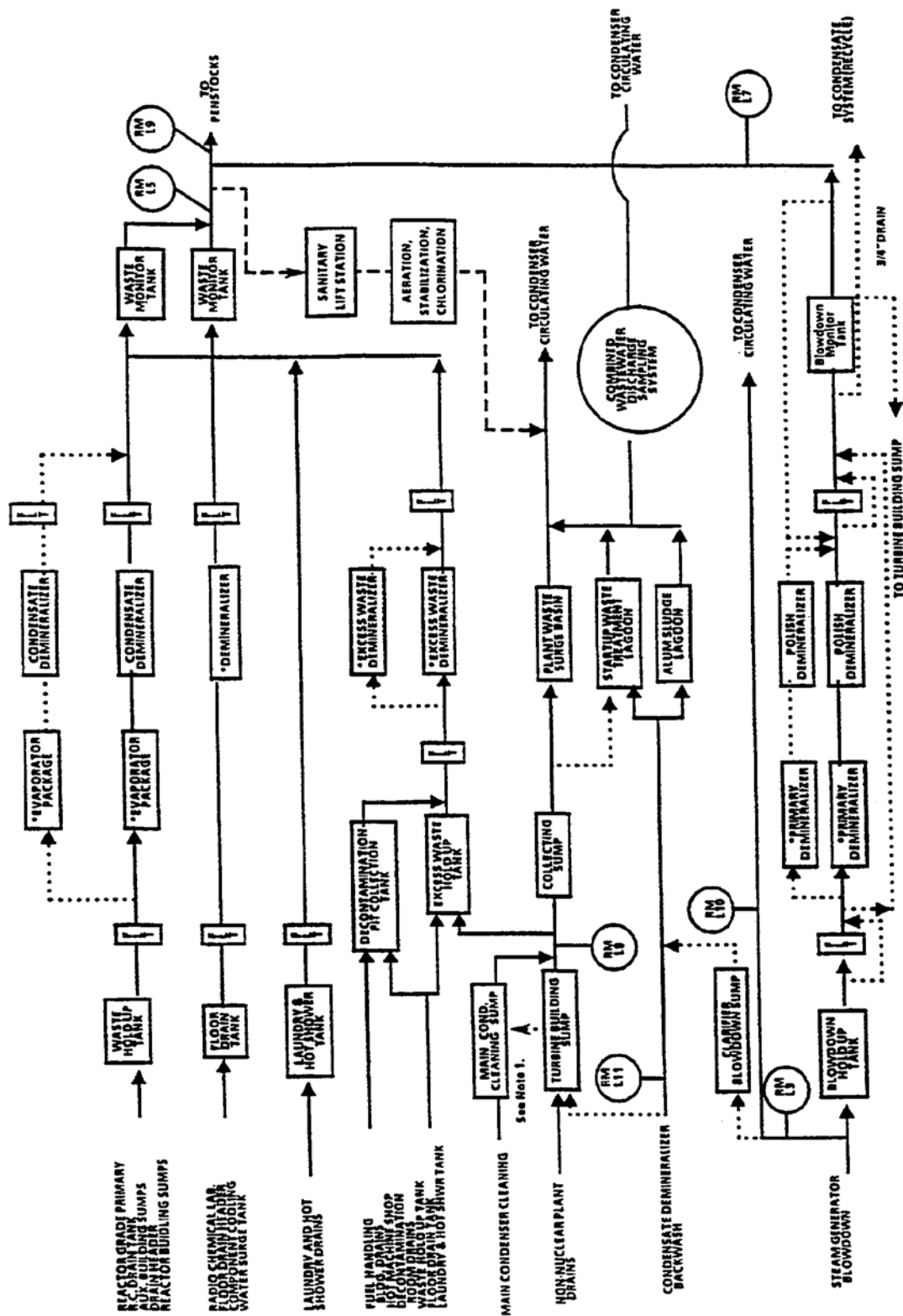

## FIGURE 2.2-1

- NOTES:
1. Turbine Building Sump contents may be processed to the main condenser cleaning sump through a portable demineralizer. This is an optional treatment pathway which provides processing flexibility in the event processing through excess liquid waste is not desirable. Since a temporary demineralizer is used for this optional treatment pathway, operability tests specified in ODCM specification 1.1.4.1 are not required. To ensure adequacy of the RM-L8 setpoint while using the alternate process pathway, samples must be obtained from the discharge side of the demineralizers or condenser cleaning sump and analyzed every twelve hours. |

### 3.0 GASEOUS EFFLUENT

#### 3.1 Gaseous Effluent Monitor Setpoints

The calculated setpoint values will be regarded as upper bounds for the actual setpoint adjustments. That is, setpoint adjustments are not required to be performed if the existing setpoint level corresponds to a lower count rate than the calculated value. Setpoints may be established at values lower than the calculated values, if desired.

Calculated monitor setpoints may be added to the ambient background count rate.

##### 3.1.1 Gaseous Effluent Monitor Setpoint Calculation Parameters

<u>Term</u>	<u>Definition</u>	<u>Section of Initial Use</u>
$C_v$ =	count rate of a station vent monitor corresponding to grab sample radionuclide concentrations, $X_{iv}$ , as determined from the monitor's calibration curve, in cpm.	(3.1.2)
$C_v'$ =	the count rate of the monitor on vent v corresponding to $X_v'$ uCi/cc of Xe-133, in cpm.	(3.1.4)
$c$ =	count rate of the gas decay system monitor for measured radionuclide concentrations corrected to discharge pressure, in cpm.	(3.1.3)
$c'$ =	the count rate of the waste gas decay system monitor corresponding to the total noble gas concentration in cpm.	(3.1.4)
$D_{SS}$ =	limiting dose rate to the skin (3000 mrem/year).	(3.1.2)
$D_{TB}$ =	limiting dose rate to the total body (500 mrem/year).	(3.1.2)
$F_v$ =	the flow rate in vent v (cc/sec) (1 cc/sec = 0.002119 cfm).	(3.1.2)
$f_s$ =	the maximum permissible waste gas discharge rate, based on the actual radionuclide mix and skin dose rate (cc/sec).	(3.1.3)
$f_t$	the maximum permissible waste gas discharge rate, based on the actual radionuclide mix and	(3.1.3)

<u>Term</u>	<u>Definition</u>	<u>Section of Initial Use</u>
	total body dose rate (cc/sec).	
$f_w$ =	the maximum permissible waste gas discharge rate, the lesser of $f_s$ and $f_t$ (cc/sec).	(3.1.3)
$f_s'$ =	the conservative maximum permissible waste gas discharge rate based on Kr-89 skin dose rate (cc/sec).	(3.1.4)
$f_t'$ =	the conservative maximum permissible waste gas discharge rate based on Kr-89 total body dose rate (cc/sec).	(3.1.4)
$K_i$ =	total body dose factor due to gamma emissions from isotope $i$ (mrem/year per uCi/m <sup>3</sup> ) from Table 3.1-1.	(3.1.2)
$K_{Kr-89}$ =	total body dose factor for Kr-89, the most restrictive isotope from Table 3.1-1 (mrem/yr per uCi/m <sup>3</sup> ).	(3.1.3)
$L_i$ =	Skin dose factor due to beta emissions from isotope $i$ (mrem/yr per uCi/m <sup>3</sup> ) from Table 3.-1-1.	(3.1.2)
$L_{Kr-89}$ =	Skin dose factor for Kr-89, the most restrictive isotope, from Table 3.1-1 (mrem/yr per uCi/m <sup>3</sup> ).	(3.1.3)
$M_i$ =	air dose factor due to gamma emissions from isotope $i$ (mrad/yr per uCi/m <sup>3</sup> ) from Table 3.1-1.	(3.1.2)
$M_{Kr-89}$ =	air dose factor for Kr-89, the most restrictive isotope, from Table 3.1-1 (mrad/yr per uCi/m <sup>3</sup> ).	(3.1.3)
$R_s$ =	count rate per mrem/yr to the skin.	(3.1.2)
$R_t$ =	count rate per mrem/yr to the total body.	(3.1.2)
$R_s'$ =	conservative count rate per mrem to the skin (Xe-133 detection, Kr-89 dose).	(3.1.4)
$R_t'$ =	conservative count rate per mrem to the total body (Xe-133 detection, Kr-89 dose).	(3.1.4)

<u>Term</u>	<u>Definition</u>	<u>Section of Initial Use</u>
$S_d$ =	count rate of the waste gas decay system noble gas monitor at the alarm setpoint, in cpm.	(3.1.3)
$S_v$ =	count rate of a station vent noble gas monitor at the alarm setpoint, in cpm.	(3.1.2)
$S_{vc}$ =	count rate of the containment purge noble gas monitor at the alarm setpoint, in cpm.	(3.1.2)
$S_{vp}$ =	count rate of the plant vent noble gas monitor at the alarm setpoint, in cpm.	(3.1.2)
$X_{id}$ =	the concentration of noble gas radionuclide i in a waste gas decay tank, as corrected to the pressure of the discharge stream at the point of its flow measurement in uCi/cc.	(3.1.3)
$X_{iv}$ =	the measured concentration of noble gas radionuclide i in the last grab sample analyzed for vent v in uCi/cc.	(3.1.2)
$X_d'$ =	the total noble gas concentration in a waste gas decay tank, as corrected to the pressure of the discharge stream at the point of its flow measurement in uCi/cc.	(3.1.4)
$X_v'$ =	a concentration of Xe-133 chosen to be in the operating range of the monitor on vent v in uCi/cc.	(3.1.4)
$\bar{X}/Q$ =	the highest annual average relative concentration in any sector, at the site boundary in $\text{sec}/\text{m}^3$ .	(3.1.2)
1.1 =	mrem skin dose per mrad air dose	(3.1.2)
0.25 =	the safety factor applied to each of the two vent noble gas monitors (plant vent and containment purge) to assure that the sum of the releases has a combined safety factor of <u>0.5</u> which allows a 100 percent margin for cumulative uncertainties of measurements.	(3.1.2)

TABLE 3.1-1

DOSE FACTORS FOR EXPOSURE TO A SEMI-INFINITE CLOUD OF NOBLE GASES,\*

<u>Nuclide</u>	$\gamma$ -Body <sup>***</sup> (K <sub>i</sub> )	$\beta$ -Skin <sup>***</sup> (L <sub>i</sub> )	$\gamma$ -Air <sup>**</sup> (M <sub>i</sub> )	$\beta$ -Air <sup>**</sup> (N <sub>i</sub> )
Kr-85m	1.17E + 03 <sup>****</sup>	1.46E + 03	1.23E + 03	1.97E + 03
Kr-85	1.61E + 01	1.34E + 03	1.72E + 01	1.95E + 03
Kr-87	5.92E + 03	9.73E + 03	6.17E + 03	1.03E + 04
Kr-88	1.47E + 04	2.37E + 03	1.52E + 04	2.93E + 03
Kr-89	1.66E + 04	1.01E + 04	1.73E + 04	1.06E + 04
Kr-90	1.56E + 04	7.29E + 03	1.63E + 04	7.83E + 03
Xe-131m	9.15E + 01	4.76E + 02	1.56E + 02	1.11E + 03
Xe-133m	2.51E + 02	9.94E + 02	3.27E + 02	1.48E + 03
Xe-133	2.94E + 02	3.06E + 02	3.53E + 02	1.05E + 03
Xe-135m	3.12E + 03	7.11E + 02	3.36E + 03	7.39E + 02
Xe-135	1.81E + 03	1.86E + 03	1.92E + 03	2.46E + 03
Xe-137	1.42E + 03	1.22E + 04	1.51E + 03	1.27E + 04
Xe-138	8.83E + 03	4.13E + 03	9.21E + 03	4.75E + 03
Ar-41	8.84E + 03	2.69E + 03	9.30E + 03	3.28E + 03

---

\*Values taken from Reference 3, Table B-1

$$** \frac{\text{mrad} - \text{m}^3}{\mu\text{Ci} - \text{yr}}$$

$$*** \frac{\text{mrem} - \text{m}^3}{\mu\text{Ci} - \text{yr}}$$

$$**** 1.17E + 03 = 1.17 \times 10^3$$

CO1→ 3.1.2 Station Vent Noble Gas Monitors (RM-A3 and RM-A4)

For the purpose of implementation of section 1.2.1 of the ODCM, the alarm setpoint level for the station vent noble gas monitors will be calculated as follows:

$$\begin{aligned}
 S_v &= \text{count rate of the plant vent noble gas monitor (= } S_{vp} \text{ for RM-A3)} \\
 &\quad \text{or the containment purge noble gas monitor (= } S_{vc} \text{ for RM-A4) at} \\
 &\quad \text{the alarm setpoint level.} \\
 (34) \quad &\leq \text{the lesser of} \quad \begin{array}{c} 0.25 \times R_t \times D_{TB} \\ \text{or} \\ 0.25 \times R_s \times D_{SS} \end{array} \quad (35)
 \end{aligned}$$

0.25 = the safety factor applied to each of the two vent noble gas monitors (plant vent and containment purge) to assure that the sum of the releases has a combined safety factor of 0.5 which allows a 100 percent margin for cumulative uncertainties of measurements.

$D_{TB}$  = Dose rate limit to the total body of an individual  
 = 500 mrem/yr

$R_t$  = count rate per mrem/yr to the total body  
 =  $C_v / ((\overline{X/Q}) \times F_v \times \sum_i K_i X_{iv})$  (36)

$D_{SS}$  = Dose rate limit to the skin of the body of an individual in an unrestricted area.  
 = 3000 mrem/year.

$R_s$  = count rate per mrem/yr to the skin.  
 =  $C_v \div [\overline{X/Q} \times F_v \times \sum_i (L_i + 1.1 M_i) X_{iv}]$  (37)

$X_{iv}$  = the measured concentration of noble gas radionuclide  $i$  in the last grab sample analyzed for vent  $v$ ,  $\mu\text{Ci/ml}$ . (For the plant vent, grab samples are taken at least



monthly. For the 6" and 36" containment purge lines, the sample is taken just prior to the release and also monthly, if the release is continuous.)

$F_v$  = the flow rate in vent  $v$ , cc/sec. (1 cc/sec = 0.002119 cfm)

$C_v$  = count rate, (cpm) of the monitor on station vent  $v$  corresponding to grab sample noble gas concentrations,  $X_{iv}$ , as determined from the monitor's calibration curve; i.e., product of the monitor response curve slope ( $^{cpm}/\mu\text{Ci}/\text{ml}$ ) and the sum of the noble gas concentrations in the grab sample ( $\mu\text{Ci}/\text{ml}$ ). (Initial calibration curves of the type shown in Figure 2.1-1 have been determined conservatively from families of response curves supplied by the monitor manufacturers. As releases occur, a historical correlation will be prepared and placed in service when sufficient data are accumulated.)

$\overline{X/Q}$  = the highest annual average relative concentration in any sector, at the site boundary (seven year average).

=  $6.3\text{E-}6 \text{ sec}/\text{m}^3$  in the ENE sector.

$K_i$  = total body dose factor due to gamma emissions from isotope  $i$  (mrem/yr per  $\mu\text{Ci}/\text{m}^3$ ) from Table 3.1-1.

$L_i$  = skin dose factor due to beta emissions from isotope  $i$  (mrem/yr per  $\mu\text{Ci}/\text{m}^3$ ) from Table 3.1-1.

1.1 = mrem skin dose per mrad air dose.

$M_i$  = air dose factor due to gamma emissions from isotope  $i$  (mrad/yr per  $\mu\text{Ci}/\text{m}^3$ ) from Table 3.1-1.

NOTE: At plant startups when no grab sample analysis is available for the continuous releases, the Alternate Methodology of Section 3.1.4 must be used.

### 3.1.3 Waste Gas Decay System Monitor (RM-A10)

The permissible conditions for discharge through the waste gas decay system monitor (RM-A10) will be calculated in a manner similar to that for the plant vent noble gas monitor. In the case of the waste gas system, however, the discharge flow rate is continuously controllable by valve HCV-014 and permissible release conditions are therefore defined in terms of both flow rate and concentration. Therefore, RM-A10 is used only to insure that a representative sample was obtained.

For operational convenience, (to prevent spurious alarms due to fluctuations in background) the setpoint level will be established at 1.5 times the measured waste concentration.

The maximum permissible flow rate will be set on the same basis but include the engineering safety factor of 0.5. The RM-A10 setpoint level  $S_d$  is defined as:

$$S_d \leq 1.5c \quad (38)$$

where:

c = count rate in CPM of the waste gas decay system monitor corresponding to the measured concentration (taken from the monitor calibration curves).

The maximum permissible waste gas flow rate  $f_w$  (cc/sec) is calculated from the maximum permissible dose rates at the site boundary according to:

$$f_w \leq \text{the lesser of } f_t \text{ or } f_s \quad (39)$$

$f_t$  = the maximum permissible discharge rate based on total body dose rate.

$$= 0.25 x D_{TB} / [\overline{X/Q} x 1.5 \sum_i X_{id} K_i] \quad (40)$$

$f_s$  = the maximum permissible discharge rate based on skin dose rate.

$$= 0.25 x D_{SS} / [\overline{X/Q} x 1.5 \sum_i X_{id} (L_i + 1.1M_i)] \quad (41)$$

$X_{id}$  = the concentration of noble gas radionuclide  $i$  in the waste gas decay tank whose contents are to be discharged, as corrected to the pressure of the discharge stream at the point of the flow rate measurement. The maximum discharge pressure as governed by the diaphragm valve, 7896, is 30 psia.

NOTE: The factor of 1.5 in the denominators of equations (40) and (41) places  $f_w$  on the same basis as  $S_d$ .

When a discharge is to be conducted, valve HCV-014 is to be opened until (a) the waste gas discharge flow rate reaches  $0.9 x f_w$  or (b) the count rate of the plant vent noble gas monitor RM-A3 approaches its setpoint, whichever of the above conditions is reached first.

When no discharges are being made from the Waste Gas Decay System, the RM-A10 setpoint should be established as near background as practical to prevent spurious alarms and yet alarm in the event of an inadvertent release.

#### 3.1.4 Alternative Methodology for Establishing Conservative Setpoints

As an alternate to the methodology of section 3.1.2, to minimize necessity for frequent adjustment of setpoint, a conservative setpoint may be calculated as follows:

For a plant vent:

$R_t'$  = conservative count rate per mrem/yr to the total body (Xe-133 detection, Kr-89 dose).

$$(42) \quad = C_v' \div [\overline{X/Q} \times K_{kr-89} \times X_v' \times F_v],$$

where:

$X_v'$  = a concentration of Xe-133 chosen to be in the operating range of the monitor on vent v,  $\mu\text{Ci/cc}$ .

$C_v'$  = the count rate in CPM of the monitor on vent v corresponding to  $X_v'$   $\mu\text{Ci/cc}$  of XE-133.

$K_{Kr-89}$  = total body dose factor for Kr-89, the most restrictive isotope from Table 3.1-1.

$R_s'$  = count rate per mrem/yr to the skin.

$$= C_v' \div [\overline{X/Q} \times (L_{Kr-89} + 1.1M_{kr-89}) \times X_v' \times F_v] \quad (43)$$

where:

$L_{Kr-89}$  = skin dose factor for Kr-89, the most restrictive isotope from Table 3.1-1.

$M_{Kr-89}$  = air dose factor for Kr-89, the most restrictive isotope, from Table 3.1-1.

For the waste gas decay system:

$f_t'$  = the conservative maximum permissible discharge rate based on Kr-89 total body dose rate.

$$= 0.25 \times D_{TB} \div [\overline{X/Q} \times 1.5 \times X_d' \times K_{kr-89}] \quad (44)$$

$f_s'$  = the conservative maximum permissible discharge rate based on Kr-89 skin dose rate.

$$= 0.25 \times D_{SS} \div [\overline{X/Q} \times 1.5 \times X_d' \times (L_{Kr-89} + 1.1M_{Kr-89})] \quad (45)$$

$X_d'$  = the total concentration of noble gas radionuclides in the waste gas decay tank whose contents are to be discharged, as corrected to the pressure of the discharge stream at the point of the flow measurement.

$c'$  = count rate in cpm of the waste gas decay system monitor corresponding to  $X_d'$   $\mu\text{Ci/cc}$  of Kr-85.

### 3.1.5 Oil Incineration

3.1.5.1 Oil incinerator was removed from service in 2010 and the structure decommissioned under Engineering Change Request 71498.

### 3.1.6 Meteorological Release Criteria for Batch Releases

Planned gaseous batch releases (WGDT) and will be performed during favorable meteorology. Limiting releases to favorable meteorology provides assurance that release conditions will be conservative with respect to annual average dispersion values,  $(\overline{X/Q}, \overline{X/Q'})$ . Favorable meteorology is defined in Table 3.1-2.

Table 3.1-2

Favorable Meteorology

Differential Temperature ( $\Delta T$ ) <sup>1</sup> °F		Stability Class	Wind Speed <sup>2</sup> (mph)	
61m - 10m	40m - 10m		10m	61m
$\Delta T \leq -1.74$	$\Delta T \leq -1.03$	A	*	*
$-1.74 < \Delta T \leq -1.56$	$-1.03 < \Delta T \leq -0.92$	B	*	*
$-1.56 < \Delta T \leq -1.38$	$-0.92 < \Delta T \leq -0.81$	C	1.3	1.6
$-1.38 < \Delta T \leq -0.46$	$-0.81 < \Delta T \leq -0.27$	D	3.1	4.1
$-0.46 < \Delta T \leq 1.38$	$-0.27 < \Delta T \leq 0.81$	E	3.5	6.6
$1.38 < \Delta T \leq 3.67$	$0.81 < \Delta T \leq 2.16$	F	5.2	14.0
$3.67 < \Delta T$	$2.16 < \Delta T$	G	7.0	18.9

Notes:

- <sup>1</sup> The  $\Delta T$  values for 61m - 10m are considered as primary indicators for determination of stability class. The 40m - 10m  $\Delta T$  values are used only when 61m - 10m values are not available. All  $\Delta T$  values are listed in °F and are based on values in USNRC Regulatory Guide 1.23.
- <sup>2</sup> The 10m wind speed is considered the primary indication for windspeed. The 61m wind speed indication should only be used if 10m is not available.
- \* No wind is required for planned releases.

Figure 3.1-1

Example Noble Gas Monitor  
Calibration Curve

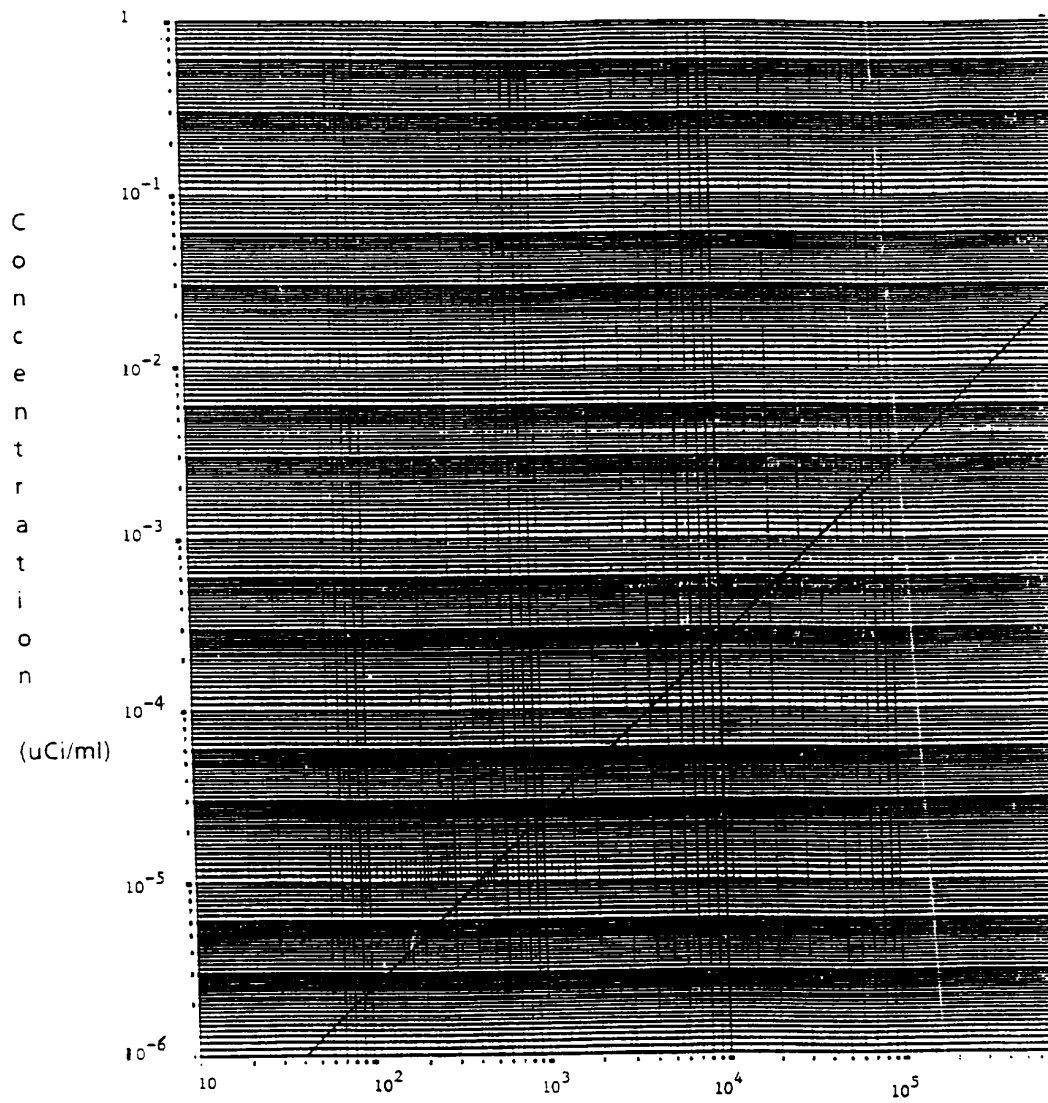

## 3.2 Dose Calculation for Gaseous Effluent

### 3.2.1 Gaseous Effluent Dose Calculation Parameters

<u>Term</u>	<u>Definition</u>	<u>Section of Initial Use</u>
$D_o$	= average organ dose rate in the current year (mrem/yr) for the child inhalation pathway.	(3.2.2.2)
$D_{oa}$	= dose to an organ from radioiodines and radionuclides in particulate form, with half-lives greater than eight days (mrem) for the specified age group a.	(3.2.3.2)
$D_s$	= average skin dose rate in current year (mrem/year).	(3.2.2.1)
$D_t$	= current total body dose rate (mrem/yr)	(3.2.2.1)
$D_\beta$	= air dose due to beta emissions from noble gas radionuclides (mrad).	(3.2.3.1)
$D_\gamma$	= air dose due to gamma emissions from noble gas radionuclides (mrad).	(3.2.3.1)
$K_i$	= total body dose factor due to gamma emissions from isotope i (mrem/year per $\mu\text{Ci}/\text{m}^3$ ) from Table 3.1-1.	(3.2.2.1)
$L_i$	= skin dose factor due to beta emissions from noble gas radionuclide i (mrad/yr per $\mu\text{Ci}/\text{m}^3$ ) from Table 3.1-1.	(3.2.2.1)
$M_i$	= air dose factor due to gamma emissions from noble gas radionuclide i (mrad/yr per $\mu\text{Ci}/\text{m}^3$ ) from Table 3.1-1.	(3.2.2.1)
$N_i$	= air dose factor due to beta emissions from noble gas radionuclide i (mrad per $\mu\text{Ci}/\text{m}^3$ ) from Table 3.1-1.	(3.2.3.1)
$P_i$	= The dose parameter for radionuclide i, (mrem/yr per $\mu\text{Ci}/\text{m}^3$ ) for the child inhalation pathway. Same as $R_i$ for child inhalation, Table 3.2-1.	(3.2.2.2)
$\bar{Q}_i$	= the release rate of noble gas radionuclide i as determined from the concentrations measured in the analysis of the appropriate sample required by Table 1.2-3 ( $\mu\text{Ci}/\text{sec}$ ).	(3.2.2.1)



$\overline{Q}_i'$	=	the release of non-noble gas radionuclide i as determined from the concentrations measured in the analysis of the appropriate sample required by Table 1.2-3 ( $\mu\text{Ci}/\text{sec}$ ).	(3.2.2.2)
$\tilde{Q}_i$	=	cumulative release of noble gas radionuclide i over the period of interest ( $\mu\text{Ci}$ ).	(3.2.3.1)
$\tilde{Q}_i'$	=	cumulative release of non-noble gas radionuclide i (required by ODCM Specification 1.2.4.1) over the period of interest ( $\mu\text{Ci}$ ).	(3.2.3.2)
$R_{aij}$	=	dose factor for age group a, radionuclide i, and pathway j, ( $\text{mrem}/\text{yr}$ per $\mu\text{Ci}/\text{m}^3$ ) or ( $\text{m}^2\text{-mrem}/\text{yr}$ per $\mu\text{Ci}/\text{sec}$ ) from Tables 3.2-1.	(3.2.3.2)
$W_{ij}'$	=	relative dispersion parameter for the maximum exposed individual, as appropriate for his exposure pathway j and radionuclide i.	(3.2.3.2)
	=	$\overline{X/Q}'$ for inhalation and all tritium / carbon-14 pathways	
	=	$\overline{D/Q}'$ for other pathways and non-tritium radionuclides	
$\overline{X/Q}$	=	the highest annual average relative concentration in any sector, at the site boundary in $\text{sec}/\text{m}^3$ .	(3.2.2.1)
$3.17 \times 10^{-8}$	=	the fraction of one year per one second	(3.2.3.1)
$\overline{X/Q}'$	=	Annual average relative concentration for the location of the maximum exposed individual for the site ( $\text{sec}/\text{m}^3$ ).	(3.2.3.2)
$\overline{D/Q}'$	=	Annual average relative deposition for the location of the maximum exposed individual for the site ( $\text{m}^{-2}$ ).	(3.2.3.2)

### 3.2.2 Unrestricted Area Boundary Dose

3.2.2.1 For the purpose of implementation of section 1.2.2.1a, ( $\leq 500$  mrem/year - total body,  $\leq 3000$  mrem/year - skin) the dose at the unrestricted area boundary due to noble gases shall be calculated as follows:

$$\begin{aligned} D_t &= \text{current total body dose rate (mrem/yr)} \\ &= \overline{X/Q} \sum_i K_i \overline{\dot{Q}}_i \end{aligned} \quad (46)$$

$$\begin{aligned} D_s &= \text{current skin dose rate (mrem/yr)} \\ &= \overline{X/Q} \sum_i (L_i + 1.1M_i) \overline{\dot{Q}}_i \end{aligned} \quad (47)$$

where:

$\overline{\dot{Q}}_i$  = the release rate of noble gas radionuclide  $i$  as determined from the concentration measured in the analysis of the appropriate sample required by Table 1.2-3 ( $\mu\text{Ci}/\text{sec.}$ ).

$\overline{X/Q}$  = the highest annual average relative concentration in any sector, at the site boundary (for value, see Section 3.1.2).

$K_i$ ,  $L_i$ , and  $M_i$  will be selected for the appropriate radionuclide from Table 3.1-1.

3.2.2.2 For the purpose of implementation of section 1.2.2.1.b ( $\leq 1500$  mrem/yr - any organ) organ doses due to radioiodines and all radioactive materials in particulate form and radionuclides (other than noble gases) with half-lives greater than eight days, will be calculated as follows:

$$\begin{aligned} D_o &= \text{current organ dose rate (mrem/yr)} \\ &= \sum_i \overline{X/Q} P_i \overline{\dot{Q}}_i \end{aligned} \quad (48)$$

where:

$\overline{X/Q}$  = the highest annual average relative concentration in any sector, at the site boundary (for value, see Section 3.1.2)

$P_i$  = The dose conversion factor for radionuclide "i", in mrem/year per  $\mu\text{Ci}/\text{m}^3$  for the child-inhalation pathway. Same as  $R_i$  for child-inhalation, Table 3.2-1.

$\overline{\dot{Q}}_i'$  = the release rate of non-noble gas radionuclide i as determined from the concentrations measured in the analysis of the appropriate sample required by Table 1.2-3 ( $\mu\text{Ci}/\text{sec.}$ ).

### 3.2.3 Unrestricted Area Dose (Air Dose and Dose to Individual)

3.2.3.1 For the purpose of implementation of section 1.2.3.1 (Calendar quarter:  $\leq 5$  mrad -  $\gamma$  and  $\leq 10$  mrad -  $\beta$ , Calendar year:  $\leq 10$  mrad -  $\gamma$  and  $\leq 20$  mrad -  $\beta$ ) and section 1.2.5.1 (air dose averaged over 31 days:  $\leq 0.2$  mrad -  $\gamma$  and  $\leq 0.4$  mrad -  $\beta$ ), the air dose in unrestricted areas shall be determined as follows:

$D_\gamma$  = air dose due to gamma emissions from noble gas radionuclide i (mrad)

$$= 3.17 \times 10^{-8} \sum_i M_i \overline{X/Q} \tilde{Q}_i \quad (49)$$

where:

$3.17 \times 10^{-8}$  = the fraction of one year per one second

$\tilde{Q}_i$  = cumulative release of noble gas radionuclide i over the period of interest ( $\mu\text{Ci}$ ).

$$\begin{aligned}
D_{\beta} &= \text{air dose due to beta emissions from noble gas} \\
&\quad \text{radionuclide } i \text{ (mrad).} \\
&= 3.17 \times 10^{-8} \sum_i N_i \overline{X/Q} \tilde{Q}_i \qquad (50)
\end{aligned}$$

where,  $N_i$  = air dose factor due to beta emission from noble gas radionuclide  $i$  (mrad/yr per uCi/m<sup>3</sup>) from Table 3.1-1.

3.2.3.2 For all gaseous effluents, dose to an individual from radioiodines and radioactive materials in particulate form and radionuclides (other than noble gases), with half-lives greater than eight (8) days (Calendar quarter:  $\leq 7.5$  mrem any organ, Calendar year:  $\leq 15$  mrem any organ) will be calculated for the purpose of implementation of section 1.2.4.1 as follows:

$$\begin{aligned}
D_{oa} &= \text{dose to an organ from radioiodines and radionuclides} \\
&\quad \text{in particulate form, with half-lives greater than eight} \\
&\quad \text{days (mrem) for the specified age group } a. \\
&= 3.17 \times 10^{-8} \sum_{ij} R_{aij} W'_{ij} \tilde{Q}'_i \qquad (51)
\end{aligned}$$

where:

$W'_{ij}$  = relative concentration or relative deposition for the maximum exposed individual, as appropriate for exposure pathway  $j$  and radionuclide  $i$ .

$\overline{X/Q}$  for inhalation and all tritium / carbon-14 pathways  
=  $3.5 \times 10^{-6}$  sec/m<sup>3</sup>

$\overline{D/Q}$  for other pathways excluding tritium and carbon-14  
=  $1.1 \times 10^{-8}$  m<sup>-2</sup>

(See the notes to Table 3.2-2 and 3.2-3 for the origin of these factors.)

$R_{aj}$  = dose factor for age group a, radionuclide i, pathway j, (mrem/yr per  $\mu\text{Ci}/\text{m}^3$ ) or ( $\text{m}^2$  - mrem/yr per  $\mu\text{Ci}/\text{sec}$ ) from Table 3.2-1

$\tilde{Q}_i'$  = Cumulative release of non-noble gas radionuclide i (required by ODCM Specification 1.2.4.1) over the period of interest ( $\mu\text{Ci}$ ).

3.2.4 For the purpose of initial assessments of the impact of unplanned gaseous releases, dose calculations for the critical receptor in each affected sector may be performed using section 3.2.3.1 and section 3.2.3.2 equations as follows:

- (1) For each affected sector,  $X/Q$  and  $D/Q$  will be calculated for one mile and critical receptor locations using actual meteorological conditions occurring during the unplanned release. Actual  $X/Q$  and  $D/Q$  values will be compared to annual average dispersion coefficients ( $\overline{X/Q}$ ,  $\overline{X/Q'}$ , and  $\overline{D/Q'}$ ). The more limiting dispersion coefficients will be used along with methodology in sections 3.2.3.1 and 3.2.3.2 for the initial assessment.
- (2) The location of the critical receptors and the pathways j which should be analyzed are shown in Table 3.2-2. (For very rough calculations, the annual average dispersion coefficients ( $\overline{X/Q}$  and  $\overline{D/Q}$ ) for each receptor are shown in Table 3.2-3.)
- (3) The  $R_{aj}$  for the appropriate exposure pathways and age groups will be selected from Table 3.2-1

**TABLE 3.2-1  
PATHWAY DOSE FACTORS (R<sub>aij</sub>)**

Age Group:	All	Pathway: Ground Plane				Units: m <sup>2</sup> x mrem/yr per μCi/sec			
Nuclide	Bone	Liver	Thyroid	Kidney	Lung	Gi-LLi	TBody	Skin	
H-3	0.00E+00	0.00E+00	0.00E+00	0.00E+00	0.00E+00	0.00E+00	0.00E+00	0.00E+00	
C-14	0.00E+00	0.00E+00	0.00E+00	0.00E+00	0.00E+00	0.00E+00	0.00E+00	0.00E+00	
NA-24	1.20E+07	1.20E+07	1.20E+07	1.20E+07	1.20E+07	1.20E+07	1.20E+07	1.39E+07	
P-32	0.00E+00	0.00E+00	0.00E+00	0.00E+00	0.00E+00	0.00E+00	0.00E+00	0.00E+00	
CR-51	4.65E+06	4.65E+06	4.65E+06	4.65E+06	4.65E+06	4.65E+06	4.65E+06	5.50E+06	
MN-54	1.38E+09	1.38E+09	1.38E+09	1.38E+09	1.38E+09	1.38E+09	1.38E+09	1.62E+09	
MN-56	8.99E+05	8.99E+05	8.99E+05	8.99E+05	8.99E+05	8.99E+05	8.99E+05	1.06E+06	
FE-55	0.00E+00	0.00E+00	0.00E+00	0.00E+00	0.00E+00	0.00E+00	0.00E+00	0.00E+00	
FE-59	2.73E+08	2.73E+08	2.73E+08	2.73E+08	2.73E+08	2.73E+08	2.73E+08	3.20E+08	
CO-58	3.80E+08	3.80E+08	3.80E+08	3.80E+08	3.80E+08	3.80E+08	3.80E+08	4.45E+08	
CO-60	2.15E+10	2.15E+10	2.15E+10	2.15E+10	2.15E+10	2.15E+10	2.15E+10	2.53E+10	
NI-63	0.00E+00	0.00E+00	0.00E+00	0.00E+00	0.00E+00	0.00E+00	0.00E+00	0.00E+00	
NI-65	2.97E+05	2.97E+05	2.97E+05	2.97E+05	2.97E+05	2.97E+05	2.97E+05	3.45E+05	
CU-64	6.05E+05	6.05E+05	6.05E+05	6.05E+05	6.05E+05	6.05E+05	6.05E+05	6.86E+05	
ZN-65	7.46E+08	7.46E+08	7.46E+08	7.46E+08	7.46E+08	7.46E+08	7.46E+08	8.57E+08	
ZN-69	0.00E+00	0.00E+00	0.00E+00	0.00E+00	0.00E+00	0.00E+00	0.00E+00	0.00E+00	
BR-83	4.88E+03	4.88E+03	4.88E+03	4.88E+03	4.88E+03	4.88E+03	4.88E+03	7.08E+03	
BR-84	2.03E+05	2.03E+05	2.03E+05	2.03E+05	2.03E+05	2.03E+05	2.03E+05	2.36E+05	
BR-85	0.00E+00	0.00E+00	0.00E+00	0.00E+00	0.00E+00	0.00E+00	0.00E+00	0.00E+00	
RB-86	9.01E+06	9.01E+06	9.01E+06	9.01E+06	9.01E+06	9.01E+06	9.01E+06	1.03E+07	
RB-88	3.32E+04	3.32E+04	3.32E+04	3.32E+04	3.32E+04	3.32E+04	3.32E+04	3.79E+04	
RB-89	1.22E+05	1.22E+05	1.22E+05	1.22E+05	1.22E+05	1.22E+05	1.22E+05	1.46E+05	
SR-89	2.16E+04	2.16E+04	2.16E+04	2.16E+04	2.16E+04	2.16E+04	2.16E+04	2.51E+04	
SR-90	0.00E+00	0.00E+00	0.00E+00	0.00E+00	0.00E+00	0.00E+00	0.00E+00	0.00E+00	
SR-91	2.14E+06	2.14E+06	2.14E+06	2.14E+06	2.14E+06	2.14E+06	2.14E+06	2.51E+06	
SR-92	7.77E+05	7.77E+05	7.77E+05	7.77E+05	7.77E+05	7.77E+05	7.77E+05	8.64E+05	
Y-90	4.50E+03	4.50E+03	4.50E+03	4.50E+03	4.50E+03	4.50E+03	4.50E+03	5.31E+03	
Y-91M	1.00E+05	1.00E+05	1.00E+05	1.00E+05	1.00E+05	1.00E+05	1.00E+05	1.16E+05	
Y-91	1.07E+06	1.07E+06	1.07E+06	1.07E+06	1.07E+06	1.07E+06	1.07E+06	1.21E+06	
Y-92	1.81E+05	1.81E+05	1.81E+05	1.81E+05	1.81E+05	1.81E+05	1.81E+05	2.15E+05	
Y-93	1.83E+05	1.83E+05	1.83E+05	1.83E+05	1.83E+05	1.83E+05	1.83E+05	2.50E+05	
ZR-95	2.45E+08	2.45E+08	2.45E+08	2.45E+08	2.45E+08	2.45E+08	2.45E+08	2.85E+08	
ZR-97	2.96E+06	2.96E+06	2.96E+06	2.96E+06	2.96E+06	2.96E+06	2.96E+06	3.44E+06	
NB-95	1.37E+08	1.37E+08	1.37E+08	1.37E+08	1.37E+08	1.37E+08	1.37E+08	1.61E+08	
MO-99	3.99E+06	3.99E+06	3.99E+06	3.99E+06	3.99E+06	3.99E+06	3.99E+06	4.62E+06	
TC-99M	1.84E+05	1.84E+05	1.84E+05	1.84E+05	1.84E+05	1.84E+05	1.84E+05	2.11E+05	
TC-101	2.03E+04	2.03E+04	2.03E+04	2.03E+04	2.03E+04	2.03E+04	2.03E+04	2.26E+04	
RU-103	1.08E+08	1.08E+08	1.08E+08	1.08E+08	1.08E+08	1.08E+08	1.08E+08	1.26E+08	

**TABLE 3.2-1  
PATHWAY DOSE FACTORS ( $R_{aij}$ )**

Age Group:	All	Pathway: Ground Plane							Units:
									$m^2 \times mrem/yr \text{ per } \mu Ci/sec$
Nuclide	Bone	Liver	Thyroid	Kidney	Lung	Gi-LLi	TBody	Skin	
RU-105	6.36E+05	6.36E+05	6.36E+05	6.36E+05	6.36E+05	6.36E+05	6.36E+05	7.21E+05	
RU-106	4.22E+08	4.22E+08	4.22E+08	4.22E+08	4.22E+08	4.22E+08	4.22E+08	5.06E+08	
AG-110M	3.45E+09	3.45E+09	3.45E+09	3.45E+09	3.45E+09	3.45E+09	3.45E+09	4.02E+09	
TE-125M	1.56E+06	1.56E+06	1.56E+06	1.56E+06	1.56E+06	1.56E+06	1.56E+06	2.13E+06	
TE-127M	9.16E+04	9.16E+04	9.16E+04	9.16E+04	9.16E+04	9.16E+04	9.16E+04	1.08E+05	
TE-127	2.98E+03	2.98E+03	2.98E+03	2.98E+03	2.98E+03	2.98E+03	2.98E+03	3.27E+03	
TE-129M	1.98E+07	1.98E+07	1.98E+07	1.98E+07	1.98E+07	1.98E+07	1.98E+07	2.31E+07	
TE-129	2.62E+04	2.62E+04	2.62E+04	2.62E+04	2.62E+04	2.62E+04	2.62E+04	3.10E+04	
TE-131M	8.02E+06	8.02E+06	8.02E+06	8.02E+06	8.02E+06	8.02E+06	8.02E+06	9.46E+06	
TE-131	2.93E+04	2.93E+04	2.93E+04	2.93E+04	2.93E+04	2.93E+04	2.93E+04	3.46E+07	
TE-132	4.24E+06	4.24E+06	4.24E+06	4.24E+06	4.24E+06	4.24E+06	4.24E+06	4.99E+06	
I-130	5.50E+06	5.50E+06	5.50E+06	5.50E+06	5.50E+06	5.50E+06	5.50E+06	6.68E+06	
I-131	1.72E+07	1.72E+07	1.72E+07	1.72E+07	1.72E+07	1.72E+07	1.72E+07	2.09E+07	
I-132	1.25E+06	1.25E+06	1.25E+06	1.25E+06	1.25E+06	1.25E+06	1.25E+06	1.47E+06	
I-133	2.45E+06	2.45E+06	2.45E+06	2.45E+06	2.45E+06	2.45E+06	2.45E+06	2.98E+06	
I-134	4.46E+05	4.46E+05	4.46E+05	4.46E+05	4.46E+05	4.46E+05	4.46E+05	5.30E+05	
I-135	2.52E+06	2.52E+06	2.52E+06	2.52E+06	2.52E+06	2.52E+06	2.52E+06	2.94E+06	
CS-134	6.83E+09	6.83E+09	6.83E+09	6.83E+09	6.83E+09	6.83E+09	6.83E+09	7.97E+09	
CS-136	1.50E+08	1.50E+08	1.50E+08	1.50E+08	1.50E+08	1.50E+08	1.50E+08	1.70E+08	
CS-137	1.03E+10	1.03E+10	1.03E+10	1.03E+10	1.03E+10	1.03E+10	1.03E+10	1.20E+10	
CS-138	3.60E+05	3.60E+05	3.60E+05	3.60E+05	3.60E+05	3.60E+05	3.60E+05	4.11E+05	
BA-139	1.05E+05	1.05E+05	1.05E+05	1.05E+05	1.05E+05	1.05E+05	1.05E+05	1.18E+05	
BA-140	2.05E+07	2.05E+07	2.05E+07	2.05E+07	2.05E+07	2.05E+07	2.05E+07	2.35E+07	
BA-141	4.17E+04	4.17E+04	4.17E+04	4.17E+04	4.17E+04	4.17E+04	4.17E+04	4.75E+04	
BA-142	4.49E+04	4.49E+04	4.49E+04	4.49E+04	4.49E+04	4.49E+04	4.49E+04	5.11E+04	
LA-140	1.92E+07	1.92E+07	1.92E+07	1.92E+07	1.92E+07	1.92E+07	1.92E+07	2.18E+07	
LA-142	7.36E+05	7.36E+05	7.36E+05	7.36E+05	7.36E+05	7.36E+05	7.36E+05	8.83E+05	
CE-141	1.37E+07	1.37E+07	1.37E+07	1.37E+07	1.37E+07	1.37E+07	1.37E+07	1.54E+07	
CE-143	2.32E+06	2.32E+06	2.32E+06	2.32E+06	2.32E+06	2.32E+06	2.32E+06	2.64E+06	
CE-144	6.96E+07	6.96E+07	6.96E+07	6.96E+07	6.96E+07	6.96E+07	6.96E+07	8.05E+07	
PR-143	0.00E+00	0.00E+00	0.00E+00	0.00E+00	0.00E+00	0.00E+00	0.00E+00	0.00E+00	
PR-144	1.83E+03	1.83E+03	1.83E+03	1.83E+03	1.83E+03	1.83E+03	1.83E+03	2.11E+03	
ND-147	8.48E+06	8.48E+06	8.48E+06	8.48E+06	8.48E+06	8.48E+06	8.48E+06	1.02E+07	
W-187	2.36E+06	2.36E+06	2.36E+06	2.36E+06	2.36E+06	2.36E+06	2.36E+06	2.74E+06	
NP-239	1.71E+06	1.71E+06	1.71E+06	1.71E+06	1.71E+06	1.71E+06	1.71E+06	1.98E+06	

**TABLE 3.2-1  
PATHWAY DOSE FACTORS (R<sub>aij</sub>)**

Age Group:	Infant	Pathway: Inhalation				Units: mrem/yr per $\mu\text{Ci}/\text{m}^3$			
Nuclide	Bone	Liver	Thyroid	Kidney	Lung	Gi-LLi	TBody	Skin	
H-3	0.00E+00	6.47E+02	6.47E+02	6.47E+02	6.47E+02	6.47E+02	6.47E+02	0.00E+00	
C-14	2.65E+04	5.31E+03	5.31E+03	5.31E+03	5.31E+03	5.31E+03	5.31E+03	0.00E+00	
NA-24	1.06E+04	1.06E+04	1.06E+04	1.06E+04	1.06E+04	1.06E+04	1.06E+04	0.00E+00	
P-32	2.03E+06	1.12E+05	0.00E+00	0.00E+00	0.00E+00	1.61E+04	7.74E+04	0.00E+00	
CR-51	0.00E+00	0.00E+00	5.75E+01	1.32E+01	1.28E+04	3.57E+02	8.95E+01	0.00E+00	
MN-54	0.00E+00	2.53E+04	0.00E+00	4.98E+03	1.00E+06	7.06E+03	4.98E+03	0.00E+00	
MN-56	0.00E+00	1.54E+00	0.00E+00	1.10E+00	1.25E+04	7.17E+04	2.21E-01	0.00E+00	
FE-55	1.97E+04	1.17E+04	0.00E+00	0.00E+00	8.69E+04	1.09E+03	3.33E+03	0.00E+00	
FE-59	1.36E+04	2.35E+04	0.00E+00	0.00E+00	1.02E+06	2.48E+04	9.48E+03	0.00E+00	
CO-58	0.00E+00	1.22E+03	0.00E+00	0.00E+00	7.77E+05	1.11E+04	1.82E+03	0.00E+00	
CO-60	0.00E+00	8.02E+03	0.00E+00	0.00E+00	4.51E+06	3.19E+04	1.18E+04	0.00E+00	
NI-63	3.39E+05	2.04E+04	0.00E+00	0.00E+00	2.09E+05	2.42E+03	1.16E+04	0.00E+00	
NI-65	2.39E+00	2.84E-01	0.00E+00	0.00E+00	8.12E+03	5.01E+04	1.23E-01	0.00E+00	
CU-64	0.00E+00	1.88E+00	0.00E+00	3.98E+00	9.30E+03	1.50E+04	7.74E-01	0.00E+00	
ZN-65	1.93E+04	6.26E+04	0.00E+00	3.25E+04	6.47E+05	5.14E+04	3.11E+04	0.00E+00	
ZN-69	5.39E-02	9.67E-02	0.00E+00	4.02E-02	1.47E+03	1.32E+04	7.18E-03	0.00E+00	
BR-83	0.00E+00	0.00E+00	0.00E+00	0.00E+00	0.00E+00	0.00E+00	3.81E+02	0.00E+00	
BR-84	0.00E+00	0.00E+00	0.00E+00	0.00E+00	0.00E+00	0.00E+00	4.00E+02	0.00E+00	
BR-85	0.00E+00	0.00E+00	0.00E+00	0.00E+00	0.00E+00	0.00E+00	2.04E+01	0.00E+00	
RB-86	0.00E+00	1.90E+05	0.00E+00	0.00E+00	0.00E+00	3.04E+03	8.82E+04	0.00E+00	
RB-88	0.00E+00	5.57E+02	0.00E+00	0.00E+00	0.00E+00	3.39E+02	2.87E+02	0.00E+00	
RB-89	0.00E+00	3.21E+02	0.00E+00	0.00E+00	0.00E+00	6.82E+01	2.06E+02	0.00E+00	
SR-89	3.98E+05	0.00E+00	0.00E+00	0.00E+00	2.03E+06	6.40E+04	1.14E+04	0.00E+00	
SR-90	4.09E+07	0.00E+00	0.00E+00	0.00E+00	1.12E+07	1.31E+05	2.59E+06	0.00E+00	
SR-91	9.56E+01	0.00E+00	0.00E+00	0.00E+00	5.26E+04	7.34E+04	3.46E+00	0.00E+00	
SR-92	1.05E+01	0.00E+00	0.00E+00	0.00E+00	2.38E+04	1.40E+05	3.91E-01	0.00E+00	
Y-90	3.29E+03	0.00E+00	0.00E+00	0.00E+00	2.69E+05	1.04E+05	8.82E+01	0.00E+00	
Y-91M	4.07E-01	0.00E+00	0.00E+00	0.00E+00	2.79E+03	2.35E+03	1.39E-02	0.00E+00	
Y-91	5.88E+05	0.00E+00	0.00E+00	0.00E+00	2.45E+06	7.03E+04	1.57E+04	0.00E+00	
Y-92	1.64E+01	0.00E+00	0.00E+00	0.00E+00	2.45E+04	1.27E+05	4.61E-01	0.00E+00	
Y-93	1.50E+02	0.00E+00	0.00E+00	0.00E+00	7.64E+04	1.67E+05	4.07E+00	0.00E+00	
ZR-95	1.15E+05	2.79E+04	0.00E+00	3.11E+04	1.75E+06	2.17E+04	2.03E+04	0.00E+00	
ZR-97	1.50E+02	2.56E+01	0.00E+00	2.59E+01	1.10E+05	1.40E+05	1.17E+01	0.00E+00	
NB-95	1.57E+04	6.43E+03	0.00E+00	4.72E+03	4.79E+05	1.27E+04	3.78E+03	0.00E+00	
MO-99	0.00E+00	1.65E+02	0.00E+00	2.65E+02	1.35E+05	4.87E+04	3.23E+01	0.00E+00	
TC-99M	1.40E-03	2.88E-03	0.00E+00	3.11E-02	8.11E+02	2.03E+03	3.72E-02	0.00E+00	
TC-101	6.51E-05	8.23E-05	0.00E+00	9.79E-04	5.84E+02	8.44E+02	8.12E-04	0.00E+00	
RU-103	2.02E+03	0.00E+00	0.00E+00	4.24E+03	5.52E+05	1.61E+04	6.79E+02	0.00E+00	
RU-105	1.22E+00	0.00E+00	0.00E+00	8.99E-01	1.57E+04	4.84E+04	4.10E-01	0.00E+00	



**TABLE 3.2-1  
PATHWAY DOSE FACTORS (R<sub>aij</sub>)**

Age Group:	Infant	Pathway: Inhalation				Units: mrem/yr per $\mu\text{Ci}/\text{m}^3$			
Nuclide	Bone	Liver	Thyroid	Kidney	Lung	Gi-LLi	TBody	Skin	
RU-106	8.68E+04	0.00E+00	0.00E+00	1.07E+05	1.16E+07	1.64E+05	1.09E+04	0.00E+00	
AG-110M	9.98E+03	7.22E+03	0.00E+00	1.09E+04	3.67E+06	3.30E+04	5.00E+03	0.00E+00	
TE-125M	4.76E+03	1.99E+03	1.62E+03	0.00E+00	4.47E+05	1.29E+04	6.58E+02	0.00E+00	
TE-127M	1.67E+04	6.90E+03	4.87E+03	3.75E+04	1.31E+06	2.73E+04	2.07E+03	0.00E+00	
TE-127	2.23E+00	9.53E-01	1.85E+00	4.86E+00	1.03E+04	2.44E+04	4.89E-01	0.00E+00	
TE-129M	1.41E+04	6.09E+03	5.47E+03	3.18E+04	1.68E+06	6.90E+04	2.23E+03	0.00E+00	
TE-129	7.88E-02	3.47E-02	6.75E-02	1.75E-01	3.00E+03	2.63E+04	1.88E-02	0.00E+00	
TE-131M	1.07E+02	5.50E+01	8.93E+01	2.65E+02	1.99E+05	1.19E+05	3.63E+01	0.00E+00	
TE-131	1.74E-02	8.22E-03	1.58E-02	3.99E-02	2.06E+03	8.22E+03	5.00E-03	0.00E+00	
TE-132	3.72E+02	2.37E+02	2.79E+02	1.03E+03	3.40E+05	4.41E+04	1.76E+02	0.00E+00	
I-130	6.36E+03	1.39E+04	1.60E+06	1.53E+04	0.00E+00	1.99E+03	5.57E+03	0.00E+00	
I-131	3.79E+04	4.44E+04	1.48E+07	5.18E+04	0.00E+00	1.06E+03	1.96E+04	0.00E+00	
I-132	1.69E+03	3.54E+03	1.69E+05	3.95E+03	0.00E+00	1.90E+03	1.26E+03	0.00E+00	
I-133	1.32E+04	1.92E+04	3.56E+06	2.24E+04	0.00E+00	2.16E+03	5.60E+03	0.00E+00	
I-134	9.21E+02	1.88E+03	4.45E+04	2.09E+03	0.00E+00	1.29E+03	6.65E+02	0.00E+00	
I-135	3.86E+03	7.60E+03	6.96E+05	8.47E+03	0.00E+00	1.83E+03	2.77E+03	0.00E+00	
CS-134	3.96E+05	7.03E+05	0.00E+00	1.90E+05	7.97E+04	1.33E+03	7.45E+04	0.00E+00	
CS-136	4.83E+04	1.35E+05	0.00E+00	5.64E+04	1.18E+04	1.43E+03	5.29E+04	0.00E+00	
CS-137	5.49E+05	6.12E+05	0.00E+00	1.72E+05	7.13E+04	1.33E+03	4.55E+04	0.00E+00	
CS-138	5.05E+02	7.81E+02	0.00E+00	4.10E+02	6.54E+01	8.76E+02	3.98E+02	0.00E+00	
BA-139	1.48E+00	9.84E-04	0.00E+00	5.92E-04	5.95E+03	5.10E+04	4.30E-02	0.00E+00	
BA-140	5.60E+04	5.60E+01	0.00E+00	1.34E+01	1.60E+06	3.84E+04	2.90E+03	0.00E+00	
BA-141	1.57E-01	1.08E-04	0.00E+00	6.50E-05	2.97E+03	4.75E+03	4.97E-03	0.00E+00	
BA-142	3.98E-02	3.30E-05	0.00E+00	1.90E-05	1.55E+03	6.93E+02	1.96E-03	0.00E+00	
LA-140	5.05E+02	2.00E+02	0.00E+00	0.00E+00	1.68E+05	8.48E+04	5.15E+01	0.00E+00	
LA-142	1.03E+00	3.77E-01	0.00E+00	0.00E+00	8.22E+03	5.95E+04	9.04E-02	0.00E+00	
CE-141	2.77E+04	1.67E+04	0.00E+00	5.25E+03	5.17E+05	2.16E+04	1.99E+03	0.00E+00	
CE-143	2.93E+02	1.93E+02	0.00E+00	5.64E+01	1.16E+05	4.97E+04	2.21E+01	0.00E+00	
CE-144	3.19E+06	1.21E+06	0.00E+00	5.38E+05	9.84E+06	1.48E+05	1.76E+05	0.00E+00	
PR-143	1.40E+04	5.24E+03	0.00E+00	1.97E+03	4.33E+05	3.72E+04	6.99E+02	0.00E+00	
PR-144	4.79E-02	1.85E-02	0.00E+00	6.72E-03	1.61E+03	4.28E+03	2.41E-03	0.00E+00	
ND-147	7.94E+03	8.13E+03	0.00E+00	3.15E+03	3.22E+05	3.12E+04	5.00E+02	0.00E+00	
W-187	1.30E+01	9.02E+00	0.00E+00	0.00E+00	3.96E+04	3.56E+04	3.12E+00	0.00E+00	
NP-239	3.71E+02	2.98E+02	0.00E+00	6.62E+01	5.95E+04	2.49E+04	1.88E+01	0.00E+00	

**TABLE 3.2-1  
PATHWAY DOSE FACTORS (R<sub>aij</sub>)**

Age Group:	Child	Pathway: Inhalation				Units: mrem/yr per $\mu\text{Ci}/\text{m}^3$			
Nuclide	Bone	Liver	Thyroid	Kidney	Lung	GI-LLi	TBody	Skin	
H-3	0.00E+00	1.12E+03	1.12E+03	1.12E+03	1.12E+03	1.12E+03	1.12E+03	0.00E+00	
C-14	3.59E+04	6.73E+03	6.73E+03	6.73E+03	6.73E+03	6.73E+03	6.73E+03	0.00E+00	
NA-24	1.61E+04	1.61E+04	1.61E+04	1.61E+04	1.61E+04	1.61E+04	1.61E+04	0.00E+00	
P-32	2.60E+06	1.14E+05	0.00E+00	0.00E+00	0.00E+00	4.22E+04	9.88E+04	0.00E+00	
CR-51	0.00E+00	0.00E+00	8.55E+01	2.43E+01	1.70E+04	1.08E+03	1.54E+02	0.00E+00	
MN-54	0.00E+00	4.29E+04	0.00E+00	1.00E+04	1.58E+06	2.29E+04	9.51E+03	0.00E+00	
MN-56	0.00E+00	1.66E+00	0.00E+00	1.67E+00	1.31E+04	1.23E+05	3.12E-01	0.00E+00	
FE-55	4.74E+04	2.52E+04	0.00E+00	0.00E+00	1.11E+05	2.87E+03	7.77E+03	0.00E+00	
FE-59	2.07E+04	3.34E+04	0.00E+00	0.00E+00	1.27E+06	7.07E+04	1.67E+04	0.00E+00	
CO-58	0.00E+00	1.77E+03	0.00E+00	0.00E+00	1.11E+06	3.44E+04	3.16E+03	0.00E+00	
CO-60	0.00E+00	1.31E+04	0.00E+00	0.00E+00	7.07E+06	9.62E+04	2.26E+04	0.00E+00	
NI-63	8.21E+05	4.63E+04	0.00E+00	0.00E+00	2.75E+05	6.33E+03	2.80E+04	0.00E+00	
NI-65	2.99E+00	2.96E-01	0.00E+00	0.00E+00	8.18E+03	8.40E+04	1.64E-01	0.00E+00	
CU-64	0.00E+00	1.99E+00	0.00E+00	6.03E+00	9.58E+03	3.67E+04	1.07E+00	0.00E+00	
ZN-65	4.26E+04	1.13E+05	0.00E+00	7.14E+04	9.95E+05	1.63E+04	7.03E+04	0.00E+00	
ZN-69	6.70E-02	9.66E-02	0.00E+00	5.85E-02	1.42E+03	1.02E+04	8.92E-03	0.00E+00	
BR-83	0.00E+00	0.00E+00	0.00E+00	0.00E+00	0.00E+00	0.00E+00	4.74E+02	0.00E+00	
BR-84	0.00E+00	0.00E+00	0.00E+00	0.00E+00	0.00E+00	0.00E+00	5.48E+02	0.00E+00	
BR-85	0.00E+00	0.00E+00	0.00E+00	0.00E+00	0.00E+00	0.00E+00	2.53E+01	0.00E+00	
RB-86	0.00E+00	1.98E+05	0.00E+00	0.00E+00	0.00E+00	7.99E+03	1.14E+05	0.00E+00	
RB-88	0.00E+00	5.62E+02	0.00E+00	0.00E+00	0.00E+00	1.72E+01	3.66E+02	0.00E+00	
RB-89	0.00E+00	3.45E+02	0.00E+00	0.00E+00	0.00E+00	1.89E+00	2.90E+02	0.00E+00	
SR-89	5.99E+05	0.00E+00	0.00E+00	0.00E+00	2.16E+06	1.67E+05	1.72E+04	0.00E+00	
SR-90	1.01E+08	0.00E+00	0.00E+00	0.00E+00	1.48E+07	3.43E+05	6.44E+06	0.00E+00	
SR-91	1.21E+02	0.00E+00	0.00E+00	0.00E+00	5.33E+04	1.74E+05	4.59E+00	0.00E+00	
SR-92	1.31E+01	0.00E+00	0.00E+00	0.00E+00	2.40E+04	2.42E+05	5.25E-01	0.00E+00	
Y-90	4.11E+03	0.00E+00	0.00E+00	0.00E+00	2.62E+05	2.68E+05	1.11E+02	0.00E+00	
Y-91M	5.07E-01	0.00E+00	0.00E+00	0.00E+00	2.81E+03	1.72E+03	1.84E-02	0.00E+00	
Y-91	9.14E+05	0.00E+00	0.00E+00	0.00E+00	2.63E+06	1.84E+05	2.44E+04	0.00E+00	
Y-92	2.04E+01	0.00E+00	0.00E+00	0.00E+00	2.39E+04	2.39E+05	5.81E-01	0.00E+00	
Y-93	1.86E+02	0.00E+00	0.00E+00	0.00E+00	7.44E+04	3.89E+05	5.11E+00	0.00E+00	
ZR-95	1.90E+05	4.18E+04	0.00E+00	5.96E+04	2.23E+06	6.11E+04	3.70E+04	0.00E+00	
ZR-97	1.88E+02	2.72E+01	0.00E+00	3.89E+01	1.13E+05	3.51E+05	1.60E+01	0.00E+00	
NB-95	2.35E+04	9.18E+03	0.00E+00	8.62E+03	6.14E+05	3.70E+04	6.55E+03	0.00E+00	
MO-99	0.00E+00	1.72E+02	0.00E+00	3.92E+02	1.35E+05	1.27E+05	4.26E+01	0.00E+00	
TC-99M	1.78E-03	3.48E-03	0.00E+00	5.07E-02	9.51E+02	4.81E+03	5.77E-02	0.00E+00	
TC-101	8.10E-05	8.51E-05	0.00E+00	1.45E-03	5.85E+02	1.63E+01	1.08E-03	0.00E+00	
RU-103	2.79E+03	0.00E+00	0.00E+00	7.03E+03	6.62E+05	4.48E+04	1.07E+03	0.00E+00	
RU-105	1.53E+00	0.00E+00	0.00E+00	1.34E+00	1.59E+04	9.95E+04	5.55E-01	0.00E+00	
RU-106	1.36E+05	0.00E+00	0.00E+00	1.84E+05	1.43E+07	4.29E+05	1.69E+04	0.00E+00	

**TABLE 3.2-1  
PATHWAY DOSE FACTORS (R<sub>aij</sub>)**

Age Group:	Child	Pathway: Inhalation							Units: mrem/yr per $\mu\text{Ci}/\text{m}^3$
Nuclide	Bone	Liver	Thyroid	Kidney	Lung	Gi-LLi	TBody	Skin	
AG-110M	1.69E+04	1.14E+04	0.00E+00	2.12E+04	5.48E+06	1.00E+05	9.14E+03	0.00E+00	
TE-125M	6.73E+03	2.33E+03	1.92E+03	0.00E+00	4.77E+05	3.38E+04	9.14E+02	0.00E+00	
TE-127M	2.49E+04	8.55E+03	6.07E+03	6.36E+04	1.48E+06	7.14E+04	3.02E+03	0.00E+00	
TE-127	2.77E+00	9.51E-01	1.96E+00	7.07E+00	1.00E+04	5.62E+04	6.11E-01	0.00E+00	
TE-129M	1.92E+04	6.85E+03	6.33E+03	5.03E+04	1.76E+06	1.82E+05	3.04E+03	0.00E+00	
TE-129	9.77E-02	3.50E-02	7.14E-02	2.57E-01	2.93E+03	2.55E+04	2.38E-02	0.00E+00	
TE-131M	1.34E+02	5.92E+01	9.77E+01	4.00E+02	2.06E+05	3.08E+05	5.07E+01	0.00E+00	
TE-131	2.17E-02	8.44E-03	1.70E-02	5.88E-02	2.05E+03	1.33E+03	6.59E-03	0.00E+00	
TE-132	4.81E+02	2.72E+02	3.17E+02	1.77E+03	3.77E+05	1.38E+05	2.63E+02	0.00E+00	
I-130	8.18E+03	1.64E+04	1.85E+06	2.45E+04	0.00E+00	5.11E+03	8.44E+03	0.00E+00	
I-131	4.81E+04	4.81E+04	1.62E+07	7.88E+04	0.00E+00	2.84E+03	2.73E+04	0.00E+00	
I-132	2.12E+03	4.07E+03	1.94E+05	6.25E+03	0.00E+00	3.20E+03	1.88E+03	0.00E+00	
I-133	1.66E+04	2.03E+04	3.85E+06	3.38E+04	0.00E+00	5.48E+03	7.70E+03	0.00E+00	
I-134	1.17E+03	2.16E+03	5.07E+04	3.30E+03	0.00E+00	9.55E+02	9.95E+02	0.00E+00	
I-135	4.92E+03	8.73E+03	7.92E+05	1.34E+04	0.00E+00	4.44E+03	4.14E+03	0.00E+00	
CS-134	6.51E+05	1.01E+06	0.00E+00	3.30E+05	1.21E+05	3.85E+03	2.25E+05	0.00E+00	
CS-136	6.51E+04	1.71E+05	0.00E+00	9.55E+04	1.45E+04	4.18E+03	1.16E+05	0.00E+00	
CS-137	9.07E+05	8.25E+05	0.00E+00	2.82E+05	1.04E+05	3.62E+03	1.28E+05	0.00E+00	
CS-138	6.33E+02	8.40E+02	0.00E+00	6.22E+02	6.81E+01	2.70E+02	5.55E+02	0.00E+00	
BA-139	1.84E+00	9.84E-04	0.00E+00	8.62E-04	5.77E+03	5.77E+04	5.37E-02	0.00E+00	
BA-140	7.40E+04	6.48E+01	0.00E+00	2.11E+01	1.74E+06	1.02E+05	4.33E+03	0.00E+00	
BA-141	1.96E-01	1.09E-04	0.00E+00	9.47E-05	2.92E+03	2.75E+02	6.36E-03	0.00E+00	
BA-142	5.00E-02	3.60E-05	0.00E+00	2.91E-05	1.64E+03	2.74E+00	2.79E-03	0.00E+00	
LA-140	6.44E+02	2.25E+02	0.00E+00	0.00E+00	1.83E+05	2.26E+05	7.55E+01	0.00E+00	
LA-142	1.30E+00	4.11E-01	0.00E+00	0.00E+00	8.70E+03	7.59E+04	1.29E-01	0.00E+00	
CE-141	3.92E+04	1.95E+04	0.00E+00	8.55E+03	5.44E+05	5.66E+04	2.90E+03	0.00E+00	
CE-143	3.66E+02	1.99E+02	0.00E+00	8.36E+01	1.15E+05	1.27E+05	2.87E+01	0.00E+00	
CE-144	6.77E+06	2.12E+06	0.00E+00	1.17E+06	1.20E+07	3.89E+05	3.61E+05	0.00E+00	
PR-143	1.85E+04	5.55E+03	0.00E+00	3.00E+03	4.33E+05	9.73E+04	9.14E+02	0.00E+00	
PR-144	5.96E-02	1.85E-02	0.00E+00	9.77E-03	1.57E+03	1.97E+02	3.00E-03	0.00E+00	
ND-147	1.08E+04	8.73E+03	0.00E+00	4.81E+03	3.28E+05	8.21E+04	6.81E+02	0.00E+00	
W-187	1.63E+01	9.66E+00	0.00E+00	0.00E+00	4.11E+04	9.10E+04	4.33E+00	0.00E+00	
NP-239	4.66E+02	3.01E+02	0.00E+00	9.73E+01	5.81E+04	6.40E+04	2.35E+01	0.00E+00	

**TABLE 3.2-1  
PATHWAY DOSE FACTORS (R<sub>aij</sub>)**

Age Group:	Teen	Pathway: Inhalation							Units: mrem/yr per $\mu\text{Ci}/\text{m}^3$
Nuclide	Bone	Liver	Thyroid	Kidney	Lung	Gi-LLi	TBody	Skin	
H-3	0.00E+00	1.27E+03	1.27E+03	1.27E+03	1.27E+03	1.27E+03	1.27E+03	0.00E+00	
C-14	2.60E+04	4.87E+03	4.87E+03	4.87E+03	4.87E+03	4.87E+03	4.87E+03	0.00E+00	
NA-24	1.38E+04	1.38E+04	1.38E+04	1.38E+04	1.38E+04	1.38E+04	1.38E+04	0.00E+00	
P-32	1.89E+06	1.10E+05	0.00E+00	0.00E+00	0.00E+00	9.28E+04	7.16E+04	0.00E+00	
CR-51	0.00E+00	0.00E+00	7.50E+01	3.07E+01	2.10E+04	3.00E+03	1.35E+02	0.00E+00	
MN-54	0.00E+00	5.11E+04	0.00E+00	1.27E+04	1.98E+06	6.68E+04	8.40E+03	0.00E+00	
MN-56	0.00E+00	1.70E+00	0.00E+00	1.79E+00	1.52E+04	5.74E+04	2.52E-01	0.00E+00	
FE-55	3.34E+04	2.38E+04	0.00E+00	0.00E+00	1.24E+05	6.39E+03	5.54E+03	0.00E+00	
FE-59	1.59E+04	3.70E+04	0.00E+00	0.00E+00	1.53E+06	1.78E+05	1.43E+04	0.00E+00	
CO-58	0.00E+00	2.07E+03	0.00E+00	0.00E+00	1.34E+06	9.52E+04	2.78E+03	0.00E+00	
CO-60	0.00E+00	1.51E+04	0.00E+00	0.00E+00	8.72E+06	2.59E+05	1.98E+04	0.00E+00	
NI-63	5.80E+05	4.34E+04	0.00E+00	0.00E+00	3.07E+05	1.42E+04	1.98E+04	0.00E+00	
NI-65	2.18E+00	2.93E-01	0.00E+00	0.00E+00	9.36E+03	3.67E+04	1.27E-01	0.00E+00	
CU-64	0.00E+00	2.03E+00	0.00E+00	6.41E+00	1.11E+04	6.14E+04	8.48E-01	0.00E+00	
ZN-65	3.86E+04	1.34E+05	0.00E+00	8.64E+04	1.24E+06	4.66E+04	6.24E+04	0.00E+00	
ZN-69	4.83E-02	9.20E-02	0.00E+00	6.02E-02	1.58E+03	2.85E+02	6.46E-03	0.00E+00	
BR-83	0.00E+00	0.00E+00	0.00E+00	0.00E+00	0.00E+00	0.00E+00	3.44E+02	0.00E+00	
BR-84	0.00E+00	0.00E+00	0.00E+00	0.00E+00	0.00E+00	0.00E+00	4.33E+02	0.00E+00	
BR-85	0.00E+00	0.00E+00	0.00E+00	0.00E+00	0.00E+00	0.00E+00	1.83E+01	0.00E+00	
RB-86	0.00E+00	1.90E+05	0.00E+00	0.00E+00	0.00E+00	1.77E+04	8.40E+04	0.00E+00	
RB-88	0.00E+00	5.46E+02	0.00E+00	0.00E+00	0.00E+00	2.92E-05	2.72E+02	0.00E+00	
RB-89	0.00E+00	3.52E+02	0.00E+00	0.00E+00	0.00E+00	3.38E-07	2.33E+02	0.00E+00	
SR-89	4.34E+05	0.00E+00	0.00E+00	0.00E+00	2.42E+06	3.71E+05	1.25E+04	0.00E+00	
SR-90	1.08E+08	0.00E+00	0.00E+00	0.00E+00	1.65E+07	7.65E+05	6.68E+06	0.00E+00	
SR-91	8.80E+01	0.00E+00	0.00E+00	0.00E+00	6.07E+04	2.59E+05	3.51E+00	0.00E+00	
SR-92	9.52E+00	0.00E+00	0.00E+00	0.00E+00	2.74E+04	1.19E+05	4.06E-01	0.00E+00	
Y-90	2.98E+03	0.00E+00	0.00E+00	0.00E+00	2.93E+05	5.59E+05	8.00E+01	0.00E+00	
Y-91M	3.70E-01	0.00E+00	0.00E+00	0.00E+00	3.20E+03	3.02E+01	1.42E-02	0.00E+00	
Y-91	6.61E+05	0.00E+00	0.00E+00	0.00E+00	2.94E+06	4.09E+05	1.77E+04	0.00E+00	
Y-92	1.47E+01	0.00E+00	0.00E+00	0.00E+00	2.68E+04	1.65E+05	4.29E-01	0.00E+00	
Y-93	1.35E+02	0.00E+00	0.00E+00	0.00E+00	8.32E+04	5.79E+05	3.72E+00	0.00E+00	
ZR-95	1.46E+05	4.58E+04	0.00E+00	6.74E+04	2.69E+06	1.49E+05	3.15E+04	0.00E+00	
ZR-97	1.38E+02	2.72E+01	0.00E+00	4.12E+01	1.30E+05	6.30E+05	1.26E+01	0.00E+00	
NB-95	1.86E+04	1.03E+04	0.00E+00	1.00E+04	7.51E+05	9.68E+04	5.66E+03	0.00E+00	
MO-99	0.00E+00	1.69E+02	0.00E+00	4.11E+02	1.54E+05	2.69E+05	3.22E+01	0.00E+00	
TC-99M	1.38E-03	3.86E-03	0.00E+00	5.76E-02	1.15E+03	6.13E+03	4.99E-02	0.00E+00	
TC-101	5.92E-05	8.40E-05	0.00E+00	1.52E-03	6.67E+02	8.72E-07	8.24E-04	0.00E+00	
RU-103	2.10E+03	0.00E+00	0.00E+00	7.43E+03	7.83E+05	1.09E+05	8.96E+02	0.00E+00	
RU-105	1.12E+00	0.00E+00	0.00E+00	1.41E+00	1.82E+04	9.04E+04	4.34E-01	0.00E+00	
RU-106	9.84E+04	0.00E+00	0.00E+00	1.90E+05	1.61E+07	9.60E+05	1.24E+04	0.00E+00	

**TABLE 3.2-1  
PATHWAY DOSE FACTORS (R<sub>aij</sub>)**

Age Group:	Teen	Pathway: Inhalation							Units: mrem/yr per $\mu\text{Ci}/\text{m}^3$
Nuclide	Bone	Liver	Thyroid	Kidney	Lung	Gi-LLi	TBody	Skin	
AG-110M	1.38E+04	1.31E+04	0.00E+00	2.50E+04	6.75E+06	2.73E+05	7.99E+03	0.00E+00	
TE-125M	4.88E+03	2.24E+03	1.40E+03	0.00E+00	5.36E+05	7.50E+04	6.67E+02	0.00E+00	
TE-127M	1.80E+04	8.16E+03	4.38E+03	6.54E+04	1.66E+06	1.59E+05	2.18E+03	0.00E+00	
TE-127	2.01E+00	9.12E-01	1.42E+00	7.28E+00	1.12E+04	8.08E+04	4.42E-01	0.00E+00	
TE-129M	1.39E+04	6.58E+03	4.58E+03	5.19E+04	1.98E+06	4.05E+05	2.25E+03	0.00E+00	
TE-129	7.10E-02	3.38E-02	5.18E-02	2.66E-01	3.30E+03	1.62E+03	1.76E-02	0.00E+00	
TE-131M	9.84E+01	6.01E+01	7.25E+01	4.39E+02	2.38E+05	6.21E+05	4.02E+01	0.00E+00	
TE-131	1.58E-02	8.32E-03	1.24E-02	6.18E-02	2.34E+03	1.51E+01	5.04E-03	0.00E+00	
TE-132	3.60E+02	2.90E+02	2.46E+02	1.95E+03	4.49E+05	4.63E+05	2.19E+02	0.00E+00	
I-130	6.24E+03	1.79E+04	1.49E+06	2.75E+04	0.00E+00	9.12E+03	7.17E+03	0.00E+00	
I-131	3.54E+04	4.91E+04	1.46E+07	8.40E+04	0.00E+00	6.49E+03	2.64E+04	0.00E+00	
I-132	1.59E+03	4.38E+03	1.51E+05	6.92E+03	0.00E+00	1.27E+03	1.58E+03	0.00E+00	
I-133	1.22E+04	2.05E+04	2.92E+06	3.59E+04	0.00E+00	1.03E+04	6.22E+03	0.00E+00	
I-134	8.88E+02	2.32E+03	3.95E+04	3.66E+03	0.00E+00	2.04E+01	8.40E+02	0.00E+00	
I-135	3.70E+03	9.44E+03	6.21E+05	1.49E+04	0.00E+00	6.95E+03	3.49E+03	0.00E+00	
CS-134	5.02E+05	1.13E+06	0.00E+00	3.75E+05	1.46E+05	9.76E+03	5.49E+05	0.00E+00	
CS-136	5.15E+04	1.94E+05	0.00E+00	1.10E+05	1.78E+04	1.09E+04	1.37E+05	0.00E+00	
CS-137	6.70E+05	8.48E+05	0.00E+00	3.04E+05	1.21E+05	8.48E+03	3.11E+05	0.00E+00	
CS-138	4.66E+02	8.56E+02	0.00E+00	6.62E+02	7.87E+01	2.70E-01	4.46E+02	0.00E+00	
BA-139	1.34E+00	9.44E-04	0.00E+00	8.88E-04	6.46E+03	6.45E+03	3.90E-02	0.00E+00	
BA-140	5.47E+04	6.70E+01	0.00E+00	2.28E+01	2.03E+06	2.29E+05	3.52E+03	0.00E+00	
BA-141	1.42E-01	1.06E-04	0.00E+00	9.84E-05	3.29E+03	7.46E-04	4.74E-03	0.00E+00	
BA-142	3.70E-02	3.70E-05	0.00E+00	3.14E-05	1.91E+03	4.79E-10	2.27E-03	0.00E+00	
LA-140	4.79E+02	2.36E+02	0.00E+00	0.00E+00	2.14E+05	4.87E+05	6.26E+01	0.00E+00	
LA-142	9.60E-01	4.25E-01	0.00E+00	0.00E+00	1.02E+04	1.20E+04	1.06E-01	0.00E+00	
CE-141	2.84E+04	1.90E+04	0.00E+00	8.88E+03	6.14E+05	1.26E+05	2.17E+03	0.00E+00	
CE-143	2.66E+02	1.94E+02	0.00E+00	8.64E+01	1.30E+05	2.55E+05	2.16E+01	0.00E+00	
CE-144	4.89E+06	2.02E+06	0.00E+00	1.21E+06	1.34E+07	8.64E+05	2.62E+05	0.00E+00	
PR-143	1.34E+04	5.31E+03	0.00E+00	3.09E+03	4.83E+05	2.14E+05	6.62E+02	0.00E+00	
PR-144	4.30E-02	1.76E-02	0.00E+00	1.01E-02	1.75E+03	2.35E-04	2.18E-03	0.00E+00	
ND-147	7.86E+03	8.56E+03	0.00E+00	5.02E+03	3.72E+05	1.82E+05	5.13E+02	0.00E+00	
W-187	1.20E+01	9.76E+00	0.00E+00	0.00E+00	4.74E+04	1.77E+05	3.43E+00	0.00E+00	
NP-239	3.38E+02	2.88E+02	0.00E+00	1.00E+02	6.49E+04	1.32E+05	1.77E+01	0.00E+00	

**TABLE 3.2-1  
PATHWAY DOSE FACTORS (R<sub>aij</sub>)**

Age Group:	Adult	Pathway: Inhalation				Units: mrem/yr per $\mu\text{Ci}/\text{m}^3$			
Nuclide	Bone	Liver	Thyroid	Kidney	Lung	Gi-LLi	TBody	Skin	
H-3	0.00E+00	1.26E+03	1.26E+03	1.26E+03	1.26E+03	1.26E+03	1.26E+03	0.00E+00	
C-14	1.82E+04	3.41E+03	3.41E+03	3.41E+03	3.41E+03	3.41E+03	3.41E+03	0.00E+00	
NA-24	1.02E+04	1.02E+04	1.02E+04	1.02E+04	1.02E+04	1.02E+04	1.02E+04	0.00E+00	
P-32	1.32E+06	7.71E+04	0.00E+00	0.00E+00	0.00E+00	8.64E+04	5.01E+04	0.00E+00	
CR-51	0.00E+00	0.00E+00	5.95E+01	2.28E+01	1.44E+04	3.32E+03	1.00E+02	0.00E+00	
MN-54	0.00E+00	3.96E+04	0.00E+00	9.84E+03	1.40E+06	7.74E+04	6.30E+03	0.00E+00	
MN-56	0.00E+00	1.24E+00	0.00E+00	1.30E+00	9.44E+03	2.02E+04	1.83E-01	0.00E+00	
FE-55	2.46E+04	1.70E+04	0.00E+00	0.00E+00	7.21E+04	6.03E+03	3.94E+03	0.00E+00	
FE-59	1.18E+04	2.78E+04	0.00E+00	0.00E+00	1.02E+06	1.88E+05	1.06E+04	0.00E+00	
CO-58	0.00E+00	1.58E+03	0.00E+00	0.00E+00	9.28E+05	1.06E+05	2.07E+03	0.00E+00	
CO-60	0.00E+00	1.15E+04	0.00E+00	0.00E+00	5.97E+06	2.85E+05	1.48E+04	0.00E+00	
NI-63	4.32E+05	3.14E+04	0.00E+00	0.00E+00	1.78E+05	1.34E+04	1.45E+04	0.00E+00	
NI-65	1.54E+00	2.10E-01	0.00E+00	0.00E+00	5.60E+03	1.23E+04	9.12E-02	0.00E+00	
CU-64	0.00E+00	1.46E+00	0.00E+00	4.62E+00	6.78E+03	4.90E+04	6.15E-01	0.00E+00	
ZN-65	3.24E+04	1.03E+05	0.00E+00	6.90E+04	8.64E+05	5.34E+04	4.66E+04	0.00E+00	
ZN-69	3.38E-02	6.51E-02	0.00E+00	4.22E-02	9.20E+02	1.63E+01	4.52E-03	0.00E+00	
BR-83	0.00E+00	0.00E+00	0.00E+00	0.00E+00	0.00E+00	2.32E+02	2.41E+02	0.00E+00	
BR-84	0.00E+00	0.00E+00	0.00E+00	0.00E+00	0.00E+00	1.64E-03	3.13E+02	0.00E+00	
BR-85	0.00E+00	0.00E+00	0.00E+00	0.00E+00	0.00E+00	0.00E+00	1.28E+01	0.00E+00	
RB-86	0.00E+00	1.35E+05	0.00E+00	0.00E+00	0.00E+00	1.66E+04	5.90E+04	0.00E+00	
RB-88	0.00E+00	3.87E+02	0.00E+00	0.00E+00	0.00E+00	3.34E-09	1.93E+02	0.00E+00	
RB-89	0.00E+00	2.56E+02	0.00E+00	0.00E+00	0.00E+00	9.28E-12	1.70E+02	0.00E+00	
SR-89	3.04E+05	0.00E+00	0.00E+00	0.00E+00	1.40E+06	3.50E+05	8.72E+03	0.00E+00	
SR-90	9.92E+07	0.00E+00	0.00E+00	0.00E+00	9.60E+06	7.22E+05	6.10E+06	0.00E+00	
SR-91	6.19E+01	0.00E+00	0.00E+00	0.00E+00	3.65E+04	1.91E+05	2.50E+00	0.00E+00	
SR-92	6.74E+00	0.00E+00	0.00E+00	0.00E+00	1.65E+04	4.30E+04	2.91E-01	0.00E+00	
Y-90	2.09E+03	0.00E+00	0.00E+00	0.00E+00	1.70E+05	5.06E+05	5.61E+01	0.00E+00	
Y-91M	2.61E-01	0.00E+00	0.00E+00	0.00E+00	1.92E+03	1.33E+00	1.02E-02	0.00E+00	
Y-91	4.62E+05	0.00E+00	0.00E+00	0.00E+00	1.70E+06	3.85E+05	1.24E+04	0.00E+00	
Y-92	1.03E+01	0.00E+00	0.00E+00	0.00E+00	1.57E+04	7.35E+04	3.02E-01	0.00E+00	
Y-93	9.44E+01	0.00E+00	0.00E+00	0.00E+00	4.85E+04	4.22E+05	2.61E+00	0.00E+00	
ZR-95	1.07E+05	3.44E+04	0.00E+00	5.42E+04	1.77E+06	1.50E+05	2.33E+04	0.00E+00	
ZR-97	9.68E+01	1.96E+01	0.00E+00	2.97E+01	7.87E+04	5.23E+05	9.04E+00	0.00E+00	
NB-95	1.41E+04	7.82E+03	0.00E+00	7.74E+03	5.05E+05	1.04E+05	4.21E+03	0.00E+00	
MO-99	0.00E+00	1.21E+02	0.00E+00	2.91E+02	9.12E+04	2.48E+05	2.30E+01	0.00E+00	
TC-99M	1.03E-03	2.91E-03	0.00E+00	4.42E-02	7.64E+02	4.16E+03	3.70E-02	0.00E+00	
TC-101	4.18E-05	6.02E-05	0.00E+00	1.08E-03	3.99E+02	1.09E-11	5.90E-04	0.00E+00	
RU-103	1.53E+03	0.00E+00	0.00E+00	5.83E+03	5.05E+05	1.10E+05	6.58E+02	0.00E+00	

**TABLE 3.2-1  
PATHWAY DOSE FACTORS (R<sub>aij</sub>)**

Age Group:	Adult	Pathway: Inhalation							Units: mrem/yr per $\mu\text{Ci}/\text{m}^3$
Nuclide	Bone	Liver	Thyroid	Kidney	Lung	Gi-LLi	TBody	Skin	
RU-105	7.90E-01	0.00E+00	0.00E+00	1.02E+00	1.10E+04	4.82E+04	3.11E-01	0.00E+00	
RU-106	6.91E+04	0.00E+00	0.00E+00	1.34E+05	9.36E+06	9.12E+05	8.72E+03	0.00E+00	
AG-110M	1.08E+04	1.00E+04	0.00E+00	1.97E+04	4.63E+06	3.02E+05	5.94E+03	0.00E+00	
TE-125M	3.42E+03	1.58E+03	1.05E+03	1.24E+04	3.14E+05	7.06E+04	4.67E+02	0.00E+00	
TE-127M	1.26E+04	5.77E+03	3.29E+03	4.58E+04	9.60E+05	1.50E+05	1.57E+03	0.00E+00	
TE-127	1.40E+00	6.42E-01	1.06E+00	5.10E+00	6.51E+03	5.74E+04	3.10E-01	0.00E+00	
TE-129M	9.76E+03	4.67E+03	3.44E+03	3.66E+04	1.16E+06	3.83E+05	1.58E+03	0.00E+00	
TE-129	4.98E-02	2.39E-02	3.90E-02	1.87E-01	1.94E+03	1.57E+02	1.24E-02	0.00E+00	
TE-131M	6.99E+01	4.36E+01	5.50E+01	3.09E+02	1.46E+05	5.56E+05	2.90E+01	0.00E+00	
TE-131	1.11E-02	5.95E-03	9.36E-03	4.37E-02	1.39E+03	1.84E+01	3.59E-03	0.00E+00	
TE-132	2.60E+02	2.15E+02	1.90E+02	1.46E+03	2.88E+05	5.10E+05	1.62E+02	0.00E+00	
I-130	4.58E+03	1.34E+04	1.14E+06	2.09E+04	0.00E+00	7.69E+03	5.28E+03	0.00E+00	
I-131	2.52E+04	3.58E+04	1.19E+07	6.13E+04	0.00E+00	6.28E+03	2.05E+04	0.00E+00	
I-132	1.16E+03	3.26E+03	1.14E+05	5.18E+03	0.00E+00	4.06E+02	1.16E+03	0.00E+00	
I-133	8.64E+03	1.48E+04	2.15E+06	2.58E+04	0.00E+00	8.88E+03	4.52E+03	0.00E+00	
I-134	6.44E+02	1.73E+03	2.98E+04	2.75E+03	0.00E+00	1.01E+00	6.15E+02	0.00E+00	
I-135	2.68E+03	6.98E+03	4.48E+05	1.11E+04	0.00E+00	5.25E+03	2.57E+03	0.00E+00	
CS-134	3.73E+05	8.48E+05	0.00E+00	2.87E+05	9.76E+04	1.04E+04	7.28E+05	0.00E+00	
CS-136	3.90E+04	1.46E+05	0.00E+00	8.56E+04	1.20E+04	1.17E+04	1.10E+05	0.00E+00	
CS-137	4.78E+05	6.21E+05	0.00E+00	2.22E+05	7.52E+04	8.40E+03	4.28E+05	0.00E+00	
CS-138	3.31E+02	6.21E+02	0.00E+00	4.80E+02	4.86E+01	1.86E-03	3.24E+02	0.00E+00	
BA-139	9.36E-01	6.66E-04	0.00E+00	6.22E-04	3.76E+03	8.96E+02	2.74E-02	0.00E+00	
BA-140	3.90E+04	4.90E+01	0.00E+00	1.67E+01	1.27E+06	2.18E+05	2.57E+03	0.00E+00	
BA-141	1.00E-01	7.53E-05	0.00E+00	7.00E-05	1.94E+03	1.16E-07	3.36E-03	0.00E+00	
BA-142	2.63E-02	2.70E-05	0.00E+00	2.29E-05	1.19E+03	1.57E-16	1.66E-03	0.00E+00	
LA-140	3.44E+02	1.74E+02	0.00E+00	0.00E+00	1.36E+05	4.58E+05	4.58E+01	0.00E+00	
LA-142	6.83E-01	3.10E-01	0.00E+00	0.00E+00	6.33E+03	2.11E+03	7.72E-02	0.00E+00	
CE-141	1.99E+04	1.35E+04	0.00E+00	6.26E+03	3.62E+05	1.20E+05	1.53E+03	0.00E+00	
CE-143	1.86E+02	1.38E+02	0.00E+00	6.08E+01	7.98E+04	2.26E+05	1.53E+01	0.00E+00	
CE-144	3.43E+06	1.43E+06	0.00E+00	8.48E+05	7.78E+06	8.16E+05	1.84E+05	0.00E+00	
PR-143	9.36E+03	3.75E+03	0.00E+00	2.16E+03	2.81E+05	2.00E+05	4.64E+02	0.00E+00	
PR-144	3.01E-02	1.25E-02	0.00E+00	7.05E-03	1.02E+03	2.15E-08	1.53E-03	0.00E+00	
ND-147	5.27E+03	6.10E+03	0.00E+00	3.56E+03	2.21E+05	1.73E+05	3.65E+02	0.00E+00	
W-187	8.48E+00	7.08E+00	0.00E+00	0.00E+00	2.90E+04	1.55E+05	2.48E+00	0.00E+00	
NP-239	2.30E+02	2.03E+02	0.00E+00	7.00E+01	3.76E+04	1.19E+05	1.24E+01	0.00E+00	

**TABLE 3.2-1  
PATHWAY DOSE FACTORS (R<sub>aij</sub>)**

Age Group:	Child	Pathway: Vegetation					Units: m <sup>2</sup> x mrem/yr per $\mu$ Ci/sec		
Nuclide	Bone	Liver	Thyroid	Kidney	Lung	GI-LLi	TBody	Skin	
H-3 *	0.00E+00	4.01E+03	4.01E+03	4.01E+03	4.01E+03	4.01E+03	4.01E+03	0.00E+00	
C-14 *	7.65E+05	1.53E+05	1.53E+05	1.53E+05	1.53E+05	1.53E+05	1.53E+05	0.00E+00	
NA-24	3.73E+05	3.73E+05	3.73E+05	3.73E+05	3.73E+05	3.73E+05	3.73E+05	0.00E+00	
P-32	3.37E+09	1.58E+08	0.00E+00	0.00E+00	0.00E+00	9.32E+07	1.30E+08	0.00E+00	
CR-51	0.00E+00	0.00E+00	6.48E+04	1.77E+04	1.18E+05	6.19E+06	1.17E+05	0.00E+00	
MN-54	0.00E+00	6.65E+08	0.00E+00	1.86E+08	0.00E+00	5.58E+08	1.77E+08	0.00E+00	
MN-56	0.00E+00	1.76E+01	0.00E+00	2.13E+01	0.00E+00	2.55E+03	3.98E+00	0.00E+00	
FE-55	8.01E+08	4.25E+08	0.00E+00	0.00E+00	2.40E+08	7.87E+07	1.32E+08	0.00E+00	
FE-59	3.97E+08	6.42E+08	0.00E+00	0.00E+00	1.86E+08	6.68E+08	3.20E+08	0.00E+00	
CO-58	0.00E+00	6.45E+07	0.00E+00	0.00E+00	0.00E+00	3.76E+08	1.97E+08	0.00E+00	
CO-60	0.00E+00	3.78E+08	0.00E+00	0.00E+00	0.00E+00	2.10E+09	1.12E+09	0.00E+00	
NI-63	3.95E+10	2.11E+09	0.00E+00	0.00E+00	0.00E+00	1.42E+08	1.34E+09	0.00E+00	
NI-65	1.02E+02	9.59E+00	0.00E+00	0.00E+00	0.00E+00	1.18E+03	5.60E+00	0.00E+00	
CU-64	0.00E+00	1.09E+04	0.00E+00	2.62E+04	0.00E+00	5.10E+05	6.56E+03	0.00E+00	
ZN-65	8.12E+08	2.16E+09	0.00E+00	1.36E+09	0.00E+00	3.80E+08	1.35E+09	0.00E+00	
ZN-69	1.35E-05	1.95E-05	0.00E+00	1.18E-05	0.00E+00	1.23E-03	1.80E-06	0.00E+00	
BR-83	0.00E+00	0.00E+00	0.00E+00	0.00E+00	0.00E+00	0.00E+00	5.23E+00	0.00E+00	
BR-84	0.00E+00	0.00E+00	0.00E+00	0.00E+00	0.00E+00	0.00E+00	3.39E-11	0.00E+00	
BR-85	0.00E+00	0.00E+00	0.00E+00	0.00E+00	0.00E+00	0.00E+00	0.00E+00	0.00E+00	
RB-86	0.00E+00	4.53E+08	0.00E+00	0.00E+00	0.00E+00	2.92E+07	2.79E+08	0.00E+00	
RB-88	0.00E+00	0.00E+00	0.00E+00	0.00E+00	0.00E+00	0.00E+00	0.00E+00	0.00E+00	
RB-89	0.00E+00	0.00E+00	0.00E+00	0.00E+00	0.00E+00	0.00E+00	0.00E+00	0.00E+00	
SR-89	3.59E+10	0.00E+00	0.00E+00	0.00E+00	0.00E+00	1.39E+09	1.02E+09	0.00E+00	
SR-90	1.24E+12	0.00E+00	0.00E+00	0.00E+00	0.00E+00	1.67E+10	3.15E+11	0.00E+00	
SR-91	5.17E+05	0.00E+00	0.00E+00	0.00E+00	0.00E+00	1.14E+06	1.95E+04	0.00E+00	
SR-92	7.11E+02	0.00E+00	0.00E+00	0.00E+00	0.00E+00	1.35E+04	2.85E+01	0.00E+00	
Y-90	2.31E+04	0.00E+00	0.00E+00	0.00E+00	0.00E+00	6.57E+07	6.18E+02	0.00E+00	
Y-91M	7.69E-09	0.00E+00	0.00E+00	0.00E+00	0.00E+00	1.51E-05	2.80E-10	0.00E+00	
Y-91	1.86E+07	0.00E+00	0.00E+00	0.00E+00	0.00E+00	2.48E+09	4.99E+05	0.00E+00	
Y-92	1.58E+00	0.00E+00	0.00E+00	0.00E+00	0.00E+00	4.57E+04	4.52E-02	0.00E+00	
Y-93	2.89E+02	0.00E+00	0.00E+00	0.00E+00	0.00E+00	4.31E+06	7.94E+00	0.00E+00	
ZR-95	3.86E+06	8.49E+05	0.00E+00	1.22E+06	0.00E+00	8.86E+08	7.56E+05	0.00E+00	
ZR-97	5.67E+02	8.19E+01	0.00E+00	1.18E+02	0.00E+00	1.24E+07	4.83E+01	0.00E+00	
NB-95	4.12E+05	1.60E+05	0.00E+00	1.51E+05	0.00E+00	2.97E+08	1.15E+05	0.00E+00	
MO-99	0.00E+00	7.69E+06	0.00E+00	1.64E+07	0.00E+00	6.36E+06	1.90E+06	0.00E+00	
TC-99M	4.64E+00	9.10E+00	0.00E+00	1.32E+02	4.62E+00	5.18E+03	1.51E+02	0.00E+00	
TC-101	0.00E+00	0.00E+00	0.00E+00	0.00E+00	0.00E+00	0.00E+00	0.00E+00	0.00E+00	
RU-103	1.53E+07	0.00E+00	0.00E+00	3.86E+07	0.00E+00	3.96E+08	5.89E+06	0.00E+00	
RU-105	8.97E+01	0.00E+00	0.00E+00	7.89E+02	0.00E+00	5.86E+04	3.25E+01	0.00E+00	
RU-106	7.45E+08	0.00E+00	0.00E+00	1.01E+09	0.00E+00	1.16E+10	9.30E+07	0.00E+00	



**TABLE 3.2-1  
PATHWAY DOSE FACTORS (R<sub>aij</sub>)**

Age Group:	Child	Pathway: Vegetation							Units: m <sup>2</sup> x mrem/yr per μCi/sec
Nuclide	Bone	Liver	Thyroid	Kidney	Lung	Gi-LLi	TBody	Skin	
AG-110M	3.21E+07	2.17E+07	0.00E+00	4.04E+07	0.00E+00	2.58E+09	1.74E+07	0.00E+00	
TE-125M	3.51E+08	9.52E+07	9.85E+07	0.00E+00	0.00E+00	3.39E+08	4.68E+07	0.00E+00	
TE-127M	1.32E+09	3.56E+08	3.16E+08	3.77E+09	0.00E+00	1.07E+09	1.57E+08	0.00E+00	
TE-127	9.76E+03	2.63E+03	6.75E+03	2.78E+04	0.00E+00	3.81E+05	2.09E+03	0.00E+00	
TE-129M	8.39E+08	2.34E+08	2.71E+08	2.46E+09	0.00E+00	1.02E+09	1.30E+08	0.00E+00	
TE-129	1.23E-03	3.45E-04	8.81E-04	3.61E-03	0.00E+00	7.69E-02	2.93E-04	0.00E+00	
TE-131M	1.54E+06	5.32E+05	1.09E+06	5.15E+06	0.00E+00	2.16E+07	5.66E+05	0.00E+00	
TE-131	2.35E-15	7.17E-16	1.80E-15	7.12E-15	0.00E+00	1.24E-14	7.00E-16	0.00E+00	
TE-132	7.00E+06	3.10E+06	4.51E+06	2.88E+07	0.00E+00	3.12E+07	3.74E+06	0.00E+00	
I-130	6.10E+05	1.23E+06	1.36E+08	1.84E+06	0.00E+00	5.76E+05	6.35E+05	0.00E+00	
I-131	1.43E+08	1.44E+08	4.75E+10	2.36E+08	0.00E+00	1.28E+07	8.16E+07	0.00E+00	
I-132	8.93E+01	1.64E+02	7.61E+03	2.51E+02	0.00E+00	1.93E+02	7.54E+01	0.00E+00	
I-133	3.52E+06	4.36E+06	8.09E+08	7.26E+06	0.00E+00	1.76E+06	1.65E+06	0.00E+00	
I-134	1.37E-04	2.55E-04	5.86E-03	3.90E-04	0.00E+00	1.69E-04	1.17E-04	0.00E+00	
I-135	6.13E+04	1.10E+05	9.77E+06	1.69E+05	0.00E+00	8.41E+04	5.22E+04	0.00E+00	
CS-134	1.60E+10	2.63E+10	0.00E+00	8.15E+09	2.93E+09	1.42E+08	5.55E+09	0.00E+00	
CS-136	8.17E+07	2.25E+08	0.00E+00	1.20E+08	1.78E+07	7.90E+06	1.45E+08	0.00E+00	
CS-137	2.39E+10	2.29E+10	0.00E+00	7.46E+09	2.68E+09	1.43E+08	3.38E+09	0.00E+00	
CS-138	6.10E-11	8.48E-11	0.00E+00	5.96E-11	6.42E-12	3.90E-11	5.37E-11	0.00E+00	
BA-139	4.27E-02	2.28E-05	0.00E+00	1.99E-05	1.34E-05	2.47E+00	1.24E-03	0.00E+00	
BA-140	2.77E+08	2.42E+05	0.00E+00	7.89E+04	1.44E+05	1.40E+08	1.61E+07	0.00E+00	
BA-141	0.00E+00	0.00E+00	0.00E+00	0.00E+00	0.00E+00	0.00E+00	0.00E+00	0.00E+00	
BA-142	0.00E+00	0.00E+00	0.00E+00	0.00E+00	0.00E+00	0.00E+00	0.00E+00	0.00E+00	
LA-140	3.25E+03	1.13E+03	0.00E+00	0.00E+00	0.00E+00	3.16E+07	3.82E+02	0.00E+00	
LA-142	2.21E-04	7.05E-05	0.00E+00	0.00E+00	0.00E+00	1.40E+01	2.21E-05	0.00E+00	
CE-141	6.55E+05	3.27E+05	0.00E+00	1.43E+05	0.00E+00	4.07E+08	4.85E+04	0.00E+00	
CE-143	1.72E+03	9.34E+05	0.00E+00	3.92E+02	0.00E+00	1.37E+07	1.35E+02	0.00E+00	
CE-144	1.27E+08	3.98E+07	0.00E+00	2.21E+07	0.00E+00	1.04E+10	6.78E+06	0.00E+00	
PR-143	1.46E+05	4.39E+04	0.00E+00	2.38E+04	0.00E+00	1.58E+08	7.25E+03	0.00E+00	
PR-144	0.00E+00	0.00E+00	0.00E+00	0.00E+00	0.00E+00	0.00E+00	0.00E+00	0.00E+00	
ND-147	7.26E+04	5.88E+04	0.00E+00	3.23E+04	0.00E+00	9.32E+07	4.56E+03	0.00E+00	
W-187	6.45E+04	3.82E+04	0.00E+00	0.00E+00	0.00E+00	5.37E+06	1.71E+04	0.00E+00	
NP-239	2.56E+03	1.84E+02	0.00E+00	5.32E+02	0.00E+00	1.36E+07	1.29E+02	0.00E+00	

**TABLE 3.2-1  
PATHWAY DOSE FACTORS (R<sub>aij</sub>)**

Age Group:	Teen	Pathway: Vegetation							Units: m <sup>2</sup> x mrem/yr per μCi/sec
Nuclide	Bone	Liver	Thyroid	Kidney	Lung	Gi-LLi	TBody	Skin	
H-3 *	0.00E+00	2.59E+03	2.59E+03	2.59E+03	2.59E+03	2.59E+03	2.59E+03	0.00E+00	
C-14 *	3.16E+05	6.32E+04	6.32E+04	6.32E+04	6.32E+04	6.32E+04	6.32E+04	0.00E+00	
NA-24	2.39E+05	2.39E+05	2.39E+05	2.39E+05	2.39E+05	2.39E+05	2.39E+05	0.00E+00	
P-32	1.61E+09	9.97E+07	0.00E+00	0.00E+00	0.00E+00	1.35E+08	6.24E+07	0.00E+00	
CR-51	0.00E+00	0.00E+00	3.42E+04	1.35E+04	8.78E+04	1.03E+07	6.15E+04	0.00E+00	
MN-54	0.00E+00	4.54E+08	0.00E+00	1.36E+08	0.00E+00	9.32E+08	9.01E+07	0.00E+00	
MN-56	0.00E+00	1.35E+01	0.00E+00	1.70E+01	0.00E+00	8.87E+02	2.40E+00	0.00E+00	
FE-55	3.26E+08	2.31E+08	0.00E+00	0.00E+00	1.47E+08	1.00E+08	5.39E+07	0.00E+00	
FE-59	1.79E+08	4.18E+08	0.00E+00	0.00E+00	1.32E+08	9.88E+08	1.61E+08	0.00E+00	
CO-58	0.00E+00	4.37E+07	0.00E+00	0.00E+00	0.00E+00	6.02E+08	1.01E+08	0.00E+00	
CO-60	0.00E+00	2.49E+08	0.00E+00	0.00E+00	0.00E+00	3.24E+09	5.60E+08	0.00E+00	
NI-63	1.61E+10	1.13E+09	0.00E+00	0.00E+00	0.00E+00	1.81E+08	5.45E+08	0.00E+00	
NI-65	5.55E+01	7.10E+00	0.00E+00	0.00E+00	0.00E+00	3.85E+02	3.23E+00	0.00E+00	
CU-64	0.00E+00	8.24E+03	0.00E+00	2.08E+04	0.00E+00	6.39E+05	3.87E+03	0.00E+00	
ZN-65	4.24E+08	1.47E+09	0.00E+00	9.41E+08	0.00E+00	6.23E+08	6.86E+08	0.00E+00	
ZN-69	7.32E-06	1.39E-05	0.00E+00	9.12E-06	0.00E+00	2.57E-05	9.76E-07	0.00E+00	
BR-83	0.00E+00	0.00E+00	0.00E+00	0.00E+00	0.00E+00	0.00E+00	2.84E+00	0.00E+00	
BR-84	0.00E+00	0.00E+00	0.00E+00	0.00E+00	0.00E+00	0.00E+00	2.00E-11	0.00E+00	
BR-85	0.00E+00	0.00E+00	0.00E+00	0.00E+00	0.00E+00	0.00E+00	0.00E+00	0.00E+00	
RB-86	0.00E+00	2.74E+08	0.00E+00	0.00E+00	0.00E+00	4.06E+07	1.29E+08	0.00E+00	
RB-88	0.00E+00	0.00E+00	0.00E+00	0.00E+00	0.00E+00	0.00E+00	0.00E+00	0.00E+00	
RB-89	0.00E+00	0.00E+00	0.00E+00	0.00E+00	0.00E+00	0.00E+00	0.00E+00	0.00E+00	
SR-89	1.51E+10	0.00E+00	0.00E+00	0.00E+00	0.00E+00	1.80E+09	4.33E+08	0.00E+00	
SR-90	7.51E+11	0.00E+00	0.00E+00	0.00E+00	0.00E+00	2.11E+10	1.85E+11	0.00E+00	
SR-91	2.81E+05	0.00E+00	0.00E+00	0.00E+00	0.00E+00	1.27E+06	1.12E+04	0.00E+00	
SR-92	3.88E+02	0.00E+00	0.00E+00	0.00E+00	0.00E+00	9.88E+03	1.65E+01	0.00E+00	
Y-90	1.24E+04	0.00E+00	0.00E+00	0.00E+00	0.00E+00	1.03E+08	3.35E+02	0.00E+00	
Y-91M	4.19E-09	0.00E+00	0.00E+00	0.00E+00	0.00E+00	1.98E-07	1.60E-10	0.00E+00	
Y-91	7.84E+06	0.00E+00	0.00E+00	0.00E+00	0.00E+00	3.21E+09	2.10E+05	0.00E+00	
Y-92	8.58E-01	0.00E+00	0.00E+00	0.00E+00	0.00E+00	2.36E+04	2.48E-02	0.00E+00	
Y-93	1.57E+02	0.00E+00	0.00E+00	0.00E+00	0.00E+00	4.80E+06	4.30E+00	0.00E+00	
ZR-95	1.72E+06	5.44E+05	0.00E+00	7.99E+05	0.00E+00	1.26E+09	3.74E+05	0.00E+00	
ZR-97	3.10E+02	6.14E+01	0.00E+00	9.31E+01	0.00E+00	1.66E+07	2.83E+01	0.00E+00	
NB-95	1.93E+05	1.07E+05	0.00E+00	1.04E+05	0.00E+00	4.58E+08	5.89E+04	0.00E+00	
MO-99	0.00E+00	5.63E+06	0.00E+00	1.29E+07	0.00E+00	1.01E+07	1.07E+06	0.00E+00	
TC-99M	2.70E+00	7.52E+00	0.00E+00	1.12E+02	4.17E+00	4.94E+03	9.75E+01	0.00E+00	
TC-101	0.00E+00	0.00E+00	0.00E+00	0.00E+00	0.00E+00	0.00E+00	0.00E+00	0.00E+00	
RU-103	6.81E+06	0.00E+00	0.00E+00	2.40E+07	0.00E+00	5.69E+08	2.91E+06	0.00E+00	
RU-105	4.90E+01	0.00E+00	0.00E+00	6.18E+02	0.00E+00	3.95E+04	1.90E+01	0.00E+00	
RU-106	3.09E+08	0.00E+00	0.00E+00	5.97E+08	0.00E+00	1.48E+10	3.90E+07	0.00E+00	

**TABLE 3.2-1  
PATHWAY DOSE FACTORS (R<sub>aij</sub>)**

Age Group:	Teen	Pathway: Vegetation							Units: m <sup>2</sup> x mrem/yr per μCi/sec
Nuclide	Bone	Liver	Thyroid	Kidney	Lung	Gi-LLi	TBody	Skin	
AG-110M	1.52E+07	1.43E+07	0.00E+00	2.74E+07	0.00E+00	4.03E+09	8.73E+06	0.00E+00	
TE-125M	1.48E+08	5.35E+07	4.15E+07	0.00E+00	0.00E+00	4.38E+08	1.98E+07	0.00E+00	
TE-127M	5.51E+08	1.96E+08	1.31E+08	2.24E+09	0.00E+00	1.37E+09	6.56E+07	0.00E+00	
TE-127	5.29E+03	1.87E+03	3.65E+03	2.14E+04	0.00E+00	4.08E+05	1.14E+03	0.00E+00	
TE-129M	3.61E+08	1.34E+08	1.16E+08	1.51E+09	0.00E+00	1.36E+09	5.71E+07	0.00E+00	
TE-129	6.67E-04	2.49E-04	4.76E-04	2.80E-03	0.00E+00	3.65E-03	1.62E-04	0.00E+00	
TE-131M	8.42E+05	4.04E+05	6.07E+05	4.21E+06	0.00E+00	3.24E+07	3.37E+05	0.00E+00	
TE-131	1.28E-15	5.27E-16	9.85E-16	5.59E-15	0.00E+00	1.05E-16	3.99E-16	0.00E+00	
TE-132	3.91E+06	2.47E+06	2.61E+06	2.37E+07	0.00E+00	7.84E+07	2.33E+06	0.00E+00	
I-130	3.47E+05	1.01E+06	8.20E+07	1.55E+06	0.00E+00	7.73E+05	4.01E+05	0.00E+00	
I-131	7.68E+07	1.08E+08	3.14E+10	1.85E+08	0.00E+00	2.13E+07	5.78E+07	0.00E+00	
I-132	5.03E+01	1.32E+02	4.43E+03	2.07E+02	0.00E+00	5.73E+01	4.72E+01	0.00E+00	
I-133	1.93E+06	3.28E+06	4.58E+08	5.75E+06	0.00E+00	2.48E+06	1.00E+06	0.00E+00	
I-134	7.73E-05	2.05E-04	3.41E-03	3.23E-04	0.00E+00	2.70E-06	7.36E-05	0.00E+00	
I-135	3.45E+04	8.88E+04	5.72E+06	1.40E+05	0.00E+00	9.85E+04	3.29E+04	0.00E+00	
CS-134	7.10E+09	1.67E+10	0.00E+00	5.31E+09	2.03E+09	2.08E+08	7.75E+09	0.00E+00	
CS-136	4.34E+07	1.71E+08	0.00E+00	9.30E+07	1.47E+07	1.37E+07	1.15E+08	0.00E+00	
CS-137	1.01E+10	1.35E+10	0.00E+00	4.59E+09	1.78E+09	1.92E+08	4.69E+09	0.00E+00	
CS-138	3.35E-11	6.44E-11	0.00E+00	4.75E-11	5.53E-12	2.92E-14	3.22E-11	0.00E+00	
BA-139	2.32E-02	1.63E-05	0.00E+00	1.54E-05	1.12E-05	2.07E-01	6.75E-04	0.00E+00	
BA-140	1.38E+08	1.69E+05	0.00E+00	5.74E+04	1.14E+05	2.13E+08	8.90E+06	0.00E+00	
BA-141	0.00E+00	0.00E+00	0.00E+00	0.00E+00	0.00E+00	0.00E+00	0.00E+00	0.00E+00	
BA-142	0.00E+00	0.00E+00	0.00E+00	0.00E+00	0.00E+00	0.00E+00	0.00E+00	0.00E+00	
LA-140	1.81E+03	8.88E+02	0.00E+00	0.00E+00	0.00E+00	5.10E+07	2.36E+02	0.00E+00	
LA-142	1.22E-04	5.42E-05	0.00E+00	0.00E+00	0.00E+00	1.65E+00	1.35E-05	0.00E+00	
CE-141	2.83E+05	1.89E+05	0.00E+00	8.88E+04	0.00E+00	5.40E+08	2.17E+04	0.00E+00	
CE-143	9.36E+02	6.81E+05	0.00E+00	3.05E+02	0.00E+00	2.05E+07	7.61E+01	0.00E+00	
CE-144	5.27E+07	2.18E+07	0.00E+00	1.30E+07	0.00E+00	1.33E+10	2.83E+06	0.00E+00	
PR-143	7.03E+04	2.81E+04	0.00E+00	1.63E+04	0.00E+00	2.31E+08	3.50E+03	0.00E+00	
PR-144	0.00E+00	0.00E+00	0.00E+00	0.00E+00	0.00E+00	0.00E+00	0.00E+00	0.00E+00	
ND-147	3.67E+04	3.99E+04	0.00E+00	2.35E+04	0.00E+00	1.44E+08	2.39E+03	0.00E+00	
W-187	3.55E+04	2.89E+04	0.00E+00	0.00E+00	0.00E+00	7.82E+06	1.01E+04	0.00E+00	
NP-239	1.39E+03	1.31E+02	0.00E+00	4.11E+02	0.00E+00	2.10E+07	7.27E+01	0.00E+00	

**TABLE 3.2-1  
PATHWAY DOSE FACTORS (R<sub>aij</sub>)**

Age Group:	Adult	Pathway: Vegetation							Units: m <sup>2</sup> x mrem/yr per $\mu$ Ci/sec
Nuclide	Bone	Liver	Thyroid	Kidney	Lung	Gi-LLi	TBody	Skin	
H-3 *	0.00E+00	2.26E+03	2.26E+03	2.26E+03	2.26E+03	2.26E+03	2.26E+03	0.00E+00	
C-14 *	1.92E+05	3.84E+04	3.84E+04	3.84E+04	3.84E+04	3.84E+04	3.84E+04	0.00E+00	
NA-24	2.69E+05	2.69E+05	2.69E+05	2.69E+05	2.69E+05	2.69E+05	2.69E+05	0.00E+00	
P-32	1.40E+09	8.73E+07	0.00E+00	0.00E+00	0.00E+00	1.58E+08	5.43E+07	0.00E+00	
CR-51	0.00E+00	0.00E+00	2.77E+04	1.02E+04	6.15E+04	1.17E+07	4.63E+04	0.00E+00	
MN-54	0.00E+00	3.13E+08	0.00E+00	9.31E+07	0.00E+00	9.58E+08	5.97E+07	0.00E+00	
MN-56	0.00E+00	1.49E+01	0.00E+00	1.90E+01	0.00E+00	4.77E+02	2.65E+00	0.00E+00	
FE-55	2.10E+08	1.45E+08	0.00E+00	0.00E+00	8.08E+07	8.31E+07	3.38E+07	0.00E+00	
FE-59	1.26E+08	2.96E+08	0.00E+00	0.00E+00	8.27E+07	9.86E+08	1.13E+08	0.00E+00	
CO-58	0.00E+00	3.08E+07	0.00E+00	0.00E+00	0.00E+00	6.24E+08	6.90E+07	0.00E+00	
CO-60	0.00E+00	1.67E+08	0.00E+00	0.00E+00	0.00E+00	3.14E+09	3.69E+08	0.00E+00	
NI-63	1.04E+10	7.21E+08	0.00E+00	0.00E+00	0.00E+00	1.50E+08	3.49E+08	0.00E+00	
NI-65	5.97E+01	7.75E+00	0.00E+00	0.00E+00	0.00E+00	1.97E+02	3.54E+00	0.00E+00	
CU-64	0.00E+00	9.09E+03	0.00E+00	2.29E+04	0.00E+00	7.75E+05	4.27E+03	0.00E+00	
ZN-65	3.17E+08	1.01E+09	0.00E+00	6.75E+08	0.00E+00	6.36E+08	4.56E+08	0.00E+00	
ZN-69	7.82E-06	1.50E-05	0.00E+00	9.72E-06	0.00E+00	2.25E-06	1.04E-06	0.00E+00	
BR-83	0.00E+00	0.00E+00	0.00E+00	0.00E+00	0.00E+00	4.36E+00	3.03E+00	0.00E+00	
BR-84	0.00E+00	0.00E+00	0.00E+00	0.00E+00	0.00E+00	1.72E-16	2.20E-11	0.00E+00	
BR-85	0.00E+00	0.00E+00	0.00E+00	0.00E+00	0.00E+00	0.00E+00	0.00E+00	0.00E+00	
RB-86	0.00E+00	2.20E+08	0.00E+00	0.00E+00	0.00E+00	4.34E+07	1.02E+08	0.00E+00	
RB-88	0.00E+00	0.00E+00	0.00E+00	0.00E+00	0.00E+00	0.00E+00	0.00E+00	0.00E+00	
RB-89	0.00E+00	0.00E+00	0.00E+00	0.00E+00	0.00E+00	0.00E+00	0.00E+00	0.00E+00	
SR-89	9.95E+09	0.00E+00	0.00E+00	0.00E+00	0.00E+00	1.60E+09	2.86E+08	0.00E+00	
SR-90	6.05E+11	0.00E+00	0.00E+00	0.00E+00	0.00E+00	1.75E+10	1.48E+11	0.00E+00	
SR-91	3.01E+05	0.00E+00	0.00E+00	0.00E+00	0.00E+00	1.43E+06	1.22E+04	0.00E+00	
SR-92	4.17E+02	0.00E+00	0.00E+00	0.00E+00	0.00E+00	8.25E+03	1.80E+01	0.00E+00	
Y-90	1.33E+04	0.00E+00	0.00E+00	0.00E+00	0.00E+00	1.41E+08	3.57E+02	0.00E+00	
Y-91M	4.50E-09	0.00E+00	0.00E+00	0.00E+00	0.00E+00	1.32E-08	1.74E-10	0.00E+00	
Y-91	5.11E+06	0.00E+00	0.00E+00	0.00E+00	0.00E+00	2.81E+09	1.37E+05	0.00E+00	
Y-92	9.14E-01	0.00E+00	0.00E+00	0.00E+00	0.00E+00	1.60E+04	2.67E-02	0.00E+00	
Y-93	1.67E+02	0.00E+00	0.00E+00	0.00E+00	0.00E+00	5.31E+06	4.62E+00	0.00E+00	
ZR-95	1.18E+06	3.77E+05	0.00E+00	5.92E+05	0.00E+00	1.20E+09	2.55E+05	0.00E+00	
ZR-97	3.35E+02	6.77E+01	0.00E+00	1.02E+02	0.00E+00	2.10E+07	3.09E+01	0.00E+00	
NB-95	1.43E+05	7.95E+04	0.00E+00	7.85E+04	0.00E+00	4.82E+08	4.27E+04	0.00E+00	
MO-99	0.00E+00	6.14E+06	0.00E+00	1.39E+07	0.00E+00	1.42E+07	1.17E+06	0.00E+00	
TC-99M	3.06E+00	8.64E+00	0.00E+00	1.31E+02	4.23E+00	5.11E+03	1.10E+02	0.00E+00	
TC-101	0.00E+00	0.00E+00	0.00E+00	0.00E+00	0.00E+00	0.00E+00	0.00E+00	0.00E+00	
RU-103	4.77E+06	0.00E+00	0.00E+00	1.82E+07	0.00E+00	5.56E+08	2.05E+06	0.00E+00	
RU-105	5.27E+01	0.00E+00	0.00E+00	6.81E+02	0.00E+00	3.23E+04	2.08E+01	0.00E+00	
RU-106	1.93E+08	0.00E+00	0.00E+00	3.72E+08	0.00E+00	1.25E+10	2.44E+07	0.00E+00	

**TABLE 3.2-1  
PATHWAY DOSE FACTORS (R<sub>aij</sub>)**

Age Group:	Adult	Pathway: Vegetation			Units: m <sup>2</sup> x mrem/yr per µCi/sec				
AG-110M	1.05E+07	9.75E+06	0.00E+00	1.92E+07	0.00E+00	3.98E+09	5.79E+06	0.00E+00	
TE-125M	9.67E+07	3.50E+07	2.91E+07	3.93E+08	0.00E+00	3.86E+08	1.30E+07	0.00E+00	
TE-127M	3.49E+08	1.25E+08	8.92E+07	1.42E+09	0.00E+00	1.17E+09	4.25E+07	0.00E+00	
TE-127	5.61E+03	2.01E+03	4.16E+03	2.28E+04	0.00E+00	4.43E+05	1.21E+03	0.00E+00	
TE-129M	2.51E+08	9.36E+07	8.62E+07	1.05E+09	0.00E+00	1.26E+09	3.97E+07	0.00E+00	
TE-129	7.12E-04	2.68E-04	5.47E-04	2.99E-03	0.00E+00	5.38E-04	1.74E-04	0.00E+00	
TE-131M	9.09E+05	4.45E+05	7.04E+05	4.50E+06	0.00E+00	4.41E+07	3.71E+05	0.00E+00	
TE-131	1.37E-15	5.74E-16	1.13E-15	6.02E-15	0.00E+00	1.95E-16	4.34E-16	0.00E+00	
TE-132	4.30E+06	2.78E+06	3.07E+06	2.68E+07	0.00E+00	1.32E+08	2.61E+06	0.00E+00	
I-130	3.89E+05	1.15E+06	9.72E+07	1.79E+06	0.00E+00	9.87E+05	4.52E+05	0.00E+00	
I-131	8.07E+07	1.15E+08	3.78E+10	1.98E+08	0.00E+00	3.05E+07	6.61E+07	0.00E+00	
I-132	5.58E+01	1.49E+02	5.22E+03	2.38E+02	0.00E+00	2.80E+01	5.22E+01	0.00E+00	
I-133	2.08E+06	3.62E+06	5.32E+08	6.31E+06	0.00E+00	3.25E+06	1.10E+06	0.00E+00	
I-134	8.55E-05	2.32E-04	4.02E-03	3.69E-04	0.00E+00	2.02E-07	8.31E-05	0.00E+00	
I-135	3.82E+04	1.00E+05	6.60E+06	1.60E+05	0.00E+00	1.13E+05	3.69E+04	0.00E+00	
CS-134	4.67E+09	1.11E+10	0.00E+00	3.59E+09	1.19E+09	1.94E+08	9.08E+09	0.00E+00	
CS-136	4.24E+07	1.68E+08	0.00E+00	9.32E+07	1.28E+07	1.90E+07	1.21E+08	0.00E+00	
CS-137	6.36E+09	8.70E+09	0.00E+00	2.95E+09	9.81E+08	1.68E+08	5.70E+09	0.00E+00	
CS-138	3.63E-11	7.17E-11	0.00E+00	5.27E-11	5.21E-12	3.06E-16	3.55E-11	0.00E+00	
BA-139	2.47E-02	1.76E-05	0.00E+00	1.64E-05	9.96E-06	4.37E-02	7.22E-04	0.00E+00	
BA-140	1.28E+08	1.61E+05	0.00E+00	5.49E+04	9.24E+04	2.65E+08	8.42E+06	0.00E+00	
BA-141	0.00E+00	0.00E+00	0.00E+00	0.00E+00	0.00E+00	0.00E+00	0.00E+00	0.00E+00	
BA-142	0.00E+00	0.00E+00	0.00E+00	0.00E+00	0.00E+00	0.00E+00	0.00E+00	0.00E+00	
LA-140	1.98E+03	9.97E+02	0.00E+00	0.00E+00	0.00E+00	7.32E+07	2.63E+02	0.00E+00	
LA-142	1.33E-04	6.05E-05	0.00E+00	0.00E+00	0.00E+00	4.42E-01	1.51E-05	0.00E+00	
CE-141	1.97E+05	1.33E+05	0.00E+00	6.18E+04	0.00E+00	5.09E+08	1.51E+04	0.00E+00	
CE-143	1.00E+03	7.40E+05	0.00E+00	3.26E+02	0.00E+00	2.77E+07	8.19E+01	0.00E+00	
CE-144	3.29E+07	1.38E+07	0.00E+00	8.16E+06	0.00E+00	1.11E+10	1.77E+06	0.00E+00	
PR-143	6.28E+04	2.52E+04	0.00E+00	1.45E+04	0.00E+00	2.75E+08	3.11E+03	0.00E+00	
PR-144	0.00E+00	0.00E+00	0.00E+00	0.00E+00	0.00E+00	0.00E+00	0.00E+00	0.00E+00	
ND-147	3.37E+04	3.90E+04	0.00E+00	2.28E+04	0.00E+00	1.87E+08	2.33E+03	0.00E+00	
W-187	3.81E+04	3.19E+04	0.00E+00	0.00E+00	0.00E+00	1.04E+07	1.11E+04	0.00E+00	
NP-239	1.43E+03	1.40E+02	0.00E+00	4.38E+02	0.00E+00	2.88E+07	7.75E+01	0.00E+00	

**TABLE 3.2-1  
PATHWAY DOSE FACTORS (R<sub>aij</sub>)**

Age Group:	Infant	Pathway: Milk			Units: m <sup>2</sup> x mrem/yr per μCi/sec			
Nuclide	Bone	Liver	Thyroid	Kidney	Lung	Gi-LLi	TBody	Skin
H-3 *	0.00E+00	2.38E+03	2.38E+03	2.38E+03	2.38E+03	2.38E+03	2.38E+03	0.00E+00
C-14 *	9.06E+05	1.93E+05	1.93E+05	1.93E+05	1.93E+05	1.93E+05	1.93E+05	0.00E+00
NA-24	1.56E+07	1.56E+07	1.56E+07	1.56E+07	1.56E+07	1.56E+07	1.56E+07	0.00E+00
P-32	1.60E+11	9.43E+09	0.00E+00	0.00E+00	0.00E+00	2.17E+09	6.22E+09	0.00E+00
CR-51	0.00E+00	0.00E+00	1.05E+05	2.30E+04	2.05E+05	4.70E+06	1.61E+05	0.00E+00
MN-54	0.00E+00	3.90E+07	0.00E+00	8.64E+06	0.00E+00	1.43E+07	8.84E+06	0.00E+00
MN-56	0.00E+00	3.00E-02	0.00E+00	2.58E-02	0.00E+00	2.73E+00	5.17E-03	0.00E+00
FE-55	1.35E+08	8.73E+07	0.00E+00	0.00E+00	4.27E+07	1.11E+07	2.33E+07	0.00E+00
FE-59	2.24E+08	3.92E+08	0.00E+00	0.00E+00	1.16E+08	1.87E+08	1.54E+08	0.00E+00
CO-58	0.00E+00	2.43E+07	0.00E+00	0.00E+00	0.00E+00	6.05E+07	6.05E+07	0.00E+00
CO-60	0.00E+00	8.81E+07	0.00E+00	0.00E+00	0.00E+00	2.10E+08	2.08E+08	0.00E+00
NI-63	3.49E+10	2.16E+09	0.00E+00	0.00E+00	0.00E+00	1.07E+08	1.21E+09	0.00E+00
NI-65	3.56E+00	4.03E-01	0.00E+00	0.00E+00	0.00E+00	3.07E+01	1.83E-01	0.00E+00
CU-64	0.00E+00	1.84E+05	0.00E+00	3.12E+05	0.00E+00	3.78E+06	8.53E+04	0.00E+00
ZN-65	5.55E+09	1.90E+10	0.00E+00	9.23E+09	0.00E+00	1.61E+10	8.78E+09	0.00E+00
ZN-69	4.91E-11	8.85E-11	0.00E+00	3.68E-11	0.00E+00	7.21E-09	6.58E-12	0.00E+00
BR-83	0.00E+00	0.00E+00	0.00E+00	0.00E+00	0.00E+00	0.00E+00	9.60E-01	0.00E+00
BR-84	0.00E+00	0.00E+00	0.00E+00	0.00E+00	0.00E+00	0.00E+00	0.00E+00	0.00E+00
BR-85	0.00E+00	0.00E+00	0.00E+00	0.00E+00	0.00E+00	0.00E+00	0.00E+00	0.00E+00
RB-86	0.00E+00	2.23E+10	0.00E+00	0.00E+00	0.00E+00	5.70E+08	1.10E+10	0.00E+00
RB-88	0.00E+00	0.00E+00	0.00E+00	0.00E+00	0.00E+00	0.00E+00	0.00E+00	0.00E+00
RB-89	0.00E+00	0.00E+00	0.00E+00	0.00E+00	0.00E+00	0.00E+00	0.00E+00	0.00E+00
SR-89	1.26E+10	0.00E+00	0.00E+00	0.00E+00	0.00E+00	2.59E+08	3.61E+08	0.00E+00
SR-90	1.22E+11	0.00E+00	0.00E+00	0.00E+00	0.00E+00	1.52E+09	3.10E+10	0.00E+00
SR-91	2.71E+05	0.00E+00	0.00E+00	0.00E+00	0.00E+00	3.20E+05	9.80E+03	0.00E+00
SR-92	4.75E+00	0.00E+00	0.00E+00	0.00E+00	0.00E+00	5.12E+01	1.76E-01	0.00E+00
Y-90	6.83E+02	0.00E+00	0.00E+00	0.00E+00	0.00E+00	9.43E+05	1.83E+01	0.00E+00
Y-91M	5.34E-19	0.00E+00	0.00E+00	0.00E+00	0.00E+00	1.78E-15	1.82E-20	0.00E+00
Y-91	7.33E+04	0.00E+00	0.00E+00	0.00E+00	0.00E+00	5.25E+06	1.95E+03	0.00E+00
Y-92	5.64E-04	0.00E+00	0.00E+00	0.00E+00	0.00E+00	1.08E+01	1.58E-05	0.00E+00
Y-93	2.15E+00	0.00E+00	0.00E+00	0.00E+00	0.00E+00	1.70E+04	5.85E-02	0.00E+00
ZR-95	6.81E+03	1.66E+03	0.00E+00	1.79E+03	0.00E+00	8.26E+05	1.18E+03	0.00E+00
ZR-97	4.06E+00	6.97E-01	0.00E+00	7.03E-01	0.00E+00	4.45E+04	3.19E-01	0.00E+00
NB-95	5.94E+05	2.45E+05	0.00E+00	1.75E+05	0.00E+00	2.07E+08	1.41E+05	0.00E+00
MO-99	0.00E+00	2.08E+08	0.00E+00	3.10E+08	0.00E+00	6.84E+07	4.05E+07	0.00E+00
TC-99M	2.76E+01	5.68E+01	0.00E+00	6.12E+02	2.97E+01	1.65E+04	7.32E+02	0.00E+00
TC-101	0.00E+00	0.00E+00	0.00E+00	0.00E+00	0.00E+00	0.00E+00	0.00E+00	0.00E+00

**TABLE 3.2-1  
PATHWAY DOSE FACTORS (R<sub>aij</sub>)**

Age Group:	Infant	Pathway: Milk							Units: m <sup>2</sup> x mrem/yr per μCi/sec
Nuclide	Bone	Liver	Thyroid	Kidney	Lung	Gi-LLi	TBody	Skin	
RU-103	8.67E+03	0.00E+00	0.00E+00	1.80E+04	0.00E+00	1.05E+05	2.90E+03	0.00E+00	
RU-105	8.07E-03	0.00E+00	0.00E+00	5.93E-02	0.00E+00	3.21E+00	2.72E-03	0.00E+00	
RU-106	1.90E+05	0.00E+00	0.00E+00	2.25E+05	0.00E+00	1.44E+06	2.38E+04	0.00E+00	
AG-110M	3.86E+08	2.82E+08	0.00E+00	4.03E+08	0.00E+00	1.46E+10	1.86E+08	0.00E+00	
TE-125M	1.51E+08	5.04E+07	5.08E+07	0.00E+00	0.00E+00	7.19E+07	2.04E+07	0.00E+00	
TE-127M	4.21E+08	1.40E+08	1.22E+08	1.04E+09	0.00E+00	1.70E+08	5.10E+07	0.00E+00	
TE-127	6.33E+03	2.12E+03	5.16E+03	1.55E+04	0.00E+00	1.33E+05	1.36E+03	0.00E+00	
TE-129M	5.57E+08	1.91E+08	2.14E+08	1.39E+09	0.00E+00	3.33E+08	8.58E+07	0.00E+00	
TE-129	2.80E-09	9.66E-10	2.35E-09	6.98E-09	0.00E+00	2.24E-07	6.54E-10	0.00E+00	
TE-131M	3.38E+06	1.36E+06	2.76E+06	9.36E+06	0.00E+00	2.29E+07	1.12E+06	0.00E+00	
TE-131	0.00E+00	0.00E+00	0.00E+00	0.00E+00	0.00E+00	0.00E+00	0.00E+00	0.00E+00	
TE-132	2.11E+07	1.05E+07	1.54E+07	6.54E+07	0.00E+00	3.87E+07	9.76E+06	0.00E+00	
I-130	3.54E+06	7.79E+06	8.74E+08	8.56E+06	0.00E+00	1.67E+06	3.13E+06	0.00E+00	
I-131	2.72E+09	3.20E+09	1.05E+12	3.74E+09	0.00E+00	1.14E+08	1.41E+09	0.00E+00	
I-132	1.46E+00	2.96E+00	1.39E+02	3.30E+00	0.00E+00	2.40E+00	1.05E+00	0.00E+00	
I-133	3.64E+07	5.30E+07	9.64E+09	6.23E+07	0.00E+00	8.97E+06	1.55E+07	0.00E+00	
I-134	1.72E-11	3.53E-11	8.22E-10	3.94E-11	0.00E+00	3.64E-11	1.25E-11	0.00E+00	
I-135	1.11E+05	2.21E+05	1.98E+07	2.47E+05	0.00E+00	8.01E+04	8.07E+04	0.00E+00	
CS-134	3.65E+10	6.80E+10	0.00E+00	1.75E+10	7.18E+09	1.85E+08	6.87E+09	0.00E+00	
CS-136	1.97E+09	5.80E+09	0.00E+00	2.31E+09	4.72E+08	8.80E+07	2.16E+09	0.00E+00	
CS-137	5.15E+10	6.02E+10	0.00E+00	1.62E+10	6.55E+09	1.88E+08	4.27E+09	0.00E+00	
CS-138	0.00E+00	0.00E+00	0.00E+00	0.00E+00	0.00E+00	0.00E+00	0.00E+00	0.00E+00	
BA-139	3.68E-07	2.44E-10	0.00E+00	1.47E-10	1.48E-10	2.33E-05	1.07E-08	0.00E+00	
BA-140	2.41E+08	2.41E+05	0.00E+00	5.72E+04	1.48E+05	5.92E+07	1.24E+07	0.00E+00	
BA-141	0.00E+00	0.00E+00	0.00E+00	0.00E+00	0.00E+00	0.00E+00	0.00E+00	0.00E+00	
BA-142	0.00E+00	0.00E+00	0.00E+00	0.00E+00	0.00E+00	0.00E+00	0.00E+00	0.00E+00	
LA-140	4.07E+01	1.60E+01	0.00E+00	0.00E+00	0.00E+00	1.88E+05	4.13E+00	0.00E+00	
LA-142	8.59E-11	3.16E-11	0.00E+00	0.00E+00	0.00E+00	5.36E-06	7.55E-12	0.00E+00	
CE-141	4.34E+04	2.64E+04	0.00E+00	8.15E+03	0.00E+00	1.37E+07	3.11E+03	0.00E+00	
CE-143	4.01E+02	2.66E+05	0.00E+00	7.74E+01	0.00E+00	1.55E+06	3.03E+01	0.00E+00	
CE-144	2.33E+06	9.52E+05	0.00E+00	3.85E+05	0.00E+00	1.33E+08	1.30E+05	0.00E+00	
PR-143	1.49E+03	5.56E+02	0.00E+00	2.07E+02	0.00E+00	7.85E+05	7.38E+01	0.00E+00	
PR-144	0.00E+00	0.00E+00	0.00E+00	0.00E+00	0.00E+00	0.00E+00	0.00E+00	0.00E+00	
ND-147	8.88E+02	9.12E+02	0.00E+00	3.52E+02	0.00E+00	5.78E+05	5.59E+01	0.00E+00	
W-187	6.14E+04	4.27E+04	0.00E+00	0.00E+00	0.00E+00	2.51E+06	1.48E+04	0.00E+00	
NP-239	3.66E+01	3.27E+00	0.00E+00	6.53E+00	0.00E+00	9.46E+04	1.85E+00	0.00E+00	

**TABLE 3.2-1  
PATHWAY DOSE FACTORS (R<sub>aij</sub>)**

Age Group:	Child	Pathway: Milk							Units: m <sup>2</sup> x mrem/yr per μCi/sec
Nuclide	Bone	Liver	Thyroid	Kidney	Lung	Gi-LLi	TBody	Skin	
H-3 *	0.00E+00	1.57E+03	1.57E+03	1.57E+03	1.57E+03	1.57E+03	1.57E+03	0.00E+00	
C-14 *	4.62E+05	9.25E+04	9.25E+04	9.25E+04	9.25E+04	9.25E+04	9.25E+04	0.00E+00	
NA-24	8.96E+06	8.96E+06	8.96E+06	8.96E+06	8.96E+06	8.96E+06	8.96E+06	0.00E+00	
P-32	7.78E+10	3.64E+09	0.00E+00	0.00E+00	0.00E+00	2.15E+09	3.00E+09	0.00E+00	
CR-51	0.00E+00	0.00E+00	5.65E+04	1.54E+04	1.03E+05	5.40E+06	1.02E+05	0.00E+00	
MN-54	0.00E+00	2.10E+07	0.00E+00	5.88E+06	0.00E+00	1.76E+07	5.59E+06	0.00E+00	
MN-56	0.00E+00	1.23E-02	0.00E+00	1.48E-02	0.00E+00	1.78E+00	2.77E-03	0.00E+00	
FE-55	1.12E+08	5.93E+07	0.00E+00	0.00E+00	3.35E+07	1.10E+07	1.84E+07	0.00E+00	
FE-59	1.20E+08	1.94E+08	0.00E+00	0.00E+00	5.64E+07	2.02E+08	9.69E+07	0.00E+00	
CO-58	0.00E+00	1.21E+07	0.00E+00	0.00E+00	0.00E+00	7.08E+07	3.71E+07	0.00E+00	
CO-60	0.00E+00	4.32E+07	0.00E+00	0.00E+00	0.00E+00	2.39E+08	1.27E+08	0.00E+00	
NI-63	2.96E+10	1.59E+09	0.00E+00	0.00E+00	0.00E+00	1.07E+08	1.01E+09	0.00E+00	
NI-65	1.68E+00	1.58E-01	0.00E+00	0.00E+00	0.00E+00	1.94E+01	9.25E-02	0.00E+00	
CU-64	0.00E+00	7.41E+04	0.00E+00	1.79E+05	0.00E+00	3.48E+06	4.48E+04	0.00E+00	
ZN-65	4.13E+09	1.10E+10	0.00E+00	6.94E+09	0.00E+00	1.93E+09	6.85E+09	0.00E+00	
ZN-69	2.31E-11	3.33E-11	0.00E+00	2.02E-11	0.00E+00	2.10E-09	3.08E-12	0.00E+00	
BR-83	0.00E+00	0.00E+00	0.00E+00	0.00E+00	0.00E+00	0.00E+00	4.52E-01	0.00E+00	
BR-84	0.00E+00	0.00E+00	0.00E+00	0.00E+00	0.00E+00	0.00E+00	0.00E+00	0.00E+00	
BR-85	0.00E+00	0.00E+00	0.00E+00	0.00E+00	0.00E+00	0.00E+00	0.00E+00	0.00E+00	
RB-86	0.00E+00	8.78E+09	0.00E+00	0.00E+00	0.00E+00	5.65E+08	5.40E+09	0.00E+00	
RB-88	0.00E+00	0.00E+00	0.00E+00	0.00E+00	0.00E+00	0.00E+00	0.00E+00	0.00E+00	
RB-89	0.00E+00	0.00E+00	0.00E+00	0.00E+00	0.00E+00	0.00E+00	0.00E+00	0.00E+00	
SR-89	6.62E+09	0.00E+00	0.00E+00	0.00E+00	0.00E+00	2.56E+08	1.89E+08	0.00E+00	
SR-90	1.12E+11	0.00E+00	0.00E+00	0.00E+00	0.00E+00	1.51E+09	2.83E+10	0.00E+00	
SR-91	1.30E+05	0.00E+00	0.00E+00	0.00E+00	0.00E+00	2.87E+05	4.90E+03	0.00E+00	
SR-92	2.23E+00	0.00E+00	0.00E+00	0.00E+00	0.00E+00	4.23E+01	8.96E-02	0.00E+00	
Y-90	3.23E+02	0.00E+00	0.00E+00	0.00E+00	0.00E+00	9.19E+05	8.64E+00	0.00E+00	
Y-91M	2.52E-19	0.00E+00	0.00E+00	0.00E+00	0.00E+00	4.93E-16	0.00E+00	0.00E+00	
Y-91	3.90E+04	0.00E+00	0.00E+00	0.00E+00	0.00E+00	5.20E+06	1.04E+03	0.00E+00	
Y-92	2.65E-04	0.00E+00	0.00E+00	0.00E+00	0.00E+00	7.66E+00	7.59E-06	0.00E+00	
Y-93	1.01E+00	0.00E+00	0.00E+00	0.00E+00	0.00E+00	1.50E+04	2.77E-02	0.00E+00	
ZR-95	3.83E+03	8.43E+02	0.00E+00	1.21E+03	0.00E+00	8.79E+05	7.50E+02	0.00E+00	
ZR-97	1.92E+00	2.77E-01	0.00E+00	3.98E-01	0.00E+00	4.20E+04	1.64E-01	0.00E+00	
NB-95	3.18E+05	1.24E+05	0.00E+00	1.16E+05	0.00E+00	2.29E+08	8.85E+04	0.00E+00	
MO-99	0.00E+00	8.13E+07	0.00E+00	1.74E+08	0.00E+00	6.72E+07	2.01E+07	0.00E+00	
TC-99M	1.33E+01	2.60E+01	0.00E+00	3.78E+02	1.32E+01	1.48E+04	4.31E+02	0.00E+00	
TC-101	0.00E+00	0.00E+00	0.00E+00	0.00E+00	0.00E+00	0.00E+00	0.00E+00	0.00E+00	
RU-103	4.28E+03	0.00E+00	0.00E+00	1.08E+04	0.00E+00	1.11E+05	1.65E+03	0.00E+00	
RU-105	3.83E-03	0.00E+00	0.00E+00	3.36E-02	0.00E+00	2.50E+00	1.39E-03	0.00E+00	
RU-106	9.24E+04	0.00E+00	0.00E+00	1.25E+05	0.00E+00	1.44E+06	1.15E+04	0.00E+00	



**TABLE 3.2-1  
PATHWAY DOSE FACTORS (R<sub>aij</sub>)**

Age Group:	Child	Pathway: Milk							Units: m <sup>2</sup> x mrem/yr per μCi/sec
Nuclide	Bone	Liver	Thyroid	Kidney	Lung	Gi-LLi	TBody	Skin	
AG-110M	2.09E+08	1.41E+08	0.00E+00	2.63E+08	0.00E+00	1.68E+10	1.13E+08	0.00E+00	
TE-125M	7.38E+07	2.00E+07	2.07E+07	0.00E+00	0.00E+00	7.12E+07	9.84E+06	0.00E+00	
TE-127M	2.08E+08	5.60E+07	4.97E+07	5.93E+08	0.00E+00	1.68E+08	2.47E+07	0.00E+00	
TE-127	2.98E+03	8.04E+02	2.06E+03	8.49E+03	0.00E+00	1.17E+05	6.40E+02	0.00E+00	
TE-129M	2.71E+08	7.58E+07	8.75E+07	7.97E+08	0.00E+00	3.31E+08	4.21E+07	0.00E+00	
TE-129	1.32E-09	3.69E-10	9.43E-10	3.87E-09	0.00E+00	8.23E-08	3.14E-10	0.00E+00	
TE-131M	1.60E+06	5.54E+05	1.14E+06	5.36E+06	0.00E+00	2.25E+07	5.89E+05	0.00E+00	
TE-131	0.00E+00	0.00E+00	0.00E+00	0.00E+00	0.00E+00	0.00E+00	0.00E+00	0.00E+00	
TE-132	1.03E+07	4.54E+06	6.61E+06	4.22E+07	0.00E+00	4.57E+07	5.49E+06	0.00E+00	
I-130	1.72E+06	3.48E+06	3.84E+08	5.21E+06	0.00E+00	1.63E+06	1.79E+06	0.00E+00	
I-131	1.30E+09	1.31E+09	4.33E+11	2.15E+09	0.00E+00	1.17E+08	7.45E+08	0.00E+00	
I-132	7.02E-01	1.29E+00	5.99E+01	1.98E+00	0.00E+00	1.52E+00	5.94E-01	0.00E+00	
I-133	1.72E+07	2.13E+07	3.96E+09	3.55E+07	0.00E+00	8.59E+06	8.06E+06	0.00E+00	
I-134	8.30E-12	1.54E-11	3.55E-10	2.36E-11	0.00E+00	1.02E-11	7.09E-12	0.00E+00	
I-135	5.35E+04	9.63E+04	8.53E+06	1.48E+05	0.00E+00	7.34E+04	4.56E+04	0.00E+00	
CS-134	2.26E+10	3.71E+10	0.00E+00	1.15E+10	4.13E+09	2.00E+08	7.84E+09	0.00E+00	
CS-136	1.01E+09	2.77E+09	0.00E+00	1.48E+09	2.20E+08	9.75E+07	1.80E+09	0.00E+00	
CS-137	3.22E+10	3.09E+10	0.00E+00	1.01E+10	3.62E+09	1.93E+08	4.55E+09	0.00E+00	
CS-138	0.00E+00	0.00E+00	0.00E+00	0.00E+00	0.00E+00	0.00E+00	0.00E+00	0.00E+00	
BA-139	1.73E-07	9.24E-11	0.00E+00	8.07E-11	5.43E-11	9.99E-06	5.02E-09	0.00E+00	
BA-140	1.17E+08	1.03E+05	0.00E+00	3.34E+04	6.12E+04	5.94E+07	6.84E+06	0.00E+00	
BA-141	0.00E+00	0.00E+00	0.00E+00	0.00E+00	0.00E+00	0.00E+00	0.00E+00	0.00E+00	
BA-142	0.00E+00	0.00E+00	0.00E+00	0.00E+00	0.00E+00	0.00E+00	0.00E+00	0.00E+00	
LA-140	1.95E+01	6.81E+00	0.00E+00	0.00E+00	0.00E+00	1.90E+05	2.29E+00	0.00E+00	
LA-142	4.09E-11	1.30E-11	0.00E+00	0.00E+00	0.00E+00	2.59E-06	4.09E-12	0.00E+00	
CE-141	2.19E+04	1.09E+04	0.00E+00	4.78E+03	0.00E+00	1.36E+07	1.62E+03	0.00E+00	
CE-143	1.89E+02	1.03E+05	0.00E+00	4.30E+01	0.00E+00	1.50E+06	1.49E+01	0.00E+00	
CE-144	1.62E+06	5.09E+05	0.00E+00	2.82E+05	0.00E+00	1.33E+08	8.66E+04	0.00E+00	
PR-143	7.19E+02	2.16E+02	0.00E+00	1.17E+02	0.00E+00	7.76E+05	3.57E+01	0.00E+00	
PR-144	0.00E+00	0.00E+00	0.00E+00	0.00E+00	0.00E+00	0.00E+00	0.00E+00	0.00E+00	
ND-147	4.48E+02	3.63E+02	0.00E+00	1.99E+02	0.00E+00	5.75E+05	2.81E+01	0.00E+00	
W-187	2.92E+04	1.73E+04	0.00E+00	0.00E+00	0.00E+00	2.43E+06	7.75E+03	0.00E+00	
NP-239	1.73E+01	1.24E+00	0.00E+00	3.59E+00	0.00E+00	9.20E+04	8.74E-01	0.00E+00	

**TABLE 3.2-1  
PATHWAY DOSE FACTORS (R<sub>aij</sub>)**

Age Group:	Teen	Pathway: Milk				Units: m <sup>2</sup> x mrem/yr per μCi/sec			
Nuclide	Bone	Liver	Thyroid	Kidney	Lung	Gi-LLi	TBody	Skin	
H-3 *	0.00E+00	9.94E+02	9.94E+02	9.94E+02	9.94E+02	9.94E+02	9.94E+02	0.00E+00	
C-14 *	1.88E+05	3.76E+04	3.76E+04	3.76E+04	3.76E+04	3.76E+04	3.76E+04	1.88E+05	
NA-24	4.30E+06	4.30E+06	4.30E+06	4.30E+06	4.30E+06	4.30E+06	4.30E+06	0.00E+00	
P-32	3.16E+10	1.96E+09	0.00E+00	0.00E+00	0.00E+00	2.65E+09	1.22E+09	0.00E+00	
CR-51	0.00E+00	0.00E+00	2.77E+04	1.09E+04	7.12E+04	8.38E+06	4.99E+04	0.00E+00	
MN-54	0.00E+00	1.40E+07	0.00E+00	4.18E+06	0.00E+00	2.87E+07	2.78E+06	0.00E+00	
MN-56	0.00E+00	7.03E-03	0.00E+00	8.89E-03	0.00E+00	4.63E-01	1.25E-03	0.00E+00	
FE-55	4.45E+07	3.16E+07	0.00E+00	0.00E+00	2.00E+07	1.37E+07	7.36E+06	0.00E+00	
FE-59	5.18E+07	1.21E+08	0.00E+00	0.00E+00	3.81E+07	2.86E+08	4.67E+07	0.00E+00	
CO-58	0.00E+00	7.94E+06	0.00E+00	0.00E+00	0.00E+00	1.09E+08	1.83E+07	0.00E+00	
CO-60	0.00E+00	2.78E+07	0.00E+00	0.00E+00	0.00E+00	3.62E+08	6.26E+07	0.00E+00	
NI-63	1.18E+10	8.35E+08	0.00E+00	0.00E+00	0.00E+00	1.33E+08	4.01E+08	0.00E+00	
NI-65	6.88E-01	8.79E-02	0.00E+00	0.00E+00	0.00E+00	4.77E+00	4.01E-02	0.00E+00	
CU-64	0.00E+00	4.22E+04	0.00E+00	1.07E+05	0.00E+00	3.27E+06	1.98E+04	0.00E+00	
ZN-65	2.11E+09	7.31E+09	0.00E+00	4.68E+09	0.00E+00	3.10E+09	3.41E+09	0.00E+00	
ZN-69	9.38E-12	1.79E-11	0.00E+00	1.17E-11	0.00E+00	3.29E-11	1.25E-12	0.00E+00	
BR-83	0.00E+00	0.00E+00	0.00E+00	0.00E+00	0.00E+00	0.00E+00	1.84E-01	0.00E+00	
BR-84	0.00E+00	0.00E+00	0.00E+00	0.00E+00	0.00E+00	0.00E+00	0.00E+00	0.00E+00	
BR-85	0.00E+00	0.00E+00	0.00E+00	0.00E+00	0.00E+00	0.00E+00	0.00E+00	0.00E+00	
RB-86	0.00E+00	4.73E+09	0.00E+00	0.00E+00	0.00E+00	7.01E+08	2.22E+09	0.00E+00	
RB-88	0.00E+00	0.00E+00	0.00E+00	0.00E+00	0.00E+00	0.00E+00	0.00E+00	0.00E+00	
RB-89	0.00E+00	0.00E+00	0.00E+00	0.00E+00	0.00E+00	0.00E+00	0.00E+00	0.00E+00	
SR-89	2.67E+09	0.00E+00	0.00E+00	0.00E+00	0.00E+00	3.18E+08	7.66E+07	0.00E+00	
SR-90	6.61E+10	0.00E+00	0.00E+00	0.00E+00	0.00E+00	1.86E+09	1.63E+10	0.00E+00	
SR-91	5.30E+04	0.00E+00	0.00E+00	0.00E+00	0.00E+00	2.40E+05	2.11E+03	0.00E+00	
SR-92	9.15E-01	0.00E+00	0.00E+00	0.00E+00	0.00E+00	2.33E+01	3.90E-02	0.00E+00	
Y-90	1.30E+02	0.00E+00	0.00E+00	0.00E+00	0.00E+00	1.08E+06	3.51E+00	0.00E+00	
Y-91M	1.03E-19	0.00E+00	0.00E+00	0.00E+00	0.00E+00	4.87E-18	0.00E+00	0.00E+00	
Y-91	1.58E+04	0.00E+00	0.00E+00	0.00E+00	0.00E+00	6.48E+06	4.24E+02	0.00E+00	
Y-92	1.08E-04	0.00E+00	0.00E+00	0.00E+00	0.00E+00	2.97E+00	3.13E-06	0.00E+00	
Y-93	4.10E-01	0.00E+00	0.00E+00	0.00E+00	0.00E+00	1.25E+04	1.12E-02	0.00E+00	
ZR-95	1.65E+03	5.21E+02	0.00E+00	7.65E+02	0.00E+00	1.20E+06	3.58E+02	0.00E+00	
ZR-97	7.89E-01	1.56E-01	0.00E+00	2.37E-01	0.00E+00	4.23E+04	7.19E-02	0.00E+00	
NB-95	1.41E+05	7.82E+04	0.00E+00	7.58E+04	0.00E+00	3.34E+08	4.30E+04	0.00E+00	
MO-99	0.00E+00	4.47E+07	0.00E+00	1.02E+08	0.00E+00	8.00E+07	8.52E+06	0.00E+00	
TC-99M	5.78E+00	1.61E+01	0.00E+00	2.40E+02	8.94E+00	1.06E+04	2.09E+02	0.00E+00	
TC-101	0.00E+00	0.00E+00	0.00E+00	0.00E+00	0.00E+00	0.00E+00	0.00E+00	0.00E+00	
RU-103	1.81E+03	0.00E+00	0.00E+00	6.38E+03	0.00E+00	1.51E+05	7.74E+02	0.00E+00	

**TABLE 3.2-1  
PATHWAY DOSE FACTORS (R<sub>aij</sub>)**

Age Group:	Teen	Pathway: Milk							Units: m <sup>2</sup> x mrem/yr per μCi/sec
Nuclide	Bone	Liver	Thyroid	Kidney	Lung	Gi-LLi	TBody	Skin	
RU-105	1.57E-03	0.00E+00	0.00E+00	1.98E-02	0.00E+00	1.27E+00	6.08E-04	0.00E+00	
RU-106	3.75E+04	0.00E+00	0.00E+00	7.24E+04	0.00E+00	1.80E+06	4.73E+03	0.00E+00	
AG-110M	9.63E+07	9.11E+07	0.00E+00	1.74E+08	0.00E+00	2.56E+10	5.54E+07	0.00E+00	
TE-125M	3.01E+07	1.08E+07	8.40E+06	0.00E+00	0.00E+00	8.87E+07	4.02E+06	0.00E+00	
TE-127M	8.44E+07	2.99E+07	2.01E+07	3.42E+08	0.00E+00	2.10E+08	1.00E+07	0.00E+00	
TE-127	1.21E+03	4.30E+02	8.37E+02	4.91E+03	0.00E+00	9.37E+04	2.61E+02	0.00E+00	
TE-129M	1.10E+08	4.09E+07	3.55E+07	4.61E+08	0.00E+00	4.13E+08	1.74E+07	0.00E+00	
TE-129	5.36E-10	2.00E-10	3.83E-10	2.25E-09	0.00E+00	2.93E-09	1.30E-10	0.00E+00	
TE-131M	6.57E+05	3.15E+05	4.74E+05	3.29E+06	0.00E+00	2.53E+07	2.63E+05	0.00E+00	
TE-131	0.00E+00	0.00E+00	0.00E+00	0.00E+00	0.00E+00	0.00E+00	0.00E+00	0.00E+00	
TE-132	4.30E+06	2.72E+06	2.87E+06	2.61E+07	0.00E+00	8.62E+07	2.56E+06	0.00E+00	
I-130	7.37E+05	2.13E+06	1.74E+08	3.28E+06	0.00E+00	1.64E+06	8.51E+05	0.00E+00	
I-131	5.37E+08	7.52E+08	2.19E+11	1.29E+09	0.00E+00	1.49E+08	4.04E+08	0.00E+00	
I-132	2.97E-01	7.77E-01	2.62E+01	1.22E+00	0.00E+00	3.38E-01	2.79E-01	0.00E+00	
I-133	7.09E+06	1.20E+07	1.68E+09	2.11E+07	0.00E+00	9.11E+06	3.67E+06	0.00E+00	
I-134	3.51E-12	9.29E-12	1.55E-10	1.46E-11	0.00E+00	1.22E-13	3.34E-12	0.00E+00	
I-135	2.26E+04	5.82E+04	3.74E+06	9.19E+04	0.00E+00	6.45E+04	2.16E+04	0.00E+00	
CS-134	9.81E+09	2.31E+10	0.00E+00	7.34E+09	2.80E+09	2.87E+08	1.07E+10	0.00E+00	
CS-136	4.47E+08	1.76E+09	0.00E+00	9.58E+08	1.51E+08	1.42E+08	1.18E+09	0.00E+00	
CS-137	1.34E+10	1.78E+10	0.00E+00	6.06E+09	2.35E+09	2.53E+08	6.20E+09	0.00E+00	
CS-138	0.00E+00	0.00E+00	0.00E+00	0.00E+00	0.00E+00	0.00E+00	0.00E+00	0.00E+00	
BA-139	7.04E-08	4.95E-11	0.00E+00	4.67E-11	3.41E-11	6.28E-07	2.05E-09	0.00E+00	
BA-140	4.85E+07	5.95E+04	0.00E+00	2.02E+04	4.00E+04	7.49E+07	3.13E+06	0.00E+00	
BA-141	0.00E+00	0.00E+00	0.00E+00	0.00E+00	0.00E+00	0.00E+00	0.00E+00	0.00E+00	
BA-142	0.00E+00	0.00E+00	0.00E+00	0.00E+00	0.00E+00	0.00E+00	0.00E+00	0.00E+00	
LA-140	8.13E+00	4.00E+00	0.00E+00	0.00E+00	0.00E+00	2.29E+05	1.06E+00	0.00E+00	
LA-142	1.69E-11	7.53E-12	0.00E+00	0.00E+00	0.00E+00	2.29E-07	1.87E-12	0.00E+00	
CE-141	8.88E+03	5.93E+03	0.00E+00	2.79E+03	0.00E+00	1.70E+07	6.81E+02	0.00E+00	
CE-143	7.71E+01	5.61E+04	0.00E+00	2.52E+01	0.00E+00	1.69E+06	6.27E+00	0.00E+00	
CE-144	6.58E+05	2.72E+05	0.00E+00	1.63E+05	0.00E+00	1.66E+08	3.54E+04	0.00E+00	
PR-143	2.91E+02	1.16E+02	0.00E+00	6.74E+01	0.00E+00	9.56E+05	1.45E+01	0.00E+00	
PR-144	0.00E+00	0.00E+00	0.00E+00	0.00E+00	0.00E+00	0.00E+00	0.00E+00	0.00E+00	
ND-147	1.83E+02	1.98E+02	0.00E+00	1.17E+02	0.00E+00	7.16E+05	1.19E+01	0.00E+00	
W-187	1.20E+04	9.81E+03	0.00E+00	0.00E+00	0.00E+00	2.65E+06	3.44E+03	0.00E+00	
NP-239	7.03E+00	6.63E-01	0.00E+00	2.08E+00	0.00E+00	1.07E+05	3.68E-01	0.00E+00	

**TABLE 3.2-1  
PATHWAY DOSE FACTORS (R<sub>aij</sub>)**

Age Group:	Adult	Pathway: Milk							Units: m <sup>2</sup> x mrem/yr per μCi/sec
Nuclide	Bone	Liver	Thyroid	Kidney	Lung	Gi-LLi	TBody	Skin	
H-3 *	0.00E+00	7.63E+02	7.63E+02	7.63E+02	7.63E+02	7.63E+02	7.63E+02	0.00E+00	
C-14 *	1.02E+05	2.04E+04	2.04E+04	2.04E+04	2.04E+04	2.04E+04	2.04E+04	0.00E+00	
NA-24	2.47E+06	2.47E+06	2.47E+06	2.47E+06	2.47E+06	2.47E+06	2.47E+06	0.00E+00	
P-32	1.71E+10	1.06E+09	0.00E+00	0.00E+00	0.00E+00	1.92E+09	6.61E+08	0.00E+00	
CR-51	0.00E+00	0.00E+00	1.71E+04	6.29E+03	3.79E+04	7.18E+06	2.86E+04	0.00E+00	
MN-54	0.00E+00	8.41E+06	0.00E+00	2.50E+06	0.00E+00	2.58E+07	1.61E+06	0.00E+00	
MN-56	0.00E+00	3.96E-03	0.00E+00	5.03E-03	0.00E+00	1.26E-01	7.03E-04	0.00E+00	
FE-55	2.51E+07	1.74E+07	0.00E+00	0.00E+00	9.68E+06	9.95E+06	4.05E+06	0.00E+00	
FE-59	2.97E+07	6.98E+07	0.00E+00	0.00E+00	1.95E+07	2.33E+08	2.67E+07	0.00E+00	
CO-58	0.00E+00	4.72E+06	0.00E+00	0.00E+00	0.00E+00	9.56E+07	1.06E+07	0.00E+00	
CO-60	0.00E+00	1.64E+07	0.00E+00	0.00E+00	0.00E+00	3.08E+08	3.62E+07	0.00E+00	
NI-63	6.73E+09	4.66E+08	0.00E+00	0.00E+00	0.00E+00	9.73E+07	2.26E+08	0.00E+00	
NI-65	3.76E-01	4.88E-02	0.00E+00	0.00E+00	0.00E+00	1.24E+00	2.23E-02	0.00E+00	
CU-64	0.00E+00	2.37E+04	0.00E+00	5.97E+04	0.00E+00	2.02E+06	1.11E+04	0.00E+00	
ZN-65	1.37E+09	4.36E+09	0.00E+00	2.92E+09	0.00E+00	2.75E+09	1.97E+09	0.00E+00	
ZN-69	5.09E-12	9.74E-12	0.00E+00	6.33E-12	0.00E+00	1.46E-12	6.78E-13	0.00E+00	
BR-83	0.00E+00	0.00E+00	0.00E+00	0.00E+00	0.00E+00	1.44E-01	9.99E-02	0.00E+00	
BR-84	0.00E+00	0.00E+00	0.00E+00	0.00E+00	0.00E+00	0.00E+00	0.00E+00	0.00E+00	
BR-85	0.00E+00	0.00E+00	0.00E+00	0.00E+00	0.00E+00	0.00E+00	0.00E+00	0.00E+00	
RB-86	0.00E+00	2.60E+09	0.00E+00	0.00E+00	0.00E+00	5.12E+08	1.21E+09	0.00E+00	
RB-88	0.00E+00	0.00E+00	0.00E+00	0.00E+00	0.00E+00	0.00E+00	0.00E+00	0.00E+00	
RB-89	0.00E+00	0.00E+00	0.00E+00	0.00E+00	0.00E+00	0.00E+00	0.00E+00	0.00E+00	
SR-89	1.45E+09	0.00E+00	0.00E+00	0.00E+00	0.00E+00	2.33E+08	4.16E+07	0.00E+00	
SR-90	4.68E+10	0.00E+00	0.00E+00	0.00E+00	0.00E+00	1.35E+09	1.15E+10	0.00E+00	
SR-91	2.88E+04	0.00E+00	0.00E+00	0.00E+00	0.00E+00	1.37E+05	1.16E+03	0.00E+00	
SR-92	5.00E-01	0.00E+00	0.00E+00	0.00E+00	0.00E+00	9.90E+00	2.16E-02	0.00E+00	
Y-90	7.10E+01	0.00E+00	0.00E+00	0.00E+00	0.00E+00	7.53E+05	1.90E+00	0.00E+00	
Y-91M	5.63E-20	0.00E+00	0.00E+00	0.00E+00	0.00E+00	1.65E-19	0.00E+00	0.00E+00	
Y-91	8.59E+03	0.00E+00	0.00E+00	0.00E+00	0.00E+00	4.73E+06	2.30E+02	0.00E+00	
Y-92	5.85E-05	0.00E+00	0.00E+00	0.00E+00	0.00E+00	1.02E+00	1.71E-06	0.00E+00	
Y-93	2.22E-01	0.00E+00	0.00E+00	0.00E+00	0.00E+00	7.05E+03	6.14E-03	0.00E+00	
ZR-95	9.44E+02	3.03E+02	0.00E+00	4.75E+02	0.00E+00	9.59E+05	2.05E+02	0.00E+00	
ZR-97	4.33E-01	8.74E-02	0.00E+00	1.32E-01	0.00E+00	2.71E+04	4.00E-02	0.00E+00	
NB-95	8.27E+04	4.60E+04	0.00E+00	4.54E+04	0.00E+00	2.79E+08	2.47E+04	0.00E+00	
MO-99	0.00E+00	2.47E+07	0.00E+00	5.60E+07	0.00E+00	5.74E+07	4.71E+06	0.00E+00	
TC-99M	3.33E+00	9.41E+00	0.00E+00	1.43E+02	4.61E+00	5.57E+03	1.20E+02	0.00E+00	
TC-101	0.00E+00	0.00E+00	0.00E+00	0.00E+00	0.00E+00	0.00E+00	0.00E+00	0.00E+00	
RU-103	1.02E+03	0.00E+00	0.00E+00	3.88E+03	0.00E+00	1.19E+05	4.39E+02	0.00E+00	
RU-105	8.58E-04	0.00E+00	0.00E+00	1.11E-02	0.00E+00	5.25E-01	3.39E-04	0.00E+00	
RU-106	2.04E+04	0.00E+00	0.00E+00	3.94E+04	0.00E+00	1.32E+06	2.58E+03	0.00E+00	

**TABLE 3.2-1  
PATHWAY DOSE FACTORS (R<sub>aij</sub>)**

Age Group:	Adult	Pathway: Milk							Units: m <sup>2</sup> x mrem/yr per μCi/sec
Nuclide	Bone	Liver	Thyroid	Kidney	Lung	Gi-LLi	TBody	Skin	
AG-110M	5.82E+07	5.39E+07	0.00E+00	1.06E+08	0.00E+00	2.20E+10	3.20E+07	0.00E+00	
TE-125M	1.63E+07	5.91E+06	4.90E+06	6.63E+07	0.00E+00	6.51E+07	2.18E+06	0.00E+00	
TE-127M	4.58E+07	1.64E+07	1.17E+07	1.86E+08	0.00E+00	1.54E+08	5.58E+06	0.00E+00	
TE-127	6.55E+02	2.35E+02	4.85E+02	2.67E+03	0.00E+00	5.16E+04	1.42E+02	0.00E+00	
TE-129M	6.02E+07	2.25E+07	2.07E+07	2.51E+08	0.00E+00	3.03E+08	9.52E+06	0.00E+00	
TE-129	2.91E-10	1.09E-10	2.23E-10	1.22E-09	0.00E+00	2.20E-10	7.09E-11	0.00E+00	
TE-131M	3.61E+05	1.77E+05	2.80E+05	1.79E+06	0.00E+00	1.75E+07	1.47E+05	0.00E+00	
TE-131	0.00E+00	0.00E+00	0.00E+00	0.00E+00	0.00E+00	0.00E+00	0.00E+00	0.00E+00	
TE-132	2.41E+06	1.56E+06	1.72E+06	1.50E+07	0.00E+00	7.36E+07	1.46E+06	0.00E+00	
I-130	4.19E+05	1.24E+06	1.05E+08	1.93E+06	0.00E+00	1.06E+06	4.88E+05	0.00E+00	
I-131	2.96E+08	4.23E+08	1.39E+11	7.26E+08	0.00E+00	1.12E+08	2.43E+08	0.00E+00	
I-132	1.67E-01	4.48E-01	1.57E+01	7.13E-01	0.00E+00	8.41E-02	1.57E-01	0.00E+00	
I-133	3.88E+06	6.76E+06	9.93E+08	1.18E+07	0.00E+00	6.07E+06	2.06E+06	0.00E+00	
I-134	1.97E-12	5.36E-12	9.29E-11	8.52E-12	0.00E+00	4.67E-15	1.92E-12	0.00E+00	
I-135	1.27E+04	3.33E+04	2.20E+06	5.34E+04	0.00E+00	3.76E+04	1.23E+04	0.00E+00	
CS-134	5.65E+09	1.34E+10	0.00E+00	4.35E+09	1.44E+09	2.35E+08	1.10E+10	0.00E+00	
CS-136	2.63E+08	1.04E+09	0.00E+00	5.77E+08	7.91E+07	1.18E+08	7.46E+08	0.00E+00	
CS-137	7.38E+09	1.01E+10	0.00E+00	3.43E+09	1.14E+09	1.95E+08	6.61E+09	0.00E+00	
CS-138	0.00E+00	0.00E+00	0.00E+00	0.00E+00	0.00E+00	0.00E+00	0.00E+00	0.00E+00	
BA-139	3.81E-08	2.71E-11	0.00E+00	2.54E-11	1.54E-11	6.75E-08	1.12E-09	0.00E+00	
BA-140	2.69E+07	3.38E+04	0.00E+00	1.15E+04	1.93E+04	5.54E+07	1.76E+06	0.00E+00	
BA-141	0.00E+00	0.00E+00	0.00E+00	0.00E+00	0.00E+00	0.00E+00	0.00E+00	0.00E+00	
BA-142	0.00E+00	0.00E+00	0.00E+00	0.00E+00	0.00E+00	0.00E+00	0.00E+00	0.00E+00	
LA-140	4.53E+00	2.28E+00	0.00E+00	0.00E+00	0.00E+00	1.68E+05	6.03E-01	0.00E+00	
LA-142	9.39E-12	4.27E-12	0.00E+00	0.00E+00	0.00E+00	3.12E-08	1.06E-12	0.00E+00	
CE-141	4.84E+03	3.28E+03	0.00E+00	1.52E+03	0.00E+00	1.25E+07	3.72E+02	0.00E+00	
CE-143	4.19E+01	3.10E+04	0.00E+00	1.37E+01	0.00E+00	1.16E+06	3.43E+00	0.00E+00	
CE-144	3.58E+05	1.50E+05	0.00E+00	8.87E+04	0.00E+00	1.21E+08	1.92E+04	0.00E+00	
PR-143	1.58E+02	6.34E+01	0.00E+00	3.66E+01	0.00E+00	6.93E+05	7.84E+00	0.00E+00	
PR-144	0.00E+00	0.00E+00	0.00E+00	0.00E+00	0.00E+00	0.00E+00	0.00E+00	0.00E+00	
ND-147	9.48E+01	1.10E+02	0.00E+00	6.41E+01	0.00E+00	5.26E+05	6.56E+00	0.00E+00	
W-187	6.58E+03	5.50E+03	0.00E+00	0.00E+00	0.00E+00	1.80E+06	1.92E+03	0.00E+00	
NP-239	3.69E+00	3.62E-01	0.00E+00	1.13E+00	0.00E+00	7.43E+04	2.00E-01	0.00E+00	

**TABLE 3.2-1  
PATHWAY DOSE FACTORS (R<sub>aij</sub>)**

Age Group:	Child	Pathway: Meat							Units: m <sup>2</sup> x mrem/yr per μCi/sec
Nuclide	Bone	Liver	Thyroid	Kidney	Lung	Gi-LLi	TBody	Skin	
H-3 *	0.00E+00	2.34E+02	2.34E+02	2.34E+02	2.34E+02	2.34E+02	2.34E+02	0.00E+00	
C-14 *	5.74E+04	1.15E+04	1.15E+04	1.15E+04	1.15E+04	1.15E+04	1.15E+04	0.00E+00	
NA-24	1.89E-03	1.89E-03	1.89E-03	1.89E-03	1.89E-03	1.89E-03	1.89E-03	0.00E+00	
P-32	7.43E+09	3.48E+08	0.00E+00	0.00E+00	0.00E+00	2.05E+08	2.87E+08	0.00E+00	
CR-51	0.00E+00	0.00E+00	4.88E+03	1.33E+03	8.90E+03	4.66E+05	8.78E+03	0.00E+00	
MN-54	0.00E+00	8.01E+06	0.00E+00	2.25E+06	0.00E+00	6.72E+06	2.13E+06	0.00E+00	
MN-56	0.00E+00	0.00E+00	0.00E+00	0.00E+00	0.00E+00	0.00E+00	0.00E+00	0.00E+00	
FE-55	4.57E+08	2.42E+08	0.00E+00	0.00E+00	1.37E+08	4.49E+07	7.51E+07	0.00E+00	
FE-59	3.76E+08	6.09E+08	0.00E+00	0.00E+00	1.76E+08	6.34E+08	3.03E+08	0.00E+00	
CO-58	0.00E+00	1.64E+07	0.00E+00	0.00E+00	0.00E+00	9.59E+07	5.03E+07	0.00E+00	
CO-60	0.00E+00	6.93E+07	0.00E+00	0.00E+00	0.00E+00	3.84E+08	2.04E+08	0.00E+00	
NI-63	2.91E+10	1.56E+09	0.00E+00	0.00E+00	0.00E+00	1.05E+08	9.91E+08	0.00E+00	
NI-65	0.00E+00	0.00E+00	0.00E+00	0.00E+00	0.00E+00	0.00E+00	0.00E+00	0.00E+00	
CU-64	0.00E+00	2.85E-07	0.00E+00	6.89E-07	0.00E+00	1.34E-05	1.72E-07	0.00E+00	
ZN-65	3.75E+08	1.00E+09	0.00E+00	6.30E+08	0.00E+00	1.76E+08	6.22E+08	0.00E+00	
ZN-69	0.00E+00	0.00E+00	0.00E+00	0.00E+00	0.00E+00	0.00E+00	0.00E+00	0.00E+00	
BR-83	0.00E+00	0.00E+00	0.00E+00	0.00E+00	0.00E+00	0.00E+00	0.00E+00	0.00E+00	
BR-84	0.00E+00	0.00E+00	0.00E+00	0.00E+00	0.00E+00	0.00E+00	0.00E+00	0.00E+00	
BR-85	0.00E+00	0.00E+00	0.00E+00	0.00E+00	0.00E+00	0.00E+00	0.00E+00	0.00E+00	
RB-86	0.00E+00	5.79E+08	0.00E+00	0.00E+00	0.00E+00	3.72E+07	3.56E+08	0.00E+00	
RB-88	0.00E+00	0.00E+00	0.00E+00	0.00E+00	0.00E+00	0.00E+00	0.00E+00	0.00E+00	
RB-89	0.00E+00	0.00E+00	0.00E+00	0.00E+00	0.00E+00	0.00E+00	0.00E+00	0.00E+00	
SR-89	4.81E+08	0.00E+00	0.00E+00	0.00E+00	0.00E+00	1.86E+07	1.38E+07	0.00E+00	
SR-90	1.04E+10	0.00E+00	0.00E+00	0.00E+00	0.00E+00	1.40E+08	2.64E+09	0.00E+00	
SR-91	2.36E-10	0.00E+00	0.00E+00	0.00E+00	0.00E+00	5.20E-10	8.89E-12	0.00E+00	
SR-92	0.00E+00	0.00E+00	0.00E+00	0.00E+00	0.00E+00	0.00E+00	0.00E+00	0.00E+00	
Y-90	1.74E+02	0.00E+00	0.00E+00	0.00E+00	0.00E+00	4.95E+05	4.65E+00	0.00E+00	
Y-91M	0.00E+00	0.00E+00	0.00E+00	0.00E+00	0.00E+00	0.00E+00	0.00E+00	0.00E+00	
Y-91	1.80E+06	0.00E+00	0.00E+00	0.00E+00	0.00E+00	2.40E+08	4.82E+04	0.00E+00	
Y-92	0.00E+00	0.00E+00	0.00E+00	0.00E+00	0.00E+00	0.00E+00	0.00E+00	0.00E+00	
Y-93	7.24E-12	0.00E+00	0.00E+00	0.00E+00	0.00E+00	1.08E-07	1.99E-13	0.00E+00	
ZR-95	2.67E+06	5.86E+05	0.00E+00	8.39E+05	0.00E+00	6.11E+08	5.22E+05	0.00E+00	
ZR-97	3.24E-05	4.68E-06	0.00E+00	6.72E-06	0.00E+00	7.09E-01	2.76E-06	0.00E+00	
NB-95	3.11E+06	1.21E+06	0.00E+00	1.14E+06	0.00E+00	2.24E+09	8.64E+05	0.00E+00	
MO-99	0.00E+00	1.15E+05	0.00E+00	2.45E+05	0.00E+00	9.50E+04	2.84E+04	0.00E+00	
TC-99M	0.00E+00	1.26E-20	0.00E+00	1.83E-19	0.00E+00	7.16E-18	2.09E-19	0.00E+00	
TC-101	0.00E+00	0.00E+00	0.00E+00	0.00E+00	0.00E+00	0.00E+00	0.00E+00	0.00E+00	
RU-103	1.55E+08	0.00E+00	0.00E+00	3.90E+08	0.00E+00	4.01E+09	5.96E+07	0.00E+00	
RU-105	0.00E+00	0.00E+00	0.00E+00	0.00E+00	0.00E+00	0.00E+00	0.00E+00	0.00E+00	
RU-106	4.44E+09	0.00E+00	0.00E+00	5.99E+09	0.00E+00	6.90E+10	5.54E+08	0.00E+00	

**TABLE 3.2-1  
PATHWAY DOSE FACTORS (R<sub>aij</sub>)**

Age Group:	Child	Pathway: Meat							Units: m <sup>2</sup> x mrem/yr per μCi/sec
Nuclide	Bone	Liver	Thyroid	Kidney	Lung	Gi-LLi	TBody	Skin	
AG-110M	8.39E+06	5.67E+06	0.00E+00	1.06E+07	0.00E+00	6.74E+08	4.53E+06	0.00E+00	
TE-125M	5.70E+08	1.54E+08	1.60E+08	0.00E+00	0.00E+00	5.50E+08	7.60E+07	0.00E+00	
TE-127M	1.78E+09	4.78E+08	4.24E+08	5.06E+09	0.00E+00	1.44E+09	2.11E+08	0.00E+00	
TE-127	3.48E-10	9.39E-11	2.41E-10	9.91E-10	0.00E+00	1.36E-08	7.47E-11	0.00E+00	
TE-129M	1.79E+09	5.00E+08	5.77E+08	5.26E+09	0.00E+00	2.18E+09	2.78E+08	0.00E+00	
TE-129	0.00E+00	0.00E+00	0.00E+00	0.00E+00	0.00E+00	0.00E+00	0.00E+00	0.00E+00	
TE-131M	7.06E+02	2.44E+02	5.02E+02	2.36E+03	0.00E+00	9.91E+03	2.60E+02	0.00E+00	
TE-131	0.00E+00	0.00E+00	0.00E+00	0.00E+00	0.00E+00	0.00E+00	0.00E+00	0.00E+00	
TE-132	2.14E+06	9.47E+05	1.38E+06	8.79E+06	0.00E+00	9.54E+06	1.14E+06	0.00E+00	
I-130	3.01E-06	6.08E-06	6.70E-04	9.09E-06	0.00E+00	2.84E-06	3.13E-06	0.00E+00	
I-131	1.66E+07	1.67E+07	5.51E+09	2.74E+07	0.00E+00	1.48E+06	9.47E+06	0.00E+00	
I-132	0.00E+00	0.00E+00	0.00E+00	0.00E+00	0.00E+00	0.00E+00	0.00E+00	0.00E+00	
I-133	5.85E-01	7.24E-01	1.34E+02	1.21E+00	0.00E+00	2.92E-01	2.74E-01	0.00E+00	
I-134	0.00E+00	0.00E+00	0.00E+00	0.00E+00	0.00E+00	0.00E+00	0.00E+00	0.00E+00	
I-135	6.09E-17	1.10E-16	9.71E-15	1.68E-16	0.00E+00	8.36E-17	5.19E-17	0.00E+00	
CS-134	9.22E+08	1.51E+09	0.00E+00	4.69E+08	1.68E+08	8.16E+06	3.19E+08	0.00E+00	
CS-136	1.61E+07	4.44E+07	0.00E+00	2.36E+07	3.52E+06	1.56E+06	2.87E+07	0.00E+00	
CS-137	1.33E+09	1.28E+09	0.00E+00	4.16E+08	1.50E+08	7.99E+06	1.88E+08	0.00E+00	
CS-138	0.00E+00	0.00E+00	0.00E+00	0.00E+00	0.00E+00	0.00E+00	0.00E+00	0.00E+00	
BA-139	0.00E+00	0.00E+00	0.00E+00	0.00E+00	0.00E+00	0.00E+00	0.00E+00	0.00E+00	
BA-140	4.39E+07	3.85E+04	0.00E+00	1.25E+04	2.29E+04	2.23E+07	2.56E+06	0.00E+00	
BA-141	0.00E+00	0.00E+00	0.00E+00	0.00E+00	0.00E+00	0.00E+00	0.00E+00	0.00E+00	
BA-142	0.00E+00	0.00E+00	0.00E+00	0.00E+00	0.00E+00	0.00E+00	0.00E+00	0.00E+00	
LA-140	5.72E-02	2.00E-02	0.00E+00	0.00E+00	0.00E+00	5.57E+02	6.74E-03	0.00E+00	
LA-142	0.00E+00	0.00E+00	0.00E+00	0.00E+00	0.00E+00	0.00E+00	0.00E+00	0.00E+00	
CE-141	2.22E+04	1.11E+04	0.00E+00	4.86E+03	0.00E+00	1.38E+07	1.64E+03	0.00E+00	
CE-143	3.36E-02	1.82E+01	0.00E+00	7.64E-03	0.00E+00	2.67E+02	2.64E-03	0.00E+00	
CE-144	2.32E+06	7.26E+05	0.00E+00	4.02E+05	0.00E+00	1.89E+08	1.24E+05	0.00E+00	
PR-143	3.36E+04	1.01E+04	0.00E+00	5.46E+03	0.00E+00	3.62E+07	1.67E+03	0.00E+00	
PR-144	0.00E+00	0.00E+00	0.00E+00	0.00E+00	0.00E+00	0.00E+00	0.00E+00	0.00E+00	
ND-147	1.19E+04	9.66E+03	0.00E+00	5.30E+03	0.00E+00	1.53E+07	7.48E+02	0.00E+00	
W-187	3.45E-02	2.04E-02	0.00E+00	0.00E+00	0.00E+00	2.87E+00	9.16E-03	0.00E+00	
NP-239	4.35E-01	3.12E-02	0.00E+00	9.03E-02	0.00E+00	2.31E+03	2.19E-02	0.00E+00	

**TABLE 3.2-1  
PATHWAY DOSE FACTORS (R<sub>aij</sub>)**

Age Group:	Teen	Pathway: Meat				Units: m <sup>2</sup> x mrem/yr per μCi/sec			
Nuclide	Bone	Liver	Thyroid	Kidney	Lung	Gi-LLi	TBody	Skin	
H-3 *	0.00E+00	1.94E+02	1.94E+02	1.94E+02	1.94E+02	1.94E+02	1.94E+02	0.00E+00	
C-14 *	3.06E+04	6.11E+03	6.11E+03	6.11E+03	6.11E+03	6.11E+03	6.11E+03	0.00E+00	
NA-24	1.19E-03	1.19E-03	1.19E-03	1.19E-03	1.19E-03	1.19E-03	1.19E-03	0.00E+00	
P-32	3.94E+09	2.44E+08	0.00E+00	0.00E+00	0.00E+00	3.31E+08	1.53E+08	0.00E+00	
CR-51	0.00E+00	0.00E+00	3.13E+03	1.23E+03	8.04E+03	9.47E+05	5.63E+03	0.00E+00	
MN-54	0.00E+00	7.00E+06	0.00E+00	2.09E+06	0.00E+00	1.44E+07	1.39E+06	0.00E+00	
MN-56	0.00E+00	0.00E+00	0.00E+00	0.00E+00	0.00E+00	0.00E+00	0.00E+00	0.00E+00	
FE-55	2.38E+08	1.69E+08	0.00E+00	0.00E+00	1.07E+08	7.31E+07	3.94E+07	0.00E+00	
FE-59	2.12E+08	4.95E+08	0.00E+00	0.00E+00	1.56E+08	1.17E+09	1.91E+08	0.00E+00	
CO-58	0.00E+00	1.41E+07	0.00E+00	0.00E+00	0.00E+00	1.94E+08	3.24E+07	0.00E+00	
CO-60	0.00E+00	5.83E+07	0.00E+00	0.00E+00	0.00E+00	7.60E+08	1.31E+08	0.00E+00	
NI-63	1.52E+10	1.07E+09	0.00E+00	0.00E+00	0.00E+00	1.71E+08	5.15E+08	0.00E+00	
NI-65	0.00E+00	0.00E+00	0.00E+00	0.00E+00	0.00E+00	0.00E+00	0.00E+00	0.00E+00	
CU-64	0.00E+00	2.12E-07	0.00E+00	5.37E-07	0.00E+00	1.65E-05	9.98E-08	0.00E+00	
ZN-65	2.50E+08	8.69E+08	0.00E+00	5.56E+08	0.00E+00	3.68E+08	4.05E+08	0.00E+00	
ZN-69	0.00E+00	0.00E+00	0.00E+00	0.00E+00	0.00E+00	0.00E+00	0.00E+00	0.00E+00	
BR-83	0.00E+00	0.00E+00	0.00E+00	0.00E+00	0.00E+00	0.00E+00	0.00E+00	0.00E+00	
BR-84	0.00E+00	0.00E+00	0.00E+00	0.00E+00	0.00E+00	0.00E+00	0.00E+00	0.00E+00	
BR-85	0.00E+00	0.00E+00	0.00E+00	0.00E+00	0.00E+00	0.00E+00	0.00E+00	0.00E+00	
RB-86	0.00E+00	4.08E+08	0.00E+00	0.00E+00	0.00E+00	6.04E+07	1.92E+08	0.00E+00	
RB-88	0.00E+00	0.00E+00	0.00E+00	0.00E+00	0.00E+00	0.00E+00	0.00E+00	0.00E+00	
RB-89	0.00E+00	0.00E+00	0.00E+00	0.00E+00	0.00E+00	0.00E+00	0.00E+00	0.00E+00	
SR-89	2.54E+08	0.00E+00	0.00E+00	0.00E+00	0.00E+00	3.03E+07	7.29E+06	0.00E+00	
SR-90	8.05E+09	0.00E+00	0.00E+00	0.00E+00	0.00E+00	2.26E+08	1.99E+09	0.00E+00	
SR-91	1.26E-10	0.00E+00	0.00E+00	0.00E+00	0.00E+00	5.70E-10	4.99E-12	0.00E+00	
SR-92	0.00E+00	0.00E+00	0.00E+00	0.00E+00	0.00E+00	0.00E+00	0.00E+00	0.00E+00	
Y-90	9.18E+01	0.00E+00	0.00E+00	0.00E+00	0.00E+00	7.57E+05	2.47E+00	0.00E+00	
Y-91M	0.00E+00	0.00E+00	0.00E+00	0.00E+00	0.00E+00	0.00E+00	0.00E+00	0.00E+00	
Y-91	9.54E+05	0.00E+00	0.00E+00	0.00E+00	0.00E+00	3.91E+08	2.56E+04	0.00E+00	
Y-92	0.00E+00	0.00E+00	0.00E+00	0.00E+00	0.00E+00	0.00E+00	0.00E+00	0.00E+00	
Y-93	3.86E-12	0.00E+00	0.00E+00	0.00E+00	0.00E+00	1.18E-07	1.06E-13	0.00E+00	
ZR-95	1.50E+06	4.74E+05	0.00E+00	6.96E+05	0.00E+00	1.09E+09	3.26E+05	0.00E+00	
ZR-97	1.74E-05	3.44E-06	0.00E+00	5.22E-06	0.00E+00	9.32E-01	1.59E-06	0.00E+00	
NB-95	1.80E+06	9.98E+05	0.00E+00	9.68E+05	0.00E+00	4.27E+09	5.49E+05	0.00E+00	
MO-99	0.00E+00	8.25E+04	0.00E+00	1.89E+05	0.00E+00	1.48E+05	1.57E+04	0.00E+00	
TC-99M	0.00E+00	1.02E-20	0.00E+00	1.52E-19	0.00E+00	6.70E-18	1.32E-19	0.00E+00	
TC-101	0.00E+00	0.00E+00	0.00E+00	0.00E+00	0.00E+00	0.00E+00	0.00E+00	0.00E+00	
RU-103	8.57E+07	0.00E+00	0.00E+00	3.02E+08	0.00E+00	7.16E+09	3.66E+07	0.00E+00	



**TABLE 3.2-1  
PATHWAY DOSE FACTORS (R<sub>aij</sub>)**

<b>Age Group:</b>	<b>Teen</b>	<b>Pathway: Meat</b>							<b>Units: m<sup>2</sup> x mrem/yr per μCi/sec</b>
<b>Nuclide</b>	<b>Bone</b>	<b>Liver</b>	<b>Thyroid</b>	<b>Kidney</b>	<b>Lung</b>	<b>Gi-LLi</b>	<b>TBody</b>	<b>Skin</b>	
RU-105	0.00E+00	0.00E+00	0.00E+00	0.00E+00	0.00E+00	0.00E+00	0.00E+00	0.00E+00	
RU-106	2.36E+09	0.00E+00	0.00E+00	4.55E+09	0.00E+00	1.13E+11	2.97E+08	0.00E+00	
AG-110M	5.06E+06	4.79E+06	0.00E+00	9.13E+06	0.00E+00	1.35E+09	2.91E+06	0.00E+00	
TE-125M	3.03E+08	1.09E+08	8.48E+07	0.00E+00	0.00E+00	8.95E+08	4.06E+07	0.00E+00	
TE-127M	9.42E+08	3.34E+08	2.24E+08	3.82E+09	0.00E+00	2.35E+09	1.12E+08	0.00E+00	
TE-127	1.85E-10	6.56E-11	1.28E-10	7.50E-10	0.00E+00	1.43E-08	3.99E-11	0.00E+00	
TE-129M	9.50E+08	3.52E+08	3.06E+08	3.97E+09	0.00E+00	3.57E+09	1.50E+08	0.00E+00	
TE-129	0.00E+00	0.00E+00	0.00E+00	0.00E+00	0.00E+00	0.00E+00	0.00E+00	0.00E+00	
TE-131M	3.79E+02	1.82E+02	2.74E+02	1.90E+03	0.00E+00	1.46E+04	1.52E+02	0.00E+00	
TE-131	0.00E+00	0.00E+00	0.00E+00	0.00E+00	0.00E+00	0.00E+00	0.00E+00	0.00E+00	
TE-132	1.17E+06	7.42E+05	7.83E+05	7.12E+06	0.00E+00	2.35E+07	6.99E+05	0.00E+00	
I-130	1.68E-06	4.87E-06	3.97E-04	7.50E-06	0.00E+00	3.74E-06	1.94E-06	0.00E+00	
I-131	8.94E+06	1.25E+07	3.65E+09	2.15E+07	0.00E+00	2.47E+06	6.72E+06	0.00E+00	
I-132	0.00E+00	0.00E+00	0.00E+00	0.00E+00	0.00E+00	0.00E+00	0.00E+00	0.00E+00	
I-133	3.15E-01	5.34E-01	7.46E+01	9.37E-01	0.00E+00	4.04E-01	1.63E-01	0.00E+00	
I-134	0.00E+00	0.00E+00	0.00E+00	0.00E+00	0.00E+00	0.00E+00	0.00E+00	0.00E+00	
I-135	3.37E-17	8.67E-17	5.57E-15	1.37E-16	0.00E+00	9.60E-17	3.21E-17	0.00E+00	
CS-134	5.23E+08	1.23E+09	0.00E+00	3.91E+08	1.49E+08	1.53E+07	5.71E+08	0.00E+00	
CS-136	9.35E+06	3.68E+07	0.00E+00	2.00E+07	3.16E+06	2.96E+06	2.47E+07	0.00E+00	
CS-137	7.24E+08	9.63E+08	0.00E+00	3.28E+08	1.27E+08	1.37E+07	3.36E+08	0.00E+00	
CS-138	0.00E+00	0.00E+00	0.00E+00	0.00E+00	0.00E+00	0.00E+00	0.00E+00	0.00E+00	
BA-139	0.00E+00	0.00E+00	0.00E+00	0.00E+00	0.00E+00	0.00E+00	0.00E+00	0.00E+00	
BA-140	2.38E+07	2.92E+04	0.00E+00	9.89E+03	1.96E+04	3.67E+07	1.53E+06	0.00E+00	
BA-141	0.00E+00	0.00E+00	0.00E+00	0.00E+00	0.00E+00	0.00E+00	0.00E+00	0.00E+00	
BA-142	0.00E+00	0.00E+00	0.00E+00	0.00E+00	0.00E+00	0.00E+00	0.00E+00	0.00E+00	
LA-140	3.12E-02	1.53E-02	0.00E+00	0.00E+00	0.00E+00	8.81E+02	4.08E-03	0.00E+00	
LA-142	0.00E+00	0.00E+00	0.00E+00	0.00E+00	0.00E+00	0.00E+00	0.00E+00	0.00E+00	
CE-141	1.18E+04	7.87E+03	0.00E+00	3.71E+03	0.00E+00	2.25E+07	9.05E+02	0.00E+00	
CE-143	1.79E-02	1.30E+01	0.00E+00	5.84E-03	0.00E+00	3.92E+02	1.45E-03	0.00E+00	
CE-144	1.23E+06	5.08E+05	0.00E+00	3.04E+05	0.00E+00	3.09E+08	6.60E+04	0.00E+00	
PR-143	1.77E+04	7.08E+03	0.00E+00	4.12E+03	0.00E+00	5.83E+07	8.83E+02	0.00E+00	
PR-144	0.00E+00	0.00E+00	0.00E+00	0.00E+00	0.00E+00	0.00E+00	0.00E+00	0.00E+00	
ND-147	6.36E+03	6.91E+03	0.00E+00	4.06E+03	0.00E+00	2.49E+07	4.14E+02	0.00E+00	
W-187	1.86E-02	1.52E-02	0.00E+00	0.00E+00	0.00E+00	4.10E+00	5.31E-03	0.00E+00	
NP-239	2.31E-01	2.18E-02	0.00E+00	6.84E-02	0.00E+00	3.50E+03	1.21E-02	0.00E+00	

**TABLE 3.2-1  
PATHWAY DOSE FACTORS (R<sub>aij</sub>)**

Age Group:	Adult	Pathway: Meat							Units: m <sup>2</sup> x mrem/yr per μCi/sec
Nuclide	Bone	Liver	Thyroid	Kidney	Lung	Gi-LLi	TBody	Skin	
H-3 *	0.00E+00	3.25E+02	3.25E+02	3.25E+02	3.25E+02	3.25E+02	3.25E+02	0.00E+00	
C-14 *	3.62E+04	7.23E+03	7.23E+03	7.23E+03	7.23E+03	7.23E+03	7.23E+03	0.00E+00	
NA-24	1.49E-03	1.49E-03	1.49E-03	1.49E-03	1.49E-03	1.49E-03	1.49E-03	0.00E+00	
P-32	4.67E+09	2.90E+08	0.00E+00	0.00E+00	0.00E+00	5.25E+08	1.80E+08	0.00E+00	
CR-51	0.00E+00	0.00E+00	4.21E+03	1.55E+03	9.35E+03	1.77E+06	7.04E+03	0.00E+00	
MN-54	0.00E+00	9.18E+06	0.00E+00	2.73E+06	0.00E+00	2.81E+07	1.75E+06	0.00E+00	
MN-56	0.00E+00	0.00E+00	0.00E+00	0.00E+00	0.00E+00	0.00E+00	0.00E+00	0.00E+00	
FE-55	2.93E+08	2.03E+08	0.00E+00	0.00E+00	1.13E+08	1.16E+08	4.72E+07	0.00E+00	
FE-59	2.65E+08	6.24E+08	0.00E+00	0.00E+00	1.74E+08	2.08E+09	2.39E+08	0.00E+00	
CO-58	0.00E+00	1.83E+07	0.00E+00	0.00E+00	0.00E+00	3.70E+08	4.09E+07	0.00E+00	
CO-60	0.00E+00	7.52E+07	0.00E+00	0.00E+00	0.00E+00	1.41E+09	1.66E+08	0.00E+00	
NI-63	1.89E+10	1.31E+09	0.00E+00	0.00E+00	0.00E+00	2.73E+08	6.33E+08	0.00E+00	
NI-65	0.00E+00	0.00E+00	0.00E+00	0.00E+00	0.00E+00	0.00E+00	0.00E+00	0.00E+00	
CU-64	0.00E+00	2.60E-07	0.00E+00	6.56E-07	0.00E+00	2.22E-05	1.22E-07	0.00E+00	
ZN-65	3.56E+08	1.13E+09	0.00E+00	7.57E+08	0.00E+00	7.13E+08	5.12E+08	0.00E+00	
ZN-69	0.00E+00	0.00E+00	0.00E+00	0.00E+00	0.00E+00	0.00E+00	0.00E+00	0.00E+00	
BR-83	0.00E+00	0.00E+00	0.00E+00	0.00E+00	0.00E+00	0.00E+00	0.00E+00	0.00E+00	
BR-84	0.00E+00	0.00E+00	0.00E+00	0.00E+00	0.00E+00	0.00E+00	0.00E+00	0.00E+00	
BR-85	0.00E+00	0.00E+00	0.00E+00	0.00E+00	0.00E+00	0.00E+00	0.00E+00	0.00E+00	
RB-86	0.00E+00	4.89E+08	0.00E+00	0.00E+00	0.00E+00	9.64E+07	2.28E+08	0.00E+00	
RB-88	0.00E+00	0.00E+00	0.00E+00	0.00E+00	0.00E+00	0.00E+00	0.00E+00	0.00E+00	
RB-89	0.00E+00	0.00E+00	0.00E+00	0.00E+00	0.00E+00	0.00E+00	0.00E+00	0.00E+00	
SR-89	3.01E+08	0.00E+00	0.00E+00	0.00E+00	0.00E+00	4.83E+07	8.65E+06	0.00E+00	
SR-90	1.24E+10	0.00E+00	0.00E+00	0.00E+00	0.00E+00	3.59E+08	3.05E+09	0.00E+00	
SR-91	1.49E-10	0.00E+00	0.00E+00	0.00E+00	0.00E+00	7.11E-10	6.03E-12	0.00E+00	
SR-92	0.00E+00	0.00E+00	0.00E+00	0.00E+00	0.00E+00	0.00E+00	0.00E+00	0.00E+00	
Y-90	1.09E+02	0.00E+00	0.00E+00	0.00E+00	0.00E+00	1.16E+06	2.93E+00	0.00E+00	
Y-91M	0.00E+00	0.00E+00	0.00E+00	0.00E+00	0.00E+00	0.00E+00	0.00E+00	0.00E+00	
Y-91	1.13E+06	0.00E+00	0.00E+00	0.00E+00	0.00E+00	6.24E+08	3.03E+04	0.00E+00	
Y-92	0.00E+00	0.00E+00	0.00E+00	0.00E+00	0.00E+00	0.00E+00	0.00E+00	0.00E+00	
Y-93	4.57E-12	0.00E+00	0.00E+00	0.00E+00	0.00E+00	1.45E-07	1.26E-13	0.00E+00	
ZR-95	1.87E+06	6.01E+05	0.00E+00	9.44E+05	0.00E+00	1.91E+09	4.07E+05	0.00E+00	
ZR-97	2.09E-05	4.21E-06	0.00E+00	6.36E-06	0.00E+00	1.30E+00	1.93E-06	0.00E+00	
NB-95	2.30E+06	1.28E+06	0.00E+00	1.27E+06	0.00E+00	7.78E+09	6.89E+05	0.00E+00	
MO-99	0.00E+00	9.98E+04	0.00E+00	2.26E+05	0.00E+00	2.31E+05	1.90E+04	0.00E+00	
TC-99M	0.00E+00	1.30E-20	0.00E+00	1.98E-19	0.00E+00	7.70E-18	1.66E-19	0.00E+00	
TC-101	0.00E+00	0.00E+00	0.00E+00	0.00E+00	0.00E+00	0.00E+00	0.00E+00	0.00E+00	
RU-103	1.05E+08	0.00E+00	0.00E+00	4.01E+08	0.00E+00	1.23E+10	4.53E+07	0.00E+00	
RU-105	0.00E+00	0.00E+00	0.00E+00	0.00E+00	0.00E+00	0.00E+00	0.00E+00	0.00E+00	
RU-106	2.80E+09	0.00E+00	0.00E+00	5.40E+09	0.00E+00	1.81E+11	3.54E+08	0.00E+00	

**TABLE 3.2-1  
PATHWAY DOSE FACTORS (R<sub>aij</sub>)**

Age Group:	Adult	Pathway: Meat							Units: m <sup>2</sup> x mrem/yr per μCi/sec
Nuclide	Bone	Liver	Thyroid	Kidney	Lung	Gi-LLi	TBody	Skin	
AG-110M	6.68E+06	6.18E+06	0.00E+00	1.22E+07	0.00E+00	2.52E+09	3.67E+06	0.00E+00	
TE-125M	3.59E+08	1.30E+08	1.08E+08	1.46E+09	0.00E+00	1.43E+09	4.81E+07	0.00E+00	
TE-127M	1.12E+09	3.99E+08	2.85E+08	4.53E+09	0.00E+00	3.74E+09	1.36E+08	0.00E+00	
TE-127	2.18E-10	7.84E-11	1.62E-10	8.89E-10	0.00E+00	1.72E-08	4.72E-11	0.00E+00	
TE-129M	1.13E+09	4.23E+08	3.89E+08	4.73E+09	0.00E+00	5.71E+09	1.79E+08	0.00E+00	
TE-129	0.00E+00	0.00E+00	0.00E+00	0.00E+00	0.00E+00	0.00E+00	0.00E+00	0.00E+00	
TE-131M	4.55E+02	2.23E+02	3.53E+02	2.25E+03	0.00E+00	2.21E+04	1.86E+02	0.00E+00	
TE-131	0.00E+00	0.00E+00	0.00E+00	0.00E+00	0.00E+00	0.00E+00	0.00E+00	0.00E+00	
TE-132	1.43E+06	9.27E+05	1.02E+06	8.93E+06	0.00E+00	4.38E+07	8.70E+05	0.00E+00	
I-130	2.09E-06	6.17E-06	5.23E-04	9.62E-06	0.00E+00	5.31E-06	2.43E-06	0.00E+00	
I-131	1.08E+07	1.54E+07	5.04E+09	2.64E+07	0.00E+00	4.06E+06	8.82E+06	0.00E+00	
I-132	0.00E+00	0.00E+00	0.00E+00	0.00E+00	0.00E+00	0.00E+00	0.00E+00	0.00E+00	
I-133	3.77E-01	6.55E-01	9.63E+01	1.14E+00	0.00E+00	5.89E-01	2.00E-01	0.00E+00	
I-134	0.00E+00	0.00E+00	0.00E+00	0.00E+00	0.00E+00	0.00E+00	0.00E+00	0.00E+00	
I-135	4.14E-17	1.08E-16	7.15E-15	1.74E-16	0.00E+00	1.22E-16	4.00E-17	0.00E+00	
CS-134	6.58E+08	1.56E+09	0.00E+00	5.06E+08	1.68E+08	2.74E+07	1.28E+09	0.00E+00	
CS-136	1.20E+07	4.73E+07	0.00E+00	2.63E+07	3.61E+06	5.38E+06	3.41E+07	0.00E+00	
CS-137	8.72E+08	1.19E+09	0.00E+00	4.05E+08	1.35E+08	2.31E+07	7.81E+08	0.00E+00	
CS-138	0.00E+00	0.00E+00	0.00E+00	0.00E+00	0.00E+00	0.00E+00	0.00E+00	0.00E+00	
BA-139	0.00E+00	0.00E+00	0.00E+00	0.00E+00	0.00E+00	0.00E+00	0.00E+00	0.00E+00	
BA-140	2.88E+07	3.62E+04	0.00E+00	1.23E+04	2.07E+04	5.93E+07	1.89E+06	0.00E+00	
BA-141	0.00E+00	0.00E+00	0.00E+00	0.00E+00	0.00E+00	0.00E+00	0.00E+00	0.00E+00	
BA-142	0.00E+00	0.00E+00	0.00E+00	0.00E+00	0.00E+00	0.00E+00	0.00E+00	0.00E+00	
LA-140	3.80E-02	1.91E-02	0.00E+00	0.00E+00	0.00E+00	1.40E+03	5.06E-03	0.00E+00	
LA-142	0.00E+00	0.00E+00	0.00E+00	0.00E+00	0.00E+00	0.00E+00	0.00E+00	0.00E+00	
CE-141	1.40E+04	9.50E+03	0.00E+00	4.41E+03	0.00E+00	3.63E+07	1.08E+03	0.00E+00	
CE-143	2.13E-02	1.57E+01	0.00E+00	6.92E-03	0.00E+00	5.88E+02	1.74E-03	0.00E+00	
CE-144	1.46E+06	6.09E+05	0.00E+00	3.61E+05	0.00E+00	4.93E+08	7.83E+04	0.00E+00	
PR-143	2.11E+04	8.45E+03	0.00E+00	4.88E+03	0.00E+00	9.23E+07	1.04E+03	0.00E+00	
PR-144	0.00E+00	0.00E+00	0.00E+00	0.00E+00	0.00E+00	0.00E+00	0.00E+00	0.00E+00	
ND-147	7.22E+03	8.34E+03	0.00E+00	4.88E+03	0.00E+00	4.00E+07	4.99E+02	0.00E+00	
W-187	2.22E-02	1.86E-02	0.00E+00	0.00E+00	0.00E+00	6.08E+00	6.49E-03	0.00E+00	
NP-239	2.64E-01	2.60E-02	0.00E+00	8.11E-02	0.00E+00	5.33E+03	1.43E-02	0.00E+00	

NOTE: The  $R_{ajj}$  values of Table 3.2-1, with the exception of C-14, were calculated in accordance with the methods of Section 5.3.1 of Reference 1.  
C-14 values were calculated using Reference 3. The values used for each parameter and the origins of the values are given in Table 3.2-4 and its notes.

Table 3.2-2

CONTROLLING RECEPTORS, LOCATIONS, AND PATHWAYS\*

<u>SECTOR</u>	<u>DISTANCE (METERS)</u>	<u>PATHWAY</u>	<u>AGE GROUP</u>	<u>ORIGIN (FOR INFORMATION ONLY)</u>
N**	6,100	Vegetation	ALL	-Vegetable Garden
NNE**	5,300	Vegetation	ALL	-Vegetable Garden
NE	4,500	Vegetation	ALL	-Vegetable Garden
	4,500	Grass/Cow/Meat		Grazing Beef Cattle
ENE	2,600	Vegetation	ALL	-Vegetable Garden
	2,600	Grass/Cow/Meat		Grazing Beef Cattle
E	1,800	Vegetation	ALL	-Vegetable Garden
ESE	1,800	Vegetation	ALL	-Vegetable Garden
SE	2,400	Vegetation	ALL	-Vegetable Garden
SSE	4,300	Vegetation	ALL	-Vegetable Garden
S**	6,300	Vegetation	ALL	-Vegetable Garden
SSW**	5,500	Vegetation	ALL	-Vegetable Garden
SW**	5,300	Vegetation	ALL	-Vegetable Garden
WSW	3,100	Grass/Cow/Meat	ALL	-Grazing Beef Cattle
W	4,300	Vegetation	ALL	-Vegetable Garden
	3,500	Grass/Cow/Meat		Grazing Beef Cattle
WNW**	7,700	Vegetation	ALL	-Vegetable Garden
NW**	6,600	Vegetation	ALL	-Vegetable Garden
	6,600	Grass/Cow/Meat		Grazing Beef Cattle
NNW	4,800	Vegetation	ALL	-Vegetable Garden
	4,800	Grass/Cow/Meat		Grazing Beef Cattle

\* See note on the following page for the method used to identify these controlling receptors.

\*\* If a cow were located at 5.0 miles (8,000 meters) in this sector, an infant consuming only its milk would receive a greater total radiation dose than would the real receptor listed. However, such an infant would not be the Maximum Exposed Individual for the site.

NOTE: The controlling receptor in each sector was identified in the following way. Receptor locations and associated pathways were obtained from the August 1991 field survey. A child was assumed at each location, except that where a milk cow was listed, an infant was assumed.  $X/Q'$  and  $D/Q'$  for each candidate receptor was calculated using five year averaged meteorological data. XOQDOQ<sup>-82</sup> software was used to analyze the meteorological data. Expected annual releases of each nuclide were taken from Table 5.2-2 of Reference 5. The specific dispersion values for each candidate are used with the methodology of ODCM section 3.2.3.2 to calculate a hypothetical dose. The controlling receptor for each sector was then chosen as the candidate receptor with the highest total annual dose of any candidate receptor in the given sector. All listed pathways are in addition to inhalation and ground plane exposure.

Table 3.2-3

**ATMOSPHERIC DISPERSION PARAMETERS  
FOR CONTROLLING RECEPTOR LOCATIONS\***

SECTOR	$\bar{X}/Q'$	$\bar{D}/Q'$	DISTANCE (MILES/METERS)
N	2.3 E-7	6.3 E-10	3.8 / 6,100
NNE	2.9 E-7	8.5 E-10	3.3 / 5,300
NE	5.4 E-7	1.5 E-9	2.8 / 4,500
ENE	1.8 E-6	5.4 E-9	1.6 / 2,600
E	3.5 E-6	1.1 E-8	1.1 / 1,800
ESE	2.1 E-6	6.8 E-9	1.1 / 1,800
SE	6.5 E-7	2.4 E-9	1.5 / 2,400
SSE	1.2 E-7	5.3 E-10	2.7 / 4,300
S	7.6 E-8	3.5 E-10	3.9 / 6,300
SSW	1.2 E-7	7.0 E-10	3.4 / 5,500
SW	1.3 E-7	9.6 E-10	3.3 / 5,300
WSW	3.6 E-7	2.5 E-9	1.9 / 3,100
W	1.8 E-7	7.7 E-10	2.7 / 4,300
WNW	2.8 E-7	1.3 E-9	2.2 / 3,500
NW	3.8 E-8	1.3 E-10	4.8 / 7,700
NNW	9.8 E-8	2.8 E-10	4.1 / 6,600
NNW	3.3 E-7	9.0 E-10	3.0 / 4,800

- \* Annual average relative dispersion and deposition values for the receptor locations in Table 3.2-2. Values were calculated from 5 year averaged meteorological data using the XOQDOQ-82 software. Dispersion values were calculated assuming ground-level release, open terrain recirculation, dry depletion, and using decay with a half-life of 8.0 days. As a result of the analysis described in the note to Table 3.2-2, the location of the maximum exposed individual for the site is assumed to be the vegetable garden at 1.1 miles in the E sector. Therefore, the site  $X/Q'$  and  $D/Q'$  (Section 3.2.3.2 and following) are those from this table for that location.

Table 3.2-4

Page 1 of 4

**PARAMETERS USED IN DOSE FACTOR CALCULATIONS**

<u>Parameter</u>	<u>Value</u>	<u>Origin of Value</u>		
		<u>Table in R.G. 1.109</u>	<u>Section of NUREG-0133</u>	<u>Site-Specific</u>
	<b>***For P<sub>i</sub>***</b>			
DFA <sub>io</sub>	Each radionuclide , organ	E-9		
BR	3700 m <sup>3</sup> /yr	E-5		
	<b>***For Ri (Vegetation)***</b>			
r	Each element type	E-1		
Y <sub>v</sub>	2.0 kg/m <sup>2</sup>	E-15		
λw	5.73 E-7 sec <sup>-1</sup>		5.3.1.3	
DFL <sub>io</sub>	Each age group ,radio-nuclide , organ	E-11 thru E-14		
U <sub>a</sub> <sup>L</sup>	Each age group	E-5		
f <sub>L</sub>	1.0		5.3.1.5	
t <sub>L</sub>	8.6 E + 4 seconds	E-15		
U <sub>a</sub> <sup>S</sup>	Each age group	E-5		
f <sub>g</sub>	0.76		5.3.1.5	
t <sub>h</sub>	5.18 E + 6 seconds	E-15		
H	8.84 gm/m <sup>3</sup>			Note 1
	<b>***For Ri (Inhalation)***</b>			
BR	Each age group	E-5		
DFA <sub>aio</sub>	Each age group , radionuclide, organ	E-7 thru E-10		



**Table 3.2-4**

**Page 2 of 4**

**PARAMETERS USED IN DOSE FACTOR CALCULATIONS**

<u>Parameter</u>	<u>Value</u>	<u>Origin of Value</u>		
		<u>Table in R.G. 1.109</u>	<u>Section of NUREG-0133</u>	<u>Site-Specific</u>
	<b>***For R<sub>i</sub> (Ground Plane)***</b>			
SF	0.7	E-15		
DFG <sub>io</sub>	Each radionuclide , organ	E-6		
t	4.73 E + 8 sec		5.3.1.2	
	<b>***For R<sub>i</sub> (Grass/Animal/Meat)***</b>			
Q <sub>F</sub> (Cow)	50 kg/day	E-3		
Q <sub>F</sub> (Goat)	6 kg/day	E-3		
U <sub>ap</sub>	Each age group	E-5		
λ <sub>w</sub>	5.73 E-7 sec <sup>-1</sup>		5.3.1.3	
F <sub>f</sub> (Both)	Each element	E-1		
r	Each element type	E-15		
DFL <sub>io</sub>	Each age group , radionuclide , organ	E-11 thru E-14		
f <sub>p</sub>	1.0			Note 2
f <sub>s</sub>	1.0			Note 2
Y <sub>p</sub>	0.7 kg/m <sup>3</sup>	E-15		
t <sub>h</sub>	7.78 E + 6 sec	E-15		
Y <sub>s</sub>	2.0 kg/m <sup>2</sup>	E-15		
t <sub>f</sub>	1.73 E + 6 sec	E-15		
H	8.84 gm/m <sup>3</sup>			Note 1

Table 3.2-4

Page 3 of 4

**PARAMETERS USED IN DOSE FACTOR CALCULATIONS**

<u>Parameter</u>	<u>Value</u>	<u>Origin of Value</u>		
		<u>Table in R.G. 1.109</u>	<u>Section of NUREG- 0133</u>	<u>Site- Specific</u>
	<b>***For R<sub>i</sub> (Grass/Animal/Milk)***</b>			Note 3
Q <sub>F</sub> (Cow)	50 kg/day	E-3		
Q <sub>F</sub> (Goat)	6 kg/day	E-3		
U <sub>ap</sub>	Each age group	E-5		
λ <sub>w</sub>	5.73 E-7 sec <sup>-1</sup>		5.3.1.3	
F <sub>m</sub>	Each element	E-1 & E-2		
r	Each element type	E-15		
DFL <sub>io</sub>	Each age group , radionuclide , organ	E-11 thru E-14		
Y <sub>p</sub>	0.7 kg/m <sup>2</sup>	E-15		
t <sub>h</sub>	7.78 E + 6 sec	E-15		
Y <sub>s</sub>	2.0 kg/m <sup>2</sup>	E-15		
t <sub>f</sub>	1.73 E + 5 sec	E-15		
f <sub>p</sub>	1.0			
f <sub>s</sub>	1.0			
f <sub>p</sub>	0.0			
f <sub>s</sub>	0.0			
H	8.84 gm/m <sup>3</sup>			Note 1

**Table 3.2-4(Continued)**

**Page 4 of 4**

**NOTES**

1. Site-specific annual average absolute humidity. For each month, an average absolute humidity was calculated from the 7 years of monthly average temperatures in Table 2.3-49 of Reference 4 and 5 years of monthly average dew points in Table 2.3-64 of Reference 4. The 12 monthly values were averaged to obtain the annual average of 8.84 gm/m<sup>3</sup>. Section 5.2.1.3 of Reference 1 gives a default value of 8 gm/m<sup>3</sup>.) The default value of 8 gm/m<sup>3</sup> from Section 5.2.1.3 of Reference 1 was used in the calculation of the R<sub>aij</sub> values for Tritium found in Table 3.2-1, providing a marginally more conservative result.
2. Typically beef cattle are raised all year on pasture. Annual land surveys have indicated that the small number of goats raised within 5 miles typically are used for grass control and not food or milk. Nevertheless, the goats were treated as full meat and milk sources where present, despite the fact that their numbers cannot sustain the meat consumption rates of Table E-5 of Reference 3.
3. According to the August 1990 land use census, dairy cattle possibly graze at 4.9 miles in the West sector. If dairy cattle graze at this location, the dose to an infant consuming milk from these animals would be less than the dose received by the critical receptor identified for the sector. No other milking activity within five miles of the plant was identified. These values are included for reference only.

# GASEOUS RADWASTE TREATMENT SYSTEM

Figure 3.2-1

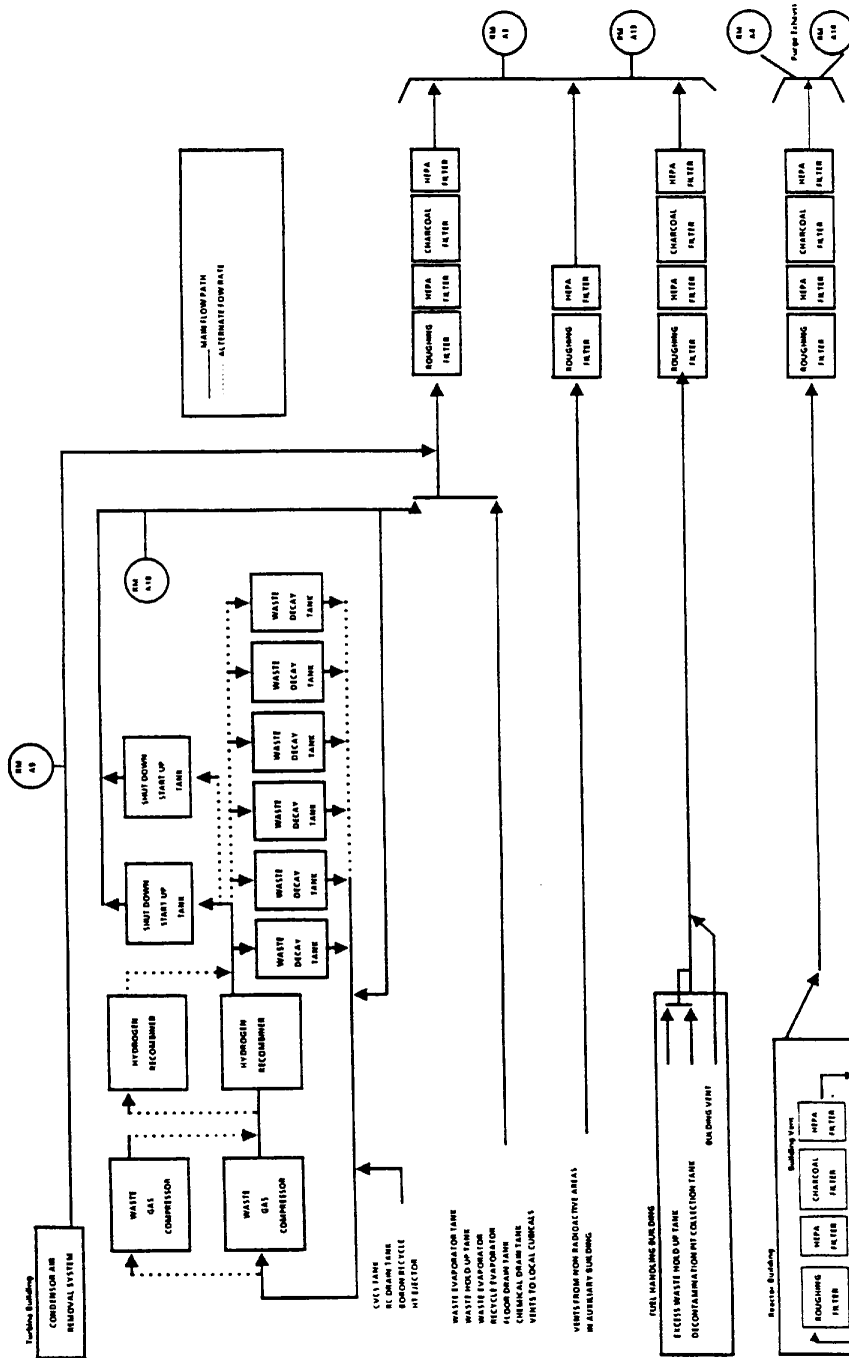

### 3.3 Meteorological Model for Dose Calculations

#### 3.3.1 Meteorological Model Parameters

<u>Term</u>	<u>Definition</u>	<u>Section of Initial Use</u>
b =	height of the containment building.	(3.3.2.1)
$D_g$ =	deposition rate for ground-level releases relative to the distance from the containment building (from Figure 3.3-3).	(3.3.2.2)
$D/Q$ =	the sector averaged relative deposition for any distance in a given sector ( $m^{-2}$ ).	(3.3.2.2)
i =	wind speed class. The wind speed classes are given in Table 4A of Reference 10 as 1-3, 4-7, 8-12, 13-18, 19-24, and > 24 miles per hour.	(3.3.2.1)
N =	total hours of valid meteorological data.	(3.3.2.1)
$n_{ij}$ =	number of hours meteorological conditions are observed to be in a given wind direction, wind speed class i, and atmospheric stability class j.	(3.3.3.1)
n =	number of hours wind is in given direction.	(3.3.2.1)
r =	distance from the containment building to the location of interest for dispersion calculations (m).	(3.3.2.1)
$\Delta T/\Delta Z$ =	temperature differential with vertical separation ( $^{\circ}K/100m$ ).	(3.3.2.1)
T =	terrain recirculation factor, Figure 3.3-4.	(3.3.2.1)
$u_i$ =	wind speed (midpoint of wind speed class i) at ground level (m/sec).	(3.3.2.1)
$X/Q$ =	the sector average relative concentration at any distance in a given sector ( $sec/m^3$ ).	(3.3.2.1)
$\delta$ =	plume depletion factor at distance r from Figure 3.3-1.	(3.3.3.1)

<u>Term</u>	<u>Definition</u>	<u>Section of Initial Use</u>
$\sigma_z$ =	vertical standard deviation of the plume (in meters), at distance r for ground level releases under the stability category indicated by $\Delta T/\Delta Z$ , from Figure 3.3-2.	(3.3.2.1)
2.032 =	$(2/\pi)^{1/2}$ divided by the width in radians of a 22.5° sector (0.3927 radians).	(3.3.2.1)
2.55 =	the inverse of the number of radians in a 22.5° sector	(3.3.2.2)

$$\frac{1}{(22.5^\circ) (0.0175 \text{ Radians}/^\circ)}$$

### 3.3.2 Meteorological Model

3.3.2.1 Atmospheric dispersion for routine venting or other routine gaseous effluent releases is calculated using a ground-level, wake-corrected form of the straight line flow model.

X/Q = the sector-averaged relative concentration at any distance in the given sector (sec/m<sup>3</sup>)

$$= 2.032 \delta T \sum_{ij} \frac{n_{ij}}{N r u_i \sum_{zj}}$$
 (52)

where:

2.032 =  $(2/\pi)^{1/2}$  divided by the width in radians of a 22.5° sector (0.3927 radians).

$\delta$  = plume depletion factor at distance r for the appropriate stability class from Figure 3.3-1.

i = wind speed class. The wind speed classes are given in Table 4A of Reference 10 as 1-3, 4-7, 8-12, 13-18, 19-24, and > 24 miles per hour.

$n_{ij}$  = number of hours meteorological conditions are observed to be in a given wind direction, wind speed class i, and atmospheric stability class j.

- N = total hours of valid meteorological data.
- r = distance from the containment building to location of interest (m)
- $u_i$  = wind speed (midpoint of wind speed class  $i$ ) at ground level (m/sec).

$$\sum_z = \text{the lesser of } (\sigma_z^2 + b^2 / 2\pi)^{\frac{1}{2}} \text{ or } (\sqrt{3}\sigma_z) \quad (53)$$

where:

- $\sigma_z$  = vertical standard deviation of the plume (in meters) at distance  $r$  for ground level releases under the stability category indicated by  $\Delta T / \Delta Z$ , from Figure 3.3-2.
- T = terrain recirculation factor, from Figure 3.3-4
- $\pi$  = 3.1416
- b = height of the containment building (50.9m)
- $\Delta T / \Delta Z$  = temperature differential with vertical separation ( $^{\circ}\text{K}/100\text{m}$ ).

Note: For calculation of  $X/Q$  using actual meteorological data for a particular release,  $u_i$  = the average wind speed for hour  $i$  and  $n_{ij}$  = number of hours with wind speed  $i$  and stability class  $j$ .

3.3.2.2 Relative deposition per unit area for all releases is calculated for a ground-level release.

- $D/Q$  = the sector-averaged relative deposition at any distance in a given sector ( $\text{m}^{-2}$ ).

$$= \frac{2.55 D_g^n}{rN} \quad (54)$$

where,

- $D_g$  = deposition rate for ground-level releases relative to distance ( $r$ ) from the containment building (from Figure 3.3-3).

2.55 = the inverse of the number of radians in a 22.5° sector

$$\frac{1}{(22.5^\circ) (0.0175 \text{ Radians}/^\circ)}$$

n = number of hours wind is in given direction (sector).

N = total hours of valid meteorological data.



FIGURE 3.3-1

Plume Depletion Effect for Ground Level Releases ( $\delta$ )  
(All Atmospheric Stability Classes)

Graph taken from Reference 8, Figure 2

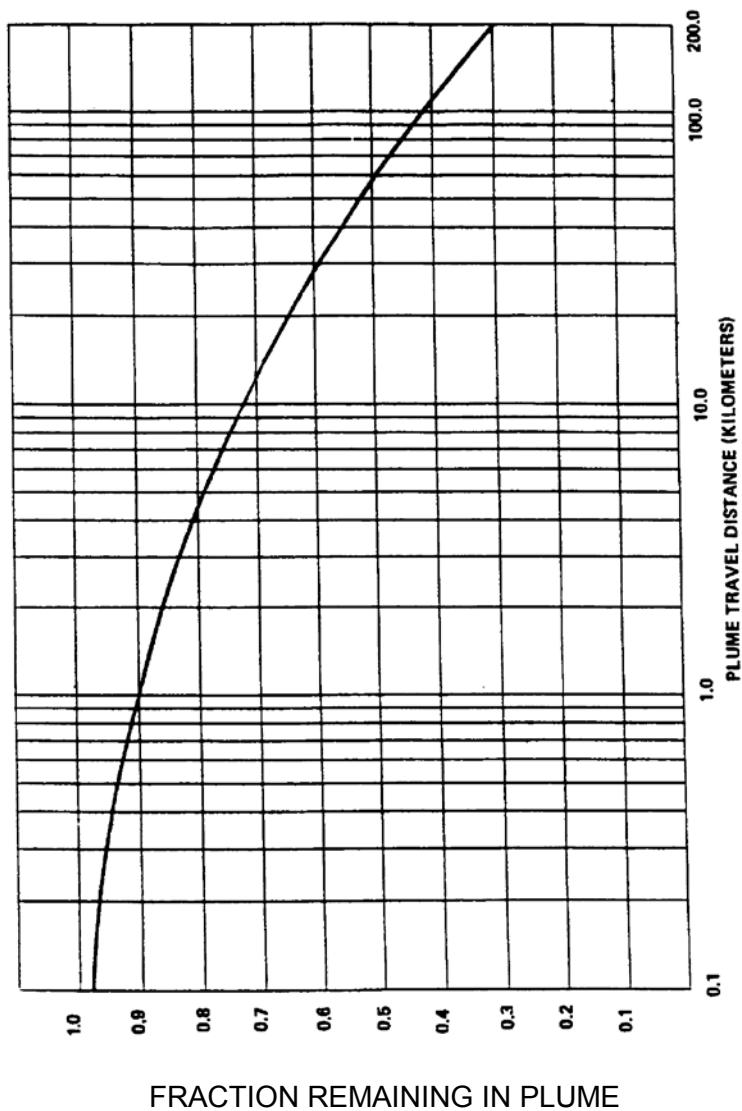
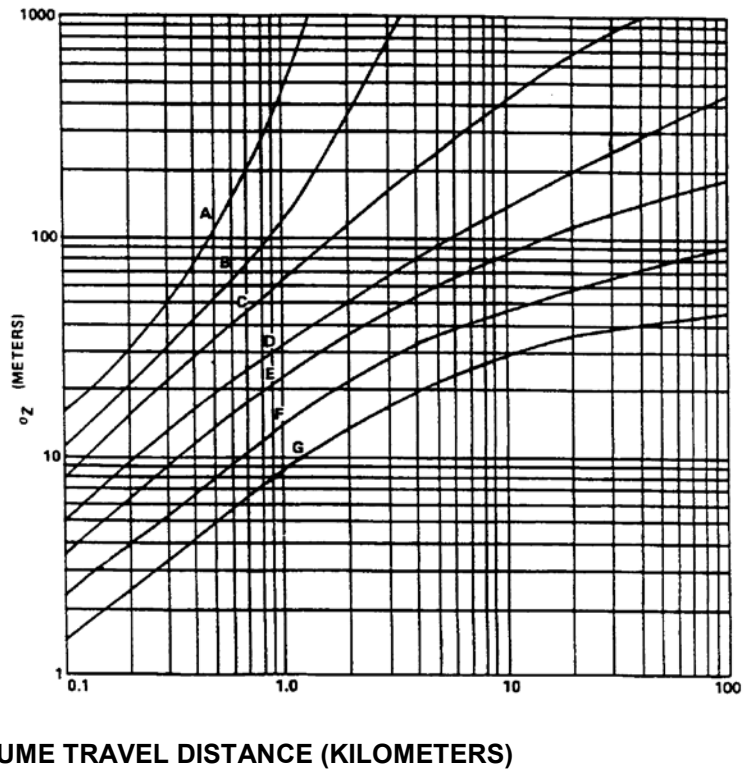

FIGURE 3.3-2

Vertical Standard Deviation of Material in a Plume ( $\delta_z$ )  
 (Letters denote Pasquill Stability Classes)

Graph taken from Reference 8, Figure 1



<u>Temperature change with Height <math>\Delta T/\Delta Z</math> (<math>^{\circ}\text{K}/100\text{m}</math>)</u>	<u>Pasquill Categories</u>	<u>Stability Classification</u>
<-1.9	A	Extremely Unstable
-1.9 to -1.7	B	Moderately Unstable
-1.7 to 1.5	C	Slightly Unstable
-1.5 to -0.5	D	Neutral
-0.5 to 1.5	E	Slightly Stable
1.5 to 4.0	F	Moderately Stable
>4.0	G	Extremely Stable

**FIGURE 3.3-3**  
**Relative Deposition for Ground Level Releases ( $D_g$ )**  
**(All Atmospheric Stability Classes)**

Graph taken from Reference 8, Figure 6

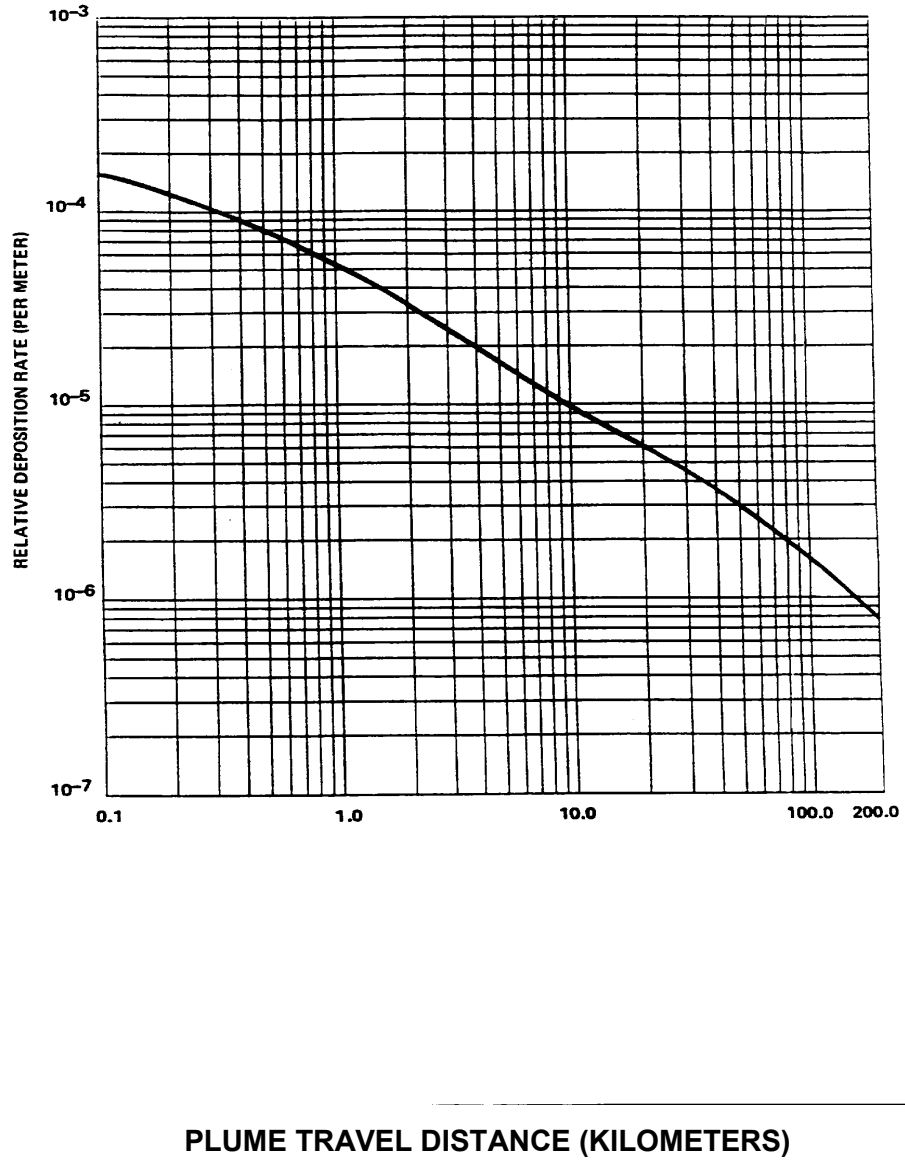
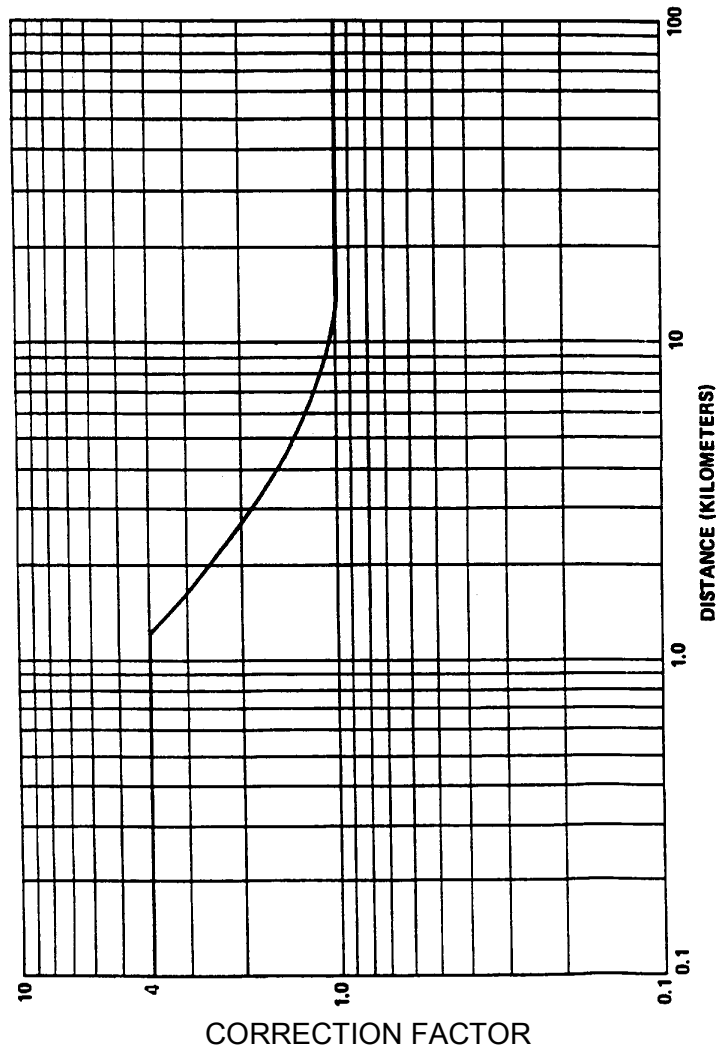

FIGURE 3.3-4

Open Terrain Recirculation Factor

Graph taken from Reference 7, Figure 2



#### 4.0 RADIOLOGICAL ENVIRONMENTAL MONITORING

Sampling locations as required in section 1.4.1 of the ODCM Specifications are described in Table 4.0-1 and shown on Figures 4.0-1 through 4.0-4. As indicated by the ditto (“”) marks in the table, entries in the sampling frequency and analysis frequency columns apply to all samples below the entry until a new entry appears.

**RADIOLOGICAL ENVIRONMENTAL MONITORING PROGRAM  
VIRGIL C. SUMMER NUCLEAR STATION  
TABLE 4.0-1**

Exposure Pathway and/or Sample	Criteria for Selection of Sample Number & Location	Sampling and Collection Frequency	Sample <sup>10</sup> Location	Locations Mi/Dir	Type & Frequency of Analysis
<b>AIRBORNE:</b> I. Particulate	A) 3 Indicator samples from locations close to the site boundary, in different sectors, of the highest calculated annual average ground level D/Q or dose. <sup>9</sup>	Continuous sampler operation with weekly collection.	2 7 30	1.2 SW 1.0 E 0.5 SSW	Gross beta following filter change; Quarterly <sup>6</sup> Composite (by location) for gamma isotopic.
	B) 1 Indicator sample to be taken close to the site boundary in the sector corresponding to the residence having the highest anticipated offsite ground level concentration or dose. <sup>9</sup>	Continuous sampler operation with weekly collection.	6	1.0 ESE	Gross beta following filter change; Quarterly <sup>6</sup> Composite (by location) for gamma isotopic.
	C) 1 Indicator sample to be taken at the location of one of the dairies being sampled meeting the criteria of VII(A). <sup>2,9</sup>	Continuous sampler operation with weekly collection.	N/A	N/A	Gross beta following filter change; Quarterly <sup>6</sup> Composite (by location) for gamma isotopic.
	D) 1 Control samples to be taken at a location at least 10 air miles from the site and not in the most prevalent wind direction. <sup>9</sup>	Continuous sampler operation with weekly collection.	17	25.0 SE	Gross beta following filter change; Quarterly <sup>6</sup> Composite (by location) for gamma isotopic.

**RADIOLOGICAL ENVIRONMENTAL MONITORING PROGRAM  
VIRGIL C. SUMMER NUCLEAR STATION  
TABLE 4.0-1**

Exposure Pathway and/or Sample	Criteria for Selection of Sample Number & Location	Sampling and Collection Frequency	Sample <sup>10</sup> Location	Locations Mi/Dir	Type & Frequency of Analysis
II. Radioiodine	A) 3 Indicator samples to be taken at two locations as given in I(A) above.  B) 1 Indicator to be taken at the location as given in I(B) above  C) 1 Indicator sample to be taken at the location as given in I(C) above  D) 1 Control sample to be taken at a location similar in nature to I(D) above.	Continuous sampler operation with weekly canister collection.  Continuous sampler operation with weekly canister collection.  Continuous sampler operation with weekly canister collection.  Continuous sampler operation with weekly canister collection.	2 7 30  6  N/A  17	1.2 SW 1.0 E 0.5 SSW  1.0 ESE  N/A  25.0 SE	Gamma Isotopic for I-131 weekly.  Gamma Isotopic for I-131 weekly.  Gamma Isotopic for I-131 weekly.  Gamma Isotopic for I-131 weekly.
III. Direct	A) 13 Indicator stations to form an inner ring of stations in the 13 accessible sectors within 1 to 2 miles of the plant.	Monthly <sup>5</sup> or quarterly <sup>6</sup> ; exchange two or more dosimeters at each location.	1,2 3,4 5,6 7,8 9,10 29 30 47	1.2 S, 1.2 SW 1.2W, 1.2WNW 0.9 SE, 1.0 ESE 1.0 E, 1.5 ENE 2.3 NE, 2.5NNE 1.0 WSW, 1.0 SSW 1.0 NW	Gamma dose monthly <sup>5</sup> or quarterly. <sup>6</sup>

**RADIOLOGICAL ENVIRONMENTAL MONITORING PROGRAM  
VIRGIL C. SUMMER NUCLEAR STATION  
TABLE 4.0-1**

Exposure Pathway and/or Sample	Criteria for Selection of Sample Number & Location	Sampling and Collection Frequency	Sample <sup>10</sup> Location	Locations Mi/Dir	Type & Frequency of Analysis
III. Direct (Continued)	<p>B) 16 Indicator stations to form an outer ring of stations in the 16 accessible sectors within 3 to 5 miles of the plant.</p> <p>C) 11 Stations to be placed in special interest areas such as population centers, nearby residences, schools and in 4 or 5 areas to serve as controls.</p> <p>D) 6 Stations to be placed around the ISFSI boundary.</p>	<p>Monthly<sup>5</sup> or quarterly<sup>6</sup>, exchange two or more dosimeters at each location.</p> <p>Monthly<sup>5</sup> or quarterly<sup>6</sup>, exchange two or more dosimeters at each location.</p> <p>Monthly<sup>5</sup> or quarterly<sup>6</sup>, exchange two or more dosimeters at each location.</p>	<p>12,13 32,33 34,35 36,37 41,42 43,44 46,60 53,55</p> <p>16, 17 18, 19 20,31 45,52 54,56 58</p> <p>78,79 80,81 82,83</p>	<p>4.2 N, 2.9 NNW 4.6 NNE, 4.2 ENE 4.9 ESE, 4.6 SE 3.1 SSE, 4.9 NW 3.8 S, 3.8 SSW 5.2 SW, 2.8 WSW 3.7 WNW, 3.5W 3.0 NE, 2.8 E</p> <p>28.0 W, 25.0 SE 16.5 S, 21.0 SSW 22.0 NW, 6.6 NNE 5.8 WSW, 3.8 NNE 1.7 ENE, 2.0 SE 2.5 SSE</p> <p>Onsite Onsite Onsite</p>	<p>Gamma dose monthly<sup>5</sup> or quarterly.<sup>6</sup></p> <p>Gamma dose monthly<sup>5</sup> or quarterly.<sup>6</sup></p> <p>Gamma &amp; neutron dose monthly<sup>5</sup> or quarterly.<sup>6</sup></p>
<p><b>WATERBORNE:</b></p> <p>IV. Surface Water</p>	<p>A) 1 Indicator sample downstream to be taken at a location which allows for mixing and dilution in the ultimate receiving river.</p> <p>B) 1 Control sample to be taken at a location on the receiving river, sufficiently far upstream such that no effects of pumped storage operation are anticipated.</p>	<p>Time composite samples with collection every month.<sup>5</sup></p> <p>Time composite samples with collection every month.<sup>5</sup></p>	<p>21<sup>3,11</sup></p> <p>22<sup>11</sup></p>	<p>2.7 SSW</p> <p>26.0 NNW</p>	<p>Gamma isotopic monthly<sup>5</sup> with quarterly<sup>6</sup> composite (by location) to be analyzed for tritium.</p> <p>Gamma isotopic monthly<sup>5</sup> with quarterly<sup>6</sup> composite (by location) to be analyzed for tritium.</p>



**RADIOLOGICAL ENVIRONMENTAL MONITORING PROGRAM  
VIRGIL C. SUMMER NUCLEAR STATION  
TABLE 4.0-1**

<b>Exposure Pathway and/or Sample</b>	<b>Criteria for Selection of Sample Number &amp; Location</b>	<b>Sampling and Collection Frequency</b>	<b>Sample<sup>10</sup> Location</b>	<b>Locations Mi/Dir</b>	<b>Type &amp; Frequency of Analysis</b>
IV. Surface Water (Continued)	C) 1 Indicator sample to be taken in the upper reservoir of the pumped storage facility at the plant discharge canal.	Time composite samples with collection every month. <sup>5</sup>	23 <sup>11</sup>	0.5 ESE	Gamma isotopic monthly <sup>5</sup> with quarterly <sup>6</sup> composite (by location) to be analyzed for tritium.
V. Ground Water	A) 12 Indicators samples to be taken within the exclusion boundary and in the direction of potentially affected ground water supplies.	Quarterly <sup>6</sup> grab sampling.	6 26, 27 101-103 106 108, 110  112 113 114	1.0 ESE Onsite Onsite Onsite Onsite  0.36 SSE 0.33 SSE 0.39 SE	Gamma isotopic and tritium analyses quarterly. <sup>6</sup>
	B) 1 Control sample from unaffected location.	Quarterly <sup>6</sup> grab sampling.	59	2.6 SSE	Gamma isotopic and tritium analyses quarterly. <sup>6</sup>
VI. Drinking Water	A) 1 Indicator sample from a nearby public ground water supply source.	Monthly <sup>5</sup> grab sampling.	28	2.6 SSE	Monthly <sup>5</sup> gamma isotopic and gross beta analyses and quarterly <sup>6</sup> composite for tritium analyses.
	B) 1 Indicator (finished water) sample from the nearest downstream water supply.	Monthly <sup>5</sup> composite sampling.	17	25.0 SE	Monthly <sup>5</sup> gamma isotopic and gross beta analyses and quarterly <sup>6</sup> composite for tritium analyses.
	C) 1 Control (finished water) sample from an unaffected water supply.	Monthly <sup>5</sup> composite sampling.	39	14.0 SSE	Monthly <sup>5</sup> gamma isotopic and gross beta analyses and quarterly <sup>6</sup> composite for tritium analyses.

**RADIOLOGICAL ENVIRONMENTAL MONITORING PROGRAM  
VIRGIL C. SUMMER NUCLEAR STATION  
TABLE 4.0-1**

Exposure Pathway and/or Sample	Criteria for Selection of Sample Number & Location	Sampling and Collection Frequency	Sample <sup>10</sup> Location	Locations Mi/Dir	Type & Frequency of Analysis
<b>INGESTION:</b> VII. Milk <sup>2</sup>	A) Samples from milking animals in 3 locations within 5 km having the highest dose potential. If there are none then 1 sample from milking animals in each of 3 areas between 5 to 8 km distance where doses are calculated to be greater than 1 mrem per year. <sup>1</sup>	Semimonthly <sup>4</sup> when animals are on pasture, monthly <sup>5</sup> other times.	To be supplied when milk animals are found in accordance with criteria VII(A).		Gamma isotopic and I-131 analysis semimonthly <sup>4</sup> when animals are on pasture monthly <sup>5</sup> other times.
	B) 1 Control sample to be taken at the location of a dairy > 20 miles distance and not in the most prevalent wind direction. <sup>2</sup>	Semimonthly <sup>4</sup> when animals are on pasture, monthly <sup>5</sup> other times. <sup>8</sup>	16	20.0 W	Gamma isotopic and I-131 analysis semimonthly <sup>4</sup> when animals are on pasture monthly <sup>5</sup> other times.
	C) 1 Indicator grass (forage) sample to be taken at the location of one of the dairies being sampled meeting the criteria of VII(A), above, when animals are on pasture.	Monthly <sup>5</sup> when available. <sup>8</sup>	To be supplied when milk animals are found in accordance with criteria VII(A).		Gamma isotopic.
	D) 1 Control grass (forage) sample to be taken at the location of VII(B) above.	Monthly <sup>5</sup> when available. <sup>8</sup>	16	20.0 W	Gamma isotopic.

**RADIOLOGICAL ENVIRONMENTAL MONITORING PROGRAM  
VIRGIL C. SUMMER NUCLEAR STATION  
TABLE 4.0-1**

Exposure Pathway and/or Sample	Criteria for Selection of Sample Number & Location	Sampling and Collection Frequency	Sample Location <sup>10</sup>	Locations Mi/Dir	Type & Frequency of Analysis
VIII. Food Products	<p>A) 2 samples of broadleaf vegetation grown in the 2 nearest offsite locations of highest calculated annual average ground level D/Q if milk sampling is not performed within 3 km or if milk sampling is not performed at a location within 5 to 8 km where the doses are calculated to be greater than 1 mrem/yr.<sup>1</sup></p> <p>B) 1 Control sample for the same foods taken at a location at least 10 miles distance and not in the most prevalent wind direction if milk sampling is not performed within 3 km or if milk sampling is not performed at a location within 5 to 8 km where the doses are calculated to be greater than 1 mrem/yr.<sup>1</sup></p>	<p>Monthly<sup>5</sup> when available.</p> <p>Monthly<sup>5</sup> when available.</p>	<p>6 7</p> <p>40</p>	<p>1.0 ESE 1.0 E</p> <p>11.9 SSE</p>	<p>Gamma isotopic on edible portion.</p> <p>Gamma isotopic on edible portion.</p>
IX. Fish	<p>A) 1 Indicator sample to be taken at a location in the upper reservoir.</p> <p>B) 1 Indicator sample to be taken at a location in the lower reservoir.</p>	<p>Seminannual<sup>7</sup> collection of the following specie types if available: bass; bream, crappie; catfish, carp.</p> <p>Seminannual<sup>7</sup> collection of the following specie types if available: bass; bream, crappie; catfish, carp.</p>	<p>23<sup>11</sup></p> <p>21<sup>11</sup></p>	<p>0.3-5</p> <p>1-3</p>	<p>Gamma isotopic on edible portions seminannually.<sup>7</sup></p> <p>Gamma isotopic on edible portions seminannually.<sup>7</sup></p>

**RADIOLOGICAL ENVIRONMENTAL MONITORING PROGRAM  
VIRGIL C. SUMMER NUCLEAR STATION  
TABLE 4.0-1**

<b>Exposure Pathway and/or Sample</b>	<b>Criteria for Selection of Sample Number &amp; Location</b>	<b>Sampling and Collection Frequency</b>	<b>Sample<sup>10</sup> Location</b>	<b>Locations Mi/Dir</b>	<b>Type &amp; Frequency of Analysis</b>
IX. Fish (Continued)	C) 1 Control sample to be taken at a location on the receiving river sufficiently far upstream such that no effects of pumped storage operation are anticipated.	Semiannual <sup>7</sup> collection of the following specie types if available: bass; bream, crappie; catfish, carp.	22 <sup>11</sup>	26.0 NNW	Gamma Isotopic on edible portions semiannually. <sup>7</sup>
<b>AQUATIC:</b> X. Sediment	A) 1 Indicator sample to be taken at a location in the upper reservoir.  B) 1 Indicator sample to be taken on or near the shoreline of the lower reservoir.  C) 1 Control sample to be taken at a location on the receiving river sufficiently far upstream such that no effects of pumped storage operation are anticipated.	Semiannual <sup>7</sup> grab sample.  Semiannual <sup>7</sup> grab sample.  Semiannual <sup>7</sup> grab sample.	23 <sup>11</sup>  21 <sup>11</sup>  22 <sup>11</sup>	0.5 ESE  2.7 SSW  26.0 NNW	Gamma isotopic.  Gamma isotopic.  Gamma isotopic.

**RADIOLOGICAL ENVIRONMENTAL MONITORING PROGRAM**  
**VIRGIL C. SUMMER NUCLEAR STATION**  
**TABLE 4.0-1**  
**TABLE NOTATION**

1. The dose shall be calculated for the maximum organ and age group, using the guidance/methodology contained in Regulatory Guide 1.109, Revision 1 and the parameters particular to the Site. The locations are selected based on the potential for the highest exposure.
2. Milking animal and garden survey results will be analyzed annually. Should the survey indicate new dairying activity the owners shall be contacted with regard to a contract for supplying sufficient samples. If contractual arrangements can be made, Site(s) will be added for additional milk sampling up to a total of 3 Indicator Locations.
3. Time composite samples are samples which are collected with equipment capable of collecting an aliquot at time intervals which are short (e.g. hourly) relative to the compositing period.
4. At least once per 18 days.
5. Not to exceed 35 days.
6. At least once per 100 days.
7. At least once per 200 days
8. Milk and forage sampling at the control location is only required when locations meeting the criteria of VII(A) are being sampled.
9. Sample site locations are based on 5 year average meteorological analysis.
10. Location numbers refer to Figures 4.0-1 through 4.0-4.
11. Though generalized areas are noted for simplicity of sample site enumeration, airborne, water and sediment sampling is done at the same location whereas biological sampling sites are generalized areas in order to reasonably assure availability of samples.

**FIGURE 4.0-1**  
**Radiological Environmental Sampling Locations (Remote)**

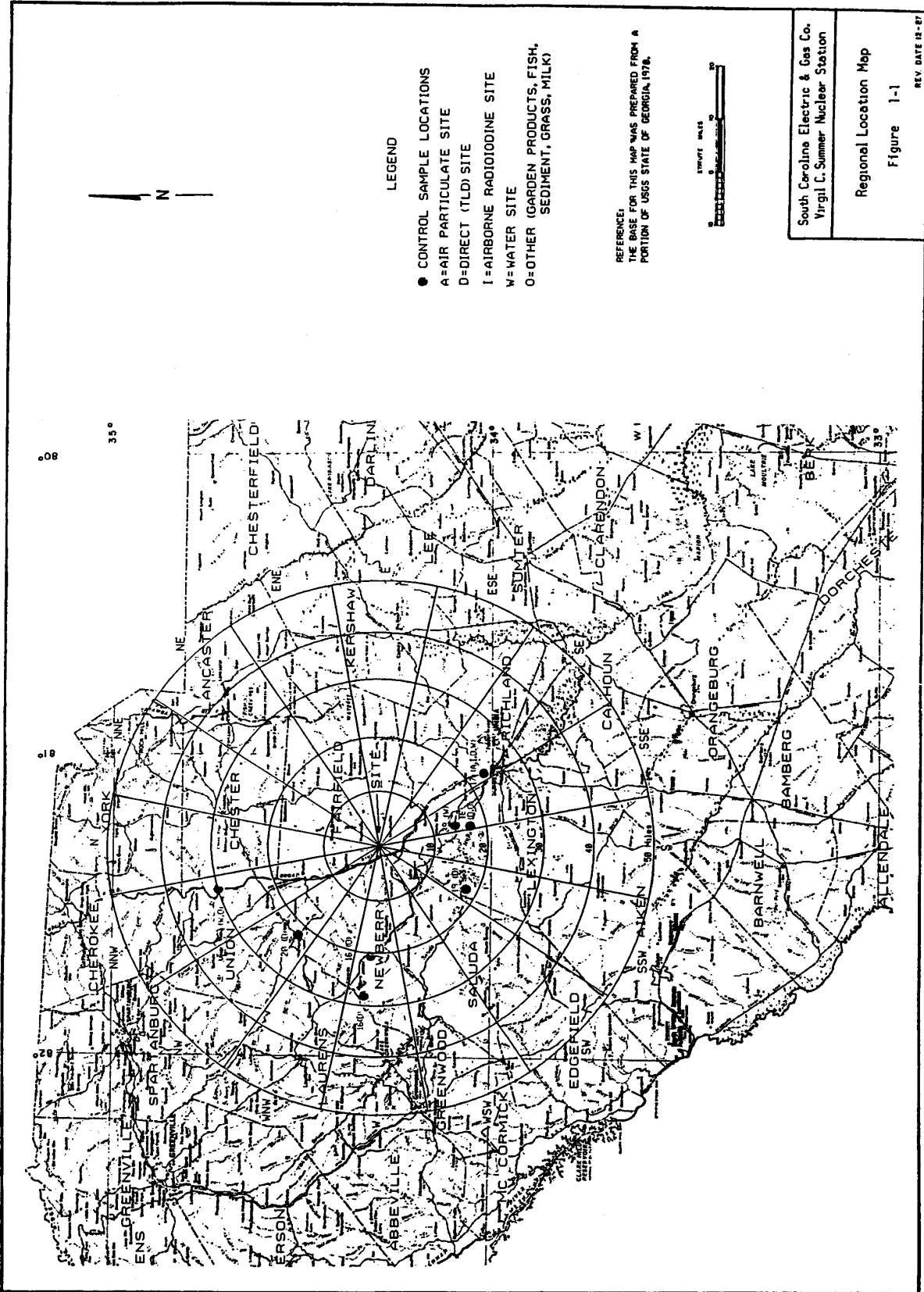
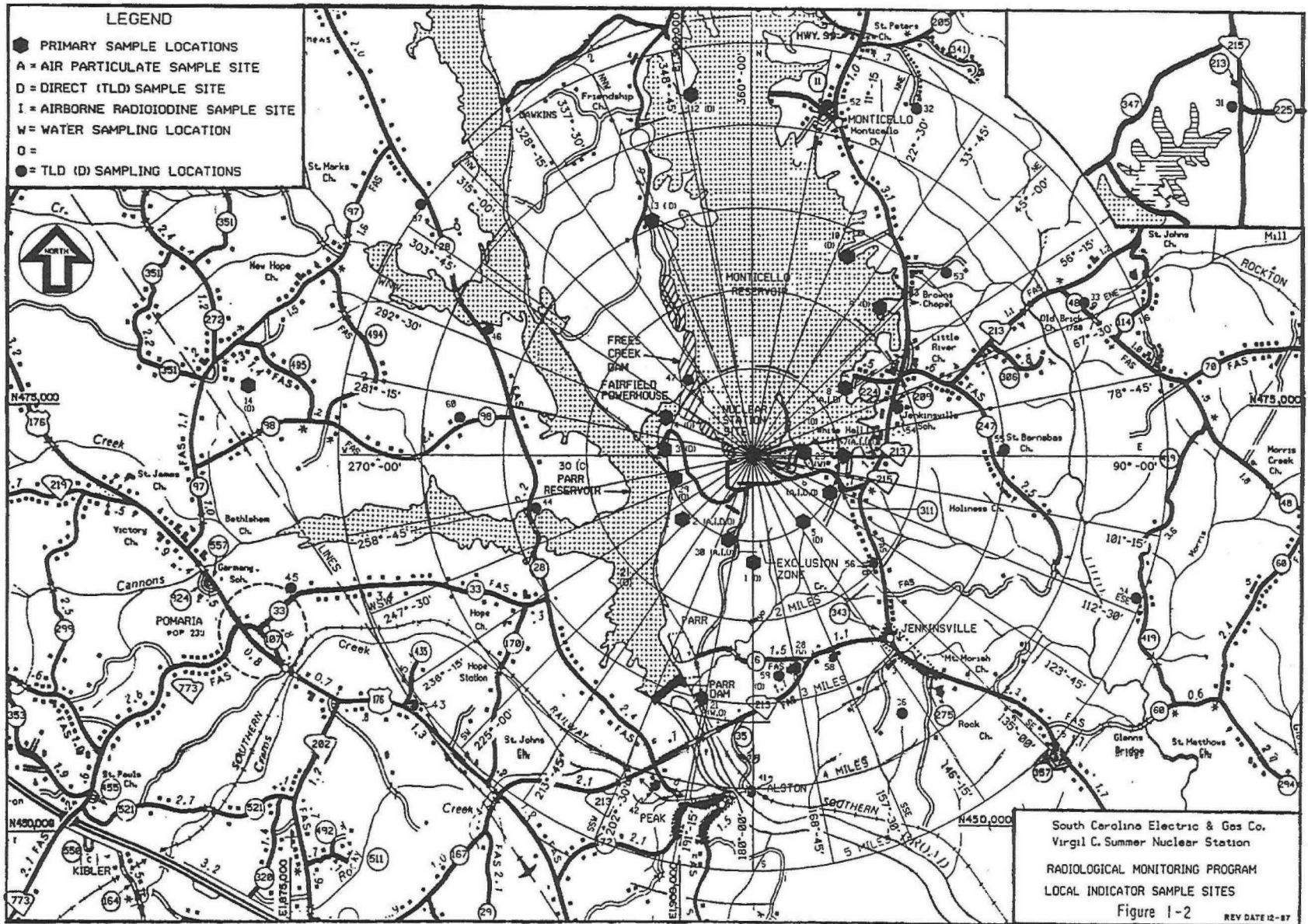
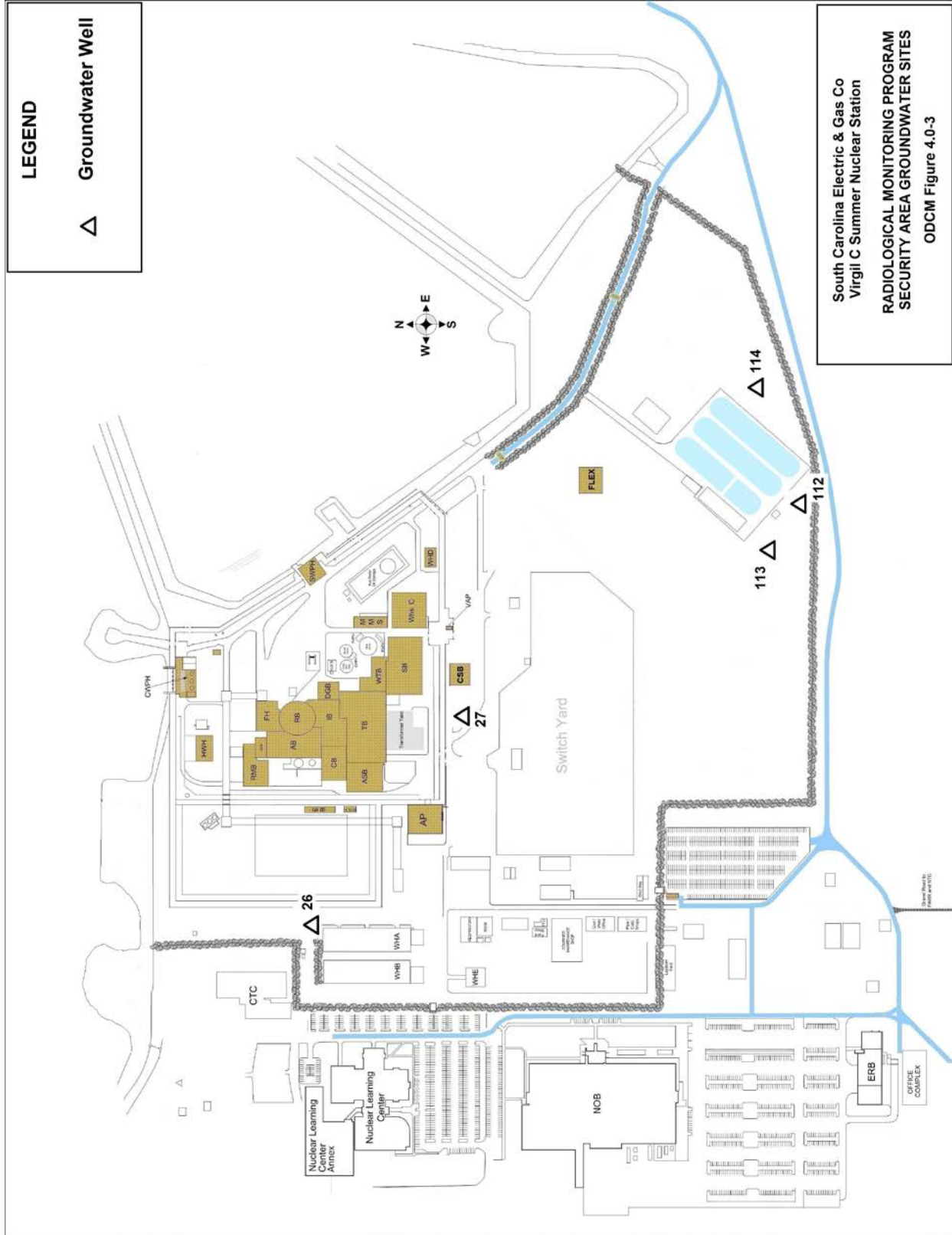

FIGURE 4.0-2  
Radiological Environmental Sampling Locations (Local)



ODCM, V. C. Summer, SCE&G: Revision 23 (September 1999)  
4.0-11

**FIGURE 4.0-3  
Radiological Environmental Sampling Locations (Local)**





**FIGURE 4.0-4**  
**Radiological Environmental Sampling Locations (Local)**

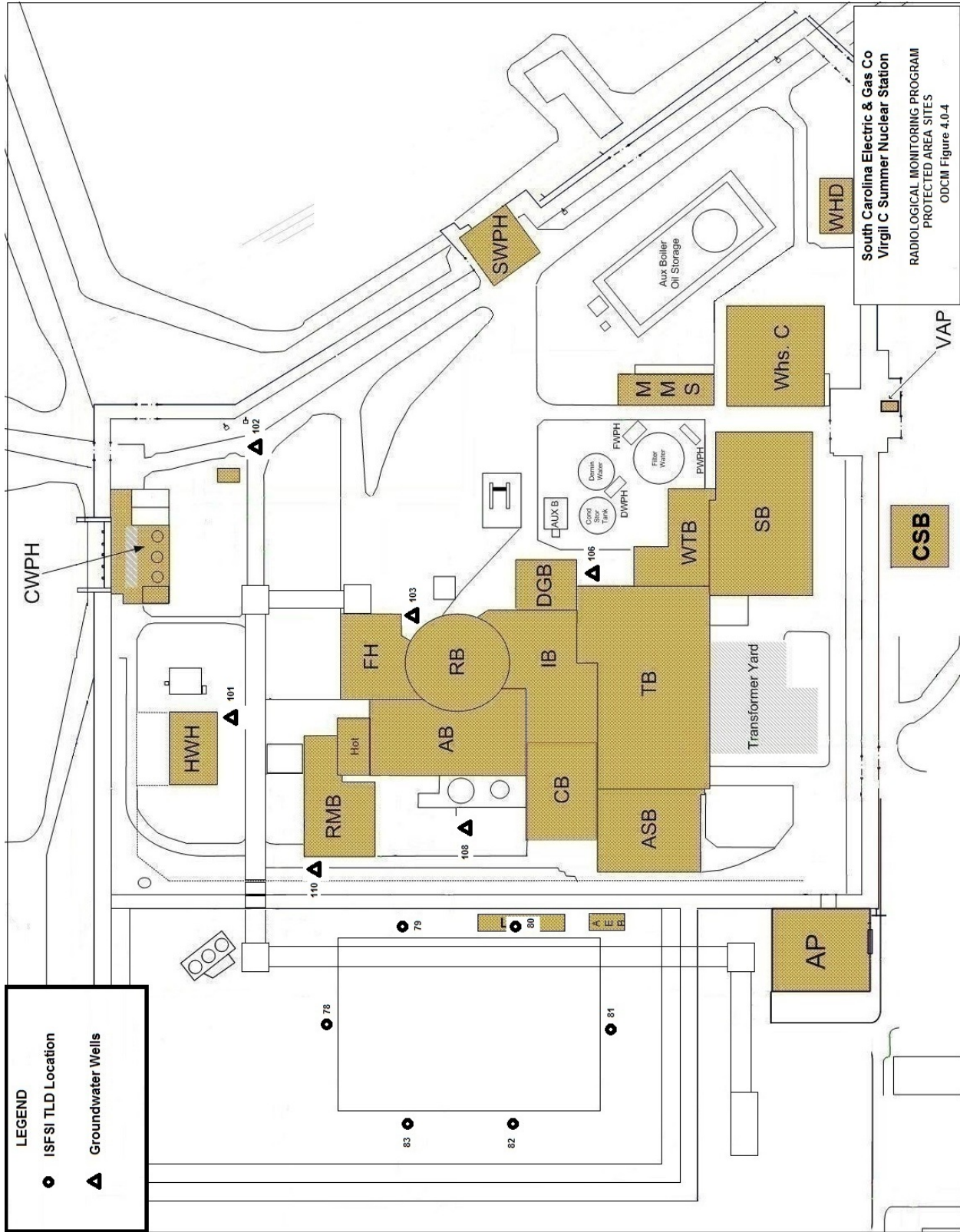

Document Review Form (DRF)

<b>Section I</b>		<b>Document Identification</b>		<b>Page 1 of 2</b>	
<b>Preparer Name:</b> Velda Cooper		<b>Ext:</b> 54643		<b>Mail Code</b> P40	
<b>Date:</b> 2/08/2016		<b>Document #:</b> ODCM		<b>Revision:</b> 30 <b>Change</b>	
<b>Title:</b> OFF SITE DOSE CALCULATION MANUAL				<input checked="" type="checkbox"/> SR <input type="checkbox"/> QR <input type="checkbox"/> NNS	
<b>Development Process:</b> <input type="checkbox"/> New <input checked="" type="checkbox"/> Revision/Change <input type="checkbox"/> Editorial Correction <input type="checkbox"/> Temporary Approval					
<b>Description:</b> See attached "Offsite Dose Calculation Manual Revision 30 Summary". <i>vc 3/9/2016</i> <span style="float: right;"><i>Page 2</i></span>					
<b>ISFSI Related?</b> <input checked="" type="checkbox"/> Yes <input checked="" type="checkbox"/> No					
<b>Has scope changed?</b> <input type="checkbox"/> Yes <input checked="" type="checkbox"/> No [If YES, attach 50.59 and/or 72.48 documentation]					
<b>Reason/Basis for Revision/Change:</b> Due to new RADEAS effluent software and ISFSI.					
<b>Temporary Approval – if final approval is not completed within 30 days; initiate CR #</b> _____					
<b>Qualified Reviewer</b> _____		<b>DCRM person notified</b> _____		<b>Shift Manager</b> _____	
				<b>Date</b> _____	
<b>Section II</b>		<b>List Required Reviewers</b> including All Impacted Groups Additional Reviewers – identify with an *			
Position	Type/Print Name	Comments <i>3/7/16</i>	Position	Type/Print Name	Comments
QR	M. Roberts	<input checked="" type="checkbox"/> Yes <input checked="" type="checkbox"/> No	MCHS	R. Mike	<input type="checkbox"/> Yes <input checked="" type="checkbox"/> No
MOPS	D. Shue	<input type="checkbox"/> Yes <input checked="" type="checkbox"/> No	MOM	T. Johnson	<input type="checkbox"/> Yes <input checked="" type="checkbox"/> No
MMS	R. Ray	<input type="checkbox"/> Yes <input checked="" type="checkbox"/> No	MPS	D. Fulmer	<input type="checkbox"/> Yes <input checked="" type="checkbox"/> No
MHPSS	M. Coleman	<input type="checkbox"/> Yes <input checked="" type="checkbox"/> No	MNL	B. Thompson	<input checked="" type="checkbox"/> Yes <input type="checkbox"/> No
<i>[Signature]</i> <b>Designated Supervisor Concurrence</b> _____		<i>2-8-16</i> <b>Date</b> _____		<b>Comment Due Date</b> <u>02/29/2016</u> GM concurrence _____ For expedited review on documents that require PSRC review.	
<b>Section III</b>		<b>Pre- implementation Actions</b>			
<b>All Comments Resolved?</b> <input type="checkbox"/> NA <input checked="" type="checkbox"/> YES		<i>Velda Cooper</i> <b>Preparer Sign</b> _____		<i>3/7/2016</i> <b>Date</b> _____	
50.59 and/or 72.48 Review Requirements Addressed?		<input type="checkbox"/> NA <input checked="" type="checkbox"/> YES		Attached? YES <input checked="" type="checkbox"/> No <input type="checkbox"/>	
50.59/Part 52 Review Requirements Addressed?		<input checked="" type="checkbox"/> NA <input type="checkbox"/> YES		Attached? YES <input type="checkbox"/> No <input type="checkbox"/>	
Commitments (PCAP and MLSA) Addressed?		<input checked="" type="checkbox"/> NA <input type="checkbox"/> YES		PCAP # _____	
QR Qualification Verified?		<input checked="" type="checkbox"/> YES		NL Initial/Date _____	
Security Compliance Review Completed?		<input checked="" type="checkbox"/> NA <input type="checkbox"/> YES			
Pre-Implementation Training Completed?		<input checked="" type="checkbox"/> NA <input type="checkbox"/> YES			
Training required after implementation?		<input checked="" type="checkbox"/> NA <input type="checkbox"/> YES		CR# _____	
PSRC Review Completed?		<input type="checkbox"/> NA <input checked="" type="checkbox"/> YES		Mtg. # <u>2016-06</u>	
NSRC Review Completed?		<input checked="" type="checkbox"/> NA <input type="checkbox"/> YES		Mtg. # _____	
CMMS Update Required? [Unit 1]		<input checked="" type="checkbox"/> NA <input type="checkbox"/> YES		Planner Notified YES <input type="checkbox"/>	
<i>[Signature]</i> <b>Designated Supervisor Approval</b> _____		<i>3/8/16</i> <b>Date</b> _____		<i>[Signature]</i> <b>Approval Authority Approval</b> _____	
				<i>3/8/16</i> <b>Date</b> _____	
				<b>Effective Date:</b> <u>NA</u>	

A  
D



DRF Form (Continued)

Page 2 of 2

DOCUMENT # \_\_\_\_\_ ODCM \_\_\_\_\_ Rev. 30 Chg. \_\_\_\_\_

DESCRIPTION CONTINUED: Organ dose calculation methodology for gaseous releases is revised allowing calculation of dose to individual organs instead of calculation of dose to a hypothetical maximum organ. Tables 3.2.1, 3.2-2, 3.2-3, 3.2-4, 3.2-5, 3.2-6 were deleted and replaced with a new table providing dose conversion factors for all organs, by pathway and age groups. Liquid release control methodology for Waste Monitor tanks and Steam Generator Blowdown is revised moving a safety factor from formulas 7 and 18 to 6 and 17, respectively, for consistency with RADEAS methodology. Reference to setpoints for dilution and discharge flow for liquid release deleted for clarity (previously identified as administrative). Ni-63 was also added as a required isotope for Waste Monitor Tanks. I-131 and Cs-137 site related ingestion dose factors for Kidney in Table 2.2-3 corrected. ISFSI added as a fuel cycle source, 6 TLD locations added to Table 1.4-1, and reporting requirements added.

REASON/BASIS CONTINUED: \_\_\_\_\_

\_\_\_\_\_  
 \_\_\_\_\_  
 \_\_\_\_\_  
 \_\_\_\_\_  
 \_\_\_\_\_  
 \_\_\_\_\_

REQUIRED REVIEWERS CONTINUED:

Position	Type/Print Name	Comments	Position	Type/Print Name	Comments
GMNPO	R. Justice	<input type="checkbox"/> Yes <input checked="" type="checkbox"/> No			<input type="checkbox"/> Yes <input type="checkbox"/> No
QA	M. Quigley	<input type="checkbox"/> Yes <input checked="" type="checkbox"/> No			<input type="checkbox"/> Yes <input type="checkbox"/> No
NL	S. Reese	<input checked="" type="checkbox"/> Yes <input type="checkbox"/> No			<input type="checkbox"/> Yes <input type="checkbox"/> No
MEP	R. Williamson	<input type="checkbox"/> Yes <input checked="" type="checkbox"/> No			<input type="checkbox"/> Yes <input type="checkbox"/> No
		<input type="checkbox"/> Yes <input type="checkbox"/> No			<input type="checkbox"/> Yes <input type="checkbox"/> No
		<input type="checkbox"/> Yes <input type="checkbox"/> No			<input type="checkbox"/> Yes <input type="checkbox"/> No
		<input type="checkbox"/> Yes <input type="checkbox"/> No			<input type="checkbox"/> Yes <input type="checkbox"/> No