

From: Banks, Mark
To: Nguyen, Quynh
Subject: FW: Alternate Core Debris Retrieval [TEPCO Weekly Fukushima Update Call] Fri, Jan. 30, 2015 at 3pm EST
Date: Tuesday, February 03, 2015 7:57:00 AM

Hi Quynh,

Below is another possible late-breaking P&P item.

Thanks,

Mark

From: Dennis Bley [mailto:dc.bley@gmail.com]
Sent: Monday, February 02, 2015 5:38 PM
To: Joy Rempe
Cc: corradin@engr.wisc.edu; Stetkar, John; Hackett, Edwin; Banks, Mark
Subject: Re: Alternate Core Debris Retrieval [TEPCO Weekly Fukushima Update Call] Fri, Jan. 30, 2015 at 3pm EST

Good topic for P&P. Could you be there this week?

What topics would you put highest on the list?

Dennis

On Feb 2, 2015, at 11:18 AM, Joy Rempe <jlrempe@cableone.net> wrote:

Hi folks,

Would ACRS be interested in a briefing by Kenji? He the TEPCO DC assignee to DC, and very helpful. His English is excellent. Unfortunately, he's being transferred back to Japan in June, so we should plan this soon if there's interest.

Thanks,
Joy

----- Forwarded Message -----

Subject: Re: Alternate Core Debris Retrieval [TEPCO Weekly Fukushima Update Call] Fri, Jan. 30, 2015 at 3pm EST
Date: Mon, 2 Feb 2015 11:10:19 -0500
From: Tateiwa, Kenji <tateiwa.kenji@tepcoco.jp>
To: Joy Rempe <jlrempe@cableone.net>

Hi Joy,

My pleasure.

If you cannot make it on the teleconferences, I can always walk you through the materials over the phone individually at a convenient time for you.

I would also be happy to meet you in person at the NRC HQ when you happen to be in the DC area for your ACRS duties.
(Maybe even an informal briefing for other ACRS members as well.)

Feel free to make use of me while I am still in DC!

All the best,
Kenji

----- Original Message -----

From: Joy Rempe
To: Tateiwa, Kenji
Sent: Saturday, January 31, 2015 12:38 PM
Subject: Re: Alternate Core Debris Retrieval [TEPCO Weekly Fukushima Update Call]
Fri, Jan. 30, 2015 at 3pm EST

Hi Kenji,

Thanks for your quick response. This presentation is very helpful to me not only in answering my question but also as I work on the FY15 Program Plan. I also appreciated your comments on my annotated outline.

I hope to join many of the upcoming teleconferences. Sometimes it is hard with ACRS duties, but we'll see how successful I am.

Best wishes,
Joy

On 1/30/2015 1:38 PM, Tateiwa, Kenji wrote:

Joy,

Thank you for joining the teleconference today.

Regarding your question on the long term plan for alternate core debris retrieval methods, page 106/120 of the following IRID document provides some information.

http://irid.or.jp/wp-content/uploads/2014/07/Sympo_SSuzuki_E.pdf

Hope this helps.

All the best,
Kenji

----- Original Message -----

From: Tateiwa, Kenji
To: Tateiwa, Kenji
Sent: Thursday, January 29, 2015 8:53 PM
Subject: [TEPCO Weekly Fukushima Update Call] Fri, Jan. 30, 2015 at 3pm EST

Nuclear Sector Colleagues,

Please find below information for tomorrow's Weekly Fukushima Update Call.

[Date/time]

Fri. Jan. 30, 2015 at 3 pm Eastern Standard Time
(Next call will be on Fri. Feb. 6 at 3 pm EST.)

[call-in information] (Please record your name and organization when joining the call.)

call number: 718-354-1184

passcode: (b)(6)

[Major topics]

1. Working-level Meeting of Decommissioning & Contaminated Water Issues Team (1/29/2015)

(only in Japanese)

1-1. Plant Status

http://www.tepco.co.jp/nu/fukushima-np/roadmap/images/d150129_04-j.pdf

1-2. Summary Status of Decommissioning Roadmap

http://www.tepco.co.jp/nu/fukushima-np/roadmap/images/d150129_05-j.pdf

(English translation as of 12/25/2014)

http://www.tepco.co.jp/en/nu/fukushima-np/roadmap/images/d141225_01-e.pdf

1-3. Retrieval of Thermocouple Installed in Unit 2 RPV Bottom via SLC Line

http://www.tepco.co.jp/nu/fukushima-np/roadmap/images/d150129_06-j.pdf

1-4. Contaminated Water Treatment

http://www.tepco.co.jp/nu/fukushima-np/roadmap/images/d150129_07-j.pdf

1-5. Environmental Radiation Issues

http://www.tepco.co.jp/nu/fukushima-np/roadmap/images/d150129_08-j.pdf

1-6. Work Condition Improvement

http://www.tepco.co.jp/nu/fukushima-np/roadmap/images/d150129_09-j.pdf

1-7. Spent Fuel Pool Issues

http://www.tepco.co.jp/nu/fukushima-np/roadmap/images/d150129_10-j.pdf

1-8. Preparation for Fuel Debris Removal

http://www.tepco.co.jp/nu/fukushima-np/roadmap/images/d150129_11-j.pdf

1-9. Radioactive Waste Disposal

http://www.tepco.co.jp/nu/fukushima-np/roadmap/images/d150129_12-j.pdf

1-10. Status Update of Study on Alternate Core Debris Retrieval Methods (METI)

http://www.tepco.co.jp/nu/fukushima-np/roadmap/images/d150129_14-j.pdf

1-11. Strategic Plan and Risk Mitigation (Nuclear Damage Compensation and Decommissioning Facilitation Corporation)

http://www.tepco.co.jp/nu/fukushima-np/roadmap/images/d150129_15-j.pdf

2. Updated Schedule on Completion of Contaminated Water Treatment (1/23/2015)

http://www.tepco.co.jp/en/nu/fukushima-np/handouts/2015/images/handouts_150123_02-e.pdf

3. Occupational Safety Corrective Actions (1/26/2015)

http://www.tepco.co.jp/en/nu/fukushima-np/handouts/2015/images/handouts_150126_01-e.pdf

4. National Academy of Sciences Fukushima Lessons Learned Committee Phase 2 #3 (1/29/2015)

<http://www8.nationalacademies.org/cp/meetingview.aspx?MeetingId=7732>

Attached is a compact version of TEPCO's presentation.
Let me know if you would like to receive the original sized file.

** If you cannot display Japanese characters, please install the following font packs:*

<http://www.adobe.com/support/downloads/detail.jsp?ftpID=4881>

(Feel free to forward this email to your colleagues or have them contact me to be added to the distribution list.)

All the best,
Kenji

Kenji Tateiwa
Manager, Nuclear Power Programs
Tokyo Electric Power Company
Washington Office
2121 K Street, NW Suite 910
Washington, DC 20037
tel: +1-202-457-0790 (ext.1116)
mobile: (b)(6)

--
Dr. Joy L. Rempe, Principal
Rempe and Associates, LLC
306 Stillwater
Idaho Falls, ID 83404
Phone: 208-520-3708
Email: jrempe@cableone.net

From: [Hackett, Edwin](#)
To: [Joy Rempe](#); [Tateiwa, Kenji](#)
Cc: [Stetkar, John](#); [Banks, Mark](#)
Subject: RE: Invitation to Brief ACRS
Date: Friday, February 13, 2015 4:52:21 PM

Thanks Joy.

Dr. Tateiwa,

We are very pleased that you will be able to do the briefing. Per your request, we will schedule an hour total for the briefing on Friday, April 10. We will get you the exact time, once we have worked out details for our April agenda in a few weeks.

Per your discussion with Joy, if you could plan for a 1/2 hour presentation, that would be great. We would then leave another half hour to allow for Committee questions. If you feel you need more time, please let us know. We would appreciate having your slides and any appropriate background material a week or two in advance so that the members can prepare appropriately.

Please let us know if you have any questions.

Thanks,

Ed Hackett

From: Joy Rempe [jlrempe@cableone.net]
Sent: Friday, February 13, 2015 3:53 PM
To: Tateiwa, Kenji
Cc: Stetkar, John; Hackett, Edwin; Banks, Mark
Subject: Re: Invitation to Brief ACRS

Great.

This is the first time that I've been involved with assisting someone that will be giving a presentation at ACRS. Ed Hackett, our executive director, will have to help us understand the next steps with scheduling. He'll also have to inform us with the process for thank you letters. However, I'm guessing that the letter will be signed by our chairman, Mr. John Stetkar. My experience is that nothing is informal when it comes to federal advisory committees! Let me know if additional assistance is needed.

I was glad to be part of the weekly teleconference today. It will be interesting to see what information is obtained with the muon tomography installation. I've also completed the draft forensics inspection report. Mitch and Mike are currently reviewing it. I hope to send you and Damian a copy next week for your comments.

Best wishes,
Joy

Dr. Joy L. Rempe, Principal
Rempe and Associates, LLC
306 Stillwater
Idaho Falls, ID 83404
Phone: 208-520-3708
Email: jlrempe@cableone.net<<mailto:jlrempe@cableone.net>>

On Fri, Feb 13, 2015 at 1:39 PM, Tateiwa, Kenji <tateiwa.kenji@tepco.co.jp<<mailto:tateiwa.kenji@tepco.co.jp>>>>
wrote:

Hi Joy,

Apologies for the late reply--TEPCO's Chief Nuclear Officer was visiting the U.S. this week and I was preoccupied, arranging and attending all the meetings with him.

I am very glad to hear that the ACRS members are eager to learn about the situation at Fukushima Daiichi and I look forward to a lively session with many "interruptions" with your colleagues.

I also appreciate your thoughtful offer to write a letter to TEPCO's senior management. It would be great if you could send a note to the following person after the meeting (email would be fine.)

Takafumi Anegawa
Chief Nuclear Officer
anegawa.takafumi@tepcoco.jp<mailto:anegawa.takafumi@tepcoco.jp>

All the best,

Kenji

----- Original Message -----

From: Joy Remppe<mailto:jrempe@cableone.net>

To: Tateiwa, Kenji<mailto:tateiwa.kenji@tepcoco.jp>

Cc: Banks, Mark<mailto:Mark.Banks@nrc.gov>; Edwin Hackett<mailto:Edwin.Hackett@nrc.gov>; Stetkar,

John<mailto:John.Stetkar@nrc.gov>

Sent: Monday, February 09, 2015 7:45 PM

Subject: Re: Invitation to Brief ACRS

Hi Kenji,

Thanks for your willingness to brief us. Unfortunately, because of the rules related to federal advisory committees, we aren't allowed to be 'casual'. Nevertheless, when it was brought up during our planning meeting, most of us knew you (or of you) and enthusiastically agreed that this was a great opportunity. Many of us were also already aware that you'd previously given the NRC staff a briefing (and regretted not being able to attend it). I've heard that it was well-received by the staff.

Please be prepared for us 'interrupting' you with questions. It is just our way of learning. Your 30 minute presentation will easily expand to fill the entire hour.

Also, several of us are already thinking that a 'thank-you' letter is needed for your kindness. Please let us know the appropriate TEPCO individual (and title) that should receive this letter.

Best wishes,

Joy

On 2/9/2015 5:27 PM, Tateiwa, Kenji wrote:

Hi Joy,

Thank you for following up on my offer to brief the ACRS members.

I was thinking about a casual meeting, but it is an overwhelming honor to be invited to the full committee meeting.

All of the dates that you proposed work for me, but my preference will be Fri, April 10th.

I look forward to the opportunity of sharing the status of Fukushima Daiichi and D&D related progress to you and your ACRS colleagues.

All the best,

Kenji

Kenji Tateiwa
Manager, Nuclear Power Programs

Tokyo Electric Power Company
Washington Office
2121 K Street, NW Suite 910
Washington, DC 20037
tel: +1-202-457-0790<tel:%2B1-202-457-0790> (ext.)116
mobile: (b)(6)

----- Original Message -----

From: Joy Rempe<<mailto:jlrempe@cableone.net>>
To: Tateiwa, Kenji<<mailto:tateiwa.kenji@tepcoco.jp>>
Cc: Edwin Hackett<<mailto:Edwin.Hackett@nrc.gov>> ; Banks, Mark<<mailto:Mark.Banks@nrc.gov>>
Sent: Friday, February 06, 2015 2:48 PM
Subject: Invitation to Brief ACRS

Hi Kenji,

I followed up on your offer to provide ACRS a briefing before you return to Tokyo. Today, the ACRS voted to invite you to provide us a briefing at either our April or May full committee meetings. The dates of these meetings are April 9-10 or May 7-8. The ACRS would like to request that your presentation focus on the status of the affected plants (especially related to results from recent investigations/inspections by TEPCO), D&D efforts, and future plans for their D&D and any examinations.. Your presentation should last approximately 30 minutes, but plan for the briefing to last an hour (e.g., ACRS members will be asking questions throughout your briefing, so the briefing tends to double in time).

I've copied Dr. Ed Hackett, Executive Director of the ACRS, and Mr. Mark Banks, Branch Manager for ACRS. We'd appreciate your responding to all three of us related to possible times that you would be available during these meetings. They will schedule a time when you are available and facilitate the processes required for your gaining access to the NRC Headquarters in North Bethesda, DC.

Thanks again for offering to provide us this presentation.

Best wishes,
Joy

Dr. Joy L. Rempe, Principal
Rempe and Associates, LLC
306 Stillwater
Idaho Falls, ID 83404
Phone: 208-520-3708<tel:208-520-3708>
Email: jlrempe@cableone.net<<mailto:jlrempe@cableone.net>>

--

Dr. Joy L. Rempe, Principal
Rempe and Associates, LLC
306 Stillwater
Idaho Falls, ID 83404
Phone: 208-520-3708<tel:208-520-3708>
Email: jlrempe@cableone.net<<mailto:jlrempe@cableone.net>>

Hackett, Edwin

From: Tateiwa, Kenji <tateiwa.kenji@tepcoco.jp>
Sent: Tuesday, April 07, 2015 2:40 AM
To: Hackett, Edwin
Cc: Joy Rempe; Banks, Mark; Stetkar, John; Meador, Sherry
Subject: Slides [ACRS Briefing on Fukushima D&D] Fri, April 10, 2015
Attachments: Fukushima Accident@ACRS_04102015.pdf

Hi Ed,

Please find attached my presentation for the ACRS briefing on Fukushima D&D on April 10. Thank you for your patience and I look forward to having a productive meeting.

All the best,
Kenji

On Tue, 07 Apr 2015 04:44:19 +0900
"Tateiwa, Kenji" <tateiwa.kenji@tepcoco.jp> wrote:

> Hi Ed,
>
> Thank you for the detailed instruction for Friday.
> I will plan on arriving at the NRC HQ at around 11:30 am.
>
> I would appreciate if you could make arrangement for my parking--I will be driving a gray Toyota Corolla

(b)(6)

(b)(6)

>
> All the best,
> Kenji

>
> On Mon, 6 Apr 2015 09:42:50 -0400
> "Hackett, Edwin" <Edwin.Hackett@nrc.gov> wrote:

>
>> Hi Kenji,
>>
>> In my previous communication, I neglected to give you more specific instructions regarding your visit.
>>
>> Given that we have you scheduled for 12:15 p.m. on Friday, it would be good if you could plan on arriving at NRC HQ no later than 11:45 a.m. You are also obviously welcome to come earlier if you choose. The NRC HQ complex is located in Rockville, MD and is at the White Flint METRO station. METRO provides the most convenient access, but if you are driving, our address is:
>>
>> 11545 Rockville Pike
>> Rockville, MD
>>
>> Also, if you are driving, please let me know in advance so we can work on arranging parking for you.
>>
>> When you arrive, please proceed to the front entrance of the One White Flint North Building (OWFN) (the tallest building directly across the street from the METRO). When you get there, you will be processed through security and you can call us for an escort.
>>

>> The ACRS Main line is 301-415-7360. My cell phone is [redacted] if you need to reach me. We are (b)(6) located in the Two White Flint North (TWFN) Building. Your presentation will be in Room T-2 B1).

>>
>> Please let me know if you have any questions.

>>
>> Best,
>>
>> Ed
>>

=====
=====
>> Sherry - Here is Dr. Tateiwa's information. I would appreciate it if you could pre-register him in the security system:

>>
>> Kenji Tateiwa
>> Manager, Nuclear Power Programs
>> Tokyo Electric Power Company
>> Washington Office
>> 2121 K Street, NW Suite 910
>> Washington, DC 20037
>> tel: +1-202-457-0790 (ext.)116

>> mobile [redacted]

>>
>> Thanks,
>>
>> Ed

>> -----Original Message-----

>> From: Tateiwa, Kenji [mailto:tateiwa.kenji@tepcoco.jp]
>> Sent: Monday, April 06, 2015 1:47 AM
>> To: Hackett, Edwin
>> Cc: Joy Rempe; Banks, Mark; Stetkar, John
>> Subject: RE: [ACRS Briefing on Fukushima D&D] Fri, April 10, 2015

>> Dear Ed,

>> Apologies for not being able to provide you with my presentation by the April 3 deadline.
>> I am still working on it and plan to send you the slides by the end of Mon, April 6.

>> Could you tell me what time and where I should meet you on Fri, April 10?

>> All the best,
>> Kenji

>> On Tue, 17 Feb 2015 08:33:36 -0500
>> "Hackett, Edwin" <Edwin.Hackett@nrc.gov> wrote:

>>> Thanks Kenji.

>>> We will be looking forward to your presentation.

>>> Ed

>>> From: Tateiwa, Kenji [tateiwa.kenji@tepcoco.jp]
>>> Sent: Monday, February 16, 2015 12:58 PM

>>> To: Joy Rempe; Hackett, Edwin
>>> Cc: Banks, Mark; Stetkar, John
>>> Subject: [ACRS Briefing on Fukushima D&D] Fri, April 10, 2015

>>> Dear Joy and Ed,

>>> Thank you for your note.

>>> I will prepare to provide a 1/2 hour briefing + 1/2 hour Q&A on Fukushima Daiichi D&D status to the ACRS on Fri, April 10.

>>> I will send you my slides by April 3 at the latest.

>>> All the best,

>>> Kenji

>>> ----- Original Message -----

>>> From: "Hackett, Edwin" <Edwin.Hackett@nrc.gov<mailto:Edwin.Hackett@nrc.gov>>

>>> To: "Joy Rempe" <jlrempe@cableone.net<mailto:jlrempe@cableone.net>>; "Tateiwa, Kenji" <tateiwa.kenji@tepco.co.jp<mailto:tateiwa.kenji@tepco.co.jp>>

>>> Cc: "Stetkar, John" <John.Stetkar@nrc.gov<mailto:John.Stetkar@nrc.gov>>; "Banks, Mark" <Mark.Banks@nrc.gov<mailto:Mark.Banks@nrc.gov>>

>>> Sent: Friday, February 13, 2015 4:52 PM

>>> Subject: RE: Invitation to Brief ACRS

>>> Thanks Joy.

>>> Dr. Tateiwa,

>>> We are very pleased that you will be able to do the briefing. Per your request, we will schedule an hour total for the briefing on Friday, April 10. We will get you the exact time, once we have worked out details for our April agenda in a few weeks.

>>> Per your discussion with Joy, if you could plan for a 1/2 hour presentation, that would be great. We would then leave another half hour to allow for Committee questions. If you feel you need more time, please let us know. We would appreciate having your slides and any appropriate background material a week or two in advance so that the members can prepare appropriately.

>>> Please let us know if you have any questions.

>>> Thanks,

>>> Ed Hackett

>>> From: Joy Rempe [jlrempe@cableone.net]

>>> Sent: Friday, February 13, 2015 3:53 PM

>>> To: Tateiwa, Kenji

>>> Cc: Stetkar, John; Hackett, Edwin; Banks, Mark

>>> Subject: Re: Invitation to Brief ACRS

>>> Great.

>>> This is the first time that I've been involved with assisting someone that will be giving a presentation at ACRS. Ed Hackett, our executive director, will have to help us understand the next steps with scheduling. He'll also have to inform us with the process for thank you letters. However, I'm guessing that the letter will be signed by our chairman, Mr. John Stetkar. My experience is that nothing is informal when it comes to federal advisory committees! Let me know if additional assistance is needed.

>>>

>>> I was glad to be part of the weekly teleconference today. It will be interesting to see what information is obtained with the muon tomography installation. I've also completed the draft forensics inspection report. Mitch and Mike are currently reviewing it. I hope to send you and Damian a copy next week for your comments.

>>>

>>> Best wishes,

>>> Joy

>>>

>>> Dr. Joy L. Rempe, Principal

>>> Rempe and Associates, LLC

>>> 306 Stillwater

>>> Idaho Falls, ID 83404

>>> Phone: 208-520-3708

>>> Email:

jlrempe@cableone.net<mailto:jlrempe@cableone.net<mailto:jlrempe@cableone.net<mailto:jlrempe@cableone.net>>

>>>

>>> On Fri, Feb 13, 2015 at 1:39 PM, Tateiwa, Kenji

<tateiwa.kenji@tepco.co.jp<mailto:tateiwa.kenji@tepco.co.jp<mailto:tateiwa.kenji@tepco.co.jp<mailto:tateiwa.kenji@tepco.co.jp>>>> wrote:

>>> Hi Joy,

>>>

>>> Apologies for the late reply--TEPCO's Chief Nuclear Officer was visiting the U.S. this week and I was preoccupied arranging and attending all the meetings with him.

>>>

>>> I am very glad to hear that the ACRS members are eager to learn about the situation at Fukushima Daiichi and I look forward to a lively session with many "interruptions" with your colleagues.

>>>

>>> I also appreciate your thoughtful offer to write a letter to TEPCO's senior management.

>>> It would be great if you could send a note to the following person after the meeting (email would be fine.)

>>>

>>> Takafumi Anegawa

>>> Chief Nuclear Officer

>>>

anegawa.takafumi@tepco.co.jp<mailto:anegawa.takafumi@tepco.co.jp<mailto:anegawa.takafumi@tepco.co.jp<mailto:anegawa.takafumi@tepco.co.jp>>

>>>

>>> All the best,

>>> Kenji

>>> ----- Original Message -----

>>> From: Joy Rempe<mailto:jlrempe@cableone.net>

>>> To: Tateiwa, Kenji<mailto:tateiwa.kenji@tepco.co.jp>

>>> Cc: Banks, Mark<mailto:Mark.Banks@nrc.gov> ; Edwin Hackett<mailto:Edwin.Hackett@nrc.gov> ; Stetkar, John<mailto:John.Stetkar@nrc.gov>

>>> Sent: Monday, February 09, 2015 7:45 PM

>>> Subject: Re: Invitation to Brief ACRS

>>>

>>> Hi Kenji,

>>>

>>> Thanks for your willingness to brief us. Unfortunately, because of the rules related to federal advisory committees, we aren't allowed to be 'casual'. Nevertheless, when it was brought up during our planning meeting, most of us knew you (or of you) and enthusiastically agreed that this was a great opportunity. Many of us were also already aware that you'd previously given the NRC staff a briefing (and regretted not being able to attend it). I've heard that it was well-received by the staff.

>>>

>>> Please be prepared for us 'interrupting' you with questions. It is just our way of learning. Your 30 minute presentation will easily expand to fill the entire hour.

>>>

>>> Also, several of us are already thinking that a 'thank-you' letter is needed for your kindness. Please let us know the appropriate TEPCO individual (and title) that should receive this letter.

>>>

>>> Best wishes,

>>> Joy

>>>

>>> On 2/9/2015 5:27 PM, Tateiwa, Kenji wrote:

>>> Hi Joy,

>>>

>>> Thank you for following up on my offer to brief the ACRS members.

>>> I was thinking about a casual meeting, but it is an overwhelming honor to be invited to the full committee meeting.

>>>

>>> All of the dates that you proposed work for me, but my preference will be Fri, April 10th.

>>> I look forward to the opportunity of sharing the status of Fukushima Daiichi and D&D related progress to you and your ACRS colleagues.

>>>

>>> All the best,

>>> Kenji

>>> -----

>>> Kenji Tateiwa

>>> Manager, Nuclear Power Programs

>>> Tokyo Electric Power Company

>>> Washington Office

>>> 2121 K Street, NW Suite 910

>>> Washington, DC 20037

>>> tel: +1-202-457-0790 (ext.)116

>>> mobile: (b)(6)

>>>

>>> ----- Original Message -----

>>> From: Joy Rempe<mailto:jlrempe@cableone.net>

>>> To: Tateiwa, Kenji<mailto:tateiwa.kenji@tepcoco.jp>

>>> Cc: Edwin Hackett<mailto:Edwin.Hackett@nrc.gov> ; Banks, Mark<mailto:Mark.Banks@nrc.gov>

>>> Sent: Friday, February 06, 2015 2:48 PM

>>> Subject: Invitation to Brief ACRS

>>>

>>> Hi Kenji,

>>>

>>> I followed up on your offer to provide ACRS a briefing before you return to Tokyo. Today, the ACRS voted to invite you to provide us a briefing at either our April or May full committee meetings. The dates of these meetings are April 9-10 or May 7-8. The ACRS would like to request that your presentation focus on the status of the affected plants (especially related to results from recent investigations/inspections by TEPCO), D&D efforts, and future plans for their D&D and any examinations. Your presentation should last approximately 30 minutes, but plan for the briefing to last an hour (e.g., ACRS members will be asking questions throughout your briefing, so the briefing tends to double in time).

>>>

>>> I've copied Dr. Ed Hackett, Executive Director of the ACRS, and Mr. Mark Banks, Branch Manager for ACRS. We'd appreciate your responding to all three of us related to possible times that you would be available during these meetings. They will schedule a time when you are available and facilitate the processes required for your gaining access to the NRC Headquarters in North Bethesda, DC.

>>>

>>> Thanks again for offering to provide us this presentation.

>>>

>>> Best wishes,

>>> Joy

>>>

>>> Dr. Joy L. Rempe, Principal

>>> Rempe and Associates, LLC

>>> 306 Stillwater

>>> Idaho Falls, ID 83404

>>> Phone: 208-520-3708<tel:208-520-3708>

>>> Email: jlrempe@cableone.net<mailto:jlrempe@cableone.net>

Fukushima Nuclear Accident Update

*Advisory Committee on Reactor Safeguards
U.S. Nuclear Regulatory Commission*

*Rockville, Maryland
April 10th, 2015*

*Kenji Tateiwa
Manager, Nuclear Power Programs
Tokyo Electric Power Company, Washington Office
tateiwa.kenji@tepcoco.jp*



TEPCO

All Rights Reserved ©2015 Tokyo Electric Power Company, Inc.

Damage Due to Great East Japan Earthquake (GEJE)

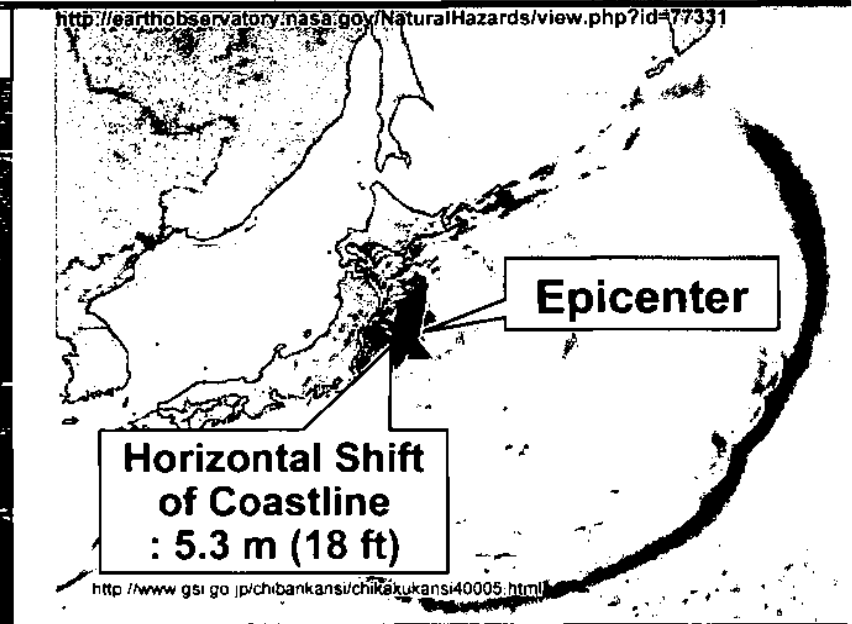

- **Largest earthquake (M9.0) and tsunami (M9.1) in recorded history of Japan**
- **20+ m (66+ ft) tsunami run-up in coastline spanning 200 km (DC-Philly or LA-SD)**
- **560 km² flooded (10x Manhattan)**
- **19,000 dead/missing**



Overview of the 10-Unit Simultaneous Accidents

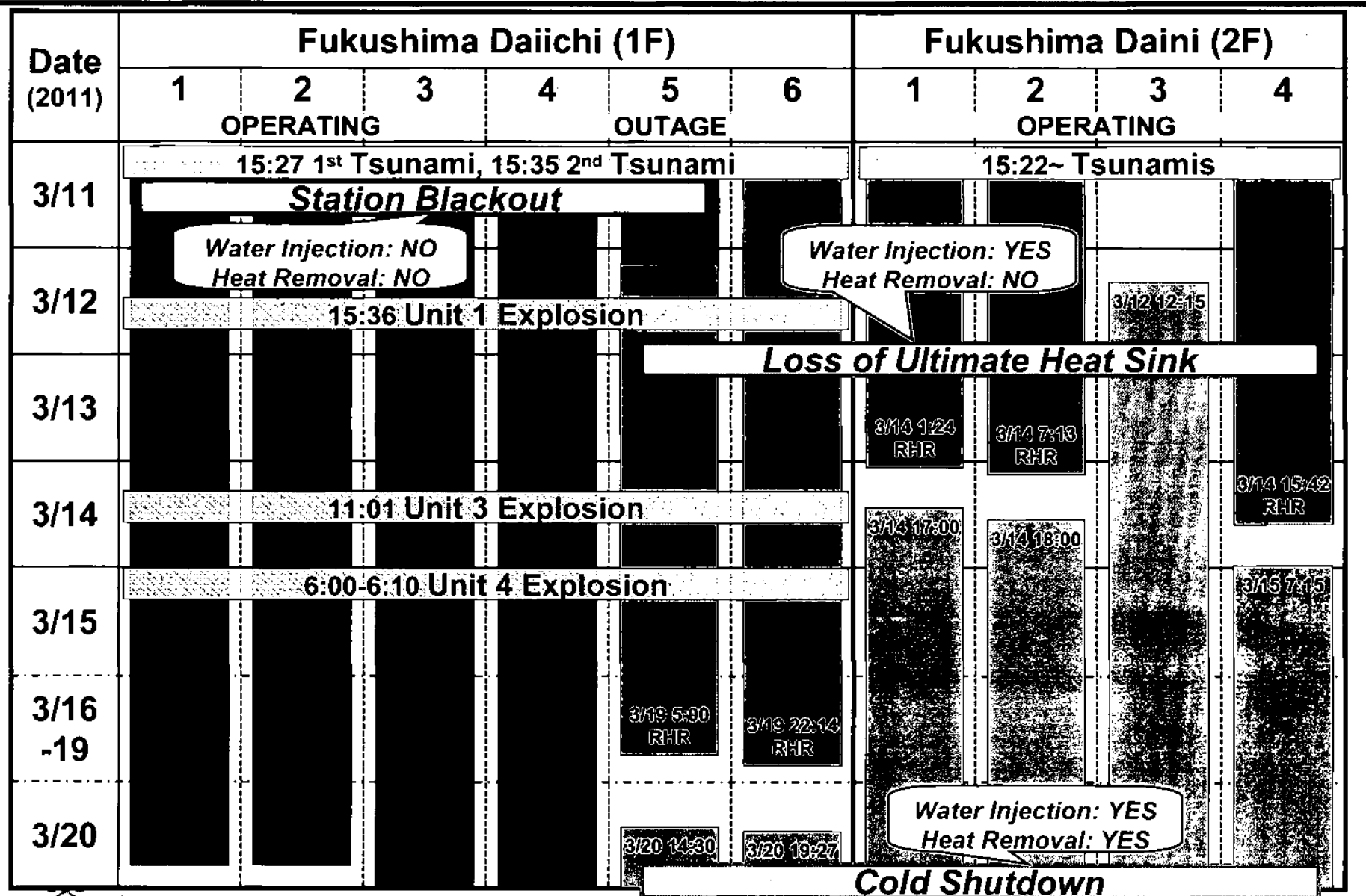

Voices from the Field (First Responders at 1F) (cont'd)

**“At that time, I was conjuring up faces of fellow colleagues who would die with me.”
(Masao Yoshida, Site Superintendent)**



**“I was determined to stay behind to my death; however I was resolved to send my men back home alive.”
(Ikuo Izawa, Shift Manager)**



**“Let me go and vent the containment. I know where the valve is and I can run fast. Let me protect the unit that I love.”
(Kazuhiro Yoshida, Deputy Shift Manager)**

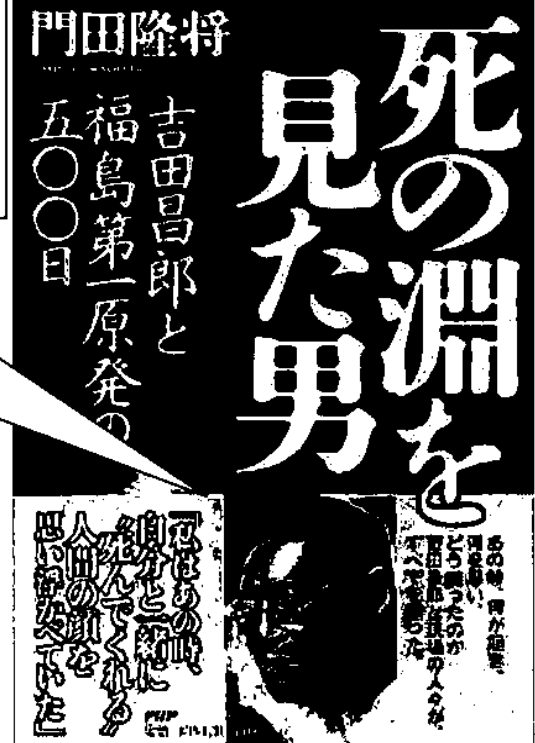

“On the Brink: The Inside Story of Fukushima Daiichi”

“Book reveals human drama in Fukushima No. 1 crisis”

The Japan Times 12/11/2012

<http://www.japantimes.co.jp/news/2012/12/11/national/book-reveals-human-drama-in-fukushima-no-1-crisis/>

→Now available in English

<http://amzn.com/4902075547>

My Post-Accident Activities

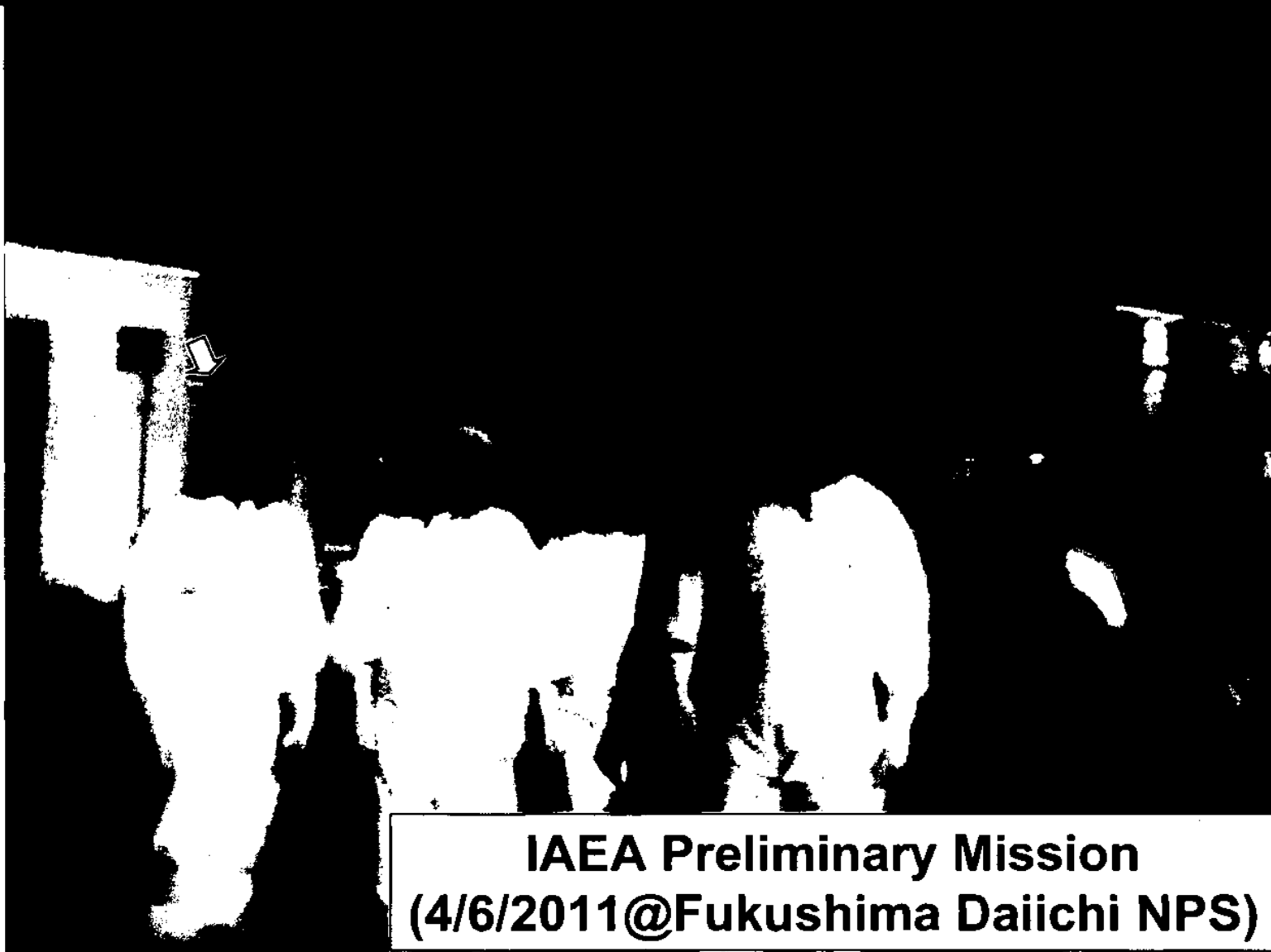

My Post-Accident Activities (cont'd)

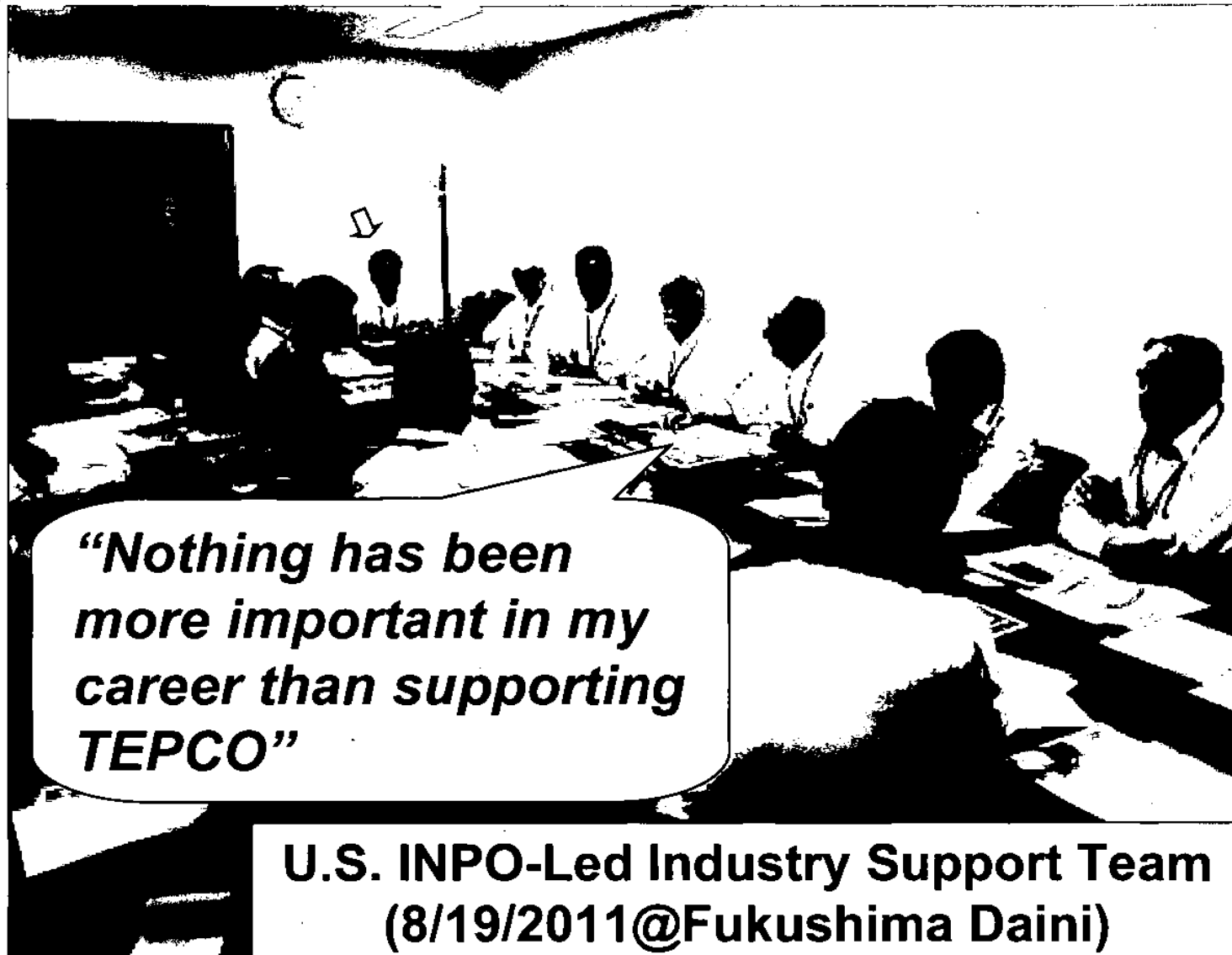

“Nothing has been more important in my career than supporting TEPCO”

**U.S. INPO-Led Industry Support Team
(8/19/2011@Fukushima Daini)**

TEPCO Internal Investigation Committee Final Report

➤ Issued on June 20, 2012

http://www.tepco.co.jp/en/press/corp-com/release/2012/1205638_1870.html

“Tangible” Countermeasures

- Flood Protection
- High-pressure Injection System
- Depressurization System
- Low-pressure Injection System
- Heat Removal/Cooling System
- Power Supply for Instrumentation
- Post-Core Damage Mitigation
- Common Items
- Mid-to-Long Term Items

“Intangible” Countermeasures

- Operational Measures in Relation to Tangible Modifications
- Emergency Preparedness
- Info. Dissemination and Sharing
- Roles and Responsibilities
- Information Disclosure
- Transportation of Resources
- Access Control
- Radiological Protection
- Plant Status Recognition
- Suggestions to the Government

Major Lessons Learned:

- Recognize large uncertainty in external events
- Prepare for the unexpected

TEPCO's Nuclear Safety Reform

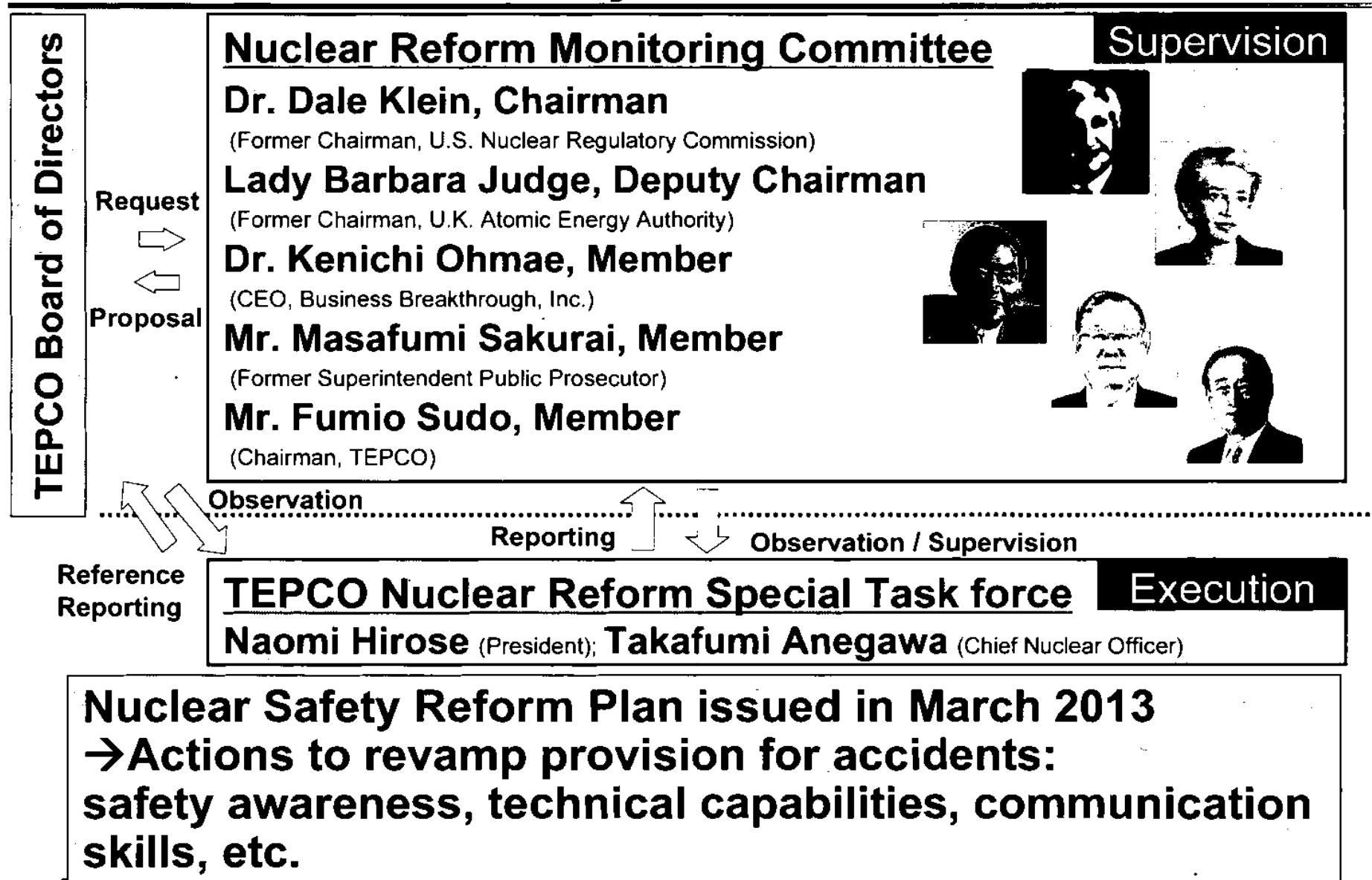

Follow-up Study on 1F Accident Unresolved Issues

➤ 1st Progress Report Issued on Dec. 13, 2013

http://www.tepco.co.jp/en/press/corp-com/release/2013/1233101_5130.html

Issue No. 3-6

Rapid depressurization of Unit 3 reactor pressure vessel on March 13

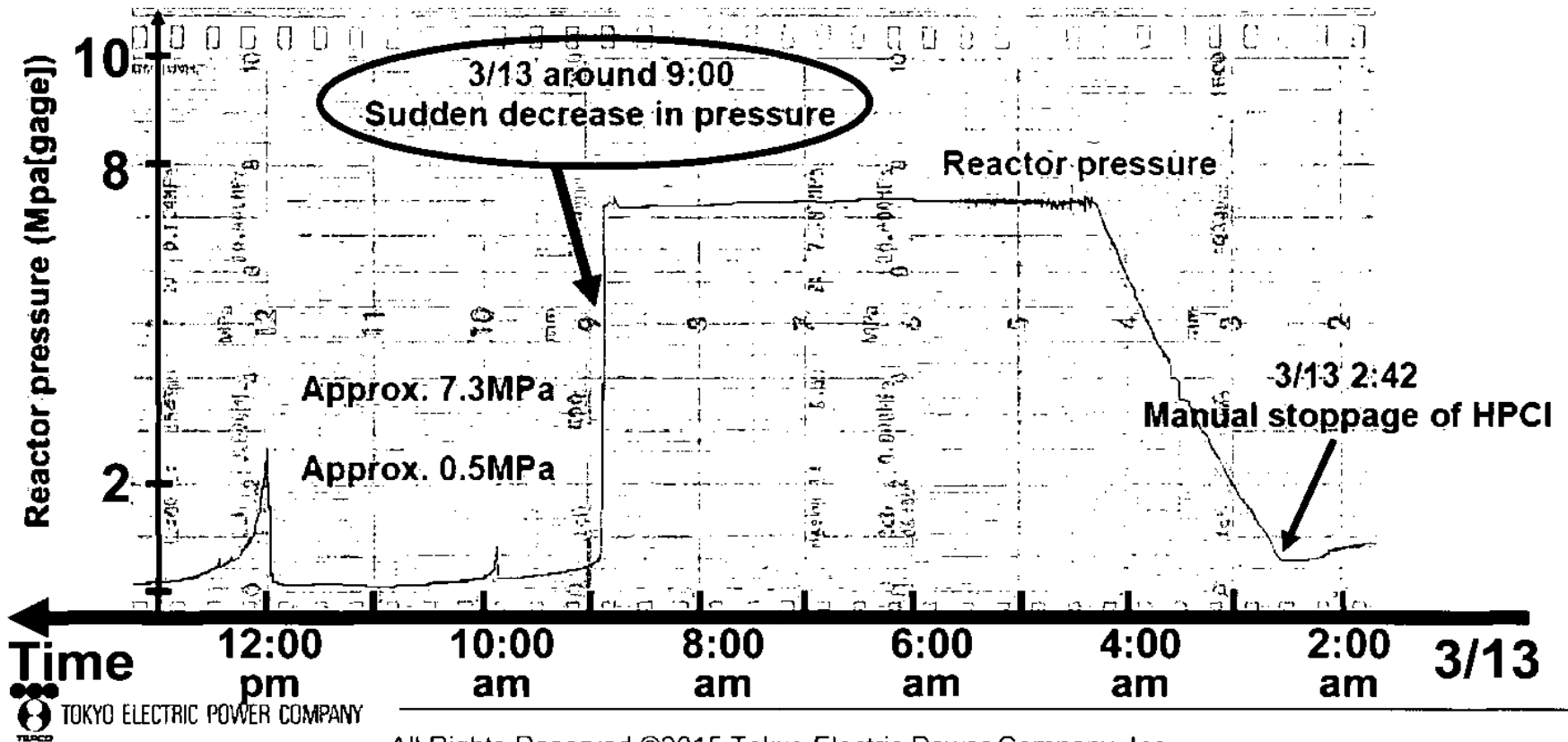

Unit 3 Depressurization Analysis: MAAP Code (March 2012)

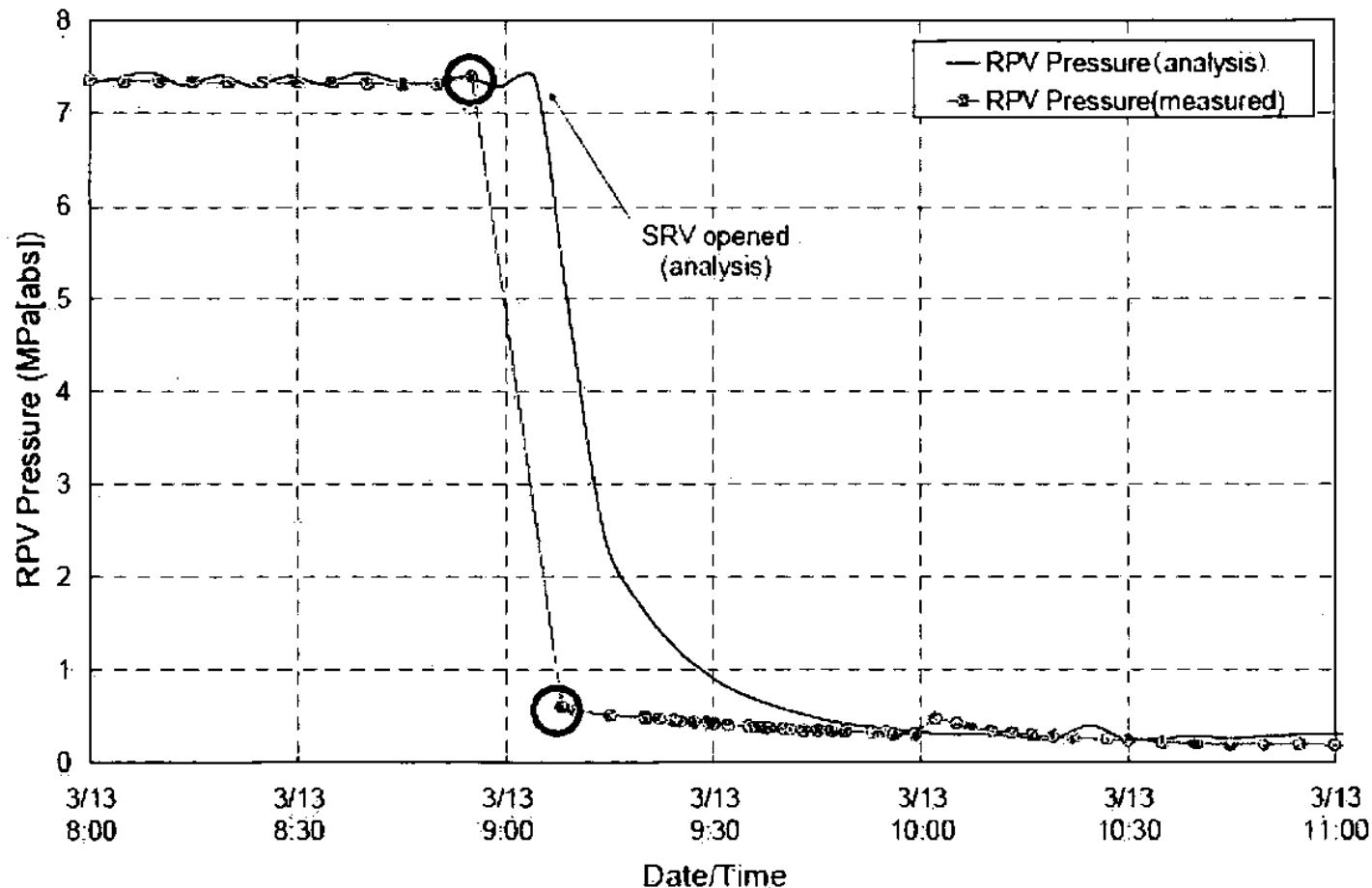

Actual depressurization behavior could NOT be reproduced by opening 1 Safety Relief Valve (SRV)

Unit 3 Depressurization Analysis: SAMPSON Code (Dec. 2013)

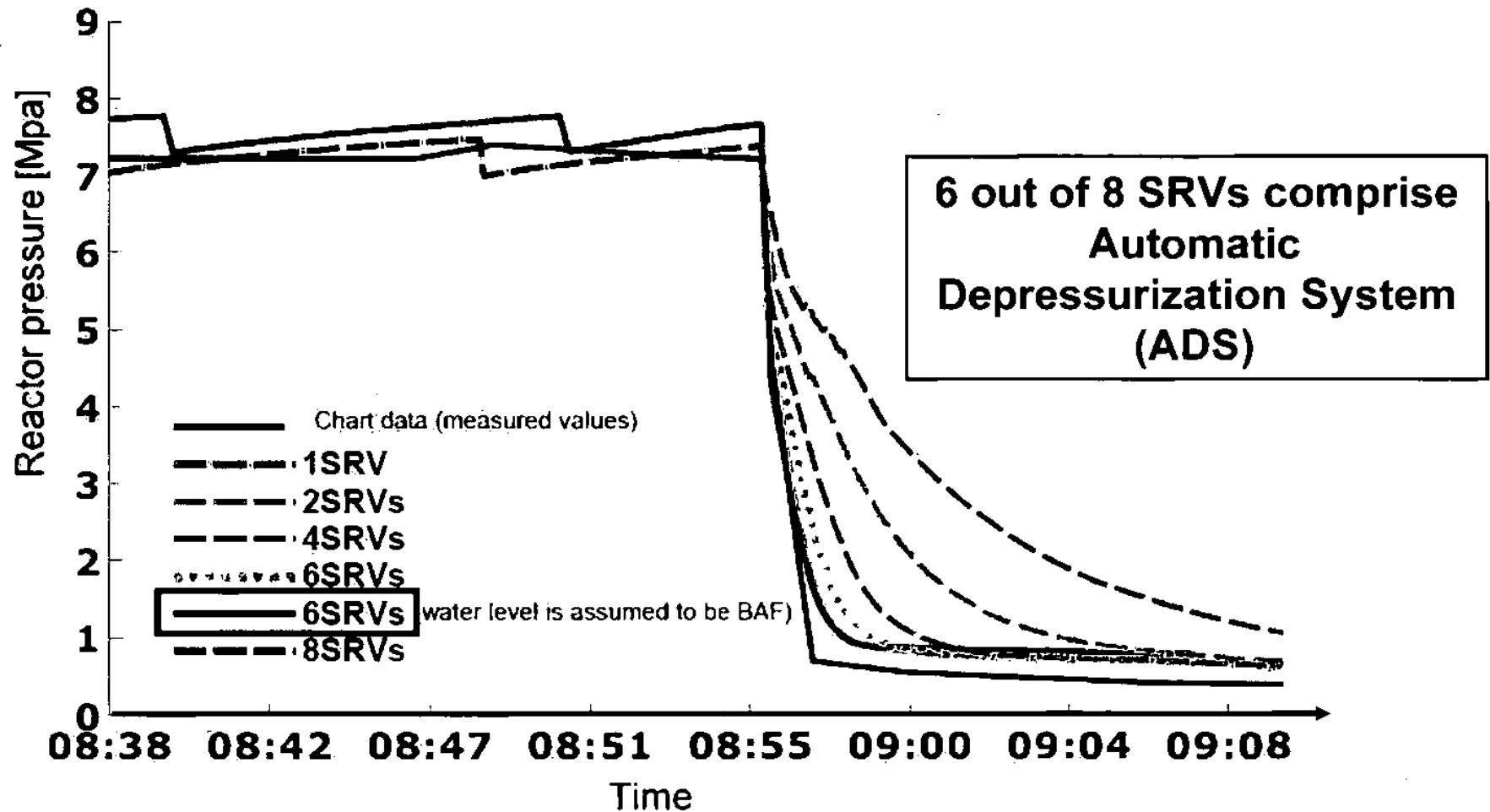

Actual depressurization behavior best reproduced by opening 6 SRVs (→ADS)

Possible Inadvertent Actuation of ADS

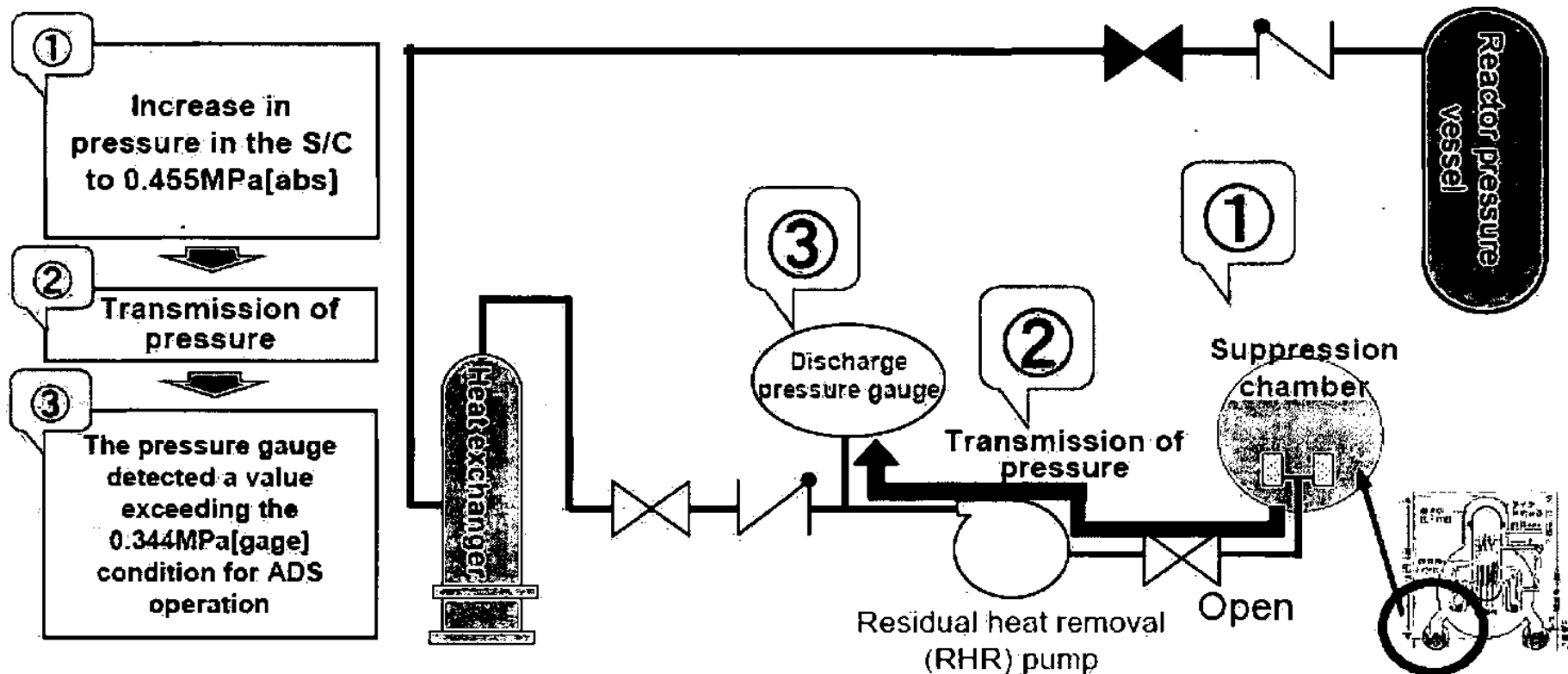

Rapid depressurization of Unit 3 RPV most likely caused by inadvertent ADS actuation; not by RPV breach

Follow-up Study on 1F Accident Unresolved Issues (cont'd)

➤ 2nd Progress Report Issued on Aug. 6, 2014

http://www.tepco.co.jp/en/press/corp-com/release/2014/1240140_5892.html

Issue No. 2-7
Unit 2 reactor pressure spikes after depressurization on March 14-15

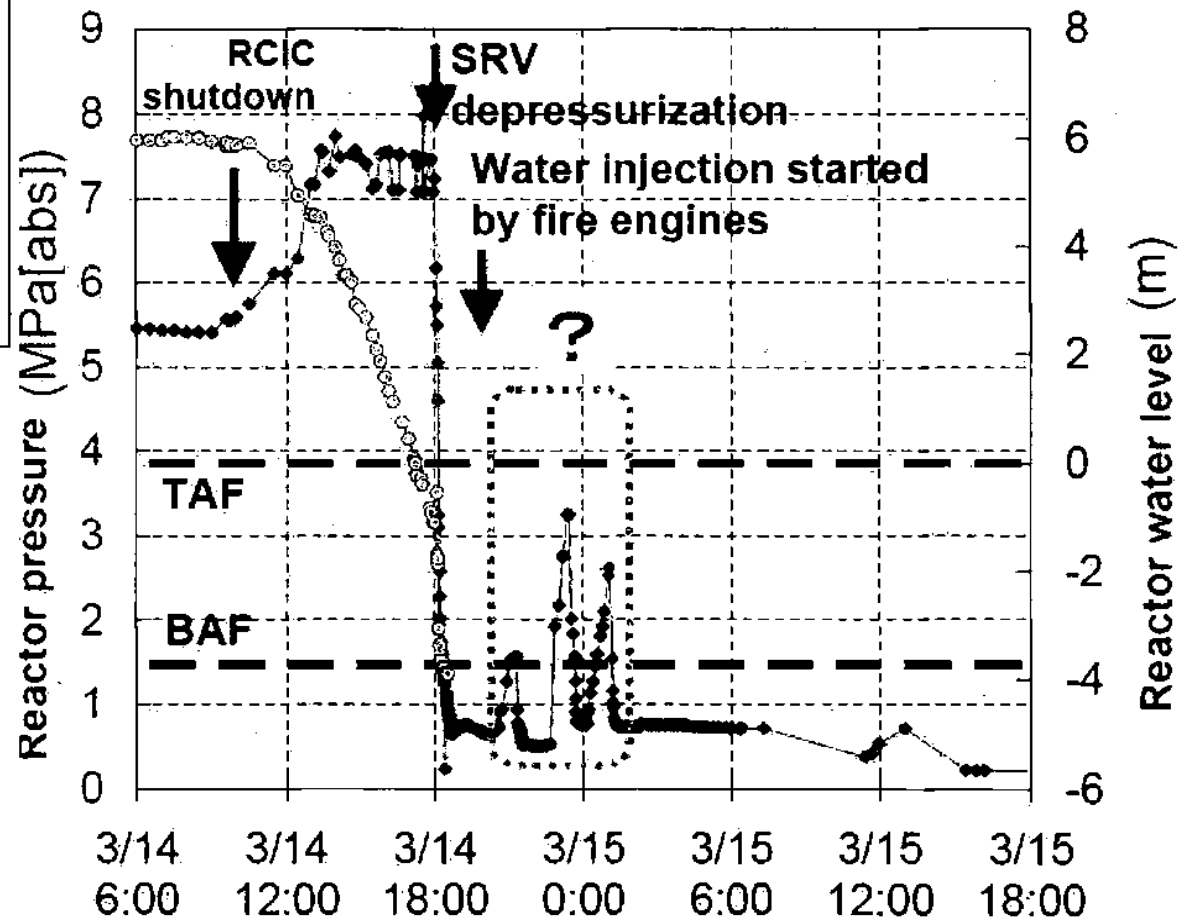

Unit 2 Reactor Pressure Spike Presumed Scenario

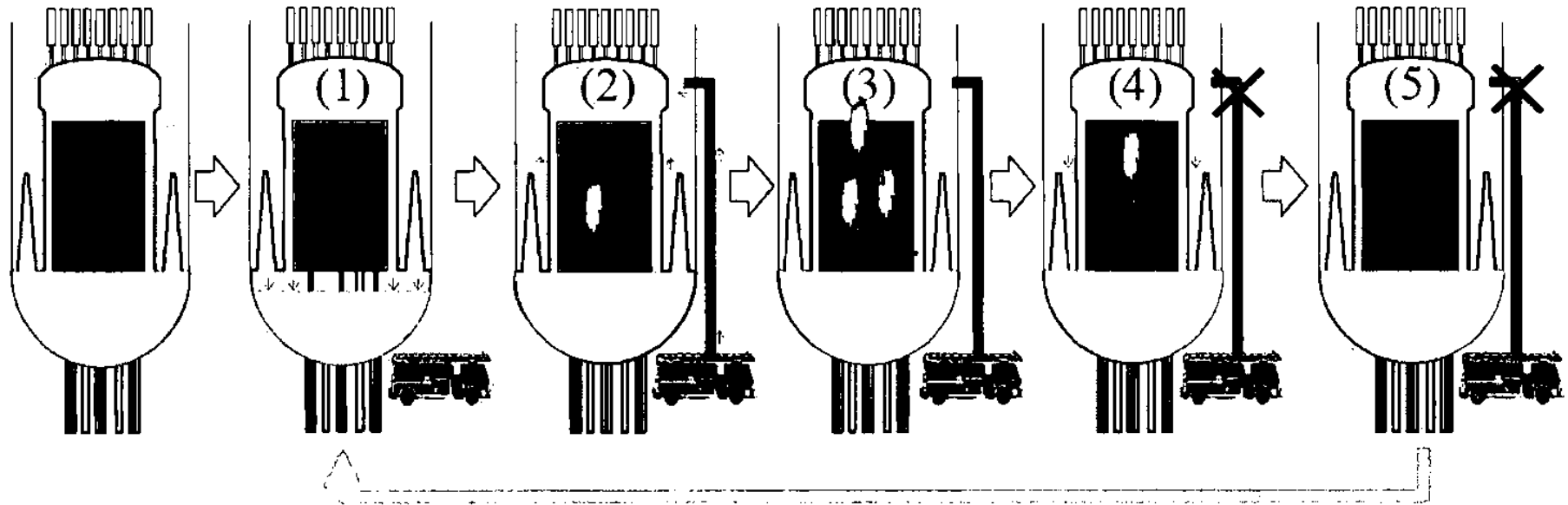

1. Depressurization causes flashing and core exposure
2. Water injection into hot core
3. Steam generation followed by metal-water reaction
4. Reactor pressure increase prohibits water injection
5. Steam generation ceases and pressure goes down

Neutron Detected at Main Gate on March 13-14

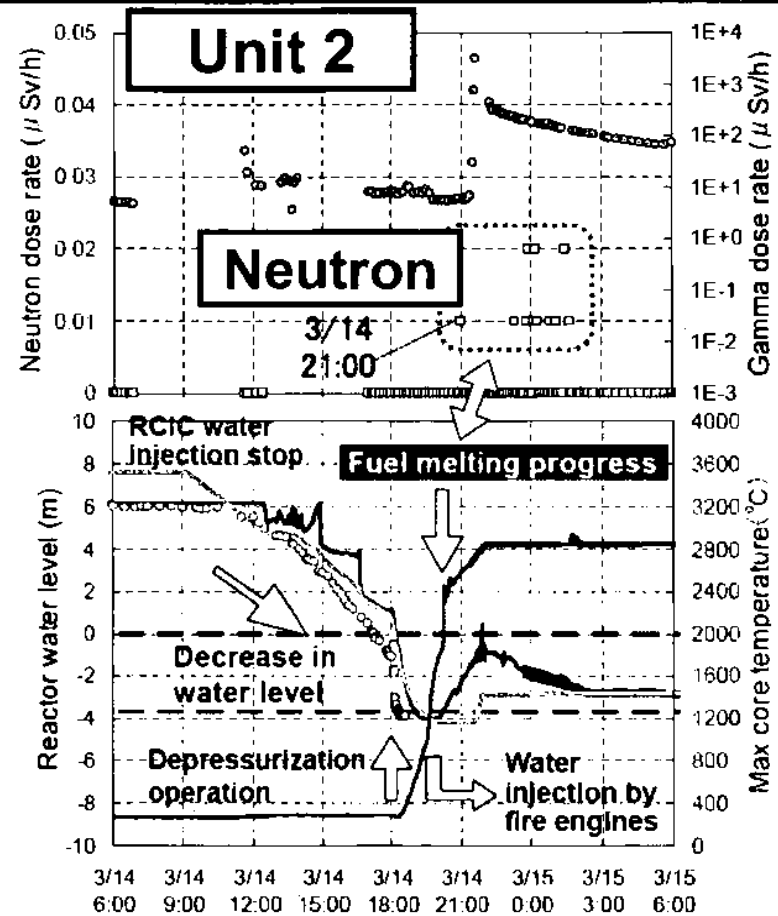
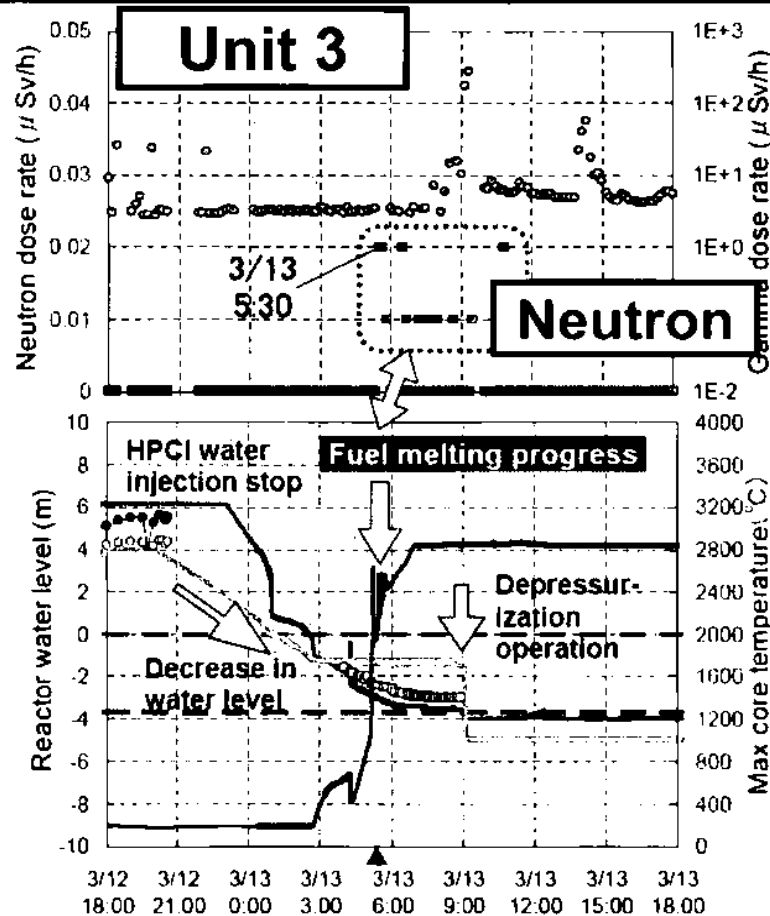

- Timing of neutron detection at main gate coincides with estimated core melt of Units 3 and 2
- Neutron likely to have originated from spontaneous fission of actinides released during core melt

Current Status of Fukushima Daiichi (1F)

TOKYO ELECTRIC POWER COMPANY, INCORPORATED 2015-04-06 15:24:05

View 1

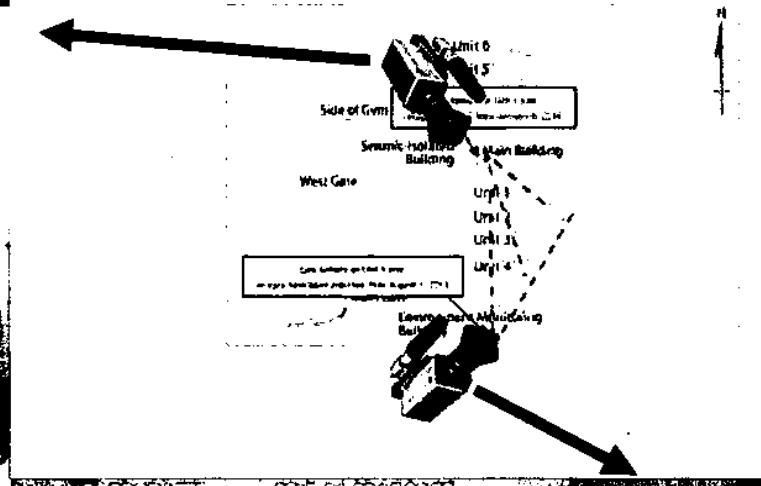
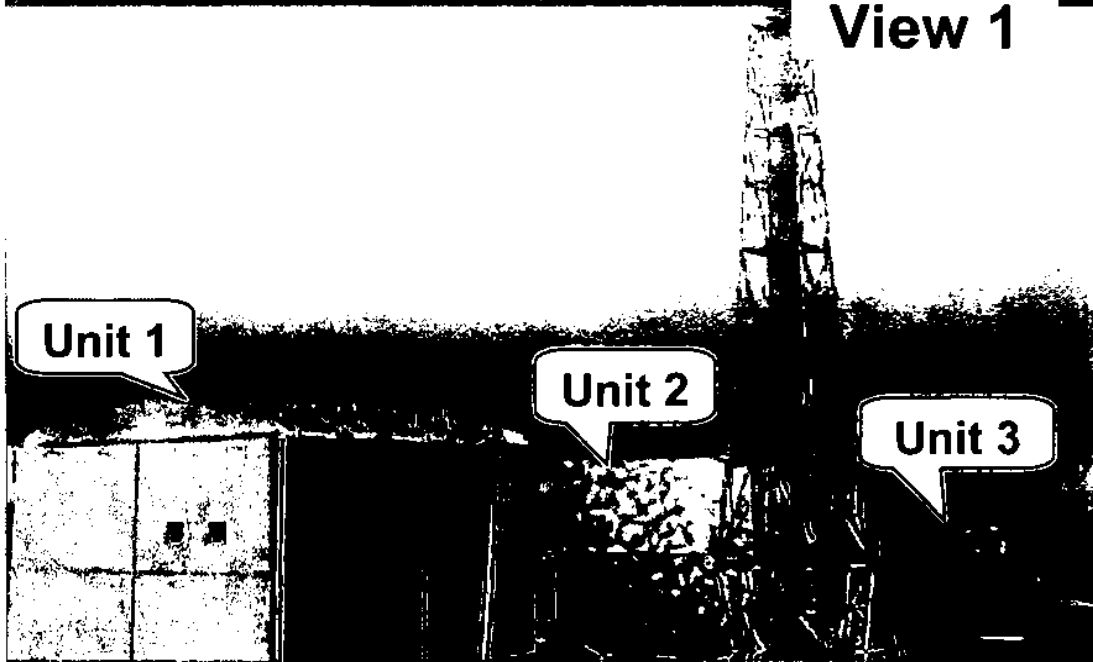

TOKYO ELECTRIC POWER COMPANY, INCORPORATED 2015-04-06 15:24:05

View 2

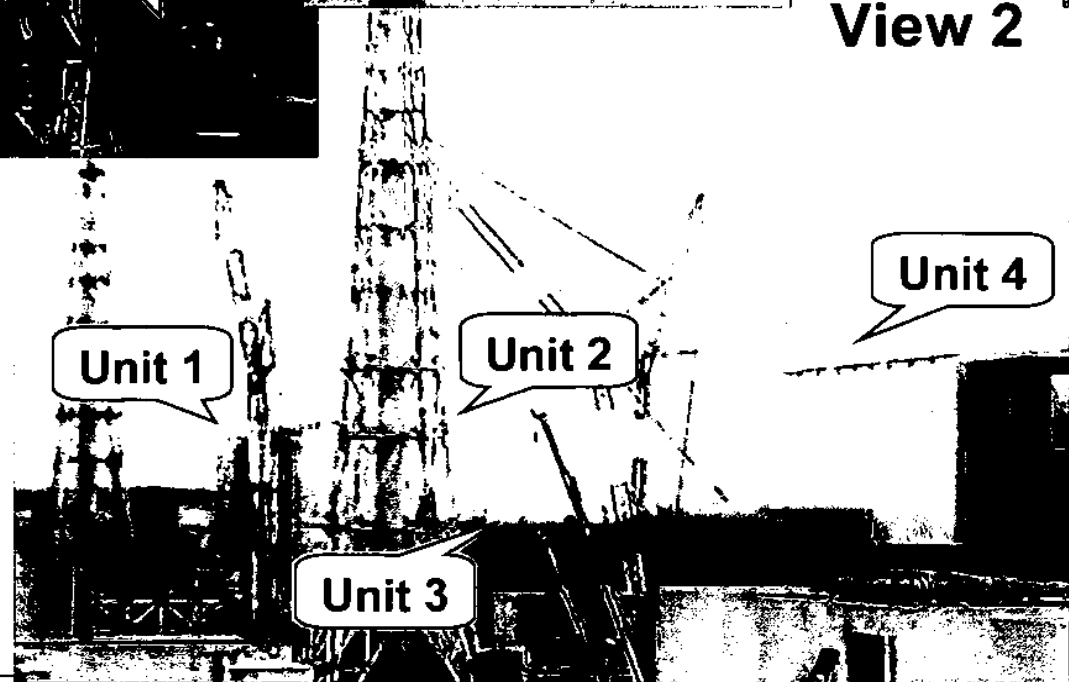

**Live Camera View
(as of 4/6/2015)**

<http://www.tepco.co.jp/en/nu/f1-np/camera/index2-e.html>
<http://www.tepco.co.jp/en/nu/f1-np/camera/index-e.html>

Progress Made at 1F Unit 1

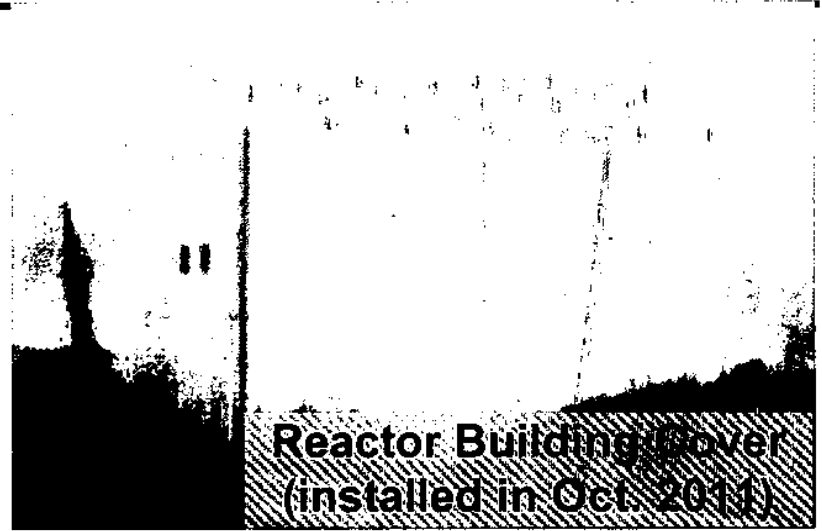
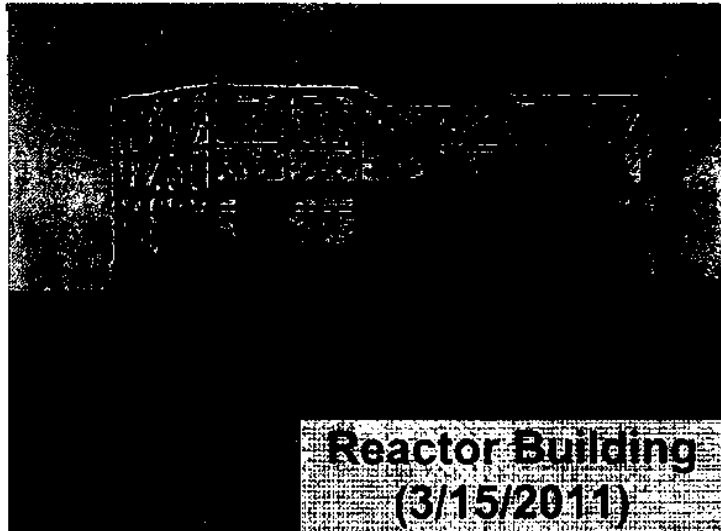

Torus Room (11/13/2013)

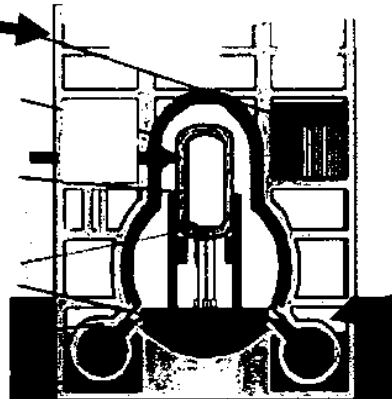

Torus Room (5/27/2014)

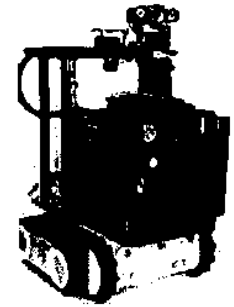

- Leakage in torus room detected by remote-operated boat and robot
- Attempt to detect core debris by muon tomography

Progress Made at 1F Unit 1 (cont'd)

Removal of Roof of Cover
(10/31/2014)



Condition of Refueling
Floor (10/31/2014)

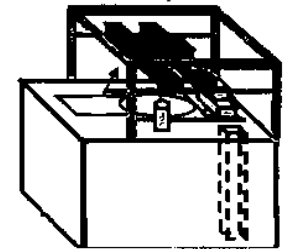

Schematic of Fuel
Removal Structure

**Reactor building cover to be dismantled in
preparation for fuel removal**

Progress Made at 1F Unit 1 (cont'd)

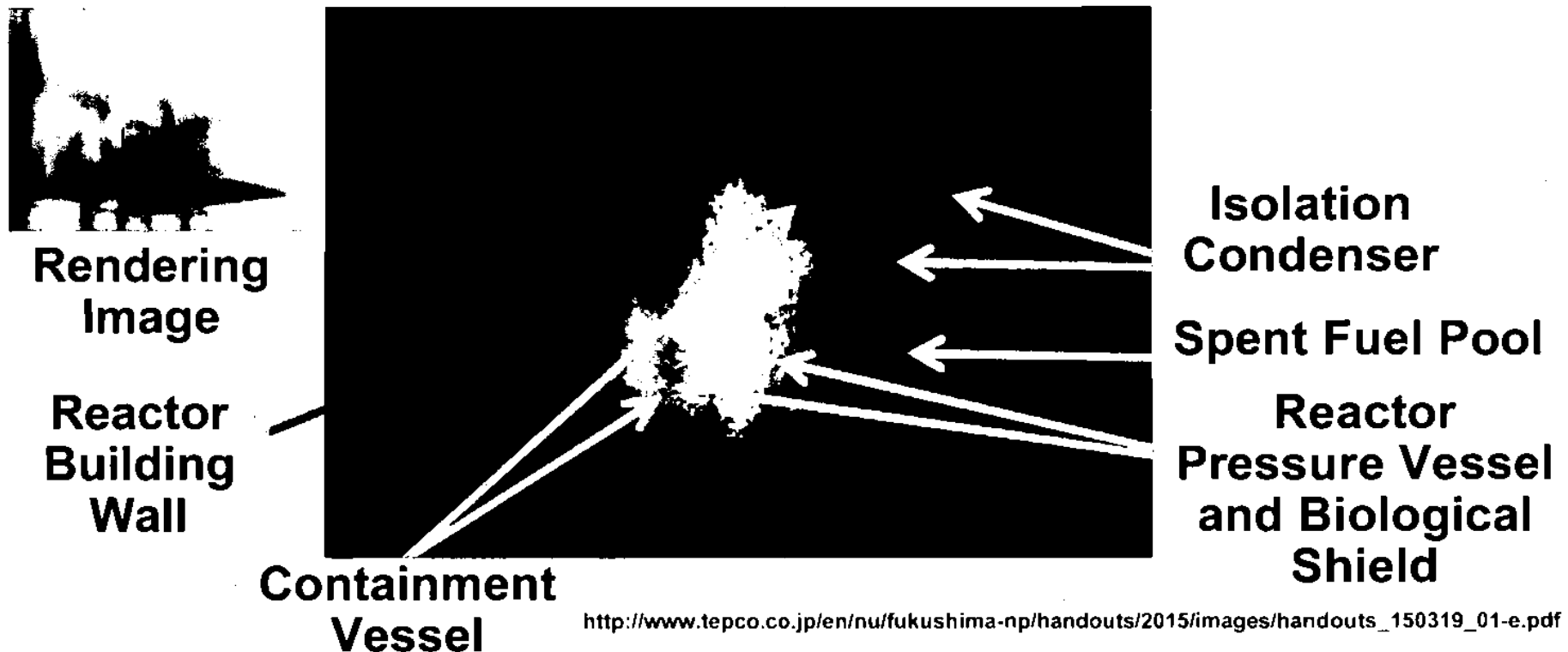

- **Preliminary findings from muon tomography (3/19/2015)**
- **Data collected for 26 days**
- **No large volume of high-density object (fuel) confirmed in core region**

Progress Made at 1F Unit 1 (cont'd)

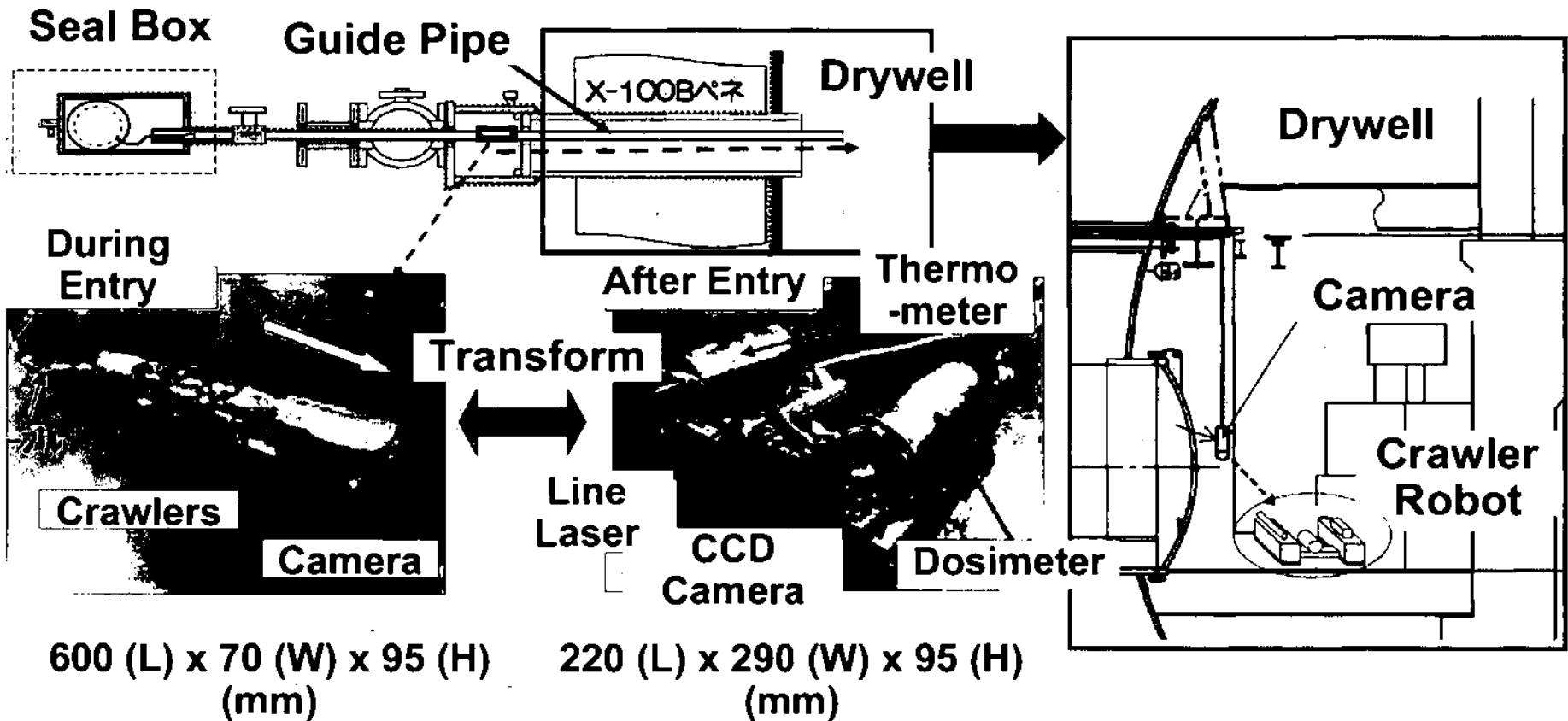

- Crawler robot to be inserted into drywell in April 2015
- Robot to pass through penetration with inner diameter of 100 mm (4")

Progress Made at 1F Unit 1 (cont'd)

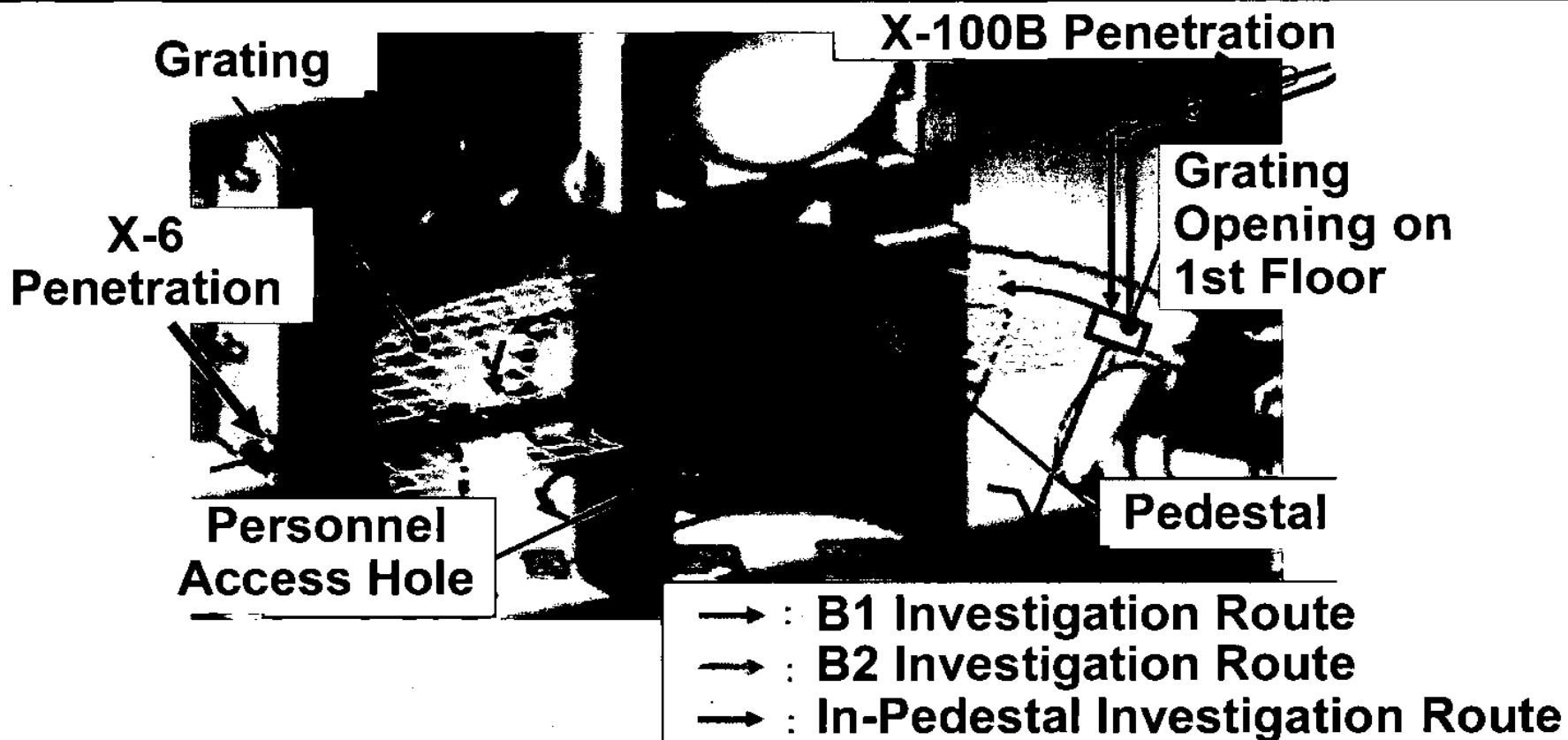

- **B1 Investigation:** above the grating on 1st floor
- **B2 Investigation:** below the grating outside of pedestal (to be planned based on results of B1)
- **In-Pedestal Investigation** to follow

Progress Made at 1F Unit 1 (cont'd)

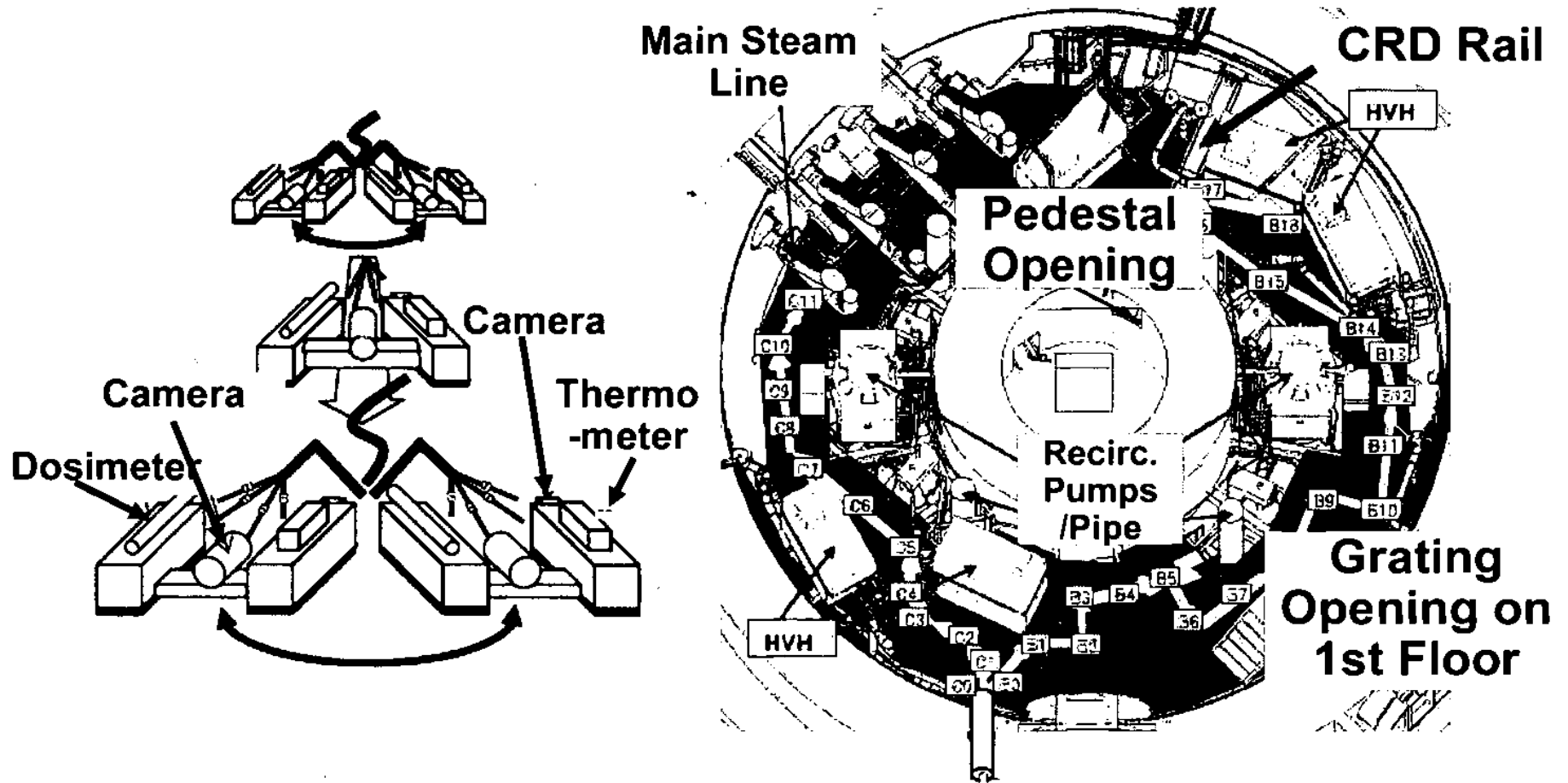

Crawler robot will progress inside drywell gradually, swivel at each investigation point, and collect images, temperature, and dose rate data

Progress Made at 1F Unit 2

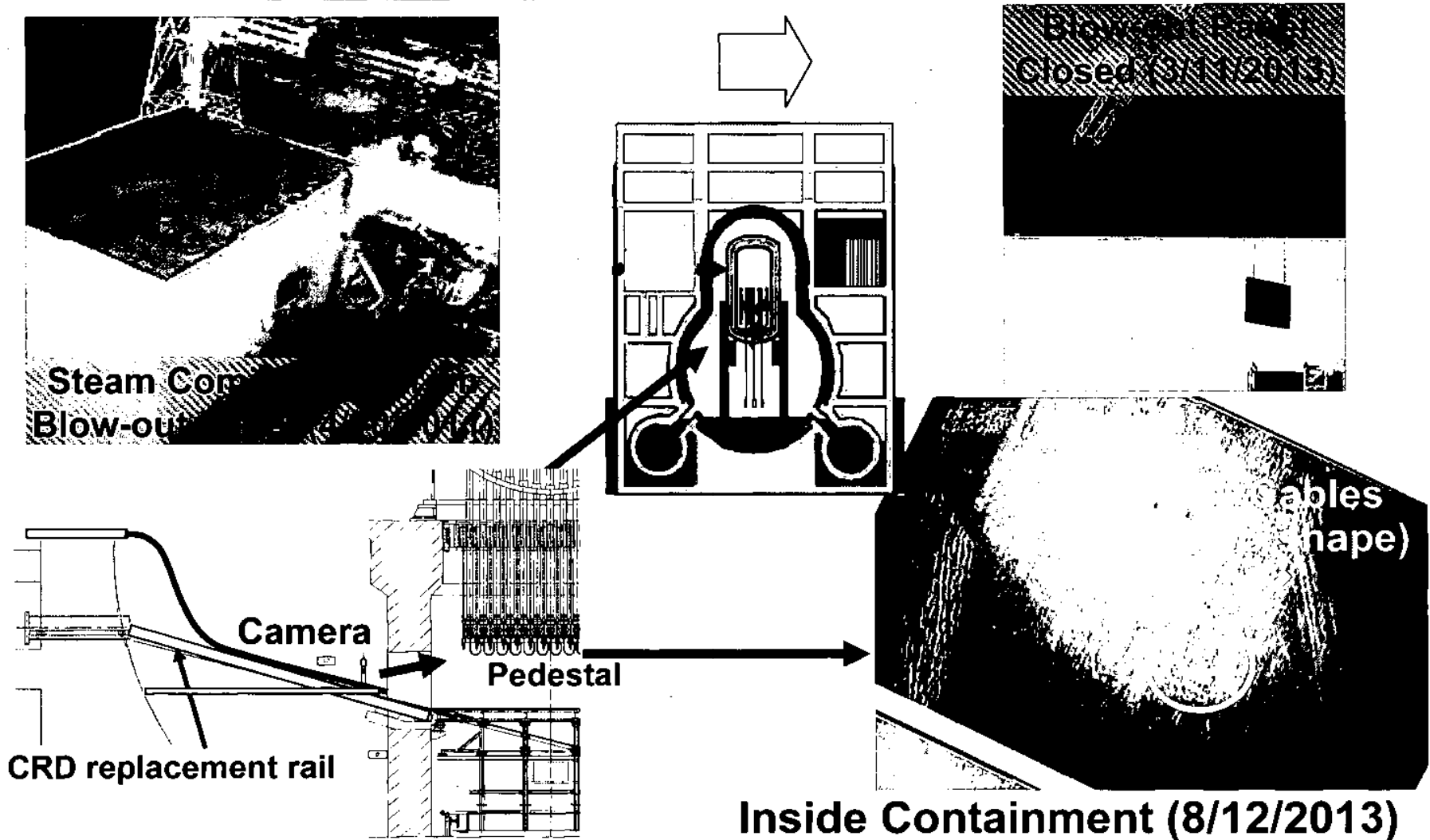

- Video images obtained inside primary containment
- Attempt to detect core debris by muon tomography

Progress Made at 1F Unit 2 (cont'd)

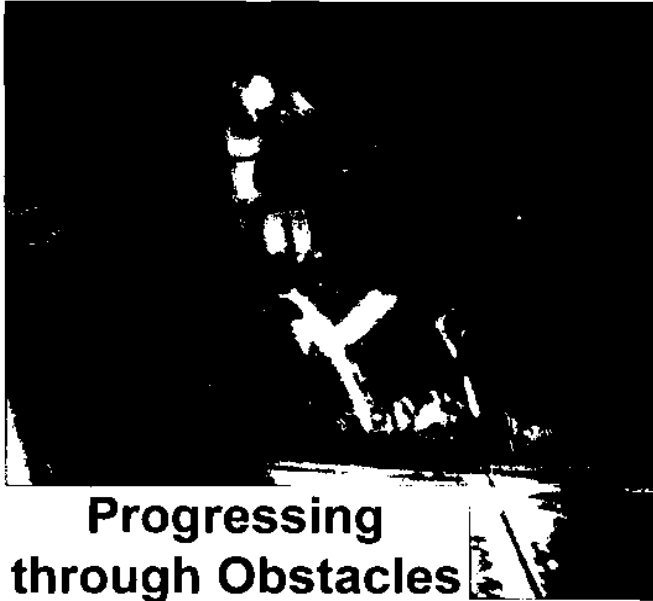

Progressing through Obstacles



Core Sampling of the Floor



Maneuverability Testing

Robot retrieved concrete samples from refueling floor (March 2014)

Progress Made at 1F Unit 2 (cont'd)

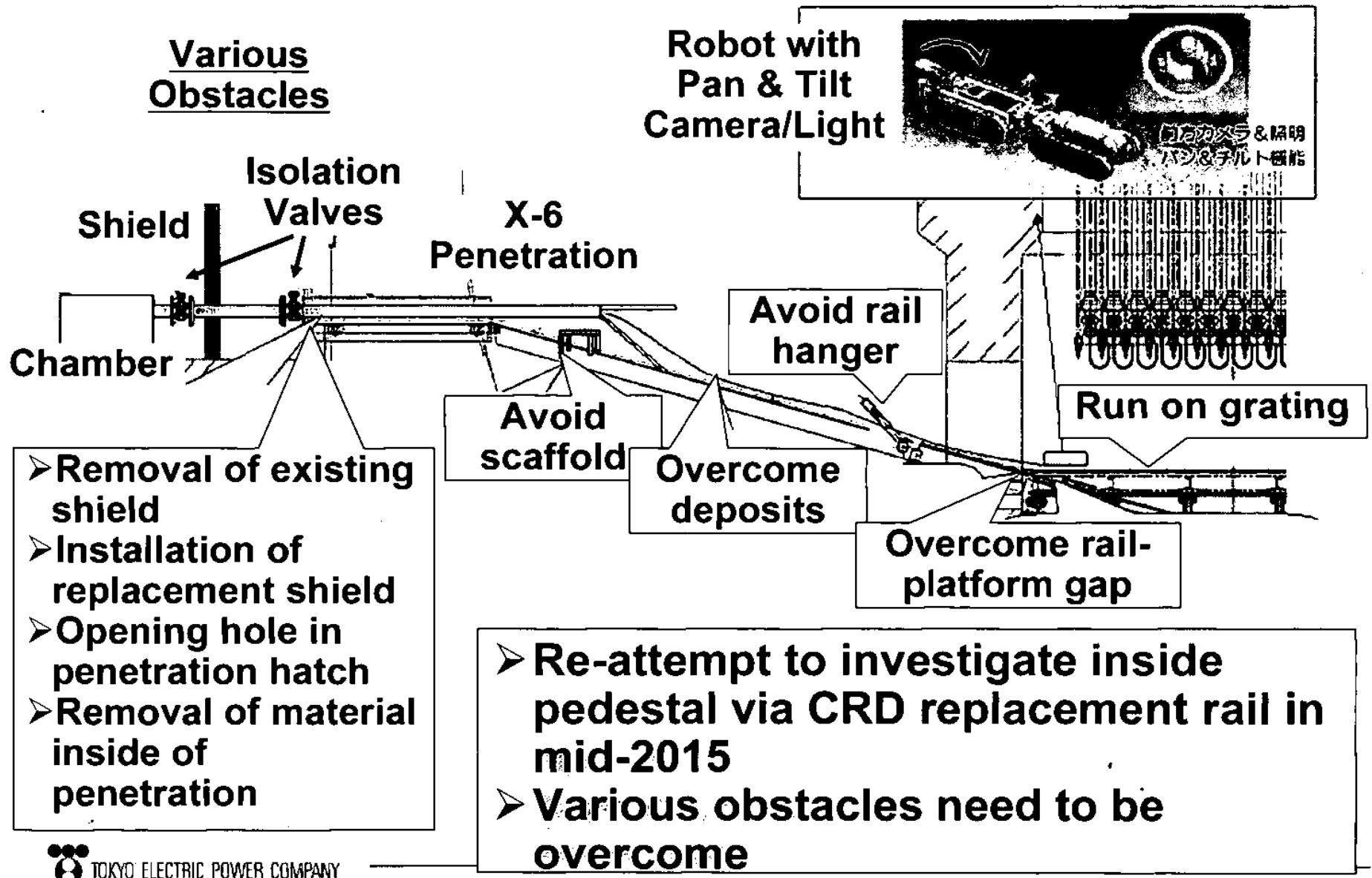

Progress Made at 1F Unit 3

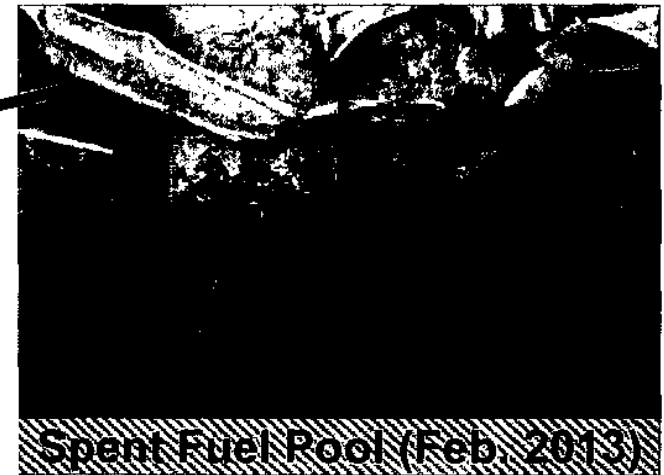
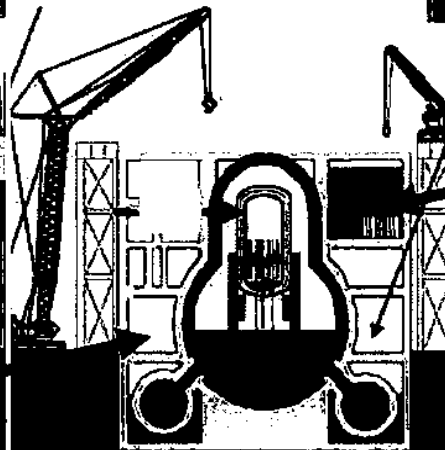
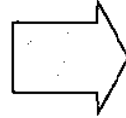

- Robot found leakage location in reactor building
- Removing rubble from SFP in preparation for defueling



Progress Made at 1F Unit 3 (cont'd)

Fuel Handling Machine (FHM)

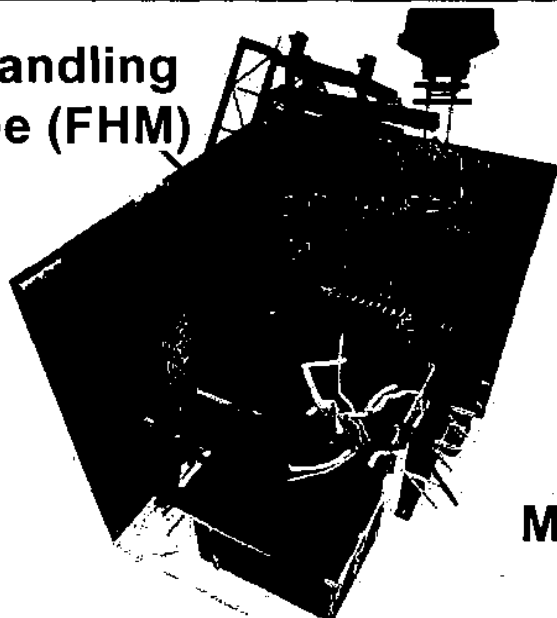

Mast

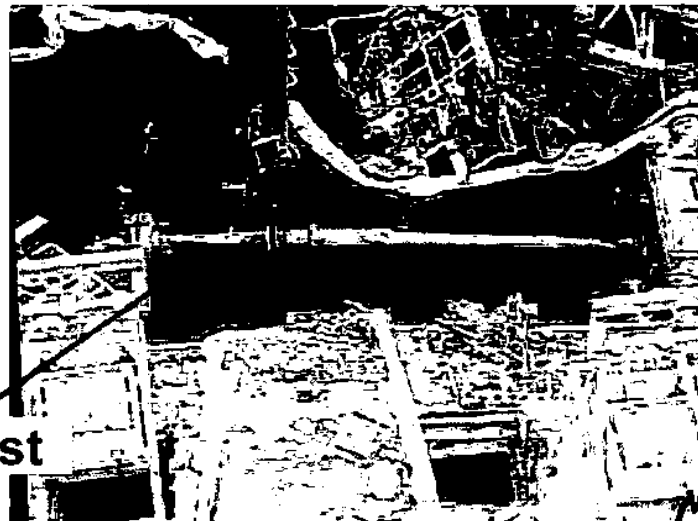

Fuel Handling Machine
Overhead Crane

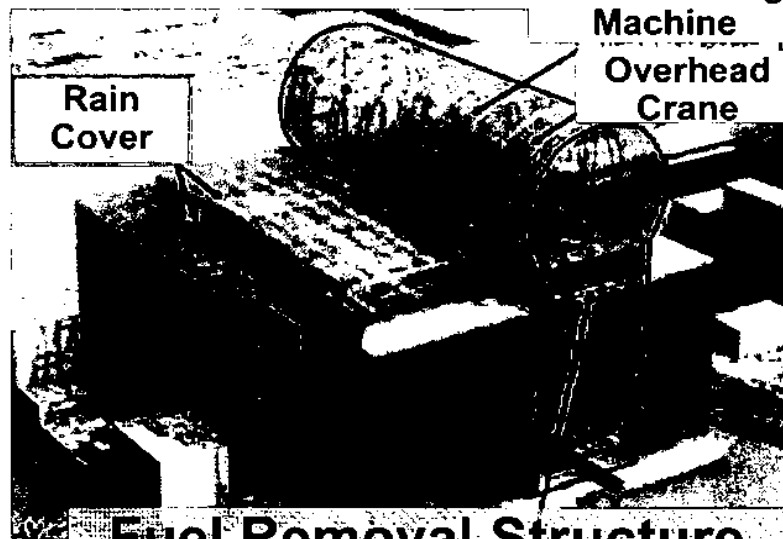

Fuel Removal Structure

- Rubble in spent fuel pool being removed by remote operation
- Preparation to construct fuel removal structure

Progress Made at 1F Unit 3 (cont'd)

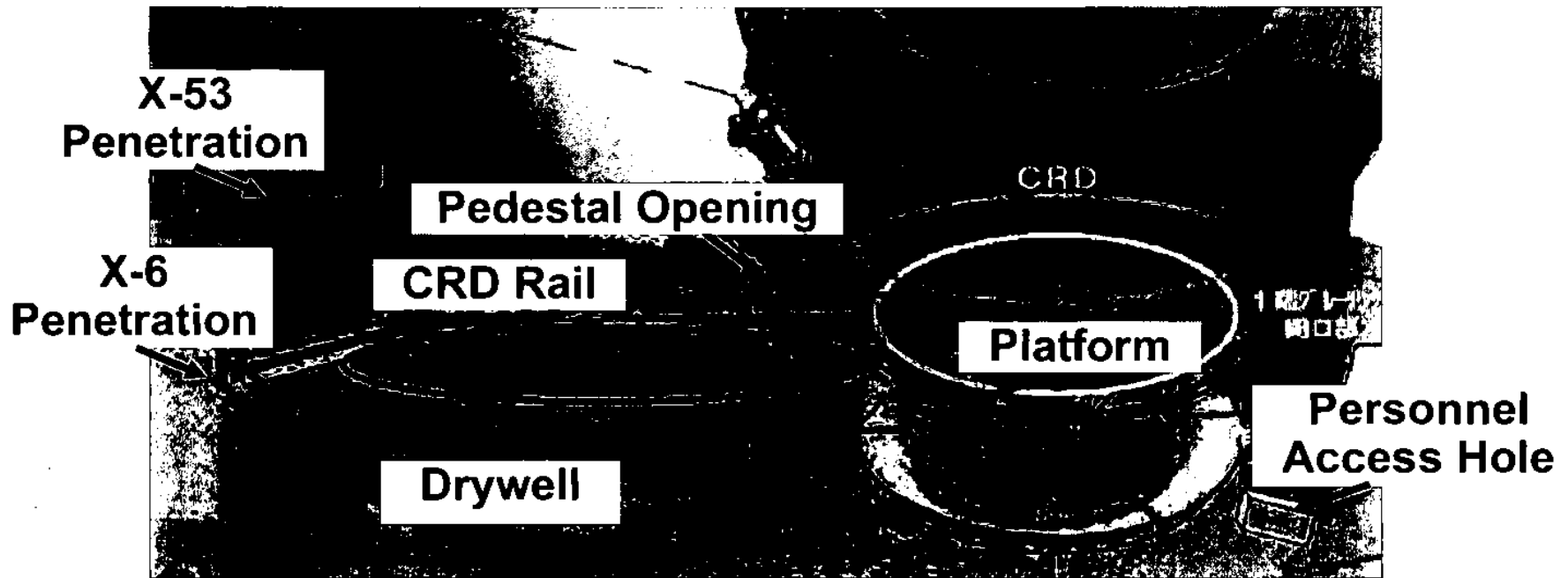

- Investigation inside drywell under consideration
- X-6 Penetration (to be used in Units 1&2) considered to be submerged
- Use of other penetrations requires further downsizing of robot and underwater maneuver to reach inside pedestal
- Investigation via X-53 Penetration (presumed un-submerged) planned in mid-2015

Investigation Insights of 1F Units 1, 2, and 3

Unit 1

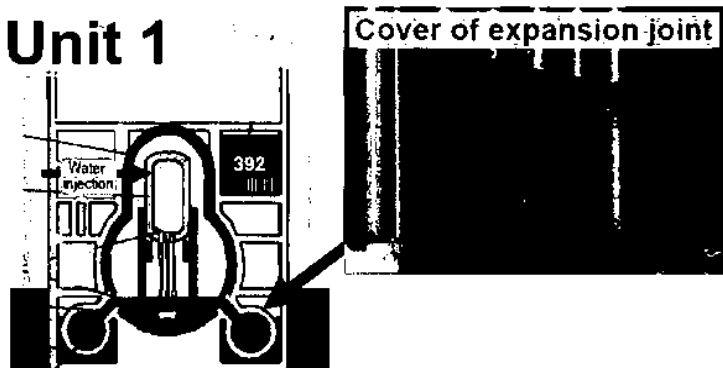

- Two locations of leakage found in torus room
- Indication of leakage in drywell shell

Unit 2

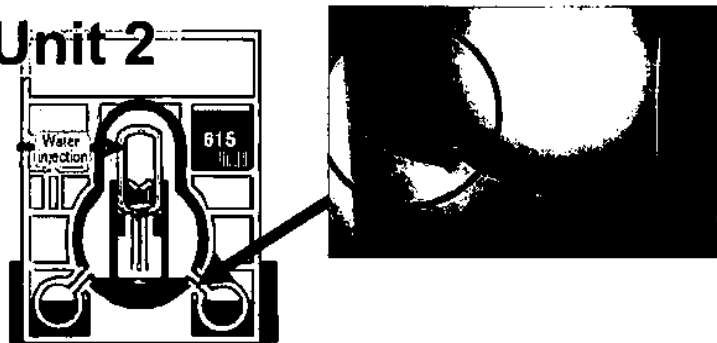

- No leakage confirmed in torus room
- Likely leakage near bottom of suppression chamber

Unit 3

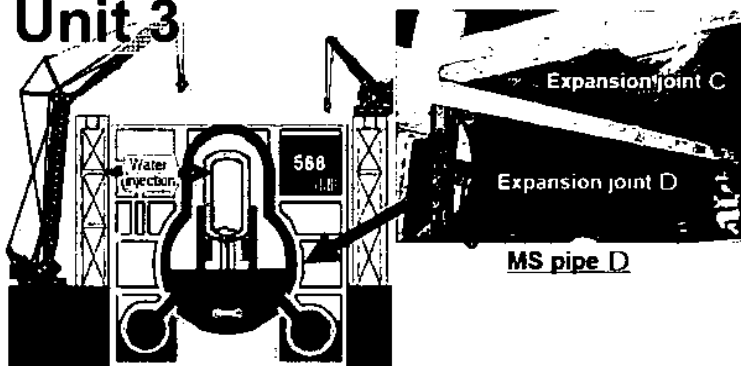

- Leakage from drywell to reactor building found at main steam line penetration
- No indication of leakage from suppression chamber

Extensive Use of Robots

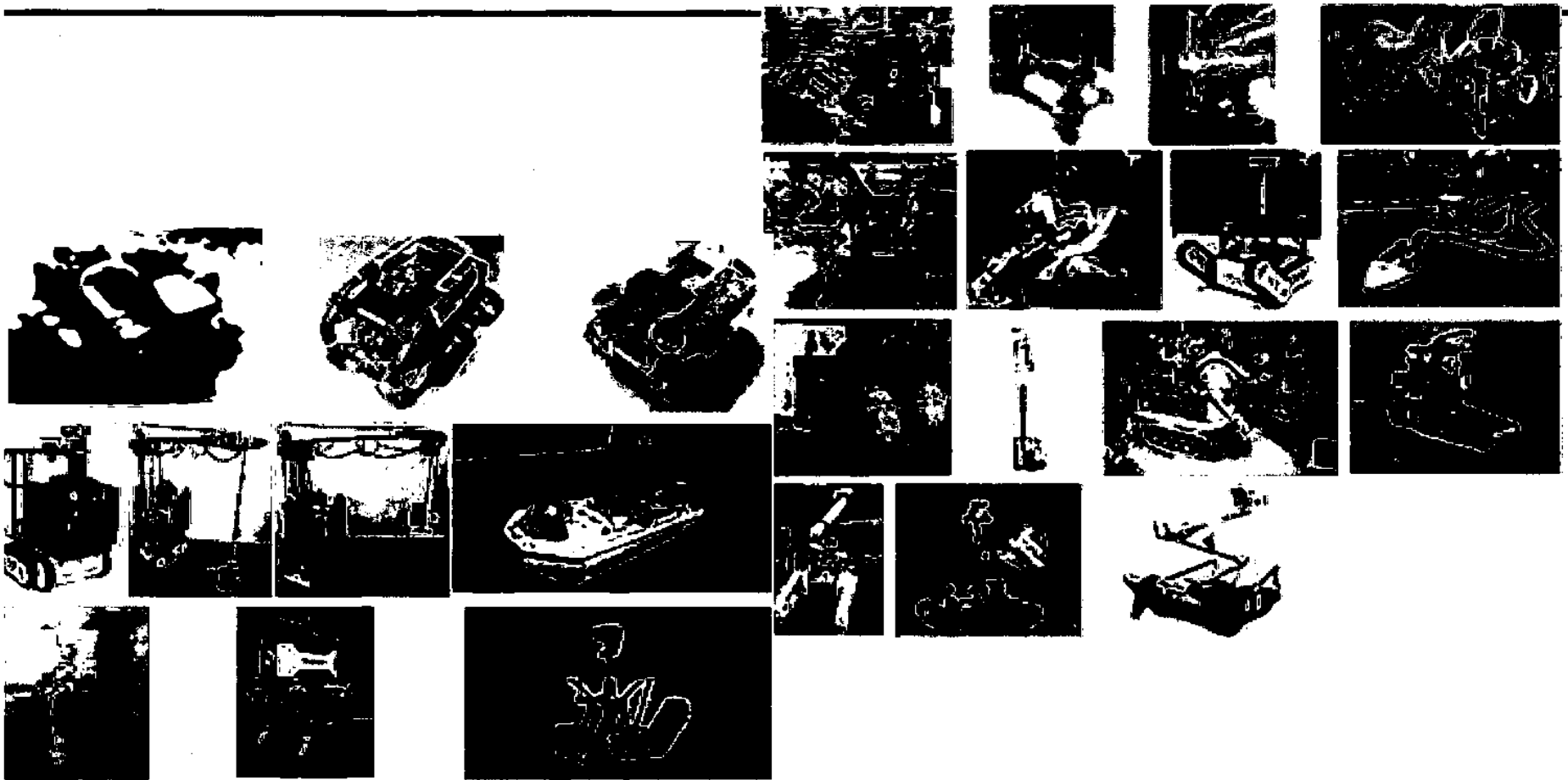

<http://photo.tepco.co.jp/en/cat3/04-e.html>

<http://www.tepco.co.jp/en/decommission/principles/robot/index-e.html>

http://www.tepco.co.jp/en/news/library/archive-e.html?video_uuid=raf8si47&catid=61795

Various robots used for investigation, measurement, decontamination, etc. in highly radioactive areas

Core Cooling and Water Treatment Systems

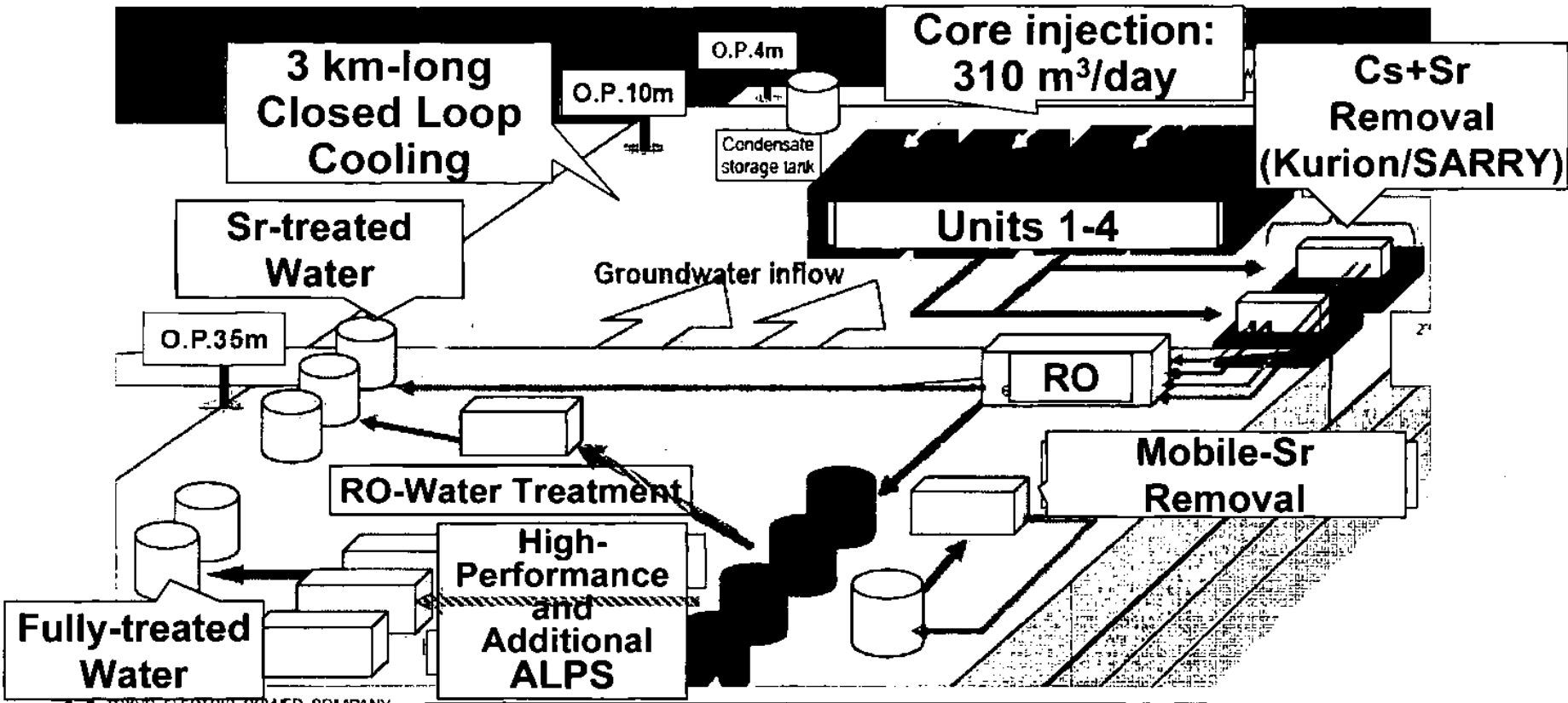
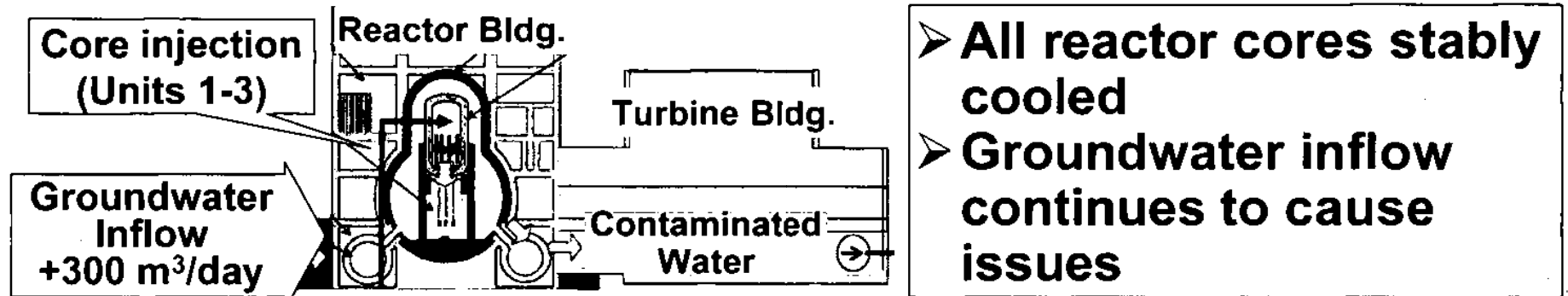

Tackling Water Issues: "Seven Samurai"

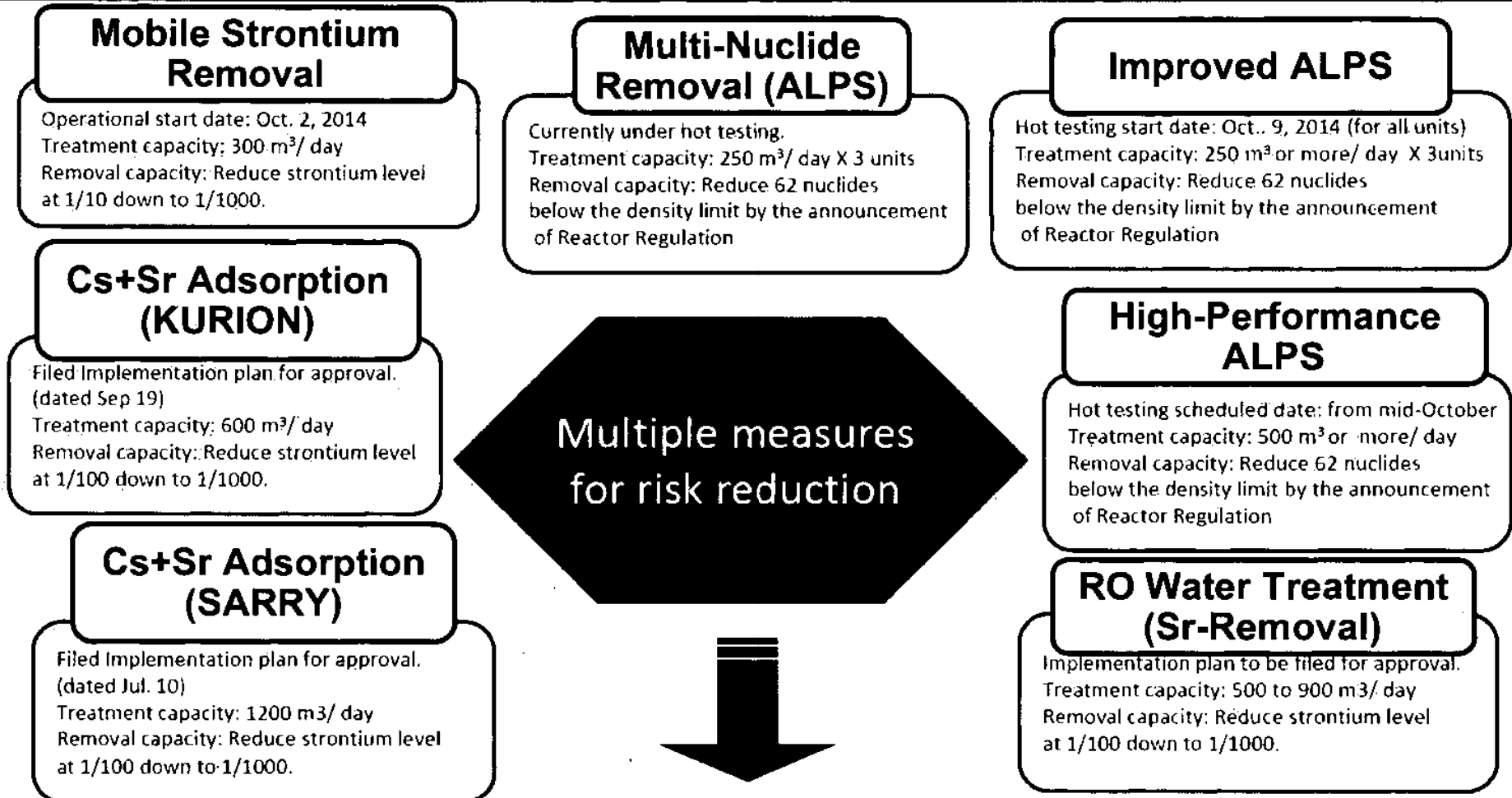

Multiple water treatment systems employed to reduce risk of contaminated water

Emergency and Fundamental Measures on Water Issues

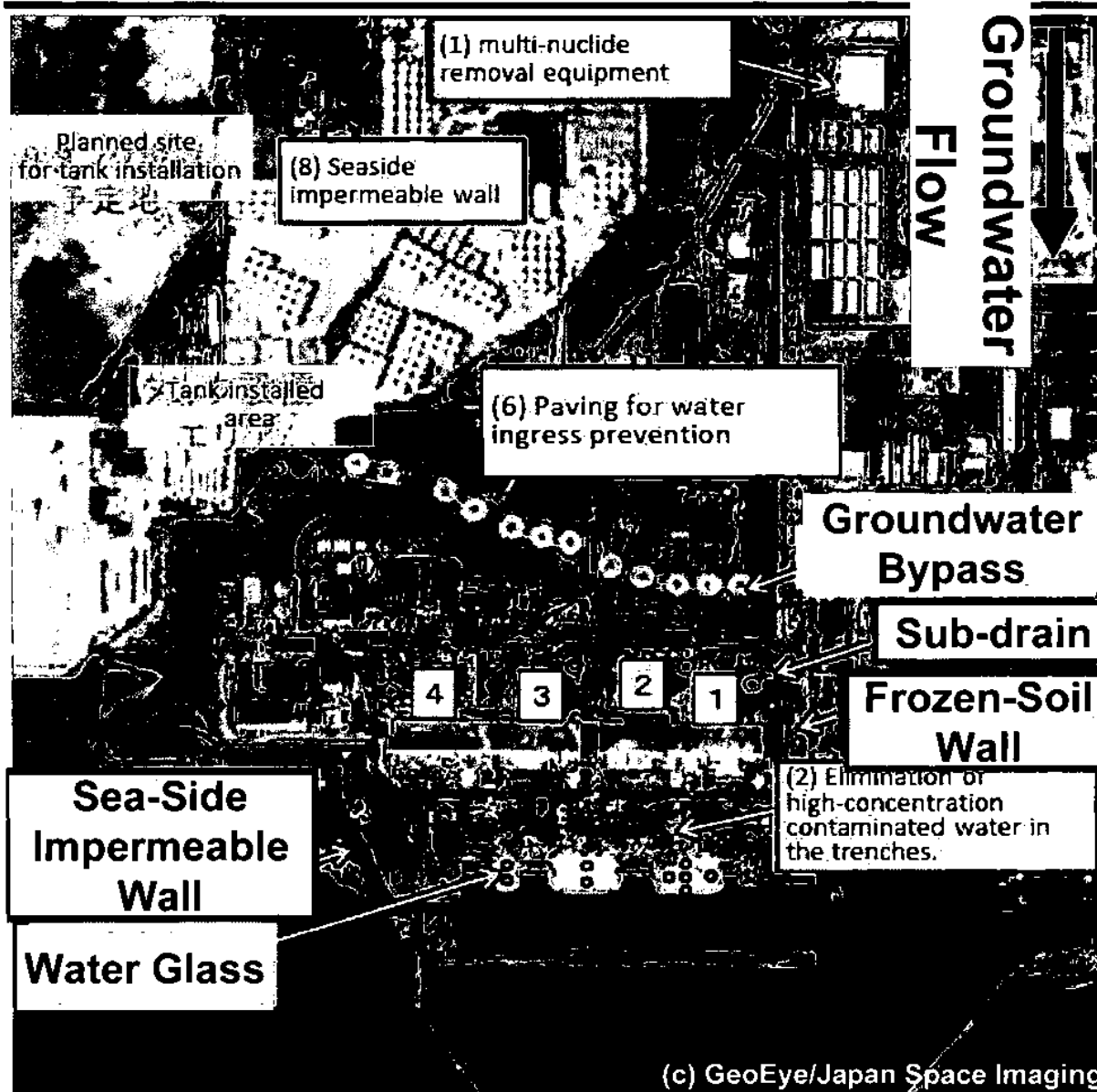

- Prevent groundwater from being contaminated
- Prevent contaminated groundwater from flowing into sea
- Reduce groundwater inflow into buildings

Tackling Water Issues: Frozen-Soil Wall

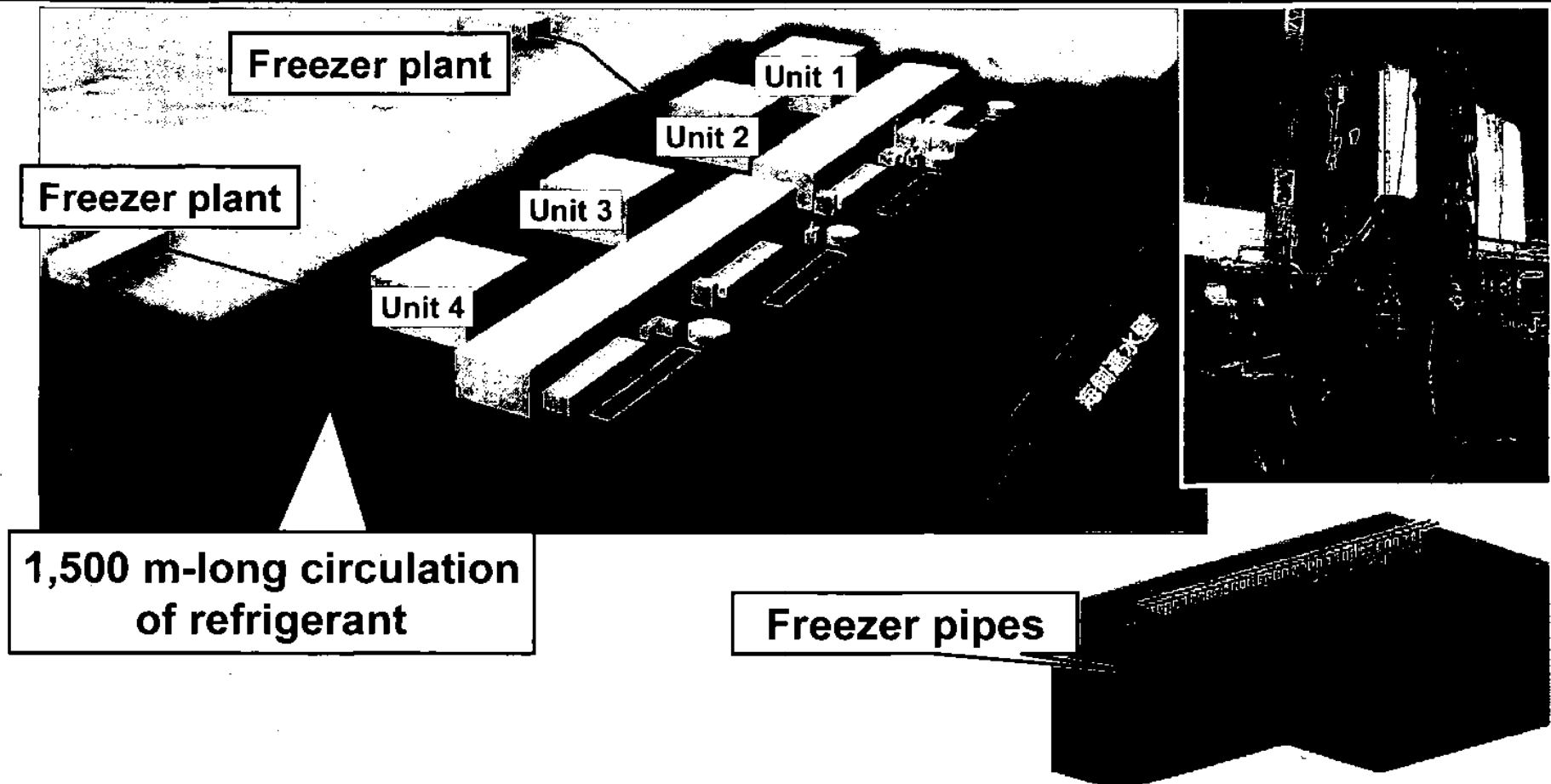

- Stop groundwater inflow by frozen-soil wall
- Construction work commenced: June 2014
- Freezer plant: 230 kW x 30 units

Decommissioning Roadmap for 1F

**Cold Shutdown
Condition Achieved
(Dec., 2011)**

**Within
2 years**

**Within
10 years**

**30 to
40 years**

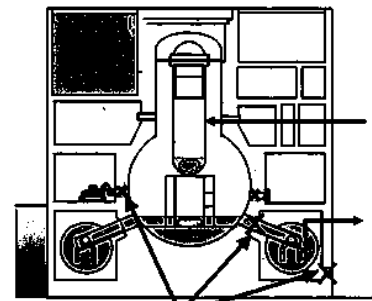
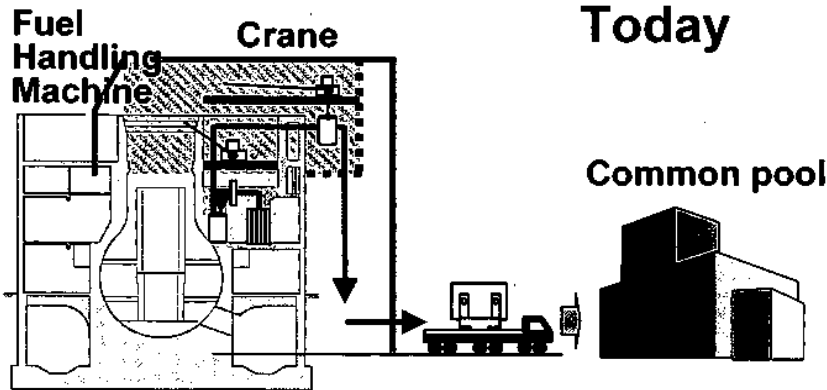
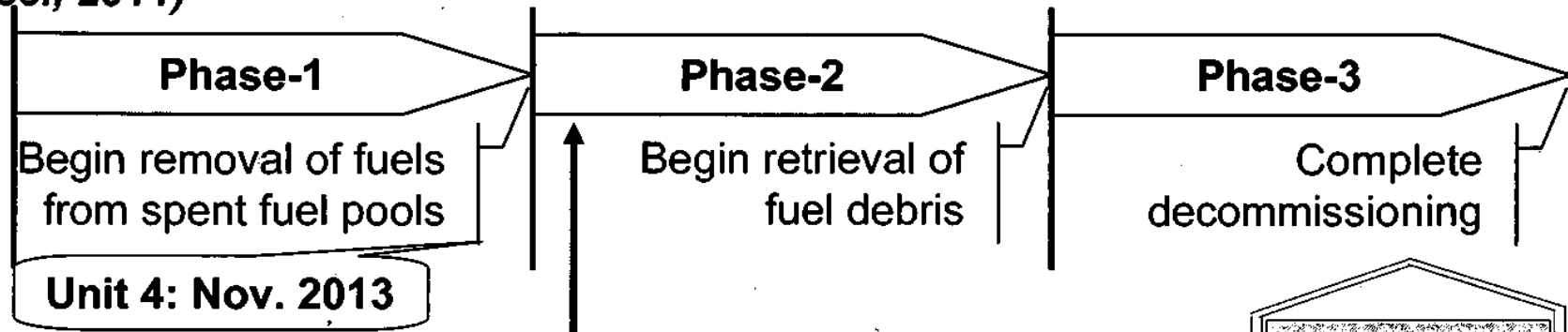

Stop Leakage

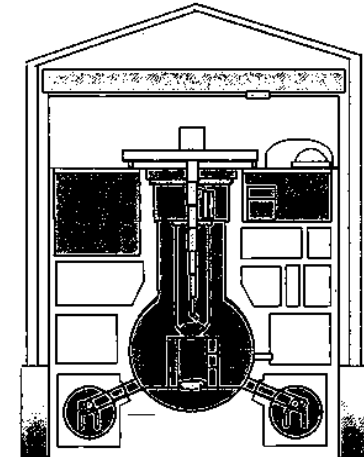

**Flood PCV and
Remove Fuel Debris**

Global collaboration vitally important to tackle this unprecedented undertaking

Global Collaboration: IAEA

**IAEA INTERNATIONAL PEER REVIEW
MISSION ON
MID-AND-LONG-TERM ROADMAP
TOWARDS THE DECOMMISSIONING
OF TEPCO'S FUKUSHIMA DAIICHI
NUCLEAR POWER STATION UNITS 1-4**

REPORT TO
THE GOVERNMENT OF JAPAN

Tokyo and Fukushima Prefecture, Japan

15-22 April 2013



Unit 4 Fuel Removal (11/27/2013)



Seismic Isolation Bldg. (2/11/2015)



<http://www.meti.go.jp/press/2013/05/20130523001/20130523001-4.pdf>

<https://www.iaea.org/sites/default/files/missionreport170215.pdf>

<https://www.iaea.org/newscenter/multimedia/photoessays/iaea-decommissioning-review-mission-fukushima-daiichi-february>

**IAEA peer review missions on decommissioning
roadmap (April 2013, Nov.-Dec. 2013, Feb. 2015)**

Global Collaboration: U.S. and U.K.

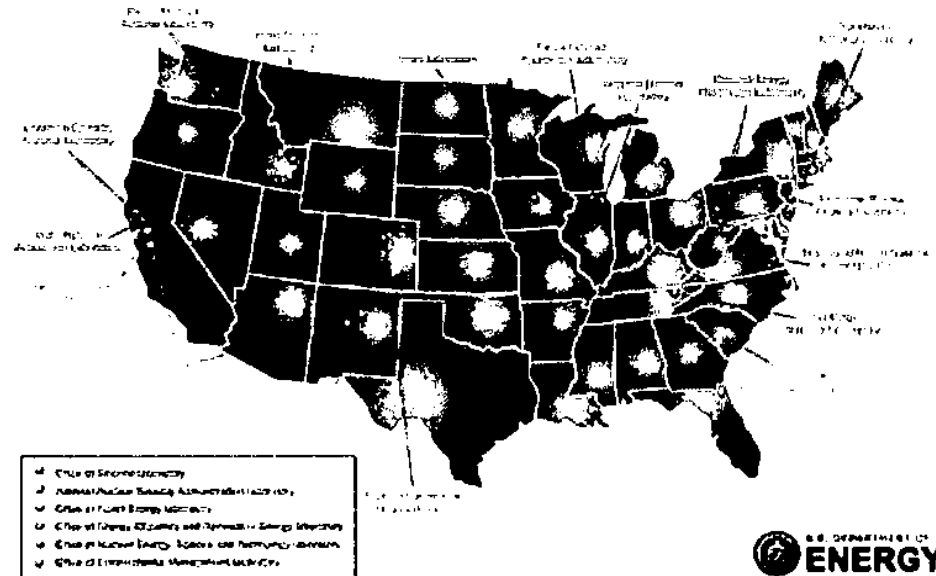
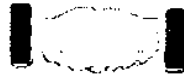

Collaboration with U.S. National Laboratories and U.K. Sellafield Ltd., among many other int'l organizations on various D&D areas

TEPCO's Post-Accident Activities in the U.S.

Nuclear Industry



Gov't Agencies



Global Organizations

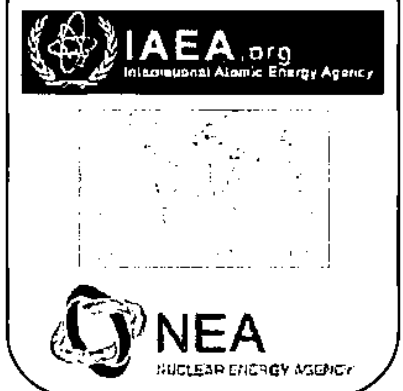

Academia

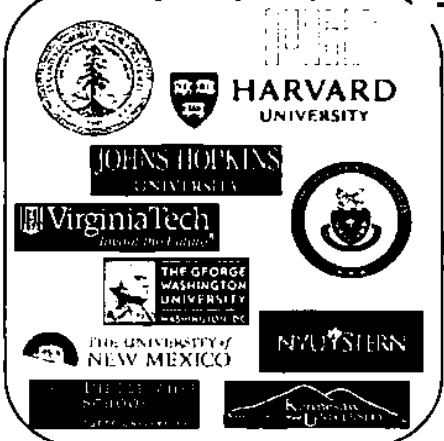

Professional Organizations, Think Tanks, NPOs, Media

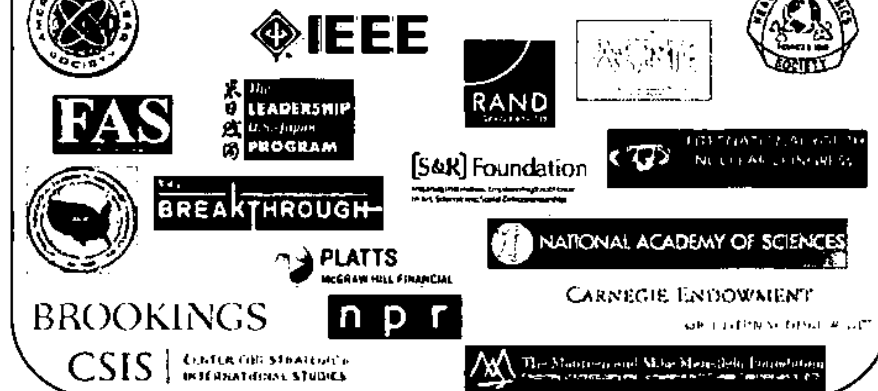

Committed to sharing lessons learned; making nuclear power plants safer; carrying out decommissioning safely
→ Hosting Weekly Update Teleconferences

References

[Japan]

- **Tokyo Electric Power Company (TEPCO)**
<http://www.tepco.co.jp/en/decommission/index-e.html>
<http://www.tepco.co.jp/en/decommission/planaction/waterprocessing-e.html>
<https://www.youtube.com/user/OfficialTEPCOen>
- **Nuclear Reform Monitoring Committee of TEPCO (NRMC)**
<http://www.nrmc.jp/en/index-e.html>
- **Ministry of Economy, Trade and Industry (METI)**
<http://www.meti.go.jp/english/earthquake/>
- **Nuclear Regulation Authority (NRA)**
<http://www.nsr.go.jp/english/>
- **Japan Atomic Industrial Forum (JAIF)**
<http://www.jaif.or.jp/en/>
- **Japan Nuclear Safety Institute (JANSI)**
<http://www.genanshin.jp/english/index.html>

[Media]

- **Japan Times “Lives on the Line”**
<http://www.japantimes.co.jp/news/column/lives-on-the-line/>

[USA]

- **Institute of Nuclear Power Operations (INPO)**
<http://www.wano.info/Documents/Lessons%20Learned.pdf>
- **Electric Power Research Institute (EPRI)**
<http://www.epri.com/Our-Work/Pages/Nuclear.aspx>
- **Nuclear Energy Institute (NEI)**
<http://safetyfirst.nei.org/japan/>
- **US Nuclear Regulatory Commission (NRC)**
<http://www.nrc.gov/reactors/operating/ops-experience/japan-dashboard.html>
- **National Academy of Science (NAS)—
Fukushima Lessons Learned Committee**
<http://www8.nationalacademies.org/cp/projectview.aspx?key=49465>

[International]

- **International Atomic Energy Agency (IAEA)**
<http://www.iaea.org/>
- **World Association of Nuclear Operators (WANO)**
<http://www.wano.info/>
- **United Nations Scientific Committee on the Effects of Atomic Radiation (UNSCEAR)**
http://www.unscear.org/unscear/en/publications/2013_1.html
- **World Health Organization (WHO)**
http://www.who.int/mediacentre/news/releases/2013/fukushima_report_20130228/en/

Hackett, Edwin

From: Joy Rempe <jlrempe@cableone.net>
Sent: Wednesday, April 08, 2015 9:17 PM
To: Mike Corradini; Charles Brown; Mike Ryan; Ronald Ballinger; John Stetkar; Stephen Schultz; Dennis Bley; Dana Powers; Dick Skillman; Riccardella, Pete; Harold Ray
Cc: Hackett, Edwin; Banks, Mark
Subject: Fwd: [TEPCO Weekly Fukushima Update Call] THU, April 9, 2015 at 3pm EDT
Attachments: handouts_150406_01-e.pdf

Hi,

As Ed mentioned, Kenji Taiteiwa will be coming to brief ACRS on the status of the affected units at Daiichi. Near the end of his presentation, he'll be mentioning the bi-weekly teleconferences that he holds to brief interested individuals on the status of TEPCO's D&D efforts. Here's an example of what he sends out prior to each of these teleconferences. I've included one of the attachments that provides additional details (in English) about the robot that will be deployed in Unit 1 this April and the type of information that they anticipate will be obtained. Although many of the links contain information that is only in Japanese, he makes an effort to explain the content of these attachments and allows questions after each topic. I find these teleconferences a useful way to keep informed about TEPCO's progress.

Joy

Dr. Joy L. Rempe, Principal
Rempe and Associates, LLC
306 Stillwater
Idaho Falls, ID 83404
Phone: 208-520-3708
Email: jlrempe@cableone.net
Website: www.rempellc.com

----- Forwarded message -----

From: Tateiwa, Kenji <tateiwa.kenji@tepcoco.jp>
Date: Wed, Apr 8, 2015 at 6:25 PM
Subject: [TEPCO Weekly Fukushima Update Call] THU, April 9, 2015 at 3pm EDT
To: "Tateiwa, Kenji" <tateiwa.kenji@tepcoco.jp>

Nuclear Sector Colleagues,

Please find below information for tomorrow's Weekly Fukushima Update Call.

[Date/time]

THU, April 9, 2015 at 3 pm Eastern Daylight Time
(No Call Next Week. Next call will be on **Fri, April 24** at 3 pm EDT.)

[call-in information] (Please record your name and organization when joining the call.)

call number: 718-354-1184

passcode

(b)(6)

[Major topics]

1. Unit 3 Shield Plug in Front of Containment Vessel Equipment Hatch: Assumed Cause of Movement (3/30/2015)

Shield plug could have moved due to pressure differential between containment vessel and reactor building when R/B hydrogen explosion occurred.

(only in Japanese)

http://www.tepco.co.jp/nu/fukushima-np/handouts/2015/images/handouts_150330_04-j.pdf

2. Unit 3 Spent Fuel Pool Gate Condition (4/6/2015)

Visual inspection found no significant impact to one of the two layers of gates (G1) maintaining water-tightness of pool.

(only in Japanese)

http://www.tepco.co.jp/nu/fukushima-np/handouts/2015/images/handouts_150406_04-j.pdf

3. Crawler Robot to Investigate Inside Unit 1 Drywell (4/6/2015)

http://www.tepco.co.jp/en/nu/fukushima-np/handouts/2015/images/handouts_150406_01-e.pdf

4-1. Nuclear Safety Reform Plan: Quarterly Progress Report (3/30/2015)

http://www.tepco.co.jp/en/press/corp-com/release/2015/1249285_6844.html

4-2. Full Report

(only in Japanese)

http://www.tepco.co.jp/cc/press/betu15_j/images/150330j0102.pdf

4-3. TEPCO's Nuclear Reform Monitoring Committee

http://www.nrmc.jp/en/report/detail/1249278_5233.html

4-4. "Reviewing the Two Years of Nuclear Safety Reform"

http://www.nrmc.jp/en/report/detail/___icsFiles/afieldfile/2015/04/02/E-5.pdf

5-1. "Trace Amounts of Fukushima Radioactivity Detected Along Shoreline of British Columbia" (4/6/2015)

Press release by the Woods Hole Oceanographic Institution.

<http://www.whoi.edu/news-release/fukushima-ucluelet>

5-2. TEPCO's Sea Water Sampling Data

<http://www.tepco.co.jp/en/nu/fukushima-np/f1/smp/index-e.html>

5-3. TEPCO's Seawater Monitoring Plan (4/1/2015)

(only in Japanese)

http://www.tepco.co.jp/nu/fukushima-np/handouts/2015/images/handouts_150401_06-j.pdf

** If you cannot display Japanese characters, please install the following font packs:*

<http://www.adobe.com/support/downloads/detail.jsp?ftpID=4881>

(Feel free to forward this email to your colleagues or have them contact me to be added to the distribution list.)

All the best,
Kenji

Kenji Tateiwa
Manager, Nuclear Power Programs
Tokyo Electric Power Company
Washington Office
2121 K Street, NW Suite 910
Washington, DC 20037
tel: +1-202-457-0790 (ext.)116
mobile:

----- Original Message -----

From: Tateiwa, Kenji

To: Tateiwa, Kenji

Sent: Thursday, March 26, 2015 8:53 PM

Subject: [TEPCO Weekly Fukushima Update Call] Fri, March 27, 2015 at 3pm EDT

Nuclear Sector Colleagues,

Please find below information for tomorrow's Weekly Fukushima Update Call.

[Date/time]

Fri, March 27, 2015 at 3 pm Eastern Daylight Time

(No Call Next Week. Next call will be on THU, April 9 at 3 pm EDT.)

[call-in information] (Please record your name and organization when joining the call.)

call number: 718-354-1184

passcode:

[Major topics]

1. Unit 1 Muon Tomography Preliminary Results (3/19/2015)

http://www.tepco.co.jp/en/nu/fukushima-np/handouts/2015/images/handouts_150319_01-e.pdf

2. Contaminated Water Committee (3/17/2015)

(only in Japanese)

2-1. Studies Related to Frozen Soil Wall

http://www.tepco.co.jp/nu/fukushima-np/roadmap/images/c150317_07-j.pdf

2-2. Studies Related to High-Performance ALPS

http://www.tepco.co.jp/nu/fukushima-np/roadmap/images/c150317_08-j.pdf

3. NRA Special Facilities Monitoring and Evaluation Committee (3/25/2015)

(only in Japanese)

3-1. "K" Drainage Line Investigation and Actions

http://www.tepco.co.jp/nu/fukushima-np/handouts/2015/images/handouts_150325_04-j.pdf

3-2. Closure of Seawater Piping Trenches of Units 2, 3, 4

http://www.tepco.co.jp/nu/fukushima-np/handouts/2015/images/handouts_150325_08-j.pdf

4. Working-level Meeting of Decommissioning & Contaminated Water Issues Team (3/26/2015)

(only in Japanese)

4-1. Plant Status

http://www.tepco.co.jp/nu/fukushima-np/roadmap/images/d150326_04-j.pdf

4-2. Summary Status of Decommissioning Roadmap

http://www.tepco.co.jp/nu/fukushima-np/roadmap/images/d150326_05-j.pdf

(English translation as of 2/26/2015)

http://www.tepco.co.jp/en/nu/fukushima-np/roadmap/images/d150226_01-e.pdf

4-3. Contaminated Water Treatment

http://www.tepco.co.jp/nu/fukushima-np/roadmap/images/d150326_07-j.pdf

4-4. Environmental Radiation Issues (large file size: 56 MB)

http://www.tepco.co.jp/nu/fukushima-np/roadmap/images/d150326_08-j.pdf

4-5. Spent Fuel Pool Issues

http://www.tepco.co.jp/nu/fukushima-np/roadmap/images/d150326_10-j.pdf

4-6. Preparation for Fuel Debris Removal

http://www.tepco.co.jp/nu/fukushima-np/roadmap/images/d150326_11-j.pdf

4-7. Radioactive Waste Processing (Radionuclide Analyses of Samples Taken from Units 1-3 R/B)

http://www.tepco.co.jp/nu/fukushima-np/roadmap/images/d150326_12-j.pdf

All the best,

Kenji

----- Original Message -----

From: Tateiwa, Kenji

To: Tateiwa, Kenji

Sent: Thursday, March 12, 2015 8:50 PM

Subject: [TEPCO Weekly Fukushima Update Call] Fri, March 13, 2015 at 3pm EDT

Nuclear Sector Colleagues,

Please find below information for tomorrow's Weekly Fukushima Update Call.

[Date/time]

Fri, March 13, 2015 at 3 pm Eastern Daylight Time

(No Call Next Week. Next call will be on Fri, March 27 at 3 pm EDT.)

[call-in information] (Please record your name and organization when joining the call.)

call number: 718-354-1184

passcode:

[Major topics]

1. NRA Special Facilities Monitoring and Evaluation Committee (3/2/2015)

(only in Japanese)

1-1. Closure of Seawater Piping Trenches of Units 2, 3, 4

http://www.tepco.co.jp/nu/fukushima-np/handouts/2015/images/handouts_150304_05-j.pdf

1-2. Measures to Reduce Radioactivity in "K" Drainage Line

http://www.tepco.co.jp/nu/fukushima-np/handouts/2015/images/handouts_150304_06-j.pdf

1-3. Investigation on Temporary Increase in Radioactivity in Downstream of "B and C" Drainage Line

http://www.tepco.co.jp/nu/fukushima-np/handouts/2015/images/handouts_150304_07-j.pdf

1-4. Water Level Management after Operation of Frozen-Soil Wall

http://www.tepco.co.jp/nu/fukushima-np/handouts/2015/images/handouts_150304_08-j.pdf

2. Rain Water Level Drop in Outer Weir of H4 Area Tank (3/12/2015)

(only in Japanese)

http://www.tepco.co.jp/nu/fukushima-np/handouts/2015/images/handouts_150312_04-j.pdf

3. New Disclosure Policy and Independent Audit in Light of Recent Drainage Water Issue (3/6/2015)

http://www.tepco.co.jp/en/press/corp-com/release/2015/1248564_6844.html

4. TEPCO President's Remarks on 4th Anniversary of Great East Japan Earthquake (3/11/2015)

http://www.tepco.co.jp/en/press/corp-com/release/2015/1248663_6844.html

5. "Nuclear Energy in Japan Since Fukushima " (2/17/2015)

TEPCO's presentation at the Platts Nuclear Energy Conference.

http://www.platts.com/IM.Platts.Content/ProductsServices/ConferenceandEvents/2015/pc509/presentations/Kenji_Tateiwa.pdf

6. "Estimated Amount of Radioactive Materials Released into the Air by the Fukushima Daiichi NPS Accident" (3/10/2015)

TEPCO's presentation at the US NRC Regulatory Information Conference (RIC.)

<https://ric.nrc-gateway.gov/docs/abstracts/tateiwak-t5-hv-r1.pdf>

All the best,

Kenji

----- Original Message -----

From: Tateiwa, Kenji

To: Tateiwa, Kenji

Sent: Thursday, February 26, 2015 10:50 PM

Subject: [TEPCO Weekly Fukushima Update Call] Fri, Feb. 27, 2015 at 3pm EST

Nuclear Sector Colleagues,

Please find below information for tomorrow's Weekly Fukushima Update Call.

[Date/time]

Fri, Feb. 27, 2015 at 3 pm Eastern Standard Time

(No Call Next Week. Next call will be on Fri, March 13 at 3 pm EDT.)

[call-in information] (Please record your name and organization when joining the call.)

call number: 718-354-1184

passcode

[Major topics]

**1. On-Site Coordination Meeting on Decommissioning & Contaminated Water Issues
(2/23/2015)**

(only in Japanese)

1-1. Water Contamination Monitoring and Effectiveness of Groundwater Bypass System

http://www.tepco.co.jp/nu/fukushima-np/roadmap/images/l150223_04-j.pdf

1-2. Dismantling Plan for Unit 1 Reactor Building Cover

http://www.tepco.co.jp/nu/fukushima-np/roadmap/images/l150223_05-j.pdf

1-3. Occupational Safety Corrective Actions

http://www.tepco.co.jp/nu/fukushima-np/roadmap/images/l150223_06-j.pdf

1-4. Contaminated Water Issues

http://www.tepco.co.jp/nu/fukushima-np/roadmap/images/l150223_12-j.pdf

**2. Working-level Meeting of Decommissioning & Contaminated Water Issues Team
(2/26/2015)**

(only in Japanese)

2-1. Plant Status

http://www.tepco.co.jp/nu/fukushima-np/roadmap/images/d150226_04-j.pdf

2-2. Summary Status of Decommissioning Roadmap

http://www.tepco.co.jp/nu/fukushima-np/roadmap/images/d150226_05-j.pdf

(English translation as of 1/29/2015)

http://www.tepco.co.jp/en/nu/fukushima-np/roadmap/images/d150129_01-e.pdf

2-3. Re-insertion of Thermocouple into Unit 2 RPV Bottom via SLC Line

http://www.tepco.co.jp/nu/fukushima-np/roadmap/images/d150226_06-j.pdf

2-4. Contaminated Water Treatment

http://www.tepco.co.jp/nu/fukushima-np/roadmap/images/d150226_07-j.pdf

2-5. Environmental Radiation Issues

http://www.tepco.co.jp/nu/fukushima-np/roadmap/images/d150226_08-j.pdf

2-6. Spent Fuel Pool Issues

http://www.tepco.co.jp/nu/fukushima-np/roadmap/images/d150226_10-j.pdf

2-7. Preparation for Fuel Debris Removal (3D Laser Scanning, Muon Tomography)

http://www.tepco.co.jp/nu/fukushima-np/roadmap/images/d150226_11-j.pdf

2-8. D&D-Related R&D Progress and Future Plans

http://www.tepco.co.jp/nu/fukushima-np/roadmap/images/d150226_13-j.pdf

2-9. Selection of Technologies to Undergo Tritium-Separation Demonstration Testing

http://www.tepco.co.jp/nu/fukushima-np/roadmap/images/d150226_14-j.pdf

2-10. Establishment of Global Decommissioning Joint Research Center

http://www.tepco.co.jp/nu/fukushima-np/roadmap/images/d150226_15-j.pdf

3. Temporary Increase in Radioactivity in Downstream of "B and C" Drainage Line (2/24/2015)

http://www.tepco.co.jp/en/press/corp-com/release/2015/1248327_6844.html

4. Unit 2 Reactor Building Truck Bay Door Roof Likely Source of Radioactivity in "K" Drainage Line (2/24/2015)

www.tepco.co.jp/en/nu/fukushima-np/handouts/2015/images/handouts_150224_01-e.pdf

5. Briefing to Fishermen's Association in Fukushima Prefecture Regarding Contaminated Water Issues (2/25/2015)

(only in Japanese)

http://www.tepco.co.jp/nu/fukushima-np/handouts/2015/images/handouts_150225_05-j.pdf

6. Unit 1 Reactor Building 4th Floor Inspection by Technical Committee of Niigata Prefecture (2/21/2015)

(only in Japanese)

http://www.tepco.co.jp/nu/fukushima-np/handouts/2015/images/handouts_150221_06-j.pdf

7. Third IAEA Review of Fukushima Daiichi Decommissioning Roadmap (2/17/2015)

<https://www.iaea.org/newscenter/pressreleases/iaea-team-completed-third-review-japans-plans-decommission-fukushima>

(photos)

http://www.tepco.co.jp/en/nu/fukushima-np/handouts/2015/images/handouts_150217_03-e.pdf

All the best,

Kenji

----- Original Message -----

From: Tateiwa, Kenji

To: Tateiwa, Kenji

Sent: Thursday, February 12, 2015 10:37 PM

Subject: [TEPCO Weekly Fukushima Update Call] Fri, Feb. 13, 2015 at 3pm EST

Nuclear Sector Colleagues,

Please find below information for tomorrow's Weekly Fukushima Update Call.

[Date/time]

Fri, Feb. 13, 2015 at 3 pm Eastern Standard Time

(No Call Next Week. Next call will be on **Fri, Feb. 27** at 3 pm EST.)

[call-in information] (Please record your name and organization when joining the call.)

call number: 718-354-1184

passcode:

[Major topics]

1. NRA Special Facilities Monitoring and Evaluation Committee (2/9/2015)

(only in Japanese)

1-1. Closure of Seawater Piping Trenches of Units 2, 3, 4

http://www.nsr.go.jp/committee/youushikisya/tokutei_kanshi/data/0031_02.pdf

1-2. Water Level Management after Operation of Frozen-Soil Wall (summary)

http://www.nsr.go.jp/committee/yuushikisya/tokutei_kanshi/data/0031_03.pdf

1-3. Water Level Management after Operation of Frozen-Soil Wall (reference information)

http://www.nsr.go.jp/committee/yuushikisya/tokutei_kanshi/data/0031_08.pdf

2. Installation of Muon Detectors for Fuel Debris Detection at Unit 1 (2/9/2015)

http://www.tepco.co.jp/en/press/corp-com/release/2015/1248057_6844.html

(photos)

http://www.tepco.co.jp/en/nu/fukushima-np/handouts/2015/images/handouts_150209_01-e.pdf

3. *"The Great Race: The Global Quest for the Car of the Future"*

<http://amzn.com/B00LD1OP0Q>

This book features TEPCO's current Chief Nuclear Officer, Takafumi Anegawa, as a visionary who jump started Japan's electric vehicle industry.

All the best,
Kenji

<Reference>

**“Development of a technology to investigate inside the
Reactor Primary Containment Vessel (PCV)”
-Site test “Investigation B1”
on grating around the pedestal inside Unit 1 PCV-**

April 6, 2015

Tokyo Electric Power Company



IRID

The content of this material includes the output of the International Research Institute for Nuclear Decommissioning (IRID).

1. Investigation overview

At Fukushima Daiichi NPS Unit 1, investigation is planned using a robot for the purpose of earning information on the 1st floor grating inside the Primary Containment Vessel (PCV). The robot will be inserted from X-100B penetration pipe.

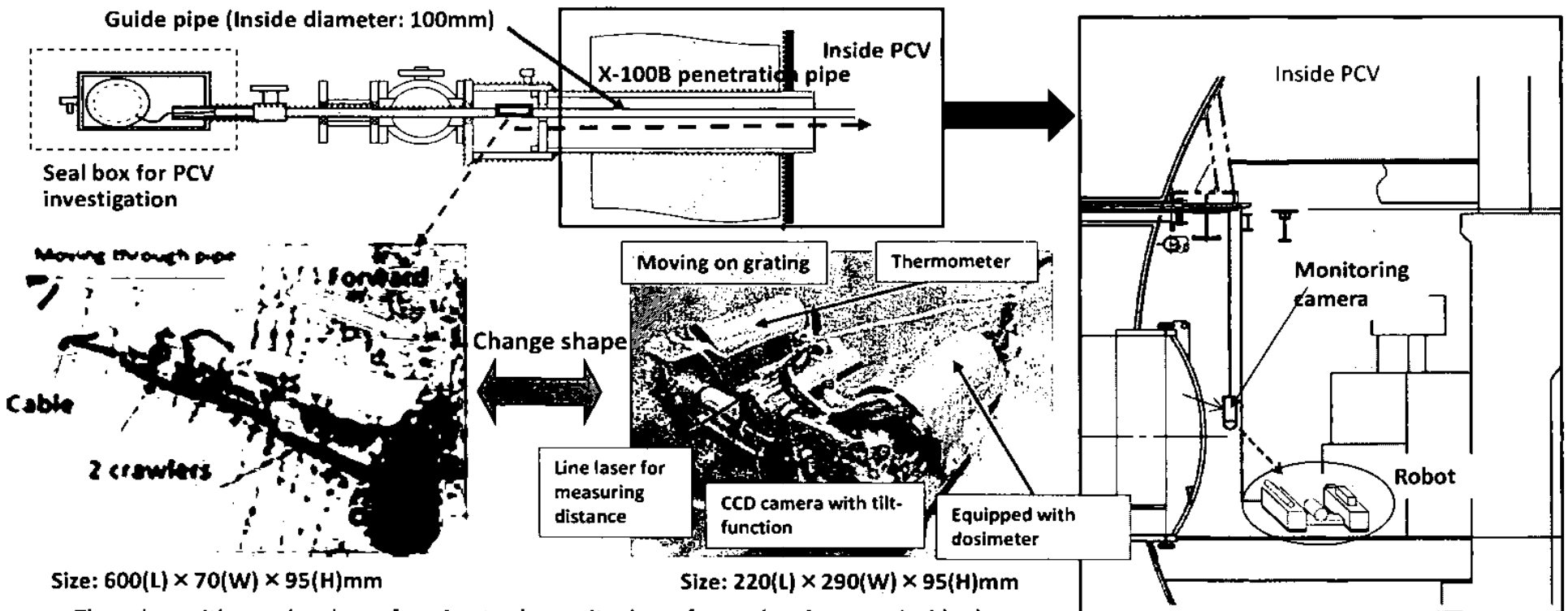

The robot with crawlers has a function to change its shape from when it moves inside the narrow pipe (X-100B penetration pipe: inside diameter: 100mm) to when it reaches inside the

PCV and moves around the grating.

2. Investigation method

The investigation will be conducted twice (Clockwise route, counterclockwise route)

Investigation plan

No.	Purpose	Location	Content	Device
①	Investigating obstacles for further investigation under the grating outside the pedestal ("Investigation B2")	Opening to access under the grating	Video	CCD camera
②	Investigating obstacles for further investigation inside the pedestal	CRD rail	Video	CCD camera
③	Investigating environment	On the access route *	Temperature Radiation	Thermometer Dosimeter
	Investigating existing structures		Video	CCD camera

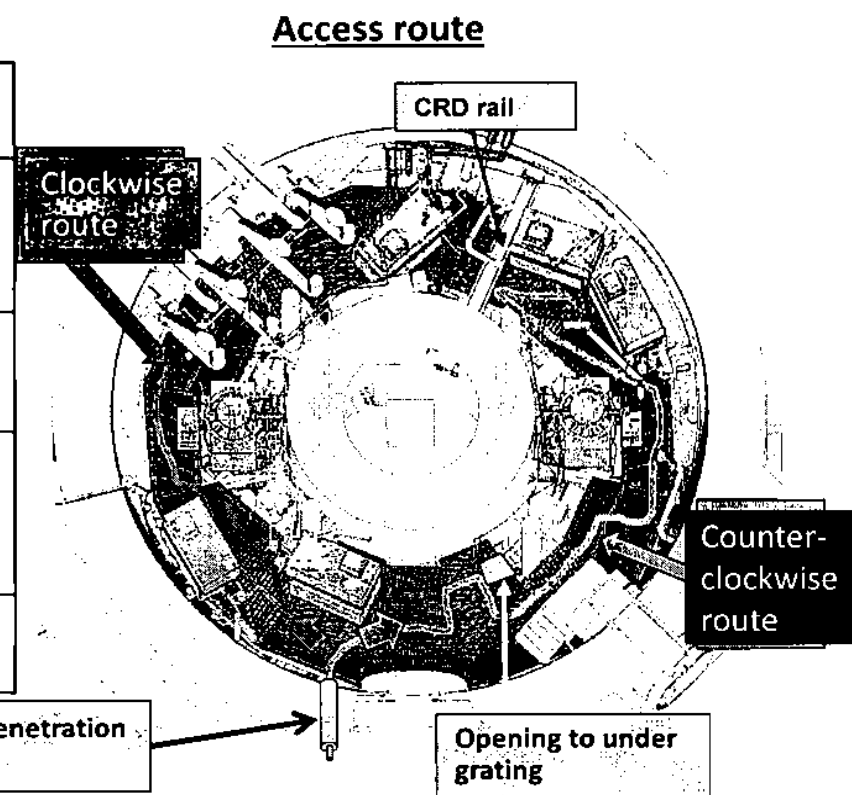

*Investigation will be conducted within the possible area.

3. Investigation location

The robot stops and collects data (images, temperature, dosage etc.) at each investigation location

B0 ~ B18 Investigation location
C0 ~ C11 Investigation location

The locations may change due to environment inside the vessel.

⬆ : Access route (counterclockwise)
 ⬆ : Access route (clockwise)

[Investigation image]

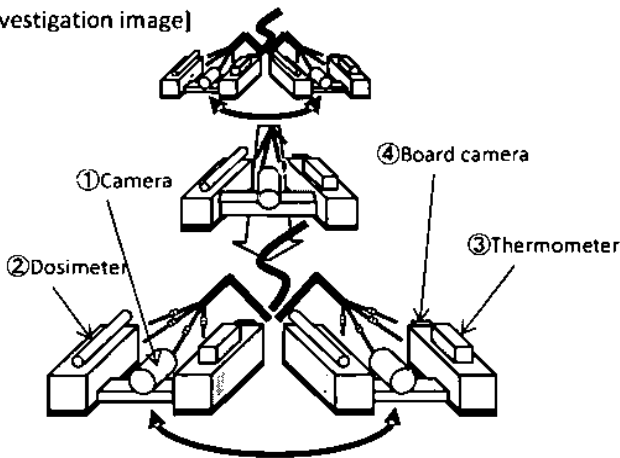

The robot moves slowly confirming its surrounding environment, moving its camera up-down and right-left on each investigation location.

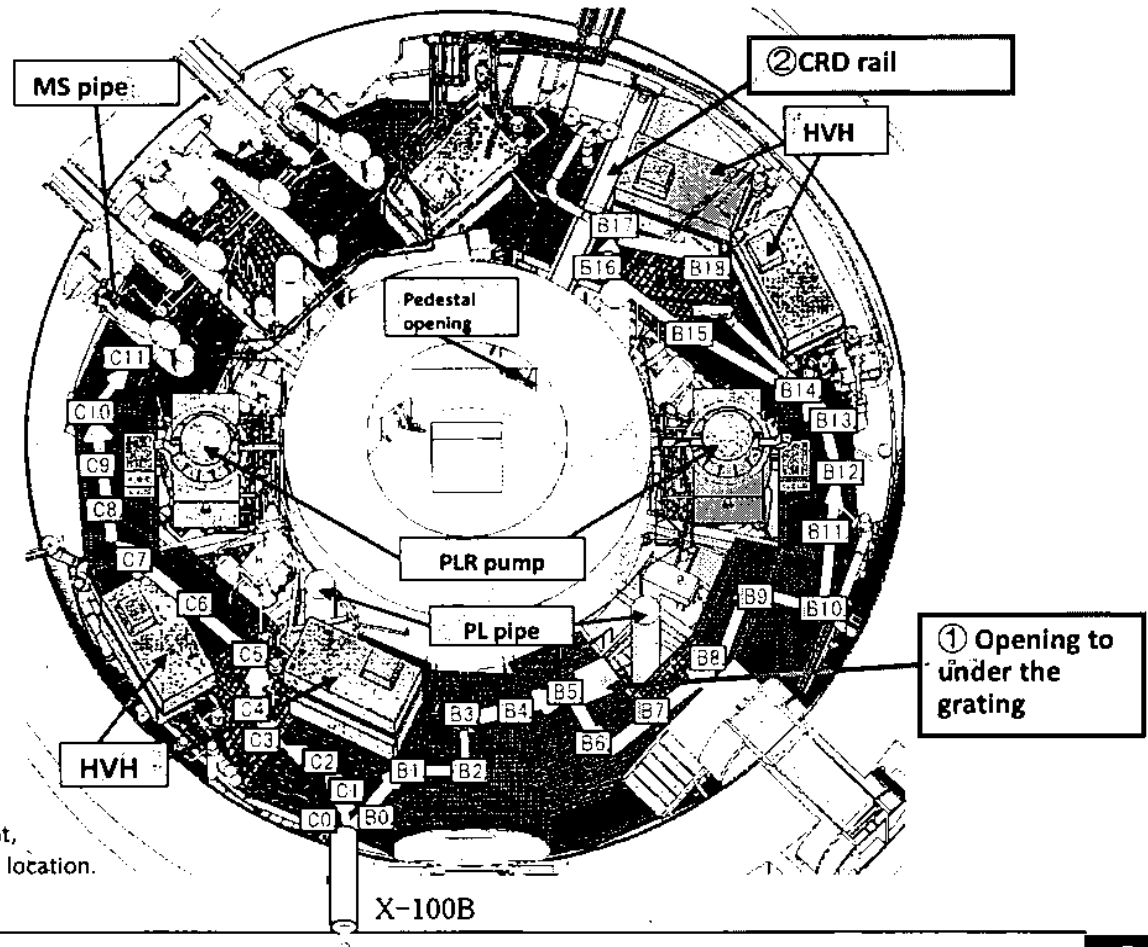

4. Purpose of "Investigation B1"

- Purpose of "Investigation B1" will be collecting information on 1st floor grating.
- Investigation results ⇒ It will be used to make a plan of "Investigation B2" *.

*"Investigation B2" ⇒ Investigation under grating outside the pedestal

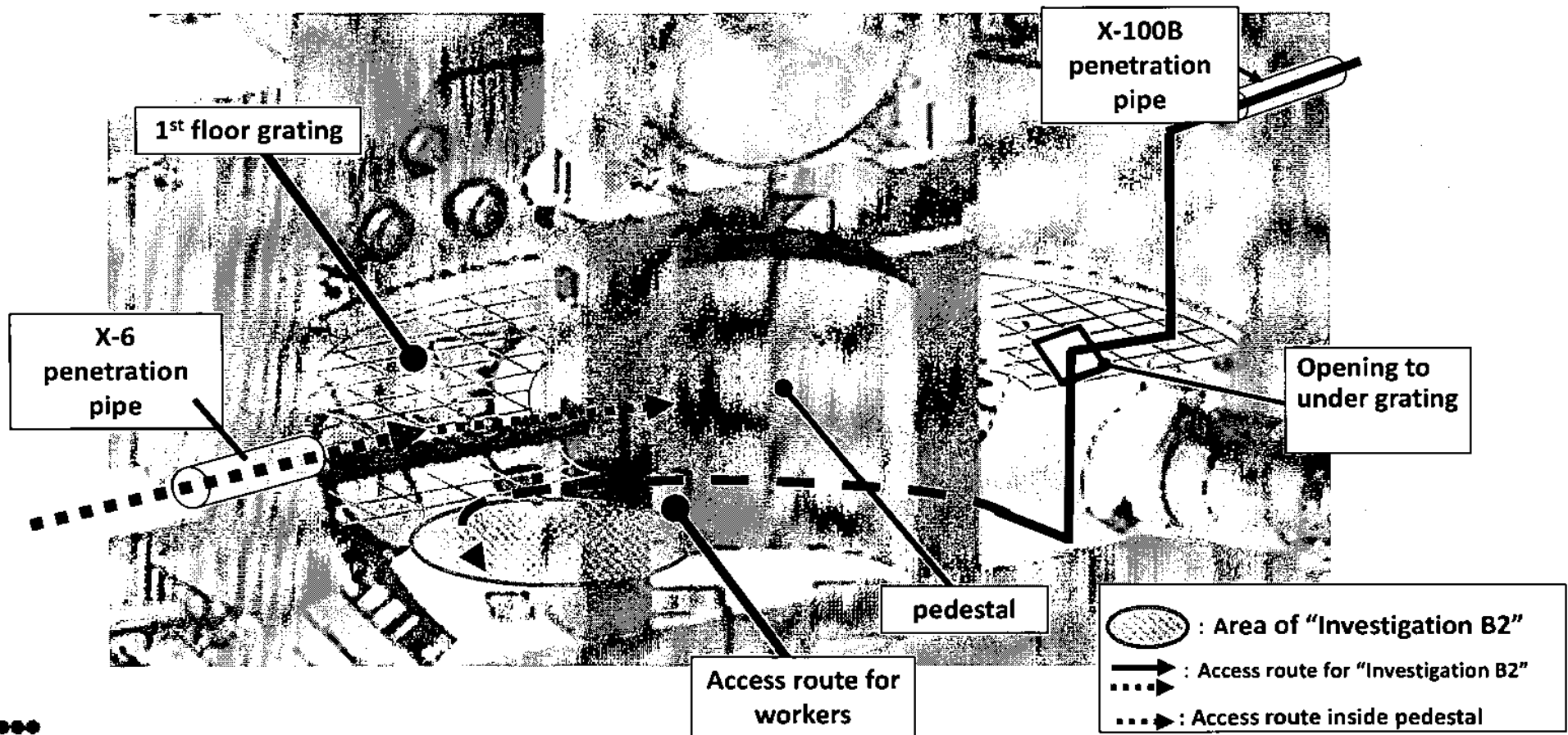

5. Others [Moving the Unit 1 PCV permanent monitoring gauge]

■ Moving the permanent monitoring gauge

The permanent monitoring gauges will be removed due to the conduct of "Investigation B1" at Unit 1, and will be installed back at the same place

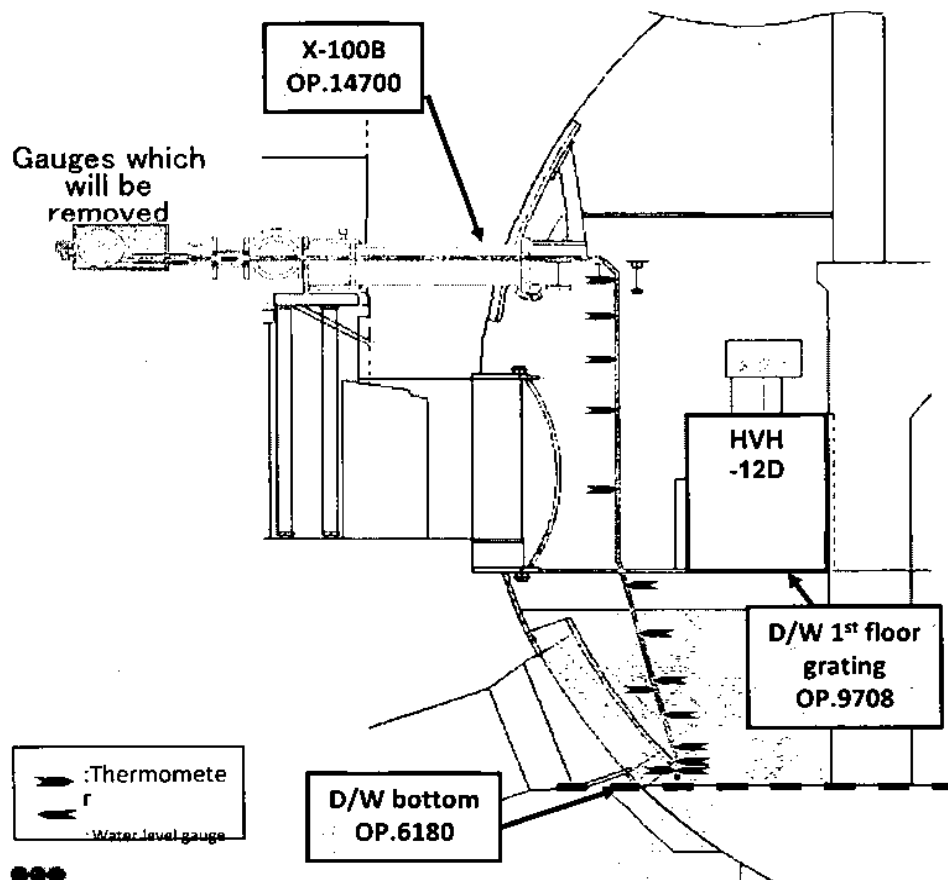

Thermometer thermocouple

T7	OP.14500
T6*	OP.14000
T5	OP.13230
T4	OP.12500
T3*	OP.11200
T2	OP.7500
T1	OP.6330

Water level gauge: electrode

L7	OP.9380
L6	OP.8580
L5	OP.7780
L4	OP.7280
L3	OP.6780
L2	OP.6480
L1	OP.6330

*Thermometer for monitoring cold shutdown condition as written in the "Implementation plan Chapter 3 provision 18"

They will be taken off from the list of monitoring cold shutdown during the investigation.

6. Schedule

	April 2015												
	6	7	8	9	10	11	12	13	14	15	16	17	18
	Mon	Tue	Wed	Thu	Fri	Sat	Sun	Mon	Tue	Wed	Thu	Fri	Sat
1. Preparing for investigation (from March 31)	■			■ Installing equipment		■ Removing/installing equipment			■ Removing equipment				
2. Removing permanent monitoring gauges		▼ Removing gauges ■											
3. Investigation B1					■			■					
4. Installing monitoring gauges on the same place										■ Installing gauges			

Hackett, Edwin

From: Joy Rempe <jlrempe@cableone.net>
Sent: Friday, April 10, 2015 10:44 AM
To: Tateiwa, Kenji
Cc: Hackett, Edwin; Banks, Mark; Stetkar, John; Meador, Sherry
Subject: Re: Revised Slides [ACRS Briefing on Fukushima D&D] Fri, April 10, 2015

Hi Kenji,

I really appreciate your adding this information, but I think that I need to mention that our hour time limit for the presentation is firm. ACRS has several letters that must be completed by noon tomorrow. I fear that it may be difficult for you to make it though all of these slides within this timeframe (because of our questions). Perhaps you may need to plan in advance that some slides may need to be omitted?

I apologize (in advance) about this short timeframe.

Best wishes,
Joy

Dr. Joy L. Rempe, Principal
Rempe and Associates, LLC
306 Stillwater
Idaho Falls, ID 83404
Phone: 208-520-3708
Email: jlrempe@cableone.net
Website: www.rempellc.com

On Fri, Apr 10, 2015 at 7:27 AM, Tateiwa, Kenji <tateiwa.kenji@tepcoco.jp> wrote:
Hi Joy and Ed,

Per Joy's request last night regarding inclusion of the topic of Unit 3 drywell shield plug, I have added 2 slides (p.28-29.)

http://www.tepcoco.jp/nu/fukushima-np/handouts/2015/images/handouts_150330_04-j.pdf

I also took this opportunity to make slight modifications in the planned timing of drywell inspections in Units 1-3.

Ed,

I hope it is OK for me to use this material this afternoon.

Thank you for arranging for a visitor's parking.

I will see you at 11:30 am.

All the best,
Kenji

On Tue, 7 Apr 2015 08:14:28 -0400
"Hackett, Edwin" <Edwin.Hackett@nrc.gov> wrote:

> Thanks Kenji. Looking forward to meeting you on Friday.
>
> Since you are driving, you will enter the NRC HQ complex at the main vehicle entrance off Marinelli Road, just down from the METRO station. I will plan on meeting you at the guard shack at the entrance at 11:30 a.m. where you will be processed through security. We have arranged for visitor parking for you.
>
> Best,
>
> Ed
>
> -----Original Message-----
> From: Tateiwa, Kenji [mailto:tateiwa.kenji@tepcoco.jp]
> Sent: Tuesday, April 07, 2015 2:40 AM
> To: Hackett, Edwin
> Cc: Joy Rempe; Banks, Mark; Stetkar, John; Meador, Sherry
> Subject: Slides [ACRS Briefing on Fukushima D&D] Fri, April 10, 2015
>
> Hi Ed,
>
> Please find attached my presentation for the ACRS briefing on Fukushima D&D on April 10.
> Thank you for your patience and I look forward to having a productive meeting.
>
> All the best,
> Kenji
>
> On Tue, 07 Apr 2015 04:44:19 +0900
> "Tateiwa, Kenji" <tateiwa.kenji@tepcoco.jp> wrote:
>
>> Hi Ed,
>>
>> Thank you for the detailed instruction for Friday.
>> I will plan on arriving at the NRC HQ at around 11:30 am.
>>
>> I would appreciate if you could make arrangement for my parking--I will be driving a gray Toyota Corolla
>>
>>
>> All the best,
>> Kenji
>>
>> On Mon, 6 Apr 2015 09:42:50 -0400
>> "Hackett, Edwin" <Edwin.Hackett@nrc.gov> wrote:
>>
>>> Hi Kenji,
>>>
>>> In my previous communication, I neglected to give you more specific instructions regarding your visit.
>>>
>>> Given that we have you scheduled for 12:15 p.m. on Friday, it would be good if you could plan on arriving at NRC HQ no later than 11:45 a.m. You are also obviously welcome to come earlier if you choose. The NRC HQ complex is located in Rockville, MD and is at the White Flint METRO station. METRO provides the most convenient access, but if you are driving, our address is:

>>>

>>> 11545 Rockville Pike

>>> Rockville, MD

>>>

>>> Also, if you are driving, please let me know in advance so we can work on arranging parking for you.

>>>

>>> When you arrive, please proceed to the front entrance of the One White Flint North Building (OWFN) (the tallest building directly across the street from the METRO). When you get there, you will be processed through security and you can call us for an escort.

>>>

>>> The ACRS Main line is 301-415-7360. My cell phone is [redacted] if you need to reach me. We are located in the Two White Flint North (TWFN) Building. Your presentation will be in Room T-2 B1). (b)(6)

>>>

>>> Please let me know if you have any questions.

>>>

>>> Best,

>>>

>>> Ed

>>>

=====

>>> Sherry - Here is Dr. Tateiwa's information. I would appreciate it if you could pre-register him in the security system:

>>>

>>> Kenji Tateiwa

>>> Manager, Nuclear Power Programs

>>> Tokyo Electric Power Company

>>> Washington Office

>>> 2121 K Street, NW Suite 910

>>> Washington, DC 20037

>>> tel: +1-202-457-0790 (ext.)116

>>> mobile: [redacted] (b)(6)

>>>

>>>

>>> Thanks,

>>>

>>> Ed

>>>

>>> -----Original Message-----

>>> From: Tateiwa, Kenji [mailto:tateiwa.kenji@tepcoco.jp]

>>> Sent: Monday, April 06, 2015 1:47 AM

>>> To: Hackett, Edwin

>>> Cc: Joy Rempe; Banks, Mark; Stetkar, John

>>> Subject: RE: [ACRS Briefing on Fukushima D&D] Fri, April 10, 2015

>>>

>>> Dear Ed,

>>>

>>> Apologies for not being able to provide you with my presentation by the April 3 deadline.

>>> I am still working on it and plan to send you the slides by the end of Mon, April 6.

>>>

>>> Could you tell me what time and where I should meet you on Fri, April 10?

>>>

>>> All the best,

>>> Kenji

>>>

>>> On Tue, 17 Feb 2015 08:33:36 -0500

>>> "Hackett, Edwin" <Edwin.Hackett@nrc.gov> wrote:

>>>

>>>> Thanks Kenji.

>>>>

>>>> We will be looking forward to your presentation.

>>>>

>>>> Ed

>>>>

>>>> From: Tateiwa, Kenji [tateiwa.kenji@tepcoco.jp]

>>>> Sent: Monday, February 16, 2015 12:58 PM

>>>> To: Joy Rempe; Hackett, Edwin

>>>> Cc: Banks, Mark; Stetkar, John

>>>> Subject: [ACRS Briefing on Fukushima D&D] Fri, April 10, 2015

>>>>

>>>> Dear Joy and Ed,

>>>>

>>>> Thank you for your note.

>>>>

>>>> I will prepare to provide a 1/2 hour briefing + 1/2 hour Q&A on Fukushima Daiichi D&D status to the ACRS on Fri, April 10.

>>>> I will send you my slides by April 3 at the latest.

>>>>

>>>> All the best,

>>>> Kenji

>>>>

>>>> ----- Original Message -----

>>>> From: "Hackett, Edwin" <Edwin.Hackett@nrc.gov<<mailto:Edwin.Hackett@nrc.gov>>>

>>>> To: "Joy Rempe" <jlrempe@cableone.net<<mailto:jlrempe@cableone.net>>>; "Tateiwa, Kenji" <tateiwa.kenji@tepcoco.jp<<mailto:tateiwa.kenji@tepcoco.jp>>>

>>>> Cc: "Stetkar, John" <John.Stetkar@nrc.gov<<mailto:John.Stetkar@nrc.gov>>>; "Banks, Mark" <Mark.Banks@nrc.gov<<mailto:Mark.Banks@nrc.gov>>>

>>>> Sent: Friday, February 13, 2015 4:52 PM

>>>> Subject: RE: Invitation to Brief ACRS

>>>>

>>>> Thanks Joy.

>>>>

>>>> Dr. Tateiwa,

>>>>

>>>> We are very pleased that you will be able to do the briefing. Per your request, we will schedule an hour total for the briefing on Friday, April 10. We will get you the exact time, once we have worked out details for our April agenda in a few weeks.

>>>>

>>>> Per your discussion with Joy, if you could plan for a 1/2 hour presentation, that would be great. We would then leave another half hour to allow for Committee questions. If you feel you need more time, please let us know. We would appreciate having your slides and any appropriate background material a week or two in advance so that the members can prepare appropriately.

>>>>

>>>> Please let us know if you have any questions.

>>>>

>>>> Thanks,

>>>>

>>>> Ed Hackett

>>>>

>>>> From: Joy Rempe [jlrempe@cableone.net]

>>>> Sent: Friday, February 13, 2015 3:53 PM

>>>> To: Tateiwa, Kenji

>>>> Cc: Stetkar, John; Hackett, Edwin; Banks, Mark

>>>> Subject: Re: Invitation to Brief ACRS

>>>>

>>>> Great.

>>>>

>>>> This is the first time that I've been involved with assisting someone that will be giving a presentation at ACRS. Ed Hackett, our executive director, will have to help us understand the next steps with scheduling. He'll also have to inform us with the process for thank you letters. However, I'm guessing that the letter will be signed by our chairman, Mr. John Stetkar. My experience is that nothing is informal when it comes to federal advisory committees! Let me know if additional assistance is needed.

>>>>

>>>> I was glad to be part of the weekly teleconference today. It will be interesting to see what information is obtained with the muon tomography installation. I've also completed the draft forensics inspection report. Mitch and Mike are currently reviewing it. I hope to send you and Damian a copy next week for your comments.

>>>>

>>>> Best wishes,

>>>> Joy

>>>>

>>>> Dr. Joy L. Rempe, Principal

>>>> Rempe and Associates, LLC

>>>> 306 Stillwater

>>>> Idaho Falls, ID 83404

>>>> Phone: 208-520-3708

>>>> Email:

jlrempe@cableone.net<<mailto:jlrempe@cableone.net><<mailto:jlrempe@cableone.net><<mailto:jlrempe@cableone.net>>>>

>>>>

>>>> On Fri, Feb 13, 2015 at 1:39 PM, Tateiwa, Kenji

<tateiwa.kenji@tepco.co.jp<<mailto:tateiwa.kenji@tepco.co.jp><<mailto:tateiwa.kenji@tepco.co.jp><<mailto:tateiwa.kenji@tepco.co.jp>>>>> wrote:

>>>> Hi Joy,

>>>>

>>>> Apologies for the late reply--TEPCO's Chief Nuclear Officer was visiting the U.S. this week and I was preoccupied arranging and attending all the meetings with him.

>>>>

>>>> I am very glad to hear that the ACRS members are eager to learn about the situation at Fukushima Daiichi and I look forward to a lively session with many "interruptions" with your colleagues.

>>>>

>>>> I also appreciate your thoughtful offer to write a letter to TEPCO's senior management.

>>>> It would be great if you could send a note to the following person after the meeting (email would be

fine.)

>>>>

>>>> Takafumi Anegawa
>>>> Chief Nuclear Officer
>>>>

anegawa.takafumi@tepcoco.jp<mailto:anegawa.takafumi@tepcoco.jp><mailto:anegawa.takafumi@tepcoco.jp>
[p<mailto:anegawa.takafumi@tepcoco.jp>>](mailto:anegawa.takafumi@tepcoco.jp)

>>>>

>>>> All the best,
>>>> Kenji

>>>> ----- Original Message -----

>>>> From: Joy Rempe<mailto:jlrempe@cableone.net>

>>>> To: Tateiwa, Kenji<mailto:tateiwa.kenji@tepcoco.jp>

>>>> Cc: Banks, Mark<mailto:Mark.Banks@nrc.gov> ; Edwin Hackett<mailto:Edwin.Hackett@nrc.gov> ;

Stetkar, John<mailto:John.Stetkar@nrc.gov>

>>>> Sent: Monday, February 09, 2015 7:45 PM

>>>> Subject: Re: Invitation to Brief ACRS

>>>>

>>>> Hi Kenji,

>>>>

>>>> Thanks for your willingness to brief us. Unfortunately, because of the rules related to federal advisory committees, we aren't allowed to be 'casual'. Nevertheless, when it was brought up during our planning meeting, most of us knew you (or of you) and enthusiastically agreed that this was a great opportunity. Many of us were also already aware that you'd previously given the NRC staff a briefing (and regretted not being able to attend it). I've heard that it was well-received by the staff.

>>>>

>>>> Please be prepared for us 'interrupting' you with questions. It is just our way of learning. Your 30 minute presentation will easily expand to fill the entire hour.

>>>>

>>>> Also, several of us are already thinking that a 'thank-you' letter is needed for your kindness. Please let us know the appropriate TEPCO individual (and title) that should receive this letter.

>>>>

>>>> Best wishes,

>>>> Joy

>>>>

>>>> On 2/9/2015 5:27 PM, Tateiwa, Kenji wrote:

>>>> Hi Joy,

>>>>

>>>> Thank you for following up on my offer to brief the ACRS members.

>>>> I was thinking about a casual meeting, but it is an overwhelming honor to be invited to the full committee meeting.

>>>>

>>>> All of the dates that you proposed work for me, but my preference will be Fri, April 10th.

>>>> I look forward to the opportunity of sharing the status of Fukushima Daiichi and D&D related progress to you and your ACRS colleagues.

>>>>

>>>> All the best,

>>>> Kenji

>>>> -----

>>>> Kenji Tateiwa

>>>> Manager, Nuclear Power Programs

>>>> Tokyo Electric Power Company
>>>> Washington Office
>>>> 2121 K Street, NW Suite 910
>>>> Washington, DC 20037
>>>> tel: +1-202-457-0790 (ext.)116
>>>> mobile: (b)(6)

>>>> ----- Original Message -----

>>>> From: Joy Rempe<mailto:jlrempe@cableone.net>
>>>> To: Tateiwa, Kenji<mailto:tateiwa.kenji@tepcoco.jp>
>>>> Cc: Edwin Hackett<mailto:Edwin.Hackett@nrc.gov> ; Banks, Mark<mailto:Mark.Banks@nrc.gov>
>>>> Sent: Friday, February 06, 2015 2:48 PM
>>>> Subject: Invitation to Brief ACRS

>>>> Hi Kenji,

>>>> I followed up on your offer to provide ACRS a briefing before you return to Tokyo. Today, the ACRS voted to invite you to provide us a briefing at either our April or May full committee meetings. The dates of these meetings are April 9-10 or May 7-8. The ACRS would like to request that your presentation focus on the status of the affected plants (especially related to results from recent investigations/inspections by TEPCO), D&D efforts, and future plans for their D&D and any examinations.. Your presentation should last approximately 30 minutes, but plan for the briefing to last an hour (e.g., ACRS members will be asking questions throughout your briefing, so the briefing tends to double in time).

>>>> I've copied Dr. Ed Hackett, Executive Director of the ACRS, and Mr. Mark Banks, Branch Manager for ACRS. We'd appreciate your responding to all three of us related to possible times that you would be available during these meetings. They will schedule a time when you are available and facilitate the processes required for your gaining access to the NRC Headquarters in North Bethesda, DC.

>>>> Thanks again for offering to provide us this presentation.

>>>> Best wishes,

>>>> Joy

>>>> Dr. Joy L. Rempe, Principal

>>>> Rempe and Associates, LLC

>>>> 306 Stillwater

>>>> Idaho Falls, ID 83404

>>>> Phone: 208-520-3708<tel:208-520-3708>

>>>> Email: jlrempe@cableone.net<mailto:jlrempe@cableone.net><mailto:jlrempe@cableone.net>>

From: Joy Rempe
To: Banks, Mark
Cc: Rempe, Joy
Subject: Fwd: Invitation to Brief ACRS
Date: Saturday, April 11, 2015 1:13:48 PM

Hi Mark,

The address of the individual to whom the thank-you letter should be sent (Anegawa) can be found in this email from Kenji. Probably a signed letter from John that is sent by email would be the best approach (then you can copy Kenji and others).

Thanks,
Joy

Dr. Joy L. Rempe, Principal
Rempe and Associates, LLC
306 Stillwater
Idaho Falls, ID 83404
Phone: 208-520-3708
Email: jrempe@cableone.net
Website: www.rempellc.com

----- Forwarded message -----

From: Tateiwa, Kenji <tateiwa.kenji@tepcoco.jp>
Date: Fri, Feb 13, 2015 at 1:39 PM
Subject: Re: Invitation to Brief ACRS
To: Joy Rempe <jrempe@cableone.net>
Cc: "Stetkar, John" <John.Stetkar@nrc.gov>, Edwin Hackett <Edwin.Hackett@nrc.gov>, "Banks, Mark" <Mark.Banks@nrc.gov>

Hi Joy,

Apologies for the late reply--TEPCO's Chief Nuclear Officer was visiting the U.S. this week and I was preoccupied arranging and attending all the meetings with him.

I am very glad to hear that the ACRS members are eager to learn about the situation at Fukushima Daiichi and I look forward to a lively session with many "interruptions" with your colleagues.

I also appreciate your thoughtful offer to write a letter to TEPCO's senior management. It would be great if you could send a note to the following person after the meeting (email would be fine.)

Takafumi Anegawa
Chief Nuclear Officer
anegawa.takafumi@tepcoco.jp

All the best,

Kenji

----- Original Message -----

From: Joy Rempe

To: Tateiwa, Kenji

Cc: Banks, Mark ; Edwin Hackett ; Stetkar, John

Sent: Monday, February 09, 2015 7:45 PM

Subject: Re: Invitation to Brief ACRS

Hi Kenji,

Thanks for your willingness to brief us. Unfortunately, because of the rules related to federal advisory committees, we aren't allowed to be 'casual'. Nevertheless, when it was brought up during our planning meeting, most of us knew you (or of you) and enthusiastically agreed that this was a great opportunity. Many of us were also already aware that you'd previously given the NRC staff a briefing (and regretted not being able to attend it). I've heard that it was well-received by the staff.

Please be prepared for us 'interrupting' you with questions. It is just our way of learning. Your 30 minute presentation will easily expand to fill the entire hour.

Also, several of us are already thinking that a 'thank-you' letter is needed for your kindness. Please let us know the appropriate TEPCO individual (and title) that should receive this letter.

Best wishes,
Joy

On 2/9/2015 5:27 PM, Tateiwa, Kenji wrote:

Hi Joy,

Thank you for following up on my offer to brief the ACRS members.

I was thinking about a casual meeting, but it is an overwhelming honor to be invited to the full committee meeting.

All of the dates that you proposed work for me, but my preference will be Fri, April 10th.

I look forward to the opportunity of sharing the status of Fukushima Daiichi and D&D related progress to you and your ACRS colleagues.

All the best,
Kenji

Kenji Tateiwa
Manager, Nuclear Power Programs
Tokyo Electric Power Company
Washington Office
2121 K Street, NW Suite 910
Washington, DC 20037
tel: +1-202-457-0790 (ext.)116

(b)(6)

mobile [REDACTED]

----- Original Message -----

From: Joy Rempe

To: Tateiwa, Kenji

Cc: Edwin Hackett ; Banks, Mark

Sent: Friday, February 06, 2015 2:48 PM

Subject: Invitation to Brief ACRS

Hi Kenji,

I followed up on your offer to provide ACRS a briefing before you return to Tokyo. Today, the ACRS voted to invite you to provide us a briefing at either our April or May full committee meetings. The dates of these meetings are April 9-10 or May 7-8. The ACRS would like to request that your presentation focus on the status of the affected plants (especially related to results from recent investigations/inspections by TEPCO), D&D efforts, and future plans for their D&D and any examinations.. Your presentation should last approximately 30 minutes, but plan for the briefing to last an hour (e.g., ACRS members will be asking questions throughout your briefing, so the briefing tends to double in time).

I've copied Dr. Ed Hackett, Executive Director of the ACRS, and Mr. Mark Banks, Branch Manager for ACRS. We'd appreciate your responding to all three of us related to possible times that you would be available during these meetings. They will schedule a time when you are available and facilitate the processes required for your gaining access to the NRC Headquarters in North Bethesda, DC.

Thanks again for offering to provide us this presentation.

Best wishes,
Joy

Dr. Joy L. Rempe, Principal
Rempe and Associates, LLC
306 Stillwater
Idaho Falls, ID 83404
Phone: 208-520-3708
Email: jirempe@cableone.net

Dr. Joy L. Rempe, Principal
Rempe and Associates, LLC
306 Stillwater
Idaho Falls, ID 83404

Phone: 208-520-3708

Email: jlrempe@cableone.net

From: [Hackett, Edwin](#)
To: [Joy Rempe](#)
Cc: [Banks, Mark](#); [Rempe, Joy](#)
Subject: RE: Documentation for Calvert Cliffs SGTR MELCOR and CFD Calculations
Date: Wednesday, April 15, 2015 2:13:13 PM

Thanks Joy – no confirmation yet – we are just sending to them today.

Ed

From: Joy Rempe [mailto:jlrempe@cablcone.net]
Sent: Wednesday, April 15, 2015 2:08 PM
To: Hackett, Edwin
Cc: Banks, Mark; Rempe, Joy
Subject: Re: Documentation for Calvert Cliffs SGTR MELCOR and CFD Calculations

If, it is selected by the Commissioners, I agreed to do it. Have the Commissioners selected this topic?

Because I am anal about preparations (and because I often just touch base with her with amusing bits of information), I sent Patty a note (and she's checking with Svinicki to verify that 'education' is why she asked to have it presented).

Joy

Dr. Joy L. Rempe, Principal
Rempe and Associates, LLC
306 Stillwater
Idaho Falls, ID 83404
Phone: 208-520-3708
Email: jlrempe@cablcone.net
Website: www.rempellc.com

On Wed, Apr 15, 2015 at 11:59 AM, Hackett, Edwin <Edwin.Hackett@nrc.gov> wrote:
Thanks Joy!

Another subject – Will you be doing the presentation to the Commission on the RES Quality Review in June?

From: Joy Rempe [mailto:jlrempe@cablcone.net]
Sent: Wednesday, April 15, 2015 1:57 PM
To: Hackett, Edwin
Cc: Banks, Mark; Rempe, Joy
Subject: Re: Documentation for Calvert Cliffs SGTR MELCOR and CFD Calculations

Yes.. I asked Kenji awhile ago for the name. I resent the information to Mark last weekend, and I think that he has it covered. If I should also resend the information to you, let me know.

Joy

Dr. Joy L. Rempe, Principal
Rempe and Associates, LLC

306 Stillwater
Idaho Falls, ID 83404
Phone: [208-520-3708](tel:208-520-3708)
Email: jrempe@cablone.net
Website: www.rempelle.com

On Wed, Apr 15, 2015 at 11:54 AM, Hackett, Edwin <Edwin.Hackett@nrc.gov> wrote:
Another subject – Do you know Kenji's boss? I was thinking we should send him an email or letter thanking him for the presentation?

Ed

From: Joy Rempe [<mailto:jrempe@cablone.net>]
Sent: Wednesday, April 15, 2015 1:17 PM
To: Hackett, Edwin
Cc: Rempe, Joy
Subject: Re: Documentation for Calvert Cliffs SGTR MELCOR and CFD Calculations

thanks... it would have been nice if richard would have just released the documents prior to the meeting rather than asking what else we wanted to see beyond what was in the draft NUREG during the meeting

Dr. Joy L. Rempe, Principal
Rempe and Associates, LLC
306 Stillwater
Idaho Falls, ID 83404
Phone: [208-520-3708](tel:208-520-3708)
Email: jrempe@cablone.net
Website: www.rempelle.com

On Wed, Apr 15, 2015 at 11:12 AM, Hackett, Edwin <Edwin.Hackett@nrc.gov> wrote:
Joy – Thanks for the explanation. I agree with your plan.

Ed

From: Joy Rempe [<mailto:jrempe@cablone.net>]
Sent: Wednesday, April 15, 2015 11:54 AM
To: Hackett, Edwin
Cc: Brown, Christopher; Rempe, Joy; Banks, Mark
Subject: Re: Documentation for Calvert Cliffs SGTR MELCOR and CFD Calculations

Hi Ed,

Perhaps this is better discussed by phone but I would recommend that I give the two reports to Christopher, and he wait and include them the next go-around (if the CSGTR comes back to us). In the table of outstanding items that I forwarded to him yesterday, I've modified the text to simply note that the NUREG should cite references for the supporting documentation.

I find the situation of the two documents a bit strange. They are not marked draft, proprietary, or with ANY report number.

- The MELCOR document is 158 pages long and dated 2012. It is authored by folks at

SNL, but it has NO report number from SNL or NRC (even though it looks like a final document). In addition to giving more details about initial MELCOR calcs for the CE plant, the report compares MELCOR and SR5 results.. a topic that the staff was silent about when queried during out meeting. As I recall, Richard referenced an old INL report rather than mentioning this document.

- The second report documents the subsequent MELCOR and CFD calcs run by the staff for the TI CSGTR evaluations. It is 378 pages long and dated 2013. It has no document number on it, but it again looks like a final report. It discusses many questions raised by the SC during out meeting such as the importance of material properties assumed in the evaluation-- it can make up to 2.5 hours difference in predictions for hot leg failure.

Frankly, I'm puzzled why the staff decided to not publish these documents or provide them to us. When I got them for supporting information for my Research Report Section (about two years ago), I was only interested in 'higher-level' information, so I did a cursory review of the exec summaries (because the fact that NRC was doing this work was all that was important), and I'd forgotten that the staff included them. Now, after pressuring the staff a bit, someone leaks some information to me pointing out that I have them?

The staff has indicated that the docs weren't published because of costs. However, when queried, Dana stated that there were some concerns about the fidelity of the CFD results but I've not heard the staff mention this.

So, my recommendation is based on there are more important issues at this time. It is on the record that ACRS wanted these documents and they weren't provided to us. Hopefully, when this comes to us again, staff will have decided to publish these documents. If not, we can have a pre-meeting (perhaps even 6 months ahead) and notify the staff that we have these documents and we plan to ask questions based on their content. So, they might as well transmit them to us this time in an official capacity.

In my opinion, this is an internal NRC issue (rather than a technical issue), but it impacts our ability to do a good technical review of this effort. So, I want you to concur on this being a politically acceptable way to proceed.

Ok?

Joy

Dr. Joy L. Rempe, Principal
Rempe and Associates, LLC
306 Stillwater
Idaho Falls, ID 83404
Phone: 208-520-3708
Email: jrempe@cablone.net
Website: www.rempellc.com

On Wed, Apr 15, 2015 at 5:35 AM, Hackett, Edwin <Edwin.Hackett@nrc.gov> wrote:
Hi Joy,

I'm not entirely clear on the decision point here? Are these documents/drawings Proprietary?

If they are, we can send to the members at their NRC email addresses and alert them to it. If they are not Proprietary and they are just internal information, we should not be restricted on disseminating further.

Ed

From: Joy Rempe [jlrempe@cableone.net]
Sent: Wednesday, April 15, 2015 2:45 AM
To: Brown, Christopher
Cc: Hackett, Edwin; Rempe, Joy
Subject: Re: Documentation for Calvert Cliffs SGTR MELCOR and CFD Calculations

Christopher,

Please do wait to send this to the other members until we hear back from Ed. I'm not sure that we want to get anyone in trouble for notifying me of the situation. Frankly, the reports aren't publicly available so I'd think that industry will have the same concerns that we expressed during the meeting. Let's think about this a bit...

Thanks,
Joy

On 4/15/2015 12:35 AM, Joy Rempe wrote:

> Hi,
>
> Today, I learned that I had access (perhaps without Richard Lee's
> knowledge and clearly without my remembering) to the CE plant
> documents. I'm attaching copies of one of them that I apparently was
> given as part of a bundle several years ago in support of the Research
> Report. I actually even found some notes in the copies that I had
> (that I've removed). The second document is 34 MB, so I'll give it to
> you next week, Christopher. It had been so long ago that I received
> them that I'd not thought about reviewing these draft documents for
> this effort (and of course, the staff decided to not provide them to
> us in preparation for the CSGTR meeting).
>
> A staffer notified me of this situation, and I'm not quite sure about
> whether to forward them to the rest of the members. However, we should
> keep them on file. In his email, the staffer mentioned that these
> draft documents were never published (so they can't be referenced in
> the NUREG).
>
> When we hear from the other members, we can update the summary table
> that I provided to you to reflect that these documents were later
> transmitted to us. By the time that this comes around to ACRS again,
> the involved characters will have forgotten (hopefully) their
> resistance to our having this information (or perhaps the staff will

> decide to publish these documents at that time).

>

> Joy

>

>

>

--

Dr. Joy L. Rempe, Principal
Rempe and Associates, LLC
306 Stillwater
Idaho Falls, ID 83404
Phone: 208-520-3708
Email: jlrempe@cableone.net
Website: www.rempellc.com

Hackett, Edwin

From: Tateiwa, Kenji <tateiwa.kenji@tepcoco.jp>
Sent: Wednesday, April 15, 2015 4:23 PM
To: Joy Rempe; Stetkar, John; Michael Corradini; Dennis Bley; Stephen Schultz; Dana Powers; Ronald Ballinger; Sanjoy Banerjee; Skillman Technical Resources, Inc.
Cc: Banks, Mark; Meador, Sherry; Hackett, Edwin
Subject: Thank You and Follow-Up [ACRS Briefing on Fukushima D&D] Fri, April 10, 2015
Attachments: Fukushima Update Call.pdf; ACRS_04102015.JPG

Dear ACRS Members,

It was a great pleasure and honor having the opportunity to meet with you and share the latest status of Fukushima Daiichi during the ACRS meeting on Friday, April 10.

Many thanks to Joy for inviting me to the meeting.

Please find attached a group photo of us and a notification email that I send out for my "Weekly Fukushima Update Teleconference."

Each week on the night prior to the teleconference, I send out such email to about 200 experts interested in the topic. I spend about 30 minutes to walk through the material (the latest information is usually available only in Japanese) over the phone and answer any questions that participants have.

If you are interested, I would be happy to add you to the distribution list and you can join the call whenever you find topics of interest or contact me separately with questions.

Ed,

Thank you for making arrangement for my presentation at the ACRS.

May I ask you to forward this email to other members of the ACRS that I did not have their email address--Drs. Brown, Ray, Riccardella, and Ryan?
Thank you in advance.

All the best,
Kenji

Kenji Tateiwa
Manager, Nuclear Power Programs
Tokyo Electric Power Company
Washington Office
2121 K Street, NW, Suite 910
Washington, DC 20037
tel: +1-202-457-0790 (ext.)116
mobile: (b)(6)

----- Original Message -----

From: "Tateiwa, Kenji" <tateiwa.kenji@tepcoco.jp>
To: "Joy Rempe" <jlrempe@cableone.net>; "Hackett, Edwin" <Edwin.Hackett@nrc.gov>
Cc: "Banks, Mark" <Mark.Banks@nrc.gov>; "Stetkar, John" <John.Stetkar@nrc.gov>; "Meador, Sherry" <Sherry.Meador@nrc.gov>
Sent: Friday, April 10, 2015 9:27 AM
Subject: Revised Slides [ACRS Briefing on Fukushima D&D] Fri, April 10, 2015

Tateiwa, Kenji

送信者: "Tateiwa, Kenji" <tateiwa.kenji@tepcoco.jp>
 宛先: "Tateiwa, Kenji" <tateiwa.kenji@tepcoco.jp>
 送信日時: 2015年4月8日 20:25
 件名: [TEPCO Weekly Fukushima Update Call] THU, April 9, 2015 at 3pm EDT

Nuclear Sector Colleagues,

Please find below information for tomorrow's Weekly Fukushima Update Call.

[Date/time]

THU, April 9, 2015 at 3 pm Eastern Daylight Time
 (No Call Next Week. Next call will be on **Fri, April 24** at 3 pm EDT.)

[call-in information] (Please record your name and organization when joining the call.)

call number: 718-354-1184

passcode:

(b)(6)

[Major topics]**1. Unit 3 Shield Plug in Front of Containment Vessel Equipment Hatch: Assumed Cause of Movement (3/30/2015)**

Shield plug could have moved due to pressure differential between containment vessel and reactor building when R/B hydrogen explosion occurred.

(only in Japanese)

http://www.tepcoco.jp/nu/fukushima-np/handouts/2015/images/handouts_150330_04-j.pdf

2. Unit 3 Spent Fuel Pool Gate Condition (4/6/2015)

Visual inspection found no significant impact to one of the two layers of gates (G1) maintaining water-tightness of pool.

(only in Japanese)

http://www.tepcoco.jp/nu/fukushima-np/handouts/2015/images/handouts_150406_04-j.pdf

3. Crawler Robot to Investigate Inside Unit 1 Drywell (4/6/2015)

http://www.tepcoco.jp/en/nu/fukushima-np/handouts/2015/images/handouts_150406_01-e.pdf

4-1. Nuclear Safety Reform Plan: Quarterly Progress Report (3/30/2015)

http://www.tepcoco.jp/en/press/corp-com/release/2015/1249285_6844.html

4-2. Full Report

(only in Japanese)

http://www.tepcoco.jp/cc/press/betu15_j/images/150330j0102.pdf

4-3. TEPCO's Nuclear Reform Monitoring Committee

http://www.nrmc.jp/en/report/detail/1249278_5233.html

4-4. "Reviewing the Two Years of Nuclear Safety Reform"

http://www.nrmc.jp/en/report/detail/_icsFiles/afieldfile/2015/04/02/E-5.pdf

5-1. "Trace Amounts of Fukushima Radioactivity Detected Along Shoreline of British Columbia" (4/6/2015)

Press release by the Woods Hole Oceanographic Institution.

<http://www.whoi.edu/news-release/fukushima-ucluelet>

5-2. TEPCO's Sea Water Sampling Data

<http://www.tepcoco.jp/en/nu/fukushima-np/f1/smp/index-e.html>

5-3. TEPCO's Seawater Monitoring Plan (4/1/2015)

(only in Japanese)

http://www.tepcoco.jp/nu/fukushima-np/handouts/2015/images/handouts_150401_06-j.pdf

** If you cannot display Japanese characters, please install the following font packs:*

<http://www.adobe.com/support/downloads/detail.jsp?ftplD=4881>

(Feel free to forward this email to your colleagues or have them contact me to be added to the distribution list.)

All the best,

Kenji

 Kenji Tateiwa

Manager, Nuclear Power Programs

Tokyo Electric Power Company
 Washington Office
 2121 K Street, NW Suite 910
 Washington, DC 20037
 tel: +1-202-457-0790 (ext 1116)
 mobile: [REDACTED]

(b)(6)

----- Original Message -----

From: Tateiwa, Kenji

To: Tateiwa, Kenji

Sent: Thursday, March 26, 2015 8:53 PM

Subject: [TEPCO Weekly Fukushima Update Call] Fri, March 27, 2015 at 3pm EDT

Nuclear Sector Colleagues,

Please find below information for tomorrow's Weekly Fukushima Update Call.

[Date/time]

Fri, March 27, 2015 at 3 pm Eastern Daylight Time

(No Call Next Week. Next call will be on THU, April 9 at 3 pm EDT.)

[call-in information] (Please record your name and organization when joining the call.)

call number: 718-354-1184

passcode: [REDACTED]

(b)(6)

[Major topics]

1. Unit 1 Muon Tomography Preliminary Results (3/19/2015)

http://www.tepco.co.jp/en/nu/fukushima-np/handouts/2015/images/handouts_150319_01-e.pdf

2. Contaminated Water Committee (3/17/2015)

(only in Japanese)

2-1. Studies Related to Frozen Soil Wall

http://www.tepco.co.jp/nu/fukushima-np/roadmap/images/c150317_07-j.pdf

2-2. Studies Related to High-Performance ALPS

http://www.tepco.co.jp/nu/fukushima-np/roadmap/images/c150317_08-j.pdf

3. NRA Special Facilities Monitoring and Evaluation Committee (3/25/2015)

(only in Japanese)

3-1. "K" Drainage Line Investigation and Actions

http://www.tepco.co.jp/nu/fukushima-np/handouts/2015/images/handouts_150325_04-j.pdf

3-2. Closure of Seawater Piping Trenches of Units 2, 3, 4

http://www.tepco.co.jp/nu/fukushima-np/handouts/2015/images/handouts_150325_08-j.pdf

4. Working-level Meeting of Decommissioning & Contaminated Water Issues Team (3/26/2015)

(only in Japanese)

4-1. Plant Status

http://www.tepco.co.jp/nu/fukushima-np/roadmap/images/d150326_04-j.pdf

4-2. Summary Status of Decommissioning Roadmap

http://www.tepco.co.jp/nu/fukushima-np/roadmap/images/d150326_05-j.pdf

(English translation as of 2/26/2015)

http://www.tepco.co.jp/en/nu/fukushima-np/roadmap/images/d150226_01-e.pdf

4-3. Contaminated Water Treatment

http://www.tepco.co.jp/nu/fukushima-np/roadmap/images/d150326_07-j.pdf

4-4. Environmental Radiation Issues (large file size: 56 MB)

http://www.tepco.co.jp/nu/fukushima-np/roadmap/images/d150326_08-j.pdf

4-5. Spent Fuel Pool Issues

http://www.tepco.co.jp/nu/fukushima-np/roadmap/images/d150326_10-j.pdf

4-6. Preparation for Fuel Debris Removal

http://www.tepco.co.jp/nu/fukushima-np/roadmap/images/d150326_11-j.pdf

4-7. Radioactive Waste Processing (Radionuclide Analyses of Samples Taken from Units 1-3 R/B)

http://www.tepco.co.jp/nu/fukushima-np/roadmap/images/d150326_12-j.pdf

All the best,
Kenji

----- Original Message -----

From: Tateiwa, Kenji
To: Tateiwa, Kenji
Sent: Thursday, March 12, 2015 8:50 PM
Subject: [TEPCO Weekly Fukushima Update Call] Fri, March 13, 2015 at 3pm EDT

Nuclear Sector Colleagues,

Please find below information for tomorrow's Weekly Fukushima Update Call.

[Date/time]

Fri, March 13, 2015 at 3 pm Eastern Daylight Time
(No Call Next Week. Next call will be on Fri, March 27 at 3 pm EDT.)

[call-in information] (Please record your name and organization when joining the call.)

call number: 718-354-1184

passcode:

(b)(6)

[Major topics]

1. NRA Special Facilities Monitoring and Evaluation Committee (3/2/2015)

(only in Japanese)

1-1. Closure of Seawater Piping Trenches of Units 2, 3, 4

http://www.tepco.co.jp/nu/fukushima-np/handouts/2015/images/handouts_150304_05-j.pdf

1-2. Measures to Reduce Radioactivity in "K" Drainage Line

http://www.tepco.co.jp/nu/fukushima-np/handouts/2015/images/handouts_150304_06-j.pdf

1-3. Investigation on Temporary Increase in Radioactivity in Downstream of "B and C" Drainage Line

http://www.tepco.co.jp/nu/fukushima-np/handouts/2015/images/handouts_150304_07-j.pdf

1-4. Water Level Management after Operation of Frozen-Soil Wall

http://www.tepco.co.jp/nu/fukushima-np/handouts/2015/images/handouts_150304_08-j.pdf

2. Rain Water Level Drop in Outer Weir of H4 Area Tank (3/12/2015)

(only in Japanese)

http://www.tepco.co.jp/nu/fukushima-np/handouts/2015/images/handouts_150312_04-j.pdf

3. New Disclosure Policy and Independent Audit in Light of Recent Drainage Water Issue (3/6/2015)

http://www.tepco.co.jp/en/press/corp-com/release/2015/1248564_6844.html

4. TEPCO President's Remarks on 4th Anniversary of Great East Japan Earthquake (3/11/2015)

http://www.tepco.co.jp/en/press/corp-com/release/2015/1248663_6844.html

5. "Nuclear Energy in Japan Since Fukushima" (2/17/2015)

TEPCO's presentation at the Platts Nuclear Energy Conference.

http://www.platts.com/IM.Platts.Content/ProductsServices/ConferenceandEvents/2015/pc509/presentations/Kenji_Tateiwa

6. "Estimated Amount of Radioactive Materials Released into the Air by the Fukushima Daiichi NPS Accident" (3/10/2015)

TEPCO's presentation at the US NRC Regulatory Information Conference (RIC.)

<https://ric.nrc-gateway.gov/docs/abstracts/tateiwa-k-t5-hv-r1.pdf>

All the best,

Kenji

----- Original Message -----

From: Tateiwa, Kenji
To: Tateiwa, Kenji
Sent: Thursday, February 26, 2015 10:50 PM
Subject: [TEPCO Weekly Fukushima Update Call] Fri, Feb. 27, 2015 at 3pm EST

Nuclear Sector Colleagues,

Please find below information for tomorrow's Weekly Fukushima Update Call.

[Date/time]

Fri, Feb. 27, 2015 at 3 pm Eastern Standard Time

(No Call Next Week. Next call will be on **Fri, March 13** at 3 pm EDT.)

[call-in information] (Please record your name and organization when joining the call.)
 call number: 718-354-1184
 passcode: 25057200#

[Major topics]

1. On-Site Coordination Meeting on Decommissioning & Contaminated Water Issues (2/23/2015)
 (only in Japanese)

1-1. Water Contamination Monitoring and Effectiveness of Groundwater Bypass System

http://www.tepco.co.jp/nu/fukushima-np/roadmap/images/l150223_04-j.pdf

1-2. Dismantling Plan for Unit 1 Reactor Building Cover

http://www.tepco.co.jp/nu/fukushima-np/roadmap/images/l150223_05-j.pdf

1-3. Occupational Safety Corrective Actions

http://www.tepco.co.jp/nu/fukushima-np/roadmap/images/l150223_06-j.pdf

1-4. Contaminated Water Issues

http://www.tepco.co.jp/nu/fukushima-np/roadmap/images/l150223_12-j.pdf

2. Working-level Meeting of Decommissioning & Contaminated Water Issues Team (2/26/2015)
 (only in Japanese)

2-1. Plant Status

http://www.tepco.co.jp/nu/fukushima-np/roadmap/images/d150226_04-j.pdf

2-2. Summary Status of Decommissioning Roadmap

http://www.tepco.co.jp/nu/fukushima-np/roadmap/images/d150226_05-j.pdf

(English translation as of 1/29/2015)

http://www.tepco.co.jp/en/nu/fukushima-np/roadmap/images/d150129_01-e.pdf

2-3. Re-insertion of Thermocouple into Unit 2 RPV Bottom via SLC Line

http://www.tepco.co.jp/nu/fukushima-np/roadmap/images/d150226_06-j.pdf

2-4. Contaminated Water Treatment

http://www.tepco.co.jp/nu/fukushima-np/roadmap/images/d150226_07-j.pdf

2-5. Environmental Radiation Issues

http://www.tepco.co.jp/nu/fukushima-np/roadmap/images/d150226_08-j.pdf

2-6. Spent Fuel Pool Issues

http://www.tepco.co.jp/nu/fukushima-np/roadmap/images/d150226_10-j.pdf

2-7. Preparation for Fuel Debris Removal (3D Laser Scanning, Muon Tomography)

http://www.tepco.co.jp/nu/fukushima-np/roadmap/images/d150226_11-j.pdf

2-8. D&D-Related R&D Progress and Future Plans

http://www.tepco.co.jp/nu/fukushima-np/roadmap/images/d150226_13-j.pdf

2-9. Selection of Technologies to Undergo Tritium-Separation Demonstration Testing

http://www.tepco.co.jp/nu/fukushima-np/roadmap/images/d150226_14-j.pdf

2-10. Establishment of Global Decommissioning Joint Research Center

http://www.tepco.co.jp/nu/fukushima-np/roadmap/images/d150226_15-j.pdf

3. Temporary Increase in Radioactivity in Downstream of "B and C" Drainage Line (2/24/2015)

http://www.tepco.co.jp/en/press/corp.com/release/2015/1248327_6844.html

4. Unit 2 Reactor Building Truck Bay Door Roof Likely Source of Radioactivity in "K" Drainage Line (2/24/2015)

www.tepco.co.jp/en/nu/fukushima-np/handouts/2015/images/handouts_150224_01-e.pdf

5. Briefing to Fishermen's Association in Fukushima Prefecture Regarding Contaminated Water Issues (2/25/2015)

(only in Japanese)

http://www.tepco.co.jp/nu/fukushima-np/handouts/2015/images/handouts_150225_05-j.pdf

6. Unit 1 Reactor Building 4th Floor Inspection by Technical Committee of Niigata Prefecture (2/21/2015)

(only in Japanese)

http://www.tepco.co.jp/nu/fukushima-np/handouts/2015/images/handouts_150221_06-j.pdf

7. Third IAEA Review of Fukushima Daiichi Decommissioning Roadmap (2/17/2015)

<https://www.iaea.org/newscenter/pressreleases/iaea-team-completed-third-review-japans-plans-decommission-fukushima>
 (photos)
http://www.tepco.co.jp/en/nu/fukushima-np/handouts/2015/images/handouts_150217_03-e.pdf

All the best,
 Kenji

----- Original Message -----

From: Tateiwa, Kenji
To: Tateiwa, Kenji
Sent: Thursday, February 12, 2015 10:37 PM
Subject: [TEPCO Weekly Fukushima Update Call] Fri, Feb. 13, 2015 at 3pm EST

Nuclear Sector Colleagues,

Please find below information for tomorrow's Weekly Fukushima Update Call.

[Date/time]

Fri, Feb. 13, 2015 at 3 pm Eastern Standard Time
 (No Call Next Week. Next call will be on Fri, Feb. 27 at 3 pm EST.)

[call-in information] (Please record your name and organization when joining the call.)

call number: 718-354-1184

passcode:

(b)(6)

[Major topics]

1. NRA Special Facilities Monitoring and Evaluation Committee (2/9/2015)

(only in Japanese)

1-1. Closure of Seawater Piping Trenches of Units 2, 3, 4

http://www.nsr.go.jp/committee/yuushikisya/tokutei_kanshi/data/0031_02.pdf

1-2. Water Level Management after Operation of Frozen-Soil Wall (summary)

http://www.nsr.go.jp/committee/yuushikisya/tokutei_kanshi/data/0031_03.pdf

1-3. Water Level Management after Operation of Frozen-Soil Wall (reference information)

http://www.nsr.go.jp/committee/yuushikisya/tokutei_kanshi/data/0031_08.pdf

2. Installation of Muon Detectors for Fuel Debris Detection at Unit 1 (2/9/2015)

http://www.tepco.co.jp/en/press/corp-com/release/2015/1248057_6844.html

(photos)

http://www.tepco.co.jp/en/nu/fukushima-np/handouts/2015/images/handouts_150209_01-e.pdf

3. "The Great Race: The Global Quest for the Car of the Future"

<http://amzn.com/B00LD1OP0Q>

This book features TEPCO's current Chief Nuclear Officer, Takafumi Anegawa, as a visionary who jump started Japan's electric vehicle industry.

All the best,
 Kenji



2015 4/10 14:04

Hackett, Edwin

From: Tateiwa, Kenji <tateiwa.kenji@tepcoco.jp>
Sent: Wednesday, April 15, 2015 7:23 PM
To: Hackett, Edwin
Subject: Re: Thank You and Follow-Up [ACRS Briefing on Fukushima D&D] Fri, April 10, 2015

Thank you, Ed.
That would be helpful.

All the best,
Kenji

----- Original Message -----

From: Hackett, Edwin
To: Tateiwa, Kenji ; Joy Rempe ; Stetkar, John ; Michael Corradini ; Dennis Bley ; Stephen Schultz ; Dana Powers ; Ronald Ballinger ; Sanjoy Banerjee ; Skillman Technical Resources, Inc.
Cc: Banks, Mark ; Meador, Sherry
Sent: Wednesday, April 15, 2015 4:27 PM
Subject: RE: Thank You and Follow-Up [ACRS Briefing on Fukushima D&D] Fri, April 10, 2015

Thanks to you Kenji – it was our pleasure to have you here and many thanks for a very informative presentation. I will make sure that the remaining members see your email.

Best,

Ed

From: Tateiwa, Kenji [mailto:tateiwa.kenji@tepcoco.jp]
Sent: Wednesday, April 15, 2015 4:23 PM
To: Joy Rempe; Stetkar, John; Michael Corradini; Dennis Bley; Stephen Schultz; Dana Powers; Ronald Ballinger; Sanjoy Banerjee; Skillman Technical Resources, Inc.
Cc: Banks, Mark; Meador, Sherry; Hackett, Edwin
Subject: Thank You and Follow-Up [ACRS Briefing on Fukushima D&D] Fri, April 10, 2015

Dear ACRS Members,

It was a great pleasure and honor having the opportunity to meet with you and share the latest status of Fukushima Daiichi during the ACRS meeting on Friday, April 10.

Many thanks to Joy for inviting me to the meeting.

Please find attached a group photo of us and a notification email that I send out for my "Weekly Fukushima Update Teleconference."

Each week on the night prior to the teleconference, I send out such email to about 200 experts interested in the topic. I spend about 30 minutes to walk through the material (the latest information is usually available only in Japanese) over the phone and answer any questions that participants have.

If you are interested, I would be happy to add you to the distribution list and you can join the call whenever you find topics of interest or contact me separately with questions.

Ed,

Thank you for making arrangement for my presentation at the ACRS.

Hackett, Edwin

From: Tateiwa, Kenji <tateiwa.kenji@tepcoco.jp>
Sent: Thursday, April 16, 2015 5:55 AM
To: Hackett, Edwin
Cc: Joy Rempe
Subject: Letter from ACRS [ACRS Briefing on Fukushima D&D] Fri, April 10, 2015

Ed,

Joy informed me that the ACRS will be sending TEPCO a thank you letter. I appreciate your kind offer in doing so.

I previously indicated that it be sent to Mr. Anegawa, TEPCO's CNO. Rather, could you have it sent to my immediate boss in DC?

Mr. Takao Onuki
Director, Washington Office, Tokyo Electric Power Company
2121 K Street, NW, Suite 910
Washington, DC 20037
tel: 202-457-0790
takao.onuki@tepcoco.jp

Thank you very much in advance.

All the best,
Kenji

On Wed, 15 Apr 2015 16:23:11 -0400
"Tateiwa, Kenji" <tateiwa.kenji@tepcoco.jp> wrote:

> Dear ACRS Members,
>
> It was a great pleasure and honor having the opportunity to meet with
> you and share the latest status of Fukushima Daiichi during the ACRS
> meeting on Friday, April 10.
>
> Many thanks to Joy for inviting me to the meeting.
>
> Please find attached a group photo of us and a notification email that
> I send out for my "Weekly Fukushima Update Teleconference."
>
> Each week on the night prior to the teleconference, I send out such
> email to about 200 experts interested in the topic.
> I spend about 30 minutes to walk through the material (the latest
> information is usually available only in Japanese) over the phone and
> answer any questions that participants have.
>
> If you are interested, I would be happy to add you to the distribution
> list and you can join the call whenever you find topics of interest or
> contact me separately with questions.
>
> Ed,

Hackett, Edwin

From: Tateiwa, Kenji <tateiwa.kenji@tepcoco.jp>
Sent: Thursday, April 16, 2015 5:55 AM
To: Hackett, Edwin
Cc: Joy Rempe
Subject: Letter from ACRS [ACRS Briefing on Fukushima D&D] Fri, April 10, 2015

Ed,

Joy informed me that the ACRS will be sending TEPCO a thank you letter. I appreciate your kind offer in doing so.

I previously indicated that it be sent to Mr. Anegawa, TEPCO's CNO. Rather, could you have it sent to my immediate boss in DC?

Mr. Takao Onuki
Director, Washington Office, Tokyo Electric Power Company
2121 K Street, NW, Suite 910
Washington, DC 20037
tel: 202-457-0790
takao.onuki@tepcoco.jp

Thank you very much in advance.

All the best,
Kenji

On Wed, 15 Apr 2015 16:23:11 -0400
"Tateiwa, Kenji" <tateiwa.kenji@tepcoco.jp> wrote:

> Dear ACRS Members,
>
> It was a great pleasure and honor having the opportunity to meet with
> you and share the latest status of Fukushima Daiichi during the ACRS
> meeting on Friday, April 10.
>
> Many thanks to Joy for inviting me to the meeting.
>
> Please find attached a group photo of us and a notification email that
> I send out for my "Weekly Fukushima Update Teleconference."
>
> Each week on the night prior to the teleconference, I send out such
> email to about 200 experts interested in the topic.
> I spend about 30 minutes to walk through the material (the latest
> information is usually available only in Japanese) over the phone and
> answer any questions that participants have.
>
> If you are interested, I would be happy to add you to the distribution
> list and you can join the call whenever you find topics of interest or
> contact me separately with questions.
>
> Ed,

Hackett, Edwin

From: Banks, Mark
Sent: Monday, April 20, 2015 9:36 AM
To: Hackett, Edwin; jwstetkar@aol.com; Dennis Bley (bley@buttonwoodconsulting.com);
corradin@cae.wisc.edu; Stephen P. Schultz (sps01749@aol.com)
Cc: Joy Rempe (jlrempe@cableone.net)
Subject: Thank you letter to Kenji's Boss
Attachments: Thank You Letter to Takafumi Anegawa (TEPCO).docx

All,

Attached is a draft thank you letter to Kenji's boss (Takafumi Anegawa – Chief Nuclear Officer, TEPCO). Please review and revise – the draft is meant as a starting point.

Thanks,

Mark Banks – Chief
Technical Support Branch
Advisory Committee on Reactor Safeguards
Nuclear Regulatory Commission
Tel. 301-415-3718
Fax 301-415-5589



UNITED STATES
NUCLEAR REGULATORY COMMISSION
ADVISORY COMMITTEE ON REACTOR SAFEGUARDS
WASHINGTON, DC 20555 - 0001

April 22, 2015

Mr. Takafumi Anegawa
Chief Nuclear Officer
Tokyo Electric Power Company
Address

Dear Mr. Anegawa:

Please accept this letter of thanks for the briefing on the status of your Fukushima Daiichi Nuclear Power Station provided by Mr. Kenji Tateiwa to the Advisory Committee on Reactor Safeguards on April 10, 2015.

Mr. Tateiwa provided us with a detailed and informative presentation on the overall status of Fukushima Daiichi and the ongoing decontamination and decommissioning efforts at the site. The opportunity to discuss directly with Mr. Tateiwa the current Tokyo Electric Power Company operations at Fukushima Daiichi and receive his unique insights was of great value to all of us. His professionalism and preparation, as well as his familiarity of the Fukushima Daiichi issues, were outstanding. Please convey our thanks to Mr. Tateiwa.

Sincerely,

John W. Stetkar
Chairman

cc: ACRS Members

Hackett, Edwin

From: Michael Corradini <corradini@engr.wisc.edu>
Sent: Monday, April 20, 2015 10:51 AM
To: John Stetkar
Cc: Michael Corradini; Banks, Mark; Hackett, Edwin; bley@buttonwoodconsulting.com; Steve Schultz; Joy Rempe; Stetkar, John
Subject: Re: Thank you letter to Kenji's Boss

Looks good to me and agree w change.

On Apr 20, 2015, at 9:10 AM, jwstetkar@aol.com wrote:

Mark,

Looks great to me with Ed's "familiar with".

John

In a message dated 4/20/2015 8:36:01 A.M. Central Daylight Time, Mark.Banks@nrc.gov writes:

All,

Attached is a draft thank you letter to Kenji's boss (Takafumi Anegawa – Chief Nuclear Officer, TEPCO). Please review and revise – the draft is meant as a starting point.

Thanks,

Mark Banks – Chief

Technical Support Branch

Advisory Committee on Reactor Safeguards

Nuclear Regulatory Commission

Tel. 301-415-3718

Fax 301-415-5589

=

Hackett, Edwin

From: Joy Rempe <jlrempe@cableone.net>
Sent: Monday, April 20, 2015 2:13 PM
To: John Stetkar
Cc: Banks, Mark; Hackett, Edwin; Dennis Bley; Mike Corradini; Stephen Schultz; Stetkar, John; Rempe, Joy
Subject: Re: Thank you letter to Kenji's Boss

with my nrc address... again, i think that ed should ask if ACRS members could a few extra days for the time required to add our nrc email (and then delete it from the nrc email account... clearly, a waste of taxpayer bucks...).

Dr. Joy L. Rempe, Principal
Rempe and Associates, LLC
306 Stillwater
Idaho Falls, ID 83404
Phone: 208-520-3708
Email: jlrempe@cableone.net
Website: www.rempellc.com

On Mon, Apr 20, 2015 at 12:11 PM, Joy Rempe <jlrempe@cableone.net> wrote:
Mark,

Please change the address. Per an email from Kenji last week (it went to Ed, but I thought that I forwarded it to you?), Kenji requested that the letter be addressed to:

Mr. Takao Onuki
Director, Washington Office, Tokyo Electric Power Company
2121 K Street, NW, Suite 910
Washington, DC 20037

Thanks!
Joy

Dr. Joy L. Rempe, Principal
Rempe and Associates, LLC
306 Stillwater
Idaho Falls, ID 83404
Phone: 208-520-3708
Email: jlrempe@cableone.net
Website: www.rempellc.com

On Mon, Apr 20, 2015 at 8:10 AM, <Jwstetkar@aol.com> wrote:
Mark,

Looks great to me with Ed's "familiar with".

From: Joy Rempe
To: Kenji Tateiwa
Cc: Joy Rempe
Subject: Fwd: Letter from ACRS [ACRS Briefing on Fukushima D&D] Fri, April 10, 2015
Date: Monday, April 20, 2015 2:15:50 PM

Mr. Takao Onuki
Director, Washington Office, Tokyo Electric Power Company
2121 K Street, NW, Suite 910
Washington, DC 20037
Dr. Joy L. Rempe, Principal
Rempe and Associates, LLC
306 Stillwater
Idaho Falls, ID 83404
Phone: 208-520-3708
Email: jlr@rempe.com
Website: www.rempe.com

----- Forwarded message -----
From: Tateiwa, Kenji <tateiwa.kenji@tepcoco.jp>
Date: Thu, Apr 16, 2015 at 3:54 AM
Subject: Letter from ACRS [ACRS Briefing on Fukushima D&D] Fri, April 10, 2015
To: "Hackett, Edwin" <Edwin.Hackett@nrc.gov>
Cc: Joy Rempe <jlr@rempe.com>

Ed,

Joy informed me that the ACRS will be sending TEPCO a thank you letter. I appreciate your kind offer in doing so.

I previously indicated that it be sent to Mr. Anegawa, TEPCO's CNO. Rather, could you have it sent to my immediate boss in DC?

Mr. Takao Onuki
Director, Washington Office, Tokyo Electric Power Company
2121 K Street, NW, Suite 910
Washington, DC 20037
tel: 202-457-0790
takao.onuki@tepcoco.jp

Thank you very much in advance.

All the best,
Kenji

On Wed, 15 Apr 2015 16:23:11 -0400
"Tateiwa, Kenji" <tateiwa.kenji@tepcoco.jp> wrote:

> Dear ACRS Members,
>
> It was a great pleasure and honor having the opportunity to meet with you
> and share the latest status of Fukushima Daiichi during the ACRS meeting on
> Friday, April 10.
>
> Many thanks to Joy for inviting me to the meeting.
>
> Please find attached a group photo of us and a notification email that I
> send out for my "Weekly Fukushima Update Teleconference."
>
> Each week on the night prior to the teleconference, I send out such email to
> about 200 experts interested in the topic.
> I spend about 30 minutes to walk through the material (the latest
> information is usually available only in Japanese) over the phone and answer
> any questions that participants have.
>
> If you are interested, I would be happy to add you to the distribution list
> and you can join the call whenever you find topics of interest or contact me
> separately with questions.
>
> Ed,
>
> Thank you for making arrangement for my presentation at the ACRS.
>
> May I ask you to forward this email to other members of the ACRS that I did
> not have their email address--Drs. Brown, Ray, Riccardella, and Ryan?
> Thank you in advance.
>
> All the best,
> Kenji
>-----
> Kenji Tateiwa
> Manager, Nuclear Power Programs
> Tokyo Electric Power Company
> Washington Office
> 2121 K Street, NW, Suite 910
> Washington, DC 20037
> tel: +1-202-457-0790 (ext.1116)
> mobi: [REDACTED]

(b)(6)
>----- Original Message -----
> From: "Tateiwa, Kenji" <tateiwa.kenji@tepcoco.jp>
> To: "Joy Rempe" <jlr@rempe.com>; "Hackett, Edwin"
> <Edwin.Hackett@nrc.gov>
> Cc: "Banks, Mark" <Mark.Banks@nrc.gov>; "Steikar, John"
> <John.Steikar@nrc.gov>; "Meador, Sherry" <Sherry.Meador@nrc.gov>
> Sent: Friday, April 10, 2015 9:27 AM

> Subject: Revised Slides [ACRS Briefing on Fukushima D&D] Fri, April 10, 2015

>

>

>> Hi Joy and Ed,

>>

>> Per Joy's request last night regarding inclusion of the topic of Unit 3

>> drywell shield plug, I have added 2 slides (p.28-29.)

>> http://www.tepco.co.jp/nu/fukushima-up/handouts/2015/images/handouts_150330_04-j.pdf

>>

>> I also took this opportunity to make slight modifications in the planned

>> timing of drywell inspections in Units 1-3.

>>

>> Ed,

>>

>> I hope it is OK for me to use this material this afternoon.

>> Thank you for arranging for a visitor's parking.

>> I will see you at 11:30 am.

>>

>> All the best,

>> Kenji

>>

>> On Tue, 7 Apr 2015 08:14:28 -0400

>> "Hackett, Edwin" <Edwin.Hackett@nrc.gov> wrote:

>>

>>> Thanks Kenji. Looking forward to meeting you on Friday.

>>>

>>> Since you are driving, you will enter the NRC HQ complex at the main

>>> vehicle entrance off Marinelli Road, just down from the METRO station. I

>>> will plan on meeting you at the guard shack at the entrance at 11:30 a.m.

>>> where you will be processed through security. We have arranged for

>>> visitor parking for you.

>>>

>>> Best,

>>>

>>> Ed

>>>

>>> -----Original Message-----

>>> From: Tateiwa, Kenji (mailto:tateiwa.kenji@tepco.co.jp)

>>> Sent: Tuesday, April 07, 2015 2:40 AM

>>> To: Hackett, Edwin

>>> Cc: Joy Rempe; Banks, Mark; Stetkar, John; Meador, Sherry

>>> Subject: Slides [ACRS Briefing on Fukushima D&D] Fri, April 10, 2015

>>>

>>> Hi Ed,

>>>

>>> Please find attached my presentation for the ACRS briefing on Fukushima

>>> D&D on April 10.

>>> Thank you for your patience and I look forward to having a productive

>>> meeting.

>>>

>>> All the best,

>>> Kenji

>>>

>>> On Tue, 07 Apr 2015 04:44:19 +0900

>>> "Tateiwa, Kenji" <tateiwa.kenji@tepco.co.jp> wrote:

>>>

>>>> Hi Ed,

>>>>

>>>> Thank you for the detailed instruction for Friday.

>>>> I will plan on arriving at the NRC HQ at around 11:30 am.

>>>>

>>>> I would appreciate if you could make arrangement for my parking--I will

>>>> be driving a gray Toyota Corolla [REDACTED]

>>>>

>>>> All the best,

>>>> Kenji

>>>>

>>>> On Mon, 6 Apr 2015 09:42:50 -0400

>>>> "Hackett, Edwin" <Edwin.Hackett@nrc.gov> wrote:

>>>>

>>>>> Hi Kenji,

>>>>>

>>>>> In my previous communication, I neglected to give you more specific

>>>>> instructions regarding your visit.

>>>>>

>>>>> Given that we have you scheduled for 12:15 p.m. on Friday, it would

>>>>> be good if you could plan on arriving at NRC HQ no later than 11:45

>>>>> a.m. You are also obviously welcome to come earlier if you choose.

>>>>> The NRC HQ complex is located in Rockville, MD and is at the White

>>>>> Flint METRO station. METRO provides the most convenient access, but

>>>>> if you are driving, our address is:

>>>>>

>>>>> 11545 Rockville Pike

>>>>> Rockville, MD

>>>>>

>>>>> Also, if you are driving, please let me know in advance so we can

>>>>> work on arranging parking for you.

>>>>>

>>>>> When you arrive, please proceed to the front entrance of the One

>>>>> White Flint North Building (OWFN) (the tallest building directly

>>>>> across the street from the METRO). When you get there, you will be

>>>>> processed through security and you can call us for an escort.

>>>>>

>>>>> The ACRS Main line is 201-415-7360. My cell phone is [REDACTED]

>>>>> you need to reach me. We are located in the Two White Flint North

>>>>> (TWFN) Building. Your presentation will be in Room T-2 B1).

>>>>>

(b)(6)

(b)(6)

>>>> Please let me know if you have any questions
>>>>
>>>> Best,
>>>>
>>>> Ed
>>>>

>>>> Sherry - Here is Dr. Tateiwa's information. I would appreciate it if
>>>> you could pre-register him in the security system:

>>>>
>>>> Kenji Tateiwa
>>>> Manager, Nuclear Power Programs
>>>> Tokyo Electric Power Company
>>>> Washington Office
>>>> 2121 K Street, NW Suite 910
>>>> Washington, DC 20037
>>>> tel: +1-202-457-0760 (ext.)116
>>>> mobile: [REDACTED]

(b)(6)

>>>>
>>>> Thanks.
>>>>
>>>> Ed
>>>>

>>>> -----Original Message-----

>>>> From: Tateiwa, Kenji [mailto:tateiwa.kenji@tepcoco.jp]
>>>> Sent: Monday, April 06, 2015 1:47 AM
>>>> To: Hackett, Edwin
>>>> Cc: Joy Rempe, Banks, Mark, Stekar, John
>>>> Subject: RE: [ACRS Briefing on Fukushima D&D] Fri, April 10, 2015
>>>>
>>>> Dear Ed,

>>>> Apologies for not being able to provide you with my presentation by
>>>> the April 3 deadline
>>>> I am still working on it and plan to send you the slides by the end
>>>> of Mon, April 6
>>>>
>>>> Could you tell me what time and where I should meet you on Fri, April
>>>> 10?

>>>>
>>>> All the best,
>>>> Kenji

>>>>
>>>> On Tue, 17 Feb 2015 08:33:36 -0500
>>>> "Hackett, Edwin" <Edwin.Hackett@nrc.gov> wrote:

>>>>
>>>> Thanks Kenji.

>>>>
>>>> We will be looking forward to your presentation
>>>>
>>>> Ed

>>>>
>>>> From: Tateiwa, Kenji [mailto:tateiwa.kenji@tepcoco.jp]
>>>> Sent: Monday, February 16, 2015 12:58 PM
>>>> To: Joy Rempe, Hackett, Edwin
>>>> Cc: Banks, Mark, Stekar, John
>>>> Subject: [ACRS Briefing on Fukushima D&D] Fri, April 10, 2015

>>>>
>>>> Dear Joy and Ed,

>>>>
>>>> Thank you for your note

>>>>
>>>> I will prepare to provide a 1/2 hour briefing + 1/2 hour Q&A on
>>>> Fukushima Daichi D&D status to the ACRS on Fri, April 10.
>>>> I will send you my slides by April 3 at the latest.

>>>>
>>>> All the best,
>>>> Kenji

>>>> ----- Original Message -----

>>>> From: "Hackett, Edwin"
>>>> <Edwin.Hackett@nrc.gov> [mailto:Edwin.Hackett@nrc.gov]]>>
>>>> To: "Joy Rempe"
>>>> <jrempe@cablphone.net> [mailto:jrempe@cablphone.net]]>>; "Tateiwa,
>>>> Kenji"
>>>> <tateiwa.kenji@tepcoco.jp> [mailto:tateiwa.kenji@tepcoco.jp]]>>
>>>> Cc: "Stekar, John"
>>>> <John.Stekar@nrc.gov> [mailto:John.Stekar@nrc.gov]]>>; "Banks, Mark"
>>>> <Mark.Banks@nrc.gov> [mailto:Mark.Banks@nrc.gov]]>>
>>>> Sent: Friday, February 13, 2015 4:52 PM
>>>> Subject: RE: Invitation to Brief ACRS

>>>>
>>>> Thanks Joy

>>>>
>>>> Dr. Tateiwa,

>>>>
>>>> We are very pleased that you will be able to do the briefing. Per
>>>> your request, we will schedule an hour total for the briefing on
>>>> Friday, April 10. We will get you the exact time, once we have
>>>> worked out details for our April agenda in a few weeks.

>>>>
>>>> Per your discussion with Joy, if you could plan for a 1/2 hour
>>>> presentation, that would be great. We would then leave another
>>>> half hour to allow for Committee questions. If you feel you need
>>>> more time, please let us know. We would appreciate having your

>>>>> slides and any appropriate background material a week or two in
>>>>> advance so that the members can prepare appropriately.
>>>>>
>>>>> Please let us know if you have any questions.
>>>>>
>>>>> Thanks,
>>>>>
>>>>> Ed Hackett
>>>>>
>>>>> From: Joy Rempe [mailto:jrempe@cableone.net]
>>>>> Sent: Friday, February 13, 2015 3:53 PM
>>>>> To: Tateiwa, Kenji
>>>>> Cc: Stetkar, John; Hackett, Edwin; Banks, Mark
>>>>> Subject: Re: Invitation to Brief ACRS
>>>>>
>>>>> Great.
>>>>>
>>>>> This is the first time that I've been involved with assisting
>>>>> someone that will be giving a presentation at ACRS. Ed Hackett,
>>>>> our executive director, will have to help us understand the next
>>>>> steps with scheduling. He'll also have to inform us with the
>>>>> process for thank you letters. However, I'm guessing that the
>>>>> letter will be signed by our chairman, Mr. John Stetkar. My
>>>>> experience is that nothing is informal when it comes to federal
>>>>> advisory committees! Let me know if additional assistance is
>>>>> needed.
>>>>>
>>>>> I was glad to be part of the weekly teleconference today. It will
>>>>> be interesting to see what information is obtained with the muon
>>>>> tomography installation. I've also completed the draft forensic
>>>>> inspection report. Mitch and Mike are currently reviewing it. I
>>>>> hope to send you and Damian a copy next week for your comments.
>>>>>
>>>>> Best wishes,
>>>>> Joy
>>>>>
>>>>> Dr. Joy L. Rempe, Principal
>>>>> Rempe and Associates, LLC
>>>>> 306 Stillwater
>>>>> Idaho Falls, ID 83404
>>>>> Phone: 208-520-1708
>>>>> Email:
>>>>> jrempe@cableone.net<mailto:jrempe@cableone.net>;mailto:jrempe@cableone.net<mailto:jrempe@cableone.net>;mailto:jrempe@cableone.net<mailto:jrempe@cableone.net>>>
>>>>>
>>>>> On Fri, Feb 13, 2015 at 1:39 PM, Tateiwa, Kenji
>>>>> <tateiwa.kenji@tepco.co.jp<mailto:tateiwa.kenji@tepco.co.jp>><mailto:tateiwa.kenji@tepco.co.jp><mailto:tateiwa.kenji@tepco.co.jp><mailto:tateiwa.kenji@tepco.co.jp>>>>>
>>>>> wrote.
>>>>> Hi Joy,
>>>>>
>>>>> Apologies for the late reply.--TEPCO's Chief Nuclear Officer was
>>>>> visiting the U.S. this week and I was preoccupied arranging and
>>>>> attending all the meetings with him.
>>>>>
>>>>> I am very glad to hear that the ACRS members are eager to learn
>>>>> about the situation at Fukushima Daiichi and I look forward to a
>>>>> lively session with many "interruptions" with your colleagues.
>>>>>
>>>>> I also appreciate your thoughtful offer to write a letter to
>>>>> TEPCO's senior management.
>>>>> It would be great if you could send a note to the following person
>>>>> after the meeting (email would be fine.)
>>>>>
>>>>> Takafumi Anegawa
>>>>> Chief Nuclear Officer
>>>>> anegawa.takafumi@tepco.co.jp<mailto:anegawa.takafumi@tepco.co.jp><mailto:anegawa.takafumi@tepco.co.jp><mailto:anegawa.takafumi@tepco.co.jp><mailto:anegawa.takafumi@tepco.co.jp>>>>>
>>>>>
>>>>> All the best,
>>>>> Kenji
>>>>> ----- Original Message -----
>>>>> From: Joy Rempe<mailto:jrempe@cableone.net>
>>>>> To: Tateiwa, Kenji<mailto:tateiwa.kenji@tepco.co.jp>
>>>>> Cc: Banks, Mark<mailto:Mark.Banks@nrc.gov>; Edwin
>>>>> Hackett<mailto:Edwin.Hackett@nrc.gov>; Stetkar,
>>>>> John<mailto:John.Stetkar@nrc.gov>
>>>>> Sent: Monday, February 09, 2015 7:45 PM
>>>>> Subject: Re: Invitation to Brief ACRS
>>>>>
>>>>> Hi Kenji,
>>>>>
>>>>> Thanks for your willingness to brief us. Unfortunately, because of
>>>>> the rules related to federal advisory committees, we aren't allowed
>>>>> to be 'casual'. Nevertheless, when it was brought up during our
>>>>> planning meeting, most of us knew you (or of you) and
>>>>> enthusiastically agreed that this was a great opportunity. Many of
>>>>> us were also already aware that you'd previously given the NRC
>>>>> staff a briefing (and regretted not being able to attend it). I've
>>>>> heard that it was well-received by the staff.
>>>>>
>>>>> Please be prepared for us 'interrupting' you with questions. It is
>>>>> just our way of learning. Your 30 minute presentation will easily
>>>>> expand to fill the entire hour.
>>>>>
>>>>> Also, several of us are already thinking that a 'thank-you' letter
>>>>> is needed for your kindness. Please let us know the appropriate
>>>>> TEPCO individual (and title) that should receive this letter.
>>>>>
>>>>> Best wishes,

>>>>> Joy
>>>>>
>>>>> On 2/9/2015 5:27 PM, Tateiwa, Kenji wrote:
>>>>> Hi Joy,
>>>>>
>>>>> Thank you for following up on my offer to brief the ACRS members.
>>>>> I was thinking about a casual meeting, but it is an overwhelming
>>>>> honor to be invited to the full committee meeting.
>>>>>
>>>>> All of the dates that you proposed work for me, but my preference
>>>>> will be Fri, April 10th.
>>>>> I look forward to the opportunity of sharing the status of
>>>>> Fukushima Daiichi and D&D related progress to you and your ACRS
>>>>> colleagues.
>>>>>
>>>>> All the best,
>>>>> Kenji

>>>>> -----
>>>>> Kenji Tateiwa
>>>>> Manager, Nuclear Power Programs
>>>>> Tokyo Electric Power Company
>>>>> Washington Office
>>>>> 2121 K Street, NW Suite 910
>>>>> Washington, DC 20037
>>>>> tel: +1-202-457-0790 (ext.)116
>>>>> mgbil

(b)(6)

>>>>> ----- Original Message -----
>>>>> From: Joy Rempe<mailto:jrempe@cableone.net>
>>>>> To: Tateiwa, Kenji<mailto:tateiwa.kenji@tepcoco.jp>
>>>>> Cc: Edwin Hackett<mailto:Edwin.Hackett@nrc.gov>; Banks,
>>>>> Mark<mailto:Mark.Banks@nrc.gov>
>>>>> Sent: Friday, February 06, 2015 2:48 PM
>>>>> Subject: Invitation to Brief ACRS
>>>>>
>>>>> Hi Kenji,
>>>>>
>>>>> I followed up on your offer to provide ACRS a briefing before you
>>>>> return to Tokyo. Today, the ACRS voted to invite you to provide us
>>>>> a briefing at either our April or May full committee meetings. The
>>>>> dates of these meetings are April 9-10 or May 7-8. The ACRS would
>>>>> like to request that your presentation focus on the status of the
>>>>> affected plants (especially related to results from recent
>>>>> investigations/inspections by TEPCO), D&D efforts, and future
>>>>> plans for their D&D and any examinations. Your presentation
>>>>> should last approximately 30 minutes, but plan for the briefing to
>>>>> last an hour (e.g., ACRS members will be asking questions
>>>>> throughout your briefing, so the briefing tends to double in time).
>>>>>
>>>>> I've copied Dr. Ed Hackett, Executive Director of the ACRS, and Mr.
>>>>> Mark Banks, Branch Manager for ACRS. We'd appreciate your
>>>>> responding to all three of us related to possible times that you
>>>>> would be available during these meetings. They will schedule a time
>>>>> when you are available and facilitate the processes required for
>>>>> your gaining access to the NRC Headquarters in North Bethesda, DC.
>>>>>
>>>>> Thanks again for offering to provide us this presentation.
>>>>>
>>>>> Best wishes,
>>>>> Joy
>>>>>
>>>>> Dr. Joy L. Rempe, Principal
>>>>> Rempe and Associates, LLC
>>>>> 306 Stillwater
>>>>> Idaho Falls, ID 83404
>>>>> Phone: 208-520-3708<tel:208-520-3708>
>>>>> Email:
>>>>> jrempe@cableone.net<mailto:jrempe@cableone.net><mailto:jrempe@cableone.net>

Hackett, Edwin

From: Banks, Mark
Sent: Monday, April 20, 2015 3:18 PM
To: Joy Rempe; John Stetkar
Cc: Hackett, Edwin; Dennis Bley; Mike Corradini; Stephen Schultz; Stetkar, John
Subject: RE: Thank you letter to Kenji's Boss
Attachments: Thank You Letter to Takao Onuki (TEPCO).docx

Attached is the letter with "to" changed to "with" and change of addressee and address.

Thanks to you all,

Mark

From: Joy Rempe [mailto:jlrempe@cableone.net]
Sent: Monday, April 20, 2015 2:12 PM
To: John Stetkar
Cc: Banks, Mark; Hackett, Edwin; Dennis Bley; Mike Corradini; Stephen Schultz; Stetkar, John
Subject: Re: Thank you letter to Kenji's Boss

Mark,

Please change the address. Per an email from Kenji last week (it went to Ed, but I thought that I forwarded it to you?), Kenji requested that the letter be addressed to:

Mr. Takao Onuki
Director, Washington Office, Tokyo Electric Power Company
2121 K Street, NW, Suite 910
Washington, DC 20037

Thanks!
Joy

Dr. Joy L. Rempe, Principal
Rempe and Associates, LLC
306 Stillwater
Idaho Falls, ID 83404
Phone: 208-520-3708
Email: jlrempe@cableone.net
Website: www.rempellc.com

On Mon, Apr 20, 2015 at 8:10 AM, <jwstetkar@aol.com> wrote:
Mark,

Looks great to me with Ed's "familiar with".

John

In a message dated 4/20/2015 8:36:01 A.M. Central Daylight Time, Mark.Banks@nrc.gov writes:



**UNITED STATES
NUCLEAR REGULATORY COMMISSION
ADVISORY COMMITTEE ON REACTOR SAFEGUARDS
WASHINGTON, DC 20555 – 0001**

April 22, 2015

Mr. Takao Onuki
Director, Washington Office
Tokyo Electric Power Company
2121 K Street, NW, Suite 910
Washington, DC 20037

Dear Mr. Onuki:

Please accept this letter of thanks for the briefing on the status of your Fukushima Daiichi Nuclear Power Station provided by Mr. Kenji Tateiwa to the Advisory Committee on Reactor Safeguards on April 10, 2015.

Mr. Tateiwa provided us with a detailed and informative presentation on the overall status of Fukushima Daiichi and the ongoing decontamination and decommissioning efforts at the site. The opportunity to discuss directly with Mr. Tateiwa the current Tokyo Electric Power Company operations at Fukushima Daiichi and receive his unique insights was of great value to all of us. His professionalism and preparation, as well as his familiarity with the Fukushima Daiichi issues, were outstanding. Please convey our thanks to Mr. Tateiwa.

Sincerely,

John W. Stetkar
Chairman

cc: ACRS Members

Hackett, Edwin

From: Dennis Bley <dc.bley@gmail.com>
Sent: Monday, April 20, 2015 4:19 PM
To: Hackett, Edwin
Cc: Banks, Mark; John Stetkar; Michael Corradini; Steve Schultz; Joy Rempe; Bley, Dennis
Subject: Re: Thank you letter to Kenji's Boss

Agree with Ed. Thanks, Mark.

On Apr 20, 2015, at 9:59 AM, Hackett, Edwin <Edwin.Hackett@nrc.gov> wrote:

Thanks Mark – looks good to me.

Just one minor edit – change “of” to “with” in the 2nd to last sentence.

Once we have everyone's comments, we should have the letter ready for John's signature on Thursday or Friday.

Ed

From: Banks, Mark
Sent: Monday, April 20, 2015 9:36 AM
To: Hackett, Edwin; jwstetkar@aol.com; Dennis Bley (bley@buttonwoodconsulting.com); corradin@cae.wisc.edu; Stephen P. Schultz (sps01749@aol.com)
Cc: Joy Rempe (jrempe@cablone.net)
Subject: Thank you letter to Kenji's Boss

All,

Attached is a draft thank you letter to Kenji's boss (Takafumi Anegawa – Chief Nuclear Officer, TEPCO). Please review and revise – the draft is meant as a starting point.

Thanks,

Mark Banks – Chief
Technical Support Branch
Advisory Committee on Reactor Safeguards
Nuclear Regulatory Commission
Tel. 301-415-3718
Fax 301-415-5589

From: Joy Rempe
To: Banks, Mark
Subject: Re: Thank you letter to Kenji's Boss
Date: Monday, April 20, 2015 8:42:11 PM

looks good to me.

please copy me (and maybe kenji) on the email when it is sent. i'll let kenji know that it was done.

thanks again for your efforts.

joy

Dr. Joy L. Rempe, Principal
Rempe and Associates, LLC
306 Stillwater
Idaho Falls, ID 83404
Phone: 208-520-3708
Email: jrempe@cableone.net
Website: www.rempelle.com

On Mon, Apr 20, 2015 at 1:18 PM, Banks, Mark <Mark.Banks@nrc.gov> wrote:

Attached is the letter with "to" changed to "with" and change of addressee and address.

Thanks to you all,

Mark

From: Joy Rempe [mailto:jrempe@cableone.net]
Sent: Monday, April 20, 2015 2:12 PM
To: John Stetkar
Cc: Banks, Mark; Hackett, Edwin; Dennis Bley; Mike Corradini; Stephen Schultz; Stetkar, John
Subject: Re: Thank you letter to Kenji's Boss

Mark,

Please change the address. Per an email from Kenji last week (it went to Ed, but I thought that I forwarded it to you?), Kenji requested that the letter be addressed to:

Mr. Takao Onuki
Director, Washington Office, Tokyo Electric Power Company
2121 K Street, NW, Suite 910

Washington, DC 20037

Thanks!

Joy

Dr. Joy L. Rempe, Principal
Rempe and Associates, LLC
306 Stillwater
Idaho Falls, ID 83404
Phone: 208-520-3708
Email: jlrempe@cableone.net

Website: www.rempelle.com

On Mon, Apr 20, 2015 at 8:10 AM, <jwstetkar@aol.com> wrote:

Mark,

Looks great to me with Ed's "familiar with".

John

In a message dated 4/20/2015 8:36:01 A.M. Central Daylight Time, Mark.Banks@nrc.gov writes:

All,

Attached is a draft thank you letter to Kenji's boss (Takafumi Anegawa – Chief Nuclear Officer, TEPCO). Please review and revise – the draft is meant as a starting point.

Thanks,

Mark Banks – Chief

Technical Support Branch

Advisory Committee on Reactor Safeguards

Nuclear Regulatory Commission

Tel. 301-415-3718

Fax 301-415-5589

=

Hackett, Edwin

From: Tateiwa, Kenji <tateiwa.kenji@tepcoco.jp>
Sent: Friday, June 26, 2015 7:55 PM
To: tateiwa.kenji@tepcoco.jp
Subject: [External_Sender] [Transition from DC to Tokyo] New Role in Decommissioning Safety

Dear Friends and Colleagues,

Today will be my last day working out of the Washington DC Office of TEPCO.

After spending 4 productive years in DC, I will be departing the U.S. on Sat, June 27 and start working at TEPCO's Tokyo HQ on July 1 as Safety Engineering Group Manager of Fukushima Daiichi Decontamination & Decommissioning Engineering Company.

Thank you for your continued support to TEPCO after the Fukushima Daiichi accident in March 2011. We could not have made it thus far without all your support.

For your information, you can find my latest interview on the online Nuclear Plant Journal describing the current status of Fukushima Daiichi.

<http://digitaleditions.nuclearplantjournal.com/MJ15/#32>

Feel free to contact me should you have any questions related to Fukushima. I look forward to keeping in touch.

All the best,
Kenji

p.s.
Please forgive my slow response in emails for the next few weeks while I make my transition back to Japan.

Kenji Tateiwa
email: tateiwa.kenji@tepcoco.jp
LinkedIn: <https://www.linkedin.com/in/ktateiwa>

-----]
(From Sep. 2011 to June 2015)
Manager, Nuclear Power Programs
Tokyo Electric Power Company
Washington Office

(From July 2015)
Safety Engineering Group Manager
Fukushima Daiichi D&D Engineering Company
Tokyo Electric Power Company
1-1-3 Uchisaiwai-cho, Chiyoda-ku
Tokyo, Japan
tel: +81-3-6373-4751

From: Joy Rempe
To: Banks, Mark
Subject: [External_Sender] Re: Copy of ACRS Thank You Letter to Kenji's Boss
Date: Monday, June 29, 2015 3:51:04 PM

Hi Mark,

Thanks. I need to apologize, but John and Sherry got it for me when you went to your meeting. I should have sent you a note telling you to nevermind. I just figured that you saw us do it before you went into Ed's office. I hope that it wasn't too much effort. I'll do better next time.

Joy

On 6/29/2015 1:48 PM, Banks, Mark wrote:

Hi Joy,

Attached is a copy of the thank you letter sent by the Committee to Kenji's boss. Sorry for taking so long – I remember, then I forget.....

Thanks,

Mark Banks – Chief
Technical Support Branch
Advisory Committee on Reactor Safeguards
Nuclear Regulatory Commission
Tel. 301-415-3718
Fax 301-415-5589

--
Dr. Joy L. Rempe, Principal
Rempe and Associates, LLC
306 Stillwater
Idaho Falls, ID 83404
Phone: 208-520-3708
Email: jlr@rempeandassociates.net
Website: www.rempeandassociates.com

From: Joy Rempe
To: Banks, Mark
Subject: [External_Sender] Re: Copy of ACRS Thank You Letter to Kenji's Boss
Date: Monday, June 29, 2015 3:51:31 PM

Kenji appreciated it. He's already posted it on the TEPCO internal website.

Joy

On 6/29/2015 1:48 PM, Banks, Mark wrote:

Hi Joy,

Attached is a copy of the thank you letter sent by the Committee to Kenji's boss. Sorry for taking so long – I remember, then I forget.....

Thanks,

Mark Banks – Chief
Technical Support Branch
Advisory Committee on Reactor Safeguards
Nuclear Regulatory Commission
Tel. 301-415-3718
Fax 301-415-5589

--
Dr. Joy L. Rempe, Principal
Rempe and Associates, LLC
306 Stillwater
Idaho Falls, ID 83404
Phone: 208-520-3708
Email: jrempe@cableone.net
Website: www.rempellc.com

Hackett, Edwin

From: Tateiwa, Kenji <tateiwa.kenji@tepcoco.jp>
Sent: Sunday, July 12, 2015 2:31 AM
To: Hackett, Edwin
Subject: [External_Sender] RE: [Transition from DC to Tokyo] New Role in Decommissioning Safety

Ed,

Thank you for your kind note.
Apologies for the extreme delay in my response.

I started working at TEPCO's Tokyo HQ on June 30 and have been working non-stop since then. It is an incredibly tough job but worth spending all the energy and passion that I have for nuclear.

It has been a great pleasure getting to know you and your colleagues at the NRC.
I look forward to keeping in touch.

All the best,
Kenji
(Please ignore the error message you might receive from my DC office email account that has been disabled.)

Kenji Tateiwa
Safety Engineering Group Manager
Fukushima Daiichi D&D Engineering Company
Tokyo Electric Power Company, Inc.
1-1-3 Uchisaiwai-cho, Chiyoda-ku
Tokyo, Japan
office: +81-3-6373-4751
cell:
(b)(6)
tateiwa.kenji@tepcoco.jp

From: Hackett, Edwin [mailto:Edwin.Hackett@nrc.gov]
Sent: Saturday, June 27, 2015 9:39 PM
To: Tateiwa, Kenji
Subject: Re: [Transition from DC to Tokyo] New Role in Decommissioning Safety

Kenji,

All the best to you and your family. I look forward to future interactions.

Ed

From: Tateiwa, Kenji <tateiwa.kenji@tepcoco.jp>
Sent: Friday, June 26, 2015 7:55:20 PM
To: tateiwa.kenji@tepcoco.jp
Subject: [External_Sender] [Transition from DC to Tokyo] New Role in Decommissioning Safety

Dear Friends and Colleagues,

Today will be my last day working out of the Washington DC Office of TEPCO.

Tateiwa, Kenji

差出人: Tateiwa, Kenji
送信日時: 2015年6月19日金曜日 11:35
宛先: Tateiwa, Kenji
件名: Last Call from DC [TEPCO Weekly Fukushima Update Call] Fri, June 19, 2015
at 2pm EDT

Nuclear Industry Colleagues,

Tomorrow will mark the last Weekly Fukushima Update Call that I will conduct from DC.

After spending almost 4 years, I will be departing DC on June 27 and start working at TEPCO's Tokyo HQ on July 1 as Safety Engineering Group Manager of Fukushima Daiichi D&D Engineering Company.

I will endeavor to continue this call from Tokyo, albeit at a less frequent basis.
I will send out a notice for the next call once I settled into my new position.

Thank you for your continued support to TEPCO and for your interest in the progress at Fukushima Daiichi.
I look forward to keeping in touch.

[Date/time]
Fri, June 19, 2015 at 2 pm Eastern Daylight Time
(Date/time of next call to be determined.)

[call-in information] (Please record your name and organization when joining the call.)
call number 718-354-1184

(b)(6) passcode

[Major topics]

1. Cabinet-Level Meeting on Decommissioning and Contaminated Water Issues (6/12/2015)

(only in Japanese)

1-1. Outline of Revised Mid-and-Long-Term Roadmap

http://www.tepco.co.jp/nu/fukushima-np/roadmap/images/t150612_03-j.pdf

1-2. Revised Mid-and-Long-Term Roadmap

http://www.tepco.co.jp/nu/fukushima-np/roadmap/images/t150612_05-j.pdf

1-3. Revised Schedule for Defueling of Units 1-3 SFPs

http://www.tepco.co.jp/nu/fukushima-np/roadmap/images/t150612_04-j.pdf

2. Summary Progress at Units 1-4 (6/12/2015)

http://www.tepco.co.jp/nu/fukushima-np/handouts/2015/images/handouts_150612_04-j.pdf

3. Transition of Different Types of Contaminated Water Stored in Tank Farms (6/12/2015)

http://www.tepco.co.jp/nu/fukushima-np/handouts/2015/images/handouts_150612_05-j.pdf

** If you cannot display Japanese characters, please install the following font packs:*

<http://www.adobe.com/support/downloads/detail.jsp?ftplID=4881>

(Feel free to forward this email to your colleagues or have them contact me to be added to the distribution list.)

All the best,
Kenji

Kenji Tateiwa
Manager, Nuclear Power Programs

Tokyo Electric Power Company
Washington Office
2121 K Street, NW Suite 910
Washington, DC 20037
tel: +1-202-457-0790 (ext.)116
mobile: (b)(6)
tateiwa.kenji@tepcoco.jp
(Email address will remain unchanged after my transition to Tokyo.)

----- Original Message -----

From: Tateiwa, Kenji
To: Tateiwa, Kenji
Sent: Thursday, June 04, 2015 10:18 PM
Subject: [TEPCO Weekly Fukushima Update Call] Fri, June 5, 2015 at 2pm EDT

Nuclear Industry Colleagues,

Please find below information for tomorrow's Weekly Fukushima Update Call.

[Date/time]

Fri, June 5, 2015 at 2 pm Eastern Daylight Time
(No Call Next Week. Next call will be on Fri, June 19 at 2 pm EDT.)

[call-in information] (Please record your name and organization when joining the call.)

call number: 718-354-1184

passcode: (b)(6)

[Major topics]

1. NRA Special Facilities Monitoring and Evaluation Committee (5/22/2015)

(only in Japanese)

1-1. Closure of Seawater Piping Trenches of Units 2, 3, 4

<http://www.nsr.go.jp/data/000107869.pdf>

1-2. Water Collected on Lid of High-Intensity Container Inside a Box Culvert

<http://www.nsr.go.jp/data/000108101.pdf>

1-3. Groundwater Inflow Mitigation Measures and Water Level Management

<http://www.nsr.go.jp/data/000107730.pdf>

2. On-Site Coordination Meeting on Decommissioning & Contaminated Water Issues (5/25/2015)

(only in Japanese)

2-1. Water Contamination Monitoring Status

http://www.tepcoco.jp/nu/fukushima-np/roadmap/images/1150525_03-i.pdf

2-2. Status of Unit 1 Reactor Building Cover Dismantling

http://www.tepcoco.jp/nu/fukushima-np/roadmap/images/1150525_04-i.pdf

2-3. Status Report on Identification of Risk Factors Related to Off-site Radiological Impact

http://www.tepcoco.jp/nu/fukushima-np/roadmap/images/1150525_07-i.pdf

2-4. Preparation for Disclosure of All Radiological Data

http://www.tepcoco.jp/nu/fukushima-np/roadmap/images/1150525_08-i.pdf

2-5. Status Report on Various Issues (146 pages, 19 MB)

http://www.tepcoco.jp/nu/fukushima-np/roadmap/images/1150525_13-j.pdf

3. Working-level Meeting of Decommissioning & Contaminated Water Issues Team (5/28/2015)

(only in Japanese)

3-1. Plant Status

http://www.tepcoco.jp/nu/fukushima-np/roadmap/images/d150528_04-j.pdf

3-2. Summary Status of Decommissioning Roadmap

http://www.tepcoco.jp/nu/fukushima-np/roadmap/images/d150528_05-j.pdf

(English translation as of 4/30/2015)

http://www.tepco.co.jp/en/nu/fukushima-np/roadmap/images/d150430_01-e.pdf

3-3. Unit 1 Drywell Water Level Measurement

http://www.tepco.co.jp/nu/fukushima-np/roadmap/images/d150528_06-j.pdf

3-4. Contaminated Water Treatment (file size: 11 MB)

http://www.tepco.co.jp/nu/fukushima-np/roadmap/images/d150528_07-j.pdf

3-5. Environmental Radiation Issues (file size: 15 MB)

http://www.tepco.co.jp/nu/fukushima-np/roadmap/images/d150528_08-j.pdf

3-6. Spent Fuel Pool Issues

http://www.tepco.co.jp/nu/fukushima-np/roadmap/images/d150528_10-j.pdf

3-7. Preparation for Fuel Debris Removal

http://www.tepco.co.jp/nu/fukushima-np/roadmap/images/d150528_11-j.pdf

3-8. Radioactive Waste Processing

http://www.tepco.co.jp/nu/fukushima-np/roadmap/images/d150528_12-j.pdf

3-9. Draft Revision of Mid-to-Long Term Decommissioning Roadmap

http://www.tepco.co.jp/nu/fukushima-np/roadmap/images/d150528_13-j.pdf

4. Leakage of Contaminated Water from Transfer Hose (6/1/2015)

(only in Japanese)

http://www.tepco.co.jp/nu/fukushima-np/handouts/2015/images/handouts_150601_06-j.pdf

All the best,
Kenji

----- Original Message -----

From: Tateiwa, Kenji

To: Tateiwa, Kenji

Sent: Thursday, May 21, 2015 9:13 PM

Subject: [TEPCO Weekly Fukushima Update Call] Fri, May 22, 2015 at 2pm EDT

Nuclear Industry Colleagues,

Please find below information for tomorrow's Weekly Fukushima Update Call.

[Date/time]

Fri, May 22, 2015 at 2 pm Eastern Daylight Time

(No Call Next Week. Next call will be on Fri, June 5 at 2 pm EDT.)

[call-in information] (Please record your name and organization when joining the call.)

call number: 718-354-1184

passcode:

(b)(6)

[Major topics]

1. IAEA Peer Review Mission Report #3 (5/14/2015)

http://www.tepco.co.jp/en/nu/fukushima-np/handouts/2015/images/handouts_150514_01-e.pdf

"IAEA Issues Report on Fukushima Decommissioning Review" (IAEA Press Release)

<https://www.iaea.org/newscenter/pressreleases/iaea-issues-report-fukushima-decommissioning-review>

2. Fukushima Nuclear Accident Unresolved Issues Progress Report # 3 (5/20/2015)

http://www.tepco.co.jp/en/press/corp-com/release/2015/1250927_6844.html

(English Summary)

http://www.tepco.co.jp/en/press/corp-com/release/betu15_e/images/150520e0101.pdf

(Japanese Full Report: 503 pages, 27 MB)

http://www.tepco.co.jp/cc/press/betu15_j/images/150520j0102.pdf

3. High-Level Meeting of Decommissioning & Contaminated Water Issues Team (5/21/2015)

(only in Japanese)

3-1. Basic Policy regarding the Mid-and-Long-Term Decommissioning Roadmap

http://www.tepco.co.jp/nu/fukushima-np/roadmap/images/t150521_05-j.pdf

3-2. Straw Man for the Mid-and-Long-Term Decommissioning Roadmap

http://www.tepco.co.jp/nu/fukushima-np/roadmap/images/t150521_06-j.pdf

3-3. Enhanced Coordination on R&D Activities for Decommissioning and Contaminated Water Issues

http://www.tepco.co.jp/nu/fukushima-np/roadmap/images/t150521_03-j.pdf

All the best,

Kenji

----- Original Message -----

From: Tateiwa, Kenji

To: Tateiwa, Kenji

Sent: Thursday, May 07, 2015 9:04 PM

Subject: [TEPCO Weekly Fukushima Update Call] Fri, May 8, 2015 at 2pm EDT

Nuclear Industry Colleagues,

Please find below information for tomorrow's Weekly Fukushima Update Call.

[Date/time]

Fri, May 8, 2015 at 2 pm Eastern Daylight Time

(No Call Next Week. Next call will be on Fri, May 22 at 2 pm EDT.)

[call-in information] (Please record your name and organization when joining the call.)

call number: 719 254 4184

passcode:

(b)(6)

[Major topics]

1. Unit 1 Drywell Internal Investigation by Transforming Robots: Summary of Findings (4/30/2015)

(only in Japanese)

http://www.tepco.co.jp/nu/fukushima-np/handouts/2015/images/handouts_150430_01-j.pdf

2. Working-level Meeting of Decommissioning & Contaminated Water Issues Team (4/30/2015)

(only in Japanese)

2-1. Plant Status

http://www.tepco.co.jp/nu/fukushima-np/roadmap/images/d150430_04-j.pdf

2-2. Summary Status of Decommissioning Roadmap

http://www.tepco.co.jp/nu/fukushima-np/roadmap/images/d150430_05-j.pdf

(English translation as of 3/26/2015)

http://www.tepco.co.jp/en/nu/fukushima-np/roadmap/images/d150326_01-e.pdf

2-3. Contaminated Water Treatment (file size: 14 MB)

http://www.tepco.co.jp/nu/fukushima-np/roadmap/images/d150430_07-j.pdf

2-4. Environmental Radiation Issues (file size: 17 MB)

http://www.tepco.co.jp/nu/fukushima-np/roadmap/images/d150430_08-j.pdf

2-5. Spent Fuel Pool Issues

http://www.tepco.co.jp/nu/fukushima-np/roadmap/images/d150430_10-j.pdf

2-6. Preparation for Fuel Debris Removal

http://www.tepco.co.jp/nu/fukushima-np/roadmap/images/d150430_11-j.pdf

2-7. Radioactive Waste Processing

http://www.tepco.co.jp/nu/fukushima-np/roadmap/images/d150430_12-j.pdf

2-8. NDF's 2015 Technical Strategy Plan in Preparation for Revising the Mid-to-Long Term Decommissioning Roadmap (file size: 18 MB)

http://www.tepco.co.jp/nu/fukushima-np/roadmap/images/d150430_14-j.pdf

2-9. Identification of Risk Factors Related to Off-site Radiological Impact

http://www.tepco.co.jp/nu/fukushima-np/roadmap/images/d150430_15-j.pdf

2-10. Preparation for Disclosing All Radiological Data

http://www.tepco.co.jp/nu/fukushima-np/roadmap/images/d150430_16-j.pdf

2-11. Government-Funded Demonstration Testing Results for 5 Contaminated Water Treatment Systems

http://www.tepco.co.jp/nu/fukushima-np/roadmap/images/d150430_17-j.pdf

3. Test Operation of Brine Circulation for Frozen Soil Wall (4/30/2015)

<http://photo.tepco.co.jp/en/date/2015/201504-e/150430-02e.html>

All the best,
Kenji

Hackett, Edwin

From: Tateiwa, Kenji <tateiwa.kenji@tepcoco.jp>
Sent: Friday, July 31, 2015 9:47 AM
To: tateiwa.kenji@tepcoco.jp
Subject: [External_Sender] Please reply to sign up [TEPCO Fukushima Update Call] Mon, Aug. 3, 2015 at 9am EDT/10pm JST
Attachments: Fukushima Update Call.pdf

Friends and Colleagues,

I hope this email finds you well.

A month has passed since I made the transition from TEPCO's Washington DC office to the Tokyo HQ as Safety Engineering Group Manager of Fukushima Daiichi D&D Engineering Company.

I intend to resume the "Fukushima Update Call" that I had been hosting on a weekly-basis since early 2012 to update interested professionals (from the industry, government sector, academia, etc.) on the latest situation at Fukushima Daiichi.

I will be sending out email notification to participants prior to the call with links to the most important topics that I will verbally cover during the call.

I endeavor to host future calls on a monthly basis, with a target duration of about 30 minutes, including Q&A. (Attached, FYI, is an email that I sent out last month from DC.)

Please reply to this email if you and/or your colleagues would like to be included in the distribution list for future calls.

Feel free to join the call whenever you find topics of interest to you.
I would also be happy to answer any questions separate from the call.

[Date/time]

Mon, August 3, 2015 at 9 am U.S. Eastern Daylight Time
(Next call: Mon, Aug. 31 at 9 am EDT.)

[call-in information] (Please record your name and organization when joining the call.)

call number (New York): 718-354-1184

passcode

^{(b)(6)} *Please let me know if any of you would like to join the call from other countries.*

[Major topics]

1. Contaminated Water Treatment Committee (7/29/2015)

(only in Japanese)

1-1. Plant Status

http://www.tepcoco.jp/nu/fukushima-np/roadmap/images/c150729_03-j.pdf

1-2. Progress of Contaminated Water Treatment and Risk Map

http://www.tepcoco.jp/nu/fukushima-np/roadmap/images/c150729_04-j.pdf

1-3. Frozen Soil Wall Taskforce

http://www.tepcoco.jp/nu/fukushima-np/roadmap/images/c150729_05-j.pdf

1-4. High-Performance ALPS Taskforce

http://www.tepcoco.jp/nu/fukushima-np/roadmap/images/c150729_06-j.pdf

1-5. Tritiated Water Taskforce

http://www.tepco.co.jp/nu/fukushima-np/roadmap/images/c150729_07-j.pdf

2. Working-level Meeting of Decommissioning & Contaminated Water Issues Team (7/30/2015)

(only in Japanese)

2-1. Plant Status

http://www.tepco.co.jp/nu/fukushima-np/roadmap/images/d150730_04-j.pdf

2-2. Summary Status of Decommissioning Roadmap (file size: 11 MB)

http://www.tepco.co.jp/nu/fukushima-np/roadmap/images/d150730_05-j.pdf

(English translation as of 6/25/2015)

http://www.tepco.co.jp/en/nu/fukushima-np/roadmap/images/d150625_01-e.pdf

2-3. Contaminated Water Issues (file size: 10 MB)

http://www.tepco.co.jp/nu/fukushima-np/roadmap/images/d150730_06-j.pdf

2-4. Spent Fuel Pool Issues (file size: 10 MB)

http://www.tepco.co.jp/nu/fukushima-np/roadmap/images/d150730_07-j.pdf

2-5. Preparation for Fuel Debris Removal

http://www.tepco.co.jp/nu/fukushima-np/roadmap/images/d150730_08-j.pdf

2-6. Radioactive Waste Processing

http://www.tepco.co.jp/nu/fukushima-np/roadmap/images/d150730_09-j.pdf

2-7. Circulating Water Core Cooling System

http://www.tepco.co.jp/nu/fukushima-np/roadmap/images/d150730_10-j.pdf

2-8. Environmental Radiation Issues (file size: 15 MB)

http://www.tepco.co.jp/nu/fukushima-np/roadmap/images/d150730_11-j.pdf

2-9. Work Environment Improvement

http://www.tepco.co.jp/nu/fukushima-np/roadmap/images/d150730_12-j.pdf

2-10. Summary of 1st Decommissioning R&D Collaboration Council (file size: 28 MB)

http://www.tepco.co.jp/nu/fukushima-np/roadmap/images/d150730_15-j.pdf

3. Completion of Removal of Highly-Contaminated Water from Seawater Piping Trenches (7/30/2015)

http://www.tepco.co.jp/en/press/corp-com/release/2015/1256382_6844.html

4. 160-page Presentation on Fukushima Accident (6/15/2015@Harvard University)

<https://drive.google.com/file/d/0B3xzjqQbkuq9aU9tX0FJS2pPenM/view?usp=sharing>

** If you cannot display Japanese characters, please install the following font packs:*

<http://www.adobe.com/support/downloads/detail.jsp?ftpID=4881>

All the best,

Kenji

Kenji Tateiwa

Safety Engineering Group Manager

Fukushima Daiichi D&D Engineering Company

Tokyo Electric Power Company, Inc.

1-1-3 Uchisaiwai-cho, Chiyoda-ku

Tokyo, Japan

office: +81-3-6373-4751

cell:

tateiwa.kenji@tepco.co.jp

Tateiwa, Kenji

差出人: Tateiwa, Kenji
送信日時: 2015年6月19日金曜日 11:35
宛先: Tateiwa, Kenji
件名: Last Call from DC [TEPCO Weekly Fukushima Update Call] Fri, June 19, 2015
at 2pm EDT

Nuclear Industry Colleagues,

Tomorrow will mark the last Weekly Fukushima Update Call that I will conduct from DC.

After spending almost 4 years, I will be departing DC on June 27 and start working at TEPCO's Tokyo HQ on July 1 as Safety Engineering Group Manager of Fukushima Daiichi D&D Engineering Company.

I will endeavor to continue this call from Tokyo, albeit at a less frequent basis.
I will send out a notice for the next call once I settled into my new position.

Thank you for your continued support to TEPCO and for your interest in the progress at Fukushima Daiichi.
I look forward to keeping in touch.

[Date/time]

Fri, June 19, 2015 at 2 pm Eastern Daylight Time
(Date/time of next call to be determined.)

[call-in information] (Please record your name and organization when joining the call.)

call number: 718-354-1184

passcode

(b)(6)

[Major topics]

1. Cabinet-Level Meeting on Decommissioning and Contaminated Water Issues (6/12/2015)

(only in Japanese)

1-1. Outline of Revised Mid-and-Long-Term Roadmap

http://www.tepco.co.jp/nu/fukushima-np/roadmap/images/t150612_03-j.pdf

1-2. Revised Mid-and-Long-Term Roadmap

http://www.tepco.co.jp/nu/fukushima-np/roadmap/images/t150612_05-j.pdf

1-3. Revised Schedule for Defueling of Units 1-3 SFPs

http://www.tepco.co.jp/nu/fukushima-np/roadmap/images/t150612_04-j.pdf

2. Summary Progress at Units 1-4 (6/12/2015)

http://www.tepco.co.jp/nu/fukushima-np/handouts/2015/images/handouts_150612_04-j.pdf

3. Transition of Different Types of Contaminated Water Stored in Tank Farms (6/12/2015)

http://www.tepco.co.jp/nu/fukushima-np/handouts/2015/images/handouts_150612_05-j.pdf

** If you cannot display Japanese characters, please install the following font packs:*

<http://www.adobe.com/support/downloads/detail.jsp?ftpID=4881>

(Feel free to forward this email to your colleagues or have them contact me to be added to the distribution list.)

All the best,
Kenji

Kenji Tateiwa
Manager, Nuclear Power Programs

Tokyo Electric Power Company
Washington Office
2121 K Street, NW Suite 910
Washington, DC 20037
tel: +1-202-457-0790 (ext.)116
mobile: (b)(6)
tatewa.kenji@tepcoco.jp
(Email address will remain unchanged after my transition to Tokyo.)

----- Original Message -----

From: Tatewa, Kenji
To: Tatewa, Kenji
Sent: Thursday, June 04, 2015 10:18 PM
Subject: [TEPCO Weekly Fukushima Update Call] Fri, June 5, 2015 at 2pm EDT

Nuclear Industry Colleagues,

Please find below information for tomorrow's Weekly Fukushima Update Call.

[Date/time]

Fri, June 5, 2015 at 2 pm Eastern Daylight Time
(No Call Next Week. Next call will be on Fri, June 19 at 2 pm EDT.)

[call-in information] (Please record your name and organization when joining the call.)

call number: 719 254 4494

passcode: (b)(6)

[Major topics]

1. NRA Special Facilities Monitoring and Evaluation Committee (5/22/2015)

(only in Japanese)

1-1. Closure of Seawater Piping Trenches of Units 2, 3, 4

<http://www.nsr.go.jp/data/000107869.pdf>

1-2. Water Collected on Lid of High-Intensity Container Inside a Box Culvert

<http://www.nsr.go.jp/data/000108101.pdf>

1-3. Groundwater Inflow Mitigation Measures and Water Level Management

<http://www.nsr.go.jp/data/000107730.pdf>

2. On-Site Coordination Meeting on Decommissioning & Contaminated Water Issues (5/25/2015)

(only in Japanese)

2-1. Water Contamination Monitoring Status

http://www.tepcoco.jp/nu/fukushima-np/roadmap/images/150525_03-j.pdf

2-2. Status of Unit 1 Reactor Building Cover Dismantling

http://www.tepcoco.jp/nu/fukushima-np/roadmap/images/150525_04-j.pdf

2-3. Status Report on Identification of Risk Factors Related to Off-site Radiological Impact

http://www.tepcoco.jp/nu/fukushima-np/roadmap/images/150525_07-j.pdf

2-4. Preparation for Disclosure of All Radiological Data

http://www.tepcoco.jp/nu/fukushima-np/roadmap/images/150525_08-j.pdf

2-5. Status Report on Various Issues (146 pages, 19 MB)

http://www.tepcoco.jp/nu/fukushima-np/roadmap/images/150525_13-j.pdf

3. Working-level Meeting of Decommissioning & Contaminated Water Issues Team (5/28/2015)

(only in Japanese)

3-1. Plant Status

http://www.tepcoco.jp/nu/fukushima-np/roadmap/images/d150528_04-j.pdf

3-2. Summary Status of Decommissioning Roadmap

http://www.tepcoco.jp/nu/fukushima-np/roadmap/images/d150528_05-j.pdf

(English translation as of 4/30/2015)

http://www.tepco.co.jp/en/nu/fukushima-np/roadmap/images/d150430_01-e.pdf

3-3. Unit 1 Drywell Water Level Measurement

http://www.tepco.co.jp/nu/fukushima-np/roadmap/images/d150528_06-j.pdf

3-4. Contaminated Water Treatment (file size: 11 MB)

http://www.tepco.co.jp/nu/fukushima-np/roadmap/images/d150528_07-j.pdf

3-5. Environmental Radiation Issues (file size: 15 MB)

http://www.tepco.co.jp/nu/fukushima-np/roadmap/images/d150528_08-j.pdf

3-6. Spent Fuel Pool Issues

http://www.tepco.co.jp/nu/fukushima-np/roadmap/images/d150528_10-j.pdf

3-7. Preparation for Fuel Debris Removal

http://www.tepco.co.jp/nu/fukushima-np/roadmap/images/d150528_11-j.pdf

3-8. Radioactive Waste Processing

http://www.tepco.co.jp/nu/fukushima-np/roadmap/images/d150528_12-j.pdf

3-9. Draft Revision of Mid-to-Long Term Decommissioning Roadmap

http://www.tepco.co.jp/nu/fukushima-np/roadmap/images/d150528_13-j.pdf

4. Leakage of Contaminated Water from Transfer Hose (6/1/2015)

(only in Japanese)

http://www.tepco.co.jp/nu/fukushima-np/handouts/2015/images/handouts_150601_06-j.pdf

All the best,

Kenji

----- Original Message -----

From: Tateiwa, Kenji

To: Tateiwa, Kenji

Sent: Thursday, May 21, 2015 9:13 PM

Subject: [TEPCO Weekly Fukushima Update Call] Fri, May 22, 2015 at 2pm EDT

Nuclear Industry Colleagues,

Please find below information for tomorrow's Weekly Fukushima Update Call.

[Date/time]

Fri, May 22, 2015 at 2 pm Eastern Daylight Time

(No Call Next Week. Next call will be on **Fri, June 5** at 2 pm EDT.)

[call-in information] (Please record your name and organization when joining the call.)

call number: 718-354-1184

passcode

(b)(6)

[Major topics]

1. IAEA Peer Review Mission Report #3 (5/14/2015)

http://www.tepco.co.jp/en/nu/fukushima-np/handouts/2015/images/handouts_150514_01-e.pdf

"IAEA Issues Report on Fukushima Decommissioning Review" (IAEA Press Release)

<https://www.iaea.org/newscenter/pressreleases/iaea-issues-report-fukushima-decommissioning-review>

2. Fukushima Nuclear Accident Unresolved Issues Progress Report # 3 (5/20/2015)

http://www.tepco.co.jp/en/press/corp-com/release/2015/1250927_6844.html

(English Summary)

http://www.tepco.co.jp/en/press/corp-com/release/betu15_e/images/150520e0101.pdf

(Japanese Full Report: 503 pages, 27 MB)

http://www.tepco.co.jp/cc/press/betu15_j/images/150520j0102.pdf

3. High-Level Meeting of Decommissioning & Contaminated Water Issues Team (5/21/2015)

(only in Japanese)

3-1. Basic Policy regarding the Mid-and-Long-Term Decommissioning Roadmap

http://www.tepco.co.jp/nu/fukushima-np/roadmap/images/t150521_05-j.pdf

3-2. Straw Man for the Mid-and-Long-Term Decommissioning Roadmap

http://www.tepco.co.jp/nu/fukushima-np/roadmap/images/t150521_06-j.pdf

3-3. Enhanced Coordination on R&D Activities for Decommissioning and Contaminated Water Issues

http://www.tepco.co.jp/nu/fukushima-np/roadmap/images/t150521_03-j.pdf

All the best,

Kenji

----- Original Message -----

From: Tateiwa, Kenji

To: Tateiwa, Kenji

Sent: Thursday, May 07, 2015 9:04 PM

Subject: [TEPCO Weekly Fukushima Update Call] Fri, May 8, 2015 at 2pm EDT

Nuclear Industry Colleagues,

Please find below information for tomorrow's Weekly Fukushima Update Call.

[Date/time]

Fri, May 8, 2015 at 2 pm Eastern Daylight Time

(No Call Next Week. Next call will be on Fri, May 22 at 2 pm EDT.)

[call-in information] (Please record your name and organization when joining the call.)

call number: 718-354-1184

passcod

(b)(6)

[Major topics]

1. Unit 1 Drywell Internal Investigation by Transforming Robots: Summary of Findings (4/30/2015)

(only in Japanese)

http://www.tepco.co.jp/nu/fukushima-np/handouts/2015/images/handouts_150430_01-j.pdf

2. Working-level Meeting of Decommissioning & Contaminated Water Issues Team (4/30/2015)

(only in Japanese)

2-1. Plant Status

http://www.tepco.co.jp/nu/fukushima-np/roadmap/images/d150430_04-j.pdf

2-2. Summary Status of Decommissioning Roadmap

http://www.tepco.co.jp/nu/fukushima-np/roadmap/images/d150430_05-j.pdf

(English translation as of 3/26/2015)

http://www.tepco.co.jp/en/nu/fukushima-np/roadmap/images/d150326_01-e.pdf

2-3. Contaminated Water Treatment (file size: 14 MB)

http://www.tepco.co.jp/nu/fukushima-np/roadmap/images/d150430_07-j.pdf

2-4. Environmental Radiation Issues (file size: 17 MB)

http://www.tepco.co.jp/nu/fukushima-np/roadmap/images/d150430_08-j.pdf

2-5. Spent Fuel Pool Issues

http://www.tepco.co.jp/nu/fukushima-np/roadmap/images/d150430_10-j.pdf

2-6. Preparation for Fuel Debris Removal

http://www.tepco.co.jp/nu/fukushima-np/roadmap/images/d150430_11-j.pdf

2-7. Radioactive Waste Processing

http://www.tepco.co.jp/nu/fukushima-np/roadmap/images/d150430_12-j.pdf

2-8. NDF's 2015 Technical Strategy Plan in Preparation for Revising the Mid-to-Long Term Decommissioning Roadmap (file size: 18 MB)

http://www.tepco.co.jp/nu/fukushima-np/roadmap/images/d150430_14-j.pdf

2-9. Identification of Risk Factors Related to Off-site Radiological Impact

http://www.tepco.co.jp/nu/fukushima-np/roadmap/images/d150430_15-j.pdf

2-10. Preparation for Disclosing All Radiological Data

http://www.tepco.co.jp/nu/fukushima-np/roadmap/images/d150430_16-j.pdf

2-11. Government-Funded Demonstration Testing Results for 5 Contaminated Water Treatment Systems

http://www.tepco.co.jp/nu/fukushima-np/roadmap/images/d150430_17-j.pdf

3. Test Operation of Brine Circulation for Frozen Soil Wall (4/30/2015)

<http://photo.tepco.co.jp/en/date/2015/201504-e/150430-02e.html>

All the best,
Kenji



UNITED STATES
NUCLEAR REGULATORY COMMISSION
ADVISORY COMMITTEE ON REACTOR SAFEGUARDS
WASHINGTON, DC 20555 – 0001

April 22, 2015

Mr. Takafumi Anegawa
Chief Nuclear Officer
Tokyo Electric Power Company
Address

Dear Mr. Anegawa:

Please accept this letter of thanks for the briefing on the status of your Fukushima Daiichi Nuclear Power Station provided by Mr. Kenji Tateiwa to the Advisory Committee on Reactor Safeguards on April 10, 2015.

Mr. Tateiwa provided us with a detailed and informative presentation on the overall status of Fukushima Daiichi and the ongoing decontamination and decommissioning efforts at the site. The opportunity to discuss directly with Mr. Tateiwa the current Tokyo Electric Power Company operations at Fukushima Daiichi and receive his unique insights was of great value to all of us. His professionalism and preparation, as well as his familiarity with the Fukushima Daiichi issues, were outstanding. Please convey our thanks to Mr. Tateiwa.

Sincerely,

John W. Stetkar
Chairman

cc: ACRS Members



UNITED STATES
NUCLEAR REGULATORY COMMISSION
ADVISORY COMMITTEE ON REACTOR SAFEGUARDS
WASHINGTON, DC 20555 – 0001

April 23, 2015

Mr. Takao Onuki
Director, Washington Office
Tokyo Electric Power Company
2121 K Street, NW, Suite 910
Washington, DC 20037

Dear Mr. Onuki:

Please accept this letter of thanks for the briefing on the status of your Fukushima Daiichi Nuclear Power Station provided by Mr. Kenji Tateiwa to the Advisory Committee on Reactor Safeguards on April 10, 2015.

Mr. Tateiwa provided us with a detailed and informative presentation on the overall status of Fukushima Daiichi and the ongoing decontamination and decommissioning efforts at the site. The opportunity to discuss directly with Mr. Tateiwa the current Tokyo Electric Power Company operations at Fukushima Daiichi and receive his unique insights was of great value to all of us. His professionalism and preparation, as well as his familiarity with the Fukushima Daiichi issues, were outstanding. Please convey our thanks to Mr. Tateiwa.

Sincerely,

John W. Stetkar
Chairman

cc: ACRS Members