

Figure 7a2.1-1 – Safety Approach for TSV Shutdown

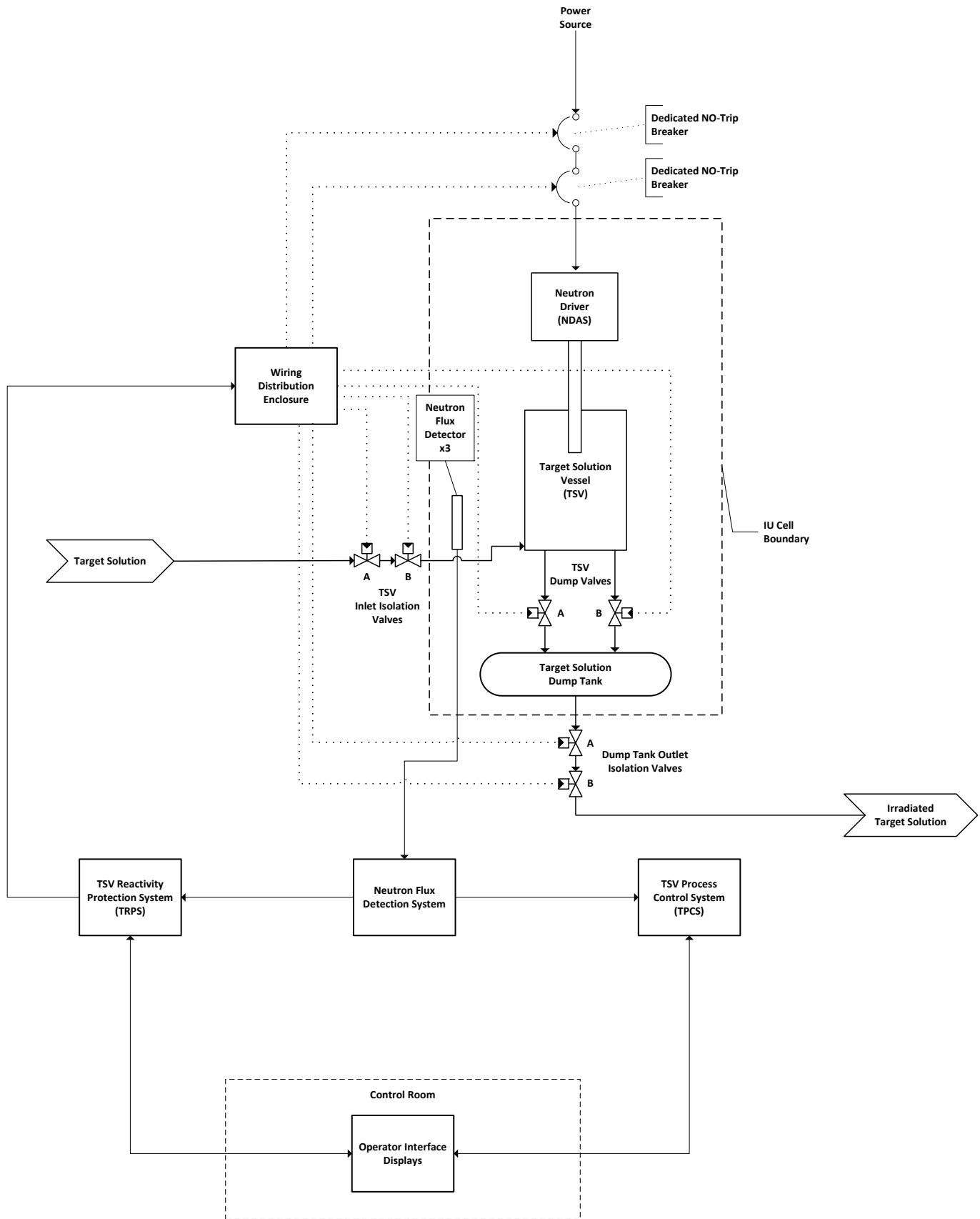

Figure 7a2.2-1 – I&C System Block Diagram for Irradiation Facility

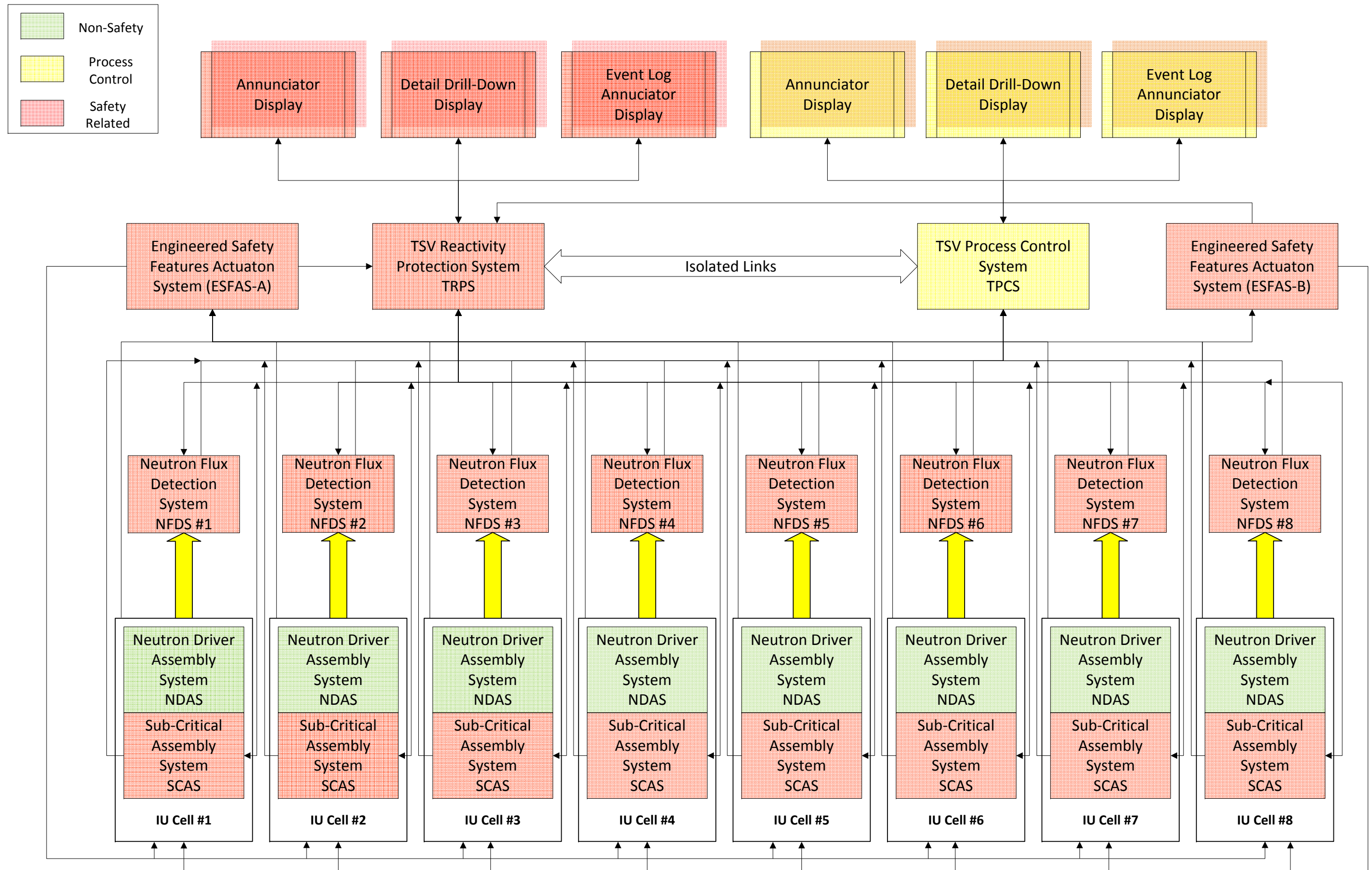

Figure 7a2.5-1 – Typical ESF Circuit

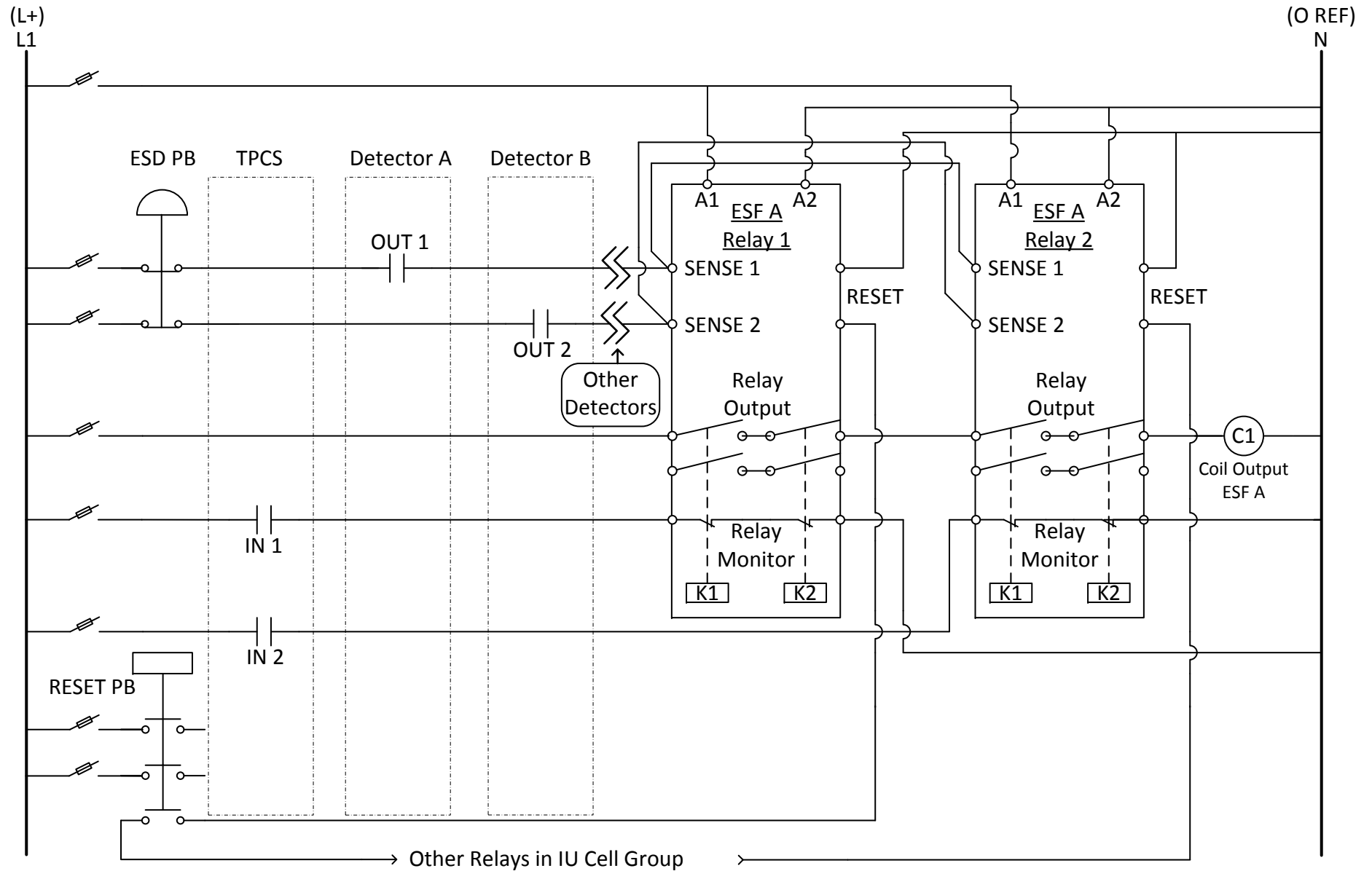
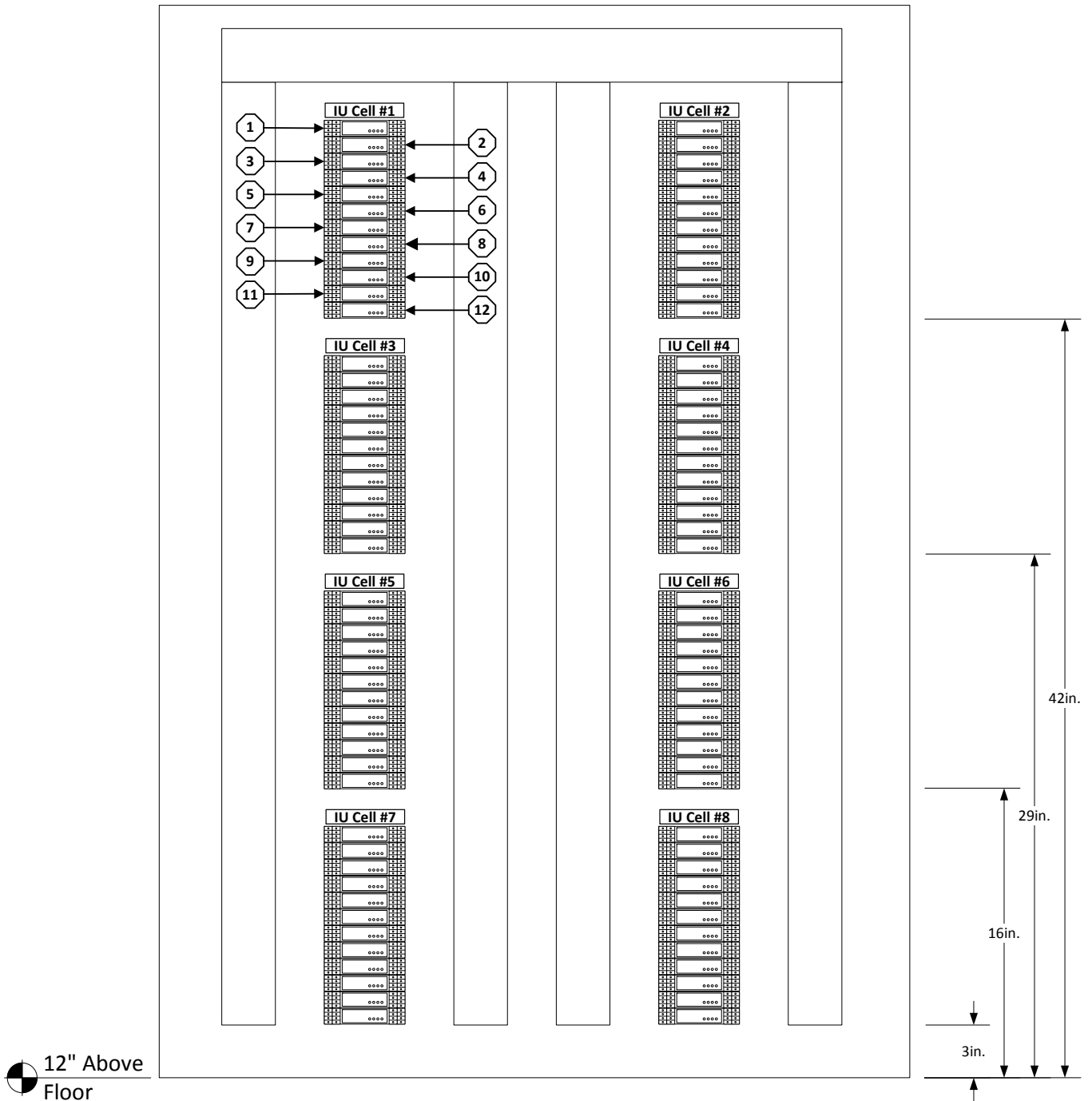

Figure 7a2.5-2 – Example ESFAS Panel



- | | |
|--------------------------------------|---|
| ① Bubble-Tight Inlet Damper Relays | ⑦ Tritium Delivery Isolation Valve Relays |
| ② Bubble-Tight Outlet Damper Relays | ⑧ Tritium Return Isolation Valve Relays |
| ③ PCLS Inlet Isolation Valve Relays | ⑨ TRPS Input Signal Trip Relays |
| ④ PCLS Outlet Isolation Valve Relays | ⑩ Spare |
| ⑤ LWPS Inlet Isolation Valve Relays | ⑪ Spare |
| ⑥ LWPS Outlet Isolation Valve Relays | ⑫ Spare |

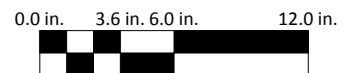
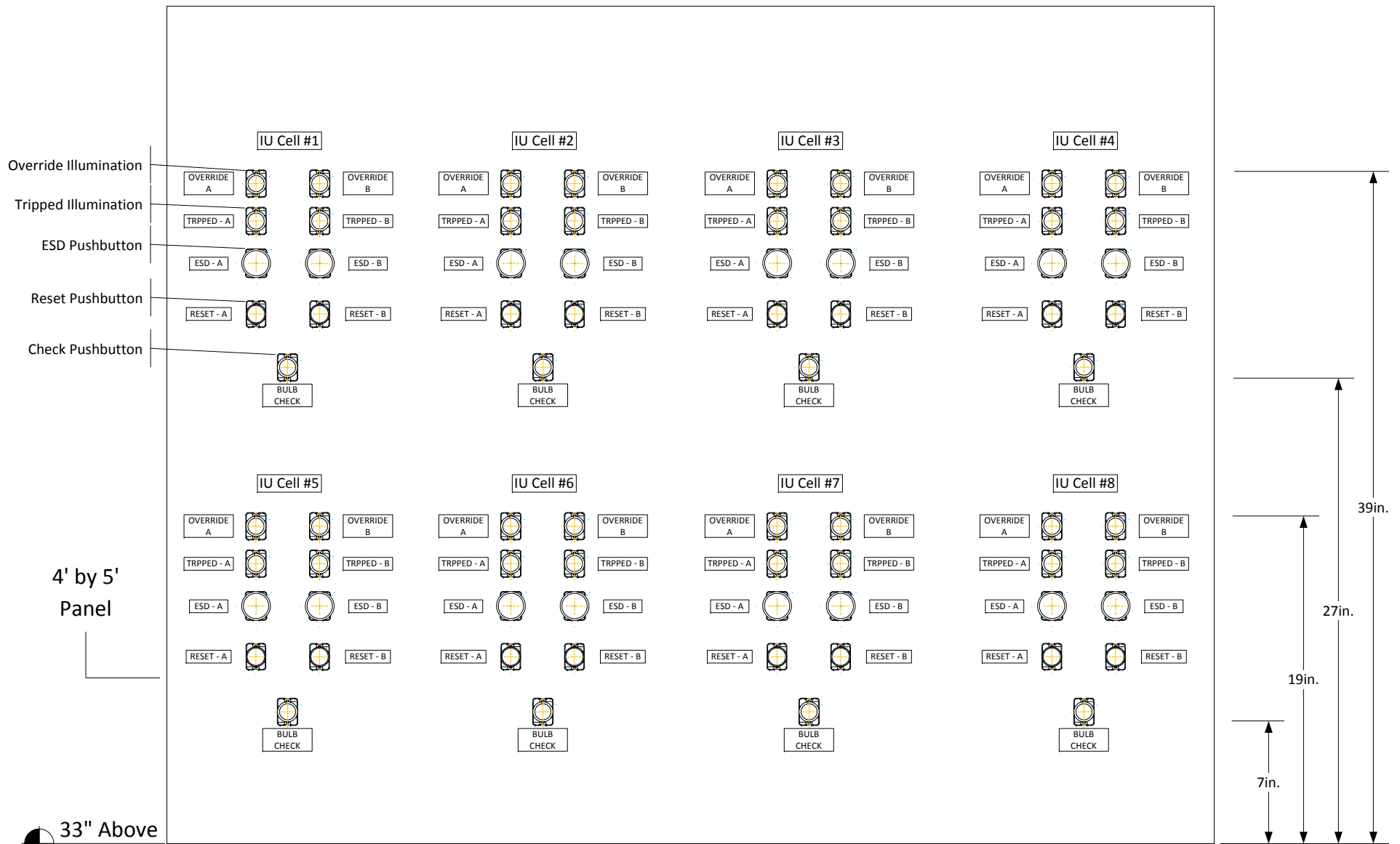

Figure 7a2.5-3 – ESFAS Manual Operator Panel



33" Above Ground

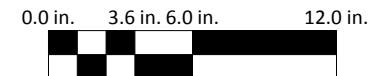

Figure 7a2.6-1 – Irradiation Facility Workstation Layout

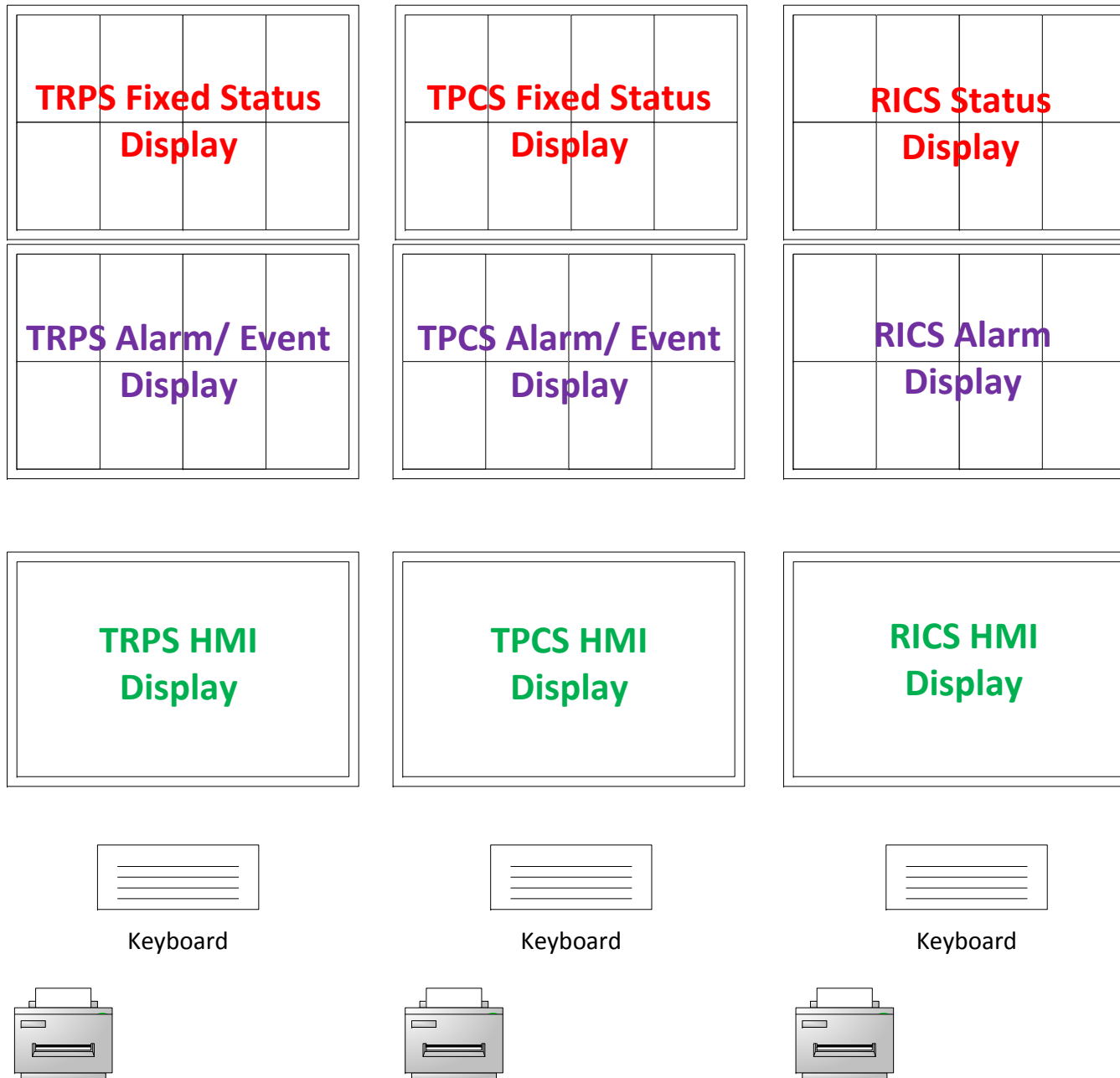

Figure 7a2.6-2 – Control Room Layout

Security-Related Information – Withhold under 10 CFR 2.390