

Figure 7a2.1-1 – Safety Approach for TSV Shutdown

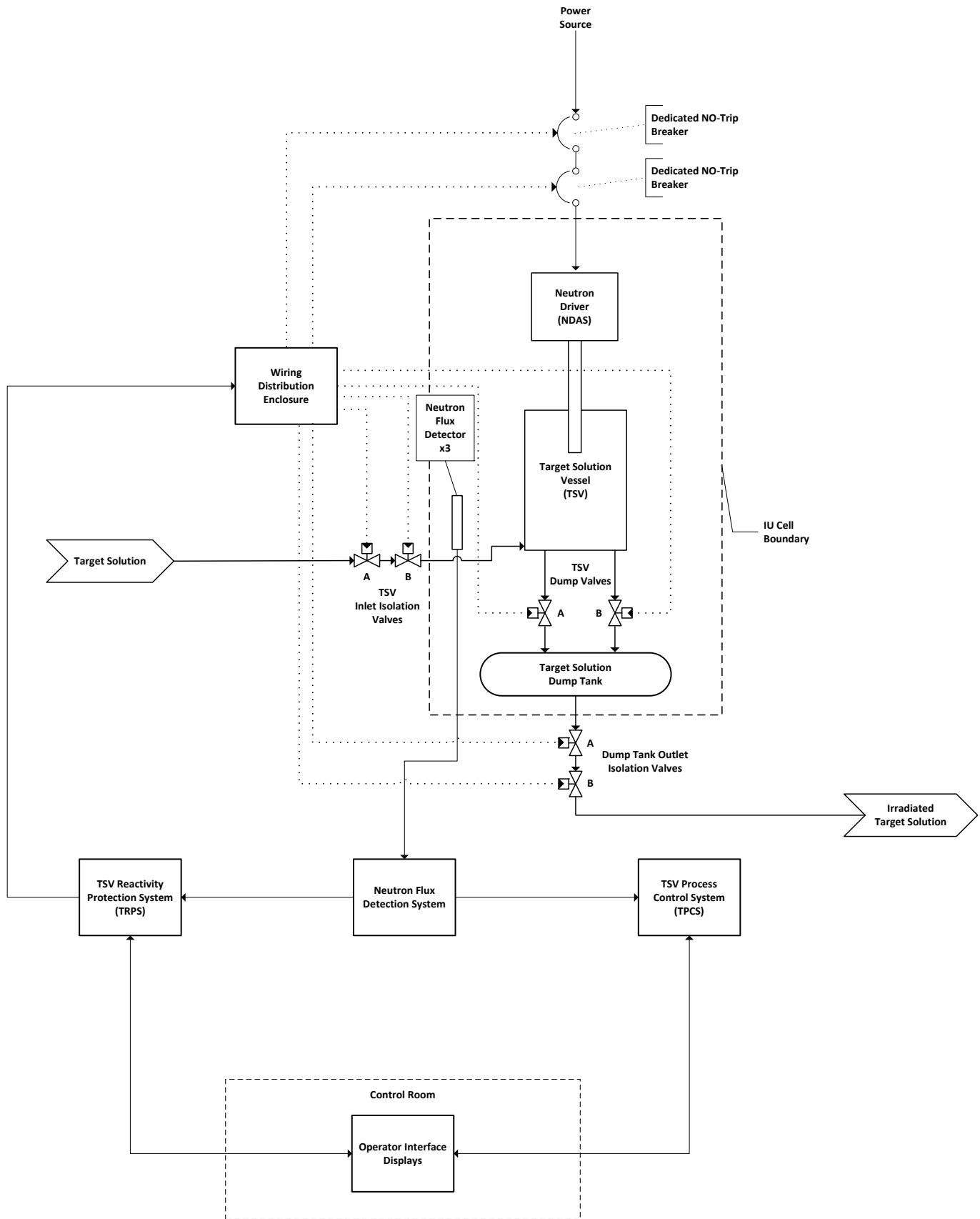

Figure 7a2.2-1 – I&C System Block Diagram for Irradiation Facility

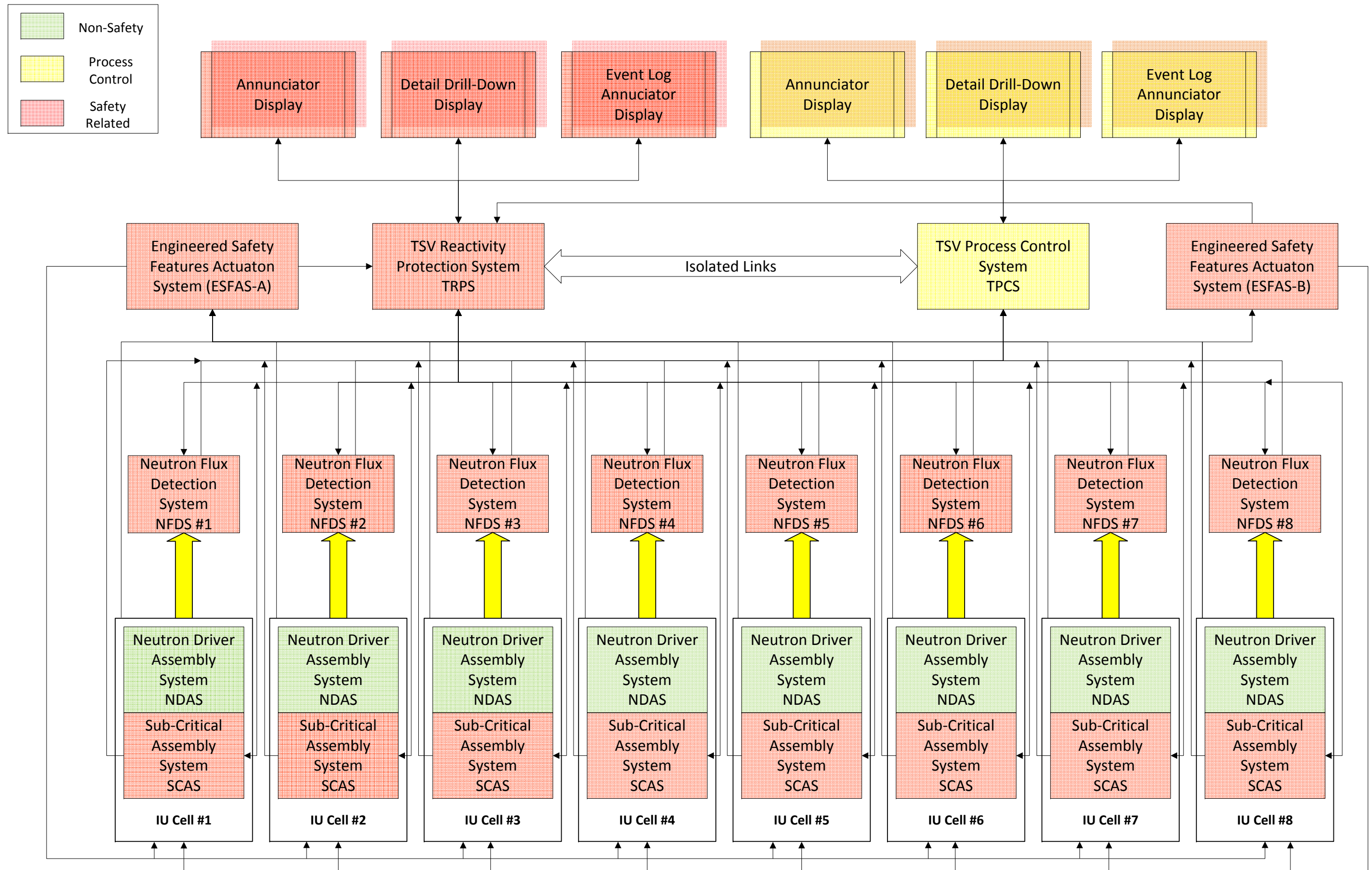

Figure 7a2.5-1 – Typical ESF Circuit

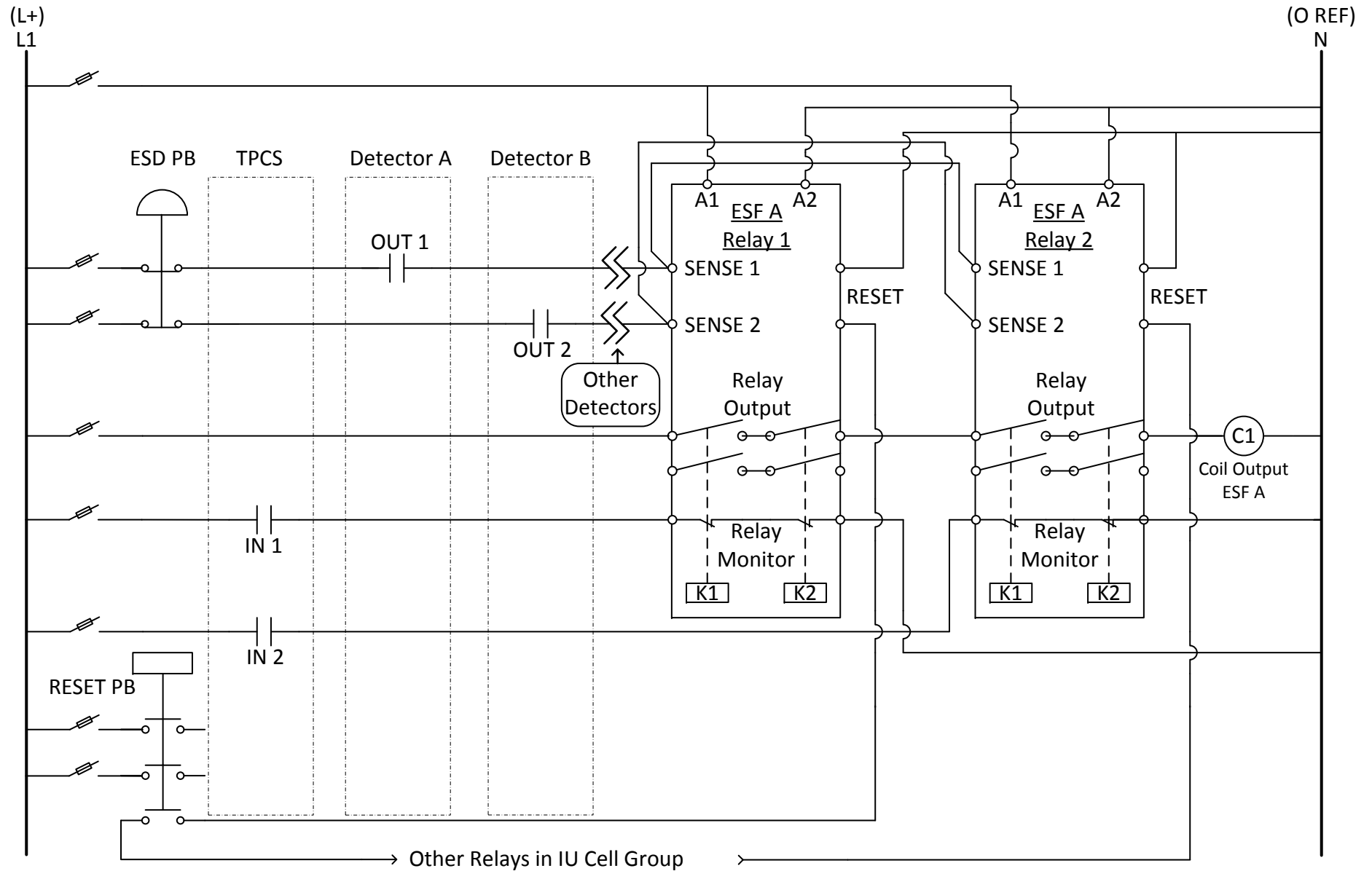
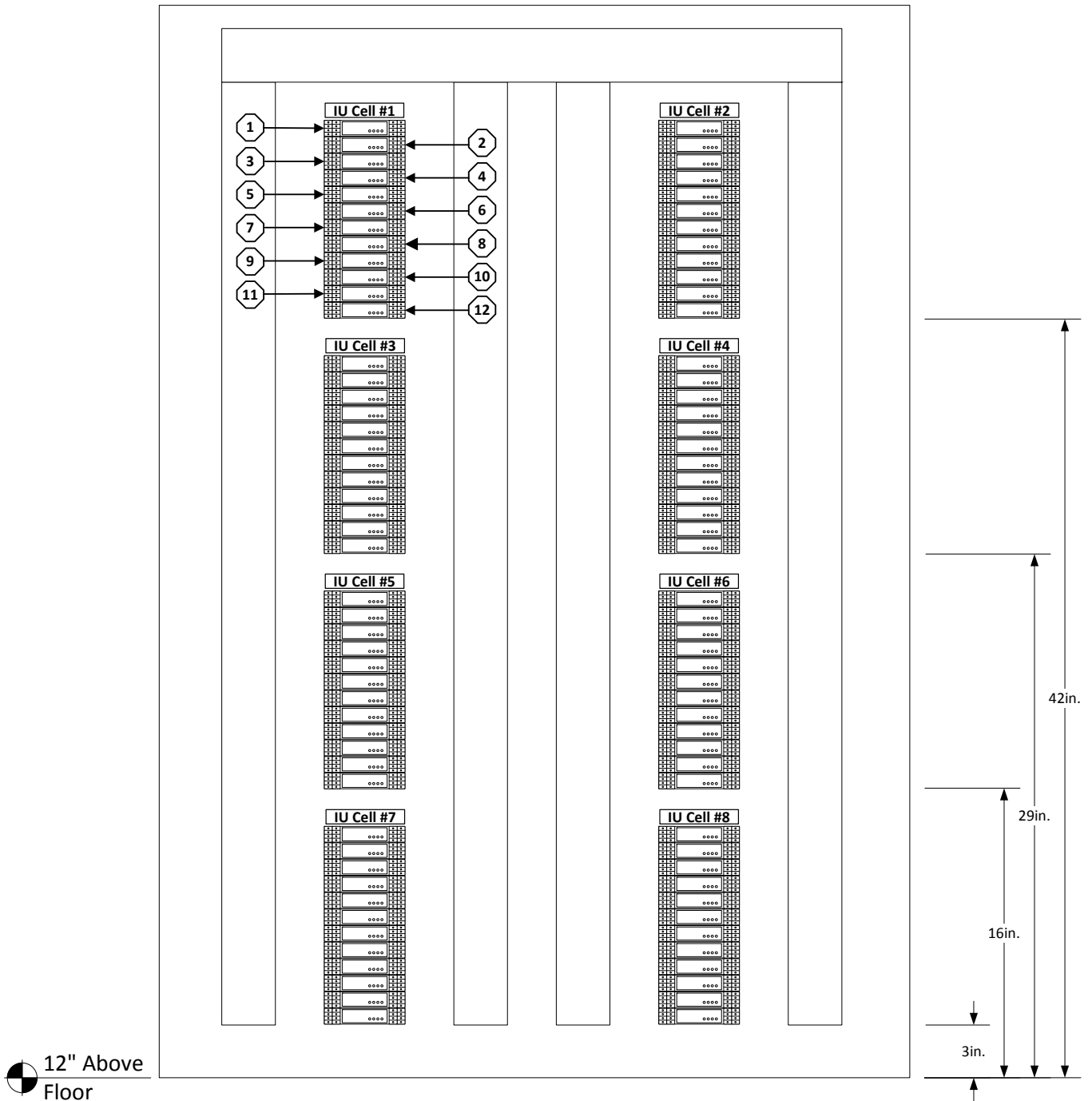

Figure 7a2.5-2 – Example ESFAS Panel



- |                                      |   |
|--------------------------------------|---|
| ① Bubble-Tight Inlet Damper Relays   | ⑦ Tritium Delivery Isolation Valve Relays |
| ② Bubble-Tight Outlet Damper Relays  | ⑧ Tritium Return Isolation Valve Relays   |
| ③ PCLS Inlet Isolation Valve Relays  | ⑨ TRPS Input Signal Trip Relays           |
| ④ PCLS Outlet Isolation Valve Relays | ⑩ Spare                                   |
| ⑤ LWPS Inlet Isolation Valve Relays  | ⑪ Spare                                   |
| ⑥ LWPS Outlet Isolation Valve Relays | ⑫ Spare                                   |

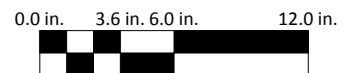

Figure 7a2.5-3 – ESFAS Manual Operator Panel

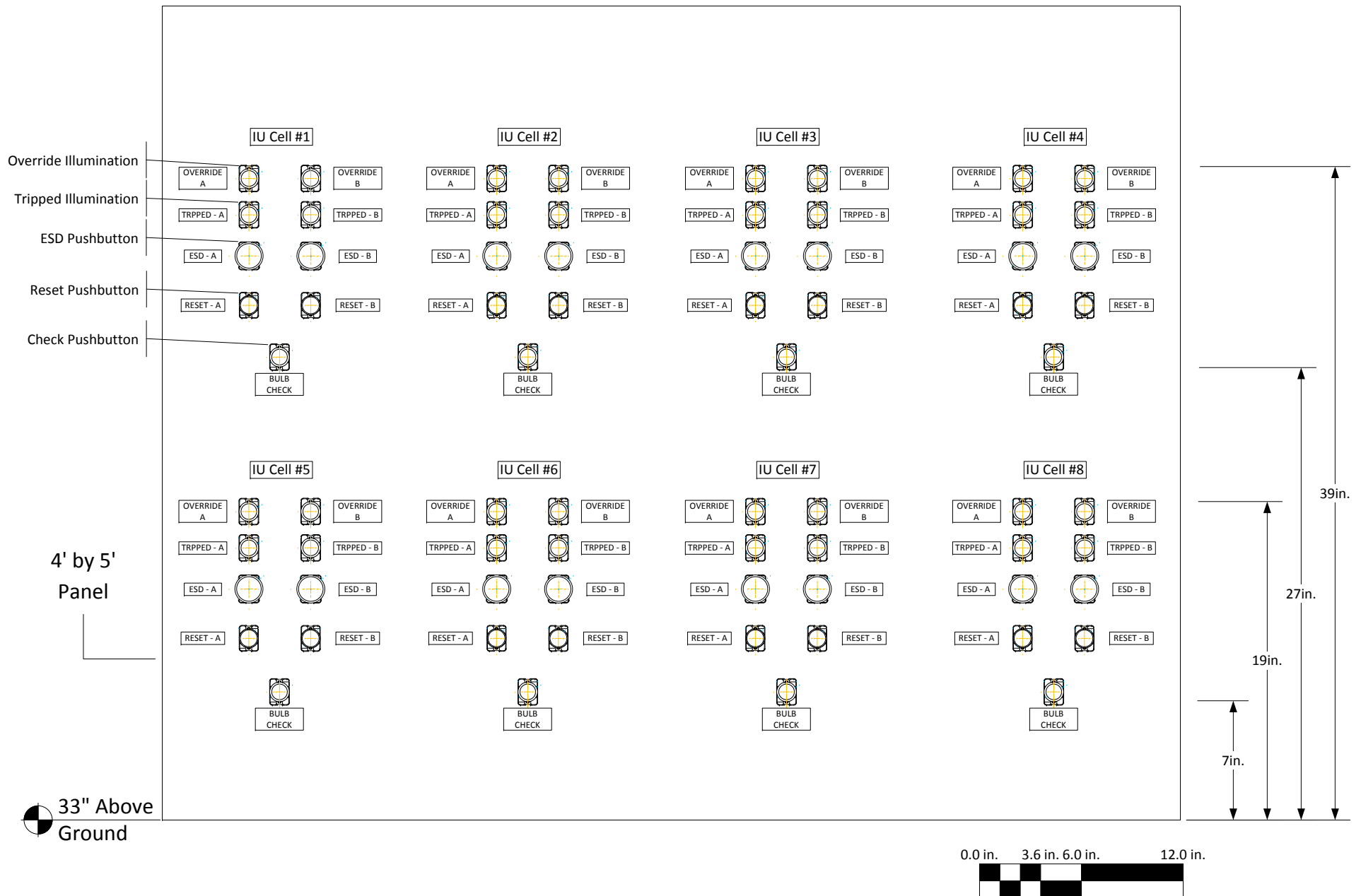
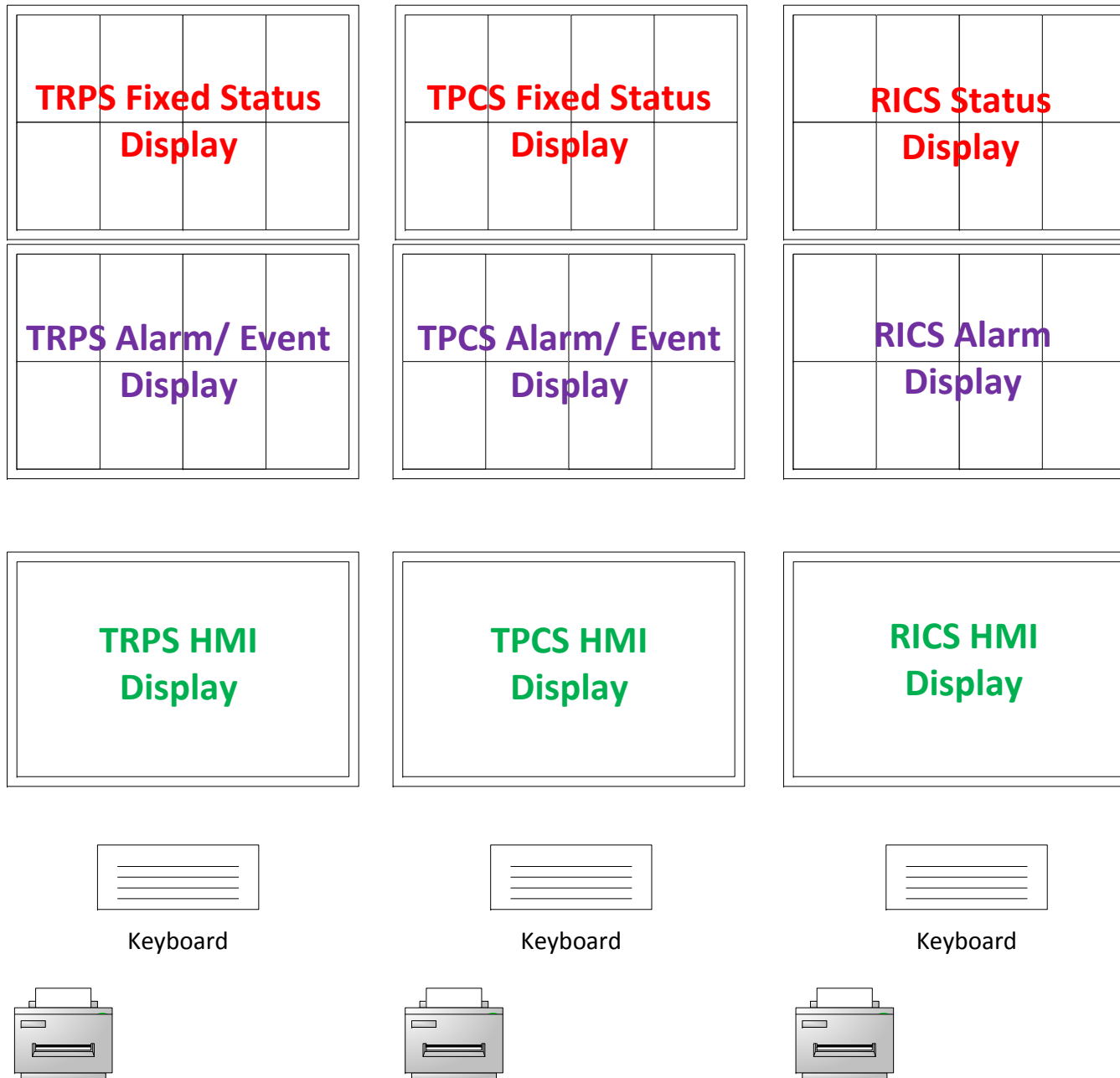

Figure 7a2.6-1 – Irradiation Facility Workstation Layout



**Figure 7a2.6-2 – Control Room Layout**

*Security-Related Information – Withhold under 10 CFR 2.390*