

## 15A Plant Nuclear Safety Operational Analysis (NSOA)

The information in this appendix of the reference ABWR DCD, including all subsections, tables, and figures, is incorporated by reference with the following departures.

STD DEP Admin (Figures 15A-13, 17, 19, 21, 25, 27, 29, 37, 38, 39, 40, 48, 51, 52, 53, 63, 64, 67, 68, 69, and 70)

STD DEP T1 2.14-1 (Figure 15A-7)

### 15A.6.2.3.11 Control Rod Worth Control

STD DEP Admin

*Any time the reactor is not shut down and is generating less than 20% power (State D), a limit is imposed on the control rod pattern to assure that control rod worth is maintained within the envelope of conditions considered by the analysis of the ~~control rod drop accident~~ rod withdrawal error (1-4).*

### 15A.6.3.1 General

STD DEP Admin

*The safety requirements and protection sequences for moderate frequency incidents (anticipated operational transients) are described in the following subsections for Events 7 through ~~22~~ 23, 26, 27, 38-40, 44, 45, 48, and 49. The protection sequence block diagrams show the sequence of frontline safety systems (Figures 15A-12 through 15A-27). The auxiliaries for the frontline safety systems are presented in the auxiliary diagrams (Figures 15A-6 and 15A-7) and the commonality of auxiliary diagrams (Figures 15A-65 through 15A-70).*

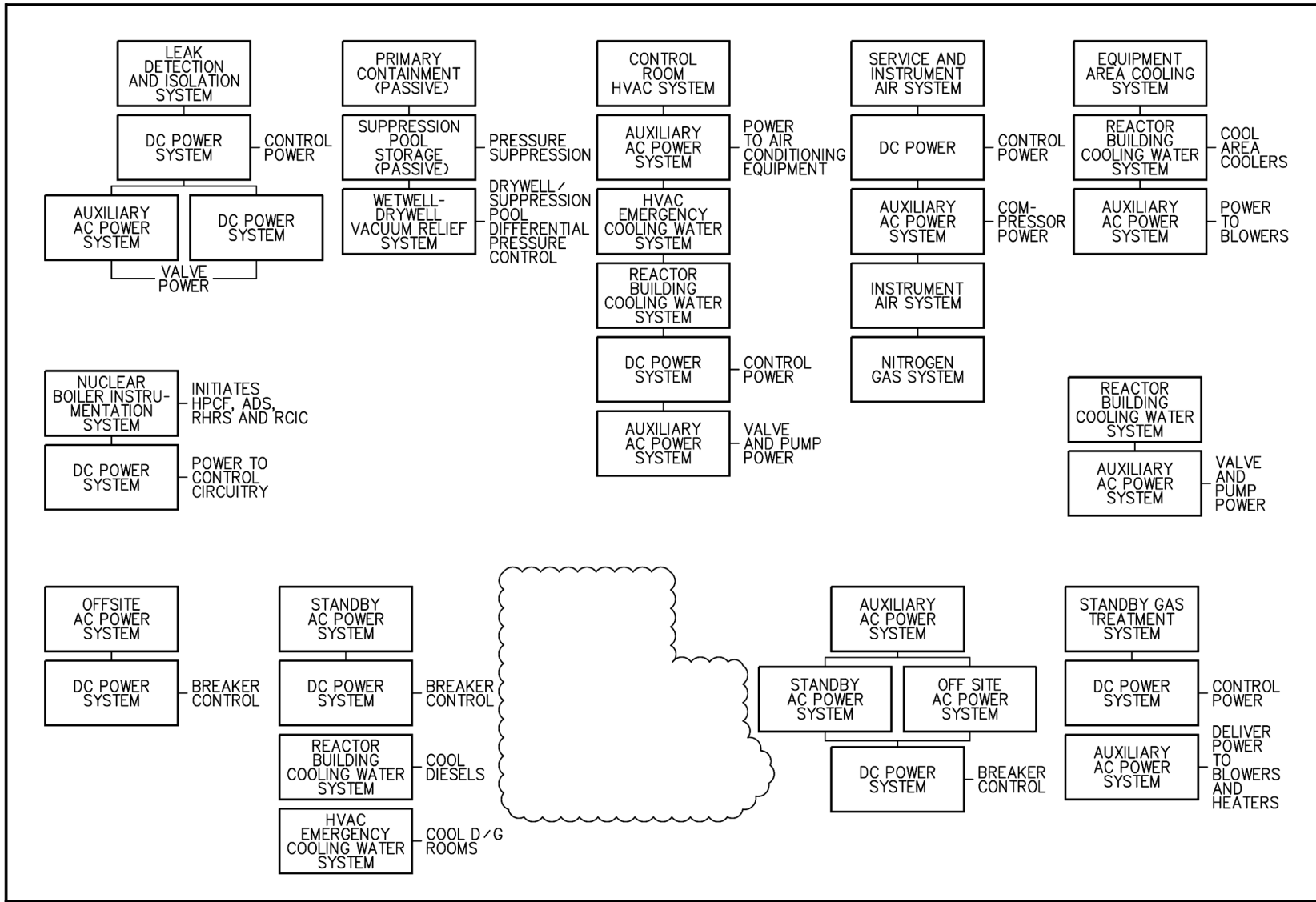
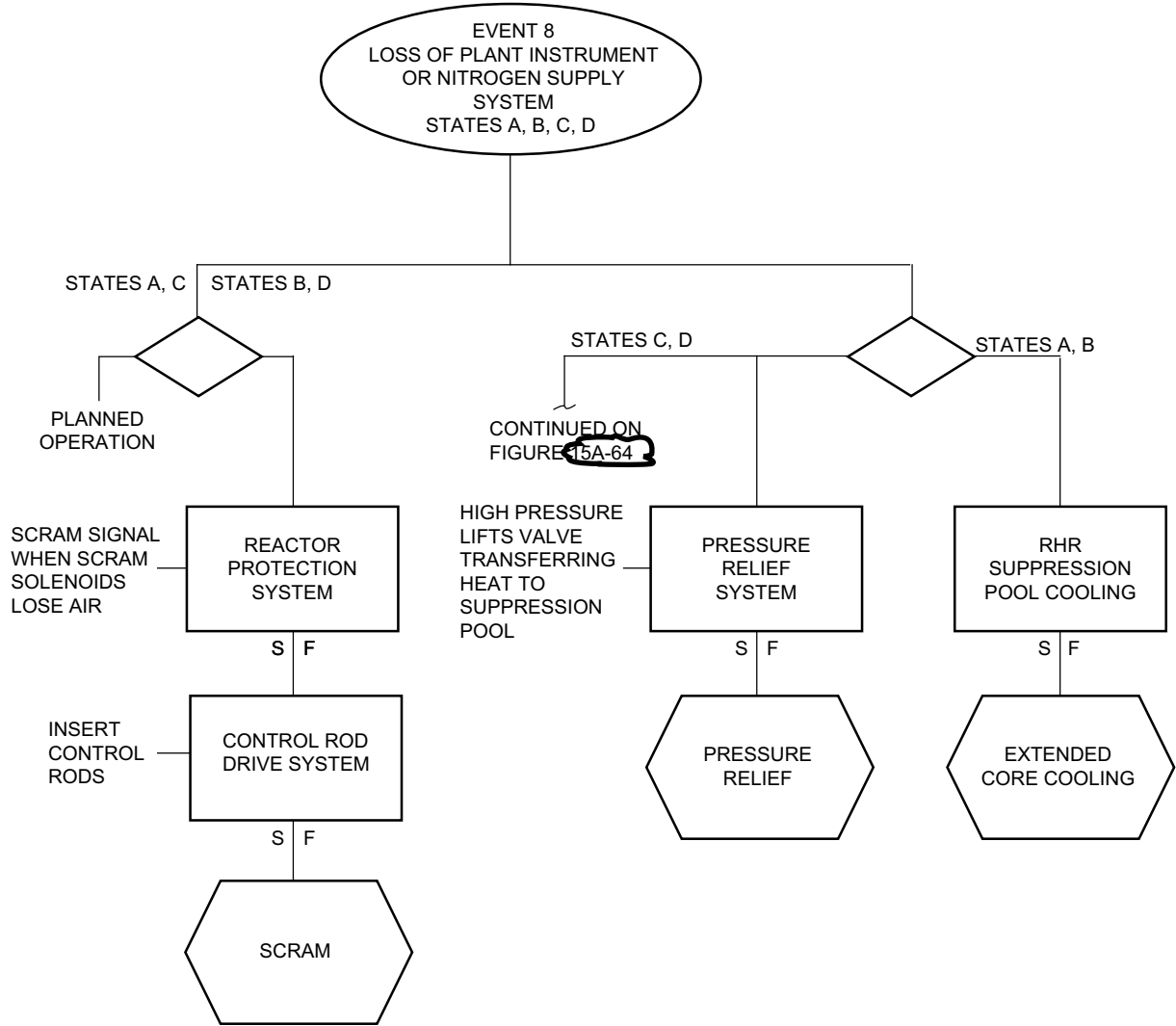

Figure 15A-7 Safety System Auxiliaries—Group 2



**Figure 15A-13 Protection Sequence for Loss of Plant Instrument or Service Air System**

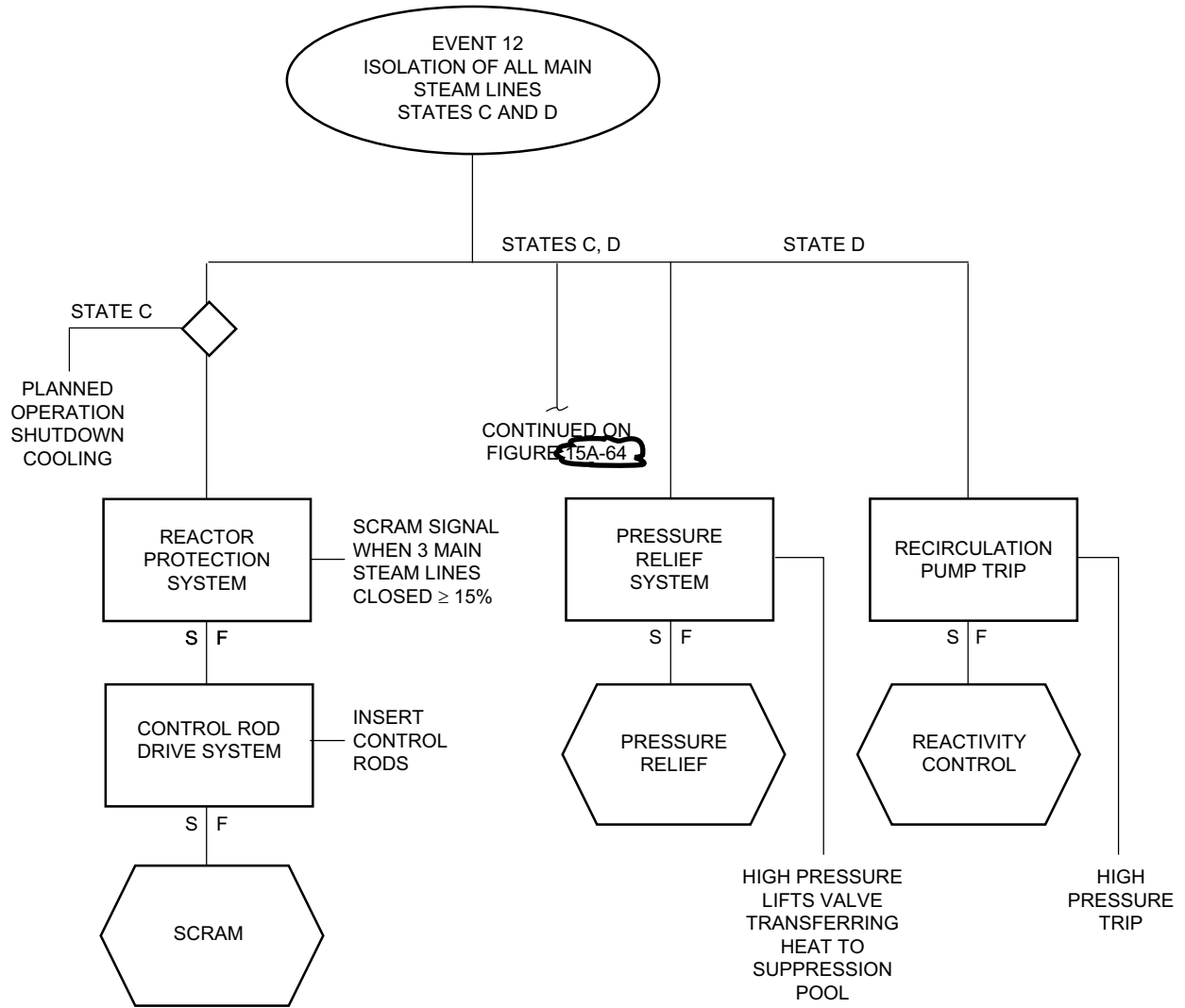

Figure 15A-17 Protection Sequences for Isolation of All Main Steamlines

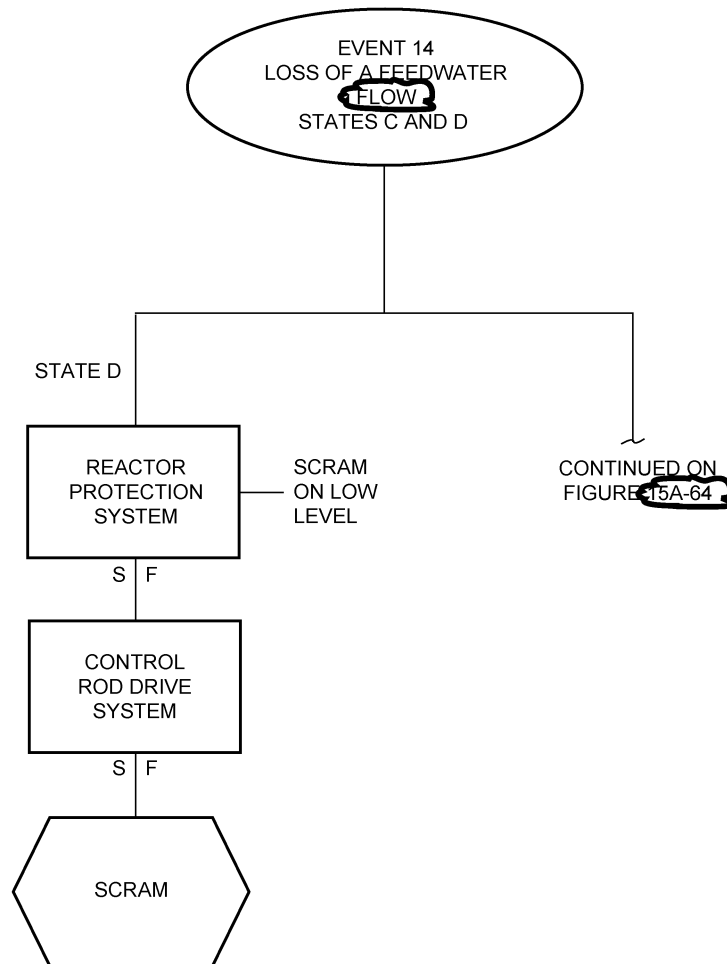

Figure 15A-19 Protection Sequence for Loss of All Feedwater Flow

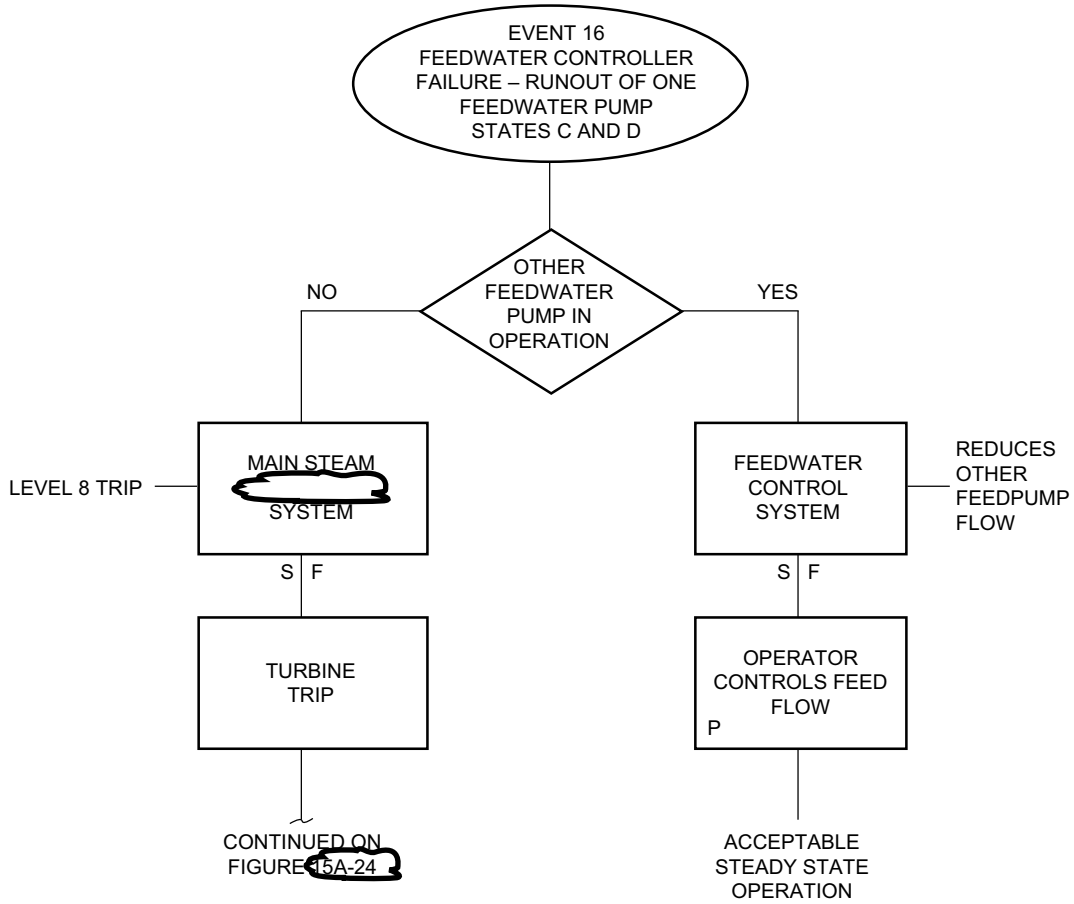

Figure 15A-21 Protection Sequence for Feedwater Controller Failure—Runout of One Feedwater Pump

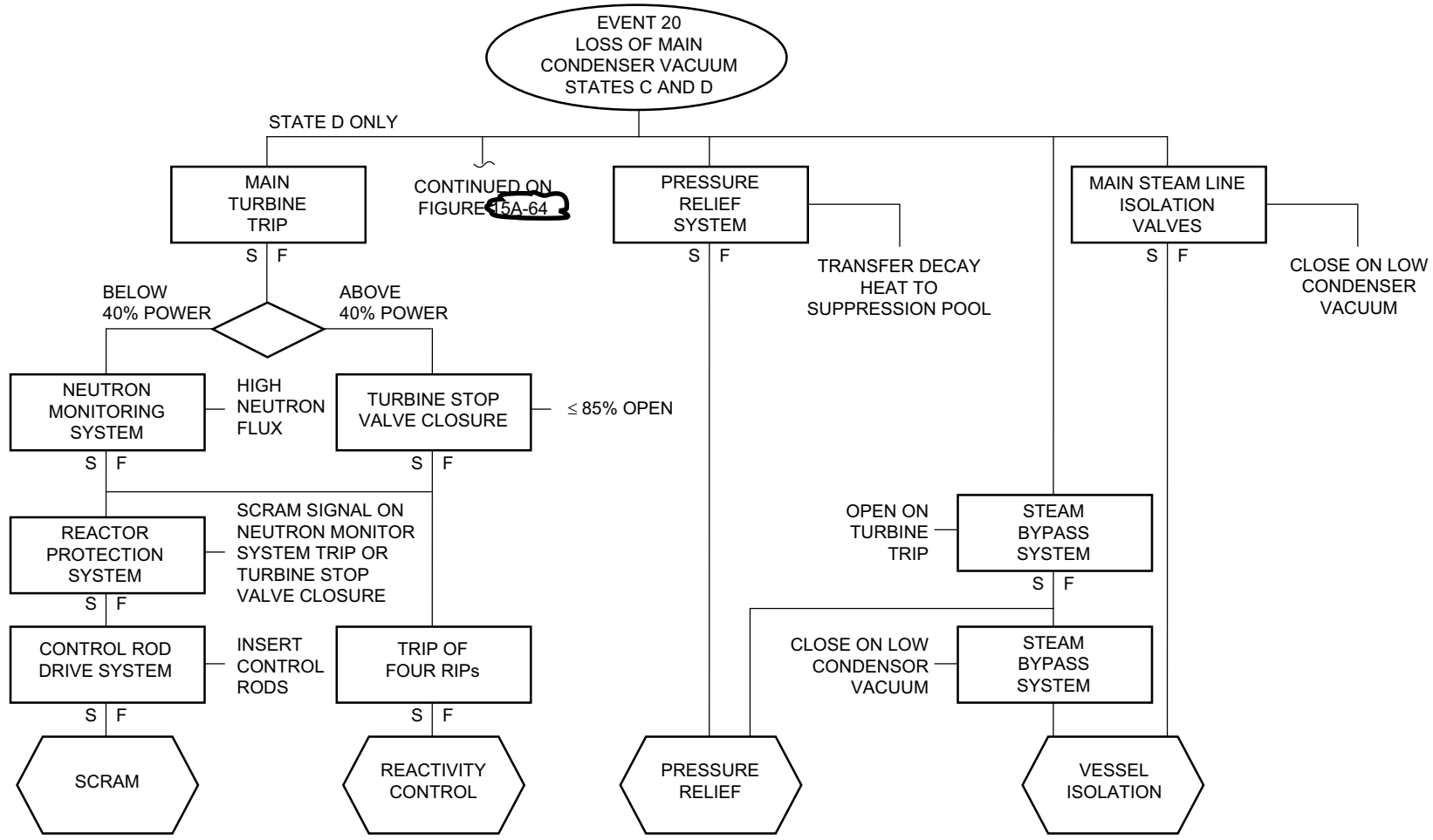

Figure 15A-25 Protection Sequences for Loss of Main Condenser Vacuum

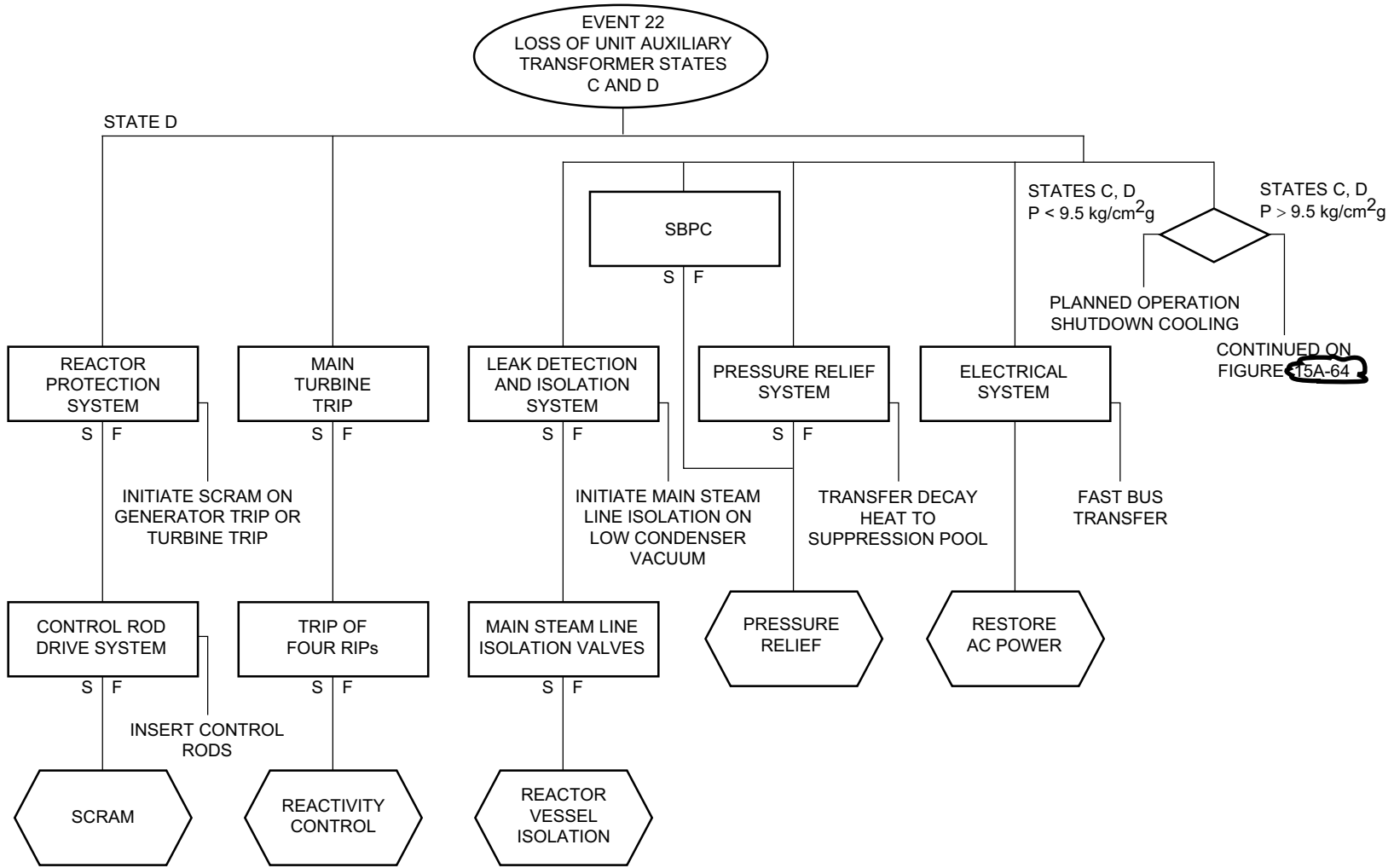

Figure 15A-27 Protection Sequence for Loss of Normal AC Power—Auxiliary Transformer Failure



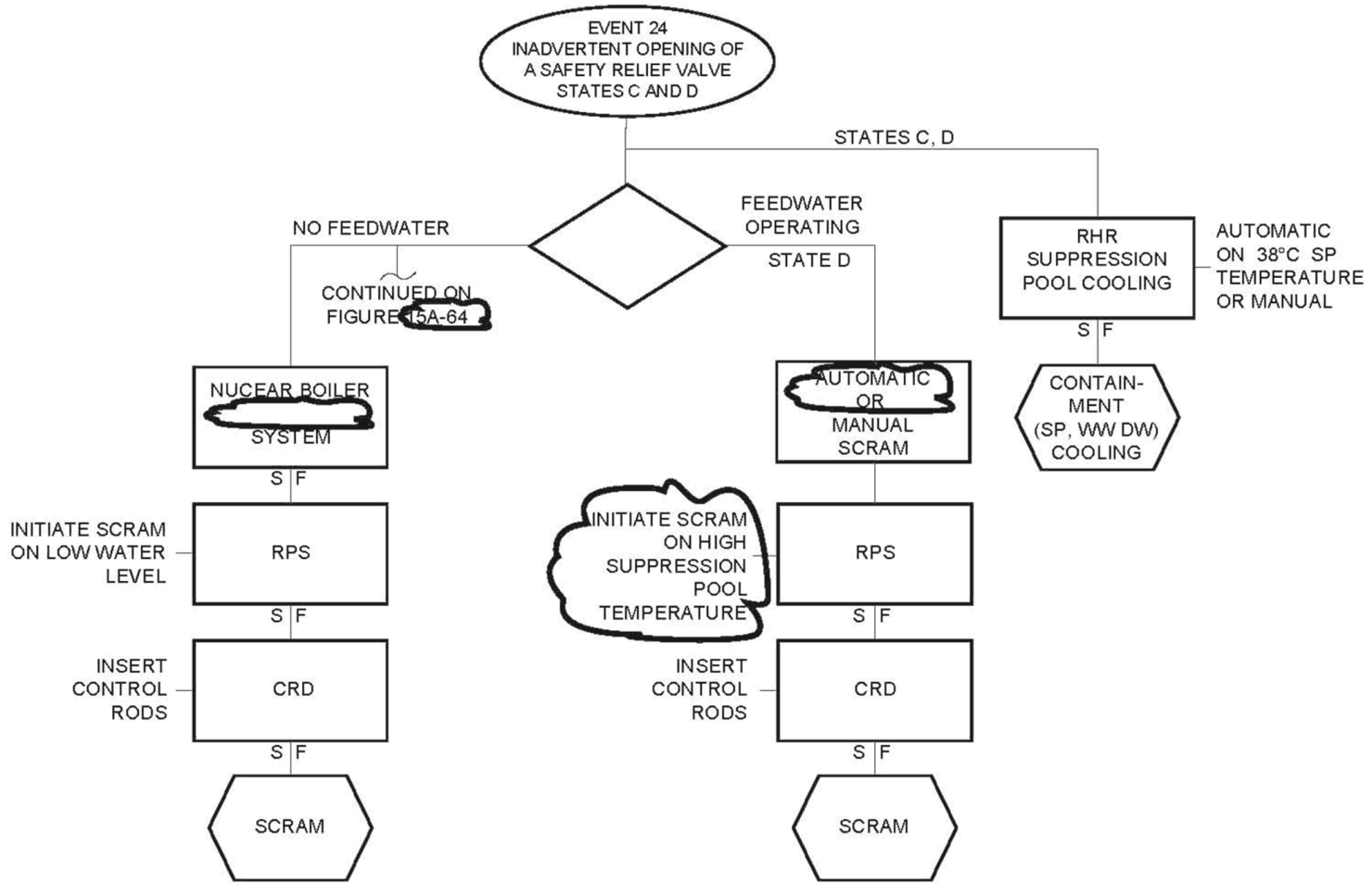

Figure 15A-29 Protection Sequences for Inadvertent Opening of a Safety Relief Valve

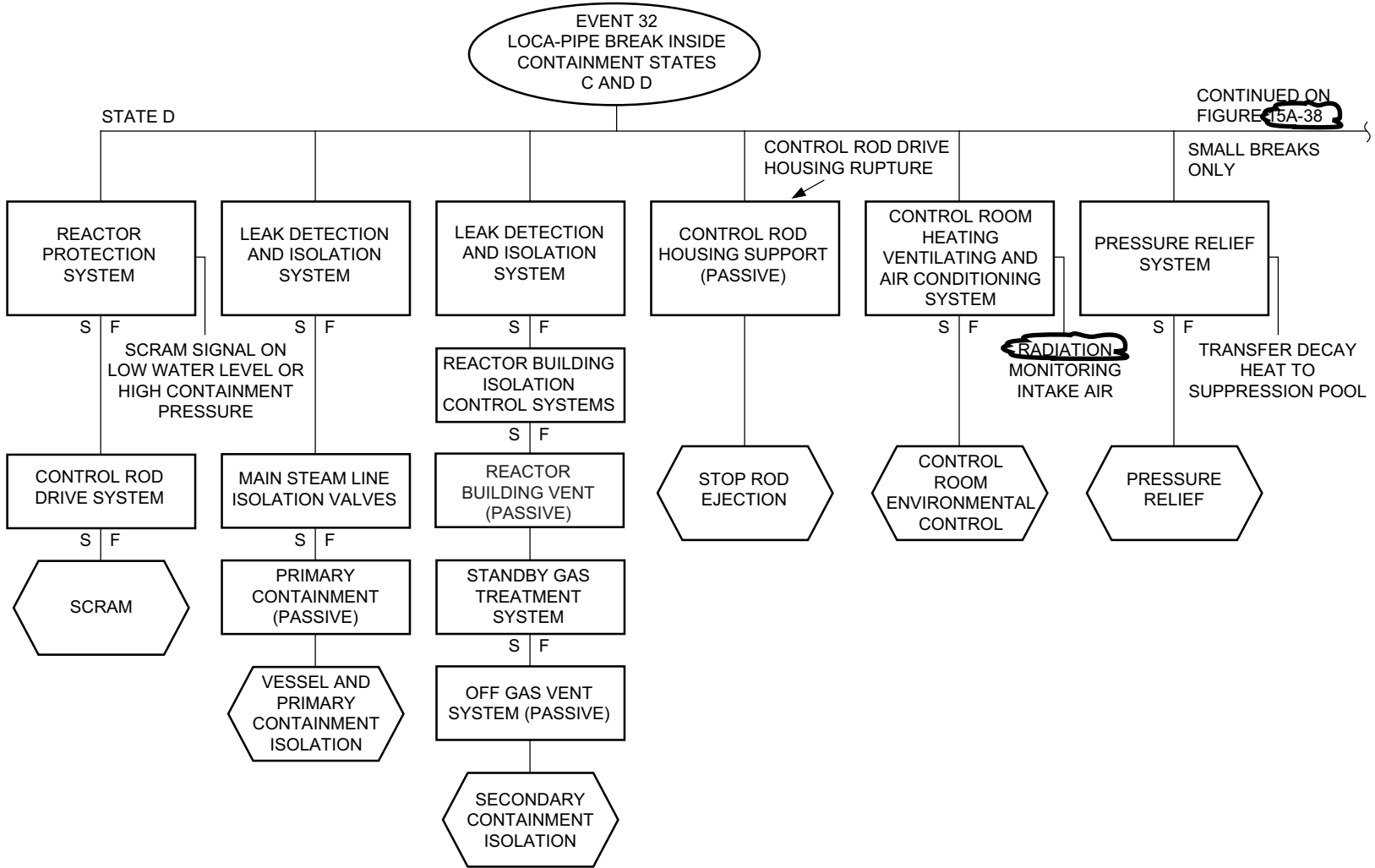

Figure 15A-37 Protection Sequences for Loss of Coolant Piping Breaks in RCPB—Inside Containment

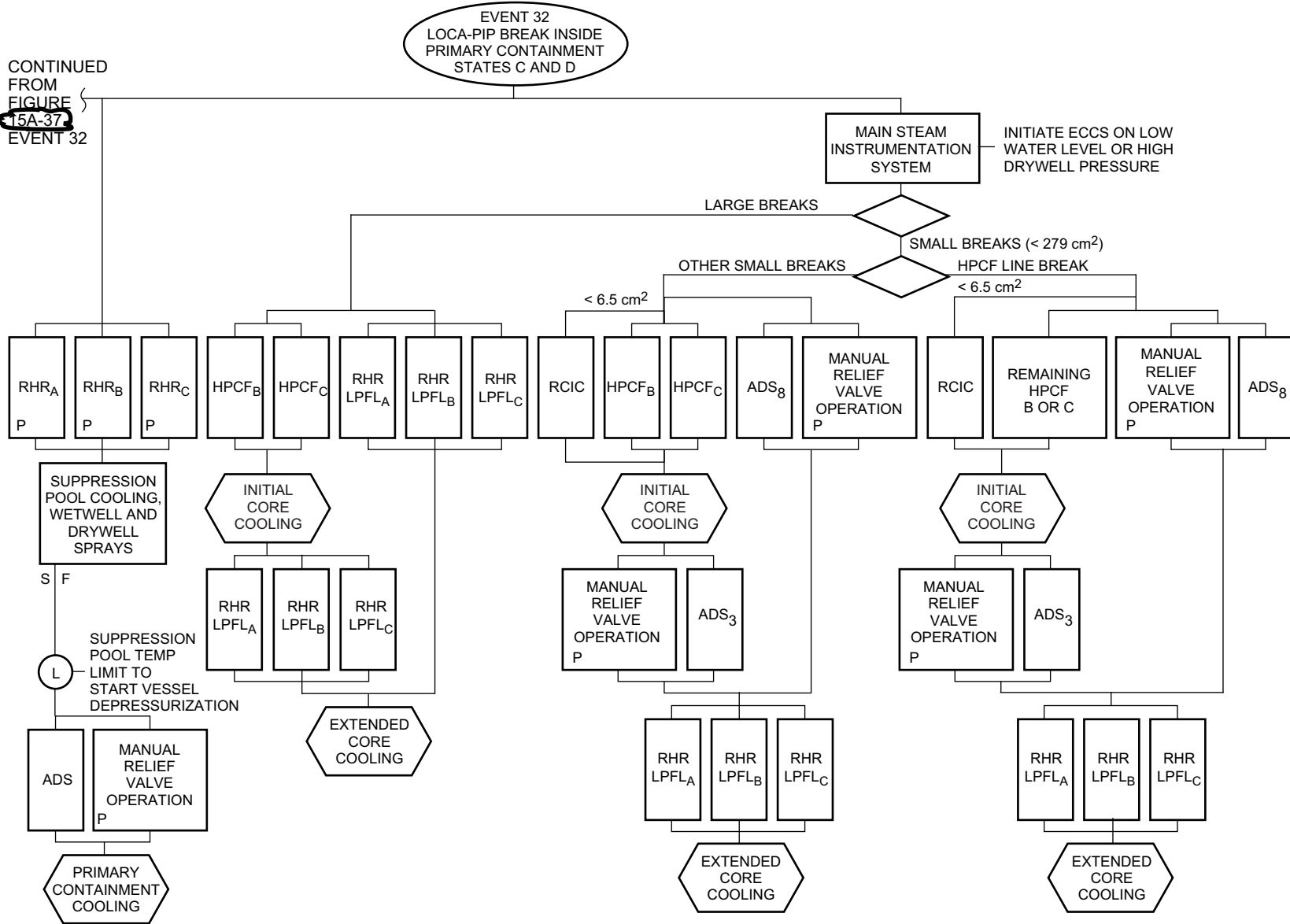
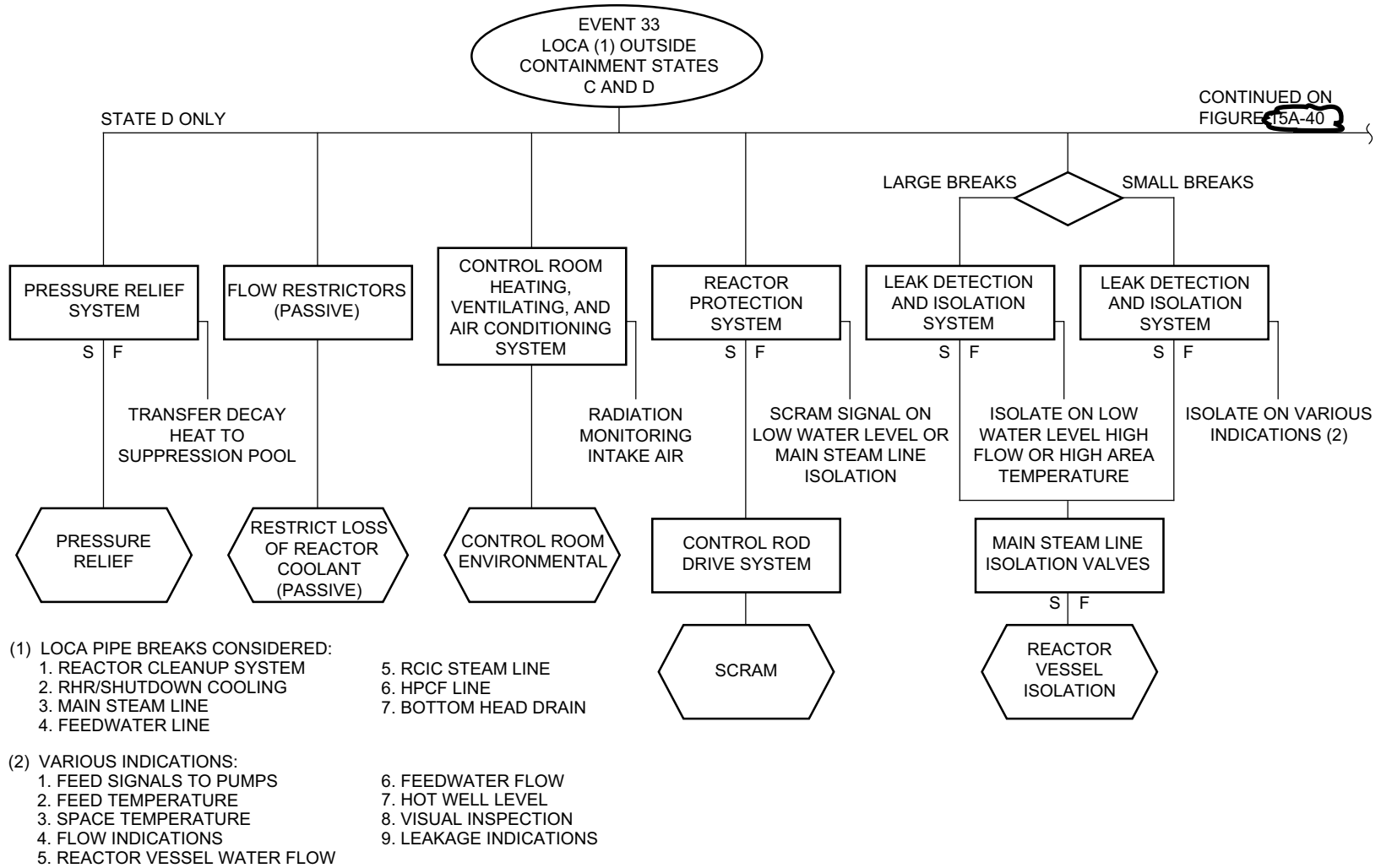

Figure 15A-38 Protection Sequence for Loss of Coolant Piping Breaks in RCPB – Inside Primary Containment



**Figure 15A-39 Protection Sequences for Liquid and Steam, Large and Small Piping Breaks Outside Containment**

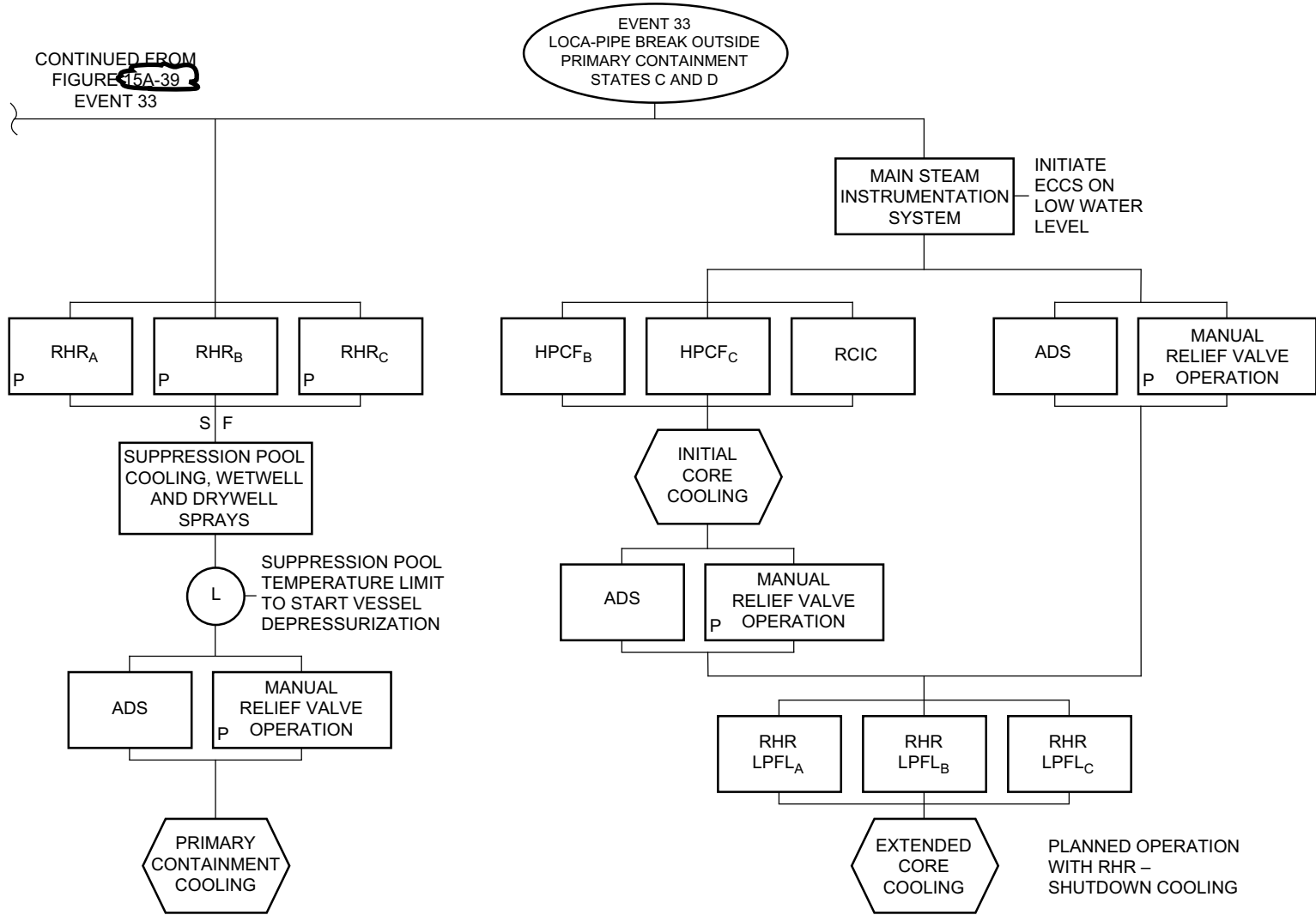

Figure 15A-40 Protection Sequence for Liquid and Steam, Large and Small Piping Breaks Outside Primary Containment

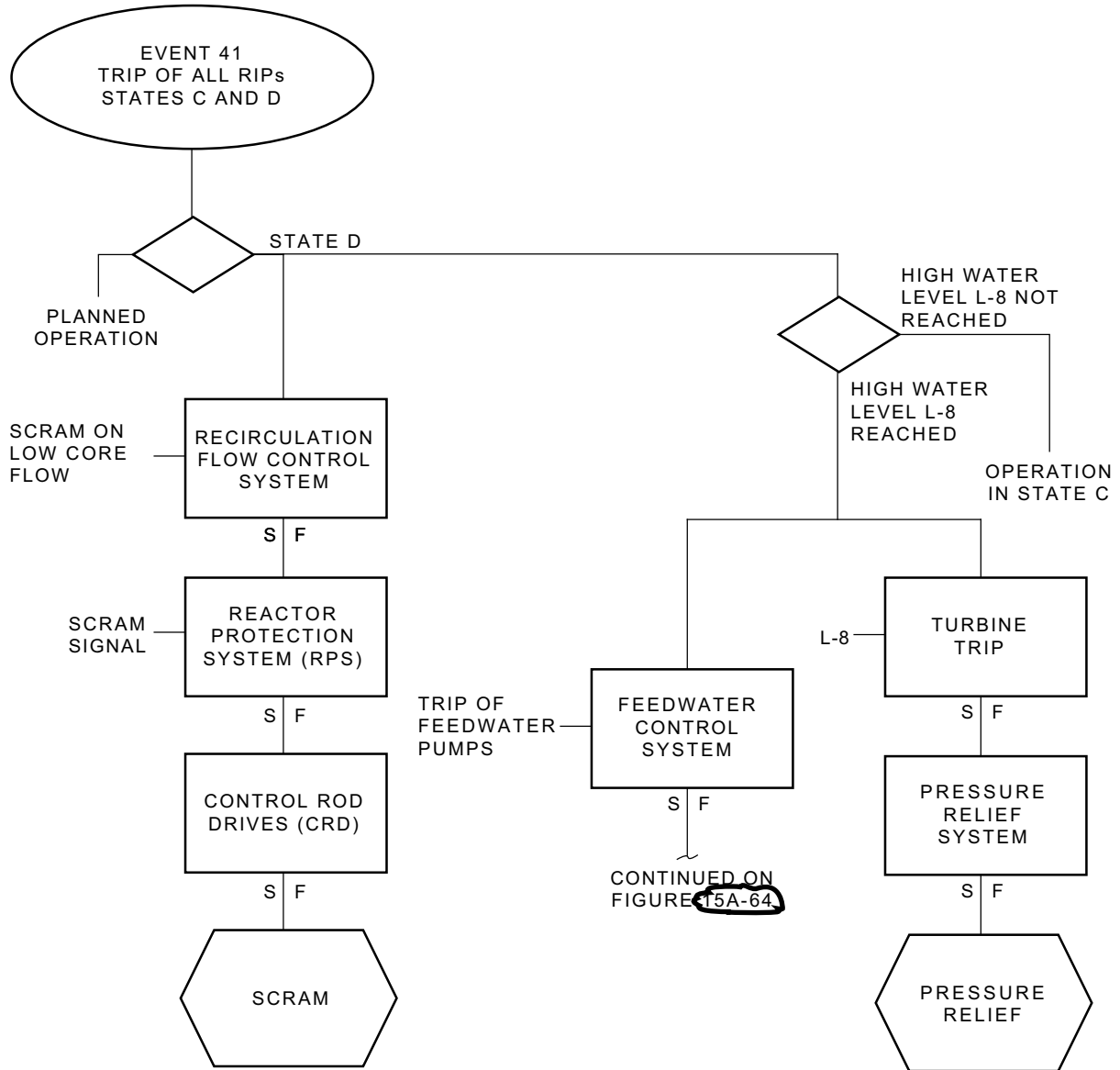

Figure 15A-48 Protection Sequence for Trip of All Reactor Internal Pumps (RIPs)

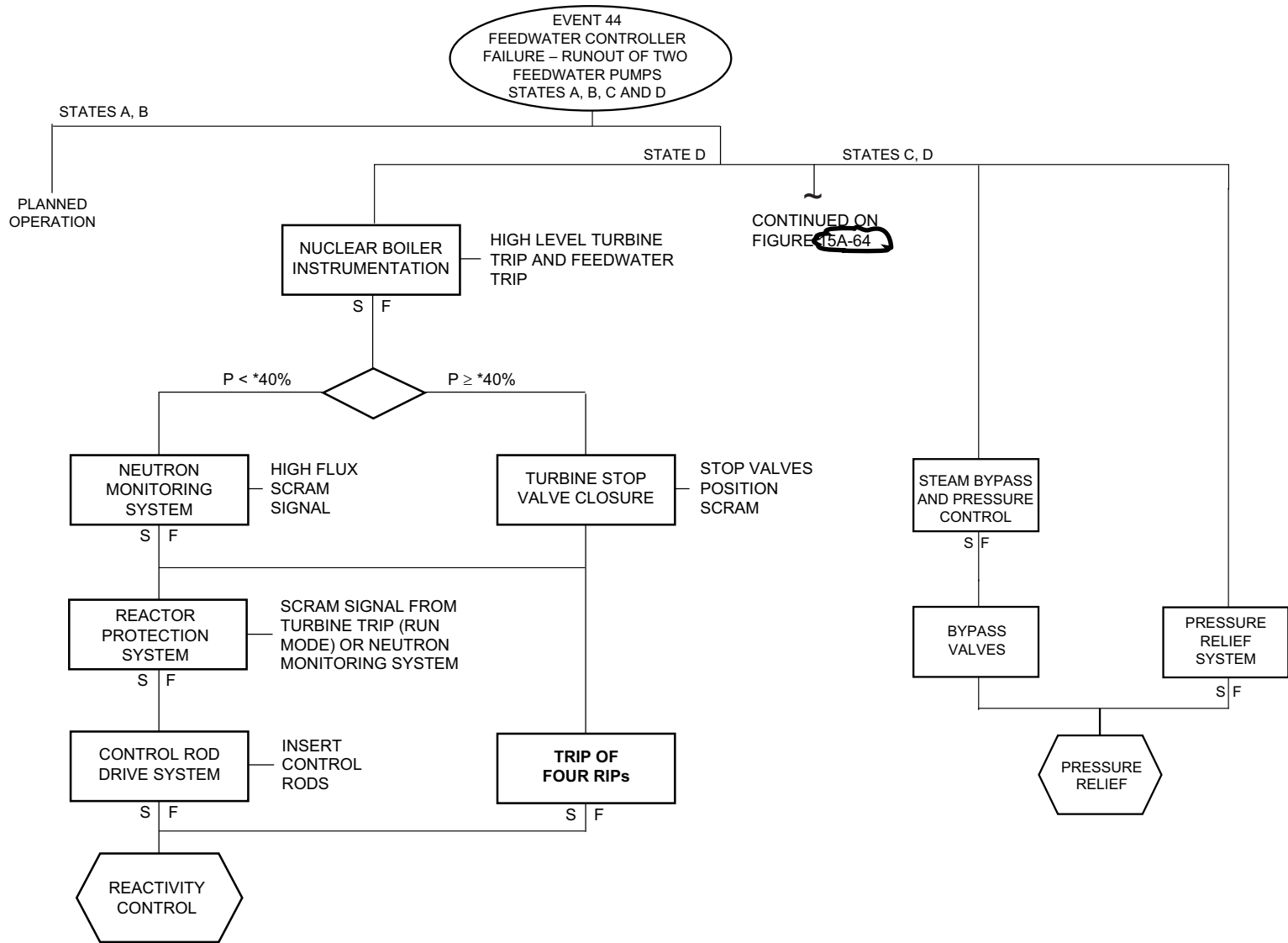

Figure 15A-51 Protection Sequences for Feedwater Controller Failure—Runout of Two Feedwater Pumps

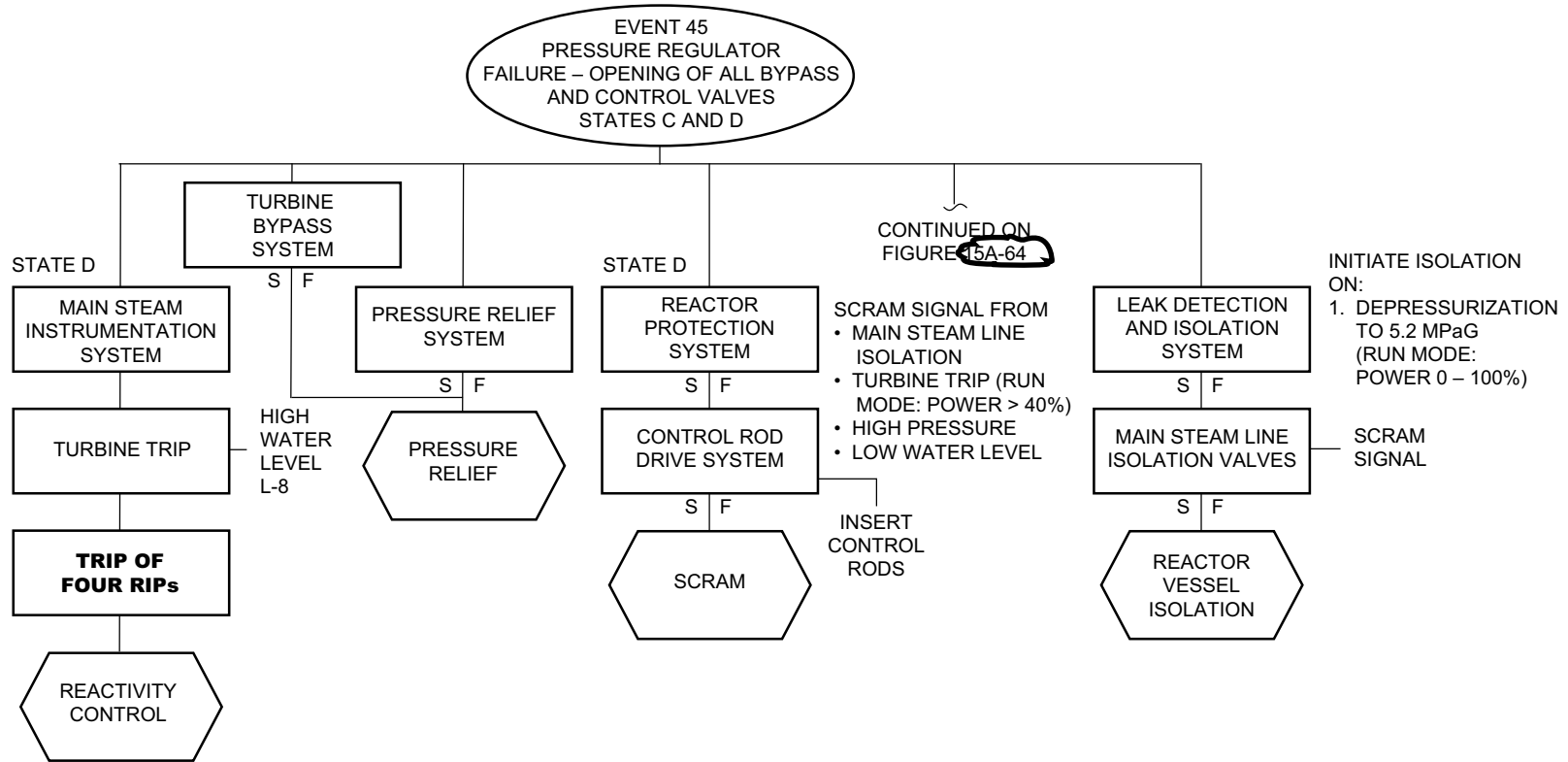

Figure 15A-52 Protection Sequences for Pressure Regulator Failure—Opening of All Bypass and Control Valves



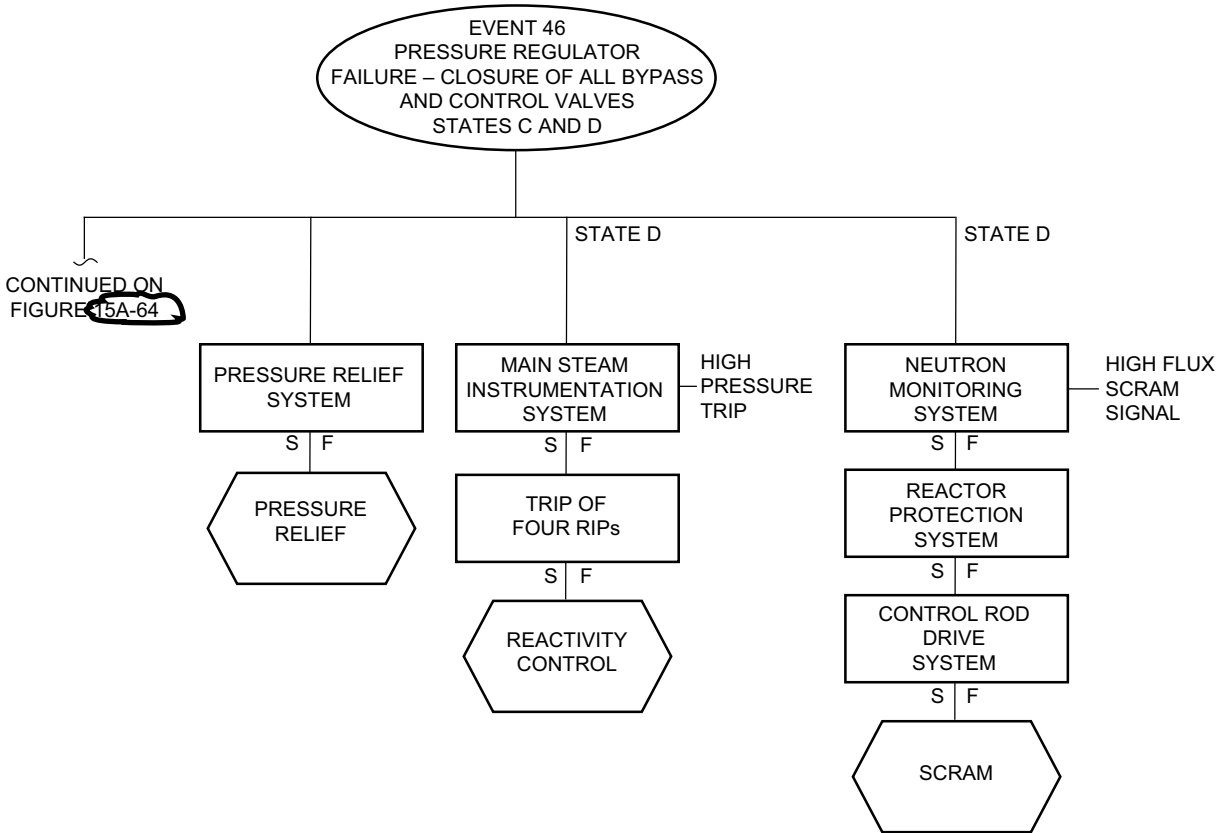

Figure 15A-53 Pressure Regulator Failure—Closure of All Bypass Valves and Control Valves

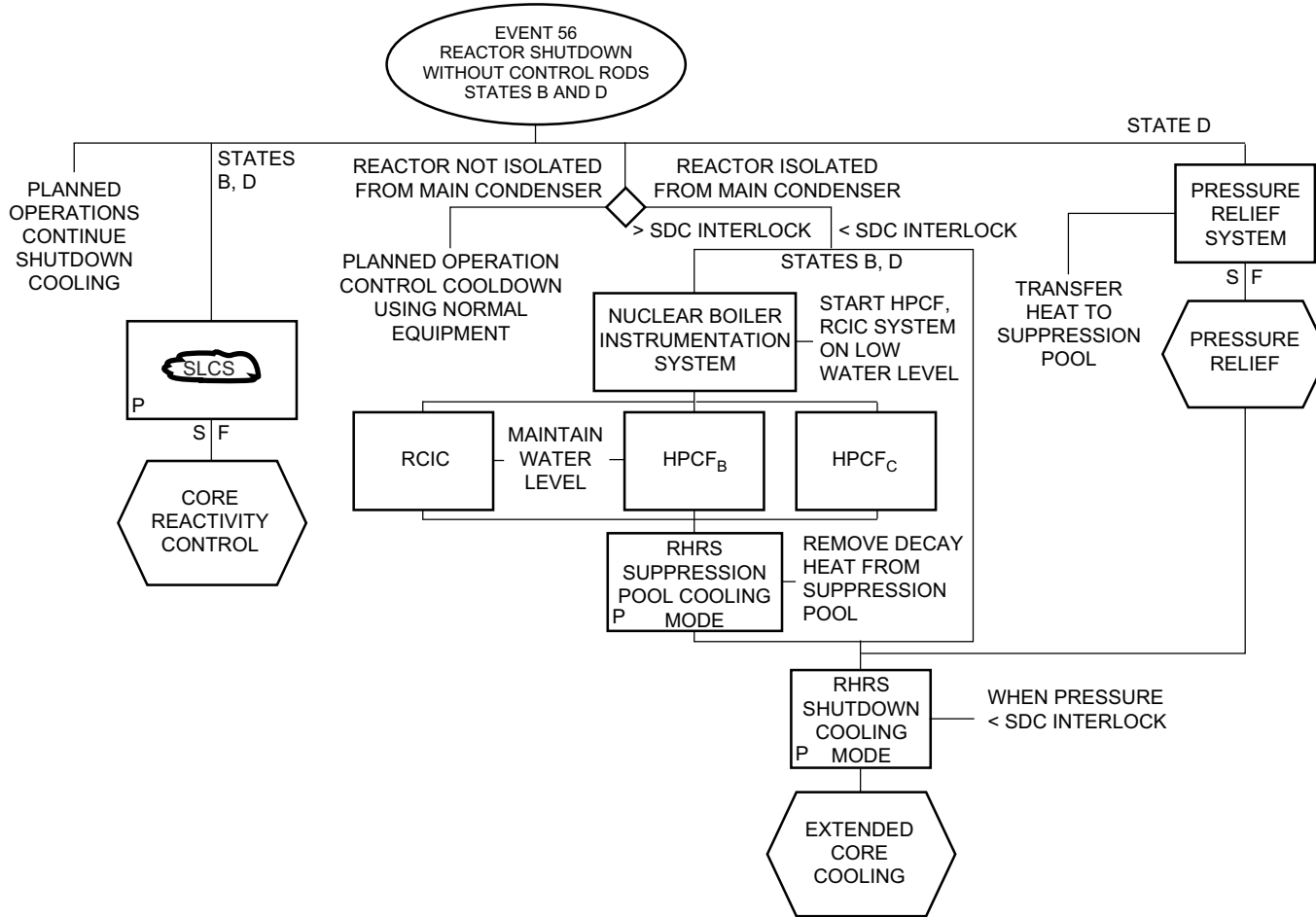

Figure 15A-63 Protection Sequence for Reactor Shutdown—Without Control Rods

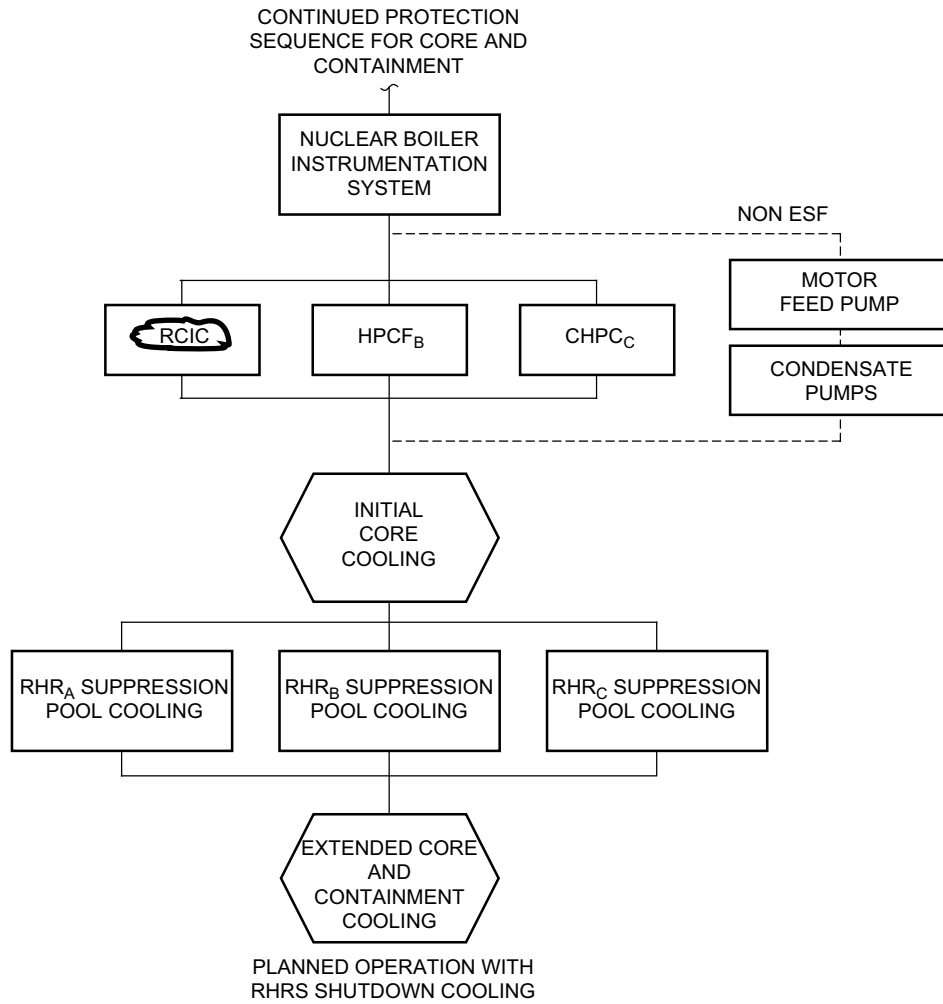
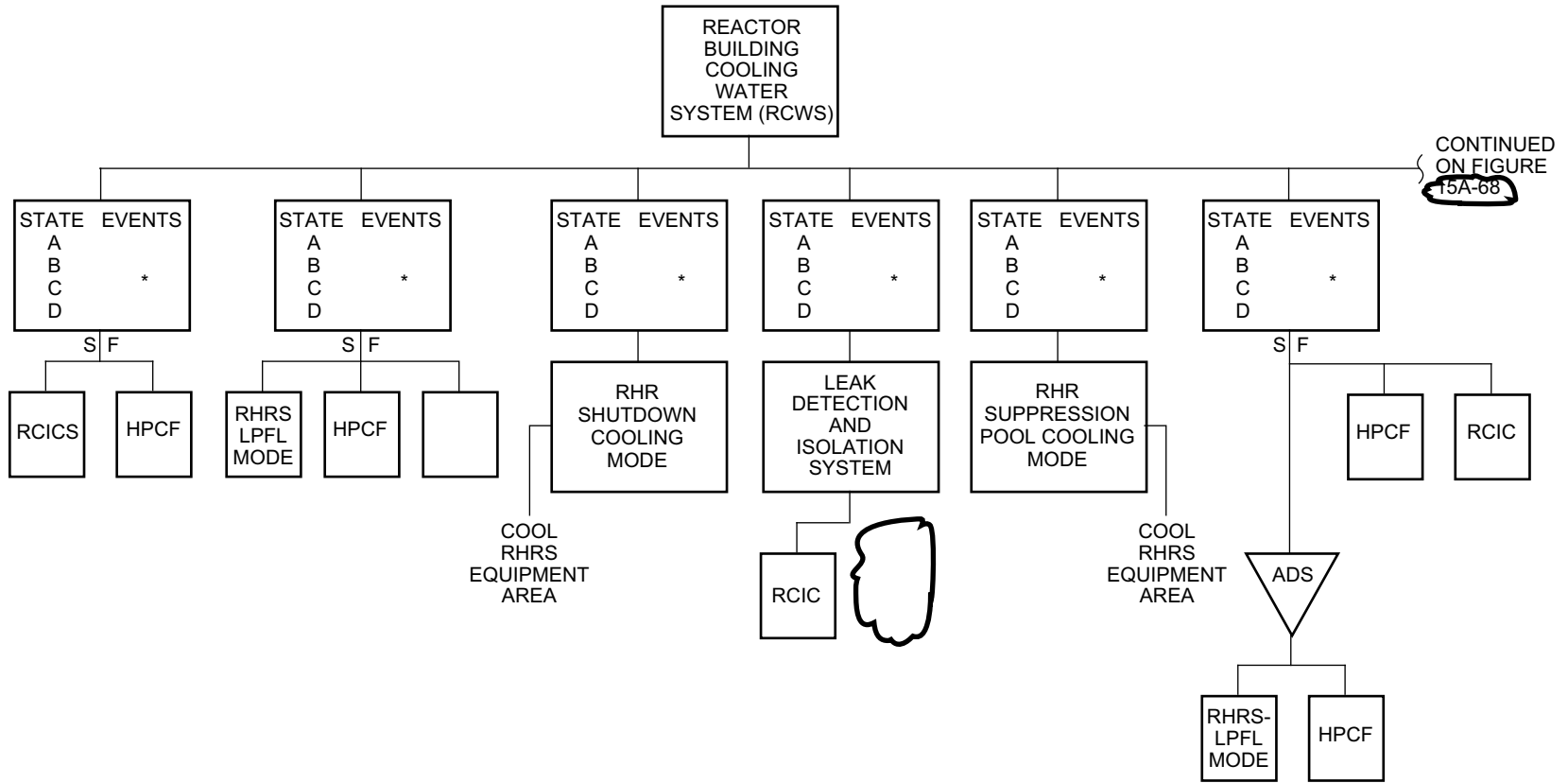
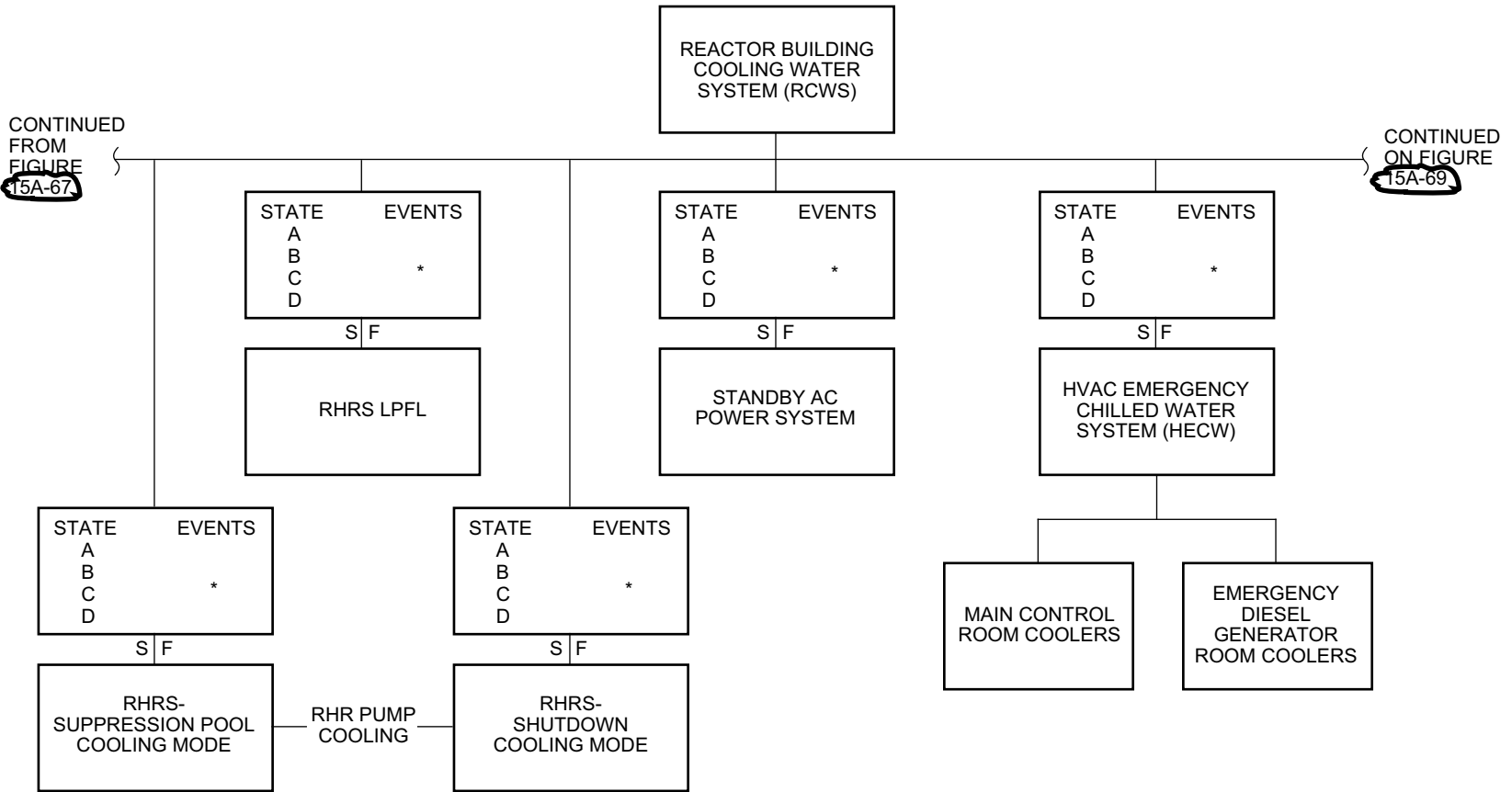

Figure 15A-64 Protection Sequence for Core and Containment Cooling for Loss of Feedwater and Vessel Isolations



\* APPLICABLE EVENTS (TABLES 15A-2 THROUGH 15A-5)  
 NOTE: SF REQUIREMENT NOT APPLICABLE IN EVENTS 54, 55 AND 56

**Figure 15A-67 Commonality of Auxiliary Systems—Reactor Building Cooling Water System (RCWS)**



\* APPLICABLE EVENTS (TABLES 15A-2 THROUGH 15A-5)  
 NOTE: SF REQUIREMENT NOT APPLICABLE IN EVENTS 54, 55 AND 56

Figure 15A-68 Commonality of Auxiliary Systems—Reactor Building Cooling Water System (RCWS) (Continued)

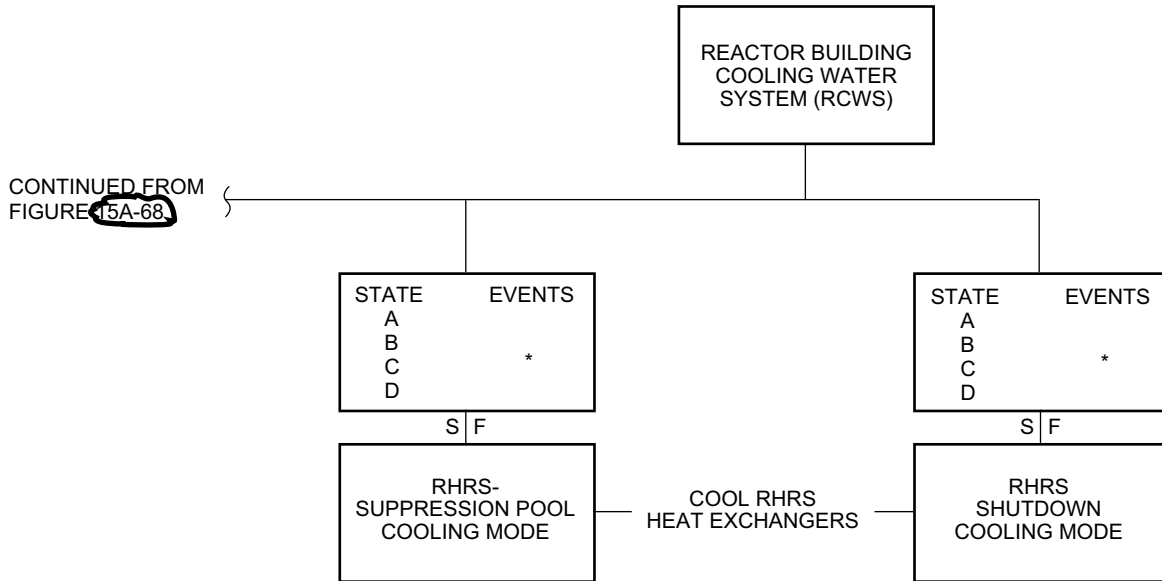

\* APPLICABLE EVENTS (TABLES 15A-2 THROUGH 15A-5)  
 NOTE: SF REQUIREMENT NOT APPLICABLE IN EVENTS 54, 55 AND 56

**Figure 15A-69 Commonality of Auxiliary Systems—Reactor Building Cooling Water System (RCWS) (Continued)**

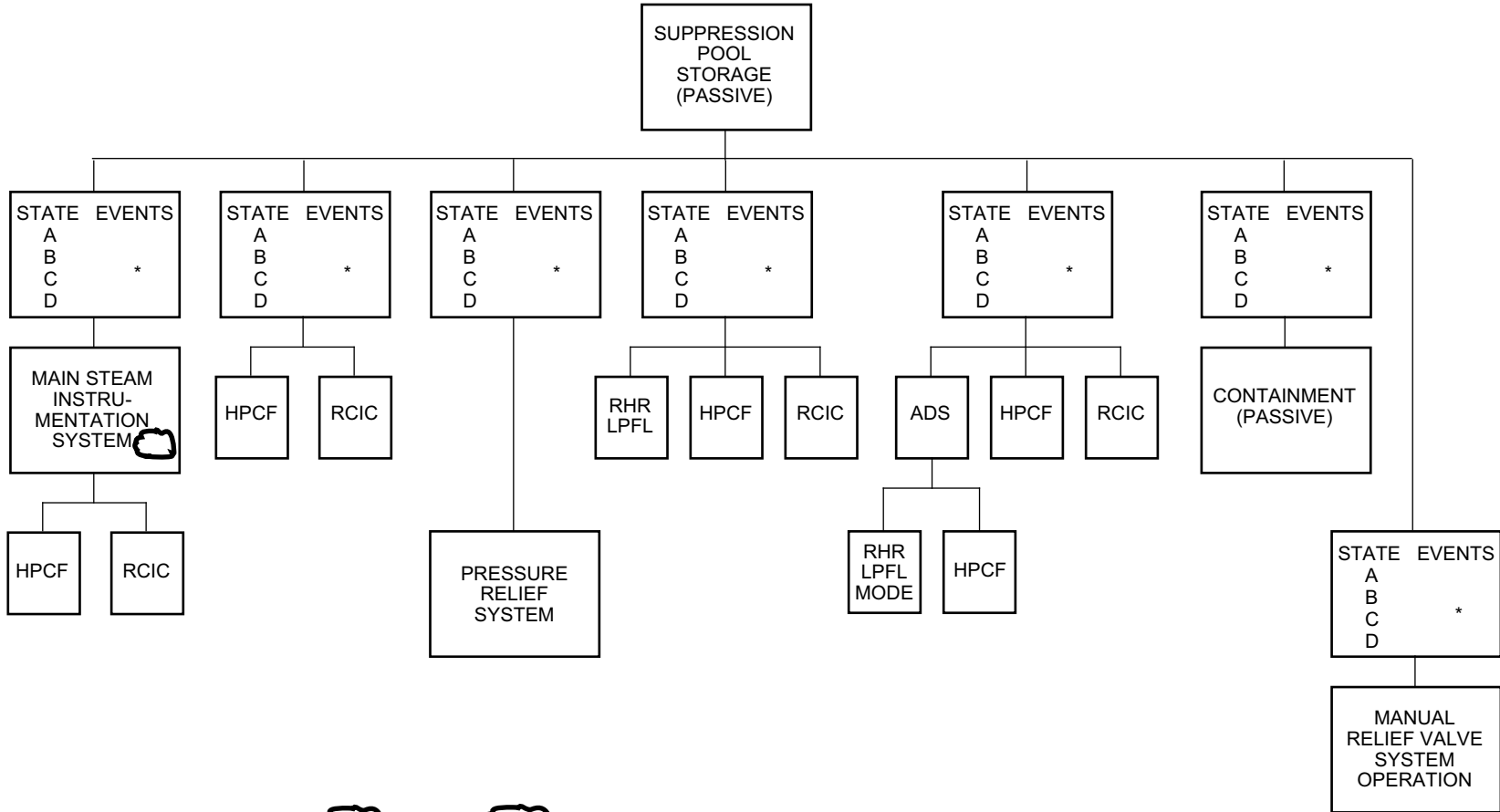

\* APPLICABLE EVENTS (TABLES 15A-2 THROUGH 15A-5)

Figure 15A-70 Commonality of Auxiliary Systems—Suppression Pool Storage

