



U.S. DEPARTMENT OF
ENERGY

Nuclear Energy

Sodium-cooled Fast Reactor (SFR) Technology and Safety Overview

**Office of Nuclear Energy
U.S. Department of Energy**

February 18, 2015
Washington, DC



■ Introduction

- Fast reactor concepts, advantages of, and challenges for, SFRs

■ SFR Technology Overview

- Neutronics, sodium coolant, fuels
- Reactor Design
 - Configurations (pool, loop)
 - Major Systems and Components
 - Reactor core and core restraint system
 - Reactivity control and shutdown system
 - Reactor and guard vessels
 - Heat transport systems (primary and intermediate)
 - Decay heat removal systems
 - Containment, I&C, and other systems

■ Past and Present SFR Designs

- EBR-II, FFTF, PRISM, TWR-P, 4S



Nuclear Energy

■ SFR Safety

- Safety principles and approach
- Inherent safety and reactivity feedback mechanisms
- Response to AOOs, postulated accidents, local faults, sodium accidents

■ Past SFR Safety Testing Programs

- EBR-II, FFTF, FBTA/WPF and TREAT tests

■ U.S. SFR Licensing Experience

- FFTF, CRBR, PRISM

■ Factors that Impact Design Criteria for SFRs

- Protection by Multiple Fission Product Barriers
- Protection and Reactivity Control Systems
- Fluid Systems
- Containment
- Additional Criteria



U.S. DEPARTMENT OF
ENERGY

Nuclear Energy

Introduction



U.S. DEPARTMENT OF
ENERGY

Fast Reactor Concepts

Nuclear Energy

- **Advanced reactor concepts under consideration aim for advances over existing and evolutionary LWRs:**
 - Sustainability
 - Safety
 - Reliability
 - Economics
 - Non-proliferation
- **Numerous national and international studies highlight importance of closed-fuel-cycle systems using reactors with fast-neutron spectrum especially to meet the sustainability goals**
 - Efficient resource utilization
 - Waste minimization



General Fast Reactor Concepts

Fast reactor concepts are typically classified by their coolant:

- Sodium-cooled fast reactor (SFR)
- Lead- or Lead-Bismuth Eutectic (LBE)-cooled fast reactor (LFR)
- Gas-cooled fast reactor (GFR)

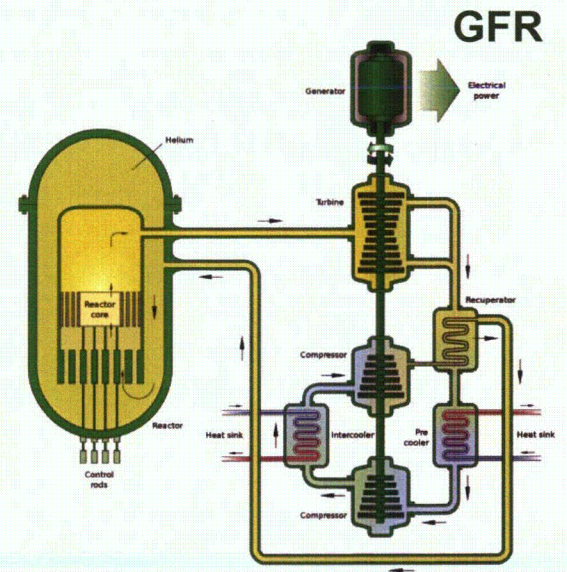
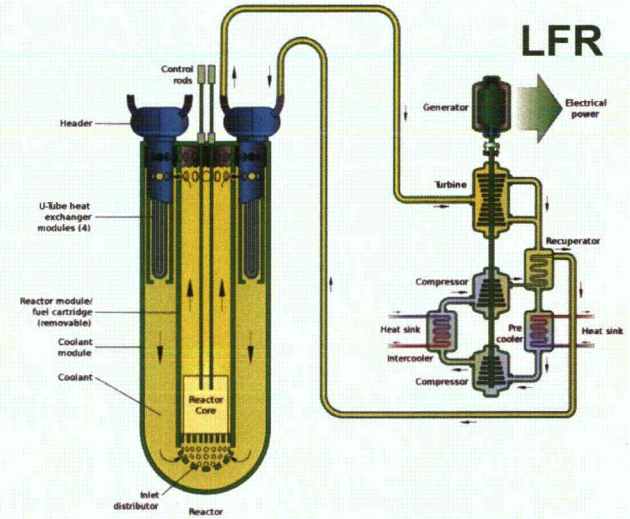
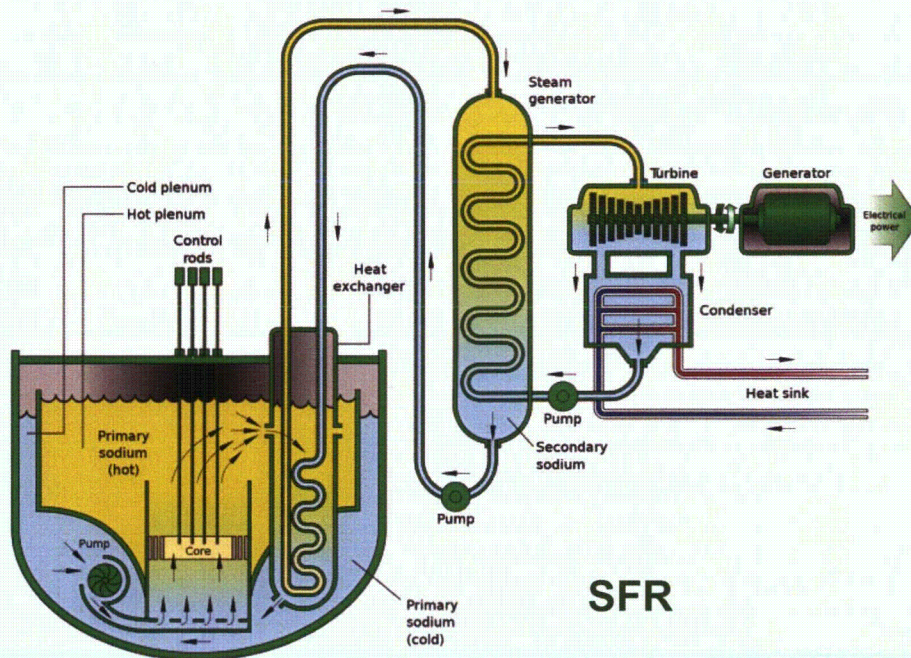



General Fast Reactor Concepts (cont.)

■ All three concepts are based on same basic principles:

- No (intentional) neutron moderators (water or graphite), resulting in a “fast” (or “hard”) neutron energy spectrum compared to “thermal reactors” (LWRs and HTGRs)
- Improved neutron economy due to larger fission-to-capture cross section ratio and greater number of neutrons per fission at high-energies
- Fast neutron spectrum can also be used for breeding or transmutation of transuranic waste products
- Higher enrichment is required to achieve criticality (in comparison to thermal reactors)

■ Other characteristics:

- High core outlet temperature allows greater thermal efficiency (~40%) for energy conversion
- Electromagnetic pumps (with no moving parts) and electromagnetic flow instrumentation are possible with liquid metal coolants (Na, Pb, LBE)
- High core power density (~5× in comparison to an LWR)
- Long core life (without refueling) is possible with breed-and-burn concepts



Safety advantages of SFRs

-
- **Low pressure primary and intermediate coolant system**
 - No LOCA concern, no need for coolant injection
 - Guard vessel (and guard pipes) to “maintain” coolant inventory
 - **Liquid-metal sodium coolant**
 - ~100 times more effective heat transfer medium compared to water
 - Wide margin (~400°C) to boiling
 - Compatible with structural components and metallic fuels
 - **Inherent safety with “net” negative reactivity feedback during accidents that lead to elevated core/coolant temperatures**
 - **Dedicated systems for decay heat removal to an ultimate heat sink**
 - Large core ΔT (150°C in an SFR vs. ~30°C in an LWR) facilitates reliance on passive systems driven by natural circulation for decay heat removal
 - **Low design pressure for containment**
 - Basis is the heat produced by a potential sodium fire
 - **Simpler operation and accident management**
 - Long grace period for corrective action, if needed



Challenges for SFRs

-
- **High temperature operation (>500°C core outlet temperature)**
 - **Fast reactor cores are not in their most reactive configuration**
 - Ensure recriticality does not occur
 - **For large cores, sodium void worth can be positive**
 - **Fast neutron spectrum makes shielding more challenging**
 - **Liquid sodium coolant reacts with air and water, and ablates concrete**
 - Motivates need for leak-tight system
 - These reactions have to be mitigated (by use of inert cells, double tubes, or steel liner) to avoid their impact on SSCs important to safety
 - **Opaqueness of sodium coolant poses in-service inspection and maintenance challenges**



U.S. DEPARTMENT OF
ENERGY

Nuclear Energy

Sodium-cooled Fast Reactor Technology Overview: Neutronics



Comparison of LWR and SFR Spectra

- In thermal reactors, most fissions occur around 0.1 eV peak
- In fast reactors, moderation is avoided – no thermal neutrons

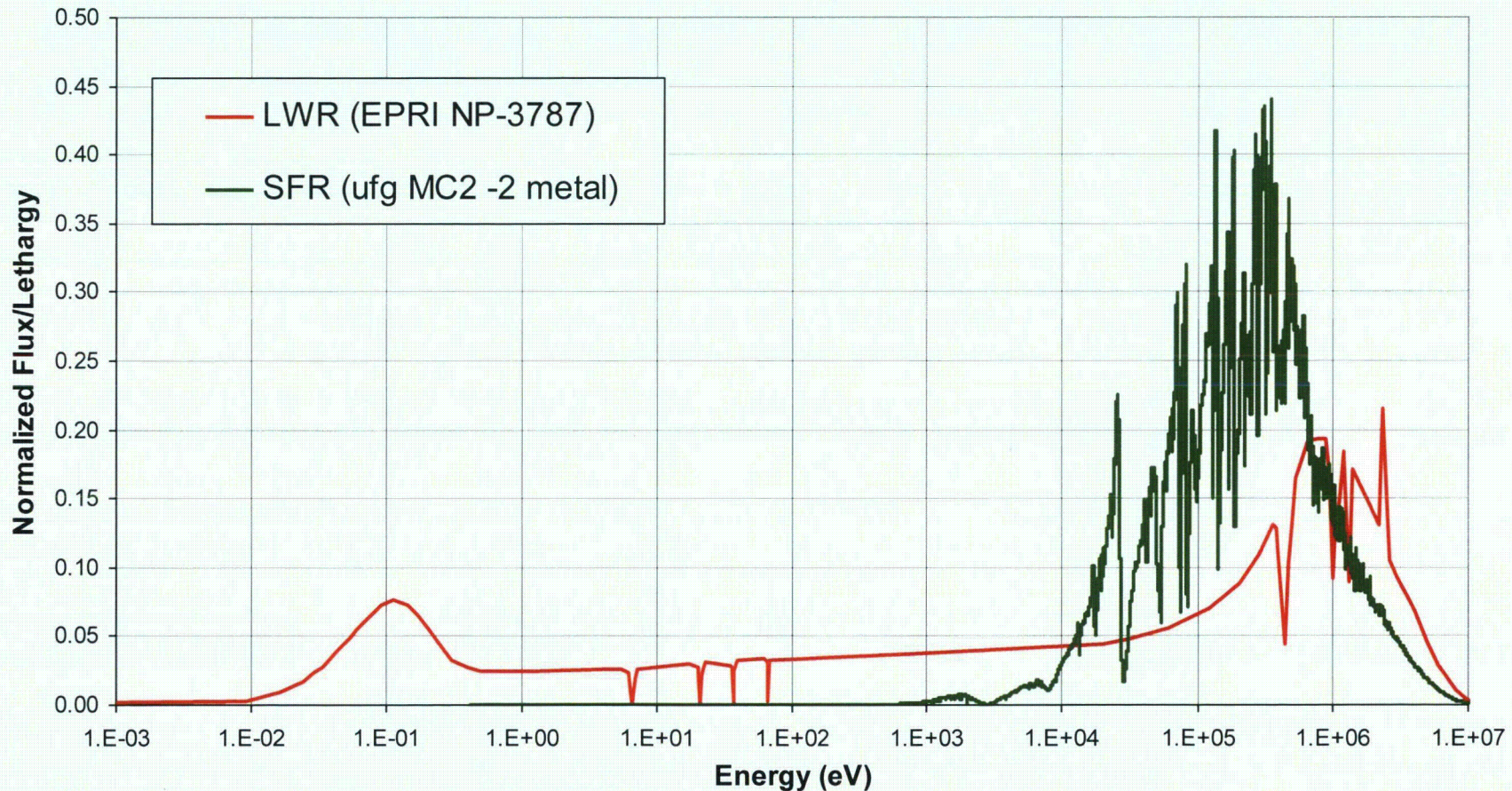



Spectral Variation of Neutron Cross Sections

- In fast spectrum, dominant fissile isotope is Pu-239 and key fertile isotope is U-238

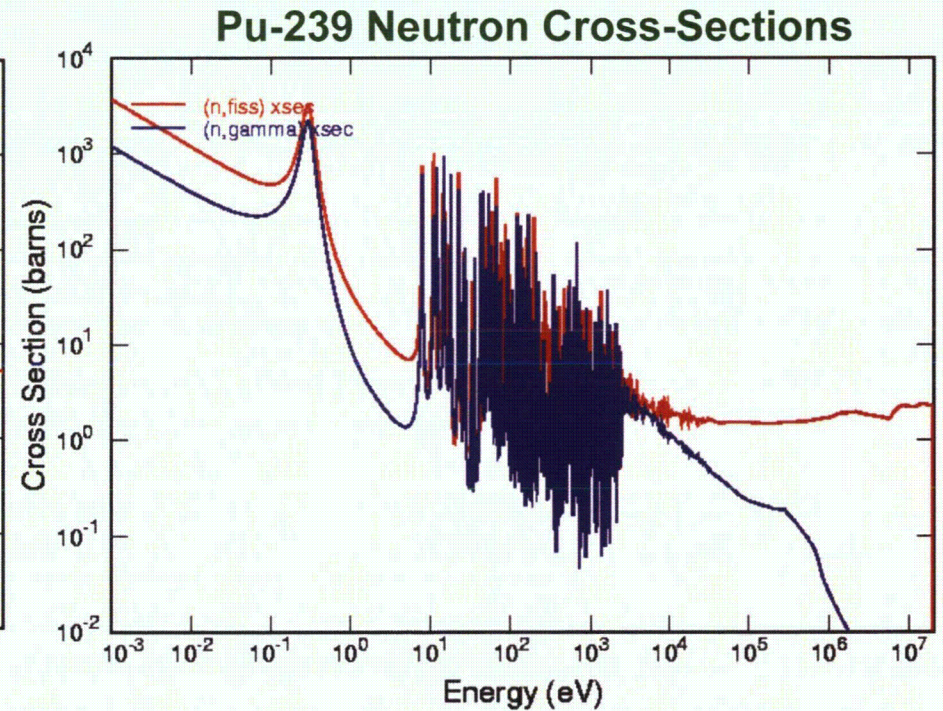
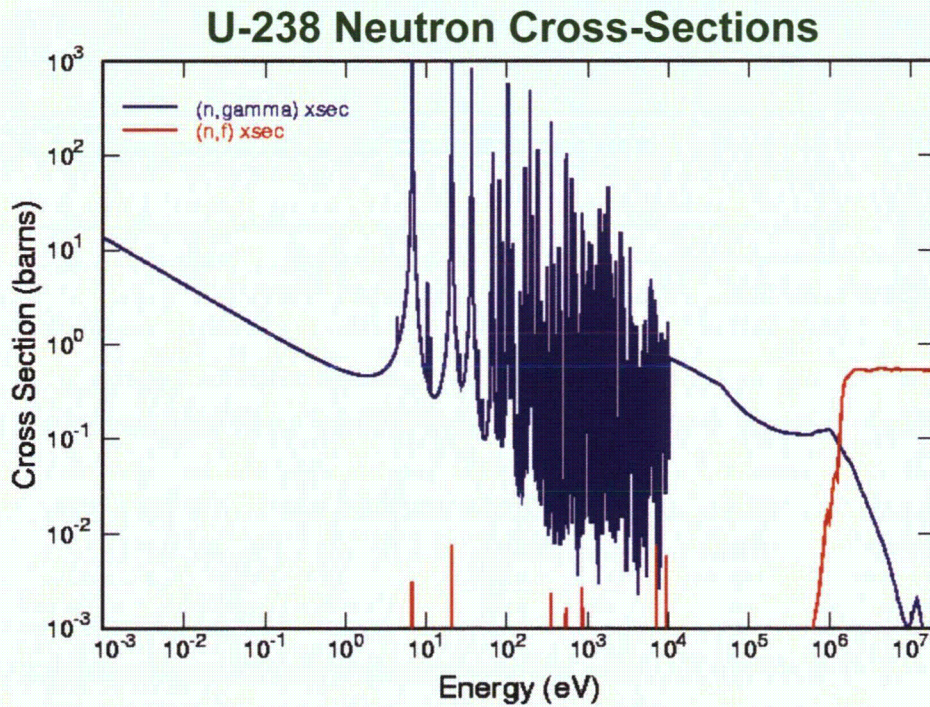



Fuel Cycle Implications of Fast Reactor Physics

- **Impact of energy spectrum on transmutation:**
 - Fission/capture ratio is higher in fast spectrum
 - Also significant fission of fertile isotopes is possible (threshold fission)
 - Net result is more excess neutrons and less actinide generation in a fast reactor
- **Consequently, fast reactors are typically intended for closed fuel cycle with uranium conversion and resource extension**
 - Higher actinide generation is suppressed
 - Neutron balance is favorable for recycled TRU
 - Can enhance U-238 conversion for traditional breeding
 - Can limit U-238 conversion for burning
- **Facilitates waste reduction for geologic disposal**
- **Increases the percentage of the natural fuel resource that is used in the fuel cycle (from today's <1% up to almost 100%)**



U.S. DEPARTMENT OF
ENERGY

Nuclear Energy

Design Impacts of Fast Spectrum on Safety

- **Fast spectrum leads to ~10× longer neutron mean-free paths**
 - Greater sensitivity to neutron leakage and minor geometric changes
 - As the core temperature increases and materials expand, a net negative reactivity feedback is inherently introduced
 - Reactivity perturbations impact the core as a whole, not locally
 - Negligible spatial self-shielding
- **Mid-energy U-238 resonances contribute to significant Doppler reactivity coefficient**
- **Breeding leads to lower reactivity swing with burnup**
 - Reduced need for excess reactivity to control the reactor
 - Less reactivity available for accidental insertion
- **Reduced parasitic capture and improved neutron balance allow greater flexibility of material selection (SS for structures)**



U.S. DEPARTMENT OF
ENERGY

Nuclear Energy

Sodium-cooled Fast Reactor Technology Overview: Sodium Coolant



LWR vs. SFR Lattice

■ In an LWR, water acts as both a coolant and a moderator

- An optimal P/D ratio is adjusted so that:
 - adequate moderation is obtained (i.e., not under- or over-moderated)
 - sufficient cooling capability is provided to remove generated nuclear heat

■ In an SFR with no neutron moderation, sodium acts only as a coolant

- Because of its excellent heat transfer properties (of all liquid metals in general), fuel pins can be packed much closer in a hexagonal lattice (triangular pitch)
 - Typically separated by a thin wire spirally wrapped around each fuel pin

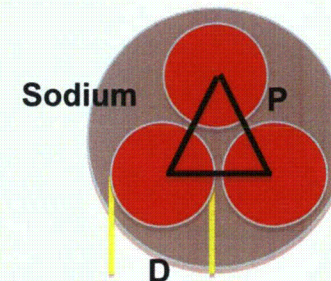
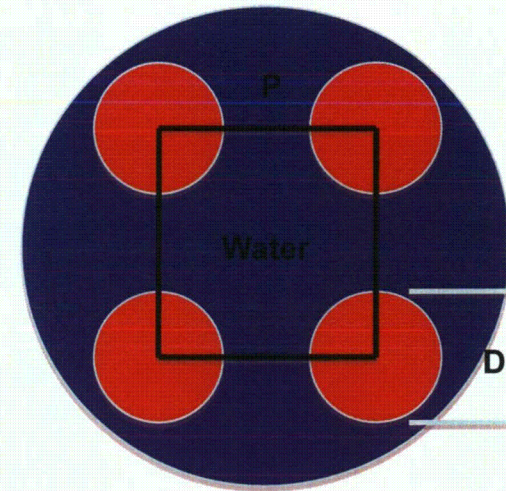



Thermal-Fluid Considerations

- **Fast reactor fuel lattice has to be kept compact primarily due to neutronic requirements**
 - Results in a high power density compared to conventional LWRs
 - Stipulates that a coolant with much better heat transfer capabilities be used for heat removal
- **Fast neutron spectrum also requires a coolant with low moderating power**
 - Coolants with low mass number, such as those that contain hydrogen, deuterium (and even oxygen) are not suitable
- **Three most common liquid metal coolants for fast reactors are sodium, lead, and lead-bismuth eutectic (LBE)**



Sodium is the Dominant Fast Reactor Coolant

■ **Neutronic, thermo-physical and thermal-hydraulic properties of sodium are comparable (✓) or superior (✓+) to other fast reactor coolants**

- Enables smaller core with higher power density, lower enrichment, and lower heavy metal inventory
- Demonstrated passive safety performance
- No corrosion issues with oxygen control and coolant purification

■ **Extensive testing of coolants lead to the use of sodium as the primary coolant in nearly all fast reactors constructed during the last 50 years**

- All current fast reactor construction projects use sodium as the primary coolant
- LBE-cooled reactors limited to Russian Alfa-class submarine experience

Thermophysical Properties:

Excellent Heat Transfer	✓+
Low Vapor Pressure	✓+
High Boiling Point	✓+
Low Melting Point	✓

Material Properties:

Thermal Stability	✓+
Radiation Stability	✓+
Material Compatibility	✓+

Neutronic Properties:

Low Neutron Absorption	✓+
Minimal Activation	✓
Negligible Moderation	✓+

Supports Passive Safety ✓+

Cost: Initial Inventory	✓+
Make-Up Inventory	✓+
Low Pumping Power	✓+

Hazards: Reacts with air and water



U.S. DEPARTMENT OF
ENERGY

Nuclear Energy

Design Impacts of Sodium Coolant on Safety

- **Low system pressure offers significant advantages in terms of safety:**
 - Minimal pressure loading on the coolant boundary
 - Reduced concern for coolant pipe breaks
 - Coolant leaks are unlikely to propagate to a large-scale failure
 - No need for emergency high-pressure injection cooling
- **Sodium coolant provides a large margin to boiling**
 - About 400°C as opposed to ~15°C in a PWR
- **~100X more effective heat transfer medium compared to water**
- **Large core ΔT allows relying on passive systems driven by natural circulation for decay heat removal**
- **Compatible with structural components and metallic fuels**
- **Presents design challenges for addressing sodium reactions**



U.S. DEPARTMENT OF
ENERGY

Nuclear Energy

Sodium-cooled Fast Reactor Technology Overview: Fuels



SFR Fuel Types

■ Large irradiation experience with oxide and metal fuels

- Oxide Fuel
 - Sintered pellet (ceramic) Uranium- or Mixed-Oxide fuel similar in design to an LWR oxide fuel pellet
 - Helium-filled gap between the fuel and cladding
 - Fission gas plenum
 - Irradiation experience in FFTF and international reactors in France, Russia, and Japan
- Metal-alloy Fuel
 - Binary (U-Zr) or ternary (U-Pu-Zr) metal-alloy full-length slugs in SS (316) or advanced alloy (D9, HT9) cladding
 - Sodium-filled gap between the fuel and cladding (bond sodium)
 - Large fission gas plenum to accommodate high burnup
 - Irradiation experience in EBR-II and FFTF
 - Fuel of choice for U.S. fast reactor R&D program and commercial vendors
- Other fuel types (with less irradiation experience) include nitride (ceramic) and carbide fuels

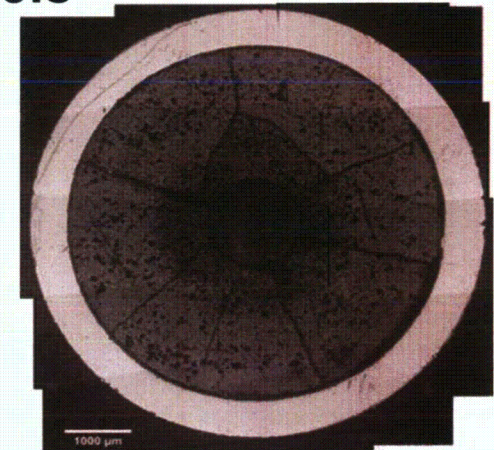

High Burnup MOX Fuel

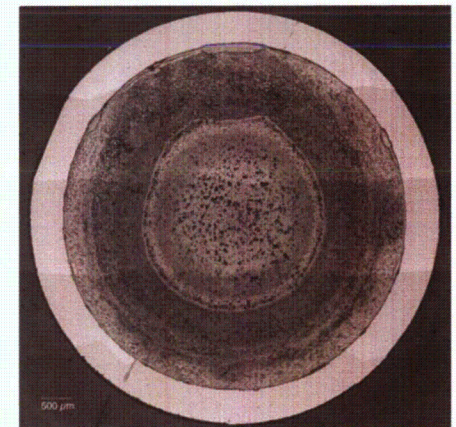

Metal Fuel with HT9 Clad



SFR Fuel Design Challenges

-
- **Fast reactor fuels are typically designed to reach much higher burnup to take advantage of higher initial fissile loading as well as the “breed and burn” characteristics**
 - Typical LWR fuel burnup is ~5%
 - SFR fuels typically reach burnup in excess of 10%
 - **Greater fuel swelling in fast spectrum**
 - Current metallic and oxide fuel pin designs can accommodate this
 - **Fuel-Cladding Mechanical Interaction**
 - Hard, strong fuel forms push on cladding, particularly at high burnup
 - Limits maximum burnup for ceramic fuels
 - **Fuel-Cladding Chemical Interaction**
 - May limit coolant outlet temperature of metallic fuel core
 - **Fuel-Coolant Compatibility**
 - Oxide fuel chemically reacts with the sodium coolant imposing stricter limits on fuel pin failures to prevent potential flow blockages



Current Status of FR Fuels

■ Oxide Fuels

- Acceptable performance and reliability demonstrated up to 10 at.% burnup, with capability demonstrated to 20 at.% burnup
- Robust overpower capability demonstrated in TREAT tests: ~ 3 to 4x nominal power; well above primary and secondary FFTF trips; failures near core mid-plane
- Performance issues typically creep rupture of cladding at high burnup, accelerated due to Fuel-Cladding Mechanical Interaction (FCMI)

■ Metallic Fuels

- Acceptable performance and reliability demonstrated up to 10 at.% burnup, with capability demonstrated to 20 at.% burnup
- Robust overpower capability demonstrated in TREAT tests: ~ 4 to 5x nominal power; failures near top of fuel column; pre-failure axial expansion
- Typical performance issue is creep rupture of cladding at high burnup, accelerated due to Fuel-Cladding Chemical Interaction (FCCI)
 - Performance and phenomena with U-Fs, U-Zr and U-Pu-Zr fuel forms are similar.
 - Burnup, temperature and cladding performance are key variables



Metal-alloy Fuel Design

■ Current U.S. R&D program and all U.S. industry designs rely on use of metal-alloy fuel

- Developed at Argonne based on experience gained through 20+ years operation of EBR-II
- Injection cast as cylindrical slugs and placed inside the cladding
- The fuel-cladding gap is sized for a low smear density to accommodate fuel swelling and achieve a high burn-up
- Liquid-metal sodium is used inside the pin to thermally bond the fuel/cladding and increase gap conductance
 - Along with the high fuel thermal conductivity, maintains significantly lower fuel operating temperatures compared to oxide fuel

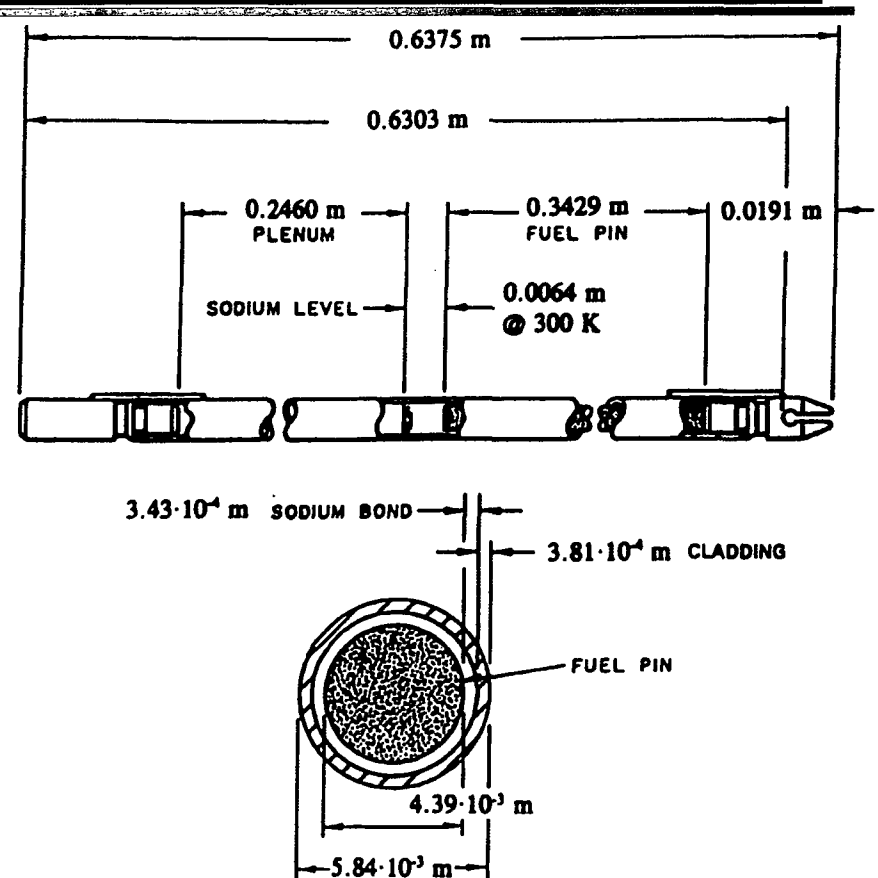

L. C. Walters, B. R. Seidel, J. H. Kittel, "Performance Of Metallic Fuels And Blankets In Liquid-Metal Fast Breeder Reactors," *Nuclear Technology*, Volume 65, Number 2, pages 179-231 (1984).



Design Impacts of Oxide and Metal-Alloy Fuels on Safety

- **Difference in thermal conductivity and gap conductance offers significant advantage for the metal fuel**
 - Much lower steady-state and transient temperatures
 - Flatter radial temperature profile
- **Despite big difference in melting point, both oxide and metal fuels have relatively similar margin to melting during transients**
- **Phenomena depending on diffusional rate processes, such as creep and fission gas release, are also similar for the two fuel types**
- **If metal fuel cladding fails (in a BDBA), it generally occurs below the coolant boiling point**
 - Damaged metal fuel pins are usually coolable
 - Metal fuel is also compatible with sodium coolant
- **All these, and the low retained heat, are significant contributing factors to inherently benign response of metallic fuel**
 - Longer grace period for operator action



U.S. DEPARTMENT OF
ENERGY

Nuclear Energy

Sodium-cooled Fast Reactor Technology Overview: Reactor Design



U.S. DEPARTMENT OF
ENERGY

SFR Configurations

Nuclear Energy

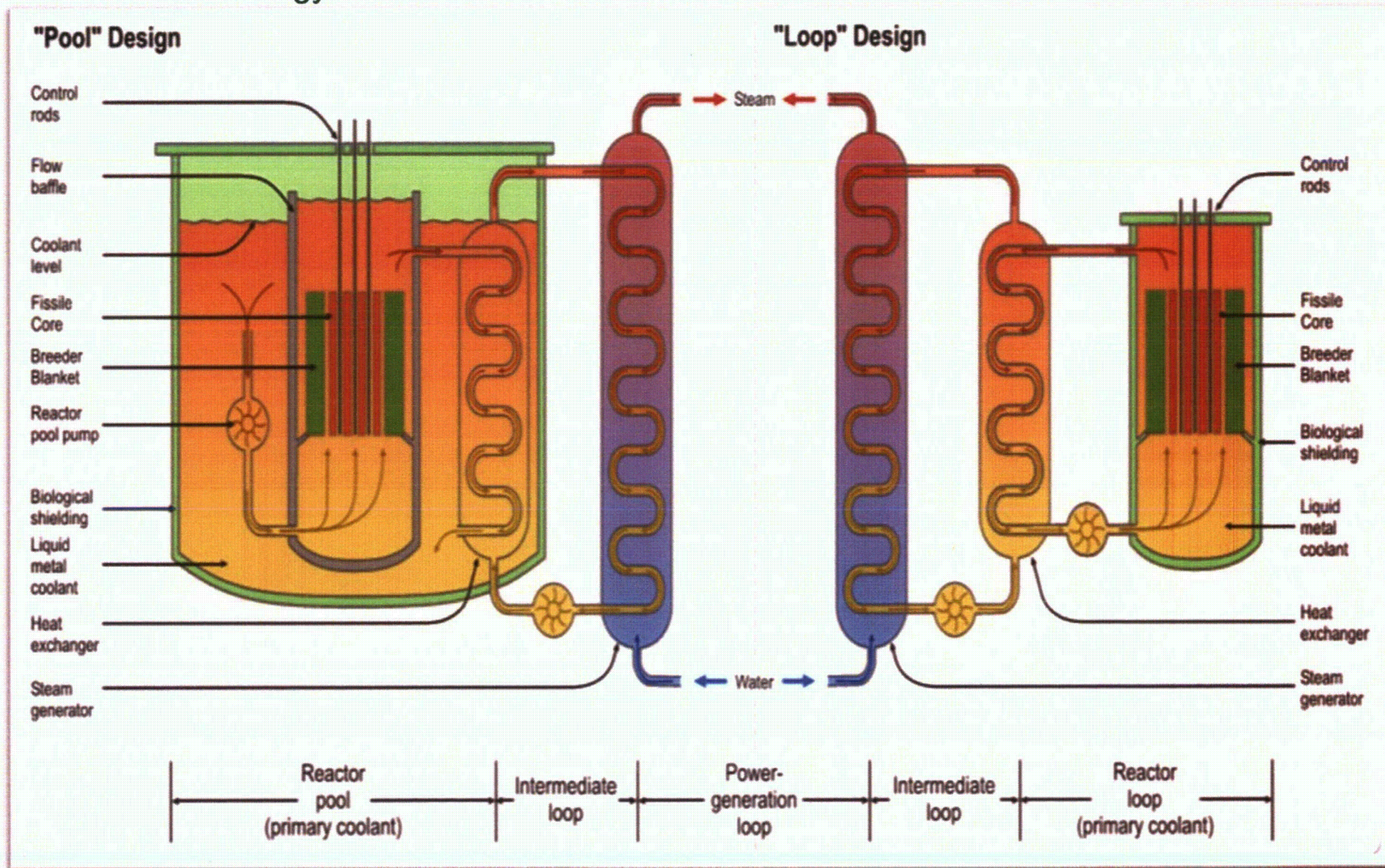



SFR Configurations (cont.)

-
- **Loop: The primary coolant is allowed to leave the reactor vessel, and the intermediate heat exchanger (IHX) is located in the containment area outside the vessel**
 - Has reliability improvements—easier to isolate the loop and do maintenance on the intermediate heat exchanger
 - Primary vessel surrounded by a guard vessel
 - Usually requires double-walled piping in areas outside the vessel
 - Preferred in Japan
 - FFTF was a loop-type plant
 - **Pool: Primary coolant is kept within the reactor vessel which also encompasses the IHX**
 - Larger reactor vessel, reduces the impact of a primary pipe break or leak
 - Preferred in the United States, France, Russia, S. Korea, China, and India
 - Primary vessel surrounded by guard vessel
 - EBR-II was a pool type plant
 - Choice for current U.S. fast reactor R&D program and U.S. commercial vendors (also 4S)



Major Systems and Components

- Reactor core
- Reactivity control and shutdown system
- Reactor and guard vessels
- Heat transport systems (primary and intermediate)
- Energy conversion system (balance of plant)
- Decay heat removal systems
- Containment
- I&C, coolant and cover-gas cleanup systems, spent fuel storage, ISI&M

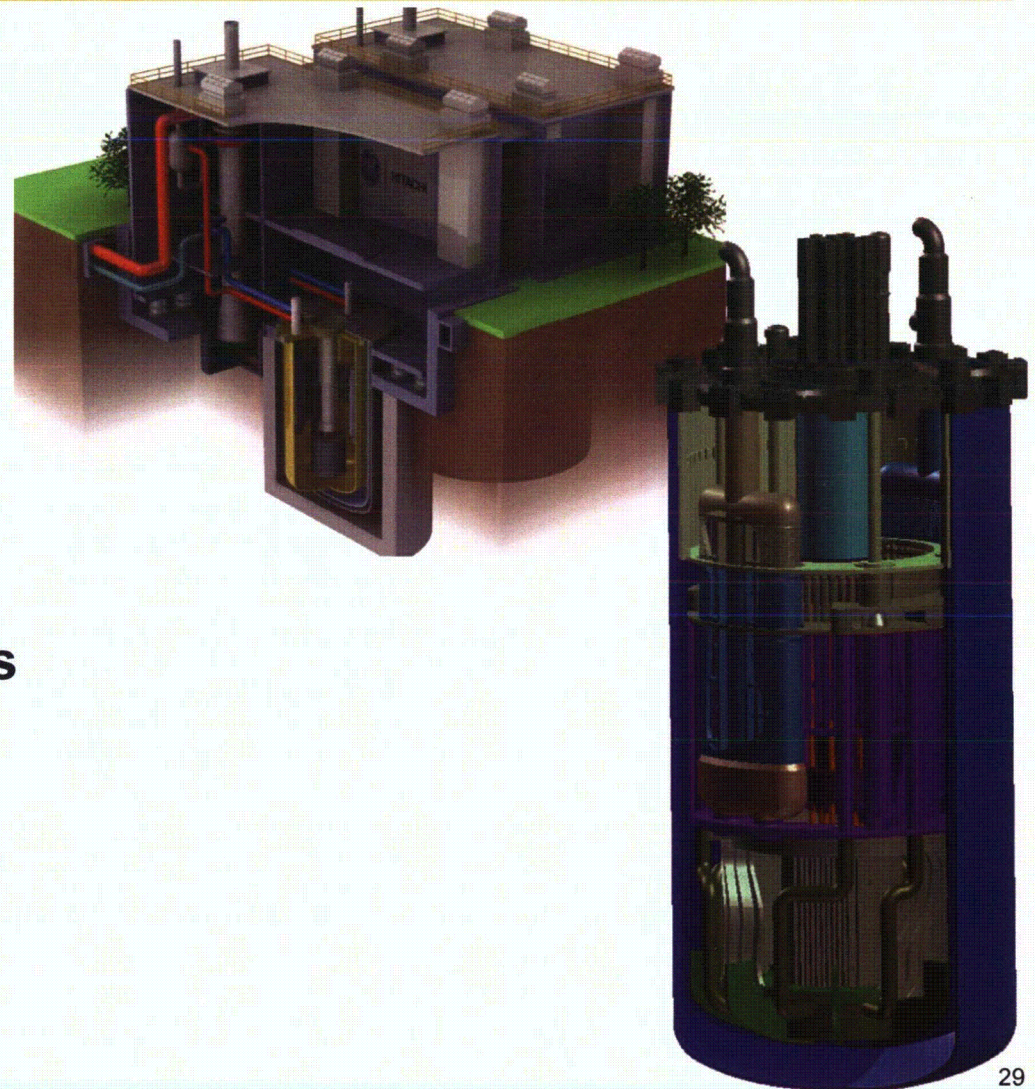



■ Typical SFR core configuration considered in the U.S.

- Argonne's AFR-100 Design

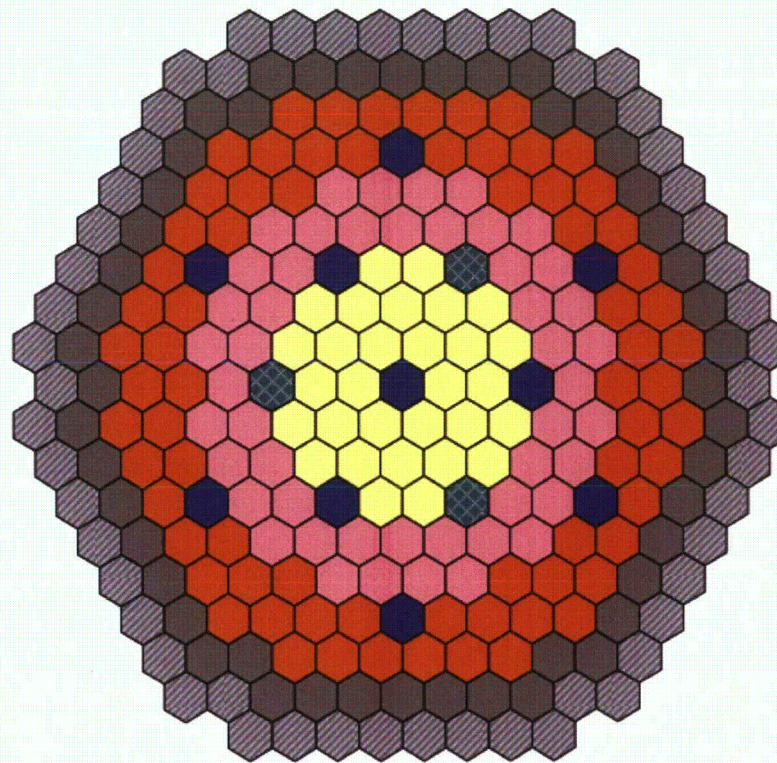
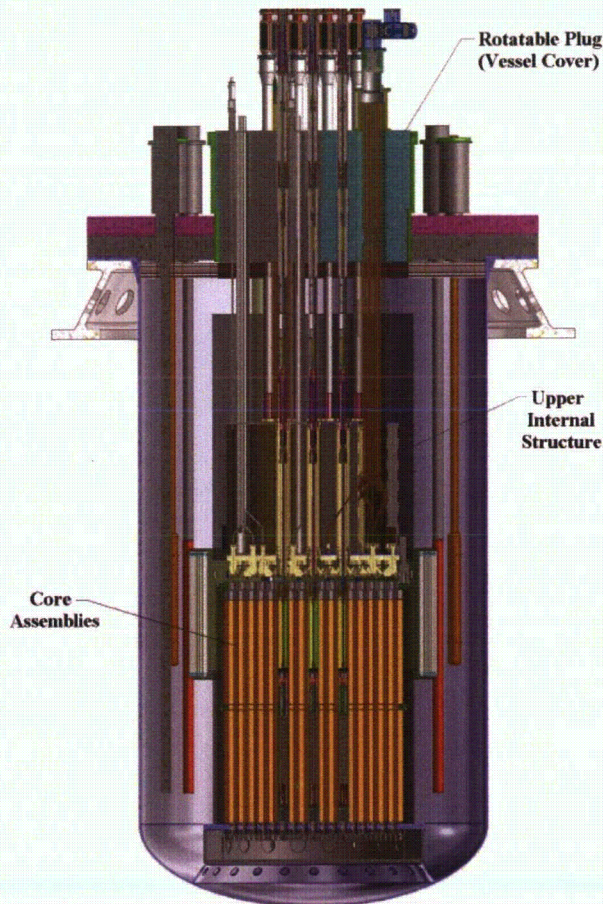



Reactor Core (cont.)

■ Fuel pin and fuel assembly design

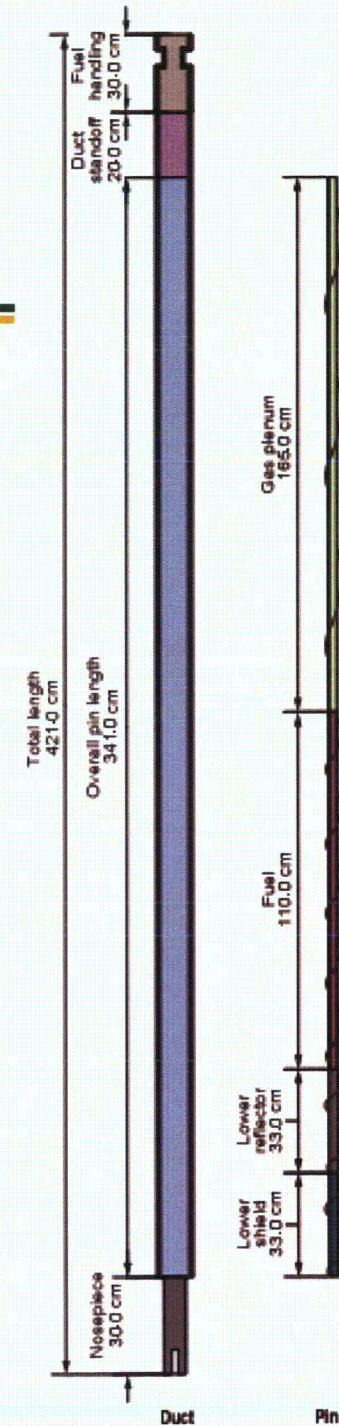
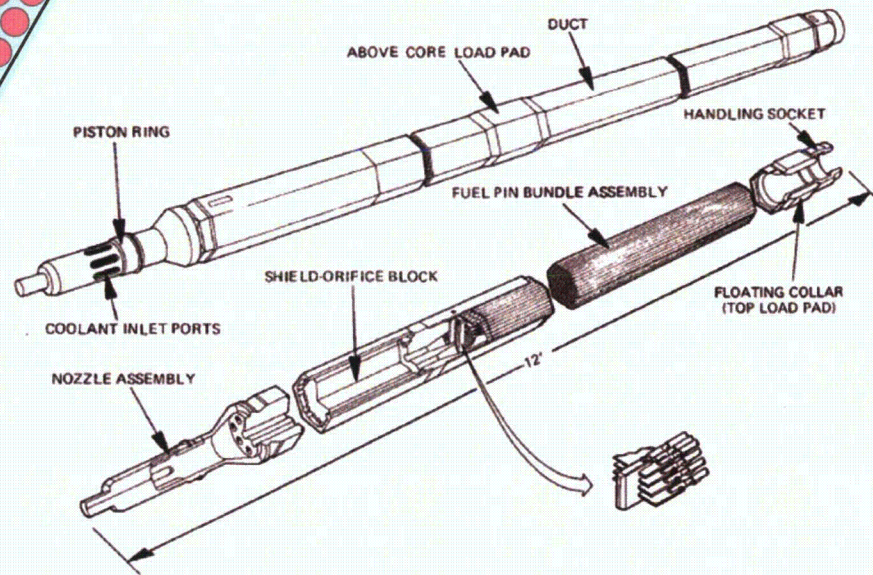
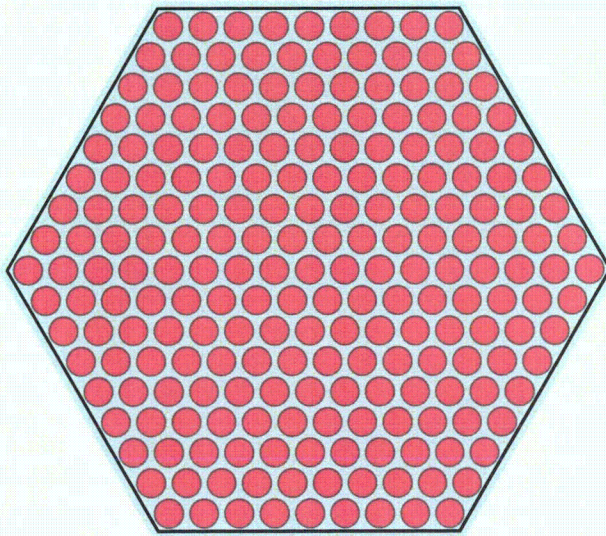



Core Restraint System

- **Controls horizontal movements of core assemblies from thermal expansion, irradiation-induced swelling, irradiation-enhanced creep**
 - Reactivity effects are acceptable
 - Control-rod driveline alignments are maintained within specified tolerances
- **Accommodates horizontal seismic motions within alignment and stress specifications**
- **Maintains sufficient clearances to facilitate refueling**
- **Design parameters include**
 - Length and stiffness of lower adaptors
 - Number, location, and configuration of assembly load pads
 - Rigidity of peripheral boundary





U.S. DEPARTMENT OF
ENERGY

Nuclear Energy

Reactivity Control and Shutdown System

■ Two independent, safety grade systems control the reactivity:

- **Primary control system:** Capable to bring the reactor from any operating condition to “cold” subcritical state at refueling temperature ($\sim 200^{\circ}\text{C}$) with most reactive control assembly inoperative
 - Also serves to compensate for burnup reactivity swing and accommodates uncertainties in criticality and fissile loading
- **Secondary control system:** Capable to bring the reactor from any operating condition to hot standby condition with most reactive control assembly inoperative

■ Other alternative reactivity control systems

- Rod stop system: Prevents substantial power increase during unintended rod withdrawal event
- Self-actuated shutdown system: Curie point magnetic alloy facilitates use of automatic delatching of control rods when the core temperature rises.
- Ultimate shutdown system: A manually actuated system that shuts down the reactor in the event that all methods of scram have failed (e.g., boron balls)



- **Reactor vessel envelopes the core and most of primary heat transport system (PHTS) components**
 - In pool type systems, entire PHTS is placed inside the reactor vessel (reactor primary coolant boundary)
 - Provides support for reactor core, inner barrel, thermal barriers, shielding...
 - Also acts as a barrier against the release of radioactive material
- **Typically made of austenitic stainless steel and shaped as a cylindrical shell with a dome or torospherical bottom**
 - Either hung from the top by a support ring, or supported at the bottom
- **The fuel assemblies rest on a core support structure**
 - Core support grid to guide the flow from the inlet plenum
 - Upper internals structure to guide the flow into the upper plenum
- **An inert cover gas separates the sodium from the reactor head that provides access for control rods and rotating plugs as refueling ports**
 - No penetrations of the reactor vessel in a pool type system



Guard Vessel

Nuclear Energy

- In case of failure of the reactor vessel (from seismic events or thermal creep induced rupture), the guard vessel wraps the reactor vessel

- Gap between the reactor and guard vessels does not contain Na under normal conditions
- It is sufficiently wide to allow inspection but narrow enough to maintain high enough sodium level
 - to keep the core covered and decay heat removal systems functional

- Both cold and hot legs (i.e., sodium inlet and outlet pipes) enter above the guard vessel so that any pipe rupture does not result in coolant loss

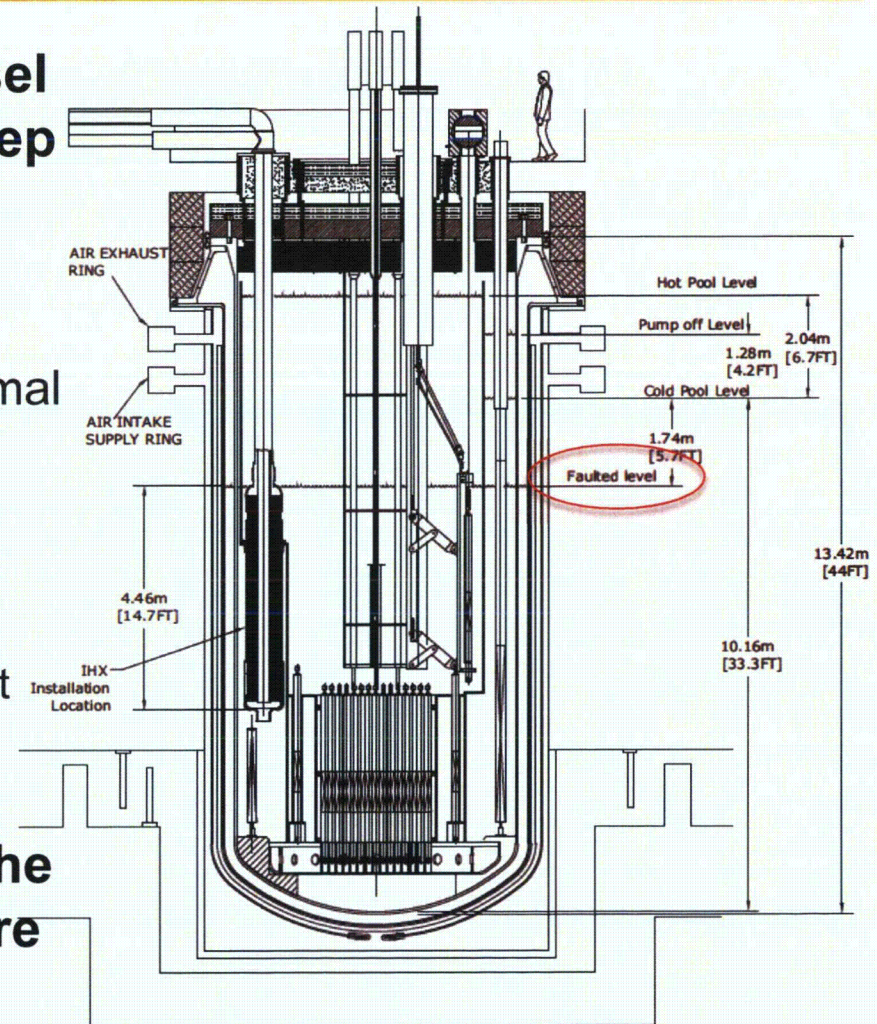



Heat Transport Systems

■ SFRs generally have three heat transfer systems:

- Primary heat transfer system (PHTS)—cools the core
- Intermediate heat transfer system (IHTS)—transfers heat from the primary loop to the steam generator (also usually with sodium)
 - Needed to avoid the possibility of activated primary sodium coolant reacting with water as a result of a steam generator tube rupture
- Energy conversion system (balance of plant)—to generate electricity with a turbine

■ Both PHTS and IHTS are kept at low pressure (near ambient) since the boiling point of Na is significantly higher than normal operational temperatures

■ Turbine/generator, condenser, feed-water systems are similar to a PWR except, in an SFR, they run at a higher temperature

- Higher energy conversion efficiency



Heat Transport Systems: Sodium Pumps and IHX

- **Mechanical pumps are generally vertical-shaft, single-stage, double-suction impeller, free-surface centrifugal pumps**
- **Electromagnetic pumps can also be used in SFRs since sodium has a very high-electrical conductivity**
 - Used on intermediate loop in EBR-II and SEFOR, the primary loop of the Dounreay Fast Reactor, in some backup decay heat removal systems of SNR-300 and SuperPhenix
- **Intermediate Heat Exchanger (IHX) transfers heat from the primary loop to the secondary loop**
 - Keeps activated primary sodium separated from secondary sodium
- **Generally shell-and-tube heat exchangers in counter flow configuration are used**
 - Straight vs. bent tubes
 - Shell vs. tube-side primary flow
 - Counter-current vs. parallel vs. cross flow

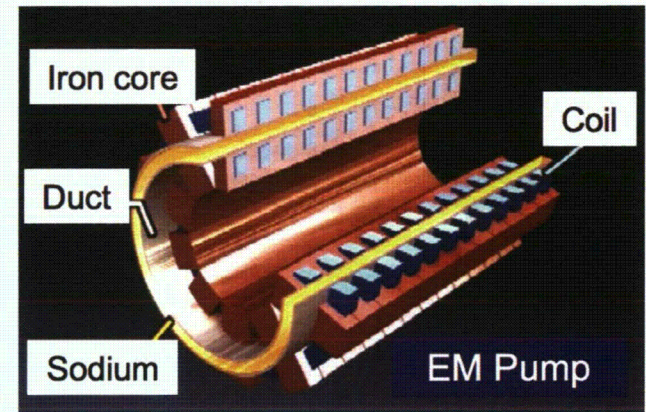



Decay Heat Removal Systems

- **SFRs rely on reliable, independent and diverse means for removal of decay heat**
- **Normal shutdown heat removal is usually via balance-of plant (BOP)**
 - Based on diverting steam (or supercritical CO₂ in Brayton cycle) from the turbine to heat sink via bypass line
 - Usually not a safety-grade system
- **In the event BOP path is not available, shutdown heat removal is achieved via redundant safety-grade emergency decay heat removal systems**
 - To maintain primary system component temperatures below allowed limits during postulated accidents
 - Usually based on passive heat removal mechanisms (using natural convection, no valves or mechanical devices to control its operation)



Decay Heat Removal Systems (cont.)

■ Decay heat removal system options for AOOs, DBAs, and BDBAs

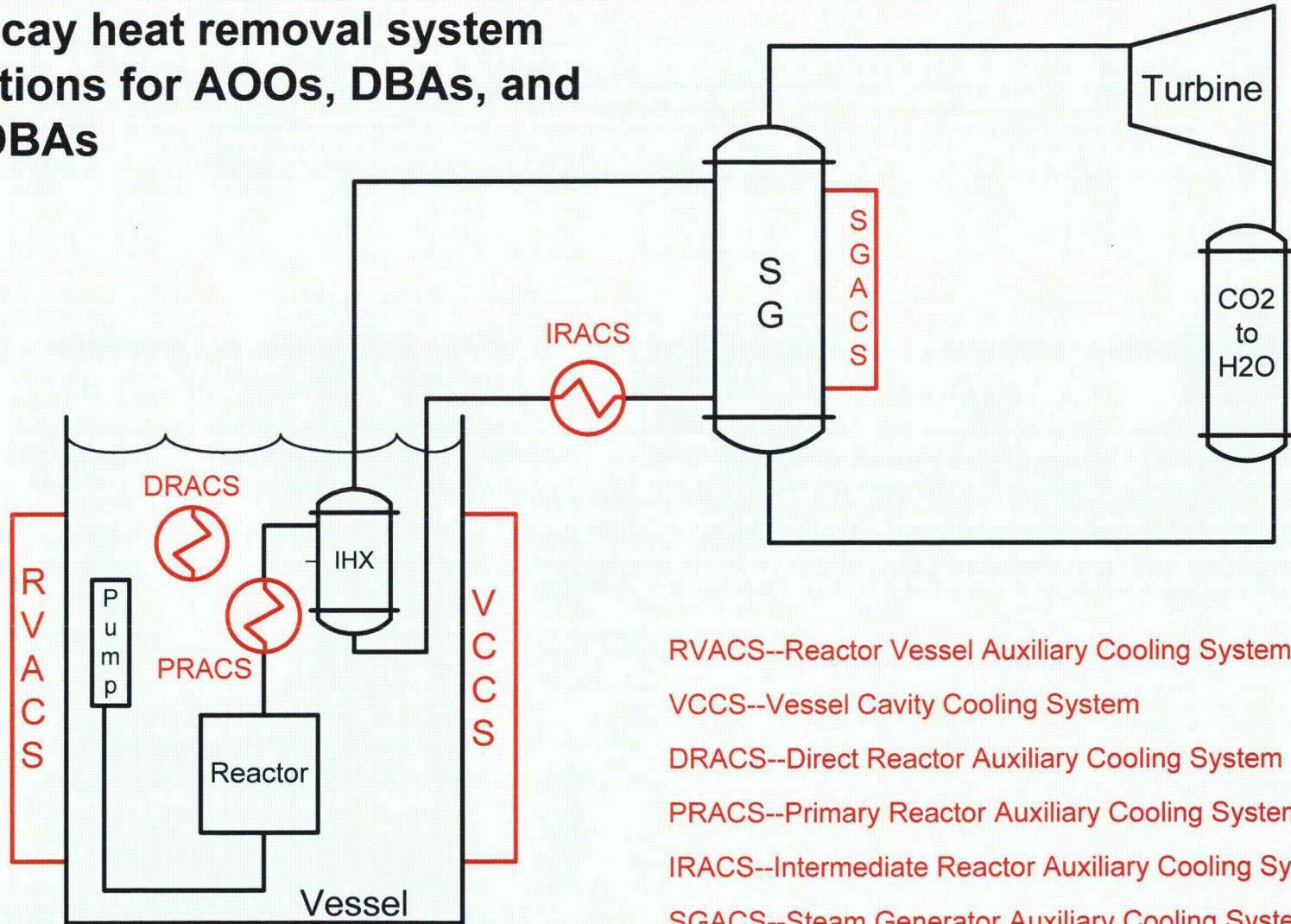

RVACS--Reactor Vessel Auxiliary Cooling System

VCCS--Vessel Cavity Cooling System

DRACS--Direct Reactor Auxiliary Cooling System

PRACS--Primary Reactor Auxiliary Cooling System

IRACS--Intermediate Reactor Auxiliary Cooling System

SGACS--Steam Generator Auxiliary Cooling System



■ SFR containment systems have evolved

- Early systems were over-designed because they were required to contain very high pressures and temperatures resulting from a Hypothetical Core Disruptive Accident (HCDA) with large energy releases
 - HCDA's involved core melting, followed by fuel-coolant and fuel-concrete interactions (CRBRP containment)
- Experiments and analyses indicate that such events are exceedingly rare, and the energy releases are far less than early analyses indicated
- Sodium aerosol analyses and experiments indicate that agglomeration is expected along with plate-out in the systems inside containment
- In pool designs, combination of reactor vessel and guard vessel provide containment function. In the loop designs, all primary piping is double walled to provide containment function
- Recent designs (PRISM) proposed an underground reactor with a dome over the reactor vessel

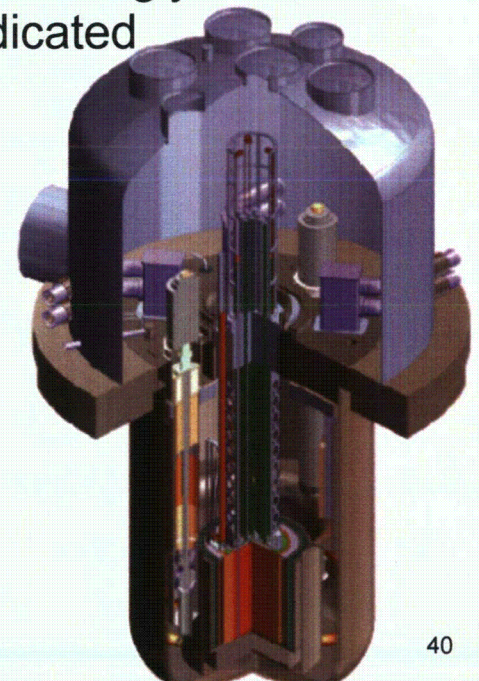



Instrumentation and Control

■ Liquid metals pose unique instrumentation challenges

■ Critical core parameters:

- Flux: In-core, ex-core (in-vessel), and ex-vessel neutron detectors
- Temperature: Resistance Temperature Detectors (RTDs) and thermocouples throughout the primary and intermediate loops to determine thermal power, operating conditions, and monitoring for anomalies
- Flow: Venturi (accurate but with slow response time) and magnetic (less accurate but with rapid response time) flowmeters to complete the thermal power calculations, determine loop operating conditions and monitor flow anomalies
- Pressure: Via NaK filled capillary tube

■ Fuel failure detection:

- In-vessel or ex-vessel delayed neutron detectors
- Gas tag system

■ Sodium leak detection



■ **Other systems unique for SFRs include:**

- Sodium purification system
- Cover-gas cleanup system
- Na leak monitoring
- Na fire protection
- Cell inerting systems
- Cell liners
- Under the head refueling systems
- Ex-vessel fuel handling
- Ex-vessel fuel storage
- Trace heating
- Seismic Isolation
- Unique ISI due to opaque coolant



U.S. DEPARTMENT OF
ENERGY

Nuclear Energy

Past and Present SFR Designs



SFRs as Proven Gen-IV Systems

Nuclear Energy

- **Since 1950s, fast reactor technology has been pursued and demonstrated worldwide, leading to the construction and operation of several experimental and prototype reactors**
 - These fast reactors have achieved over 400 reactor-years of operation
- **US has built and operated six fast reactors** (excluding submarine & space reactors)
 - First usable nuclear electricity was generated by EBR-I in 1951
 - EBR-II (20 MWe) was operated at Argonne's Idaho site from 1963 to 1994
 - FERMI-1 was first commercial SFR (61 MWe) in 1965
 - Fast Flux Test Facility (400 MWt) operated from 1980 to 1992

Facility	First Critical	Coolant
Clementine	1946	Mercury
EBR-I	1951	NaK
Fermi	1963	Sodium
EBR-II	1963	Sodium
SEFOR	1969	Sodium
FFTF	1980	Sodium



World Wide Experience

Nuclear Energy

Facility	Country	1st Critical	Coolant
BR-2	Russia	1956	Mercury
BR-5/BR-10	Russia	1958	Sodium
DFR	UK	1959	NaK
Rapsodie	France	1967	Sodium
BOR-60	Russia	1968	Sodium
KNK-II	Germany	1972	Sodium
BN-350	Kazakhstan	1972	Sodium
Phenix	France	1973	Sodium
PFR	UK	1974	Sodium
BN-600	Russia	1980	Sodium
JOYO	Japan	1982	Sodium
FBTR	India	1985	Sodium
Super-Phenix	France	1985	Sodium
MONJU	Japan	1995	Sodium
CEFR	China	2010	Sodium
BN-800	Russia	2015	Sodium
PFBR	India	2015	Sodium

■ New SFRs under consideration

- BN 1200 (pool, nitride)
- MBIR (pool, oxide)
- PRISM (pool, metal)
- TWR-P (pool, metal)
- ARC-100 (pool, metal)
- 4S (pool, metal)
- ASTRID (pool, oxide)
- JSFR (loop, oxide)
- PGSFR (pool, metal)



U.S. DEPARTMENT OF
ENERGY

Nuclear Energy

EBR-II

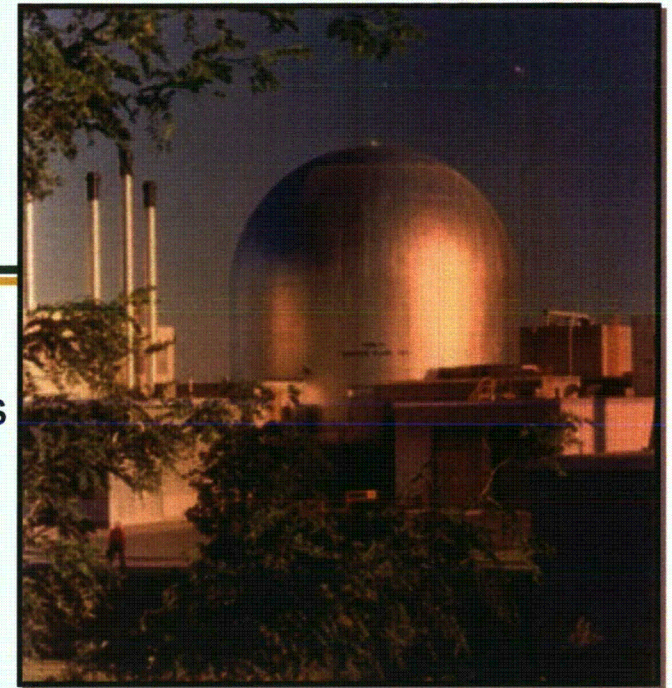

■ Significantly expanded SFR technology base

- Pool-type design with all PHTS system components in cold pool, serving as a massive heat sink
- Unique configuration allowing most of the sodium inventory to be at reactor inlet temperature and minimizing thermal stresses on major primary system components
- Complete power plant with superheated steam cycle and double-wall SG tubes
- Easy to fabricate (injection cast) 0.36 m tall metal-alloy fuel with high thermal conductivity and high burnup potential (20% demonstrated), favorable reactivity feedback characteristics, and benign operation with breached cladding

■ Missions during 30 years of operation

- High capacity factors approaching 80% even with an aggressive testing program
- Maintenance techniques were proven: Very low exposure to personnel, excellent safety record, sodium management demonstrated
- Over 150,000 metal fuel pins irradiated up to 20% burn-up without failure
- Fuel reprocessing was demonstrated with 35,000 metal fuel pins reprocessed



■ **FFTF was operated at DOE's Hanford site as a fast-flux test facility**

- 400 MWt loop type reactor with 0.9 m tall oxide fuel in two enrichment zones, surrounded by radial blankets and reflectors
- Three loops and 12 DHX modules, $T_{in}=360^{\circ}\text{C}$ and $T_{out}=527^{\circ}\text{C}$
- ~150 fuel pellets/pin in 316 SS cladding, 217 pins/assembly
- Avg. burnup: 45 MWd/kg, peak burnup: 80 MWd/kg

■ **Fuels irradiation test program**

- Oxide: >48,000 driver pins and over 16,000 test pins irradiated. Also 23 assemblies with annular fuel and HT9 cladding irradiated beyond 200 MWd/Kg
- Metal: ~1000 full length pins irradiated (U-19Pu-10Zr) up to 150 MWd/Kg
- Carbide: ~18 sodium-bonded and ~200 helium-bonded pins irradiated
- Nitride: ~54 shorter pins irradiated (for space reactors)

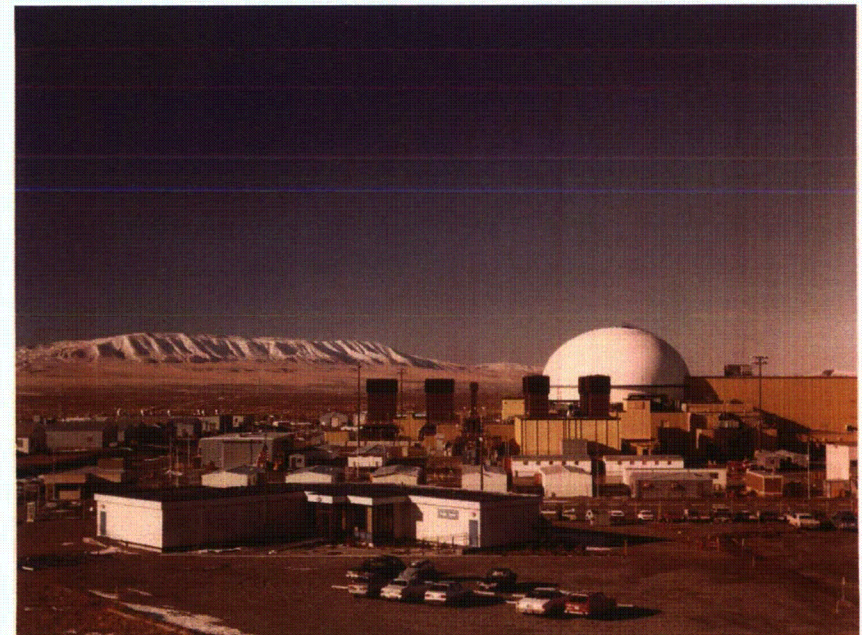



GEH PRISM Design

■ Reference PRISM design:

- Multiple power modules co-located with a spent fuel reprocessing facility
- 425 MWt, U-Pu-Zr metallic fuel in HT9 cladding, pool-type primary system, one intermediate loop
- Reactor core: 42 fuel assemblies in two enrichment zones, 6 control assemblies, 61 blanket assemblies
- Coolant outlet 470°C, inlet 320°C
- Burnup: 100,000 MWd/T
- 1.2 m core height (additional 1.8 m FG plenum)
- Normal shutdown cooling by turbine bypass
- Emergency heat removal systems
 - Reactor vessel air cooling system (RVACS)
 - Air cooling system (ACS) on the steam generator shell
 - Primary sodium auxiliary cooling system (PSACS)
- Compact containment shell design

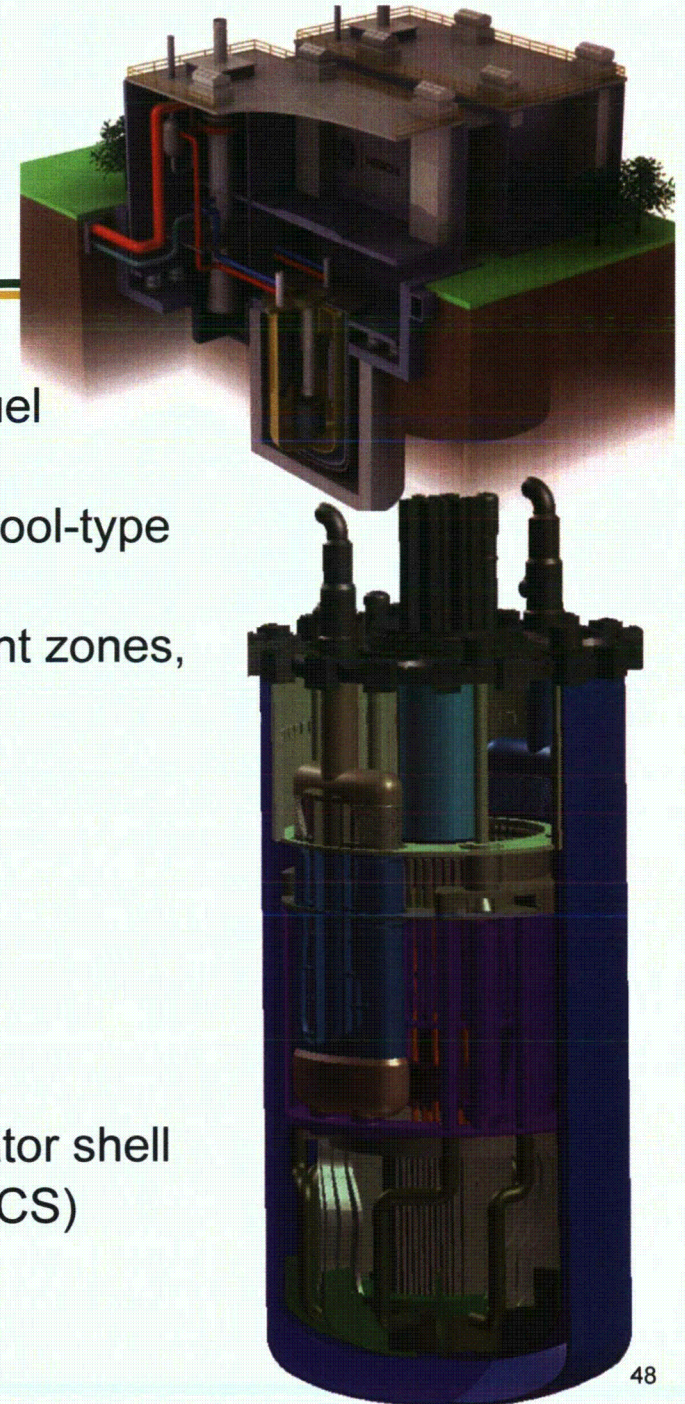



TerraPower TRW-P Design

■ 600 MWe (1475 MWt) metal fueled pool type prototype reactor

- Confirm feasibility of “breed and burn” concept using natural/depleted U
 - Long core life with no refueling
- Demonstrate key plant equipment
- Support fuels and materials qualification program
- Provide technical, licensing and economic basis for commercial TWR design

■ Design features for testing & development

- Accommodates lead test fuel assemblies
- Refueling capability for PIE
- First-of-a-kind instrumentation, maintenance considerations
- High-burnup (>30%) metal fuel in HT9 cladding for 2 m tall core

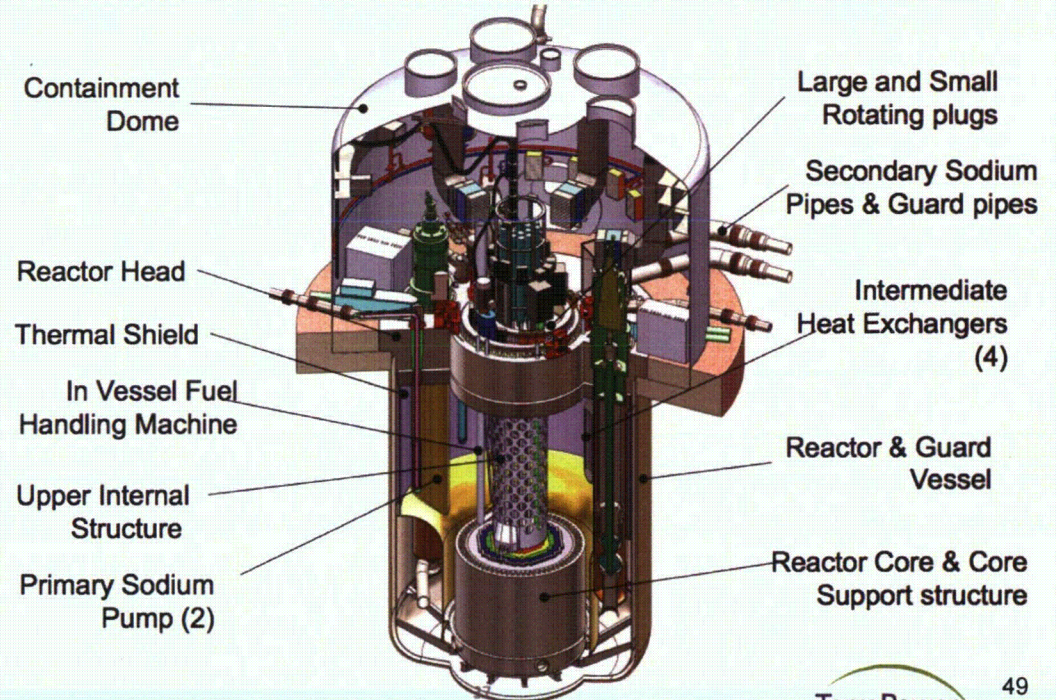



■ Small modular SFR concept aimed at deployment in remote areas

- 30 MWt (10 MWe) unit for generating electricity and/or process heat
- No onsite refueling for 30 years
- Pool type, metal-fueled tall/slender SFR with EM pumps in single-loop PHTS
- Core inlet/outlet temperature: 355/510 C
- Reactor vessel height: 24 m
- Core height: 2.5 m
- Core diameter: 0.95 m
- Six movable annular reflectors to control reactivity over the core life
- Central shutdown rod
- Avg/peak burnup: 34000/55000 MWd/t
- Maximum linear power: 8 kW/m

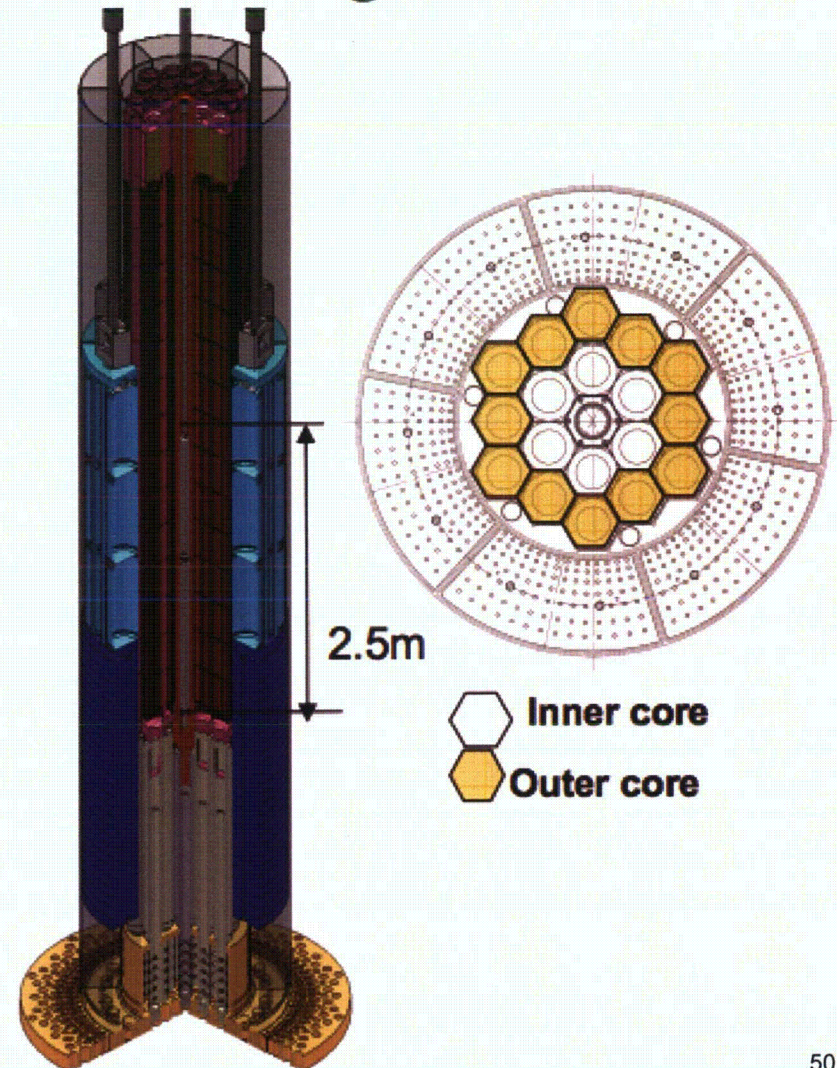



U.S. DEPARTMENT OF
ENERGY

Nuclear Energy

Sodium-cooled Fast Reactor Safety



■ **Defense-in-depth is the key concept on which SFR safety is based**

- To compensate for potential human and component failures
- To maintain the effectiveness of physical barriers against radioactive release by averting damage to the facilities and to the barriers themselves
- To protect the public and the environment from harm in the event that these barriers are not fully effective

■ **Multiple barriers for defense-in-depth include:**

- The fuel matrix for retaining most fission products, except for noble gases and certain volatile elements such as iodine and cesium
- Cladding as a thin tube sealed at both ends (except for vented fuel concept)
- Primary sodium coolant with fission product adsorption and dissolution properties
- Primary coolant and cover gas boundary, consisting of the reactor vessel, the primary coolant piping (if any), and vessel head with sealed penetrations
- Guard vessel (and guard pipes, if any)
- The containment as a low leakage structure surrounding the reactor



SFR Safety Principles (cont.)

■ Five levels of defense:

- Level 1 – Prevention of operational failures
 - Achieved by proper selection of fuel, cladding, coolant, and structural materials that are stable and compatible, and by following high quality practices in construction and operation
- Level 2 – Control of abnormal operation and detection of failures
 - Achieved by providing large margins between normal operating conditions and limiting failure conditions, and surveillance features for detection of anomalies
- Level 3 – Control of accidents within the design basis
 - Achieved by conservative design and engineered safety systems for reactor shutdown, decay heat removal, and emergency power
- Level 4 – Control of severe plant conditions, including prevention of accident progression and mitigation of severe accident consequences
 - Achieved mainly by the containment structure but also via accident mitigation measures including in-vessel retention and maintaining a coolable configuration, as well as accident management guidelines
- Level 5 – Mitigation of radiological consequences should significant releases of radioactive materials occur
 - Achieved by off-site emergency response (sheltering, evacuation, etc.)



SFR Safety Approach

-
- **Like LWRs, SFR safety is first based on utilization of multiple redundant engineered protection systems to lower the probability of accident occurrence and to limit its consequences:**
 - independent scram systems
 - multiple coolant pumps and heat transport loops
 - multiple barriers to prevent the release of radioactive materials
 - **Design features that enhance inherent negative reactivity feedback and passive decay heat removal provide additional measures**
 - to protect the reactor during very low probability beyond-design basis accidents (if the engineered protection systems fail)
 - **These additional design features rely on fundamental phenomena such as thermal expansion, buoyancy-driven flow, and gravity**
 - Superb heat removal characteristics of liquid sodium coolant and large heat capacity of primary coolant system
 - Natural circulation decay heat removal
 - Inherent negative reactivity feedback for passive shutdown in BDBAs



- **Essence of the inherent/passive safety is to rely on intrinsic characteristics of the design to maintain a balance between generated heat and reactor cooling capability to prevent core damage even when engineered safety systems fail.**
- **The focus of inherent safety is to avoid:**
 - large uncontrolled increases in core power
 - insufficient cooling of the reactor core
 - rearrangement of fuel that could lead to a recriticality
- **Inherent safety uses three basic principles:**
 - favorable reactivity feedback (through core physics and structural design)
 - sufficient natural circulation cooling for decay heat removal
 - appropriate selection of fuel and cladding materials



Reactivity Feedback Mechanisms

■ The elements of total reactivity feedback in an SFR include

- Doppler feedback: Effect of changes in neutron fission and absorption cross sections due to Doppler broadening
 - Negative for SFRs at elevated temps
- Coolant density and void worth: Effect of changes in Na coolant atom #s
 - At elevated temperatures, this could be positive due to reduced Na absorption, or negative due to enhanced neutron leakage
- Axial fuel expansion: Effect of thermal expansion of oxide/metal fuels in the cladding tube
 - Negative at elevated temperatures due to reduced number density of fissionable isotopes
- Radial core expansion: Due to thermal expansion, irradiation-induced swelling, and irradiation-enhanced creep
 - Negative at elevated temperatures due to enhanced leakage
- Control rod driveline expansion: Due to difference in thermal expansion of control-rod driveline and reactor vessel
 - Usually negative at elevated temperatures



Response to AOO's and Postulated Accidents

- **For normal operation, AOOs and DBAs, the main difference between oxide or metal-alloy fueled SFRs is the operating temperature and stored heat**
- **High fuel thermal conductivity of metal fuel and high gap conductance (through use of bond sodium inside the fuel pin) help maintain significantly lower fuel operating temperatures and flatter radial temperature profile in comparison to oxide fuel**
 - Peak operating temperature for metallic fuel is ~1060 K and the radial temperature rise across the fuel is typically <200 K
- **Much lower stored heat in metal fuel compared to oxide-core**
 - Longer grace period for operator action for a metal-fueled SFR to correct cooling deficiencies
- **These differences, however, do not impact safety response of the reactor to AOOs and DBAs**
 - Both metal or oxide fuels would maintain integrity during AOOs and DBAs



Local Faults

- **Local faults are statistical fuel failures due to fuel fabrication defects, fuel loading or enrichment errors etc.**
- **Since metallic fuel is compatible with sodium coolant, local faults can be tolerated for an extended period with proper monitoring of fission gas release**
 - Demonstrated during the Run Beyond Cladding Breach (RBCB) tests at EBR-II
 - No fuel loss into coolant, no significant liquid or solid fission product escape from fuel pin
- **Oxide fuel chemically reacts with sodium**
 - Local faults can lead to formation of reaction products with fuel loss into coolant
 - Require a rigorous fuel failure detection program

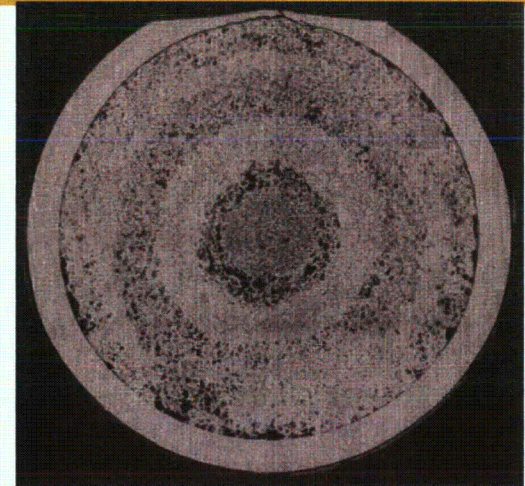

Metal Fuel (12% burnup) RBCB Test

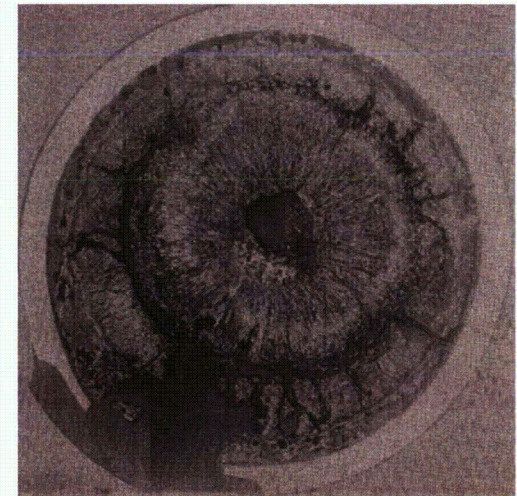

Oxide Fuel (9% burnup) RBCB Test ⁵⁸



Sodium Reactions

Nuclear Energy

- **Liquid sodium coolant reacts with air, water and concrete**
 - These reactions need be mitigated to avoid their impact on SSCs important to safety
- **Sources of sodium leakage inside of containment**
 - Sodium from primary loop piping in a loop type SFR
 - Sodium from intermediate loop piping inside the containment
 - Primary sodium from sodium storage system (if any)
 - Primary sodium from purification system
- **Sodium reaction scenarios considered in licensing are those with the potential of leading to radioactive releases**
 - Primary sodium fires
 - Low pressure (< 0.5 MPa) intermediate sodium leak
 - Characterized by Na pouring onto the containment floor
 - High pressure (~ 0.5 MPa) intermediate sodium leak
 - Could cause a dispersed sodium spray in the containment atmosphere
 - Steam Generator (SG) tube rupture



Sodium Reactions (cont.)

■ Implications of sodium reactions

- Impact of elevated temperatures on SSCs
- Containment atmosphere temperature and pressure
- Deposit of aerosols from sodium fires onto SSCs
- Integrity of IHTS from steam generator tube ruptures

■ Phenomena involved in sodium leaks and fires

- Oxygen availability/deficiency
- Phenomena relevant to low-pressure leakage
 - Surface combustion and oxygen transport to surface (often impeded by deposits)
 - Heat transfer from surface to atmosphere and structure (aerosol/smoke formation)
 - Sodium-concrete interaction (usually prevented by use of steel liners)
- Phenomena relevant to high-pressure leakage (use double-walled piping reduces potential for sodium spray)
 - Jet/spray breakup and spray combustion
 - Heat transfer from spray
 - Aerosol (smoke) formation from spray
- Heat transfer from atmosphere to structure



U.S. DEPARTMENT OF
ENERGY

Nuclear Energy

Past Safety Testing Programs



U.S. DEPARTMENT OF
ENERGY

U.S. SFR Safety Test Program

Nuclear Energy

- **In the U.S., past SFR R&D programs focused on development and demonstration by testing of the concepts with inherent and passive safety features that lead to no serious consequence even during unprotected (without scram) accidents**
 - EBR-II Shutdown Heat Removal Tests
 - Includes landmark EBR-II inherent safety demonstration test
 - FFTF passive safety tests without scram
 - Transient fuel behavior tests:
 - Mild off-normal transients on whole fuel assemblies in EBR-II and FFTF
 - Pin disruptive transient tests on one or a few whole fuel pins in TREAT
 - Lab-tests on segments of fuel pins in the Fuel Behavior Test Apparatus (FBTA) and on whole fuel pins in the Whole-Pin Furnace (WPF) facility



- **EBR-II testing program, initially aimed at verifying safe and reliable operation of EBR-II, evolved into an experimental program to support design and performance assessment of ALMRs with special emphasis on inherent safety**
 - Testing program started from mild steady-state natural circulation tests and culminated with unprotected (no scram) transients
 - These collective efforts aimed at understanding EBR-II response to a wide variety of upset conditions and validating computer codes for application to new plant designs
- **Initial emphasis was on phenomena for reactor and primary heat transport system, and later on, the focus shifted on whole-plant dynamic behavior**
 - Plant instrumentation was upgraded so that flow rates and temperatures in the primary, secondary, and steam systems can be measured and collected by a data acquisition system
 - Additional control system functions were added to facilitate the conduct of whole-plant dynamic testing



EBR-II Tests (cont.)

-
- **Over 100 EBR-II safety tests that were conducted during 1984-1986 period can be arranged into several categories:**
 - Loss of flow with scram to natural circulation
 - Scram with delayed LOF to natural circulation
 - Loss of flow without reactor scram at different levels of severity
 - Includes landmark inherent safety demonstration test (station blackout without scram)
 - Reactivity feedback characterization
 - Dynamic frequency response tests
 - Reactivity perturbation and rod-drop tests
 - Multi-frequency control rod and secondary flow oscillations
 - Loss-of-heat-sink tests (with or without scram)
 - Steam drum pressure reduction
 - Plant inherent control tests (to demonstrate “load-following” features of the reactor)



U.S. DEPARTMENT OF
ENERGY

Nuclear Energy

EBR-II Tests (cont.) Instrumented Fuel Assemblies

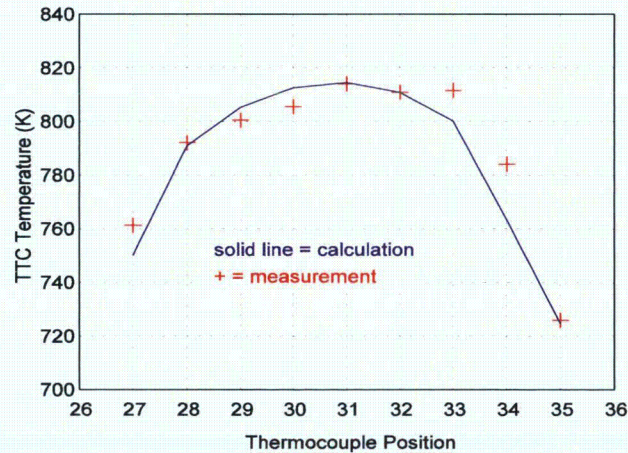
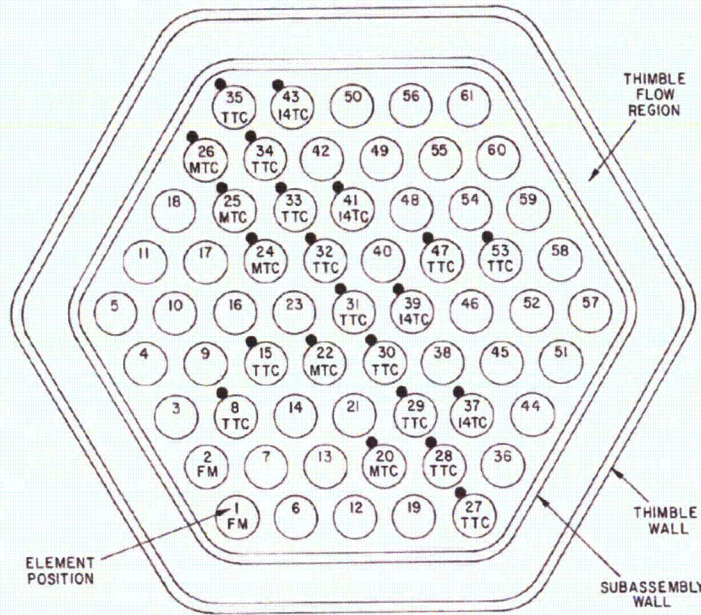

DB: SHRT-17.3D.sasdata
Cycle: 0 Time:0

Pseudocolor
Var: Temperature
750.0
650.0
550.0
450.0
350.0
Max: 700.0
Min: 351.0

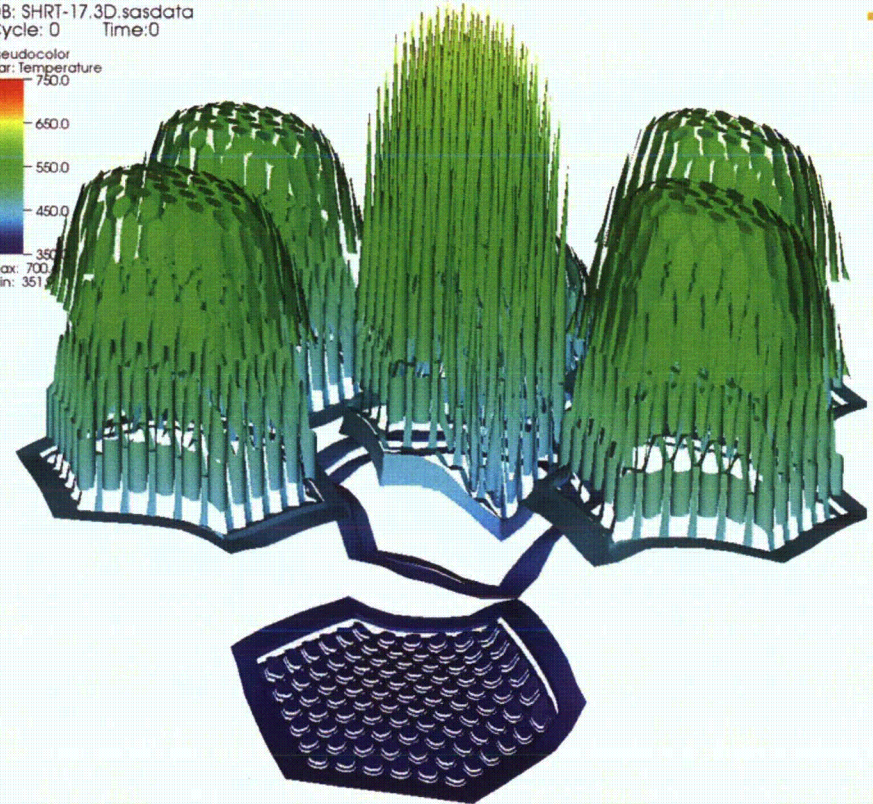

Mesh represents sodium temp. distribution at top of the XX09 and surrounding assemblies (elevation and color represents temperature)



U.S. DEPARTMENT OF
ENERGY

Nuclear Energy

FFTF Tests



■ **Fast Flux Test Facility (FFTF)** was a mixed-oxide-fueled sodium-cooled fast reactor operating at 400 MW-thermal

■ **In late 1980's, a series of passive safety tests were conducted:**

- to demonstrate the safety margins of SFR designs
- to provide data for validation of computational models

■ **Of particular interest was a series of Loss of Flow Without Scram tests from power levels up to 50%**

- Due to large Doppler feedback and stored heat, oxide fueled SFRs have smaller margins to coolant boiling and large scale fuel failures than metal fueled SFRs
- To overcome this deficiency, a reactor self-shutdown device called the Gas Expansion Module (GEM) was introduced into the core design to mitigate the consequences of an unprotected (without scram) loss of flow event



FFTF Tests (cont.): Gas Expansion Modules

- **GEM is essentially an empty assembly, sealed at the top but open at the bottom, fitted with FFTF core compatible hardware at both ends to permit insertion into the inner row of the reactor radial reflector**

- During normal operation, sodium level in the device rises until the core inlet pressure equals the compressed argon gas pressure, about 12-16" above the active core height

- **It provides a mechanism for automatic removal of reactivity if primary flow is lost**

- A passive protective feature against a reduction in inlet plenum pressure caused by a loss of primary flow
- The loss of pressure causes the trapped argon gas to expand, forcing the sodium in the internal volume back down below the core level
- Displacement of sodium increases the neutron leakage from the core, introduced $-\$1.50$ reactivity

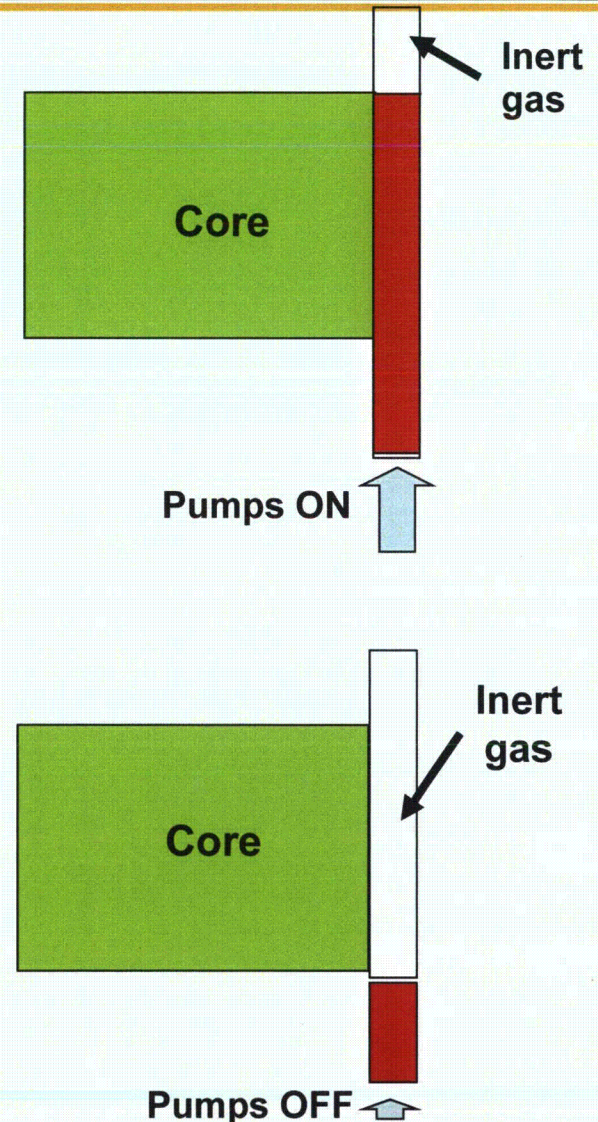



FFTF Tests (cont.) Unprotected Loss of Flow Tests

- **First series of ULOF tests were conducted with the primary pump pony motors on throughout the transient so that the minimum flow reached in each test was 9%**
 - Peak coolant temperature for the test series was approximately 493 C
- **ULOF tests were then repeated with the same initial conditions, except the primary pony motors were left off**
 - A direct transition to natural circulation flow in the primary system
 - Tests were repeated from 10, 20, 30, 40, 45, and 50% power
 - The peak temperature for this series was 509 C

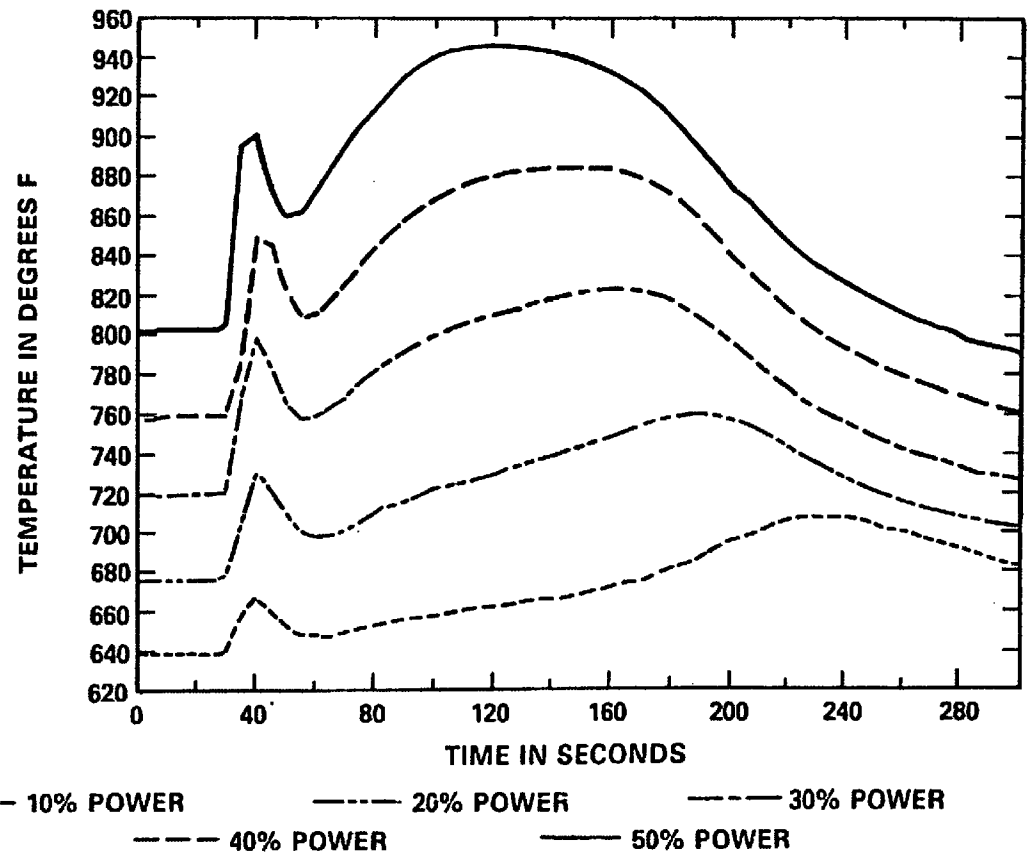



Transient Fuel Behavior Tests

-
- **Database developed from various types of tests is considerable and it provides a significant basis for the current understanding of the transient behavior of fast reactor fuels for a range of off-normal conditions**
 - **Experiments performed with metallic fuels focused on the key issues:**
 - transient-induced changes in fuel morphology
 - fuel-cladding chemical interactions (FCCI)
 - fission-gas release behavior
 - cladding failure margins
 - fuel motions before and after cladding breach
 - **Fuel Behavior Test Apparatus was used for heating short (~1 cm) segments of irradiated fuel pins**
 - Test temperatures ranged from 670-850°C, test duration ranged from 5 minutes to 4 hours
 - **Whole Pin Furnace tests on whole (intact) irradiated fuel pins**
 - Peak test temperatures varied from 650 to 820°C and test duration ranged from few minutes to 36 hours



- **Transient overpower tests demonstrated both oxide and metal fuel behavior providing valuable insight**
 - Estimates for margins to cladding failure and insight into accident progression
- **The seven tests (M1 through M7) investigated the response of a variety of metallic fuel designs to overpower transients**
 - Tests M1-M4 tested U-5Fs fuel in 316-SS cladding
 - Tests M5-M7 tested U-Zr and U-Pu-Zr fuels in D9 and HT9 clad
 - Designed to be sufficiently severe to cause fuel damage
 - In-pin fuel motions were made with a neutron hodoscope
- **Metal fuel tests at TREAT demonstrated that:**
 - Metal-alloy fuel slugs behave like toothpaste in the cladding tube during overpower transients before the fuel melting and cladding breach
 - Combined with in-pin and/or ex-pin molten fuel motion, metal fuel introduces a powerful shutdown mechanism during accident that lead to fuel failures

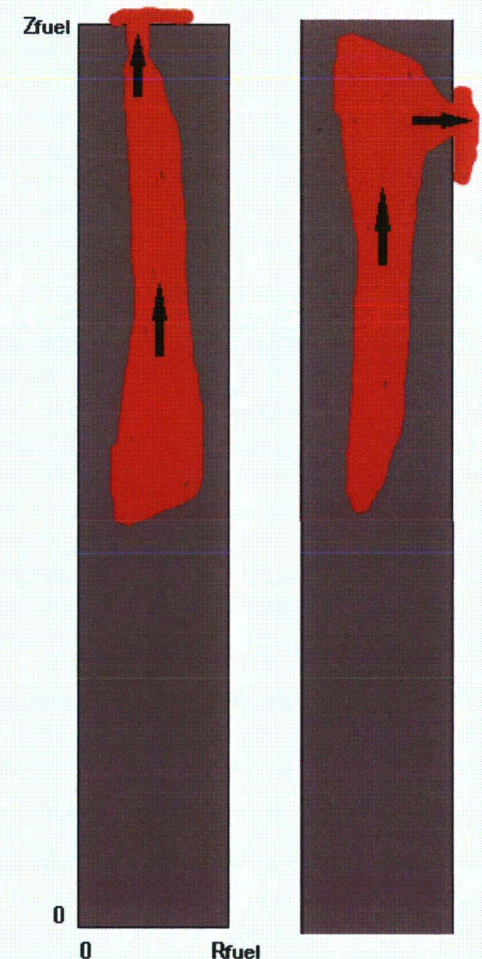



U.S. DEPARTMENT OF
ENERGY

Nuclear Energy

U.S. SFR Licensing Experience



FFTF Regulatory Review History

- **Initiated under AEC (PSAR submitted in Sep 1970)**
- **Completed under DOE**
 - NRC Final Safety Evaluation Report (SER) issued in Aug 1978
- **Owners of FFTF were first AEC, then ERDA, and finally DOE**
- **Continuity was maintained with the operator**
 - Originally Battelle Northwest
 - Transferred on July 1, 1970 to Westinghouse Hanford Company (WHC), who then operated the Hanford Engineering Development Laboratory (HEDL)
- **PSAR submitted in September 1970**
 - Review took 31 months
 - Included 23 substantive meetings with the NRC and the Advisory Committee on Reactor Safety (ACRS)
- **Construction Permitting**
 - Interim construction authorized in Feb. 1972
 - Full construction authorization (via ACRS letter) in May 1973



FFTF Regulatory Review History (cont.)

■ Design Basis Accidents (DBA) were used to

- identify initiating mechanisms
- minimize frequency of off-normal events
- ensure adequate safety margins
- verify reactor design is fundamentally safe

■ Beyond Design Basis Accidents (BDBA) were used to

- characterize containment margins
- calculate possible radioactive releases (source term)

DBA examples:

- Reactivity insertion events
 - Control rod withdrawal or meltdown
 - Loss of hydraulic hold-down
 - Movement of radial core restraint
 - Cold sodium insertion
- Loss of cooling events
 - Loss of off-site electrical power (and emergency diesel-electrical power)
 - Loss of electrical power to one primary pump
 - Continuous flow reduction by controllers
 - Mechanical seizure of one primary pump
 - Loss of air flow in the dump heat exchangers

BDBA examples:

- Transient Over-Power With Failure to Scram
- Loss Of Flow With Failure To Scram
- Loss Of Heat Sink With Failure To Scram



FFTF Regulatory Review History (cont.)

-
- **FFTF FSAR was submitted in March 1976**
 - **DOE and NRC reached agreement on all issues except**
 - Natural Circulation Cooling: NRC required tests at startup for scram from full power and pump coast-down without power to verify that natural circulation is established and temperatures are acceptable (successfully conducted)
 - Piping Integrity: Sodium aerosol leak detection system against pipe leaks were required (later installed).
 - Control Room Habitability: CR isolation required against sodium aerosol or radiation to protect operators during postulated accidents (changed locations of air intakes and installed isolation dampers)
 - Containment Margins: Additional studies conducted on sodium/concrete interactions and hydrogen generation to assure containment margins, and resulted in filtered containment vent system being added
 - **FSAR approved by NRC in August 1978 (NUREG-0358)**
 - NRC issued supplement to final SER in May 1979



U.S. DEPARTMENT OF
ENERGY

CRBR Program

Nuclear Energy

- **In 1970s and early 1980s, DOE attempted to license CRBR, but the U.S. Congress cut funding before the project was completed**
 - A limited work authorization was issued which allowed some non-safety related construction at the site
 - The project was cancelled before the full construction permit was issued
 - While hypothetical core disruptive accidents (HCDAs) were not considered as part of the design basis for CRBR, accidents that could lead to HCDAs (including unprotected accidents and large-break LOCA) received regulatory scrutiny prolonging the licensing process
 - The U.S. NRC Atomic Safety and Licensing Board (ASLB) eventually excluded HCDAs from the licensing basis, stating that “probability of core melt and disruptive accidents can and must be reduced to a sufficiently low level to justify their exclusion from the design basis accident spectrum”
 - CRBR licensing process resulted in a U.S. NRC Safety Evaluation Report in 1983, NUREG-0968



U.S. DEPARTMENT OF
ENERGY

ALMR Program

Nuclear Energy

- **After CRBR project was canceled, DOE embarked on the Advanced Liquid Metal Reactor (ALMR) and Integral Fast Reactor (IFR) programs**
 - Emphasis on a pool-type reactor concept and metal fuel to avoid severe accident related regulatory issues that impeded CRBR licensing
- **Two reactor concepts submitted Preliminary Safety Information Document (PSID) to the U.S. NRC in 1986:**
 - PRISM (GE)
 - Sodium Advanced Fast Reactor (SAFR) (Rockwell/Westinghouse)
- **GE-led PRISM design became sole the focus of the ALMR program in 1988**



U.S. DEPARTMENT OF
ENERGY

PRISM Licensing

Nuclear Energy

- **NRC's Pre-application Safety Evaluation Report (PSER) for PRISM PSID highlighted key regulatory issues at that time:**
 - limited performance and reliability data for passive safety feature
 - unverified analytical tools used to predict plant response
 - limited supporting technology and research
 - limited construction and operating experience
 - incomplete information on the proposed metallic fuel
- **IFR program addressed these identified issues until its termination in 1994**
- **Ongoing work under DOE-NE's Advanced Reactor Technologies (ART) and Fuel Cycle Technologies (FCT) programs continue to address these concerns**



- **In addition to the key regulatory issues outlined in the NUREG 1368, the review of the PRISM principal design criteria (PDC) in Chapter 3 provide insight as to expectations for new reactor PDC**
 - Non-conventional containment design
 - Positive void coefficient and compliance with GDC 11
 - Passive residual heat removal
 - Low pressure coolant operation (large margin to two-phase conditions)
 - Non-reliance on offsite power for safety during postulated accidents
 - Unique control and protection system designs
 - Opaque and chemically reactive coolant
 - Fast neutron spectrum
 - Control room design
- **In addition to addressing the GDC/PDC differences, Chapter 3 of NUREG 1368 also indicated how the review process might make use of previous sodium reactor regulatory experience and national consensus standards**



U.S. DEPARTMENT OF
ENERGY

Nuclear Energy

Factors that Impact Design Criteria for SFRs



U.S. DEPARTMENT OF
ENERGY

Nuclear Energy

Protection by Multiple Fission Product Barriers

■ SFR-DC Specified Acceptable Fuel Design Limits (SAFDL) for normal operations and AOOs in SFR DC 10

- SFR use is similar to LWR SAFDL for normal operation and AOOs
 - Will vary between oxide fueled systems and metal fueled systems and by cladding type being used in the design.
 - Based on fuel testing and qualification as well as safety related testing and analysis

■ SFR-DC inherent protection in SFR DC 11

- SFR relies on prompt, strongly negative Doppler reactivity feedback and negative reactivity feedback from core expansion and assembly bowing
- Need to assure that any positive effects as a result of sodium density changes during transients are offset by the negative feedback such that the overall reactivity feedback is negative



Protection by Multiple Fission Product Barriers (cont.)

■ **Suppression of power oscillations in SFR DC 12**

- SFR have inherent mechanisms to control power oscillations
 - Fast spectrum results in neutron free paths that are long compared to LWRs and result in tightly coupled cores
 - Negative Doppler coefficient ensures a stable response to reactivity perturbations

■ **Reactor primary coolant boundary in SFR DC 14 and others**

- Low pressure single phase operation reduces rapid propagating failure of the boundary
- Materials used are ductile at the high temperatures found during all operational modes
- The criterion applies to the primary system surrounding the core which includes the cover gas volume above the core
- Requirements do not apply to the intermediate cooling loop which is not a fission product barrier
 - Intermediate loop has additional requirements addressed in SFR DC 70



Protection by Multiple Fission Product Barriers (cont.)

■ Cooling system design in SFR DC 15

- SFR low pressure operations and use of a high boiling point coolant provide large margins to design condition challenges during normal operation and AOOs.

■ Containment in SFR DC 16

- SFRs will have a containment structure surrounding the reactor vessel (guard vessel) and primary coolant boundary.
- The structure will act as a barrier designed to contain fission products as necessary to meet regulatory off-site dose consequence limits under postulated accident conditions.

■ Electrical power in SFR DC 17

- SFRs will use passive systems for core cooling and will not rely on off-site electrical power for a coping period identified by the designers.
- Use of on-site power to supplement safety functions will be determined by the designer.



U.S. DEPARTMENT OF
ENERGY

Nuclear Energy

Protection and Reactivity Control Systems

■ Protection system failure modes in SFR DC 23

- SFR sodium and sodium reaction products must be considered as adverse environmental contributors to protection system failure modes

■ Protection system requirements for reactivity control malfunctions in SFR DC 25 and SFR DC 28

- SFR postulated accidents do not include rod ejection or dropout
- DC only applies to AOO conditions so reactivity control malfunctions resulting in postulated accidents will need to be listed as exemptions to SFR DC 25
- Same reactivity control malfunctions need to be addressed in SFR DC 28

■ Reactivity control system redundancy and capability in SFR DC 26

- Fast neutron spectrum systems do not have Xenon burnout power changes
- Cold subcritical conditions need to be defined for high temperature systems

■ Combined reactivity control systems capability in SFR DC 27

- SFRs do not have emergency core cooling systems as addressed in SFR DC 35, therefore, poison addition using such a system is not applicable



- **Fracture prevention of the primary coolant boundary in SFR DC 31**
 - Same factors apply as listed for SFR DC 14,
 - Additional factors were added to DC 31 to reflect the high temperature and ductile properties of the coolant boundary material and dominant failure mechanisms for the boundary
- **Reactor coolant inventory maintenance in SFR DC 33**
 - The design requirement of SFRs is to maintain the coolant inventory in the core so as to keep the fuel covered (natural convection cooling within the core) and assure that the RHR capability is preserved
 - Vessel piping penetrations above core and use of guard vessel around the reactor vessel
 - Small pipes and other systems that form the primary coolant boundary are located above the core. Low pressure system leaks in these do not result in two phase conditions and do not require makeup for AOOs to meet the inventory maintenance criteria



■ Residual heat removal in SFR DC 34

- SFR designs use the same safety-related residual heat removal system for AOO and postulated accidents
- Therefore, this DC addresses issues related to both AOO and postulated accident conditions including the transfer of heat to an ultimate heat sink
- SFR DC 36 and 37 relate to inspection and testing of the RHR

■ SFR DC 35 is subsumed into DC 34.

■ Containment atmosphere cleanup in SFR 41

- Sodium chemical reactions may produce reaction products that impact the containment atmosphere and will need to be addressed.
- Oxygen and hydrogen are not present in SFR systems



Reactor Containment

■ Containment design basis in SFR DC 50

- SFRs use a containment structure surrounding the primary system designed so that the leakage is significantly lower than the minimum needed to meet off-site regulatory requirements following a postulated accident
- Energy sources that affect containment pressure and temperature do not result from metal water reactions or steam, but are associated with the sodium coolant chemical reactions
- Low pressure and lack of two-phase conditions of the coolant means that SFR containments act as a barrier and are not a pressure boundary in **SFR DC 51**

■ Piping systems penetrating containment in SFR DC 54

- SFR designs do not have primary system piping penetrating the containment
- Major penetrations are intermediate loop and RHR piping which do not contain primary coolant. For some RHR systems, isolation requirements may result in a reduced reliability, therefore, the case for isolation is left to the applicant to address in **SFR DC 57**



■ Intermediate coolant systems in SFR DC 70

- SFRs have an intermediate loop - the primary purpose of which is to assure that a steam generator tube rupture does not impact the primary cooling system
- The intermediate loop may not in itself, provide a safety function; however, criteria are necessary to assure there is no impact on other systems which perform a safety function stemming from the intermediate loop
 - Compatible fluid between primary and intermediate systems
 - For single barriers between primary and intermediate loops, pressure differential assures leakage from intermediate (non radioactive) to primary should the barrier develop a leak
 - Inspection and surveillance of the intermediate coolant boundary where leaks might impact SSCs deemed important to safety



■ Primary system purity control in SFR DC 71

- SFR's primary coolant is sodium which is reactive with many materials. It is necessary that purity control be maintained in both the coolant and cover gas in order to:
 - Prevent chemical attack
 - Prevent build up of corrosion products to levels that might lead to fouling or plugging
 - Reduce radioactivity levels in the coolant

■ Sodium heating systems in SFR DC 72

- Sodium is solid at room temperature
- Heating systems may be needed to prevent freezing in some SSCs deemed important to safety that contain sodium
- Design of heating systems should account for
 - Proper control of temperature
 - Heating rates
 - Temperature distributions



■ Sodium leakage detection and reaction prevention and mitigation in SFR DC 73

- SFR coolant is reactive with many materials; in particular, interaction with air or concrete may impact SSCs deemed important to safety
- SFR designs should address
 - Detection and mitigation of leaks
 - Inerting areas containing sodium
 - Additional barriers such as guard vessels or double-walled piping

■ Sodium/water reaction prevention/mitigation in SFR DC 74

- Energetic sodium-water reactions are to be avoided by proper design
- Steam generators (SG) are systems where non-radioactive sodium from the Intermediate loop (low pressure) and water from the power generation system (high pressure) are separated by single or double-walled tubes
- SG design should preclude to extent possible sodium water interactions and provide the capability of early detection and mitigation to reduce the impacts of any potential reaction



U.S. DEPARTMENT OF
ENERGY

Nuclear Energy

Questions?