

SEABROOK STATION UPDATED FINAL SAFETY ANALYSIS REPORT	Time History Accelogram (0.25g), Horizontal Component 1 - SSE	
		Figure 3.7(B)-1

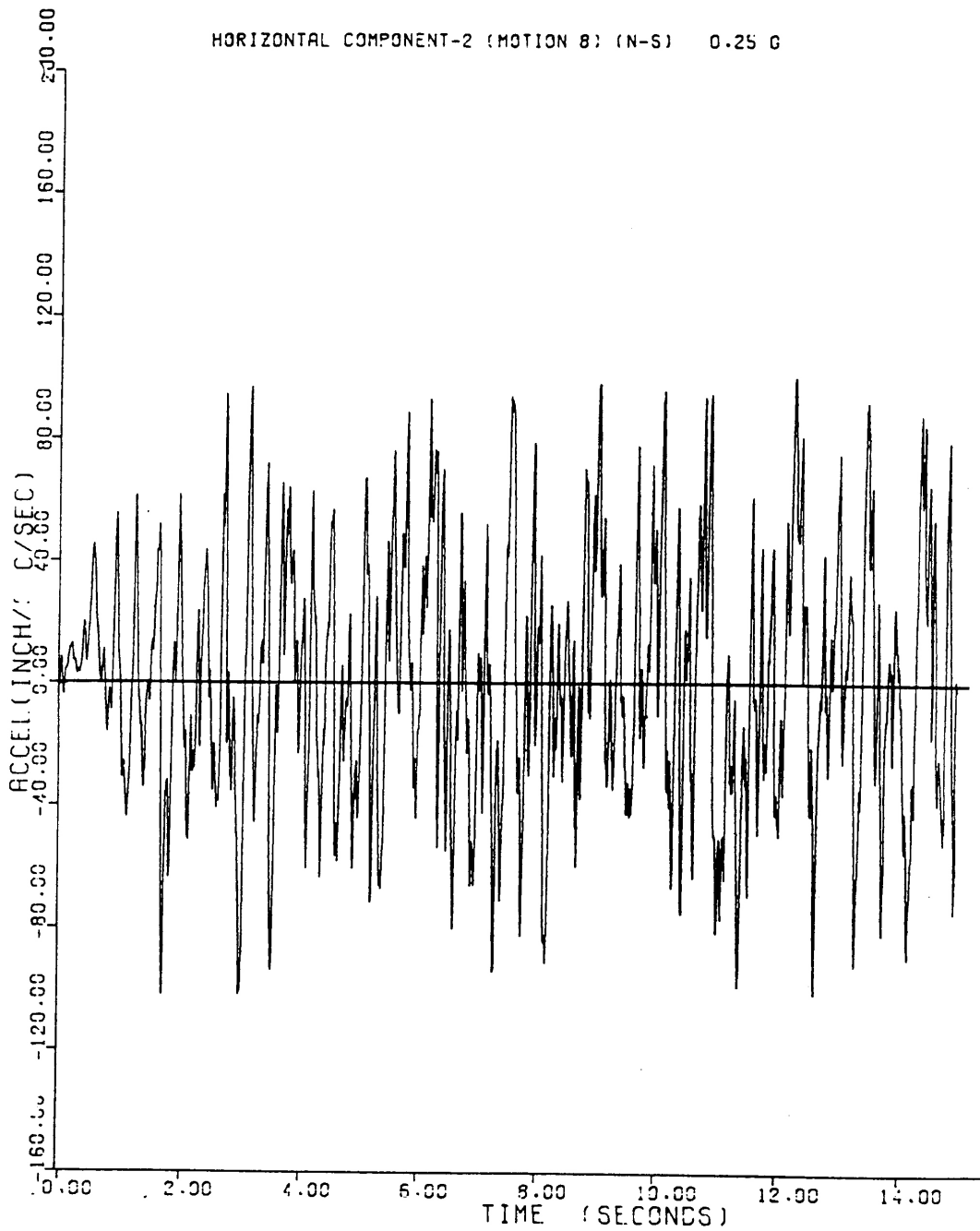

SEABROOK STATION UPDATED FINAL SAFETY ANALYSIS REPORT	Time History Accelogram (0.25g), Horizontal Component 2 - SSE	
	Figure	3.7(B)-2

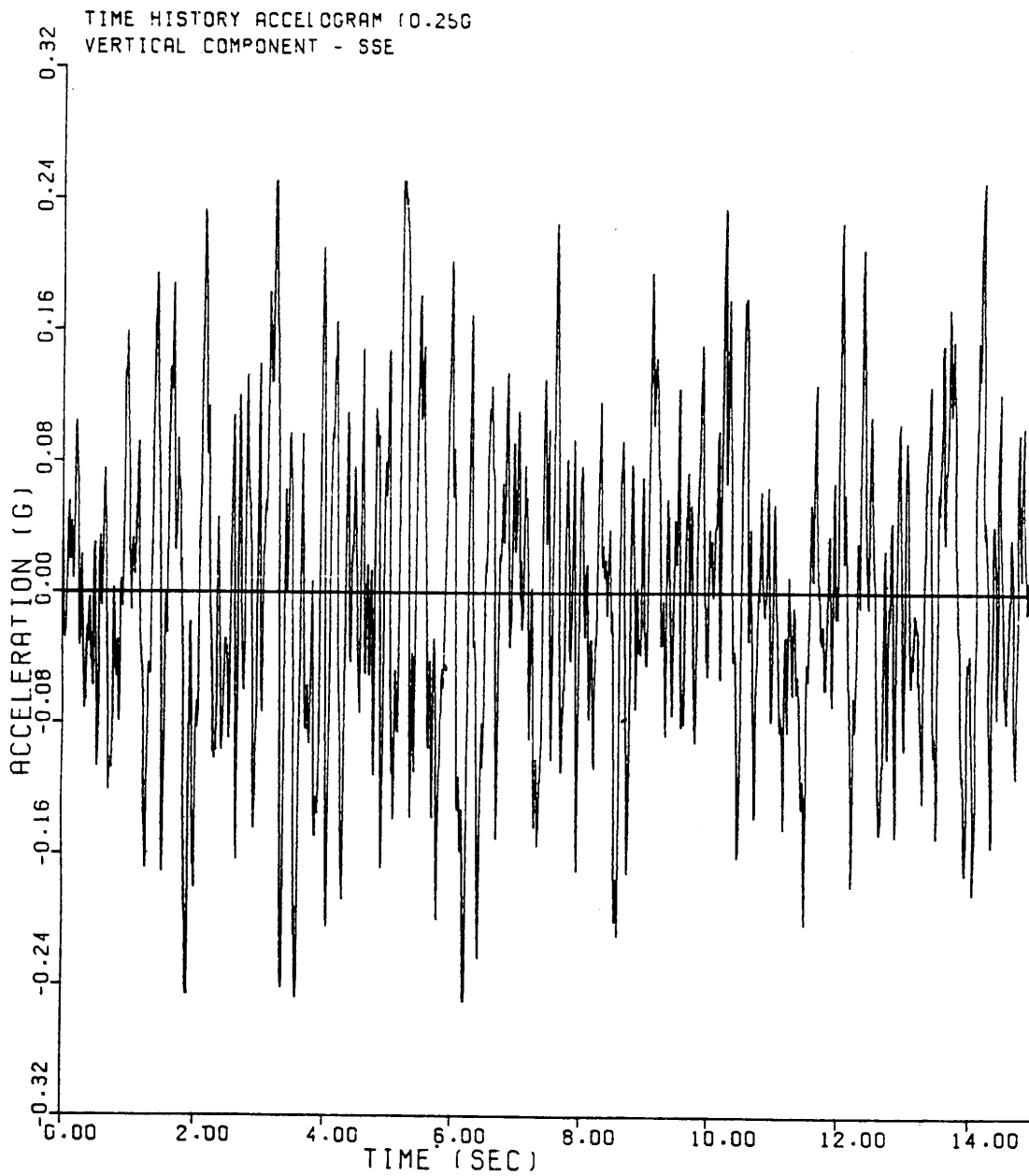

SEABROOK STATION UPDATED FINAL SAFETY ANALYSIS REPORT	Time History Accelogram (0.25g), Vertical Component - SSE	
		Figure 3.7(B)-3

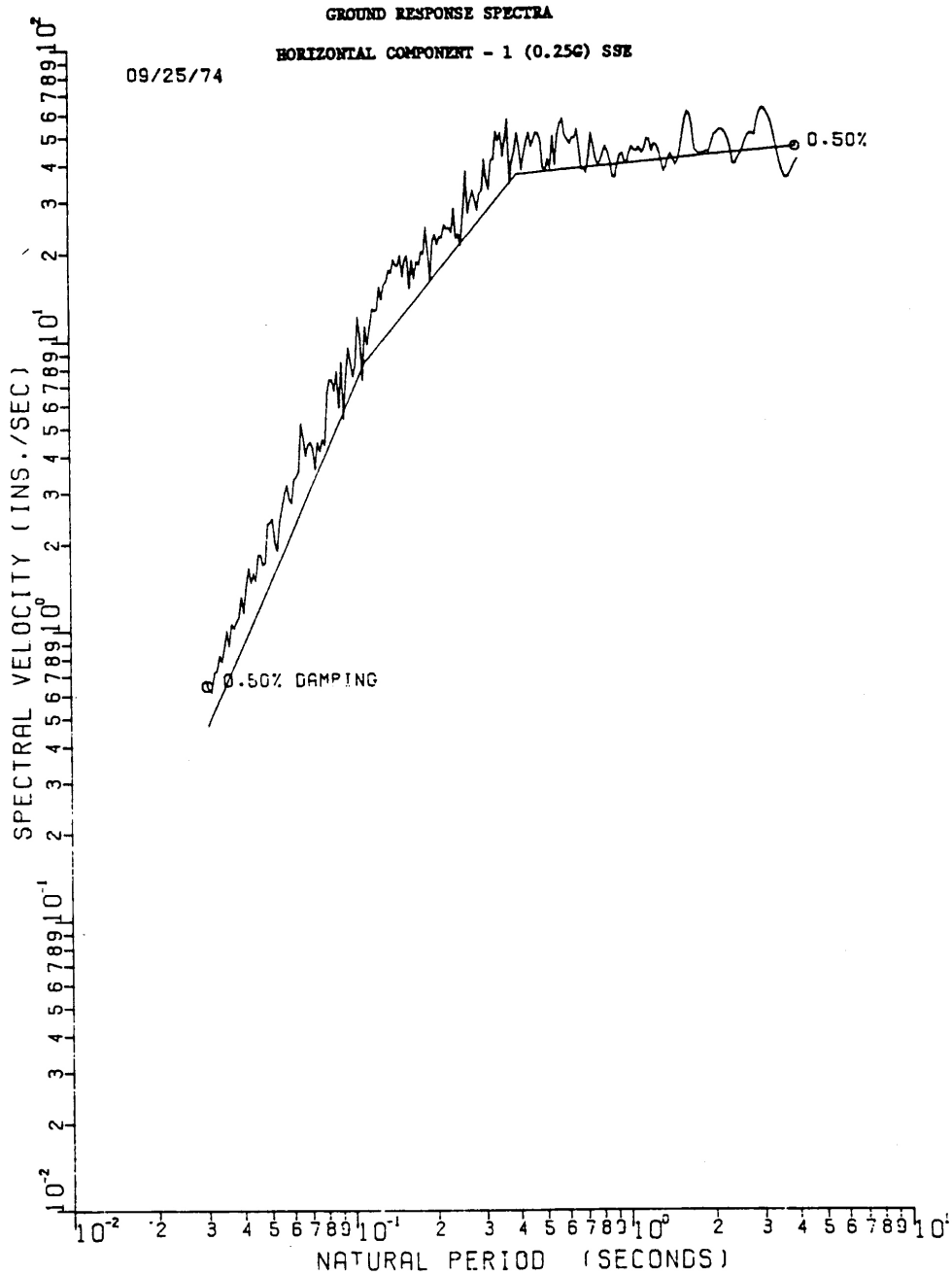

SEABROOK STATION UPDATED FINAL SAFETY ANALYSIS REPORT	0.50% Critical Damping Ground Response Spectrum, Horizontal Component 1 - SSE	
		Figure 3.7(B)-4

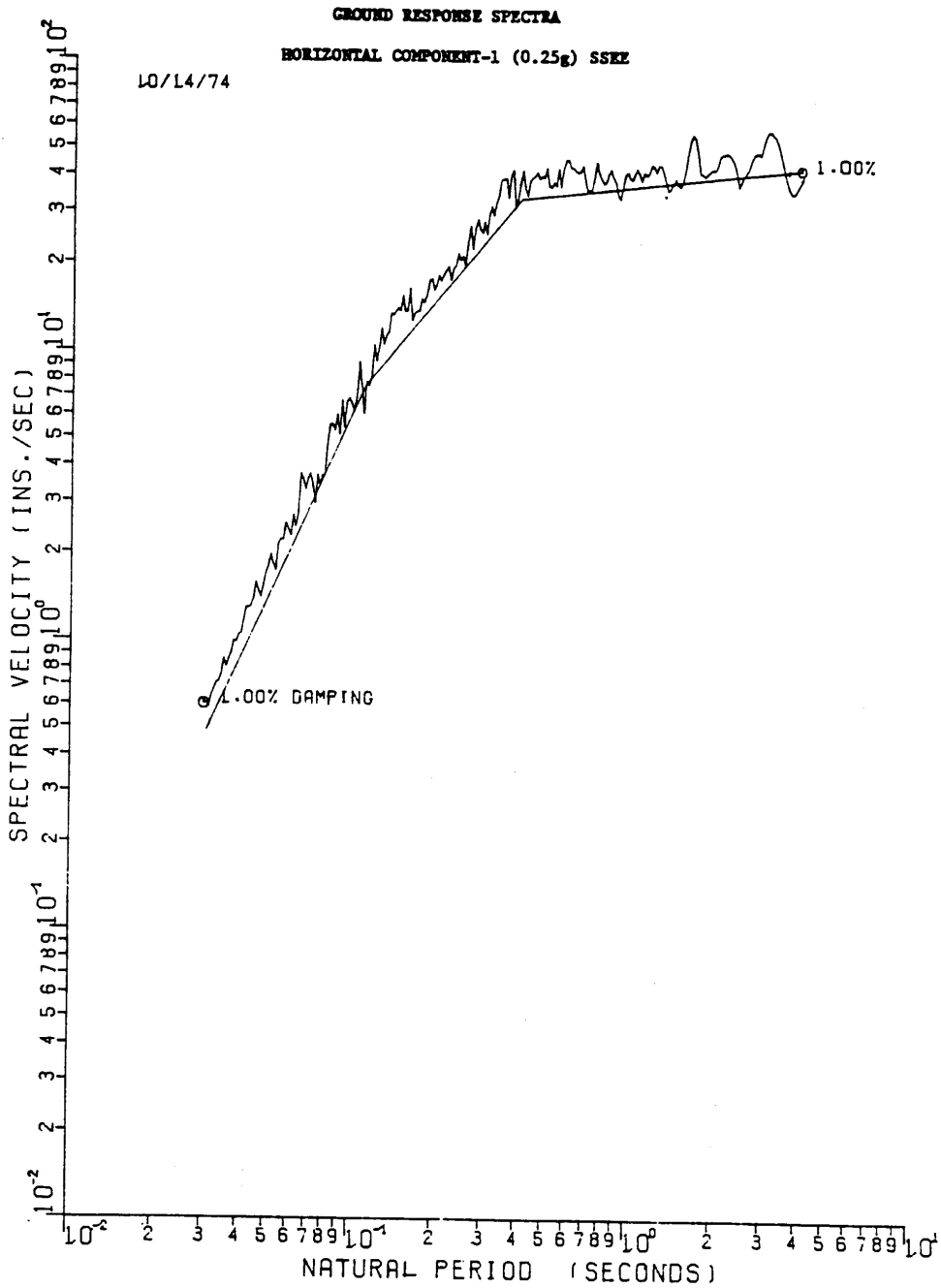

SEABROOK STATION UPDATED FINAL SAFETY ANALYSIS REPORT	1% Critical Damping Ground Response Spectrum, Horizontal Component 1 - SSE	
		Figure 3.7(B)-5

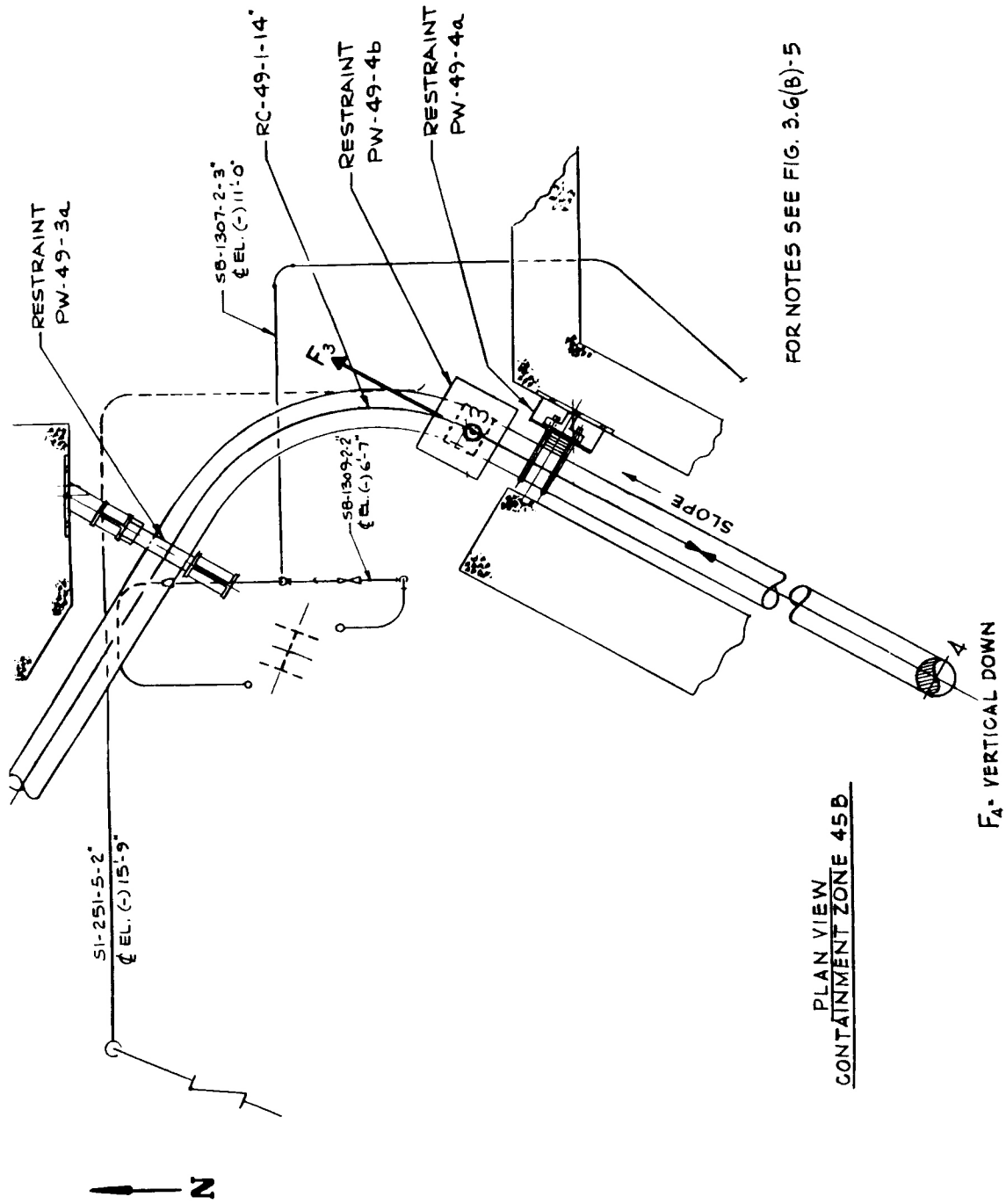

SEABROOK STATION UPDATED FINAL SAFETY ANALYSIS REPORT	Pressurizer Surge Line Pipe Whip Restraint Protecting Steam Generator Blowdown and Safety Injection Lines - Containment Zone 45B	Figure 3.6(B)-6
---	--	-----------------

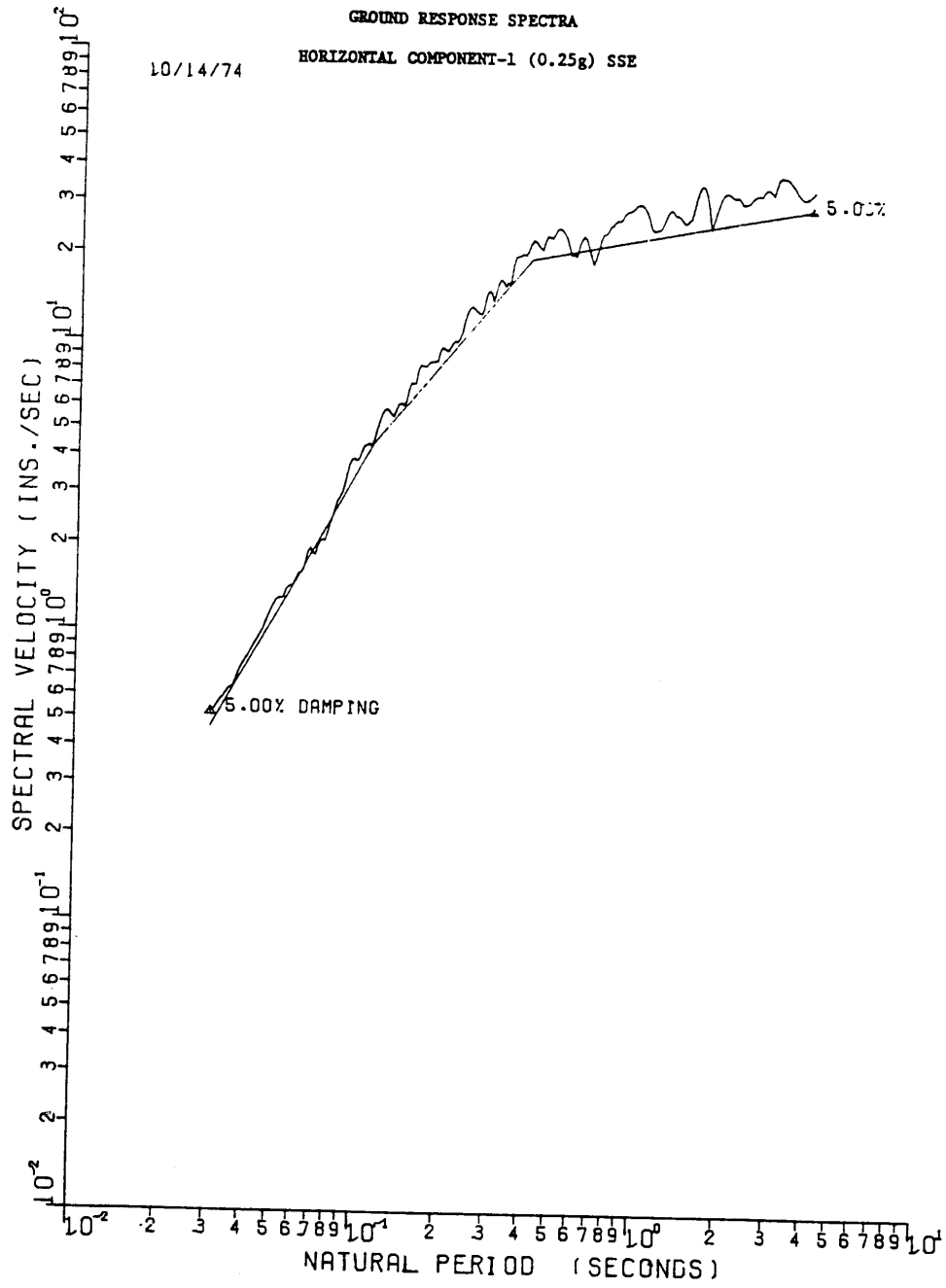

SEABROOK STATION UPDATED FINAL SAFETY ANALYSIS REPORT	5% Critical Damping Ground Response Spectrum, Horizontal Component 1 - SSE	
		Figure 3.7(B)-7

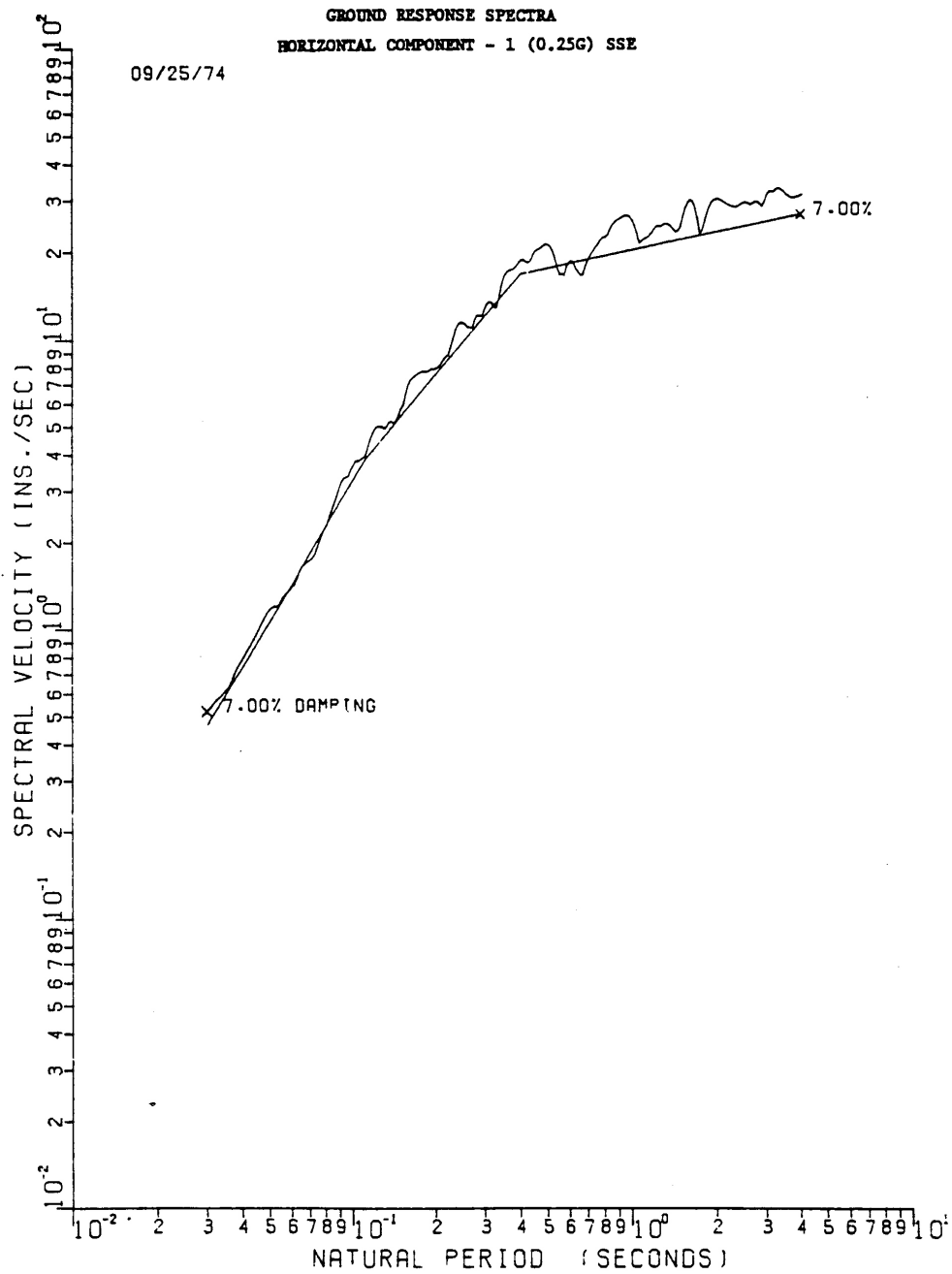

SEABROOK STATION UPDATED FINAL SAFETY ANALYSIS REPORT	7% Critical Damping Ground Response Spectrum, Horizontal Component 1 - SSE	
		Figure 3.7(B)-8



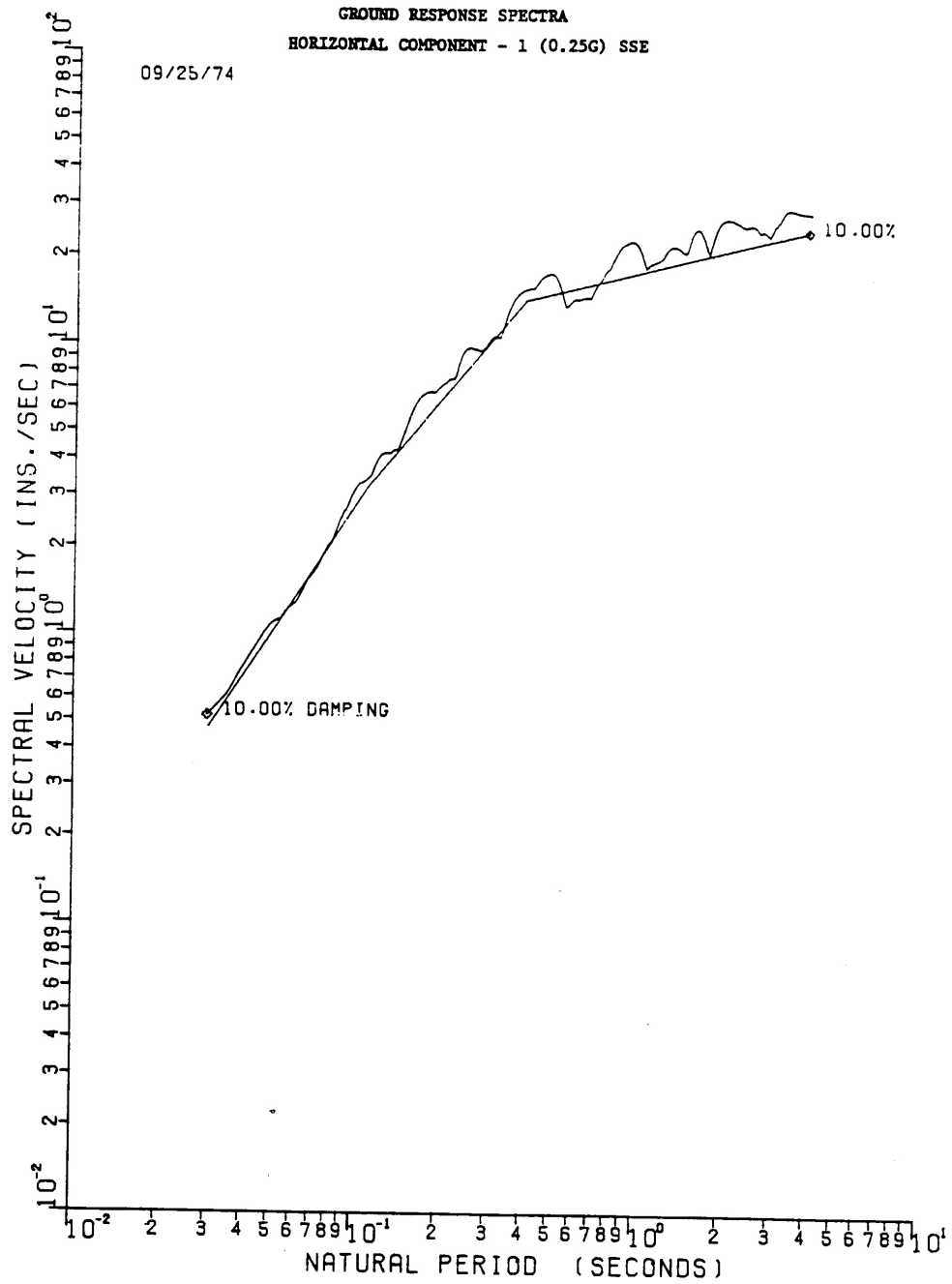

SEABROOK STATION UPDATED FINAL SAFETY ANALYSIS REPORT	10% Critical Damping Ground Response Spectrum, Horizontal Component 1 - SSE	
	Figure	3.7(B)-9

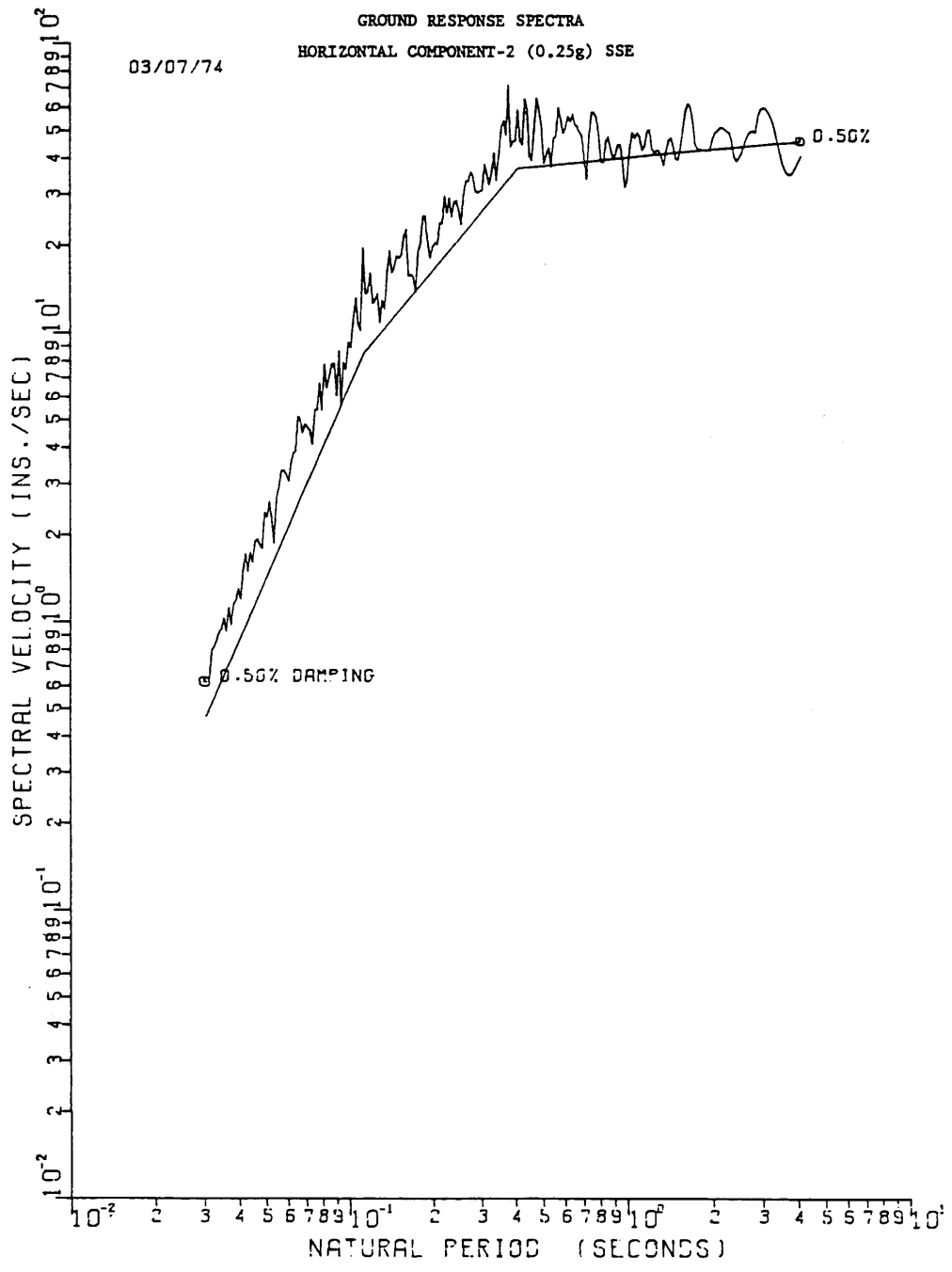

SEABROOK STATION UPDATED FINAL SAFETY ANALYSIS REPORT	0.5% Critical Damping Ground Response Spectrum, Horizontal Component 2 - SSE	
		Figure 3.7(B)-10

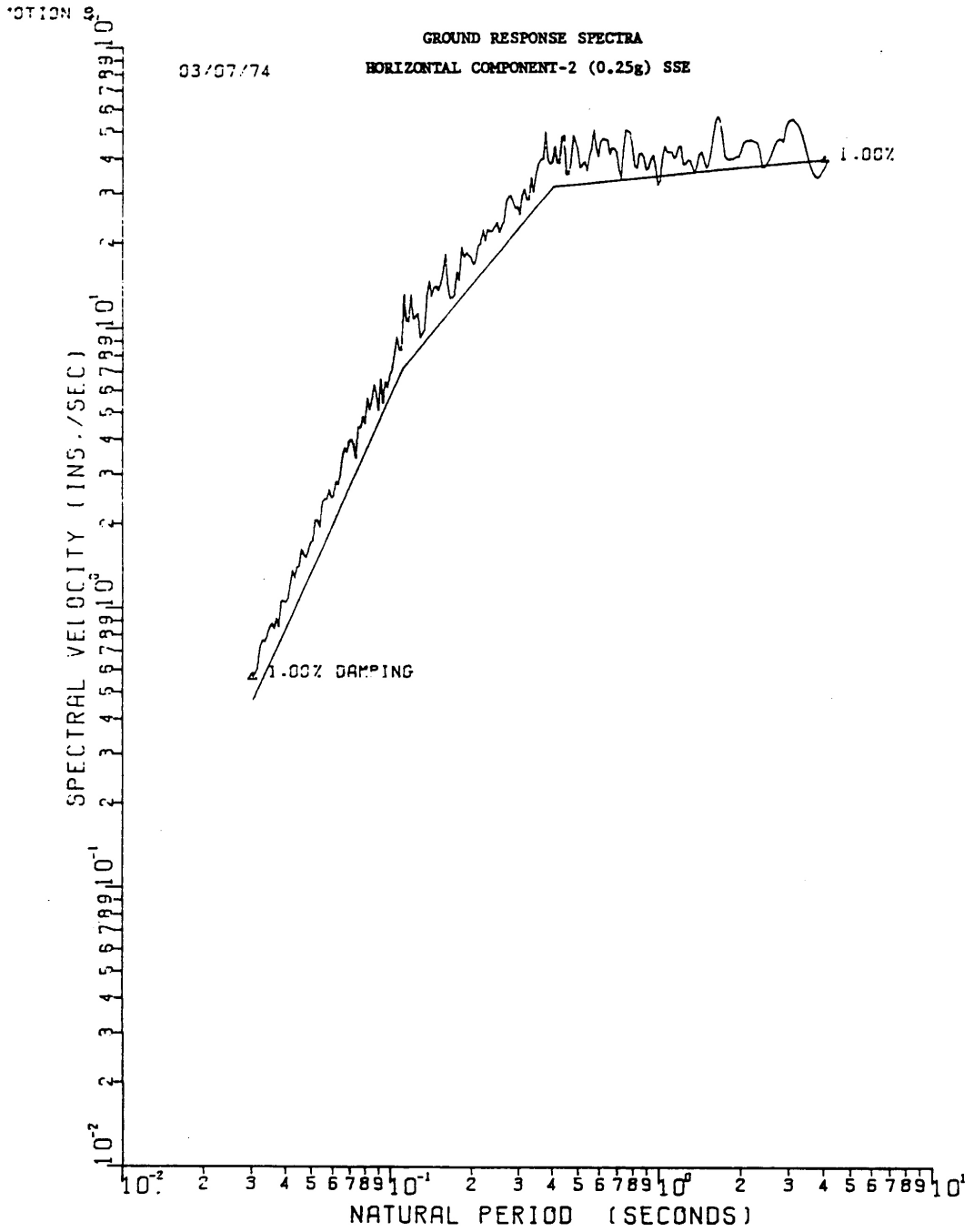

SEABROOK STATION UPDATED FINAL SAFETY ANALYSIS REPORT	1% Critical Damping Ground Response Spectrum, Horizontal Component 2 - SSE	
		Figure 3.7(B)-11

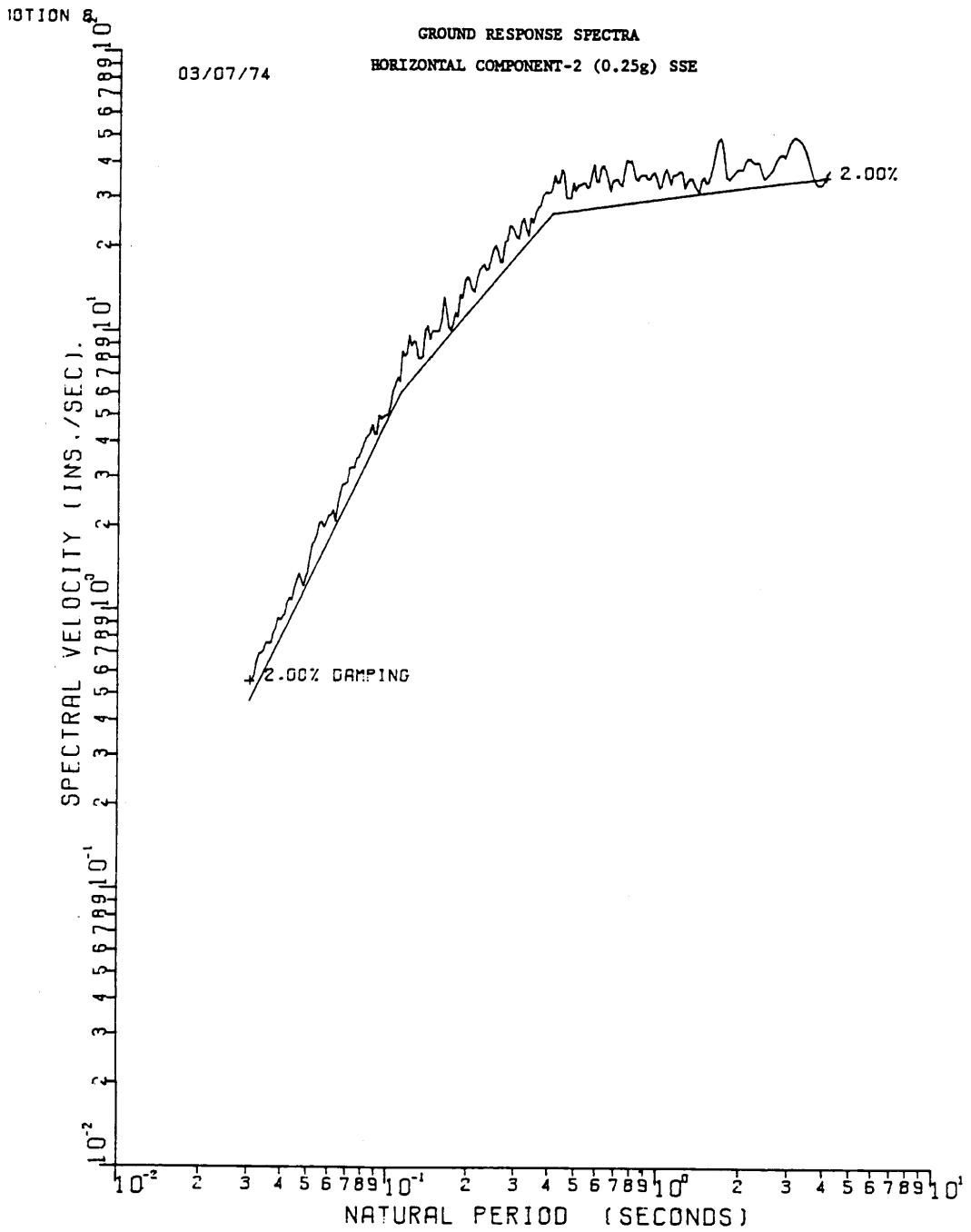

SEABROOK STATION UPDATED FINAL SAFETY ANALYSIS REPORT	2% Critical Damping Ground Response Spectrum, Horizontal Component 2 - SSE	
		Figure 3.7(B)-12

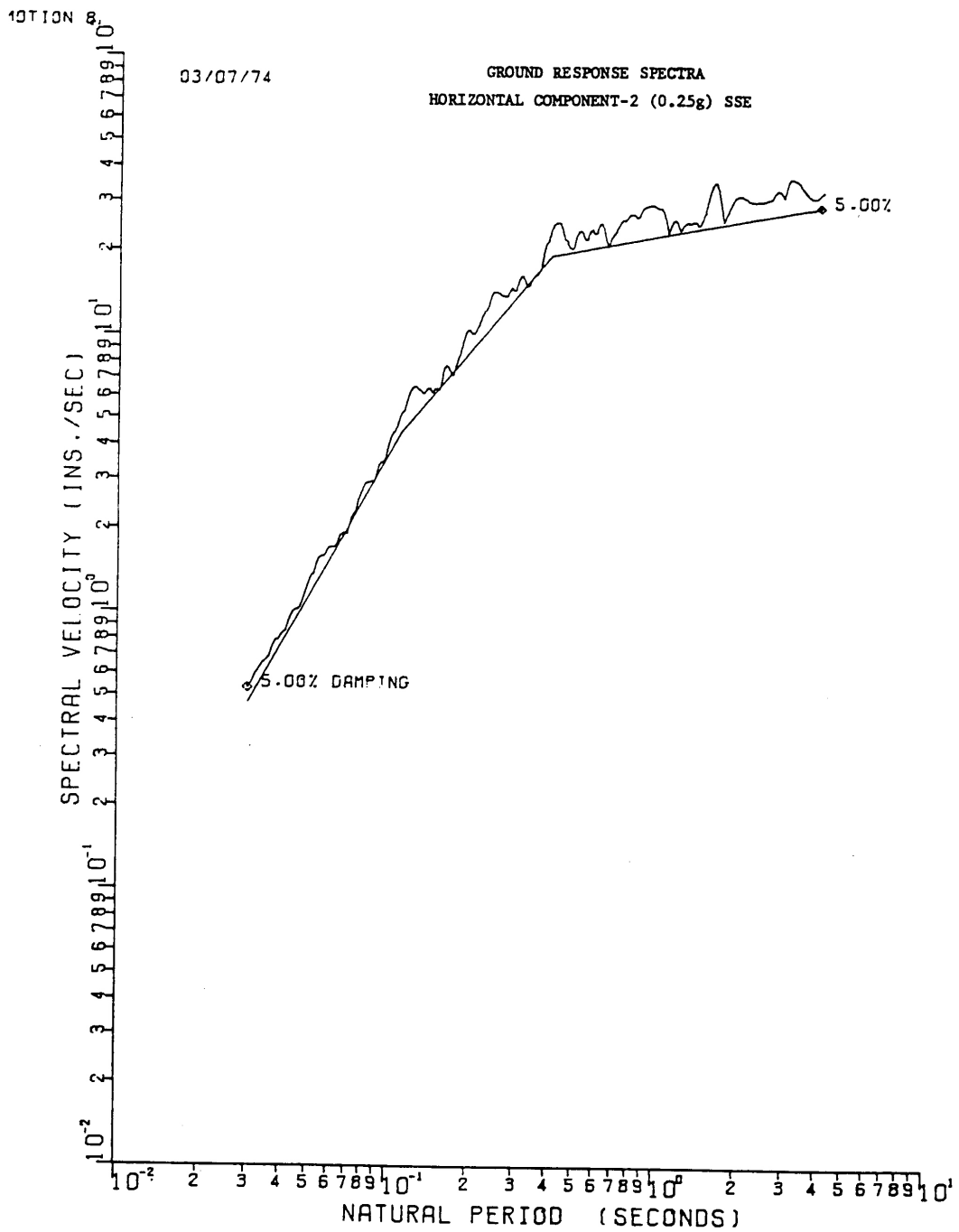

SEABROOK STATION UPDATED FINAL SAFETY ANALYSIS REPORT	5% Critical Damping Ground Response Spectrum, Horizontal Component 2 - SSE	
		Figure 3.7(B)-13

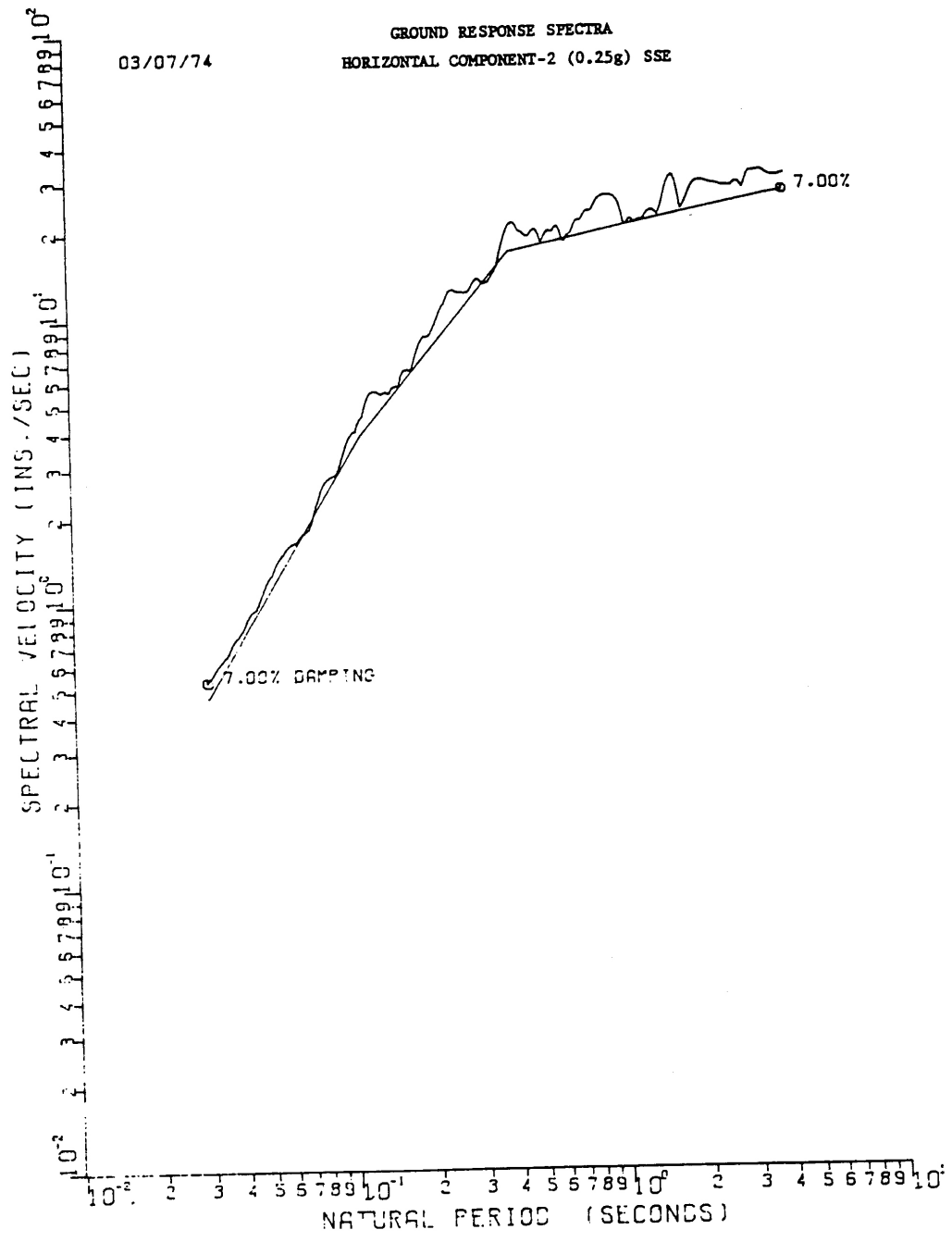

SEABROOK STATION UPDATED FINAL SAFETY ANALYSIS REPORT	7% Critical Damping Ground Response Spectrum, Horizontal Component 2 - SSE	
		Figure 3.7(B)-14

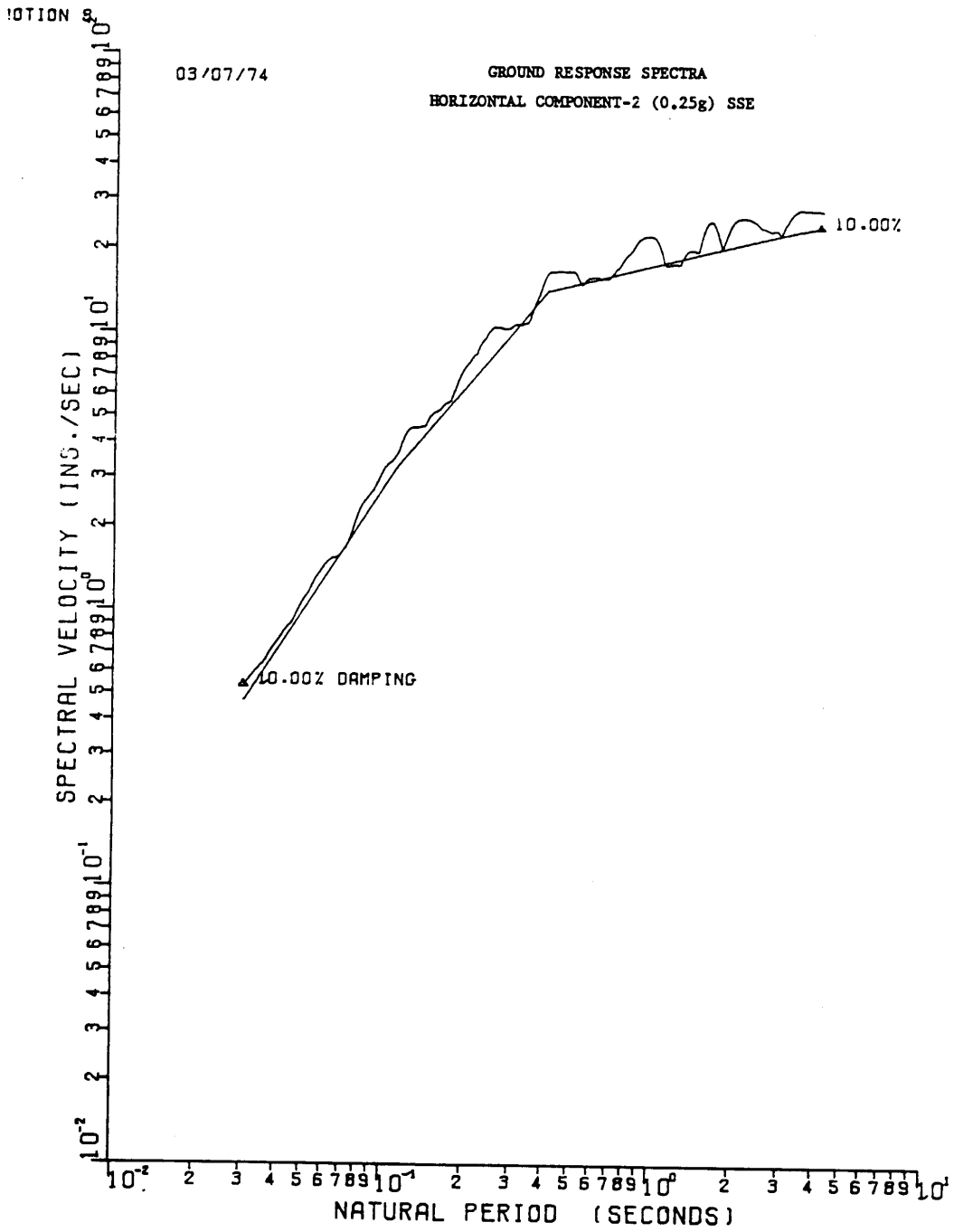

SEABROOK STATION UPDATED FINAL SAFETY ANALYSIS REPORT	10% Critical Damping Ground Response Spectrum, Horizontal Component 2 - SSE	
		Figure 3.7(B)-15

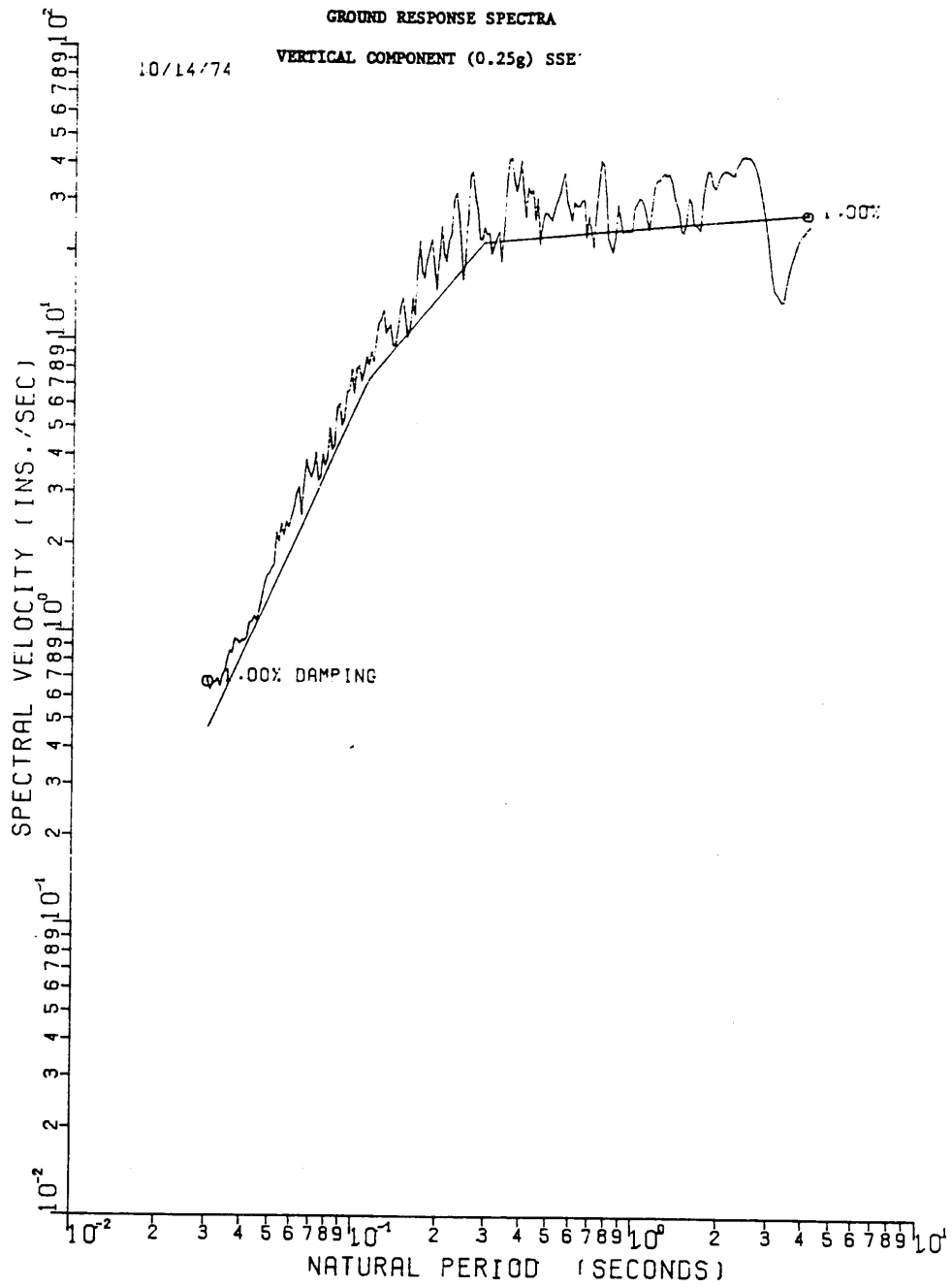



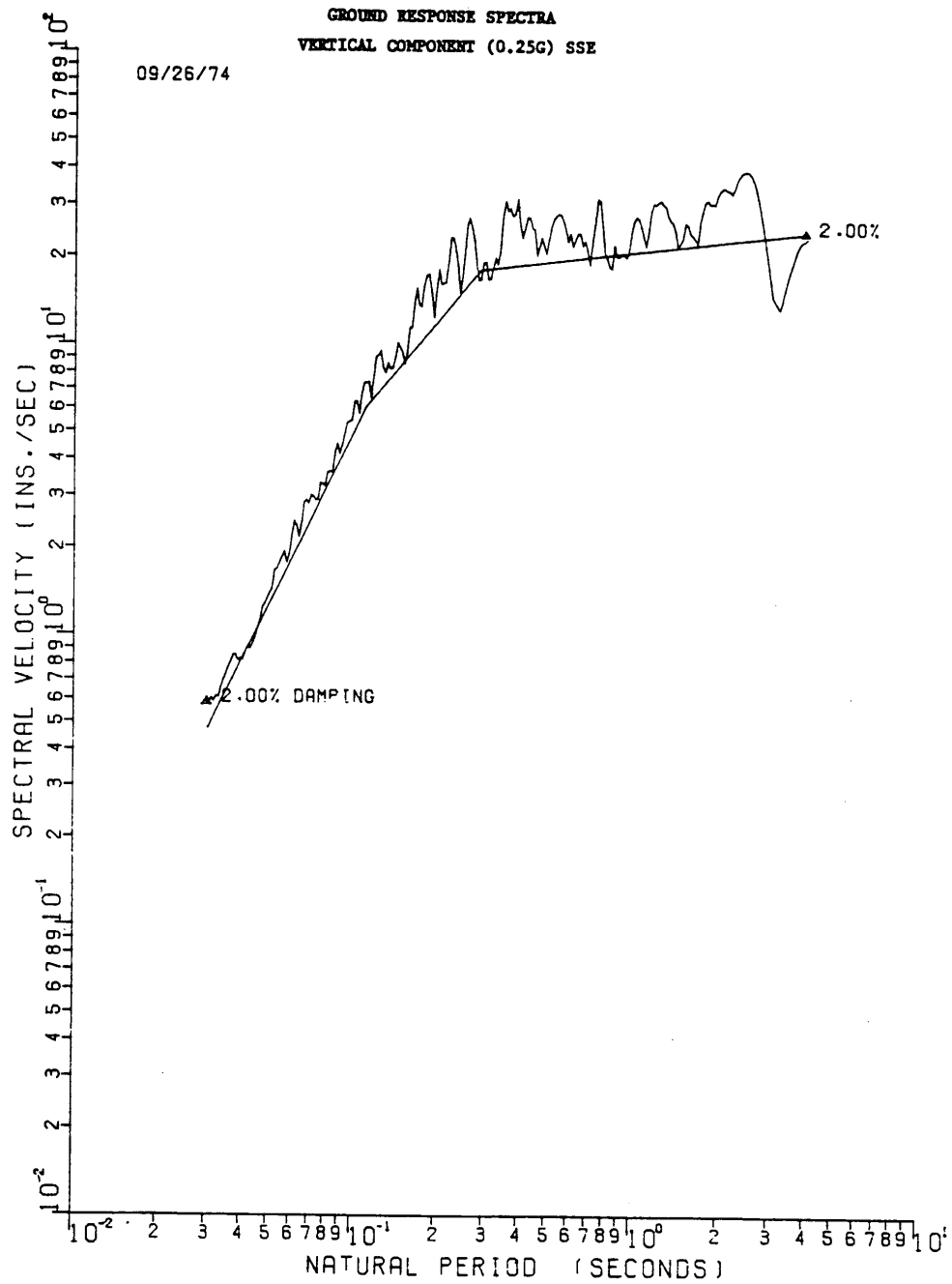

SEABROOK STATION UPDATED FINAL SAFETY ANALYSIS REPORT	2% Critical Damping Ground Response Spectrum, Vertical Component - SSE	
		Figure 3.7(B)-17

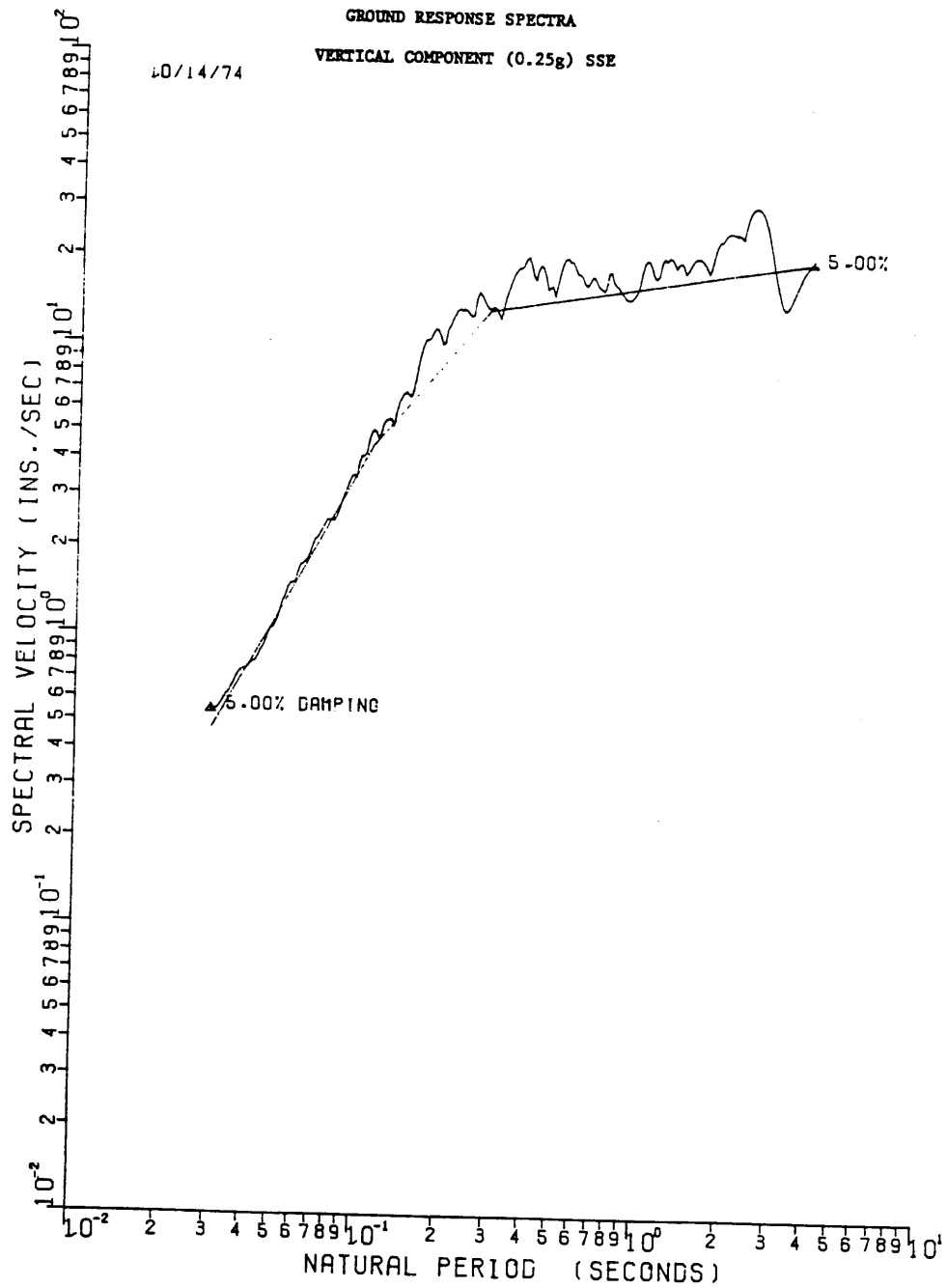

SEABROOK STATION UPDATED FINAL SAFETY ANALYSIS REPORT	5% Critical Damping Ground Response Spectrum, Vertical Component - SSE	
		Figure 3.7(B)-18

GROUND RESPONSE SPECTRA  
 VERTICAL COMPONENT (0.25G) SSE

09/26/74

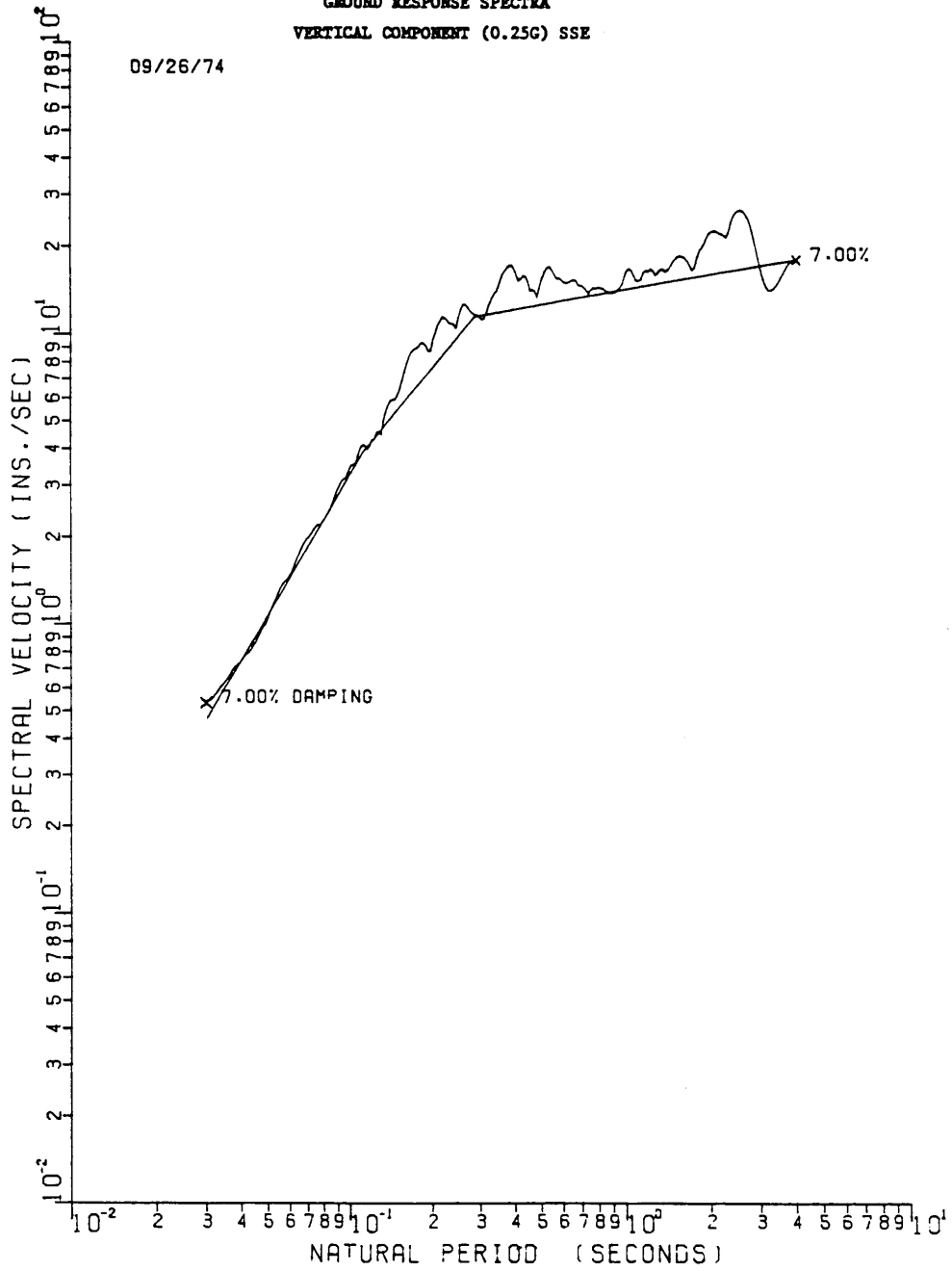

SEABROOK STATION UPDATED FINAL SAFETY ANALYSIS REPORT	7% Critical Damping Ground Response Spectrum, Vertical Component - SSE	
		Figure 3.7(B)-19

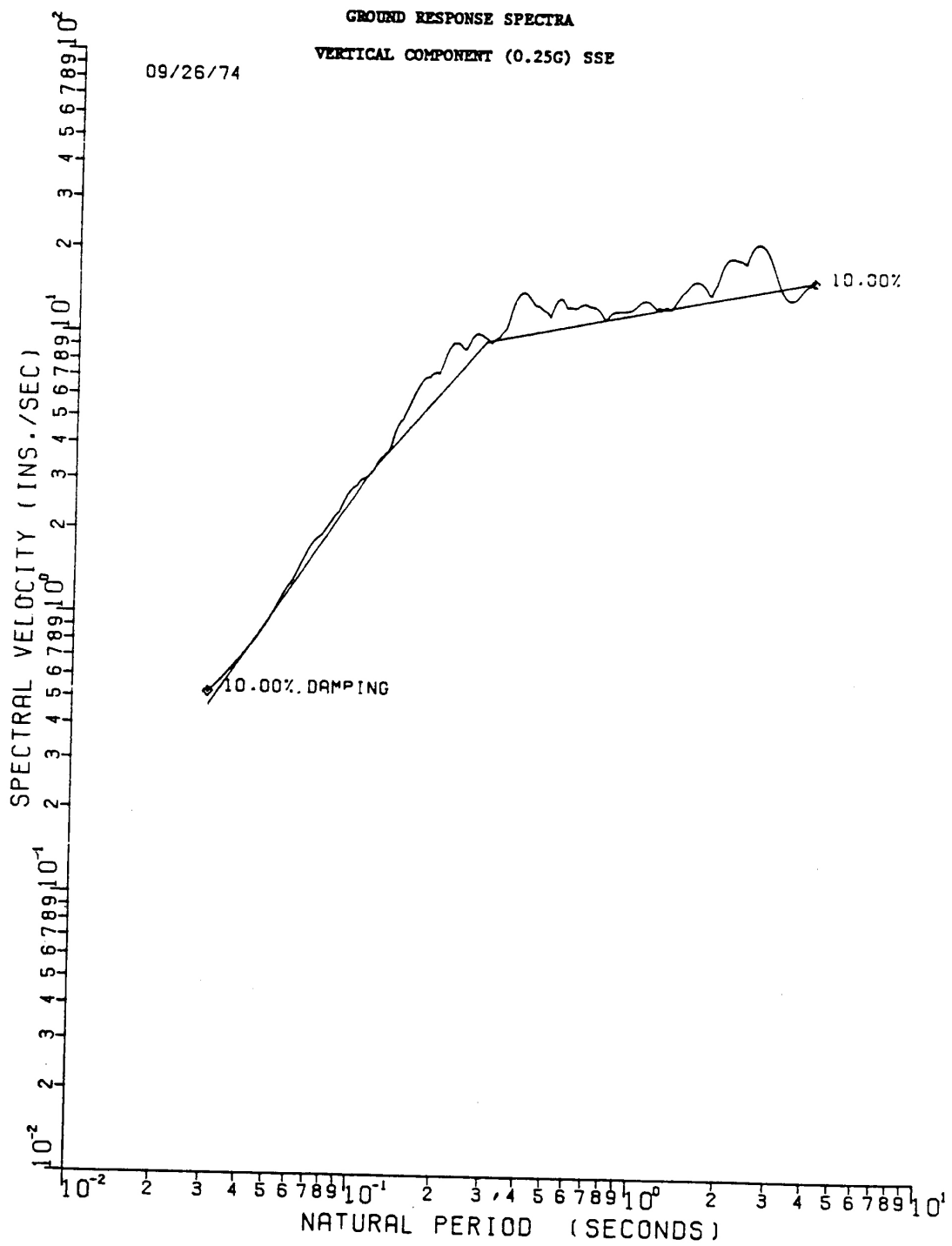

SEABROOK STATION UPDATED FINAL SAFETY ANALYSIS REPORT	10% Critical Damping Ground Response Spectrum, Vertical Component - SSE	
		Figure 3.7(B)-20

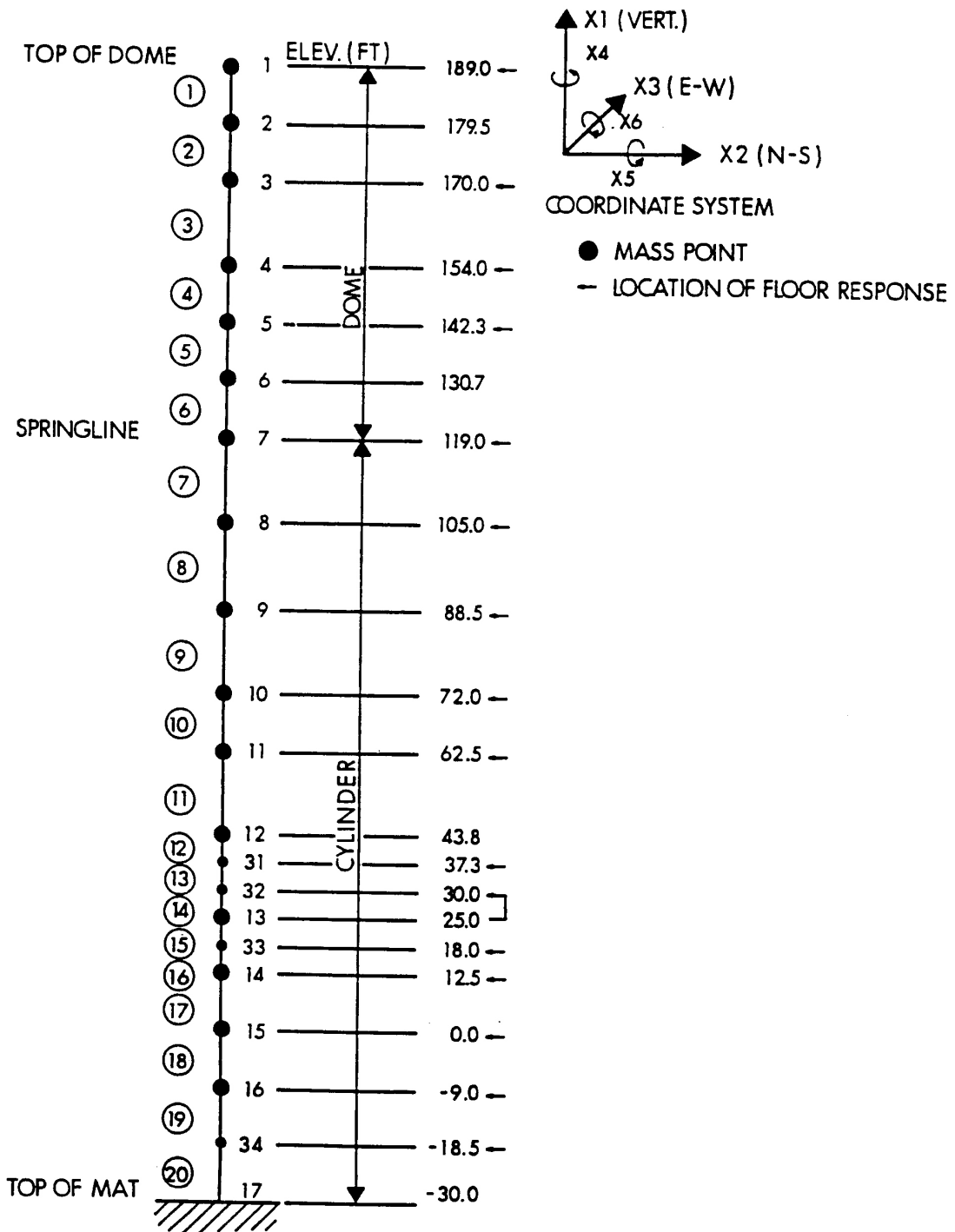

SEABROOK STATION UPDATED FINAL SAFETY ANALYSIS REPORT	Containment Shell - Seismic Model	
		Figure 3.7(B)-21

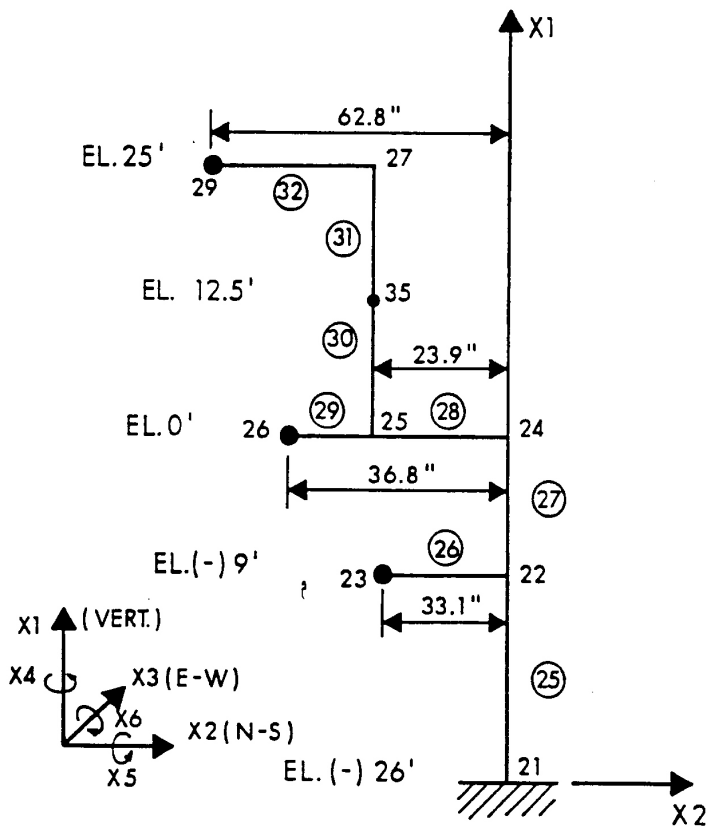

SEABROOK STATION UPDATED FINAL SAFETY ANALYSIS REPORT	Containment Internals - Mathematical Model	
		Figure 3.7(B)-22

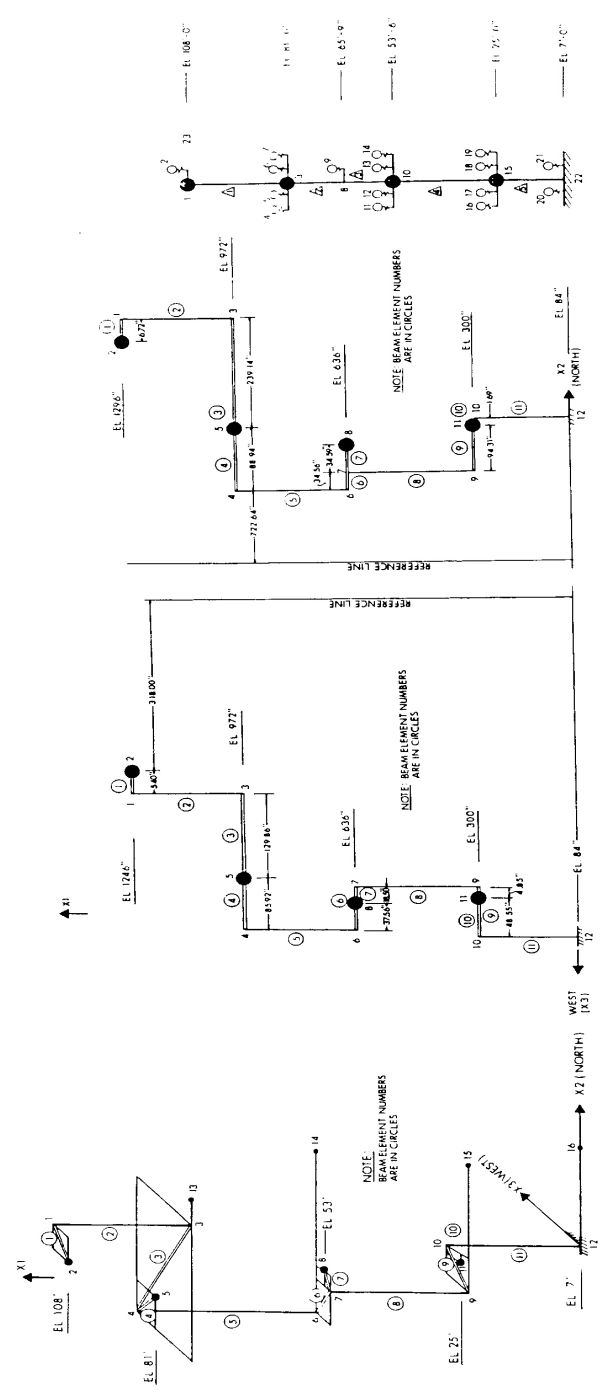

(a) HORIZONTAL COUPLED TORSION MODEL  
 (b) PROJECTION OF THE MATHEMATICAL MODEL ON X<sub>1</sub>-X<sub>2</sub> PLANE (N-S MODEL)  
 (c) PROJECTION OF THE MATHEMATICAL MODEL ON X<sub>1</sub>-X<sub>3</sub> PLANE (E-W MODEL)  
 (d) COUPLED VERTICAL MODEL

Figure 3.7(B)-23

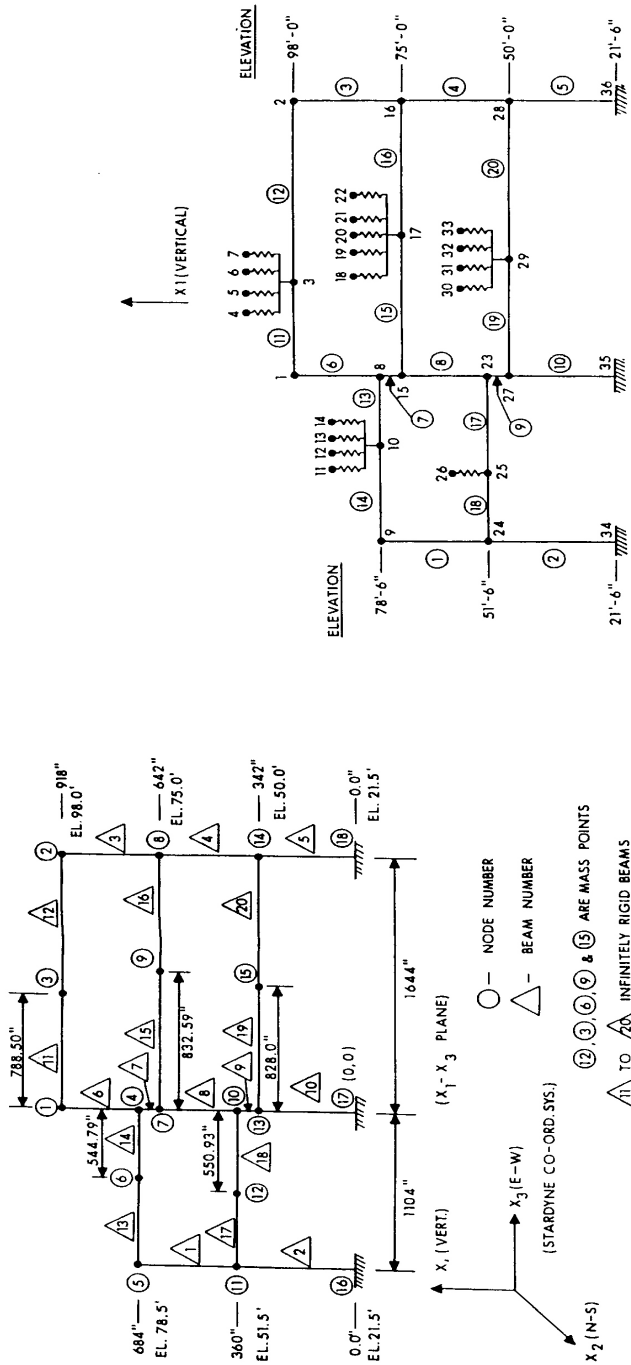

(b) VERTICAL MODEL.

(c) PROJECTION OF THE MATHEMATICAL MODEL ON  $X_1-X_2$  PLANE.



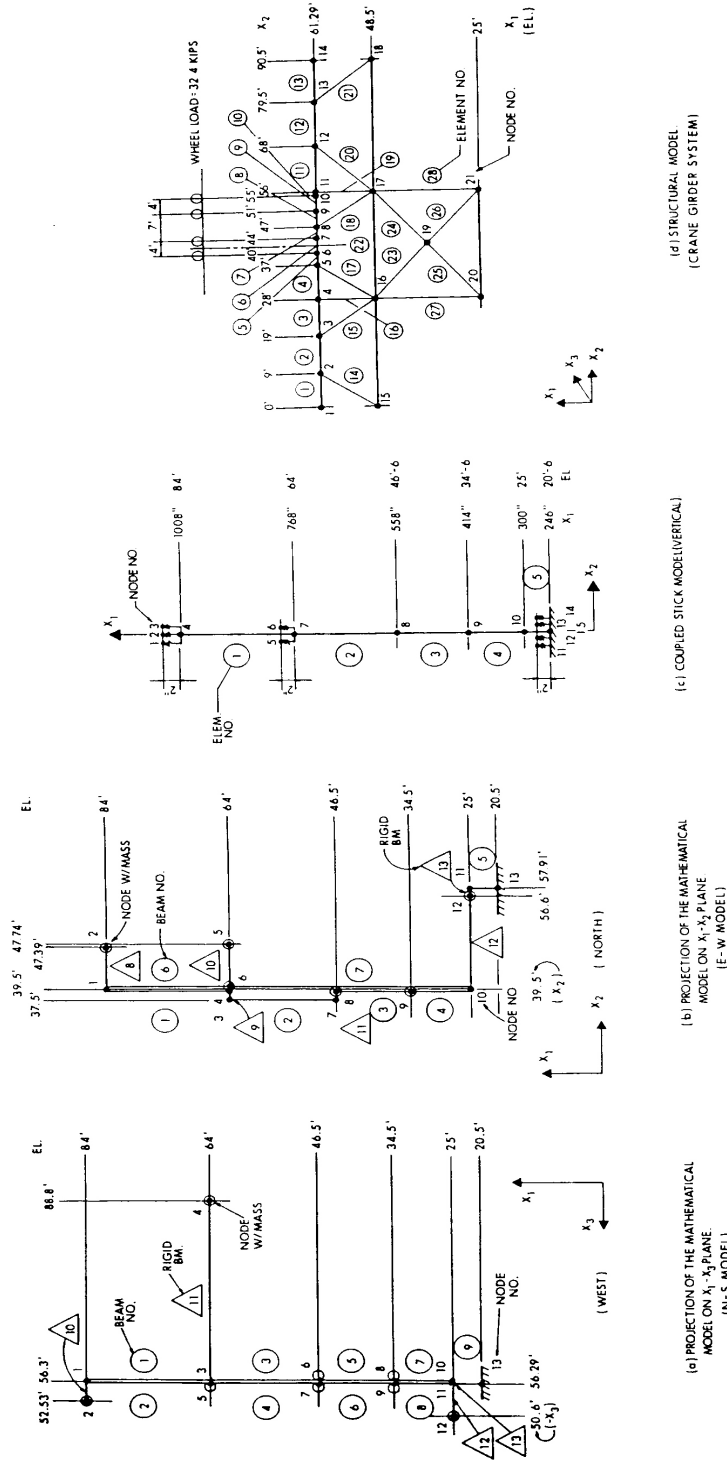

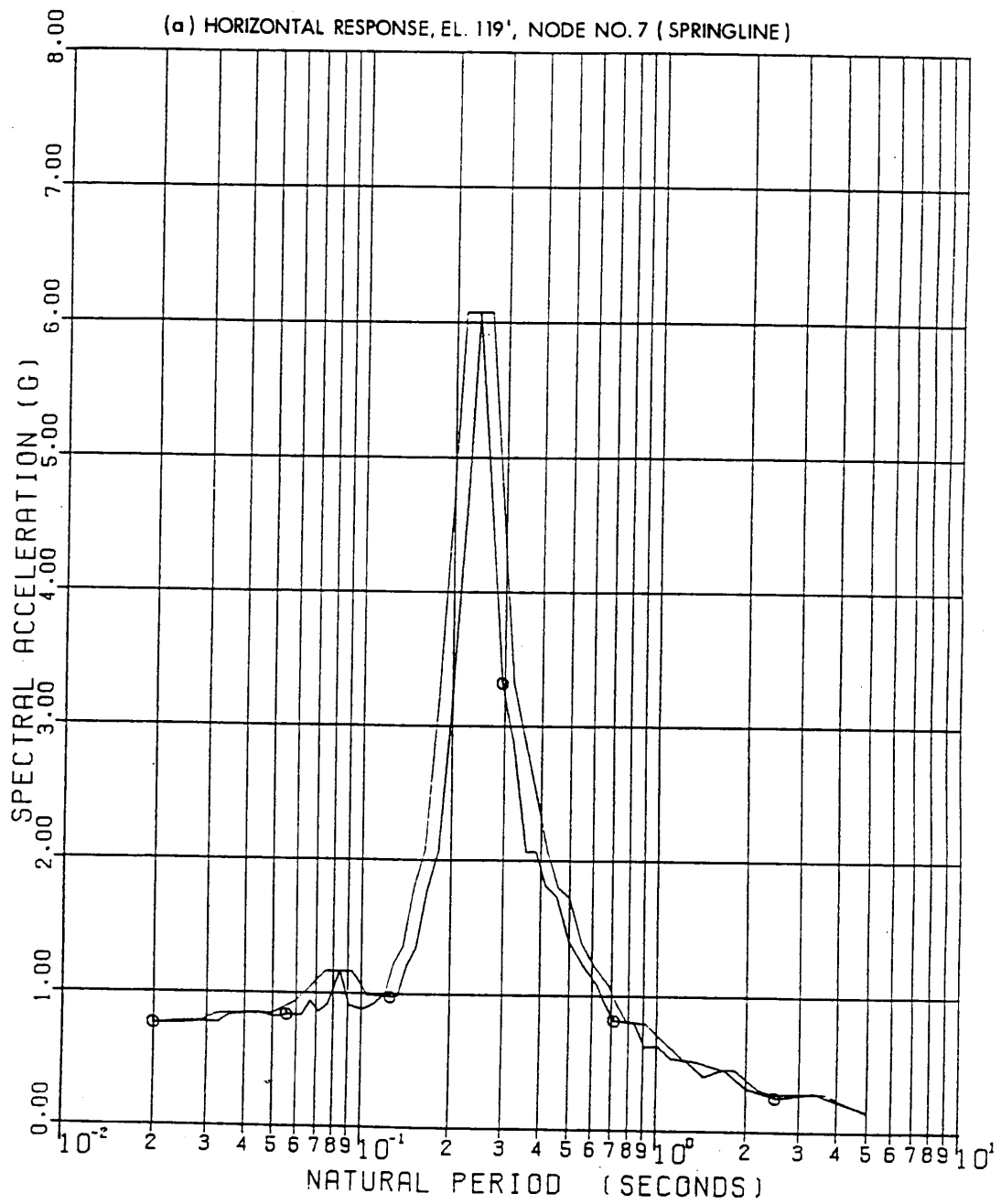

SEABROOK STATION UPDATED FINAL SAFETY ANALYSIS REPORT	Amplified Response Spectra - SSE - Containment Shell - 7% Structural Damping; 2% Equipment Damping [2 Sheets]
	Figure 3.7(B)-26      Sh 1 of 2

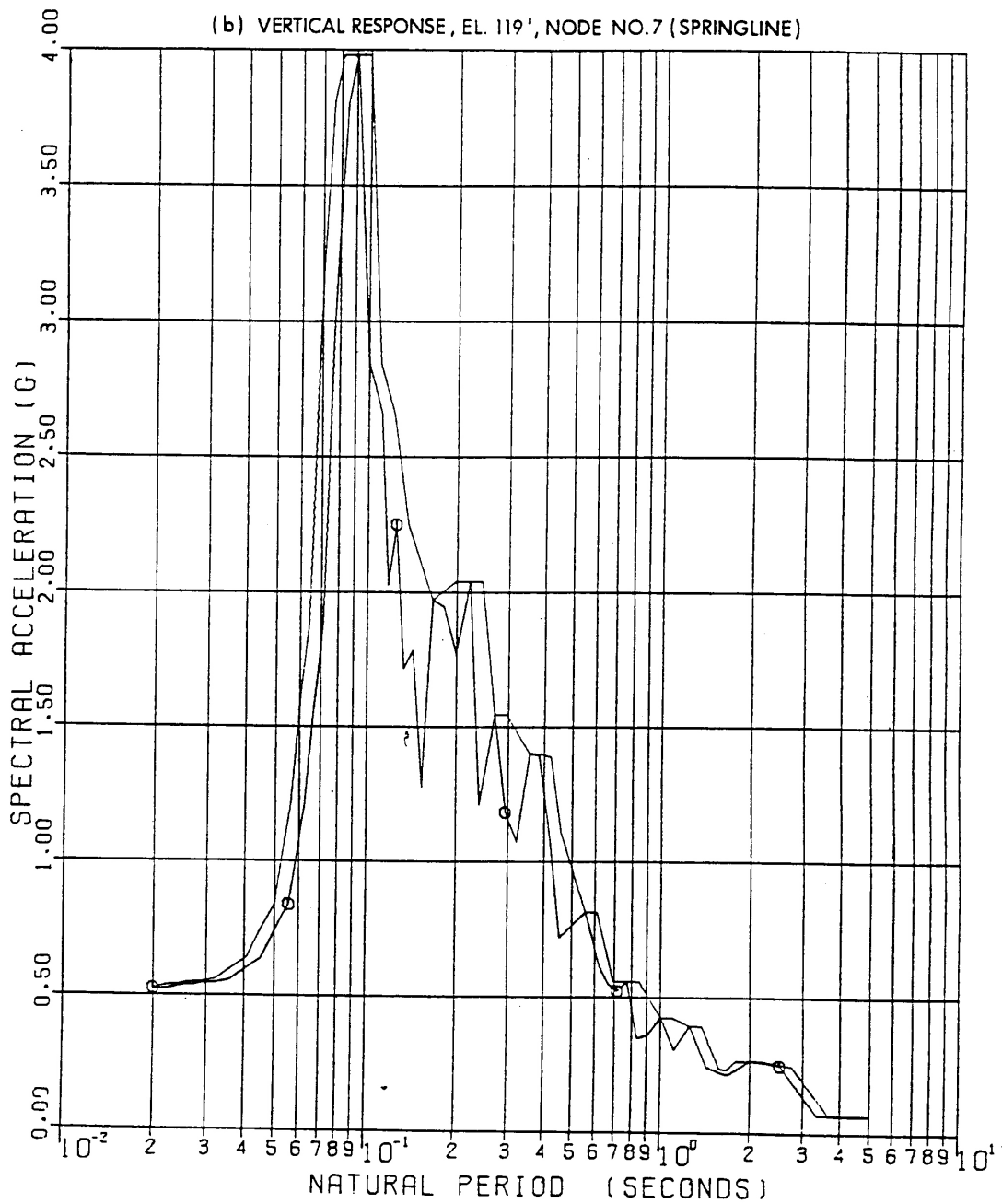

SEABROOK STATION UPDATED FINAL SAFETY ANALYSIS REPORT	Amplified Response Spectra - SSE - Containment Shell - 7% Structural Damping; 2% Equipment Damping [2 Sheets]
	Figure 3.7(B)-26      Sh 2 of 2

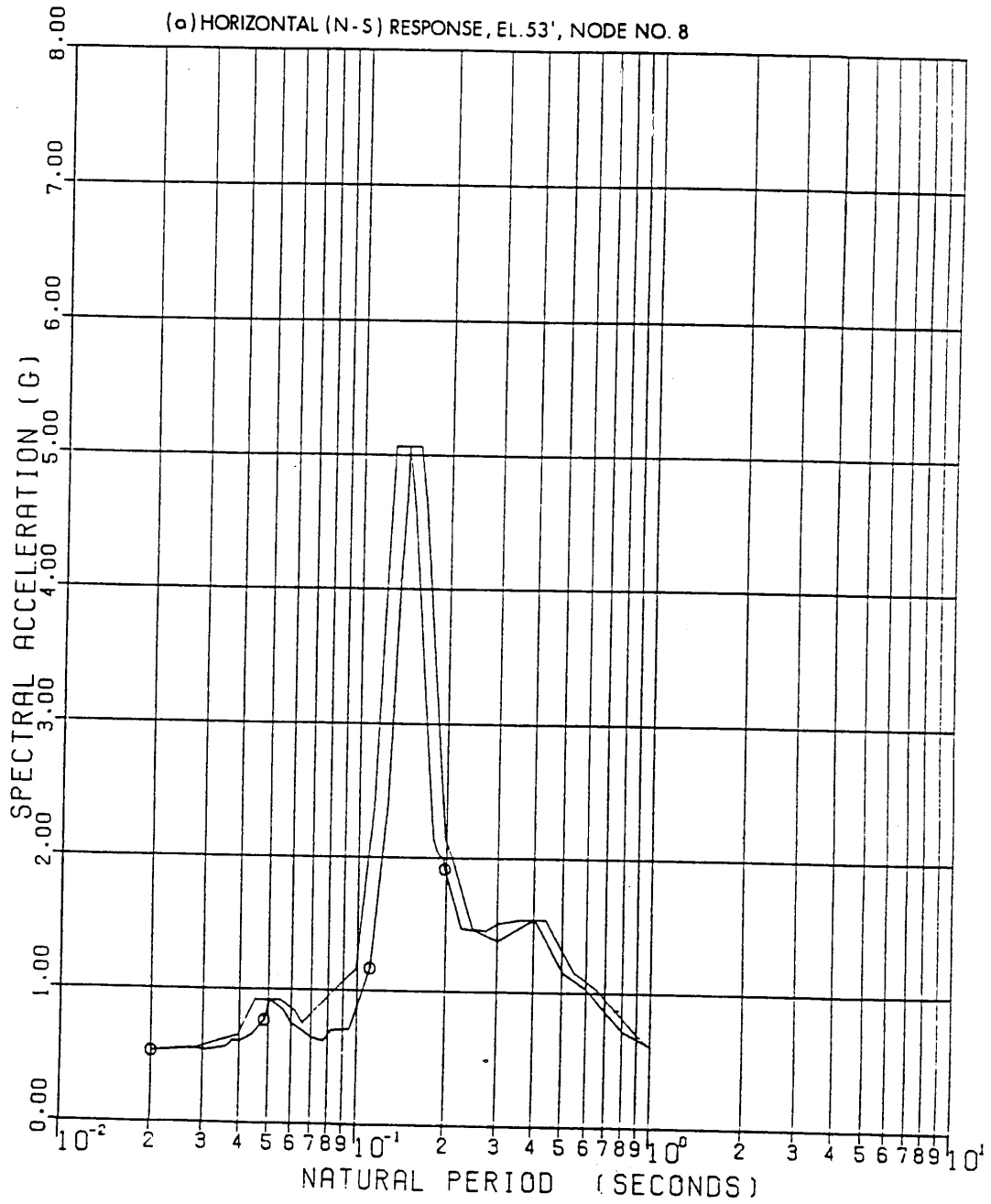

SEABROOK STATION UPDATED FINAL SAFETY ANALYSIS REPORT	Amplified Response Spectra - SSE - Primary Auxiliary Building -7% Structural Damping; 2% Equipment Damping [4 Sheets]
	Figure 3.7(B)-27      Sh 1 of 4

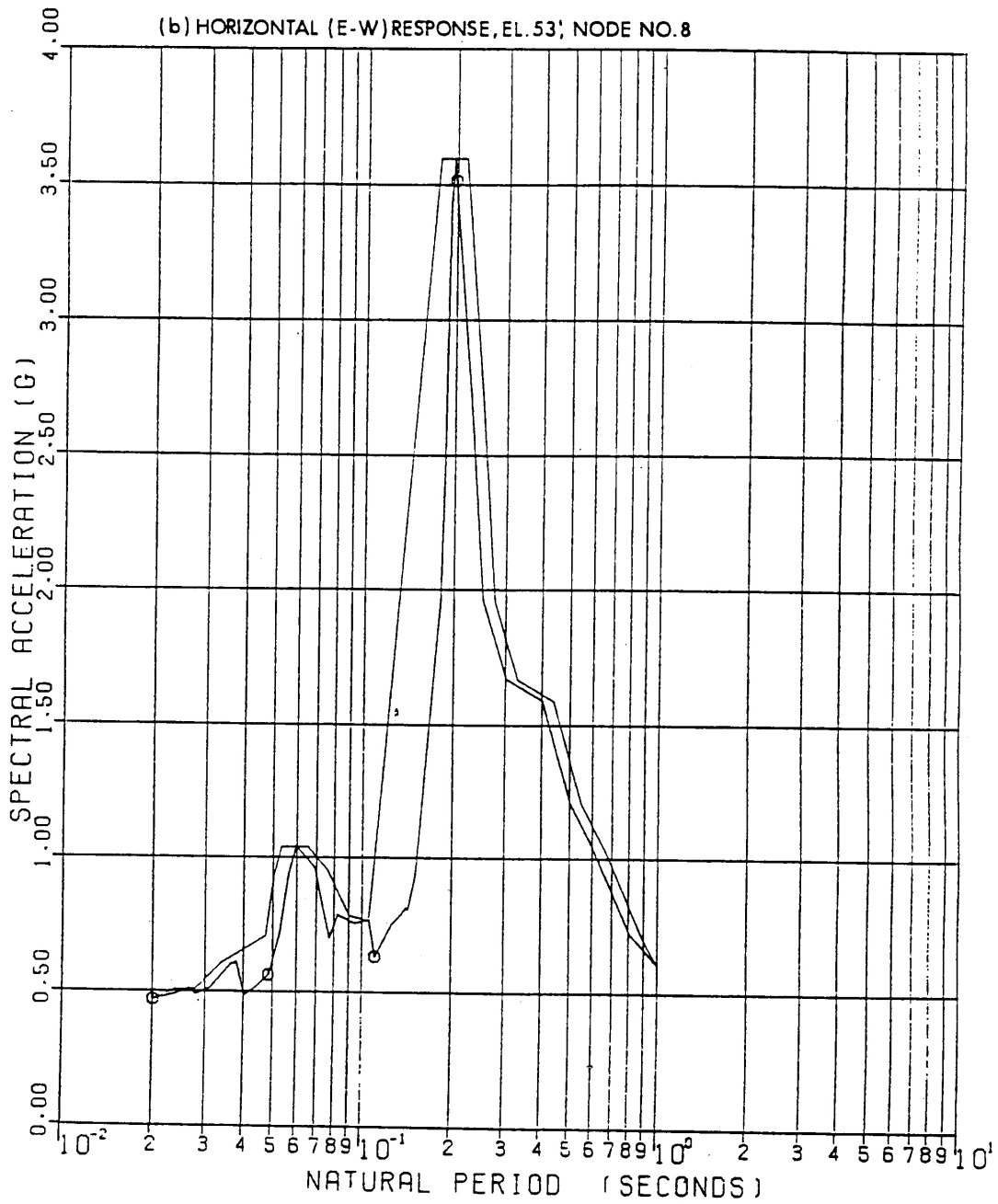

SEABROOK STATION UPDATED FINAL SAFETY ANALYSIS REPORT	Amplified Response Spectra - SSE - Primary Auxiliary Building -7% Structural Damping; 2% Equipment Damping [4 Sheets]
	Figure 3.7(B)-27 Sh 2 of 4

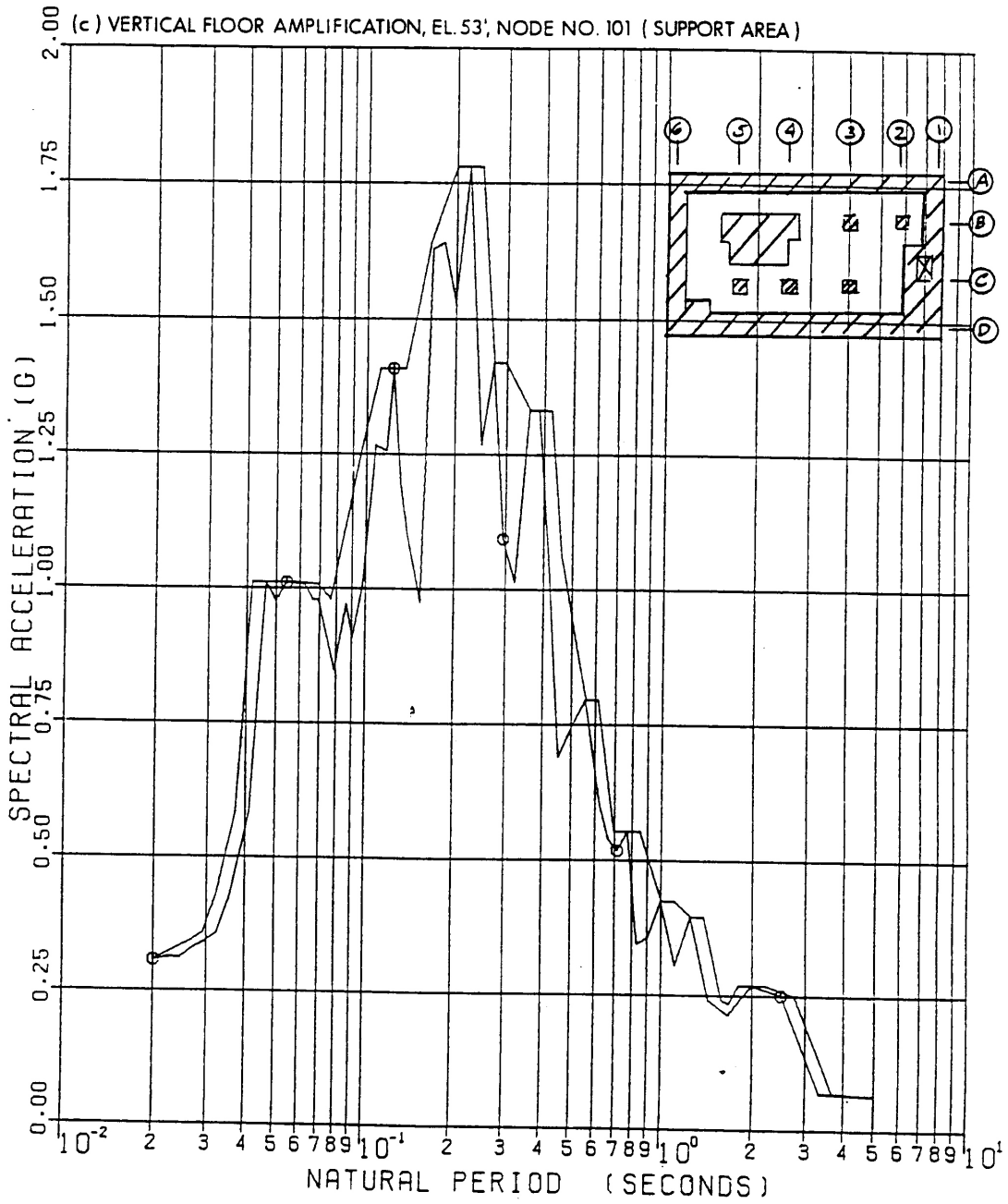

SEABROOK STATION UPDATED FINAL SAFETY ANALYSIS REPORT	Amplified Response Spectra - SSE - Primary Auxiliary Building -7% Structural Damping; 2% Equipment Damping [4 Sheets]	Figure 3.7(B)-27 Sh 3 of 4

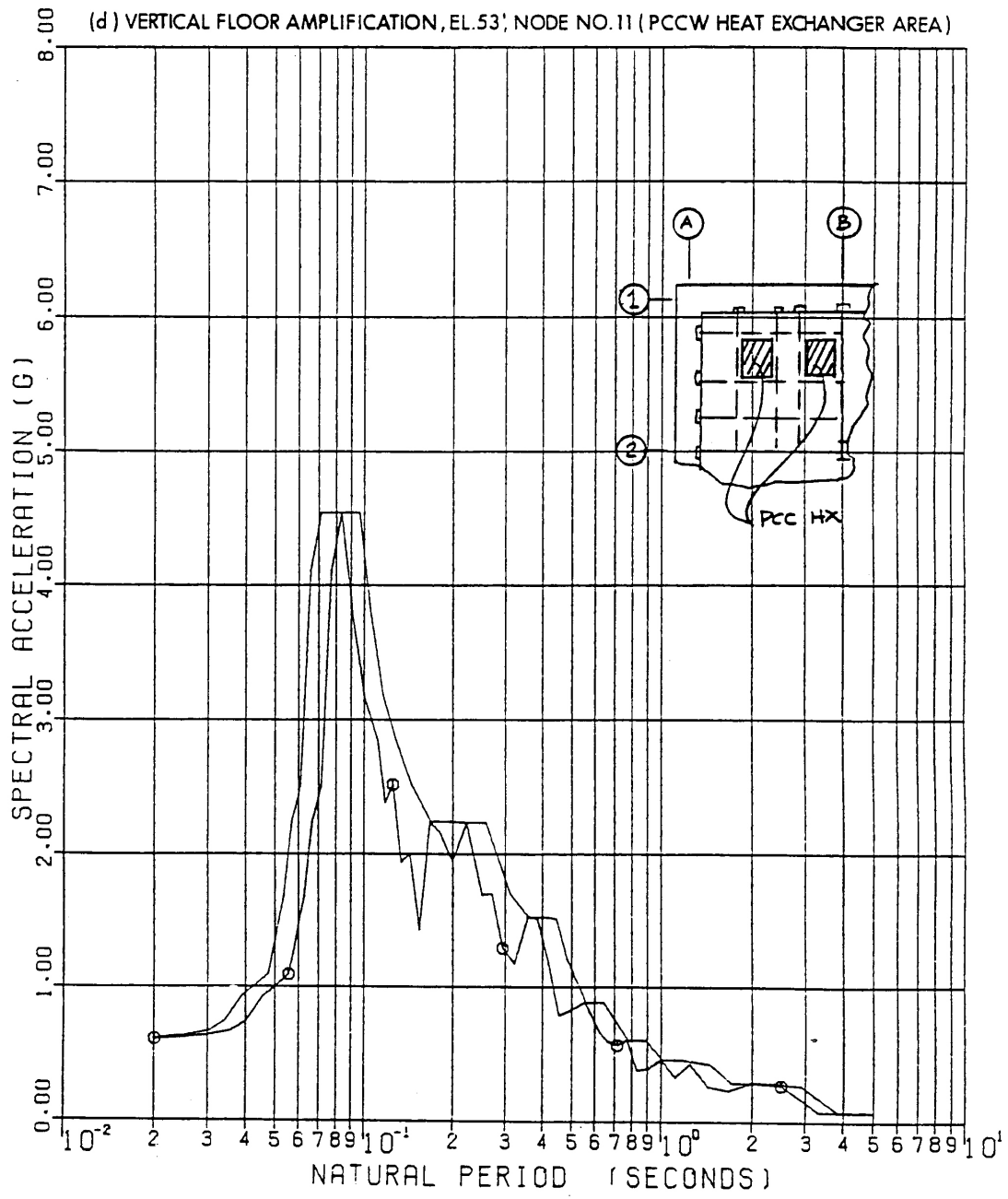

<p>SEABROOK STATION          UPDATED FINAL SAFETY          ANALYSIS REPORT</p>	<p>Amplified Response Spectra - SSE - Primary Auxiliary          Building -7% Structural Damping; 2% Equipment Damping          [4 Sheets]</p>
	<p>Figure 3.7(B)-27 Sh 4 of 4</p>

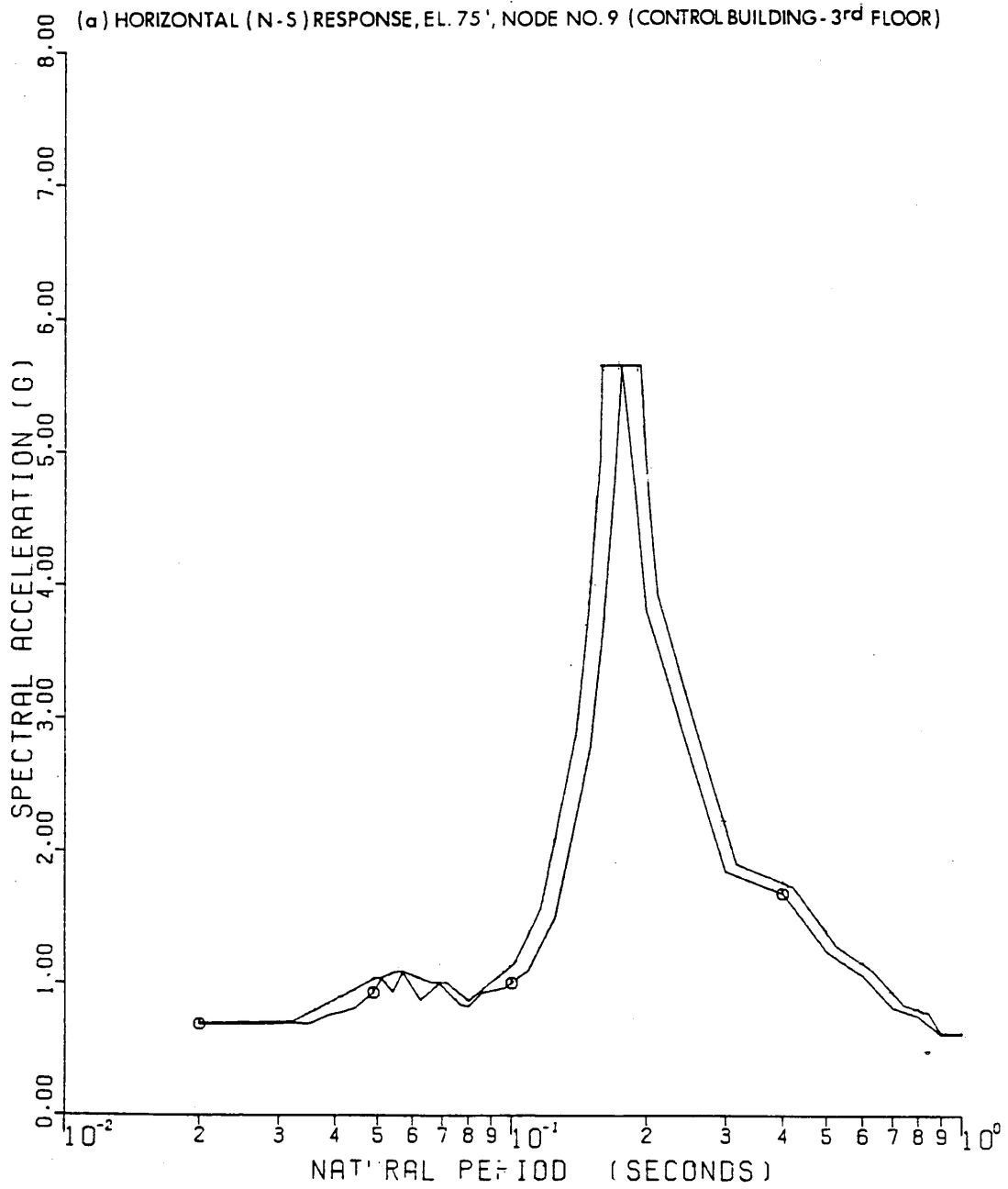

SEABROOK STATION UPDATED FINAL SAFETY ANALYSIS REPORT	Amplified Response Spectra - SSE - Control/Diesel Generator Building - 7% Structural Damping; 2% Equipment Damping [8 Sheets]	
	Figure 3.7(B)-28	Sh 1 of 8



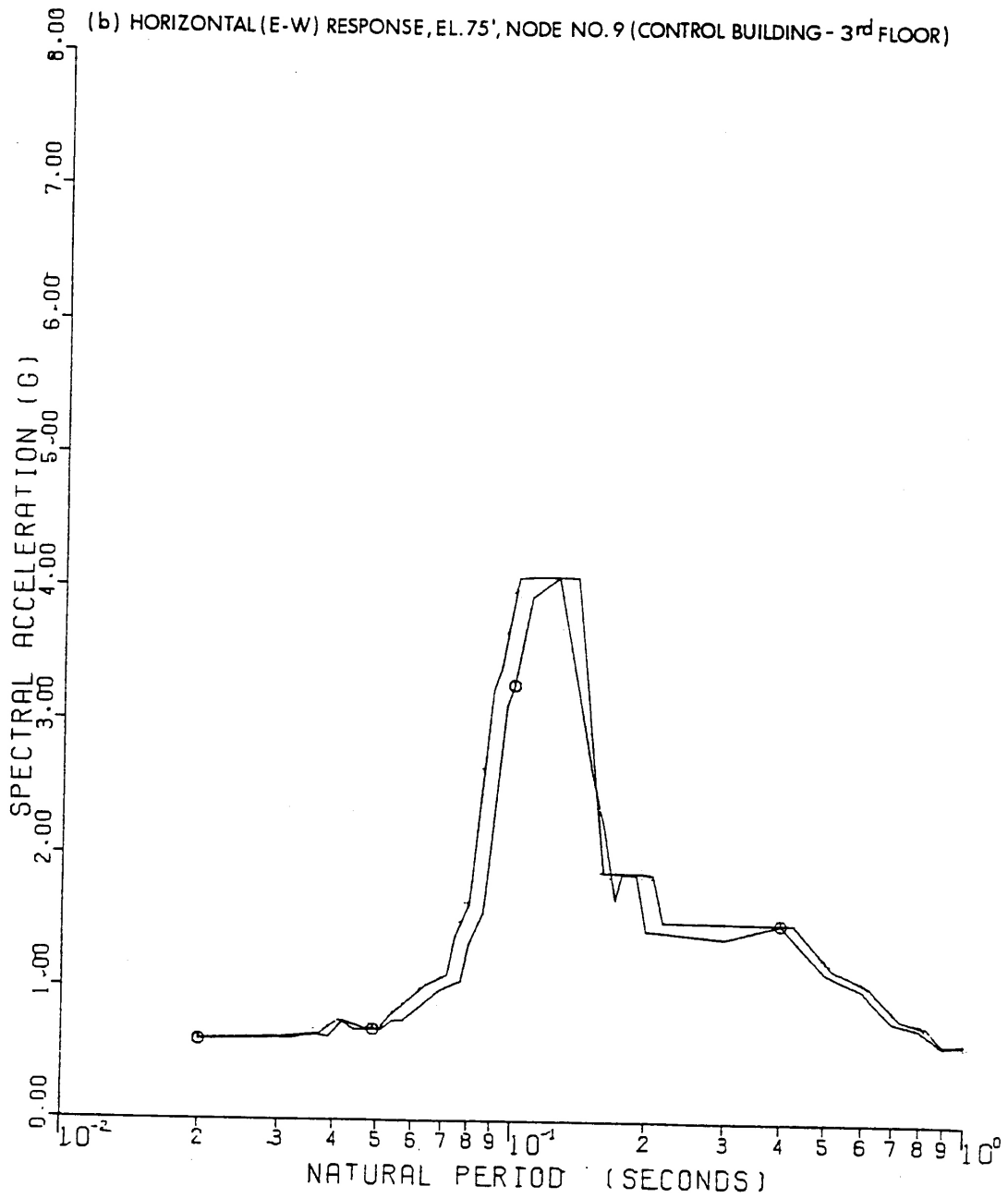

SEABROOK STATION UPDATED FINAL SAFETY ANALYSIS REPORT	Amplified Response Spectra - SSE - Control/Diesel Generator Building - 7% Structural Damping; 2% Equipment Damping [8 Sheets]	
	Figure 3.7(B)-28	Sh 2 of 8

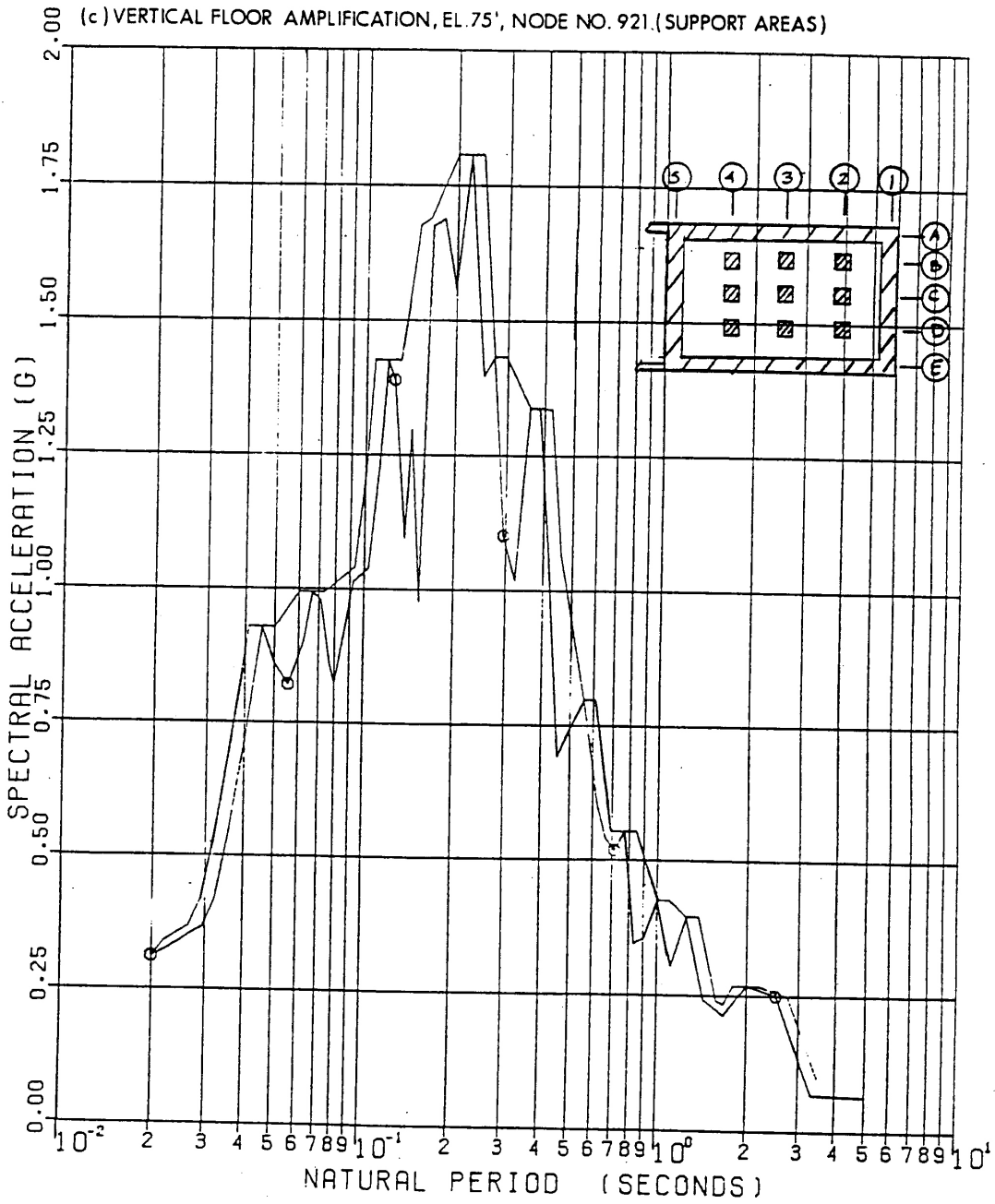

SEABROOK STATION UPDATED FINAL SAFETY ANALYSIS REPORT	Amplified Response Spectra - SSE - Control/Diesel Generator Building - 7% Structural Damping; 2% Equipment Damping [8 Sheets]	
	Figure 3.7(B)-28	Sh 3 of 8

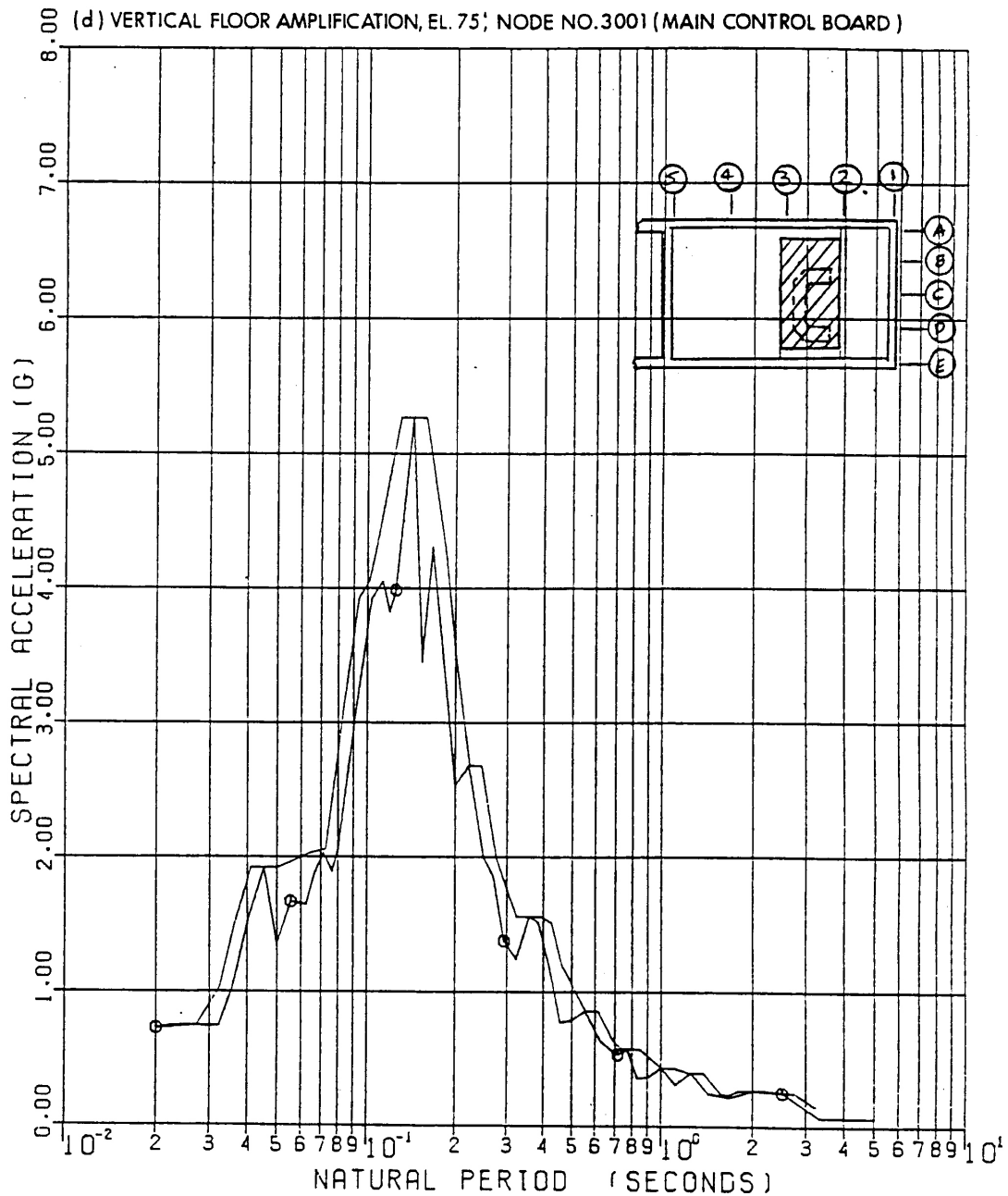

SEABROOK STATION UPDATED FINAL SAFETY ANALYSIS REPORT	Amplified Response Spectra - SSE - Control/Diesel Generator Building - 7% Structural Damping; 2% Equipment Damping [8 Sheets]	
	Figure 3.7(B)-28	Sh 4 of 8

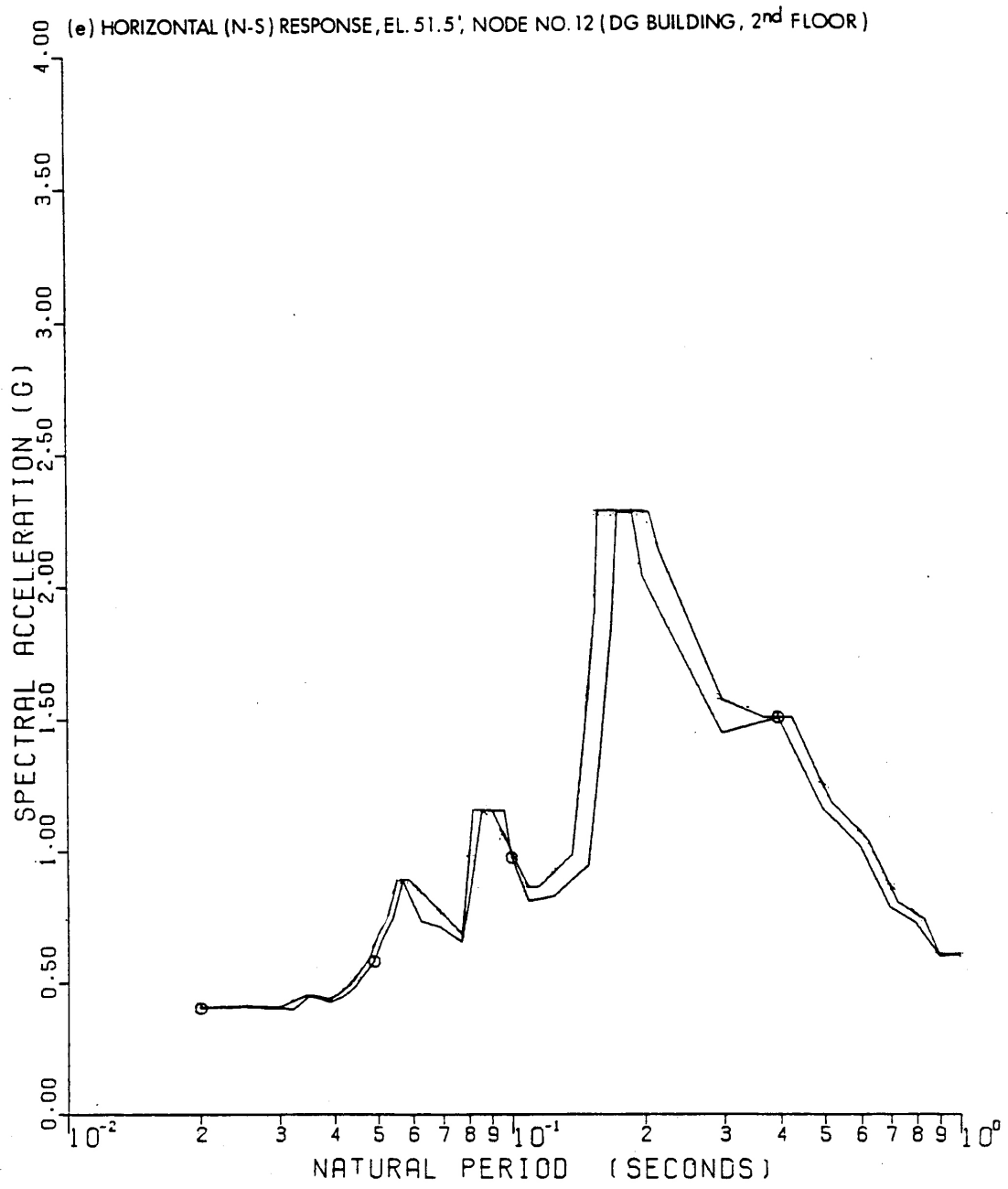

SEABROOK STATION UPDATED FINAL SAFETY ANALYSIS REPORT	Amplified Response Spectra - SSE - Control/Diesel Generator Building - 7% Structural Damping; 2% Equipment Damping [8 Sheets]	
	Figure 3.7(B)-28	Sh 5 of 8

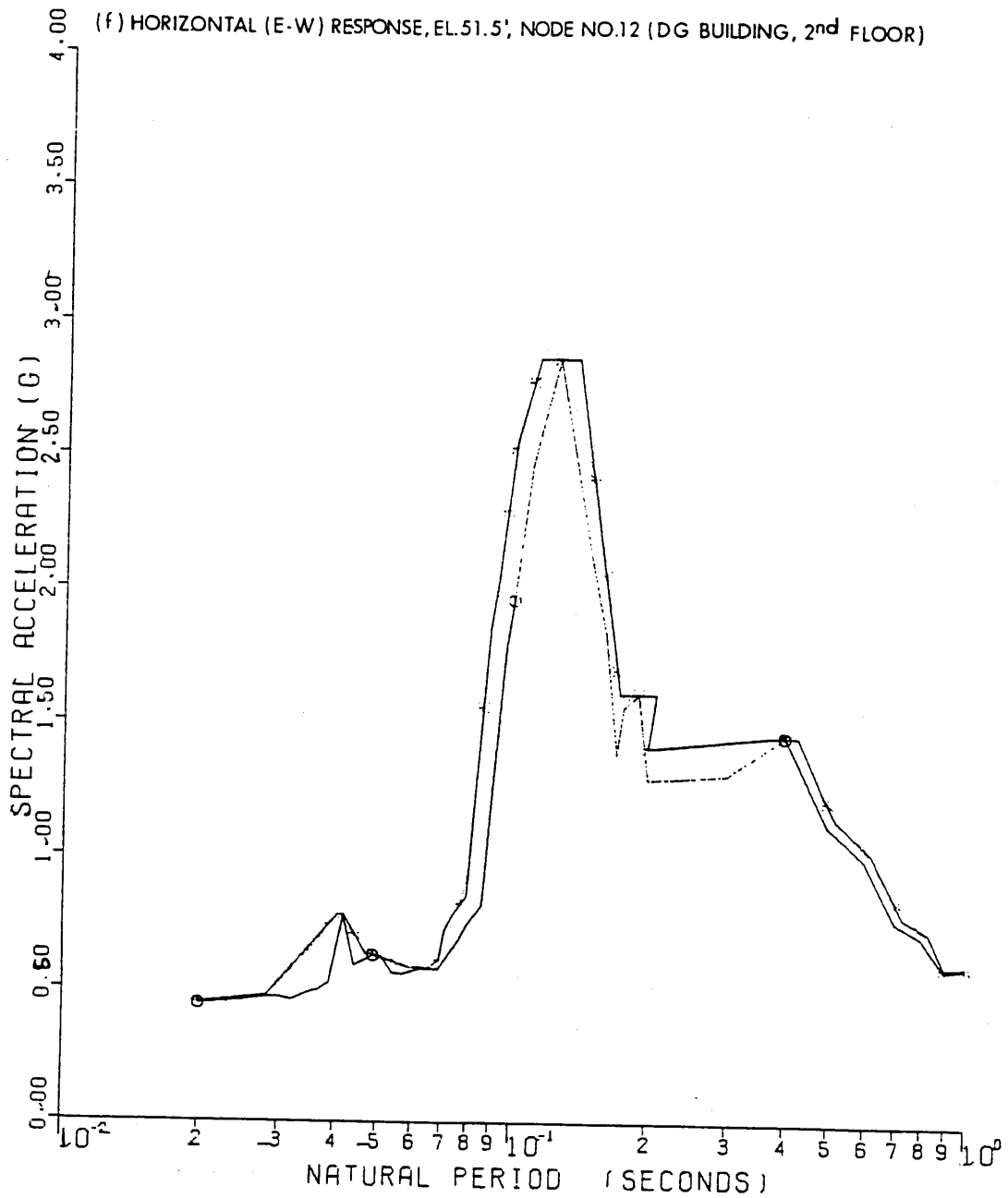

SEABROOK STATION UPDATED FINAL SAFETY ANALYSIS REPORT	Amplified Response Spectra - SSE - Control/Diesel Generator Building - 7% Structural Damping; 2% Equipment Damping [8 Sheets]	
	Figure 3.7(B)-28	Sh 6 of 8

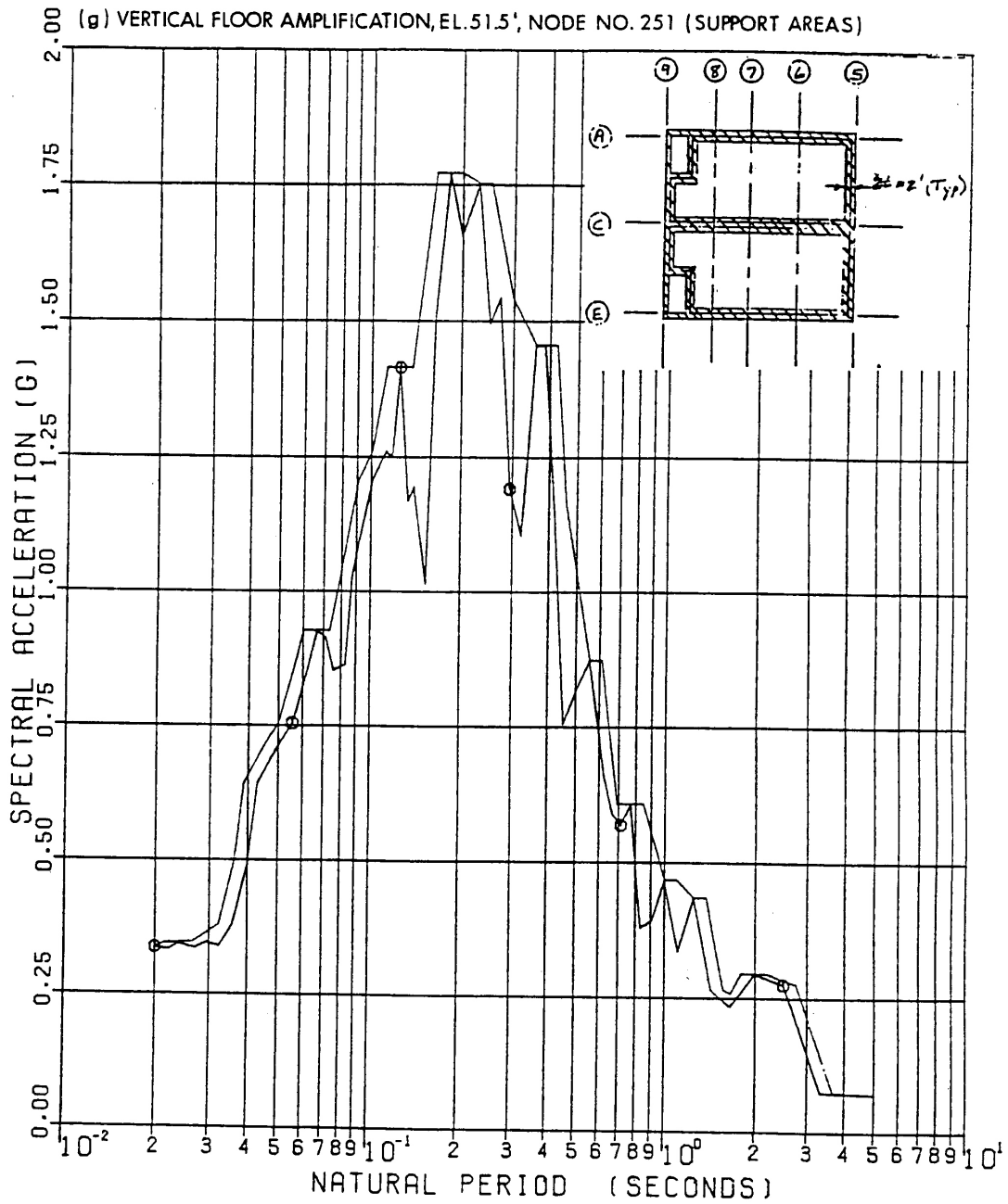

SEABROOK STATION UPDATED FINAL SAFETY ANALYSIS REPORT	Amplified Response Spectra - SSE - Control/Diesel Generator Building - 7% Structural Damping; 2% Equipment Damping [8 Sheets]	
	Figure 3.7(B)-28	Sh 7 of 8

(h) VERTICAL FLOOR AMPLIFICATION, EL. 51.5', NODE NO. 261

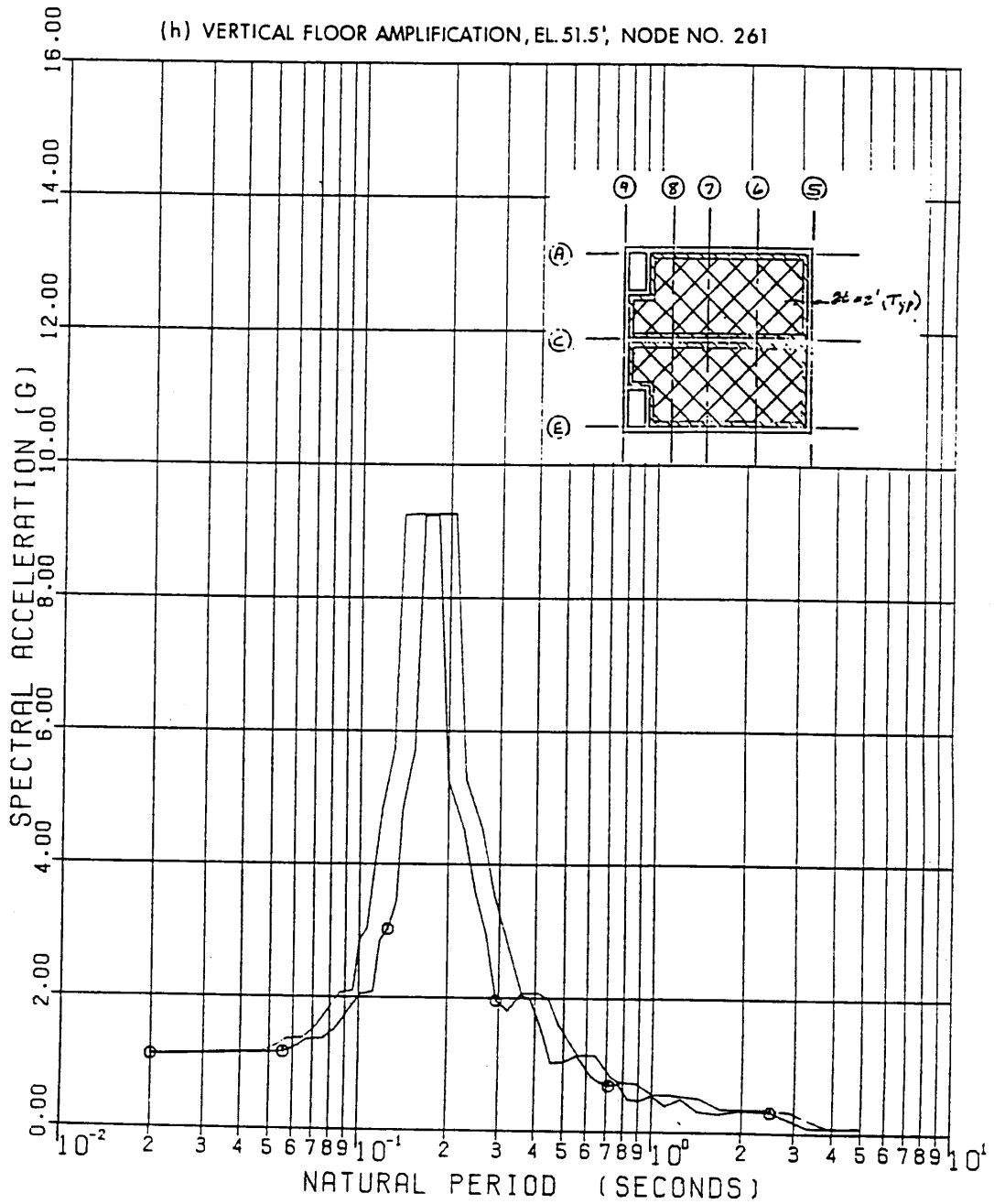

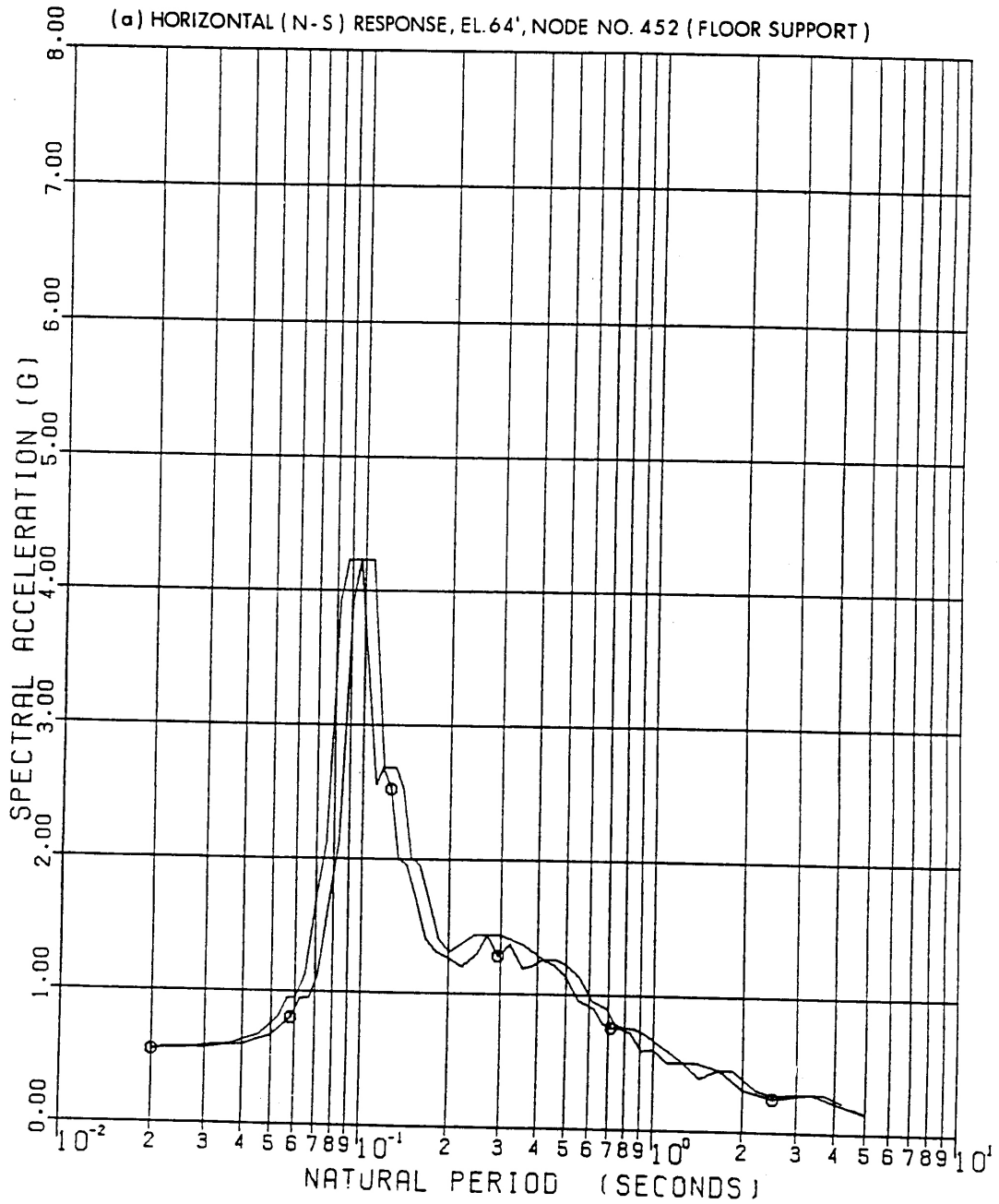

SEABROOK STATION UPDATED FINAL SAFETY ANALYSIS REPORT	Amplified Response Spectra - SSE - Fuel Storage Building - 7% Structural Damping; 2% Equipment Damping [4 Sheets]
	Figure 3.7(B)-29      Sh 1 of 4



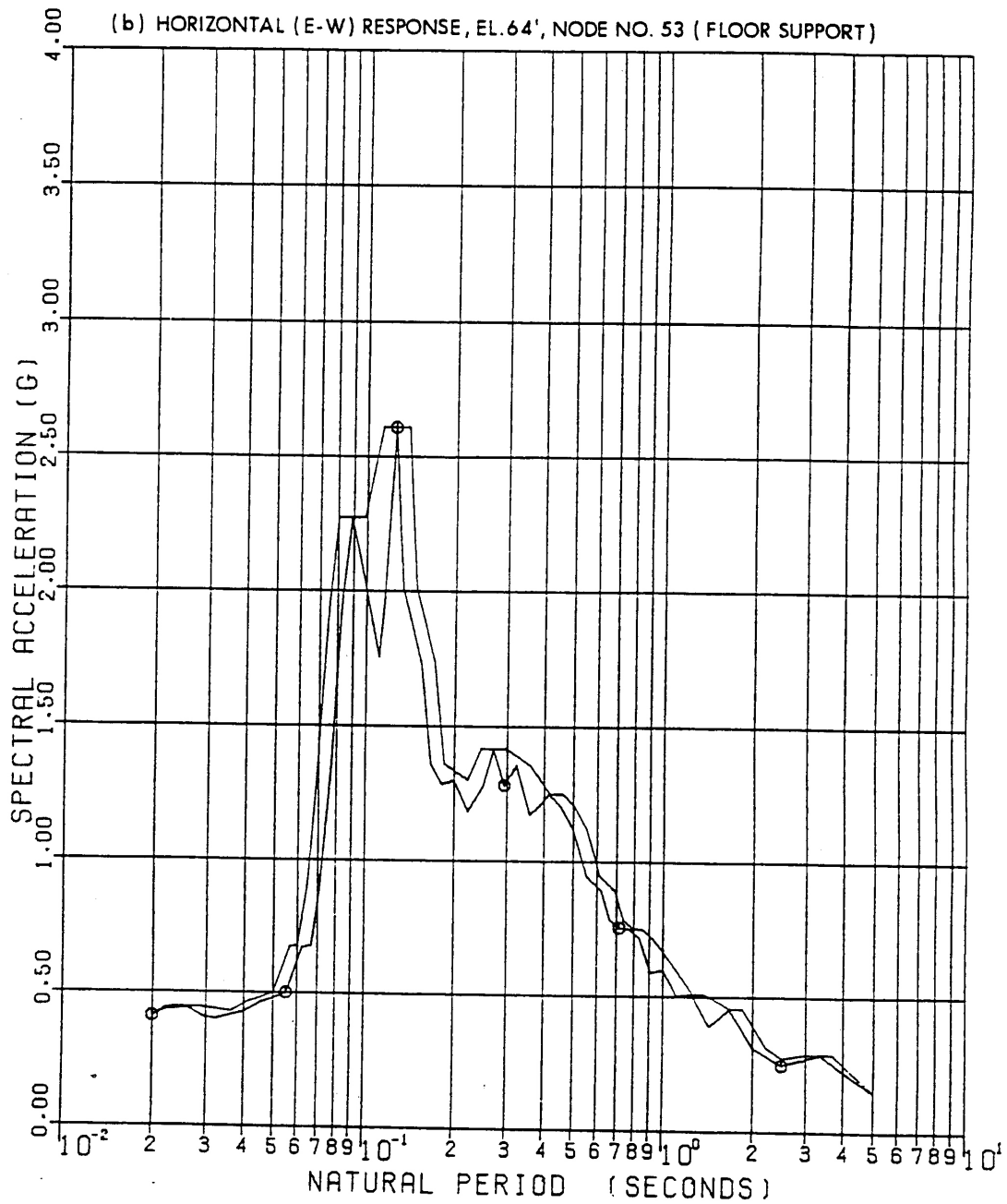

SEABROOK STATION UPDATED FINAL SAFETY ANALYSIS REPORT	Amplified Response Spectra - SSE - Fuel Storage Building - 7% Structural Damping; 2% Equipment Damping [4 Sheets]	
	Figure 3.7(B)-29	Sh 2 of 4

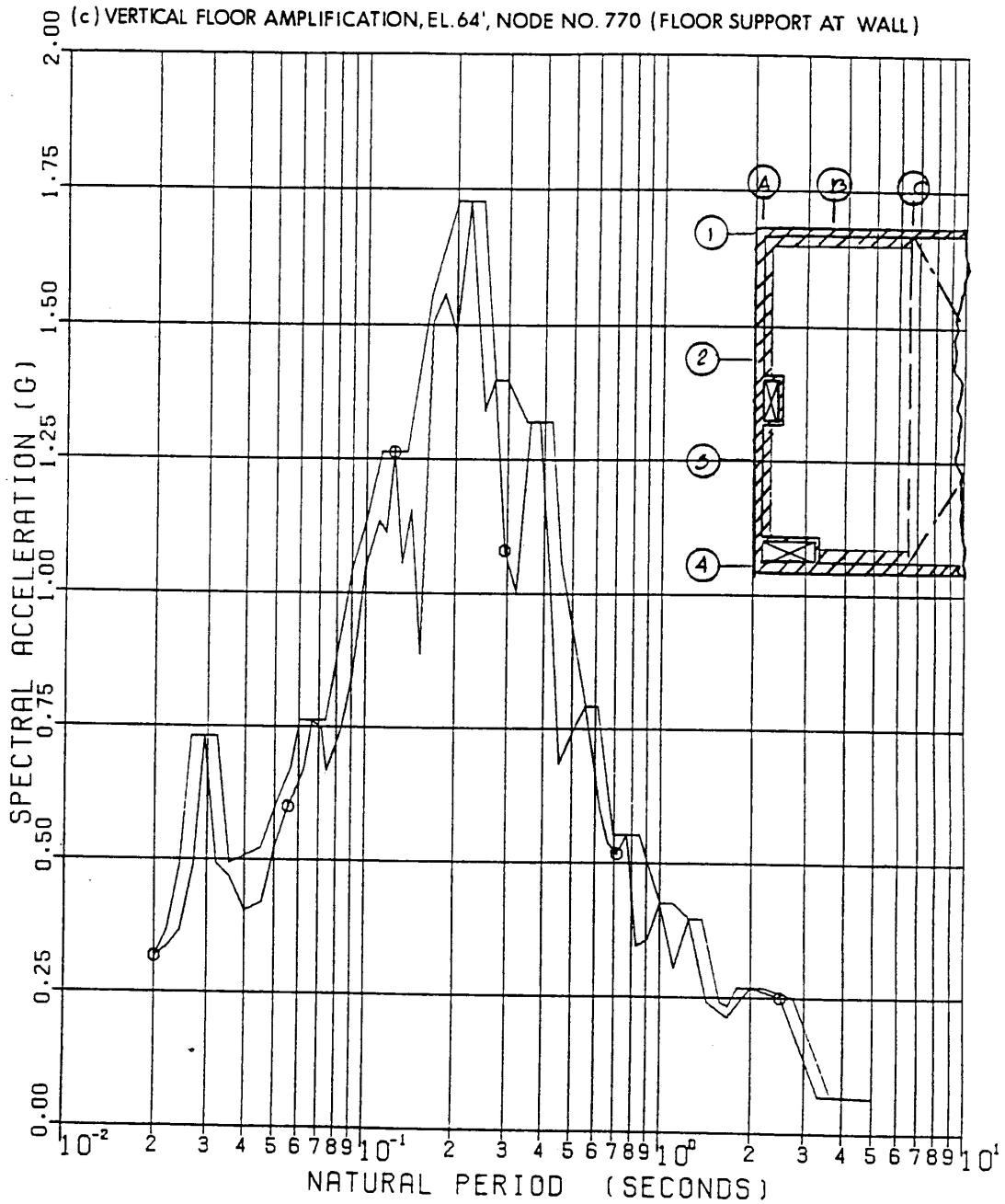

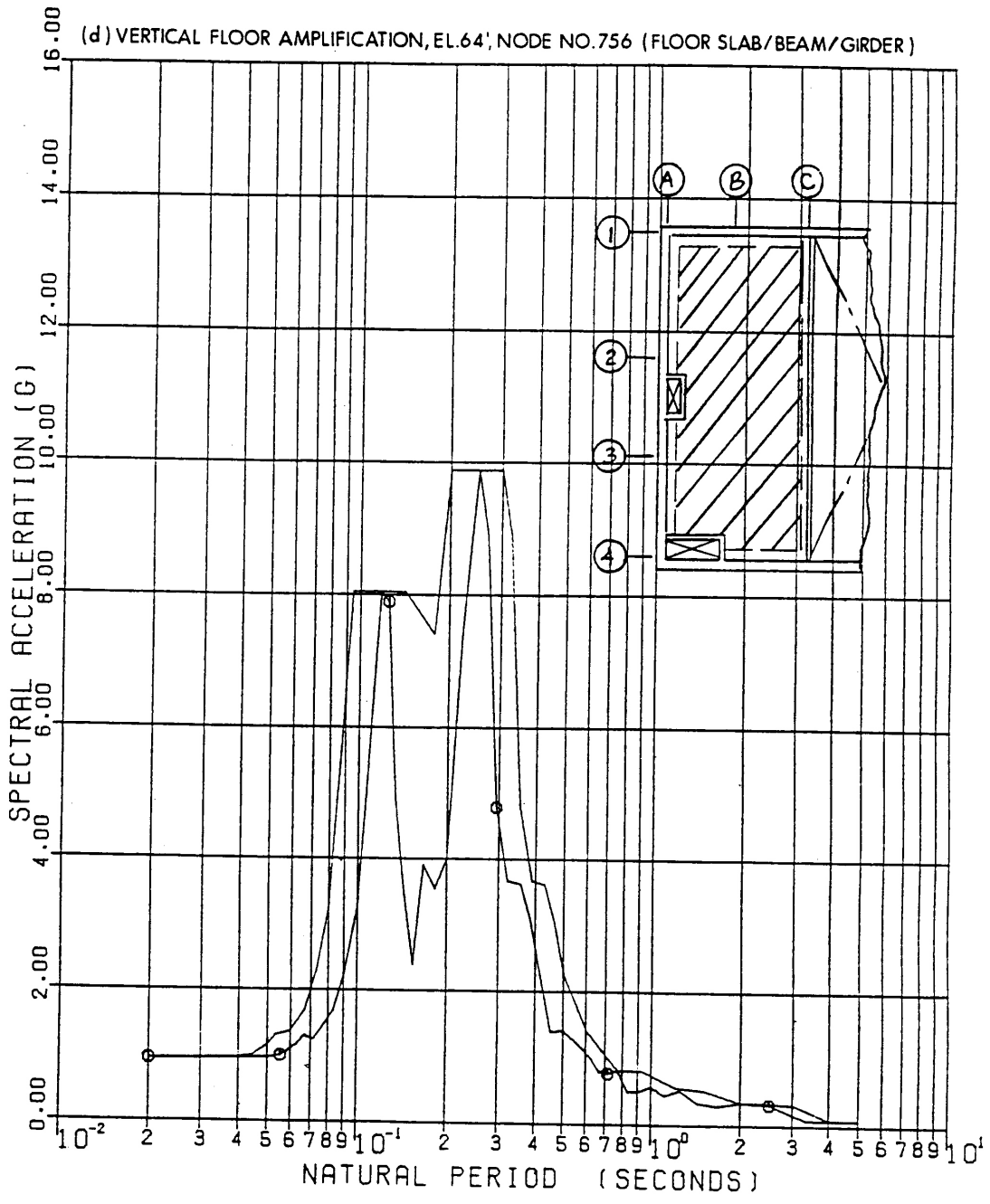

SEABROOK STATION UPDATED FINAL SAFETY ANALYSIS REPORT	Amplified Response Spectra - SSE - Fuel Storage Building - 7% Structural Damping; 2% Equipment Damping [4 Sheets]
	Figure 3.7(B)-29      Sh 4 of 4

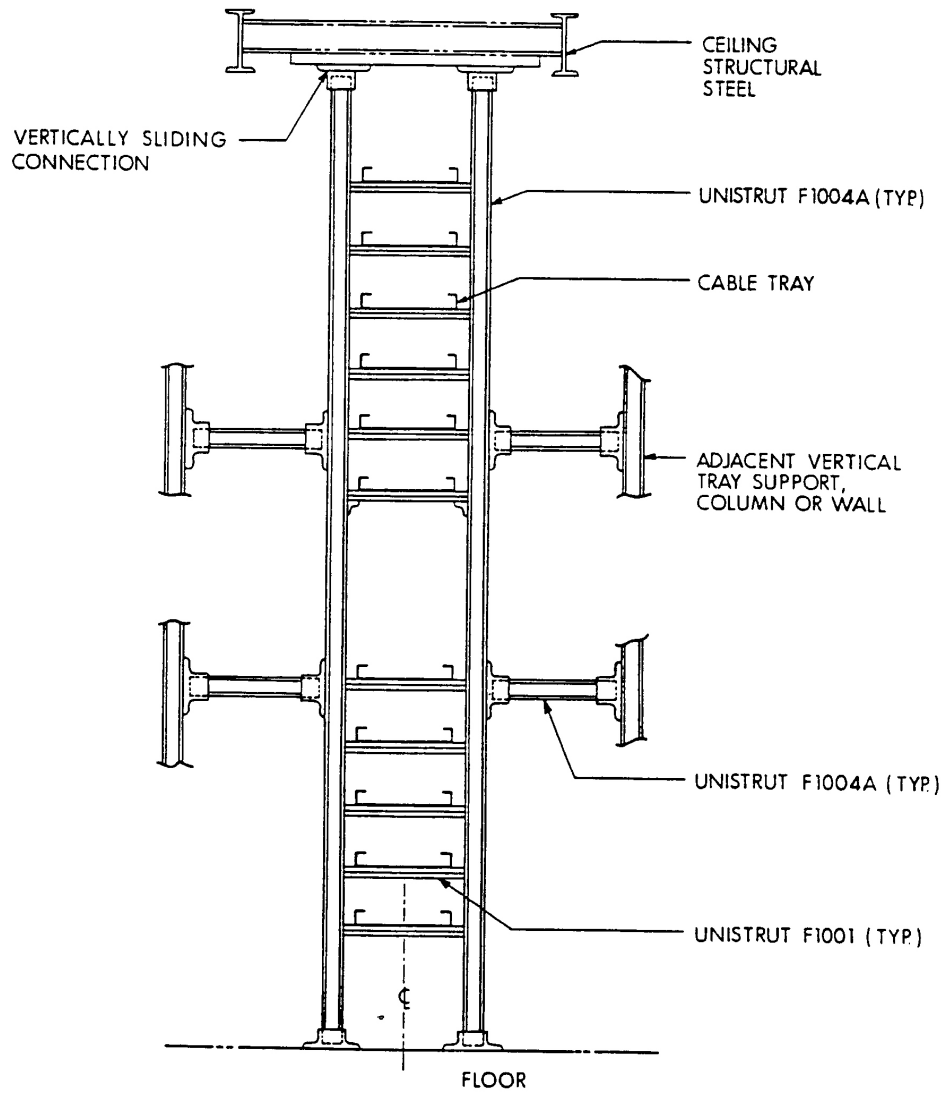

SEABROOK STATION UPDATED FINAL SAFETY ANALYSIS REPORT	Typical Ceiling-to-Floor Supported Cable Tray System	
		Figure 3.7(B)-30

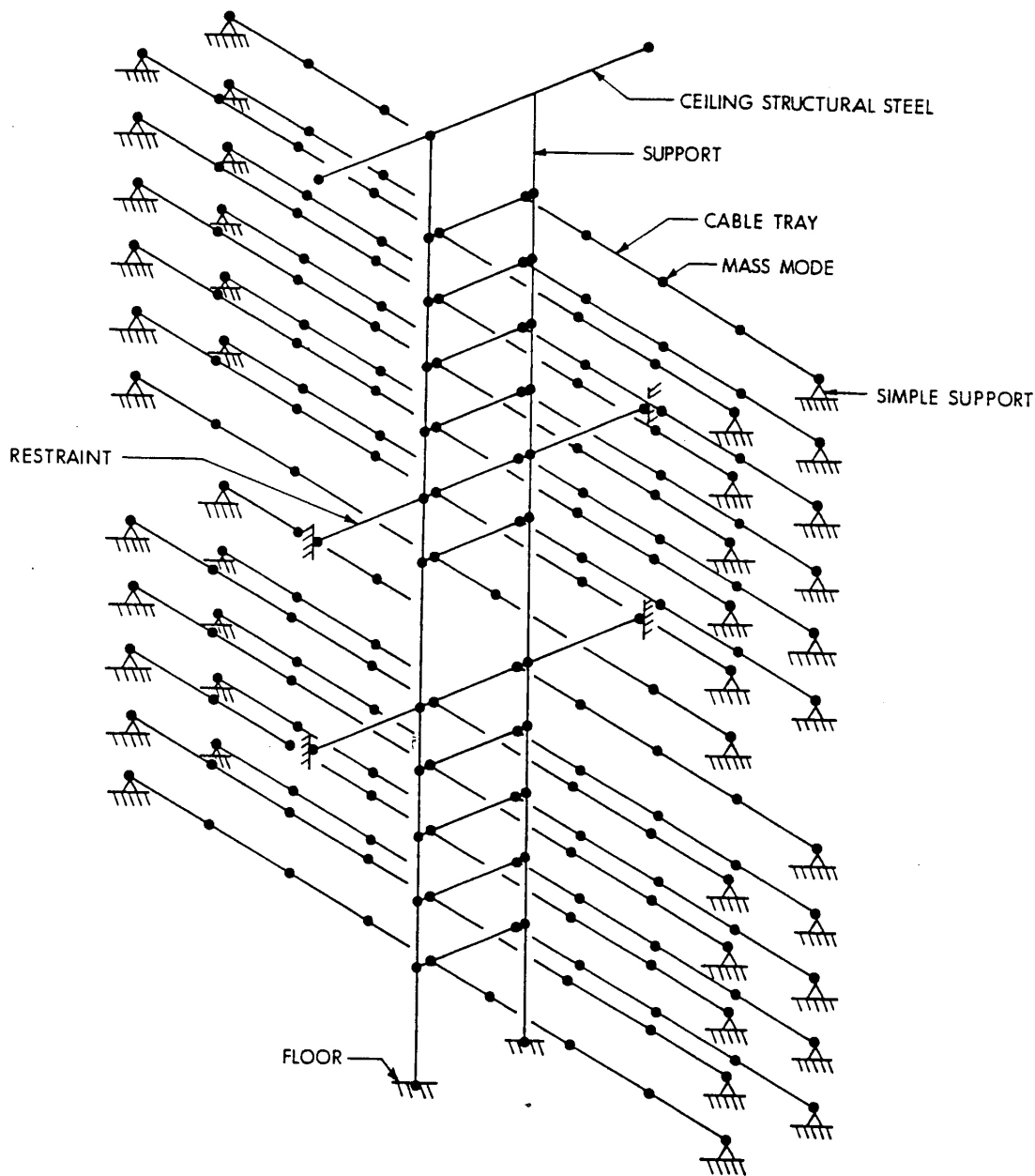

SEABROOK STATION UPDATED FINAL SAFETY ANALYSIS REPORT	Mathematical Model of Typical Ceiling-to-Floor Supported Cable Tray System	
		Figure 3.7(B)-31

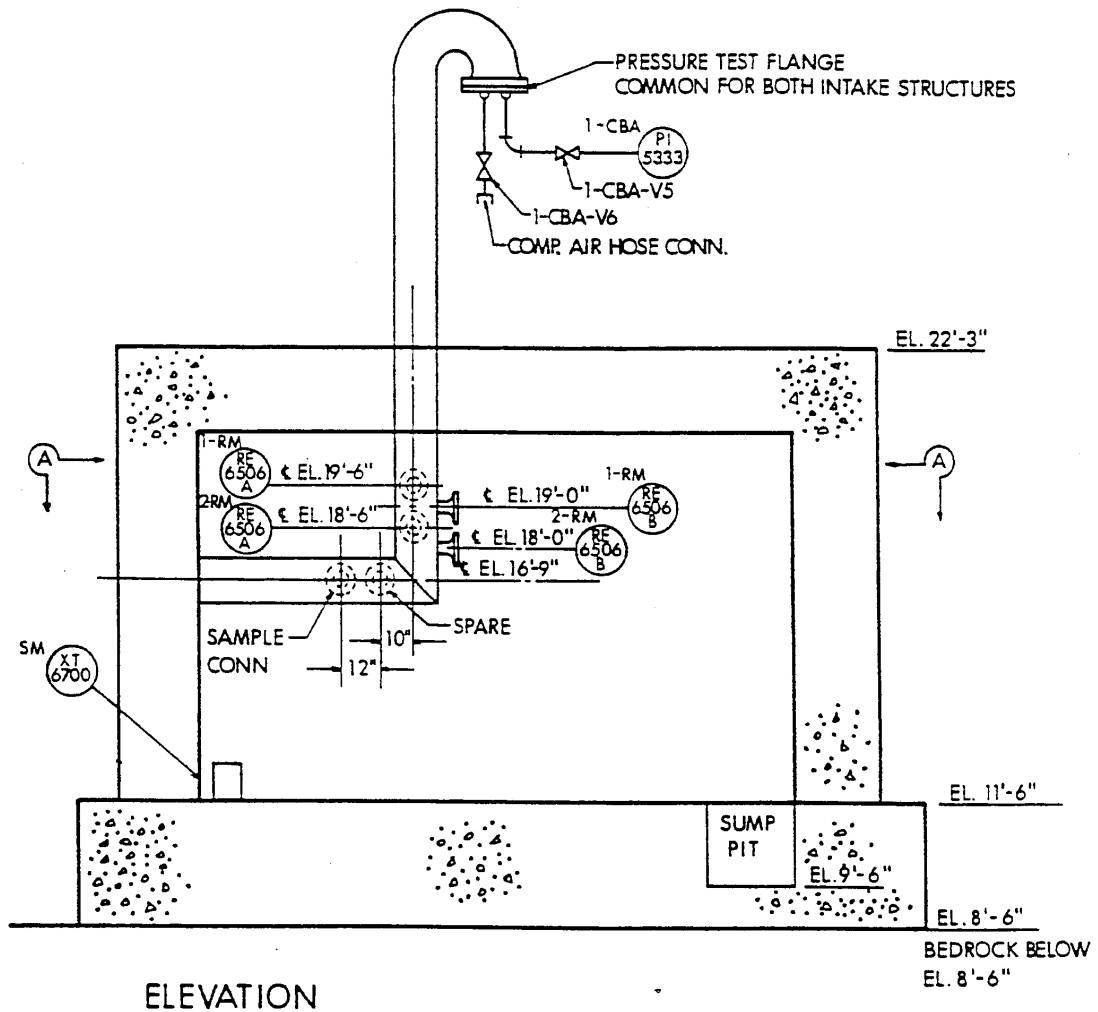

SEABROOK STATION UPDATED FINAL SAFETY ANALYSIS REPORT	Mounting Detail of Triaxial Time History Accelerograph, XT-6700, in East Air Intake Structure	
	Figure	3.7(B)-32

NOTES

1. TORQUE THE INST. MOUNTING SCREW TO  $40 \pm 10$  IN-LBS
2. TORQUE U-BOLTS TO 80 FT-LBS  $\pm 20$
3. LEVEL MOUNTING PLATE WITHIN  $1/4"$  ( $1/64"$  IN  $3 1/2"$ ).
4. EDGE OF MOUNTING PLATE TO BE PARALLEL WITH  $\phi$  OF PIPE.
5. ALIGN LONG SIDE OF INSTRUMENT PARALLEL WITH THE EDGE OF MOUNTING PLATE WITHIN  $3"$  ( $1/4"$  IN  $5"$ ).

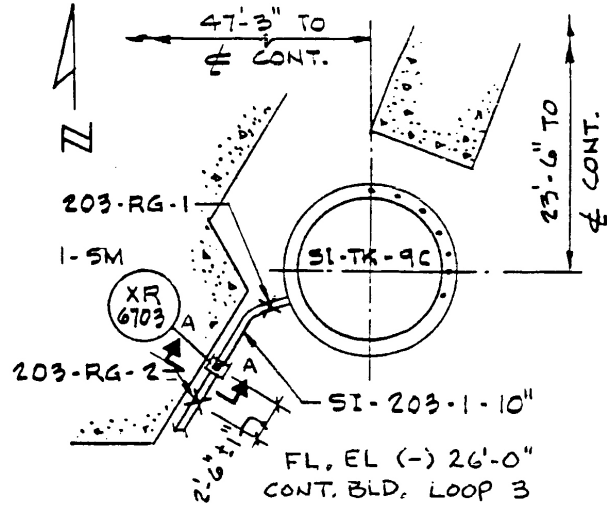

KEY PLAN

N.T.S.

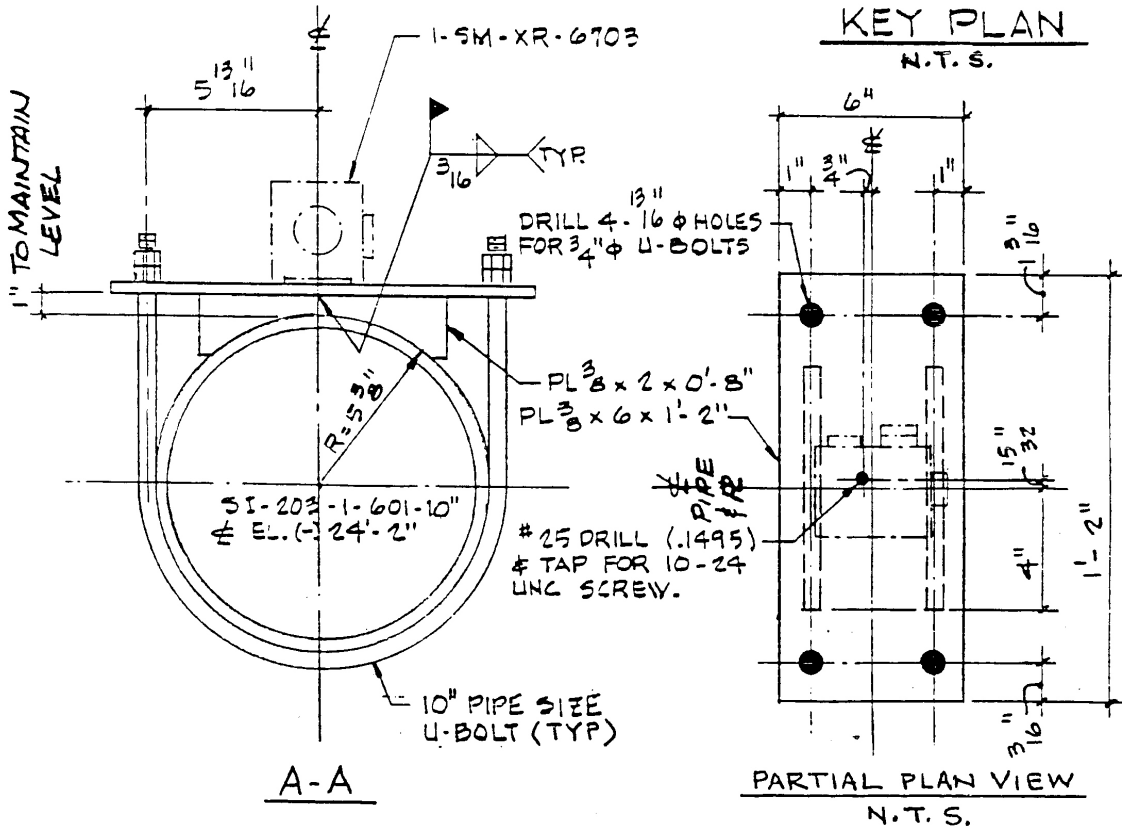

MOUNTING DETAIL

SEABROOK STATION UPDATED FINAL SAFETY ANALYSIS REPORT	Mounting Detail of Triaxial Peak Accelerograph, XR-6703, on Safety Injection Piping (Line 203)	
	Figure	3.7(B)-33

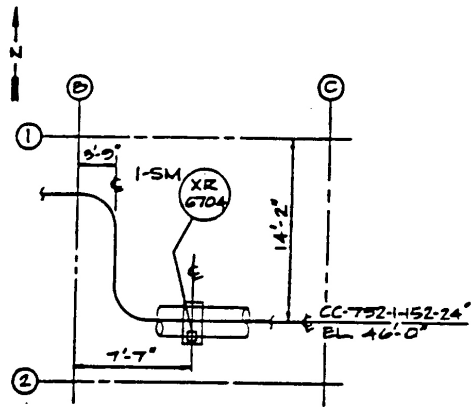

KEY PLAN AT FLR, EL. 25'-0"  
PRIMARY AUXILIARY BUILDING  
(N.T.S.)

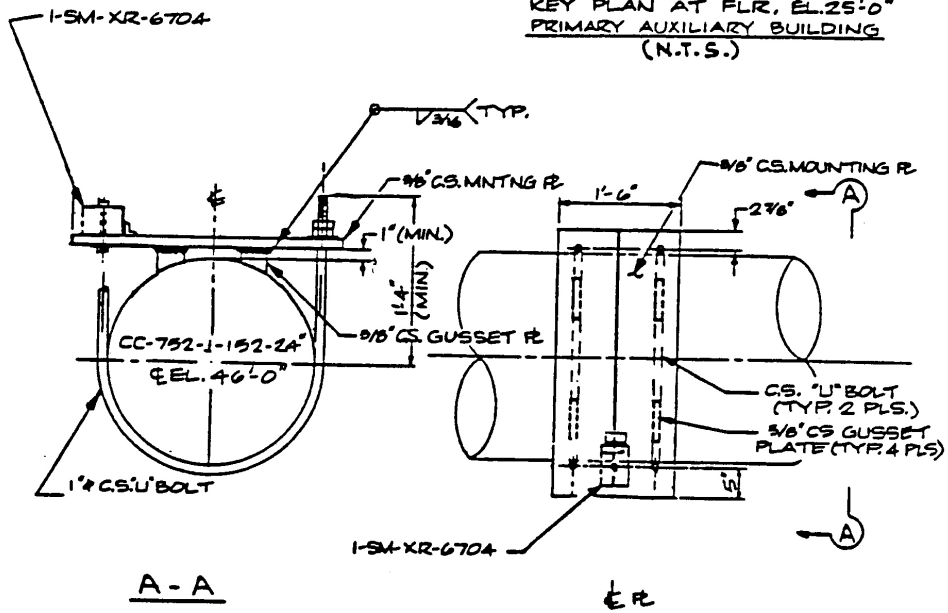

PARTIAL PLAN VIEW  
(N.T.S.)

MOUNTING DETAIL

SEABROOK STATION UPDATED FINAL SAFETY ANALYSIS REPORT	Mounting Detail of Triaxial Peak Accelerograph, XR-6704, on PCCW Piping	
	Figure	3.7(B)-34



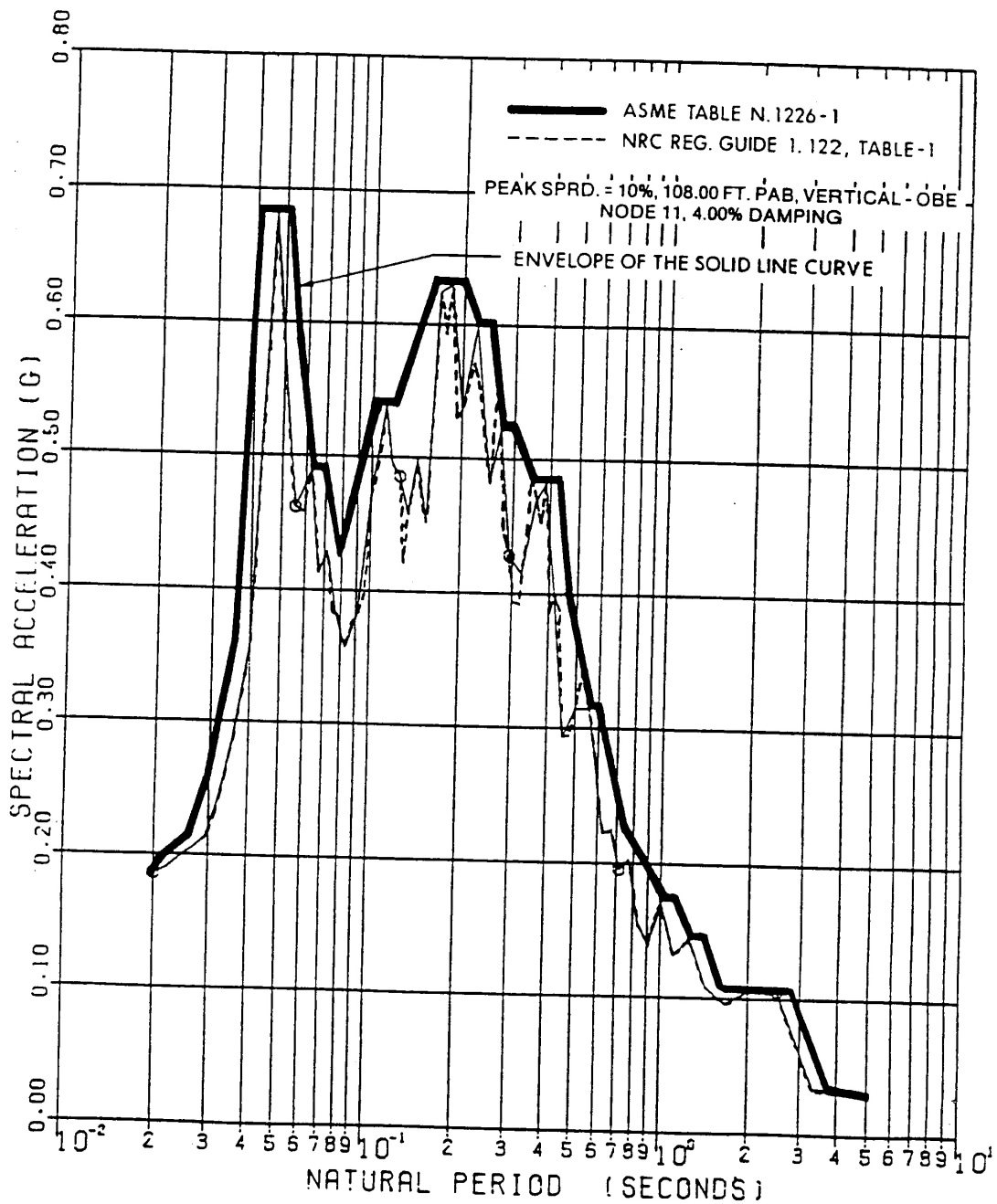

SEABROOK STATION UPDATED FINAL SAFETY ANALYSIS REPORT	Primary Auxiliary Building Amplified Response Spectra (Vertical) OBE, 4% Damping	
	Figure	3.7(B)-35

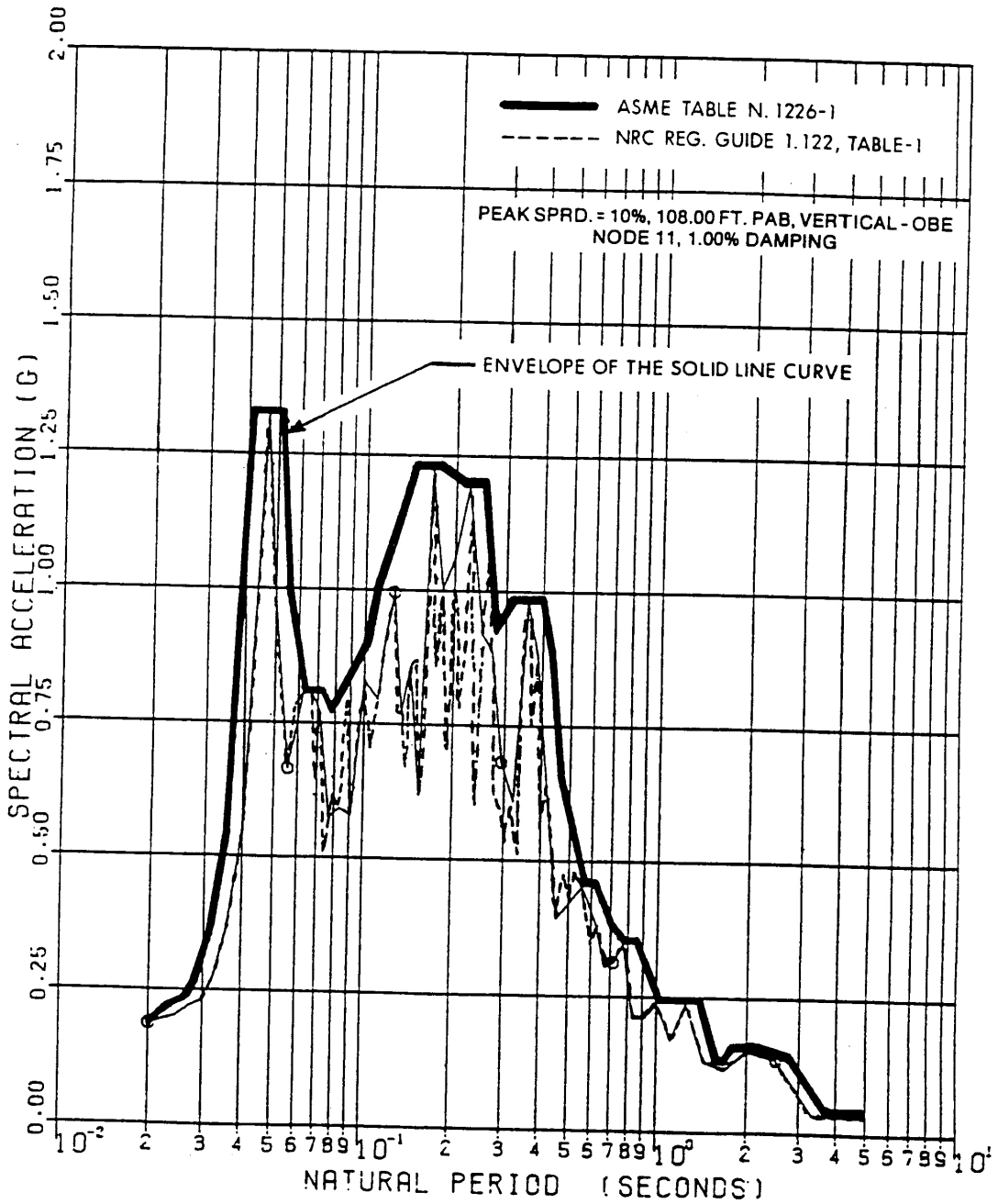

SEABROOK STATION UPDATED FINAL SAFETY ANALYSIS REPORT	Primary Auxiliary Building Amplified Response Spectra (Vertical) OBE, 1% Damping	
		Figure 3.7(B)-36

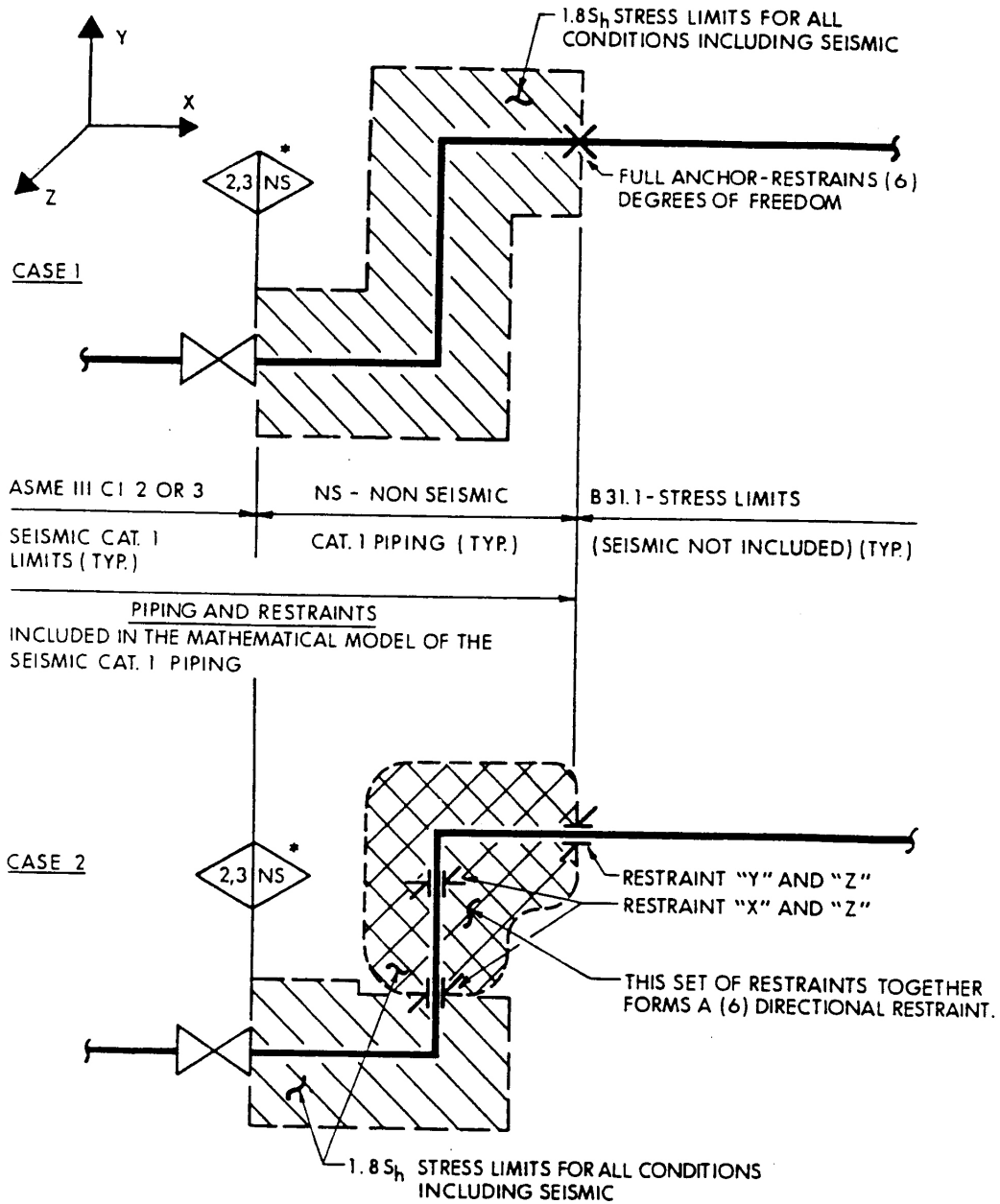

\* SYMBOL INDICATES BOUNDARY BETWEEN ASME III CLASS 2 OR 3 AND NON-SEISMIC PIPING.

SEABROOK STATION UPDATED FINAL SAFETY ANALYSIS REPORT	Typical Pipe Support Systems	
		Figure 3.7(B)-37

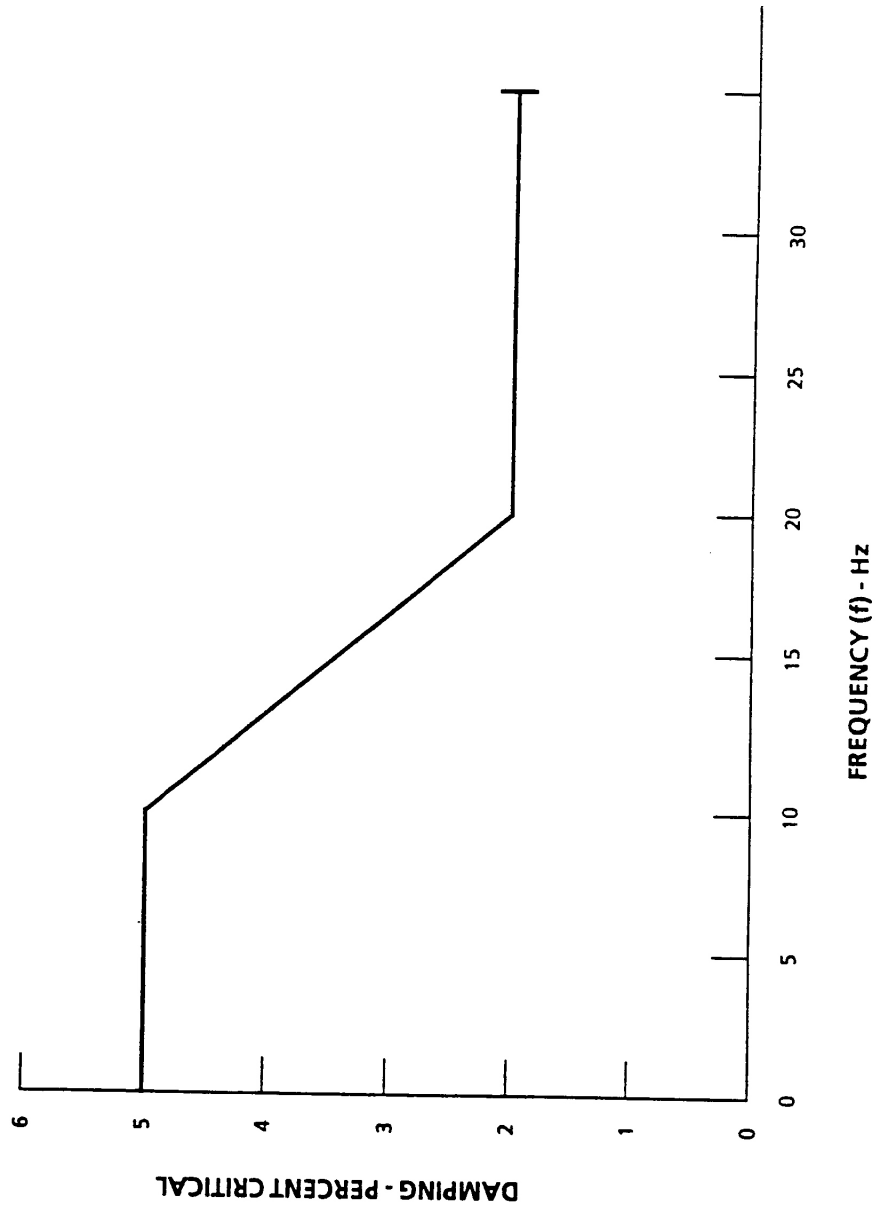

SEABROOK STATION UPDATED FINAL SAFETY ANALYSIS REPORT	Alternative to Regulatory Guide 1.61 Damping Values	
		Figure 3.7(B)-38

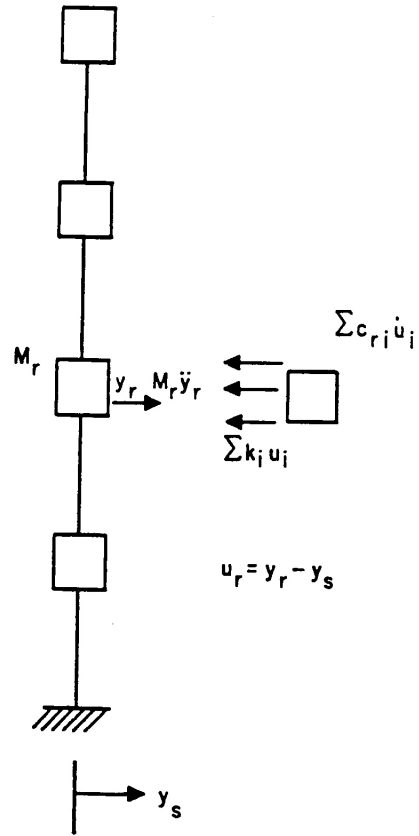

SEABROOK STATION UPDATED FINAL SAFETY ANALYSIS REPORT	Multi-Degree of Freedom System	
		Figure 3.7(N)-1