



---

Florida Power & Light Company  
Turkey Point Plant, Units 6 & 7  
COL Application

**COLA Table of Contents**

Part 1 — General and Financial Information

Part 2 — Final Safety Analysis Report (FSAR)

Part 3 — Applicant's Environmental Report (ER)

Part 4 — Technical Specifications

Part 5 — Emergency Plan

Part 6 — Limited Work Authorization (LWA)/Redress Plan

Part 7 — Departures and Exemption Requests

Part 8 — Safeguards/Security Plans

Part 9 — Withheld Information

Part 10 — License Conditions (Including ITAAC)

Part 11 — Enclosures

---

**Turkey Point Nuclear Plant Units 6 & 7**

**COL Application**

**Revision 6**

**Part 5**

**Emergency Plan**

**Turkey Point Plant  
COL Application  
Part 5, Emergency Plan**

Explanatory notes regarding the Emergency Plan and Supplemental Information:

The Turkey Point Plant Radiological Emergency Plan consists of a full and integrated emergency plan, three annexes, and six appendices. The plan is formatted in accordance with NUREG-0654 and provides detailed information regarding each of the sixteen Planning Standards and associated Evaluation Criteria. Part 1 of the plan provides introductory information, and Part 2 provides generic information applicable to any of the units. The three annexes describe unit specific information. Specifically, Annex 1 applies to the existing Units 3 & 4; Annex 2 applies to the new Unit 6; and Annex 3 applies to the new Units 6 & 7. The six appendices that follow provide a list of references; list of letters of agreement; list of procedure cross-reference to the emergency plan; abbreviations, acronyms and definitions; reference to the evacuation time estimate study; and a cross-reference of the plan to NUREG-0654.

The following table delineates documents included in COLA Part 5. The local emergency plans (Supplements 8 and 9 below) are being submitted under Part 9 of the application per 10 CFR 2.390. Emergency Planning Inspections, Tests, Analyses and Acceptance Criteria (ITAAC) are included in Part 10 of the COLA.

<b>COLA Part 5</b>	
Integrated Plan	Turkey Point Plant Radiological Emergency Plan
<b>Supplemental Information</b>	
1.	Turkey Point Nuclear Power Plant Evacuation Time Estimate
2.	Turkey Point Plant (PTN) COLA Emergency Plan Regulatory Requirements Matrix
3.	State and County 10 CFR 52.79(a)(22) Certification Letters
4.	Letters of Agreement
5.	NUREG-0654 Section II, Evaluation Criteria Cross-Reference to Florida Radiological Emergency Management Plan (REMP) & Appendix II, Turkey Point Nuclear Plant Site Plan
6.	The State of Florida Radiological Emergency Preparedness Annex (Annex to the State Comprehensive Emergency Management Plan) – w/o Appendices
7.	The State of Florida Radiological Emergency Preparedness Annex, Appendix II, Turkey Point Nuclear Power Plant Site Plan
8.	Turkey Point Response Plan, Miami-Dade County, Florida
9.	Radiological Emergency Preparedness Plan AND Standard Operating Procedures, Monroe County, Florida

**FLORIDA POWER & LIGHT COMPANY**

**TURKEY POINT PLANT  
RADIOLOGICAL EMERGENCY PLAN**

**REVISION 6**



	<u>Page</u>
<b>Part 1: Introduction</b> .....	1-1
<b>Section A: Purpose</b> .....	1-1
<b>Section B: Background</b> .....	1-2
1. Facility Description .....	1-2
2. Emergency Planning Zone.....	1-3
<b>Section C: Scope</b> .....	1-4
<b>Section D: Planning Basis</b> .....	1-4
<b>Section E: Contiguous-Jurisdiction Emergency Planning</b> .....	1-5
<b>Section F: Integrated Guidance and Criteria</b> .....	1-5
<b>Section G: Technical Assistance</b> .....	1-5
<b>Section H: Emergency Response Organization</b> .....	1-5
<b>Section I: Federal Response</b> .....	1-5
<b>Section J: Form and Content of Plan</b> .....	1-6
<b>Part 2: Planning Standards and Criteria</b> .....	2A-1
<b>Section A: Assignment of Responsibility</b> .....	2A-1
1. Concept of Operations .....	2A-1
2. State and County Functions and Responsibilities .....	2A-11
3. Agreements in Planning Effort .....	2A-11
4. Continuous Coverage .....	2A-12
<b>Section B: Emergency Response Organization</b> .....	2B-1
1. On-Shift Emergency Response Organization Assignments .....	2B-1
2. Authority over the Emergency Response Organization .....	2B-3
3. Criteria for Assuming Command and Control (Succession) .....	2B-4
4. Emergency Coordinator Responsibilities/Non-Delegable Duties .....	2B-4
5. Emergency Response Organization Positional Responsibilities .....	2B-5
6. Emergency Response Organization Block Diagram.....	2B-17
7. Industry/Private Support Organizations .....	2B-17
8. Supplemental Emergency Assistance to the Emergency Response Organization .....	2B-19
<b>Section C: Emergency Response Support and Resources</b> .....	2C-1
1. Federal Response Support and Resources.....	2C-1
2. Liaisons .....	2C-2
3. Radiological Laboratories.....	2C-2
4. Other Assistance .....	2C-2
<b>Section D: Emergency Classification System</b> .....	2D-1
1. Emergency Classification System.....	2D-1
2. Emergency Action Level Technical Basis .....	2D-7
3. Offsite Classification Systems.....	2D-8
4. Offsite Emergency Procedures .....	2D-8

<b>Section E: Notification Methods and Procedures</b> .....	2E-1
1. Bases for Emergency Response Organization .....	2E-1
2. Notification and Mobilization of Emergency Response Personnel .....	2E-1
3. Initial Notification Messages .....	2E-3
4. Follow-Up Messages.....	2E-4
5. State and County Information Dissemination .....	2E-5
6. Notification of the Public.....	2E-5
7. Messages to the Public.....	2E-6
<b>Section F: Emergency Communications</b> .....	2F-1
1. Communications/Notifications.....	2F-1
2. Communications with Fixed and Mobile Medical Support Facilities .....	2F-5
3. Communications Testing.....	2F-5
<b>Section G: Public Education and Information</b> .....	2G-1
1. Public Information Publication.....	2G-1
2. Public Education Materials.....	2G-1
3. Media Accommodations.....	2G-2
4. Coordination of Public Information .....	2G-3
5. Media Orientation.....	2G-4
<b>Section H: Emergency Facilities and Equipment</b> .....	2H-1
1. Control Room, TSC, and OSC.....	2H-1
2. Emergency Operations Facility .....	2H-5
3. Emergency News Center .....	2H-6
4. Emergency Operations Centers.....	2H-7
5. Activation.....	2H-7
6. Monitoring Equipment Onsite.....	2H-8
7. Monitoring Equipment Offsite.....	2H-12
8. Offsite Monitoring Equipment Storage.....	2H-13
9. Meteorological Monitoring .....	2H-13
10.OSC Capabilities .....	2H-13
11.Facility and Equipment Readiness.....	2H-14
12.Emergency Equipment and Supplies.....	2H-14
13.Collection Point for Field Samples .....	2H-15
<b>Section I: Accident Assessment</b> .....	2I-1
1. Plant Parameters and Corresponding Emergency Classification .....	2I-1
2. Onsite Accident Assessment Capabilities.....	2I-1
3. Source Term Determination.....	2I-2
4. Effluent Monitor Data and Dose Projection .....	2I-3
5. Meteorological Information.....	2I-4
6. Unmonitored Release .....	2I-5
7. Field Monitoring.....	2I-5
8. Field Monitoring Teams.....	2I-6
9. Iodine Monitoring.....	2I-7
10.Dose Estimates .....	2I-7
11.State/Federal Monitoring Capabilities .....	2I-7

<b>Section J: Protective Response</b> .....	2J-1
1. Notification of Onsite Personnel.....	2J-1
2. Evacuation Locations.....	2J-1
3. Radiological Monitoring of Evacuees.....	2J-2
4. Protective Actions for Onsite Personnel .....	2J-3
5. Accountability .....	2J-4
6. Provisions for Onsite Personnel.....	2J-4
7. Mechanism for Implementing Protective Action Recommendations .....	2J-5
8. Evacuation Time Estimate .....	2J-6
9. Capability of Implementing Protective Action Recommendations .....	2J-6
10. Implementation of Protective Action Recommendations .....	2J-7
11. Ingestion Pathway Protective Measures.....	2J-8
12. Monitoring of Evacuees.....	2J-8
<b>Section K: Radiological Exposure Control</b> .....	2K-1
1. Emergency Exposure Guidelines.....	2K-1
2. Emergency Radiation Protection Program.....	2K-2
3. Personnel Monitoring .....	2K-3
4. Non-Turkey Point Personnel Exposure Authorization .....	2K-3
5. Contamination and Decontamination.....	2K-4
6. Contamination Control Measures .....	2K-4
7. Decontamination of Relocated Personnel.....	2K-5
<b>Section L: Medical and Public Health Support</b> .....	2L-1
1. Offsite Hospital and Medical Services .....	2L-1
2. Onsite First Aid Capability.....	2L-2
3. Medical Service Facilities.....	2L-3
4. Medical Transportation.....	2L-3
<b>Section M: Reentry and Recovery Planning</b> .....	2M-1
1. Reentry and Recovery .....	2M-1
2. Recovery Organization.....	2M-4
3. Recovery Phase Notifications.....	2M-8
4. Total Population Exposure .....	2M-8
<b>Section N: Drill and Exercise Program</b> .....	2N-1
1. Exercises.....	2N-1
2. Drills .....	2N-3
3. Conduct of Drills and Exercises .....	2N-4
4. Critique and Evaluation.....	2N-5
5. Resolution of Drill and Exercise Findings .....	2N-6
<b>Section O: Emergency Response Training</b> .....	2O-1
1. Assurance of Training .....	2O-1
2. Functional Training of the Emergency Response Organization .....	2O-2
3. First-Aid Response.....	2O-2
4. Emergency Response Organization Training Program .....	2O-2
5. General, Initial, and Annual Training Program Maintenance .....	2O-3

<b>Section P: Responsibility for the Planning Effort</b> .....	2P-1
1. Emergency Preparedness Staff Training .....	2P-1
2. Authority for the Emergency Preparedness Effort .....	2P-1
3. Responsibility for Development and Maintenance of the Plan .....	2P-1
4. Emergency Plan and Agreement Revisions .....	2P-2
5. Emergency Plan Distribution.....	2P-3
6. Supporting Emergency Response Plans .....	2P-3
7. Implementing and Supporting Procedures.....	2P-4
8. Table of Contents and Cross-Reference to Planning Criteria.....	2P-4
9. Audit/Assessment of the Emergency Preparedness Program.....	2P-4
10. Maintenance of Emergency Telephone Numbers .....	2P-5
<b>Annex 1: Units 3 &amp; 4</b> .....	Annex 1-1
<b>Section 1: Introduction</b> .....	Annex 1-3
1. Unit 3 & 4 Description .....	Annex 1-3
<b>Section 2: Organizational Control of Emergencies</b> .....	Annex 1-5
1. Emergency Response Organization On-Shift Positional Responsibilities .....	Annex 1-5
2. Normal Shift Staffing .....	Annex 1-5
3. Shift Emergency Response Positional Responsibilities.....	Annex 1-6
<b>Section 3: Classification of Emergencies</b> .....	Annex 1-9
<b>Section 4: Emergency Facilities and Equipment</b> .....	Annex 1-10
1. Unit-Specific Emergency Facilities.....	Annex 1-10
2. Assessment Resources .....	Annex 1-11
<b>Section 5: Emergency Measures</b> .....	Annex 1-13
1. Protective Actions .....	Annex 1-13
2. Assembly Areas .....	Annex 1-13
3. Evacuation Routes.....	Annex 1-14
<b>Attachment 1: Emergency Action Levels</b> .....	Annex 1-15
<b>Annex 2: Unit 6</b> .....	Annex 2-1
<b>Section 1: Introduction</b> .....	Annex 2-3
1. Unit 6 Description.....	Annex 2-3
<b>Section 2: Organizational Control of Emergencies</b> .....	Annex 2-5
1. Emergency Response Organization On-Shift Positional Responsibilities .....	Annex 2-5
2. Normal Shift Staffing .....	Annex 2-6
3. Shift Emergency Response Positional Responsibilities.....	Annex 2-6
<b>Section 3: Classification of Emergencies</b> .....	Annex 2-9
<b>Section 4: Emergency Facilities and Equipment</b> .....	Annex 2-9
1. Unit-Specific Emergency Facilities.....	Annex 2-9
2. Assessment Resources .....	Annex 2-10
<b>Section 5: Emergency Measures</b> .....	Annex 2-13
1. Protective Actions .....	Annex 2-13
2. Assembly Areas .....	Annex 2-14
3. Evacuation Routes.....	Annex 2-14
<b>Attachment 1: Emergency Action Levels</b> .....	Annex 2-15

**Annex 3: Units 6 & 7** ..... Annex 3-1

**Section 1: Introduction** ..... Annex 3-3

1. Units 6 & 7 Description..... Annex 3-3

**Section 2: Organizational Control of Emergencies** ..... Annex 3-5

1. Emergency Response Organization On-Shift Positional Responsibilities ..... Annex 3-5

2. Normal Shift Staffing ..... Annex 3-6

3. Shift Emergency Response Positional Responsibilities..... Annex 3-6

**Section 3: Classification of Emergencies** ..... Annex 3-8

**Section 4: Emergency Facilities and Equipment** ..... Annex 3-8

1. Unit-Specific Emergency Facilities..... Annex 3-8

2. Assessment Resources ..... Annex 3-9

**Section 5: Emergency Measures** ..... Annex 3-12

1. Protective Actions ..... Annex 3-12

2. Assembly Areas ..... Annex 3-13

3. Evacuation Routes ..... Annex 3-13

**Attachment 1: Emergency Action Levels** ..... Annex 3-14

**Appendices**

Appendix 1: References ..... Appendix 1-1

Appendix 2: Letters of Agreement ..... Appendix 2-1

Appendix 3: Procedure Cross-Reference to the Emergency Plan ..... Appendix 3-1

Appendix 4: Abbreviations, Acronyms and Definitions ..... Appendix 4-1

Appendix 5: Evacuation Time Estimate Study ..... Appendix 5-1

Appendix 6: NUREG-0654 Cross Reference Document ..... Appendix 6-1

**Figures**

Figure 1-1	General Location of the Site and Surrounding Area .....	1-7
Figure 1-2	Turkey Point Site Layout.....	1-8
Figure 1-3	10-Mile Emergency Planning Zone.....	1-9
Figure 1-4	50-Mile Emergency Planning Zone.....	1-10
Figure A-1	Agency Response Organization Interrelationships .....	2A-13
Figure A-2	Turkey Point Plant Augmented Emergency Response Organization Interrelationships .....	2A-14
Figure B-1a	Overall Emergency Response Organization Command Structure.....	2B-20
Figure B-1b.a	Onsite Emergency Response Organization.....	2B-21
Figure B-1b.b	Onsite Emergency Response Organization-TSC .....	2B-22
Figure B-1b.c	Onsite Emergency Response Organization-OSC.....	2B-23
Figure B-1c	Offsite Emergency Response Organization.....	2B-24
Figure B-1d	Emergency News Center Organization.....	2B-25
Figure F-1	Notification Scheme (After Full Augmentation).....	2F-6
Figure F-2	Emergency Response Facility Communications Matrix.....	2F-7
Figure F-3	NRC Communications for Nuclear Response.....	2F-8
Figure I-1	Environmental Survey Team Map Turkey Point Nuclear Power Plant – 10 Mile EPZ .....	2I-8
Figure J-1	Sector Population Distribution.....	2J-9
Figure J-2	Protective Action Recommendations Based on Plant Conditions and Offsite Dose Estimates .....	2J-10
Figure J-3	Evacuation Routes and Assembly Areas.....	2J-13
Figure A1-1	Units 3 & 4 Facility Layout .....	Annex 1-4
Figure B1-1	Unit 6 Facility Layout.....	Annex 2-4
Figure C1-1	Units 6 & 7 Facility Layout .....	Annex 3-4

**Tables**

Table B-1b	Staffing Requirements for the Turkey Point Plant Emergency Response Organization .....	2B-26
Table H-1	Typical Emergency Supplies Available for Emergency Response Facilities.....	2H-16
Table I-1	Summary of Available Meteorological Data .....	2I-9
Table I-2	Summary of Available Meteorological Data .....	2I-10
Table K-1	Emergency Exposure Guidelines.....	2K-2
Table 2-1	Turkey Point Unit Emergency Response Organization On-Shift Staffing.....	Annex 1-5
Table B-1a	Unit Shift Emergency Response Organization.....	Annex 1-8
Table 2-1	Turkey Point Emergency Response Organization On-Shift Staffing.....	Annex 2-5
Table B-1a	Shift Emergency Response Organization .....	Annex 2-8
Table 2-1	Turkey Point Emergency Response Organization On-Shift Staffing.....	Annex 3-5
Table B-1a	Shift Emergency Response Organization .....	Annex 3-7

## **PART 1: INTRODUCTION**

### **SECTION A: PURPOSE**

As required in the conditions set forth by the NRC for the operating licenses for Turkey Point Units 3, 4, 6, & 7, the management of Florida Power & Light Company (FPL) recognizes its responsibility and authority to operate and maintain the nuclear power plant in such a manner as to provide for the safety of the general public. This document describes the Turkey Point Radiological Emergency Preparedness Program. The philosophy that guides the development and maintenance of this program is the protection of the health and safety of the general public in the communities around the nuclear power plant and the personnel who work at the plant.

This Radiological Emergency Plan establishes the concepts, evaluation and assessment criteria, and protective actions that are necessary to limit and mitigate the consequences of potential or actual radiological emergencies. It has been prepared to establish the procedures and practices for management control over unplanned or emergency events that may occur at Turkey Point. It also provides the necessary prearrangements, directions, and organization so that all nuclear emergencies can be effectively and efficiently resolved.

The Turkey Point Radiological Emergency Preparedness Program consists of the Emergency Plan, Unit Annexes, Emergency Plan Implementing Procedures (EPIPs), and associated program administrative documents. The Emergency Plan outlines the basis for response actions that would be implemented in an emergency. This document is not intended to be used as a procedure.

The Unit Annexes are a part of the Emergency Plan and are subject to the same review and audit requirements as the Emergency Plan.

Annex Format and Specific Content: As a minimum, Unit Annexes shall address the areas described as follows:

- Section 1: Introduction

The unit description is provided along with the inclusion of maps, drawings, and/or diagrams. It describes the specifics of each unit and its location. A summary statement describes the Annex's interface with the Emergency Plan.

- Section 2: Organizational Control of Emergencies

Unit-specific on-shift staffing is outlined in the Unit Annexes to the Emergency Plan. The on-call Emergency Response Organization (ERO) positions are outlined in Section B of the Emergency Plan.

- Section 3: Classification of Emergencies

Unit-specific Emergency Action Levels (EALs) are included for all emergency classes for the purpose of event classification in each Unit Annex.

- Section 4: Emergency Facilities and Equipment

A description of unit-specific facilities and equipment available for use during an emergency response or to support the remainder of the site is included in each Unit Annex.

- Section 5: Emergency Measures

A description of unit-specific personnel protective actions, assembly areas, and evacuation routes are presented.

Detailed EIPs are maintained separately and are used to guide those responsible for implementing emergency response actions.

## **SECTION B: BACKGROUND**

### **1. FACILITY DESCRIPTION**

The Turkey Point site is an approximate 9400-acre tract located near the shores of Biscayne Bay in southeastern Miami-Dade County, Florida. Detailed site location information is contained in the Final Safety Analysis Report (FSAR) for each unit. The site includes seven FPL power plants: two natural gas/oil conventional boiler units (Units 1 & 2), one combined cycle natural gas unit (Unit 5), and four nuclear units (Units 3, 4, 6, & 7). The Units 3 & 4 site is approximately 3300 acres. The Units 6 & 7 site is approximately 218 acres, and the center point of Units 6 & 7 is located approximately 3600 feet south-southwest of Unit 4. The exclusion area boundary (EAB) for Units 3, 4, 6, & 7 is shown in Figure 1-2.

The site is located in Miami-Dade County, in southern Florida approximately 25 miles south of Miami, eight miles east of Florida City, and nine miles southeast of Homestead, Florida. The



closest primary public road is U.S. Highway 1, and typical access to the site is from Palm Drive (SW 344th Street).

Figure 1-1 shows the general location of the Turkey Point site.

Figure 1-2 shows the Exclusion Area Boundary for Units 3, 4, 6 & 7.

## 2. EMERGENCY PLANNING ZONE

The plume exposure pathway Emergency Planning Zone (EPZ) for Turkey Point is an area surrounding the plant with Unit 3 at the center and a radius of approximately 10 miles. Principal exposure sources from the plume exposure pathway are (a) external exposure to gamma and beta radiation from the plume and from deposition materials and (b) exposure of the internal organs to gamma and beta radiation from inhaled radioactive gases and/or radioactive particles. The time of potential exposure can range from hours to days. In coordination with state and county authorities, the same EPZ is used for Turkey Point Units 6 & 7. (Exact boundaries are determined in concurrence with state and county authorities). Figure 1-3 shows the plume exposure EPZ.

The ingestion exposure pathway EPZ is an area surrounding the plant with Unit 3 as the center and a radius of approximately 50 miles. Principal exposure sources from the ingestion exposure pathway are contaminated water or food such as milk or fresh vegetables. The time of potential exposure can range in length from hours to months. Figure 1-4 shows the ingestion exposure EPZ.

The primary hazard consideration at the nuclear power plant is the potential unplanned release of radioactive material resulting from an accident. The probability of such a release is considered very low due to the design of the units and strict operational guidelines enforced by the NRC. Notwithstanding, federal regulations require that an emergency preparedness program exist for each commercial nuclear power plant. FPL has developed this Emergency Plan to minimize the number of ad hoc decisions made during an emergency and to ensure that necessary equipment, supplies, and essential services are available to meet the needs of an emergency.

This Emergency Plan is applicable to Turkey Point and considers the consequences of radiological emergencies, as required by 10 CFR 50.47 and 10 CFR 50 Appendix E. In addition, this Plan addresses guidance and meets the intent of the criteria established and provided within NUREG-0654/FEMA-REP-1 Rev. 1 (NUREG-0654), which is a joint NRC and Federal Emergency Management Agency (FEMA) document. RG 1.101, *Emergency Planning and*

*Preparedness for Nuclear Power Reactors*, endorses the criteria and recommendations in NUREG-0654, as methods acceptable to the NRC staff for complying with the standards in 10 CFR 50.47.

The Emergency Plan also considers the consequences of nonradiological emergencies.

## **SECTION C: SCOPE**

This document describes actions to be taken in the event of a radiological accident at Turkey Point that may impact the health and safety of the general public or plant employees. It also serves to limit the damage to facilities and property, and provides for the restoration of such facilities in the event of an emergency. If such an accident were to occur, the ERO would be put in place and maintained until such time when the plant is returned to a stable condition and the threat to the general public or plant personnel no longer exists. This plan describes the functions and operation of the ERO, including assignments of authority and responsibility. It does not, nor is it intended to, provide guidance for actual plant equipment manipulations. These instructions are contained in site-specific normal and emergency operating procedures, as required by technical specifications and other regulatory guidance. The Emergency Plan provides for identification and evaluation of emergency situations, protective measures, communications, coordination and notification of governmental authorities, document review and control, emergency preparedness assessment, and training of all emergency response personnel. A method for recovering from a declared emergency is also described in this Plan.

## **SECTION D: PLANNING BASIS**

The Emergency Plan, in conjunction with the Unit Annexes and the EIPs and administrative procedures, documents the methods by which the Turkey Point Radiological Emergency Preparedness Program meets the planning standards set forth in 10 CFR 50.47(b) and the requirements of 10 CFR 50 Appendix E.

Development of the Emergency Plan was based on NUREG-0654. Acceptable alternate methods, which deviate from NUREG-0654, are allowed under RG 1.101, "Emergency Planning and Preparedness for Nuclear Power Reactors". However, any and all deviations will be documented in the respective Unit Annexes and evaluated as continuing to meet the planning standards of 10 CFR 50.47(b) and 10 CFR 50 Appendix E. This evaluation process is employed to ensure the continued effectiveness of the Emergency Plan and respective Unit Annexes.

Other applicable regulations, publications, and guidance were used (see Appendix 1, References) along with site-specific documents to ensure consistency in the planning effort.

## **SECTION E: CONTIGUOUS-JURISDICTION EMERGENCY PLANNING**

The Emergency Plan recognizes the state of Florida, in cooperation with the EPZ counties, as the overall authority responsible for protective action areas to protect the health and safety of the general public.

## **SECTION F: INTEGRATED GUIDANCE AND CRITERIA**

This Plan was developed in conjunction with federal, state, and county emergency response plans to ensure a consistent and integrated response to a classified event.

## **SECTION G: TECHNICAL ASSISTANCE**

FPL is dedicated to providing the level of support necessary, as dictated by federal regulation, to ensure appropriate integration of the state, county, and Turkey Point radiological emergency preparedness programs.

## **SECTION H: EMERGENCY RESPONSE ORGANIZATION**

FPL acknowledges its primary responsibility for planning and implementing emergency measures within the EAB and for overall plant accident assessment. These emergency measures include corrective actions, protective measures, and aid for personnel onsite. To accomplish these responsibilities, FPL has established an augmented ERO that will be mobilized to provide the initial response to an event classified as an *Alert*, *Site Area Emergency*, or *General Emergency*. The ERO may be partially or fully activated during an *Unusual Event*, if the Emergency Coordinator determines their assistance is needed to mitigate the event. In addition, advance arrangements have been made with offsite organizations for special emergency assistance such as ambulance, medical, hospital, fire, and police services.

This Plan describes a framework for an organization to direct the recovery of the unit(s) from an emergency. It is recognized that the normal plant organization will be used for much of the recovery effort, with additional resources identified at the time of the event.

## **SECTION I: FEDERAL RESPONSE**

Provisions are made within the Emergency Plan for the integration of federal assistance activities, as appropriate. Arrangements have been made to accommodate a federal response organization presence in the Turkey Point emergency response facilities as well as support communications between Turkey Point and federal emergency facilities.

**SECTION J: FORM AND CONTENT OF PLAN**

In accordance with regulatory guidance provided in NUREG-0800, the Emergency Plan is referenced in Chapter 13 of each unit's FSAR. The Emergency Plan is administratively maintained as a separate document.

Appendix 3, *Procedure Cross-Reference to Emergency Plan*, provides a subject matter cross-reference between the NUREG-0654 evaluation criteria and the EIPs and applicable administrative documents. Appendix 6 is a specific requirements cross-reference between the Emergency Plan and NUREG-0654.

Figure 1-1. General Location of the Site and Surrounding Area



Figure 1-2. Turkey Point Site Layout

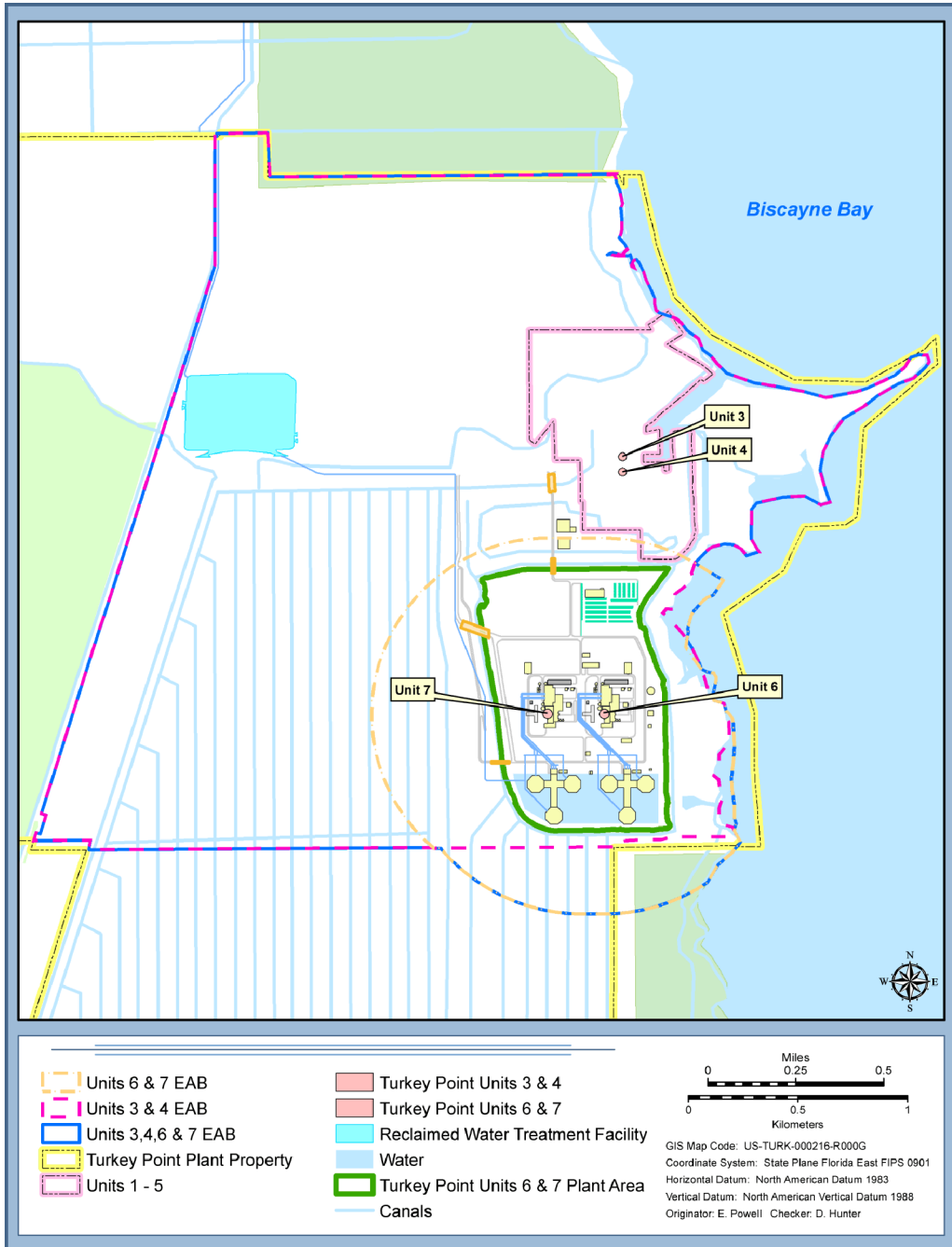

Figure 1-3. 10-Mile Emergency Planning Zone

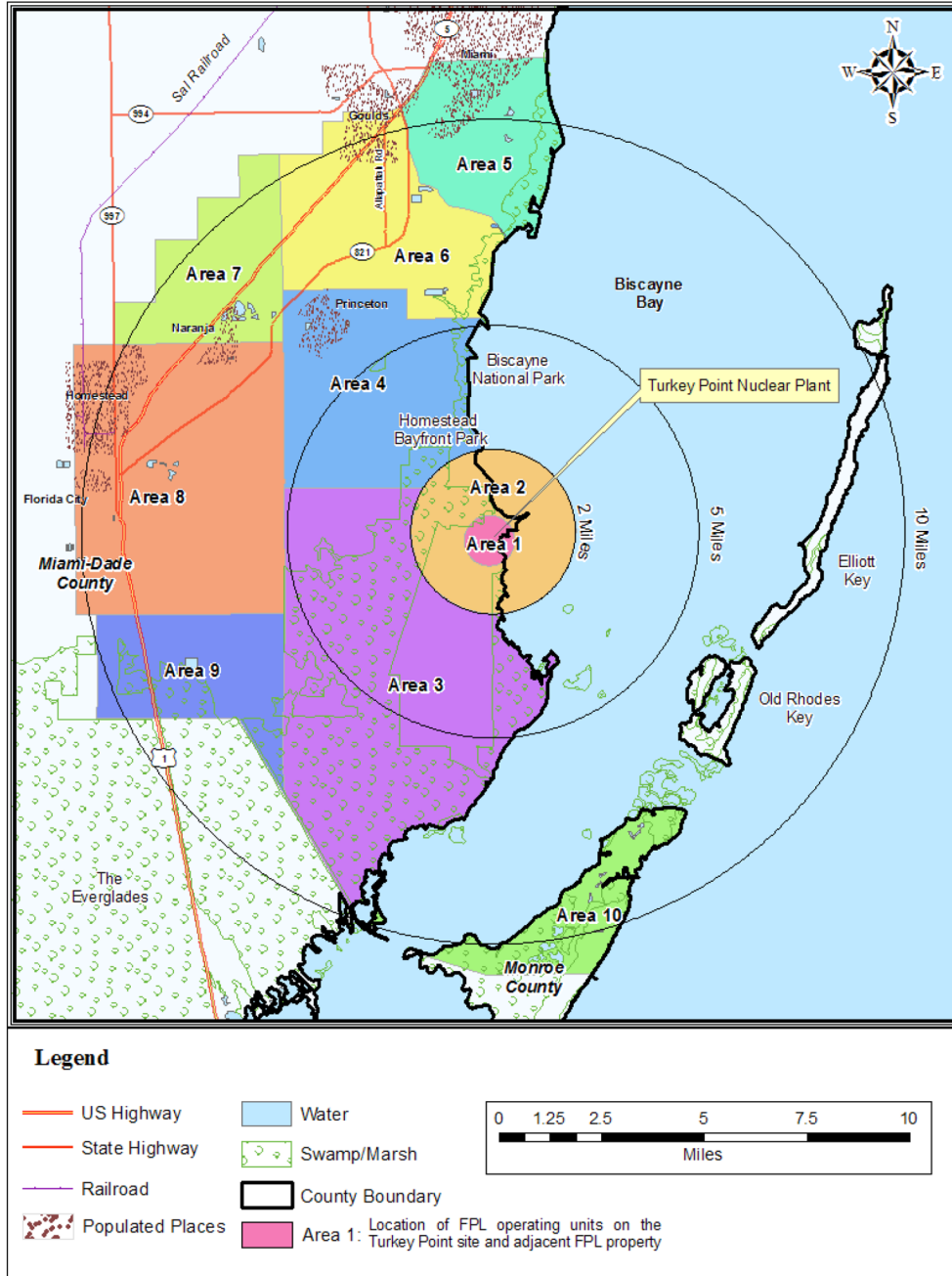
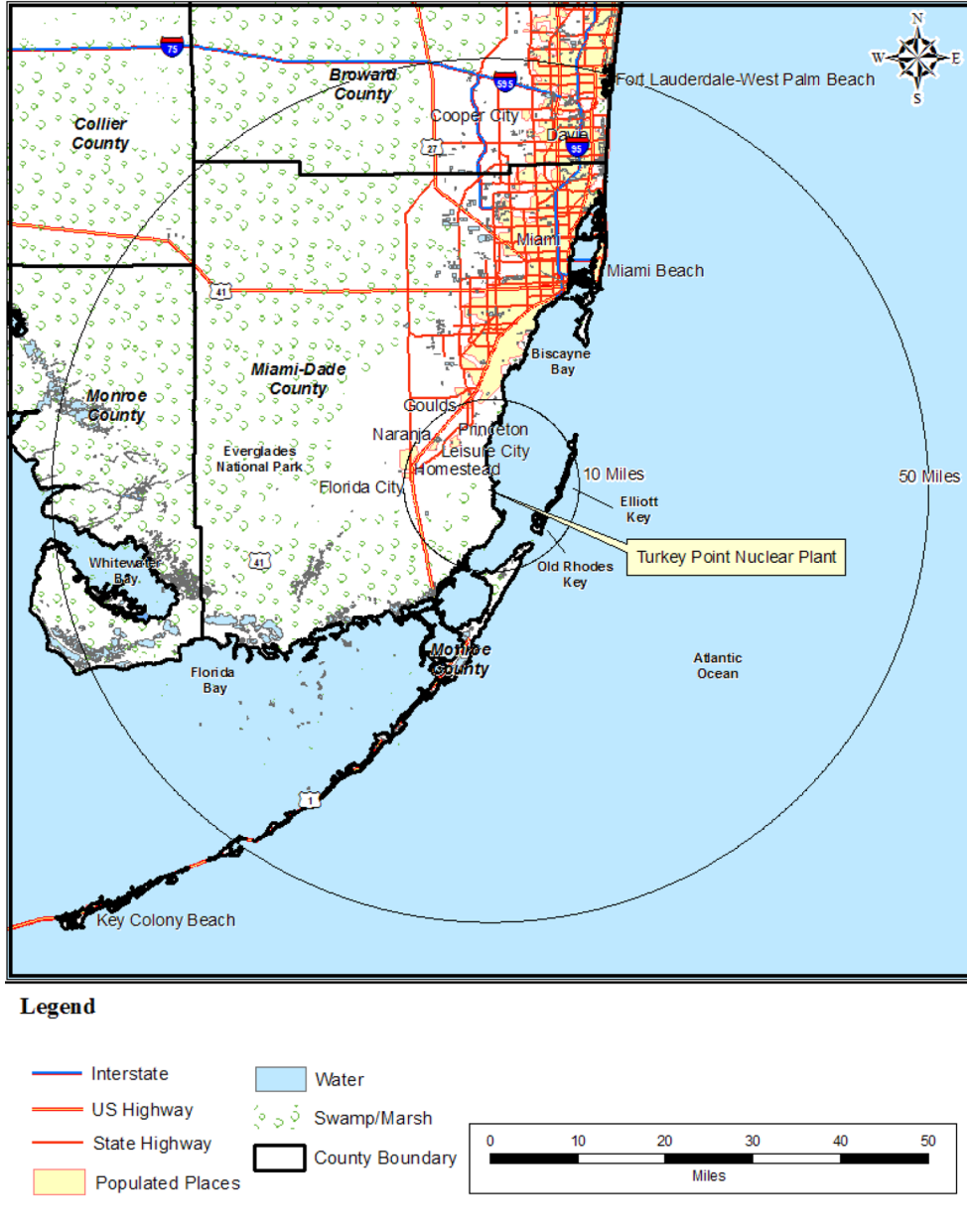

Figure 1-4. 50-Mile Emergency Planning Zone





## **PART 2: PLANNING STANDARDS AND CRITERIA**

### **SECTION A: ASSIGNMENT OF RESPONSIBILITY**

This section describes the primary responsibilities and organizational control of FPL, federal, state, county, and other emergency response organizations within the plume exposure pathway and the ingestion pathway EPZs. Various supporting organizations are also described as well as staffing for initial and continuous response.

#### **1. CONCEPT OF OPERATIONS**

The relationships and the concept of operations for the organizations and agencies that are a part of the overall emergency response organization are as follows:

- a. Federal, state, and county organizations (and other local governmental agencies) that are involved in a response to an emergency at Turkey Point are identified below and described in Figure A-1.
  - 1) Federal Agencies: The National Response Framework (NRF) outlines federal statutory and regulatory responsibilities during incidents requiring a coordinated federal response. The primary federal response for supporting an emergency at Turkey Point includes:
    - a) The NRC regional office has the responsibility for auditing nuclear power stations. It is responsible for ensuring that such activities are conducted in accordance with the terms and conditions of such NRC licenses and that as a result of such operations, there is no undue risk to the health and safety of the public.

The NRC Office of Nuclear Reactor Regulation, established by the Energy Reorganization Act of 1974, as amended, performs licensing functions associated with the construction and operation of nuclear reactors and with the receipt, possession, ownership, and use of special nuclear and byproduct materials used at reactor facilities.

With regard to emergency preparedness, the NRC shall:

- Assess licensee emergency plans for adequacy.

- Review the FEMA findings and determinations on the adequacy and capability of implementation of state and local plans.
- Make decisions regarding the overall state of emergency preparedness and issuance of operating licenses.

The NRC shall respond to incidents at licensed facilities or vehicular accidents involving licensed materials in transit. Within the sphere of the NRF, the NRC shall act as a coordinating agency. In this role the NRC:

- Performs an independent assessment of the incident and potential offsite consequences and, as appropriate, provides recommendations concerning any protective measures.
- Performs oversight of the licensee, to include monitoring, evaluation of protective action recommendations, advice, assistance, and, as appropriate, direction.
- Dispatches an NRC site team of technical experts to the licensee's facility when appropriate.

Under certain situations involving the protection of public health/safety or national security, the NRC may take possession of special nuclear materials and/or operate certain facilities regulated by the NRC. FEMA shall act as the lead federal agency for offsite, nontechnical concerns.

During an incident, the Chairman of the Commission is the senior NRC authority for all aspects of a response. The Chairman shall transfer control of emergency response activities to the Site Team Director when deemed appropriate by the Chairman.

All NRC regions as well as Headquarters are prepared to respond to potential emergencies and have developed plans and procedures for responding to radiological incidents involving NRC licensees. Headquarters has developed the NRC incident response plans and implementing procedures. Each NRC region has developed regional supplements that detail how the region will fulfill all of the responsibilities assigned in the NRC Incident Response Plan. All NRC organizations are

responsible for maintaining an effective state of preparedness through periodic training, drills, and exercises.

Each region and Headquarters has established and maintains an Incident Response Center designed to centralize and coordinate the emergency response function. Adequate communications are established to link the licensee, Headquarters, and the region. The NRC has established lines of communications with local government, state government, other federal agencies, Congress, and the White House. Public information will be disseminated in a timely manner and periodically.

Each region is prepared to send a team of qualified specialists to the scene expeditiously. All of the necessary supplies and equipment needed for emergency response will be provided and maintained by the NRC.

The objectives of the NRC Incident Response Plan are to provide for protection of the public health and safety, property, and the environment, from the effects of radiological incidents that may occur at licensed facilities or which involve licensed materials, including radionuclides in transit.

The objectives of the agency plan set forth the organizational and management concepts and responsibilities needed to ensure that NRC has an effective emergency response program.

The NRC Incident Response Plan is intended to ensure NRC preparedness:

- To receive and evaluate notification information of incidents, accidents, and *unusual events* and determine the extent of NRC response necessary to meet NRC responsibilities for mitigating the consequences of these events.
- To determine the cause of incidents, accidents, and *unusual events* to ensure that appropriate corrective actions are taken by the licensee to minimize the consequences of these events.
- To provide onsite expertise in a timely manner, to evaluate the nature and extent of the incident, ascertain plant status (for

reactors and fuel facilities), monitor licensee activities, determine compliance, make recommendations, and, if necessary, issue orders relative to the event.

- To inform the public and others of plant status and technical details concerning the incident.
- To recommend adequate protective actions to the responsible local and/or state agencies.
- To provide technical assistance.
- To ensure the plant is returned to a safe condition.
- To return the NRC Headquarters and regional office to normal operations.

- b) Department of Homeland Security (DHS): Emergency Preparedness and Response FEMA: In accordance with the National Response Framework (NRF), DHS is responsible for the overall coordination of a multiagency federal response to a significant radiological incident. The primary role of DHS/EPR/FEMA is to support the state by coordinating the delivery of federal nontechnical assistance. DHS/EPR/FEMA coordinates state requests for federal assistance, identifying which federal agency can best address specific needs. If deemed necessary by the DHS, it will establish a Homeland Security Operations Center (HSOC) from which it will manage its assistance activities.
- c) U.S. Department of Energy (DOE): The DOE has extensive radiological monitoring equipment and personnel resources that it can assemble and dispatch to the scene of a radiological incident. The DOE local operations office at the Savannah River site can assist Turkey Point following a radiological incident, as outlined in the Federal Radiological Monitoring and Assessment Plan. If Turkey Point or the state deems that assistance from the DOE is necessary or desirable, the state would notify the appropriate DOE operations office to request assistance.

- d) U.S. Environmental Protection Agency (EPA): The EPA assists with field radiological monitoring/sampling and non-plant-related recovery and reentry guidance.
  - e) Federal Bureau of Investigation (FBI): FBI support is available through its statutory responsibility based in Public Law and the U.S. Code, and through a memorandum of understanding for cooperation with the NRC. Notification to the FBI of emergencies in which they would have an interest will be through provisions of the Turkey Point Physical Security Plan or by the NRC.
  - f) National Weather Service (NWS): The NWS provides meteorological information during emergency situations, if required. Data available will include existing and forecasted wind directions, wind speed, and ambient air temperature.
  - g) U.S. Coast Guard: The Coast Guard can provide maritime asset support (for example, establish safety and security zones and transport response personnel, equipment, and injured personnel), in accordance with their general authority, if requested through the state.
- 2) State Agencies
- a) The State of Florida: The state of Florida has the statutory responsibility and authority for protecting the health and safety of the public in Florida and has developed the *State of Florida Radiological Emergency Management Plan*. The Plan has received 44 CFR 350 unconditional approvals from the Department of Homeland Security for all nuclear generating plant(s) within the state boundaries. The state of Florida has primary responsibility for the local population and environs, including the possible need for evacuation. The principal state and county agencies having emergency responsibilities are described in the state plan. The State Watch Office-Tallahassee is the primary notification point for activation of the state plan. The State Watch Office-Tallahassee (or alternate Watch Office Tallahassee Weather Service, Florida State University Campus) is available on a 24-hour basis to receive emergency communications from Turkey Point and, in turn, contact the state and county emergency response agencies.

Basic descriptions for the state of Florida agencies responsible for actions in the event of a nuclear power plant emergency are:

- Governor of Florida: The governor of the state has overall command authority for radiological and nonradiological aspects of a nuclear incident. The governor will provide for public protection through assignment of appropriate state resources and agencies. The governor has appointed the Director, State of Florida Division of Emergency Management (DEM), or another designated alternate, as the State Coordinating Officer to act in his/her behalf during a radiological emergency. During emergencies, all state agencies will report to the State Coordinating Officer. The governor, or designee, shall make the final recommendation for protective actions and shall serve as the state's primary spokesperson.
- State of Florida Division of Emergency Management (DEM): The state of Florida Division of Emergency Management and all jurisdictions of the state of Florida are authorized in Sections 252.35, 252.37, and 252.60 of the Florida statute to participate in cooperative relationships to accept services, equipment, supplies, materials, or funds for emergency management efforts and may assign this right to any appropriate local governing body or agency. The DEM is the state agency authorized to receive initial notification from Turkey Point via the State Watch Office which is staffed on a 24-hour basis. The DEM has overall responsibility for coordinating development and implementation of state and county emergency response plans; command and control of state emergency response resources; notification of state and county response agencies; and coordination of state, federal, and local emergency response activities. The Director, Division of Emergency Management, is responsible for coordinating operational response and recovery functions of all state agencies from the state emergency operations center (EOC) in Tallahassee, Florida, including implementation of protective action recommendations.

The Division of Emergency Management's response action to a nuclear incident will fall into one of the following functional areas:

- Command for all (state-related) radiological aspects of a nuclear incident, including milk, water and food control; radiation exposure control for state emergency workers, and confirmatory accident assessment.
- Coordination of field radiological functions (state-related) of confirmatory accident assessments during a nuclear emergency through the Department of Health Bureau of Radiation Control. This may include setup of a Mobile Emergency Radiological Laboratory (MERL) and dispatch of monitoring and sampling teams.
- State of Florida Department of Health (DOH): The DOH provides technical support and expertise in public health matters and responds to any emergency that involves possible or actual releases of radiological materials in order to protect health, safety, and property. DOH responsibilities include emergency medical services, public health, sanitation, and economic and social services. The DOH Bureau of Radiation Control (BRC) maintains a radiological hazard assessment capability; provides technical consultation and support to the governor, Division of Emergency Management, and local governments regarding radiation and radiological health; and conducts and/or coordinates offsite radiological surveillance and monitoring, in coordination with the Turkey Point offsite field monitoring group. As the primary radiological assessment agency, the DOH-BRC makes recommendations to the governor, the state coordinating officer, and county emergency management directors for protective actions in the 10-mile plume exposure pathway. The DOH-BRC provides laboratory analysis of air, water, and food samples from the 50-mile ingestion exposure pathway and provides technical support in decision-making for reentry and recovery efforts.
- Division of Florida Highway Patrol, Department of Highway Safety and Motor Vehicles: The Florida Highway Patrol, through the

coordination of the Department of Law Enforcement, provides traffic control assistance; law enforcement coordination with state and county officials; assistance in the transportation of samples for analysis (if requested); and communications support, as required.

- The Florida Fish and Wildlife Conservation Commission: The Fish and Wildlife Conservation Commission conducts warning and evacuation of both deep and shallow waterways in and around nuclear power plants during a radiological emergency and coordinates patrol activities with county and state law enforcement officials. The U.S. Coast Guard is responsible for officially closing the waterways to all boating traffic.

### 3) County Government Agencies

The counties that fall within the Turkey Point plume exposure EPZ include Miami-Dade County and Monroe County. Counties that fall within the ingestion exposure EPZ include Miami-Dade County, Monroe County, Broward County, and Collier County. Miami-Dade and Monroe Counties have responsibility for plume exposure risk response, hosting of evacuees, and ingestion pathway protection. Broward and Collier Counties have responsibility for ingestion pathway protective measures.

The state plan addresses short-term actions required in the plume exposure EPZ and addresses the ingestion pathway EPZ. State agencies take the lead in controlling ingestion pathway response.

Miami-Dade and Monroe Counties have developed county-wide integrated emergency response programs that describe resources to respond to an event at Turkey Point in accordance with their respective county emergency plans, which are appended to the state Plan.

In Miami-Dade and Monroe Counties, the responsibility for direction and control during a radiological emergency rests with the County Mayors, unless a disaster declaration under the provisions of Florida Statutes, Chapter 252 is in effect. If a disaster has been declared, responsibility for direction and control rests with the



governor or authorized representative (State Coordinating Officer who is normally the State Director, Division of Emergency Management).

The Miami-Dade and Monroe County mayors will take proper and responsible action to protect life, health, safety, property, and the environment from the consequences of a nuclear power plant emergency, in accordance with their county plans. The resources and personnel of Miami-Dade and Monroe Counties will be reserved and available for use by the county mayors.

The decision to implement Protective Action Recommendations (PARs) will be coordinated between the Miami-Dade and Monroe County mayors (or designees) and either the Governor or the State Coordinating Officer (Director, Division of Emergency Management). If time does not permit state involvement in initial decision making, the decision to take protective actions may be made by the county mayors (or designees).

The Miami-Dade County and Monroe County mayors have responsibility for overall emergency planning in their respective counties. The emergency management directors in Miami-Dade County and Monroe County report directly to their county mayors and are responsible for plan development and maintenance. The Miami-Dade County and Monroe County emergency management directors are responsible for direction and control of county emergency resources; protective response for offsite areas including warning and evacuation; communications; public information; offsite radiological exposure control; and coordination of arrangements for shelter and feeding of evacuees. Protective action decisions are made by the county mayors and implemented by the emergency management directors in each county.

The Miami-Dade County and Monroe County Emergency Operations Centers (EOCs) serve as the primary coordinating centers for local government response within the county's jurisdiction and for coordination between the counties and the state. Both Miami-Dade and Monroe Counties have made provisions for and are capable of 24-hour operation for extended periods of time during an emergency at Turkey Point.

## 4) Local Agency/Private Agency Support

FPL has acquired letters of agreement with local and private agencies that can provide support during an emergency. These agencies have agreed to provide firefighting, medical, and resource support, as needed. The letters of agreement are listed in Appendix 2 and are reviewed and updated as necessary.

- b. During an emergency condition classified as an *Alert*, *Site Area Emergency*, or *General Emergency*, the plant's augmented ERO is notified and responds to replace the normal plant organization. The Emergency Coordinator and Recovery Manager will assess the emergency situation and expand the ERO, if necessary.

The augmented ERO consists of three major response suborganizations with interrelationships, as illustrated in Figure A-2:

1) The onsite ERO, directed by the Emergency Coordinator, provides for:

- Control and operation of the plant.
- Mitigation of the emergency condition.
- Protection of plant personnel inside the Protected Area.
- Emergency support for operations, engineering, maintenance, firefighting, material acquisition, security, and first aid.

The onsite ERO is made up primarily of personnel from the plant's day-to-day management team, operations, radiation protection, chemistry, engineering, maintenance, security, and other site support personnel.

2) The offsite ERO, directed by the Emergency Offsite Manager, provides for:

- Offsite radiological accident assessment.
- Protection of plant personnel outside the Protected Area.
- Emergency support for acquisition of materials and support personnel.
- The primary interface between Turkey Point and outside organizations responsible for the protection of the public.

The offsite ERO is made up primarily of personnel from the plant's senior-level management team, security, and radiation protection, including support from other plant and corporate departments as necessary.

- 3) The Emergency News Center (ENC) organization, directed by the FPL Public Information Officer, coordinates with public information officers from other organizations to provide information to the public through the news media.
- c. The Recovery Manager is a senior FPL official with responsibility for policy and the authority to expend funds; has overall responsibility for coordinating emergency response actions of the company organization with the affected state/county agencies; and is responsible for EOF activation and operation during the emergency event.
- d. Procedures for training and maintenance of the ERO are in place to ensure 24-hour-per-day staffing for emergency response, including established communication links.

## **2. STATE AND COUNTY FUNCTIONS AND RESPONSIBILITIES**

The state of Florida and Miami-Dade and Monroe Counties have emergency response plans that specify the responsibilities and functions for the major agencies, departments, and key individuals of their emergency response organizations. This information is located in their respective plans.

## **3. AGREEMENTS IN PLANNING EFFORT**

Written agreements have been developed that establish the concept of operations between FPL and other support organizations having an emergency response role in support of this Plan. These agreements identify the services to be provided, the mutually accepted criteria for implementation, and the arrangements for exchange of information. Agreement letters are not necessary with federal agencies that are legally required to respond based on federal law. However, agreements are necessary if the agency is expected to provide assistance not required by law. A signed contract may take the place of a letter of agreement as long as the contract provides sufficient detail describing emergency support. Letters of Agreement shall be obtained with private contractors and others who provide services in support of the plant during a declared emergency. A list of agreements is provided in Appendix 2 of this Plan. The actual letters are maintained on file at the plant. Letters of Agreement, as a minimum, state that the cooperating organization will provide their normal services in support of an emergency at the Turkey Point site.

#### **4. CONTINUOUS COVERAGE**

Turkey Point maintains 24-hour emergency response capability. The normal on-shift complement provides the initial response to an emergency. This group is trained to handle emergency situations (e.g., initiate implementation of the emergency plan, make initial accident assessment, emergency classification, notifications, communications, and protective action recommendations) until the augmented ERO arrives. Personnel from the unaffected unit(s) are available and respond when notified. Minimum staffing will be maintained in the unaffected units in accordance with guidance in NUREG-0654 Table B-1. The ERO is composed of a broad spectrum of personnel with specialties in operations, maintenance, engineering, radiochemistry, radiation protection, material control, fire protection, security, communications, and emergency preparedness who are available and trained to augment on-shift personnel in an emergency. Procedures for training and maintenance of the emergency organization are in place to provide the capability of continuous (24-hour) operations.

The Recovery Manager, located in the EOF, has the authority to request federal assistance and responsibility for assuring continuity of resources (technical, administrative, and material) in the event of the activation of the ERO.

**Figure A-1. Agency Response Organization Interrelationships**

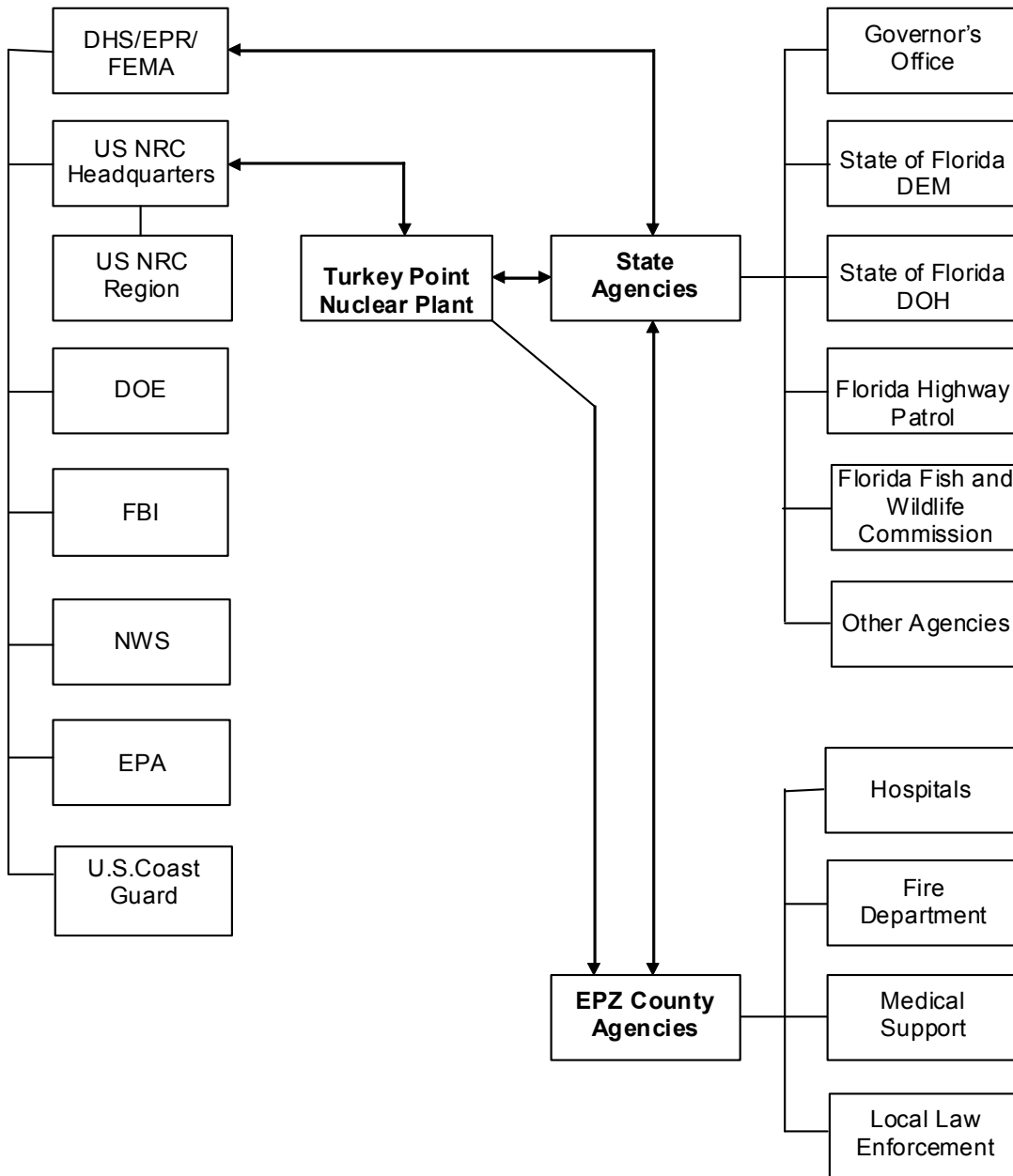

**Figure A-2. Turkey Point Plant Augmented Emergency Response Organization Interrelationships**

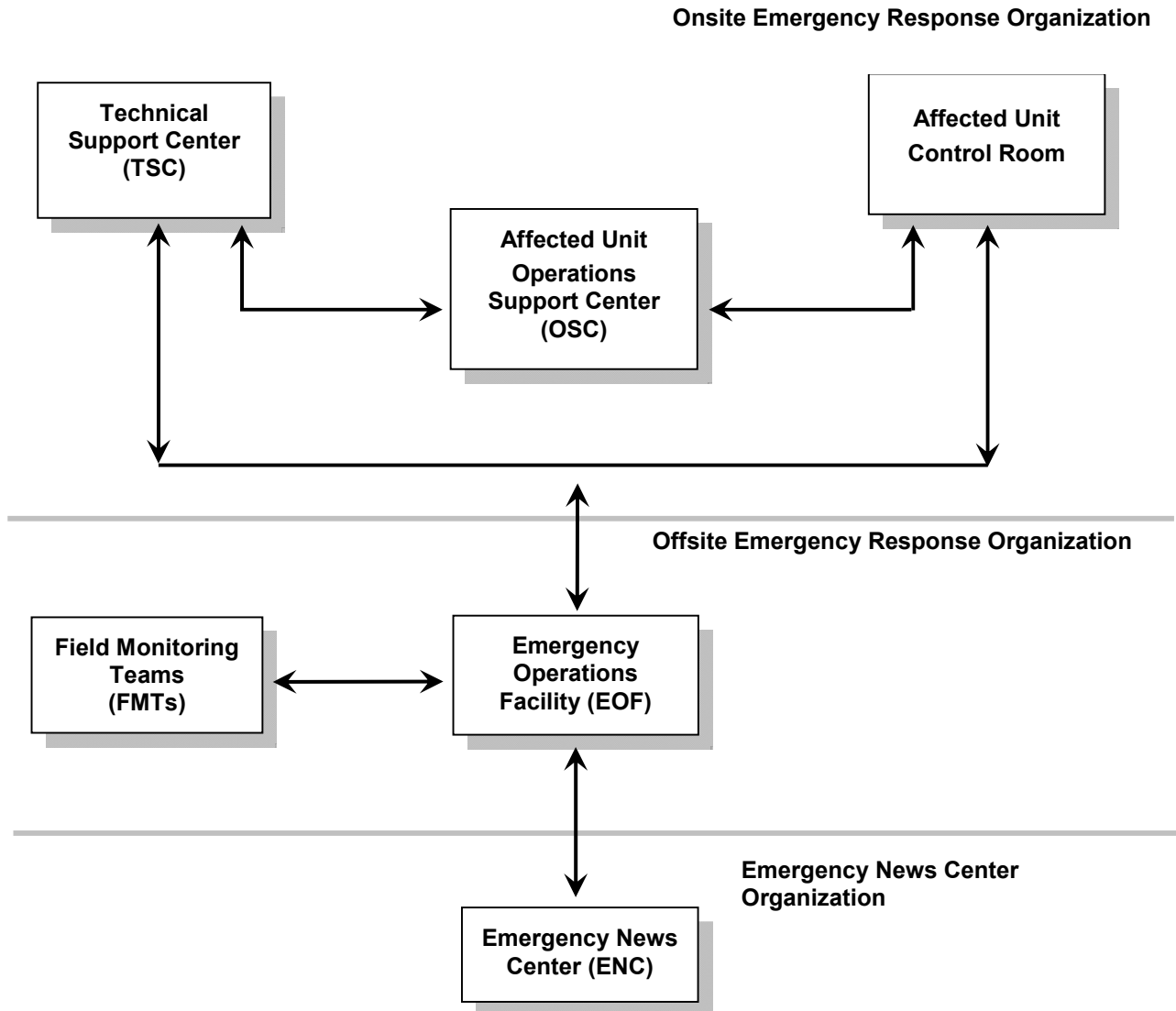

## SECTION B: EMERGENCY RESPONSE ORGANIZATION

This section describes the ERO, its key positions, and associated responsibilities. This section outlines the staffing requirements that provide initial emergency response actions and provisions for timely augmentation of on-shift personnel when required.

### 1. ON-SHIFT EMERGENCY RESPONSE ORGANIZATION ASSIGNMENTS

The normal plant personnel complement is established with the Site Vice President, Turkey Point plant, having overall authority for plant operations. The Site Vice President, Turkey Point plant, directs the site organization in the management of the various departments while the shift manager retains the responsibility for actual operation of plant systems. Emergency Preparedness must consider the capabilities of the normal plant organization and the ERO. The initial phases of an emergency situation at Turkey Point will most likely involve a relatively small number of individuals. These individuals must be capable of (1) determining that an emergency exists, (2) providing initial classification and assessment, (3) promptly notifying offsite authorities and individuals in the emergency organization, and (4) making protective action recommendations as needed for onsite and offsite personnel. The subsequent phases of the emergency situation will require augmentation of the emergency organization.

The plant has personnel on-shift at all times that can provide an initial response to an emergency event. Minimum shift staffing is maintained to support the ERO as listed in Tables 2-1 and B-1a contained in each appropriate Annex. These tables outline the unit on-shift ERO and its relation to the normal staff complement and is not determined by the technical specifications. Members of the on-shift organization are trained on their responsibilities and duties in the event of an emergency and are capable of performing all response actions in an *Unusual Event* and the initial actions of higher classifications. On-shift staffing will be augmented with additional ERO personnel at an *Alert* emergency classification and higher (or earlier as deemed necessary).

On-Shift Personnel: Shift personnel have the capability at all times to perform detection, mitigation, classification, and notification functions required in the early phases of an emergency. Shift augmentation and further ERO involvement will be determined by the extent and magnitude of the event. When a transition to severe accident management guidelines is initiated, the on-shift crew assumes the duties and responsibilities for the severe accident management guidelines implementation.

Shift Manager: Has the responsibility and the authority to declare an emergency and becomes the Emergency Coordinator. In that role, the Emergency Coordinator will initiate the appropriate immediate action in accordance with written procedures, mitigate the consequences of the emergency, activate the full ERO, as needed, or at an *Alert* or higher classification, and notify offsite support and government agencies, as appropriate. In the Shift Manager's absence or incapacitation, the affected Unit Control Room Supervisor will assume the duties as Emergency Coordinator. In the event that these two individuals are not capable of assuming the duties of Emergency Coordinator, the Shift Technical Advisor will assume that function.

Shift Technical Advisor (STA): A qualified individual assumes an overview role as the STA with the specific responsibility of monitoring the maintenance of core cooling and containment integrity. An individual assigned the duty as the STA shall be available to the unit control room at all times. This position may be filled by a Senior Reactor Operator serving as STA/SRO for that shift.

Control Room Operators: Qualified reactor operators are assigned to each shift at each unit during normal operations, in accordance with plant technical specifications. They are responsible for operating plant equipment from the control room.

Auxiliary Operators: Non-licensed operators are assigned to each shift at each unit, in accordance with plant Technical Specifications. They are responsible for operating plant equipment throughout the plant.

Radiation Protection: The plant's radiation protection personnel are responsible for the handling and monitoring of radioactive materials. Radiation protection supervisors and technicians are included in this organization, as defined in Technical Specifications for on-shift staffing requirements.

Chemistry: The plant's chemistry personnel are responsible for sampling of system effluents, and the chemical and radio-analytical analysis of those samples. Chemistry supervisors and technicians are included in this organization as defined in Technical Specifications for on-shift staffing requirements.

Security: The plant's security personnel are responsible for the physical security of the site. Security management and security officers are included in this organization. The Security Plan describes staffing requirements for minimum shift complement.



A Fire Brigade for each Protected Area has been established and staffed by designating trained individuals from the above-listed groups as brigade members in accordance with the Fire Protection Manual. The Fire Brigade Leader will be from the Operations staff within the affected Protected Area.

A First-Aid Team for each Protected Area has been established by designating trained individuals from the above-listed groups as team members.

An individual (or group of individuals) on each shift is trained and made available to act as the Shift Communicator for each Protected Area. The Shift Communicator is typically the unaffected unit SRO or another licensed operator. This individual can notify plant personnel, state agencies, county agencies, and the NRC. The Shift Communicator will maintain communications as necessary until relieved by members of the on-call ERO.

## **2. AUTHORITY OVER THE EMERGENCY RESPONSE ORGANIZATION**

The Shift Manager, when initially classifying an emergency condition, will assume the responsibilities of the Emergency Coordinator until properly relieved by another qualified individual. The Shift Manager, acting as Emergency Coordinator, has responsibility for direction and control of the emergency. The Emergency Coordinator is the Shift Manager from the affected unit. In the event there is a simultaneous emergency condition affecting multiple units, or the site is in an emergency due to natural phenomena or a security event, the Unit 3 Shift Manager will typically be designated as the Emergency Coordinator, unless conditions warrant otherwise. In the event of the Shift Manager's absence or incapacitation, the affected unit Control Room Supervisor will assume command and control. If the affected Unit Control Room Supervisor cannot perform these duties, the Unit STA assumes the command and control function until relieved by a qualified on-shift EC.

If the emergency escalates from an *Unusual Event* to an *Alert* emergency classification or higher, another qualified individual will assume the Emergency Coordinator responsibilities from the Control Room.

If the EOF is activated at a *Site Area Emergency* or *General Emergency* classification (or lower level emergency if deemed necessary), the Recovery Manager in the EOF is responsible for overall direction and control of the entire activated ERO at Turkey Point and for coordinating the emergency response with offsite agencies. At that time, the Emergency Coordinator is responsible for coordinating the onsite emergency response under the direction and control of the Recovery Manager.

### 3. CRITERIA FOR ASSUMING COMMAND AND CONTROL (SUCCESSION)

The responsibility for initial assessment of, and response to, an emergency rests with the Shift Manager, who assumes the authority and responsibilities of the Emergency Coordinator until relieved by another qualified Emergency Coordinator in the Technical Support Center (TSC). The line of succession in the Control Room for the position of Emergency Coordinator should the Shift Manager be incapacitated is as follows (in order of succession):

- 1) Unit Supervisor
- 2) Any other member of the plant staff with an active Senior Reactor Operator license

Upon relieving the Shift Manager, the Emergency Coordinator (TSC), is responsible for continued assessment of the severity of the emergency and for coordinating and directing the combined activities of personnel in the Control Room, TSC, Operations Support Center (OSC), elsewhere on owner-controlled property and field team monitoring activities. When the EOF is declared operational, overall direction and control of the emergency response is transferred to the Recovery Manager in the EOF. The Emergency Coordinator (TSC) maintains responsibility for onsite direction and control for the duration of the event. Turnover of command and control and emergency response functions does not transfer to the TSC and EOF until the following criteria have been met:

- Adequate staffing levels are present in support of the non-delegable responsibilities.
- The status of the plant is well understood by the relieving individual.
- The staff has been fully briefed as to the status of the event and the current proposed plan of action.
- A formal turnover between the Shift Manager (Control Room-Emergency Coordinator) to the Emergency Coordinator (TSC) and Recovery Manager in the EOF has occurred.

### 4. EMERGENCY COORDINATOR RESPONSIBILITIES/NON-DELEGABLE DUTIES

The Emergency Coordinator has the responsibility and authority to initiate emergency actions necessary to protect the life, health, and safety of both the plant staff and affected public. The responsibilities of the Emergency Coordinator include:

- Classifying the emergency.
- Authorizing notifications to the state, counties, and the NRC.

- Issuing protective action recommendations.
- Authorizing emergency exposure limits.
- Authorizing the distribution and use of potassium iodide.
- Mobilizing the ERO and initiating activation of emergency response facilities.
- Directing onsite emergency response activities and corrective actions to mitigate the accident, including dispatch of emergency response teams.
- Implementing severe accident management guidelines as required.

The Emergency Coordinator shall not delegate the following responsibilities:

- Event classification.
- Notification of offsite authorities (approval of state, county, and NRC notifications).
- Protective action recommendations for the general public.

The Emergency Coordinator maintains the responsibility of Event classification, however, the responsibilities of notification of the offsite authorities and the issuance of protective action recommendations are transferred to the Recovery Manager with the activation of the EOF.

The Emergency Coordinator may delegate other responsibilities. When the EOF is staffed and operational, the Recovery Manager assumes the responsibility for offsite notifications to the state and counties; recommending protective action recommendations; and approval of information released to the news media.

## **5. EMERGENCY RESPONSE ORGANIZATION POSITIONAL RESPONSIBILITIES**

Tables 2-1 and B-1a contained in each Unit Annex outline ERO positions required to meet minimum staffing and describe full augmentation of the on-shift complement at an *Alert* or higher classification, including major tasks assigned to each position. The Table B-1a for each unit's on-shift personnel is in that unit's Annex to the Emergency Plan. The full augmentation staffing levels are used as a planning basis to cover a wide range of possible events. For extended events (those that are expected to continue for more than 24 hours), actual staffing will be established by the Emergency Coordinator based on the event and personnel availability.

However, reduced staffing will only occur after discussion concerning the impact on plant operations and emergency response with the Recovery Manager.

As shown on Figure B-1a, the overall ERO is made up of three (3) suborganizations:

- Onsite ERO: Responsible for onsite emergency response activities, including protecting plant personnel, mitigating the results of the event, and keeping the offsite organization informed of onsite events and actions being taken.
- Offsite ERO: Responsible for offsite emergency response activities, including providing information to and interfacing with offsite authorities; monitoring offsite results of the event; protecting plant personnel outside the Protected Area(s); supporting the onsite organization; and coordinating public information.
- Emergency News Center organization: Responsible for providing accurate information to the public about the event through the news media.

Specific responsibilities for each suborganization and related positions are as follows:

- a. Onsite ERO (Figure B-1b): The onsite ERO is activated during an emergency classified as an *Alert* or higher. It can also be activated by the Emergency Coordinator at his discretion during an *Unusual Event*. It functions under the direction of the Emergency Coordinator (TSC), who is responsible for organizing and coordinating the emergency efforts at and within the Protected Area of the affected unit(s).

The onsite ERO consists of plant personnel who are involved with emergency response efforts necessary to control the plant during an incident. This organization operates out of the Control Room, the TSC, and the affected unit OSC. Collectively, members of the onsite ERO provide for the following activities during an emergency:

- Plant systems operations
- Radiological survey and monitoring (including environmental monitoring)
- Firefighting
- Rescue operations and first aid
- Decontamination

- Security of plant and access control
- Repair and damage control
- Personnel protection including assembly, accountability, and evacuation
- Communications

When plant conditions warrant entry into the Severe Accident Management Guidelines (SAMG), the Emergency Coordinator assumes the role of decision-maker. The Technical Assessment Coordinator and/or another qualified individual(s) assume the role of evaluators, and the Control Room staff assumes the role of implementers. Control Room personnel will perform mitigating actions for severe accidents in accordance with SAMG before TSC activation.

Those individuals identified to augment the on-shift personnel within 60 minutes of the notification of an *Alert* or higher classification are part of the on-call ERO. These personnel are immediately available during normal working hours or are contacted during nonworking hours by an automated callout system that employs pagers or commercial telephone, as described in Section E of this Plan.

For security-related events that would prevent the emergency responders from reaching the site, the TSC, OSC, and Control Room responders would be directed to respond to the TSC or another designated offsite location. TSC / OSC / Control Room staffs will provide any possible assistance from this offsite staging area until such time as site access is restored.

Because of the configuration of the site and the presence of two separate and different technologies, there are selected positions in the ERO that have expertise in a specific technology. Those personnel will staff the specific ERO positions when that unit is the affected unit.

All onsite ERO personnel shall have the authority to perform assigned duties in a manner consistent with the objectives of this Plan. In addition to maintaining adequate documentation of the event, position responsibilities include:

**1) Shift Manager (Emergency Coordinator) \_\_\_\_\_ CR**

A Shift Manager is on duty 24 hours a day and is the Emergency Coordinator in a declared emergency until relieved of this function. While serving in this capacity, the Shift Manager is responsible for:

- Activating the ERO (as deemed appropriate or as procedurally required).
- Initiating the NRC Emergency Response Data System (ERDS).
- Performing those duties outlined for the Emergency Coordinator.

The on-duty Shift Manager directs the activities of the operating crew and is responsible for the safe operation of the plant in compliance with the unit NRC operating license and the unit operating procedures. The Shift Manager, after relinquishing command and control, functionally reports to the Emergency Coordinator in the TSC.

The Shift Manager's responsibilities, when not acting as Emergency Coordinator, are described below:

- The authority and responsibility to shut down the reactor when determined that the safety of the reactor is in jeopardy or when operating parameters exceed any of the reactor protection circuit setpoints and automatic shutdown does not occur.
- To ensure a review has been completed to determine the circumstance, cause, and limits under which operations can safely proceed before the reactor is returned to power following a trip or an unscheduled or unexplained power reduction.
- The responsibility to be present at the plant and to provide direction for returning the reactor to power following a trip or an unscheduled or unexplained power reduction.
- The responsibility to adhere to the unit technical specifications and to review routine operating data to assure safe operation.
- The responsibility to identify applicable EALs and emergency classifications.

- The responsibility to adhere to unit operating procedures and the requirements for their use. During an emergency, authorize operations personnel to depart from approved procedures where necessary to prevent injury to personnel, including the public, or damage to the facility consistent with the requirements of 10 CFR 50.54(x) and (y).
- Initiate immediate corrective actions to limit or contain the emergency invoking the provisions of 10 CFR 50.54(x) if appropriate, and specifically when addressing severe accident management guidelines.
- Approve procedures and implement as required under the provisions of 10 CFR 50.54(x).
- Supervise the activities of the Control Room crew and Shift Communicator.

## 2) Recovery Manager \_\_\_\_\_ EOF

Responsibilities of the Recovery Manager include:

- Assume overall direction and control of emergency response activities and the non-delegable responsibilities for protective action recommendations determination and the notification of offsite authorities.
- Ensure that federal, state, and county authorities and industry support agencies remain cognizant of the status of the emergency situation. If requested, dispatch informed individuals to offsite governmental EOCs.
- Approve the technical content of Turkey Point press releases before they are released to the media.
- Coordinate all Turkey Point activities involved with the emergency response.
- Ensure offsite agency updates are periodically communicated as required/requested.
- Request assistance from non-FPL emergency response organizations, as necessary.

**3) Recovery Manager Operations Advisor \_\_\_\_\_ EOF**

There are two Recovery Manager Operations Advisors. One is from the affected technology unit(s) and the other from the unaffected technology unit(s). Both individuals report to the Recovery Manager in the EOF when activated. The individual from the affected unit provides support with technical information regarding the affected unit, including monitoring changes in plant conditions in the event classification and determination of plant-based protective action recommendations. The individual from the unaffected unit provides technical support, as necessary.

**4) Emergency Coordinator \_\_\_\_\_ TSC**

The Emergency Coordinator reports to the Recovery Manager and supervises and directs activities of the onsite ERO from the TSC. The Emergency Coordinator's responsibilities include organizing and coordinating the onsite emergency efforts including mitigation of the emergency condition; protection of plant personnel inside the Protected Area; and emergency support for operations, engineering, maintenance, firefighting, equipment support, security, and first aid. Upon activation of the TSC, the Emergency Coordinator assumes responsibility from the Control Room Emergency Coordinator for emergency classification changes, notifications to offsite agencies, and protective action recommendation determination. The responsibility for notifications to state/counties and protective action recommendation determination are transferred to the EOF when activated.

**5) Emergency Coordinator Assistants \_\_\_\_\_ TSC**

There are two Emergency Coordinator Assistants (who have senior reactor operator level of knowledge) that respond to the TSC and report to the Emergency Coordinator – one from the affected technology unit(s) and the other from the unaffected technology unit(s). Primary responsibilities include coordinating TSC efforts to determine the nature/extent of emergencies pertaining to equipment and plant facilities in support of Control Room actions, assisting with determining priorities assigned to the OSC activities, and evaluating changes in event classification.



**6) TSC Manager \_\_\_\_\_ TSC**

The TSC Manager reports to the Emergency Coordinator and directs the TSC staff in performing technical assessments of plant and emergency conditions and assistance in recovery planning.

**7) Technical Assessment Coordinator \_\_\_\_\_ TSC**

The Technical Assessment Coordinator is from the affected technology unit(s) and reports to the TSC Manager. The Technical Assessment Coordinator is responsible for engineering support to address technical issues that affect long-term safe shutdown and/or mitigation of the release. The Technical Assessment Coordinator supervises activities of the technical assessment staff (Electrical Engineer, Mechanical Engineer, Instrumentation and Controls (I&C) Engineer, and Core/Thermal Hydraulic Engineer); Plant Data Operators; and TSC Station Area Operations Advisor.

**8) Radiation Protection Manager \_\_\_\_\_ TSC**

The Radiation Protection Manager reports to the Emergency Coordinator and supervises the activities of dose assessment personnel and other radiation protection personnel in the TSC during the emergency. The Radiation Protection Manager directs a staff in determining the extent and nature of radiological or hazardous material problems on site and is the lead radiological advisor for the onsite ERO on radiological control matters, including protective actions for emergency response personnel. The Radiation Protection Manager also formulates the offsite protective action recommendations until the EOF is activated.

**9) Control Room Operations Manager \_\_\_\_\_ CR**

The Control Room Operations Manager reports to the Emergency Coordinator and is an ERO member with operations management expertise. The Control Room Operations Manager is dispatched to the Control Room to coordinate emergency response activities between the Control Room and the TSC and free up the on-shift shift manager from routine ERO interface and related duties.

**10) TSC Data Coordinator \_\_\_\_\_ TSC**

The TSC Data Coordinator is the unaffected technology Technical Assessment Coordinator. The TSC Data Coordinator reports to the TSC Manager and is responsible

for the content of information transmitted from the TSC to other onsite/offsite facilities; documenting information received in the TSC; and supervising activities of the State/County Communicators; Technical Communicator; Emergency Notification System and Health Physics Network communicators; Computer/Information Technology Support personnel; and other TSC support personnel (status board plotters; log-keepers; and clerical/document control).

**11) State/County Communicator \_\_\_\_\_ TSC**

The State/County Communicator reports to the TSC Data Coordinator and transmits information to appropriate state/county agencies, until the EOF is activated.

**12) Emergency Notification System Communicator \_\_\_\_\_ TSC**

The Emergency Notification System Communicator reports to the TSC Data Coordinator and transmits plant status and technical information to the NRC.

**13) Health Physics Network Communicator \_\_\_\_\_ TSC**

The Health Physics Network Communicator reports to the TSC Data Coordinator and transmits information updates to the NRC, including offsite environmental data and release status. This position also transmits information on dose projections and changes to protective action recommendations for the general public to the NRC, until the EOF is activated.

**14) Operations Support Center Manager \_\_\_\_\_ OSC**

The OSC Manager reports to the Emergency Coordinator and supervises the activities of OSC personnel. Responsibilities include directing OSC operations, including assigning tasks to designated OSC leads, maintaining OSC resources, and maintaining accountability of OSC personnel.

**15) Operations Support Center Technicians \_\_\_\_\_ OSC**

Technicians and operations personnel form the OSC pool. OSC pool personnel form the teams that perform emergency mitigation tasks throughout the plant. Individuals from radiation protection, maintenance, chemistry, and operations are always available as part of the OSC pool. Individuals from other plant organizations may also be called to assist in emergency mitigation efforts.

- b. Offsite ERO (Figure B-1c): The Offsite ERO is activated during an emergency classified as an *Alert* or higher. It can also be activated by the Recovery Manager at his discretion during an *Unusual Event*. It functions under the direction of the Emergency Offsite Manager and is responsible for offsite emergency response activities. These activities include providing information to, and interface with, offsite authorities; monitoring offsite results of the event; protecting plant personnel outside the Protected Area(s), supporting the onsite organization, and coordinating the flow of information to the emergency public information (Emergency News Center) organization. Personnel from corporate management, administrative and technical support personnel may be used at the EOF and ENC to augment plant staff and possibly interface with governmental authorities.

**1) Emergency Offsite Manager \_\_\_\_\_ EOF**

The Emergency Offsite Manager reports to the Recovery Manager and has the authority, management ability, and technical knowledge to assist the Recovery Manager in the management of FPL's offsite ERO by directing and coordinating the activation and response efforts of the EOF staff in support of the Recovery Manager, assisting the Recovery Manager in determining protective action recommendations when necessary, and preparing state and county notification forms with the assistance of the Protective Measures Manager and the Communications Manager.

**2) Protective Measures Manager \_\_\_\_\_ EOF**

The Protective Measures Manager reports to the Emergency Offsite Manager and directs the activities of the EOF radiation protection staff. These duties include recommending changes in the event classification and protective action recommendations based on effluent releases or dose projections; assisting the Emergency Offsite Manager in the evaluation of the significance of an emergency with respect to the public; and advising the Emergency Offsite Manager on the need for emergency exposures or for issuance of potassium iodide to the field monitoring teams required to enter the plume. Since FPL and the state both deploy field monitoring teams, the Protective Measures Manager coordinates field monitoring team information with the state representative in the EOF or the state EOC.

**3) Dose Assessment Coordinator \_\_\_\_\_ EOF**

The Dose Assessment Coordinator reports to the Protective Measures Manager. The Dose Assessment Coordinator directs activities of the Dose Assessors and keeps the

Protective Measures Manager and EOF staff updated on changes to emergency classifications based on effluent releases or dose projections.

**4) Dose Assessors \_\_\_\_\_ EOF**

The Dose Assessors report to the Dose Assessment Coordinator and perform dose projections using the dose assessment computer models. The Dose Assessors also evaluate the need for administering potassium iodine to field monitoring team members, if requested.

**5) Communications Manager \_\_\_\_\_ EOF**

The Communications Manager reports to the Emergency Offsite Manager and directs activities of the EOF communications staff. The Communications Manager is responsible for the content of information transmitted from the EOF to other onsite/offsite facilities; documenting information received in the EOF and supervising activities of the State/County Communicators; Technical Communicator; Emergency Notification System and Health Physics Network communicators; and EOC Communicator.

**6) Health Physics Network Communicator \_\_\_\_\_ EOF**

The Health Physics Network Communicator reports to the Communications Manager and transmits information updates to the NRC, including offsite environmental data, release status, dose projections, and changes to protective action recommendations for the general public.

**7) State/County Communicator \_\_\_\_\_ EOF**

The State/County Communicator reports to the Communications Manager and transmits information to appropriate state and county agencies.

**8) Emergency Notification System Communicator \_\_\_\_\_ EOF**

The Emergency Notification System Communicator reports to the Communications Manager and transmits plant status and technical information to the NRC.

- c. Emergency News Center (ENC) Organization (Figure B-1d): The Emergency News Center organization is part of the overall ERO that is activated during an emergency. It functions under the FPL Public Information Officer and reports to the Recovery Manager.

The Emergency News Center organization consists of corporate and plant personnel who are involved with emergency public information efforts and coordinate FPL emergency response with offsite agencies. Collectively, members of the ERO provide for the following activities during an emergency:

- Developing and issuing news releases
- Coordinating and conducting media briefings
- Rumor control
- Media monitoring and correction of misinformation.

Emergency News Center position responsibilities include:

**1) FPL Public Information Officer \_\_\_\_\_ ENC**

The FPL Public Information Officer reports to the Emergency Offsite Manager and is responsible for directing the FPL Emergency News Center organization; coordinating emergency information with federal, state, and county agencies; and providing emergency information to the news media.

**2) Chief Nuclear Spokesperson \_\_\_\_\_ ENC**

The Chief Nuclear Spokesperson reports to the FPL Public Information Officer and provides technical and plant status information to the news media during news conferences.

**3) Emergency News Center Manager \_\_\_\_\_ ENC**

The Emergency News Center Manager reports to the FPL Public Information Officer and is responsible for ensuring the operability of, and supervision of, the activities in the Emergency News Center, including coordination with offsite agencies involved in the emergency response and rumor control.

**4) Emergency News Center Liaison \_\_\_\_\_ ENC**

The Emergency News Center Liaison reports to the Emergency News Center Manager; coordinates activities with the Emergency News Center support staff; ensures availability of equipment; and coordinates interface between Turkey Point and the news

media/public including briefings, news conferences, and responses to information requests.

**5) Technical Assistant \_\_\_\_\_ ENC**

The Technical Assistant reports to the FPL Public Information Officer. Two Technical assistants report to the Emergency News Center – one from the affected technology unit(s) and one from the unaffected technology unit(s). The affected unit(s) Technical Assistant takes the position in the Emergency News Center and the other assistant provides support. The Technical Assistant obtains technical and plant status information for use in news releases and media briefings and assists the News Writer in preparation of news releases.

**6) News Writer \_\_\_\_\_ EOF**

The News Writer reports to the FPL Public Information Officer and develops news releases with assistance from the EOF staff and the Emergency News Center Technical Assistants.

**7) Media Monitoring Staff \_\_\_\_\_ ENC**

The Media Monitors report to the Emergency News Center Manager. The Media Monitors monitor media reports to ensure information is factual and update the Emergency News Center Manager of all media reports and actions taken to correct misinformation or rumors.

**8) Rumor Control Staff \_\_\_\_\_ ENC**

The Rumor Control staff reports to the Emergency News Center Manager and provides support to the Media Monitors. Rumor Control personnel ensure that rumors are reviewed, documented, and addressed as appropriate.

The above-listed ERO positions form the basis of FPL's emergency response. All company personnel and resources can and will be used to ensure the safety of offsite populations, plant personnel, and protection of plant equipment needed to maintain nuclear safety.

## 6. EMERGENCY RESPONSE ORGANIZATION BLOCK DIAGRAM

Tables 2-1 and B-1a (located in unit-specific Annexes) and Table B-1b of this section, list the key positions of the ERO and the supporting positions assigned to interface with federal, state, and county authorities. Figures B-1a through B-1d illustrate the overall ERO. Section B.5 addresses specific responsibilities and the interrelationships for key positions.

## 7. INDUSTRY/PRIVATE SUPPORT ORGANIZATIONS

Turkey Point retains contractors to provide supporting services. A contract/purchase order with a private contractor is acceptable in lieu of an agreement letter for the specified duration of the contract. Among services currently provided are the following:

- a. Institute of Nuclear Power Operations (INPO): Experience has shown that a utility may need resources beyond in-house capabilities for the recovery from a nuclear plant emergency. One of the roles of INPO is to assist affected utilities by quickly applying the resources of the nuclear industry to meet the needs of an emergency. INPO has an emergency response plan that enables it to provide the following emergency support functions:
  - Assistance to the affected utility in locating sources of emergency personnel, equipment, and operational analysis.
  - INPO, Electric Power Research Institute (EPRI), and Nuclear Energy Institute (NEI) maintain a coordination agreement on emergency information with their member utilities.
  - INPO provides the "Nuclear Network," or its replacement, electronic communications system to its members, participants, NEI, and Electric Power Research Institute to coordinate the flow of media and technical information about the emergency.
  - Turkey Point may obtain utility industry information and assistance from any party to this agreement through the coordination of INPO.

To support these functions, INPO maintains the following emergency support capabilities:

- A dedicated emergency call number.

- Designated INPO representative(s) who can be quickly dispatched to the Turkey Point ERO to coordinate INPO support activities and information flow.
- The 24-hour-per-day operation of an emergency response center at INPO headquarters.

INPO will be notified (via the designated emergency call number) for all situations involving an *Alert*, *Site Area Emergency*, or *General Emergency* declaration. INPO has coordinated the preparation of a voluntary assistance agreement for transportation accidents. FPL has signed this agreement, which establishes the rights and responsibilities of electric utilities in requesting or providing assistance for response to a transportation accident involving nuclear materials.

- b. American Nuclear Insurers (ANI): In early 1982, ANI issued Bulletin #5B (1981) *Accident Notification Procedures for Liability Insured*, which provides revised criteria for the notification of the pools in the event of a nuclear emergency at one of the liability insured nuclear power reactor sites. This revision brings the ANI/Mutual Atomic Energy Liability Underwriters notification criteria into alignment with the standard emergency classification system adopted by the nuclear industry. This document also identifies a suitable channel for follow-up communication by ANI after initial notification.
- c. DOE Radiation Emergency Assistance Center/Training Site (REAC/TS): DOE REAC/TS provides emergency medical consultation for incidents involving radiation. DOE REAC/TS provides radiation incident response, consultation and preparedness training, and participates in simulation exercises to address the medical aspects of human exposure to ionizing radiation.
- d. Bechtel Power Corporation: Under established contracts, the unit(s) design engineering company provides design engineering expertise, specialized equipment, and other services identified as needed and deemed appropriate to assist in an emergency situation.
- e. URS Washington Division: URS Washington Division is an architectural/engineering organization in the nuclear industry and can supply emergency technical services upon request.
- f. AREVA: Framatome is a nuclear services company that can provide engineering and technical support if requested.



## **8. SUPPLEMENTAL EMERGENCY ASSISTANCE TO THE EMERGENCY RESPONSE ORGANIZATION**

Agreements are maintained with outside support agencies who do not take part in the organizational control of the emergency that provide assistance when called on during an emergency or during the recovery phase. These agreements identify the emergency measures to be provided, the mutually accepted criteria for implementation, and the arrangements for exchange of information. These support agencies (listed in Appendix 2 of this plan) provide services of:

- a. Law enforcement
- b. Fire protection
- c. Ambulance services
- d. Medical and hospital support

Support groups providing transportation and treatment of injured plant personnel are described in Section L of this Plan.

**Figure B-1a. Overall Emergency Response Organization Command Structure**

**Senior ERO Management Structure**

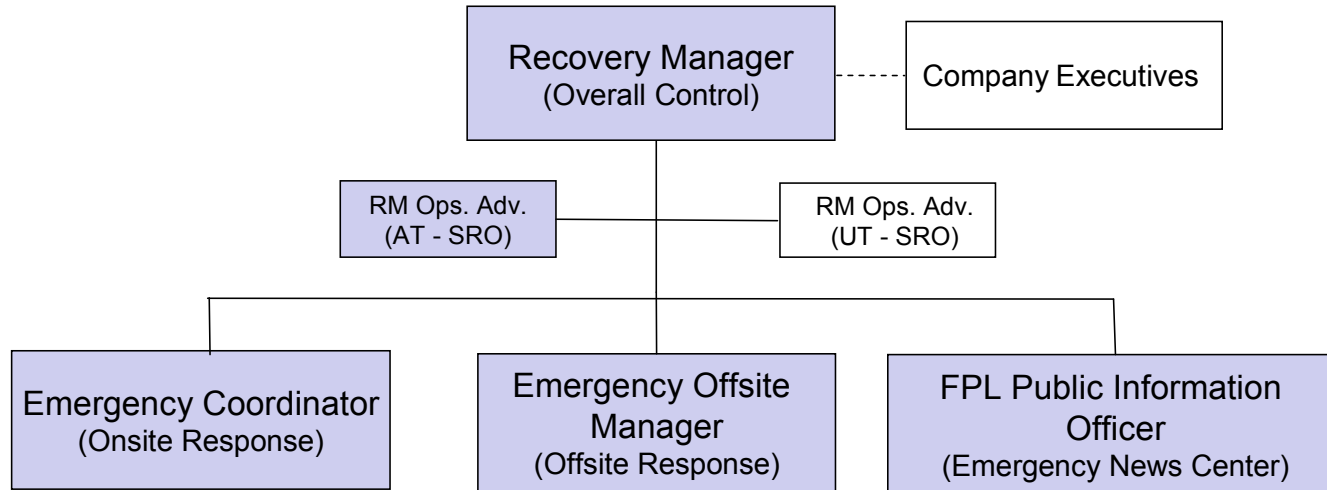

AT = Affected Technology  
UT = Unaffected Technology

Shaded boxes indicate minimum staffing positions to activate the facility.

**Figure B-1b.a: Onsite Emergency Response Organization**

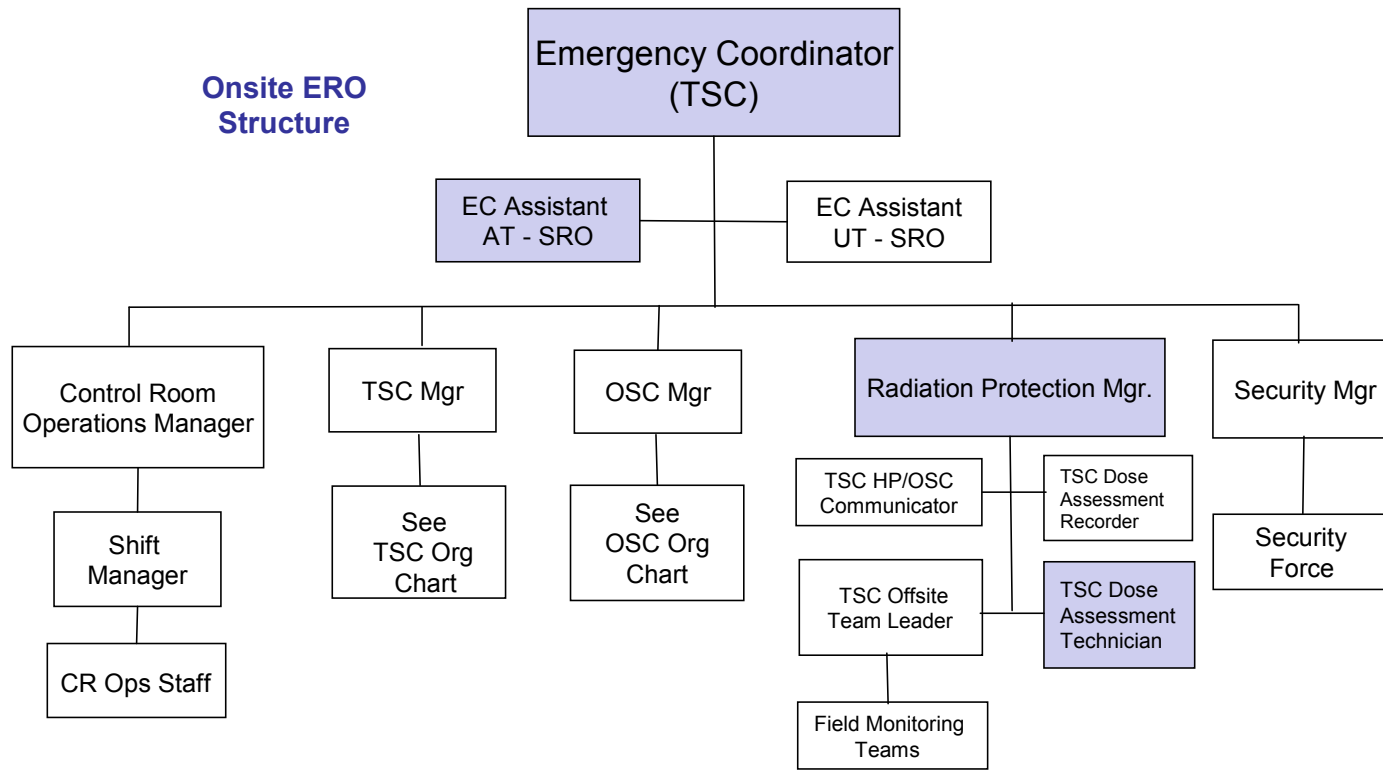

AT = Affected Technology  
UT = Unaffected Technology

Shaded boxes indicate minimum staffing positions to activate the facility.

**Figure B-1b.b: Onsite Emergency Response Organization - TSC**

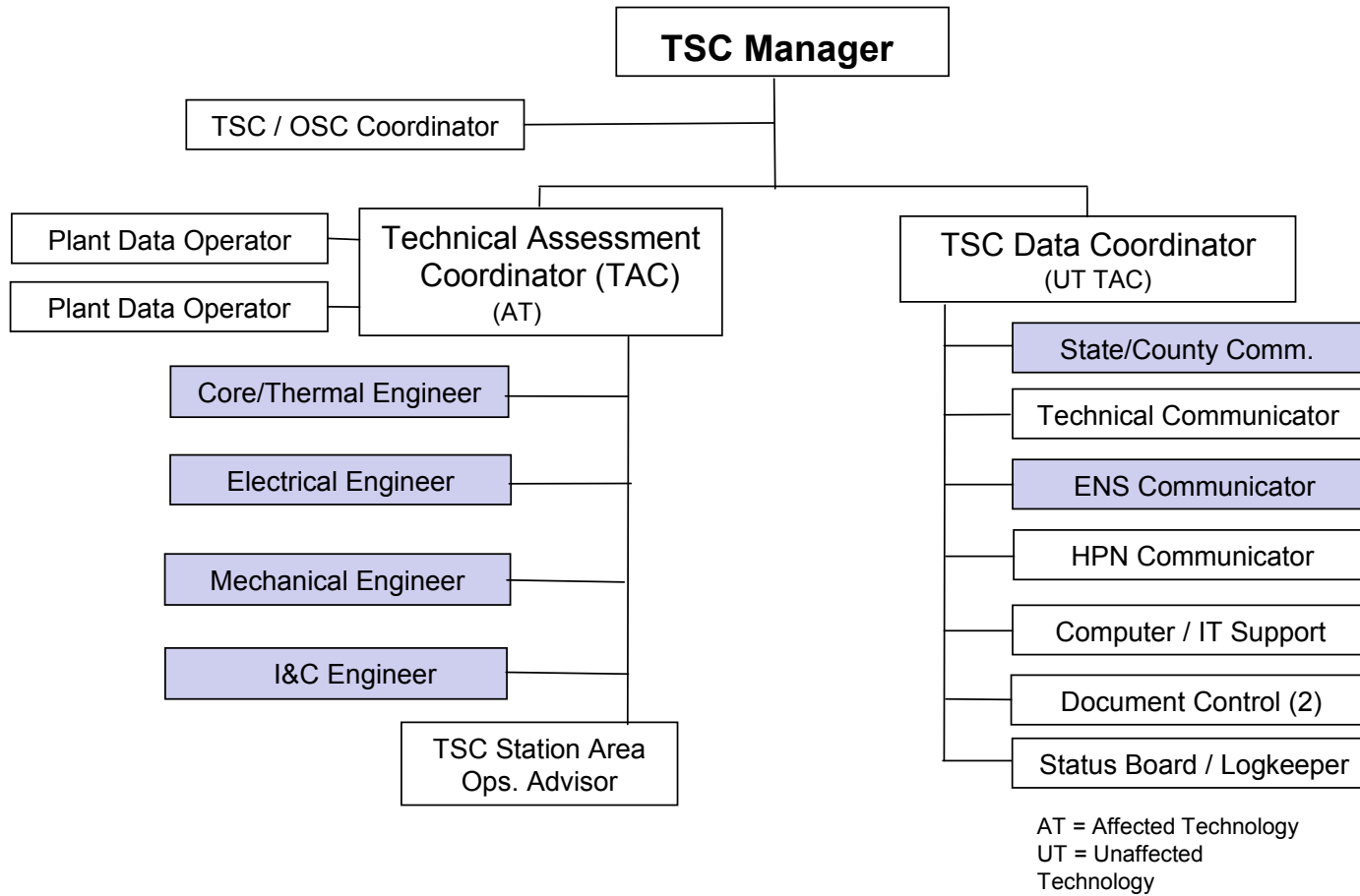

Shaded boxes indicate minimum staffing positions to activate the facility.

**Figure B-1b.c: Onsite Emergency Response Organization - OSC**

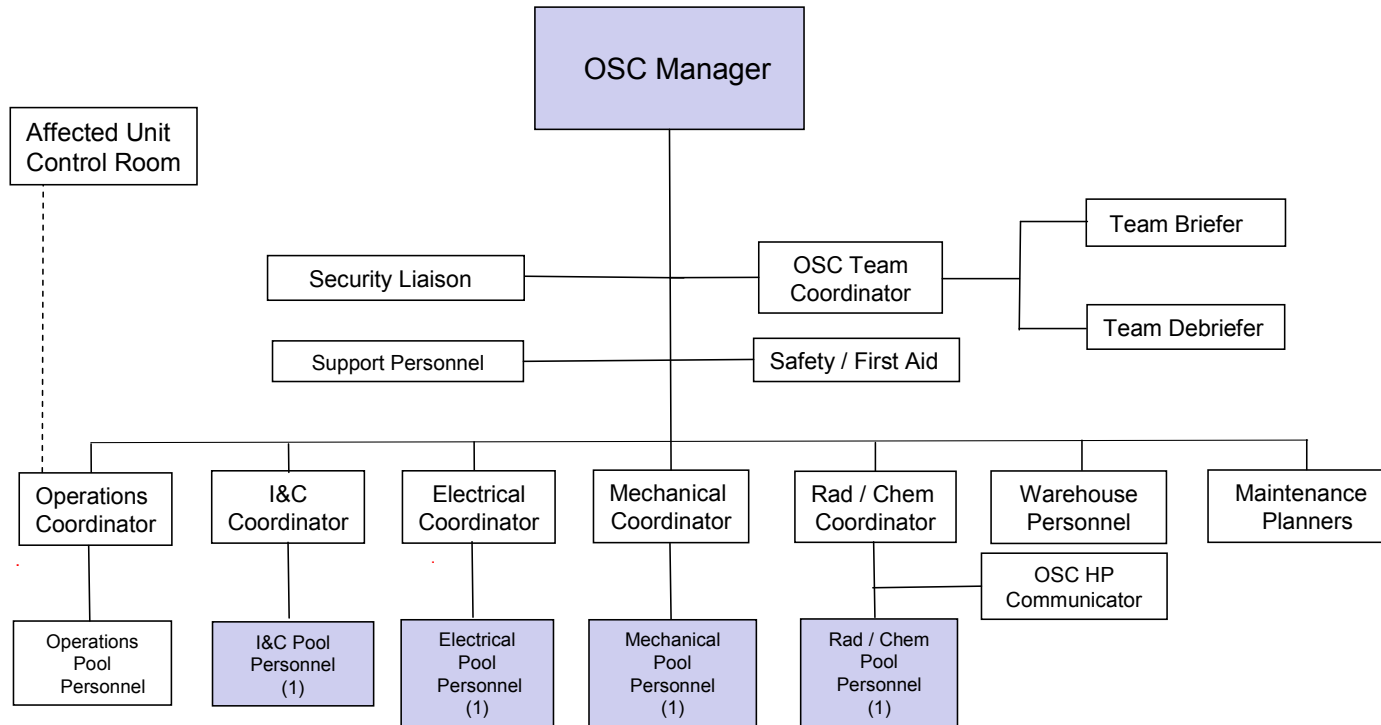

Shaded boxes indicate minimum staffing positions to activate the facility.

**Figure B-1c: Offsite Emergency Response Organization**

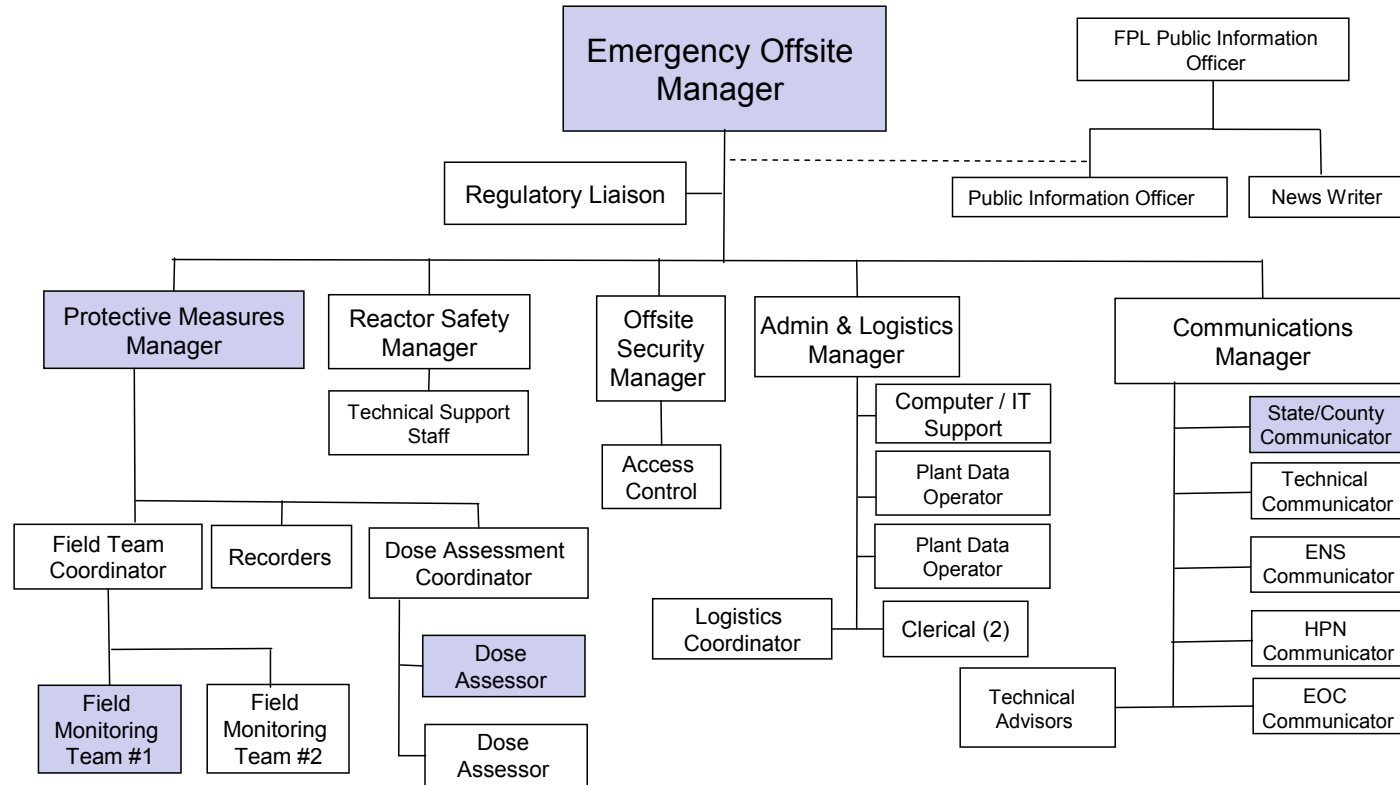

Shaded boxes indicate minimum staffing positions to activate the facility.

Figure B-1d: Emergency News Center Organization

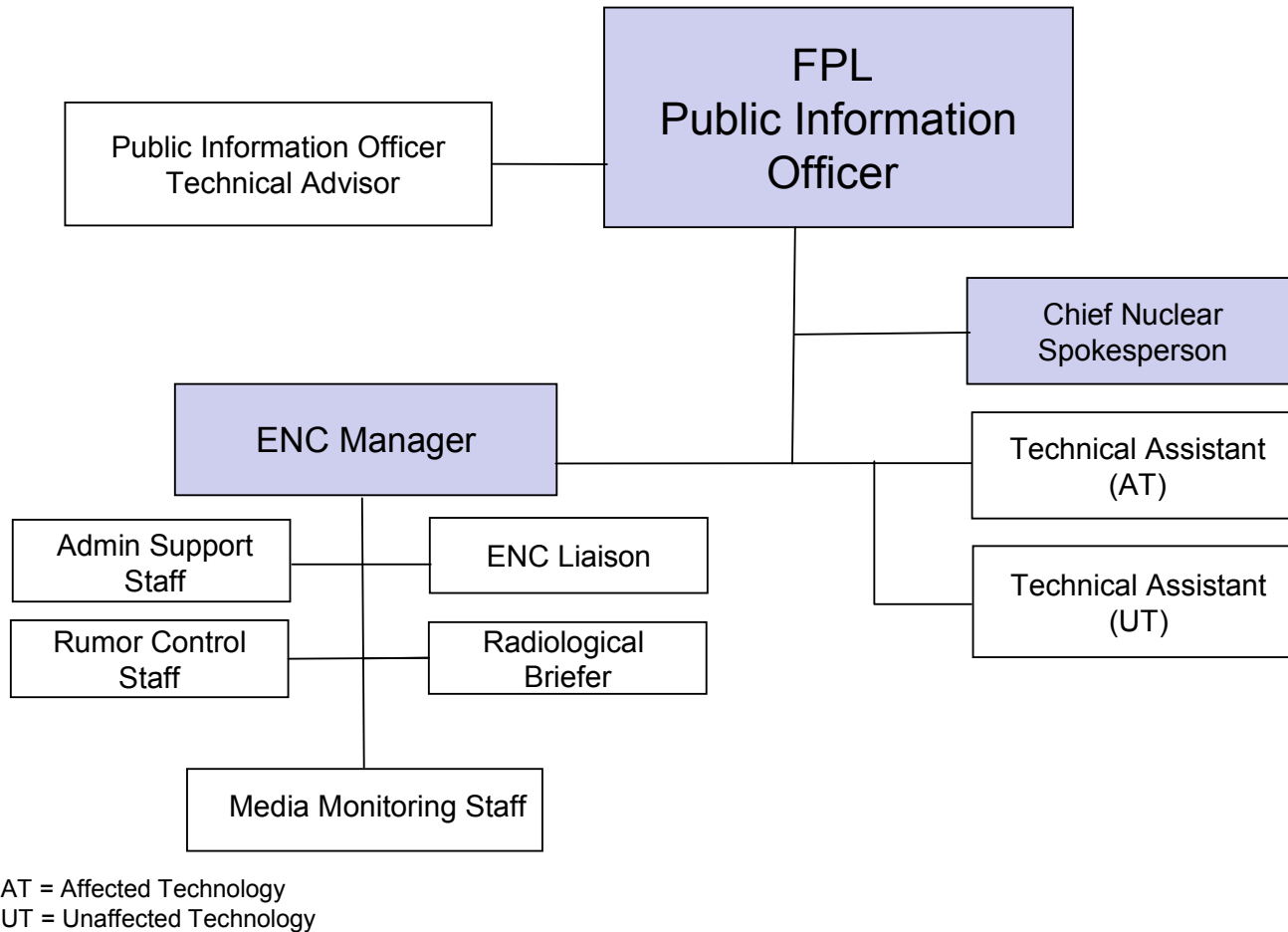

Shaded boxes indicate minimum staffing positions to activate the facility.

**Table B-1b: Staffing Requirements for the Turkey Point Plant Emergency Response Organization**

Functional Area	Major Tasks	Emergency Positions	Facility Staffing		Full Augmentation
			<sup>(a)</sup> 60-Minute Augmentation	Other On-Call	
1. Plant Operations and Assessment of Operational Aspects	Control Room Staff	See Table B-1a located in Unit-Specific Annexes for Shift Staffing. <sup>(f)</sup>			
2. Emergency Direction and Control	Command and Control	Emergency Coordinator <sup>(f)</sup> (CR) Control Room Operations Manager (CR) Emergency Coordinator (TSC) Recovery Manager (EOF)	1 1	1	
3. Notification & Communication	Emergency Communications	Plant Shift Personnel <sup>(f)</sup> State/County Communicator (TSC) State/County Communicator (EOF) ENS Communicator (EOF) Communications Manager (EOF) TSC Manager Emergency Offsite Manager (TSC) ENS Communicator (EOF) HPN Communicator (TSC) HPN Communicator (EOF)	1 1 1 1 1 1	1 1 1	
	Plant Status	Recovery Manager Ops. Adv. (EOF)	1	1	
4. Radiological Assessment	Offsite Dose Assessment	Plant Shift Personnel <sup>(f)</sup> Radiation Protection Manager (TSC) Protective Measures Manager (EOF) Dose Assessor (EOF)	1 1 1	1	
	Offsite Surveys	Dose Assessor (TSC) Field Monitoring Team Personnel RP(or others trained) Driver	1 2 2		
	Onsite Surveys	Onsite Field Team Personnel	2		(c)
	In-plant Surveys	RP Personnel <sup>(f)</sup>	1		(c)
	Chemistry	Chemistry Personnel <sup>(f)</sup>	1		(c)
	RP Supervisory	Rad/Chem. Coordinator (OSC)	1		



**Table B-1b: Staffing Requirements for the Turkey Point Plant Emergency Response Organization**

Functional Area	Major Tasks	Emergency Positions	Facility Staffing		Full Augmentation
			<sup>(a)</sup> 60-Minute Augmentation	Other On-Call	
5. Plant System Engineering, Repair, and Corrective Actions	Technical Support/Accident Analysis	Shift Technical Advisor <sup>(f)</sup> (CR) Emergency Coordinator Asst (SRO) (TSC) Core/Thermal Engineer (TSC) Mechanical Engineer (TSC) Electrical Engineer (TSC) I&C Engineer (TSC)	1 1 1 1 1		
	Repair and Corrective Actions	Mechanical Maintenance <sup>(b)</sup> (OSC) Electrical/I&C Maintenance <sup>(b)</sup> (OSC) OSC Manager (OSC)	1 2 1		(c) (c)
6. In-Plant Protective Actions	Radiation Protection	RP Personnel <sup>(f)</sup>	4		(c)
7. Fire Fighting	—	Fire Brigade	(d)		
8. First Aid and Rescue Ops	—	Plant Personnel	(b)		(c)
9. Site Access Control and Personnel Accountability	Security & Accountability	Security Team Personnel	(e)		
10. Public Information	Media Interface	FPL Public Information Officer (ENC) Technical Assistant (ENC) Chief Nuclear Spokesperson (ENC)		1 2 1	
	Information Development	ENC Liaison News Writer (EOF)		1 1	
	Media Monitoring and Rumor Control	Media Monitoring Staff (ENC) Rumor Control Staff (ENC)			(c) (c)
	Facility Operation and Control	ENC Manager (ENC)		1	
<b>TOTAL:</b>			<b>34</b>	<b>14</b>	<b>0<sup>(c)</sup></b>

- (a) Response time is based on optimum travel conditions
- (b) May be provided by personnel assigned other functions
- (c) Personnel numbers depend on the type and extent of the emergency
- (d) Fire brigade per FSAR/Technical Specifications, as applicable
- (e) In accordance with Security Plan
- (f) All shift ERO positions are listed in Table B-1a, contained in unit specific annexes. Note: OSC coordinators can be used to fill technical/craft positions in mechanical, electrical, I&C, radiation protection, and chemistry.

**SECTION C: EMERGENCY RESPONSE SUPPORT AND RESOURCES**

This section describes the provisions for requesting and effectively using support resources and for accommodating offsite officials at the Turkey Point emergency response facilities.

**1. FEDERAL RESPONSE SUPPORT AND RESOURCES**

During an emergency, federal agencies provide assistance through the National Response Framework (NRF). The NRC is the lead federal agency who provides direct assistance to Turkey Point during an emergency. Other federal agencies, such as the Department of Homeland Security and the DOE, provide assistance to the state of Florida through implementation of the NRF.

- a. Sections A and B of this Plan identify the specific individuals by title who are authorized to request federal assistance.
- b. Federal agencies that may provide assistance in direct support of Turkey Point in the event of an accident are identified in Section A of this Plan. It is expected that such assistance will be provided primarily by the NRC; however, FEMA may send a representative for near-site coordination. It is expected that NRC personnel will begin to arrive at the site within 6 hours after declaration of a *Site Area Emergency* or *General Emergency*.
- c. FPL has reserved space for federal and state agency personnel in the emergency response facilities. Federal assistance teams can access the plant via the Miami International Airport which is approximately 1 hour from the site. Each emergency response facility has the equipment and communications capability necessary for a continuous high level of response, interaction, and communication among key personnel during emergency conditions. The emergency response facilities are able to accommodate federal representatives with working areas provided for their use. Based on the NRC Response Coordination Manual 1996 (RCM-96) or NUREG-0728, accommodations for the initial site response team assume the following approximate numbers for each facility:

<b>Facility</b>	<b>Accommodations</b>
EOF	12
TSC	6
CR	1
ENC	2

## 2. LIAISONS

- a. The NRC, FEMA, state of Florida, and Miami-Dade and Monroe Counties may dispatch representatives to the EOF where accommodations have been provided.
- b. At the *Alert* level and above, Turkey Point personnel are assigned as liaisons to the state of Florida, Miami-Dade County, and Monroe County EOCs, when they are activated. These representatives act as technical liaisons to interpret EALs, explain accident conditions, and provide technical information regarding the affected unit's actions by the plant's ERO.

## 3. RADIOLOGICAL LABORATORIES

Support of the radiation monitoring and analysis effort is provided by an onsite laboratory. The onsite laboratory is the central point for receipt and analysis of all onsite samples and includes equipment for chemical analyses and for the analysis of radioactivity.

Additional laboratory facilities that can provide support include: 1) the Radiation Protection counting room facilities; 2) St. Lucie Plant radiological facilities which have the capability and services for analyzing high-level radioactivity samples; and 3) the state of Florida Mobile Emergency Radiological Laboratory (MERL), which will perform analysis of offsite environmental samples. This mobile lab can be in position near the site within approximately 6 to 8 hours of notification. A DOH-BRC representative dispatched to the EOF will coordinate all state offsite field monitoring data and sample media.

## 4. OTHER ASSISTANCE

Through INPO, other utilities with operating nuclear facilities are available to provide certain types of assistance and support, including technicians, engineering, design, consultation, whole body counting, and dosimetry evaluation and equipment. Additional facilities, organizations, and individuals, as listed in the emergency response directory, are available and may be used in support of emergency response. In addition, ANI provides insurance to cover FPL's legal liability up to the limits imposed by the Price-Anderson Act, for bodily injury and/or property damage caused by the nuclear energy hazard resulting from an incident at the plant.

Written agreements that describe the level of assistance and resources provided to FPL by external sources are included in Appendix 2 of this Plan, as applicable.

## SECTION D: EMERGENCY CLASSIFICATION SYSTEM

This section describes the classification and EAL scheme used to determine the minimum response to an abnormal event at the plant. This scheme is based on plant systems, effluent parameters, and operating procedures for each unit. The initial response of federal, state, and county agencies depends on information provided by the ERO. The Emergency Preparedness staff works closely with the state of Florida and county agencies to ensure consistency in classification schemes and procedural interfaces.

### 1. EMERGENCY CLASSIFICATION SYSTEM

The Emergency Plan provides for classification of emergencies into four categories or conditions, covering the postulated spectrum of emergency situations. They are:

- Notification of *Unusual Event* (referred to as *Unusual Event*)
- Alert
- Site Area Emergency
- General Emergency

Each classification is characterized by EALs or event initiating conditions and addresses emergencies of increasing severity.

- a. Unusual Event: Events are in process or have occurred that indicate a potential degradation of the level of safety of the plant or indicate a security threat to facility protection has been initiated. No releases of radioactive material requiring offsite response or monitoring are expected unless further degradation of safety systems occurs.

This is the least severe of the four levels. The purpose of this classification is to bring response personnel and offsite agencies to a state of readiness in the event the situation degrades and to provide systematic handling of information and decision making.

Required FPL actions at this classification include:

- Notifications to plant and company management.
- Notification, within 15 minutes, of the state and counties.

- At the discretion of the Emergency Coordinator or plant management, full or selective staffing of any one or more of the emergency response facilities may be initiated.
  - Notification of the NRC as soon as possible but within 60 minutes of classification.
  - Assessment of the situation and response as necessary, which may include escalating to a higher classification when and if conditions warrant.
  - Periodic plant status updates (typically every 60 minutes, upon significant change in plant conditions, or as agreed to with state, county, and federal agencies).
  - When the event is terminated, close-out is performed over communication links to offsite authorities participating in the response by providing a summary of the event (i.e., NRC, state, county), followed by formal written summary transmitted to the state and counties within 24 hours.
- b. Alert: Events are in process or have occurred that involve an actual or potential substantial degradation of the level of safety of the plant or a security event that involves probable life-threatening risk to site personnel or damage to site equipment because of intentional malicious dedicated efforts of hostile action. Any releases are expected to be limited to small fractions of the EPA Protective Action Guideline (PAG) exposure levels.

The purpose of this classification is to ensure that emergency response personnel are readily available and to provide offsite authorities with current status information. An *Alert* will be classified as the initiating event or as escalation from an *Unusual Event*.

Required FPL actions at this classification include:

- Notifications to plant and company management.
- Notification, within 15 minutes, of the state and counties.
- Activation of the TSC and OSC. The Recovery Manager places the EOF and ENC personnel in the facility ready for activation to support the response as conditions warrant.
- Notification of the NRC as soon as possible but within 60 minutes of classification.

- Notification of INPO and ANI.
  - Assessment of the situation and response as necessary, which may include escalating to a higher classification, if and when conditions warrant.
  - Dispatch of field monitoring teams to staging areas or to monitor for releases of radiation to the environment.
  - Provide periodic plant status updates (typically every 60 minutes, upon significant change in plant conditions, or as agreed to with state, county, and federal agencies), and provide meteorological assessments if releases are anticipated or occurring. If releases are occurring, provide dose estimates for actual releases.
  - Dispatch of plant technical representatives to the county and state EOCs when they are activated to provide a plant-knowledgeable individual to explain plant communications regarding the emergency and support the interaction with the offsite authorities during the emergency.
  - When the event is terminated, close-out is performed over communication links to offsite authorities participating in the response by providing a verbal summary of the event (i.e., NRC, state, county), followed by formal written summary transmitted to the state and counties within 8 hours.
- c. Site Area Emergency: Events are in process or have occurred that involve actual or likely major failures of plant functions needed for protection of the public or security events that result in intentional damage or malicious acts: (1) toward site personnel or equipment that could lead to the likely failure of or, (2) prevent effective access to equipment needed for the protection of the public. Any releases are not expected to result in exposure levels which exceed EPA PAG exposure levels beyond the site.

Required FPL actions at this classification include:

- Notifications to plant and company management.
- Notification, within 15 minutes, of the state and counties.
- Activation of the TSC, OSC, EOF and ENC.
- Notification of the NRC as soon as possible but within 60 minutes of classification.

- Assessment of the situation and response as necessary, which may include escalating to a higher classification, if and when conditions warrant.
  - Dispatch of field monitoring teams to monitor for releases of radiation to the environment.
  - Provide periodic plant status updates (typically every 60 minutes, upon significant change in plant conditions, or as agreed to with state, county, and federal agencies) and provide meteorological assessments and release and dose projections based on available plant and meteorological information and foreseeable contingencies.
  - If not previously performed, initiation of site evacuation of nonessential personnel and assembly/accountability.
  - When the event is terminated, close-out is performed over communication links to offsite authorities participating in the response by providing a verbal summary of the event (i.e., NRC, state, county), followed by formal written summary transmitted to the state and counties within 8 hours.
- d. General Emergency: Events are in process or have occurred that involve actual or imminent substantial core degradation or melting with potential for loss of containment integrity or security events that result in an actual loss of physical control of the facility. Releases can be reasonably expected to exceed EPA PAG exposure levels offsite for more than the immediate site area.

The purpose of this classification, in addition to those of the *Site Area Emergency* level, is to initiate predetermined protective actions for the public and provide continuous assessment of information from monitoring groups.

FPL required actions at this classification include:

- Notifications to plant and company management.
- Notification, within 15 minutes, of the state and counties, including protective action recommendations.
- Activation of the TSC, OSC, EOF and ENC.

- Notification of the NRC as soon as possible but within 60 minutes of classification.
  - Dispatch of field monitoring teams to monitor for releases of radiation to the environment.
  - Provide periodic plant status updates (typically every 60 minutes, upon significant change in plant conditions, or as agreed to with state, county, and federal agencies) and provide release and dose projections based on available plant and meteorological information and foreseeable contingencies.
  - If not previously performed, initiation of site evacuation of nonessential personnel and assembly/accountability.
  - Assessment of the situation and response as necessary, which may include de-escalation to a lower classification, if and when conditions warrant.
  - When the event is terminated, close-out is performed over communication links to offsite authorities participating in the response by providing a verbal summary of the event (i.e., NRC, state, county), followed by formal written summary transmitted to the state and counties within 8 hours.
- e. Classification Downgrading: An emergency classification may be downgraded to a lower classification in accordance with guidelines and criteria as described in EIPs. The Emergency Coordinator may downgrade a classification from an *Alert* to an *Unusual Event* with the concurrence of the Recovery Manager if the EOF is activated and in accordance with applicable EIPs. However, if the event is classified as a *Site Area Emergency* the Emergency Coordinator must obtain concurrence from the Recovery Manager in the EOF prior to de-escalation.
- f. Guidance for Termination of an Emergency: The purpose of terminating an emergency is to provide an orderly turnover of plant control from the ERO to the normal Turkey Point organization. Termination of the emergency is authorized by the Emergency Coordinator and conducted in accordance with the EIPs. Considerations for entry into recovery must be performed before exiting the emergency event. If the event is classified as a *Site Area Emergency* or *General Emergency*, governmental agencies must be consulted. Notifications shall be transmitted to appropriate agencies to terminate an event. When a classified event is terminated, a recovery phase will be entered.



- g. Recovery Phase: That period when the emergency phase is over and activities are being taken to return the situation to a normal state (acceptable condition). The plant is under control, and no potential for further degradation to the plant or the environment is believed to exist.

Entry into the Recovery Phase will be determined by the Emergency Coordinator and Recovery Manager after consultation with the Emergency Coordinator at an *Alert* or higher classification and the offsite authorities if a *Site Area Emergency* or *General Emergency* was declared. The Shift Manager, acting as Emergency Coordinator, may enter the recovery/termination phase after the *Unusual Event*, when conditions warrant.

Required actions at this classification include:

- The state and the NRC shall be consulted before entry into recovery from a *Site Area Emergency* or a *General Emergency*.
  - Notifications will be made to plant management, state, counties, and NRC.
  - A recovery organization will be established to manage repairs to return the affected unit(s) to an acceptable condition, and support environmental monitoring activities as requested in coordination with federal and state efforts.
  - INPO and ANI are notified of recovery classification.
- h. Turkey Point Physical Security Plan: Turkey Point has a Security Plan that complies with the requirements of 10 CFR 73. The interface between the Radiological Emergency Plan and the Security Plan is one of parallel operation. The plans are compatible. The Radiological Emergency Plan response measures, once initiated, are executed in parallel with measures taken in accordance with the Security Plan. During a classified event, the individual in overall command and control has responsibility for implementing both plans.

Threats made to Turkey Point facilities are evaluated in accordance with established threat assessment procedures and the Security Plan. The Security Plan Safeguards Contingency Plan identifies situations that could be initiating conditions for EAL classifications. Contingency events include bomb threats, attack threats, civil disturbances, Protected Area intrusions, loss of guard/post contact, vital area intrusions, bomb devices discovered, loss of guard force, hostages, extortion, fire/explosions, internal disturbances, security communications failure, and obvious attempts of

tampering. The Safeguards Contingency Plan provides guidance for decisions and actions to be taken for each security contingency event. As guidance, the Safeguards Contingency Plan allows for differing responses depending upon the assessment of the actual situation within each contingency event classification.

The assessment of any security contingency event and the decision to initiate, or not to implement, the Radiological Emergency Plan, will be the responsibility of the Shift Manager or Emergency Coordinator. All identified security contingency events have the potential of being assessed as initiating conditions for a radiological emergency declaration.

## **2. EMERGENCY ACTION LEVEL TECHNICAL BASIS**

Unit Annexes include unit-specific EALs consistent with the general class descriptions and provided in NEI guidance documentation in accordance with RG 1.101, *Emergency Planning and Preparedness for Nuclear Power Reactors*. Where possible, these EALs will be related to plant instrumentation readings.

Emergency classifications are characterized by EALs. The threshold values are referenced whenever an initiating condition is reached. An initiating condition is one of a predetermined subset of unit conditions where either the potential exists for a radiological emergency, or such an emergency has occurred. Defined in this manner, an initiating condition is an emergency condition, which sets it apart from the broad class of conditions that may or may not have the potential to escalate into a radiological emergency. Initiating conditions are arranged in one of the recognition categories.

EALs are for unplanned events. A planned evolution involves preplanning to address the limitations imposed by the condition, the performance of required surveillance testing, and the implementation of specific controls before knowingly entering the condition. Planned evolutions to test, manipulate, repair, perform maintenance or modifications to systems and equipment that result in an EAL threshold value being met or exceeded are not subject to classification and activation requirements as long as the evolution proceeds as planned. However, these conditions may be subject to the reporting requirements of 10 CFR 50.72.

An emergency is classified after assessing abnormal plant conditions and comparing them to EAL threshold values for the appropriate initiating conditions. Classifications are based on the evaluation of each unit at Turkey Point. EAL matrix tables organized by recognition categories are used to facilitate the comparison. The EAL matrix for Units 3 & 4 is used when the unit is in the Technical Specification defined modes of power operations as: Power Operations, Startup,

Hot Standby, Hot Shutdown, Cold Shutdown, Refueling or Defueled. The EAL matrix for Units 6 & 7 is used when either unit is in the Technical Specification defined modes of power operations as: Power Operations, Startup, Hot Standby, Safe Shutdown, Cold Shutdown, Refueling, or Defueled.

All recognition categories should be reviewed for applicability before classification. The initiating conditions are coded with a letter and/or number designator. All initiating conditions, which describe the severity of a common condition (series), have the same initial designator.

### **3. OFFSITE CLASSIFICATION SYSTEMS**

FPL works with the state to ensure consistency between classification schemes. The content of the EALs is reviewed with the state and county authorities on an annual basis. The state and counties are informed regarding any EAL changes that significantly impact the initiating conditions or technical basis.

### **4. OFFSITE EMERGENCY PROCEDURES**

FPL coordinates with the state and county authorities to ensure that procedures are in place that provide for emergency actions to be taken which are consistent with the protective actions recommended by the plant, accounting for local offsite conditions that exist at the time of the emergency.

## SECTION E: NOTIFICATION METHODS AND PROCEDURES

This section describes notification of ERO personnel; state, county, and federal agencies; and the general public during a declared emergency at Turkey Point. This section outlines the content of initial and follow-up messages to response organizations within the plume exposure pathway EPZ. Details regarding notification responsibilities, communications systems, information required to be transmitted to offsite agencies, and notification techniques, are specifically described in appropriate EIPs.

### 1. BASES FOR EMERGENCY RESPONSE ORGANIZATION NOTIFICATION

FPL, in cooperation with state and county authorities, has established mutually agreeable methods and procedures for notification of offsite response organizations consistent with the emergency classification and action level scheme. Notifications to offsite agencies include a means of verification or authentication, such as the use of dedicated communications networks, verification code words, or providing call-back verification phone numbers.

If an emergency classification involves all Units (3, 4, 6, & 7) (i.e., for a natural phenomena emergency or security-related event), and the classification for each unit is the same, the emergency shall be reported as affecting all units at the site. Unit 3 is typically designated as the lead unit for site-wide emergencies that include offsite notifications, unless conditions warrant otherwise. When an event affecting the site is detected, Unit 3 will be contacted and provided information for emergency declaration. If an emergency classification involves only one unit, the affected unit will declare the emergency and initiate required notifications.

### 2. NOTIFICATION AND MOBILIZATION OF EMERGENCY RESPONSE PERSONNEL

EIPs are established for notification and mobilization of emergency response personnel as follows:

- a. Onsite: When an emergency is declared, reclassified, or terminated, an announcement is made (over the plant public address system or by other means) that includes the emergency classification declared and response actions to be taken by site personnel.

At the *Unusual Event* classification, select ERO augmentation personnel may be notified and requested to remain available to respond. At an *Alert* classification or higher, ERO augmentation personnel are notified for activation of the TSC, OSC, EOF and ENC using an automated callout system (pagers), or call lists in the emergency response directory using commercial telephone as a backup.

b. Offsite: Notifications are promptly made to offsite agencies as follows:

1) State/County Agencies: A notification shall be made within 15 minutes of:

- The initial emergency classification
- Classification escalation
- The issuance of, or change to a Protective Action Recommendation (PAR) for the general public
- Changes in radiological release status, occurring outside of an event classification or protective action recommendation notification;
- Event termination

The emergency warning points are notified using a dedicated notification system. Commercial telephone lines, emergency satellite communications system (EMNET), cellular telephones, and/or radios are available as backup notification methods.

Personnel receiving the information at the emergency warning points are designated by the State/County Agencies. They include: the on-shift representative at the Miami-Dade Warning Point as designated by the Miami-Dade County Mayor, the on-shift representative at the Monroe County Warning Point as designated by the Monroe County Mayor and the on-shift representative at State Watch Office-Tallahassee as designated by the Director - Division of Emergency Management, and the assigned communicators in the County and State Emergency Operations Centers (EOCs).

2) NRC: An event will be reported to the NRC Operations Center immediately after notification of the appropriate state and county agencies, but not later than 1 hour after the time of initial classification, escalation, or event termination. The primary means of notification between the plant and the NRC is a dedicated system called the Emergency Notification System (ENS). Commercial telephone lines, cellular telephones, and a satellite telephone are available as a backup notification method.

Specific requirements for the NRC notifications for classified emergency events are detailed in 10 CFR 50.72 with guidance provided in the plant's notification procedures.

The Emergency Response Data System (ERDS), which is a computerized data link to the NRC, will be initiated within 1 hour of the declaration of an *alert* classification or higher.

Mobilization of federal, state, and county response organizations is performed in accordance with their applicable emergency plans and procedures. At a minimum, mobilization of federal response organizations and activation of state and county EOCs is expected to occur at the declaration of a *Site Area Emergency*. The state and county authorities are responsible for the process of notification of the general public.

- c. Support Organizations: When an emergency is initially classified, escalated, or terminated, notifications are promptly made to the following support organizations for assistance, as required:
- Medical, rescue, and firefighting support services
  - INPO and ANI (*Alert* or higher classification)
  - Vendor and contractor support services

### 3. INITIAL NOTIFICATION MESSAGES

- a. FPL, in conjunction with state and county authorities, has established the contents of the Florida Nuclear Plant Emergency Notification Form, which is completed and transmitted to the state and counties during a classified emergency. For an initial notification, the form includes, as a minimum, the emergency classification, whether a release is taking place, basic meteorological data, potentially affected population/areas, and any recommended protective actions. As additional information describing the emergency situation and local conditions becomes available, supplemental messages containing more detail than the initial notification will be provided.
- b. The NRC is notified of a classified emergency following state/county notification, using the Event Notification Worksheet (NRC Form 361) for initial notifications. If the NRC requests an open line for communications, the Event Notification Worksheet does not have to be completed for transmittal of supplemental information. Event information is communicated verbally per NRC request.

**4. FOLLOW-UP MESSAGES**

- a. For all emergency classifications, follow-up messages to state and county authorities will be provided on a prearranged frequency to provide further description of the emergency utilizing the Florida Nuclear Plant Emergency Notification Form. The following information would be supplied to the extent the information is available and appropriate:
- 1) Incident location and name and contact information of caller.
  - 2) Incident time and date.
  - 3) Emergency classification.
  - 4) Information regarding any actual or potential radioactive releases, including medium (i.e. airborne, waterborne) and duration.
  - 5) Estimates of total and relative quantities and concentrations of noble gases, iodine, and particulates.
  - 6) Other available and pertinent information regarding the release.
  - 7) Meteorological conditions, including wind speed and direction, stability class, and precipitation.
  - 8) Projected doses at the Turkey Point site boundary and at 2, 5, and 10 miles.
  - 9) Emergency response actions underway.
  - 10) Protective Action Recommendations (PARs).
  - 11) Requests for any onsite support by offsite organizations (e.g., firefighting or medical transportation support).
  - 12) Prognosis for changes in event classification or other conditions based on current assessments of plant conditions.
- b. Follow-up notifications are provided to the NRC Operations Center as soon as possible, but not later than 1 hour after significant new information is available involving:
- 1) Incident location and name and contact information of caller.

- 2) The effectiveness of response or protective measures taken.
- 3) Information related to plant behavior that is not understood.

If requested by the NRC, an open, continuous communications channel will be maintained with the NRC Operations Center using the ENS and/or HPN circuits. The Event Notification Worksheet does not have to be completed for information transmittal, but it can be used as a guide for transfer of event status as requested.

## **5. STATE AND COUNTY INFORMATION DISSEMINATION**

The state and county emergency response plans describe procedures for state and county officials to make a public notification decision promptly on being informed by the plant of an emergency. The system for disseminating information to the public includes notification by prescribed messages through appropriate broadcast media such as the Emergency Alert System (EAS).

## **6. NOTIFICATION OF THE PUBLIC**

It is the responsibility of FPL, along with state and local governmental organizations, to provide adequate means for prompt notification of the general public within the 10-mile plume exposure pathway EPZ around Turkey Point. Administrative and physical means have been established for providing early initial warning and subsequent clear instructions to the public within the 10-mile EPZ. This notification capability consists of two principal elements: the Alert and Notification System (ANS) and the Emergency Alert System (EAS) radio and television stations.

The ANS consists of fixed sirens located throughout the 10-mile EPZ. The locations of the sirens were determined by an engineering study that addressed population density, geographical features, siren output, and mounting height of sirens, to ensure coverage of the EPZ. Activation of the sirens, when directed by the county officials, will alert the public to tune to a local radio or television station affiliated with the EAS for detailed information on the emergency. Local and state actions are then initiated in accordance with the State of Florida Radiological Emergency Management Plan to ensure the implementation of appropriate protective measures.

The EAS is a network of local radio and television stations prepared to transmit or relay emergency information and instructions from the county officials to the general public.



The ANS will be activated by Miami-Dade County from the EOC or Miami Dade County 911, upon coordination and direction by state or local authorities, as specified in existing agreements concerning system activation. The siren system is designed in such a fashion that it can be operationally segregated by county boundary within the 10-mile radius.

To ensure the ANS is maintained in a state of operational readiness, the local agencies have agreed to a testing frequency for the system by sounding the sirens on a periodic basis that meets or exceeds FEMA guidance. Reports of inoperable equipment are provided to maintenance personnel designated by emergency preparedness. The goal of the testing and maintenance program is to identify inoperable equipment in a timely manner and to restore equipment to a functional status commensurate with FEMA operability requirements, as referenced in FEMA-REP-10, *Guide for the Evaluation of Alert and Notification Systems for Nuclear Power Plants*. In addition to the routine test and repair program, preventive maintenance of the ANS will be performed in accordance with the approved FEMA-REP-10 approved program.

In the unlikely event that the ANS would fail to activate, the State of Florida Radiological Emergency Plan and Miami-Dade and Monroe counties maintain the capacity to perform backup route alerting.

## **7. MESSAGES TO THE PUBLIC**

The Offsite Response Organization (ORO) has developed EAS messages, as described in the offsite plans. EAS messages are consistent with the classification scheme and contain instructions with regard to specific protective actions to be taken by occupants and visitors of affected areas. FPL will provide offsite authorities with supporting information for messages to the public. The messages provide information on the nature of the emergency and recommended protective actions, including sheltering, evacuation, and the use of potassium iodide, as appropriate. The state and/or the counties control the distribution of radioprotective drugs to the general public.

## **SECTION F: EMERGENCY COMMUNICATIONS**

This section describes the provisions used for communications between Turkey Point and principal response organizations including state, local, and federal agencies and also describes communications between the emergency response facilities. EIPs describe use of communications systems during an emergency; and emergency plan administrative procedures provide additional details describing testing and maintenance of communications systems.

### **1. COMMUNICATIONS/NOTIFICATIONS**

FPL has extensive and reliable communication systems installed at Turkey Point. Examples of the communications network include systems such as normal and dedicated telephone lines on landlines, fiber-optic voice channels, cellular telephones, satellite telephones, mobile radio units, portable radios, and computer peripherals. This network provides voice communication through normal telephone, dedicated line, and automatic ring-down between selected facilities; satellite and cell phone capability to maintain communication links to the emergency response facilities and offsite authorities; communications between emergency vehicles and fixed locations; and facsimile, computer network, and modem transmission.

Figure F-1 shows the initial notification paths and the organizational titles from the Turkey Point emergency response facilities to federal, state, and county emergency response organizations, and industry support agencies. The primary and alternate methods of communication between FPL emergency response facilities, and the NRC communications network, are illustrated on Figures F-2 and F-3.

FPL maintains the capability to make initial notifications to the designated offsite agencies on a 24-hour-per-day basis. The offsite notification system state hot ring down telephone provides primary communications to state and county warning points and EOCs from each Control Room, TSC, and the EOF. Backup or secondary methods include commercial telephone lines, emergency satellite communications system (EMNET), cellular telephones, and radios. State and county warning points are continuously staffed.

FPL has established several communication systems that ensure reliable and timely exchange of information necessary to provide effective command and control over any emergency response (1) between the plant and state and county agencies within the EPZs, (2) with federal emergency response organizations, (3) between the plant, the EOF and the state and county EOCs, and (4) between the emergency response facilities and Field Monitoring Teams.

Communications Equipment

- a. Plant Page System: The Plant Page System is a public address system with speakers and handsets located throughout the plant, including the Control Rooms and TSC. The system provides for transmission of warning and instructions in the event of an emergency. Plant alarms are broadcast over the Plant Page System. The system is primarily used for intra-plant communications and permits merging with and separation from other units of the plant. Power to the system is supplied from a variety of sources, and an alternate power supply is provided.
- b. Private Branch Exchange (PBX) Telephone System: The PBX telephone system provides communication capability between telephones located in the Turkey Point facilities through direct dialing. The PBX is used to connect the affected unit's Control Room, TSC, OSC, EOF and ENC. The PBX telephone system also provides for outside communications through interconnections with the FPL Intelligent Tandem Network (ITN) corporate telephone communications system and local commercial telephone lines. This system may be utilized as a secondary communication link to the county governments. Power to the PBX is provided from non-Class 1E dc and uninterruptible power supply system.
- c. Commercial Telephone System: This system provides standard commercial telephone service which is installed by the local telephone company for normal dial telephone service in the plant. This system includes connections to the PBX and FPL ITN System, dedicated lines to emergency response facilities, and is the primary system for routine communication with areas outside the plant. This system may be utilized as a secondary communication link to the county governments. The commercial vendor provides primary and secondary power for their lines
- d. FPL Intelligent Tandem Network (ITN) System: The ITN System can be accessed in most plant locations and allows direct dial capability to company office locations, access to Wide Area Telephone Services (WATS) line, and local telephone calls.
- e. State Hot Ring Down Telephone: The state hot ring down is a dedicated communications system that has been installed for the purpose of notifying state and county authorities of declared emergencies at Turkey Point. This system links together the Control Rooms, TSC, EOF and state and county government agencies as appropriate and is the primary means of communication.

- f. Emergency Satellite Communication System (EMNET): EMNET is an emergency satellite communication system that is available in the Control Rooms, TSC, and EOF. The initial notification of all emergencies and other required notifications to the State Division of Emergency Management (DEM) and the County's Department of Public Safety will be made via the Hot Ring Down telephone with EMNET as the alternate communications pathway.
- g. Automated ERO Callout System: Turkey Point uses an automated callout system that employs pagers and telephones to notify the ERO. If the callout system fails, plant personnel may be required to manually activate the ERO group page feature and/or directly callout ERO personnel.
- h. Dedicated Phone Lines: A dedicated phone link is established by limiting a phone line to one purpose, blocking its use for all other purposes. Several dedicated telephone links have been established for use by the ERO to perform key communication tasks, including:
- 1) Communications between the affected unit's Control Room, TSC, and OSC to coordinate dispatch of teams from the OSC (see Figure F-2).
  - 2) Communications between the affected unit Control Room, the TSC, and the EOF to monitor the activities of the Control Room staff and provide technical data to facilities outside the Control Room (see Figure F-2).
  - 3) Conferencing between the TSC and the EOF (see Figure F-2).
  - 4) Communications between the Recovery Manager in the EOF, the Control Room, and the TSC (see Figure F-2).
- i. NRC Telephones:
- Separate telephone lines are dedicated for communications to the NRC and include the following:
- 1) Emergency Notification System (ENS): The ENS is used for initial notification from the plant to the NRC, as well as ongoing information on plant systems, status, and parameters. The ENS is located in each Control Room, the TSC, and EOF. A separate line is available in the EOF with the capability of being patched with the plant through the NRC. Backup power is provided for these lines, which

complies with the requirements of NRC Bulletin 80-15 regarding loss of offsite power to the ENS.

- 2) Health Physics Network (HPN): The HPN is used to transmit information to the NRC regarding radiological conditions (in-plant and offsite), meteorological conditions, and assessment of trends and needs for protective measures onsite and offsite. The HPN is located in the TSC and EOF and may be used as an open communication line with the NRC. Backup power is provided for these lines.
  - 3) Reactor Safety Counterpart Link (RSCL): This system allows for internal NRC discussions regarding plant and equipment conditions. RSCL lines are located in the TSC and EOF.
  - 4) Protective Measures Counterpart Link (PMCL): This system allows for conduct of internal NRC discussions on radiological releases, meteorological conditions, and protective measures. PMCL lines are located in the TSC and EOF.
  - 5) Management Counterpart Link (MCL): This system has been established for internal discussions between the NRC executive team director/members and the NRC Site Team Director or FPL management. MCL lines are located in the TSC and EOF.
  - 6) Emergency Response Data System (ERDS): As prescribed by 10 CFR 50 Appendix E.VI, ERDS will supply the NRC with selected plant data points on a near real-time basis. ERDS is activated by the ERO as soon as possible but not later than 1 hour after declaration of an *Alert*, *Site Area Emergency*, or *General Emergency*. The selected data points are transmitted via modem to the NRC at approximately 1-minute intervals. The ERO has backup methods available to provide required information to the NRC in the event that ERDS is inoperable during the declared emergency.
- j. Satellite Telephones: This satellite system is a portable satellite phone with international calling capabilities. The system is capable of communication with any telephone (public network, cellular, satellite, etc.). This system is available to Control Room, TSC, and EOF personnel and provides a backup or secondary communication link in the event that the landlines are rendered inoperative.

- k. Company Radio System: Radio systems are provided for offsite communication with other FPL facilities and government agencies. This radio system consists of a variety of fixed base radio equipment. The system operations power coordinator's office, trouble dispatcher offices, service centers, power plants, and mobile service vehicles are equipped with one or more of these radio systems. The radio may be used to communicate with the EOF System Operations, Storm Headquarters, and other FPL facilities and mobile units throughout Miami-Dade County, including the EOC. The radio may be used for longer range communications to the EOF and FPL Corporate Offices in Juno Beach. A repeater channel for plant use is also available to DOH-BRC for communication with emergency response teams and/or from the Mobile Emergency Radiological Laboratory (MERL) sites. In addition, the U.S. Coast Guard and NOAA Weather Radio Channels are also available on the systems for emergency communications, as required, and to monitor weather conditions and receive weather advisories. In the event of interruption of onsite electric service to the base radio stations, backup power is available to equipment.
- l. 900 Megahertz Radio System: The 900 megahertz radio system is available to supplement fixed communications in the plant and is used for Field Monitoring Team communications. This system consists of necessary hardware to allow radio communication between the affected unit Control Room, EOF and mobile units in FPL vehicles. Commercial cell phones are available as backup to the primary field team communications system. This radio system also provides the ability to be used as a crisis management radio system.

## **2. COMMUNICATIONS WITH FIXED AND MOBILE MEDICAL SUPPORT FACILITIES**

Communications are established from the site to the primary and backup medical hospitals and transportation services via telephone or radio. In all cases, telephone notification is made by the site to the hospital concerning the pending arrival of injured personnel. Additionally, if a helicopter is needed for transport, the hospital can maintain ground-to-air communications. Cellular telephones are available on site to be used as an alternate means of communication.

## **3. COMMUNICATIONS TESTING**

Communications equipment is checked in accordance with Section N.2 of this Plan. Communication drills between Turkey Point and state and county government facilities are conducted in accordance with Section N.2.a. Sirens are tested in accordance with the approved FEMA-REP-10 approved program.

Figure F-1. Notification Scheme (After Full Augmentation)

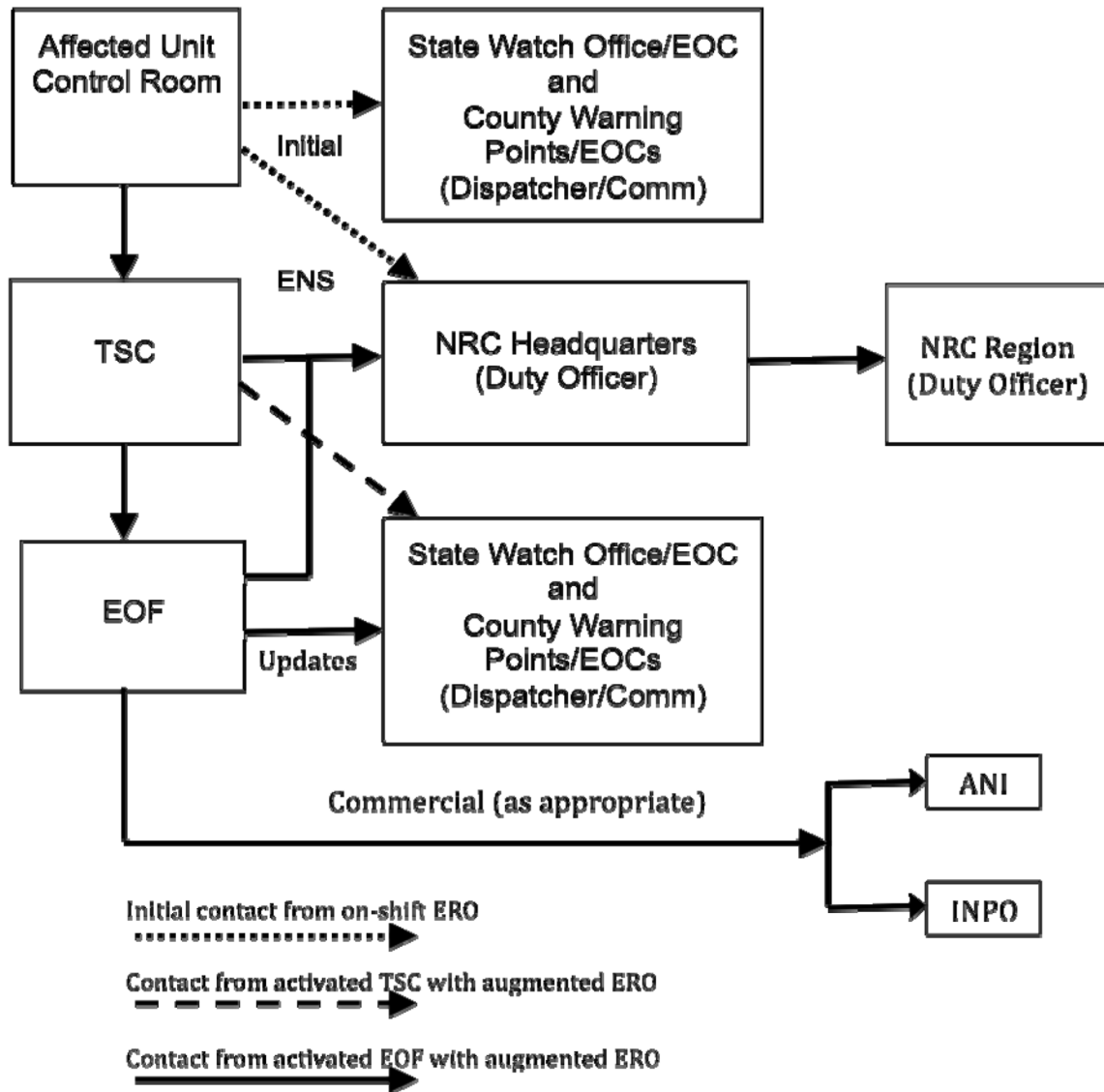

**Figure F-2. Emergency Response Facility Communications Matrix**

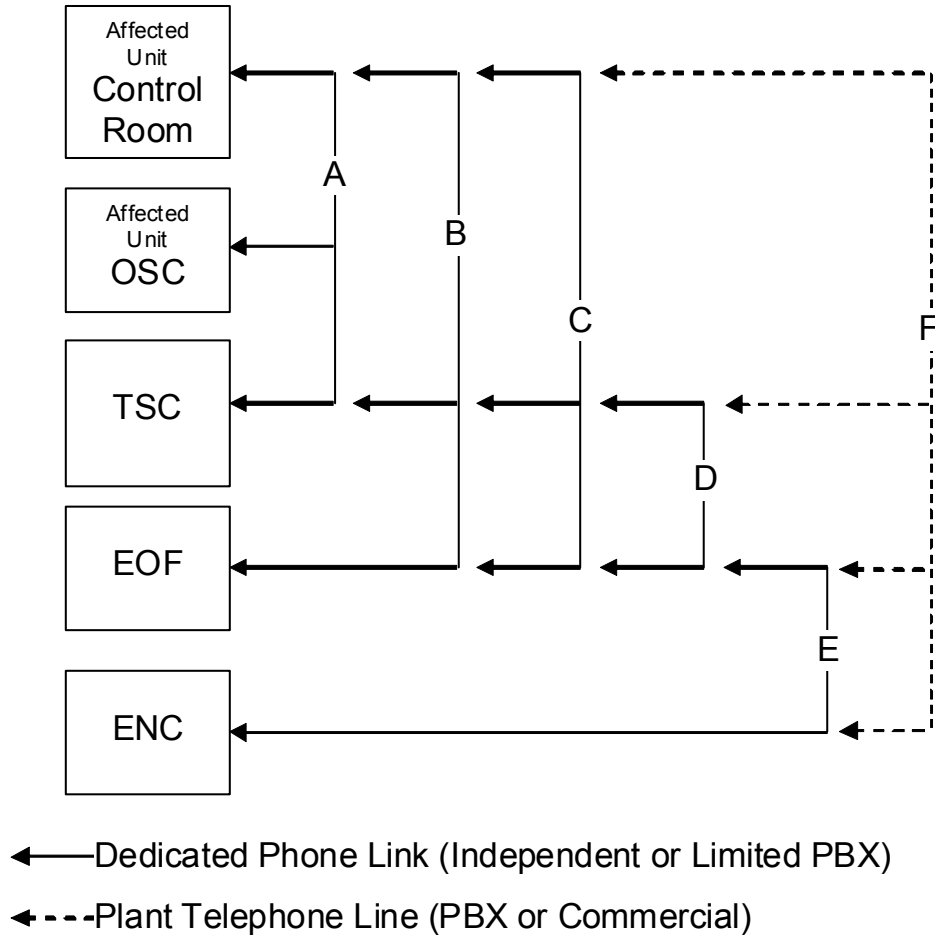

- A = Dedicated phone link for the affected unit to coordinate dispatch of OSC teams between the OSC, TSC, and affected unit Control Room.
- B = Dedicated phone link for use by the Recovery Manager, Emergency Coordinator, and Shift Manager/Control Room Operations Manager between the affected unit Control Room, the TSC, and the EOF
- C = Dedicated phone link for transmission of technical data between the TSC, affected unit Control Room, and the EOF
- D = Dedicated phone link between the TSC and EOF
- E = Dedicated phone link to discuss changes in plant or affected plant conditions and emergency public information needs between the EOF and the ENC.
- F = Plant telephone line that is a communication link between all activated facilities, with the exception of the OSC.



**Figure F-3. NRC Communications for Nuclear Response**

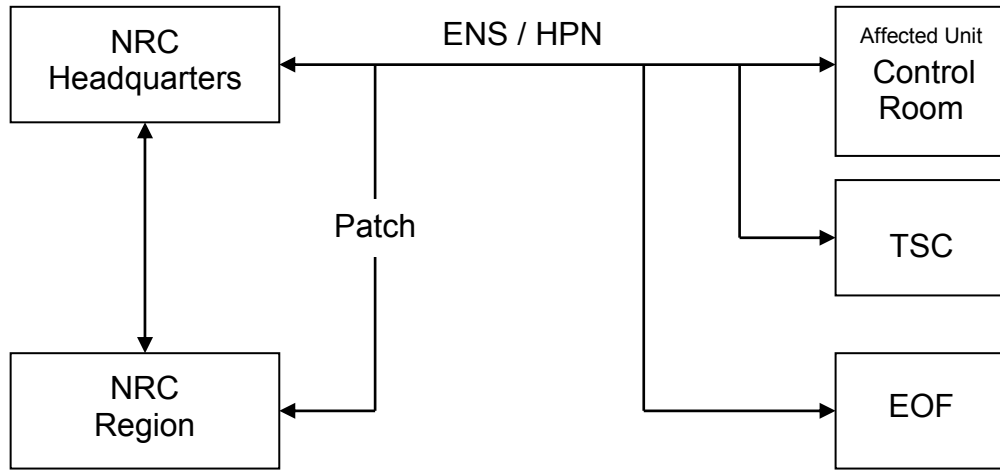

## **SECTION G: PUBLIC EDUCATION AND INFORMATION**

This section describes the FPL public education and information program and outlines the process for keeping the public in the 10-mile EPZ informed in the event of an emergency.

### **1. PUBLIC INFORMATION PUBLICATION**

FPL has the responsibility for maintaining a public information program with support from the State Division of Emergency Management and the Miami-Dade County and Monroe County emergency management offices. The state of Florida has overall responsibility for maintaining a continuing disaster preparedness public education program. The public information publication for Turkey Point is updated annually, in coordination with state and county agencies, to address how the general public is notified and what their actions should be in an emergency. FPL distributes the publication annually to all residents within the 10-mile plume exposure EPZ and to appropriate locations where a transient population may obtain a copy. The public information publication includes the following information:

- a. Educational information on radiation.
- b. Information regarding who to contact for additional information.
- c. A description of possible protective measures for the public (take shelter, evacuate, and/or ingest a radioprotective drug).
- d. A map of major evacuation routes.
- e. A list of reception centers to coordinate sheltering of evacuees and instructions on how to obtain additional information, especially for the disabled or their caretakers and those without transportation.

### **2. PUBLIC EDUCATION MATERIALS**

Public information publications instruct the public to go indoors and turn on their televisions or radios when they hear the ANS sirens operating. These publications also identify the local television or radio stations to which the public should tune in for information related to the emergency. Information is also provided to the transient population by means of signs on siren poles that instruct them to turn to EAS stations in English and Spanish. Public notices at local business establishments, parks, beaches, and other outdoor recreational facilities around Turkey Point provide a list of television and radio stations that will transmit emergency information and numbers where additional information can be obtained.

### 3. MEDIA ACCOMMODATIONS

- a. The FPL Marketing and Communications Department is notified upon declaration of an *Unusual Event* or higher emergency classification. They will handle public and media inquiries in the early stages of the event, until the Emergency News Center (ENC) is activated, by distributing background information, news releases, and providing information to FPL management.
  - 1) The ENC organization is comprised of senior managers from FPL and personnel from Turkey Point and may be activated at any time at the discretion of FPL management. However, when there is a procedural requirement to activate the EOF the ENC shall also be activated. For an *Unusual Event* classification or before ERO activation, the authority for issuing news releases will always reside with the FPL Marketing and Communications Department. However, upon activation of the ENC, the ENC organization has the responsibility and authority for issuing news releases to the public, upon approval by the Recovery Manager. When the ENC is operational, the FPL spokespersons and ENC staff coordinate emergency information with the EOF, Marketing and Communications personnel in the Juno Beach office, and federal, state, and county spokespersons located in the ENC.
  - 2) The ENC is located on the second floor of the FPL General Office Building in Miami, Florida, and is collocated with the EOF. The FPL Public Information Officer directs activities at the ENC. The ENC serves as a location where media personnel gather to receive information related to the emergency event and approved news releases will be provided to the media for dissemination to the public. The ENC functions as the single point of contact to interface with federal, state, and local authorities that are responsible for disseminating information to the public. Public information personnel coordinate development and distribution of news releases from the EOF and the ENC.

The ENC is equipped with appropriate seating, lighting, and visual aids to allow for public announcements and briefings to be given to the news media. Additionally, the ENC is equipped with commercial telephone lines for making outgoing calls.

The ENC is activated at the declaration of an *Alert* or higher classification, or at an earlier classification if conditions warrant. Functions of the ENC include:

- Serving as the primary location for accumulating accurate and current information regarding the emergency conditions and developing news releases.
  - Providing work space and phones for public information personnel from the state, counties, NRC, FEMA, and industry-related organizations.
  - Providing work space and telephones for use by news media personnel.
  - Providing responses to media inquiries through media monitoring staff telephones that the media can call for information about an emergency.
- b. The news media is not permitted into the EOF during an emergency.

#### **4. COORDINATION OF PUBLIC INFORMATION**

- a. The ENC is staffed by FPL and government public information representatives who will be the source of public information during an emergency at the plant. The FPL Public Information Officer is the primary spokesperson for FPL and is assisted by the Chief Nuclear Spokesperson. The FPL Public Information Officer has direct access to all necessary information related to the emergency (see Section B.5).
- b. The ENC is staffed by federal, state, county, and FPL personnel to assure timely, periodic exchange and coordination of information. Representatives coordinate information before conducting news briefings.
- c. The timely exchange of information between designated spokespersons will enhance communications flow to the public and news media and also aid in dispelling rumors. Media Monitors and Rumor Control personnel in the ENC may identify rumors or misinformation when responding to telephone calls from the general public and the news media, and from monitoring media reports. Rumors and misinformation are then communicated to other ENC personnel for follow up. In addition, the Miami-Dade County Office of Emergency Management maintains telephones designated for rumor control. The telephone lines will usually be staffed by representatives from local government and the telephone number will be widely publicized at the time of the emergency. Rumors should be kept to a minimum through the use of this location for authentication of information. State and local plans and procedures provide further details for control of rumors and other misinformation.

**5. MEDIA ORIENTATION**

FPL, in cooperation with the state of Florida and Miami-Dade and Monroe Counties, will conduct an annual program to acquaint the news media with information concerning nuclear power, and points of contact for release of public information in an emergency.

## SECTION H: EMERGENCY FACILITIES AND EQUIPMENT

This section describes the functions and locations of the emergency response facilities and equipment that will be used and maintained by FPL in coordinating and performing emergency response activities. This section also describes the surveillance programs used to monitor and ensure that these facilities and equipment are maintained in a high degree of constant readiness.

The emergency response facilities that have been established at Turkey Point to assist Control Room personnel in mitigating the consequences of accidents include the TSC, OSC, EOF and ENC.

### 1. CONTROL ROOM, TSC, AND OSC

Turkey Point has established a TSC that is activated upon declaration of an *Alert* or higher classification. Turkey Point has also established two OSCs, one to support Units 3 & 4 and another to support Units 6 & 7. During a classified emergency, the OSC in the affected unit will be activated. Until the emergency response facilities become operational, required functions of these facilities are performed by shift personnel and directed from the affected unit control room. These emergency response facilities may be activated at the discretion of the Emergency Coordinator at an *Unusual Event* classification.

a. Control Room: There is a Control Room for each of the units on the site. The Turkey Point reactors and major plant systems are operated from these locations. Each Control Room is equipped with instrumentation to supply detailed information on the reactor and its major systems. Each Control Room is continuously staffed with qualified licensed operators. The Control Room is the first onsite facility to become involved with the response to emergency events. The Control Room for the affected unit will be the designated location for the Emergency Coordinator. In the event of an emergency affecting the entire site or multiple units (security or natural phenomena), the Unit 3 Control Room will typically take the lead, unless conditions warrant otherwise, and will house the Emergency Coordinator. Control Room personnel must evaluate and effect control over the emergency and initiate activities necessary for coping with the emergency until such time that the augmented emergency response facilities can be activated. These activities shall include:

- Reactor and plant control.
- Initial direction of all plant related operations.

- Accident recognition, classification, mitigation, and initial corrective actions.
- Alerting of onsite personnel.
- Activation of the ERO automatic callout system.
- Activation of the emergency response facilities.
- Notification of offsite agencies.
- Activation of ERDS.
- Continuous evaluation of the magnitude and potential consequences of an incident.
- Initial dose projections.
- Recommendations for immediate protective actions for the public.

When the TSC and EOF become operational, they will provide support to the Control Room. Emergency Coordinator responsibilities will transfer to the TSC and EOF when the facilities are properly staffed and prepared to take over these responsibilities. Overall command and control of the emergency will transfer to the EOF and direction and control for onsite activities will transfer to the TSC. Throughout all emergencies, the Control Room maintains its emergency activation status until its normal operational status may be resumed or its recovery activities are initiated.

- b. Technical Support Center (TSC) Turkey Point has established a TSC for use during emergency situations by plant management, technical, and engineering support personnel. This facility is located in the Turkey Point Nuclear Training Building. This location provides the ability to respond and activate the facility in a timely fashion independent of the unit(s) that may be affected by the emergency. It also will permit the use of the TSC in a security event that may curtail the entry of ERO personnel into a Protected Area of the affected unit(s).

The TSC meets the guidance of NUREG-0696, *Functional Criteria for Emergency Response Facilities* and RG 1.206, *Combined License Applications for Nuclear Power Plants* regarding structure, habitability, size, communications, instrumentation, data system equipment, power supplies, technical data, records availability, and management. The TSC does not meet the guidance of NUREG-0696, *Functional Criteria*

*for Emergency Response Facilities*, regarding location of the TSC. The location of the TSC is outside of the Protected Areas between the Control Room for Units 3 & 4 and the Control Rooms for Units 6 & 7. Although the TSC does not provide capability for face-to-face communications with the affected Control Room(s), it is provided with communication links that can transmit and receive direct voice and data communications from the affected Control Room. These communications have alternate pathways that can also be used as needed. Security personnel are positioned in the TSC to expedite the movement of personnel between the TSC and the Control Room as necessary.

The TSC is the onsite location used to support the Control Room for assessment of plant status and potential offsite impact, and for implementation of emergency actions. The TSC provides plant management and technical support to Control Room personnel and relieves the reactor operators of peripheral duties not directly related to reactor system manipulations during an emergency. The TSC provides technical data and information to the EOF and may also be used to provide technical support during recovery operations following an emergency. The TSC is activated for all emergencies classified as *Alert* or higher and may be activated at an *Unusual Event*, if deemed necessary by the Emergency Coordinator. When operational, the TSC functions include:

- Support for the affected Control Room's emergency response efforts.
- Continued evaluation of event classification.
- Assessment of the plant status and potential offsite impact.
- Coordination of emergency response actions within the Protected Area.
- Protective actions onsite and offsite (until EOF is operational).
- Communication with offsite government agencies (state, county, and NRC, until the EOF is operational).

Figure B-1b illustrates the staffing and organization of the TSC.

When operational, the TSC becomes the primary onsite communications center during an emergency. The TSC provides reliable voice communications to the Control Room, OSC, EOF, NRC, and other offsite agencies. In addition, it provides facsimile transmission capability and electronic transfer capabilities (see Section F of this Plan).



The TSC is sized to accommodate a minimum of 40 people and their supporting equipment. This includes provisions for six NRC representatives.

Personnel in the TSC shall be protected from radiological hazards, including direct radiation and airborne contaminants under accident conditions with similar radiological habitability as Control Room personnel. To ensure adequate radiological protection, permanent radiation monitoring systems (RMS) have been installed in the TSC and/or periodic radiation surveys are conducted. These systems indicate radiation dose rates and airborne radioactivity inside the TSC while in use. In addition, potassium iodine is available for use as required.

The TSC has access to a complete set of drawings and other records, including general arrangement diagrams, piping and instrument diagrams, and the electrical schematics. The TSC has the capability to record and display vital plant data, in real time, to be used by knowledgeable individuals responsible for engineering and management support of reactor operations, and for implementation of emergency procedures.

After TSC activation, if it becomes uninhabitable for any reason, implementing procedures will provide guidance on the transfer of duties and relocation of the staff until such time that the TSC staff is able to fulfill their duties as assigned.

- c. Operations Support Center (OSC): Each Protected Area has established an OSC to support each unit. The OSC is located separate from the Control Room and provides an area for coordination of shift personnel to support emergency response operations without causing congestion in the Control Room. The OSC is a location from which survey, operations, and repair teams are dispatched into areas of the plant and is the staging area for individuals who may be assigned to first aid, search and rescue, and emergency repair and damage control activities. The Emergency Coordinator will initiate activation of the affected unit's OSC for an *Alert*, *Site Area Emergency*, or *General Emergency*. Activation for other events is optional. In the event that the affected unit OSC becomes uninhabitable, the Emergency Coordinator will designate an alternate location in accordance with EPIPs.

Turkey Point disciplines reporting to the OSC include, but are not limited to:

- Operating personnel not assigned to the Control Room
- Radiation protection personnel

- Chemistry personnel
- Maintenance personnel (mechanical, electrical and I&C)

Figure B-1b illustrates the staffing and organization for the OSC.

Each OSC is equipped with communication links to the Control Room and the TSC (see Section F of this Plan). A limited inventory of supplies will be kept in the OSC. This inventory will include respirators, protective clothing, flashlights, and portable survey instruments.

Refer to the Unit Annexes for additional information regarding the OSCs.

## 2. EMERGENCY OPERATIONS FACILITY

The EOF is located outside the 10-mile EPZ at the FPL General Office building in Miami, Florida and is located 26 miles from the Turkey Point site, as approved by the NRC. The EOF is the location where the Recovery Manager will direct a staff in evaluating and coordinating all FPL activities related to an emergency. Activation of the EOF is initiated by the Recovery Manager and is mandatory upon declaration of a *Site Area Emergency* or higher classification. The Recovery Manager may initiate activation of the EOF at a lower classification, if conditions warrant. The EOF provides for:

- Management of overall emergency response.
- Notification of offsite government agencies (county, state, and NRC) and other corporate agencies as applicable.
- Coordination of radiological and environmental assessments.
- Determination of recommended public protective actions.
- Management of recovery operations as applicable.
- Coordination of emergency response activities with federal, state, and county agencies.

The EOF was designed with the following considerations:

- The location provides optimum functional and availability characteristics for carrying out overall strategic direction of FPL emergency response; determination of public protective

action recommendations to offsite officials; and coordination with federal, state, and county agencies.

- It is of sufficient size to accommodate approximately 75 personnel, including FPL, state, and county and 12 NRC representatives. The EOF contains available workspace for representatives from offsite governmental agencies (state of Florida and Miami-Dade and Monroe Counties) who may dispatch representatives as they deem necessary to support emergency response activities.
- It meets the criteria of NUREG-0696, *Functional Criteria for Emergency Response Facilities* regarding location, structure, habitability, size, communications, instrumentation, data system equipment, power supplies, technical data, records availability, and management.
- It is equipped with reliable voice communications systems which include communications to the TSC, Control Room, ENC, offsite state and county EOCs, NRC, and offsite Field Monitoring Teams. In addition, the EOF has facsimile, computer transmission, and electronic transfer capabilities (see Section F of this Plan).
- It contains equipment to gather, store, and display data needed in the EOF to analyze and exchange information on plant conditions with the plant. The EOF technical data system receives, stores, processes, and displays information sufficient to perform assessments of the actual and potential onsite and offsite environmental consequences of an emergency condition.
- The EOF has ready access (either through hard copies or electronic media) to plant records, procedures, and emergency plans needed for effective overall management of Turkey Point emergency response resources.
- The EOF also functions as a back-up TSC and back-up OSC staging areas in the event of an emergency that limits access to the site during a hostile action.

The Recovery Manager may designate an alternate, temporary location for the EOF if a natural disaster or other external events significantly affect the operational capability of the facility.

### **3. EMERGENCY NEWS CENTER**

The ENC is the location where the FPL Public Information Spokesperson will direct a staff in providing and coordinating the release of information during an emergency. The ENC is located outside the 10-mile EPZ and is the facility in which media personnel gather to receive

information related to the emergency event. The ENC is also the location where approved news releases will be provided to the media for dissemination to the public. Emergency information that is released to the news media and the public is coordinated between EOF and ENC personnel, including representatives from FPL, the state of Florida, Miami-Dade and Monroe Counties, the NRC, and FEMA.

#### 4. EMERGENCY OPERATIONS CENTERS

The state of Florida, Miami-Dade County, and Monroe County establish and operate EOCs as a location for direction and control of emergency response functions, in accordance with their respective emergency plans.

The state of Florida EOC is capable of continuous (24-hour) operations for a protracted period. The state EOC contains sufficient communications (radio, telephone, and facsimile) equipment, maps, emergency plans, and status boards to provide the necessary interfaces with other federal, state, county, and FPL emergency facilities.

The Miami-Dade and Monroe County EOCs serve as direction and control headquarters for local emergency response activities, including coordination of communications to field units and to the state EOC. The county EOCs have the equipment necessary, (such as facsimile machines, telecommunications equipment, radios, photocopiers, wall maps, etc.) to carry out their emergency responsibilities. The county EOCs are also capable of 24-hour operation for extended periods of time during an emergency at the plant.

#### 5. ACTIVATION

**NOTE:** NUREG-0654 Criterion II.B.5 states that the “licensee must be able to augment on-shift capabilities within a short period after declaration of an emergency.” It further defines that short period as 30 and 60 minutes. Turkey Point will use unaffected unit on-shift personnel to augment the affected unit on-shift personnel upon declaration of an *Alert* or higher classification (or at a lower classification if conditions warrant). This staffing augmentation will fulfill the NUREG-0654 Criterion II.B.5 for 30-minute responders and provides additional support to the On-shift ERO to permit a 60 minute response for on-call ERO personnel. The time frames for rapid augmentation of a nuclear power plant staff in the event of an emergency are not rigid inviolate requirements but rather goals. It is Turkey Point’s intent to expend its best efforts to meet the augmentation criteria goals regarding staffing Emergency Response Facilities with sufficiently skilled individuals capable of handling an emergency. Both the NRC and FPL realize that due to diversity of normal residential patterns for the plant’s staff, possible adverse weather conditions and road congestion, these time frames might be exceeded.

Turkey Point has put into place plans and procedures to ensure timely activation of the emergency response facilities. The Shift Manager (as Emergency Coordinator) will initiate a call-out in accordance with the EIPs. The ERO augmentation process identifies individuals who are capable of fulfilling the specific response functions that are listed in Table B-1b. This table was developed based on the functions listed in NUREG-0654, Table B-1.

Although the response time will vary due to factors such as weather and traffic conditions, a goal of 60 minutes for minimum staffing, following the notification of an *Alert* or higher emergency classification, has been established for the ERO personnel responding to the plant's emergency response facilities and the EOF. Additionally, plans have been developed to ensure timely functional activation and staffing of the ENC when the classification of *Alert* is declared.

It is the goal of the organization to be capable of declaring the applicable emergency response facility operational within 15 minutes of achieving minimum staffing. The facility can be declared operational when the following conditions are met:

- Minimum staffing has been achieved.
- Personnel have been briefed on the situation and a proper turnover has been conducted.
- The facility is functionally capable of performing the appropriate emergency response activity.

The 60-minute response time and 15-minute activation times are not applicable to the ENC. ENC personnel must first coordinate the decision to activate the ENC with the appropriate offsite authorities responding to the facility.

The senior manager in charge may elect to activate his/her facility without meeting minimum staffing if it has been determined that sufficient personnel are available to fully respond to the specific event (this would not constitute a successful minimum staff response). Using professional judgment, the facility manager may appoint alternate personnel to fill vacant positions on an interim basis to respond to the emergency. Every effort to match the appropriate skill with position should be taken.

## **6. MONITORING EQUIPMENT ONSITE**

The plant is equipped with instrumentation for seismic monitoring, radiation monitoring, fire protection, and meteorological monitoring. Instrumentation for the detection or analysis of emergency conditions is maintained in accordance with plant Technical Specifications, if

applicable or commitments made to the NRC. The actual instrumentation varies somewhat from unit to unit and thus will not be described in detail in this plan. Additional details describing this equipment, if required, are contained in each unit's Annex. This equipment includes, but is not limited to, the following:

a. Geophysical Monitors

- 1) Meteorological Instrumentation: There are two permanent meteorological monitoring stations located near the plant for display and recording of wind speed, wind direction, and ambient and differential temperature for use in making offsite dose projections. Meteorological information is presented in the Control Room, TSC, and EOF by means of the plant computer system. This information is remotely interrogated using a computer or other data access terminal and is used by Turkey Point, the state, and the NRC to provide near real-time predictions of the atmospheric effluent transport and diffusion. Additional information on the meteorological monitoring system is located in Section I of this Plan.

The NWS, or regional weather forecast providers, may be contacted for localized weather forecasts for the Turkey Point area, as appropriate.

- 2) Seismic Monitoring: The seismic monitoring system measures and records the acceleration (earthquake ground motion) of the structure. Earthquakes produce low frequency accelerations which, when detected by the remote sensing devices, are permanently recorded as information which defines the response spectrum. The system remains in a standby condition until an earthquake causes the remote unit(s) to activate the recording circuits and tape transports. It also provides signals for immediate remote indication that specific preset response accelerations have been exceeded.
- 3) Hydrological Monitors: The design basis flood, probable maximum precipitation, and other improbable, conceivable extremes in hydrologic natural phenomena are described in each unit's FSAR.

b. Radiological Monitors and Sampling

- 1) The Radiation Monitoring System (RMS): In-plant radiological measurements provide information that may help determine the nature, extent, and source of emergency conditions. The RMS is available to give early warning of a possible

emergency and provides for a continuing evaluation of the situation in the Control Room. Radiation monitoring instruments are located at selected areas within the facility to detect, measure, and record radiation levels. In the event the radiation level should increase above a preset level, an alarm is initiated in the Control Room. Certain radiation monitoring instruments also alarm locally in selected areas of the facility. The radiation monitoring system is divided into 3 subsystems:

- a) Area Radiation Monitors are used for the direct measurement of in-plant exposure rates. The Area Radiation Monitor readings allow in-plant exposure rate determinations to be made remotely without requiring local handheld meter surveys. This information may be used, initially, to aid in determining plant area accessibility. In addition to permanent monitors, portable continuous air monitors measure airborne particulate and airborne iodine activities at various locations within the operating areas.
- b) Process radiation monitors are used for the measurement of radioactive noble gas, iodine, and particulate concentrations in plant effluent and other gaseous and fluid streams.
- c) The accident, or high-range, RMS monitors radiation levels at various locations within the operating area. These are high-range instruments used to track radiation levels under accident or post-accident conditions. These instruments include the containment monitors.

The RMS provides the necessary activity or radiation levels required for determining source terms in dose projection procedures. Key radiation monitoring system data is linked to the plant computer, which allows information to be passed to the TSC and EOF. The isotopic mix, including isotopes such as those in Table 3 of NUREG-0654, is based on a default accident mix. Refer to the unit-specific FSAR for further detail on the radiation monitoring system capabilities and design.

- 2) Liquid and Gaseous Sampling Systems: The process sampling system consists of the normal sampling system and additional sampling panels located throughout the plant. Sampling systems are installed or can be modified to permit reactor coolant and containment atmosphere sampling even under severe accident conditions.

The sampling systems use a number of manual sampling techniques to enable reactor coolant and containment sampling operations over a wide range of plant conditions. They are capable of providing information relative to post-accident plant conditions to allow operator actions to be taken to mitigate and control the course of an accident. Refer to the respective unit FSAR for further detail on sampling capabilities.

- 3) Portable Radiation Monitoring Equipment: Portable radiation survey instruments are available for a wide variety of uses such as area, sample, and personnel surveys and continued accident assessment. Instruments are stored throughout the plant and in the emergency response facilities.
- c. Process Monitors: The Control Room and applicable redundant backup locations are equipped with extensive plant process monitors for use in both normal and emergency conditions. These indications include but are not limited to reactor coolant system pressure and temperature, containment pressure and temperature, liquid levels, flow rates, status or lineup of equipment components. This instrumentation provides the basis for initiation of corrective actions.
- 1) Plant Data System: A plant monitoring/information system provides the data acquisition and database capability for performing plant monitoring and functions. The system is designed to scan, convert to engineering units, conduct reasonability and alarm limit checks, apply required transformations, store for recall and analysis, and display the reading of transformed data from plant instrumentation. The system scans flows, pressures, temperatures, fluid levels, radiation levels, equipment, and valve status at required frequencies. Scanned variables are quality tagged. The system provides for short and midterm storage of data for online retrieval and fast recall, and long-term storage to appropriate media.
  - 2) Safety Parameter Display System (SPDS): The SPDS provides a display of plant parameters from which the safety status of operation may be assessed in the Control Room, TSC, and EOF for the plant. The primary function of the SPDS is to assist operating personnel in the Control Room to make quick assessments of plant safety status. The SPDS and/or other display systems in the TSC and EOF promote the exchange of information between these facilities and the Control Room and assists the emergency organization in the decision making process.



- d. Fire Detection System: The fire detection system is designed to quickly detect visible or invisible smoke (or other products of combustion) and/or heat in designated areas of the plant. The fire alarm communication systems and subsystems are located at strategic points throughout the plant to warn personnel of a nuclear incident or other emergency conditions. Existing plant alarm systems are sufficiently audible to alert personnel in the event of a fire or need for assembly. These alarm communication systems consist of warning sirens and lights (in high noise areas) and the Public Address system. Refer to the respective unit FSAR for further description of the unit's fire protection system.

## 7. MONITORING EQUIPMENT OFFSITE

Turkey Point has made provisions to acquire data from and have access to the following offsite sources of monitoring and analysis equipment:

- a. Geophysical Monitors: In the event that both meteorological towers and monitoring instrumentation become inoperative, meteorological data may be obtained directly from the NWS.

Offsite seismic monitoring information can be obtained from the United States Geological Survey's National Earthquake Information Center in Golden, Colorado.

The EOF will coordinate hydrology and seismology expertise in the event onsite information becomes unavailable.

- b. Radiological Environmental Monitors and Sampling: The state of Florida DOH-BRC maintains an extensive offsite environmental monitoring program to provide data on measurable levels of radiation and radioactive materials in the environs. The program (described fully in the Offsite Dose Calculation Manual), includes a system of approximately 35 thermoluminescent dosimeter stations in the vicinity of Turkey Point. Stations are provided in each 22.5 degree land sector at the 1-mile (approximate), 5-mile (approximate), and 10-mile (approximate) radii. At the 10-mile radius, stations are located with special emphasis on the more densely populated area.
- c. Laboratory Facilities: External facilities that are available during an emergency for counting and analyzing samples include the St. Lucie Plant radiological facilities and the state of Florida Mobile Emergency Radiological Laboratory (MERL). These laboratories can act as backup facilities in the event that the affected plant's counting room and laboratory become unusable or the offsite radiological monitoring and environmental

sampling operation exceeds the capacity of the plant's capabilities. It is estimated that these laboratories will be able to respond within several hours from initial notification.

Outside analytical assistance may be requested from state and federal agencies, or through contracted vendors. The state maintains a radiological laboratory that provides independent analysis. The NRC mobile laboratory may be made available for *Site Area Emergencies* and *General Emergencies*. The DOE, through the Interagency Radiological Assistance Program, has access to any national laboratory with a DOE contract (i.e., Savannah River Site, Brookhaven, Oak Ridge, Lawrence Livermore, etc.).

A general description of the laboratory capabilities is provided in Section C of this Plan.

## **8. OFFSITE MONITORING EQUIPMENT STORAGE**

Turkey Point maintains a sufficient supply of emergency equipment (such as portable survey, counting, and air sampling instrumentation and other radiological monitoring equipment and supplies) that may be used for environmental monitoring. These supplies meet the initial requirements of two offsite Field Monitoring Teams. During subsequent phases of an emergency, additional equipment is available via INPO mutual aid and offsite response organizations.

## **9. METEOROLOGICAL MONITORING**

FPL has installed and maintains two meteorological towers equipped with instrumentation for continuous reading of the wind speed, wind direction, air temperature, and vertical temperature difference ( $\Delta T$ ). Additional capabilities are available to obtain representative current meteorological information from other sources, such as the NWS. Further description of the meteorological monitoring capabilities is provided in Section I of this Plan.

## **10. OSC CAPABILITIES**

Each OSC provides an area for coordinating and planning OSC activities and staging of personnel. Additional space is available in adjacent offices and locker rooms to accommodate additional personnel as required. Alternate locations are also available. The onsite storerooms maintain a supply of parts and equipment for normal plant maintenance. These parts, supplies, and equipment are available for damage control use as necessary.

Sufficient radiation protection equipment (i.e., protective clothing, respiratory protection gear, potassium iodine, and other radiation protection equipment and supplies) is stored and maintained near the OSC (as well as the other emergency response facilities). Damage control

team equipment is available in the maintenance shops located near the OSC. This equipment includes items such as a camera, portable lighting, and additional portable communications equipment. The OSCs are stocked with an assortment of first-aid and medical treatment equipment and supplies. The OSCs maintain reliable voice communications with the Control Room, TSC, and EOF. For a complete description of communications equipment, refer to Section F. When an emergency condition exists at one unit, additional supplies can be obtained from other unaffected units and through corporate resources upon request.

## **11. FACILITY AND EQUIPMENT READINESS**

Emergency facilities and equipment are inspected and inventoried in accordance with emergency plan administrative procedures and other plant procedures, as appropriate. These procedures provide information on location and availability of emergency equipment and supplies. An inventory of all emergency equipment and supplies is performed on a quarterly basis and after each use in an actual emergency or drill. During this inventory, radiation monitoring equipment is checked to verify that required calibration period and location are in accordance with the inventory lists. Surveillances include an operational check of instruments and equipment. Equipment, supplies, and parts which have a shelf-life are identified, checked, and replaced as necessary. Sufficient reserves of instruments and equipment are maintained to replace those which are removed from emergency kits or lockers for calibration or repair.

## **12. EMERGENCY EQUIPMENT AND SUPPLIES**

Equipment and supplies are located in each Control Room, TSC, each OSC, EOF and ENC and are described in detail in emergency plan administrative procedures. General categories of equipment include:

- Communications equipment
- Protective clothing
- Respiratory protection equipment
- Environmental monitoring equipment
- Decontamination supplies
- Miscellaneous tools and equipment
- Data and reference material

Table H-1 provides a typical list of emergency equipment and supplies available in the emergency response facilities.

### **13. COLLECTION POINT FOR FIELD SAMPLES**

The onsite lab has been designated as the central point for the receipt and analysis of radiological field monitoring samples. Sampling and analysis equipment is available for activity determination of these samples. Sufficient field monitoring equipment is maintained at the plant for initial sampling. Instrumentation and equipment used for sample activity determination are routinely calibrated to ensure timely availability.

**Table H-1. Typical Emergency Supplies Available for Emergency Response Facilities**

FPL maintains inventories of emergency equipment and supplies for use by emergency response personnel in the emergency response facilities and the Turkey Point offsite Field Monitoring Teams. Specific equipment and supplies for each facility are described in emergency plan administrative procedures and other plant procedures, as applicable, and typically include:

- Radiation survey instrument(s)
- Surface contamination control and survey supplies
- Air sampling equipment and sampling media
- Protective clothing
- Respiratory protection equipment
- Self reading dosimeters/dosimeter chargers
- Contamination control and decontamination supplies
- Potassium Iodide
- Plans, procedures, drawings
- Communications equipment
- Administrative and recordkeeping supplies
- Computer equipment
- Appropriate maps
- Flashlights
- Batteries and other expendable supplies

## **SECTION I: ACCIDENT ASSESSMENT**

This section describes the methods, systems, and equipment available for assessing and monitoring actual or potential offsite consequences of a radiological emergency.

When an off-normal event has been detected and classified in accordance with EALs, a process for continuing assessment will be initiated. All four emergency classifications have similar assessment methods; however, each classification requires a greater magnitude of assessment effort dependent upon the plant symptoms and/or initiating event(s). Specifications of instrumentation used for accident assessment are contained in procedures. Emergency operating procedures and severe accident management guidelines should be used as required.

### **1. PLANT PARAMETERS AND CORRESPONDING EMERGENCY CLASSIFICATION**

Plant system and effluent parameter values are used in determining accident severity and subsequent emergency classification. Environmental and meteorological events are also determining factors in emergency classification. An emergency condition can be the result of just one parameter or condition change, or the combination of several. The specific symptoms, parameter values, or events for each level of emergency classification are detailed in EIPs. Specific plant system and effluent parameters that characterize a classifiable event (EALs) are presented in each Unit Annex.

To adequately assess the emergency condition, each emergency facility has the necessary equipment and instrumentation installed to make available essential plant information on a continuous basis. Evaluation of plant conditions is accomplished through the monitoring of plant parameters both from indication in the Control Room and within the plant. Some of the more important plant parameters to be monitored in the Control Room are assembled into a single display location, which is called the Safety Parameter Display System (SPDS). The SPDS monitors parameters relative to the plant design such as reactor coolant system pressure, reactor or pressurizer water level, containment pressure, reactor power, safety system status, containment radiation level, and effluent monitor readings. The instrumentation and equipment capabilities available for each emergency facility are described in Section H of this Plan.

### **2. ONSITE ACCIDENT ASSESSMENT CAPABILITIES**

The resources available to provide initial and continuing information for accident assessment throughout the course of an event include plant parameter display systems, liquid and gaseous sampling system, area and process radiation monitoring systems, and accident radiation

monitoring systems (which includes the containment high range radiation monitors). Descriptions of these systems are provided in Section H of this Plan.

### 3. SOURCE TERM DETERMINATION

Source term (or core damage) estimations serve several roles within the Turkey Point Emergency Preparedness program. For planning purposes, core damage considerations are used as the bases for several of the EAL initiating conditions and as the threshold for the declaration of a *General Emergency* (the definition of a *General Emergency* specifies conditions which involve substantial core degradation or melting as one of the bases for classification).

From an implementation perspective, core damage estimations provide a means of realistically differentiating between the four core states (no damage, clad failure, fuel melt, and vessel melt-through) to:

- Evaluate the status of the fuel barriers and how their status relates to the risks and possible consequences of the accident.
- Provide input on core configuration for prioritization of mitigating activities.
- Determine the potential quality (type) and/or quantity (%) of source term available for release in support of projected offsite doses and protective action recommendations.
- Provide information that quantifies the severity of an accident in terms that can be readily understood.
- Support the determination of radiological protective actions that should be considered for long-term recovery activities.

The assessment methodologies used by Turkey Point are intended to provide a rapid best estimate of core damage which, when evaluated together, help to develop an overall picture of the extent of core damage. The methods used to estimate the amount or type of core damage occurring under accident conditions includes the following:

- Containment Radiation Monitors: An indirect method used to determine the amount of core damage. Applicable to loss of coolant accident (LOCA) scenarios. Based on an end-of-life source term and static nuclide ratio assumptions yielding a limited accuracy. Valid any time following an accident.

- Core Temperatures: Methods such as core exit thermocouple, peak core temperatures, and hot leg temperatures provide indirect methods used to indicate the type and/or amount of core damage. Applicable for all types of accidents. Valid any time following an accident.
- Core Uncovery: Methods such as core uncovery time, reactor vessel level (Units 3 & 4), or hot leg level (Units 6 & 7), and source range monitor readings provide indirect methods used to indicate the type of core damage (clad failure or fuel melt). Applicable for all types of accidents. Provides a relatively accurate estimate of the state of the core early in the event. Valid any time following an accident.
- Containment Hydrogen Concentration: An indirect method used to establish the type of core damage. Applicable to LOCA-type accidents where all the hydrogen generated by the metal-water reaction is released into containment. Valid any time following an accident.
- Sample Analysis — Isotopic Ratio Comparison: A direct method used to establish the type of core damage. Compares expected isotopic ratios with a sample to determine a general core state. Applicable under all types of accidents. Valid any time following an accident.
- Sample Analysis — Presence of Abnormal Isotopes: A direct method used to provide a go/no-go indication of fuel melt by the presence of unusually high concentrations of the less volatile fission products. Applicable under all types of accidents. Valid any time following an accident.
- Sample Analysis — Concentration Evaluation: A direct method that yields the most accurate numerical estimations of the amount of core damage. Applicable for all types of accidents. Requires the sampled system(s) be in a steady state that usually prevents its use until the plant is in a stable condition.

#### 4. EFFLUENT MONITOR DATA AND DOSE PROJECTION

Dose assessment or projection represents the calculation of an accumulated dose at some time in the future, if current or projected conditions continue. During an accident, the plant parameter display system and personal computers will provide the ERO with the timely information required to make decisions. Radiological and meteorological instrumentation readings are used to project dose rates at predetermined distances from the plant, and to determine the integrated dose received. Dose assessment methods used by the ERO to project offsite doses include:



- a. Monitored Release Points: This method uses the plant's effluent radiation monitors and system flow rates. Effluent release points are used to directly calculate a release rate. The point of the release determines the way the source term is affected and is adjusted by the dose assessment process.
- b. Containment Leakage/Failure: This method uses a variety of containment failures or leak rates in conjunction with available source term estimations to develop a release rate to the environment. A direct vent of containment can be modeled as a failure to isolate.
- c. Release Point Samples: This method uses a sample at the release point and an estimated flow rate to develop a release rate at the point of release.
- d. Field Monitoring Team Data: This method uses a field survey or sample and the atmospheric model to back calculate a release rate and ratio concentrations of radioactive material at various points up and downwind of plume centerline.

The computer applications used to provide dose calculations to evaluate dose against the EPA PAGs applicable for the early phase of an accident. These evaluations place an emphasis on determining the necessity for offsite protective action recommendations. Dose assessment actions will be performed in the following sequence:

- First: Onset of a release to emergency response facility activation: On-shift personnel will rely on a computerized dose model to assist them in developing offsite dose projections using real time data from effluent monitors and site meteorology.
- Second: Upon emergency response facility activation to event termination, dedicated ERO personnel will analyze the offsite consequences of a release using a computerized dose model.

## 5. METEOROLOGICAL INFORMATION

Meteorological data is required to make estimates of offsite radiation exposure in the event of a release of gaseous radioactivity. Measurements of wind speed, wind direction, and atmospheric stability are required to make estimates of atmospheric dispersion.

Meteorological data is collected at the Turkey Point land utilization site 10-meter tower, the South Dade Site 60-meter tower, or obtained directly from the NWS in Miami. Table I-1 summarizes the available data. Data that represents primary and backup sources is summarized on Table I-2. The geographical coordinates for the South Dade tower are: 25° 21'

05.74120" north latitude and 80° 22' 45.54962" west longitude. The geographical coordinates for the LU tower are: 25° 25' 35.072" north latitude and 80° 20' 15.536" west longitude.

As indicated in Table I-1, values of the key meteorological parameters are provided for the Turkey Point and South Dade site meteorological installations. These readouts are provided continuously, and the data is directly available at each unit's Control Room, TSC, and EOF via the plant monitoring/information system.

Meteorological data is provided to the state via initial and follow-up notifications and response to direct inquiries from the Division of Emergency Management and DOH-BRC. The EOF and NRC can receive timely meteorological information through the TSC, upon request, from direct data logger and fiber optic modem connection, or the plant monitoring/information system.

At least three (3) months prior to the start of Units 6 & 7 construction activities that could potentially impact the location and/or monitoring capabilities of the current 10 meter meteorological tower, a replacement 10 meter meteorological tower will be installed and made operational at an appropriate location on the Turkey Point plant property.

## **6. UNMONITORED RELEASE**

Dose projections can be made during a release through use of actual sample data in situations where effluent monitors are either off-scale or inoperative or the release occurs by an unmonitored flow path. In the absence of effluent sample data, a dose projection can be performed simply by specifying the accident category as a default. The selection of a default accident category defines the mix, the total curies, and the release pathway(s). The total number of curies from a default mix for each isotope is used to provide an upper bound for release concentration, and hence, an upper bound for the dose rate and dose to the public.

## **7. FIELD MONITORING**

In addition to the capabilities and resources described in Section H.7 and H.8 of this Plan, Turkey Point maintains the ability to take offsite air samples and to directly measure gamma dose rates in the event of an airborne or liquid release. The capability to take offsite soil, water, and vegetation samples is also provided by either the Field Monitoring Teams or state of Florida DOH-BRC teams.

The environmental monitoring equipment, as described in Section H, includes portable survey, counting, and air sampling instrumentation and other radiological monitoring equipment and supplies to be used by the field monitoring teams. Samples are taken at predetermined

locations, as illustrated in Figure I-1, as well as those specified both during and after a release. Environmental measurements are used as an aid in the determination and assessment of protective and recovery actions for the general public.

## 8. FIELD MONITORING TEAMS

Field Monitoring Teams are dispatched by Turkey Point to perform field monitoring in the 10-mile EPZ during conditions that may involve significant releases of radioactive materials from the plant. These teams are trained to conduct field surveys, obtain air samples, and collect environmental samples. EIPs provide guidance for performance of field monitoring team activities. Plant procedures also include information on sampling techniques, measurement of airborne concentrations of radioiodine, direct radiation dose rates, transportation of teams, expected deployment times, and communications. Each team is provided with air sampling equipment, personnel dosimetry, radiological survey instruments, procedures, communications equipment, and supplies to facilitate performance of radiation, surface contamination, and airborne radioactivity monitoring. Radiological survey and sample data is used to define affected area boundaries, verify or modify dose projections and protective action recommendations, and assess the actual magnitude, extent, and significance of a liquid or gaseous release. In addition to contamination and dose rate measurements, the change out of environmental thermoluminescent dosimeters can be performed. Other actions may include soil, water, and vegetation sampling.

The initial environmental surveys involve simple-to-perform measurements to quickly confirm or modify the dose projections based on plant parameters. Subsequent environmental monitoring efforts will be aimed at further defining the offsite consequences including instituting an expanded program to enable prompt assessments of any subsequent releases from the plant.

The expertise necessary to conduct limited offsite environmental survey and sampling is available onsite on a 24-hour basis. A minimum of two offsite Field Monitoring Teams are notified and activated at an *Alert* or higher classification. Teams are composed of two individuals who are assembled to use dedicated survey and sampling equipment. Teams are then dispatched into the surrounding area when a release is ongoing or is expected to occur. Radiological survey and sample data is transmitted to the emergency facilities.

Information from FPL offsite radiological assessment is exchanged and coordinated with the state. State of Florida DOH-BRC support can be used to perform collection, shipment, and analysis of environmental sample media.

## **9. IODINE MONITORING**

Field monitoring equipment has the capability to detect and measure airborne radioiodine concentrations as low as  $1 \times 10^{-7}$   $\mu\text{Ci/cc}$  in the field. Interference from the presence of noble gas and background radiation will be minimized by ensuring that monitoring teams move to areas of low background before analyzing the sample cartridge. The collected air sample is measured by hand-held survey meter as an initial check of the projection derived from plant data to determine if significant quantities of elemental iodine have actually been released (the chemical form that would pose a health hazard).

## **10. DOSE ESTIMATES**

Specific procedures exist for the correlation of air activity levels to dose rate. These procedures also provide a method to estimate the integrated dose from the projected and actual dose rates and for the comparison of these estimates with the PAGs.

## **11. STATE/FEDERAL MONITORING CAPABILITIES**

The state plan describes the state's role in accident assessment, including capability and resources, field team compositions, transportation, communications, equipment, and estimated deployment times. The state DOH-BRC has the ability to dispatch their own field monitoring teams to track the airborne radioactive plume. State DOH-BRC representatives are stationed at the EOF. Direction and control of field operations for the state DOH-BRC will be provided by the State DOH Operations Officer who will conduct/supervise accident assessment and response of field teams from a post in the EOF before the arrival of DOH-BRC personnel. Coordination of this information will be through follow-up communications with the State Division of Emergency Management and Miami-Dade and Monroe Counties.

The state also has the ability and resources to coordinate with federal and Turkey Point field monitoring teams to compare sample results. DOE offsite monitoring assistance, if required, will be requested by the Division of Emergency Management in consultation with DOH-BRC personnel. Lead responsibility for coordination with DOE is assigned to DOH-BRC personnel.

The Miami-Dade County and Monroe County emergency plans also describe accident assessment and coordination of activities.



**Table I-1. Summary of Available Meteorological Data**

<b>Source</b>	<b>Data</b>	<b>Display</b>
Turkey Point Land Utilization 10-Meter Tower	Wind Speed Wind Direction Sigma-Theta	Plant Data System Strip Chart Record
South Dade Site 60-Meter Tower	Delta T (60-10m) Wind Speed Wind Direction	Plant Data System Strip Chart Record
NOAA/NWS Forecast Center (Miami)	Wind Speed Wind Direction Cloud Cover Ceiling Height Air Temperature	None; via telephone

**Table I-2. Summary of Available Meteorological Data**

<b>Meteorological Parameter</b>	<b>Primary Source</b>	<b>First Backup</b>	<b>Second Backup</b>
Atmospheric Stability	Delta T (South Dade Site Tower)	Sigma-Theta (Turkey Point Land Utilization Tower)	Surface Observations NOAA
Wind Speed	Turkey Point Land Utilization Tower	South Dade Site Tower	NOAA
Wind Direction	Turkey Point Land Utilization Tower	South Dade Site Tower	NOAA

## **SECTION J: PROTECTIVE RESPONSE**

This section describes the range of protective actions that have been developed for Turkey Point emergency workers and the general public in the plume exposure pathway EPZ. Protective response consists of emergency actions taken during or after an emergency situation, which are intended to minimize or eliminate hazards to the health and safety of the public and/or plant personnel. Additionally, guidelines have been established to aid in choosing protective actions during an emergency that are consistent with federal guidance. Turkey Point is responsible for onsite actions, and the responsibility for offsite actions rests with the state, county, and other offsite response agencies.

Detailed information describing onsite and offsite protective response actions is located in EPIPs and the state and county emergency management plans.

### **1. NOTIFICATION OF ONSITE PERSONNEL**

In the event of an emergency at Turkey Point, methods are established for notifying personnel within the Protected Areas and Owner-Controlled Area for all emergency classifications. The primary means of notification within the Protected Areas is the plant public address system and evacuation alarms, as described in Section F of this Plan. Announcements include the emergency classification and response actions to be taken by personnel onsite (such as ERO, non-ERO, contractor personnel, and visitors) and are made within 15 minutes of the declaration of an emergency. Provisions are made to alert personnel in high noise areas and outbuildings within the Protected Areas, as applicable. Turkey Point informs individuals located outside the Protected Areas, but inside the Owner-Controlled Area, via public address system announcements, alarms, and the activities of the Security Force (e.g. vehicle-mounted public address systems) within approximately 30 minutes of the declaration of an emergency. Turkey Point provides information regarding the meaning of the various warning systems and the appropriate response actions via plant training programs, visitor orientation, escort instructions, posted instructions, or within the content of audible messages. Escorts provide instructions to visitors who may not be trained to take specific emergency response actions.

### **2. EVACUATION LOCATIONS**

If a local area evacuation is required, personnel will be directed to assemble at a location designated by the Emergency Coordinator.

Turkey Point establishes and maintains preplanned primary and alternate site evacuation routes and assembly areas. An alternate route is provided for evacuation in the event the primary route



is rendered impassable, for example due to radiological or meteorological conditions or other impediments to evacuation. The directions of travel and offsite assembly area(s) are determined by the Emergency Coordinator based on current meteorological and emergency conditions.

The primary evacuation route uses the plant access road west to Palm Drive, continuing west on Palm Drive approximately 7 miles to Farm Life School Road, turning south on Farm Life School Road, and then traveling approximately 100 yards to the Florida City substation (the primary assembly area). The alternate evacuation route uses the road north of the main discharge canal from the plant (Lake Warren), continuing west past the contractor entrance road through the access gates of the cooling canals, past the north end of the cooling canals and then turning south along the west perimeter road of the canals for approximately 4 miles to the alternate assembly area, turning west to the Levee 31 Access Road then south to Card Sound Road. The primary and alternate evacuation routes and assembly areas are illustrated in Figure J-3.

If an Owner-Controlled Area evacuation is required, nonessential personnel, including those in the Protected Areas, are directed to exit the site via the primary or alternate evacuation route and reassemble at an offsite location or proceed to their homes. Visitors to the plant will assemble with and follow the instructions of their escorts.

Nonessential personnel within the Protected Areas will normally exit through the normal access point. Affected individuals evacuate the site via personnel vehicles. Personnel without transportation will be identified and provided transportation as necessary. Security is responsible for traffic direction and control of persons leaving Turkey Point, including special provisions for a coordinated evacuation under adverse conditions (e.g., weather-related, radiological, or traffic density conditions).

### **3. RADIOLOGICAL MONITORING OF EVACUEES**

The Emergency Coordinator directs contamination monitoring of personnel, vehicles, and personal property if conditions warrant. Personnel evacuating the site will be monitored for contamination by the portal monitors as they exit the Protected Areas or sent to offsite assembly areas and monitored with portable friskers. If there is no release of radioactive materials within the affected unit, limited monitoring (less than 100 percent of evacuees) may be used to speed the evacuation process.

Personnel entering the offsite assembly areas and vehicles will be monitored for contamination by individuals trained in the operation of portable monitoring equipment. Vehicles will be monitored, as necessary, depending on the amount and direction of radioactivity released.

Personnel and vehicle monitoring and decontamination will be conducted in accordance with radiation protection procedures and instructions in EIPs.

#### 4. PROTECTIVE ACTIONS FOR ONSITE PERSONNEL

Onsite protective actions for a radiological emergency consist of evacuation of the affected area (localized evacuation or site evacuation), monitoring of all personnel who were in the affected area, and decontamination as required.

Local area evacuations are performed as required for specific areas of the site experiencing hazardous conditions (for example, fire, radiological, or toxic gas). Personnel are notified via public address announcement and directed to a designated assembly location.

Evacuation is the primary protective action anticipated for onsite personnel within the Protected Areas who are not filling ERO positions. Contractors not having an emergency response function and visitors are normally evacuated at the *Alert* or higher classification. Evacuation of all other nonessential personnel, including personnel not required for the shutdown of the fossil units, occurs at the *Site Area Emergency* and *General Emergency* classification. The Owner-Controlled Area outside the Protected Areas is evacuated, if conditions warrant, of all non-FPL personnel at an *Alert* or higher emergency classification.

Turkey Point has identified offsite locations that serve as assembly areas for nonessential personnel if they are not instructed to proceed home. The specific locations of these areas are provided in Section J.2 and in the Unit Annexes. EIPs and emergency plan administrative procedures describe equipment, supplies, and general operation of these facilities. The Emergency Coordinator will designate personnel within the Owner-Controlled Area as essential or nonessential. The Emergency Coordinator shall use good judgment before initiating evacuation and relocating personnel, including an evaluation of plant and radiological conditions as they relate to the emergency. If large doses will be received during an evacuation, it may be more effective to shelter nonessential personnel onsite. Evacuation will be initiated in accordance with Turkey Point procedures and as directed by the Emergency Coordinator. As conditions warrant, the Emergency Coordinator may delay, postpone, or make special arrangements on the evacuation. Examples of special circumstances include the following:

- a. Radiological conditions (puff releases) where large doses may be received during an evacuation.
- b. Security events where unknown hazards or dangers are perceived that would have an adverse impact on personnel while leaving the site.

- c. Plant conditions where additional personnel are necessary to put the plant in a safer configuration (e.g., equipment hatch open or primary system open for repair).
- d. Onsite hazards such as adverse weather conditions, toxic gas, fires, or explosions where the movement of personnel would be placing them at additional risk.

The initiation of an Owner-Controlled Area evacuation will be reported to the appropriate state and county agencies. Security forces will be dispatched, when available, to access road(s) to control entry to site facilities. Unauthorized and non-ERO personnel will be denied entry into the site.

In the event that evacuation is not the best protective action, the onsite personnel will be directed to take other protective actions, such as sheltering for extremely inclement weather or during an ongoing radiological release, or taking immediate cover for security events when evacuation will place personnel in jeopardy.

## **5. ACCOUNTABILITY**

The purpose of accountability is to determine the locations of all personnel inside the Protected Areas and to muster emergency personnel at prearranged locations. At the declaration of an Owner-Controlled Area evacuation (usually at a *Site Area Emergency* or *General Emergency*), all nonessential personnel are evacuated. All individuals in the Protected Areas are accounted for and names of personnel not accounted for are established within 30 minutes of the initiation of the evacuation. Upon notification that personnel are missing, the Emergency Coordinator shall ensure search and rescue operations are initiated. Accountability is coordinated by personnel in the TSC, and results are forwarded to the Emergency Coordinator. Once established, accountability within the Protected Areas is maintained throughout the event, unless specifically terminated by the Emergency Coordinator. Accountability of individuals within the Owner-Controlled Area but outside the Protected Areas is not required.

The movement of personnel for the purposes of accountability may be delayed if their health and safety could be in jeopardy, such as severe weather or for security concerns. In addition, if it is determined that the prearranged assembly area is unfit for personnel, the Emergency Coordinator may designate an alternate assembly area.

## **6. PROVISIONS FOR ONSITE PERSONNEL**

Turkey Point maintains an inventory of adequate supplies of radiation protection equipment for personnel remaining in or entering the Protected Area or emergency response facilities,

including respiratory protection equipment, protective clothing, and radioprotective drugs (potassium iodine) if onsite conditions warrant. This emergency equipment is listed, maintained, and inspected in accordance with radiation protection procedures. Table H-1 of this Plan provides a description of typical emergency equipment and supplies available to personnel in the emergency response facilities. During the course of an emergency, protective actions are considered to minimize radiological exposures or contamination problems associated with all onsite personnel. For those who must work within the restricted area of the affected unit, measures that are considered are:

- a. Use of Respirators: On-shift and emergency response personnel use respiratory protection in any environment involving exposure to high-level gaseous activity or oxygen deficient atmosphere, or where air quality is in doubt. In the presence of airborne particulates, emergency response personnel may be directed by radiation protection personnel to use full-face, filter-type respirators. In areas where there is a suspicion or evidence that breathable air would not be suitable for emergency response personnel entry, a Self Contained Breathing Apparatus (SCBA) or similar device will be utilized. The criteria for issuance of respiratory protection are described in radiation protection procedures.
- b. Use of Protective Clothing: Anti-contamination clothing, located in the OSC and plant dress-out areas, is available for use by onsite personnel. The criteria for issuing protective clothing are described in radiation protection procedures.
- c. Use of Potassium Iodide: The use of potassium iodine may be recommended when a projected dose of 50 Rem committed dose equivalent is exceeded for an emergency worker's thyroid. This is the value specified in EPA 400-R-92-001, *Manual of Protective Action Guides and Protective Actions for Nuclear Incidents*. Each OSC and the TSC maintain a supply of potassium iodine. The Emergency Coordinator has the responsibility for approval of issuing potassium iodine to Turkey Point onsite emergency workers.

## 7. MECHANISM FOR IMPLEMENTING PROTECTIVE ACTION RECOMMENDATIONS

Plant conditions, projected dose and dose rates, and/or field monitoring data are evaluated to develop Protective Action Recommendations (PARs) for the purpose of preventing or minimizing exposure to the general public. PARs are approved by the Emergency Coordinator (Recovery Manager when the EOF is operational) and provided to the offsite agencies responsible for implementing protective actions for the general public.

In an emergency that requires immediate protective actions be taken before activation of the offsite emergency facilities, PARs are provided directly to the state and county 24-hour warning points.

## **8. EVACUATION TIME ESTIMATE**

An independent Evacuation Time Estimate study has been performed to provide estimates of the time required to evacuate resident and transient populations surrounding the Turkey Point site for various times of the year under favorable and adverse conditions. The Evacuation Time Estimate for evacuation of the plume exposure EPZ is referenced in Appendix 5 and detailed in the referenced Evacuation Time Estimate report.

## **9. CAPABILITY OF IMPLEMENTING PROTECTIVE ACTION RECOMMENDATIONS**

In a radiological emergency, an estimate must be made of the radiation dose that affected population groups may potentially receive. A protective action is taken to avoid or reduce the effects of the projected radiation dose. The Protective Action Guideline (PAG) is a predetermined level of the projected dose to individuals in the population at which protective actions are warranted.

Turkey Point recommends protective actions to the state of Florida and Miami-Dade and Monroe County emergency management agencies, as described in EIPs. The State Division of Emergency Management and Miami-Dade and Monroe county emergency management directors are responsible for implementing protective measures based on PAGs for the offsite population at risk. Procedures for public protective actions, including notification and coordination with other state and local agencies, are contained in the state and county radiological emergency management plans as appropriate.

The State Division of Emergency Management (DEM) and DOH-BRC are responsible for evaluating Turkey Point PARs and preparing a recommendation to the governor. The Director, State Division of Emergency Management, is appointed by the governor as the State Coordinating Officer and can make the final recommendation for protective actions to offsite authorities by the state on the governor's behalf. Miami-Dade and Monroe county emergency management directors may implement protective actions if the governor has not signed an executive order.

If plant conditions are stable and offsite radiological conditions do not pose a danger to public health and safety, Turkey Point may discuss a return to evacuated areas with the state. The

state authorities are then responsible for actually recommending return and transmitting this recommendation to the general public.

## 10. IMPLEMENTATION OF PROTECTIVE ACTION RECOMMENDATIONS

Turkey Point will provide PARs to the state and counties, and the state of Florida, Miami-Dade and Monroe county officials will then implement protective measures for the plume exposure pathway. Considerations by Turkey Point and offsite agencies during this process include:

- a. Most of the public evacuees are expected to travel in their own vehicles, leaving the EPZ via designated evacuation routes. The state and county emergency management plans contain official maps and information on the locations of reception centers and shelters.
- b. Population distribution around the plant for the 10-mile radius, as described in Figure J-1.
- c. As indicated in Section E of this Plan, offsite agencies are notified in the event of an emergency at Turkey Point. State and county agencies have the capability to notify members of the transient and resident population within the plume exposure pathway EPZ.
- d. State and county emergency plans address the means for protection of mobility impaired individuals; provisions and decisions for administering radioprotective drugs; relocation information, including a description of relocation centers in host areas; projected traffic capacities of evacuation routes; control of access to evacuated areas; identification of potential impediments to evacuation; and time estimates for evacuation of various sectors of the plume exposure pathway.
- e. At a *General Emergency* classification, Turkey Point will provide the state and counties with PARs for the public. For incidents involving actual, potential, or imminent releases of radioactive material to the atmosphere, EPA 400-R-92-001 and NUREG-0654, Supplement 3, are used as the basis for the general PARs.

Figure J-2 has been developed to aid Turkey Point personnel in providing PARs based on plant conditions and offsite dose estimates.

Many assumptions exist in dose assessment calculations, involving both source term and meteorological factors, which make computer predictions over long distances suspect. Field Monitoring Teams, dispatched by FPL, are utilized to track the plume and

verify or provide information to adjust the offsite dose estimates provided by the dose assessment computer projections.

Plant personnel normally do not have the necessary information to determine whether offsite conditions would require sheltering instead of evacuation. An effort to base PARs on external factors (such as road conditions, traffic/traffic control, weather, or offsite emergency response capabilities) is performed by the offsite response organization.

#### **11. INGESTION PATHWAY PROTECTIVE MEASURES**

The state of Florida has responsibility for protective measures for the plume exposure pathway as described above. In addition, the state is responsible for specifying protective measures for the ingestion pathway, including methods for protecting the public from consumption of contaminated water and foodstuffs.

#### **12. MONITORING OF EVACUEES**

County organizations have the capability to register and monitor evacuees at designated reception centers. This capability includes personnel and equipment capable of monitoring residents and transients evacuating from the plume exposure EPZ at the reception centers, in accordance with FEMA guidelines.

**Figure J-1. Sector Population Distribution**

[Source Data: Turkey Point Evacuation Time Estimate]

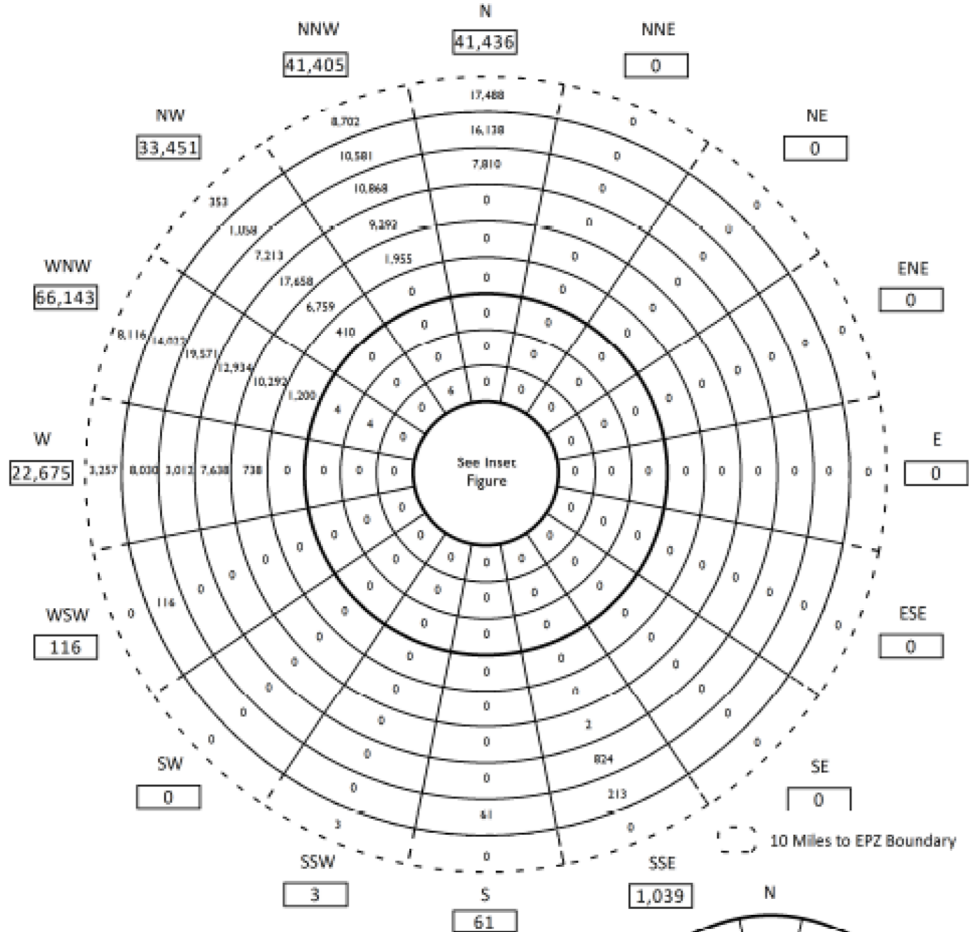

**Resident Population**

Miles	Subtotal by Ring	Cumulative Total
0 - 1	0	0
1 - 2	0	0
2 - 3	6	6
3 - 4	4	10
4 - 5	4	14
5 - 6	1,610	1,624
6 - 7	19,744	21,368
7 - 8	47,525	68,893
8 - 9	49,298	118,191
9 - 10	50,219	168,410
10 - EPZ	37,919	206,329
Total:		206,329

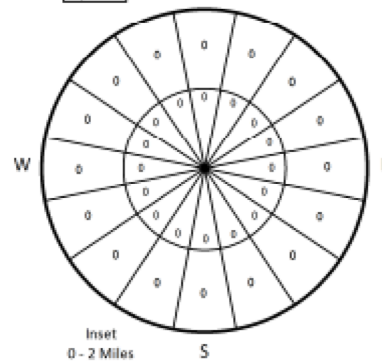



**Figure J-2. Protective Action Recommendations Based on Plant Conditions and Offsite Dose Estimates (Sheet 1 of 3)**

**Guidance for Determining Protective Action Recommendations Based on Plant Conditions**

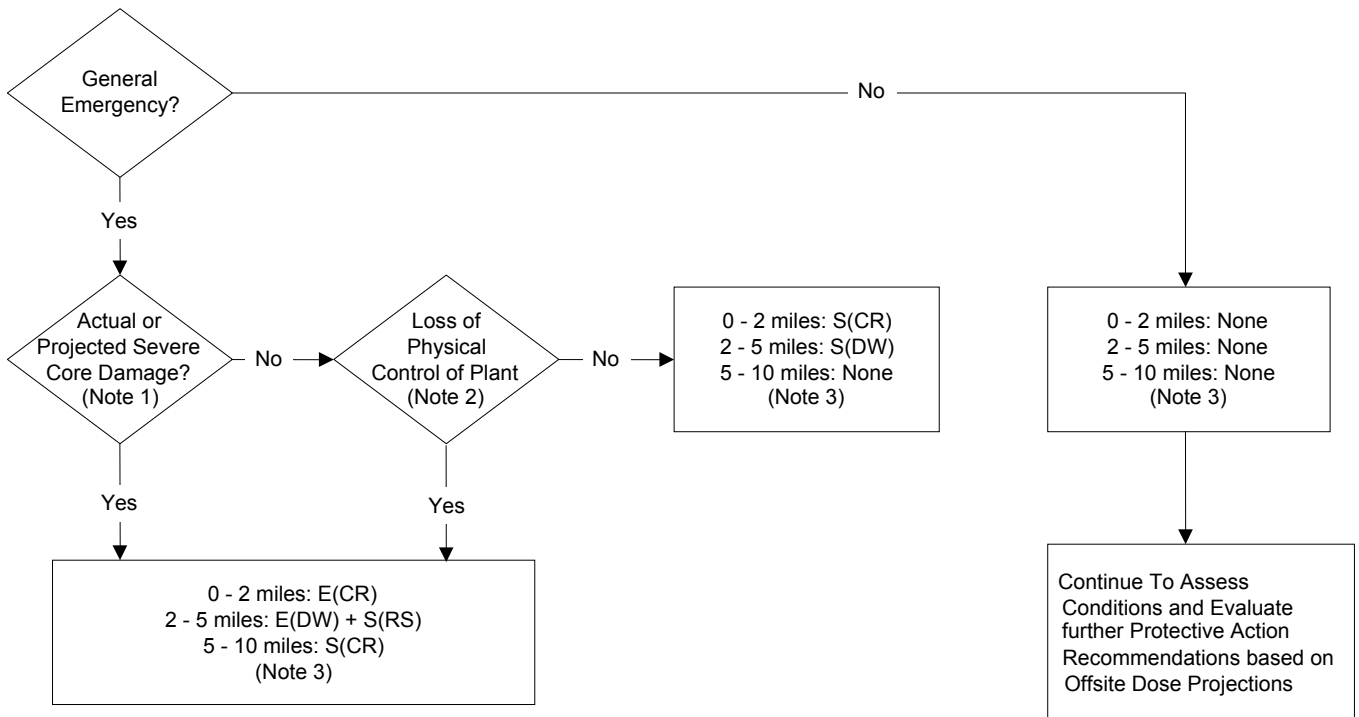

**NOTE:**

(1) Severe core damage is indicated by core melt indications via containment high-range radiation monitors or other accident monitors.

(2) Loss of physical control of control room or reactor operating areas required for continued safe plant operation to intruders.

(3) See additional guidance for determining protective action recommendations in EPIPs.

**Figure J-2. Protective Action Recommendations Based on Plant Conditions and Offsite Dose Estimates (Sheet 2 of 3)**

**Guidance for Determining Protective Action Recommendations  
Based on Plant Conditions  
RELEASE DURATION LESS THAN 2 HOURS (PUFF RELEASE)**

Total Dose TEDE (mrem)		OR	Thyroid Dose CDE (mrem)	0-2 Miles Use 1 Mi. value	2-5 Miles Use 2 Mi. Value	Beyond 10 miles use this column and the 10 mile dose value. 5-10 Miles Use 5 Mi. Value
< 500mrem			<1000mrem	None	None	None
≥ 500 mrem but <1000 mrem			≥ 1000 mrem but <5000 mrem	S(CR)	S(DW)	S(DW)
≥1000 mrem but <5000 mrem			≥ 5000 mrem but < 25000 mrem	S(CR)	S(CR)	S(CR)
≥ 5000 mrem			≥ 25000 mrem	E(CR)	E(DW)+S(RS)	E(DW)+S(RS)

**RELEASE DURATION GREATER THAN OR EQUAL TO 2 HOURS**

Total Dose TEDE (mrem)		OR	Thyroid Dose CDE (mrem)	0-2 Miles Use 1 Mi. value	2-5 Miles Use 2 Mi. Value	Beyond 10 miles use this column and the 10 mile dose value. 5-10 Miles Use 5 Mi. Value
< 500mrem			<1000mrem	None	None	None
≥ 500 mrem but <1000 mrem			≥ 1000 mrem but <5000 mrem	S(CR)	S(DW)	S(DW)
≥1000 mrem but <5000 mrem			≥ 5000 mrem but < 25000 mrem	E(CR)	E(DW)+S(RS)	E(DW)+S(RS)
≥ 5000 mrem			≥ 25000 mrem	E(CR)	E(CR)	E(DW)+S(RS)
<b>SUMMARY</b>				<b>0 - 2 MI.</b>	<b>2 - 5 MI.</b>	<b>5 - 10 MI.</b>
PARs based on – Plant Conditions						
PARs based on – Total Dose (TEDE)						
PARs based on – Thyroid Dose (CDE)						
Most Conservative PARs based on Plant Conditions and Dose Projections						

**LEGEND OF ABBREVIATIONS**

- CDE – committed dose equivalent
- CR – complete radius around plant at specified distance
- DW – downwind plus 2 adjoining sectors
- E – evacuation recommended
- PAR – protective action recommendation
- RS – remaining sectors
- S – sheltering recommended
- TEDE – total effective dose equivalent

**Figure J-2. Protective Action Recommendations Based on Plant Conditions and Offsite Dose Estimates (Sheet 3 of 3)**

Wind From			Wind Toward	
Sector	Direction	Degrees	Direction	Sectors
A	N	348-11	S	H J K
B	NNE	11-33	SSW	J K L
C	NE	33-56	SW	K L M
D	ENE	56-78	WSW	L M N
E	E	78-101	W	M N P
F	ESE	101-123	WNW	N P Q
G	SE	123-146	NW	P Q R
H	SSE	146-168	NNW	Q R A
J	S	168-191	N	R A B
K	SSW	191-213	NNE	A B C
L	SW	213-236	NE	B C D
M	WSW	236-258	ENE	C D E
N	W	258-281	E	D E F
P	WNW	281-303	ESE	E F G
Q	NW	303-326	SE	F G H
R	NNW	326-348	SSE	G H J

Figure J-3. Evacuation Routes and Assembly Areas

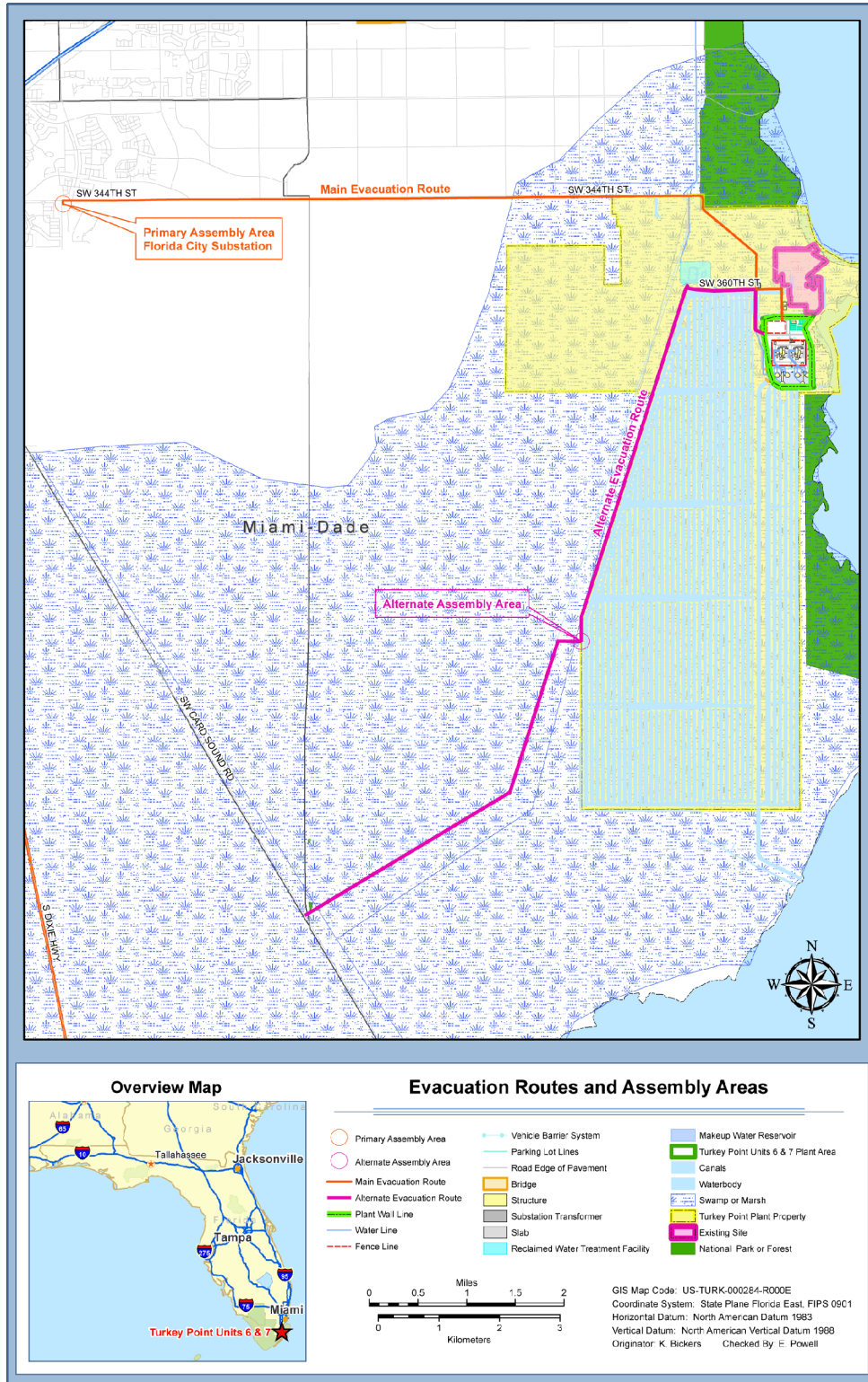

## **SECTION K: RADIOLOGICAL EXPOSURE CONTROL**

This section describes the means for controlling emergency worker radiological exposures during an emergency, as well as the measures that are used by Turkey Point to provide necessary assistance to persons injured or exposed to radiation and/or radioactive materials. Exposure guidelines in this section are consistent with EPA Emergency Worker and Lifesaving Activity PAGs described in EPA 400-R-92-001 (EPA-400).

### **1. EMERGENCY EXPOSURE GUIDELINES**

Turkey Point maintains personnel exposure control programs in accordance with 10 CFR 20 under normal operating conditions. In an emergency situation, all reasonable measures will be taken to maintain the radiation exposure of emergency response personnel providing medical treatment, first aid and rescue, corrective and assessment actions, and decontamination within applicable limits specified in 10 CFR 20. Conditions may warrant reentry into high radiation areas leading exposure in excess of the regulatory limit. The Emergency Coordinator is assigned the non-delegable responsibility for authorizing personnel exposure levels under emergency conditions consistent with EPA-400. Authorization must be given in advance of the exposure, except for rescue of personnel (life-saving only). For those remote circumstances involving an event in progress, and obtaining Emergency Coordinator approval will result in leaving the accident scene or decrease the victim(s) chance of survival, life-saving actions may be performed without obtaining emergency coordinator approval. The Emergency Coordinator shall be notified immediately following the rescue operation. If time permits, the Emergency Coordinator should obtain concurrence from the Recovery Manager, if the EOF is operational. In any case, where regulatory limits have been exceeded, the Emergency Coordinator shall notify the Recovery Manager of the event.

In emergency situations, workers may receive exposure under a variety of circumstances in order to ensure the safety and protection of others and of valuable property. These exposures will be justified if the maximum risks or costs to others that are avoided by their actions outweigh the risks to which the workers are subjected. The emergency worker dose guidelines are as follows:

**Table K-1 Emergency Exposure Guidelines**

<b>Dose Limit (Rem TEDE)</b>	<b>Activity</b>	<b>Condition</b>
0-5	All	Personnel should be kept within normal 10 CFR 20 limits during bona fide emergencies, except as authorized for activities as indicated below.
5-10	Protecting valuable property	Lower dose not practicable.
10-25	Lifesaving or protection of large populations	Lower dose not practicable.
> 25	Lifesaving or protection of large populations	Only on a voluntary basis to persons fully aware of the risks involved.

1. Limit dose to the lens of the eye to 3 times the above values and doses to any other organ (including skin and body extremities) to 10 times the above values.
2. Whenever possible, the concurrence of the Recovery Manager should be secured before exposing individuals to dose equivalents beyond the EPA-400 lower limit.
3. Both total dose (total effective dose equivalent) and thyroid dose (committed dose equivalent) should be used for controlling exposure.

## **2. EMERGENCY RADIATION PROTECTION PROGRAM**

The Radiation Protection Manager is the individual responsible for implementing radiation protection actions during an emergency. Guidelines include the following:

- Volunteers over 45 years of age are considered first for any emergency response action requiring exposure greater than normal limits. Routine dose limits shall not be extended to emergency dose limits for declared pregnant individuals. As in the case of normal occupational exposure, doses received under emergency conditions should be maintained as low as reasonably achievable.
- Individuals undertaking any emergency operation in which the dose will exceed 25 Rem total effective dose equivalent should do so only on a voluntary basis and with full awareness of the risks involved including the numerical levels of dose at which acute effects of radiation will be incurred and numerical estimates of the risk of delayed effects.
- In the context of the emergency limits, exposure of workers that is incurred for the protection of large populations may be considered justified for situations in which the

collective dose avoided by the emergency operation is significantly larger than that incurred by the workers involved.

- Exposure accountability is maintained and proper personnel radiological monitoring equipment is provided for all personnel during emergency conditions.
- Access to high radiation areas is only permitted with prior approval of Radiation Protection. Personnel are not allowed to enter known or potential high radiation areas unless their exposure has been properly evaluated.
- Periodic habitability surveys of emergency facilities are performed during an emergency. If the facility is determined to be uninhabitable, the facility is evacuated in order to prevent or minimize exposure to radiation and radioactive materials. Alternate assembly areas are established, as necessary, to relocate and monitor evacuated personnel.

### **3. PERSONNEL MONITORING**

FPL maintains a site personnel radiation dosimetry program that includes the capability to determine both external and internal doses consistent with the requirements of 10 CFR 20 on a 24-hour-per-day basis. All emergency response personnel under the authority of FPL who potentially will be exposed to radiation in the course of their duties will be monitored by the plant radiation exposure monitoring program.

- a. Emergency workers will receive thermoluminescent dosimeter badges and personal self-reading dosimeters capable of measuring expected exposures on a real time basis. The capability exists for the emergency processing of thermoluminescent dosimeters on a 24-hour-per-day basis, if necessary.
- b. Emergency worker dose records are maintained by the Radiation Protection Manager (as appropriate) in accordance with the emergency and radiological protection procedures. Emergency workers are instructed to read their dosimeters frequently. Thermoluminescent dosimeters may be processed with increased periodicity.

### **4. NON-TURKEY POINT PERSONNEL EXPOSURE AUTHORIZATION**

The state and counties are responsible for authorizing state and local agency emergency workers to receive exposures in excess of the Turkey Point standards unless the offsite emergency workers are on the Turkey Point site. In this situation, the Emergency Coordinator would authorize exposure as appropriate.

## 5. CONTAMINATION AND DECONTAMINATION

During an emergency, radiation protection is responsible for preventing or minimizing personnel exposure to radioactive materials deposited on the ground or other surfaces inside the Protected Areas and within the Owner-Controlled Area. Special consideration should be given to setting up contamination control arrangements for personnel entering the OSC after completion of assigned activities. If the EOF is operational, the Protective Measures Manager is responsible for preventing or minimizing personnel exposure of the Turkey Point Field Monitoring Team members that are assigned to track and sample the release plume.

- a. During emergency conditions, normal plant contamination control criteria will be adhered to as much as possible. However, these limits may be modified by Radiation Protection in accordance with existing radiation protection procedures, should conditions warrant.
- b. Contamination Control Means: Personnel found to be contaminated will normally be attended to at decontamination areas located on site, as described in radiation protection procedures. Temporary decontamination areas can also be set up inside at various locations. Decontamination showers and supplies are provided on site with additional personnel decontamination equipment and capabilities. Shower and sink drains in the controlled area are routed to the miscellaneous waste processing system where the liquid is processed and monitored before discharge. Except in cases of serious injury, accepted decontamination practices will be conducted on site. Life-endangering injuries such as extensive burns, serious wounds, or fractures shall receive prompt attention in preference to decontamination. Personnel with injuries involving radiation or radioactive contamination will be handled by an offsite medical facility, as described in Section L of this Plan. Potentially contaminated emergency vehicles will be surveyed before they are allowed to leave the plant or designated offsite assembly area. If the survey area is not suitable for monitoring and decontamination due to radiological or other concerns, vehicles will be surveyed at an alternate location.

## 6. CONTAMINATION CONTROL MEASURES

Controls are established and maintained 24 hours per day to contain the spread of loose surface radioactive contamination.

- a. Contaminated areas are isolated as restricted areas with appropriate radiological protection and access control. Personnel leaving contaminated areas are monitored to ensure that they and their clothing are not contaminated. If contamination above acceptable levels is found, they will be decontaminated in accordance with radiation



protection procedures. If normal decontamination procedures do not reduce personnel contamination to acceptable levels, the case will be referred to a competent medical authority. Supplies, instruments, and equipment that are in contaminated areas or have been brought into contaminated areas will be monitored before removal. If personnel are found to be contaminated, they will be decontaminated using normal plant decontamination techniques and facilities. Contaminated materials will be disposed of as radwaste. Contaminated vehicles will be decontaminated before being released. An ambulance responding and transporting injured contaminated personnel will be monitored and decontaminated before departing the medical facility by Turkey Point personnel.

- b. Measures will be taken to control onsite access to potentially contaminated potable water and food supplies. Under emergency conditions, when uncontrolled releases of activity have occurred, eating, drinking, and chewing are prohibited in all Turkey Point emergency response facilities until such time as habitability surveys indicate that such activities are permissible.
- c. Restricted areas and contaminated items will be returned to normal use when contamination levels have been returned to acceptable levels. Contamination control criteria for returning areas and items to normal use are contained in the radiation protection procedures.

## **7. DECONTAMINATION OF RELOCATED PERSONNEL**

Efforts will be made to prevent contaminated vehicles operated by nonessential personnel to depart the Turkey Point site. Alternate forms of transportation may be made available to reduce the possibilities of transporting contamination offsite with suspected contaminated vehicles.

Onsite personnel not needed for emergency response may be evacuated to an offsite assembly area or holding area, as discussed in Section J. As conditions warrant, radiological protection personnel at the assembly area monitor evacuees and determine the need for decontamination. Existing and temporary facilities to limit contamination and exposure will be used and established at the site, as necessary, during an emergency situation. In the event that decontamination of site evacuees locally is not possible, personnel will be sent to designated locations for monitoring and decontamination. Provisions for extra clothing are made and suitable decontaminates are available for the expected types of contaminations, particularly with regards to skin contaminations.

## **SECTION L: MEDICAL AND PUBLIC HEALTH SUPPORT**

This section describes the arrangements for medical services for contaminated injured personnel at the Turkey Point site. Details outlining radiological medical emergencies and response are described in EPIPs.

### **1. OFFSITE HOSPITAL AND MEDICAL SERVICES**

Arrangements by written agreement are maintained by FPL for medical treatment of Turkey Point personnel who may have injuries complicated by the presence of radioactive contamination and/or overexposure to radiation.

Sheridan Emergency Physician Services of South Dade, located at Baptist Hospital of Miami, provides for the immediate availability of fully equipped medical facilities with a staff of physicians and nurses skilled in the treatment of personal injury accompanied by radioactive contamination. This facility is available on a 24-hour basis. The patient receiving area is equipped for patient decontamination and the performance of emergency medical procedures for life saving purposes. Additional emergency medical facilities in the hospital include the emergency room and an intensive care unit available for the treatment of decontaminated radiation accident casualties or persons who have received only internal radiation exposures.

Emergency Room Medical Associates (ERMA), located within Mercy Hospital of Miami, also provides for the immediate availability of medical facilities for treatment of personal injury accompanied by radioactive contamination and is available on a 24-hour basis.

Hospital personnel have been trained in the treatment of personal injury accompanied by radioactive contamination, and the hospital is equipped to handle contaminated or radiation injured individuals. Specifically, training of medical support personnel includes basic training on the nature of radiological emergencies, diagnosis and treatment, and follow-up medical care. Turkey Point personnel are available to assist medical personnel with decontamination, radiation exposure, and contamination control. Materials that are identified as contaminated are collected by radiation protection personnel and returned to Turkey Point for decontamination or disposal.

Letters of agreement with Baptist Hospital of Miami and Mercy Hospital of Miami are maintained on file by Turkey Point Emergency Preparedness and listed in Appendix 2 of this Plan.

## 2. ONSITE FIRST AID CAPABILITY

Turkey Point maintains an onsite first-aid facility and emergency vehicle with first-aid supplies and equipment necessary for the treatment of contaminated or injured persons. In addition, standard 24-unit first-aid kits are maintained at numerous locations throughout the plant.

The First-Aid Team is comprised of on-shift personnel who are American Red Cross Multi-media first-aid qualified. The First Aid Team is dispatched by the Control Room or the OSC when it is activated. At least two of these individuals are available on shift at all times to support immediate response in each Protected Area. In addition, FPL may staff their onsite clinic with additional medical support personnel that can aid in the response.

Radiation protection personnel at Turkey Point are experienced and trained in the control of radioactive contamination and decontamination activities for injured or ill personnel. Radiation protection technicians are dispatched to support medical response if there is a possibility of contamination associated with the injury/illness. The functions of plant personnel in handling onsite injured people are:

- a. Initiate rescue.
- b. Administer first responder aid including resuscitative measures as deemed necessary.
- c. Request and escort offsite medical assistance to the injured/ill individual in a timely manner when needed.
- d. Begin decontamination procedures as appropriate.
- e. Arrange for suitable transportation to a hospital when required.

Primary attention shall be directed to the actual factors involved in the treatment of injuries or illness, such as control of bleeding, resuscitation including heart and lung, control of bleeding after resuscitation, protection of wounds from bacterial or radioactive contamination, and the immobilization of fractures.

Turkey Point personnel provide an initial estimate of the magnitude of surface contamination of the injured and preliminary estimates of total body dose to the injured. Primary rapid and simple decontamination of the surface of the body (when possible and advisable) before transportation to a designated hospital may be carried out. This activity would be as directed or performed by radiation protection personnel. If decontamination is not considered due to the immediacy of medical treatment, efforts will be made to isolate and reduce the spread of the contamination

before transportation. When additional professional medical care is needed and contamination is not a factor, injured or ill individuals are transported to a local clinic or hospital. Contaminated and injured or ill individuals are transported to either Sheridan Emergency Physicians Services of South Dade or Emergency Room Medical Associates from the Turkey Point site.

First-aid facilities at Turkey Point are designed to provide basic first aid to injured or ill personnel before arrival of offsite medical support. Emergency treatment areas are located in each of the units and are described in the appropriate Unit Annex to this Plan. Medical equipment and supplies are available at these locations.

In the event of a mass casualty incident, and plant and local response resources are exceeded by the number of casualties, Turkey Point may request additional resources through the state Division of Emergency Management. The state Division of Emergency Management will coordinate additional support, in accordance with the state Radiological Emergency Management Plan.

### **3. MEDICAL SERVICE FACILITIES**

Because of the specialized nature of the diagnosis and treatment of radiation injuries, FPL maintains an agreement with the REAC/TS in Oak Ridge, Tennessee. REAC/TS will provide a backup response capability for patients with serious contamination/ingestion or who have been excessively exposed to radiation. REAC/TS has a radiological emergency response team of physicians, nurses, health physicists, and necessary support personnel on 24-hour call to provide consultative or direct medical or radiological assistance. Specifically, the REAC/TS team has expertise and is equipped to conduct: medical and radiological triage; decontamination procedures and therapies for external contamination and internally deposited radionuclides, including chelation therapy; diagnostic and prognostic assessments or radiation-induced injuries; and radiation dose estimates by methods that include cytogenetic analysis, bioassay, and in vivo counting.

### **4. MEDICAL TRANSPORTATION**

Arrangements are in place for transport of persons with injuries and/or illness involving radioactivity from the site to Sheridan Emergency Physicians Services of South Dade or Emergency Room Medical Associates in Miami. Turkey Point maintains an onsite emergency vehicle that is equipped to provide prompt transport of an injured and/or contaminated victim(s) to an offsite medical facility if required. The Miami-Dade Fire Rescue Department is available to provide ambulance support if offsite medical transportation is required. Miami-Dade Fire Rescue is staffed with emergency medical technicians, paramedics, and additional qualified personnel

capable of handling medical emergencies. This service is available on a 24-hour-per-day basis and is confirmed by a letter of agreement, as described in Appendix 2. If an offsite ambulance is requested, Turkey Point security personnel will expedite and escort the responding ambulance(s) to the victim(s) location. Turkey Point maintains a communications link with the ambulance by means of radio as well as telemetry. Cellular telephones are also available onsite to be used as an alternate communications method. In all cases, telephone notification is made by the plant to the hospital concerning the pending arrival of injured personnel.

In the event that a helicopter is needed to transport victim(s), the U.S. Coast Guard and Miami-Dade Fire Rescue can provide 24-hour-per-day helicopter transportation in a life-threatening situation to a designated hospital on an as available basis. A primary helicopter landing area is available onsite. Alternate landing areas are determined by response personnel and marked to assist the landing of the helicopter. If a helicopter is used for transportation to the hospital, the hospital can maintain a ground-to-air communications link.

Radiation monitoring services shall be provided by Turkey Point radiation protection personnel whenever it becomes necessary to use the ambulance service for the transportation of contaminated persons. A qualified radiation protection person shall accompany the ambulance to the hospital upon the determination that the injured or ill person is contaminated, or if the determination cannot be made that the individual is free of surface contamination. Additional radiation protection personnel may be contacted and dispatched to Sheridan Emergency Physicians Services of South Dade or Emergency Room Medical Associates in Miami to assist in monitoring and decontamination of the injured victim(s), the hospital facilities, and the ambulance and response personnel, as needed.

## SECTION M: REENTRY AND RECOVERY PLANNING

This section describes activities for reentry into the areas of the plant that have been evacuated as a result of an accident. It also outlines the Turkey Point recovery organization and its concepts of operation. Detailed information describing reentry and recovery activities are contained in the EIPs.

### 1. REENTRY AND RECOVERY

#### a. Evaluating Reentry Conditions

During an emergency, immediate actions are directed toward limiting the consequences of the accident in a manner that gives maximum protection to plant personnel and the general public. After corrective measures have been taken and effective control of the plant has been reestablished, a more methodical approach to reentry is taken. Reentry can be divided into two separate categories:

- Reentry *during the emergency phase of an accident* is performed to save a life, control a release of radioactive material, prevent further damage to plant equipment, or restore plant equipment. If necessary, this category of reentry may be performed using emergency exposure limits. Briefings, rather than written radiation protection procedures, may be used when making these entries. All reentry activities conducted during the emergency are authorized by the Emergency Coordinator and coordinated by the OSC Manager and the Radiation Protection Manager.
- Reentry *during the recovery phase of an accident* is performed using normal exposure limits. Either normal procedures or procedures that consider existing as well as potential conditions inside affected areas are developed specifically for each reentry. Reentry during the recovery phase is authorized by the Emergency Coordinator and Recovery Manager and coordinated by the recovery organization managers in charge of personnel making the reentry.

The following items are considered when planning for any reentry:

- Review of available radiation surveillance data to determine plant areas potentially affected by radiation and/or contamination.
- Review of radiation exposure history of personnel required to participate in the accident mitigation or recovery operations.

- Determination of the need for additional personnel and the source of additional personnel.
- Review of adequacy of radiation survey instrumentation and equipment (for example, types, ranges number, and calibration).
- Review of nonradiological hazards and required protective measures (e.g., fire, electrical, atmosphere, Hazmat).
- Preplanning of activities and briefings for the reentry team that include the following:
  - Personnel knowledge requirements
  - Methods and procedures that will be employed during the entry
  - Specific tasks to be performed
  - Anticipated radiation and contamination levels as well as “turn back” limits
  - Radiation survey equipment and types and ranges of dosimetry required
  - Shielding requirements and availability
  - Appropriate communications
  - Personal protective equipment requirements
  - Access control procedures
  - Decontamination requirements
  - Debriefing requirements
  - Respiratory protection
- A review of security controls to prevent unauthorized or unintentional entry into hazardous or secured areas.

## b. Evaluating Entry into Recovery

The recovery phase is that period when major repairs are being performed to return the plant to an acceptable condition, and the possibility of the emergency condition degrading no longer exists. When the plant has been stabilized, contained, and controlled, the recovery phase may be entered.

An *Unusual Event* or *Alert* classification may be terminated by the Emergency Coordinator. Turkey Point may consult with/notify the cognizant offsite governmental agencies before declaring recovery or event termination during an *Unusual Event* or *Alert* classification. A *Site Area Emergency* or *General Emergency* classification may only be deescalated by the Recovery Manager and will require a recovery phase to be established before event termination. The Recovery Manager has the authority to deescalate the emergency classification and initiate entry into recovery after obtaining concurrence from the Emergency Coordinator and consulting with offsite authorities.

There may be cases where certain EAL initiating conditions remain exceeded, but the plant is under control and no further danger of degradation exists. Termination/recovery considerations are described in the EIPs and provide guidance for evaluating the risk of entering recovery without alleviating the intent of the initiating condition. The purpose of recovery is to provide the necessary personnel to affect the long-term activities and to return the plant to an acceptable condition.

The recovery phase will begin only when the plant conditions are stable, and the following guidelines are met. (Note: This is not intended to be a complete list, and additional criteria may apply, depending on the specifics of the event):

- Review of the EALs indicates that plant conditions no longer exist or are likely to occur that meet criteria requiring entry into the Emergency Plan.
- The plant is stable, under control, and trend or prognosis indicated that improvement is the most likely prospect. The following is considered:
  - Subcriticality
  - Core cooling mode
  - Heat sink mode
  - Reactor coolant system pressure boundary integrity



- Inventory control (primary and secondary coolant)
  - Reactor is in stable condition
  - Radiation levels in all in-plant areas are stable or decreasing with time
  - Releases of radioactive materials to the environment from the plant are under control or have ceased
  - Any fire, flooding, or similar emergency conditions are controlled or have ceased
- There is no foreseeable likelihood of a significant uncontrolled release when considering containment pressure, containment/auxiliary building radiation levels, waste gas storage tank pressures and activities, and containment water volumes and activities.
  - Long-term staffing for recovery is organized and in place as appropriate for the event.
  - Appropriate offsite organizations, including the state and county emergency management agencies and the NRC, are informed that de-escalation of the emergency classification and initiation of the recovery phase is in order.
  - Any security threat has been neutralized, and/or plant security is under the direction of Turkey Point and law enforcement personnel.

It is not necessary that all conditions listed above be met; however, all items must be considered before entering the recovery phase. For example, it is possible after a severe accident that some conditions remain that exceed an emergency action level, but entry into the recovery phase is appropriate.

## **2. RECOVERY ORGANIZATION**

When the decision is made to enter the recovery phase, the Recovery Manager, with assistance from senior management, will determine the extent of staffing for the Turkey Point Recovery Organization. The ERO will be notified of the change, and the appropriate personnel will be assigned responsibilities for the recovery effort. The Recovery Manager will also initiate notification to offsite governmental authorities that the site is transitioning to a Recovery Organization and include information concerning changes in the organizational structure that

may occur. These types of alterations should be discussed with the NRC before they are implemented.

- For events of a minor nature, (for example, for *Unusual Event* classifications), the normal on-shift organization should be adequate to perform necessary recovery actions.
- For events where damage to the plant has been significant, but no offsite releases have occurred and/or protective actions were not performed, (for example, for *Alert* classifications) the plant ERO, or portions thereof, should be adequate to perform the recovery tasks before returning to the normal plant organization.
- For events involving major damage to systems required to maintain safe shutdown of the plant and/or offsite radioactive releases have occurred, (for example, for *Site Area Emergency* or *General Emergency* classifications), the plant Recovery Organization is put into place.

The specific members of the Recovery Organization are selected based on the sequence of events that preceded the recovery activities as well as the requirements of the recovery phase. The basic framework of the plant Recovery Organization includes:

- a. The Recovery Manager: The Recovery Manager who responds to the event transitions into the Recovery Organization and has the responsibility for directing the activities of the plant recovery organization. These responsibilities include:
  - Ensuring sufficient personnel, equipment, or other resources from Turkey Point and other organizations are available to support recovery.
  - Directing the development of a recovery plan and procedures.
  - Deactivating any of the plant ERO that was retained to aid in recovery, in the appropriate manner. Depending on the type of accident and the onsite and offsite affects of the accident, portions of the ERO may remain in place after initiation of the recovery phase.
  - Coordinating the integration of available federal and state assistance into onsite recovery activities.
  - Coordinating the integration of Turkey Point support with federal, state, and county authorities into required offsite recovery activities.

- Approving information released by the Emergency News Center organization that pertains to the emergency or the recovery phase of the accident.
  - Determining when the recovery phase is terminated.
- b. The Recovery Coordinator: The Emergency Coordinator who responds to the event transitions into the Recovery Organization and becomes the Recovery Coordinator. The Recovery Coordinator reports to the Recovery Manager and is responsible for:
- Coordinating the development and implementation of the recovery plan and procedures, including maintenance of plans and schedules to meet the objectives of the recovery operation.
  - Directing all onsite activities in support of the plant's recovery effort, including supervision of in-plant maintenance and operations activities; supervision of the in-plant security program; and supervision of radiation protection activities (onsite sampling programs, dose assessment, dose management and radiation protection).
  - Designating other Turkey Point recovery positions required in support of onsite recovery activities.
- c. The Recovery Offsite Manager: A senior member of plant management, or a designated alternate, is the Recovery Offsite Manager. The Recovery Offsite Manager reports to the Recovery Manager, and is responsible for:
- Providing liaison with offsite agencies and coordinating Turkey Point assistance for offsite recovery activities.
  - Coordinating Turkey Point ingestion exposure pathway EPZ sampling activities and the development of an offsite accident analysis report.
  - Developing a radiological release report.
  - Designating other Turkey Point recovery positions required in support of offsite recovery activities.
- d. The FPL Public Information Officer: The FPL Public Information Officer who responds to the event transitions into the Recovery Organization; reports to the Recovery Manager; and is responsible for:

- Functioning as the official spokesperson to the press for FPL on all matters relating to the accident or recovery.
- Coordinating with all public information groups (federal, state, county, etc.).
- Coordinating media monitoring and rumor control.
- Determining what public information portions of the ERO will remain activated.

The remainder of the Recovery Organization is established on an initial recovery plan developed at the end of the emergency phase or just after entry into the recovery phase. Consideration is given to recovery activity needs and use of the normal Turkey Point organizations. Individual recovery supervisors may be designated in any or all of the following areas:

- Training
- Radiation protection
- Chemistry
- Technical/engineering support
- Nuclear oversight
- Operations
- Security
- Maintenance
- Corporate support
- Special offsite areas (community representatives, etc.)

The state will be the lead organization for offsite recovery operations, and the state's recovery organization will be set up in accordance with the State of Florida Radiological Emergency Management Plan.

### **3. RECOVERY PHASE NOTIFICATIONS**

When the decision is made to enter the recovery phase, all members of the ERO are informed of the change. All Turkey Point personnel are instructed on the Recovery Organization and their responsibilities during the recovery effort. The offsite authorities are notified of the shift and the basic structure and management of the Recovery Organization.

### **4. TOTAL POPULATION EXPOSURE**

Total population exposure calculations are performed and periodically updated during the recovery phase of an accident. A method has been developed for estimating the total population exposure resulting from the accident from data collected in conjunction with the state and other federal agencies. Total population exposure is determined through a variety of processes including:

- Examination of prepositioned environment monitoring thermoluminescent dosimeters
- Bioassay
- Estimates based on release rates and meteorology
- Estimates based on environmental monitoring of food, water, and ambient dose rates

Population exposure estimates are discussed in the state plan. The state plan also describes the projected dose calculations and assessment and monitoring in the ingestion pathway EPZ. The state is responsible for environmental monitoring activities to support Turkey Point and will be the lead agency in the collection and analysis of environmental air, soil, foliage, food, and water samples and for the generation of radiation monitoring reports. Environmental monitoring results will be shared with the cognizant agencies.

## SECTION N: DRILL AND EXERCISE PROGRAM

This section describes the program for drills and exercises conducted to practice, test, and evaluate the adequacy of the emergency preparedness program, including facilities, equipment, procedures, communication links, actions of ERO personnel, and coordination between Turkey Point and offsite emergency response organizations. Details for conduct of drills and exercises are described in emergency plan administrative procedures.

### 1. EXERCISES

Exercises provide an opportunity to evaluate the ability of participating organizations to implement a coordinated response to postulated emergency conditions. Exercises are conducted to ensure that all major elements of the Emergency Plan and preparedness program are demonstrated at least once per 8-year cycle. The plant shall conduct at least one off-hours exercise between 6:00 p.m. and 4:00 a.m. per 8-year cycle. Weekends and holidays are also considered off-hour periods. A hostile action-based exercise of the onsite emergency plan is conducted each exercise cycle. Provisions will be made for qualified personnel from Turkey Point and other commercial nuclear facilities, federal, state, or county governments to observe and critique each exercise as appropriate.

#### a. Biennial Exercises

An evaluated exercise will be conducted biennially. In the evaluated exercise, county personnel and resources will be mobilized to verify the adequate capability to respond to an accident scenario. Evaluated exercises include a Site Area Emergency or General Emergency classification. The evaluated exercise will be evaluated by the NRC and FEMA sponsored observers/evaluators. The scenario for the evaluated exercise shall be submitted to the NRC for review and verification at least 60 days prior to the exercise. The scenario should be varied from year to year, such that all major elements of the plans and preparedness organizations are tested at least once per 8-year cycle. This will include provisions for an off-hours exercise/drill. The exercises/drills will be run under various weather conditions. Some exercises/drills will be unannounced. Drills and exercise scenarios should be conducted in a manner to provide reasonable assurance that anticipatory responses will not result. A hostile action-based exercise involving full or partial offsite participation is conducted in alternating exercise cycles. A wide spectrum of radiological releases (including scenarios with no release) and events are used, to train responders to respond to more realistic events and to avoid preconditioning the responders to success with inappropriate anticipatory responses.

Exercises shall provide the opportunity for ERO Teams to demonstrate key skills specific to emergency response duties. These key skills are:

- Event classification.
- Timely notification of offsite authorities.
- PAR development (development of PARs involving public evacuation or sheltering is required only in exercises that include a general emergency).
- Radiological assessment (if scenario includes a release).
- Shift staff response to accident transients or other events that meet EAL criteria while implementing the emergency plan.
- ERO response and ERF activation following declared emergencies.
- Integration of licensee response with OROs to include briefings, coordination of worker protection, and, as appropriate to the scenario, coordination of public protective actions, radiological release monitoring, and offsite response to the site.
- Communications that support response between onsite and offsite ERFs.
- Dissemination of information to the public via media channels and press briefings.
- Development and implementation of radiological or physical protection (i.e., in response to hostile action) protective actions for onsite workers as appropriate to the scenario.
- Operational and engineering assessment of accident sequences.
- Accident mitigation through the simulated repair of equipment. This should include mechanical, electrical, and/or I&C activities. The scenario should be designed to allow some repairs to be successful, but should provide the opportunity to demonstrate mitigation planning and repair execution. Radiological control activities should support some repair teams.

If the key skills (listed above) are not successfully demonstrated, a remedial exercise may result. A remedial exercise may also be called for if the confidentiality of an exercise scenario is compromised in a way that broadly affects the ability of the ERO to successfully demonstrate the key skills.

Ingestion pathway exercises are conducted on an 8-year cycle. Turkey Point participates on a rotating basis with the other fixed nuclear facilities in the state of Florida. These exercises may be conducted in conjunction with a full participation exercise as determined by the state.

b. Off-Year Exercises

An off-year exercise is conducted at the plant during the calendar year when an NRC evaluated exercise is not scheduled. An off-year exercise shall involve one of the plant units and its facilities in order to demonstrate at least the functions of management and coordination of emergency response, accident assessment, protective action decision-making, or plant system repair and corrective actions. Off-year exercises do not require participation by offsite agencies, although an offer must be made to determine the extent of participation by the offsite authorities. Players may be able, by implementing appropriate procedures and corrective actions, to determine the outcome of the scenario to a greater extent than when core damage and the release of radioactivity that are prerequisites for demonstration of all objectives which may include security response activities.

## 2. DRILLS

In addition to the exercises described above, Turkey Point conducts drills for the purpose of testing, developing, and maintaining the proficiency of emergency responders. Drills are conducted to ensure that adequate emergency response capabilities are maintained. As a minimum, the following drills will be conducted:

a. Communication Drills

- Monthly: (1) Communication between the Control Rooms, TSC, EOF state and county warning points and EOCs shall be tested. (2) Communication between the Control Rooms, TSC, and EOF to the NRC Operations Center shall be tested using the Emergency Notification System (ENS).
- Quarterly: Emergency Response Data System (ERDS) will be activated and tested to ensure capability for data to be transferred to the NRC.
- Annually: (1) Communications between Turkey Point and the state and local EOCs and Field Monitoring Teams shall be tested. (2) Communications between the Control Rooms, TSC, EOF and ENC shall be tested. Communications



between the Turkey Point emergency response facilities and the appropriate offsite response organizations shall be tested during annual drills and include the aspect of understanding the content of messages.

- b. Fire Drills: Fire drills shall be conducted in accordance with the plant Technical Specifications, fire protection plan, and/or plant procedures.
- c. Medical Emergency Drills: A medical emergency drill, involving a simulated contaminated individual and containing provisions for participation by local support services organizations (i.e., ambulance and support hospital), shall be conducted annually. The offsite portions of the medical drill may be performed as part of the required biennial exercise.
- d. Radiological Monitoring Drills: Plant environs and radiological monitoring drills (onsite and offsite) are conducted annually. These drills include collection and analysis of sample media and provisions for communications and record keeping.
- e. Radiation Protection Drills: Radiation protection drills involving a response to, and analysis of, simulated elevated airborne and liquid samples and direct radiation measurements within the plant are conducted semiannually in each Protected Area.
- f. Augmentation (off-hour) Drills: Augmentation drills shall be run at least once per 8-year cycle. They are to be planned outside of normal working hours (beginning after 6:00 p.m. and before 4:00 a.m., Monday through Friday OR anytime on a weekend or holiday).
- g. Assembly and Accountability Drills: Accountability drills are conducted at least once per 8-year cycle. The drill includes ascertaining the names of all missing individuals within that protected area and accounting for all individuals within the Protected Area continuously throughout the event.
- h. Hostile Action-Based (HAB) Drills: At least once per 8-year cycle, an HAB drill will be conducted with offsite participation.

### 3. CONDUCT OF DRILLS AND EXERCISES

The Turkey Point Emergency Preparedness Manager will be responsible for planning, scheduling, and coordinating all drills and exercises involving offsite agencies.

Advance knowledge of the scenario will be kept to a minimum to allow "free-play" decision-making and to ensure realistic participation by those involved. Before the drill or exercise, a

package will be distributed to the controllers and evaluators that will include the scenario, a list of performance objectives, and a description of the expected responses.

Drills will be provided to ensure that each member of the ERO will have an opportunity to participate in a drill in their assigned facility at least once in a 2-year period. Drills will be rotated among the units and their specific emergency response facilities to provide the needed opportunities for the members of the ERO.

For each emergency preparedness exercise or drill conducted, a scenario package is developed that includes at least the following:

- a. The basic objective(s) of the drill or exercise and the appropriate evaluation criteria.
- b. The date(s), time period, place(s), and participating organizations.
- c. The simulated events.
- d. A list of anticipated drill/exercise performance opportunities including classification, notifications, and Protective Action Recommendations (PARs).
- e. A time schedule of real and simulated initiating events.
- f. A narrative summary describing the conduct of the scenario to include such items as simulated casualties, offsite fire department assistance, rescue of personnel, use of protective clothing, deployment of radiological monitoring teams, and public information activities.
- g. A list of qualified participants.
- h. Instructions for the conduct and evaluation of the drill/exercise for the controller/evaluator organization.

Prior approval by Turkey Point plant management is obtained for all drills and exercises conducted in support of the emergency preparedness program.

#### **4. CRITIQUE AND EVALUATION**

Before the drill or exercise, a package will be distributed to the controllers and evaluators that will include the scenario, a list of performance objectives, and a description of expected responses. During conduct of the drill or exercise, qualified evaluators who have the skills and

knowledge to effectively evaluate the participants will evaluate drill/exercise performance objectives against measurable demonstration criteria.

As soon as possible following the conclusion of each drill or exercise, a critique is conducted to evaluate the ability of the ERO to implement the Emergency Plan and its implementing procedures. The Turkey Point Emergency Preparedness Manager (or designee) will prepare a formal written critique report involving the evaluation of designated objectives and based on input from the participants, controllers/evaluators, and observers. The written critique will document the ability of the ERO to respond to a simulated emergency situation or sequence of events and may identify the need for changes to the Plan, procedures, equipment, facilities, or other components of the emergency preparedness program. The report will also contain corrective actions and recommendations for improvement.

Official observers from federal, state, or local governments will observe, evaluate, and critique the required biennial exercise in which the state and counties participate. In addition, representatives from the NRC will observe and evaluate Turkey Point's ability to conduct an adequate self-critique.

## **5. RESOLUTION OF DRILL AND EXERCISE FINDINGS**

The critique and evaluation process is used to identify areas of the emergency preparedness program that require improvement. The Turkey Point Emergency Preparedness Manager (or designee) is responsible for evaluating recommendations and comments to determine which items will be incorporated into the program or require corrective actions, and for the scheduling, tracking, and evaluation of the resolution to the items. The items designated as corrective actions will be placed and tracked in the station's corrective action program. The Turkey Point Emergency Preparedness Manager is responsible for initiating changes to the Emergency Plan or supporting procedures resulting from drill/exercise critiques.

## **SECTION O: EMERGENCY RESPONSE TRAINING**

This section describes the radiological emergency response training program which ensures the training, qualification, and requalification of individuals who will be required to provide assistance during an emergency at Turkey Point. FPL implements a training program that provides for initial training and retraining for individuals who have been assigned emergency response duties, including both Turkey Point ERO personnel and offsite support agencies that may be requested to provide assistance. Training requirements for the Emergency Response Organization are delineated in an implementing procedure.

The Turkey Point Emergency Preparedness Manager has the overall responsibility for the Turkey Point emergency preparedness training program. The Turkey Point Training Manager is responsible for ensuring that initial training and annual retraining of ERO personnel is conducted and documented. The Turkey Point Emergency Preparedness Manager is responsible for the content and accuracy of the emergency preparedness training.

Training will be conducted in accordance with the general requirements described below and emergency plan administrative procedures.

### **1. ASSURANCE OF TRAINING**

The emergency preparedness training program ensures the training, qualification, and requalification of individuals who may be called on for assistance during an emergency. The ERO training program consists of lesson plans, written examinations and supporting materials, as described in the Nuclear Training Department Program Manual, and administrative guidelines.

Offsite training is provided to support organizations that may be called upon to provide assistance in the event of an emergency, as outlined below:

- a. Local law enforcement, fire and rescue, medical support, and principal decision-makers for the state and county shall be offered training annually. The training made available is designed to acquaint the participants with the special problems potentially encountered during a nuclear plant emergency, notification procedures, and their expected emergency response roles. Those organizations that must enter the site shall also receive site-specific emergency response training and be instructed as to the identity (by position and title) of those individuals in the onsite organization who will control their support activities. Training of medical support personnel at the agreement hospitals will include basic training in radiological controls and medical consideration of contaminated

injuries. Training of state and local emergency management agency personnel will include a review of the EALs.

- b. Training of offsite emergency response organizations is described in their respective radiological emergency plans, with support provided by Turkey Point, as requested.

## **2. FUNCTIONAL TRAINING OF THE EMERGENCY RESPONSE ORGANIZATION**

In addition to general and specialized classroom training, members of the ERO may receive periodic performance-based emergency response training. Performance-based training is provided using one or more of the following methods:

- Facility Tours: Consists of a facility walk-through to familiarize ERO personnel with procedures, communications equipment, and facility layout. Walk-throughs also provide the opportunity to discuss facility activities, responsibilities, and procedures with an instructor.
- Drills: A drill is a supervised instruction period aimed at testing, developing, and maintaining skills in a particular operation, as described in Section N of this Plan. Drills are conducted as a training opportunity to allow each individual to demonstrate the ability to perform his/her assigned emergency functions. During drills, on-the-spot correction of erroneous performance may be made and a demonstration of the proper performance offered by the controller.

## **3. FIRST-AID RESPONSE**

Personnel assigned to emergency teams that provide first aid will complete American Red Cross Multi-Media First Aid or equivalent on a schedule compatible with the Red Cross requirements.

## **4. EMERGENCY RESPONSE ORGANIZATION TRAINING PROGRAM**

The training program for emergency response personnel is developed based on the requirements of 10 CFR 50, Appendix E and position-specific responsibilities as defined in this plan.

On-shift emergency response personnel perform emergency response activities as an extension of their normal duties and are trained annually as part of their duty specific training. Additional emergency preparedness information is provided as part of general employee training.

New ERO personnel receive an initial overview course that familiarizes them with the Emergency Plan by providing basic information in the following areas as well as specific information as delineated in the sections below:

- Planning basis
- Emergency classifications
- ERO and responsibilities
- Call-out of ERO
- Emergency response facilities
- Offsite organizations

ERO personnel are trained in accordance with the Turkey Point emergency preparedness training program. This training is typically performed every year.

## **5. GENERAL, INITIAL, AND ANNUAL TRAINING PROGRAM MAINTENANCE**

- a. Turkey Point departments, Emergency Preparedness, and Nuclear Training share the responsibility for ensuring that the ERO receives all necessary initial training and retraining. Initial and retraining of ERO personnel shall be conducted using approved lesson plans. Discipline supervisors shall ensure the attendance of onsite personnel for ERO training and are responsible for ensuring their personnel maintain current qualifications.
- b. Initial and Requalification ERO Training: The proficiency of emergency response personnel (as defined in 10 CFR 50 Appendix E) is ensured by the following means:
  - Assigning individuals to emergency duties that are similar to those performed as a part of their regular work assignment or experience.
  - Initial training and annual retraining on applicable generic and site-specific portions of the Emergency Plan and the corresponding implementing procedures. Individuals not demonstrating the required level of knowledge in initial or retraining classes receive additional training on the areas requiring improvement. Annual retraining is conducted on a calendar year basis.
  - Training on Emergency Plan changes, as described in EPIPs.

- Participation in exercises and/or drills as developed or authorized by the Emergency Preparedness Department and designed to sharpen those skills that they are expected to use in the event of an actual emergency.

All personnel assigned position-specific responsibilities in the ERO are documented by inclusion in the Emergency Response Directory listing of positions and personnel.

- c. General Employee Training (GET): All personnel with unescorted plant access are provided with initial orientation training on the notification and instruction methods used in the event of an emergency. Additionally, all badged individuals also receive initial orientation on the basic principles of radiological safety including the effects of radiation and the theory and use of radiation detection devices. Appropriate actions for escorted individuals shall be the responsibility of the escort. GET provides initial and annual requalification training on the basic elements of the emergency plan for all personnel working at the plant. Specifically, these elements include:

- Plant emergency alarms and their meaning
- Assembly areas
- Localized and site evacuation procedures
- Special precautions and limitations during an emergency
- Purpose of the Emergency Plan

## **SECTION P: RESPONSIBILITY FOR THE PLANNING EFFORT**

This section describes the responsibilities associated with maintaining the emergency preparedness program, including the development, review and distribution of the Emergency Plan. This section also outlines the criteria for ensuring that personnel responsible for the emergency planning effort are trained appropriate to their duties and responsibilities.

### **1. EMERGENCY PREPAREDNESS STAFF TRAINING**

The Emergency Preparedness staff is involved in maintaining an adequate knowledge of regulatory requirements, guidance, and accepted good practices on a regular basis. Each member of the Emergency Preparedness staff is normally involved in one of the following activities:

- Training courses specific or related to emergency preparedness.
- Observation of, or participation in, drills and/or exercises at other plants.
- Participation in industry review and evaluation programs aimed towards emergency preparedness programs/issues.
- Participation in regional or national emergency preparedness seminars, committees, workshops, or forums.
- Specific training courses in related areas, such as systems, equipment, operations, radiological protection, or problem identification and resolution.

### **2. AUTHORITY FOR THE EMERGENCY PREPAREDNESS EFFORT**

The Chief Nuclear Officer has overall authority and responsibility for radiological emergency preparedness and planning and is assigned the responsibility for overall implementation of the Turkey Point Radiological Emergency Plan and Unit Annexes.

### **3. RESPONSIBILITY FOR DEVELOPMENT AND MAINTENANCE OF THE PLAN**

The Emergency Preparedness Program at Turkey Point is implemented through the coordinated efforts of the Director, Emergency Preparedness and the Emergency Preparedness Manager at the site. These individuals are jointly responsible for the overall radiological emergency preparedness program including program administration and maintenance.



The Chief Nuclear Officer is responsible for implementation of the Emergency Plan. The Director, Emergency Preparedness and the Turkey Point Emergency Preparedness Manager oversee the process and have the following responsibilities for maintenance of the Emergency Preparedness Program:

- Ensure the adequate staffing and training of plant ERO members.
- Schedule and conduct drills and exercises to maintain the state of readiness of the Emergency Preparedness Program.
- Ensure the operational readiness of plant facilities and communication systems for use during an emergency.
- Ensure the operational readiness of plant emergency equipment and supplies is maintained.
- Ensure the Emergency Plan Implementing Procedures (EIPs) are maintained.

The Turkey Point Emergency Preparedness Manager is assisted by other staff members to ensure that the program is appropriately implemented and maintained in accordance with EIPs, emergency plan administrative procedures, and plant procedures, as appropriate.

#### **4. EMERGENCY PLAN AND AGREEMENT REVISIONS**

The Emergency Plan and Unit Annexes are reviewed every year. Implementing procedures will be reviewed on a continuing basis through their use in drills, exercises, and actual emergency events. The annual Emergency Plan review/update includes required changes, as directed by management, and those changes identified during audits, assessments, training, drills, and exercises. The Turkey Point Emergency Preparedness Manager is responsible for coordinating the annual review of the Emergency Plan and for determining which recommended changes are incorporated into an Emergency Plan or implementing procedure revision.

The Emergency Plan and its Annexes shall be revised as needed, and the most current approved revisions shall remain in effect as long as they are certified as current. Revisions to the Emergency Plan are reviewed by the Plant Nuclear Safety Committee before approval. All changes to the Emergency Plan must be approved by the Site Vice President before implementation. Changes to the Plan are made without NRC approval only if such changes do not decrease the effectiveness of the Plan in accordance with 10 CFR 50.54(q), and the Plan, as changed, continues to meet the standards of 10 CFR 50.47(b) and the requirements of

10 CFR 50, Appendix E. Proposed changes that decrease or have a potential to decrease the effectiveness of the approved Plan are not implemented without prior approval by the NRC.

Proposed revisions to the Emergency Plan, Unit Annexes, and implementing procedures shall be completed in accordance with the Turkey Point review and approval processes. The implementing procedures shall be developed and revised concurrent with the Emergency Plan and Annexes and are subject to periodic reviews as delineated in site administrative procedures.

Each letter of agreement with offsite support agencies is reviewed and certified current on an annual basis in order to ensure the availability of assistance from each supporting organization.

## **5. EMERGENCY PLAN DISTRIBUTION**

The Turkey Point Emergency Preparedness Manager will ensure that elements of the emergency organization (e.g., FPL, state, federal, and local) are informed of amendments and revisions to the Emergency Plan, as applicable. The Emergency Plan, Unit Annexes, and implementing procedures are distributed as necessary on a controlled basis to the emergency response facilities and designated offsite locations. All controlled document holders are issued revision changes upon approval. Electronic copies of the documents are also available on the company's computer network.

## **6. SUPPORTING EMERGENCY RESPONSE PLANS**

Other plans that support this Emergency Plan are:

- NUREG-0728, *NRC Incident Response Plan*
- National Response Framework
- The State of Florida Radiological Emergency Preparedness Annex, Appendix II, Turkey Point Nuclear Power Plant Site Plan
- Turkey Point Response Plan, Miami-Dade County, Florida
- Radiological Emergency Preparedness Plan AND Standard Operating Procedures, Monroe County, Florida
- Interagency Radiological Assistance Plan
- DOE, Region 3, *Radiological Assistance Plan*

- INPO Emergency Resources Manual
- Turkey Point Physical Security Plan — Note: The plan contains safeguards information that must be withheld from public disclosure under provisions of 10 CFR 73.21.

## **7. IMPLEMENTING AND SUPPORTING PROCEDURES**

Appendix 3 of this Plan contains a listing, by title, of those procedures that implement the Plan during an emergency and a listing of administrative procedures which describe actions to maintain the Turkey Point Emergency Preparedness Program. In addition, Appendix 3 describes the section(s) of the Plan that are implemented by each procedure.

## **8. TABLE OF CONTENTS AND CROSS-REFERENCE TO PLANNING CRITERIA**

The Plan contains a specific table of contents. The Plan is formatted in the same manner as NUREG-0654, *Criteria for Preparation and Evaluation of Radiological Emergency Response Plans and Preparedness in support of Nuclear Power Plants*. The use of this format lends itself to uncomplicated comparison of the plan information to the criteria set forth in NUREG-0654.

## **9. AUDIT/ASSESSMENT OF THE EMERGENCY PREPAREDNESS PROGRAM**

To meet the requirements of 10 CFR 50.54(t), the Turkey Point Nuclear Oversight Manager shall coordinate an independent review of the Emergency Preparedness Program to examine conformance with 10 CFR 50.47, 10 CFR 50.54, and 10 CFR 50, Appendix E. Included in the audit/assessment are the following:

- The Emergency Plan and associated implementing procedures
- The emergency preparedness training program
- The readiness of the plant ERO to perform its function (for example, in drills and exercises).
- The documents and programs used to direct and document the administrative portion of the Emergency Preparedness Program.
- The readiness of emergency response facilities, equipment, and supplies.
- The interfaces between Turkey Point, the state, and county governmental agencies pertaining to the overall Emergency Preparedness Program.

The Turkey Point Nuclear Oversight Department will perform an independent audit of the Emergency Preparedness Program either:

- a. At least every 12 months, or
- b. As necessary, based on an assessment against performance indicators, and as soon as reasonably practicable after a change occurs in personnel, procedures, equipment, or facilities that potentially could adversely affect emergency preparedness, but no longer than 12 months after the change. In any case, all elements of the Emergency Preparedness Program must be reviewed every 24 months.

Results of the audit are submitted to Turkey Point management, the Director, Emergency Preparedness, and other members of senior management, as appropriate. The Turkey Point Emergency Preparedness Manager ensures that any findings that deal with offsite interfaces are reviewed with the appropriate agencies. The part of the review involving the evaluation of adequacy of interface with state and local governments is made available to the state and local governments. The results of independent reviews of the emergency preparedness program, including recommendations for improvement, will be retained for a period of five years.

#### **10. MAINTENANCE OF EMERGENCY TELEPHONE NUMBERS**

Names and phone numbers of the ERO, support personnel/agencies, and emergency response facilities in the EIPs and the Emergency Response Directory shall be reviewed and updated at least quarterly.

**ANNEX 1: UNITS 3 & 4**

**TURKEY POINT PLANT**

**RADIOLOGICAL EMERGENCY PLAN**

**UNITS 3 & 4 ANNEX**

**Table of Contents**

<b><u>Section</u></b>	<b><u>Page</u></b>
<b>Section 1: Introduction</b>	<b>Annex 1-3</b>
1. Unit 3 & 4 Description	Annex 1-3
<b>Section 2: Organization Control of Emergencies</b>	<b>Annex 1-5</b>
1. Emergency Response Organization On-Shift Positional Responsibilities	Annex 1-5
2. Normal Shift Staffing	Annex 1-5
3. Shift Emergency Response Positional Responsibilities	Annex 1-6
<b>Section 3: Classification of Emergencies</b>	<b>Annex 1-9</b>
<b>Section 4: Emergency Facilities and Equipment</b>	<b>Annex 1-10</b>
1. Unit-Specific Emergency Facilities	Annex 1-10
2. Assessment Resources	Annex 1-11
<b>Section 5: Emergency Measures</b>	<b>Annex 1-13</b>
1. Protective Actions	Annex 1-13
2. Assembly Areas	Annex 1-13
3. Evacuation Routes	Annex 1-14
<b>Attachment 1: Emergency Action Levels</b>	<b>Annex 1-15</b>



Figure A1-1. Units 3 & 4 Facility Layout

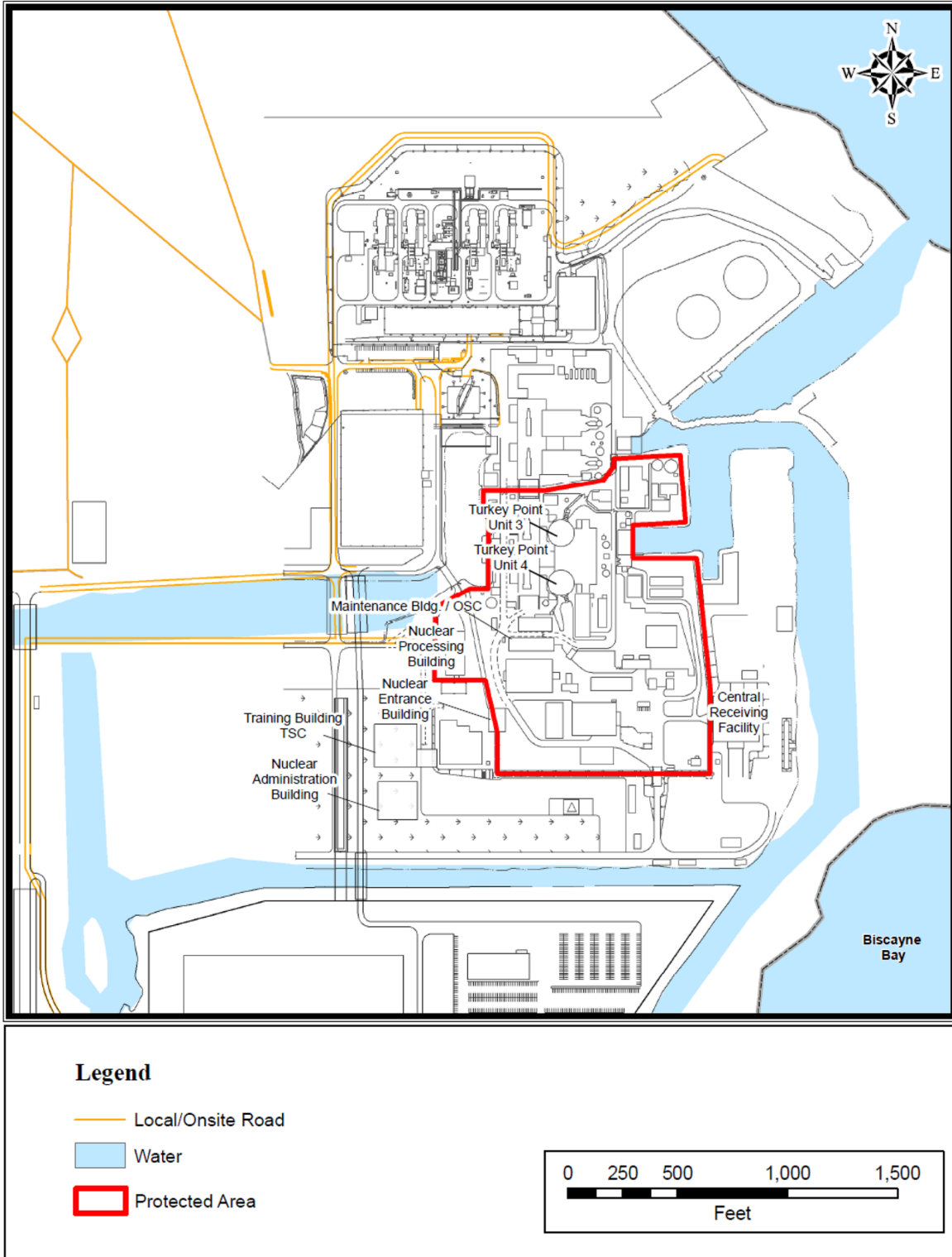



## SECTION 2: ORGANIZATIONAL CONTROL OF EMERGENCIES

Section B of the plan describes the plant's ERO. When the ERO is fully activated, it will be staffed as described in Section B of the plan. This section of the Unit Annex describes the on-shift ERO staffing and their responsibilities to implement the Plan.

### 1. EMERGENCY RESPONSE ORGANIZATION ON-SHIFT POSITIONAL RESPONSIBILITIES

**Table 2-1 Turkey Point Unit Emergency Response Organization  
On-Shift Staffing**

Functional Area	Major Tasks	On-Shift Positions	On-Shift Emergency Plan Positions
1. Plant Operations and Assessment of Operational Aspects	Control Room Staff	Senior Reactor Operator (CR) Reactor Operator (CR)	
2. Emergency Direction and Control	Command and Control	Shift Manager (CR)	Emergency Coordinator
3. Notification & Communication	Emergency Communications	Non-Licensed Operator	State and County Communicator ENS Communicator
	In-Plant Team Control	Shift Manager (CR)	Emergency Coordinator
4. Radiological Assessment	Offsite Dose Assessment	Chemistry Technician <sup>(a)</sup>	Dose Assessment
	Offsite Surveys	RP Technician <sup>(a)</sup>	Field Monitoring Team Personnel
	Onsite Surveys	RP Technician <sup>(a)</sup>	Onsite Monitoring Team Personnel
	In-plant Surveys	RP Technician	Onsite Monitoring Team Personnel
	Chemistry RP Supervisory	Chemistry Technician RP Lead <sup>(b)</sup>	Chemistry Team Direct RP Team Personnel
5. Plant System Engineering, Repair, and Corrective Actions	Technical Support/Accident Analysis	Operations Personnel	Operations Personnel
6. Fire Fighting	—	Fire Brigade	Fire Brigade
7. First Aid and Rescue Operations	—	Plant Personnel	Plant Personnel

- (a) Responders from an unaffected Unit  
 (b) A designated shift Radiation Protection Technician

### 2. NORMAL SHIFT STAFFING

The Turkey Point operating organization includes the personnel encompassing both the management and operation of the unit. The maintenance and technical support personnel staffing the plant organization are normally onsite daily Monday through Friday, holidays excluded. Plant personnel who are on duty on a 24-hour basis are listed in Table 2-1.

The Shift Manager is responsible for the safe and efficient operation of the plant in accordance with the Technical Specifications and operating procedures during his assigned shift. The duty Shift Manager maintains control over plant operations as the senior licensed operator unless properly relieved by another member of the plant staff who holds a valid senior reactor operator license and is qualified as an Emergency Coordinator. The Shift Manager maintains control over the conduct of operations and personnel in the Control Room.

The Shift Technical Advisor performs accident assessment and evaluates operating conditions. Organizationally, they report to the Operations Manager. While on duty, they diagnose off-normal events and report to the Shift Manager. The duties of the Shift Technical Advisor do not include the manipulation of controls or the supervision of operators. When on duty, they will be available to the Shift Manager in the Control Room within 10 minutes of being summoned. During emergency conditions, the Shift Technical Advisor will report to the affected unit Control Room.

During off-hour shifts, the plant is staffed to support continuous operation. The normal operational staff includes (as a minimum) three licensed Senior Reactor Operators (the Shift Manager, Unit Supervisor, and Field supervisor), two licensed reactor operators, four non-licensed operators, and one assistant nuclear plant operator. In addition, a Shift Technical Advisor is assigned to each shift. The initial emergency organization during off-hours shifts consists of the operating staff, with the Shift Manager serving as the Emergency Coordinator. Another Senior Reactor Operator qualified as an Emergency Coordinator may relieve the Emergency Coordinator in the Control Room. Initial actions in regard to first aid, firefighting, rescue, damage control, radiation monitoring, emergency classification, notifications, and dose assessment are performed by the normal operational staff.

### **3. SHIFT EMERGENCY RESPONSE POSITIONAL RESPONSIBILITIES**

The Unit 3 & 4 Annex, Table B-1a outlines shift ERO positions required to meet minimum staffing and the major tasks assigned to each position. In the event that Unit 3 or 4 declares an emergency and it is the affected unit, available shift personnel from the other unit(s) may be dispatched to assist the affected unit on-shift personnel in the response to the event. These additional personnel will provide the needed resources to enhance the response to the event until the on-call ERO personnel respond, and are ready to activate the emergency response facilities. Typically, Unit 3 is also the lead unit for declaring and responding to an emergency that affects the entire site such as a security or natural phenomena-related event. Should one of these events occur, the shift personnel from the other unit(s) may not be able to respond safely to support the response. These personnel will respond when it is safe to do so. Typically, Unit 3

will also take the role as the lead plant if more than one Turkey Point unit declares an emergency simultaneously.

**Table B-1a. Unit Shift Emergency Response Organization**

Functional Area	Major Tasks	Emergency Positions	Minimum Shift Size
1. Plant Operations and Assessment of Operational Aspects	Control Room Staff	Shift Manager (CR) Unit	1
		Supervisor (CR) Field	1
		Supervisor	1
		Reactor Operator (CR) Non-licensed Operator	2
		Assistant Non-licensed Operator	4
2. Emergency Direction and Control	Command and Control/ Emergency Operations	Emergency Coordinator (CR)	1 <sup>(a)</sup>
3. Notification & Communication	Emergency Communications	Shift Communicator (CR)	1 <sup>(b)</sup>
4. Radiological Accident Assessment and Support of Operational Accident Assessment	In-plant Surveys	RP Technicians	1
	Chemistry	Chemistry Personnel	1
5. Plant System Engineering, Repair and Corrective Actions	Technical Support	Shift Technical Advisor (CR)	1
	Repair and Corrective Actions	Shift Operations Personnel	(b)
6. In-Plant Protective Actions	Radiation Protection	RP Personnel	2 <sup>(b)</sup>
7. Fire Fighting	—	Fire Brigade	(c)
8. First Aid and Rescue Operations	—	Plant Personnel	2 <sup>(b)</sup>
9. Site Access Control and Personnel Accountability	Security and Accountability	Security Team Personnel	(d)
<b>TOTAL</b>			<b>13<sup>(e)</sup></b>

- (a) The Units 3 & 4 Shift Manager shall function as the Emergency Coordinator until relieved by another qualified Emergency Coordinator in the Control Room or the on-call Emergency Coordinator in the TSC when the TSC is activated.
- (b) May be provided by personnel assigned other functions. Personnel can fulfill multiple functions.
- (c) In accordance with plant Technical Specifications.
- (d) In accordance with Turkey Point Physical Security Plan.
- (e) This number represents the total number of personnel per unit on shift available to fill response positions (non-superscript positions).

**SECTION 3: CLASSIFICATION OF EMERGENCIES**

Section D in Part 2 of the plan describes the classification of emergencies into four classification levels. They are: *Unusual Event*, *Alert*, *Site Area Emergency*, and *General Emergency*. These classification levels are entered by meeting the criteria of EALs provided in this section of the Annex. EALs and the technical bases for the EALs are based on NEI 99-01, Revision 5, *Methodology for the Development of Emergency Action Levels*.

Attachment 1 of this Annex provides the EALs for Units 3 & 4.

## SECTION 4: EMERGENCY FACILITIES AND EQUIPMENT

### 1. UNIT-SPECIFIC EMERGENCY FACILITIES

#### a. OSC

The OSC is located in the Maintenance Building within the Protected Area and is separate from the Control Room. The OSC is the location from which survey, operations, and repair teams are dispatched into areas of the plant and is the staging area for individuals who may be assigned to first aid, search, survey, rescue, repair, and corrective action teams.

The OSC Manager is responsible for managing the activities in the OSC including:

- Ongoing accountability of anyone dispatched from the OSC. The Control Room Shift Manager or the Security Shift Supervisor track individuals who are assigned to the Control Room or the Security Force, respectively.
- Radiological exposure control for the individuals within the OSC.
- Mobilizing individuals on the emergency roster needed to fill the positions in the OSC and other support personnel such as warehouse personnel.

The OSC is activated with a minimum staff within 60 minutes after the notification of an *Alert, Site Area Emergency, or General Emergency*.

Equipment and supplies for the OSC include protective clothing, dosimetry, sampling and survey equipment to be used by the OSC teams.

Radiological exposure controls for the OSC include monitoring conditions and relocation if necessary.

Tools and parts available for normal plant maintenance are also available for damage control operations during emergencies.

In the event the OSC becomes uninhabitable, the EIPs provide details on how to relocate OSC personnel.

**b. Onsite Laboratories**

The onsite lab is available for emergency response during an accident, and the radiation protection counting room facilities provide backup capability. The laboratories can receive power from the plant's emergency diesel generators.

- Radionuclide identification in various sample media.
- Analysis and measurement of radionuclides in samples taken within the plant and samples taken in the plant site and offsite environment.

FPL has primary and backup radiological laboratory facilities available. Environmental sampling will be augmented by the state's Mobile Emergency Radiological Laboratory (MERL) within approximately 6 hours of notification. If required, the laboratory facilities at FPL's St. Lucie Plant can be used; appropriate arrangements will be made.

**2. ASSESSMENT RESOURCES****a. Onsite Radiation Monitoring Equipment**

The onsite radiation monitoring capability includes an installed process, effluent, and area Radiation Monitoring System (RMS); portable survey instrumentation; counting equipment for radiochemical analysis; and a personnel dosimetry program to record integrated exposure. Some onsite equipment is particularly valuable for accident situations.

**1. Area Radiation Monitoring**

The area monitoring system provides information on existing radiation levels in various areas of the plant to ensure safe occupancy. It is equipped with Control Room and local readout and audible alarms to warn personnel of a raised radiation level.

**2. Radiological Noble Gas Effluent Monitoring**

The wide range gas monitors are installed on normal station effluent release points. Each monitor system has a microprocessor which uses digital processing techniques to analyze data and control monitor functions. These monitors provide readout and alarm functions to the Control Room.

### 3. Radioiodine and Particulate Effluent Monitoring

The wide range gas monitor includes a sampling rack for collection of the auxiliary building vent stack particulate and radioiodine samples. Filter holders and valves are provided to allow grab sample collection for isotopic analyses in the station's counting rooms. The sampling rack is shielded to minimize personnel exposure. The sampling media will be analyzed by a gamma ray spectrometer which uses a gamma spectrometer system. In addition, Silver Zeolite cartridges are available to further reduce the interference of noble gases.

### 4. High-Range Containment Radiation Monitors

Two high-range containment radiation monitors are installed. The monitors will detect and measure the radiation level within the reactor containment during and following an accident.

### 5. In-plant Iodine Instrumentation

Effective monitoring of increasing iodine levels in buildings under accident conditions will include the use of portable instruments using Silver Zeolite as a sample media. It is expected that a sample can be obtained, purged, and analyzed for iodine content within 2 hours.

## b. Onsite Process Monitors

An adequate monitoring capability exists to properly assess the plant status for all modes of operation and is described in the Unit 3 & 4 FSAR. The operability of the post-accident instrumentation ensures information is available on selected plant parameters to monitor and assess important variables following an accident. Instrumentation is available to monitor the parameters in Technical Specifications.

The Unit's Emergency Operating Procedures assist personnel in recognizing inadequate core cooling using applicable instrumentation.

## c. Onsite Fire Detection Instrumentation

The fire detection system is designed in accordance with applicable National Fire Protection Association (NFPA) standards. The system is equipped with electrically supervised ionization smoke and heat detectors to quickly detect any fires and the instrumentation to provide local indication and Control Room annunciation. In addition to



the smoke and heat detection systems, each fire protection carbon dioxide, halon, or water system is instrumented to inform the Control Room of its actuation or of system trouble.

In the event that a portion of the fire detection instrumentation is inoperable, fire watches in affected areas may be required.

Further details on the unit's fire detection system can be found in the FSAR and fire protection plan.

## **SECTION 5: EMERGENCY MEASURES**

### **1. PROTECTIVE ACTIONS**

During emergencies, personnel in Unit 3 & 4 will be provided instruction by the Control Room or TSC regarding actions they are to take for their protection. Protective actions for site personnel range from *take immediate cover*, *assembly*, or *evacuation* of an area or the site. Protective actions will be issued individually or in combination, based on the health and safety of site personnel. There are four distinct zones of the site that personnel may encounter when protective actions are issued. These zones include: vital area, protected area, the area within the VBS, and the Owner-Controlled Area. Each of these zones has well-established entrance and exit points. These areas are well defined and presented in the general employee training that is provided to each employee annually. *Take immediate cover* may be used in a security threat situation where there is little or no time to relocate personnel, or in conjunction with a protective action to evacuate the Protected Area. *Assembly* may be used to move personnel into an area where they can be controlled and communicated with in an organized manner. Personnel may be held in the assembly area until personnel accountability has been established for the Protected Area. Personnel may be directed to evacuate the Protected Area or the site. If there is a need for personnel or vehicle monitoring after evacuation, personnel will be directed to an offsite assembly area for that activity. If necessary, decontamination will be conducted at the offsite holding area.

### **2. ASSEMBLY AREAS**

The Units 3 & 4 assembly areas are located in the Turkey Point Training Building located west of the Units 3 & 4 outside the Protected Area. During assembly, personnel will be provided information regarding the emergency and will be provided direction regarding their actions.

There are two designated offsite assembly areas available if it is determined that onsite personnel should be relocated offsite for further direction and/or monitoring of their vehicles. The primary offsite assembly area is the Florida City Substation located on Old Palm Drive approximately 7.5 miles west of the plant. Depending on wind direction, the Florida City Substation may not be feasible as an offsite assembly area, so the Levee 31 Access Road which is located on the cooling canal system West Perimeter Road will be used as the alternate offsite assembly area. In the event a radiological hazard does not exist, the intersection of Palm Drive and Contractor Road will be used as an assembly area for personnel. Signs are posted outside of Turkey Point to direct personnel to the designated locations.

The scope of the emergency will dictate the assembly area location, how personnel will be released from the area, and whether or not they will be able to return to their work spaces outside the Protected Area.

### **3. EVACUATION ROUTES**

The primary evacuation route is the primary route to be used to evacuate personnel from the owner-controlled area when radiological conditions permit. This route uses the plant access road west to Palm Drive, continuing west on Palm Drive approximately 7 miles to Farm Life School Road, turning south on Farm Life School Road, and then traveling approximately 100 yards to the Florida City Substation.

The alternate evacuation route will be used to evacuate personnel when radiological conditions prohibit the use of the primary evacuation route. This route uses the road north of the main discharge canal from the plant (Lake Warren), continuing west past the contractor entrance road through the access gates of the cooling canals, past the north end of the cooling canals and then turning south along the west perimeter road of the canals for approximately 4 miles to the alternate assembly area, turning west to the Levee 31 Access Road then south to Card Sound Road.

The primary and alternate evacuation routes are illustrated in Figure J-3.

## Attachment 1 Emergency Action Levels

### Recognition Category R - Abnormal Radiation Levels/Radiological Effluents Initiating Condition Matrix

GENERAL EMERGENCY	SITE AREA EMERGENCY	ALERT	UNUSUAL EVENT
RG1 Offsite dose resulting from an actual or IMMINENT release of gaseous radioactivity Greater Than 1000 mrem TEDE or 5000 mrem Thyroid CDE for the actual or projected duration of the release using actual meteorology. <i>Op. Modes: All</i>	RS1 Offsite dose resulting from an actual or IMMINENT release of gaseous radioactivity Greater Than 100 mrem TEDE or 500 mrem Thyroid CDE for the actual or projected duration of the release. <i>Op. Modes: All</i>	RA1 Any release of gaseous or liquid radioactivity to the environment Greater Than 200 times the Radiological Effluent Technical Specifications/ODCM for 15 minutes or longer. <i>Op. Modes: All</i>	RU1 Any release of gaseous or liquid radioactivity to the environment Greater Than 2 times the Radiological Effluent Technical Specifications/ODCM for 60 minutes or longer. <i>Op. Modes: All</i>
		RA3 Rise in radiation levels within the facility that impedes operation of systems required to maintain plant safety functions. <i>Op. Modes: All</i>	RU2 UNPLANNED rise in plant radiation levels. <i>Op. Modes: All</i>
		RA2 Damage to irradiated fuel or loss of water level that has resulted or will result in the uncovering of irradiated fuel outside the reactor vessel. <i>Op. Modes: All</i>	

## Attachment 1 Emergency Action Levels

### Recognition Category C - Cold Shutdown / Refueling System Malfunction Initiating Condition Matrix

GENERAL EMERGENCY	SITE AREA EMERGENCY	ALERT	UNUSUAL EVENT
CG1 Loss of RCS/RPV inventory affecting fuel clad integrity with containment challenged. <i>Op. Modes: 5, 6</i>	CS1 Loss of RCS/RPV inventory affecting core decay heat removal capability. <i>Op. Modes: 5, 6</i>	CA1 Loss of RCS/RPV inventory. <i>Op. Modes: 5, 6</i>	CU1 RCS leakage. <i>Op. Modes: 5</i>
			CU2 UNPLANNED loss of RCS/RPV inventory. <i>Op. Modes: 6</i>
		CA3 Loss of all Offsite and all Onsite AC power to emergency busses for 15 minutes or longer. <i>Op. Modes: 5, 6, Defueled</i>	CU3 AC power capability to emergency busses reduced to a single power source for 15 minutes or longer such that any additional single failure would result in station blackout. <i>Op. Modes: 5, 6</i>
		CA4 Inability to maintain plant in cold shutdown. <i>Op. Modes: 5, 6</i>	CU4 UNPLANNED loss of decay heat removal capability. <i>Op. Modes: 5, 6</i>
			CU6 UNPLANNED loss of all Onsite or Offsite communications capabilities. <i>Op. Modes: 5, 6, Defueled</i>
			CU7 UNPLANNED loss of required DC power for 15 minutes or longer. <i>Op. Modes: 5, 6</i>
			CU8 Inadvertent criticality. <i>Op. Modes: 5, 6</i>

**Attachment 1  
Emergency Action Levels**

**Recognition Category F - Fission Product Barrier Threshold  
Thresholds for LOSS or POTENTIAL LOSS of Barriers<sup>(a)</sup>**

<b>FG1</b> Loss of ANY two barriers AND Loss or Potential Loss of third barrier.		<b>FS1</b> Loss or Potential Loss of ANY two barriers.		<b>FA1</b> ANY Loss or ANY Potential Loss of EITHER Fuel Clad or RCS.		<b>FU1</b> ANY Loss or Potential Loss of Containment.	
<b>Fuel Clad Barrier Thresholds</b>		<b>RCS Barrier Thresholds</b>		<b>Containment Barrier Thresholds</b>			
<b>Loss</b>	<b>Potential Loss</b>	<b>Loss</b>	<b>Potential Loss</b>	<b>Loss</b>	<b>Potential Loss</b>	<b>Loss</b>	<b>Potential Loss</b>
<b>1.Critical Safety Function Status</b>		<b>1.Critical Safety Function Status</b>		<b>1.Critical Safety Function Status</b>			
1. CSF Status Tree for Core Cooling Red Conditions Met.	1. CSF Status Tree for Core Cooling Orange Conditions Met. <b>OR</b> 2. CSF Status Tree for Heat Sink Red Conditions Met.	Not Applicable	1. CSF Status Tree for Integrity Red Conditions Met. <b>OR</b> 2. CSF Status Tree for Heat Sink Red Conditions Met.	Not Applicable	1. CSF Status Tree for Containment-Red Conditions Met.		
<b>2.Primary Coolant Activity Level</b>		<b>2.RCS Leak Rate</b>		<b>2.Containment Pressure</b>			
1. Coolant activity greater than 300 uCi/gm Dose Equivalent I-131.	Not Applicable	1. RCS leak rate greater than available makeup capacity as indicated by a loss of RCS sub cooling based on core exit TCs - LESS THAN 30°F [210°F].	1. RCS leak rate indicated by greater than maximum charging with Letdown isolated.	1. A containment pressure rise followed by a rapid unexplained drop in containment pressure. <b>OR</b> 2. Containment pressure or sump level response not consistent with LOCA conditions.	1. Containment pressure greater than 55 psig and rising. <b>OR</b> 2.a. Containment Pressure greater than 20 psig. <b>AND</b> b. Less than one full train of depressurization equipment operating.		

**Attachment 1  
Emergency Action Levels**

**Recognition Category F - Fission Product Barrier Threshold  
Thresholds for LOSS or POTENTIAL LOSS of Barriers<sup>(a)</sup>**

<b>3. Core Exit Thermocouple Readings</b>		<b>3. Not Applicable</b>		<b>3. Core Exit Thermocouple Readings</b>	
1. Core exit thermocouples reading greater than 1200 °F.	1. Core exit thermocouples reading greater than 700 °F.	Not Applicable	Not Applicable	Not Applicable	1. a. Core exit thermocouples in excess of 1200 °F. <b>AND</b> b. FR-C.1 <b>NOT</b> effective within 15 minutes. <b>OR</b> 2.a. Core exit thermocouples in excess of 700 °F. <b>AND</b> b. RVLMS indicates head voids. <b>AND</b> c. FR-C.2 <b>NOT</b> effective within 15 minutes.
<b>4. Reactor Vessel Water Level</b>		<b>4. SG Tube Rupture</b>		<b>4. SG Secondary Side Release with P-to-S Leakage</b>	
Not Applicable	1. RVLMS (QSPDS) 0%.	1. RUPTURED SG results in an SI actuation.	Not Applicable	1. RUPTURED SG is also FAULTED outside of containment. <b>OR</b> 2.a. Primary-to-Secondary leak rate greater than 10 gpm. <b>AND</b> b. UNISOLABLE steam release from affected SG to the environment.	Not Applicable
<b>5. Not Applicable</b>		<b>5. Not Applicable</b>		<b>5. Containment Isolation Failure or Bypass</b>	
Not Applicable	Not Applicable	Not Applicable	Not Applicable	1.a. Failure of all valves in any one line to close. <b>AND</b> b. Direct downstream pathway to the environment exists after containment isolation signal.	Not Applicable

**Attachment 1  
Emergency Action Levels**

**Recognition Category F - Fission Product Barrier Threshold  
Thresholds for LOSS or POTENTIAL LOSS of Barriers<sup>(a)</sup>**

<b>6. Containment Radiation Monitoring</b>		<b>6. Containment Radiation Monitoring</b>		<b>6. Containment Radiation Monitoring</b>	
1. CHRRM reading greater than 3.1E+3 R/hr.	Not Applicable	1. Fuel Manipulator Crane radiation monitor R-2[5] reading greater than 75 mR/hr	Not Applicable	Not Applicable	1. CHRRM reading greater than 1.2E+4 R/hr.
<b>7. Other Site Specific Indications</b>		<b>7. Other Site Specific Indications</b>		<b>7. Other Site Specific Indications</b>	
Not applicable	Not applicable	Not applicable	Not applicable	Not applicable	Not applicable
<b>8. Emergency Coordinator Judgment</b>		<b>8. Emergency Coordinator Judgment</b>		<b>8. Emergency Coordinator Judgment</b>	
1. Any condition in the opinion of the emergency coordinator that indicates Loss OR Potential Loss of the Fuel Clad Barrier.	1. Any condition in the opinion of the emergency coordinator that indicates Loss OR Potential Loss of the RCS Barrier.	1. Any condition in the opinion of the emergency coordinator that indicates Loss OR Potential Loss of the Containment Barrier.	1. Any condition in the opinion of the emergency coordinator that indicates Loss OR Potential Loss of the Fuel Clad Barrier.	1. Any condition in the opinion of the emergency coordinator that indicates Loss OR Potential Loss of the RCS Barrier.	1. Any condition in the opinion of the emergency coordinator that indicates Loss OR Potential Loss of the Containment Barrier.

(a) Determine which combination of the three barriers are lost or have a potential loss and use the following key to classify the event. Also, multiple events could occur which result in the conclusion that exceeding the loss or potential loss thresholds is IMMEDIATE. In this IMMEDIATE loss situation, use judgment and classify as if the thresholds are exceeded.

**LEGENDS OF ABBREVIATIONS**

CHRRM – containment high range radiation monitor  
 CSF – critical safety function  
 RCS – reactor coolant system  
 RVLMS – reactor vessel level monitoring system  
 SG – steam generator

## Attachment 1 Emergency Action Levels

### Recognition Category H – Hazards and Other Conditions Affecting Plant Safety Initiating Condition Matrix

GENERAL EMERGENCY	SITE AREA EMERGENCY	ALERT	UNUSUAL EVENT
		HA1 Natural or destructive phenomena affecting VITAL AREAS. <i>Op. Modes: All</i>	HU1 Natural or destructive phenomena affecting the PROTECTED AREA. <i>Op. Modes: All</i>
		HA2 FIRE or EXPLOSION affecting the operability of plant safety systems required to establish or maintain safe shutdown. <i>Op. Modes: All</i>	HU2 FIRE within the PROTECTED AREA not extinguished in within 15 minutes of detection OR EXPLOSION within the PROTECTED AREA. <i>Op. Modes: All</i>
		HA3 Access to a VITAL AREA is prohibited due to release of toxic, corrosive, asphyxiant or flammable gases which jeopardize operation of systems required to maintain safe operations or safely shutdown the reactor. <i>Op. Modes: All</i>	HU3 Release of toxic, corrosive, asphyxiant, or flammable gases deemed detrimental to NORMAL PLANT OPERATIONS. <i>Op. Modes: All</i>
	HS2 Control Room evacuation has been initiated and plant control cannot be established. <i>Op. Modes: All</i>	HA5 Control Room evacuation has been initiated. <i>Op. Modes: All</i>	
HG1 HOSTILE ACTION resulting in loss of physical control of the facility. <i>Op. Modes: All</i>	HS4 HOSTILE ACTION within the PROTECTED AREA. <i>Op. Modes: All</i>	HA4 HOSTILE ACTION within the OWNER-CONTROLLED AREA or airborne attack threat. <i>Op. Modes: All</i>	HU4 Confirmed SECURITY CONDITION or threat which indicates a potential degradation in the level of safety of the plant. <i>Op. Modes: All</i>
HG2 Other conditions exist which in the judgment of the emergency coordinator warrant declaration of a General Emergency. <i>Op. Modes: All</i>	HS3 Other conditions exist which in the judgment of the emergency coordinator warrant declaration of a Site Area Emergency. <i>Op. Modes: All</i>	HA6 Other conditions exist which in the judgment of the emergency coordinator warrant declaration of an Alert. <i>Op. Modes: All</i>	HU5 Other conditions exist which in the judgment of the emergency coordinator warrant declaration of a Notification of Unusual Event. <i>Op. Modes: All</i>



**Attachment 1  
Emergency Action Levels**

**Recognition Category S – System Malfunction  
Initiating Condition Matrix**

GENERAL EMERGENCY	SITE AREA EMERGENCY	ALERT	UNUSUAL EVENT
SG1 Prolonged loss of all Offsite and all Onsite AC power to emergency busses. <i>Op. Modes: 1, 2, 3, 4</i>	SS1 Loss of all Offsite and all Onsite AC power to emergency busses for 15 minutes or longer. <i>Op. Modes: 1, 2, 3, 4</i>	SA5 AC power capability to emergency busses reduced to a single power source for 15 minutes or longer such that any additional single failure would result in station blackout. <i>Op. Modes: 1, 2, 3, 4</i>	SU1 Loss of all Offsite AC power to emergency busses for 15 minutes or longer. <i>Op. Modes: 1, 2, 3, 4</i>
	SS3 Loss of all vital DC power for 15 minutes or longer. <i>Op. Modes: 1, 2, 3, 4</i>		
SG2 Automatic Trip and all manual actions fail to shutdown the reactor and indication of an extreme challenge to the ability to cool the core exists. <i>Op. Modes: 1, 2</i>	SS2 Automatic Trip fails to shutdown the reactor and manual actions taken in the Control Room are not successful in shutting down the reactor. <i>Op. Modes: 1, 2</i>	SA2 Automatic Trip fails to shutdown the reactor and the manual actions taken in the Control Room are successful in shutting down the reactor. <i>Op. Modes: 1, 2</i>	SU8 Inadvertent criticality. <i>Op. Modes: 1, 2, 3, 4</i>
	SS6 Inability to monitor a SIGNIFICANT TRANSIENT in progress. <i>Op. Modes: 1, 2, 3, 4</i>	SA4 UNPLANNED loss of safety system annunciation or indication in Control Room with EITHER (1) a SIGNIFICANT TRANSIENT in progress, or (2) compensatory indicators are unavailable. <i>Op. Modes: 1, 2, 3, 4</i>	SU3 UNPLANNED loss of safety system annunciation or indication in the Control Room for 15 minutes or longer. <i>Op. Modes: 1, 2, 3, 4</i>
			SU2 Inability to reach required shutdown within Technical Specification limits. <i>Op. Modes: 1, 2, 3, 4</i>
			SU4 Fuel Clad degradation. <i>Op. Modes: 1, 2, 3, 4</i>
			SU5 RCS leakage. <i>Op. Modes: 1, 2, 3, 4</i>
			SU6 Loss of all Onsite or Offsite communications capabilities. <i>Op. Modes: 1, 2, 3, 4</i>

**ANNEX 2: UNIT 6**

**TURKEY POINT PLANT**

**RADIOLOGICAL EMERGENCY PLAN**

**UNIT 6 ANNEX**

**Table of Contents**

<b><u>Section</u></b>	<b><u>Page</u></b>
<b>Section 1: Introduction</b>	<b>Annex 2-3</b>
1. Unit 6 Description	<b>Annex 2-3</b>
<b>Section 2: Organizational Control of Emergencies</b>	<b>Annex 2-5</b>
1. Emergency Response Organization On-Shift Positional Responsibilities	Annex 2-5
2. Normal Shift Staffing	Annex 2-6
3. Shift Emergency Response Positional Responsibilities	Annex 2-6
<b>Section 3: Classification of Emergencies</b>	<b>Annex 2-9</b>
<b>Section 4: Emergency Facilities and Equipment</b>	<b>Annex 2-9</b>
1. Unit-Specific Emergency Facilities	Annex 2-9
2. Assessment Resources	Annex 2-10
<b>Section 5: Emergency Measures</b>	<b>Annex 2-13</b>
1. Protective Actions	Annex 2-13
2. Assembly Areas	Annex 2-14
3. Evacuation Routes	Annex 2-14
<b>Attachment 1: Emergency Action Levels</b>	<b>Annex 2-15</b>

## SECTION 1: INTRODUCTION

This Plan Annex provides unit-specific details for Unit 6.

This includes a unit description (type of reactor, relationship to other units, special emergency equipment), shift staffing, EALs, and any emergency facility locations that differ from those described in the Emergency Plan for a full understanding and representation of the plant's emergency response capabilities. This Unit 6 Annex is subject to the same review and audit requirements as the Radiological Emergency Plan.

### 1. UNIT 6 DESCRIPTION

The Turkey Point is owned and operated by FPL. An area map showing the geographical location of the facility is provided Figure 1-1 in Part 1 of the plan.

The design of Unit 6 is that of a passive pressurized water-type nuclear steam supply system supplied and manufactured by Westinghouse. A diagram identifying Turkey Point Unit 6 facilities is provided in Figure B1-1.

<b>Unit 6:</b>	<b>Latitude</b>	N 25° 25' 27"
	<b>Longitude</b>	W 80° 19' 55"

Figure B1-1 Unit 6 Facility Layout

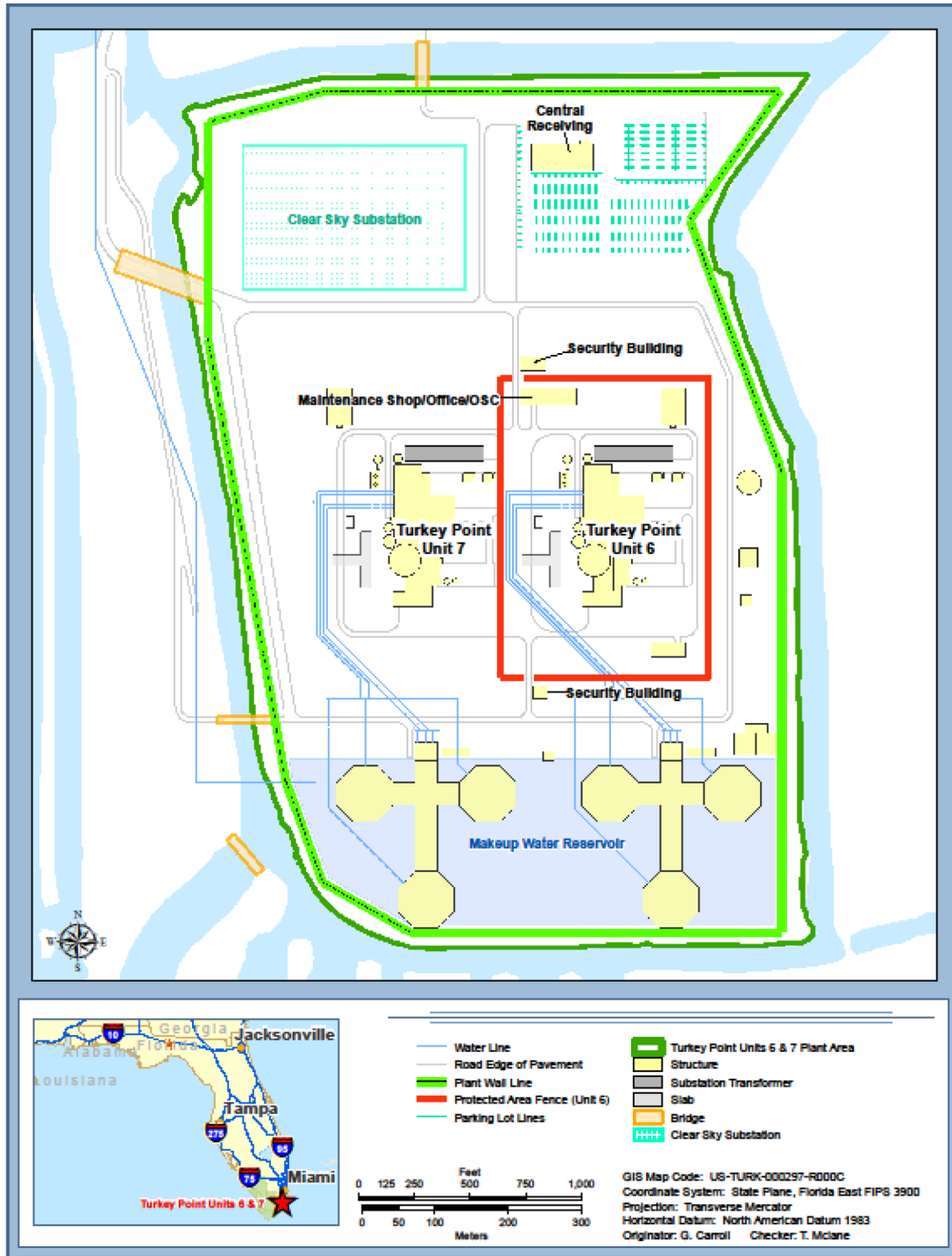

## SECTION 2: ORGANIZATIONAL CONTROL OF EMERGENCIES

Section B of the plan describes the plant's ERO. When the ERO is fully activated, it will be staffed as described in Section B of the Plan. This section of the Unit 6 Annex describes the on-shift ERO staffing and their responsibilities to implement the Plan.

### 1. EMERGENCY RESPONSE ORGANIZATION ON-SHIFT POSITIONAL RESPONSIBILITIES

**Table 2-1 Turkey Point Emergency Response Organization On-Shift Staffing**

Functional Area	Major Tasks	On-Shift Positions	On-Shift Emergency Plan Positions
1. Plant Operations and Assessment of Operational Aspects	Control Room Staff	Senior Reactor Operator (CR) Reactor Operator (CR)	
2. Emergency Direction and Control	Command and Control	Shift Manager (CR)	Emergency Coordinator
3. Notification and Communication	Emergency Communications	Non-Licensed Operator	State and County Communicator ENS Communicator
	In-Plant Team Control	Shift Manager (CR)	Emergency Coordinator
4. Radiological Assessment	Offsite Dose Assessment	Chemistry Technician	Dose Assessment
	Offsite Surveys	RP Technician	Field Monitoring Team Personnel
	Onsite Surveys	RP Technician	Onsite Monitoring Team Personnel
	In-plant Surveys	RP Technician	Onsite Monitoring Team Personnel
	Chemistry	Chemistry Technician	Chemistry Team
	RP Supervisory	RP Lead <sup>(a)</sup>	Direct RP Team Personnel
5. Plant System Engineering, Repair, and Corrective Actions	Technical Support/Accident Analysis	Operations Personnel	Operations Personnel
6. Fire Fighting	—	Fire Brigade	Fire Brigade
7. First Aid and Rescue Operations	—	Plant Personnel	Plant Personnel

(a) A designated shift Radiation Protection Technician

## **2. NORMAL SHIFT STAFFING**

The Turkey Point operating organization includes the personnel encompassing both the management and operation of the unit. The maintenance and technical support personnel staffing the plant organization are normally onsite daily Monday through Friday, holidays excluded. Personnel who are on duty on a 24-hour basis are listed in Table 2-1.

The Shift Manager is responsible for the safe and efficient operation of the plant in accordance with the Technical Specifications and operating procedures during their assigned shift. The duty Shift Manager maintains control over plant operations as the senior licensed operator unless properly relieved by another member of the plant staff who holds a valid Senior Reactor Operator License. The Shift Manager maintains control over the conduct of operations and personnel in the Control Room.

The Shift Technical Advisor performs accident assessment, evaluates operating conditions, diagnoses off-normal events, and reports to the Shift Manager. The duties of the Shift Technical Advisor do not include the manipulation of controls or the supervision of operators. When on duty, the Shift Technical Advisor will be available to the Shift Manager in the Control Room within 10 minutes of being summoned. During emergency conditions, the Shift Technical Advisor will report to the Control Room and perform as a Shift Technical Advisor.

During off-hour shifts, the plant is staffed to support continuous operation. The normal operational staff includes (as a minimum) two licensed Senior Reactor Operators (the Shift Manager and Control Room Supervisor), two licensed reactor operators, and two non-licensed operators. In addition, a Shift Technical Advisor is assigned to each shift. The initial emergency organization during off-hours shifts consists of the operating staff, with the Shift Manager serving as the Emergency Coordinator. The Emergency Coordinator may be relieved in the Control Room by another Senior Reactor Operator qualified as an Emergency Coordinator. Initial actions in regard to first aid, firefighting, rescue, damage control, radiation monitoring, emergency classification, notifications, and dose assessment are performed by the normal operational staff.

## **3. SHIFT EMERGENCY RESPONSE POSITIONAL RESPONSIBILITIES**

The Unit 6 Annex, Table B-1a outlines shift ERO positions required to meet minimum staffing and the major tasks assigned to each position in all modes. In the event that Unit 6 declares an emergency and it is the affected unit, the Unit 6 Shift Manager will assume the duties of the Emergency Coordinator. The Unit 6 on-shift personnel will be augmented by shift personnel from the other site unit(s). Personnel from the other site unit(s) may be dispatched to assist the

Unit 6 on-shift personnel when it is safe to do so. These additional personnel will provide the needed resources to enhance the response to the event until the on-call ERO personnel respond, and are ready to activate the emergency response facilities. Personnel that augment the on-shift response inside the Protected Area from the unaffected units will be dispatched as a member of a team that has at least one Unit 6 responder. Personnel filling RP Technician positions that perform onsite and offsite surveys will be provided an orientation of Unit 6. Unit 3 is typically the lead unit for declaring and responding to an emergency that affects the entire site, such as a security or natural phenomena related event, or if there are multiple units in an independently declared emergency simultaneously. Should one of these events occur, the Shift Manager from Unit 6 would direct the operational response of the emergency/event when it is safe to do so. The Unit 6 Shift Manager would provide the needed information to the Units 3 & 4 Shift Manager who declares the emergency and assumes the role of Emergency Coordinator and all of the duties associated with that position.



**Table B-1a Shift Emergency Response Organization**

Functional Area		Major Tasks	Emergency Positions	Minimum Shift Size
1.	Plant Operations and Assessment of Operational Aspects	Control Room Staff	Shift Manager (CR)	1
			Control Room Supervisor (CR)	1
			Reactor Operator (CR)	2
			Non-licensed Operator	2
			Assistant Non-licensed Operator	1
2.	Emergency Direction and Control	Command and Control/Emergency Operations	Emergency Coordinator (CR)	1 <sup>(a)</sup>
3.	Notification & Communication	Emergency Communications	Shift Communicator (CR)	1
4.	Radiological Accident Assessment and Support of Operational Accident Assessment	In-plant Surveys	RP Technicians	4
		Chemistry	Chemistry Personnel	2
5.	Plant System Engineering, Repair and Corrective Actions	Technical Support	Shift Technical Advisor/Incident Assessor (CR)	1 <sup>(b)</sup>
		Repair and Corrective Actions	Operations Personnel	1 <sup>(b)</sup> 1 <sup>(b)</sup> 1 <sup>(b)</sup>
6.	In-Plant Protective Actions	Radiation Protection	RP Personnel	2 <sup>(b)</sup>
7.	Fire Fighting	—	Fire Brigade	<sup>(c)</sup>
8.	First Aid and Rescue Operations	—	Plant Personnel	2 <sup>(b)</sup>
9.	Site Access Control and Personnel Accountability	Security and Accountability	Security Team Personnel	<sup>(d)</sup>
<b>TOTAL</b>				<b>14<sup>(e)</sup></b>

- (a) The Shift Manager shall function as the Emergency Coordinator until relieved by the on-call Emergency coordinator in the TSC, when the TSC is activated.
- (b) May be provided by personnel assigned other functions. Personnel can fulfill multiple functions.
- (c) In accordance with FSAR and plant fire protection plan.
- (d) In accordance with Turkey Point Physical Security Plan.
- (e) This number represents the total number of personnel on shift available to fill response positions (non-superscript positions).

### SECTION 3: CLASSIFICATION OF EMERGENCIES

Section D of the plan describes the classification of emergencies into four classification levels. They are *Unusual Event*, *Alert*, *Site Area Emergency*, and *General Emergency*. These classification levels are entered by meeting the criteria of EALs provided in this section of the Unit Annex. The EALs and the technical bases for the EALs are based on NEI 07-01, Rev 0 *Methodology for Development of Emergency Action Levels Advanced Passive Light Water Reactors*.

Attachment 1 of this Annex provides EALs for Unit 6 based on the guidance of NEI 07-01.

### SECTION 4: EMERGENCY FACILITIES AND EQUIPMENT

#### 1. UNIT-SPECIFIC EMERGENCY FACILITIES

##### a. OSC

The OSC is located in the Maintenance Shop/Office Building inside the Protected Area. The OSC is the location from which survey, operations, and repair teams are dispatched into areas of the plant and is the staging area for individuals who may be assigned to first aid, search, survey, rescue, repair, and corrective action teams.

The OSC Manager is responsible for managing the activities in the OSC including:

- Ongoing accountability of anyone dispatched from the OSC. The Control Room Shift Manager or the Security Shift Supervisor tracks individuals who are assigned to the Control Room watch or the Security Force respectively.
- Radiological exposure control for the individuals within the OSC.
- Mobilizing individuals on the emergency roster needed to fill the positions in the OSC and other support personnel such as materials and warehouse personnel.

The OSC may be activated when “minimum staffing positions” are filled and all positions will be staffed within 60 minutes after the notification of an *Alert*, *Site Area Emergency*, or *General Emergency*.

Equipment and supplies for the OSC include protective clothing, dosimetry, sampling, and survey equipment to be used by the OSC teams.

Radiological exposure controls for the OSC include monitoring conditions and relocation if necessary.

Tools and parts available for normal plant maintenance are also available for damage control operations during emergencies.

In the event the OSC becomes uninhabitable, EIPs provide details on how to relocate OSC personnel.

b. Onsite Laboratories

The radiochemistry laboratory on the 82'-6" elevation in the Auxiliary Building is available for emergency response during an accident. The laboratory can receive power from the plant's diesel generators. General capabilities include:

- Radionuclide identification in various sample media.
- Analysis and measurement of radionuclides in samples taken within the plant and samples taken in the plant site and offsite environment.

**2. ASSESSMENT RESOURCES**

a. Onsite Radiation Monitoring Equipment

The onsite radiation monitoring capability includes an installed process, effluent, and area Radiation Monitoring System (RMS); portable survey instrumentation; counting equipment for radiochemical analysis; and a personnel dosimetry program to record integrated exposure. Some onsite equipment is particularly valuable for accident situations.

1. Area Radiation Monitoring

The area monitoring system provides information on existing radiation levels in various areas of the plant to ensure safe occupancy. It is equipped with Control Room and local readout and audible alarms to warn personnel of a raised radiation level.

2. Radiological Noble Gas Effluent Monitoring

The wide range gas monitors are installed on normal station effluent release points. Each monitor system has a microprocessor which uses digital processing

techniques to analyze data and control monitor functions. These monitors provide readout and alarm functions to the Control Room.

3. Radioiodine and Particulate Effluent Monitoring

The wide range gas monitor includes a sampling rack for collection of the auxiliary building vent stack particulate and radioiodine samples. Filter holders and valves are provided to allow grab sample collection for isotopic analyses in the plant's counting rooms. The sampling rack is shielded to minimize personnel exposure. The sampling media will be analyzed by a gamma ray spectrometer which uses a gamma spectrometer system. In addition, Silver Zeolite cartridges are available to further reduce the interference of noble gases.

4. High-Range Containment Radiation Monitors

Two high-range containment radiation monitors are installed. The monitors will detect and measure the radiation level within the reactor containment during and following an accident.

5. In-Plant Iodine Instrumentation

Effective monitoring of increasing iodine levels in buildings under accident conditions will include the use of portable instruments using Silver Zeolite as a sample media. It is expected that a sample can be obtained, purged, and analyzed for iodine content within 2 hours.

b. Onsite Process Monitors

An adequate monitoring capability exists to properly assess the plant status for all modes of operation and is described in the Unit 6 FSAR. Instrumentation is available to monitor the parameters in Technical Specifications.

The unit's emergency operating procedures assist personnel in recognizing inadequate core cooling using applicable instrumentation.

c. Seismic Monitors

Unit 6 has four triaxial acceleration sensor units and they are connected to a time-history analyzer. The time-history analyzer recording and playback system is located in a panel in the nuclear island in a room near the Control Room. Seismic event data from

these is recorded on a solid-state digital recording system at 200 samples per second per data channel.

This solid-state recording and analysis system has internal batteries and a charger to prevent the loss of data during a power outage, and to allow data collection and analysis in a seismic event during which the power fails. Normally, 120-volt alternating current power is supplied from the non-Class 1E DC and uninterruptible power supply system. The system uses triaxial acceleration sensor input signals to initiate the time-history analyzer recording and Control Room alarms. The system initiation value is adjustable from 0.002 g to 0.02 g.

The time-history analyzer starts recording triaxial acceleration data from each of the triaxial acceleration sensors after the initiation value has been exceeded. Pre-event recording time is adjustable from 1.2 to 15.0 seconds, and will be set to record at least 3 seconds of pre-event signal. Post-event run time is adjustable from 10 to 90 seconds. A minimum of 25 minutes of continuous recording is provided. Each recording channel has an associated timing mark record with 2 marks per second, with an accuracy of about 0.02 percent.

The sensor installation anchors are rigid so that the vibratory transmissibility over the design spectra frequency range is essentially unity.

### **Triaxial Acceleration Sensors**

Each sensor unit contains three accelerometers mounted in a mutually orthogonal array with one horizontal axis parallel to the major axis assumed in the seismic analysis. The triaxial acceleration sensors have a dynamic range of 1000 to 1 (0.001 to 1.0 g) and a frequency range of 0.2 to 50 hertz.

One sensor unit will be located in the free field.

A second sensor unit is located on the nuclear island basemat in the spare battery charger room at elevation 66'-6" near column lines 9 and L.

A third sensor unit is located on the shield building structure at elevation 266' near column lines 4-1 and K.

The fourth sensor unit is located on the containment internal structure on the east wall of the east steam generator compartment just above the operating floor at elevation 138' close to column lines 6 and K.

Seismic instrumentation is not located on equipment, piping, or supports since experience has shown that data obtained at these locations is obscured by vibratory motion associated with normal plant operation.

d. Onsite Fire Detection Instrumentation

The fire detection system is designed in accordance with applicable NFPA standards. The system is equipped with electrically supervised ionization smoke and heat detectors to quickly detect any fires and the instrumentation to provide local indication and control room annunciation. In addition to the smoke and heat detection systems, each fire protection carbon dioxide, halon, or water system is instrumented to inform the Control Room of its actuation or of system trouble.

In the event that a portion of the fire detection instrumentation is inoperable, fire watches in affected areas may be required.

Further details on the unit's fire detection system can be found in the FSAR and Fire Protection Plan.

## **SECTION 5: EMERGENCY MEASURES**

### **1. PROTECTIVE ACTIONS**

During emergencies, personnel in Unit 6 will be provided instruction by the Control Room or TSC regarding actions they are to take for their protection. Protective actions for site personnel range from *take immediate cover*, *assembly*, and *evacuation* of an area or the site. Protective actions will be issued by themselves or in combination, based on the health and safety of site personnel. There are three distinct zones of the site that personnel may encounter when protective actions are issued. These zones include vital area, Protected Area, and the Owner-Controlled Area. Each of these zones has well-established entrance and exit points. These areas are well defined and presented in the general employee training that is provided to each employee annually. *Take immediate cover* may be used in a security threat situation where there is little or no time to relocate personnel or in conjunction with a protective action to evacuate the Protected Area. *Assembly* may be used to move personnel into an area where they can be controlled and communicated with in an organized manner. Personnel may be held in the assembly area until personnel accountability has been established for each Protected Area. Personnel may be directed to evacuate the Protected Area or the site. If there is a need for personnel or vehicle monitoring after evacuation, personnel will be directed to an offsite assembly area for that activity. If necessary, decontamination will be conducted at the offsite holding area.

## **2. ASSEMBLY AREAS**

The Unit 6 Assembly Area is located in the Unit 6 & 7 Training Building located north of the Unit 6 outside the Protected Area. During assembly, personnel will be provided information regarding the emergency and will be provided direction regarding their actions.

There are two designated offsite assembly areas available if it is determined that onsite personnel should be relocated offsite for further direction and/or monitoring of their vehicles. The primary offsite assembly area is the Florida City Substation located on Old Palm Drive approximately 7.5 miles west of the plant. Depending on wind direction, the Florida City Substation may not be feasible as an offsite assembly area, so the Levee 31 Access Road which is located on the cooling canal system West Perimeter Road will be used as the alternate offsite assembly area. In the event a radiological hazard does not exist, the intersection of Palm Drive and Contractor Road will be used as an assembly area for personnel. Signs are posted outside of Turkey Point to direct personnel to the designated locations.

The scope of the emergency will dictate the assembly area location, how personnel will be released from the area, and whether or not they will be able to return to their work spaces outside the Protected Area.

## **3. EVACUATION ROUTES**

The primary evacuation route is the main evacuation route to be used to evacuate personnel from the owner-controlled area when radiological conditions permit. This route uses the plant access road west to Palm Drive, continuing west on Palm Drive approximately 7 miles to Farm Life School Road, turning south on Farm Life School Road, and then traveling approximately 100 yards to the Florida City Substation.

The alternate evacuation route will be used to evacuate personnel when radiological conditions prohibit the use of the primary evacuation route. This route uses the road north of the main discharge canal from the plant (Lake Warren), continuing west past the contractor entrance road through the access gates of the cooling canals, past the north end of the cooling canals and then turning south along the west perimeter road of the canals for approximately 4 miles to the alternate assembly area, turning west to the Levee 31 Access Road then south to Card Sound Road.

The primary and alternate evacuation routes are illustrated in Figure J-3.

## **Attachment 1**

### **Emergency Action Levels**

As identified in the NRC letter to Alan Nelson dated December 2, 2008 certain aspects of the PTN Units 6 & 7 emergency action levels (EAL) required by 10 CFR 50.47(b)(4) and Appendix E.IV.B of 10 CFR Part 50 cannot be completed. This is due to actual set points that cannot be derived until actual as-built information is available and certain Technical Specifications are finalized.

FPL adopts NRC Option 2 that includes - Submit Emergency Plan Section D, "Emergency Classification System", which addresses the four critical elements of an EAL scheme (listed below).

- *Critical Element 1* – FPL proposes an overview of its emergency action level scheme including defining the four emergency classification levels, (i.e., Notification of Unusual Event, Alert, Site Area Emergency, and General Emergency), as stated in NEI 99-01, Revision 5, with a general list of licensee actions at each emergency classification level.
- *Critical Element 2* – FPL proposes to develop the remainder of its EAL scheme by using a specified NRC endorsed guidance document. In the development of its EALs, the proposed EALs should be developed with few or no deviations or differences, other than those attributable to the specific reactor design. NEI 07- 01, Revision 0, for the AP1000. If applicable, EALs related to digital instrumentation and control must be included.
- *Critical Element 3* – FPL proposes a license condition, which requires that the licensee create a fully developed set of plant-specific EALs, in accordance with the specified guidance document, that have been discussed and agreed upon with State and local officials, and submit the EALs to the NRC for confirmation at least 180 days prior to initial fuel load.
- *Critical Element 4* – FPL proposes to maintain the EALs in a document that is controlled by the 10 CFR 50.54(q) change process (e.g., in the Emergency Plan or a lower tier document, such as Emergency Plan Implementing Procedures).



**ANNEX 3: UNITS 6 & 7**

**TURKEY POINT PLANT**  
**RADIOLOGICAL EMERGENCY PLAN**  
**UNITS 6 & 7 ANNEX**

**Table of Contents**

<b><u>Section</u></b>	<b><u>Page</u></b>
<b>Section 1: Introduction</b>	<b>Annex 3-3</b>
1. Units 6 & 7 Description	Annex 3-3
<b>Section 2: Organizational Control of Emergencies</b>	<b>Annex 3-5</b>
1. Emergency Response Organization On-Shift Positional Responsibilities	Annex 3-5
2. Normal Shift Staffing	Annex 3-6
3. Shift Emergency Response Positional Responsibilities	Annex 3-6
<b>Section 3: Classification of Emergencies</b>	<b>Annex 3-8</b>
<b>Section 4: Emergency Facilities and Equipment</b>	<b>Annex 3-8</b>
1. Unit-Specific Emergency Facilities	Annex 3-8
2. Assessment Resources	Annex 3-9
<b>Section 5: Emergency Measures</b>	<b>Annex 3-12</b>
1. Protective Actions	Annex 3-12
2. Assembly Areas	Annex 3-13
3. Evacuation Routes	Annex 3-13
<b>Attachment 1: Emergency Action Levels</b>	<b>Annex 3-14</b>

**SECTION 1: INTRODUCTION**

This Plan Annex provides unit-specific details for Units 6 & 7. Unit 6 Annex will be superseded with the implementation of this Annex.

This section includes a unit description (type of reactor, relationship to other units, special emergency equipment), shift staffing, EALs, and any emergency facility locations that differ from those described in the Emergency Plan for a full understanding and representation of the station's emergency response capabilities. This Units 6 & 7 Annex is subject to the same review and audit requirements as the Radiological Emergency Plan.

**1. UNITS 6 & 7 DESCRIPTION**

The Turkey Point is owned and operated by FPL. An area map showing the geographical location of the facility is provided Figure 1-1 in Part 1 of the plan.

The design of Units 6 & 7 is that of a passive pressurized water type nuclear steam supply system supplied and manufactured by Westinghouse. A diagram identifying Turkey Point Units 6 & 7 facilities is provided in Figure C1-1.

<b>Unit 6:</b>	<b>Latitude</b>	N 25°25' 27"
	<b>Longitude</b>	W 80°19' 55"
<b>Unit 7:</b>	<b>Latitude</b>	N 25°25' 27"
	<b>Longitude</b>	W 80°20' 04"

Figure C1-1 Units 6 & 7 Facility Layout

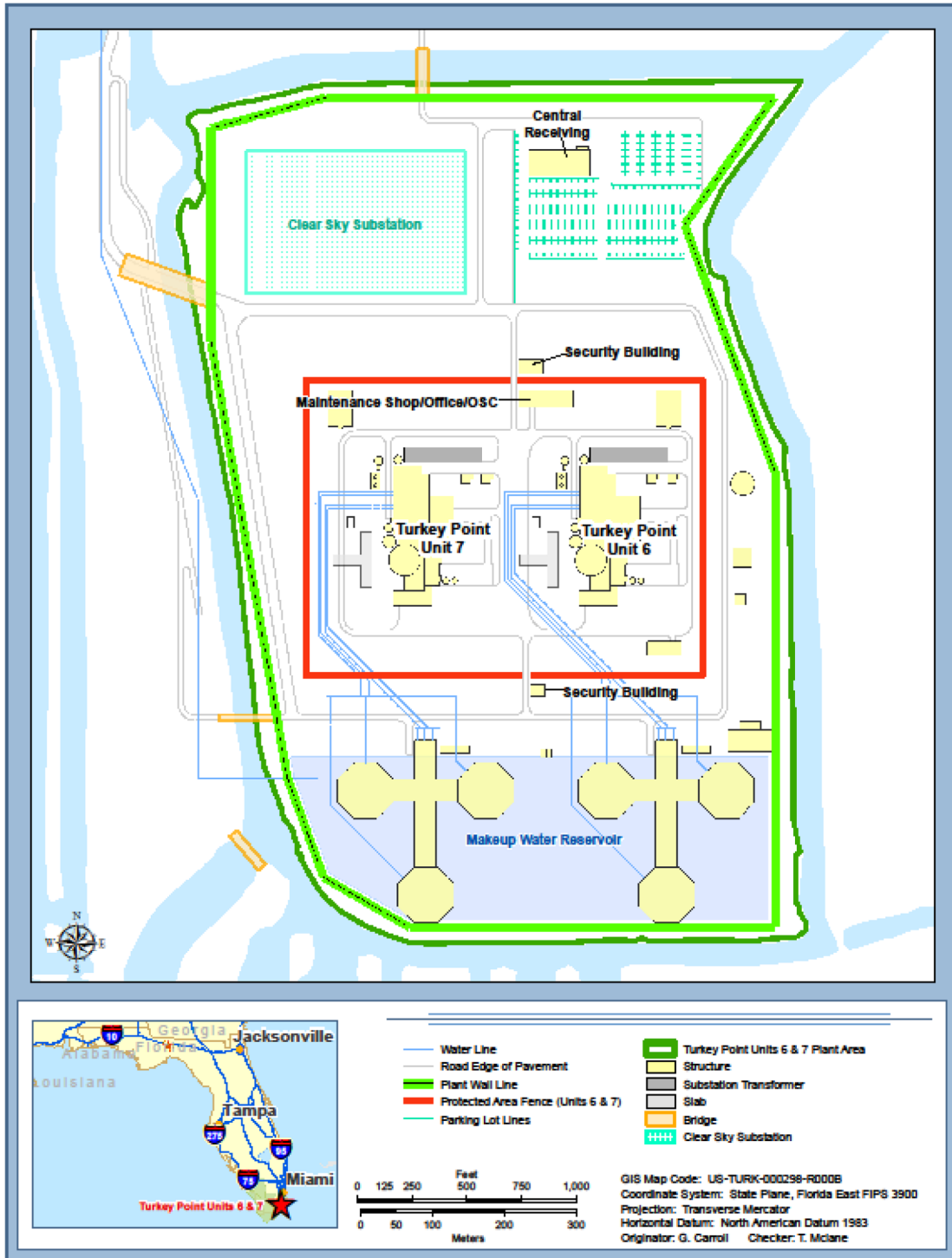

**SECTION 2: ORGANIZATIONAL CONTROL OF EMERGENCIES**

Section B of the Turkey Point radiological Emergency Plan describes the plant’s ERO. When the ERO is fully activated, it will be staffed as described in Section B of the plan. This section of the Units 6 & 7 Annex describes the on-shift ERO staffing and their responsibilities to implement the emergency plan.

**1. EMERGENCY RESPONSE ORGANIZATION ON-SHIFT POSITIONAL RESPONSIBILITIES**

**Table 2-1 Turkey Point Emergency Response Organization On-Shift Staffing**

Functional Area	Major Tasks	On-Shift Positions	On-Shift Emergency Plan Positions
1. Plant Operations and Assessment of Operational Aspects	Control Room Staff	Senior Reactor Operator (CR) Reactor Operator (CR)	
2. Emergency Direction and Control	Command and Control	Shift Manager (CR)	Emergency Coordinator
3. Notification & Communication	Emergency Communications In-Plant Team Control	Non-Licensed Operator Shift Manager (CR)	State and County Communicator ENS Communicator Emergency Coordinator
4. Radiological Assessment	Offsite Dose Assessment Offsite Surveys Onsite Surveys In-plant Surveys Chemistry RP Supervisory	Chemistry Technician <sup>(a)</sup> RP Technician <sup>(b)</sup> RP Technician <sup>(b)</sup> RP Technician Chemistry Technician RP Lead <sup>(a)</sup>	Dose Assessment Field Monitoring Team Personnel Onsite Monitoring Team Personnel Onsite Monitoring Team Personnel Chemistry Team Direct RP Team Personnel
5. Plant System Engineering, Repair, and Corrective Actions	Technical Support/Accident Analysis	Operations Personnel	Operations Personnel
6. Fire Fighting	—	Fire Brigade	Fire Brigade
7. First Aid and Rescue Operations	—	Plant Personnel	Plant Personnel

(a) Responders from an unaffected Unit  
(b) A designated shift Radiation Protection Technician

## **2. NORMAL SHIFT STAFFING**

The Turkey Point operating organization includes the personnel encompassing both the management and operation of the unit. The maintenance and technical support personnel staffing the plant organization are normally onsite daily Monday through Friday, holidays excluded. Personnel who are on duty on a 24-hour basis are listed in Table 2-1.

The Shift Manager is responsible for the safe and efficient operation of the Units in accordance with the Technical Specifications and operating procedures during their assigned shift. The duty Shift Manager maintains control over Units 6 & 7 operations as the senior licensed operator unless properly relieved by another member of the plant staff who holds a valid Senior Reactor Operator License. The Shift Manager maintains control over the conduct of operations and personnel in both Units 6 & 7 Control Rooms.

During off-hour shifts, each Unit is staffed to support continuous operation. The normal operational staff includes (as a minimum) one licensed Senior Reactor Operator (the Control Room Supervisor), two licensed reactor operators, and two non-licensed operators. In addition, a Shift Technical Advisor is assigned to each Unit. The initial emergency organization during off-hours shifts consists of the operating staff, with the Shift Manager serving as the Emergency Coordinator. The Emergency Coordinator may be relieved in the Control Room by another Senior Reactor Operator qualified as an Emergency Coordinator. Initial actions in regard to first aid, firefighting, rescue, damage control, radiation monitoring, emergency classification, notifications, and dose assessment are performed by the normal operational staff.

## **3. SHIFT EMERGENCY RESPONSE POSITIONAL RESPONSIBILITIES**

The Units 6 & 7 Annex, Table B-1a outlines shift ERO positions required to meet minimum staffing and the major tasks assigned to each position in all modes. In the event that either Unit 6 or Unit 7 independently declares an emergency and it is the affected unit, the Units 6 & 7 Shift Manager will assume the duties of the Emergency Coordinator. The affected Unit's on-shift personnel may be augmented by personnel from the other site unit(s). Personnel from the other site unit(s) may be dispatched to assist the affected Unit on-shift personnel when it is safe to do so. These additional personnel will provide the needed resources to enhance the response to the event until the on-call ERO personnel respond, and are ready to activate the emergency response facilities. Unit 3 is typically the lead unit for declaring and responding to an emergency that affects the entire site, such as a security or natural phenomena related event, or if there are multiple units in an independently declared emergency simultaneously. Should one of these events occur or if there are multiple units in a declared emergency simultaneously, the Shift Manager from Units 6 & 7 would direct the operational response of the emergency/event when it

is safe to do so. The Units 6 & 7 Shift Manager would provide the needed information to the Units 3 & 4 Shift Manager who declares the emergency and assumes the role of Emergency Coordinator and all of the duties associated with that position.

**Table B-1a Shift Emergency Response Organization**

Functional Area	Major Tasks	Emergency Positions	Minimum Shift Size
1. Plant Operations and Assessment of Operational Aspects	Control Room Staff	Shift Manager (CR) Control Room Supervisor (CR) Reactor Operator (CR) Non-licensed Operator Assistant Non-licensed Operator	1 1/Unit 2/Unit 2/Unit 1/Unit
2. Emergency Direction and Control	Command and Control/ Emergency Operations	Emergency Coordinator (CR)	1 <sup>(a)</sup>
3. Notification & Communication	Emergency Communications	Shift Communicator (CR)	1/Unit
4. Radiological Accident Assessment and Support of Operational Accident Assessment	In-plant Surveys	RP Technicians	2/Unit
	Chemistry	Chemistry Personnel	1/Unit
5. Plant System Engineering, Repair and Corrective Actions	Technical Support	Shift Technical Advisor/Incident Assessor (CR)	1 <sup>(b)</sup>
	Repair and Corrective Actions	Operations Personnel	1 <sup>(b)</sup> 1 <sup>(b)</sup> 1 <sup>(b)</sup>
6. In-Plant Protective Actions	Radiation Protection	RP Personnel	2 <sup>(b)</sup>
7. Fire Fighting	—	Fire Brigade	<sup>(c)</sup>
8. First Aid and Rescue Operations	—	Plant Personnel	2 <sup>(b)</sup>
9. Site Access Control and Personnel Accountability	Security and Accountability	Security Team Personnel	<sup>(d)</sup>
<b>TOTAL:</b>			<b>21<sup>(e)</sup></b>

- (a) The Units 6 & 7 Shift Manager shall function as the Emergency Coordinator until relieved by another qualified Unit 6 & 7 Shift Manager in the TSC, when the TSC is activated.
- (b) May be provided by personnel assigned other functions. Personnel can fulfill multiple functions.
- (c) In accordance with plant fire protection plan.
- (d) In accordance with Turkey Point Physical Security Plan.
- (e) This number represents the total number of personnel on shift available to fill response positions (non-superscript positions).

### SECTION 3: CLASSIFICATION OF EMERGENCIES

Section D of the Plan describes the classification of emergencies into four classification levels. They are *Unusual Event*, *Alert*, *Site Area Emergency*, and *General Emergency*. These classification levels are entered by meeting the criteria of EALs provided in this section of the Unit Annex. The EALs and the technical bases for the EALs are based on NEI 07-01, Rev. 0, *Methodology for Development of Emergency Action Levels Advanced Passive Light Water Reactors*.

Attachment 1 of this Annex provides the EALs for Units 6 & 7 based on the guidance of NEI 07-01.

### SECTION 4: EMERGENCY FACILITIES AND EQUIPMENT

#### 1. UNIT-SPECIFIC EMERGENCY FACILITIES

##### a. OSC

The OSC is located in the Maintenance Shop/Office Building inside the Protected Area. The OSC is the location from which survey, operations, and repair teams are dispatched into areas of the plant and is the staging area for individuals who may be assigned to first aid, search, survey, rescue, repair, and corrective action teams.

The OSC Manager is responsible for managing the activities in the OSC including:

- Ongoing accountability of anyone dispatched from the OSC. The Control Room Shift Manager or the Security Shift Supervisor tracks individuals who are assigned to the Control Room watch or the Security Force respectively.
- Radiological exposure control for the individuals within the OSC.
- Mobilizing individuals on the emergency roster needed to fill the positions in the OSC and other support personnel such as materials and warehouse personnel.

The OSC may be activated when “minimum staffing positions” are filled and all positions will be staffed within 60 minutes after the notification of an *Alert*, *Site Area Emergency*, or *General Emergency*.

Equipment and supplies for the OSC include protective clothing, dosimetry, sampling, and survey equipment to be used by the OSC teams.



Radiological exposure controls for the OSC include monitoring conditions and relocation if necessary.

Tools and parts available for normal plant maintenance are also available for damage control operations during emergencies.

In the event the OSC becomes uninhabitable, EIPs provide details on how to relocate OSC personnel.

b. Onsite Laboratories

The radiochemistry laboratory is located on the 82'-6" elevation in each Unit's Auxiliary Building and is available for emergency response during an accident. Each laboratory can receive power from the plant's diesel generators. General capabilities include:

- Radionuclide identification in various sample media.
- Analysis and measurement of radionuclides in samples taken within the plant and samples taken in the plant site and offsite environment.

## 2. ASSESSMENT RESOURCES

a. Onsite Radiation Monitoring Equipment

The onsite radiation monitoring capability in each Unit includes an installed process, effluent, and area Radiation Monitoring System (RMS); portable survey instrumentation; counting equipment for radiochemical analysis; and a personnel dosimetry program to record integrated exposure. Some onsite equipment is particularly valuable for accident situations.

1. Area Radiation Monitoring

The area monitoring system provides information on existing radiation levels in various areas of the plant to ensure safe occupancy. It is equipped with Control Room and local readout and audible alarms to warn personnel of a raised radiation level.

2. Radiological Noble Gas Effluent Monitoring

The wide range gas monitors are installed on normal plant effluent release points. Each monitor system has a microprocessor that uses digital processing

techniques to analyze data and control monitor functions. These monitors provide readout and alarm functions to the Control Room.

3. Radioiodine and Particulate Effluent Monitoring

The wide range gas monitor includes a sampling rack for collection of the auxiliary building vent stack particulate and radioiodine samples. Filter holders and valves are provided to allow grab sample collection for isotopic analyses in the plant's counting rooms. The sampling rack is shielded to minimize personnel exposure. The sampling media will be analyzed by a gamma ray spectrometer that uses a gamma spectrometer system. In addition, Silver Zeolite cartridges are available to further reduce the interference of noble gases.

4. High-Range Containment Radiation Monitors

Two high-range containment radiation monitors are installed. The monitors will detect and measure the radiation level within the reactor containment during and following an accident.

5. In-plant Iodine Instrumentation

Effective monitoring of increasing iodine levels in buildings under accident conditions will include the use of portable instruments using Silver Zeolite as a sample media. It is expected that a sample can be obtained, purged, and analyzed for iodine content within 2 hours.

b. Onsite Process Monitors

An adequate monitoring capability exists to properly assess the plant status for all modes of operation and is described in the Unit 6 and 7 FSARs. Instrumentation is available to monitor the parameters in Technical Specifications.

The unit's emergency operating procedures assist personnel in recognizing inadequate core cooling using applicable instrumentation.

c. Seismic Monitors

Units 6 & 7 have four triaxial acceleration sensor units and they are connected to a time-history analyzer. The time-history analyzer recording and playback system is located in a panel in the nuclear island in a room near the Control Room. Seismic event

data from these sensors is recorded on a solid-state digital recording system at 200 samples per second per data channel.

This solid-state recording and analysis system has internal batteries and a charger to prevent the loss of data during a power outage, and to allow data collection and analysis in a seismic event during which the power fails. Normally, 120-volt alternating current power is supplied from the non-Class 1E DC and uninterruptible power supply system. The system uses triaxial acceleration sensor input signals to initiate the time-history analyzer recording and Control Room alarms. The system initiation value is adjustable from 0.002g to 0.02g.

The time-history analyzer starts recording triaxial acceleration data from each of the triaxial acceleration sensors after the initiation value has been exceeded. Pre-event recording time is adjustable from 1.2 to 15.0 seconds, and will be set to record at least 3 seconds of pre-event signal. Post-event run time is adjustable from 10 to 90 seconds. A minimum of 25 minutes of continuous recording is provided. Each recording channel has an associated timing mark record with 2 marks per second, with an accuracy of about 0.02 percent.

The sensor installation anchors are rigid so that the vibratory transmissibility over the design spectra frequency range is essentially unity.

### **Triaxial Acceleration Sensors**

Each sensor unit contains three accelerometers mounted in a mutually orthogonal array with one horizontal axis parallel to the major axis assumed in the seismic analysis. The triaxial acceleration sensors have a dynamic range of 1000 to 1 (0.001 to 1.0g) and a frequency range of 0.2 to 50 hertz.

One sensor unit will be located in the free field.

A second sensor unit is located on the nuclear island basemat in the spare battery charger room at elevation 66'-6" near column lines 9 and L.

A third sensor unit is located on the shield building structure at elevation 266' near column lines 4-1 and K.

The fourth sensor unit is located on the containment internal structure on the east wall of the east steam generator compartment just above the operating floor at elevation 138' close to column lines 6 and K.

Seismic instrumentation is not located on equipment, piping, or supports since experience has shown that data obtained at these locations are obscured by vibratory motion associated with normal plant operation.

d. Onsite Fire Detection Instrumentation

The fire detection system is designed in accordance with applicable NFPA standards. The system is equipped with electrically supervised ionization smoke and heat detectors to quickly detect any fires and the instrumentation to provide local indication and Control Room annunciation. In addition to the smoke and heat detection systems, each fire protection carbon dioxide, halon, or water system is instrumented to inform the Control Room of its actuation or of system trouble.

In the event that a portion of the fire detection instrumentation is inoperable, fire watches in affected areas may be required.

Further details on the unit's fire detection system can be found in the FSAR and Fire Protection Plan.

## SECTION 5: EMERGENCY MEASURES

### 1. PROTECTIVE ACTIONS

During emergencies, personnel in Units 6 & 7 will be provided instruction by the Control Room or TSC regarding actions they are to take for their protection. Protective actions for site personnel range from *take immediate cover*, *assembly*, and *evacuation* of an area or the site. Protective actions will be issued by themselves or in combination based on the health and safety of site personnel. There are three distinct zones of the site that personnel may encounter when protective actions are issued. These zones include the Vital Area, Protected Area, and the Owner-Controlled Area. Each of these zones has well-established entrance and exit points. These areas are well defined and presented in the general employee training that is provided to each employee annually. *Take immediate cover* may be used in a security threat situation where there is little or no time to relocate personnel or in conjunction with a protective action to evacuate the Protected Area. *Assembly* may be used to move personnel into an area where they can be controlled and communicated with in an organized manner. Personnel may be held in the Assembly Area until personnel accountability has been established for the Protected Area. Personnel may be directed to evacuate the Protected Area or the site. If there is a need for personnel or vehicle monitoring after evacuation, personnel will be directed to an offsite assembly area for that activity. If necessary, decontamination will be conducted at the offsite holding area.

## 2. ASSEMBLY AREAS

The Units 6 & 7 assembly area is located in the Unit 6 & 7 Training Building located north of Units 6 & 7 outside the Protected Area. During assembly, personnel will be provided information regarding the emergency and will be provided direction regarding their actions.

There are two designated offsite assembly areas available if it is determined that onsite personnel should be relocated offsite for further direction and/or monitoring of their vehicles. The primary offsite assembly area is the Florida City Substation located on Old Palm Drive approximately 7.5 miles west of the plant. Depending on wind direction, the Florida City Substation may not be feasible as an offsite assembly area, so the Levee 31 Access Road which is located on the cooling canal system West Perimeter Road will be used as the alternate offsite assembly area. In the event a radiological hazard does not exist, the intersection of Palm Drive and Contractor Road will be used as an assembly area for personnel. Signs are posted outside of Turkey Point to direct personnel to the designated locations.

The scope of the emergency will dictate the assembly area location, how personnel will be released from the area, and whether or not they will be able to return to their work spaces outside the Protected Area.

## 3. EVACUATION ROUTES

The primary evacuation route is the primary evacuation route to be used to evacuate personnel from the owner-controlled area when radiological conditions permit. This route uses the plant access road west to Palm Drive, continuing west on Palm Drive approximately 7 miles to Farm Life School Road, turning south on Farm Life School Road, and then traveling approximately 100 yards to the Florida City substation.

The alternate evacuation route will be used to evacuate personnel when radiological conditions prohibit the use of the primary evacuation route. This route uses the road north of the main discharge canal from the plant (Lake Warren), continuing west past the contractor entrance road through the access gates of the cooling canals, past the north end of the cooling canals and then turning south along the west perimeter road of the canals for approximately 4 miles to the alternate assembly area, turning west to the Levee 31 Access Road then south to Card Sound Road.

The primary and alternate evacuation routes are illustrated in Figure J-3.

**Attachment 1**  
**Emergency Action Levels**

Refer to Attachment 1 of Annex 2.

**TURKEY POINT PLANT  
RADIOLOGICAL EMERGENCY PLAN  
APPENDIX 1**

### References

American Nuclear Insurers (ANI) Bulletin #5B	Accident Notification Procedures for Liability Insured, 1981
APP-GW-GL-700	Westinghouse AP1000 Design Control Document, Revision 16, May 26, 2007
EPA-400-R-92-001	Manual of Protective Action Guides and Protective Actions for Nuclear Incidents
FEMA-REP-10, Section E.6.2.1	Guide for the Evaluation of Alert and Notification Systems for Nuclear Power Plants, November 1985
NEI 07-01, Revision 0	Methodology for Development of Emergency Action Levels Advanced Passive Light Water Reactors
NEI 99-01, Revision 5	Methodology for Development of Emergency Action Levels
NRC Bulletin 2005-02	Emergency Preparedness and Response Actions for Security-Based Events, July 18, 2005
NRC Bulletin 80-15	Possible Loss of Emergency Notification System (ENS) with Loss of Offsite Power, June 18, 1980
NRC Generic Letter 91-14	Emergency Telecommunications, September 23, 1991
NRC Information Notice 85-44	Emergency Communication System Monthly Test, May 30, 1985
NRC Regulatory Guide 1.101	Emergency Planning and Preparedness for Nuclear Power Reactors, Revision 3, August 1992
NRC Regulatory Guide 1.206	Combined License Applications for Nuclear Power Plants, June 2007
NRC RTM-96	Response Technical Manual, March 1996
NUREG- 0696	Functional Criteria for Emergency Response Facilities
NUREG/BR-0230, RCM-96	Response Coordination Manual, 1996
NUREG-0654/FEMA-REP-1 Rev. 1	Criteria for Preparation and Evaluation of Radiological Emergency Response Plans and Preparedness in Support of Nuclear Power Plants



NUREG-0728

NRC Incident Response Plan

NUREG-0737

Clarification of TMI Action Plan Requirements

Regulatory Issue Summary 2004-13

Consideration of Sheltering in Licensee's  
Range of Protective Action Recommendations,  
August 2, 2004

Turkey Point Plant Evacuation Time Estimate,  
Final Report

Turkey Point Units 3 & 4 Final Safety Analysis  
Report

Turkey Point Units 6 & 7 Final Safety Analysis  
Report

Turkey Point Physical Security Plans

**TURKEY POINT PLANT  
RADIOLOGICAL EMERGENCY PLAN  
APPENDIX 2**

### Letters of Agreement

This appendix contains a list of written agreements between FPL and other organizations that may be required to provide support to Turkey Point in the event of an emergency. These letters are maintained in the Turkey Point emergency preparedness department and are provided in Supplement 4.

1. Letter from URS Energy & Construction dated April 4, 2012 (1 page)
2. Letter from Areva dated April 4, 2012 (1 page)
3. Letter from Baptist Hospital of Miami dated April 10, 2012 (1 page)
4. Letter from Bechtel Power Corporation dated April 4, 2012 (2 pages)
5. Letter from Florida Highway Safety and Motor Vehicles dated April 23, 2012 (1 page)
6. Letter from the Department of Energy dated April 17, 2012 (2 pages)
7. Letter from National Nuclear Security Administration dated April 12, 2012 (1 page)
8. Letter from INPO dated October 30, 2012 (1 page)
9. Letter from Monroe County Sheriff's Office dated April 9, 2012 (1 page)
10. Letter from the Miami-Dade Fire Rescue Department dated April 11, 2012 (3 pages)
11. Letter from Mercy Hospital dated September 20, 2012 (1 page)
12. Memo from the Turkey Point Security Department dated February 18, 2013 (1 page)
13. Letter from the United States Coast Guard dated April 20, 2012 (3 pages)
14. Letter from Miami-Dade Police Department dated July 30, 2012 (1 page)

Note: Purchase orders or contracts may be used in lieu of letters of agreement. Copies are on file in the Turkey Point emergency preparedness department.

**TURKEY POINT PLANT  
RADIOLOGICAL EMERGENCY PLAN  
APPENDIX 3**

**Procedure Cross-Reference to the Emergency Plan**

<b>Implementing Procedure</b>	<b>Plan Section Implemented</b>
Emergency Classification	B; D.1; D.2; I.1; Annex 1, Section 3; Annex 2, Section 3; Annex 3, Section 3
Notifications/Communications	A.2; B.4; D.1, E; F
Protective Action Recommendations	B.4; D.1; E.2; E.4; J
Dose Assessment Methodology	I.4
Core Damage Assessment	I
TSC Activation and Operation	A; B.5; D.1; F.1; H
OSC Activation and Operation	A; B.5; D.1; F.1; H; K.3; Annex 1, Section 4; Annex 2, Section 4; Annex 3, Section 4
EOF Activation and Operation	A; B.5; D.1; F.1; H; K.3
Emergency News Center Activation and Operation	A; B.5; D.1; G.3; G.4; H
Evacuation and Accountability	J.4; J.5; Annexes 1, 2, 3, Section 5.1
Offsite Radiological Monitoring	I; J.3; K.5
Medical Response	L
Reentry and Recovery	M
<b>Administrative Procedures</b>	<b>Plan Section Implemented</b>
Maintaining Emergency Preparedness	P
Emergency Response Facilities & Equipment	H; Annex 1, Section 4; Annex 2, Section 4; Annex 3, Section 4
Drills & Exercises	N
Radiological Emergency Response Training	O
Public Education and Information	G
Emergency Response Directory	P

**TURKEY POINT PLANT  
RADIOLOGICAL EMERGENCY PLAN  
APPENDIX 4**

### Abbreviations, Acronyms, and Definitions

ALARA	(As Low As Reasonably Achievable): A radiation protection philosophy requiring that personnel exposure to radiation and radioactive material be kept not only within regulatory limits but be maintained As Low As Reasonably Achievable in the light of current technology with appropriate consideration for economic and social factors and for the benefits to be expected. ALARA applies not only to minimizing occupational exposure to radiation workers, but also to limiting the radioactivity of plant effluent and minimizing the potential for exposure to the public.
Annual	Occurring once per calendar year (January 1 through December 31).
ANI	American Nuclear Insurers
ANS	alert and notification system
CDE (Committed Dose Equivalent)	Total dose from internally deposited radionuclide over subsequent 50 year period to a specific organ.
CEDE (Committed Effective Dose Equivalent)	Sum of risk-weighted committed dose equivalents to organs.
CET	Core Exit Thermocouple
CFR (Code of Federal Regulations)	The Code of Federal Regulations is a codification of the general and permanent rules published in the Federal Register by the Executive departments and agencies of the federal government. The Code is divided into 50 titles that represent broad areas subject to federal regulation. Each title is divided into chapters that usually bear the name of the issuing agency. Each chapter further subdivided into parts covering specific regulatory areas.

### Abbreviations, Acronyms, and Definitions

Cold Shutdown	A reactor condition in which the coolant temperature has been reduced to 200°F or below and the pressure has essentially been reduced to atmospheric pressure.
Contaminated Area	An area where radioactive material is deposited where it is not desired.
CR	Control Room
CROM	Control Room Operations Manager
DAC (Derived Air Concentration)	The concentration of a given radionuclide in air.
DDE (Deep Dose Equivalent)	Dose equivalent from external radiation at a tissue depth of 1 centimeter.
DEM	(State of Florida) Division of Emergency Management
DEP	Drill Exercise Performance
DHS	Department of Homeland Security
DOE	Department of Energy
DOH	(State of Florida) Department of Health
DOH-BRC	(State of Florida) Department of Health Bureau of Radiation Control
Dose (Radiation)	The quantity of radiation absorbed per unit of mass by the body or by any portion of the body. The unit of radiation dose is the RAD.
Dose Equivalent	Quantity that expresses all radiations on a common scale for calculating the absorbed dose. It is defined as the product of the absorbed dose in rads and certain modifying factors. The unit is rem.
Dose Rate	Dose delivered per unit time.



### Abbreviations, Acronyms, and Definitions

Dosimeter	An instrument used for measuring the absorbed dose, exposure, or similar radiation quantity.
Dosimetry	A system of dosimeters for evaluating the absorbed dose, exposure, or similar radiation quantity.
EAB	Exclusion Area Boundary
EALs	Emergency Action Levels
EAS (Emergency Alert System)	A network of broadcast stations and interconnecting facilities authorized by the Federal Communications Commission to operate in a controlled manner during a war, state of public peril, disaster or other national, state and local emergencies.
EC	Emergency Coordinator
ENC (Emergency News Center)	A designated facility for use by the FPL public information officer and staff in communicating with the news media. Public information officers from state, county and federal response agencies also staff the ENC, and all agencies coordinate information to be released to the media and general public to ensure the information releases is accurate and consistent. This center becomes the central point for media access to latest developments and emergency information.
EOM	Emergency Offsite Manager
EPZ (Emergency Planning Zone)	A generic area defined about a nuclear facility to facilitate offsite emergency planning and develop a significant response base. It is defined for the plume and ingestion exposure pathways.
ENS	Emergency Notification System
EOC	Emergency Operations Center
EOF	Emergency Operations Facility

**Abbreviations, Acronyms, and Definitions**

EPA	Environmental Protection Agency
EPIP	Emergency Plan Implementing Procedure
EPZ	Emergency Planning Zone
ERDS	Emergency Response Data System
ERF	Emergency Response Facilities
ERO	Emergency Response Organization
ETE	Evacuation Time Estimate
Evacuation	The removal of people from an area on an emergency basis to avoid or reduce possible short term radiation exposure.
Exposure	Being exposed to ionizing radiation or to radioactive material.
External Dose	Dose from a source of radioactive material outside the body.
FBI	Federal Bureau of Investigation
FEMA	Federal Emergency Management Agency
Filter, HEPA	High-efficiency particulate air filter.
FPL	Florida Power & Light
Frisker	Radiation monitoring equipment. This is a hand-held probe that is slowly passed near the area of interest to determine the presence or absence of radioactive material.
FRMAP	Federal Radiation Monitoring and Assessment Plan
FSAR	Final Safety Analysis Report

**Abbreviations, Acronyms, and Definitions**

Gamma Rays	High-energy, short-wavelength electromagnetic radiation. Gamma rays are essentially similar to x-rays, but are usually more energetic and are nuclear in origin.
GET	General Employee Training
Health Physics	A general term used as a modifying phrase that may refer to facilities, equipment, programs, etc. used in the discipline of health physics; and a profession devoted to the protection of man and his environment from unwarranted radiation exposure.
High Radiation Area	Any area, accessible to personnel, in which there exists radiation originating in whole or in part within licensed material at such levels that a dose equivalent could be received in any one hour in excess of 100 millirem at 30 centimeters.
Hostile Action	An act toward the plant or plant personnel that includes the use of violent force to destroy equipment, takes hostages, and/or intimidates the licensee to achieve an end. This includes attack by air, land, or water using guns, explosives, projectiles, vehicles, or other devices used to deliver destructive force. Other acts that satisfy the overall intent may be included. HOSTILE ACTION should not be construed to include acts of civil disobedience or felonious acts that are not part of a concerted attack on the nuclear power plant. Non-terrorism-based EALs should be used to address such activities, (e.g., violent acts between individuals in the owner-controlled area.)
Hostile Force	One or more individuals who are engaged in a determined assault, overtly or by stealth and deception, equipped with suitable weapons capable of killing, maiming, or causing destruction.
Health Physics Network	Health Physics Network
HSOC	Homeland Security Operations Center

### Abbreviations, Acronyms, and Definitions

I&C	Instrument and Controls
Ingestion Pathway Zone	That area, approximately 50 miles in radius from the center of the plant, for which detailed plans are made to protect people from ingestion of foodstuffs and water contaminated by radioactive materials released from the plant.
INPO (Institute of Nuclear Power Operations)	An organization established by the utilities to set up standardized operations. By letter of agreement, INPO agrees to provide the service provided by their organization, coordinate the activities of the organization and provide telephone contacts of the organization during an emergency at the Station.
Internal Dose	Dose from a source of radioactive material within the body (as a result of deposition of radionuclides in body tissue).
Ionization Chamber	An instrument that detects and measures ionizing radiation by measuring the electrical current that flows when radiation ionizes gas in a chamber, making the gas a conductor of the electricity.
KI	Potassium Iodide
LOCA	A loss of coolant accident can result from an opening in the primary cooling system, such as a pipe break or a stuck open relief valve.
MERL	Mobile Emergency Radiological Laboratory
Monitor (Radiation)	A radiation detector whose purpose is to measure the level of ionizing radiation (or quantity of radioactive material).
Monitoring (Radiation)	The continuous or periodic collection and assessment of pertinent information.
NEI	Nuclear Energy Institute

**Abbreviations, Acronyms, and Definitions**

NFPA	National Fire Protection Association
NRC	Nuclear Regulatory Commission
NRF	National Response Framework
NUREG-0654/FEMA-REP-1, Rev 1	Criteria for Preparation and Evaluation of Radiological Emergency Response Plans and Preparedness in Support of Nuclear Power Plants: The purpose of this guidance and upgraded acceptance criteria is to provide a basis for NRC licensees, and State and local governments to develop radiological emergency plans and improve emergency preparedness.
NWS	National Weather Service
Occupational Dose	A dose received by a permanent or temporary employee while engaged in activities relating to the use, possession, or surveillance of licensed radioactive material or sources of ionizing radiation. Occupational dose shall not include any exposure of an individual to radiation for the purpose of medical diagnosis or therapy. Determination of occupational dose is the responsibility of the licensee.
OCA	Owner-Controlled Area
ORO	Offsite Response Organization
OSC	Operations Support Center
PAG	Protective Action Guidelines
PAR	Protective Action Recommendation
PBX	Private Branch Exchange

### Abbreviations, Acronyms, and Definitions

Personnel Monitoring Equipment	Devices designed to be worn or carried by an individual for the purpose of measuring occupational radiation doses, e.g. thermoluminescent dosimeters, pocket dosimeters, and finger badges.
Plume Exposure Pathway	That area, approximately 10 miles in radius from the center of the plant, for which detailed plans are made to protect people from exposure to a plume containing radioactive materials.
Pocket Dosimeter	An ionization chamber carried or worn by an individual for personnel dose monitoring.
Portal Monitor	A walk-through radiation detector whose purpose is to detect beta and gamma emitting contamination on personnel exiting selected areas.
Posted Area	An area in which radiation and/or contamination exists or might exist at levels such that the use of warning signs or devices is required.
PPE	Personal Protective Equipment
Primary Coolant or Reactor Coolant System	The fluid circulated through the reactor to remove heat.
Projected Dose	An estimate of the radiation dose that affected individuals could potentially receive if protective actions are not taken.
Protection Factor	A measure of the protection afforded by a respirator; the ratio of the concentration of the radionuclide in the ambient atmosphere to the concentration inside the respiratory equipment (usually inside the facepiece) under conditions of use.
Protective Action	An action taken to avoid or reduce a projected dose.

### Abbreviations, Acronyms, and Definitions

Protective Clothing	Used interchangeably with the term anti-contamination clothing and has the same general meaning in radiation protection procedures.
PTN	Turkey Point Nuclear Plant
Quarterly	Occurring once per calendar quarter, with quarters ending on March 31, June 30, September 30, and December 31 in a year.
Rad	A measure of the dose produced by directly or indirectly ionizing radiation in terms of the energy absorbed per unit mass of any irradiated material. One rad is the dose corresponding to 100 ergs of absorbed energy per gram of irradiated material.
Radiation (Ionizing)	Any or all of the following: alpha, beta, gamma, X-rays, neutrons, high speed protons or electrons, and other atomic particles (sound, radio waves, visible, and infrared or ultraviolet light are non-ionizing forms of radiation).
Radiation Area	Any area, accessible to personnel, in which radiation levels could result in an individual receiving a dose equivalent in excess of 5 millirem in 1 hour at 30 centimeters.
Radiation Exposure	Refers very broadly to the act or state of being exposed to ionizing radiation.
Radiation Protection	Used interchangeably with the term health physics.
Radiation Work Permit (RWP)	A document providing radiological evaluation and authorization to perform specific activities involving personnel exposure to ionizing radiation or radioactive material. It describes the radiological conditions and specifies radiation protection controls to be used when performing the activities.

### Abbreviations, Acronyms, and Definitions

Radioactive Contamination	The presence of radioactive material in an undesired location. Contamination may be loose, fixed, or present in air.
Radionuclide	A radioactive nuclide is one that has the capability of spontaneously emitting radiation.
RCS	Reactor Coolant System
REAC/TS	Radiation Emergency Assistance Center/Training Site
Reactor Trip (SCRAM)	An automatic procedure by which control rods are rapidly inserted into the core of a reactor to stop the chain reaction.
Recovery	The process of reducing radiation exposure rates and concentrations in the environment to acceptable levels for unconditional occupancy.
Relocation	The removal or continued exclusion of people from contaminated areas to avoid chronic radiation exposure.
Rem	Special unit of any of the quantities expressed as dose equivalent. The dose equivalent in Rem is equal to the absorbed dose in rads multiplied by the quality factor.
REMP	(State of Florida) Radiological Emergency Management Plan
RM	Recovery Manager
RMS	Radiation Monitoring System
SAMG	Severe Accident Management Guidelines
SCBA	Self-contained breathing apparatus



### Abbreviations, Acronyms, and Definitions

Secondary Coolant	A separate stream of coolant that is converted to steam by the primary coolant in a heat exchanger (steam generator) to power the turbine.
Self-Reading Dosimeter	A self-reading dosimeter is a direct-reading pocket dosimeter shaped like a pen with a pocket clip. It is generally used to measure X and gamma radiation.
Severe Accident: PWR	A nuclear accident involving a loss of core cooling and damage so severe that there are core geometry changes and possible relocation of core materials, e.g., a core melt. In accordance with the Severe Accident Management Guidelines, a severe accident has occurred when core exit thermocouple temperatures are greater than 1200°F and actions to cool the core have been, and continue to be, unsuccessful. The plant is outside of the design bases for the plant.
Shelter	The use of the closest available structure that will provide protection from exposure to an airborne plume.
SPDS	Safety Parameter Display System
SRO	Senior Reactor Operator
STA	Shift Technical Advisor
TEDE (Total Effective Dose Equivalent)	Sum of the deep dose equivalent and the committed effective dose equivalent.

### Abbreviations, Acronyms, and Definitions

TLD (Thermoluminescent Dosimeter)	A dosimeter based on the effect of ionizing radiation on certain thermoluminescent crystals, in which radiation excites orbital electrons of some atoms to a higher energy state orbit than normal. Stimulating the crystal by controlled heating allows the electrons to return to normal orbit, thereby emitting discrete quanta of light proportional to the amount of ionizing radiation absorbed by the crystal. Emitted light can be measured and related to personnel dose from ionizing radiation.
TSC	Technical Support Center
USCG	U.S. Coast Guard
X-Ray	Highly penetrating radiation similar to gamma rays.

# **TURKEY POINT PLANT RADIOLOGICAL EMERGENCY PLAN APPENDIX 5**

## **Evacuation Time Estimate**

The Evacuation Time Estimate Study was prepared by  
KLD Engineering, P.C.

This document is submitted as COLA Part 5, Supplemental Information 1.

**TURKEY POINT PLANT  
RADIOLOGICAL EMERGENCY PLAN  
APPENDIX 6**

**NUREG-0654 Cross Reference Document****NUREG-0654 Cross Reference****Note: Offsite responsibility is shaded in Statement Column.**

<b>Planning Element</b>	<b>Statement</b>	<b>EPLAN</b>	<b>OTHER</b>	<b>Comments</b>
A.1.a	Each plan shall identify the State, local, Federal and private sector organizations (including utilities), that are intended to be part of the overall response organization for Emergency Planning Zones. (See Appendix 5).	A.1		
A.1.b	Each organization and sub organization having an operational role shall specify its concept of operations, and its relationship to the total effort.	A.1		
A.1.c	Each plan shall illustrate these interrelationships in a block diagram.	A.1, Figure A-1 & A-2		
A.1.d	Each organization shall identify a specific individual by title who shall be in charge of the emergency response.	A.1; B.2		
A.1.e	Each organization shall provide for 24-hour per day emergency response, including 24-hour per day manning of communications links.	A.1, A.4 & F.1		

## NUREG-0654 Cross Reference

Note: Offsite responsibility is shaded in Statement Column.

Planning Element	Statement	EPLAN	OTHER	Comments
A.2.a	Each organization shall specify the functions and responsibilities for major elements and key individuals by title, of emergency response, including the following: Command and Control,			Offsite Responsibility
A.2.a (continued)	Alerting and Notification,			
A.2.a (continued)	Communications,			Offsite Responsibility
A.2.a (continued)	Public Information,			
A.2.a (continued)	Accident Assessment,			
A.2.a (continued)	Public Health and Sanitation,			
A.2.a (continued)	Social Services,			
A.2.a (continued)	Fire and Rescue,			
A.2.a (continued)	Traffic Control,			Offsite Responsibility

## NUREG-0654 Cross Reference

Note: Offsite responsibility is shaded in Statement Column.

Planning Element	Statement	EPLAN	OTHER	Comments
A.2.a (continued)	Emergency Medical Services,			Offsite Responsibility
A.2.a (continued)	Law Enforcement,			
A.2.a (continued)	Transportation,			
A.2.a (continued)	Protective Response (including authority to request Federal assistance and to initiate other protective actions), and			
A.2.a (continued)	Radiological Exposure Control.			
A.2.a (continued)	The description of these functions shall include a clear and concise summary such as a table of primary and support responsibilities using the agency as one axis, and the function as the other. (See Section B for licensee).			
A.2.b	Each plan shall contain (by reference to specific acts, codes or statutes) the legal basis for such authorities.	A.2		Offsite Responsibility

**NUREG-0654 Cross Reference****Note: Offsite responsibility is shaded in Statement Column.**

Planning Element	Statement	EPLAN	OTHER	Comments
A.3	Each plan shall include written agreements referring to the concept of operations developed between Federal, State, and local agencies and other support organizations having an emergency response role within the Emergency Planning Zones. The agreements shall identify the emergency measures to be provided and the mutually acceptable criteria for their implementation, and specify the arrangements for exchange of information. These agreements may be provided in an appendix to the plan or the plan itself may contain descriptions of these matters and a signature page in the plan may serve to verify the agreements. The signature page format is appropriate for organizations where response functions are covered by laws, regulations or executive orders where separate written agreements are not necessary.	A.3 & Appendix 2		
A.4	Each principal organization shall be capable of continuous (24-hour) operations for a protracted period.	A.4		



**NUREG-0654 Cross Reference****Note: Offsite responsibility is shaded in Statement Column.**

<b>Planning Element</b>	<b>Statement</b>	<b>EPLAN</b>	<b>OTHER</b>	<b>Comments</b>
A.4 (continued)	The individual in the principal organization who will be responsible for assuring continuity of resources (technical, administrative, and material) shall be specified by title.	A.4		
B.1	Each licensee shall specify the onsite emergency organization of plant staff personnel for all shifts and its relation to the responsibilities and duties of the normal staff complement.	B.1; Table B-1b; Tables 2-1 & B-1a (Unit Annexes)		
B.2	Each licensee shall designate an individual as emergency coordinator who shall be on shift at all times and who shall have the authority and responsibility to immediately and unilaterally initiate any emergency actions, including providing protective action recommendations to authorities responsible for implementing offsite emergency measures.	B.2 through B.4		
B.3	Each licensee shall identify a line of succession for the emergency coordinator position and identify the specific conditions for higher level utility officials assuming this function.	B.3		

**NUREG-0654 Cross Reference****Note: Offsite responsibility is shaded in Statement Column.**

<b>Planning Element</b>	<b>Statement</b>	<b>EPLAN</b>	<b>OTHER</b>	<b>Comments</b>
B.4	Each licensee shall establish the functional responsibilities assigned to the emergency coordinator and shall clearly specify which responsibilities may not be delegated to other elements of the emergency organization.	B.4		
B.4 (continued)	Among the responsibilities which may not be delegated shall be the decision to notify and to recommend protective actions to authorities responsible for offsite emergency measures.	B.4		

**NUREG-0654 Cross Reference****Note: Offsite responsibility is shaded in Statement Column.**

Planning Element	Statement	EPLAN	OTHER	Comments
B.5	Each licensee shall specify the positions or title and major tasks to be performed by the persons to be assigned to the functional areas of emergency activity. For emergency situations, specific assignments shall be made for all shifts and for plant staff members, both onsite and away from the site. These assignments shall cover the emergency functions in Table B-1 entitled, "Minimum Staffing Requirements for Nuclear Power Plant Emergencies." The minimum on-shift staffing levels shall be as indicated in Table B-1. The licensee must be able to augment on-shift capabilities within a short period after declaration of an emergency. This capability shall be as indicated in Table B-1. The implementation schedule for licensed operators, auxiliary operators and the shift technical advisor on shift shall be as specified in the July 31, 1980 letter to all power reactor licensees. Any deficiencies in the other staffing requirements of Table B-1 must be capable of augmentation within 30 minutes by September 1, 1981, and such deficiencies must be fully removed by July 1, 1982.	B.5; B.6; Figures B-1a through B-1d; Table B-1b; Section 2 (Unit Annexes); Tables 2-1 & B-1a (Unit Annexes)		

**NUREG-0654 Cross Reference****Note: Offsite responsibility is shaded in Statement Column.**

<b>Planning Element</b>	<b>Statement</b>	<b>EPLAN</b>	<b>OTHER</b>	<b>Comments</b>
B.6	Each licensee shall specify the interfaces between and among the onsite functional areas of emergency activity, licensee headquarters support, local services support, and State and local government response organization.	Figure A-1; Figure A-2; B.6		
B.6 (continued)	This shall be illustrated in a block diagram and shall include the onsite TSC and the operational support (assembly) center and the licensee's near-site EOF	B.6, Figures B-1a through B-1d		
B.7	Each licensee shall specify the corporate management, administrative, and technical support personnel who will augment the plant staff as specified in the table entitled "Minimum Staffing Requirements for Nuclear Power Plant Emergencies," (Table B-1) and in the following areas:	B.5, Figures B-1a through B-1d		
B.7.a	a. logistics support for emergency personnel, e.g., transportation, communications, temporary quarters, food and water, sanitary facilities in the field, and special equipment and supplies procurement;	B.5		

**NUREG-0654 Cross Reference****Note: Offsite responsibility is shaded in Statement Column.**

<b>Planning Element</b>	<b>Statement</b>	<b>EPLAN</b>	<b>OTHER</b>	<b>Comments</b>
B.7.b	b. technical support for planning and reentry/recovery operations;	M.1; M.2		
B.7.c	c. management level interface with governmental authorities; and	B.5		
B.7.d	d. release of information to news media during an emergency (coordinated with governmental authorities).	B.5; Figure B-1d; Table B-1b; G.3 through G.4; H.3		
B.8	Each licensee shall specify the contractor and private organizations who may be requested to provide technical assistance to and augmentation of the emergency organization.	B.7; B.8		
B.9	Each licensee shall identify the services to be provided by local agencies for handling emergencies, e.g., police, ambulance, medical, hospital, and fire-fighting organizations shall be specified.	B.8; L.1; L.3		
B.9 (continued)	The licensee shall provide for transportation and treatment of injured personnel who may also be contaminated.	L.4		

**NUREG-0654 Cross Reference****Note: Offsite responsibility is shaded in Statement Column.**

Planning Element	Statement	EPLAN	OTHER	Comments
B.9 (continued)	Copies of the arrangements and agreements reached with contractor, private, and local support agencies shall be appended to the plan. The agreements shall delineate the authorities, responsibilities, and limits on the actions of the contractor, private organization, and local services support groups.	Appendix 2		

## NUREG-0654 Cross Reference

Note: Offsite responsibility is shaded in Statement Column.

Planning Element	Statement	EPLAN	OTHER	Comments
C.1.a	<p>The Federal government maintains in-depth capability to assist licensees, States and local governments through the Federal Radiological Monitoring and Assessment Plan (formerly Radiological Assistance Plan (RAP) and Interagency Radiological Assistance Plan (IRAP).*</p> <p>Each State and licensee shall make provisions for incorporating the Federal response capability into its operation plan, including the following:</p> <p><i>* FEMA issued the Federal Radiological Emergency Response Plan (FRERP) on May 8, 1996 (61 FR 20944), which supersedes these documents. (Source NUREG-0654 Addenda Mar 2002)</i></p> <p>a. specific persons by title authorized to request Federal assistance; see A.1.d., A.2.a.</p>	A.1; C.1		
C.1.b	b. specific Federal resources expected, including expected times of arrival at specific nuclear facility sites; and	C.1.b		

**NUREG-0654 Cross Reference****Note: Offsite responsibility is shaded in Statement Column.**

<b>Planning Element</b>	<b>Statement</b>	<b>EPLAN</b>	<b>OTHER</b>	<b>Comments</b>
C.1.c	c. specific licensee, State and local resources available to support the Federal response, e.g., airfields, command posts, telephone lines, radio frequencies and telecommunications centers.	C.1.c		
C.2.a	Each principal offsite organization may dispatch representatives to the licensee's near-site EOF. (State technical analysis representatives at the near site EOF are preferred.)	C.2		Offsite Responsibility
C.2.b	b. The licensee shall prepare for the dispatch of a representative to principal offsite governmental emergency operations centers.	C.2		
C.3	Each organization shall identify radiological laboratories and their general capabilities and expected availability to provide radiological monitoring and analyses services which can be used in an emergency.	C.3; Section 4 (Unit Annexes)		



**NUREG-0654 Cross Reference****Note: Offsite responsibility is shaded in Statement Column.**

<b>Planning Element</b>	<b>Statement</b>	<b>EPLAN</b>	<b>OTHER</b>	<b>Comments</b>
C.4	Each organization shall identify nuclear and other facilities, organizations or individuals which can be relied upon in an emergency to provide assistance. Such assistance shall be identified and supported by appropriate letters of agreement.	C.4		
D.1	An emergency classification and emergency action level scheme as set forth in Appendix 1 must be established by the licensee.	D.1; Section 3 (Unit Annexes); Attachment 1 (Unit Annexes)		
D.1 (continued)	The specific instruments, parameters or equipment status shall be shown for establishing each emergency class, in the in-plant emergency procedures.	D.1; Section 3 (Unit Annexes); Attachment 1 (Unit Annexes)		
D.1 (continued)	The plan shall identify the parameter values and equipment status for each emergency class.	D.1; Section 3 (Unit Annexes); Attachment 1 (Unit Annexes)		

**NUREG-0654 Cross Reference****Note: Offsite responsibility is shaded in Statement Column.**

<b>Planning Element</b>	<b>Statement</b>	<b>EPLAN</b>	<b>OTHER</b>	<b>Comments</b>
D.2	The initiating conditions shall include the example conditions found in Appendix I and all postulated accidents in the Final Safety Analysis Report (FSAR) for the nuclear facility.	D.2; Section 3 (Unit Annexes); Attachment 1 (Unit Annexes)		
D.3	Each State and local organization shall establish an emergency classification and emergency action level scheme consistent with that established by the facility licensee.	D.3		Offsite Responsibility
D.4	Each State and local organization should have procedures in place that provide for emergency actions to be taken which are consistent with the emergency actions recommended by the nuclear facility licensee, taking into account local offsite conditions that exist at the time of the emergency.	D.4		Offsite Responsibility

**NUREG-0654 Cross Reference****Note: Offsite responsibility is shaded in Statement Column.**

<b>Planning Element</b>	<b>Statement</b>	<b>EPLAN</b>	<b>OTHER</b>	<b>Comments</b>
E.1	Each organization shall establish procedures which describe mutually agreeable bases for notification of response organizations consistent with the emergency classification and action level scheme set forth in Appendix 1. These procedures shall include means for verification of messages. The specific details of verification need not be included in the plan.	E.1		
E.2	Each organization shall establish procedures for alerting, notifying, and mobilizing emergency response personnel.	E.2		
E.3	The licensee in conjunction with State and local organizations shall establish the contents of the initial emergency messages to be sent from the plant. These measures shall contain information about the class of emergency, whether a release is taking place, potentially affected population and areas, and whether protective measures may be necessary.	E.3		

## NUREG-0654 Cross Reference

Note: Offsite responsibility is shaded in Statement Column.

Planning Element	Statement	EPLAN	OTHER	Comments
E.4.a	Each licensee shall make provisions for follow up messages from the facility to offsite authorities which shall contain the following information if it is known and appropriate: a. location of incident and name and telephone number (or communications channel identification) of caller;	E.4		
E.4.b	b. date/time of incident;	E.4		
E.4.c	c. class of emergency;	E.4		
E.4.d	d. type of actual or projected release (airborne, waterborne, surface spill), and estimated duration/impact times;	E.4		
E.4.e	e. estimate of quantity of radioactive material released or being released and the points and height of releases;	E.4		
E.4.f	f. chemical and physical form of released material, including estimates of the relative quantities and concentration of noble gases, iodines and particulates;	E.4		
E.4.g	g. meteorological conditions at appropriate levels (wind speed, direction (to and from), indicator of stability, precipitation, if any);	E.4		

**NUREG-0654 Cross Reference****Note: Offsite responsibility is shaded in Statement Column.**

<b>Planning Element</b>	<b>Statement</b>	<b>EPLAN</b>	<b>OTHER</b>	<b>Comments</b>
E.4.h	h. actual or projected dose rates at site boundary; projected integrated dose at site boundary;	E.4		
E.4.i	i. projected dose rates and integrated dose at the projected peak and at 2, 5 and 10 miles, including sector(s) affected;	E.4		
E.4.j	j. estimate of any surface radioactive contamination in plant, onsite or offsite;	E.4		
E.4.k	k. licensee emergency response actions underway;	E.4		
E.4.l	l. recommended emergency actions, including protective measures;	E.4		
E.4.m	m. request for any needed onsite support by offsite organizations; and	E.4		
E.4.n	n. prognosis for worsening or termination of event based on plant information.	E.4		

## NUREG-0654 Cross Reference

Note: Offsite responsibility is shaded in Statement Column.

Planning Element	Statement	EPLAN	OTHER	Comments
E.5	<p>State and local government organizations shall establish a system for disseminating to the public appropriate information contained in initial and follow up messages received from the licensee including the appropriate notification to appropriate broadcast media, e.g., the Emergency Broadcast System (EBS).*</p> <p><i>* The Emergency Broadcast System (EBS) was replaced by the Emergency Alert System by a Report and Order that the Federal Communications Commission issued on December 28, 1994 (59 FR 67090). (Source NUREG-0654 Addenda Mar 2002)</i></p>	E.5		Offsite Responsibility

**NUREG-0654 Cross Reference****Note: Offsite responsibility is shaded in Statement Column.**

Planning Element	Statement	EPLAN	OTHER	Comments
E.6	Each organization shall establish administrative and physical means, and the time required for notifying and providing prompt instructions to the public within the plume exposure pathway Emergency Planning Zone. (See Appendix 3.) It shall be the licensee's responsibility to demonstrate that such means exist, regardless of who implements this requirement. It shall be the responsibility of the State and local governments to activate such a system.	E.6		

## NUREG-0654 Cross Reference

Note: Offsite responsibility is shaded in Statement Column.

Planning Element	Statement	EPLAN	OTHER	Comments
E.7	<p>Each organization shall provide written messages intended for the public, consistent with the licensee's classification scheme. In particular, messages to the public giving instruction with regard to specific protective actions to be taken by occupants of affected areas shall be prepared and included as part of the State and local plans. Such messages should include the appropriate aspects of sheltering, ad hoc, respiratory protection, e.g., handkerchief over mouth, thyroid blocking or evacuation. The role of the licensee is to provide supporting information for the messages. For ad hoc respiratory protection see "Respiratory Protective Devices Manual" American Industrial Hygiene Association, 1963 pp. 123-126.*</p> <p><i>* The current Respiratory Protective Devices Manual (2nd edition) and the forthcoming 3rd edition do not contain a similar table for ad hoc respiratory protection; however, according to the American Industrial Hygiene Association, it is still correct to refer to the 1963 manual as the most recent version of the Respiratory Protection Manual that contains the ad hoc respiratory protection table. (Source NUREG-0654 Addenda Mar 2002)</i></p>	E.7		Shaded area offsite responsibility



**NUREG-0654 Cross Reference****Note: Offsite responsibility is shaded in Statement Column.**

<b>Planning Element</b>	<b>Statement</b>	<b>EPLAN</b>	<b>OTHER</b>	<b>Comments</b>
F.1	The communication Plans for emergencies shall include organizational titles and alternates for both ends of the communication links.	F.1		
F.1 (continued)	Each organization shall establish reliable primary and backup means of communication for licensees, local, and State response organizations. Such systems should be selected to be compatible with one another.	F.1		
F.1.a	Each plan shall include:  a. provision for 24-hour per day notification to and activation of the State/local emergency response network; and at a minimum, a telephone link and alternate, including 24-hour per day manning of communications links that initiate emergency response actions.	F.1		
F.1.b	b. provision for communications with contiguous State/local governments within the Emergency Planning Zones;	F.1		

**NUREG-0654 Cross Reference****Note: Offsite responsibility is shaded in Statement Column.**

<b>Planning Element</b>	<b>Statement</b>	<b>EPLAN</b>	<b>OTHER</b>	<b>Comments</b>
F.1.c	c. provision for communications as needed with Federal emergency response organizations;	F.1		
F.1.d	d. provision for communications between the nuclear facility and the licensee's near-site EOF, State and local emergency operations center, and radiological monitoring teams;	F.1; Figure F-1		
F.1.e	e. provision for alerting or activating emergency personnel in each response organization; and	F.1		
F.1.f	f. provision for communication by the licensee with NRC headquarters and NRC Regional Office EOCs and the licensee's near-site EOF facility and radiological monitoring team assembly area.	F.1; Figure F-1		
F.2	Each organization shall ensure that a coordinated communication link for fixed and mobile medical support facilities exists.	F.2		
F.3	Each organization shall conduct periodic testing of the entire emergency communications system (see evaluation criteria H.10, N.2.a and Appendix 3).	F.3; N.2.a		

**NUREG-0654 Cross Reference****Note: Offsite responsibility is shaded in Statement Column.**

<b>Planning Element</b>	<b>Statement</b>	<b>EPLAN</b>	<b>OTHER</b>	<b>Comments</b>
G.1	Each organization shall provide a coordinated periodic (at least annually) dissemination of information to the public regarding how they will be notified and what their actions should be in an emergency.	G.1		
G.1.a	This information shall include, but not necessarily be limited to: a. educational information on radiation;	G.1.a		
G.1.b	b. contact for additional information;	G.1.b		
G.1.c	c. protective measures, e.g., evacuation routes and relocation centers, sheltering, respiratory protection, radioprotective drugs; and	G.1.c & G.1.d		
G.1.d	d. special needs of the handicapped.	G.1.e		
G.1 (continued)	Means for accomplishing this dissemination may include, but are not necessarily limited to: information in the telephone book; periodic information in utility bills; posting in public areas; and publications distributed on an annual basis.	G.1;G.2		

**NUREG-0654 Cross Reference****Note: Offsite responsibility is shaded in Statement Column.**

Planning Element	Statement	EPLAN	OTHER	Comments
G.2	The public information program shall provide the permanent and transient adult population within the plume exposure EPZ an adequate opportunity to become aware of the information annually. The programs should include provision for written material that is likely to be available in a residence during an emergency.	G.2		
G.2 (continued)	Updated information shall be disseminated at least annually.	G.1		
G.2 (continued)	Signs or other measures (e.g., decals, posted notices or other means, placed in hotels, motels, gasoline stations and phone booths) shall also be used to disseminate to any transient population within the plume exposure pathway EPZ appropriate information that would be helpful if an emergency or accident occurs.	G.2		
G.2 (continued)	Such notices should refer the transient to the telephone directory or other source of local emergency information and guide the visitor to appropriate radio and television frequencies.	G.2		

**NUREG-0654 Cross Reference****Note: Offsite responsibility is shaded in Statement Column.**

<b>Planning Element</b>	<b>Statement</b>	<b>EPLAN</b>	<b>OTHER</b>	<b>Comments</b>
G.3.a	a. Each principal organization shall designate the points of contact and physical locations for use by news media during an emergency.	G.3.a		
G.3.b	b. Each licensee shall provide space which may be used for a limited number of the news media at the near site EOF.	G.3.b		
G.4.a	a. Each principal organization shall designate a spokesperson who should have access to all necessary information.	G.4.a		
G.4.b	b. Each organization shall establish arrangements for timely exchange of information among designated spokespersons.	G.4.b		
G.4.c	c. Each organization shall establish coordinated arrangements for dealing with rumors.	G.4.c		
G.5	Each organization shall conduct coordinated programs at least annually to acquaint news media with the emergency plans, information concerning radiation, and points of contact for release of public information in an emergency.	G.5		

## NUREG-0654 Cross Reference

Note: Offsite responsibility is shaded in Statement Column.

Planning Element	Statement	EPLAN	OTHER	Comments
H.1	Each licensee shall establish a TSC and an onsite OSC (assembly area) in accordance with NUREG-0696, Revision 1.* <i>**Revision 1" should be deleted; NUREG-0696 has not been revised. (Source NUREG-0654 Addenda Mar 2002)</i>	H.1; H.10; Section 4 (Unit Annexes)		
H.2	Each licensee shall establish an EOF from which evaluation and coordination of all licensee activities related to an emergency is to be carried out and from which the licensee shall provide information to Federal, State and local authorities responding to radiological emergencies in accordance with NUREG-0696, Revision 1.* <i>**Revision 1" should be deleted; NUREG-0696 has not been revised. (Source NUREG-0654 Addenda Mar 2002)</i>	H.2		
H.3	Each organization shall establish an EOC for use in directing and controlling response functions.	H.4		Offsite Responsibility
H.4	Each organization shall provide for timely activation and staffing of the facilities and centers described in the plan.	H.5		

**NUREG-0654 Cross Reference****Note: Offsite responsibility is shaded in Statement Column.**

Planning Element	Statement	EPLAN	OTHER	Comments
H.5.a	<p>Each licensee shall identify and establish onsite monitoring systems that are to be used to initiate emergency measures in accordance with Appendix 1, as well as those to be used for conducting assessment.</p> <p>The equipment shall include:</p> <p>a. geophysical phenomena monitors, (e.g., meteorological, hydrologic, seismic);</p>	H.6.a		
H.5.b	<p>b. radiological monitors, (e.g., process, area, emergency, effluent, wound and portable monitors and sampling equipment);</p>	H.6.b; Section 4 (Unit Annexes)		
H.5.c	<p>c. process monitors, (e.g., reactor coolant system pressure and temperature, containment pressure and temperature, liquid levels, flow rates, status or lineup of equipment components); and</p>	H.6.c; Section 4 (Unit Annexes)		
H.5.d	<p>d. fire and combustion products detectors.</p>	H.6.d; Section 4.2.C (Unit Annexes)		

## NUREG-0654 Cross Reference

Note: Offsite responsibility is shaded in Statement Column.

Planning Element	Statement	EPLAN	OTHER	Comments
H.6.a	Each licensee shall make provision to acquire data from or for emergency access to offsite monitoring and analysis equipment including:  a. geophysical phenomena monitors, (e.g., meteorological, hydrologic, seismic);	H.7.a		
H.6.b	b. radiological monitors including radiometers and sampling devices.	H.7.b		
H.6.b (continued)	Dosimetry shall be provided and shall meet, as a minimum, the NRC Radiological Assessment Branch Technical position for the Environmental Radiological Monitoring Program; and	H.7.b		
H.6.c	c. laboratory facilities, fixed or mobile.	C.3; H.7.c		
H.7	Each organization, where appropriate, shall provide for offsite radiological monitoring equipment in the vicinity of the nuclear facility.	H.8		
H.8	Each licensee shall provide meteorological instrumentation and procedures which satisfy the criteria in Appendix 2,	H.9		



**NUREG-0654 Cross Reference****Note: Offsite responsibility is shaded in Statement Column.**

<b>Planning Element</b>	<b>Statement</b>	<b>EPLAN</b>	<b>OTHER</b>	<b>Comments</b>
H.8 (continued)	And provisions to obtain representative current meteorological information from other sources.	H.9; I.5; Table I-1; Table I-2		
H.9	Each licensee shall provide for an onsite OSC (assembly area) which shall have adequate capacity, and supplies, including, for example, respiratory protection,	H.1; H.10		
H.9 (continued)	protective clothing,	H.1; H.10		
H.9 (continued)	portable lighting,	H.1; H.10		
H.9 (continued)	portable radiation monitoring equipment,	H.1; H.10		
H.9 (continued)	cameras and	H. 10		
H.9 (continued)	communications equipment for personnel present in the assembly area.	H. 10		
H.10	Each organization shall make provisions to inspect, inventory and operationally check emergency equipment/instruments at least once each calendar quarter and after each use.	H.11		

**NUREG-0654 Cross Reference****Note: Offsite responsibility is shaded in Statement Column.**

<b>Planning Element</b>	<b>Statement</b>	<b>EPLAN</b>	<b>OTHER</b>	<b>Comments</b>
H.10 (continued)	There shall be sufficient reserves of instruments/equipment to replace those which are removed from emergency kits for calibration or repair.	H.11		
H.10 (continued)	Calibration of equipment shall be at intervals recommended by the supplier of the equipment.	H.11		
H.11	Each plan shall, in an appendix, include identification of emergency kits by general category (protective equipment, communications equipment, radiological monitoring equipment and emergency supplies).	H.12 & Table H-1		
H.12	Each organization shall establish a central point (preferably associated with the licensee's near-site EOF), for the receipt and analysis of all field monitoring data and coordination of sample media.	H.13		

## NUREG-0654 Cross Reference

Note: Offsite responsibility is shaded in Statement Column.

Planning Element	Statement	EPLAN	OTHER	Comments
I.1	Each licensee shall identify plant system and effluent parameter values characteristic of a spectrum of off-normal conditions and accidents, and shall identify the plant parameter values or other information, which correspond to the example initiating conditions of Appendix 1.	I.1		
I.1 (continued)	Such parameter values and the corresponding emergency class shall be included in the appropriate facility emergency procedures.	I.1		
I.1 (continued)	Facility emergency procedures shall specify the kinds of instruments being used and their capabilities.	I.1		
I.2	Onsite capability and resources to provide initial values and continuing assessment throughout the course of an accident shall include: post-accident sampling capability,	I.2		
I.2 (continued)	radiation and effluent monitors,	I.2		
I.2 (continued)	in-plant iodine instrumentation, and	I.2		

## NUREG-0654 Cross Reference

Note: Offsite responsibility is shaded in Statement Column.

Planning Element	Statement	EPLAN	OTHER	Comments
I.2 (continued)	Containment radiation monitoring in accordance with NUREG-0578, as elaborated in the NRC letter to all power reactor licensees dated October 30, 1979.* <i>* NUREG-0737, "Clarification of TMI Action Plan Requirements," November 1980, and Supplement 1 to NUREG-0737, January 1983, supersede these citations. (Source NUREG-0654 Addenda Mar 2002)</i>	I.2		
I.3.a	Each licensee shall establish methods and techniques to be used for determining:  a. the source term of releases of radioactive material within plant systems. An example is the relationship between the containment radiation monitor(s) reading(s) and radioactive material available for release from containment.	I.3		
I.3.b	b. the magnitude of the release of radioactive materials based on plant system parameters and effluent monitors.	I.3		

## NUREG-0654 Cross Reference

Note: Offsite responsibility is shaded in Statement Column.

Planning Element	Statement	EPLAN	OTHER	Comments
I.4	Each licensee shall establish the relationship between effluent monitor readings and onsite and offsite exposures and contamination for various meteorological conditions.	I.4		
I.5	Each licensee shall have the capability of acquiring and evaluating meteorological information sufficient to meet the criteria of Appendix 2.	I.5, Table I-1 & Table I-2		
I.5 (continued)	There shall be provisions for access to meteorological information by at least the near site EOF, the TSC, the Control Room and an offsite NRC center.	I.5		
I.5 (continued)	The licensee shall make available to the State suitable meteorological data processing interconnections which will permit independent analysis by the State, of facility generated data in those States with the resources to effectively use this information.	I.5		

## NUREG-0654 Cross Reference

Note: Offsite responsibility is shaded in Statement Column.

Planning Element	Statement	EPLAN	OTHER	Comments
I.6	Each licensee shall establish the methodology for determining the release rate/projected doses if the instrumentation used for assessment are off scale or inoperable.	I.6		
I.7	Each organization shall describe the capability and resources for field monitoring within the plume exposure Emergency Planning Zone which are an intrinsic part of the concept of operations for the facility.	I.7		
I.8	Each organization, where appropriate, shall provide methods, equipment and expertise to make rapid assessments of the actual or potential magnitude and locations of any radiological hazards through liquid or gaseous release pathways. This shall include activation,	I.8		
I.8 (continued)	notification means,	I.8		
I.8 (continued)	field team composition,	I.8		
I.8 (continued)	transportation,	I.8		
I.8 (continued)	communication,	I.8		
I.8 (continued)	monitoring equipment and	I.8		
I.8 (continued)	estimated deployment times.	I.8		

## NUREG-0654 Cross Reference

Note: Offsite responsibility is shaded in Statement Column.

Planning Element	Statement	EPLAN	OTHER	Comments
I.9	Each organization shall have a capability to detect and measure radioiodine concentrations in air in the plume exposure EPZ as low as $10^{-7}$ uCi/cc (microcuries per cubic centimeter) under field conditions. Interference from the presence of noble gas and background radiation shall not decrease the stated minimum detectable activity.	I.9		
I.10	Each organization shall establish means for relating the various measured parameters (e.g., contamination levels, water and air activity levels) to dose rates for key isotopes (i.e., those given in Table 3, page 18) and gross radioactivity measurements.	I.10		
I.10 (continued)	Provisions shall be made for estimating integrated dose from the projected and actual dose rates and for comparing these estimates with the protective action guides. The detailed provisions shall be described in separate procedures.	I.10		

## NUREG-0654 Cross Reference

Note: Offsite responsibility is shaded in Statement Column.

Planning Element	Statement	EPLAN	OTHER	Comments
I.11	Arrangements to locate and track the airborne radioactive plume shall be made, using either or both Federal and State resources.	I.11		Offsite Responsibility
J.1.a	Each licensee shall establish the means <u>and time</u> required to warn or advise onsite individuals and individuals who may be in areas controlled by the operator, including:  a. Employees not having emergency assignments;	J.1		
J.1.b	b. Visitors;	J.1		
J.1.c	c. Contractor and construction personnel; and	J.1		
J.1.d	d. Other persons who may be in the public access areas on or passing through the site or within the owner-controlled area.	J.1		
J.2	Each licensee shall make provisions for evacuation routes and transportation for onsite individuals to some suitable offsite location, including alternatives for inclement weather, high traffic density and specific radiological conditions.	J.2; Section 5 (Unit Annexes)		



**NUREG-0654 Cross Reference****Note: Offsite responsibility is shaded in Statement Column.**

<b>Planning Element</b>	<b>Statement</b>	<b>EPLAN</b>	<b>OTHER</b>	<b>Comments</b>
J.3	Each licensee shall provide for radiological monitoring of people evacuated from the site.	J.3		
J.4	Each licensee shall provide for the evacuation of onsite non-essential personnel in the event of a Site or General Emergency and	J.4; Section 5 (Unit Annexes)		
J.4 (continued)	shall provide a decontamination capability at or near the monitoring point specified in J.3.	J.3		
J.5	Each licensee shall provide for a capability to account for all individuals onsite at the time of the emergency and ascertain the names of missing individuals within 30 minutes of the start of an emergency and account for all onsite individuals continuously thereafter.	J.5		
J.6.a	Each licensee shall, for individuals remaining or arriving onsite during the emergency, make provisions for:  a. Individual respiratory protection;	J.6.a		
J.6.b	b. Use of protective clothing; and	J.6.b		

## NUREG-0654 Cross Reference

Note: Offsite responsibility is shaded in Statement Column.

Planning Element	Statement	EPLAN	OTHER	Comments
J.6.c	c. Use of radioprotective drugs, (e.g., individual thyroid protection).	J.6.c		
J.7	Each licensee shall establish a mechanism for recommending protective actions to the appropriate State and local authorities.	J.7		
J.7 (continued)	These shall include Emergency Action Levels corresponding to projected dose to the population-at-risk, in accordance with Appendix 1 and	J.7		
J.7 (continued)	with the recommendations set forth in Tables 2.1 and 2.2 of the Manual of Protective Action Guides and Protective Actions for Nuclear Incidents (EPA-520/1-75-001).* <i>* EPA issued EPA-400-R-92-001, May 1992, which supersedes this document. (Source NUREG-0654 Addenda Mar 2002)</i>	J.7		
J.7 (continued)	As specified in Appendix 1, prompt notification shall be made directly to the offsite authorities responsible for implementing protective measures within the plume exposure pathway Emergency Planning Zone.	J.7		

**NUREG-0654 Cross Reference****Note: Offsite responsibility is shaded in Statement Column.**

<b>Planning Element</b>	<b>Statement</b>	<b>EPLAN</b>	<b>OTHER</b>	<b>Comments</b>
J.8	Each licensee's plan shall contain time estimates for evacuation within the plume exposure EPZ. These shall be in accordance with Appendix 4.	J.8		
J.9	Each State and local organization shall establish a capability for implementing protective measures based upon protective action guides and other criteria.	J.9		Offsite Responsibility

## NUREG-0654 Cross Reference

Note: Offsite responsibility is shaded in Statement Column.

Planning Element	Statement	EPLAN	OTHER	Comments
J.9 (continued)	<p>This shall be consistent with the recommendations of EPA regarding exposure resulting from passage of radioactive airborne plumes, (EPA-520/1-75-001) and with those of DHEW (DHHS)/FDA regarding radioactive contamination of human food and animal feeds as published in the Federal Register of December 15, 1978 (43 FR 58790).*</p> <p><i>* EPA issued EPA-400-R-92-001, May 1992, which supersedes EPA-520/1-75-001. The Food and Drug Administration (FDA), Department of Health and Human Services (DHHS), issued "Guidance on Accidental Radioactive Contamination of Human Food and Animal Feeds, Recommendations for State and Local Agencies, Availability," on August 13, 1998 (63 FR 43402). (Source NUREG-0654 Addenda Mar 2002)</i></p>	J.9		Offsite Responsibility
J.10.a	<p>The organization's plans to implement protective measures for the plume exposure pathway shall include:</p> <p>a. Maps showing evacuation routes,</p>	J.10.a		

## NUREG-0654 Cross Reference

Note: Offsite responsibility is shaded in Statement Column.

Planning Element	Statement	EPLAN	OTHER	Comments
J.10.a (continued)	evacuation areas,	J.10.a		
J.10.a (continued)	preselected radiological sampling and monitoring points, (identification of radiological sampling and monitoring points shall include the designators in Table J-1 or an equivalent uniform system described in the plan);			
J.10.a (continued)	relocation centers in host areas,	J.10.a		
J.10.a (continued)	and shelter areas.	J.10.a		
J.10.b	b. Maps showing population distribution around the nuclear facility. This shall be by evacuation areas (licensees shall also present the information in a sector format);	J.10.b		
J.10.c	c. Means for notifying all segments of the transient and resident population;	J.10.c		
J.10.d	d. Means for protecting those persons whose mobility may be impaired due to such factors as institutional or other confinement;	J.10.d		Offsite Responsibility

## NUREG-0654 Cross Reference

Note: Offsite responsibility is shaded in Statement Column.

Planning Element	Statement	EPLAN	OTHER	Comments
J.10.e	e. Provisions for the use of radioprotective drugs, particularly for emergency workers and institutionalized persons within the plume exposure EPZ whose immediate evacuation may be infeasible or very difficult,	J.10.d		Offsite Responsibility
J.10.e (continued)	including quantities, storage, and means of distribution.	J.10.d		Offsite Responsibility
J.10.f	f. State and local organizations' plans should include the method by which decisions by the State Health Department for administering radioprotective drugs to the general population are made during an emergency	J.10.d		Offsite Responsibility
J.10.f (continued)	and the predetermined conditions under which such drugs may be used by offsite emergency workers;* * <i>The Food and Drug Administration (FDA) issued "Potassium Iodide as a Thyroid Blocking Agent in a Radiation Emergency," on December 11, 2001 (66 FR 238:64046), which supersedes this citation. (Source NUREG-0654 Addenda Mar 2002)</i>	J.10.d		Offsite Responsibility

## NUREG-0654 Cross Reference

Note: Offsite responsibility is shaded in Statement Column.

Planning Element	Statement	EPLAN	OTHER	Comments
J.10.g	g. Means of relocation;	J.10.d		Offsite Responsibility
J.10.h	h. Relocation centers in host areas which are at least 5 miles, and preferably 10 miles, beyond the boundaries of the plume exposure emergency planning zone; (See J.12)	J.10.d		Offsite Responsibility
J.10.i	i. Projected traffic capacities of evacuation routes under emergency conditions;	J.10.d		Offsite Responsibility
J.10.j	j. Control of access to evacuated areas and organization responsibilities for such control;	J.10.d		Offsite Responsibility
J.10.k	k. Identification of and means for dealing with potential impediments (e.g., seasonal impassability of roads) to use of evacuation routes, and contingency measures;	J.10.d		Offsite Responsibility
J.10.l	Time estimates for evacuation of various sectors and distances based on a dynamic analysis (time-motion study under various conditions) for the plume exposure pathway emergency planning zone (See Appendix 4); and	J.10.d		Offsite Responsibility

## NUREG-0654 Cross Reference

Note: Offsite responsibility is shaded in Statement Column.

Planning Element	Statement	EPLAN	OTHER	Comments
J.10.m	m. The bases for the choice of recommended protective actions from the plume exposure pathway during emergency conditions.	J.10.e		
J.10.m (continued)	This shall include expected local protection afforded * in residential units or other shelter for direct and inhalation exposure, as well as evacuation time estimates. <i>*EPA issued EPA 400-R-92-001 in May 1992, which supersedes this citation. (Source NUREG-0654 Addenda Mar 2002)</i>	J.10.e		
J.11	Each State shall specify the protective measures to be used for the ingestion pathway, including the methods for protecting the public from consumption of contaminated foodstuffs.	J.11		Offsite Responsibility
J.11 (continued)	This shall include criteria for deciding whether dairy animals should be put on stored feed.	J.11		Offsite Responsibility
J.11 (continued)	The plan shall identify procedures for detecting contamination,	J.11		Offsite Responsibility
J.11 (continued)	for estimating the dose commitment consequences of uncontrolled ingestion,	J.11		Offsite Responsibility



## NUREG-0654 Cross Reference

Note: Offsite responsibility is shaded in Statement Column.

Planning Element	Statement	EPLAN	OTHER	Comments
J.11 (continued)	and for imposing protection procedures such as impoundment, decontamination, processing, decay, product diversion, and preservation.	J.11		Offsite Responsibility
J.11 (continued)	Maps for recording survey and monitoring data, key land use data (e.g., farming), dairies, food processing plants, water sheds, water supply intake and treatment plants and reservoirs shall be maintained.	J.11		Offsite Responsibility
J.11 (continued)	Provisions for maps showing detailed crop information may be by including reference to their availability and location and a plan for their use.	J.11		Offsite Responsibility
J.11 (continued)	The maps shall start at the facility and include all of the 50-mile ingestion pathway EPZ.	J.11		Offsite Responsibility
J.11 (continued)	Up-to-date lists of the name and location of all facilities which regularly process milk products and other large amounts of food or agricultural products originating in the ingestion pathway Emergency Planning Zone, but located elsewhere, shall be maintained.	J.11		Offsite Responsibility

## NUREG-0654 Cross Reference

Note: Offsite responsibility is shaded in Statement Column.

Planning Element	Statement	EPLAN	OTHER	Comments
J.12	Each organization shall describe the means for registering and monitoring of evacuees at relocation centers in host areas.	J.12		Offsite Responsibility
J.12 (continued)	The personnel and equipment available should be capable of monitoring within about a 12 hour period all residents and transients in the plume exposure EPZ arriving at relocation centers.	J.12		Offsite Responsibility
K.1.a	Each licensee shall establish onsite exposure guidelines consistent with EPA Emergency Worker and Lifesaving Activity Protective Actions Guides (EPA-520/1-75/001) for: * EPA issued EPA 400-R-92-001 in May 1992, which supersedes this citation. (Source NUREG-0654 Addenda Mar 2002)	K.1		
K.1.a	a. removal of injured persons;	K.1		
K.1.b	b. undertaking corrective actions;	K.1		
K.1.c	c. performing assessment actions;	K.1		
K.1.d	d. providing first aid;	K.1		

## NUREG-0654 Cross Reference

Note: Offsite responsibility is shaded in Statement Column.

Planning Element	Statement	EPLAN	OTHER	Comments
K.1.e	e. performing personnel decontamination;	K.1		
K.1.f	f. providing ambulance service; and	K.1		
K.1.g	g. providing medical treatment services.	K.1		
K.2	Each licensee shall provide an onsite radiation protection program to be implemented during emergencies, including methods to implement exposure guidelines. The plan shall identify individual(s), by position or title, who can authorize emergency workers to receive doses in excess of 10 CFR Part 20 limits.	K.2		
K.2 (continued)	Procedures shall be worked out in advance for permitting onsite volunteers to receive radiation exposures in the course of carrying out lifesaving and other emergency activities. These procedures shall include expeditious decision making and a reasonable consideration of relative risks.	K.2		
K.3.a	a. Each organization shall make provision for 24-hour-per-day capability to determine the doses received by emergency personnel involved in any nuclear accident, including volunteers.	K.3		

## NUREG-0654 Cross Reference

Note: Offsite responsibility is shaded in Statement Column.

Planning Element	Statement	EPLAN	OTHER	Comments
K.3.a (continued)	Each organization shall make provisions for distribution of dosimeters, both self-reading and permanent record devices.	K.3		
K.3.b	Each organization shall ensure that dosimeters are read at appropriate frequencies and	K.3		
K.3.b (continued)	provide for maintaining dose records for emergency workers involved in any nuclear accident.	K.3		
K.4	Each State and local organization shall establish the decision chain for authorizing emergency workers to incur exposures in excess of the EPA General Public Protective Action Guides (i.e., EPA PAGs for emergency workers and lifesaving activities).	K.4		Offsite Responsibility
K.5.a	a. Each organization as appropriate shall specify action levels for determining the need for decontamination.	K.5		
K.5.b	b. Each organization, as appropriate, shall establish the means for radiological decontamination of emergency personnel wounds, supplies, instruments and equipment, and for waste disposal.	K.5		

## NUREG-0654 Cross Reference

Note: Offsite responsibility is shaded in Statement Column.

Planning Element	Statement	EPLAN	OTHER	Comments
K.6.a	Each licensee shall provide onsite contamination control measures including:  a. area access control;	K.6.a		
K.6.b	b. drinking water and food supplies;	K.6.b		
K.6.c	c. criteria for permitting return of areas and items to normal use, see ANSI 13.12.* <i>*EPA PAG Manual, EPA 400-R-92-001 (see items 16 and 17), and the Food and Drug Administration, DHHS, "Guidance on Accidental Radioactive Contamination of Human Food and Animal Feeds: Recommendations for State and Local Agencies," dated August 13, 1998 (63 FR 43402) supersede this citation. (Source NUREG-0654 Addenda Mar 2002)</i>	K.6.c		
K.7	Each licensee shall provide the capability for decontaminating relocated onsite personnel,	K.7		
K.7 (continued)	including provisions for extra clothing and decontaminants suitable for the type of contamination expected, with particular attention given to radioiodine contamination of the skin.	K.7		

## NUREG-0654 Cross Reference

Note: Offsite responsibility is shaded in Statement Column.

Planning Element	Statement	EPLAN	OTHER	Comments
L.1	Each organization shall arrange for local and backup hospital and medical services having the capability for evaluation of radiation exposure and uptake,	L.1; L.3; Appendix 2		
L.1 (continued)	Including assurance that persons providing these services are adequately prepared to handle contaminated individuals.	L.1		
L.2	Each licensee shall provide for onsite first aid capability.	L.2		
L.3	Each State shall develop lists indicating the location of public, private and military hospitals and other emergency medical services facilities within the State or contiguous States considered capable of providing medical support for any contaminated injured individual.	N/A		Offsite Responsibility
L.3 (continued)	The listing shall include the name, location, type of facility and capacity and any special radiological capabilities.	N/A		Offsite Responsibility
L.3 (continued)	These emergency medical services should be able to radiologically monitor personnel contamination, and	N/A		Offsite Responsibility

## NUREG-0654 Cross Reference

Note: Offsite responsibility is shaded in Statement Column.

Planning Element	Statement	EPLAN	OTHER	Comments
L.3 (continued)	have facilities and trained personnel able to care for contaminated injured persons.	N/A		Offsite Responsibility
L.4	Each organization shall arrange for transporting victims of radiological accidents to medical support facilities.	L.4		
M.1	Each organization, as appropriate, shall develop general plans and procedures for reentry and recovery and describe the means by which decisions to relax protective measures (e.g., allow reentry into an evacuated area) are reached.	M.1		
M.1 (continued)	This process should consider both existing and potential conditions.	M.1		
M.2	Each licensee plan shall contain the position/title, authority and responsibilities of individuals who will fill key positions in the facility recovery organization.	M.2		

## NUREG-0654 Cross Reference

Note: Offsite responsibility is shaded in Statement Column.

Planning Element	Statement	EPLAN	OTHER	Comments
M.2 (continued)	<p>This organization shall include technical personnel with responsibilities to develop, evaluate and direct recovery and reentry operations. The recovery organization recommended by the Atomic Industrial Forum's "Nuclear Power Plant Emergency Response Plan" dated October 11, 1979, is an acceptable framework.*</p> <p><i>**"Functional Criteria for Emergency Response Facilities," NUREG-0696, issued on February 1981, and "Clarification of TMI Action Plan Requirements, Requirements for Emergency Response Capability," NUREG-0737, Supplement No. 1, issued January 1983, supersede this citation. (Source NUREG-0654 Addenda Mar 2002)</i></p>	M.2		
M.3	<p>Each licensee and State plan shall specify means for informing members of the response organizations that a recovery operation is to be initiated, and of any changes in the organizational structure that may occur.</p>	M.3		



**NUREG-0654 Cross Reference****Note: Offsite responsibility is shaded in Statement Column.**

<b>Planning Element</b>	<b>Statement</b>	<b>EPLAN</b>	<b>OTHER</b>	<b>Comments</b>
M.4	Each plan shall establish a method for periodically estimating total population exposure.	M.4		
N.1.a	a. An exercise is an event that tests the integrated capability and a major portion of the basic elements existing within emergency preparedness plans and organizations. The emergency preparedness exercise shall simulate an emergency that results in offsite radiological releases which would require response by offsite authorities. Exercises shall be conducted as set forth in NRC and FEMA rules.	N.1		
N.1.b	b. An exercise shall include mobilization of State and local personnel and resources adequate to verify the capability to respond to an accident scenario requiring response.	N.1		
N.1.b (continued)	The organization shall provide for a critique of the annual exercise by Federal and State observers/evaluators.	N.4		

**NUREG-0654 Cross Reference****Note: Offsite responsibility is shaded in Statement Column.**

<b>Planning Element</b>	<b>Statement</b>	<b>EPLAN</b>	<b>OTHER</b>	<b>Comments</b>
N.1.b (continued)	The scenario should be varied from year to year such that all major elements of the plans and preparedness organizations are tested within a five-year period.	N.1		
N.1.b (continued)	Each organization should make provisions to start an exercise between 6:00 p.m. and midnight, and	N.1		
N.1.b (continued)	another between midnight and 6:00 a.m. once every six years.	N.1		
N.1.b (continued)	Exercises should be conducted under various weather conditions.	N.1		
N.1.b (continued)	Some exercises should be unannounced.	N.1		

## NUREG-0654 Cross Reference

Note: Offsite responsibility is shaded in Statement Column.

Planning Element	Statement	EPLAN	OTHER	Comments
N.2.a	<p>A drill is a supervised instruction period aimed at testing, developing and maintaining skills in a particular operation. A drill is often a component of an exercise. A drill shall be supervised and evaluated by a qualified drill instructor. Each organization shall conduct drills, in addition to the annual exercise at the frequencies indicated below:</p> <p>a. <u>Communication Drills</u> Communications with State and local governments within the plume exposure pathway Emergency Planning Zone shall be tested monthly.</p>	N.2.a		
N.2.a (continued)	Communications with Federal emergency response organizations and States within the ingestion pathway shall be tested quarterly.	N.2.a		
N.2.a (continued)	Communications between the nuclear facility, State and local EOCs, and field assessment teams shall be tested annually.	N.2.a		

## NUREG-0654 Cross Reference

Note: Offsite responsibility is shaded in Statement Column.

Planning Element	Statement	EPLAN	OTHER	Comments
N.2.a (continued)	Communication drills shall also include the aspect of understanding the content of messages.	N.2.a		
N.2.b	b. <u>Fire Drills</u> Fire drills shall be conducted in accordance with the plant (nuclear facility) technical specifications.	N.2.b		
N.2.c	c. <u>Medical Emergency Drills</u> A medical emergency drill involving a simulated contaminated individual which contains provisions for participation by the local support services agencies (i.e., ambulance and offsite medical treatment facility) shall be conducted annually. The offsite portions of the medical drill may be performed as part of the required annual exercise.	N.2.c		
N.2.d	d. <u>Radiological Monitoring Drills</u> Plant environs and radiological monitoring drills (onsite and offsite) shall be conducted annually.	N.2.d		

**NUREG-0654 Cross Reference****Note: Offsite responsibility is shaded in Statement Column.**

<b>Planning Element</b>	<b>Statement</b>	<b>EPLAN</b>	<b>OTHER</b>	<b>Comments</b>
N.2.d (continued)	These drills shall include collection and analysis of all sample media (e.g., water, vegetation, soil and air), and provisions for communications and record keeping. The State drills need not be at each site. Where appropriate, local organizations shall participate.	N.2.d		
N.2.e.1	e. <u>Health Physics Drills</u> (1) Health Physics drills shall be conducted semi-annually which involve response to, and analysis of, simulated elevated airborne and liquid samples and direct radiation measurements in the environment. The State drills need not be at each site.	N.2.e		
N.2.e.2	(2) Analysis of in plant liquid samples with actual elevated radiation levels including use of the post-accident sampling system shall be included in Health Physics drills by licensees annually.	N,2,e		

## NUREG-0654 Cross Reference

Note: Offsite responsibility is shaded in Statement Column.

Planning Element	Statement	EPLAN	OTHER	Comments
N.3.a	Each organization shall describe how exercises and drills are to be carried out to allow free play for decision making and to meet the following objectives. Pending the development of exercise scenarios and exercise evaluation guidance by NRC and FEMA the scenarios for use in exercises and drills shall include but not be limited to, the following:  a. The basic objective(s) of each drill and exercise and appropriate evaluation criteria;	N.3.a		
N.3.b	b. The date(s), time period, place(s) and participating organizations;	N.3.b		
N.3.c	c. The simulated events;	N.3.c		
N.3.d	d. A time schedule of real and simulated initiating events;	N.3.e		

**NUREG-0654 Cross Reference****Note: Offsite responsibility is shaded in Statement Column.**

<b>Planning Element</b>	<b>Statement</b>	<b>EPLAN</b>	<b>OTHER</b>	<b>Comments</b>
N.3.e	e. A narrative summary describing the conduct of the exercises or drills to include such things as simulated casualties, offsite fire department assistance, rescue of personnel, use of protective clothing, deployment of radiological monitoring teams, and public information activities; and	N.3.f		
N.3.f	f. A description of the arrangements for and advance materials to be provided to official observers.	N.3.h		
N.4	Official observers from Federal, State or local governments will observe, evaluate, and critique the required exercises. A critique shall be scheduled at the conclusion of the exercise to evaluate the ability of organizations to respond as called for in the plan. The critique shall be conducted as soon as practicable after the exercise, and	N.4		
N.4 (continued)	a formal evaluation should result from the critique.	N.4		

**NUREG-0654 Cross Reference****Note: Offsite responsibility is shaded in Statement Column.**

<b>Planning Element</b>	<b>Statement</b>	<b>EPLAN</b>	<b>OTHER</b>	<b>Comments</b>
N.5	Each organization shall establish means for evaluating observer and participant comments on areas needing improvement, including emergency plan procedural changes, and	N.5		
N.5 (continued)	for assigning responsibility for implementing corrective actions.	N.5		
N.5 (continued)	Each organization shall establish management control used to ensure that corrective actions are implemented.	N.5		
O.1.a	Each organization shall assure the training of appropriate individuals.  a. Each facility to which the plant applies shall provide site specific emergency response training for those offsite emergency organizations who may be called upon to provide assistance in the event of an emergency,	O.1.a		



## NUREG-0654 Cross Reference

Note: Offsite responsibility is shaded in Statement Column.

Planning Element	Statement	EPLAN	OTHER	Comments
O.1.b	b. Each offsite response organization shall participate in and receive training. Where mutual aid agreements exist between local agencies such as fire, police and ambulance/rescue, the training shall also be offered to the other departments who are members of the mutual aid district.	O.1.a; O.1.b		Offsite Responsibility
O.2	The training program for members of the onsite emergency organization shall, besides classroom training, include practical drills in which each individual demonstrates ability to perform his assigned emergency function.	O.2		
O.2 (continued)	During the practical drills, on-the-spot correction of erroneous performance shall be made and a demonstration of the proper performance offered by the instructor.	O.2		
O.3	Training for individuals assigned to licensee first aid teams shall include courses equivalent to Red Cross Multi-Media.	O.3		

**NUREG-0654 Cross Reference****Note: Offsite responsibility is shaded in Statement Column.**

<b>Planning Element</b>	<b>Statement</b>	<b>EPLAN</b>	<b>OTHER</b>	<b>Comments</b>
O.4.a	Each organization shall establish a training program for instructing and qualifying personnel who will implement radiological emergency response plans. The specialized initial training and periodic retraining programs (including the scope, nature and frequency) shall be provided in the following categories:  a. Directors or coordinators of the response organizations;	O.4		
O.4.b	b. Personnel responsible for accident assessment;	O.4		
O.4.c	c. Radiological monitoring teams and radiological analysis personnel;	O.4		
O.4.d	d. Police, security and fire fighting personnel;	O.4		
O.4.e	e. Repair and damage control/corrective action teams (onsite);	O.4		
O.4.f	f. First aid and rescue personnel;	O.4		
O.4.g	g. Local support services personnel including Civil Defense/Emergency Service personnel;	O.4		

**NUREG-0654 Cross Reference****Note: Offsite responsibility is shaded in Statement Column.**

<b>Planning Element</b>	<b>Statement</b>	<b>EPLAN</b>	<b>OTHER</b>	<b>Comments</b>
O.4.h	h. Medical support personnel;	O.4		
O.4.i	i. Licensee's headquarters support personnel;	O.4		
O.4.j	j. Personnel responsible for transmission of emergency information and instructions.	O.4		
O.5	Each organization shall provide for the initial and annual retraining of personnel with emergency response responsibilities.	O.5		
P.1	Each organization shall provide for the training of individuals responsible for the planning effort.	P.1		
P.2	Each organization shall identify by title the individual with the overall authority and responsibility for radiological emergency response planning.	P.2		
P.3	Each organization shall designate an Emergency Planning Coordinator with responsibility for the development and updating of emergency plans and coordination of these plans with other response organizations.	P.3		

**NUREG-0654 Cross Reference****Note: Offsite responsibility is shaded in Statement Column.**

<b>Planning Element</b>	<b>Statement</b>	<b>EPLAN</b>	<b>OTHER</b>	<b>Comments</b>
P.4	Each organization shall update its plan and agreements as needed, review and certify it to be current on an annual basis.	P.4		
P.4 (continued)	The update shall take into account changes identified by drills and exercises.	P.4		
P.5	The emergency response plans and approved changes to the plans shall be forwarded to all organizations and appropriate individuals with responsibility for implementation of the plans.	P.5		
P.5 (continued)	Revised pages shall be dated and marked to show where changes have been made.	P.5		
P.6	Each plan shall contain a detailed listing of supporting plans and their source.	P.6		
P.7	Each plan shall contain as an appendix listing, by title, procedures required to implement the plan.	P.7; Appendix 3		
P.7 (continued)	The listing shall include the section(s) of the plan to be implemented by each procedure.	P.7; Appendix 3		
P.8	Each plan shall contain a specific table of contents.	Table of Contents & P.8		

**NUREG-0654 Cross Reference****Note: Offsite responsibility is shaded in Statement Column.**

<b>Planning Element</b>	<b>Statement</b>	<b>EPLAN</b>	<b>OTHER</b>	<b>Comments</b>
P.8 (continued)	Plans submitted for review should be cross-referenced to these criteria.	P.8		
P.9	Each licensee shall arrange for and conduct independent reviews of the emergency preparedness program at least every 12 months. (An independent review is one conducted by any competent organization either internal or external to the licensees' organization, but who are not immediately responsible for the emergency preparedness program).	P.9		
P.9 (continued)	The review shall include the emergency plan, its implementing procedures and practices, training, readiness testing, equipment, and interfaces with State and local governments.	P.9		
P.9 (continued)	Management controls shall be implemented for evaluation and correction of review findings.	P.9		

**NUREG-0654 Cross Reference****Note: Offsite responsibility is shaded in Statement Column.**

<b>Planning Element</b>	<b>Statement</b>	<b>EPLAN</b>	<b>OTHER</b>	<b>Comments</b>
P.9 (continued)	The result of the review, along with recommendations for improvements, shall be documented, reported to appropriate licensee corporate and plant management, and involved Federal, State and local organizations,	P.9		
P.9 (continued)	and retained for a period of five years.	P.9		
P.10	Each organization shall provide for updating telephone numbers in emergency procedures at least quarterly.	P.10		