

Turkey Point Units 6 & 7
COL Application
Part 2 — FSAR

SUBSECTION 2.4.2: FLOODS

2.4.2	FLOODS	2.4.2-1
2.4.2.1	Flood History	2.4.2-1
2.4.2.2	Flood Design Considerations	2.4.2-3
2.4.2.3	Effects of Local Intense Precipitation	2.4.2-4
2.4.2.4	References	2.4.2-10

SUBSECTION 2.4.2 LIST OF TABLES

<u>Number</u>	<u>Title</u>
2.4.2-201	List of Major Flooding Events in Miami-Dade County, Florida
2.4.2-202	Peak Water Levels at Card Sound Canal Gage
2.4.2-203	Peak Water Levels at Manatee Bay Creek Gage
2.4.2-204	Peak Water Levels at West Highway Creek Gage
2.4.2-205	Peak Tide Level at Virginia Key Tide Gage Station
2.4.2-206	Peak Tide Level at Vaca Key Tide Gage Station
2.4.2-207	Units 6 & 7 Site Short Duration Local PMP Depths
2.4.2-208	Subbasin Drainage Area
2.4.2-209	Subbasin Point of Interest (POI) Drainage Areas
2.4.2-210	Swale Dimensions
2.4.2-211	Units 6 & 7 Subbasin Local PMP Peak Discharges
2.4.2-212	Flow Depth Over the Crest of Makeup Water Reservoir Walls
2.4.2-213	Total Discharge Over the Northern Wall of the Makeup Water Reservoir
2.4.2-214	Units 6 & 7 Flow Path Cross Section PMP Peak Discharge
2.4.2-215	HEC-RAS Model Result for Units 6 & 7
2.4.2-216	Sheet Flow Depth Over the Retaining Wall
2.4.2-217	Sheet Flow Depth Near Safety-Related Buildings

SUBSECTION 2.4.2 LIST OF FIGURES

<u>Number</u>	<u>Title</u>
2.4.2-201	Units 6 & 7 Site Local PMP Intensity-Duration Curve
2.4.2-202	Units 6 & 7 Power Block Finish Grading Plan
2.4.2-203	Units 6 & 7 Local PMP Analysis Subbasin Drainage Areas
2.4.2-204	Units 6 & 7 Local PMP Analysis HEC-RAS Cross Section Locations
2.4.2-205	Units 6 & 7 Local PMP HEC-RAS Cross Section and PMP Flood Level: Cooling Tower East Cross Section 1100
2.4.2-206	Units 6 & 7 Local PMP HEC-RAS Cross Section and PMP Flood Level: Cooling Tower East Cross Section 700
2.4.2-207	Units 6 & 7 Local PMP HEC-RAS Cross Section and PMP Flood Level: Cooling Tower East Cross Section 250 Inline Structure (IS)
2.4.2-208	Units 6 & 7 Local PMP HEC-RAS Cross Section and PMP Flood Level: Cooling Tower East Cross Section 50
2.4.2-209	Units 6 & 7 Local PMP HEC-RAS Cross Section and PMP Flood Level: Cooling Tower East Cross Section 10 IS
2.4.2-210	Units 6 & 7 Local PMP HEC-RAS Cross Section and PMP Flood Level: Cooling Tower West Cross Section 1100
2.4.2-211	Units 6 & 7 Local PMP HEC-RAS Cross Section and PMP Flood Level: Cooling Tower West Cross Section 700
2.4.2-212	Units 6 & 7 Local PMP HEC-RAS Cross Section and PMP Flood Level: Cooling Tower West Cross Section 300
2.4.2-213	Units 6 & 7 Local PMP HEC-RAS Cross Section and PMP Flood Level: Cooling Tower West Cross Section 100
2.4.2-214	Units 6 & 7 Local PMP HEC-RAS Cross Section and PMP Flood Level: Cooling Tower West Cross Section 80 IS
2.4.2-215	Units 6 & 7 Local PMP HEC-RAS Cross Section and PMP Flood Level: Cooling Tower West Cross Section 20
2.4.2-216	Units 6 & 7 Local PMP HEC-RAS Cross Section and PMP Flood Level: Cooling Tower West Cross Section 10 IS
2.4.2-217	Units 6 & 7 Local PMP HEC-RAS Cross Section and PMP Flood Level: Parking Lot East Cross Section 900
2.4.2-218	Units 6 & 7 Local PMP HEC-RAS Cross Section and PMP Flood Level: Parking Lot East Cross Section 600
2.4.2-219	Units 6 & 7 Local PMP HEC-RAS Cross Section and PMP Flood Level: Parking Lot East Cross Section 200

Turkey Point Units 6 & 7
COL Application
Part 2 — FSAR

SUBSECTION 2.4.2 LIST OF FIGURES (CONT.)

<u>Number</u>	<u>Title</u>
2.4.2-220	Units 6 & 7 Local PMP HEC-RAS Cross Section and PMP Flood Level: Parking Lot East Cross Section 88 IS
2.4.2-221	Units 6 & 7 Local PMP HEC-RAS Cross Section and PMP Flood Level: Parking Lot East Cross Section 50
2.4.2-222	Units 6 & 7 Local PMP HEC-RAS Cross Section and PMP Flood Level: Parking Lot East Cross Section 20
2.4.2-223	Units 6 & 7 Local PMP HEC-RAS Cross Section and PMP Flood Level: Parking Lot East Cross Section 10 IS
2.4.2-224	Units 6 & 7 Local PMP HEC-RAS Cross Section and PMP Flood Level: Parking Lot East Cross Section 1290
2.4.2-225	Units 6 & 7 Local PMP HEC-RAS Cross Section and PMP Flood Level: Parking Lot East Cross Section 1190
2.4.2-226	Units 6 & 7 Local PMP HEC-RAS Cross Section and PMP Flood Level: Switchyard West Cross Section 800
2.4.2-227	Units 6 & 7 Local PMP HEC-RAS Cross Section and PMP Flood Level: Switchyard West Cross Section 500
2.4.2-228	Units 6 & 7 Local PMP HEC-RAS Cross Section and PMP Flood Level: Switchyard West Cross Section 200
2.4.2-229	Units 6 & 7 Local PMP HEC-RAS Cross Section and PMP Flood Level: Switchyard West Cross Section 150
2.4.2-230	Units 6 & 7 Local PMP HEC-RAS Cross Section and PMP Flood Level: Switchyard West Cross Section 125 IS
2.4.2-231	Units 6 & 7 Local PMP HEC-RAS Cross Section and PMP Flood Level: Switchyard West Cross Section 50
2.4.2-232	Units 6 & 7 Local PMP HEC-RAS Cross Section and PMP Flood Level: Switchyard West Cross Section 20
2.4.2-233	Units 6 & 7 Local PMP HEC-RAS Cross Section and PMP Flood Level: Switchyard West Cross Section 10 IS
2.4.2-234	Schematic of Overflow Condition at the Retaining Wall Boundary
2.4.2-235	Schematic of a Typical Sheet Flow Condition Adjacent to a Safety-related Building

2.4.2 FLOODS

PTN COL 2.4-2

This subsection examines the historical flooding at the vicinity of Units 6 & 7, including Card Sound Canal, Manatee Bay Creek, West Highway Creek, Virginia Key, Vaca Key, Miami-Dade County and Miami areas, Miami Palm Beach areas, Biscayne Bay, and the Atlantic Ocean, and summarizes the individual types and combinations of flood-producing phenomena considered in establishing the flood design basis for safety-related facilities. The potential impacts of local intense precipitation are also described in this subsection.

2.4.2.1 Flood History

As described in [Subsection 2.4.1](#), there are no major streams or rivers near Units 6 & 7. There is, however, an extensive network of man-made canals that traverses portions of the Miami-Dade County, Florida, where Units 6 & 7 are located. Located along the Atlantic Ocean, Florida Bay, and Biscayne Bay, the area is susceptible to flooding from storm surge associated with tropical storms and hurricanes. In addition, Miami-Dade County experiences ponding in the very flat, poorly drained areas and drainage canals ([Reference 201](#)). The most severe flooding events (up to 1992) in Miami-Dade County, as reported by the Federal Emergency Management Agency (FEMA) in the 1994 flood insurance study for Miami-Dade County, Florida and incorporated areas ([Reference 201](#)), are summarized in [Table 2.4.2-201](#). As shown in the table, the maximum recorded storm tide level is at 11.7 feet NAVD 88, occurred between September 6 and 22, 1926. The design grade elevation at 26 feet NAVD 88 for all safety-related buildings of Units 6 & 7 is above this maximum recorded storm tide level.

The effects of Hurricane Andrew and other hurricane events on flooding at Units 6 & 7 are described in detail in [Subsection 2.4.5](#). Hurricane Andrew caused the worst flooding on record for the area near Units 6 & 7. During Hurricane Andrew, rainfall totals of more than 7 inches were recorded in southeastern Florida ([Reference 202](#)). On the southeast Florida coast, the peak storm surge occurred near the time of high astronomical tide. The height of the storm tide ranged from 4 to 6 feet in northern Biscayne Bay and increased to a maximum value of 16.9 feet NGVD 29 (15.37 feet NAVD 88) in southeastern Biscayne Bay, approximately 13 miles north of Units 6 & 7. However, the height of the storm tide was 4 to 5 feet in southern Biscayne Bay ([Reference 203](#)).

Turkey Point Units 6 & 7
COL Application
Part 2 — FSAR

The gage height measurements at three USGS gages are examined for high water levels that occurred in more recent years: Card Sound Canal (USGS Gage 251816080232200), Manatee Bay Creek (USGS Gage 251549080251200), and West Highway Creek (USGS Gage 251433080265000). These USGS stations are located along the southeastern Florida shoreline south of Units 6 & 7 as shown in [Figure 2.4.1-212](#). Data from the Card Sound Canal gage are available from October 2003 through September 2007, data from the Manatee Bay Creek gage are available from October 2003 through September 2007, and data from the West Highway Creek gage are available from October 1995 through September 2007. Gage height data at all three stations are recorded in 15-minute intervals. [Tables 2.4.2-202](#) through [2.4.2-204](#) present the four highest gage heights recorded at these gages ([Reference 204](#)). The majority of the recorded peak water levels are associated with tropical storm or hurricane events. The maximum gage heights recorded are 1.11 feet NAVD 88 on November 12, 2003, at the Card Sound Canal gage; 2.27 feet NAVD 88 on September 20, 2005, at the Manatee Bay Creek gage; and 2.59 feet NAVD 88 on October 24, 2005, at the West Highway Creek gage ([Reference 204](#)).

Tide level measurements are also examined at two tide gage stations: the Virginia Key tide gage (Station ID: 8723214), which is 25 miles north of Units 6 & 7, and the Vaca Key tide gage (Station ID: 8723970), which is 70 miles south of Units 6 & 7. The Virginia Key tide gage was installed in January 1994 and has been collecting water levels continuously. Verified data are available from February 1994 through August 2008. The maximum water level recorded in the Virginia Key station is 2.8 feet NAVD 88 on October 24, 2005 ([Reference 205](#)). The Vaca Key tide gage was established in 1970. Verified data are available from January 1971 through August 2008. The maximum water level recorded in Vaca Key station was 5.4 feet NAVD 88 on October 24, 2005 ([Reference 206](#)). The five highest tide levels recorded at the two tide gage stations are presented in [Tables 2.4.2-205](#) and [2.4.2-206](#) ([References 205](#) and [206](#)). As shown in the tables, all the peak tide levels at the two tide gage stations are associated with tropical storm or hurricane events.

From [Tables 2.4.2-202](#) through [2.4.2-206](#), it is evident that the design grade elevation at 26 feet NAVD 88 for all safety-related buildings of Units 6 & 7 is above the maximum water levels recorded at the USGS gages and the tide gages as described above.

There are no records of dam break flooding or tsunami-induced flooding events near the Units 6 & 7 site, as described in [Subsections 2.4.4](#) and [2.4.6](#), respectively. There are no records of any ice sheet formations, wind-driven ice

ridges, or ice jams on any of the rivers, creeks, or estuaries near Units 6 & 7 as presented in [Subsection 2.4.7](#).

2.4.2.2 Flood Design Considerations

The design basis flooding (DBF) elevation for Units 6 & 7 is determined by considering a number of different flooding scenarios. The potential flooding scenarios applicable and investigated for Units 6 & 7 include the following: probable maximum flood (PMF) on streams and rivers, potential dam failures, probable maximum surge and seiche flooding, probable maximum tsunami, flooding due to ice effects, and potential flooding caused by channel diversions. The flooding scenarios were investigated in conjunction with other flooding and meteorological events, such as wind-generated waves and tidal levels, as recommended in the guidelines presented in ANSI/ANS-2.8-1992 ([Reference 207](#)). Detailed descriptions on each of these flooding events and the analysis are described in [Subsections 2.4.3](#) through [2.4.7](#), and [Subsection 2.4.9](#).

Flooding due to the PMF on streams and rivers is assessed and described in [Subsection 2.4.3](#). The PMF on streams and rivers is defined by the probable maximum precipitation (PMP) storm event over the stream or river watershed. As addressed in [Subsection 2.4.3](#), flood levels at Units 6 & 7 during severe storms, such as the PMP event, would be controlled by storm tides in the Biscayne Bay because Units 6 & 7 are located on the Biscayne Bay shoreline and there are no major streams or rivers nearby. As a result, a detailed modeling analysis to determine the flood levels from PMF on streams and rivers was not performed for the Units 6 & 7.

The impacts of potential dam failures on the Units 6 & 7 safety-related structures, systems, and components (SSC) are addressed in [Subsection 2.4.4](#). There are no dams located upstream or downstream of Units 6 & 7. Thus, a detailed modeling analysis to determine the flood levels as a result of dam breach was not performed. The makeup water reservoir (MWR), located south of the power block, is constructed of a concrete basin with a top of basin wall at 24 feet NAVD 88, which is 2 feet below the design grade of 26 feet NAVD 88 for the safety-related structures. It is concluded in [Subsection 2.4.4](#) that a postulated breach of the reservoir wall would not pose a flooding risk to the safety-related facilities of the plant.

Probable maximum surge and seiche flooding as a result of the probable maximum hurricane (PMH) is presented in [Subsection 2.4.5](#). The maximum water surface elevation including wave run-up at the plant area during the postulated

Turkey Point Units 6 & 7
COL Application
Part 2 — FSAR

passage of the PMH is estimated to be 24.8 feet NAVD 88. This flood level also constitutes the DBF elevation for the site, and is below the design grade including the elevation of floor entrances and openings of all safety-related facilities at 26 feet (7.9 meters) NAVD 88. Thus, the safety functions of the plant are not impacted by the PMH-induced flooding.

Subsection 2.4.6 describes the estimation of flood levels associated with the probable maximum tsunami (PMT). The maximum water level associated with the PMT at Units 6 & 7 is conservatively estimated to be 14.0 feet NAVD 88. Therefore, the PMT does not pose a flood risk to the safety-related facilities for Units 6 & 7.

Based on the historical data assessed in **Subsections 2.4.7**, it is unlikely that ice effects would pose any flood risk to Units 6 & 7.

Subsection 2.4.9 describes the effects of channel diversions, and it is determined that channel diversion would not pose any flood risk to Units 6 & 7.

The maximum water level at Units 6 & 7 due to a local probable maximum precipitation (PMP) storm event is estimated and described in **Subsection 2.4.2.3** below. The maximum water level in the power block area due to a local PMP storm event is estimated to be at 24.5 feet NAVD 88, which is lower than the design grade of 26.0 feet NAVD 88 of the safety-related facilities by 1.5 feet. Thus, no safety-related facilities are affected due to flooding as a result of the local PMP storm.

2.4.2.3 Effects of Local Intense Precipitation

The effects of local intense precipitation or local PMP on Units 6 & 7 are presented in this subsection. The drainage system for the plant area is analyzed for the local PMP event to determine the flood levels.

2.4.2.3.1 Probable Maximum Precipitation Depth

The design basis for the local intense precipitation is the all-season, 1-square-mile or point PMP as obtained from the NWS Hydro-meteorological Reports No. 51 and 52 (HMR 51 and HMR 52) (**Reference 208** and **209**). Section 5 of HMR 51 (**Reference 208**) indicates that the PMP values of the southernmost isoline can be used to determine the PMP values for basins located further south, such as a basin in southern Florida where Units 6 & 7 are located. Rainfall records near the site also indicate that no large rainfall events have occurred since the publication

of HMR 51 and HMR 52 that would potentially influence the information presented in these publications ([References 215](#) and [216](#)).

The PMP depths given in HMR 51 are for durations ranging from 6 to 72 hours and for drainage areas ranging from 10 to 20,000 square miles. Using these depths, HMR 52 provides procedures for estimating short duration point (or 1 square mile) PMP depths for durations up to 1 hour. [Table 2.4.2-207](#) presents the 1 square-mile PMP depths and intensities for various durations at Units 6 & 7. [Figure 2.4.2-201](#) shows the PMP intensities for storm durations up to 1 hour for Units 6 & 7.

2.4.2.3.2 Local Drainage Components and Subbasins

The Units 6 & 7 power block layout and the finish grades are shown in [Figure 2.4.2-202](#).

As addressed in [Subsection 2.4.1](#), the plant area for Units 6 & 7 is built up from the existing ground with backfill and is surrounded by a retaining wall structure. The design grade for all safety-related facilities, which consist of the containment/shields building and auxiliary building, is at 26 feet NAVD 88. The grade elevation adjacent to the retaining wall is 19 feet NAVD 88. The top of the retaining wall is at 21.5 feet NAVD 88 along the eastern perimeter and the western perimeter and 20 feet NAVD 88 along the northern perimeter. The southern portion of the plant area is occupied by the makeup water reservoir with the top of the reservoir wall at 24 feet NAVD 88. The safety-related facilities are located in the center portion of the power block and the finish grade slopes away from the safety-related facilities at a minimum slope of 0.5 percent towards the retaining wall in the east and west and to the swales to the north and south of the power block. The swales located south of the power block also collect overflow from the makeup water reservoir during extreme rainfall events, and the swales to the north of the power block collect stormwater runoff from the switchyard (Clear Sky substation) and parking lot areas. The stormwater runoff flow paths, principally along the swales, in the plant area are shown in [Figure 2.4.2-203](#). Water levels in the swales during the local PMP are determined along their flow paths using the step-backwater methodology in the computer program HEC-RAS ([Reference 210](#)).

For typical design storm events, runoff from the power block area is conveyed via catch basins and storm drains to a system of piping and swales that release to the industrial wastewater facility/cooling canal system (cooling canals).

Turkey Point Units 6 & 7
COL Application
Part 2 — FSAR

For the local PMP flooding analysis, all storm drains, culverts, and catch basins are assumed clogged and not functioning. All flow during PMP condition is assumed to be either overland or directed through the swales.

The local PMP analysis considered the combined event of a preceding large precipitation event such as a 40% PMP by considering saturated ground cover conditions and no available storage area in the makeup water reservoir at the beginning of the PMP event. Additionally, high water levels in the industrial wastewater facility as a result of flooding events in the Atlantic Ocean and Biscayne Bay were also considered. As indicated in [Subsection 2.4.3](#), the 500-year flood level in the Biscayne Bay is elevation 10.8 feet NAVD 88, which is more than 10 feet below the eastern and western edges of the site perimeter retaining wall at elevation 21.5 feet NAVD 88, where local PMP flows are discharged over the retaining wall.

Even if the highly unlikely combined event of the probable maximum storm surge (PMSS) associated with the probable maximum hurricane (PMH) in the Atlantic Ocean and Biscayne Bay is considered coincident with the peak discharge from the local PMP there would be no impact to the safety functions of the plant. As indicated in FSAR [Subsection 2.4.5](#), the PMSS water level at the site is elevation 21.1 feet NAVD 88, which is below the top of the eastern and western edges of the perimeter retaining wall. Thus, precipitation runoff flowing over the retaining wall and the resulting flood elevations in the power block area are not influenced by the PMSS elevation in Biscayne Bay and industrial wastewater facility.

In the PMP flood analysis, the swales south of the power block are referred to as flow paths Cooling Tower East (CT-E) and West (CT-W). The swales north of the power block are referred to as flow paths Parking Lot East (PL-E) and Switchyard West (SY-W). The flow path SY-W consists of two parallel swales located in the switchyard and access road area north of the power block. These two parallel swales are modeled as one channel because during a PMP event the road is postulated to be overtopped.

As shown on [Figures 2.4.2-203](#) and [2.4.2-204](#), the plant area has been delineated into 22 drainage subbasins, with 19 subbasins for the power block area and 3 subbasins for the makeup water reservoir. The overflow from the makeup water reservoir during the PMP contributes to the flood flow discharges along flow paths CT-E and CT-W. [Table 2.4.2-208](#) lists the individual subbasin drainage areas of the 19 subbasins for the power block of Units 6 & 7.

Turkey Point Units 6 & 7
COL Application
Part 2 — FSAR

The northern half of the switchyard and the parking lot is graded down from the high-point elevations of 21.0 feet and 23.0 feet NAVD 88, respectively, toward the retaining wall along the northern perimeter of the plant site where grade elevation is at 19.0 feet NAVD 88. Runoff from these areas would generally behave as sheet flows during the PMP condition. The runoff would flow along and over the swales on the northern perimeters of the plant area into the industrial wastewater facility. Therefore, the runoffs from these areas do not contribute flood flow to the major flow paths defined in the PMP analysis.

2.4.2.3.3 Peak Discharges

The steady-state backwater routing option of the U.S. Army Corps of Engineers computer program HEC-RAS ([Reference 210](#)) is used to estimate the maximum local PMP water levels along the flow paths as defined above. Cross section locations along the flow paths, i.e., the modeled channels, are shown on [Figure 2.4.2-204](#).

For the runoff analysis, the PMP peak discharge at each subbasin outlet (referred to as the point of interest or POI) is determined using the Rational Method. To estimate the total discharge at each subbasin outlet, the drainage area of all subbasins upstream is included as summarized in [Table 2.4.2-209](#) and shown on [Figure 2.4.2-203](#). The PMP peak discharge for each subbasin is determined using the runoff coefficient, PMP intensity, and the subbasin POI drainage area.

Runoff coefficients were selected to represent the ground cover conditions of the subbasins. Conservative coefficients are selected to represent saturated ground conditions and as a result of the intense rainfall that would occur during a PMP event. Thus, a runoff coefficient of 1.0, representing 100 percent impervious surfaces, is conservatively selected for all subbasins.

The time of concentration for each subbasin is estimated using the National Resources Conservation Service (NRCS) methodologies ([Reference 211](#)). The flow paths for the time of concentration estimation are illustrated in [Figure 2.4.2-203](#). It is postulated that in the first 100 feet of each flow path, the runoff is in the sheet flow regime. Beyond the sheet flow area, the runoff behaves as shallow concentrated flow until it reaches the swales. According to the guidance of the U.S. Army Corps of Engineers, to account for the nonlinear response during the PMP event, the estimated time of concentration for each subbasin should be reduced ([Reference 212](#)). Hence, the estimated time of concentration for each subbasins is reduced by 25 percent. The adjusted times of concentration at the subbasin POIs are in the range of 5 minutes to 19.9 minutes, as summarized in

Table 2.4.2-211. The corresponding PMP intensities are determined from **Figure 2.4.2-201**. Accordingly, the Rational Method, based on runoff coefficients, rainfall intensities, and subbasin drainage areas as determined above, is used to compute the peak discharges at each of the subbasin POIs. The PMP peak discharges for the POIs are listed in **Table 2.4.2-211**.

The top of wall of the makeup water reservoir is at 24 feet NAVD 88. It is conservatively assumed that the makeup water reservoir is full at the beginning of the PMP event. In order to estimate the peak discharge contribution from the reservoir, the overflow discharge on all sides of the reservoir is also calculated using the Rational Method. The PMP peak runoff is computed based on the area of the reservoir, a runoff coefficient of 1.0, and the 5-minute PMP intensity of 74.5 inches per hour for the 5-minute storm duration, as presented in **Table 2.4.2-212**. The depth of the contributing overflow discharges from the makeup water reservoir to flow paths CT-E and CT-W is determined using the broad-crested weir equation and the length of reservoir wall, as presented in **Table 2.4.2-213**. The peak discharges for subbasin POIs 1S3, 1S4, and 2S2, as presented in **Table 2.4.2-211**, include the overflow contributions from the makeup water reservoir.

The invert elevations of the swales and the modeled cross sections are determined from the finish grade elevation, as shown in **Figure 2.4.2-202**. The invert elevations and dimensions of the swales are presented in **Table 2.4.2-210**. The peak discharges of subbasins determined in **Table 2.4.2-211** are distributed to the channel cross sections, as shown in **Table 2.4.2-214**.

Road crossings and retaining walls are modeled as inline structures with broad-crested weirs with a discharge coefficient of 2.6 (**Reference 213**). Using this fairly low weir coefficient produces higher and, therefore, more conservative water levels over the structures. **Figure 2.4.2-234** is a schematic of a typical cross section at the East and West retaining walls and shows the overflow condition during the local PMP event.

The Manning's roughness coefficients (n values) for the channel and over bank areas are assigned based on guidance provided by Chow (**Reference 214**). A Manning's n of 0.033, the maximum value for dredged straight channel with short grass and few weeds, is used for the swales. The power block area is primarily paved with impervious surface. The area between the power block and the makeup water reservoir and the area between the power block and the parking lot/switchyard consist of grassy surfaces. These areas are represented by a

Manning's n of 0.05, which is the maximum value for over bank areas with high grass.

2.4.2.3.4 Flood Elevations

The results of the HEC-RAS model analysis and the estimated local PMP water levels at each model cross section are shown in [Table 2.4.2-215](#). Plots of representative cross sections along the model flow paths are shown on [Figures 2.4.2-205](#) through [2.4.2-233](#). In the figures, blue color indicates water and gray color indicates no-flow area such as obstruction or blockage associated with the wall and road crossings. There are no abrupt changes in the channel cross sections in the HEC-RAS model flow paths near the safety-related facilities, and the simulated water surface profile has a mild slope.

As shown in [Table 2.4.2-215](#), the maximum local PMP water level in the power block area is approximately 24.5 feet NAVD 88, which is approximately 1.5 feet below the design grade of 26 feet NAVD 88 for safety-related structures. A sensitivity analysis was performed by adding interpolated cross sections to the HEC-RAS model ([Reference 217](#)). The results of the sensitivity analysis indicate that the maximum water level in the power block area due to the local PMP is not sensitive to additional interpolated cross sections.

In addition to the HEC-RAS analysis, the maximum water depth where runoff will be sheet flowing toward the east and west away from the safety-related structures in the power block is estimated. Grading in the power block is designed to provide positive drainage such that the local PMP ground and roof runoff will sheet flow toward the swales and the perimeters of the plant area, away from the buildings, to prevent flooding at the safety-related facilities. The peak water levels over the retaining wall are estimated as shown in [Table 2.4.2-216](#) using the broad-crested weir equation where the retaining walls are treated as weirs. Some ponding may occur near the catch basins and other depressed areas. The ponding will be temporary and localized to the depressed areas.

The PMP-generated sheet flow depths near the safety-related structures are calculated. Peak discharges from the roofs of the safety-related structures are estimated using the Rational Method. The flow depth is estimated using Manning's Equation by postulating that the runoff will flow over the sides of the safety-related buildings and then sheet flow away from the buildings. [Figure 2.4.2-235](#) shows a schematic cross section that illustrates the sheet flow condition away from a safety-related building. A conservatively high Manning's n value of 0.05 is used to represent a rough surface and to account for an increased roughness

Turkey Point Units 6 & 7
COL Application
Part 2 — FSAR

influence on shallow flows over the surface. The estimated sheet flow depths in the yard area next to the safety-related structures are presented in [Table 2.4.2-217](#). As shown in the table, the sheet flow depth near the safety-related facilities during a PMP is estimated to be in the range of 1.4 inches to 3.8 inches. The highest finish grade elevation in the power block is at 25.5 feet NAVD 88, which is 6 inches below the design grade of 26 feet NAVD 88 for safety-related facilities. Therefore, safety-related facilities are not impacted by PMP flooding.

The site drainage facilities and grading in the power block area are designed to provide positive drainage to evacuate runoff from the local PMP storm event. The finished floor slab elevations for all safety-related buildings are located above the estimated local PMP flood levels. No flood protection measures are considered necessary for the safety-related facilities of Units 6 & 7.

2.4.2.4 References

201. Federal Emergency *Management Agency, Flood Insurance Study*, Dade County, Florida and Incorporated Areas, Revised March 1994.
202. Lovelace, J., and B. McPherson, *Effects of Hurricane Andrew (1992) on Wetlands in Southern Florida and Louisiana*, U.S. Geological Survey, Water Supply Paper 2425, 1996.
203. Rappaport, E., *Preliminary Report: Hurricane Andrew, 16–28 August, 1992*, National Hurricane Center, National Oceanic and Atmosphere Administration. Available at <http://www.nhc.noaa.gov/1992andrew.html>, accessed October 2, 2008.
204. U.S. Geological Survey, *South Florida Information Access-Data Exchange*, Hydrology Data. Available at http://sofia.usgs.gov/exchange/zucker_woods_patino/index.html#card, accessed October 15, 2008.
205. National Oceanic and Atmospheric Administration, *Tide and Current Record*, Gage 8723214, Virginia Key, Florida. Available at <http://tidesandcurrents.noaa.gov/geo.shtml?location=8723214>, accessed October 3, 2008.
206. National Oceanic and Atmospheric Administration, *Tide and Current Record*, Gage 8723970, Vaca Key, Florida. Available at <http://tidesandcurrents.noaa.gov/geo.shtml?location=8723970>, accessed October 15, 2008.

Turkey Point Units 6 & 7
COL Application
Part 2 — FSAR

207. American National Standards Institute/American Nuclear Society, *American National Standard for Determining Design Basis Flooding at Nuclear Reactor Sites*, ANSI/ANS-2.8-1992, 1992 (withdrawn 2002).
208. National Oceanic and Atmospheric Administration, NWS, *Probable Maximum Precipitation Estimates*, United States East of the 105th Meridian, Hydrometeorological Report 51, June 1978.
209. National Oceanic and Atmospheric Administration, U.S. National Weather Service, *Application of Probable Maximum Precipitation Estimates — United States East of the 105th Meridian*, Hydrometeorological Report 52, August 1992.
210. U.S. Army Corps of Engineers, *Hydrologic Engineering Center*, River Analysis System, Ver. 3.1.3, May 2005.
211. U.S. Department of Agriculture, Natural Resources Conservation Service, *Urban Hydrology for Small Watersheds*, Technical Release 55, June 1986.
212. U.S. Army Corps of Engineers, *Flood-Runoff Analysis*, EM 1110-2-1417, August 1994.
213. Brater, E., and H. King, *Handbook of Hydraulics*, 6th ed., 1982.
214. Chow, V., *Open Channel Hydraulics*, 1959.
215. Southeast Regional Climate Center, *Climate Data*, Station 084091, Homestead Exp STN, Florida, Station 087760, Royal Palm Ranger Station, Florida, Station 087020, Perrine 4W, Florida. Available at http://www.sercc.com/climateinfo/historical/historical_fl.html, accessed April 7, 2010.
216. Southeast Regional Climate Center, *Climate Data*, Station 081716 Miami 12 SSW, Florida 1931–1958, Station 085678 Miami 12 SSW, Florida 1958–1988, Station 085663 Miami WSCMO Airport, Florida, Station 085658 Miami Beach, Florida, Station 083909 Hialeah, Florida and Station 088780 Tamiami Trail 40 MI BEN, Florida. Available at http://www.sercc.com/climateinfo/historical/historical_fl.html, accessed July 2, 2010.

Turkey Point Units 6 & 7
COL Application
Part 2 — FSAR

217. U.S. Army Corps of Engineers, *Hydrologic Engineering Center, River Analysis System*, Ver. 4.0, March 2008.

Turkey Point Units 6 & 7
COL Application
Part 2 — FSAR

PTN COL 2.4-2

Table 2.4.2-201
List of Major Flooding Events in Miami-Dade County, Florida

Flood Date	Flooding Event Description
September 6–22, 1926	The most severe storm recorded to hit the Miami area. Storm tides of 13.2 and 10.9 feet NGVD (11.7 and 9.4 feet NAVD 88) were recorded at Coconut Grove and mouth of Miami River, respectively.
October 30–November 8, 1935	Tide of 8 feet NGVD (6.5 feet NAVD 88) was recorded at Dinner Key, south of Miami.
September 11–19, 1947	Tides at Miami Beach reached 4.2 feet NGVD (2.7 feet NAVD 88).
October 9–15, 1947	This hurricane resulted in minor flooding on the bay side of Miami Beach.
October 15–19, 1950	Hurricane King: Tides of over 5 feet NGVD (3.5 feet NAVD 88) were recorded in Biscayne Bay.
August 20–September 5, 1964	Hurricane Cleo: Tides of 3.6 feet NGVD (2.1 feet NAVD 88) were recorded at the Florida Keys.
August 27–September 12, 1965	Hurricane Betsy: Considerable flooding between the greater Miami and Palm Beach area occurred. Miami Beach reported at 6.1 feet mean low water tide.
August 24, 1992	Hurricane Andrew: This hurricane caused considerable damage in South Dade County near Homestead.

Reference 201

Turkey Point Units 6 & 7
COL Application
Part 2 — FSAR

PTN COL 2.4-2

Table 2.4.2-202
Peak Water Levels at Card Sound Canal Gage

Card Sound Canal (USGS Gage 251816080232200)			
Date	Time	Water Level (feet, NAVD 88)	Tropical Storm/Hurricane Event
11/12/2003	2:15	1.11	N/A
10/24/2005	8:00	1.01	Hurricane Wilma (10/15–10/26)
11/5/2006	0:15	0.69	N/A
10/8/2004	7:30	0.15	Tropical Storm Matthew (10/8–10/11)

Note: N/A = No association found
Reference 204

PTN COL 2.4-2

Table 2.4.2-203
Peak Water Levels at Manatee Bay Creek Gage

Manatee Bay Creek (USGS Gage 251549080251200)			
Date	Time	Water Level (feet, NAVD 88)	Tropical Storm/Hurricane Event
9/20/2005	16:00	2.27	Hurricane Rita (9/18–9/26)
11/11/2003	14:45	0.97	N/A
10/16/2005	14:00	0.9	Hurricane Wilma (10/15–10/26)
5/22/2007	19:00	0.83	N/A

Note: N/A = No association found
Reference 204

Turkey Point Units 6 & 7
COL Application
Part 2 — FSAR

PTN COL 2.4-2

Table 2.4.2-204
Peak Water Levels at West Highway Creek Gage

West Highway Creek (USGS Gage 251433080265000)			
Date	Time	Water Level (feet, NAVD 88)	Tropical Storm/Hurricane Event
10/24/2005	19:45	2.59	Hurricane Wilma (10/15–10/26)
10/16/1999	3:30	1.86	Hurricane Irene (10/12–10/19)
9/5/2004	17:30	1.38	Hurricane Ivan (9/2–9/24)
9/21/1999	15:00	1.05	Tropical Storm Harvey (9/19–9/22)

Reference 204

PTN COL 2.4-2

Table 2.4.2-205
Peak Tide Level at Virginia Key Tide Gage Station

Virginia Key (Station ID: 8723214) Station Extreme Tide Level Report				
Peak Tide Level (feet STND ^(a))	Peak Tide Level (feet NAVD 88)	Date of Peak Level	Time of Peak level	Tropical Storm/Hurricane Event
14.92	2.79	10/24/2005	12:30	Hurricane Wilma (10/15–10/26)
14.30	2.17	9/20/2005	16:00	Hurricane Rita (9/18–9/26)
14.28	2.15	11/15/1994	11:12	Hurricane Gordon (11/8–11/21)
14.25	2.12	10/15/1999	19:42	Hurricane Irene (10/12–10/19)
14.05	1.92	9/26/2008	11:12	Hurricane Ike (9/1–9/14)

(a) STND = Station Datum

Reference 205

Turkey Point Units 6 & 7
COL Application
Part 2 — FSAR

PTN COL 2.4-2

Table 2.4.2-206
Peak Tide Level at Vaca Key Tide Gage Station

Vaca Key (Station ID: 8723970) Station Extreme Tide Level Report				
Peak Tide Level (feet STND ^(a))	Peak Tide Level (feet NAVD 88)	Date of Peak Level	Time of Peak Level	Tropical Storm/Hurricane Event
9.31	5.43	10/24/2005	15:42	Hurricane Wilma (10/15–10/26)
5.07	1.19	8/26/2005	8:48	Hurricane Katrina (8/23–9/3)
4.94	1.06	10/07/1974	3:18	Subtropical Storm Unnamed Subtropical Storm 4 (10/4–10/9)
4.89	1.01	10/16/1999	1:12	Hurricane Irene (10/12–10/19)
4.86	0.98	11/06/2001	6:42	Hurricane Michelle (10/29–11/6)

(a) STND = Station Datum
Reference 205

PTN COL 2.4-2

Table 2.4.2-207
Units 6 & 7 Site Short Duration Local PMP Depths

PMP Duration & Area	1-hr, Point Location Ratio	Source	PMP Depth (in)	Intensity (in/hr)
6 hr, 10 mi ²	—	HMR 51 — Figure 18	32.0	5.3
1 hr, point location	—	HMR 52 — Figure 24	19.4	19.4
30 min, point	0.73	HMR 52 — Figure 38	14.2	28.3
15 min, point	0.50	HMR 52 — Figure 37	9.7	38.8
5 min, point	0.32	HMR 52 — Figure 36	6.2	74.5

Turkey Point Units 6 & 7
COL Application
Part 2 — FSAR

PTN COL 2.4-2

Table 2.4.2-208
Subbasin Drainage Area

Subbasin	Drainage Area (ft ²)	Drainage Area (acres)
1S1	130,000	2.98
1S2	34,375	0.79
1S3	428,750	9.84
1S4	297,500	6.83
1N1	150,000	3.44
1N2	30,625	0.70
1N3	150,000	3.44
1N4	135,563	3.11
1N5	572,600	13.15
1N6	1,052,800	24.17
1W1	285,156	6.55
1W2	194,688	4.47
2S1	60,625	1.39
2S2	610,156	14.01
2N1	102,813	2.36
2N2	102,813	2.36
2N3	883,722	20.29
2N4	67,500	1.55
2E1	766,875	17.61

Turkey Point Units 6 & 7
COL Application
Part 2 — FSAR

PTN COL 2.4-2

Table 2.4.2-209
Subbasin Point of Interest (POI) Drainage Areas

Subbasin POI	Contributing Upstream Subbasin	Total Drainage Area (acres)
1S1	1S1	2.98
1S3	1S1, 1S3	12.83
1S4	1S1-1S4	20.45
2S1	2S1	1.39
2S2	2S1, 2S2	15.40
1N1	1N1	3.44
1N3	1N1, 1N3	6.89
1N5	1N1, 1N3, 1N5	20.03
1N6	1N1-1N6	48.02
2N1	2N1	2.36
2N3	2N1-2N4	26.56
1W1	1W1	6.55
1W2	1W2	4.47
2E1	2E1	17.61

Turkey Point Units 6 & 7
COL Application
Part 2 — FSAR

PTN COL 2.4-2

Table 2.4.2-210 (Sheet 1 of 2)
Swale Dimensions^(a)

	Cross Section	Swale Invert NAVD 88 (ft)
Cooling Tower EAST	1100	20.3
	900	19.9
	700	19.5
	400	18.9
	300	18.6
	200	18.4
	150	18.3
	100	18.2
	50	18.1
	20	18.1
	Cross Section	Swale Invert NAVD 88 (ft)
Cooling Tower WEST	1100	20.3
	900	19.9
	700	19.5
	500	19.1
	350	18.8
	300	18.6
	200	18.4
	150	18.3
	100	18.2
	20	18.1
	Cross Section	Swale Invert NAVD 88 (ft)
Parking Lot - East	900	19.5
	800	19.3
	600	19.0
	400	18.6
	300	18.5
	240	18.4
	200	18.3
	50	18.1
	20	18.0

Turkey Point Units 6 & 7
COL Application
Part 2 — FSAR

PTN COL 2.4-2

Table 2.4.2-210 (Sheet 2 of 2)
Swale Dimensions^(a)

	Cross Section	North of Power Block Area Swale Invert NAVD 88 (ft)	Clear Sky Substation Swale Invert NAVD 88 (ft)
Switch Yard - West	1290	19.5	N/A
	1190	19.3	21.0
	1000	19.1	20.5
	800	18.9	20.0
	600	18.7	19.5
	500	18.5	19.2
	300	18.3	18.8
	200	18.2	18.5
	150	18.2	18.4
	50	18.0	18.1
	20	18.0	18.1

(a) Side-slope of all swales is 2 (horizontal) to 1 (vertical)

Turkey Point Units 6 & 7
COL Application
Part 2 — FSAR

PTN COL 2.4-2

Table 2.4.2-211
Units 6 & 7 Subbasin Local PMP Peak Discharges

Subbasin POI	Drainage Area (acres)	Composite Runoff Coefficient	Time of Concentration (min)	Rainfall Intensity (in/hr)	PMP Peak Discharge without MWR Overflow (cfs)	MWR Overflow (cfs)	Combined PMP Peak Discharge (cfs)
1S1	2.98	1	5.0	74.5	222.3	—	222.3
1S3	12.83	1	8.1	63.0	808.1	275.1	1083.2
1S4	20.45	1	10.0	56.0	1145.0	235.8	1655.9
2S1	1.39	1	5.0	74.5	103.7	—	103.7
2S2	15.40	1	10.3	56.0	862.3	534.5	1396.8
1N1	3.44	1	5.0	74.5	256.5	—	256.5
1N3	6.89	1	5.5	73.0	502.8	—	502.8
1N5	20.03	1	13.0	47.0	941.5	—	941.5
1N6	48.02	1	19.9	36.0	1728.6	—	1728.6
2N1	2.36	1	5.2	74.0	174.7	—	174.7
2N3	26.56	1	13.6	45.0	1195.1	—	1195.1
1W1	6.55	1	5.0	74.5	487.7	—	487.7
1W2	4.47	1	5.0	74.5	333.0	—	333.0
2E1	17.61	1	5.5	73.0	1285.2	—	1285.2

Turkey Point Units 6 & 7
COL Application
Part 2 — FSAR

PTN COL 2.4-2

Table 2.4.2-212
Flow Depth Over the Crest of Makeup Water Reservoir Walls

Reservoir	Storage Reservoir Wall Length (feet)	Drainage Area (acres)	PMP Peak Discharge (cfs)	Flow Depth over MWR Wall (feet)	Flow Depth over MWR Wall (inches)
CT	5717	36.19	2696.1	0.32	3.8

PTN COL 2.4-2

Table 2.4.2-213
Total Discharge Over the Northern Wall of the Makeup Water Reservoir

Subbasin	MWR Wall Length (feet)	Flow Depth over MWR Wall (feet)	PMP Peak Discharge From MWR Overflow (cfs)
CT-1N1	583	0.32	275.1
CT-1N2	500	0.32	235.8
CT-2N1	1133	0.32	534.5
sum=	2217	sum=	1045.4

Turkey Point Units 6 & 7
COL Application
Part 2 — FSAR

PTN COL 2.4-2

Table 2.4.2-214 (Sheet 1 of 2)
Units 6 & 7 Flow Path Cross Section PMP Peak Discharge

	Cross Section Channel Station	Contributing Subbasin	Subbasin POI Cumulative Peak Discharge (cfs)	Subbasin POI Incremental Peak Discharge (cfs)	Peak Discharge Allocation Percentage	Upstream Contributing Subbasins	Cross Section Peak Discharge (cfs)
Cooling Tower West	1100	1S3	1083.2	1083.2	5%	1S1, 1S3, CT-1N1	54.2
	900	1S3	1083.2	1083.2	50%	1S1, 1S3, CT-1N1	541.6
	700	1S3	1083.2	1083.2	100%	1S1, 1S3, CT-1N1	1083.2
	500	1S4	1655.9	572.7	10%	1S1-1S4,CT-1N1, CT-1N2	1140.5
	350	1S4	1655.9	572.7	30%	1S1-1S4,CT-1N1, CT-1N2	1255.0
	300	1S4	1655.9	572.7	40%	1S1-1S4,CT-1N1, CT-1N2	1312.3
	200	1S4	1655.9	572.7	70%	1S1-1S4,CT-1N1, CT-1N2	1484.1
	150	1S4	1655.9	572.7	80%	1S1-1S4,CT-1N1, CT-1N2	1541.4
	100	1S4	1655.9	572.7	90%	1S1-1S4,CT-1N1, CT-1N2	1598.6
	20	1S4	1655.9	572.7	100%	1S1-1S4,CT-1N1, CT-1N3	1655.9
0	1S4	1655.9	572.7	100%	1S1-1S4,CT-1N1, CT-1N2	1655.9	
Cooling Tower East	1100	2S2	1396.8	1396.8	5%	2S1, 2S2, CT-2N1	69.8
	900	2S2	1396.8	1396.8	20%	2S1, 2S2, CT-2N1	279.4
	700	2S2	1396.8	1396.8	40%	2S1, 2S2, CT-2N1	558.7
	400	2S2	1396.8	1396.8	60%	2S1, 2S2, CT-2N1	838.1
	300	2S2	1396.8	1396.8	70%	2S1, 2S2, CT-2N1	977.8
	200	2S2	1396.8	1396.8	80%	2S1, 2S2, CT-2N1	1117.5
	150	2S2	1396.8	1396.8	85%	2S1, 2S2, CT-2N1	1187.3
	100	2S2	1396.8	1396.8	90%	2S1, 2S2, CT-2N1	1257.2
	50	2S2	1396.8	1396.8	95%	2S1, 2S2, CT-2N1	1327.0
	20	2S2	1396.8	1396.8	100%	2S1, 2S2, CT-2N2	1396.8
0	2S2	1396.8	1396.8	100%	2S1, 2S2, CT-2N1	1396.8	
Parking Lot — East	900	2N3	1195.1	1195.1	5%	2N1, 2N2, 2N4	59.8
	800	2N3	1195.1	1195.1	15%	2N1, 2N2, 2N4	179.3
	600	2N3	1195.1	1195.1	35%	2N1, 2N2, 2N4	418.3
	400	2N3	1195.1	1195.1	55%	2N1, 2N2, 2N4	657.3
	300	2N3	1195.1	1195.1	60%	2N1, 2N2, 2N4	717.1
	240	2N3	1195.1	1195.1	75%	2N1, 2N2, 2N4	896.3
	200	2N3	1195.1	1195.1	80%	2N1, 2N2, 2N4	956.1
	50	2N3	1195.1	1195.1	95%	2N1, 2N2, 2N4	1135.3
	20	2N3	1195.1	1195.1	100%	2N1, 2N2, 2N5	1195.1
0	2N3	1195.1	1195.1	100%	2N1, 2N2, 2N4	1195.1	

Turkey Point Units 6 & 7
COL Application
Part 2 — FSAR

PTN COL 2.4-2

Table 2.4.2-214 (Sheet 2 of 2)
Units 6 & 7 Flow Path Cross Section PMP Peak Discharge

	Cross Section Channel Station	Contributing Subbasin	Subbasin POI Cumulative Peak Discharge (cfs)	Subbasin POI Incremental Peak Discharge (cfs)	Peak Discharge Allocation Percentage	Upstream Contributing Subbasins	Cross Section Peak Discharge (cfs)
Switch Yard — West	1290	1N5	941.5	941.5	20%	1N1, 1N53, 1N5	188.3
	1190	1N5	941.5	941.5	45%	1N1, 1N53, 1N5	423.7
	1000	1N5	941.5	941.5	100%	1N1, 1N53, 1N5	941.5
	800	1N6	1728.6	787.1	10%	1N1-1N6	1020.2
	600	1N6	1728.6	787.1	35%	1N1-1N6	1217.0
	500	1N6	1728.6	787.1	50%	1N1-1N6	1335.0
	300	1N6	1728.6	787.1	70%	1N1-1N6	1492.5
	200	1N6	1728.6	787.1	80%	1N1-1N6	1571.2
	150	1N6	1728.6	787.1	85%	1N1-1N6	1610.5
	50	1N6	1728.6	787.1	95%	1N1-1N6	1689.2
	20	1N6	1728.6	787.1	100%	1N1-1N7	1728.6
	0	1N6	1728.6	787.1	100%	1N1-1N6	1728.6

Turkey Point Units 6 & 7
COL Application
Part 2 — FSAR

PTN COL 2.4-2

Table 2.4.2-215 (Sheet 1 of 3)
HEC-RAS Model Result for Units 6 & 7

Flow Path	Reach	Channel Station (cross section)	Profile	PMP Peak Discharge (cfs)	Minimum Channel Elevation NAVD 88 (ft)	Water Surface Elevation NAVD 88 (ft)	Channel Velocity (ft/s)	Froude Number
Cooling Tower W	PMP CT-W	1100	PMP	54.2	20.3	24.5	0.1	0.01
Cooling Tower W	PMP CT-W	1000 ^(a)	PMP	54.2	20.1	24.5	0.1	0.01
Cooling Tower W	PMP CT-W	900	PMP	541.6	19.9	24.5	1.5	0.13
Cooling Tower W	PMP CT-W	800 ^(a)	PMP	541.6	19.7	24.4	1.5	0.13
Cooling Tower W	PMP CT-W	700	PMP	1083.2	19.5	24.4	3.3	0.27
Cooling Tower W	PMP CT-W	600 ^(a)	PMP	1083.2	19.3	24.3	2.9	0.23
Cooling Tower W	PMP CT-W	500	PMP	1140.5	19.1	24.2	3.2	0.25
Cooling Tower W	PMP CT-W	425 ^(a)	PMP	1140.5	18.9	24.2	3.3	0.26
Cooling Tower W	PMP CT-W	350	PMP	1255.0	18.8	24.1	3.9	0.30
Cooling Tower W	PMP CT-W	300	PMP	1312.3	18.6	24.1	4.2	0.32
Cooling Tower W	PMP CT-W	200	PMP	1484.1	18.4	23.9	5.5	0.42
Cooling Tower W	PMP CT-W	150	PMP	1541.4	18.3	23.7	6.3	0.49
Cooling Tower W	PMP CT-W	100	PMP	1598.6	18.2	23.2	10.2	0.82
Cooling Tower W	PMP CT-W	80	Inline Structure	1598.6	N/A	23.2	N/A	N/A
Cooling Tower W	PMP CT-W	20	PMP	1655.9	18.1	22.8	3.3	0.28
Cooling Tower W	PMP CT-W	10	Inline Structure	1655.9	N/A	22.8	N/A	N/A
Cooling Tower W	PMP CT-W	0	PMP	1655.9	0.0	1.3	6.5	1.01
Cooling Tower E	PMP CT-E	1100	PMP	69.8	20.3	23.9	0.2	0.02
Cooling Tower E	PMP CT-E	1000 ^(a)	PMP	69.8	20.1	23.9	0.2	0.02
Cooling Tower E	PMP CT-E	900	PMP	279.4	19.9	23.9	1.0	0.09
Cooling Tower E	PMP CT-E	800 ^(a)	PMP	279.4	19.7	23.8	1.0	0.09
Cooling Tower E	PMP CT-E	700	PMP	558.7	19.5	23.8	2.1	0.19
Cooling Tower E	PMP CT-E	600 ^(a)	PMP	558.7	19.3	23.8	2.2	0.19
Cooling Tower E	PMP CT-E	500 ^(a)	PMP	558.7	19.1	23.7	2.3	0.19
Cooling Tower E	PMP CT-E	400	PMP	838.1	18.9	23.6	4.5	0.37
Cooling Tower E	PMP CT-E	300	PMP	977.8	18.6	23.1	7.3 ^(b)	0.63

Turkey Point Units 6 & 7
COL Application
Part 2 — FSAR

PTN COL 2.4-2

Table 2.4.2-215 (Sheet 2 of 3)
HEC-RAS Model Result for Units 6 & 7

Flow Path	Reach	Channel Station (cross section)	Profile	PMP Peak Discharge (cfs)	Minimum Channel Elevation NAVD 88 (ft)	Water Surface Elevation NAVD 88 (ft)	Channel Velocity (ft/s)	Froude Number
Cooling Tower E	PMP CT-E	250	Inline Structure	977.8	N/A	23.1	N/A	N/A
Cooling Tower E	PMP CT-E	200	PMP	1117.5	18.4	23.1	5.9 ^(b)	0.50
Cooling Tower E	PMP CT-E	150	PMP	1187.3	18.3	22.9	6.6 ^(b)	0.56
Cooling Tower E	PMP CT-E	100	PMP	1257.2	18.2	22.7	6.9 ^(b)	0.59
Cooling Tower E	PMP CT-E	50	PMP	1327.0	18.1	22.6	5.4 ^(b)	0.46
Cooling Tower E	PMP CT-E	20	PMP	1396.8	18.1	22.7	2.7	0.23
Cooling Tower E	PMP CT-E	10	Inline Structure	1396.8	N/A	22.7	N/A	N/A
Cooling Tower E	PMP CT-E	0	PMP	1396.8	0.0	0.6	4.6	1.00
Switch Yard	PMP SY-W	1290	PMP	188.3	19.5	22.9	0.5	0.05
Switch Yard	PMP SY-W	1190	PMP	423.7	19.3	22.9	0.5	0.08
Switch Yard	PMP SY-W	1095 ^(a)	PMP	423.7	19.2	22.9	0.4	0.06
Switch Yard	PMP SY-W	1000	PMP	941.5	19.1	22.9	0.8	0.12
Switch Yard	PMP SY-W	900 ^(a)	PMP	941.5	19.0	22.8	0.8	0.11
Switch Yard	PMP SY-W	800	PMP	1020.2	18.9	22.8	0.9	0.12
Switch Yard	PMP SY-W	700 ^(a)	PMP	1020.2	18.8	22.8	0.8	0.12
Switch Yard	PMP SY-W	600	PMP	1217	18.6	22.8	1.1	0.14
Switch Yard	PMP SY-W	500	PMP	1335	18.5	22.7	1.1	0.15
Switch Yard	PMP SY-W	400 ^(a)	PMP	1335	18.4	22.7	1.1	0.15
Switch Yard	PMP SY-W	300	PMP	1492.5	18.3	22.7	1.2	0.17
Switch Yard	PMP SY-W	200	PMP	1571.2	18.2	22.6	1.3	0.18
Switch Yard	PMP SY-W	150	PMP	1610.5	18.2	22.6	1.6	0.21
Switch Yard	PMP SY-W	125	Inline Structure	1610.5	N/A	22.6	N/A	N/A
Switch Yard	PMP SY-W	50	PMP	1689.2	18.0	22.6	1.5	0.2
Switch Yard	PMP SY-W	20	PMP	1728.6	18.0	22.6	1.1	0.14
Switch Yard	PMP SY-W	10	Inline Structure	1728.6	N/A	22.6	N/A	N/A
Switch Yard	PMP SY-W	0	PMP	1728.6	0.0	1.3	6.6	1.01
Parking Lot	PMP PL E	900	PMP	59.8	19.4	22.8	0.2	0.02

Turkey Point Units 6 & 7
COL Application
Part 2 — FSAR

PTN COL 2.4-2

Table 2.4.2-215 (Sheet 3 of 3)
HEC-RAS Model Result for Units 6 & 7

Flow Path	Reach	Channel Station (cross section)	Profile	PMP Peak Discharge (cfs)	Minimum Channel Elevation NAVD 88 (ft)	Water Surface Elevation NAVD 88 (ft)	Channel Velocity (ft/s)	Froude Number
Parking Lot	PMP PL E	800	PMP	179.3	19.3	22.8	0.5	0.05
Parking Lot	PMP PL E	700 ^(a)	PMP	179.3	19.1	22.8	0.5	0.04
Parking Lot	PMP PL E	600	PMP	418.3	19.0	22.8	1.1	0.1
Parking Lot	PMP PL E	500 ^(a)	PMP	418.3	18.8	22.8	1.1	0.1
Parking Lot	PMP PL E	400	PMP	657.3	18.6	22.8	1.8	0.16
Parking Lot	PMP PL E	300	PMP	717.1	18.5	22.7	2.0	0.17
Parking Lot	PMP PL E	240	PMP	896.3	18.4	22.7	2.5	0.22
Parking Lot	PMP PL E	200	PMP	956.1	18.3	22.7	2.8	0.24
Parking Lot	PMP PL E	88	Inline Structure	956.1	N/A	22.7	N/A	N/A
Parking Lot	PMP PL E	50	PMP	1135.3	18.1	22.6	2.7	0.23
Parking Lot	PMP PL E	20	PMP	1195.1	18.0	22.6	3.8	0.32
Parking Lot	PMP PL E	10	Inline Structure	1195.1	N/A	22.6	N/A	N/A
Parking Lot	PMP PL E	0	PMP	1195.1	0.0	1	8.6	1.48

(a) Interpolated Cross Section

(b) Segments of the drainage swale experiencing high velocity are protected with rip rap or concrete lining

N/A Not applicable for Inline Structure

Turkey Point Units 6 & 7
COL Application
Part 2 — FSAR

PTN COL 2.4-2

Table 2.4.2-216
Sheet Flow Depth Over the Retaining Wall

Subbasin	PMP Peak Discharge for Subbasin (cfs)	Weir Coefficient for Broad Crested Weir	Retaining Wall Length (ft)	Flow Depth over the Retaining Wall NAVD 88 (ft)	Maximum Water Level over Retaining wall (ft NAVD 88)
1W1	487.7	2.6	733.0	0.4	21.9
1W2	333.0	2.6	666.0	0.3	21.8
2E1	1232.4	2.6	1133.0	0.6	22.1

PTN COL 2.4-2

Table 2.4.2-217
Sheet Flow Depth Near Safety-Related Buildings

Subbasin	Proportion of Safety Buildings Contributing to Sheet Flow Depth	Safety Building (acre)	PMP Peak Discharge Generated Near Safety Building (cfs)	Manning's <i>n</i>	Width, <i>b</i> (ft)	Slope, <i>S</i>	Flow Depth (ft)	Flow Depth (in)	Maximum Water Level Near Safety-Related Structures (ft NAVD 88)
1W1	1/4 of Containment Building, 1/20 of Auxiliary Building	0.13	9.7	0.1	100.0	0.005	0.2	1.9	25.7
1W2	1/4 of Containment Building	0.10	7.5	0.1	125.0	0.005	0.1	1.4	25.6
2E1	1/3 of Containment Building, 2/3 of Auxiliary Building	1.24	92.4	0.1	300.0	0.005	0.3	3.8	25.8

Turkey Point Units 6 & 7
COL Application
Part 2 — FSAR

PTN COL 2.4-2

Figure 2.4.2-201 Units 6 & 7 Site Local PMP Intensity-Duration Curve

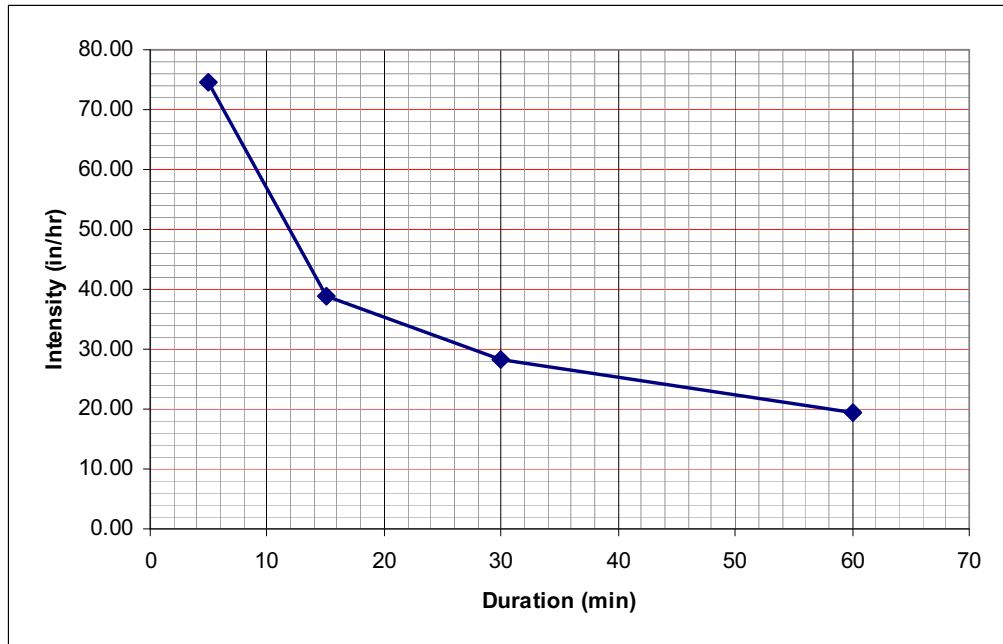

Turkey Point Units 6 & 7
COL Application
Part 2 — FSAR

PTN COL 2.4-2

Figure 2.4.2-202 Units 6 & 7 Power Block Finish Grading Plan



Turkey Point Units 6 & 7
 COL Application
 Part 2 — FSAR

PTN COL 2.4-2 **Figure 2.4.2-203 Units 6 & 7 Local PMP Analysis Subbasin Drainage Areas**

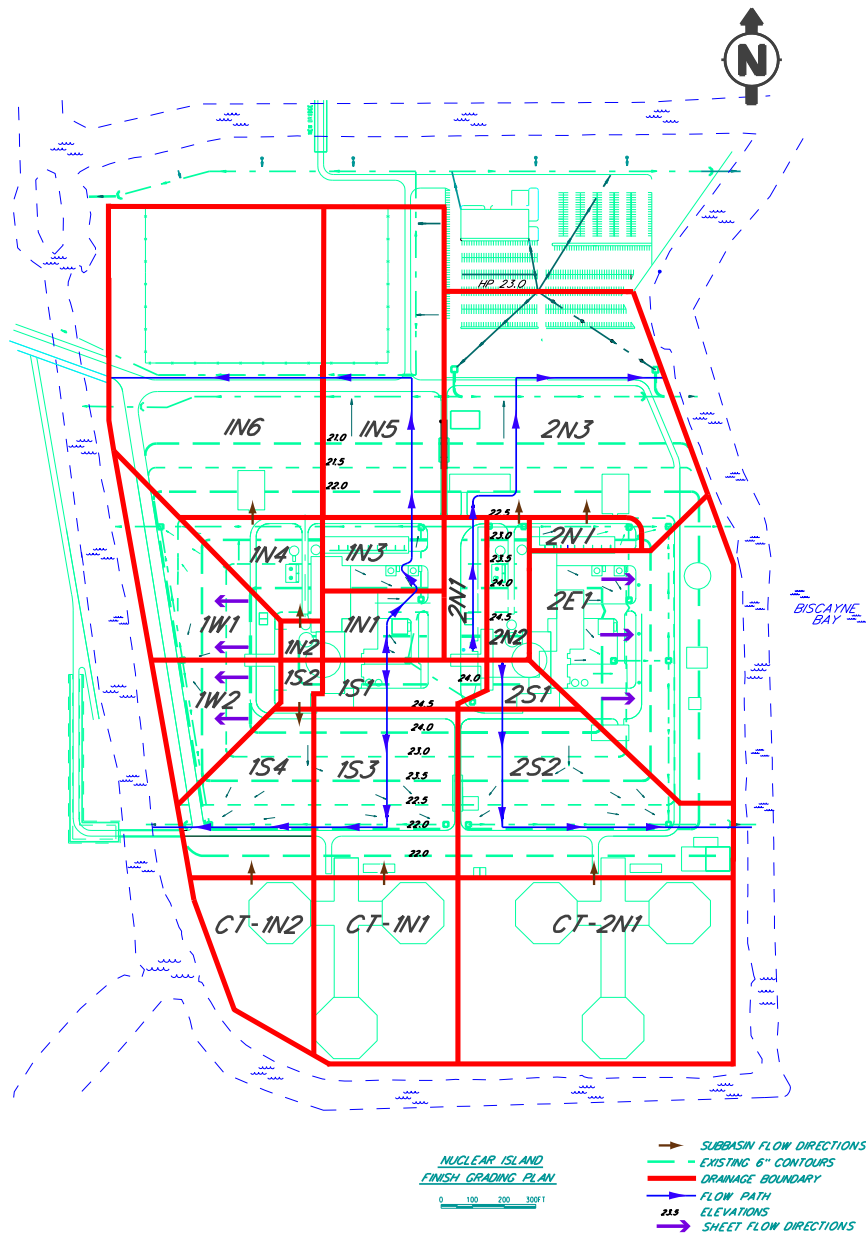

Turkey Point Units 6 & 7
 COL Application
 Part 2 — FSAR

PTN COL 2.4-2

Figure 2.4.2-204 Units 6 & 7 Local PMP Analysis HEC-RAS Cross Section Locations

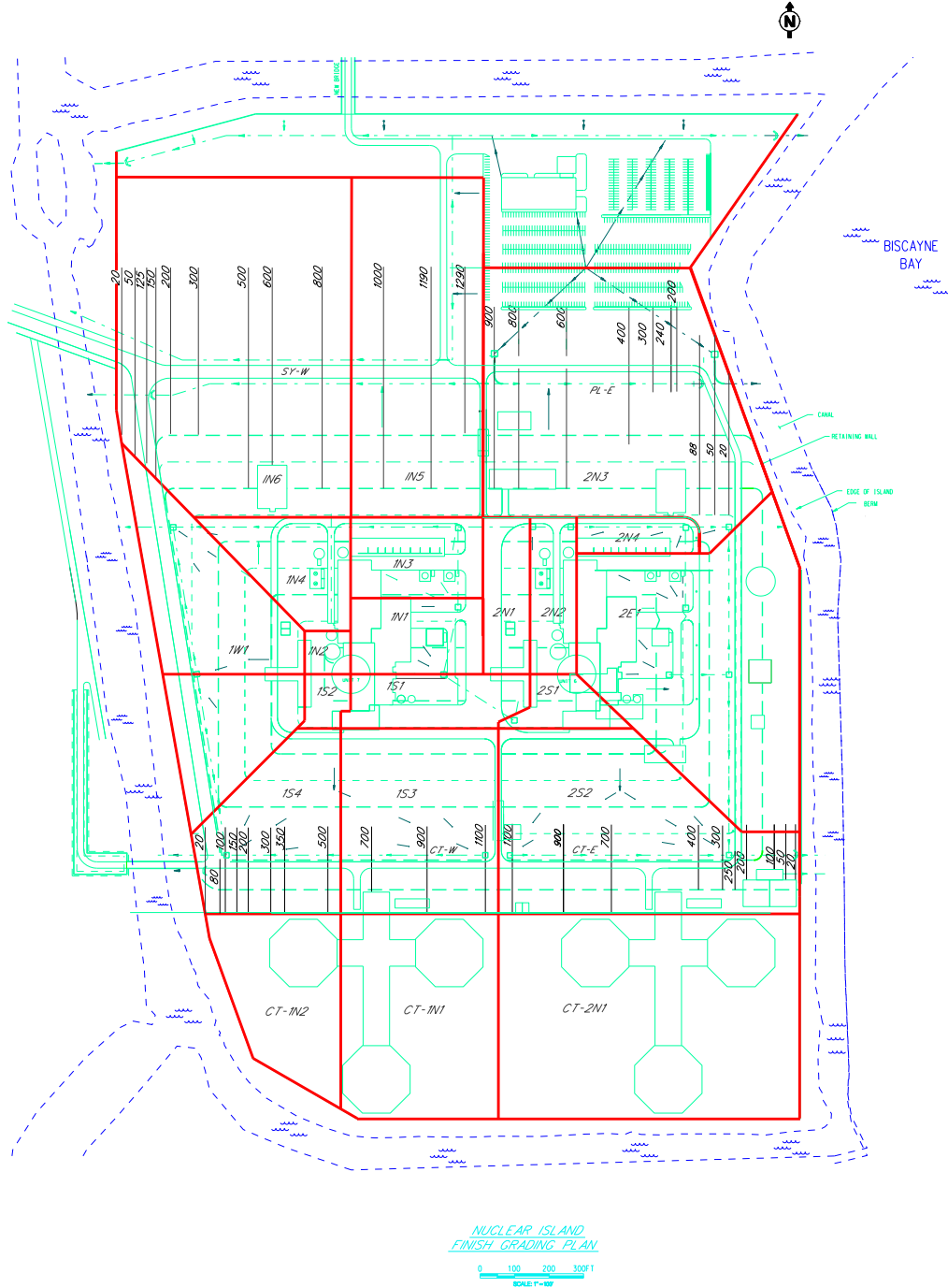

Note: River Station 0 of each of the HEC-RAS model flow paths is located 20 to 30 feet downstream of River Station 20 and does not represent any physical feature.

Turkey Point Units 6 & 7
COL Application
Part 2 — FSAR

PTN COL 2.4-2

Figure 2.4.2-205 Units 6 & 7 Local PMP HEC-RAS Cross Section and PMP Flood Level: Cooling Tower East Cross Section 1100

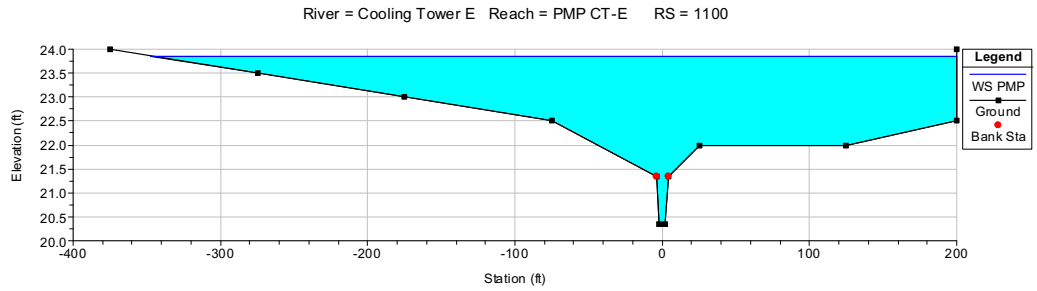

PTN COL 2.4-2

Figure 2.4.2-206 Units 6 & 7 Local PMP HEC-RAS Cross Section and PMP Flood Level: Cooling Tower East Cross Section 700

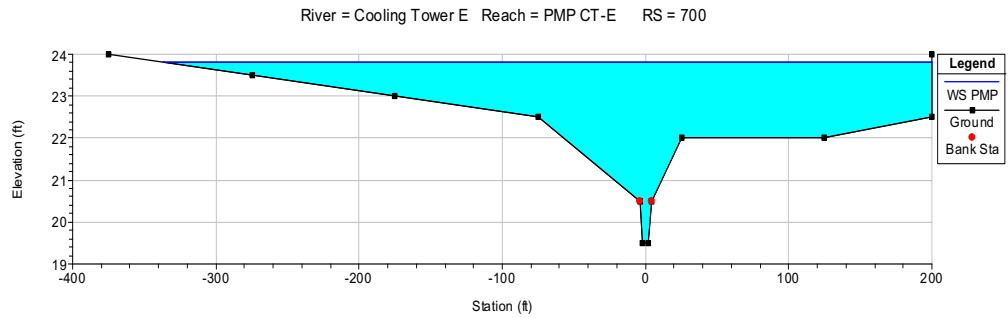

PTN COL 2.4-2

Figure 2.4.2-207 Units 6 & 7 Local PMP HEC-RAS Cross Section and PMP Flood Level: Cooling Tower East Cross Section 250 Inline Structure (IS)

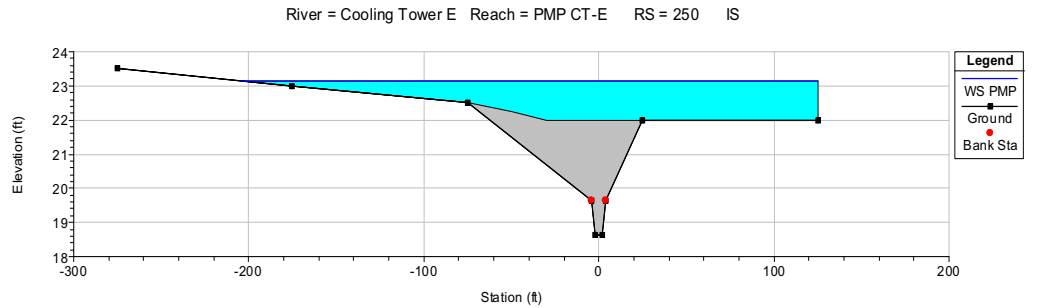

Turkey Point Units 6 & 7
COL Application
Part 2 — FSAR

PTN COL 2.4-2

Figure 2.4.2-208 Units 6 & 7 Local PMP HEC-RAS Cross Section and PMP Flood Level: Cooling Tower East Cross Section 50

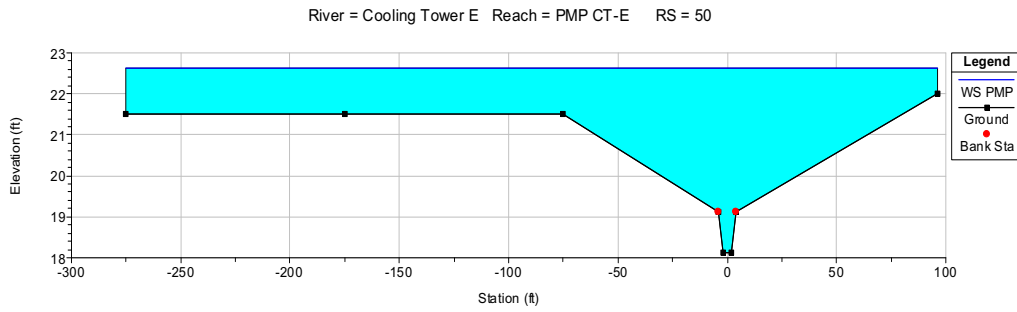

PTN COL 2.4-2

Figure 2.4.2-209 Units 6 & 7 Local PMP HEC-RAS Cross Section and PMP Flood Level: Cooling Tower East Cross Section 10 IS

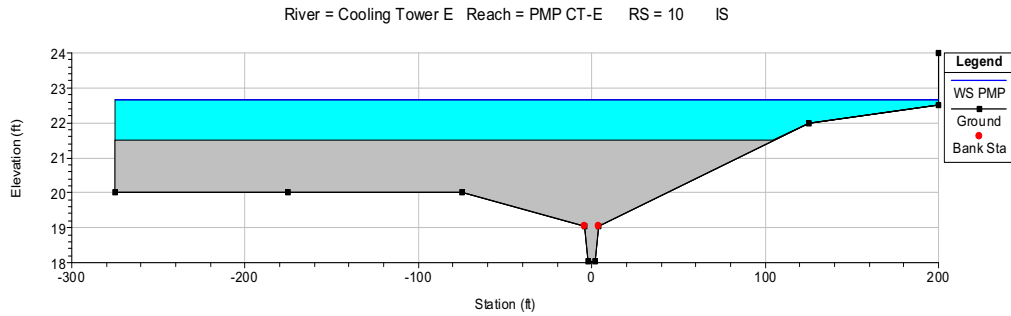

PTN COL 2.4-2

Figure 2.4.2-210 Units 6 & 7 Local PMP HEC-RAS Cross Section and PMP Flood Level: Cooling Tower West Cross Section 1100

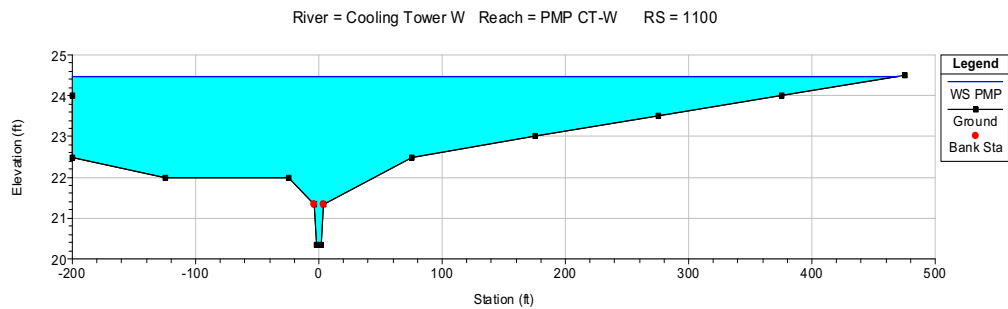

Turkey Point Units 6 & 7
 COL Application
 Part 2 — FSAR

PTN COL 2.4-2

Figure 2.4.2-211 Units 6 & 7 Local PMP HEC-RAS Cross Section and PMP Flood Level: Cooling Tower West Cross Section 700

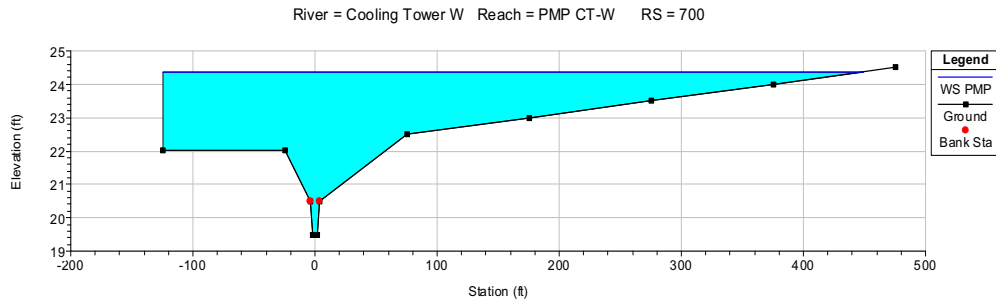

PTN COL 2.4-2

Figure 2.4.2-212 Units 6 & 7 Local PMP HEC-RAS Cross Section and PMP Flood Level: Cooling Tower West Cross Section 300

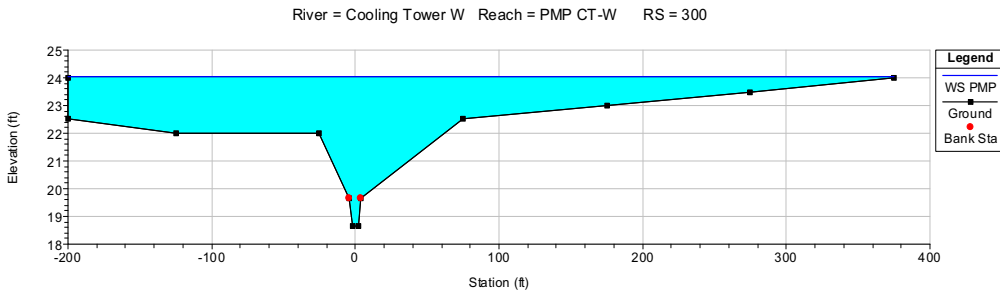

PTN COL 2.4-2

Figure 2.4.2-213 Units 6 & 7 Local PMP HEC-RAS Cross Section and PMP Flood Level: Cooling Tower West Cross Section 100

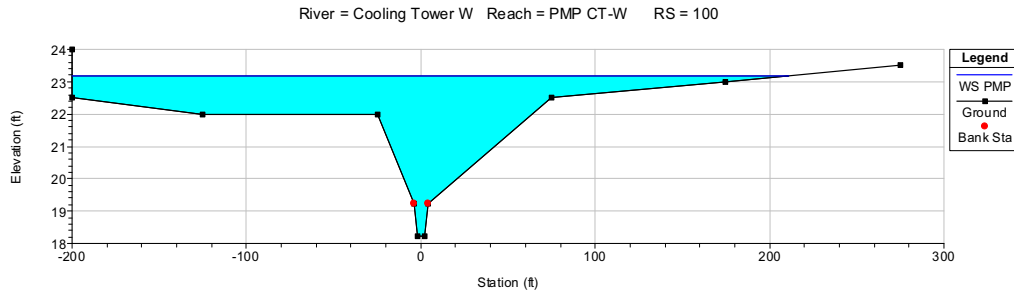

Turkey Point Units 6 & 7
 COL Application
 Part 2 — FSAR

PTN COL 2.4-2

Figure 2.4.2-214 Units 6 & 7 Local PMP HEC-RAS Cross Section and PMP Flood Level: Cooling Tower West Cross Section 80 IS

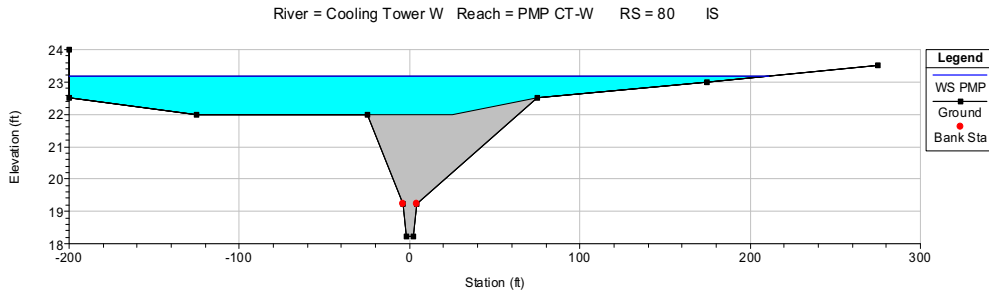

PTN COL 2.4-2

Figure 2.4.2-215 Units 6 & 7 Local PMP HEC-RAS Cross Section and PMP Flood Level: Cooling Tower West Cross Section 20

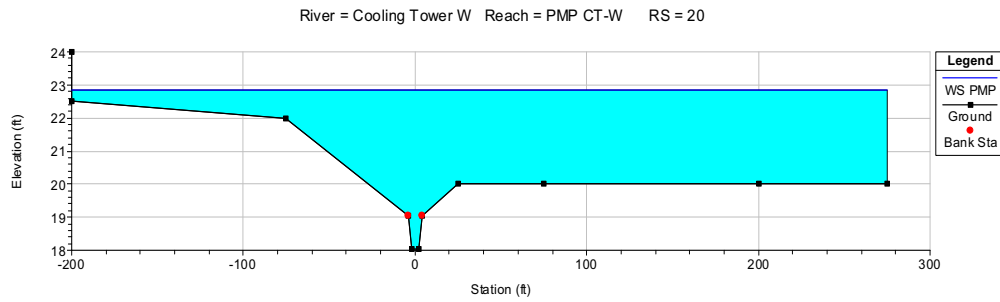

PTN COL 2.4-2

Figure 2.4.2-216 Units 6 & 7 Local PMP HEC-RAS Cross Section and PMP Flood Level: Cooling Tower West Cross Section 10 IS

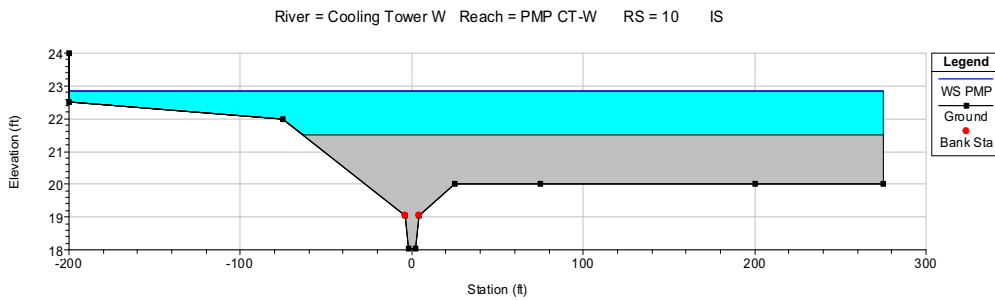

Turkey Point Units 6 & 7
 COL Application
 Part 2 — FSAR

PTN COL 2.4-2

Figure 2.4.2-217 Units 6 & 7 Local PMP HEC-RAS Cross Section and PMP Flood Level: Parking Lot East Cross Section 900

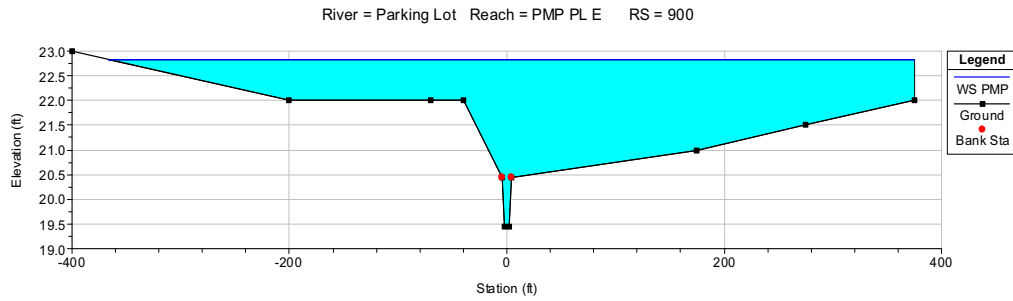

PTN COL 2.4-2

Figure 2.4.2-218 Units 6 & 7 Local PMP HEC-RAS Cross Section and PMP Flood Level: Parking Lot East Cross Section 600

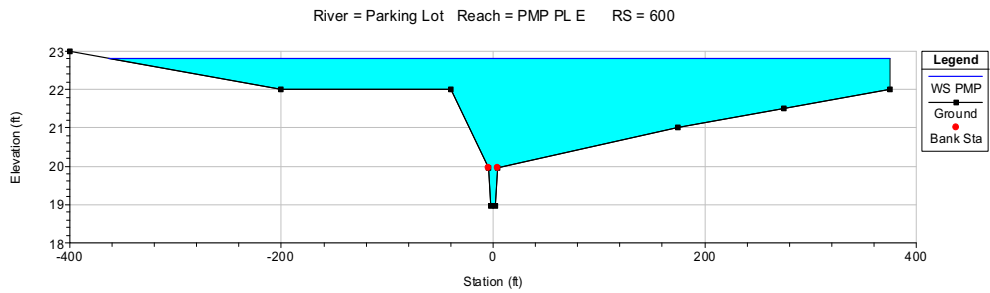

PTN COL 2.4-2

Figure 2.4.2-219 Units 6 & 7 Local PMP HEC-RAS Cross Section and PMP Flood Level: Parking Lot East Cross Section 200

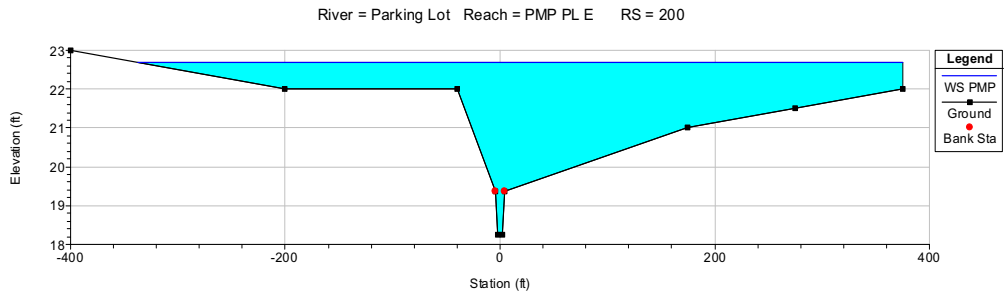

Turkey Point Units 6 & 7
 COL Application
 Part 2 — FSAR

PTN COL 2.4-2

Figure 2.4.2-220 Units 6 & 7 Local PMP HEC-RAS Cross Section and PMP Flood Level: Parking Lot East Cross Section 88 IS

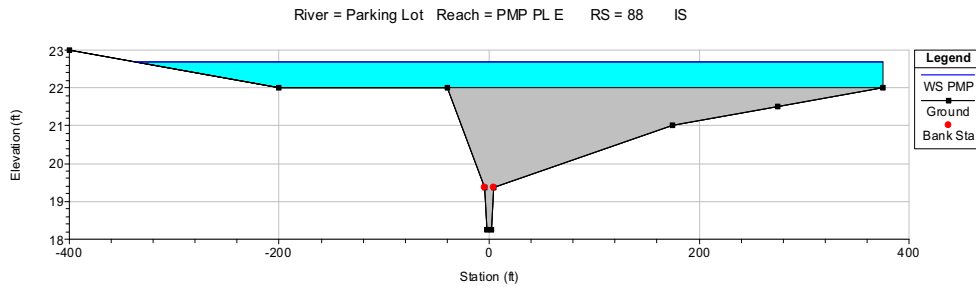

PTN COL 2.4-2

Figure 2.4.2-221 Units 6 & 7 Local PMP HEC-RAS Cross Section and PMP Flood Level: Parking Lot East Cross Section 50

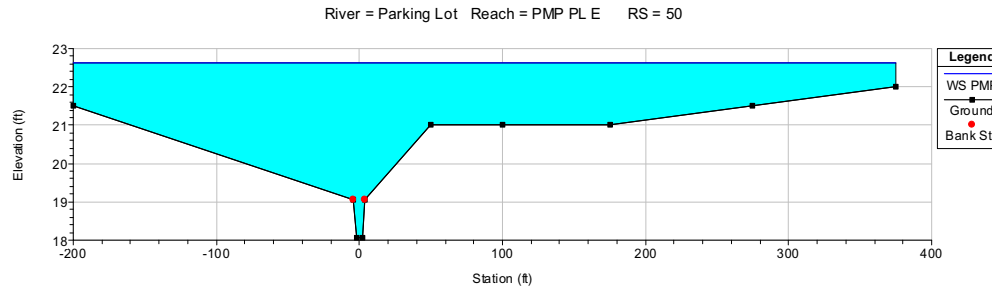

PTN COL 2.4-2

Figure 2.4.2-222 Units 6 & 7 Local PMP HEC-RAS Cross Section and PMP Flood Level: Parking Lot East Cross Section 20

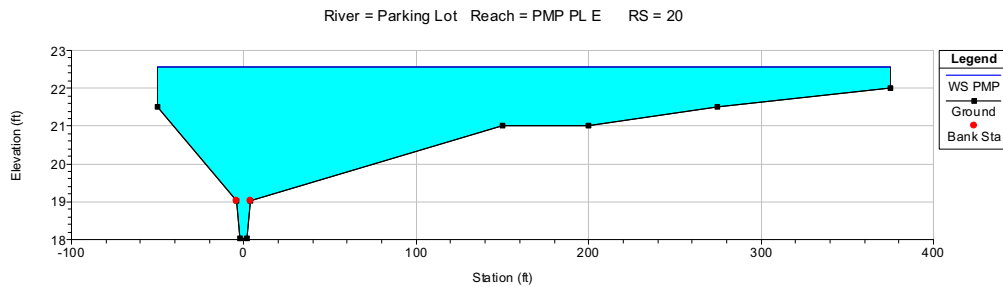

Turkey Point Units 6 & 7
 COL Application
 Part 2 — FSAR

PTN COL 2.4-2

Figure 2.4.2-223 Units 6 & 7 Local PMP HEC-RAS Cross Section and PMP Flood Level: Parking Lot East Cross Section 10 IS

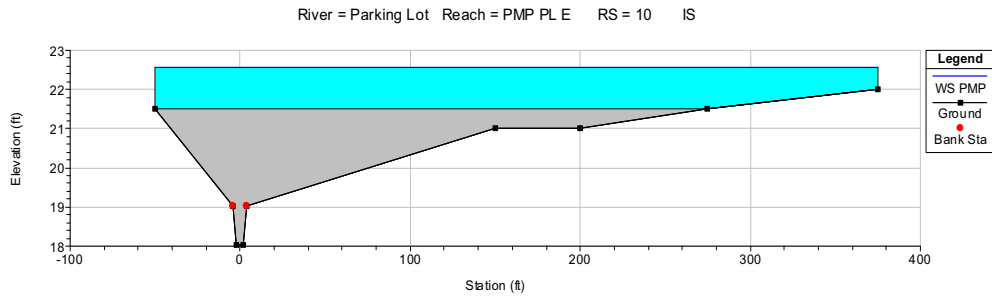

PTN COL 2.4-2

Figure 2.4.2-224 Units 6 & 7 Local PMP HEC-RAS Cross Section and PMP Flood Level: Parking Lot East Cross Section 1290

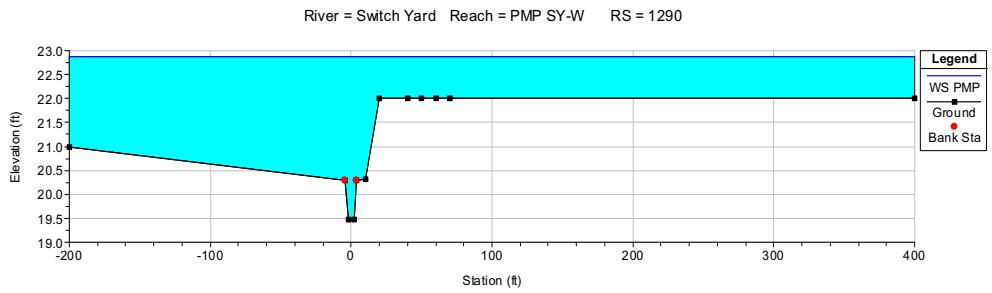

PTN COL 2.4-2

Figure 2.4.2-225 Units 6 & 7 Local PMP HEC-RAS Cross Section and PMP Flood Level: Parking Lot East Cross Section 1190

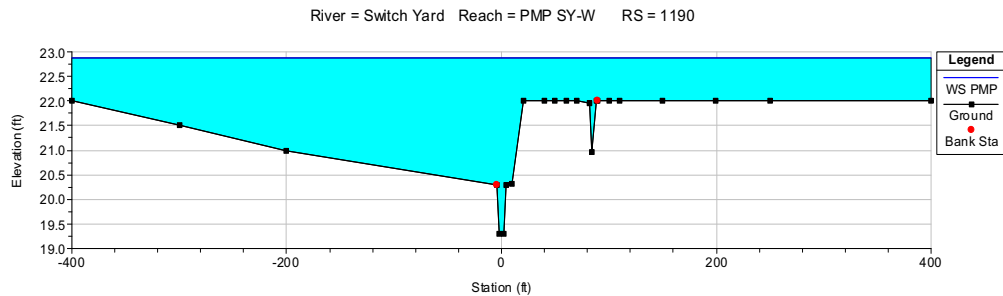

Turkey Point Units 6 & 7
COL Application
Part 2 — FSAR

PTN COL 2.4-2

Figure 2.4.2-226 Units 6 & 7 Local PMP HEC-RAS Cross Section and PMP Flood Level: Switchyard West Cross Section 800

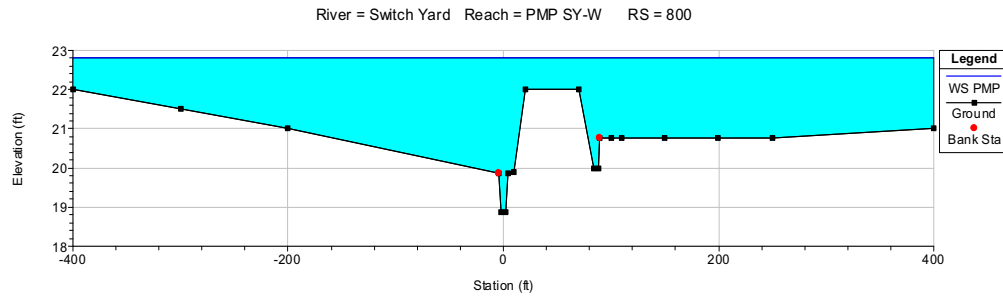

PTN COL 2.4-2

Figure 2.4.2-227 Units 6 & 7 Local PMP HEC-RAS Cross Section and PMP Flood Level: Switchyard West Cross Section 500

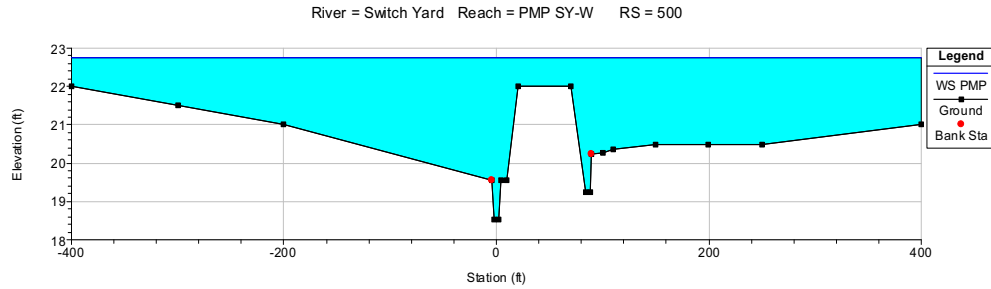

PTN COL 2.4-2

Figure 2.4.2-228 Units 6 & 7 Local PMP HEC-RAS Cross Section and PMP Flood Level: Switchyard West Cross Section 200

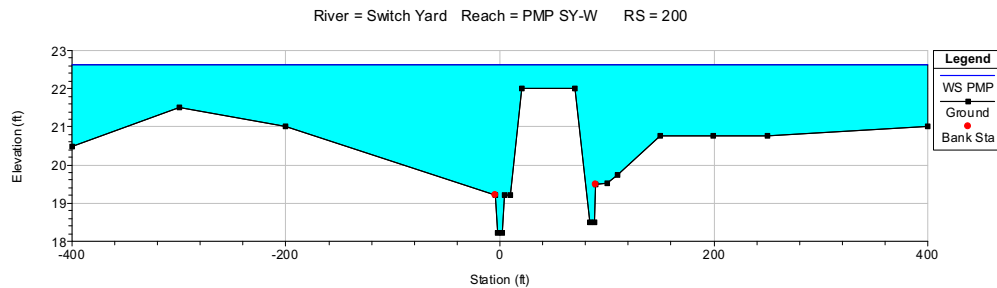

Turkey Point Units 6 & 7
 COL Application
 Part 2 — FSAR

PTN COL 2.4-2

Figure 2.4.2-229 Units 6 & 7 Local PMP HEC-RAS Cross Section and PMP Flood Level: Switchyard West Cross Section 150

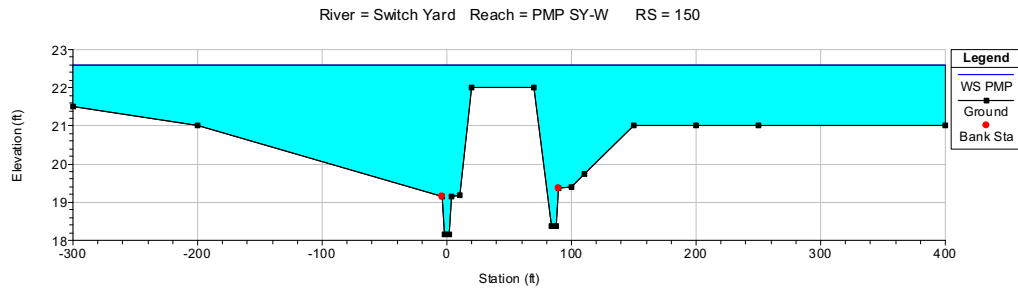

PTN COL 2.4-2

Figure 2.4.2-230 Units 6 & 7 Local PMP HEC-RAS Cross Section and PMP Flood Level: Switchyard West Cross Section 125 IS

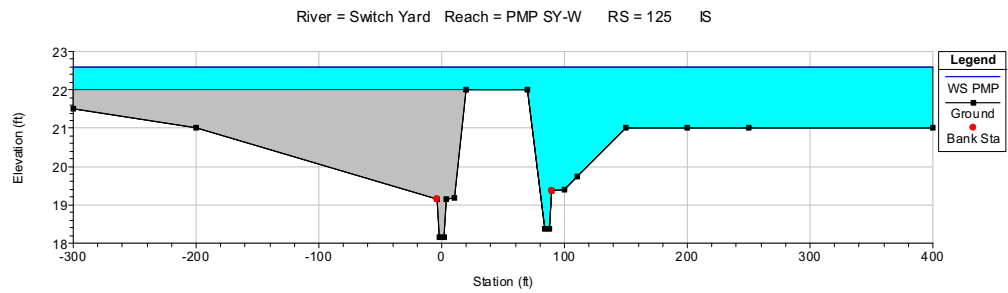

PTN COL 2.4-2

Figure 2.4.2-231 Units 6 & 7 Local PMP HEC-RAS Cross Section and PMP Flood Level: Switchyard West Cross Section 50

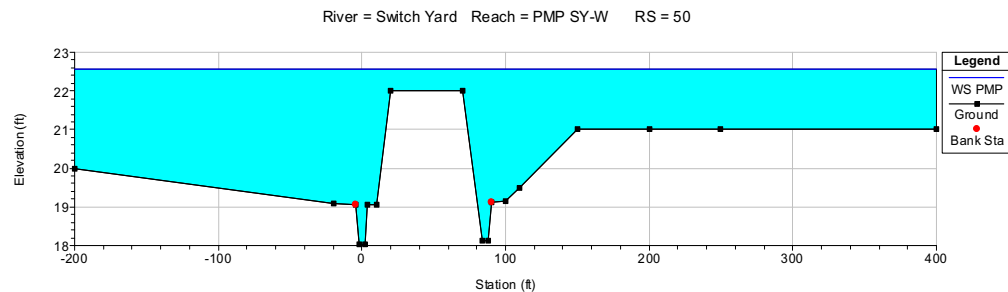

Turkey Point Units 6 & 7
COL Application
Part 2 — FSAR

PTN COL 2.4-2

Figure 2.4.2-232 Units 6 & 7 Local PMP HEC-RAS Cross Section and PMP Flood Level: Switchyard West Cross Section 20

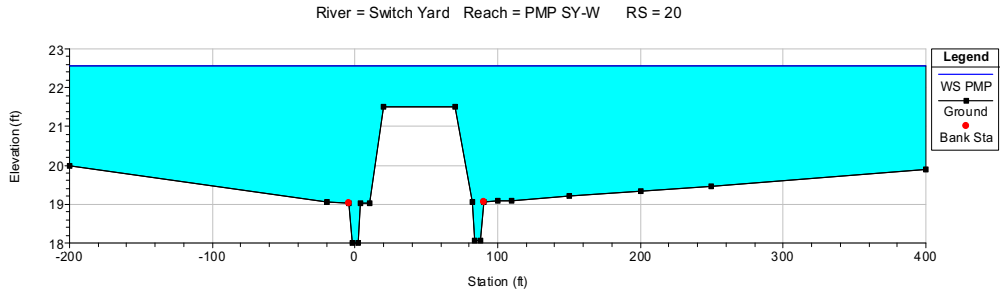

PTN COL 2.4-2

Figure 2.4.2-233 Units 6 & 7 Local PMP HEC-RAS Cross Section and PMP Flood Level: Switchyard West Cross Section 10 IS

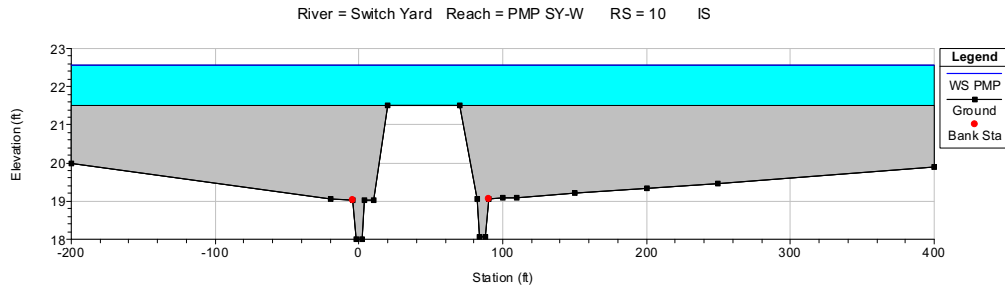

Turkey Point Units 6 & 7
COL Application
Part 2 — FSAR

Figure 2.4.2-234 Schematic of Overflow Condition at the Retaining Wall Boundary

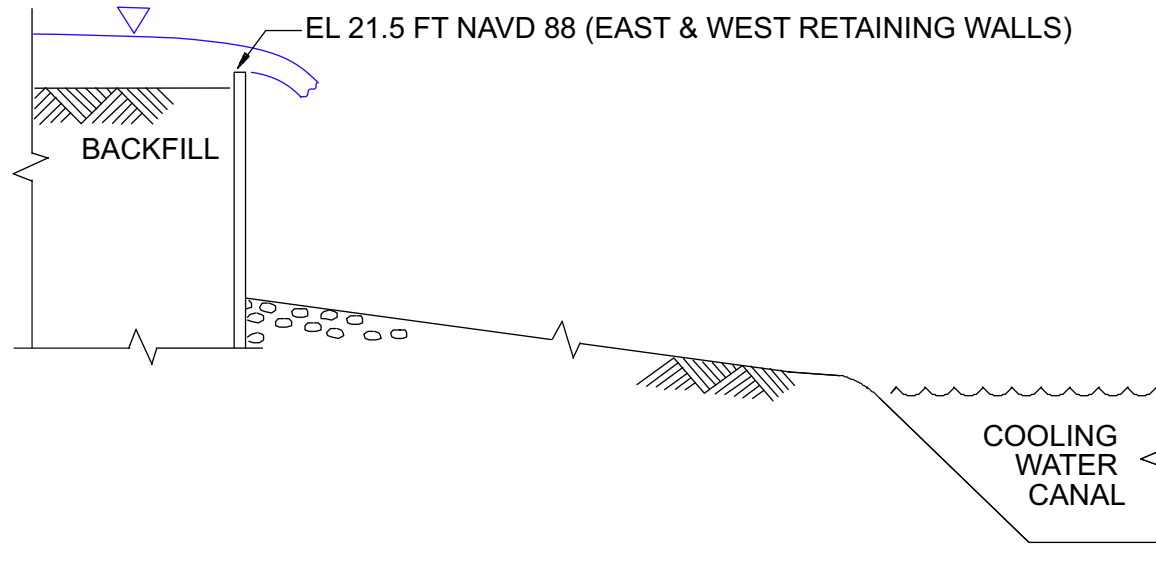

Note: Not to scale.

Turkey Point Units 6 & 7
COL Application
Part 2 — FSAR

Figure 2.4.2-235 Schematic of a Typical Sheet Flow Condition Adjacent to a Safety-related Building

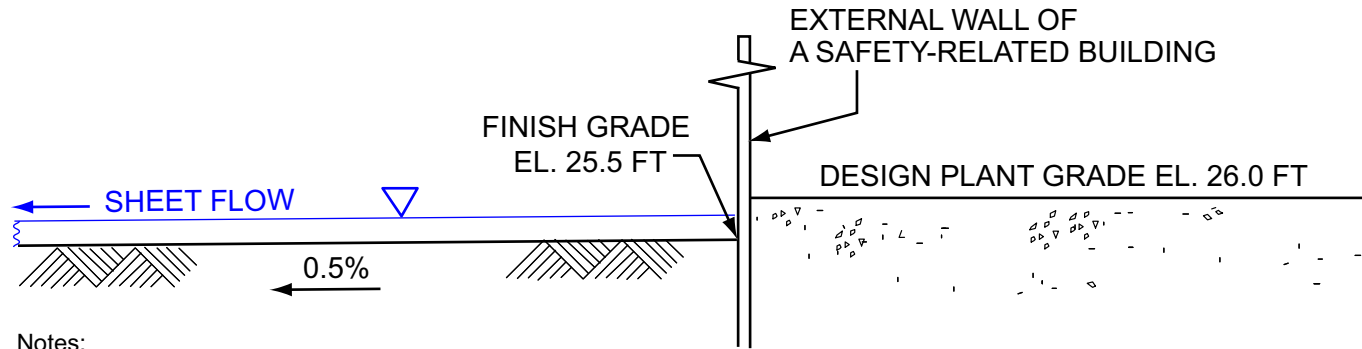

Notes:

- Elevation in NAVD 88.
- Not to scale.